

PB185M HELION ACER TENDL-2021 LIBRARY; T=0.K  
Principal cross sections

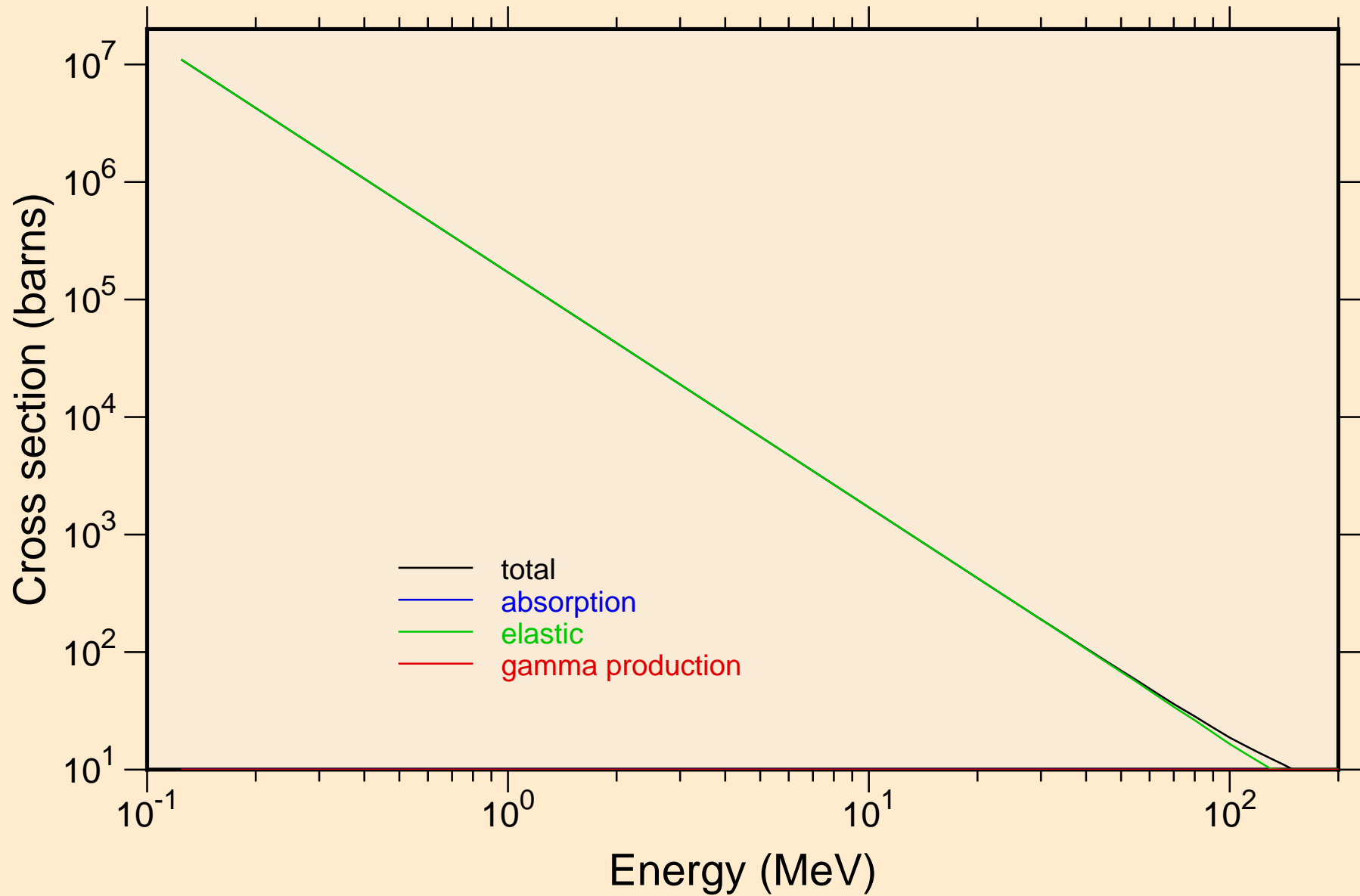

PB185M HELION ACER TENDL-2021 LIBRARY; T=0.K  
Heating

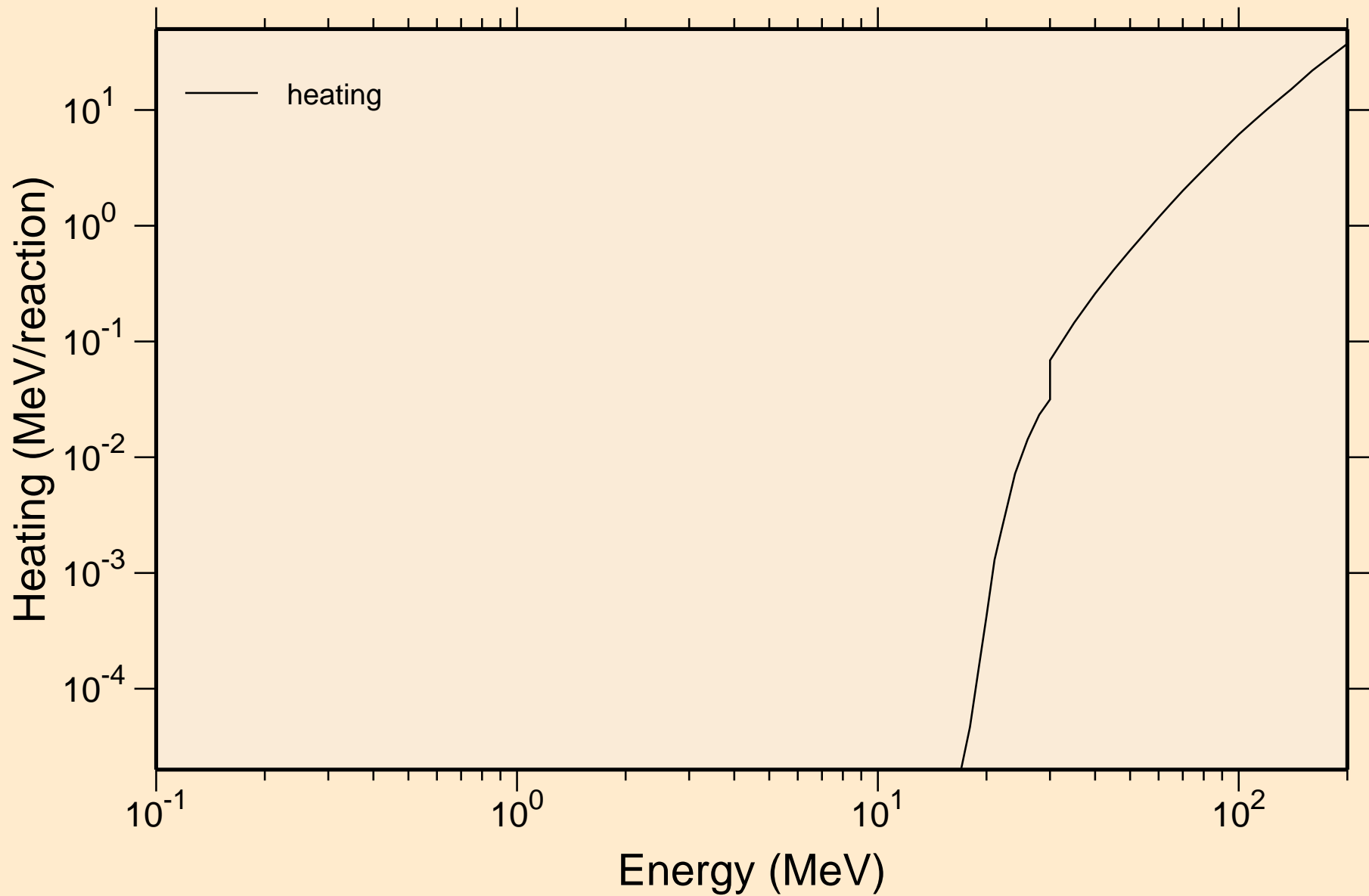

PB185M HELION ACER TENDL-2021 LIBRARY; T=0.K

Principal cross sections

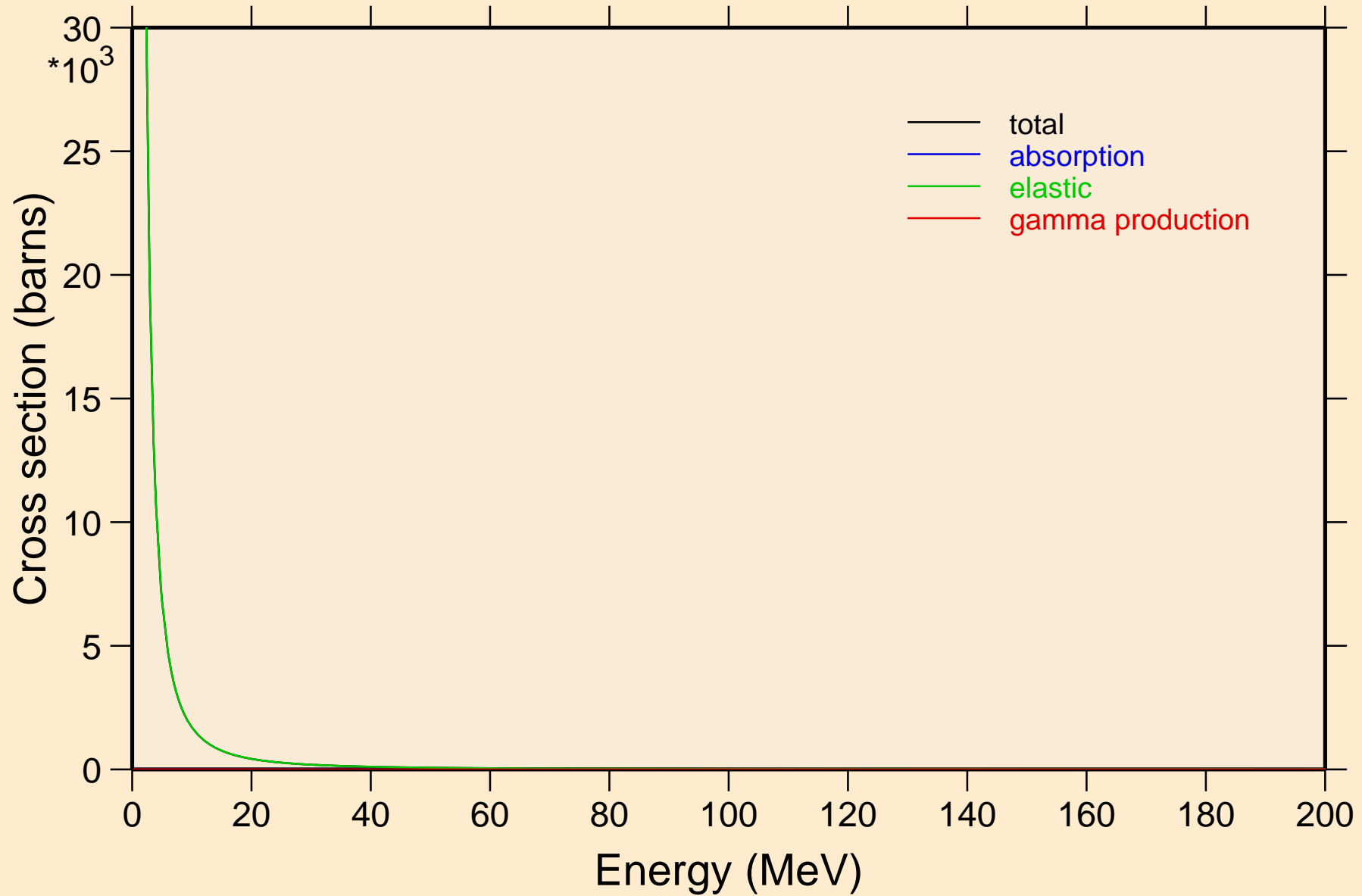

PB185M HELION ACER TENDL-2021 LIBRARY; T=0.K

Heating

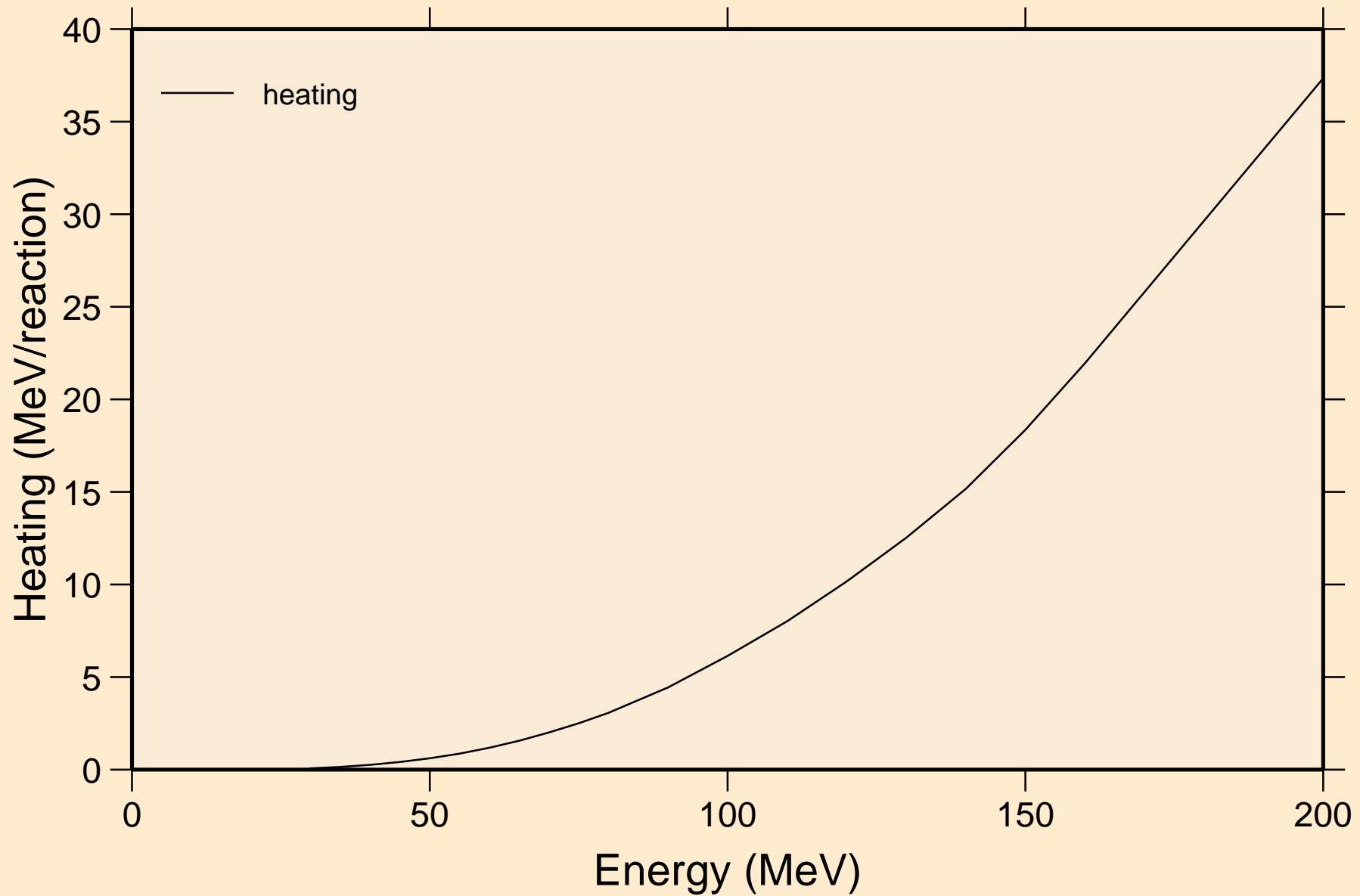

PB185M HELION ACER TENDL-2021 LIBRARY; T=0.K  
Threshold reactions

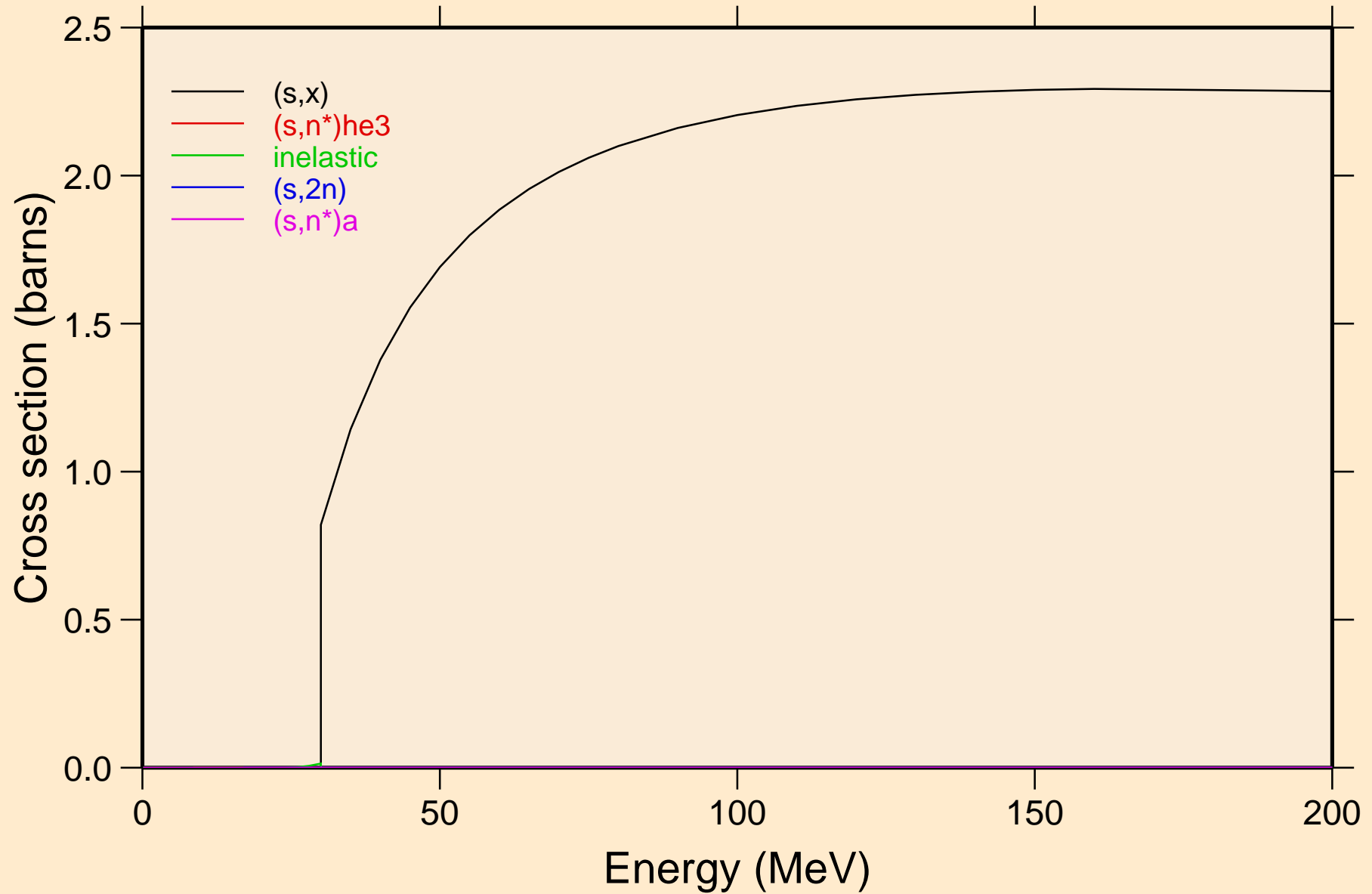

PB185M HELION ACER TENDL-2021 LIBRARY; T=0.K  
Threshold reactions

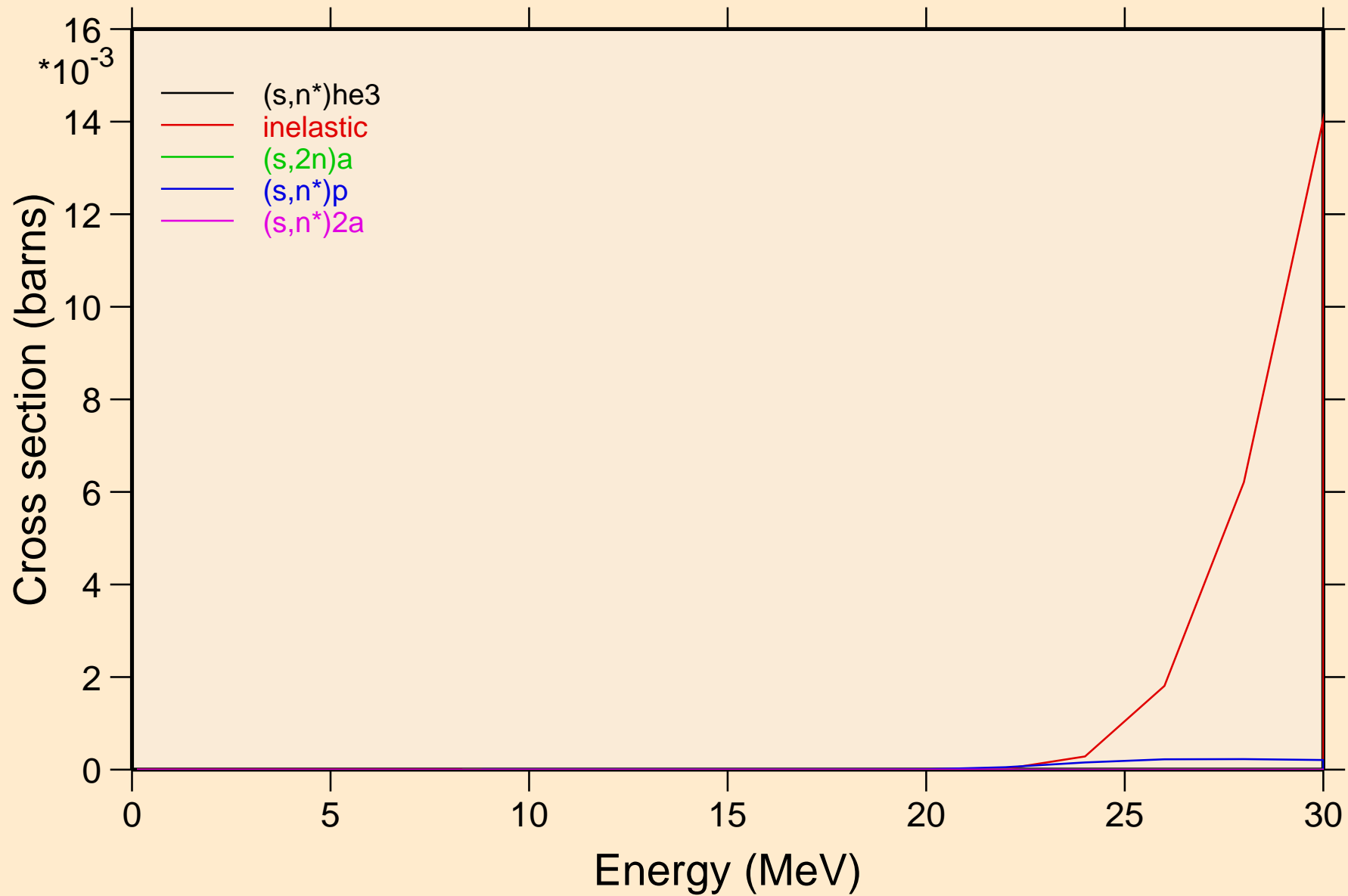

PB185M HELION ACER TENDL-2021 LIBRARY; T=0.K  
Threshold reactions

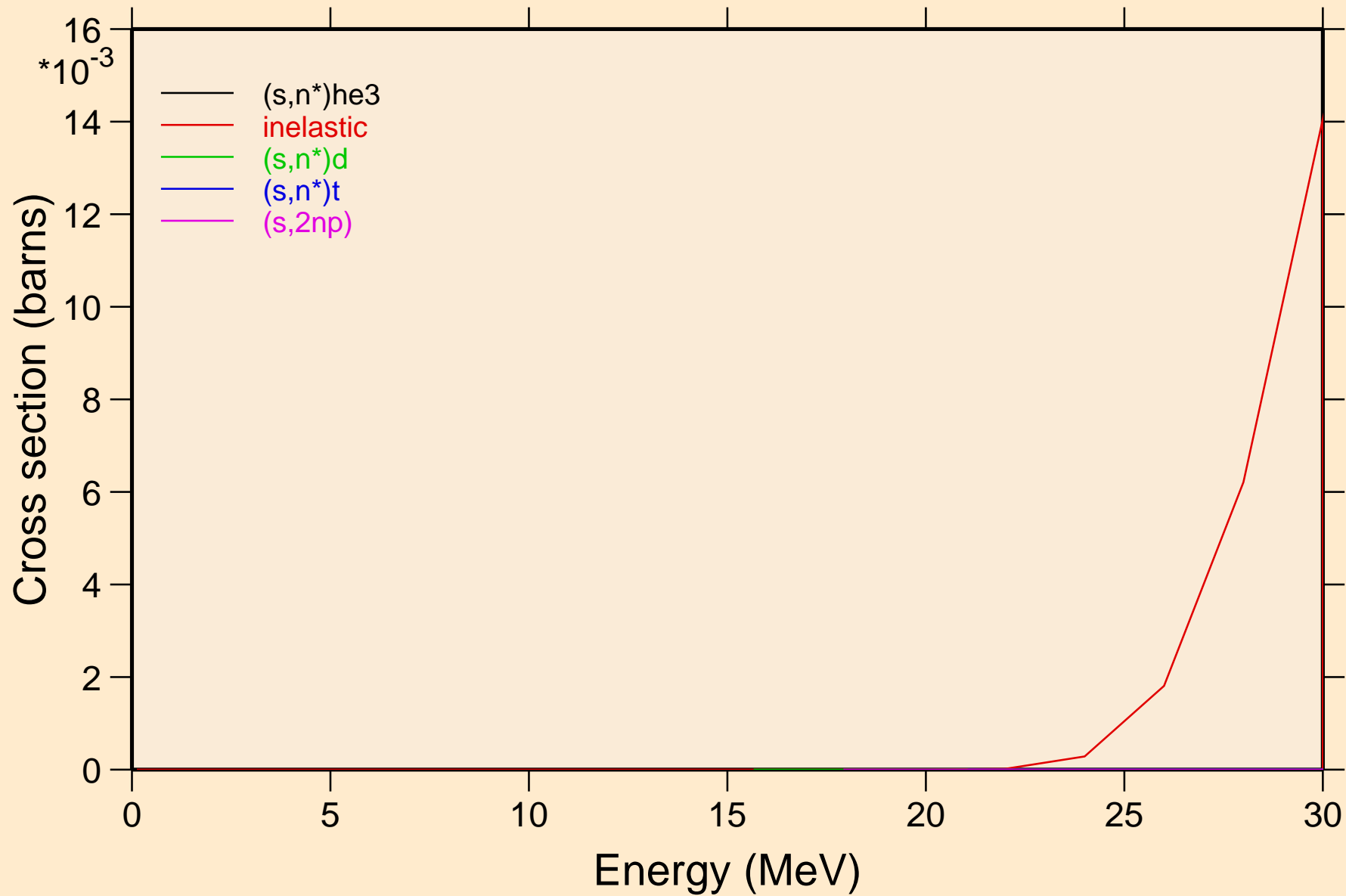

PB185M HELION ACER TENDL-2021 LIBRARY; T=0.K  
Threshold reactions

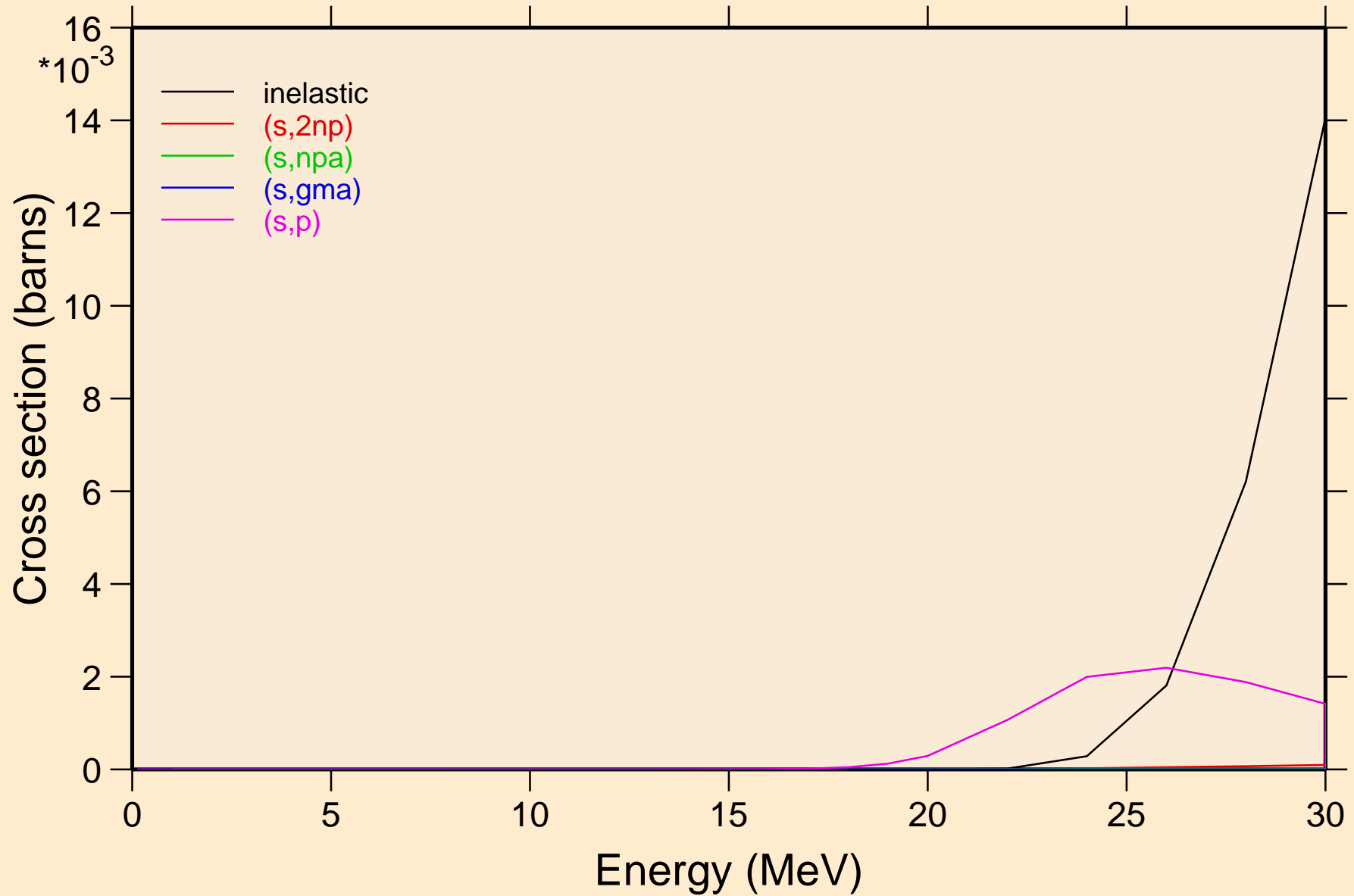



PB185M HELION ACER TENDL-2021 LIBRARY; T=0.K  
Threshold reactions

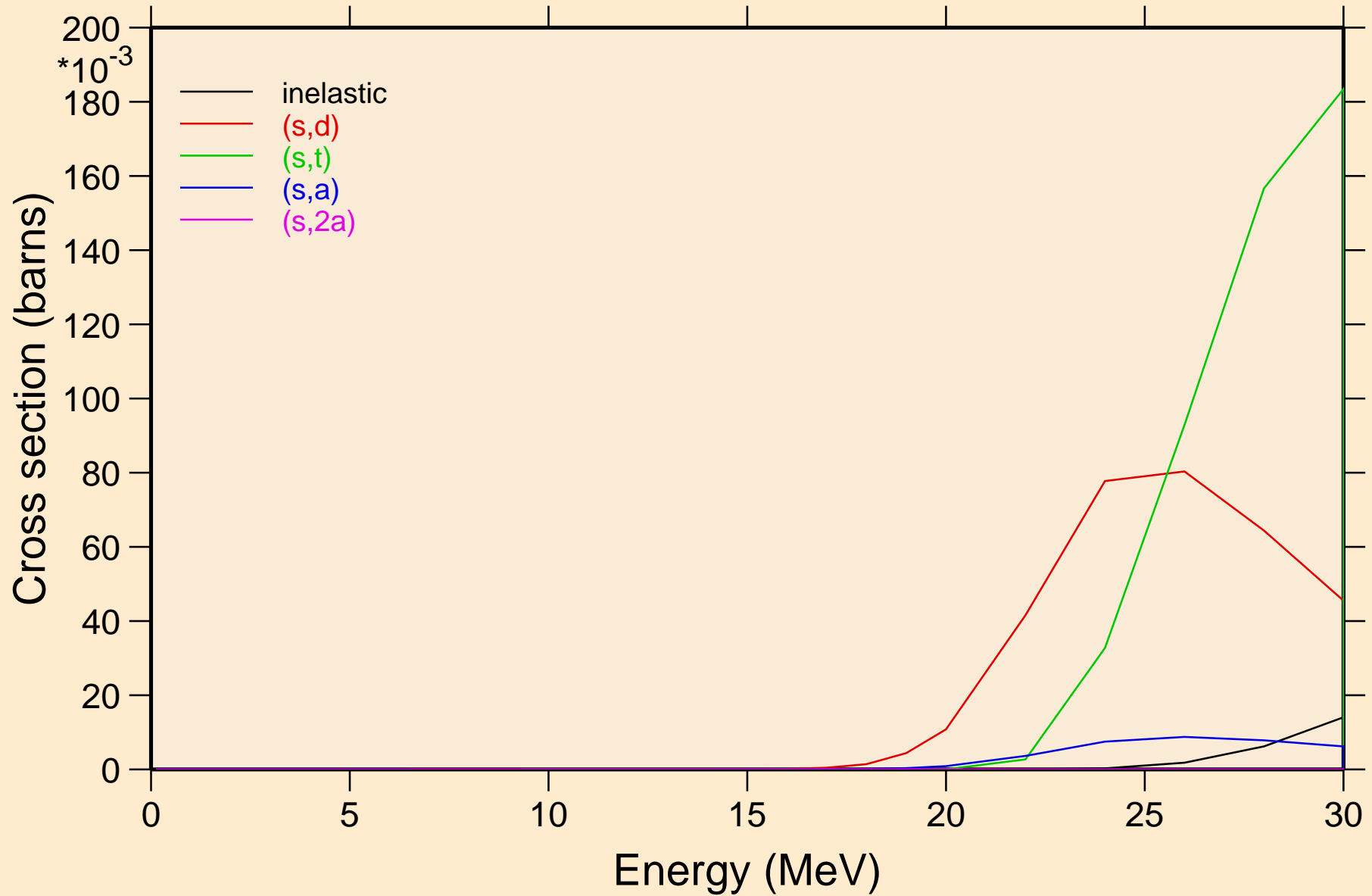

PB185M HELION ACER TENDL-2021 LIBRARY; T=0.K  
Threshold reactions

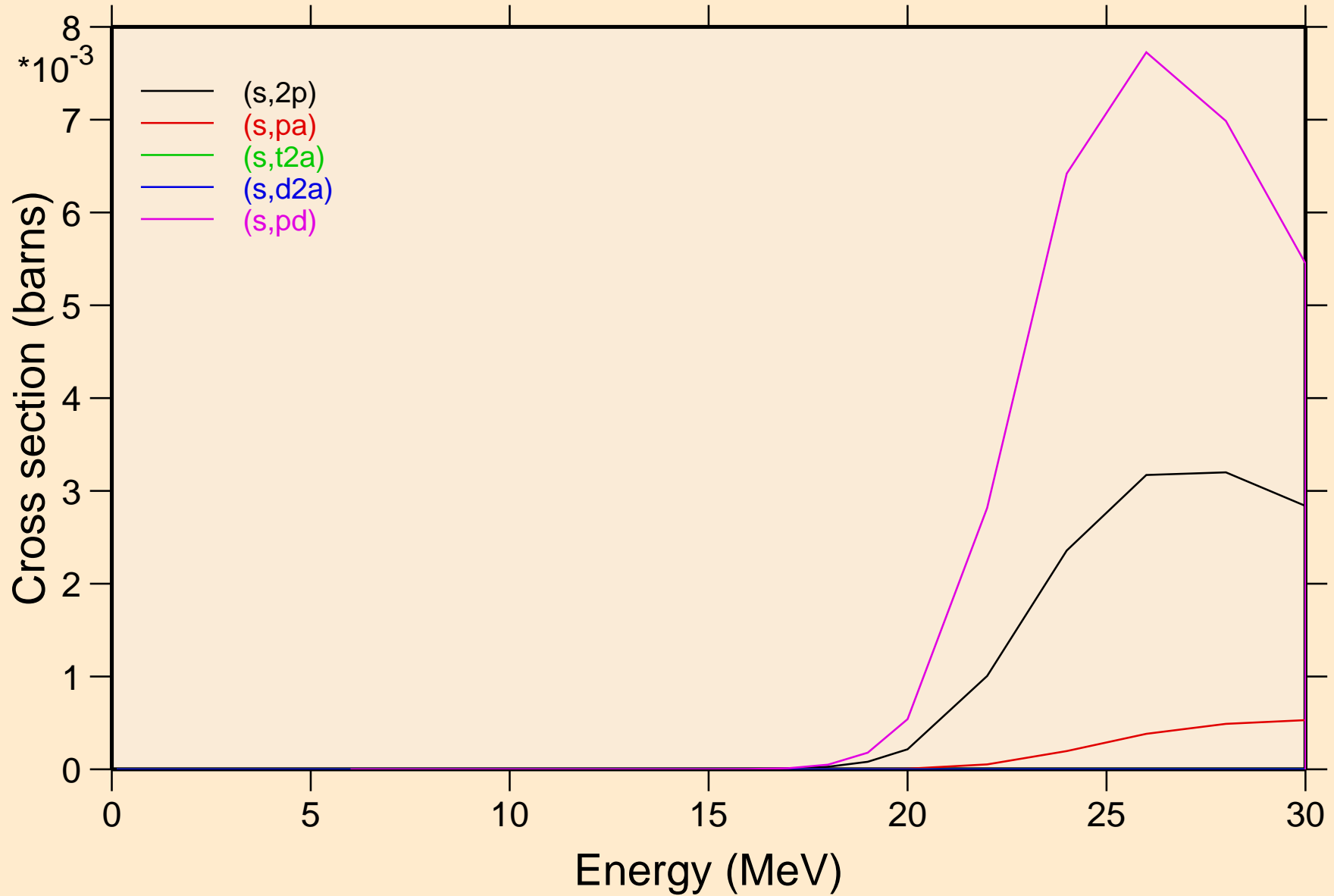

PB185M HELION ACER TENDL-2021 LIBRARY; T=0.K  
Threshold reactions

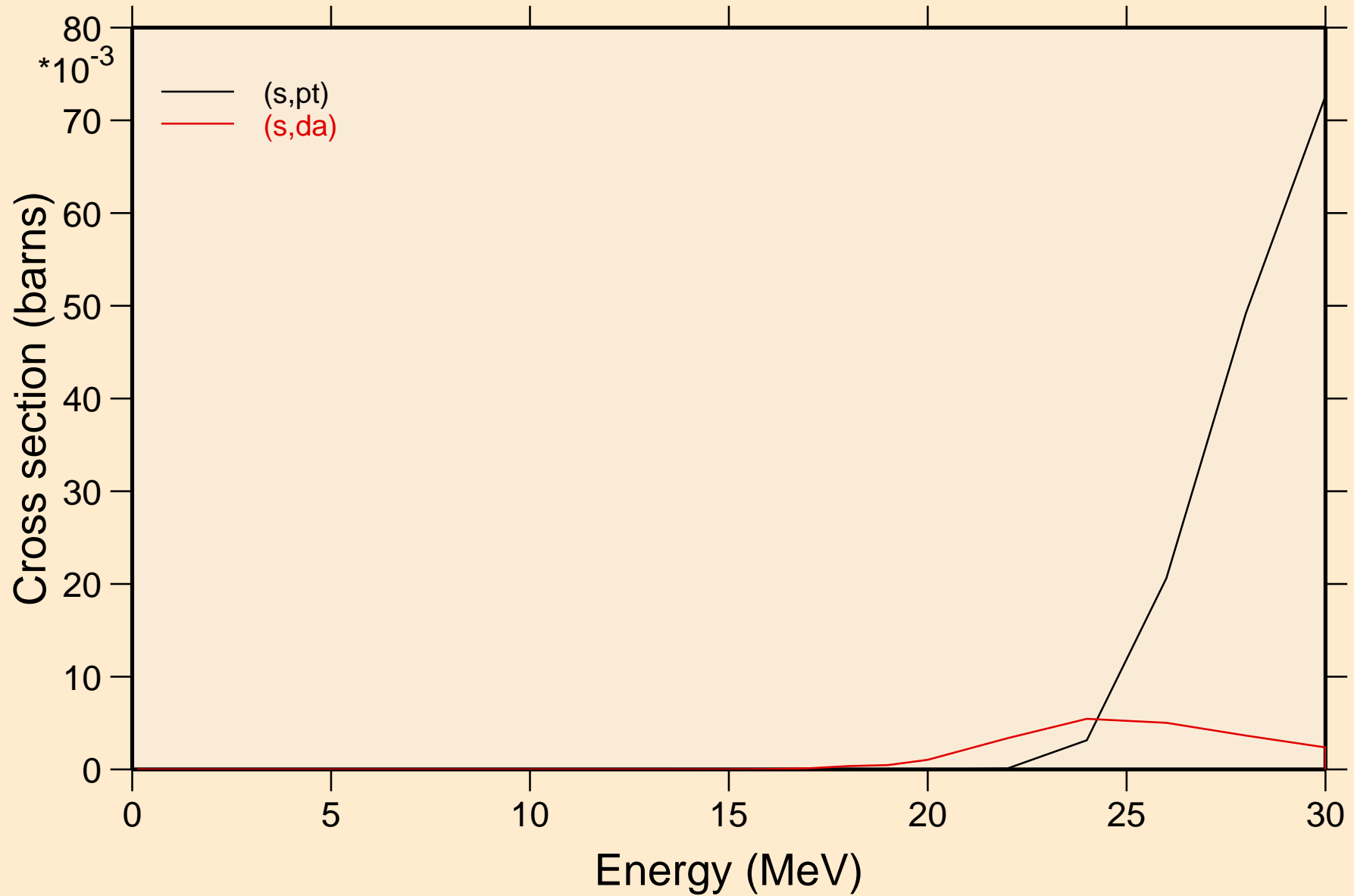

PB185M HELION ACER TENDL-2021 LIBRARY; T=0.K  
angular distribution for elastic

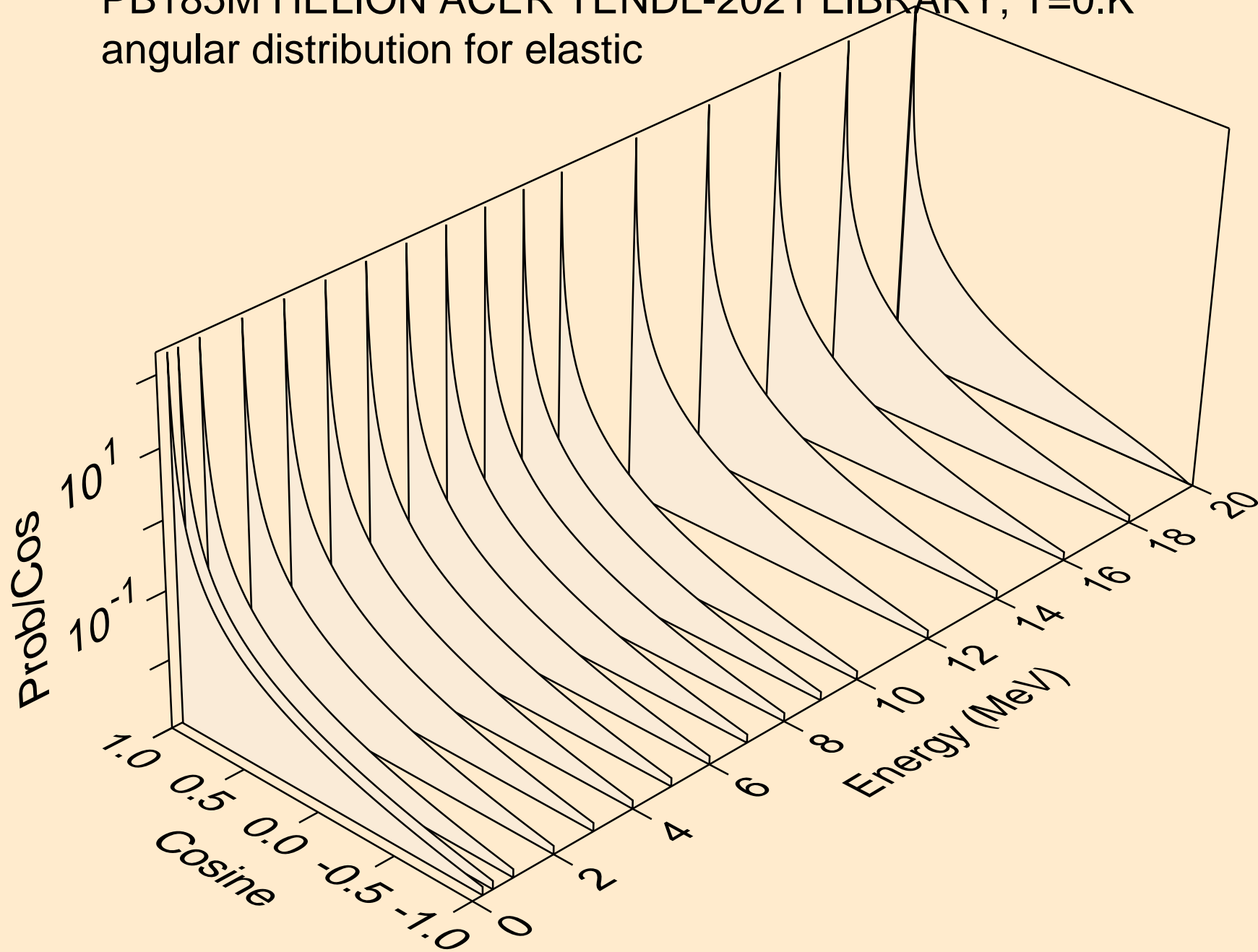

PB185M HELION ACER TENDL-2021 LIBRARY; T=0.K  
angular distribution for elastic

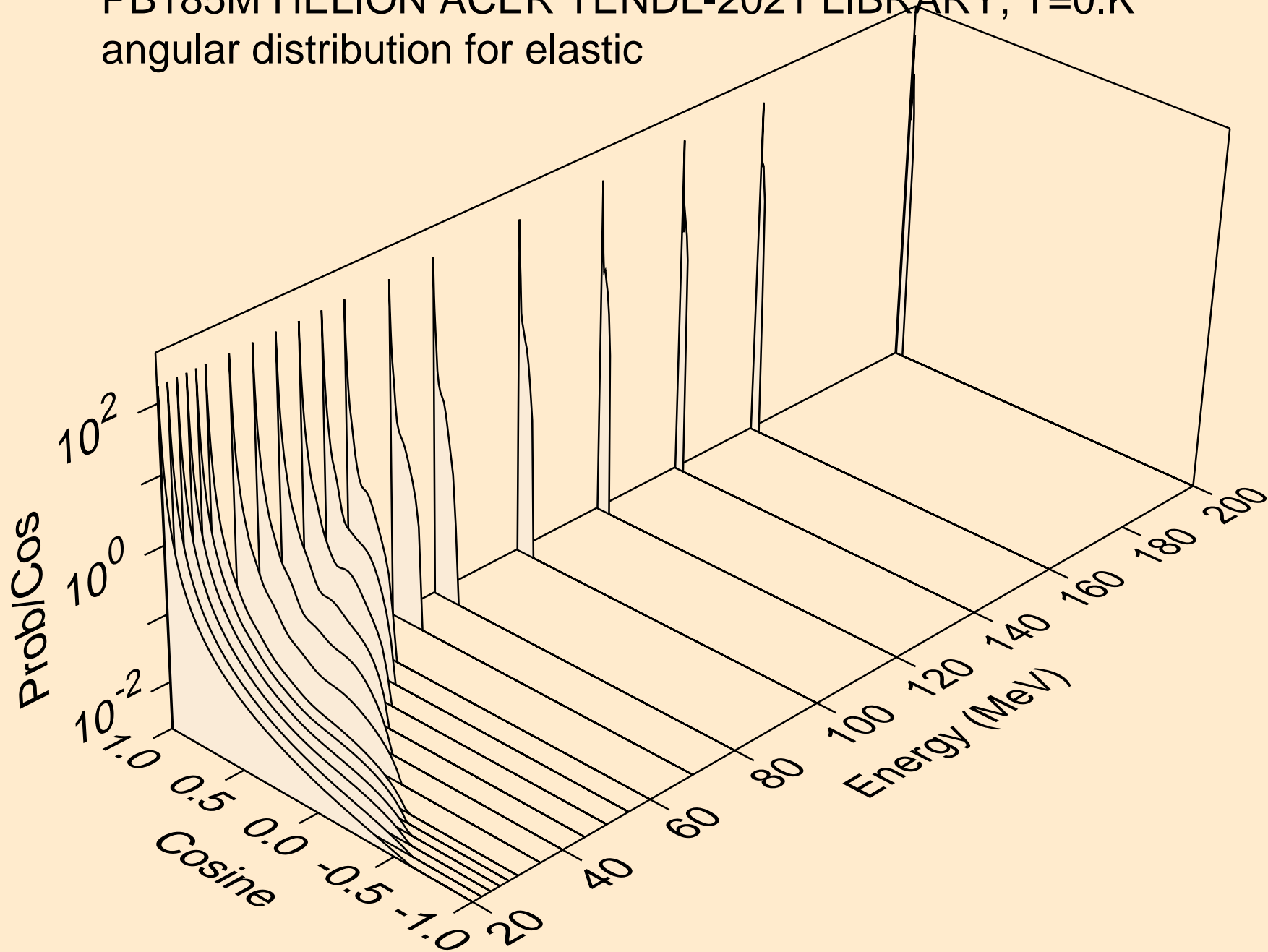

PB185M HELION ACER TENDL-2021 LIBRARY; T=0.K  
He-3 emission for (s,x)

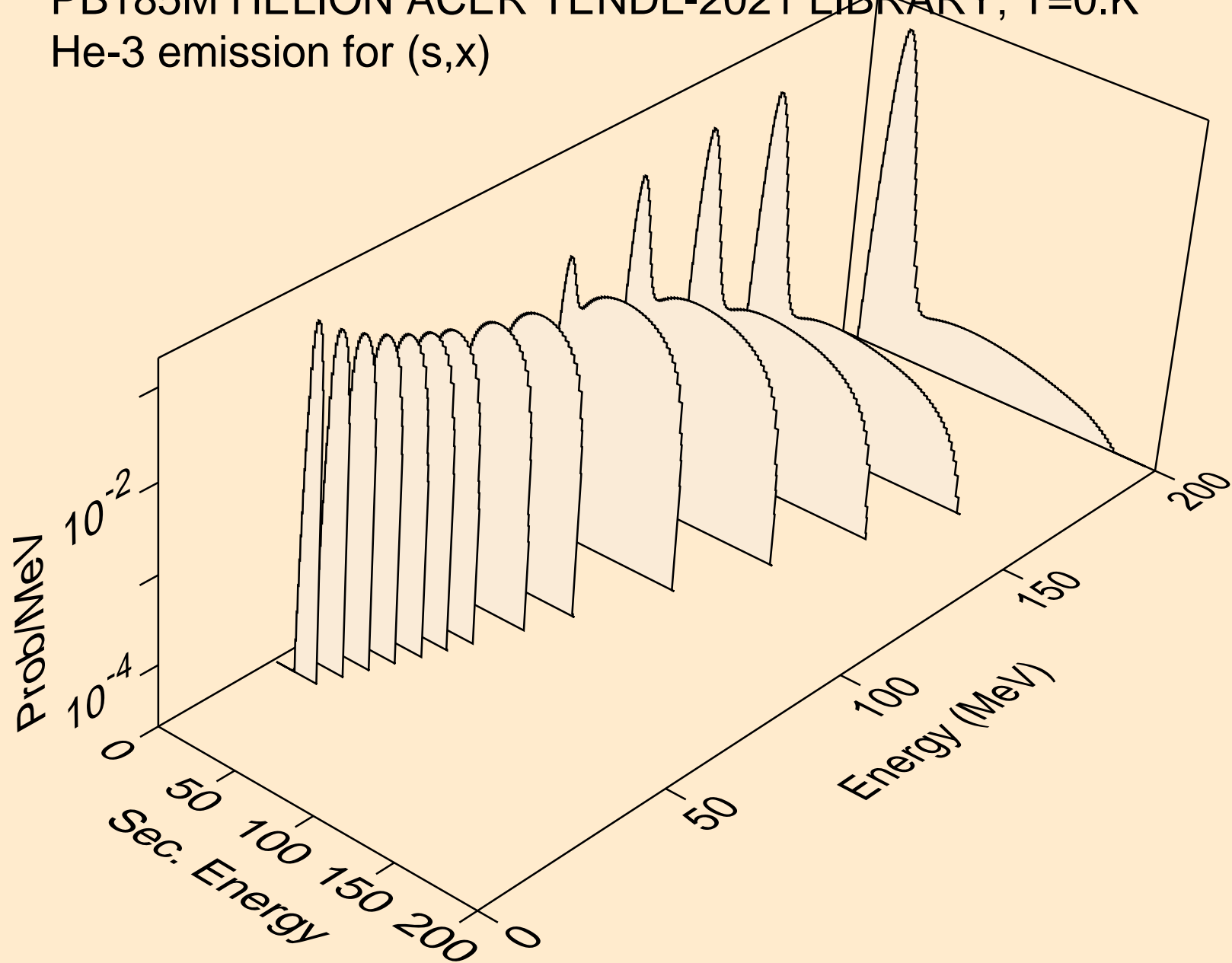

PB185M HELION ACER TENDL-2021 LIBRARY; T=0.K  
He-3 emission for (s,n\*)he3

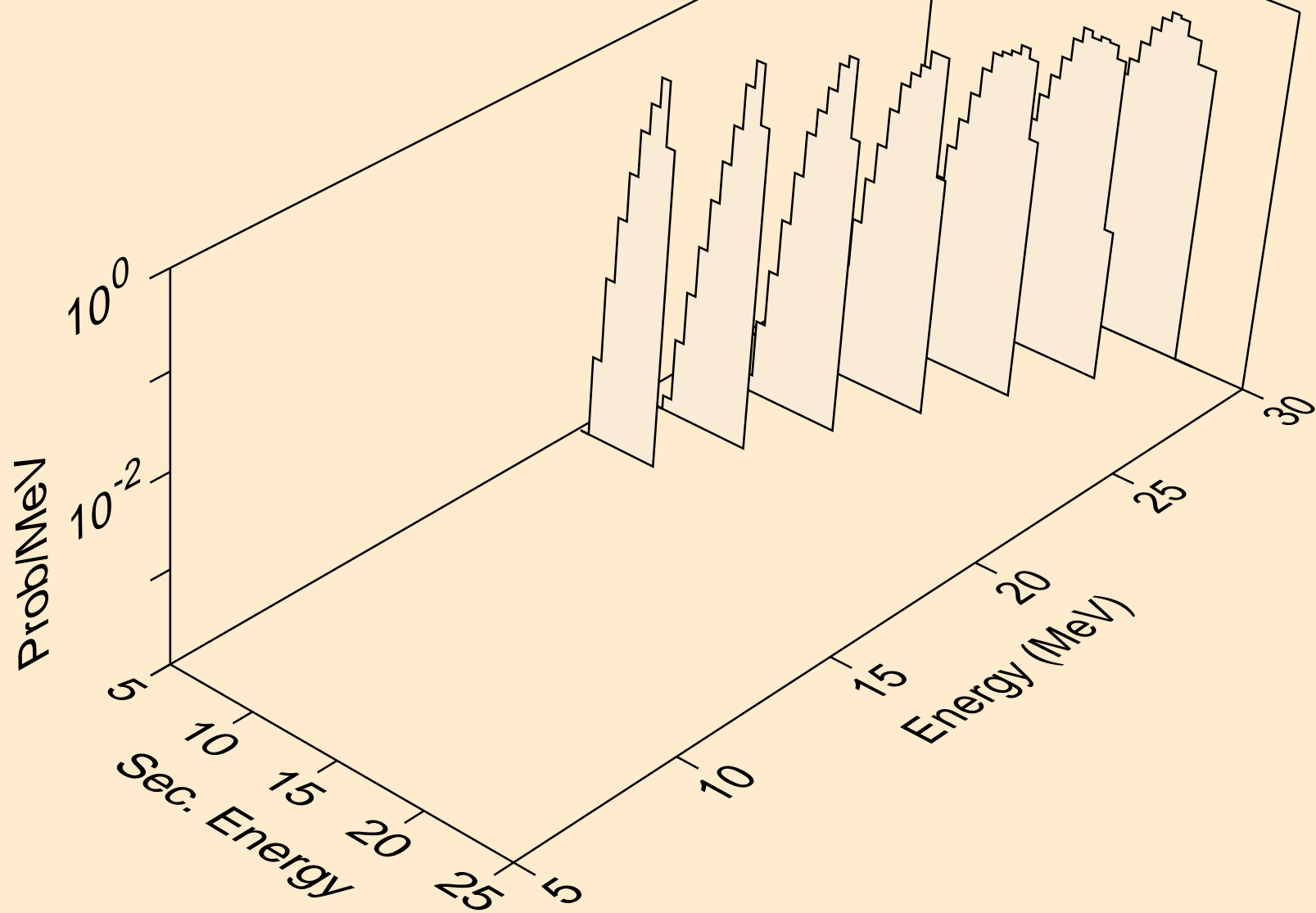

PB185M HELION ACER TENDL-2021 LIBRARY; T=0.K  
He-3 emission for inelastic

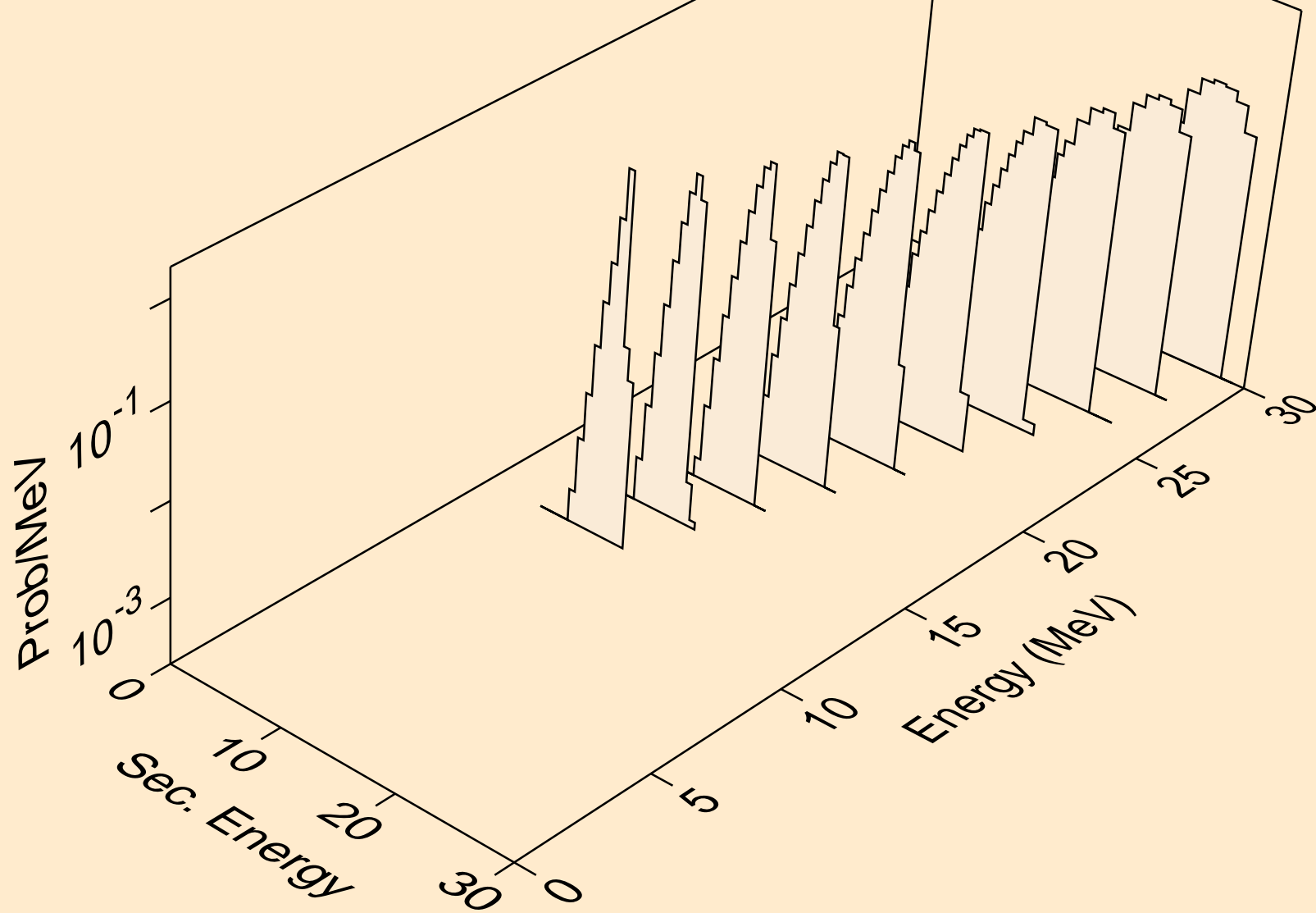



PB185M HELION ACER TENDL-2021 LIBRARY; T=0.K  
Photon emission for (z,n)

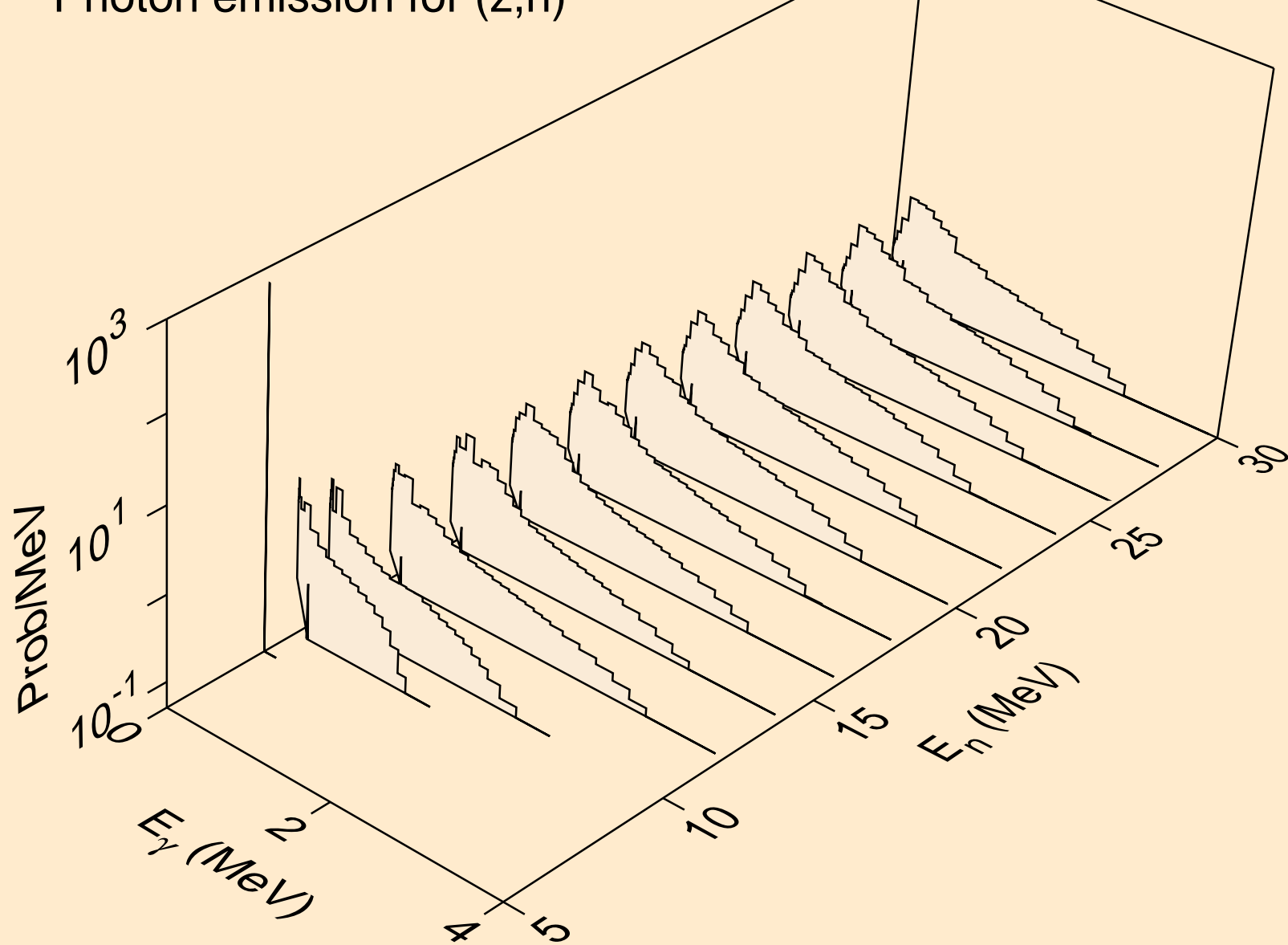

PB185M HELION ACER TENDL-2021 LIBRARY; T=0.K  
Photon emission for (n,x)

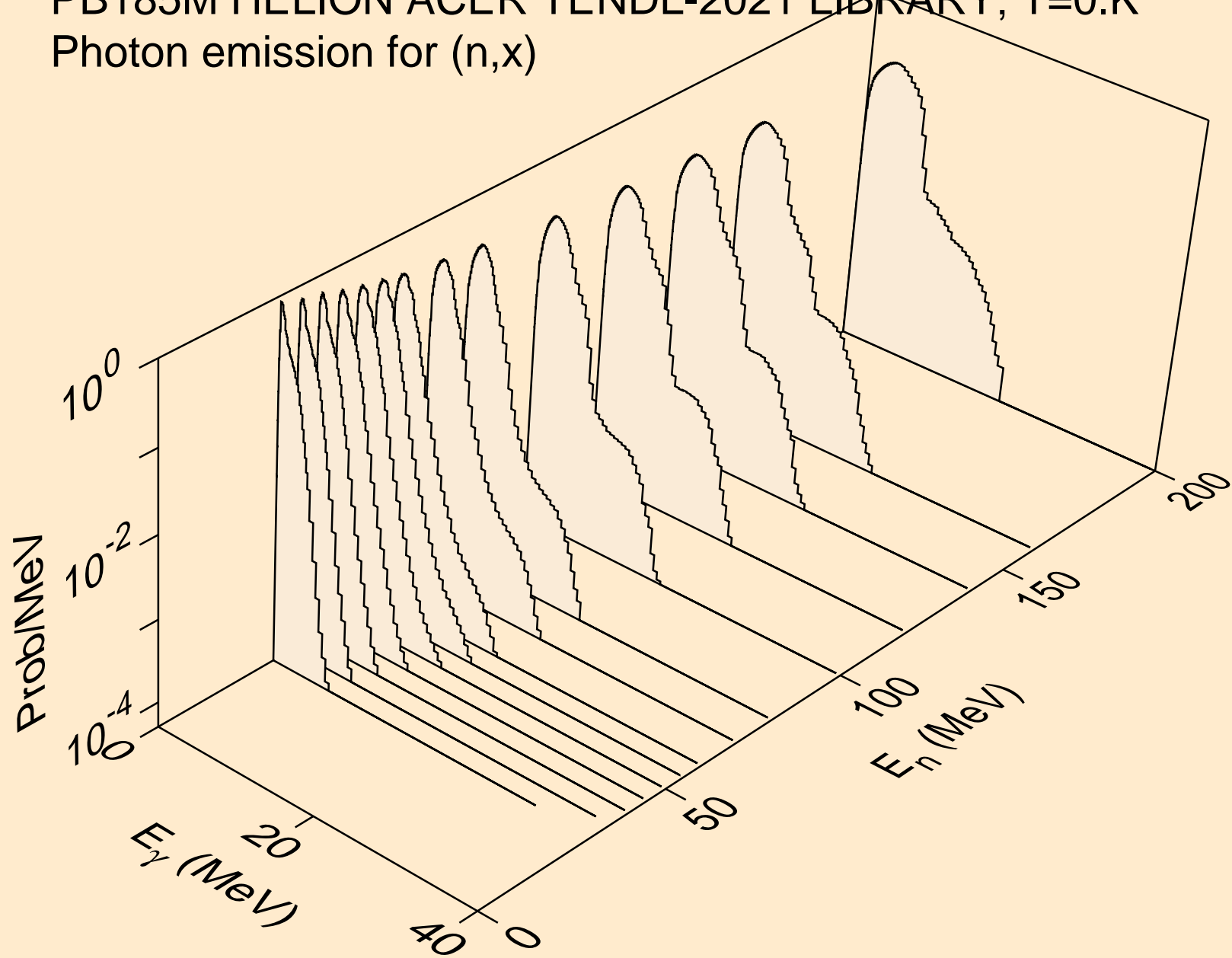

PB185M HELION ACER TENDL-2021 LIBRARY; T=0.K  
Photon emission for (n,2n)

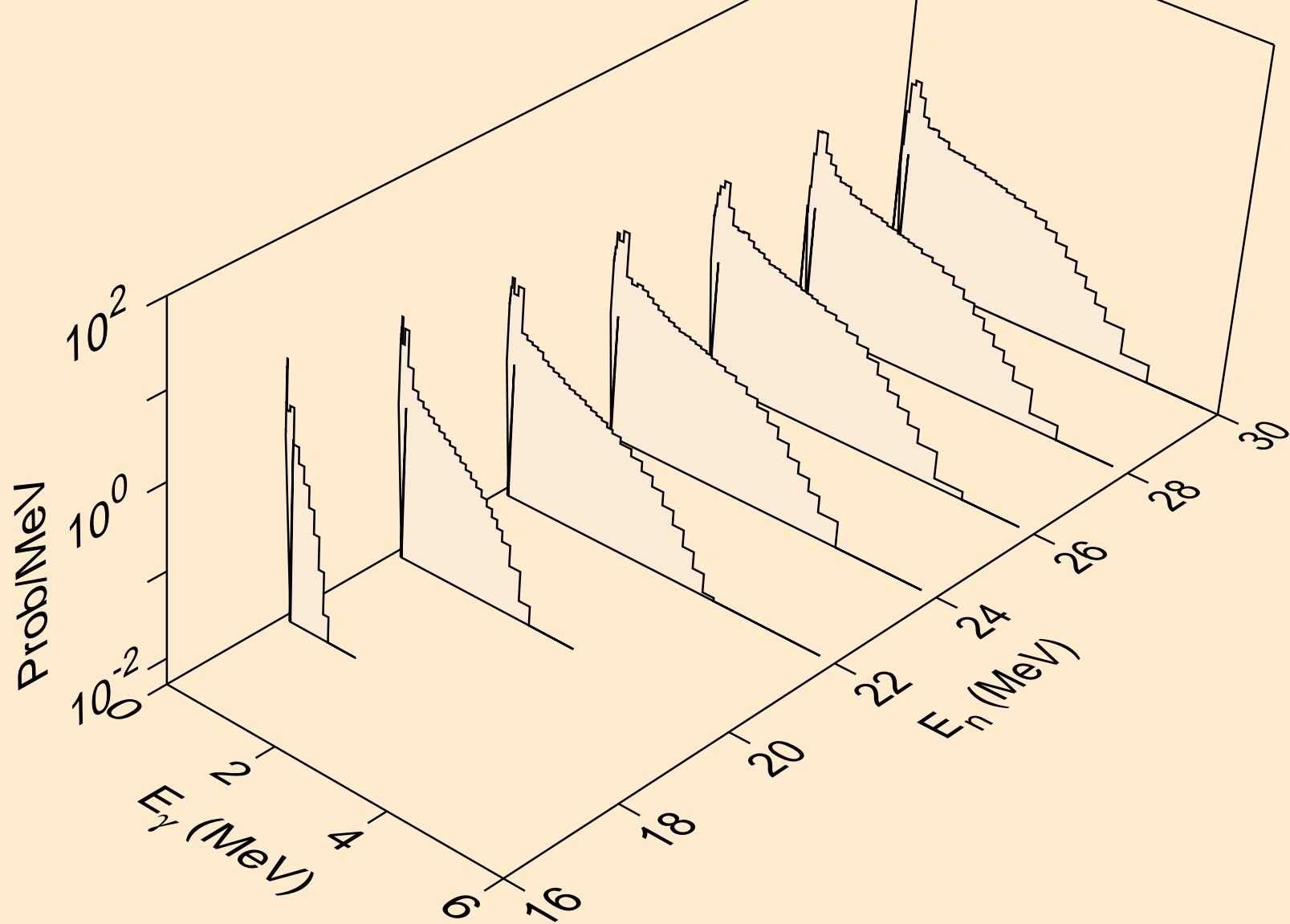

PB185M HELION ACER TENDL-2021 LIBRARY; T=0.K  
Photon emission for (n,n\*)a

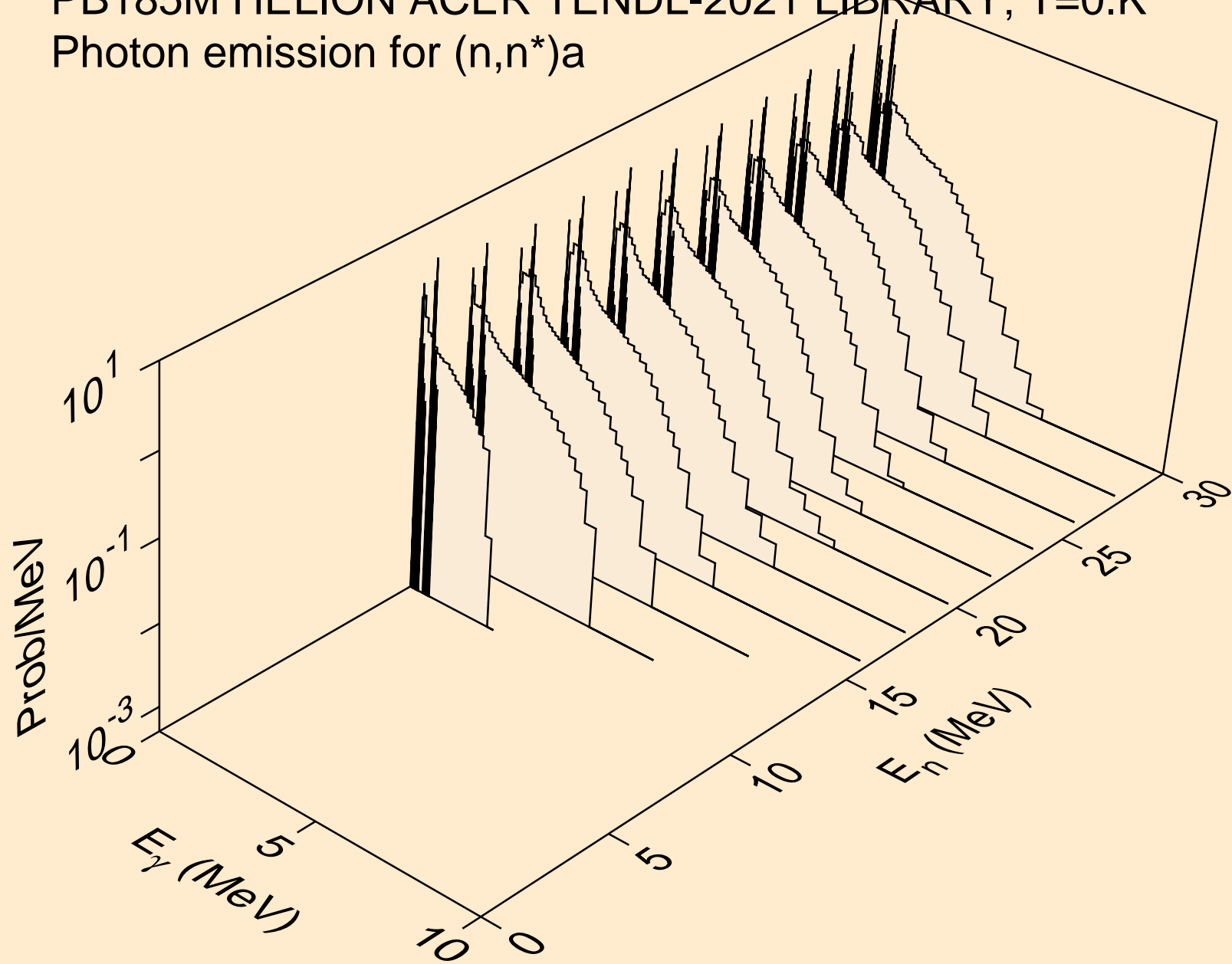

PB185M HELION ACER TENDL-2021 LIBRARY; T=0.K  
Photon emission for (n,2n)a

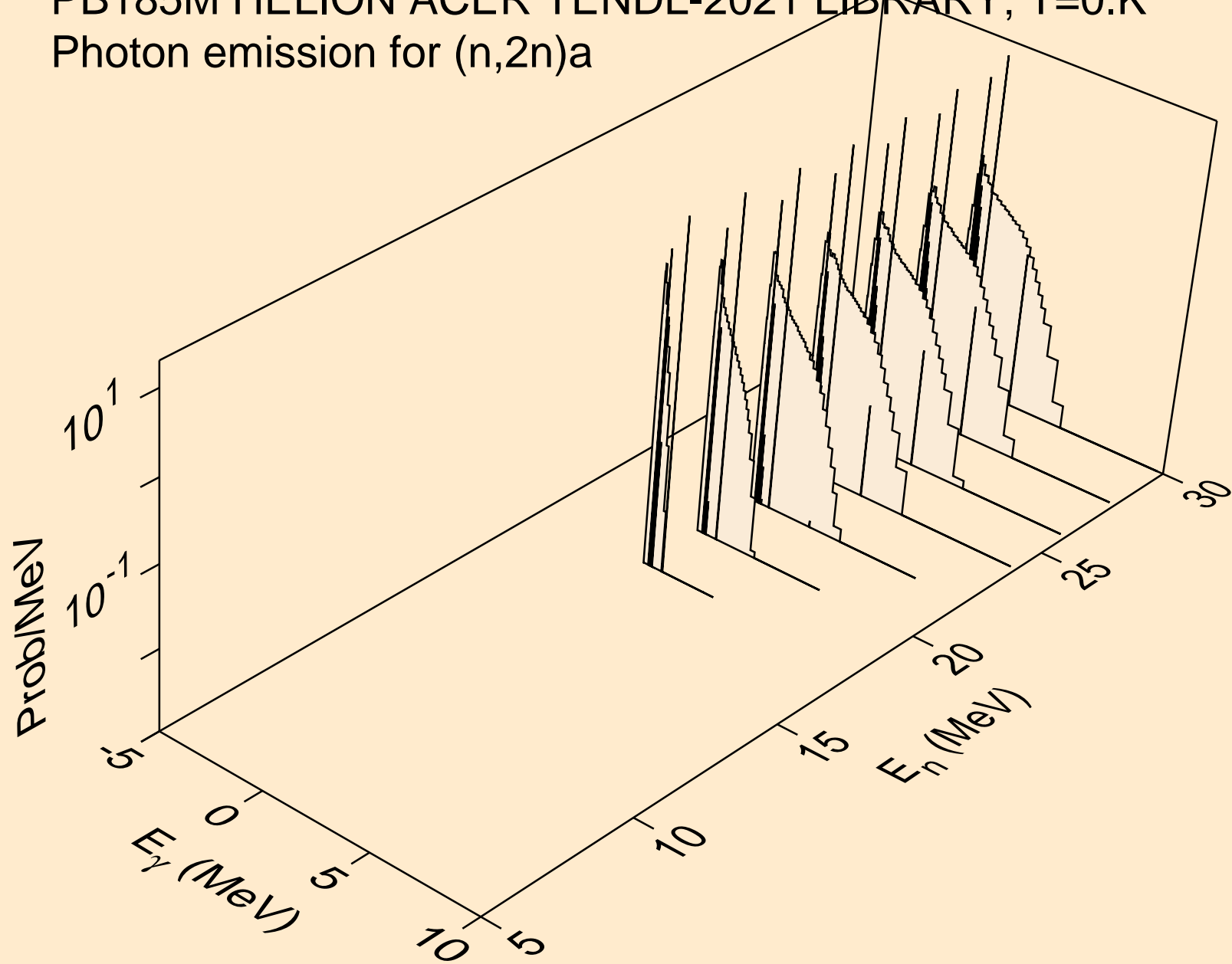

PB185M HELION ACER TENDL-2021 LIBRARY; T=0.K  
Photon emission for (n,n\*)p

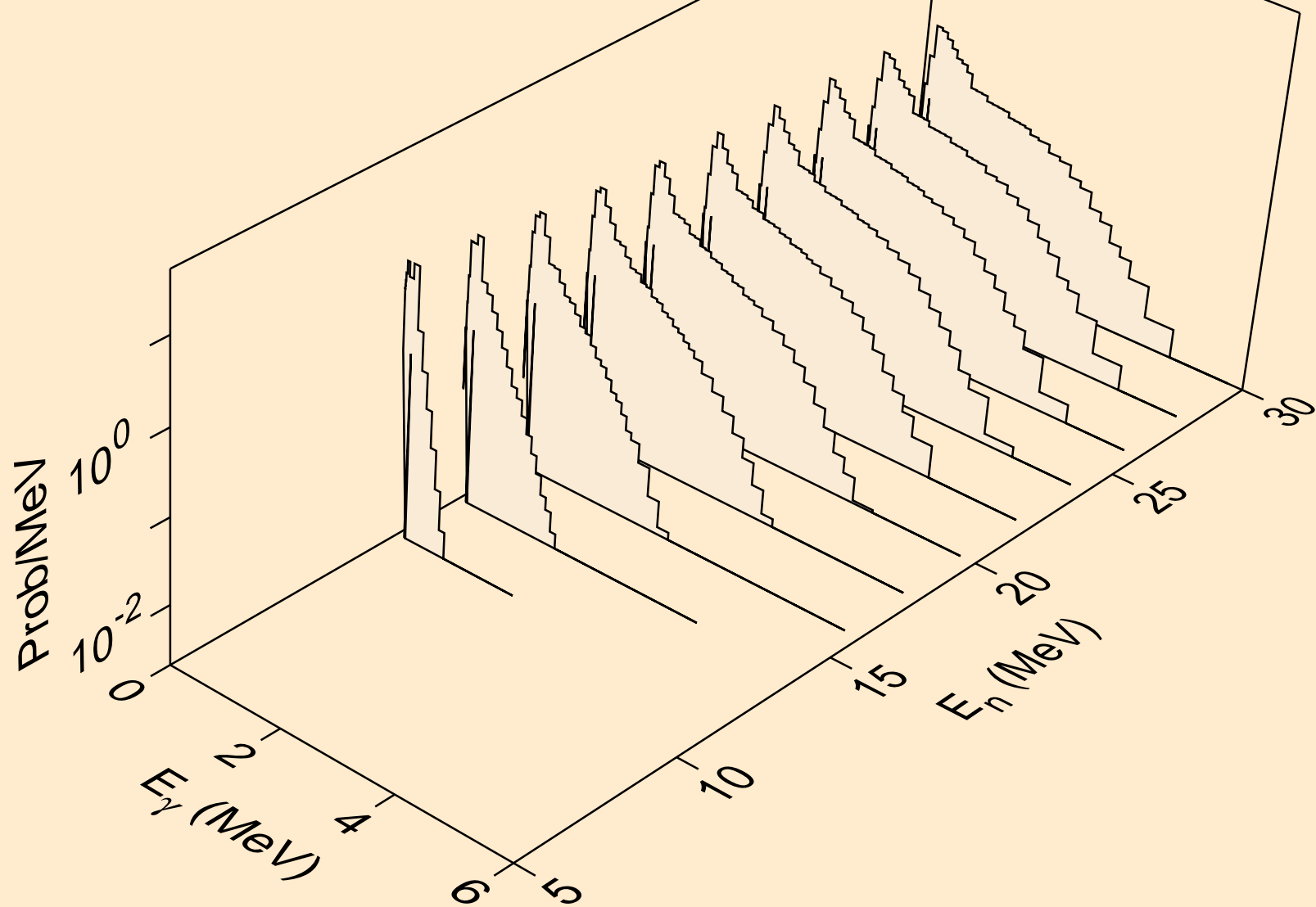

PB185M HELION ACER TENDL-2021 LIBRARY; T=0.K  
Photon emission for (n,n\*)2a

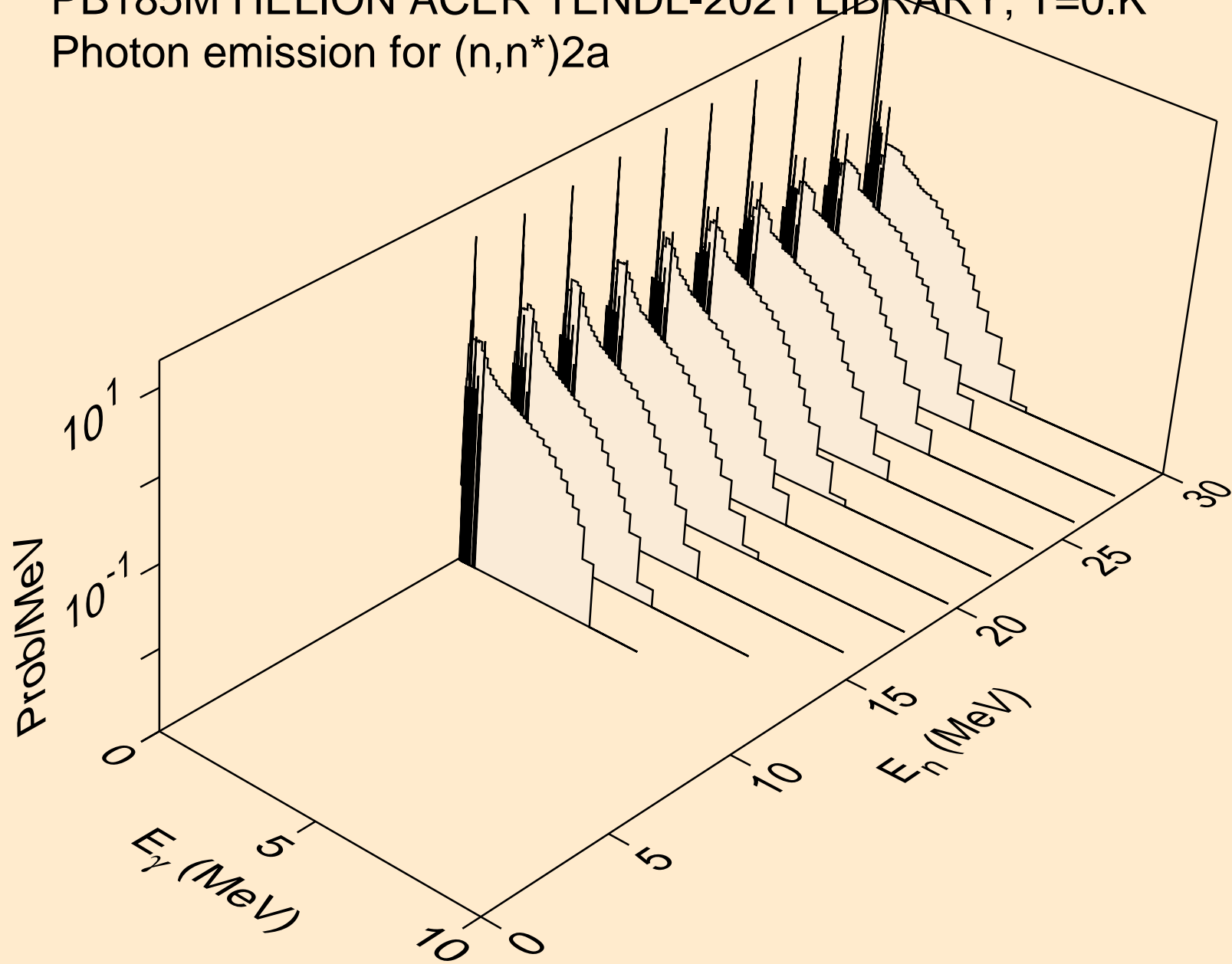

PB185M HELION ACER TENDL-2021 LIBRARY; T=0.K  
Photon emission for (n,n\*)d

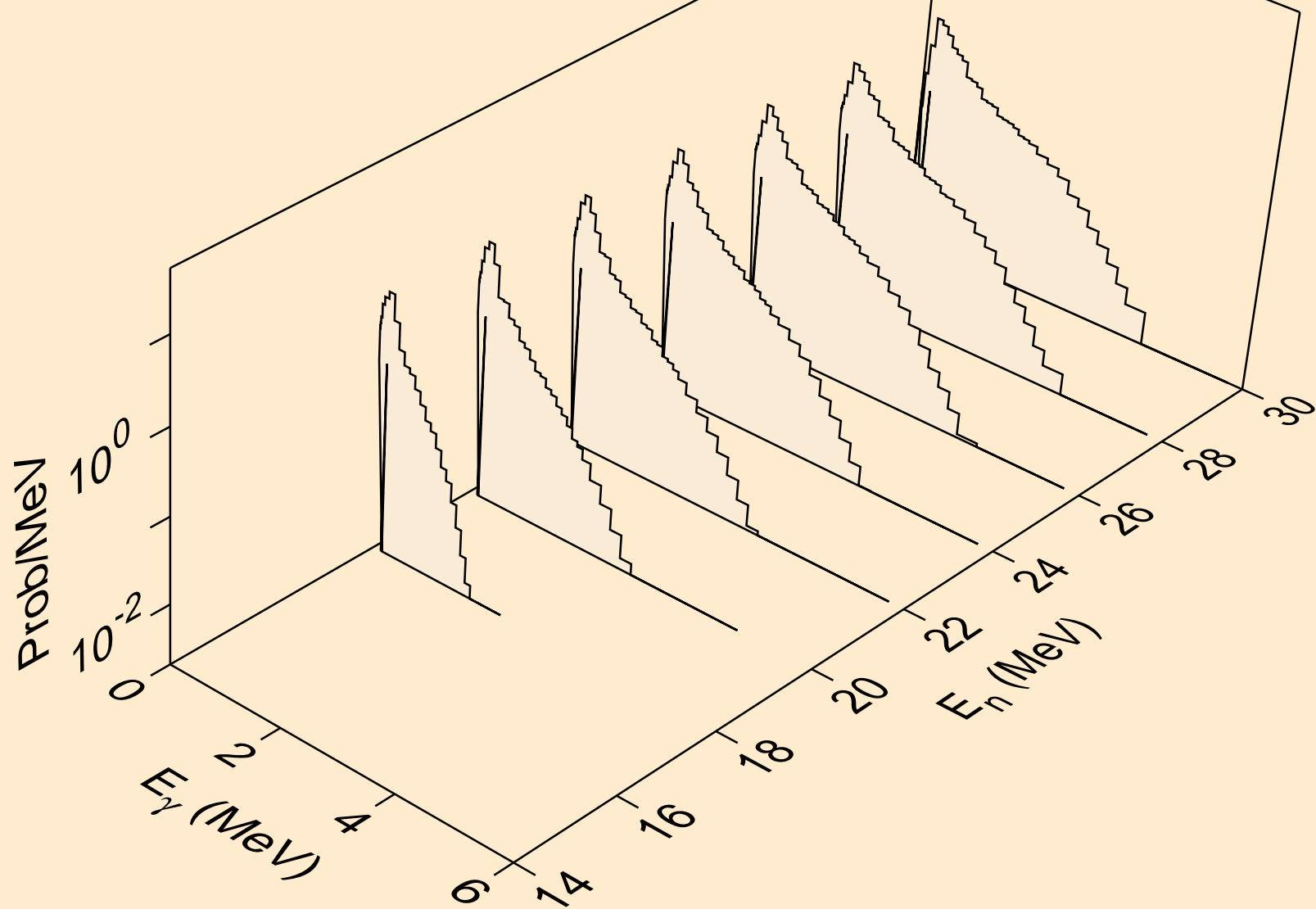



PB185M HELION ACER TENDL-2021 LIBRARY; T=0.K  
Photon emission for (n,n\*)t

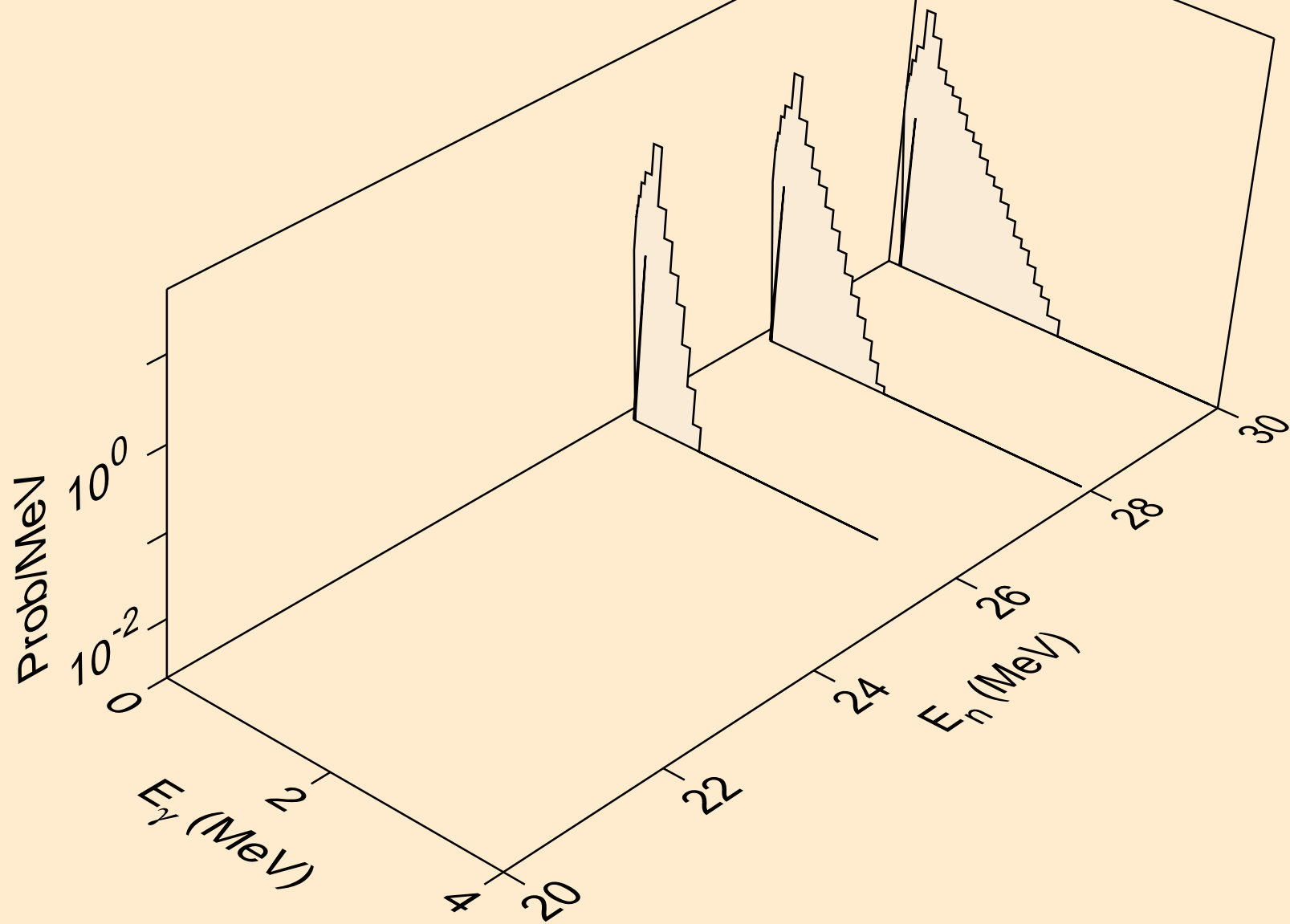

PB185M HELION ACER TENDL-2021 LIBRARY; T=0.K  
Photon emission for (n,n\*)he3

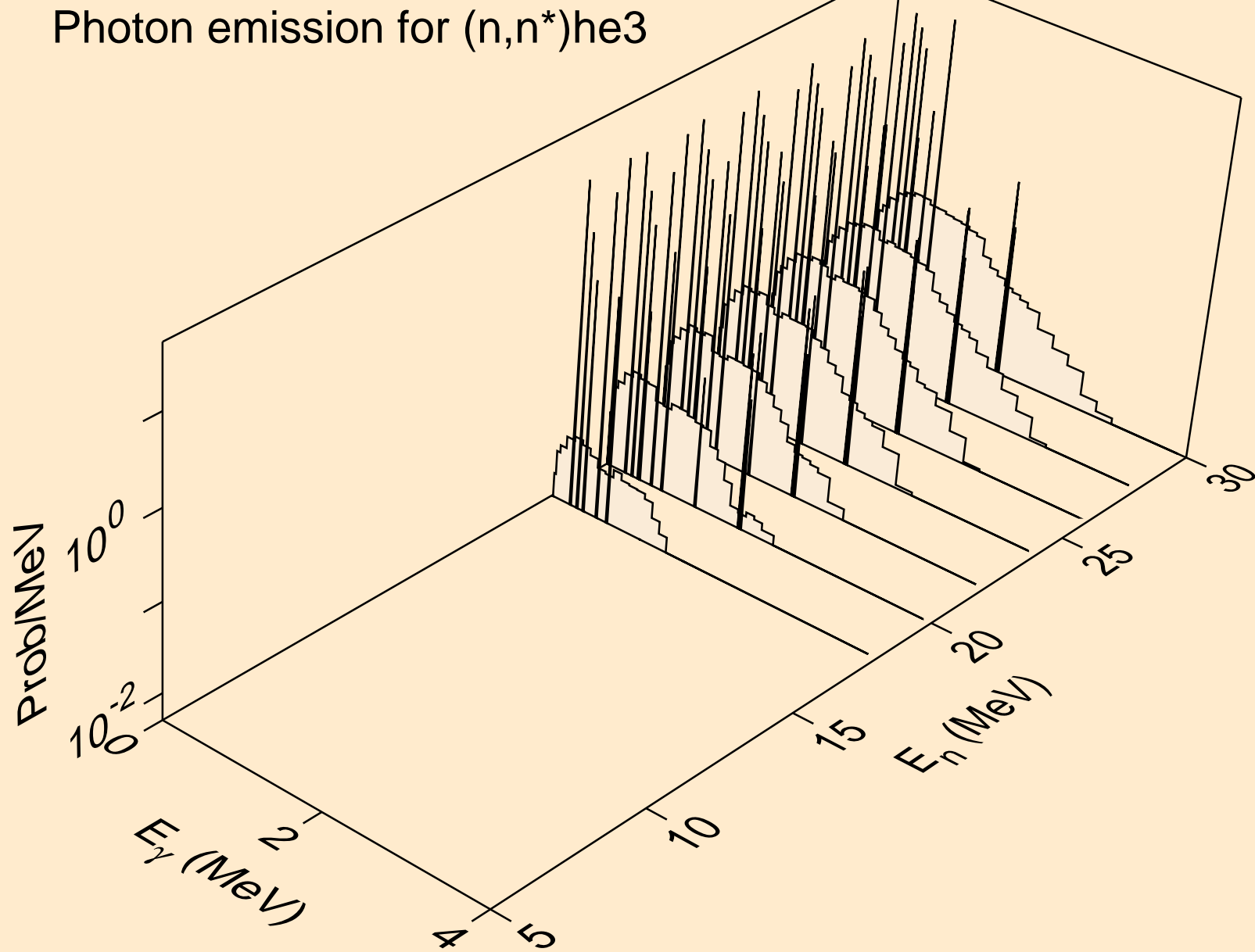

PB185M HELION ACER TENDL-2021 LIBRARY; T=0.K  
Photon emission for (n,2np)

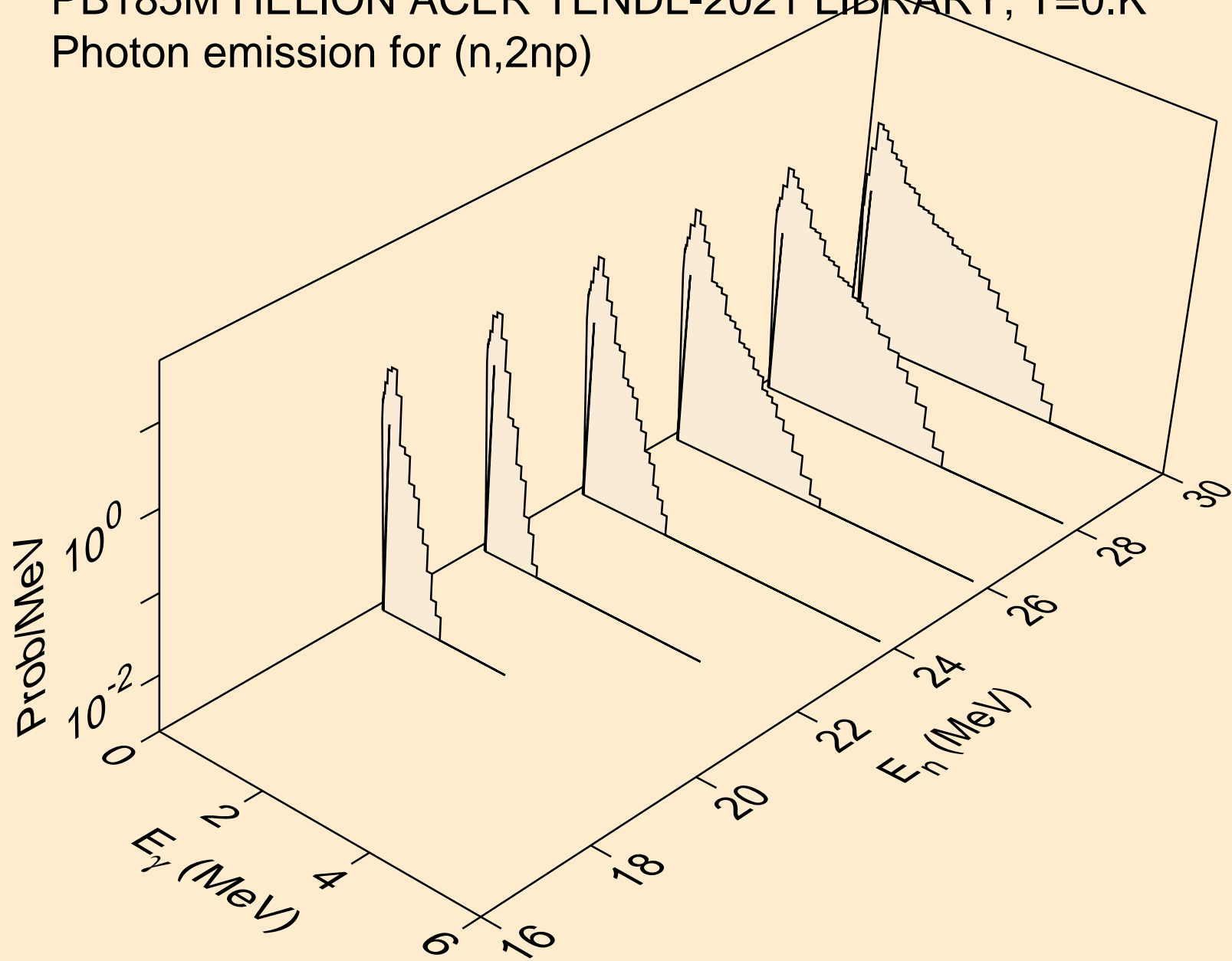

PB185M HELION ACER TENDL-2021 LIBRARY; T=0.K  
Photon emission for (n,2np)

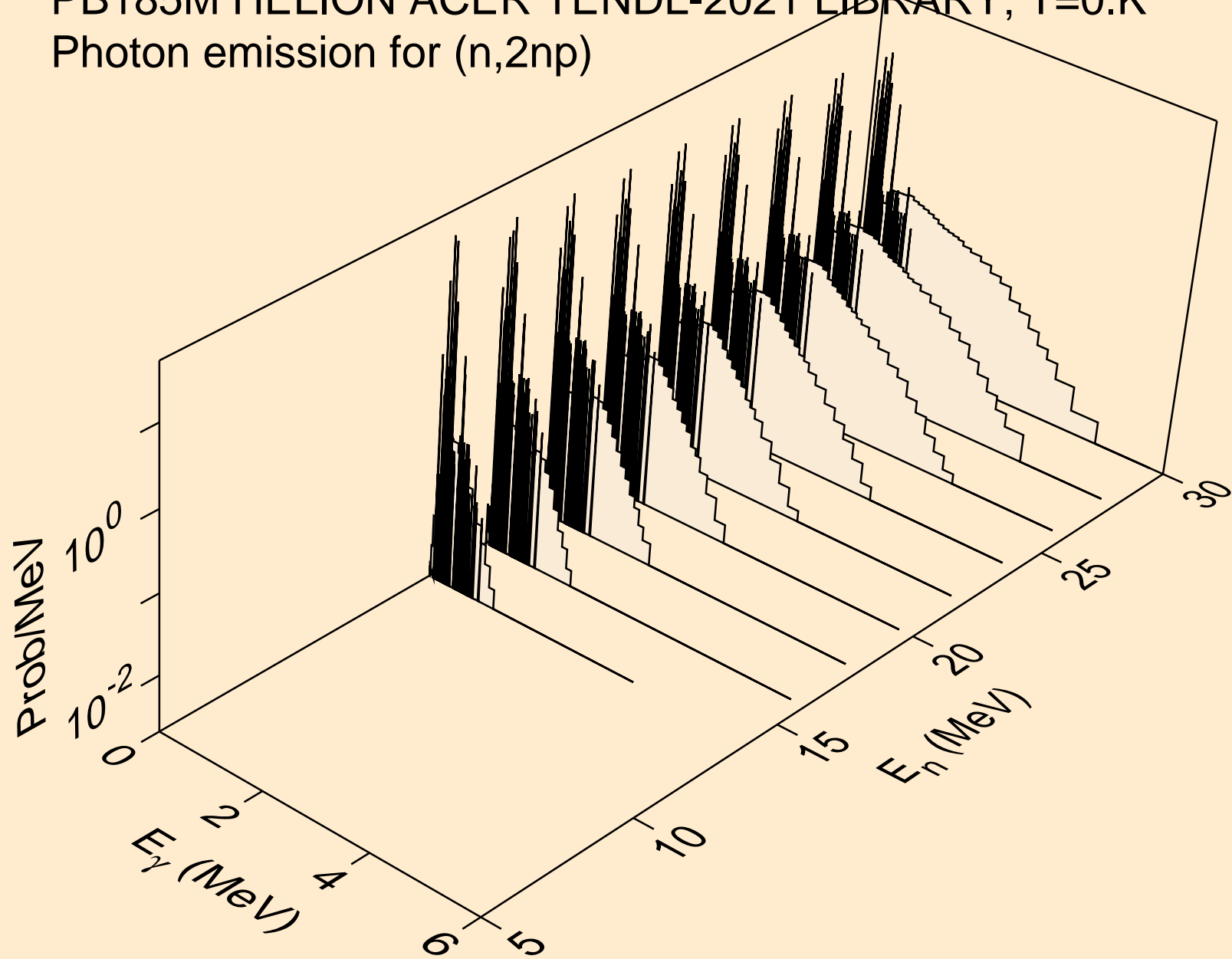

PB185M HELION ACER TENDL-2021 LIBRARY; T=0.K  
Photon emission for (n,npa)

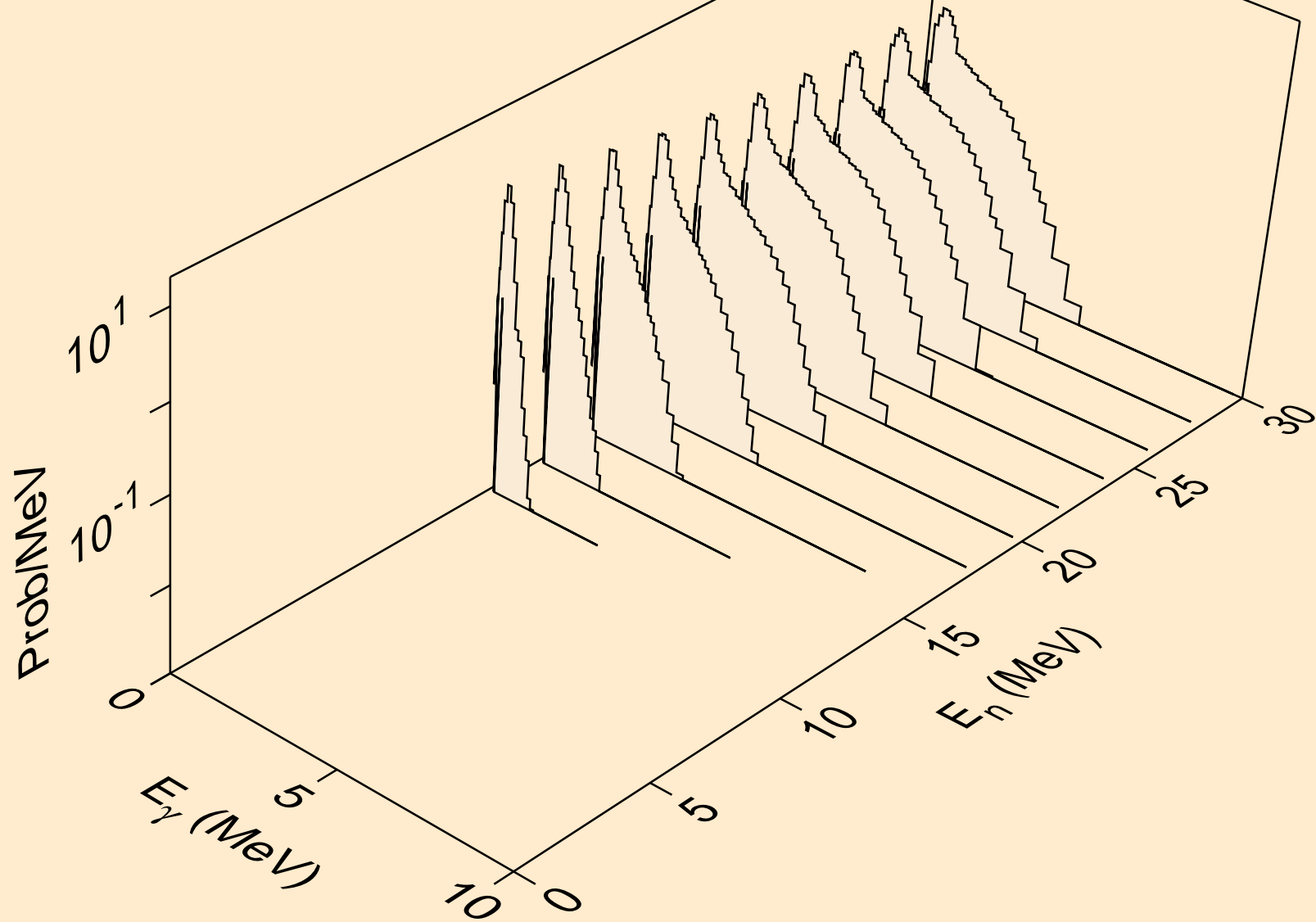

PB185M HELION ACER TENDL-2021 LIBRARY; T=0.K  
Photon emission for (n,gma)

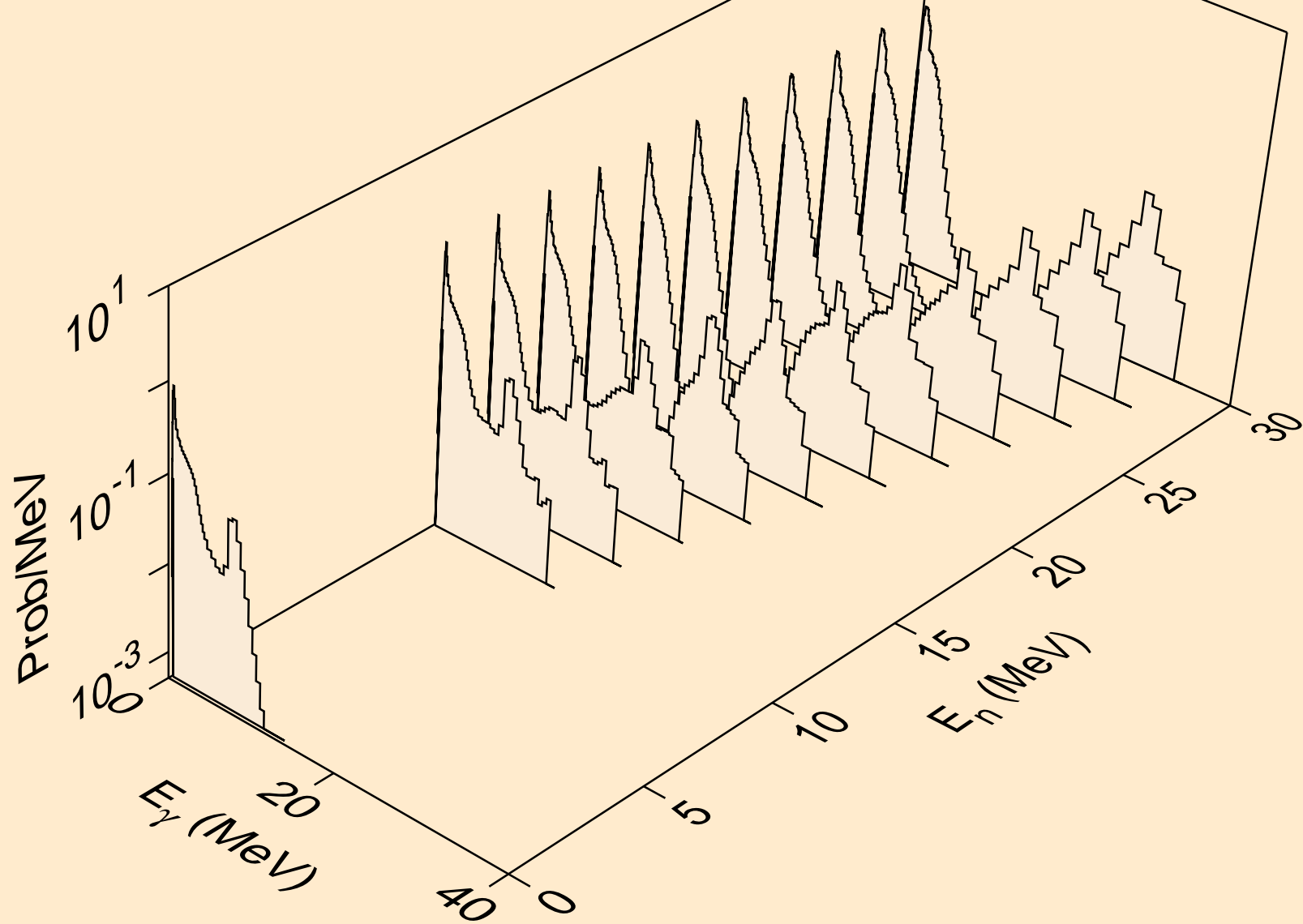

PB185M HELION ACER TENDL-2021 LIBRARY; T=0.K  
Photon emission for (n,p)

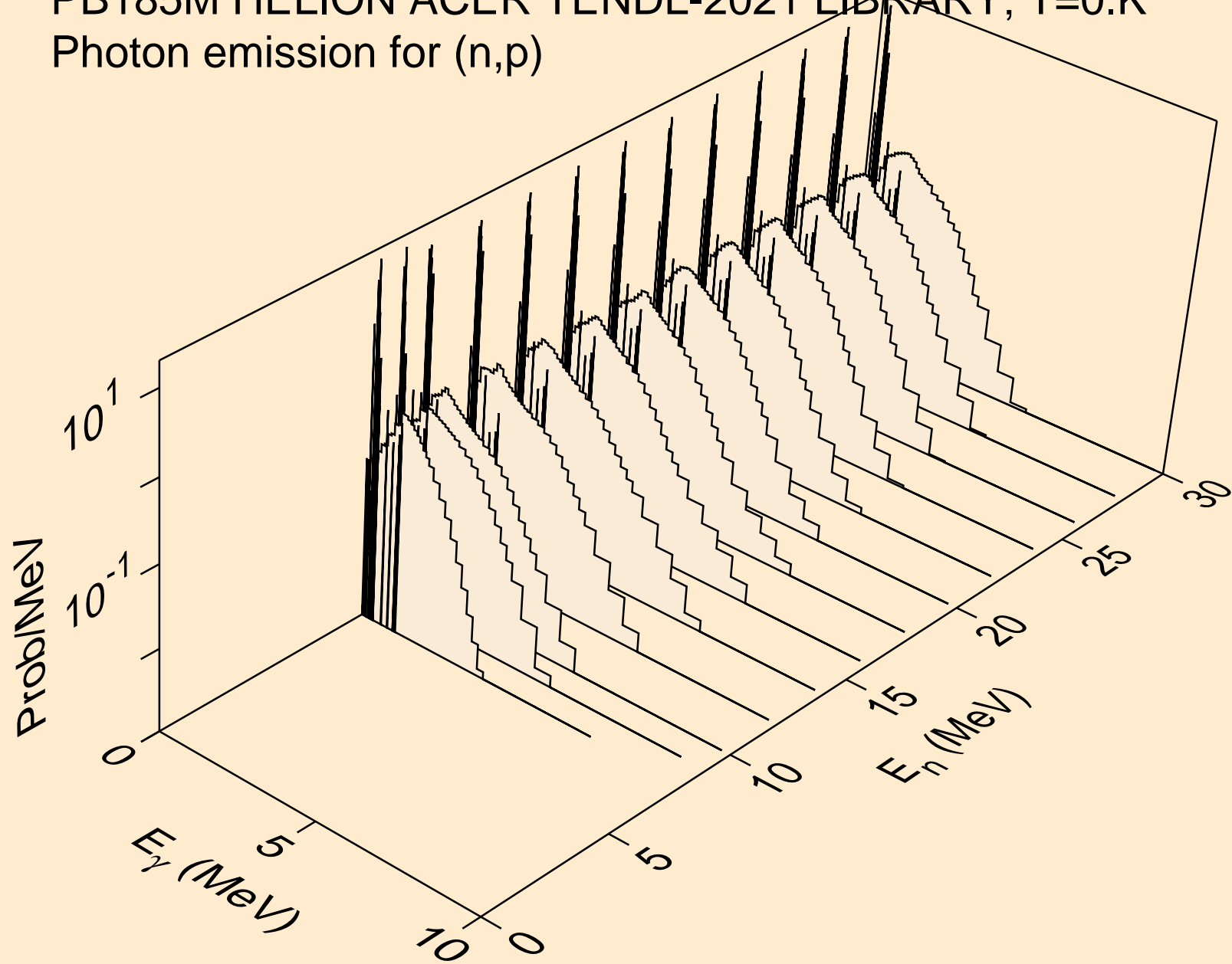

PB185M HELION ACER TENDL-2021 LIBRARY; T=0.K  
Photon emission for (n,d)

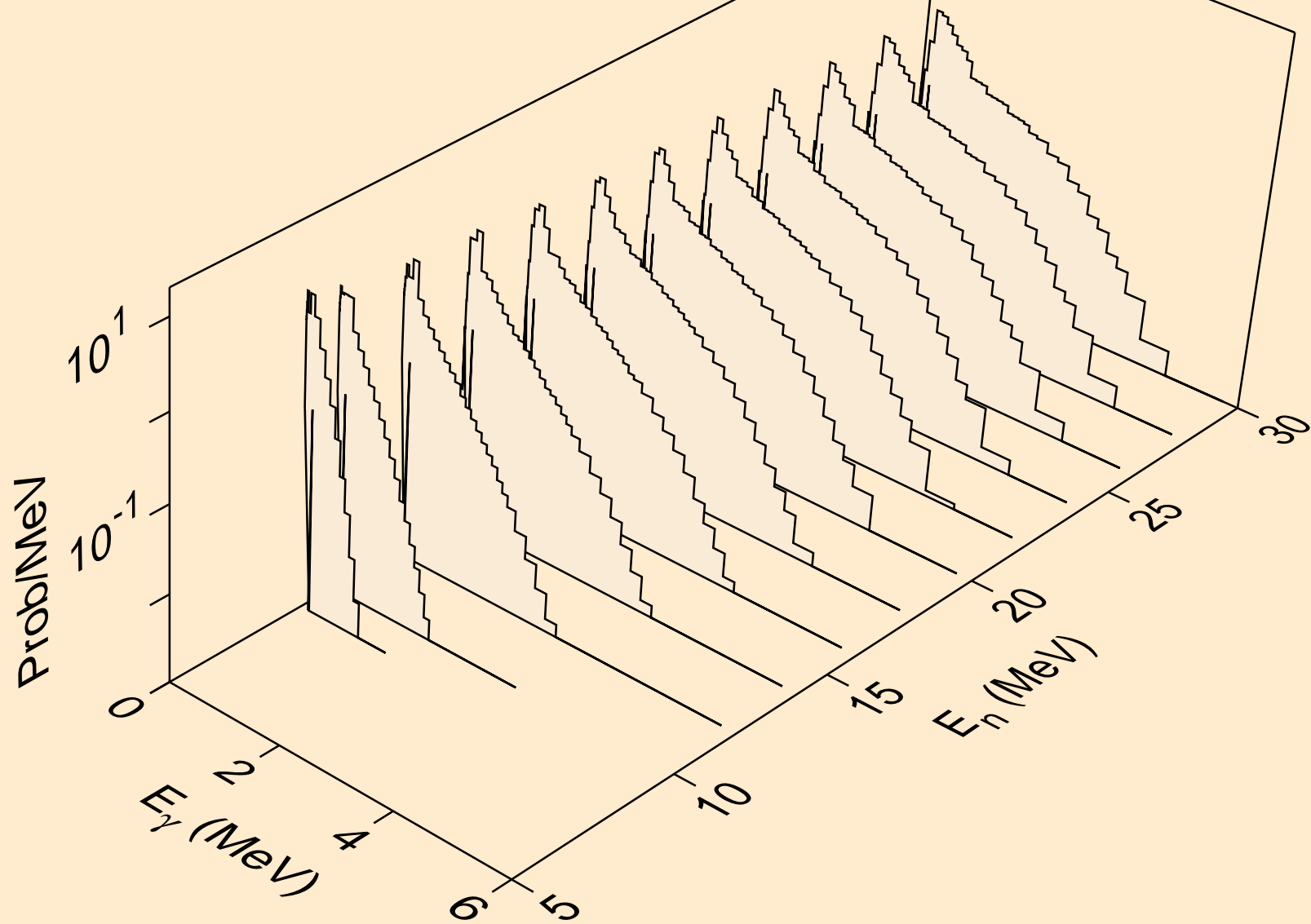



PB185M HELION ACER TENDL-2021 LIBRARY; T=0.K  
Photon emission for (n,t)

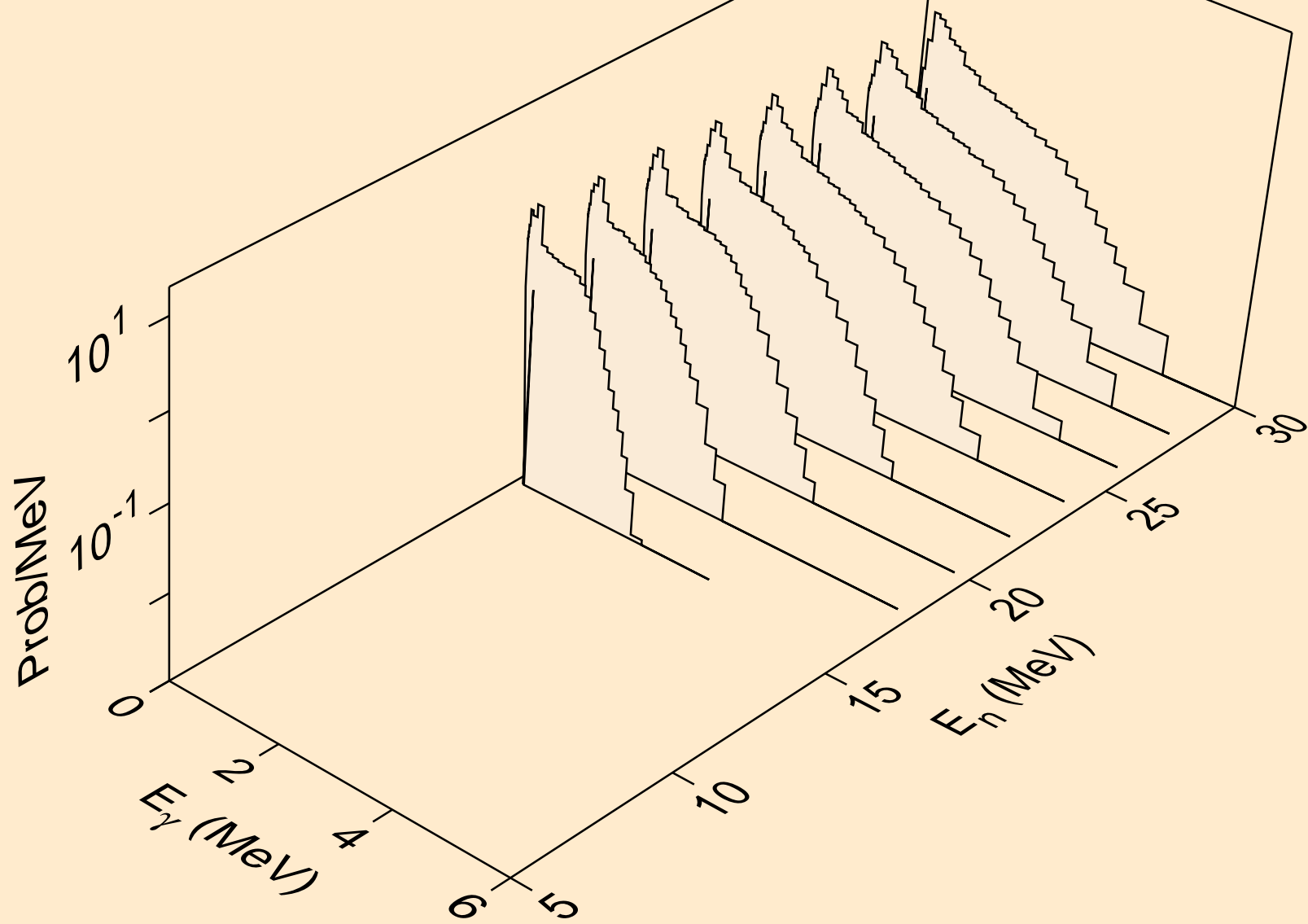

PB185M HELION ACER TENDL-2021 LIBRARY; T=0.K  
Photon emission for inelastic

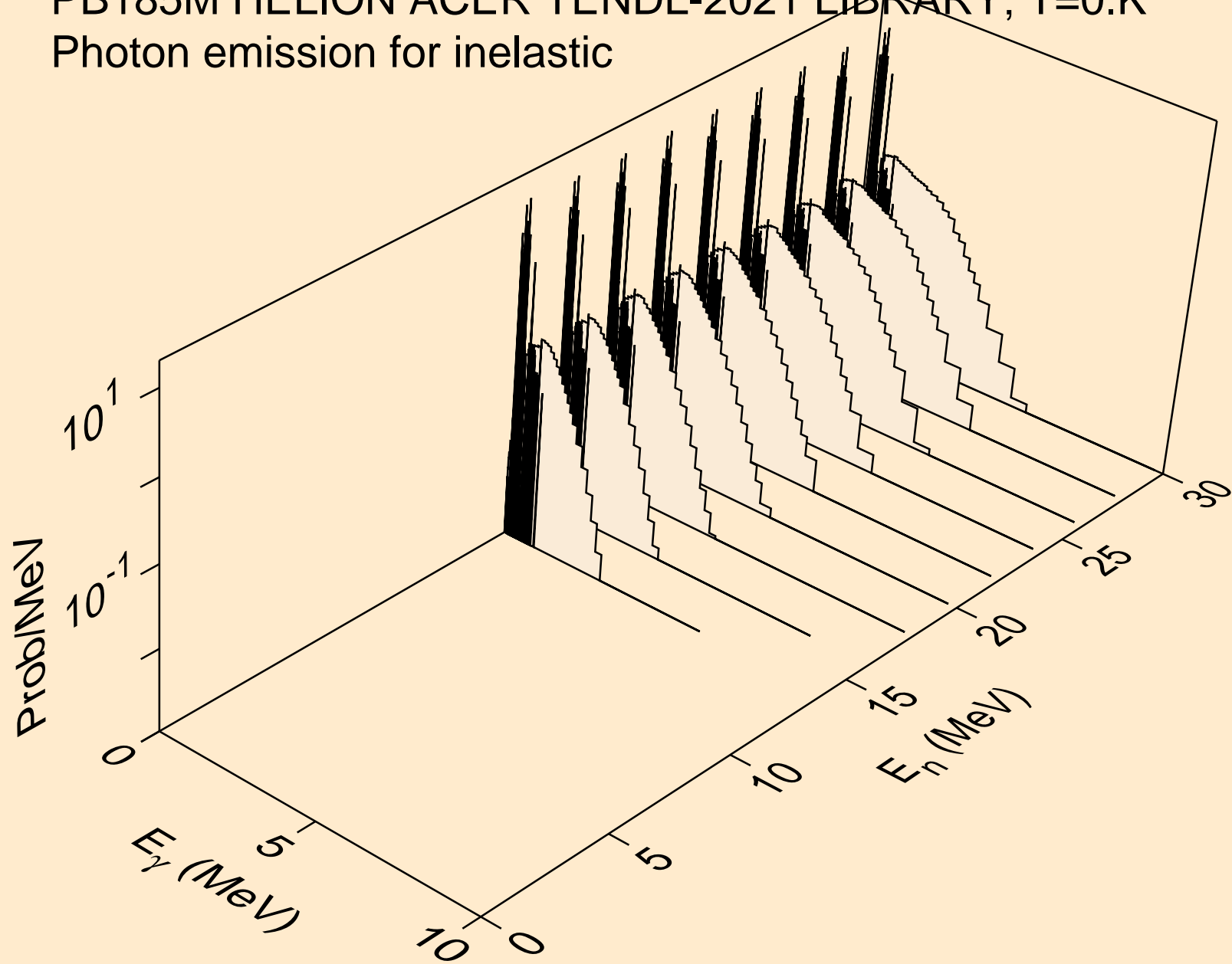

PB185M HELION ACER TENDL-2021 LIBRARY; T=0.K  
Photon emission for (n,a)

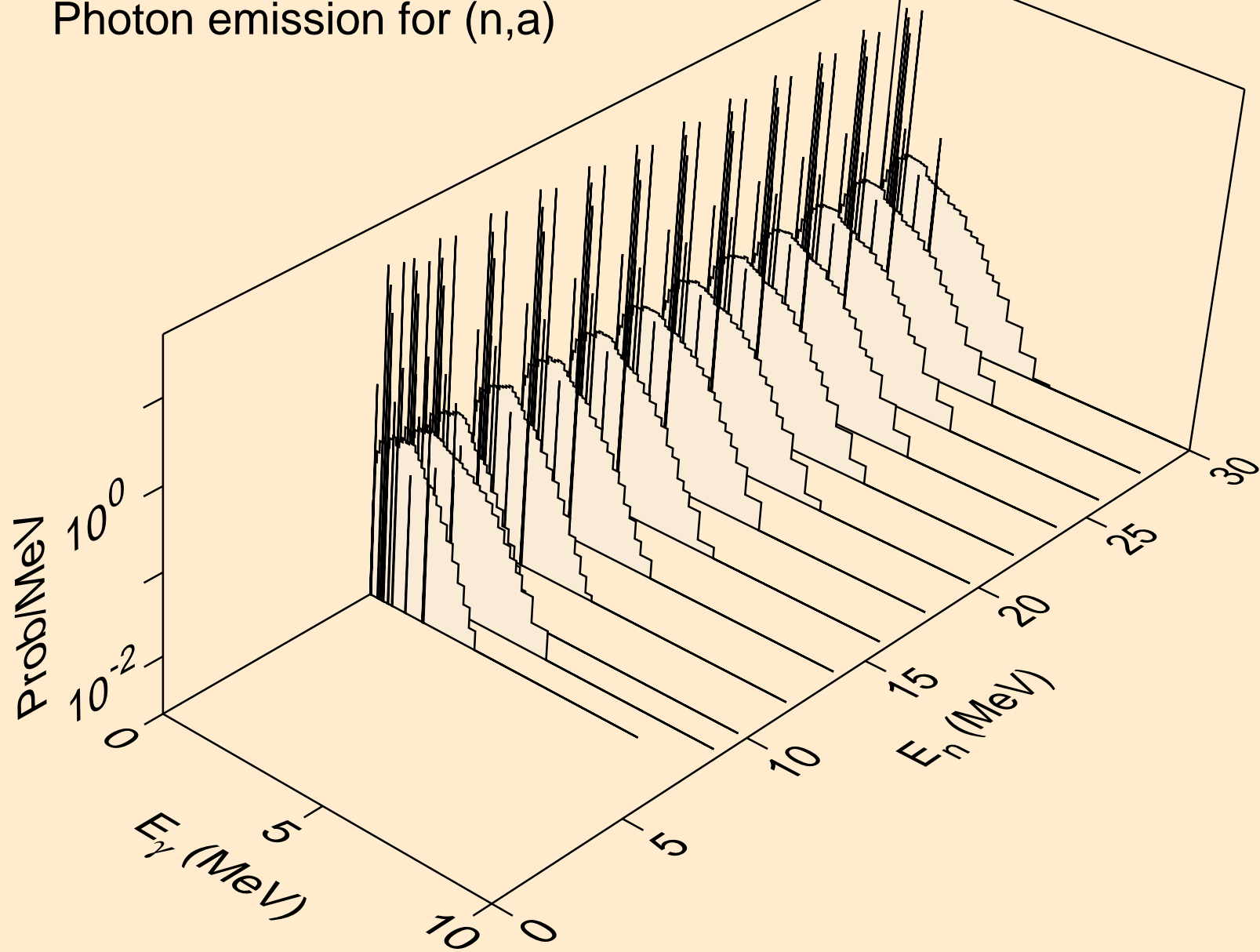

PB185M HELION ACER TENDL-2021 LIBRARY; T=0.K  
Photon emission for (n,2a)

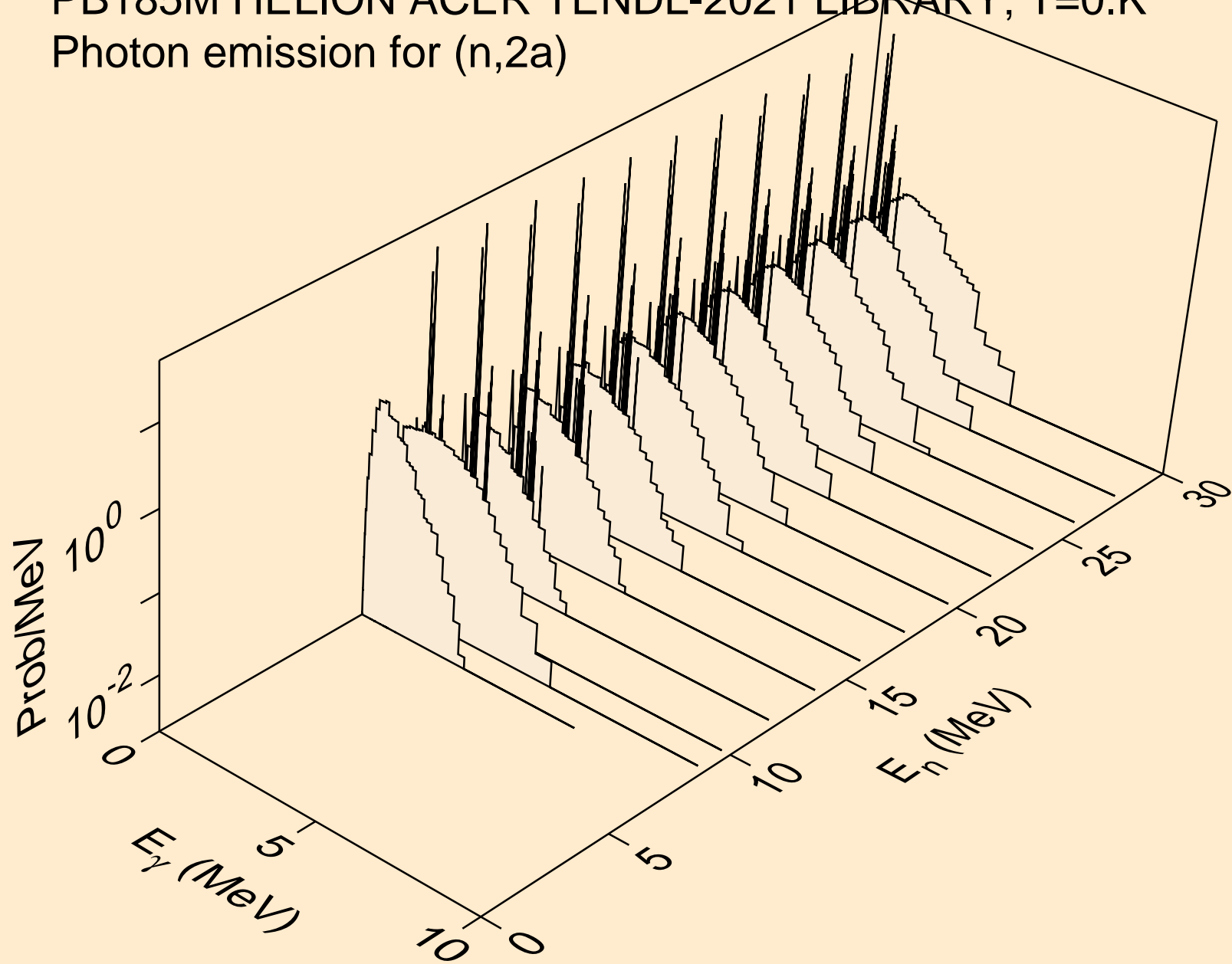

PB185M HELION ACER TENDL-2021 LIBRARY; T=0.K  
Photon emission for (n,2p)

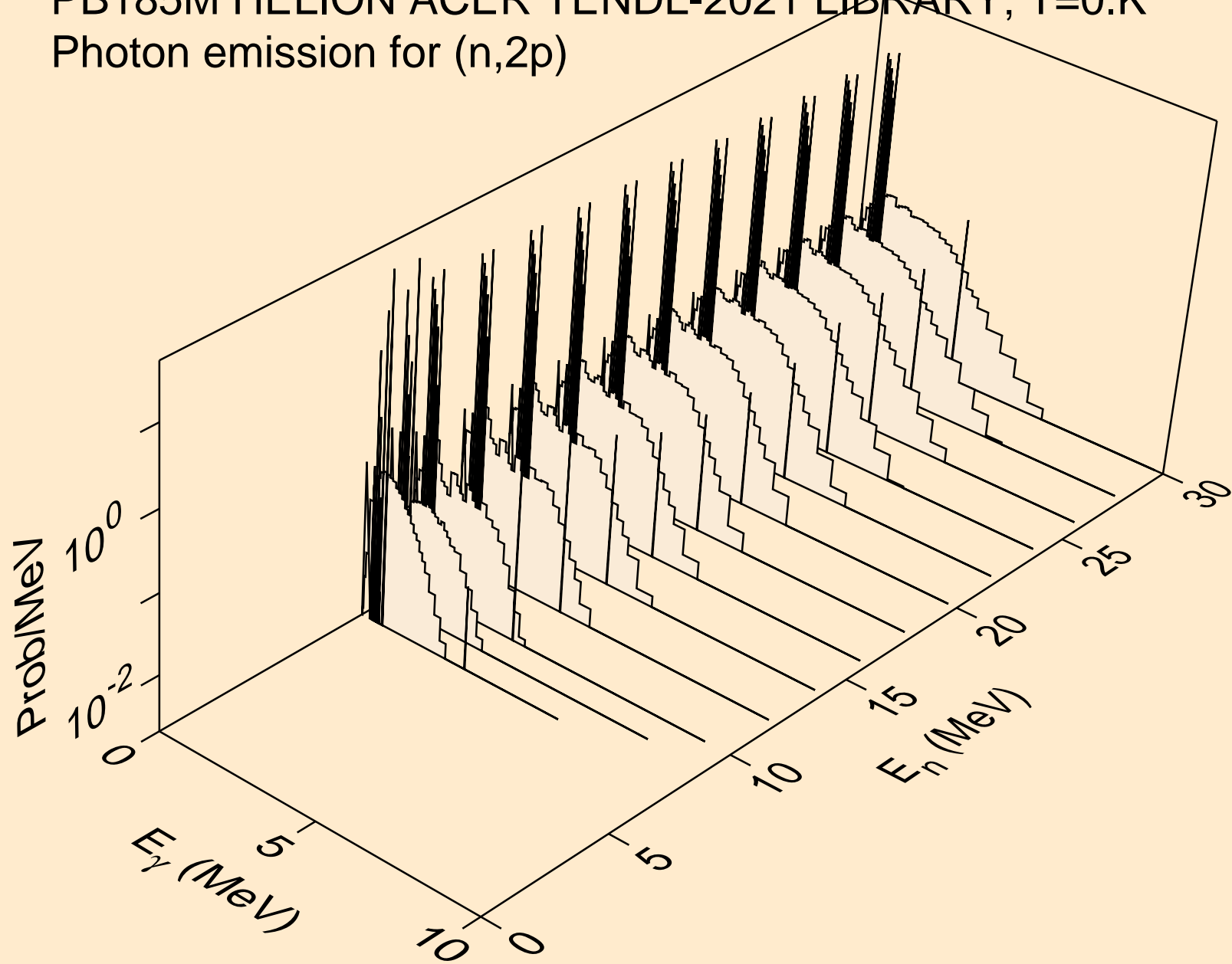

PB185M HELION ACER TENDL-2021 LIBRARY; T=0.K  
Photon emission for (n,pa)

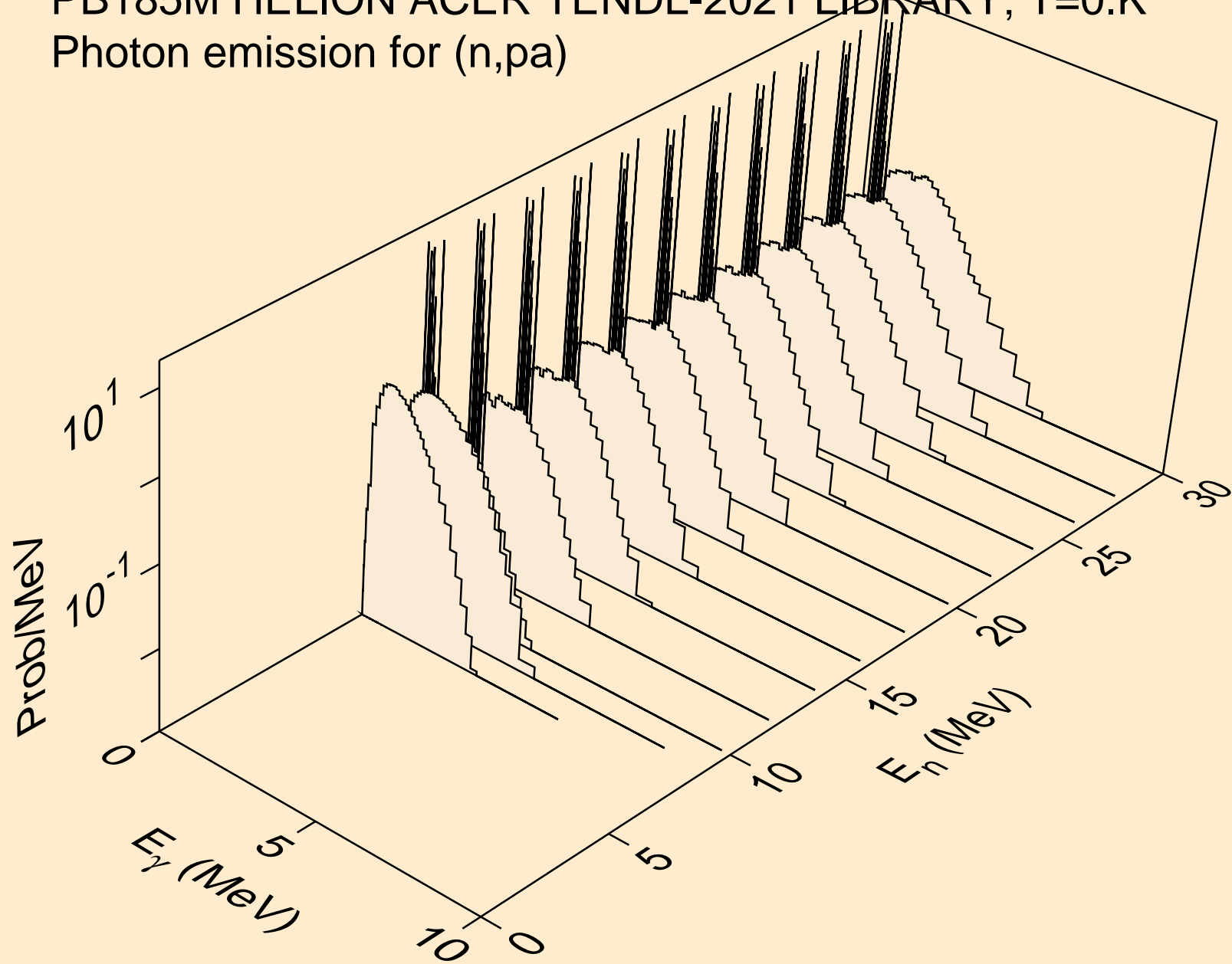

PB185M HELION ACER TENDL-2021 LIBRARY; T=0.K  
Photon emission for (n,t2a)

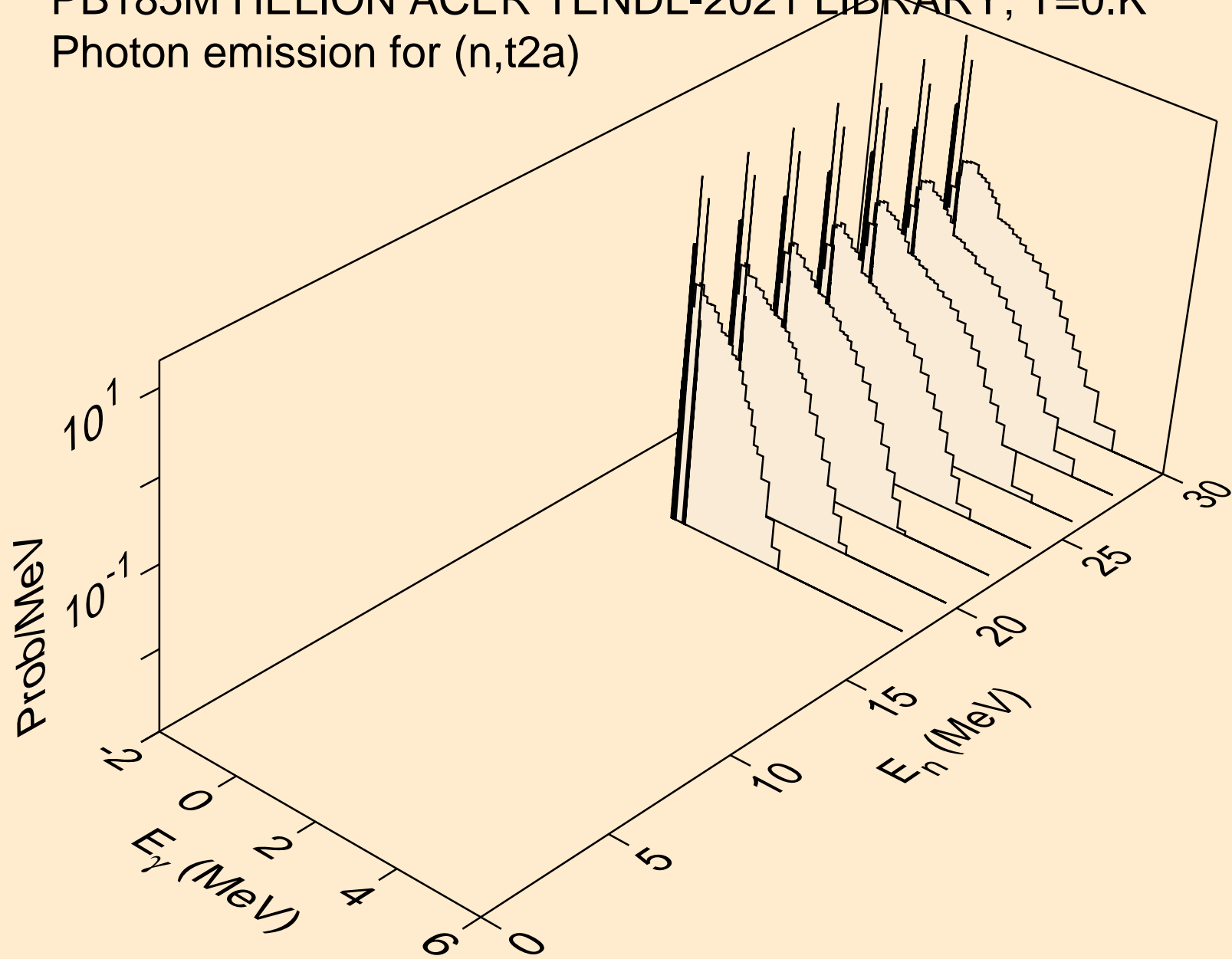

PB185M HELION ACER TENDL-2021 LIBRARY; T=0.K  
Photon emission for (n,d2a)

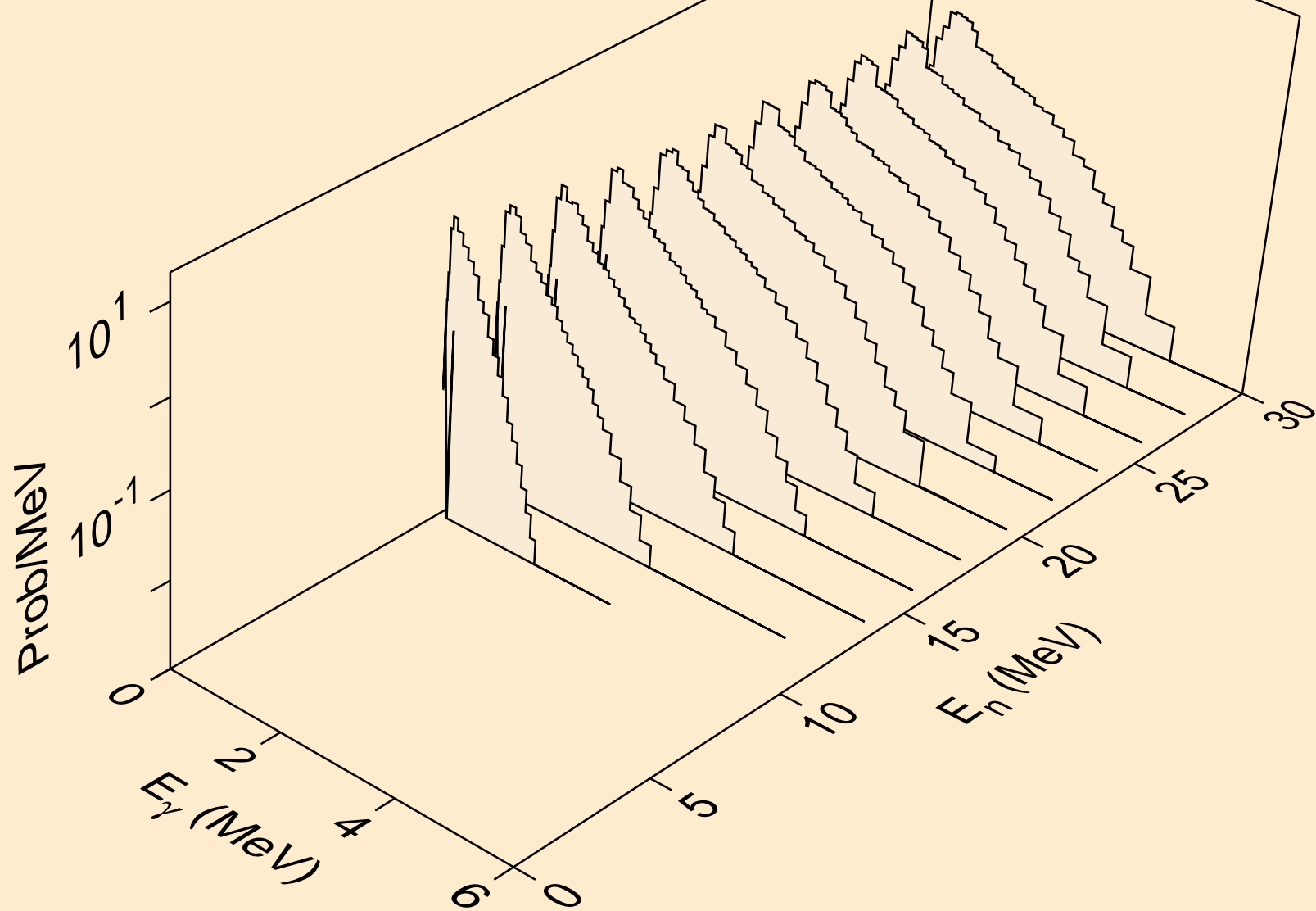



PB185M HELION ACER TENDL-2021 LIBRARY; T=0.K  
Photon emission for (n,pd)

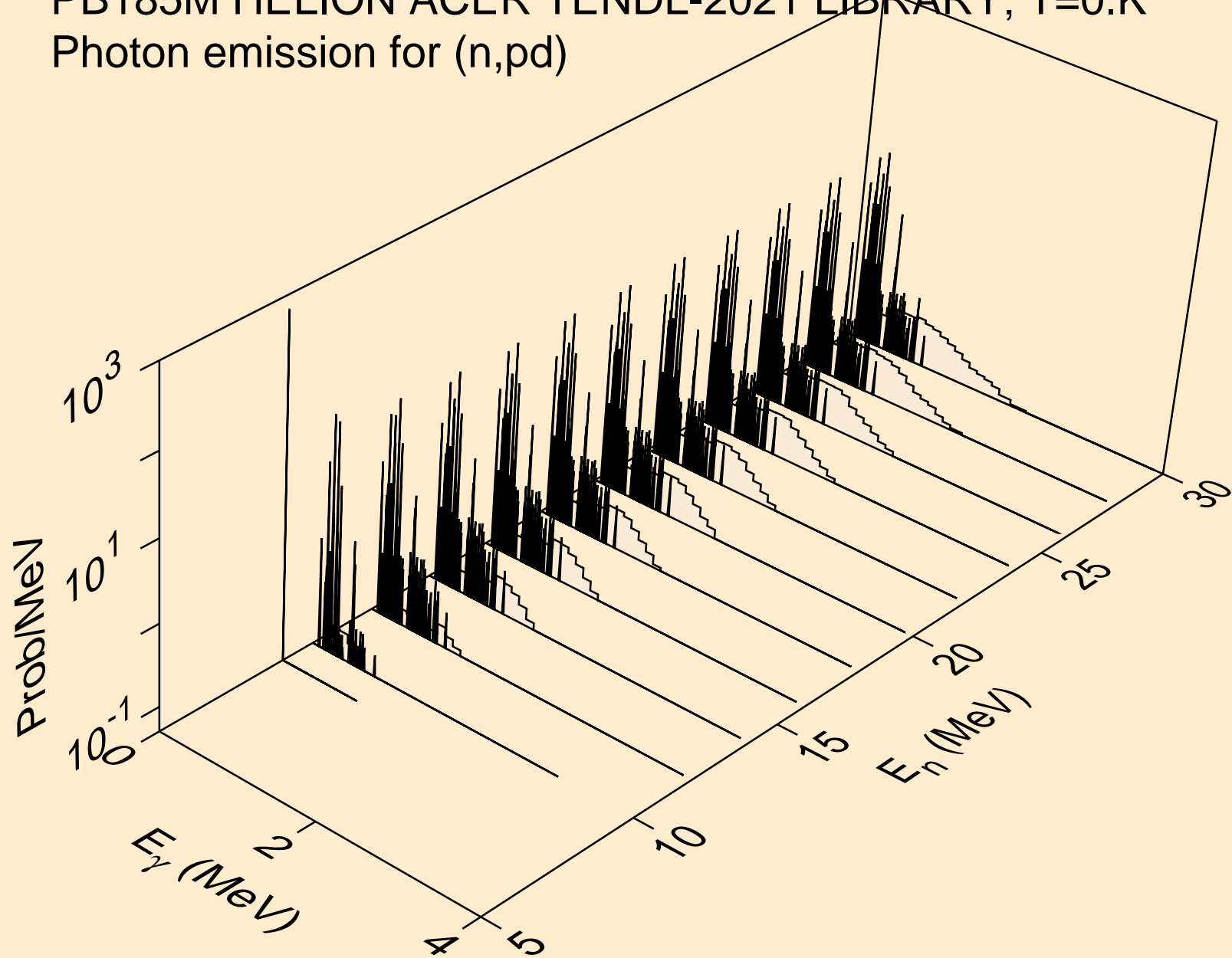

PB185M HELION ACER TENDL-2021 LIBRARY; T=0.K  
Photon emission for (n,pt)

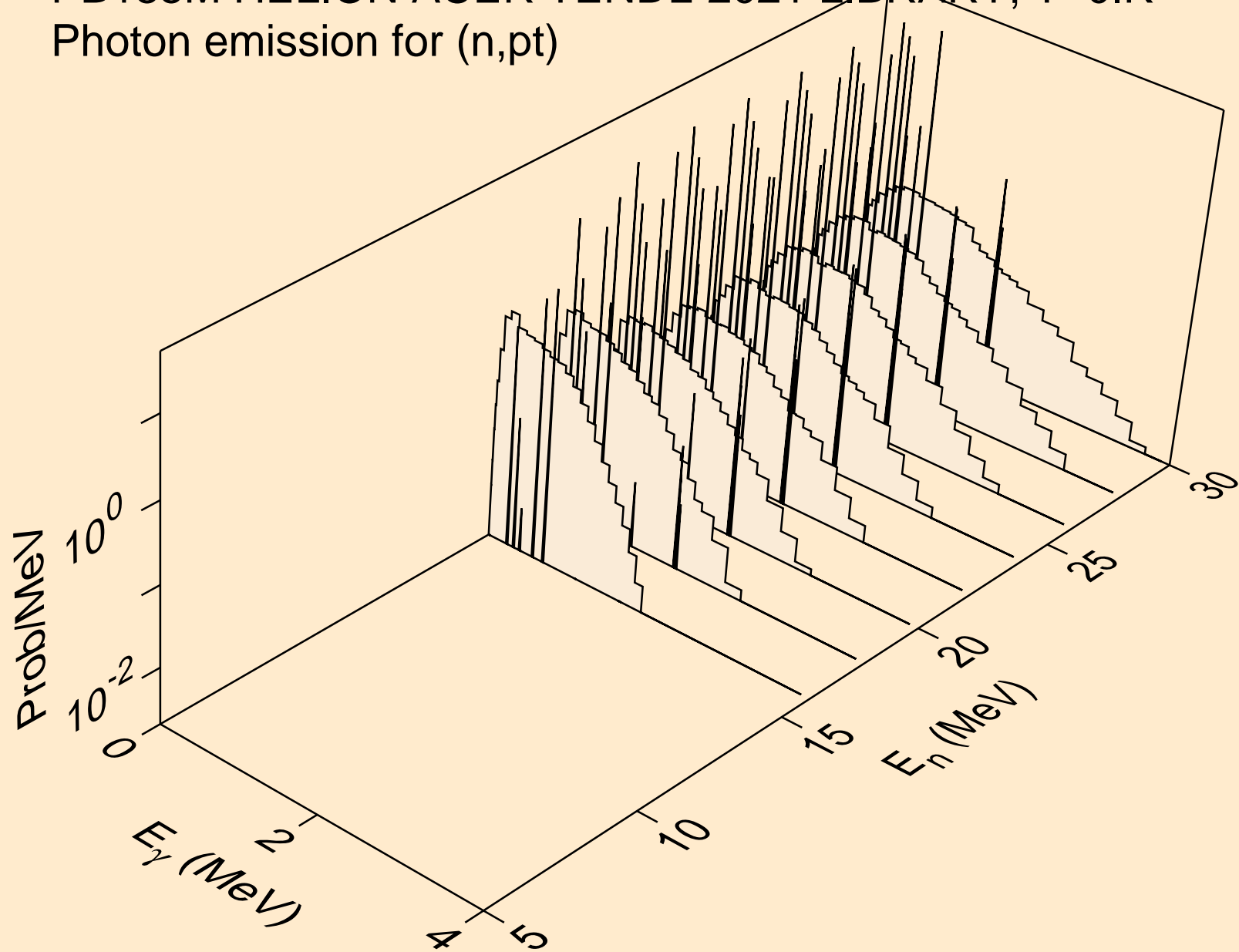

PB185M HELION ACER TENDL-2021 LIBRARY; T=0.K  
Photon emission for (n,da)

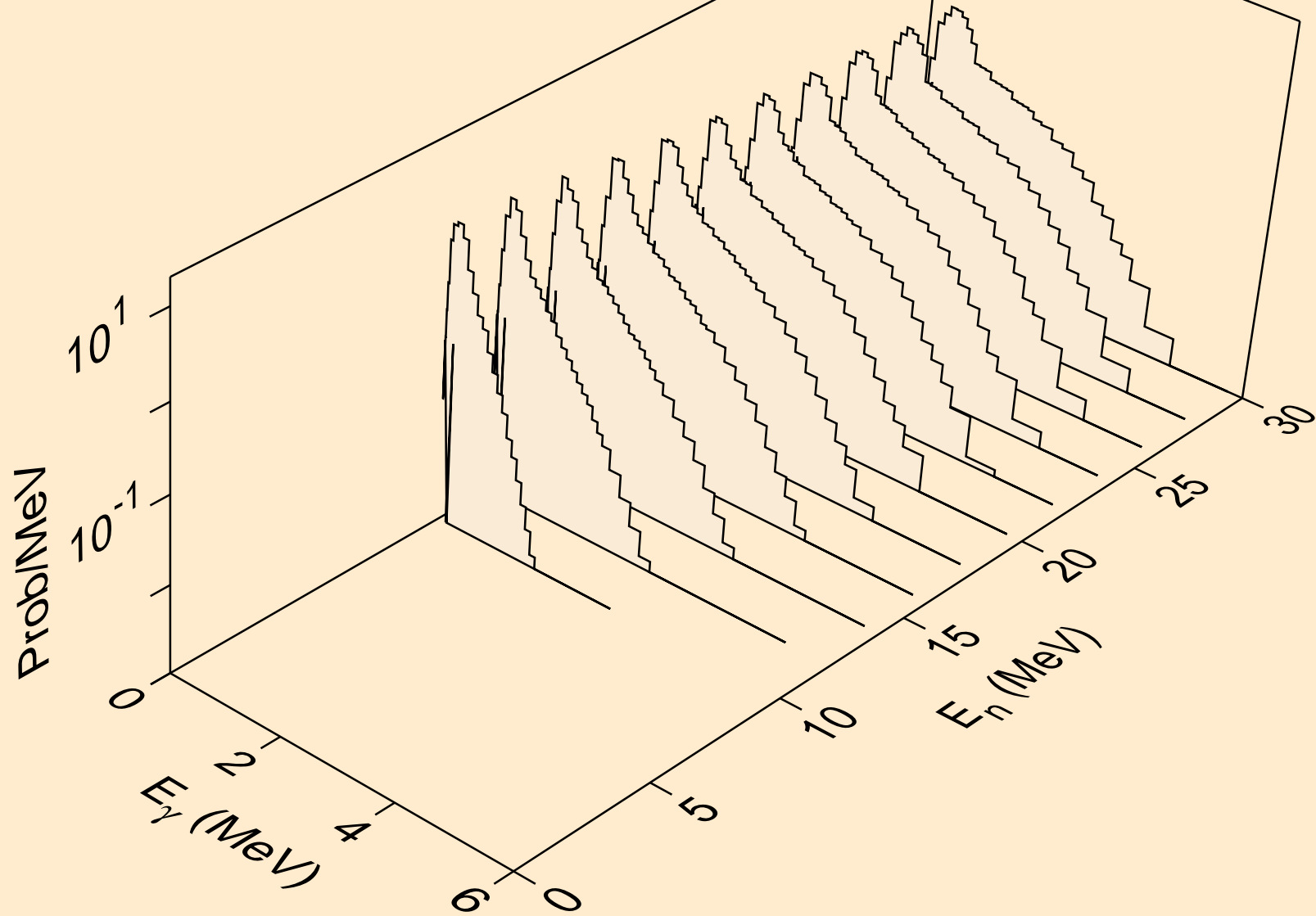

PB185M HELION ACER TENDL-2021 LIBRARY; T=0.K  
Particle heating contributions

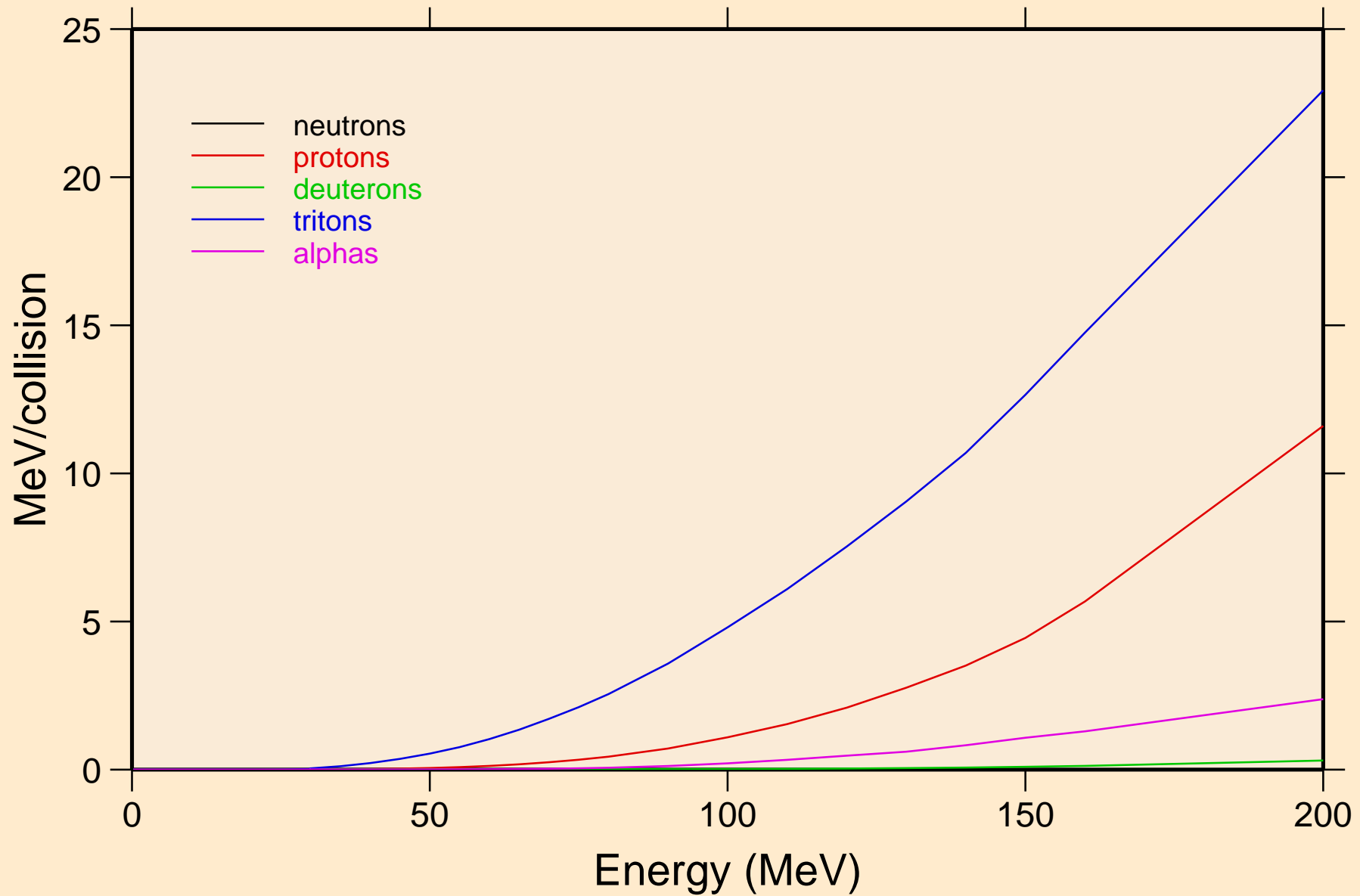

PB185M HELION ACER TENDL-2021 LIBRARY; T=0.K  
Recoil Heating

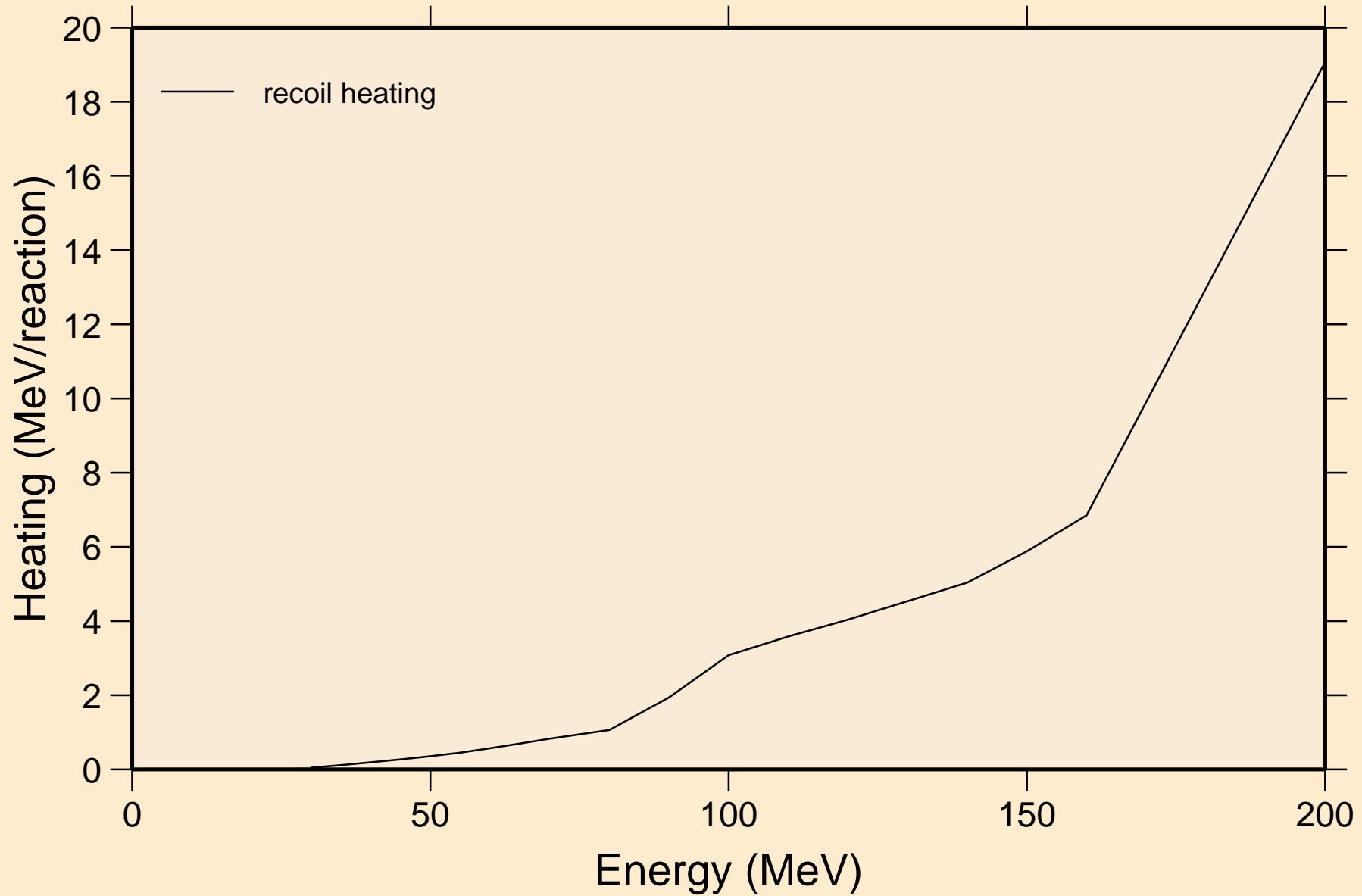

PB185M HELION ACER TENDL-2021 LIBRARY; T=0.K  
Particle production cross sections

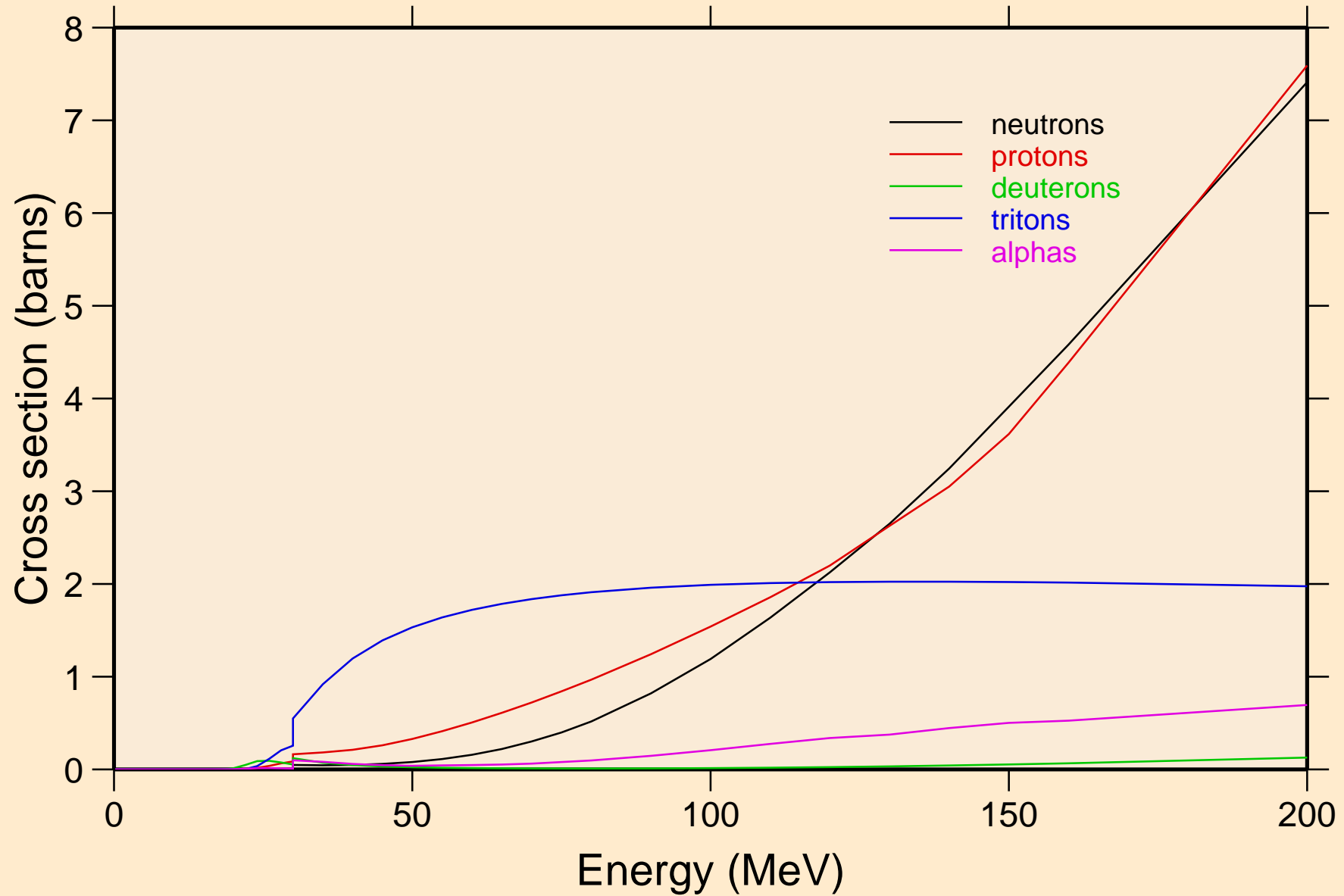

PB185M HELION ACER TENDL-2021 LIBRARY; T=0.K  
neutrons from (s,n)

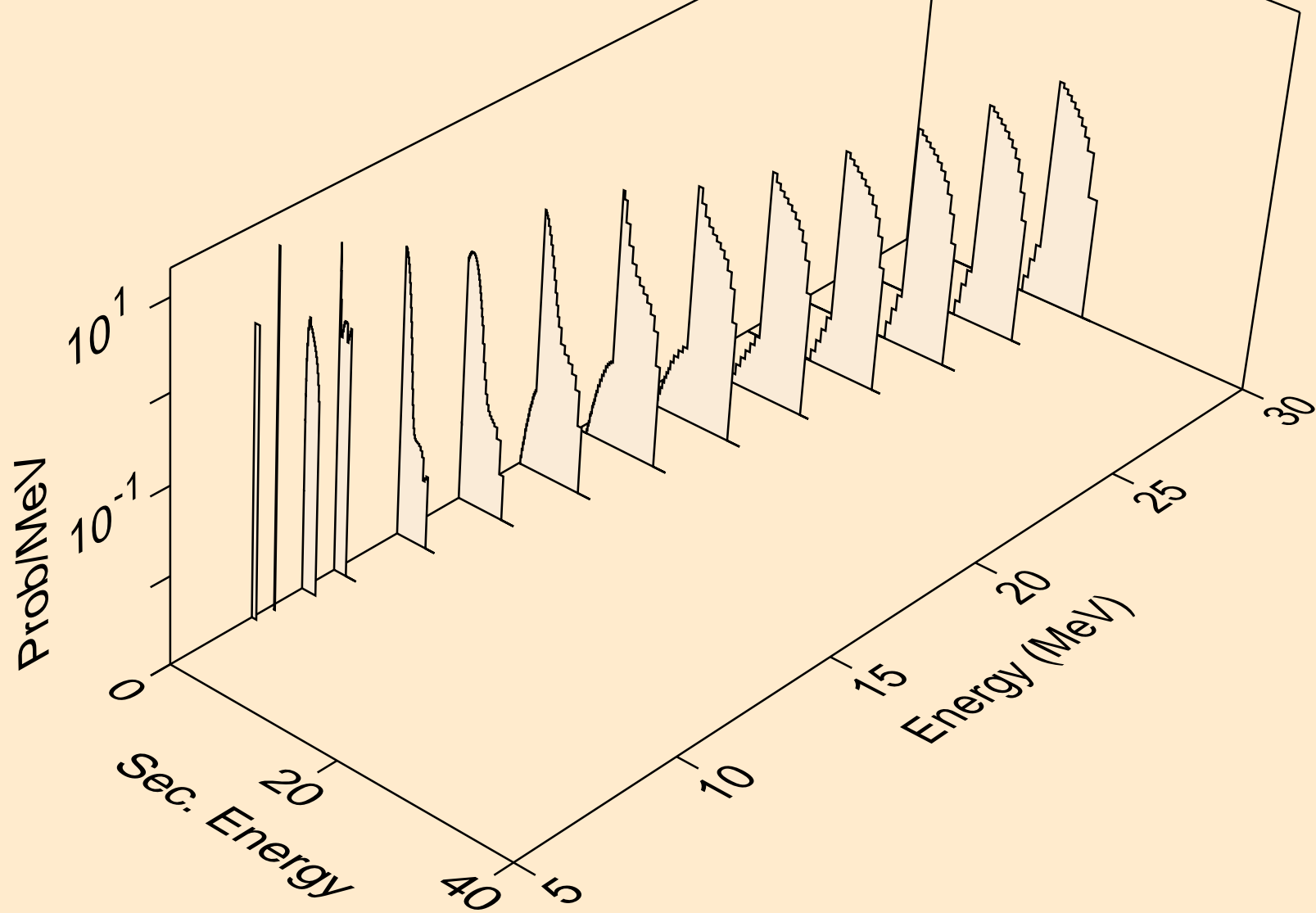

PB185M HELION ACER TENDL-2021 LIBRARY; T=0.K  
neutrons from (s,x)

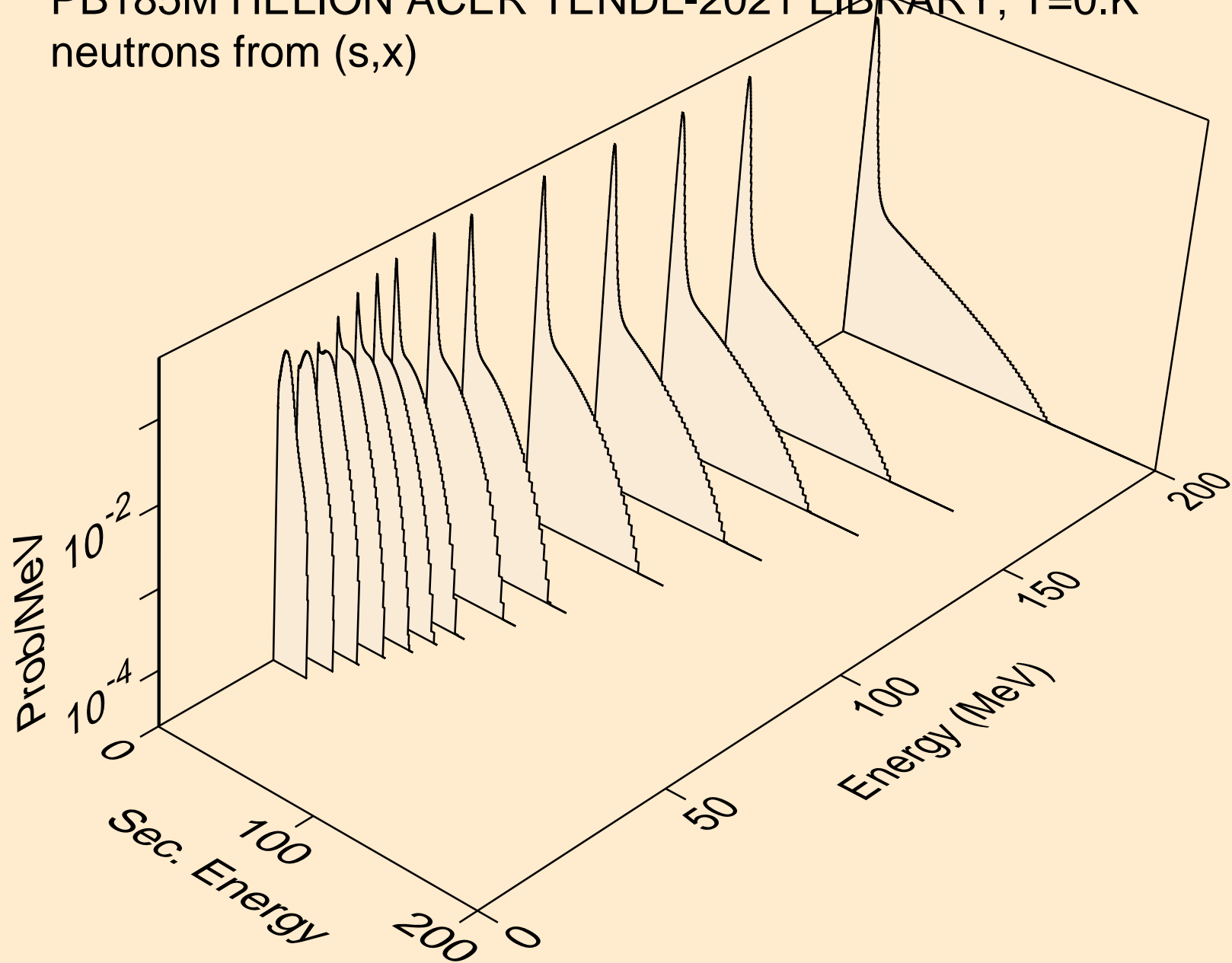



PB185M HELION ACER TENDL-2021 LIBRARY; T=0.K  
neutrons from (s,2n)

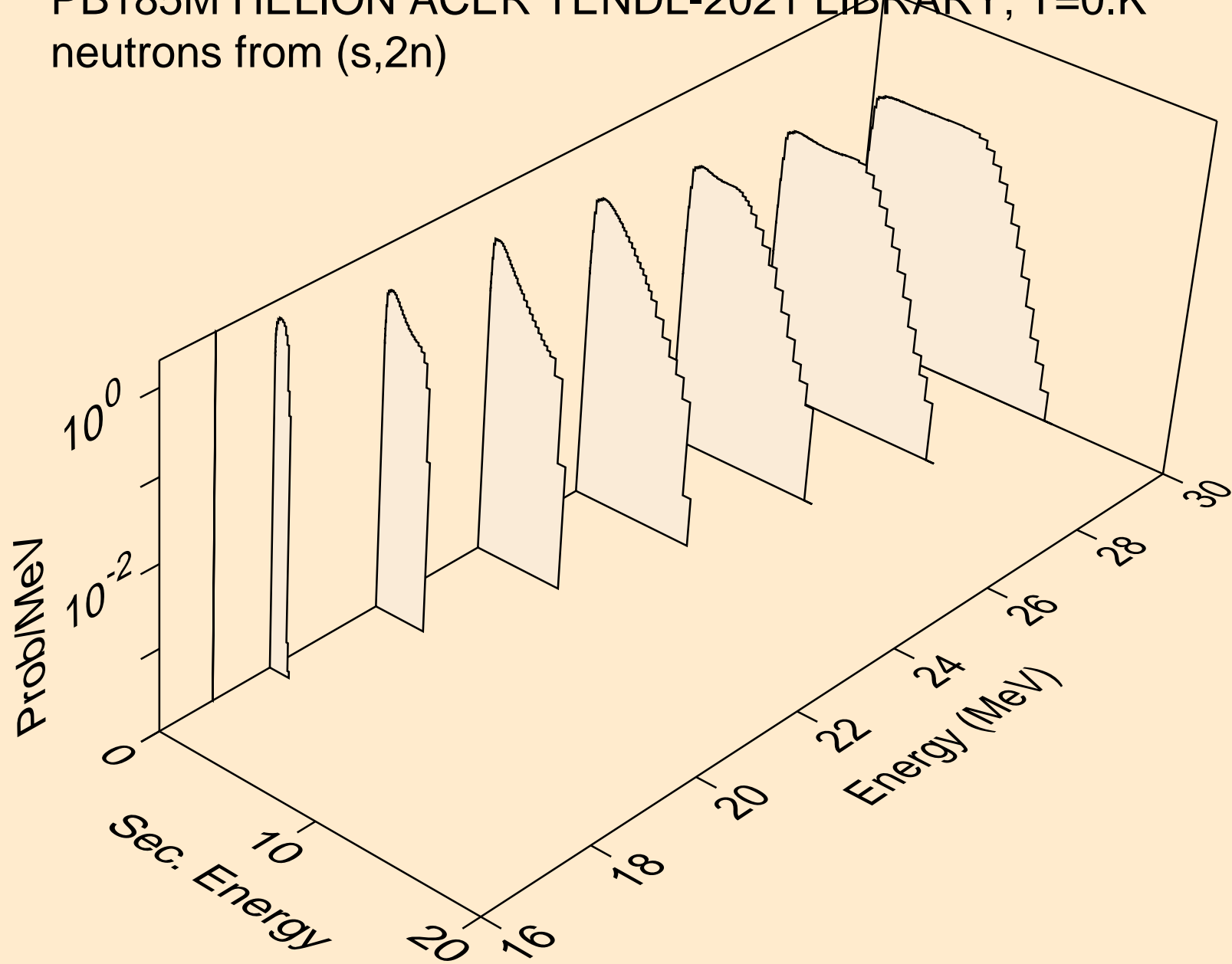

PB185M HELION ACER TENDL-2021 LIBRARY; T=0.K  
neutrons from (s,n\*)a

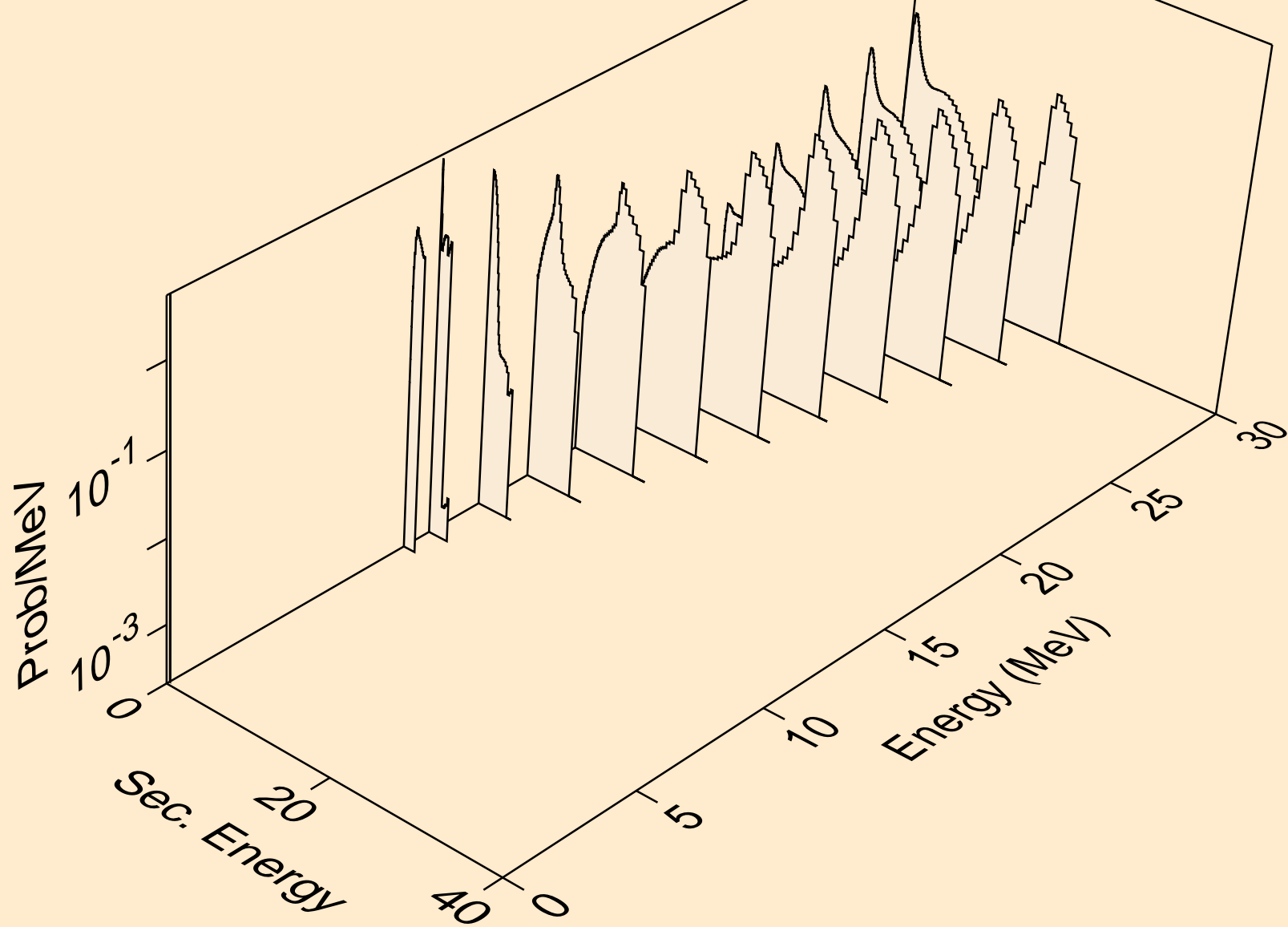

PB185M HELION ACER TENDL-2021 LIBRARY; T=0.K  
neutrons from (s,2n)a

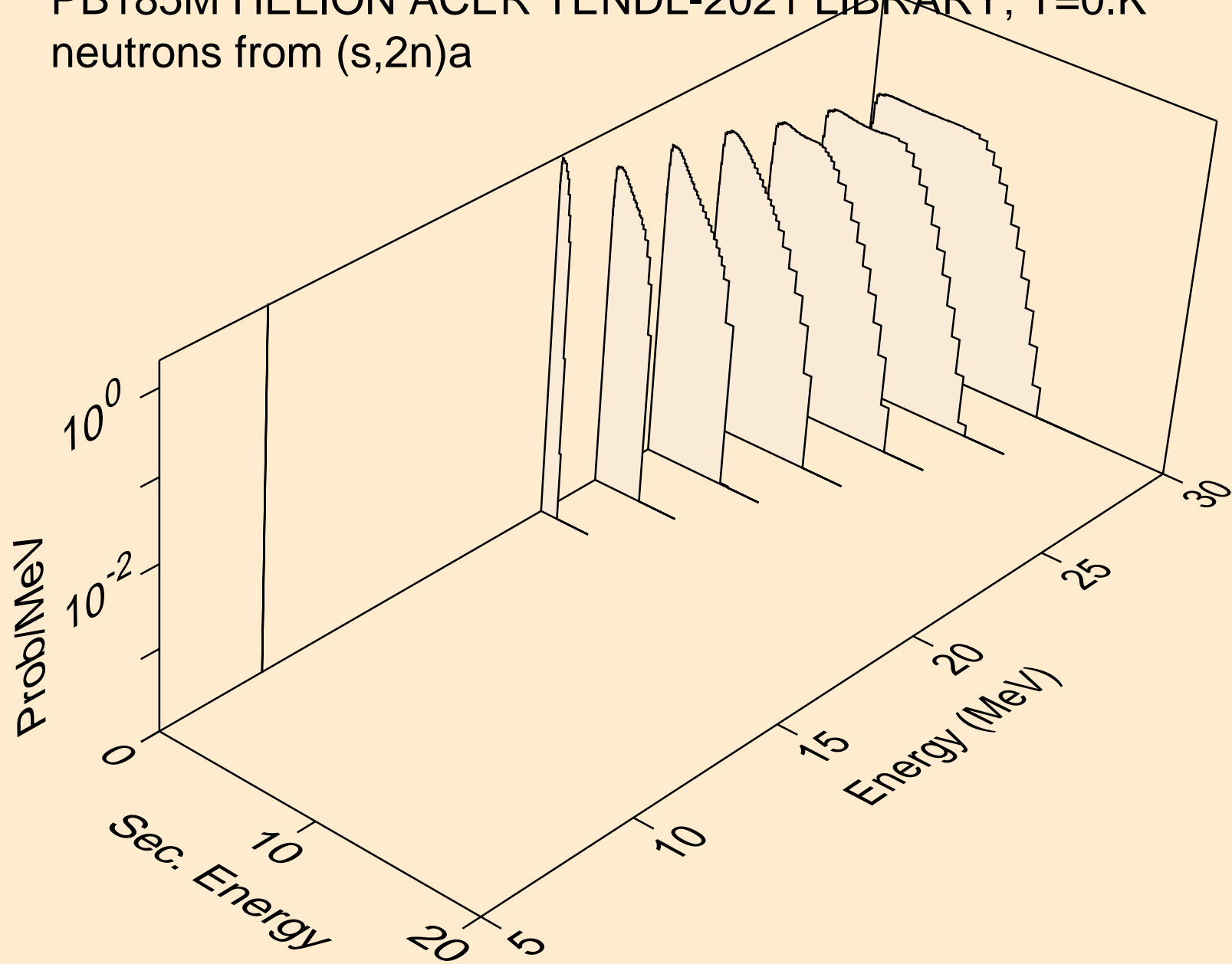

PB185M HELION ACER TENDL-2021 LIBRARY; T=0.K  
neutrons from (s,n\*)p

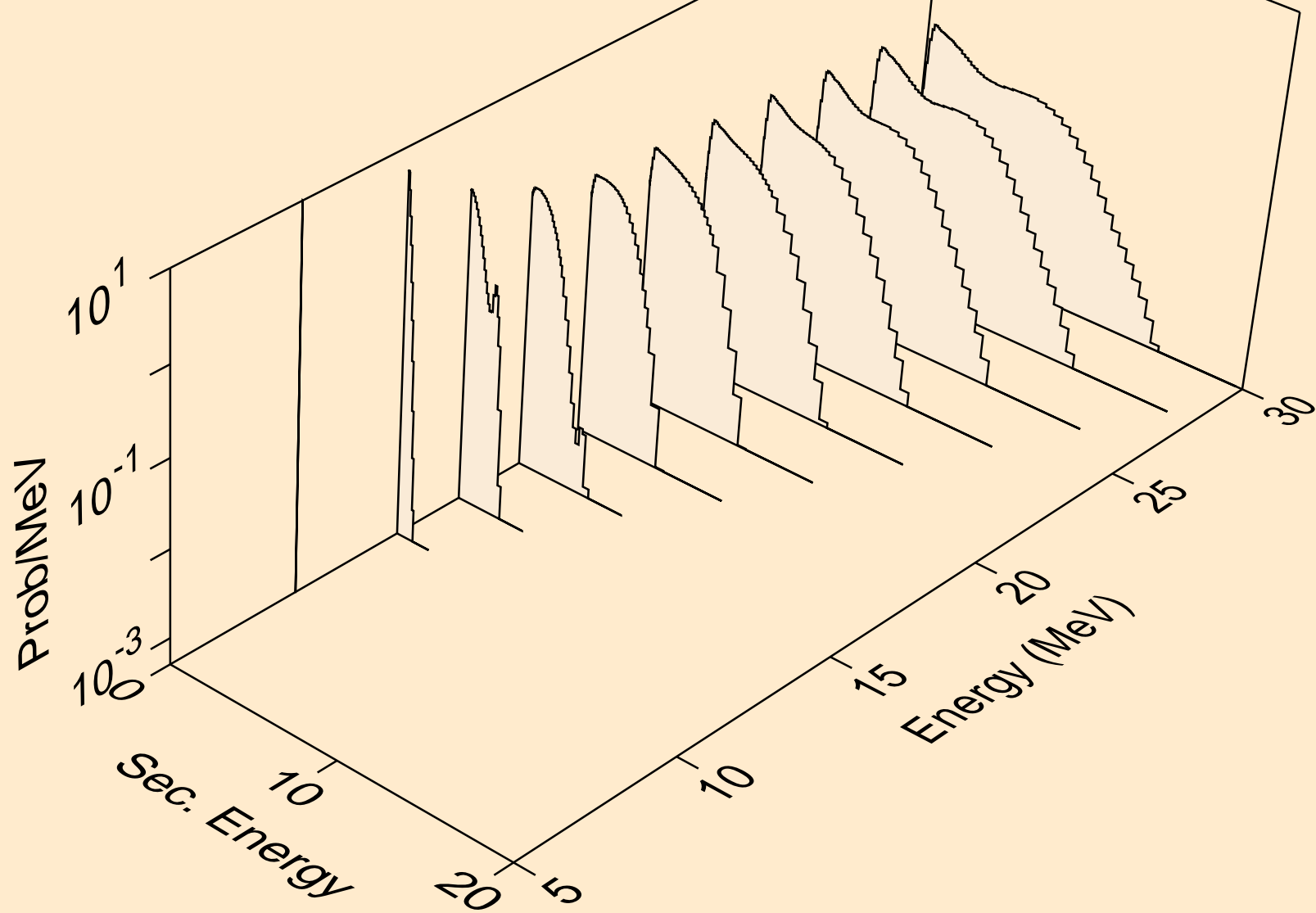

PB185M HELION ACER TENDL-2021 LIBRARY; T=0.K  
neutrons from (s,n\*)2a

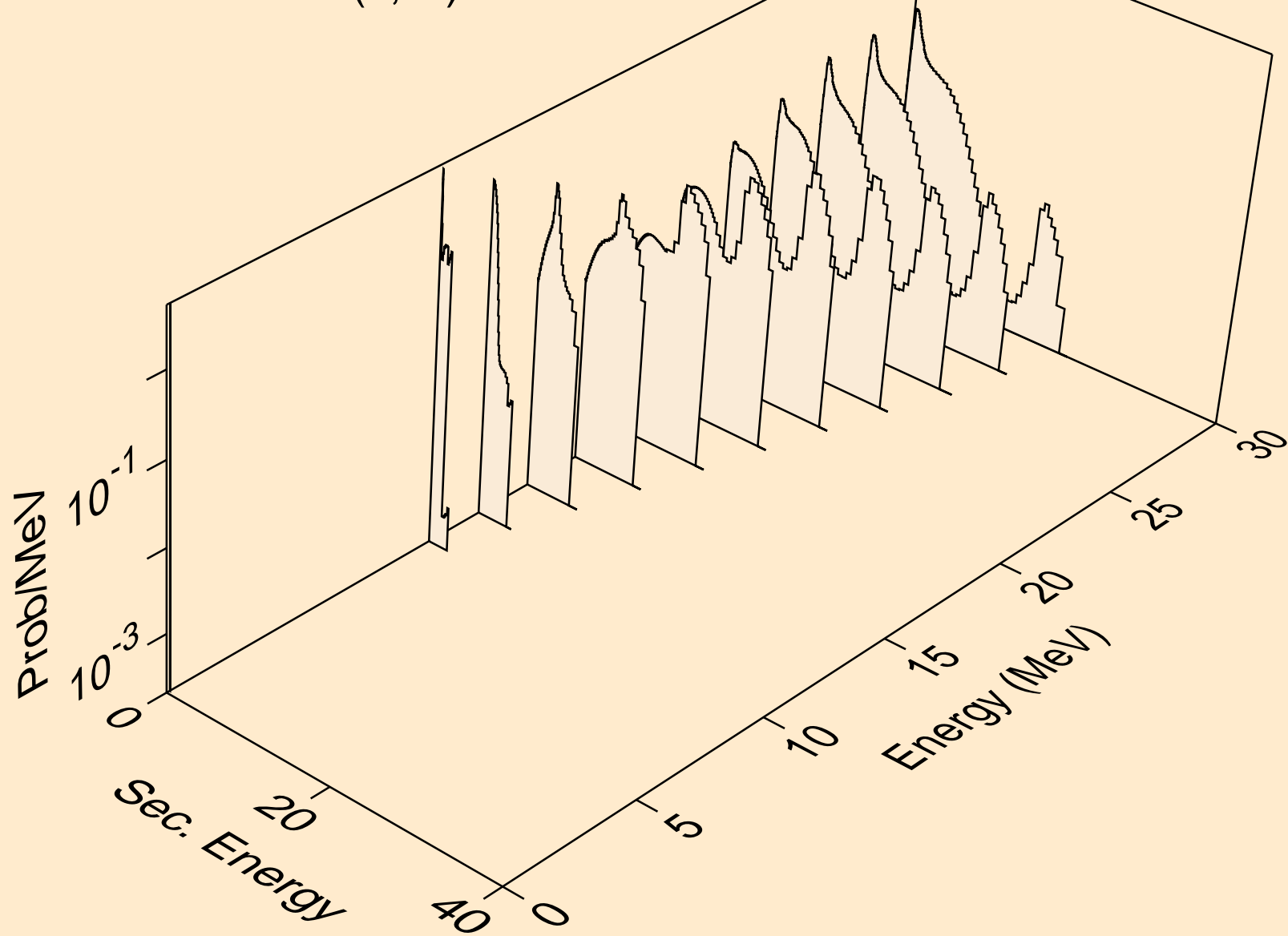

PB185M HELION ACER TENDL-2021 LIBRARY; T=0.K  
neutrons from (s,n\*)d

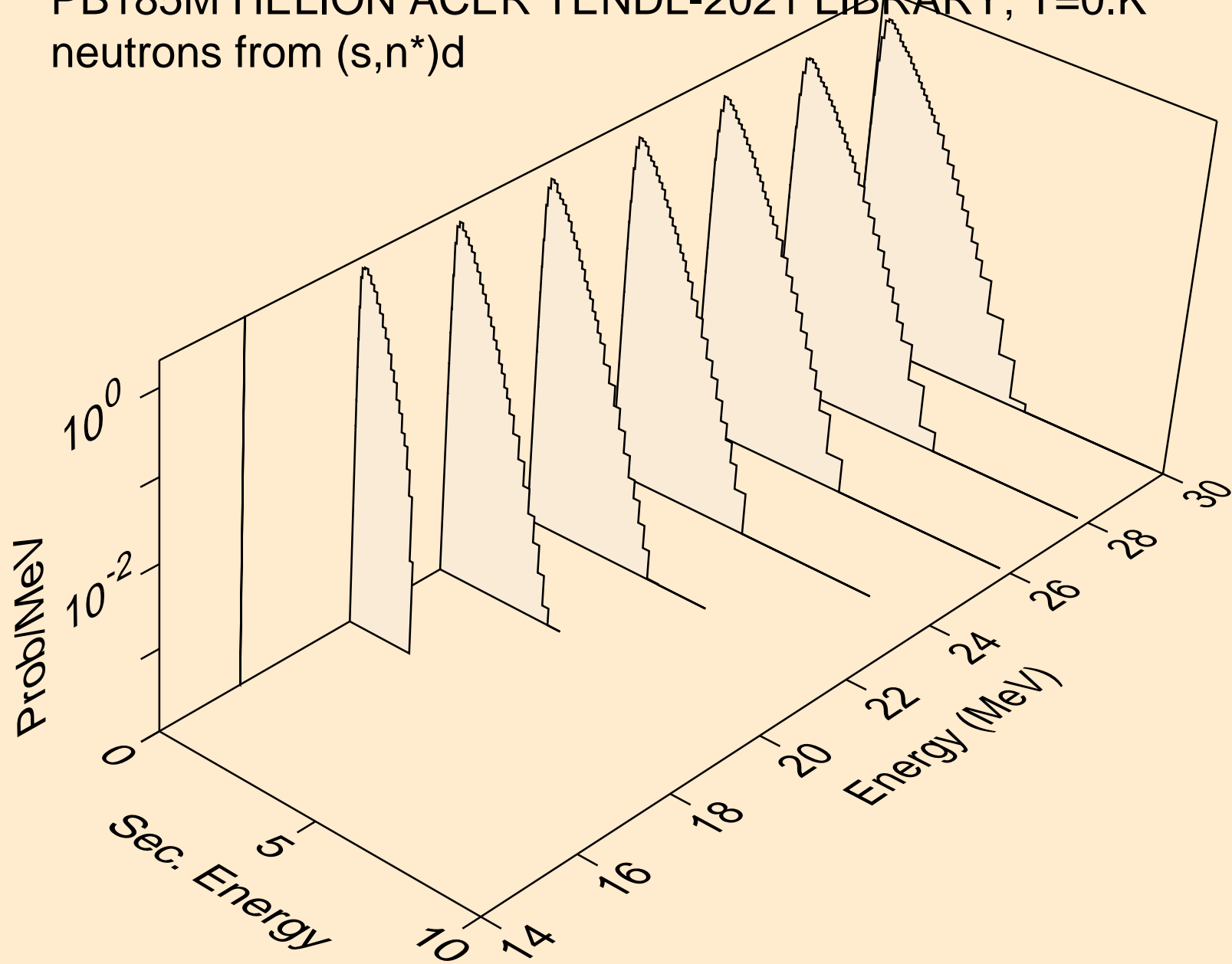

PB185M HELION ACER TENDL-2021 LIBRARY; T=0.K  
neutrons from (s,n\*)t

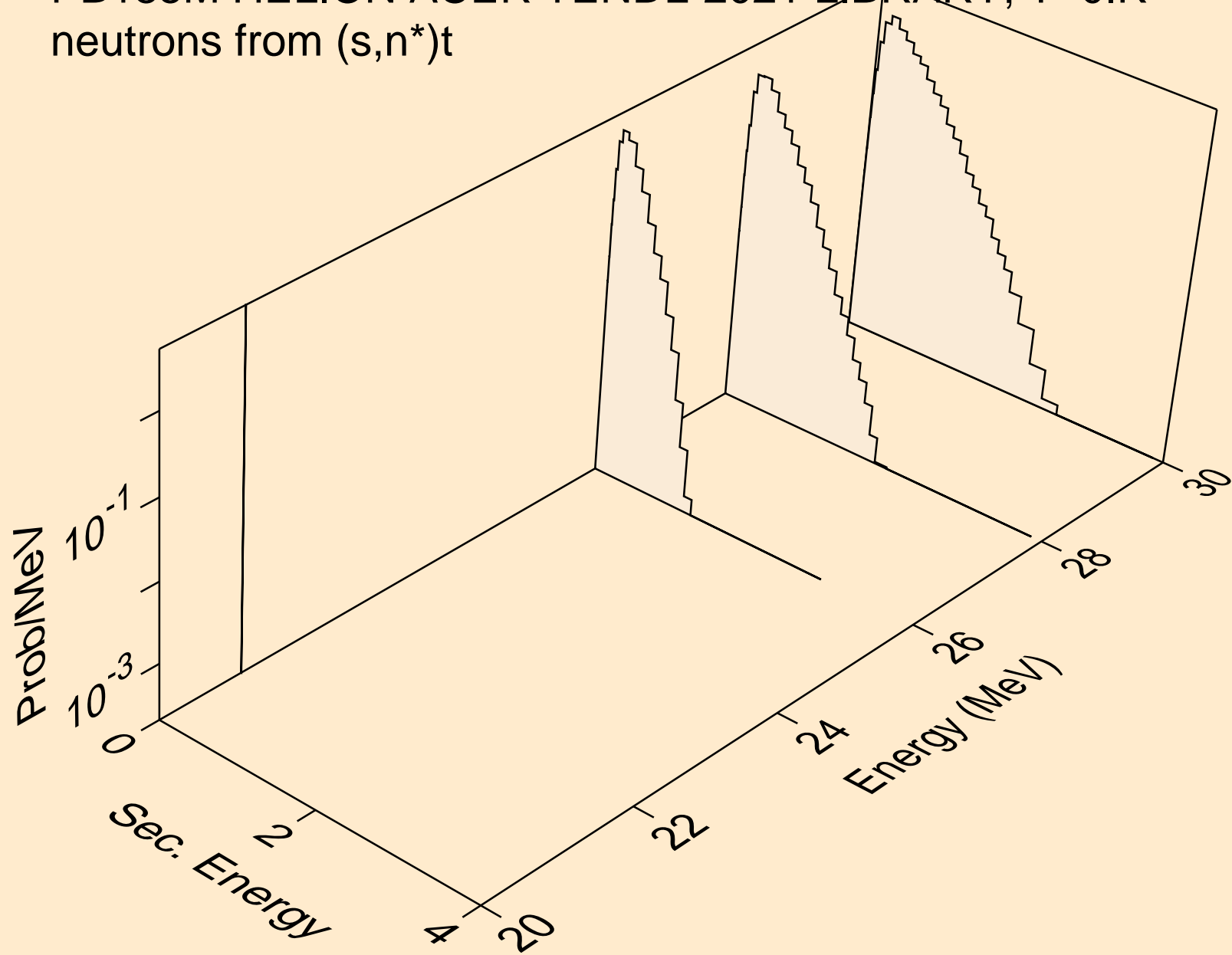

PB185M HELION ACER TENDL-2021 LIBRARY; T=0.K  
neutrons from (s,n\*)he3

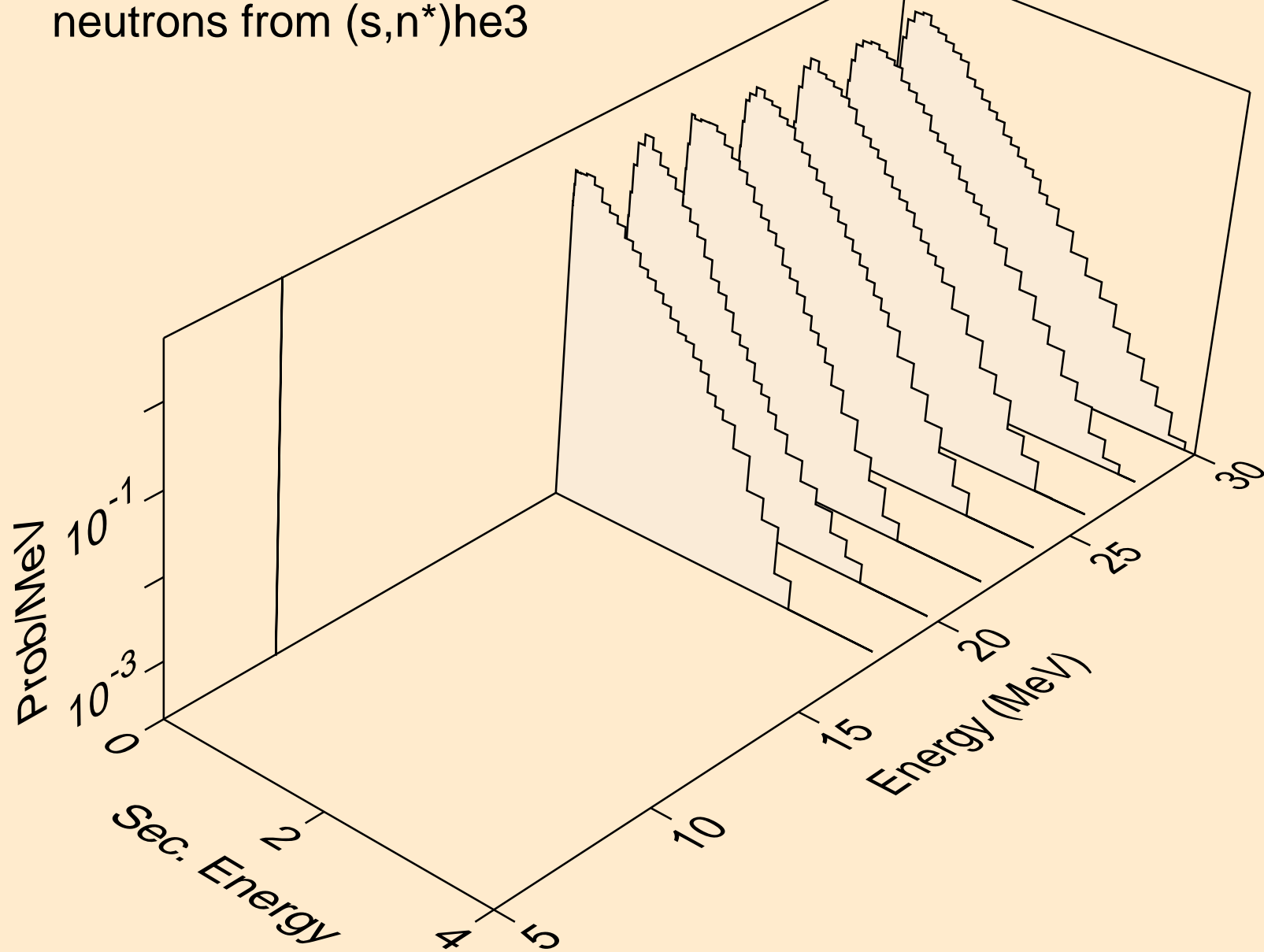



PB185M HELION ACER TENDL-2021 LIBRARY; T=0.K  
neutrons from (s,2np)

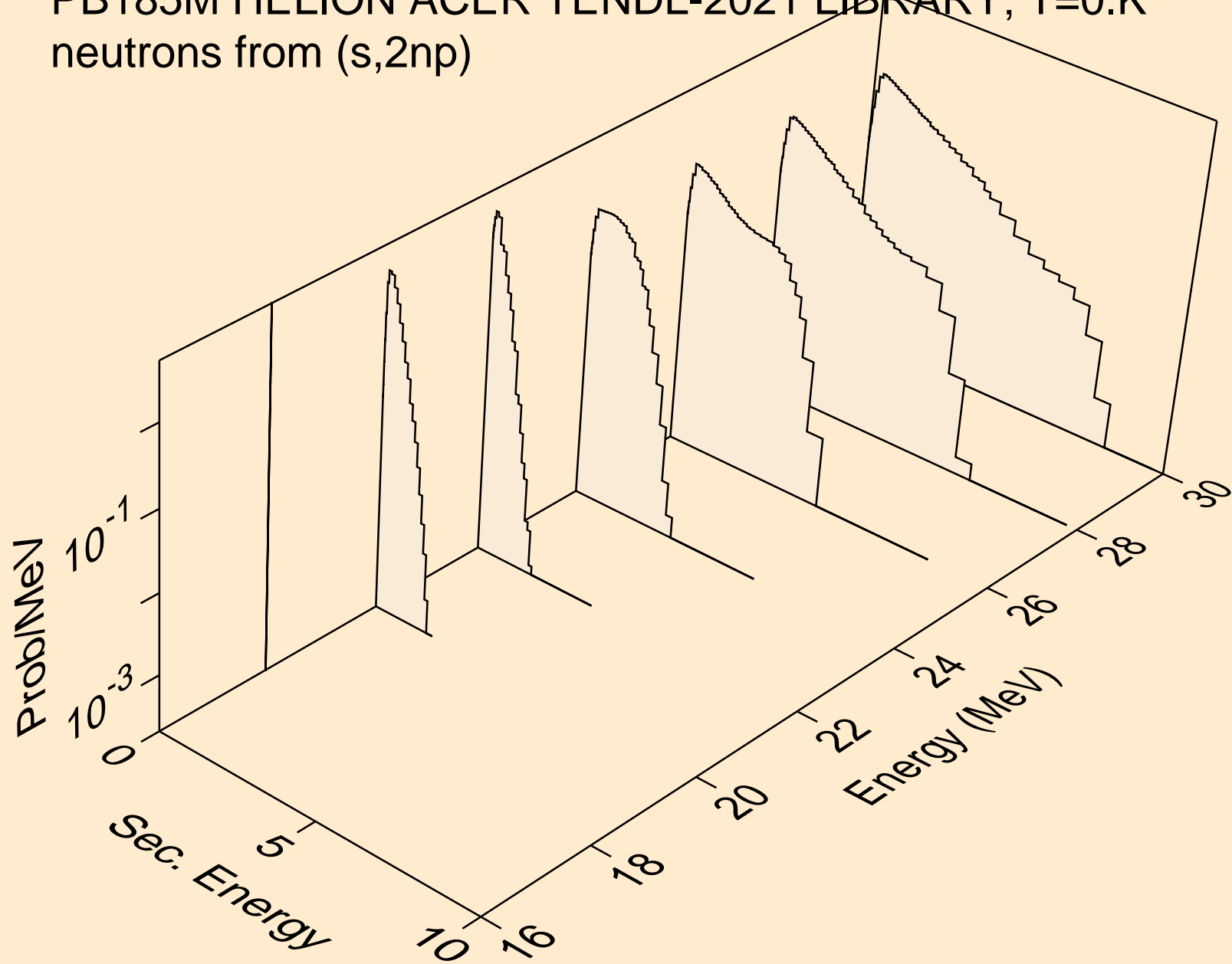

PB185M HELION ACER TENDL-2021 LIBRARY; T=0.K  
neutrons from (s,2np)

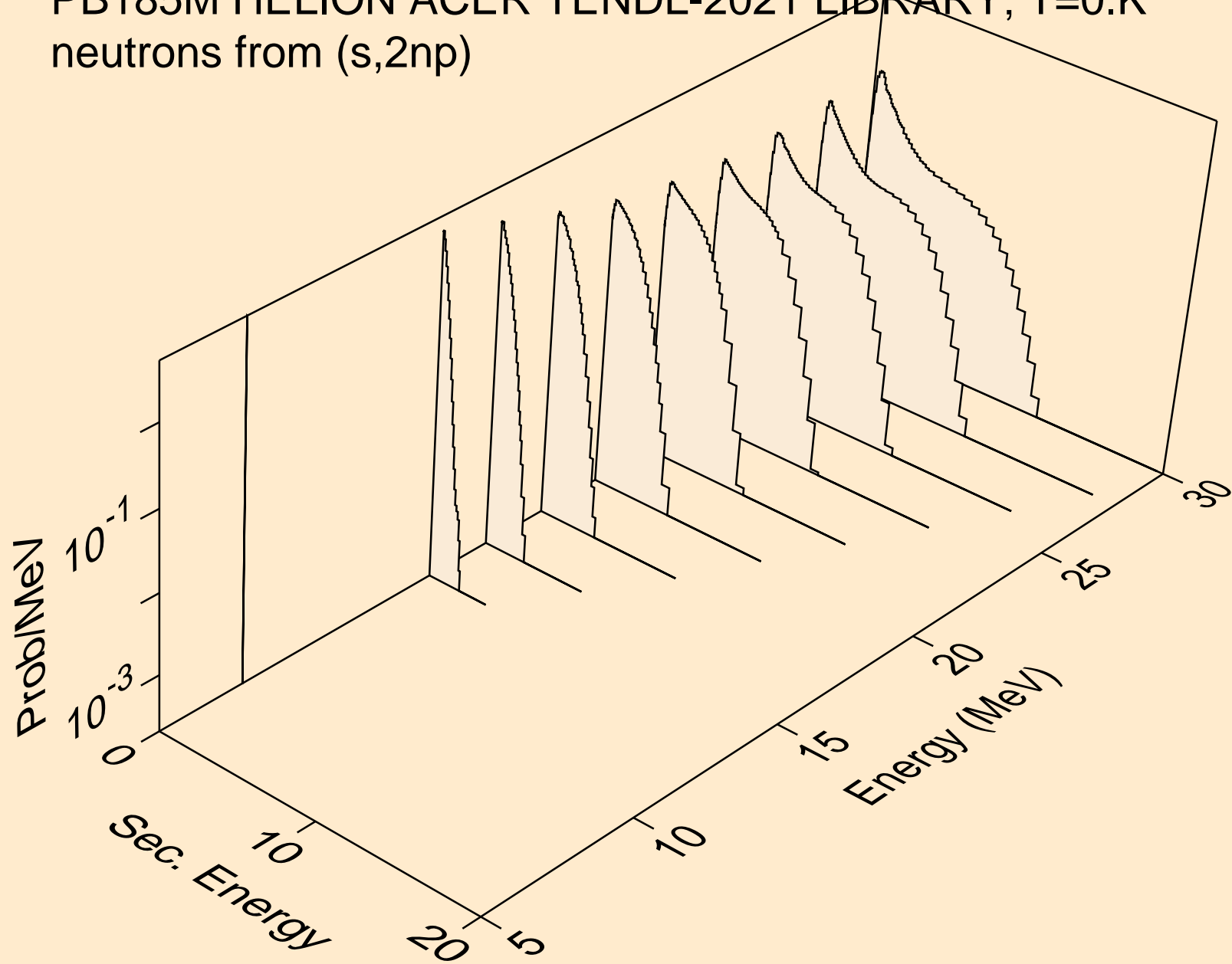

PB185M HELION ACER TENDL-2021 LIBRARY; T=0.K  
neutrons from (s,npa)

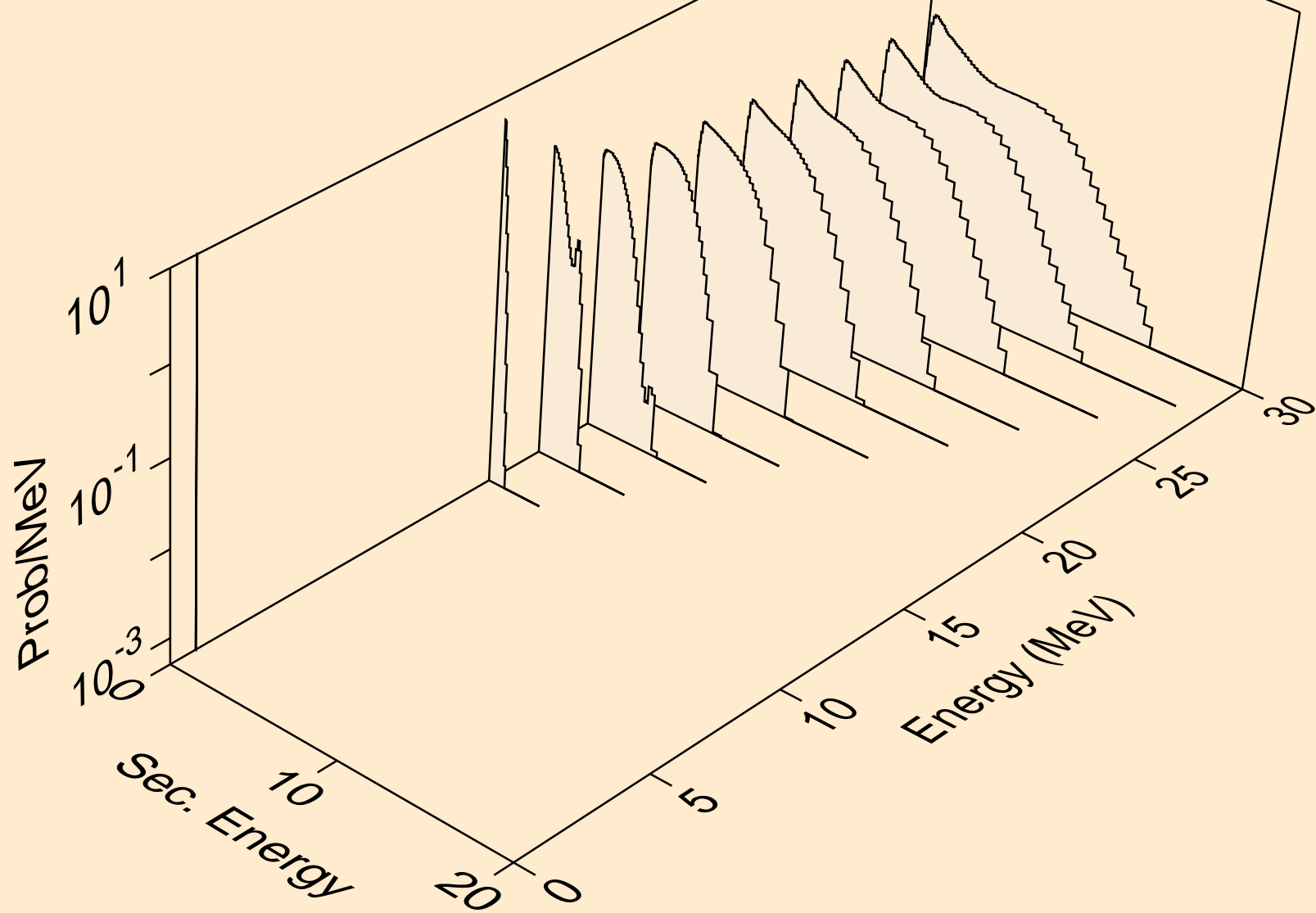

PB185M HELION ACER TENDL-2021 LIBRARY; T=0.K  
protons from (s,x)

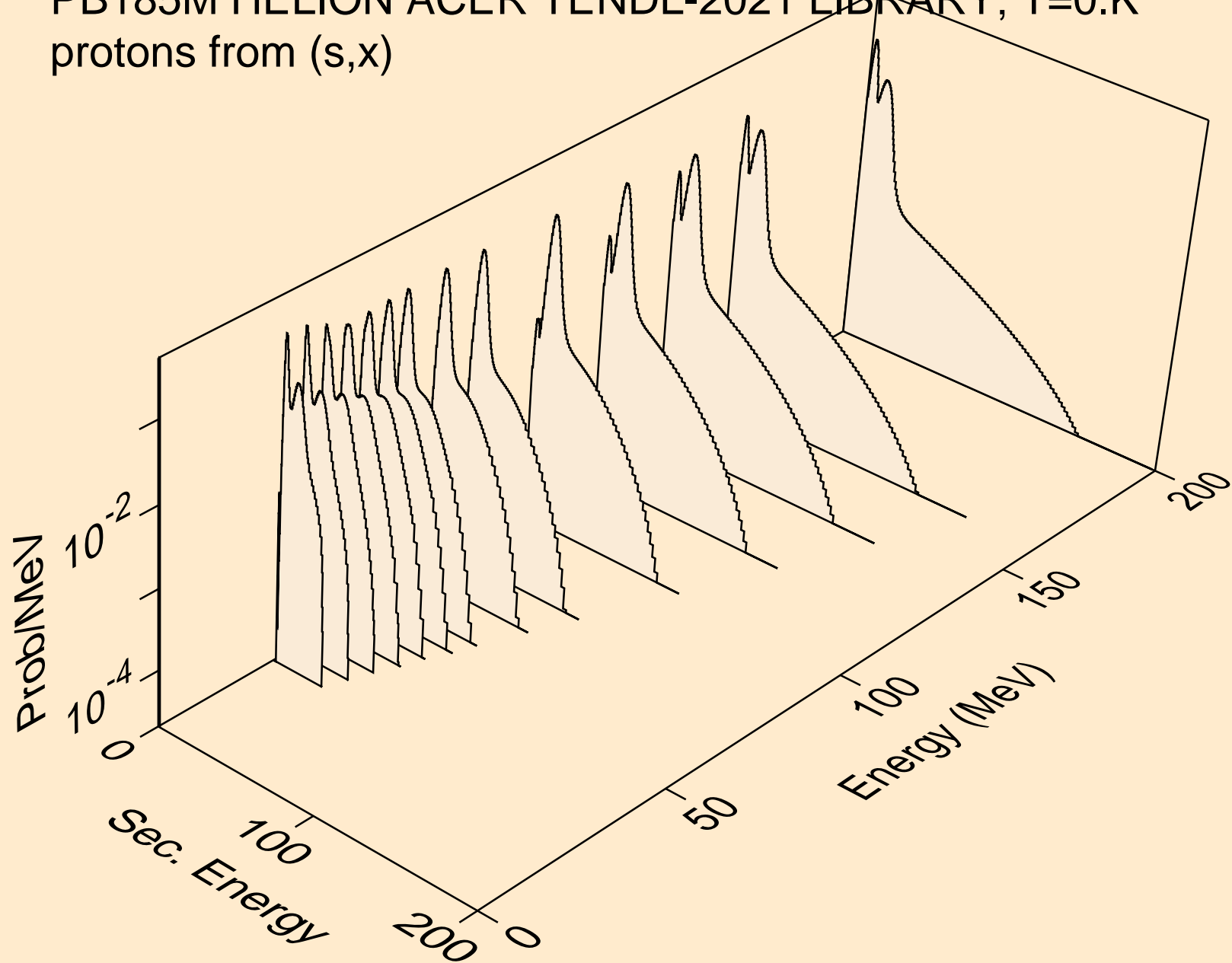

PB185M HELION ACER TENDL-2021 LIBRARY; T=0.K  
protons from (s,n\*)p

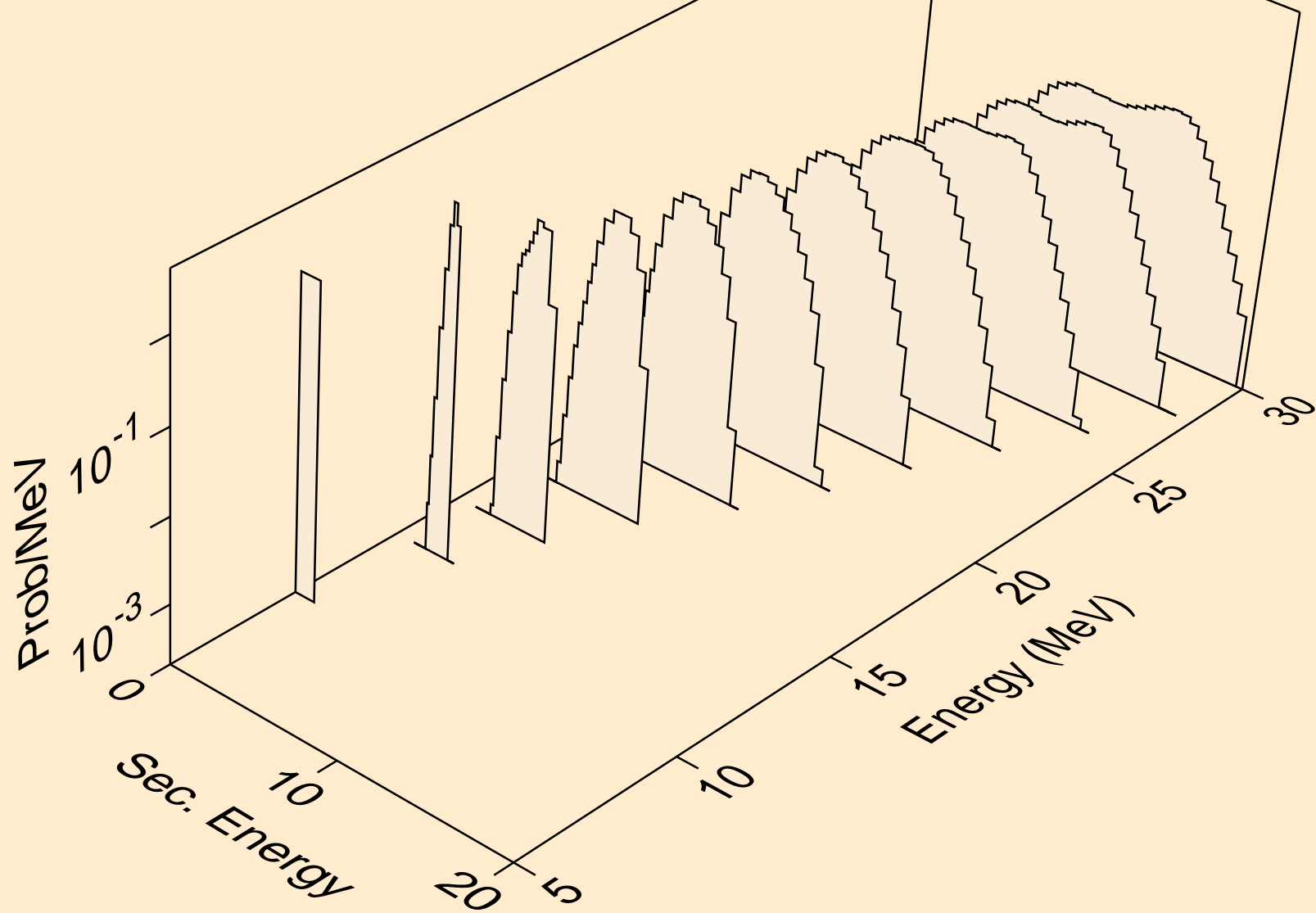

PB185M HELION ACER TENDL-2021 LIBRARY; T=0.K  
protons from (s,2np)

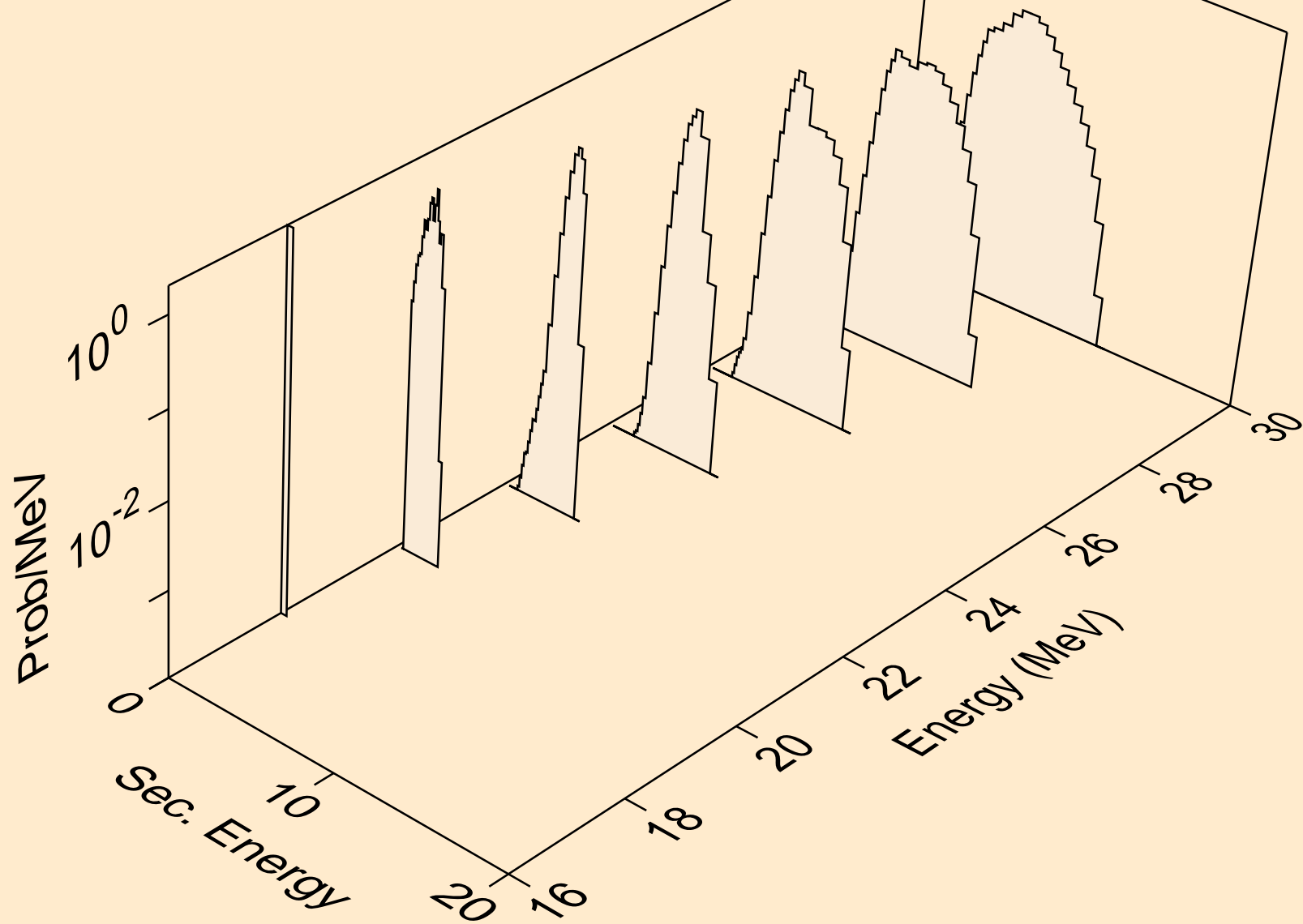

PB185M HELION ACER TENDL-2021 LIBRARY; T=0.K  
protons from (s,2np)

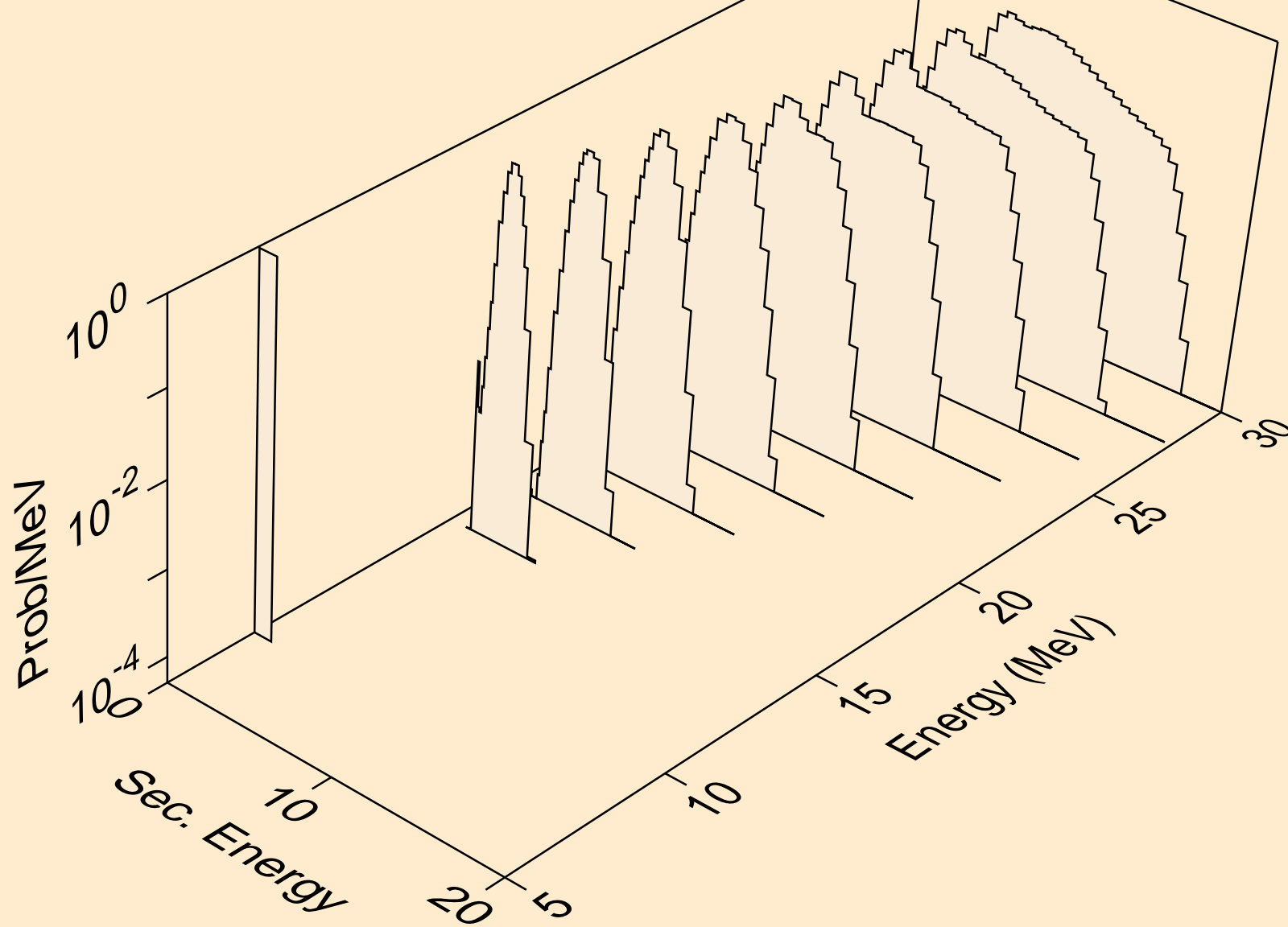

PB185M HELION ACER TENDL-2021 LIBRARY; T=0.K  
protons from (s,npa)

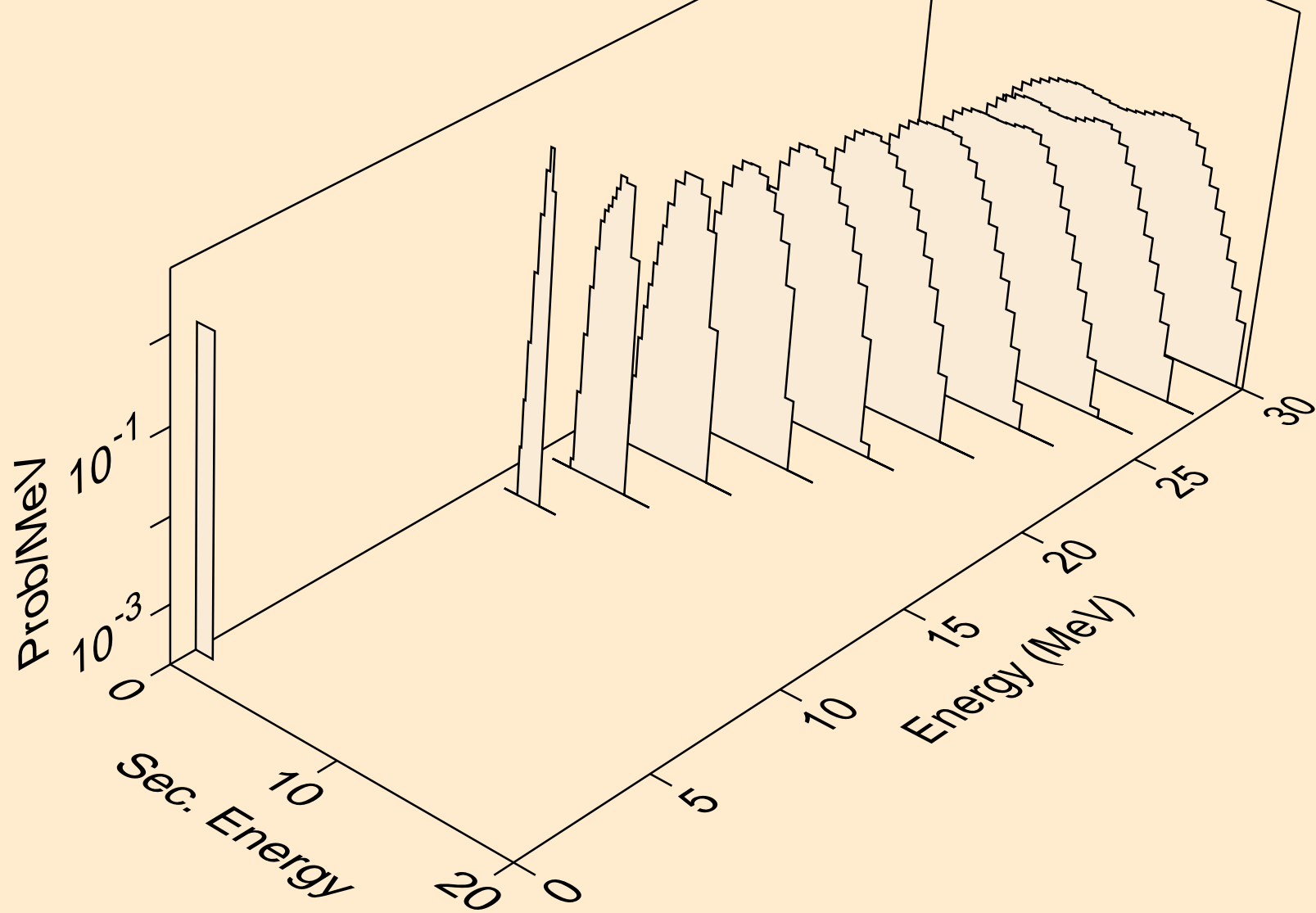



PB185M HELION ACER TENDL-2021 LIBRARY; T=0.K  
protons from (s,p)

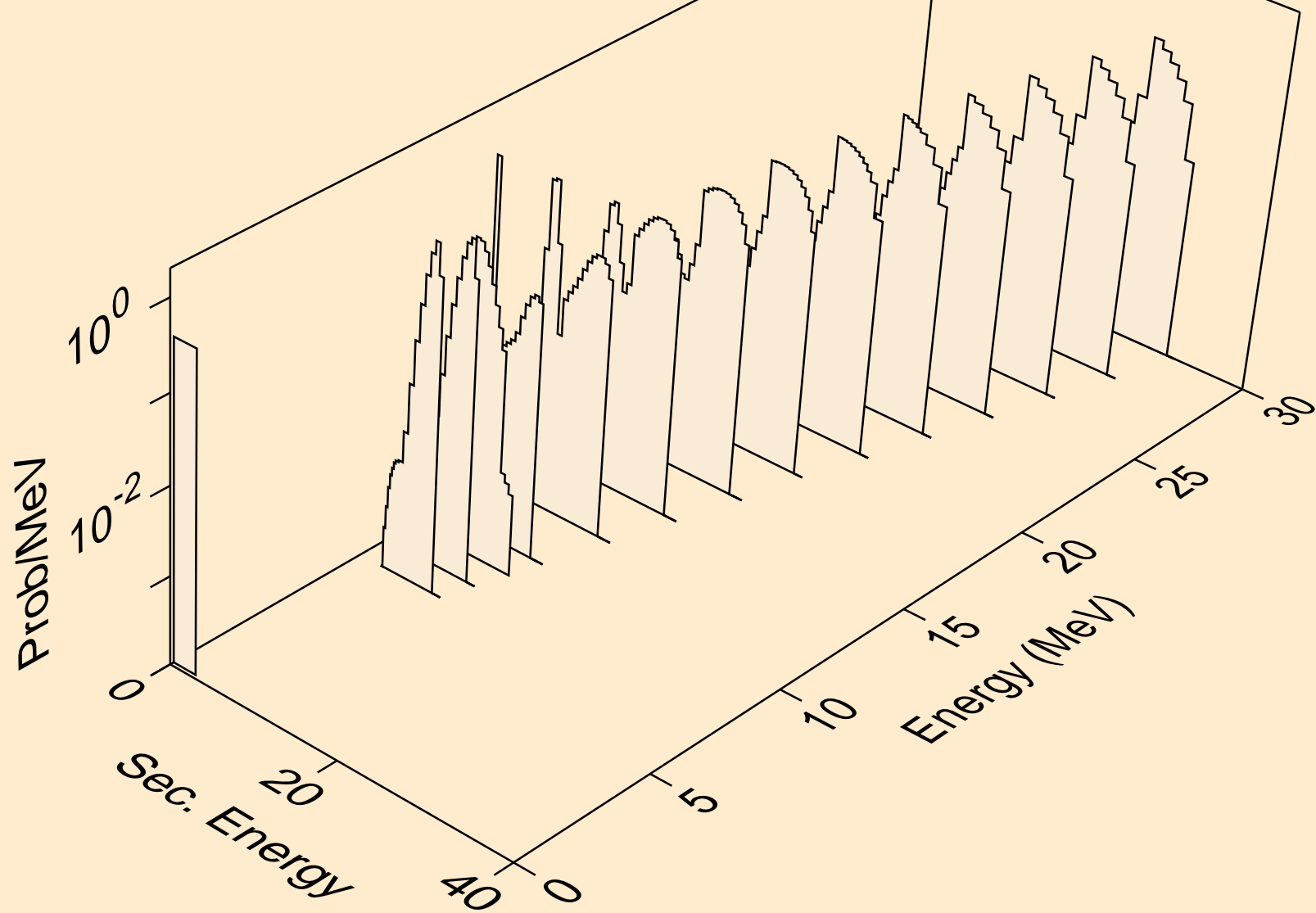

PB185M HELION ACER TENDL-2021 LIBRARY; T=0.K  
protons from (s,2p)

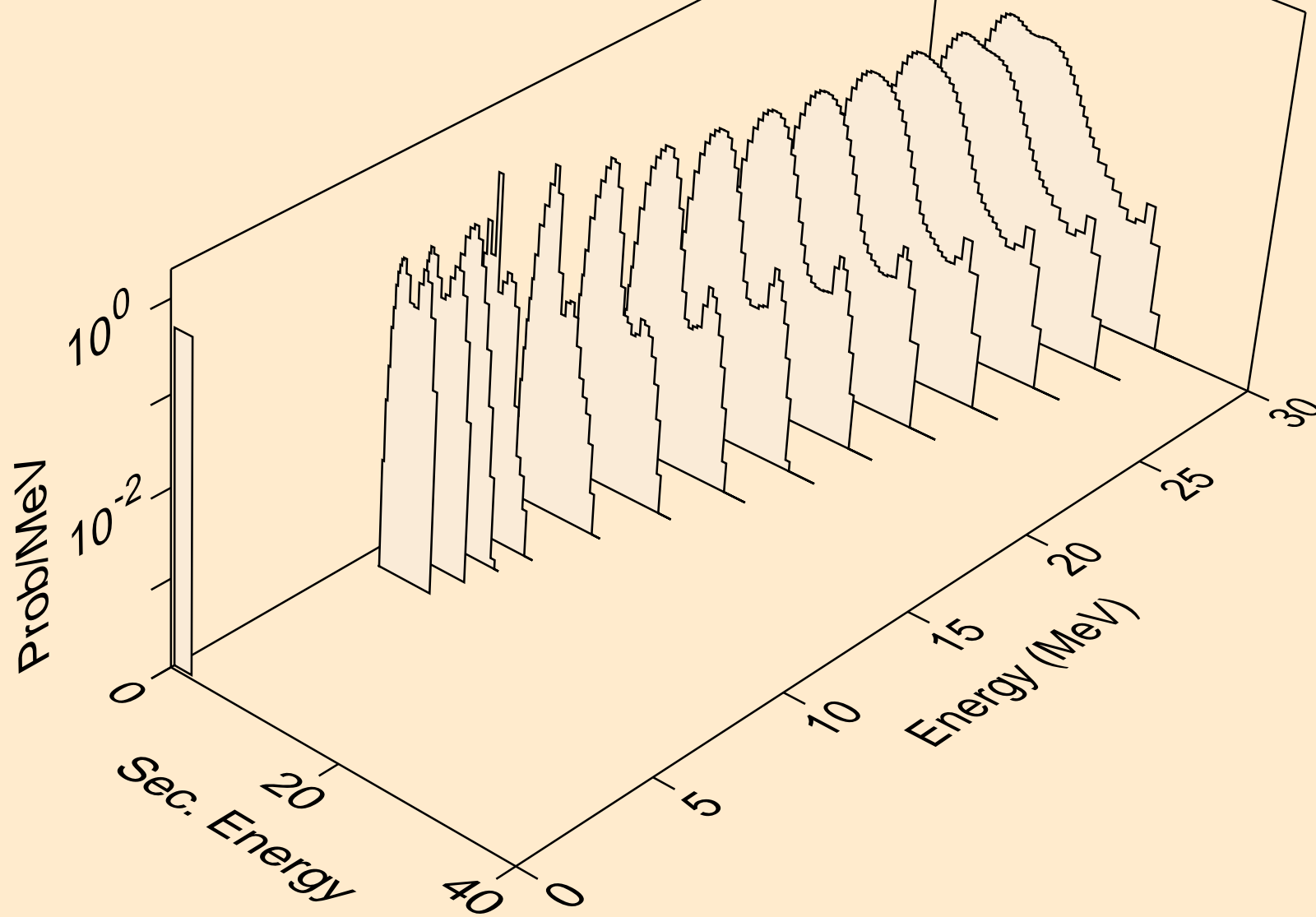

PB185M HELION ACER TENDL-2021 LIBRARY; T=0.K  
protons from (s,pa)

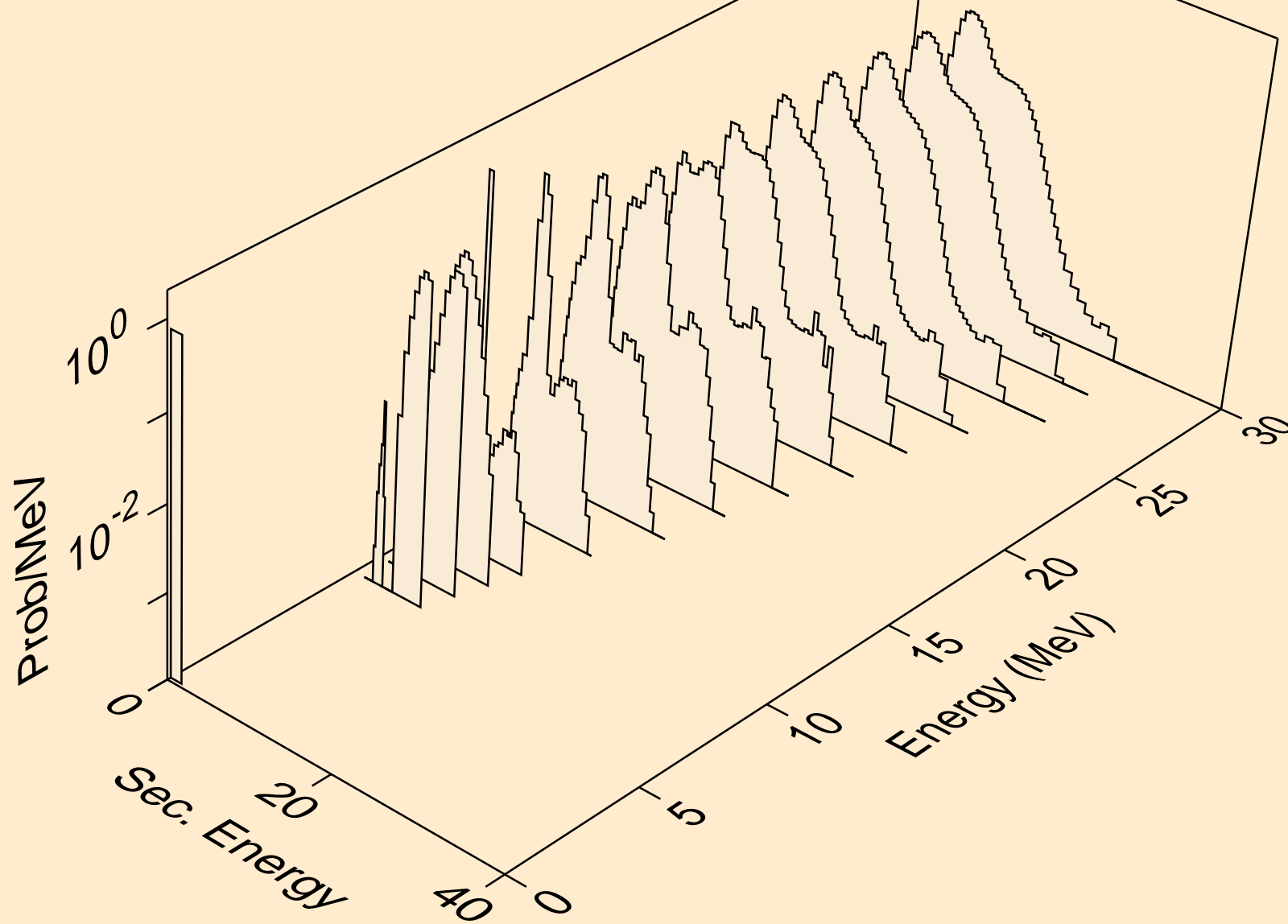

PB185M HELION ACER TENDL-2021 LIBRARY; T=0.K  
protons from (s,pd)

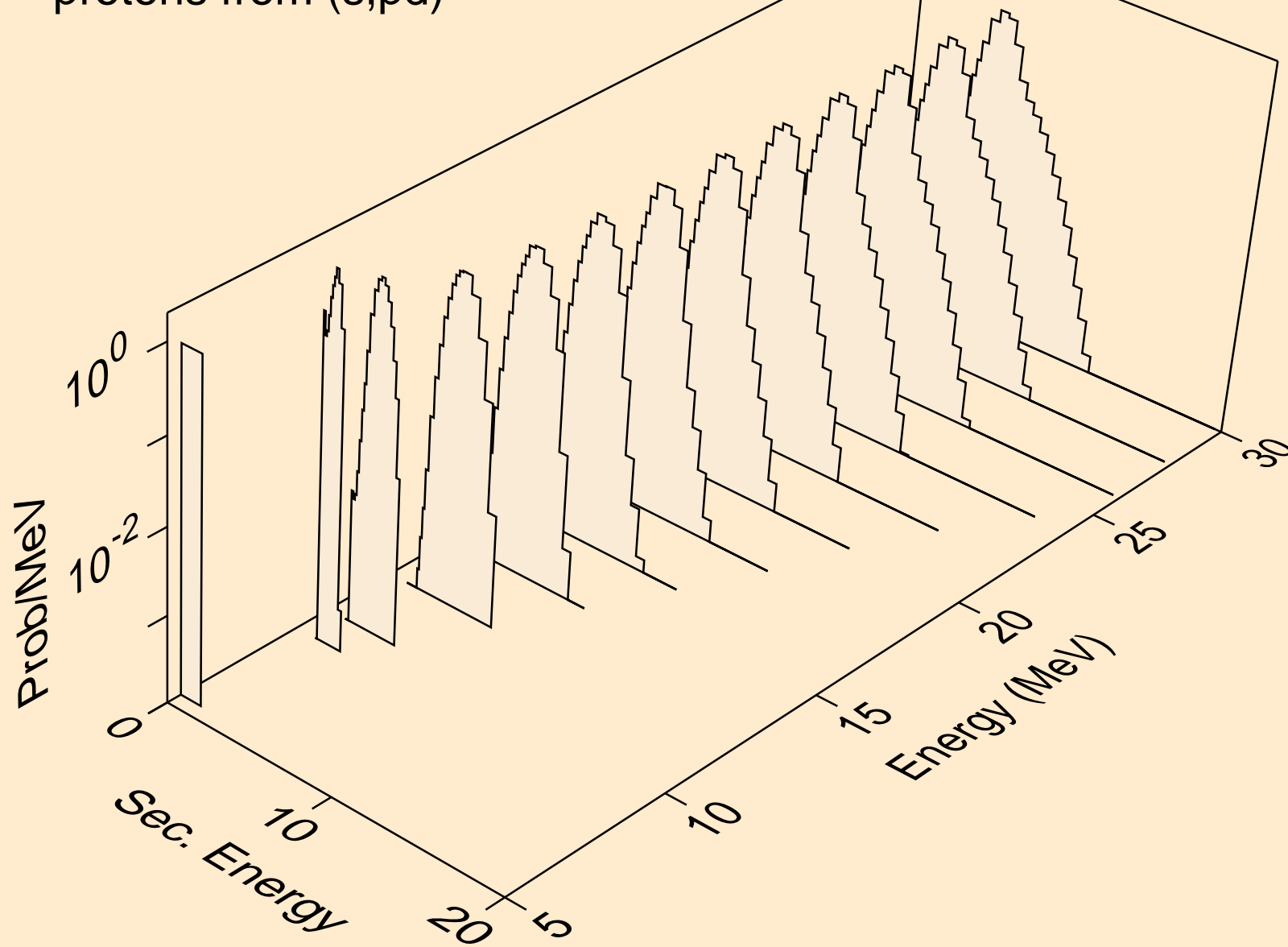

PB185M HELION ACER TENDL-2021 LIBRARY; T=0.K  
protons from (s,pt)

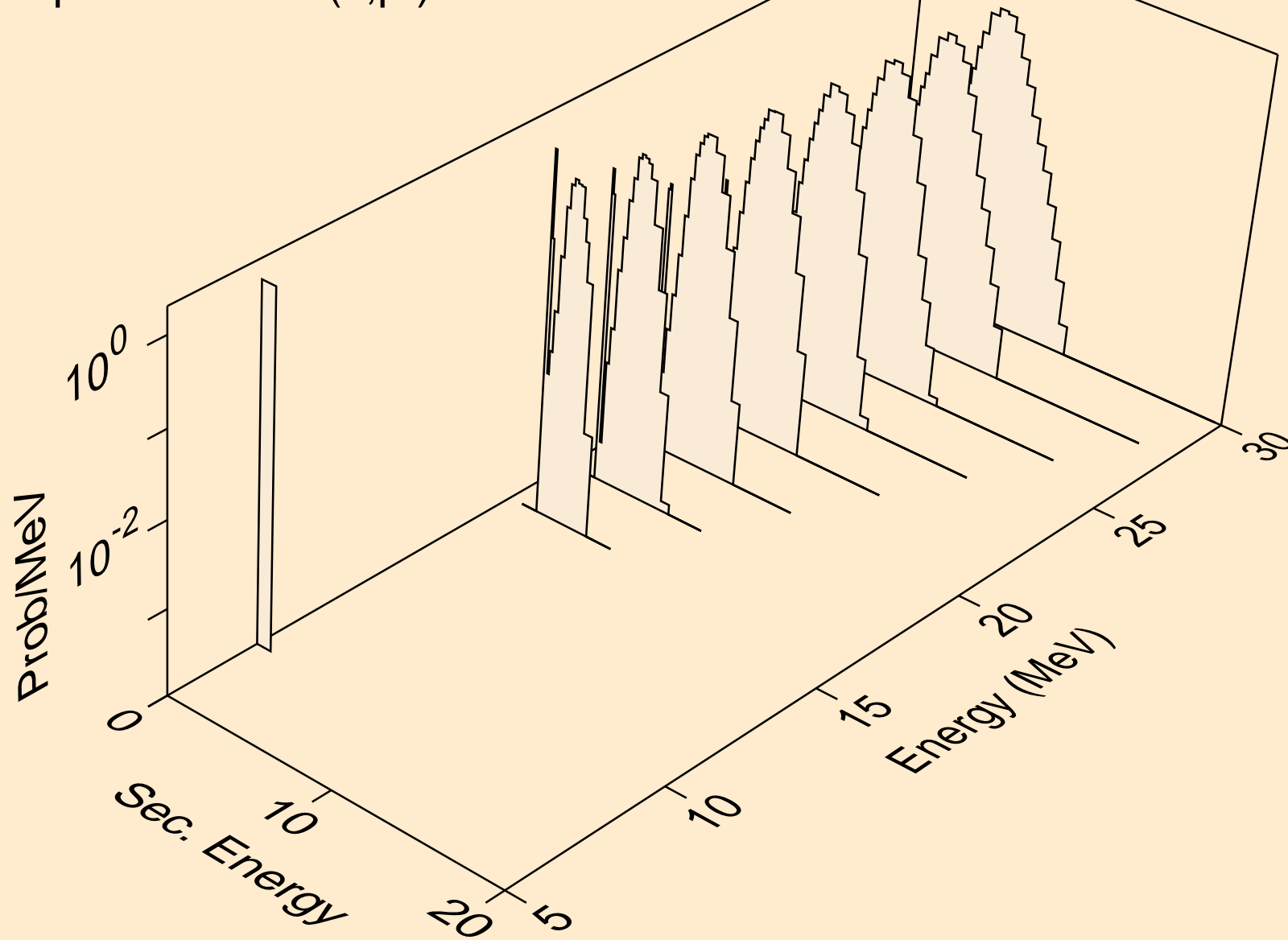

PB185M HELION ACER TENDL-2021 LIBRARY; T=0.K  
deuterons from (s,x)

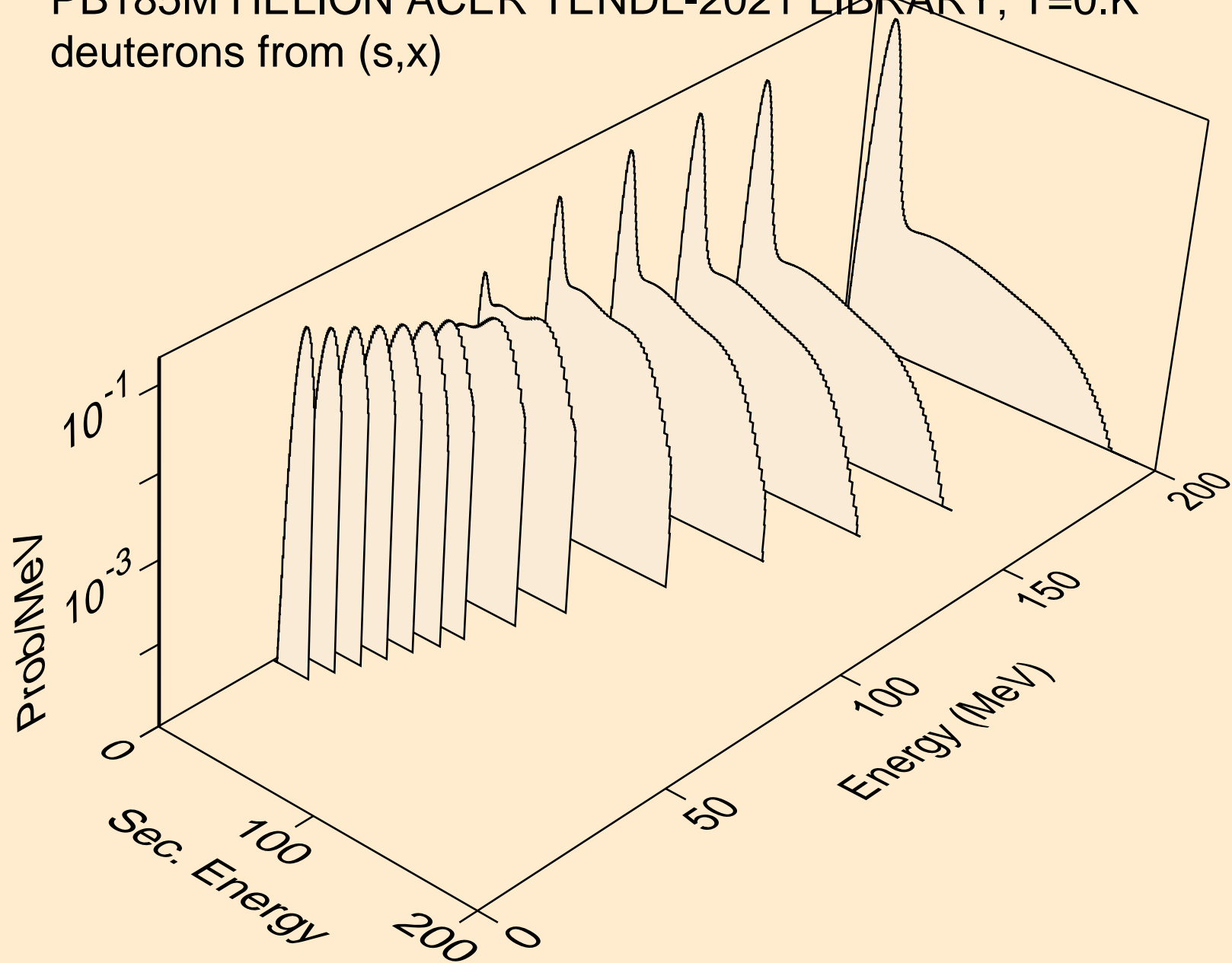

PB185M HELION ACER TENDL-2021 LIBRARY; T=0.K  
deuterons from (s,n\*)d

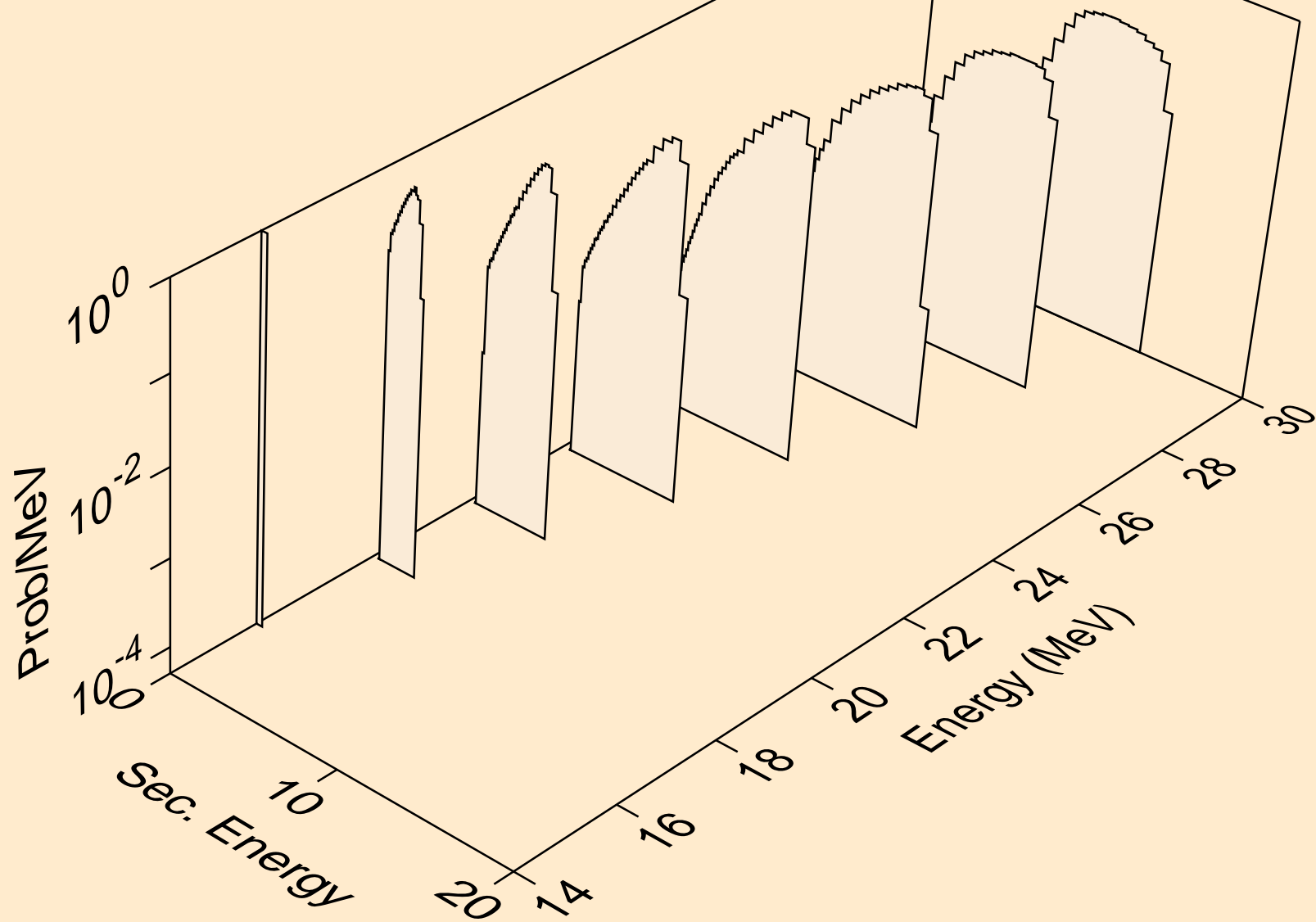

PB185M HELION ACER TENDL-2021 LIBRARY; T=0.K  
deuterons from (s,d)

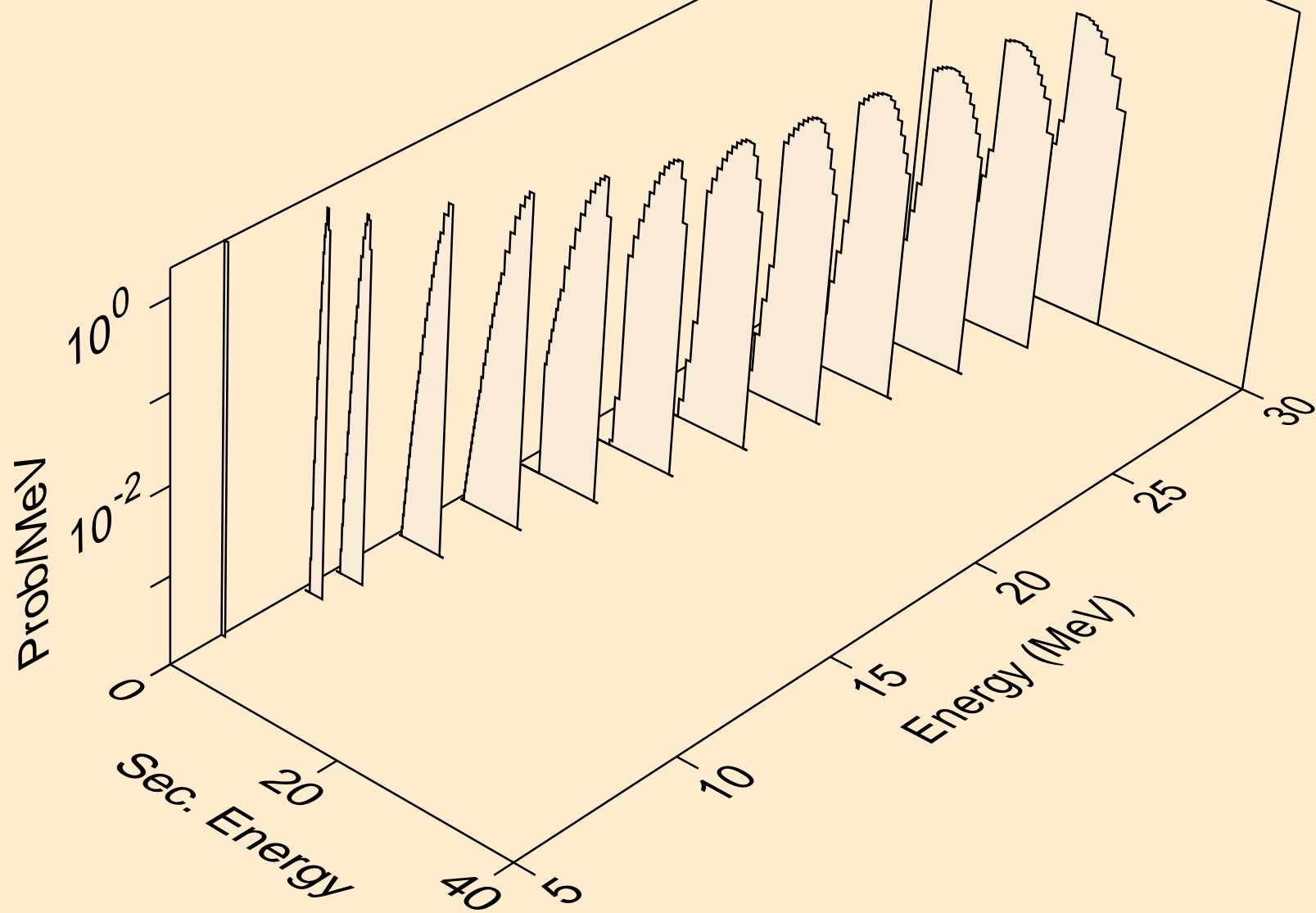



PB185M HELION ACER TENDL-2021 LIBRARY; T=0.K  
deuterons from (s,d2a)

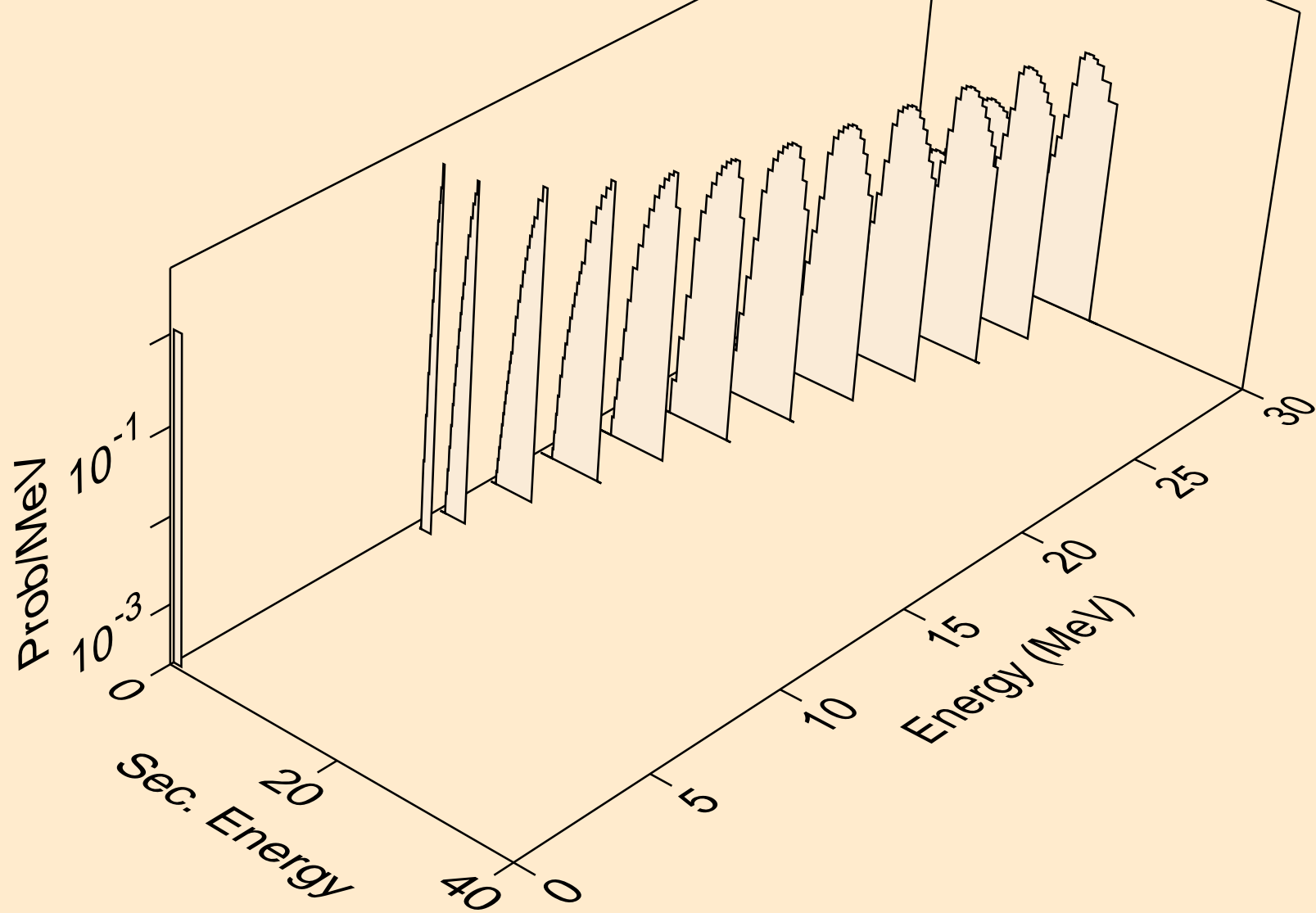

PB185M HELION ACER TENDL-2021 LIBRARY; T=0.K  
deuterons from (s,pd)

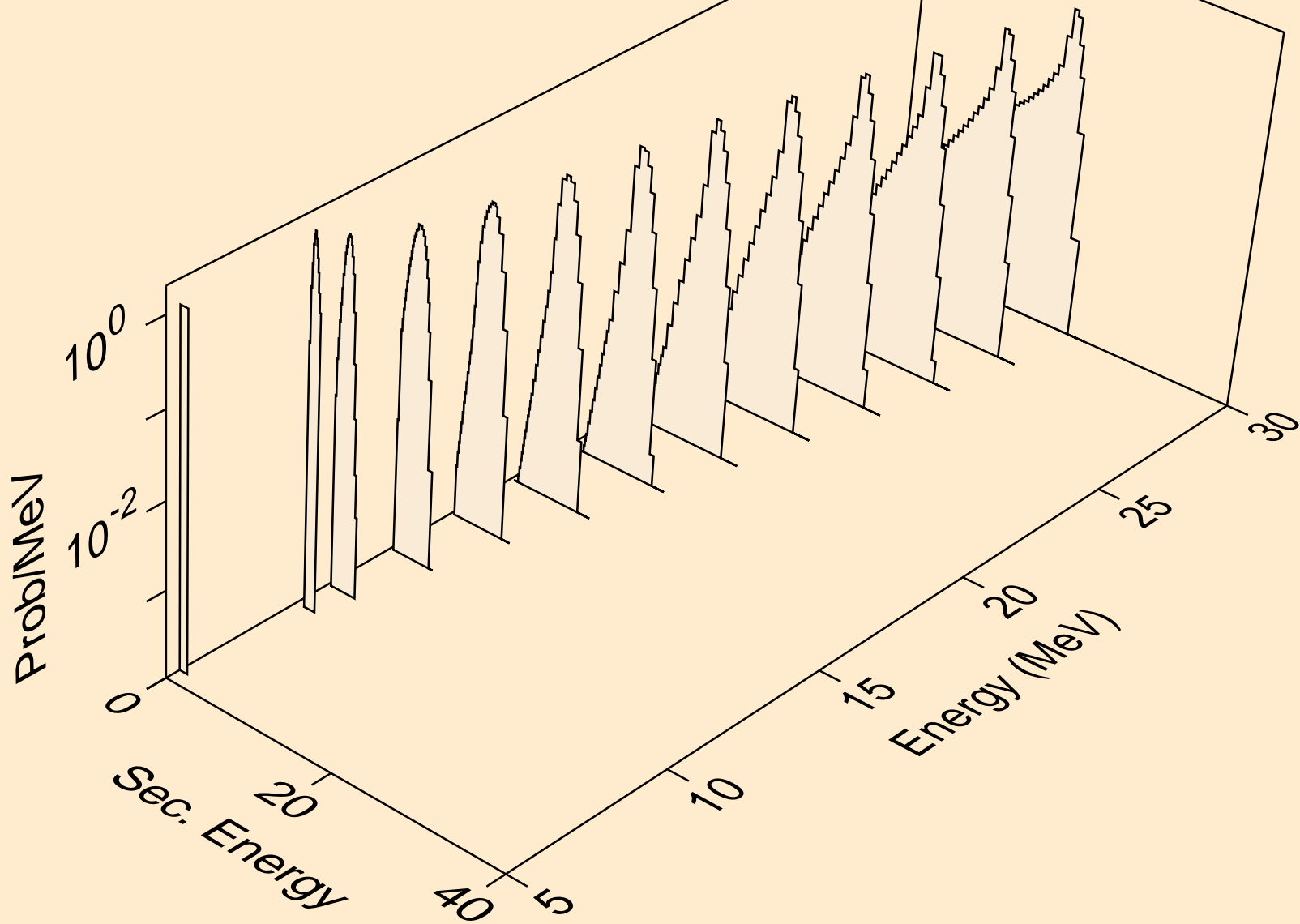

PB185M HELION ACER TENDL-2021 LIBRARY; T=0.K  
deuterons from (s,da)

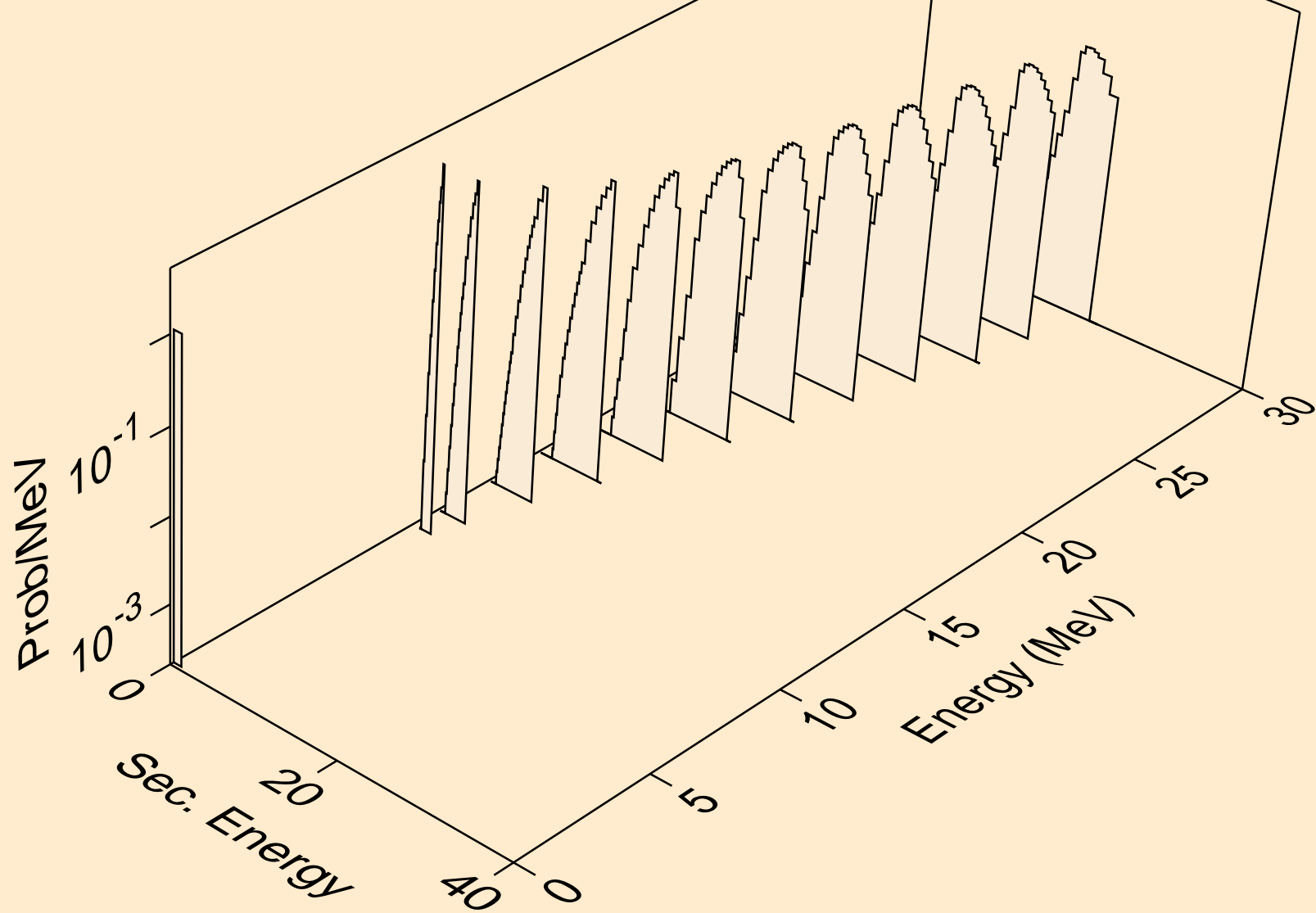

PB185M HELION ACER TENDL-2021 LIBRARY; T=0.K  
tritons from (s,x)

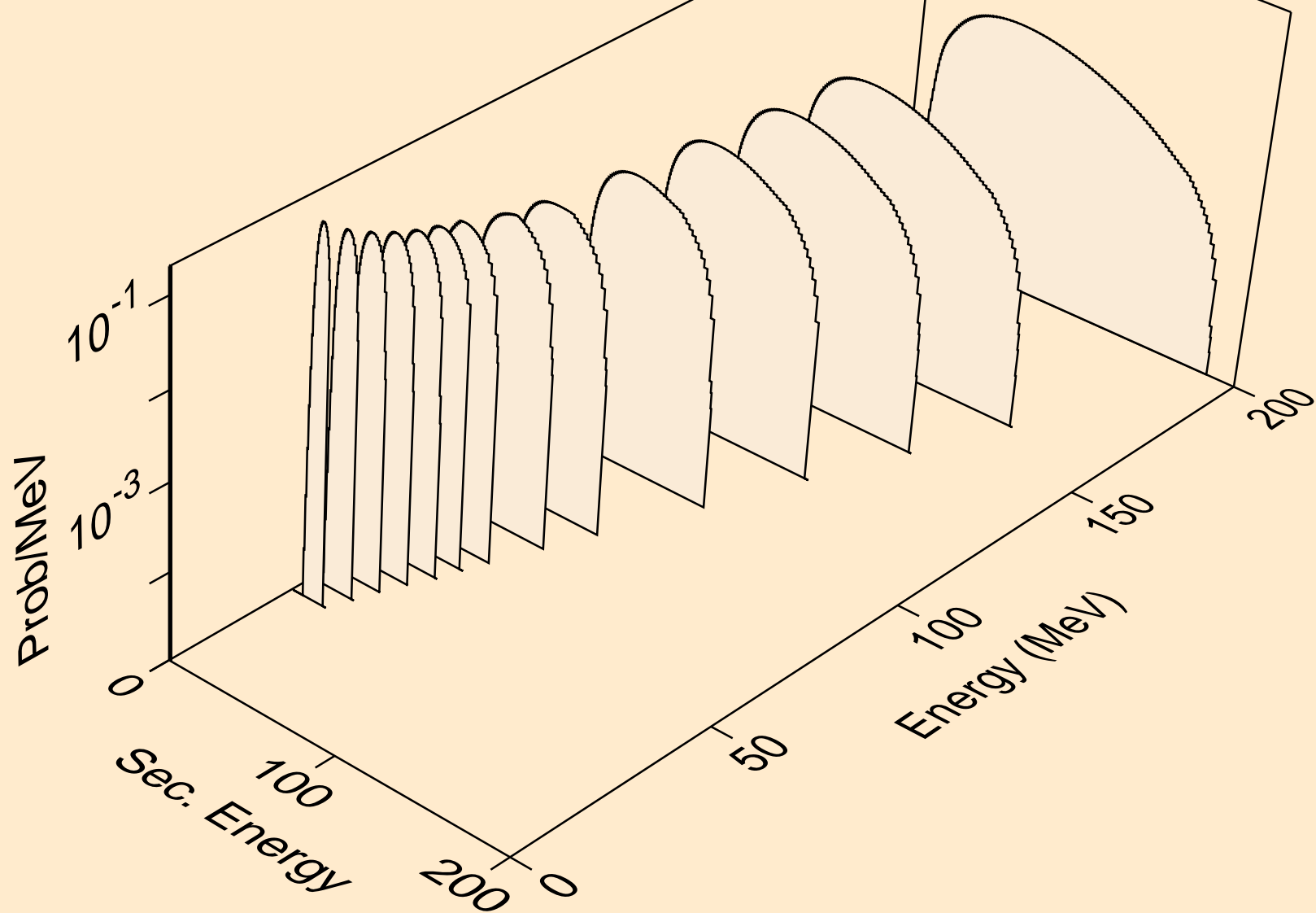

PB185M HELION ACER TENDL-2021 LIBRARY; T=0.K  
tritons from (s,n\*)t

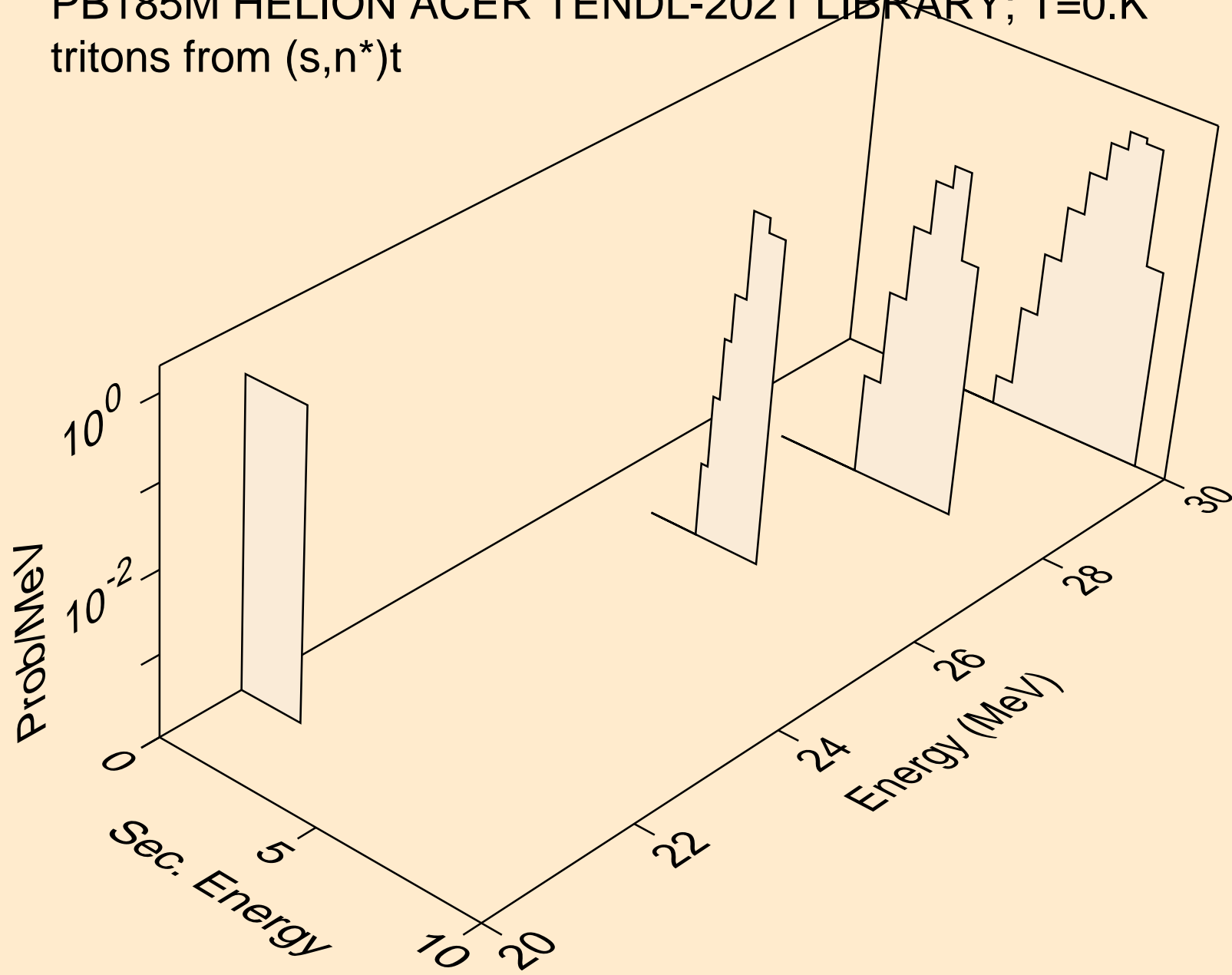

PB185M HELION ACER TENDL-2021 LIBRARY; T=0.K  
tritons from (s,t)

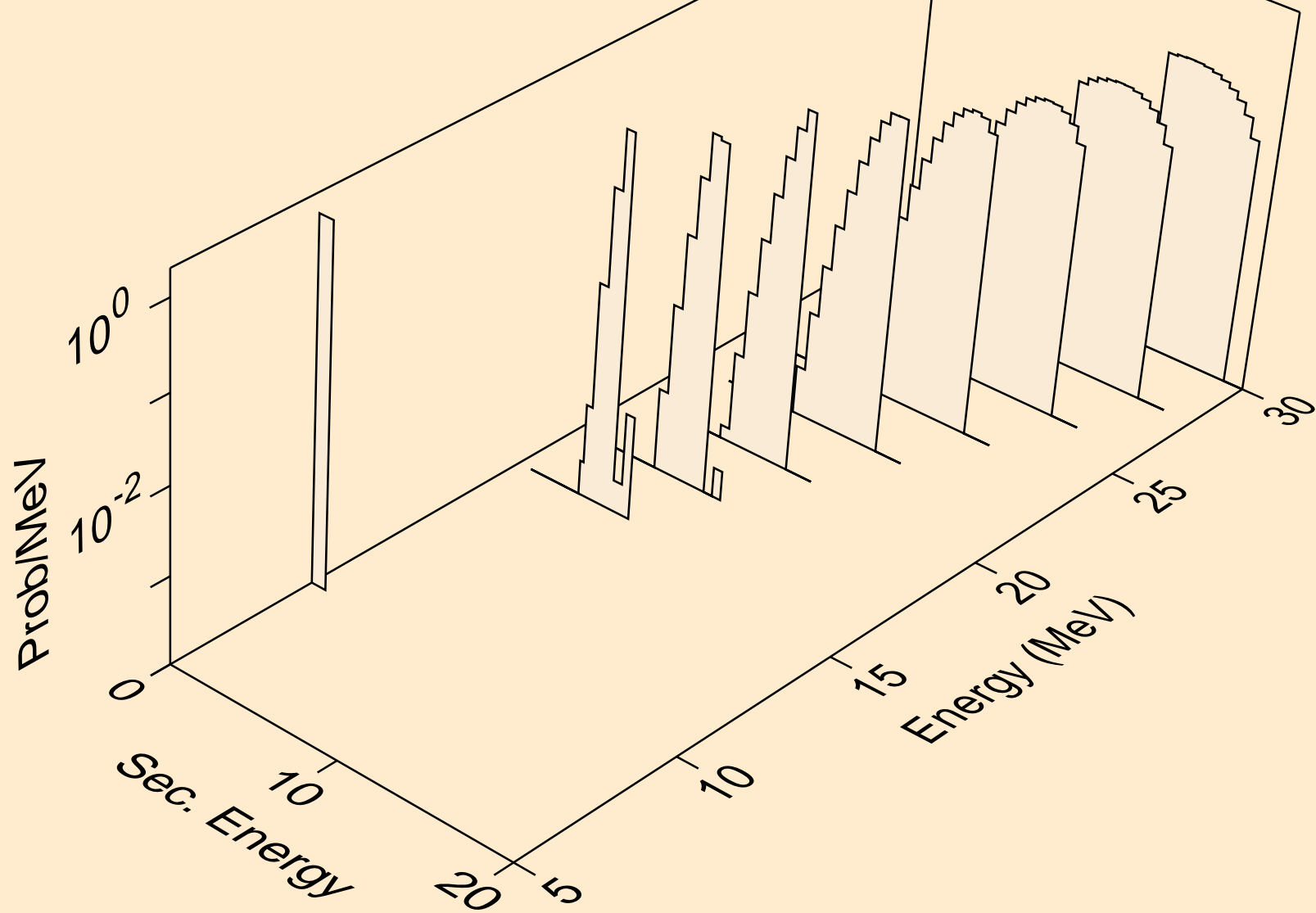

PB185M HELION ACER TENDL-2021 LIBRARY; T=0.K  
tritons from (s,t2a)

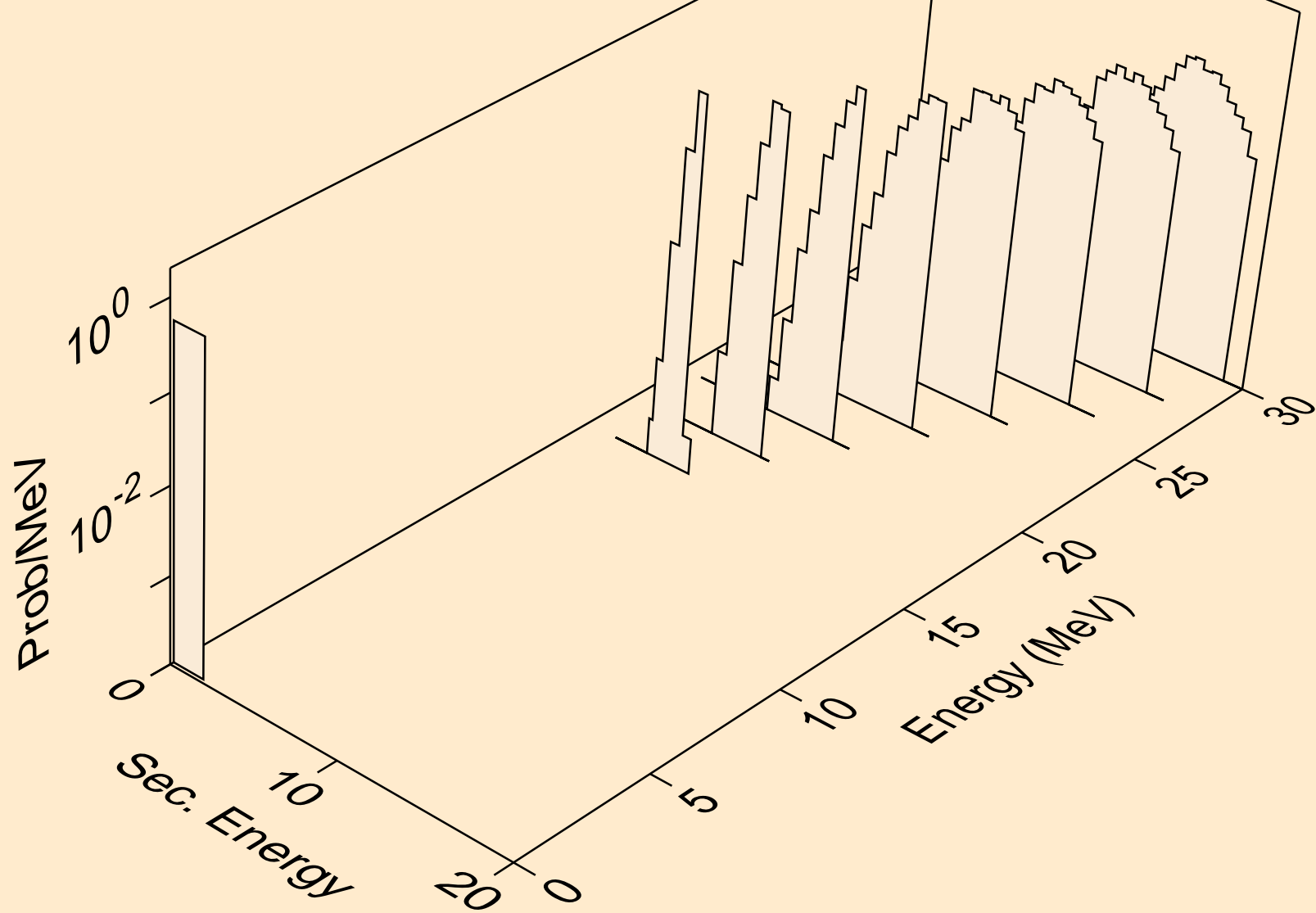

PB185M HELION ACER TENDL-2021 LIBRARY; T=0.K  
tritons from (s,pt)

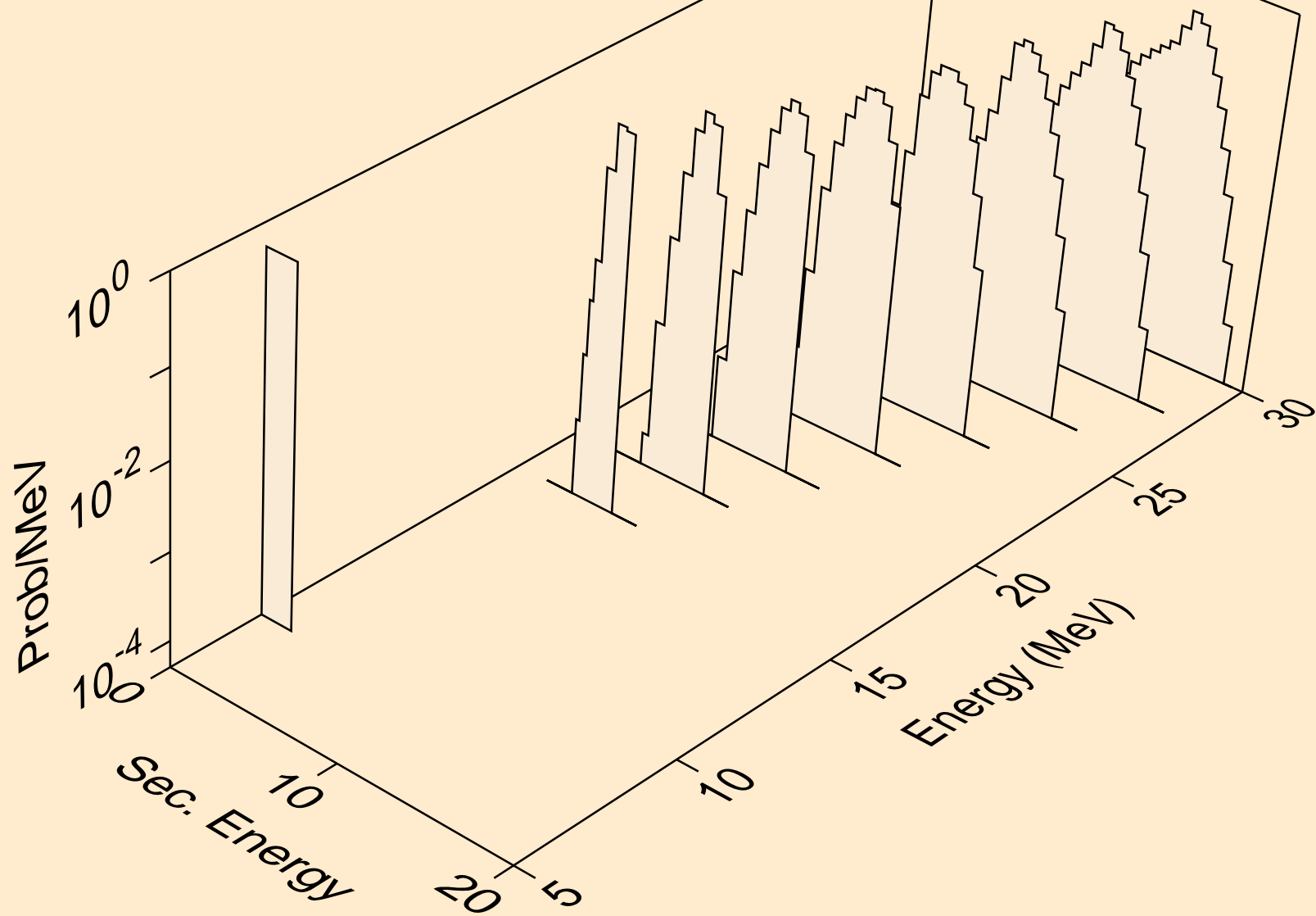



PB185M HELION ACER TENDL-2021 LIBRARY; T=0.K  
alphas from (s,x)

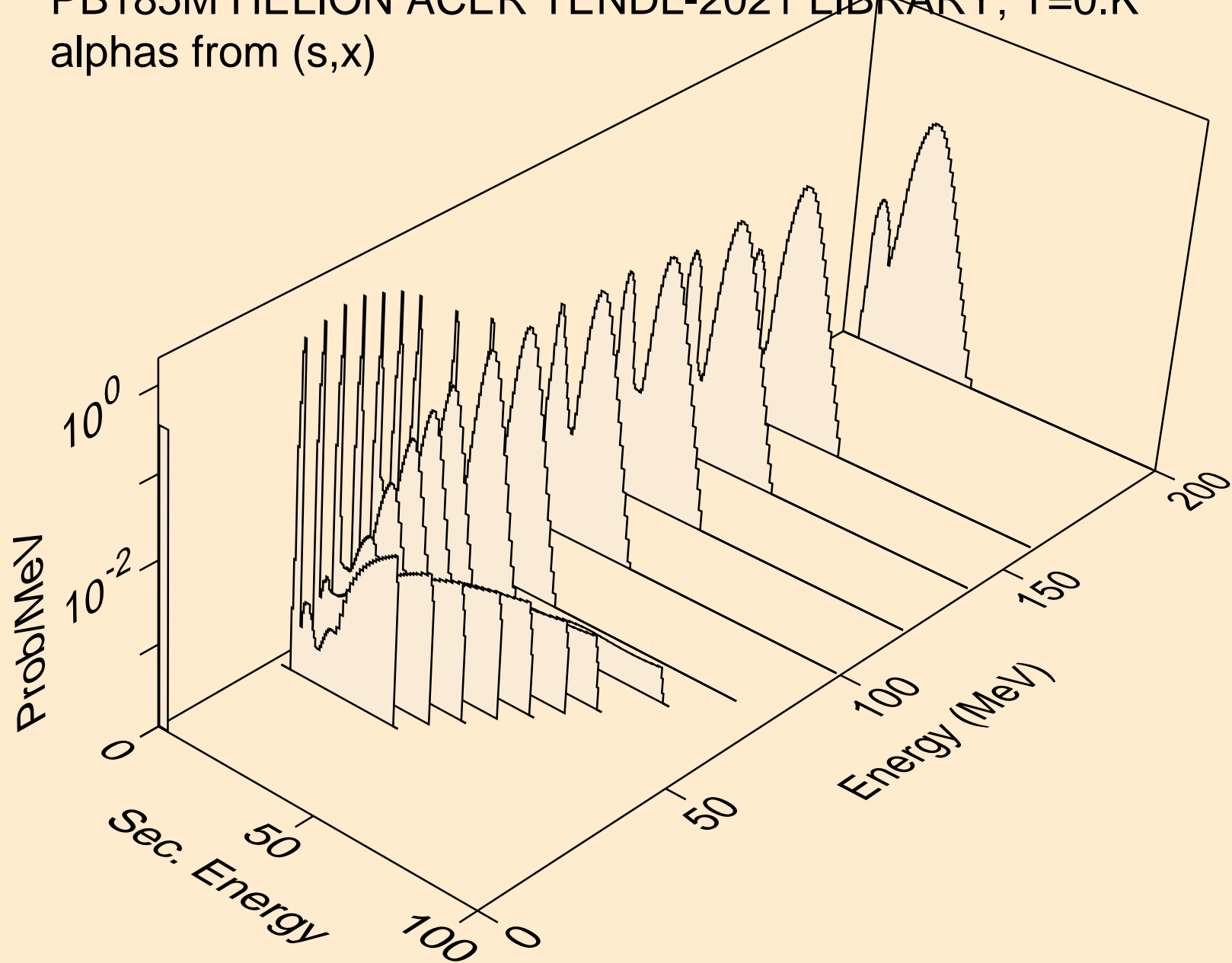

PB185M HELION ACER TENDL-2021 LIBRARY; T=0.K  
alphas from (s,n\*)a

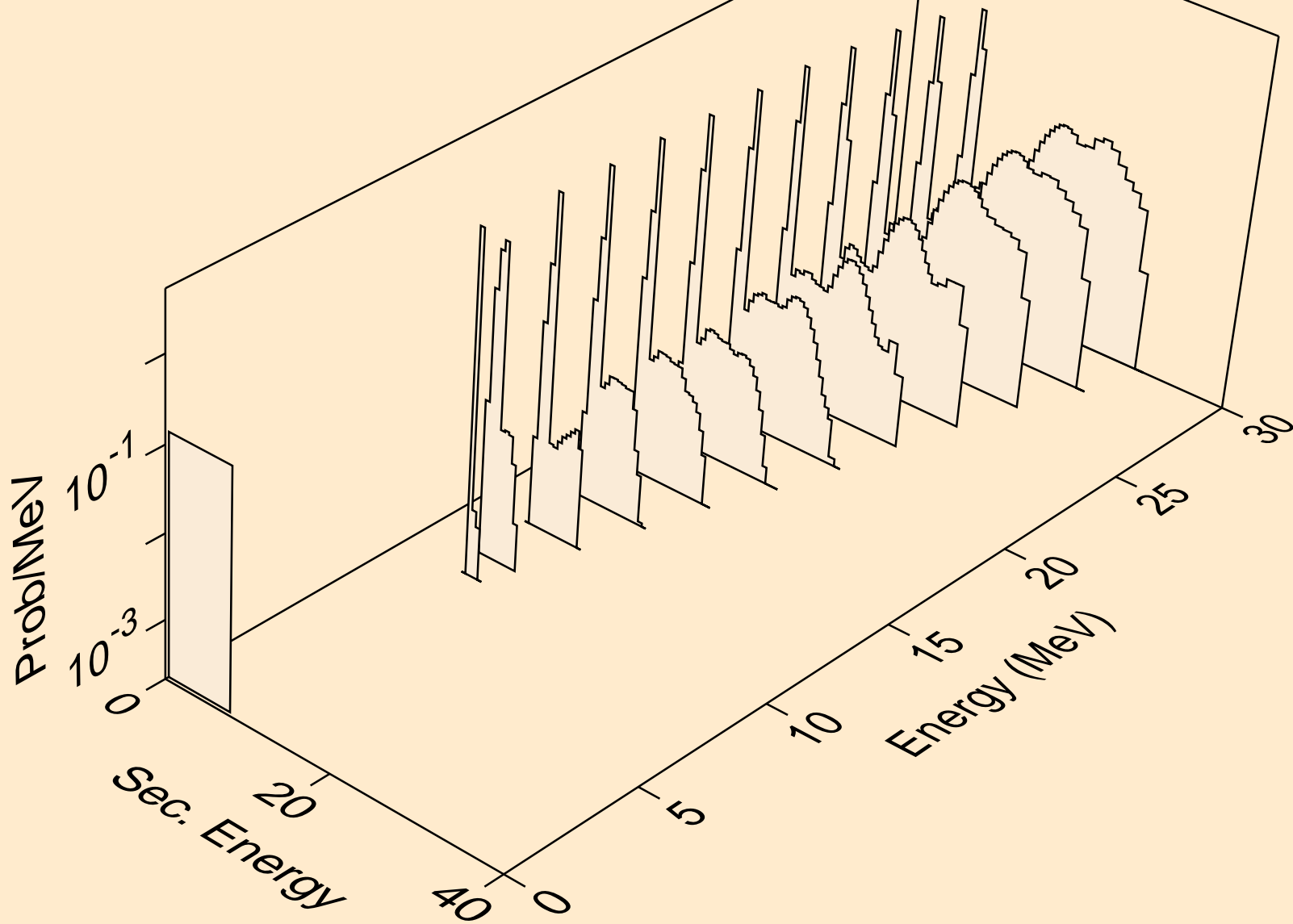

PB185M HELION ACER TENDL-2021 LIBRARY; T=0.K  
alphas from (s,2n)a

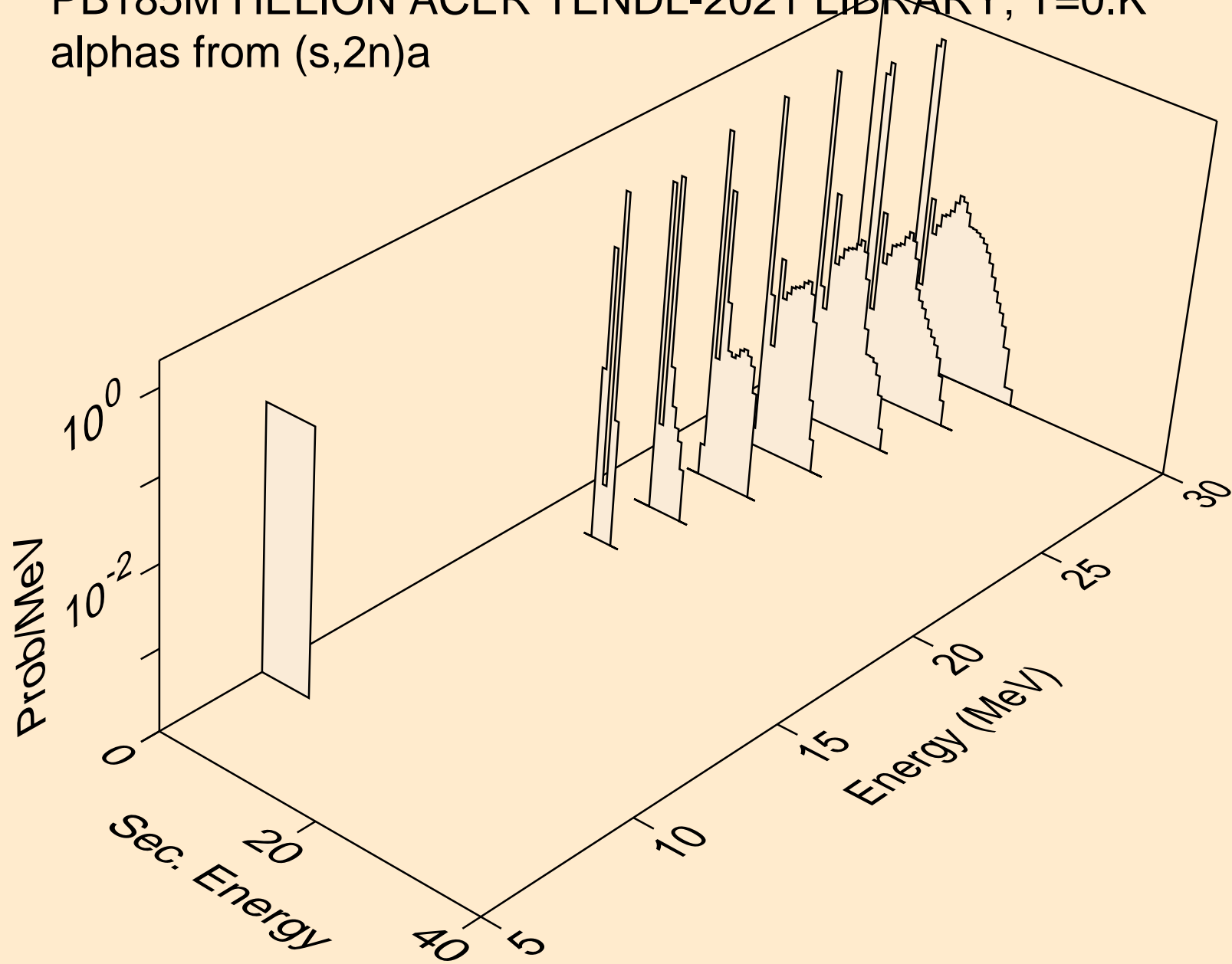

PB185M HELION ACER TENDL-2021 LIBRARY; T=0.K  
alphas from (s,n\*)2a

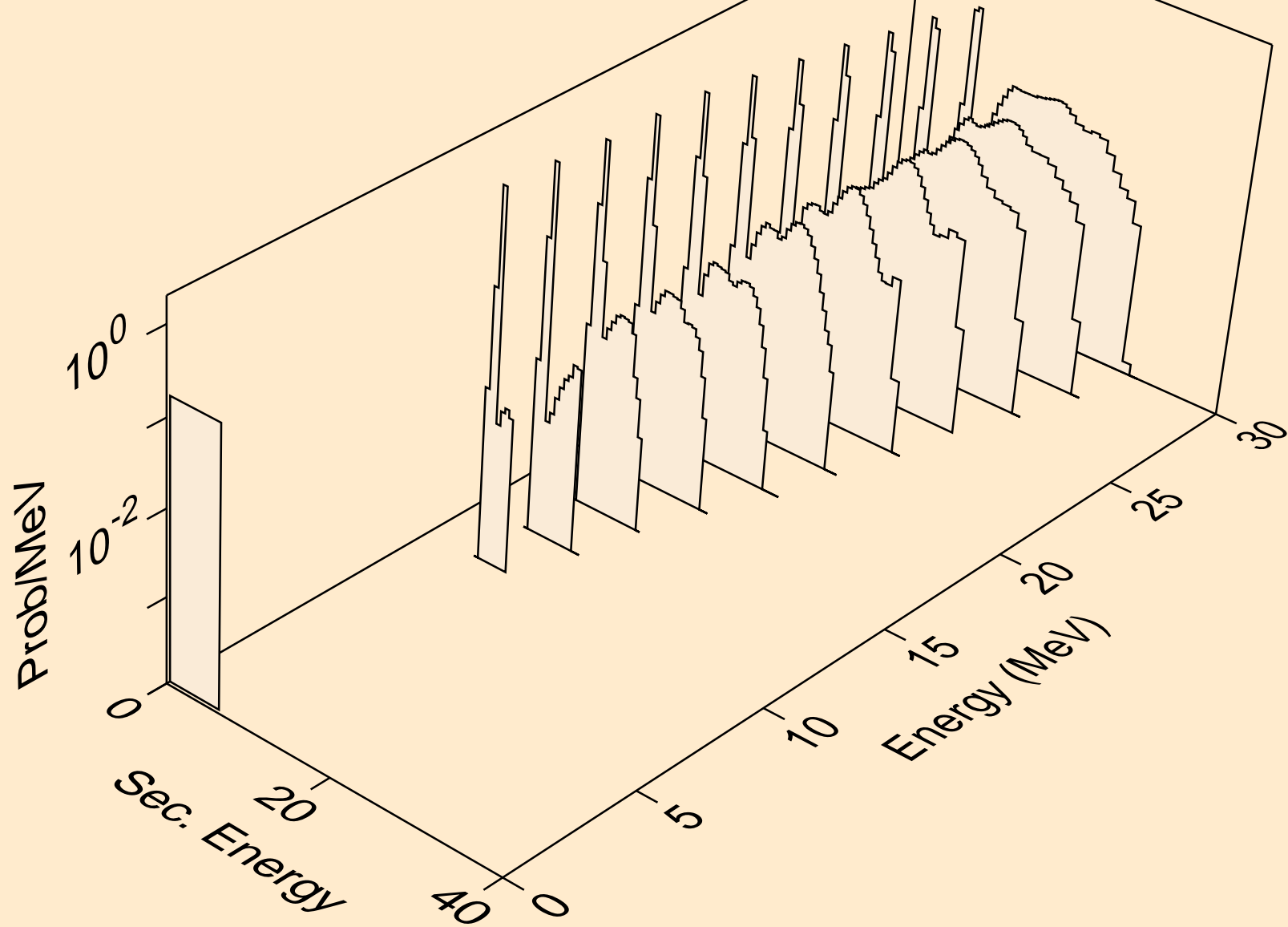

PB185M HELION ACER TENDL-2021 LIBRARY; T=0.K  
alphas from (s,npa)

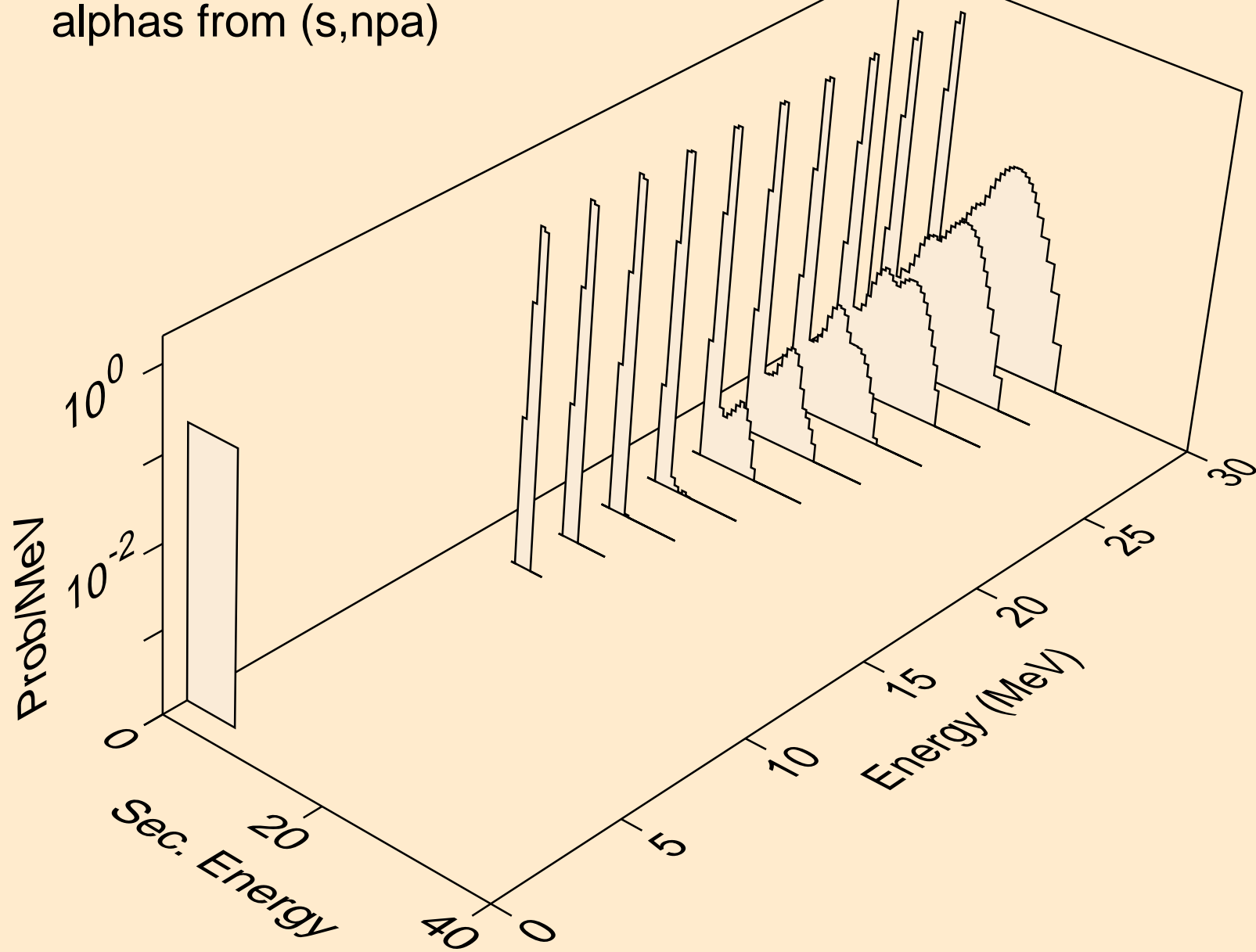

PB185M HELION ACER TENDL-2021 LIBRARY; T=0.K  
alphas from (s,a)

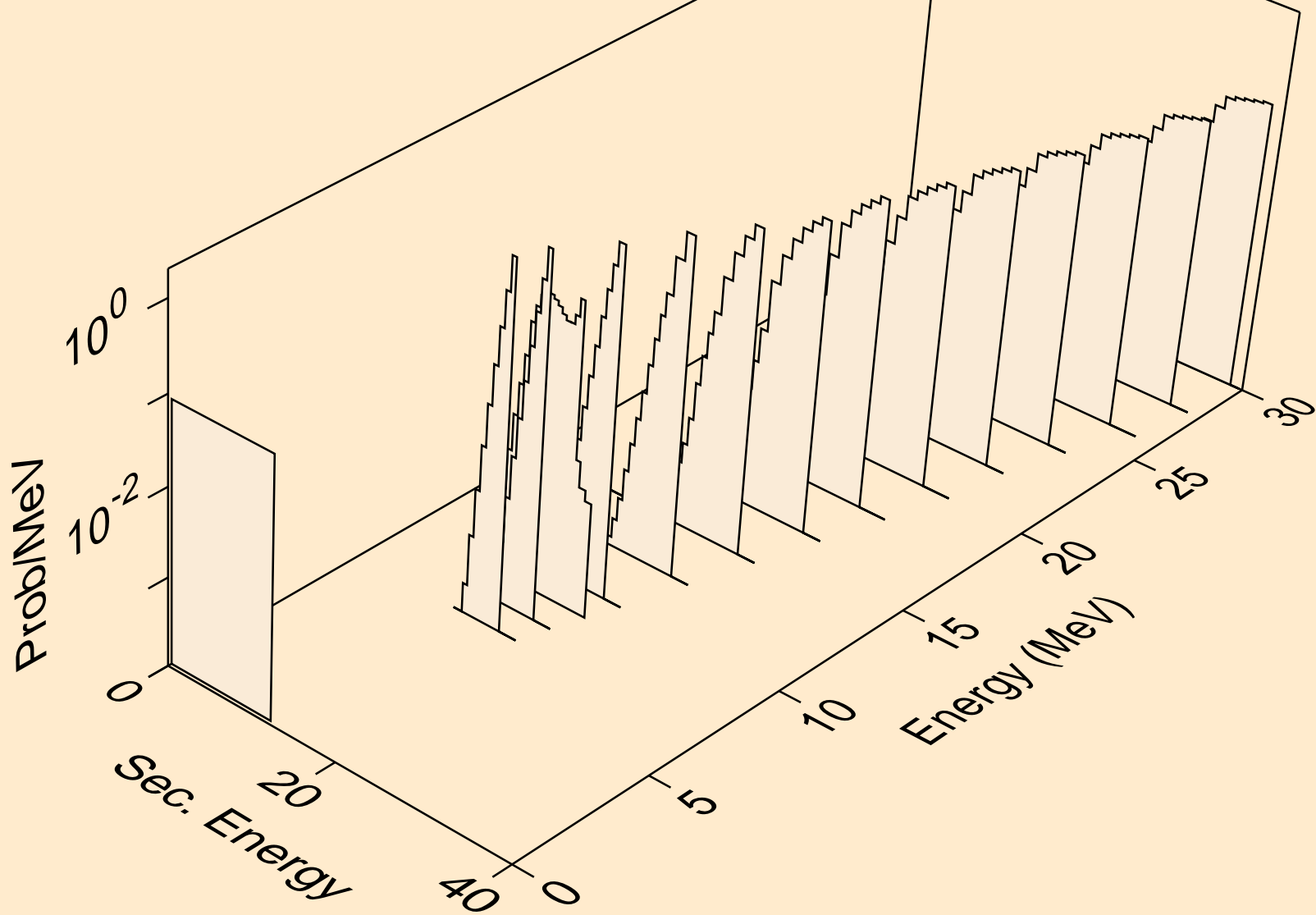

PB185M HELION ACER TENDL-2021 LIBRARY; T=0.K  
alphas from (s,2a)

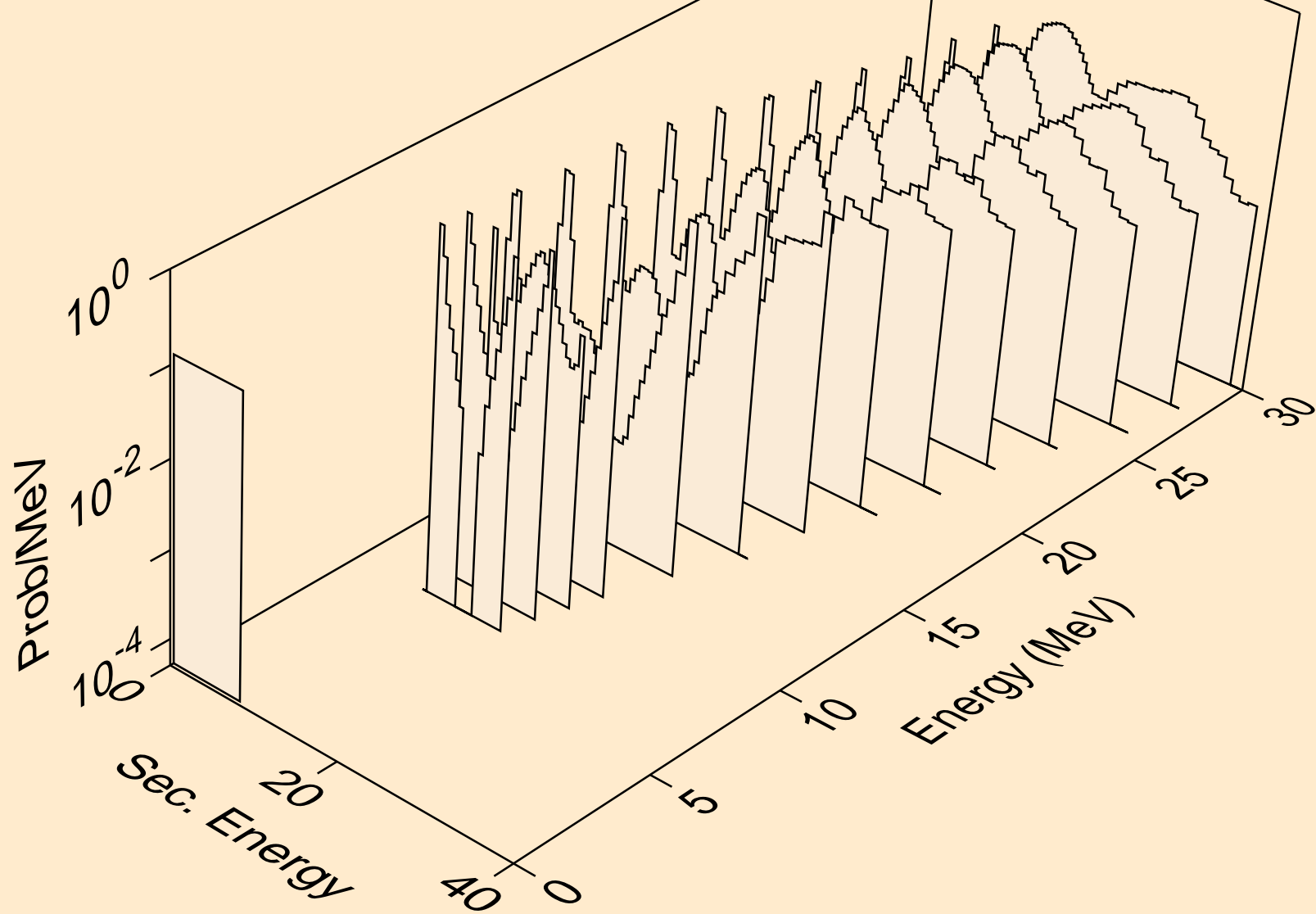

PB185M HELION ACER TENDL-2021 LIBRARY; T=0.K  
alphas from (s,pa)

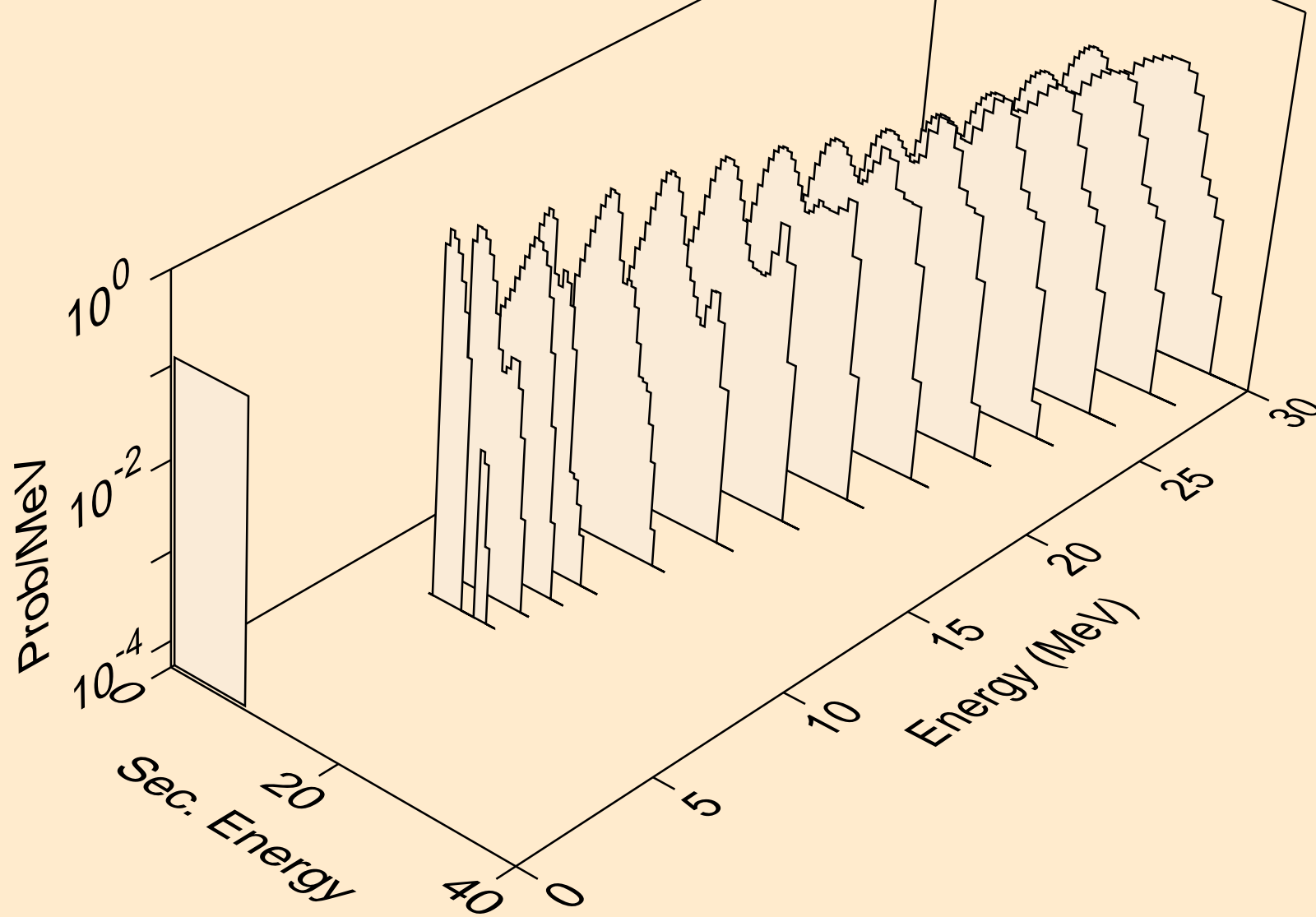



PB185M HELION ACER TENDL-2021 LIBRARY; T=0.K  
alphas from (s,t2a)

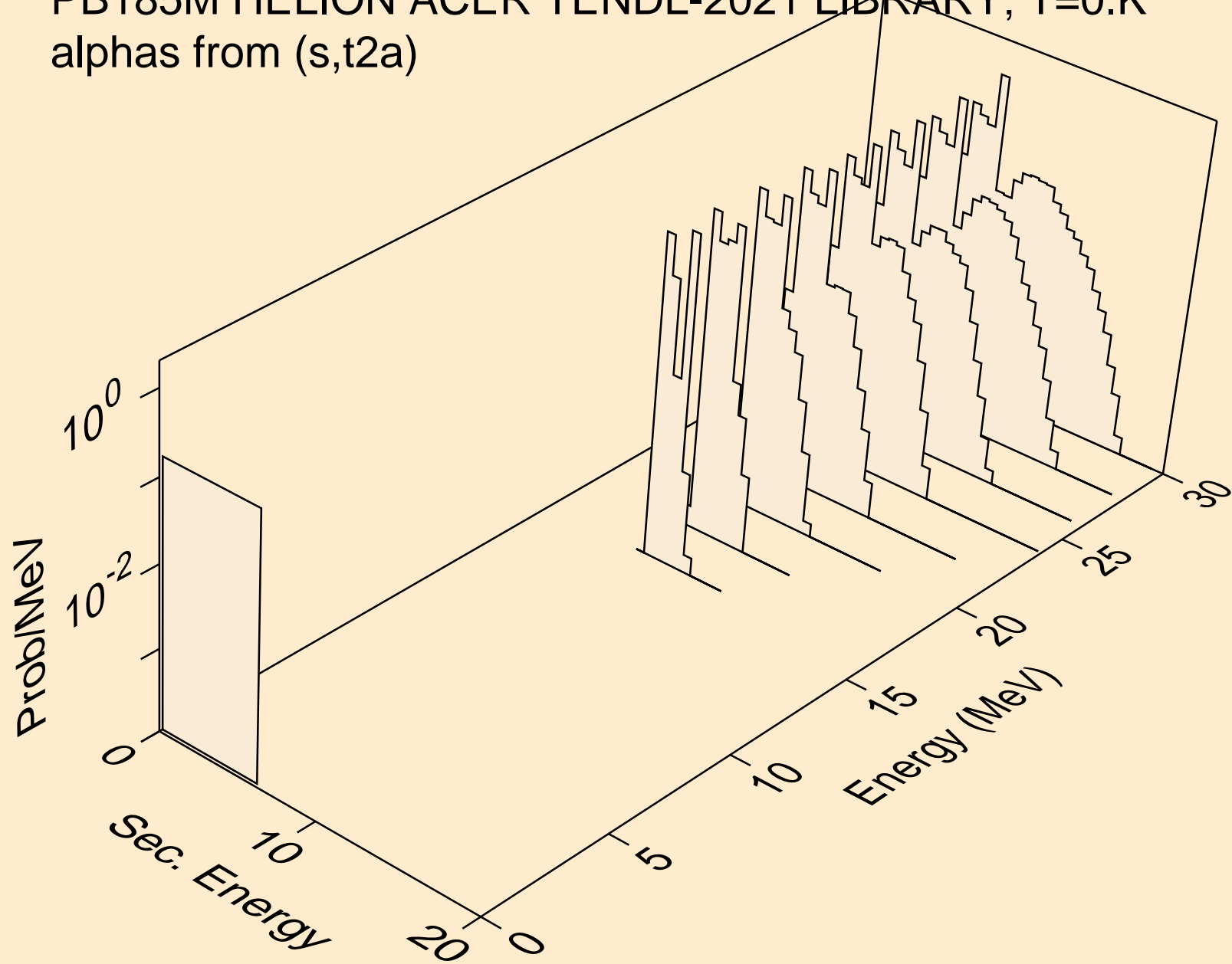

PB185M HELION ACER TENDL-2021 LIBRARY; T=0.K  
alphas from (s,d2a)

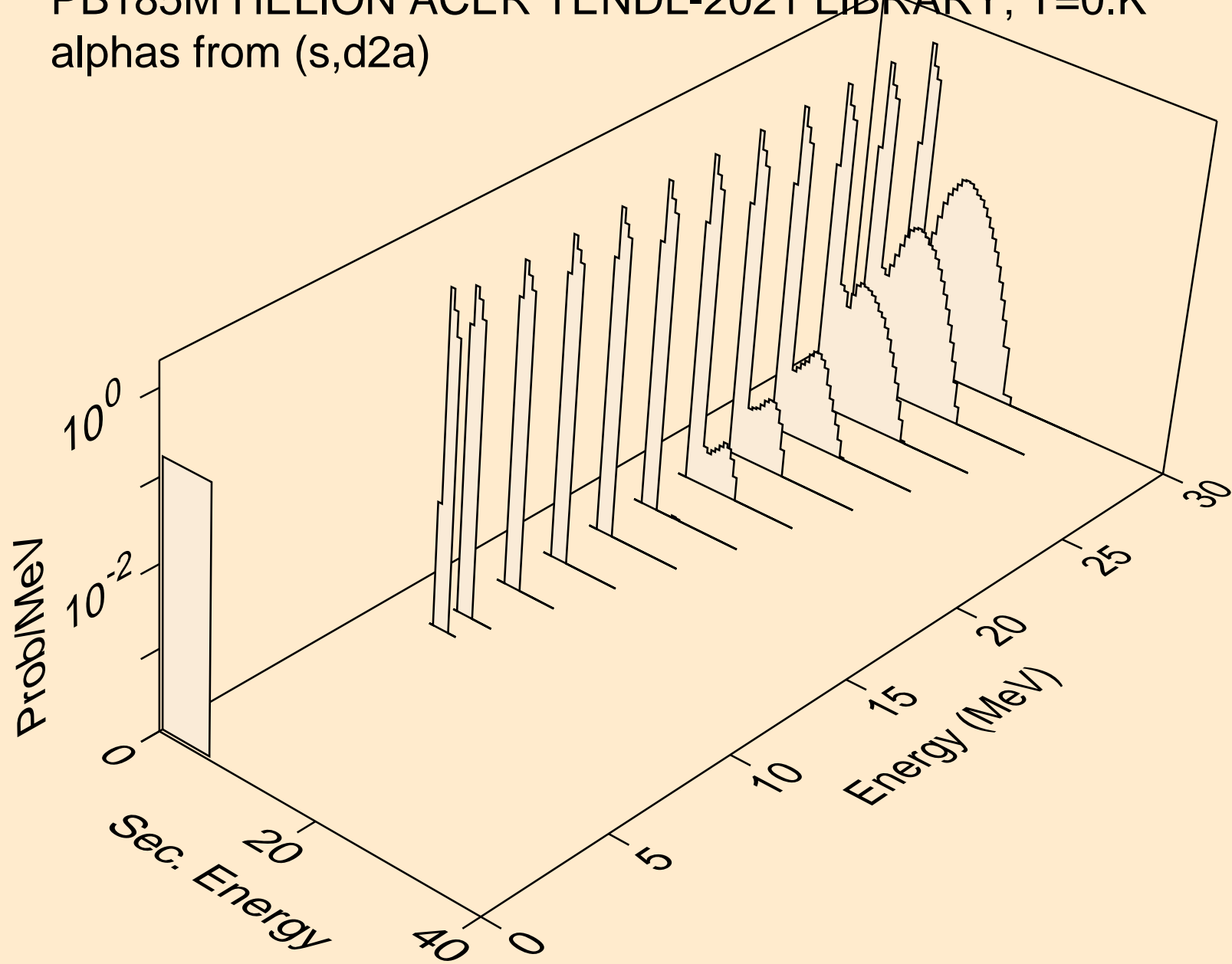

PB185M HELION ACER TENDL-2021 LIBRARY; T=0.K  
alphas from (s,da)

