

PB219 HELION ACER TENDL-2021 LIBRARY; T=0.K  
Principal cross sections

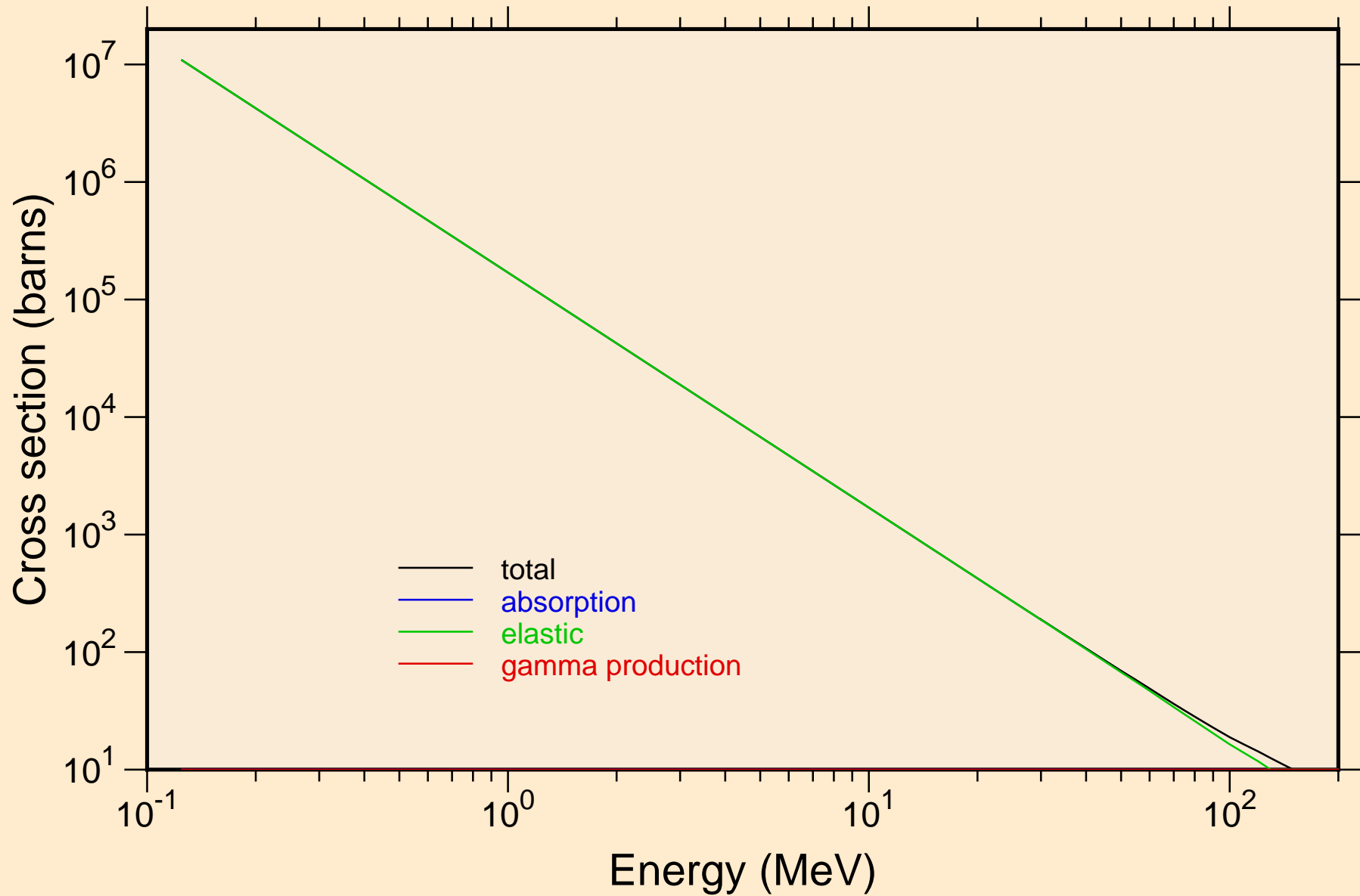

PB219 HELION ACER TENDL-2021 LIBRARY; T=0.K

Heating

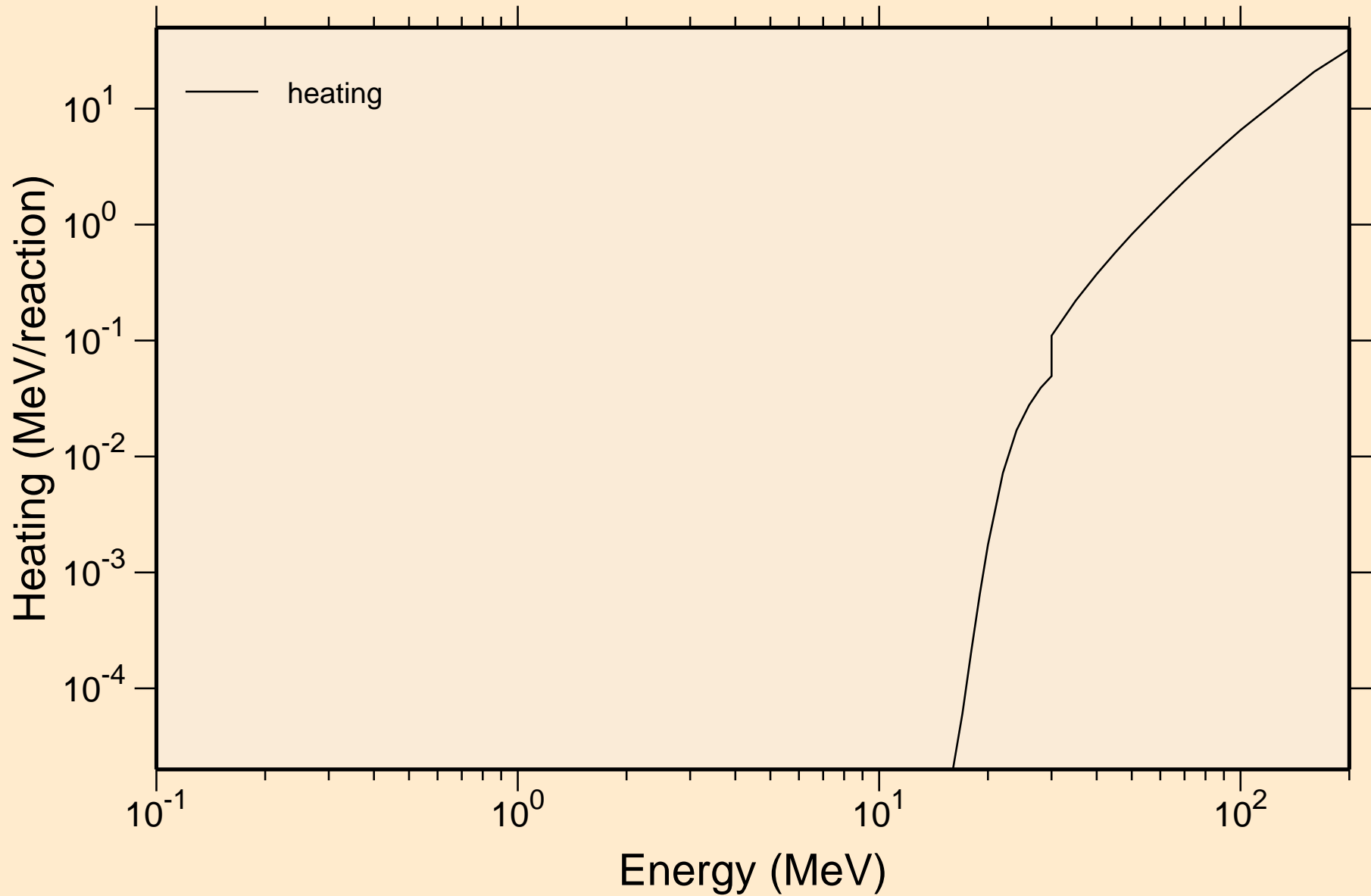

PB219 HELION ACER TENDL-2021 LIBRARY; T=0.K

Principal cross sections

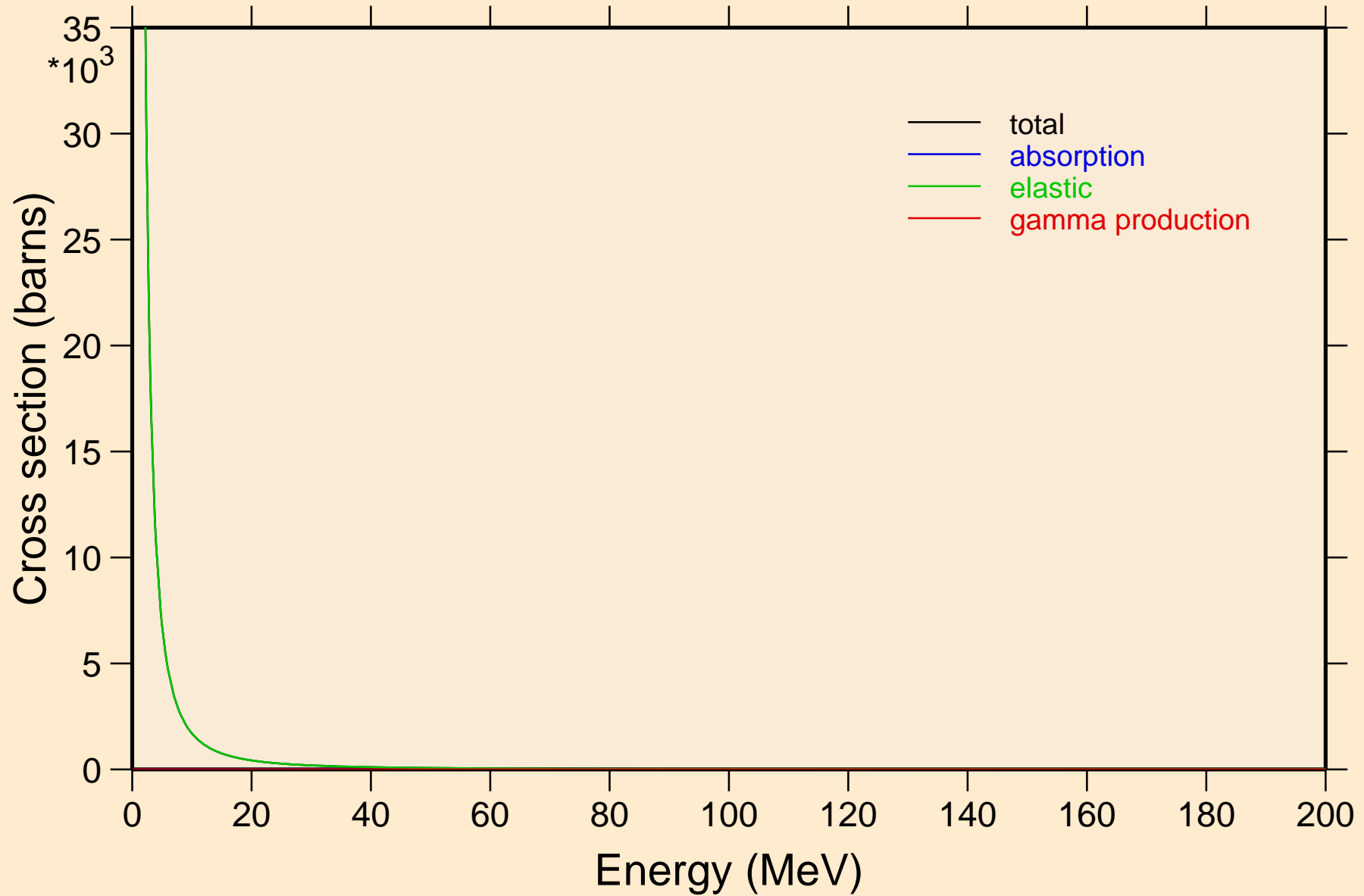

PB219 HELION ACER TENDL-2021 LIBRARY; T=0.K

Heating

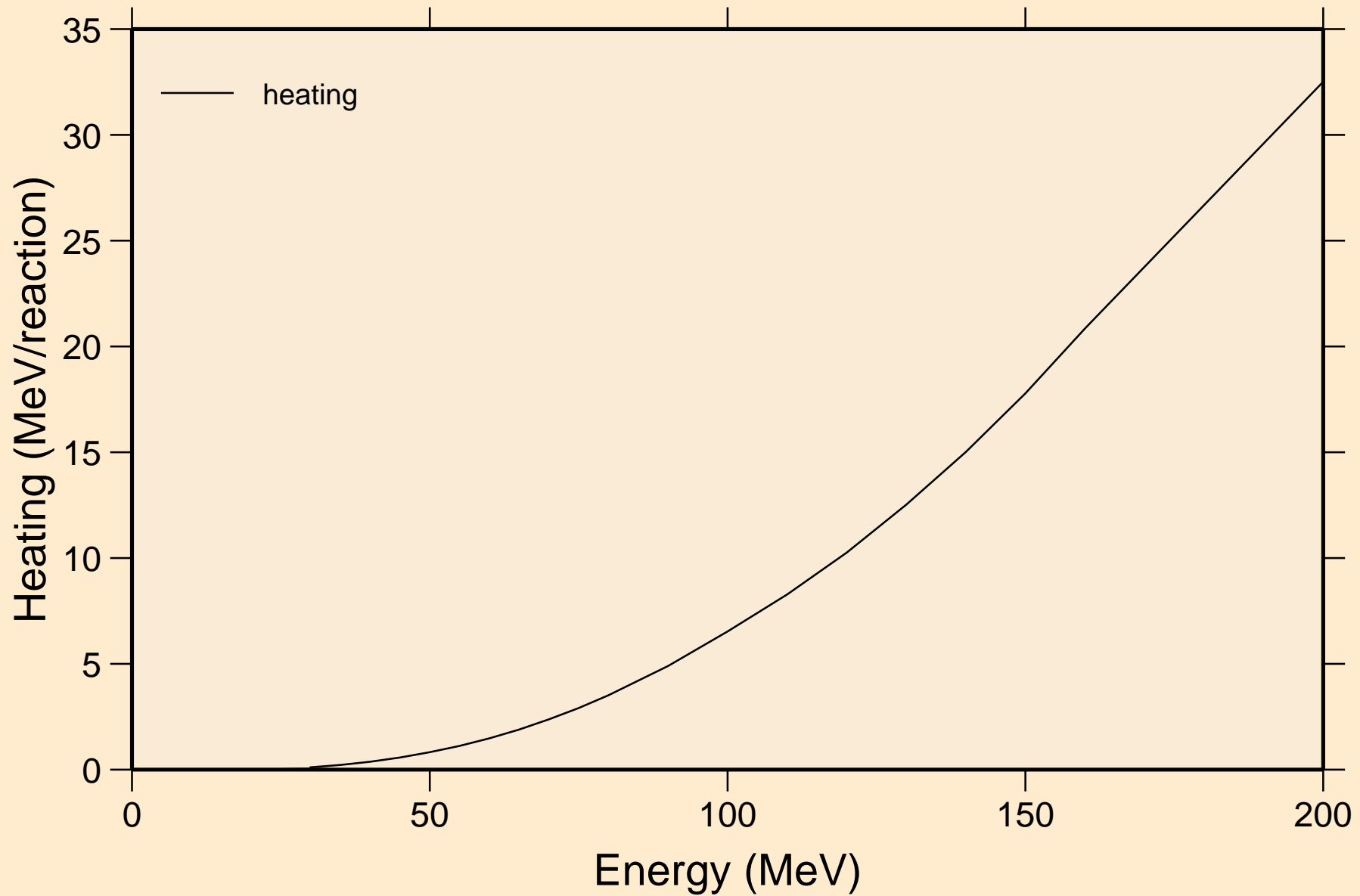

PB219 HELION ACER TENDL-2021 LIBRARY; T=0.K  
Threshold reactions

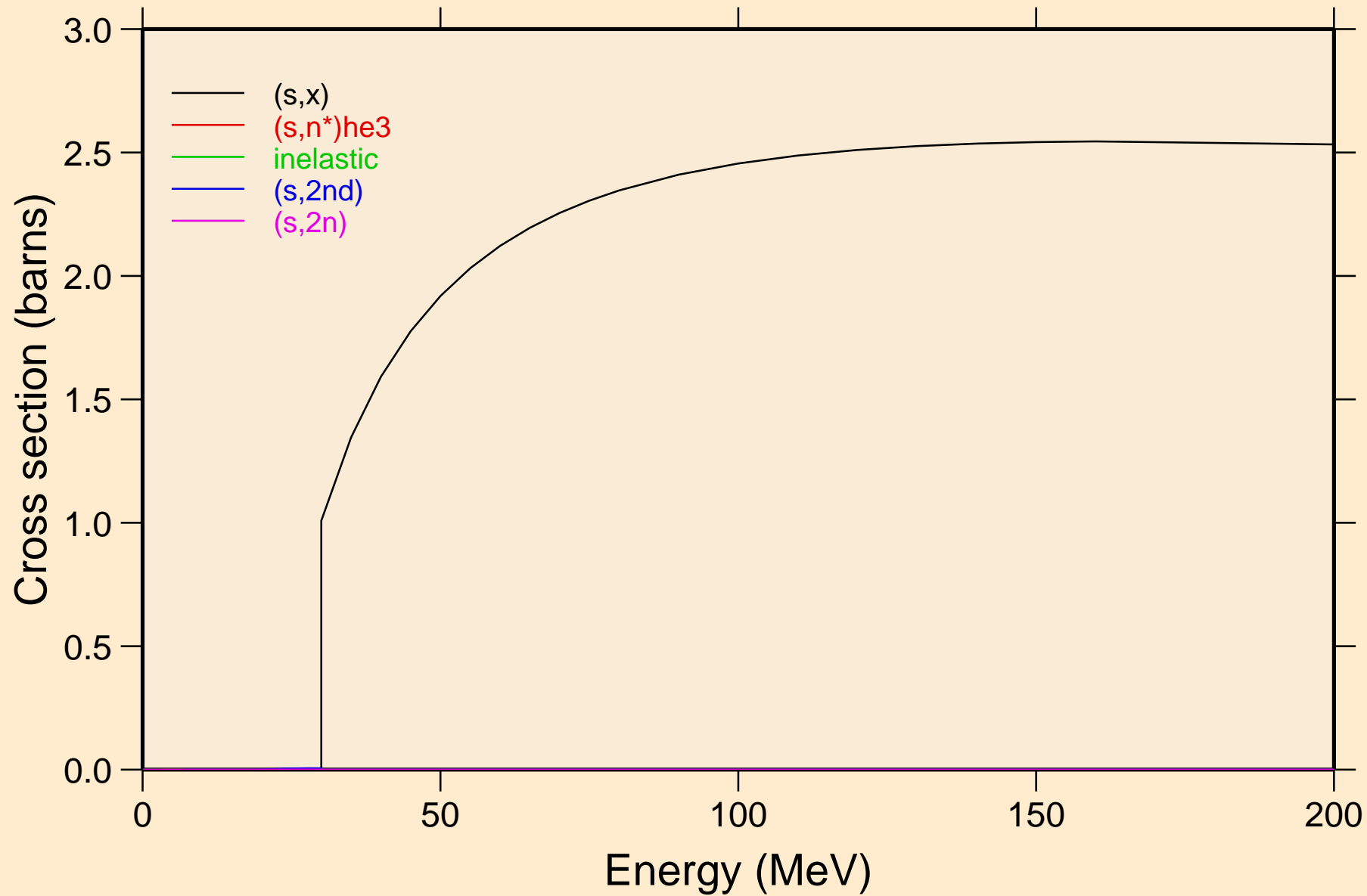

PB219 HELION ACER TENDL-2021 LIBRARY; T=0.K  
Threshold reactions

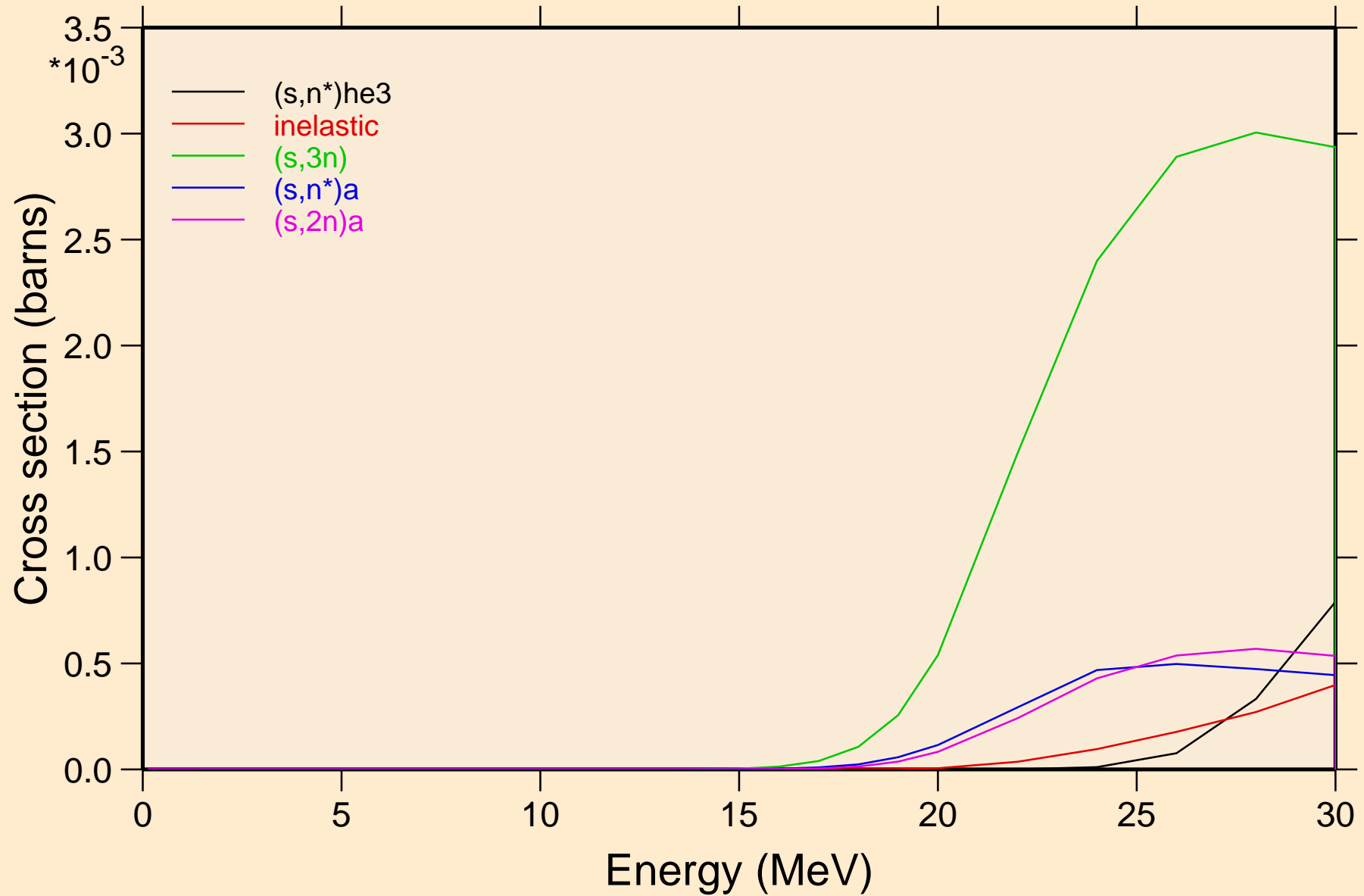

PB219 HELION ACER TENDL-2021 LIBRARY; T=0.K  
Threshold reactions

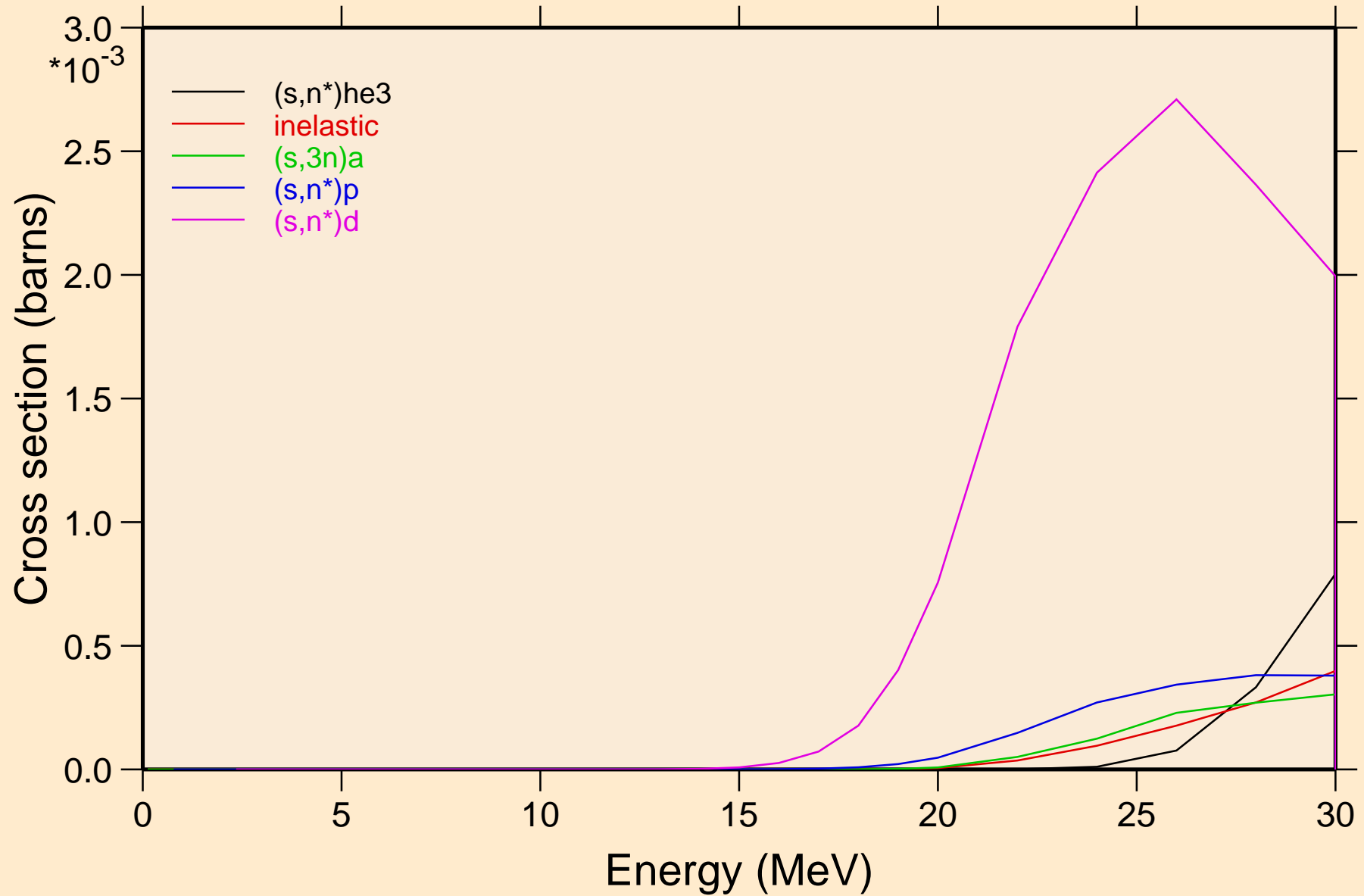

PB219 HELION ACER TENDL-2021 LIBRARY; T=0.K  
Threshold reactions

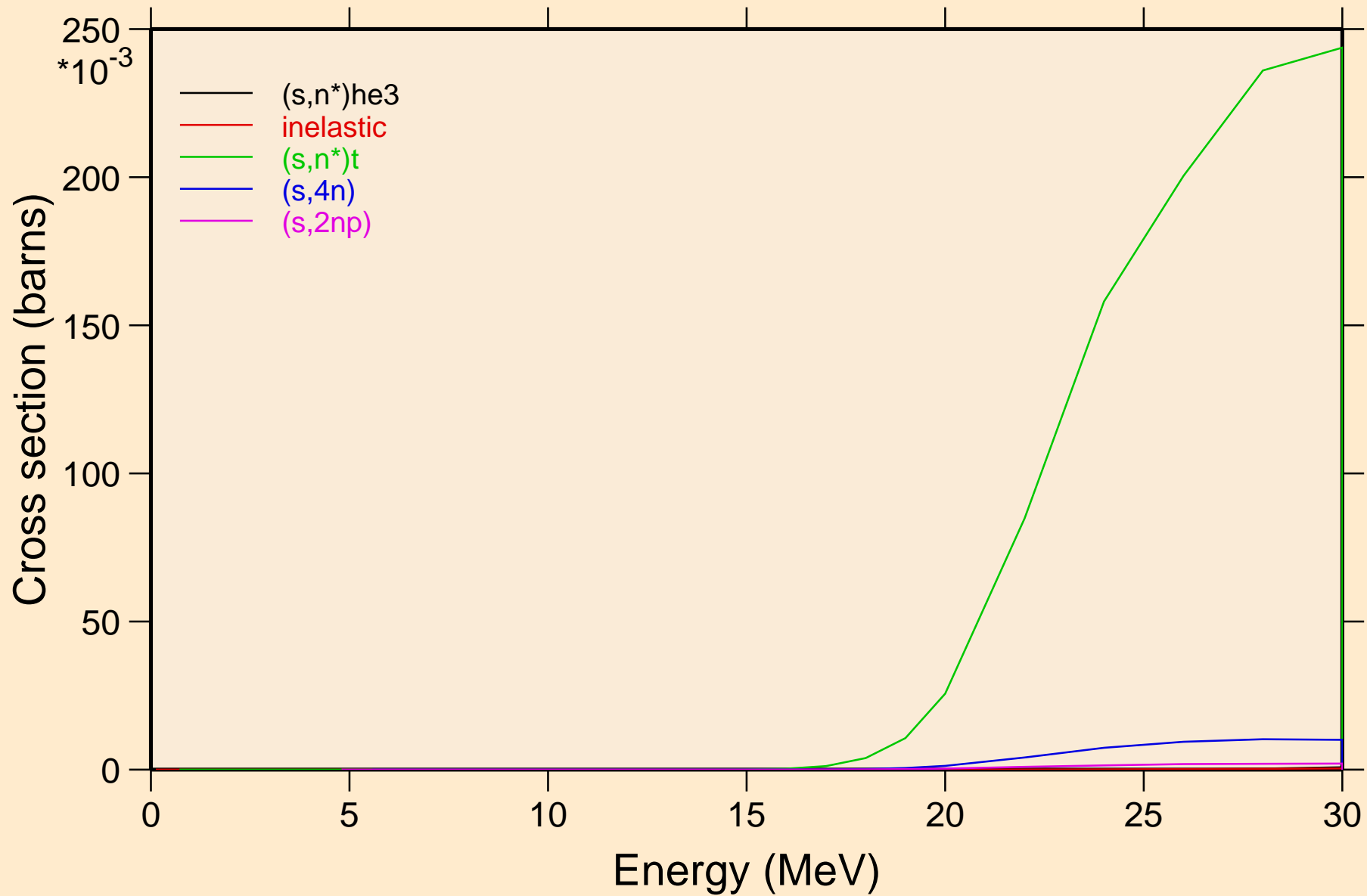



PB219 HELION ACER TENDL-2021 LIBRARY; T=0.K  
Threshold reactions

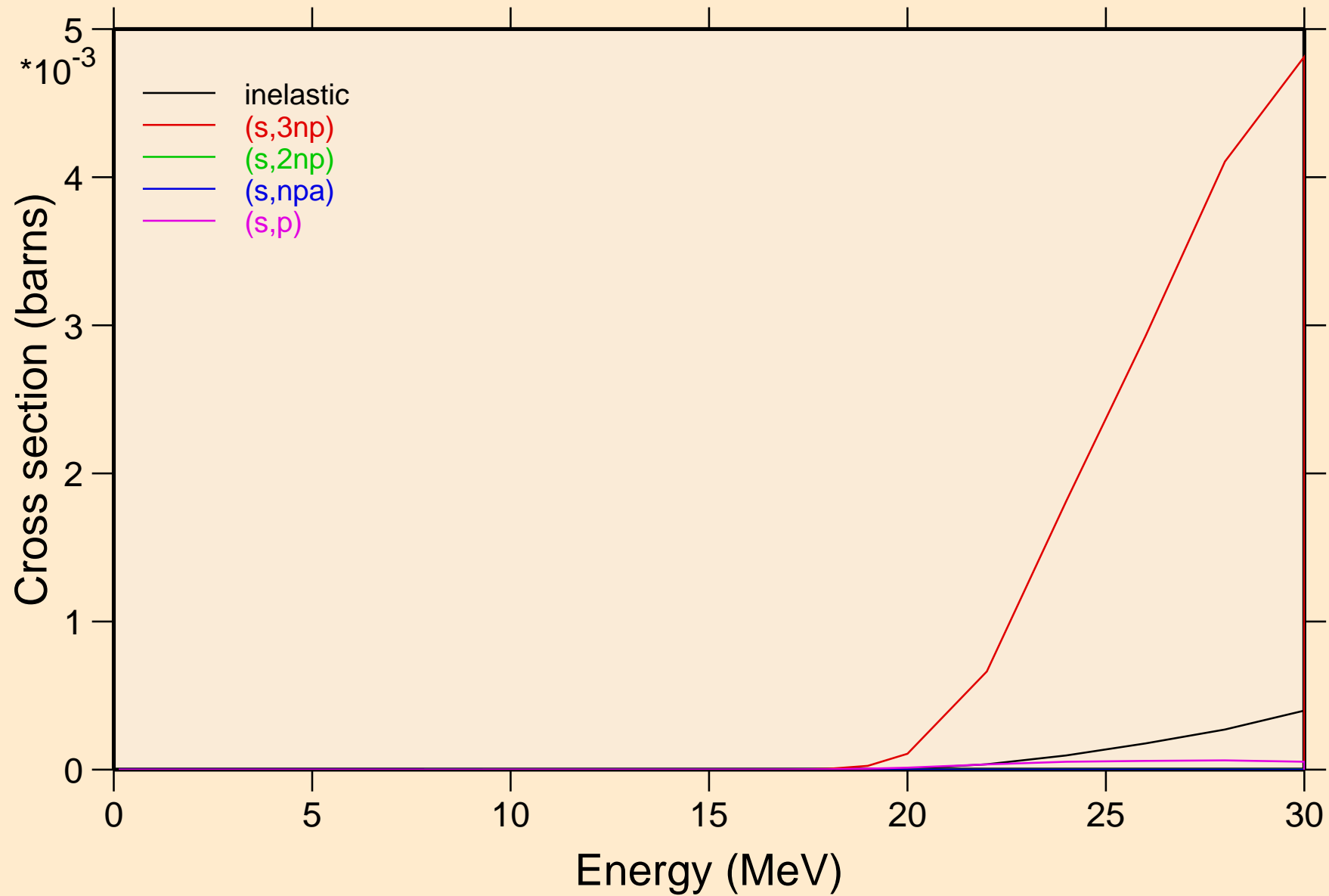

PB219 HELION ACER TENDL-2021 LIBRARY; T=0.K  
Threshold reactions

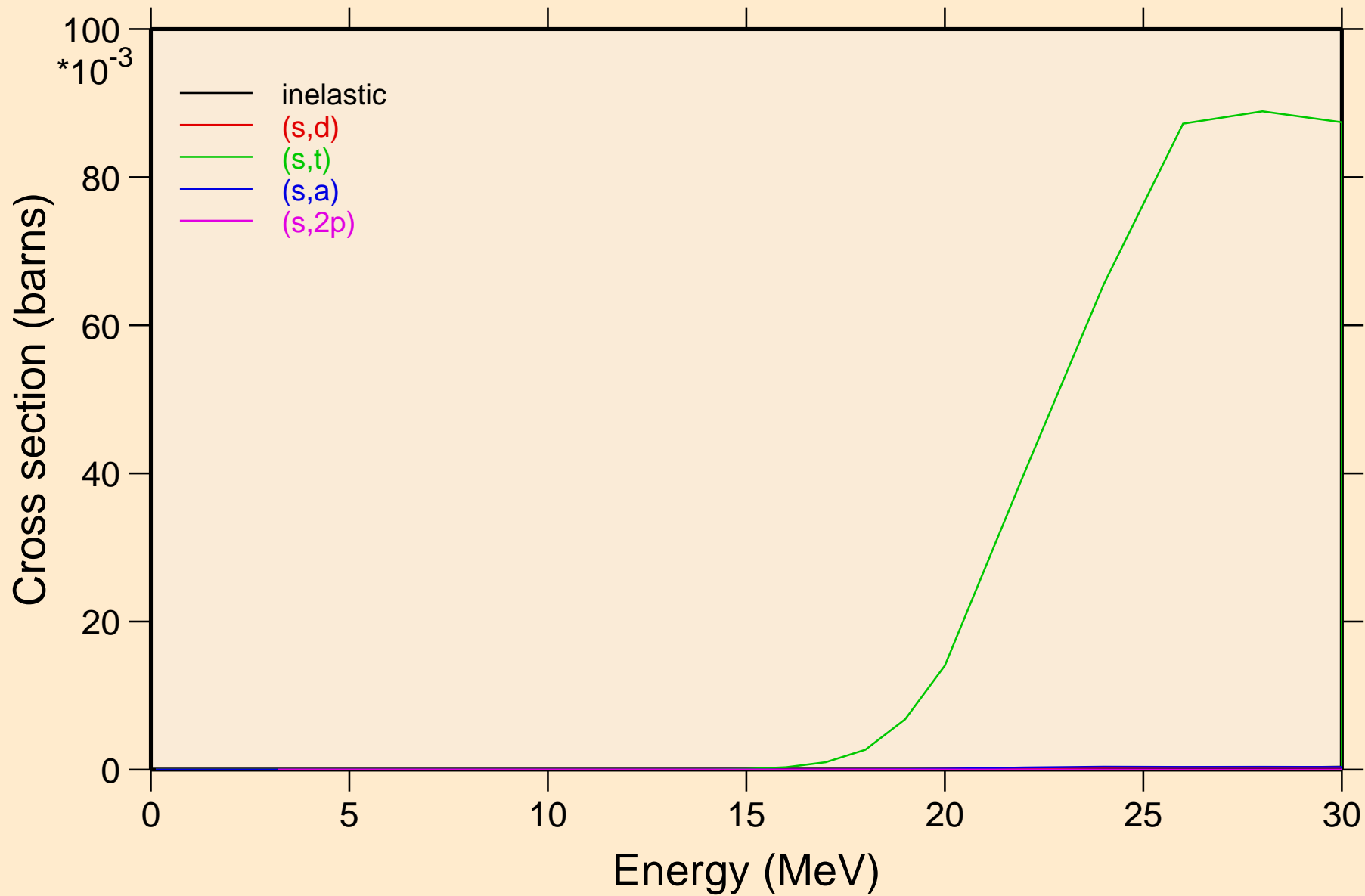

PB219 HELION ACER TENDL-2021 LIBRARY; T=0.K  
Threshold reactions

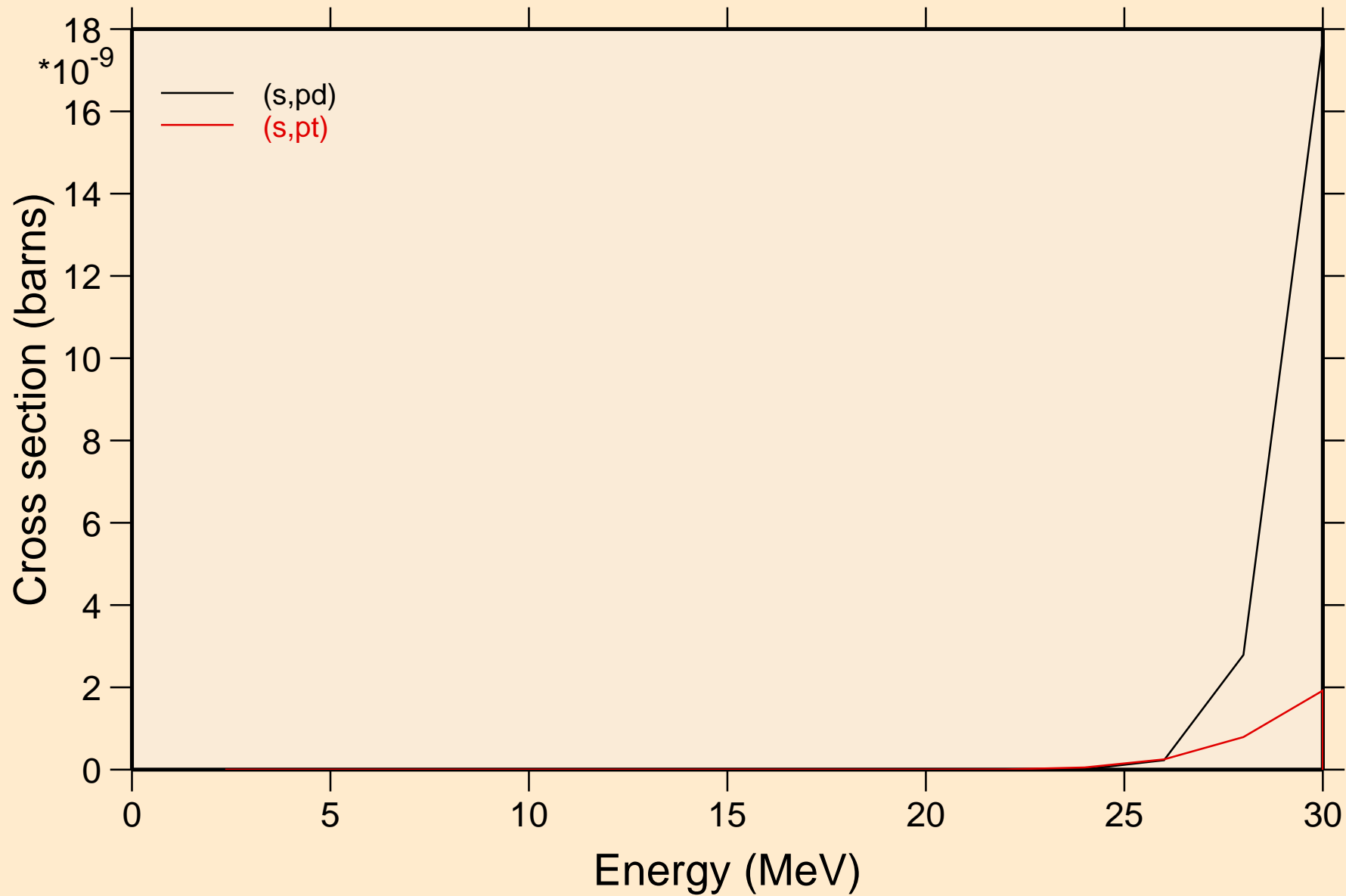

PB219 HELION ACER TENDL-2021 LIBRARY; T=0.K  
angular distribution for elastic

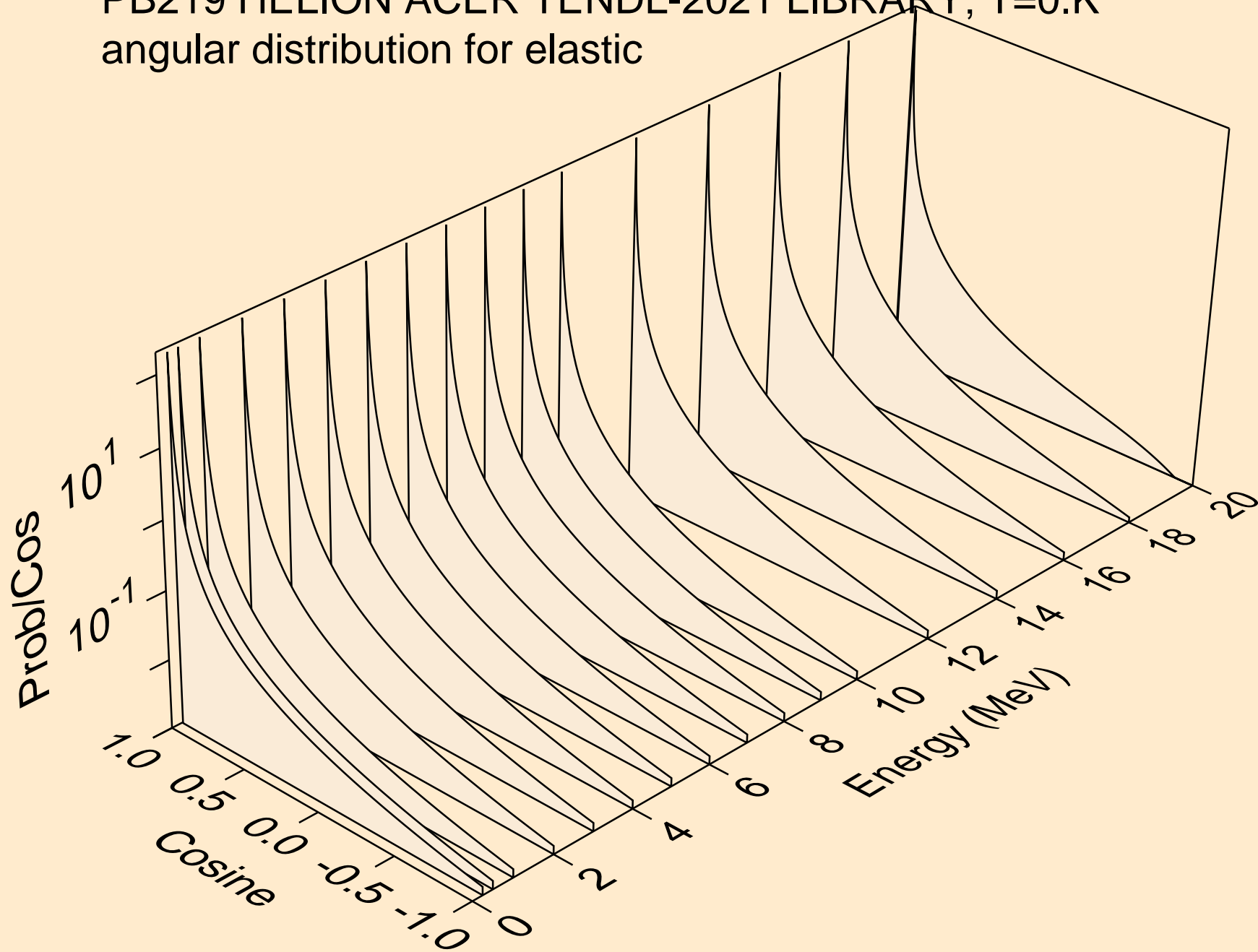

PB219 HELION ACER TENDL-2021 LIBRARY; T=0.K  
angular distribution for elastic

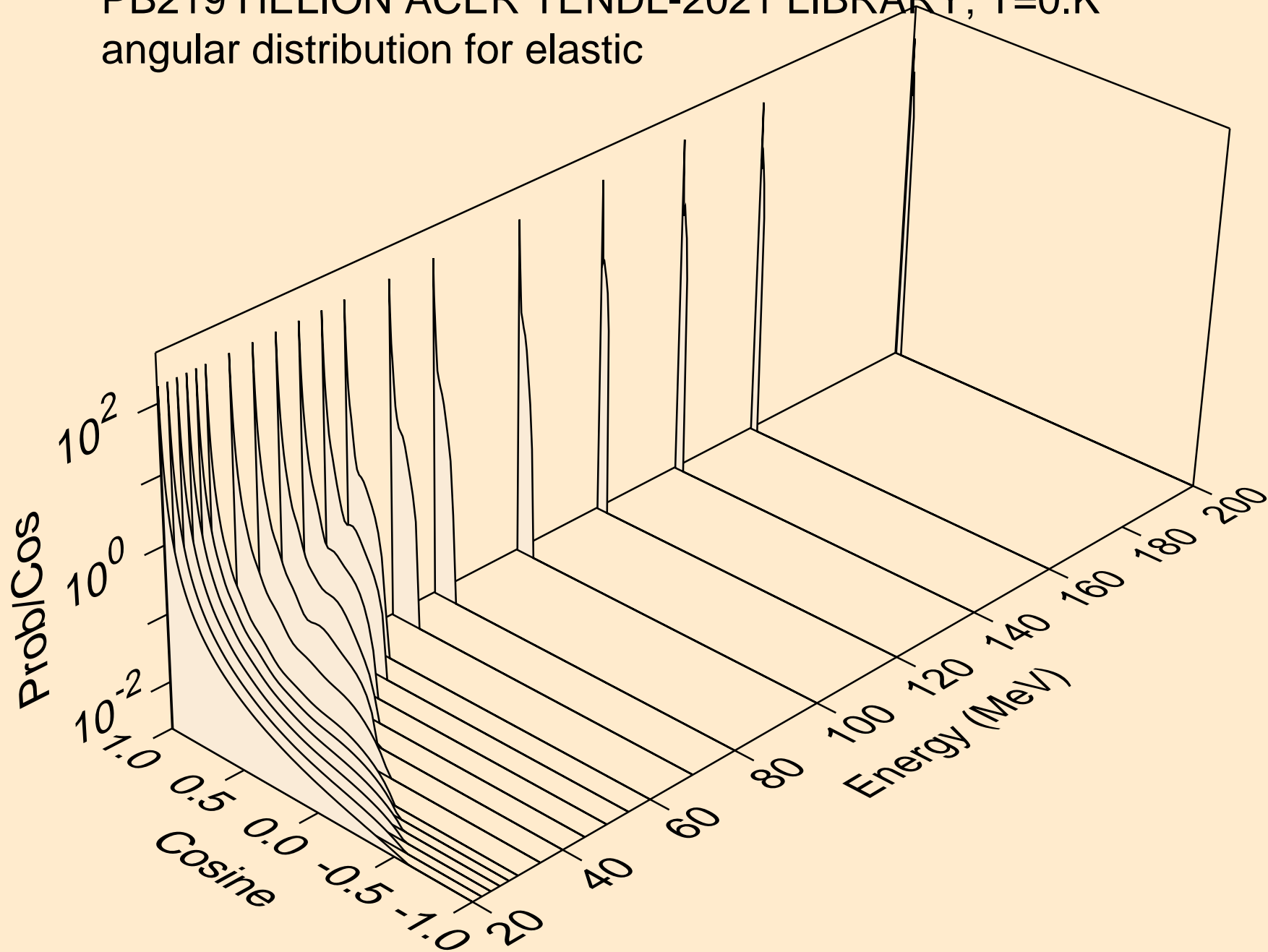

PB219 HELION ACER TENDL-2021 LIBRARY; T=0.K  
He-3 emission for (s,x)

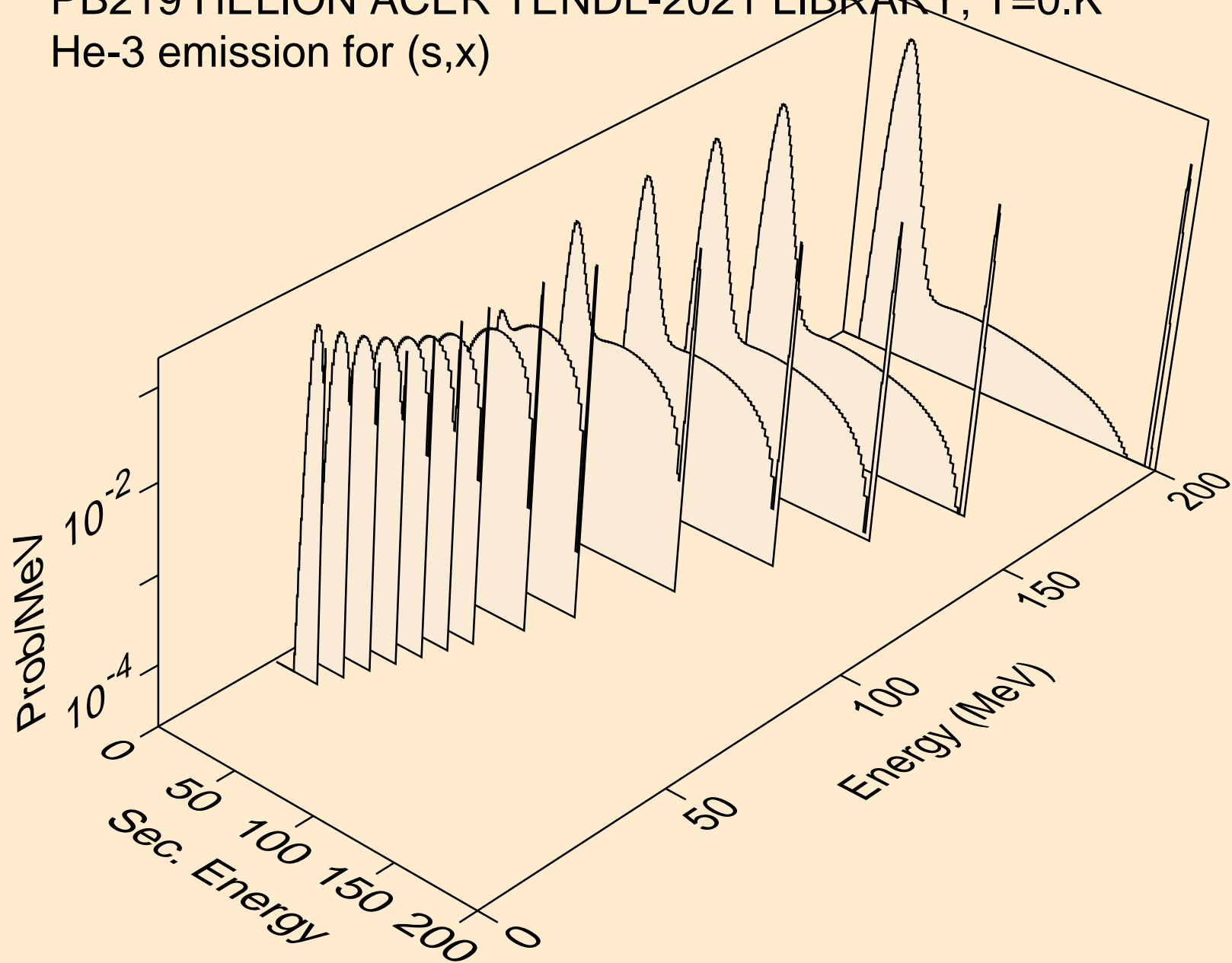

PB219 HELION ACER TENDL-2021 LIBRARY; T=0.K  
He-3 emission for (s,n\*)he3

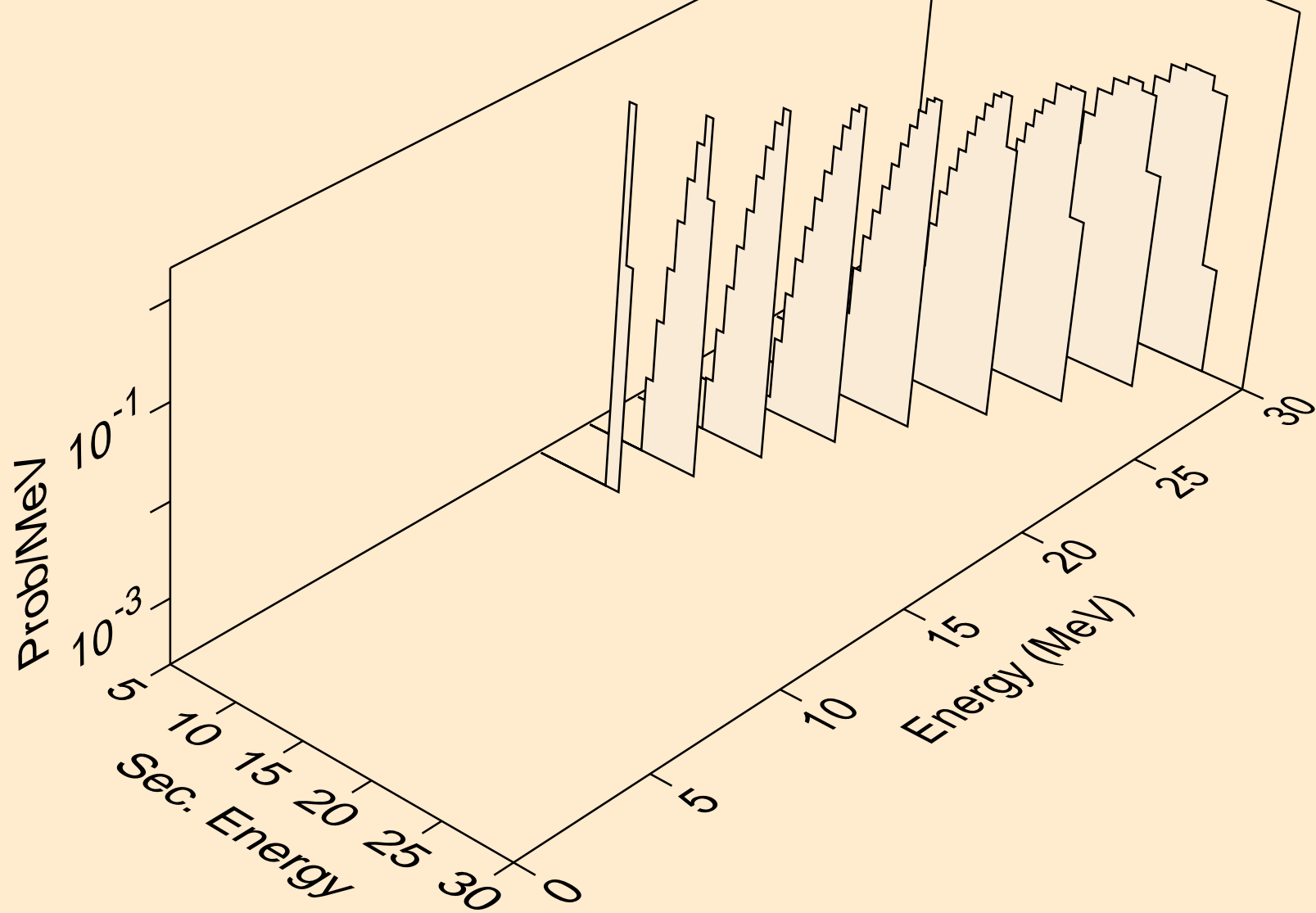

PB219 HELION ACER TENDL-2021 LIBRARY; T=0.K  
He-3 emission for inelastic

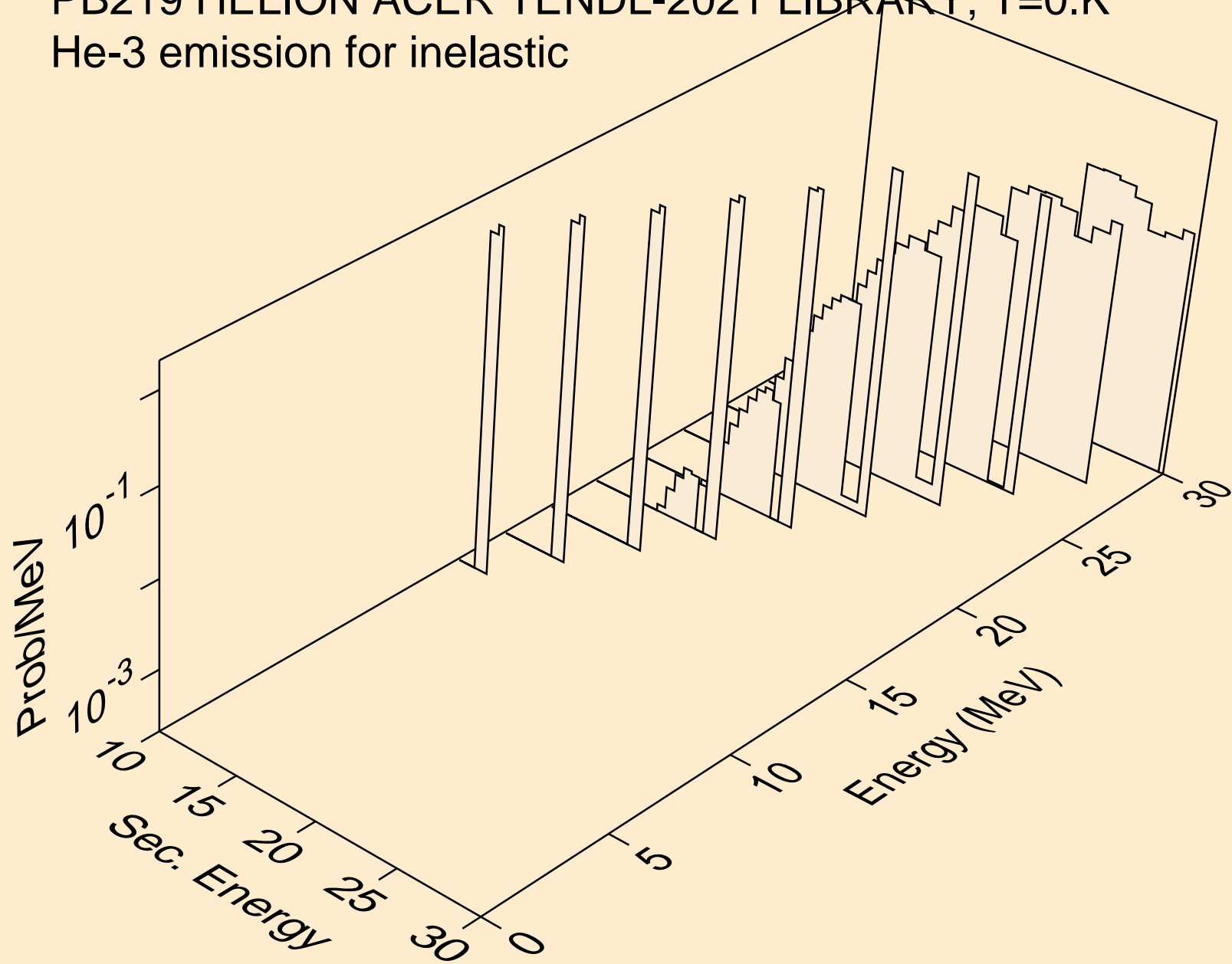



PB219 HELION ACER TENDL-2021 LIBRARY; T=0.K  
Photon emission for (z,n)

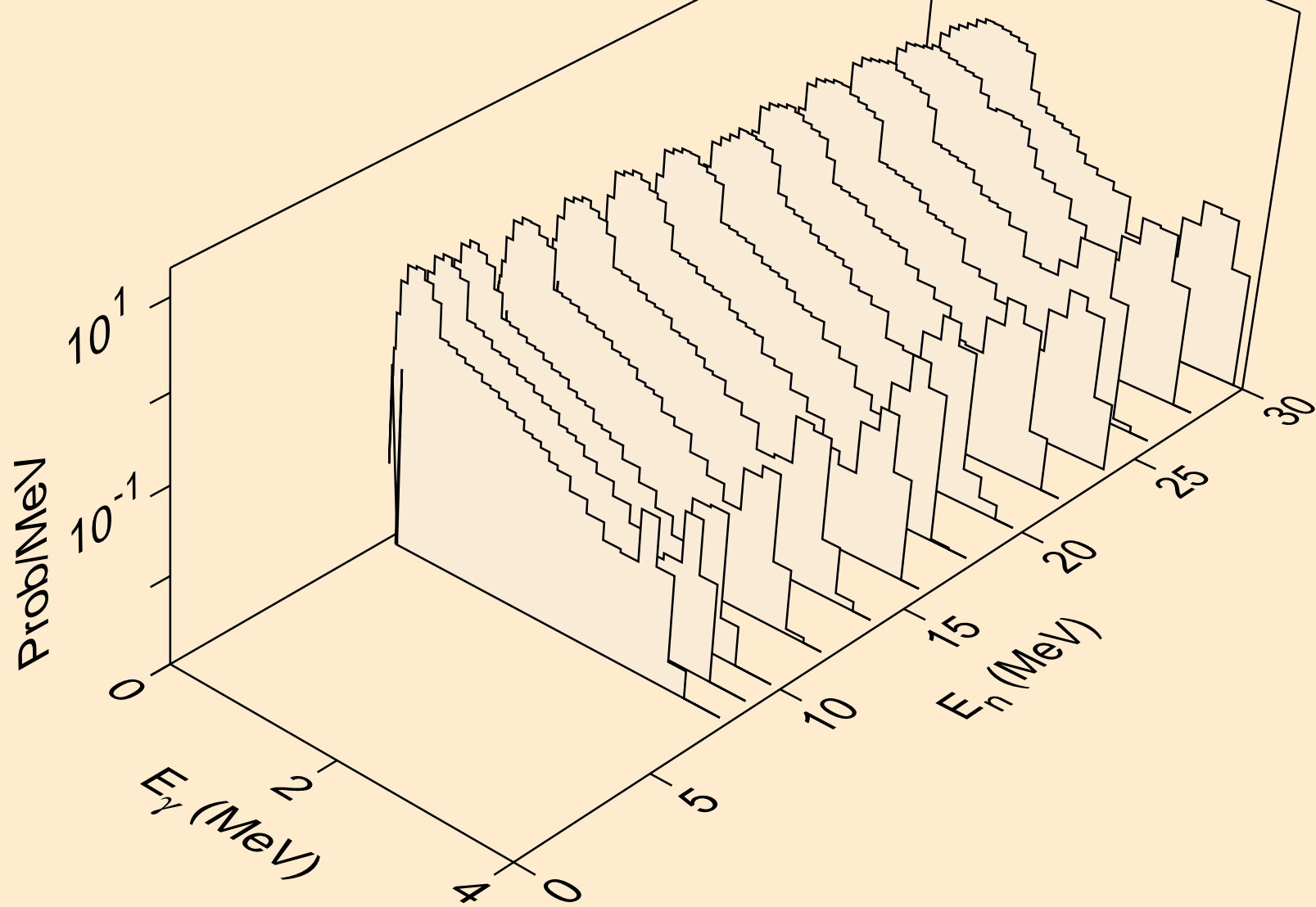

PB219 HELION ACER TENDL-2021 LIBRARY; T=0.K  
Photon emission for (n,x)

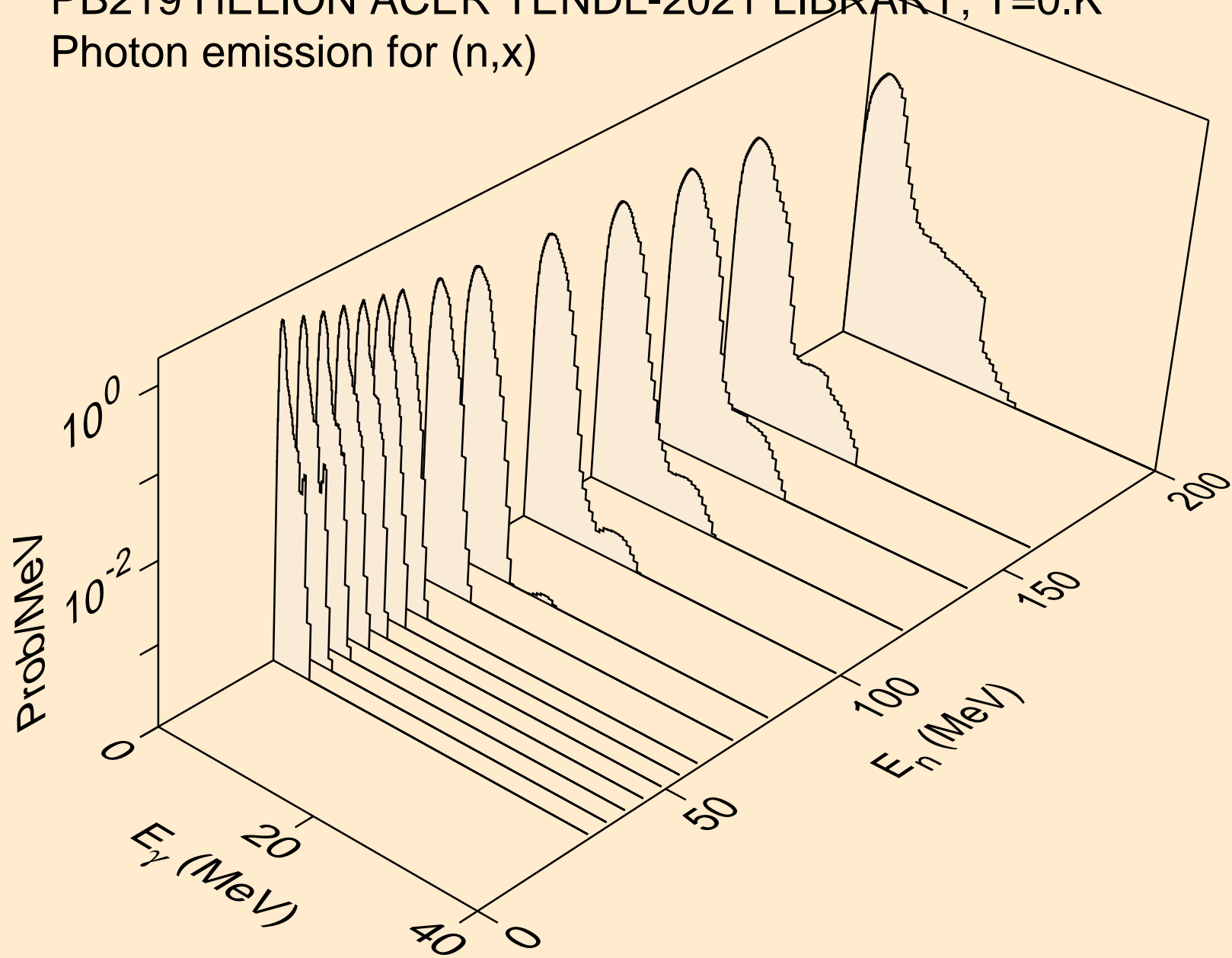

PB219 HELION ACER TENDL-2021 LIBRARY; T=0.K  
Photon emission for (n,2nd)

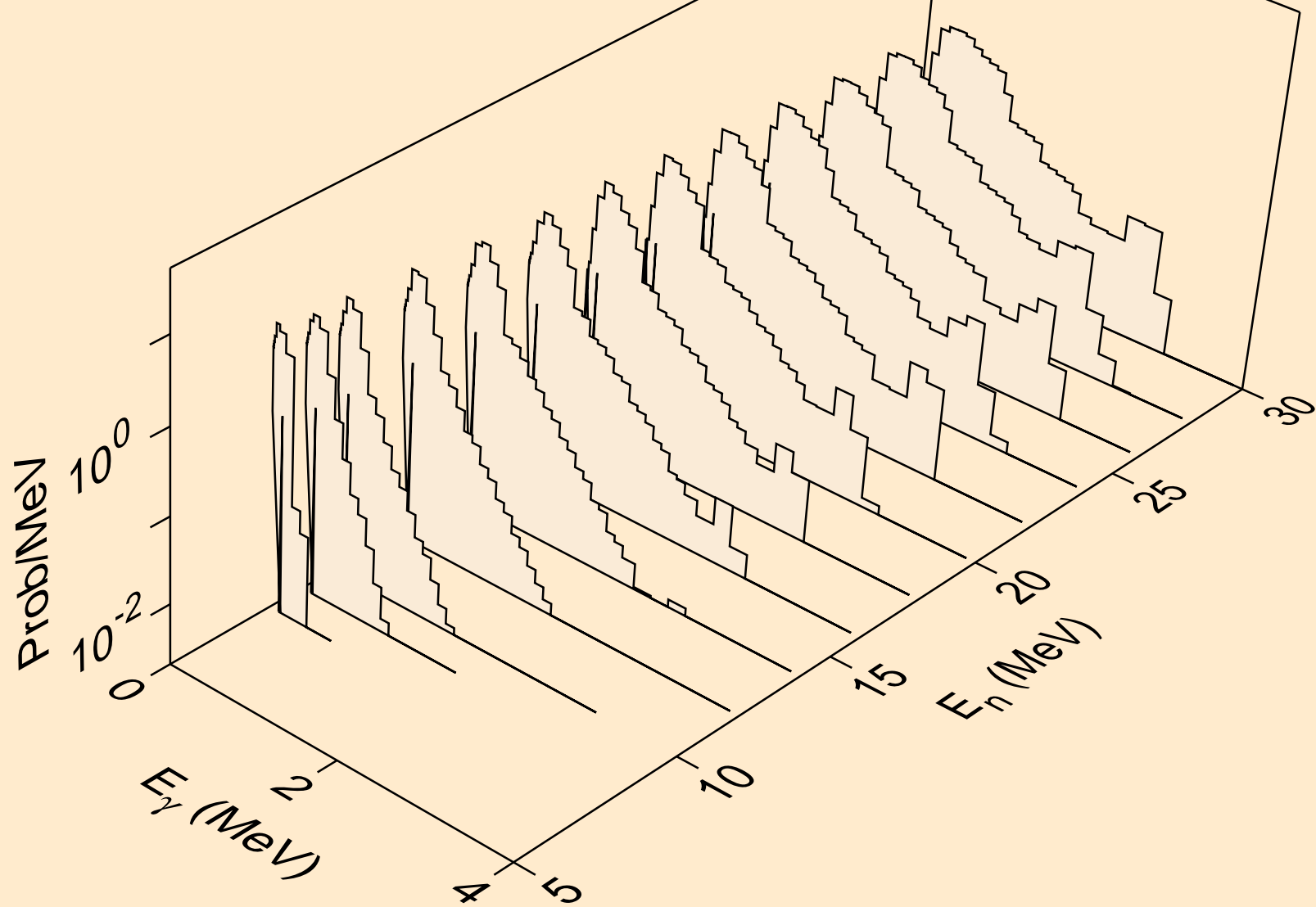

PB219 HELION ACER TENDL-2021 LIBRARY; T=0.K  
Photon emission for (n,2n)

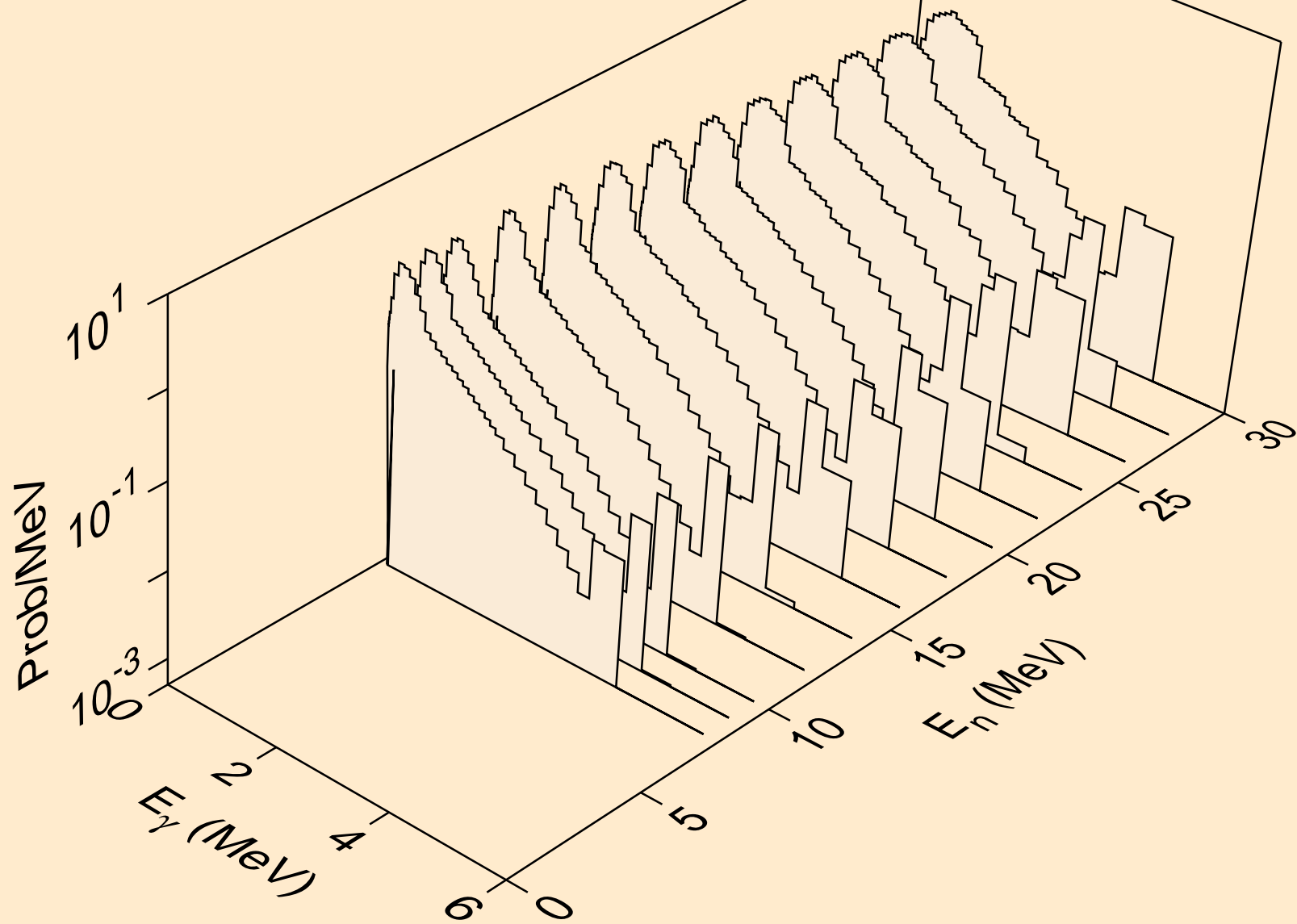

PB219 HELION ACER TENDL-2021 LIBRARY; T=0.K  
Photon emission for (n,3n)

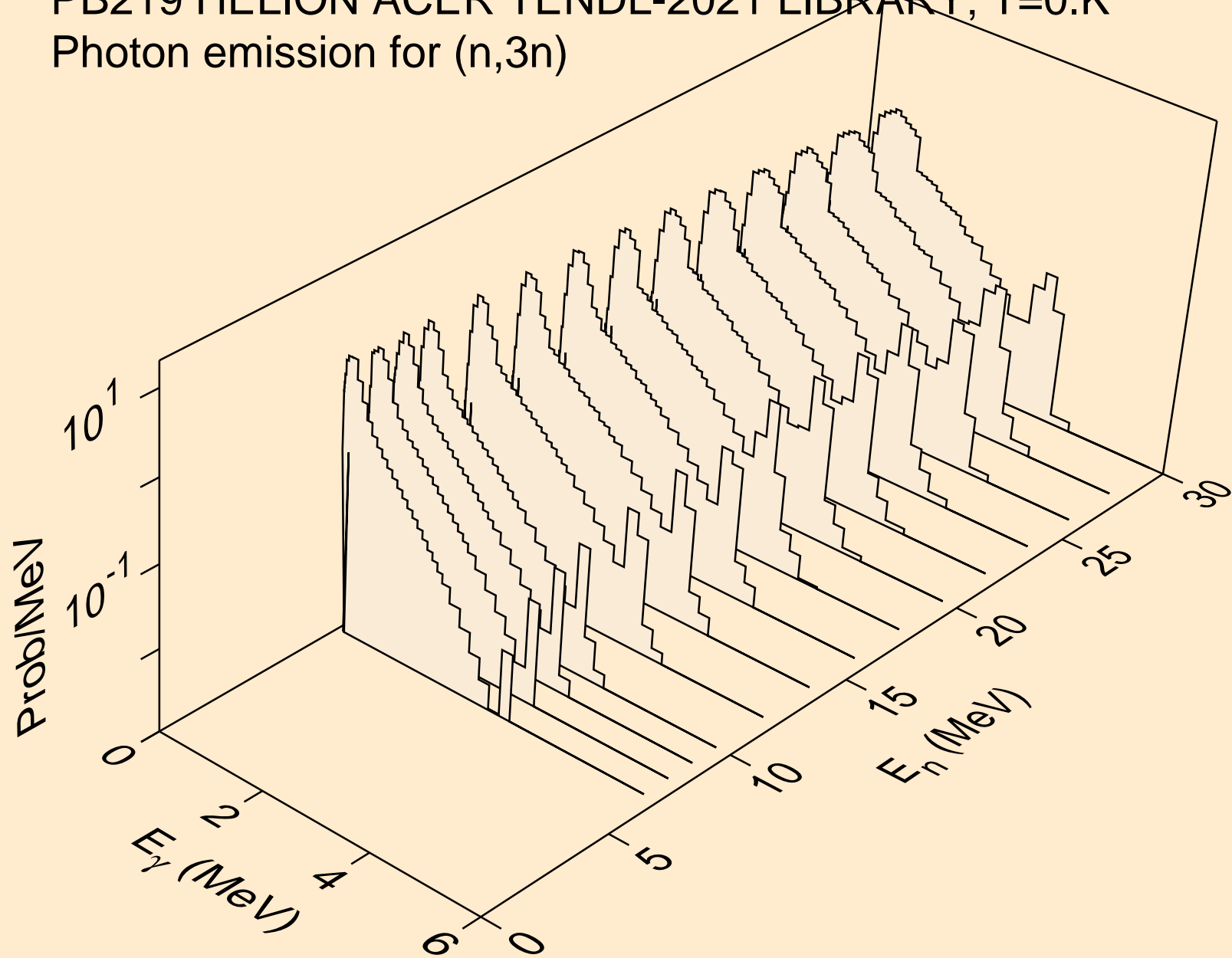

PB219 HELION ACER TENDL-2021 LIBRARY; T=0.K  
Photon emission for (n,n\*)a

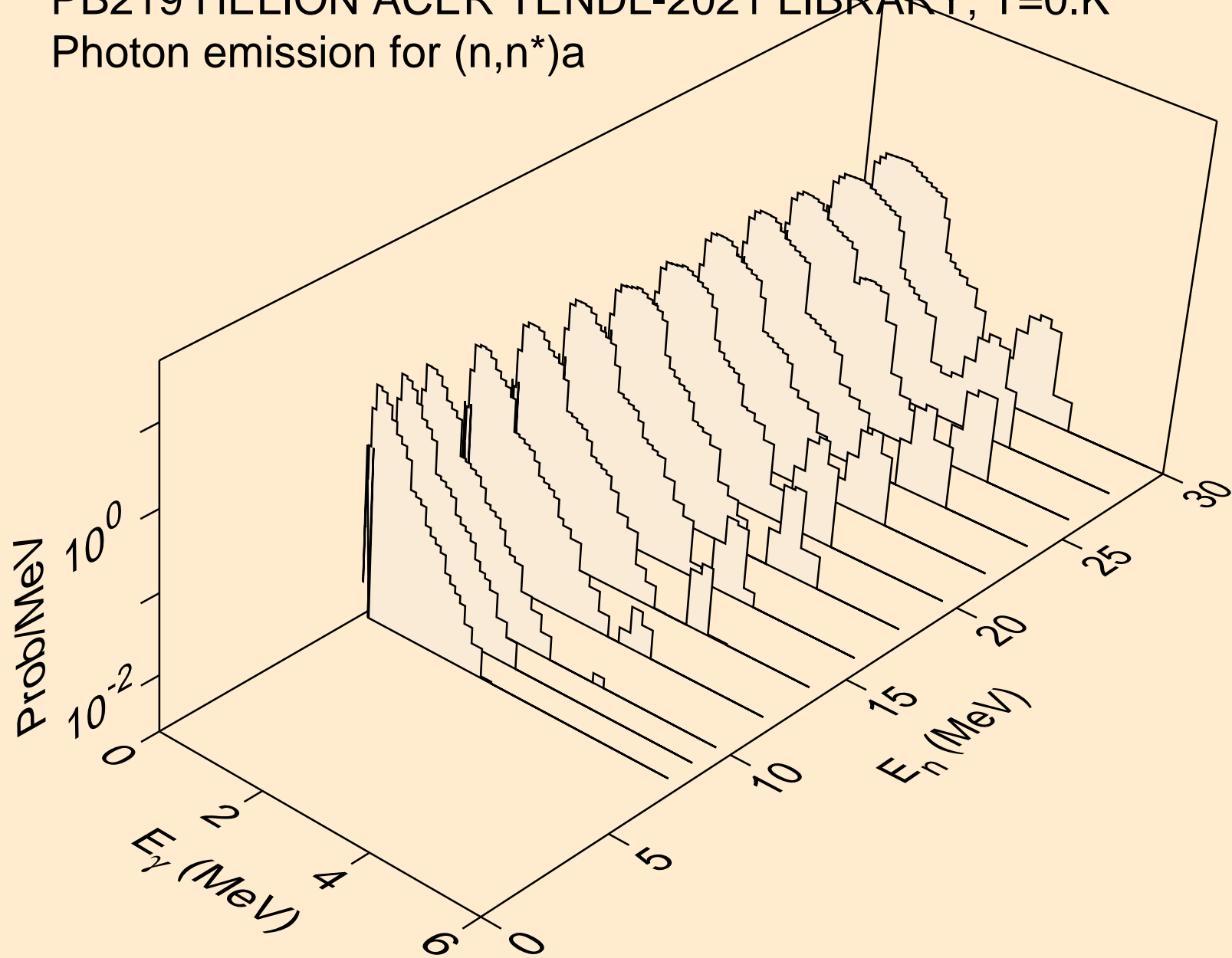

PB219 HELION ACER TENDL-2021 LIBRARY; T=0.K  
Photon emission for (n,2n)a

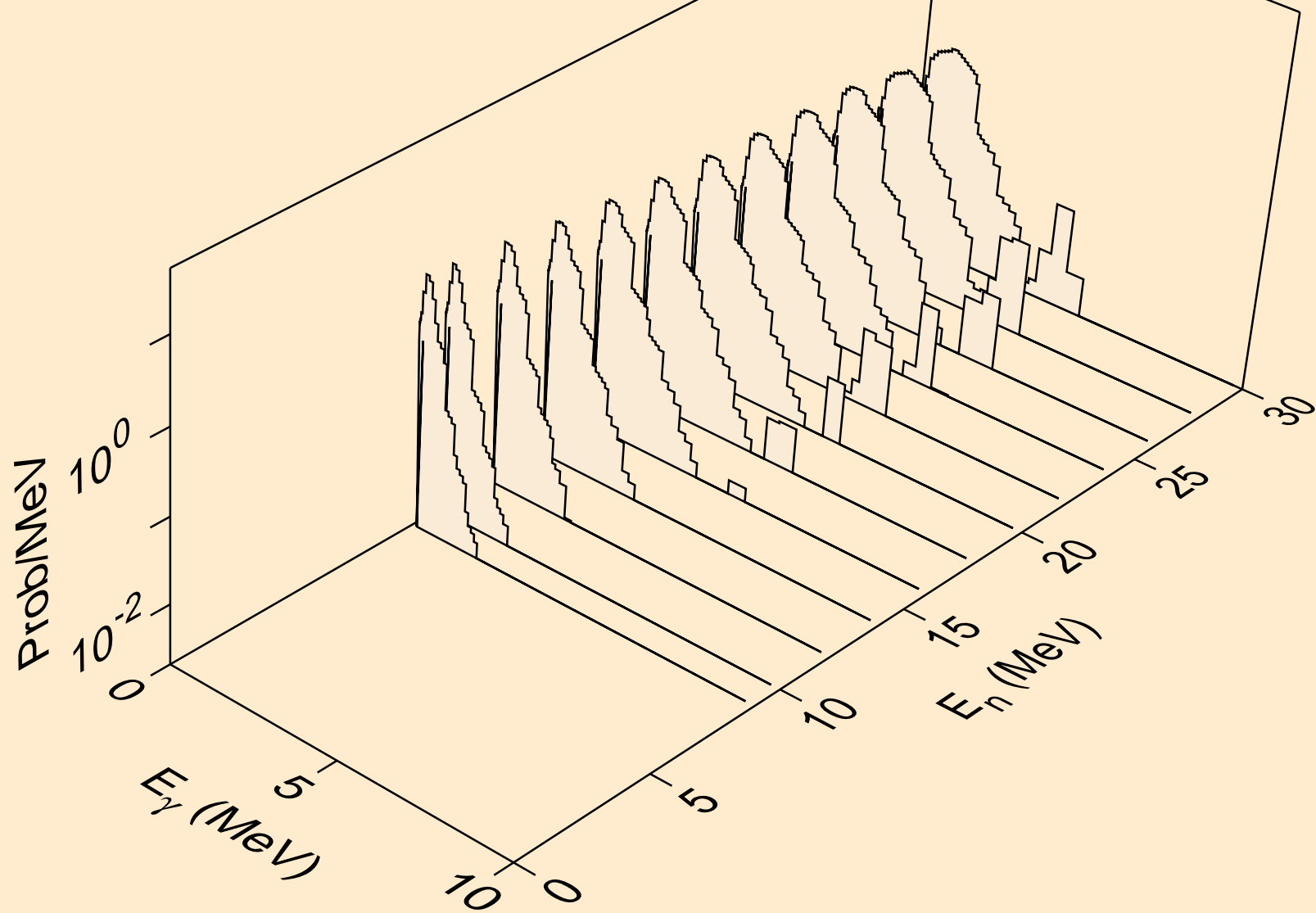

PB219 HELION ACER TENDL-2021 LIBRARY; T=0.K  
Photon emission for (n,3n)a

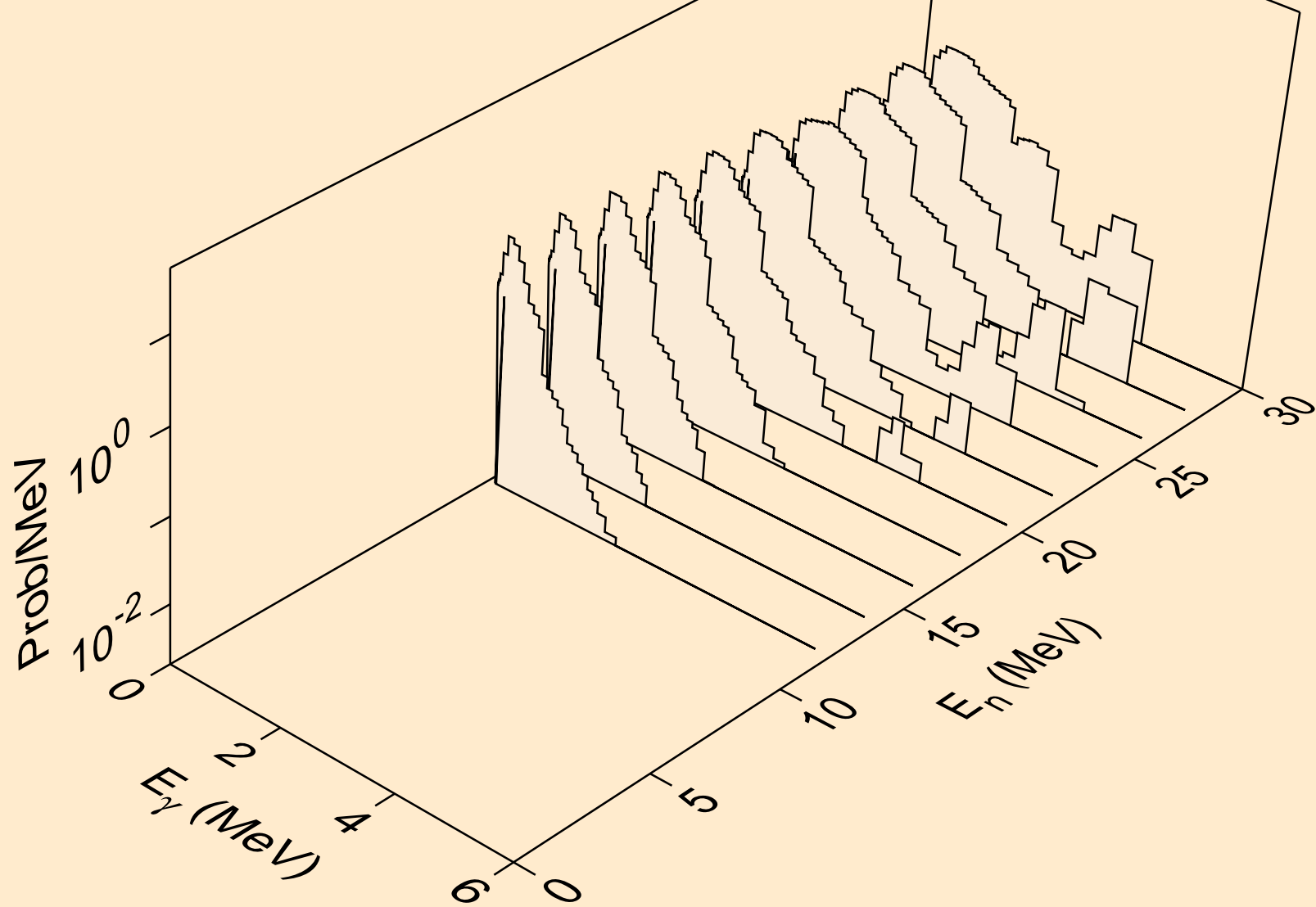



PB219 HELION ACER TENDL-2021 LIBRARY; T=0.K  
Photon emission for (n,n\*)p

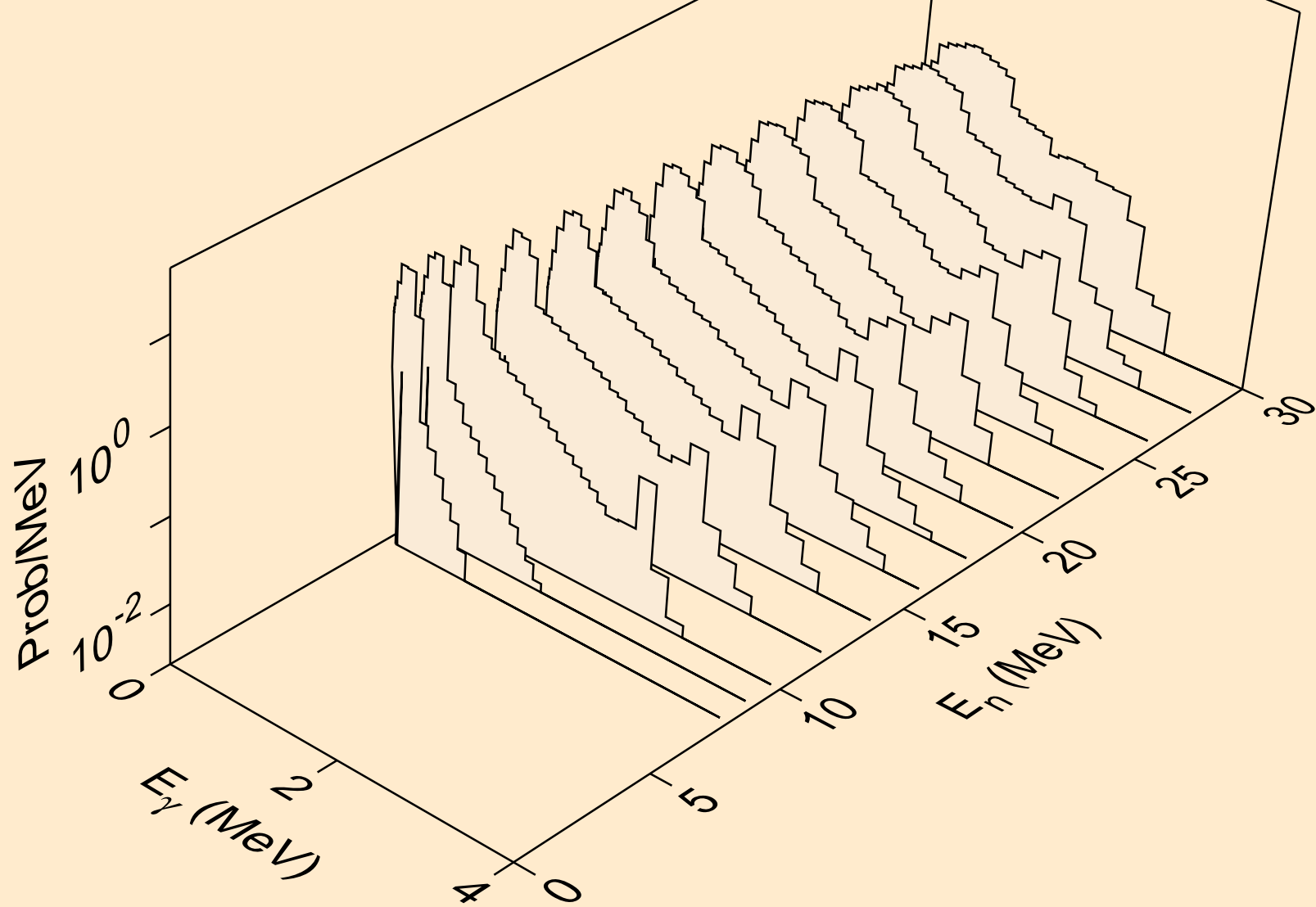

PB219 HELION ACER TENDL-2021 LIBRARY; T=0.K  
Photon emission for (n,n\*)d

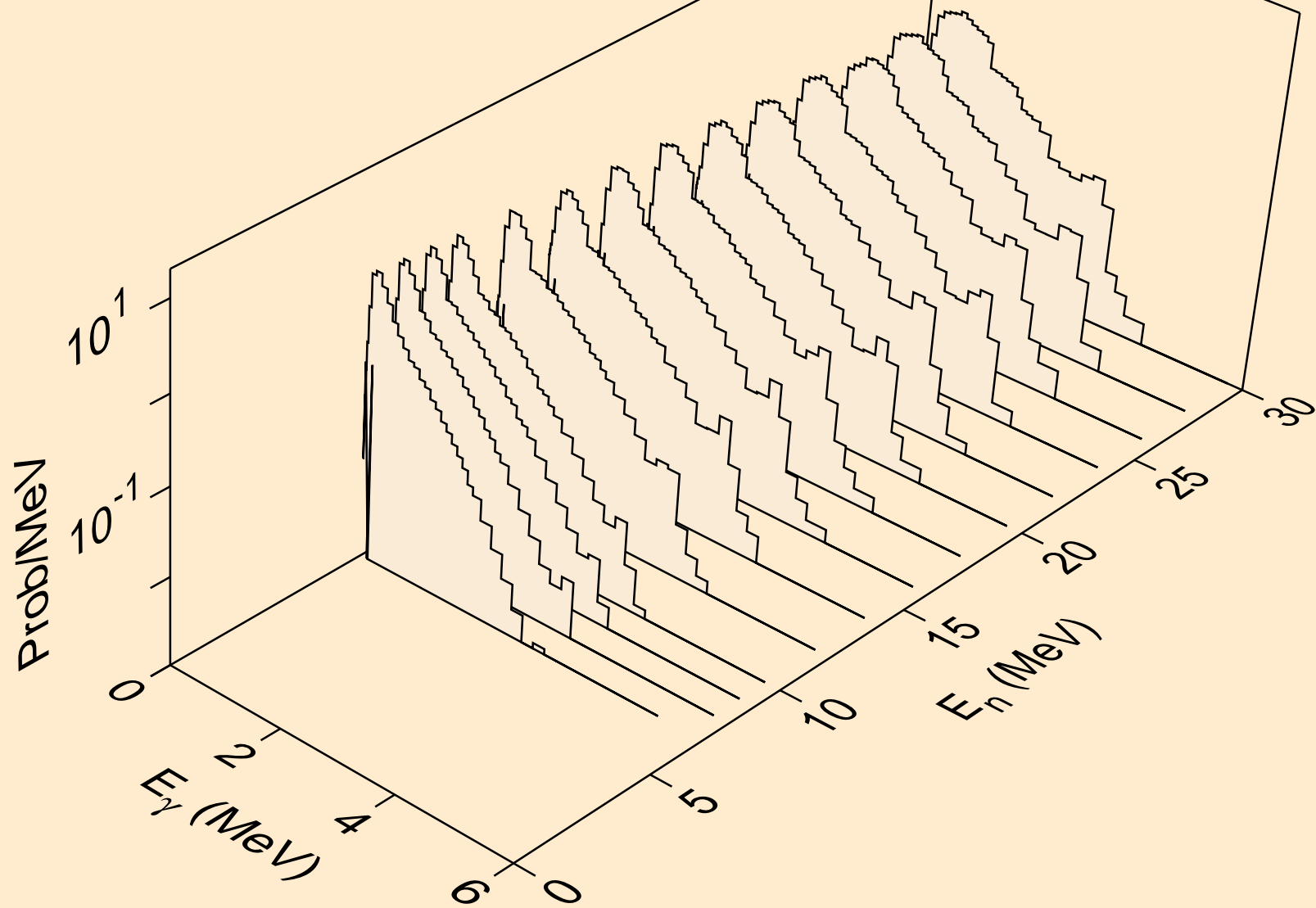

PB219 HELION ACER TENDL-2021 LIBRARY; T=0.K  
Photon emission for (n,n\*)t

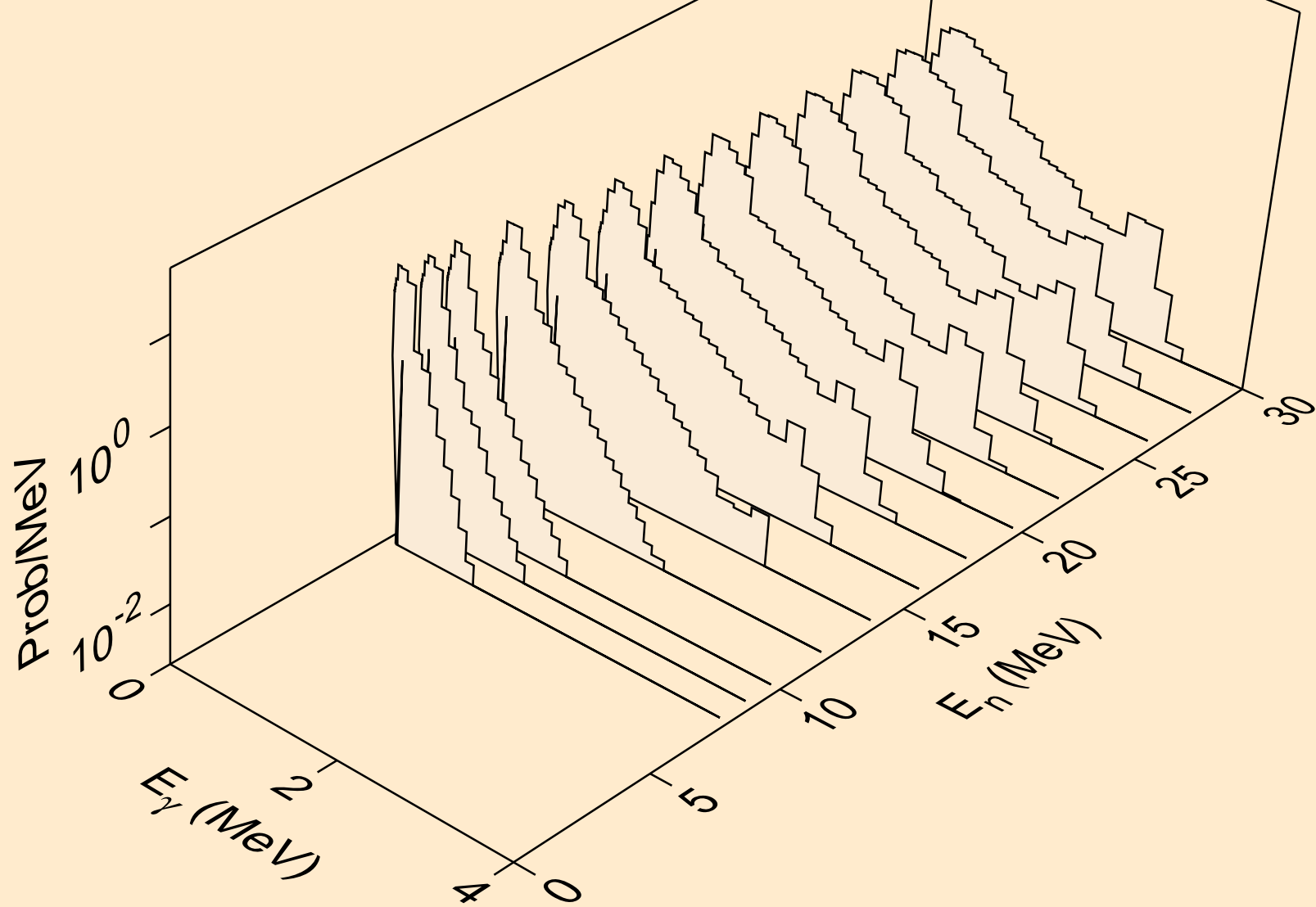

PB219 HELION ACER TENDL-2021 LIBRARY; T=0.K  
Photon emission for (n,n\*)he3

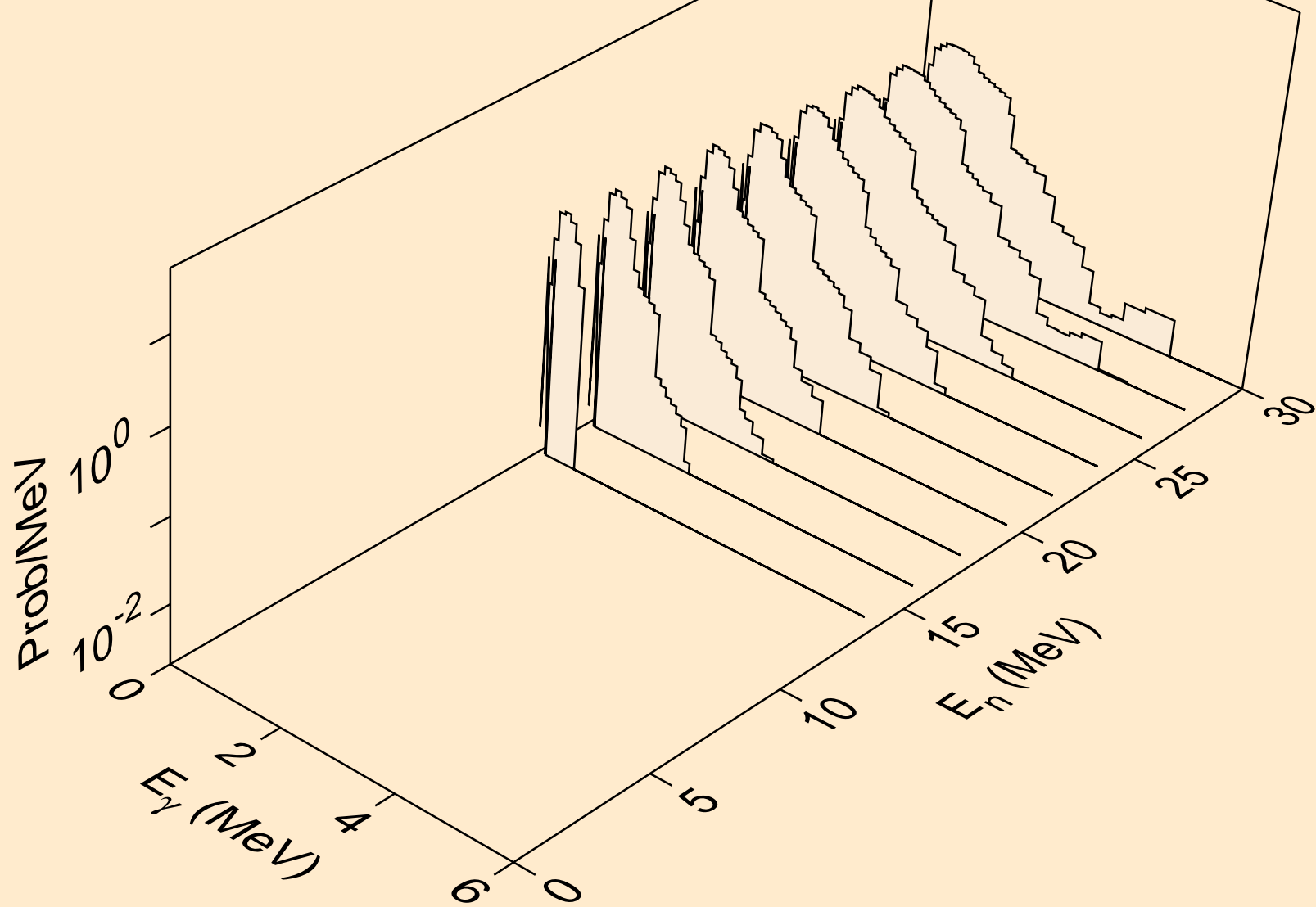

PB219 HELION ACER TENDL-2021 LIBRARY; T=0.K  
Photon emission for (n,4n)

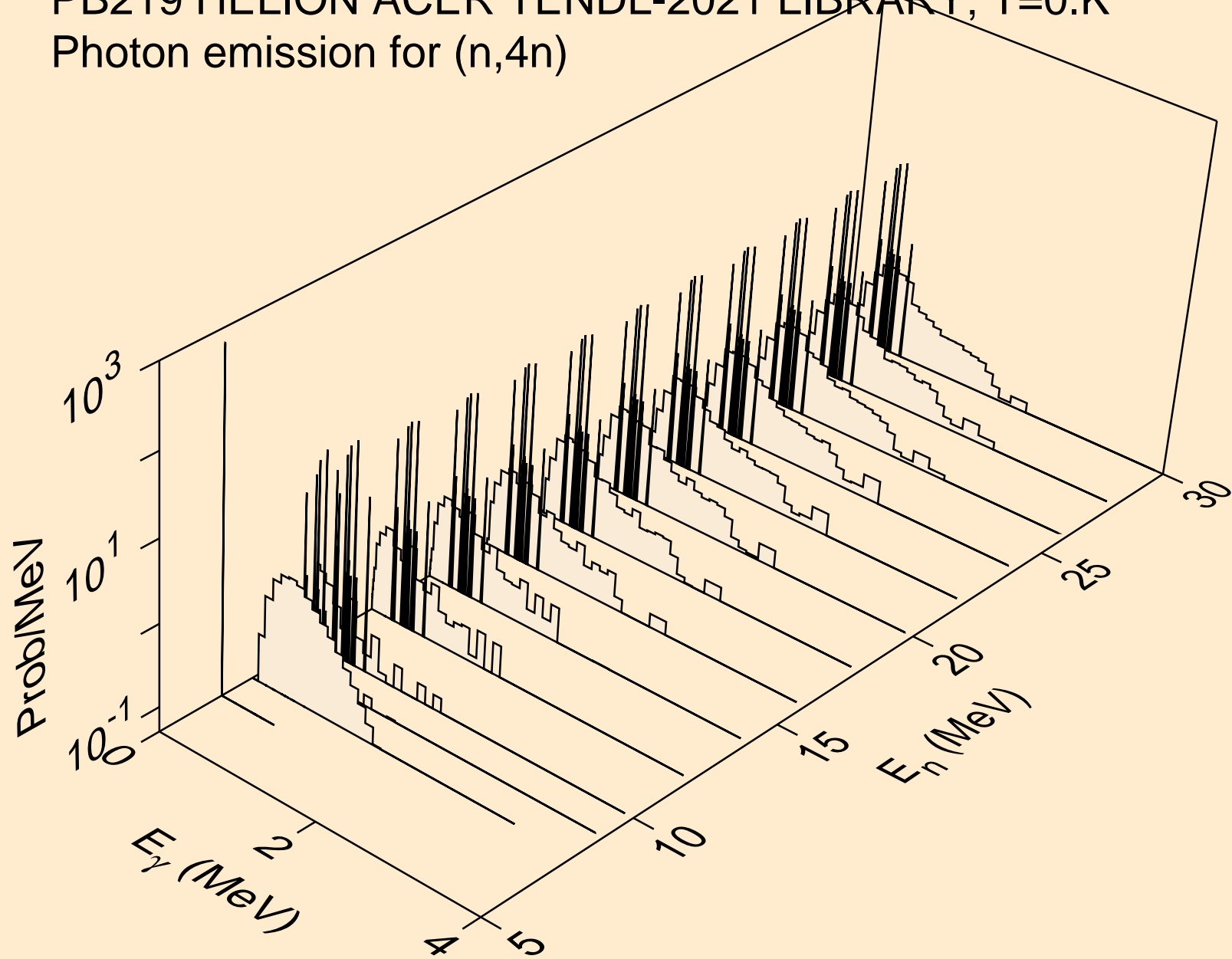

PB219 HELION ACER TENDL-2021 LIBRARY; T=0.K  
Photon emission for (n,2np)

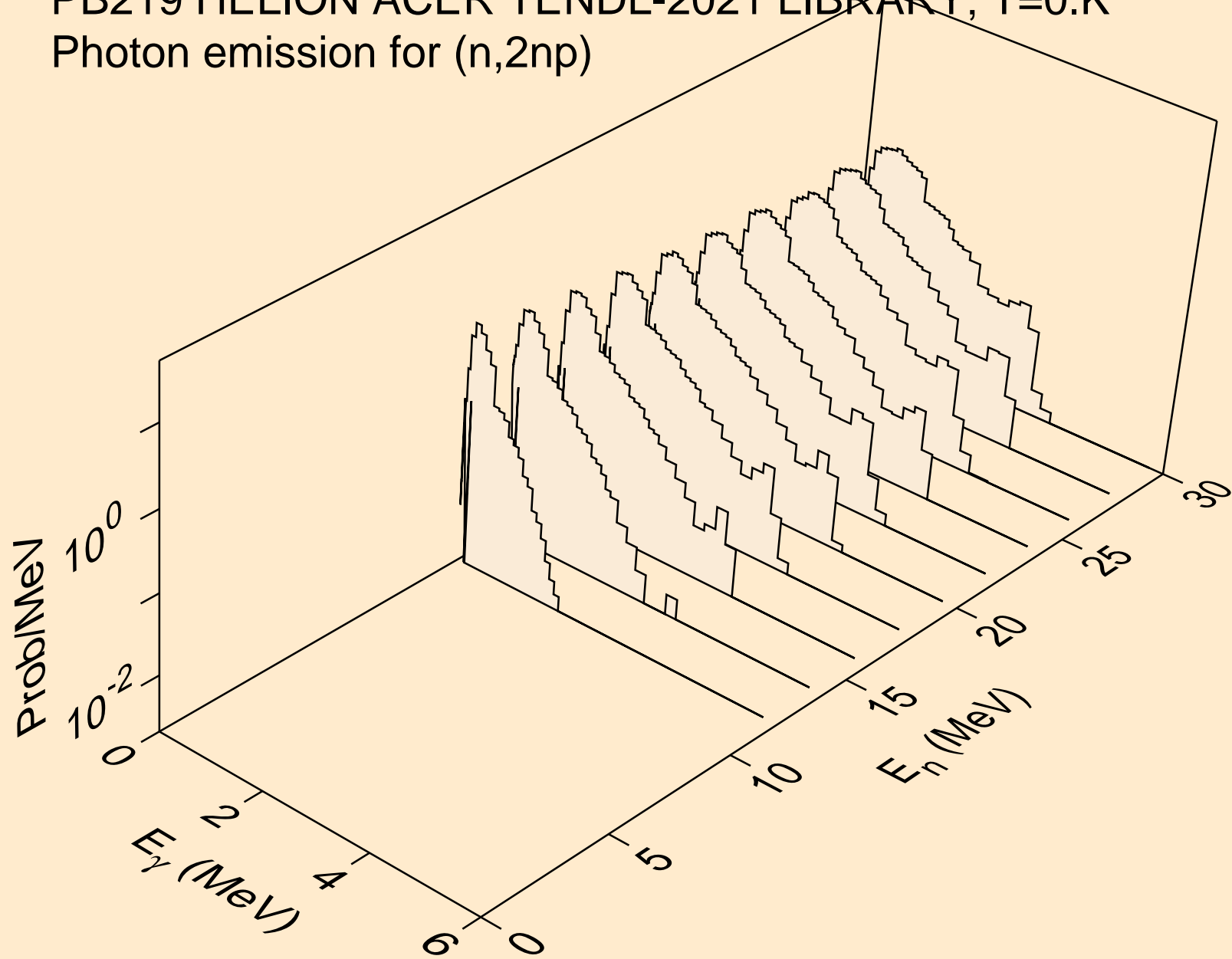

PB219 HELION ACER TENDL-2021 LIBRARY; T=0.K  
Photon emission for (n,3np)

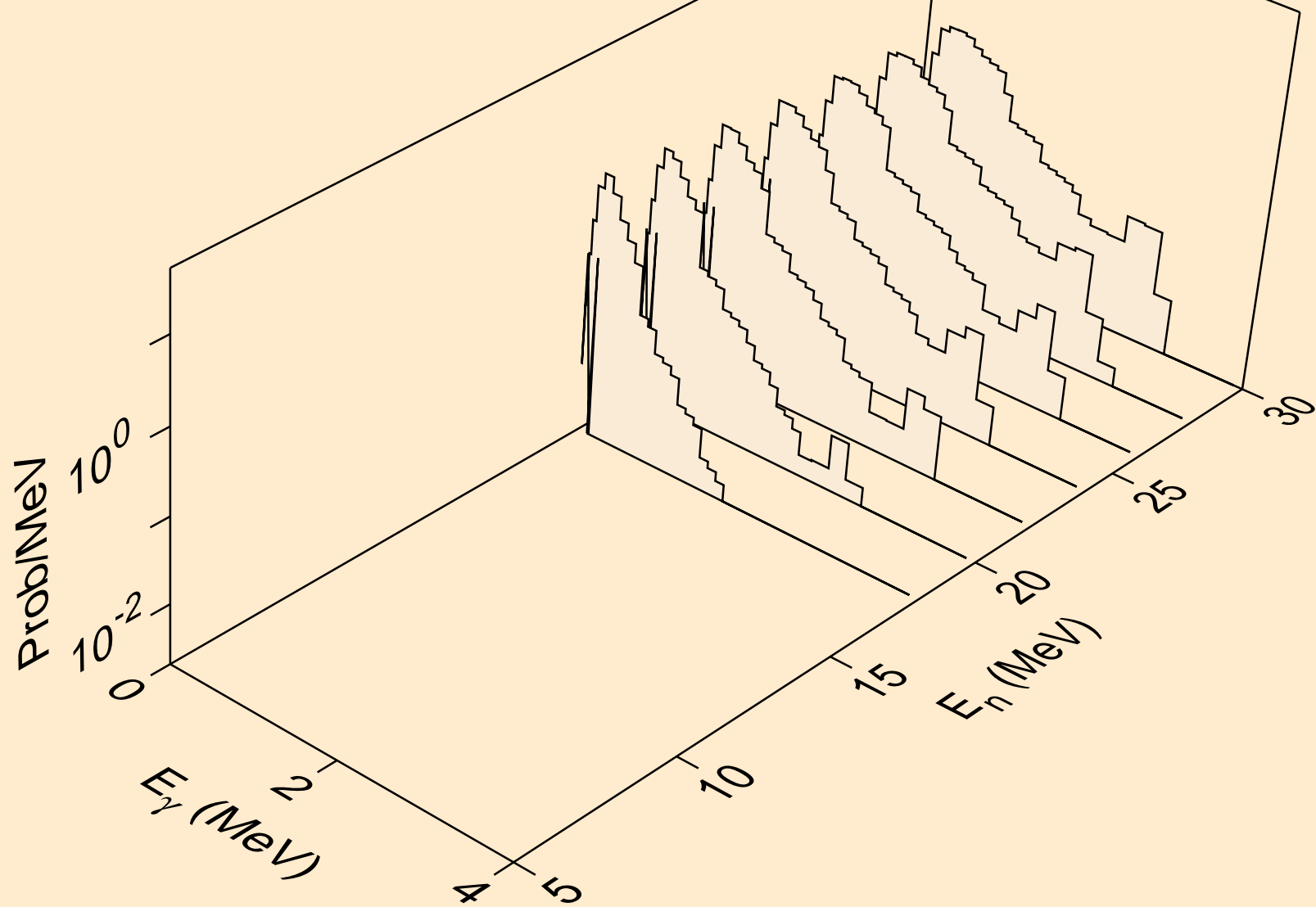

PB219 HELION ACER TENDL-2021 LIBRARY; T=0.K  
Photon emission for (n,2np)

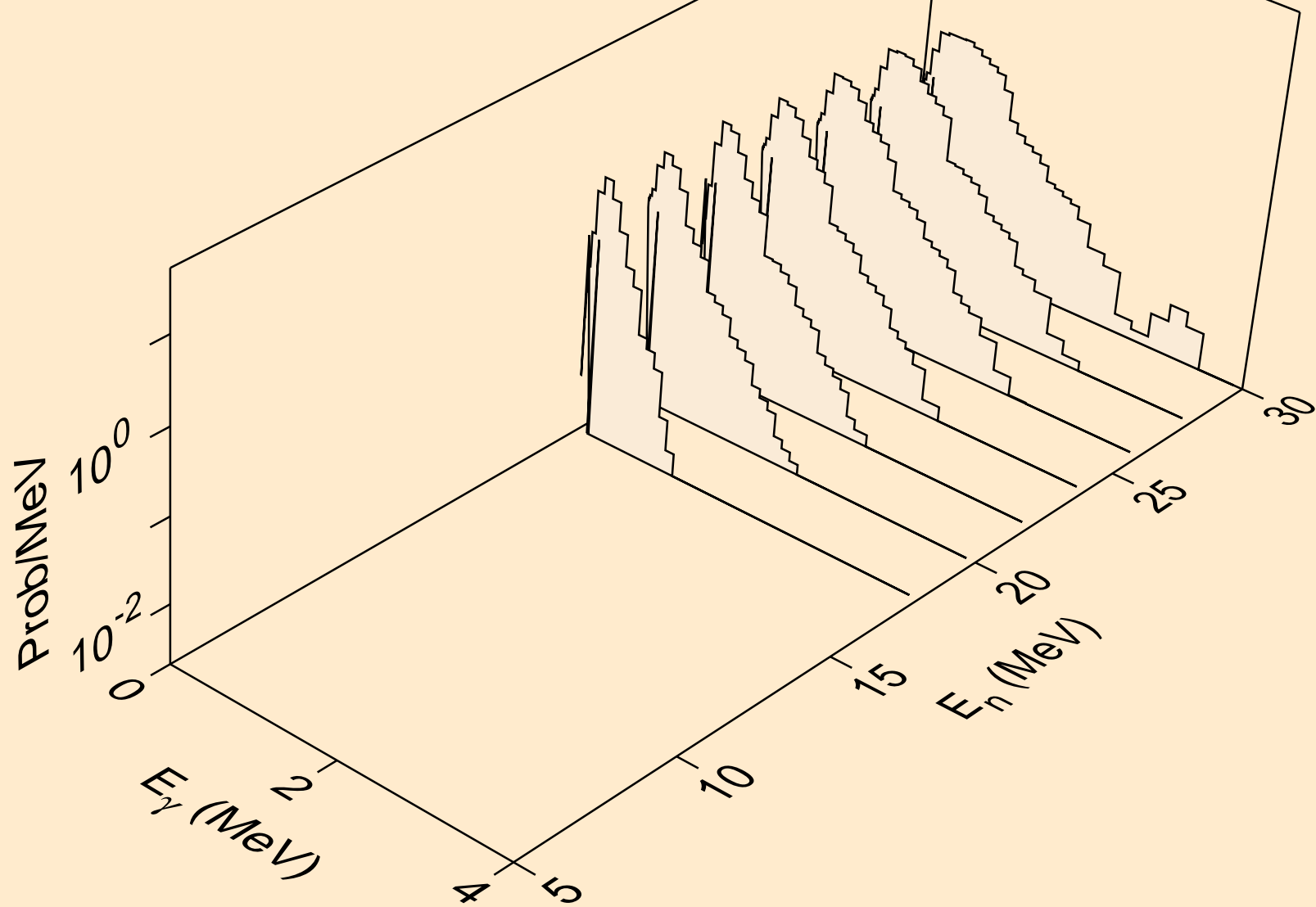



PB219 HELION ACER TENDL-2021 LIBRARY; T=0.K  
Photon emission for (n,npa)

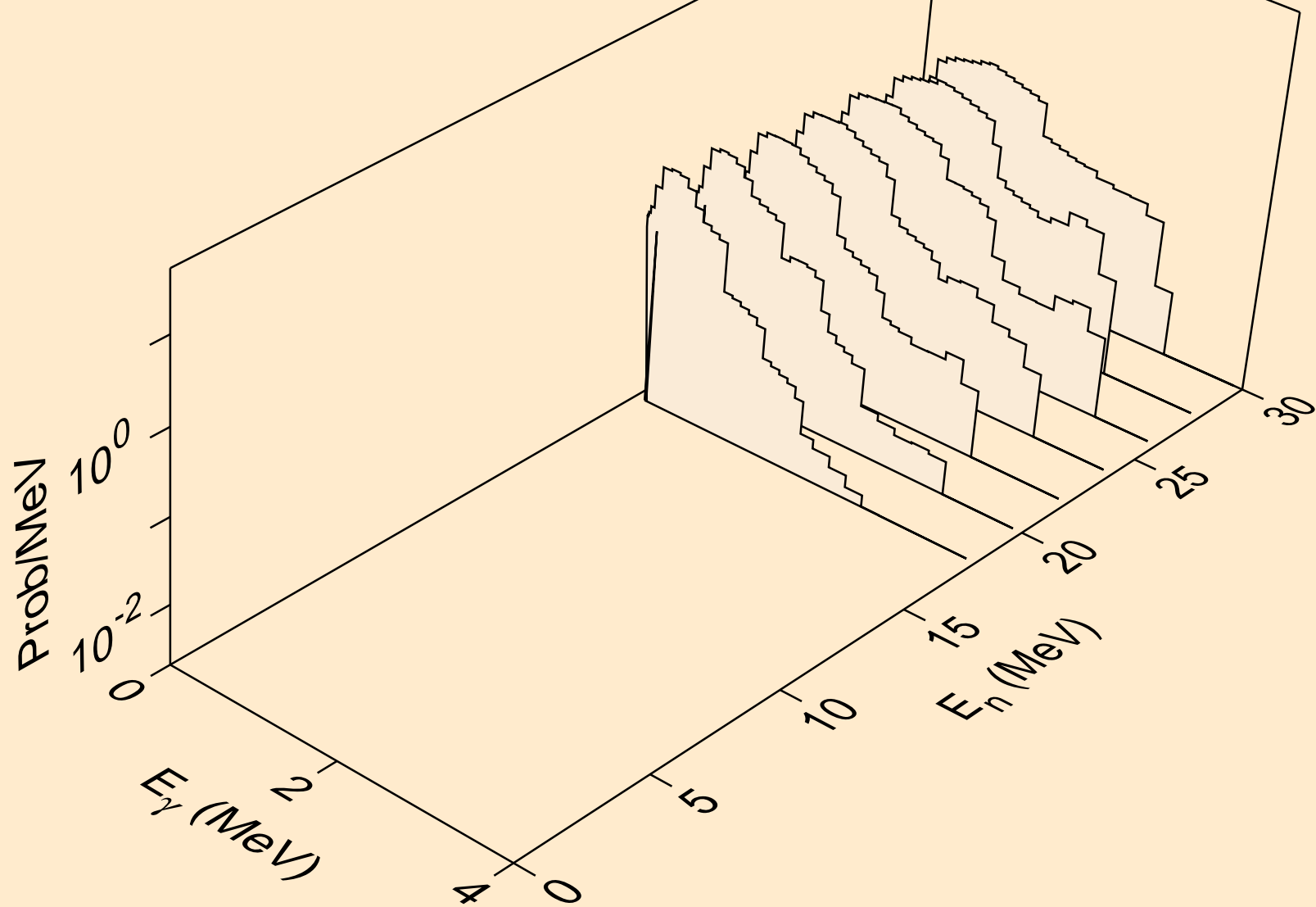

PB219 HELION ACER TENDL-2021 LIBRARY; T=0.K  
Photon emission for (n,p)

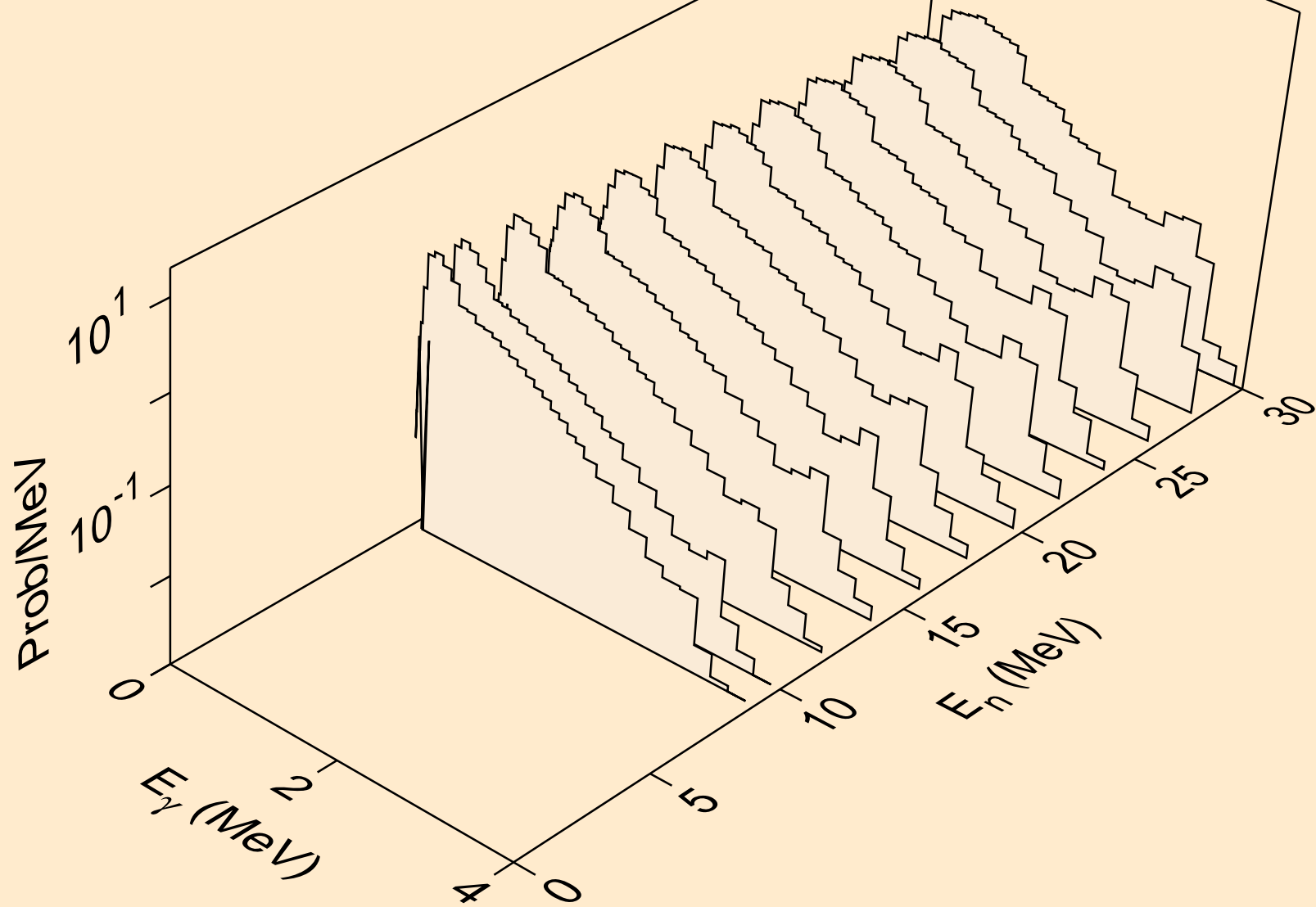

PB219 HELION ACER TENDL-2021 LIBRARY; T=0.K  
Photon emission for (n,d)

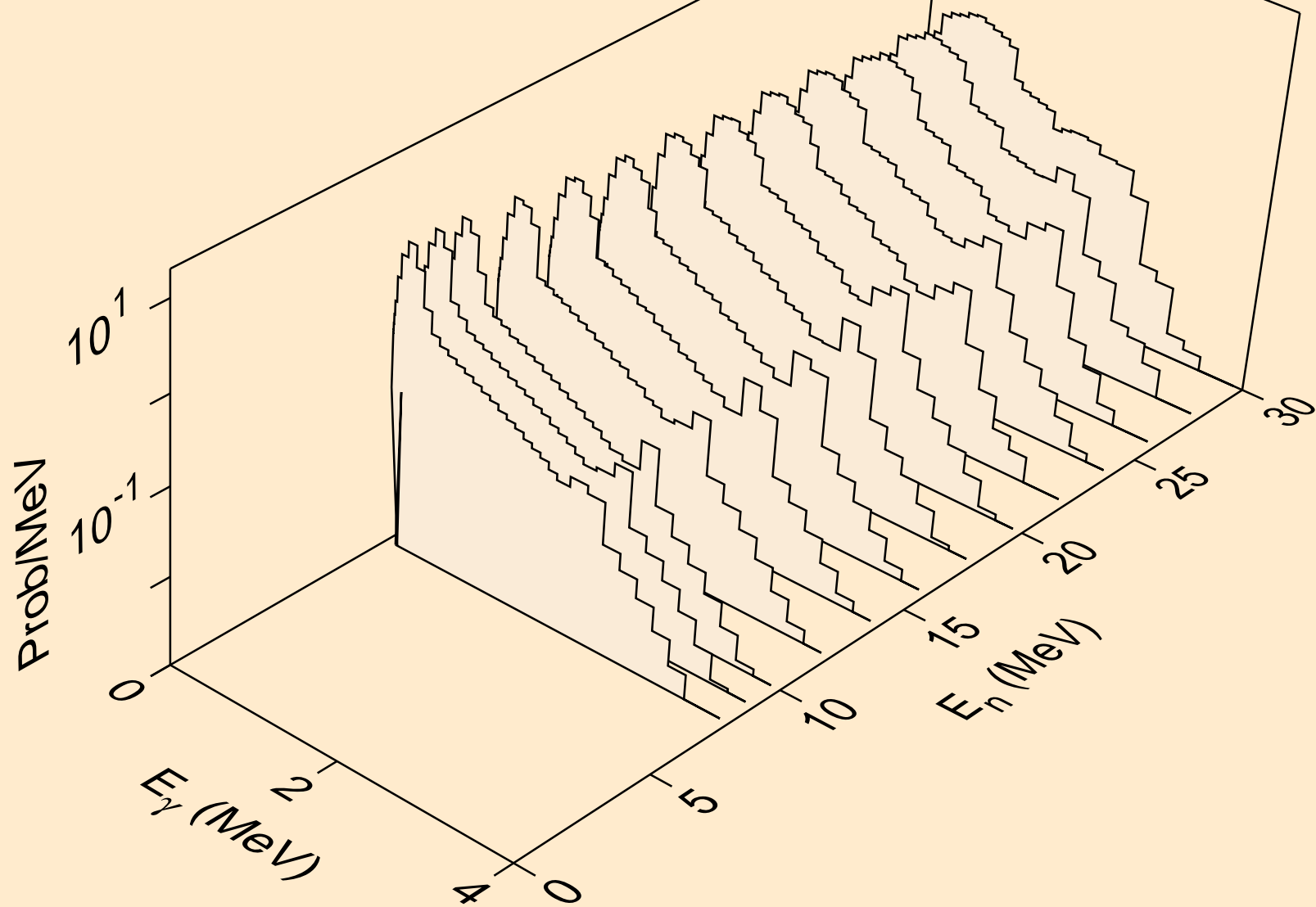

PB219 HELION ACER TENDL-2021 LIBRARY; T=0.K  
Photon emission for (n,t)

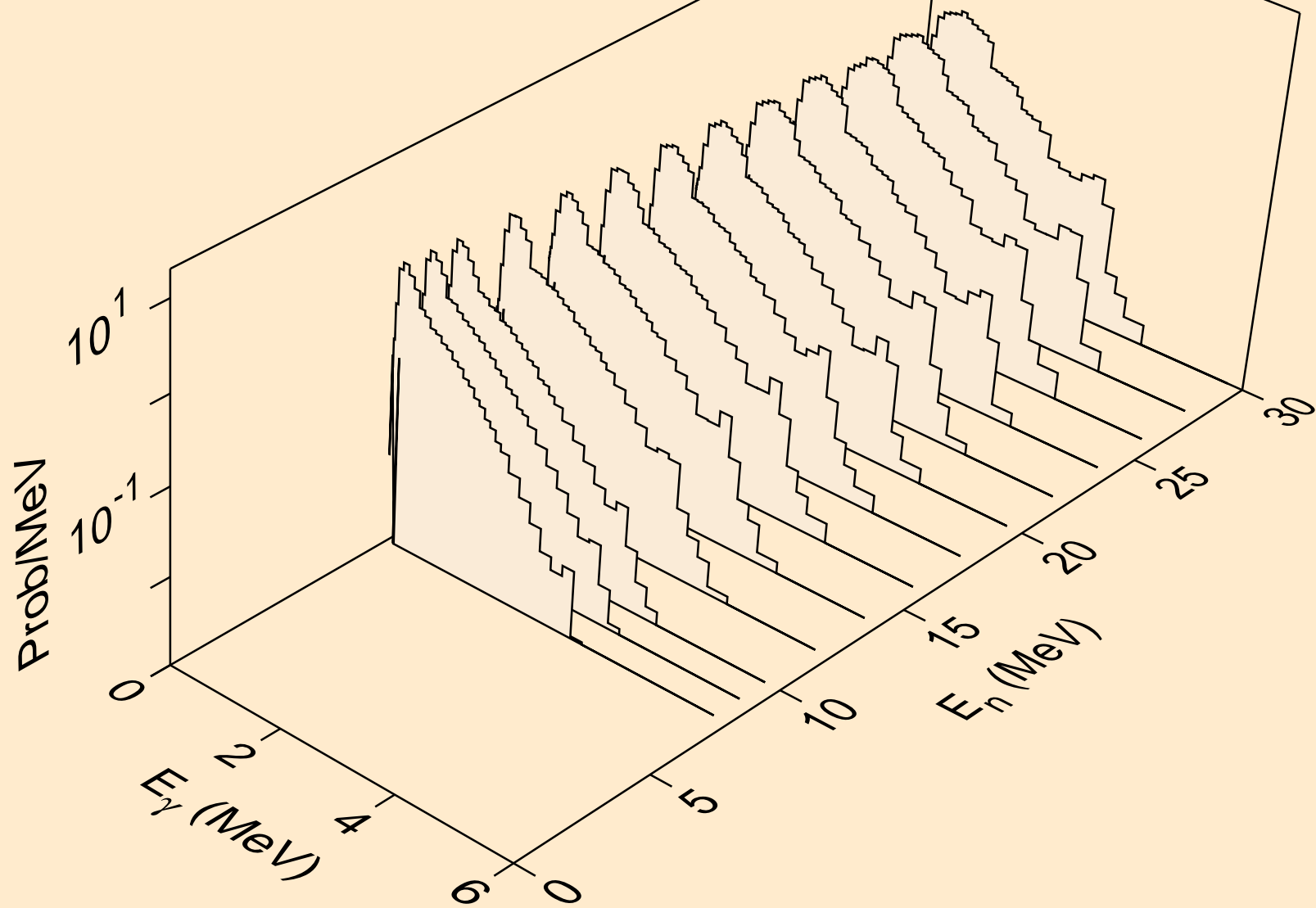

PB219 HELION ACER TENDL-2021 LIBRARY; T=0.K  
Photon emission for inelastic

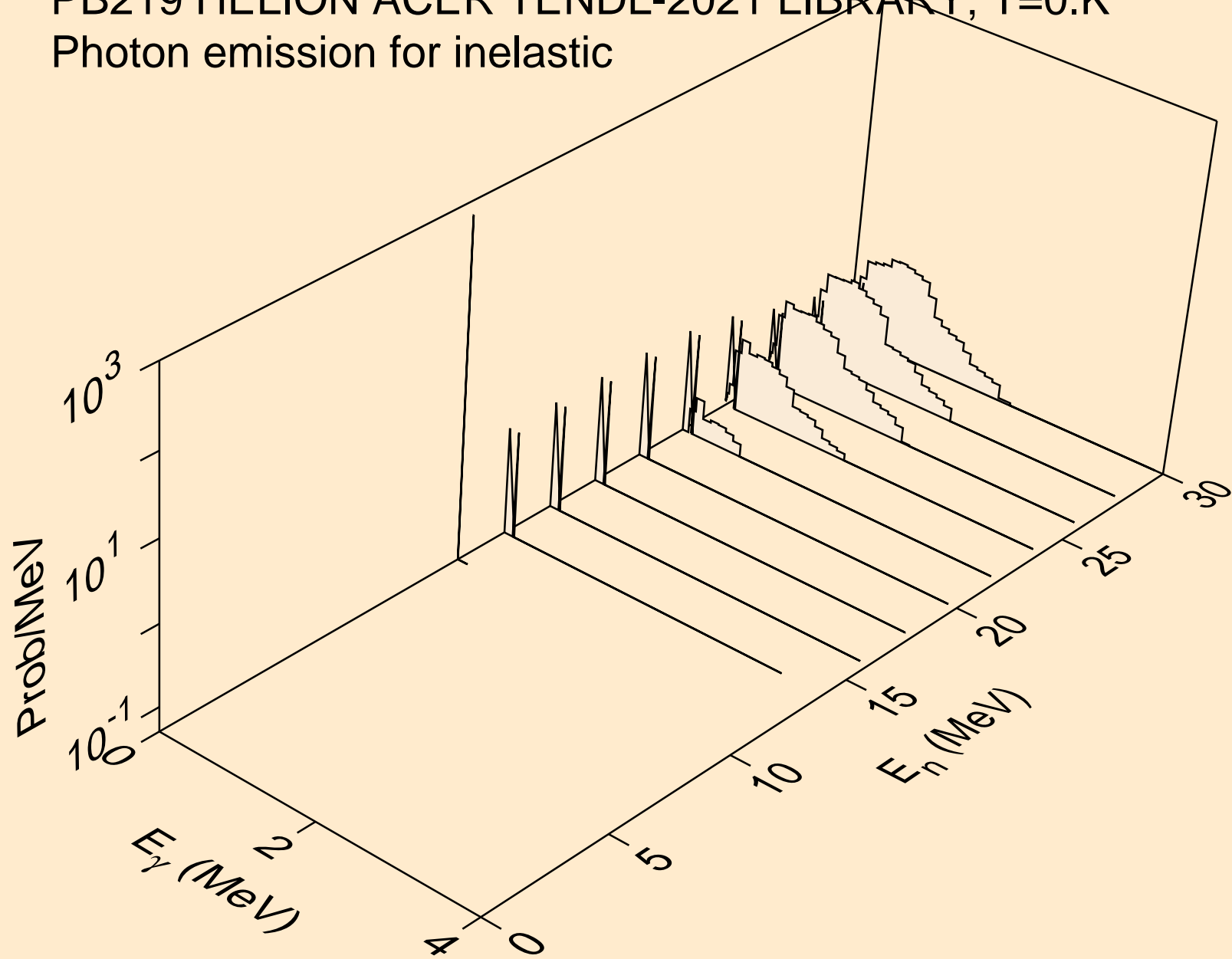

PB219 HELION ACER TENDL-2021 LIBRARY; T=0.K  
Photon emission for (n,a)

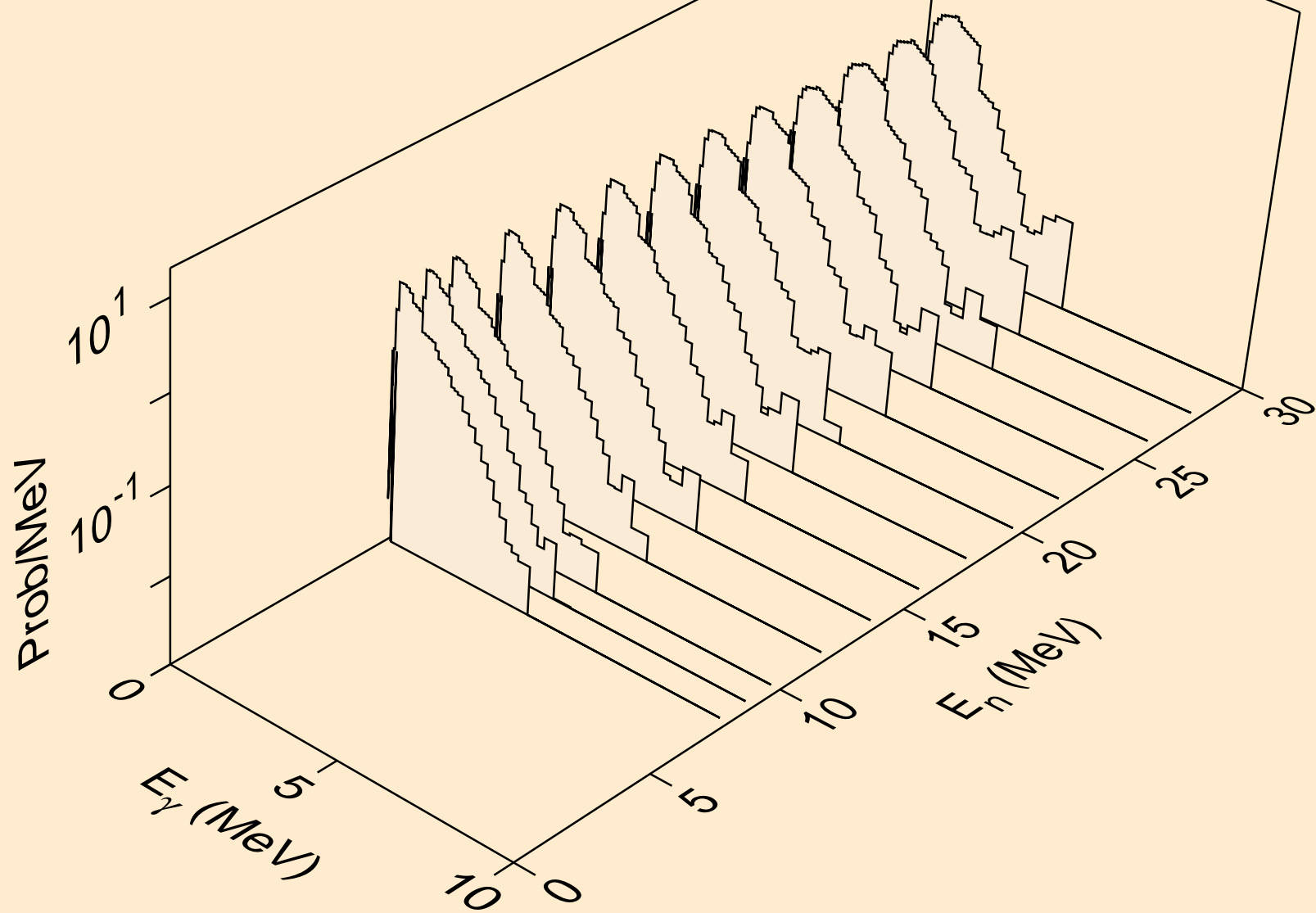

PB219 HELION ACER TENDL-2021 LIBRARY; T=0.K  
Photon emission for (n,2p)

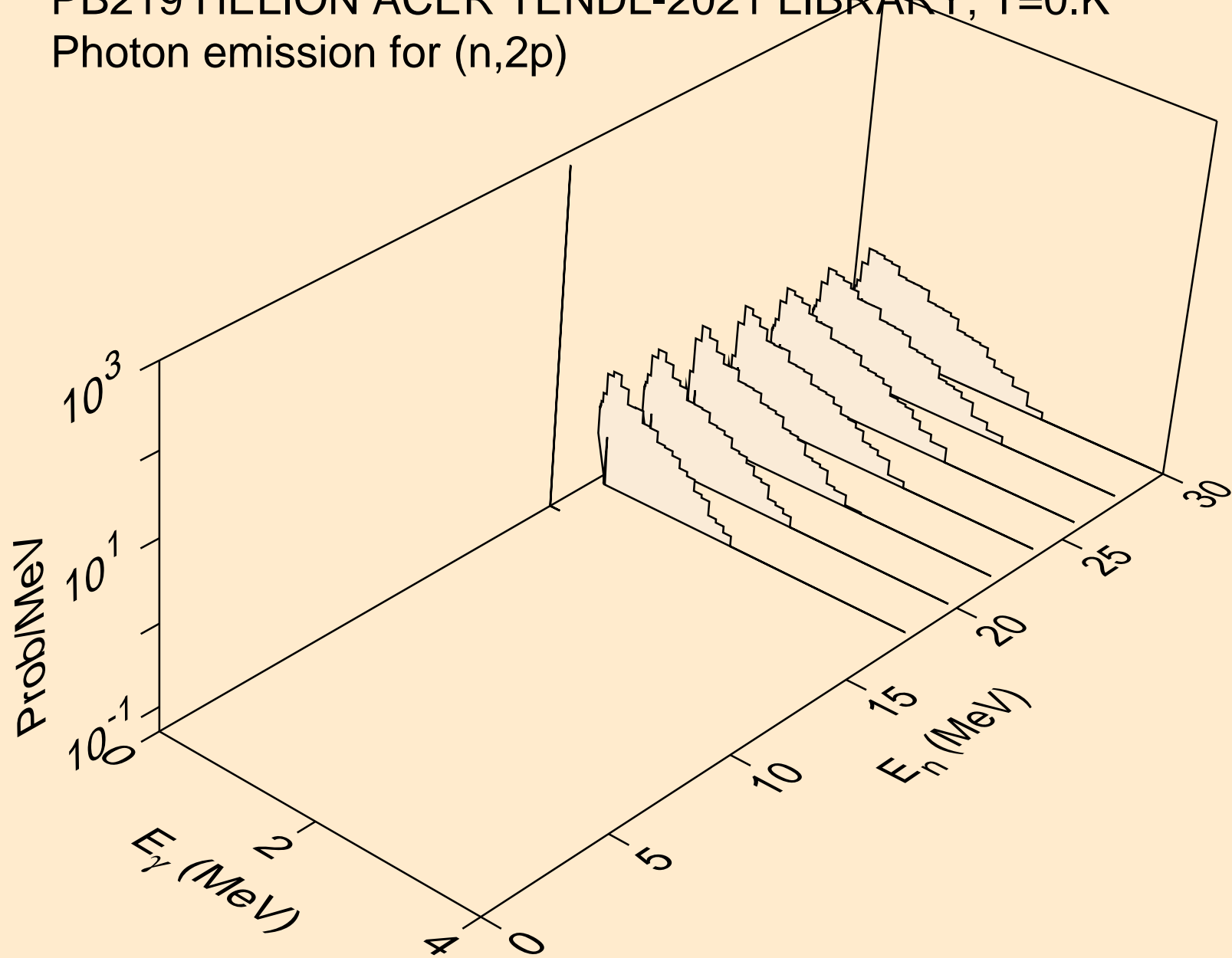

PB219 HELION ACER TENDL-2021 LIBRARY; T=0.K  
Photon emission for (n,pd)

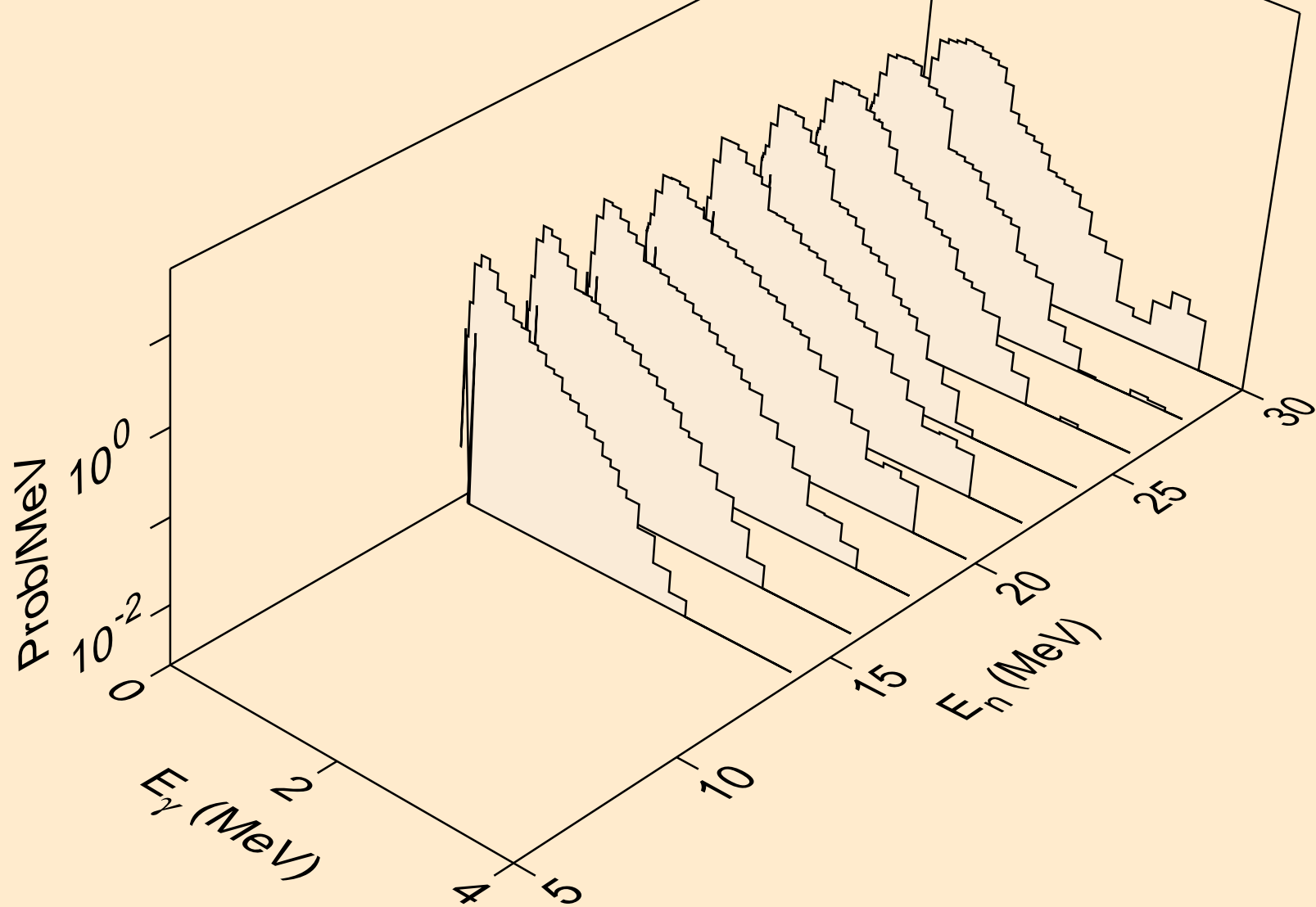



PB219 HELION ACER TENDL-2021 LIBRARY; T=0.K  
Photon emission for (n,pt)

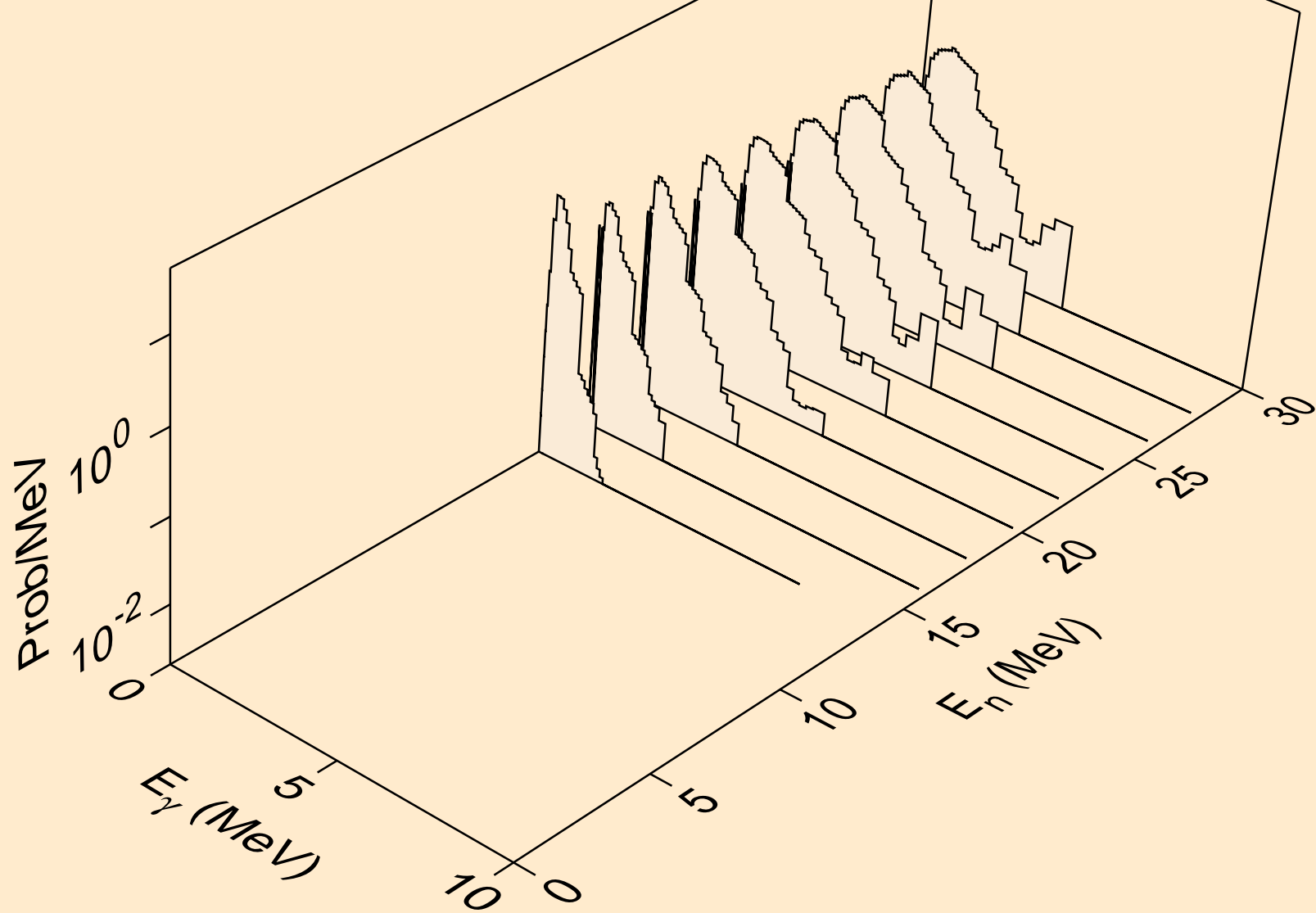

PB219 HELION ACER TENDL-2021 LIBRARY; T=0.K  
Particle heating contributions

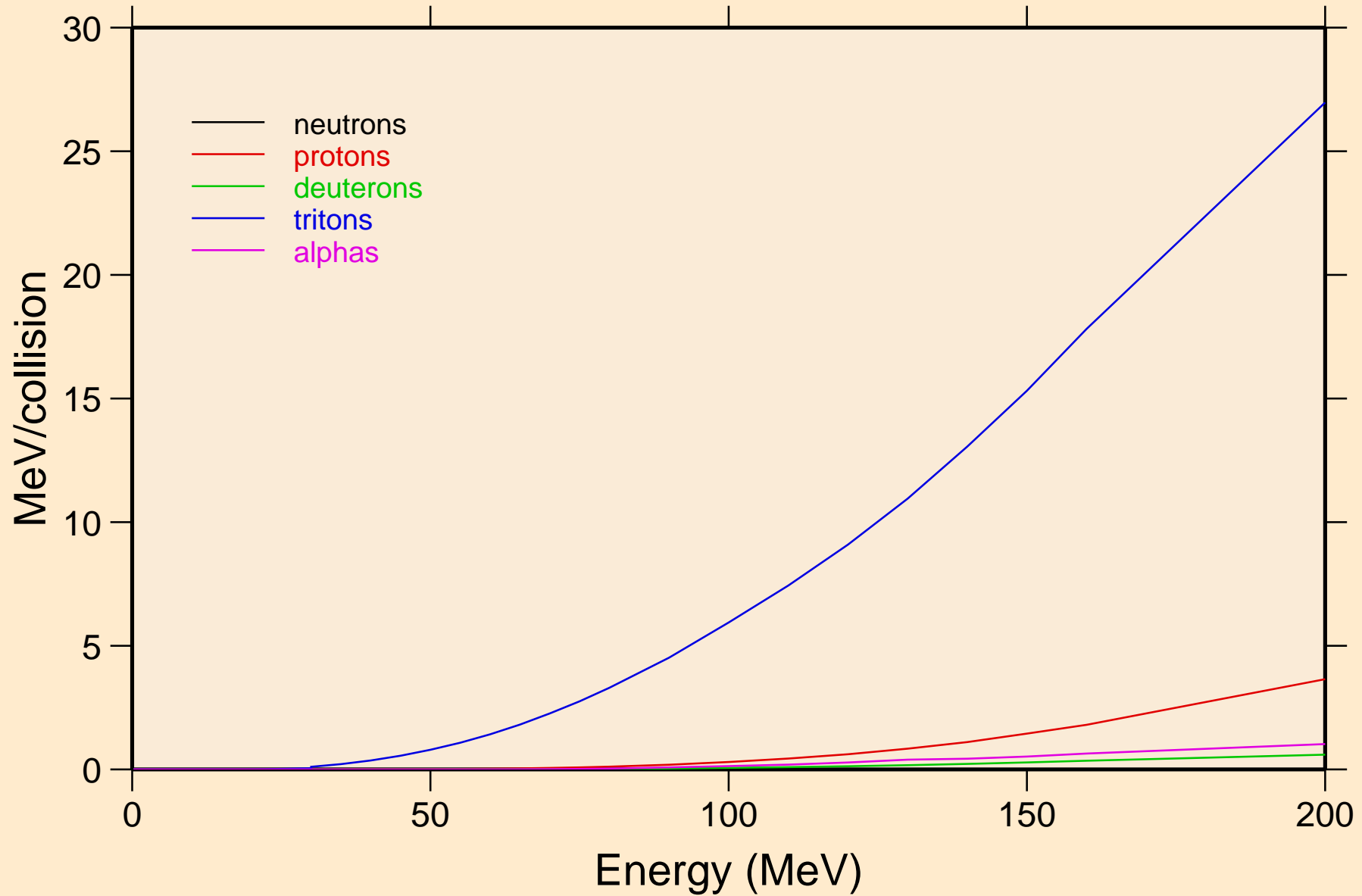

PB219 HELION ACER TENDL-2021 LIBRARY; T=0.K  
Recoil Heating

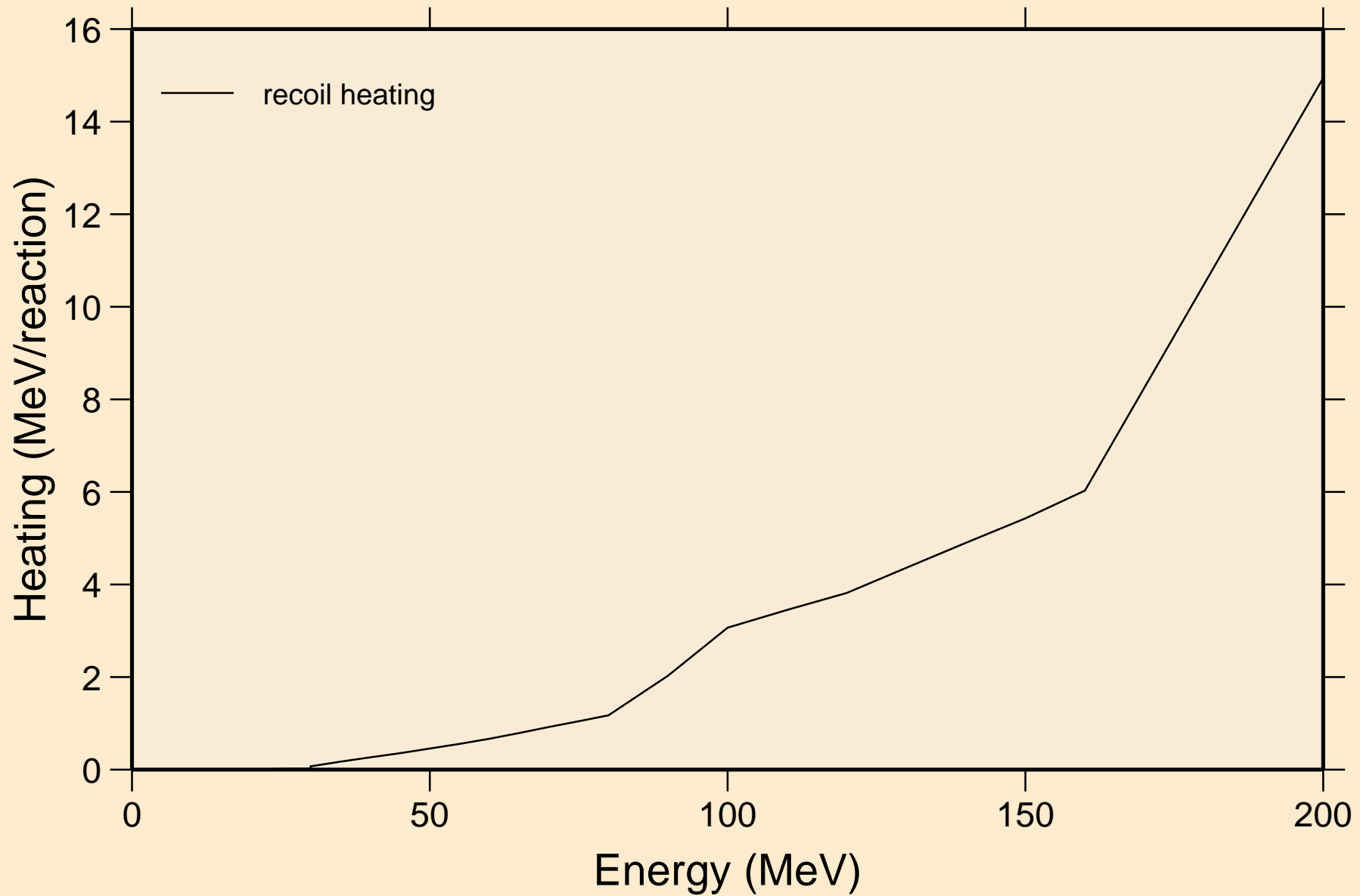

PB219 HELION ACER TENDL-2021 LIBRARY; T=0.K  
Particle production cross sections

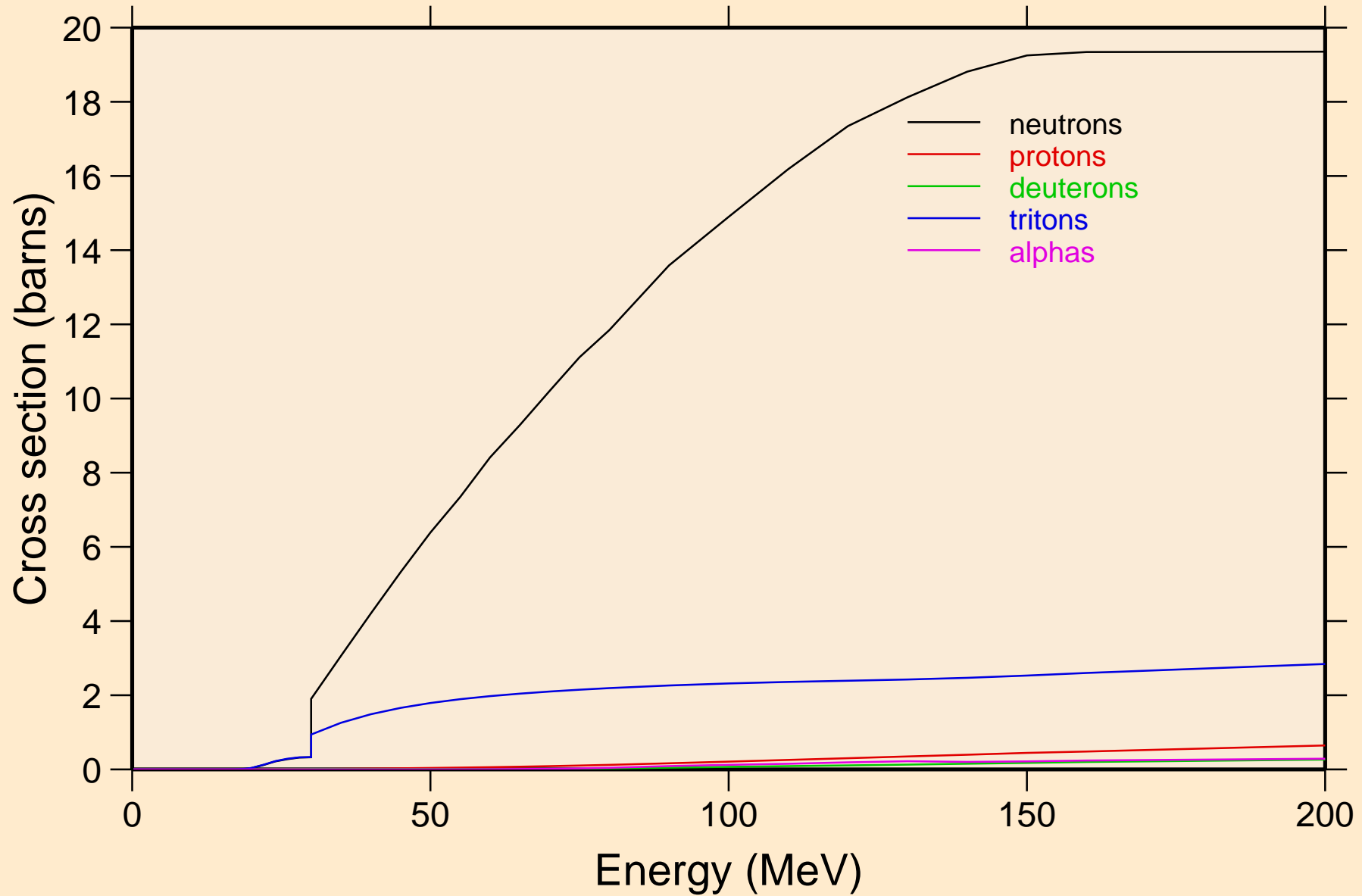

PB219 HELION ACER TENDL-2021 LIBRARY; T=0.K  
neutrons from (s,n)

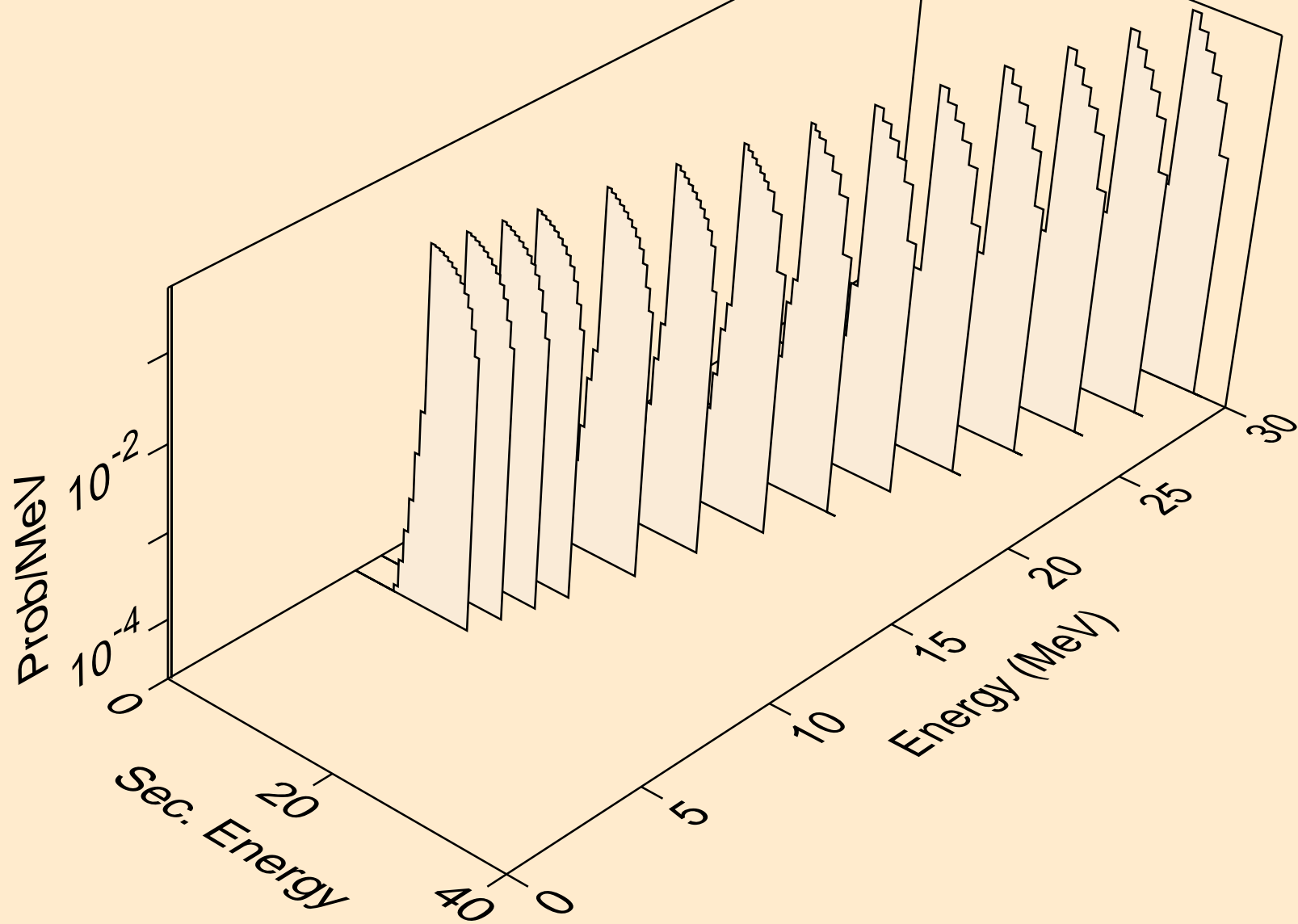

PB219 HELION ACER TENDL-2021 LIBRARY; T=0.K  
neutrons from (s,x)

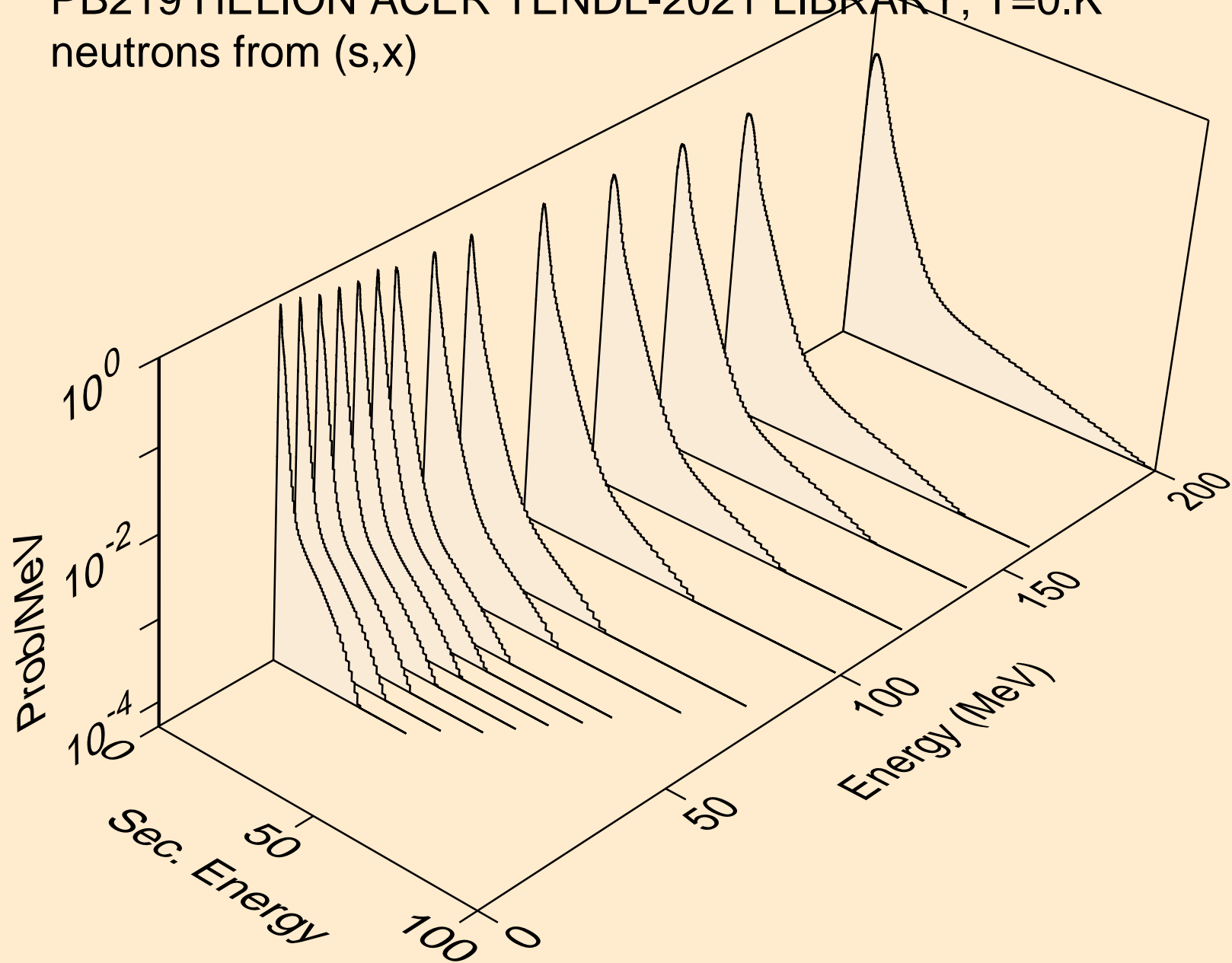

PB219 HELION ACER TENDL-2021 LIBRARY; T=0.K  
neutrons from (s,2nd)

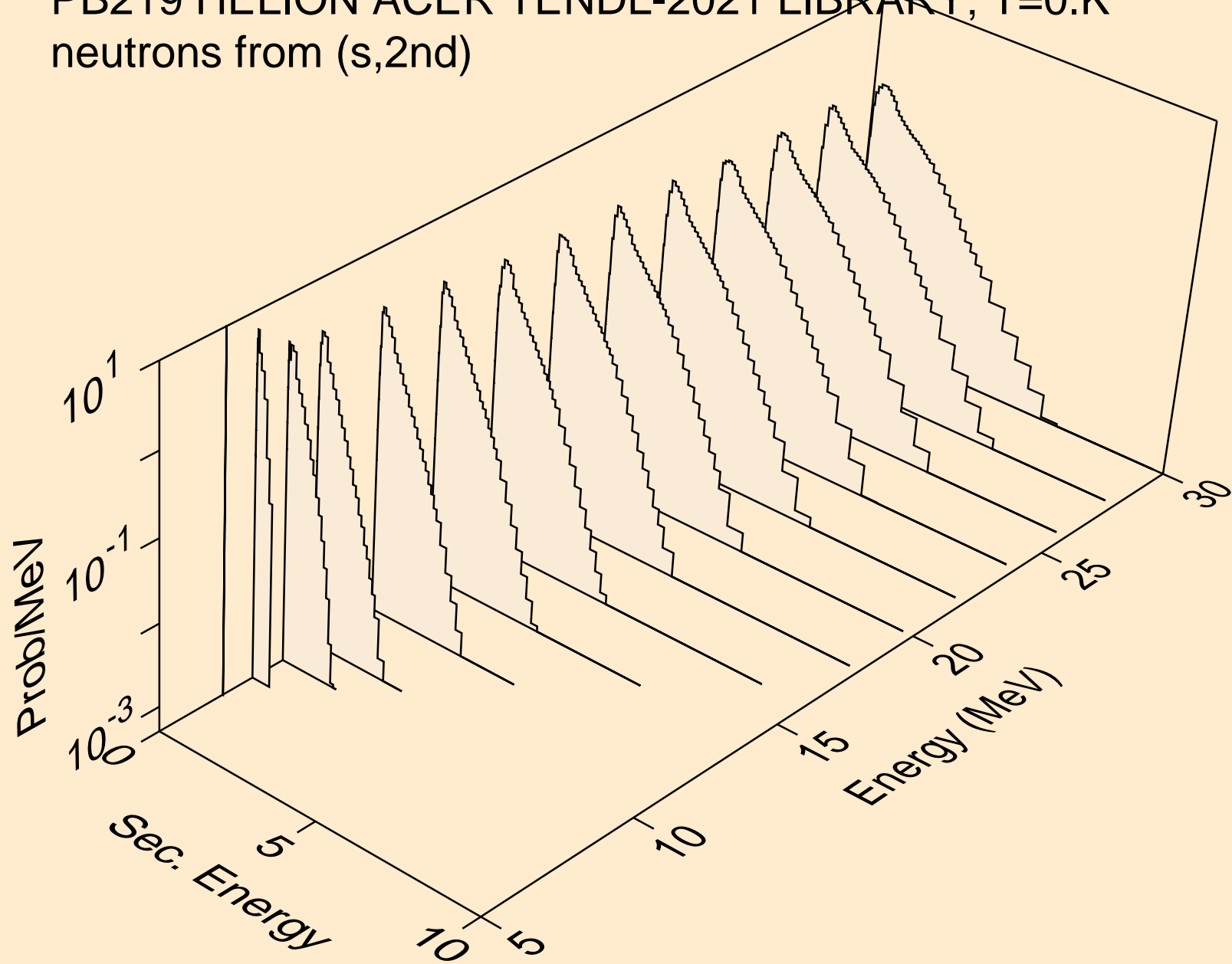

PB219 HELION ACER TENDL-2021 LIBRARY; T=0.K  
neutrons from (s,2n)

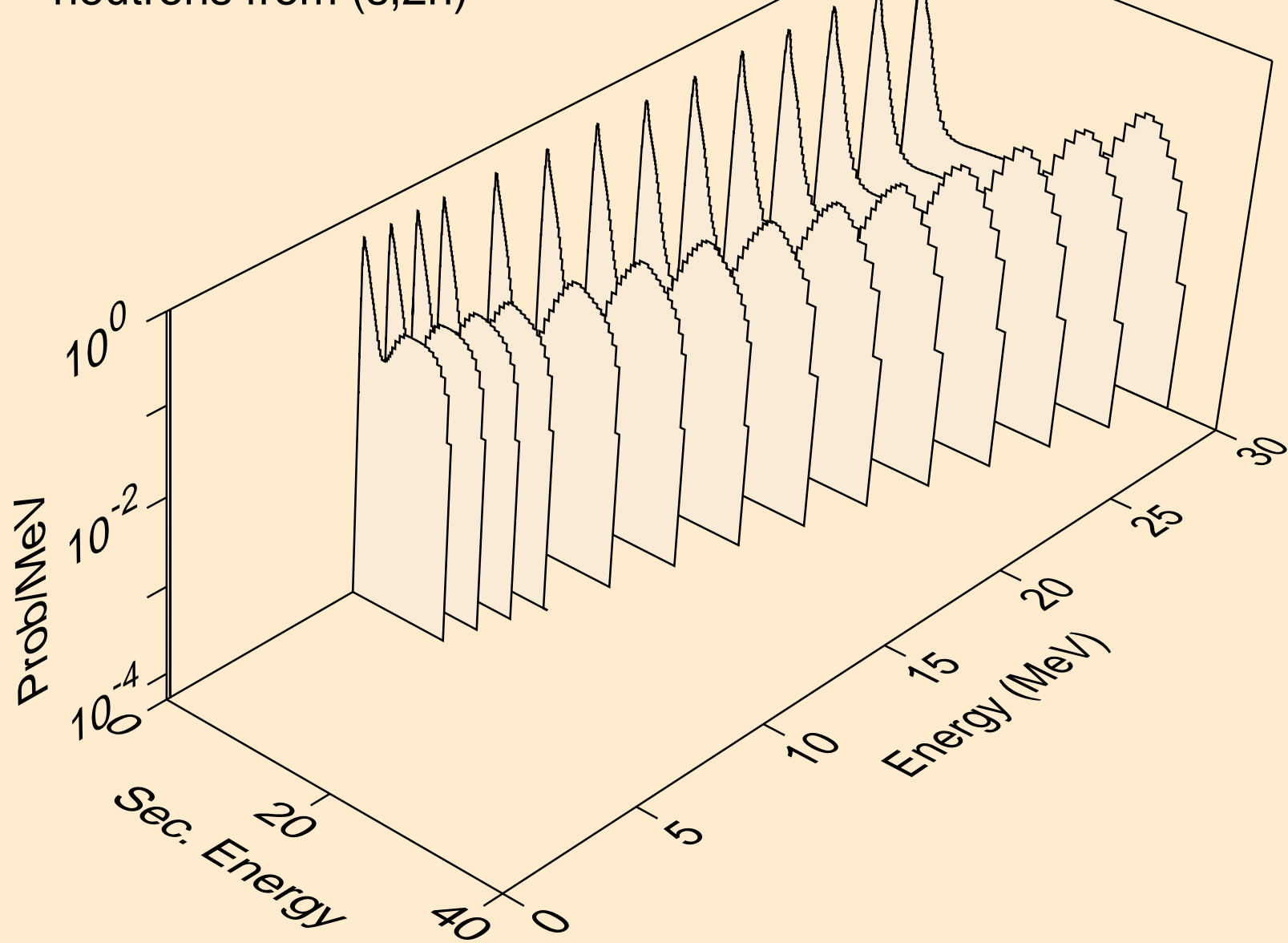



PB219 HELION ACER TENDL-2021 LIBRARY; T=0.K  
neutrons from (s,3n)

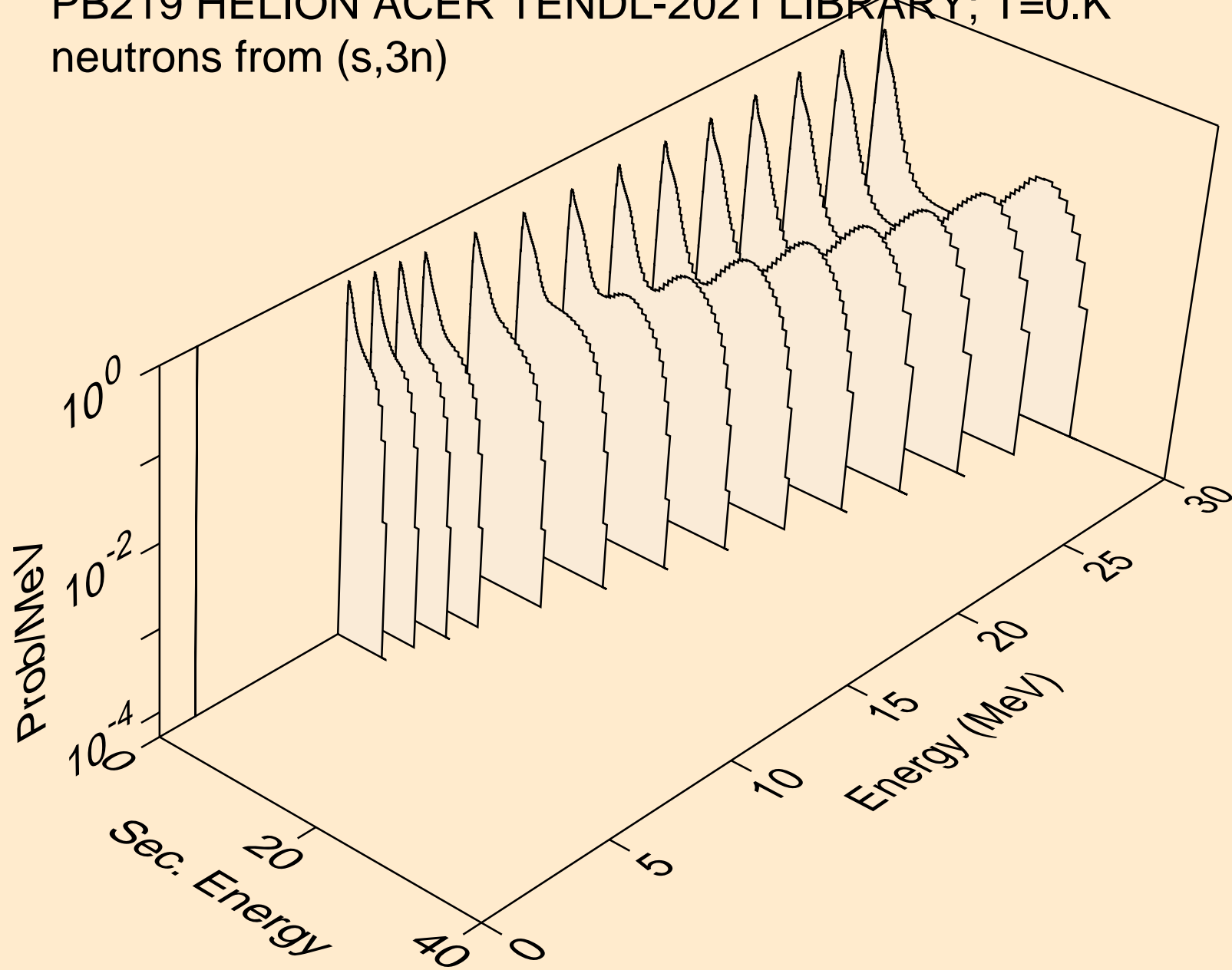

PB219 HELION ACER TENDL-2021 LIBRARY; T=0.K  
neutrons from (s,n\*)a

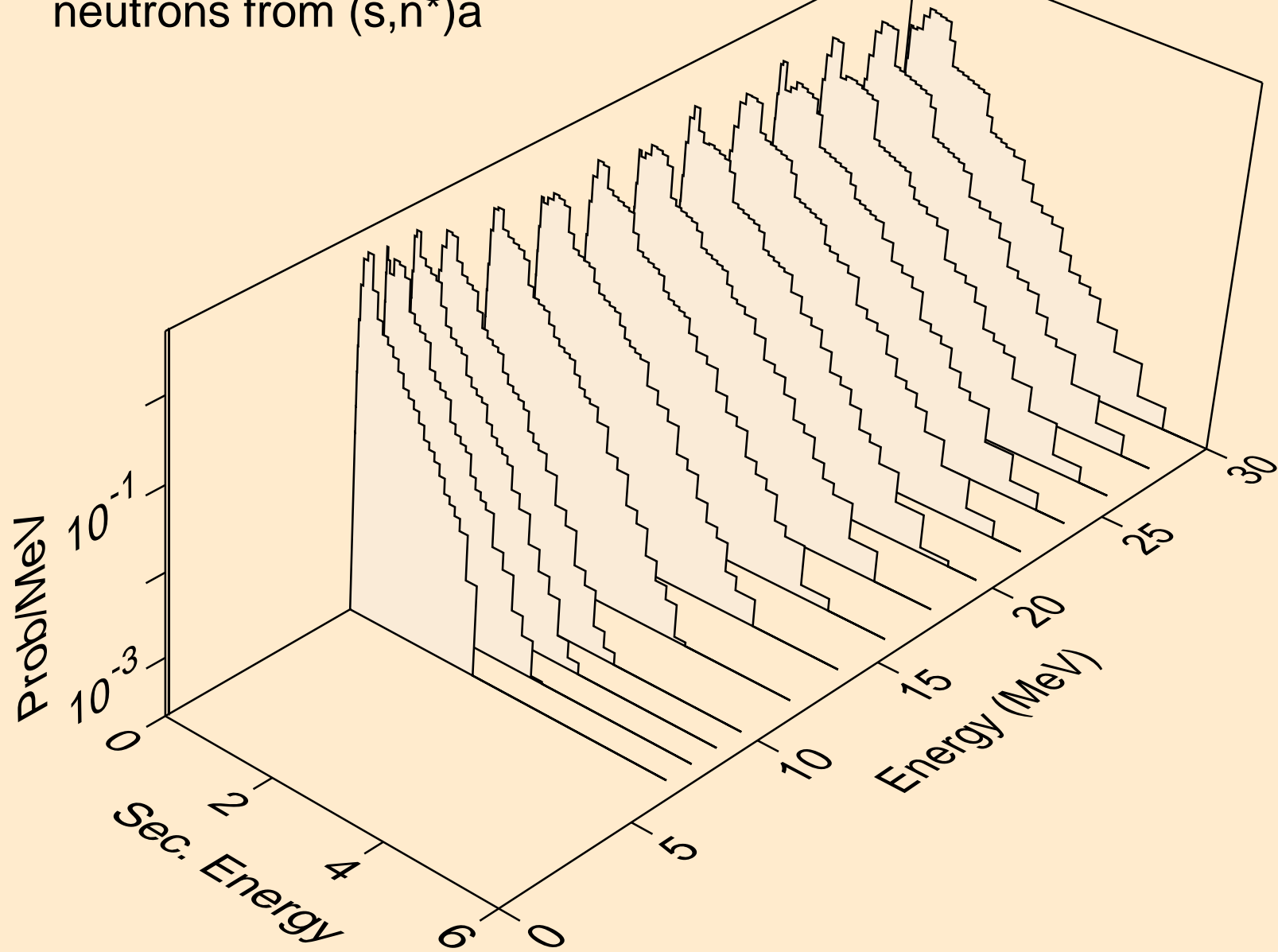

PB219 HELION ACER TENDL-2021 LIBRARY; T=0.K  
neutrons from (s,2n)a

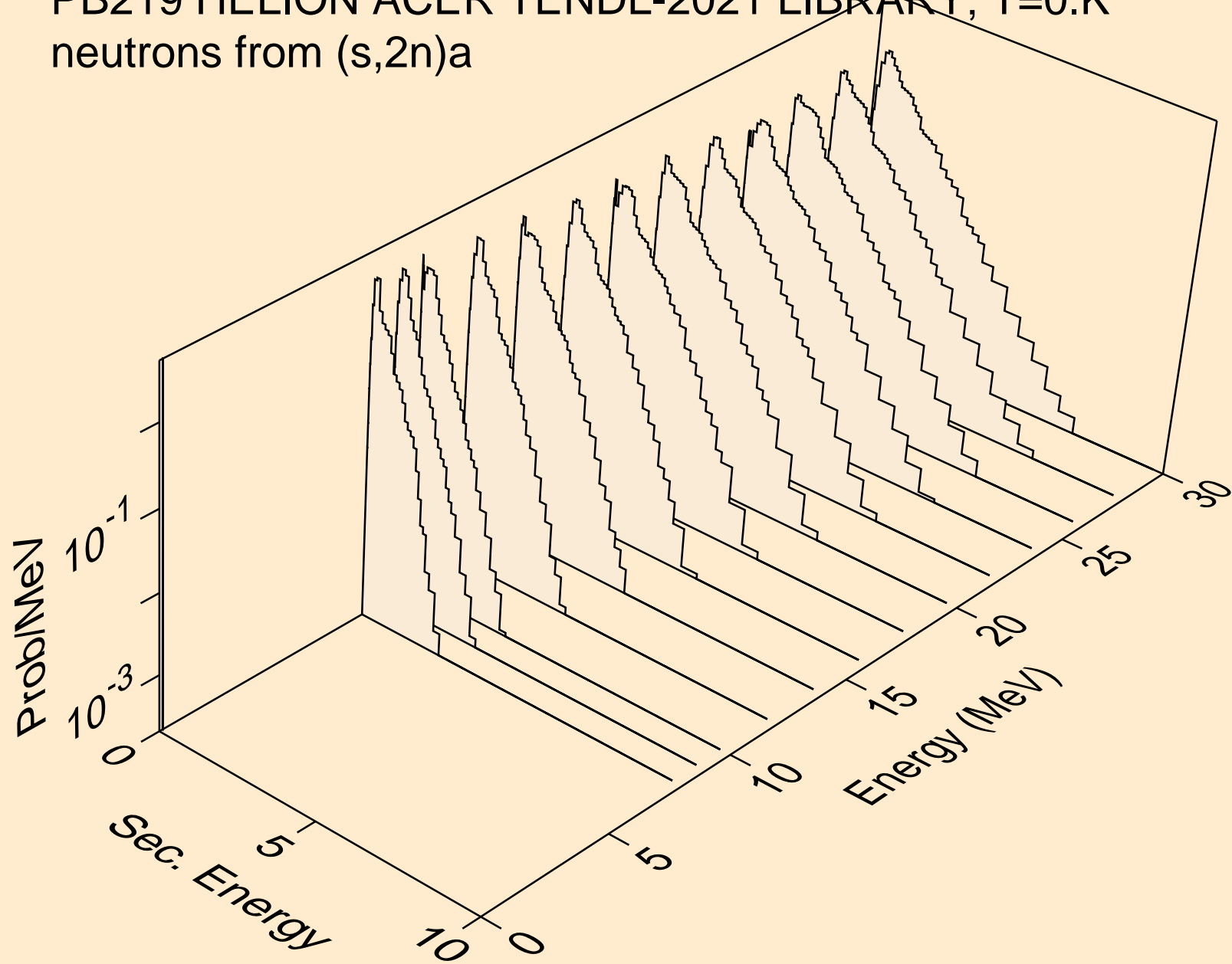

PB219 HELION ACER TENDL-2021 LIBRARY; T=0.K  
neutrons from (s,3n)a

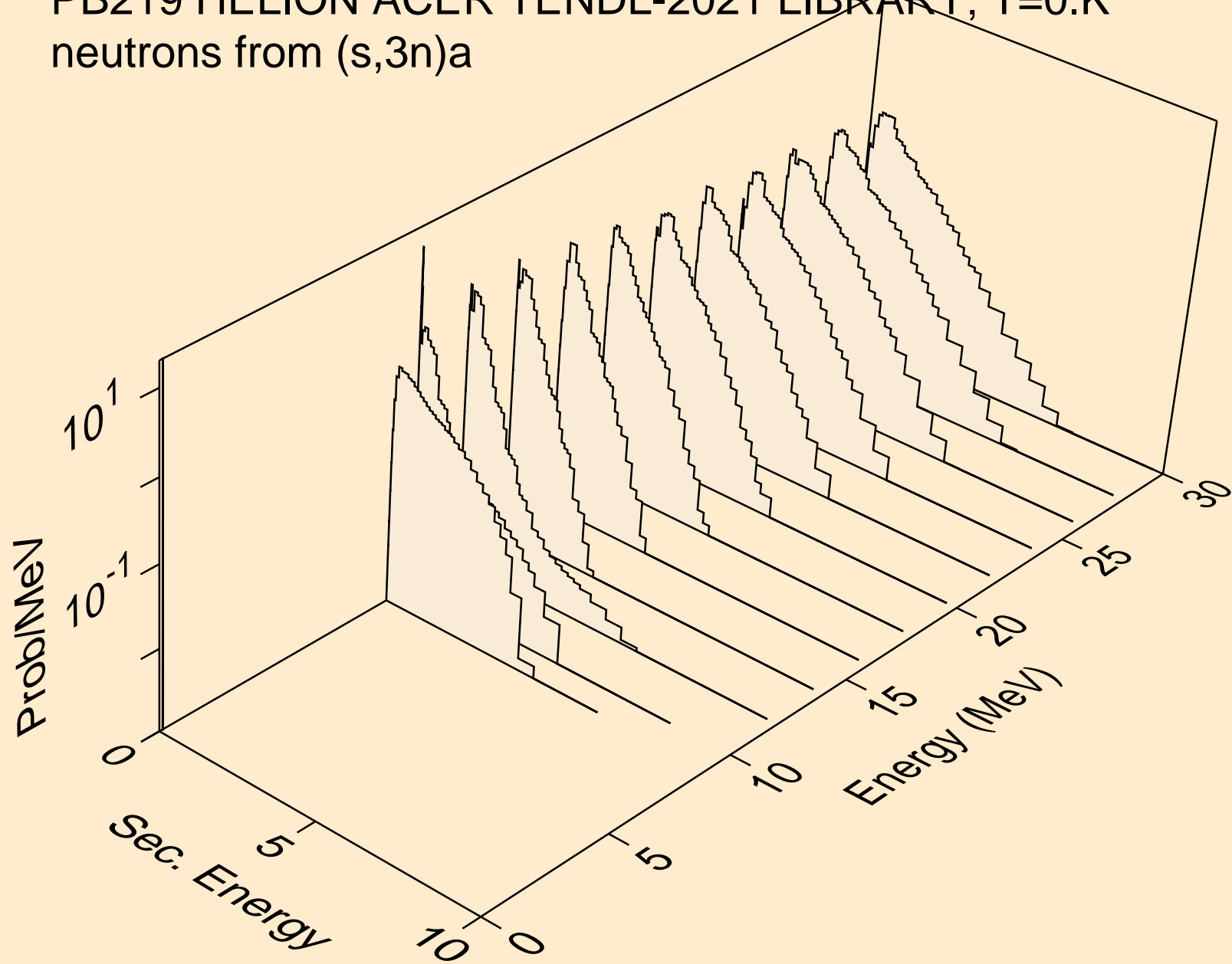

PB219 HELION ACER TENDL-2021 LIBRARY; T=0.K  
neutrons from (s,n\*)p

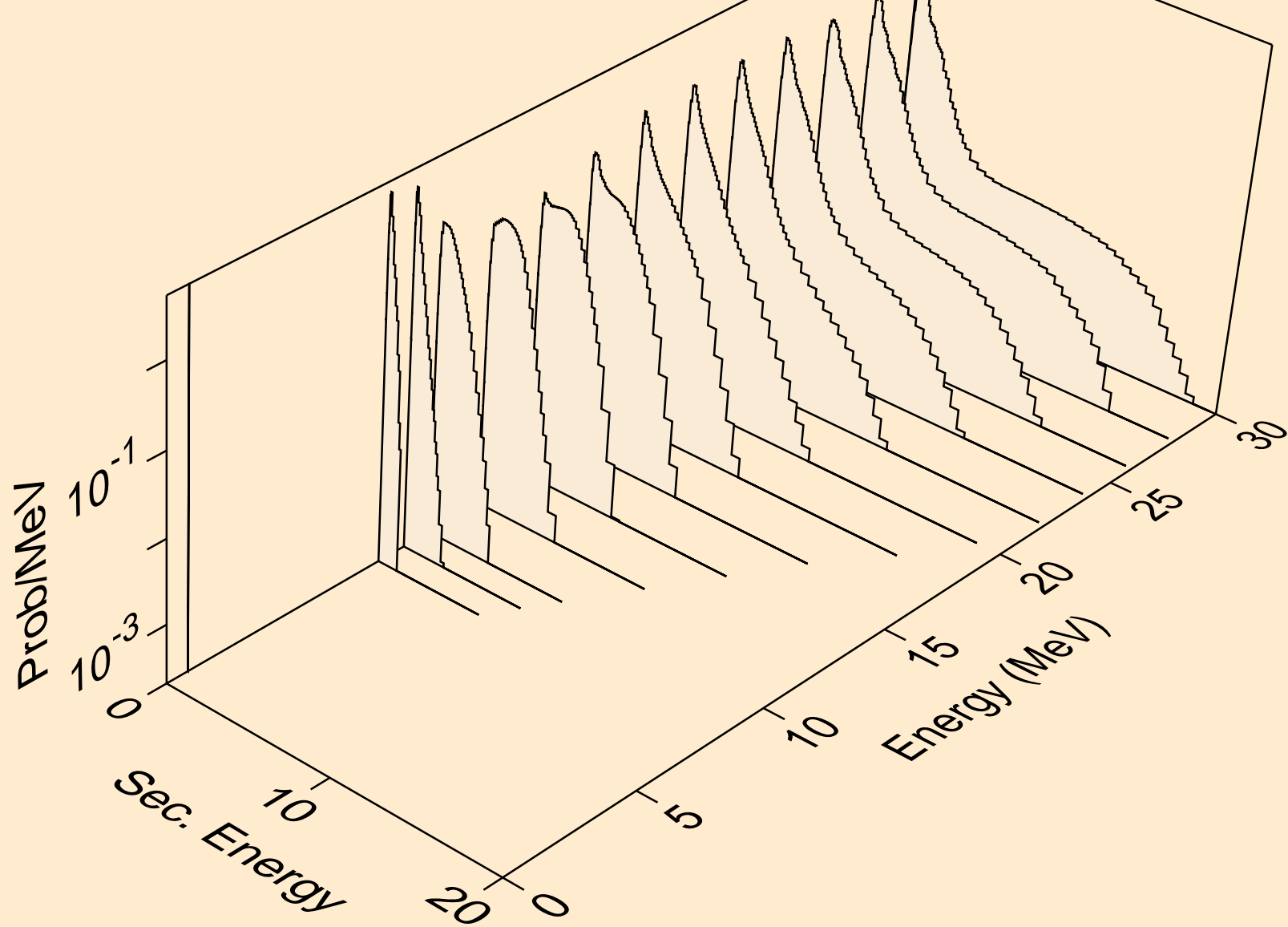

PB219 HELION ACER TENDL-2021 LIBRARY; T=0.K  
neutrons from (s,n\*)d

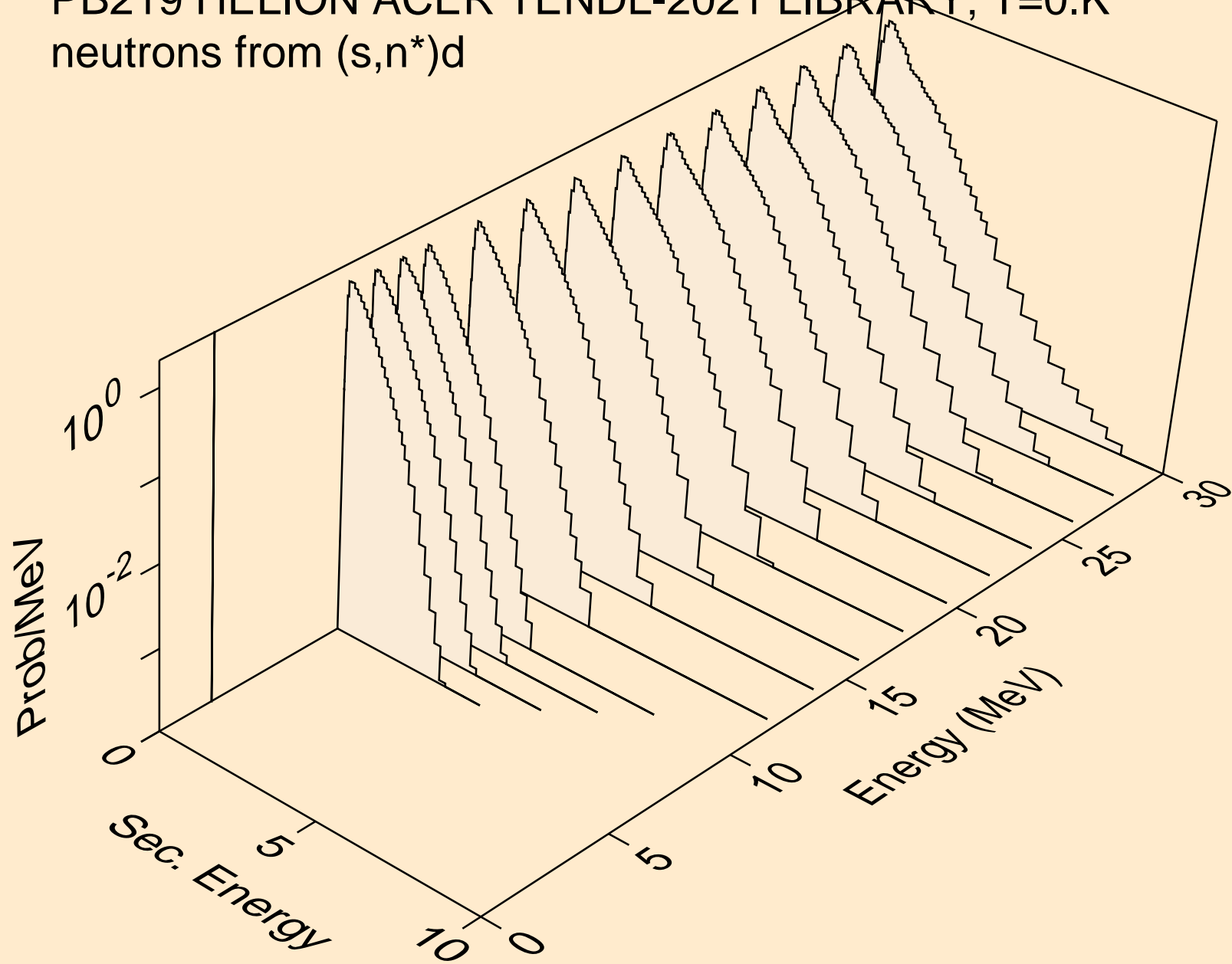

PB219 HELION ACER TENDL-2021 LIBRARY; T=0.K  
neutrons from (s,n\*)t

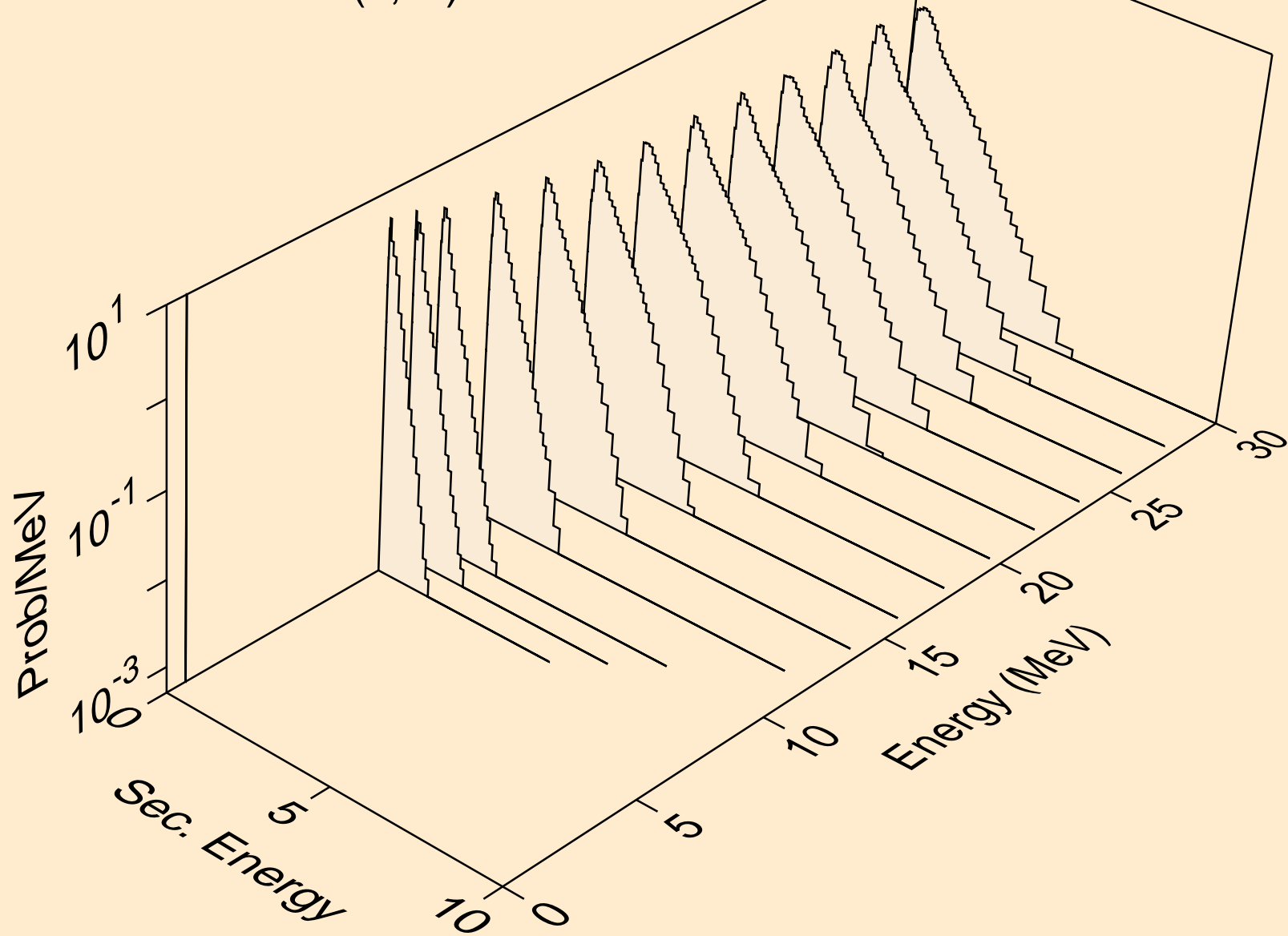

PB219 HELION ACER TENDL-2021 LIBRARY; T=0.K  
neutrons from (s,n\*)he3

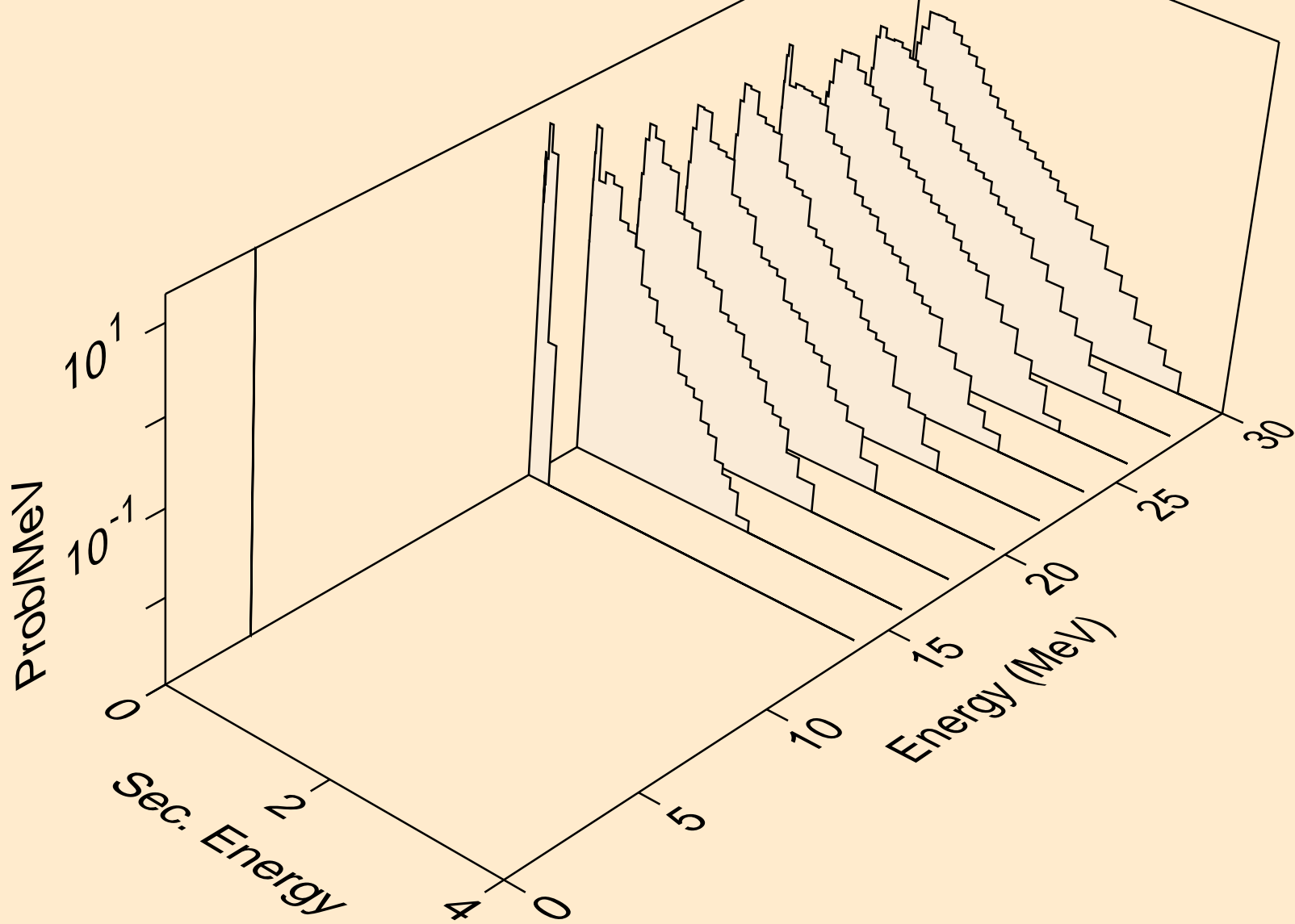



PB219 HELION ACER TENDL-2021 LIBRARY; T=0.K  
neutrons from (s,4n)

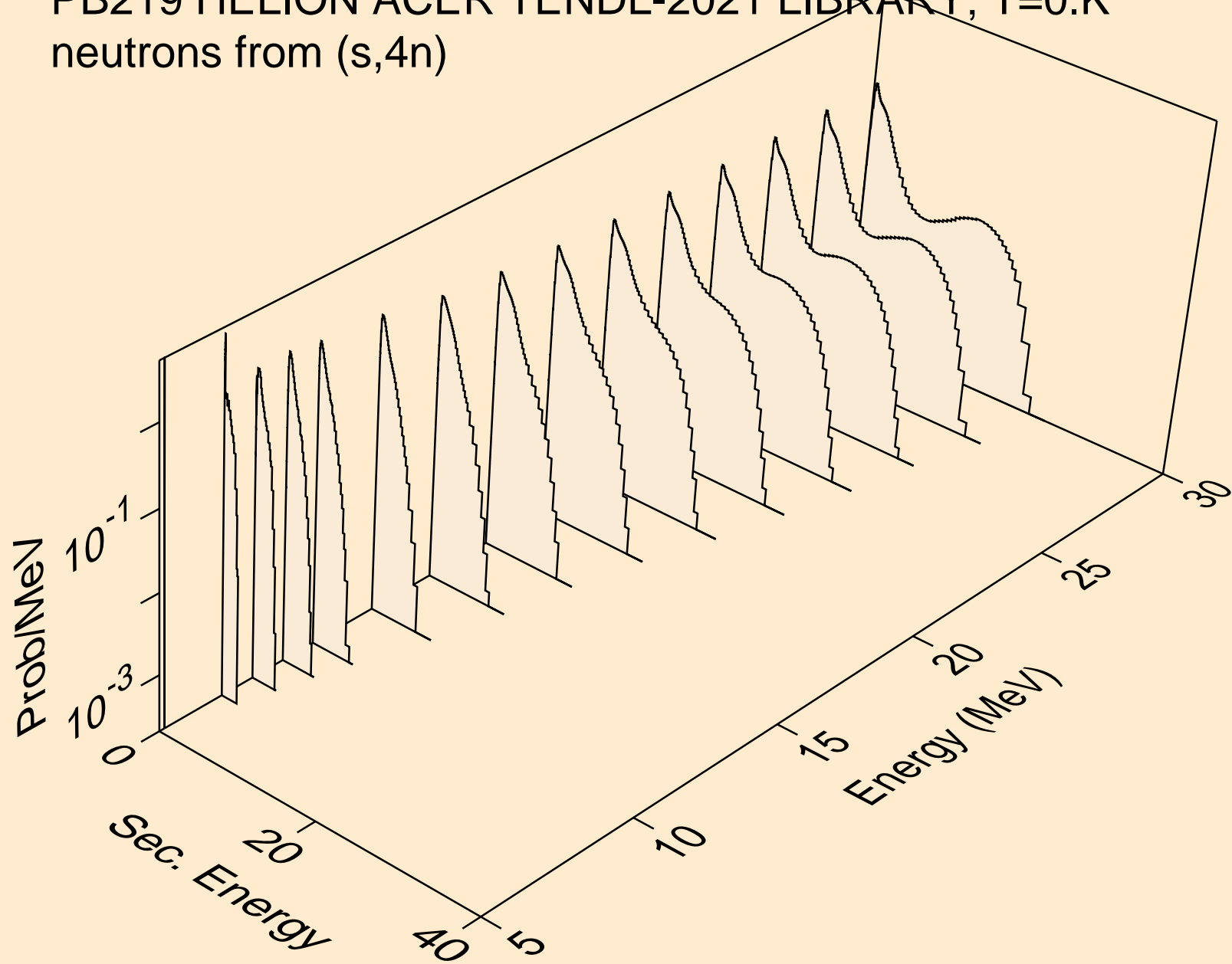

PB219 HELION ACER TENDL-2021 LIBRARY; T=0.K  
neutrons from (s,2np)

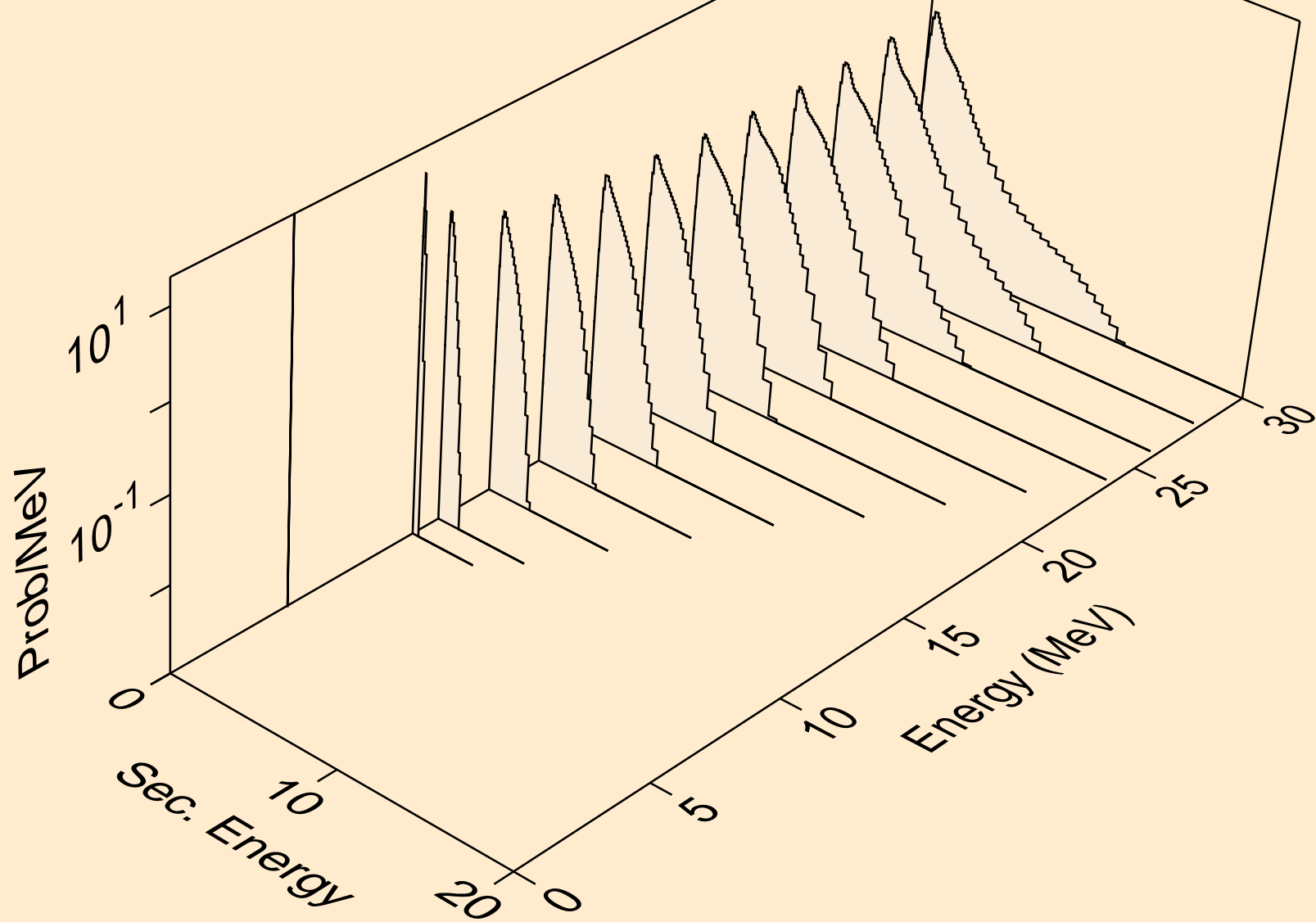

PB219 HELION ACER TENDL-2021 LIBRARY; T=0.K  
neutrons from (s,3np)

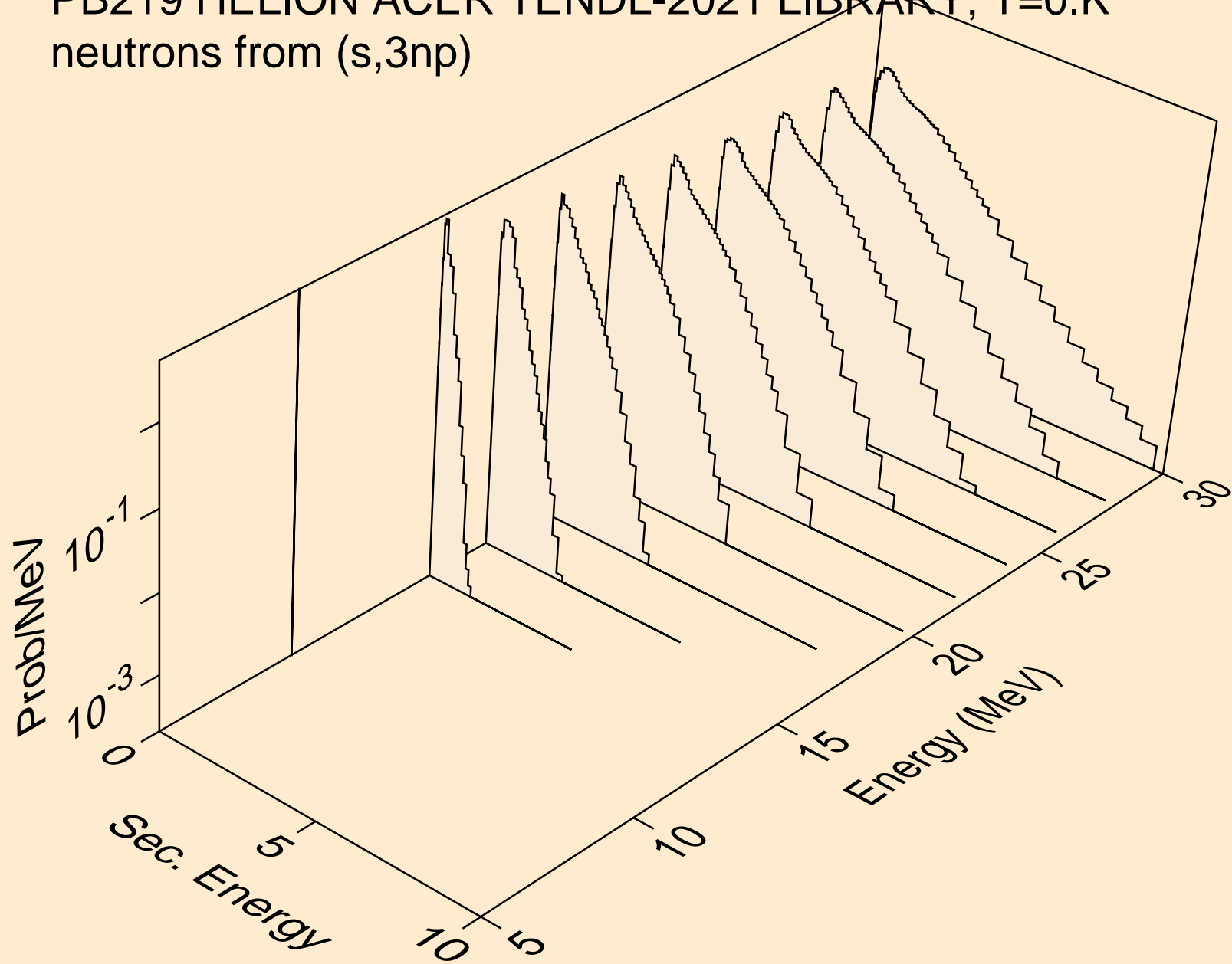

PB219 HELION ACER TENDL-2021 LIBRARY; T=0.K  
neutrons from (s,2np)

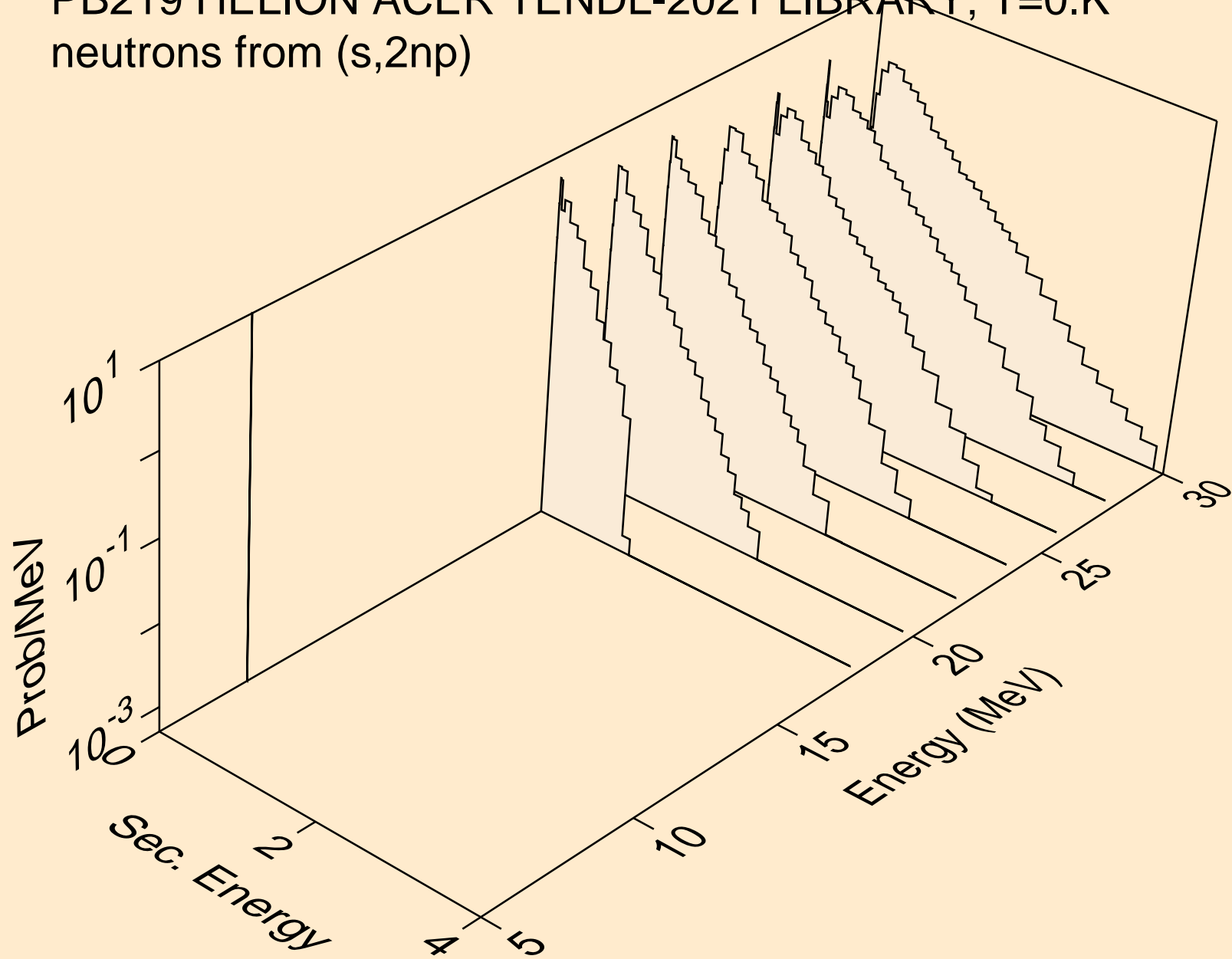

PB219 HELION ACER TENDL-2021 LIBRARY; T=0.K  
neutrons from (s,npa)

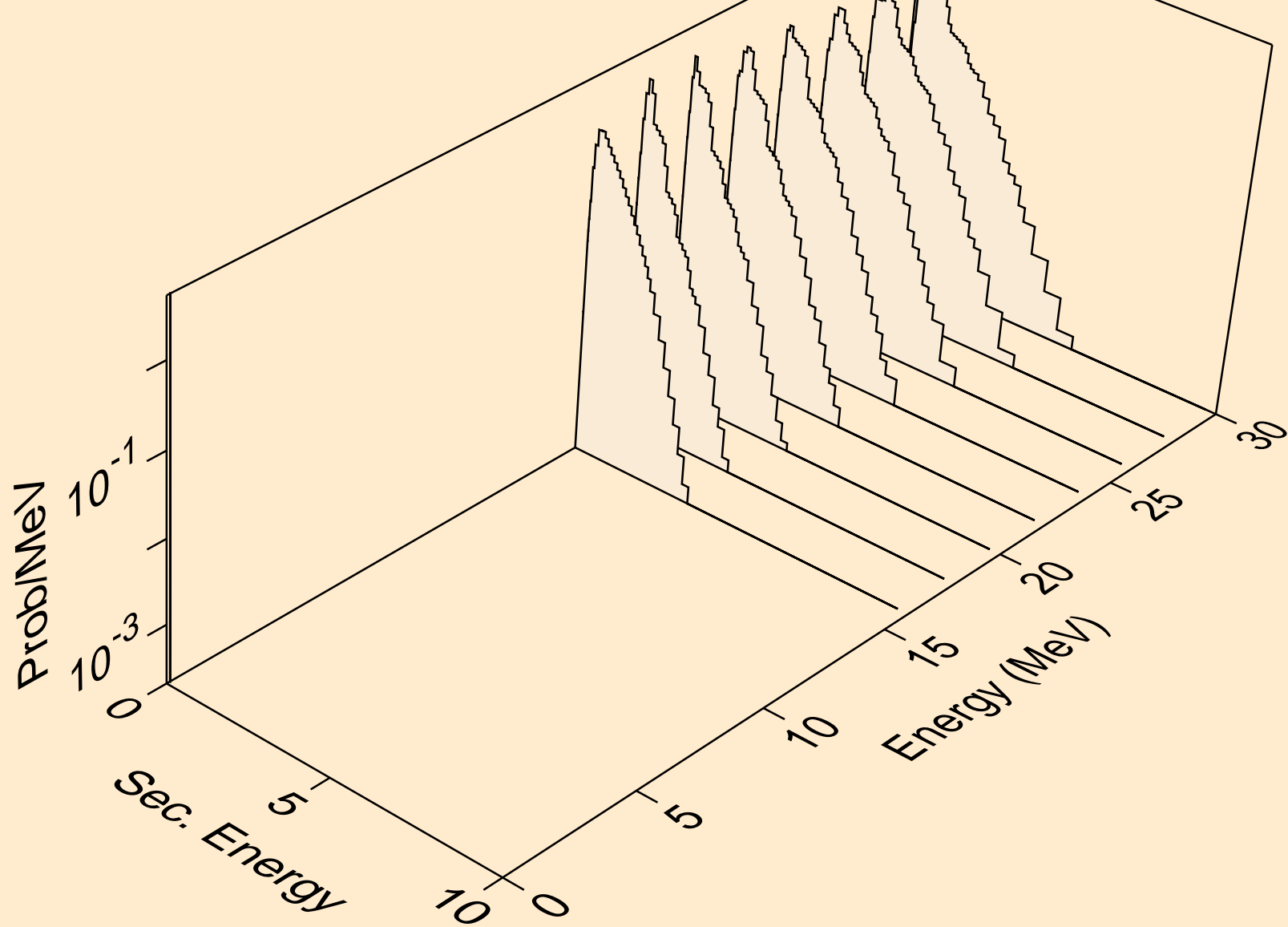

PB219 HELION ACER TENDL-2021 LIBRARY; T=0.K  
protons from (s,x)

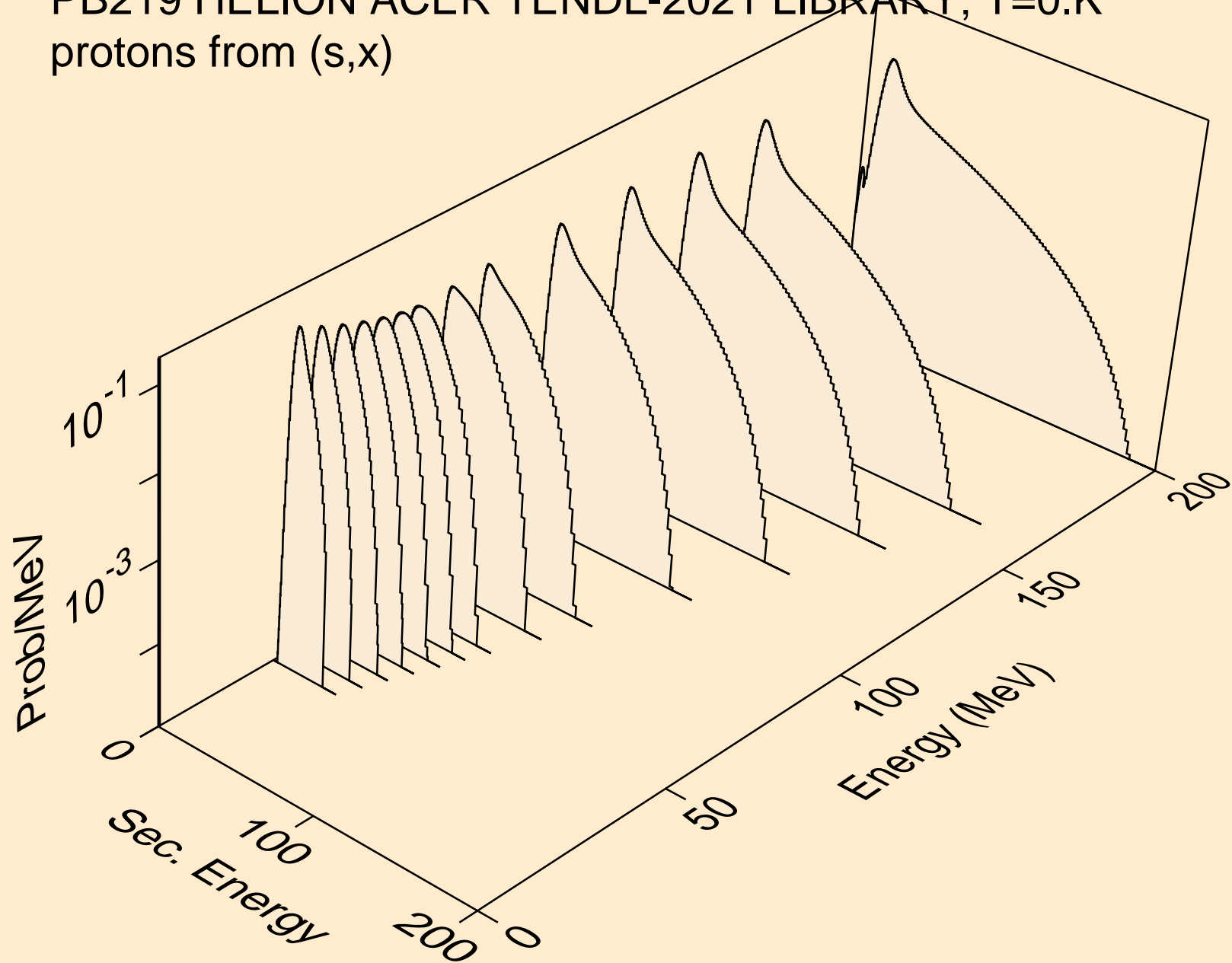

PB219 HELION ACER TENDL-2021 LIBRARY; T=0.K  
protons from (s,n\*)p

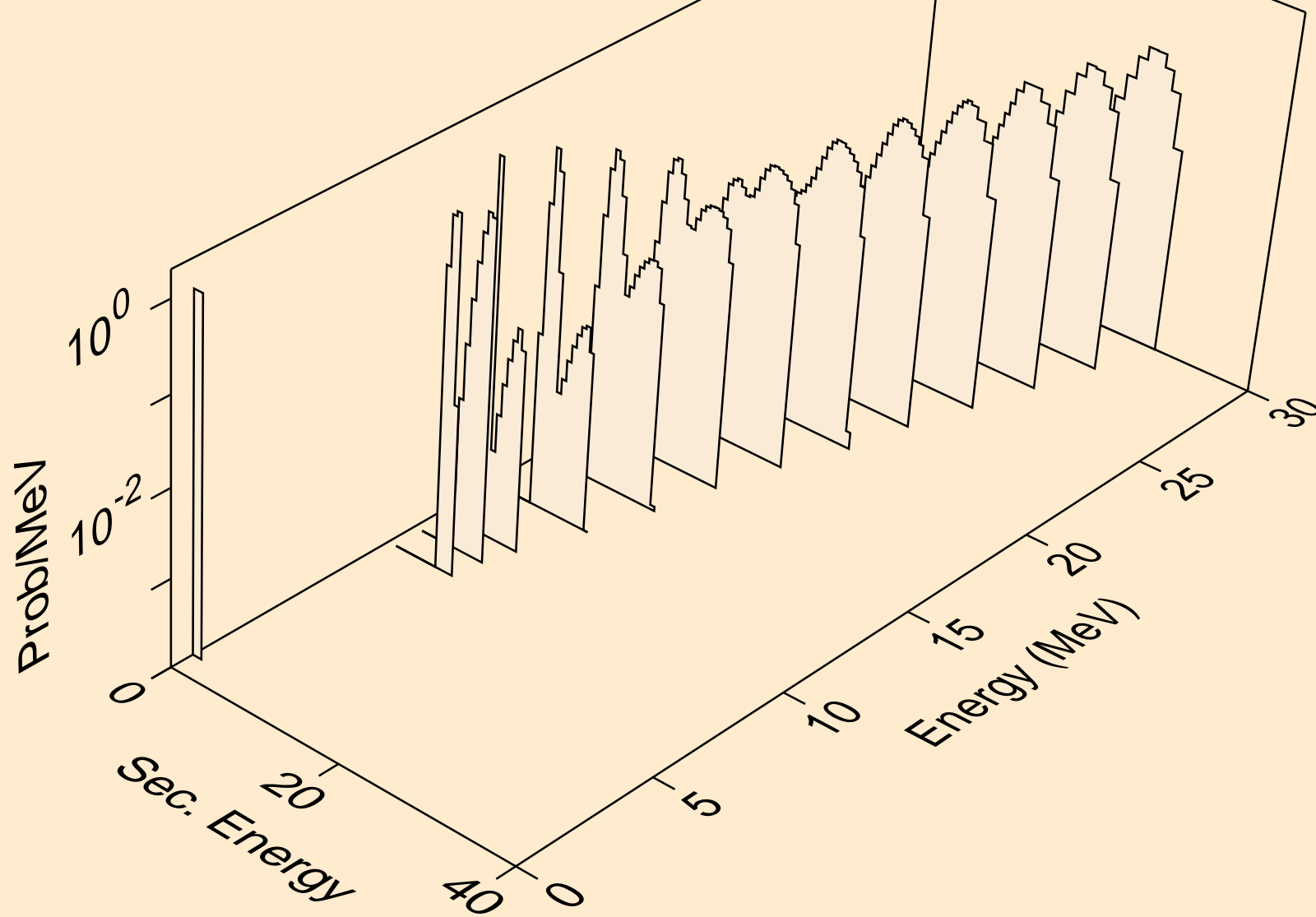

PB219 HELION ACER TENDL-2021 LIBRARY; T=0.K  
protons from (s,2np)

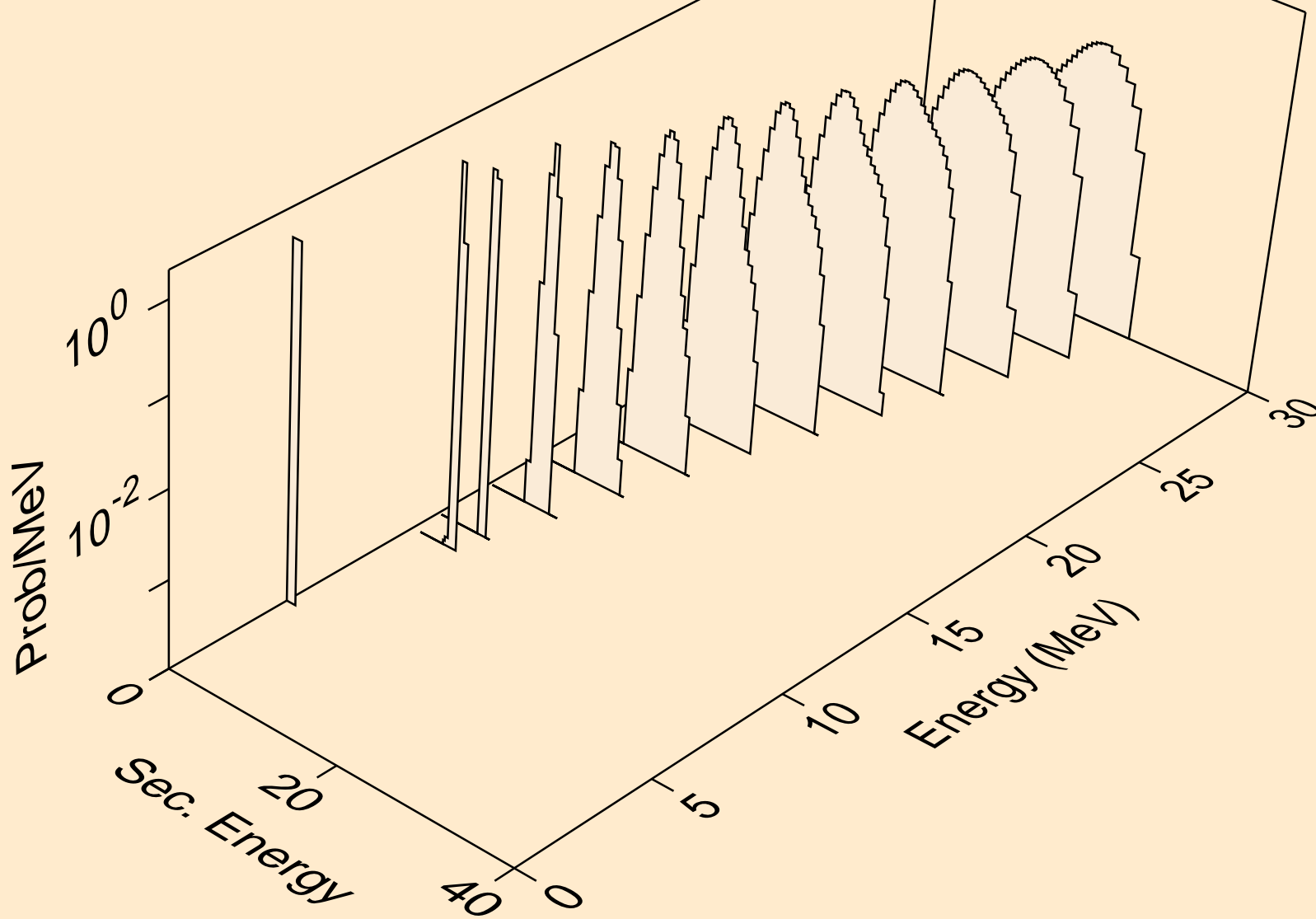



PB219 HELION ACER TENDL-2021 LIBRARY; T=0.K  
protons from (s,3np)

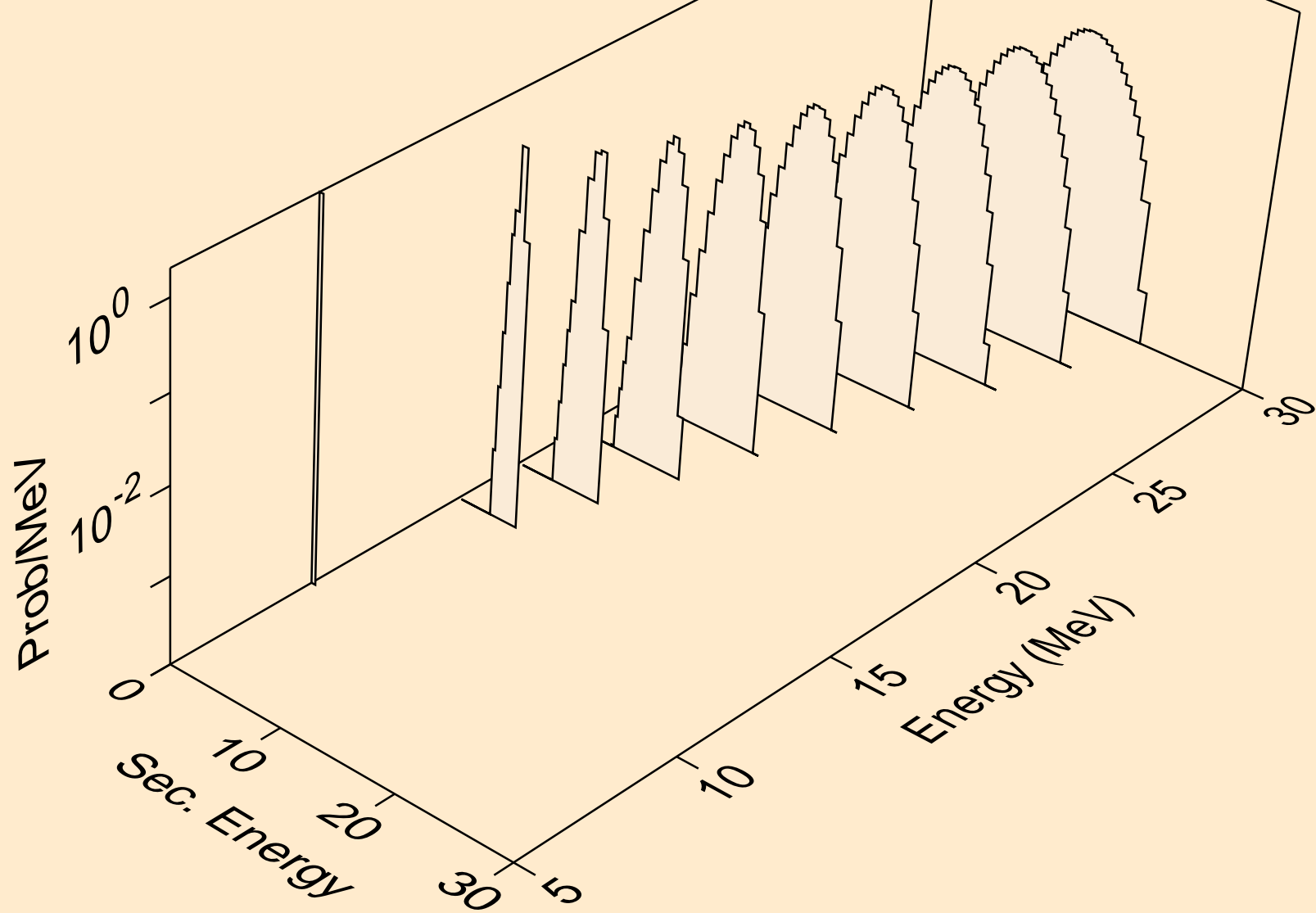

PB219 HELION ACER TENDL-2021 LIBRARY; T=0.K  
protons from (s,2np)

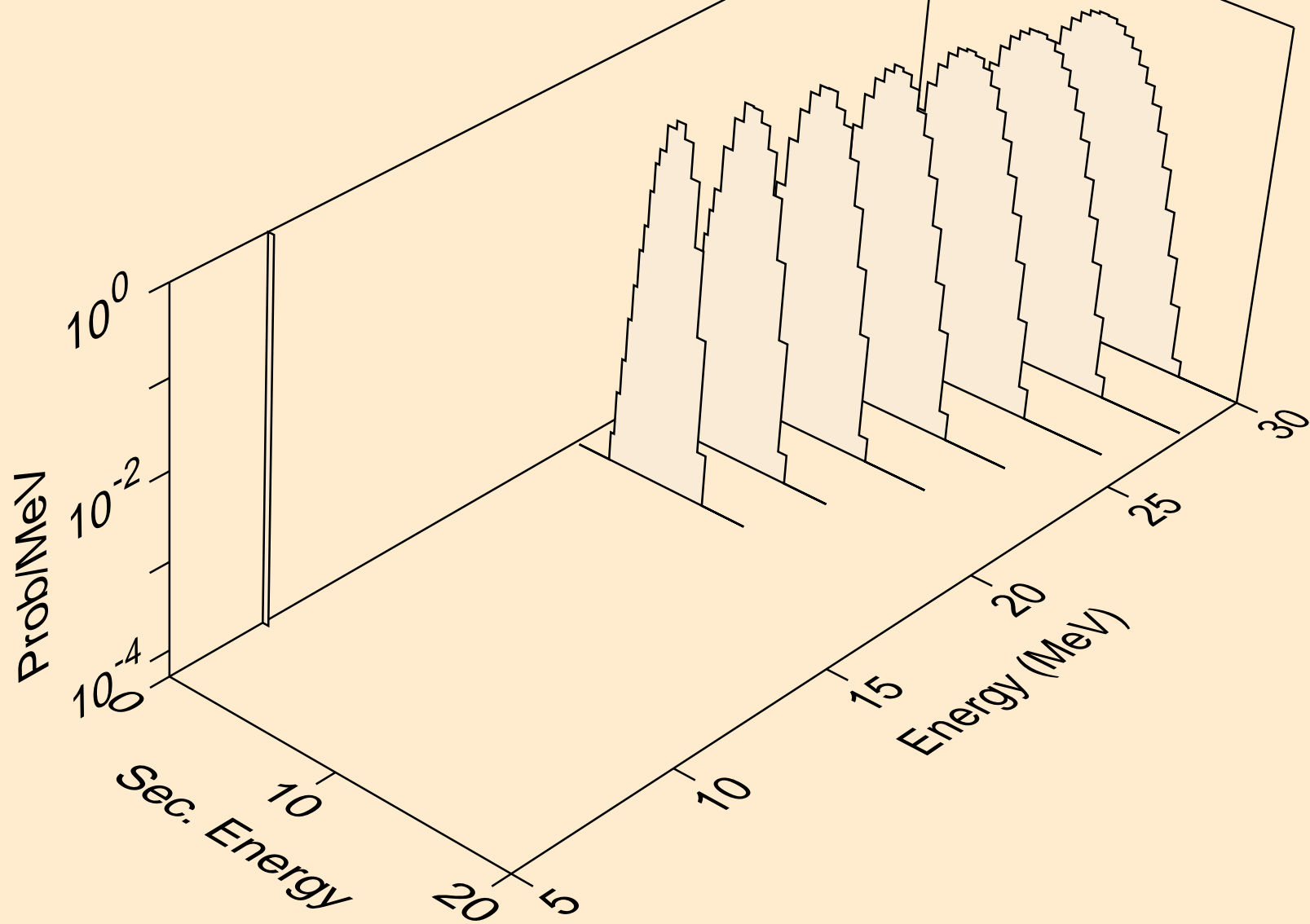

PB219 HELION ACER TENDL-2021 LIBRARY; T=0.K  
protons from (s,npa)

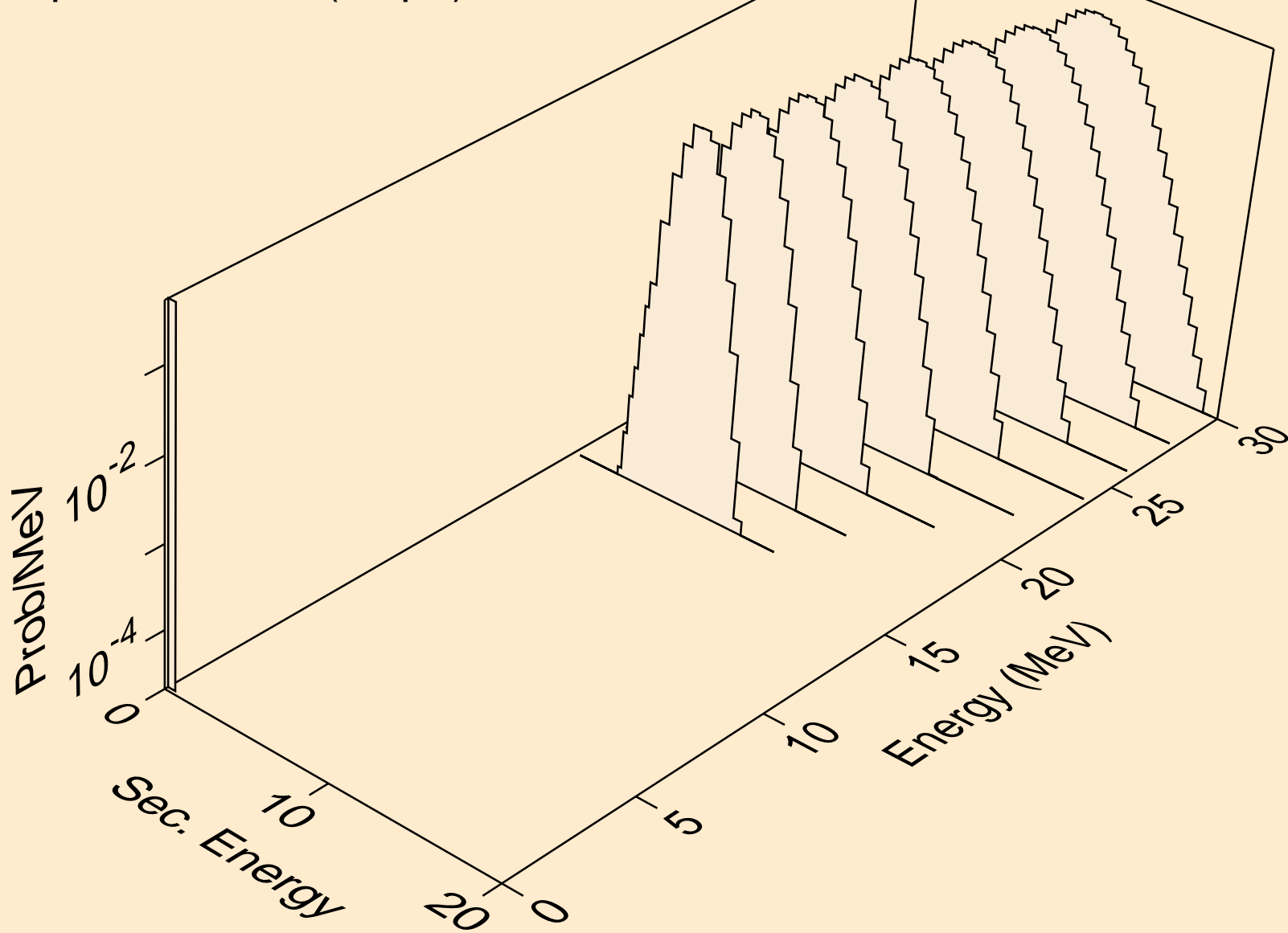

PB219 HELION ACER TENDL-2021 LIBRARY; T=0.K  
protons from (s,p)

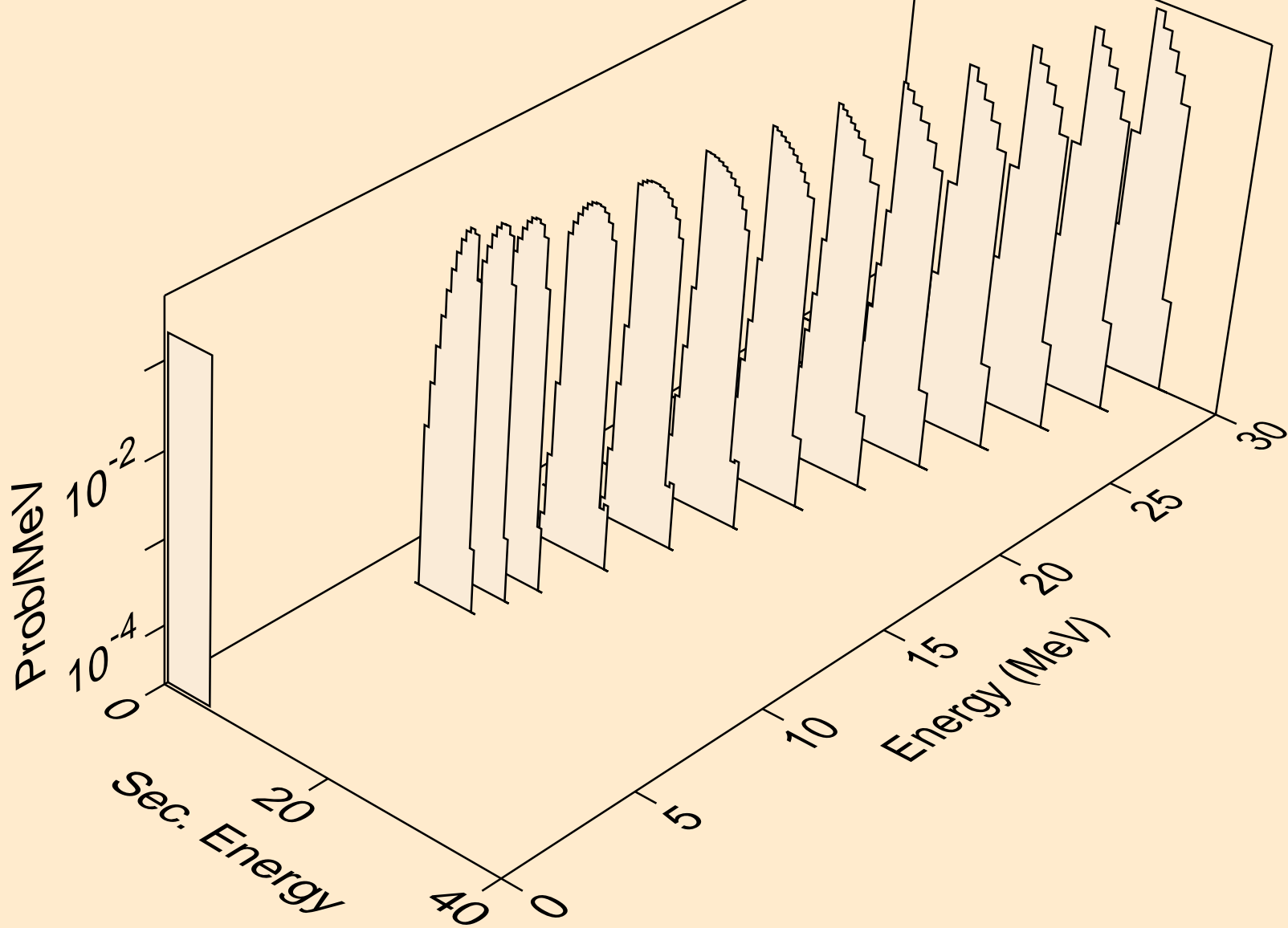

PB219 HELION ACER TENDL-2021 LIBRARY; T=0.K  
protons from (s,2p)

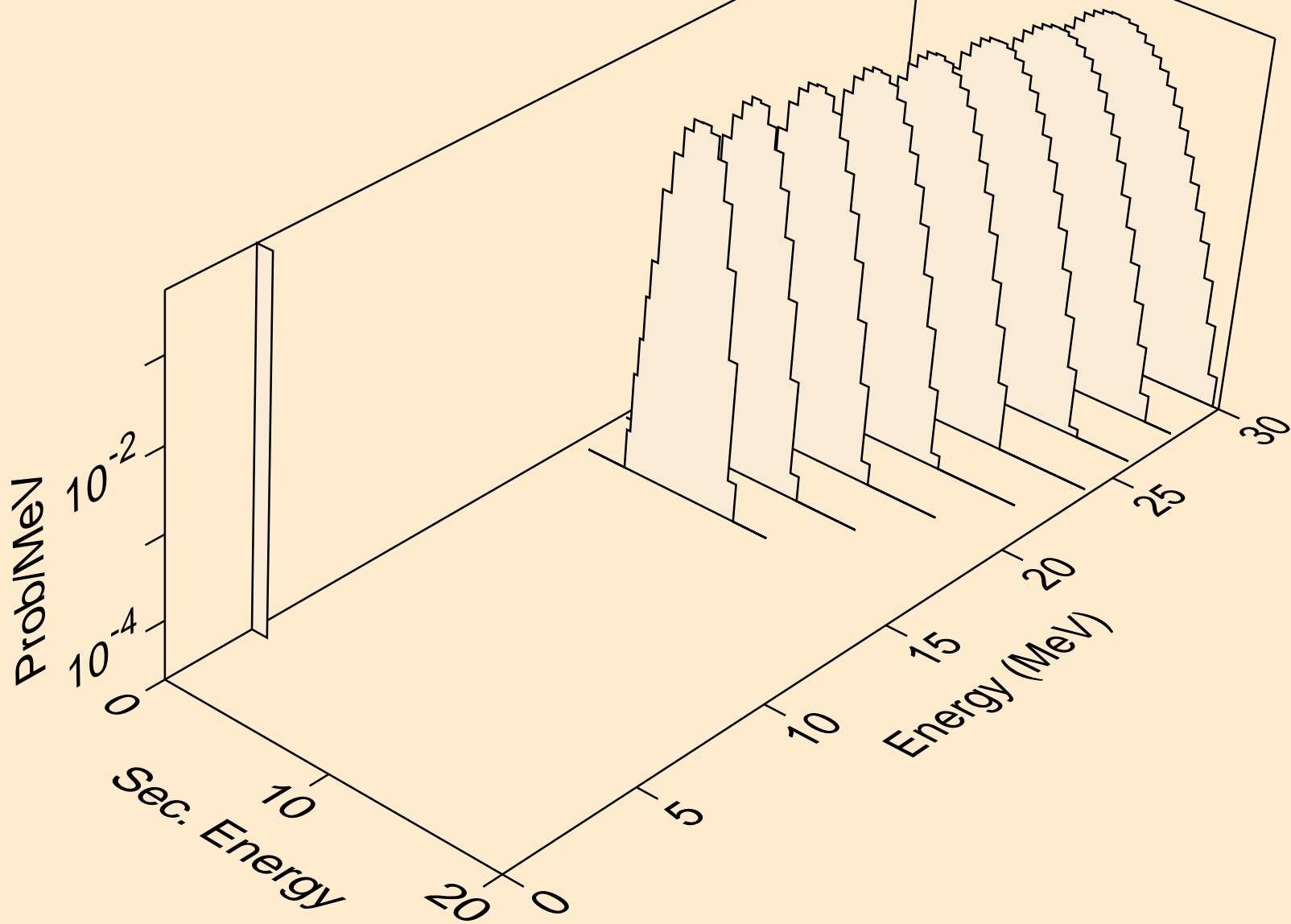

PB219 HELION ACER TENDL-2021 LIBRARY; T=0.K  
protons from (s,pd)

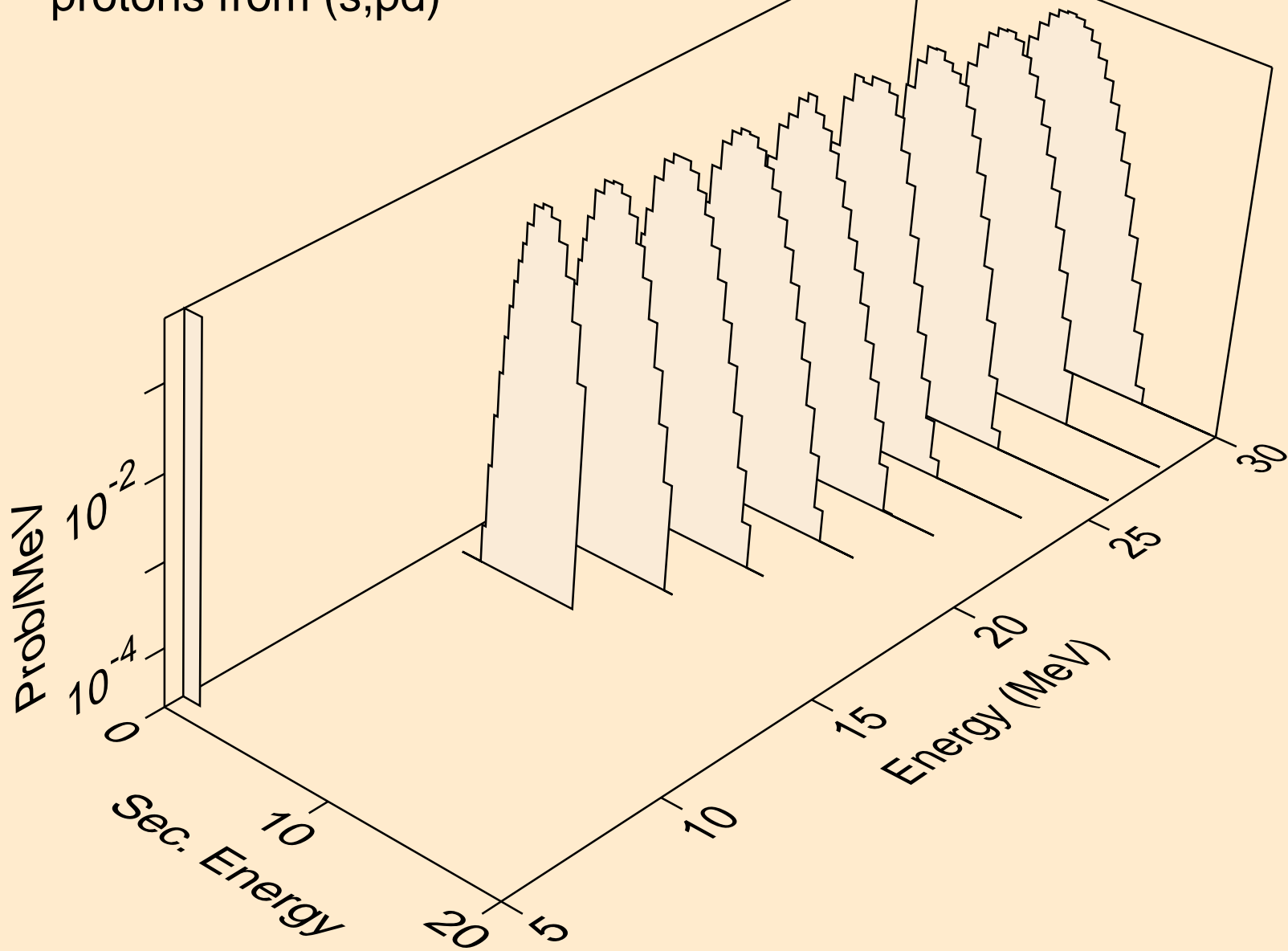

PB219 HELION ACER TENDL-2021 LIBRARY; T=0.K  
protons from (s,pt)

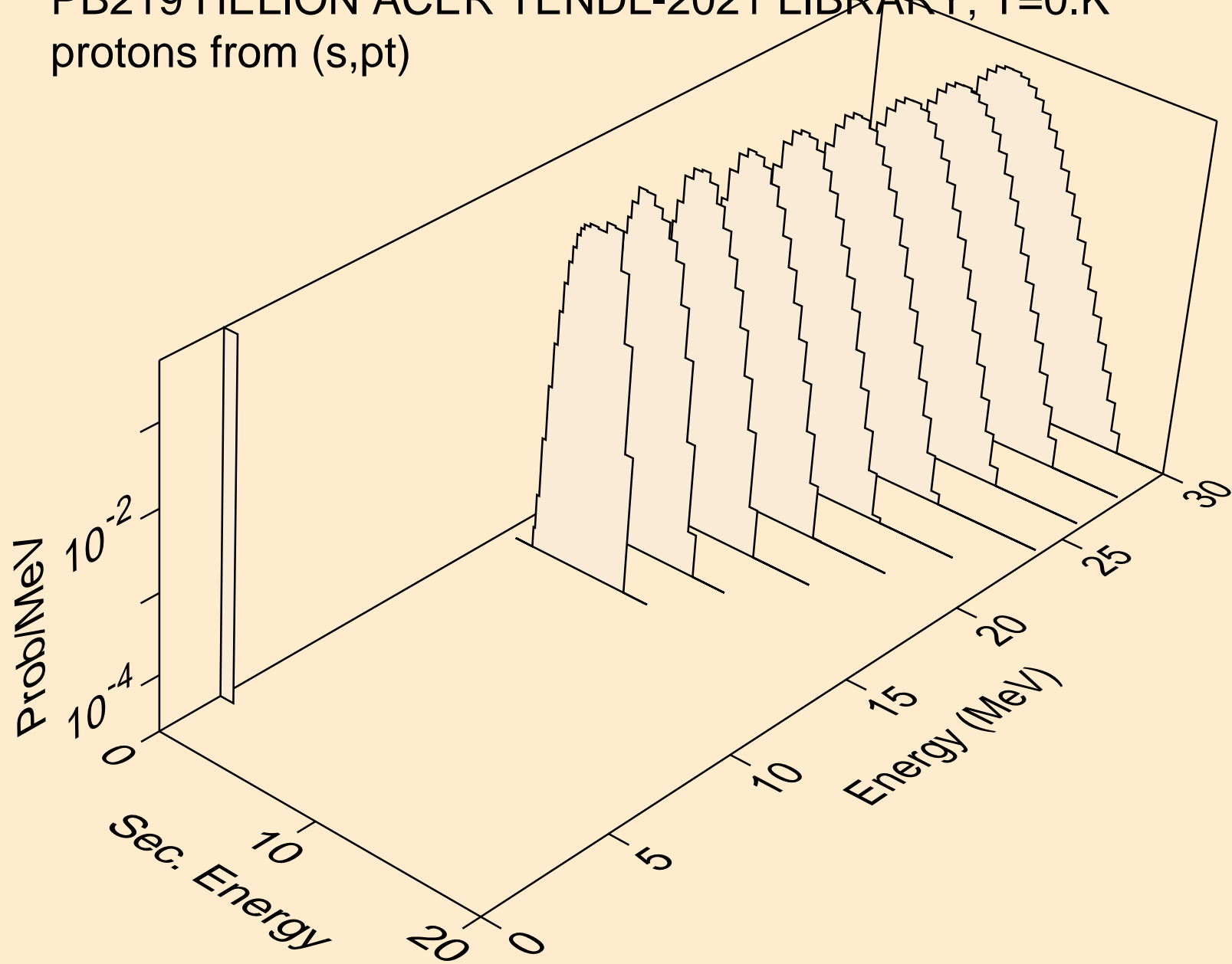

PB219 HELION ACER TENDL-2021 LIBRARY; T=0.K  
deuterons from (s,x)

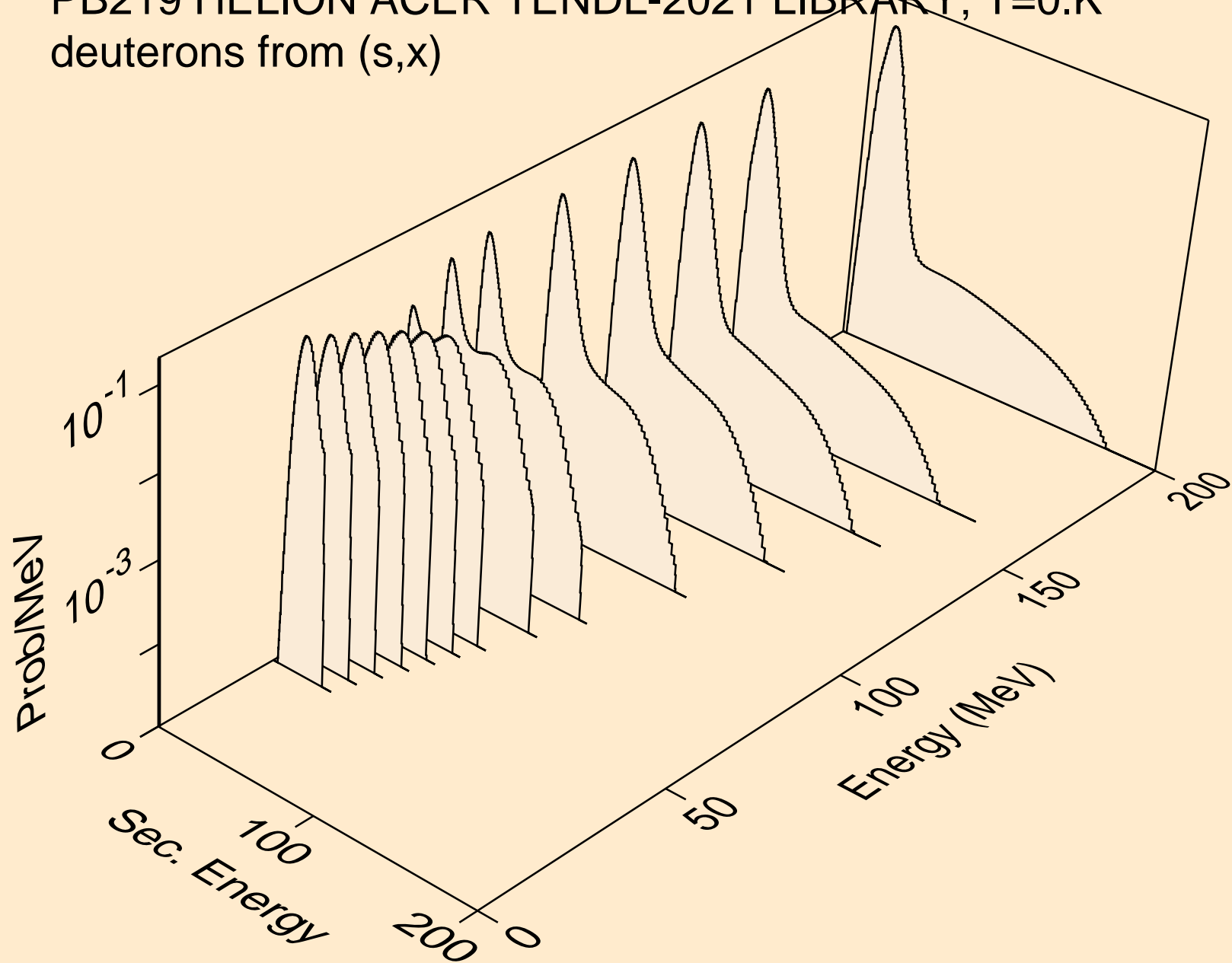



PB219 HELION ACER TENDL-2021 LIBRARY; T=0.K  
deuterons from (s,2nd)

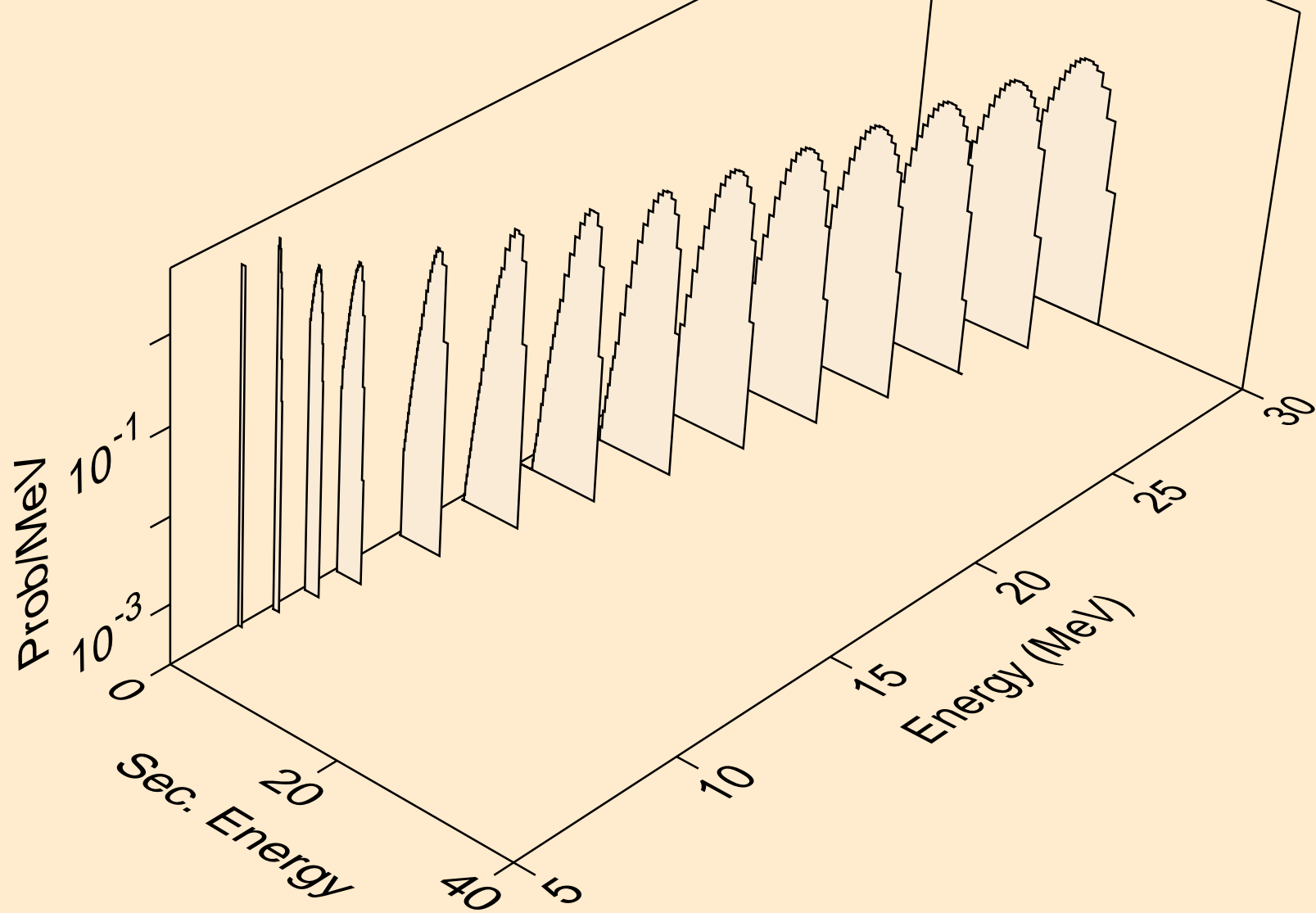

PB219 HELION ACER TENDL-2021 LIBRARY; T=0.K  
deuterons from (s,n\*)d

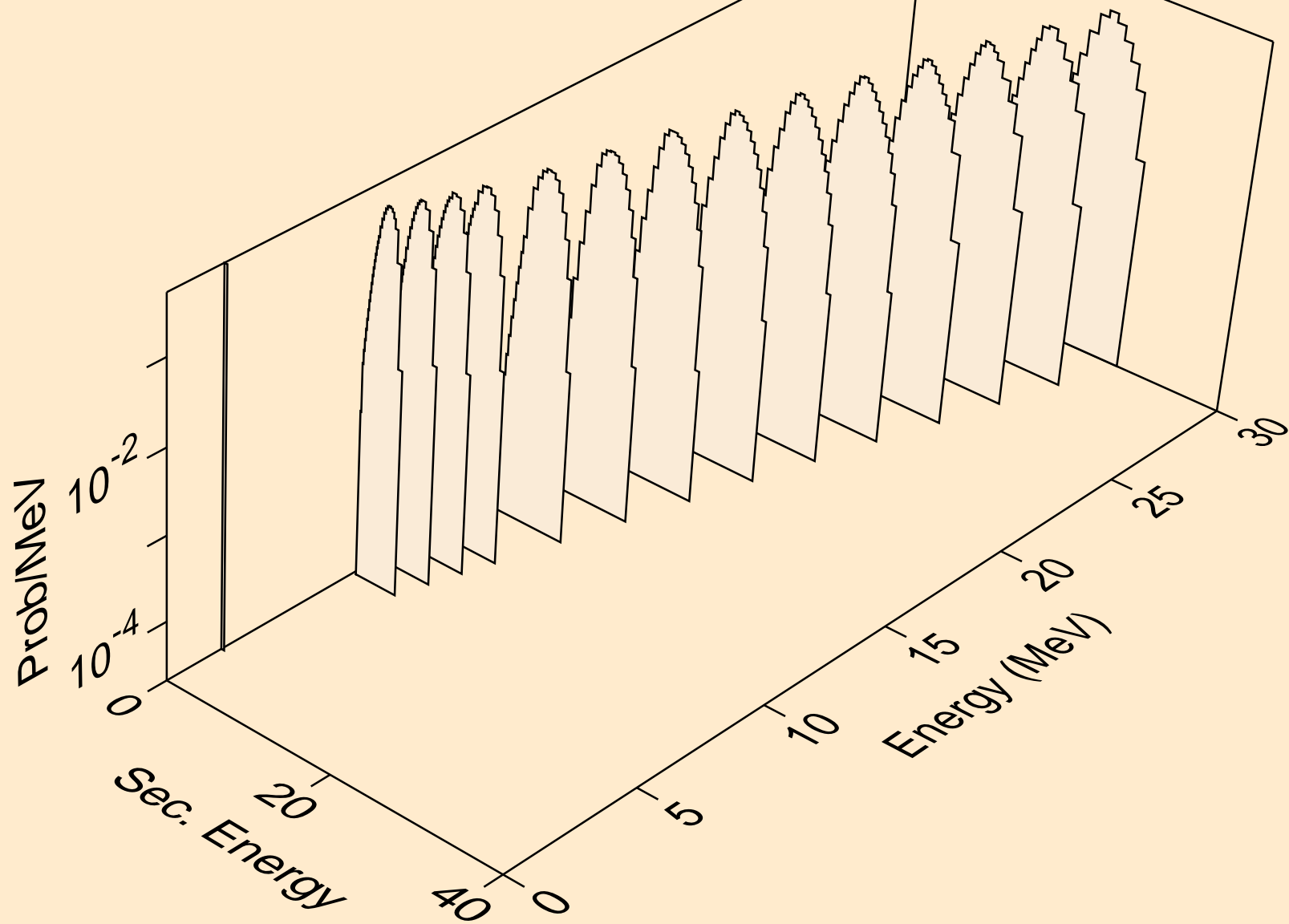

PB219 HELION ACER TENDL-2021 LIBRARY; T=0.K  
deuterons from (s,d)

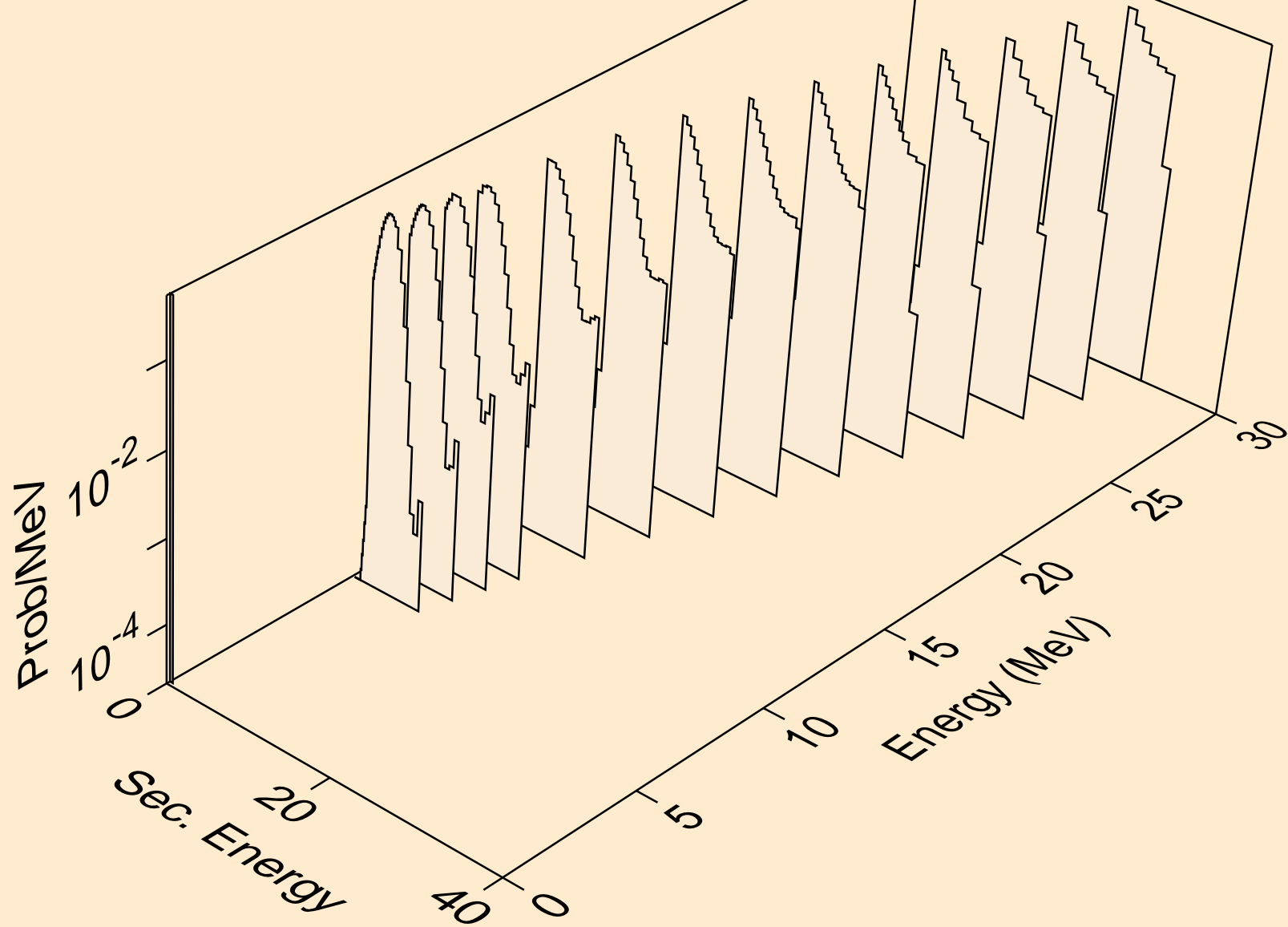

PB219 HELION ACER TENDL-2021 LIBRARY; T=0.K  
deuterons from (s,pd)

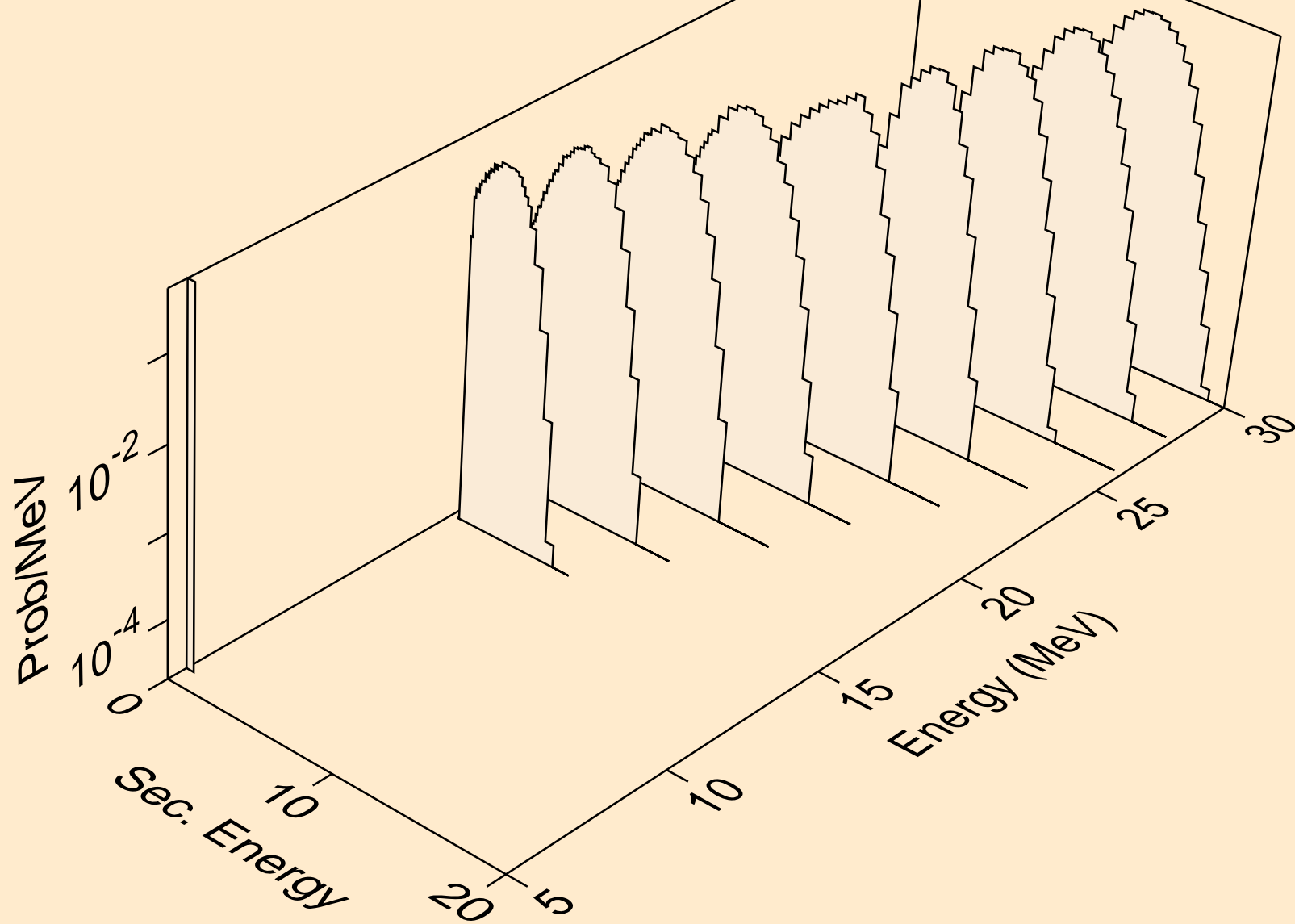

PB219 HELION ACER TENDL-2021 LIBRARY; T=0.K  
tritons from (s,x)

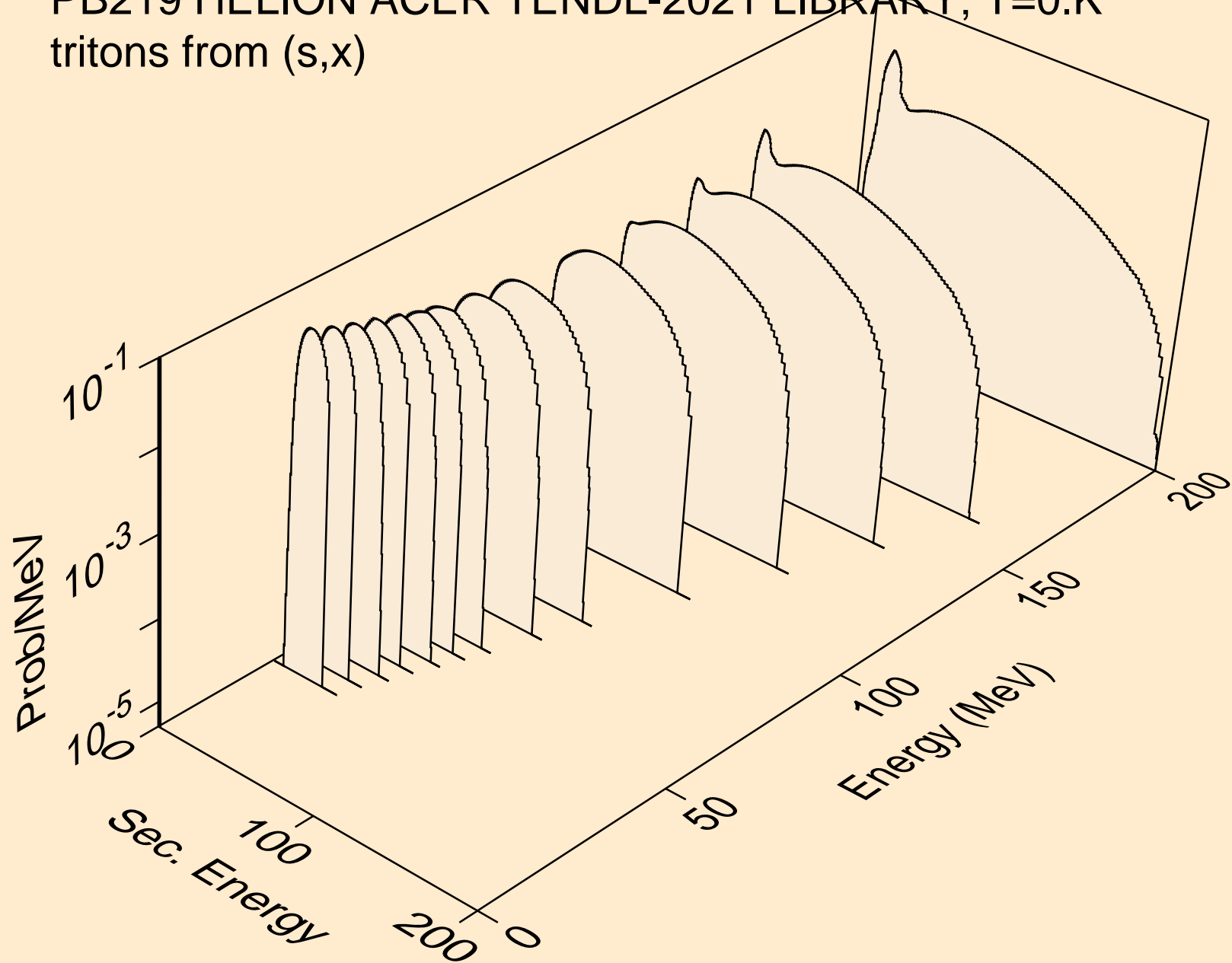

PB219 HELION ACER TENDL-2021 LIBRARY; T=0.K  
tritons from (s,n\*)t

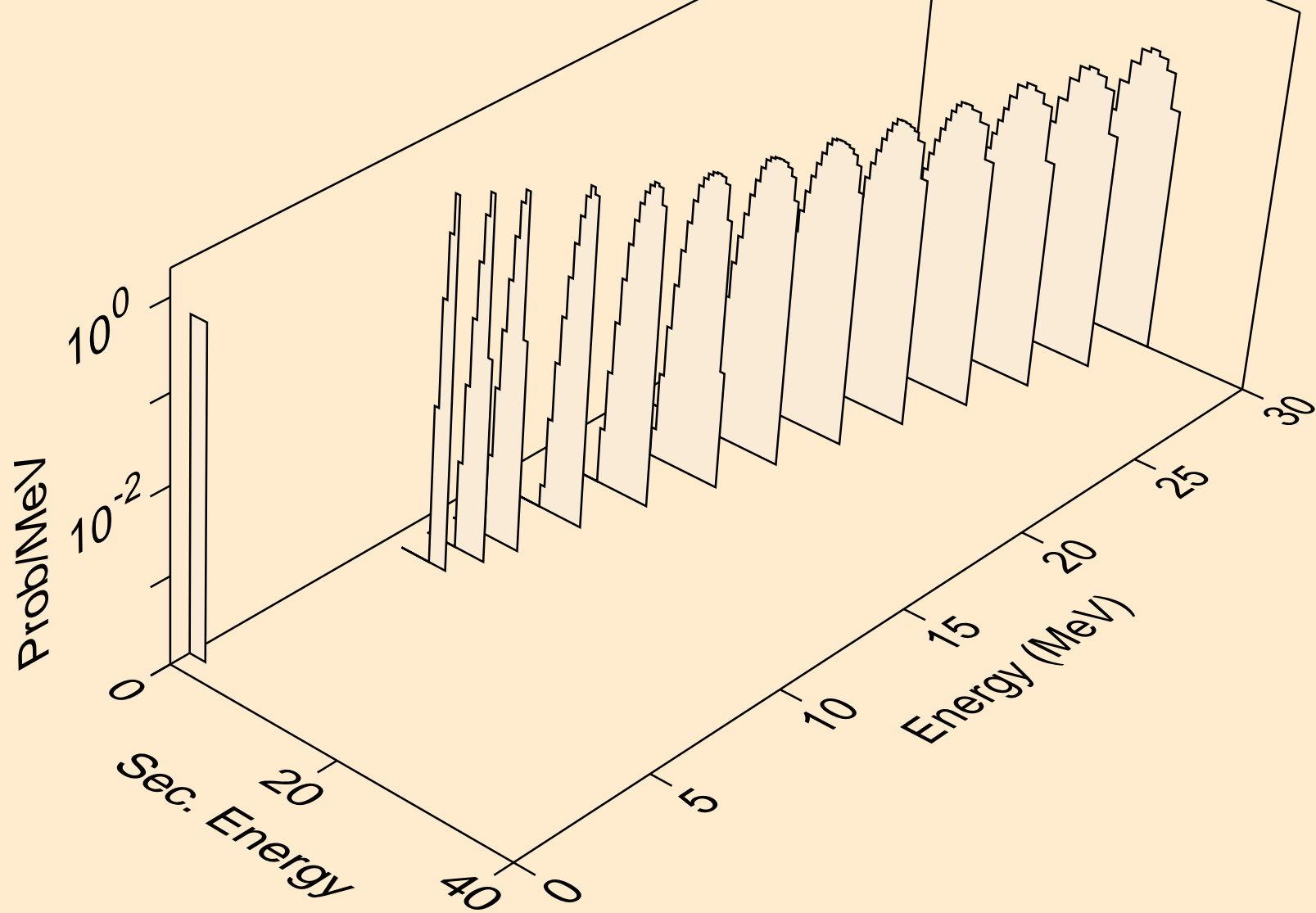

PB219 HELION ACER TENDL-2021 LIBRARY; T=0.K  
tritons from (s,t)

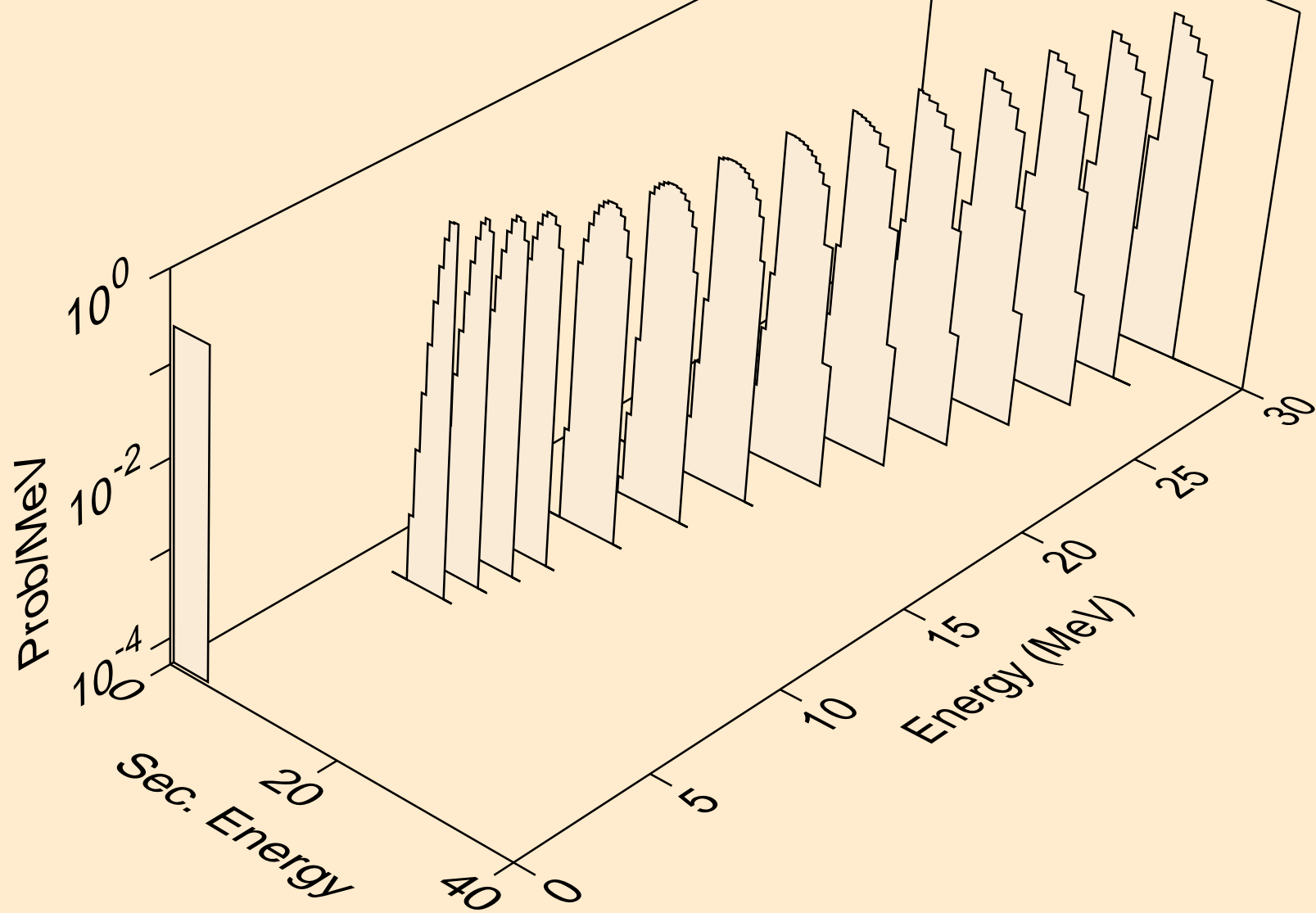

PB219 HELION ACER TENDL-2021 LIBRARY; T=0.K  
tritons from (s,pt)

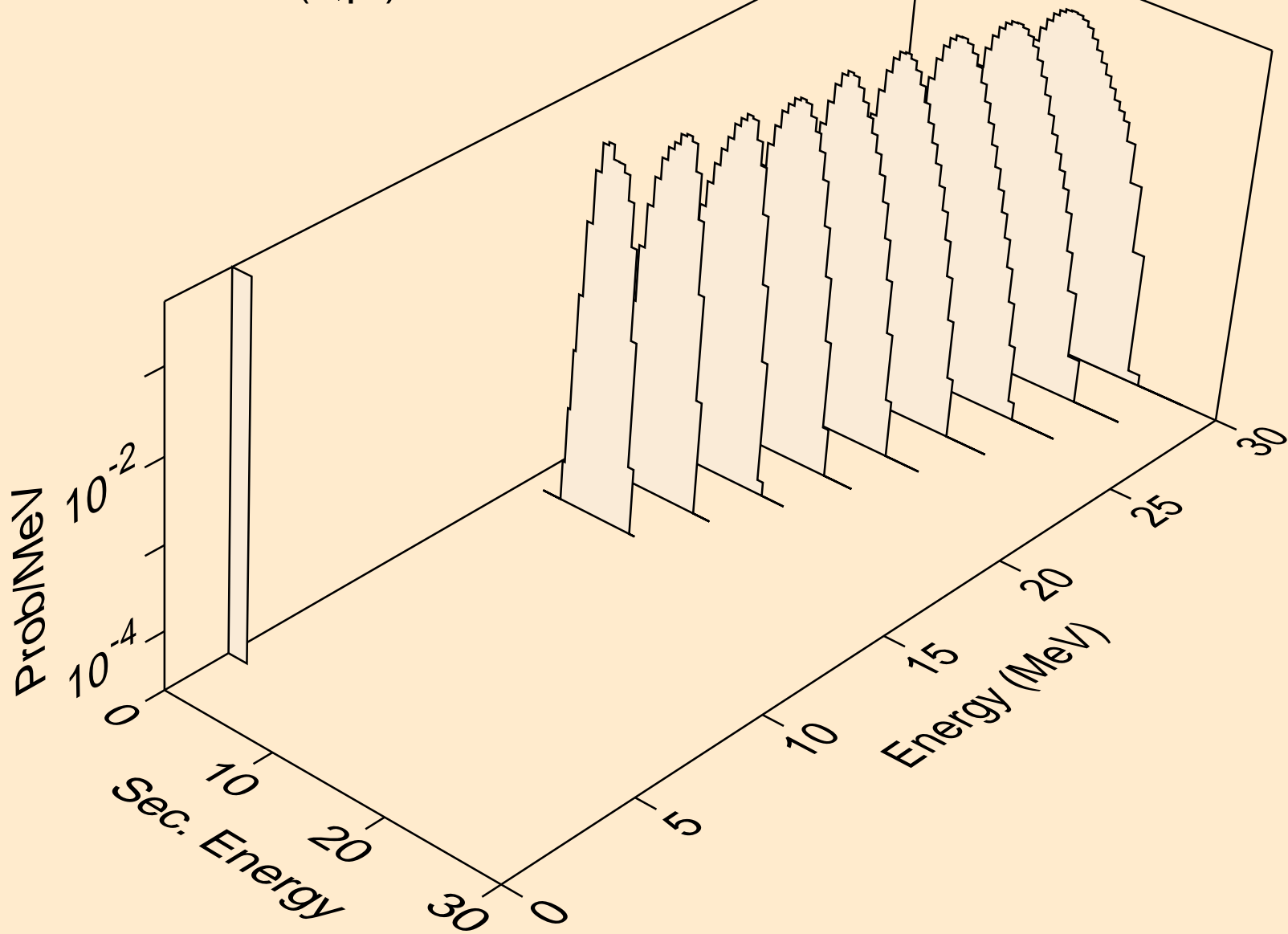



PB219 HELION ACER TENDL-2021 LIBRARY; T=0.K  
alphas from (s,x)

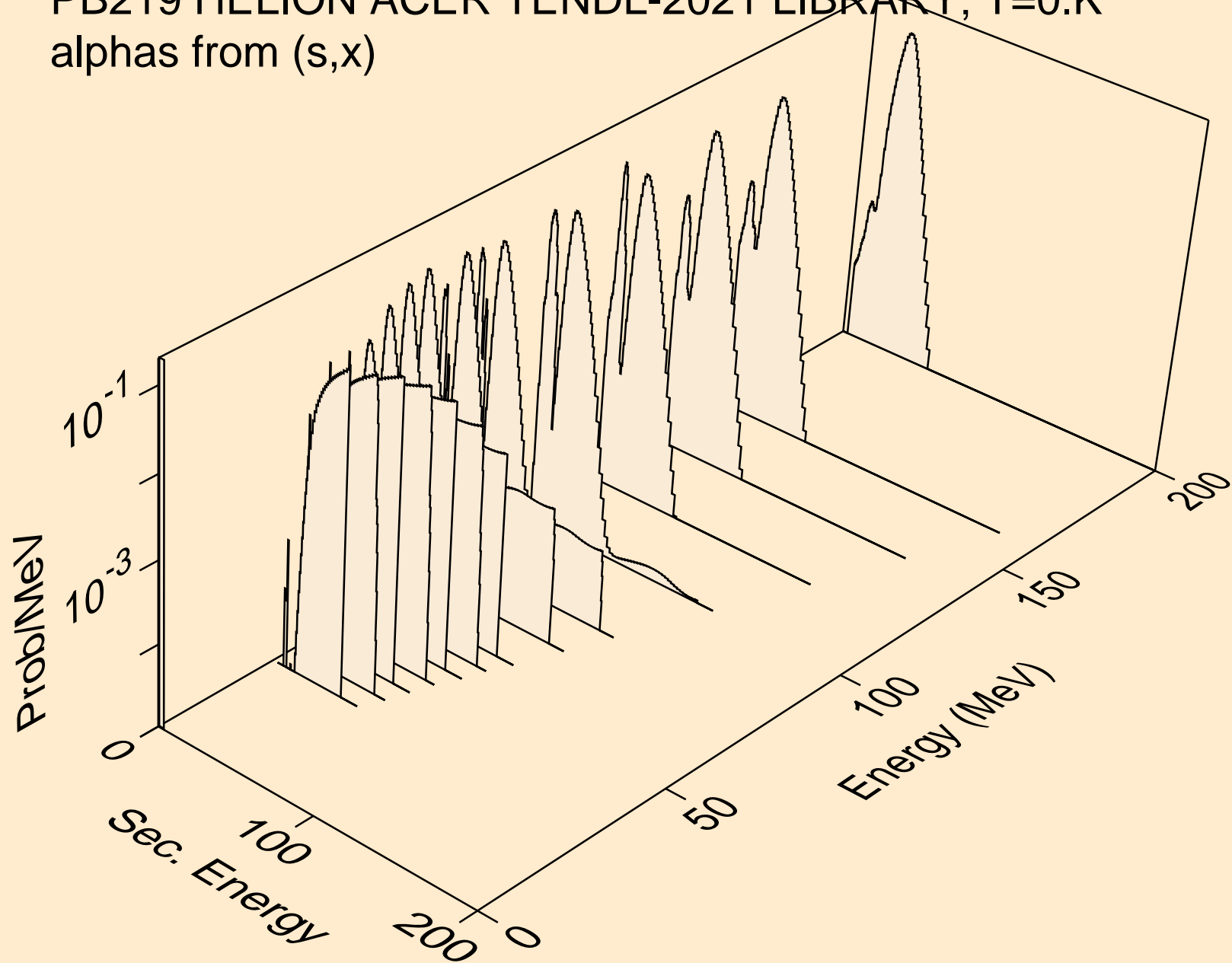

PB219 HELION ACER TENDL-2021 LIBRARY; T=0.K  
alphas from (s,n\*)a

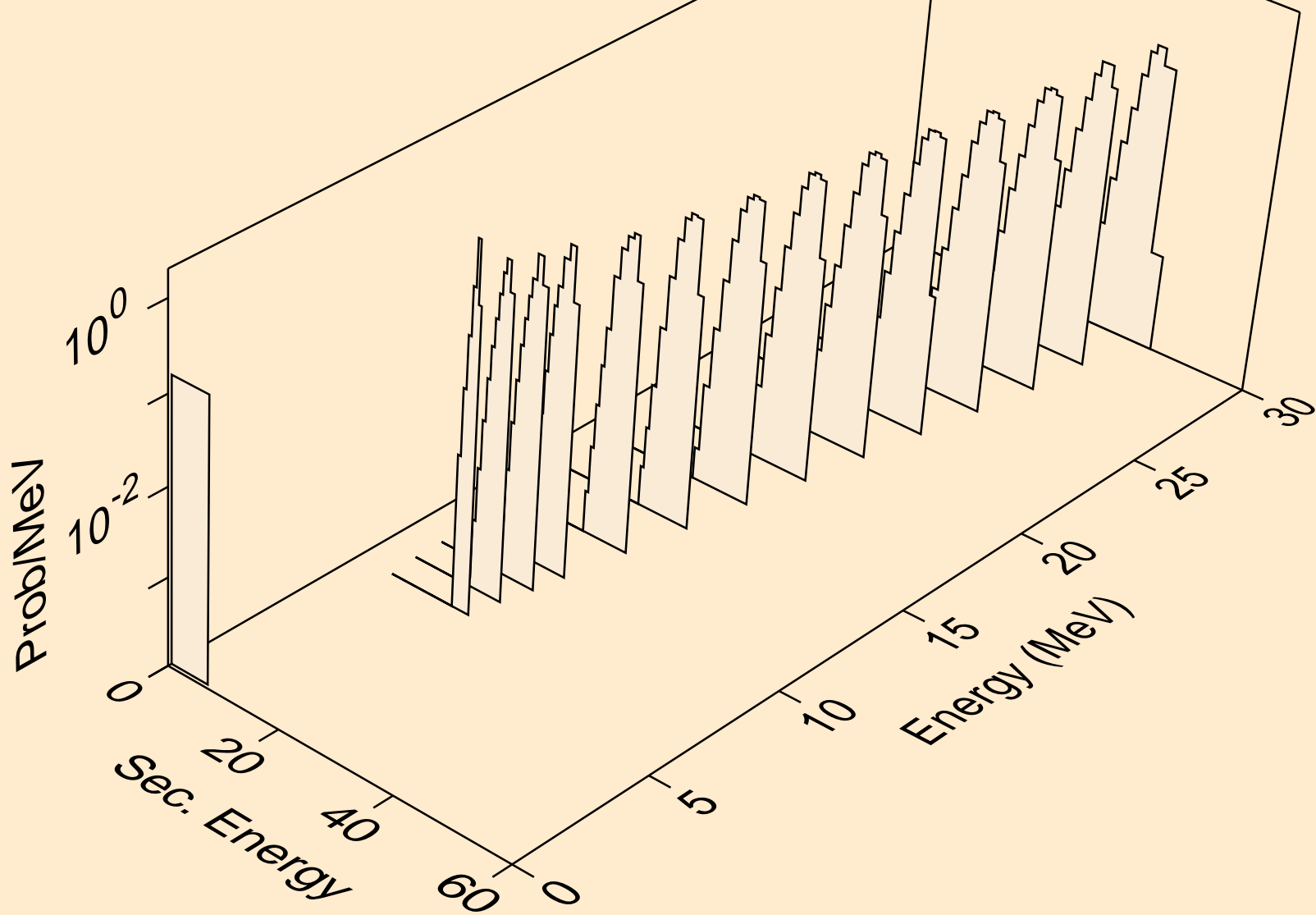

PB219 HELION ACER TENDL-2021 LIBRARY; T=0.K  
alphas from (s,2n)a

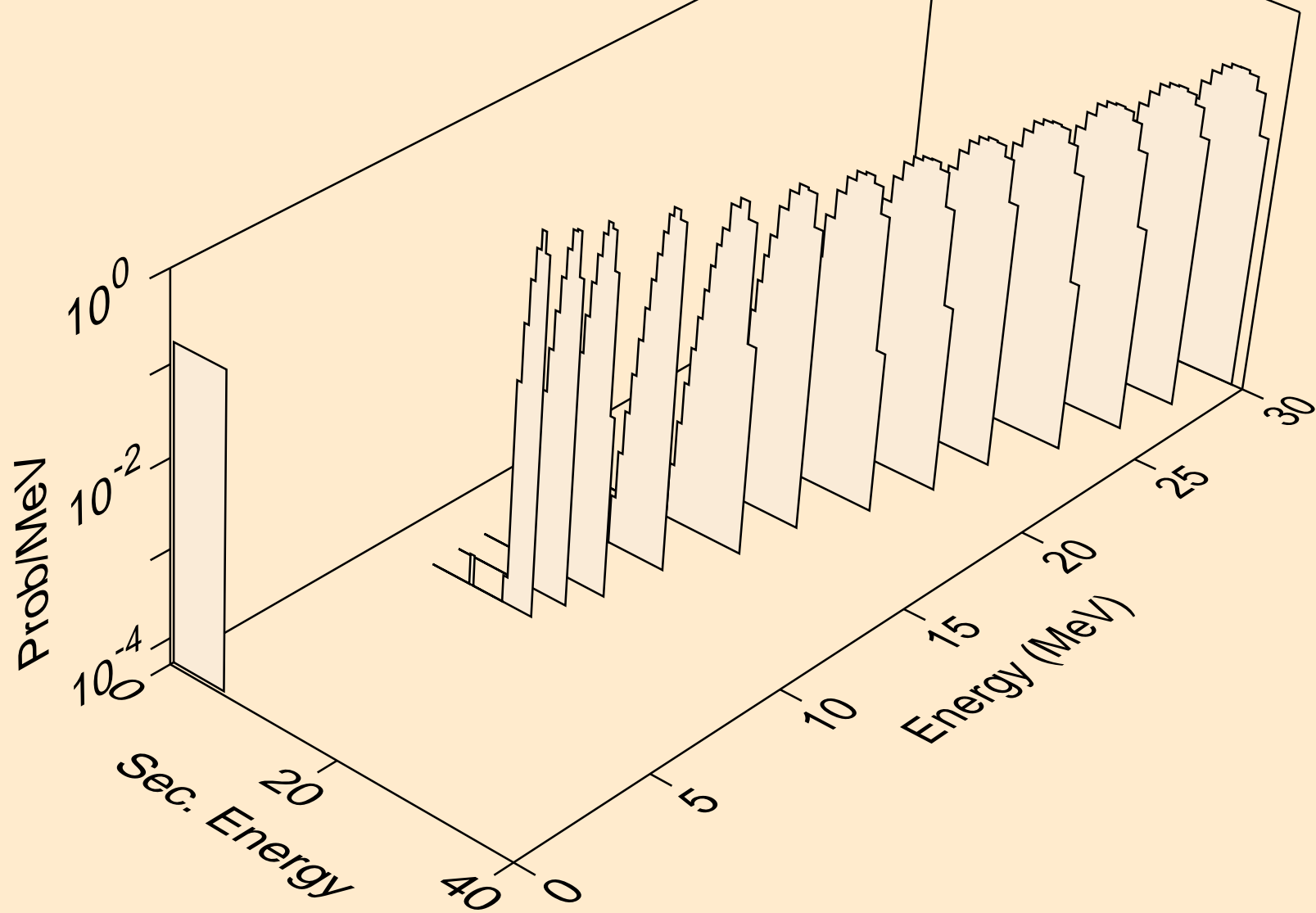

PB219 HELION ACER TENDL-2021 LIBRARY; T=0.K  
alphas from (s,3n)a

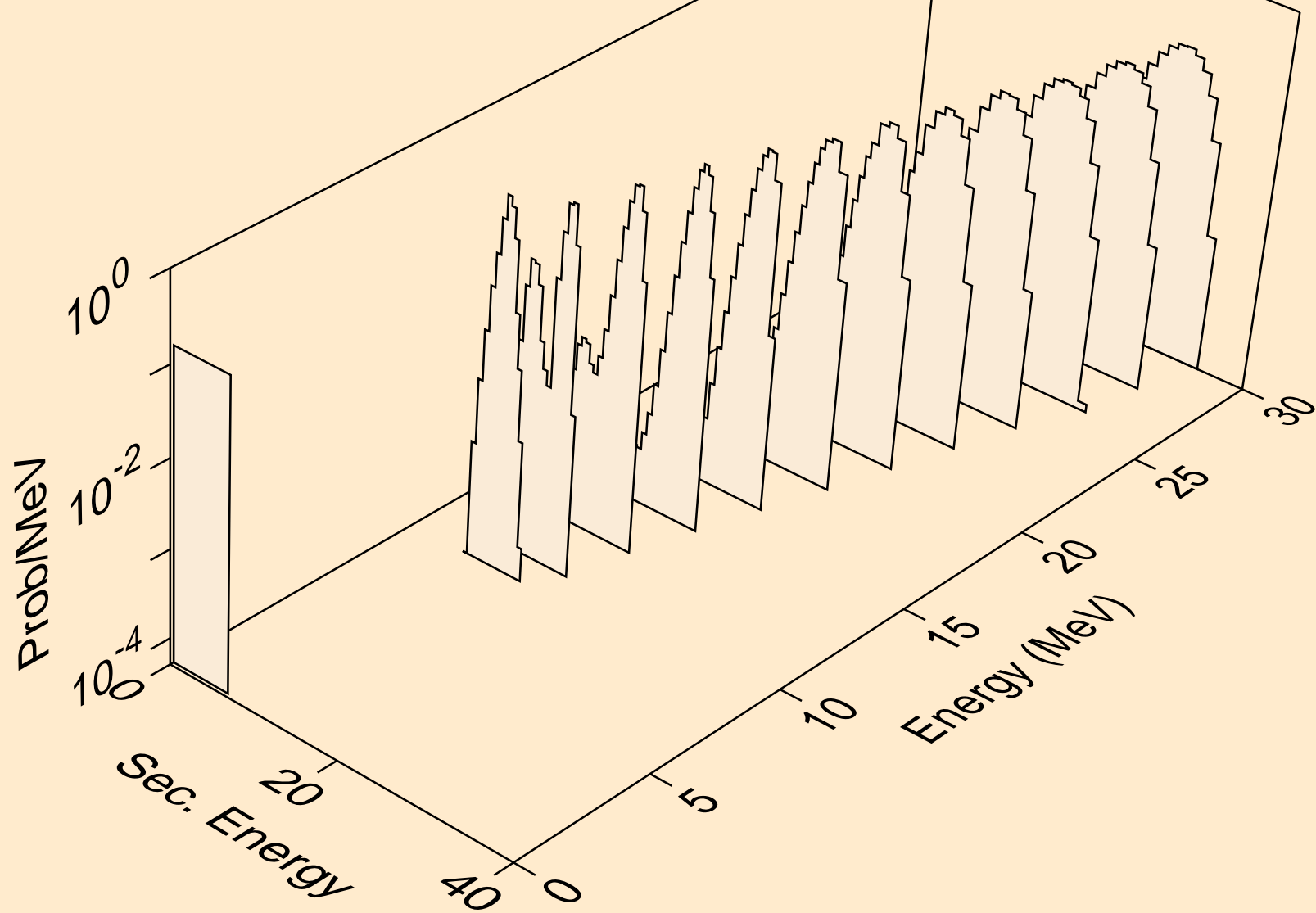

PB219 HELION ACER TENDL-2021 LIBRARY; T=0.K  
alphas from (s,npa)

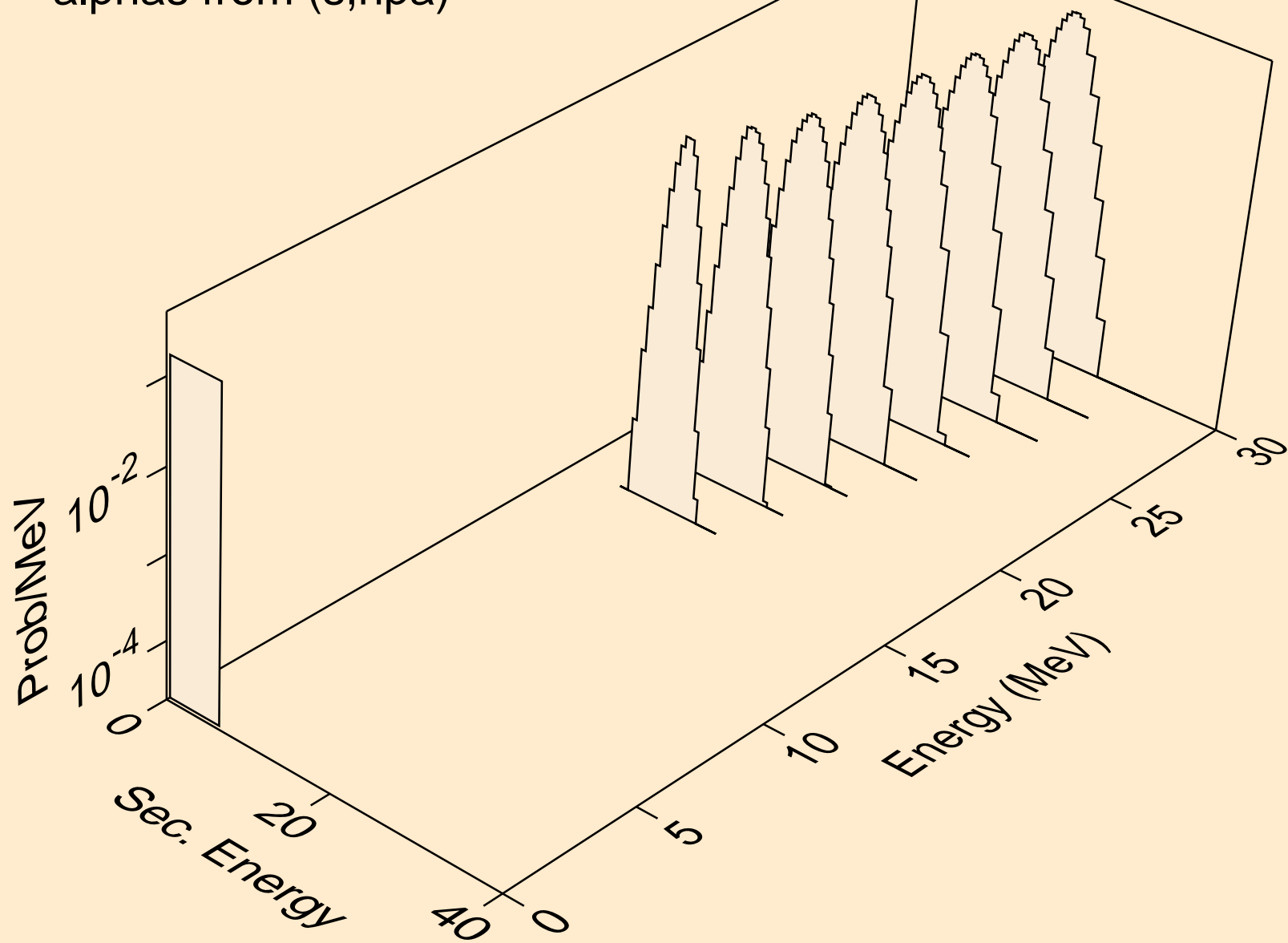

PB219 HELION ACER TENDL-2021 LIBRARY; T=0.K  
alphas from (s,a)

