

PD107M HELION ACER TENDL-2021 LIBRARY; T=0.K  
Principal cross sections

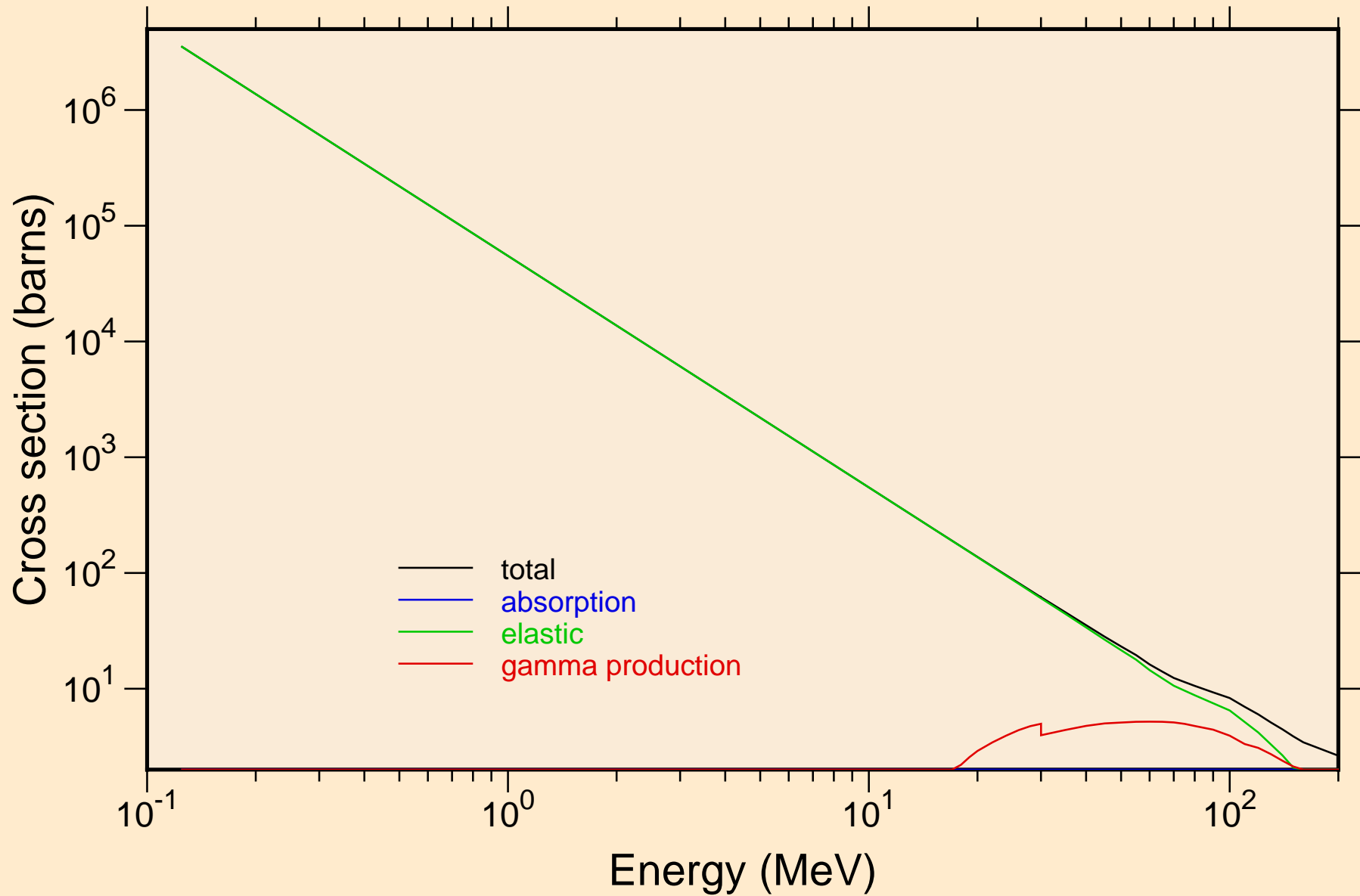

PD107M HELION ACER TENDL-2021 LIBRARY; T=0.K

Heating

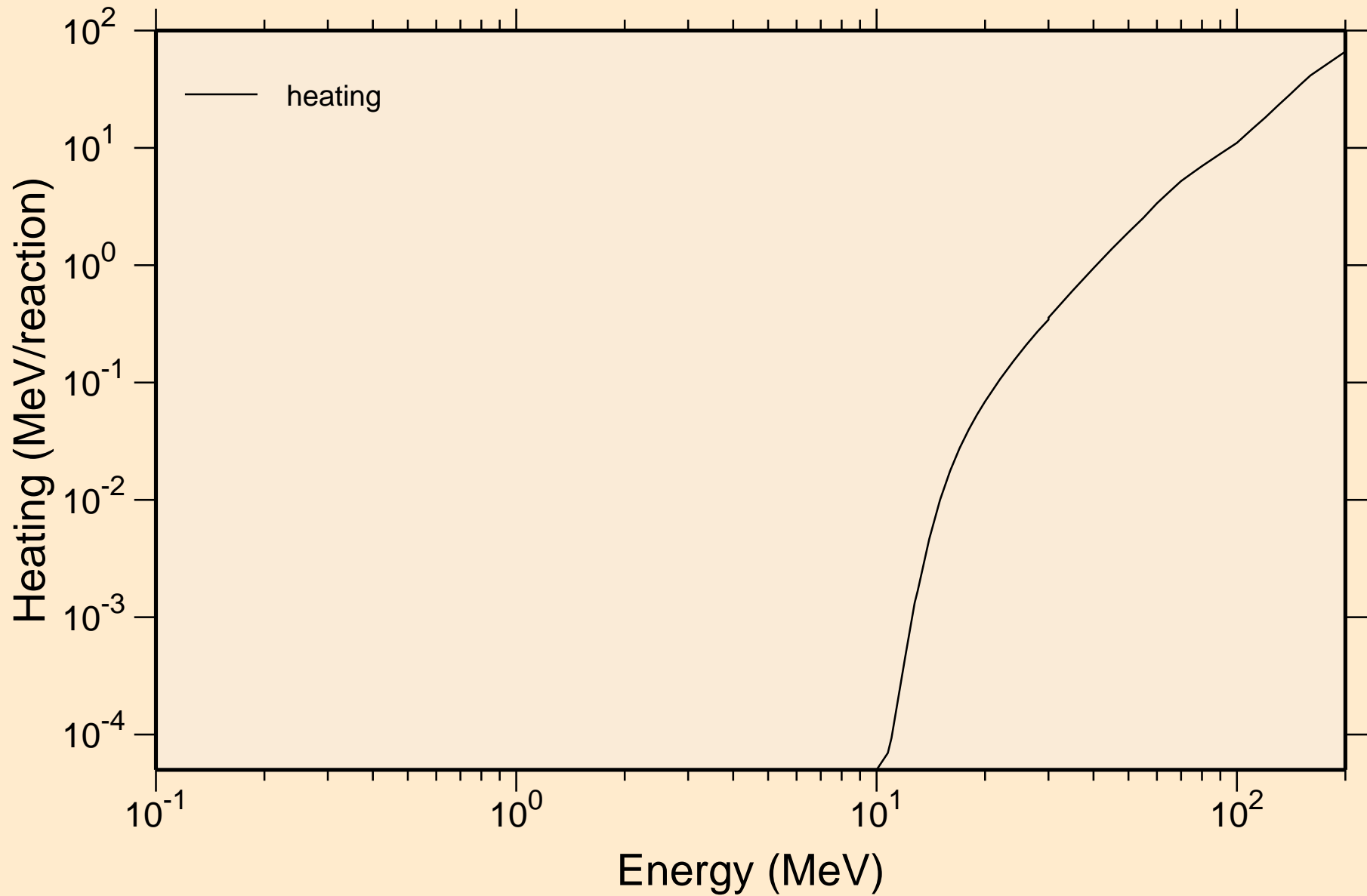

PD107M HELION ACER TENDL-2021 LIBRARY; T=0.K

Principal cross sections

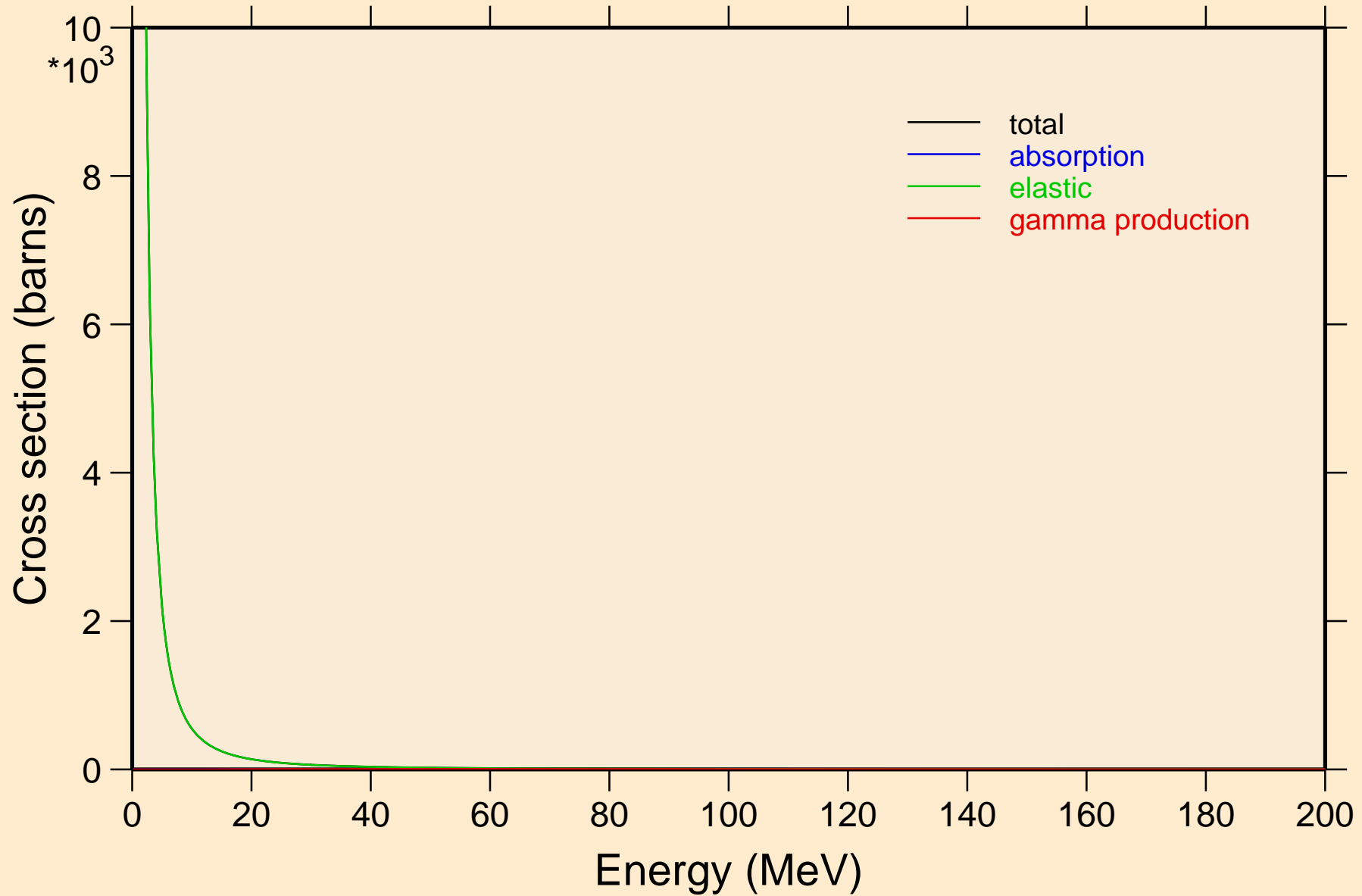

PD107M HELION ACER TENDL-2021 LIBRARY; T=0.K

Heating

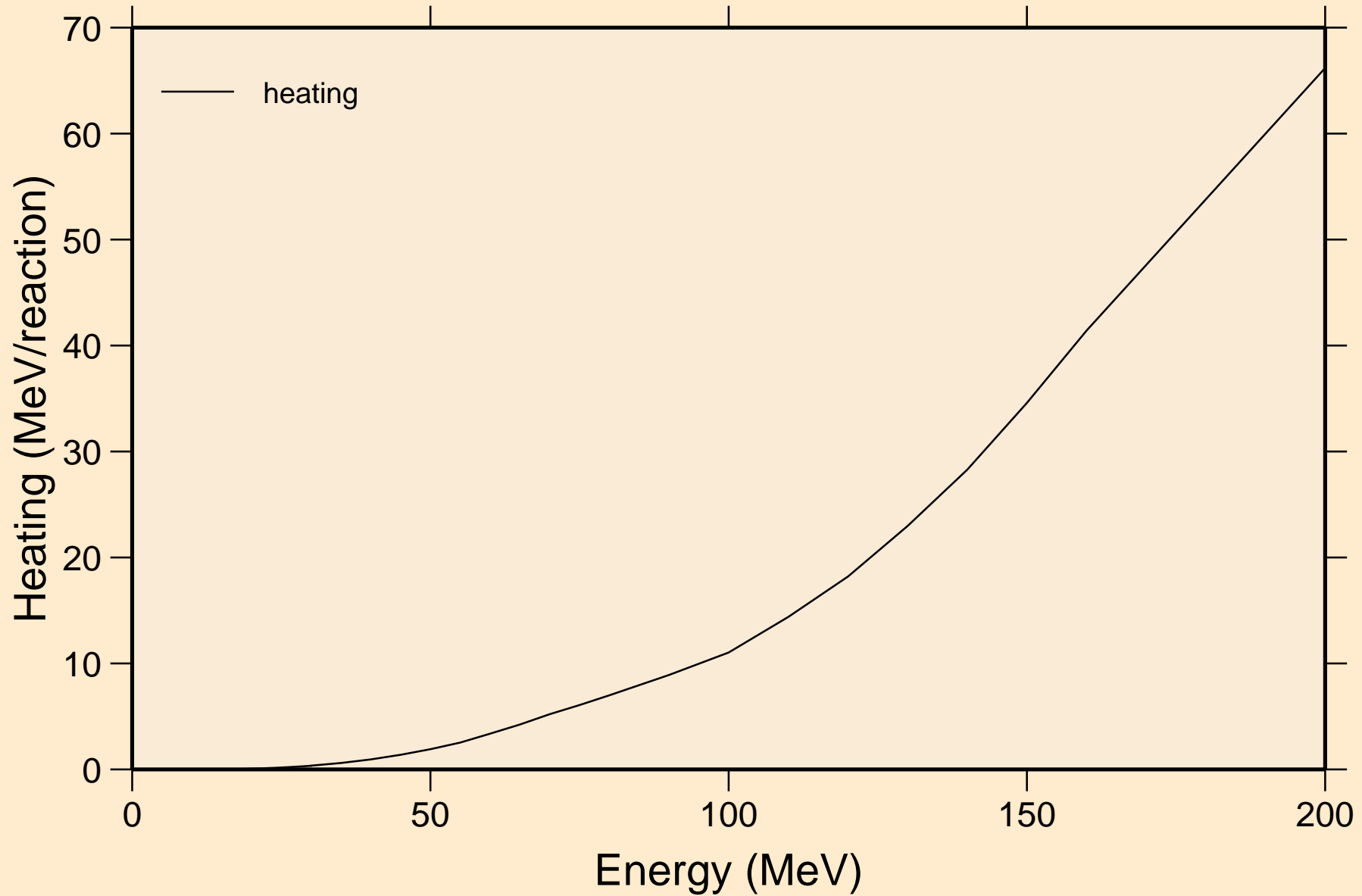

PD107M HELION ACER TENDL-2021 LIBRARY; T=0.K  
Threshold reactions

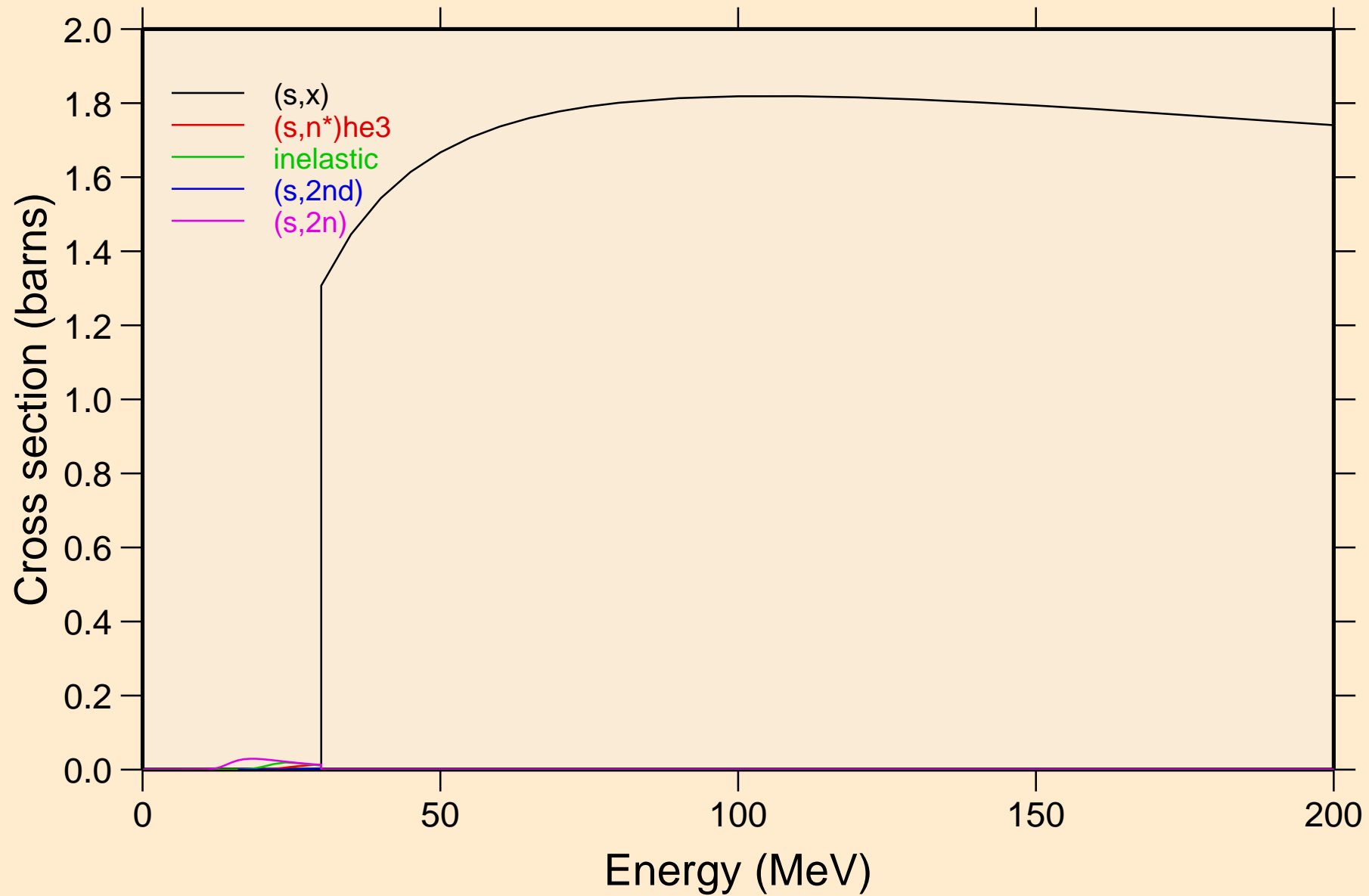

PD107M HELION ACER TENDL-2021 LIBRARY; T=0.K  
Threshold reactions

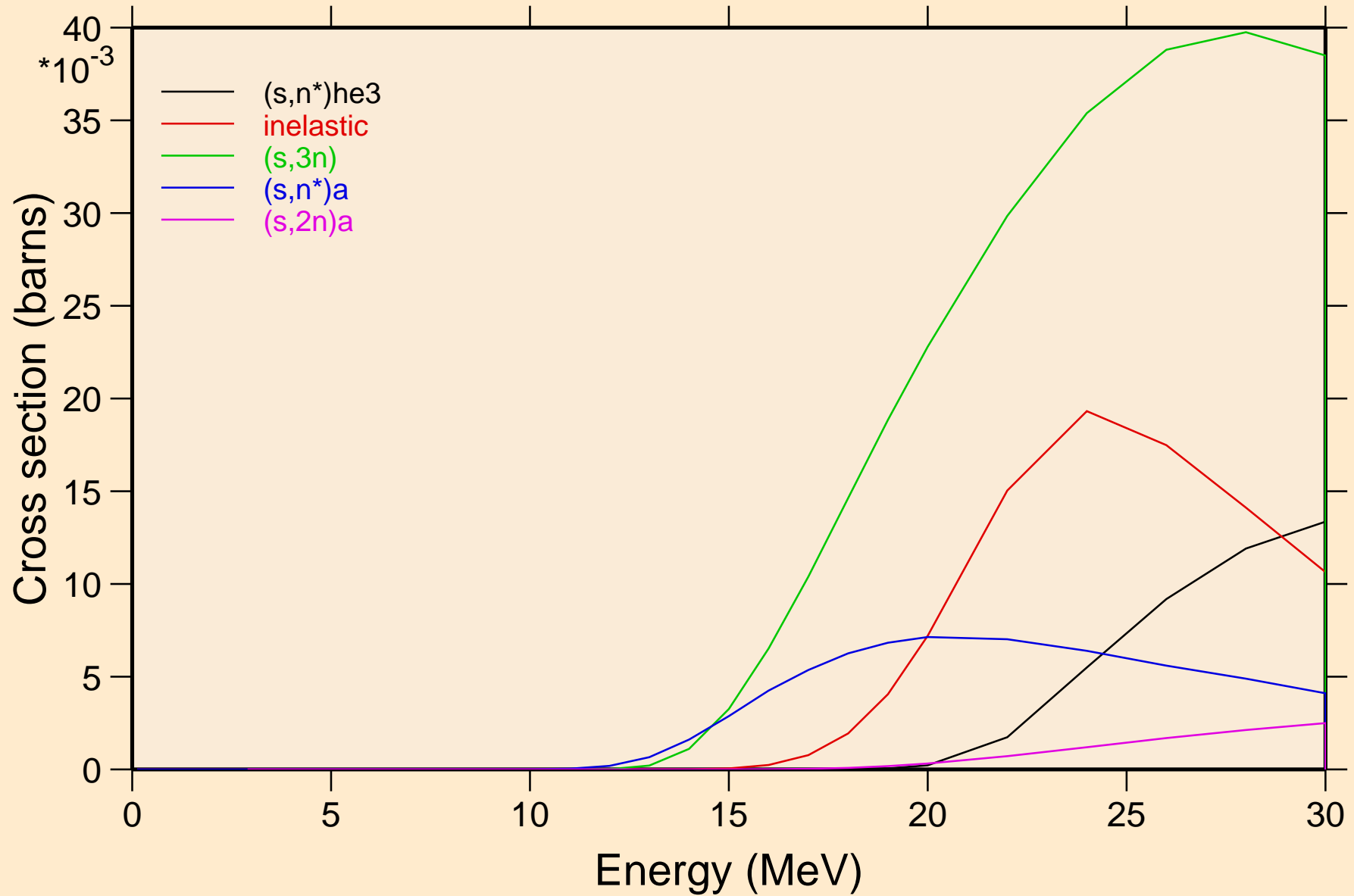

PD107M HELION ACER TENDL-2021 LIBRARY; T=0.K  
Threshold reactions

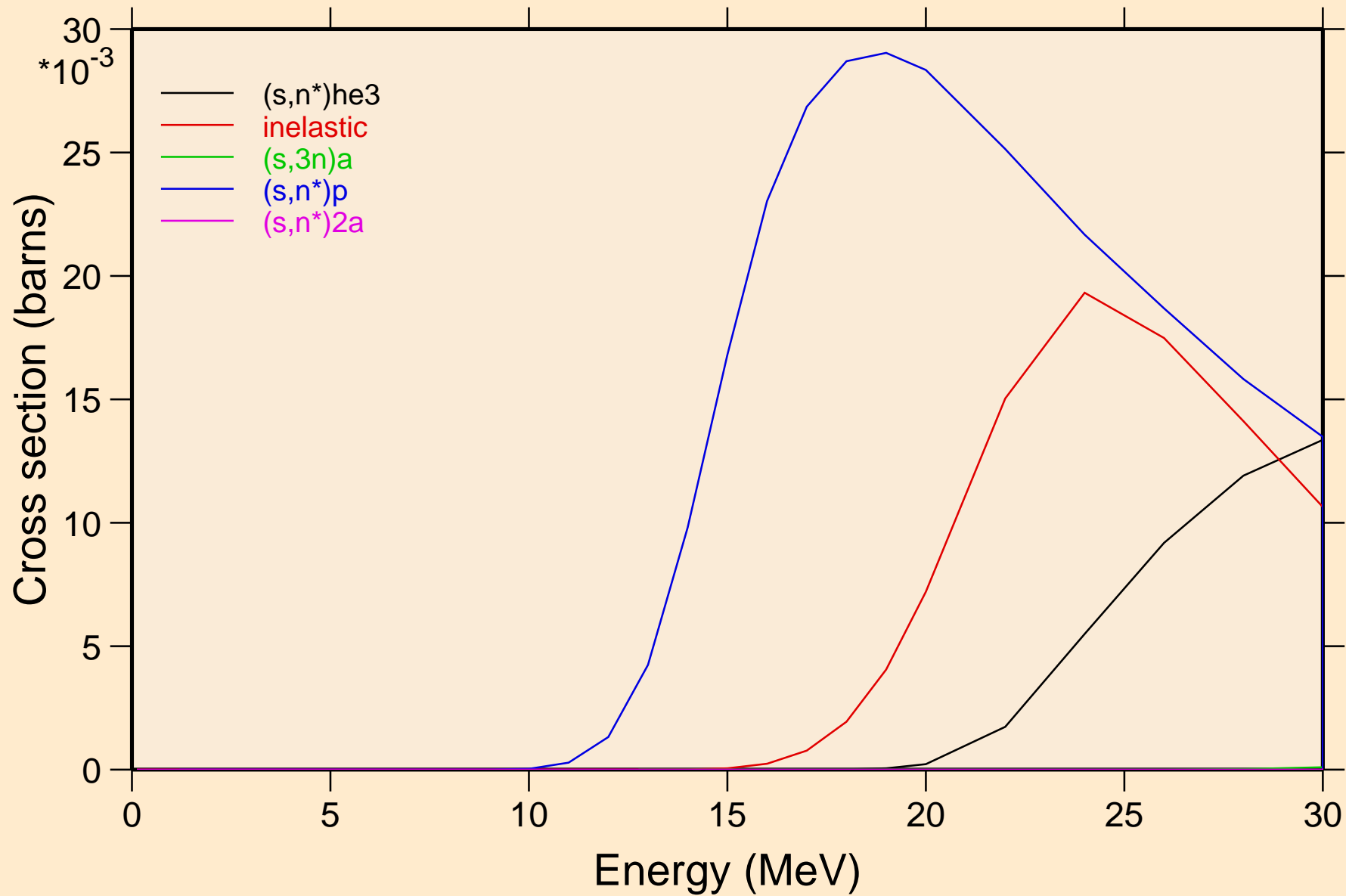

PD107M HELION ACER TENDL-2021 LIBRARY; T=0.K  
Threshold reactions

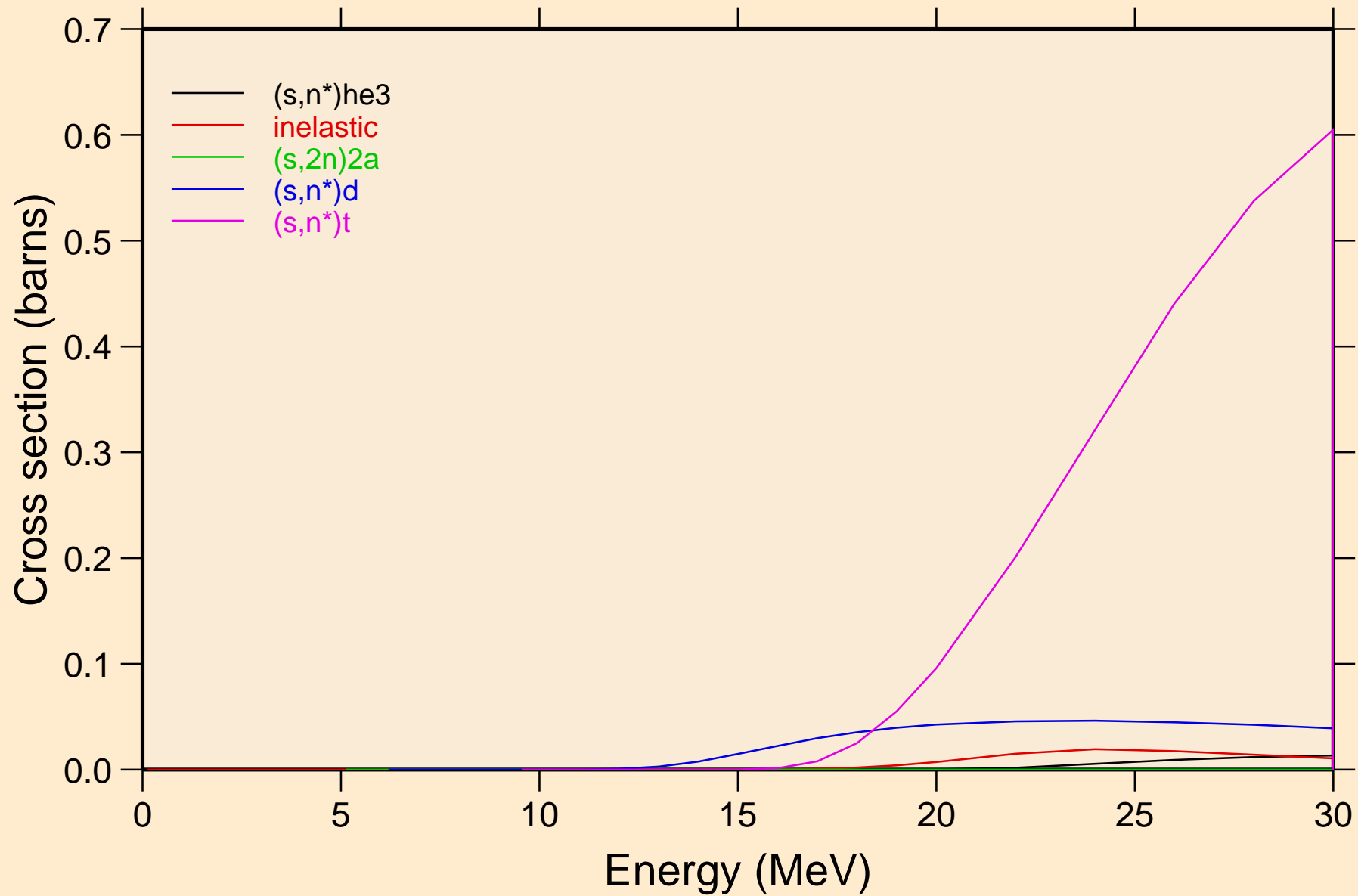



PD107M HELION ACER TENDL-2021 LIBRARY; T=0.K  
Threshold reactions

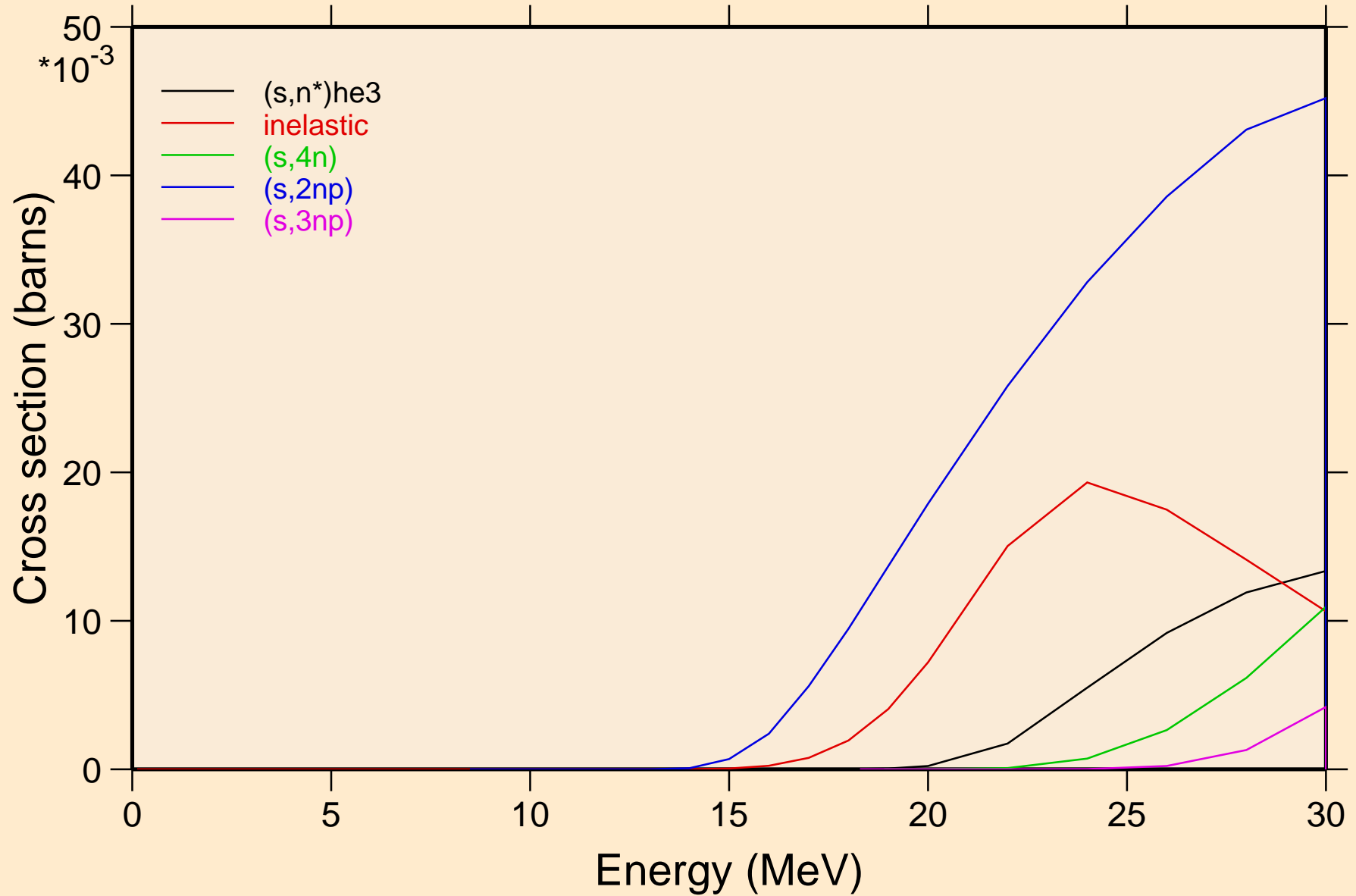

PD107M HELION ACER TENDL-2021 LIBRARY; T=0.K  
Threshold reactions

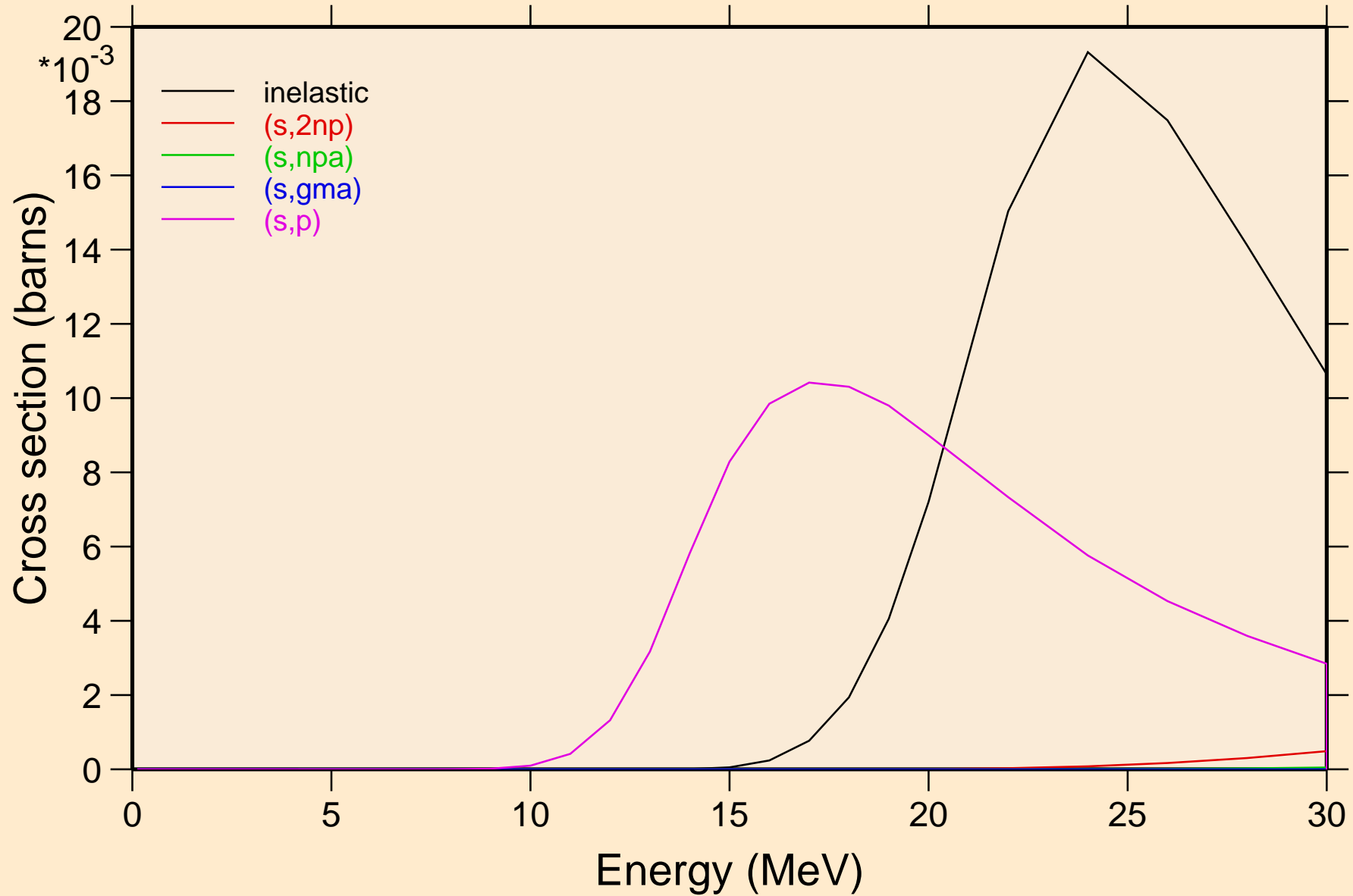

PD107M HELION ACER TENDL-2021 LIBRARY; T=0.K  
Threshold reactions

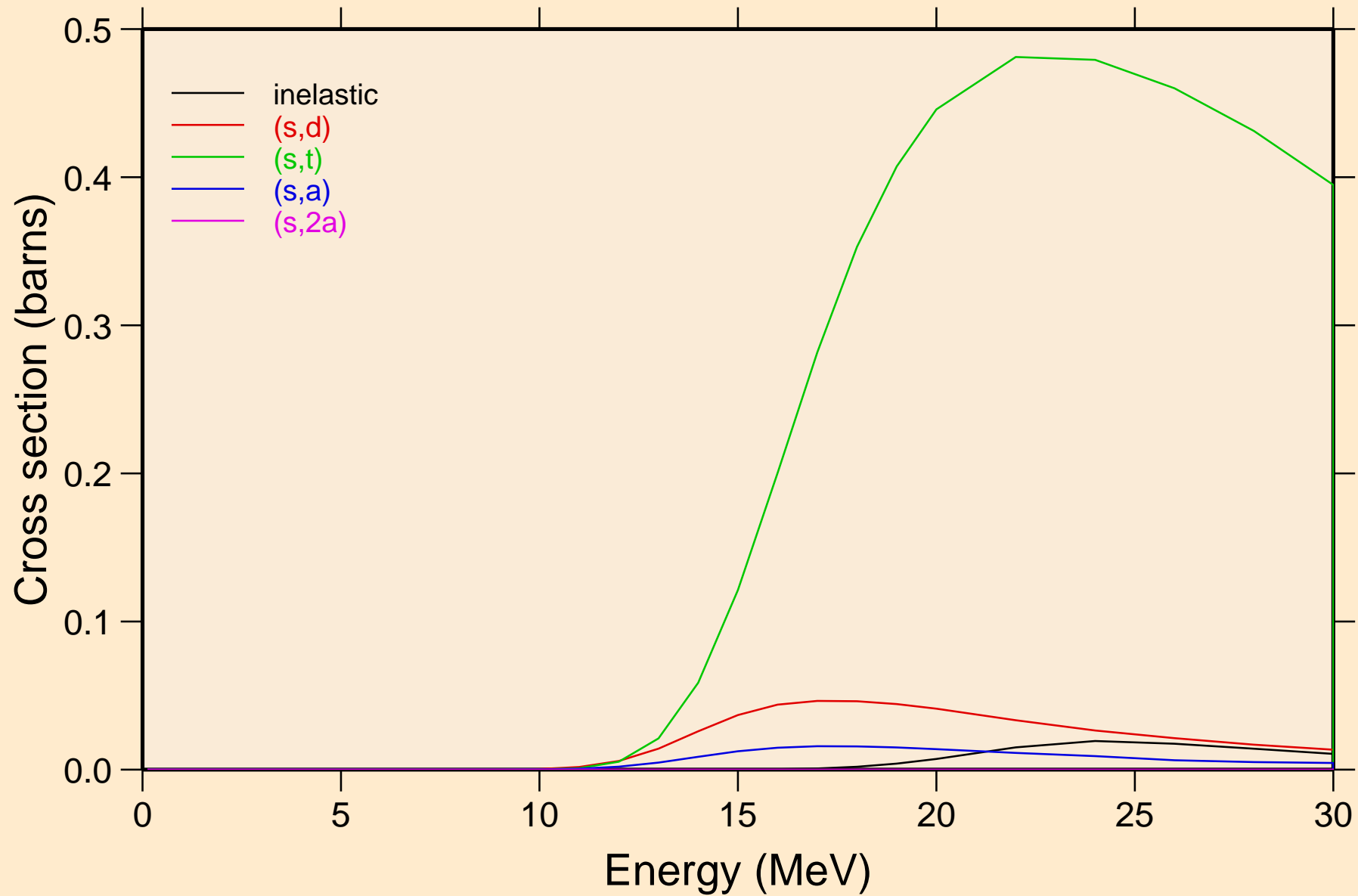

PD107M HELION ACER TENDL-2021 LIBRARY; T=0.K  
Threshold reactions

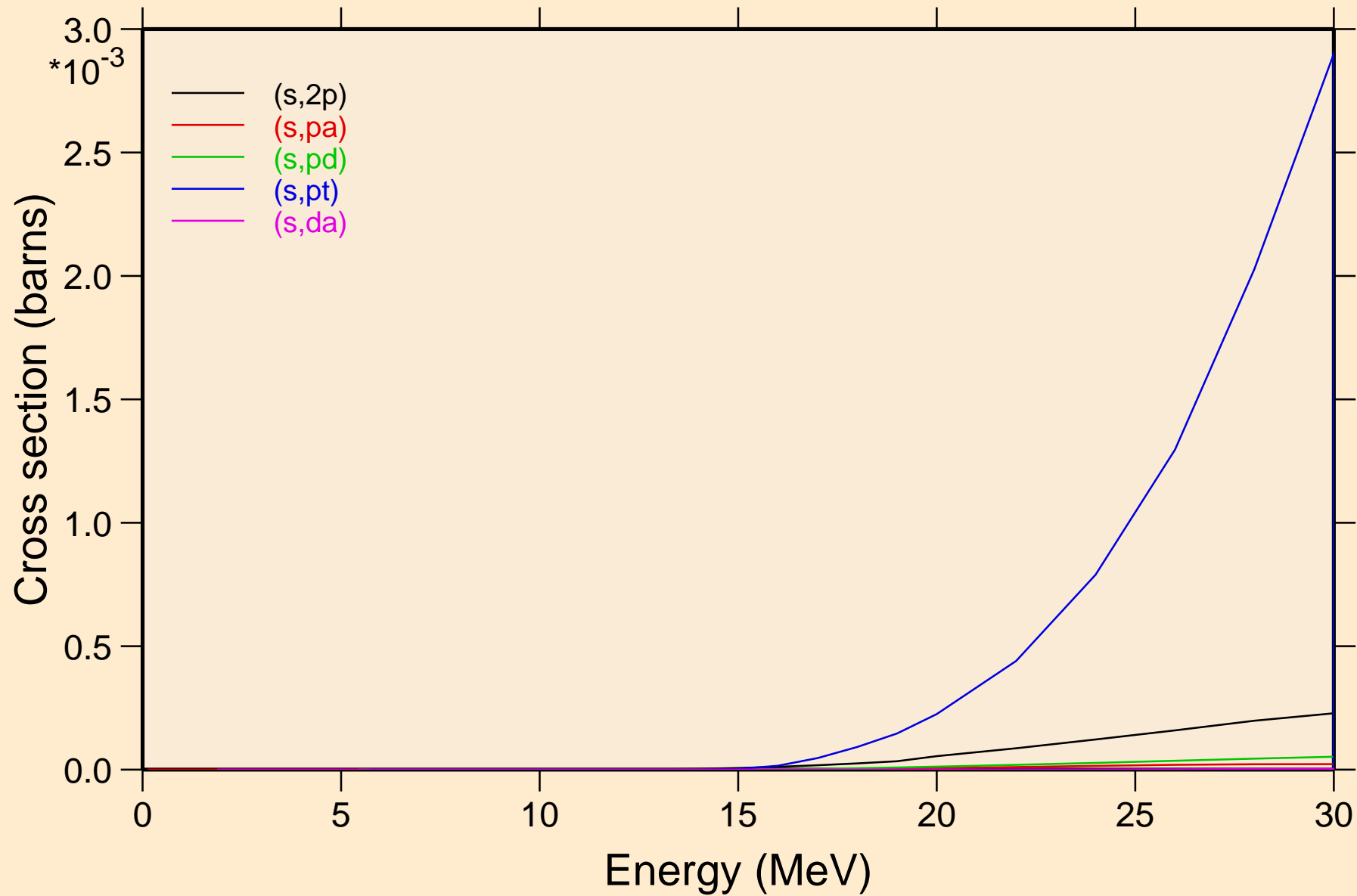

PD107M HELION ACER TENDL-2021 LIBRARY; T=0.K  
angular distribution for elastic

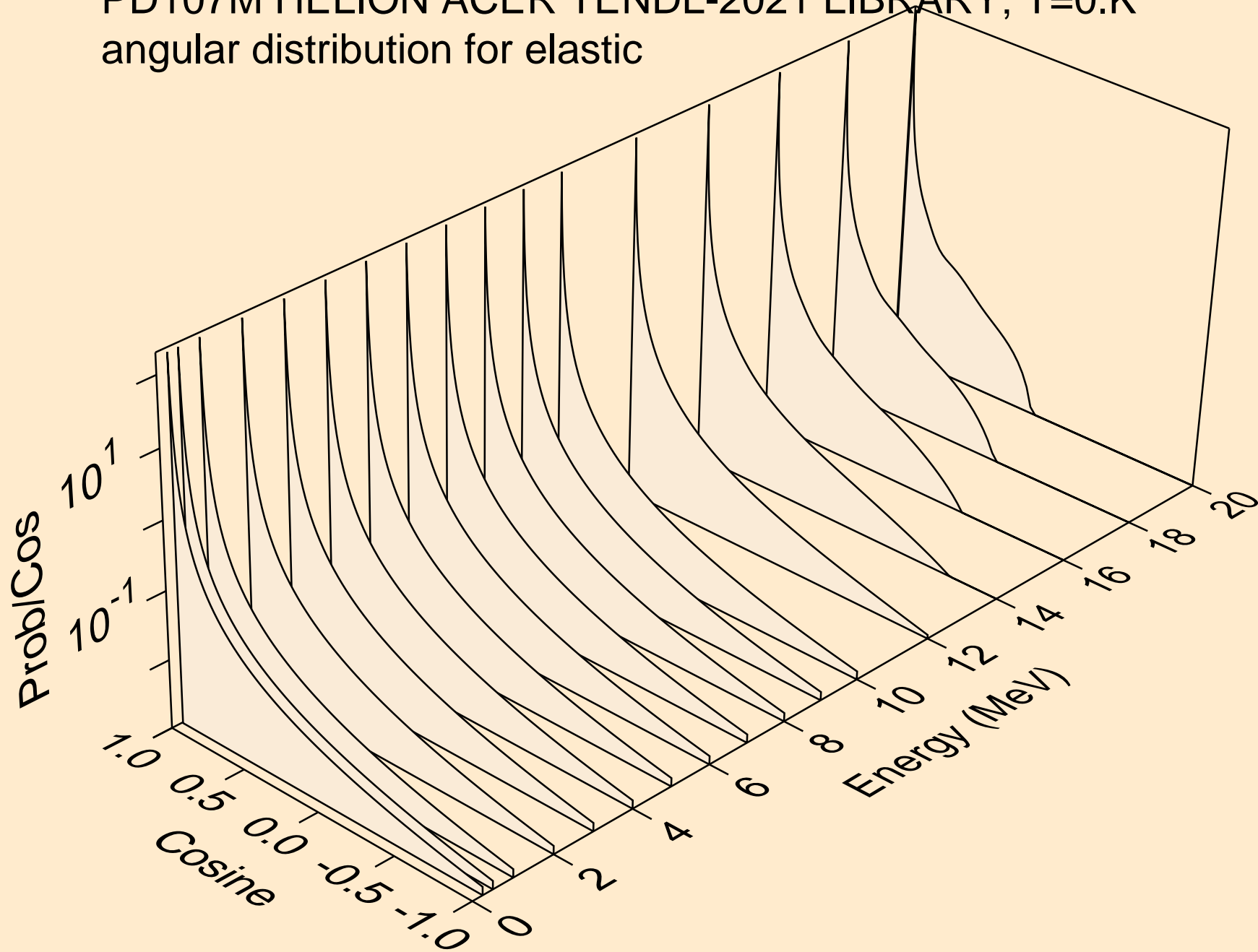

PD107M HELION ACER TENDL-2021 LIBRARY; T=0.K  
angular distribution for elastic

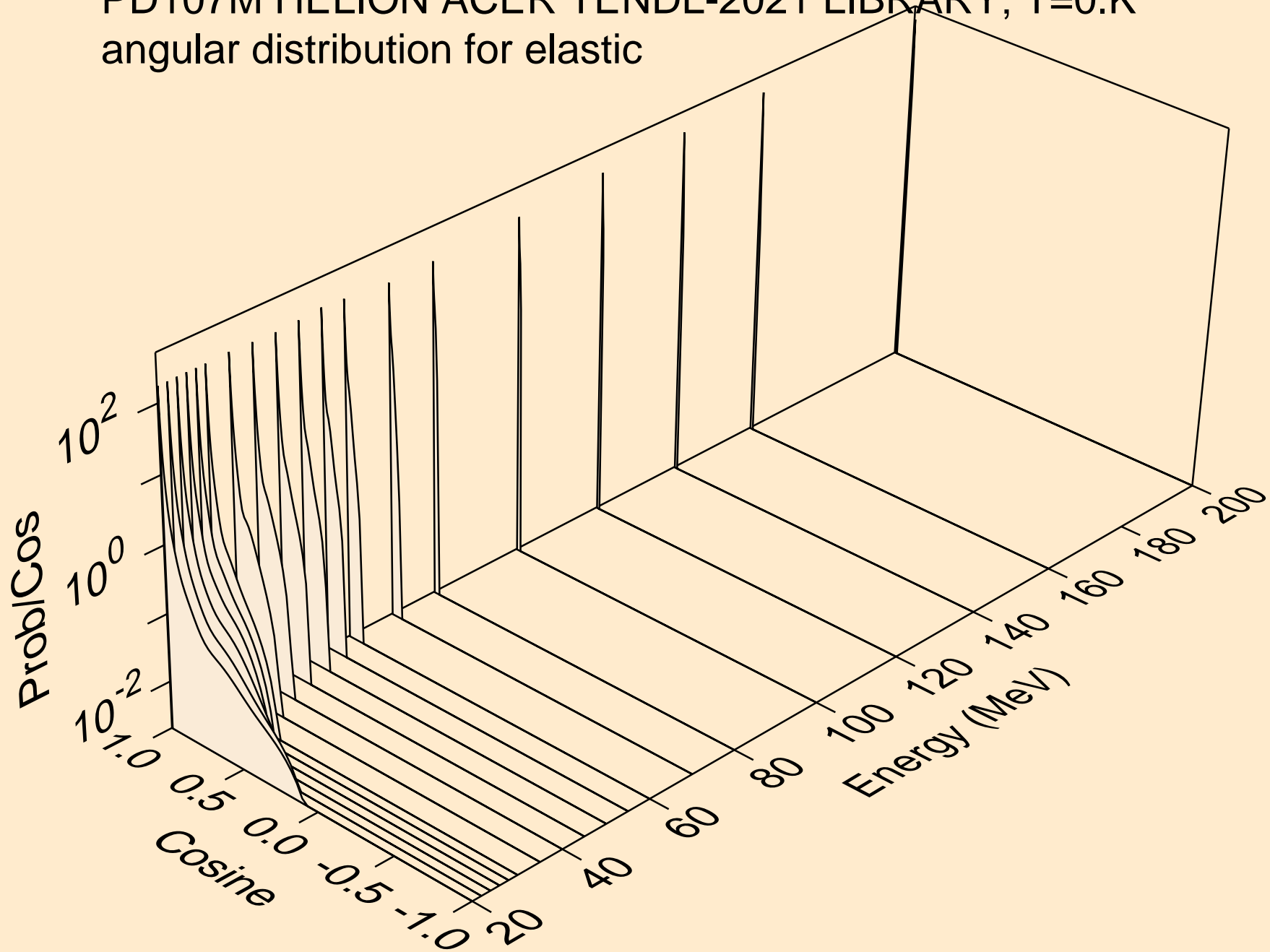

PD107M HELION ACER TENDL-2021 LIBRARY; T=0.K  
He-3 emission for (s,x)

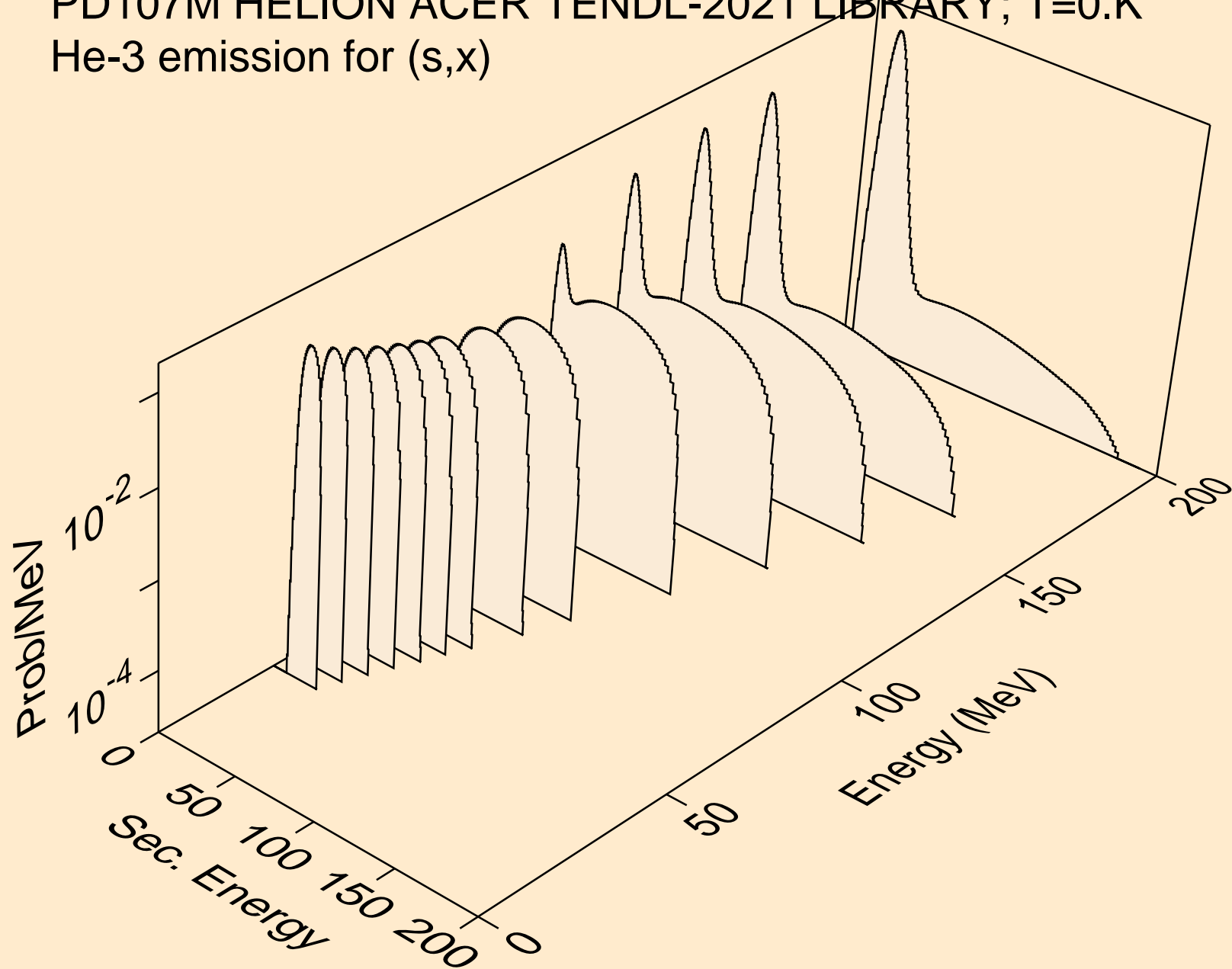

PD107M HELION ACER TENDL-2021 LIBRARY; T=0.K  
He-3 emission for (s,n\*)he3

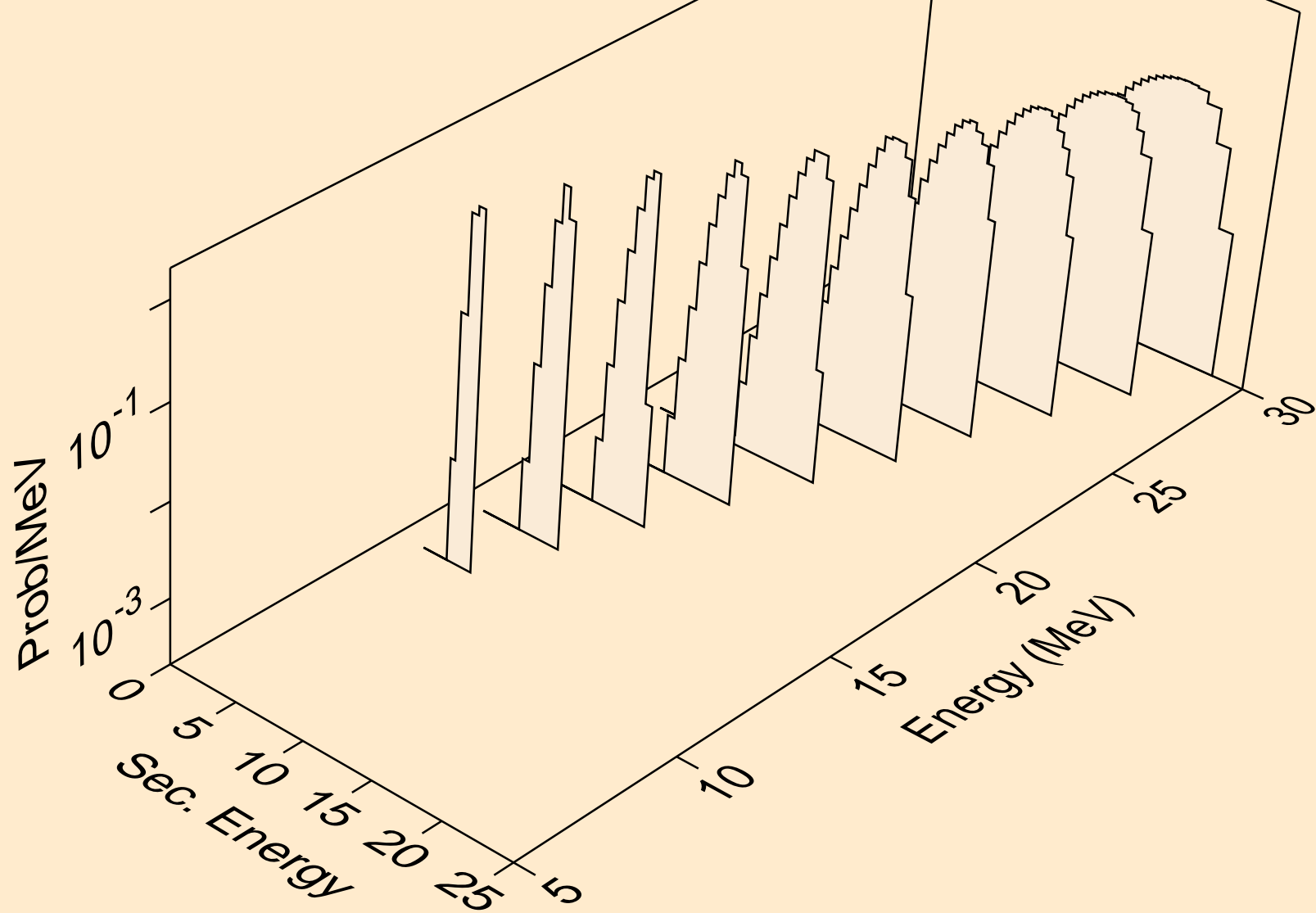



PD107M HELION ACER TENDL-2021 LIBRARY; T=0.K  
He-3 emission for inelastic

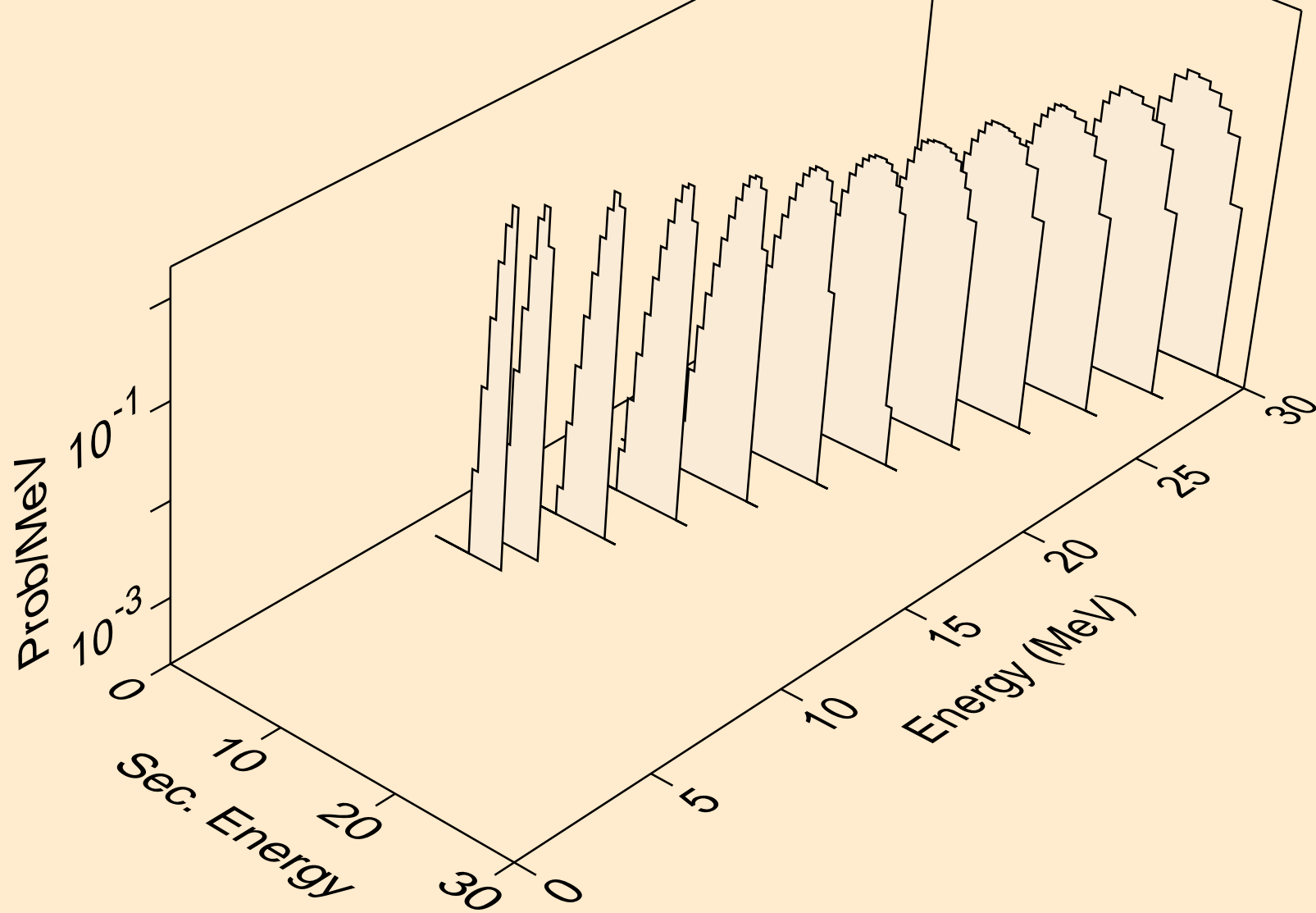

PD107M HELION ACER TENDL-2021 LIBRARY; T=0.K  
Photon emission for (z,n)

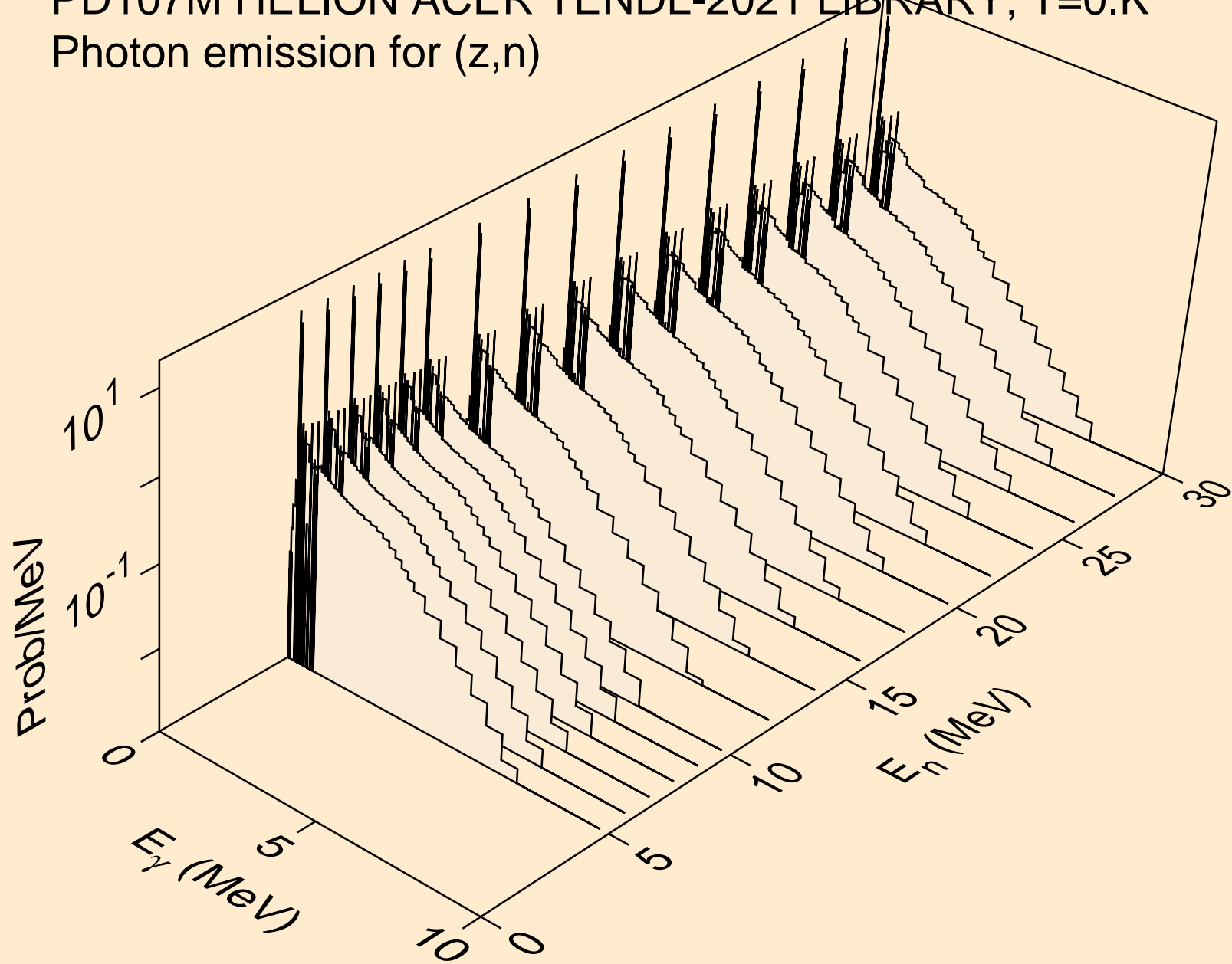

PD107M HELION ACER TENDL-2021 LIBRARY; T=0.K  
Photon emission for (n,x)

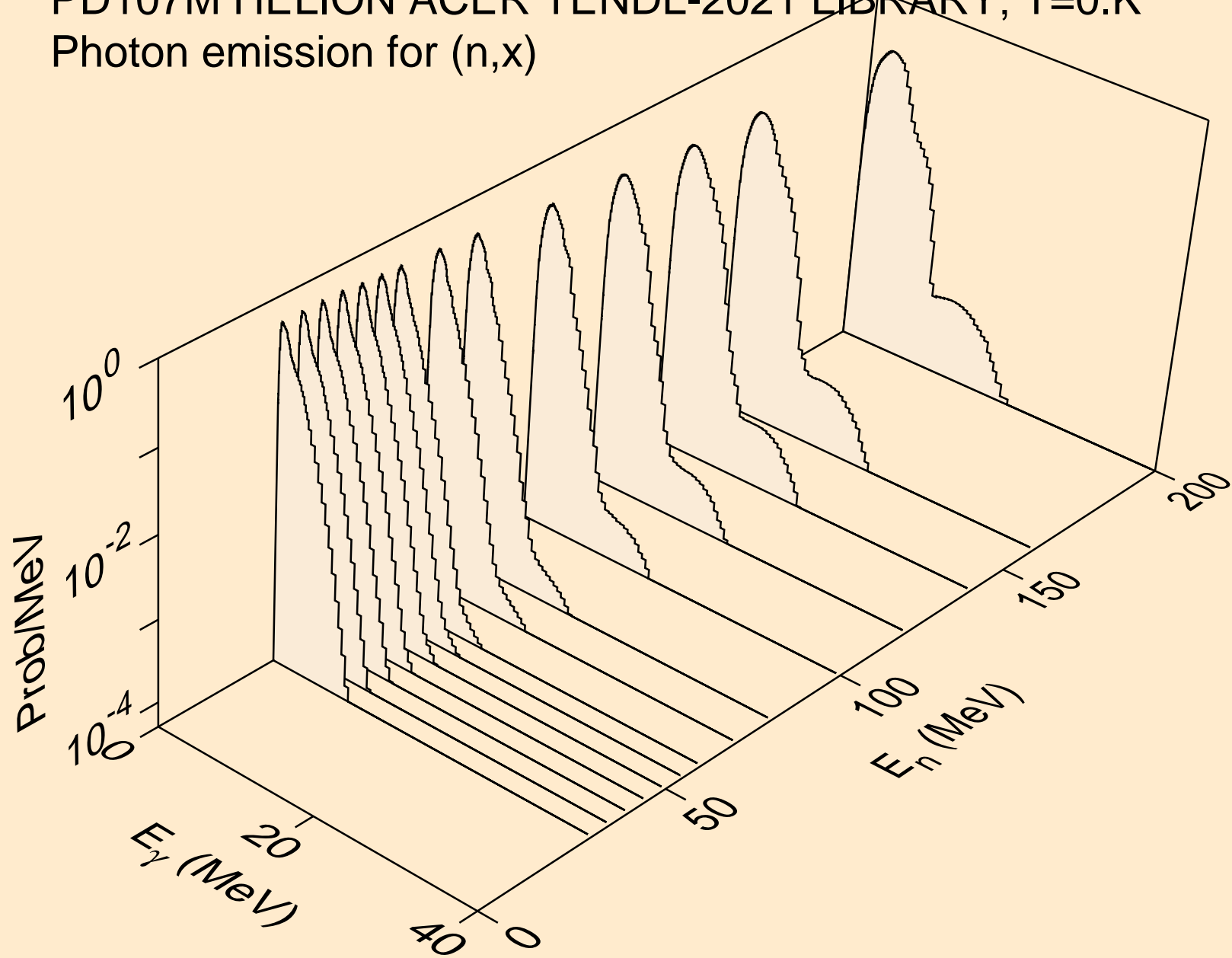

PD107M HELION ACER TENDL-2021 LIBRARY; T=0.K  
Photon emission for (n,2nd)

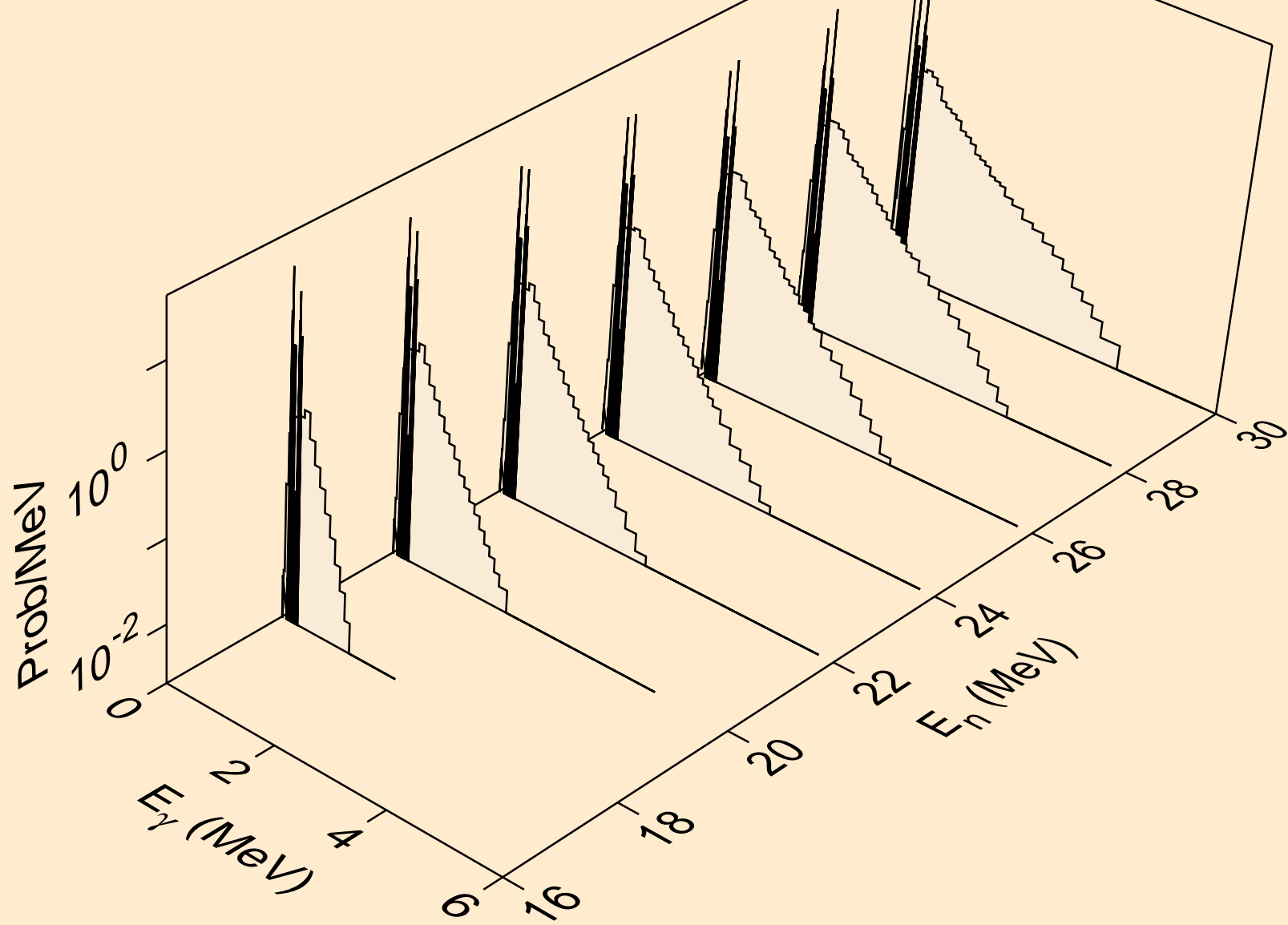

PD107M HELION ACER TENDL-2021 LIBRARY; T=0.K  
Photon emission for (n,2n)

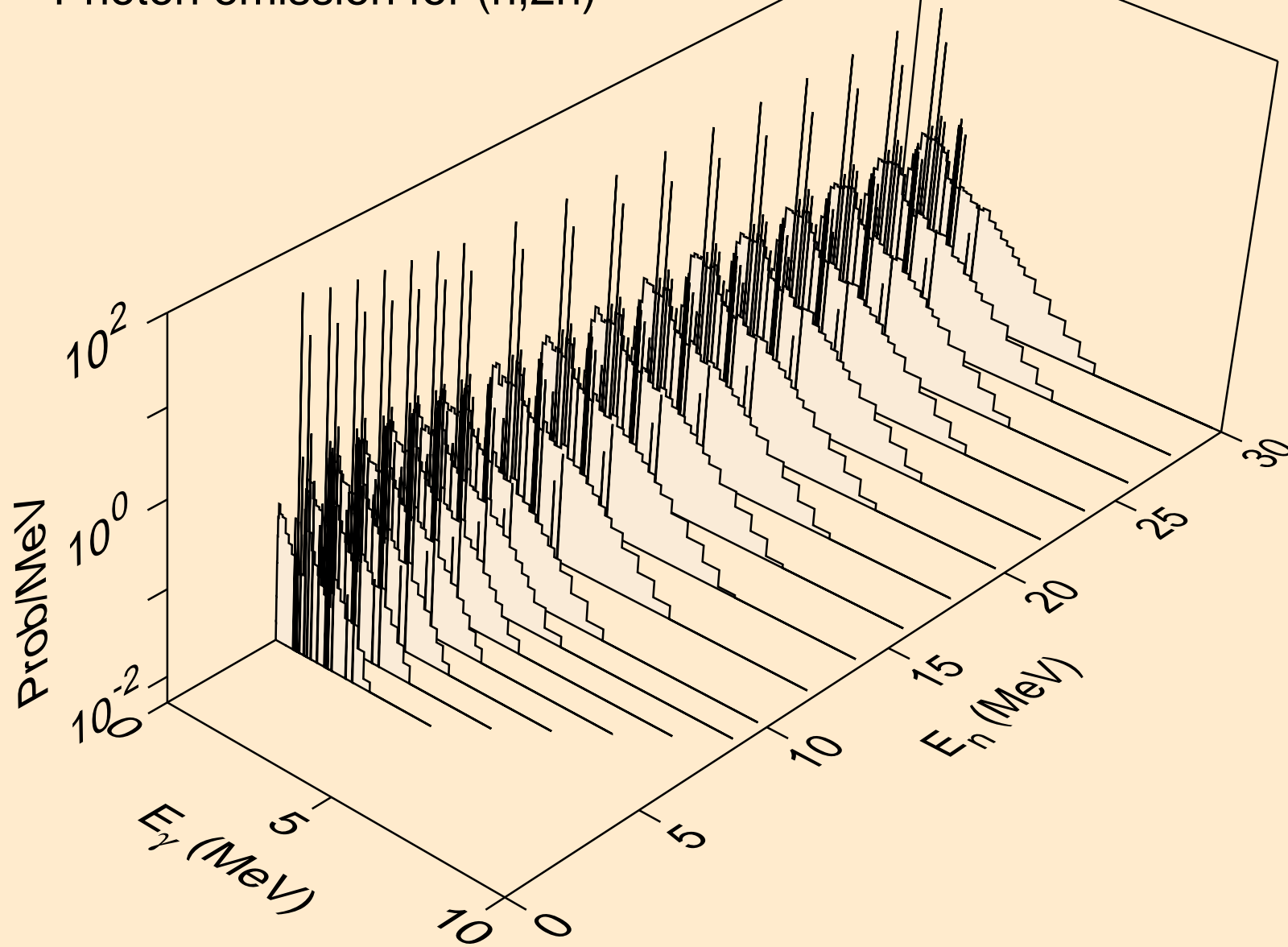

PD107M HELION ACER TENDL-2021 LIBRARY; T=0.K  
Photon emission for (n,3n)

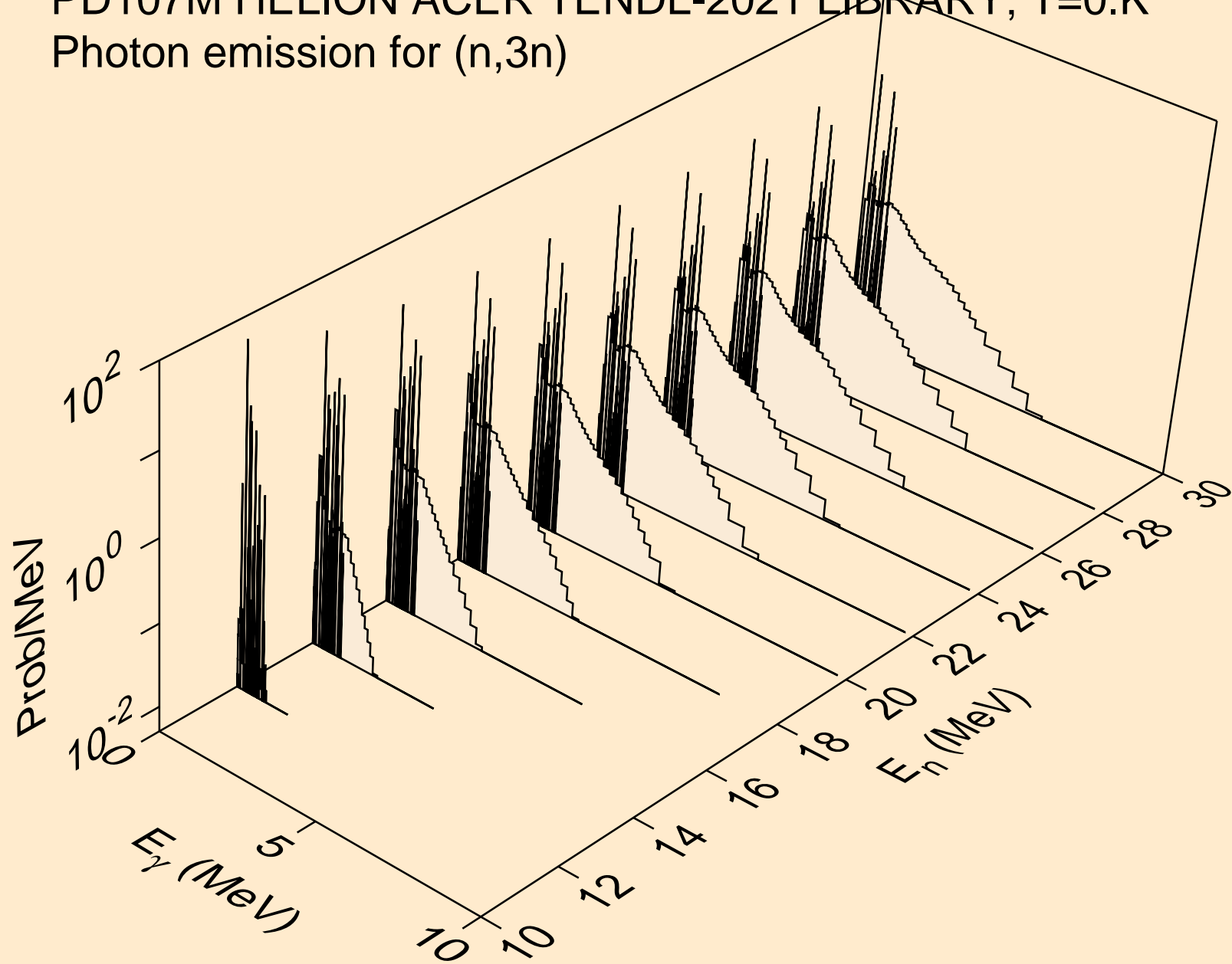

PD107M HELION ACER TENDL-2021 LIBRARY; T=0.K  
Photon emission for (n,n\*)a

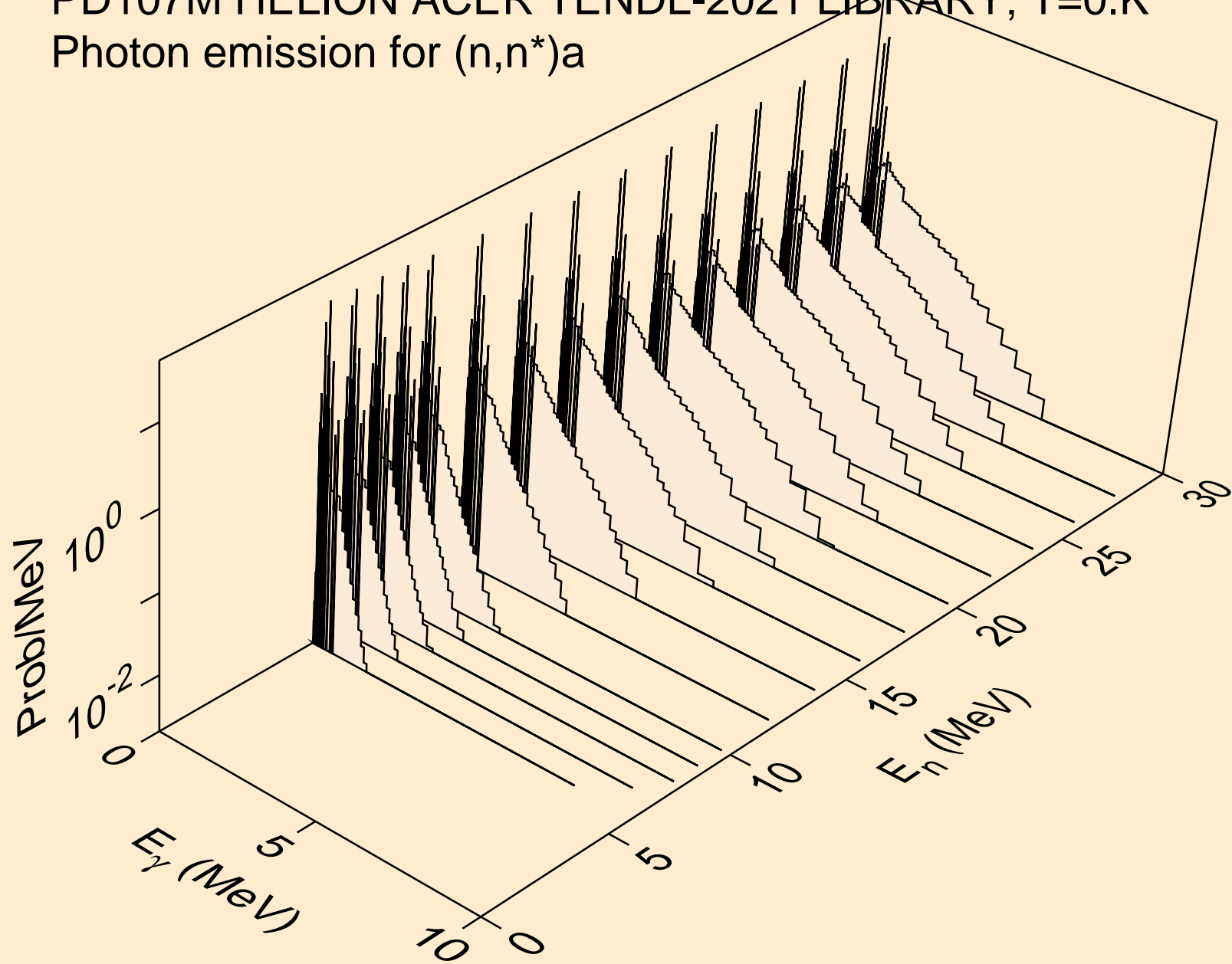

PD107M HELION ACER TENDL-2021 LIBRARY; T=0.K  
Photon emission for (n,2n)a

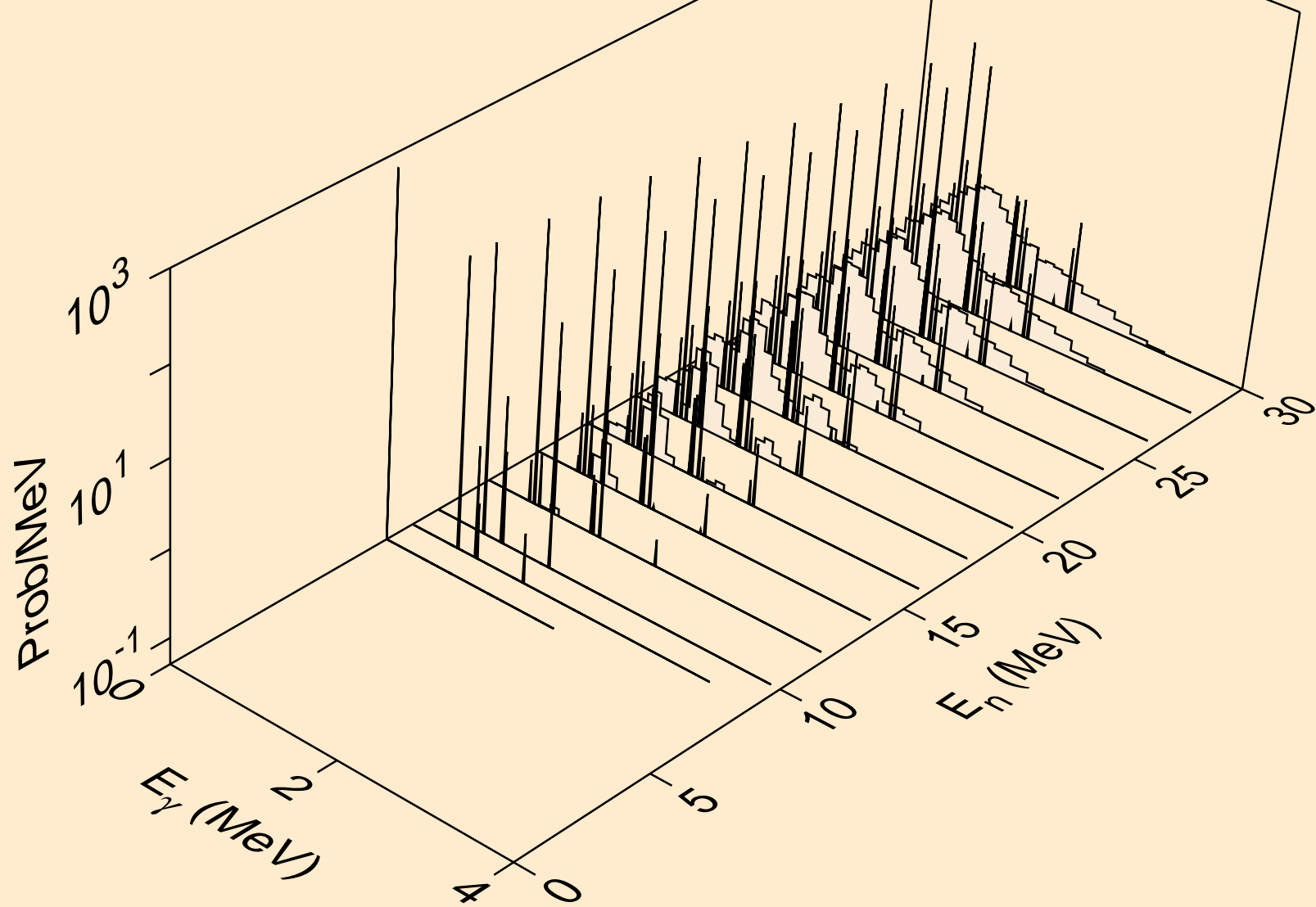



PD107M HELION ACER TENDL-2021 LIBRARY; T=0.K  
Photon emission for (n,3n)a

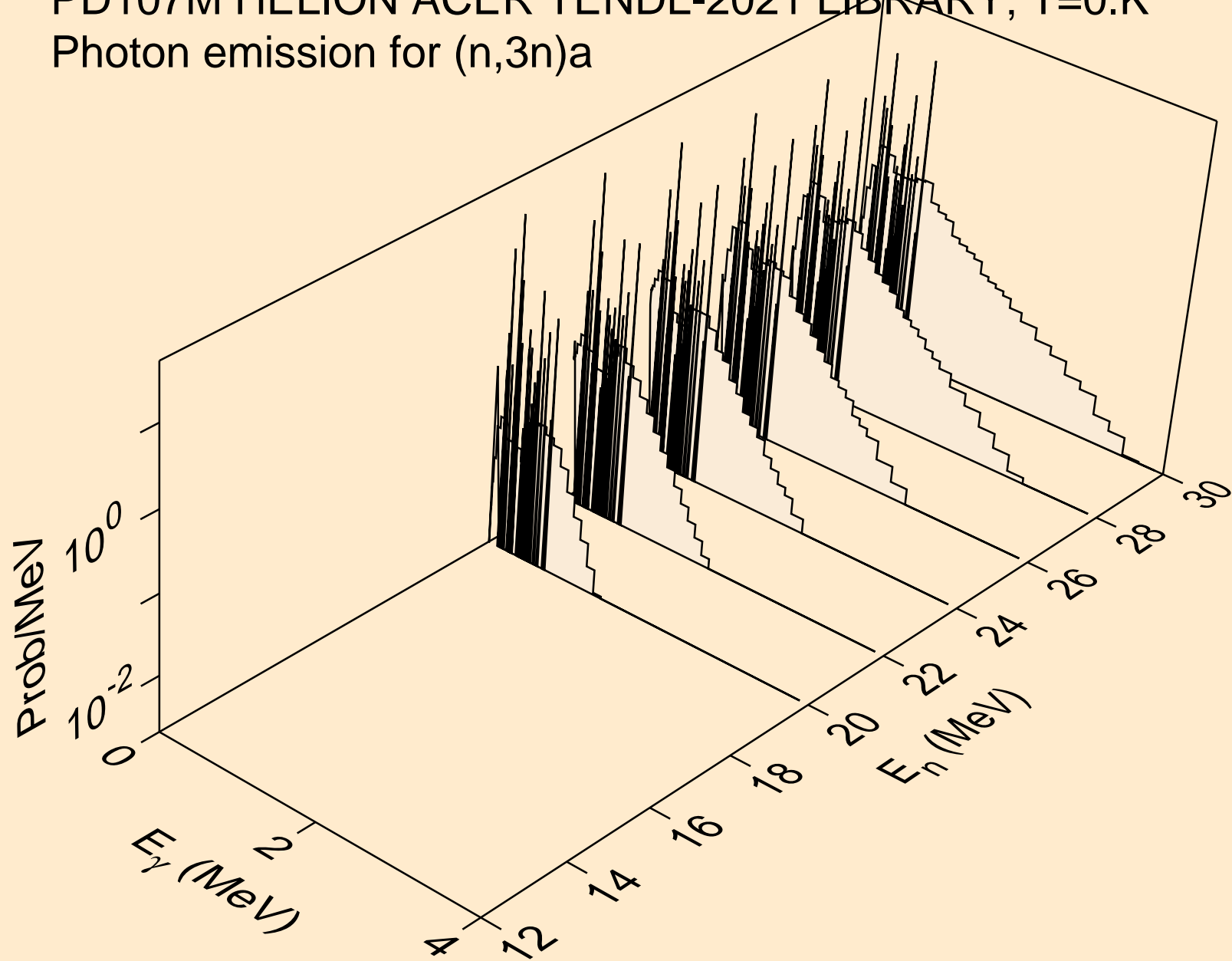

PD107M HELION ACER TENDL-2021 LIBRARY; T=0.K  
Photon emission for (n,n\*)p

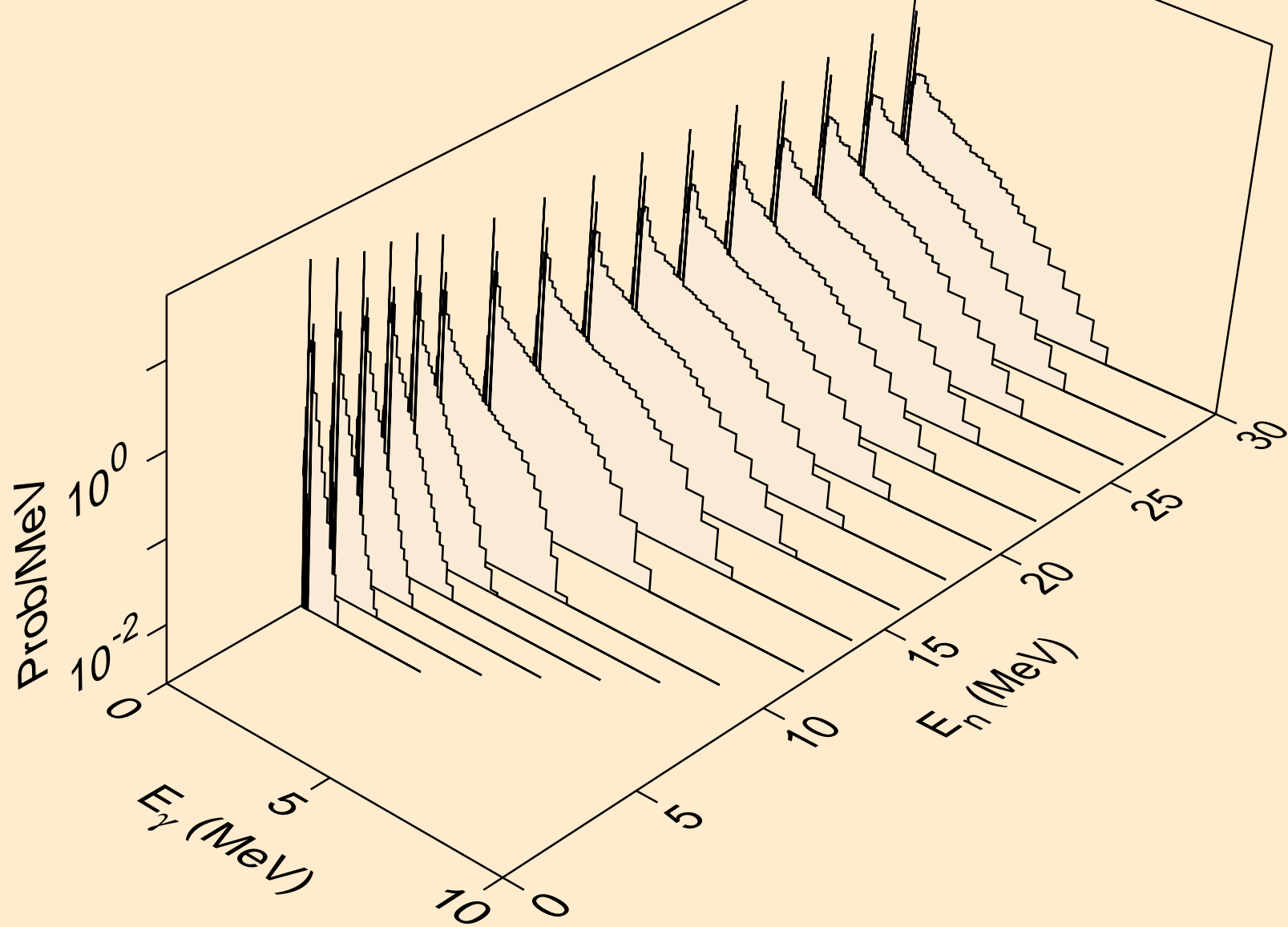

PD107M HELION ACER TENDL-2021 LIBRARY; T=0.K  
Photon emission for (n,n\*)2a

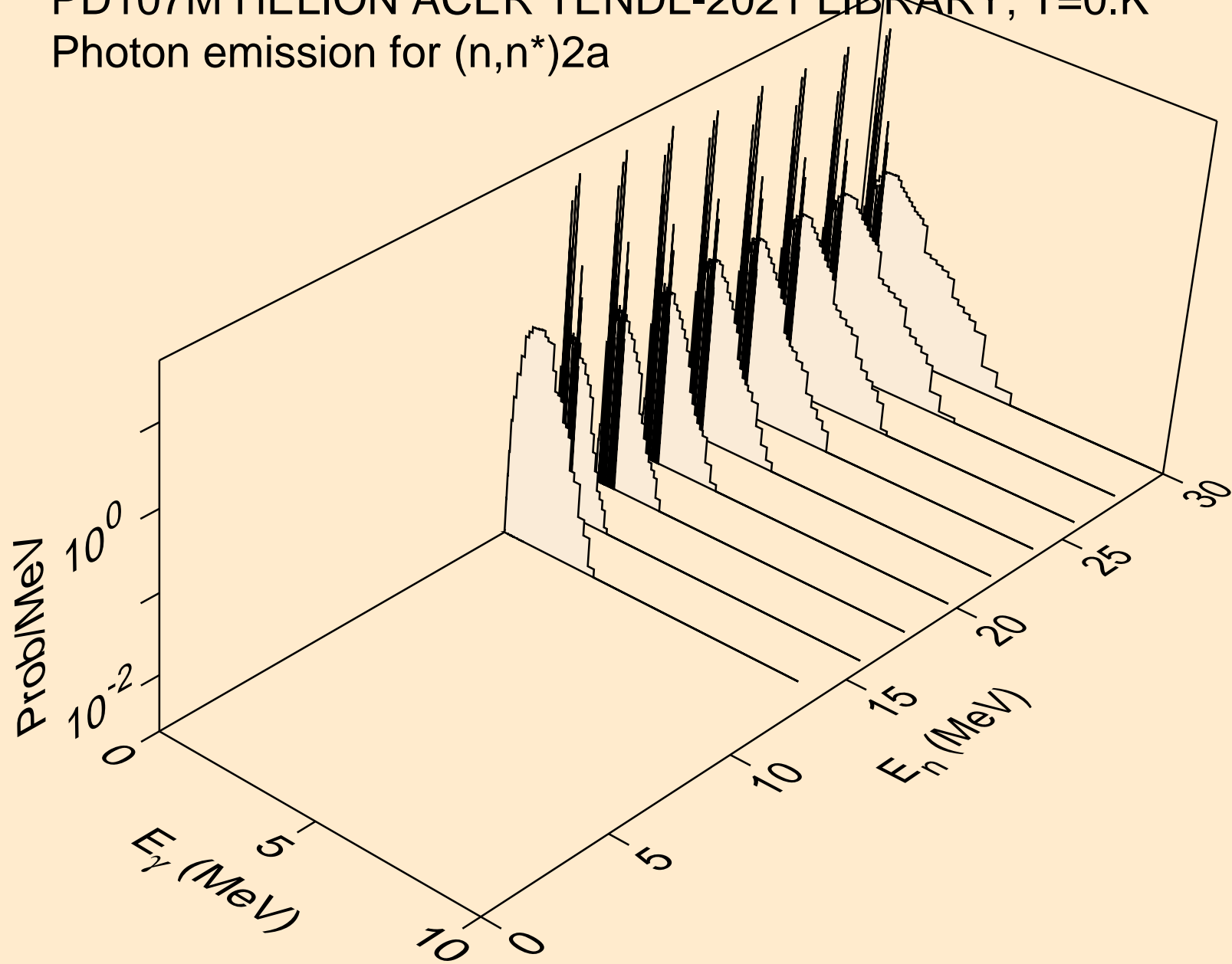

PD107M HELION ACER TENDL-2021 LIBRARY; T=0.K  
Photon emission for (n,2n)2a

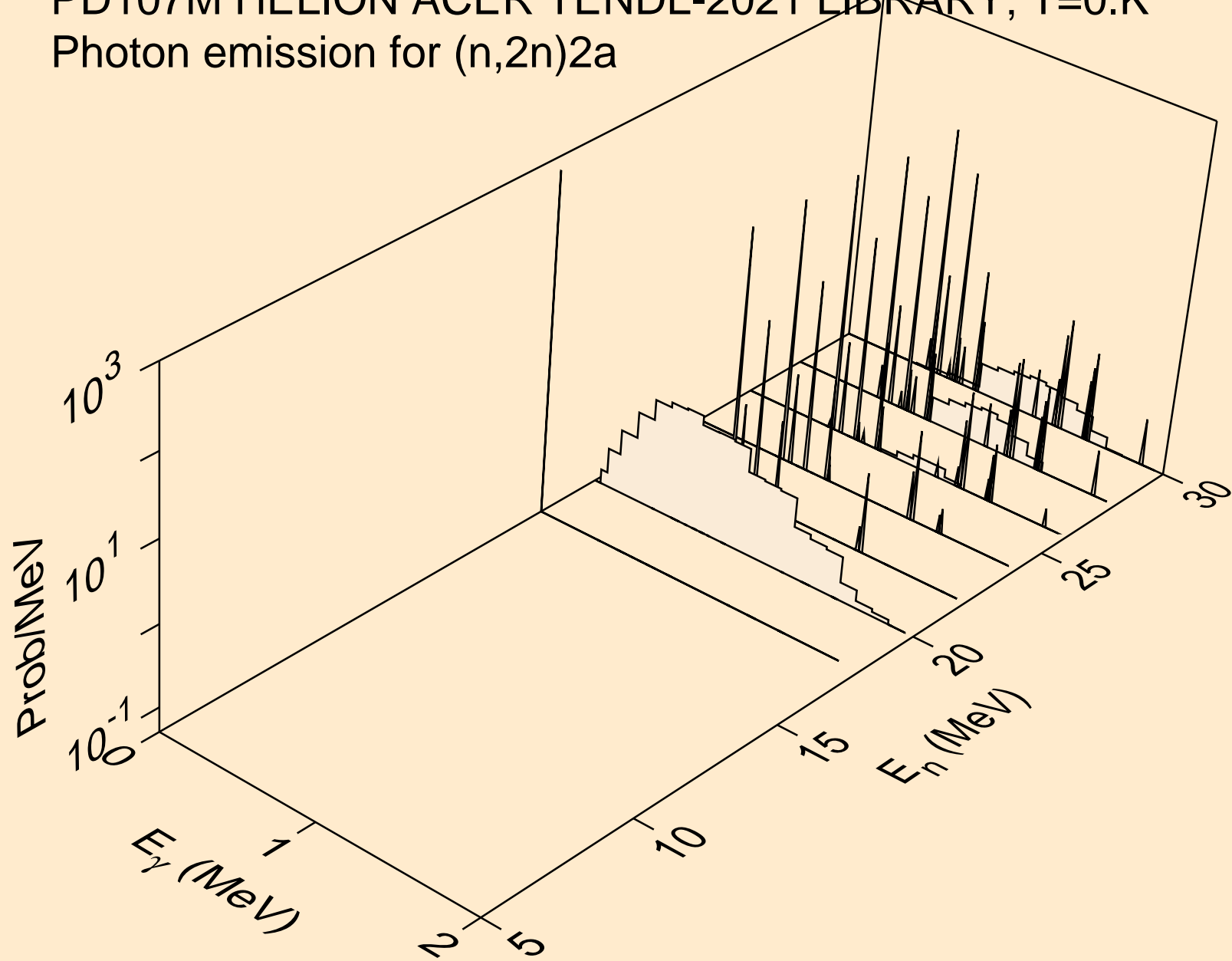

PD107M HELION ACER TENDL-2021 LIBRARY; T=0.K  
Photon emission for (n,n\*)d

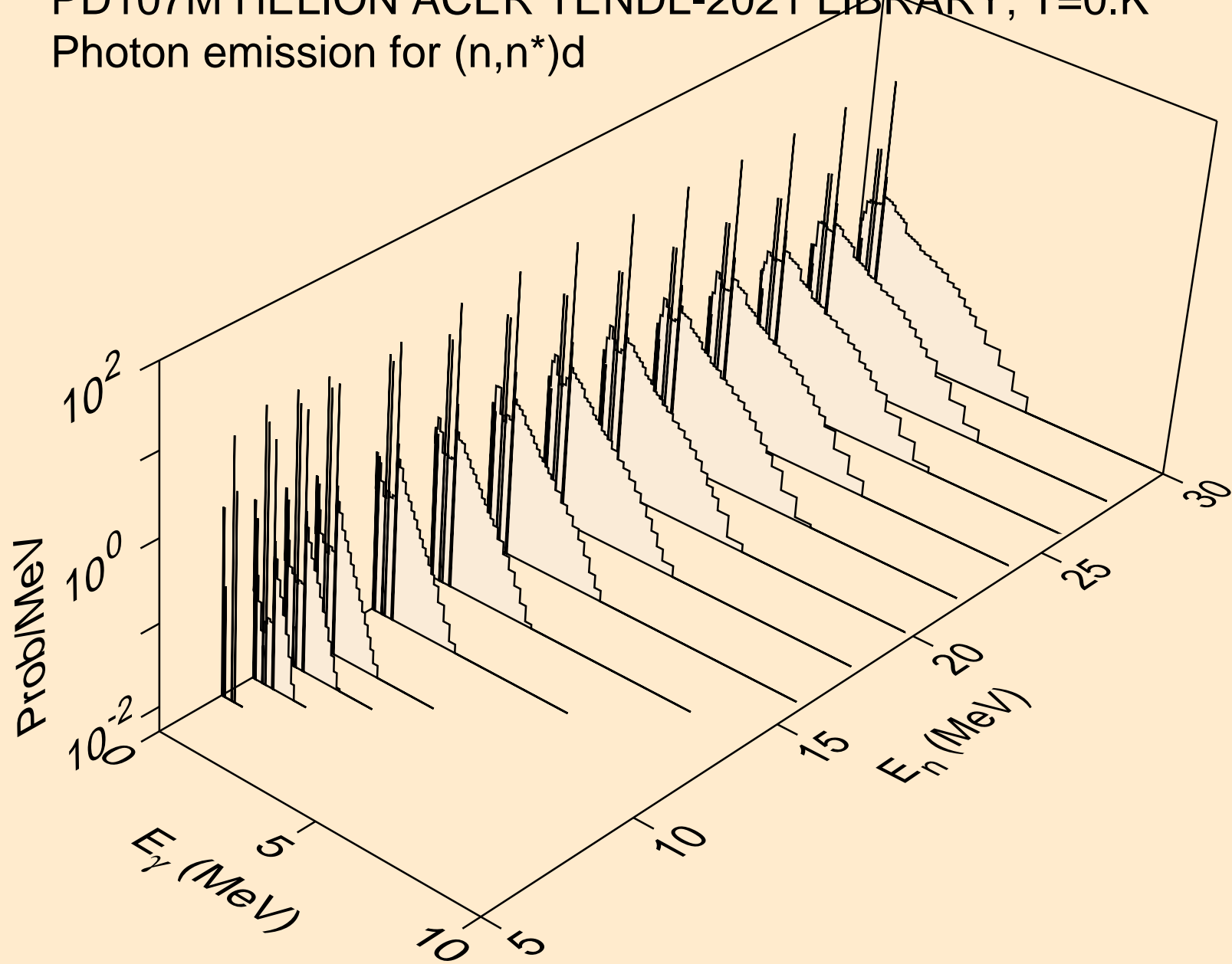

PD107M HELION ACER TENDL-2021 LIBRARY; T=0.K  
Photon emission for (n,n\*)t

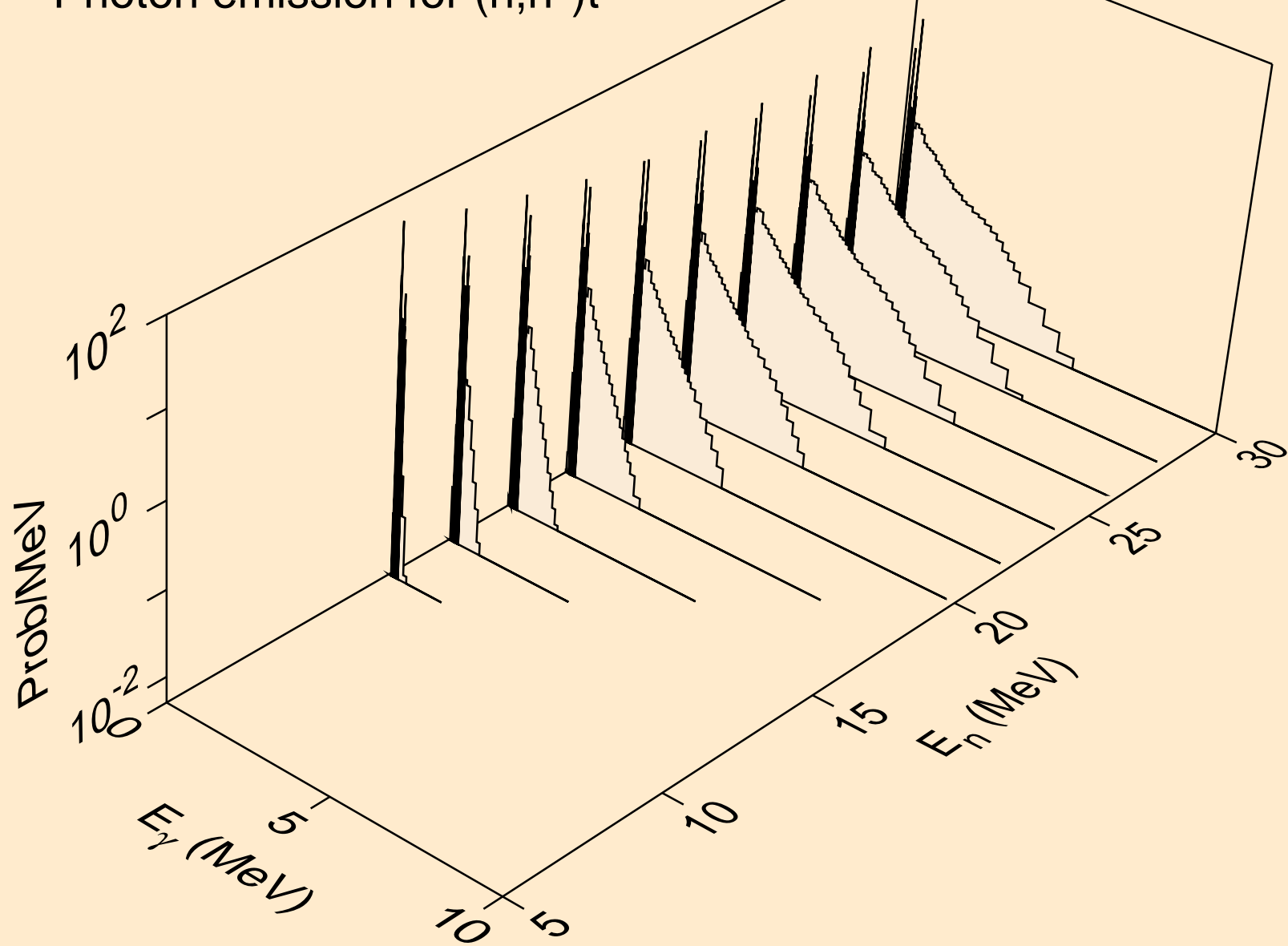

PD107M HELION ACER TENDL-2021 LIBRARY; T=0.K  
Photon emission for (n,n\*)he3

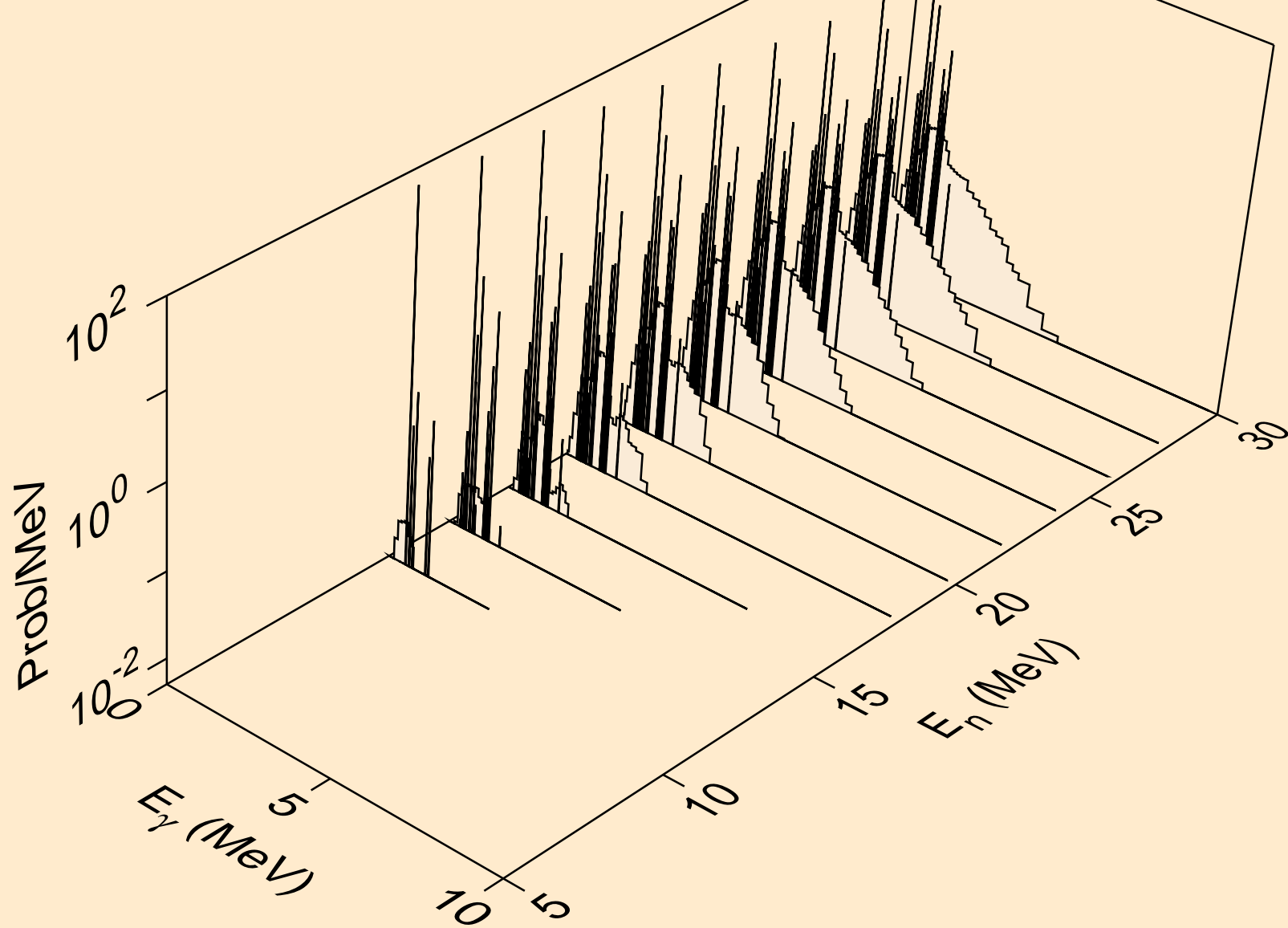

PD107M HELION ACER TENDL-2021 LIBRARY; T=0.K  
Photon emission for (n,4n)

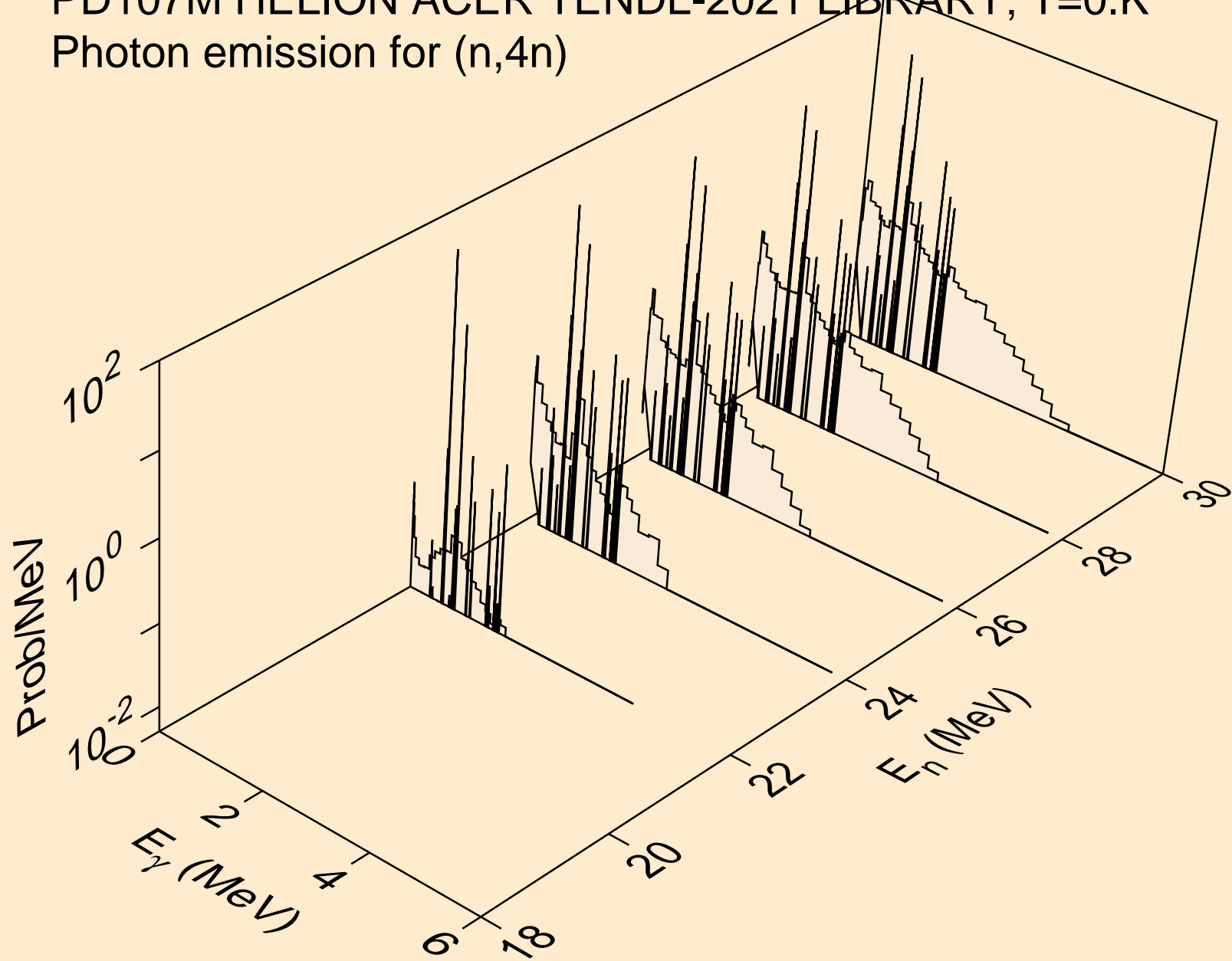



PD107M HELION ACER TENDL-2021 LIBRARY; T=0.K  
Photon emission for (n,2np)

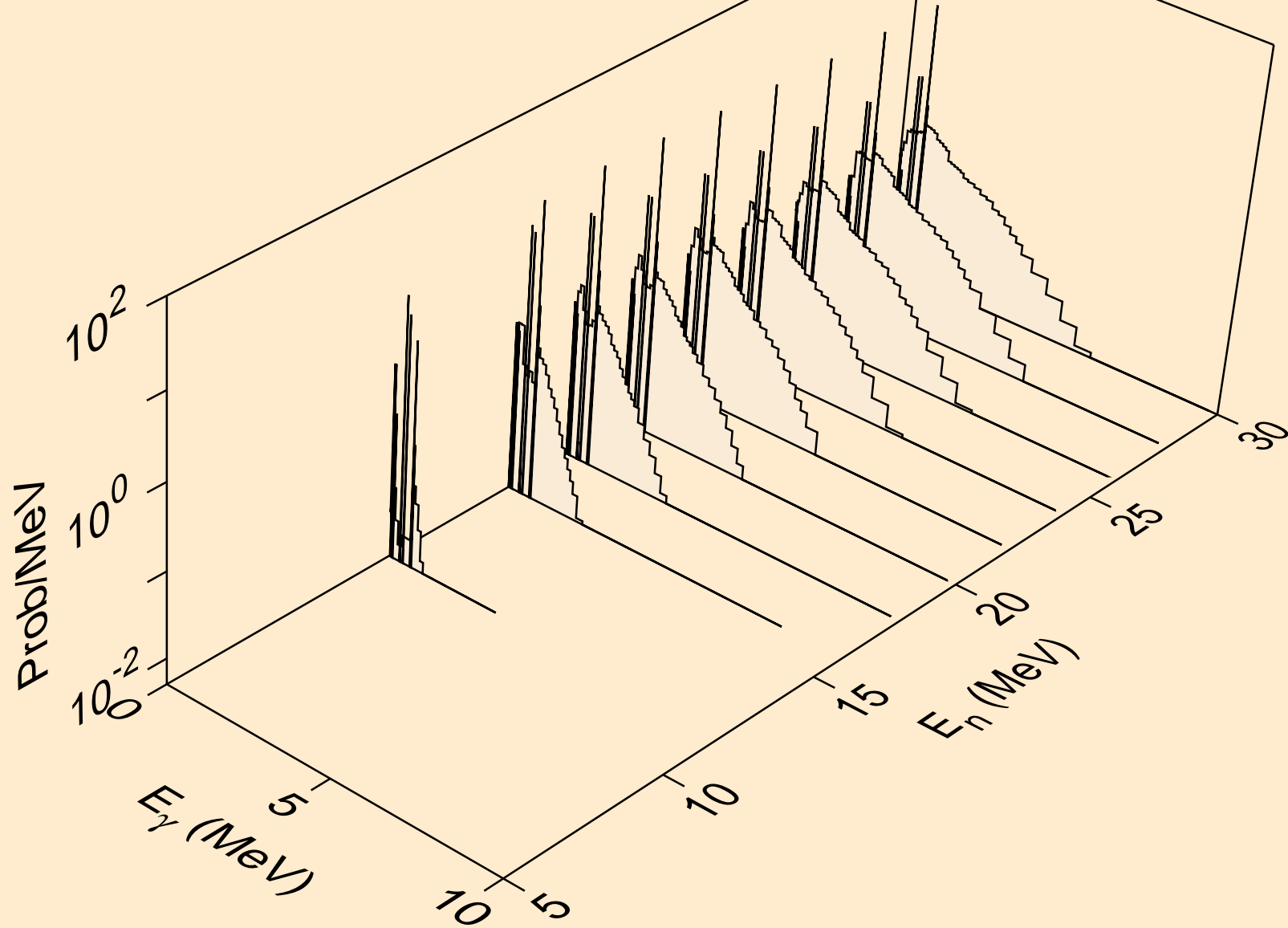

PD107M HELION ACER TENDL-2021 LIBRARY; T=0.K  
Photon emission for (n,3np)

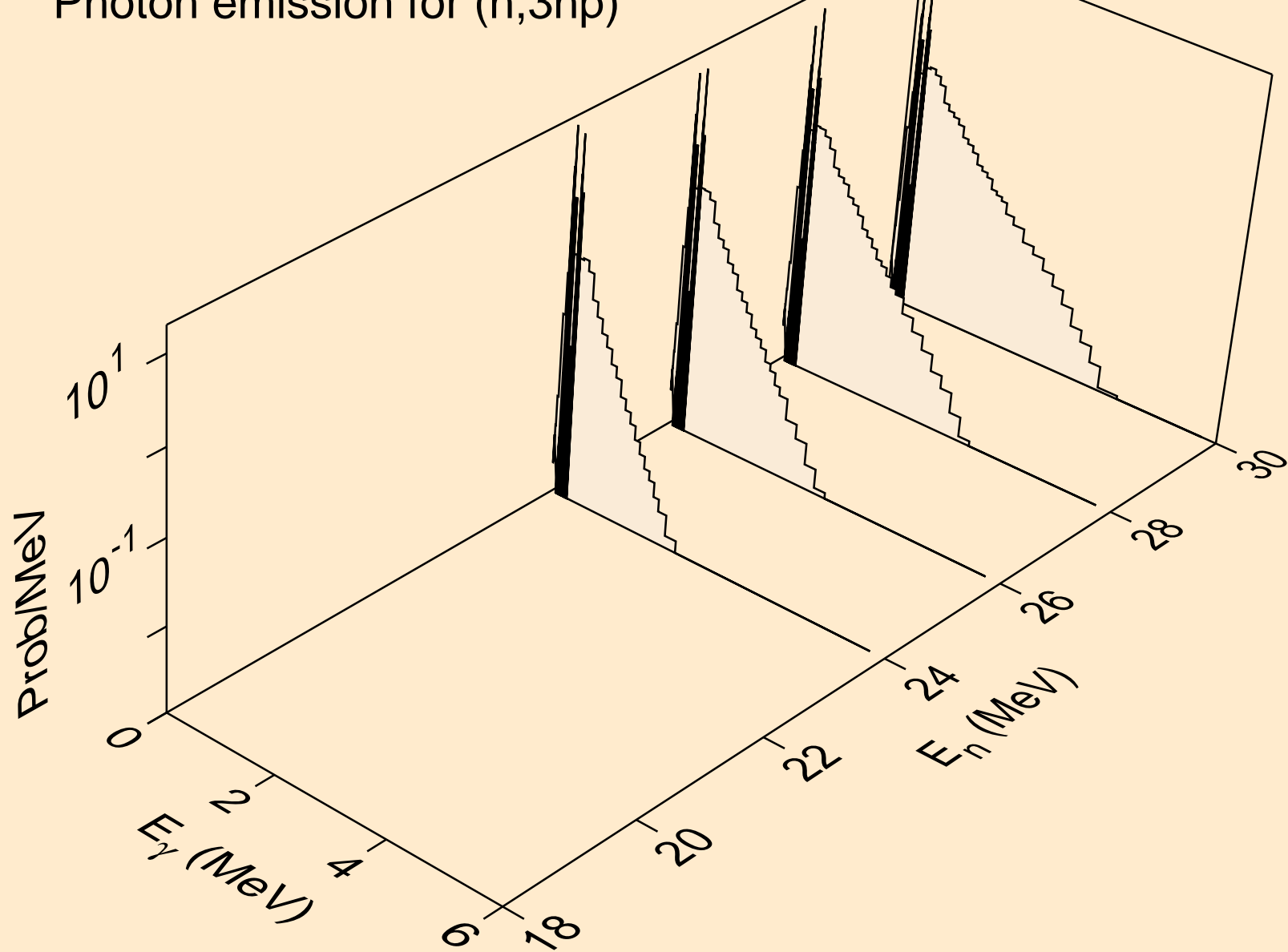

PD107M HELION ACER TENDL-2021 LIBRARY; T=0.K  
Photon emission for (n,2np)

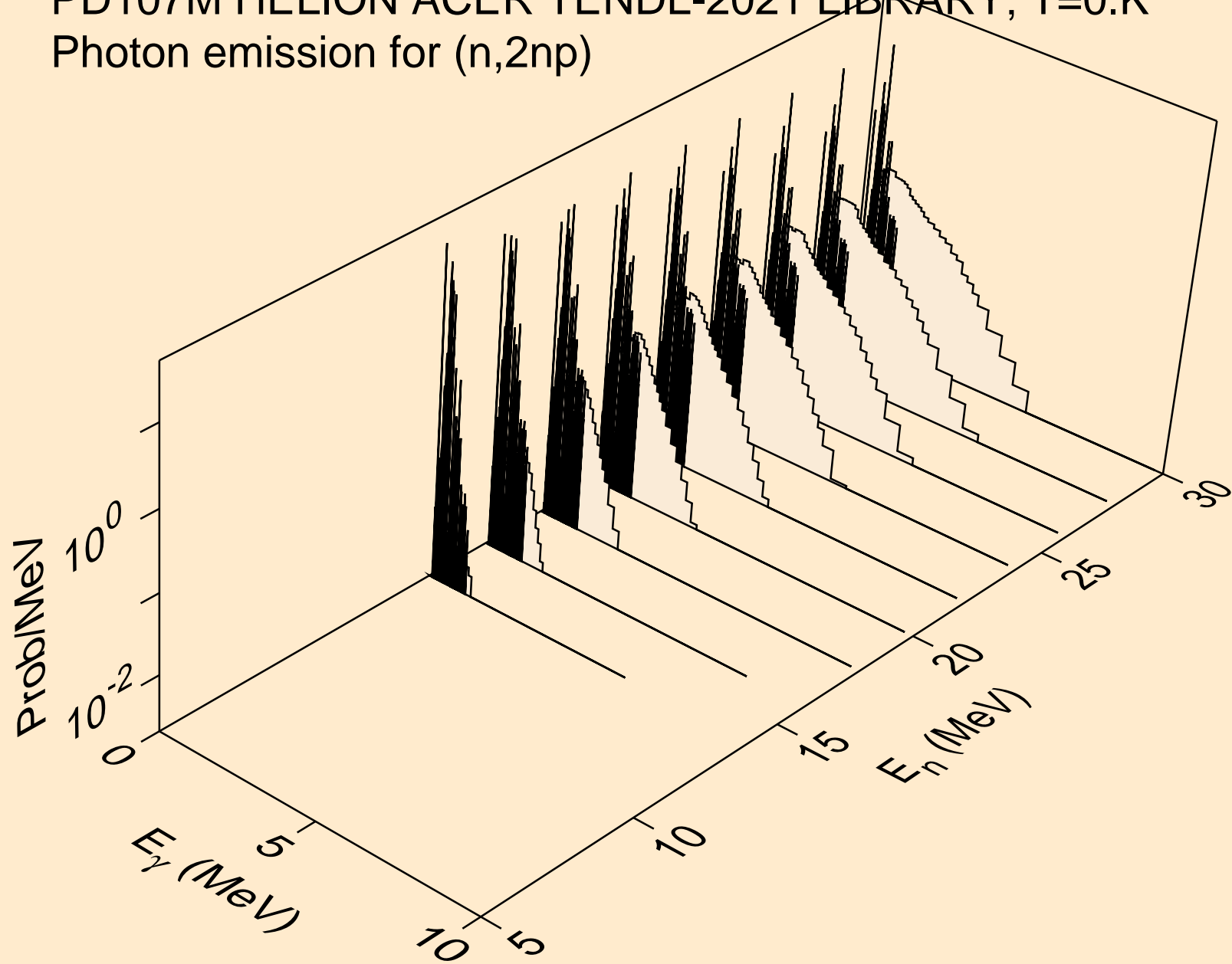

PD107M HELION ACER TENDL-2021 LIBRARY; T=0.K  
Photon emission for (n,npa)

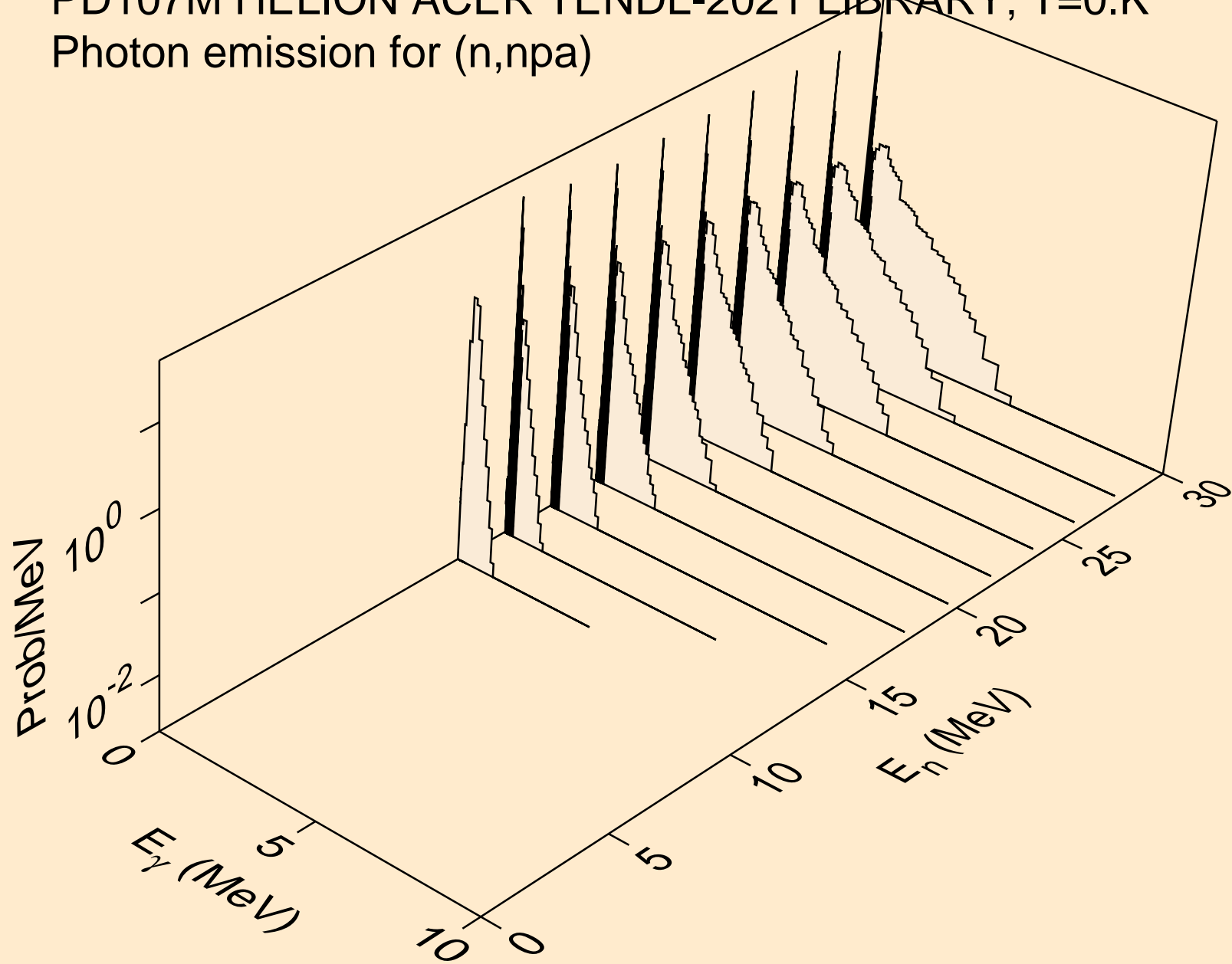

PD107M HELION ACER TENDL-2021 LIBRARY; T=0.K  
Photon emission for (n,gma)

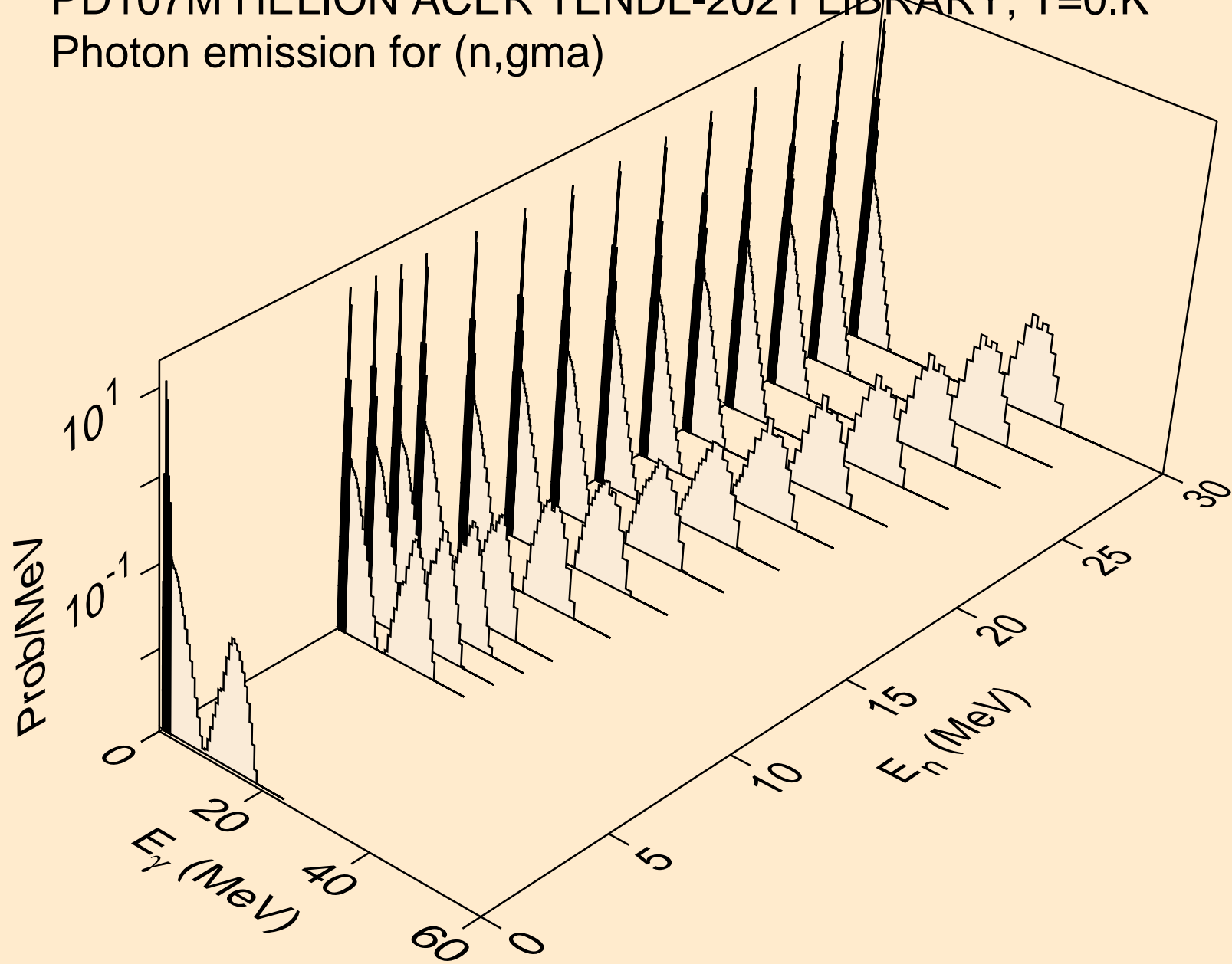

PD107M HELION ACER TENDL-2021 LIBRARY; T=0.K  
Photon emission for (n,p)

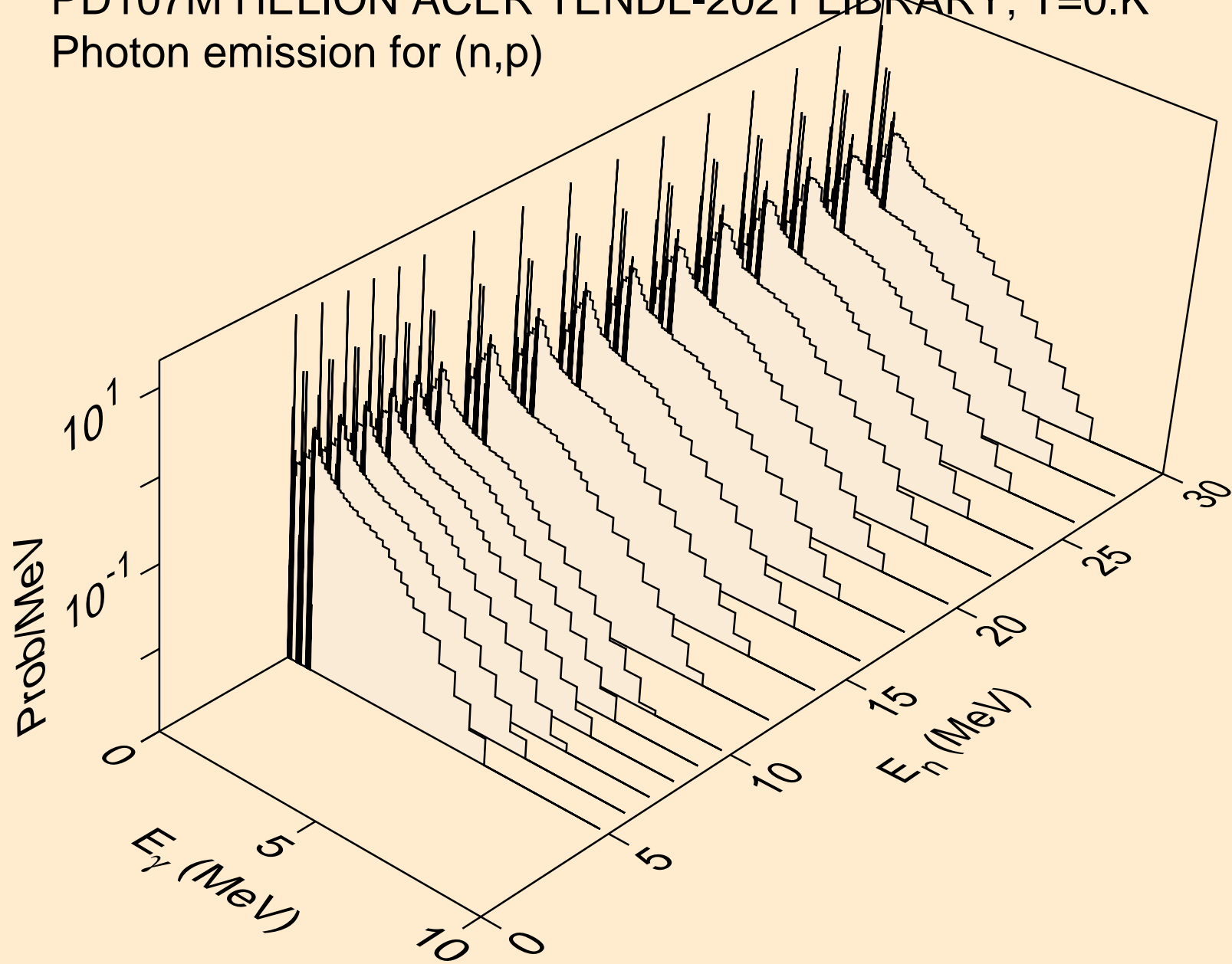

PD107M HELION ACER TENDL-2021 LIBRARY; T=0.K  
Photon emission for (n,d)

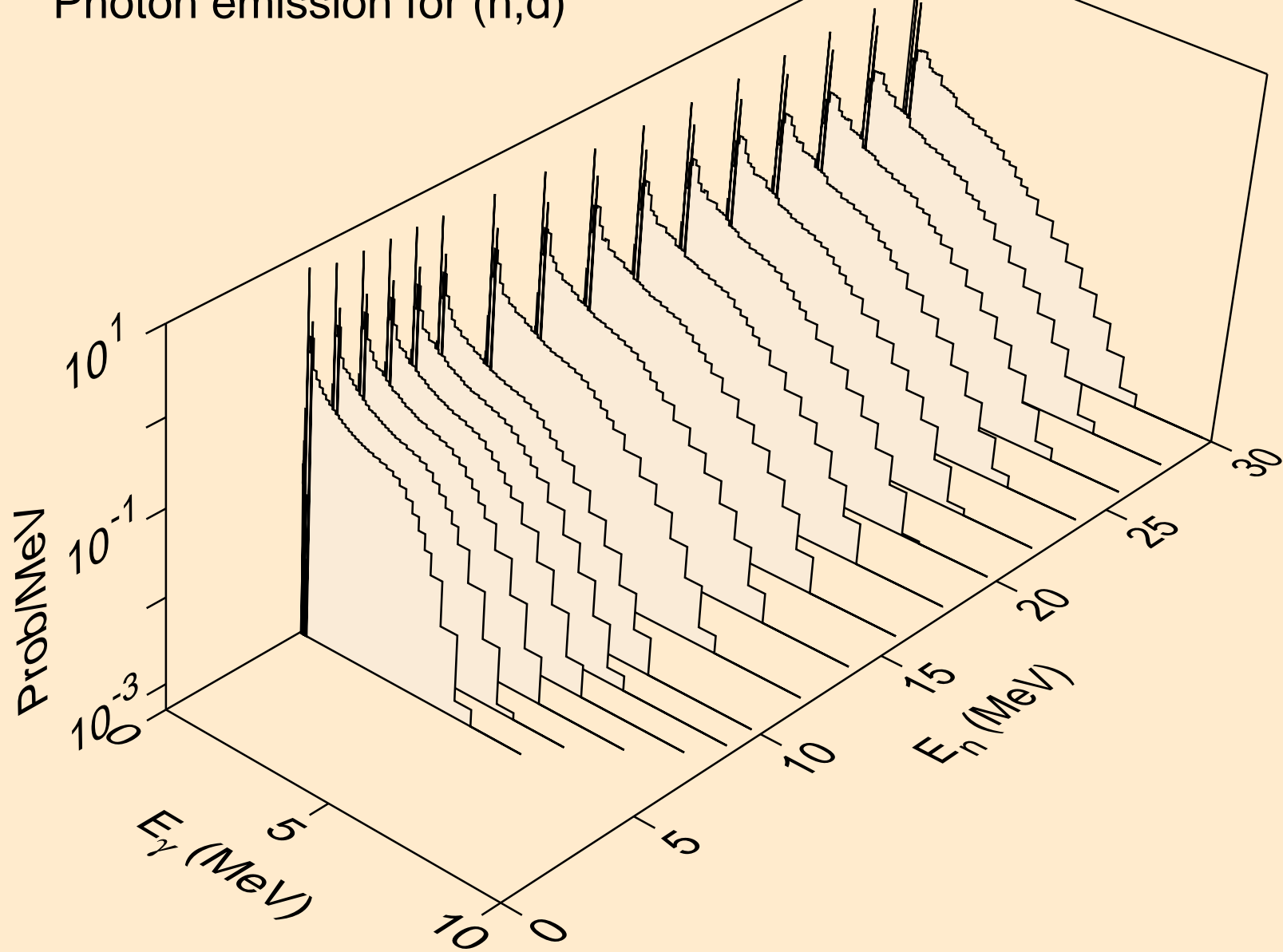

PD107M HELION ACER TENDL-2021 LIBRARY; T=0.K  
Photon emission for (n,t)

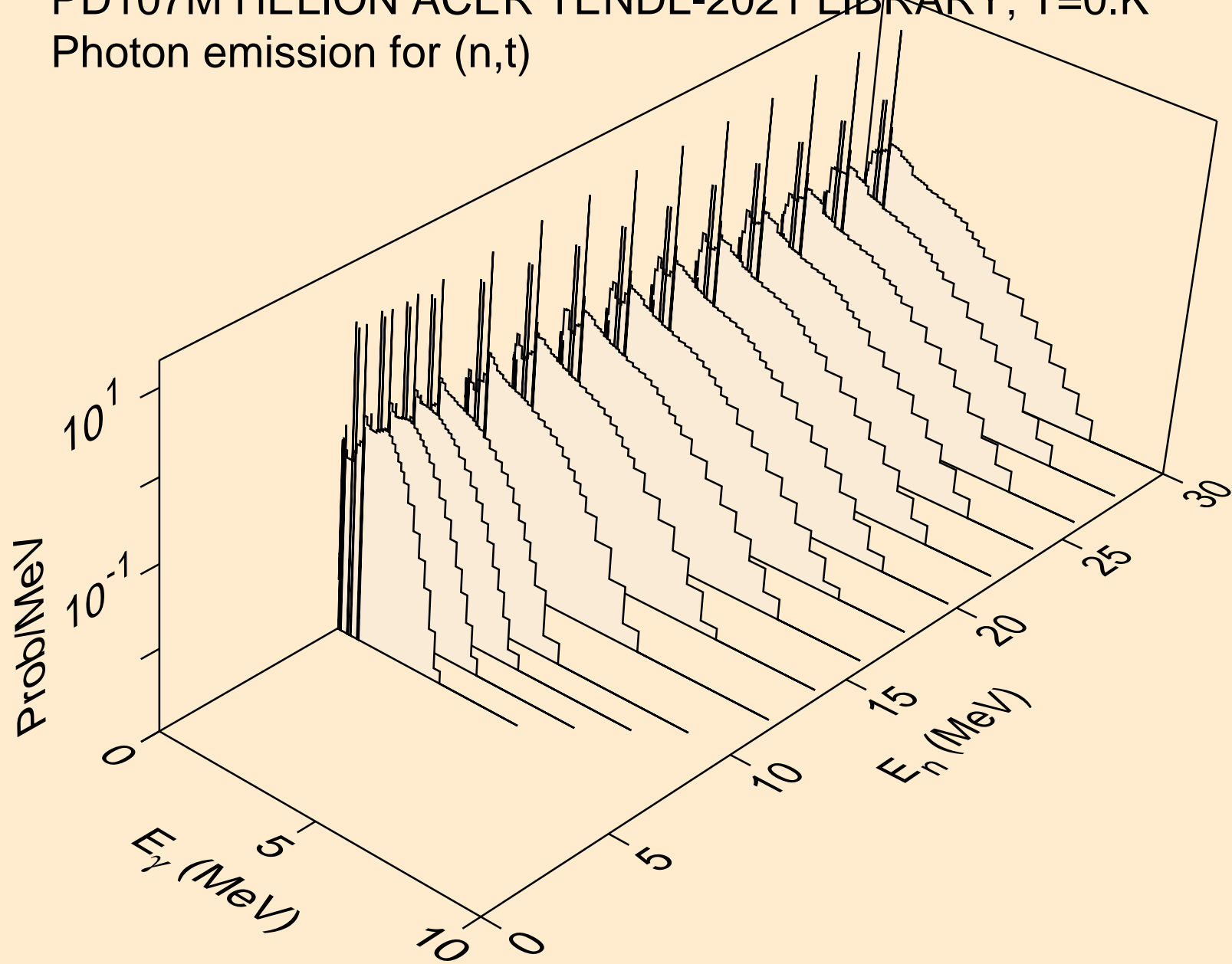



PD107M HELION ACER TENDL-2021 LIBRARY; T=0.K  
Photon emission for inelastic

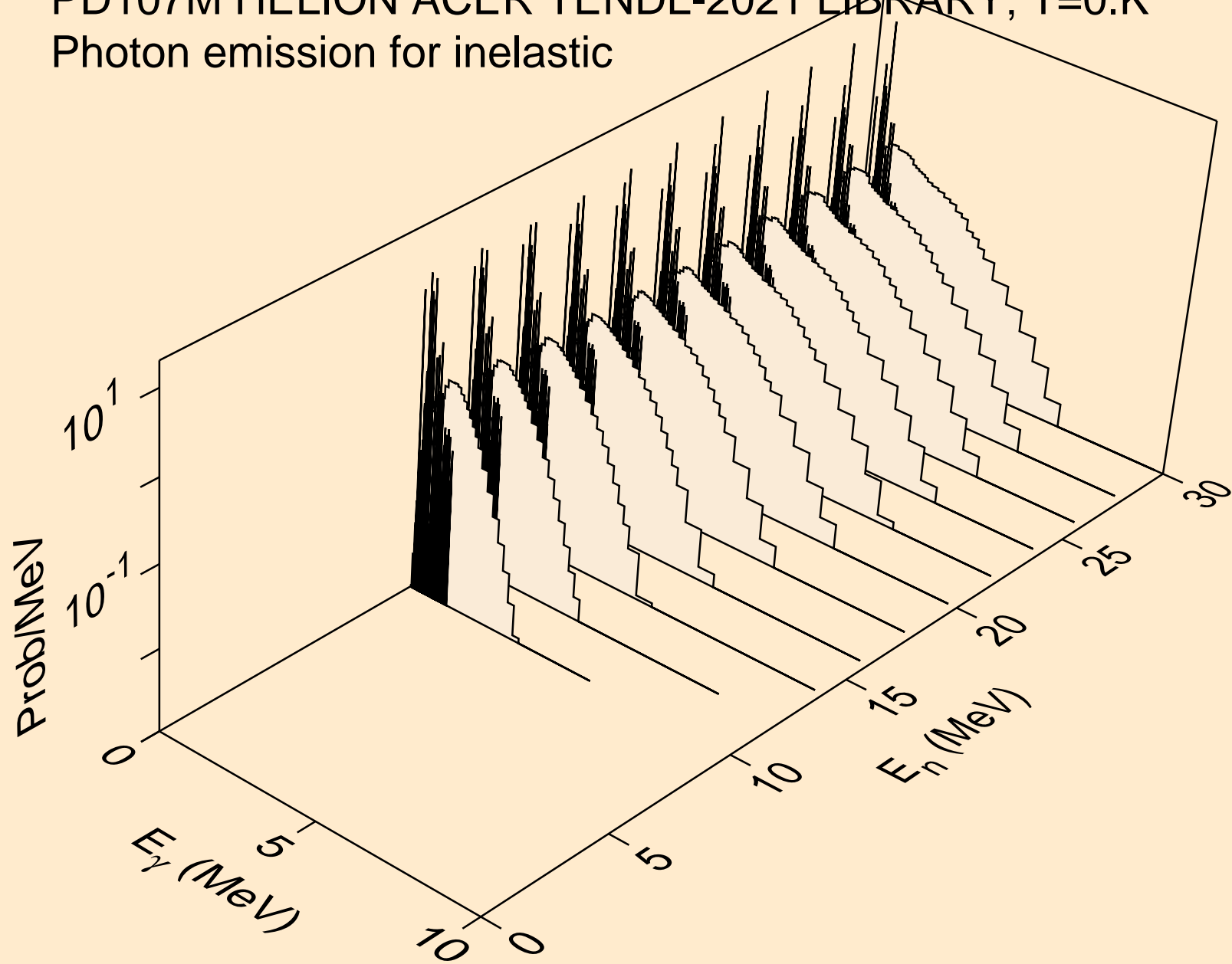

PD107M HELION ACER TENDL-2021 LIBRARY; T=0.K  
Photon emission for (n,a)

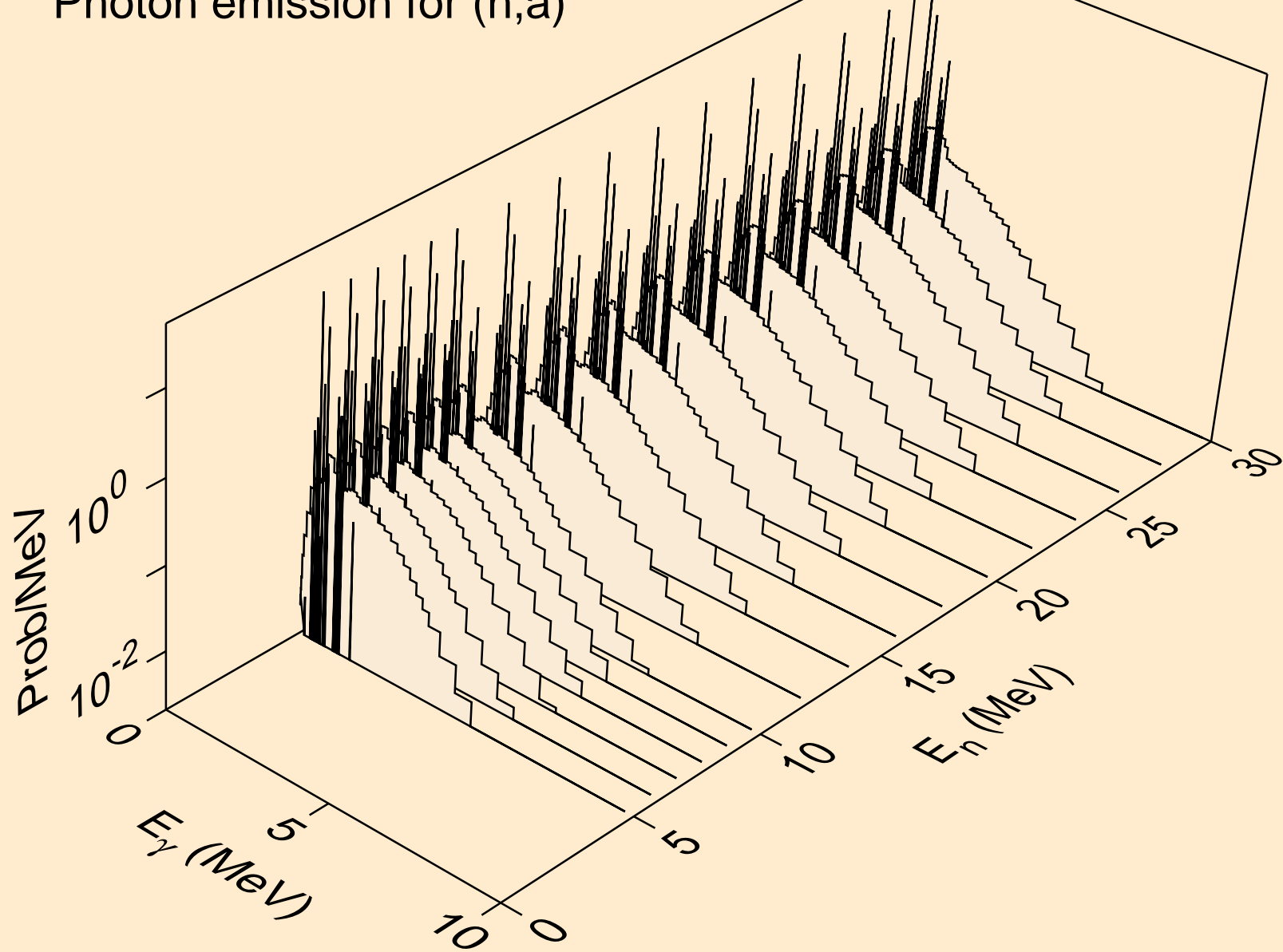

PD107M HELION ACER TENDL-2021 LIBRARY; T=0.K  
Photon emission for (n,2a)

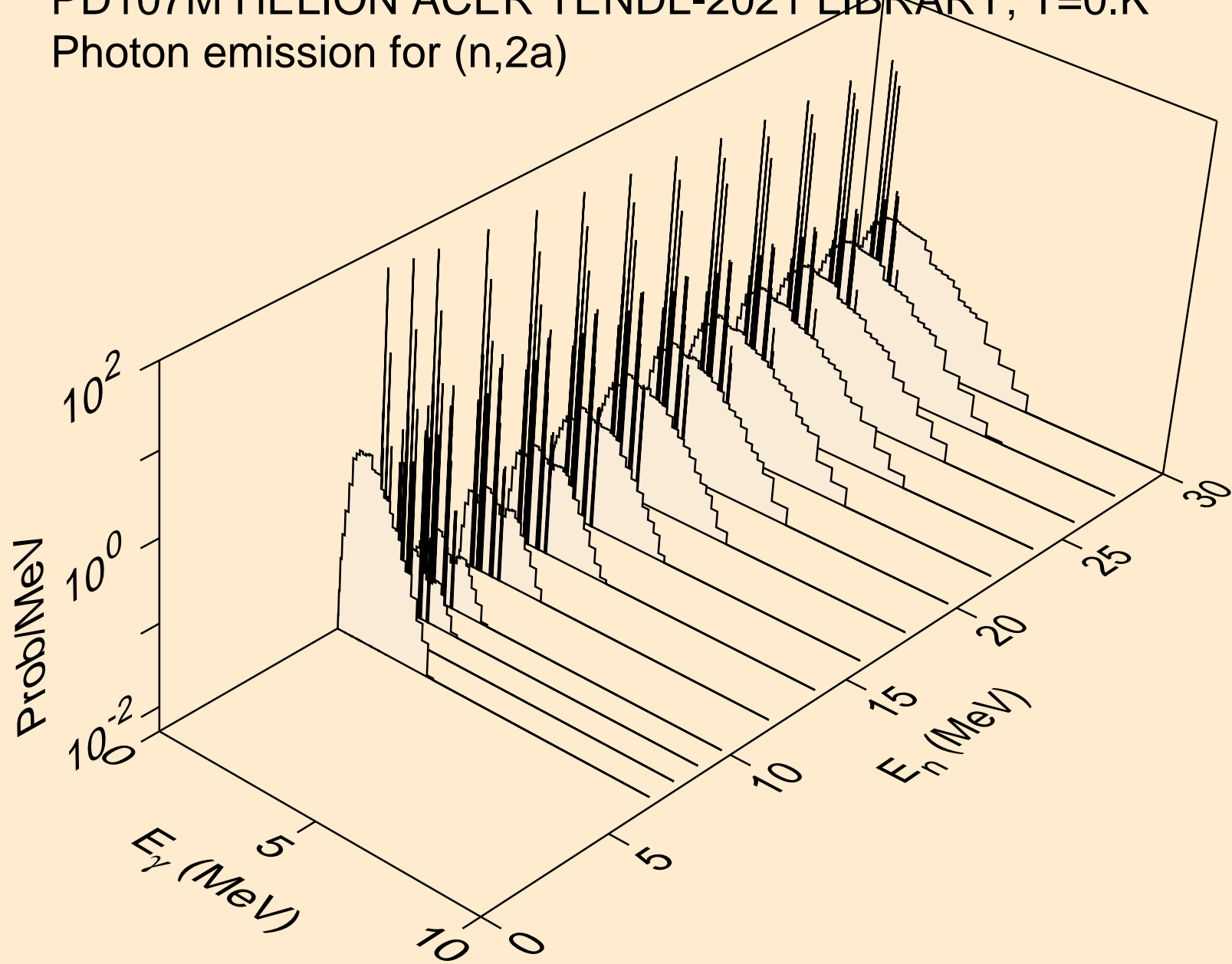

PD107M HELION ACER TENDL-2021 LIBRARY; T=0.K  
Photon emission for (n,2p)

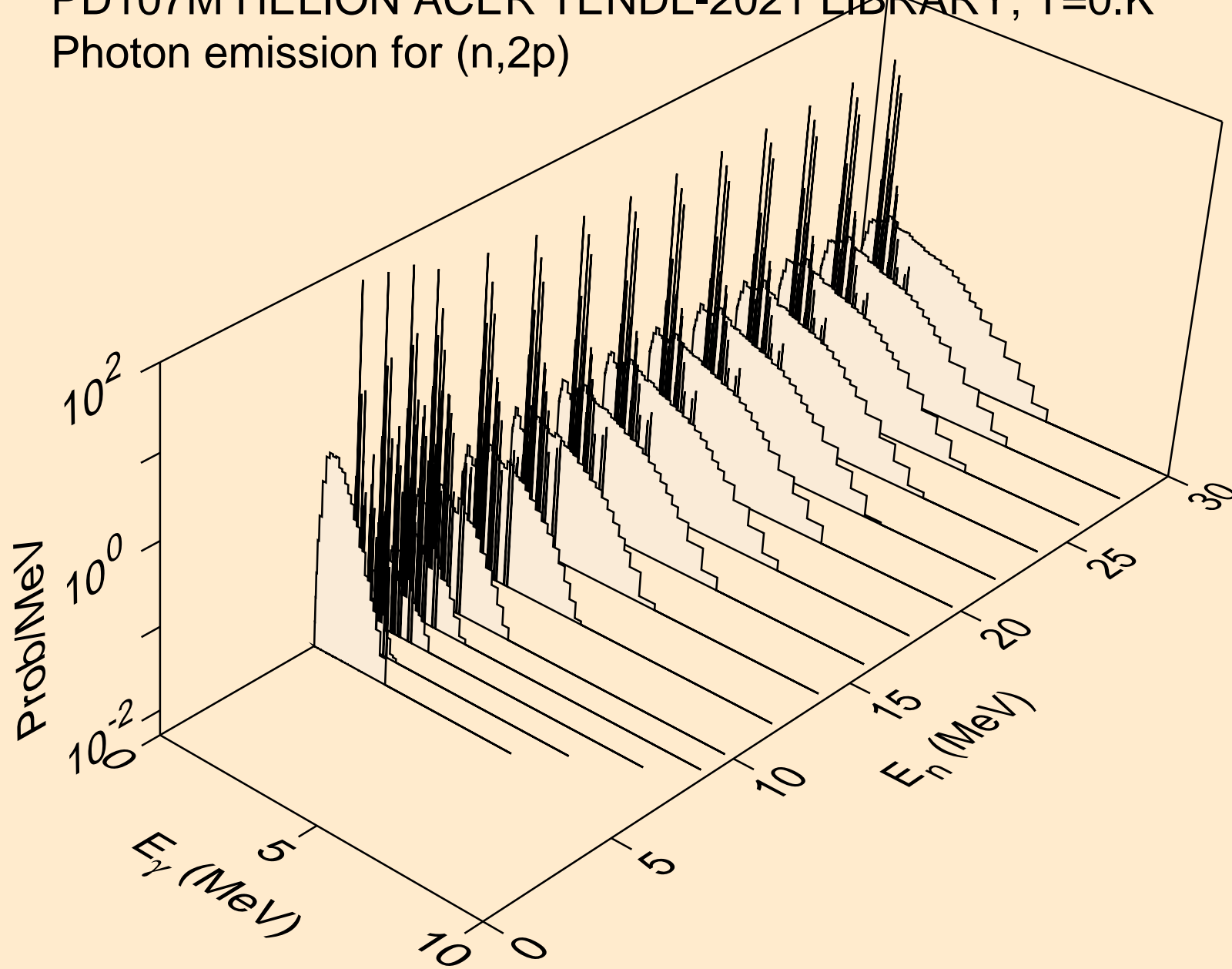

PD107M HELION ACER TENDL-2021 LIBRARY; T=0.K  
Photon emission for (n,pa)

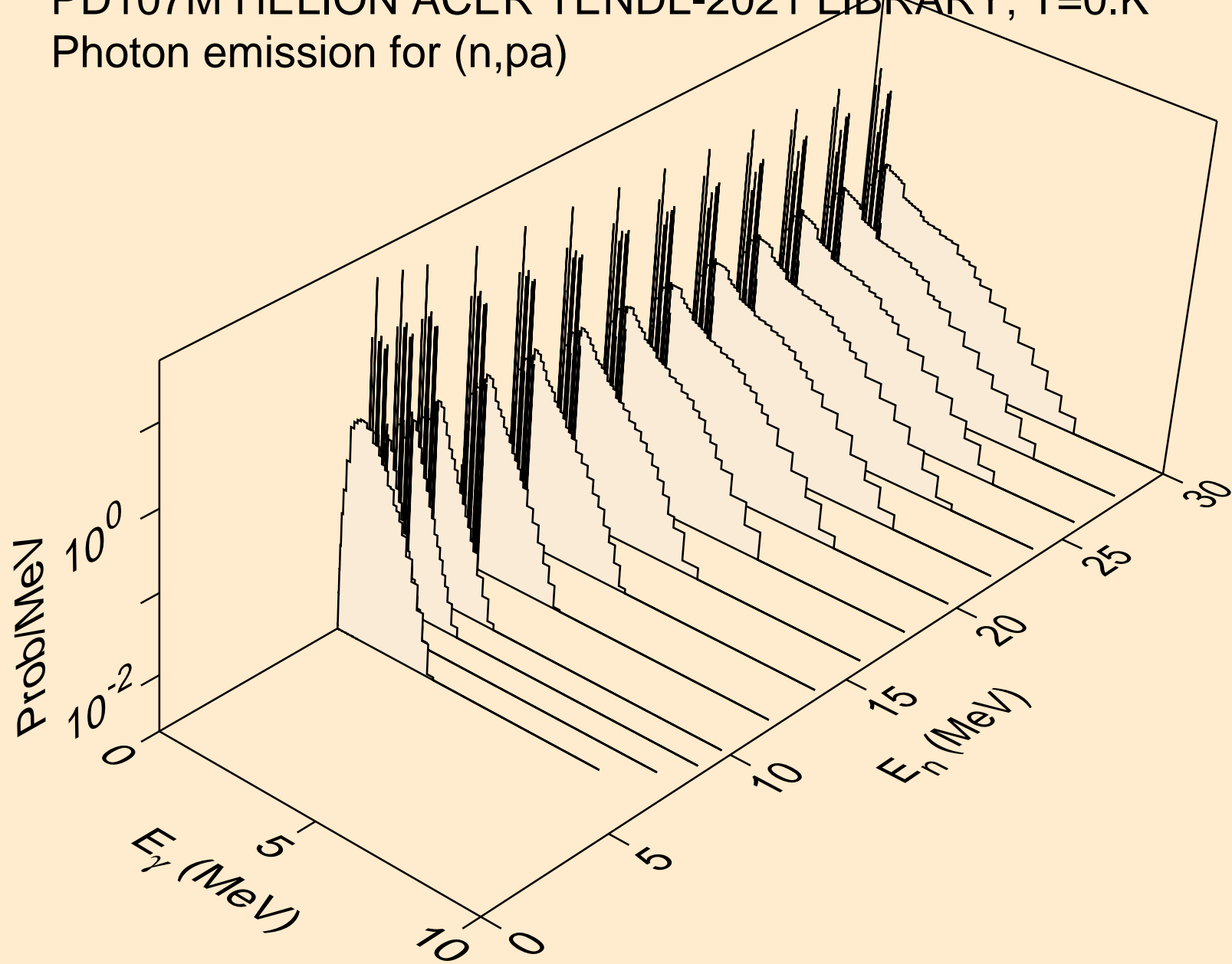

PD107M HELION ACER TENDL-2021 LIBRARY; T=0.K  
Photon emission for (n,pd)

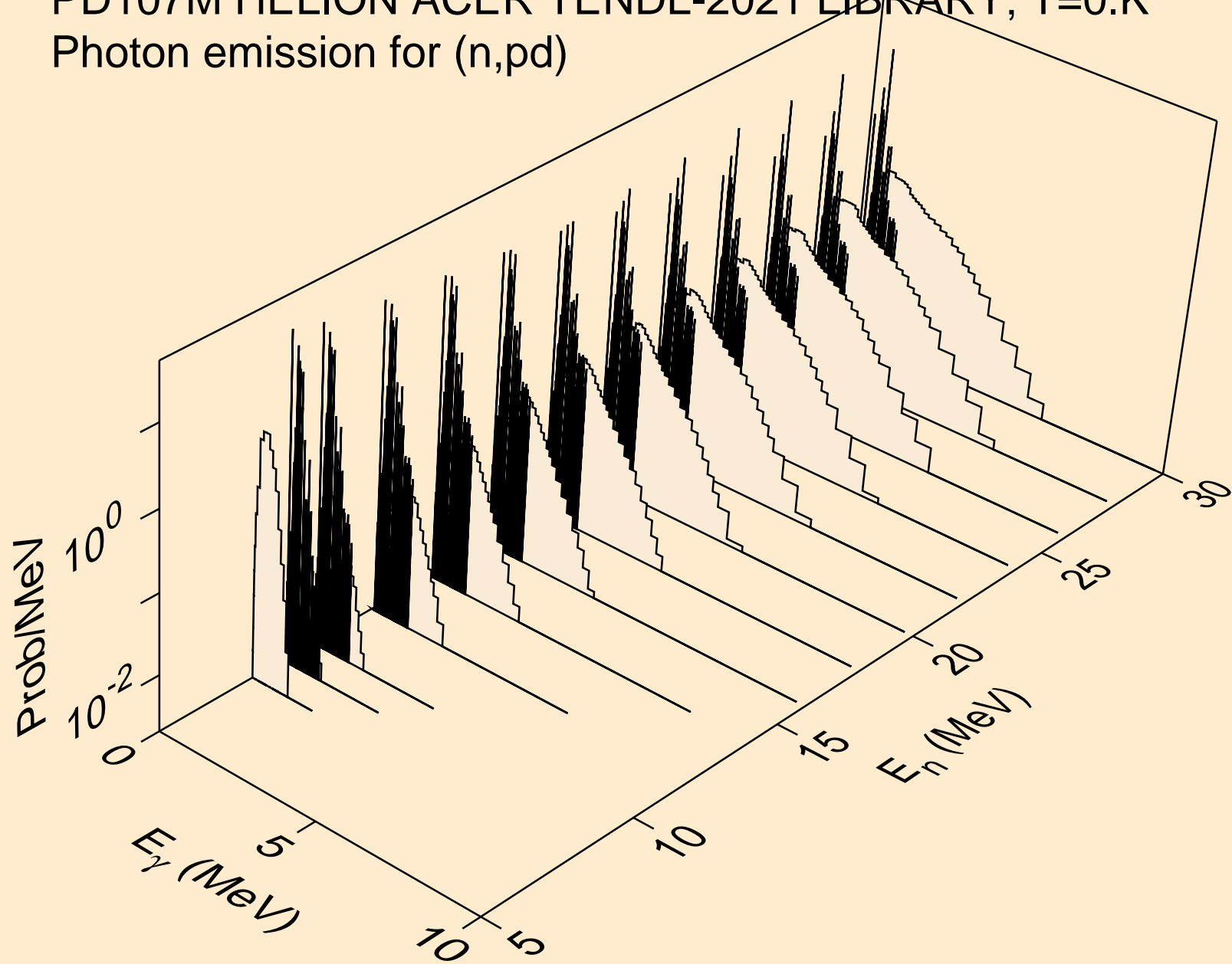

PD107M HELION ACER TENDL-2021 LIBRARY; T=0.K  
Photon emission for (n,pt)

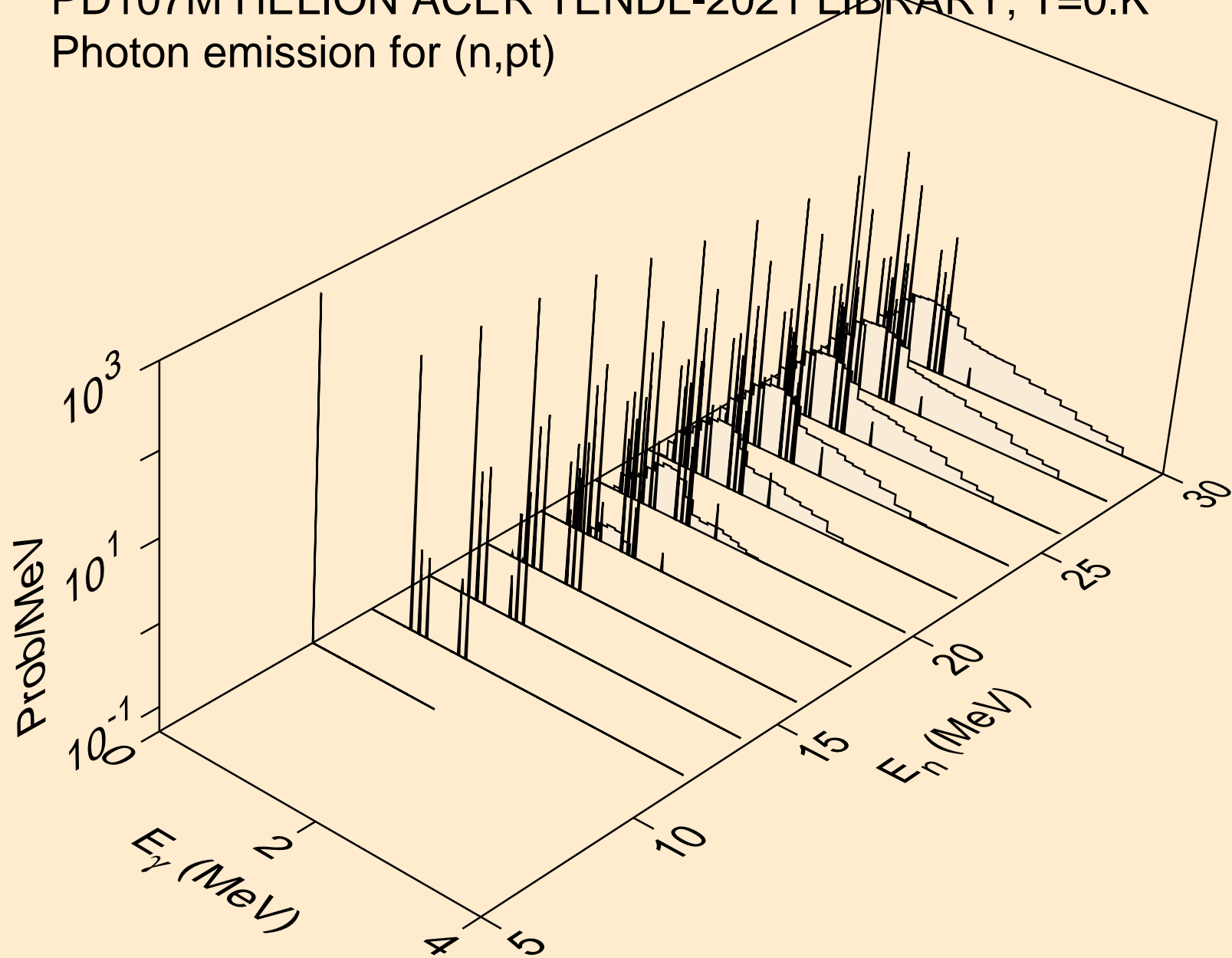

PD107M HELION ACER TENDL-2021 LIBRARY; T=0.K  
Photon emission for (n,da)

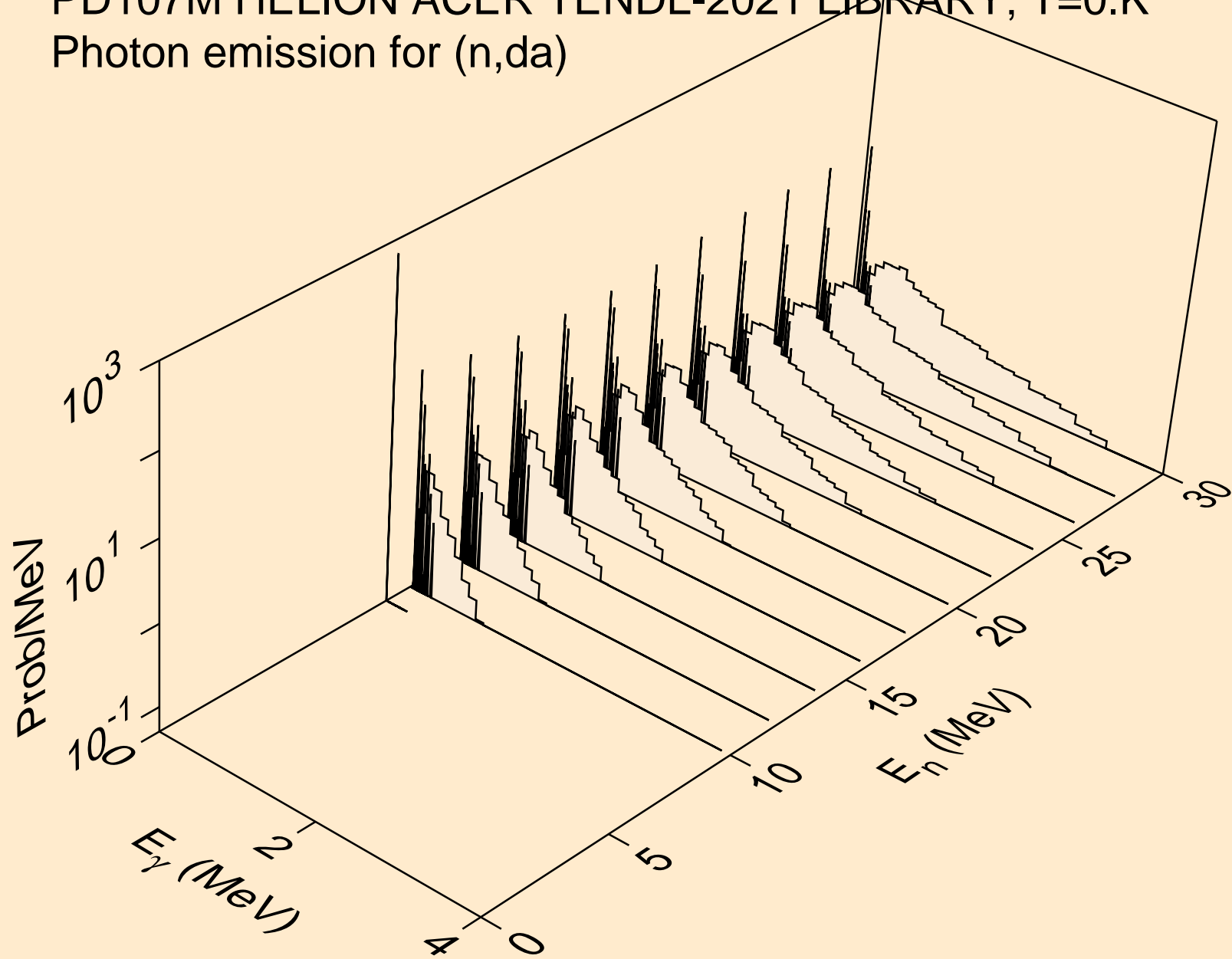



PD107M HELION ACER TENDL-2021 LIBRARY; T=0.K  
Particle heating contributions

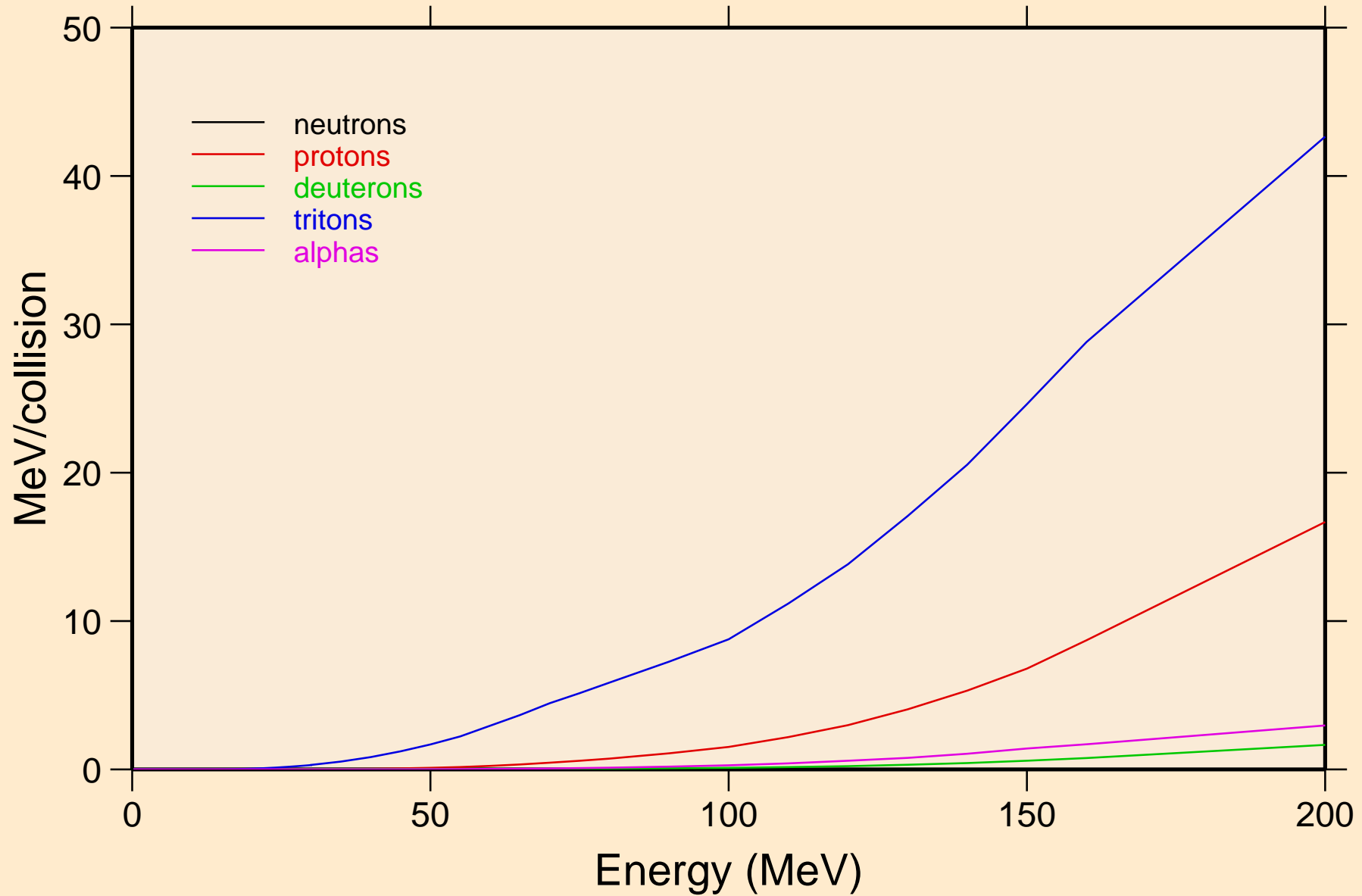

PD107M HELION ACER TENDL-2021 LIBRARY; T=0.K  
Recoil Heating

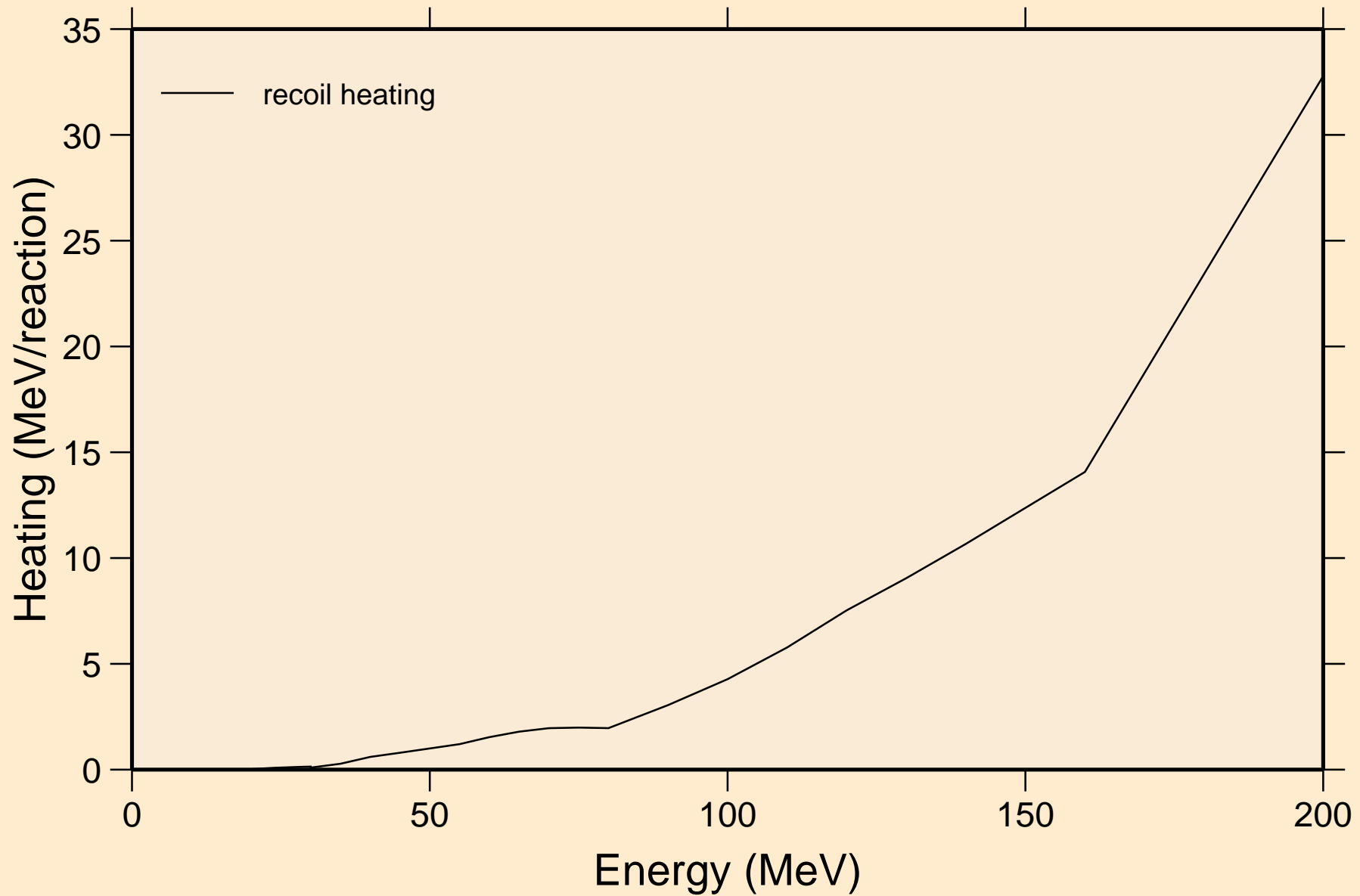

PD107M HELION ACER TENDL-2021 LIBRARY; T=0.K  
Particle production cross sections

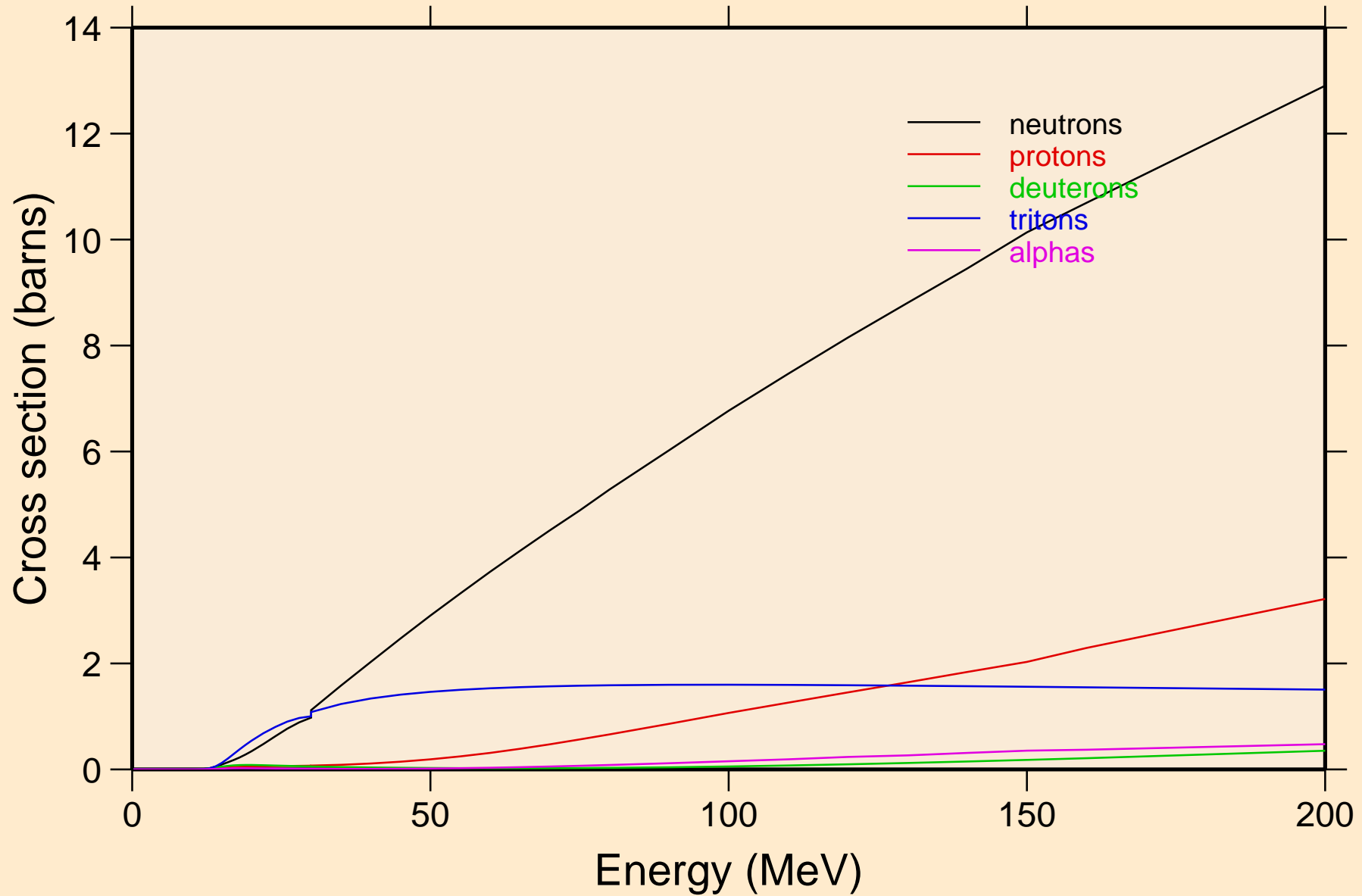

PD107M HELION ACER TENDL-2021 LIBRARY; T=0.K  
neutrons from (s,n)

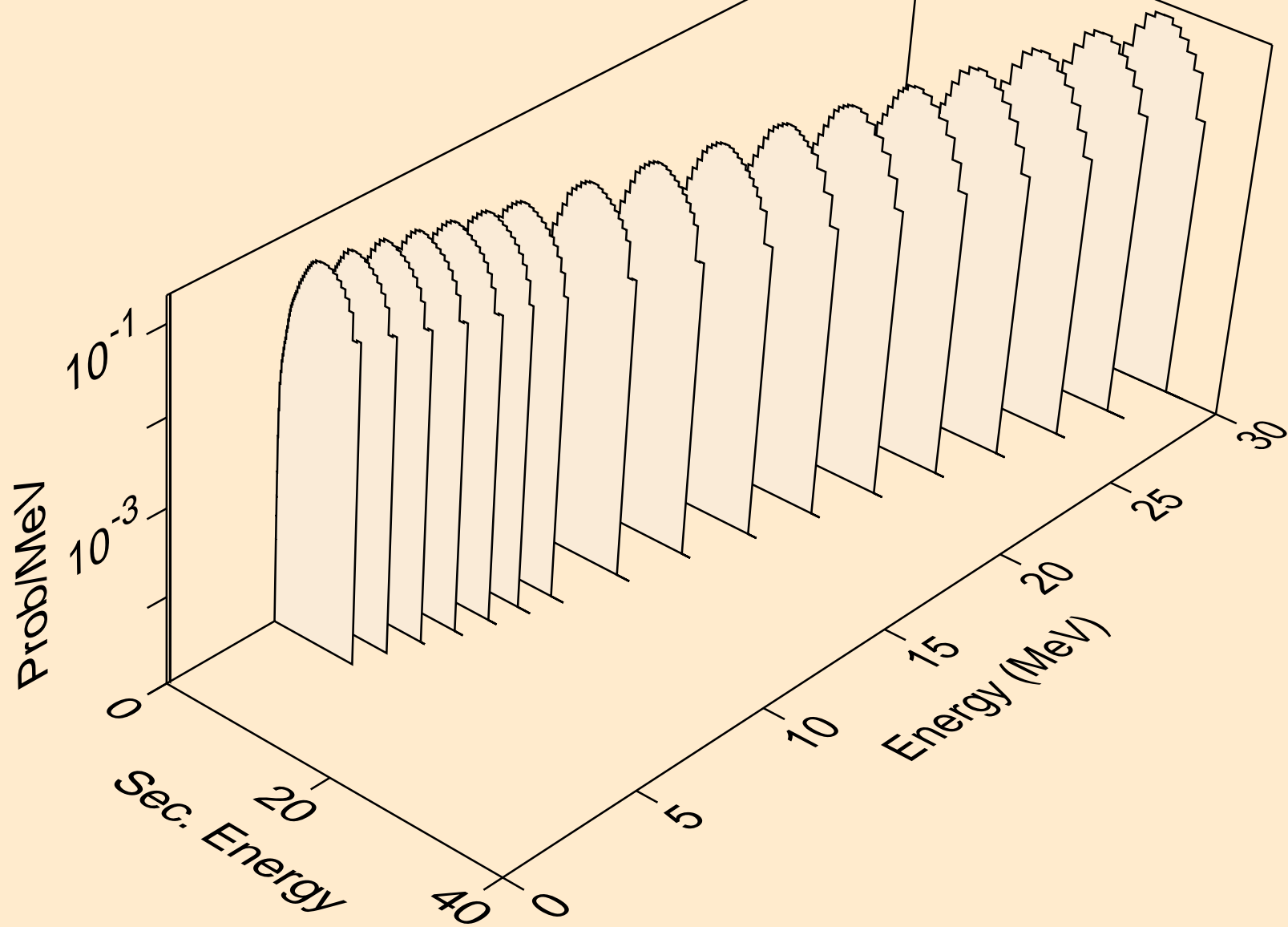

PD107M HELION ACER TENDL-2021 LIBRARY; T=0.K  
neutrons from (s,x)

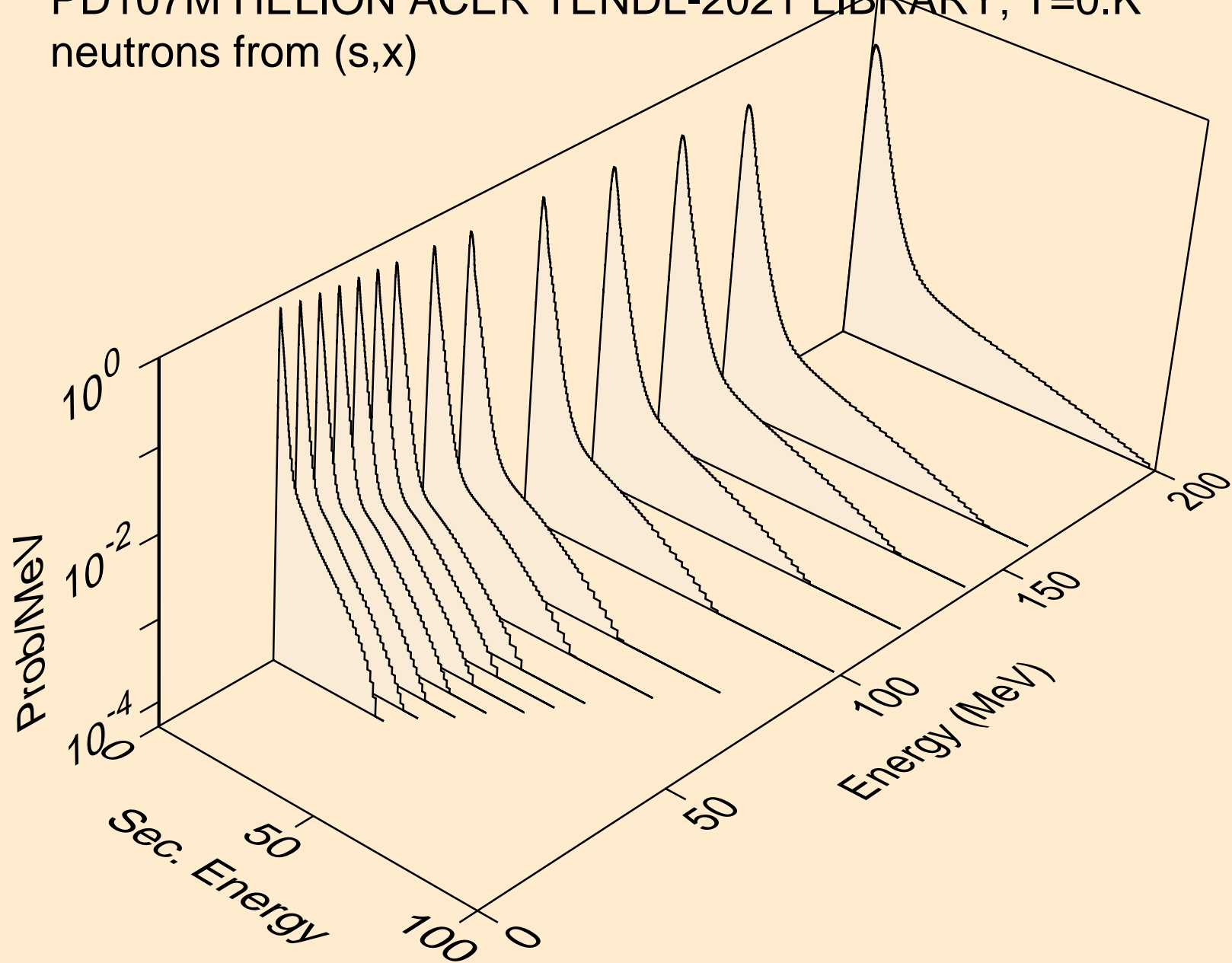

PD107M HELION ACER TENDL-2021 LIBRARY; T=0.K  
neutrons from (s,2nd)

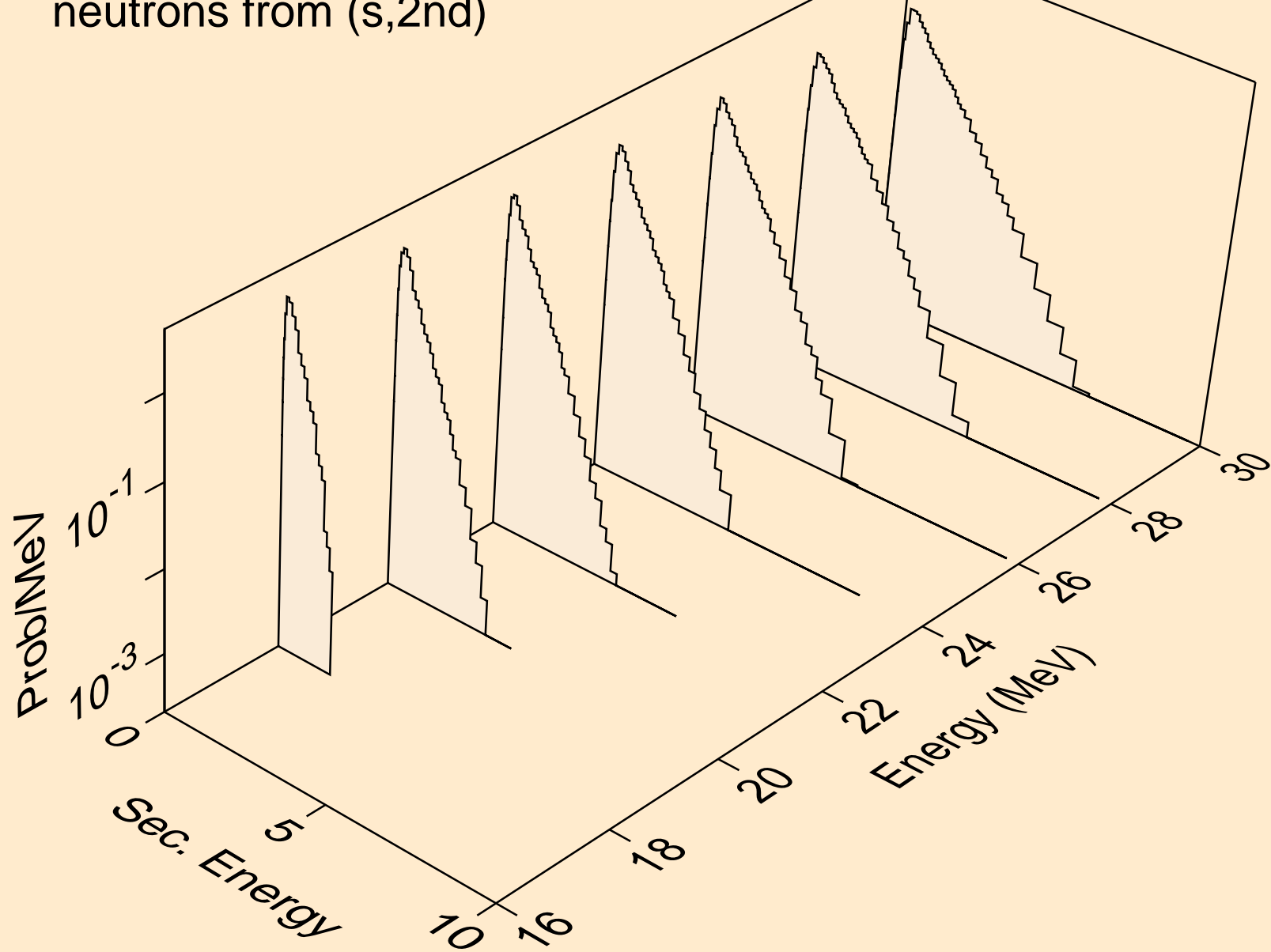

PD107M HELION ACER TENDL-2021 LIBRARY; T=0.K  
neutrons from (s,2n)

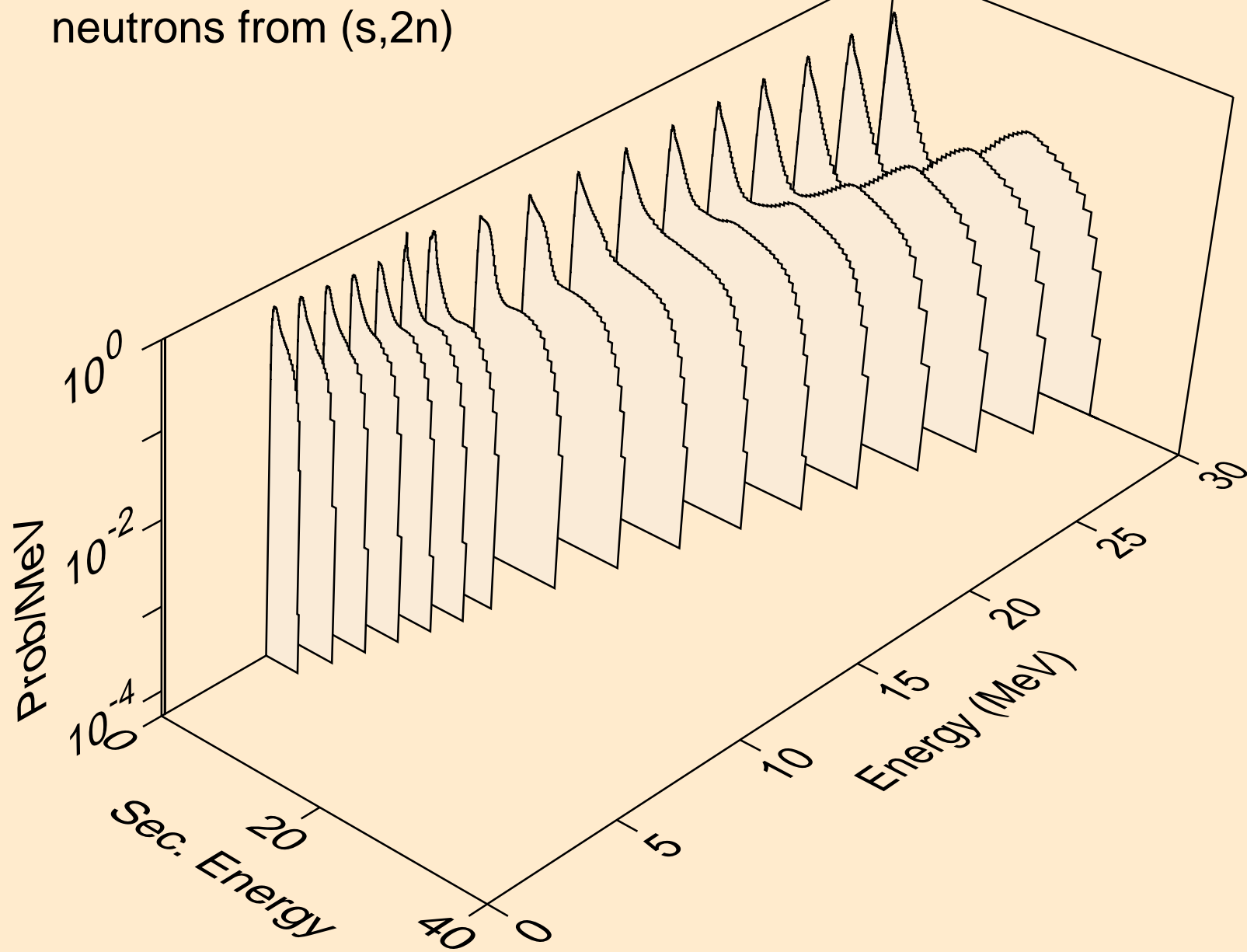

PD107M HELION ACER TENDL-2021 LIBRARY; T=0.K  
neutrons from (s,3n)

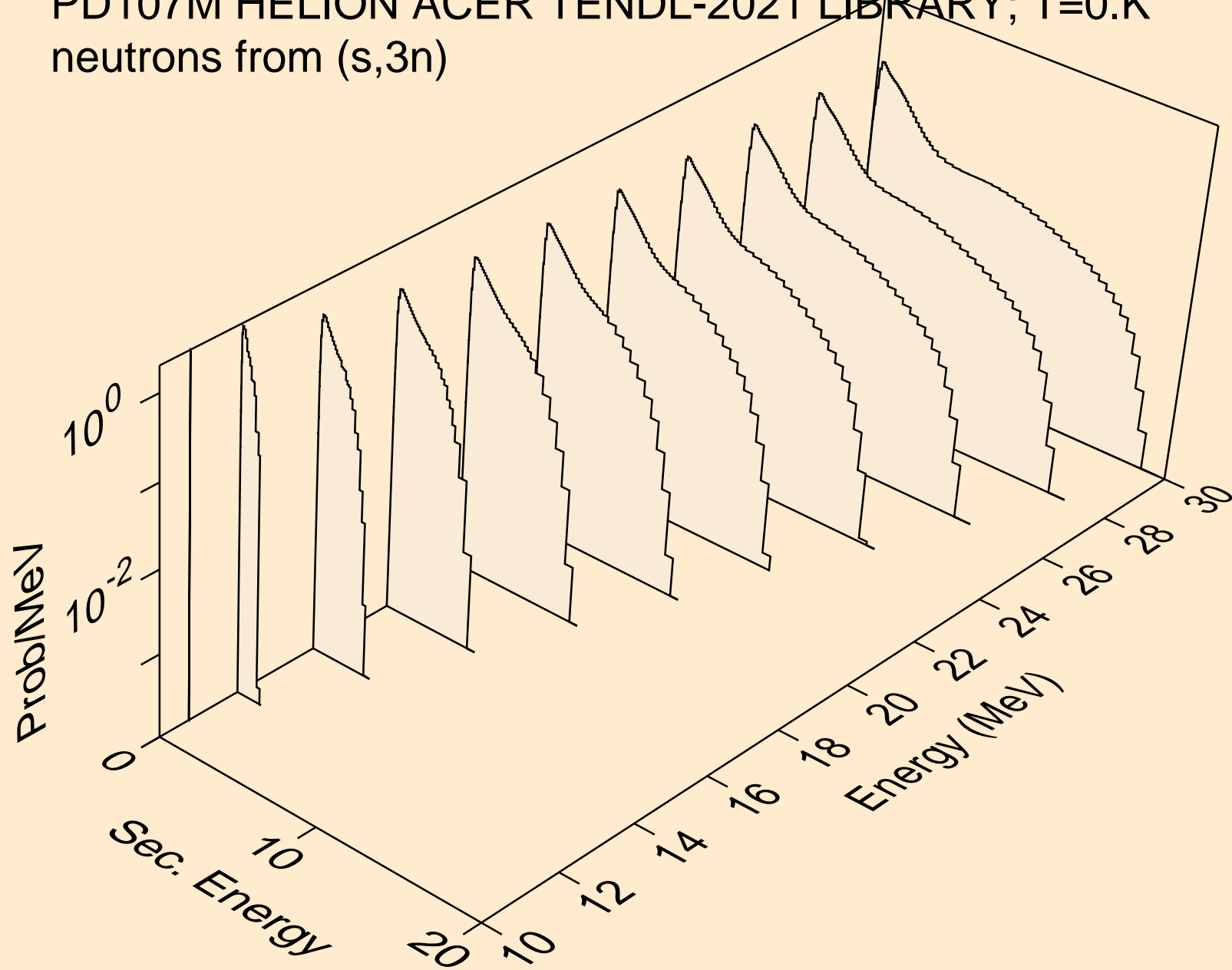



PD107M HELION ACER TENDL-2021 LIBRARY; T=0.K  
neutrons from (s,n\*)a

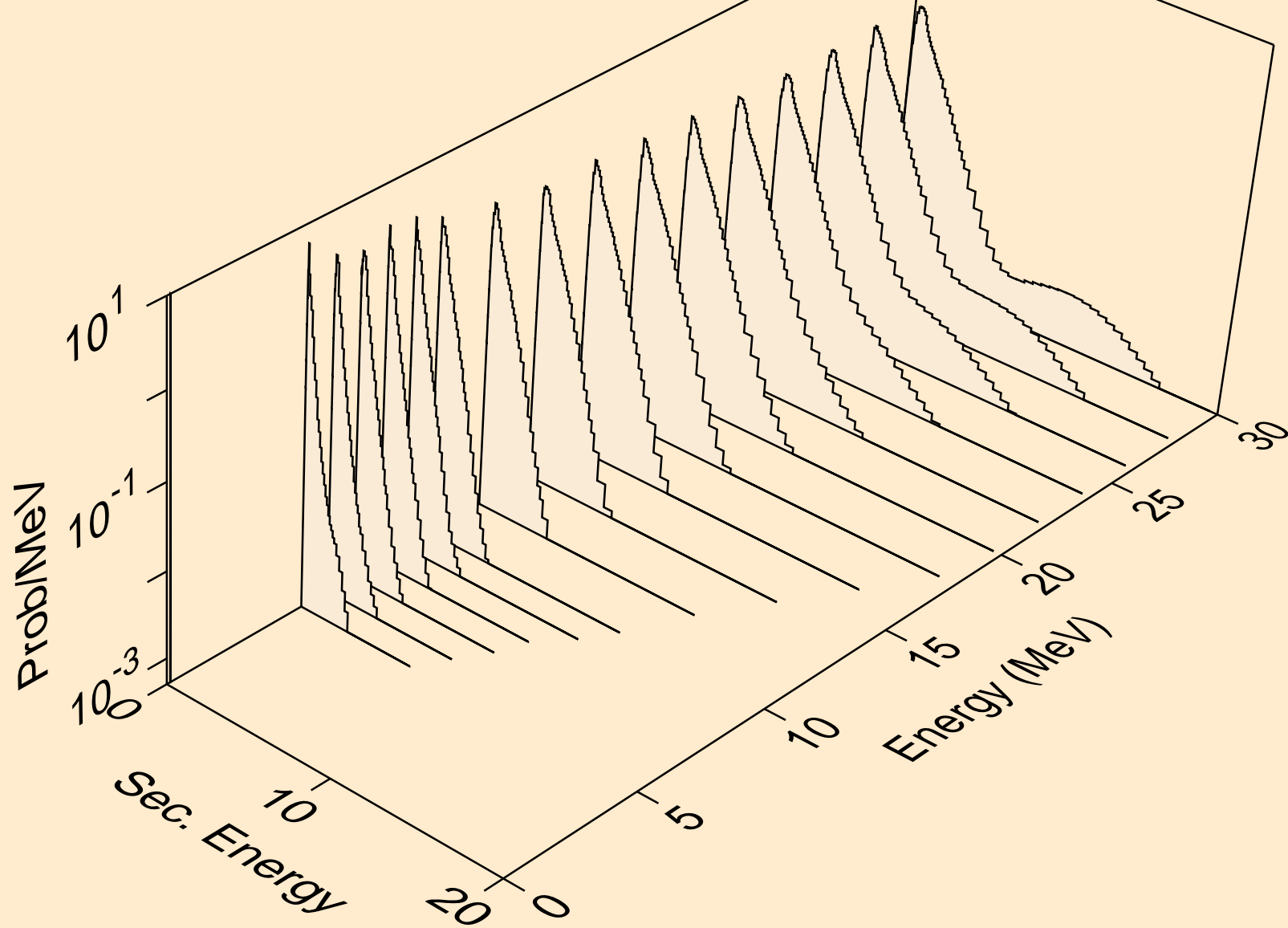

PD107M HELION ACER TENDL-2021 LIBRARY; T=0.K  
neutrons from (s,2n)a

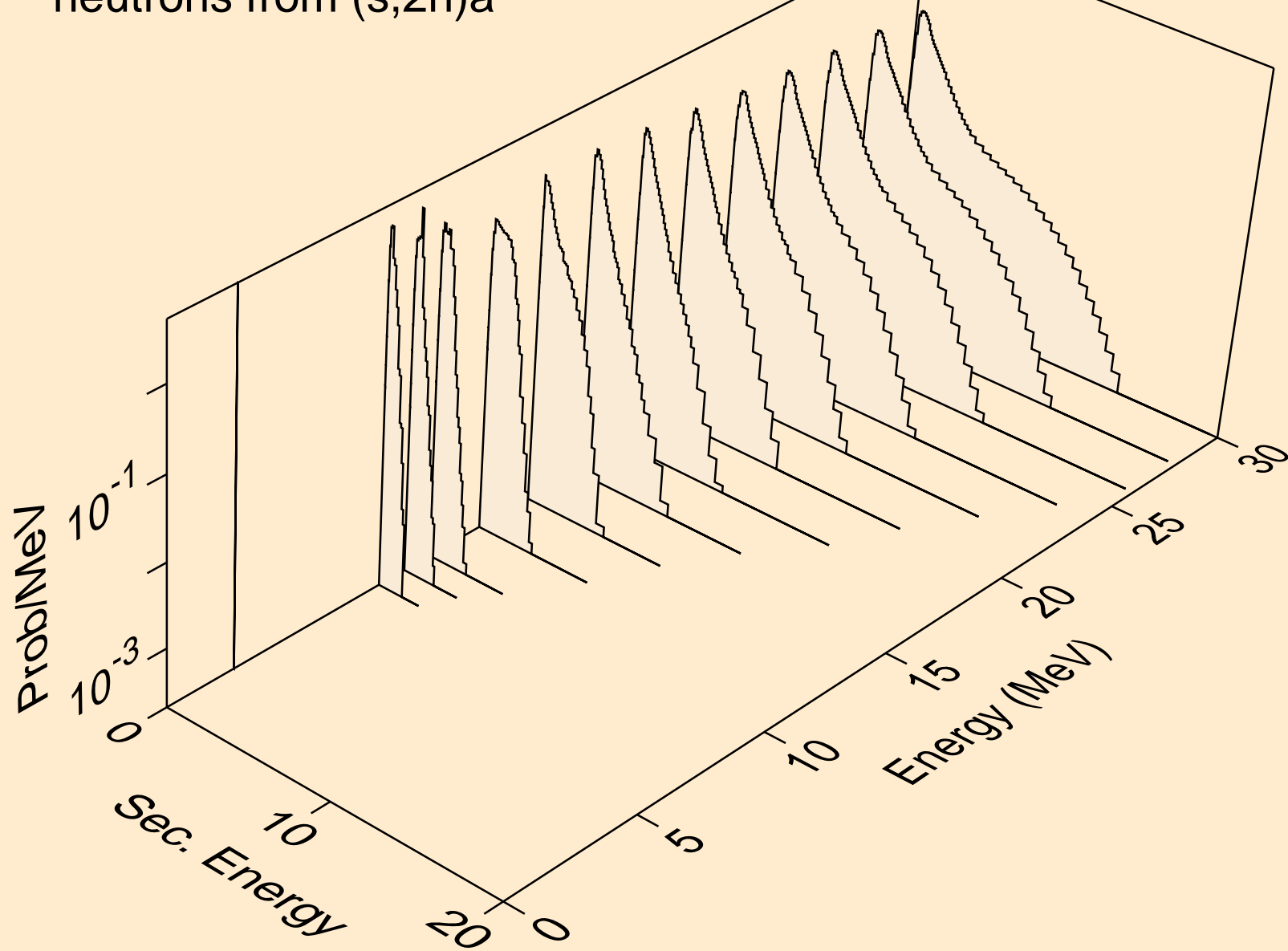

PD107M HELION ACER TENDL-2021 LIBRARY; T=0.K  
neutrons from (s,3n)a

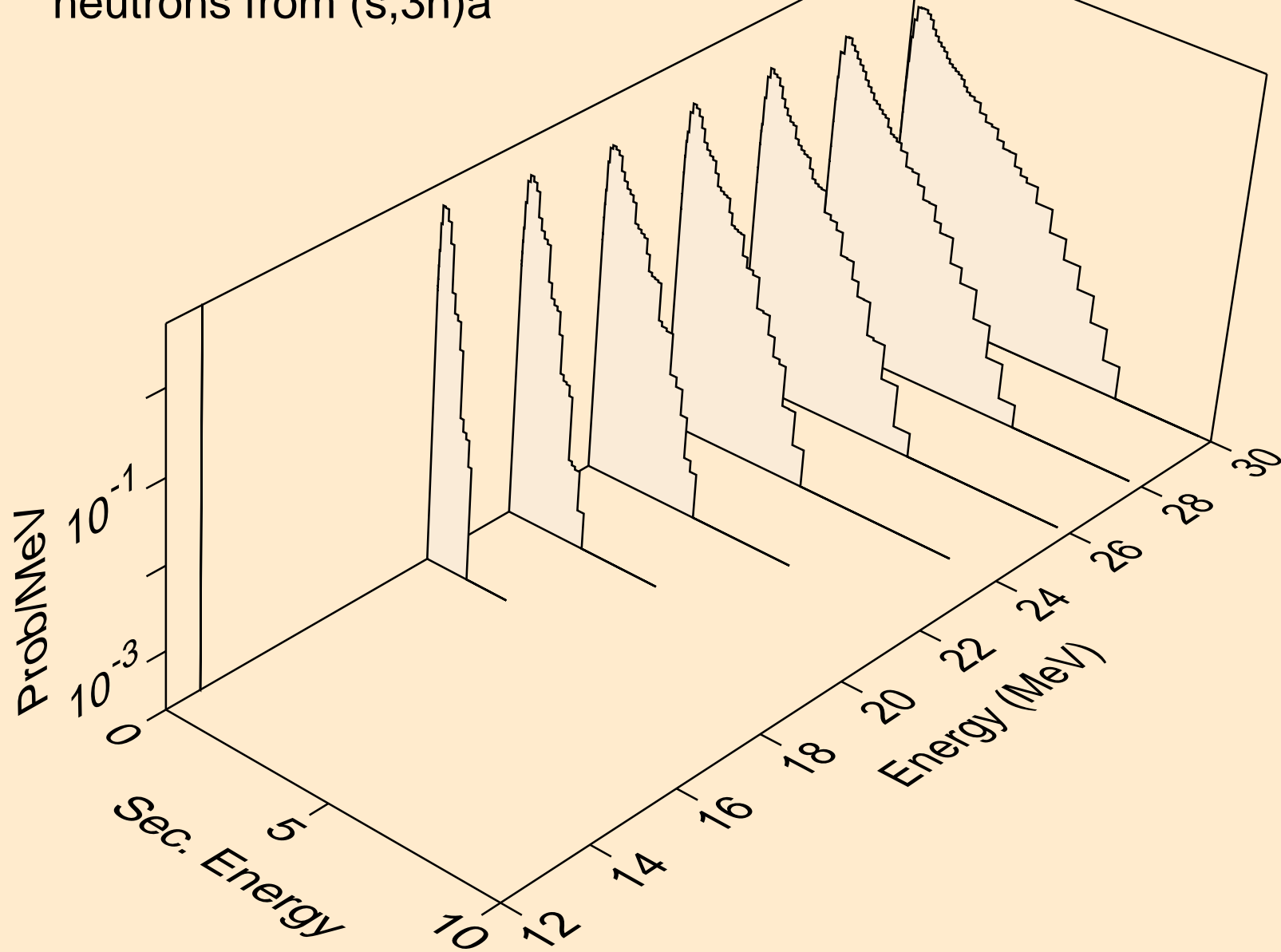

PD107M HELION ACER TENDL-2021 LIBRARY; T=0.K  
neutrons from (s,n\*)p

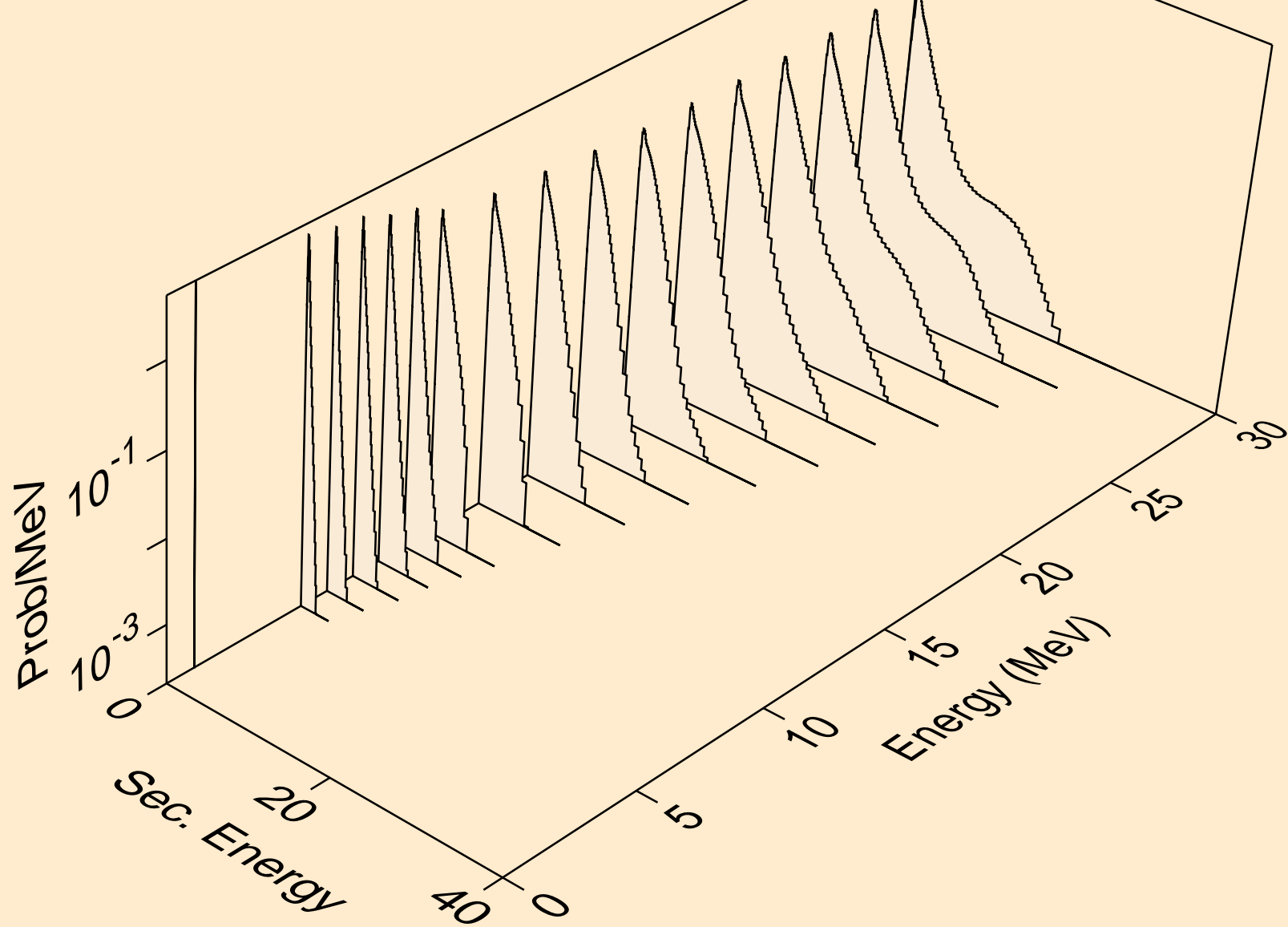

PD107M HELION ACER TENDL-2021 LIBRARY; T=0.K  
neutrons from (s,n\*)2a

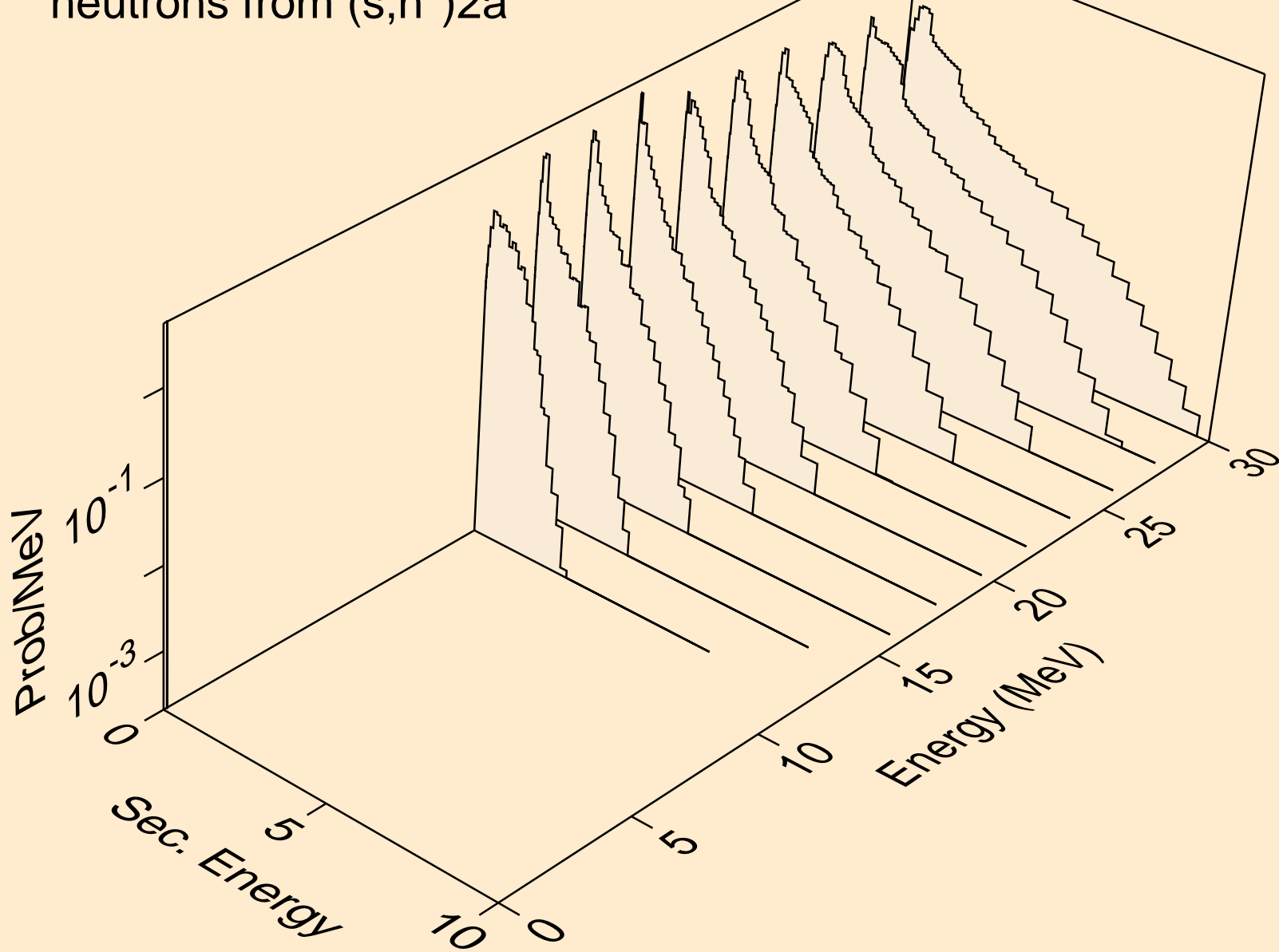

PD107M HELION ACER TENDL-2021 LIBRARY; T=0.K  
neutrons from (s,2n)2a

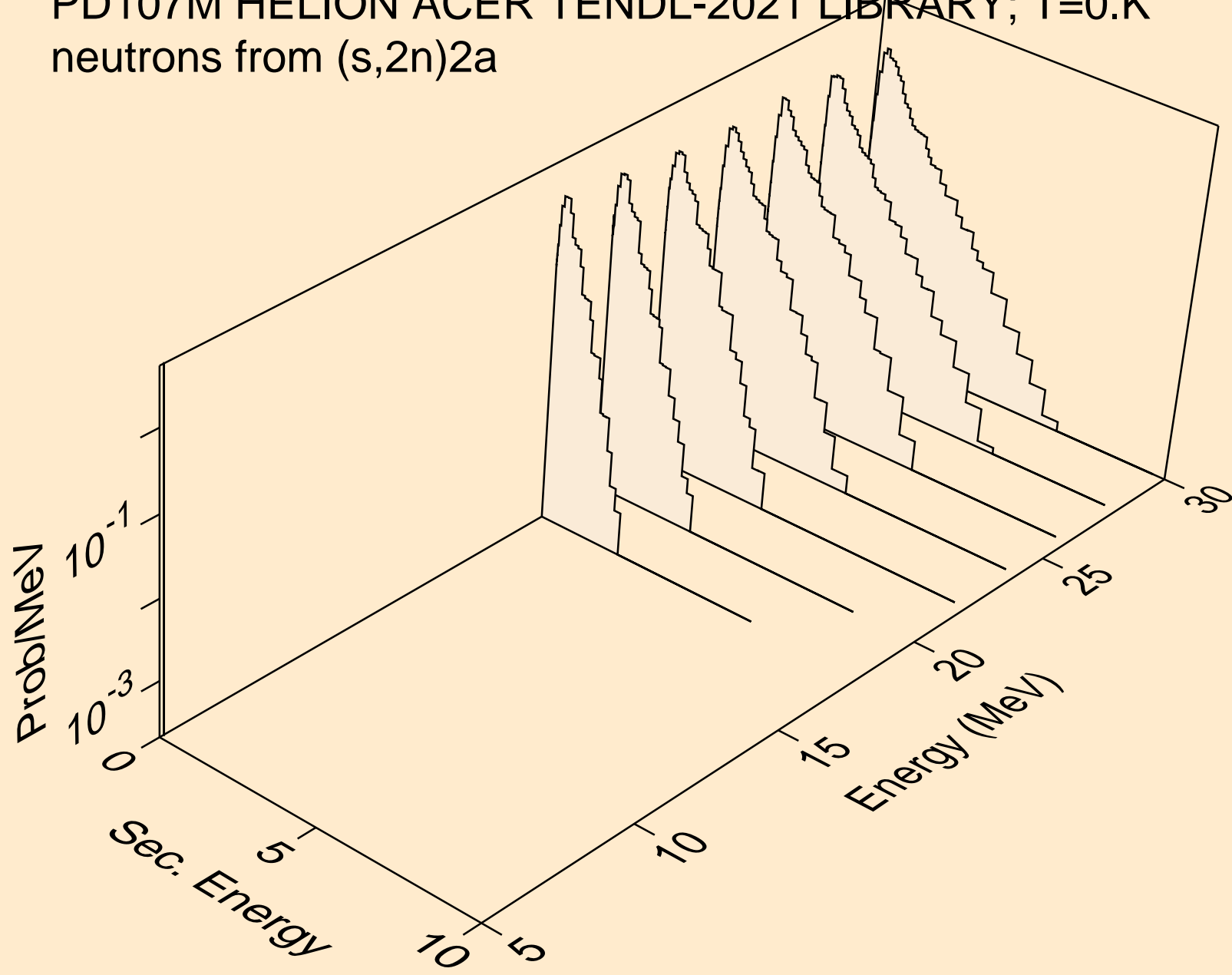

PD107M HELION ACER TENDL-2021 LIBRARY; T=0.K  
neutrons from (s,n\*)d

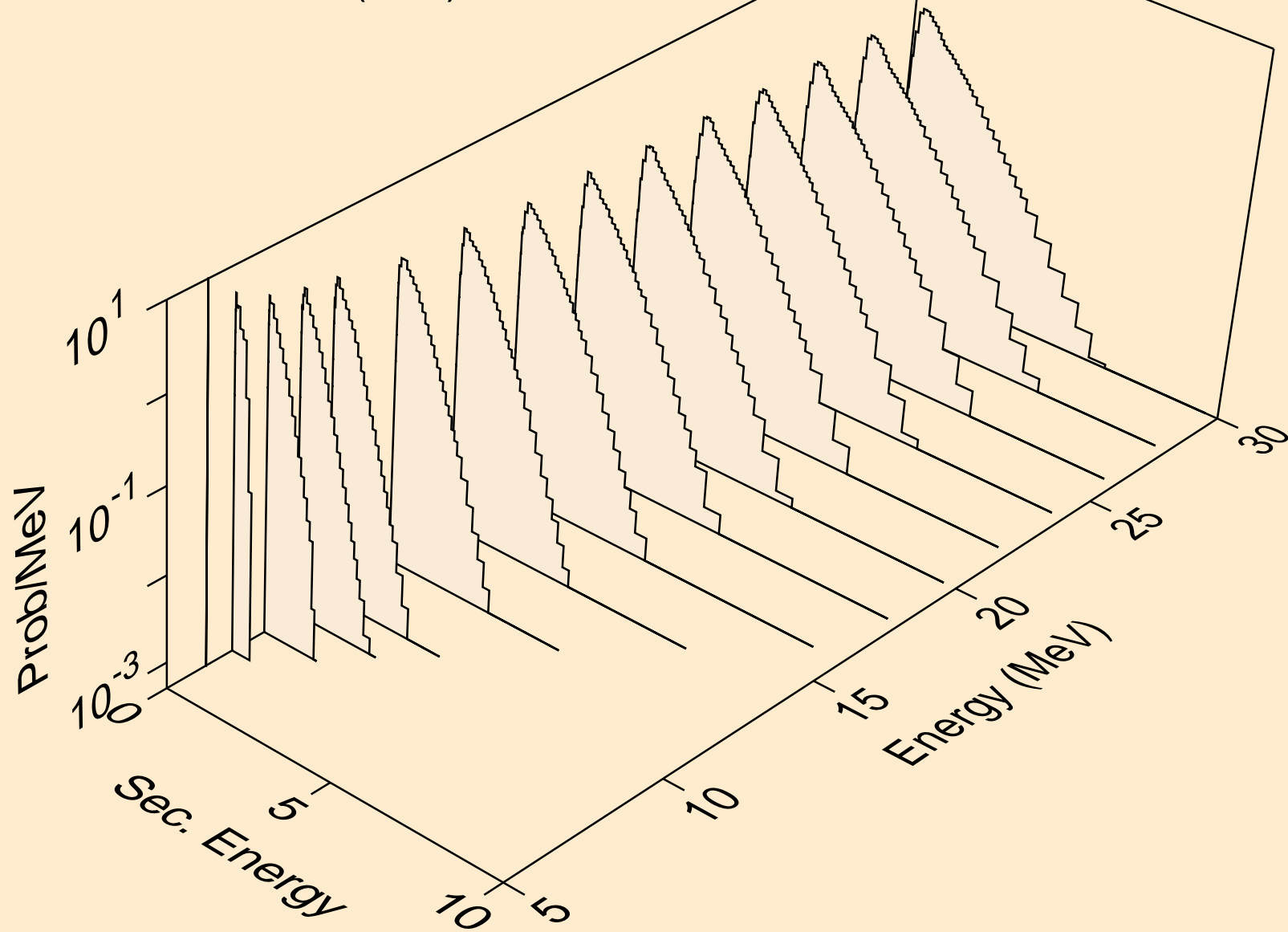

PD107M HELION ACER TENDL-2021 LIBRARY; T=0.K  
neutrons from (s,n\*)t

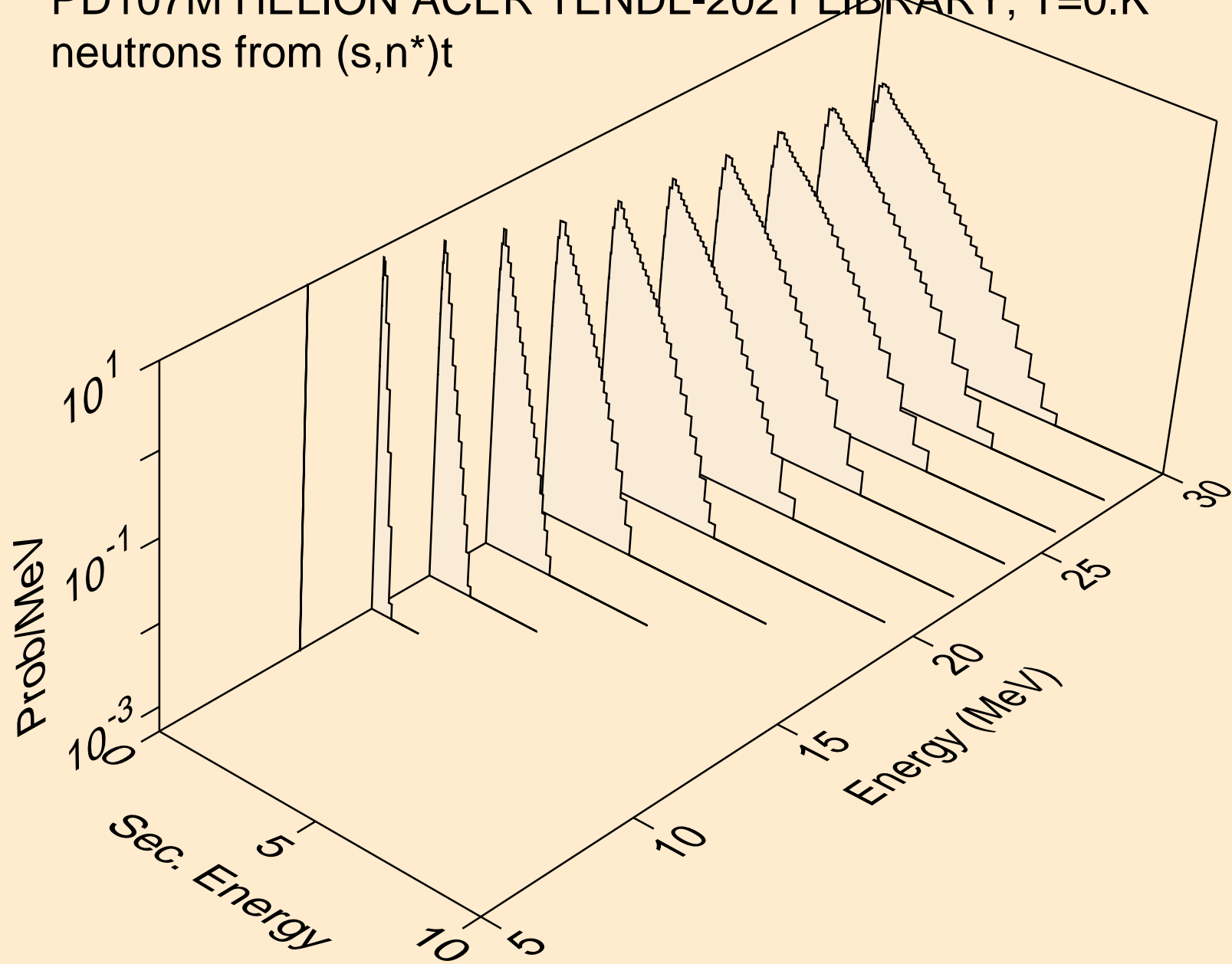



PD107M HELION ACER TENDL-2021 LIBRARY; T=0.K  
neutrons from (s,n\*)he3

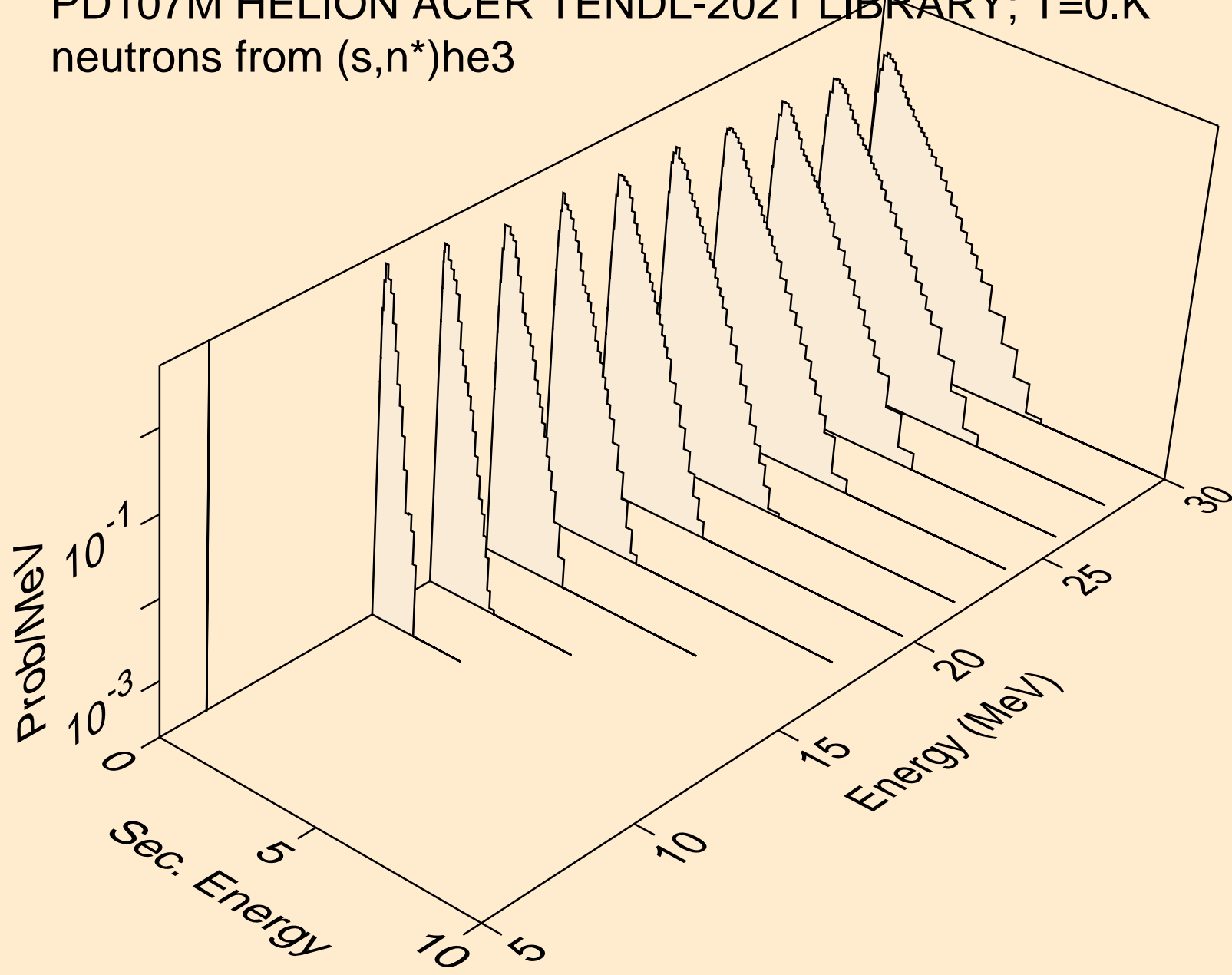

PD107M HELION ACER TENDL-2021 LIBRARY; T=0.K  
neutrons from (s,4n)

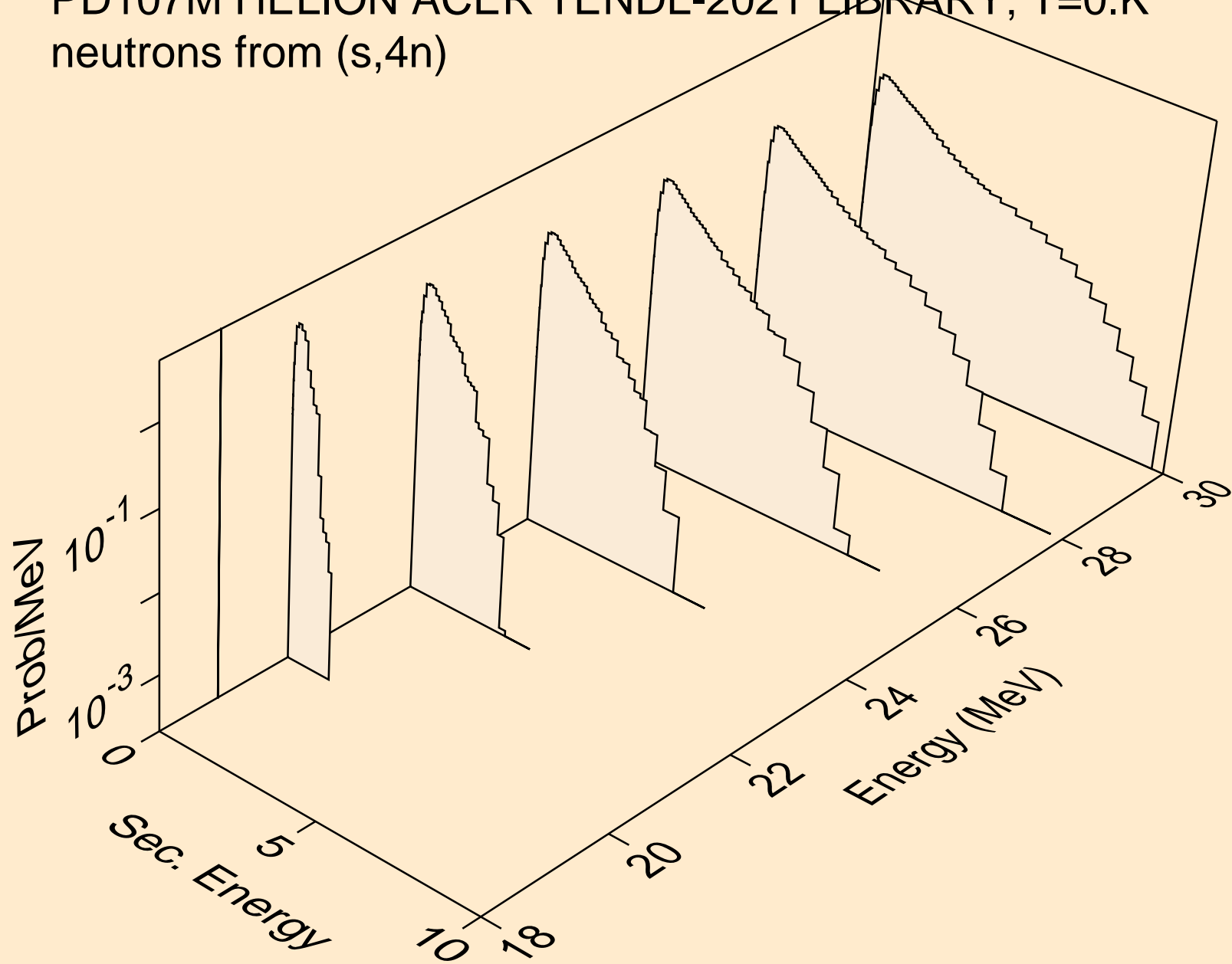

PD107M HELION ACER TENDL-2021 LIBRARY; T=0.K  
neutrons from (s,2np)

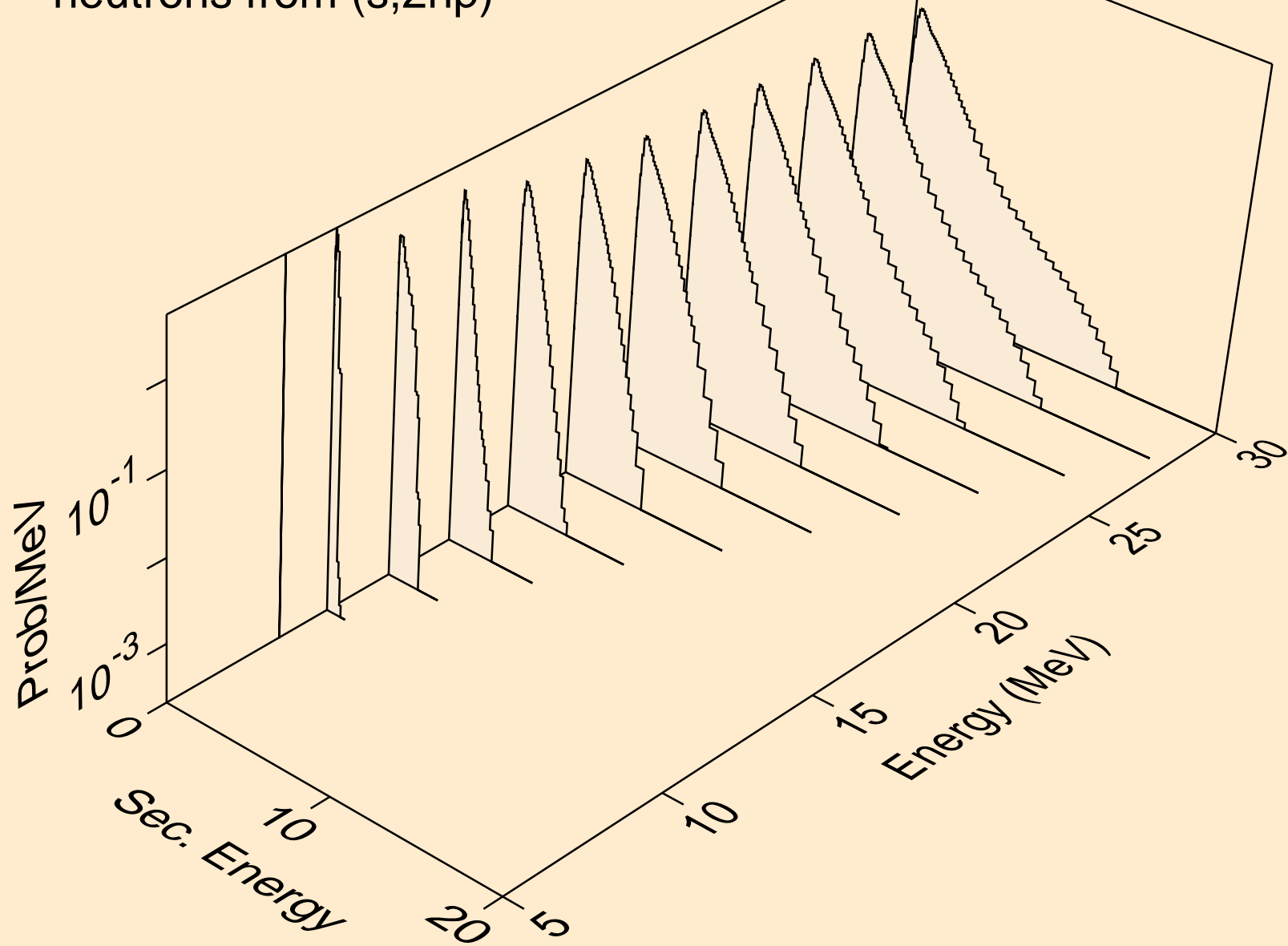

PD107M HELION ACER TENDL-2021 LIBRARY; T=0.K  
neutrons from (s,3np)

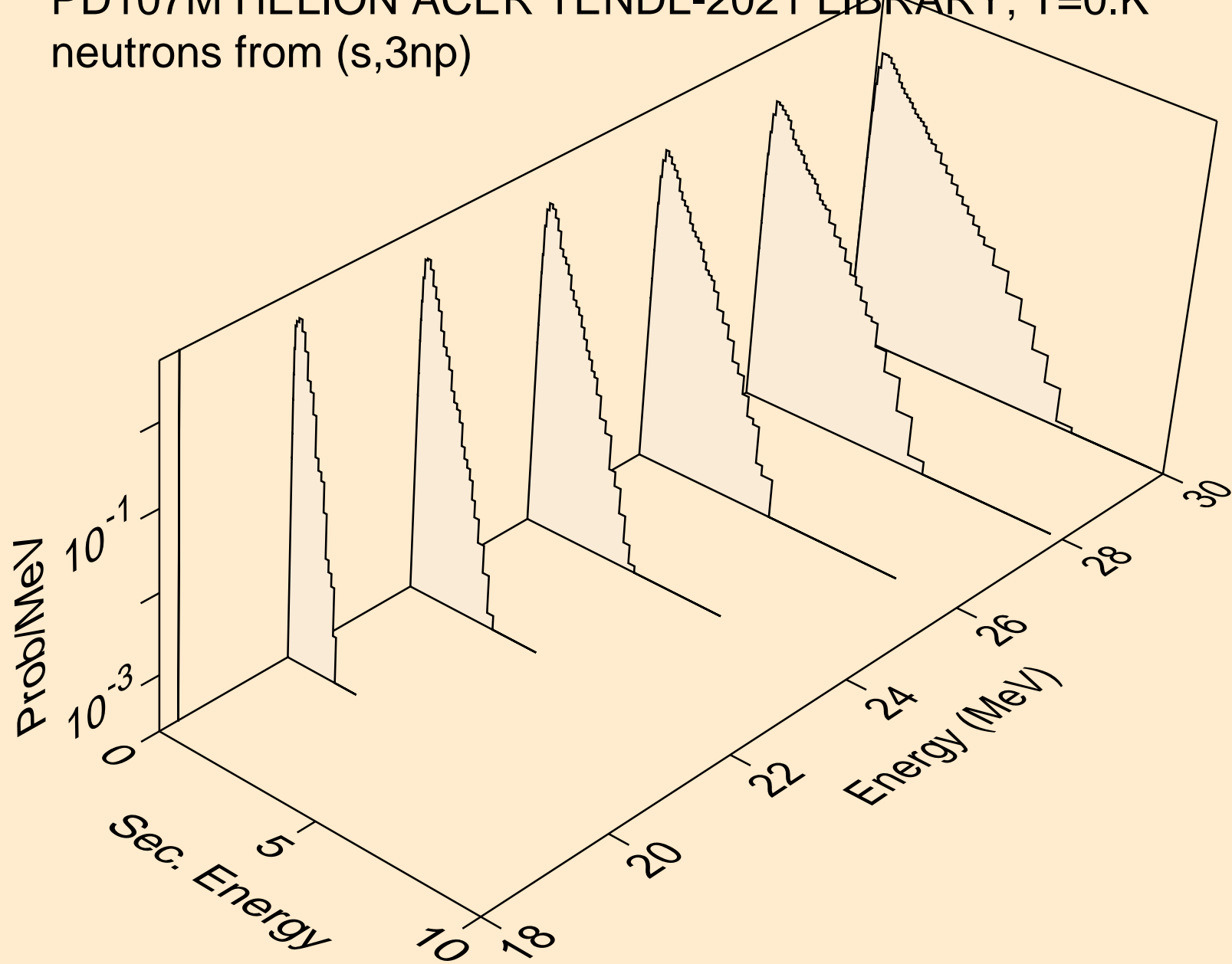

PD107M HELION ACER TENDL-2021 LIBRARY; T=0.K  
neutrons from (s,2np)

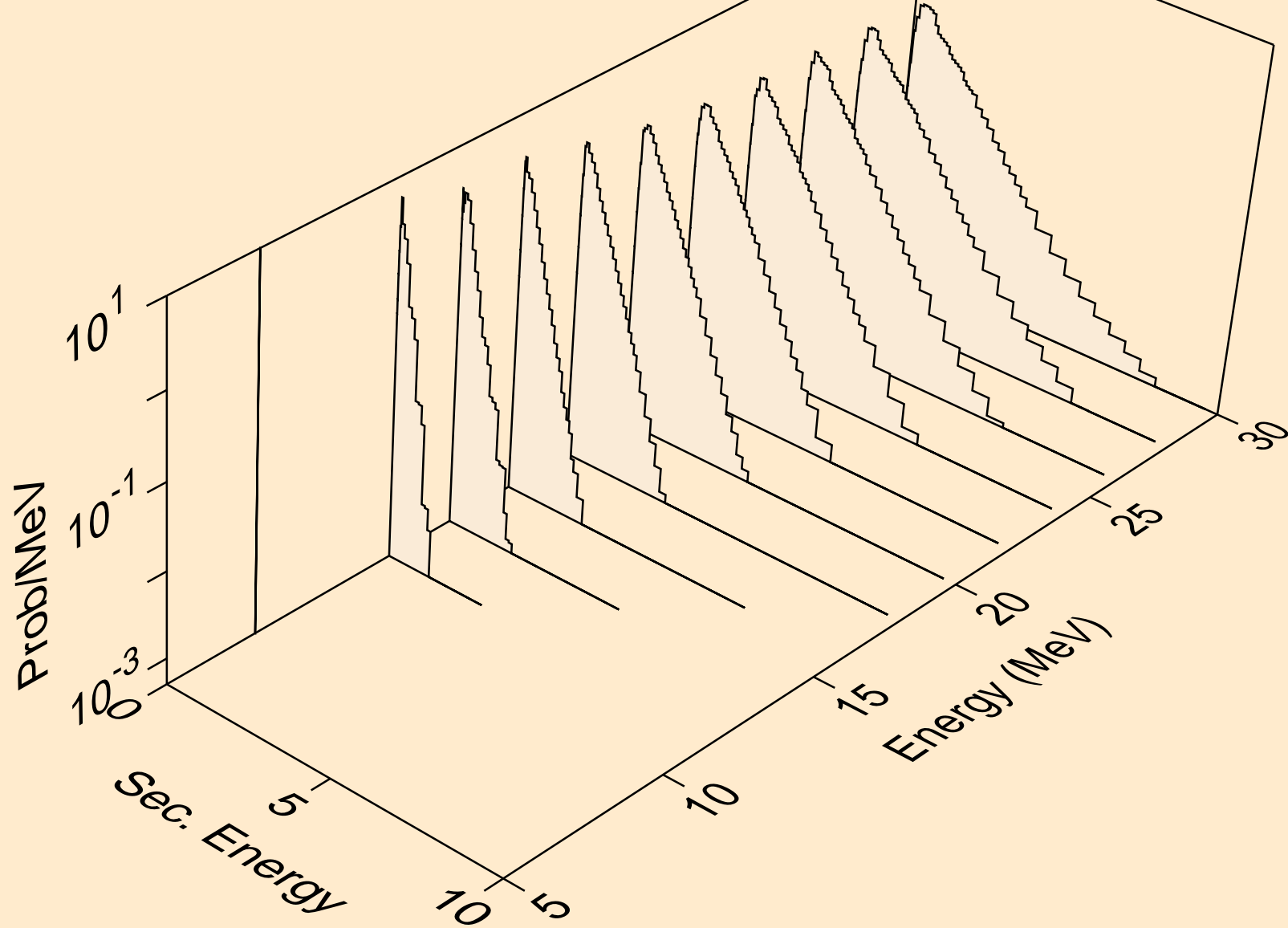

PD107M HELION ACER TENDL-2021 LIBRARY; T=0.K  
neutrons from (s,npa)

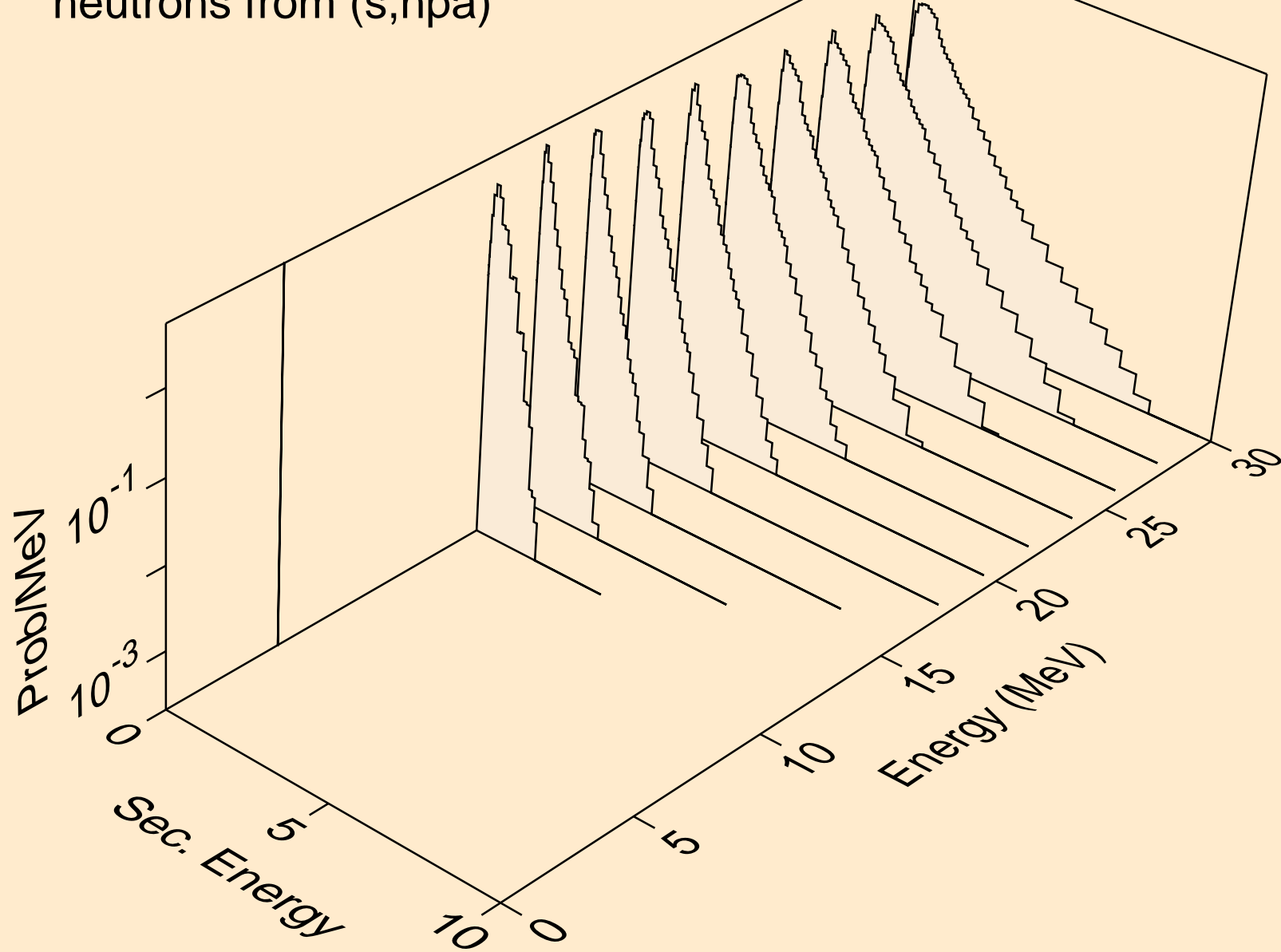

PD107M HELION ACER TENDL-2021 LIBRARY; T=0.K  
protons from (s,x)

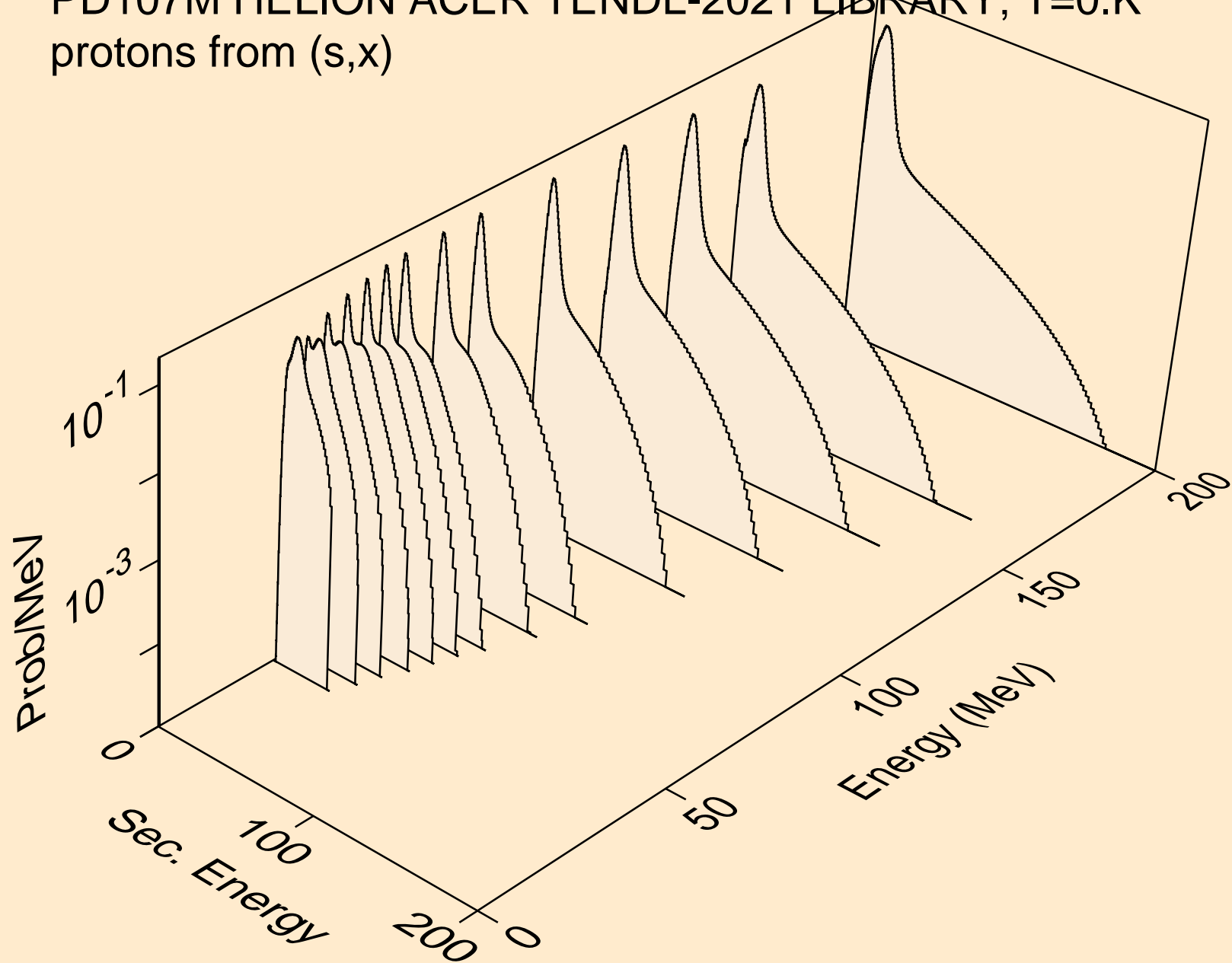

PD107M HELION ACER TENDL-2021 LIBRARY; T=0.K  
protons from (s,n\*)p

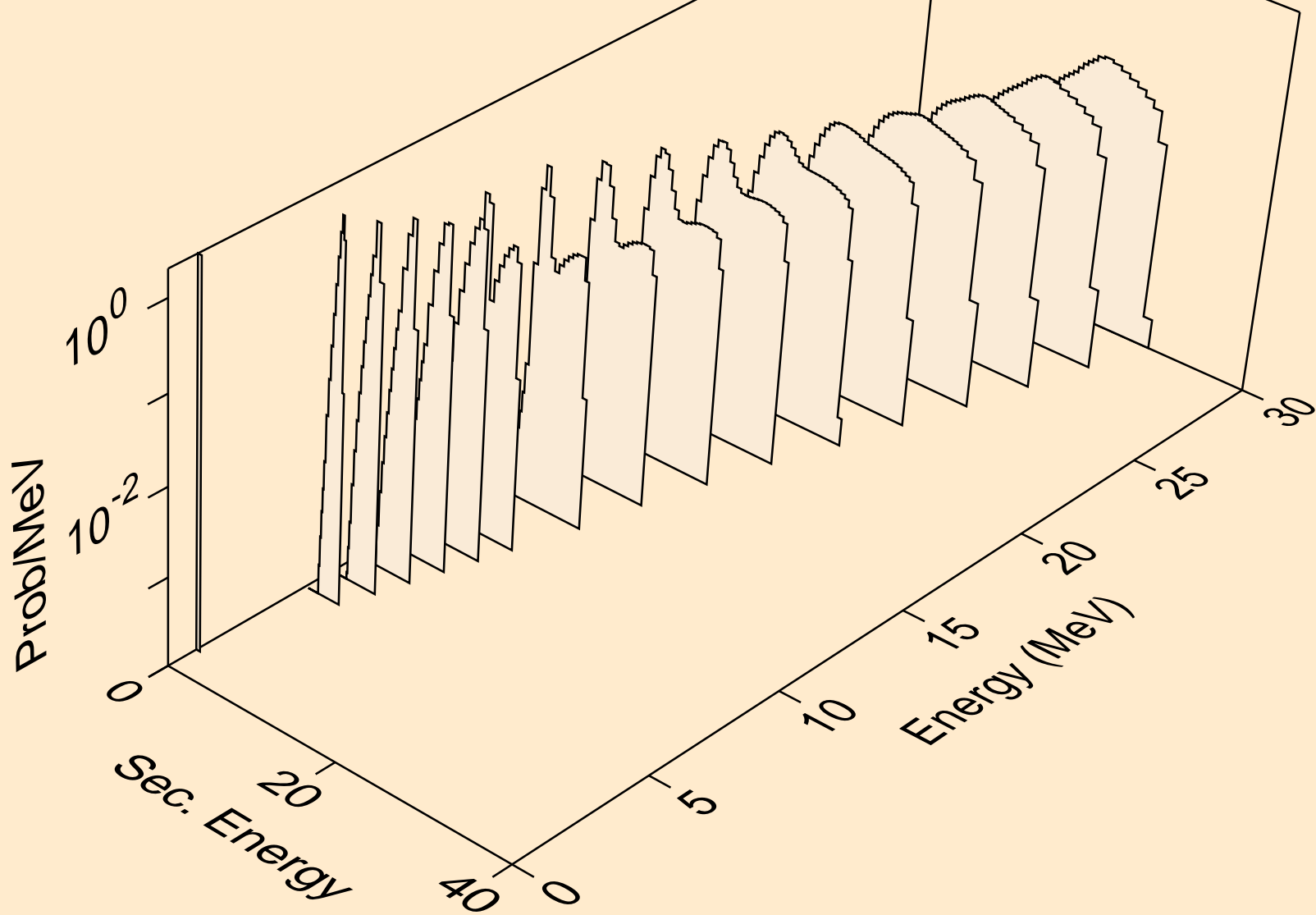



PD107M HELION ACER TENDL-2021 LIBRARY; T=0.K  
protons from (s,2np)

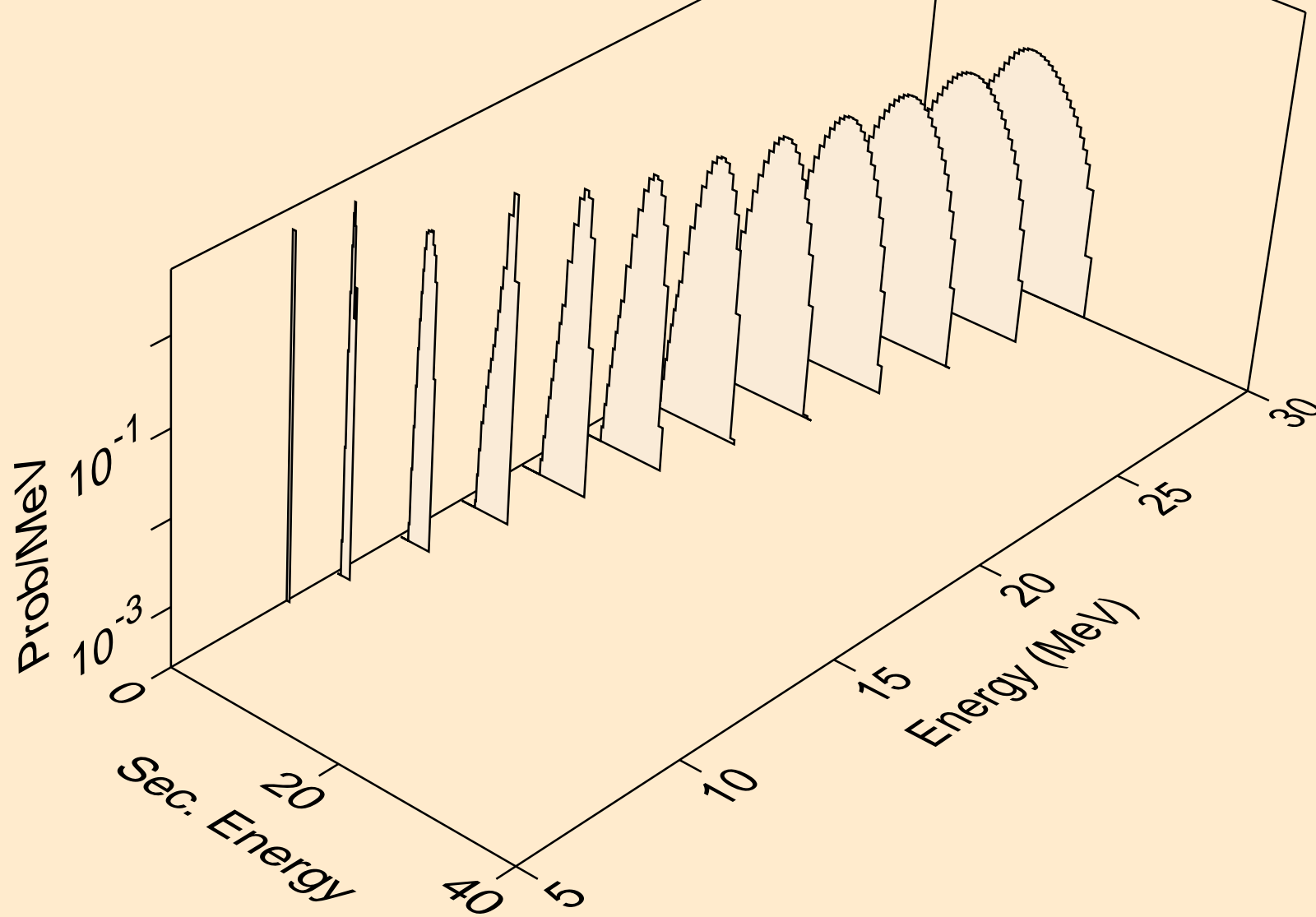

PD107M HELION ACER TENDL-2021 LIBRARY; T=0.K  
protons from (s,3np)

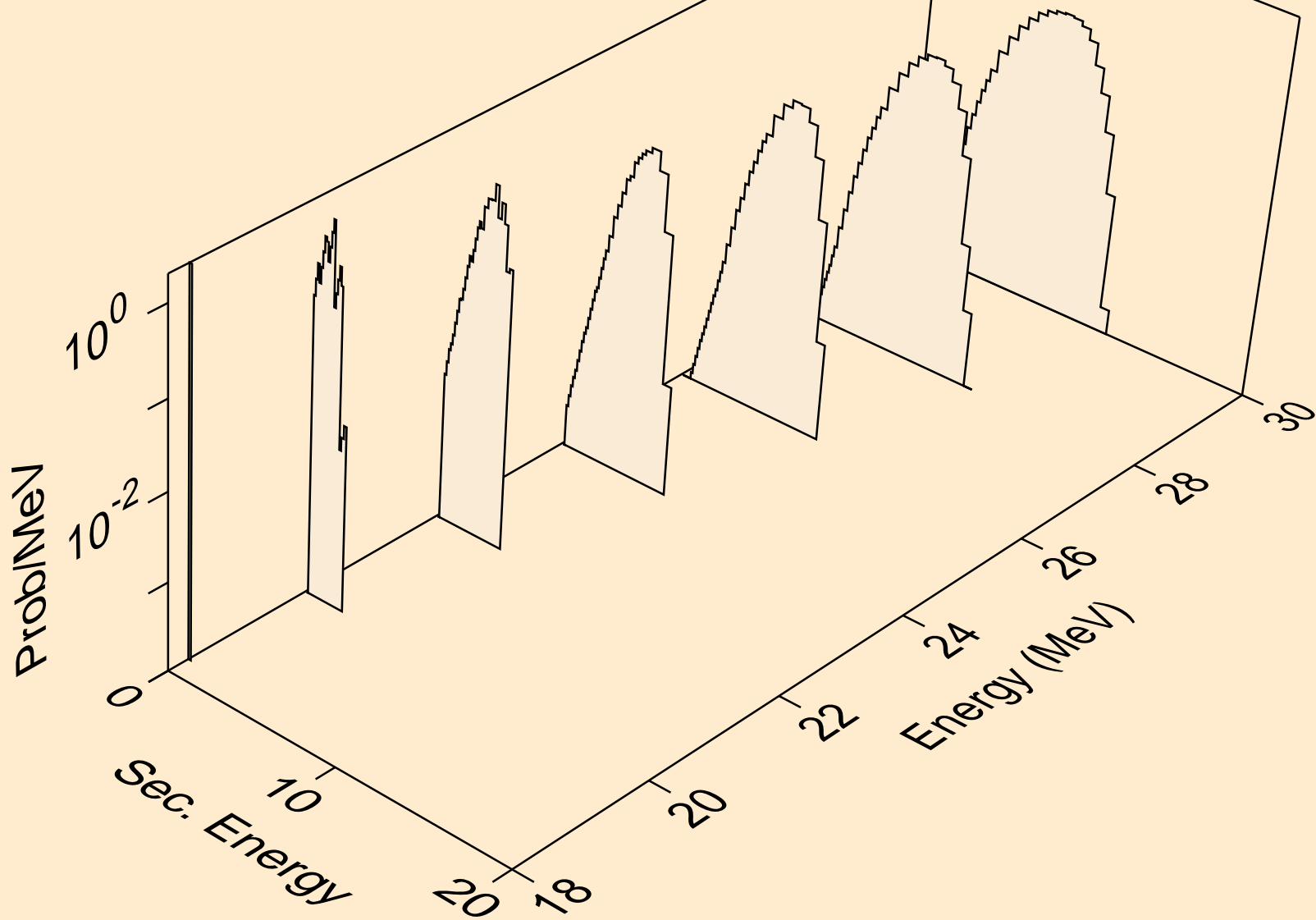

PD107M HELION ACER TENDL-2021 LIBRARY; T=0.K  
protons from (s,2np)

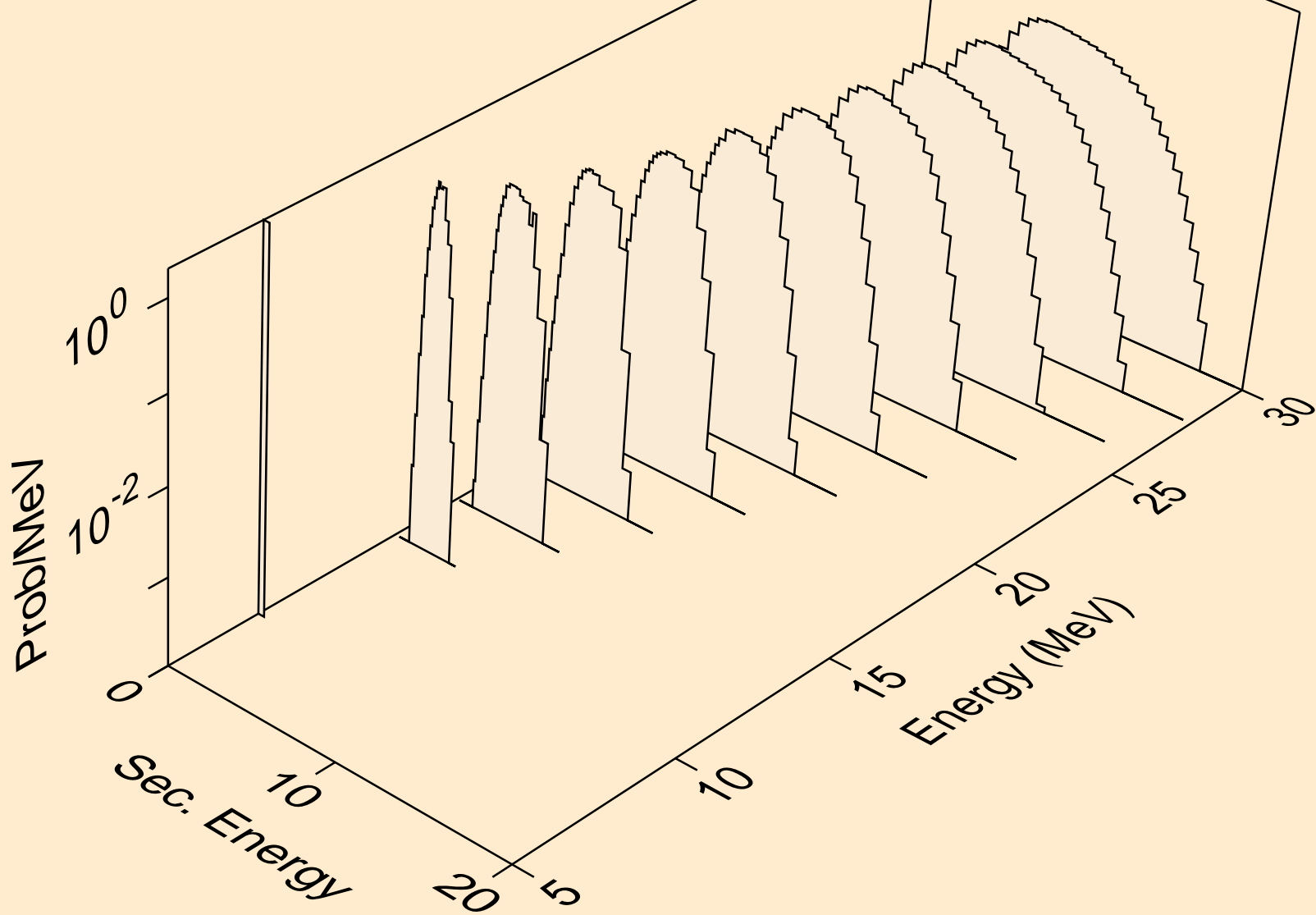

PD107M HELION ACER TENDL-2021 LIBRARY; T=0.K  
protons from (s,npa)

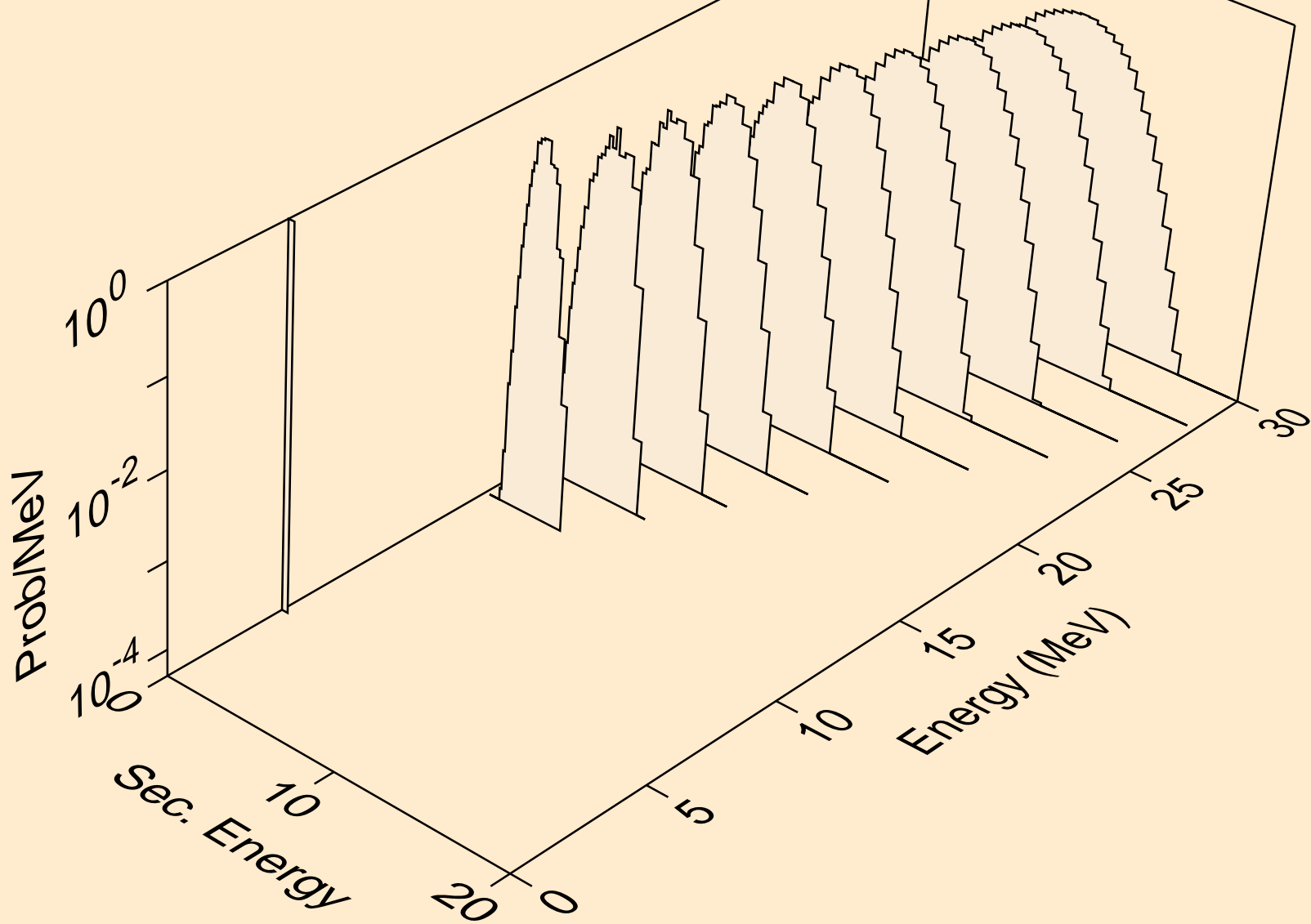

PD107M HELION ACER TENDL-2021 LIBRARY; T=0.K  
protons from (s,p)

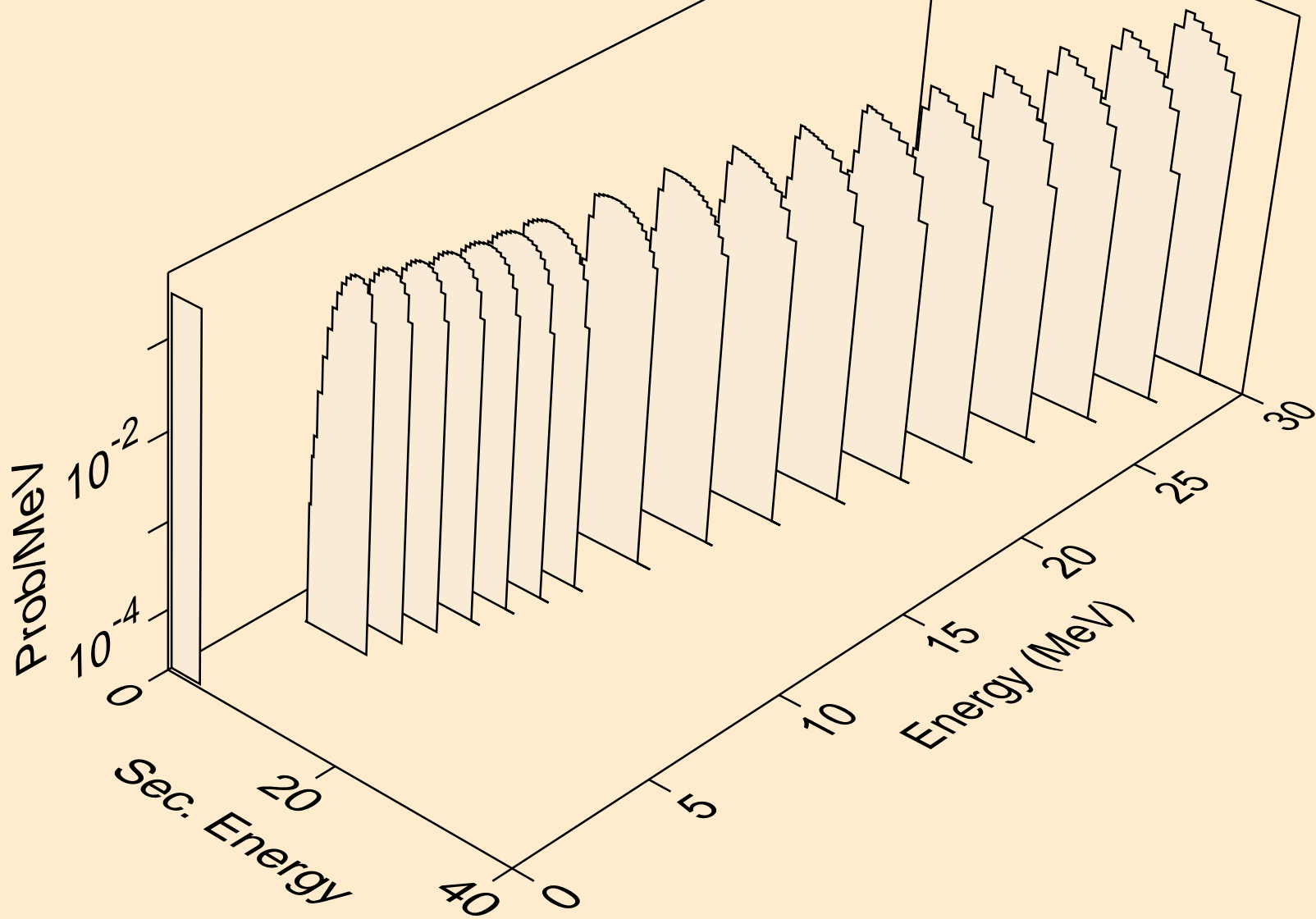

PD107M HELION ACER TENDL-2021 LIBRARY; T=0.K  
protons from (s,2p)

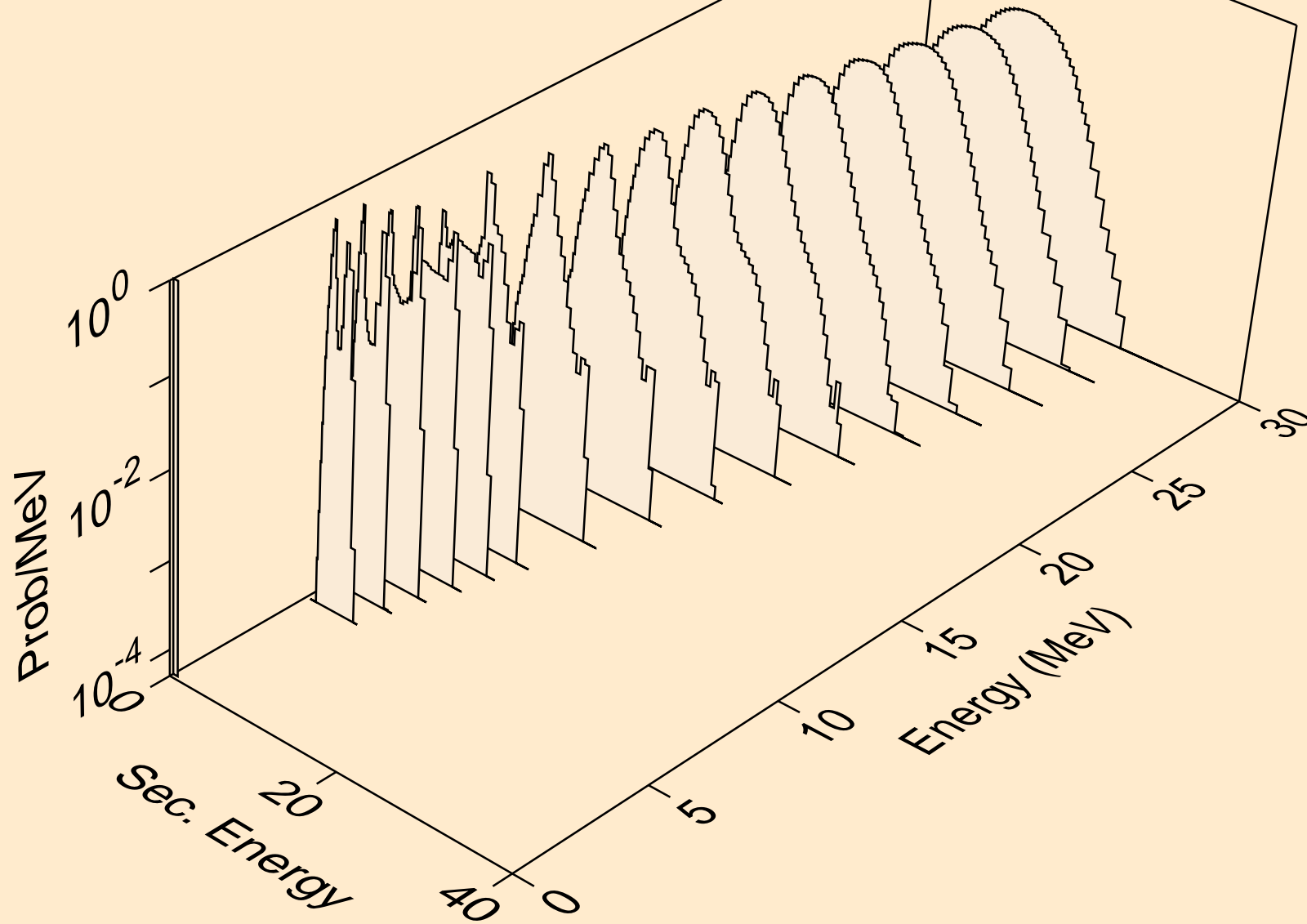

PD107M HELION ACER TENDL-2021 LIBRARY; T=0.K  
protons from (s,pa)

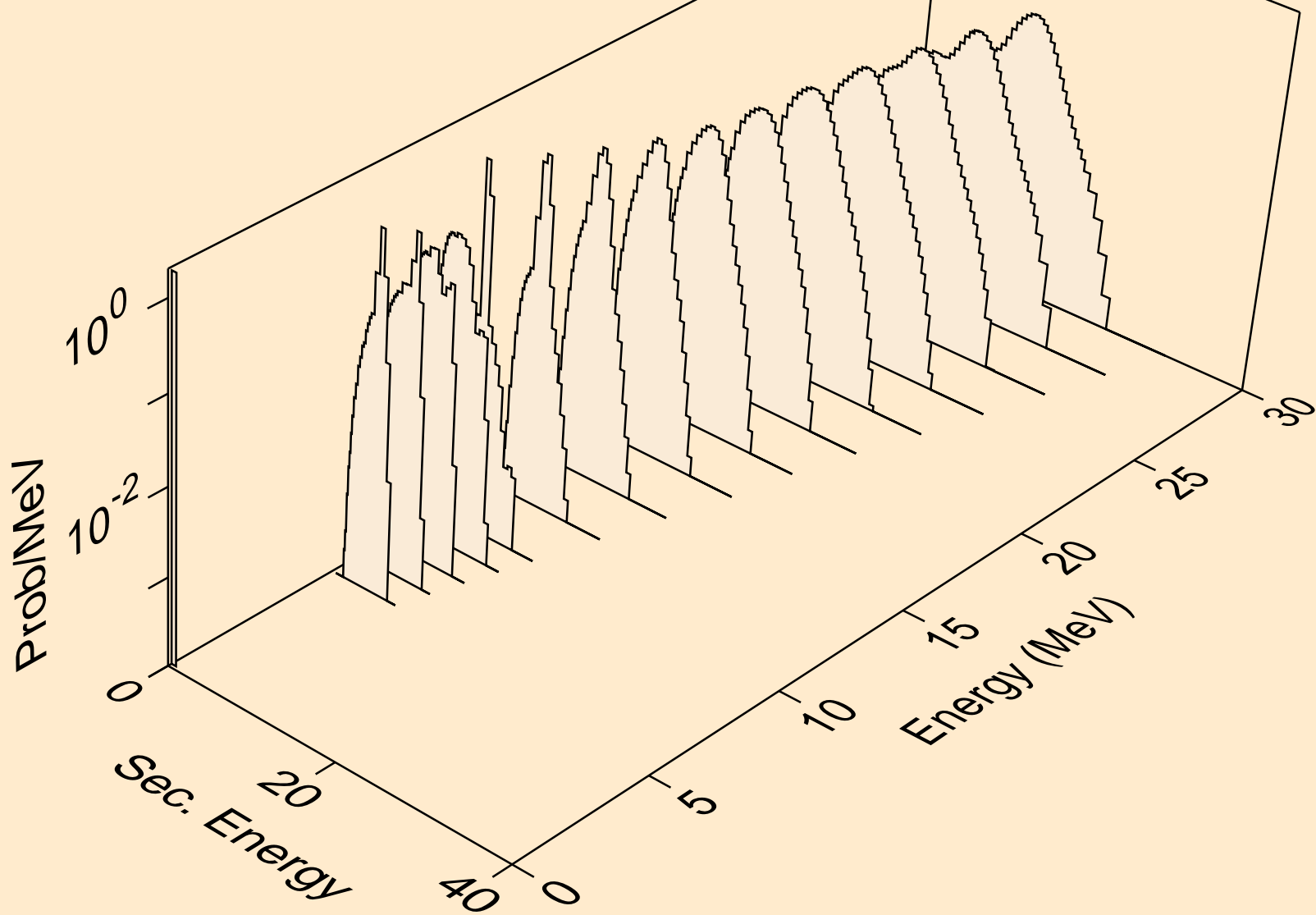

PD107M HELION ACER TENDL-2021 LIBRARY; T=0.K  
protons from (s,pd)

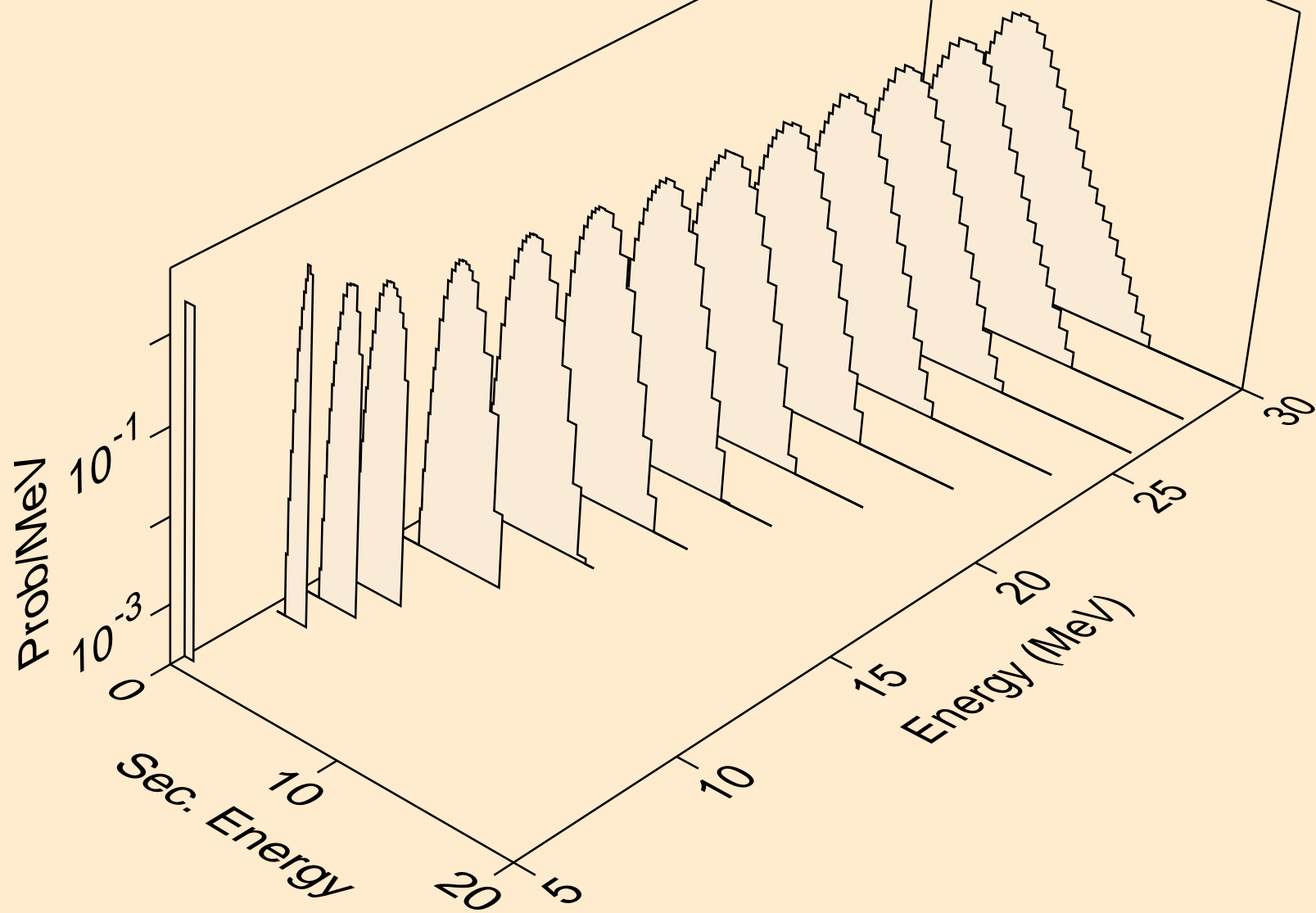



PD107M HELION ACER TENDL-2021 LIBRARY; T=0.K  
protons from (s,pt)

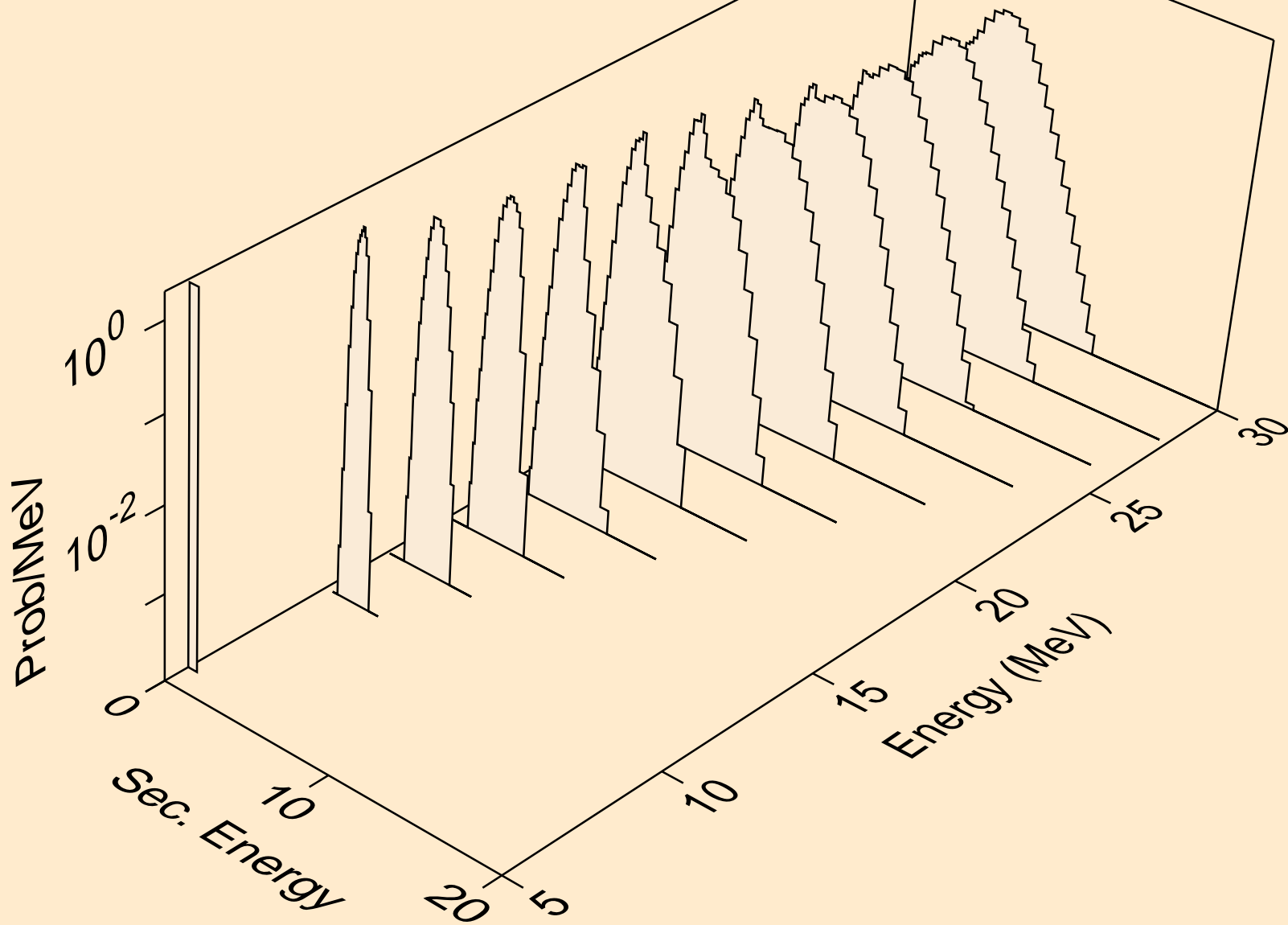

PD107M HELION ACER TENDL-2021 LIBRARY; T=0.K  
deuterons from (s,x)

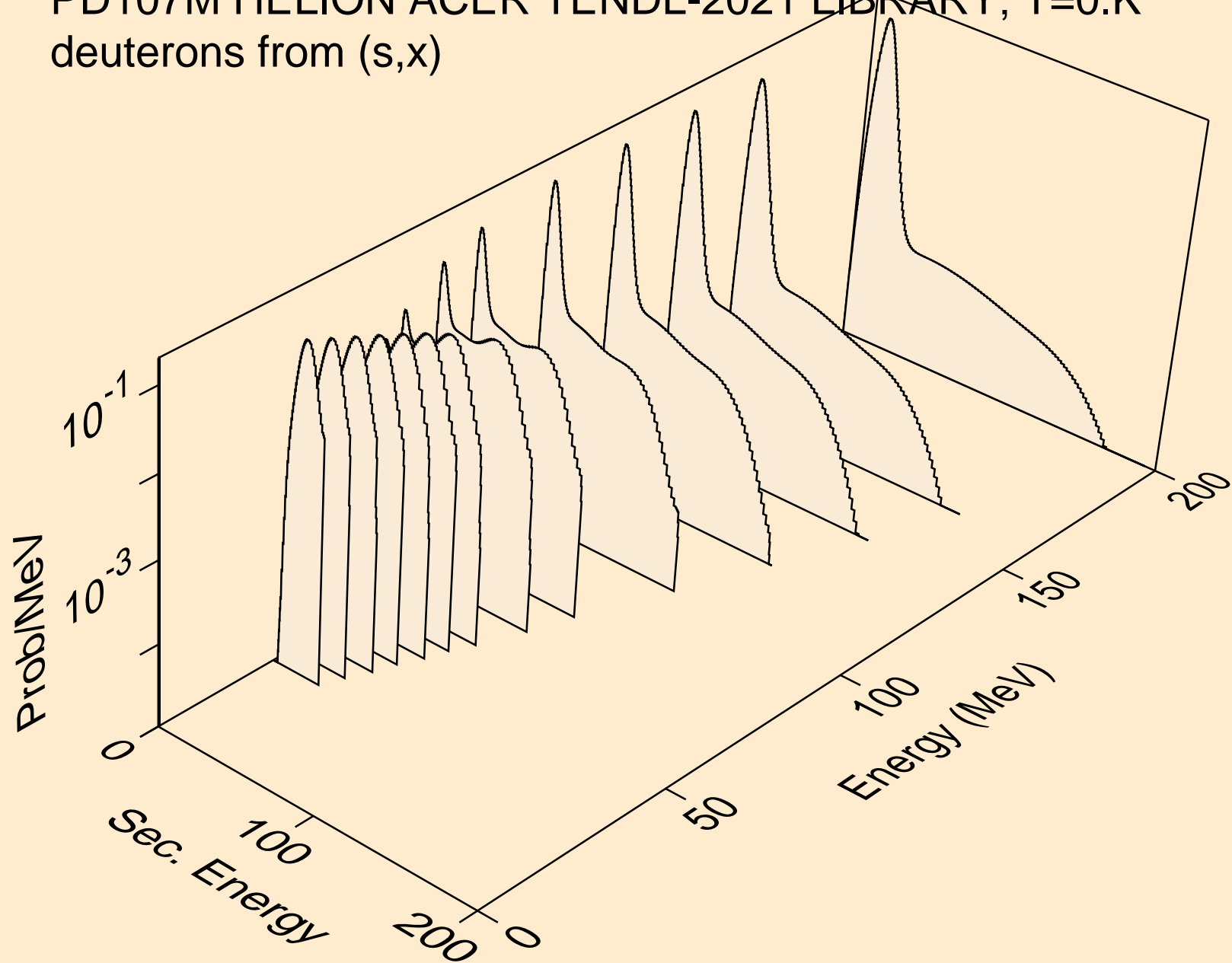

PD107M HELION ACER TENDL-2021 LIBRARY; T=0.K  
deuterons from (s,2nd)

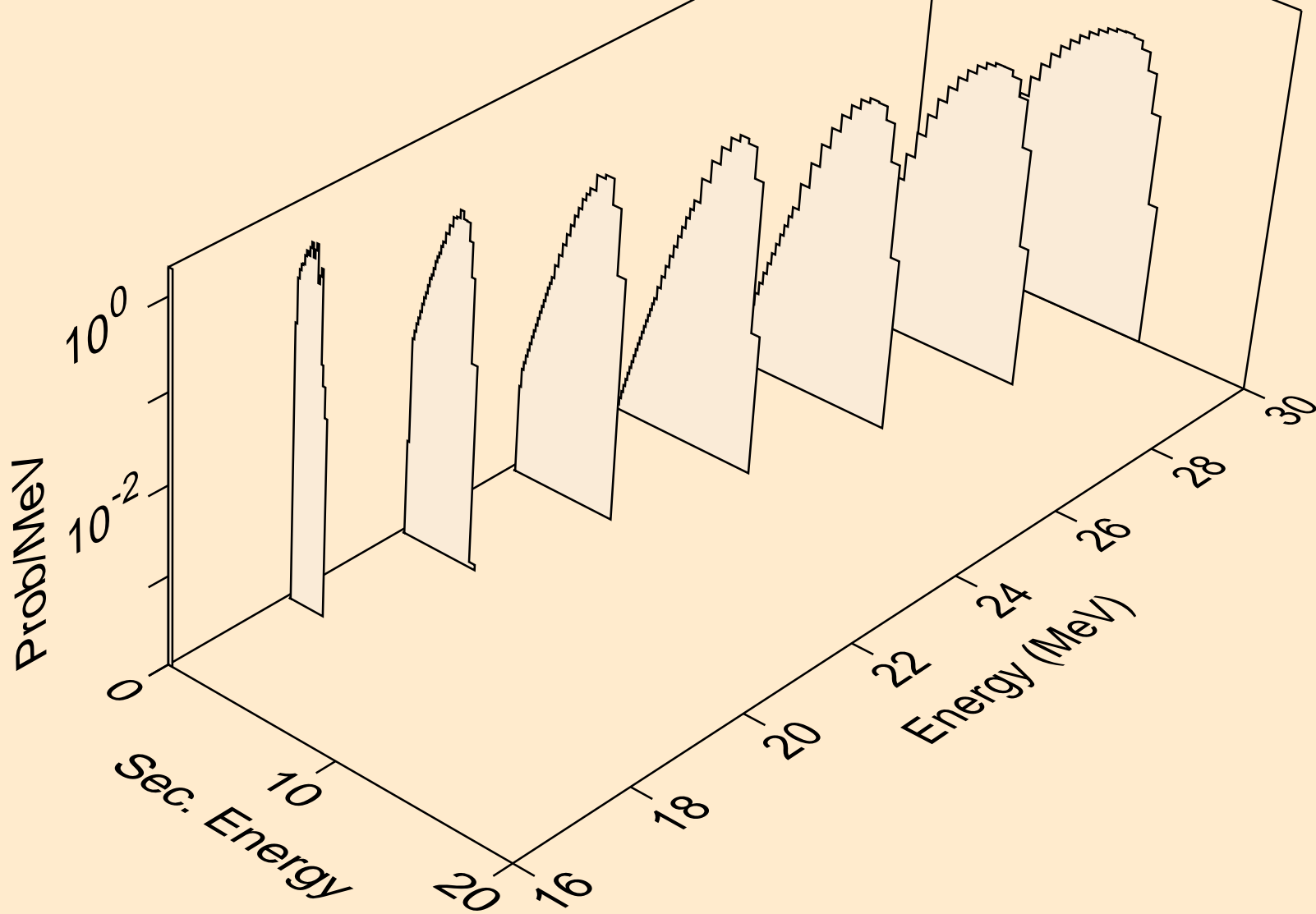

PD107M HELION ACER TENDL-2021 LIBRARY; T=0.K  
deuterons from (s,n\*)d

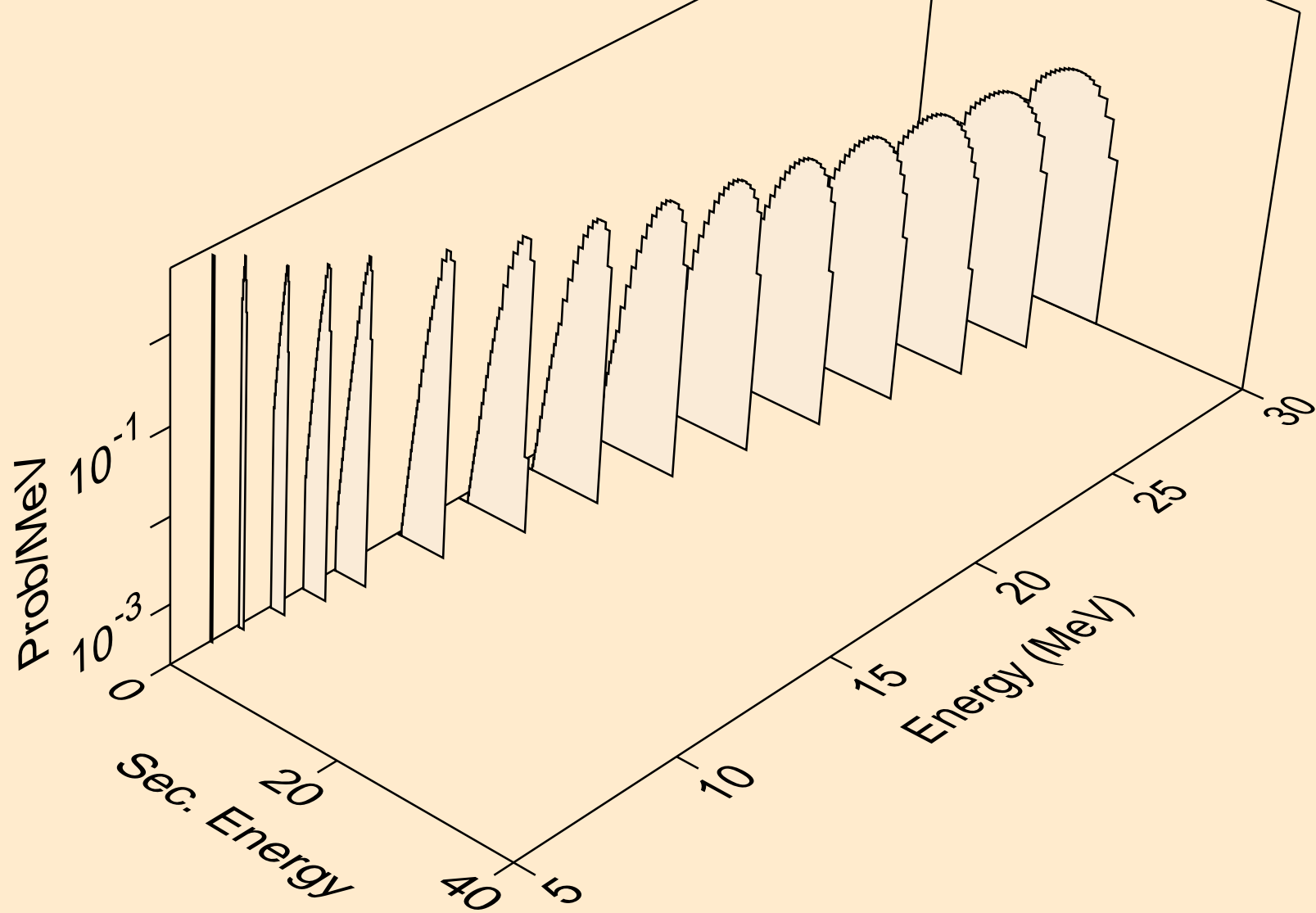

PD107M HELION ACER TENDL-2021 LIBRARY; T=0.K  
deuterons from (s,d)

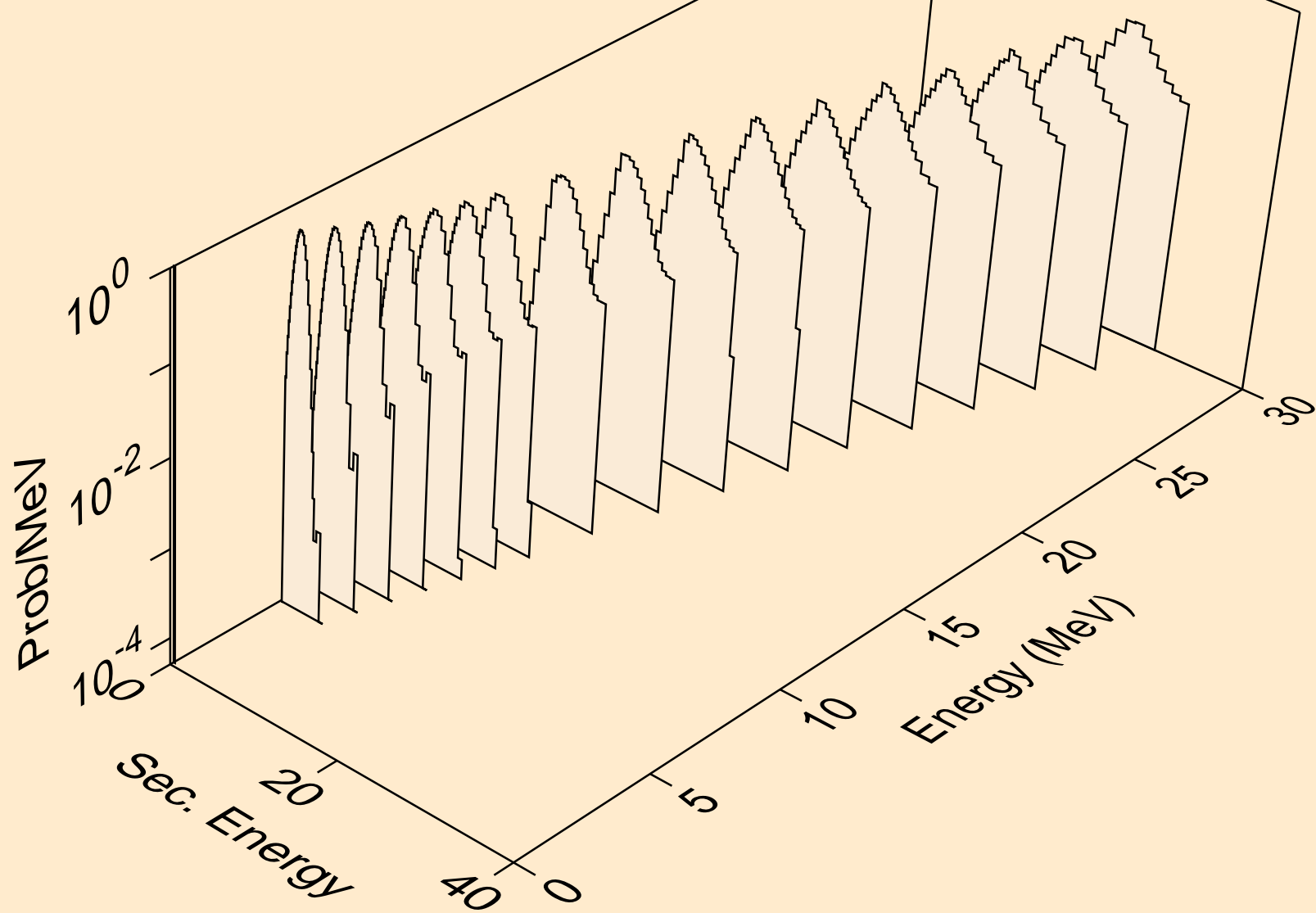

PD107M HELION ACER TENDL-2021 LIBRARY; T=0.K  
deuterons from (s,pd)

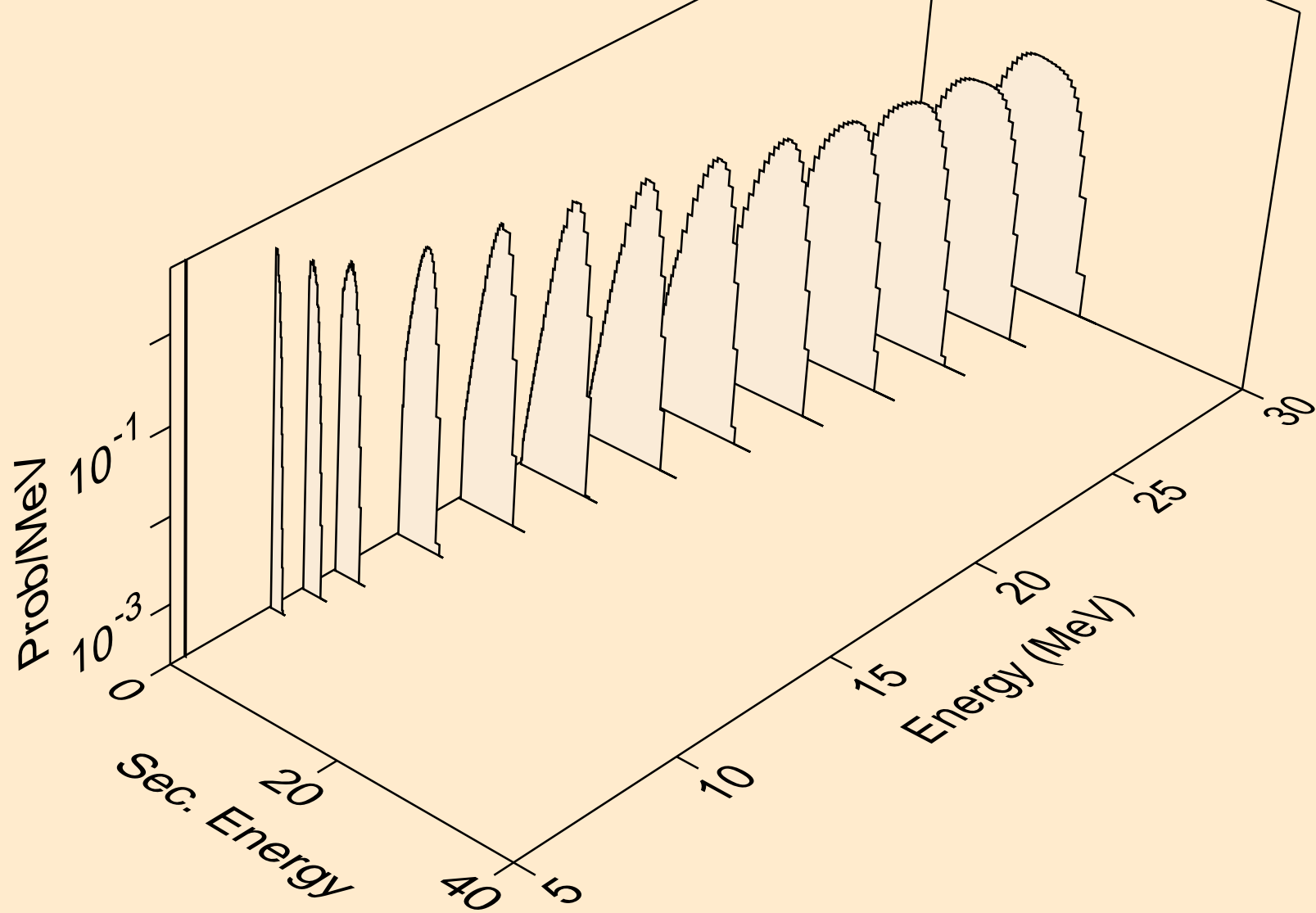

PD107M HELION ACER TENDL-2021 LIBRARY; T=0.K  
deuterons from (s,da)

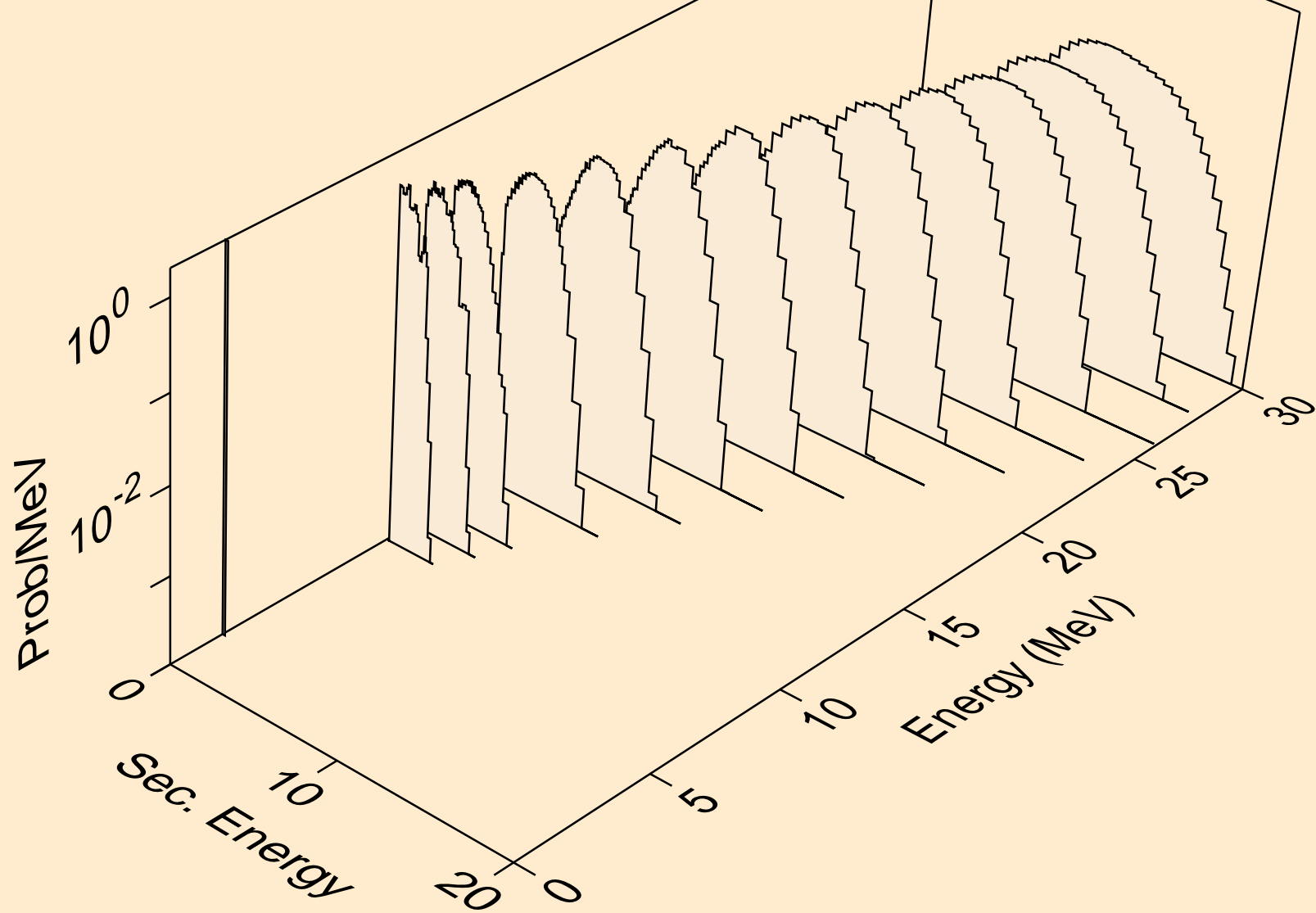

PD107M HELION ACER TENDL-2021 LIBRARY; T=0.K  
tritons from (s,x)

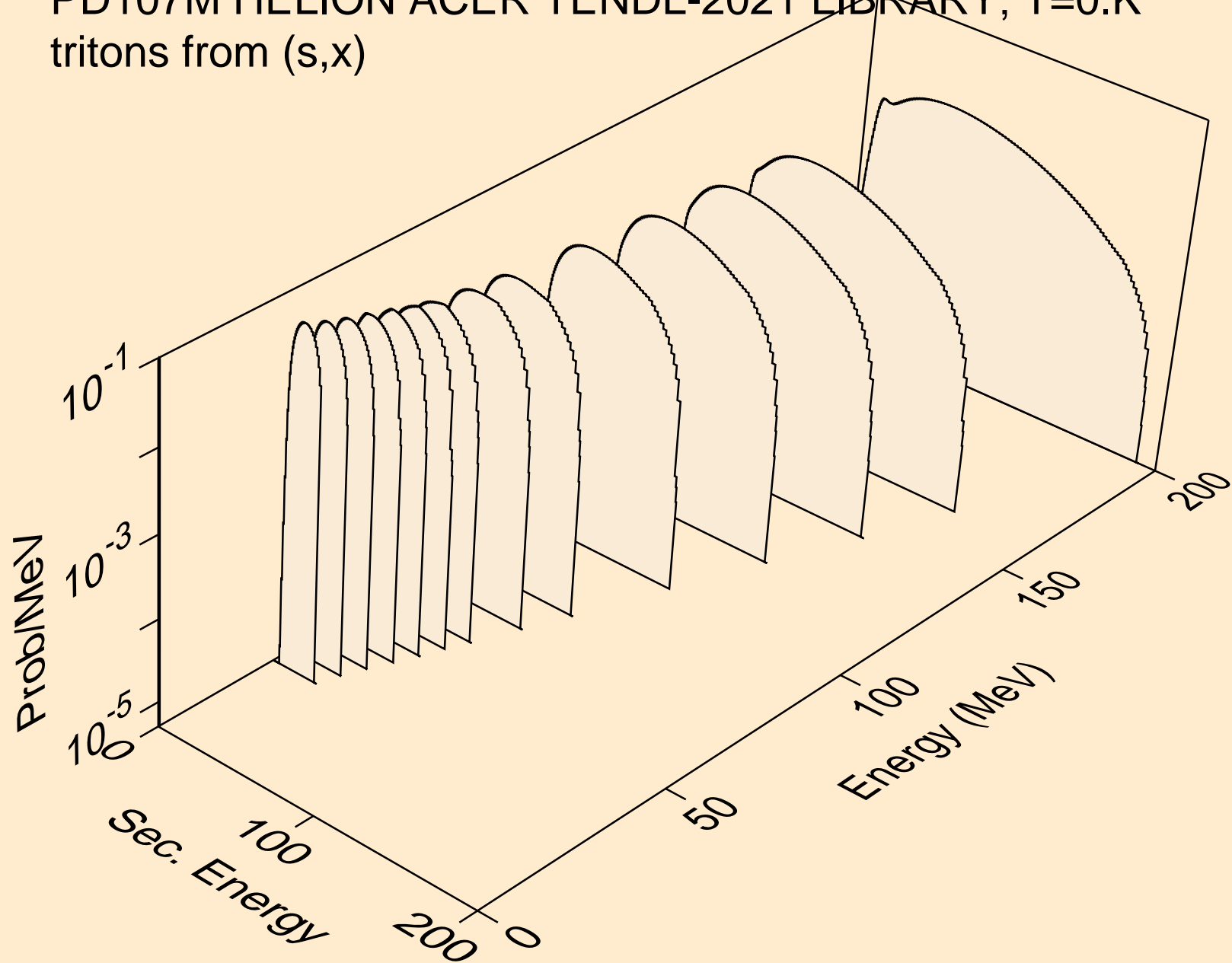



PD107M HELION ACER TENDL-2021 LIBRARY; T=0.K  
tritons from (s,n\*)t

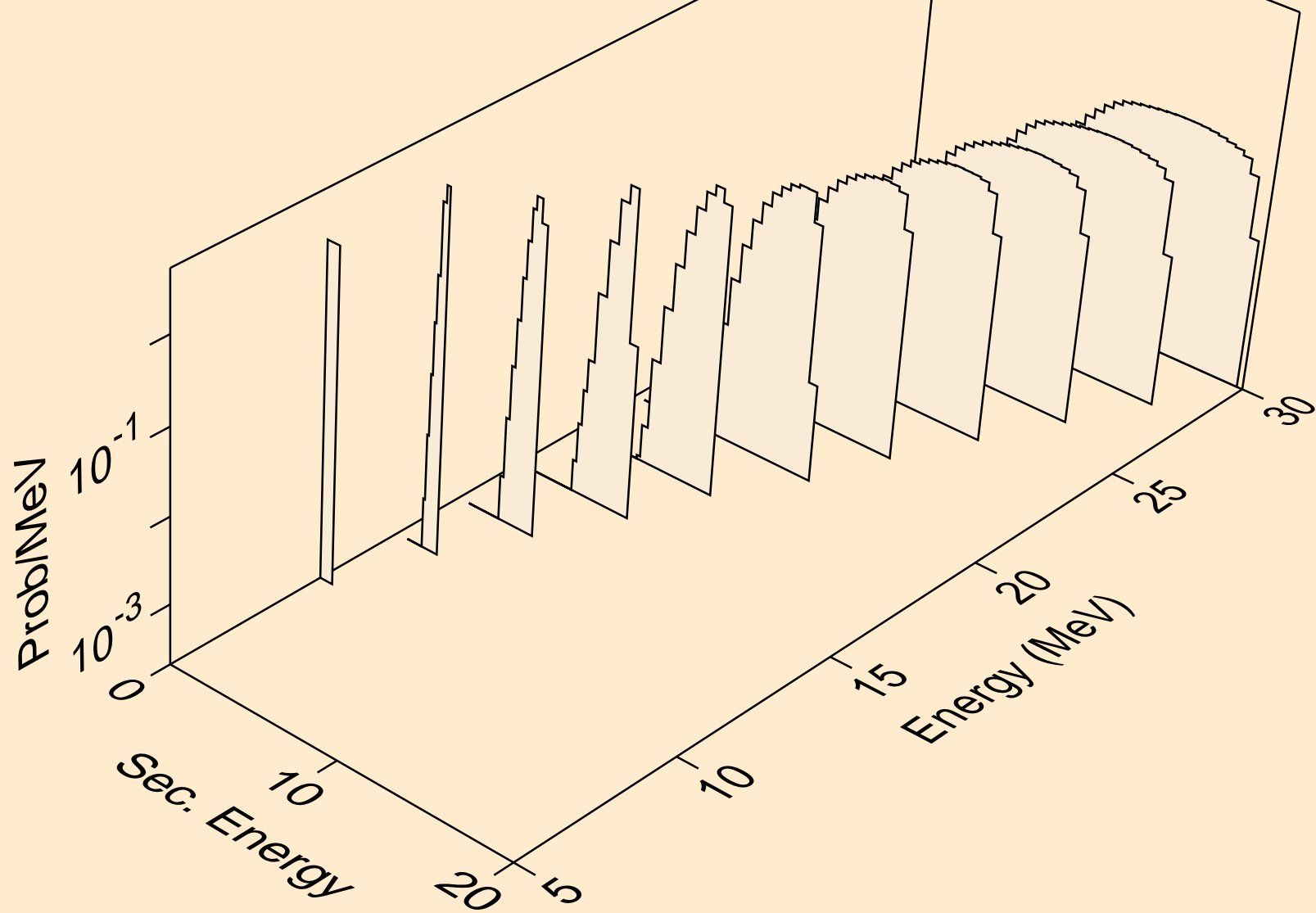

PD107M HELION ACER TENDL-2021 LIBRARY; T=0.K  
tritons from (s,t)

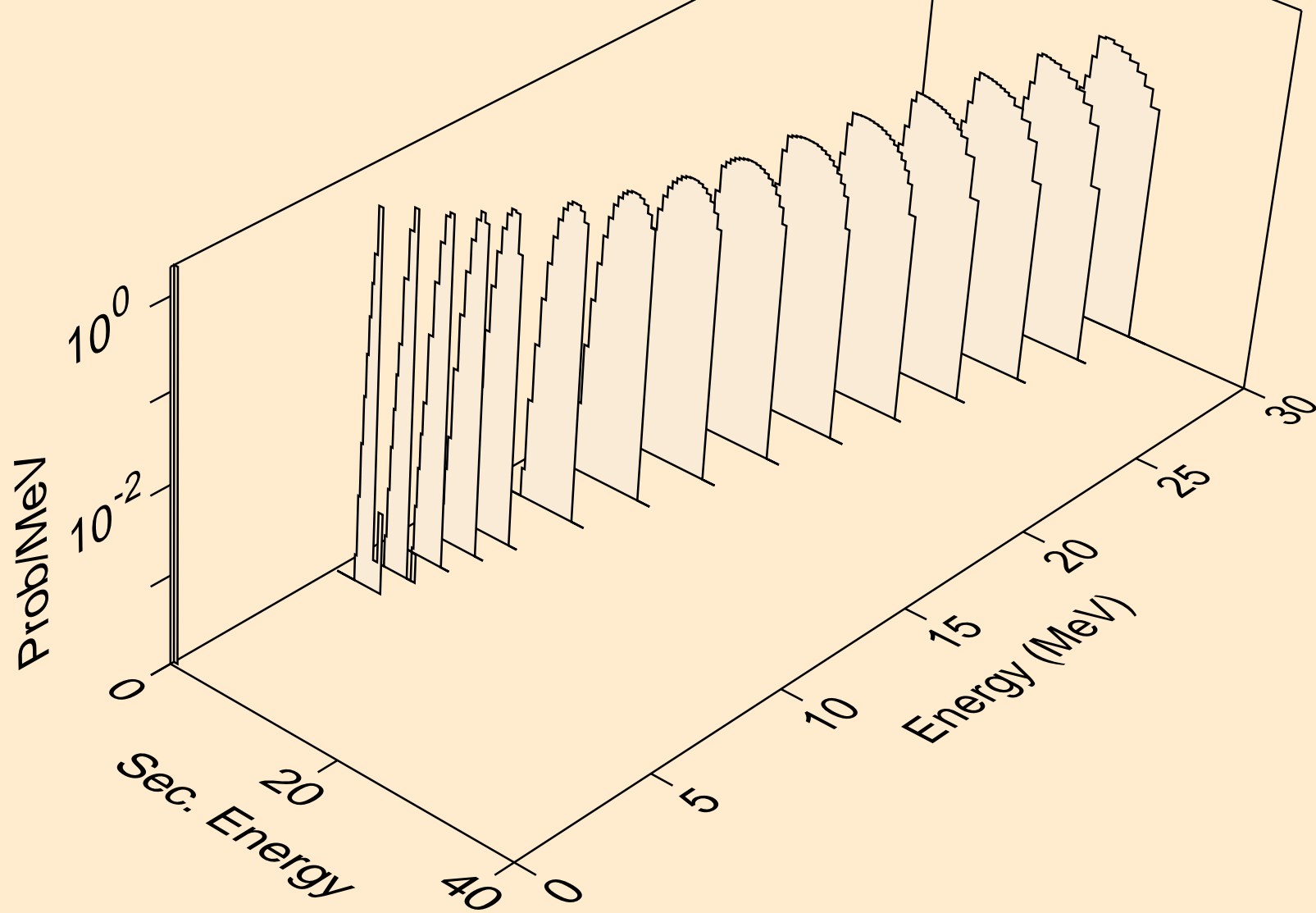

PD107M HELION ACER TENDL-2021 LIBRARY; T=0.K  
tritons from (s,pt)

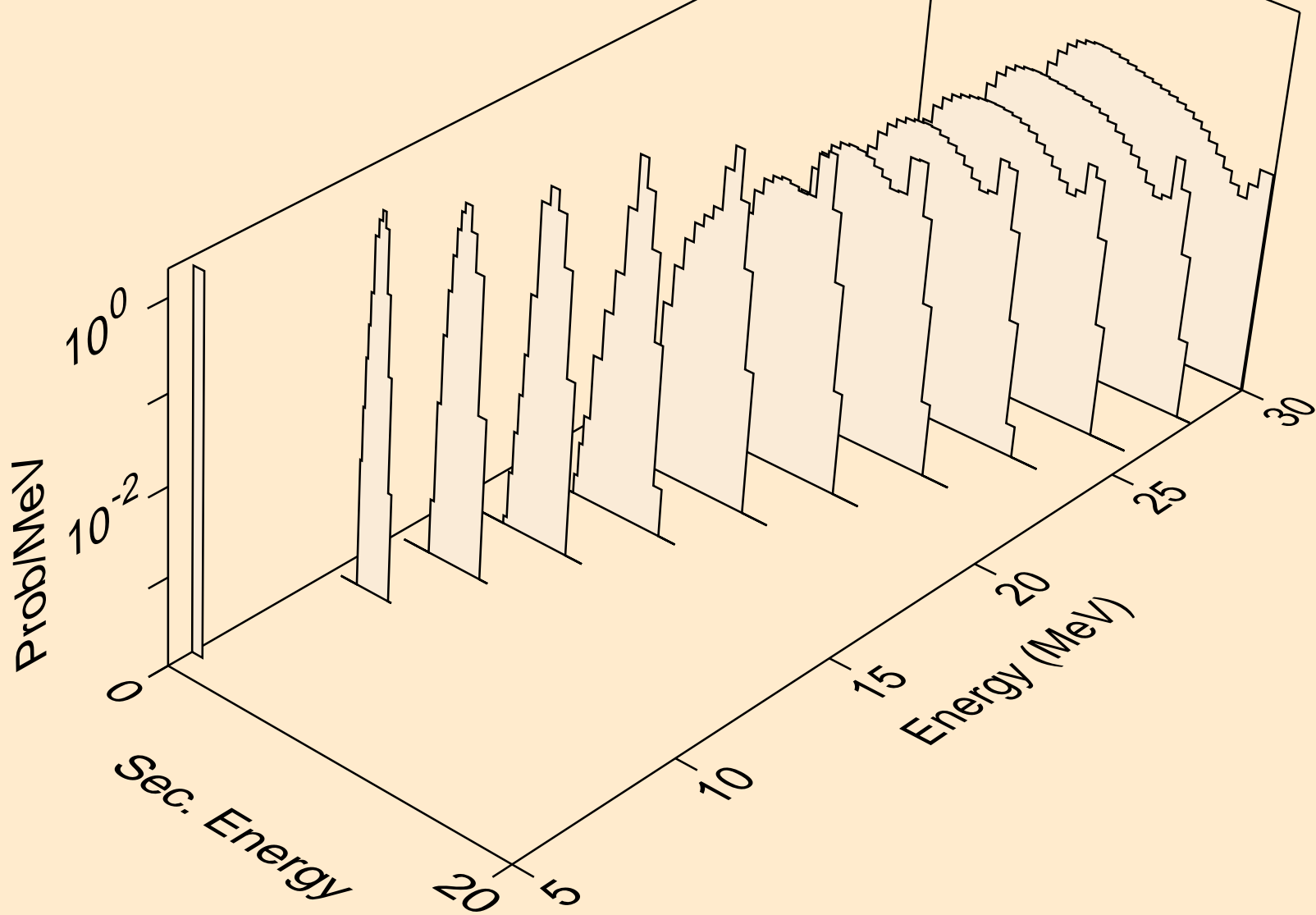

PD107M HELION ACER TENDL-2021 LIBRARY; T=0.K  
alphas from (s,x)

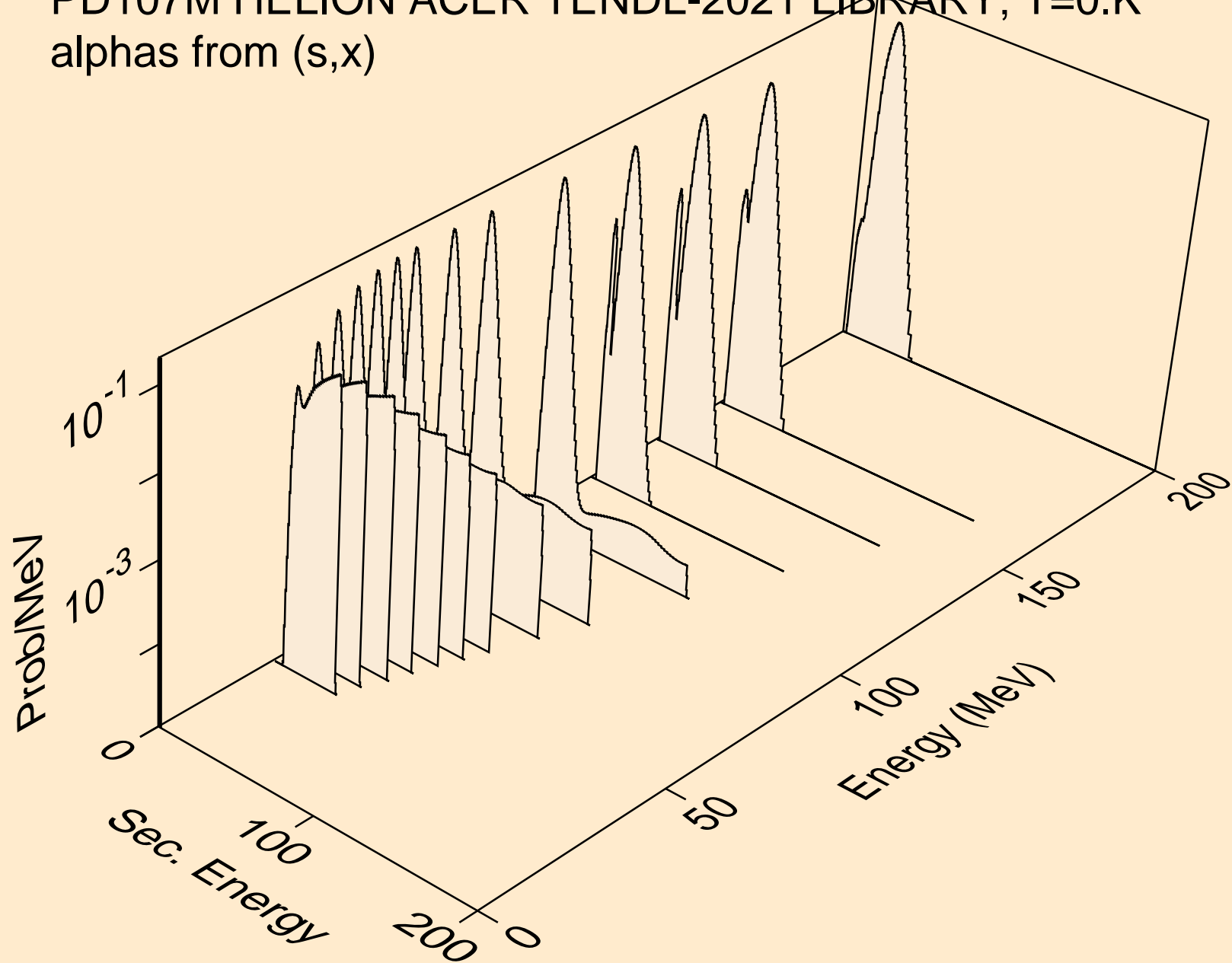

PD107M HELION ACER TENDL-2021 LIBRARY; T=0.K  
alphas from (s,n\*)a

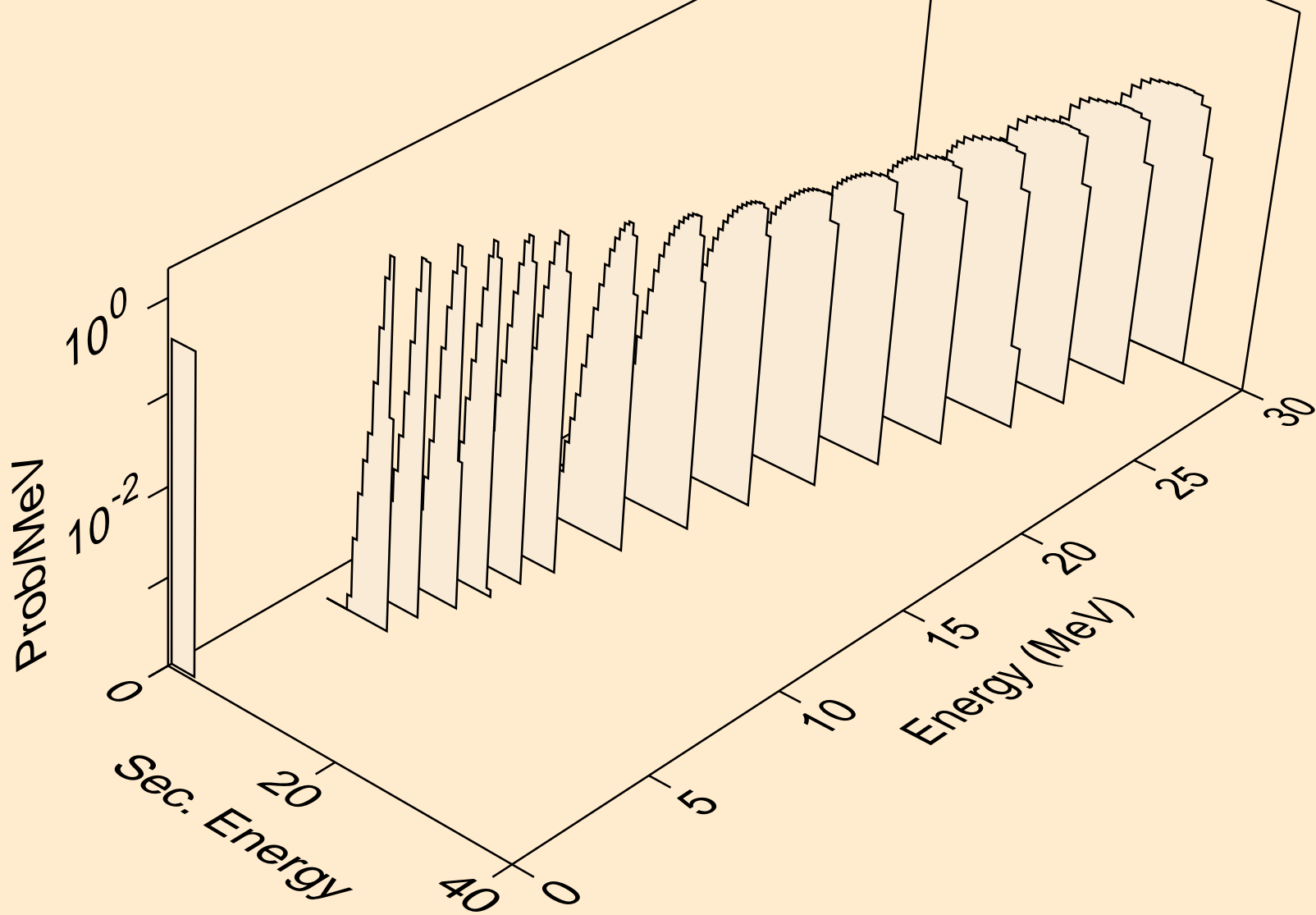

PD107M HELION ACER TENDL-2021 LIBRARY; T=0.K  
alphas from (s,2n)a

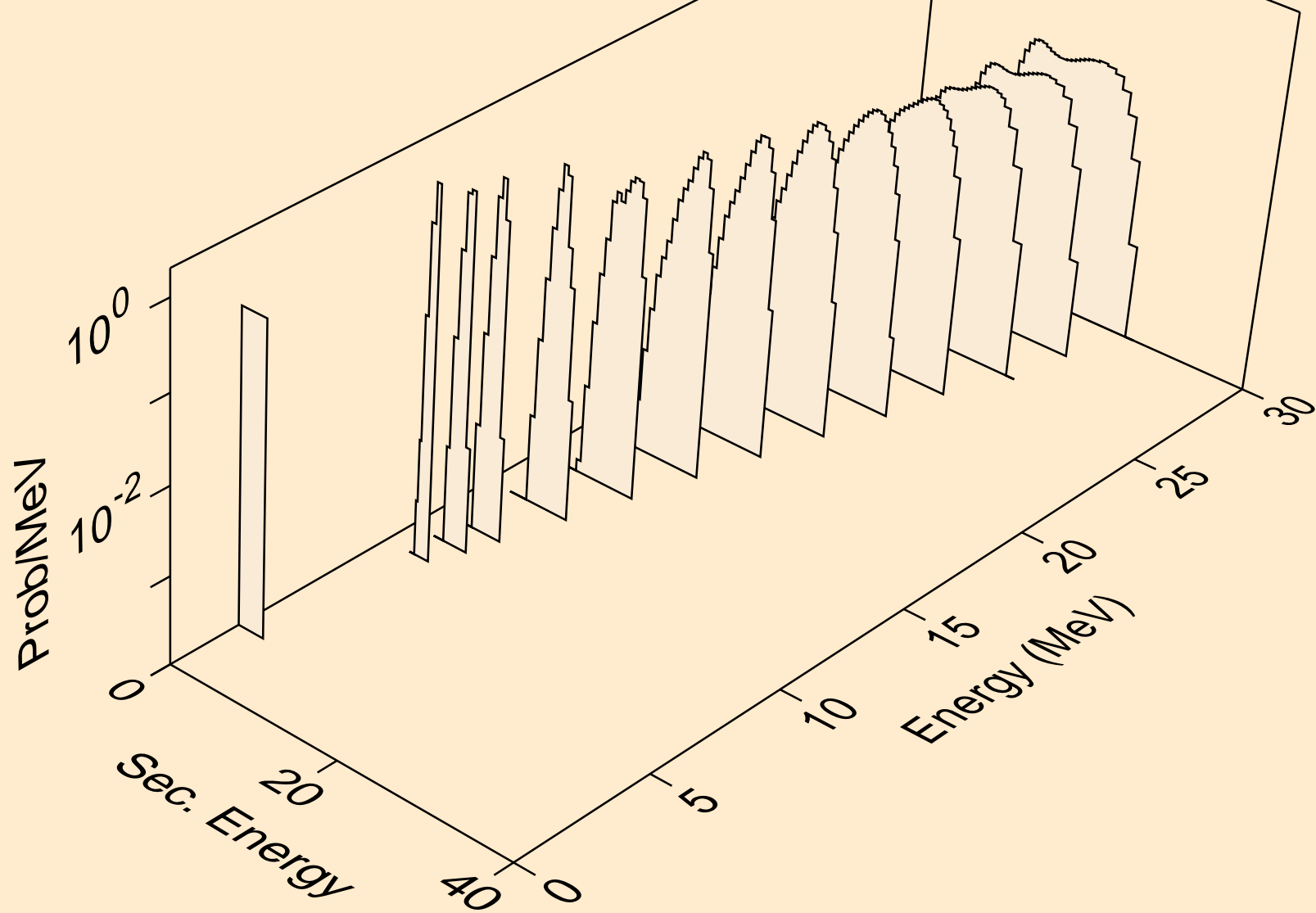

PD107M HELION ACER TENDL-2021 LIBRARY; T=0.K  
alphas from (s,3n)a

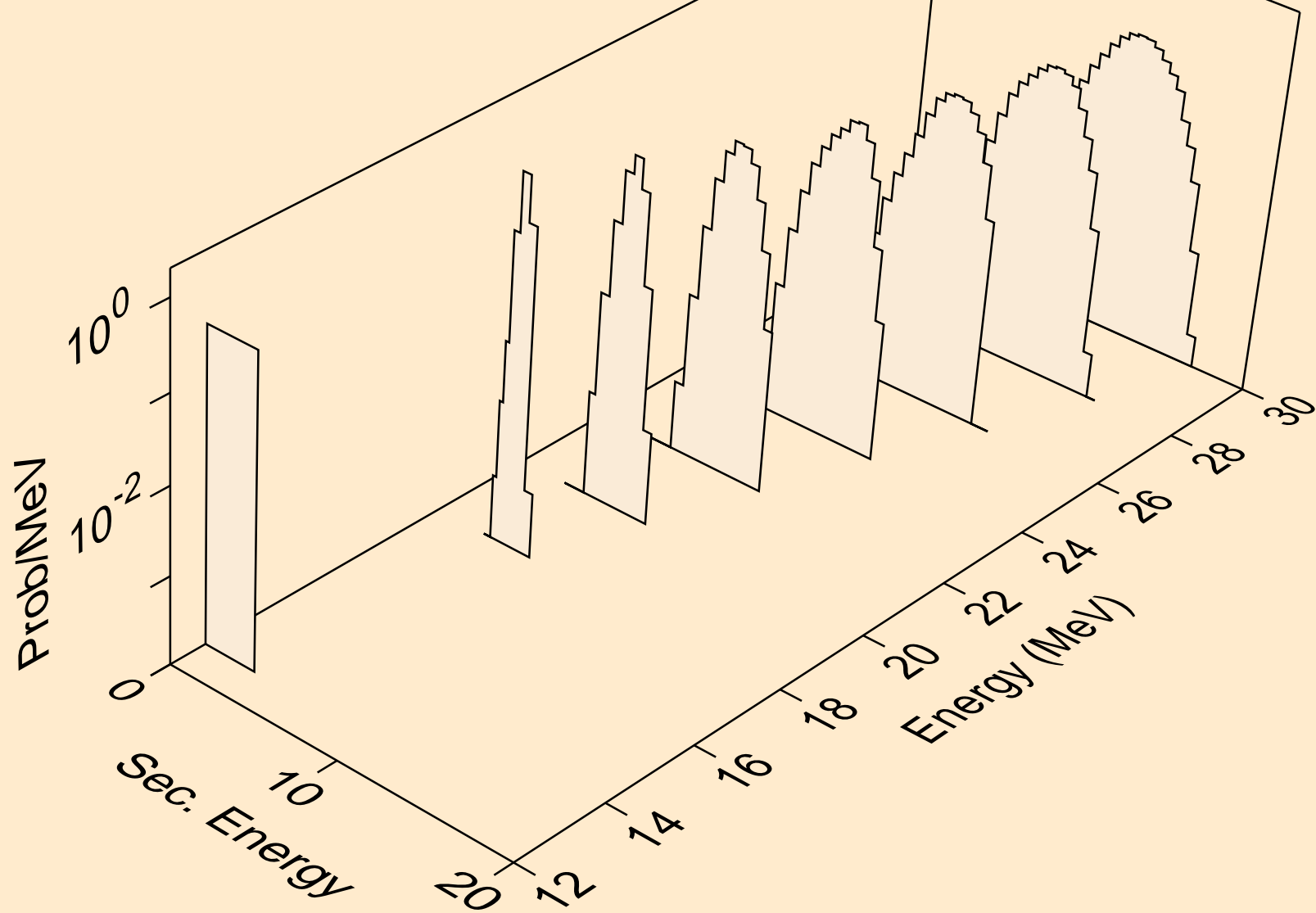

PD107M HELION ACER TENDL-2021 LIBRARY; T=0.K  
alphas from (s,n\*)2a

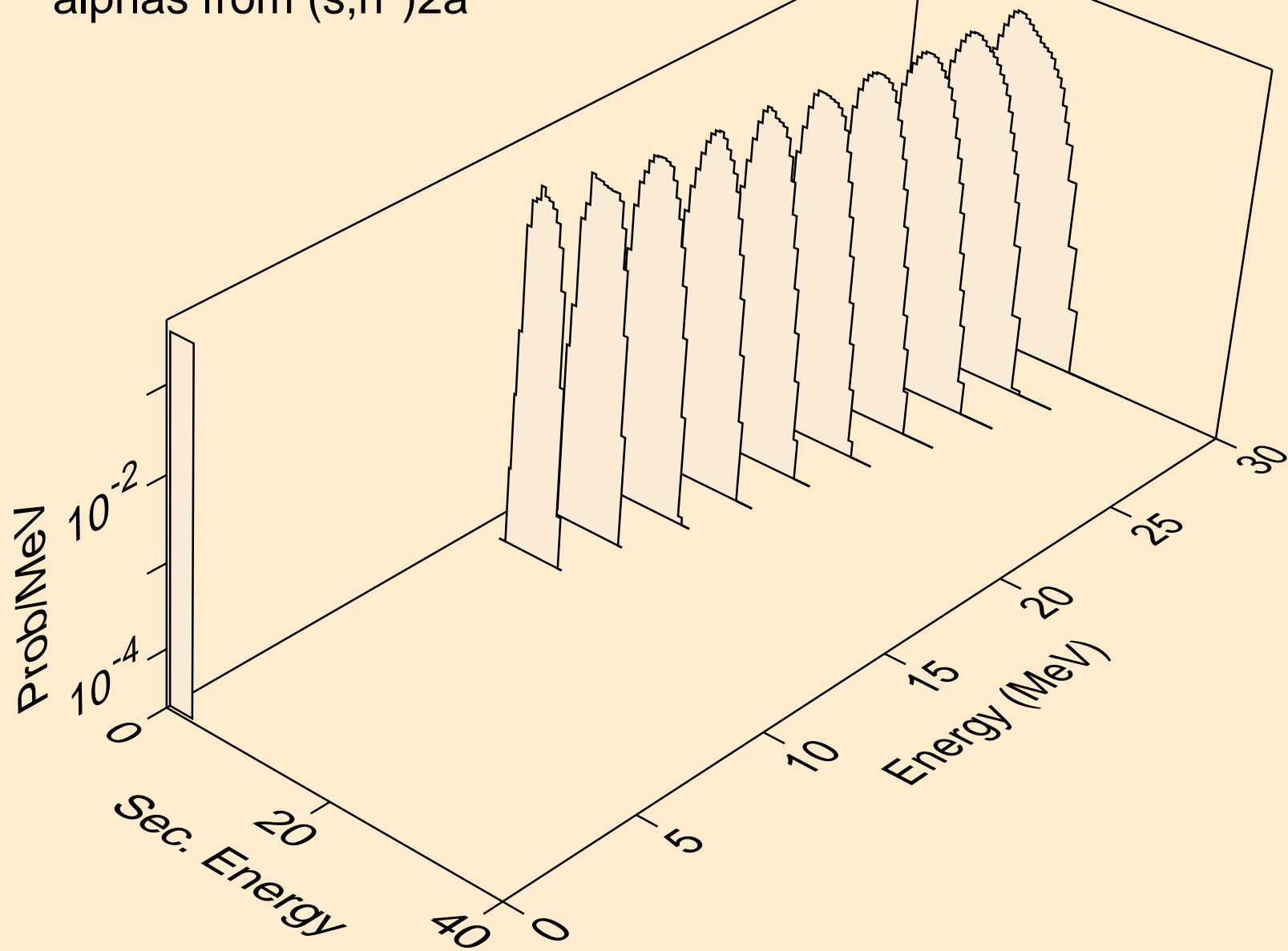



PD107M HELION ACER TENDL-2021 LIBRARY; T=0.K  
alphas from (s,2n)2a

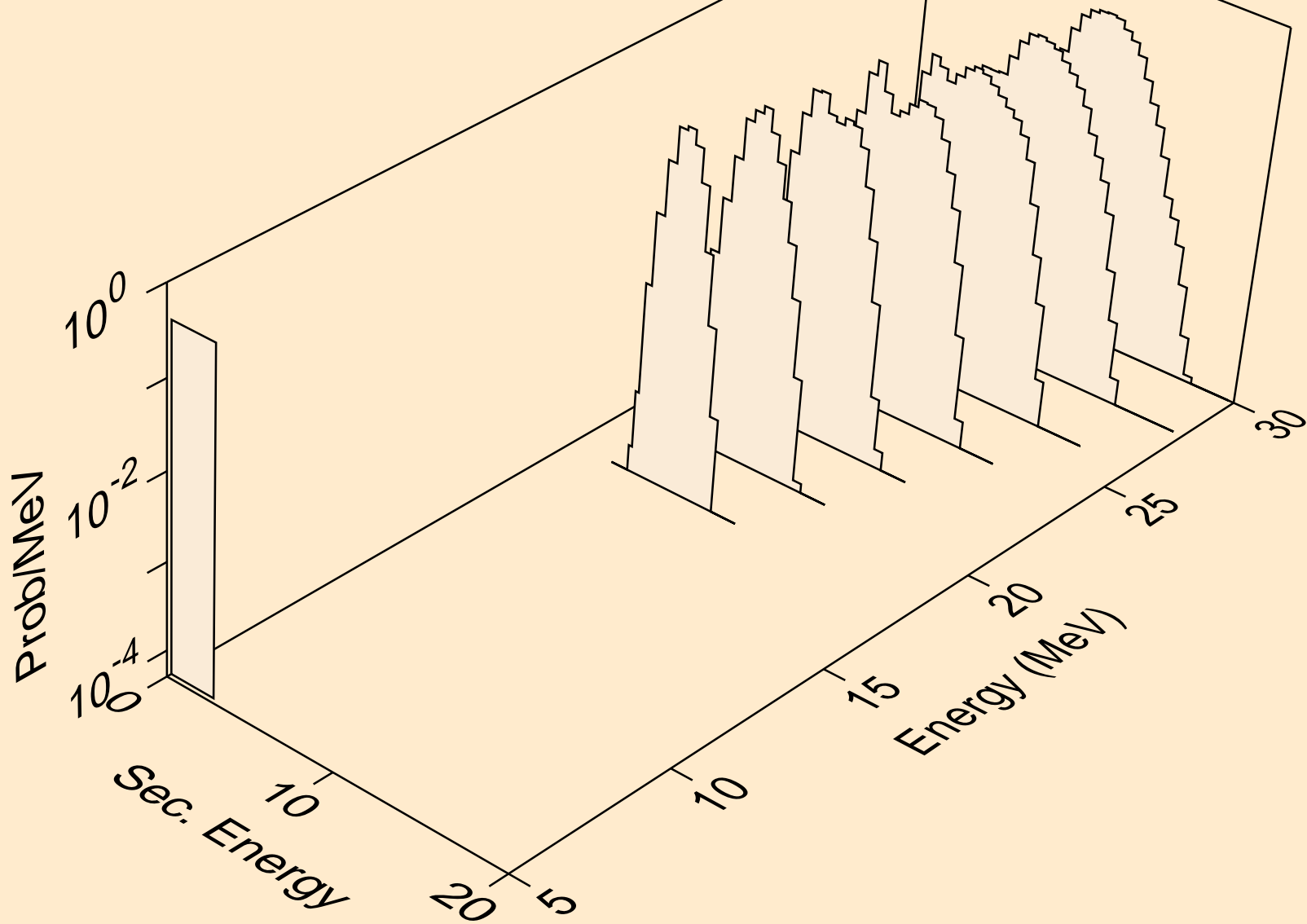

PD107M HELION ACER TENDL-2021 LIBRARY; T=0.K  
alphas from (s,npa)

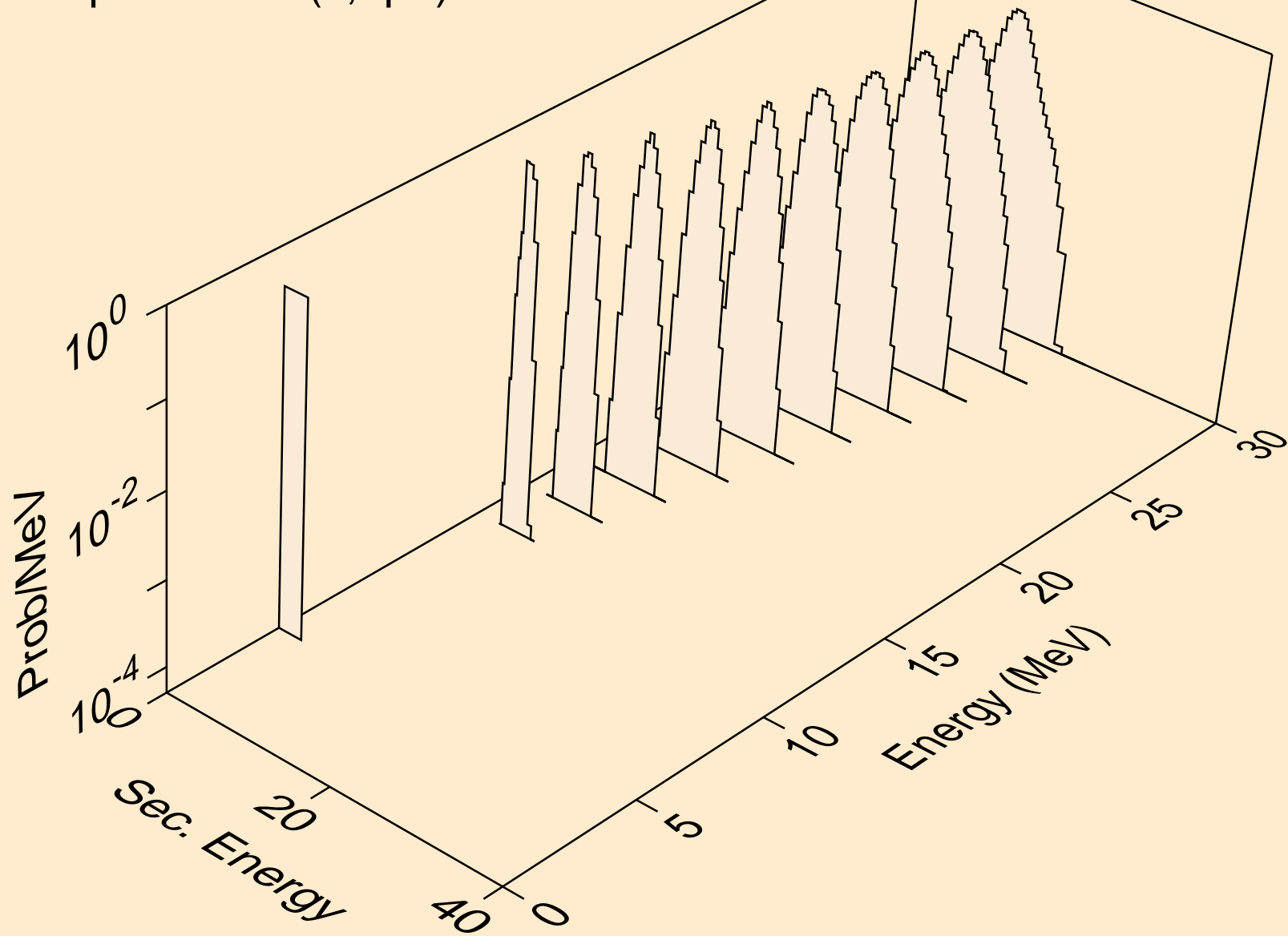

PD107M HELION ACER TENDL-2021 LIBRARY; T=0.K  
alphas from (s,a)

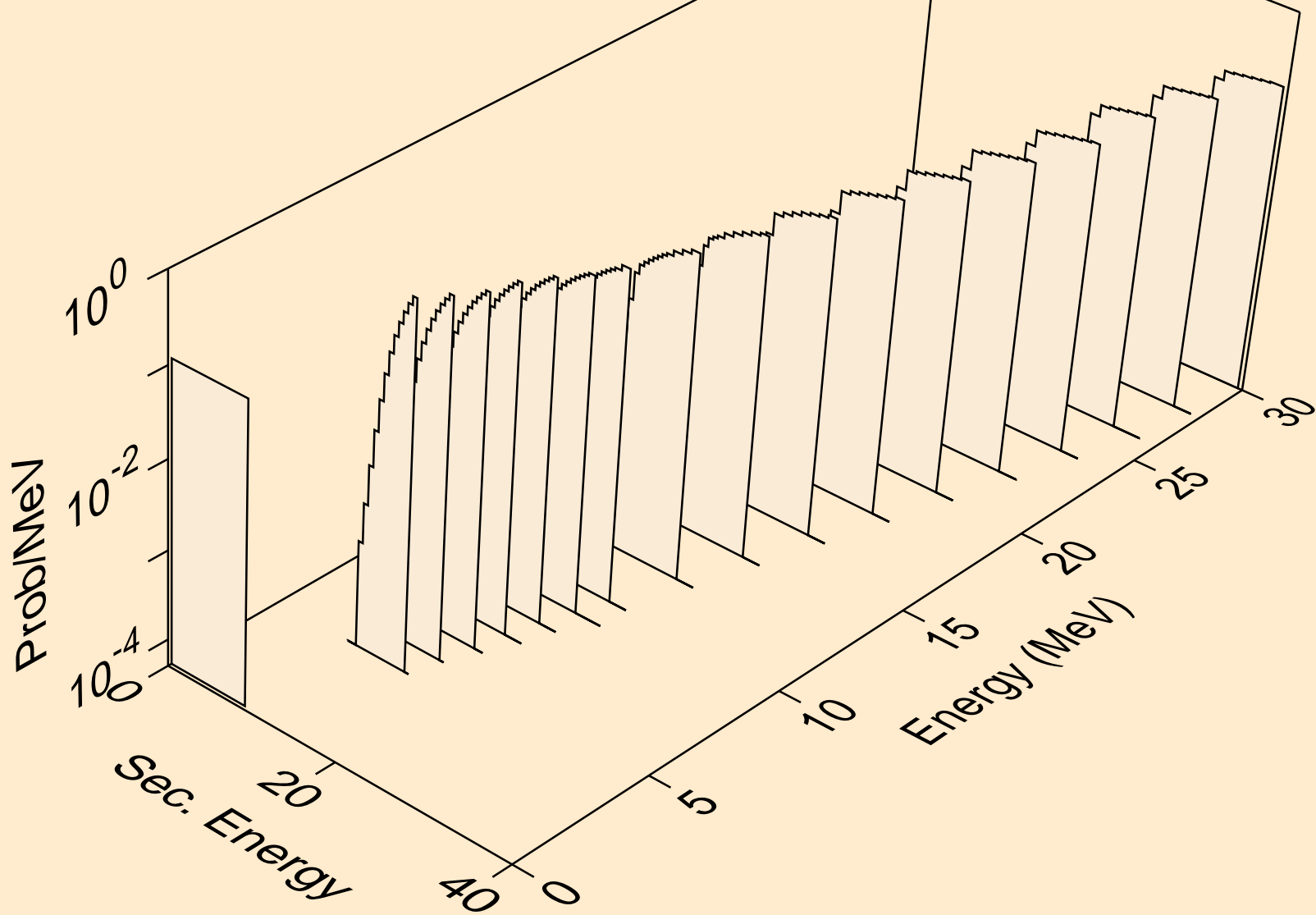

PD107M HELION ACER TENDL-2021 LIBRARY; T=0.K  
alphas from (s,2a)

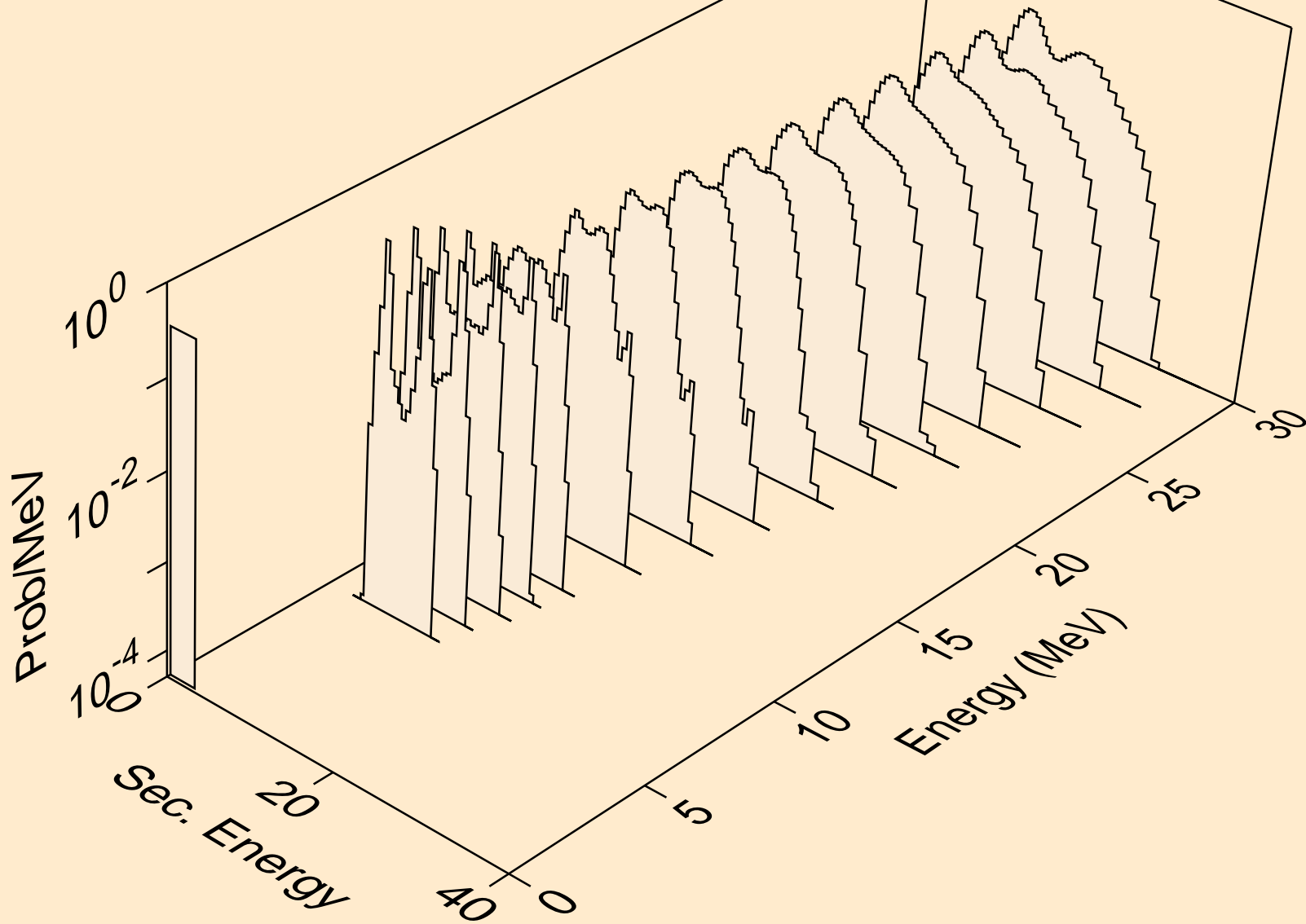

PD107M HELION ACER TENDL-2021 LIBRARY; T=0.K  
alphas from (s,pa)

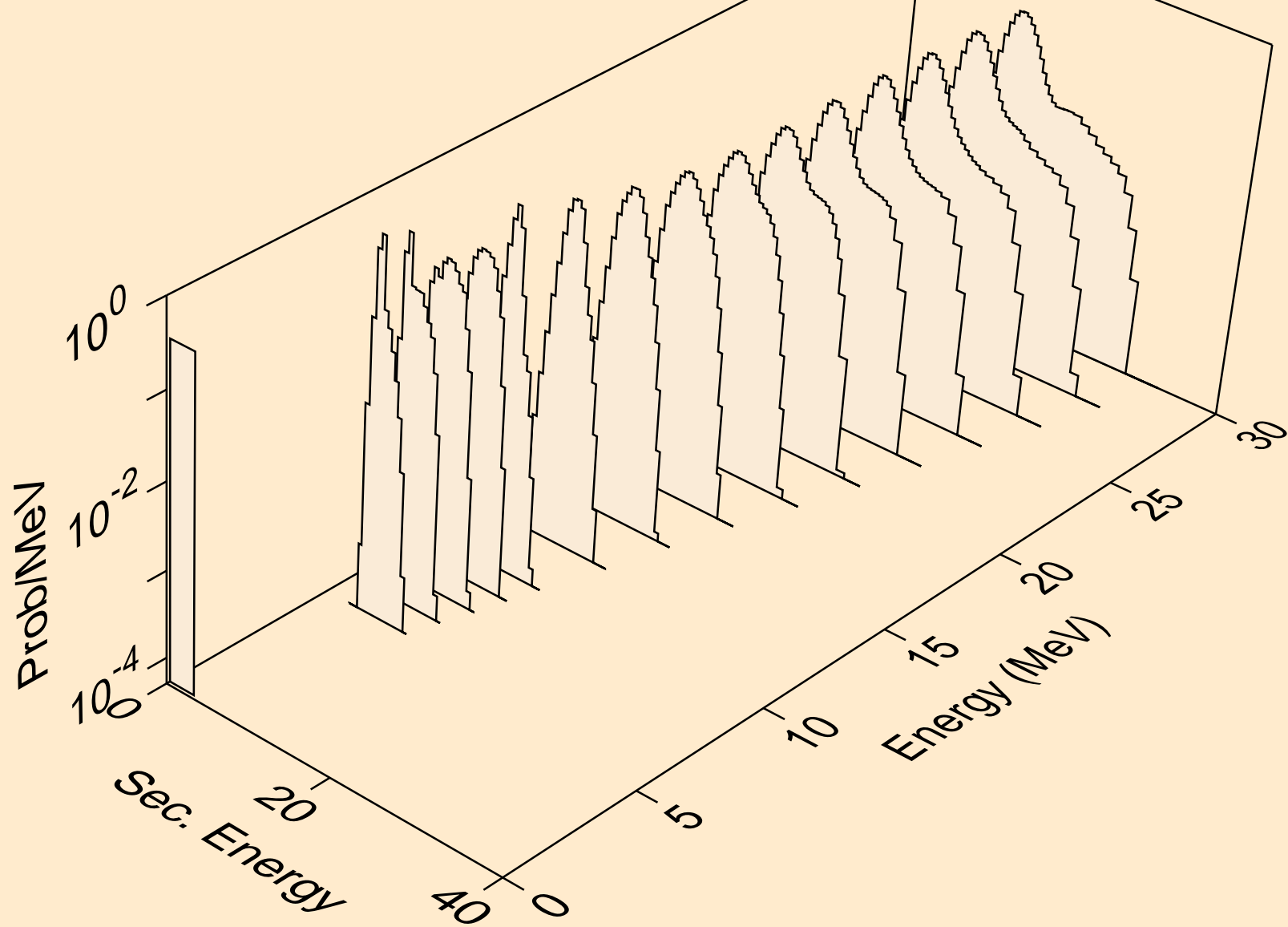

PD107M HELION ACER TENDL-2021 LIBRARY; T=0.K  
alphas from (s,da)

