

PM127 HELION ACER TENDL-2021 LIBRARY; T=0.K  
Principal cross sections

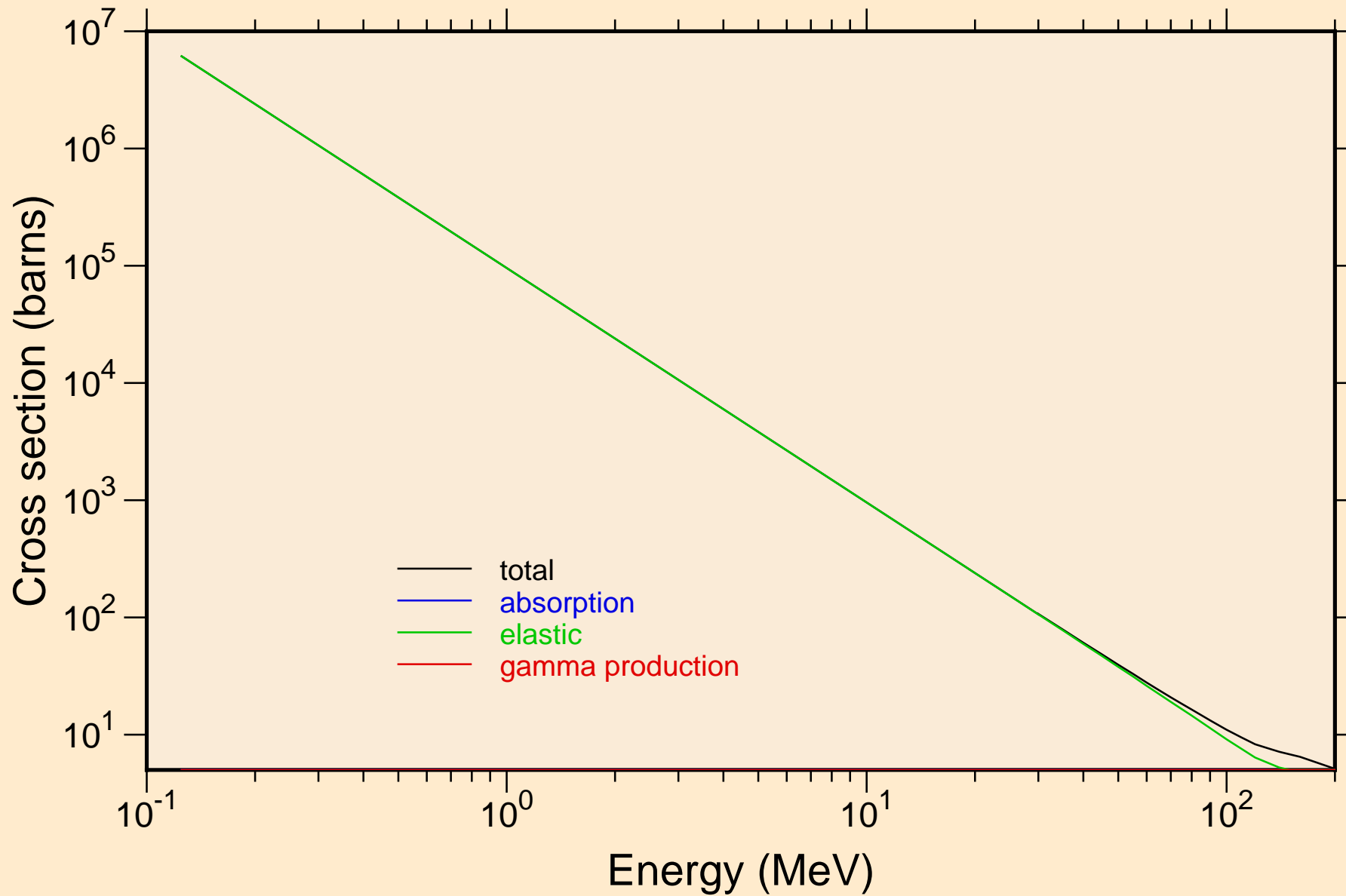

# PM127 HELION ACER TENDL-2021 LIBRARY; T=0.K

## Heating

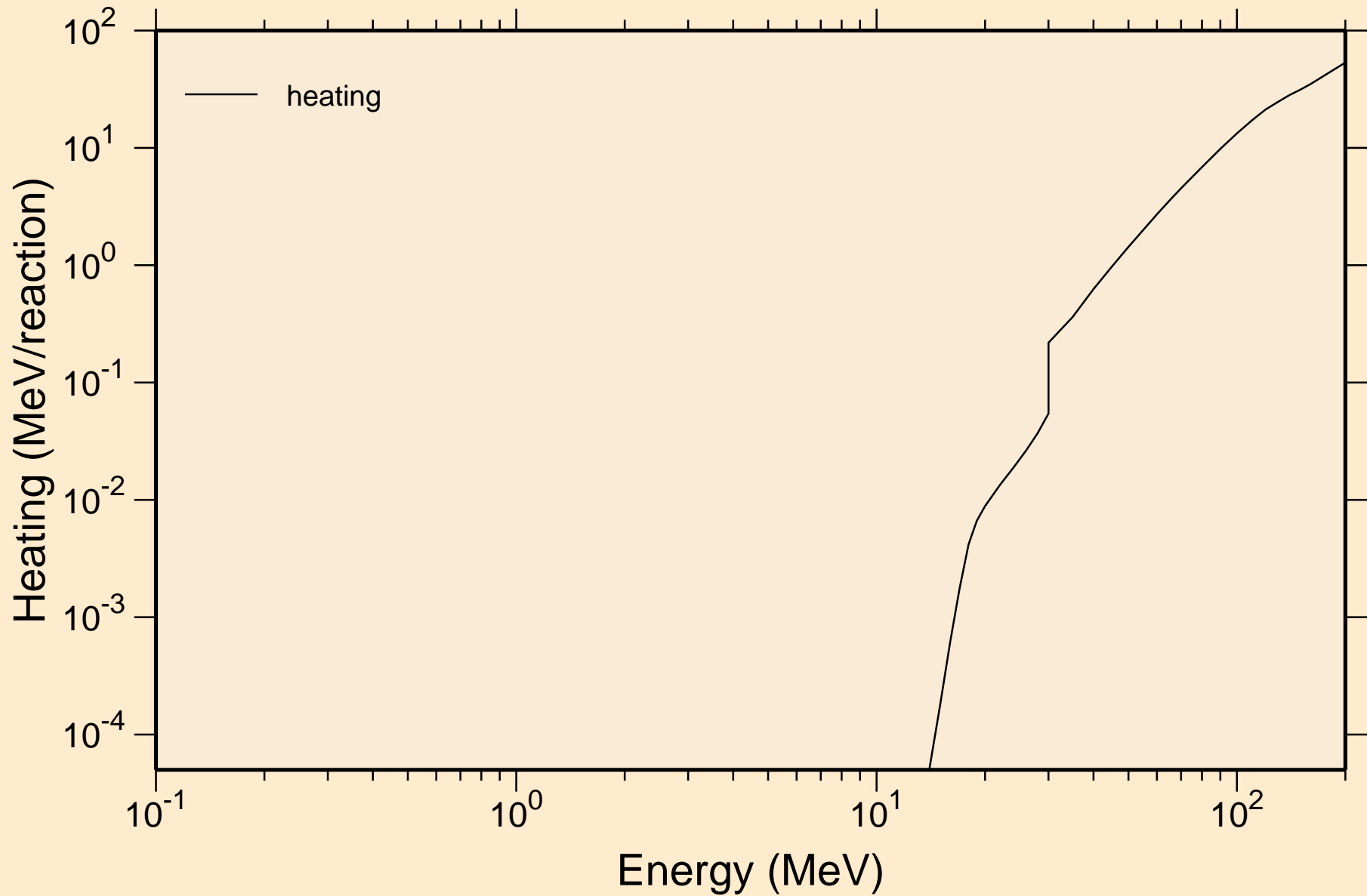

# PM127 HELION ACER TENDL-2021 LIBRARY; T=0.K

## Principal cross sections

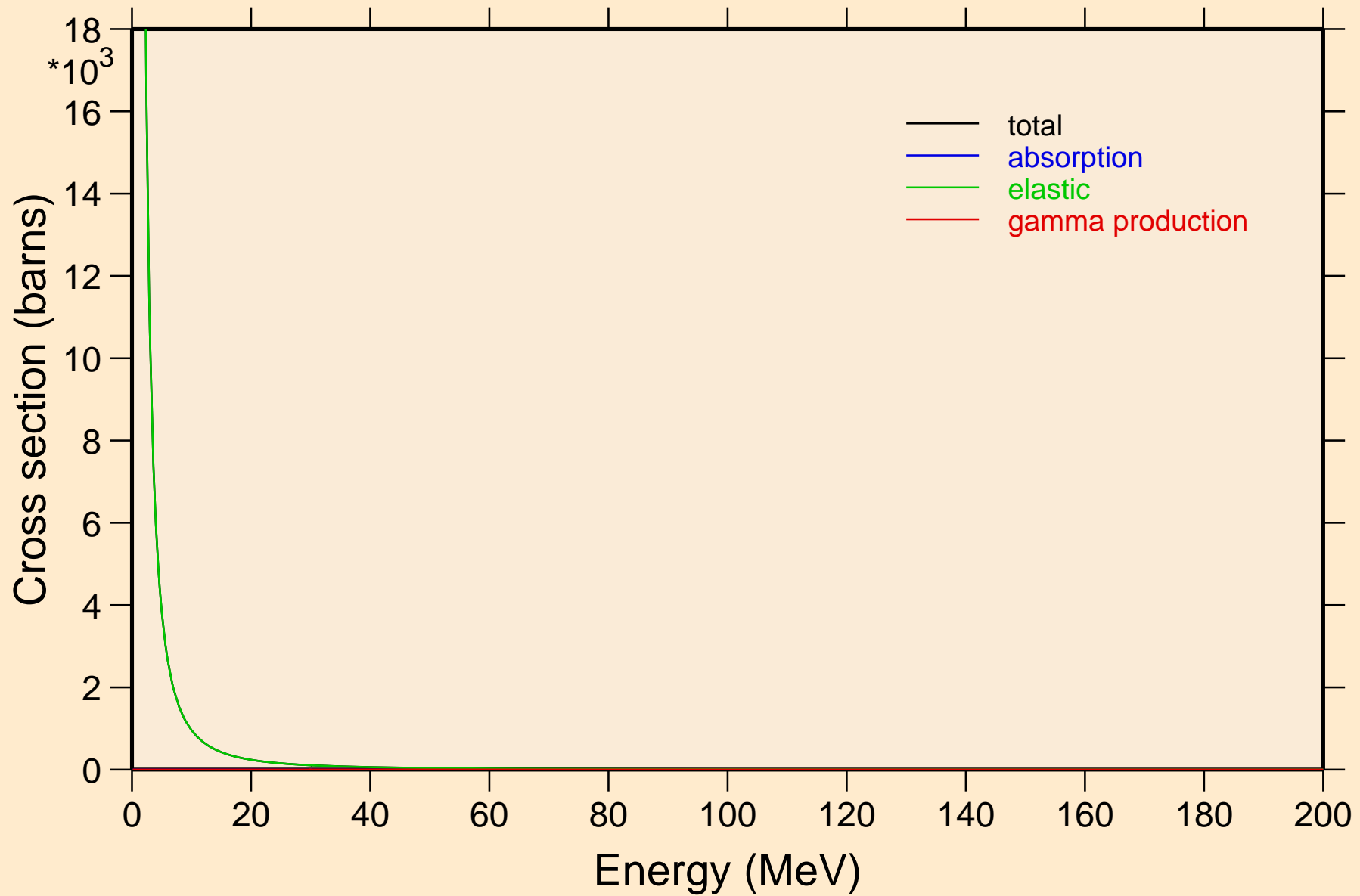

PM127 HELION ACER TENDL-2021 LIBRARY; T=0.K

Heating

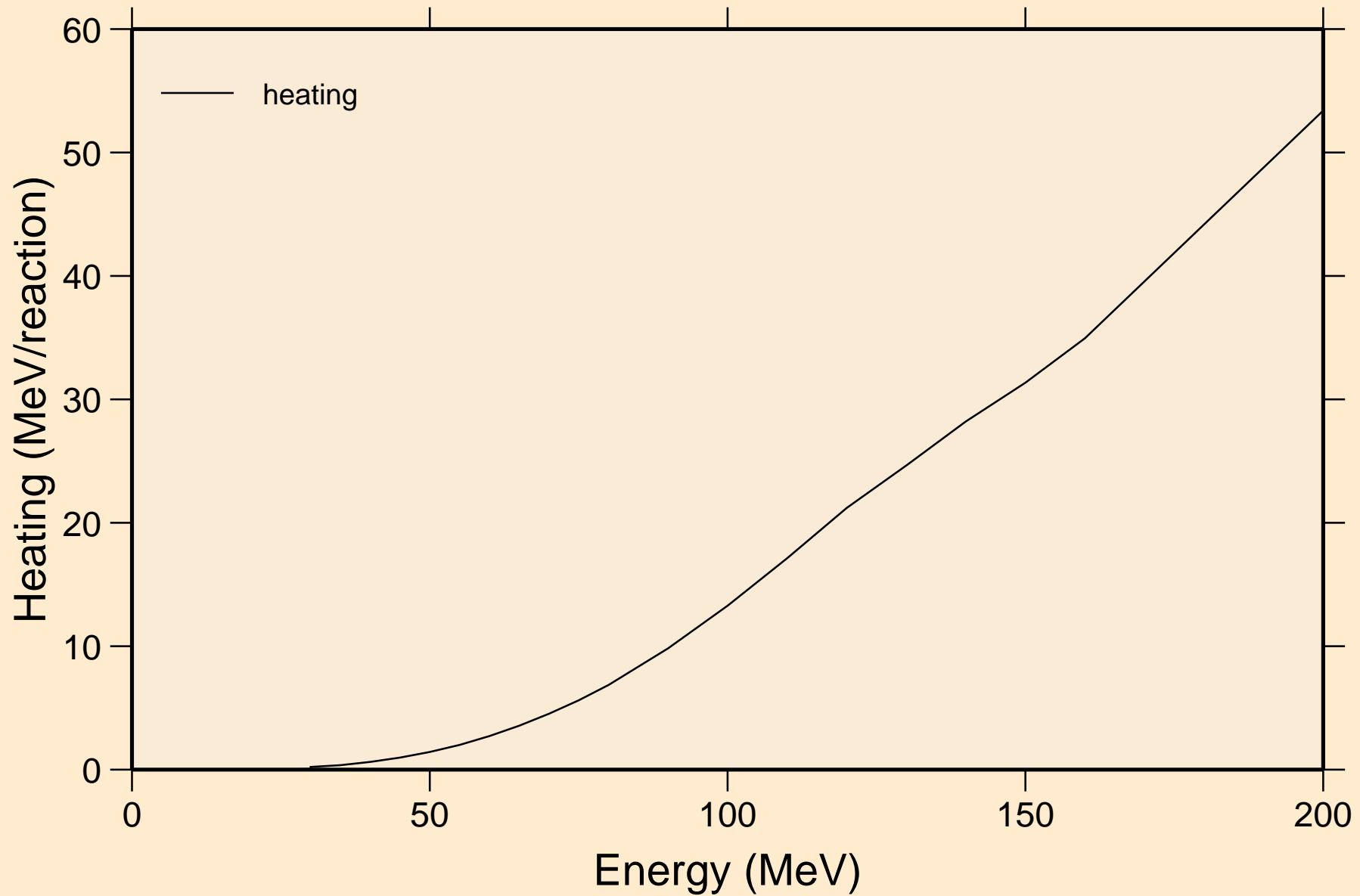

PM127 HELION ACER TENDL-2021 LIBRARY; T=0.K  
Threshold reactions

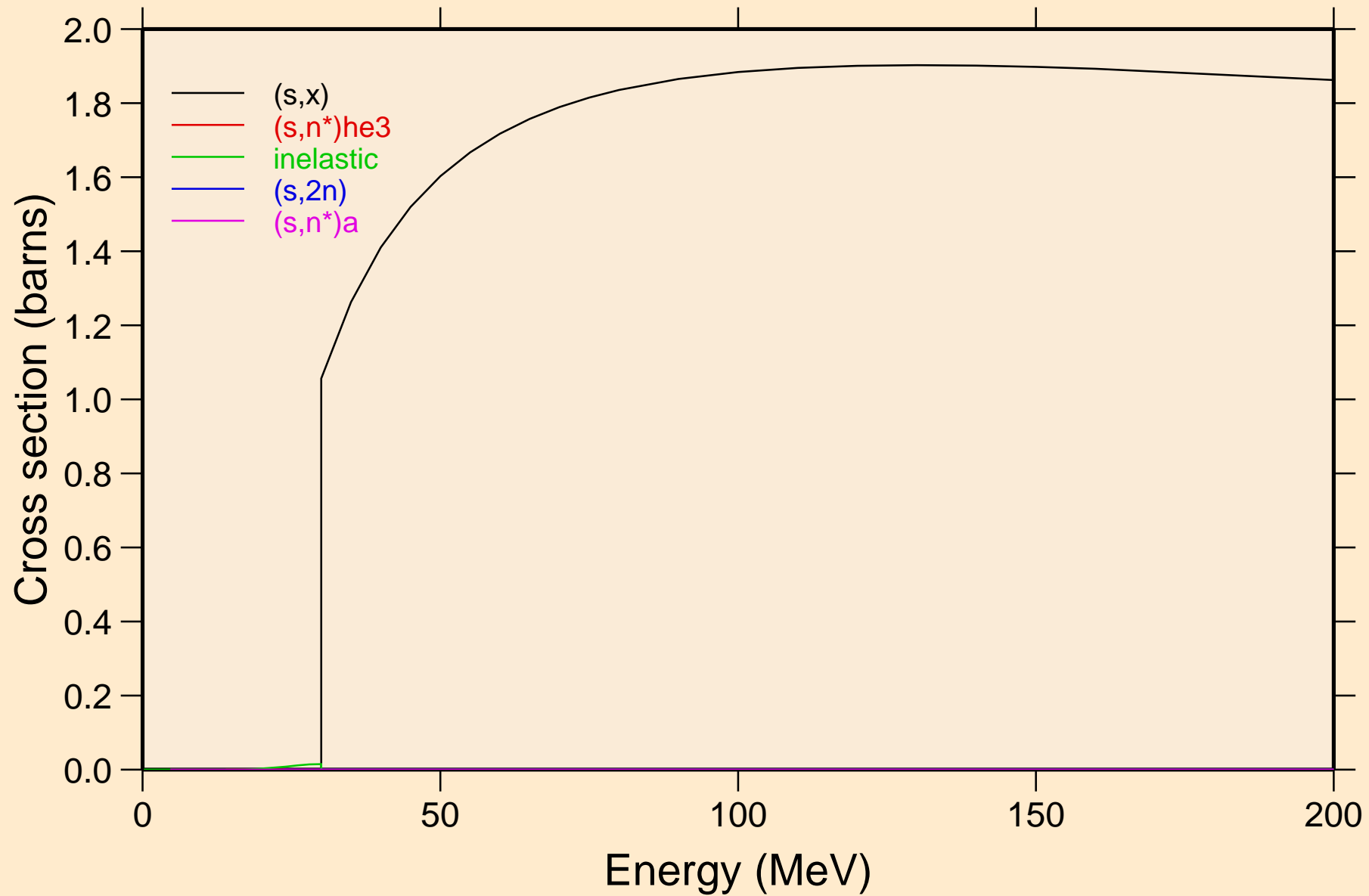

PM127 HELION ACER TENDL-2021 LIBRARY; T=0.K  
Threshold reactions

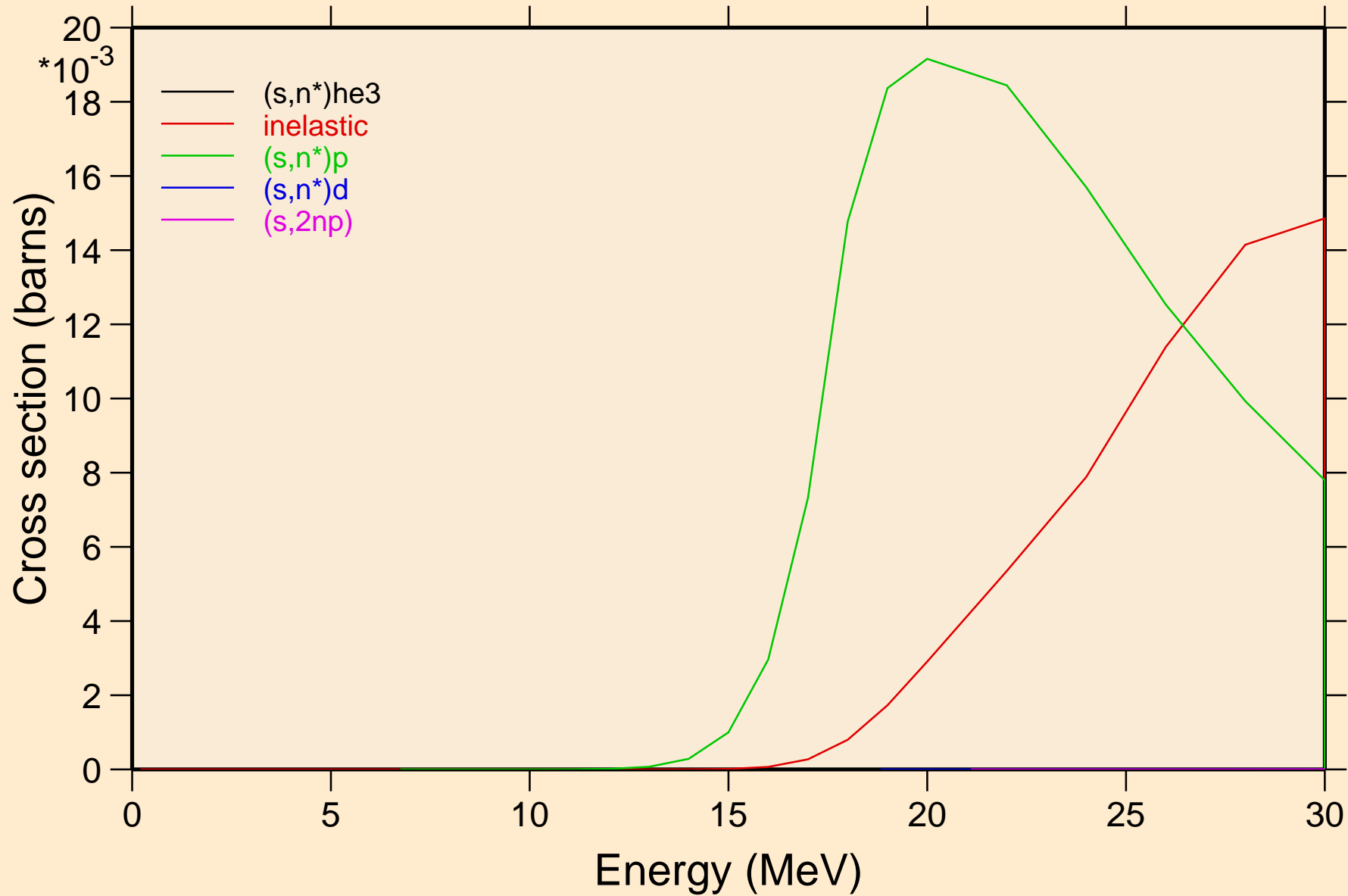

PM127 HELION ACER TENDL-2021 LIBRARY; T=0.K  
Threshold reactions

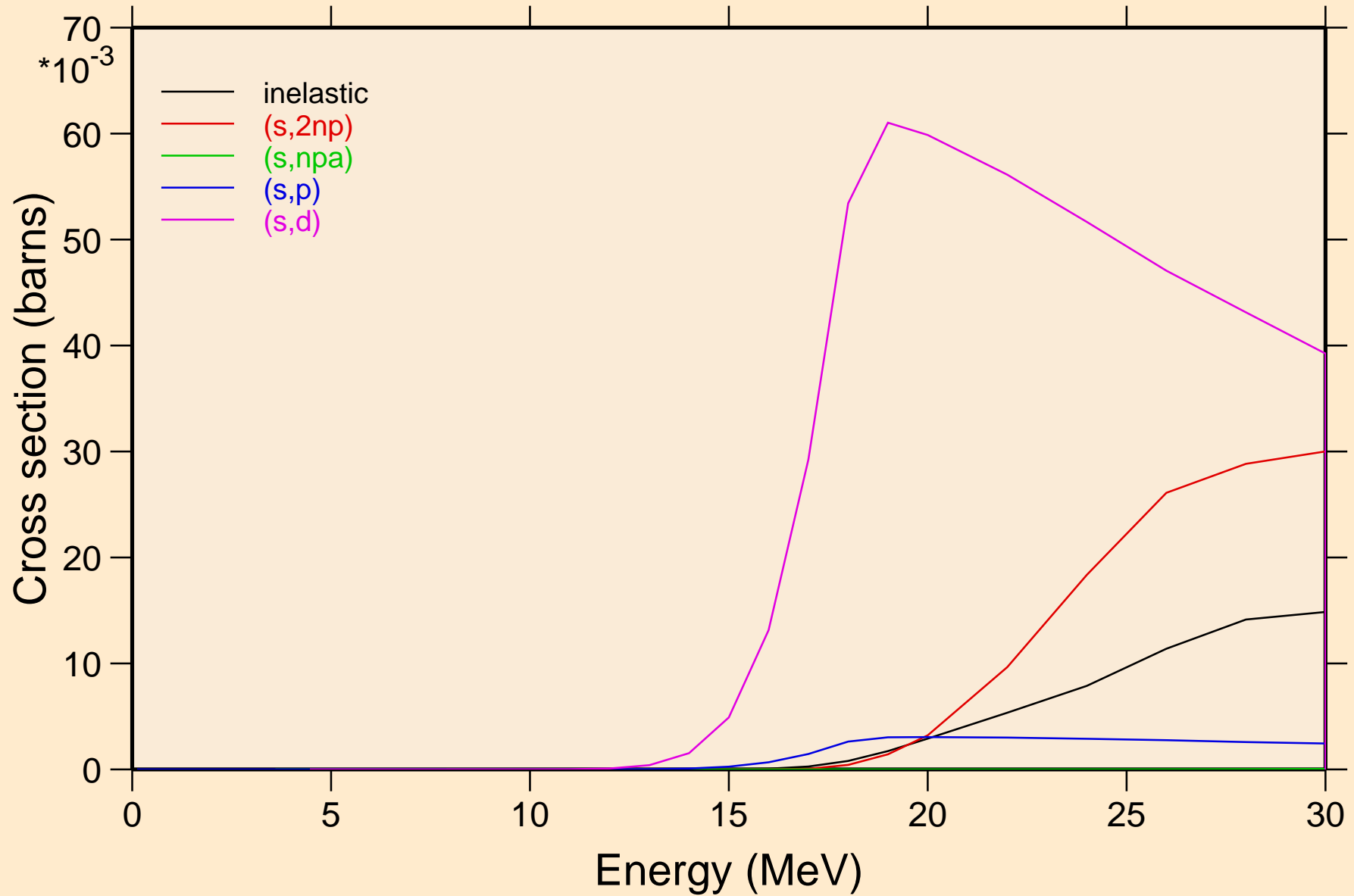

PM127 HELION ACER TENDL-2021 LIBRARY; T=0.K  
Threshold reactions

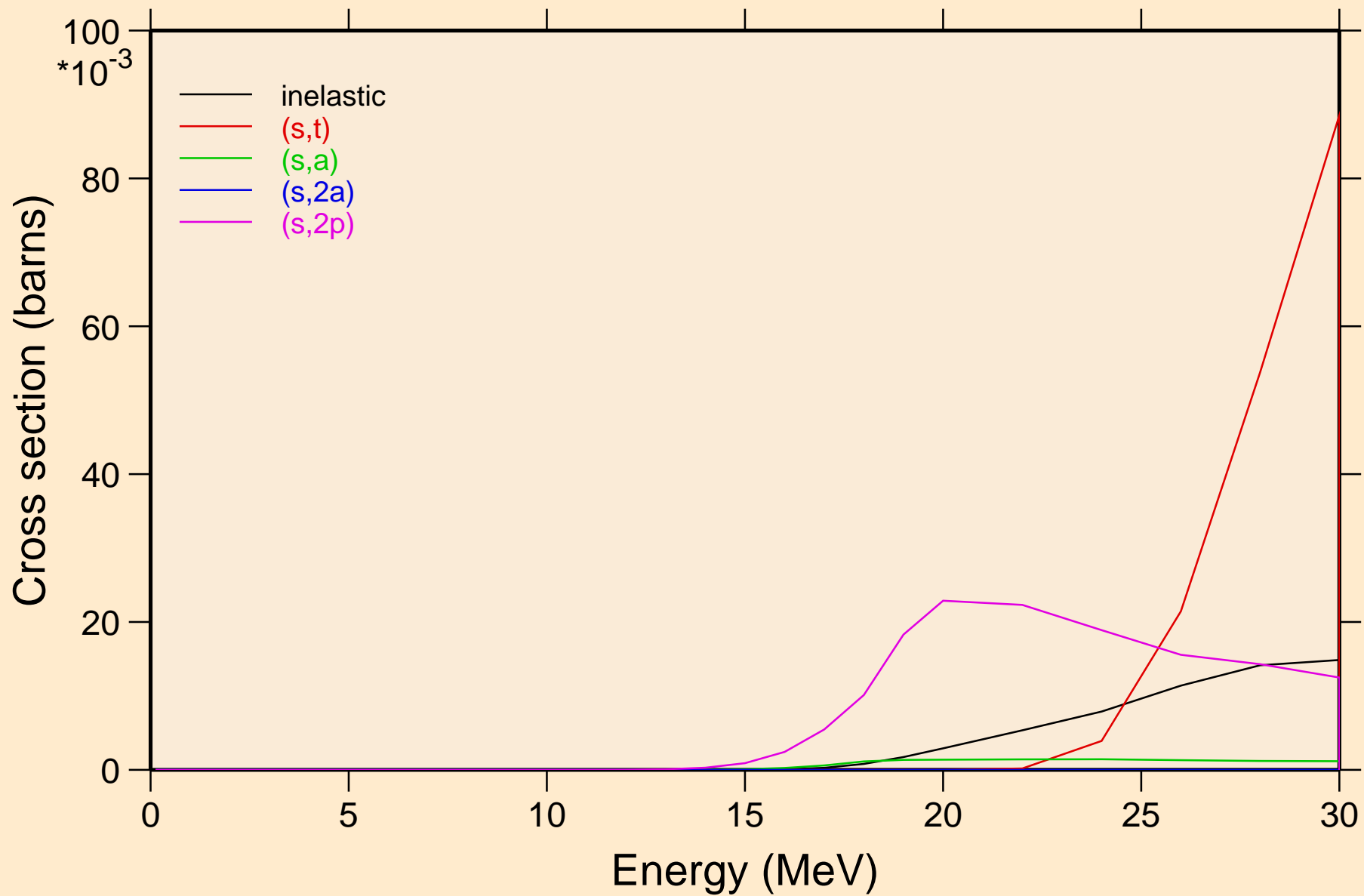



PM127 HELION ACER TENDL-2021 LIBRARY; T=0.K  
Threshold reactions

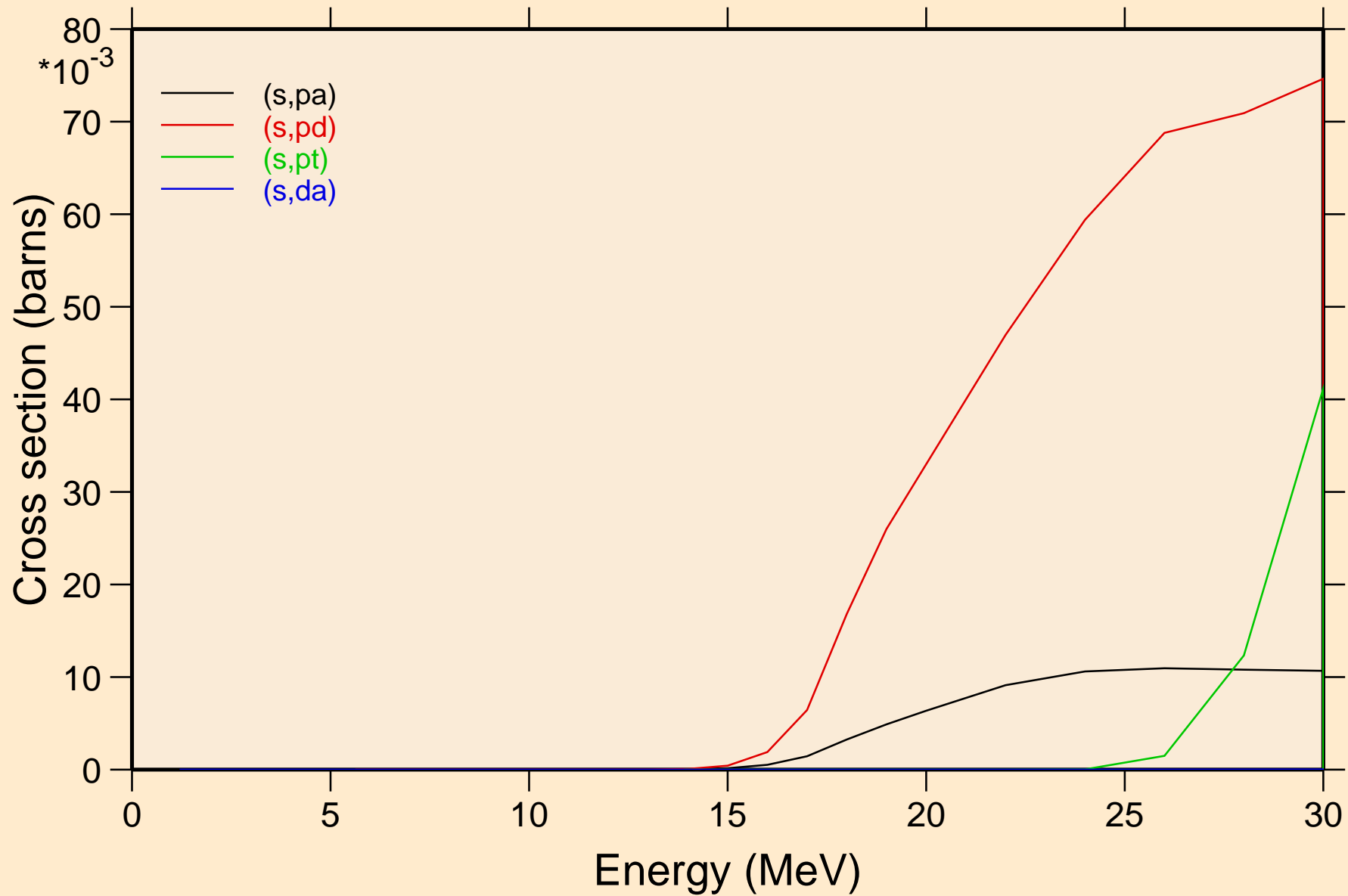

PM127 HELION ACER TENDL-2021 LIBRARY; T=0.K  
angular distribution for elastic

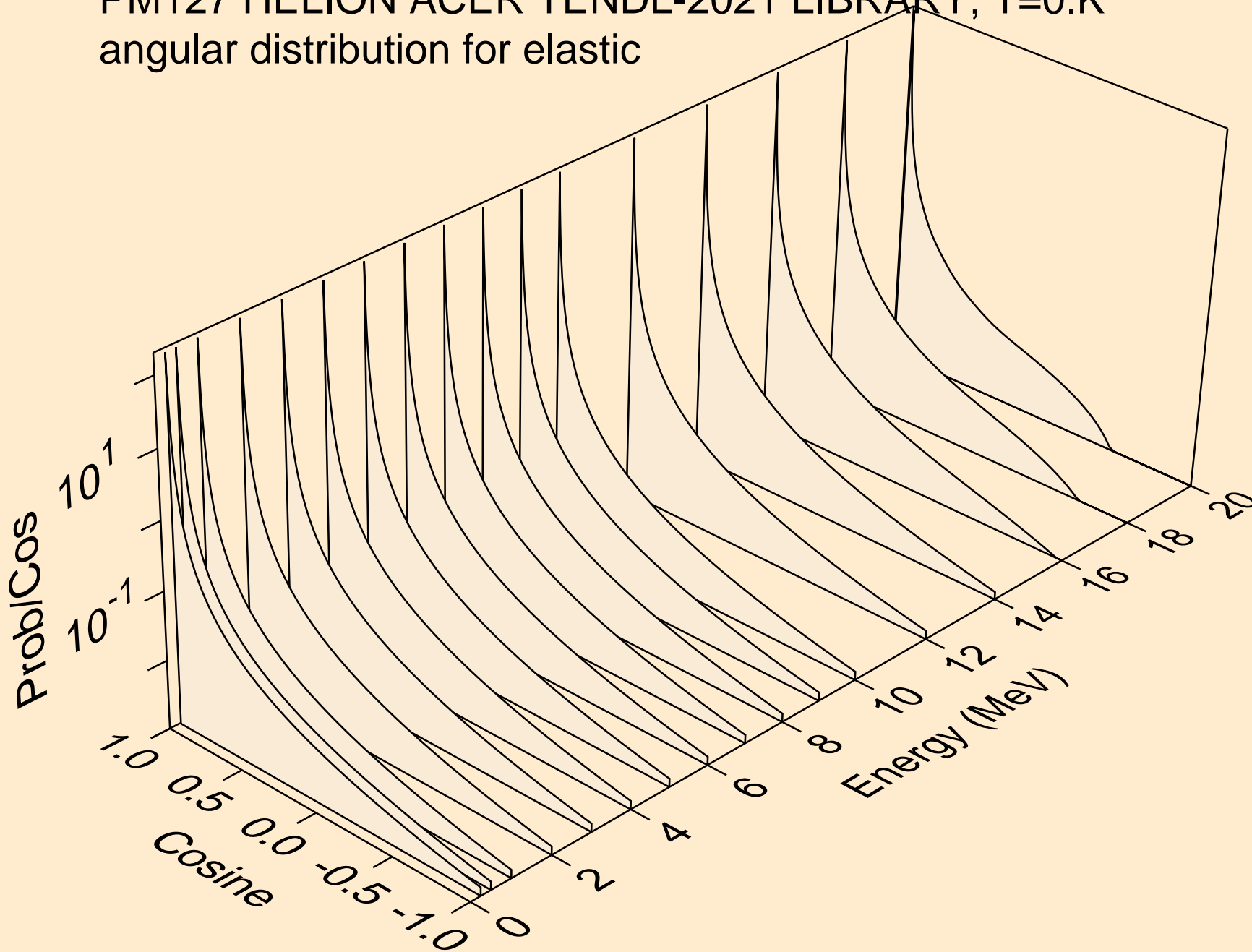

PM127 HELION ACER TENDL-2021 LIBRARY; T=0.K  
angular distribution for elastic

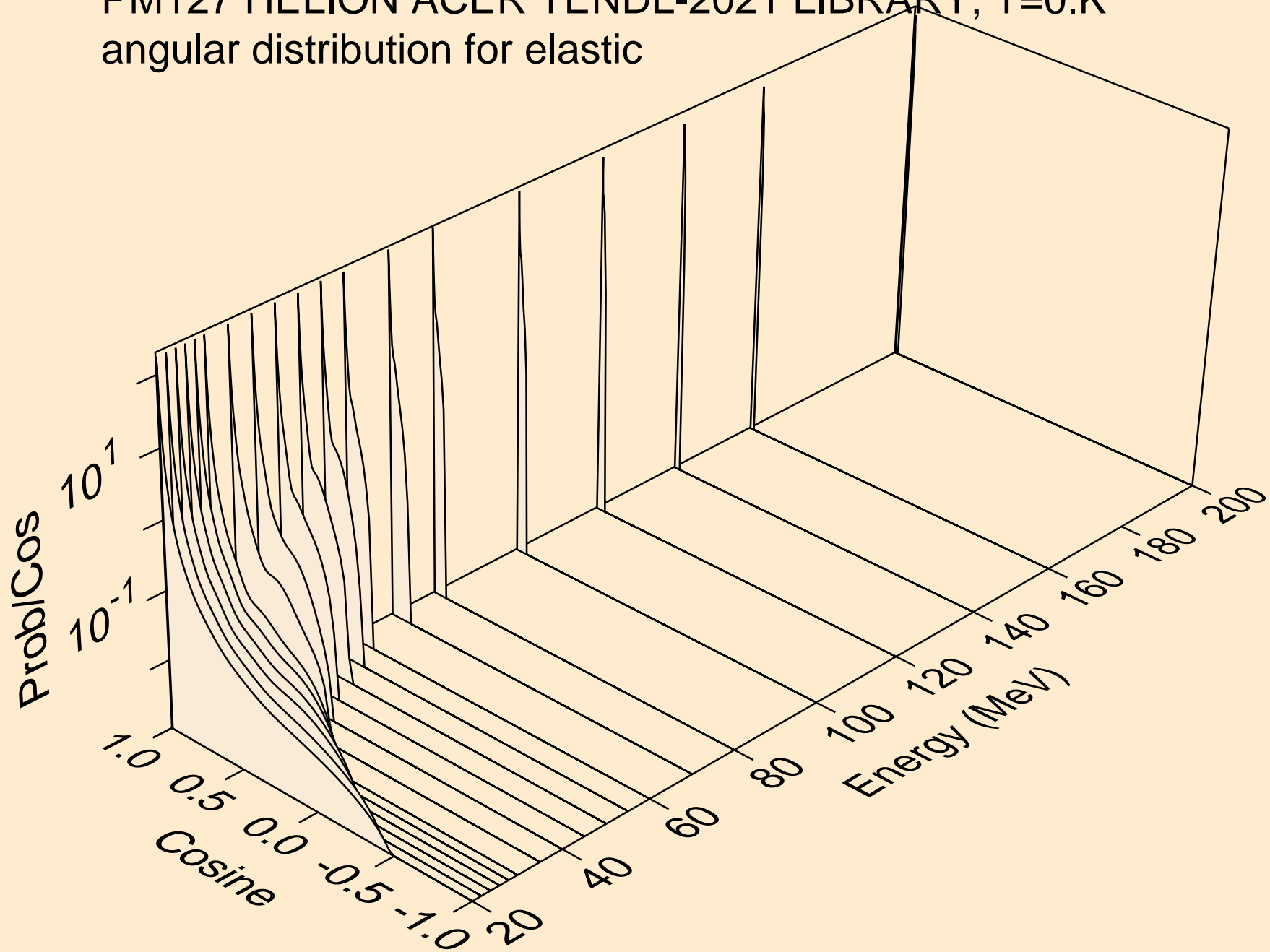

PM127 HELION ACER TENDL-2021 LIBRARY; T=0.K  
He-3 emission for (s,x)

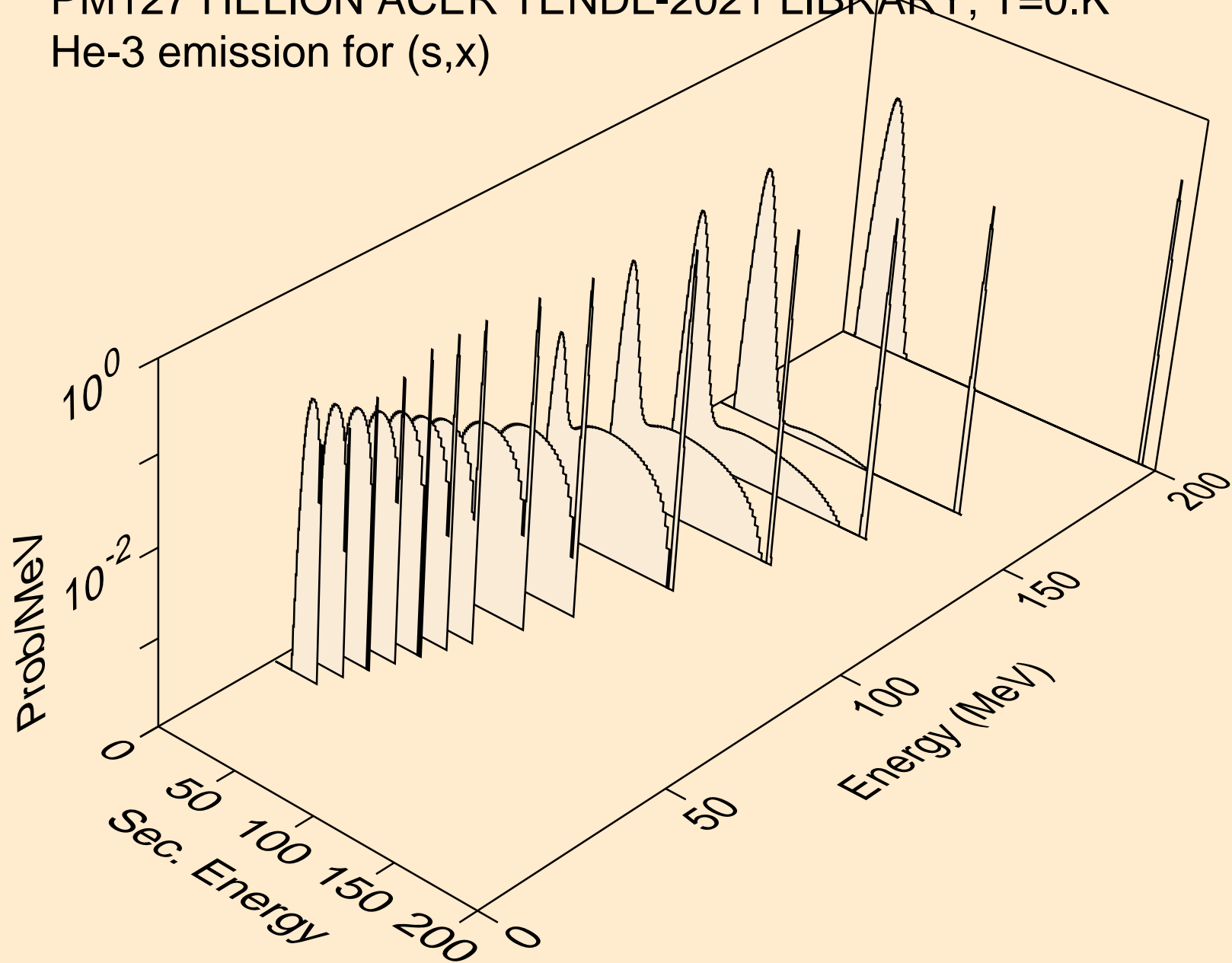

PM127 HELION ACER TENDL-2021 LIBRARY; T=0.K  
He-3 emission for (s,n\*)he3

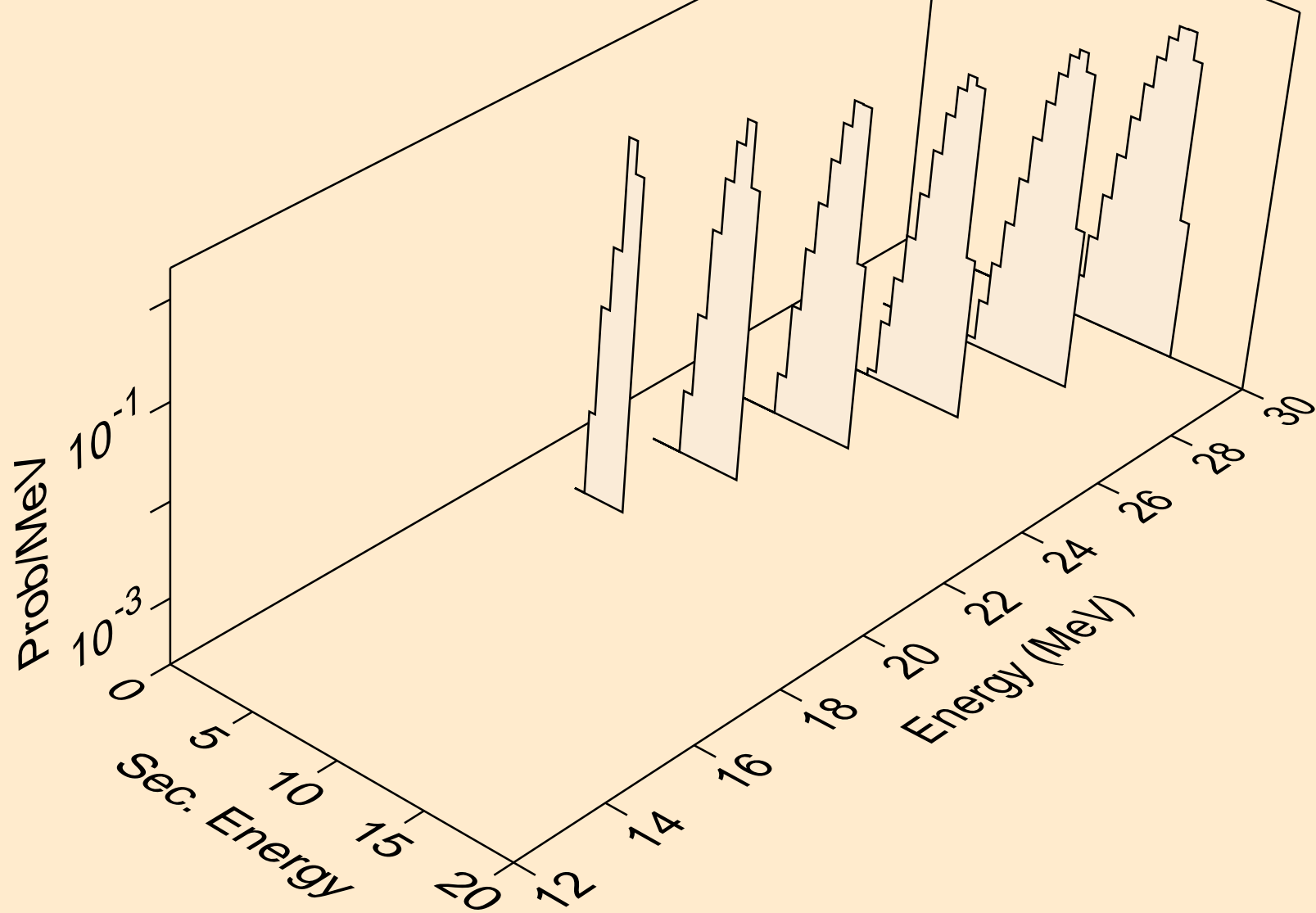

PM127 HELION ACER TENDL-2021 LIBRARY; T=0.K  
He-3 emission for inelastic

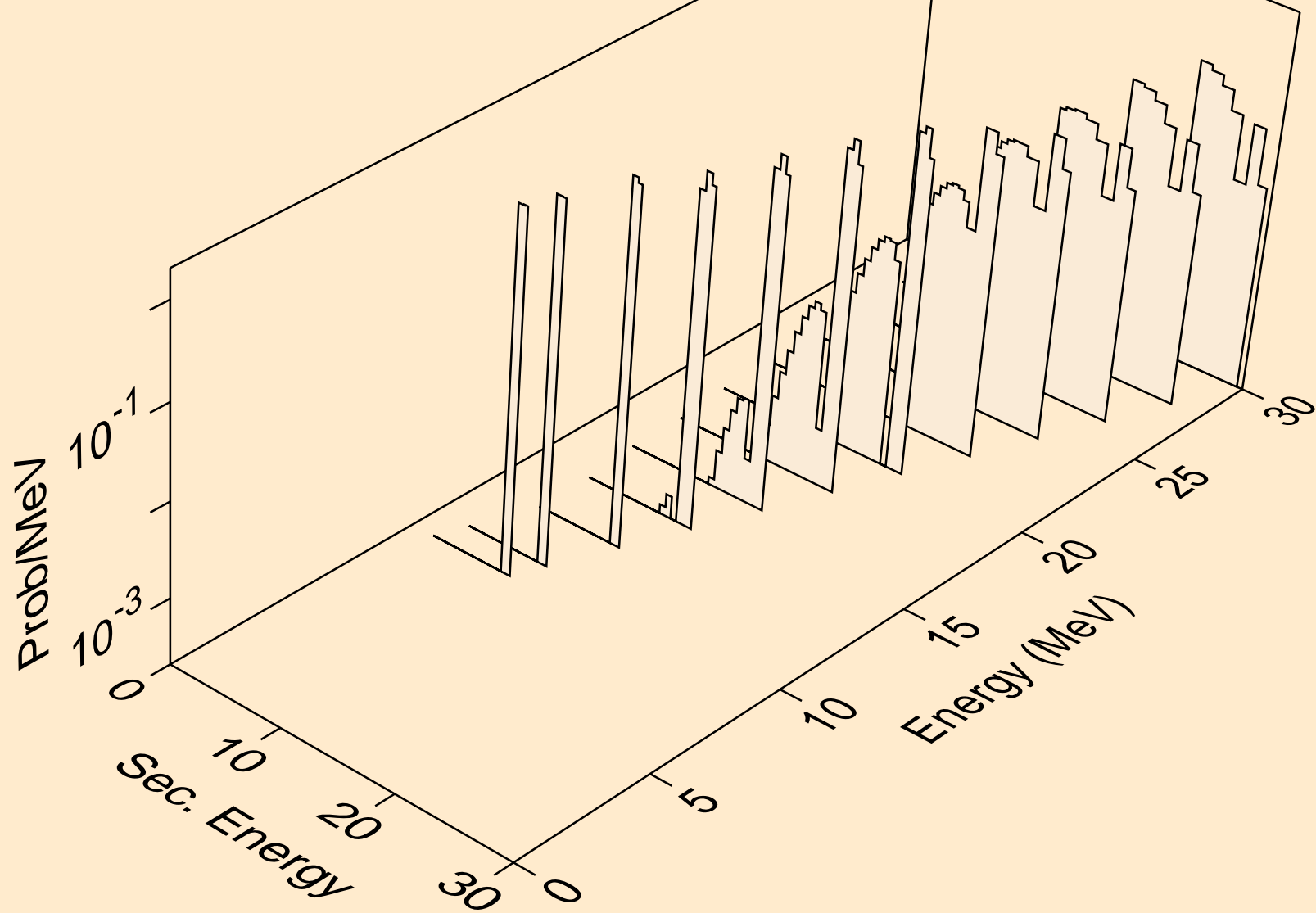

PM127 HELION ACER TENDL-2021 LIBRARY; T=0.K  
Photon emission for (z,n)

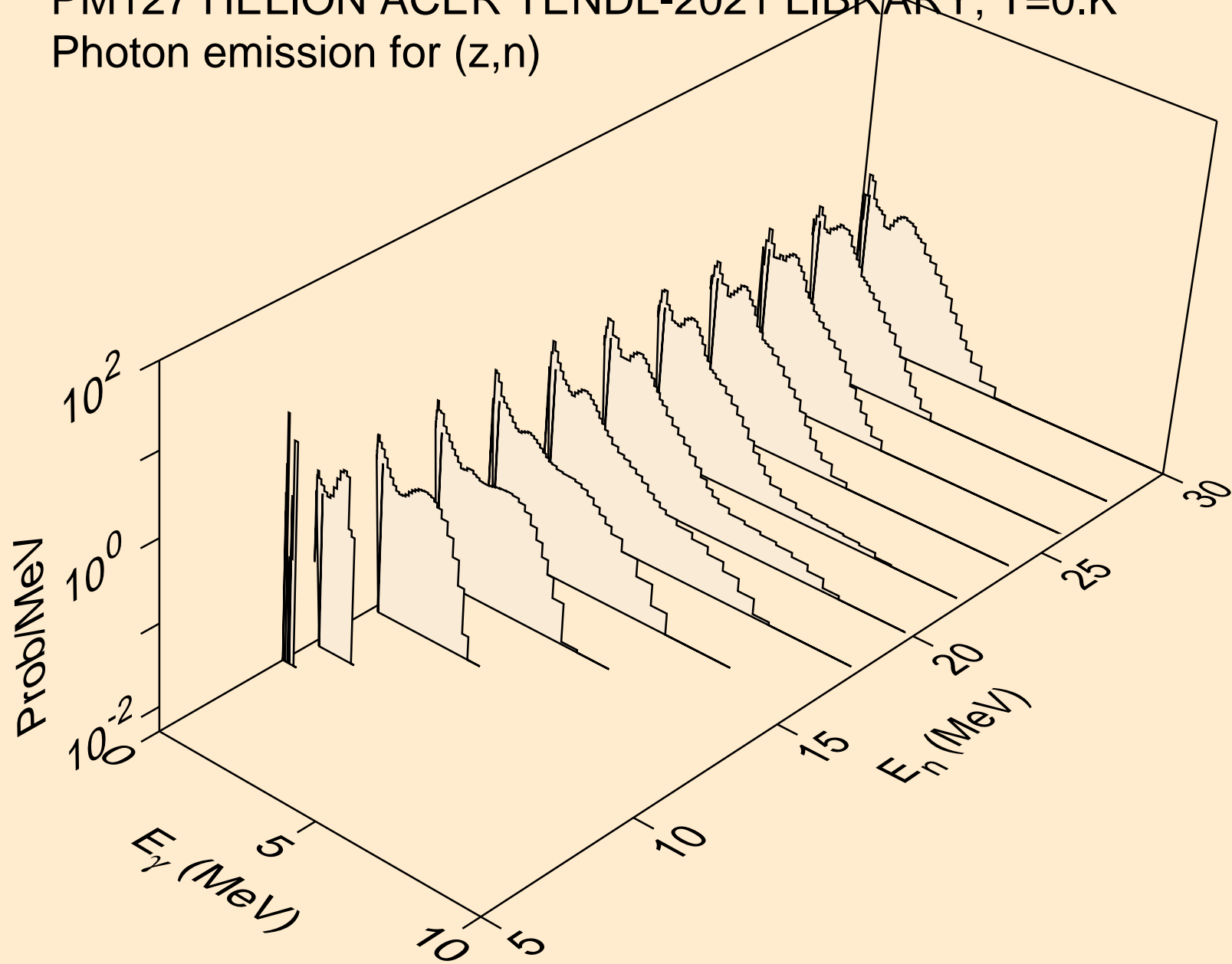

PM127 HELION ACER TENDL-2021 LIBRARY; T=0.K  
Photon emission for (n,x)

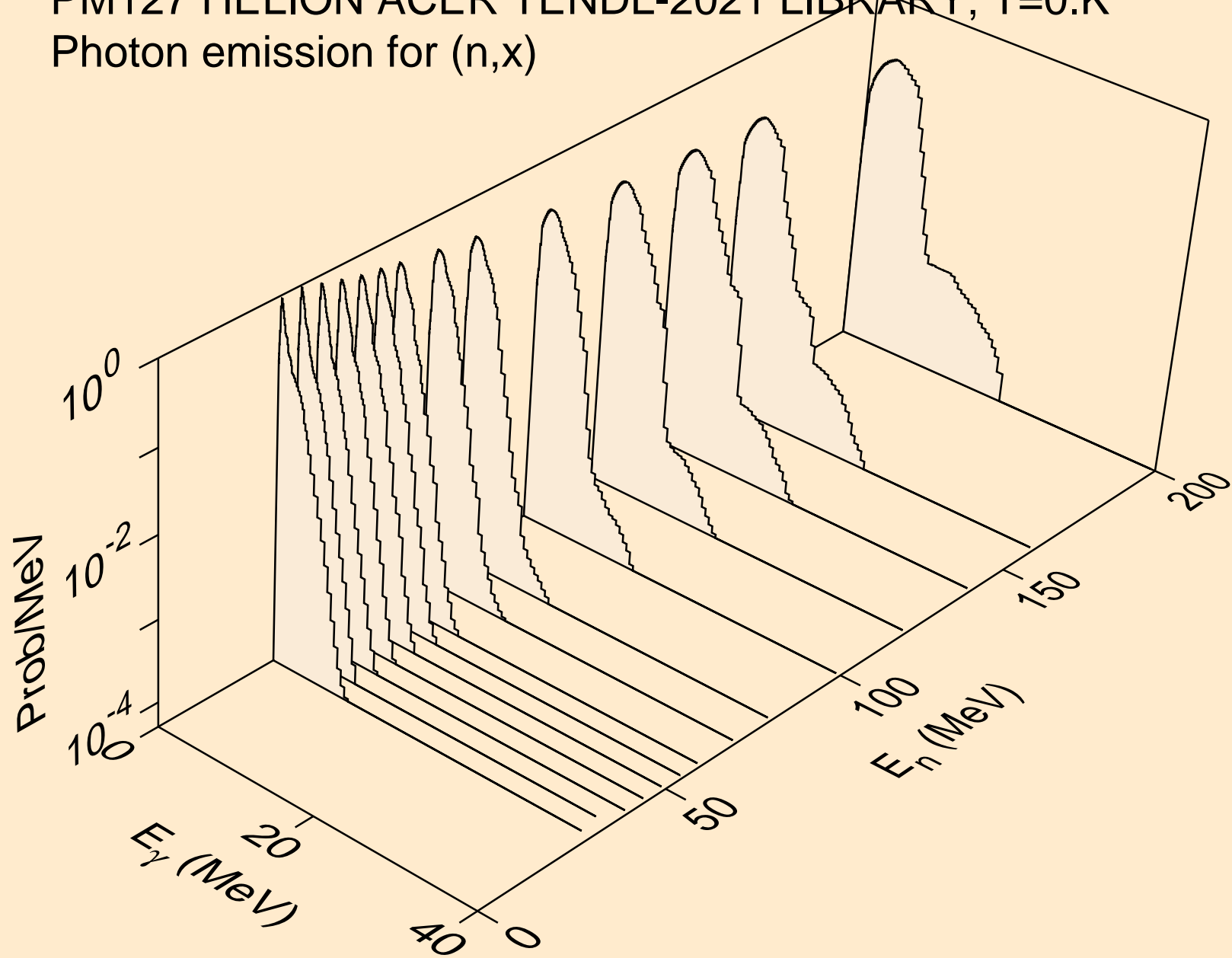



PM127 HELION ACER TENDL-2021 LIBRARY; T=0.K  
Photon emission for (n,2n)

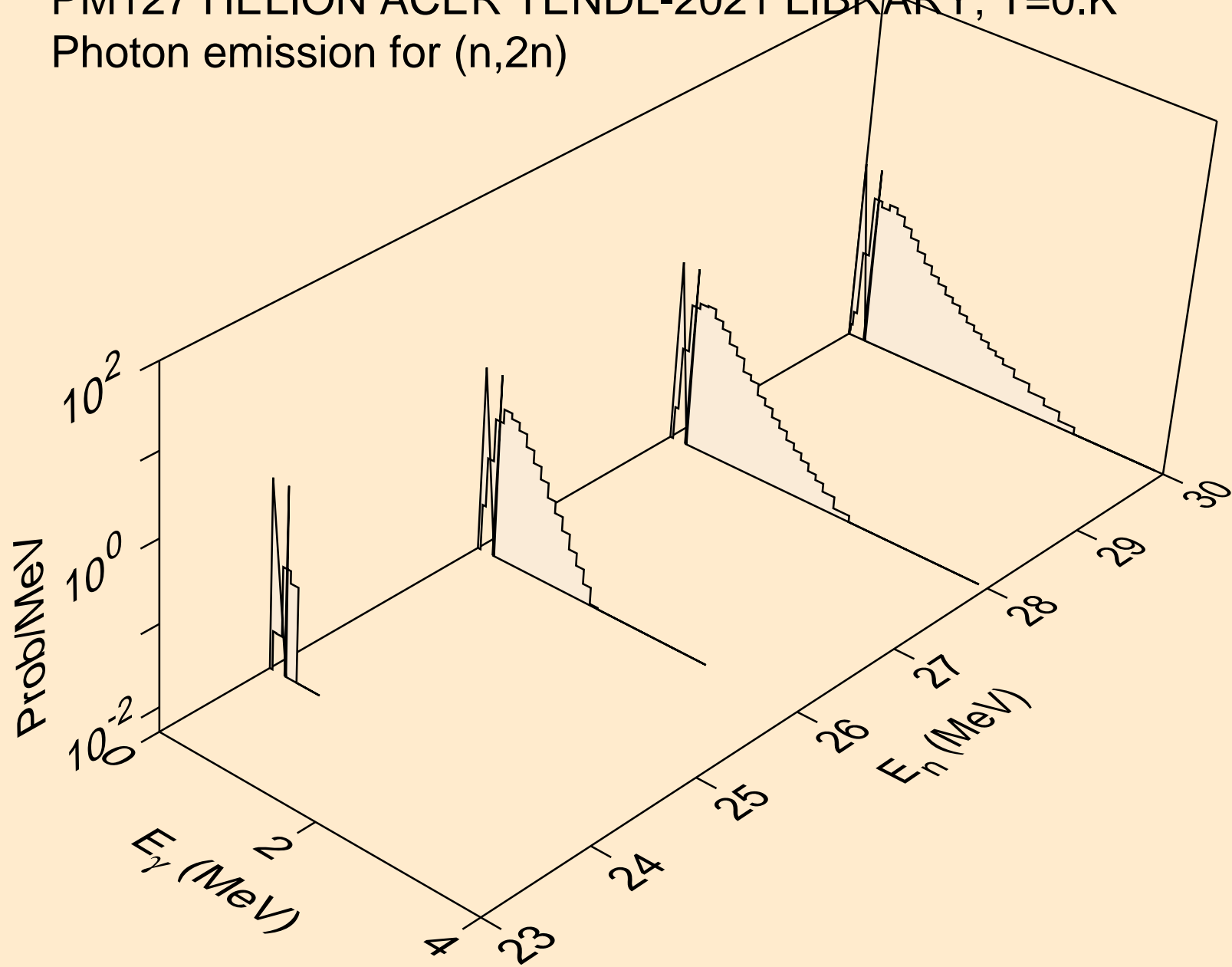

PM127 HELION ACER TENDL-2021 LIBRARY; T=0.K  
Photon emission for (n,n\*)a

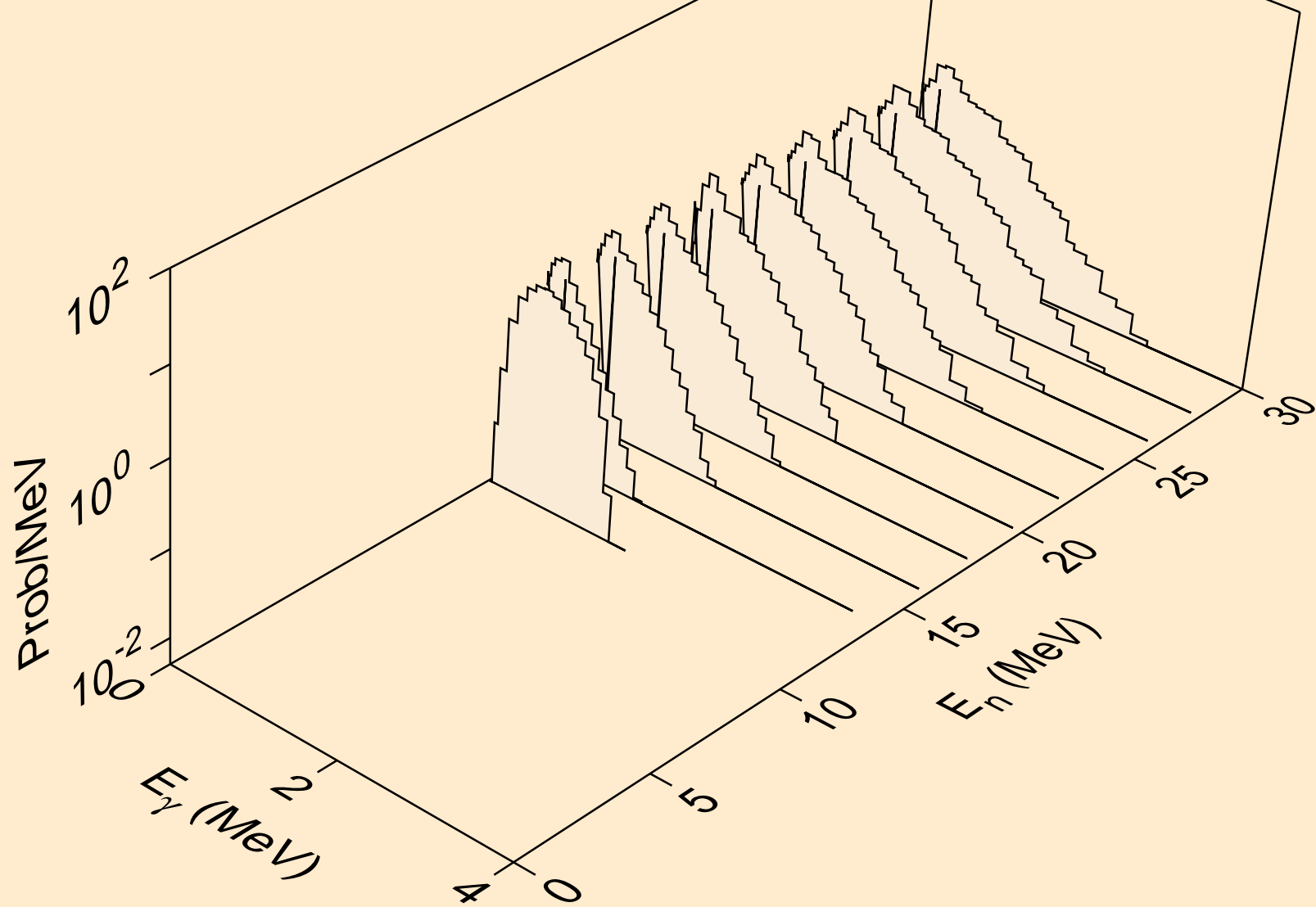

PM127 HELION ACER TENDL-2021 LIBRARY; T=0.K  
Photon emission for (n,n\*)p

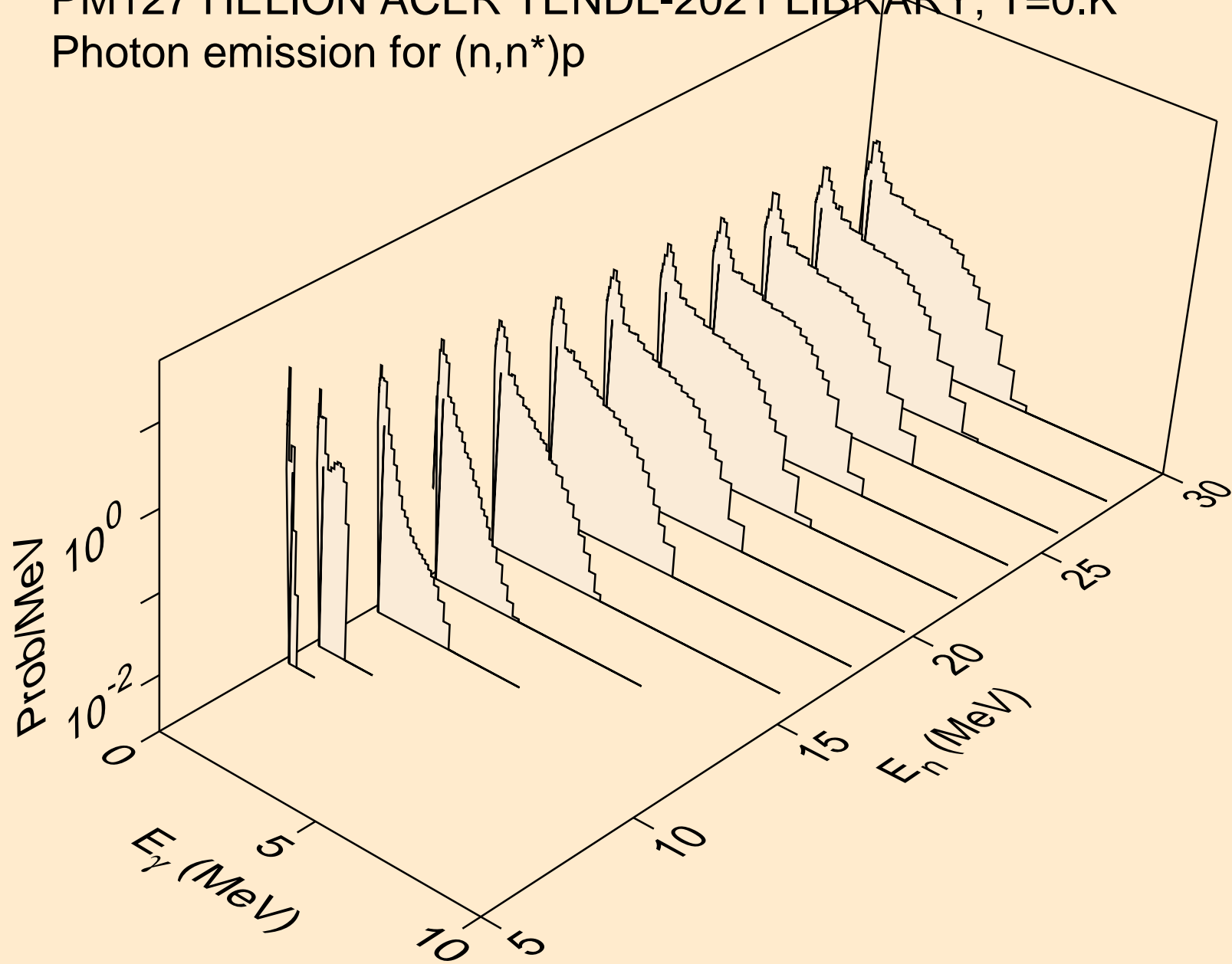

PM127 HELION ACER TENDL-2021 LIBRARY; T=0.K  
Photon emission for (n,n\*)d

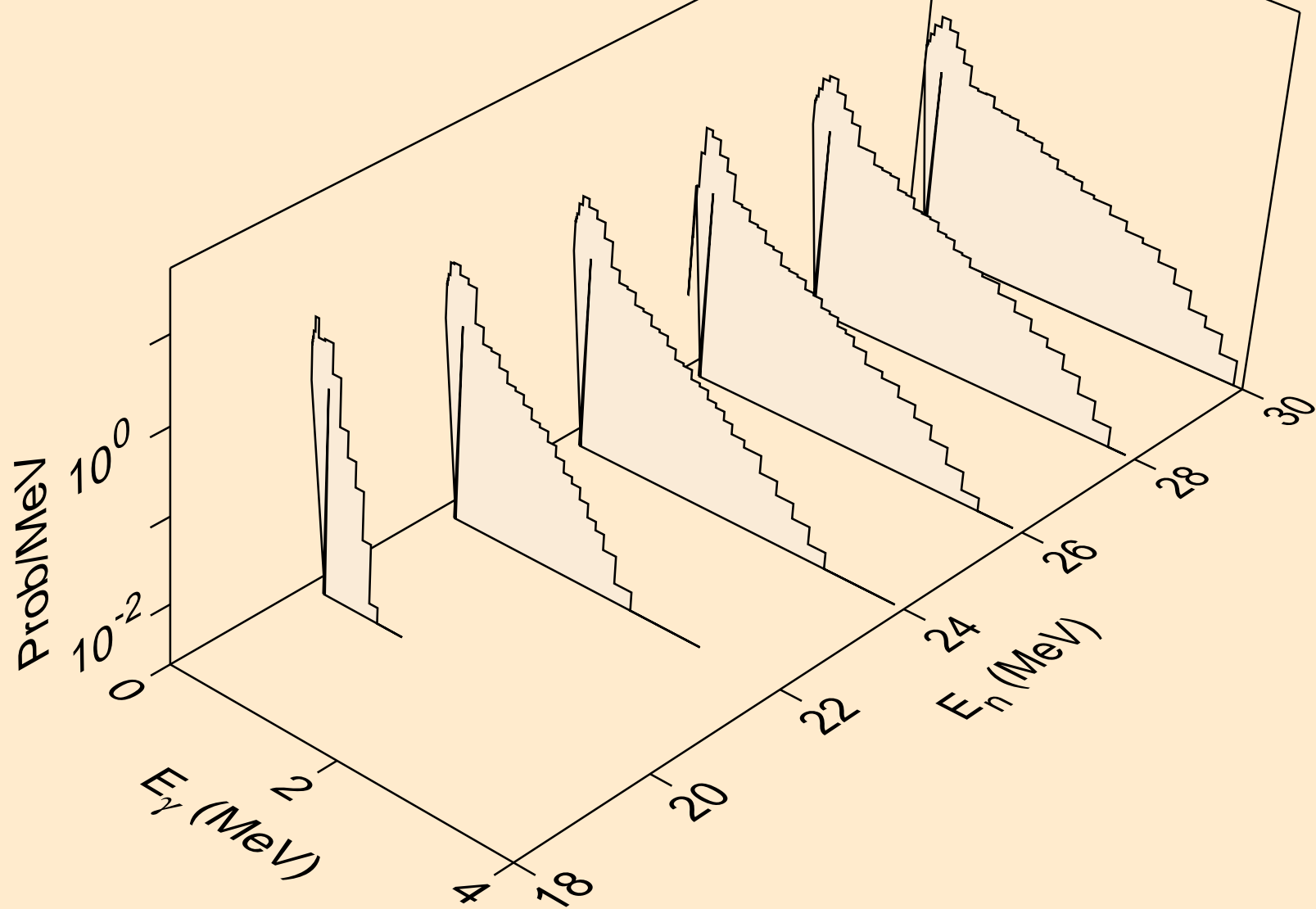

PM127 HELION ACER TENDL-2021 LIBRARY; T=0.K  
Photon emission for (n,n\*)he3

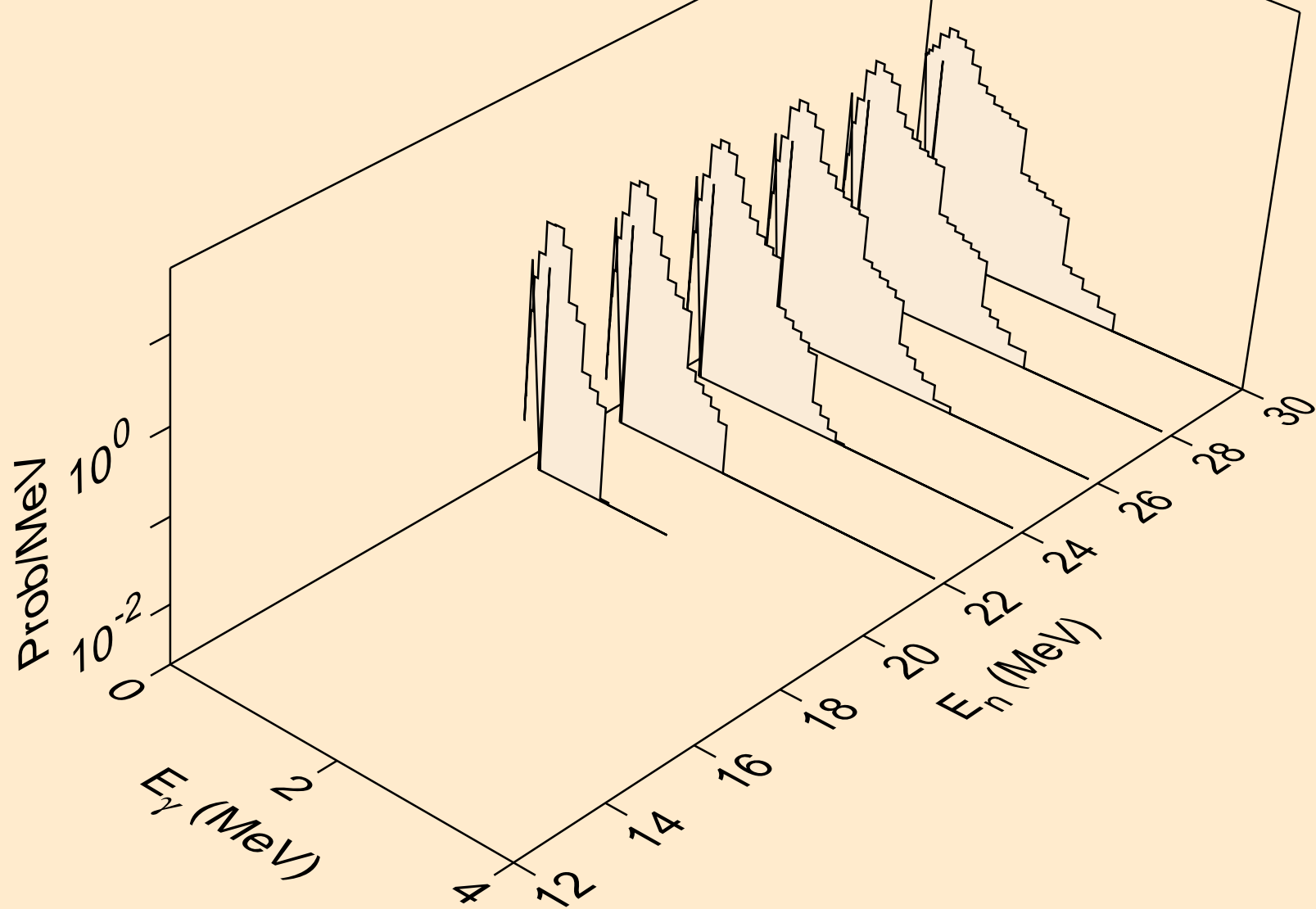

PM127 HELION ACER TENDL-2021 LIBRARY; T=0.K  
Photon emission for (n,2np)

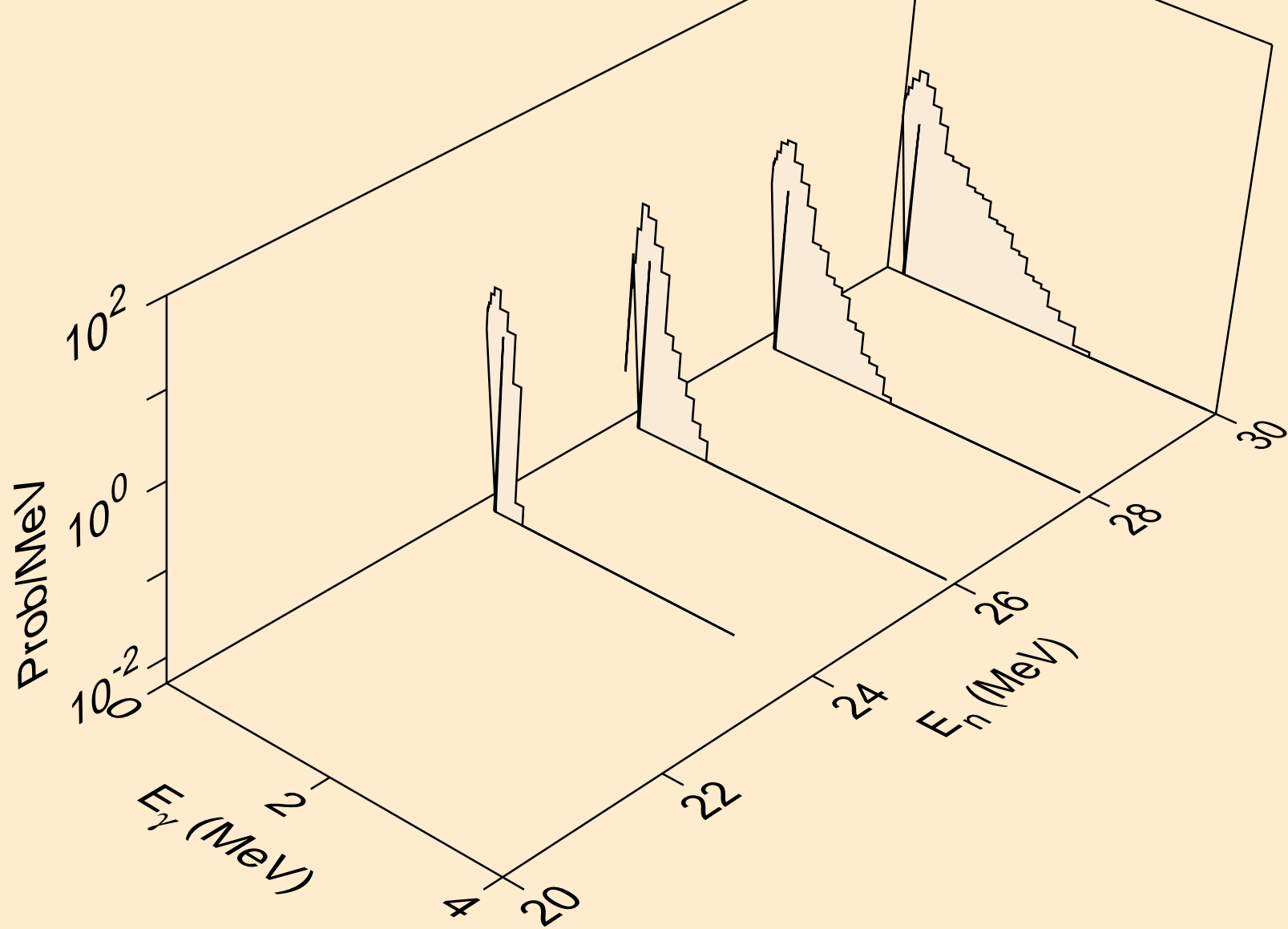

PM127 HELION ACER TENDL-2021 LIBRARY; T=0.K  
Photon emission for (n,2np)

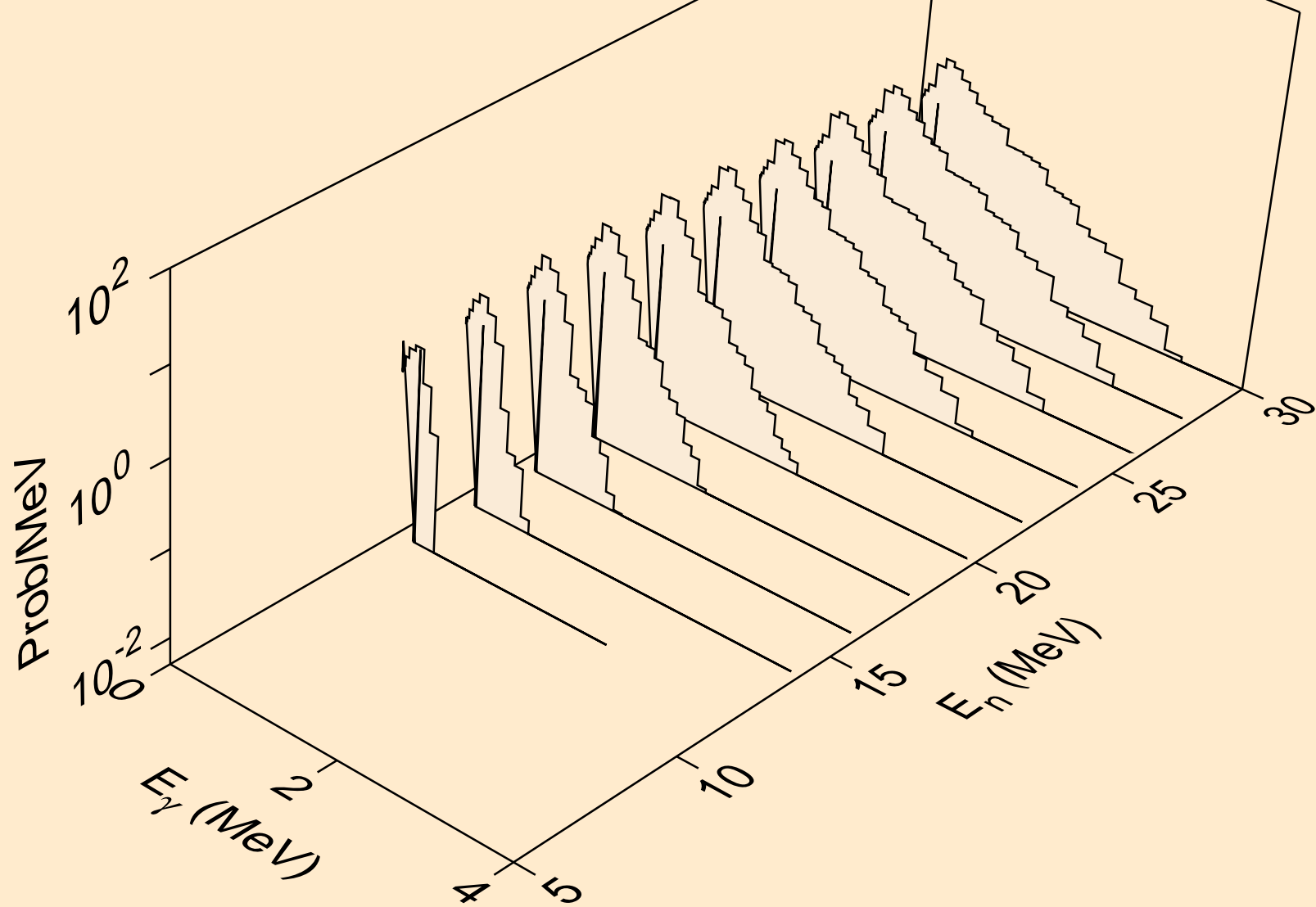

PM127 HELION ACER TENDL-2021 LIBRARY; T=0.K  
Photon emission for (n,npa)

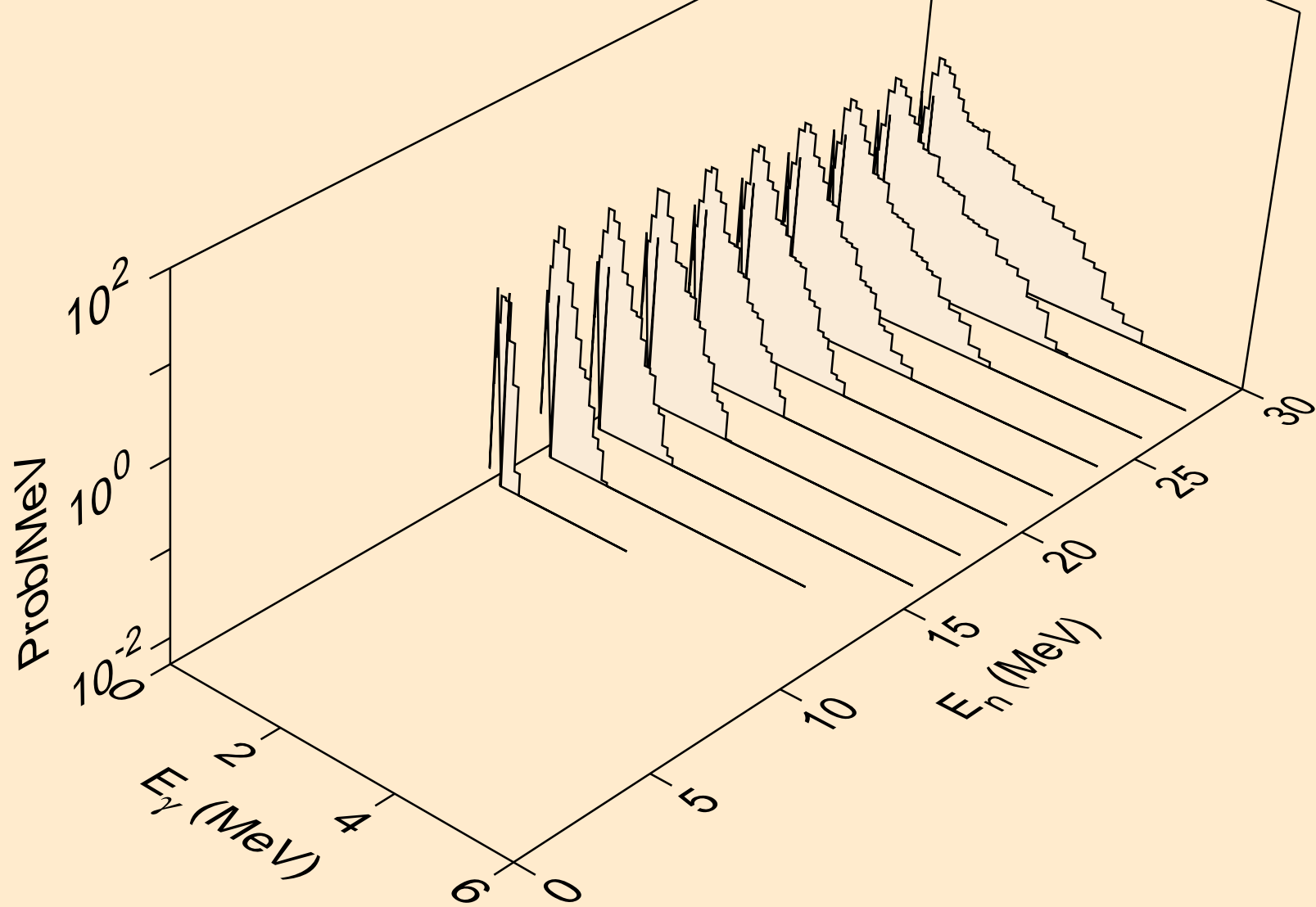



PM127 HELION ACER TENDL-2021 LIBRARY; T=0.K  
Photon emission for (n,p)

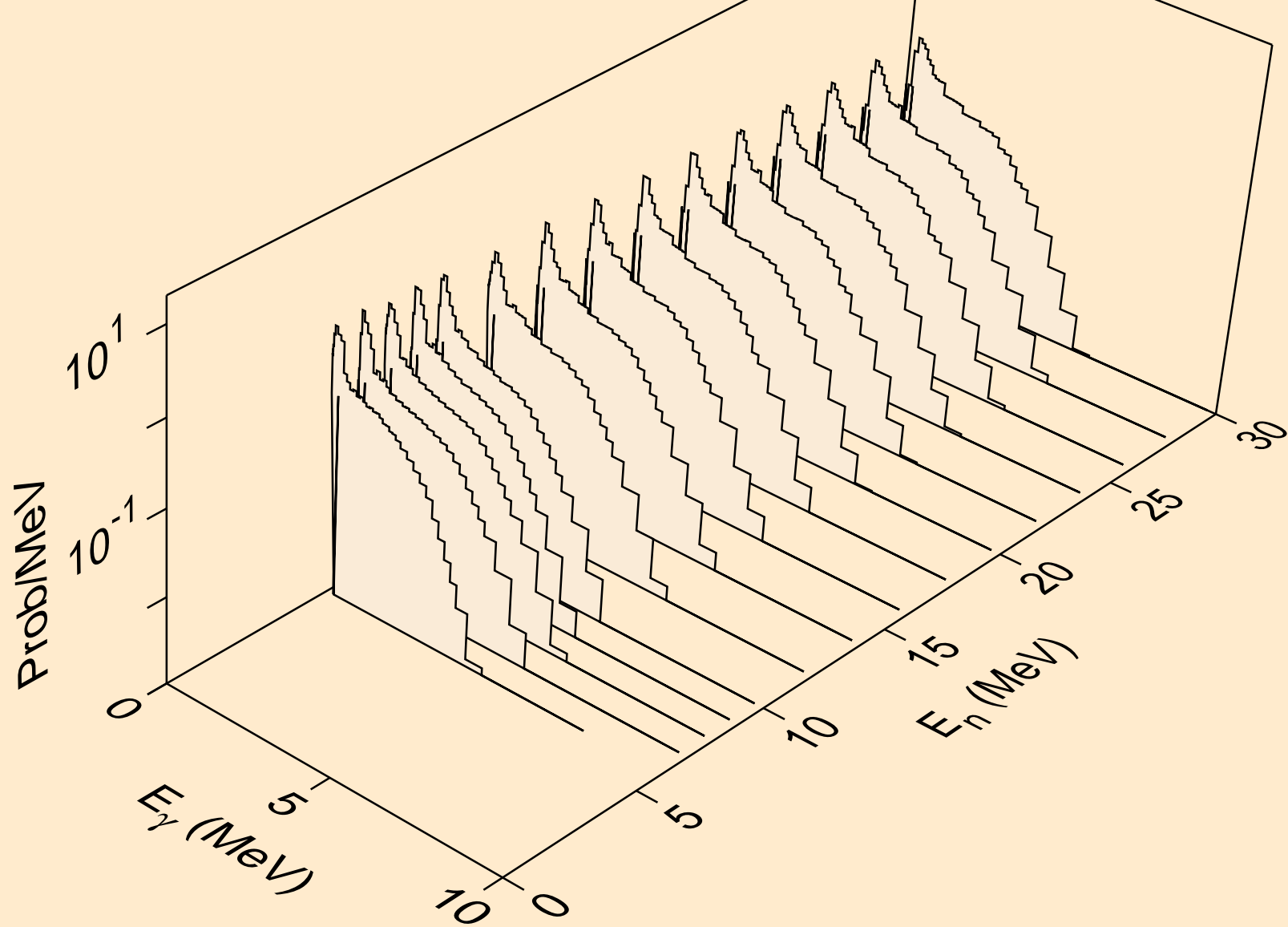

PM127 HELION ACER TENDL-2021 LIBRARY; T=0.K  
Photon emission for (n,d)

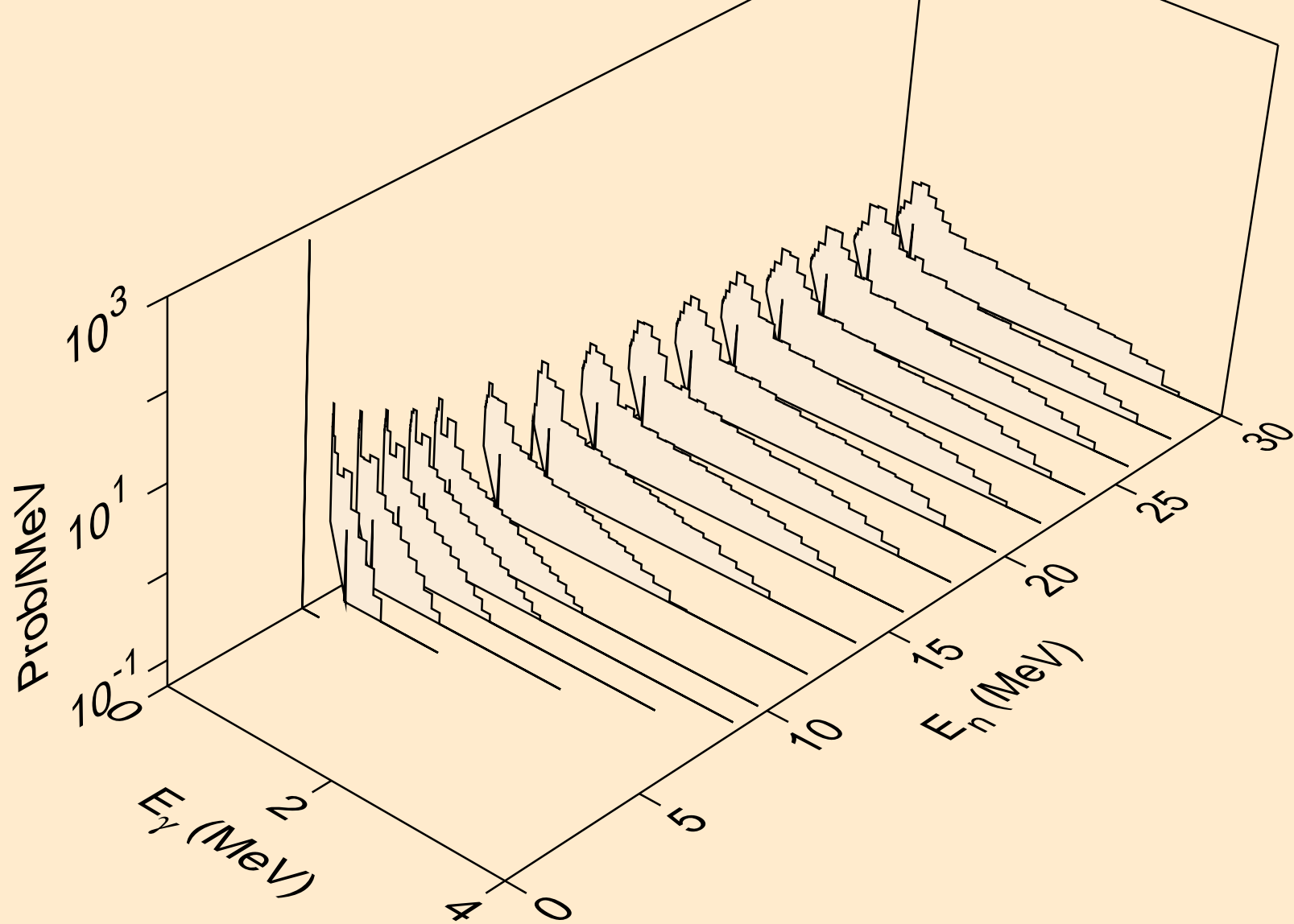

PM127 HELION ACER TENDL-2021 LIBRARY; T=0.K  
Photon emission for (n,t)

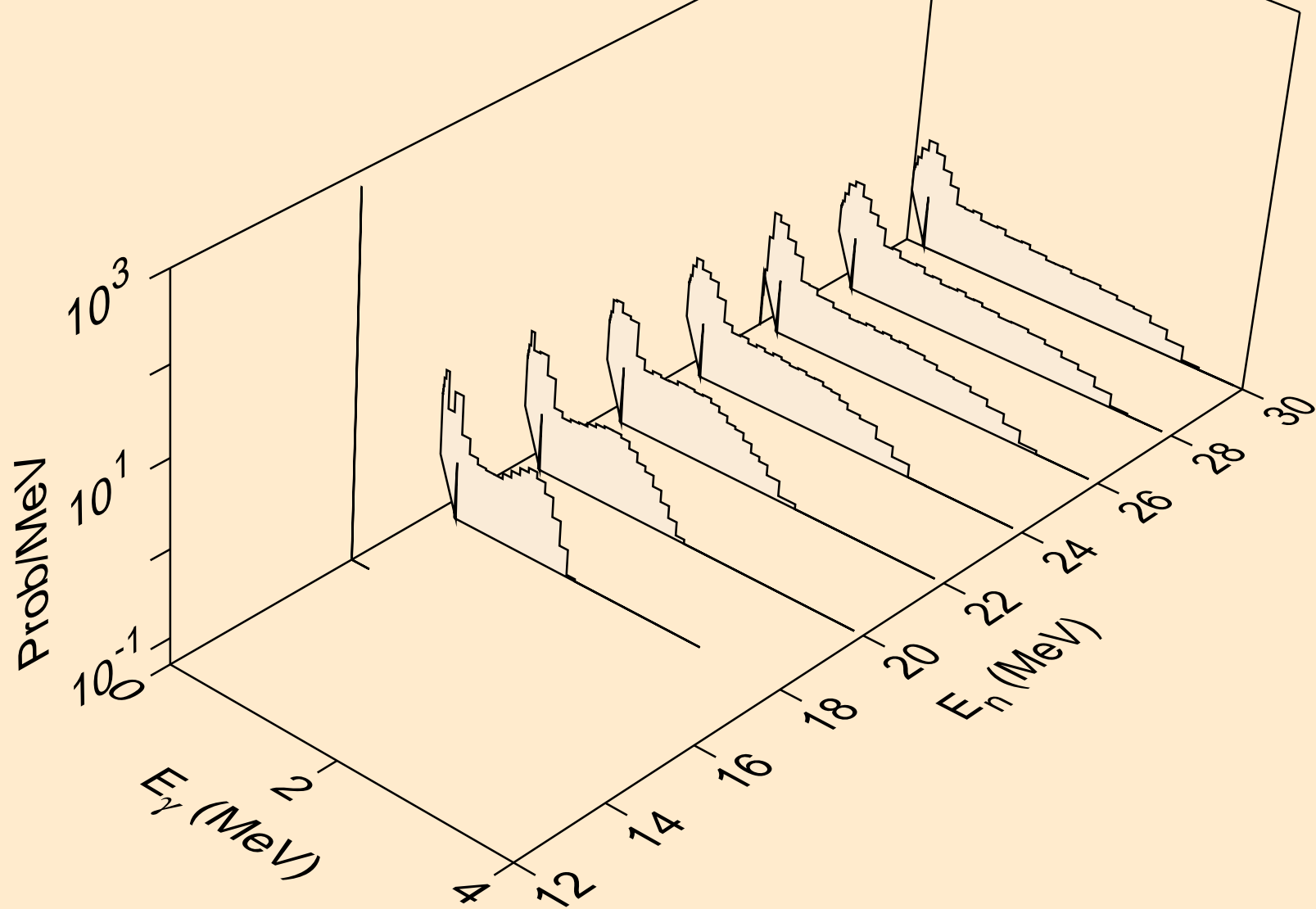

PM127 HELION ACER TENDL-2021 LIBRARY; T=0.K  
Photon emission for inelastic

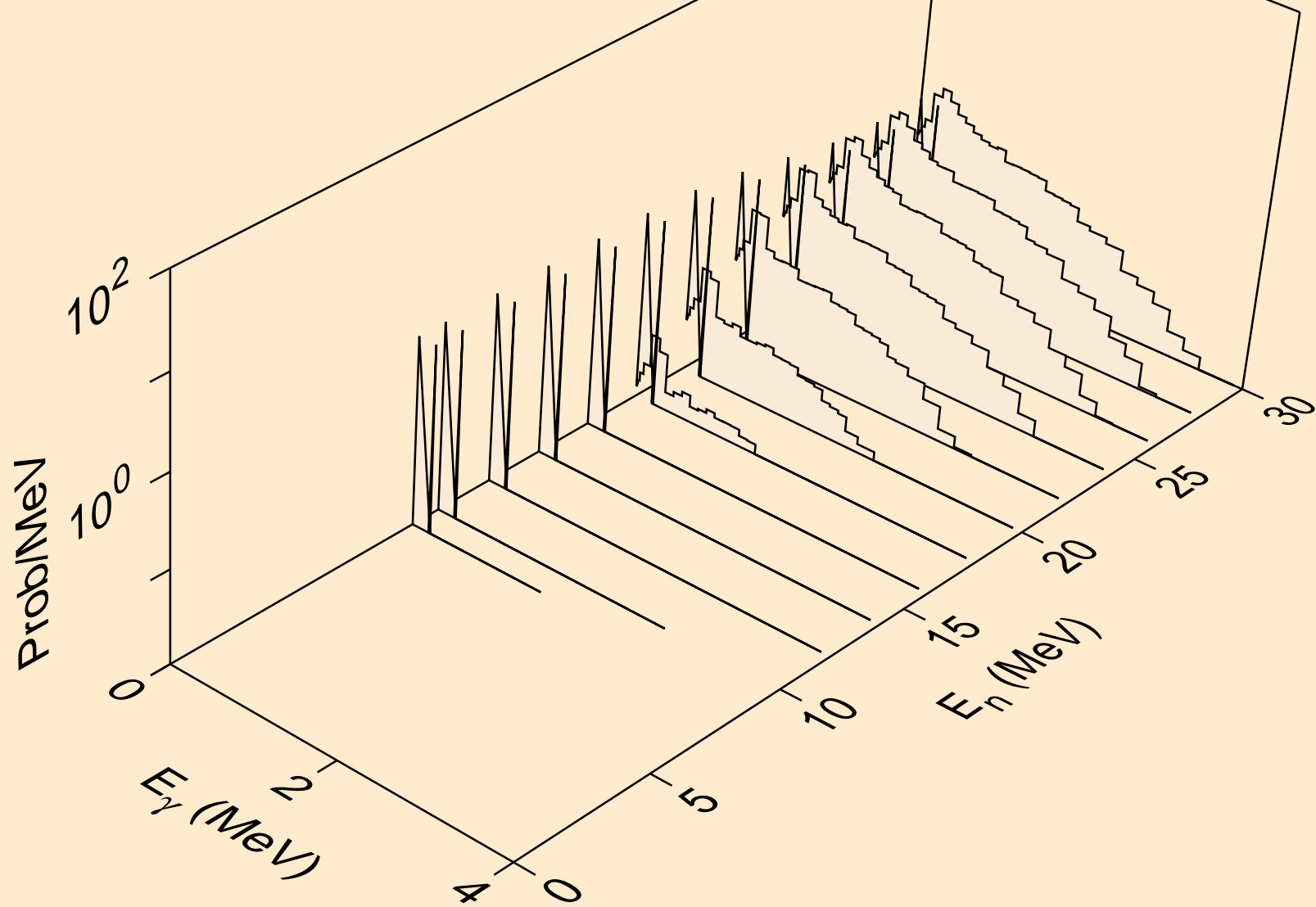

PM127 HELION ACER TENDL-2021 LIBRARY; T=0.K  
Photon emission for (n,a)

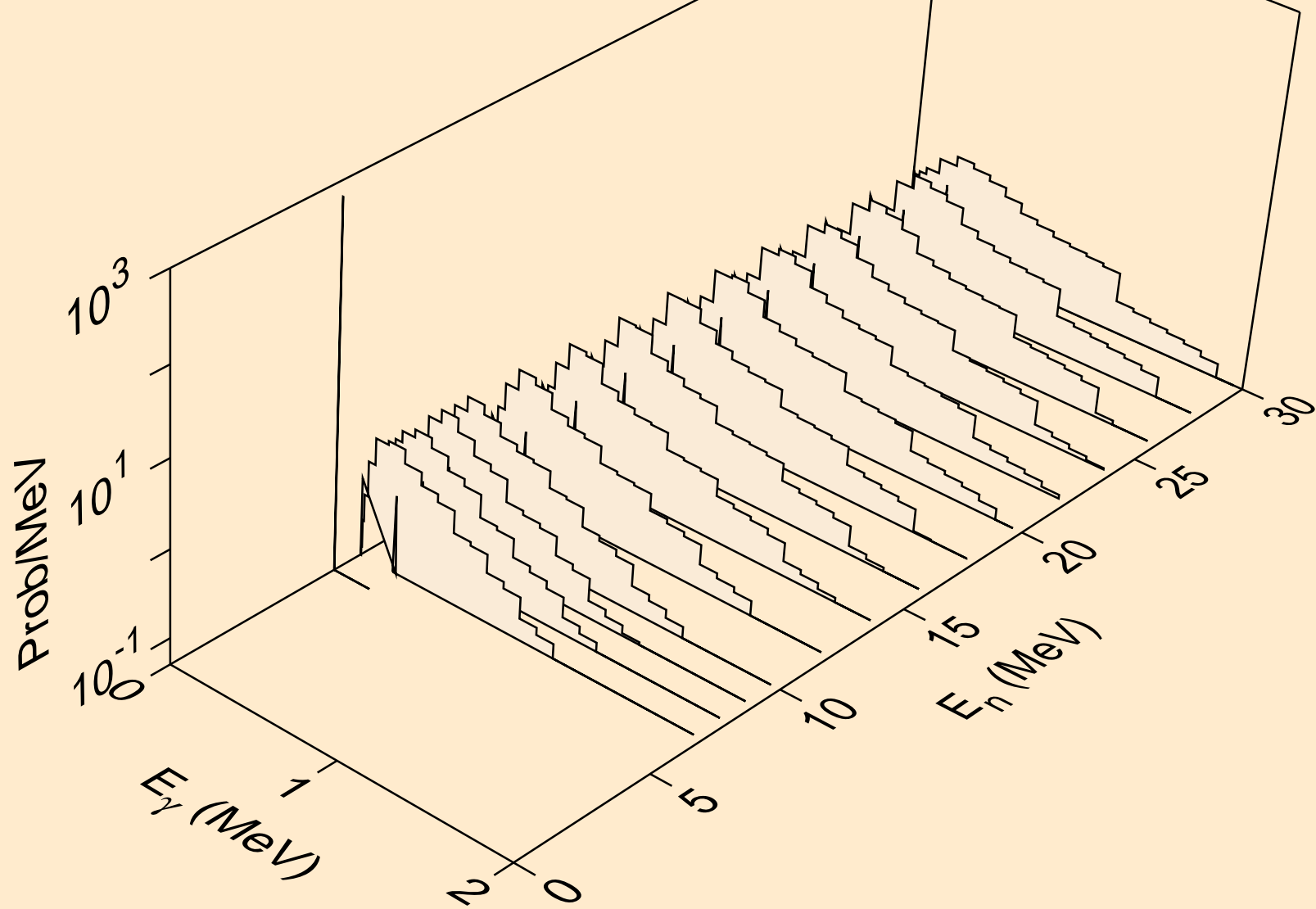

PM127 HELION ACER TENDL-2021 LIBRARY; T=0.K  
Photon emission for (n,2a)

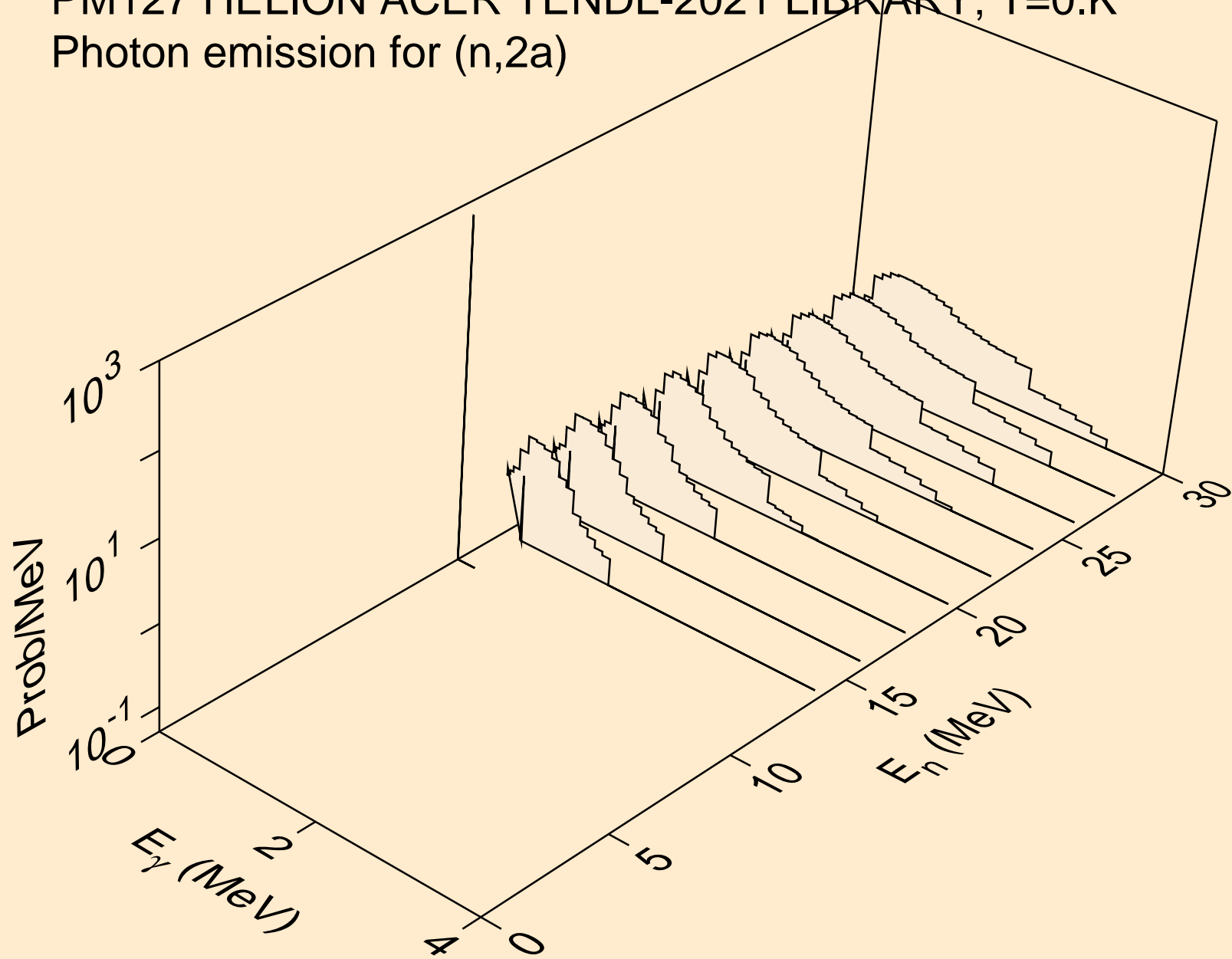

PM127 HELION ACER TENDL-2021 LIBRARY; T=0.K  
Photon emission for (n,2p)

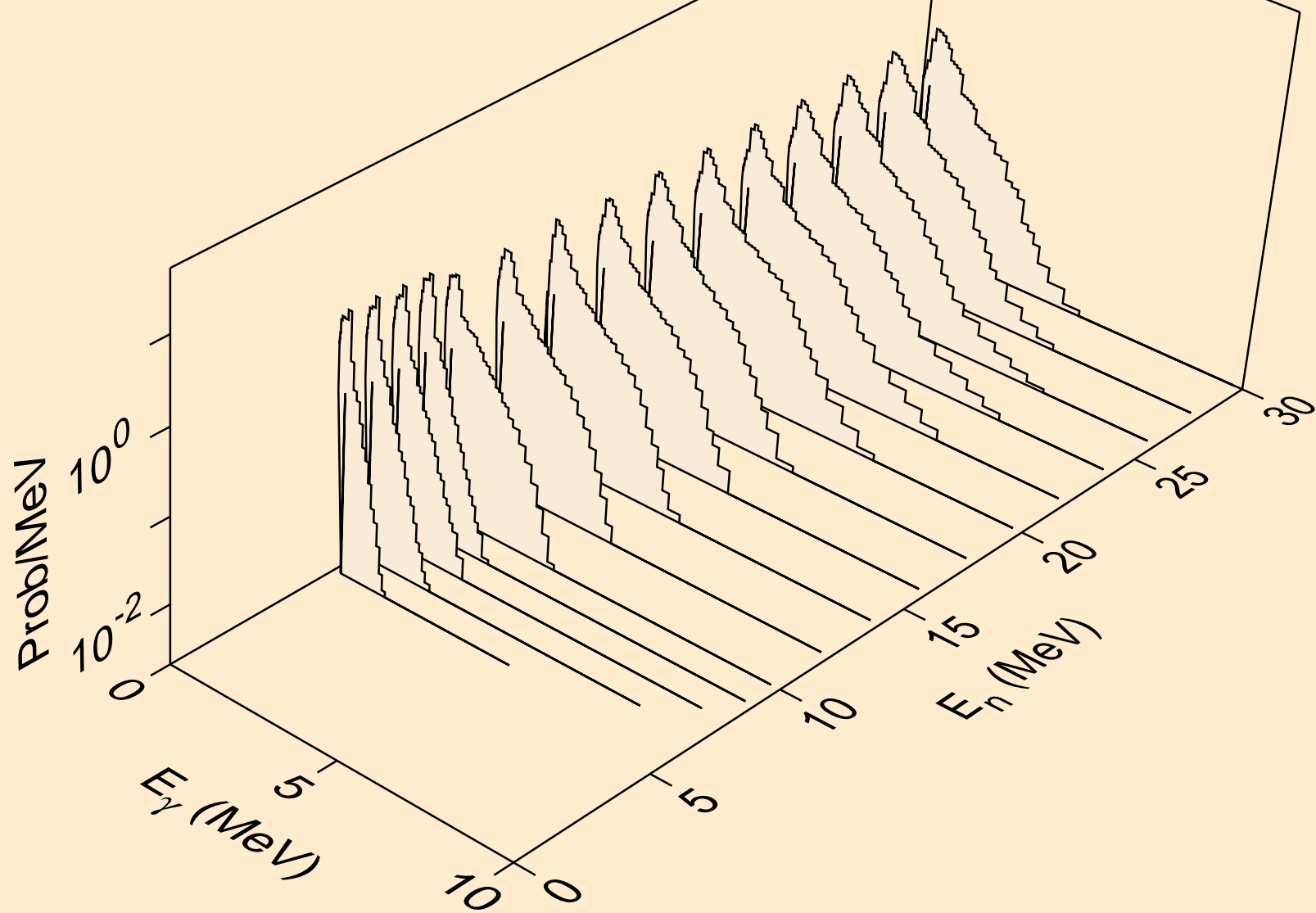

PM127 HELION ACER TENDL-2021 LIBRARY; T=0.K  
Photon emission for (n,pa)

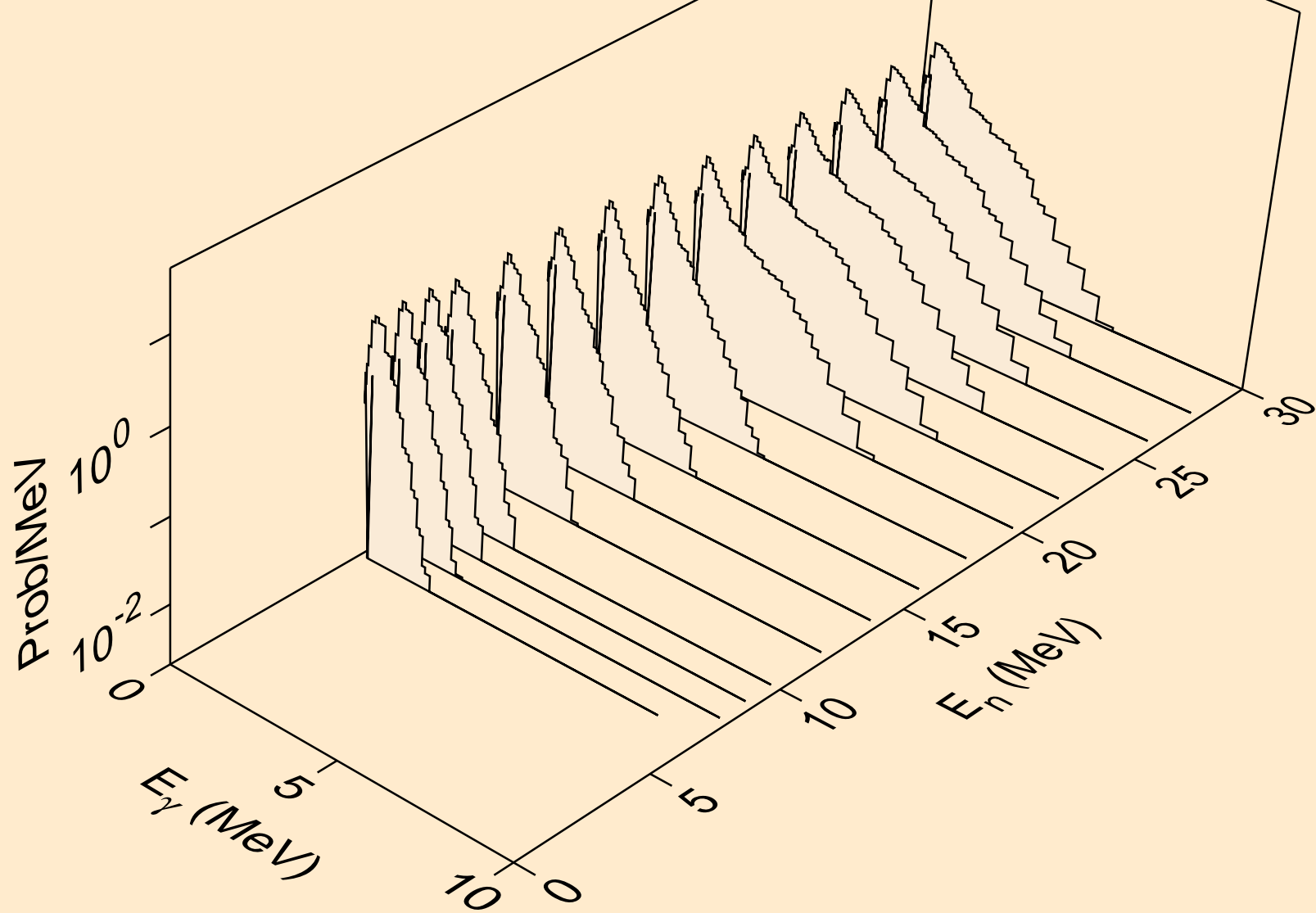



PM127 HELION ACER TENDL-2021 LIBRARY; T=0.K  
Photon emission for (n,pd)

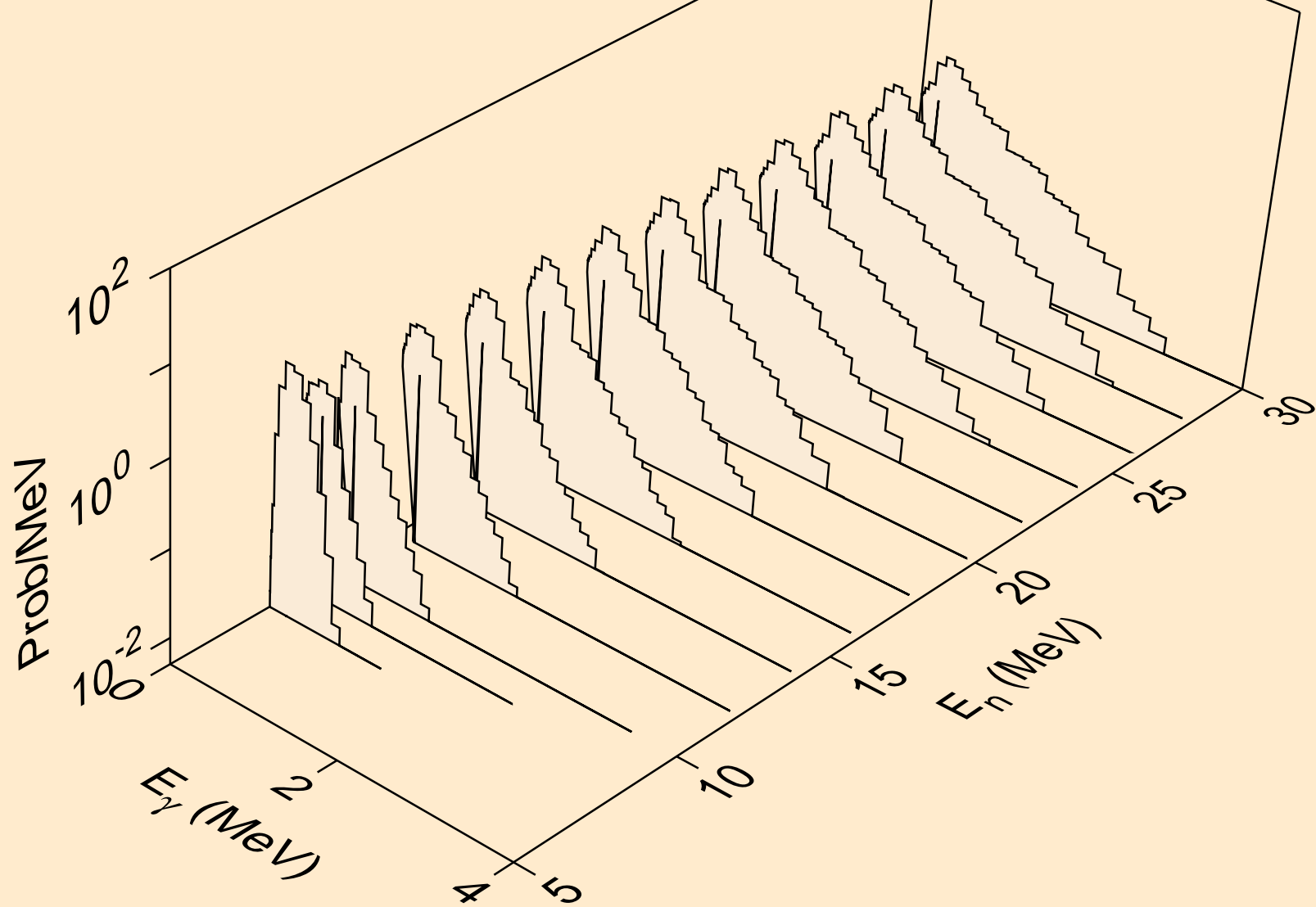

PM127 HELION ACER TENDL-2021 LIBRARY; T=0.K  
Photon emission for (n,pt)

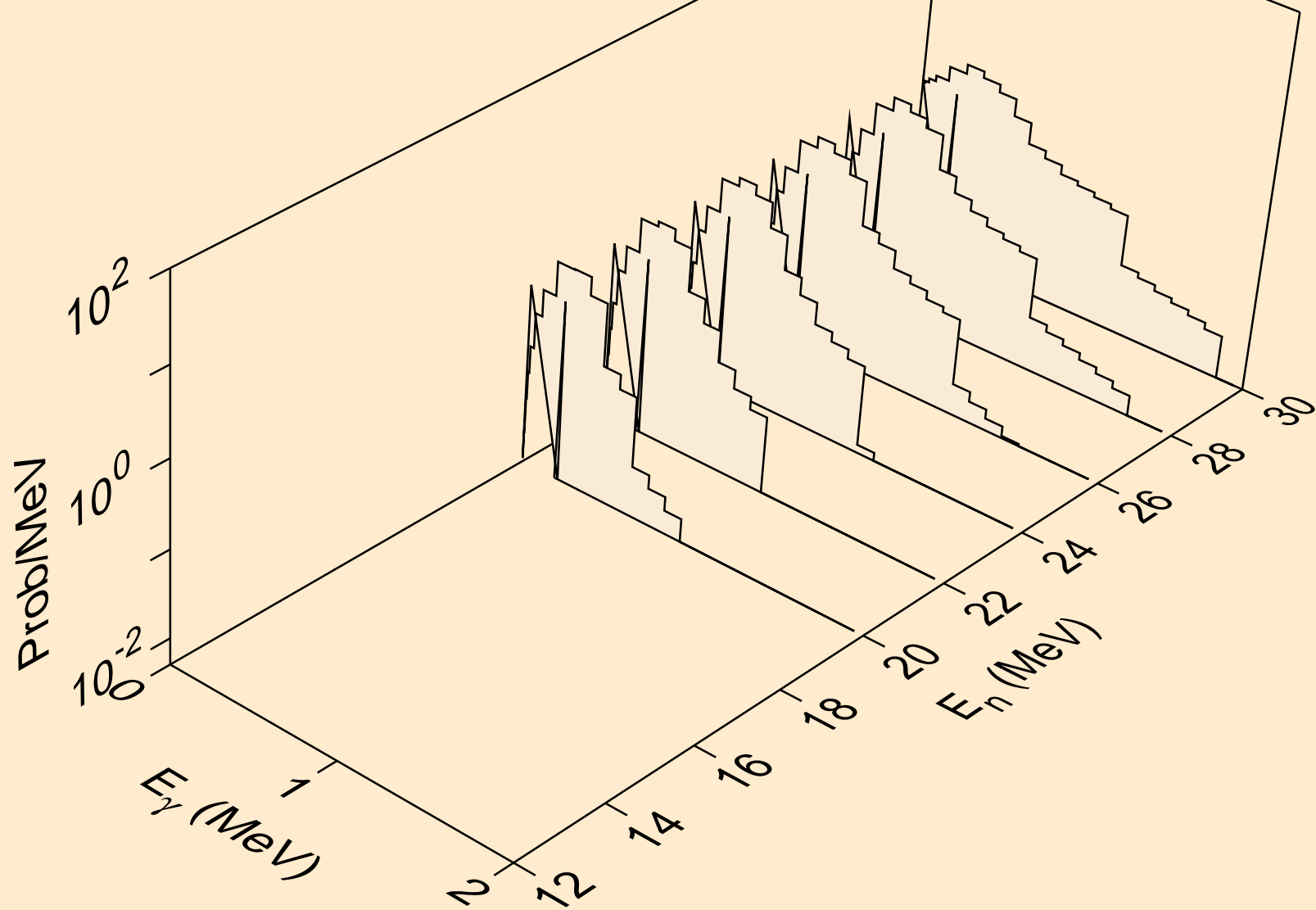

PM127 HELION ACER TENDL-2021 LIBRARY; T=0.K  
Photon emission for (n,da)

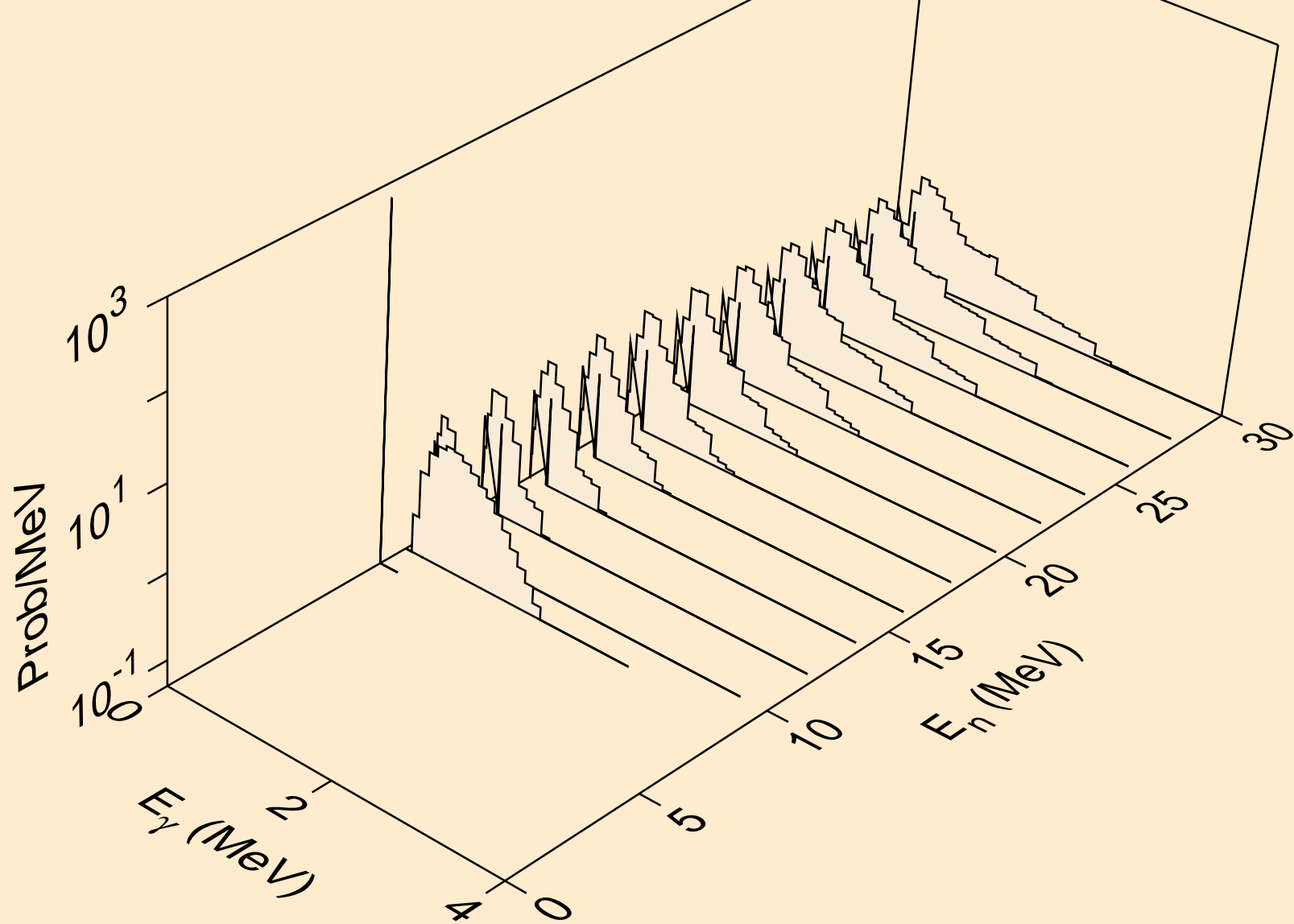

# PM127 HELION ACER TENDL-2021 LIBRARY; T=0.K

## Particle heating contributions

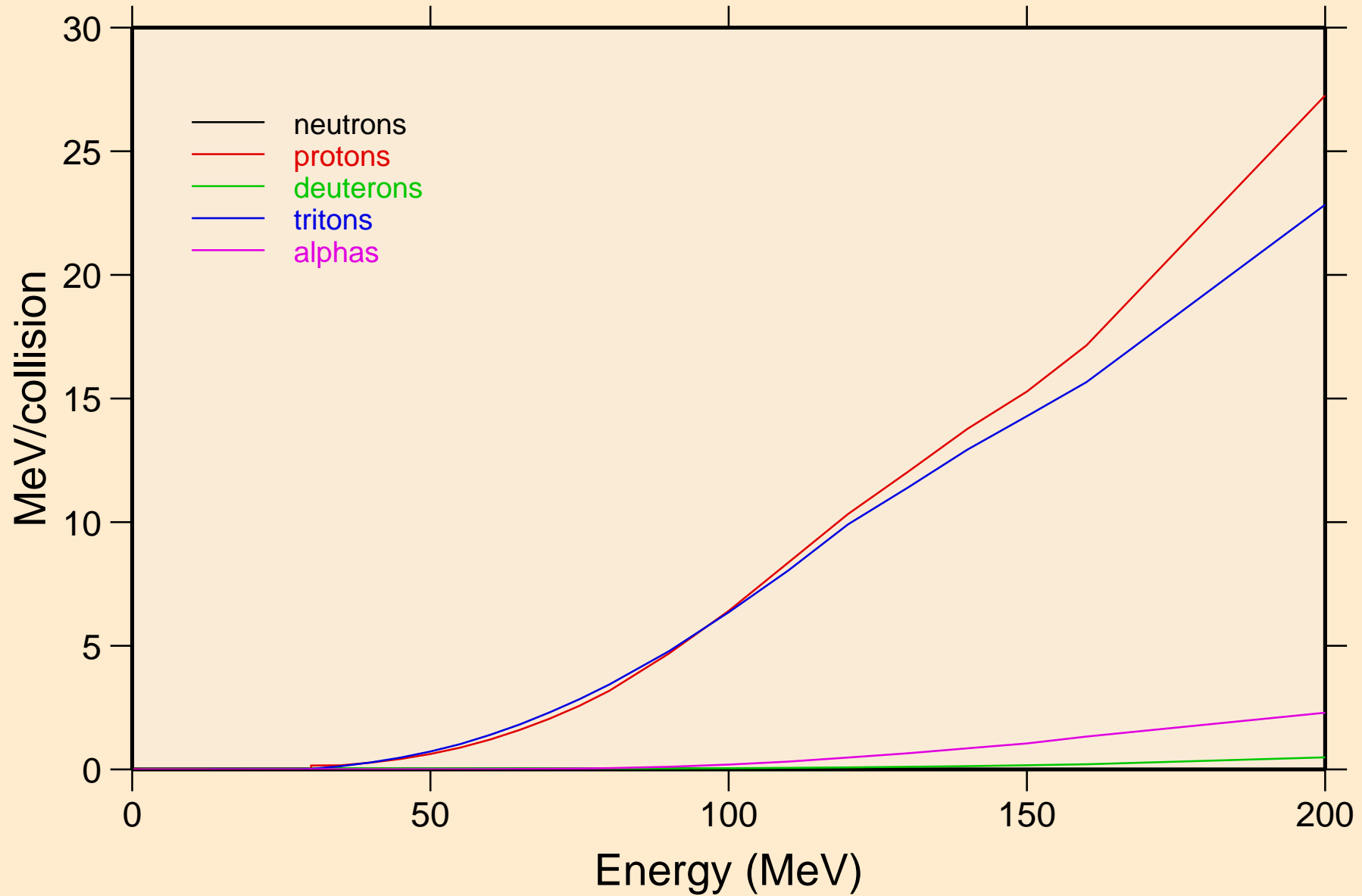

PM127 HELION ACER TENDL-2021 LIBRARY; T=0.K  
Recoil Heating

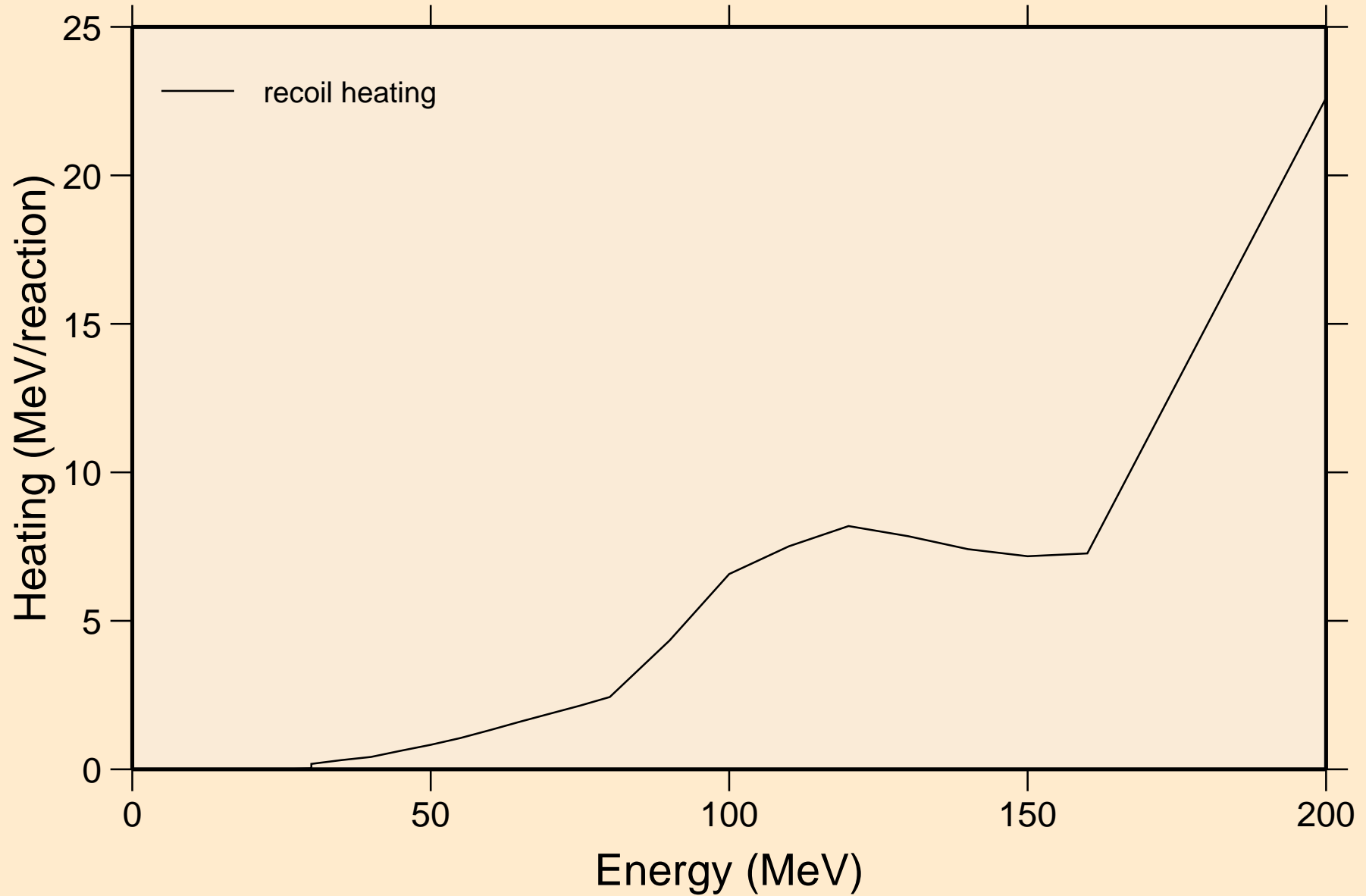

PM127 HELION ACER TENDL-2021 LIBRARY; T=0.K  
Particle production cross sections

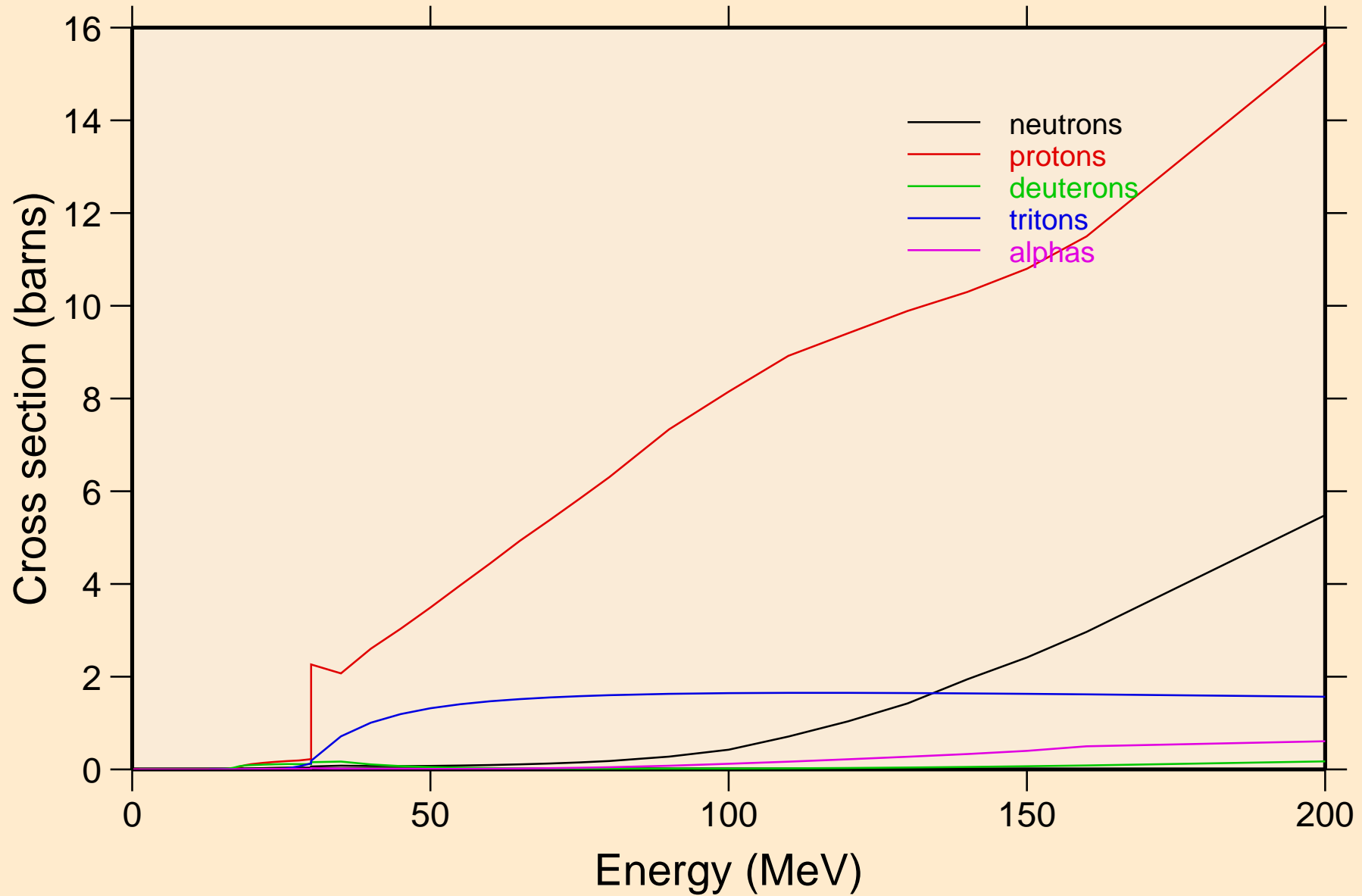

PM127 HELION ACER TENDL-2021 LIBRARY; T=0.K  
neutrons from (s,n)

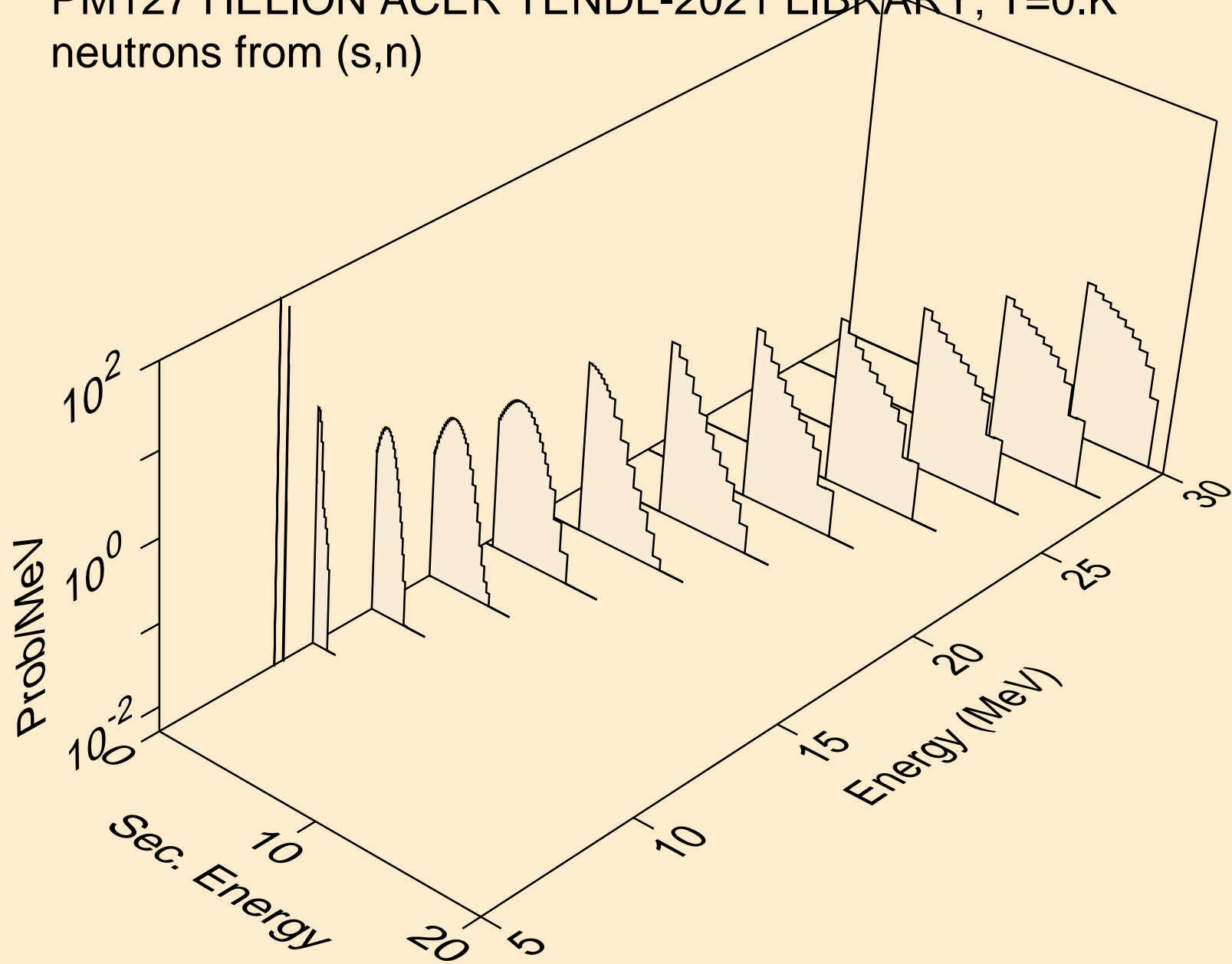

PM127 HELION ACER TENDL-2021 LIBRARY; T=0.K  
neutrons from (s,x)

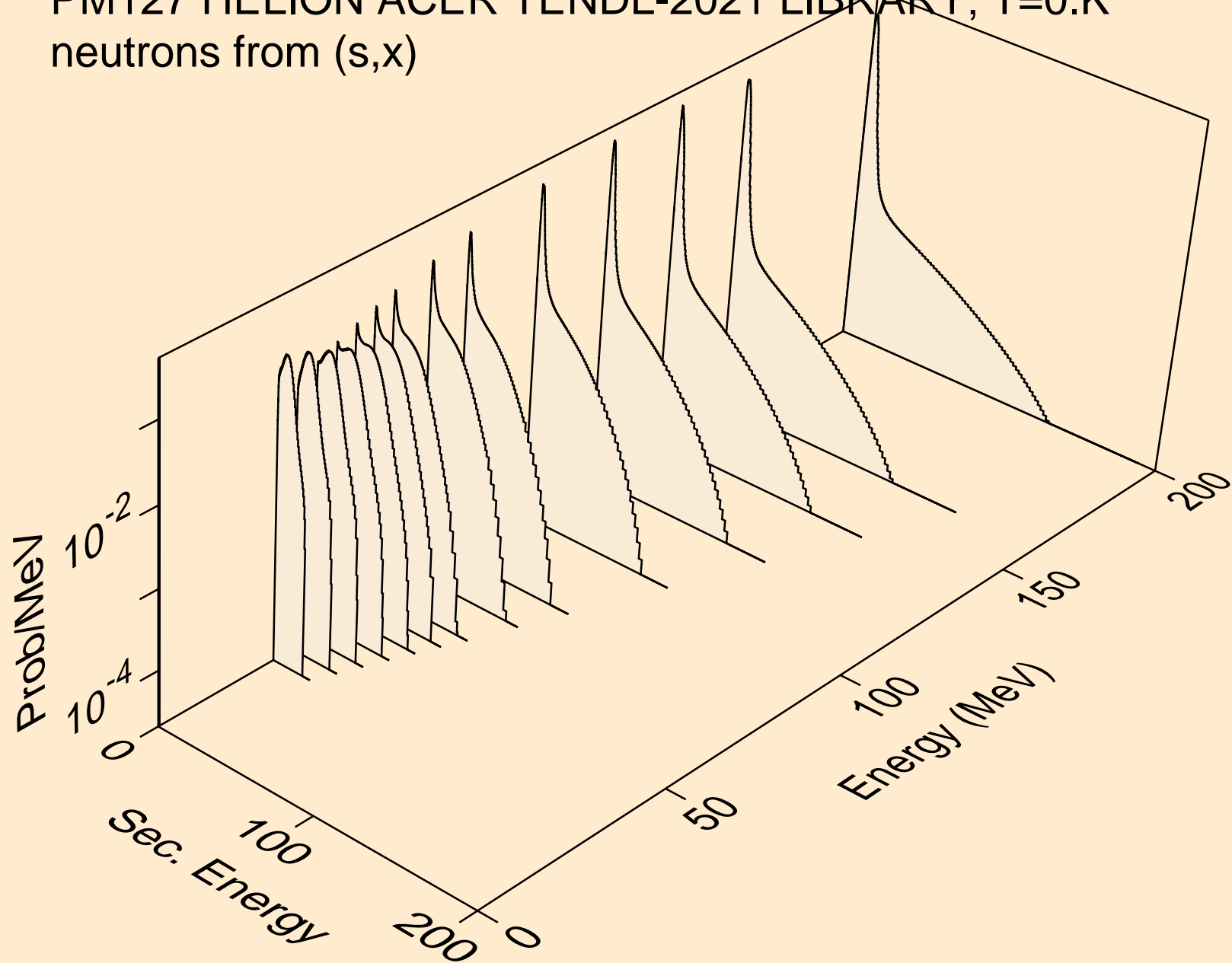



PM127 HELION ACER TENDL-2021 LIBRARY; T=0.K  
neutrons from (s,2n)

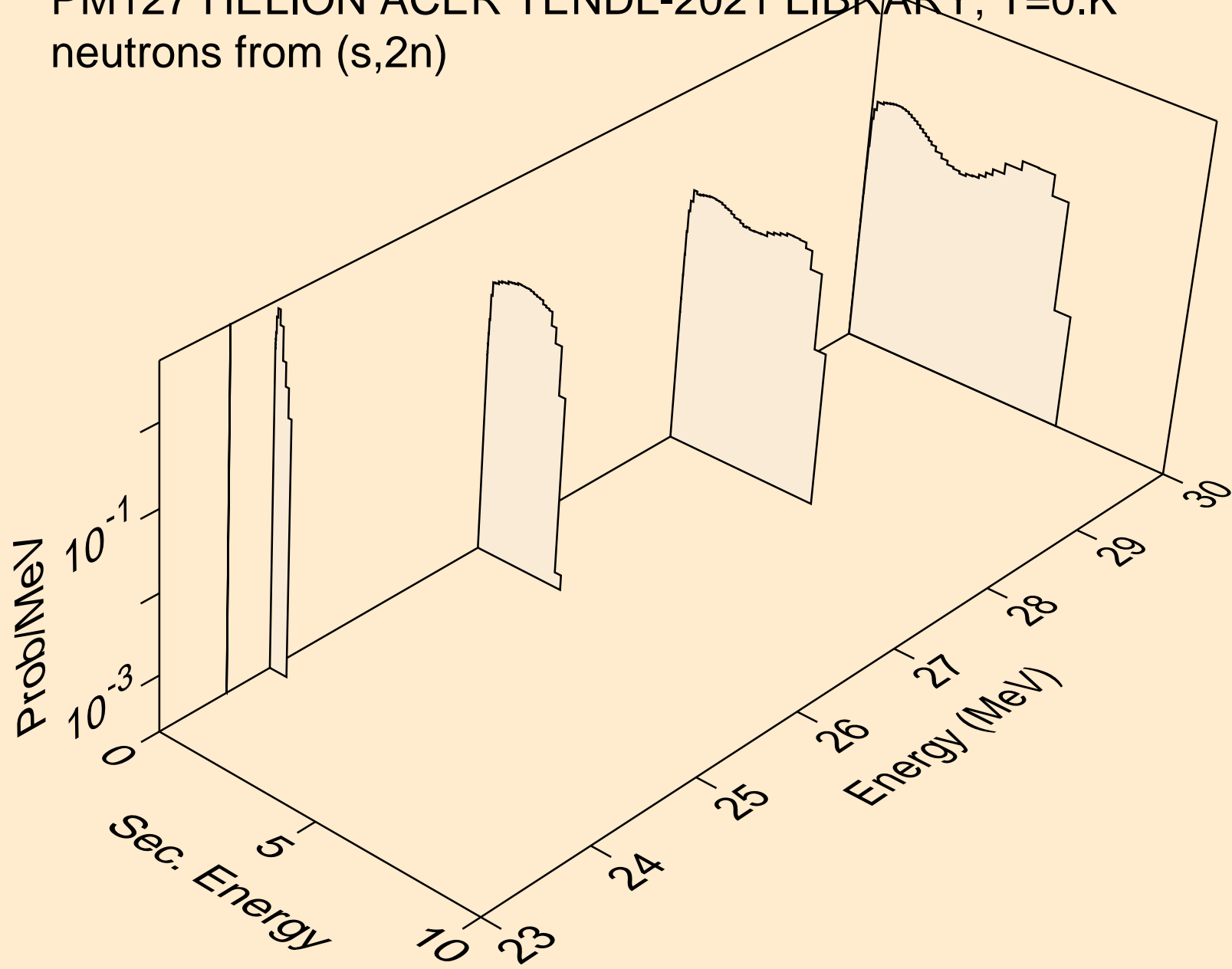

PM127 HELION ACER TENDL-2021 LIBRARY; T=0.K  
neutrons from (s,n\*)a

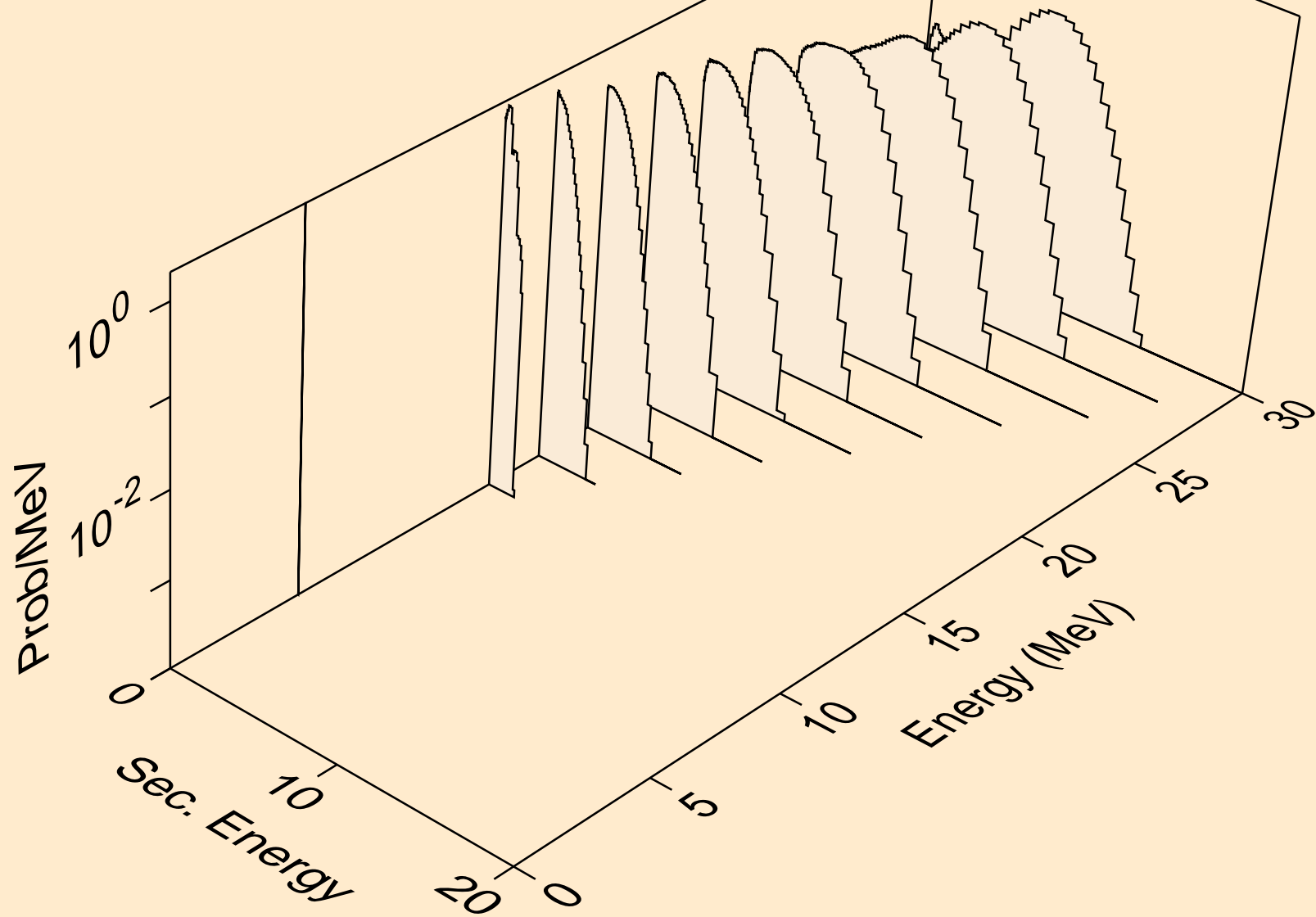

PM127 HELION ACER TENDL-2021 LIBRARY; T=0.K  
neutrons from (s,n\*)p

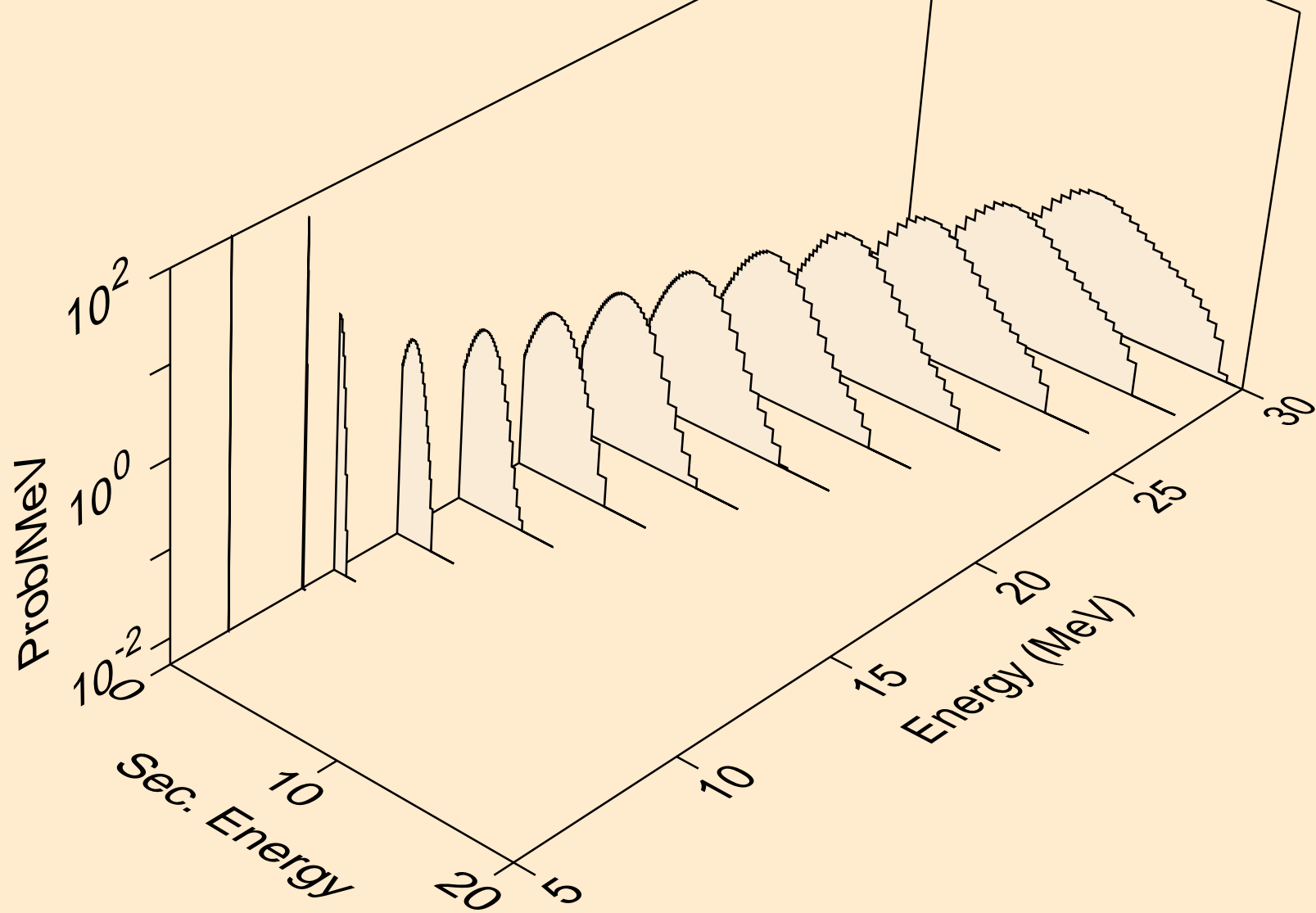

PM127 HELION ACER TENDL-2021 LIBRARY; T=0.K  
neutrons from (s,n\*)d

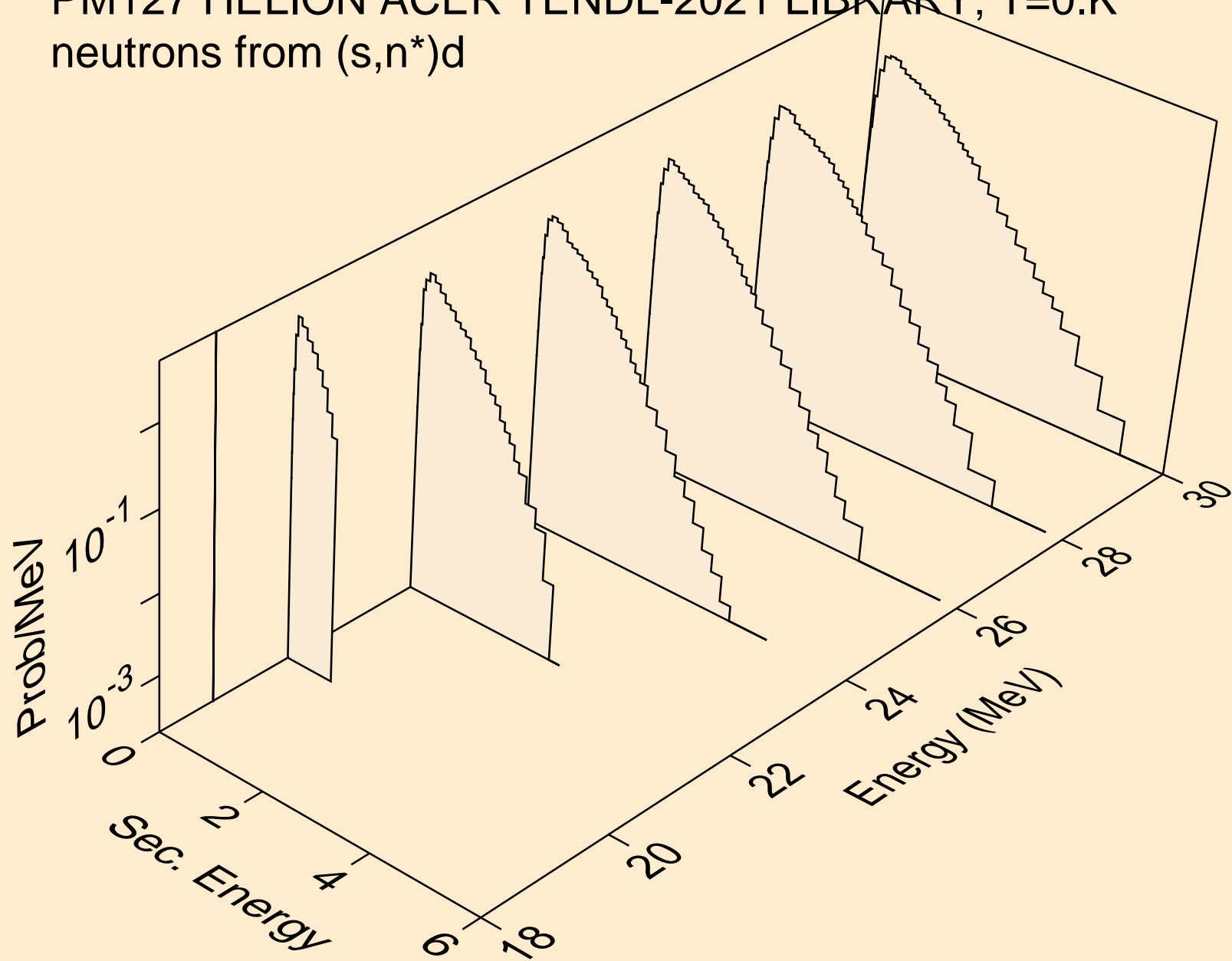

PM127 HELION ACER TENDL-2021 LIBRARY; T=0.K  
neutrons from (s,n\*)he3

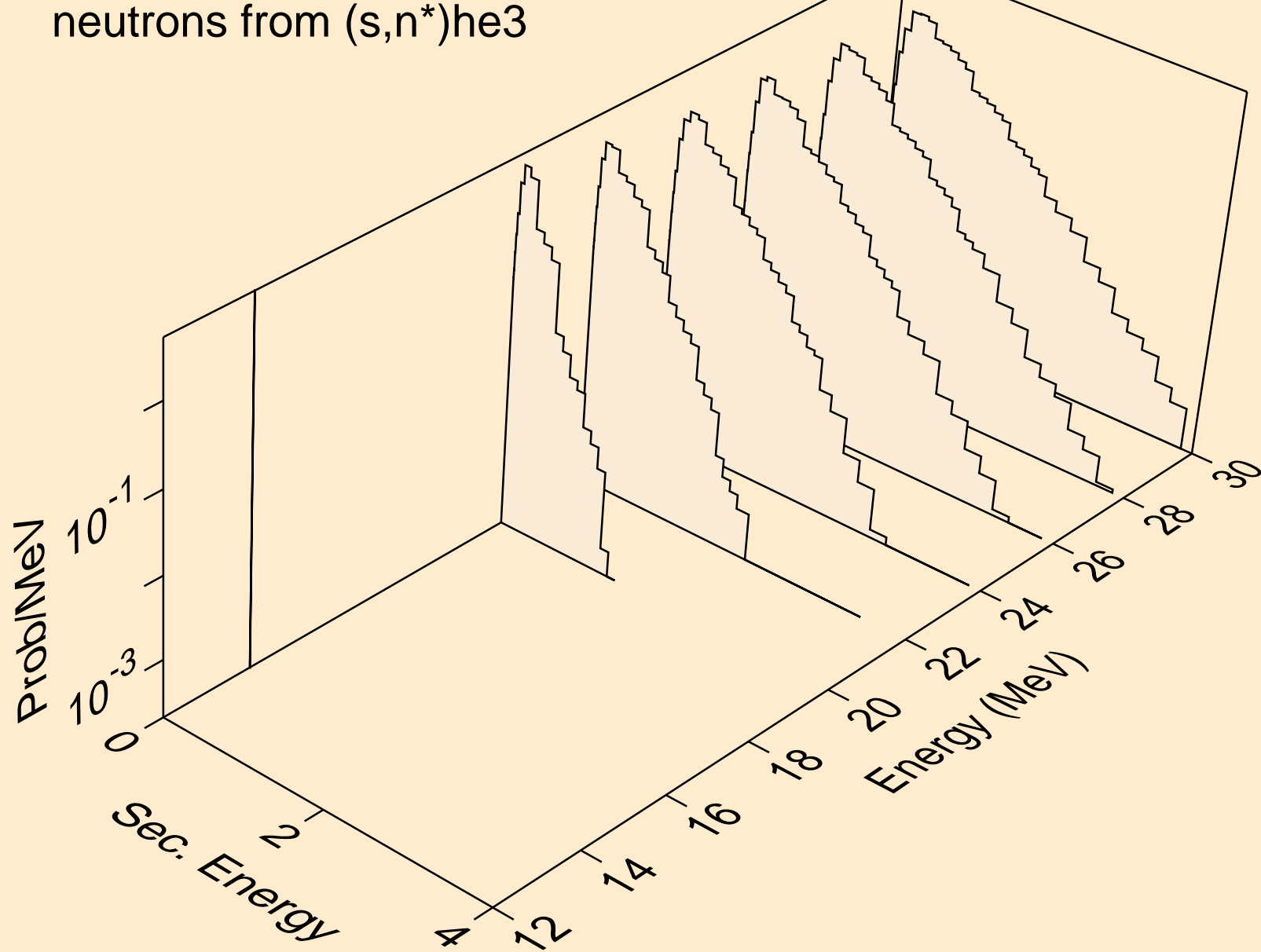

PM127 HELION ACER TENDL-2021 LIBRARY; T=0.K  
neutrons from (s,2np)

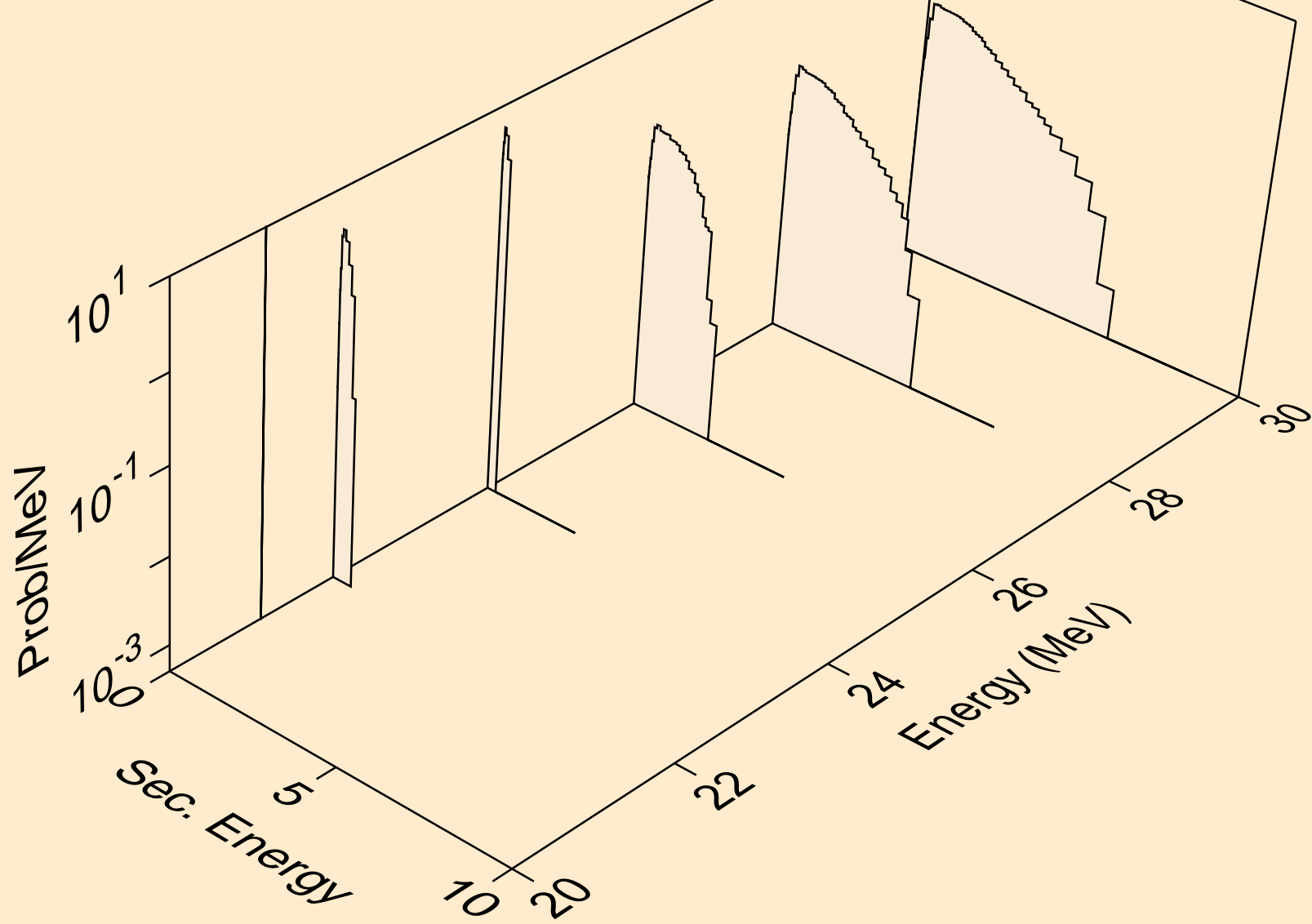

PM127 HELION ACER TENDL-2021 LIBRARY; T=0.K  
neutrons from (s,2np)

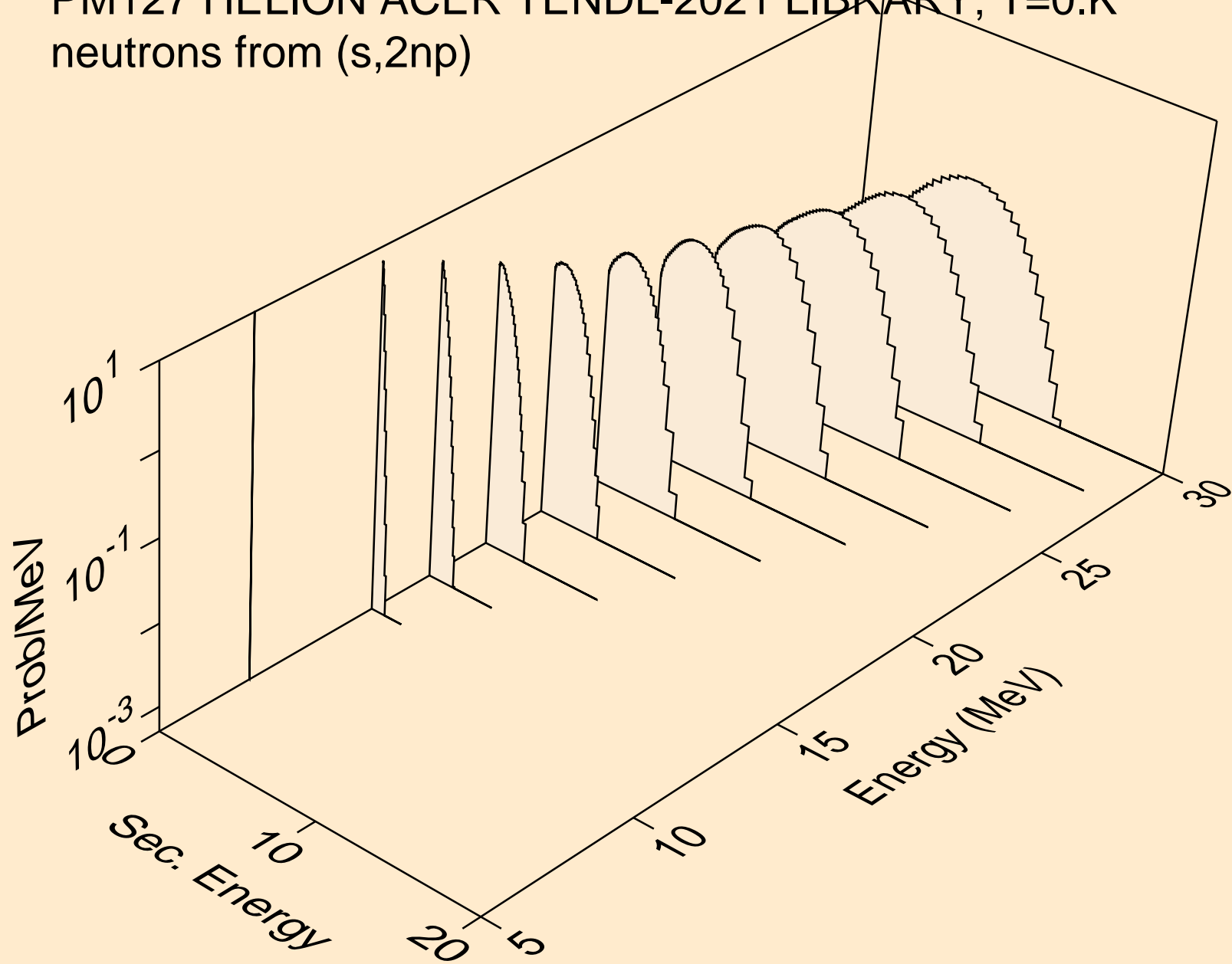

PM127 HELION ACER TENDL-2021 LIBRARY; T=0.K  
neutrons from (s,npa)

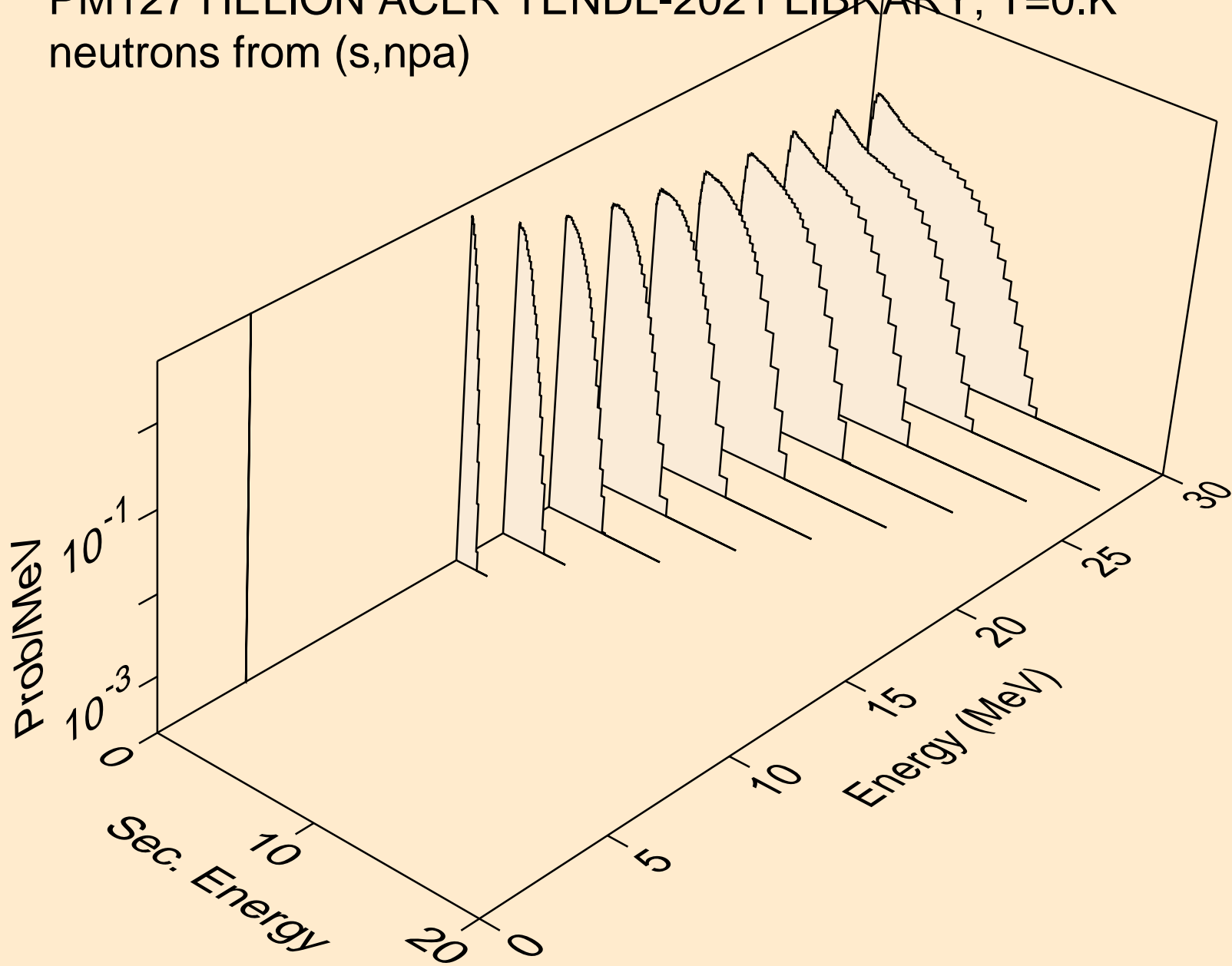



PM127 HELION ACER TENDL-2021 LIBRARY; T=0.K  
protons from (s,x)

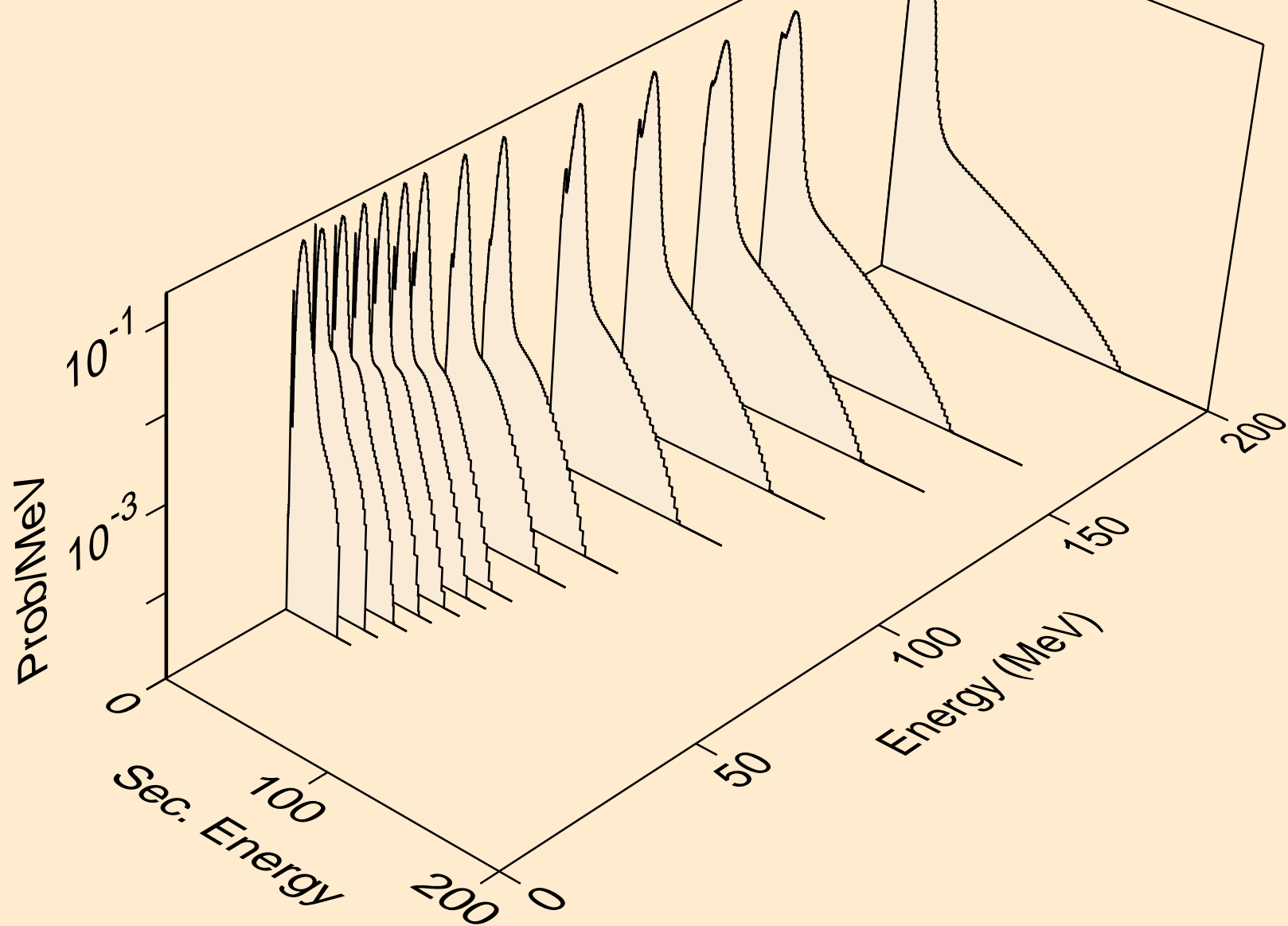

PM127 HELION ACER TENDL-2021 LIBRARY; T=0.K  
protons from (s,n\*)p

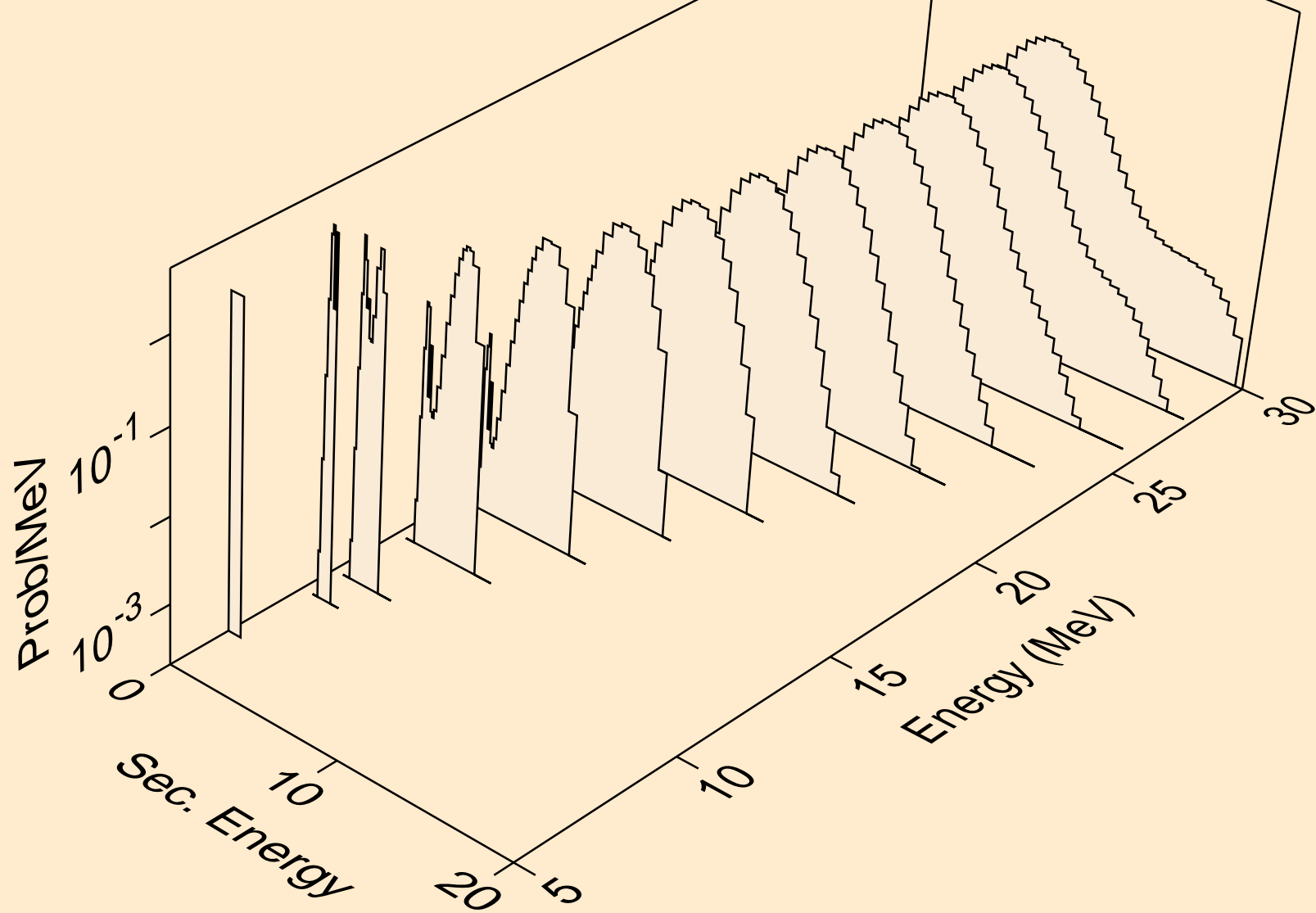

PM127 HELION ACER TENDL-2021 LIBRARY; T=0.K  
protons from (s,2np)

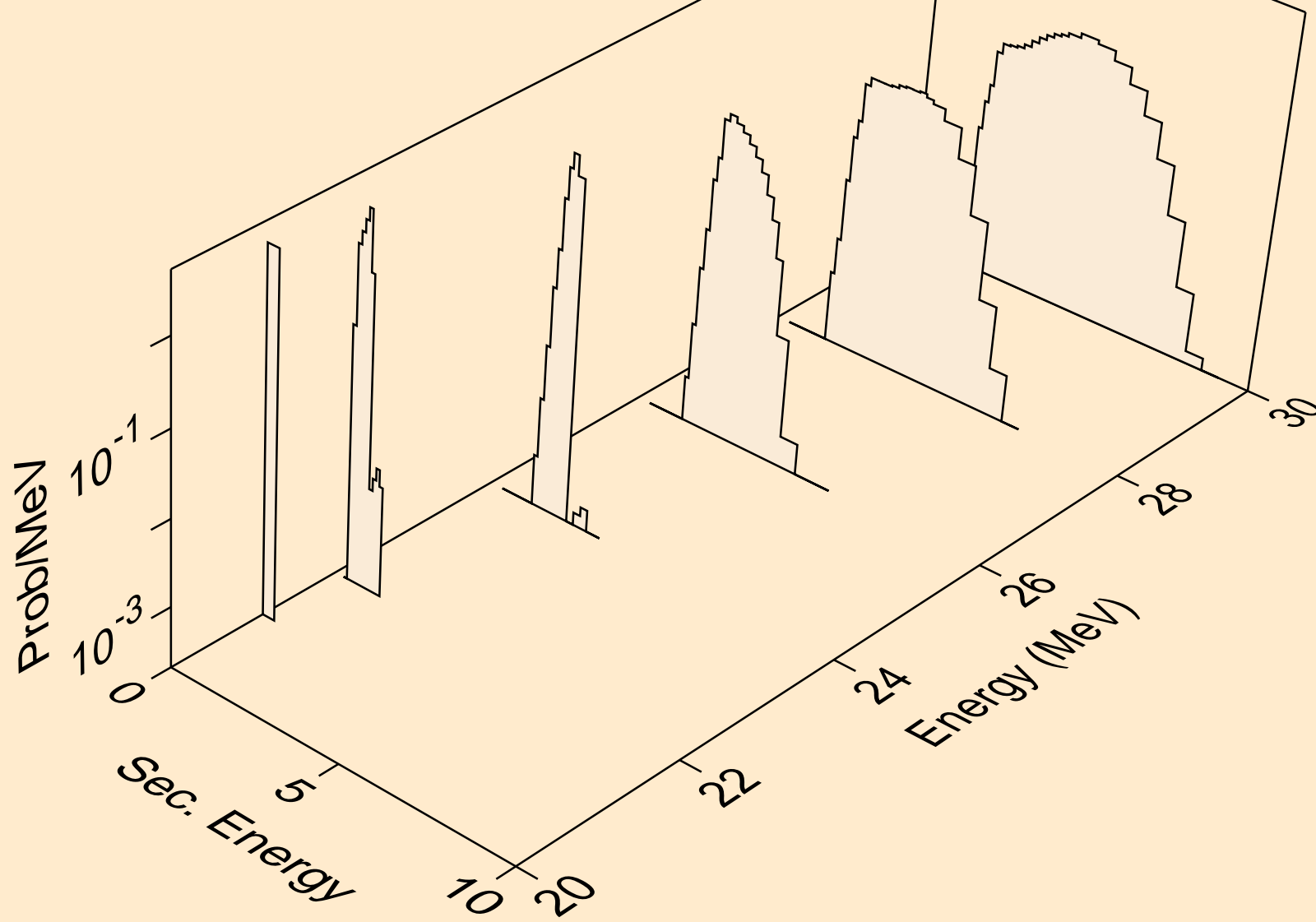

PM127 HELION ACER TENDL-2021 LIBRARY; T=0.K  
protons from (s,2np)

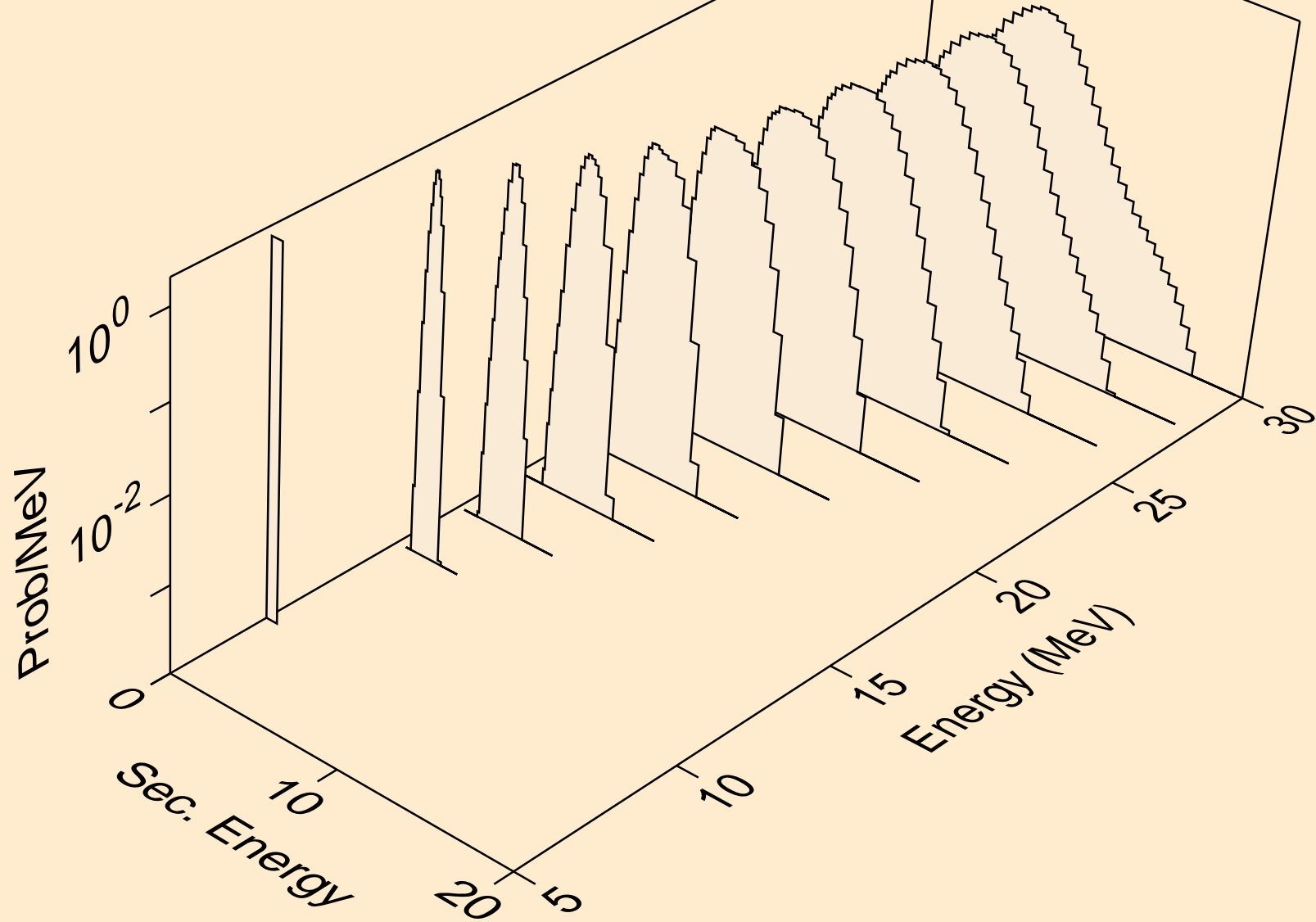

PM127 HELION ACER TENDL-2021 LIBRARY; T=0.K  
protons from (s,npa)

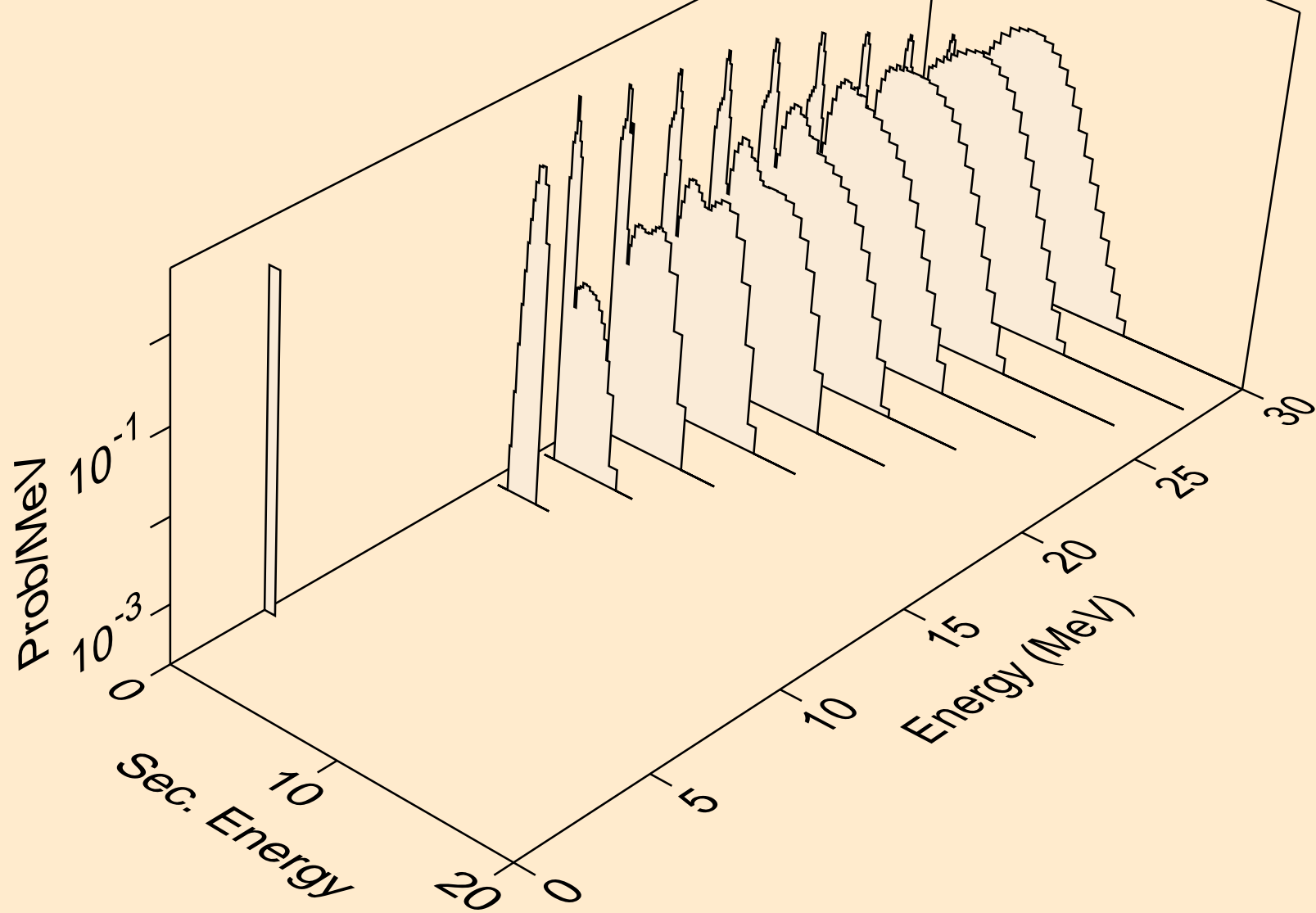

PM127 HELION ACER TENDL-2021 LIBRARY; T=0.K  
protons from (s,p)

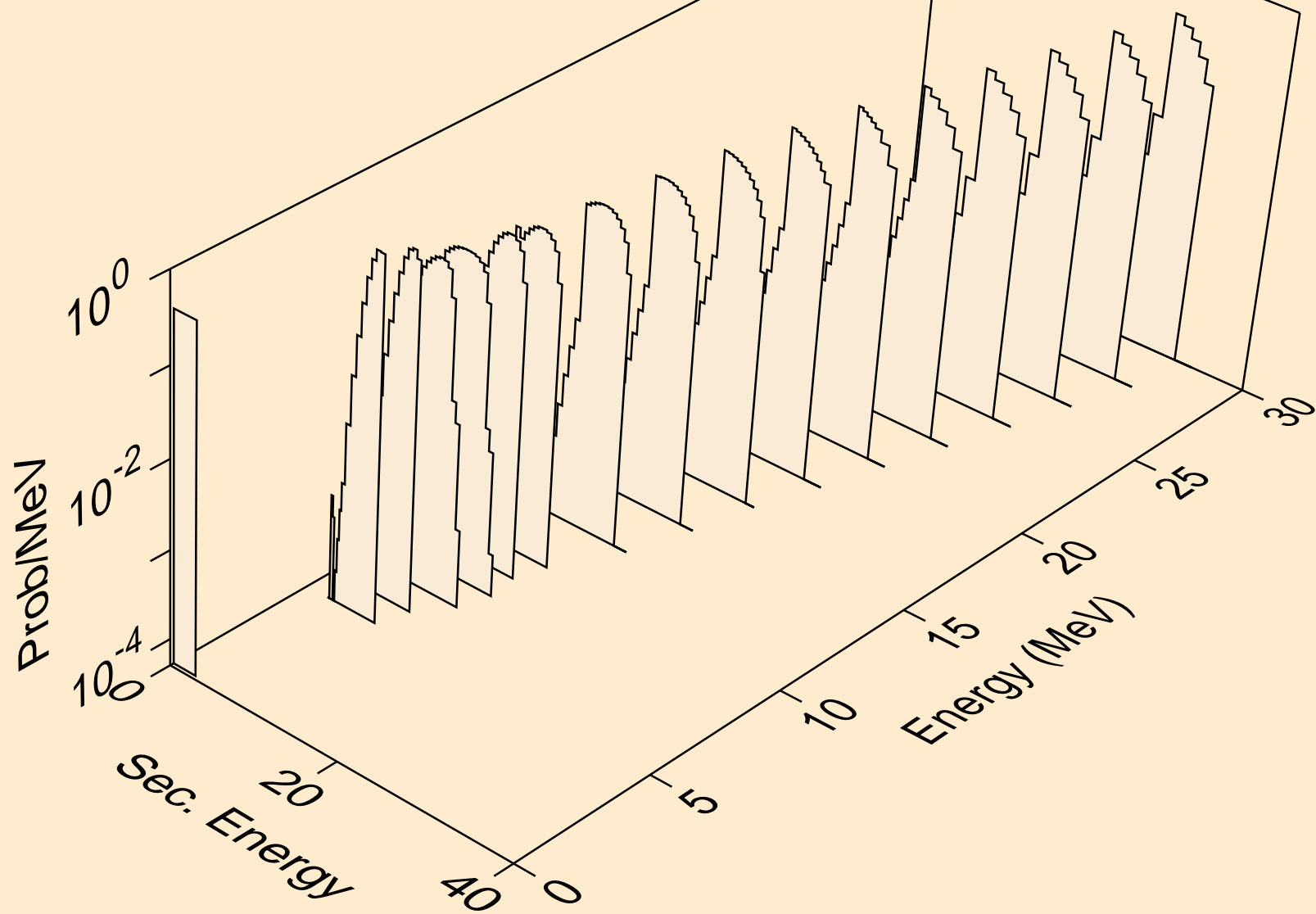

PM127 HELION ACER TENDL-2021 LIBRARY; T=0.K  
protons from (s,2p)

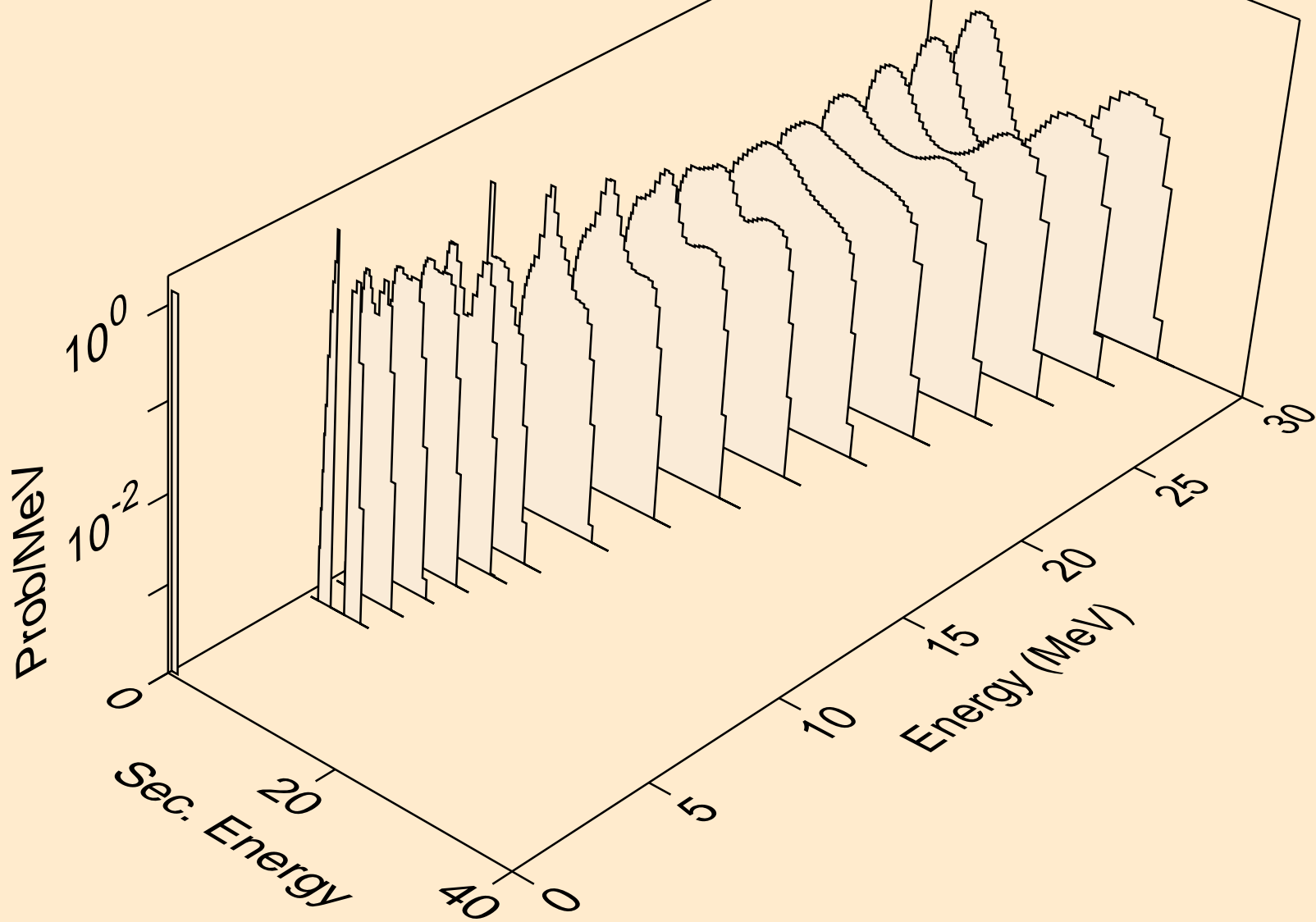

PM127 HELION ACER TENDL-2021 LIBRARY; T=0.K  
protons from (s,pa)

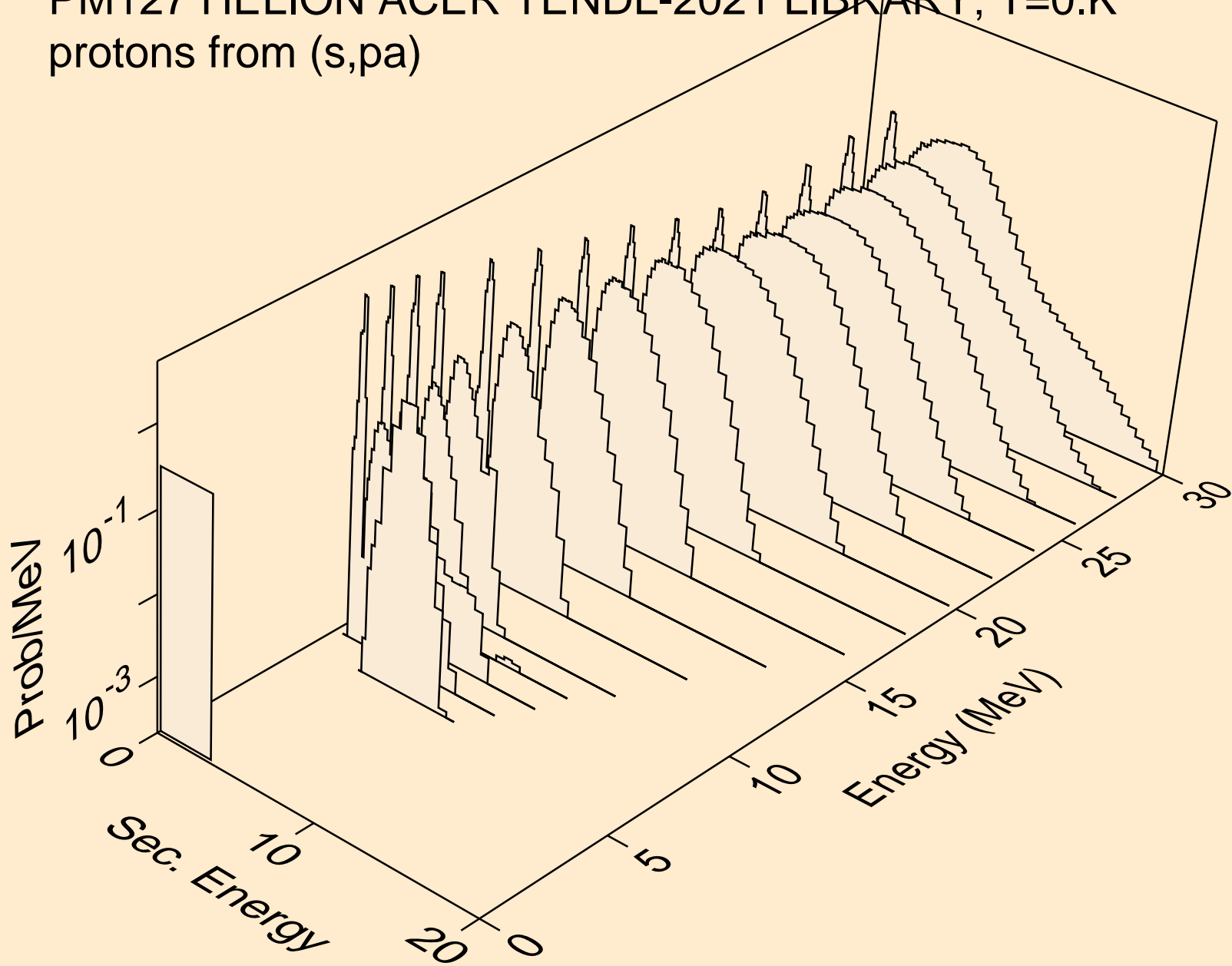



PM127 HELION ACER TENDL-2021 LIBRARY; T=0.K  
protons from (s,pd)

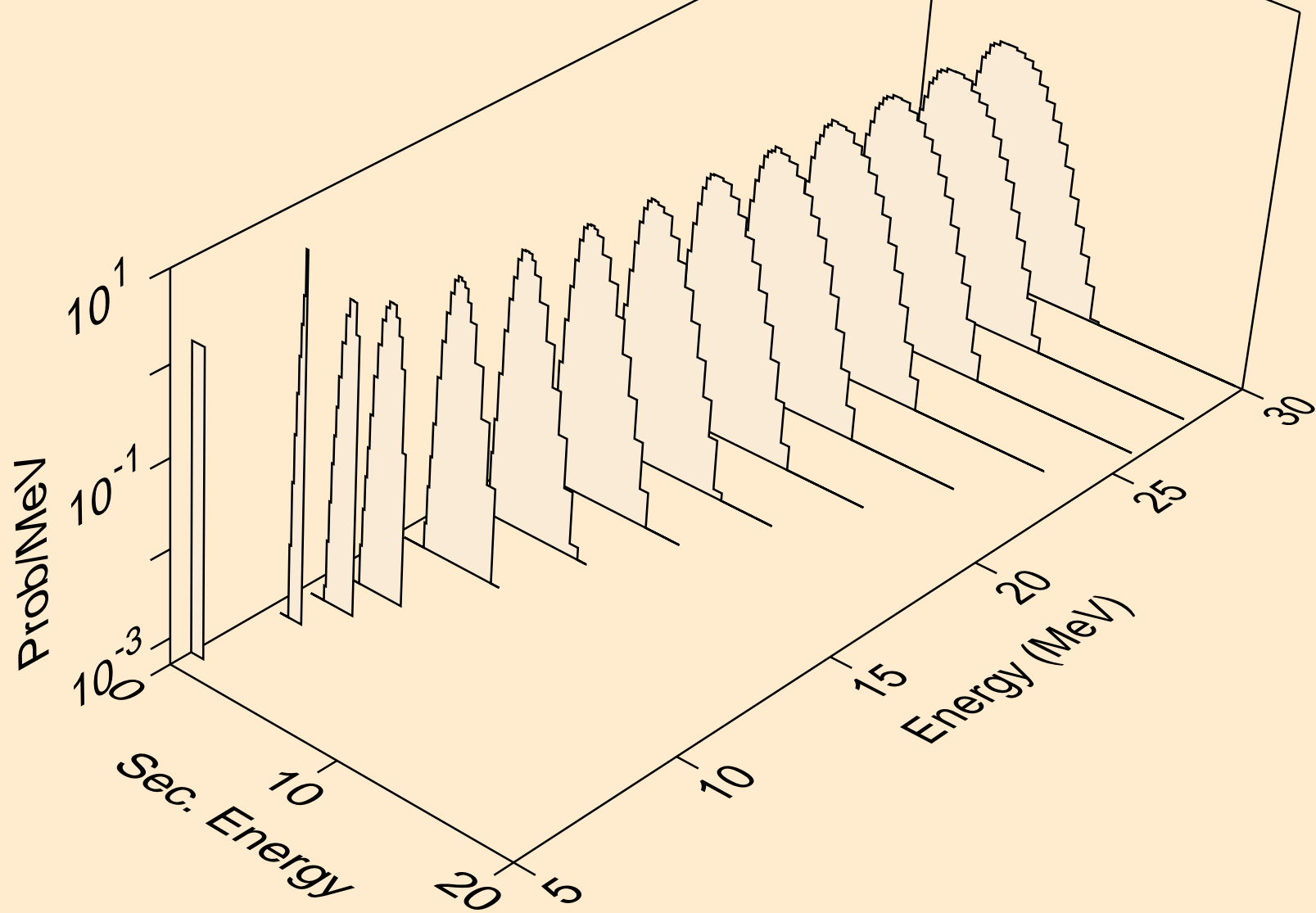

PM127 HELION ACER TENDL-2021 LIBRARY; T=0.K  
protons from (s,pt)

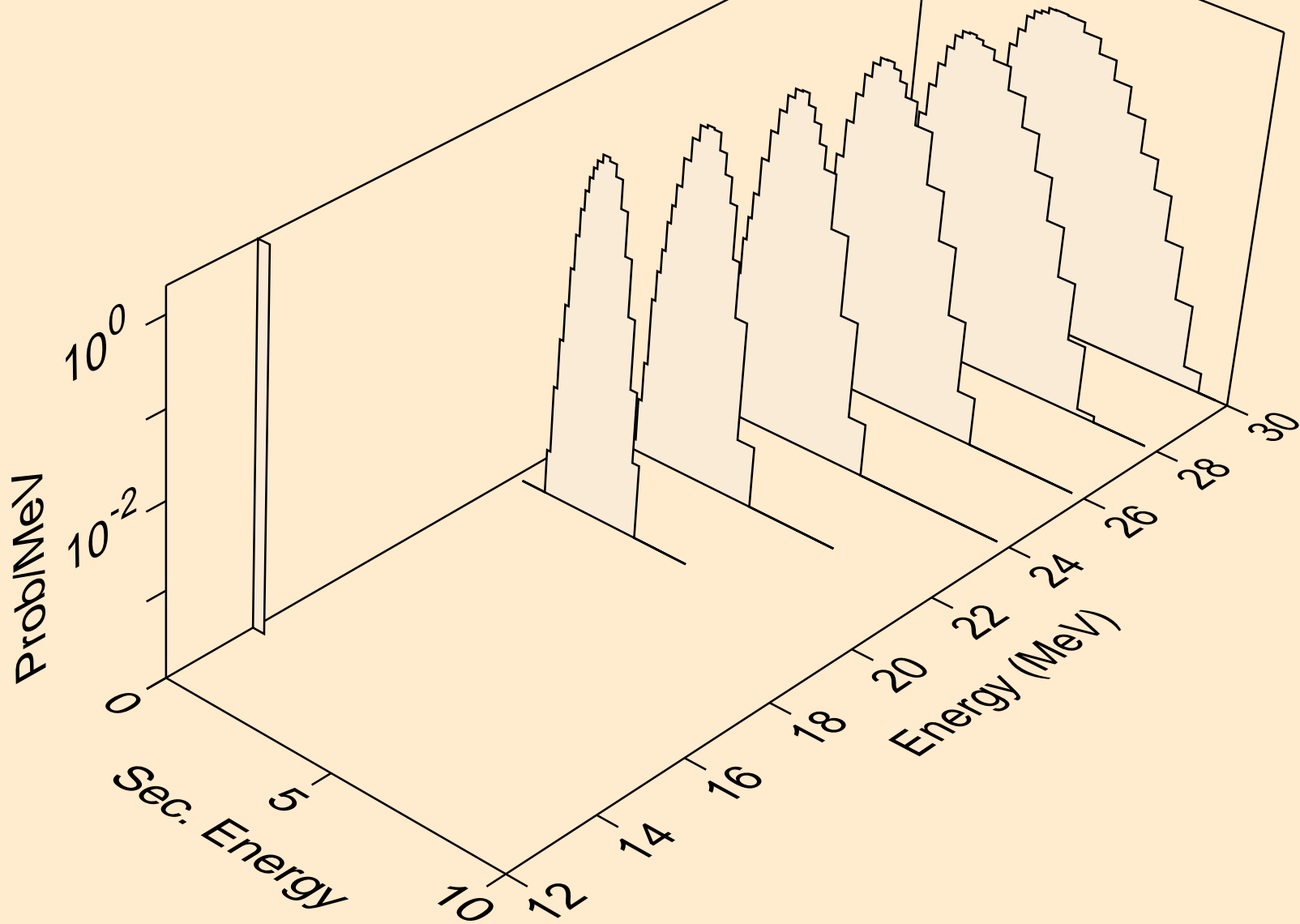

PM127 HELION ACER TENDL-2021 LIBRARY; T=0.K  
deuterons from (s,x)

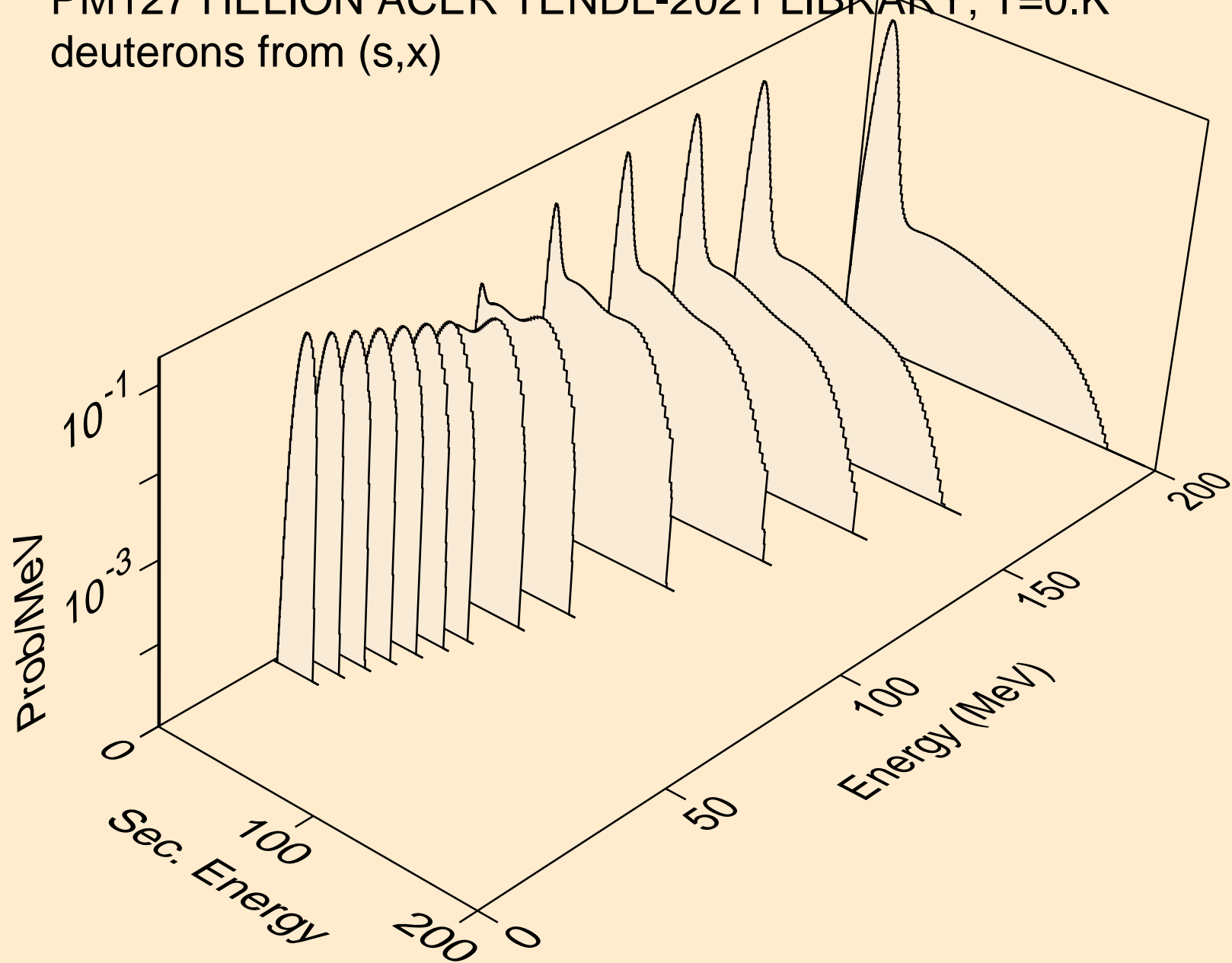

PM127 HELION ACER TENDL-2021 LIBRARY; T=0.K  
deuterons from (s,n\*)d

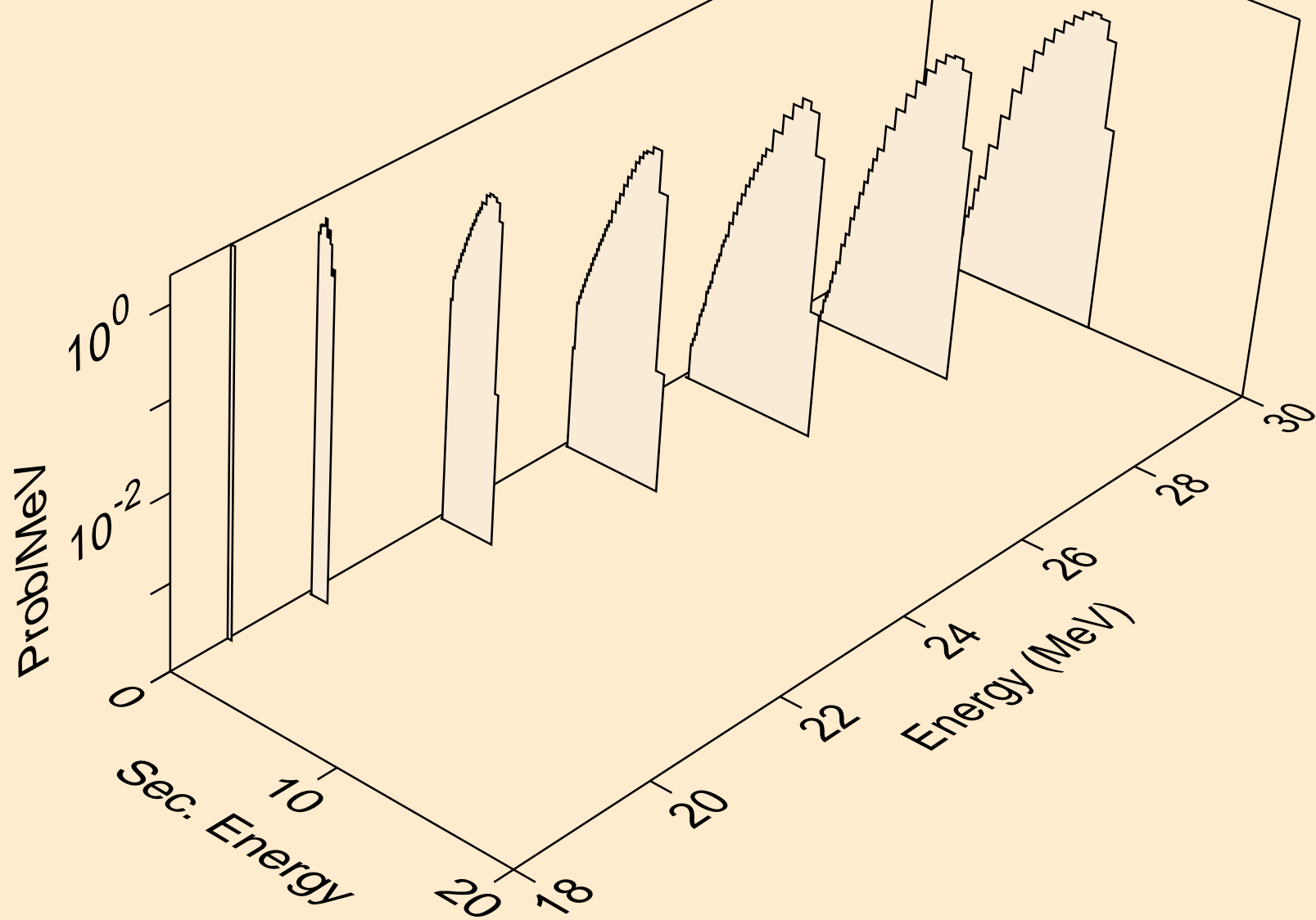

PM127 HELION ACER TENDL-2021 LIBRARY; T=0.K  
deuterons from (s,d)

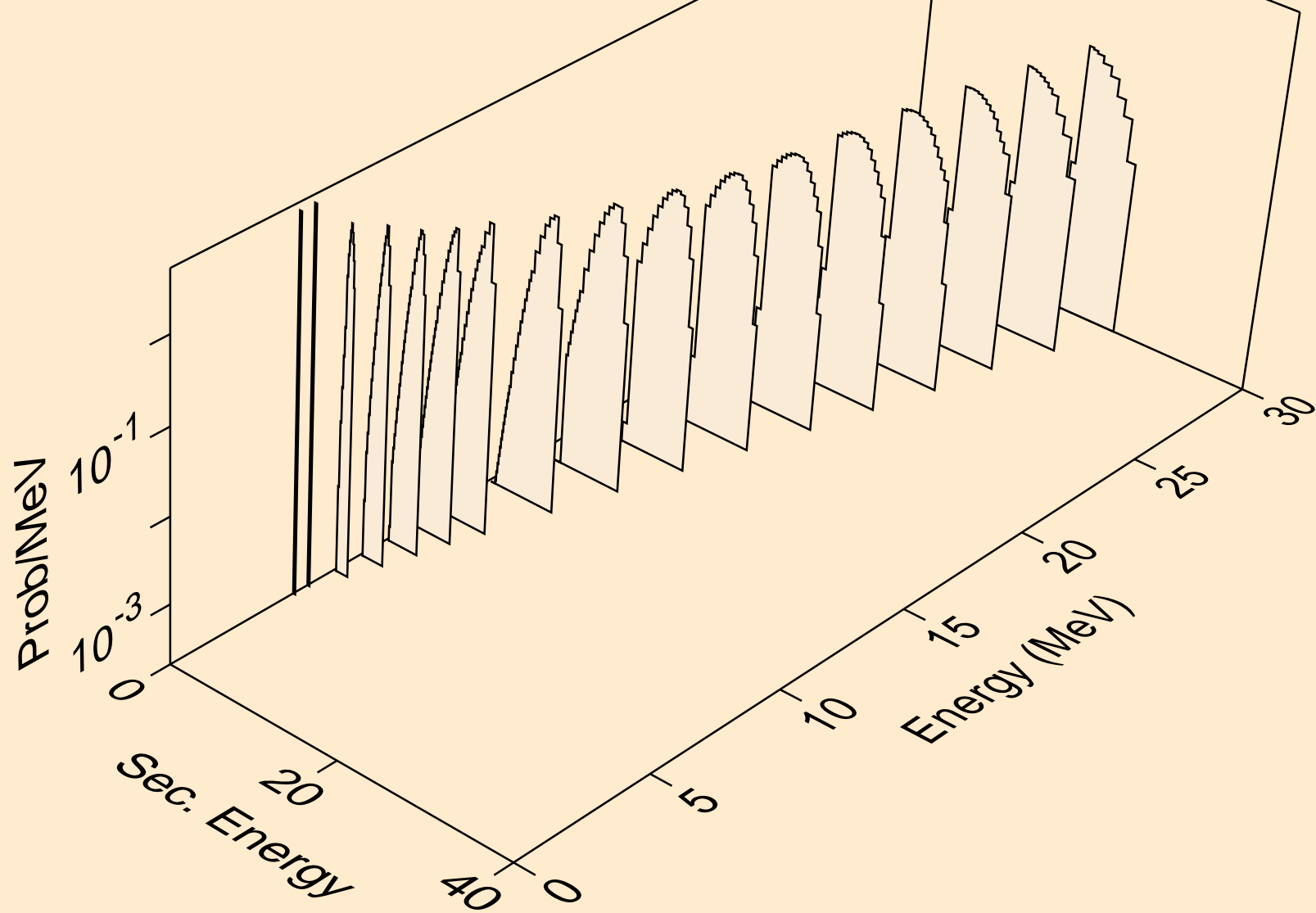

PM127 HELION ACER TENDL-2021 LIBRARY; T=0.K  
deuterons from (s,pd)

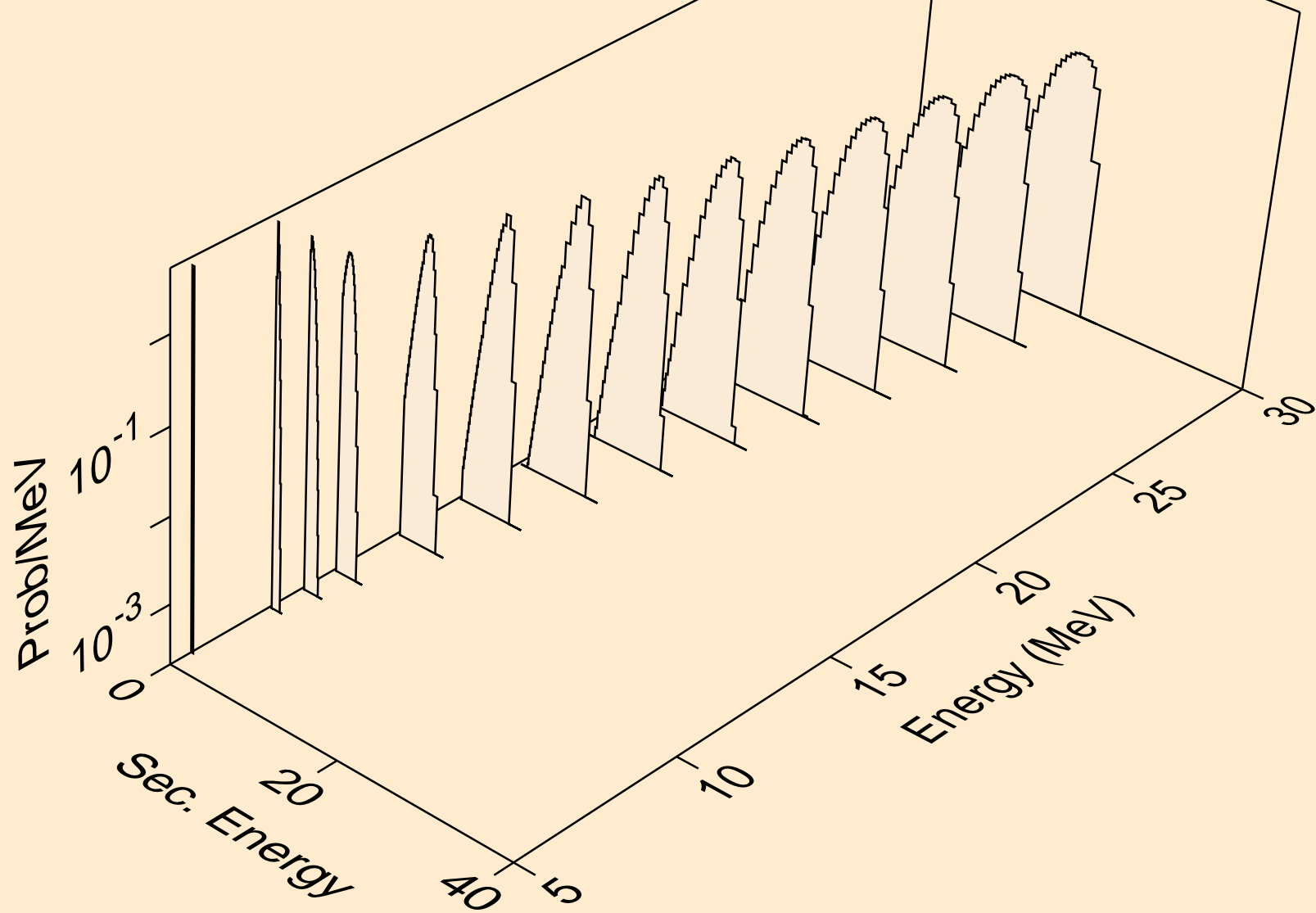

PM127 HELION ACER TENDL-2021 LIBRARY; T=0.K  
deuterons from (s,da)

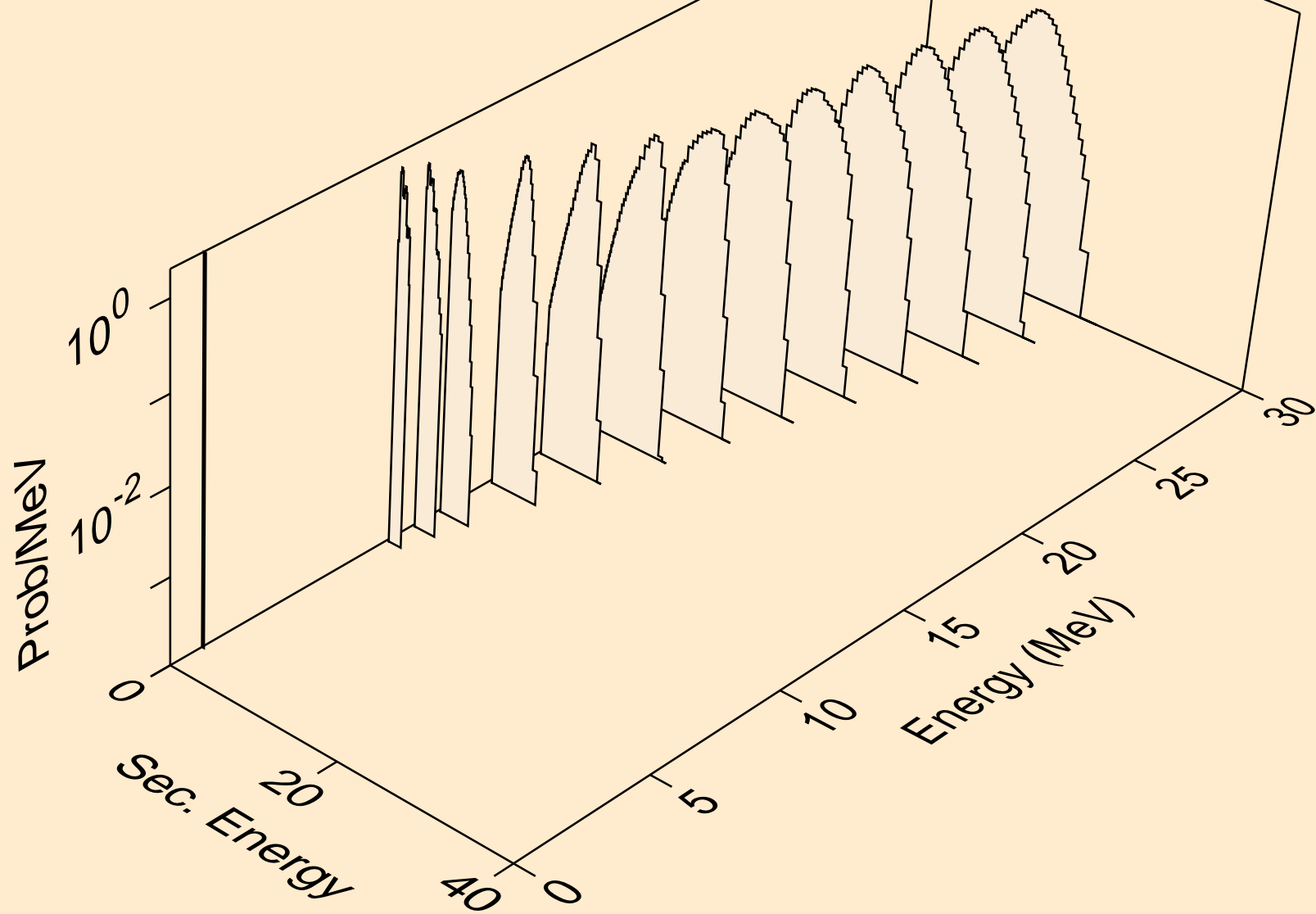

PM127 HELION ACER TENDL-2021 LIBRARY; T=0.K  
tritons from (s,x)

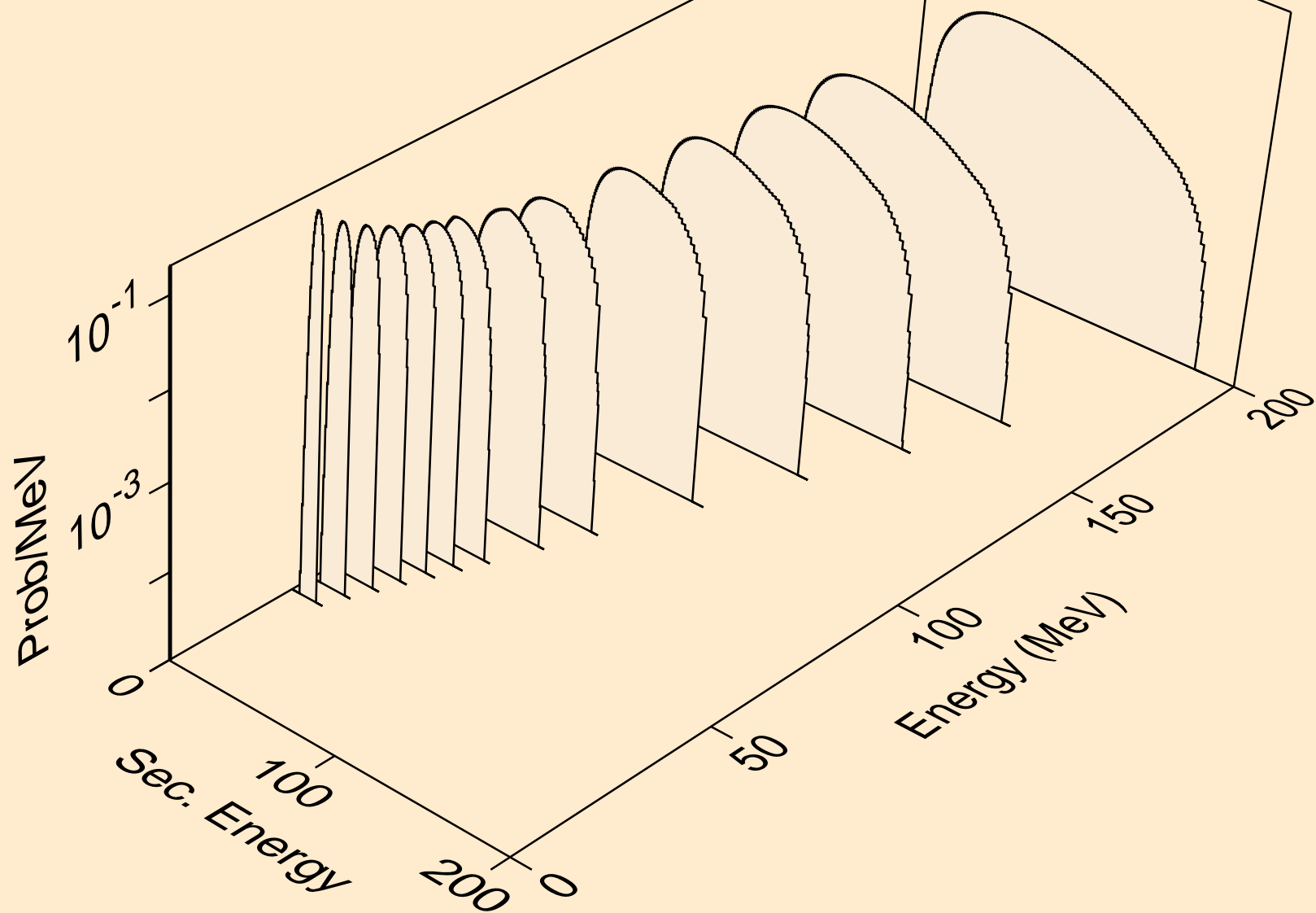



PM127 HELION ACER TENDL-2021 LIBRARY; T=0.K  
tritons from (s,t)

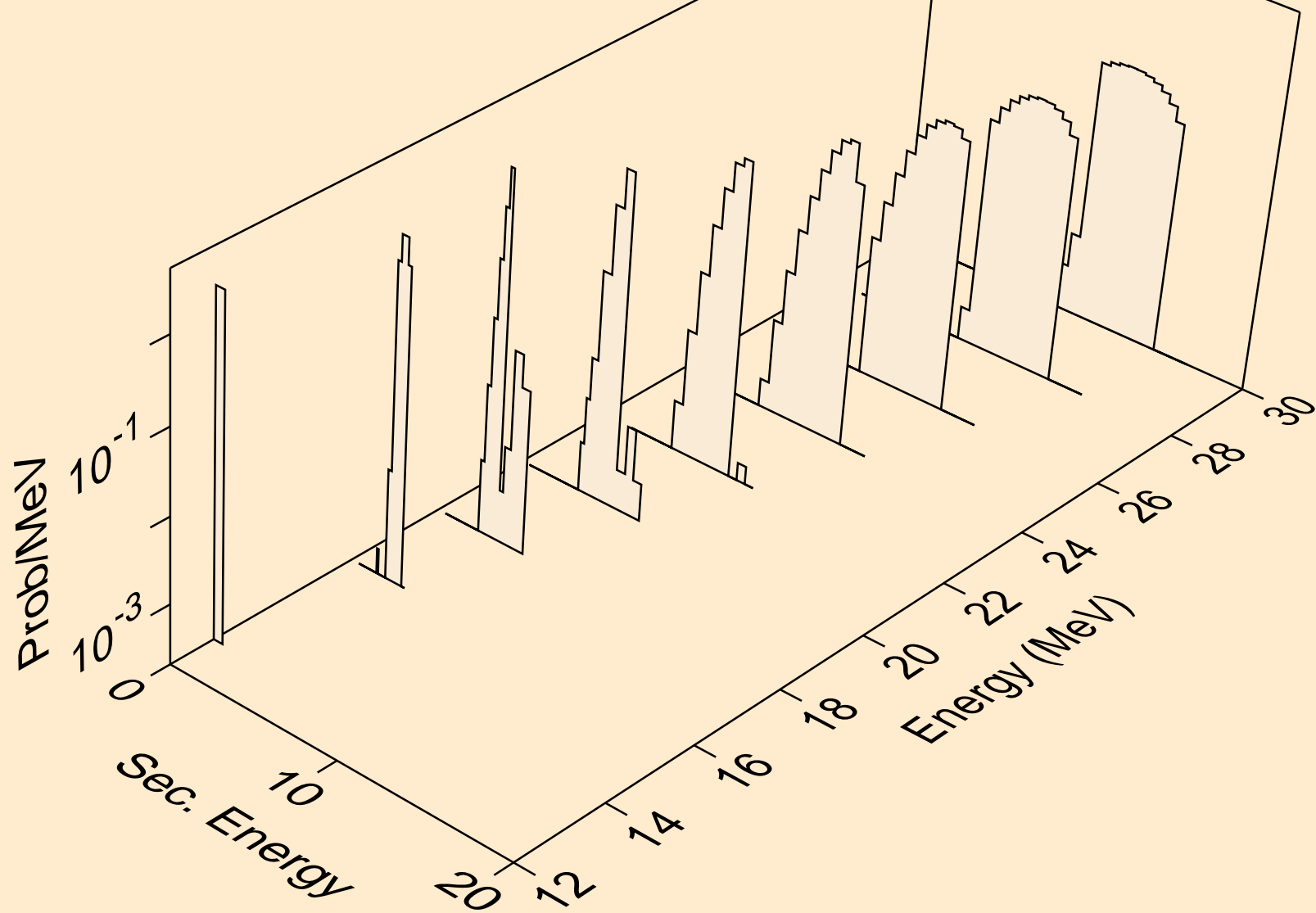

PM127 HELION ACER TENDL-2021 LIBRARY; T=0.K  
tritons from (s,pt)

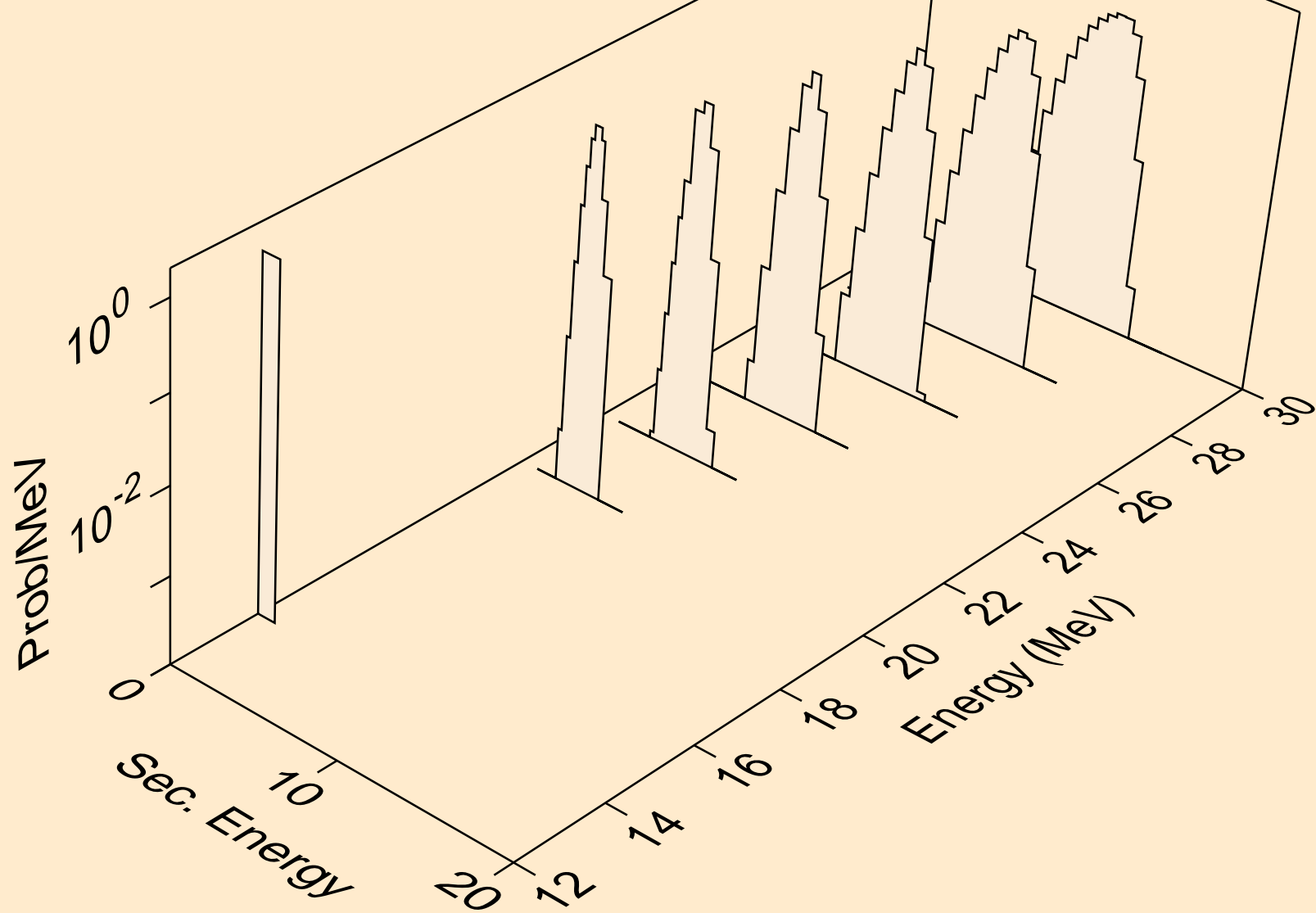

PM127 HELION ACER TENDL-2021 LIBRARY; T=0.K  
alphas from (s,x)

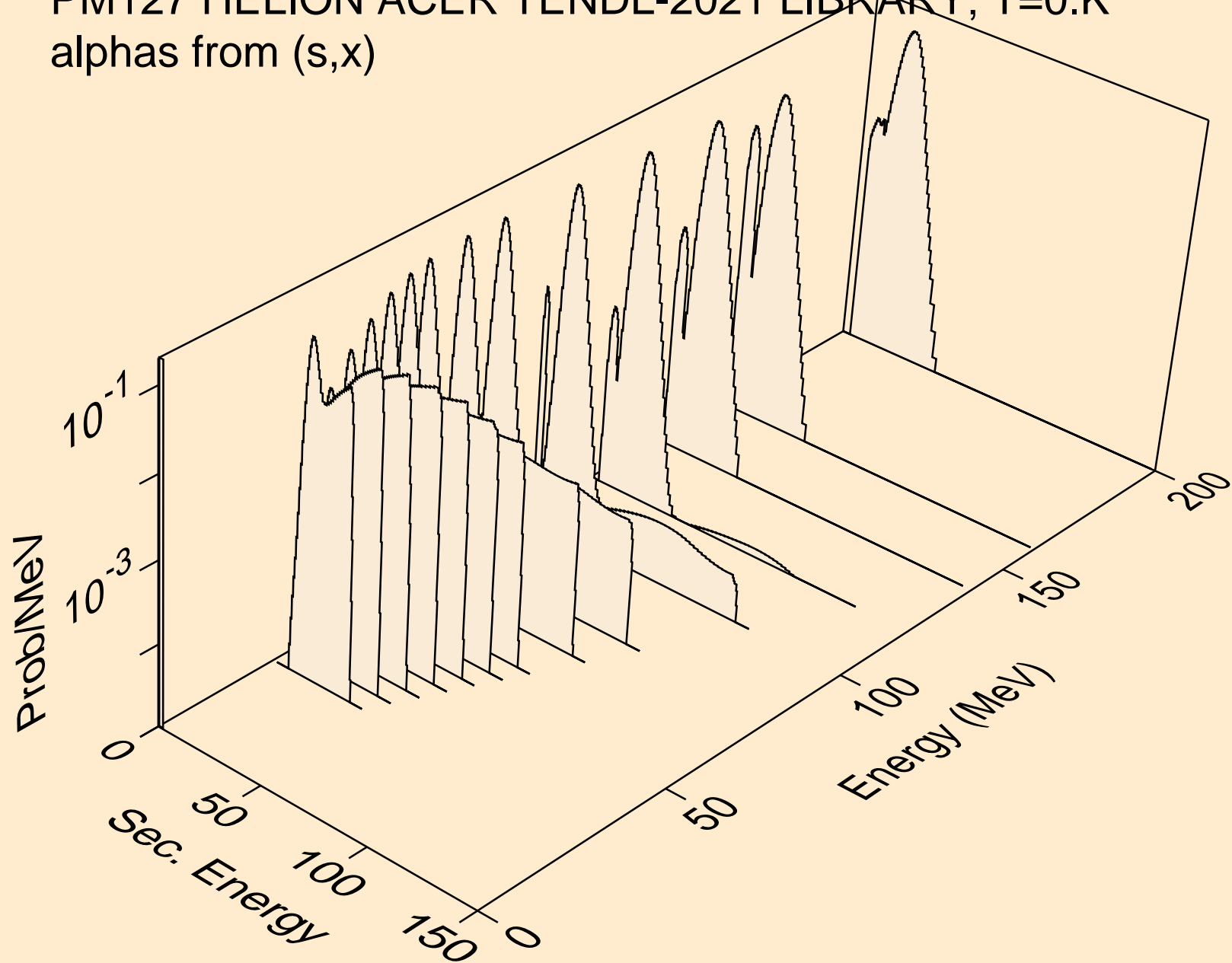

PM127 HELION ACER TENDL-2021 LIBRARY; T=0.K  
alphas from (s,n\*)a

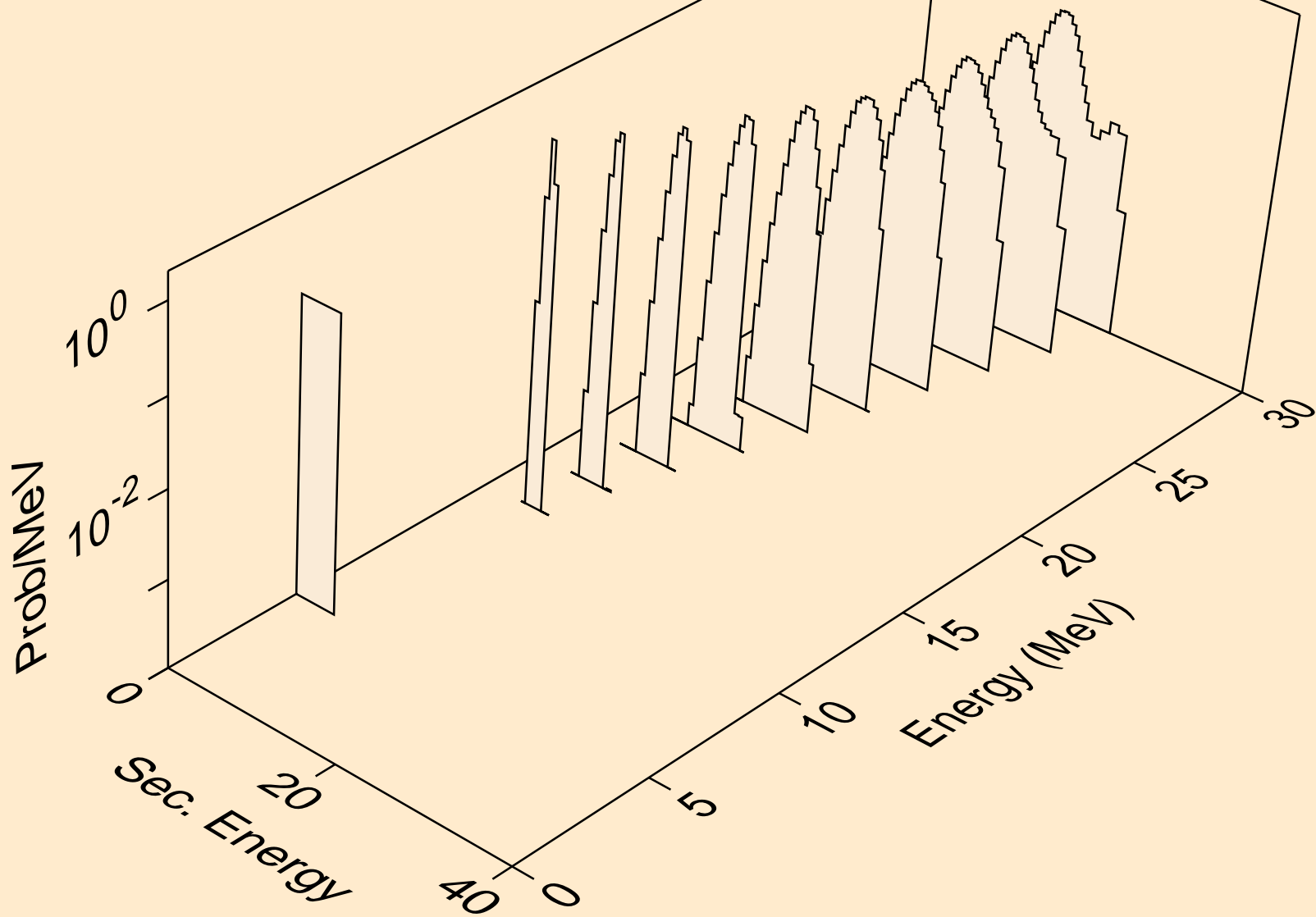

PM127 HELION ACER TENDL-2021 LIBRARY; T=0.K  
alphas from (s,npa)

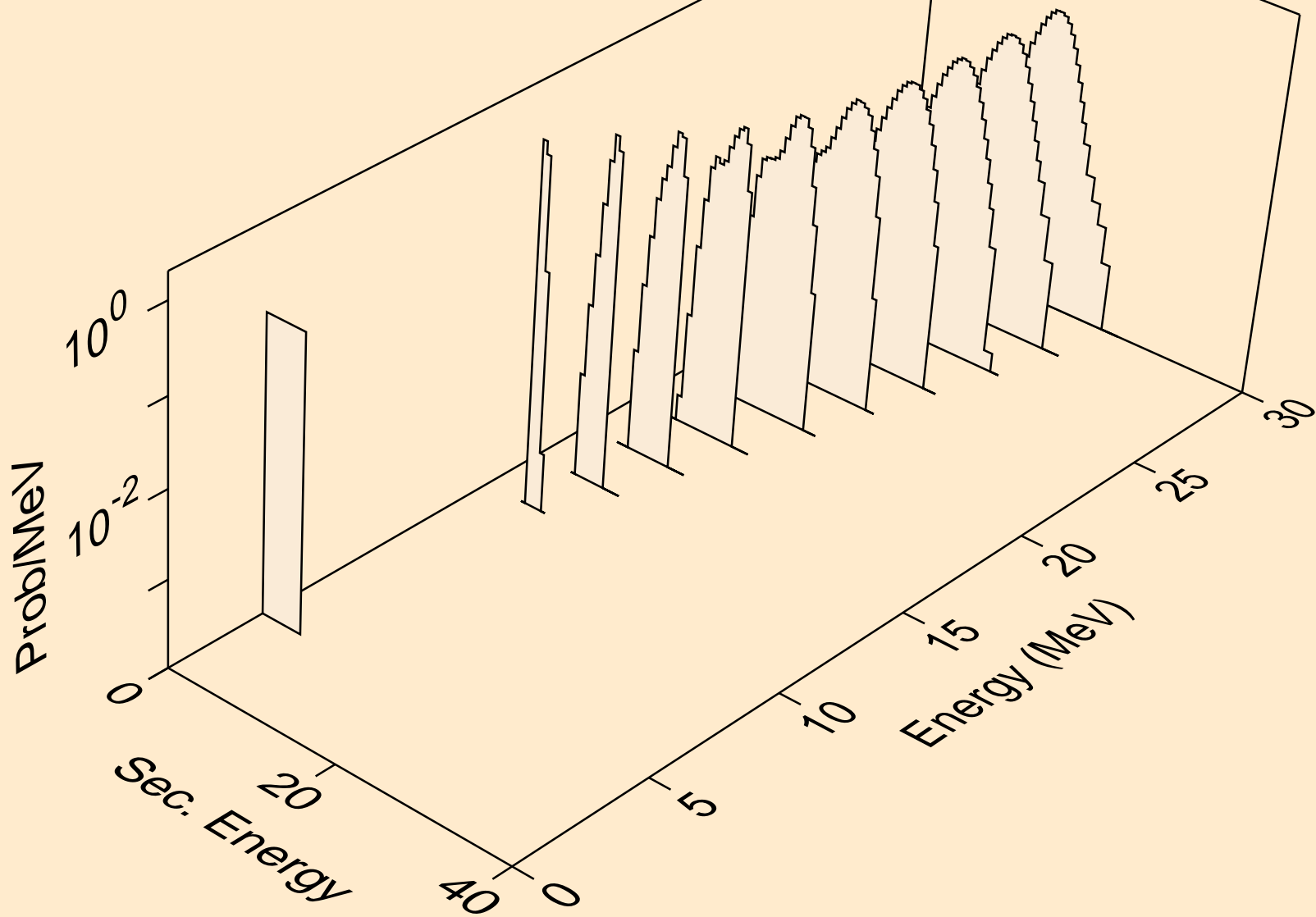

PM127 HELION ACER TENDL-2021 LIBRARY; T=0.K  
alphas from (s,a)

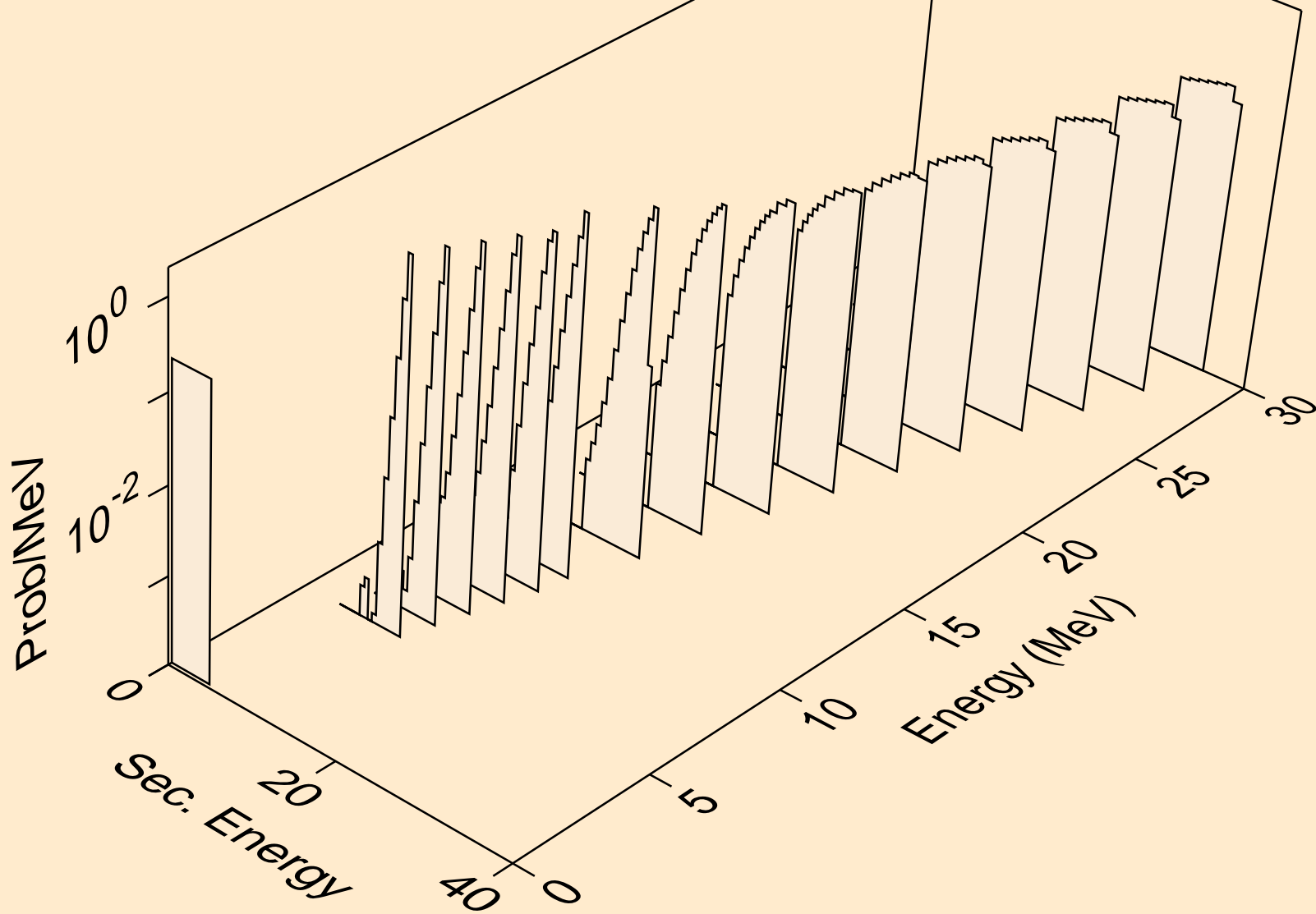

PM127 HELION ACER TENDL-2021 LIBRARY; T=0.K  
alphas from (s,2a)

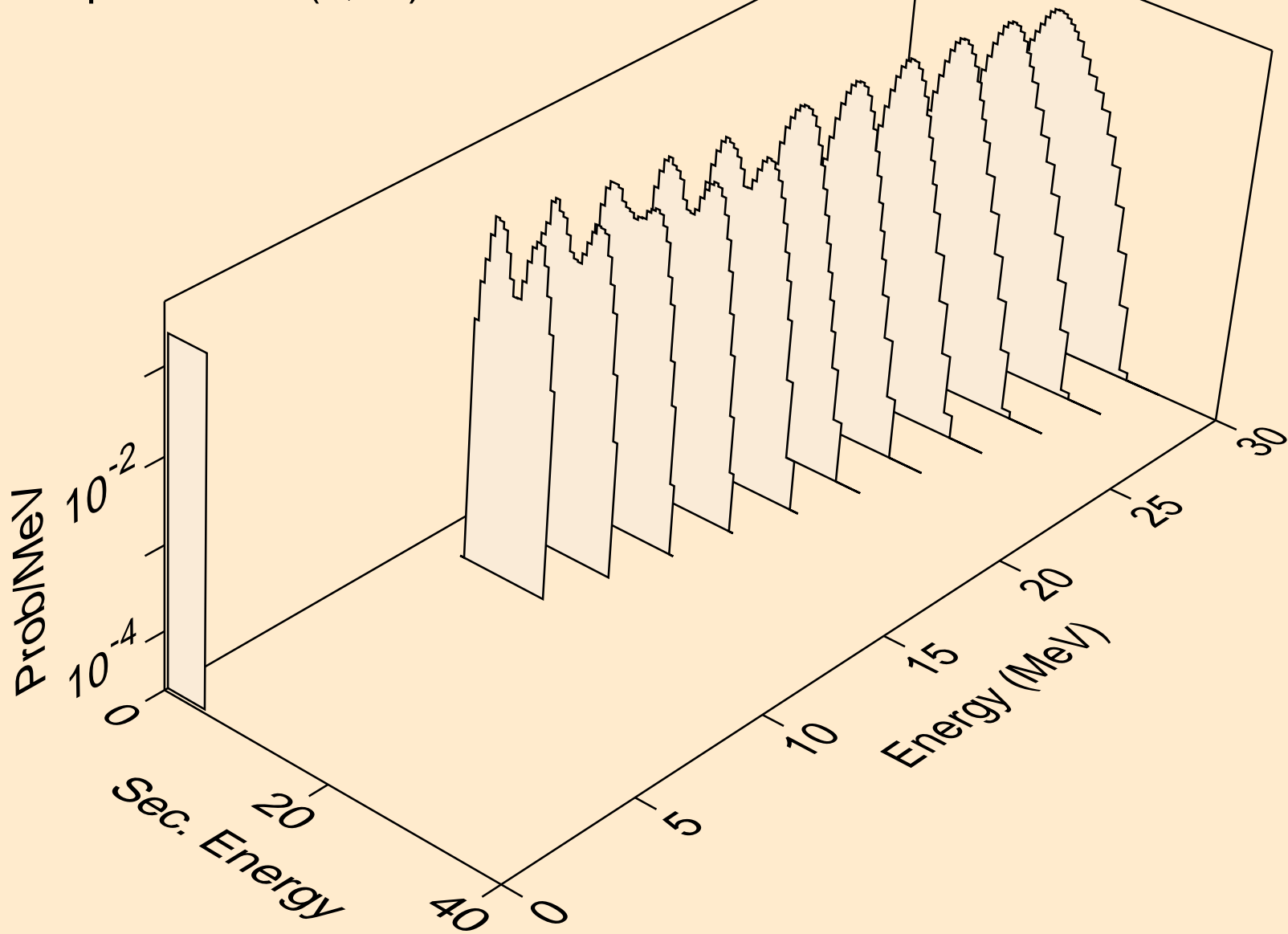

PM127 HELION ACER TENDL-2021 LIBRARY; T=0.K  
alphas from (s,pa)

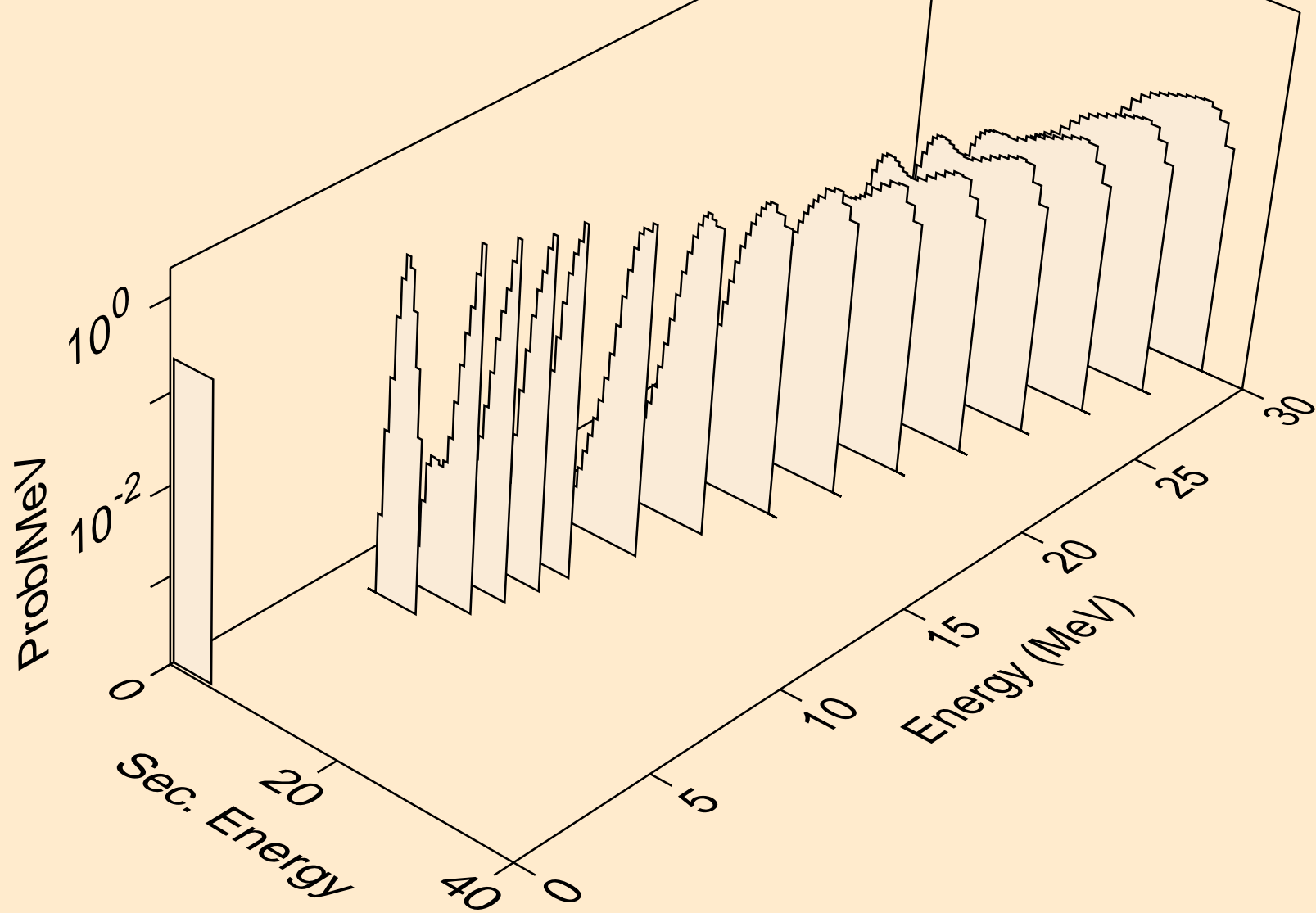



PM127 HELION ACER TENDL-2021 LIBRARY; T=0.K  
alphas from (s,da)

