

PM129 HELION ACER TENDL-2021 LIBRARY; T=0.K  
Principal cross sections

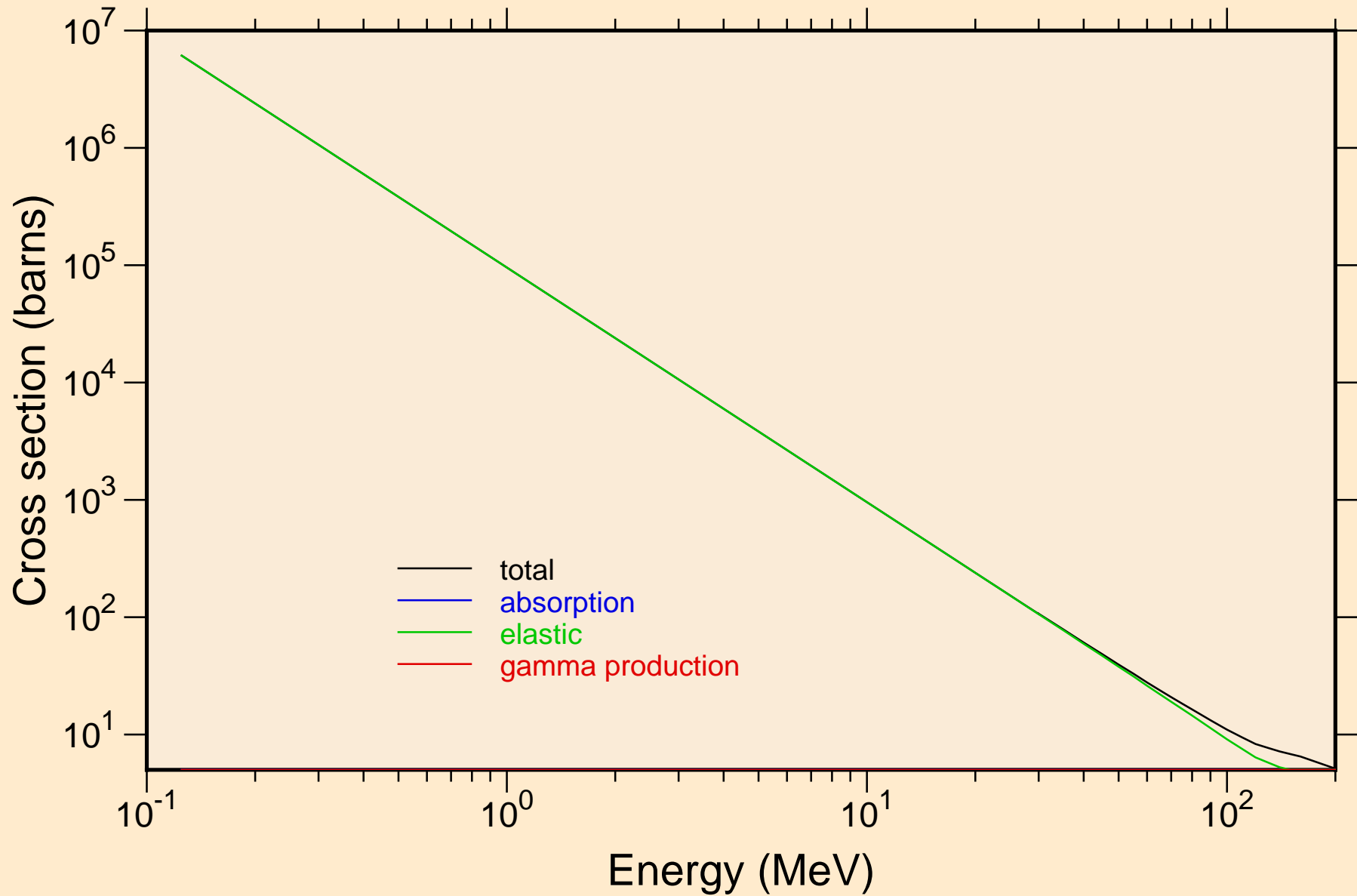

# PM129 HELION ACER TENDL-2021 LIBRARY; T=0.K

## Heating

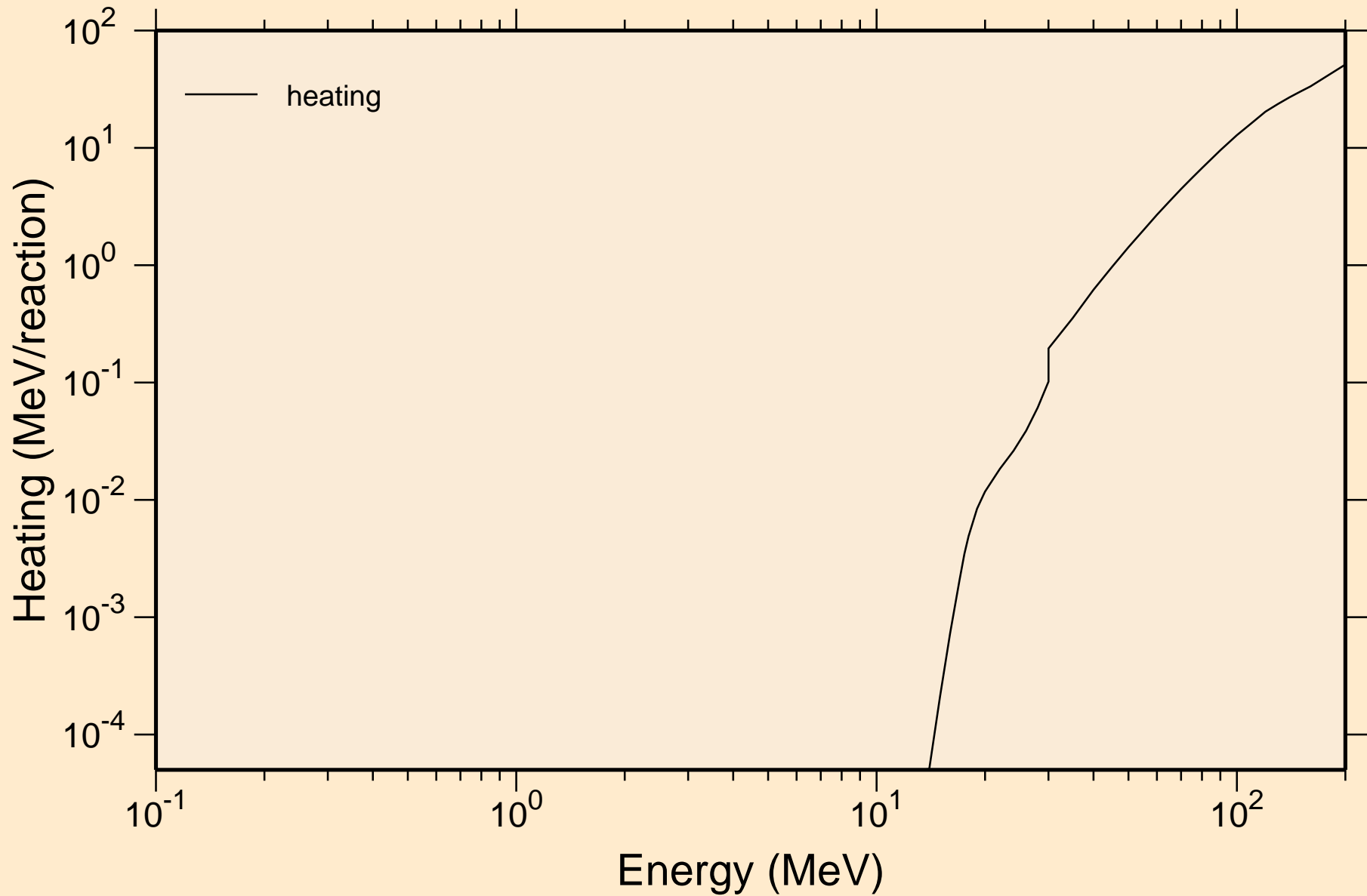

# PM129 HELION ACER TENDL-2021 LIBRARY; T=0.K

## Principal cross sections

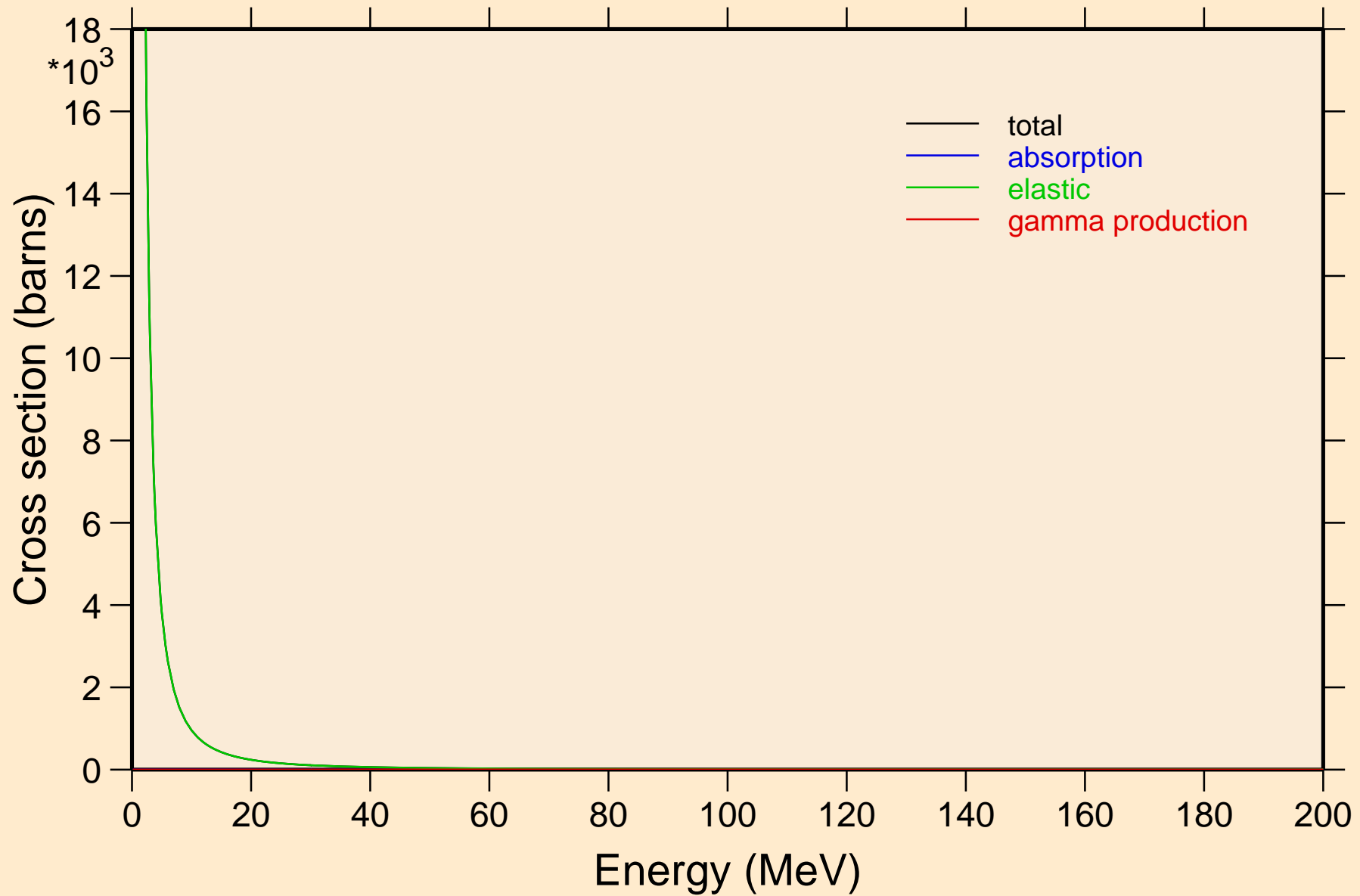

PM129 HELION ACER TENDL-2021 LIBRARY; T=0.K

Heating

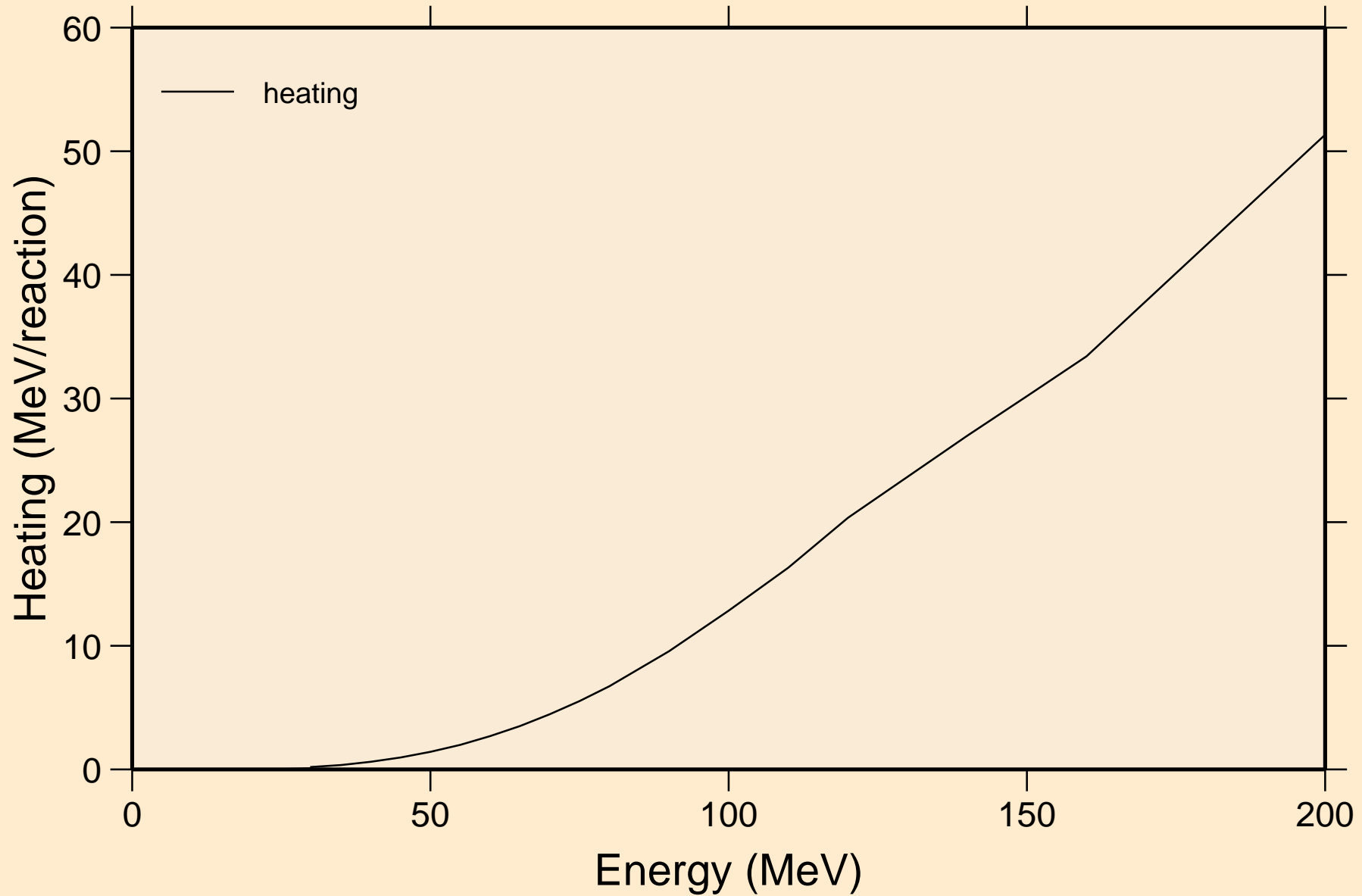

PM129 HELION ACER TENDL-2021 LIBRARY; T=0.K  
Threshold reactions

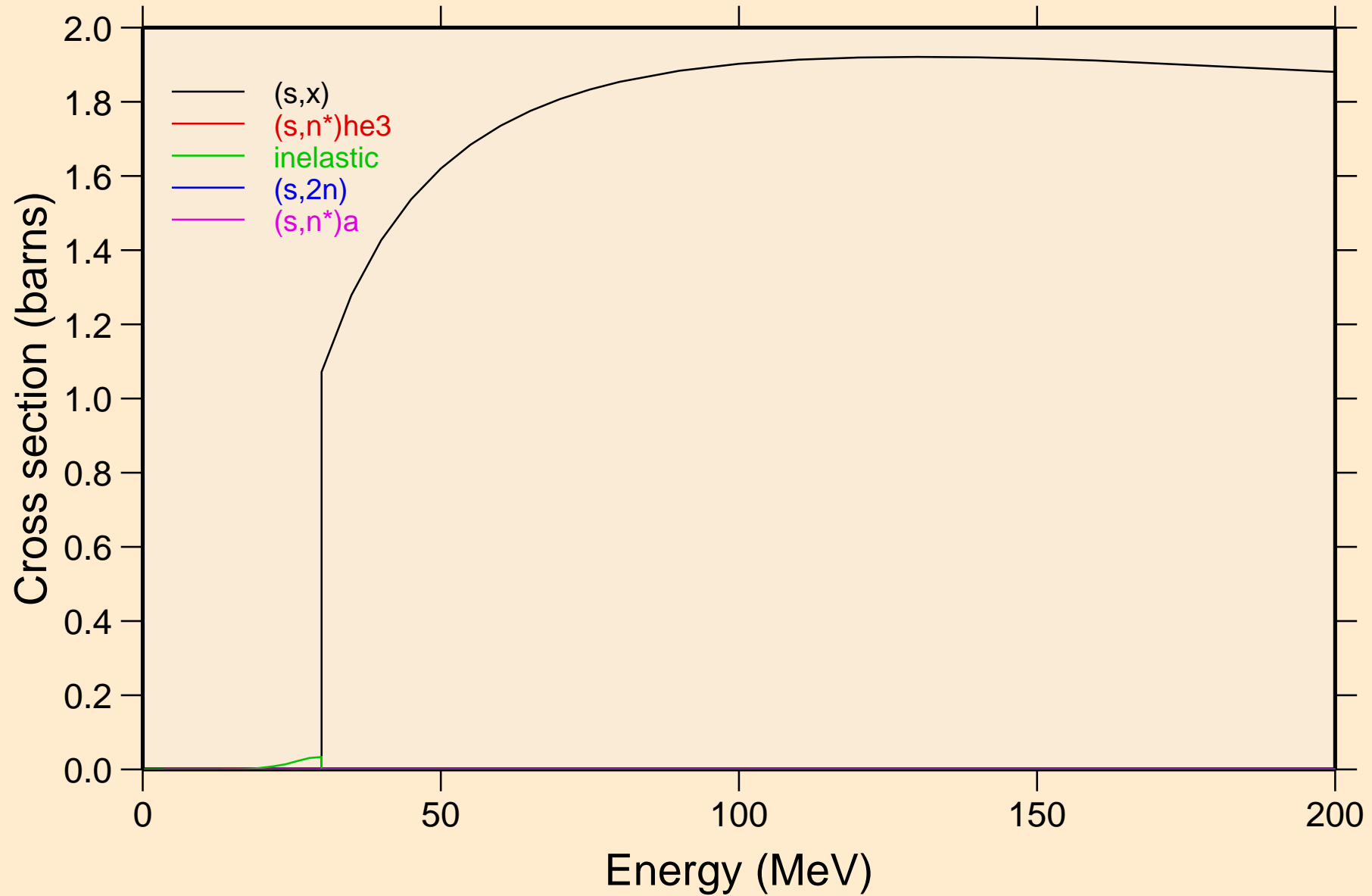

PM129 HELION ACER TENDL-2021 LIBRARY; T=0.K  
Threshold reactions

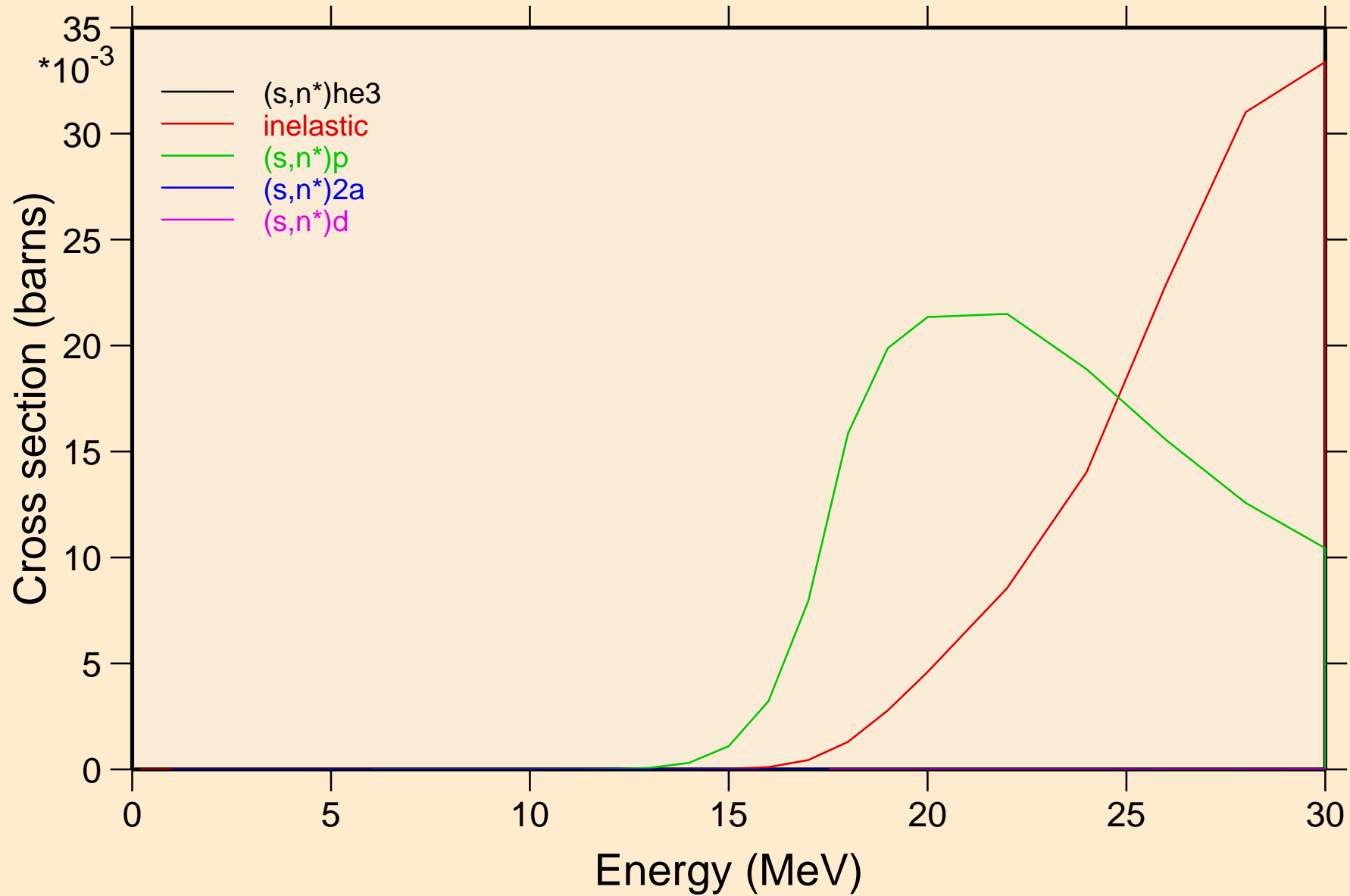

PM129 HELION ACER TENDL-2021 LIBRARY; T=0.K  
Threshold reactions

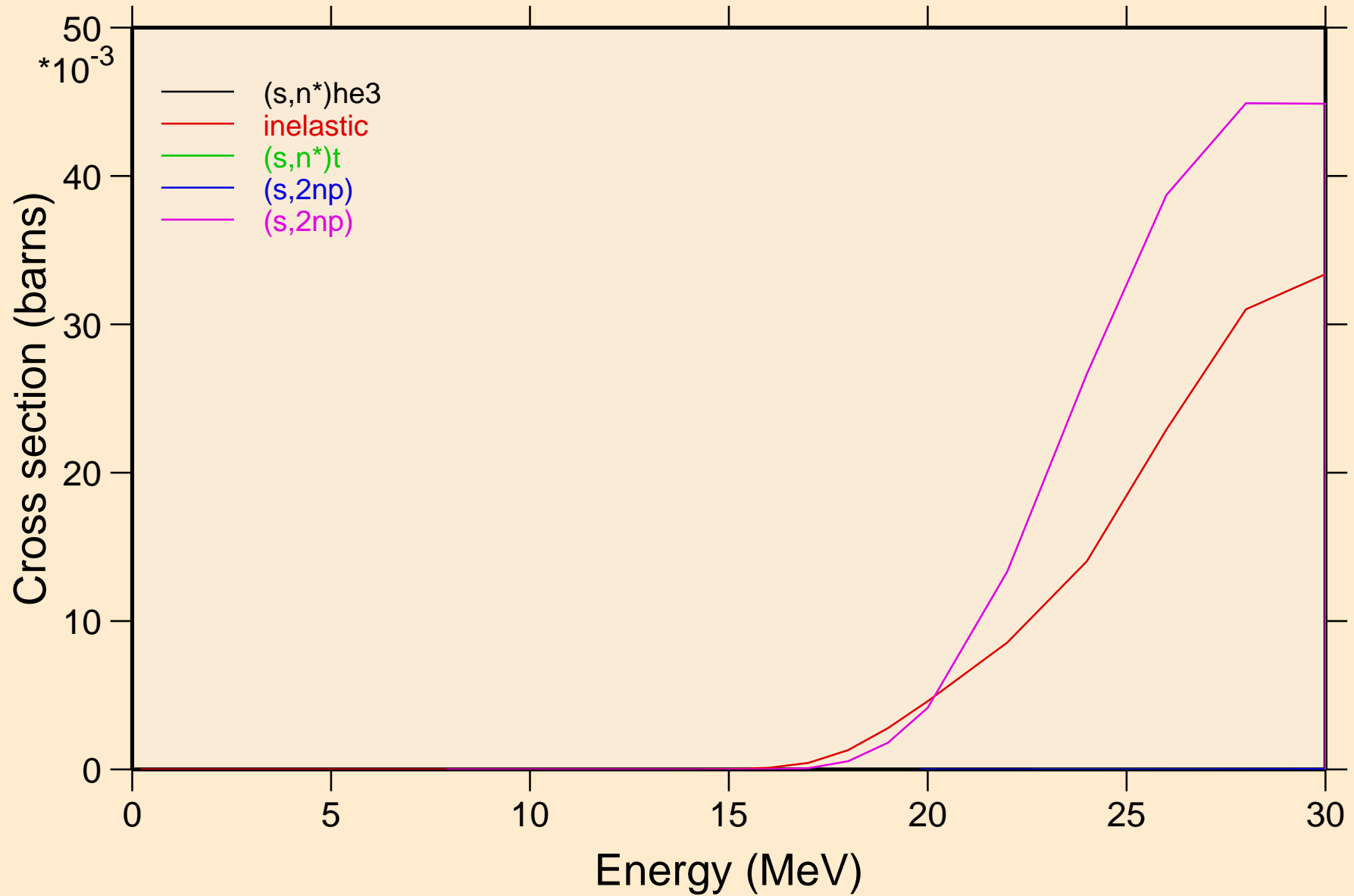

PM129 HELION ACER TENDL-2021 LIBRARY; T=0.K  
Threshold reactions

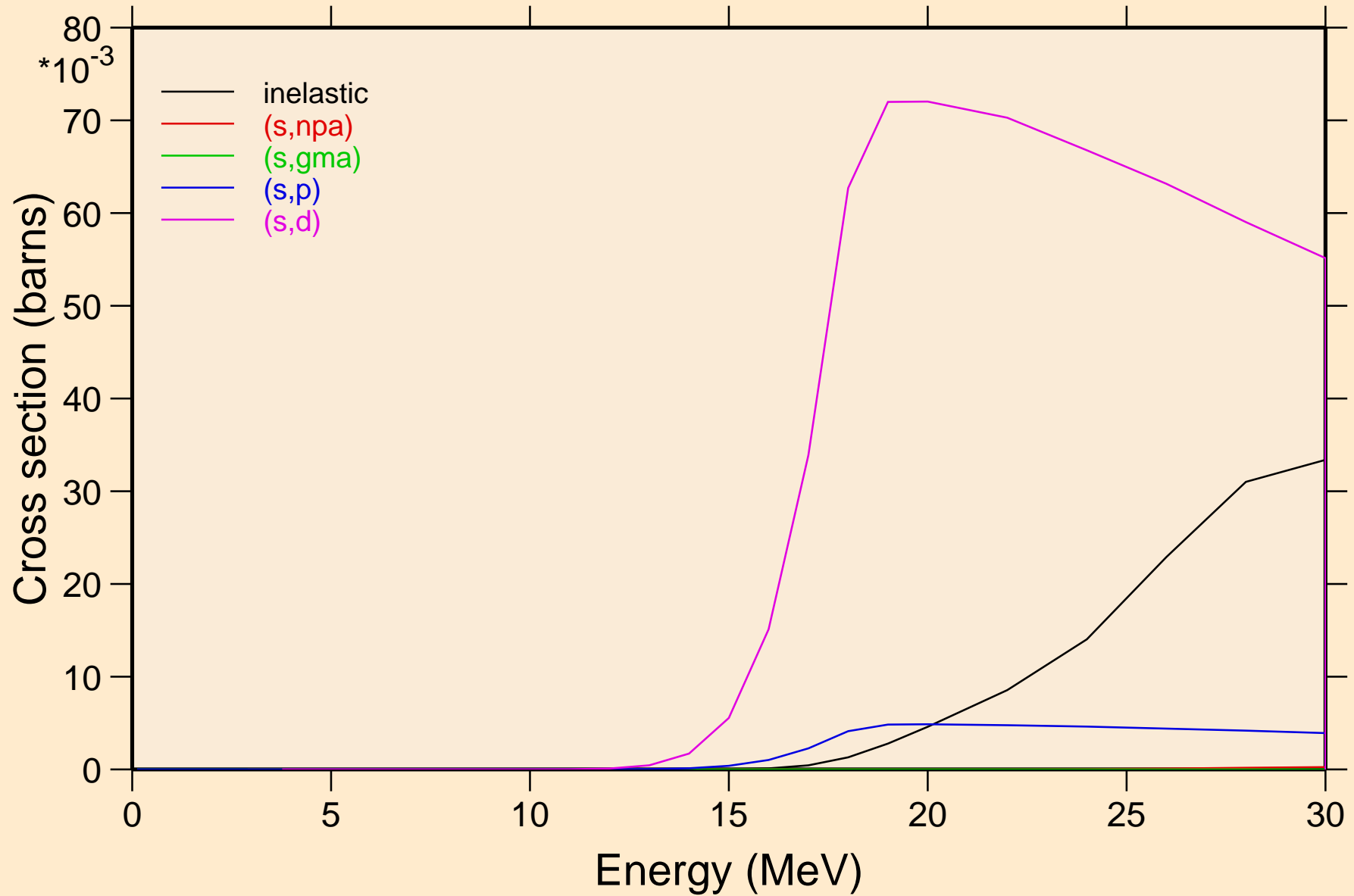



PM129 HELION ACER TENDL-2021 LIBRARY; T=0.K  
Threshold reactions

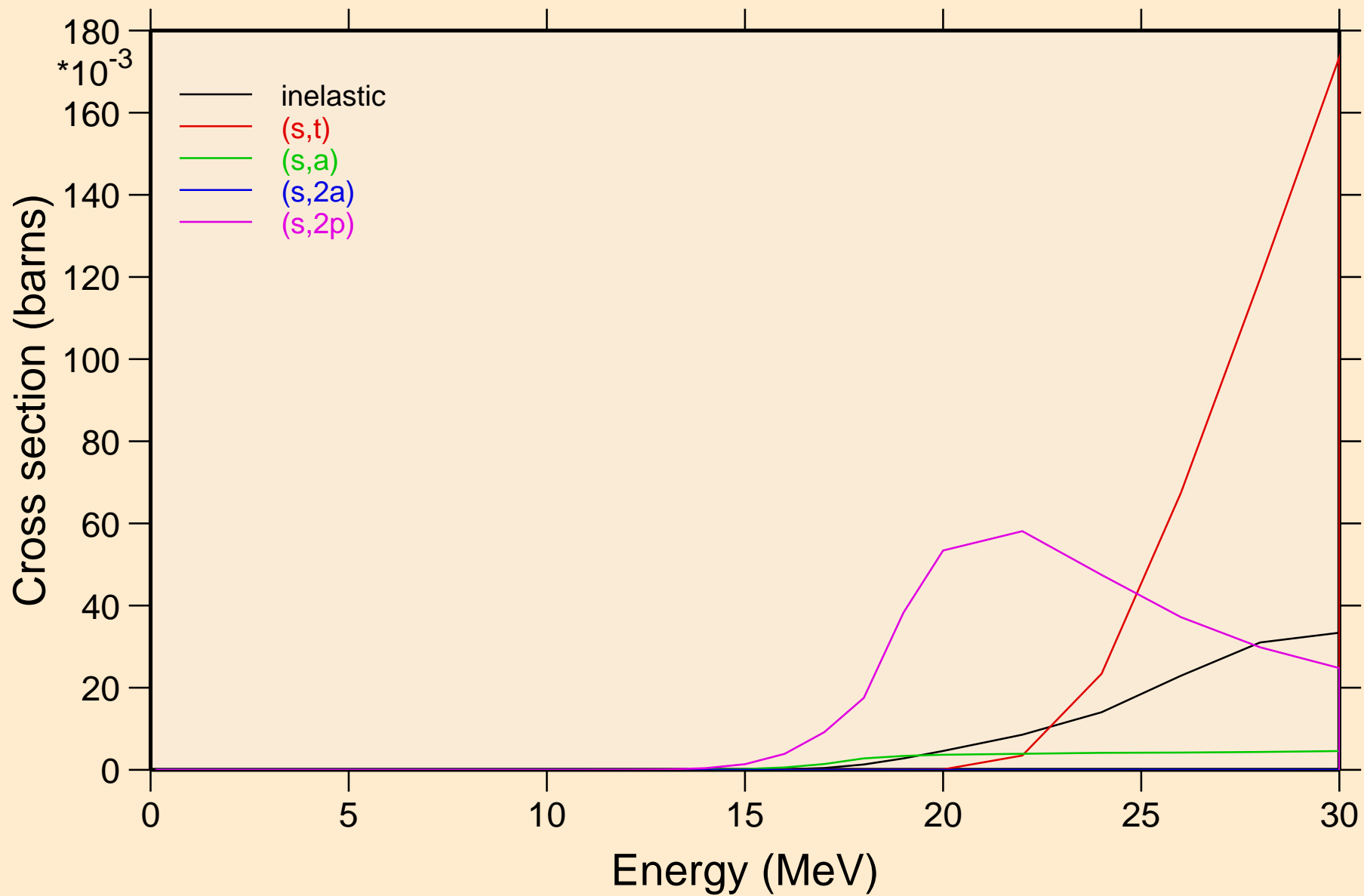

PM129 HELION ACER TENDL-2021 LIBRARY; T=0.K  
Threshold reactions

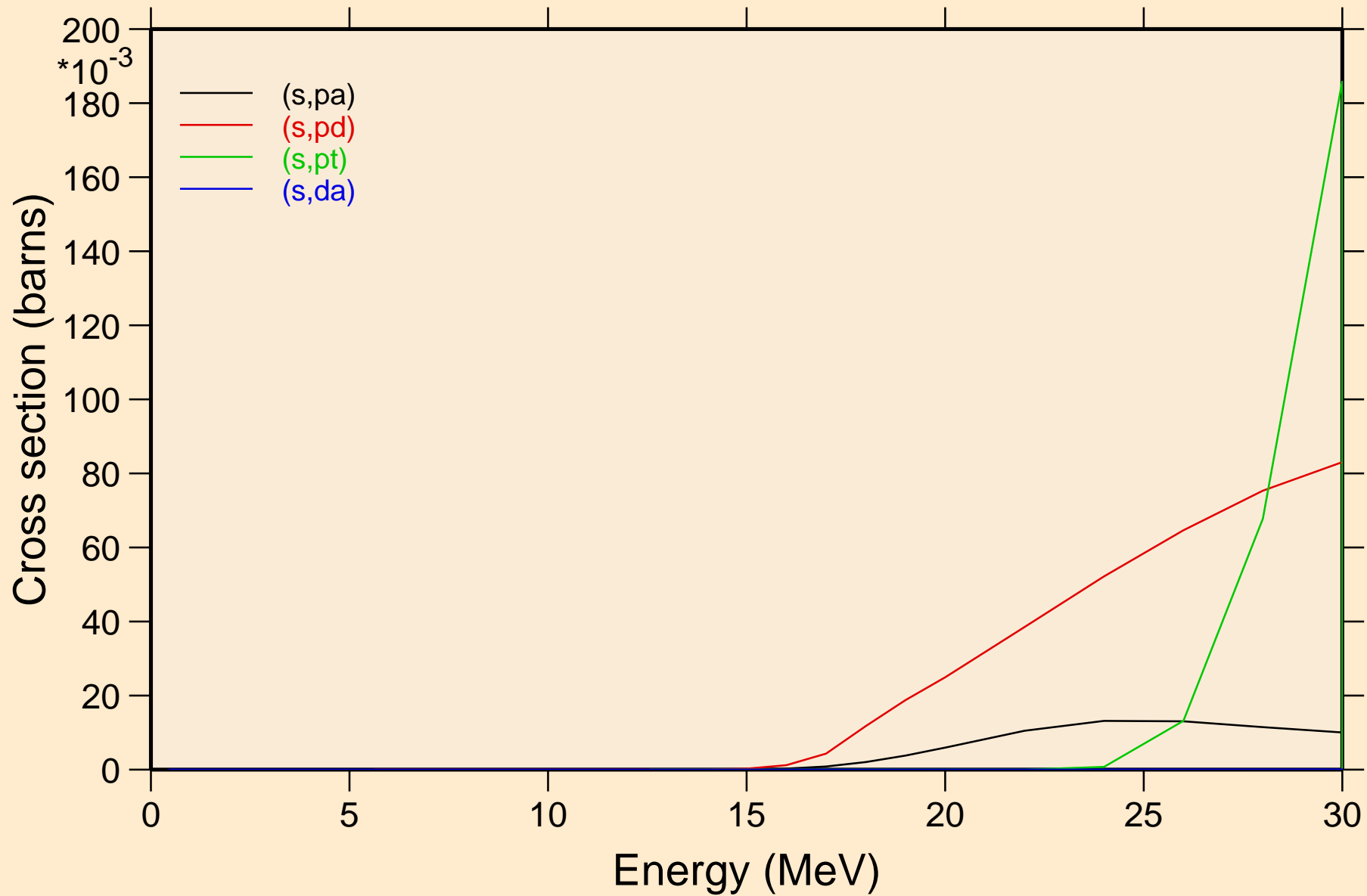

PM129 HELION ACER TENDL-2021 LIBRARY; T=0.K  
angular distribution for elastic

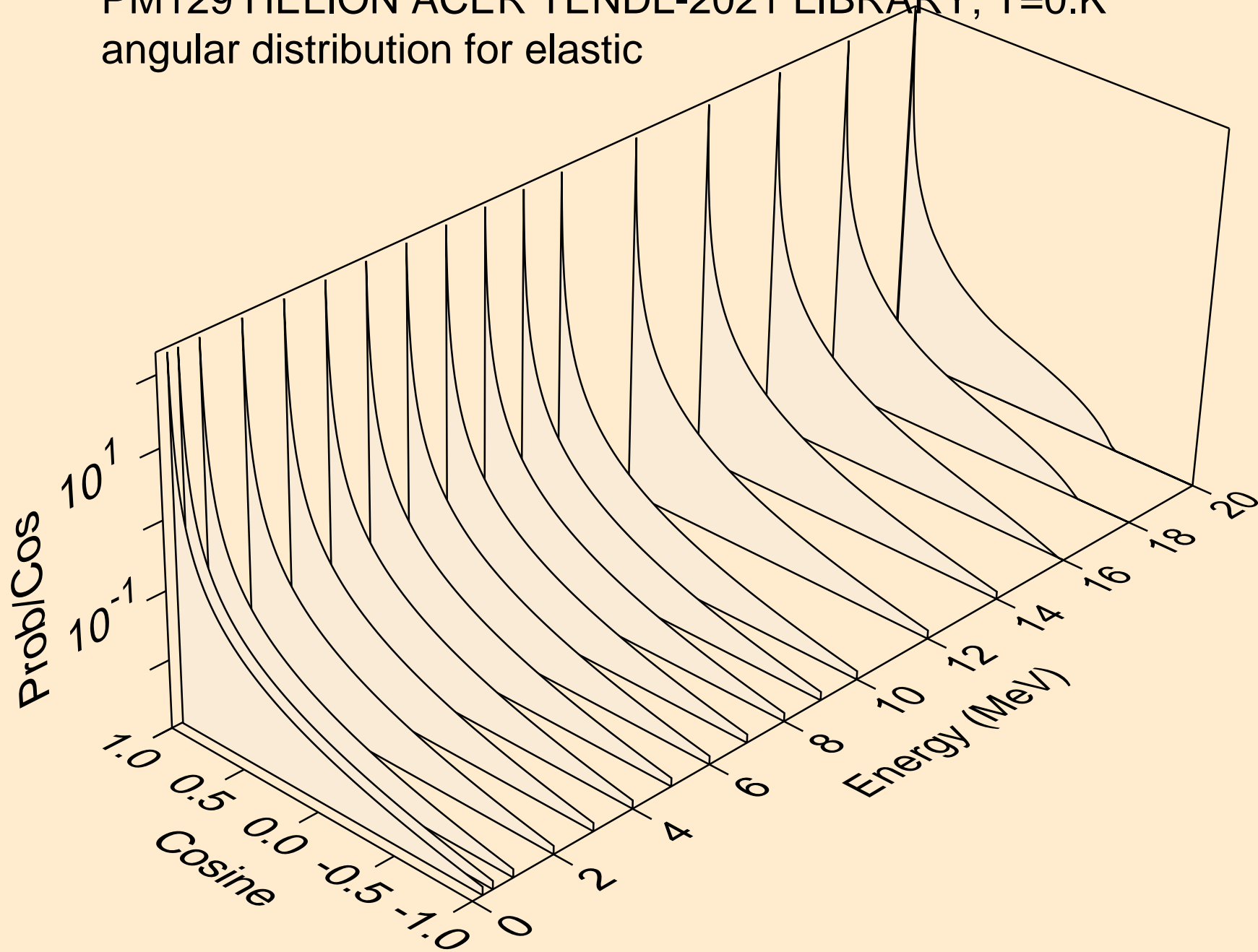

PM129 HELION ACER TENDL-2021 LIBRARY; T=0.K  
angular distribution for elastic

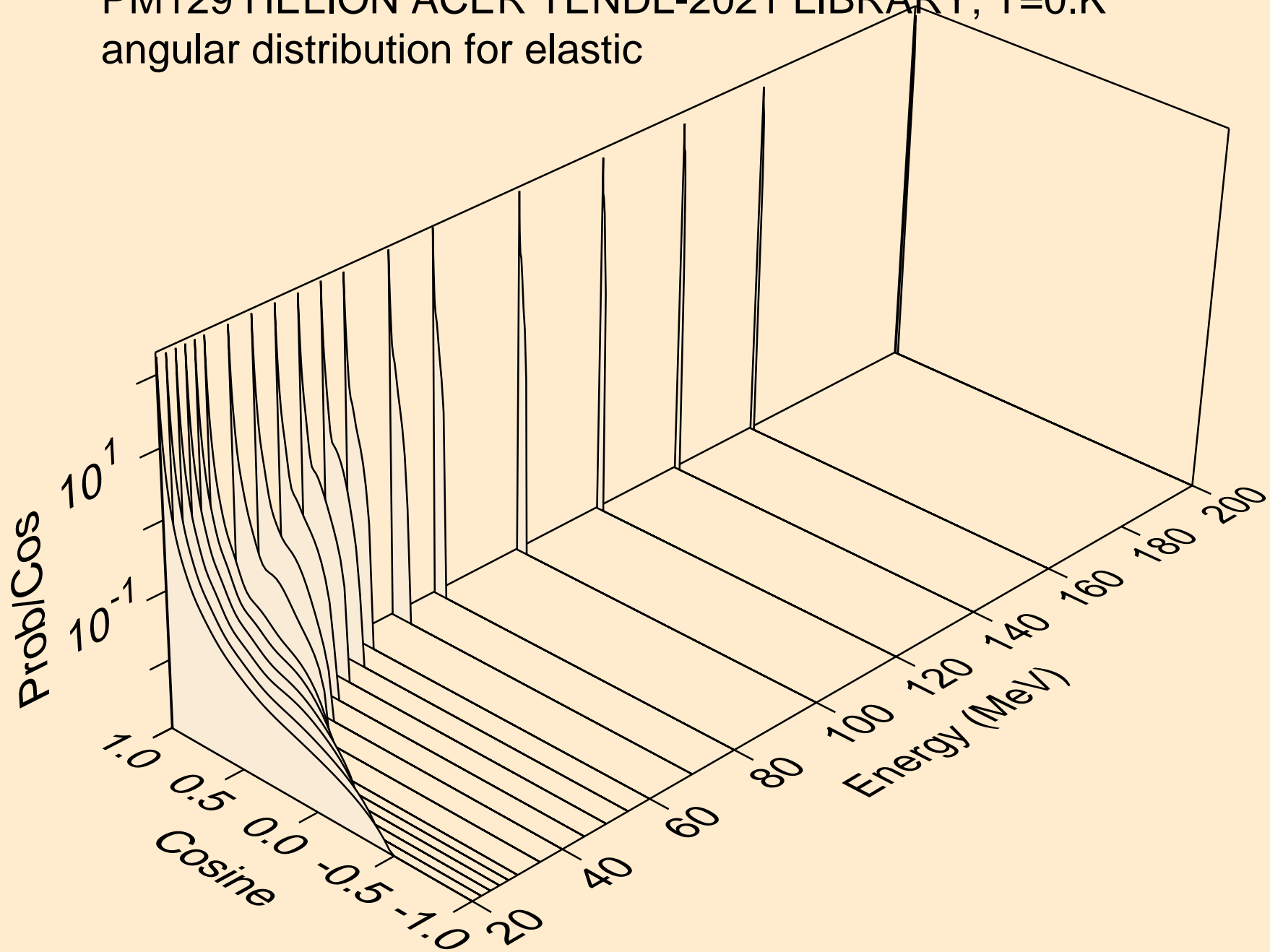

PM129 HELION ACER TENDL-2021 LIBRARY; T=0.K  
He-3 emission for (s,x)

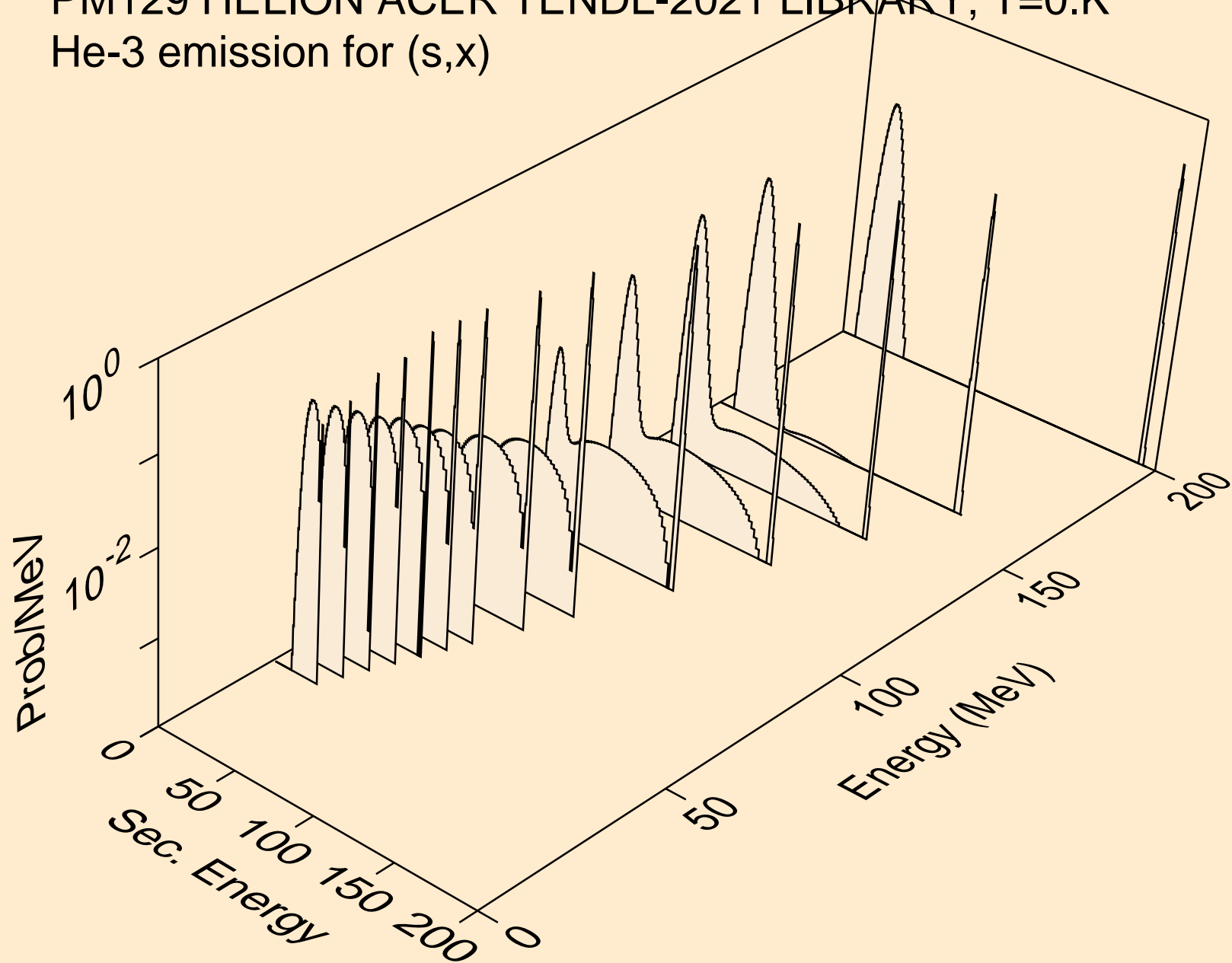

PM129 HELION ACER TENDL-2021 LIBRARY; T=0.K  
He-3 emission for (s,n\*)he3

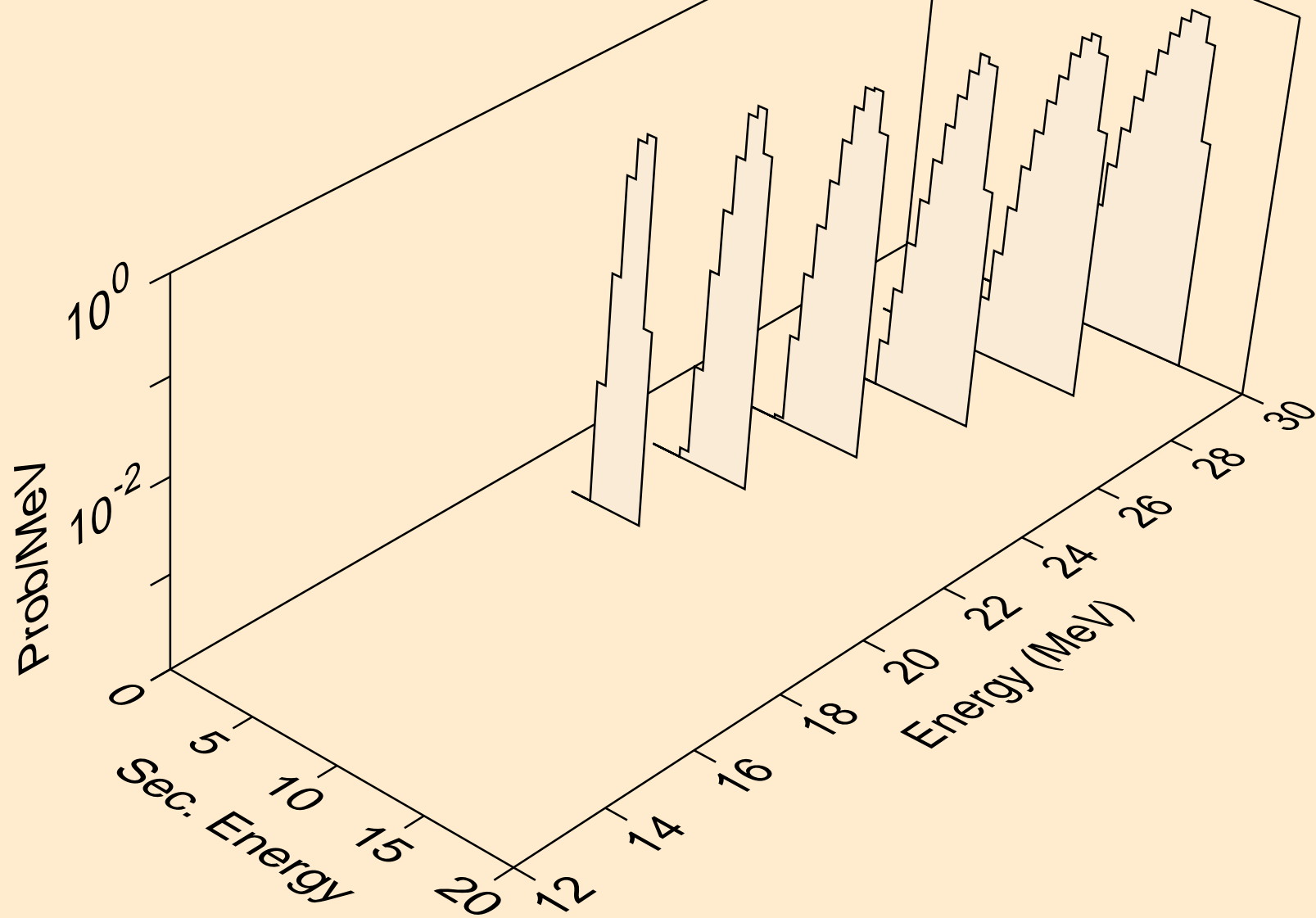

PM129 HELION ACER TENDL-2021 LIBRARY; T=0.K  
He-3 emission for inelastic

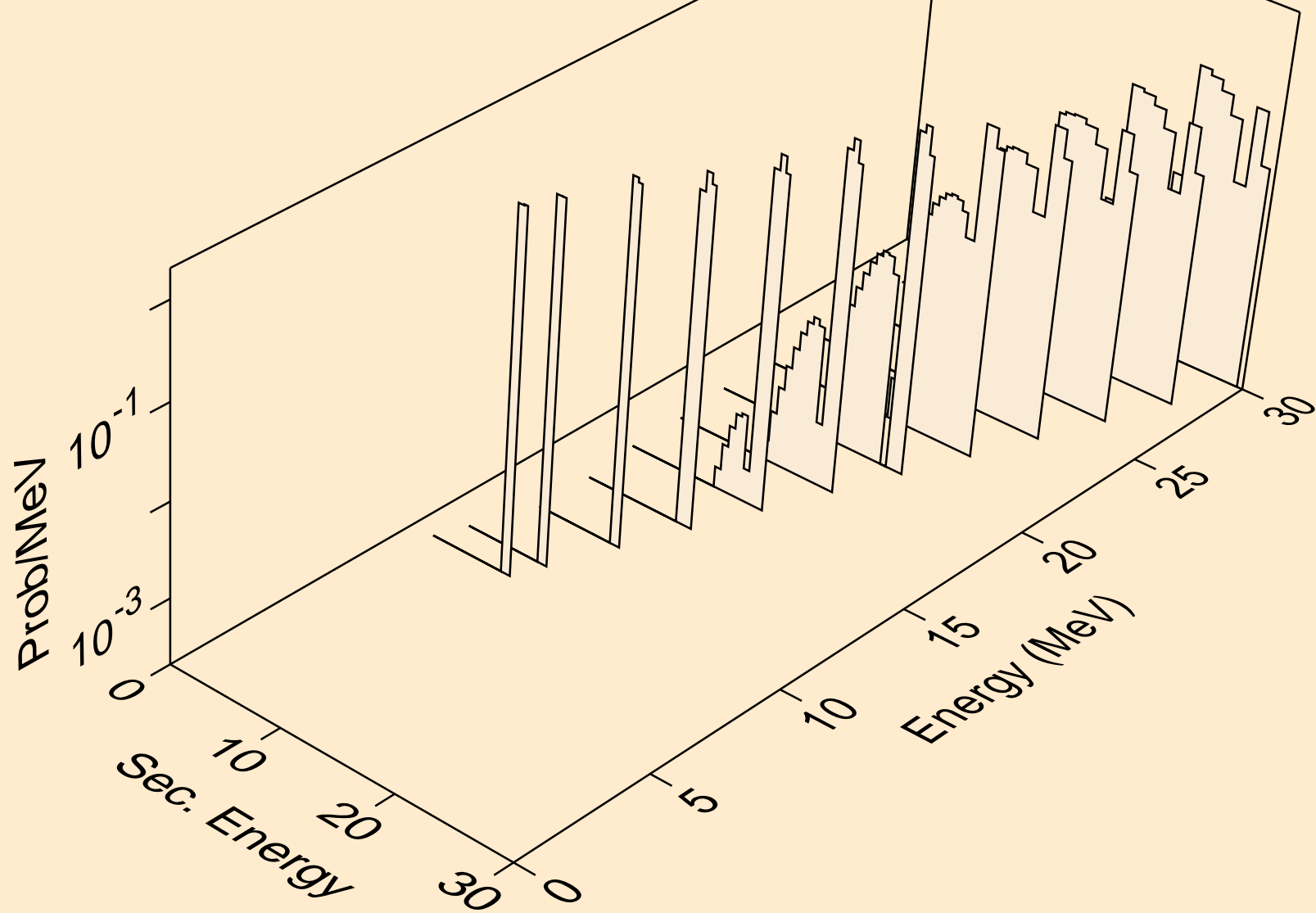

PM129 HELION ACER TENDL-2021 LIBRARY; T=0.K  
Photon emission for (z,n)

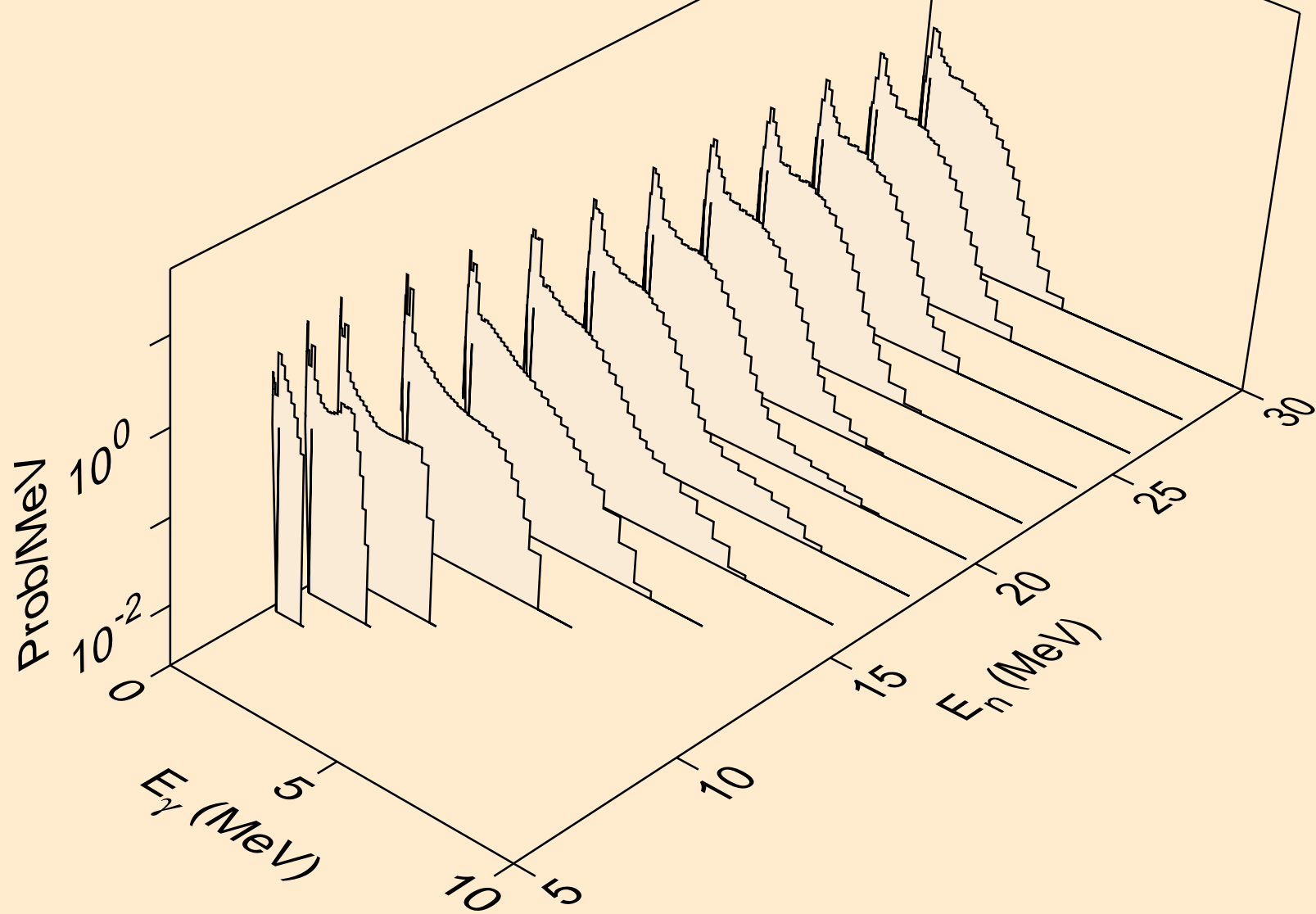



PM129 HELION ACER TENDL-2021 LIBRARY; T=0.K  
Photon emission for (n,x)

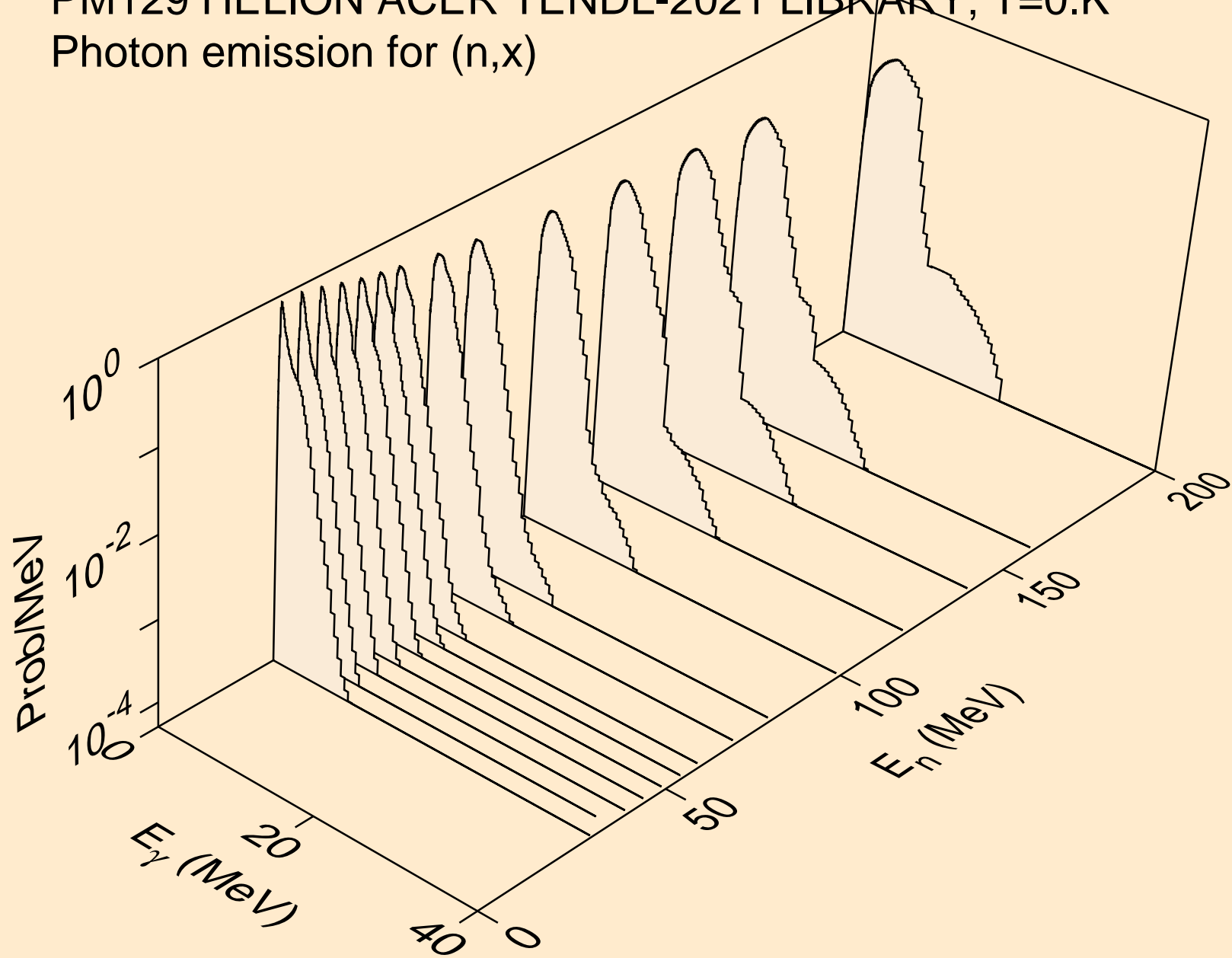

PM129 HELION ACER TENDL-2021 LIBRARY; T=0.K  
Photon emission for (n,2n)

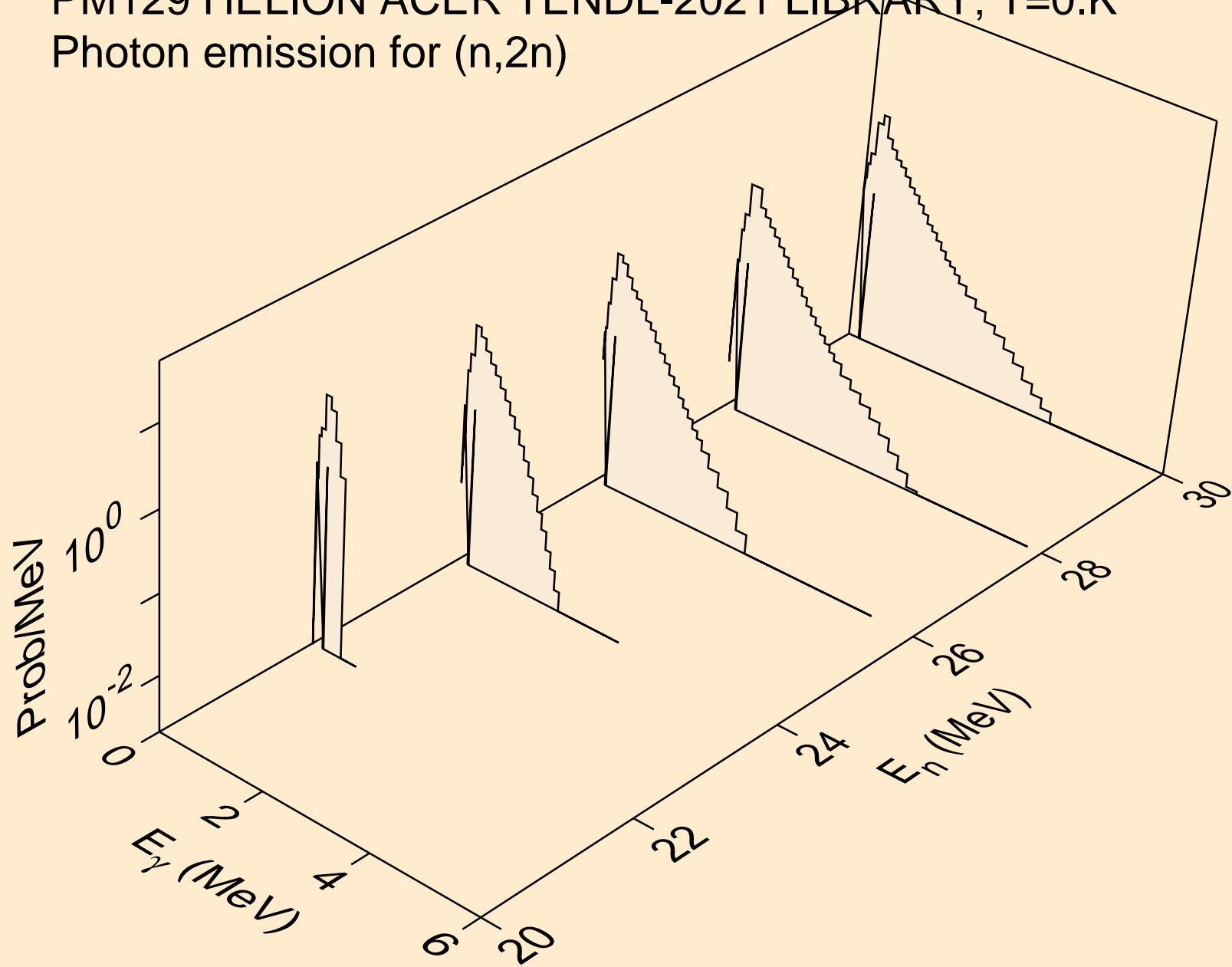

PM129 HELION ACER TENDL-2021 LIBRARY; T=0.K  
Photon emission for (n,n\*)a

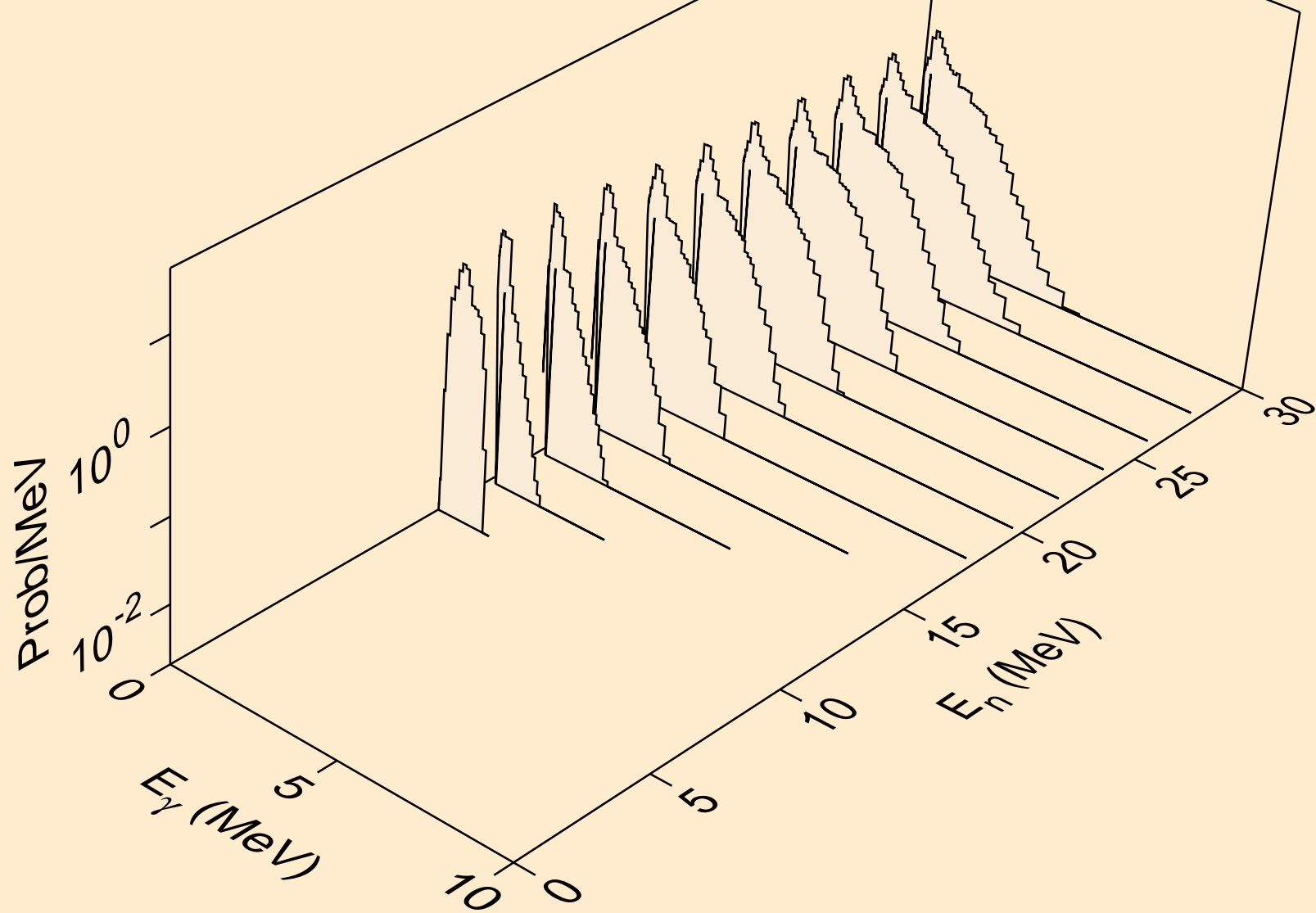

PM129 HELION ACER TENDL-2021 LIBRARY; T=0.K  
Photon emission for (n,n\*)p

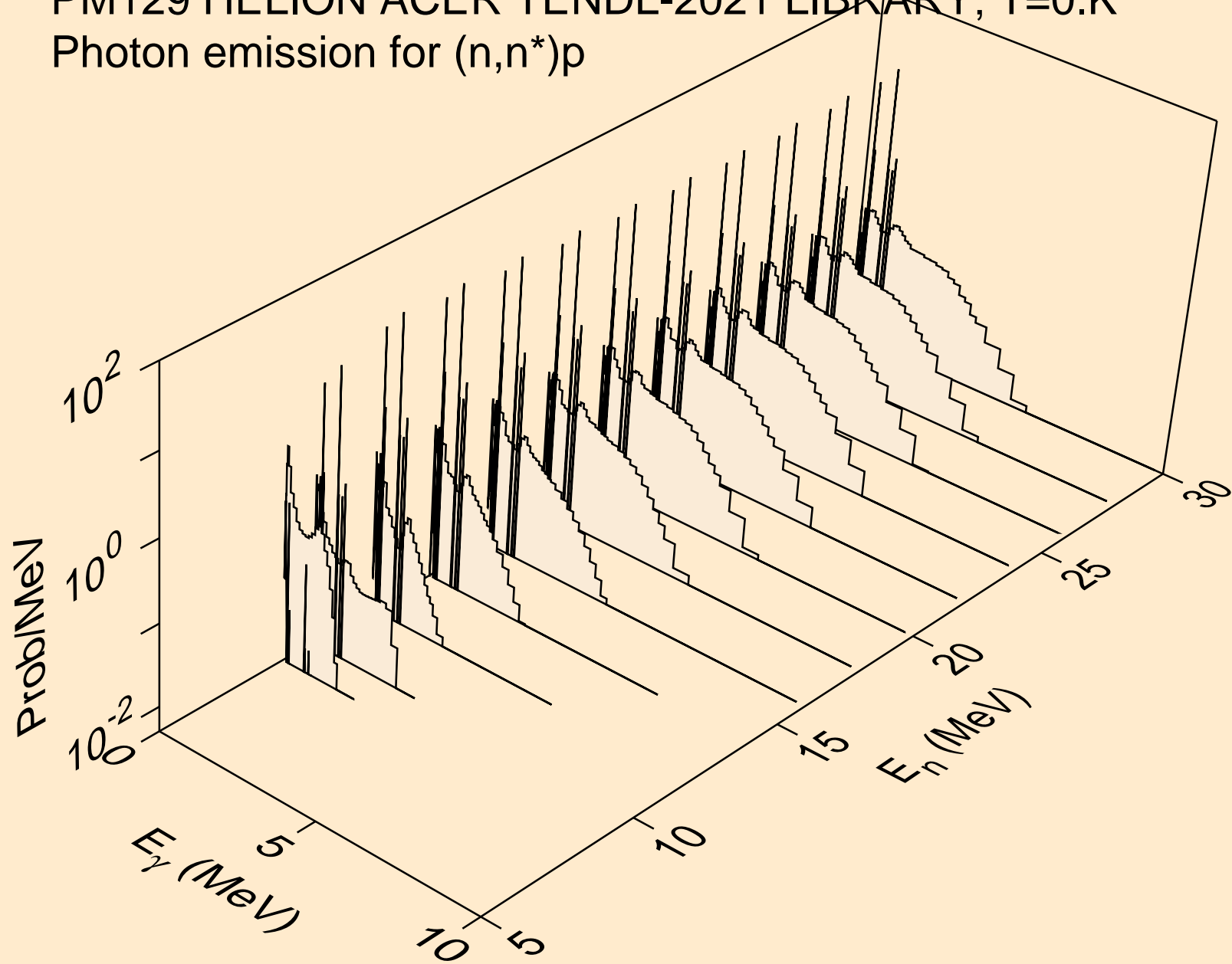

PM129 HELION ACER TENDL-2021 LIBRARY; T=0.K  
Photon emission for (n,n\*)2a

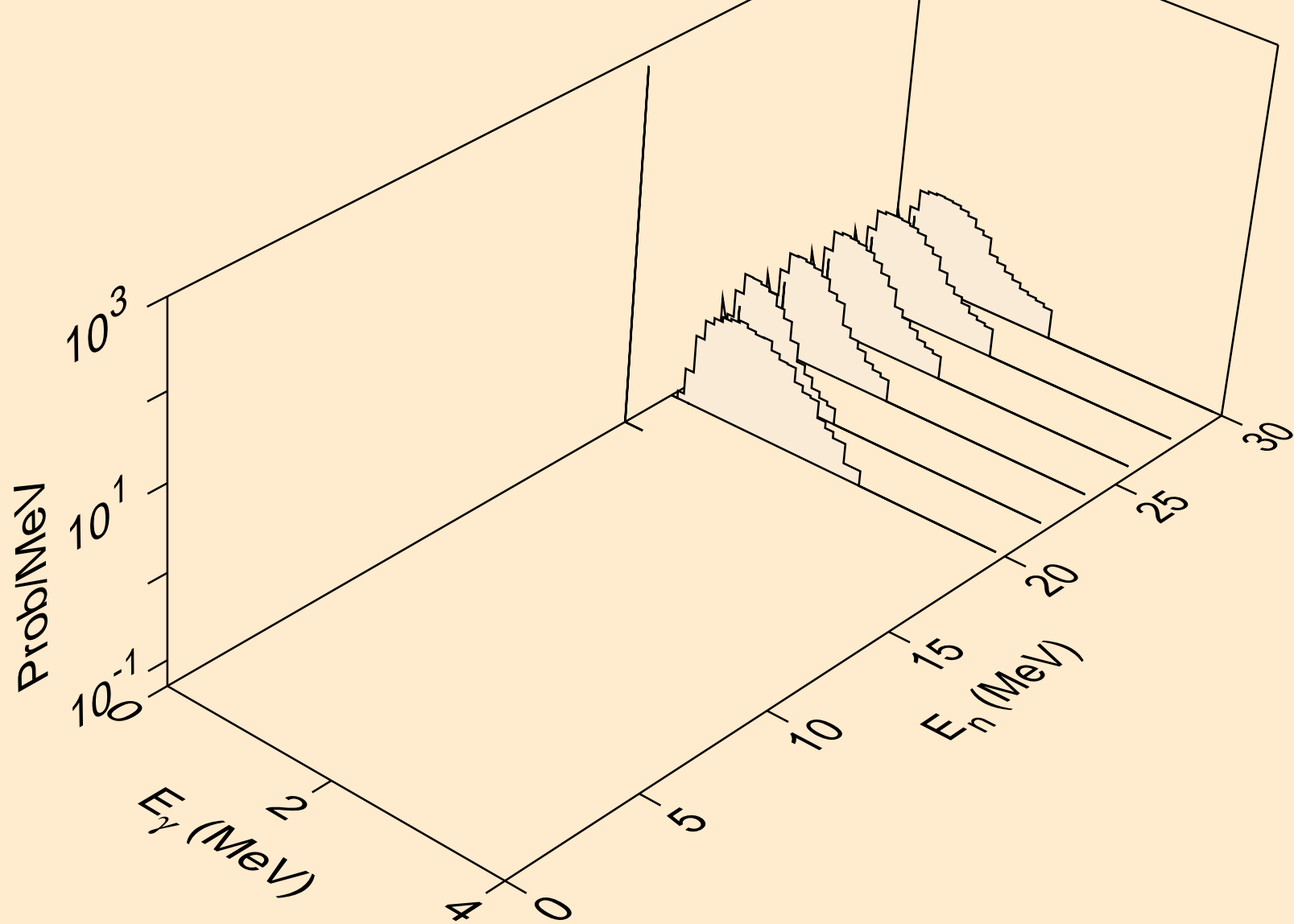

PM129 HELION ACER TENDL-2021 LIBRARY; T=0.K  
Photon emission for (n,n\*)d

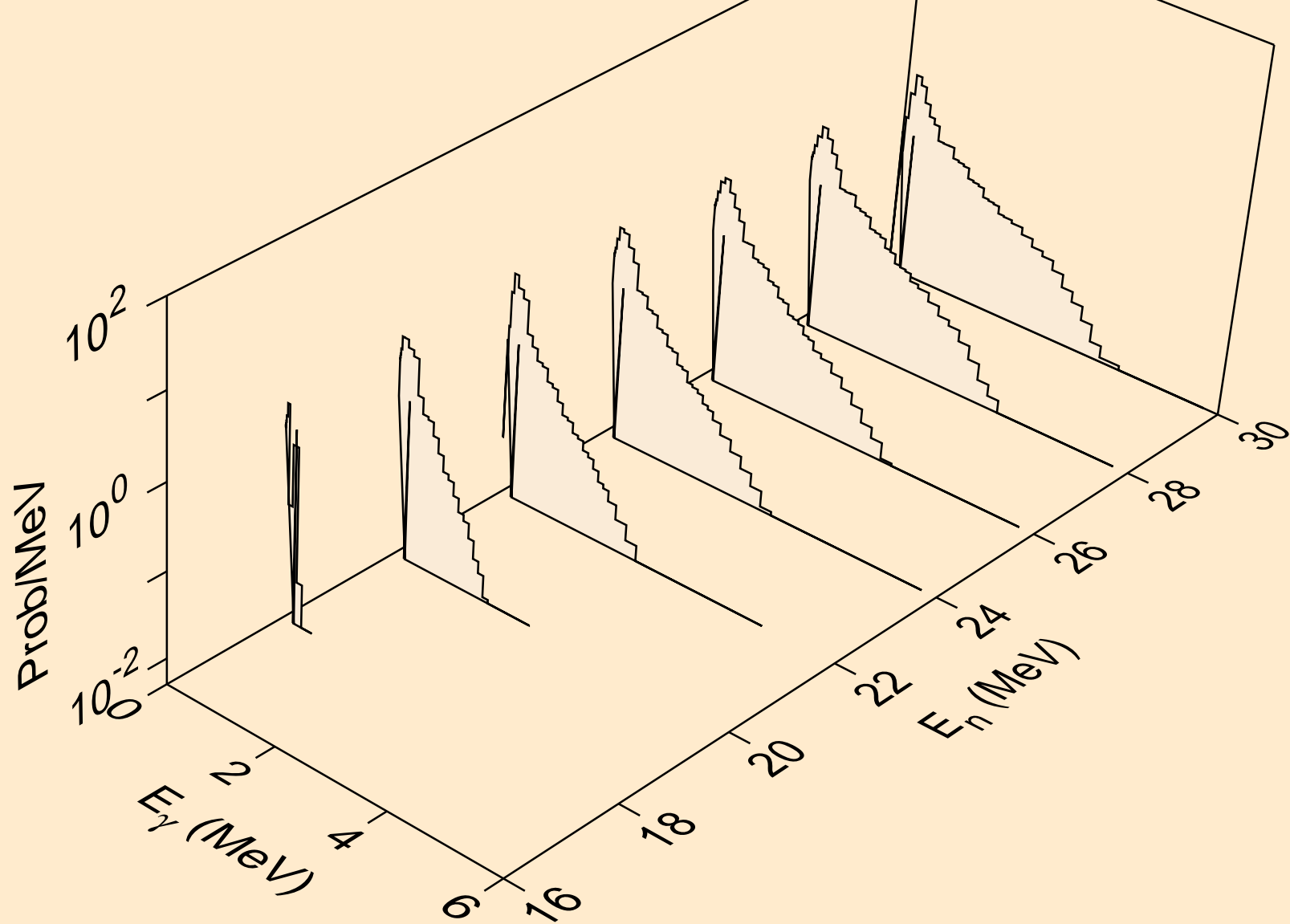

PM129 HELION ACER TENDL-2021 LIBRARY; T=0.K  
Photon emission for (n,n\*)t

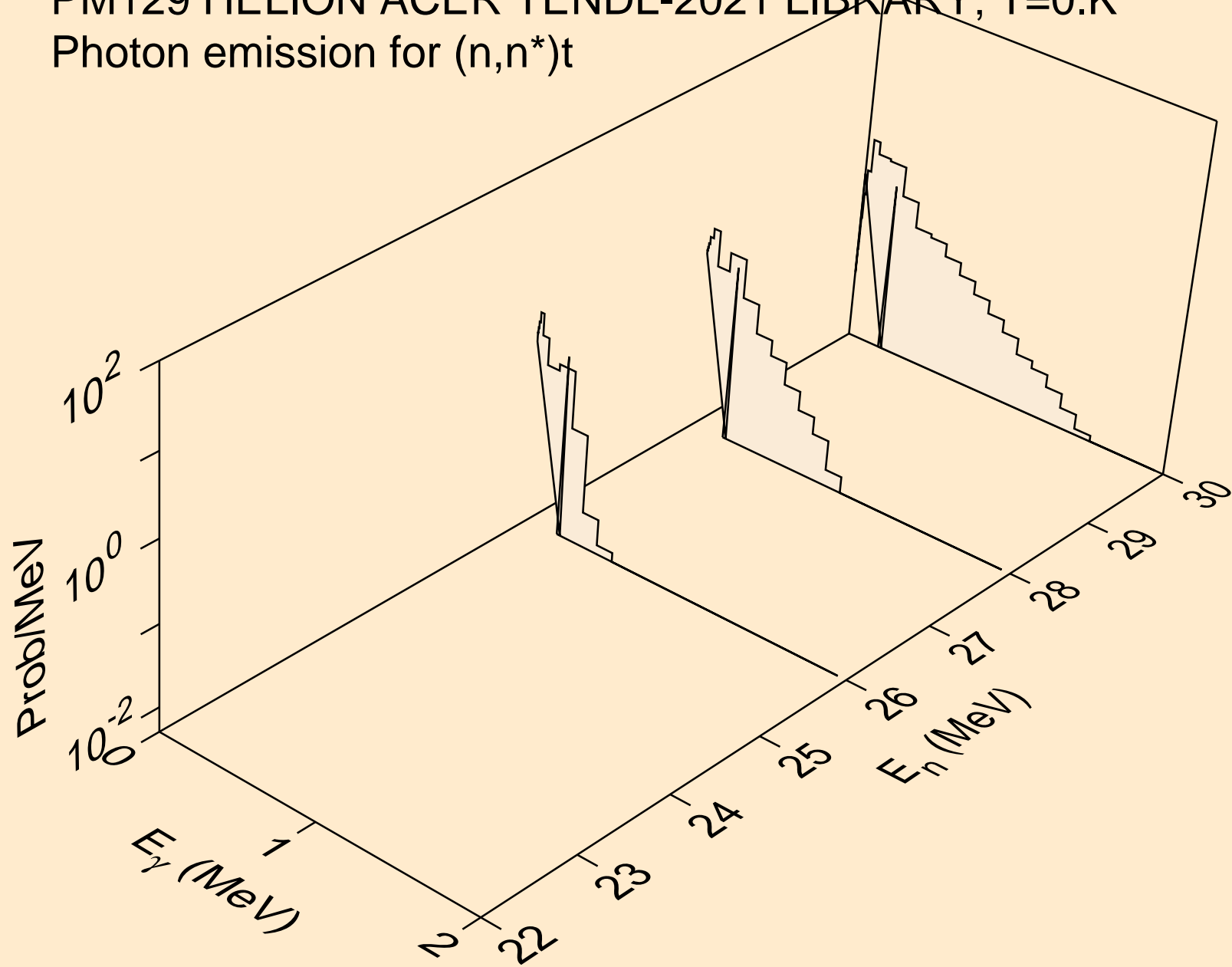

PM129 HELION ACER TENDL-2021 LIBRARY; T=0.K  
Photon emission for (n,n\*)he3

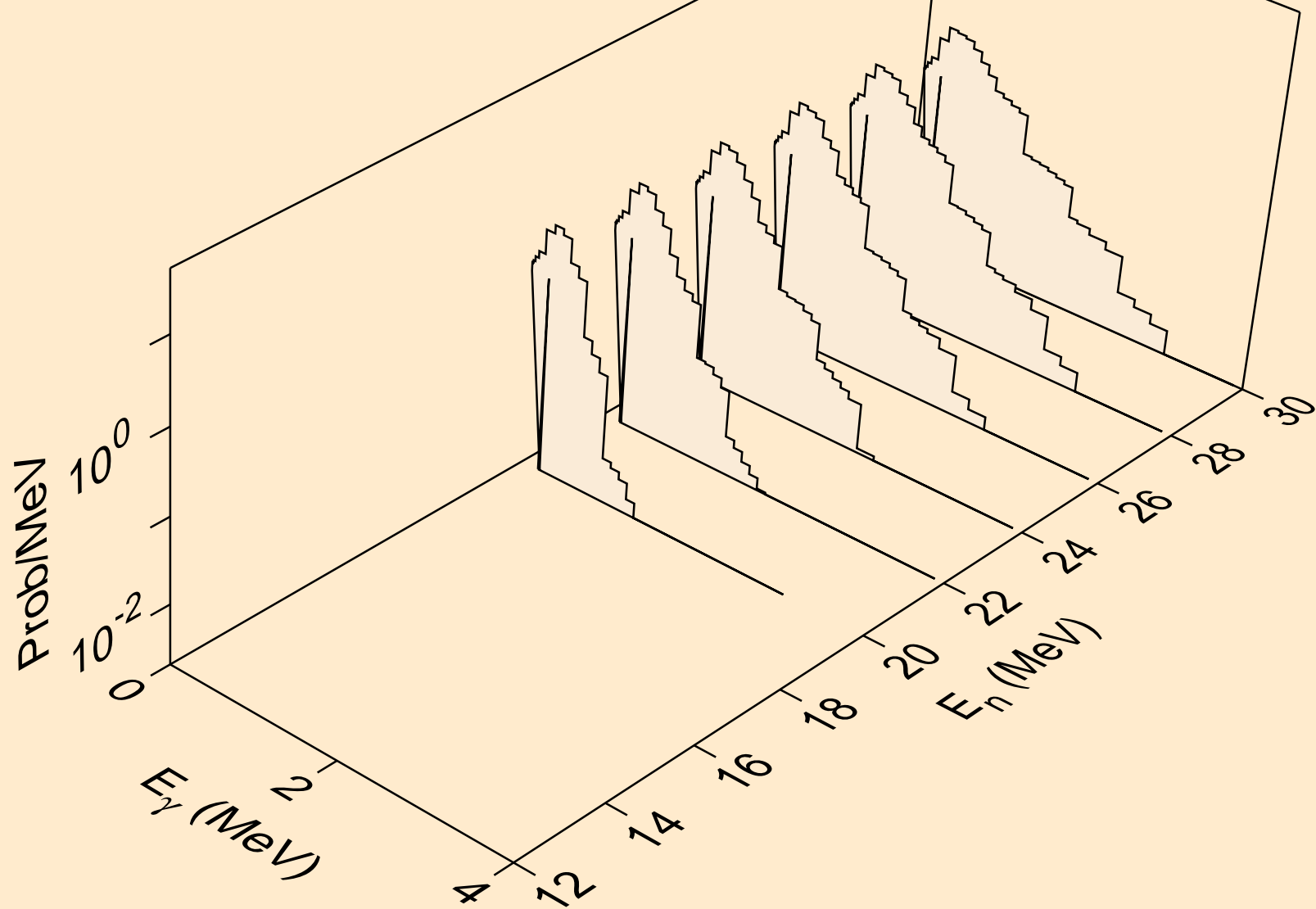



PM129 HELION ACER TENDL-2021 LIBRARY; T=0.K  
Photon emission for (n,2np)

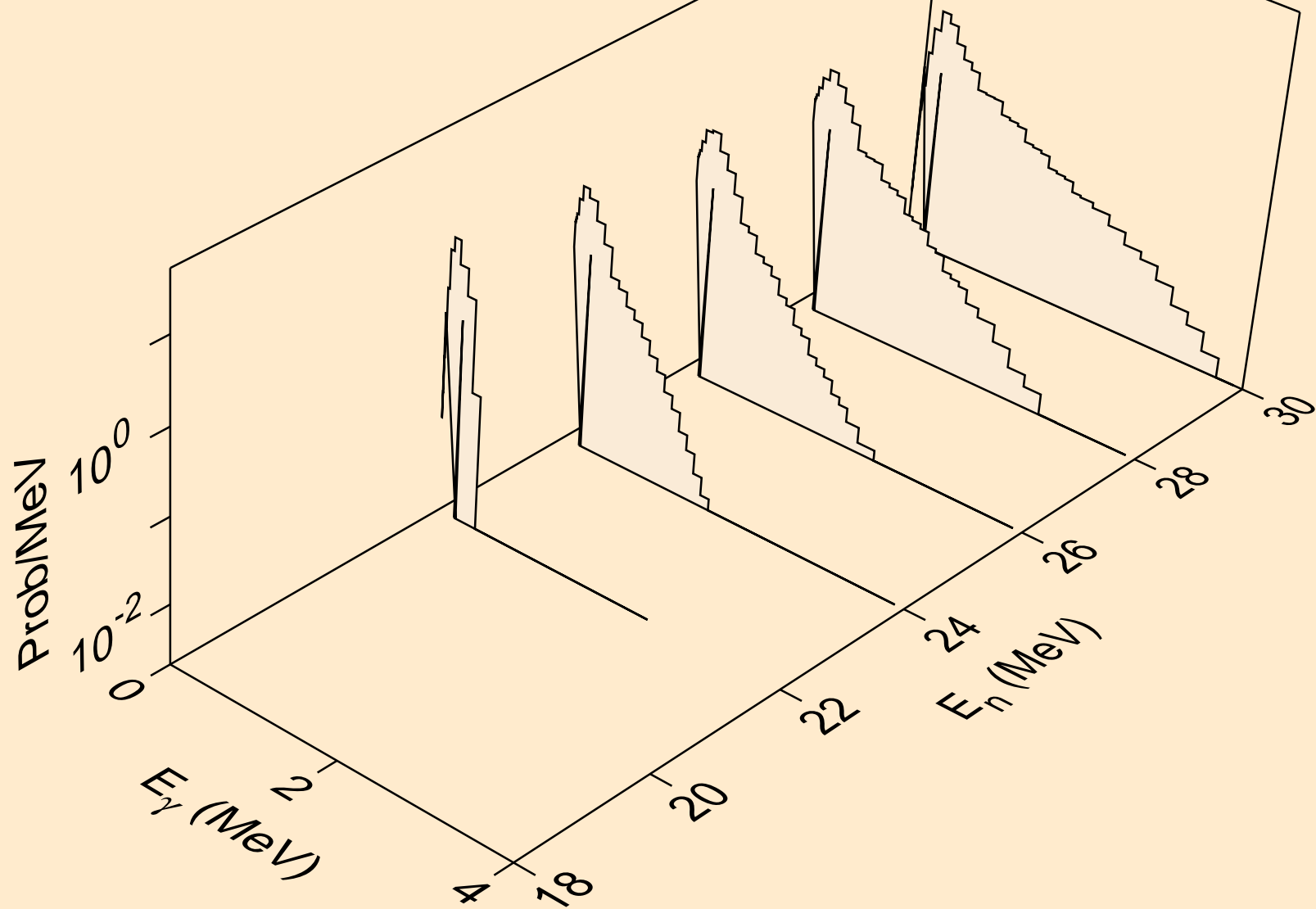

PM129 HELION ACER TENDL-2021 LIBRARY; T=0.K  
Photon emission for (n,2np)

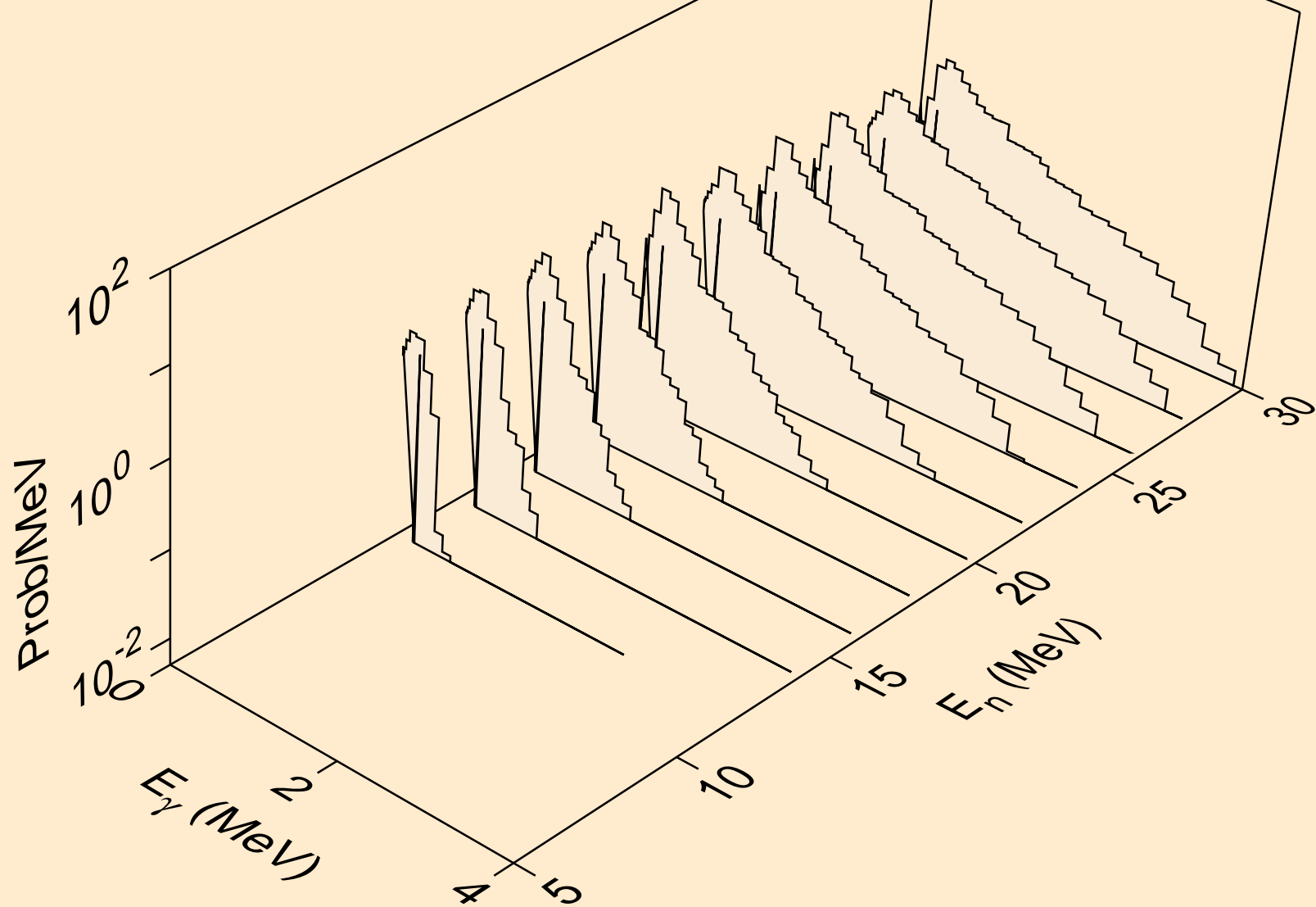

PM129 HELION ACER TENDL-2021 LIBRARY; T=0.K  
Photon emission for (n,npa)

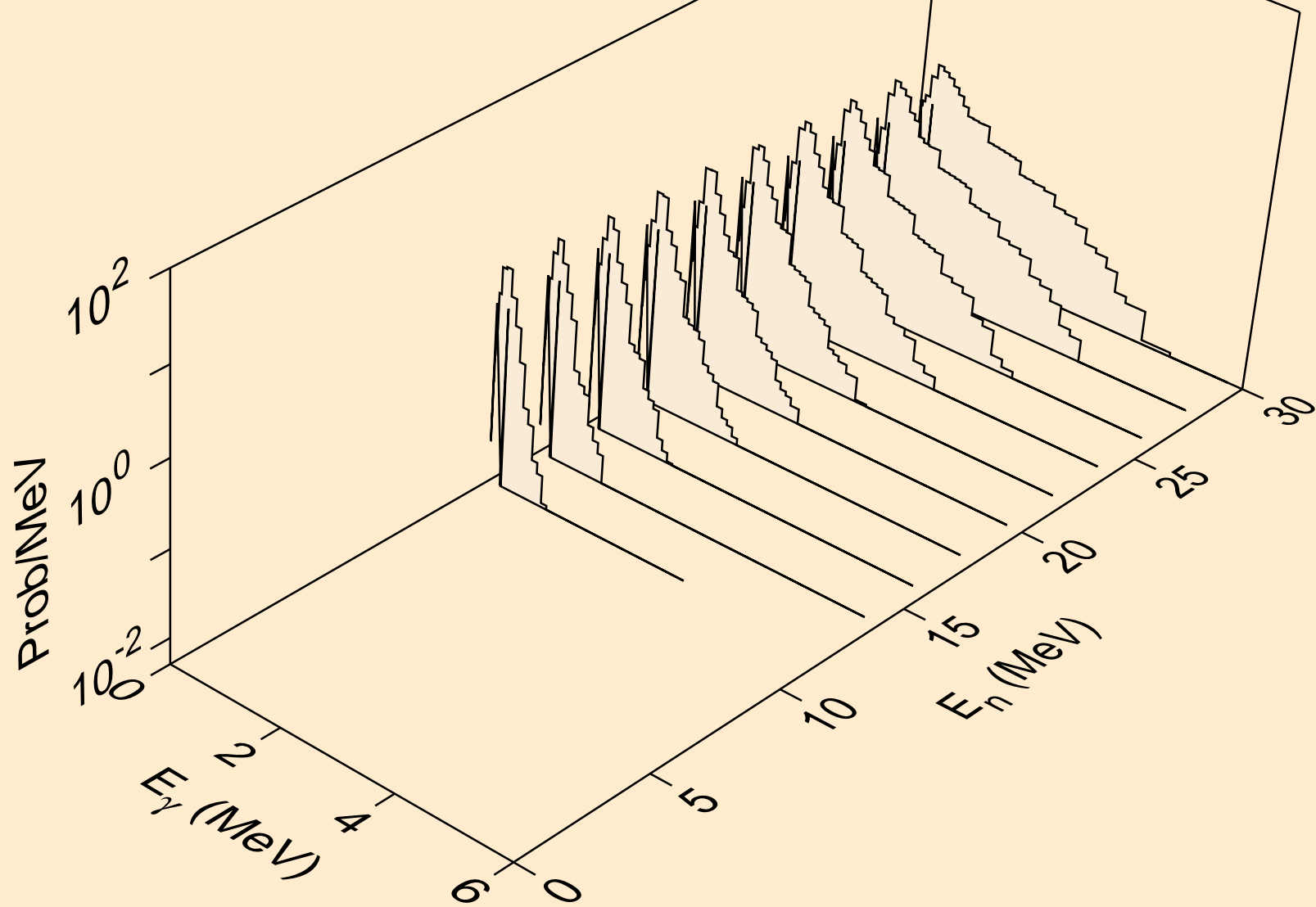

PM129 HELION ACER TENDL-2021 LIBRARY; T=0.K  
Photon emission for (n,gma)

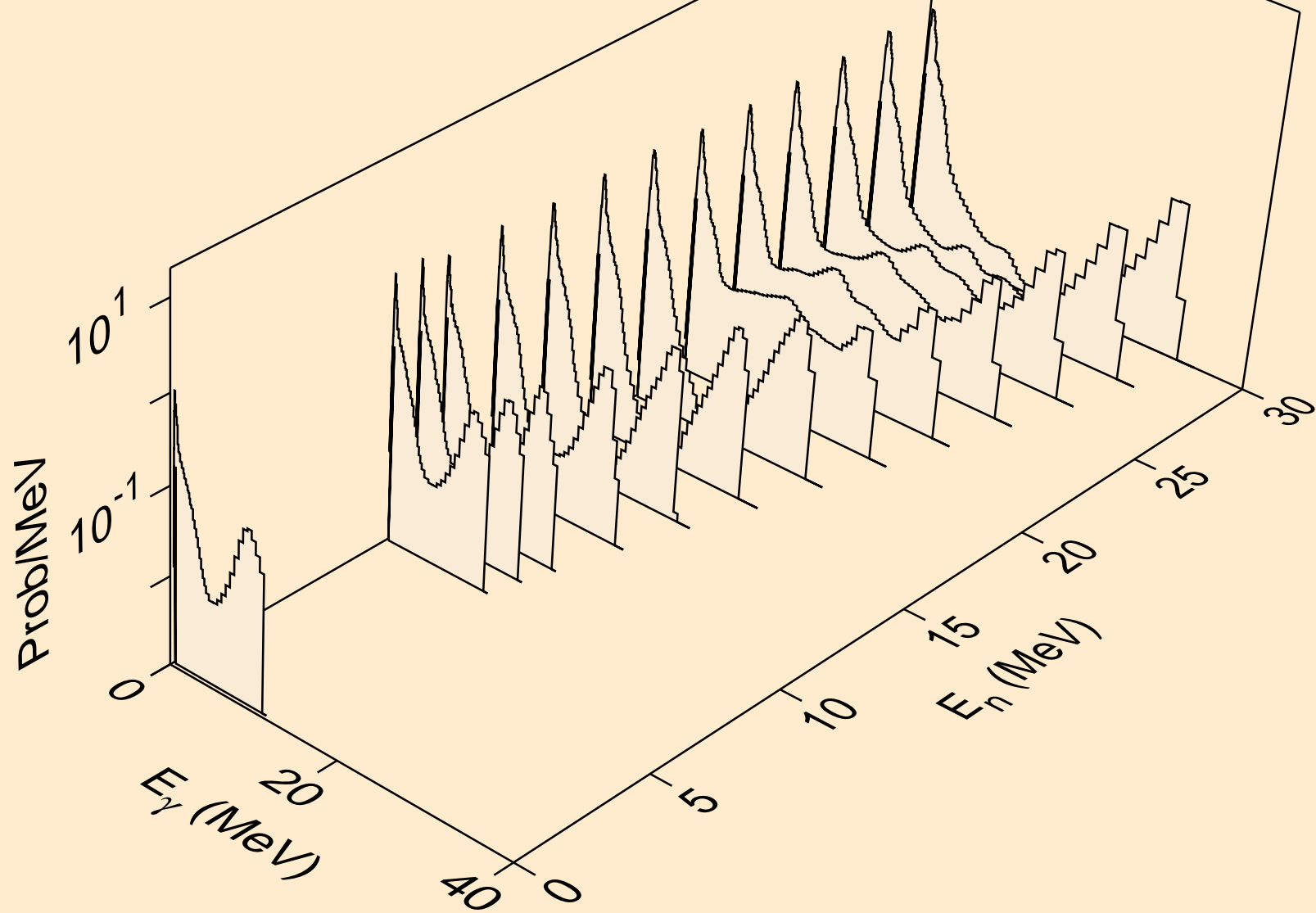

PM129 HELION ACER TENDL-2021 LIBRARY; T=0.K  
Photon emission for (n,p)

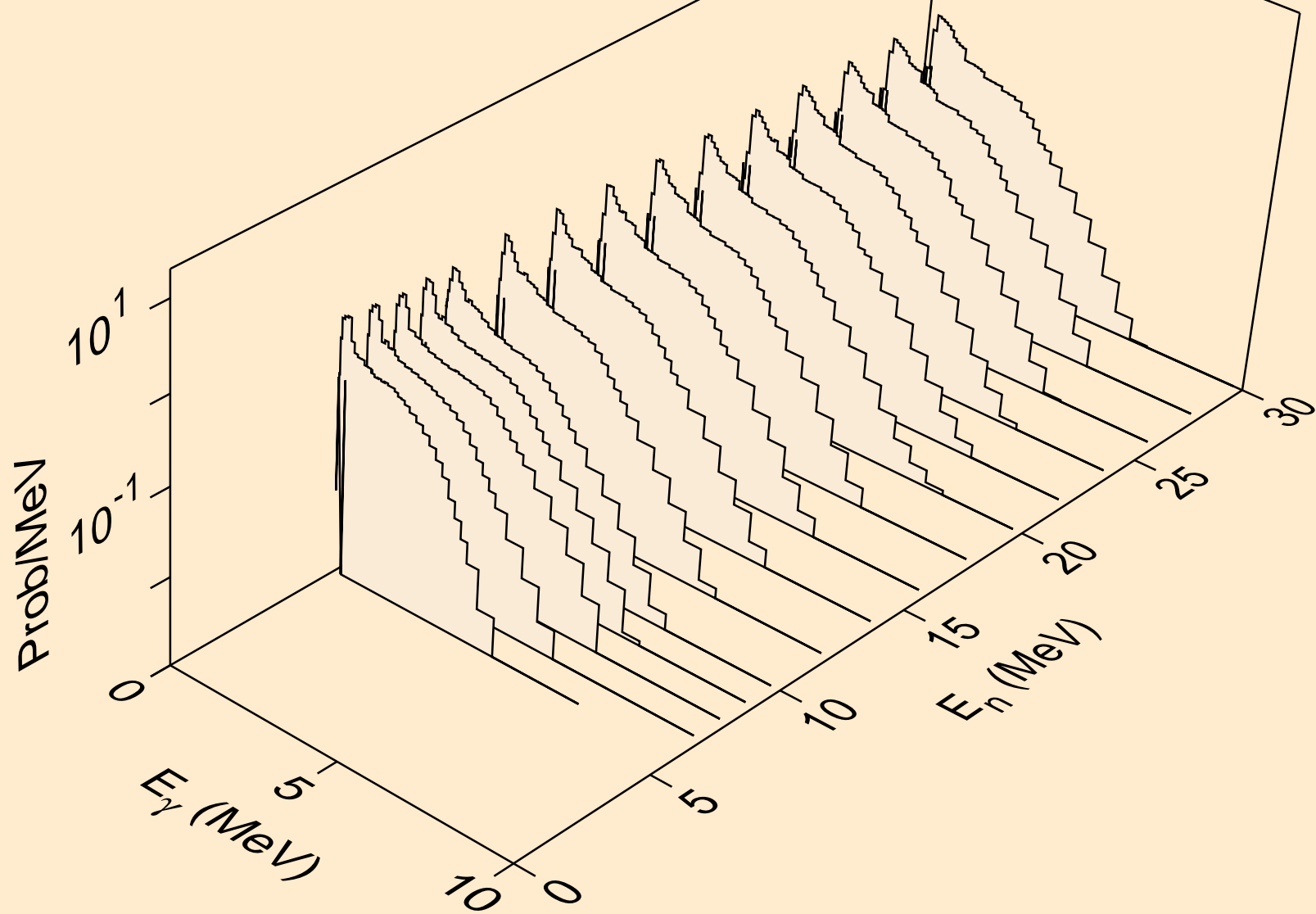

PM129 HELION ACER TENDL-2021 LIBRARY; T=0.K  
Photon emission for (n,d)

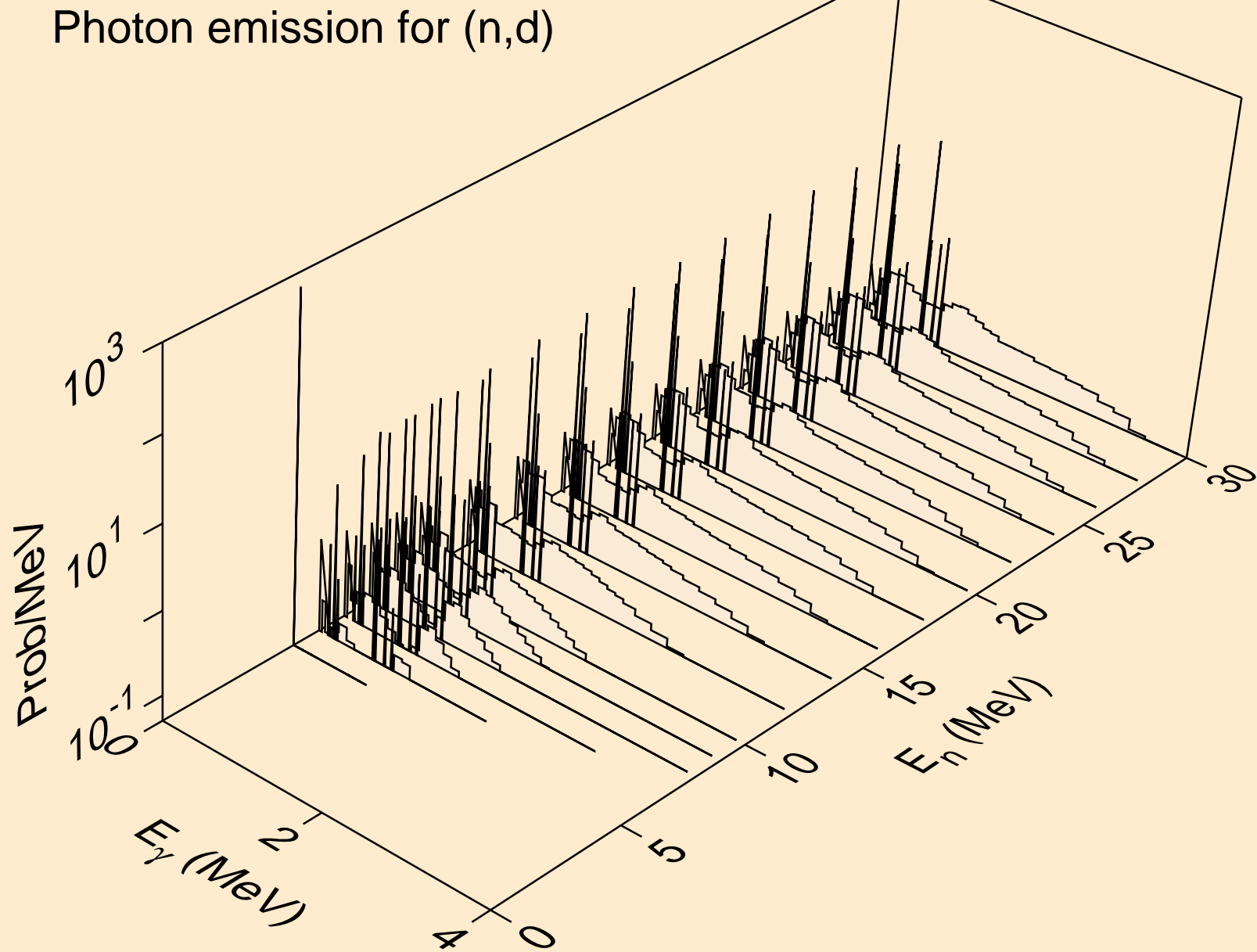

PM129 HELION ACER TENDL-2021 LIBRARY; T=0.K  
Photon emission for (n,t)

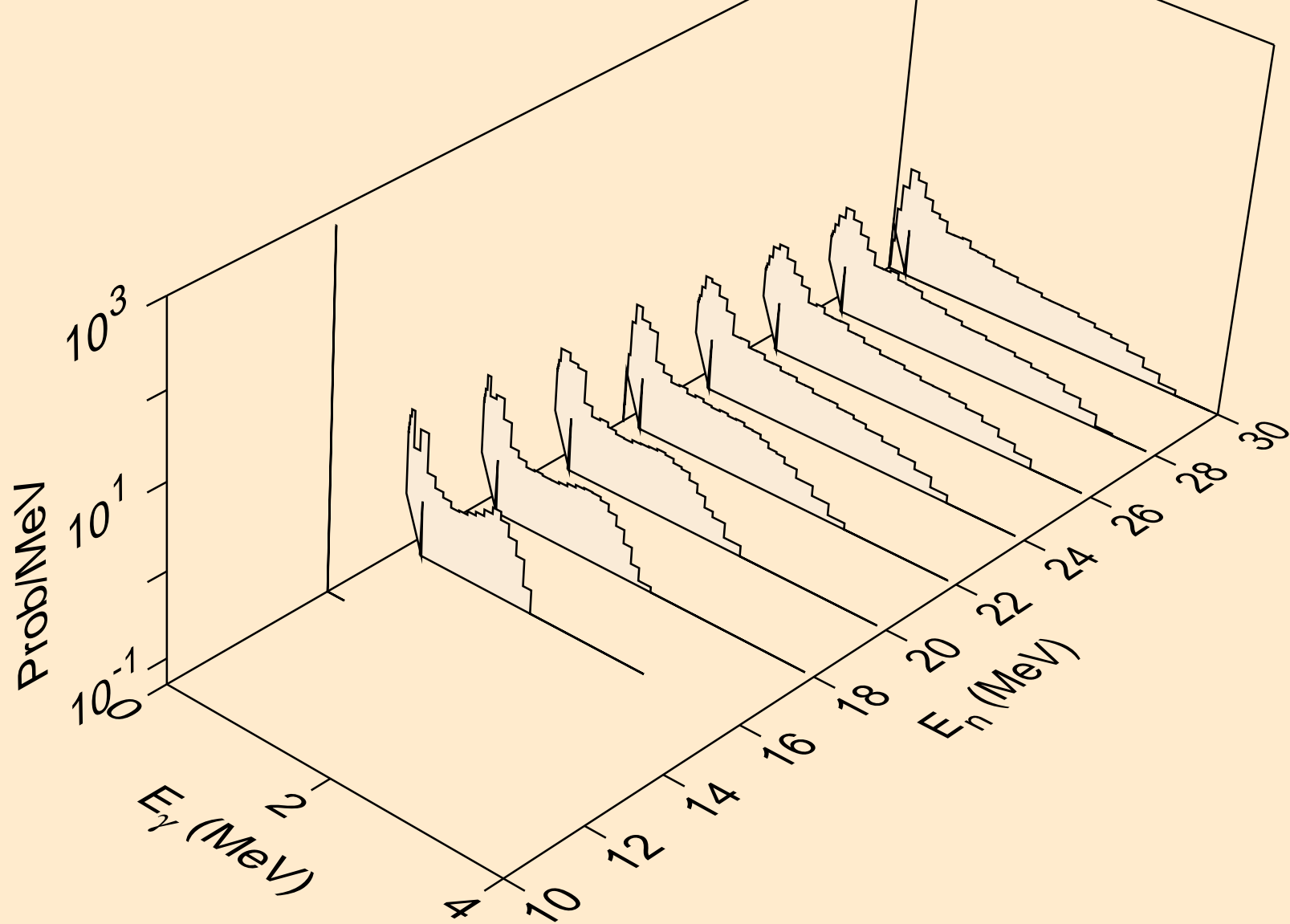

PM129 HELION ACER TENDL-2021 LIBRARY; T=0.K  
Photon emission for inelastic

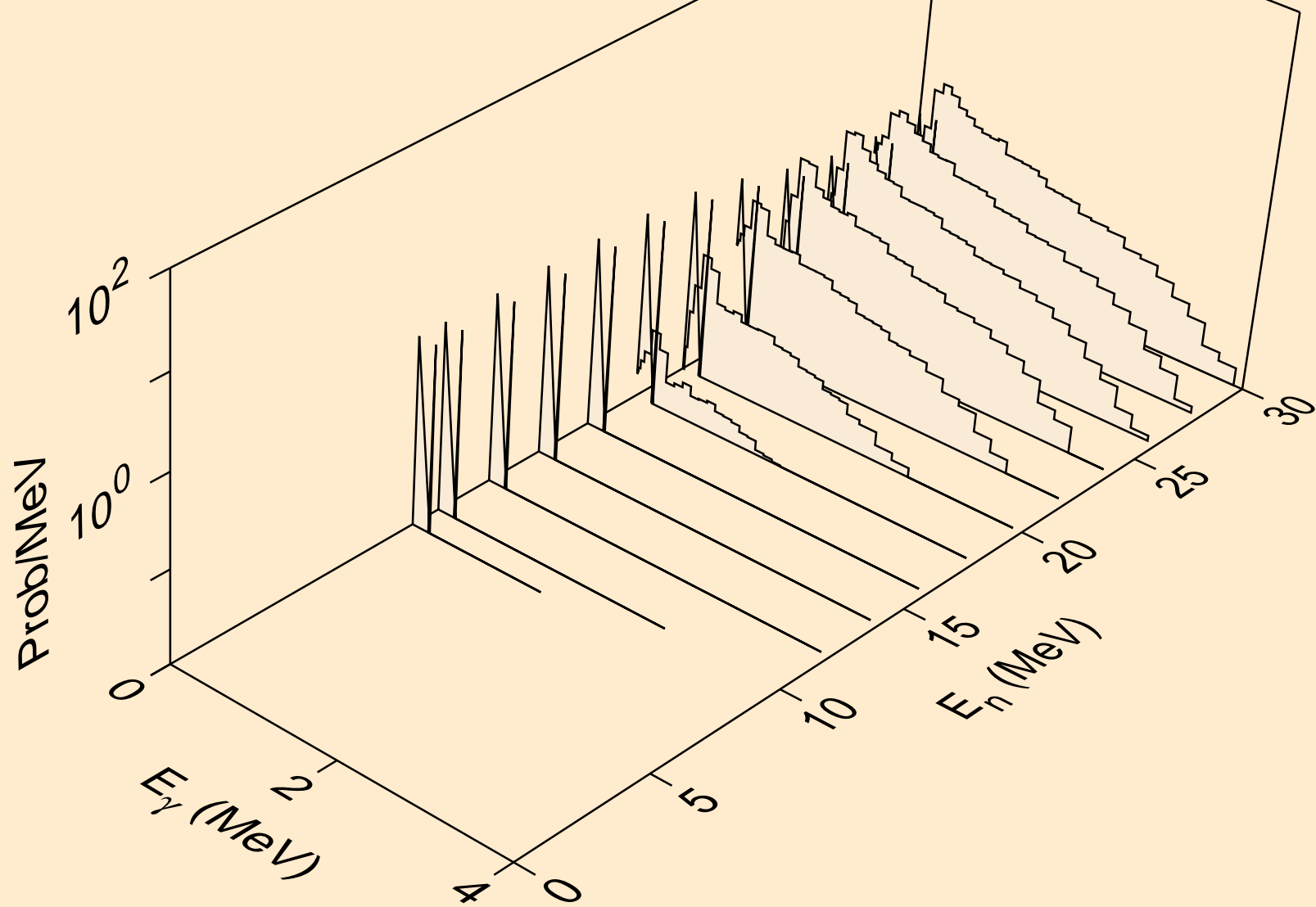



PM129 HELION ACER TENDL-2021 LIBRARY; T=0.K  
Photon emission for (n,a)

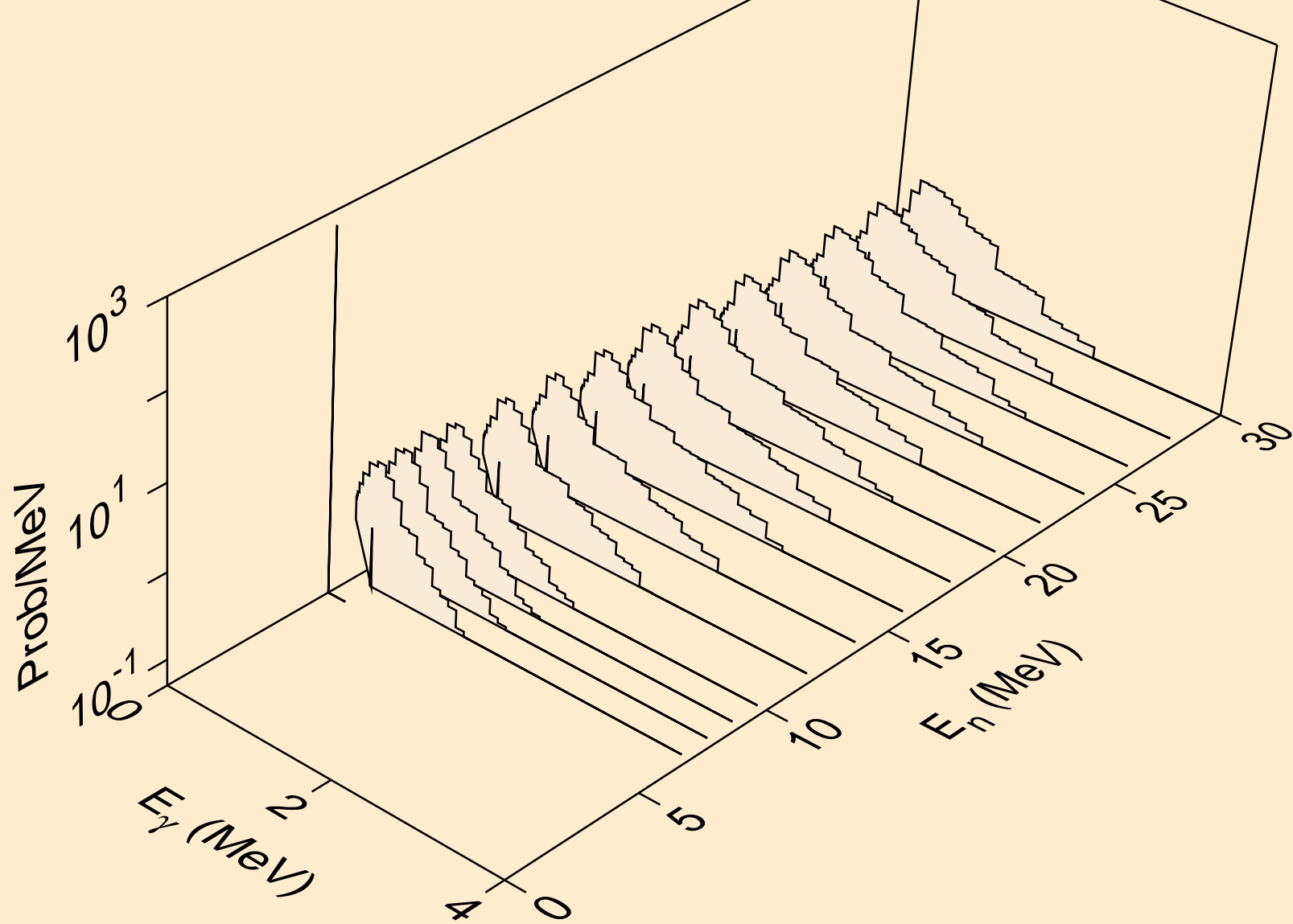

PM129 HELION ACER TENDL-2021 LIBRARY; T=0.K  
Photon emission for (n,2a)

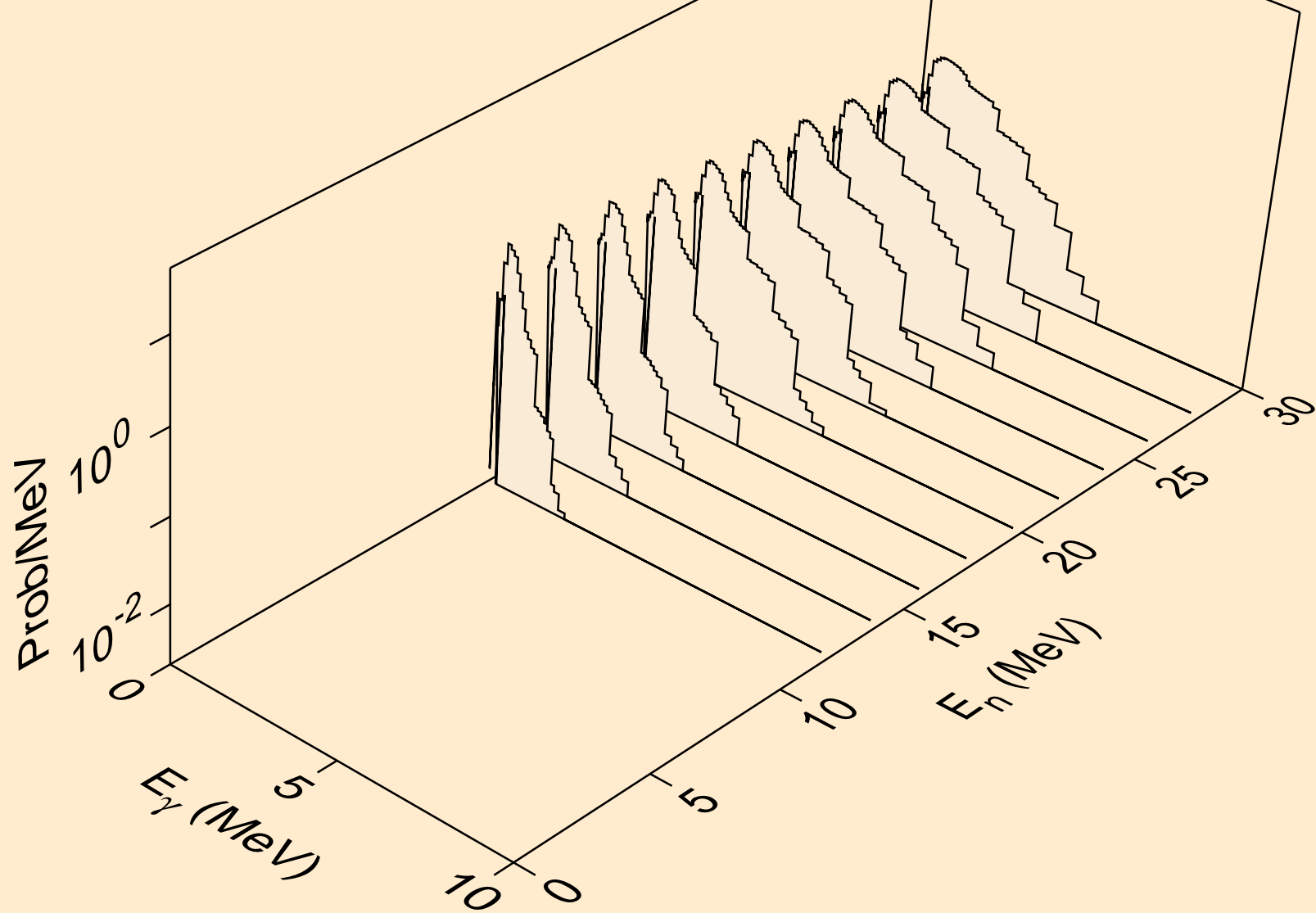

PM129 HELION ACER TENDL-2021 LIBRARY; T=0.K  
Photon emission for (n,2p)

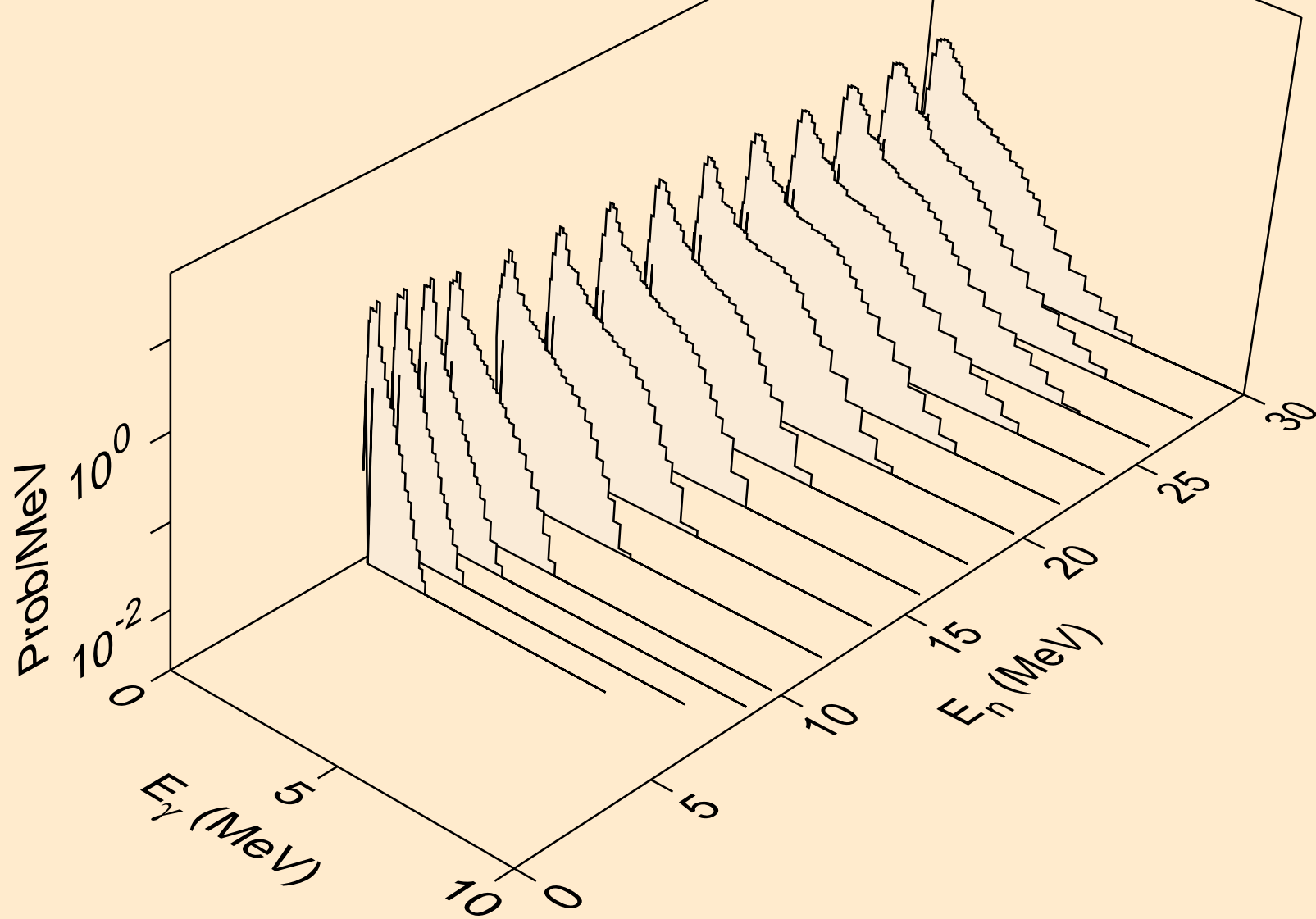

PM129 HELION ACER TENDL-2021 LIBRARY; T=0.K  
Photon emission for (n,pa)

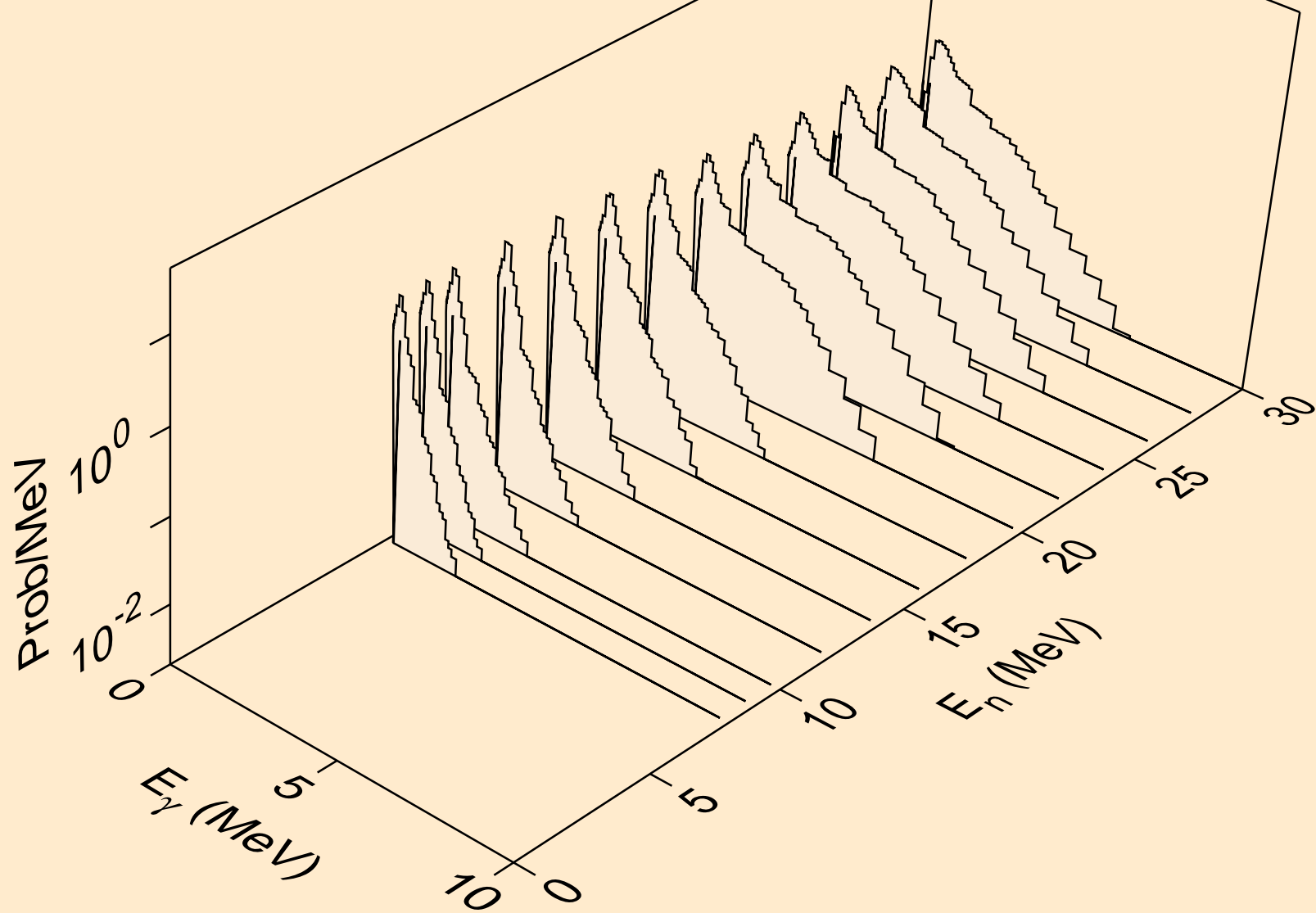

PM129 HELION ACER TENDL-2021 LIBRARY; T=0.K  
Photon emission for (n,pd)

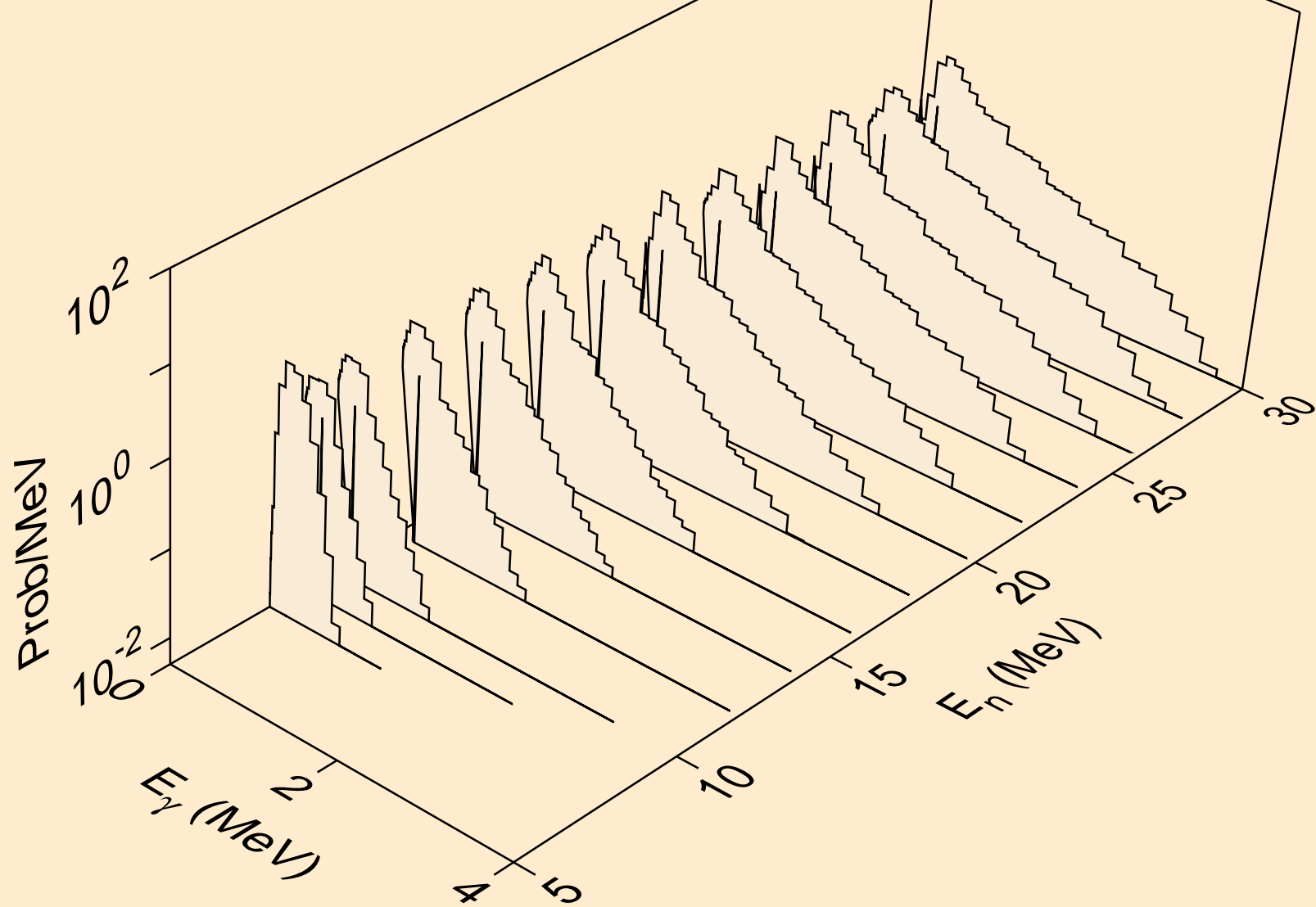

PM129 HELION ACER TENDL-2021 LIBRARY; T=0.K  
Photon emission for (n,pt)

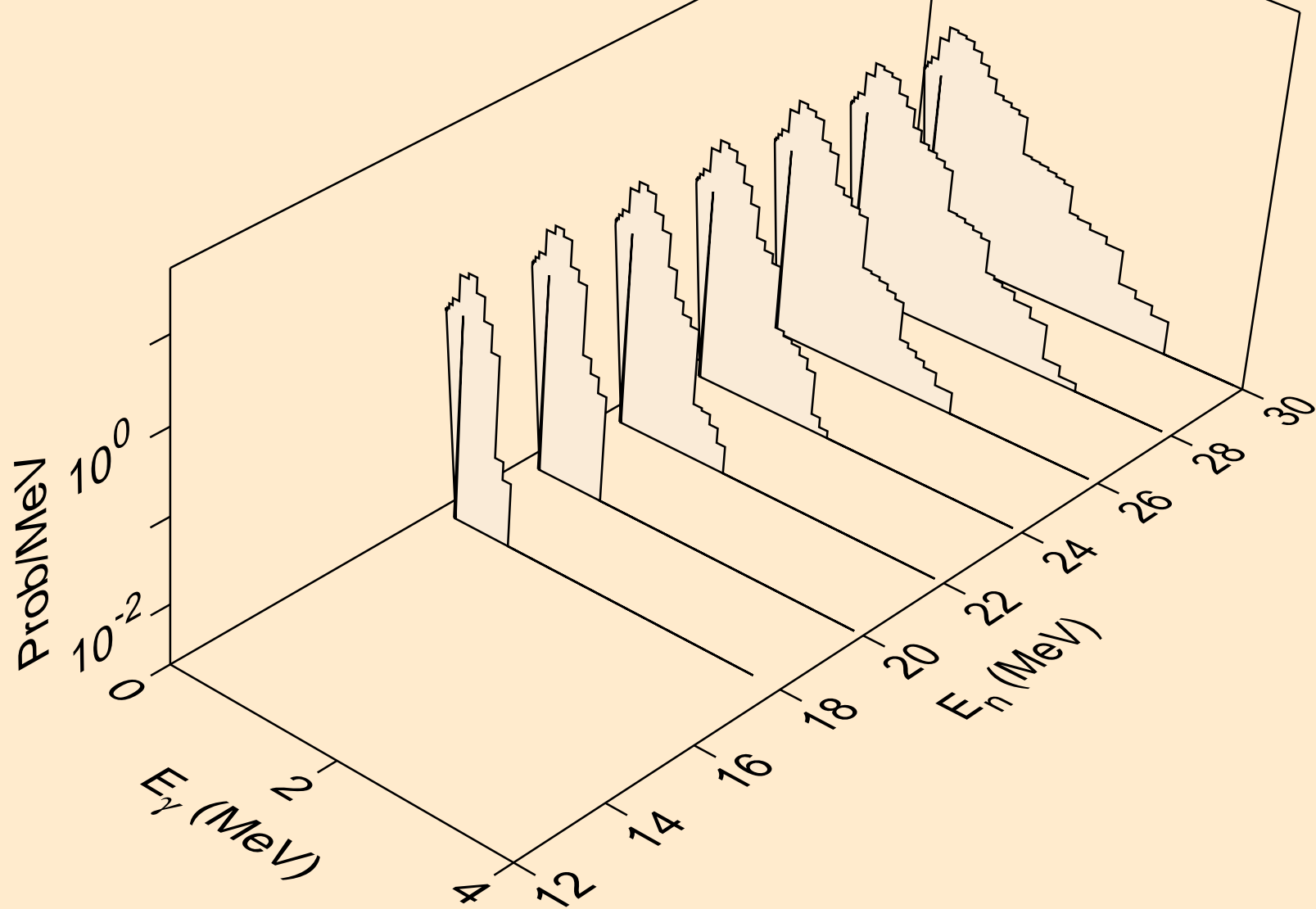

PM129 HELION ACER TENDL-2021 LIBRARY; T=0.K  
Photon emission for (n,da)

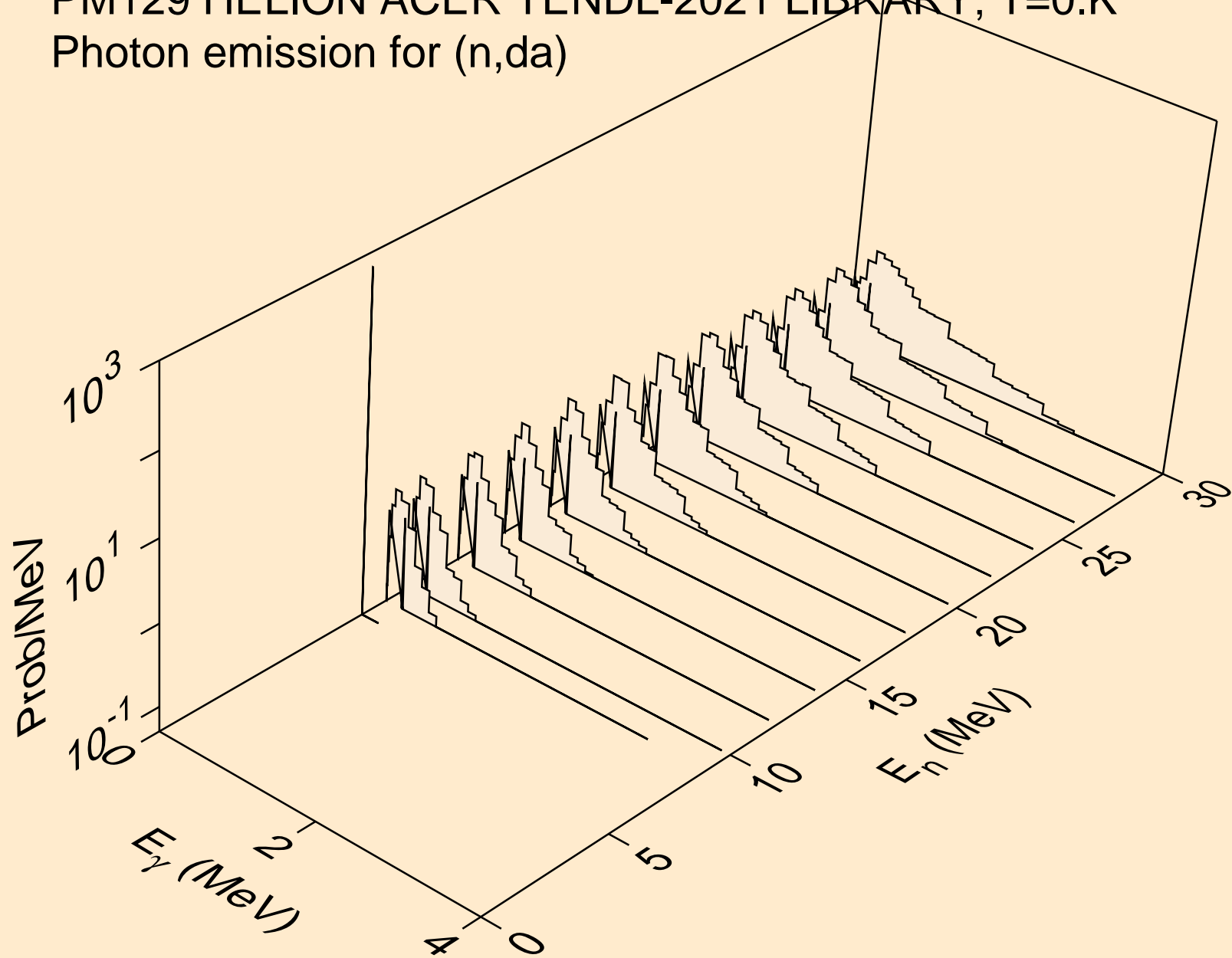

PM129 HELION ACER TENDL-2021 LIBRARY; T=0.K  
Particle heating contributions

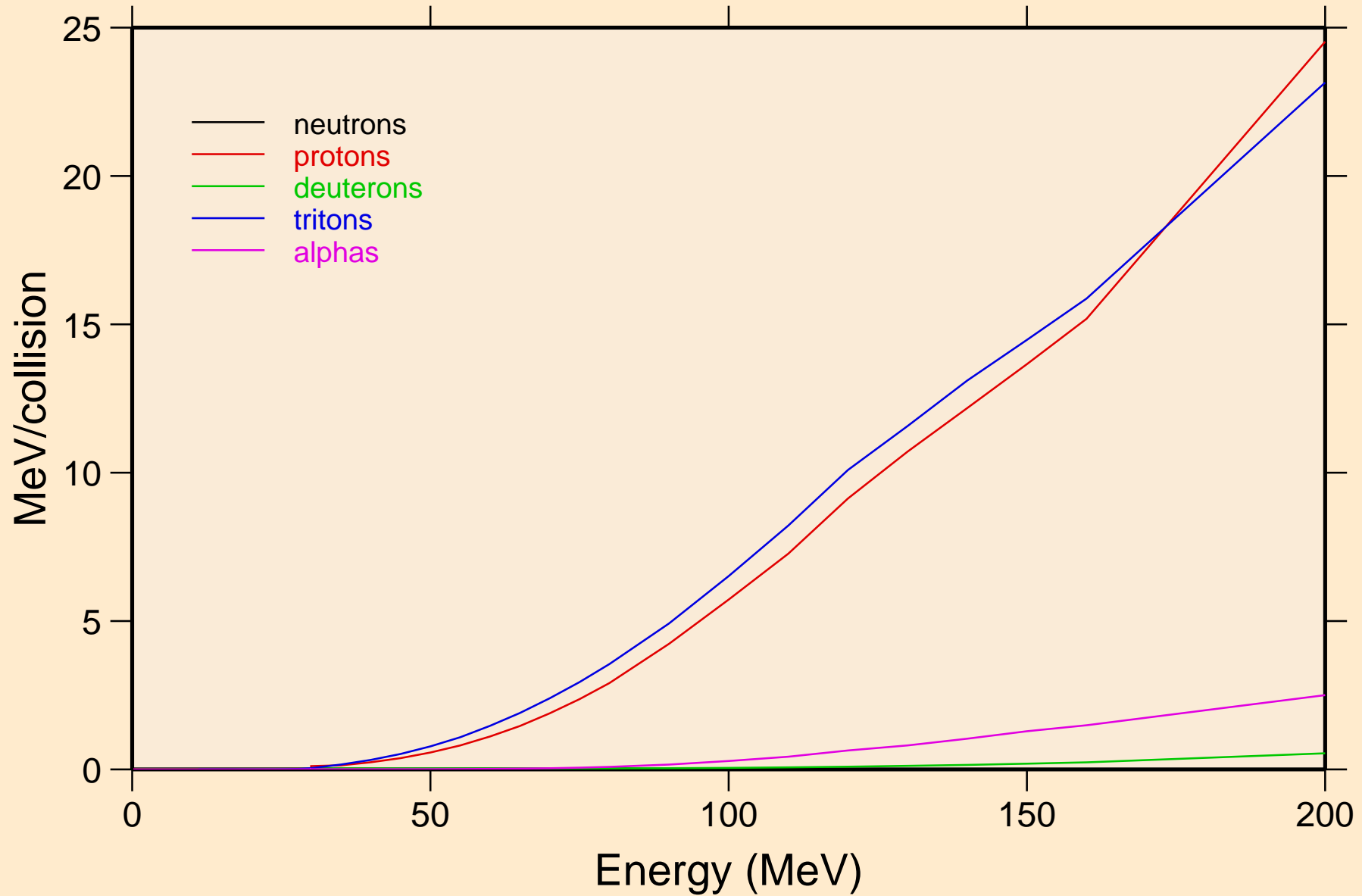



PM129 HELION ACER TENDL-2021 LIBRARY; T=0.K  
Recoil Heating

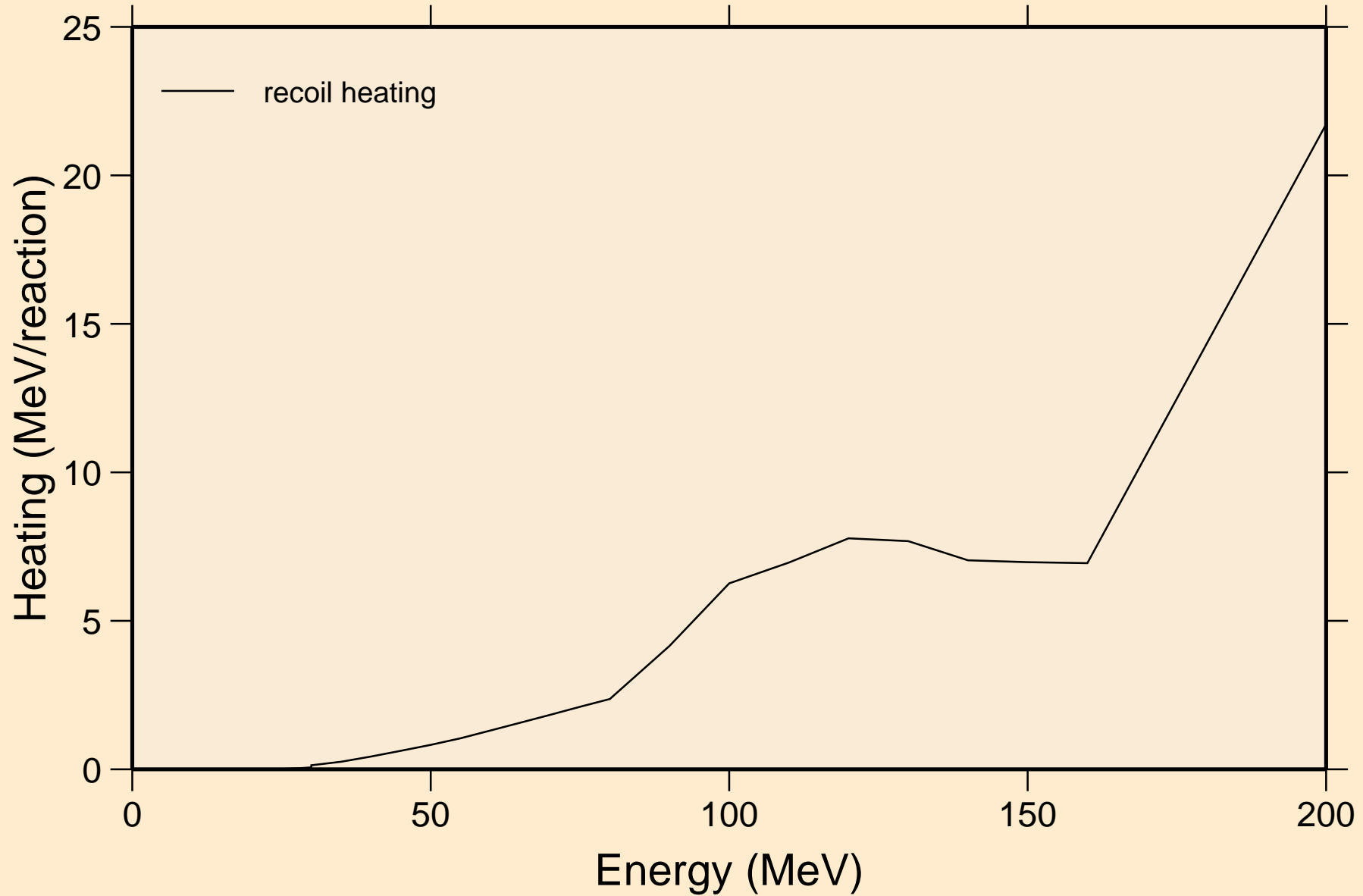

PM129 HELION ACER TENDL-2021 LIBRARY; T=0.K  
Particle production cross sections

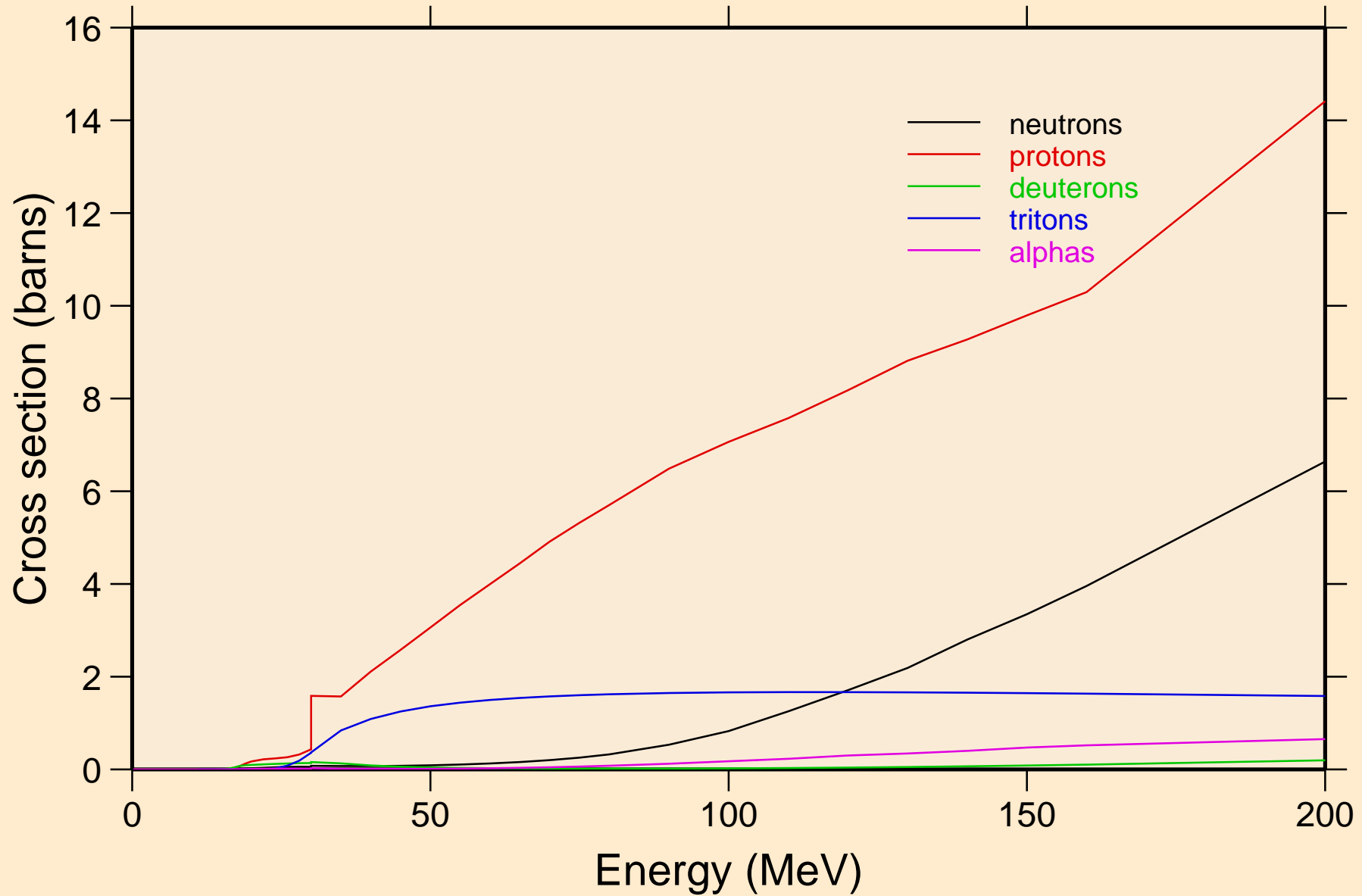

PM129 HELION ACER TENDL-2021 LIBRARY; T=0.K  
neutrons from (s,n)

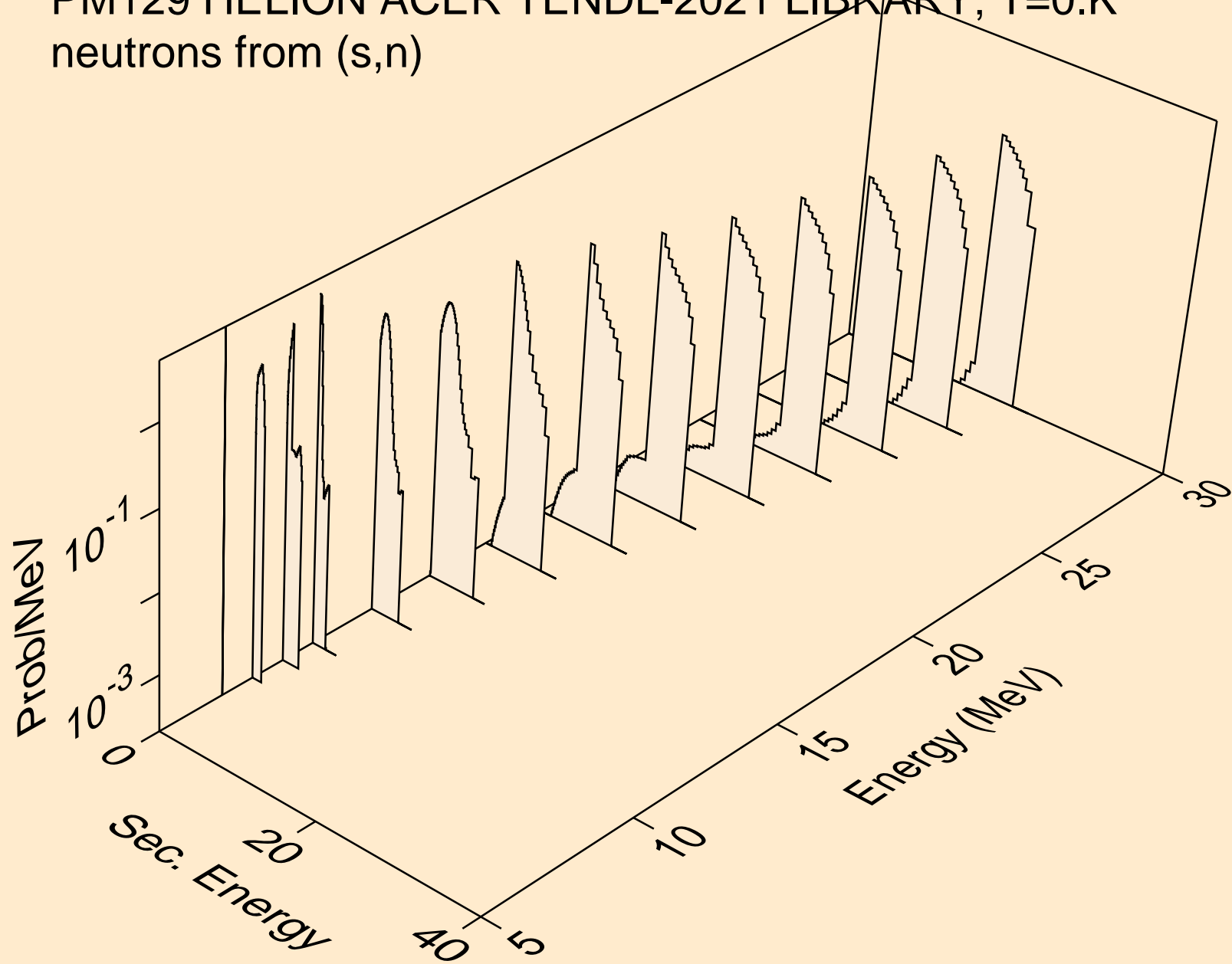

PM129 HELION ACER TENDL-2021 LIBRARY; T=0.K  
neutrons from (s,x)

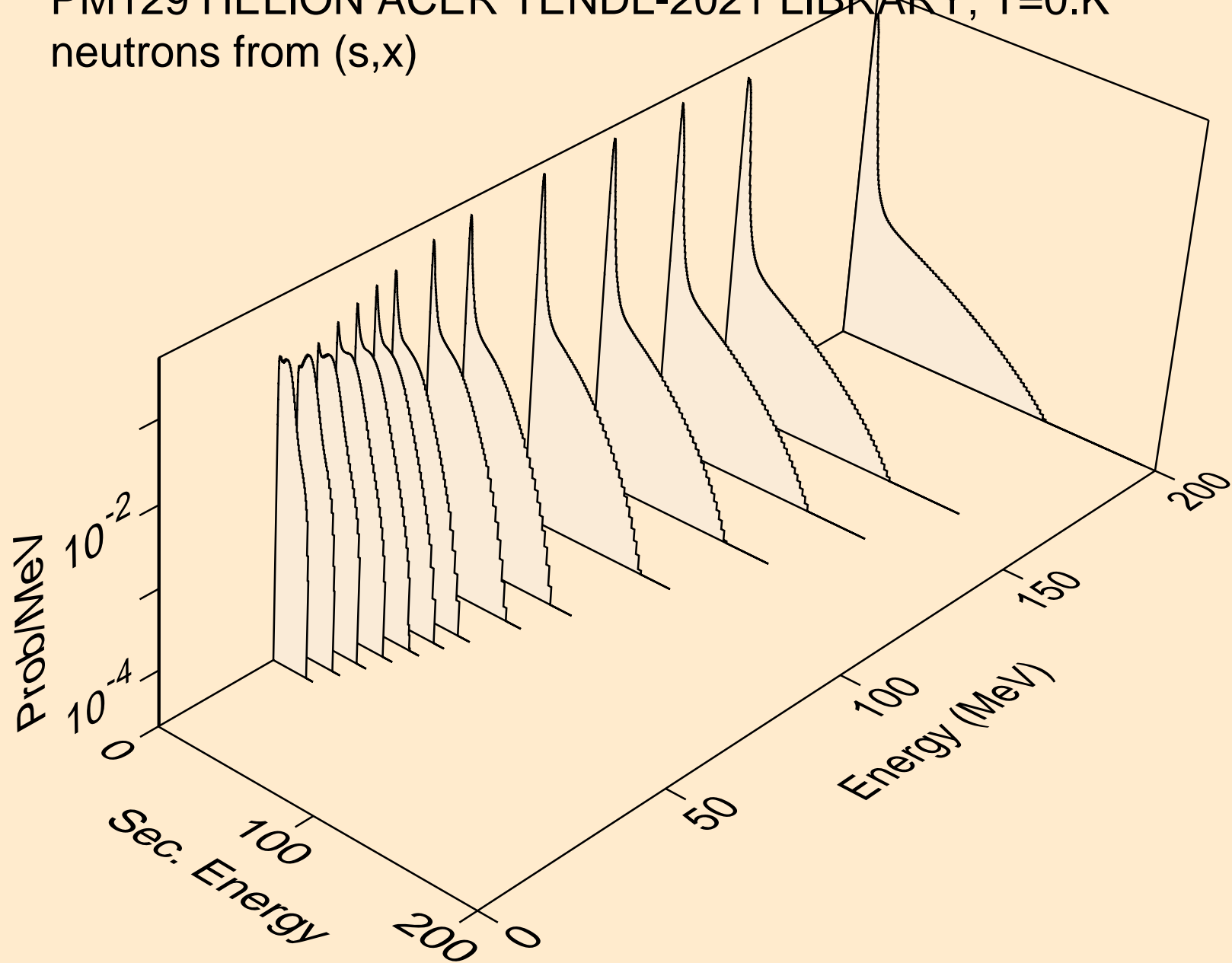

PM129 HELION ACER TENDL-2021 LIBRARY; T=0.K  
neutrons from (s,2n)

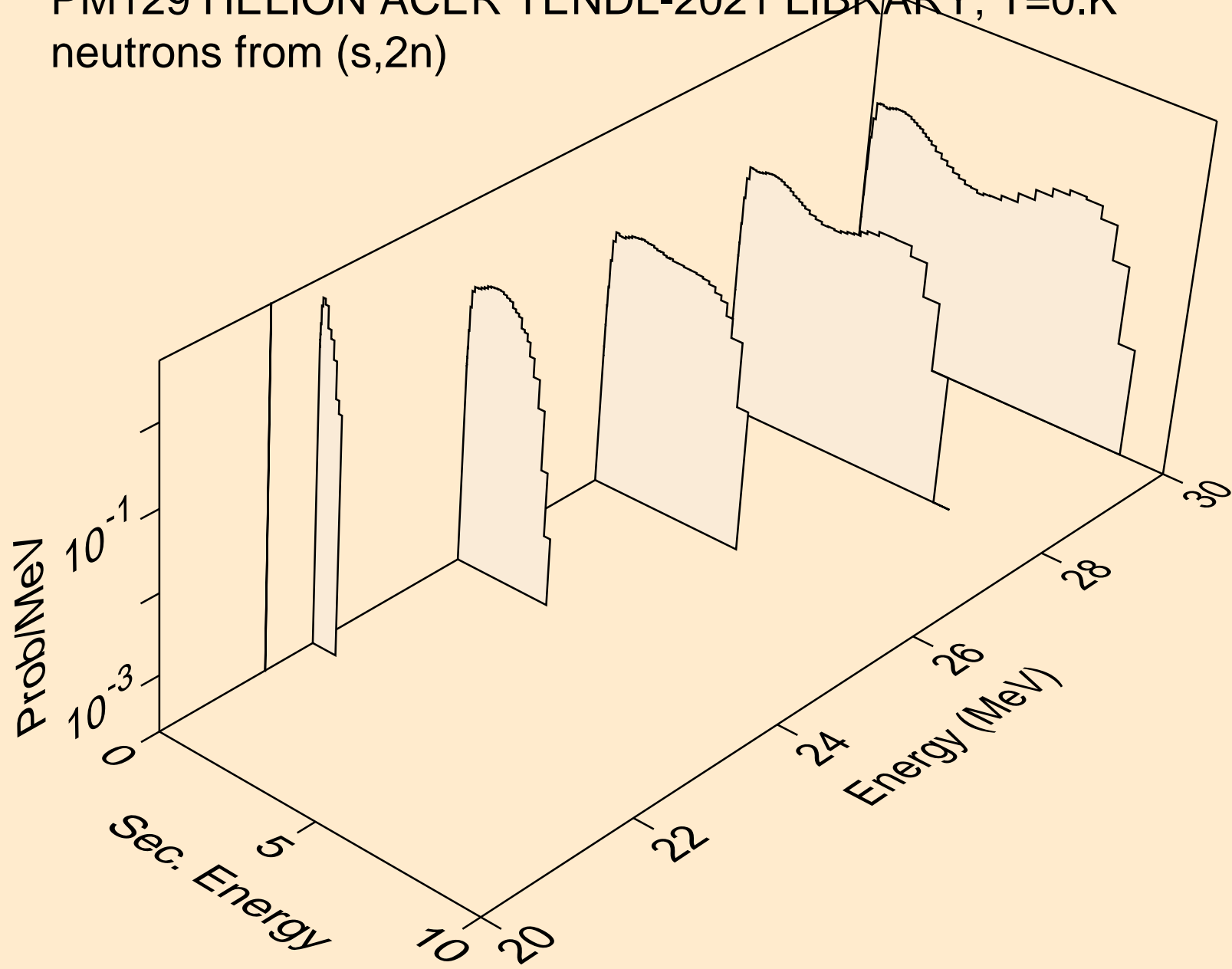

PM129 HELION ACER TENDL-2021 LIBRARY; T=0.K  
neutrons from (s,n\*)a

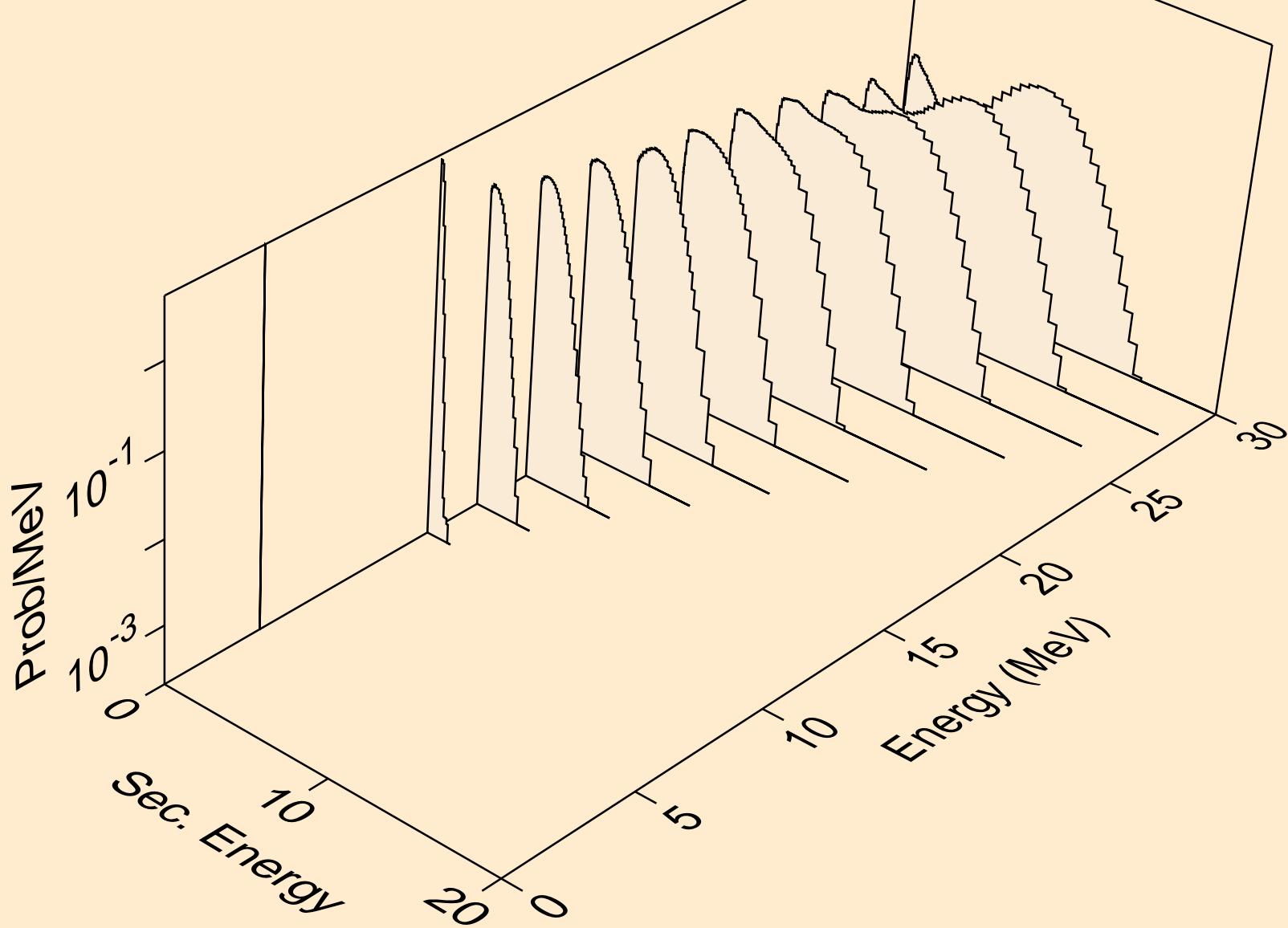

PM129 HELION ACER TENDL-2021 LIBRARY; T=0.K  
neutrons from (s,n\*)p

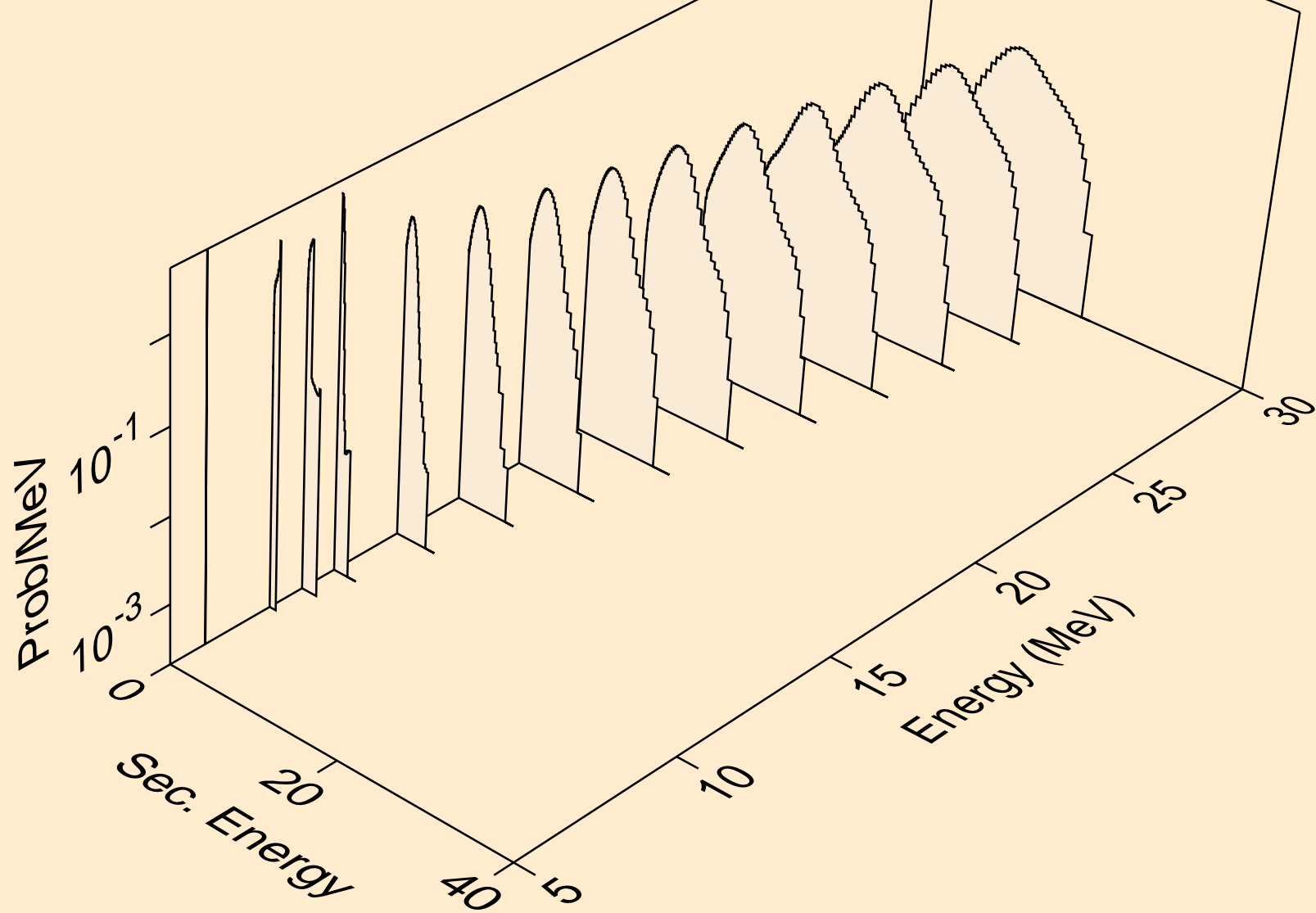

PM129 HELION ACER TENDL-2021 LIBRARY; T=0.K  
neutrons from (s,n\*)2a

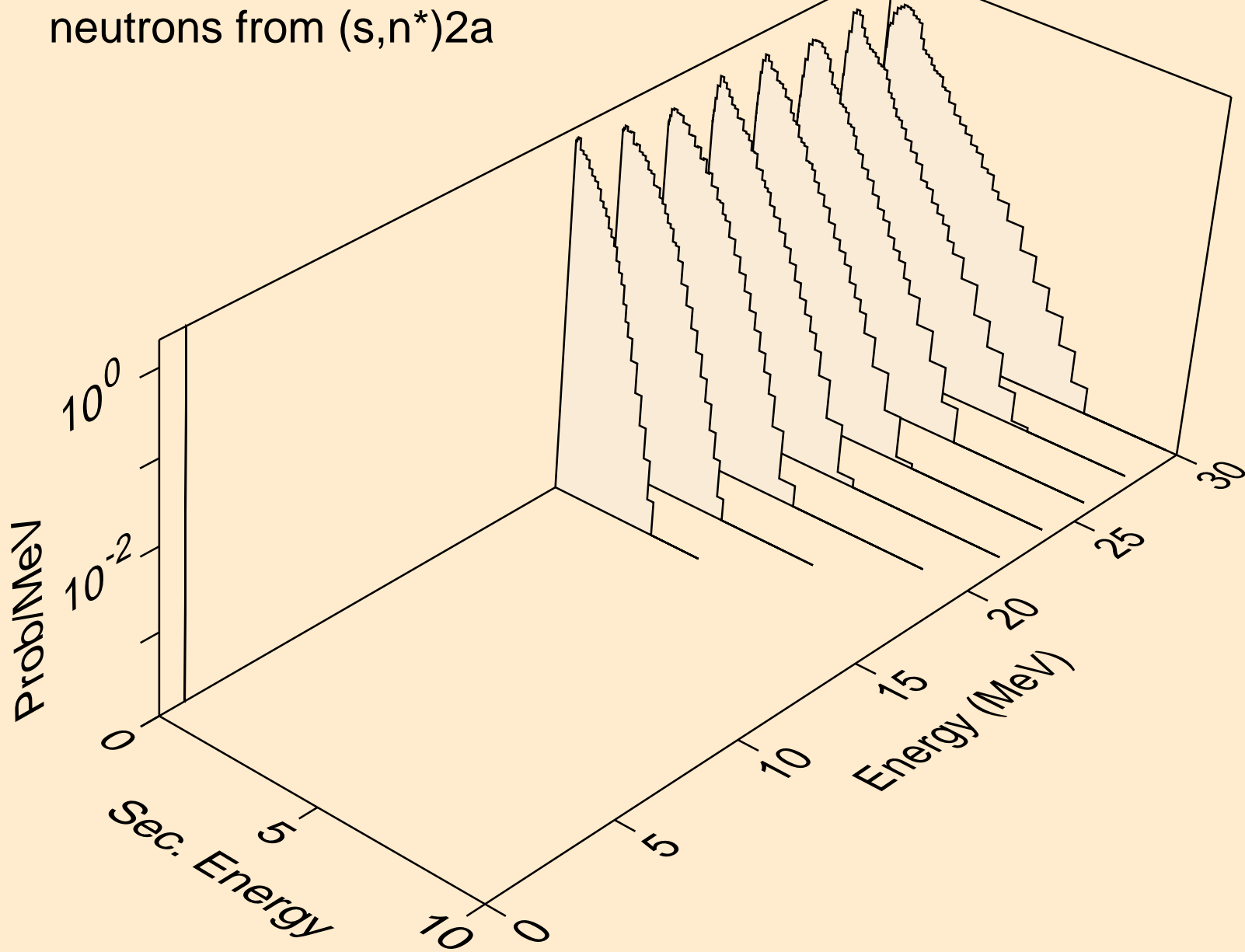



PM129 HELION ACER TENDL-2021 LIBRARY; T=0.K  
neutrons from (s,n\*)d

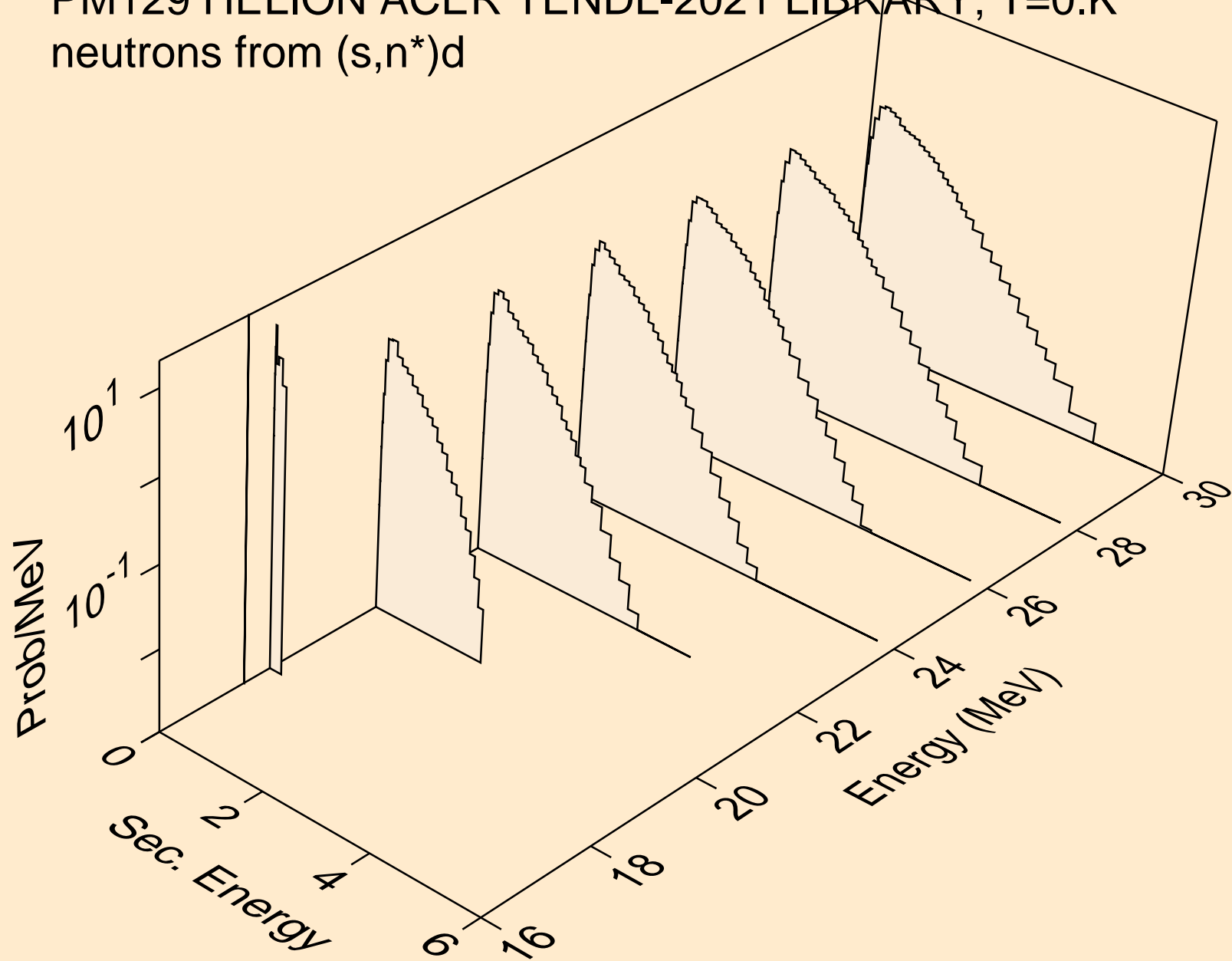

PM129 HELION ACER TENDL-2021 LIBRARY; T=0.K  
neutrons from (s,n\*)t

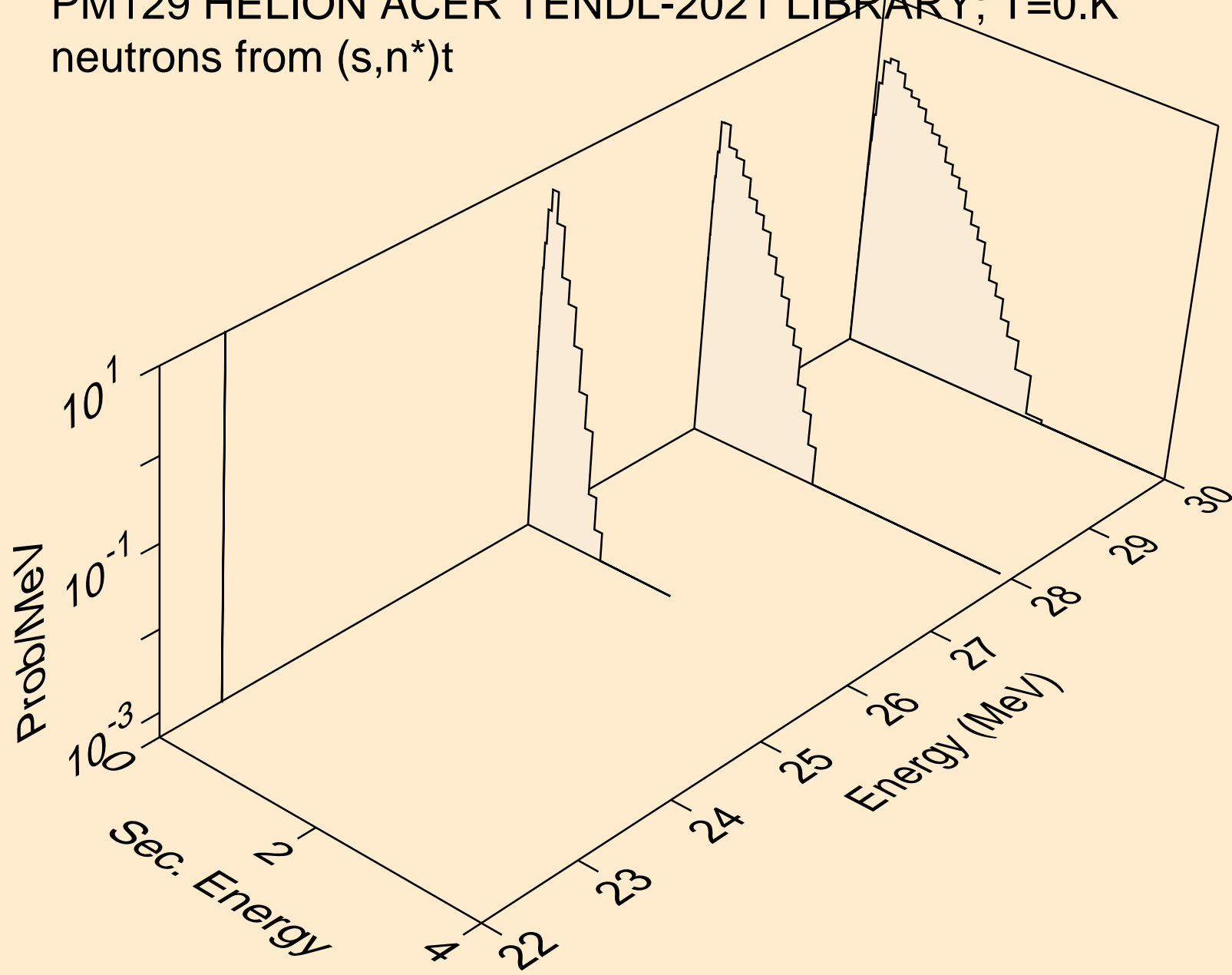

PM129 HELION ACER TENDL-2021 LIBRARY; T=0.K  
neutrons from (s,n\*)he3

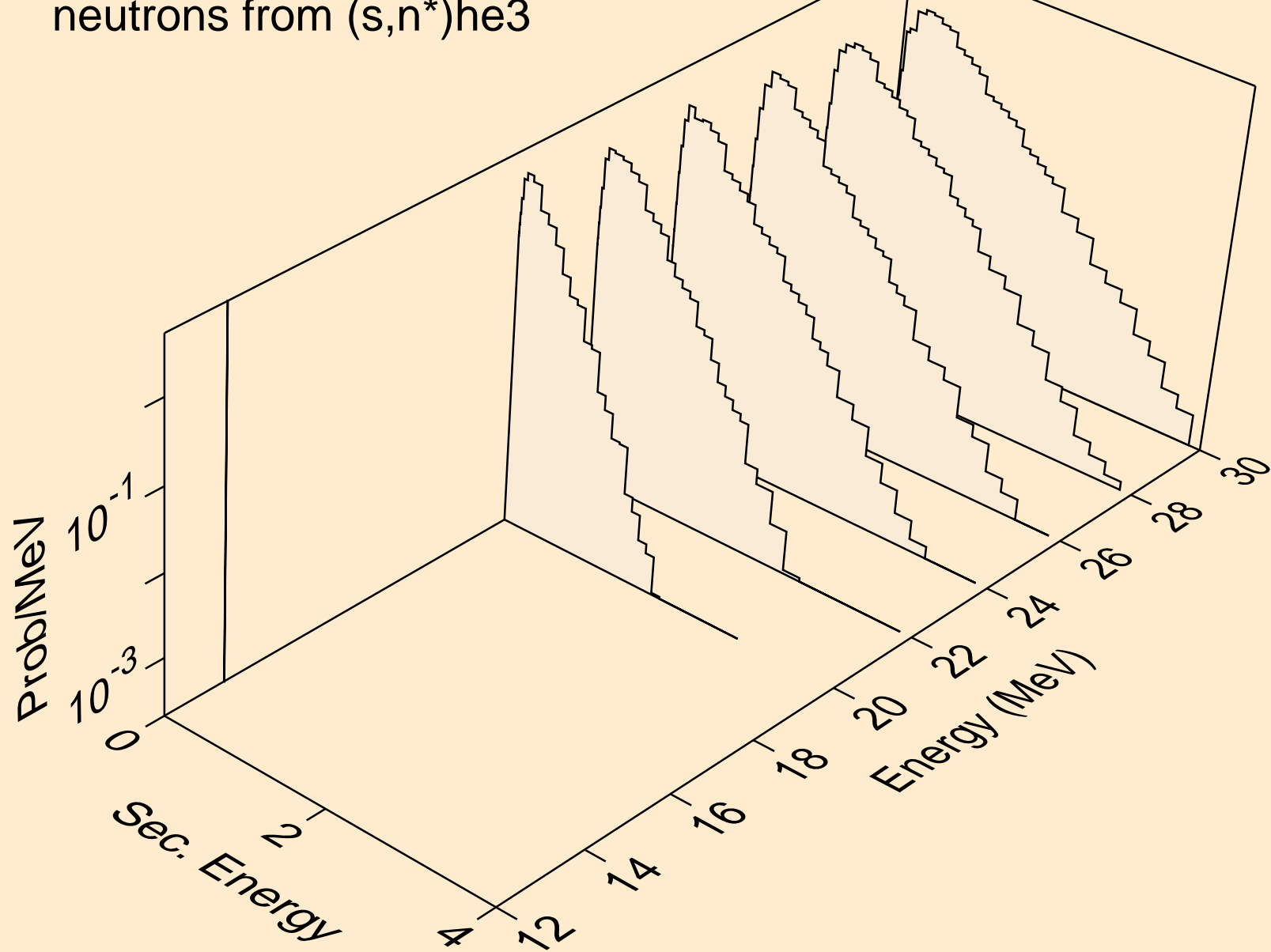

PM129 HELION ACER TENDL-2021 LIBRARY; T=0.K  
neutrons from (s,2np)

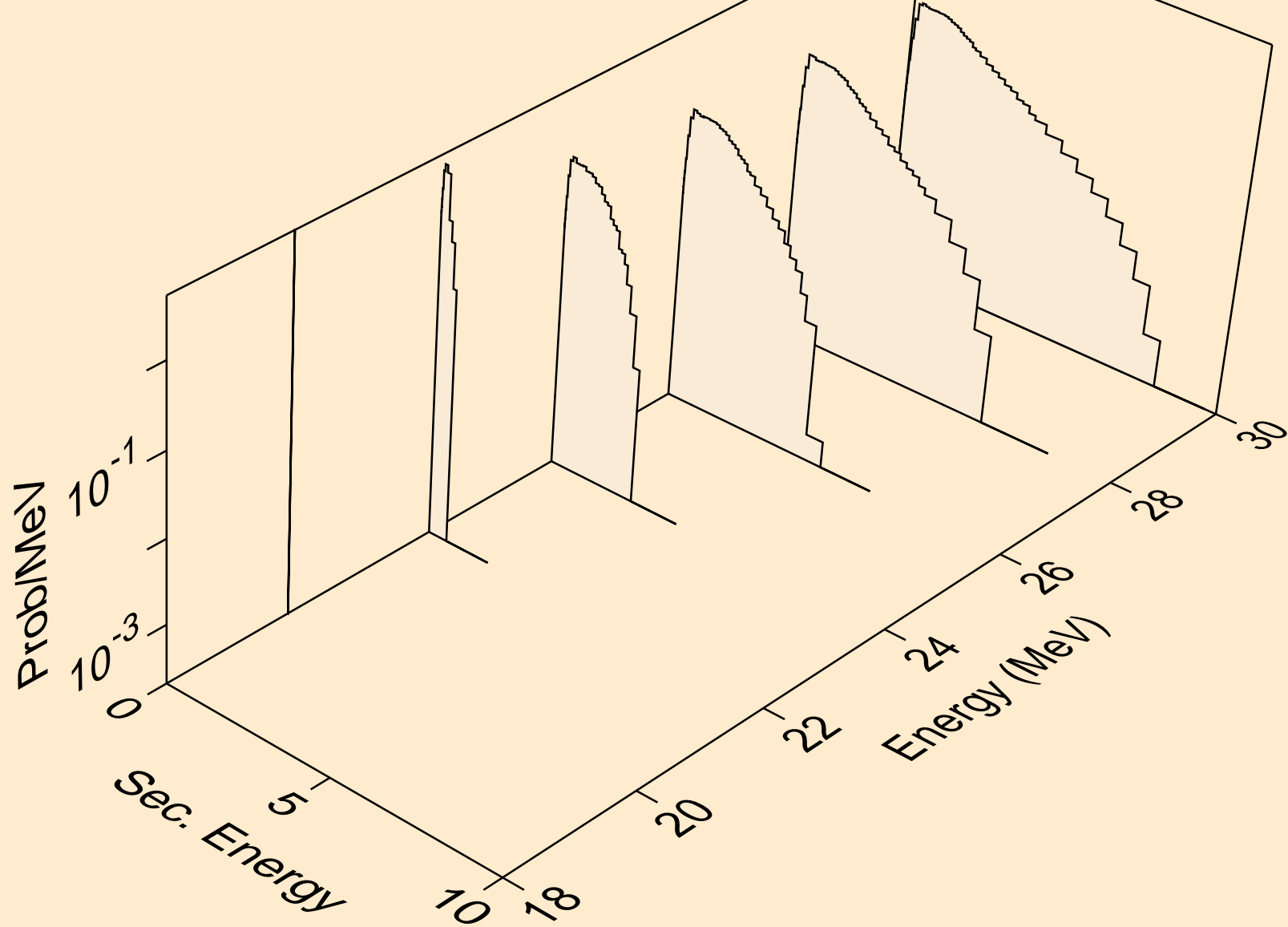

PM129 HELION ACER TENDL-2021 LIBRARY; T=0.K  
neutrons from (s,2np)

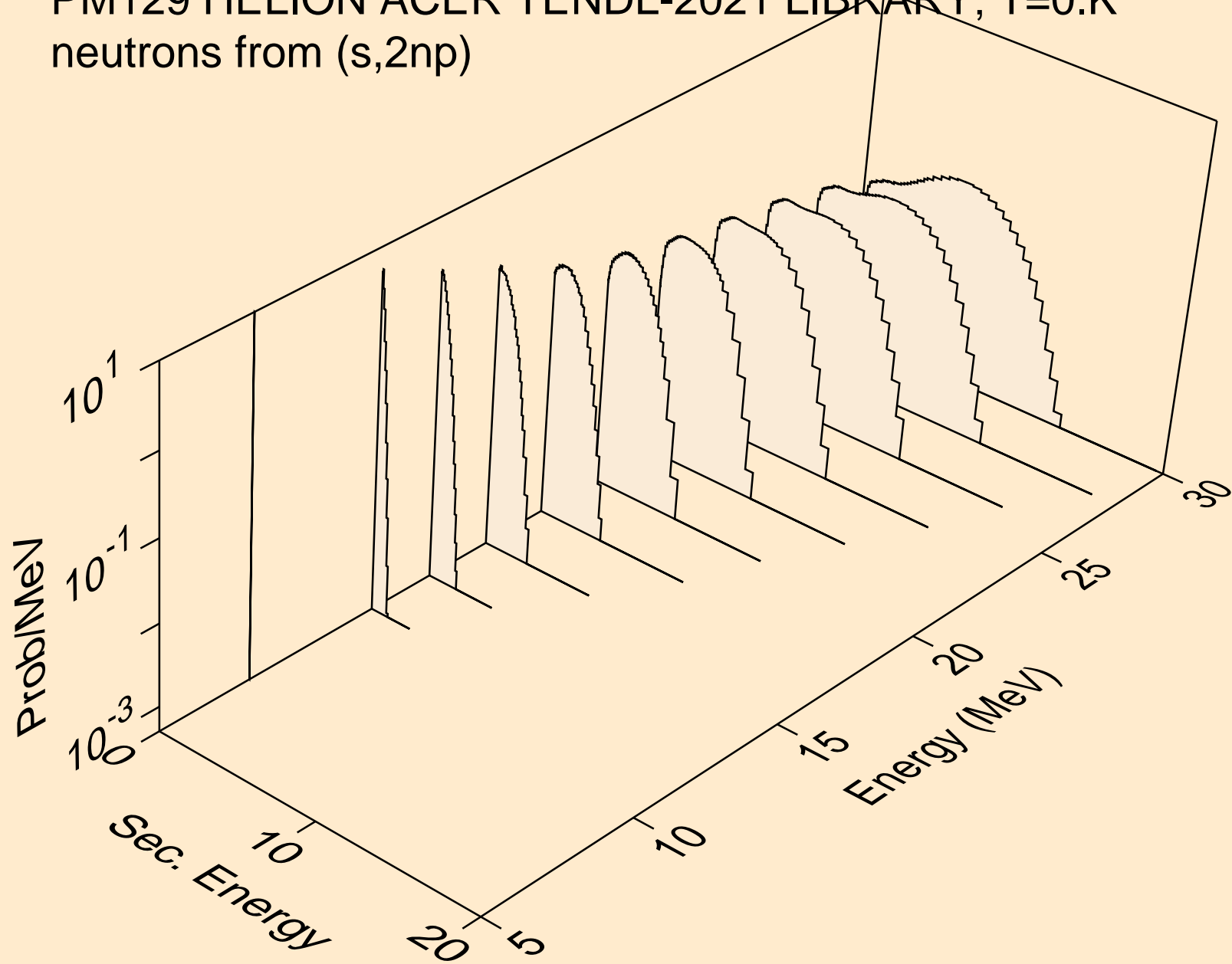

PM129 HELION ACER TENDL-2021 LIBRARY; T=0.K  
neutrons from (s,npa)

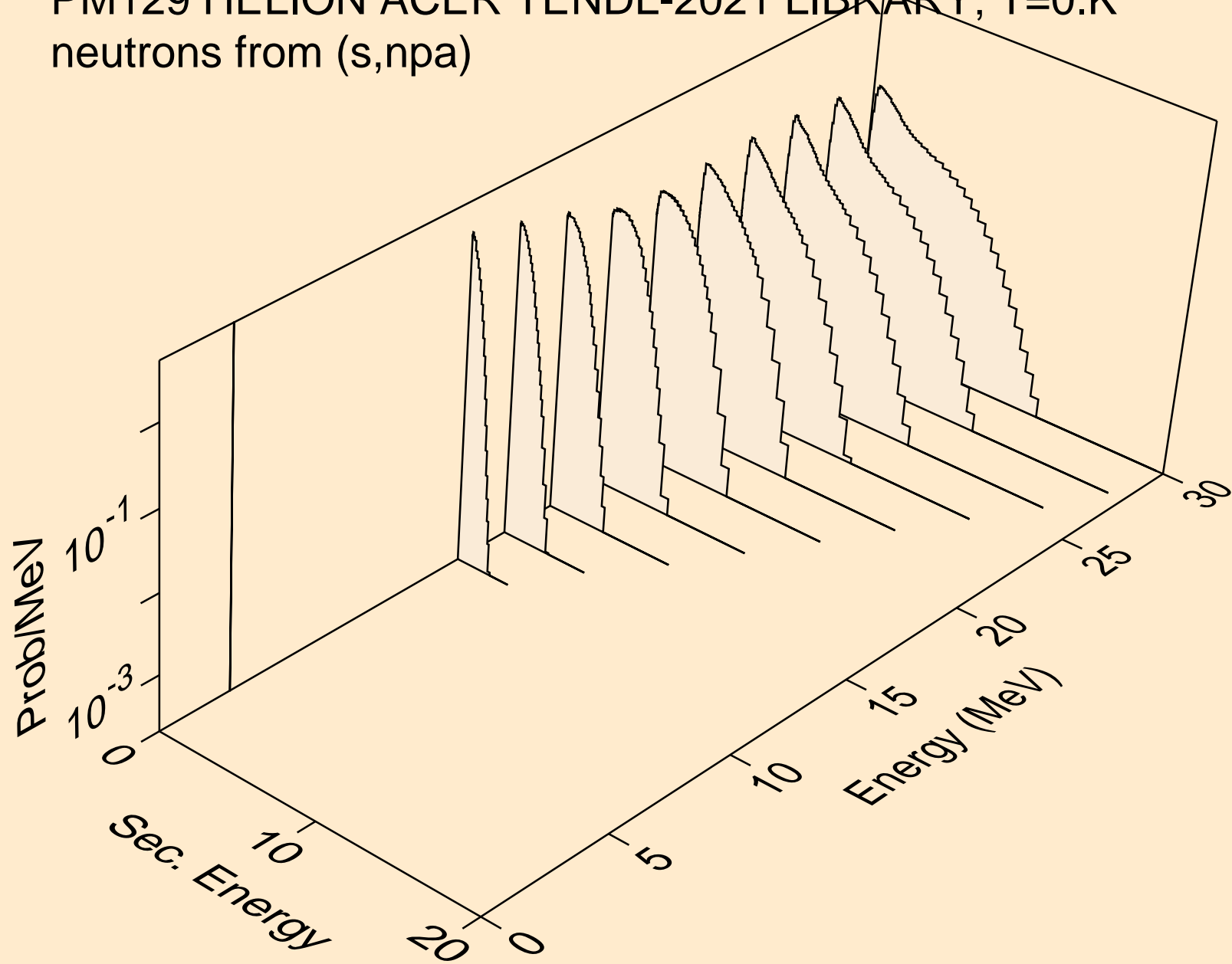

PM129 HELION ACER TENDL-2021 LIBRARY; T=0.K  
protons from (s,x)

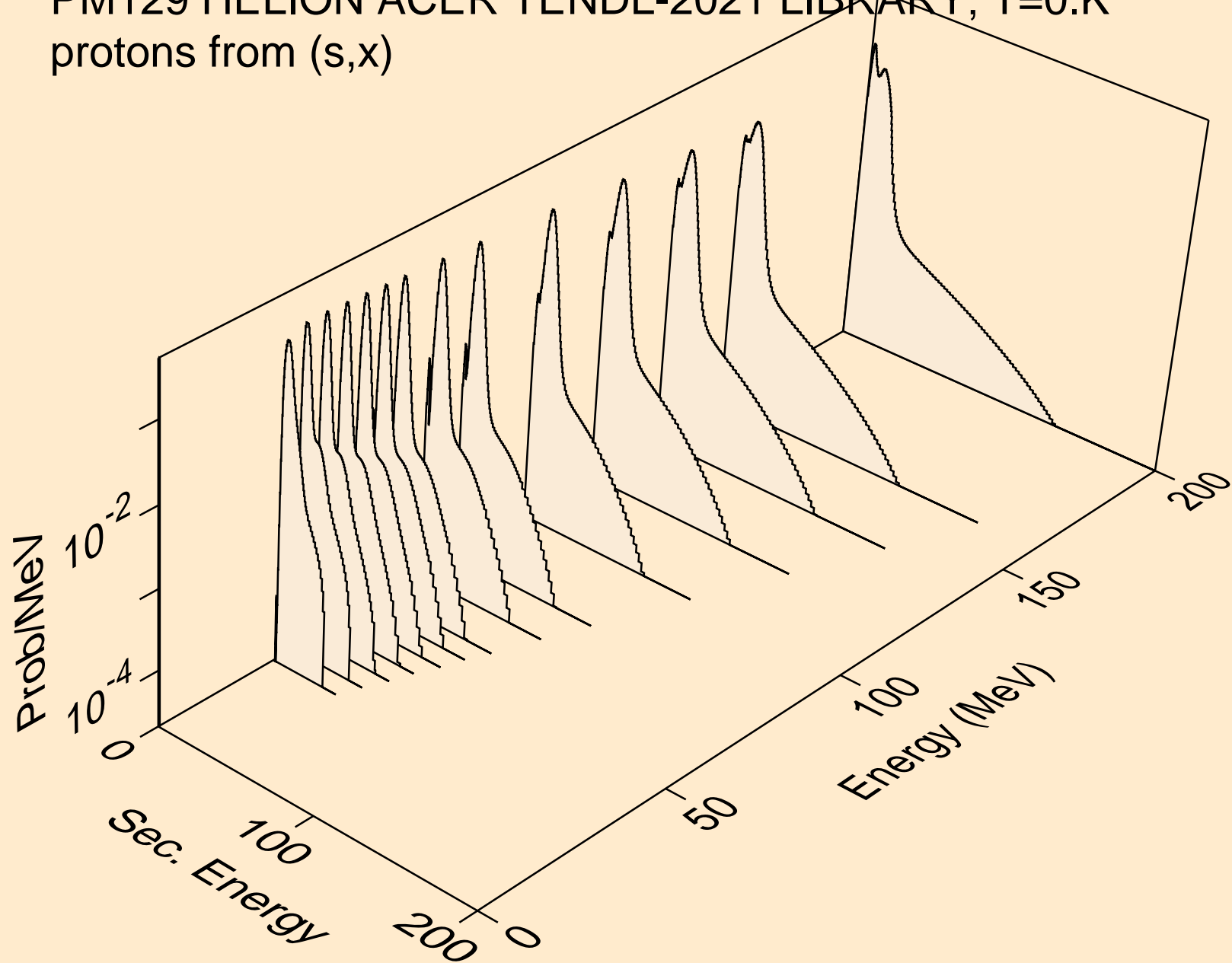

PM129 HELION ACER TENDL-2021 LIBRARY; T=0.K  
protons from (s,n\*)p

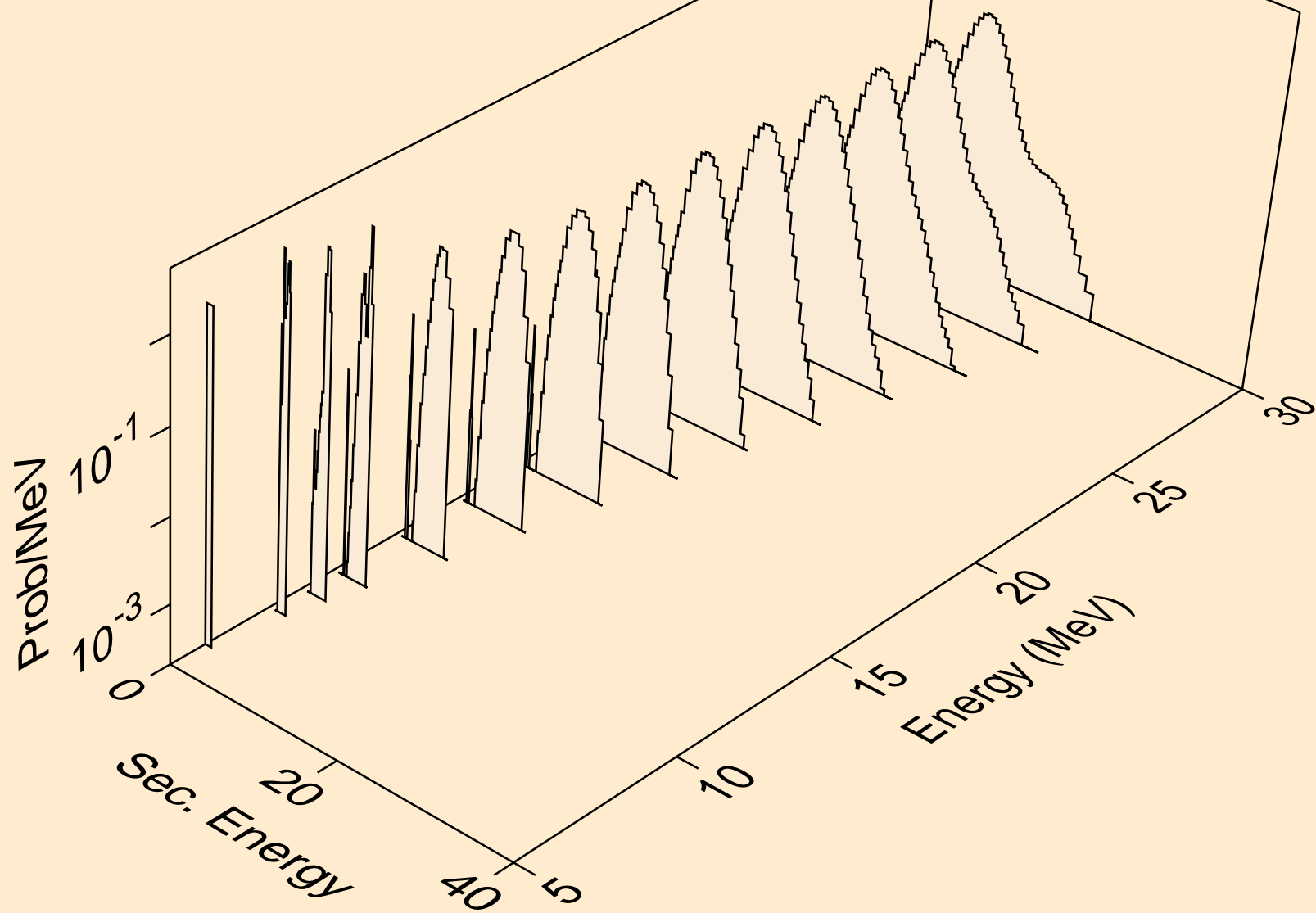



PM129 HELION ACER TENDL-2021 LIBRARY; T=0.K  
protons from (s,2np)

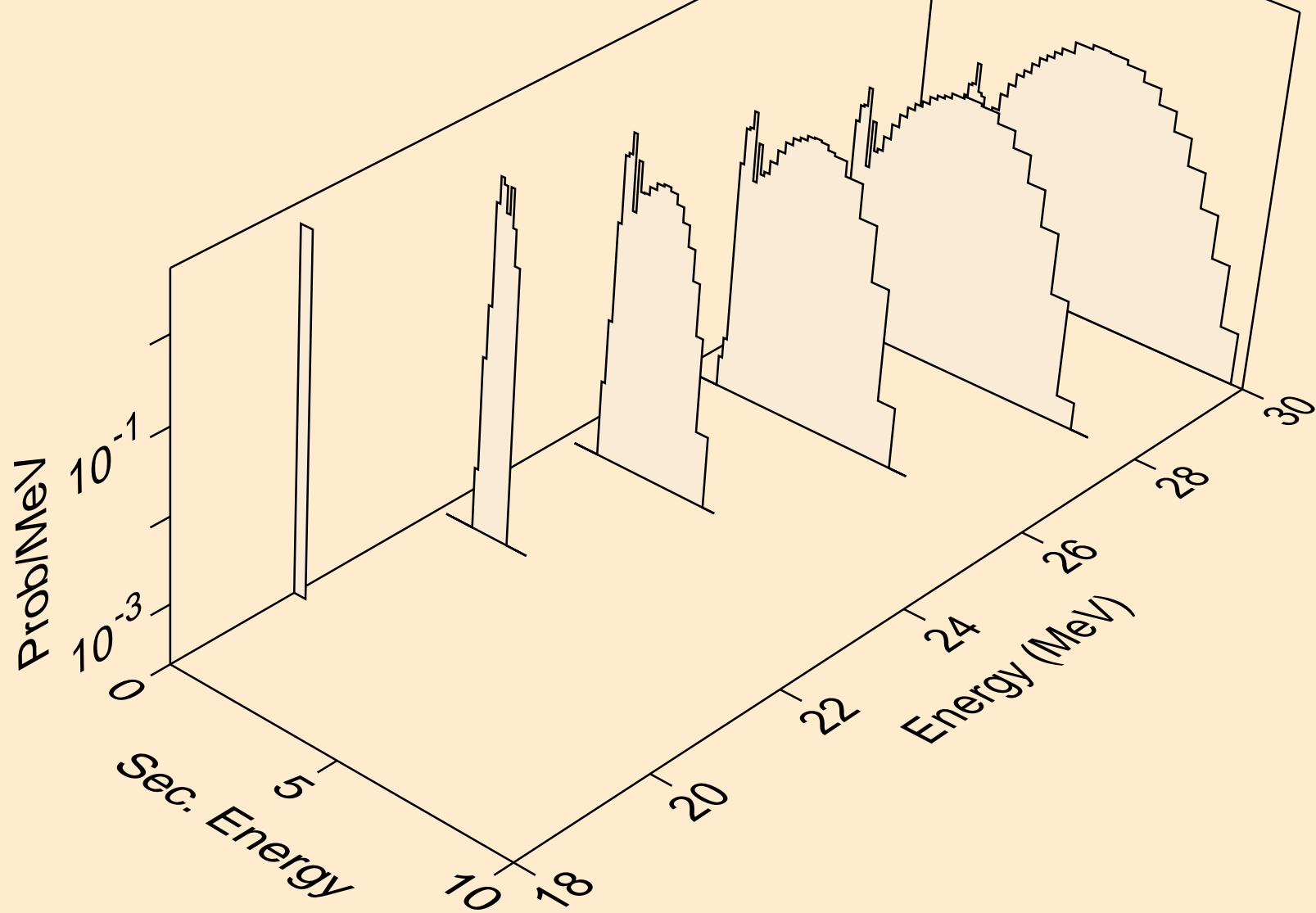

PM129 HELION ACER TENDL-2021 LIBRARY; T=0.K  
protons from (s,2np)

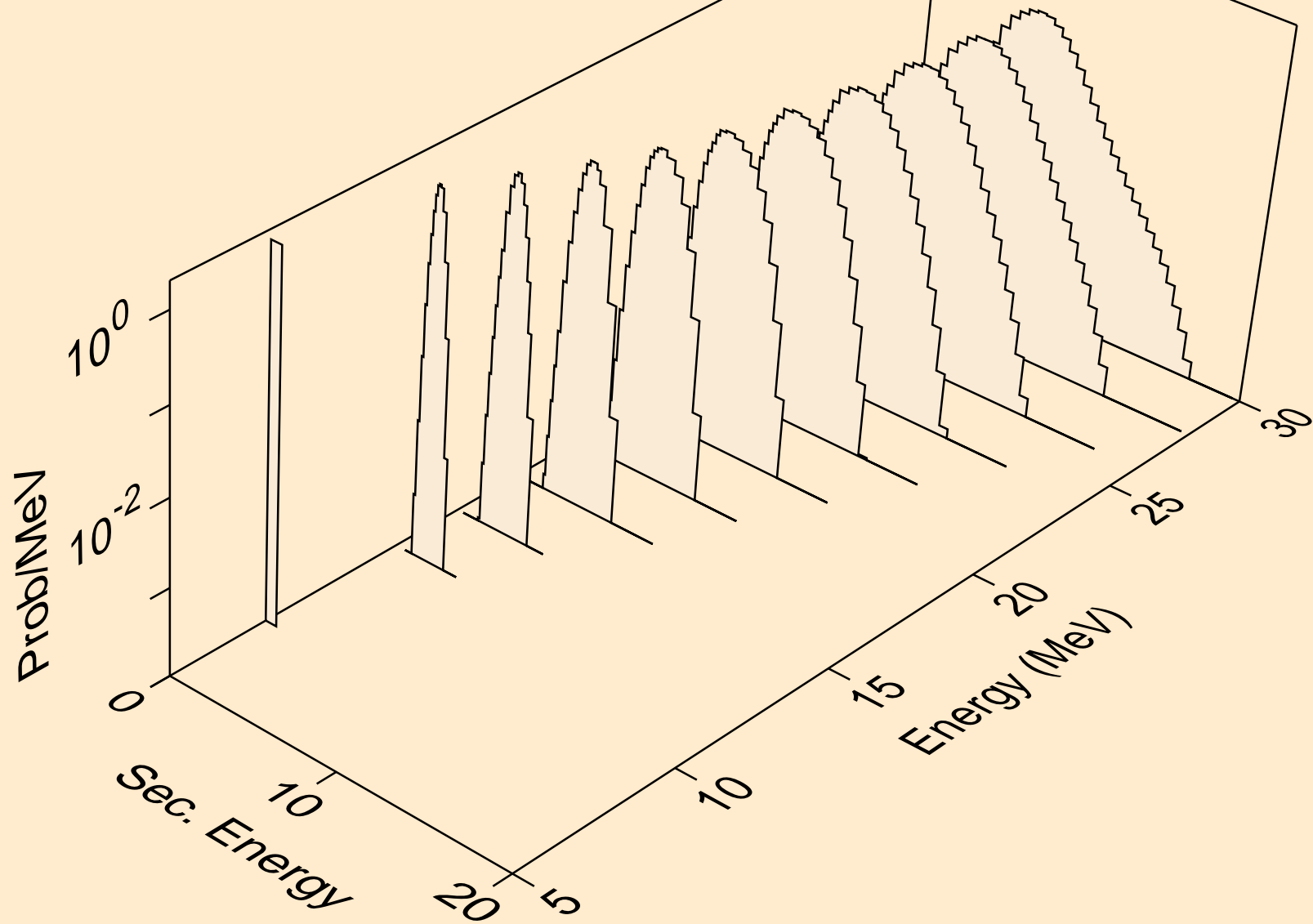

PM129 HELION ACER TENDL-2021 LIBRARY; T=0.K  
protons from (s,npa)

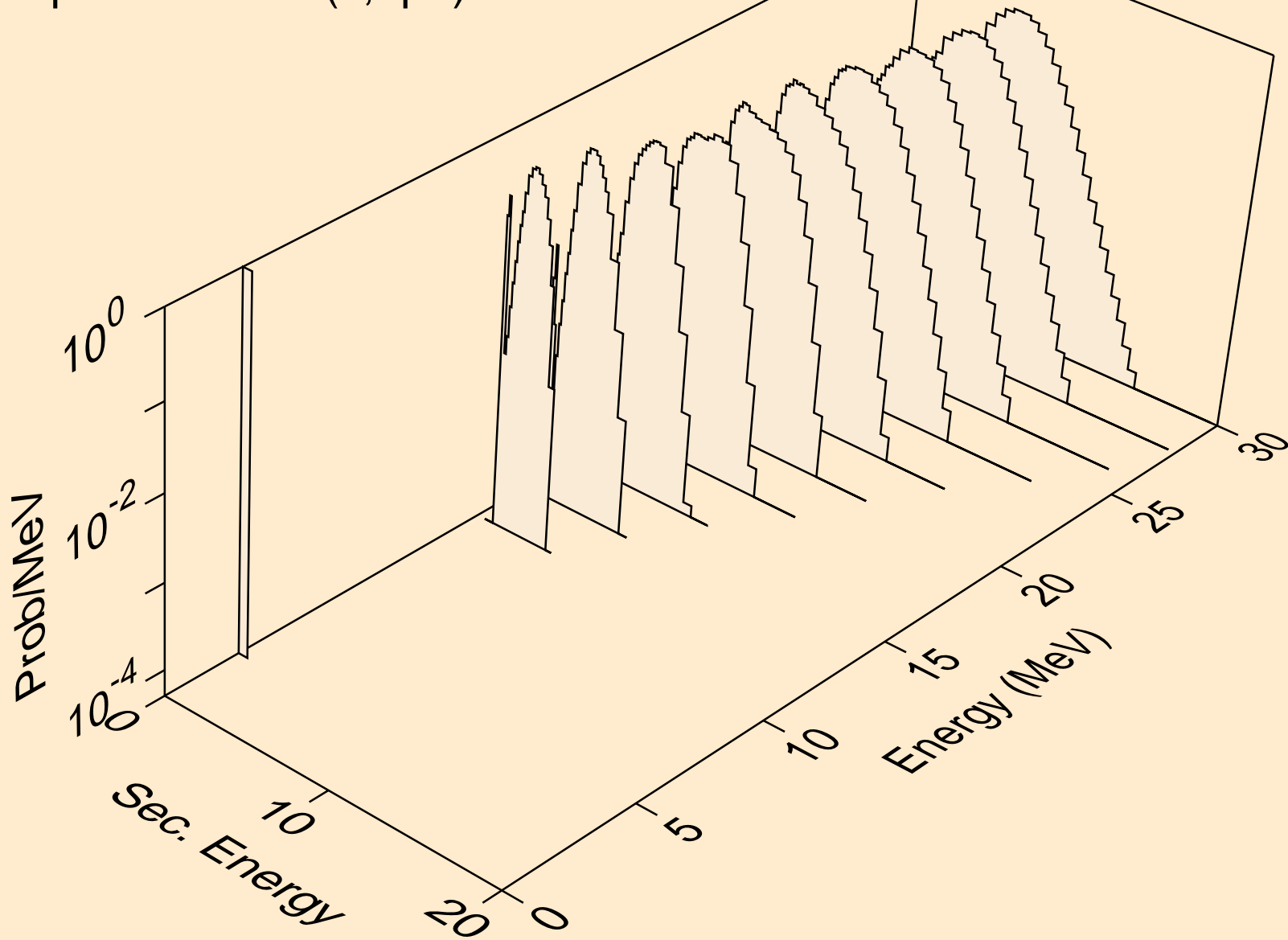

PM129 HELION ACER TENDL-2021 LIBRARY; T=0.K  
protons from (s,p)

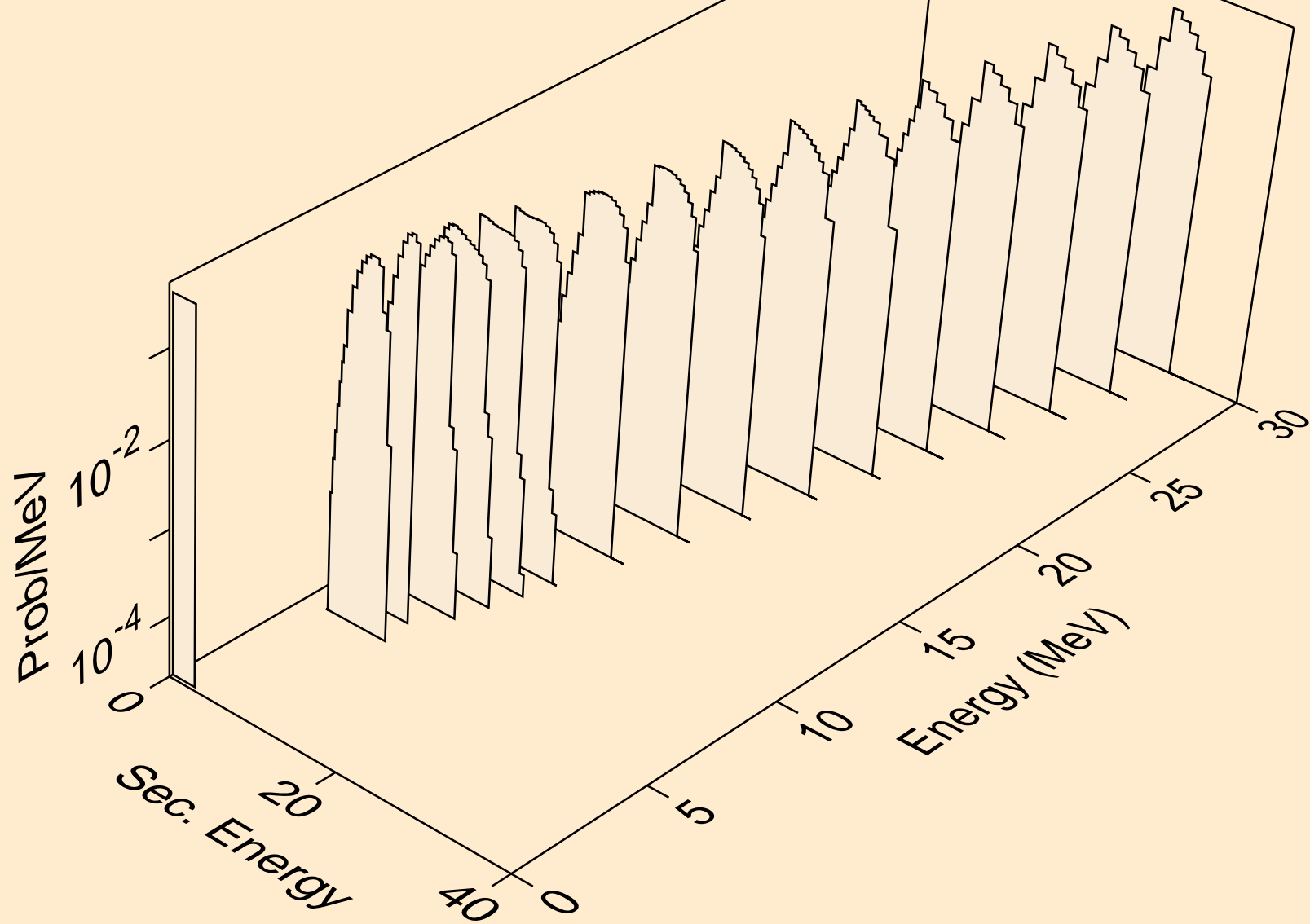

PM129 HELION ACER TENDL-2021 LIBRARY; T=0.K  
protons from (s,2p)

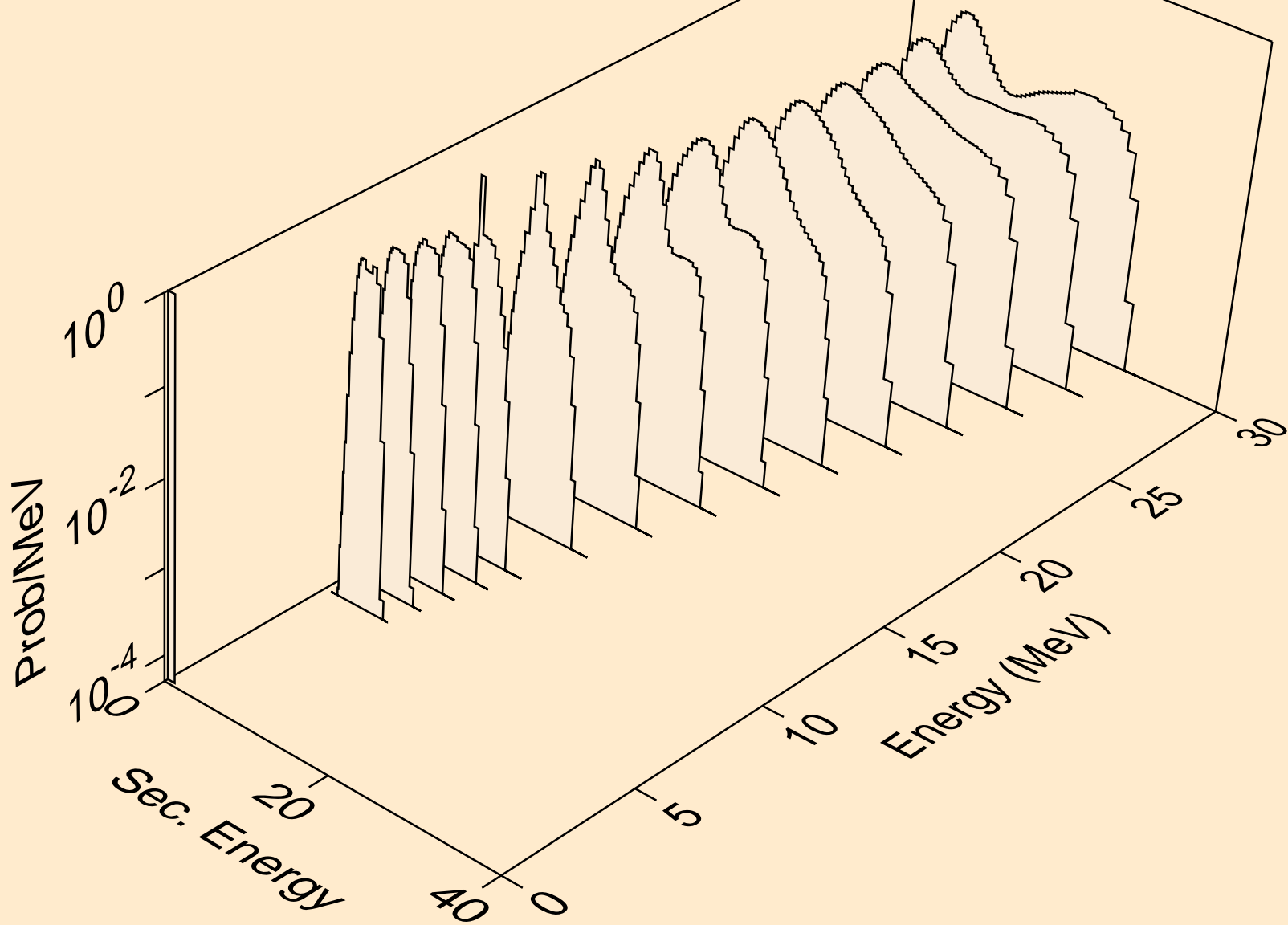

PM129 HELION ACER TENDL-2021 LIBRARY; T=0.K  
protons from (s,pa)

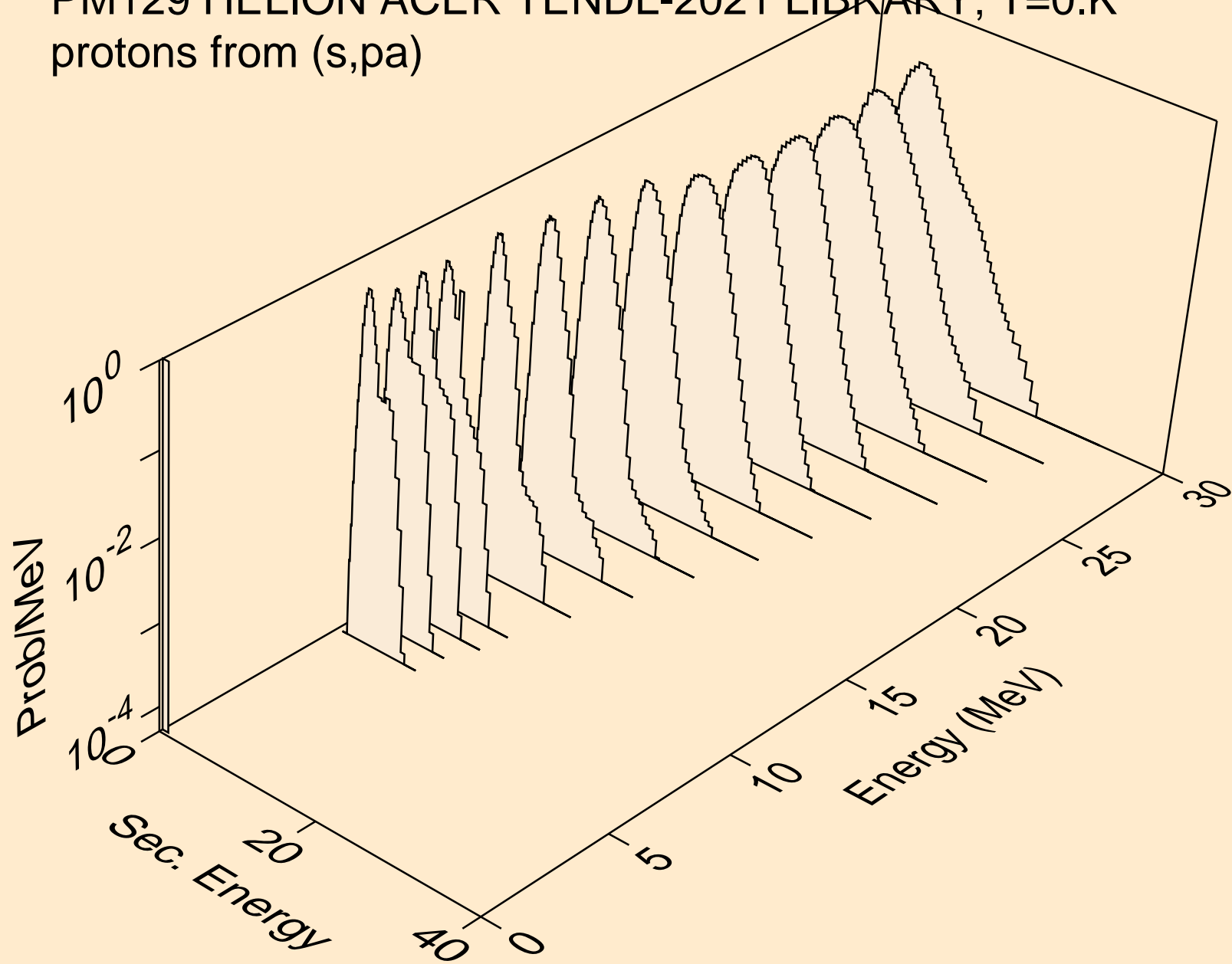

PM129 HELION ACER TENDL-2021 LIBRARY; T=0.K  
protons from (s,pd)

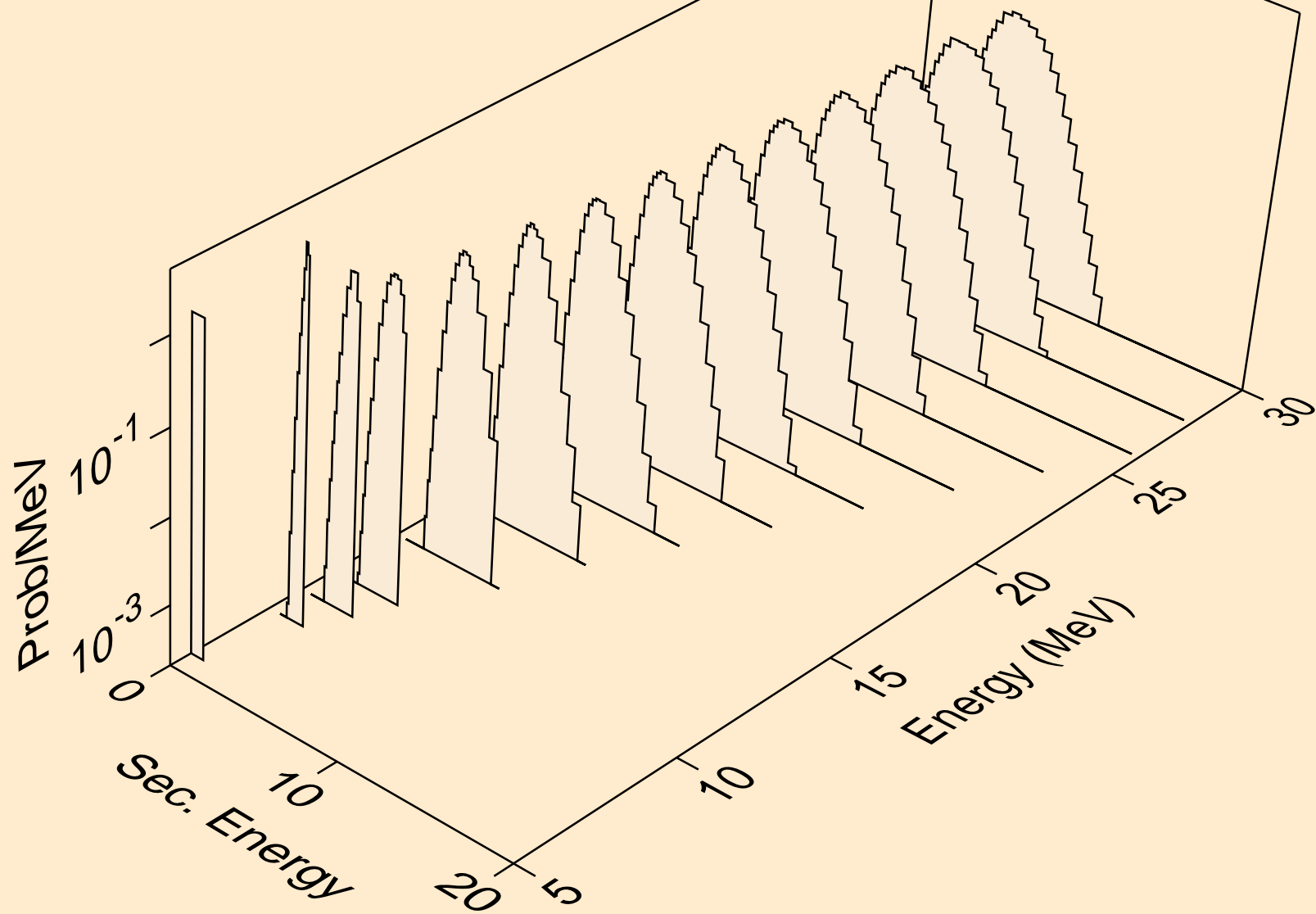

PM129 HELION ACER TENDL-2021 LIBRARY; T=0.K  
protons from (s,pt)

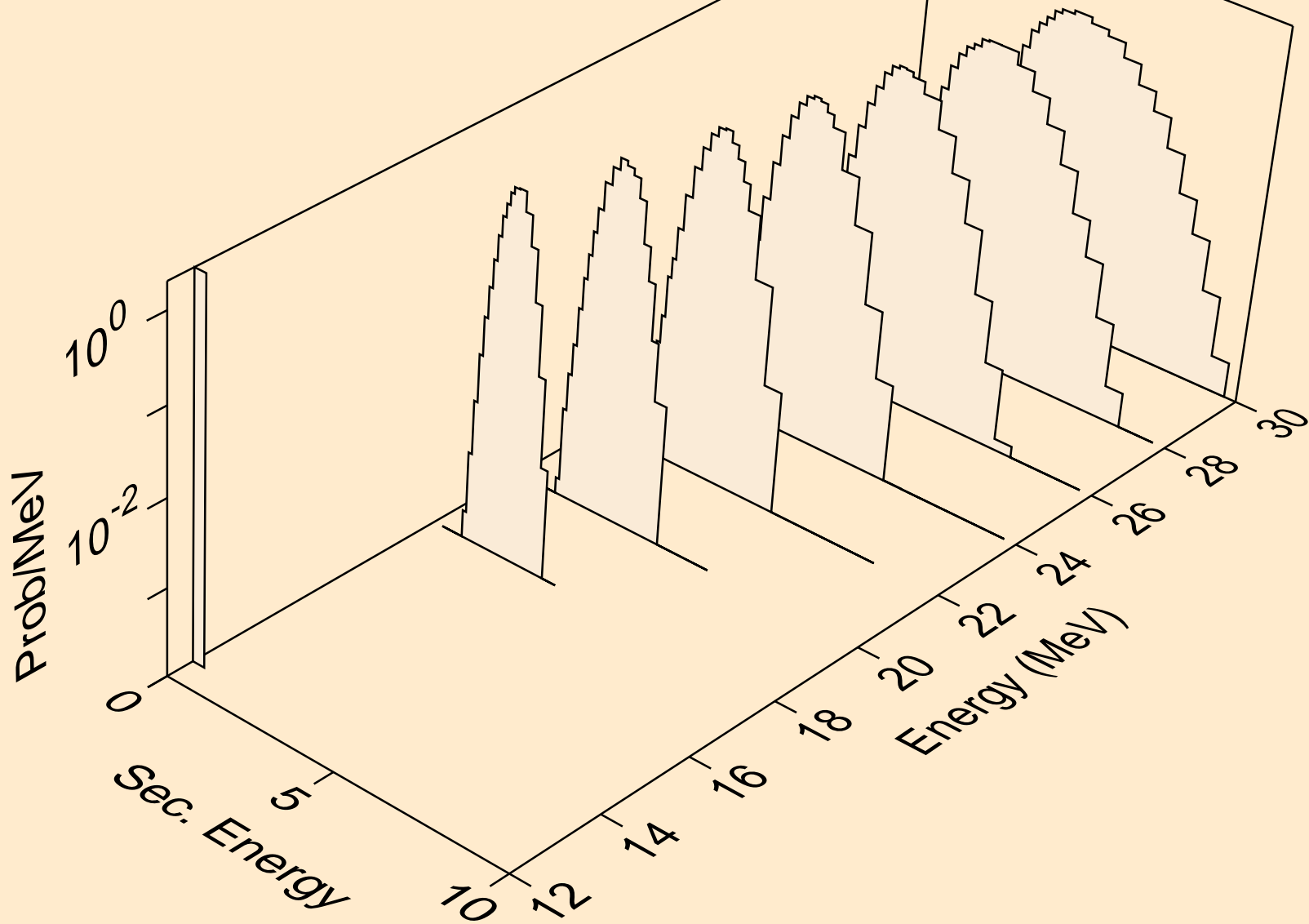



PM129 HELION ACER TENDL-2021 LIBRARY; T=0.K  
deuterons from (s,x)

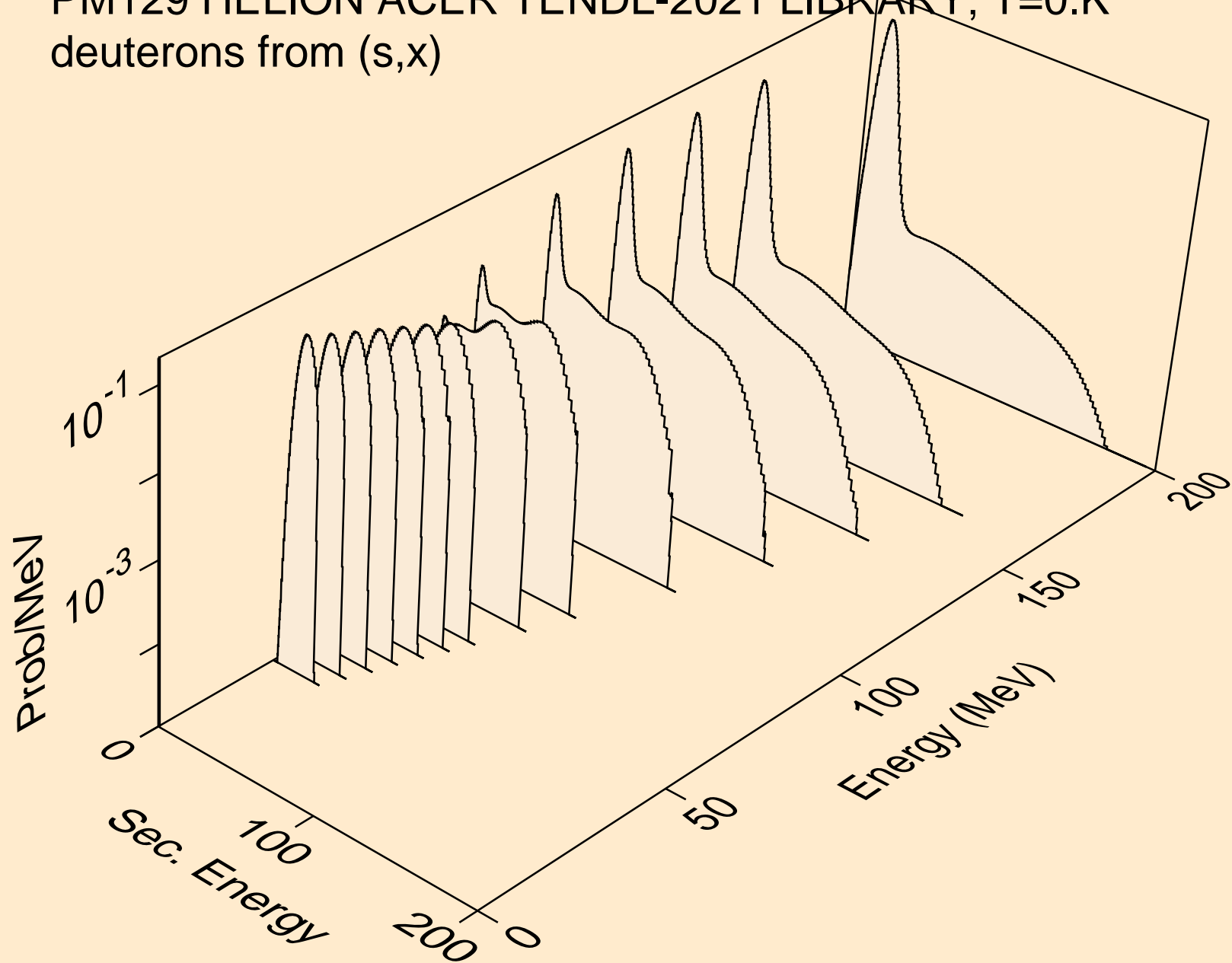

PM129 HELION ACER TENDL-2021 LIBRARY; T=0.K  
deuterons from (s,n\*)d

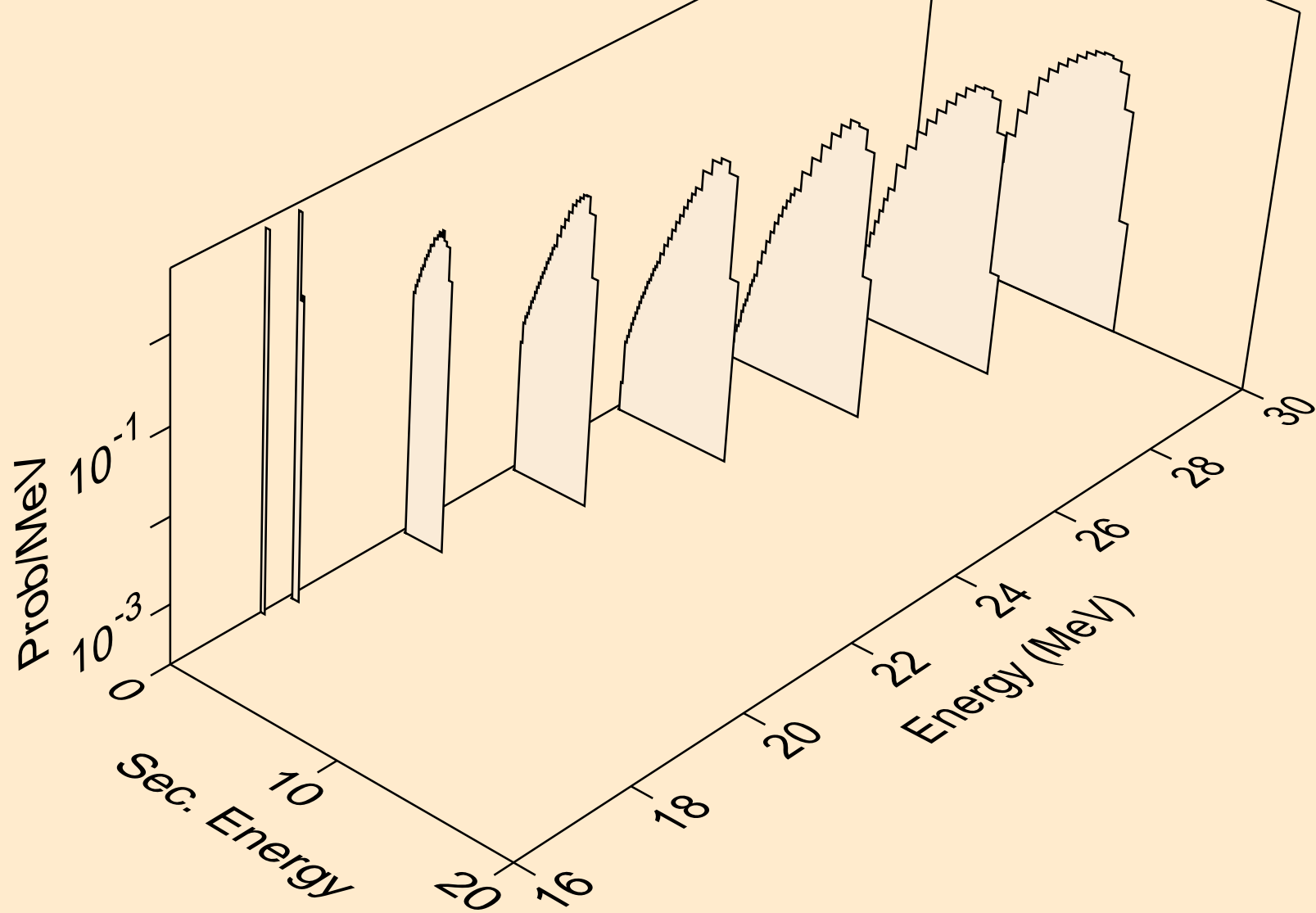

PM129 HELION ACER TENDL-2021 LIBRARY; T=0.K  
deuterons from (s,d)

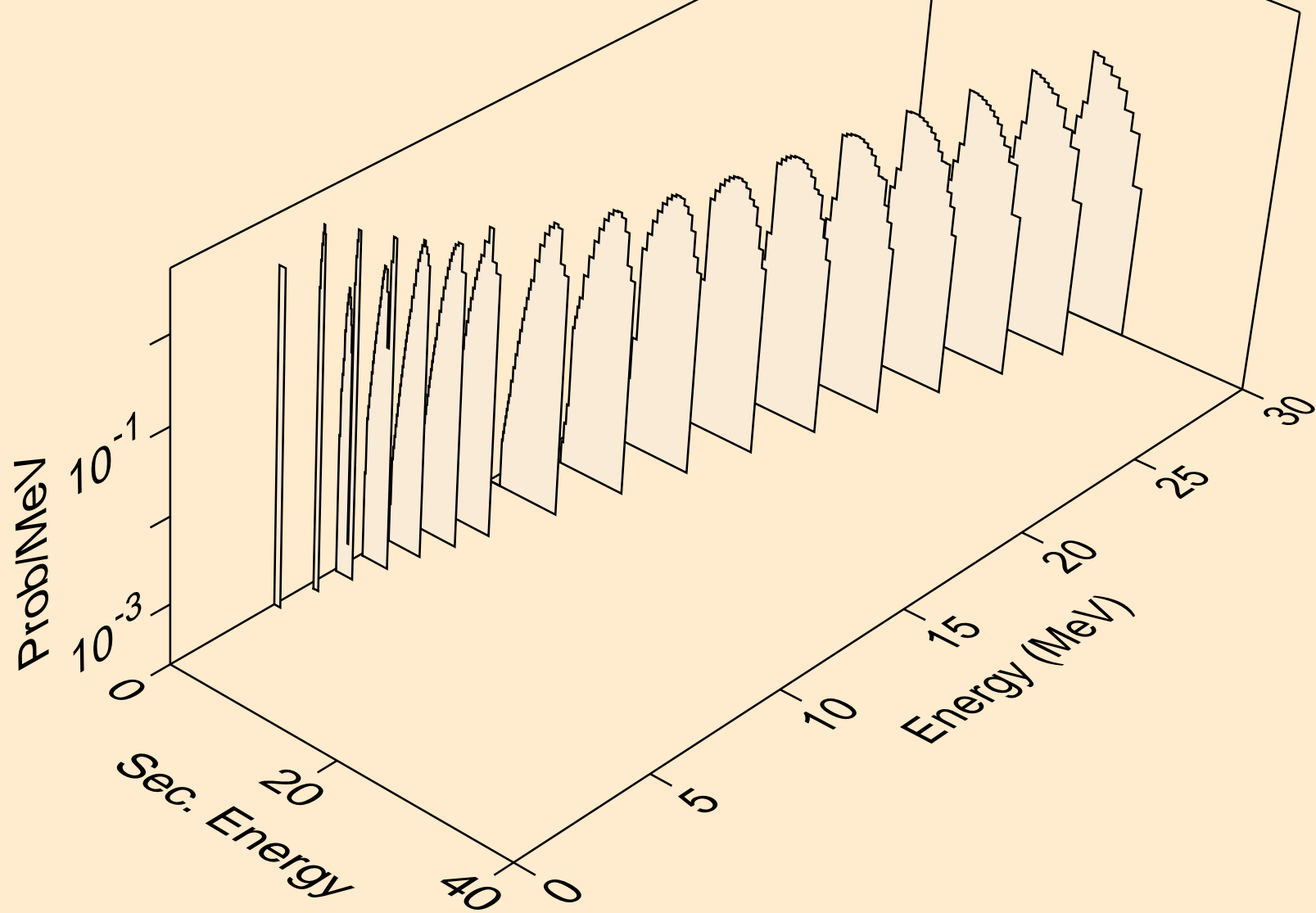

PM129 HELION ACER TENDL-2021 LIBRARY; T=0.K  
deuterons from (s,pd)

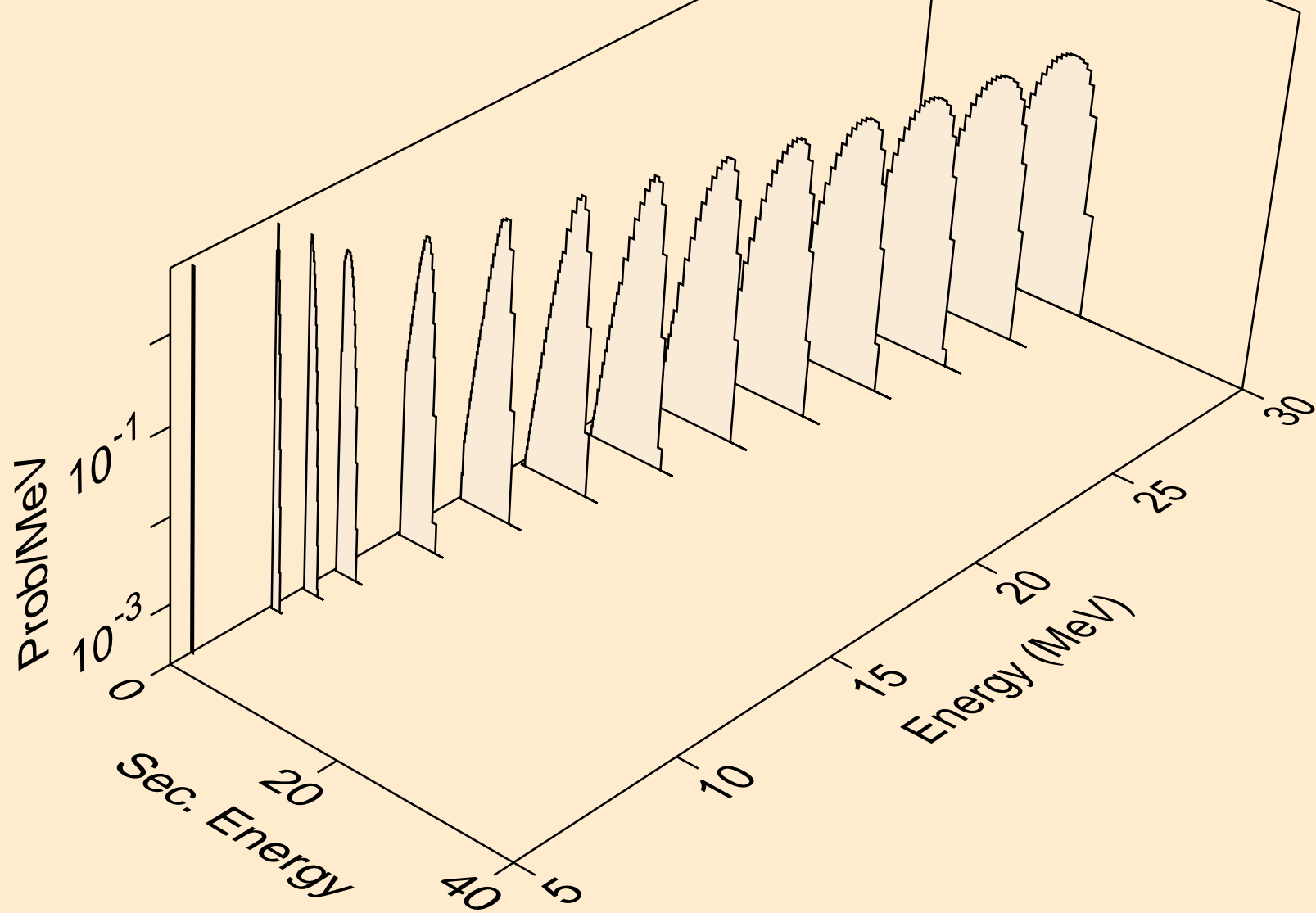

PM129 HELION ACER TENDL-2021 LIBRARY; T=0.K  
deuterons from (s,da)

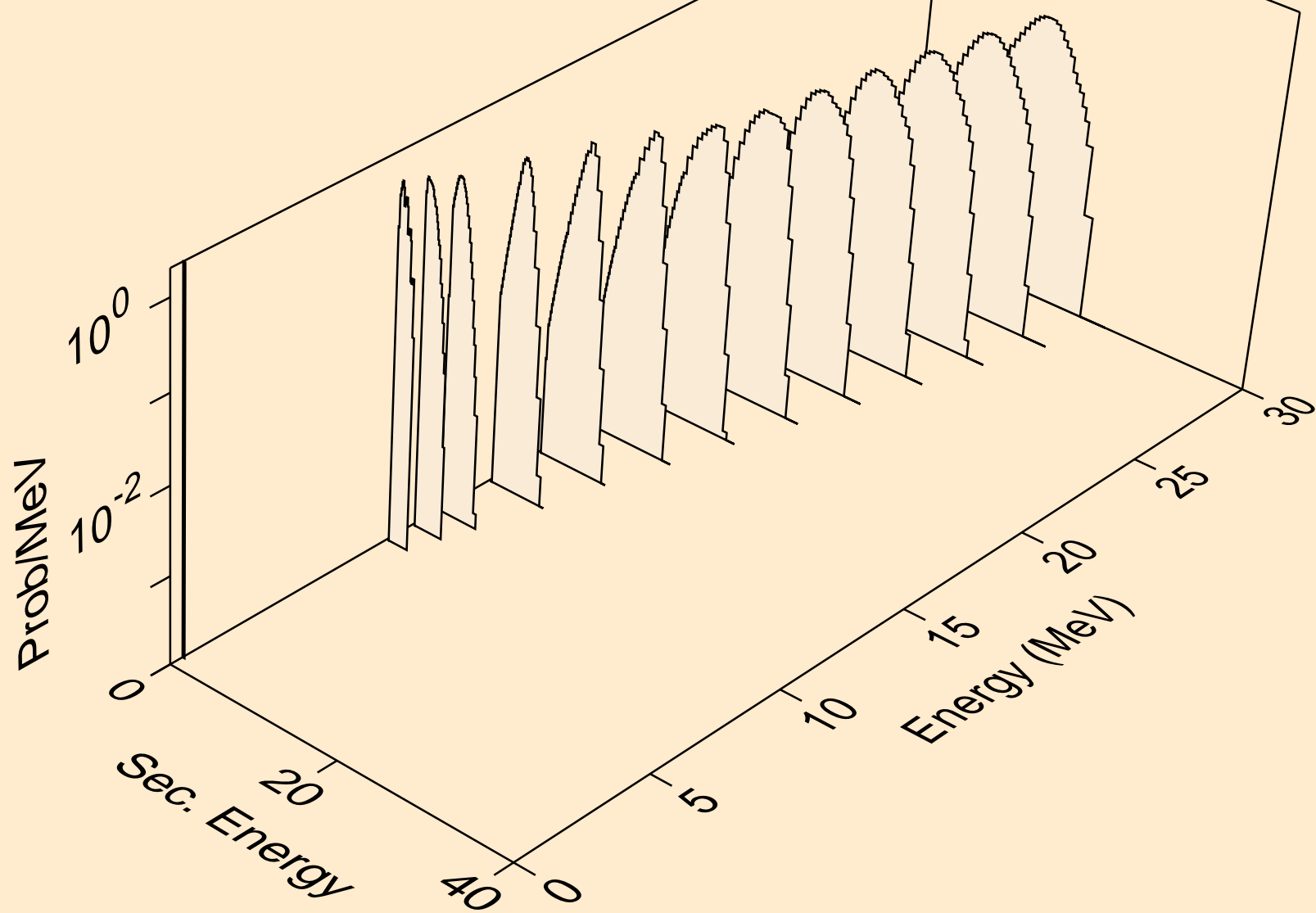

PM129 HELION ACER TENDL-2021 LIBRARY; T=0.K  
tritons from (s,x)

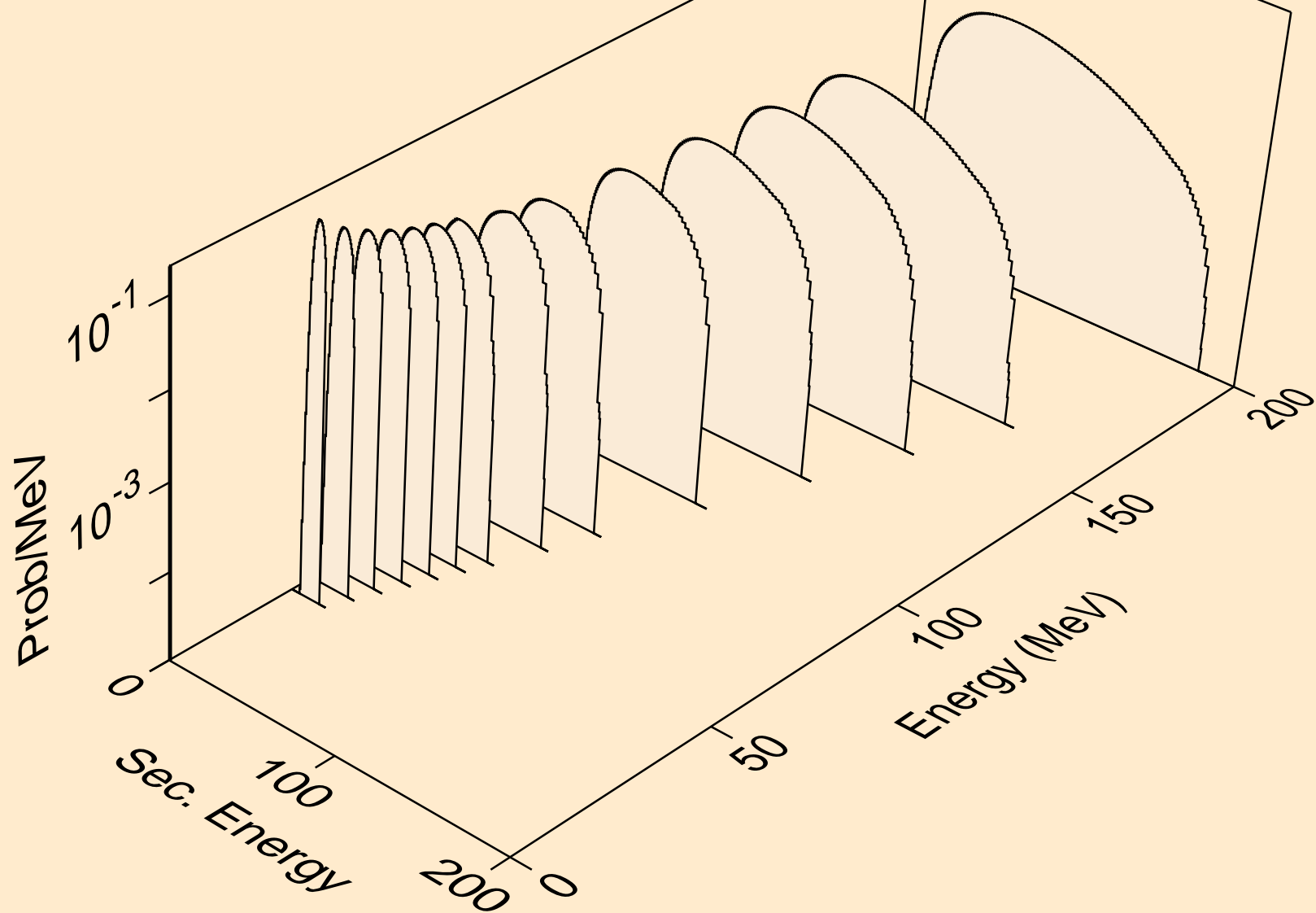

PM129 HELION ACER TENDL-2021 LIBRARY; T=0.K  
tritons from (s,n\*)t

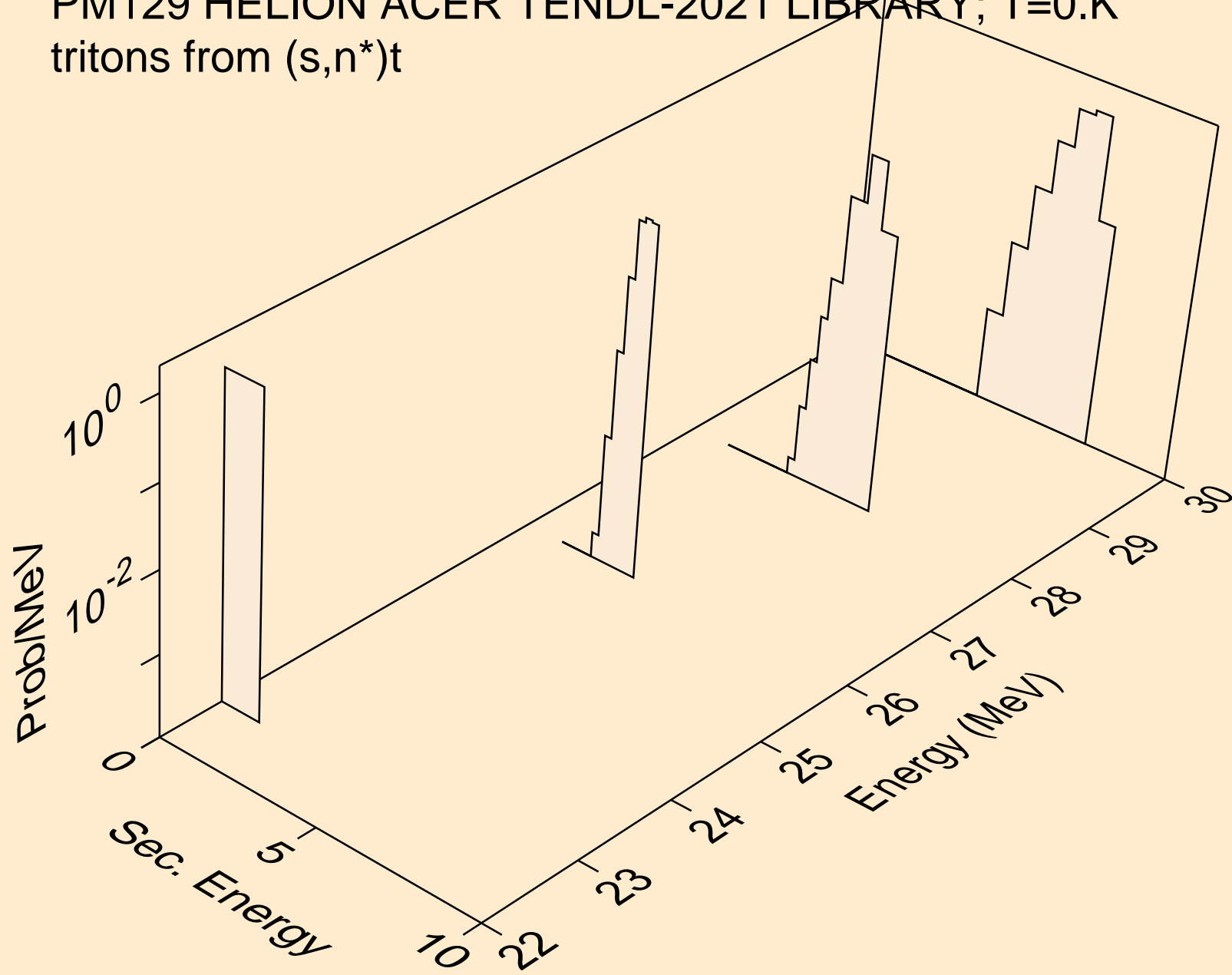

PM129 HELION ACER TENDL-2021 LIBRARY; T=0.K  
tritons from (s,t)

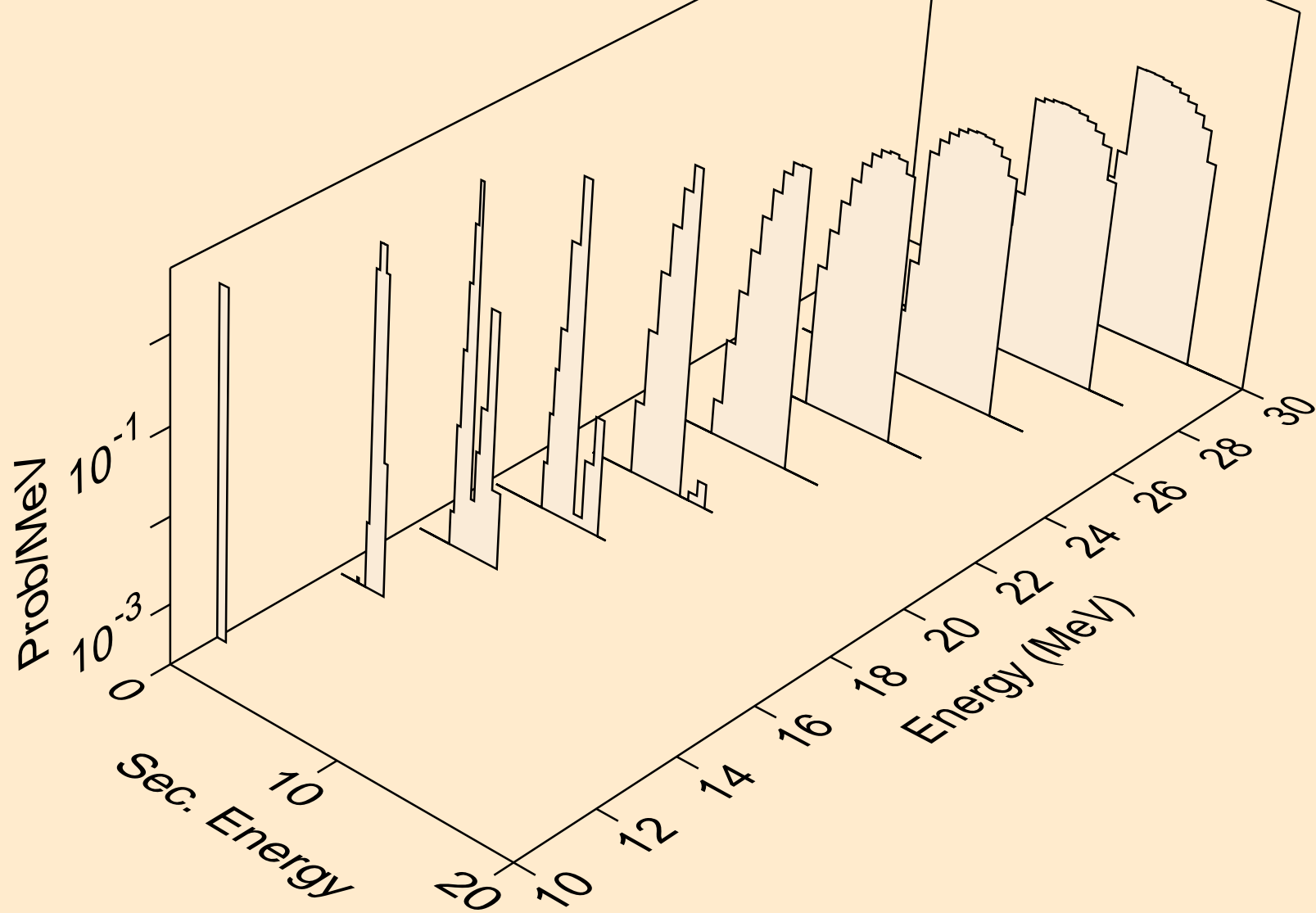



PM129 HELION ACER TENDL-2021 LIBRARY; T=0.K  
tritons from (s,pt)

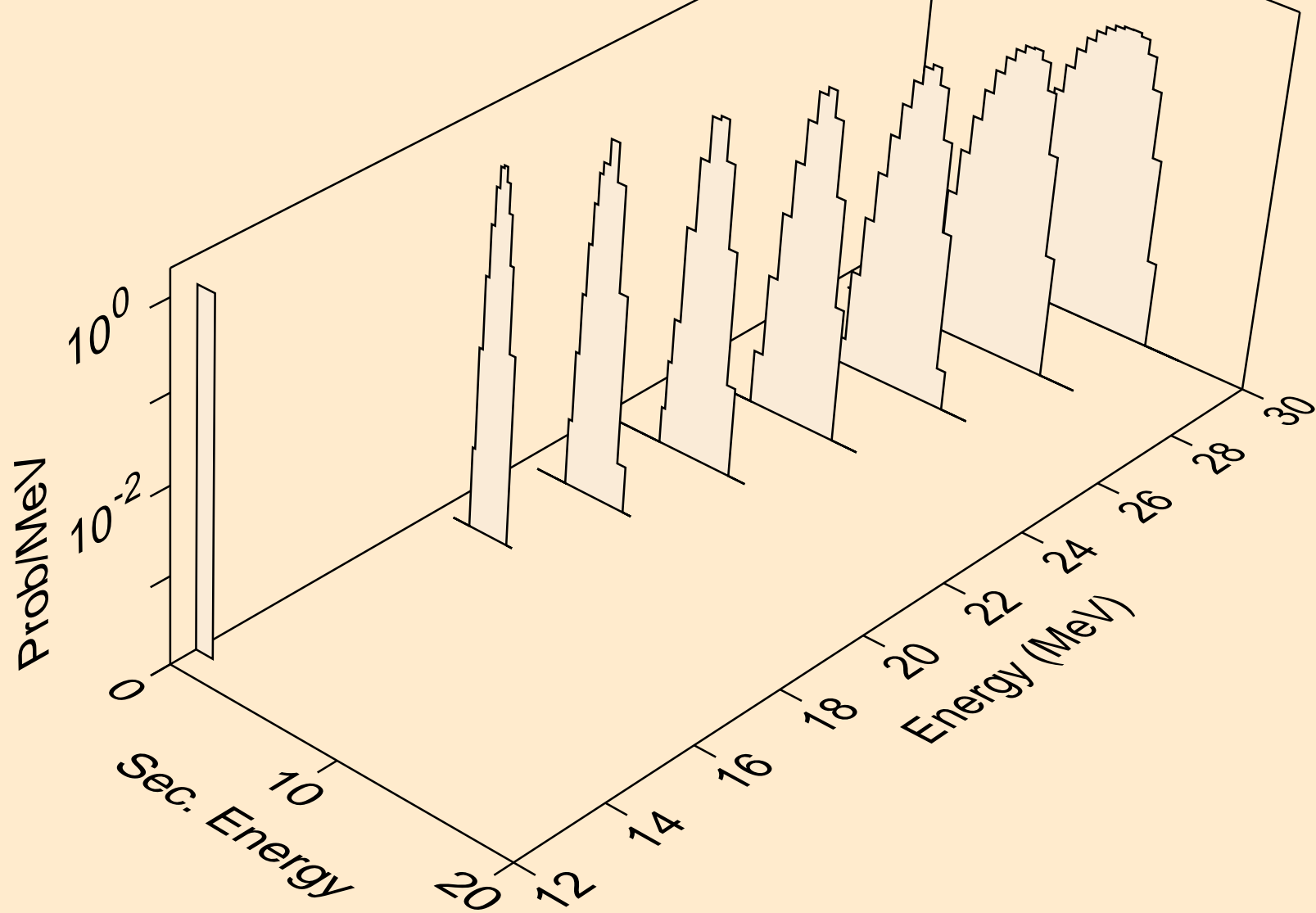

PM129 HELION ACER TENDL-2021 LIBRARY; T=0.K  
alphas from (s,x)

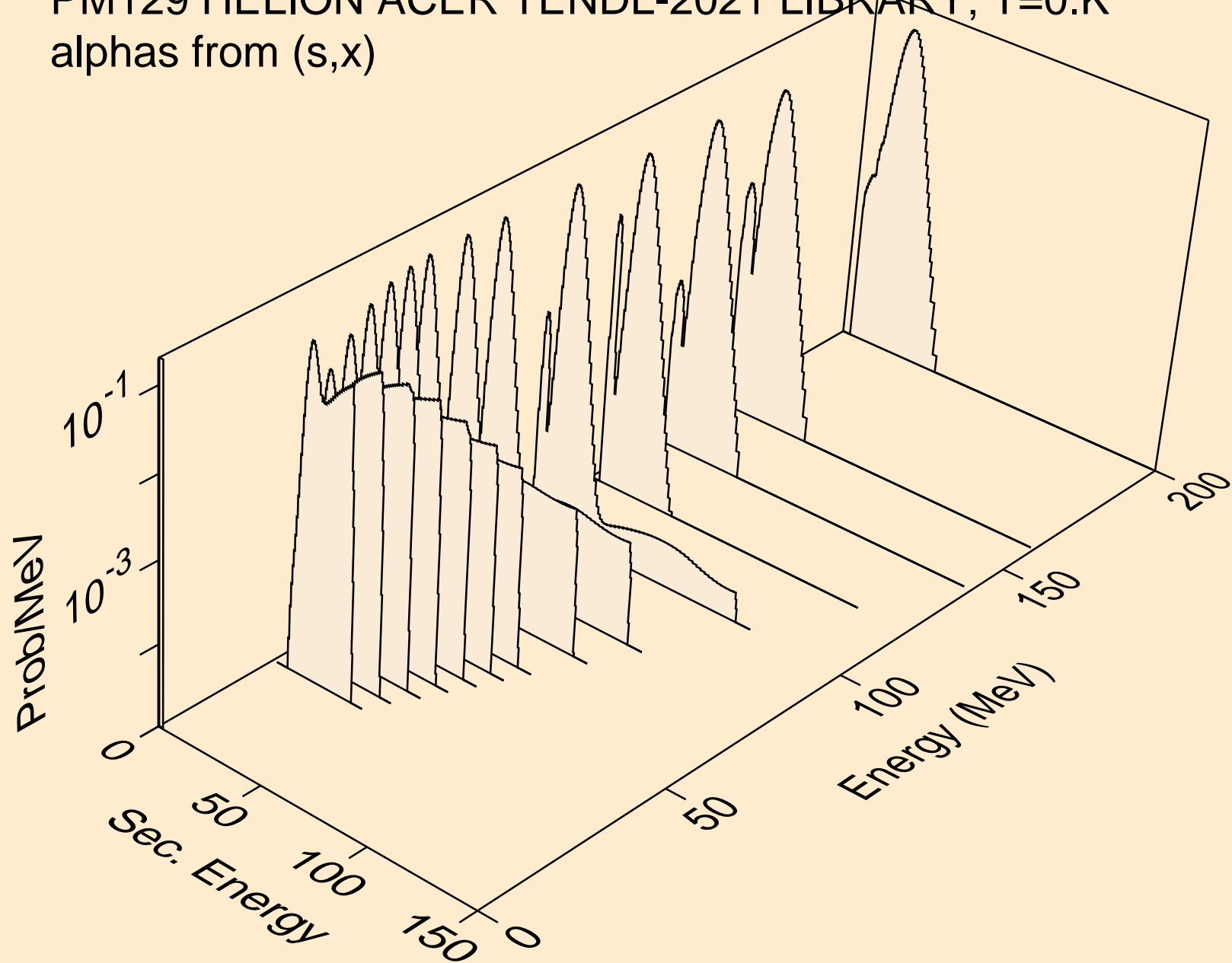

PM129 HELION ACER TENDL-2021 LIBRARY; T=0.K  
alphas from (s,n\*)a

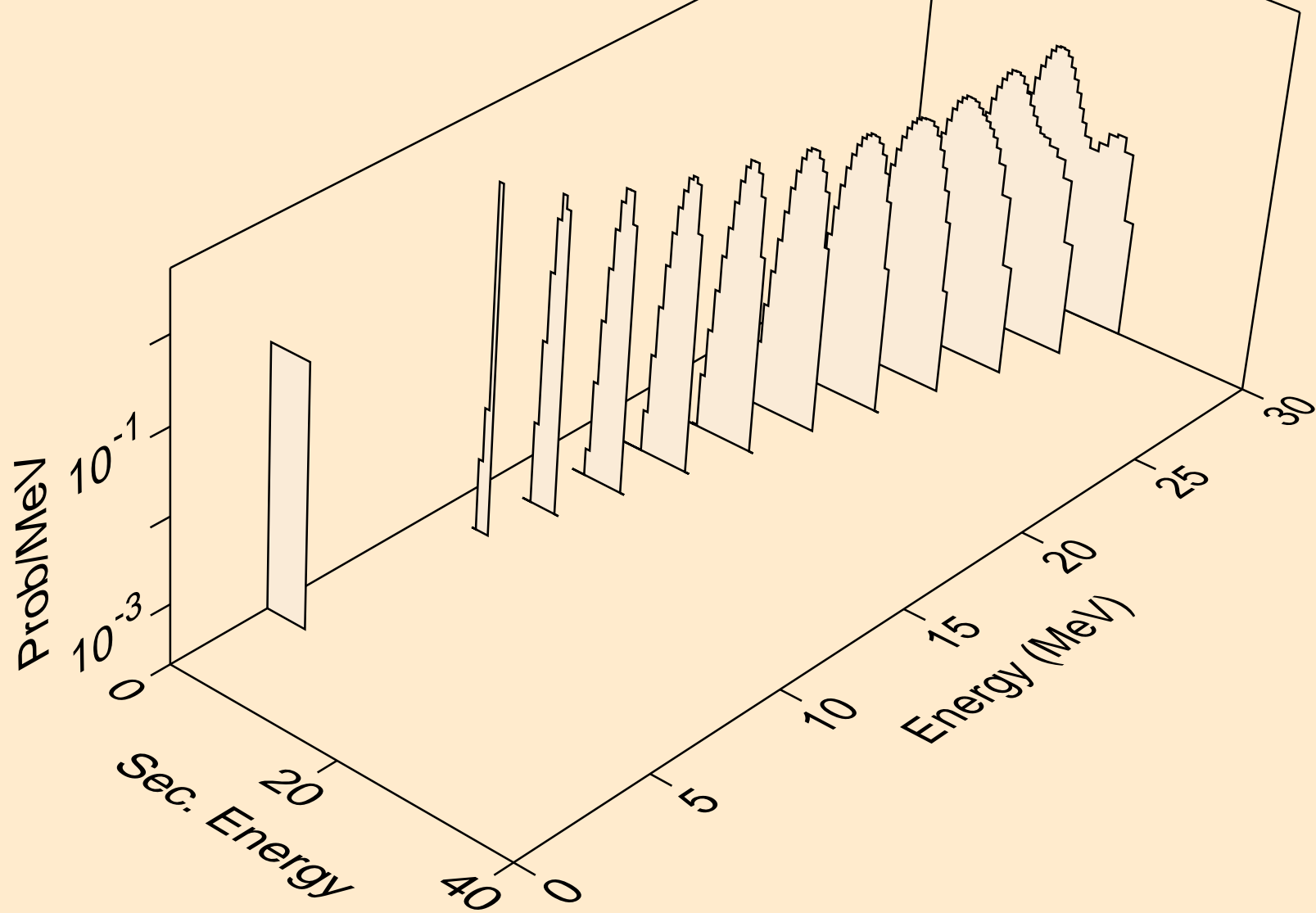

PM129 HELION ACER TENDL-2021 LIBRARY; T=0.K  
alphas from (s,n\*)2a

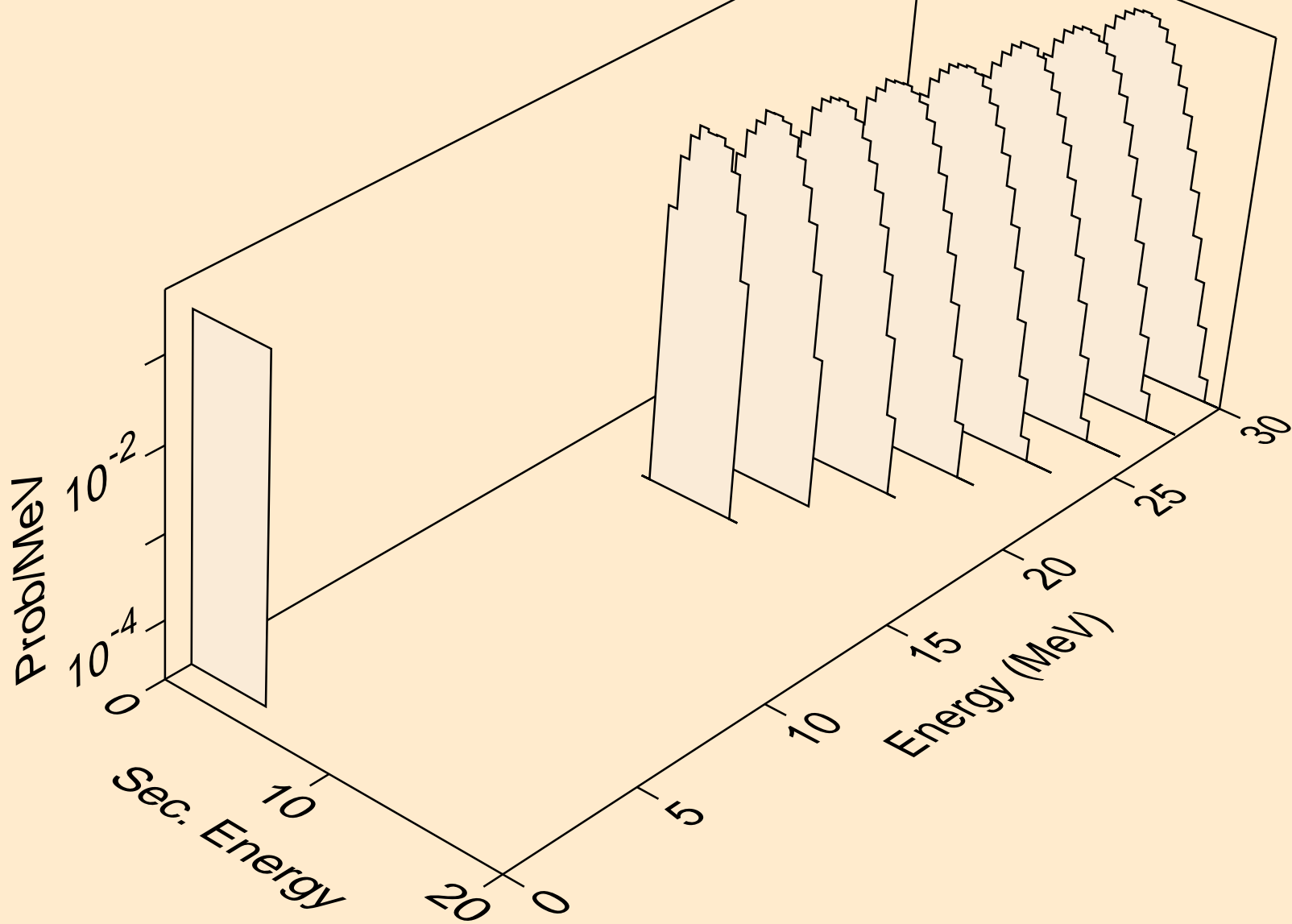

PM129 HELION ACER TENDL-2021 LIBRARY; T=0.K  
alphas from (s,npa)

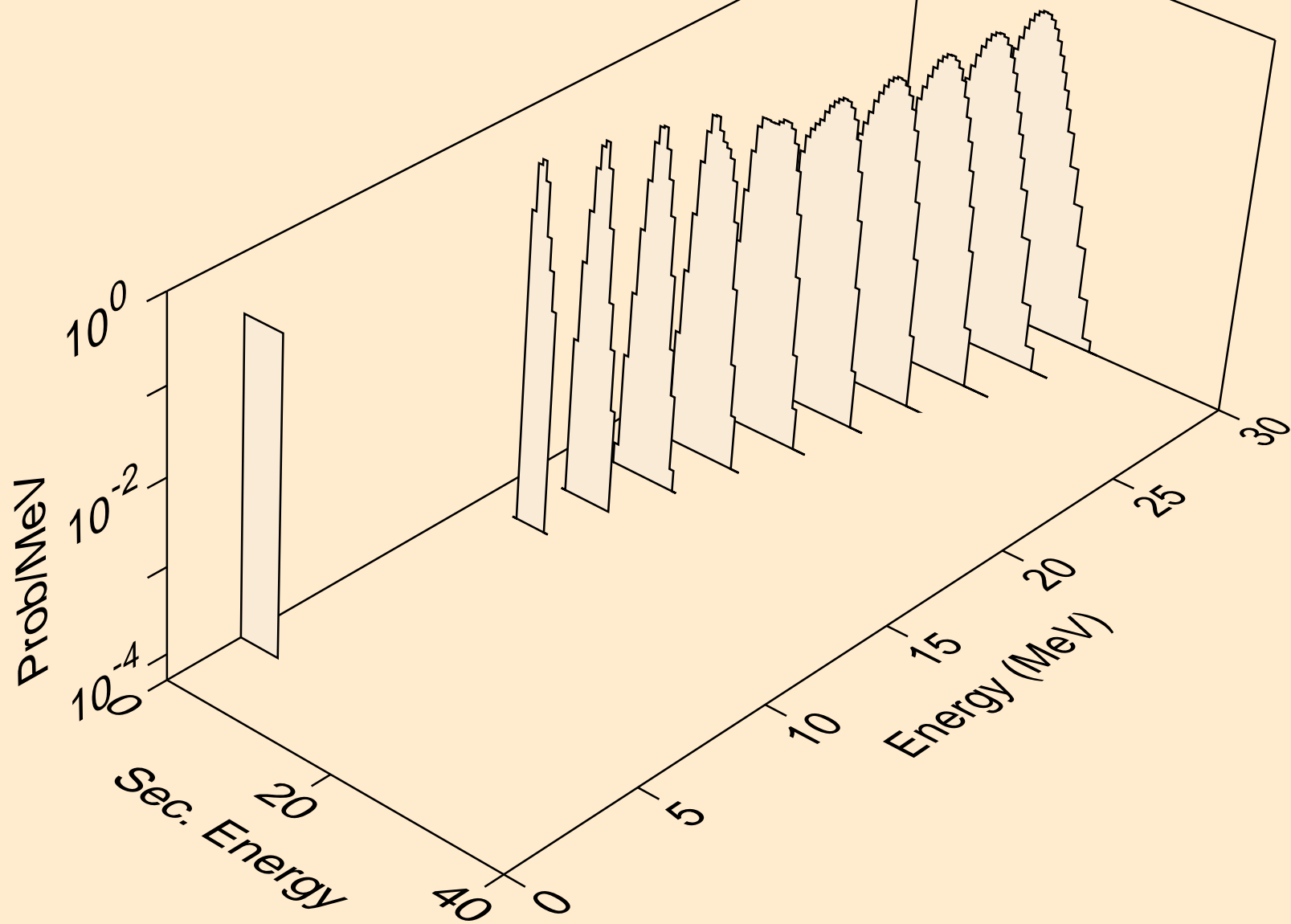

PM129 HELION ACER TENDL-2021 LIBRARY; T=0.K  
alphas from (s,a)

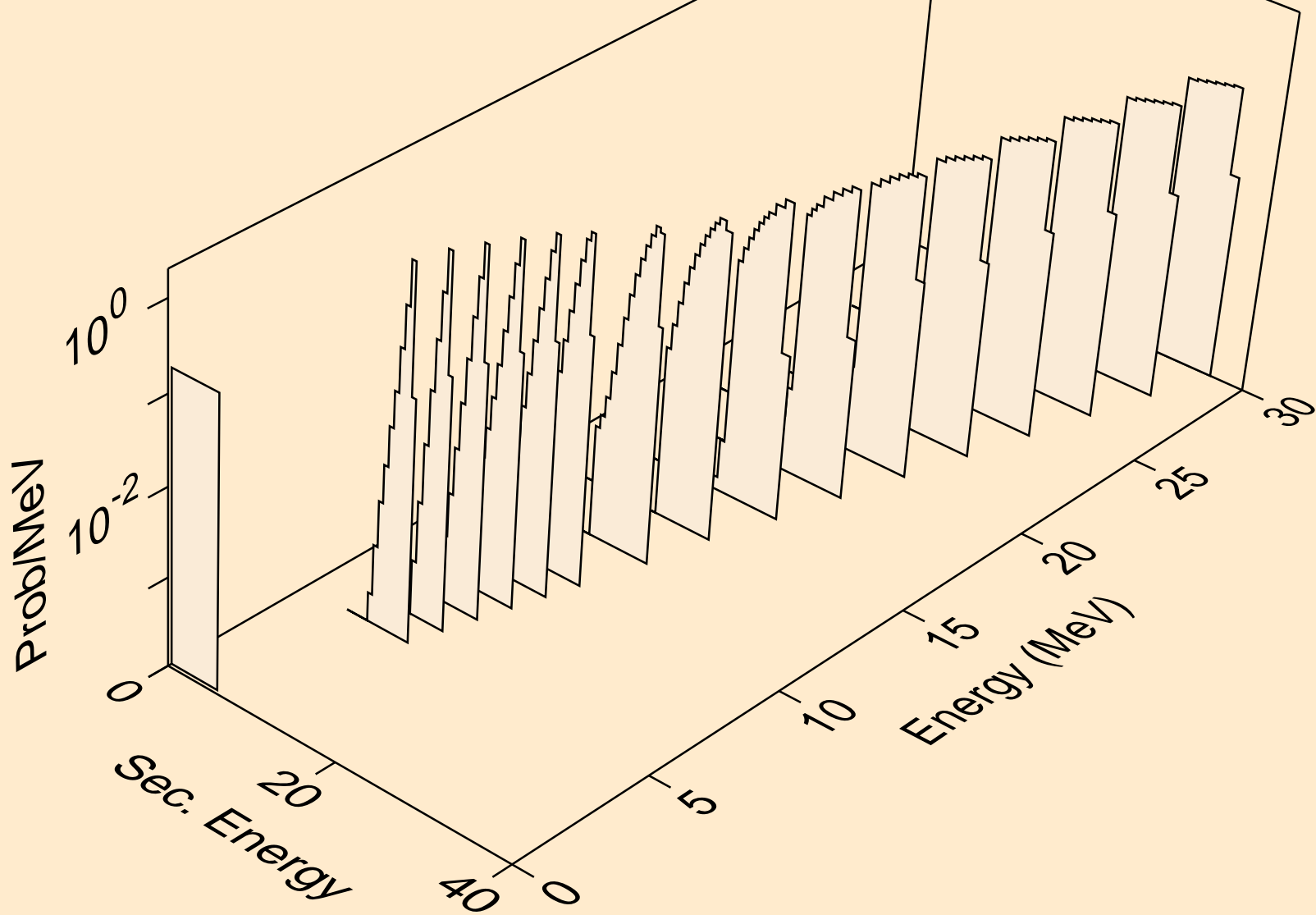

PM129 HELION ACER TENDL-2021 LIBRARY; T=0.K  
alphas from (s,2a)

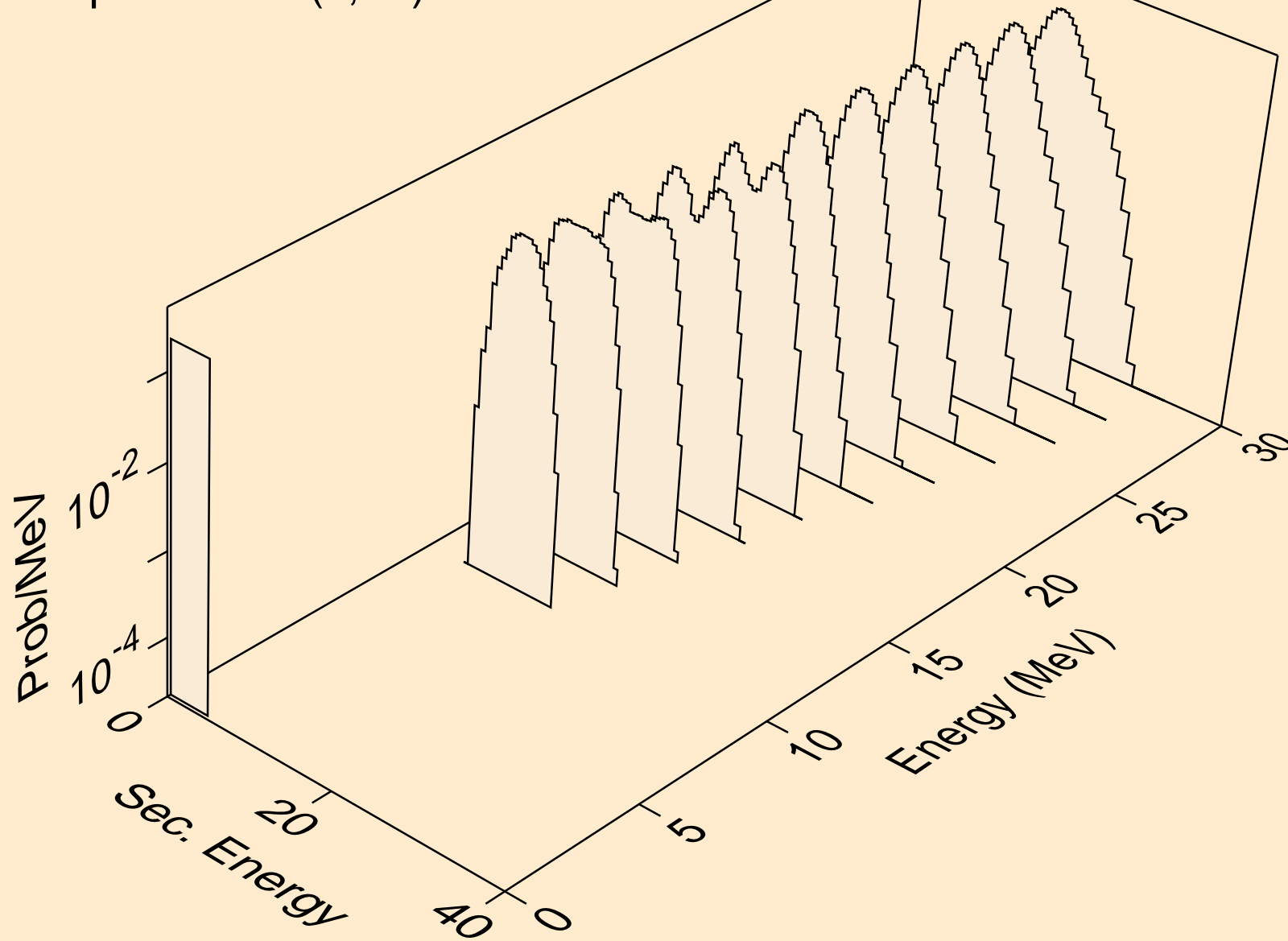

PM129 HELION ACER TENDL-2021 LIBRARY; T=0.K  
alphas from (s,pa)

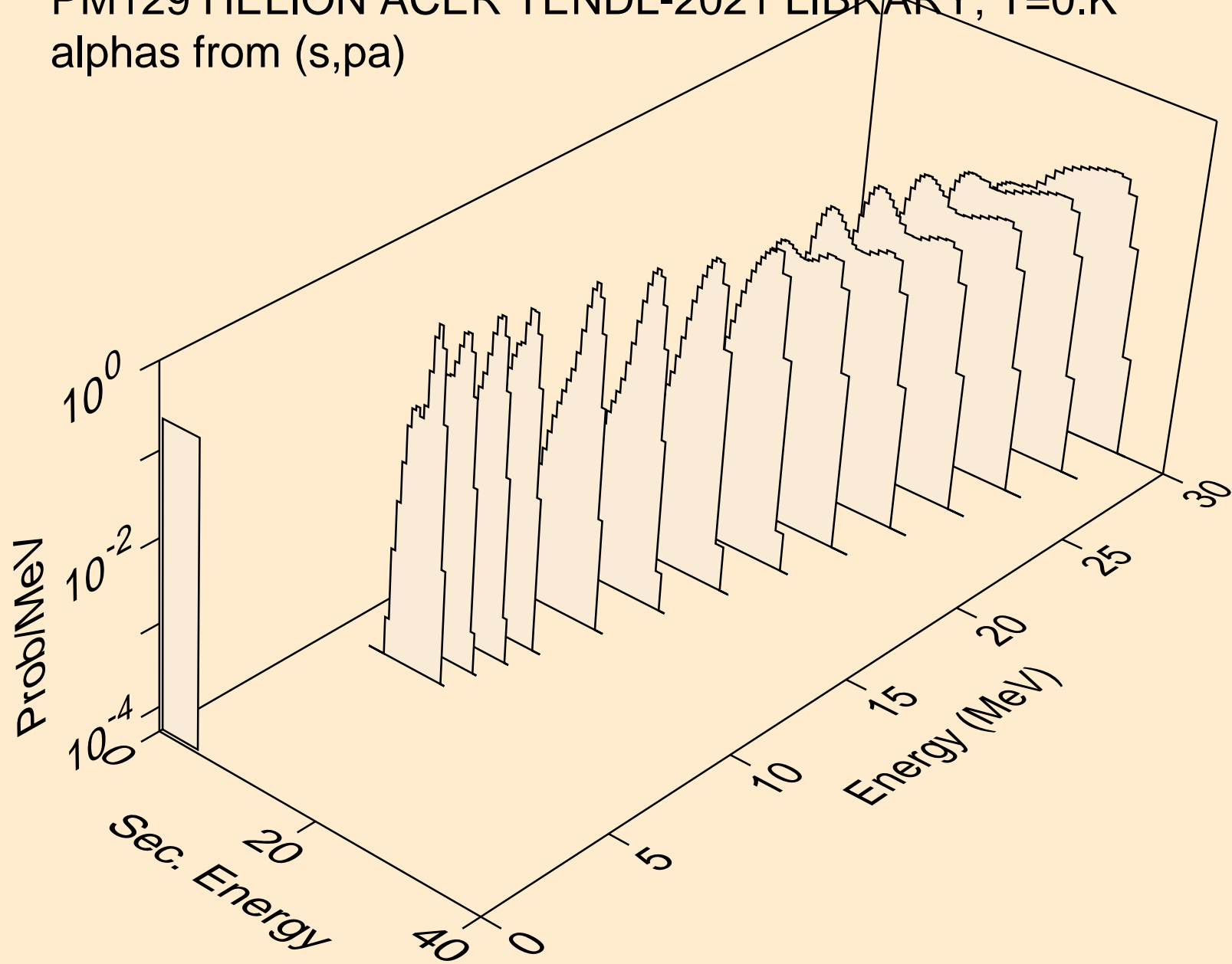



PM129 HELION ACER TENDL-2021 LIBRARY; T=0.K  
alphas from (s,da)

