

PM134M HELION ACER TENDL-2021 LIBRARY; T=0.K  
Principal cross sections

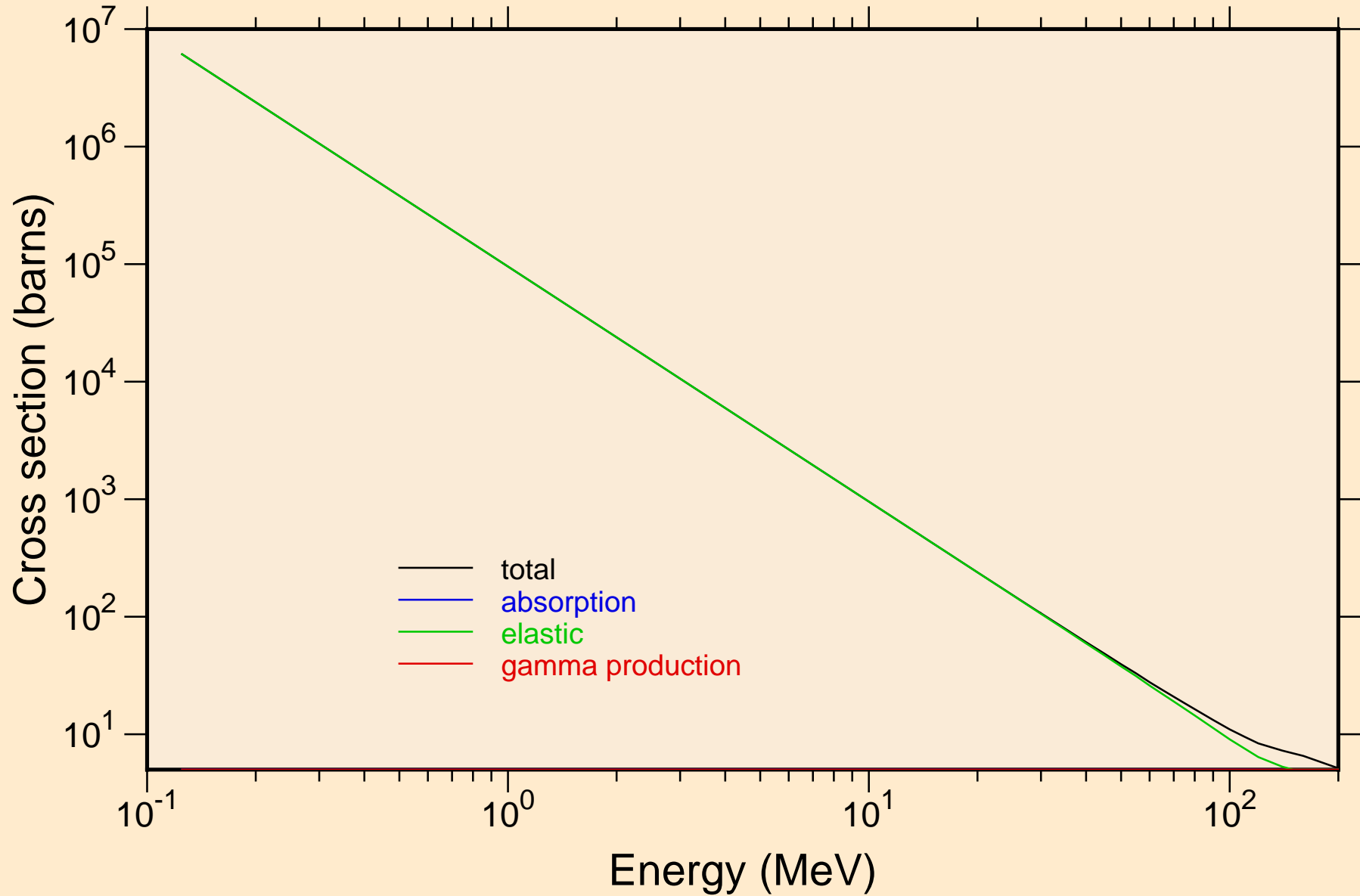

PM134M HELION ACER TENDL-2021 LIBRARY; T=0.K

Heating

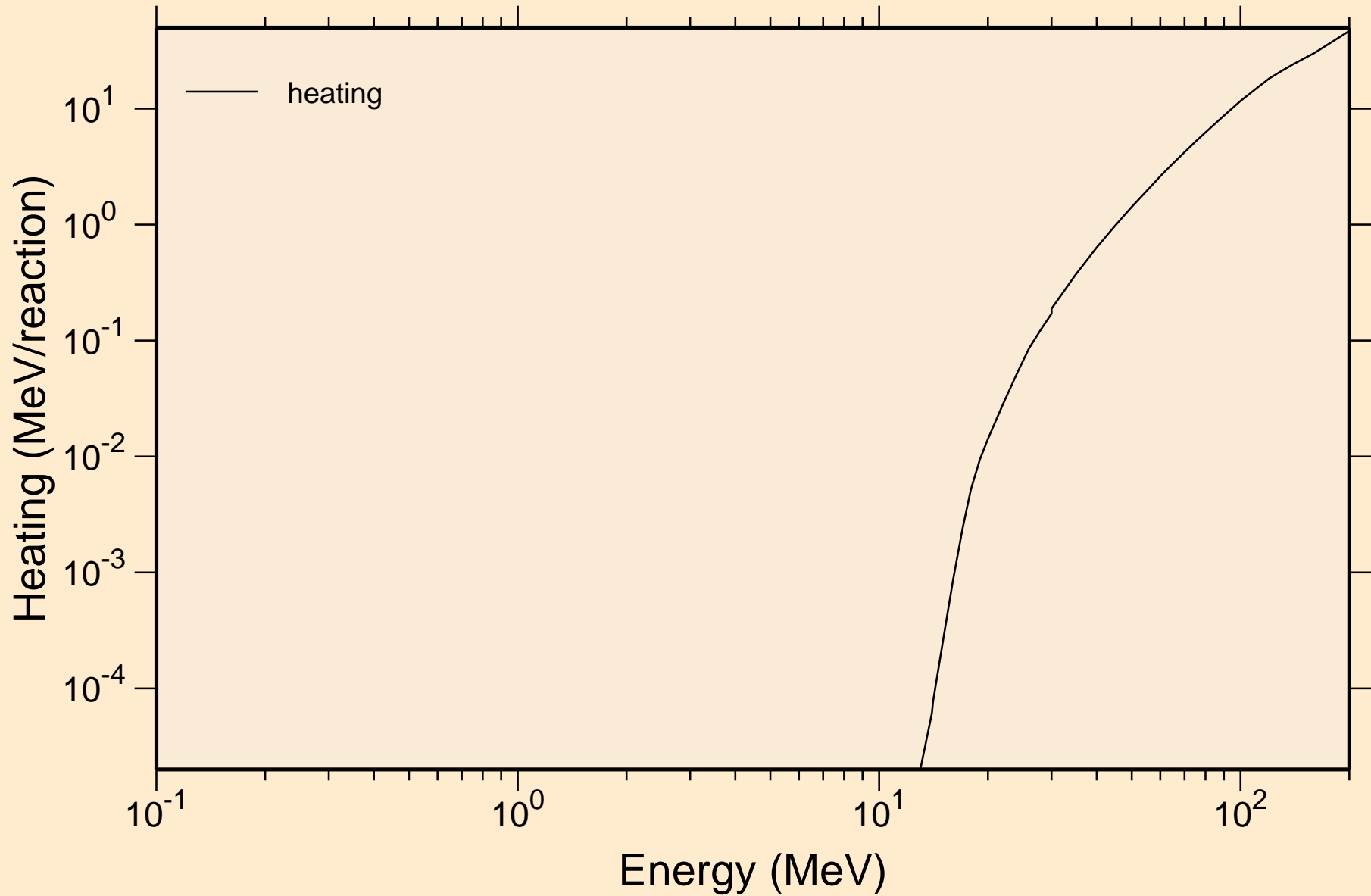

# PM134M HELION ACER TENDL-2021 LIBRARY; T=0.K

## Principal cross sections

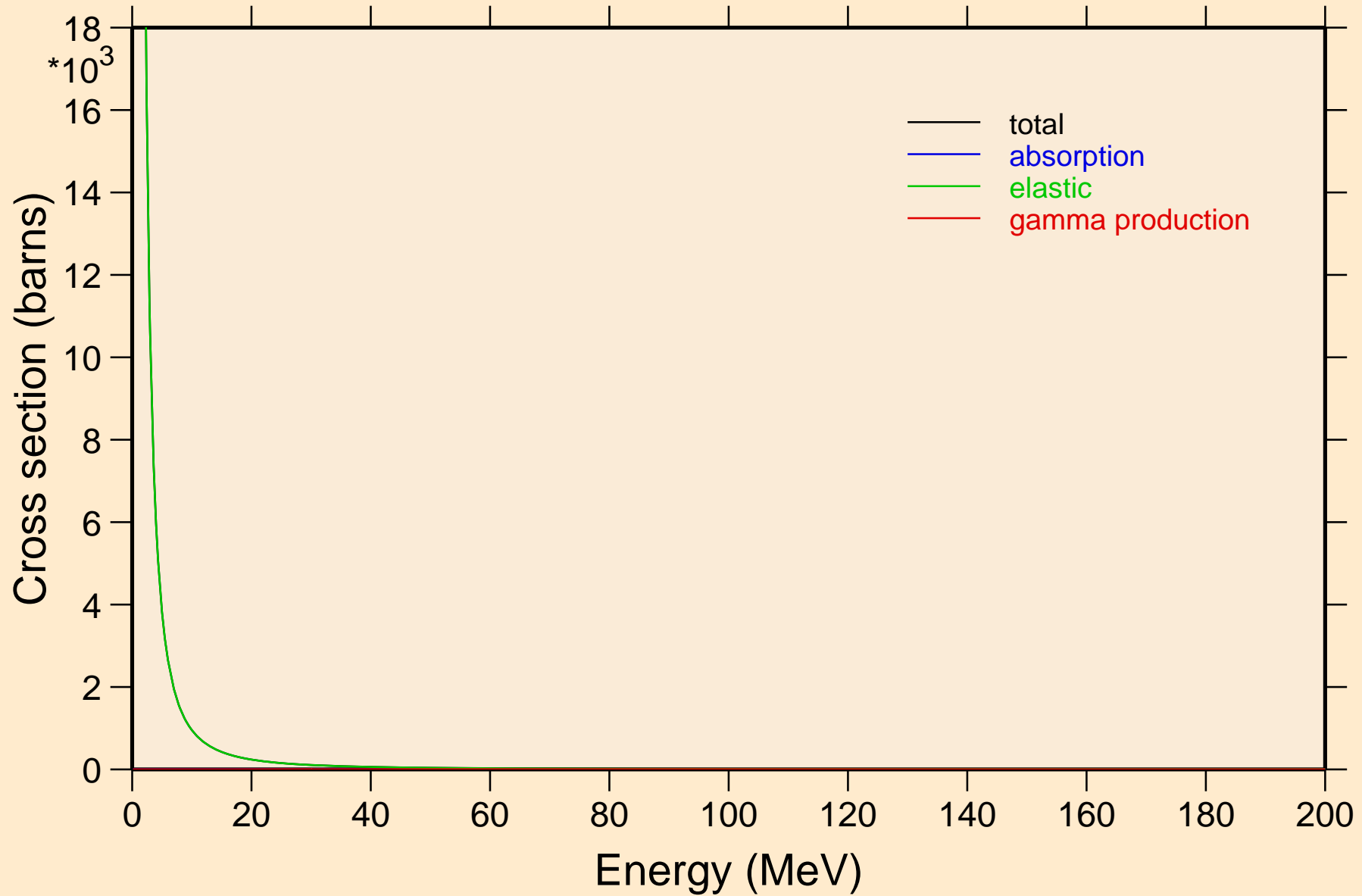

PM134M HELION ACER TENDL-2021 LIBRARY; T=0.K

Heating

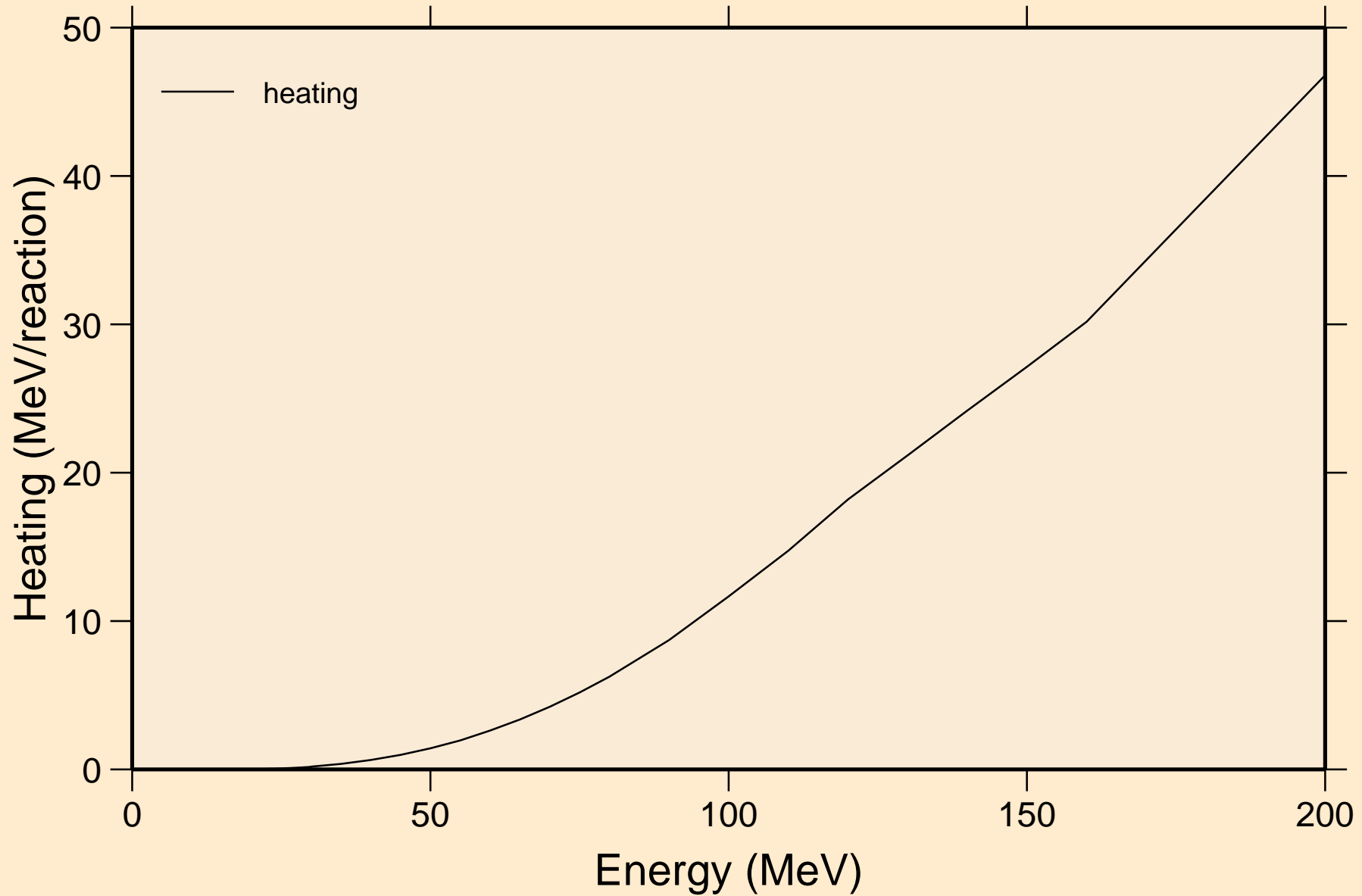

PM134M HELION ACER TENDL-2021 LIBRARY; T=0.K  
Threshold reactions

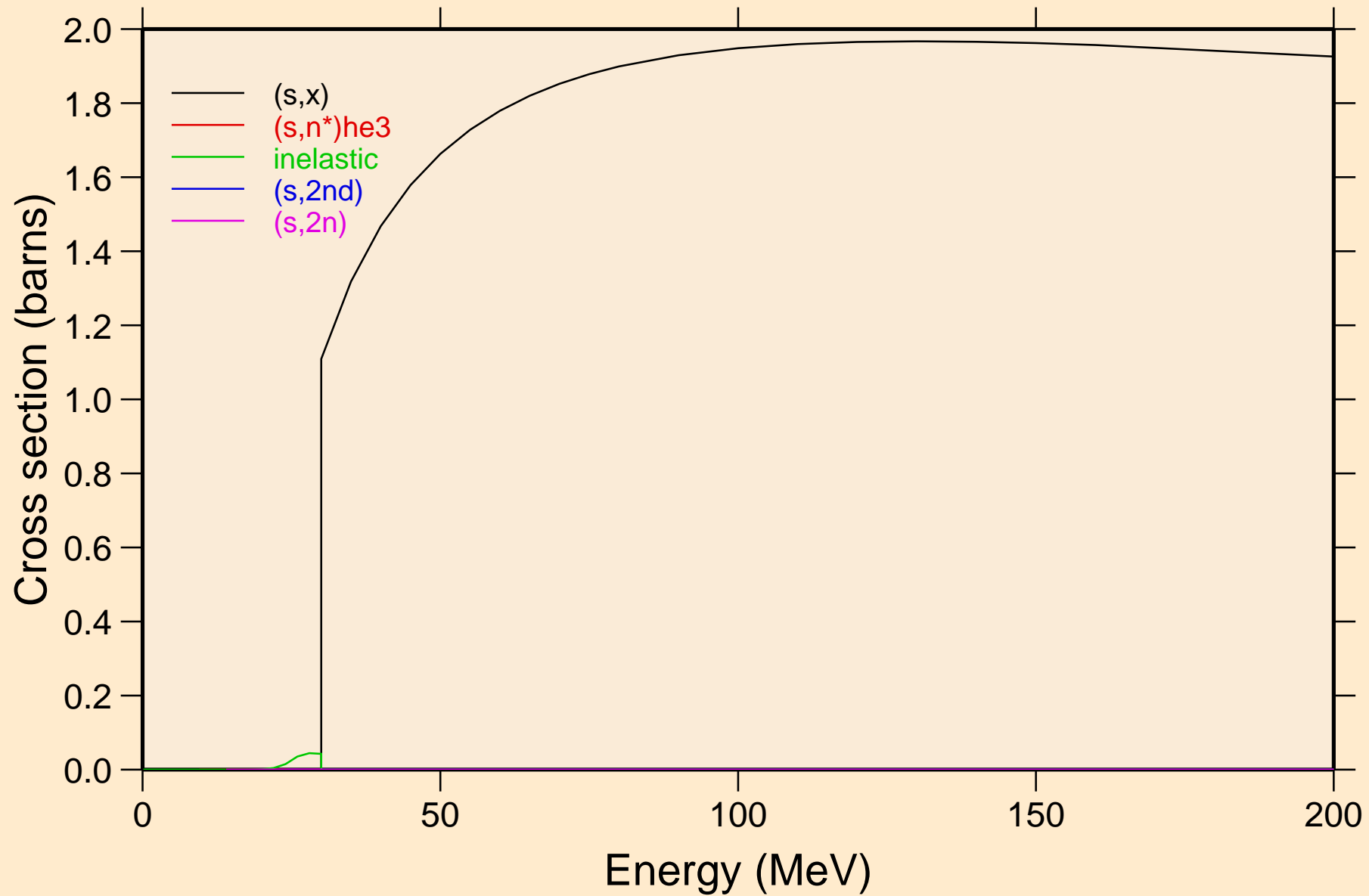

PM134M HELION ACER TENDL-2021 LIBRARY; T=0.K  
Threshold reactions

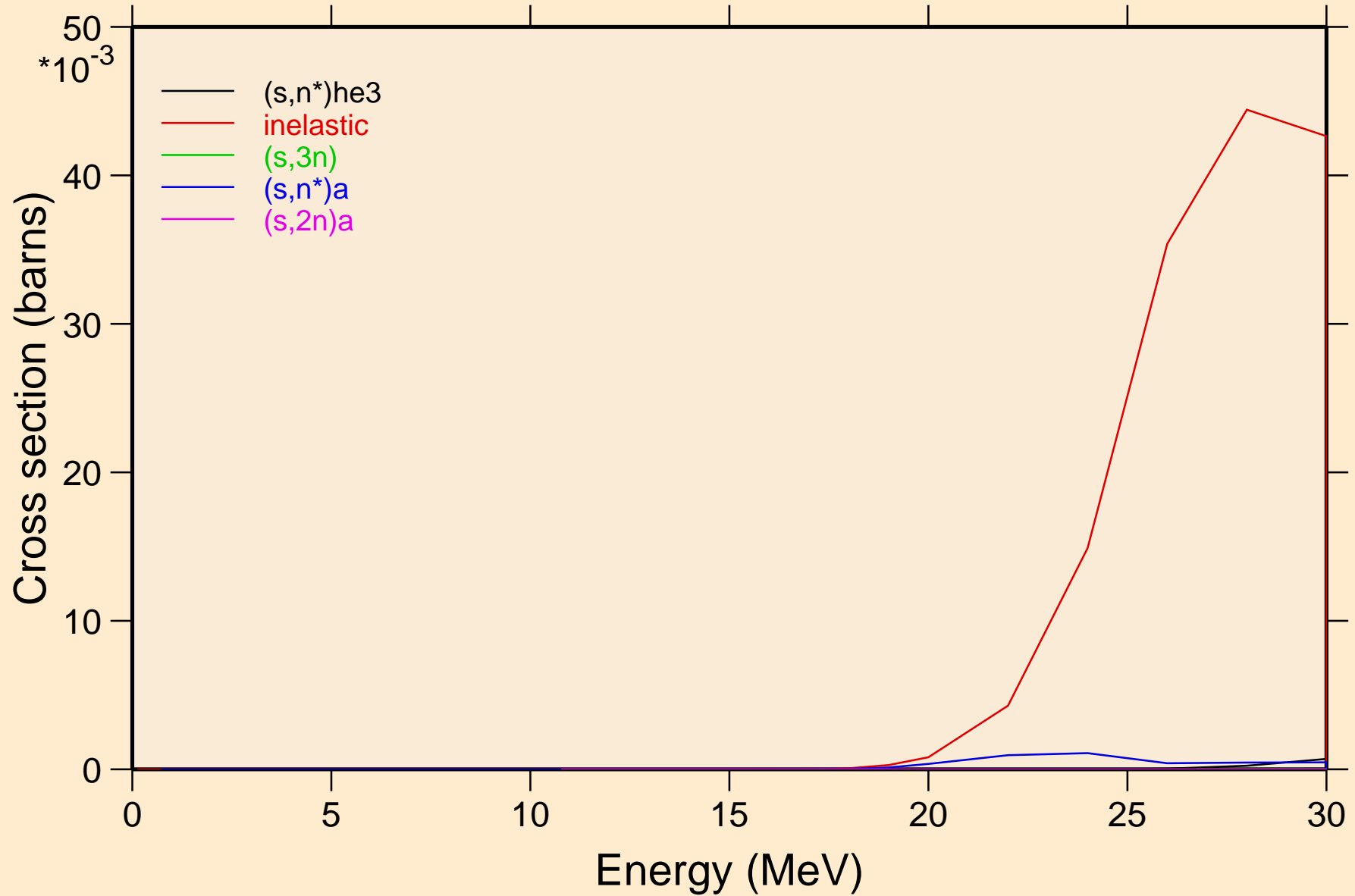

PM134M HELION ACER TENDL-2021 LIBRARY; T=0.K  
Threshold reactions

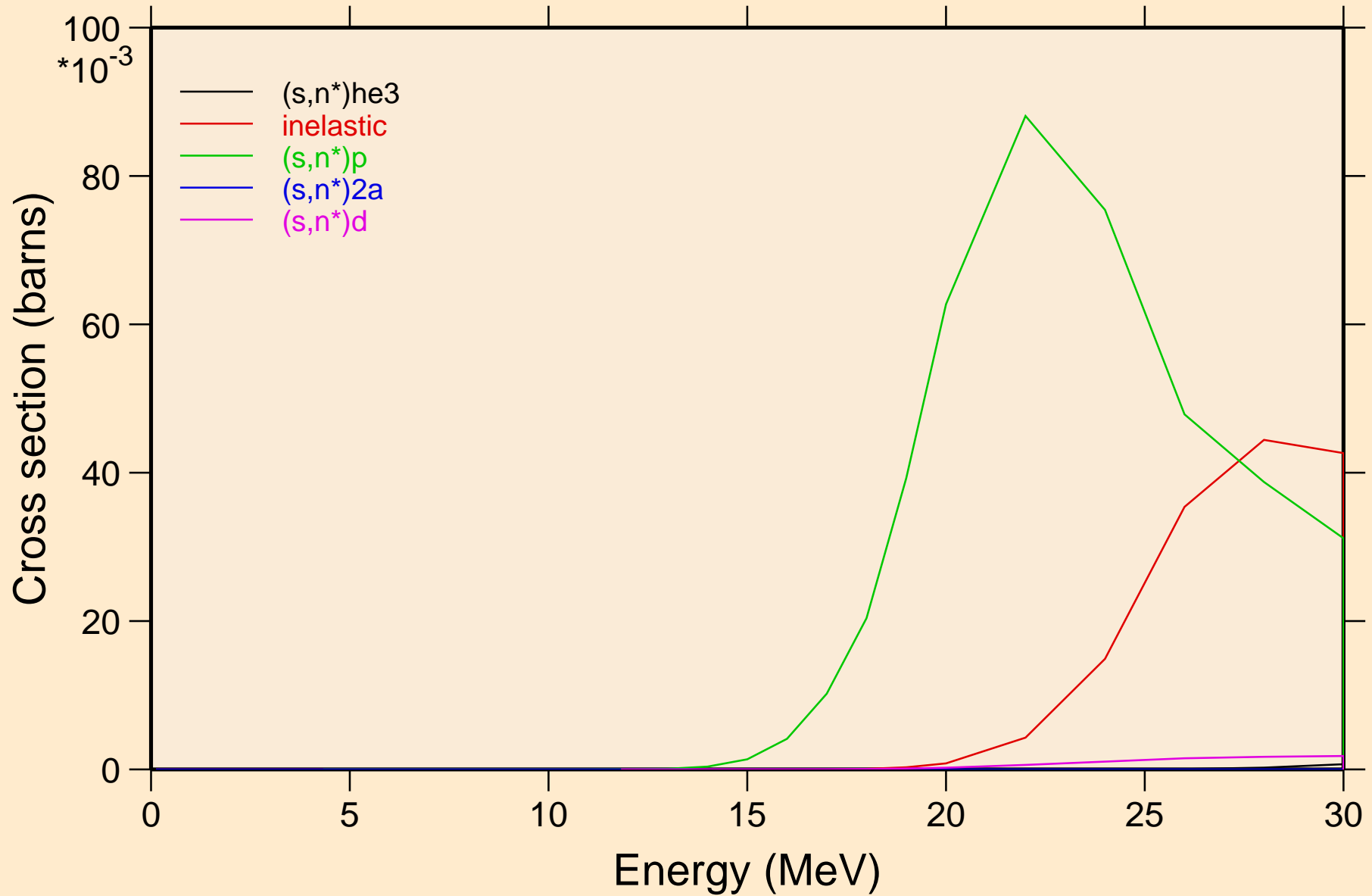

PM134M HELION ACER TENDL-2021 LIBRARY; T=0.K  
Threshold reactions

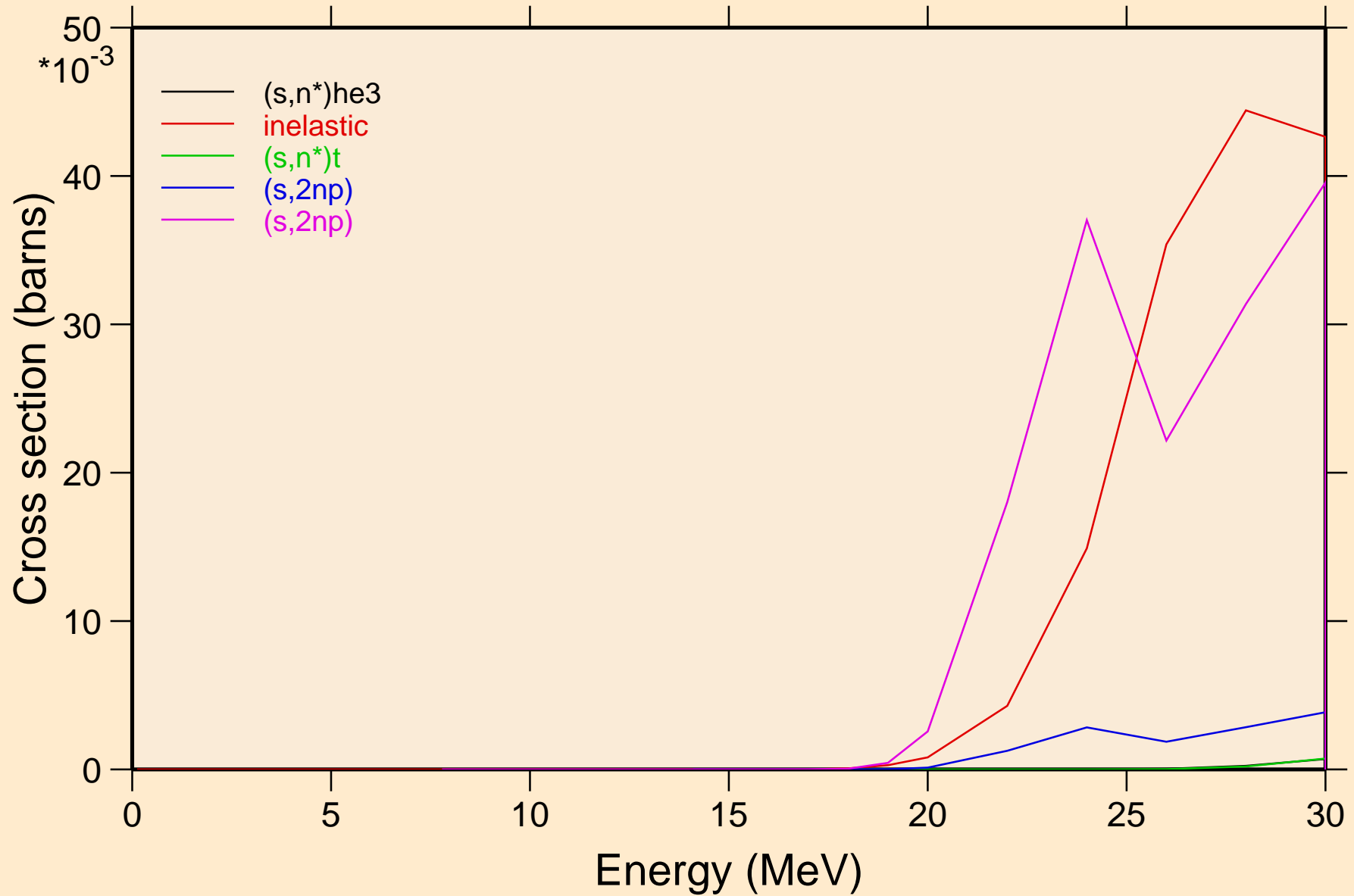



PM134M HELION ACER TENDL-2021 LIBRARY; T=0.K  
Threshold reactions

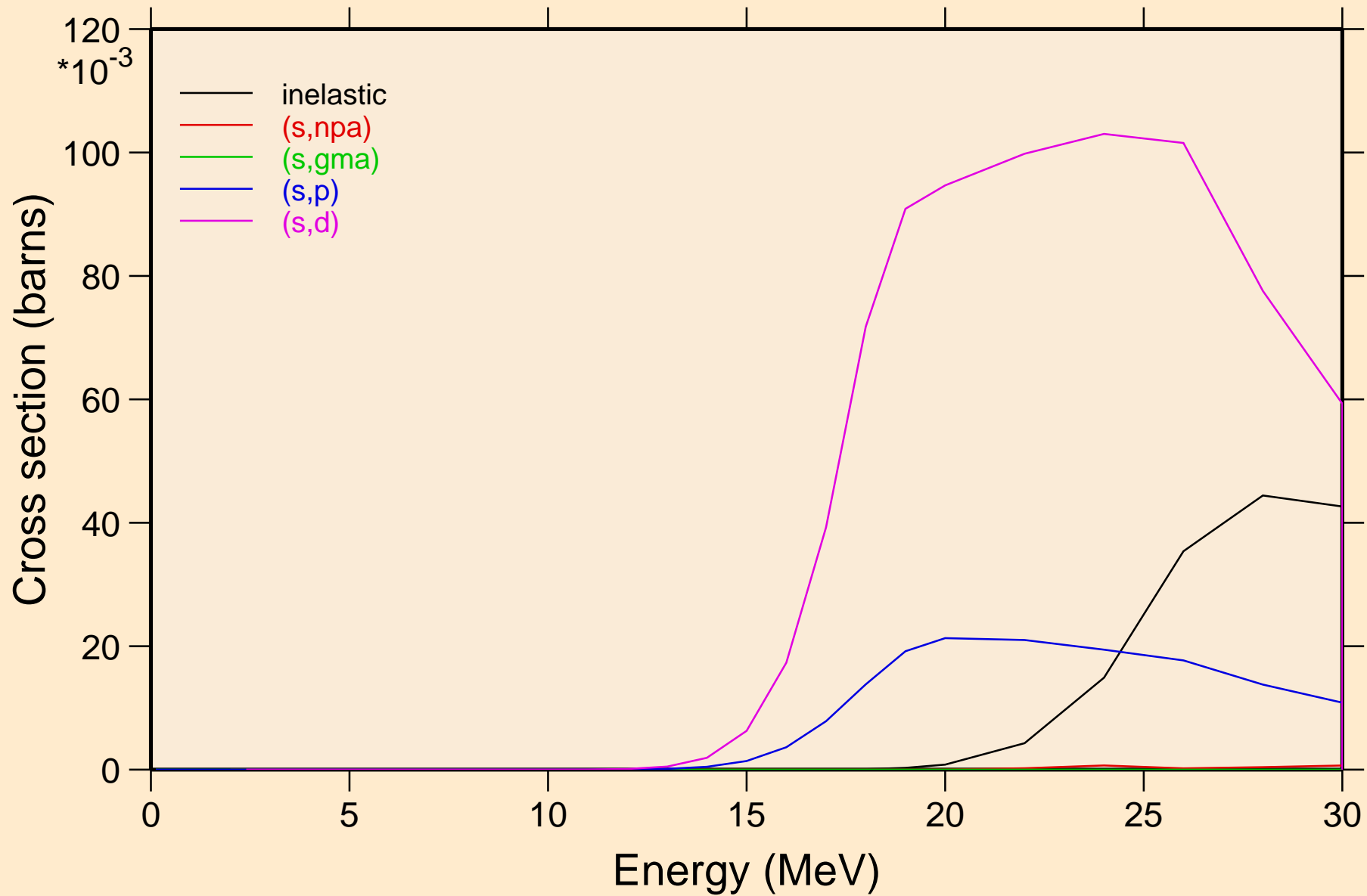

PM134M HELION ACER TENDL-2021 LIBRARY; T=0.K  
Threshold reactions

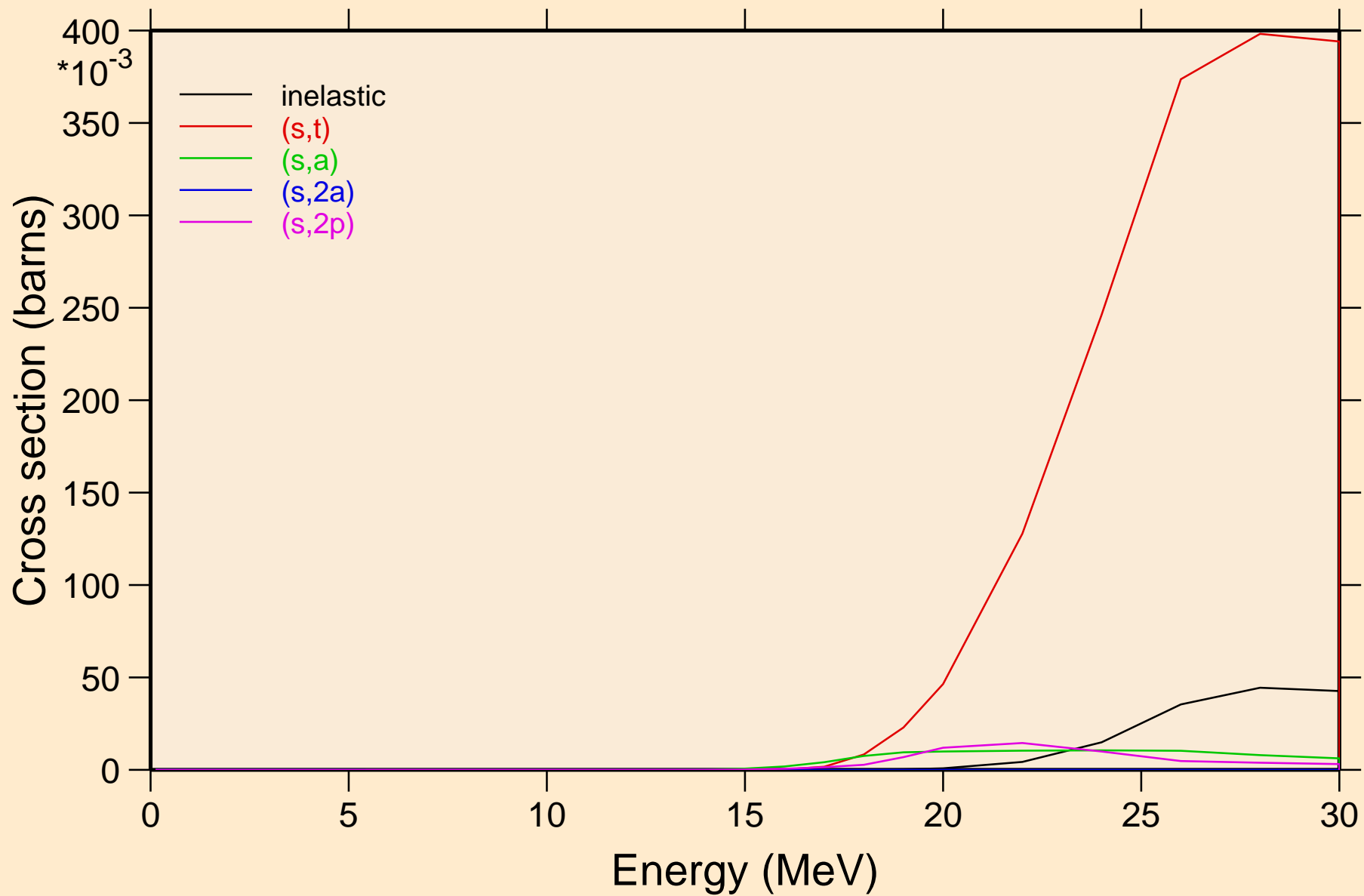

PM134M HELION ACER TENDL-2021 LIBRARY; T=0.K  
Threshold reactions

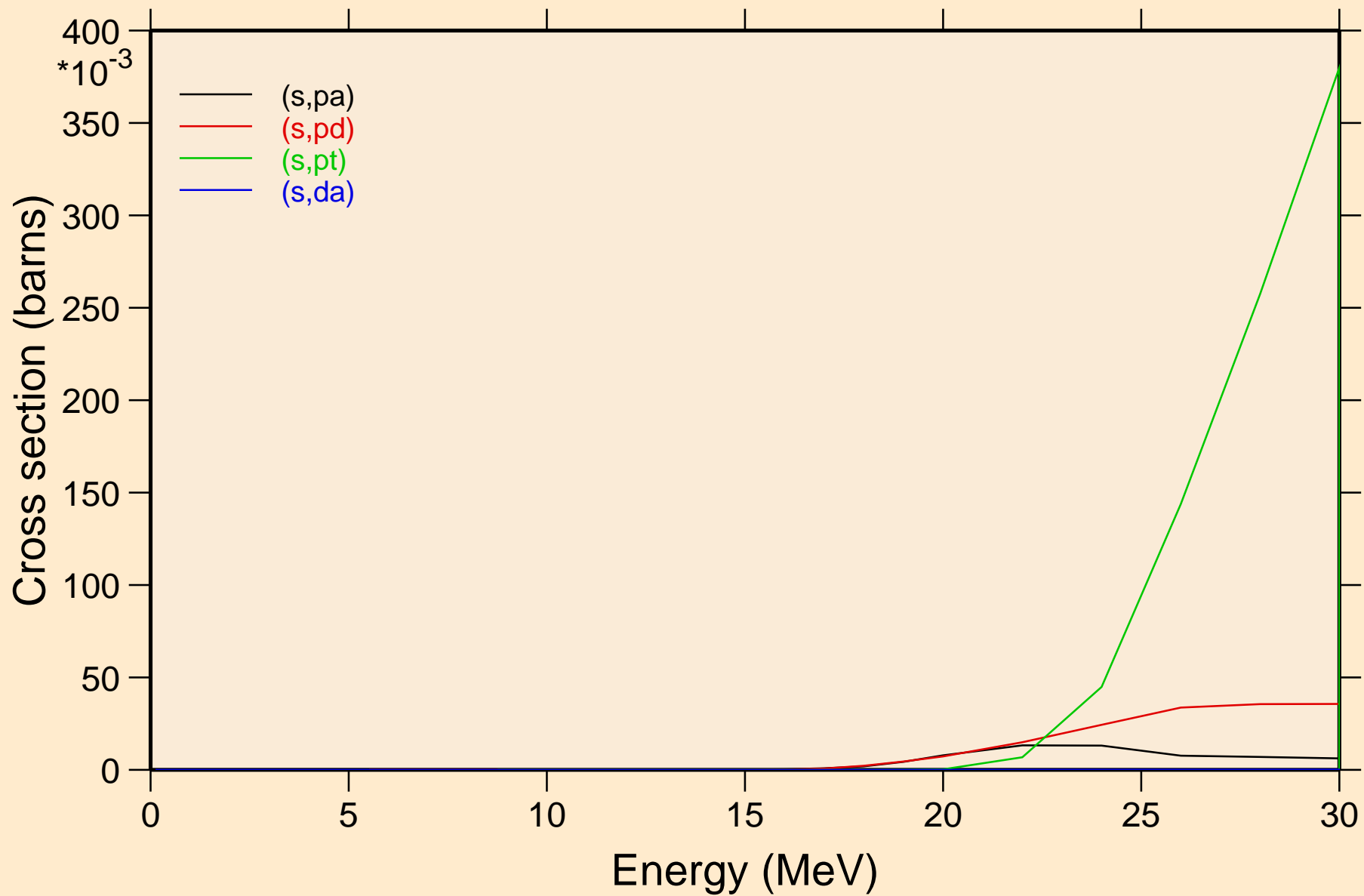

PM134M HELION ACER TENDL-2021 LIBRARY; T=0.K  
angular distribution for elastic

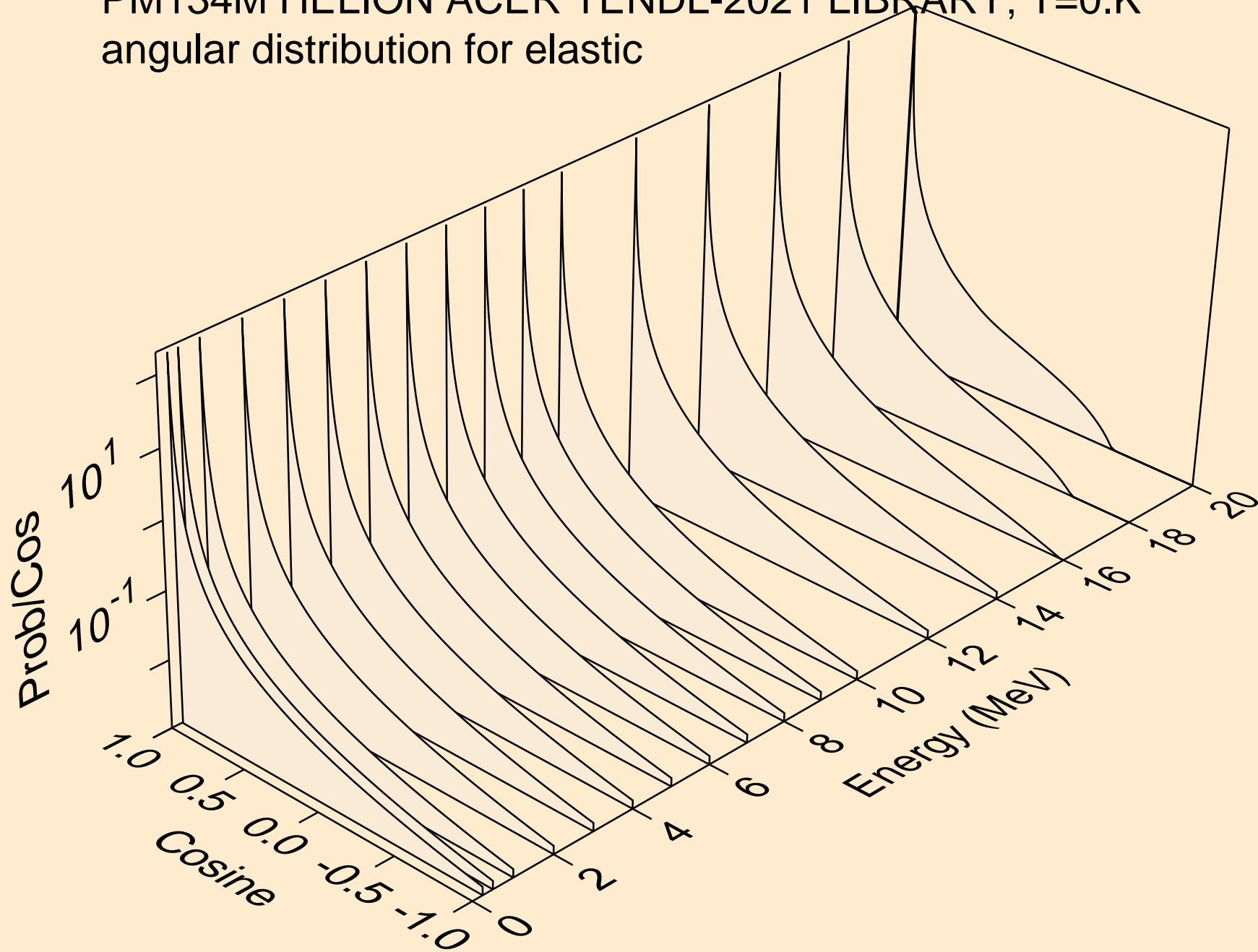

PM134M HELION ACER TENDL-2021 LIBRARY; T=0.K  
angular distribution for elastic

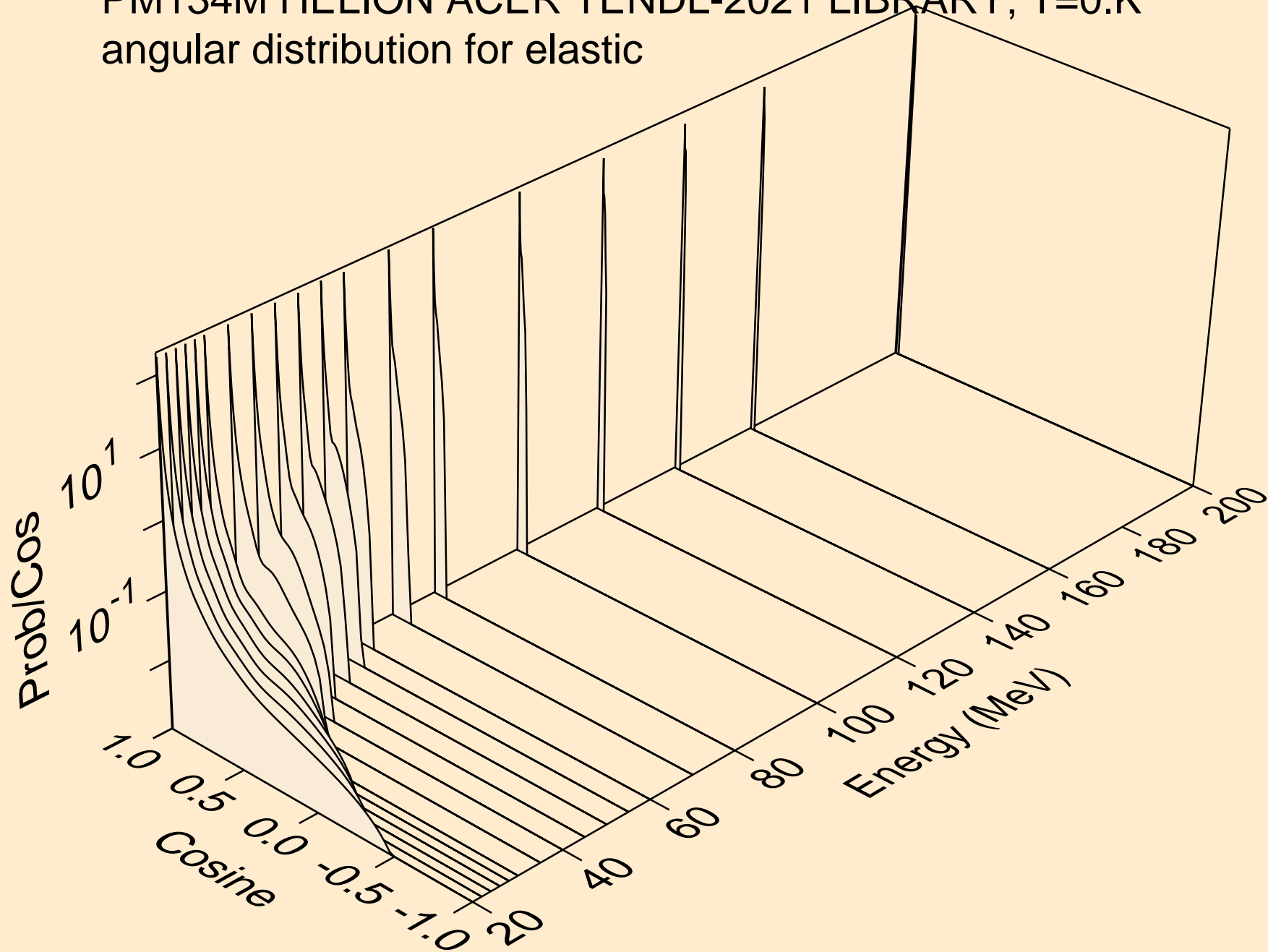

PM134M HELION ACER TENDL-2021 LIBRARY; T=0.K  
He-3 emission for (s,x)

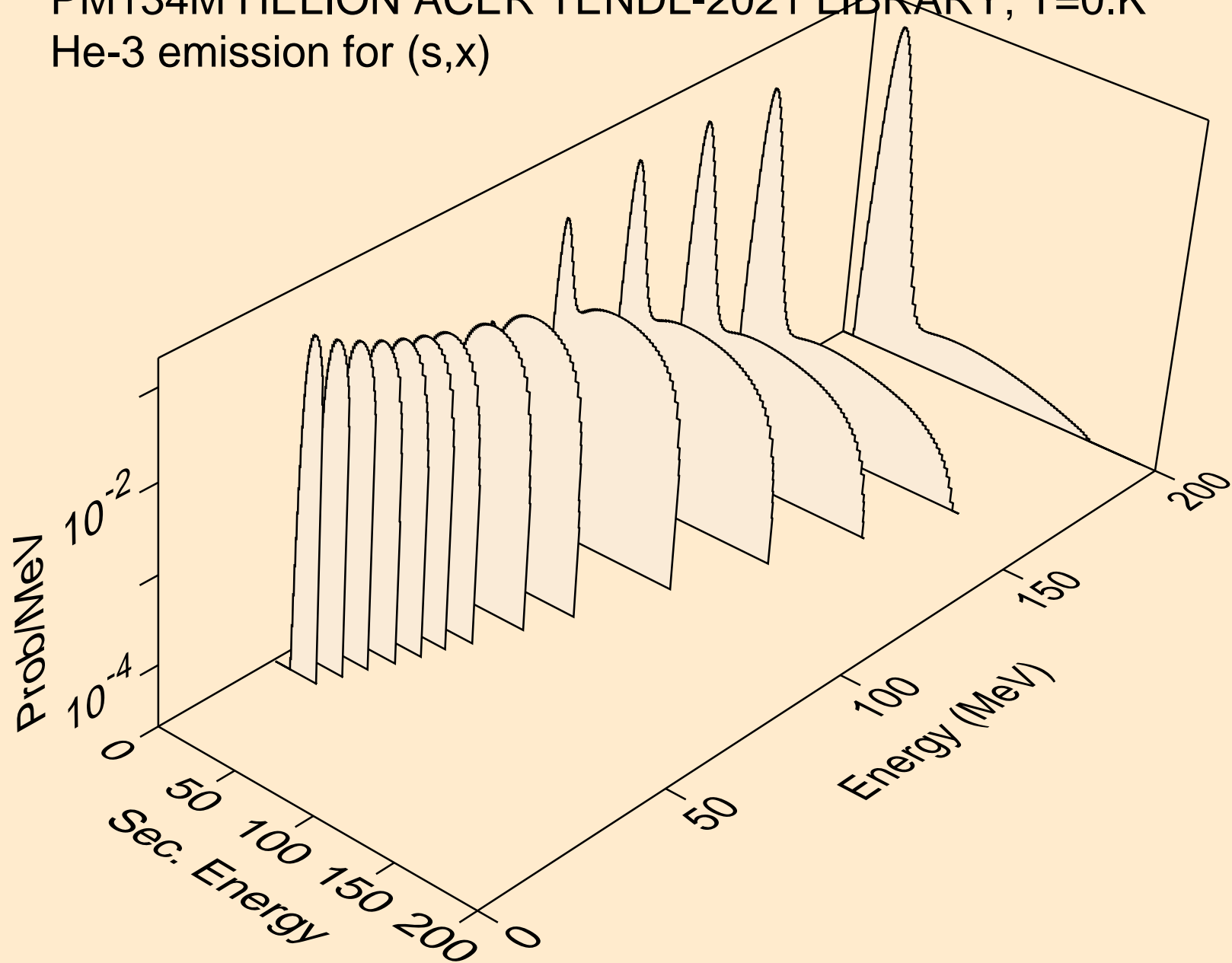

PM134M HELION ACER TENDL-2021 LIBRARY; T=0.K  
He-3 emission for (s,n\*)he3

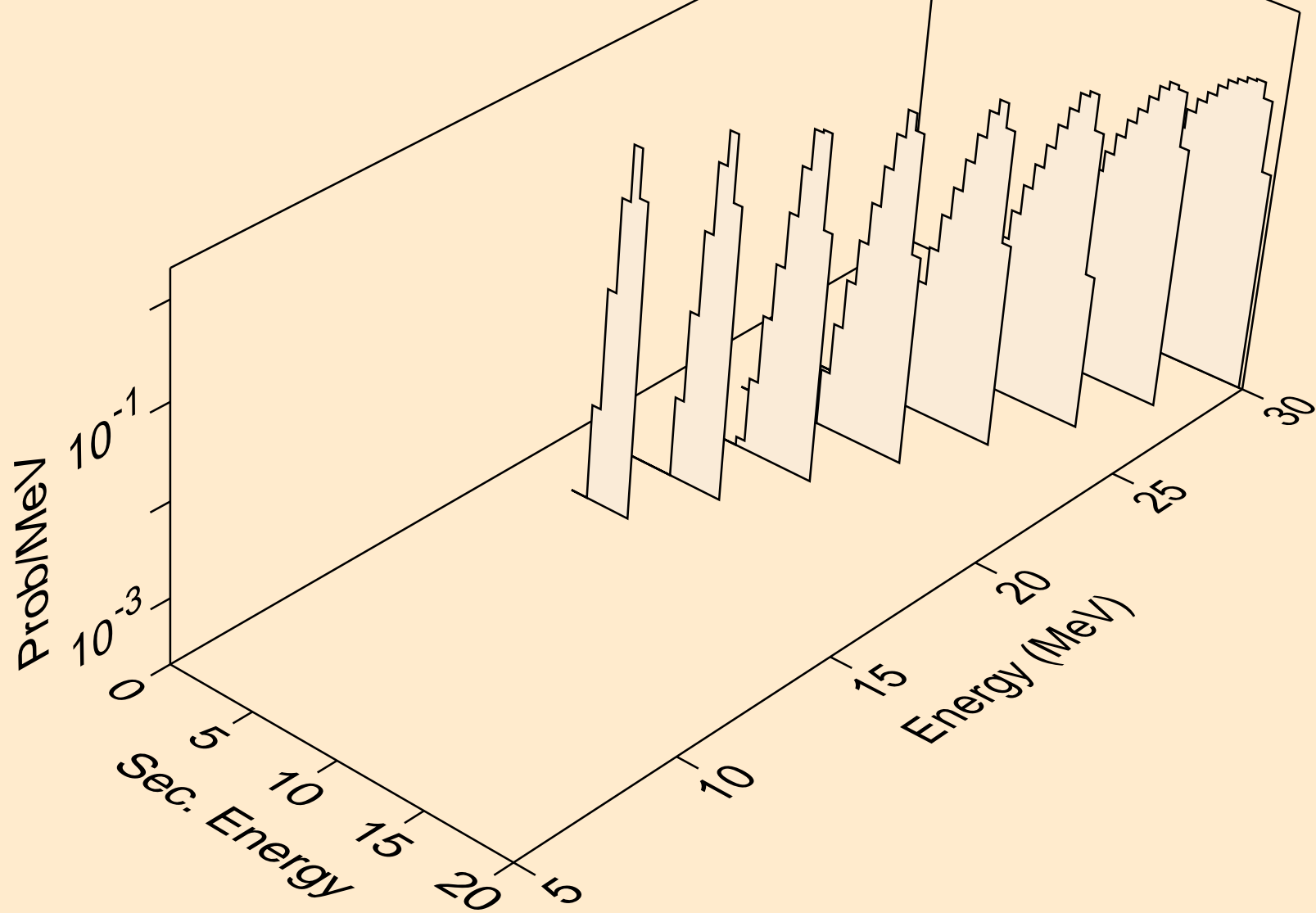

PM134M HELION ACER TENDL-2021 LIBRARY; T=0.K  
He-3 emission for inelastic

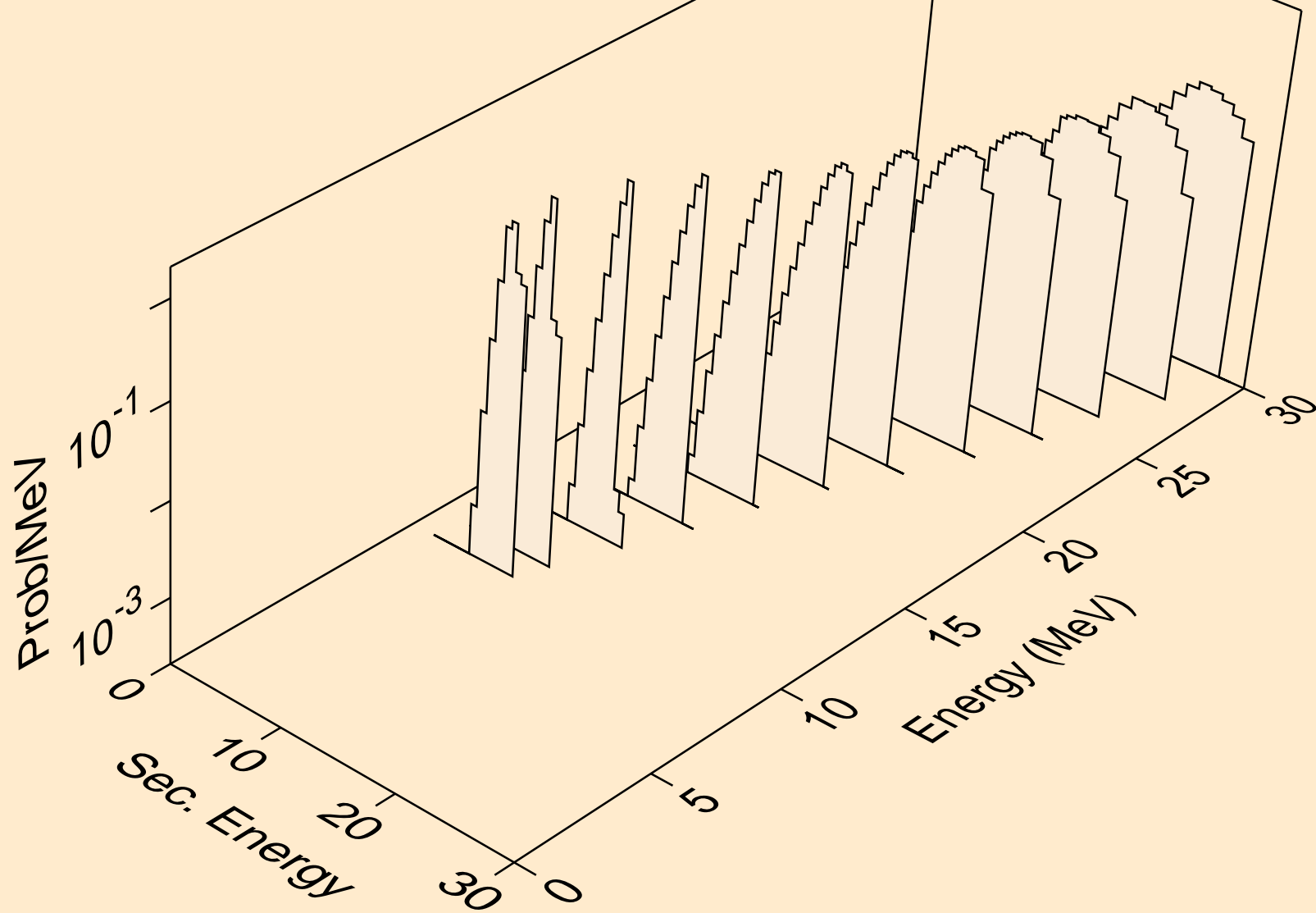



PM134M HELION ACER TENDL-2021 LIBRARY; T=0.K  
Photon emission for (z,n)

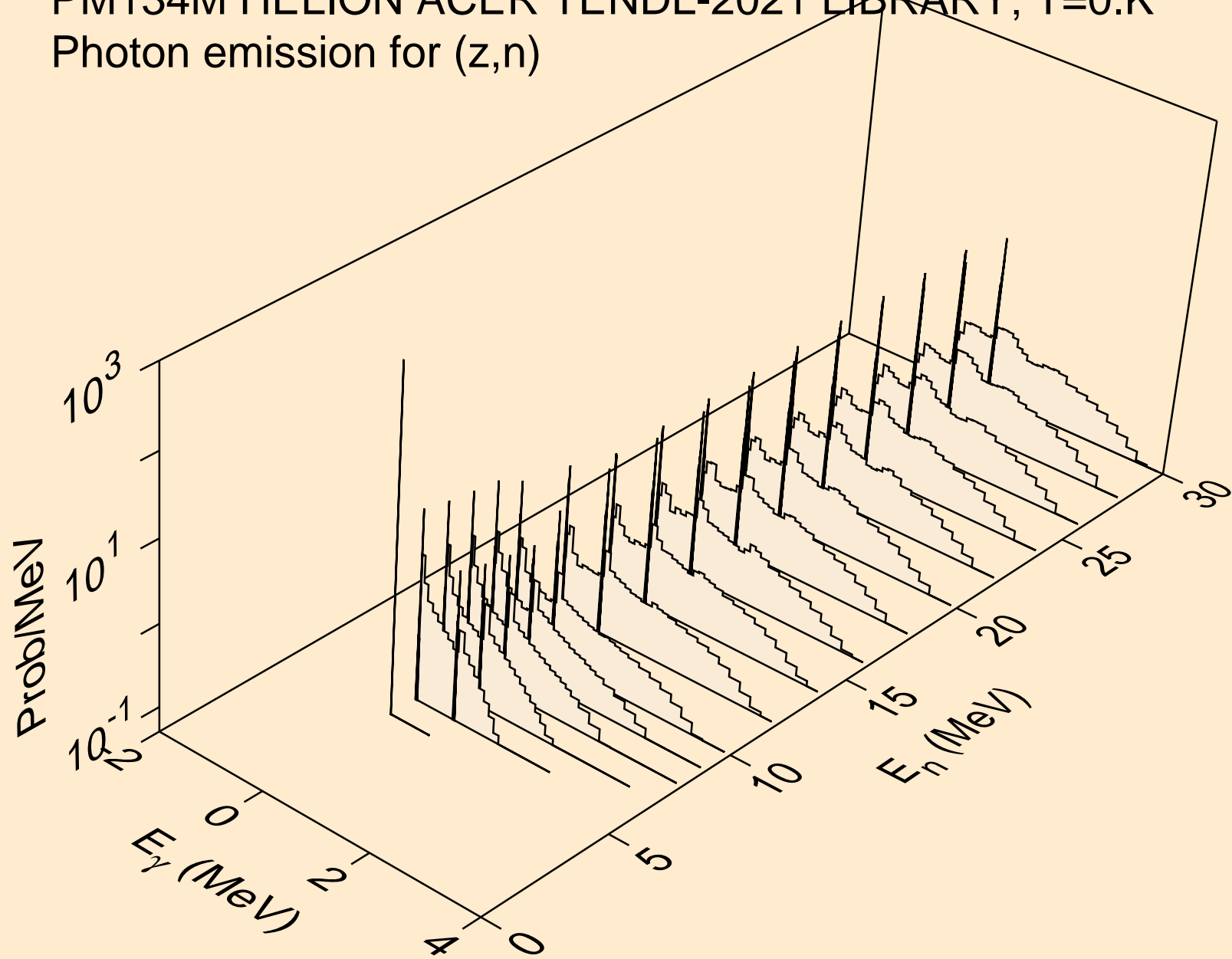

PM134M HELION ACER TENDL-2021 LIBRARY; T=0.K  
Photon emission for (n,x)

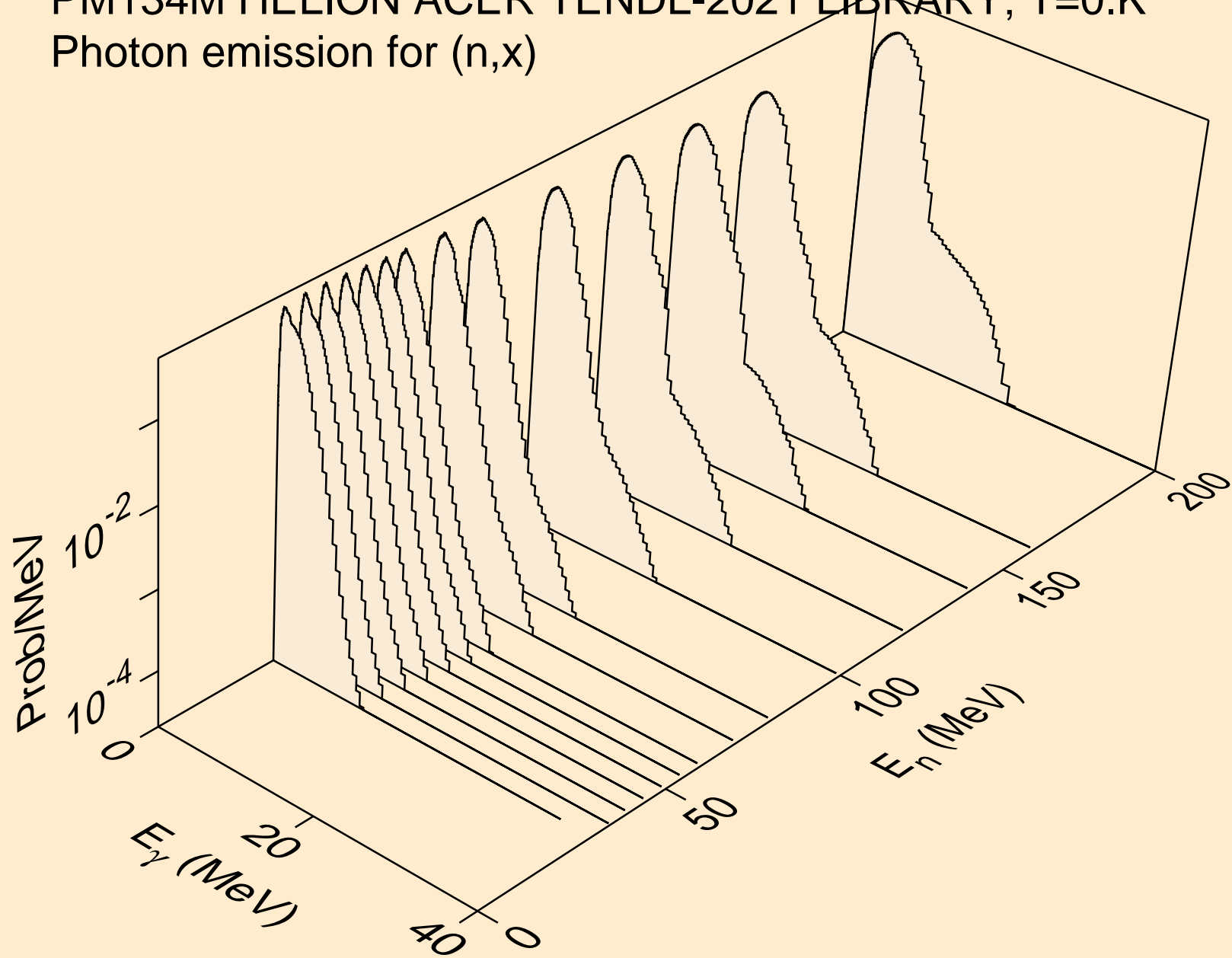

PM134M HELION ACER TENDL-2021 LIBRARY; T=0.K  
Photon emission for (n,2nd)

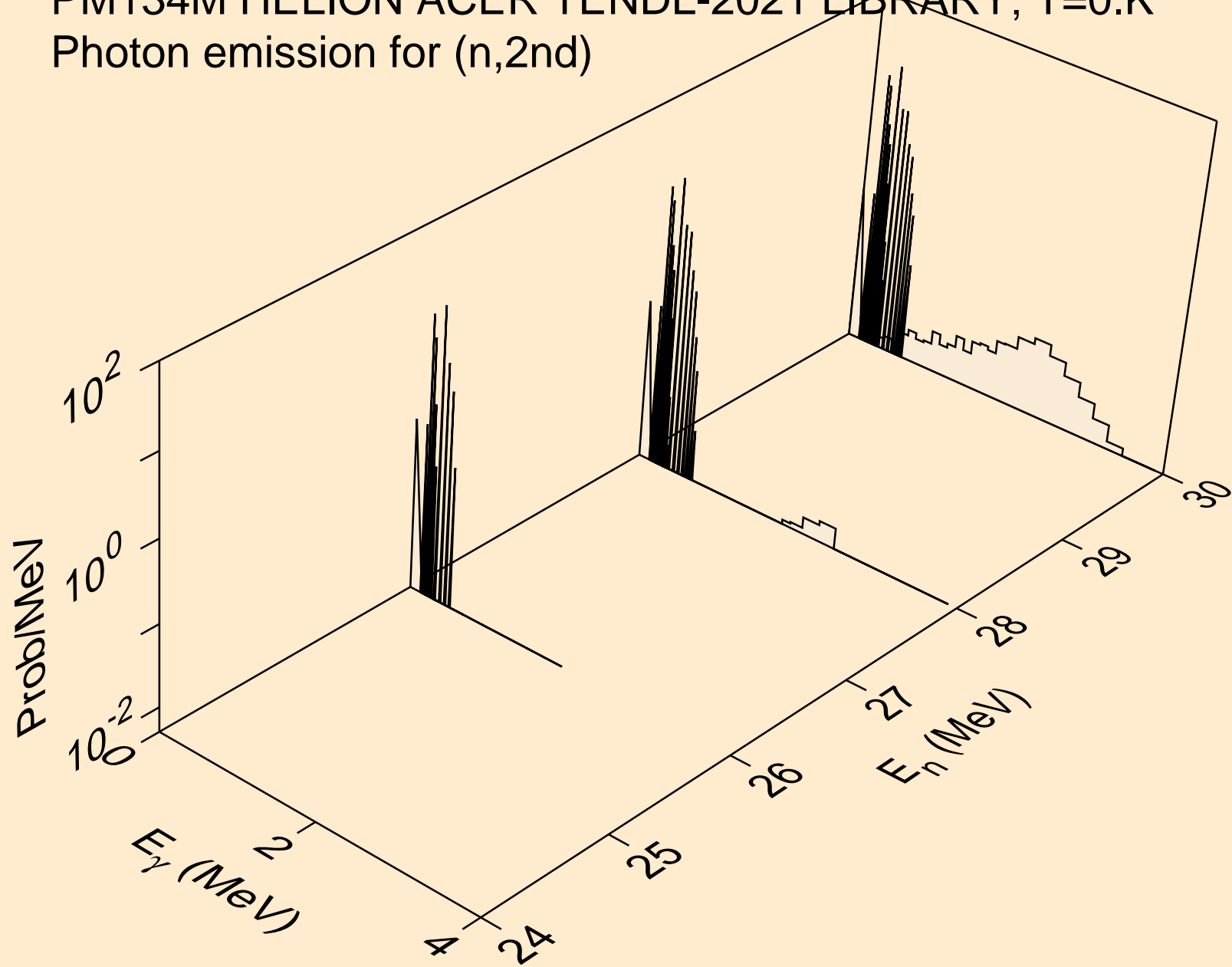

PM134M HELION ACER TENDL-2021 LIBRARY; T=0.K  
Photon emission for (n,2n)

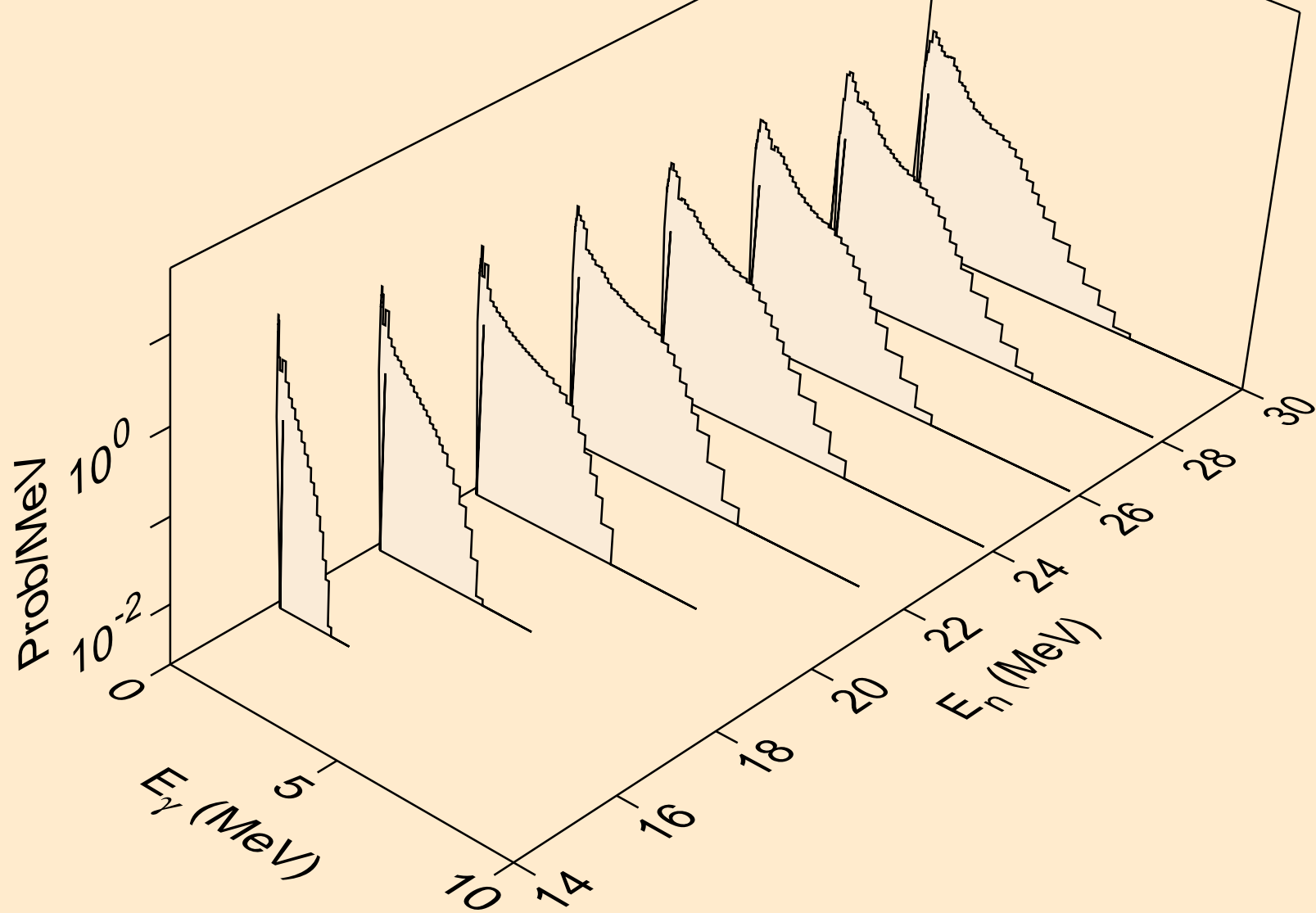

PM134M HELION ACER TENDL-2021 LIBRARY; T=0.K  
Photon emission for (n,3n)

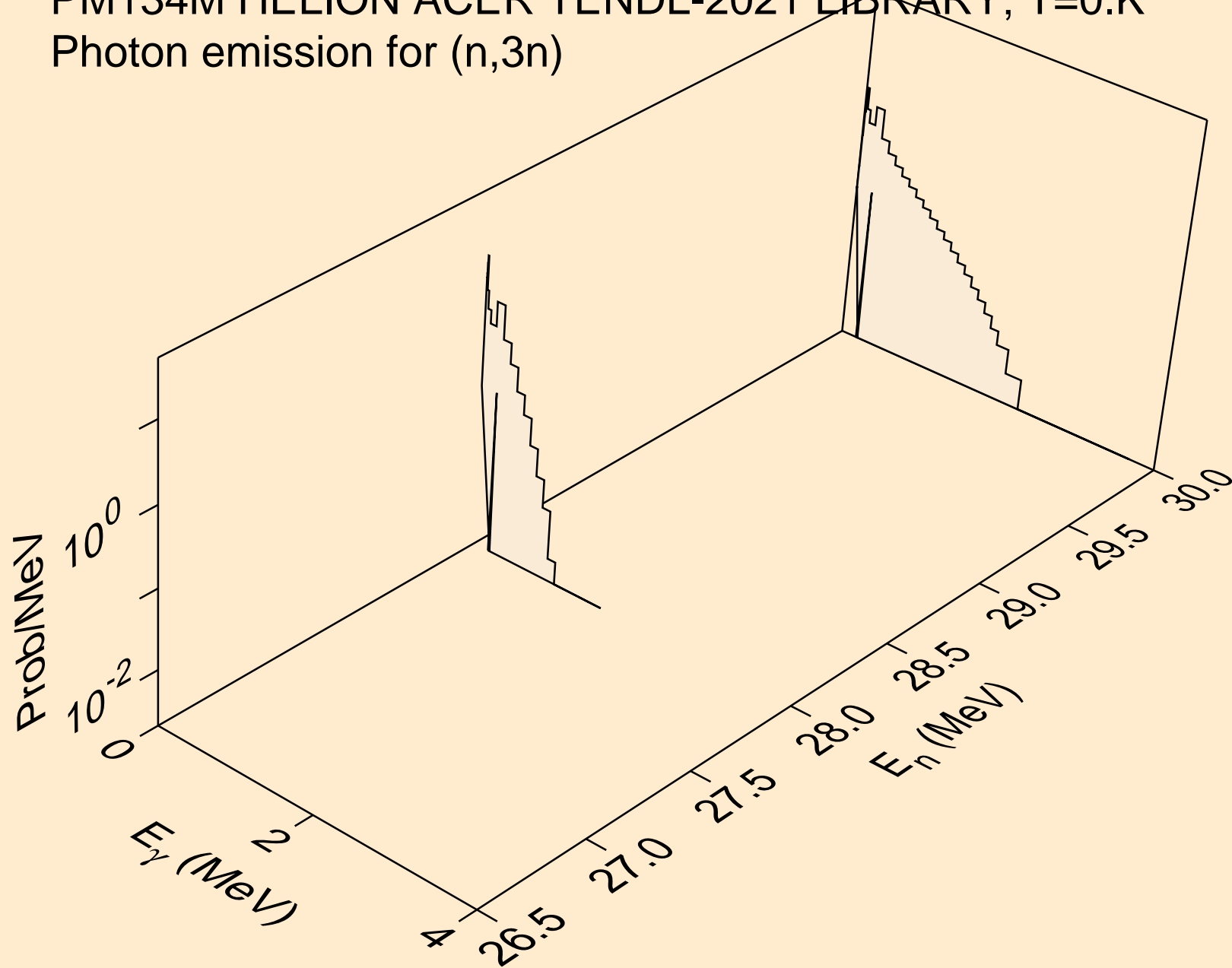

PM134M HELION ACER TENDL-2021 LIBRARY; T=0.K  
Photon emission for (n,n\*)a

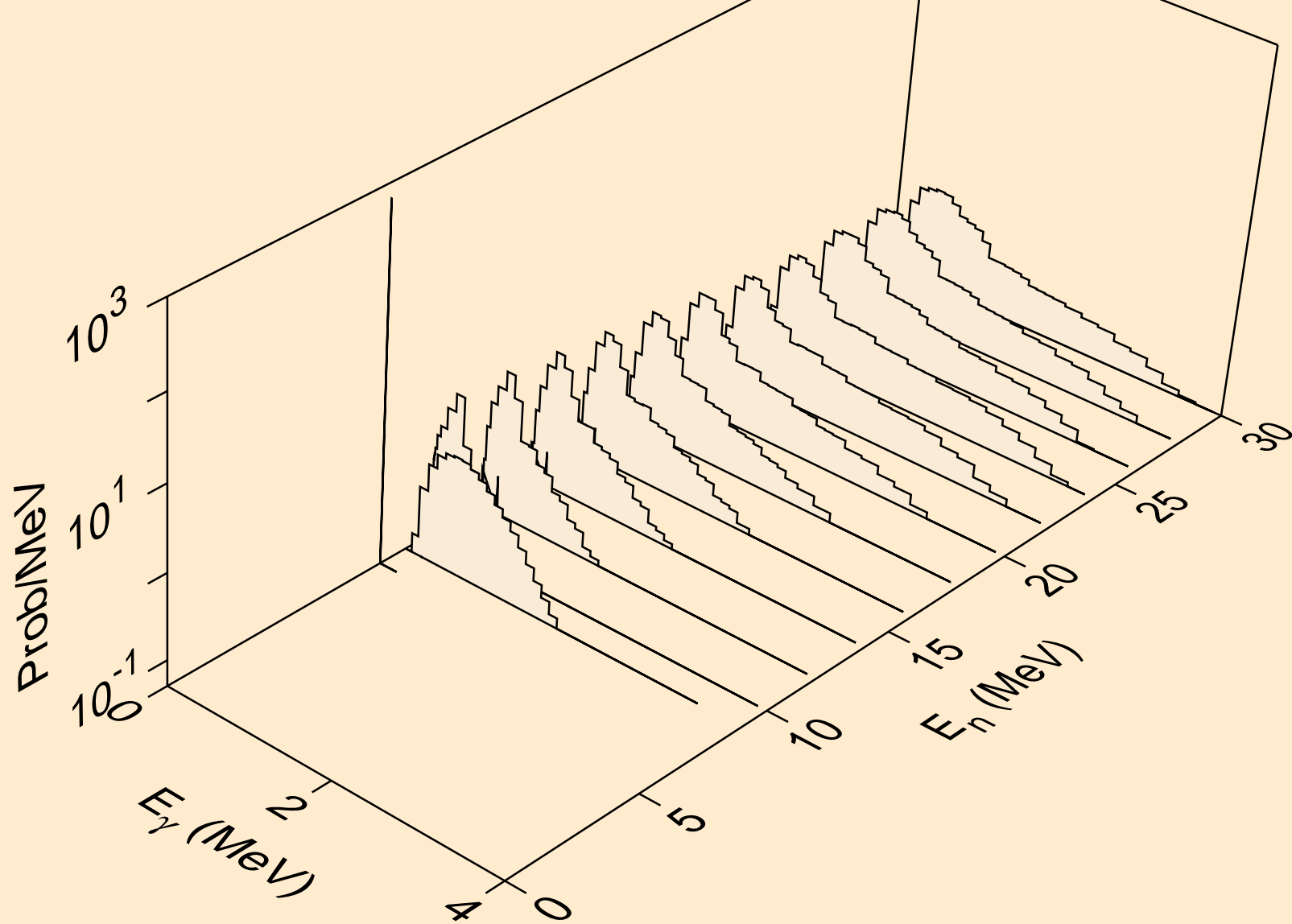

PM134M HELION ACER TENDL-2021 LIBRARY; T=0.K  
Photon emission for (n,2n)a

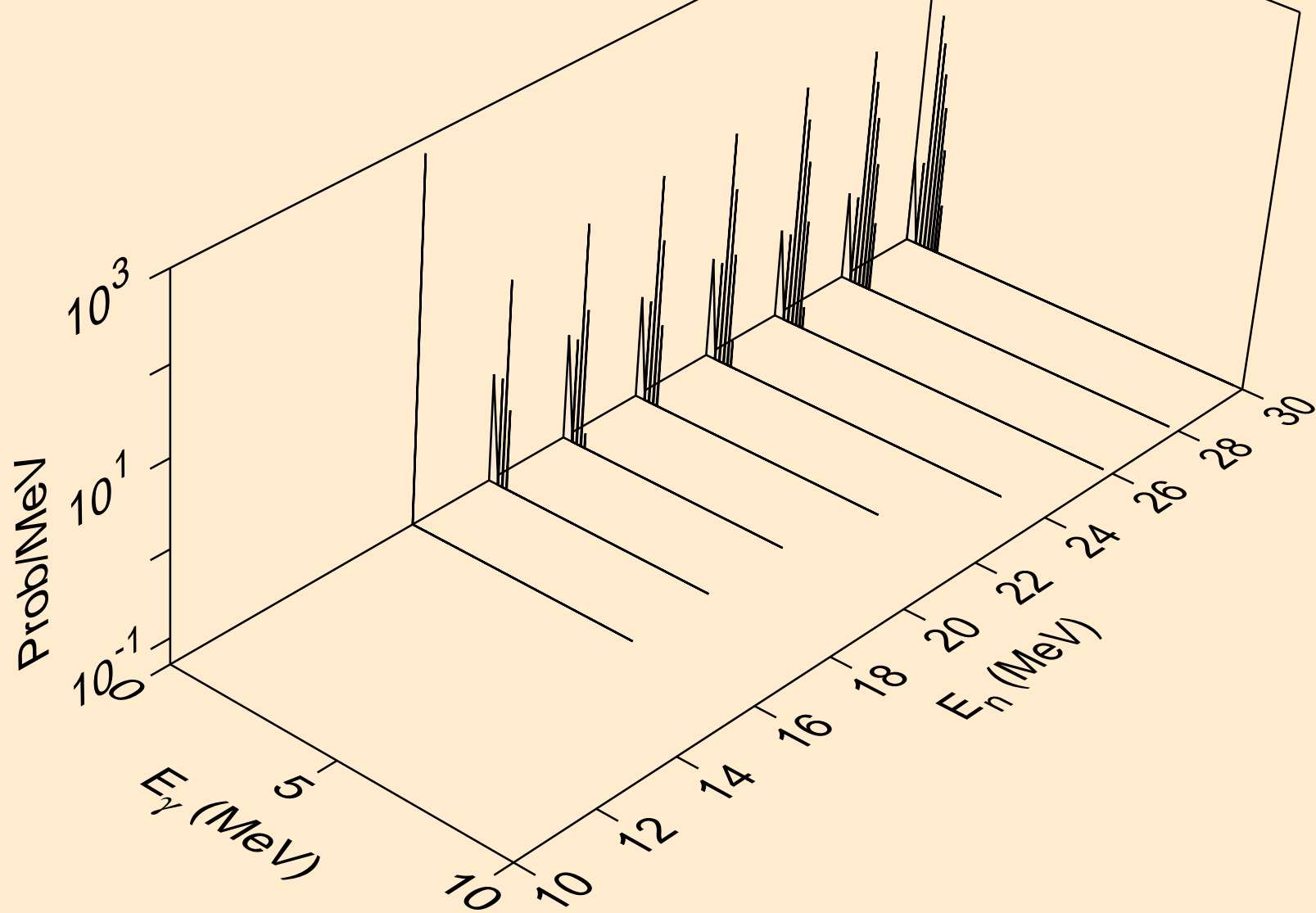

PM134M HELION ACER TENDL-2021 LIBRARY; T=0.K  
Photon emission for (n,n\*)p

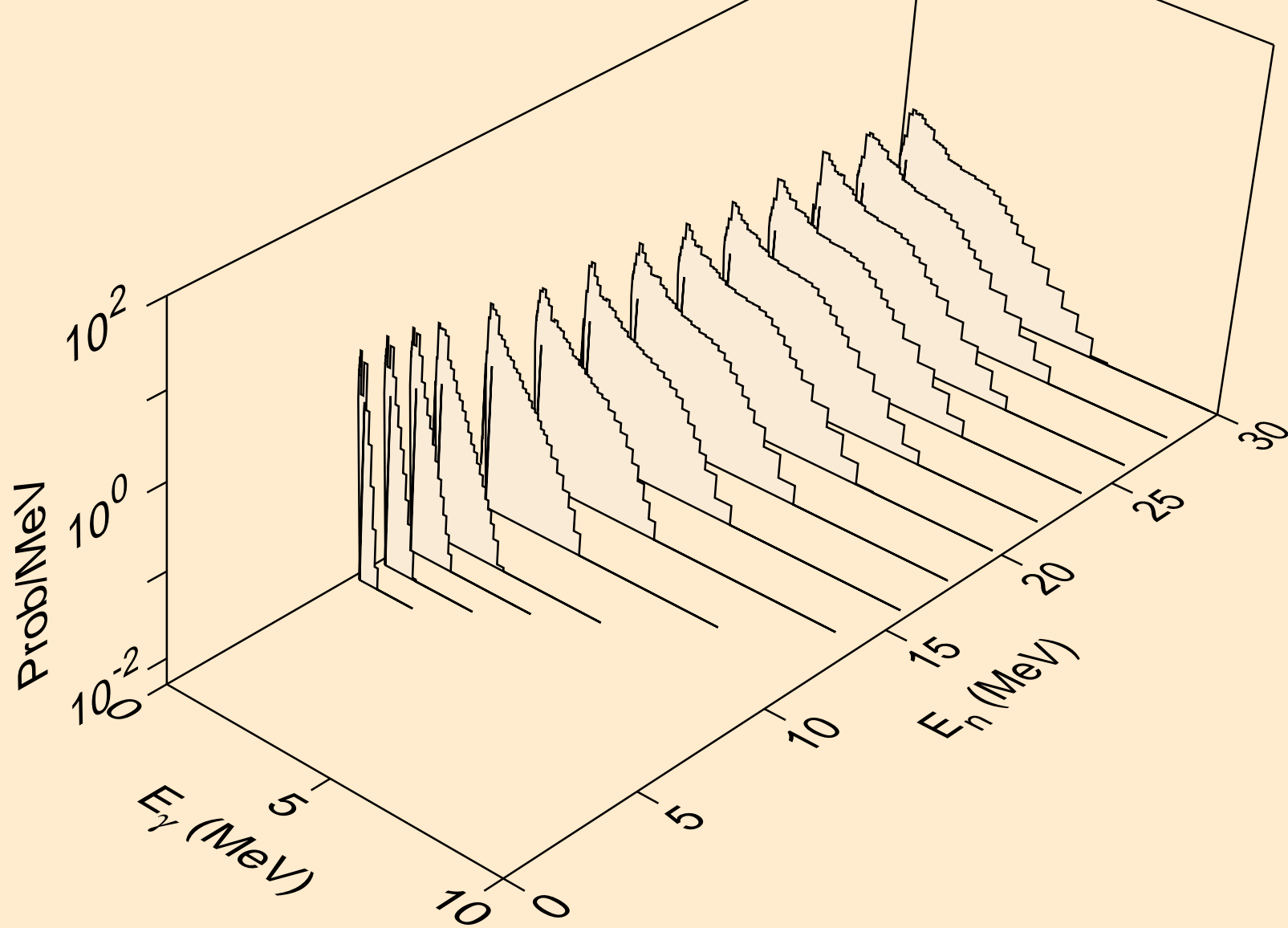



PM134M HELION ACER TENDL-2021 LIBRARY; T=0.K  
Photon emission for (n,n\*)2a

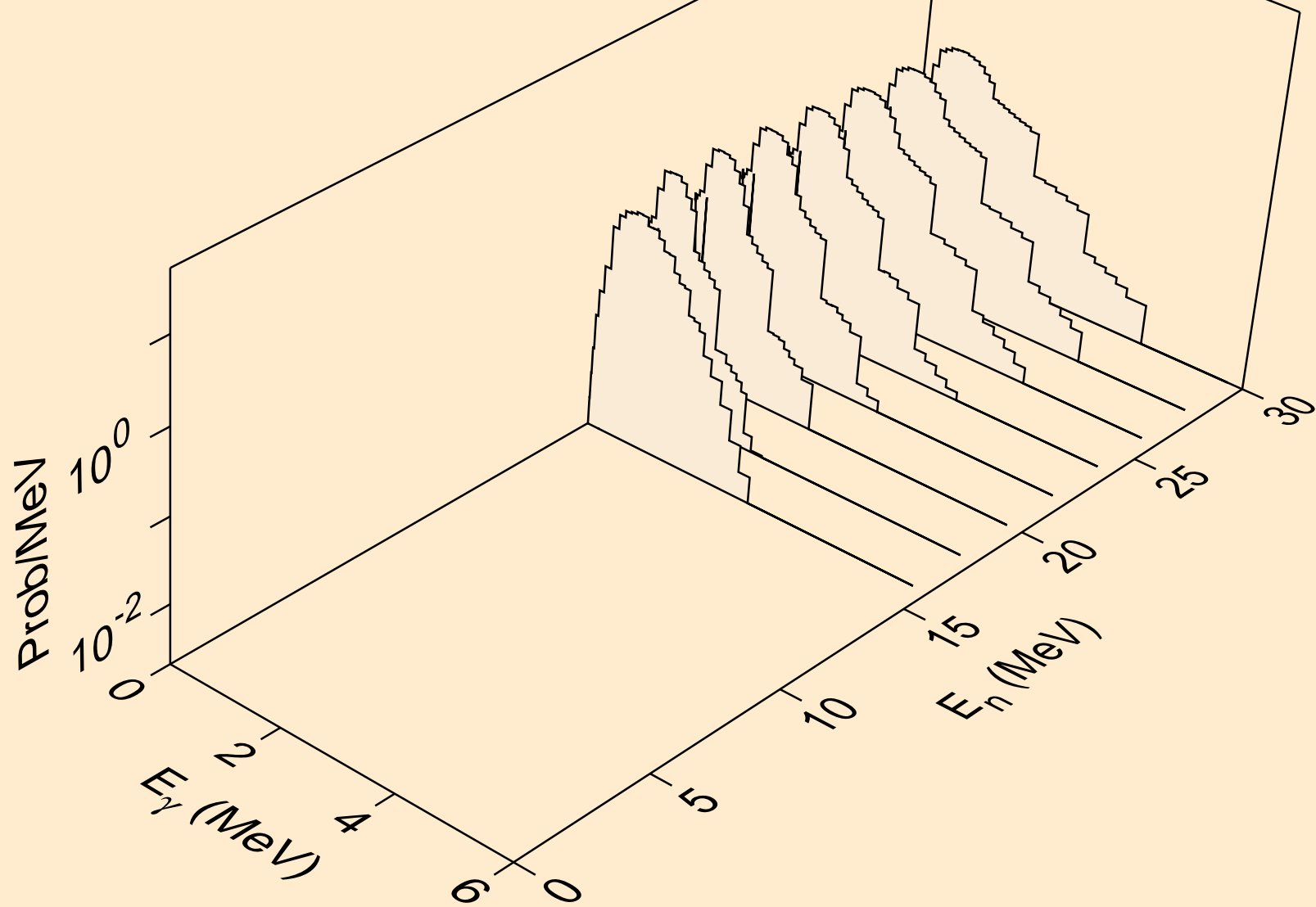

PM134M HELION ACER TENDL-2021 LIBRARY; T=0.K  
Photon emission for (n,n\*)d

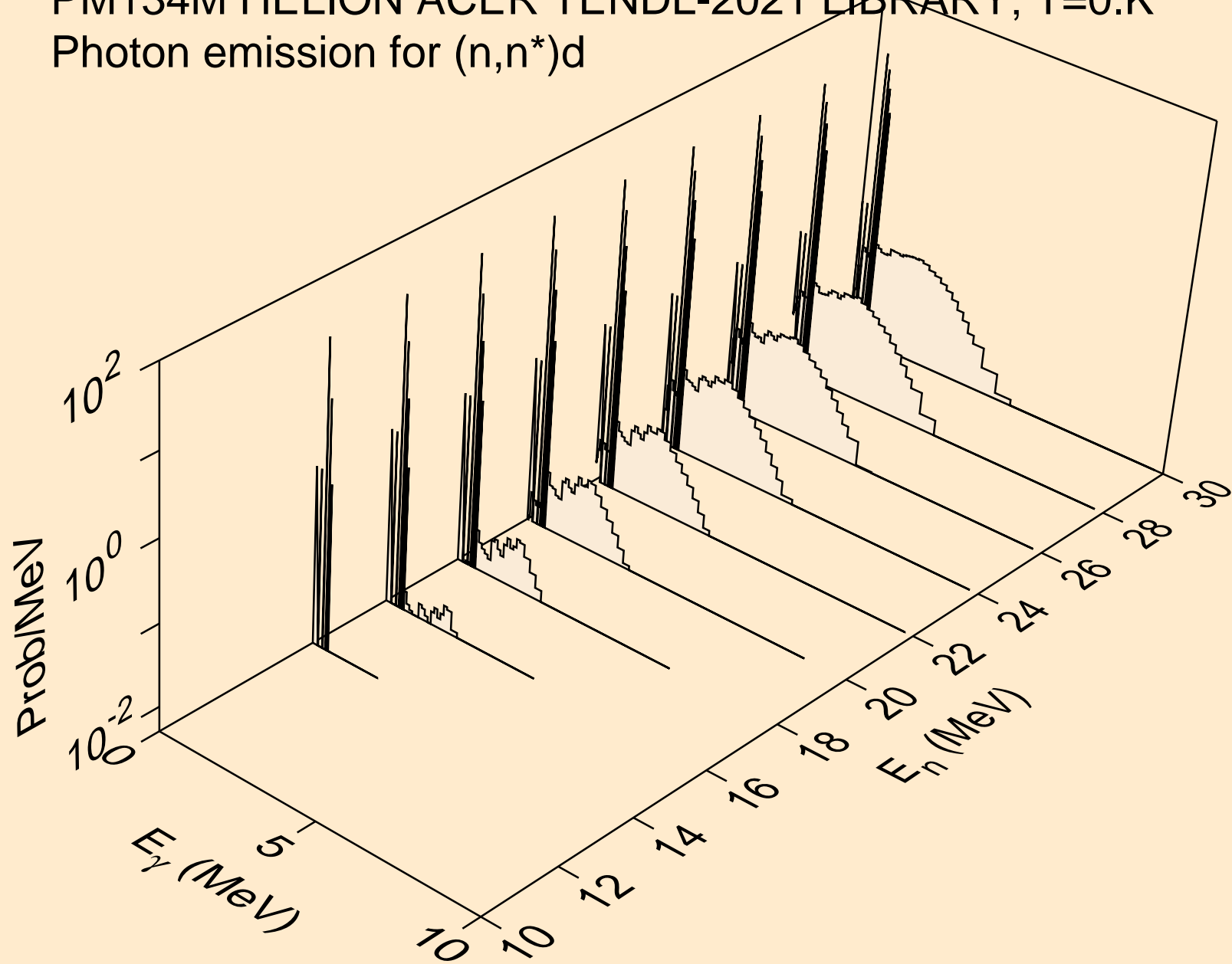

PM134M HELION ACER TENDL-2021 LIBRARY; T=0.K  
Photon emission for (n,n\*)t

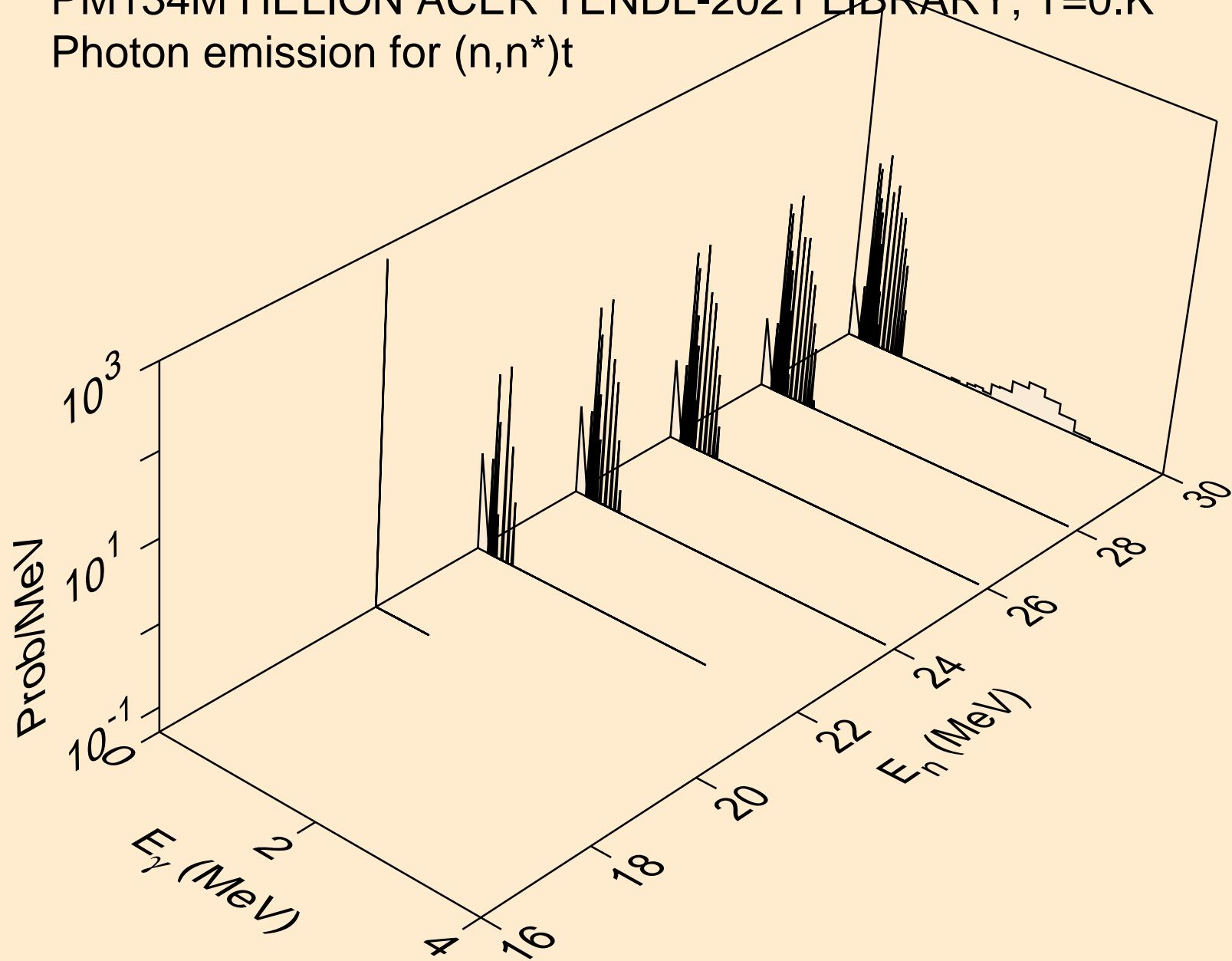

PM134M HELION ACER TENDL-2021 LIBRARY; T=0.K  
Photon emission for (n,n\*)he3

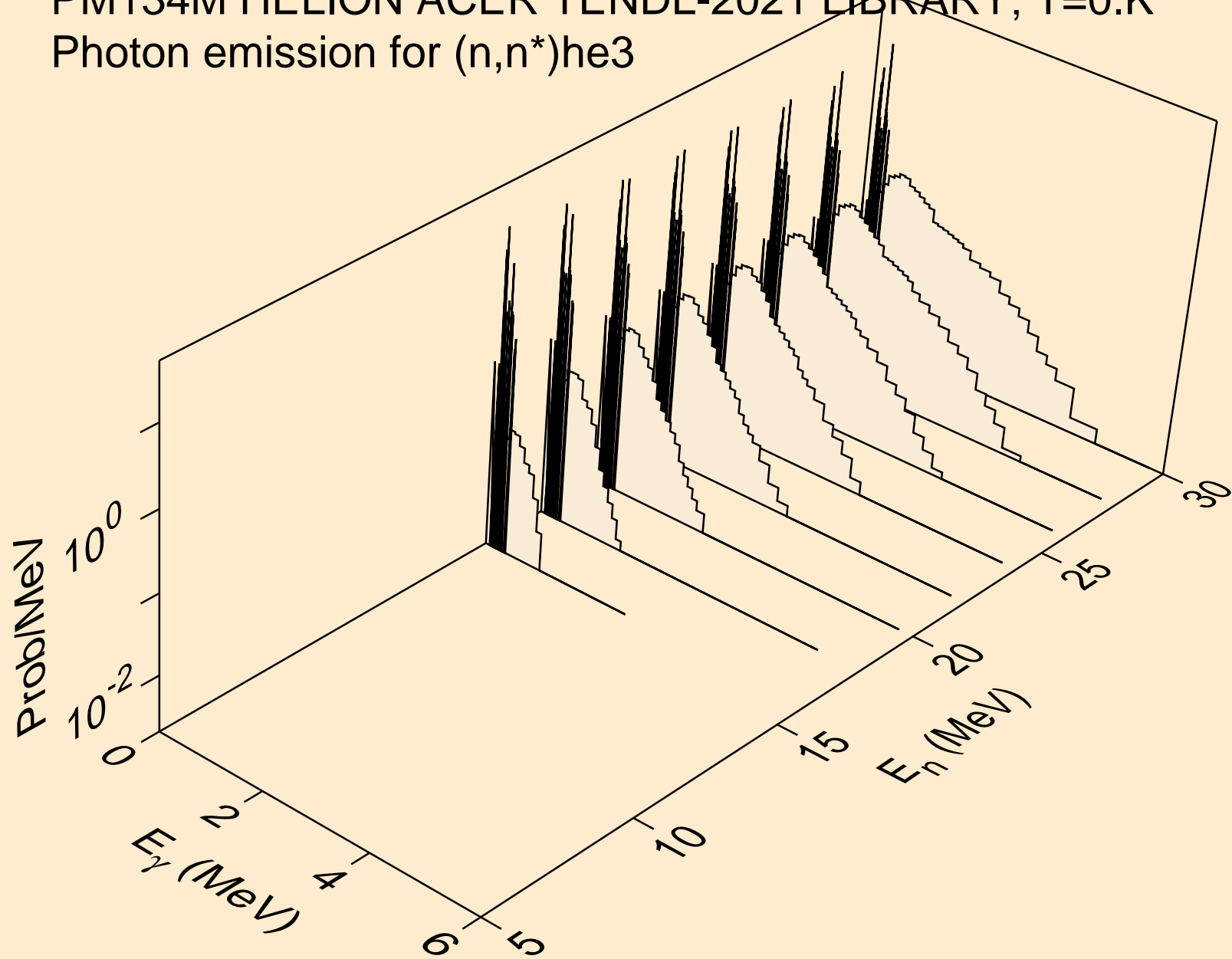

PM134M HELION ACER TENDL-2021 LIBRARY; T=0.K  
Photon emission for (n,2np)

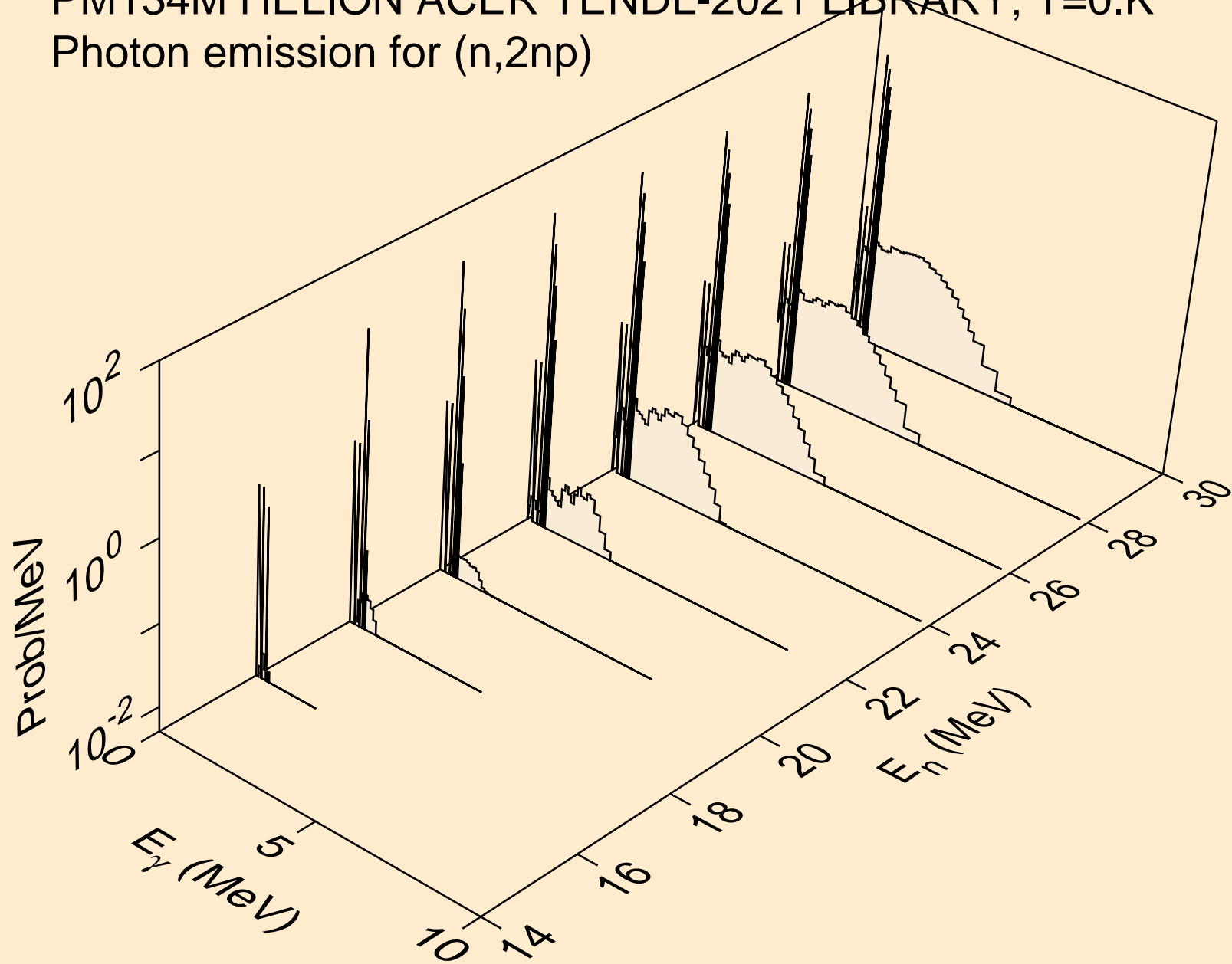

PM134M HELION ACER TENDL-2021 LIBRARY; T=0.K  
Photon emission for (n,2np)

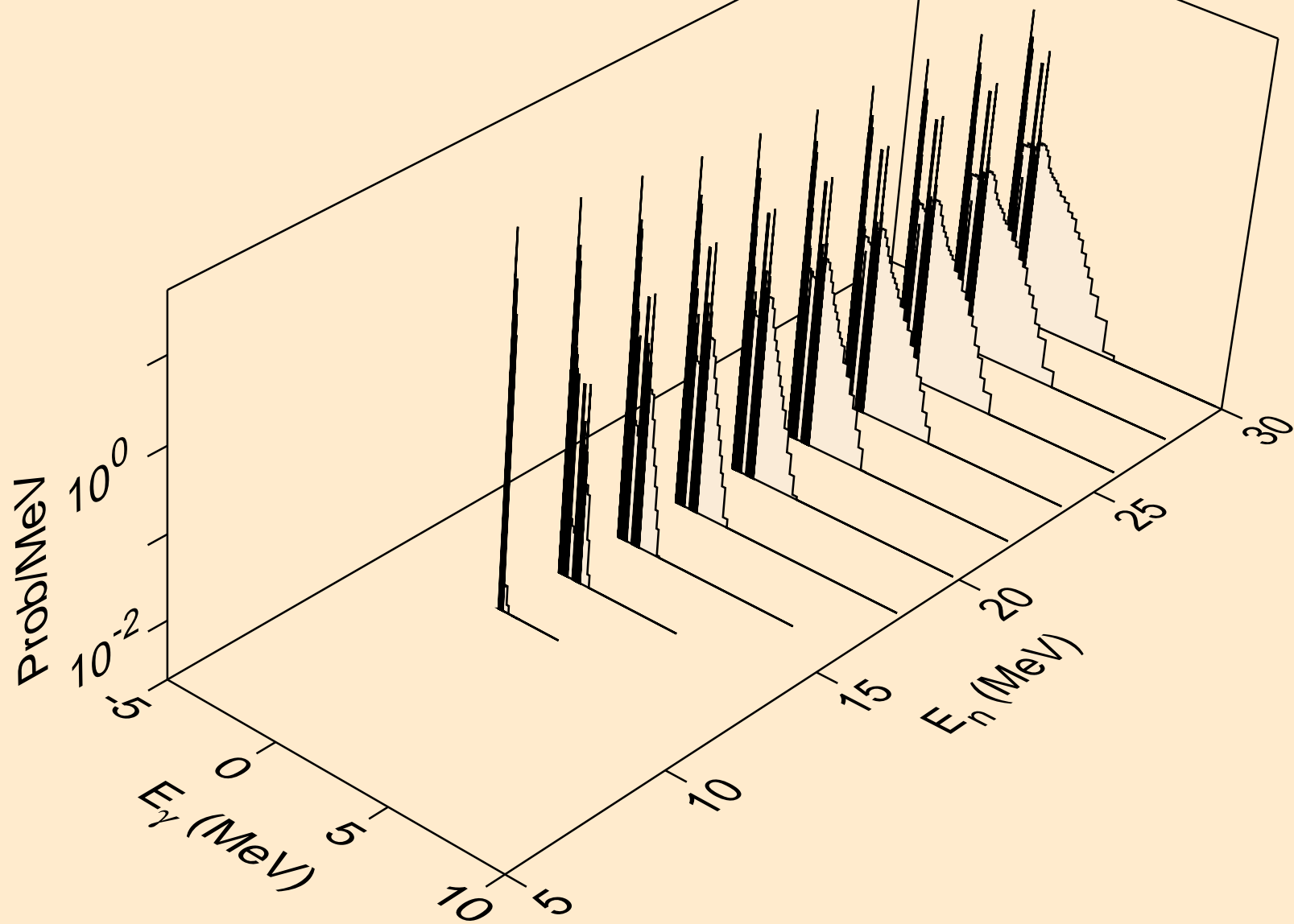

PM134M HELION ACER TENDL-2021 LIBRARY; T=0.K  
Photon emission for (n,npa)

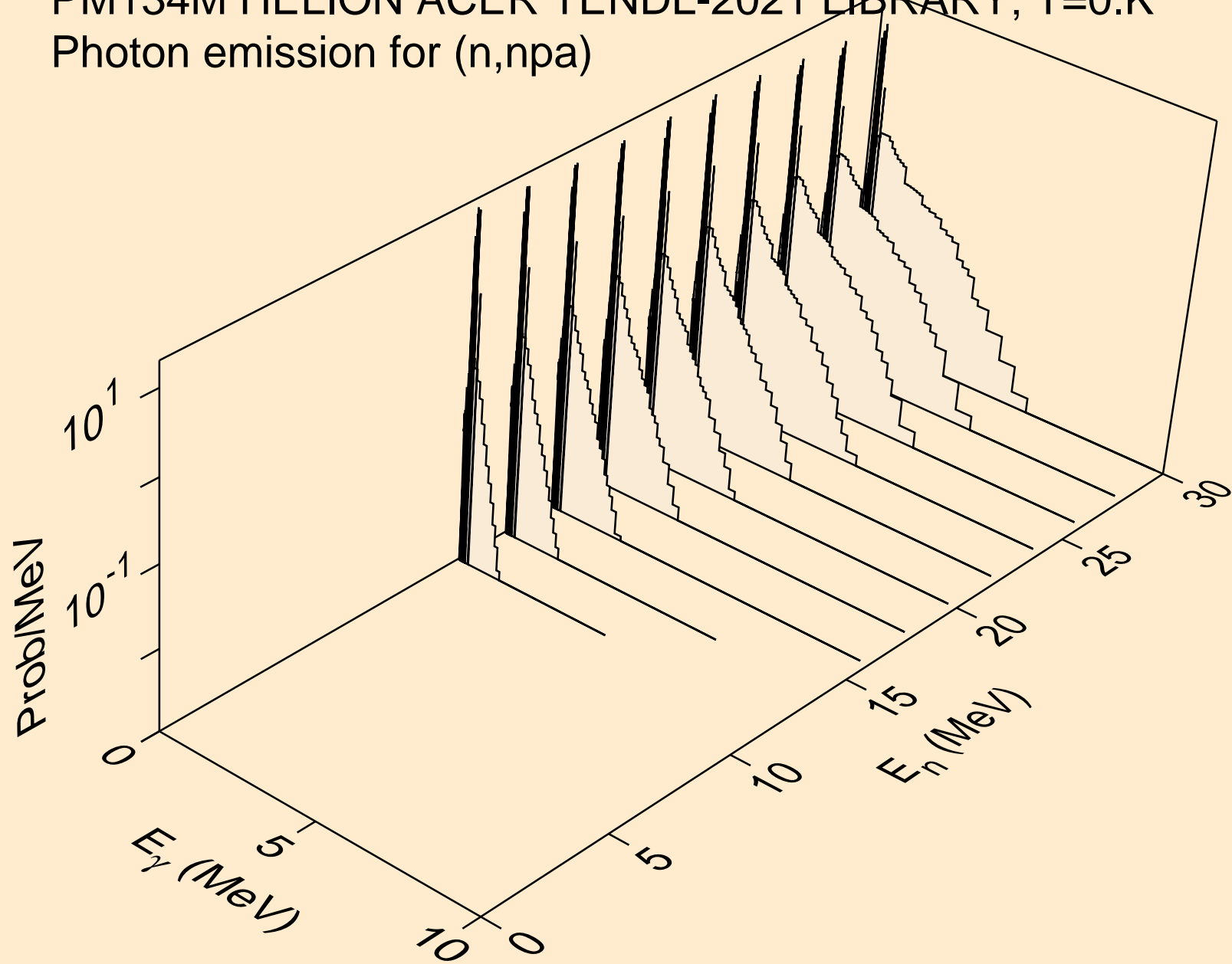

PM134M HELION ACER TENDL-2021 LIBRARY; T=0.K  
Photon emission for (n,gma)

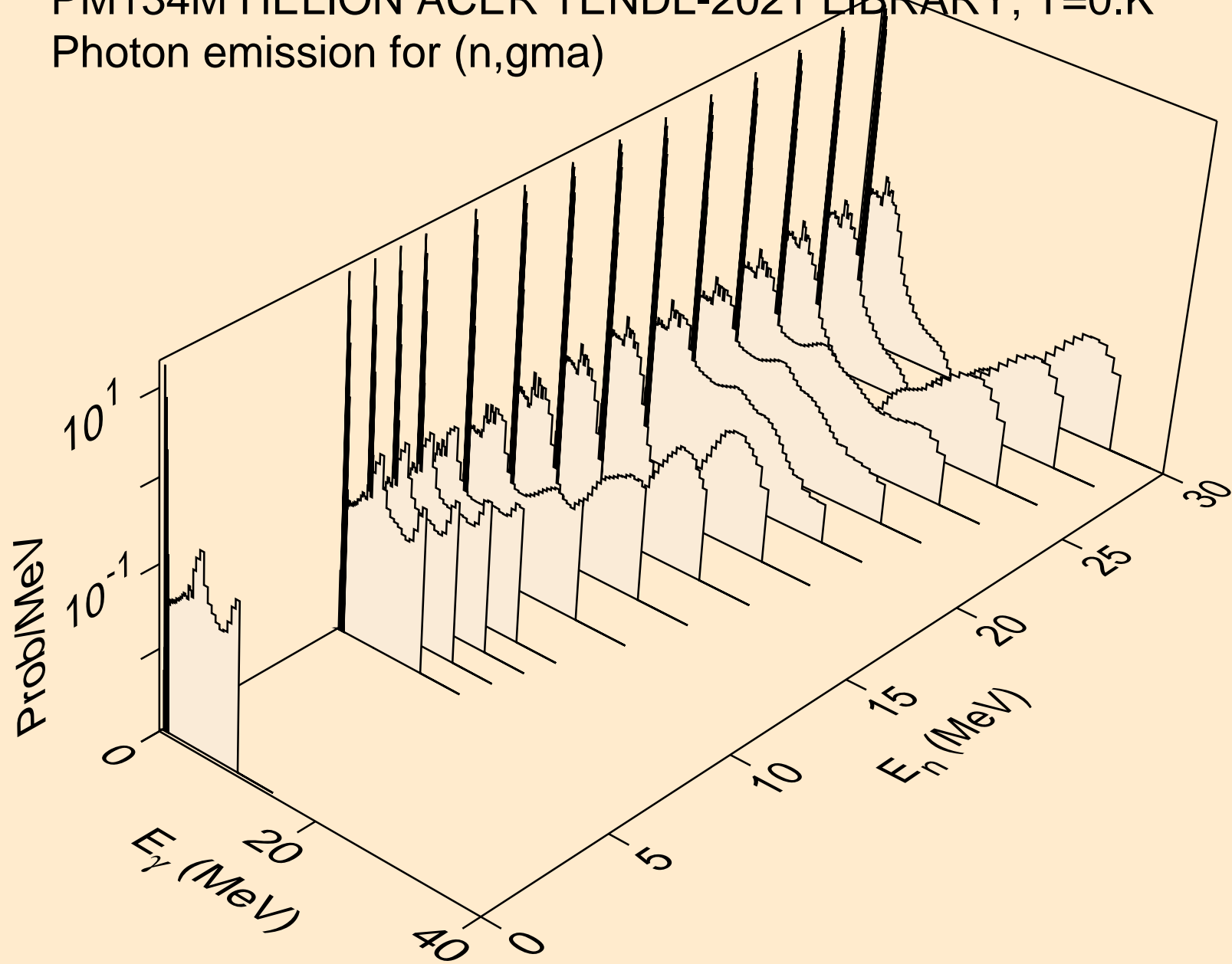



PM134M HELION ACER TENDL-2021 LIBRARY; T=0.K  
Photon emission for (n,p)

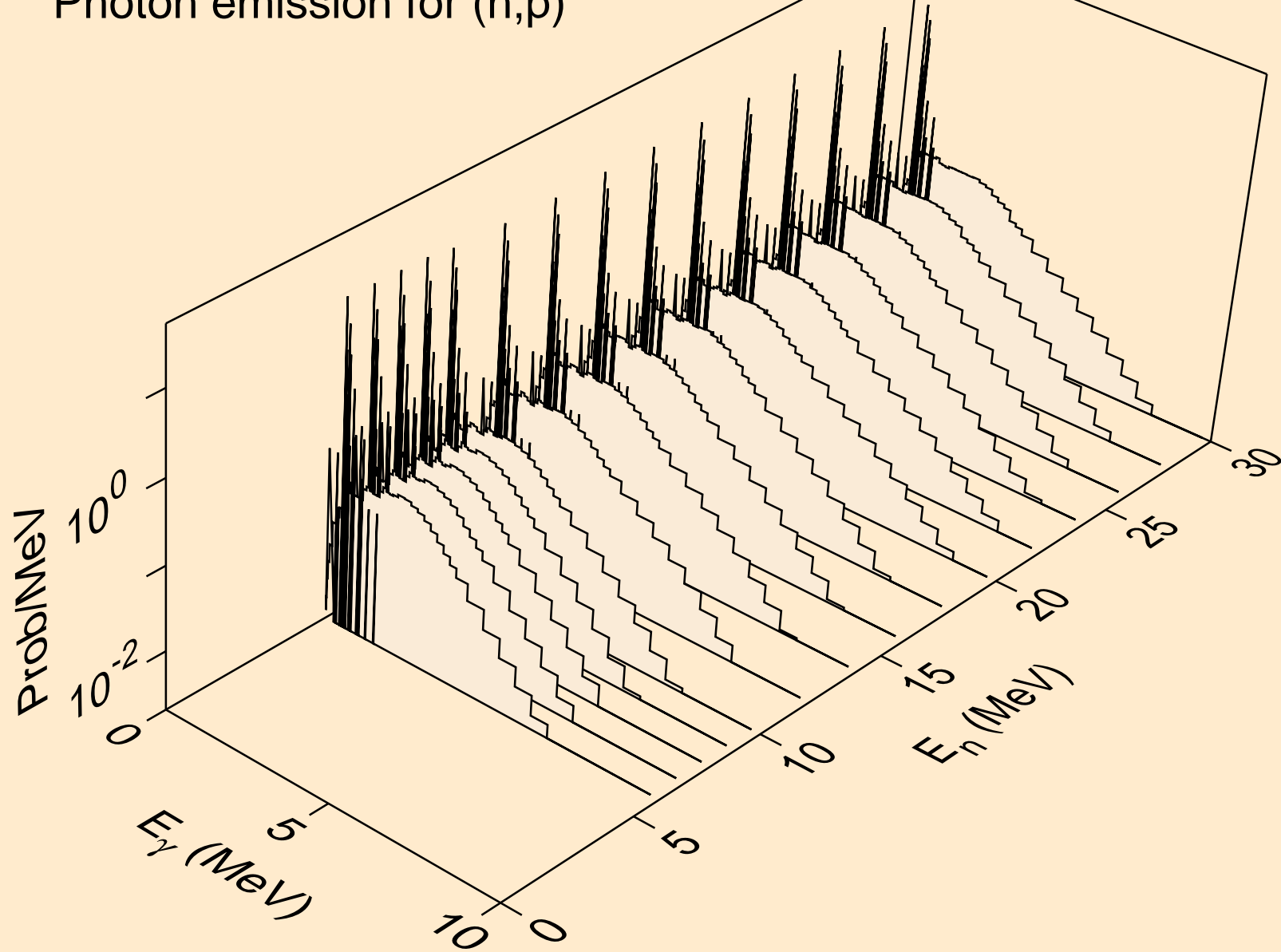

PM134M HELION ACER TENDL-2021 LIBRARY; T=0.K  
Photon emission for (n,d)

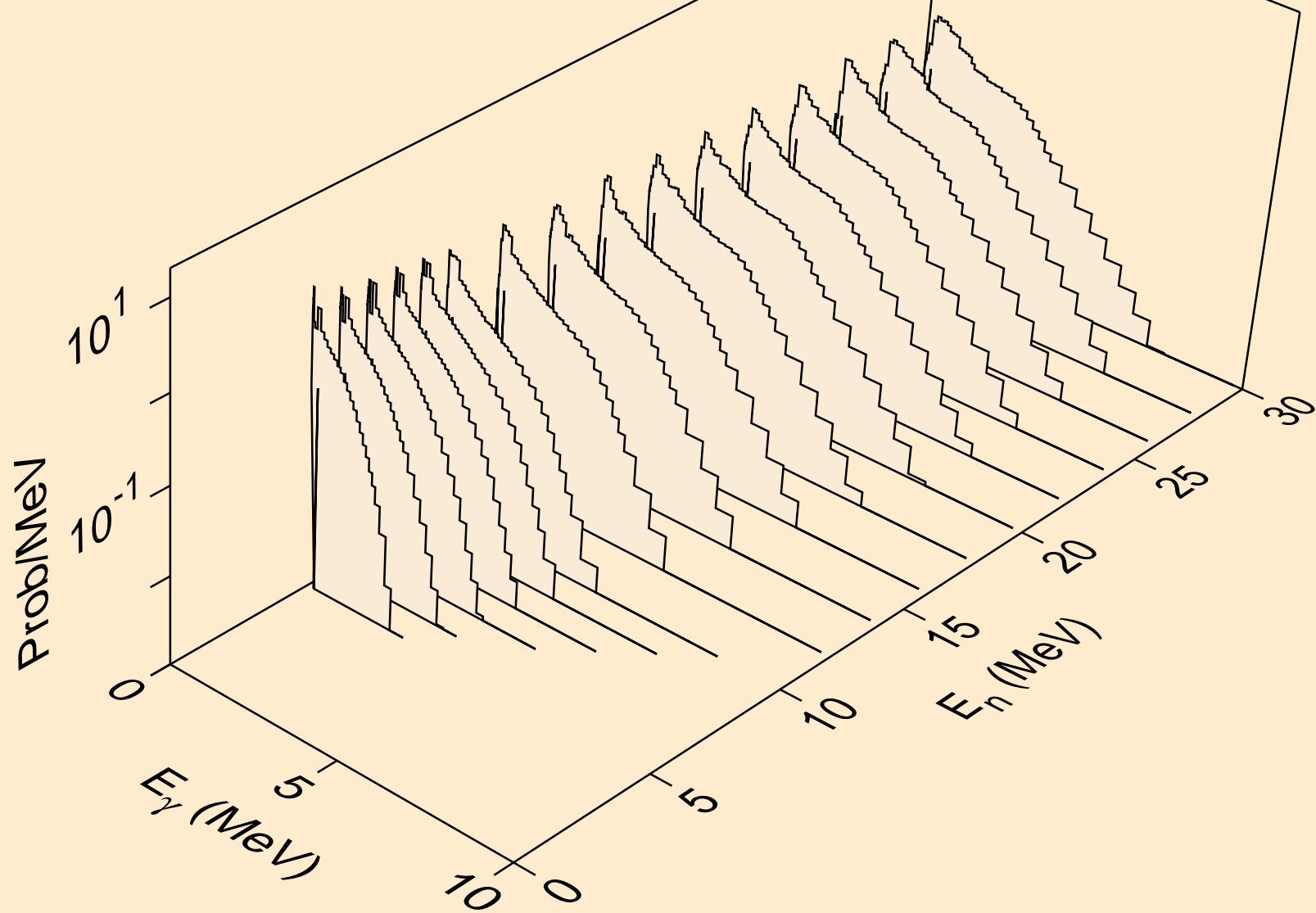

PM134M HELION ACER TENDL-2021 LIBRARY; T=0.K  
Photon emission for (n,t)

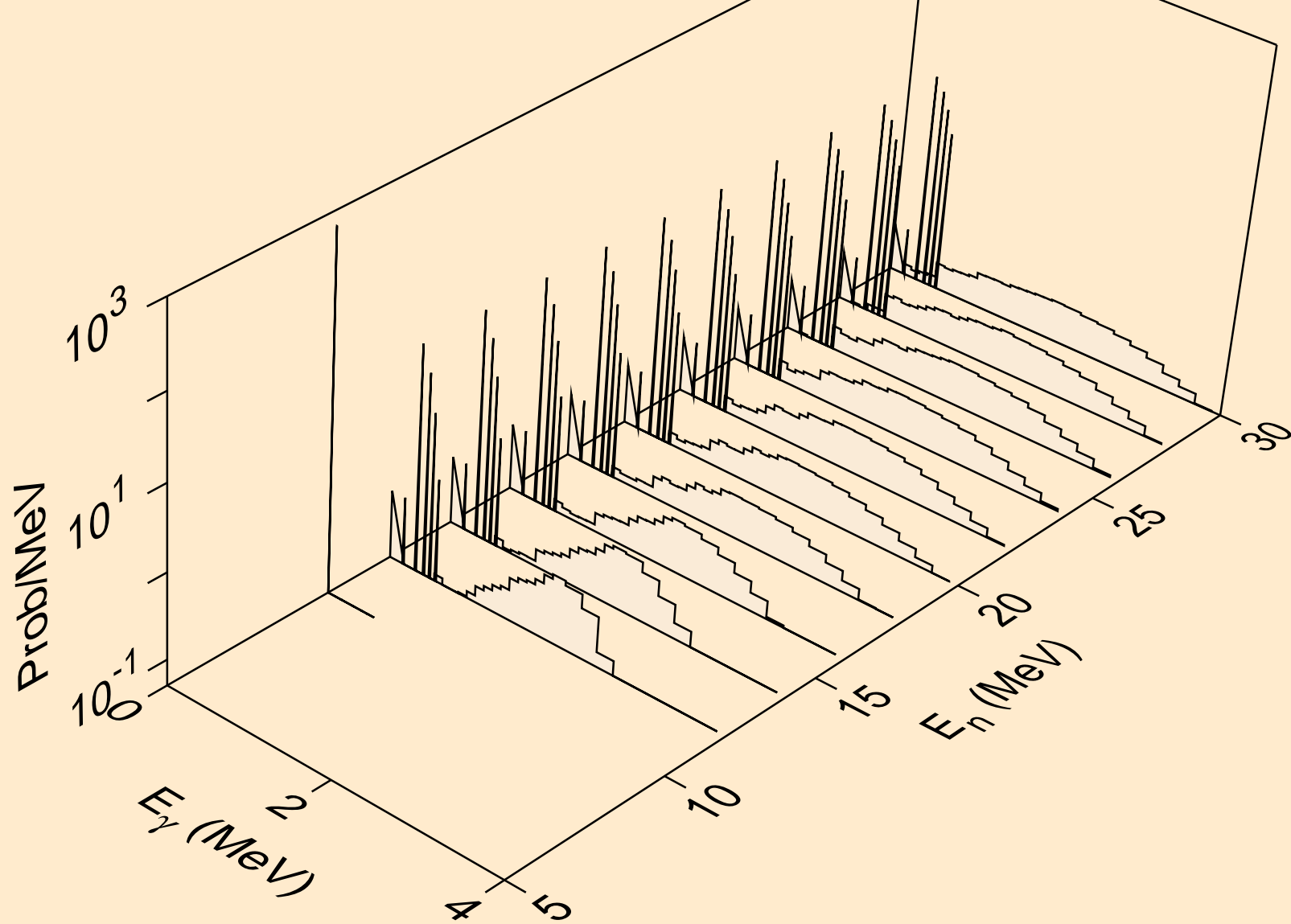

PM134M HELION ACER TENDL-2021 LIBRARY; T=0.K  
Photon emission for inelastic

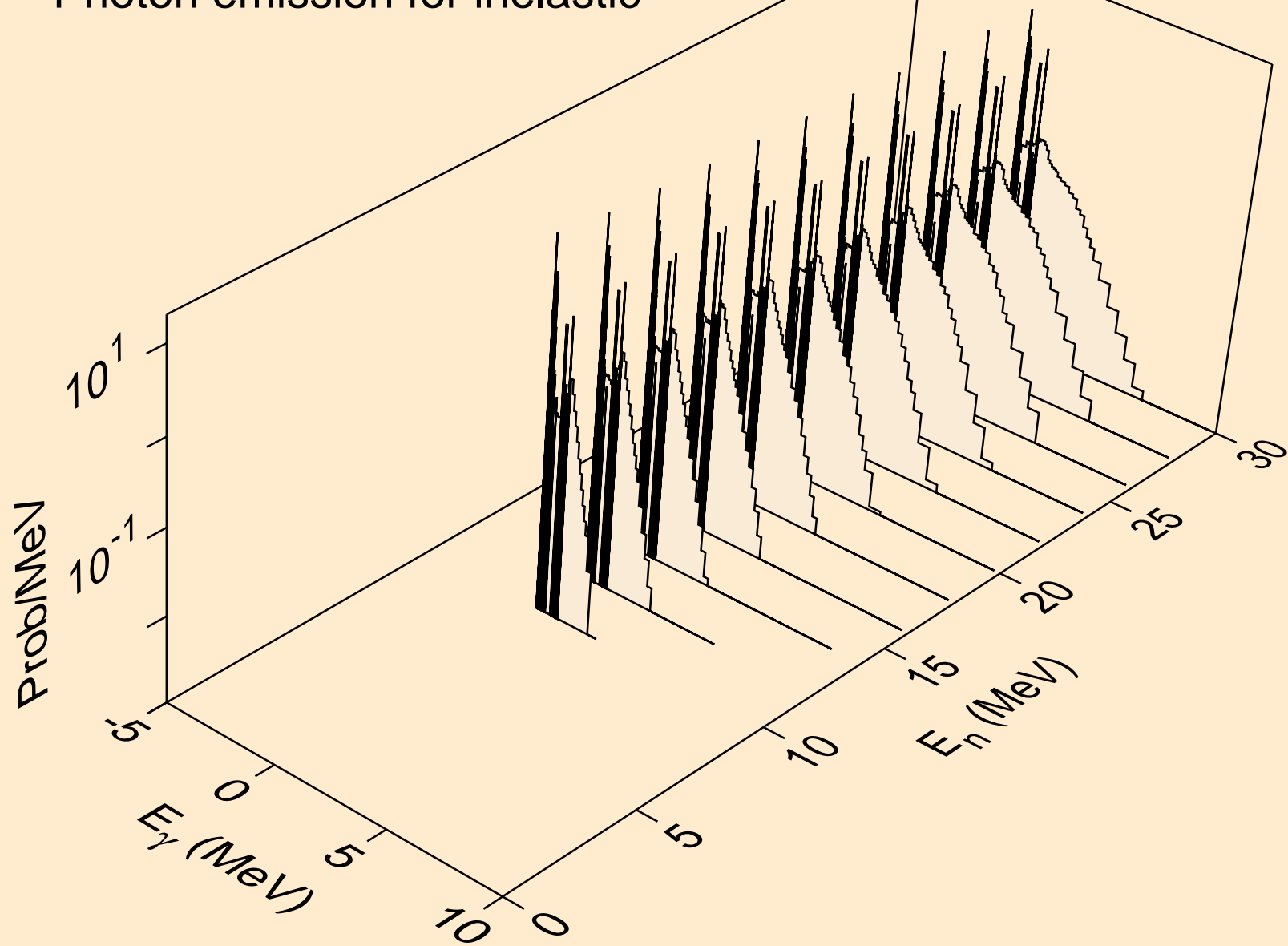

PM134M HELION ACER TENDL-2021 LIBRARY; T=0.K  
Photon emission for (n,a)

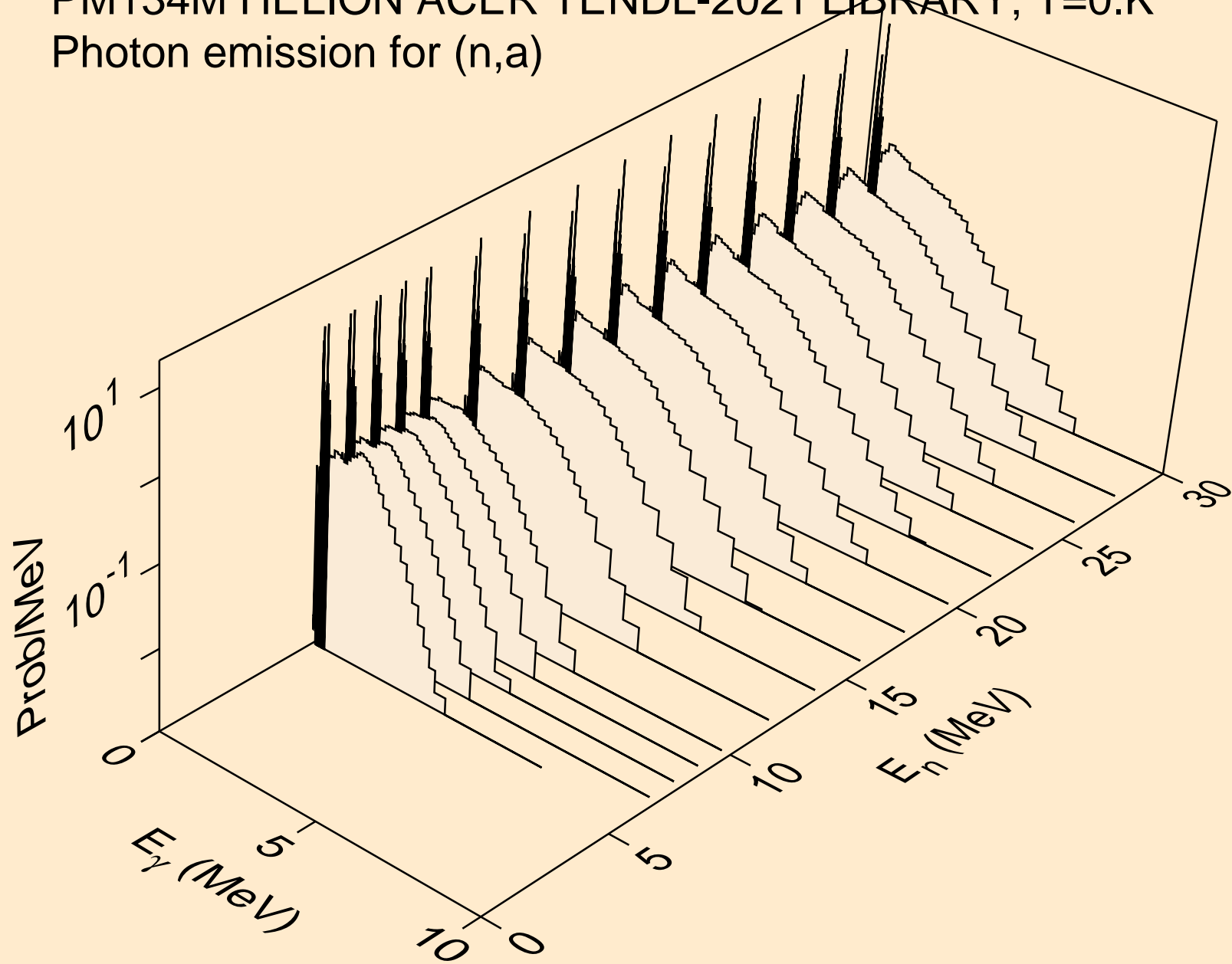

PM134M HELION ACER TENDL-2021 LIBRARY; T=0.K  
Photon emission for (n,2a)

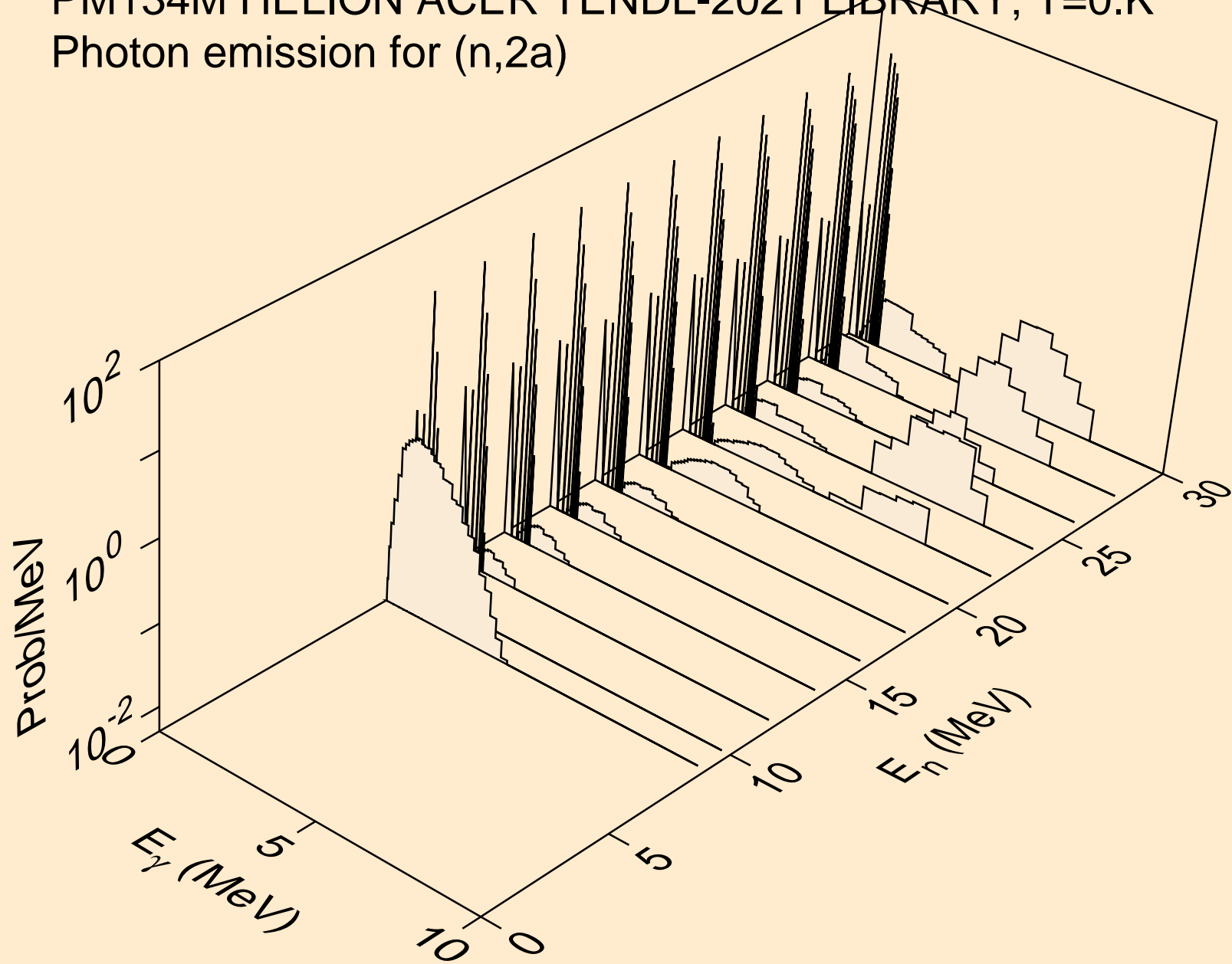

PM134M HELION ACER TENDL-2021 LIBRARY; T=0.K  
Photon emission for (n,2p)

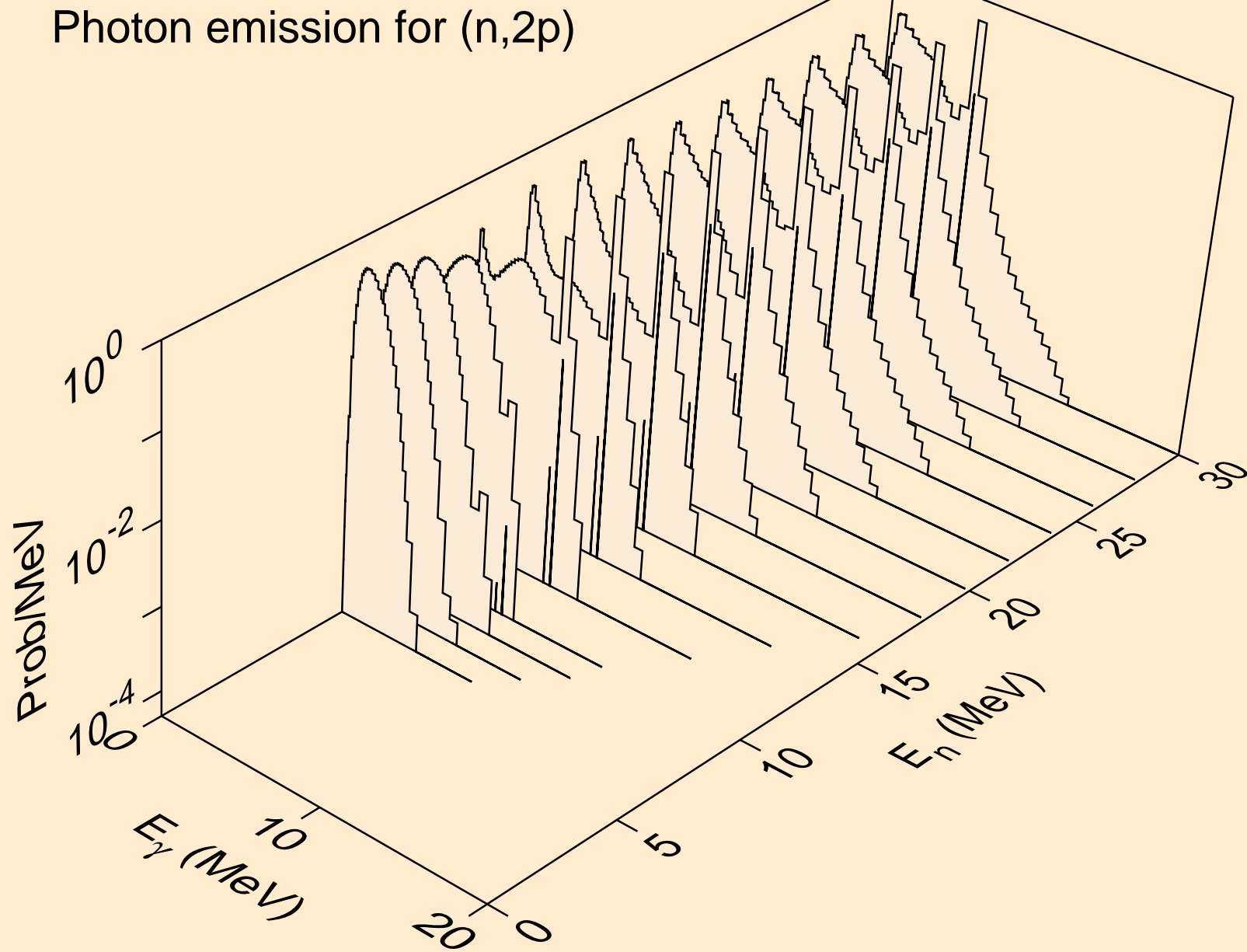

PM134M HELION ACER TENDL-2021 LIBRARY; T=0.K  
Photon emission for (n,pa)

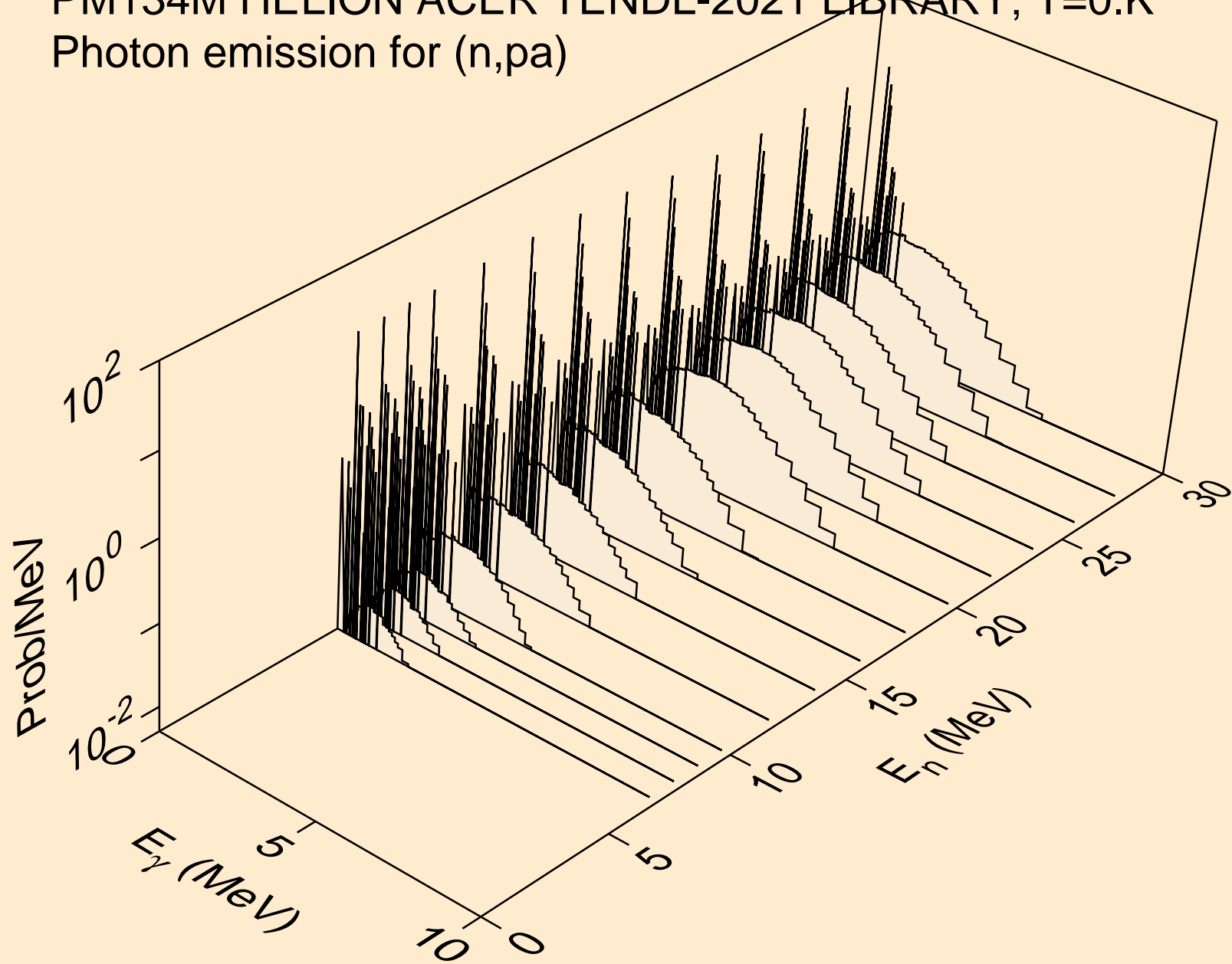



PM134M HELION ACER TENDL-2021 LIBRARY; T=0.K  
Photon emission for (n,pd)

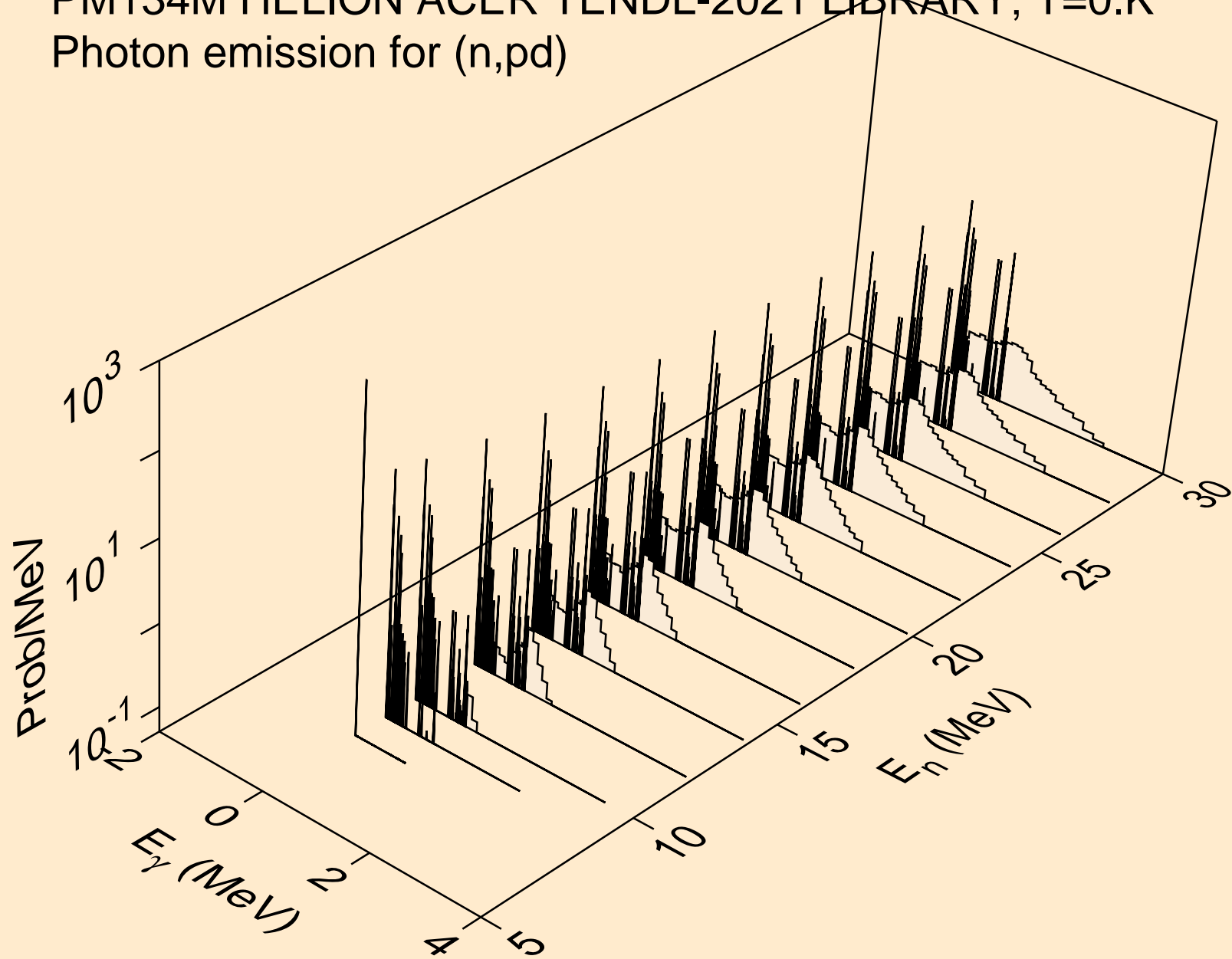

PM134M HELION ACER TENDL-2021 LIBRARY; T=0.K  
Photon emission for (n,pt)

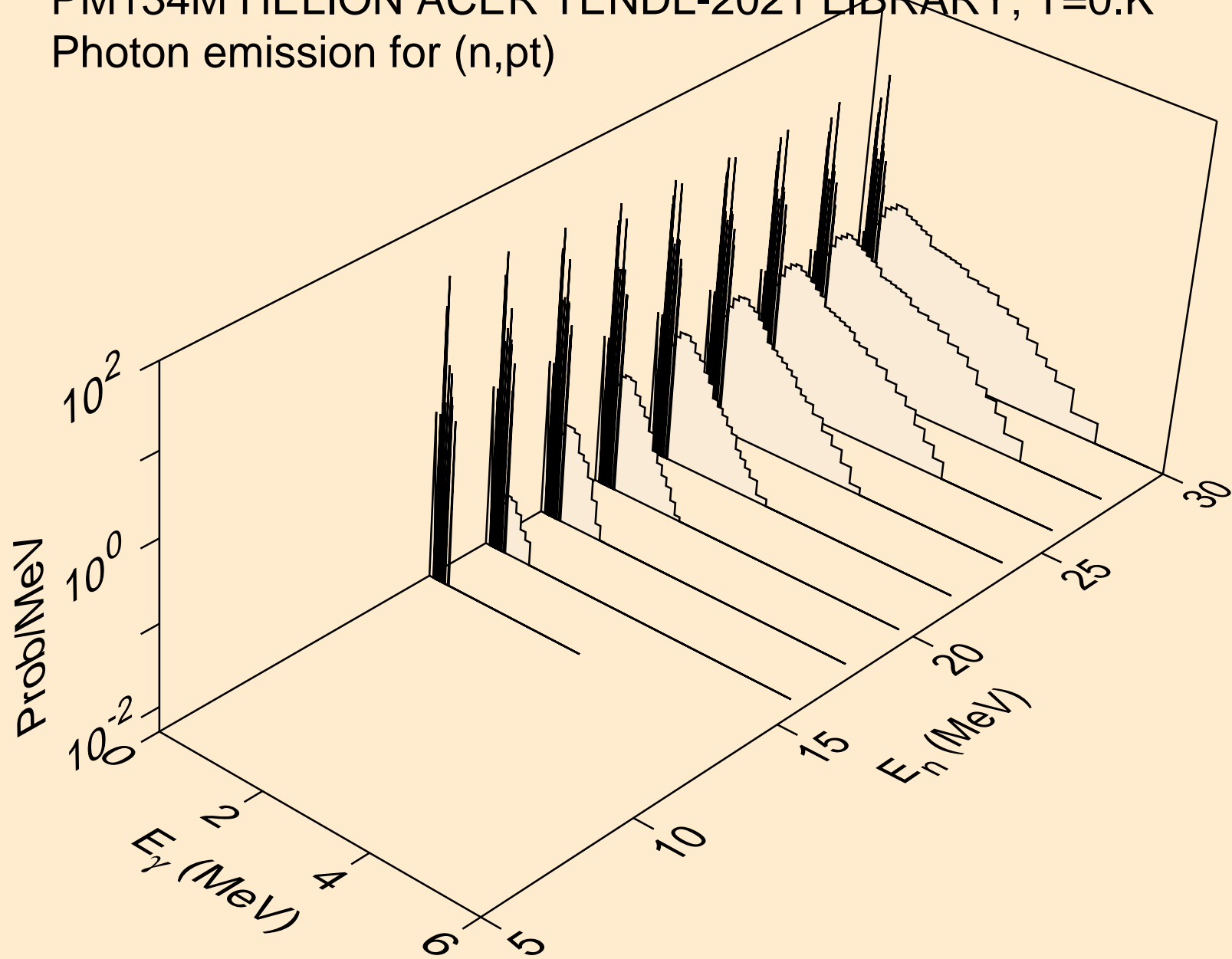

PM134M HELION ACER TENDL-2021 LIBRARY; T=0.K  
Photon emission for (n,da)

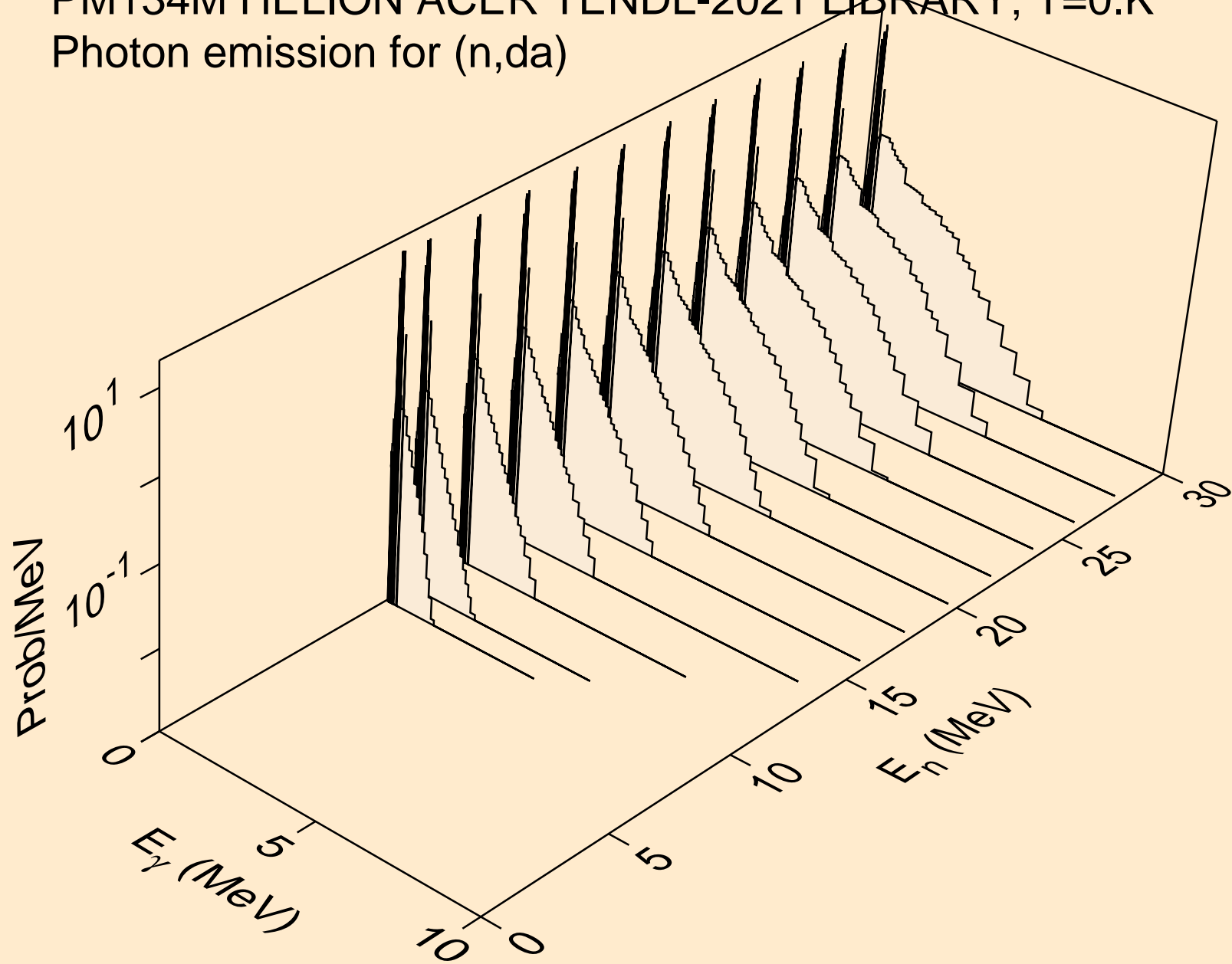

PM134M HELION ACER TENDL-2021 LIBRARY; T=0.K  
Particle heating contributions

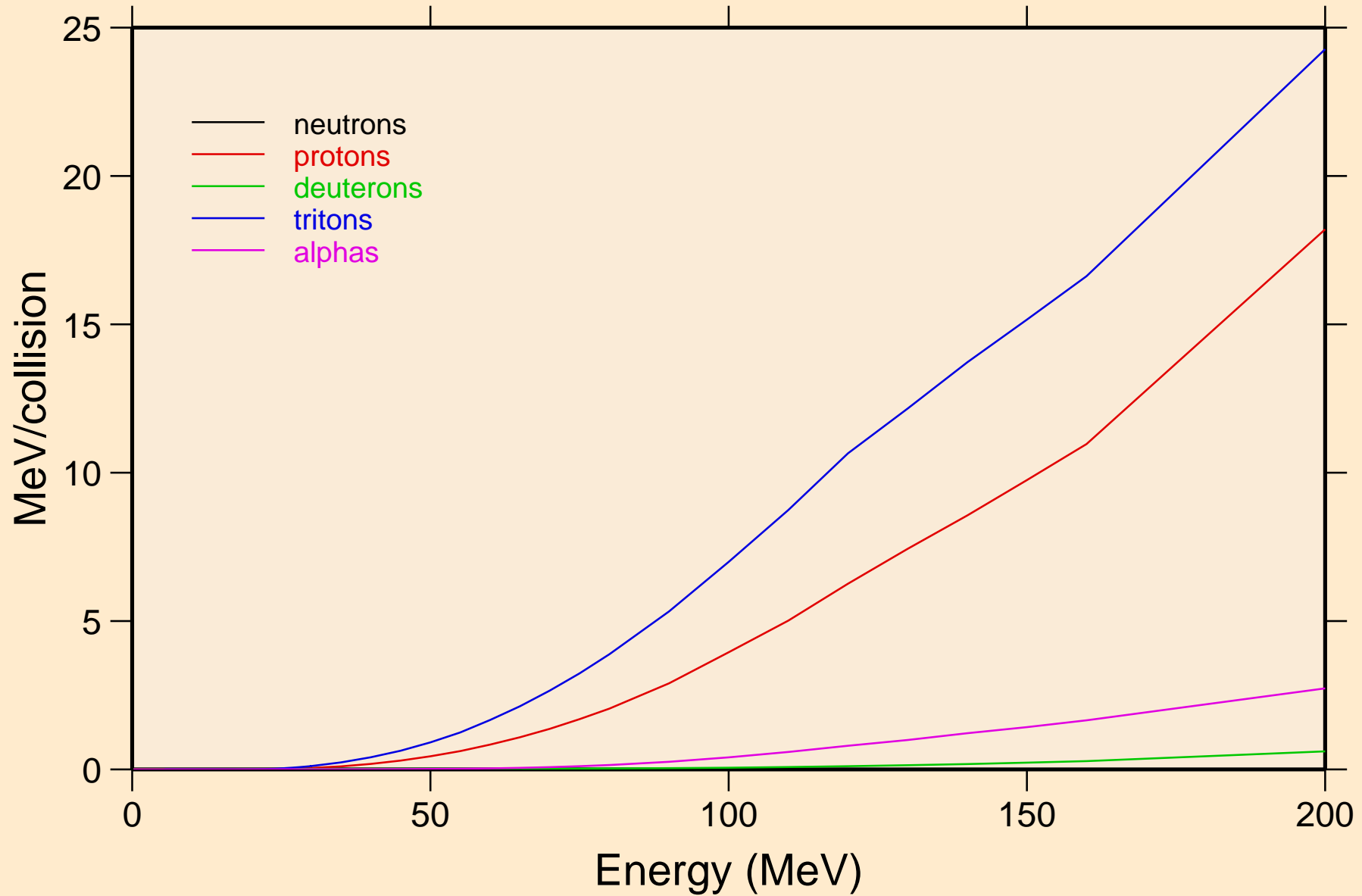

PM134M HELION ACER TENDL-2021 LIBRARY; T=0.K  
Recoil Heating

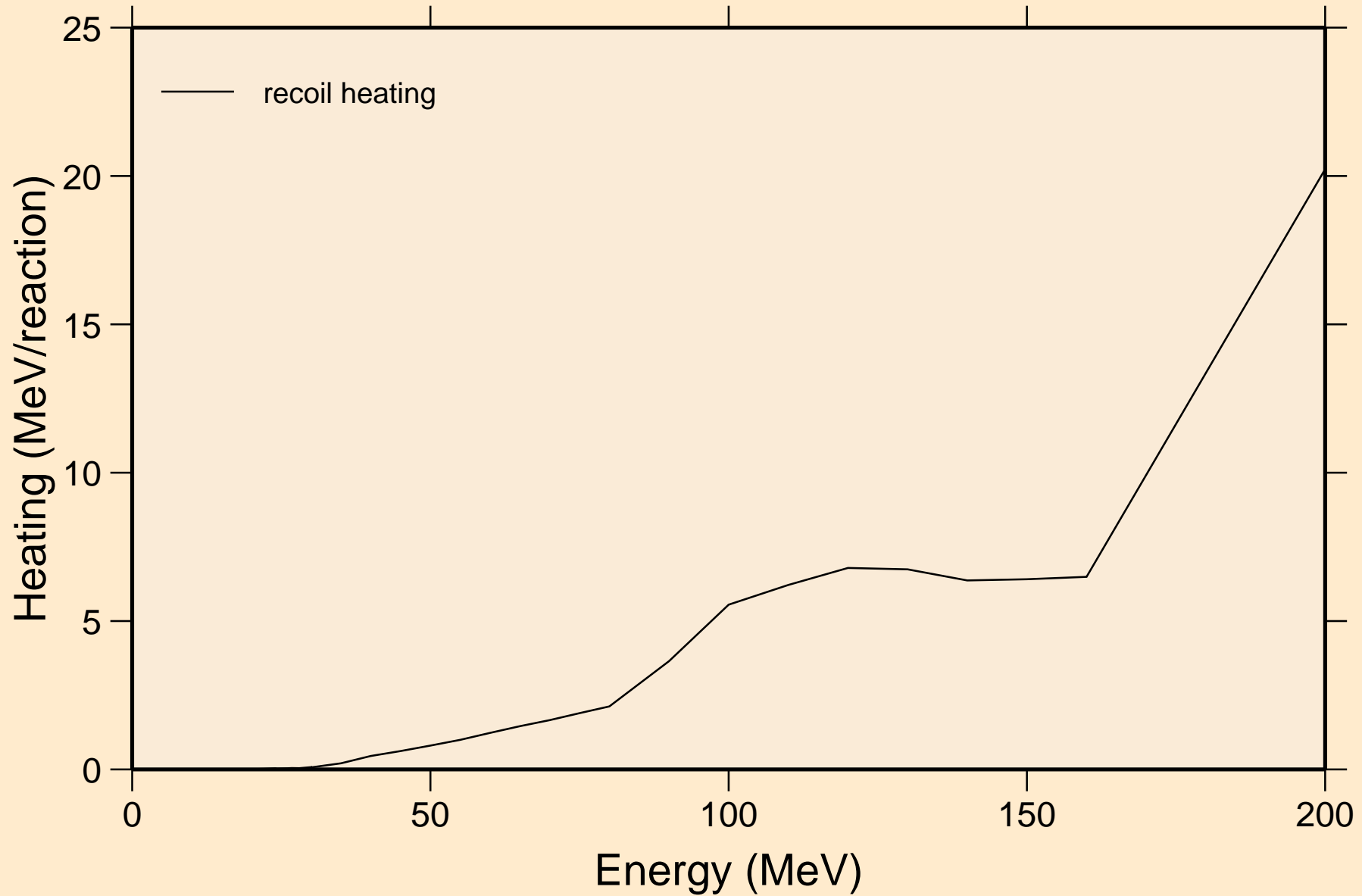

PM134M HELION ACER TENDL-2021 LIBRARY; T=0.K  
Particle production cross sections

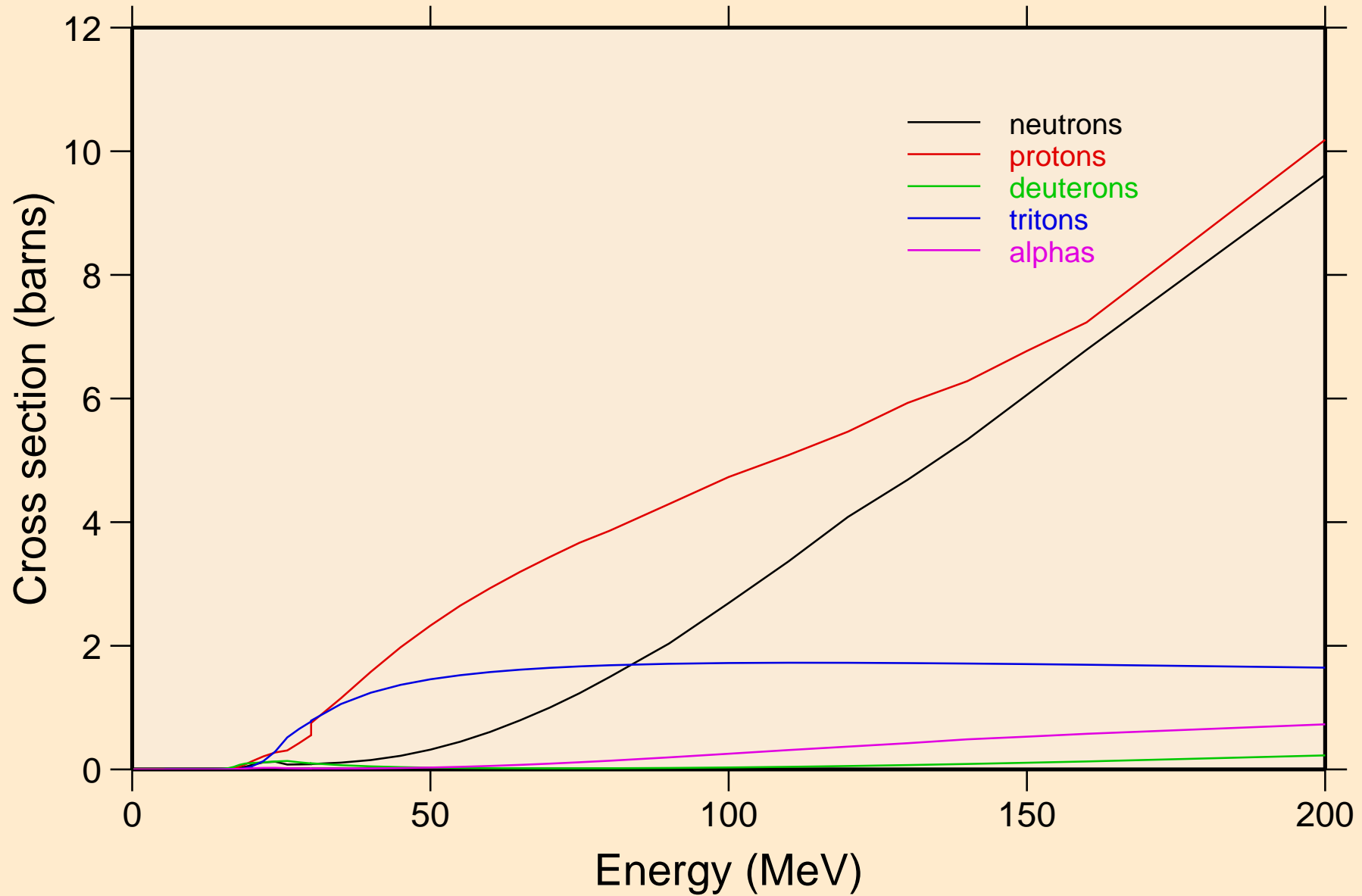

PM134M HELION ACER TENDL-2021 LIBRARY; T=0.K  
neutrons from (s,n)

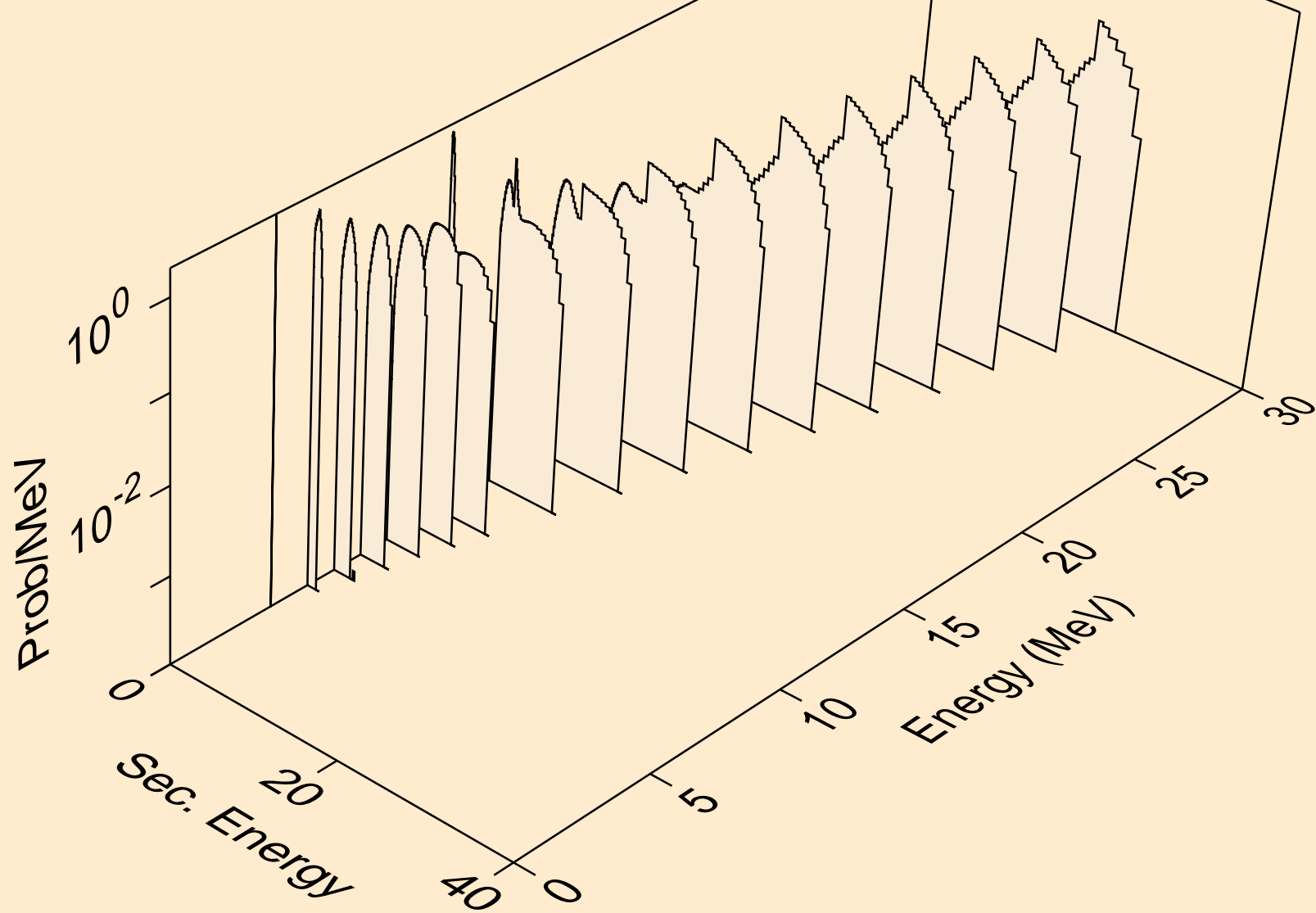

PM134M HELION ACER TENDL-2021 LIBRARY; T=0.K  
neutrons from (s,x)

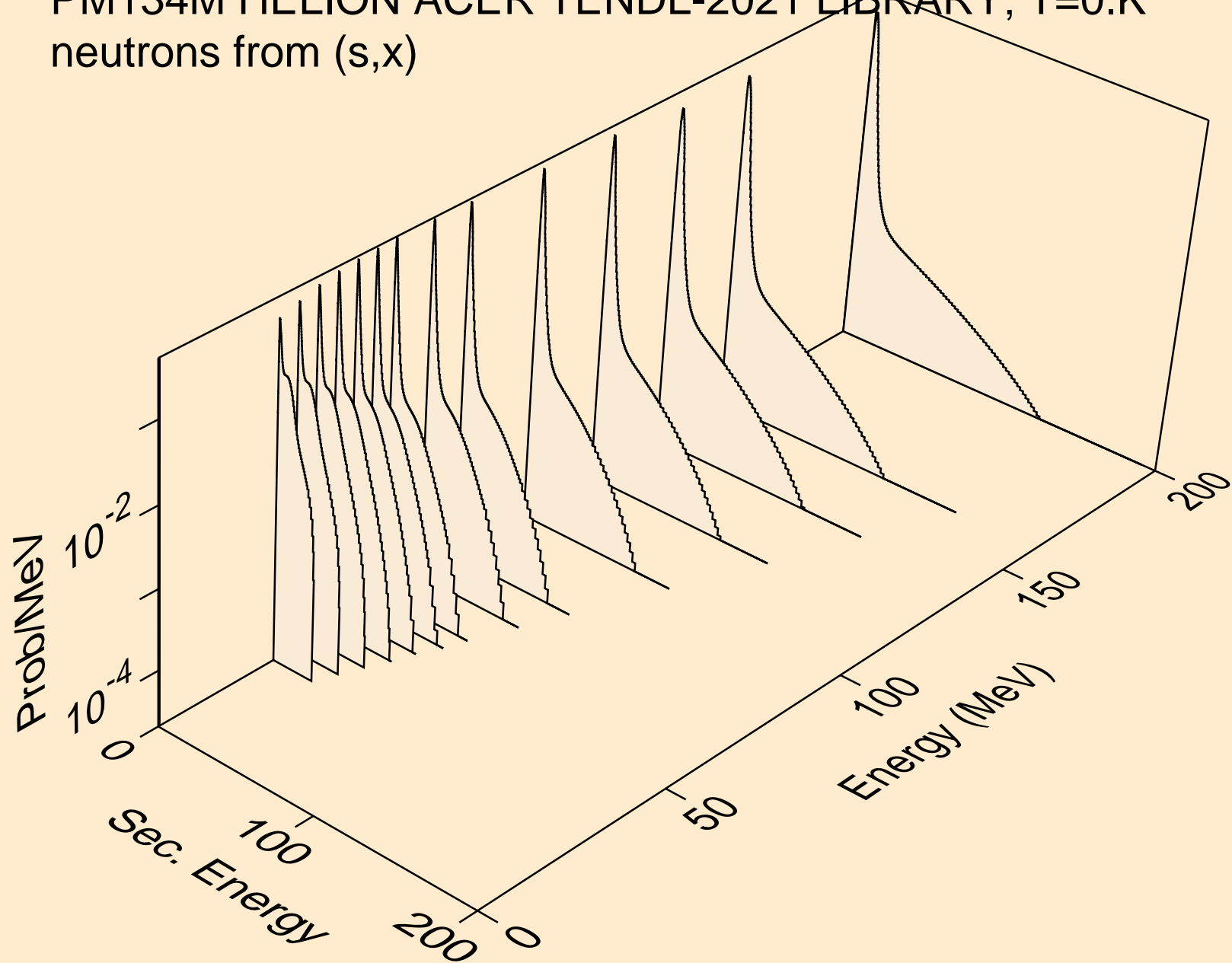



PM134M HELION ACER TENDL-2021 LIBRARY; T=0.K  
neutrons from (s,2nd)

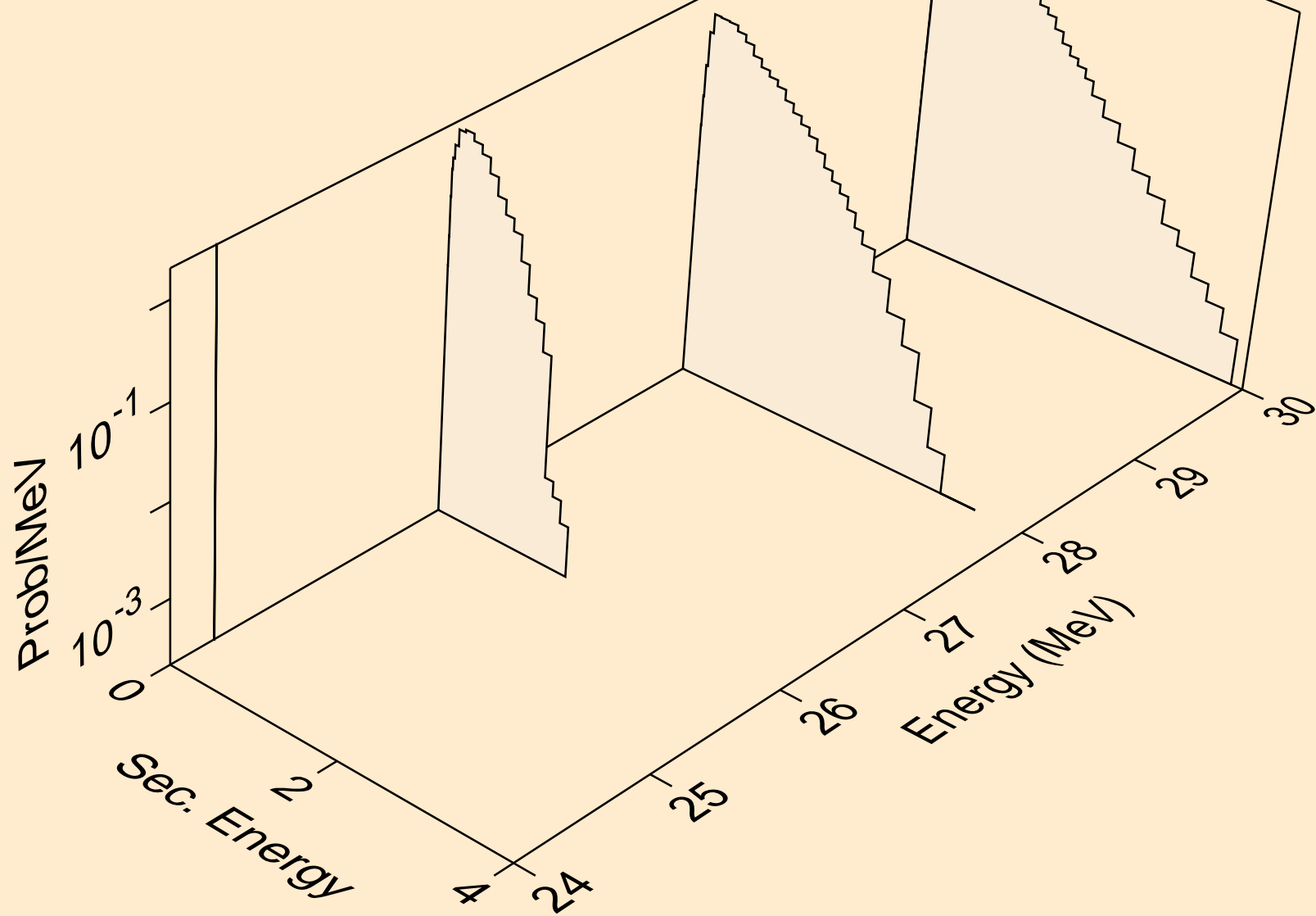

PM134M HELION ACER TENDL-2021 LIBRARY; T=0.K  
neutrons from (s,2n)

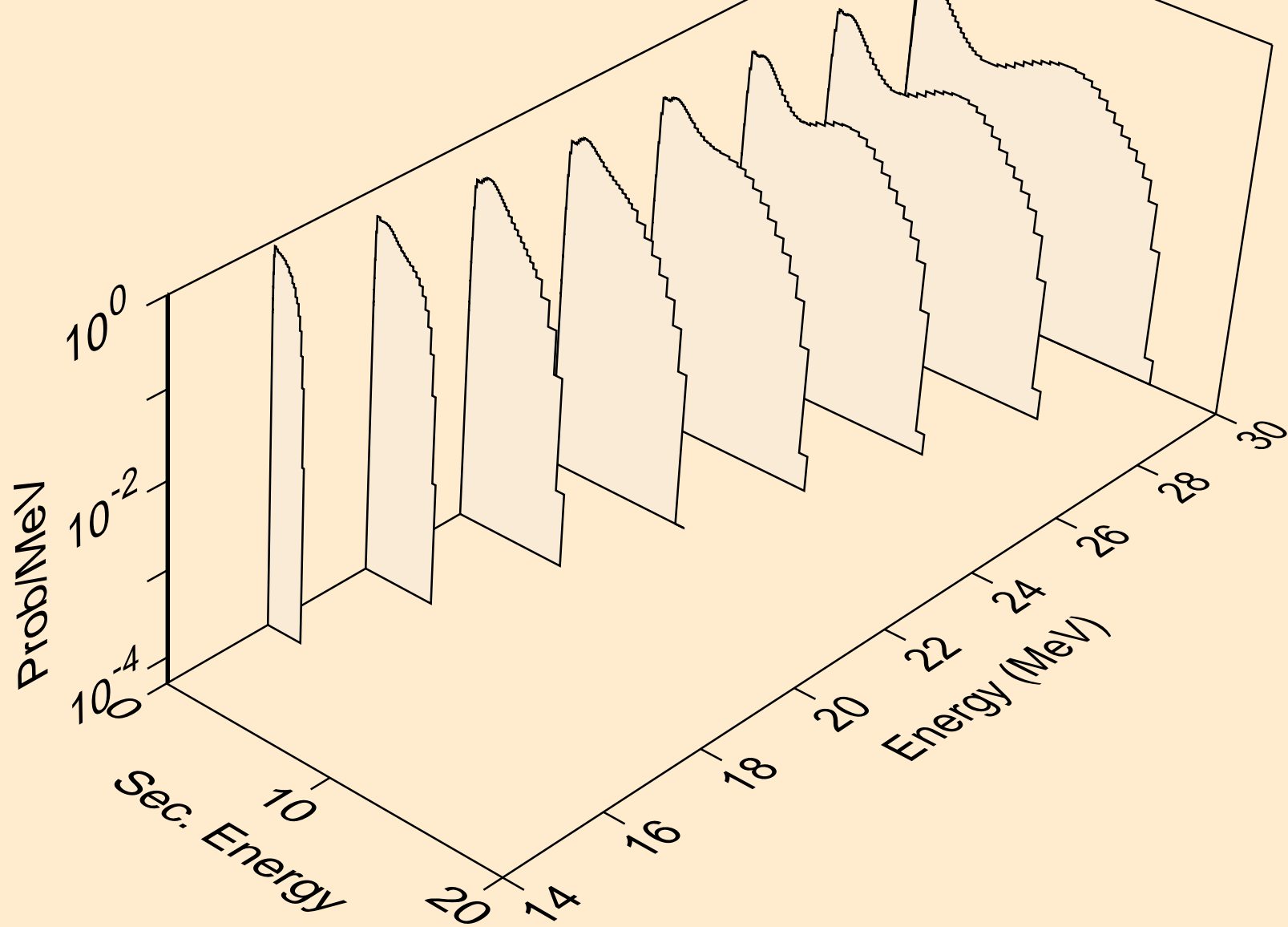

PM134M HELION ACER TENDL-2021 LIBRARY; T=0.K  
neutrons from (s,3n)

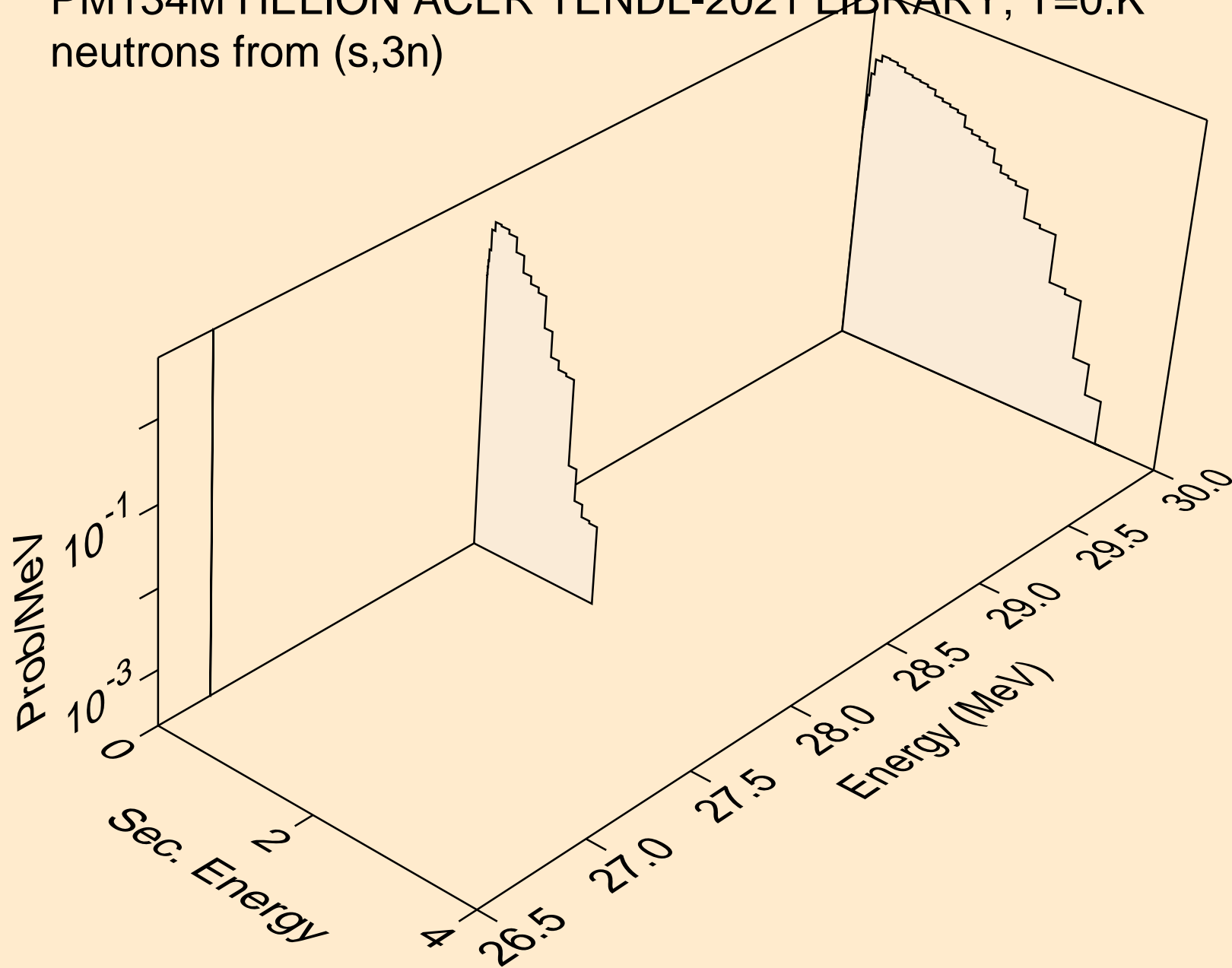

PM134M HELION ACER TENDL-2021 LIBRARY; T=0.K  
neutrons from (s,n\*)a

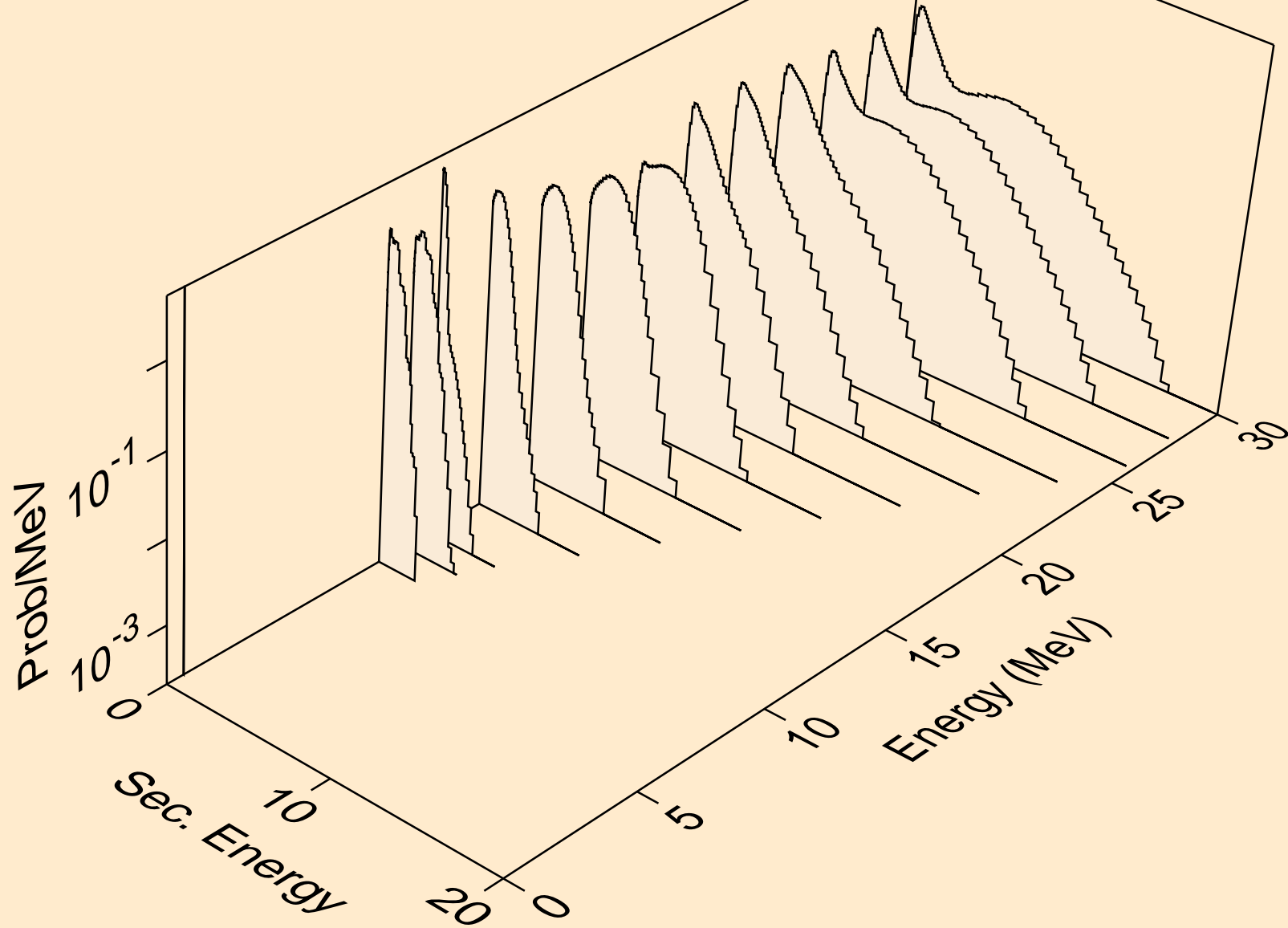

PM134M HELION ACER TENDL-2021 LIBRARY; T=0.K  
neutrons from (s,2n)a

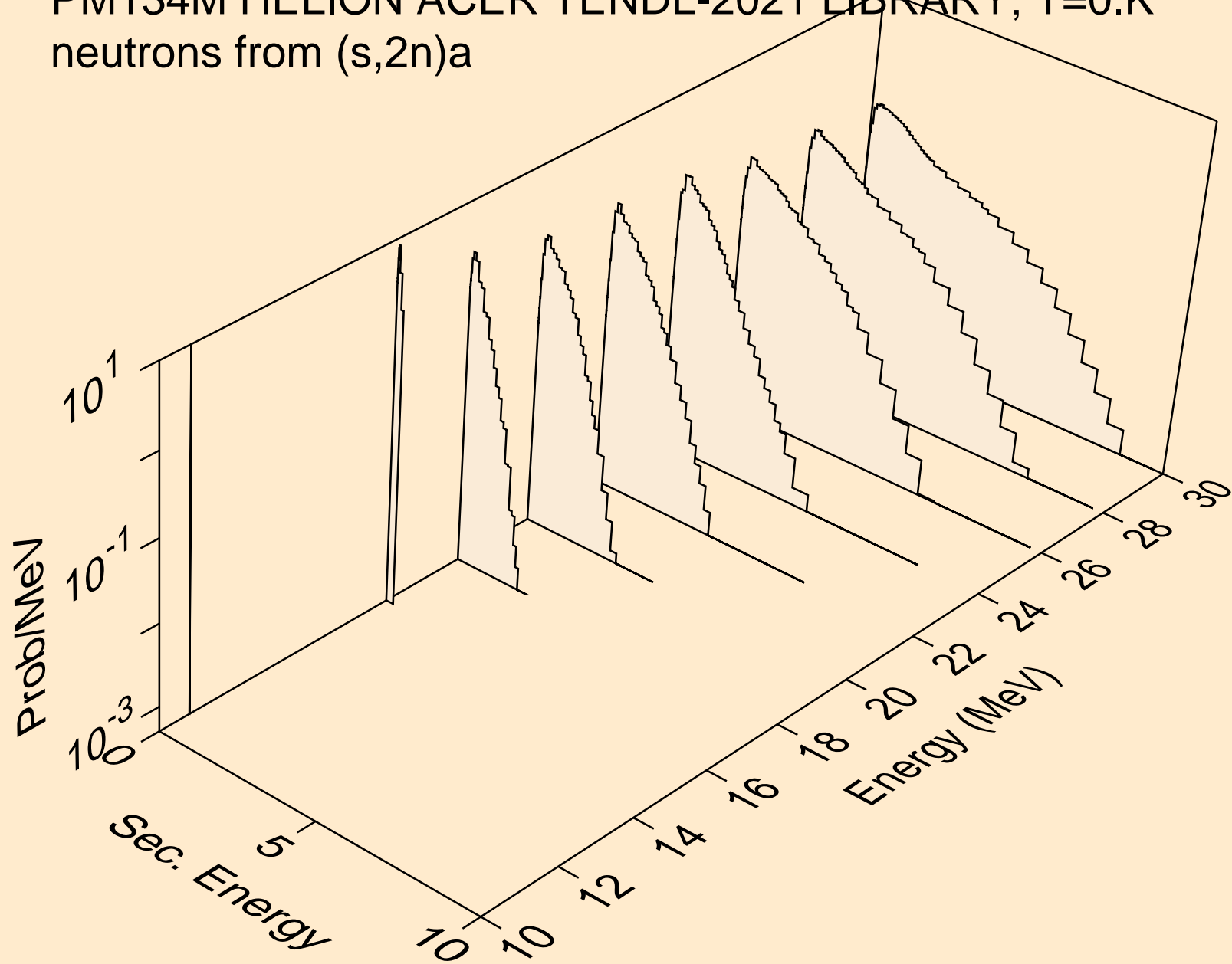

PM134M HELION ACER TENDL-2021 LIBRARY; T=0.K  
neutrons from (s,n\*)p

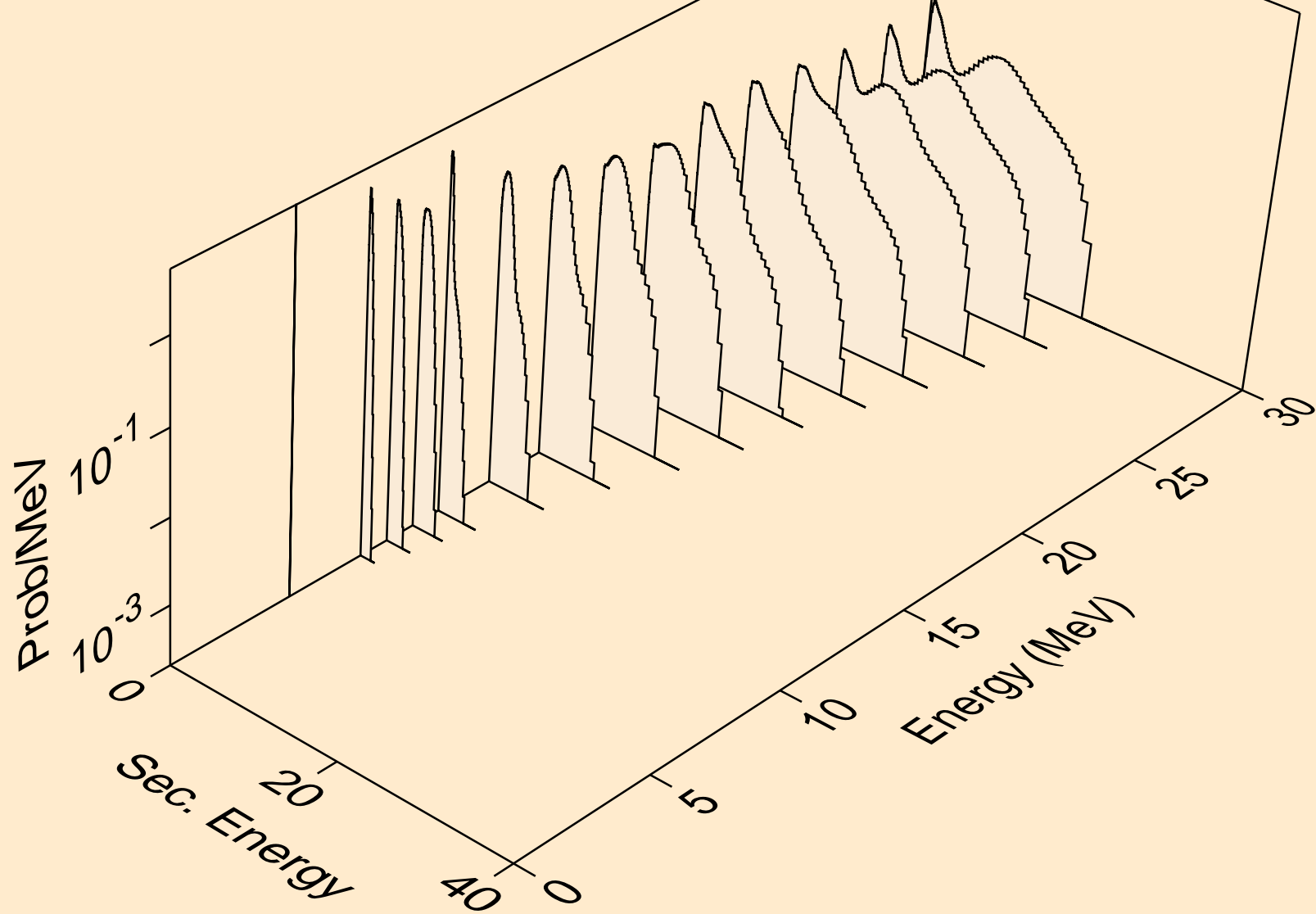

PM134M HELION ACER TENDL-2021 LIBRARY; T=0.K  
neutrons from (s,n\*)2a

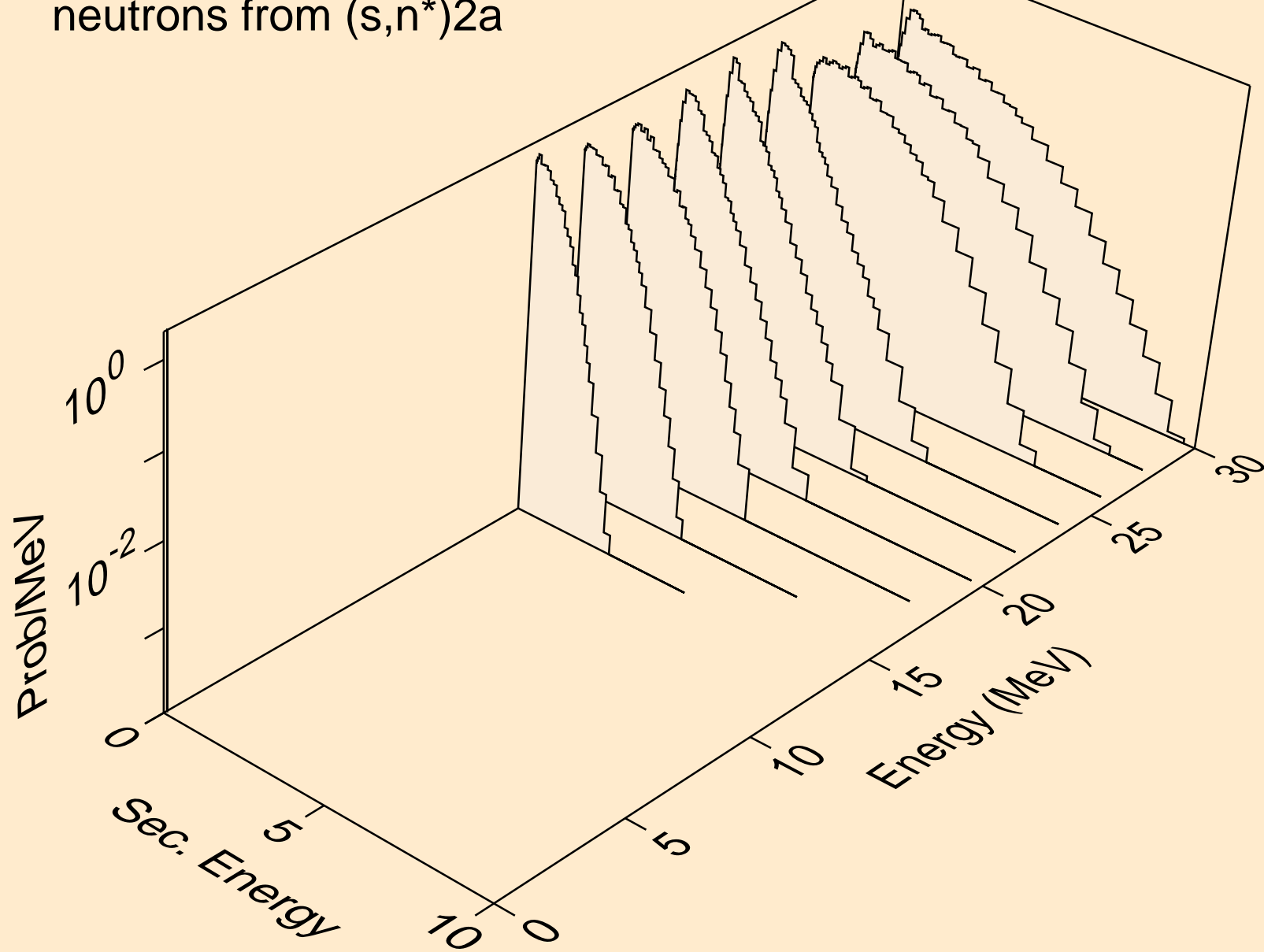

PM134M HELION ACER TENDL-2021 LIBRARY; T=0.K  
neutrons from (s,n\*)d

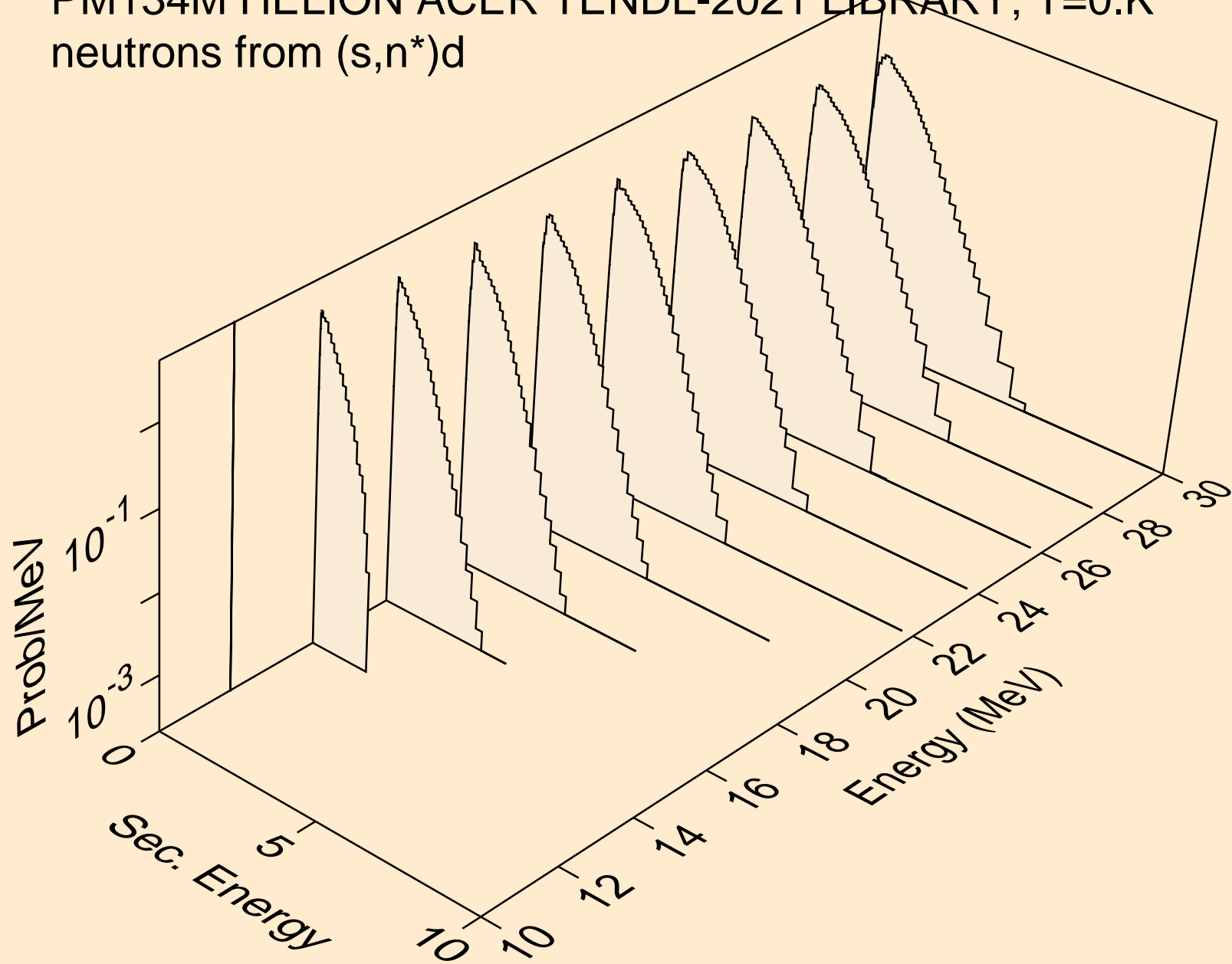



PM134M HELION ACER TENDL-2021 LIBRARY; T=0.K  
neutrons from (s,n\*)t

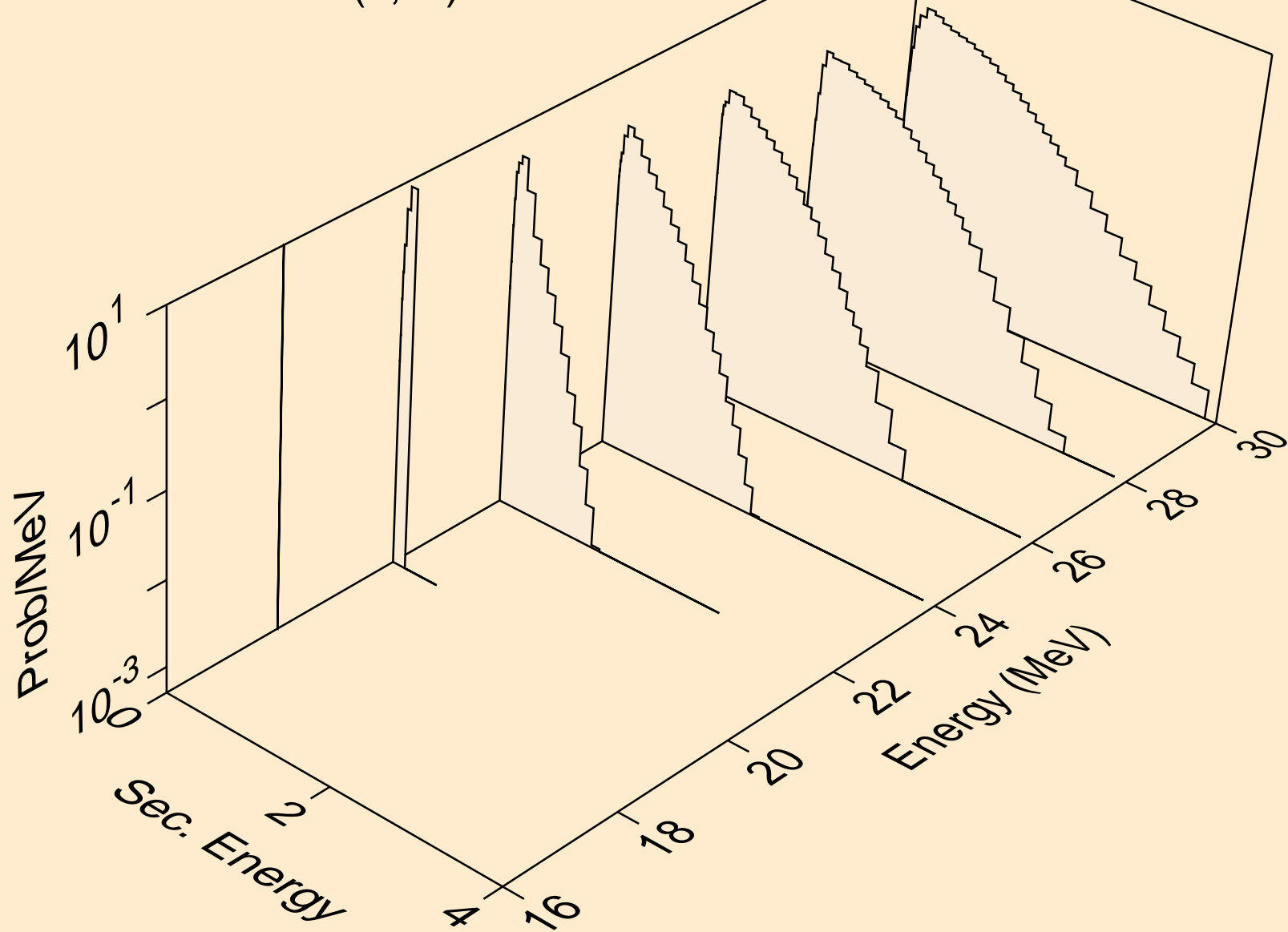

PM134M HELION ACER TENDL-2021 LIBRARY; T=0.K  
neutrons from (s,n\*)he3

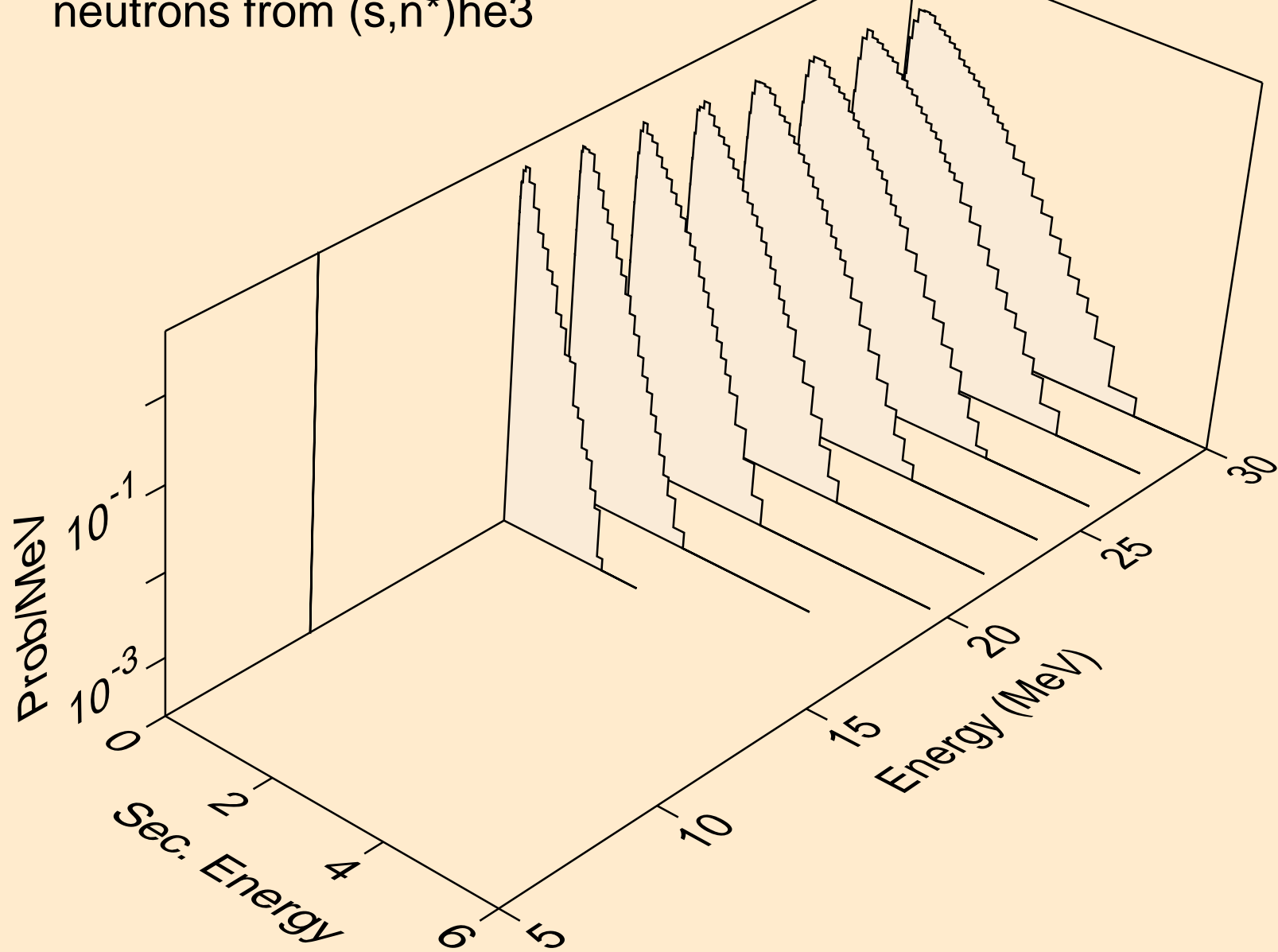

PM134M HELION ACER TENDL-2021 LIBRARY; T=0.K  
neutrons from (s,2np)

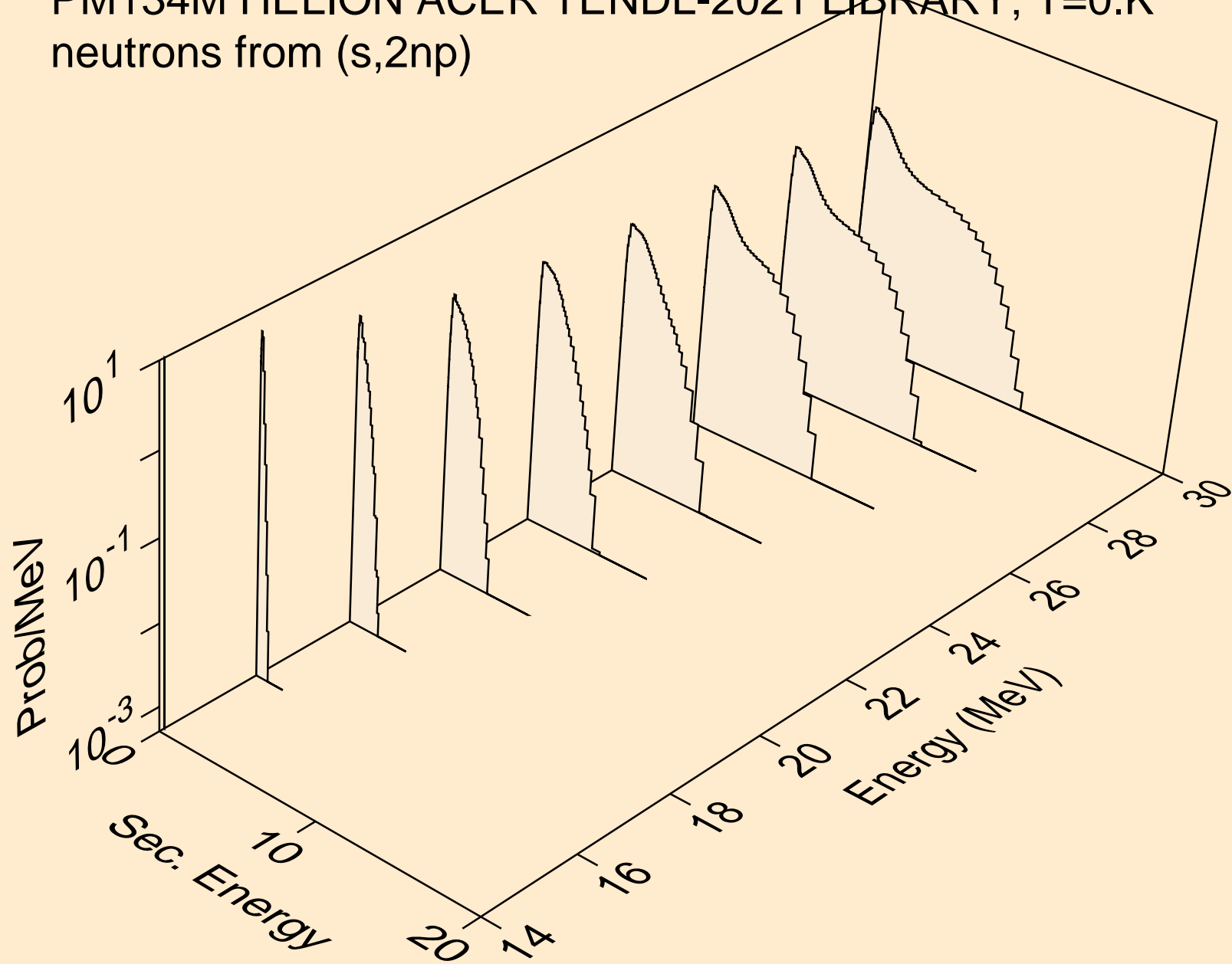

PM134M HELION ACER TENDL-2021 LIBRARY; T=0.K  
neutrons from (s,2np)

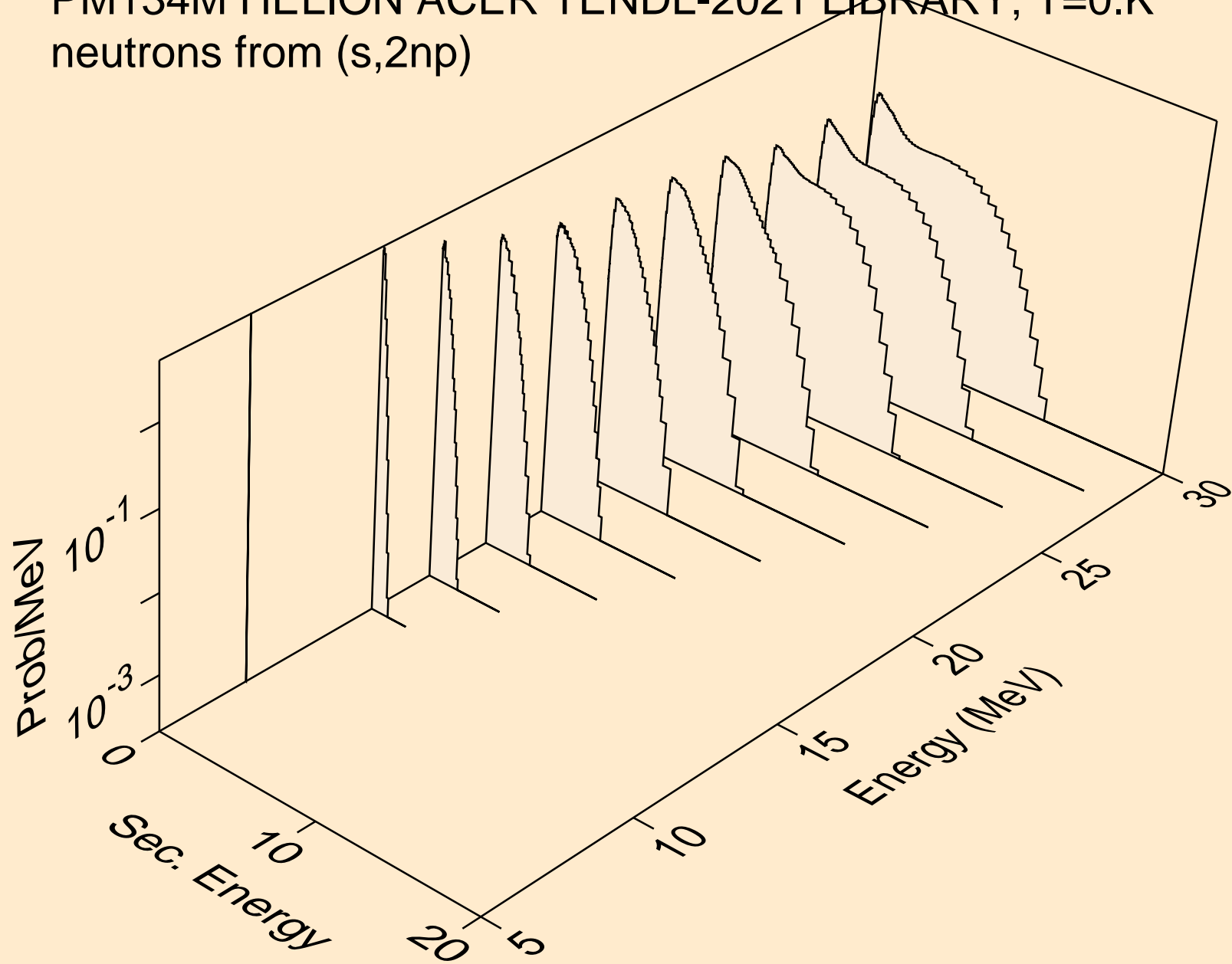

PM134M HELION ACER TENDL-2021 LIBRARY; T=0.K  
neutrons from (s,npa)

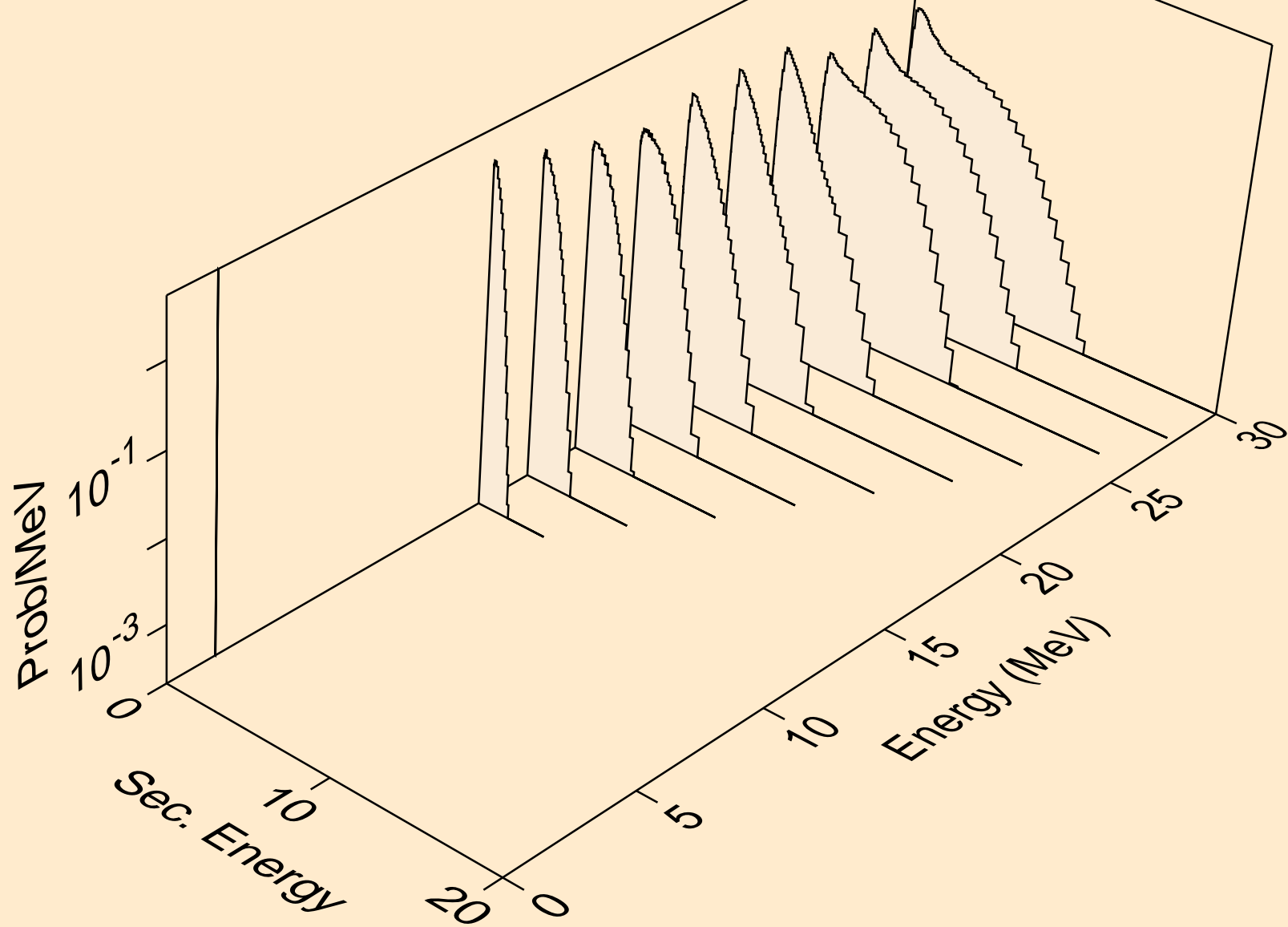

PM134M HELION ACER TENDL-2021 LIBRARY; T=0.K  
protons from (s,x)

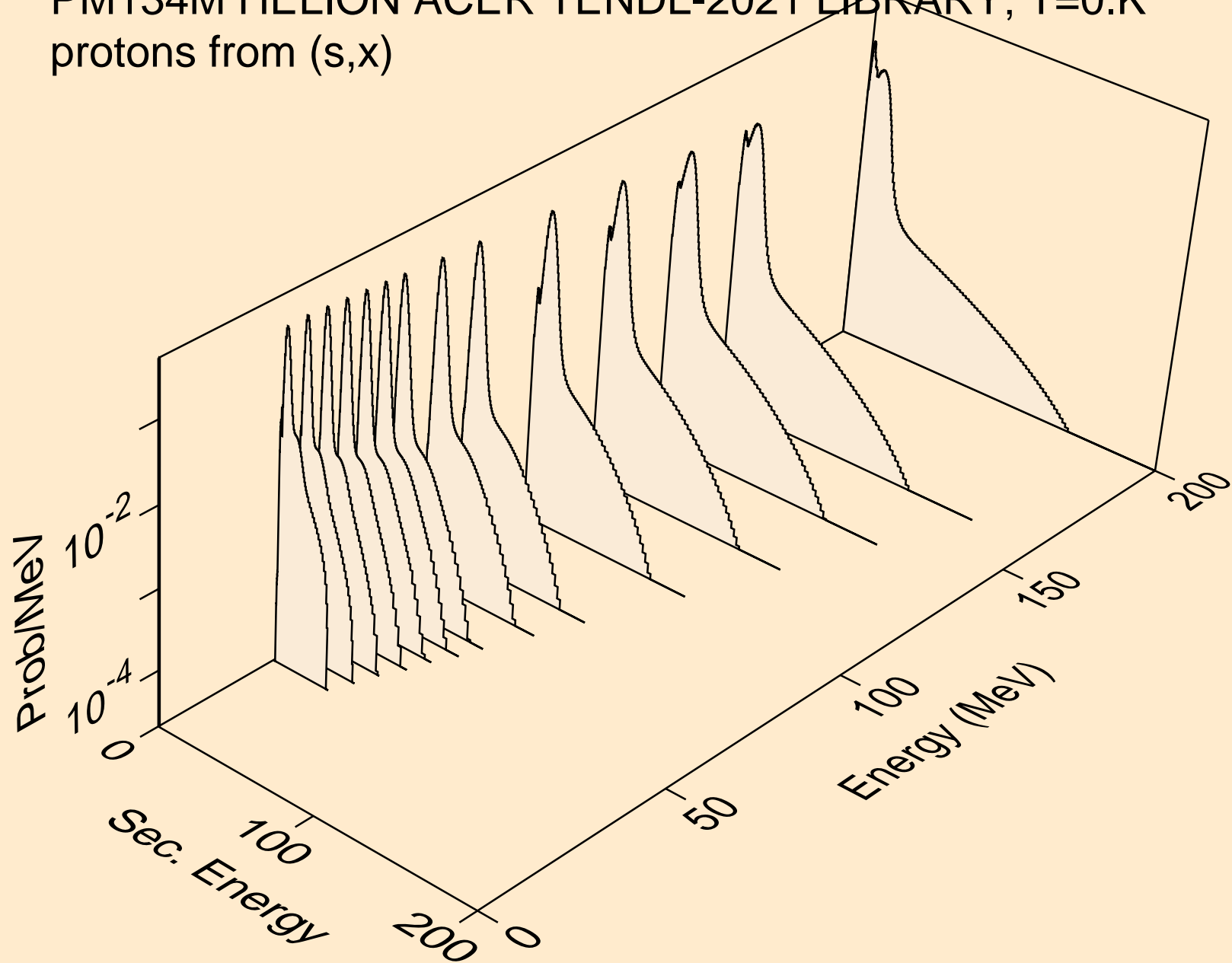

PM134M HELION ACER TENDL-2021 LIBRARY; T=0.K  
protons from (s,n\*)p

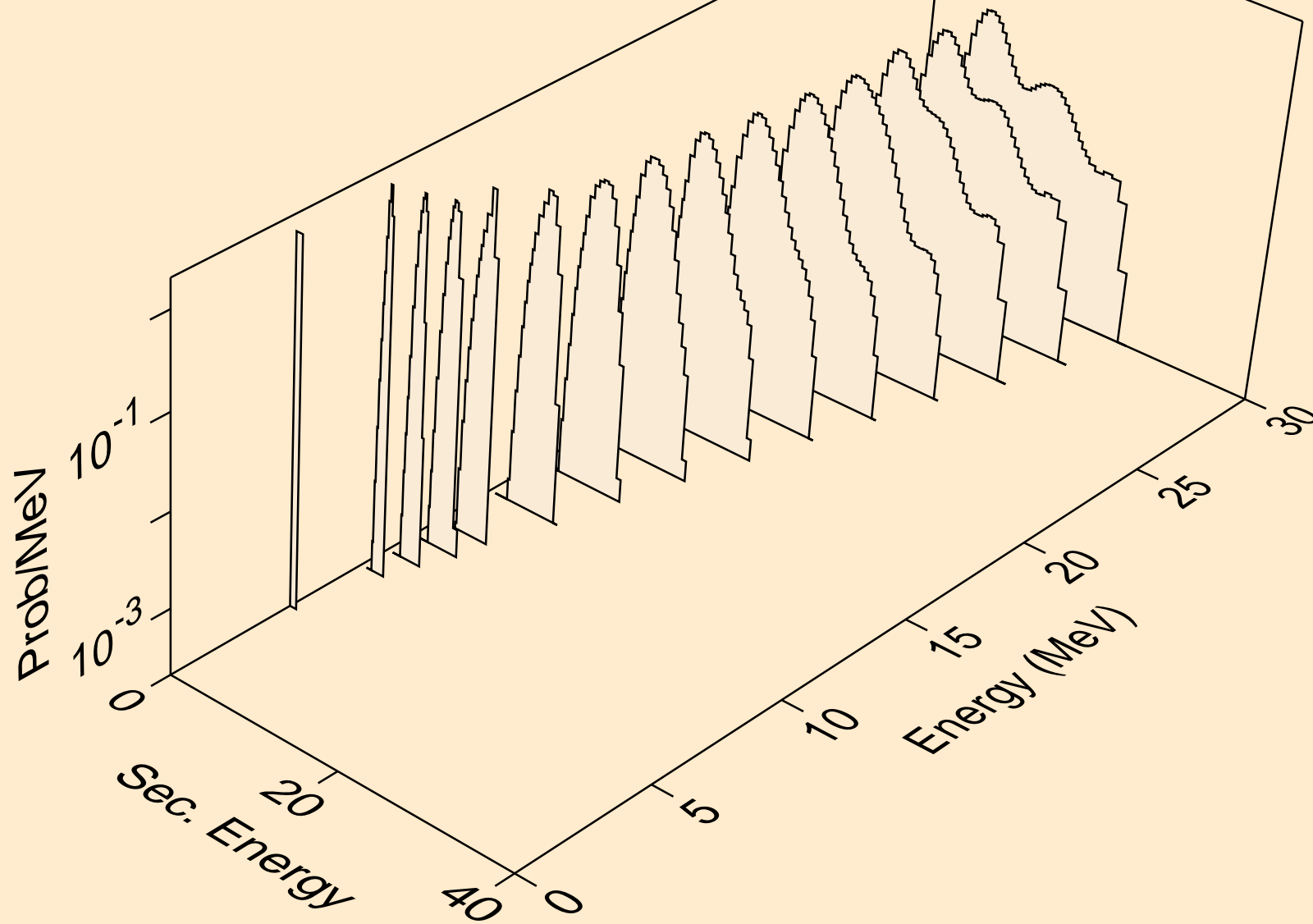

PM134M HELION ACER TENDL-2021 LIBRARY; T=0.K  
protons from (s,2np)

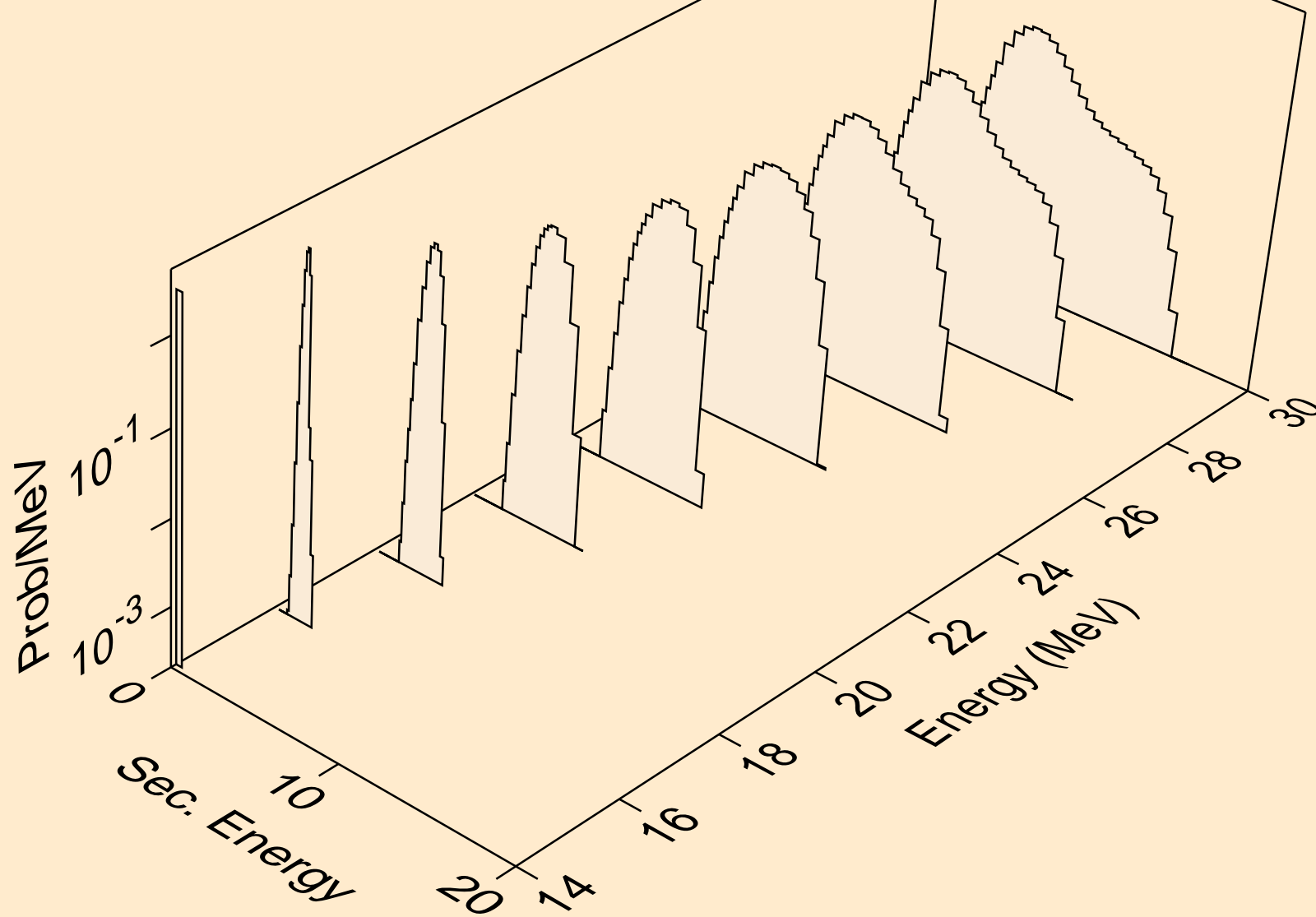



PM134M HELION ACER TENDL-2021 LIBRARY; T=0.K  
protons from (s,2np)

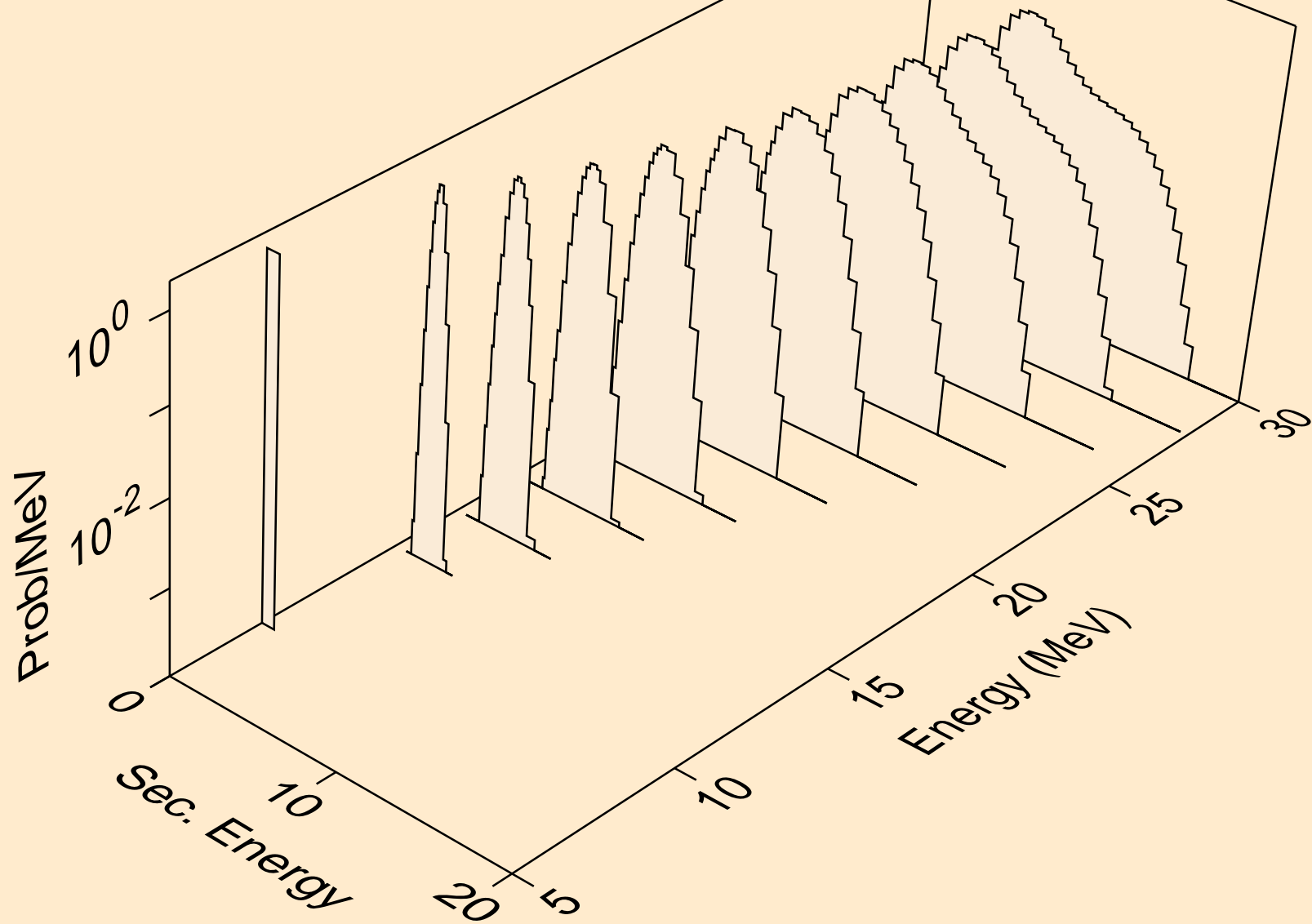

PM134M HELION ACER TENDL-2021 LIBRARY; T=0.K  
protons from (s,npa)

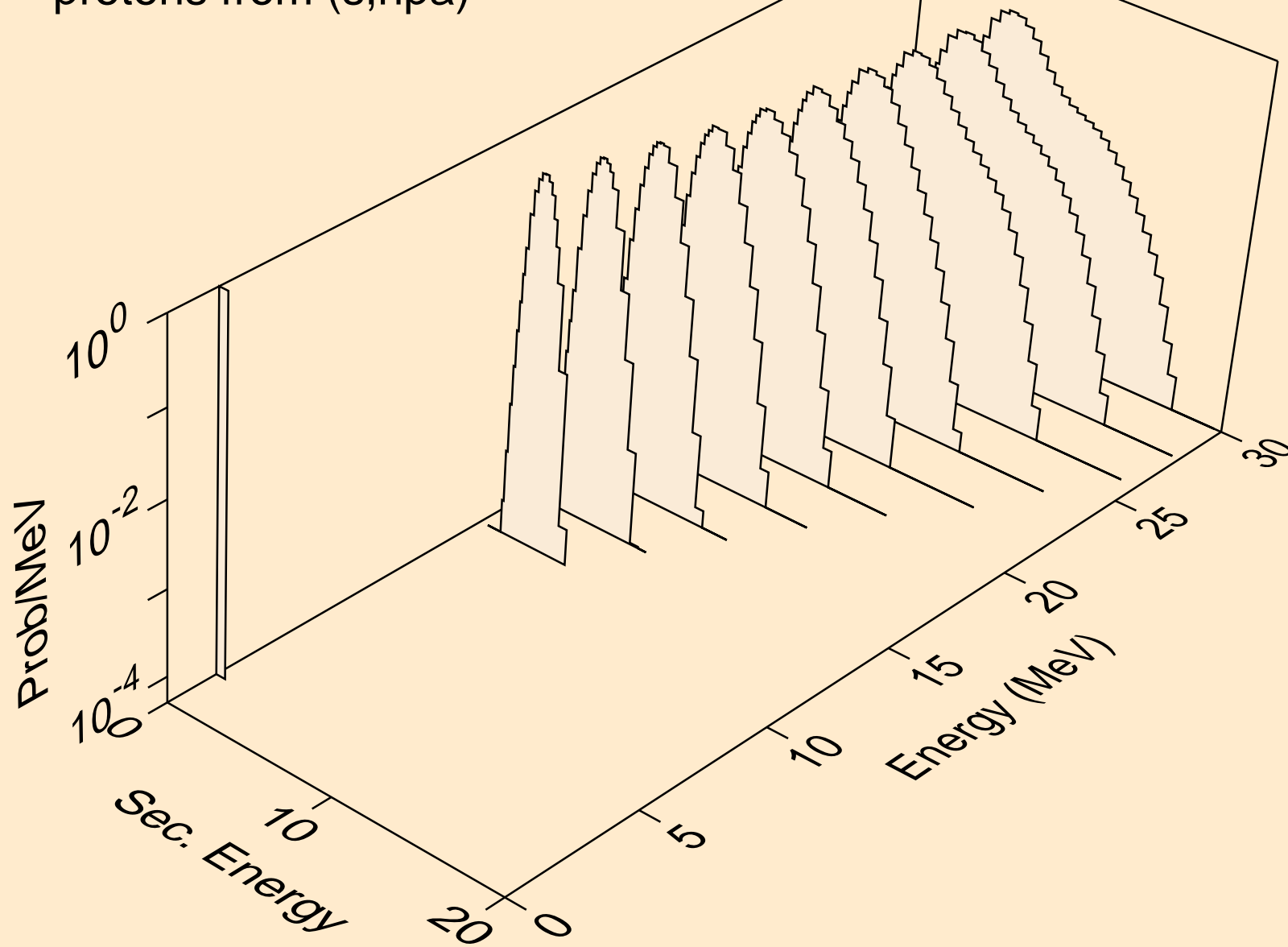

PM134M HELION ACER TENDL-2021 LIBRARY; T=0.K  
protons from (s,p)

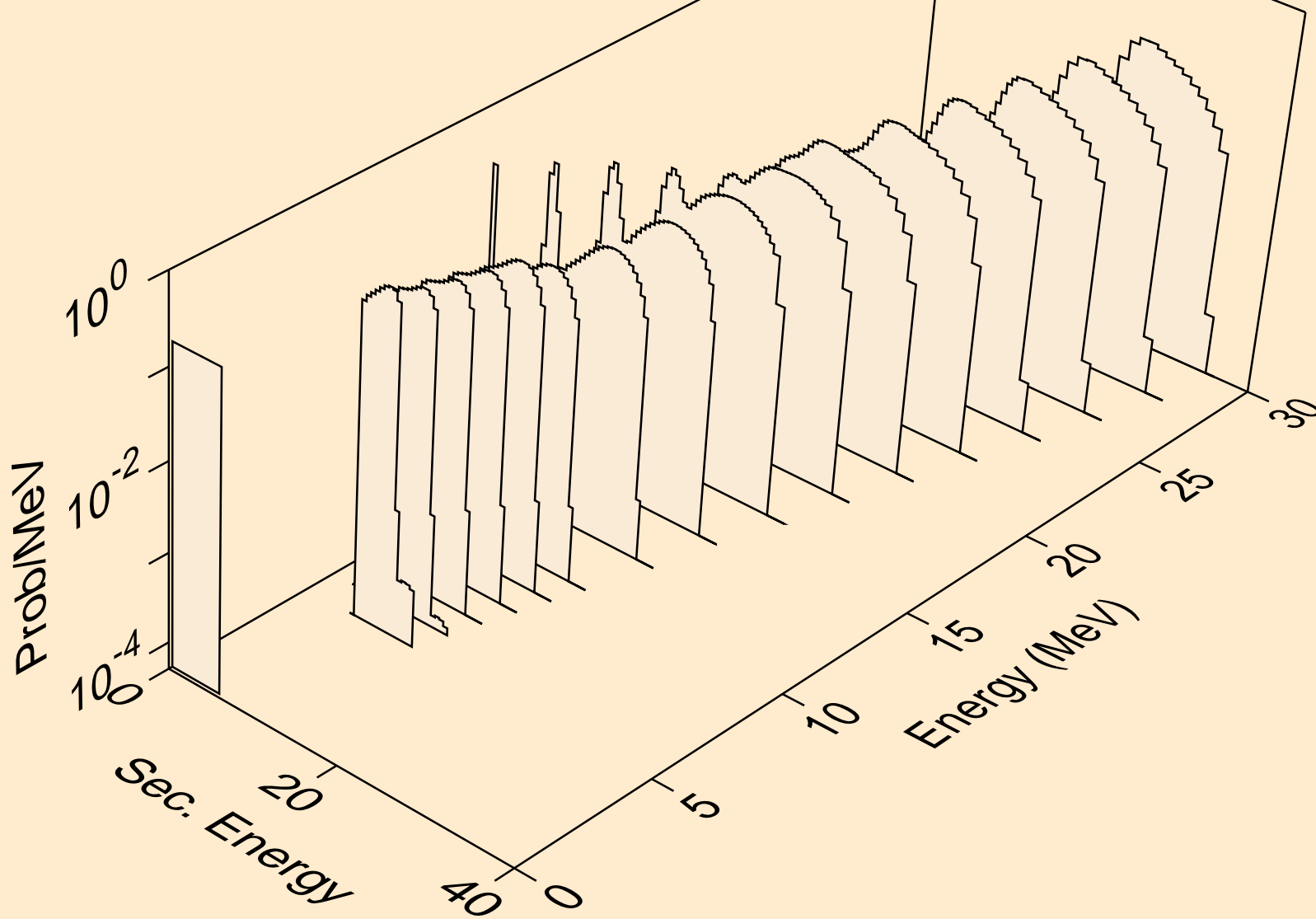

PM134M HELION ACER TENDL-2021 LIBRARY; T=0.K  
protons from (s,2p)

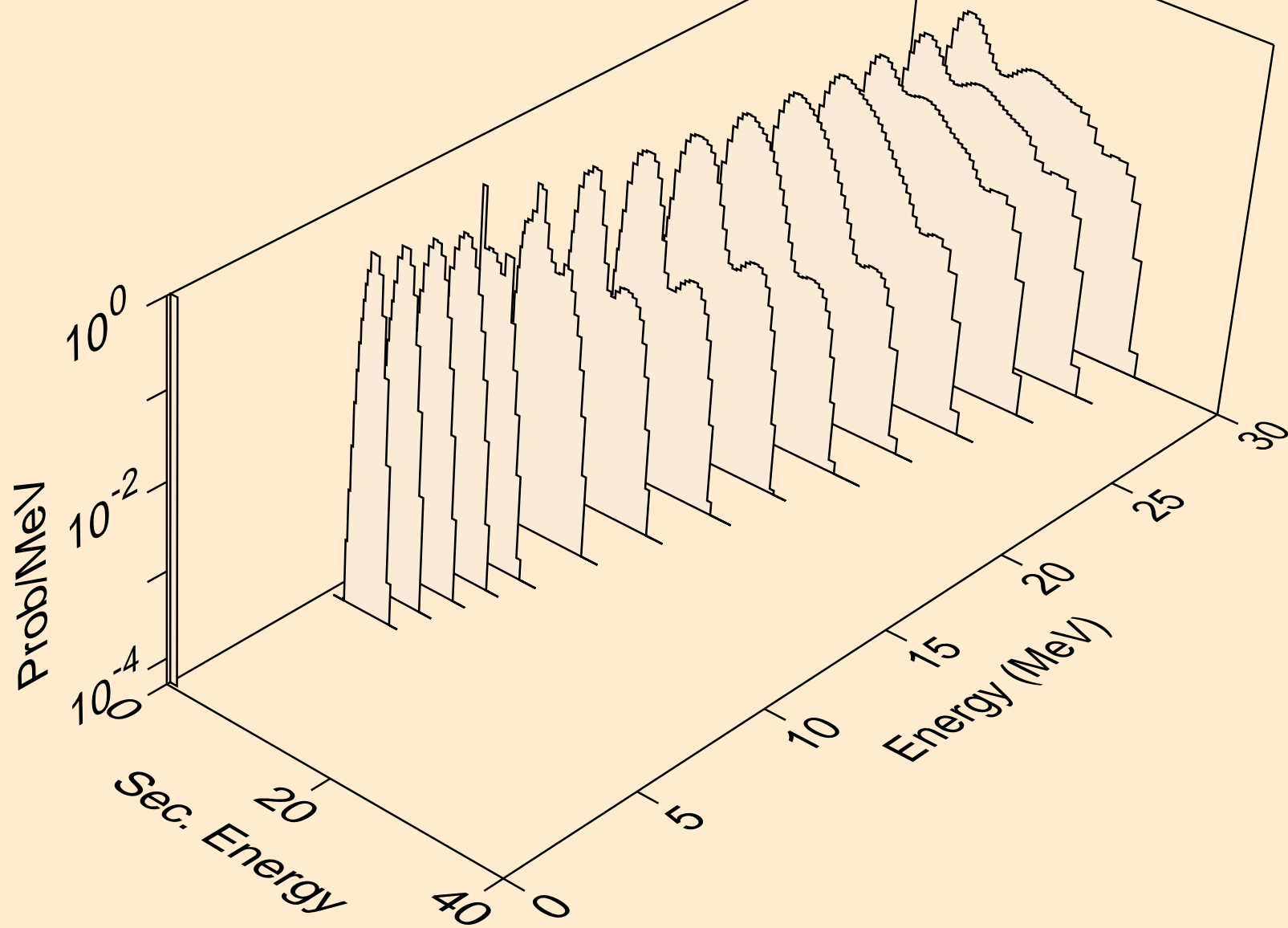

PM134M HELION ACER TENDL-2021 LIBRARY; T=0.K  
protons from (s,pa)

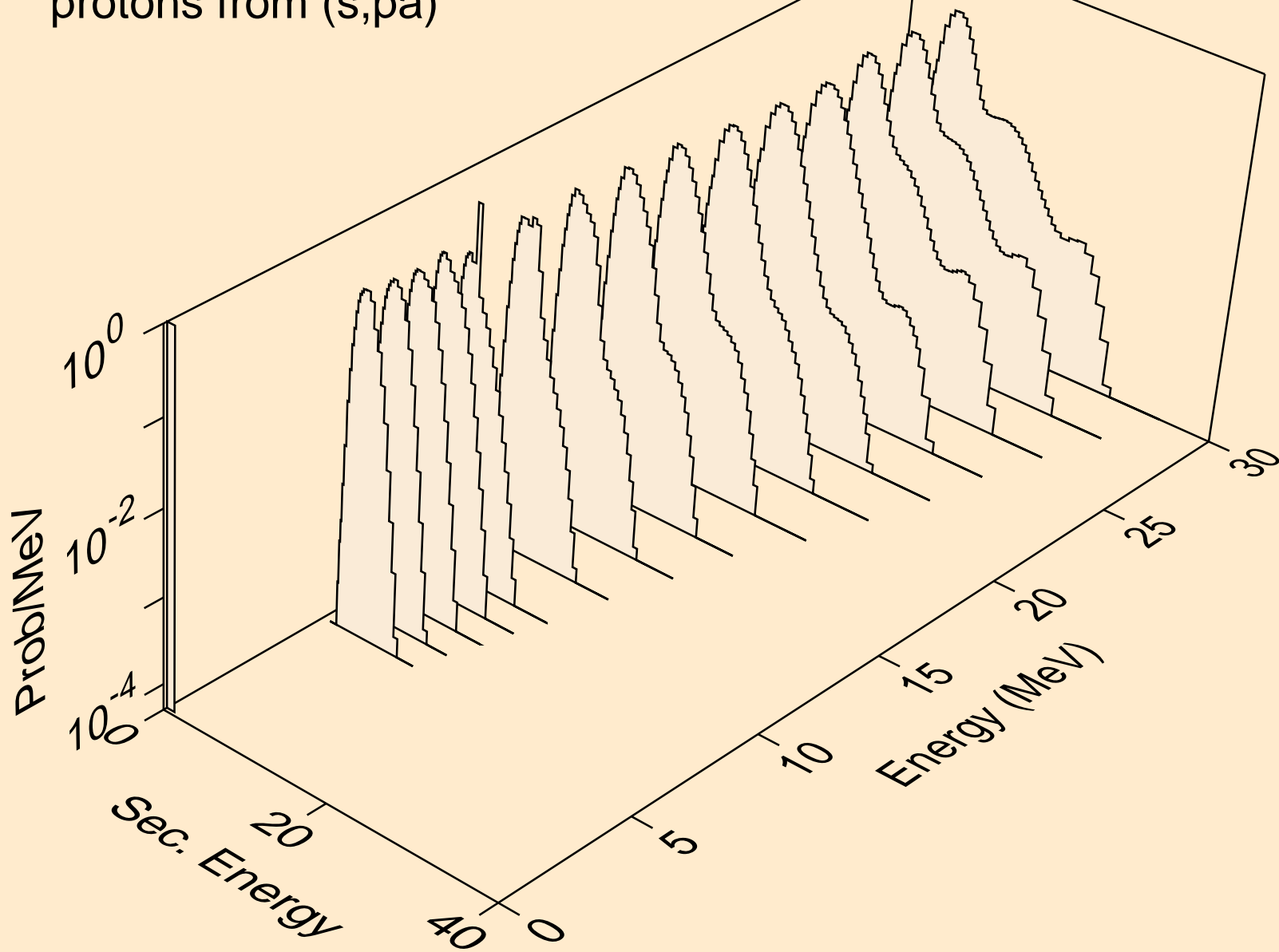

PM134M HELION ACER TENDL-2021 LIBRARY; T=0.K  
protons from (s,pd)

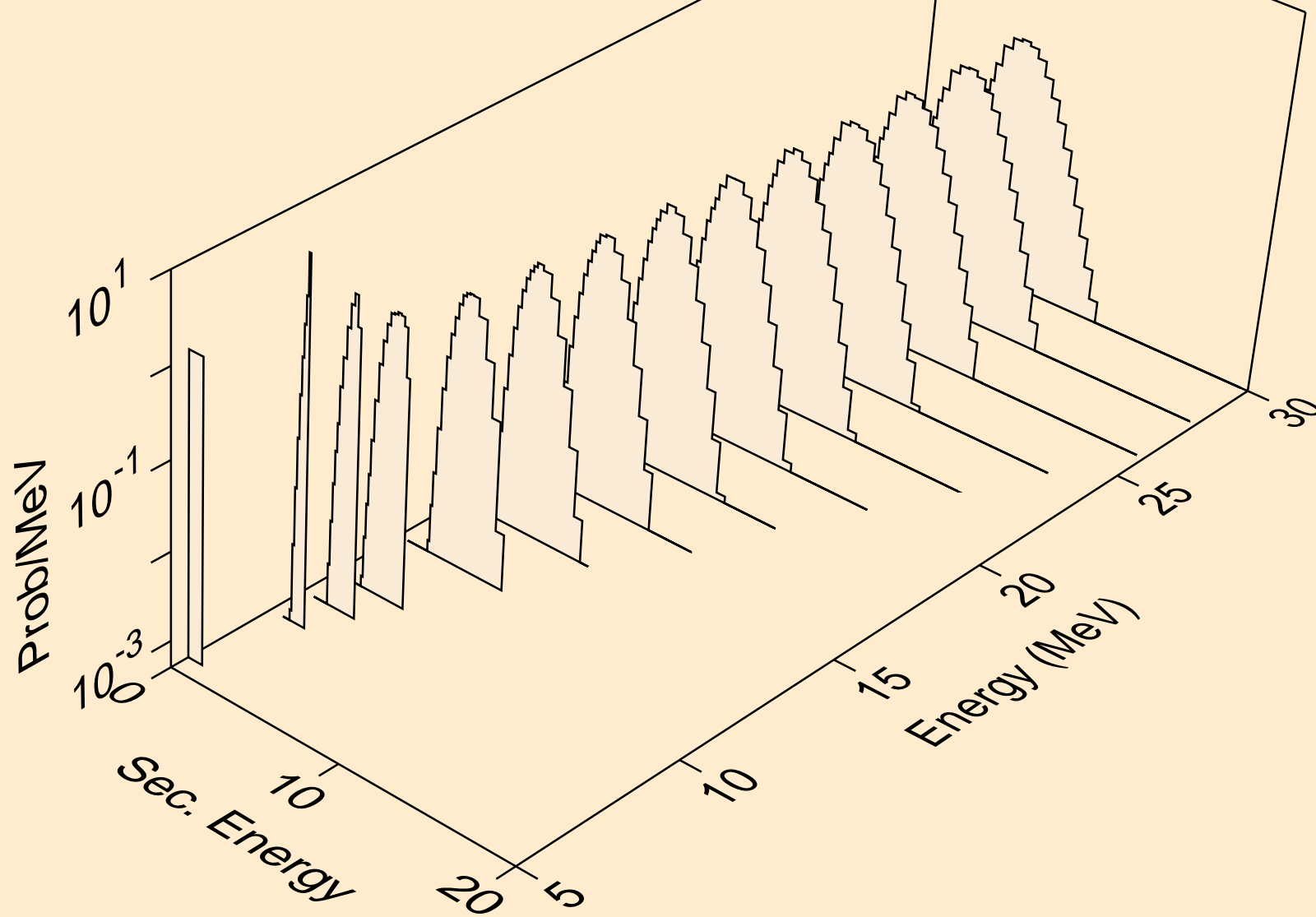

PM134M HELION ACER TENDL-2021 LIBRARY; T=0.K  
protons from (s,pt)

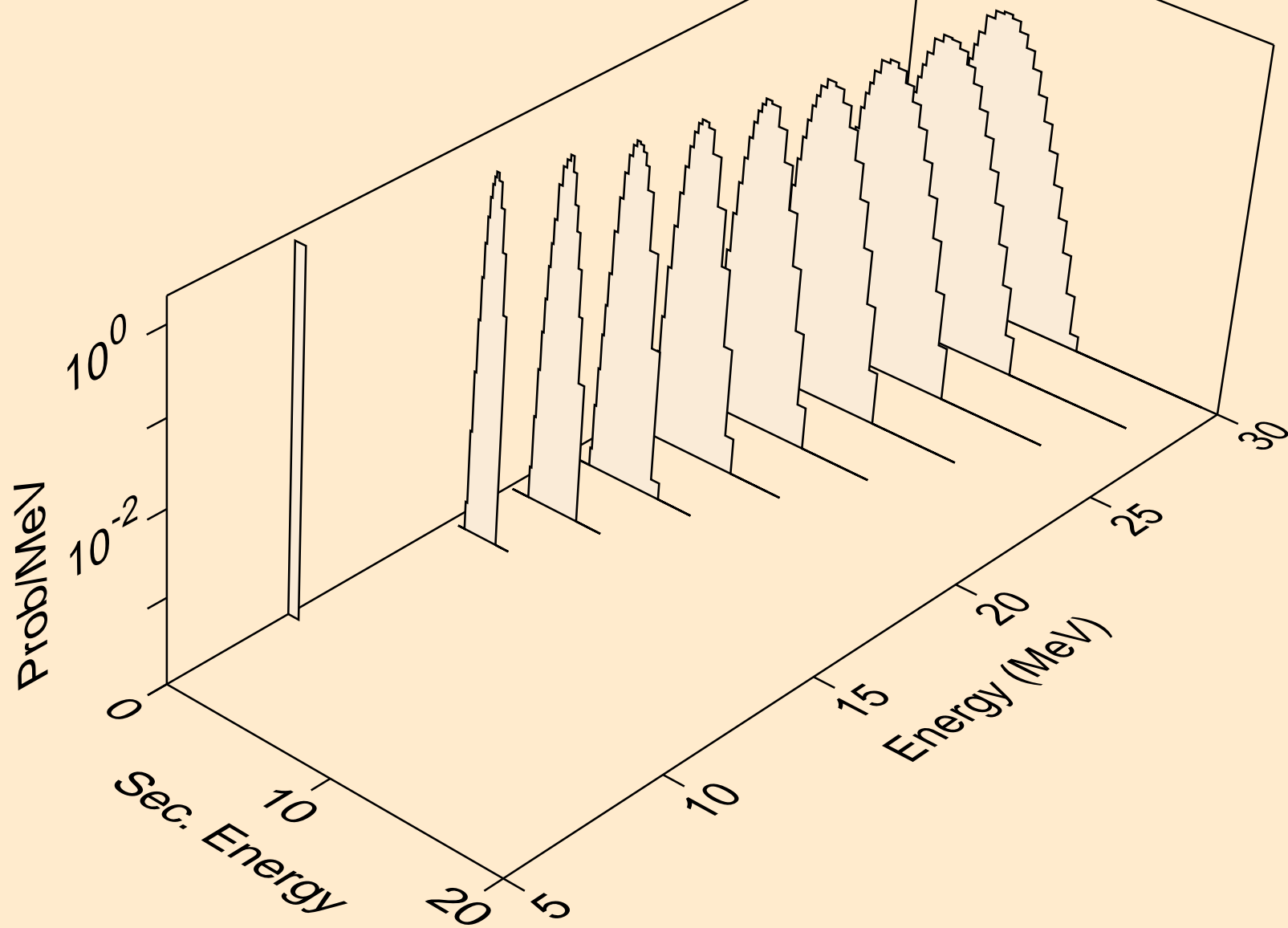

PM134M HELION ACER TENDL-2021 LIBRARY; T=0.K  
deuterons from (s,x)

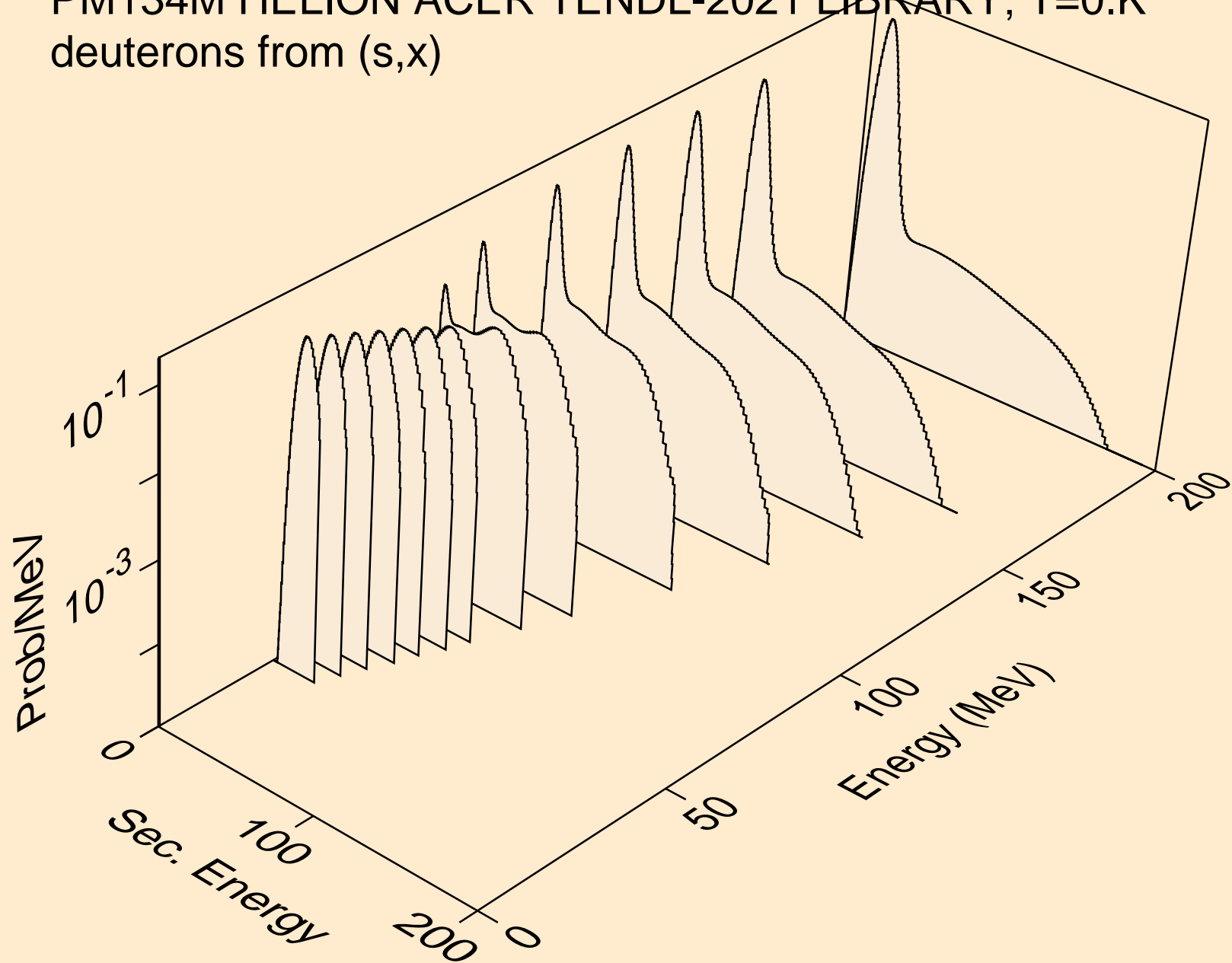



PM134M HELION ACER TENDL-2021 LIBRARY; T=0.K  
deuterons from (s,2nd)

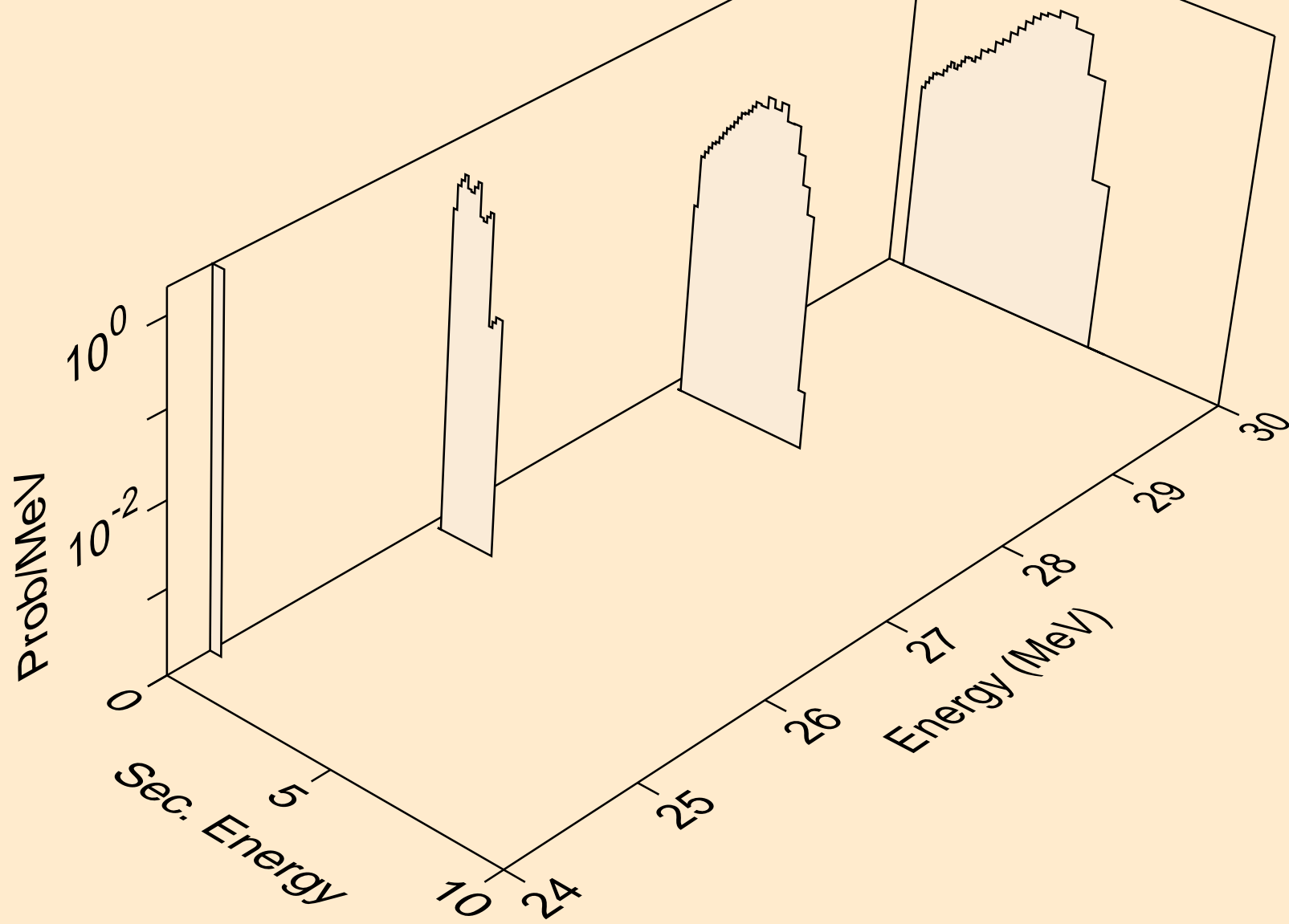

PM134M HELION ACER TENDL-2021 LIBRARY; T=0.K  
deuterons from (s,n\*)d

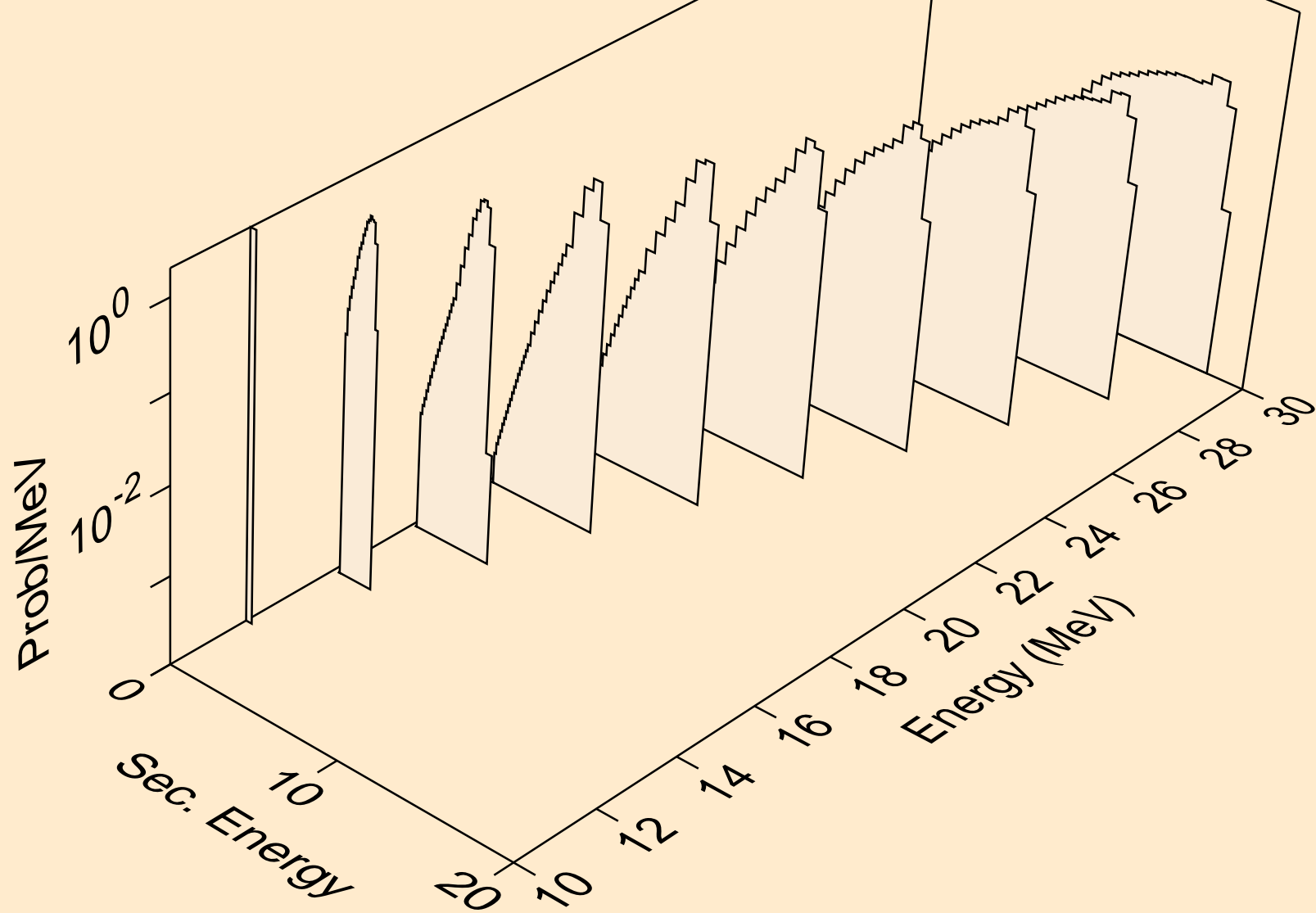

PM134M HELION ACER TENDL-2021 LIBRARY; T=0.K  
deuterons from (s,d)

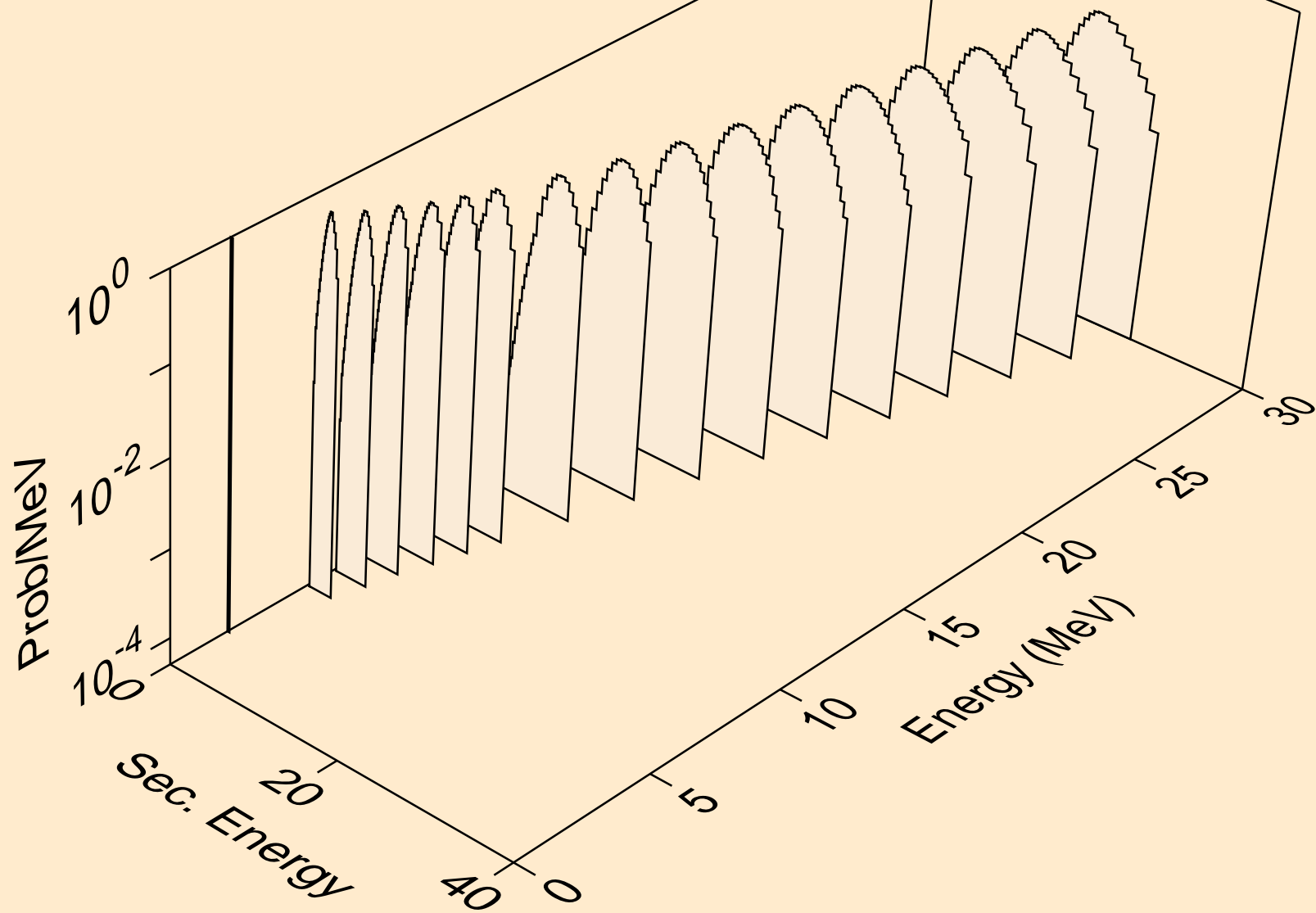

PM134M HELION ACER TENDL-2021 LIBRARY; T=0.K  
deuterons from (s,pd)

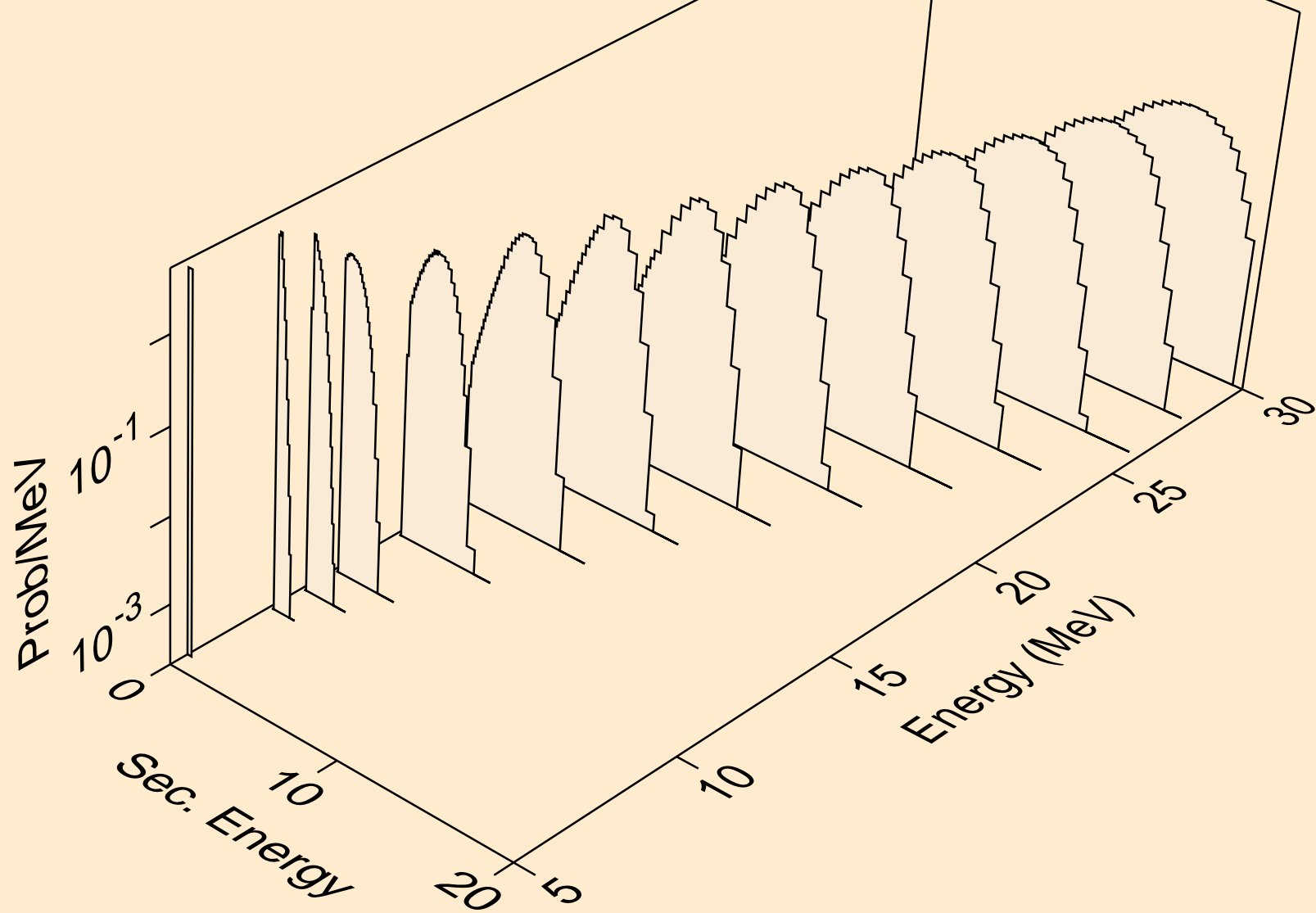

PM134M HELION ACER TENDL-2021 LIBRARY; T=0.K  
deuterons from (s,da)

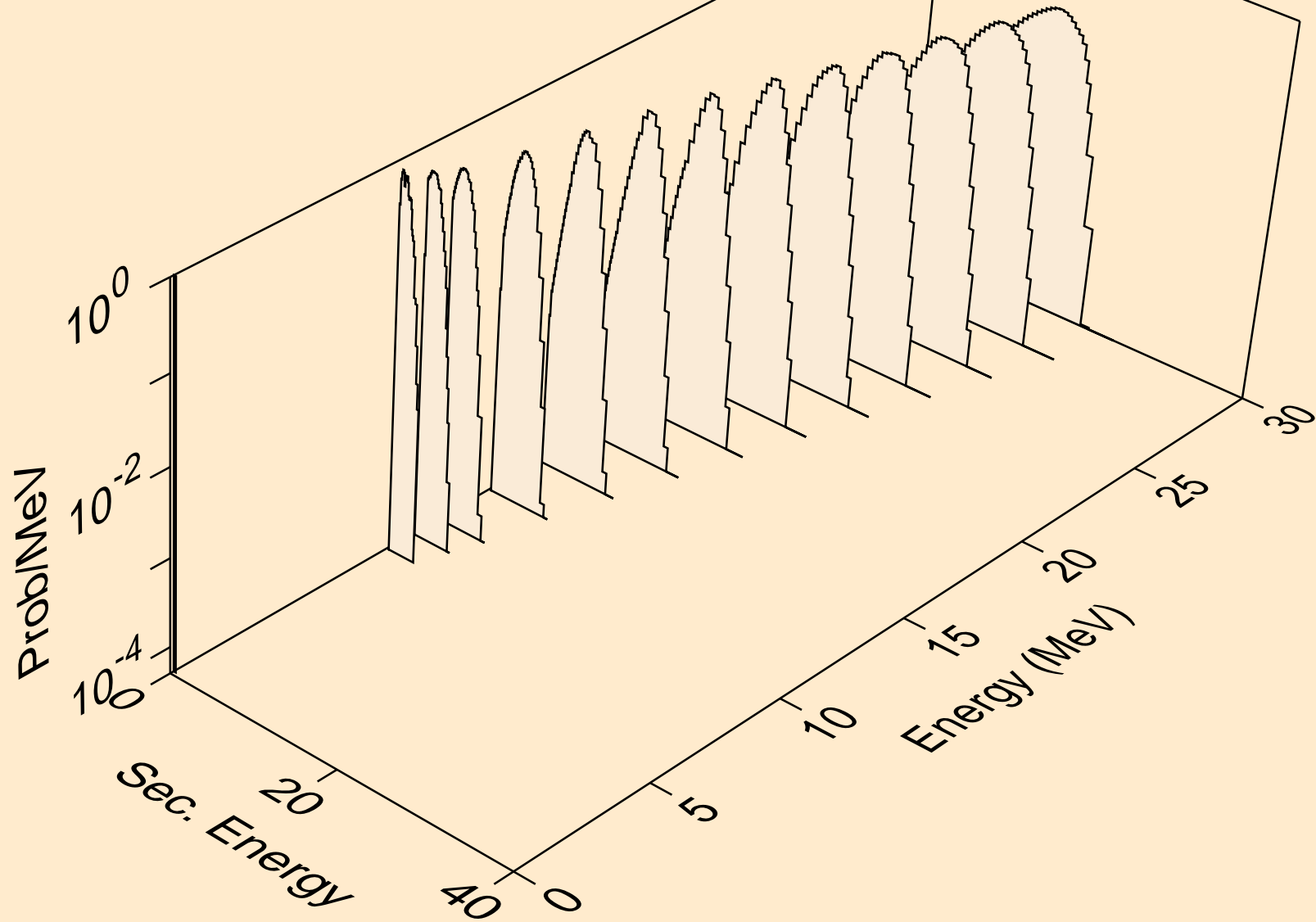

PM134M HELION ACER TENDL-2021 LIBRARY; T=0.K  
tritons from (s,x)

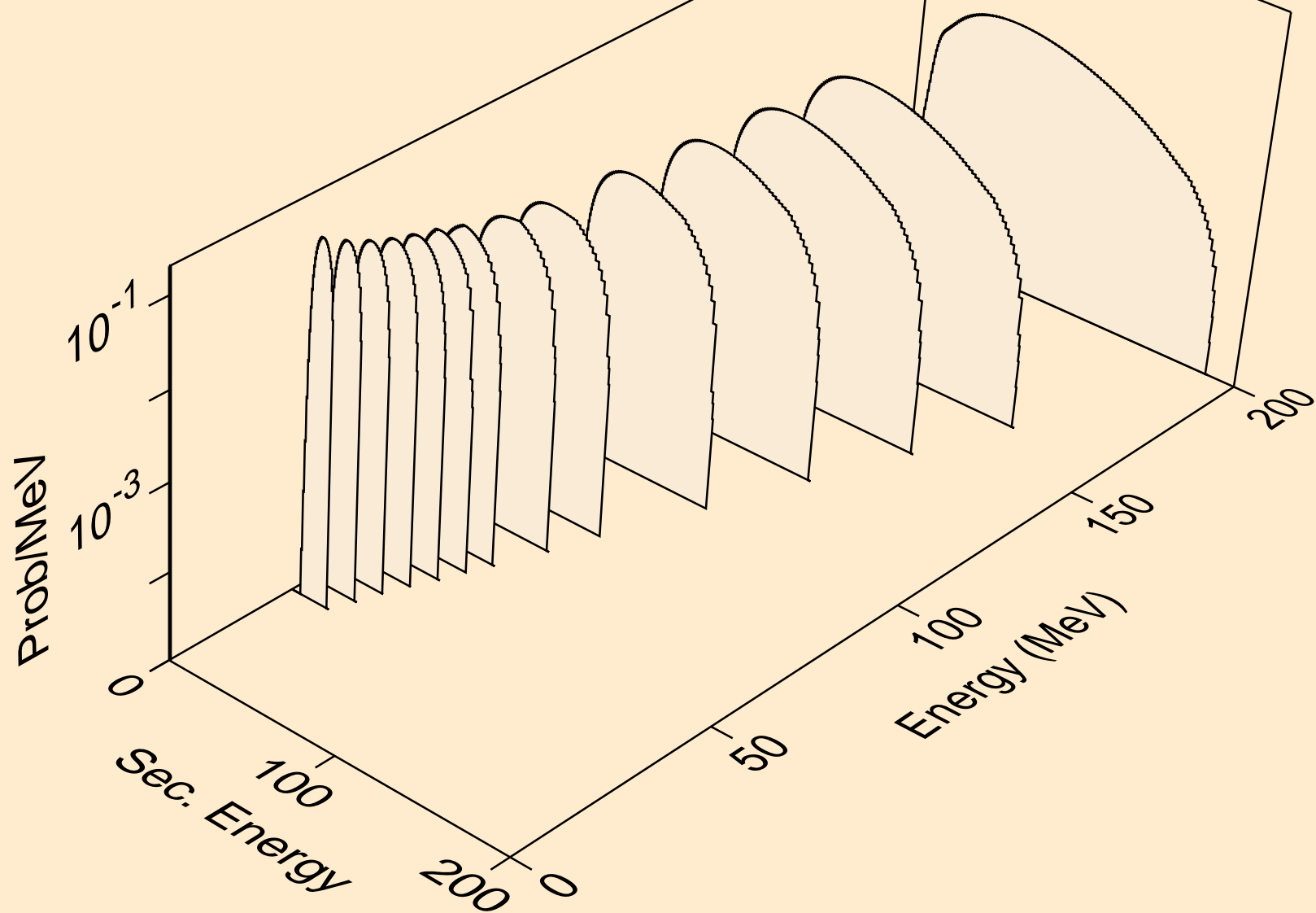

PM134M HELION ACER TENDL-2021 LIBRARY; T=0.K  
tritons from (s,n\*)t

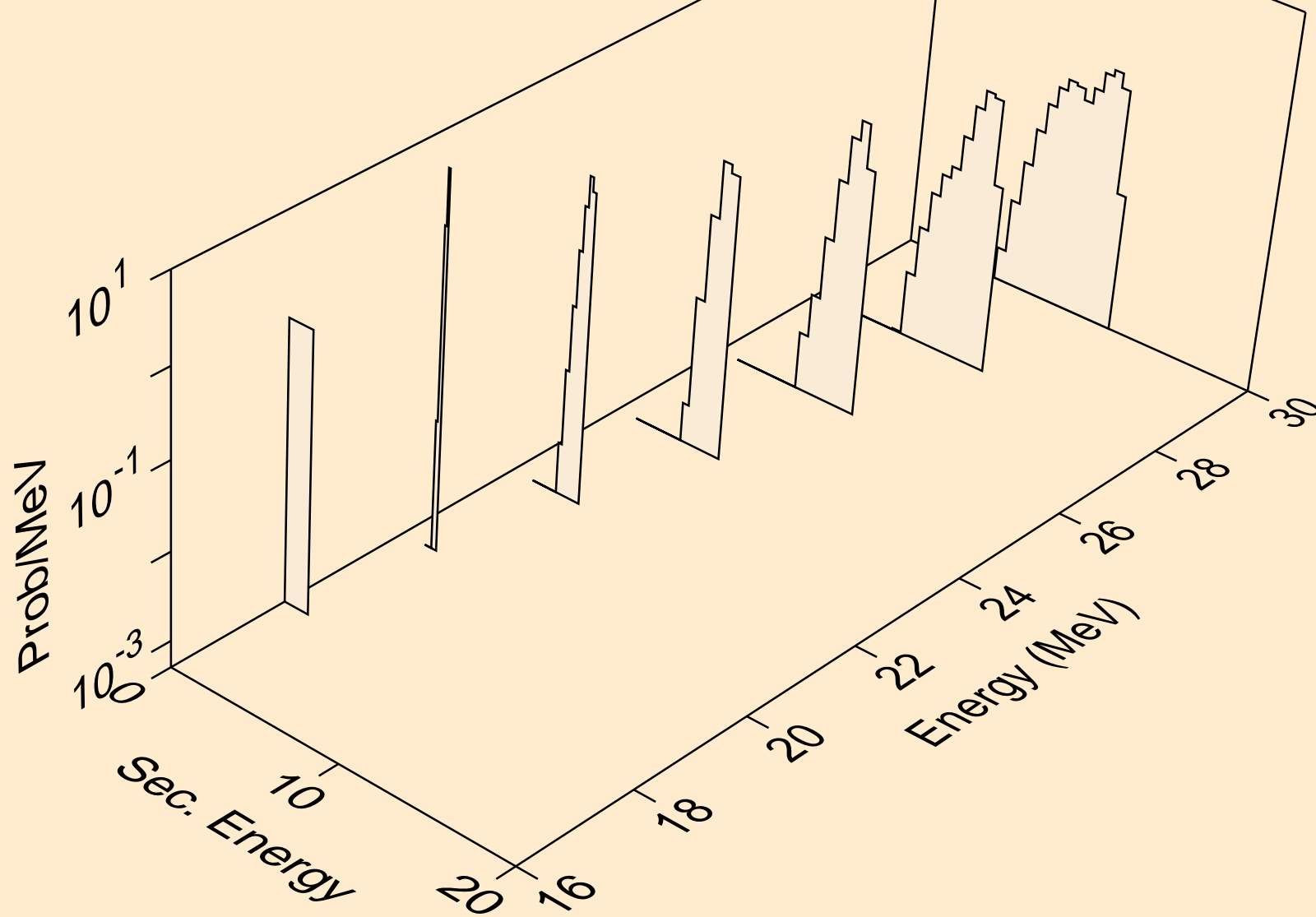

PM134M HELION ACER TENDL-2021 LIBRARY; T=0.K  
tritons from (s,t)

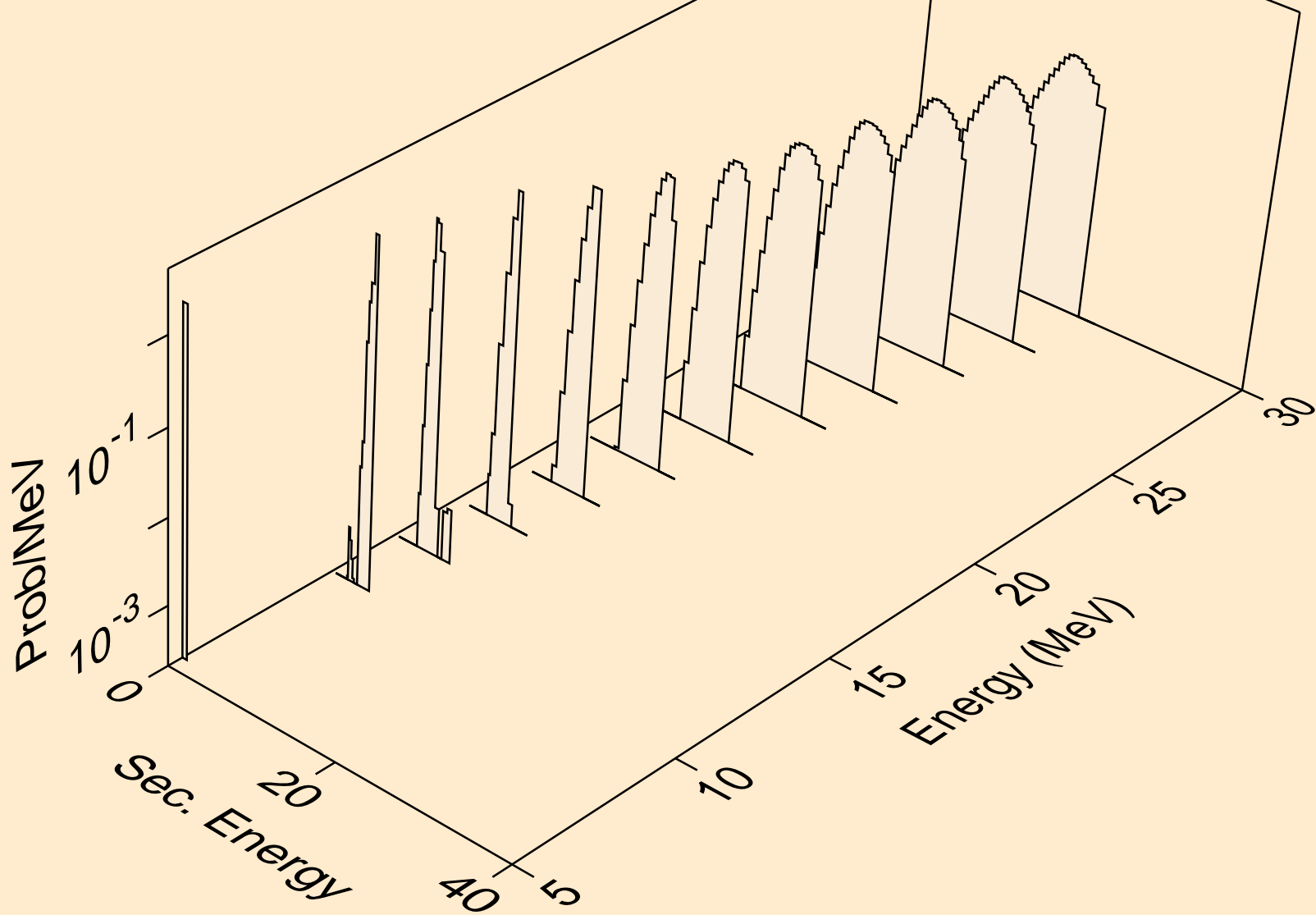



PM134M HELION ACER TENDL-2021 LIBRARY; T=0.K  
tritons from (s,pt)

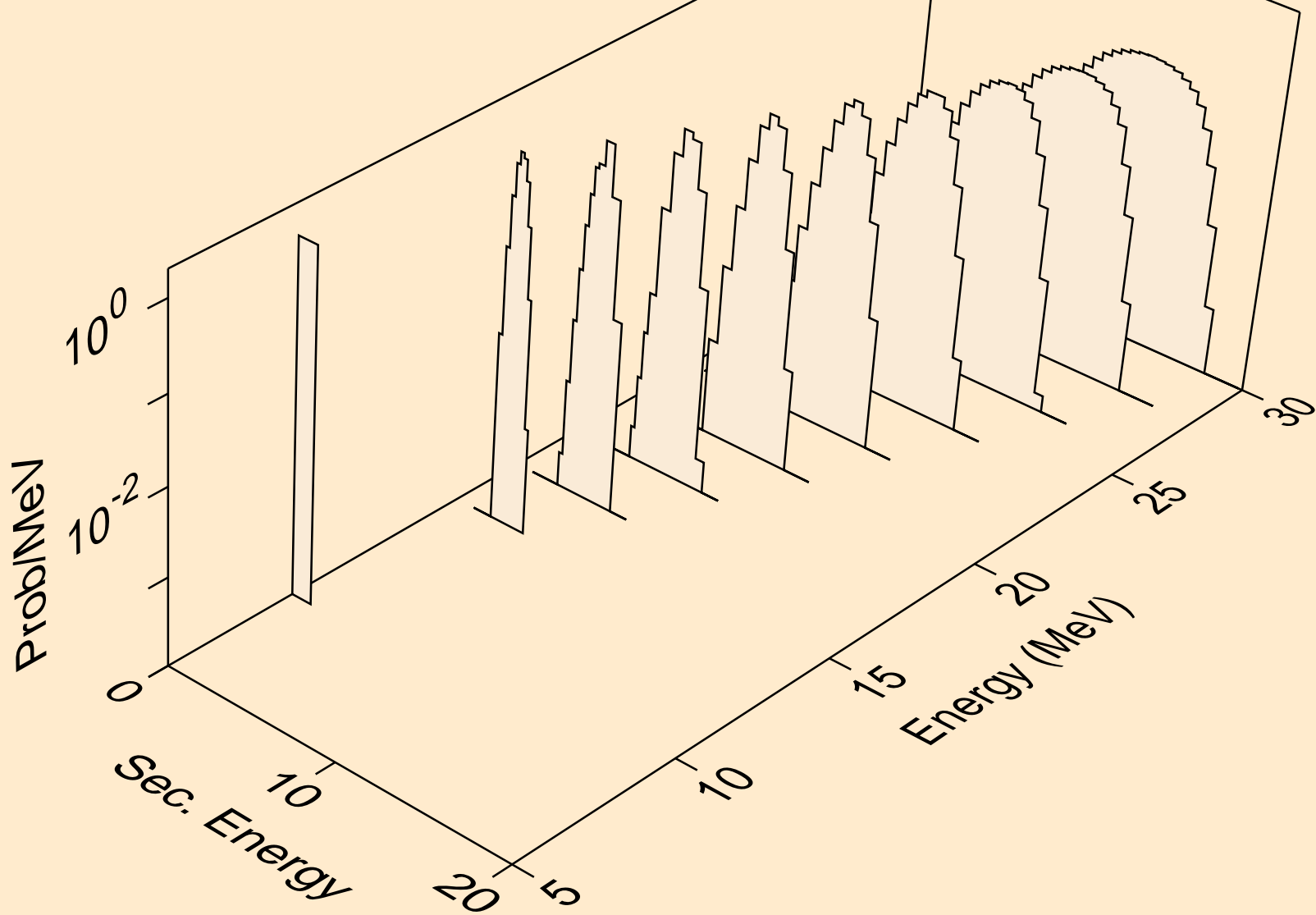

PM134M HELION ACER TENDL-2021 LIBRARY; T=0.K  
alphas from (s,x)

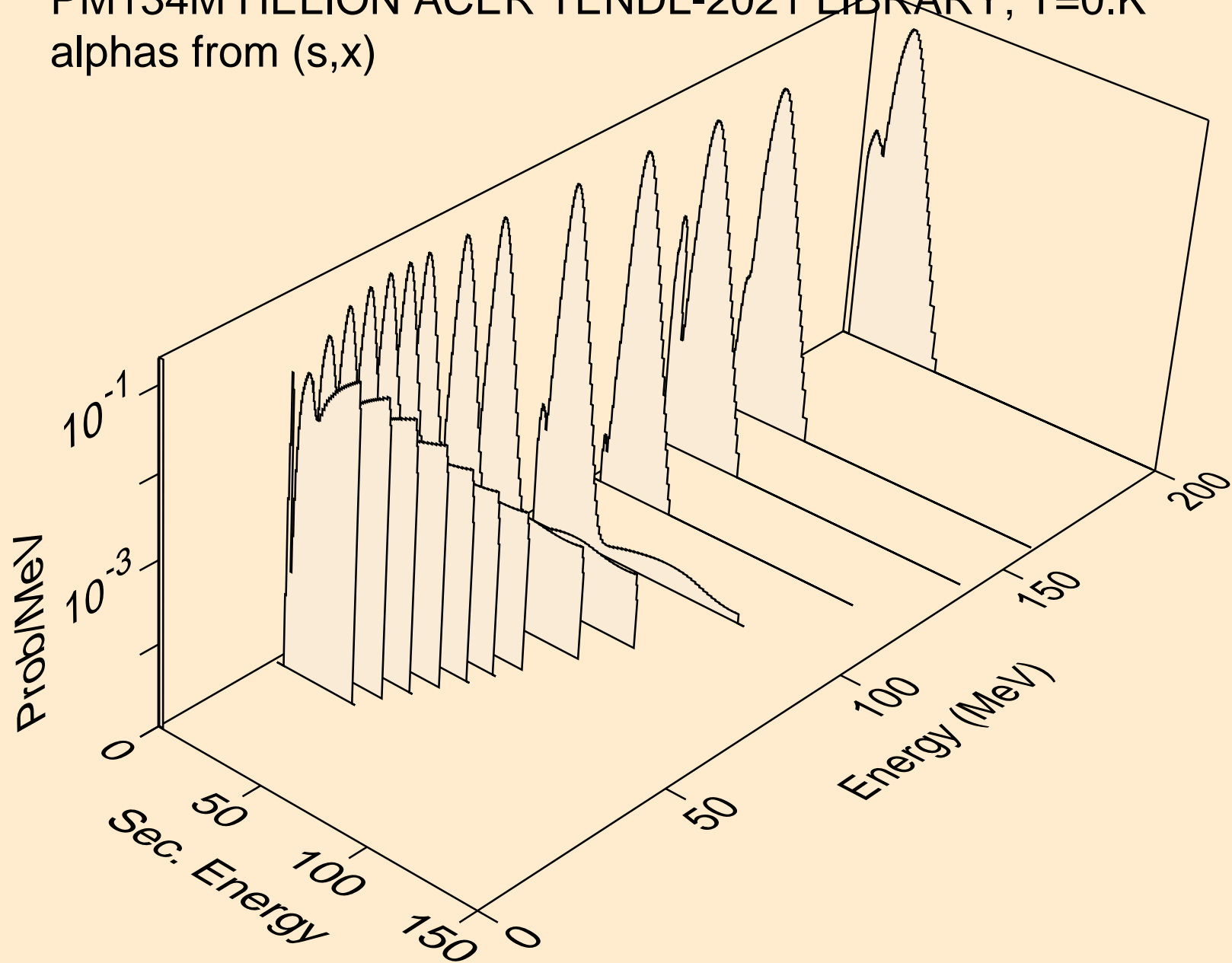

PM134M HELION ACER TENDL-2021 LIBRARY; T=0.K  
alphas from (s,n\*)a

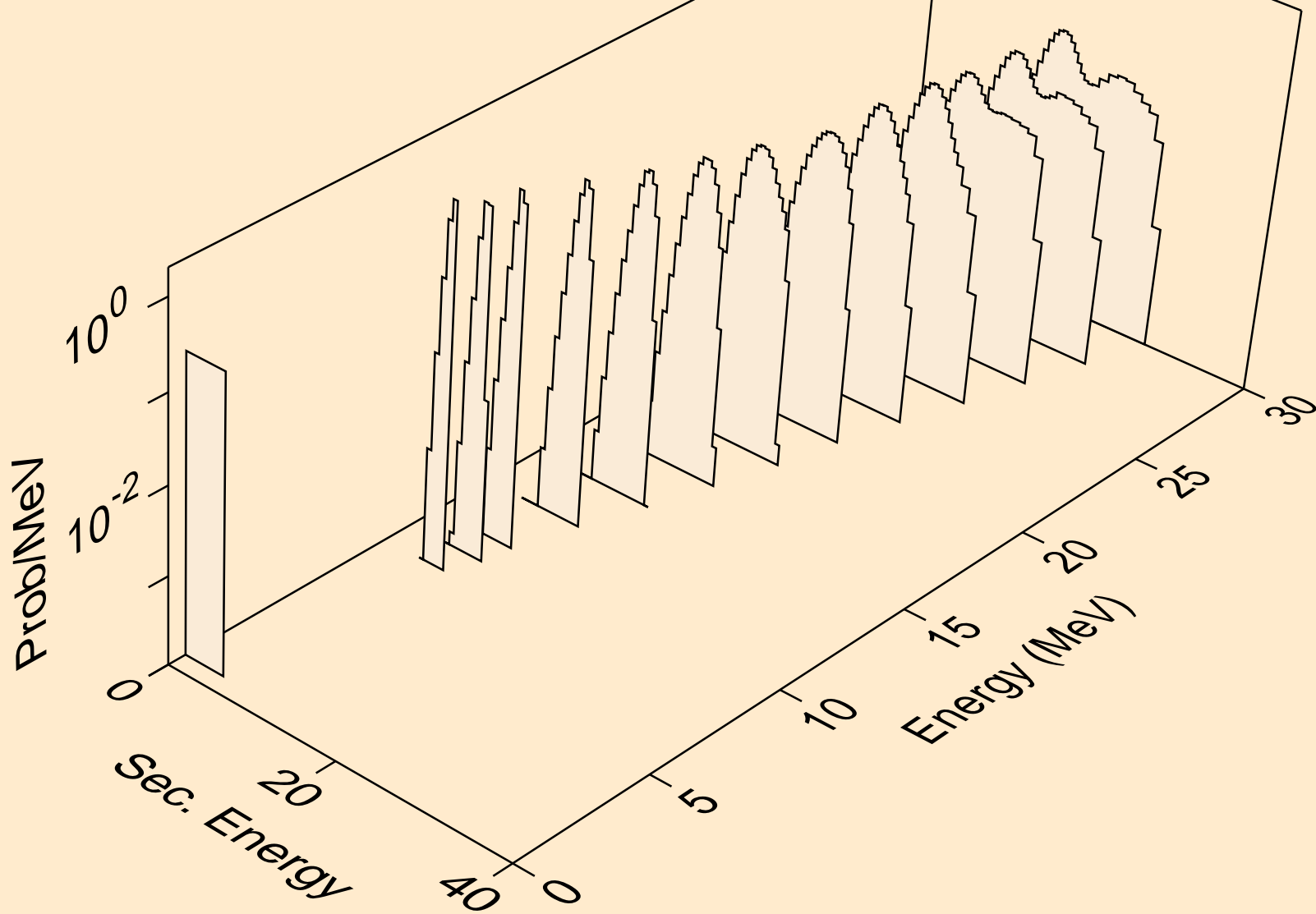

PM134M HELION ACER TENDL-2021 LIBRARY; T=0.K  
alphas from (s,2n)a

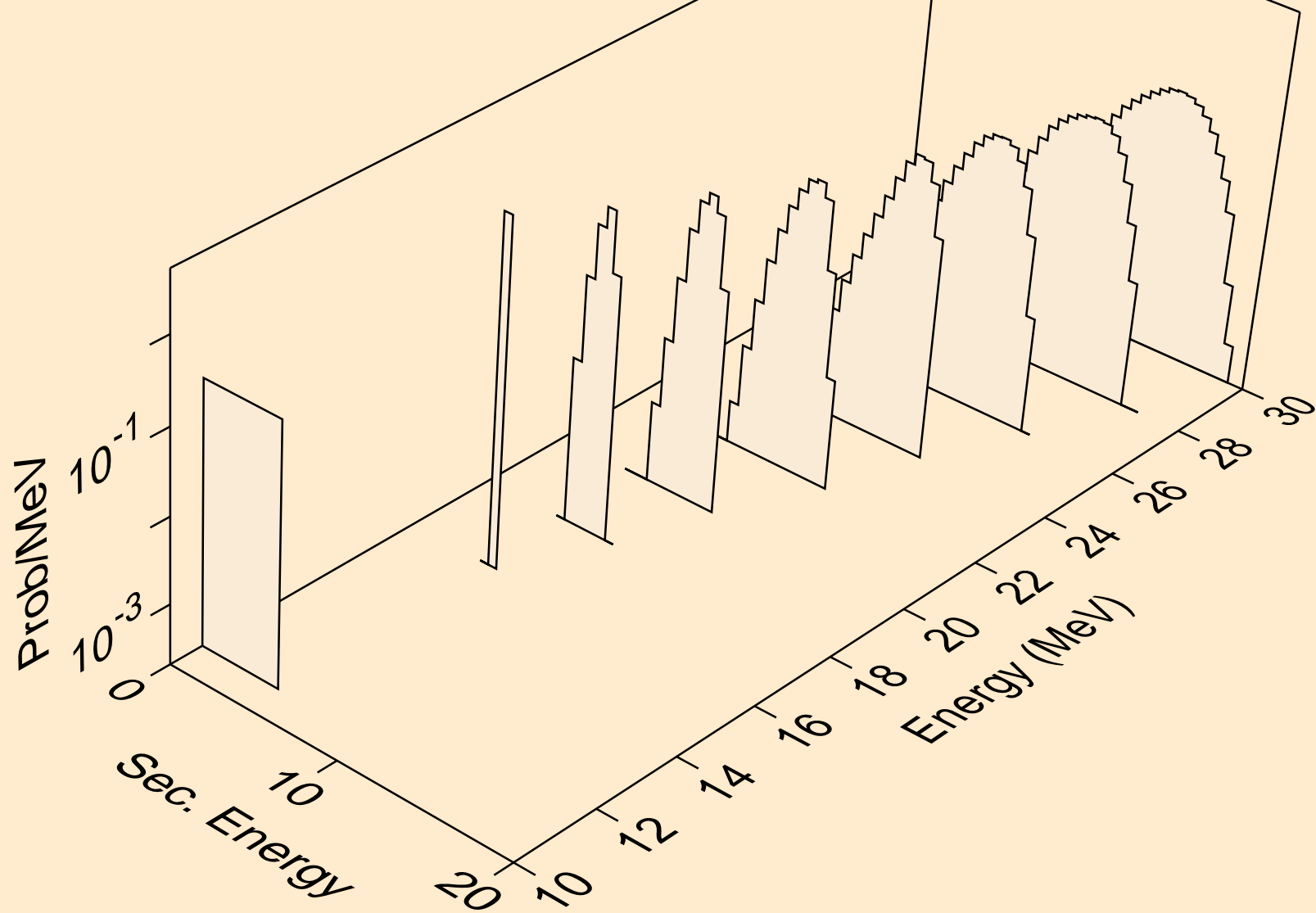

PM134M HELION ACER TENDL-2021 LIBRARY; T=0.K  
alphas from (s,n\*)2a

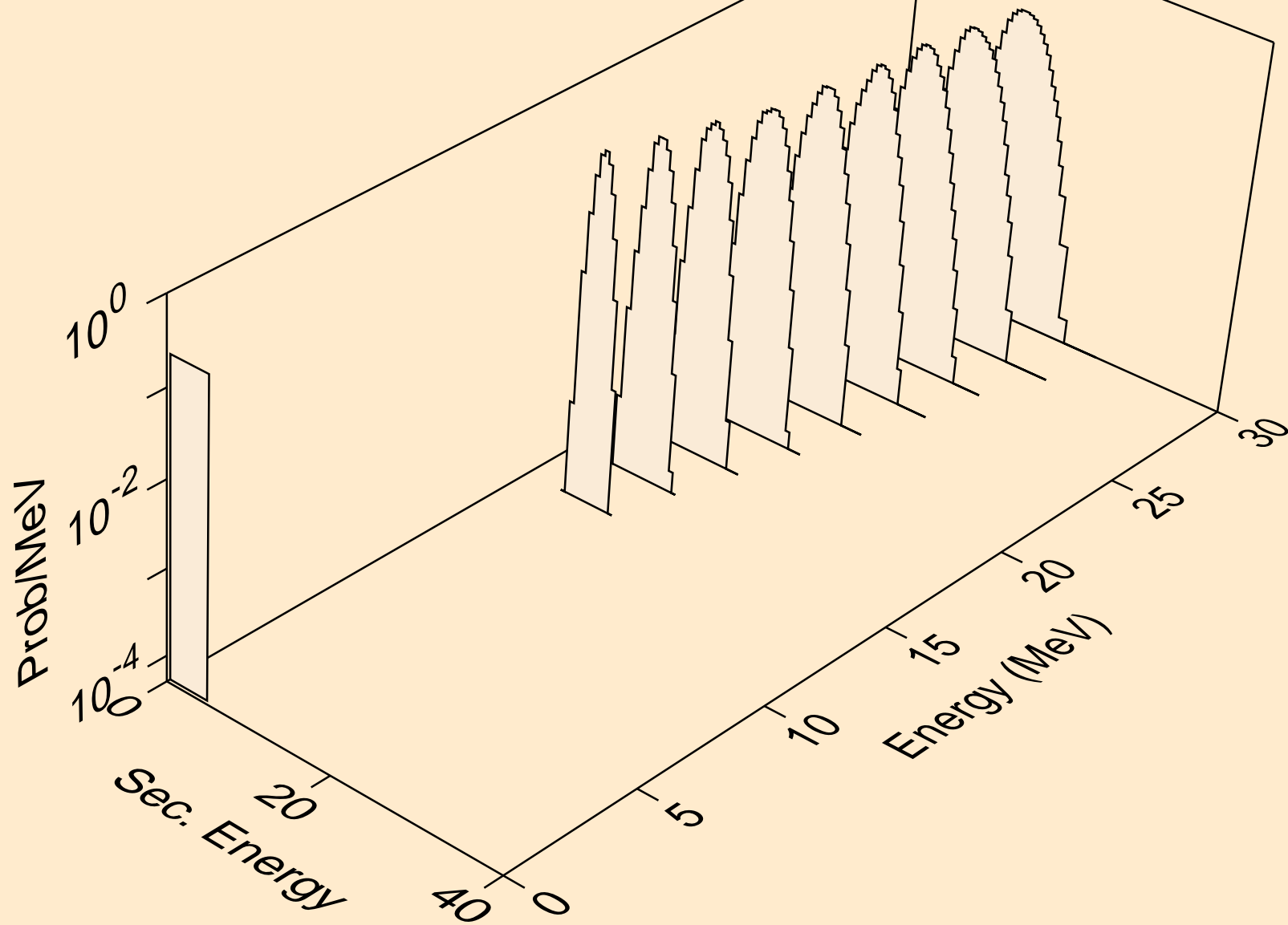

PM134M HELION ACER TENDL-2021 LIBRARY; T=0.K  
alphas from (s,npa)

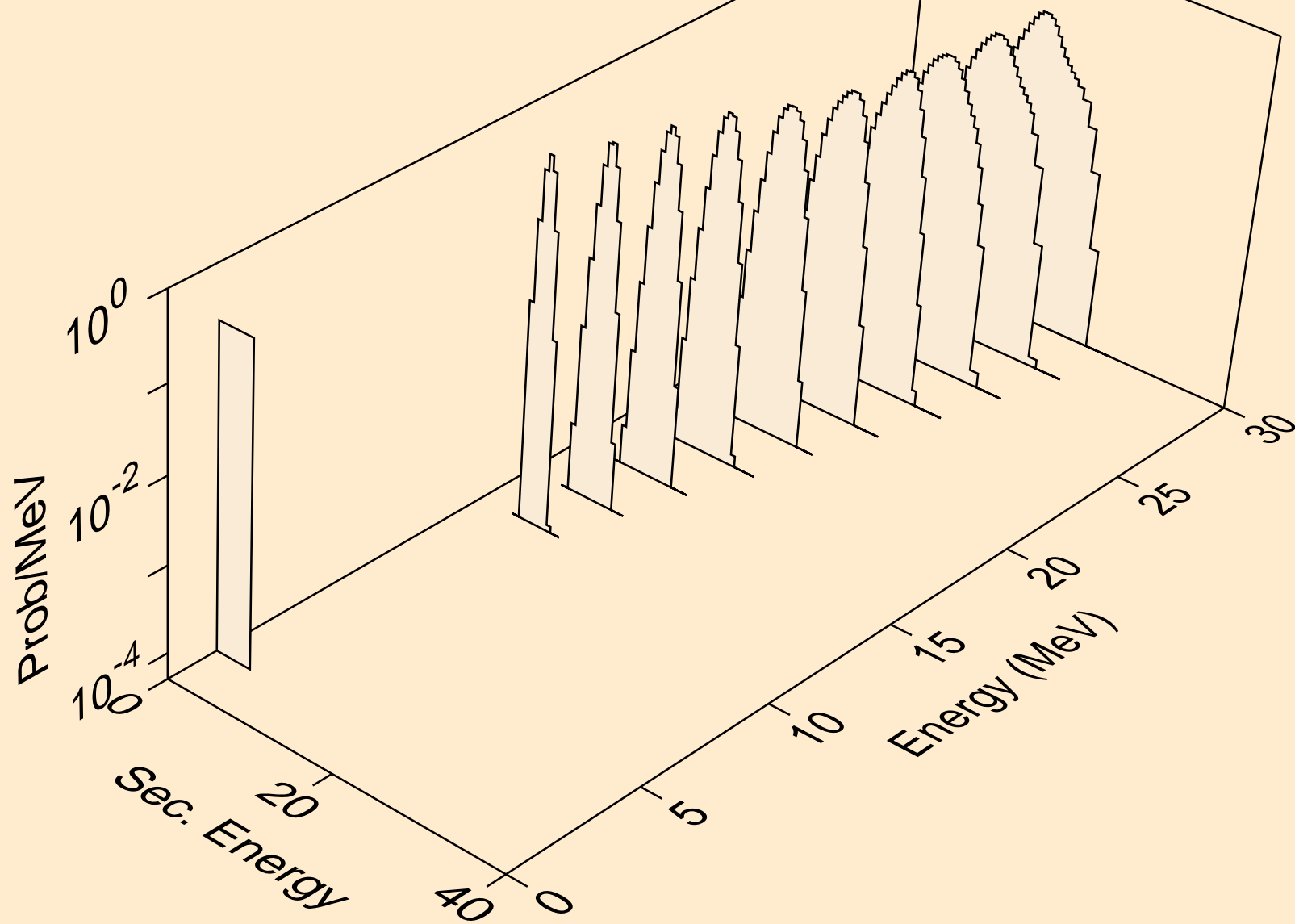

PM134M HELION ACER TENDL-2021 LIBRARY; T=0.K  
alphas from (s,a)

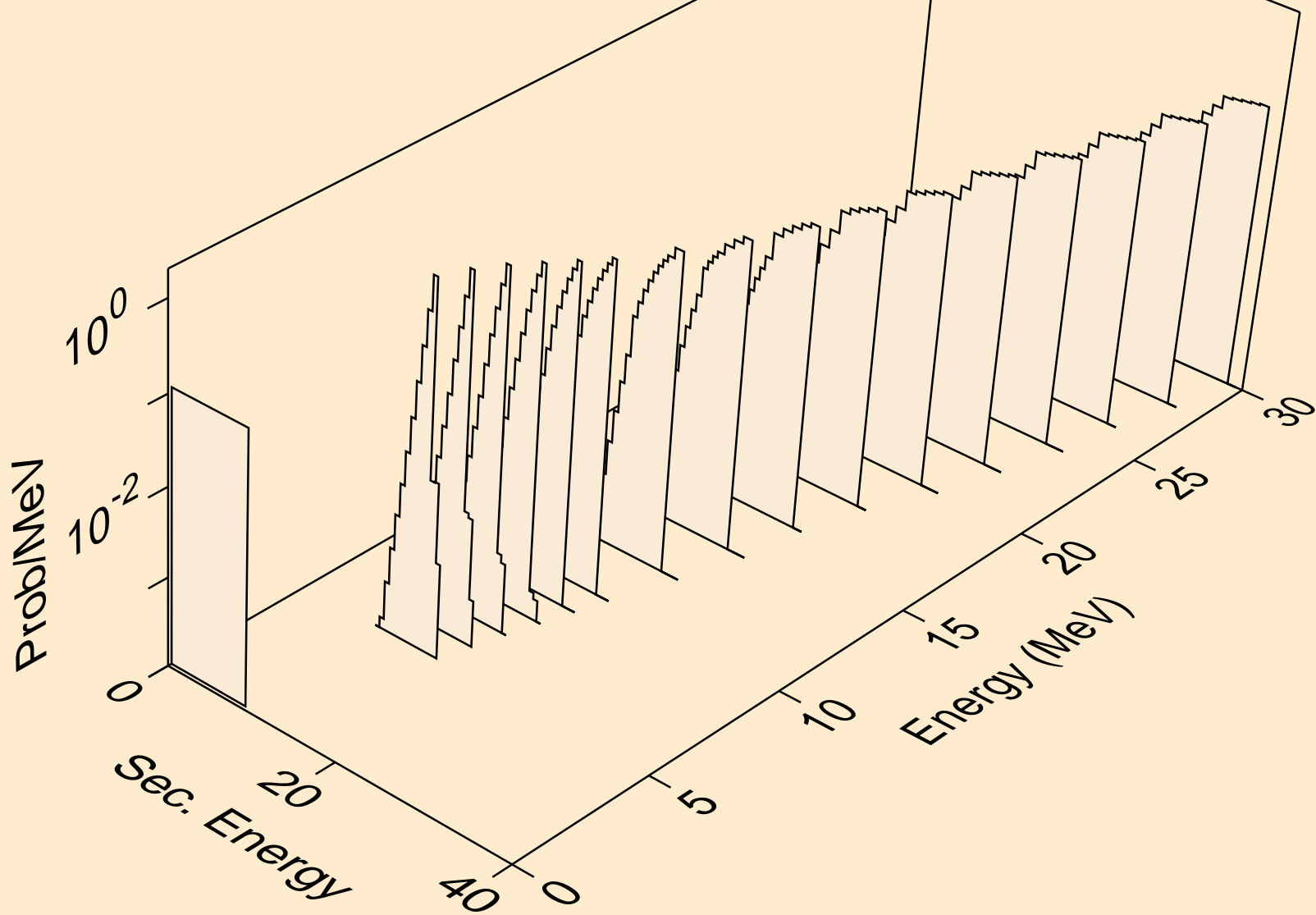

PM134M HELION ACER TENDL-2021 LIBRARY; T=0.K  
alphas from (s,2a)

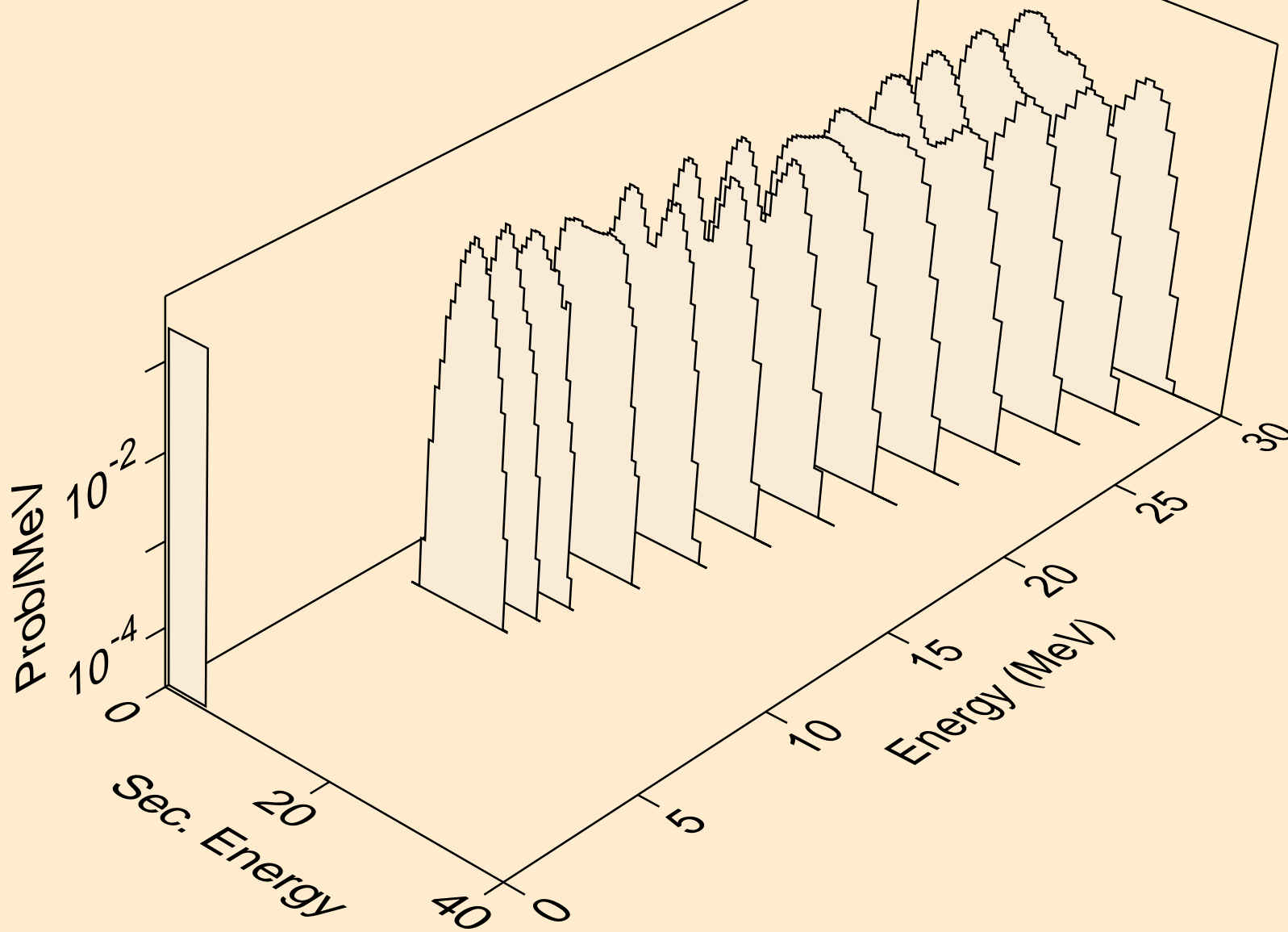



PM134M HELION ACER TENDL-2021 LIBRARY; T=0.K  
alphas from (s,pa)

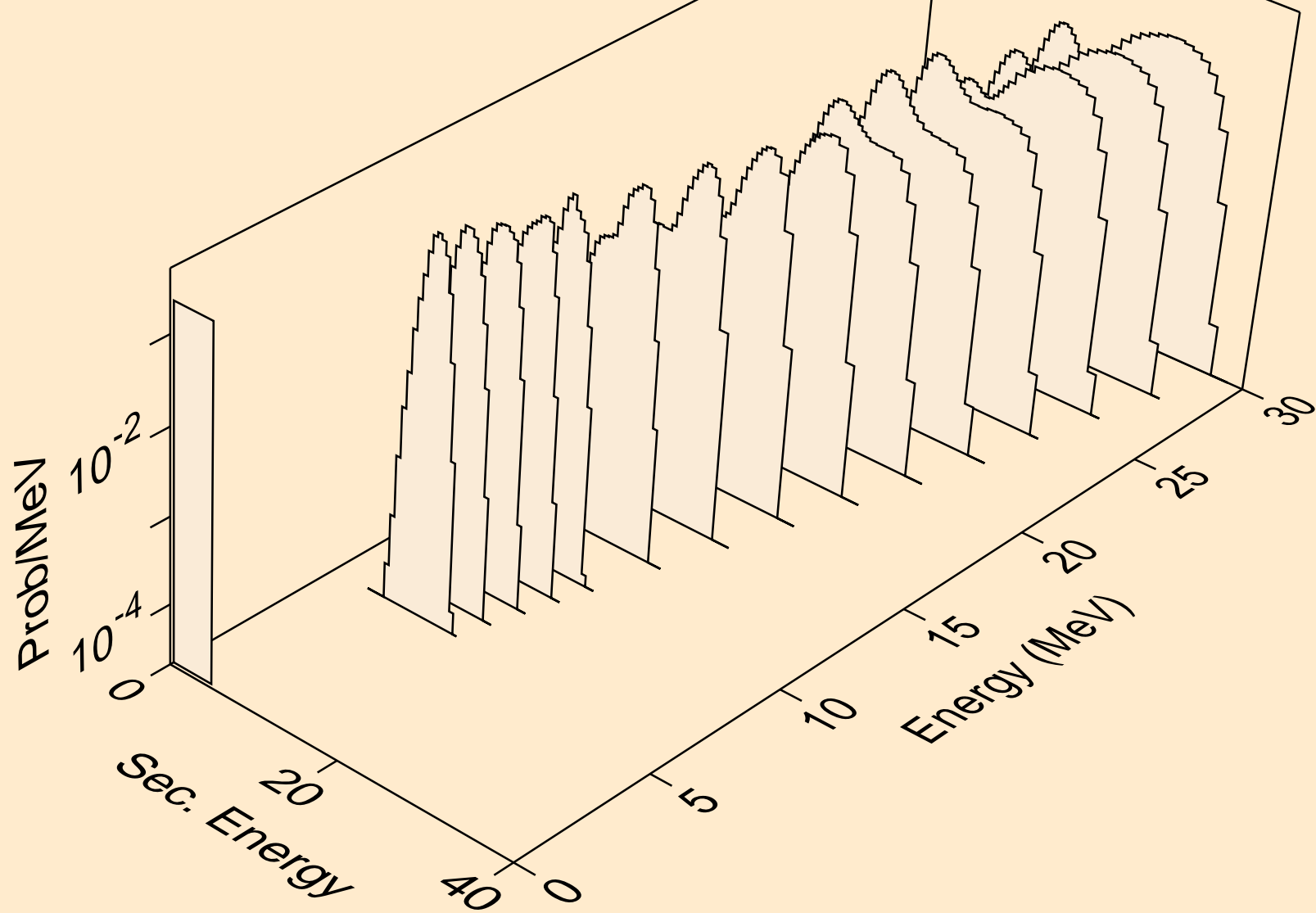

PM134M HELION ACER TENDL-2021 LIBRARY; T=0.K  
alphas from (s,da)

