

PM136 HELION ACER TENDL-2021 LIBRARY; T=0.K
Principal cross sections

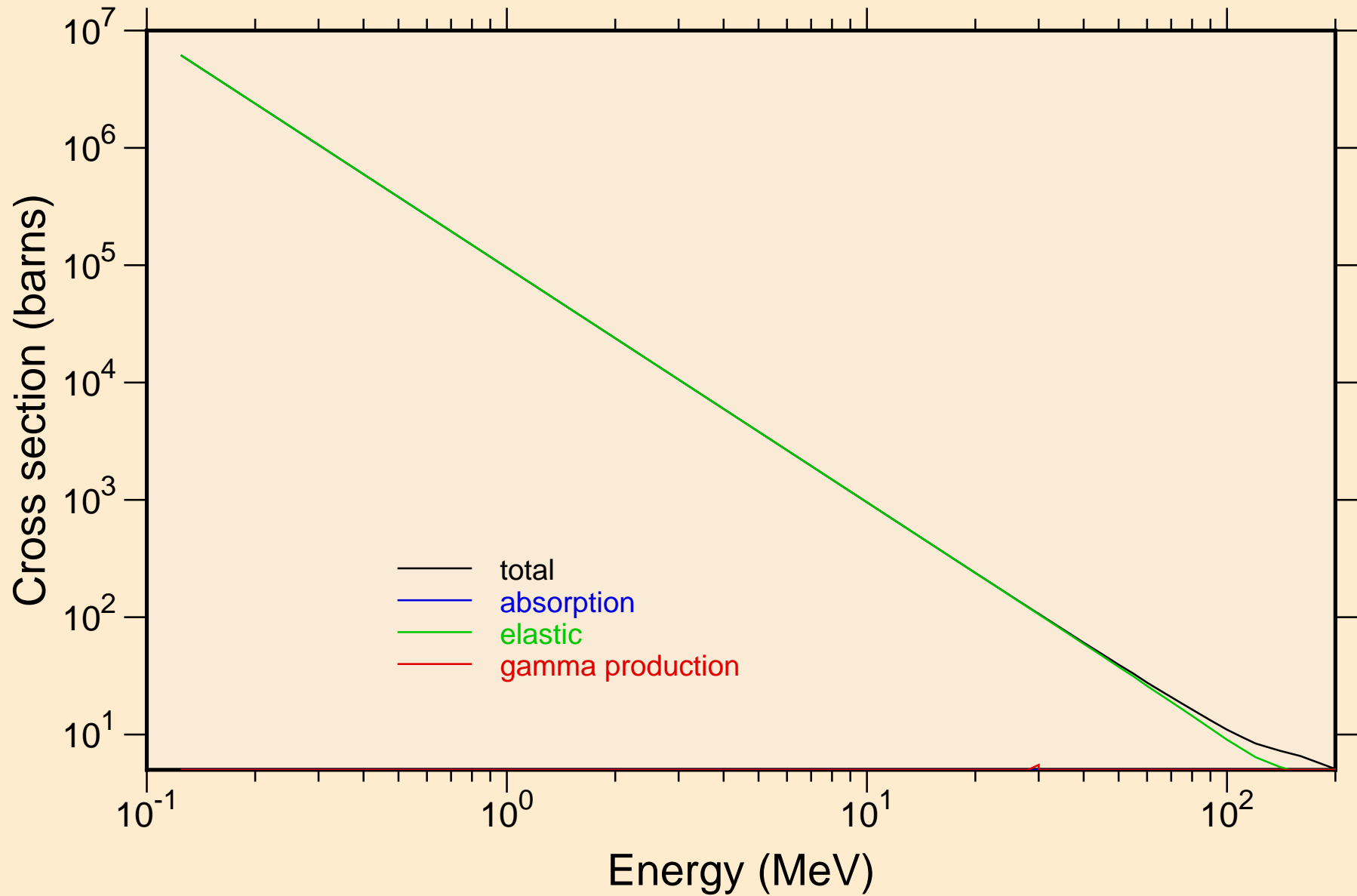

PM136 HELION ACER TENDL-2021 LIBRARY; T=0.K
Heating

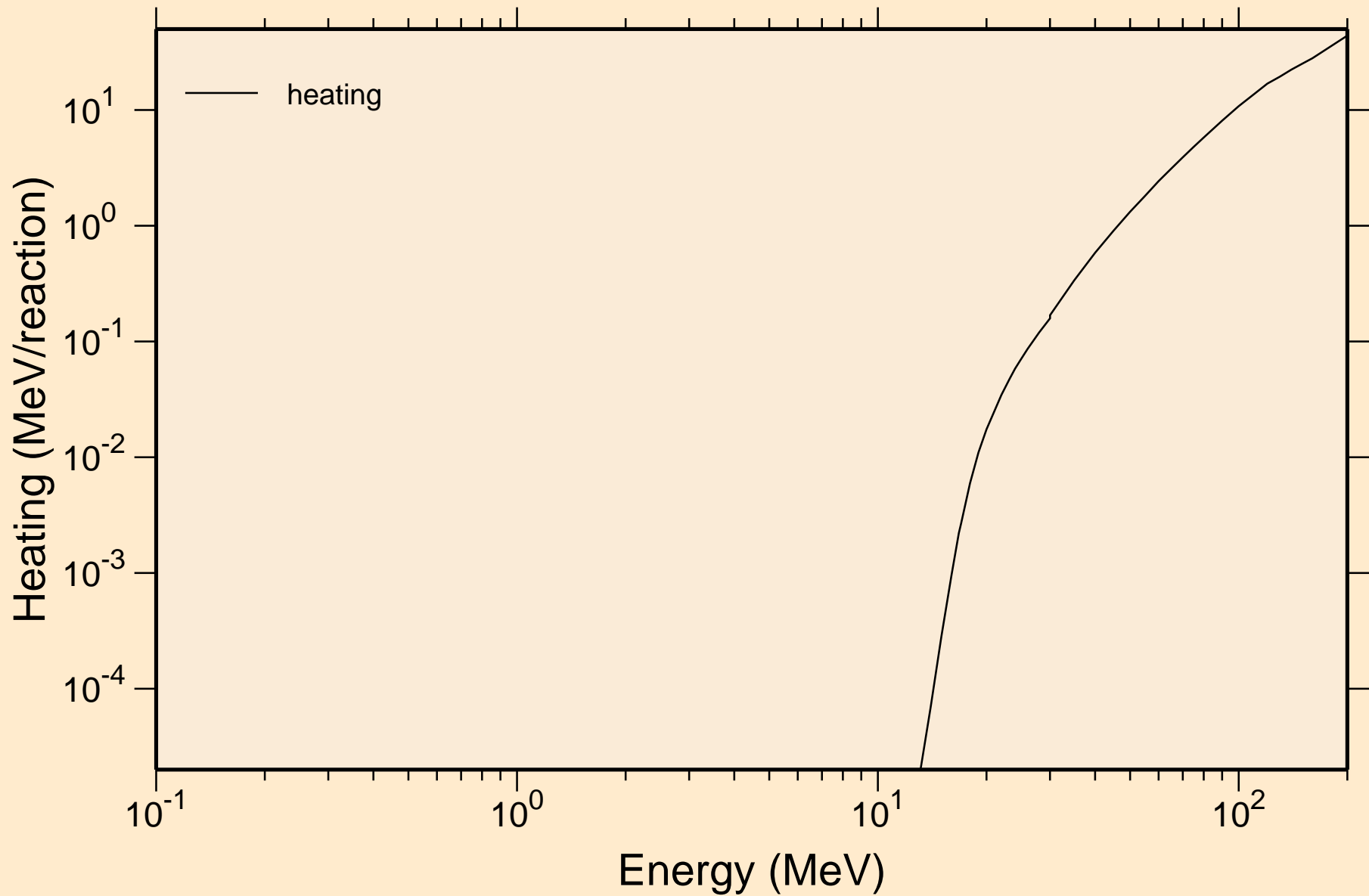

PM136 HELION ACER TENDL-2021 LIBRARY; T=0.K

Principal cross sections

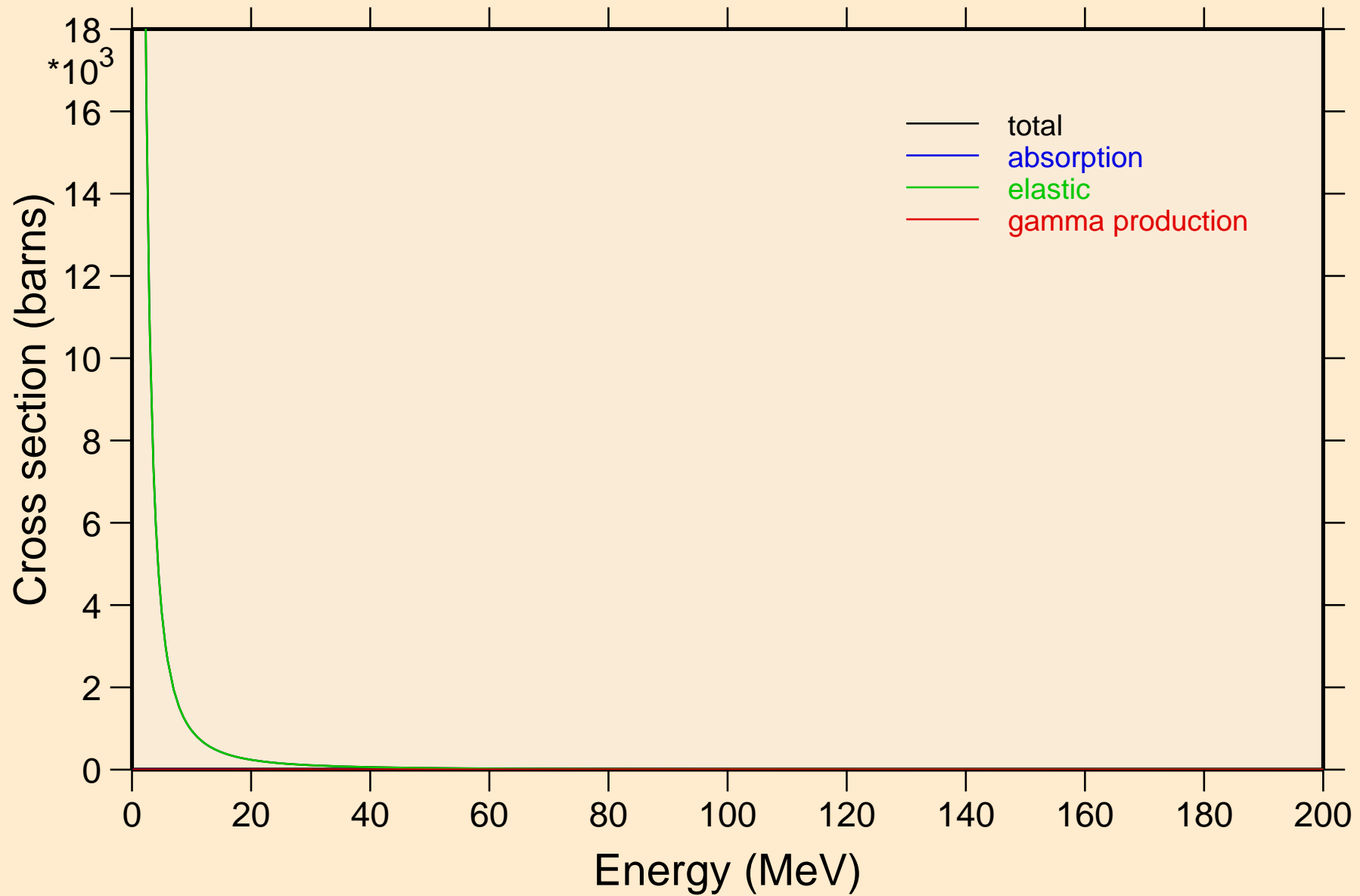

PM136 HELION ACER TENDL-2021 LIBRARY; T=0.K

Heating

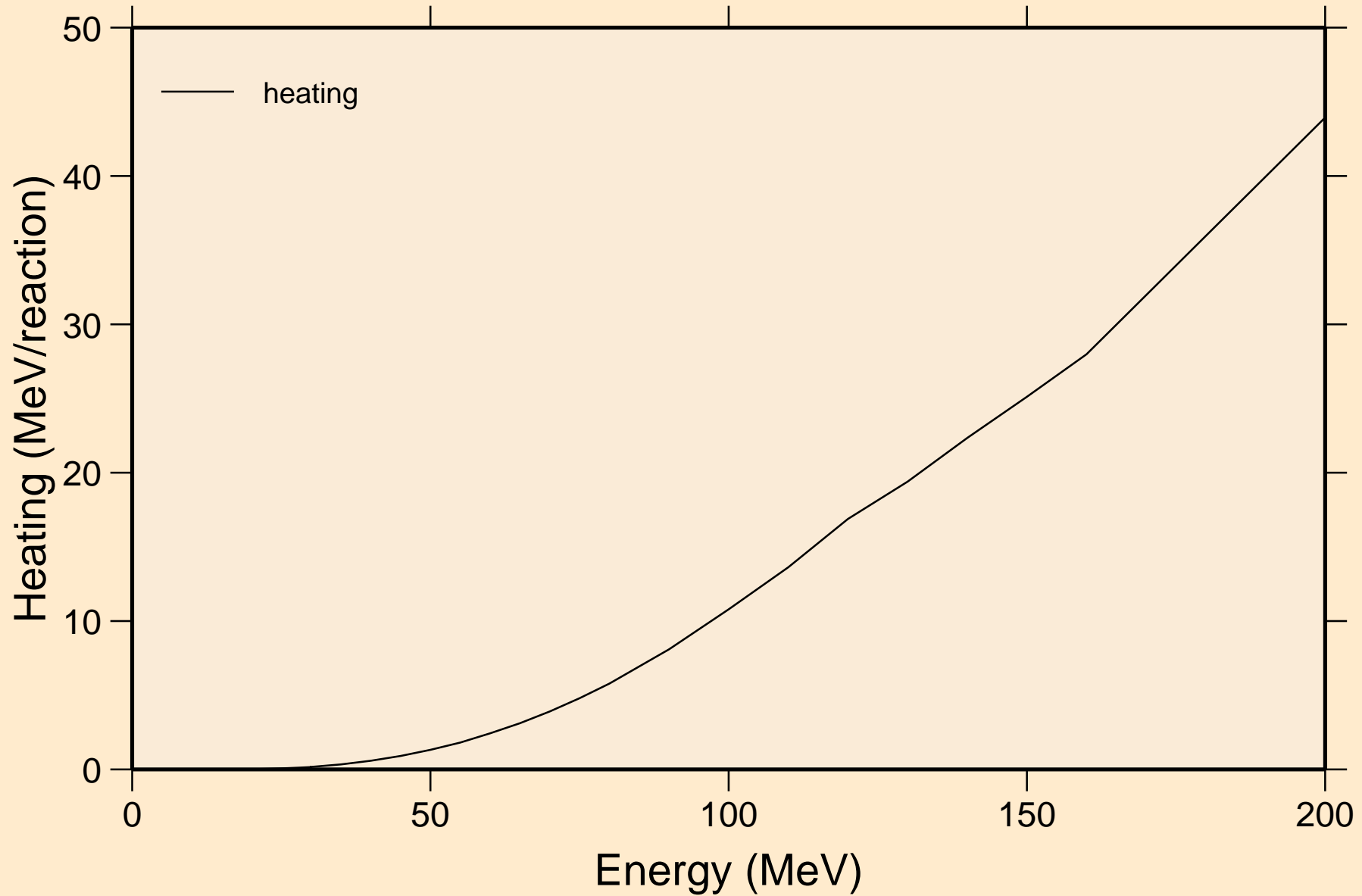

PM136 HELION ACER TENDL-2021 LIBRARY; T=0.K
Threshold reactions

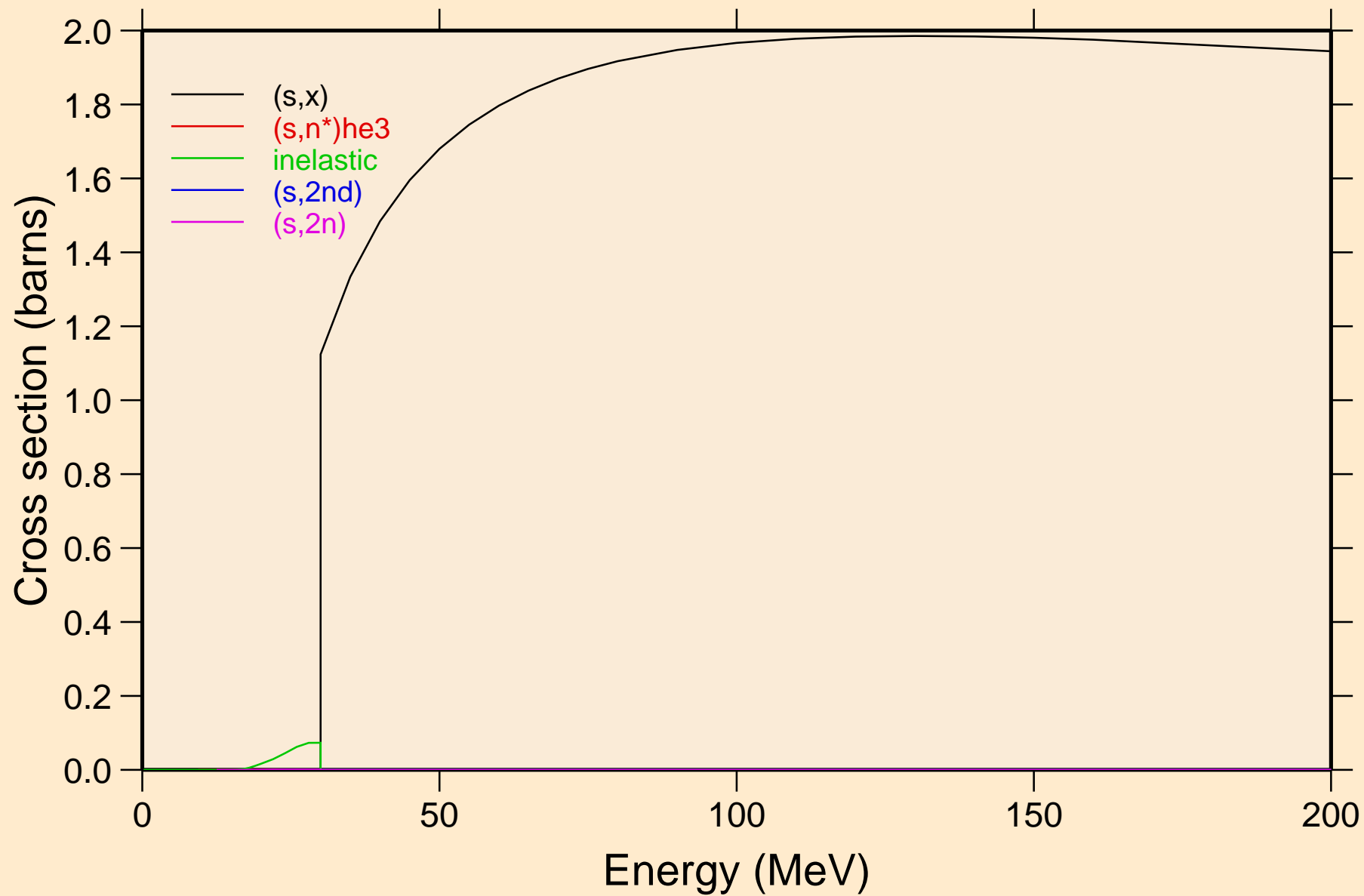

PM136 HELION ACER TENDL-2021 LIBRARY; T=0.K
Threshold reactions

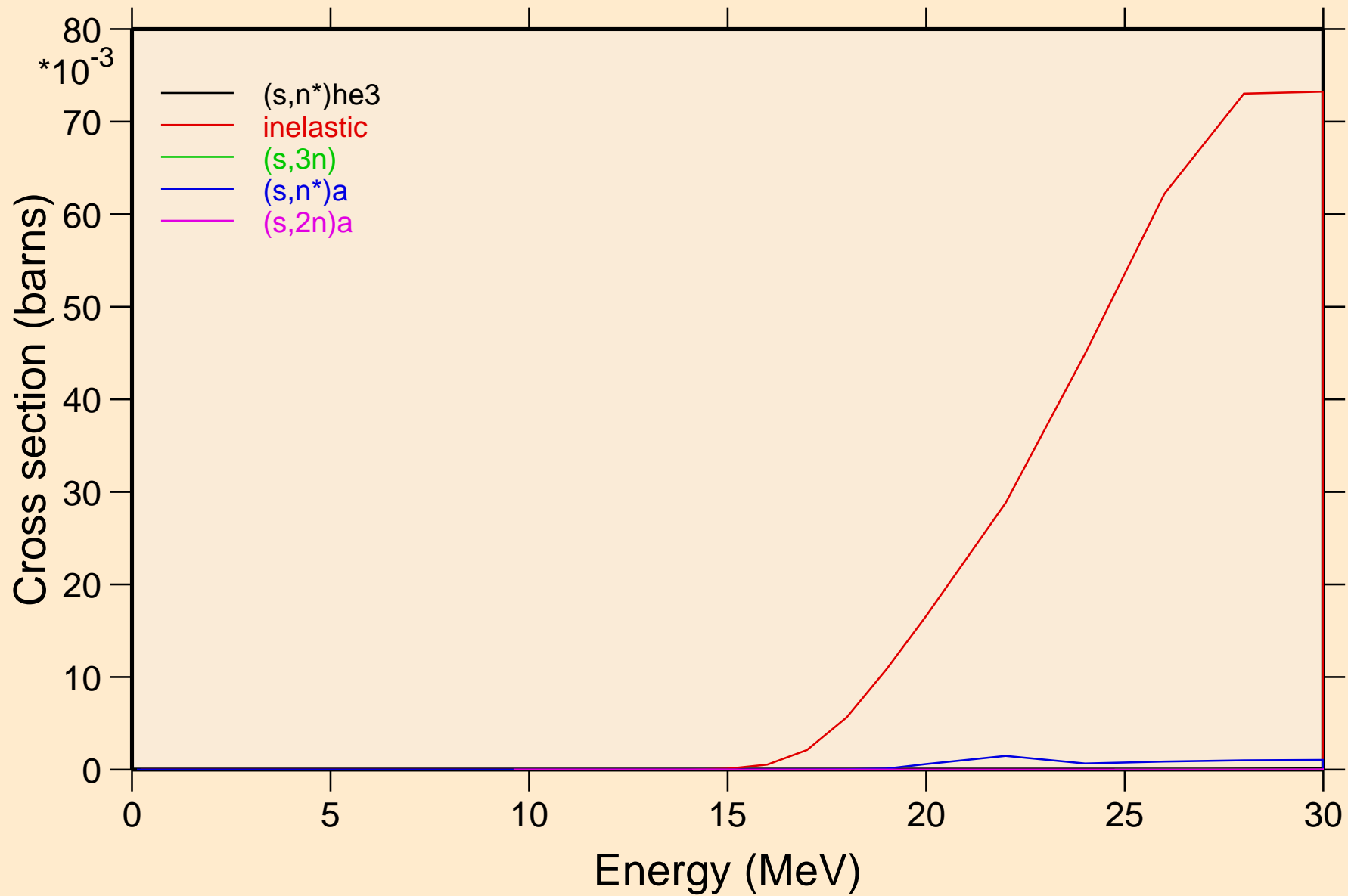

PM136 HELION ACER TENDL-2021 LIBRARY; T=0.K
Threshold reactions

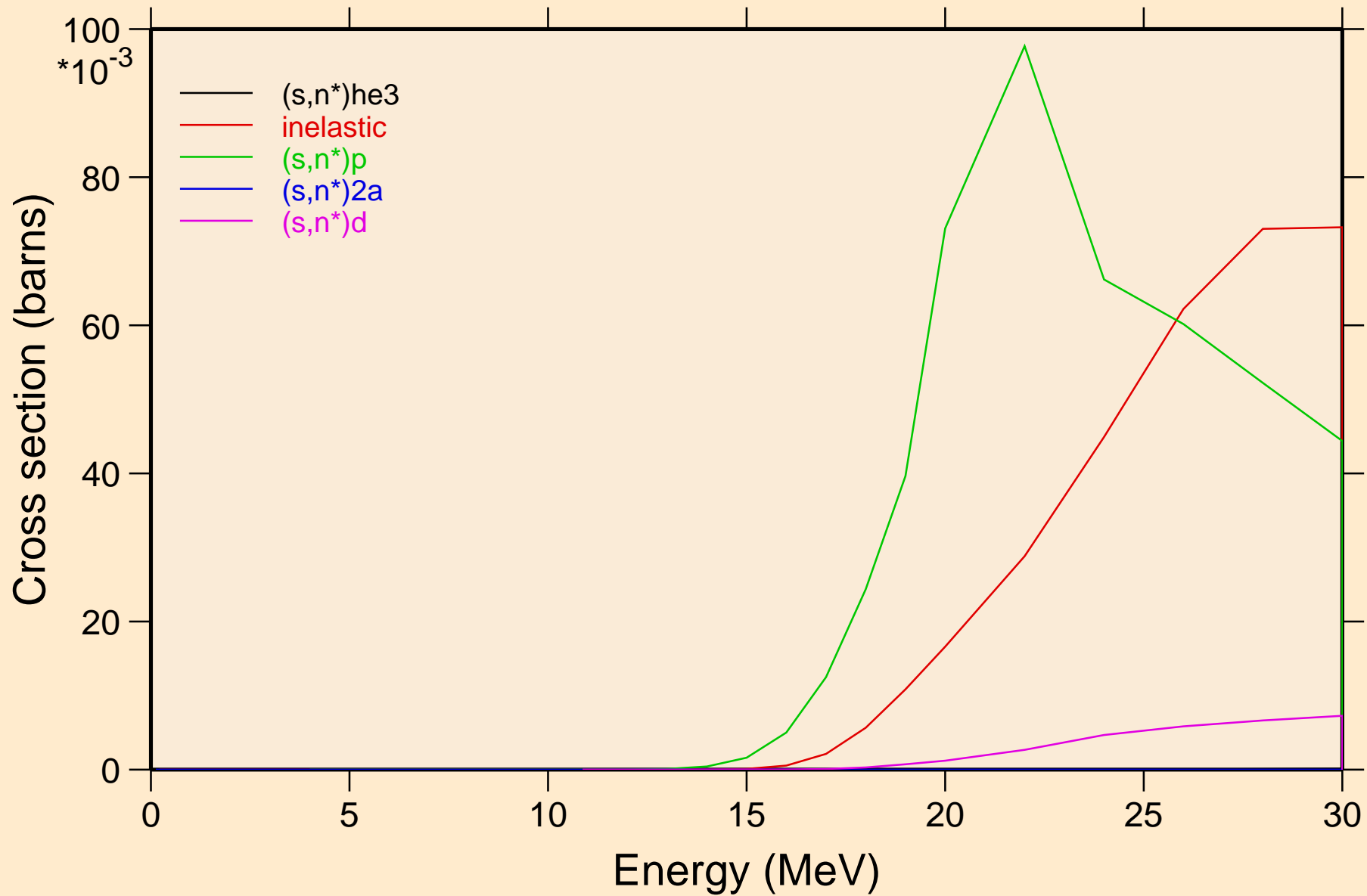

PM136 HELION ACER TENDL-2021 LIBRARY; T=0.K
Threshold reactions

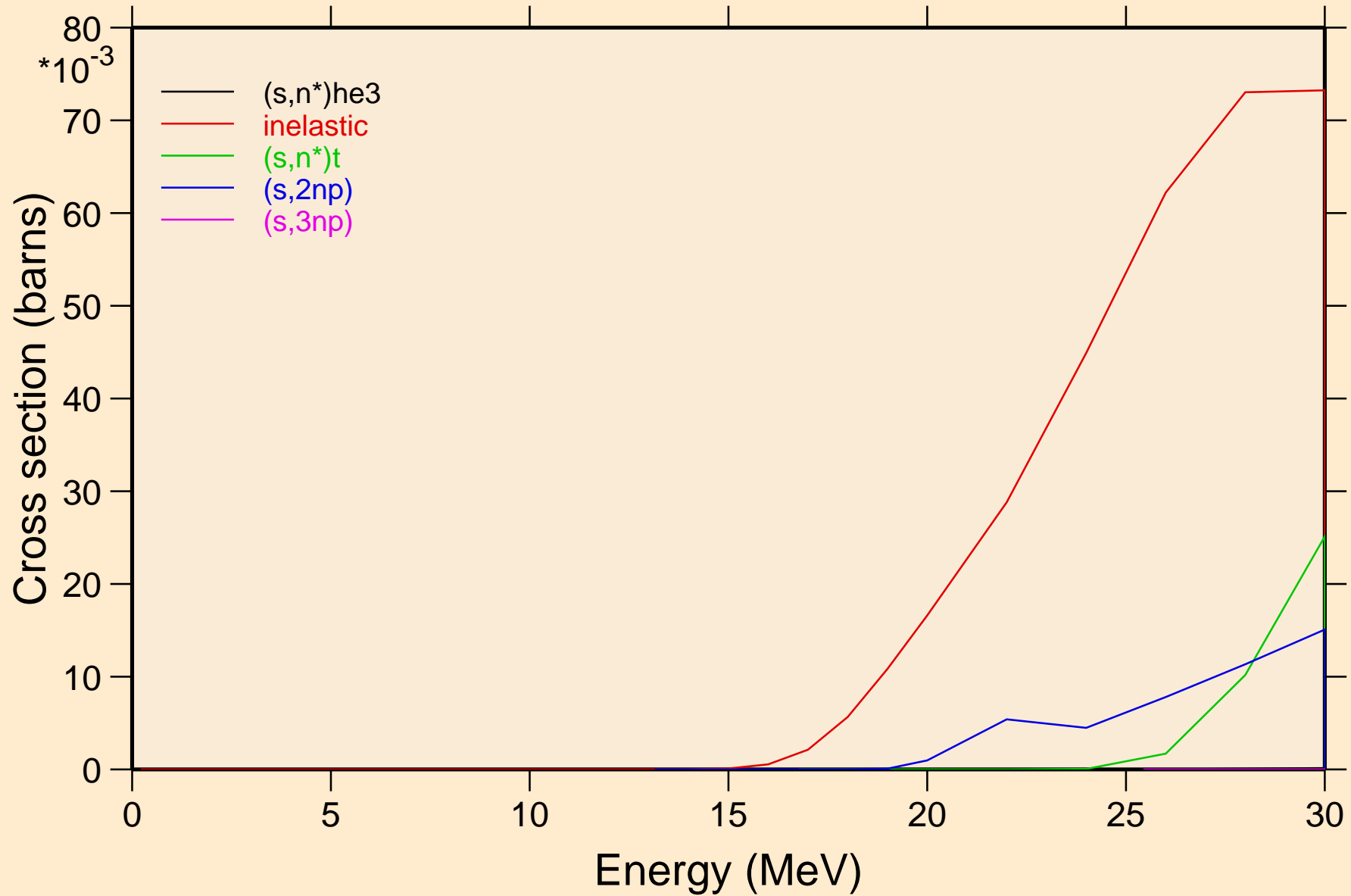

PM136 HELION ACER TENDL-2021 LIBRARY; T=0.K
Threshold reactions

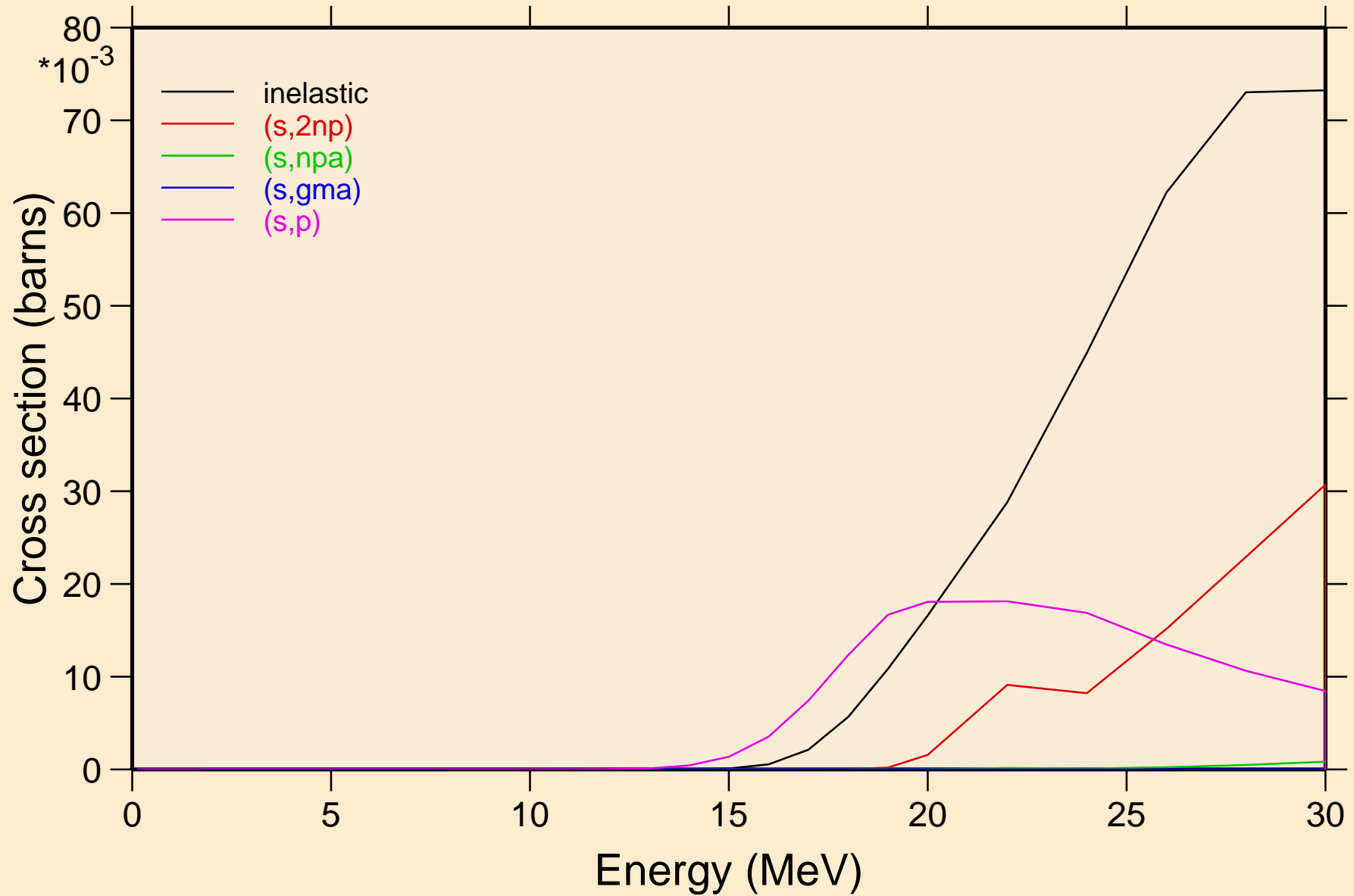

PM136 HELION ACER TENDL-2021 LIBRARY; T=0.K
Threshold reactions

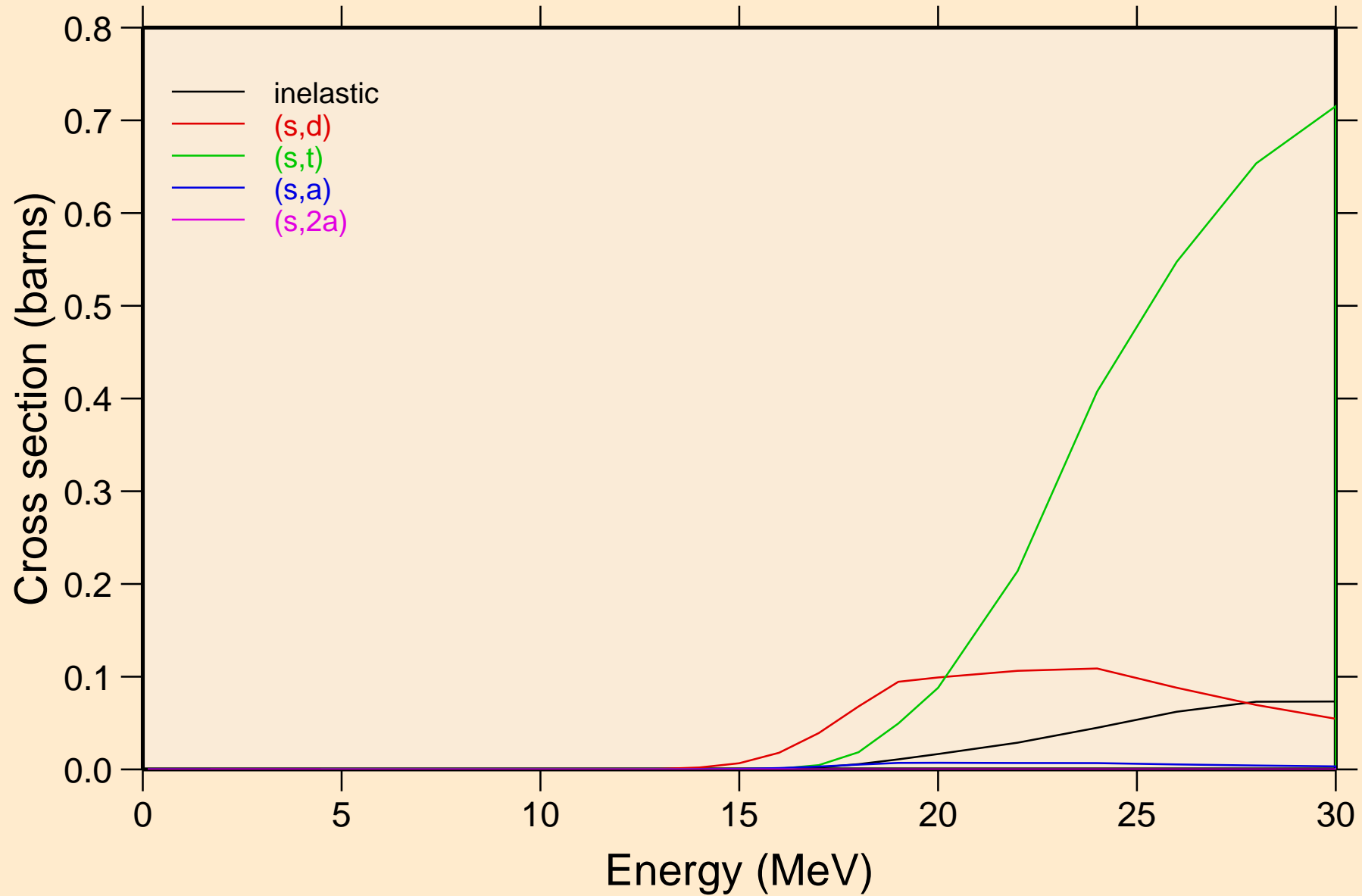

PM136 HELION ACER TENDL-2021 LIBRARY; T=0.K
Threshold reactions

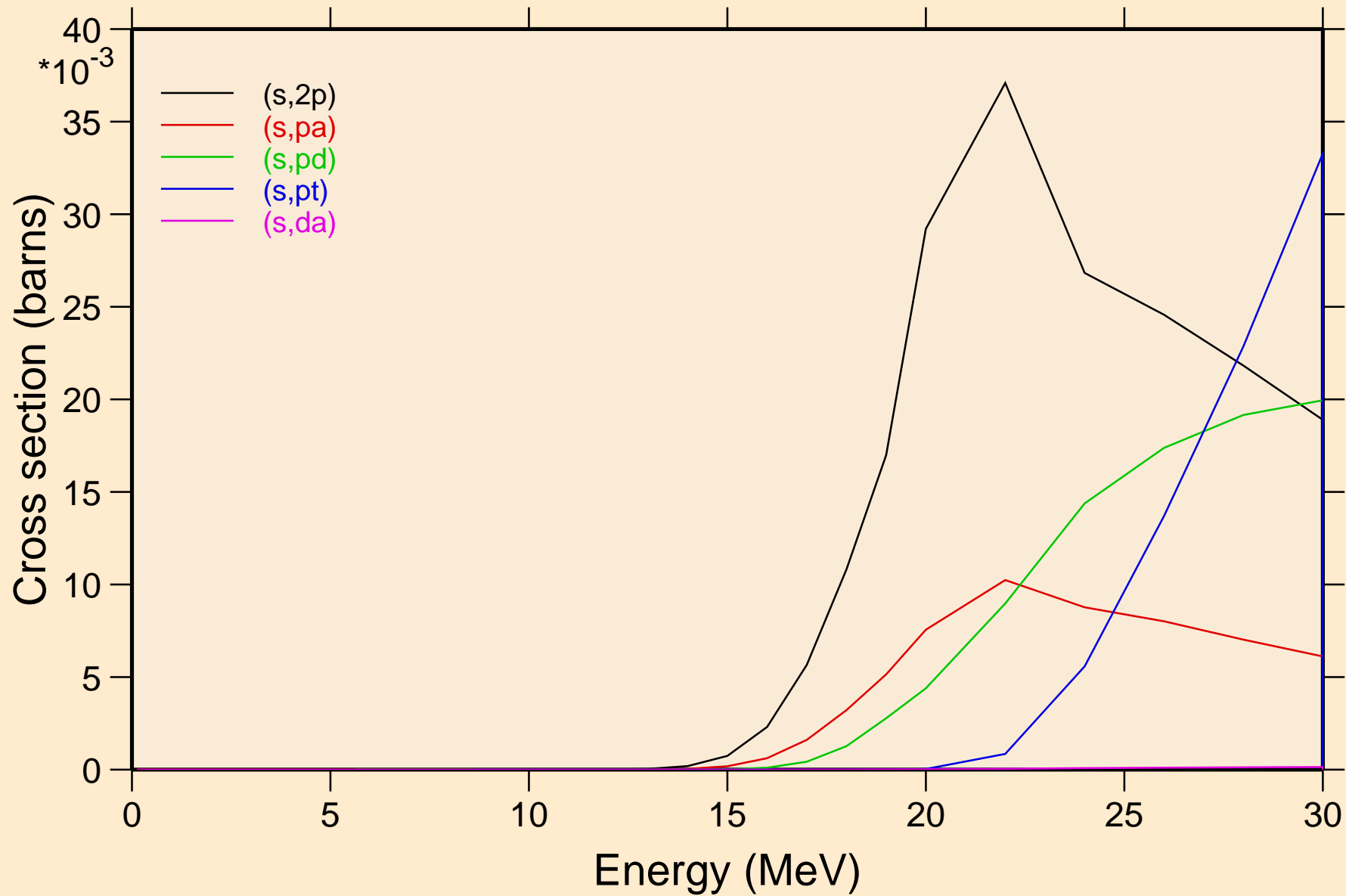

PM136 HELION ACER TENDL-2021 LIBRARY; T=0.K
angular distribution for elastic

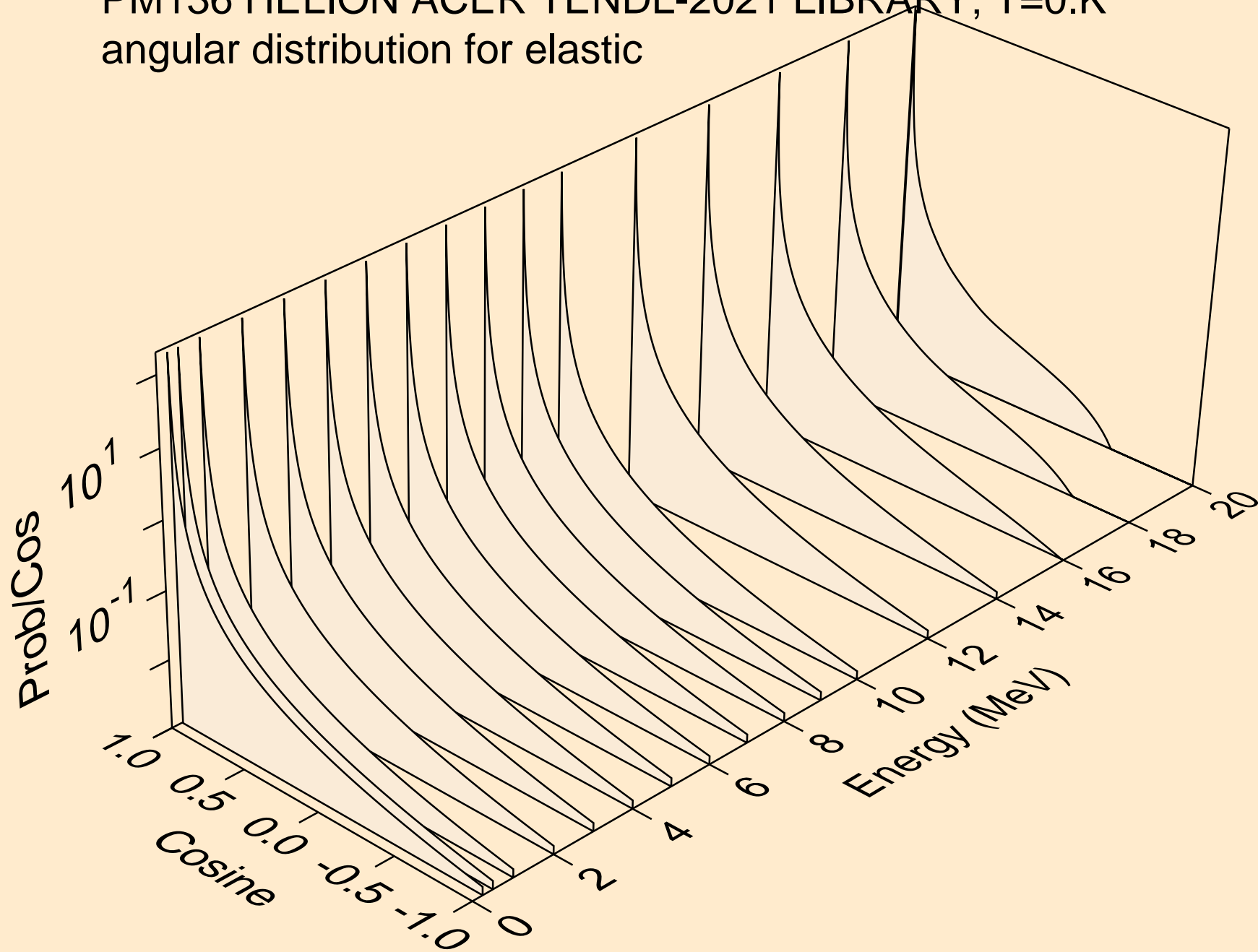

PM136 HELION ACER TENDL-2021 LIBRARY; T=0.K
angular distribution for elastic

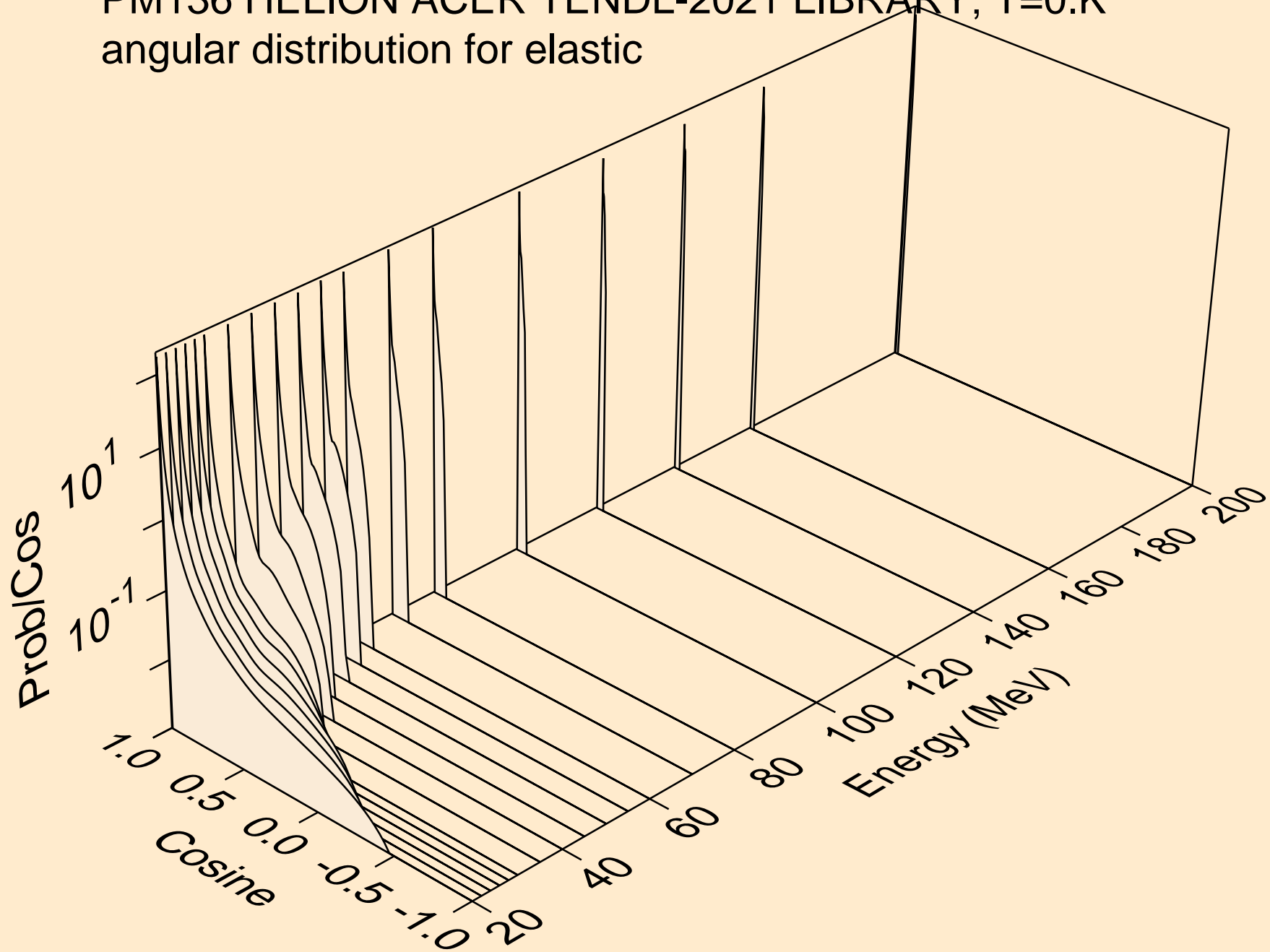

PM136 HELION ACER TENDL-2021 LIBRARY; T=0.K
He-3 emission for (s,x)

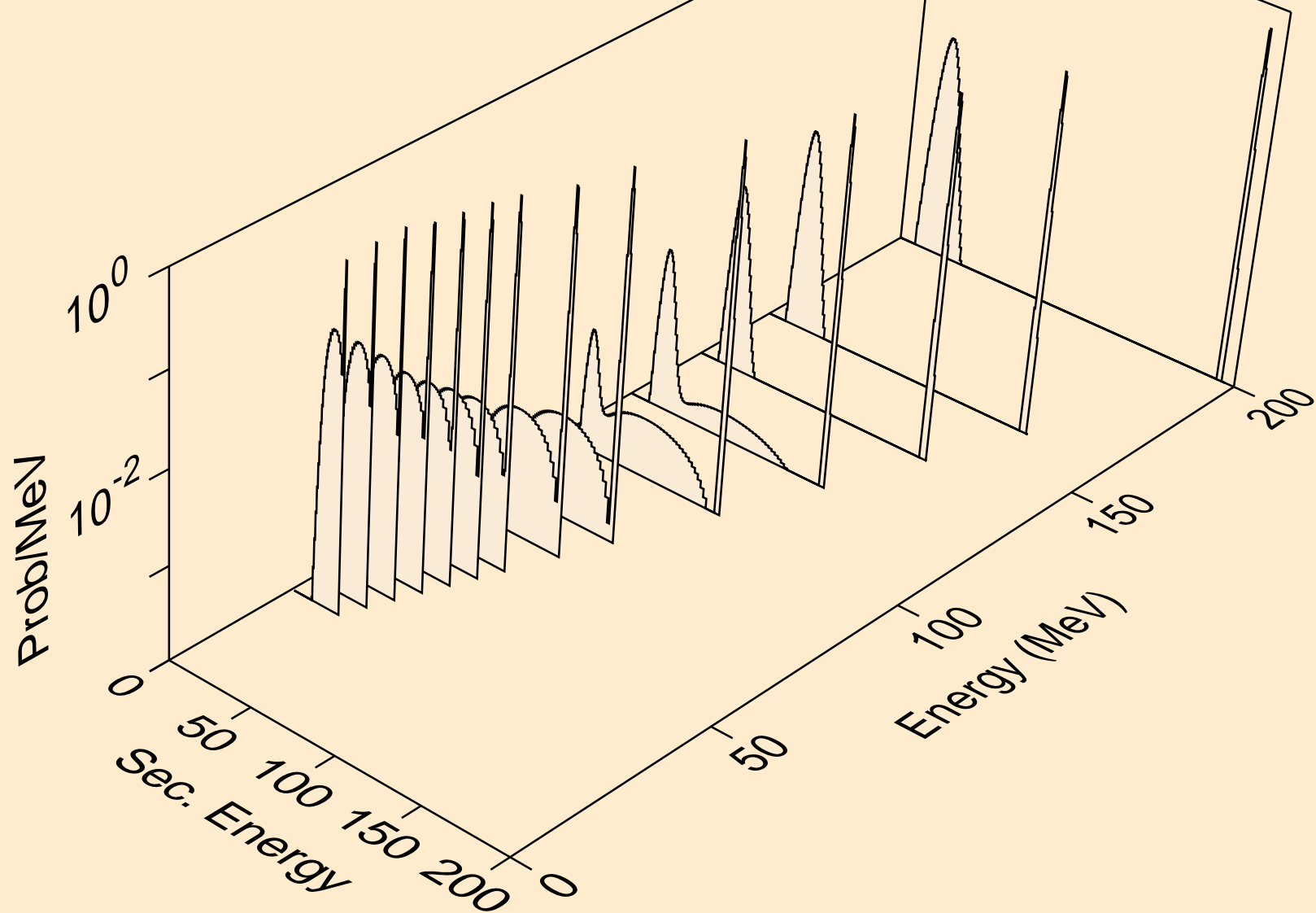

PM136 HELION ACER TENDL-2021 LIBRARY; T=0.K
He-3 emission for (s,n*)he3

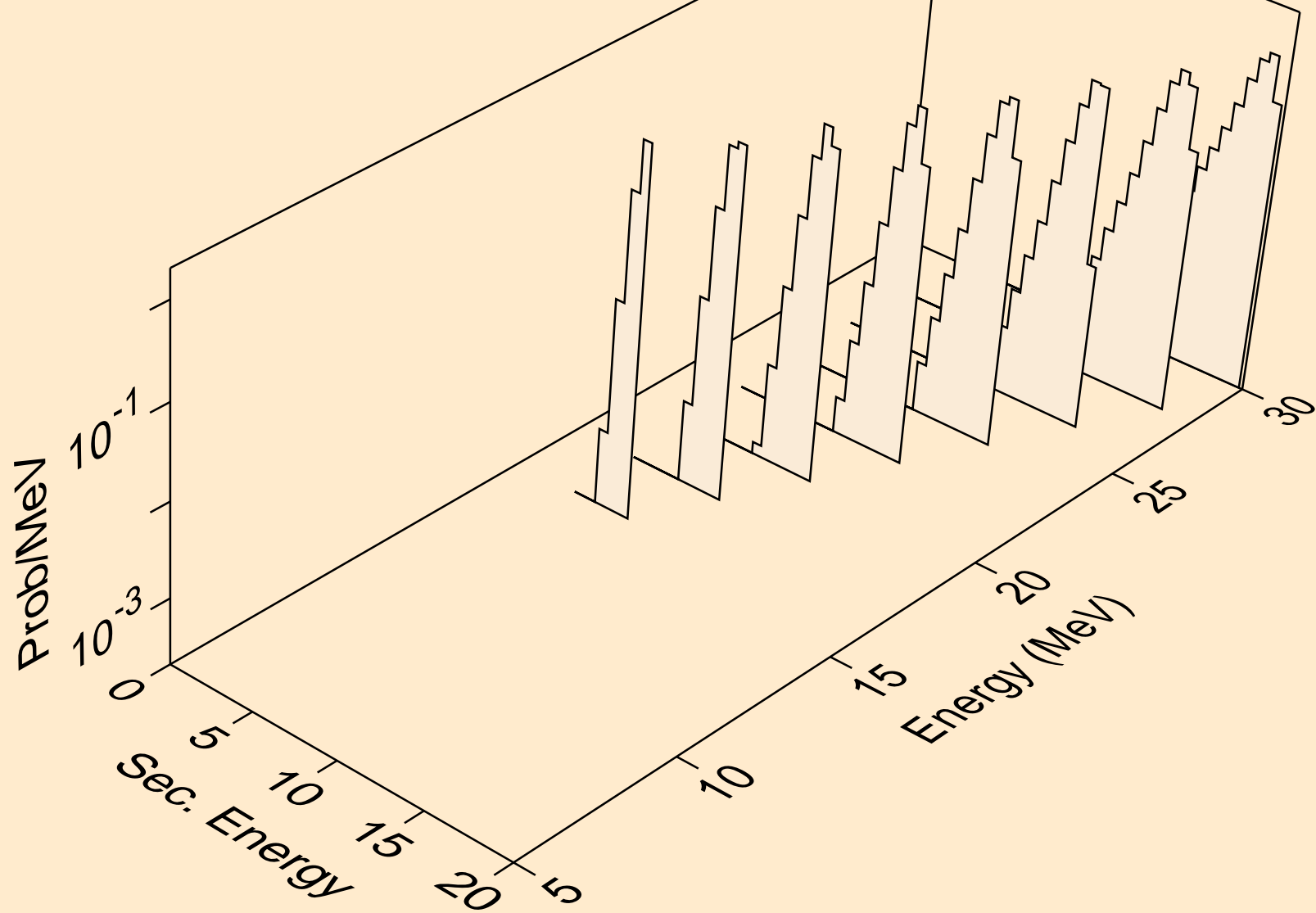

PM136 HELION ACER TENDL-2021 LIBRARY; T=0.K
He-3 emission for inelastic

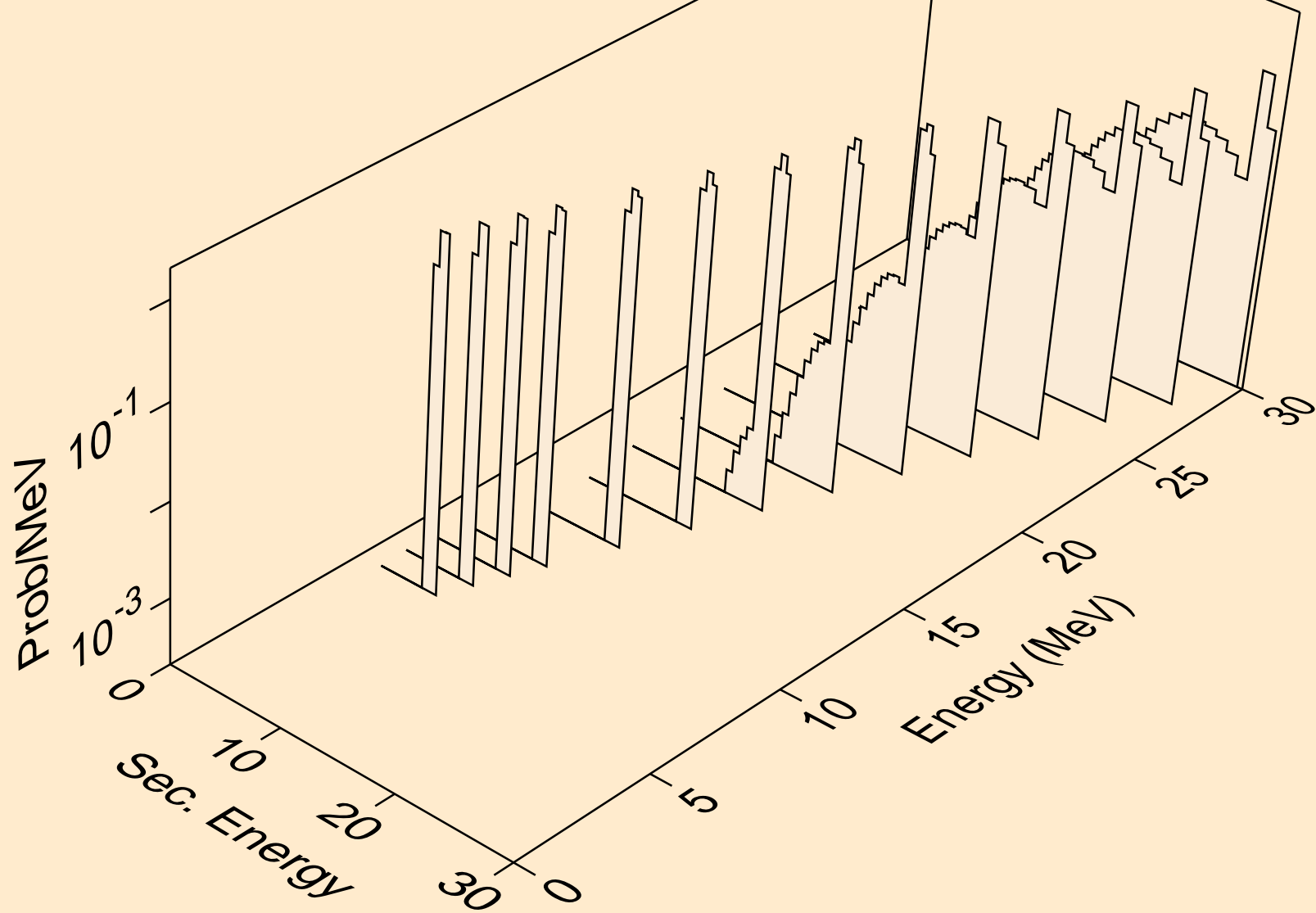

PM136 HELION ACER TENDL-2021 LIBRARY; T=0.K
Photon emission for (z,n)

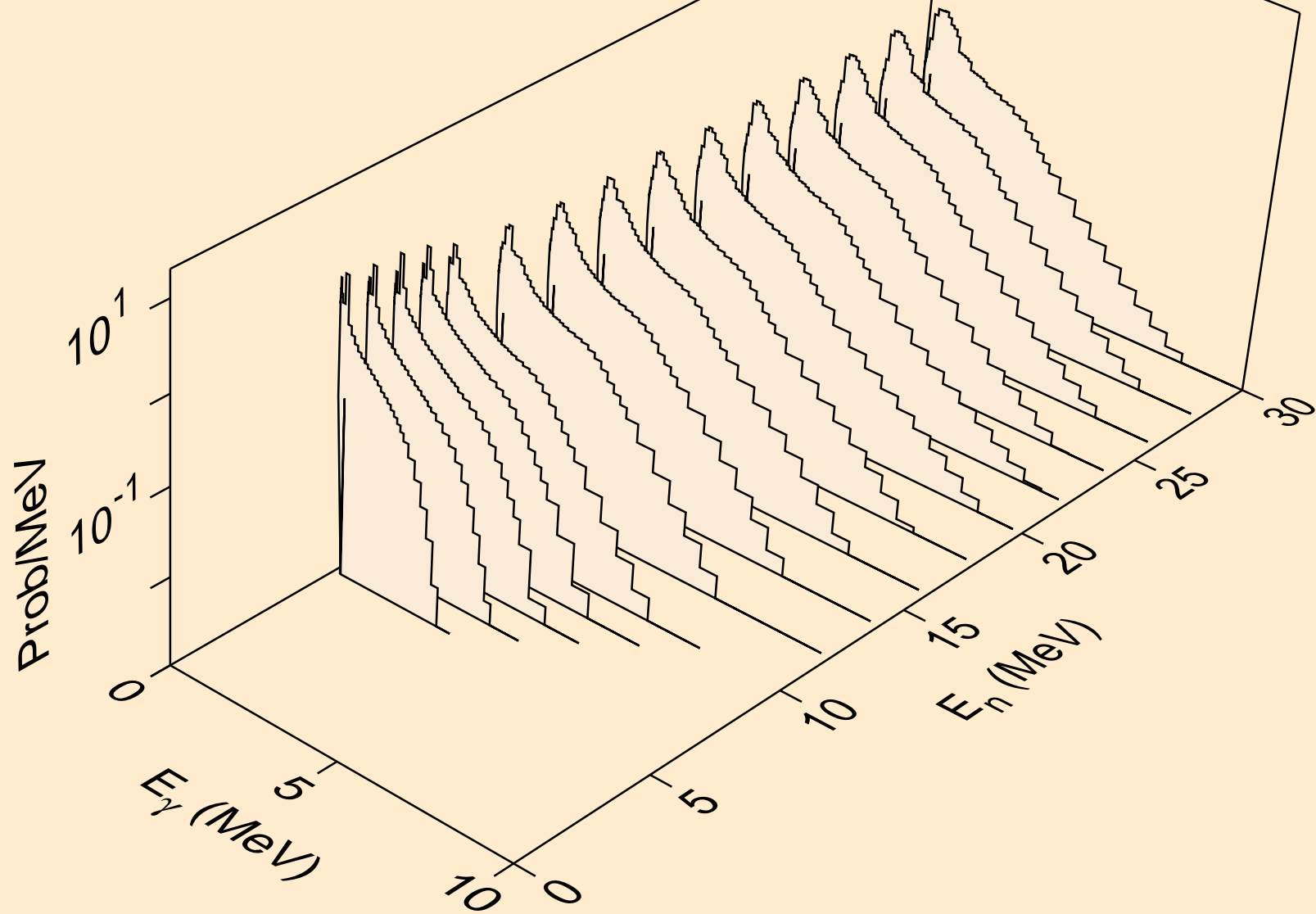

PM136 HELION ACER TENDL-2021 LIBRARY; T=0.K
Photon emission for (n,x)

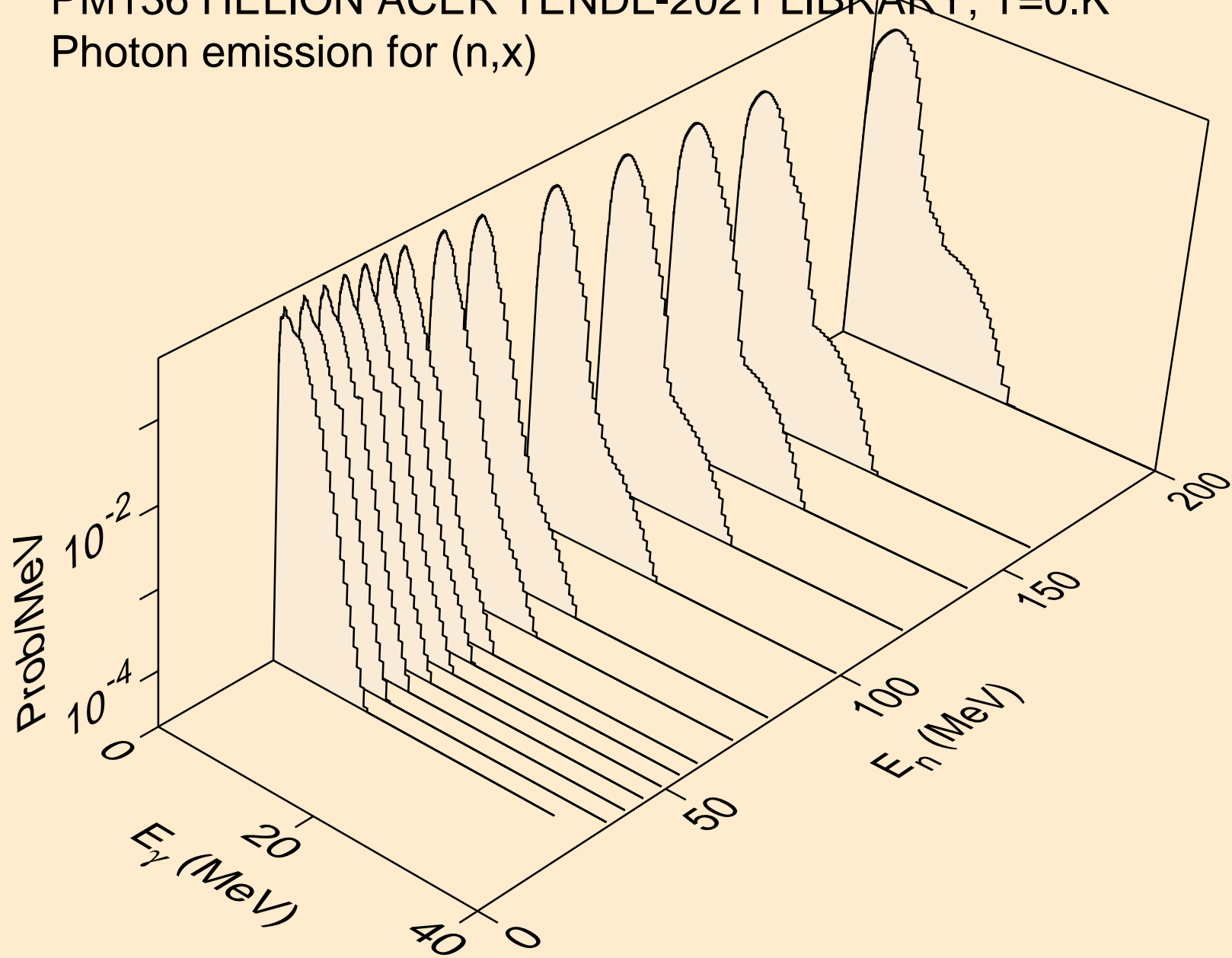

PM136 HELION ACER TENDL-2021 LIBRARY; T=0.K
Photon emission for (n,2nd)

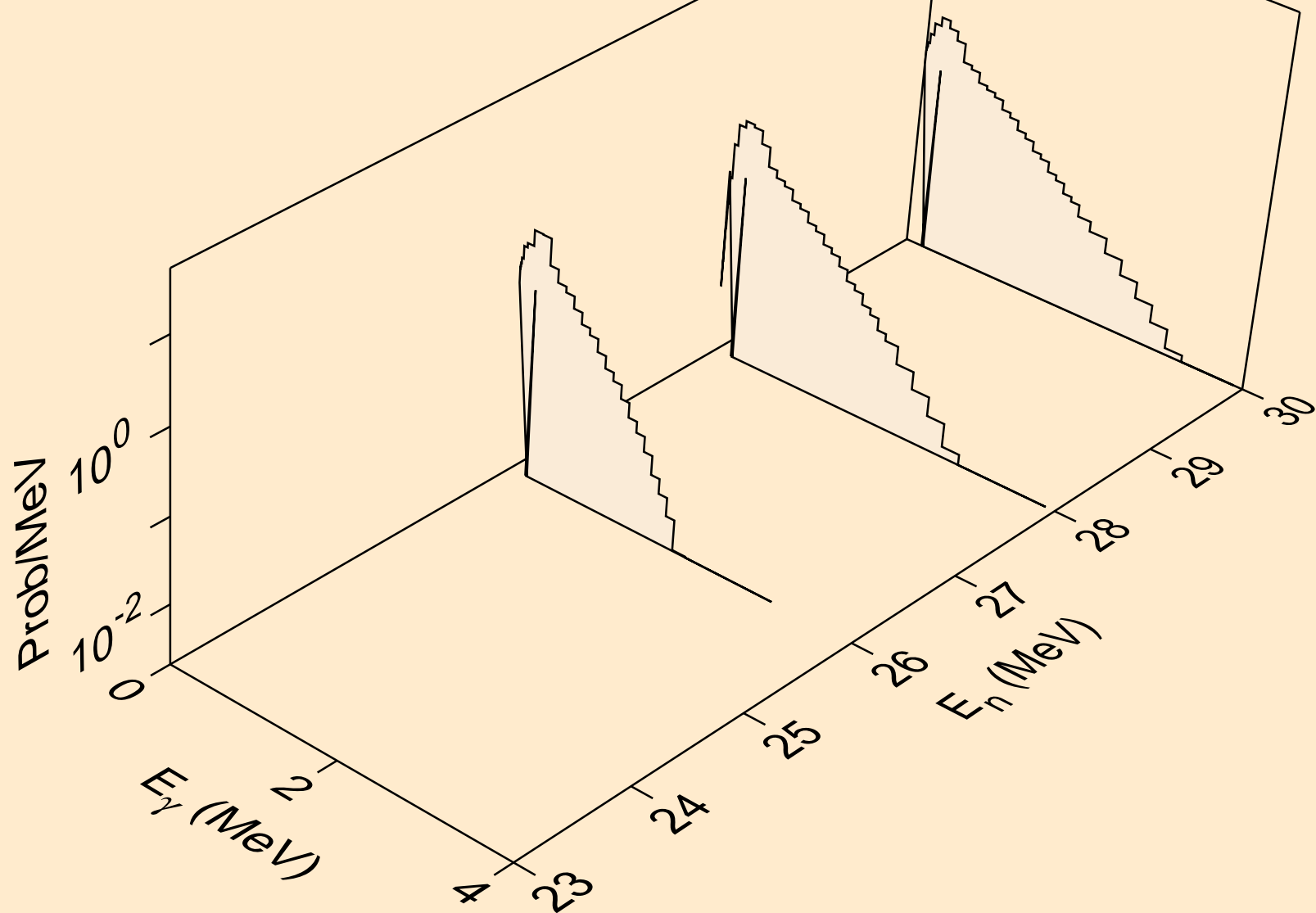

PM136 HELION ACER TENDL-2021 LIBRARY; T=0.K
Photon emission for (n,2n)

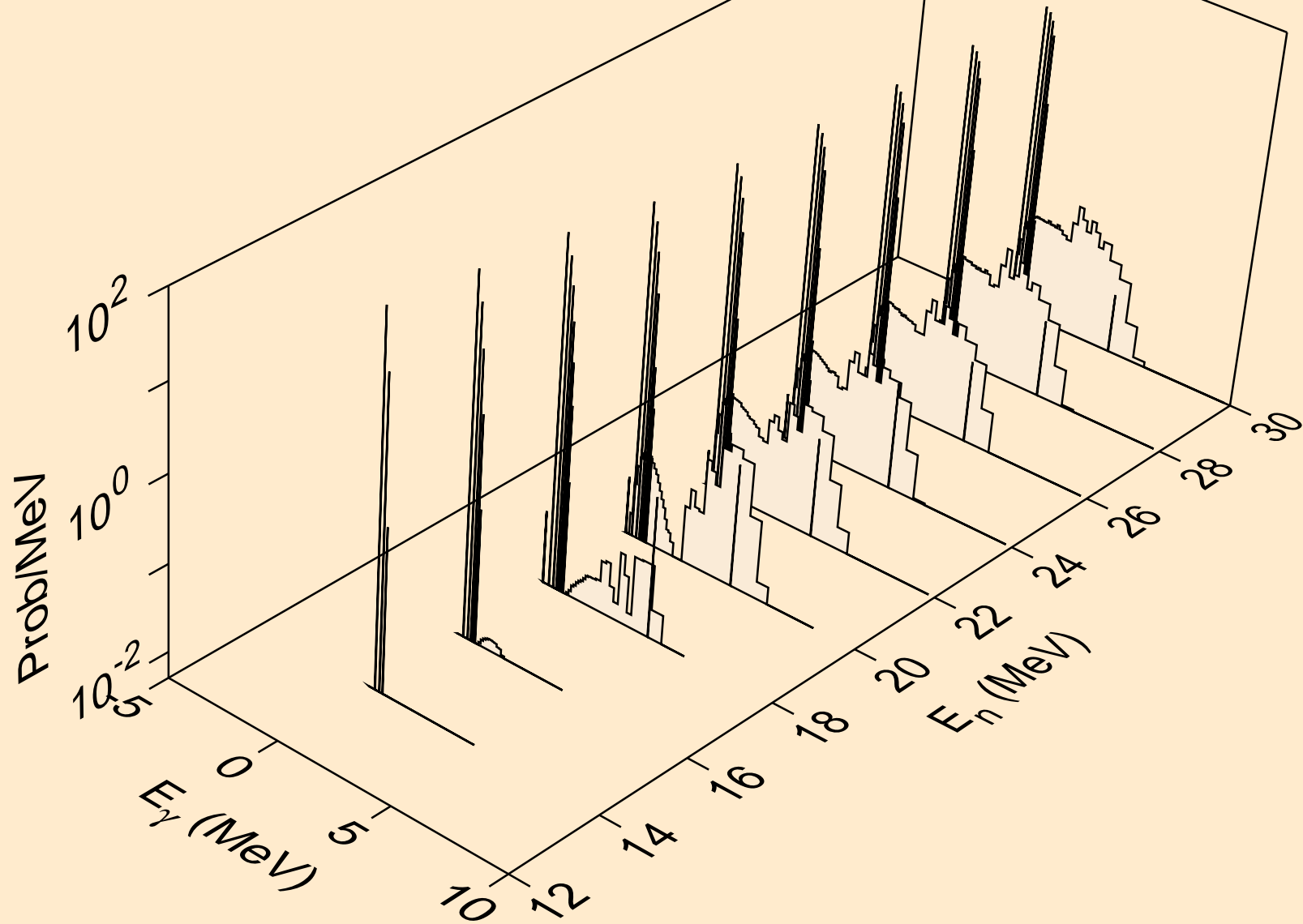

PM136 HELION ACER TENDL-2021 LIBRARY; T=0.K
Photon emission for (n,3n)

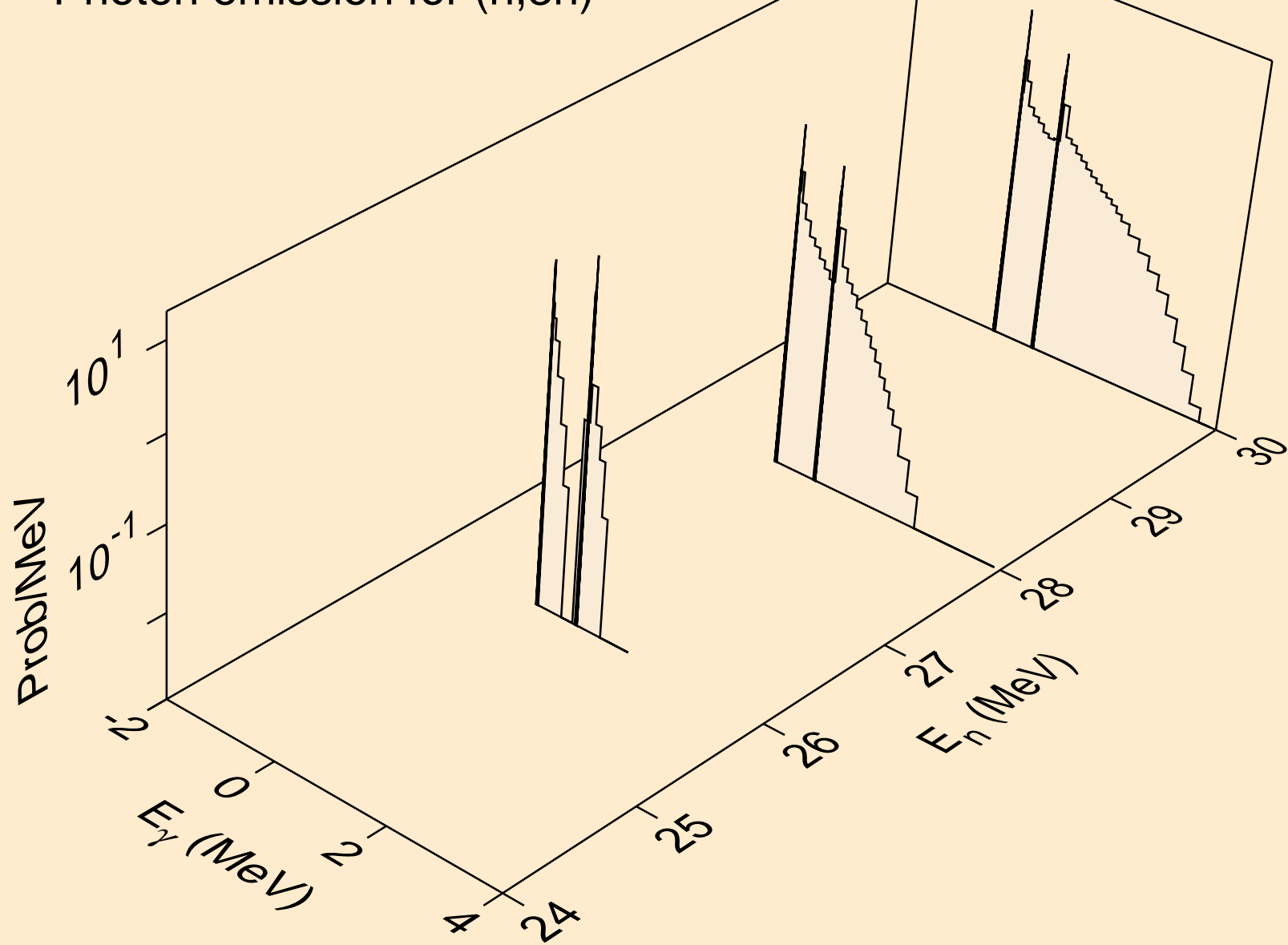

PM136 HELION ACER TENDL-2021 LIBRARY; T=0.K
Photon emission for (n,n*)a

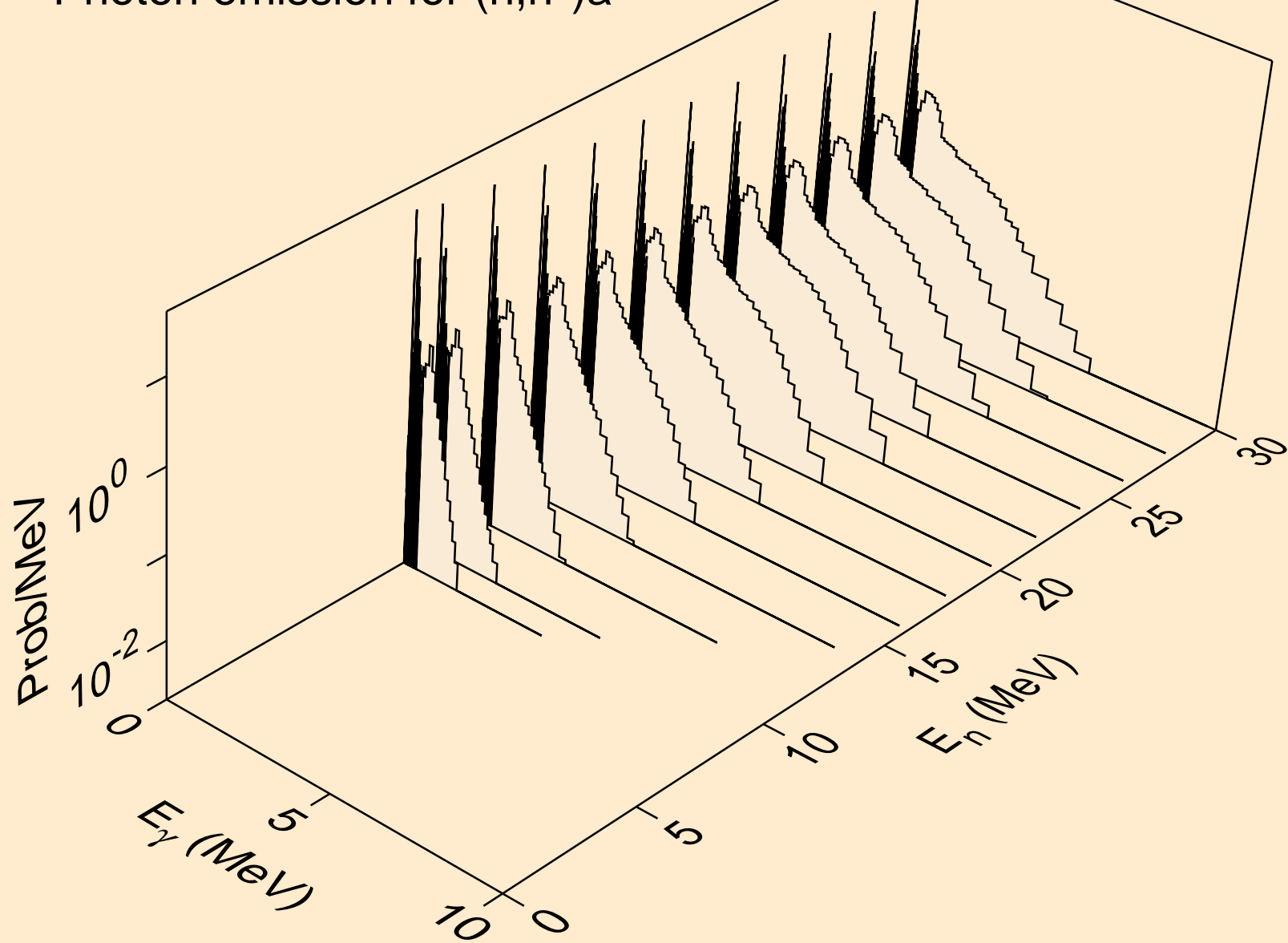

PM136 HELION ACER TENDL-2021 LIBRARY; T=0.K
Photon emission for (n,2n)a

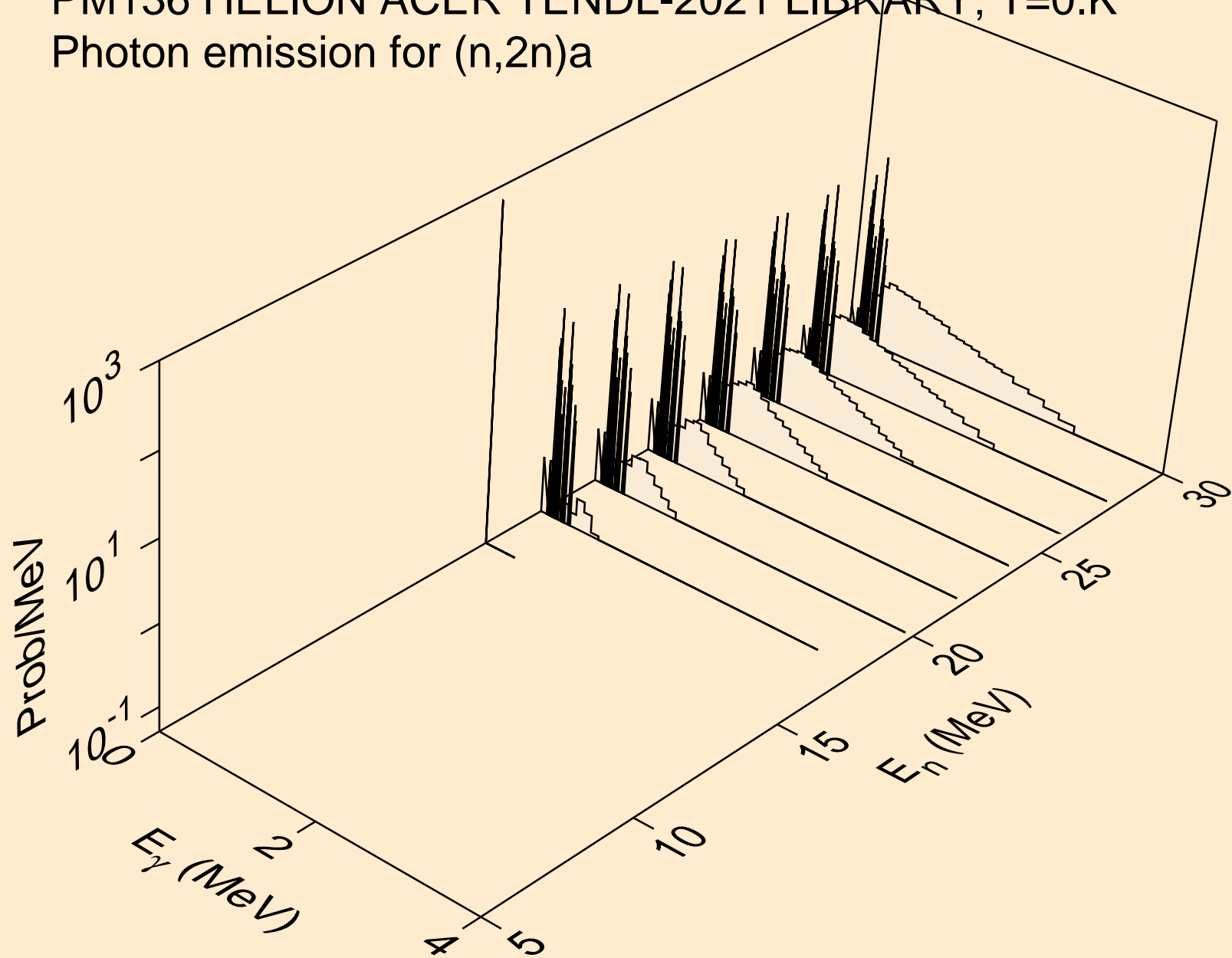

PM136 HELION ACER TENDL-2021 LIBRARY; T=0.K
Photon emission for (n,n*)p

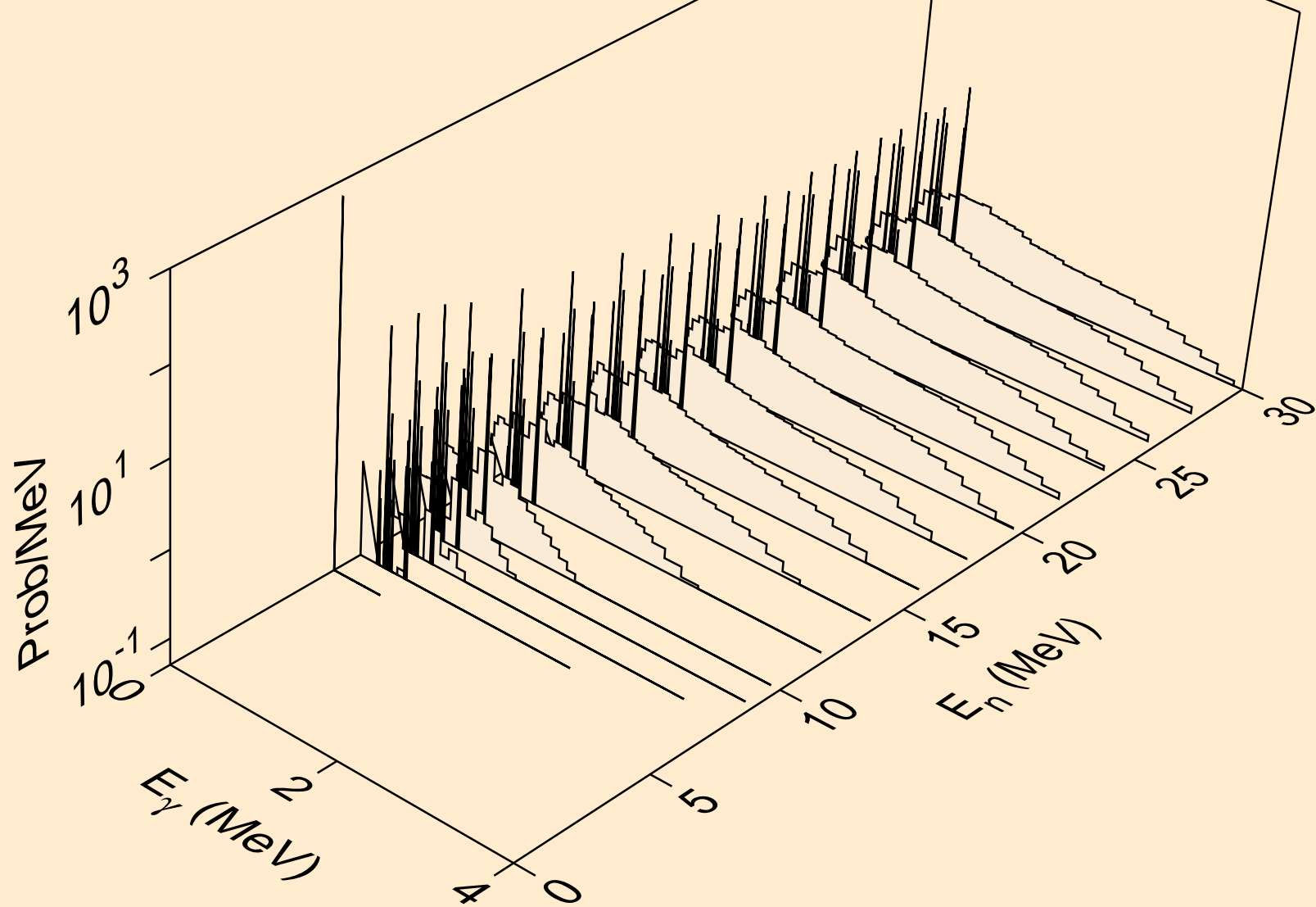

PM136 HELION ACER TENDL-2021 LIBRARY; T=0.K
Photon emission for (n,n*)2a

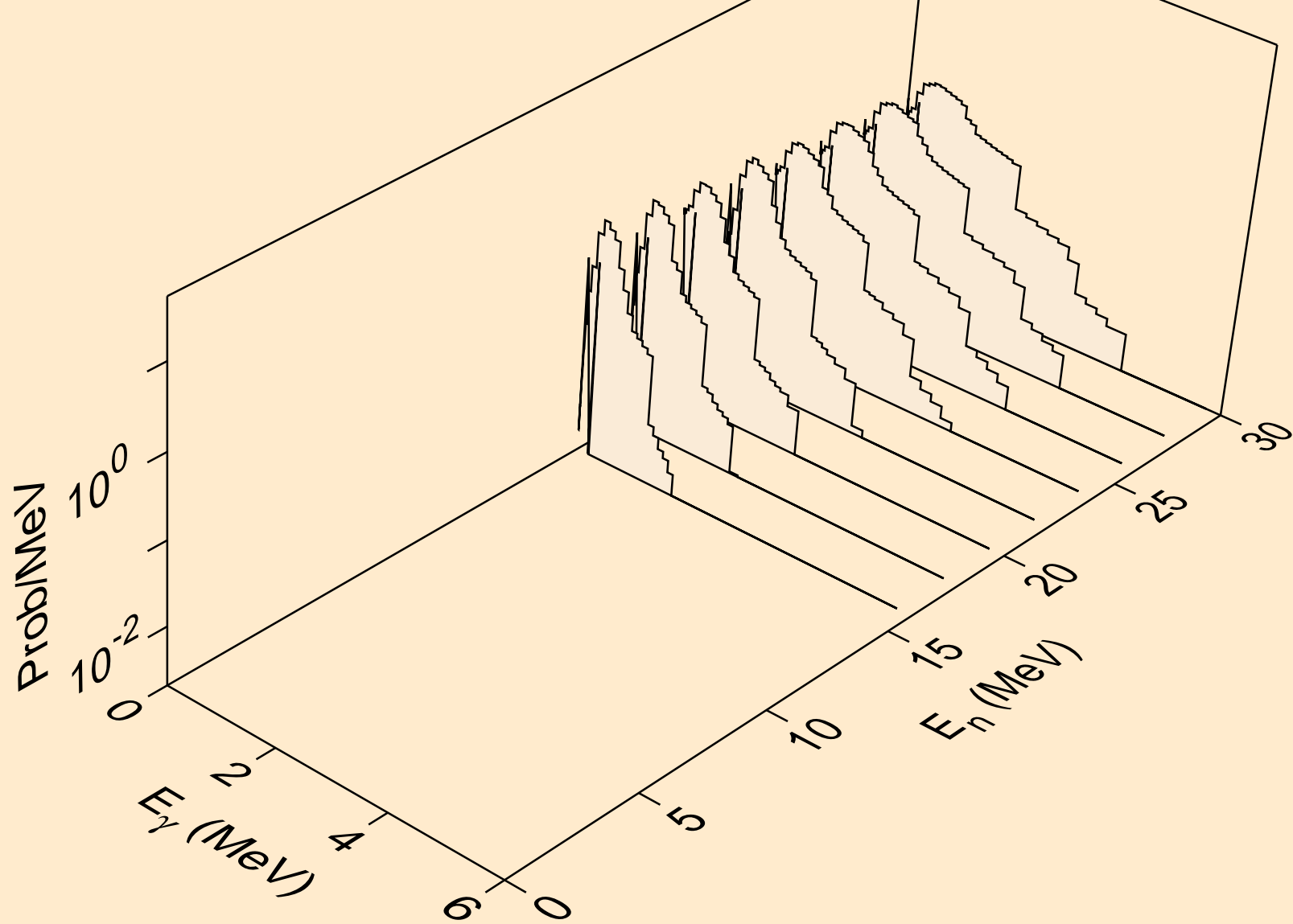

PM136 HELION ACER TENDL-2021 LIBRARY; T=0.K
Photon emission for (n,n*)d

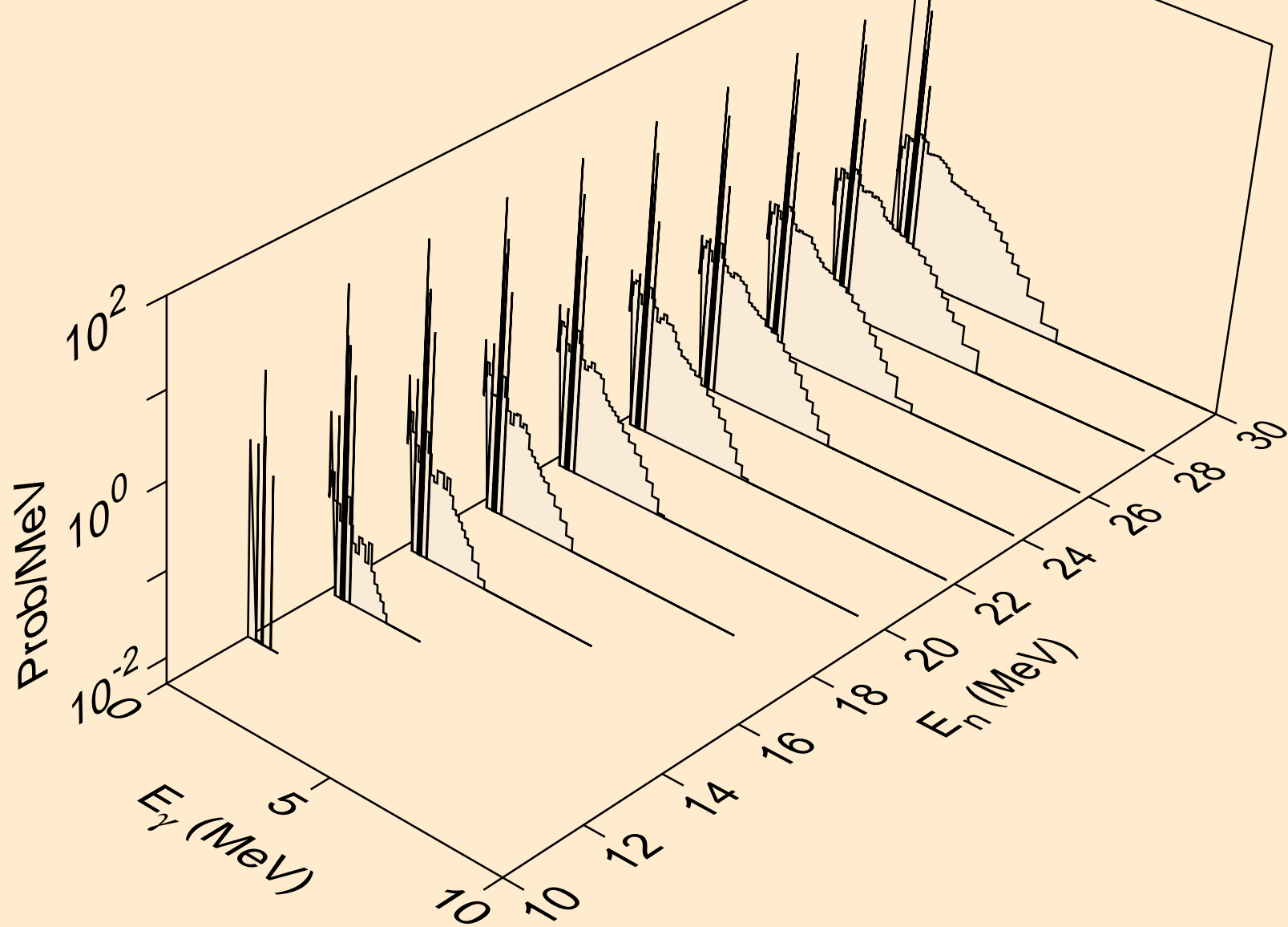

PM136 HELION ACER TENDL-2021 LIBRARY; T=0.K
Photon emission for (n,n*)t

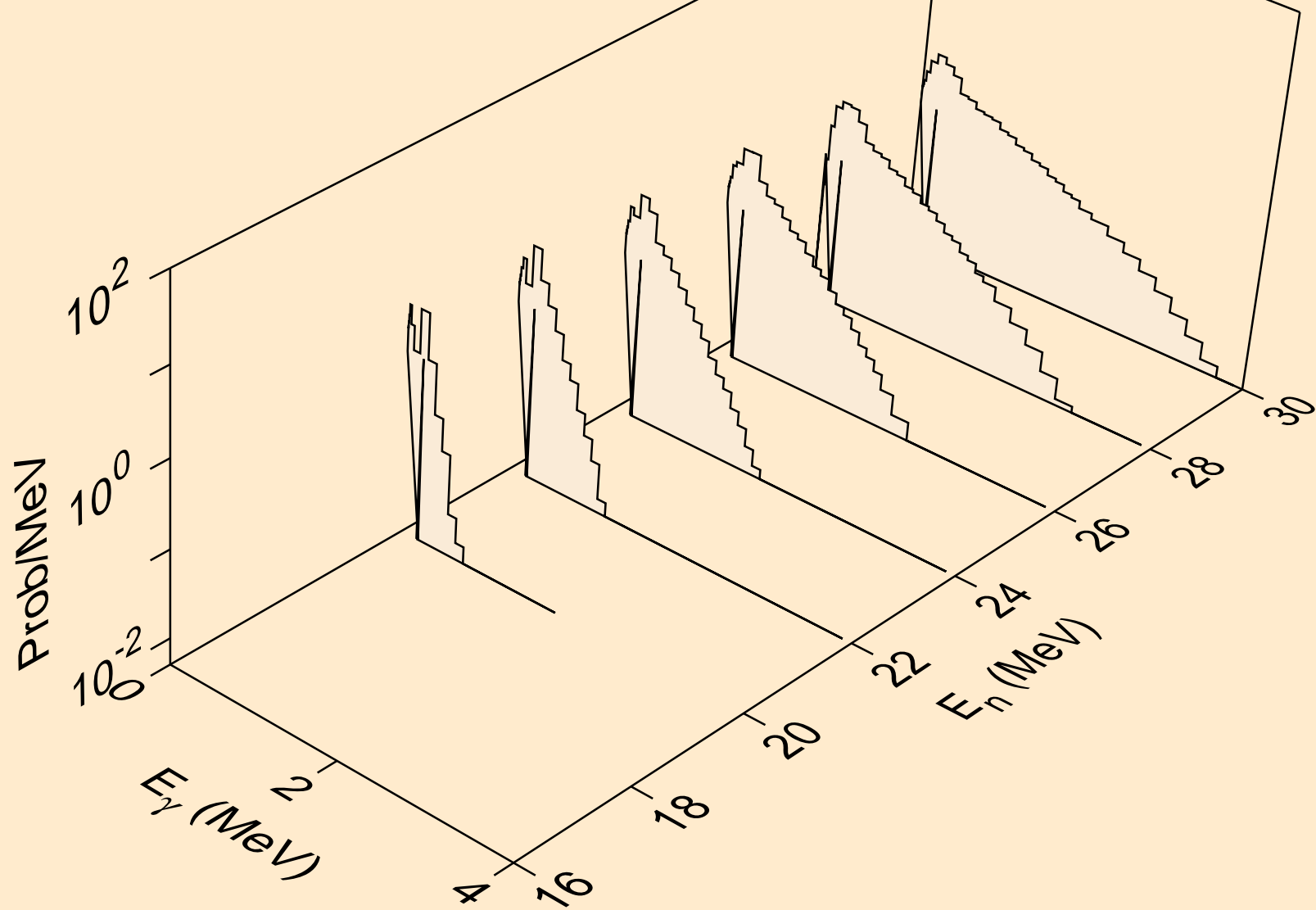

PM136 HELION ACER TENDL-2021 LIBRARY; T=0.K
Photon emission for (n,n*)he3

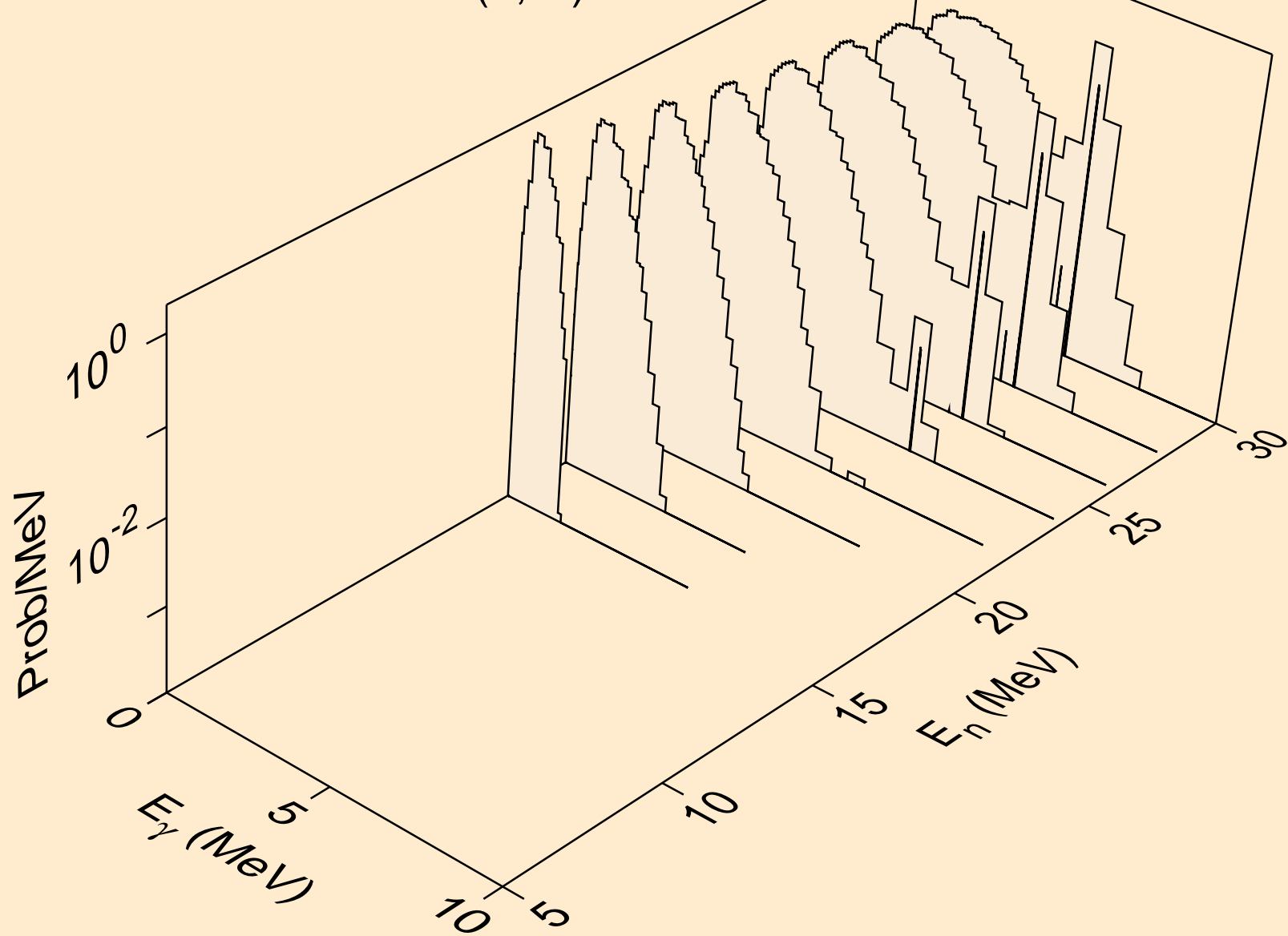

PM136 HELION ACER TENDL-2021 LIBRARY; T=0.K
Photon emission for (n,2np)

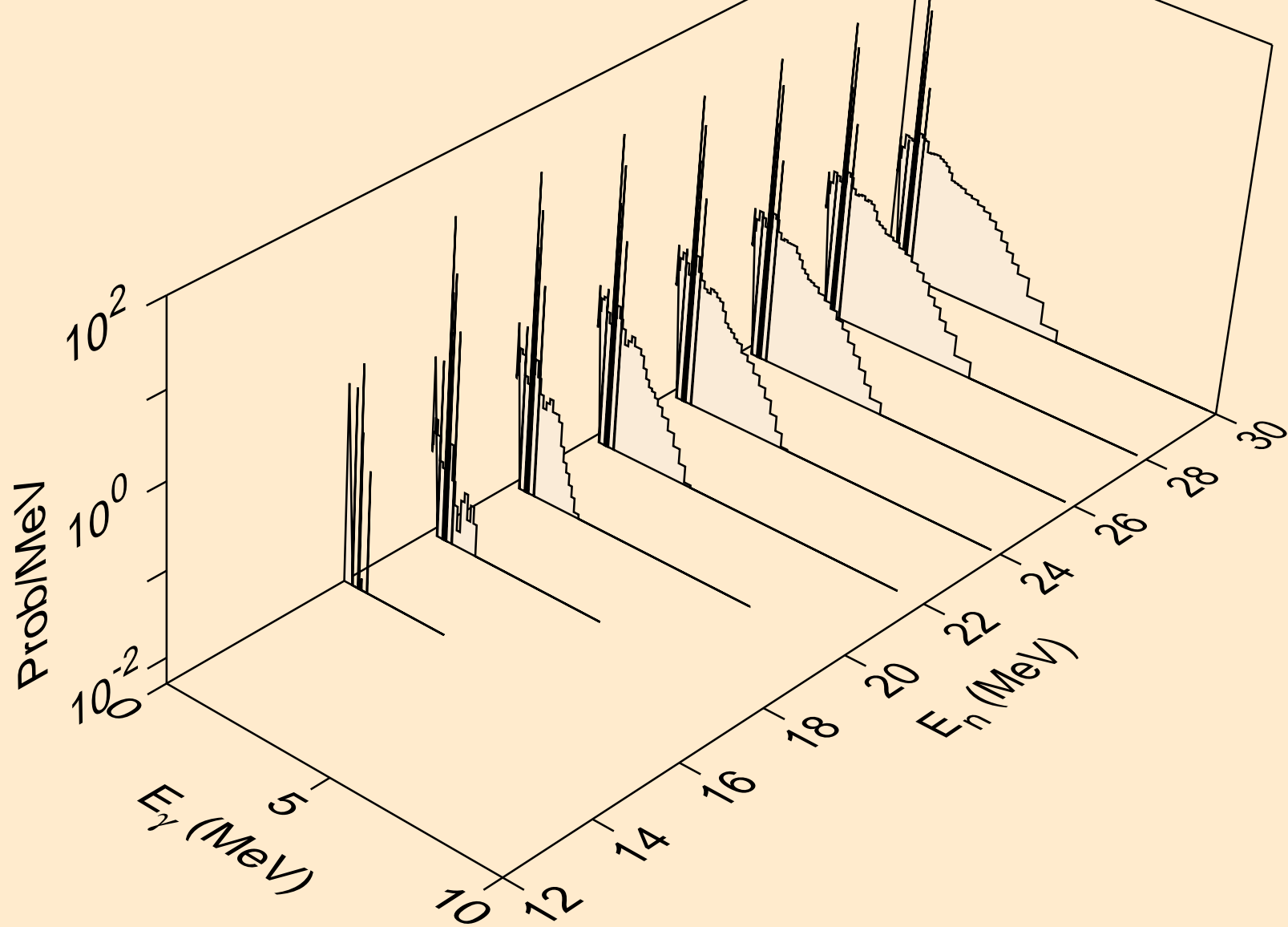

PM136 HELION ACER TENDL-2021 LIBRARY; T=0.K
Photon emission for (n,3np)

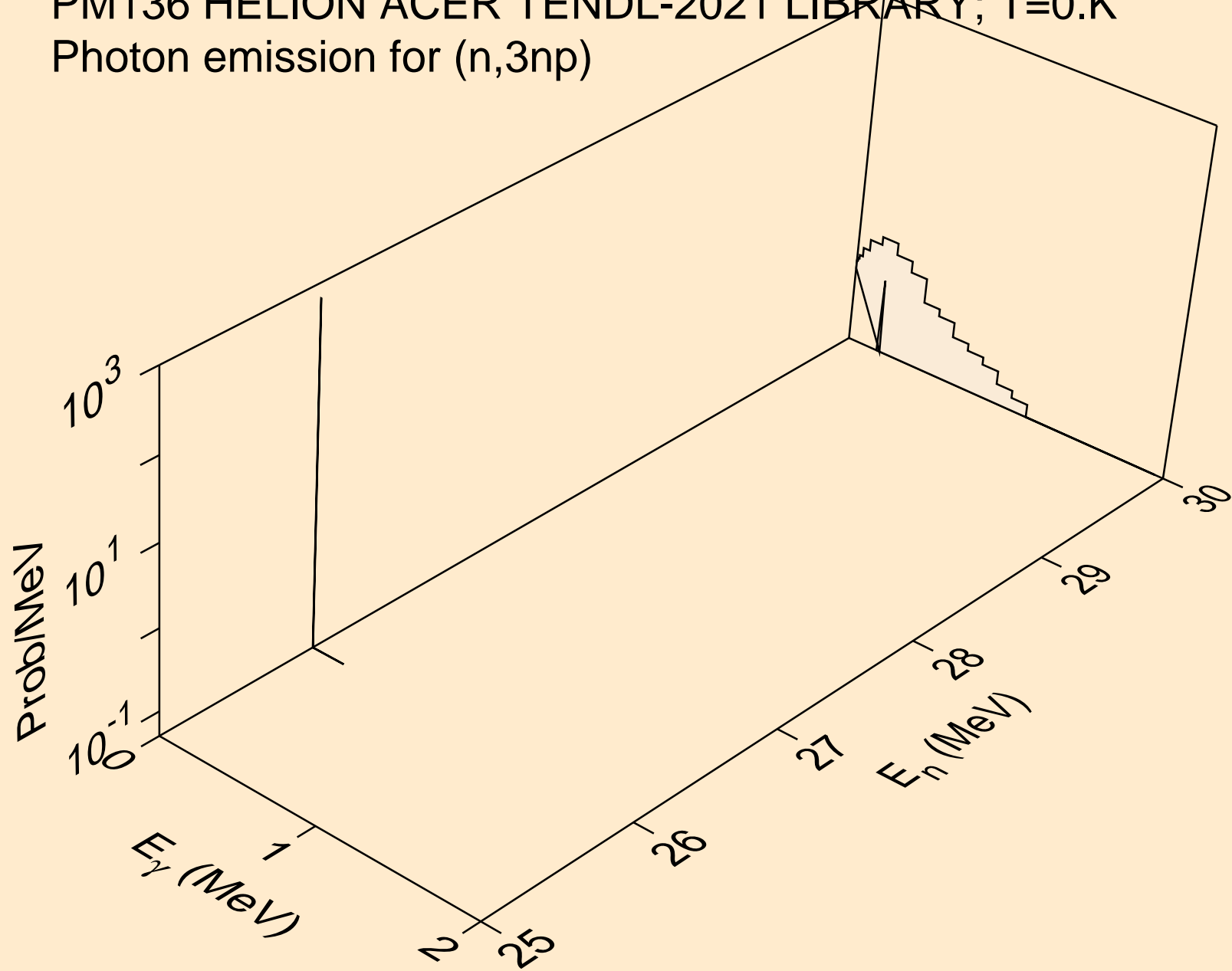

PM136 HELION ACER TENDL-2021 LIBRARY; T=0.K
Photon emission for (n,2np)

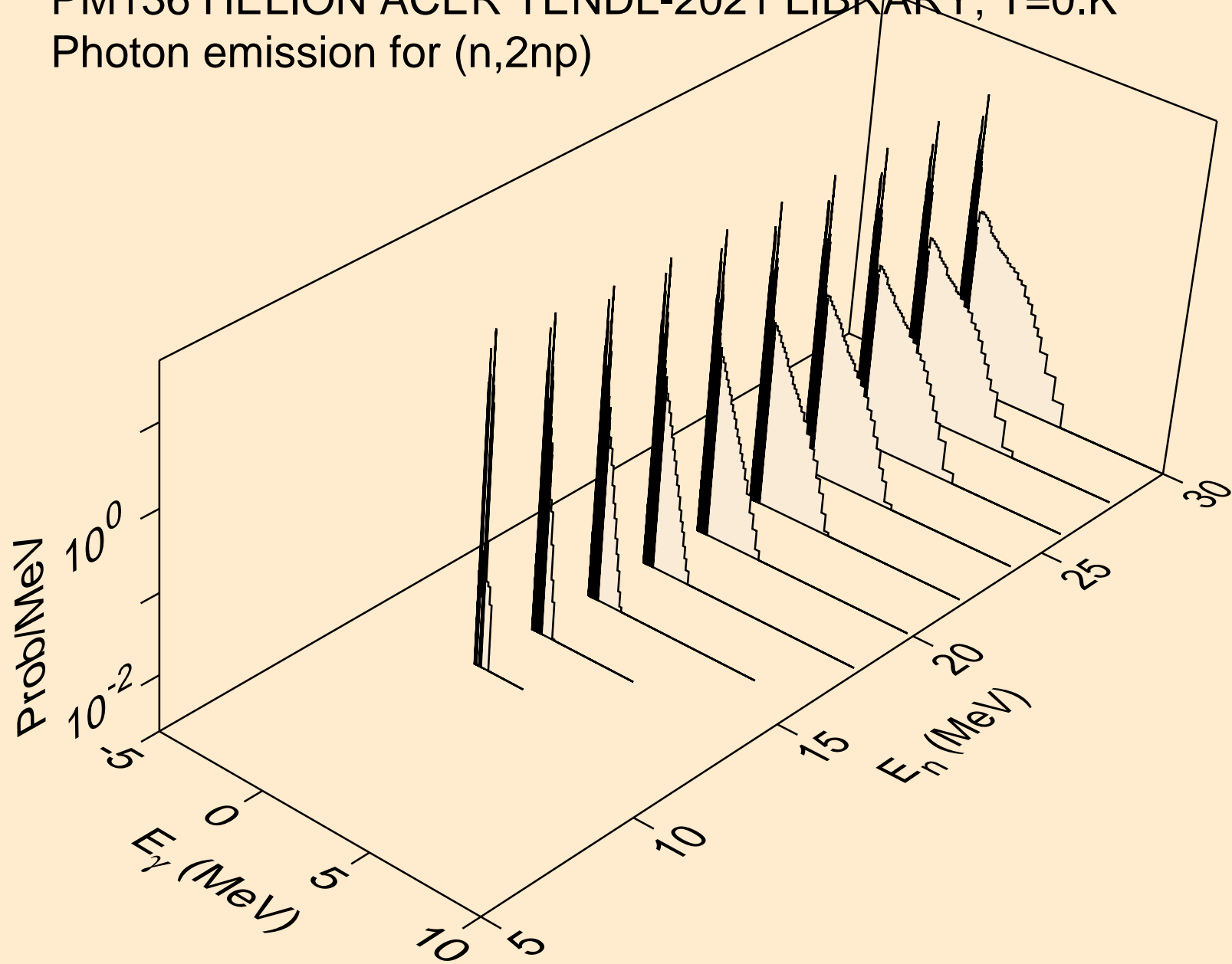

PM136 HELION ACER TENDL-2021 LIBRARY; T=0.K
Photon emission for (n,npa)

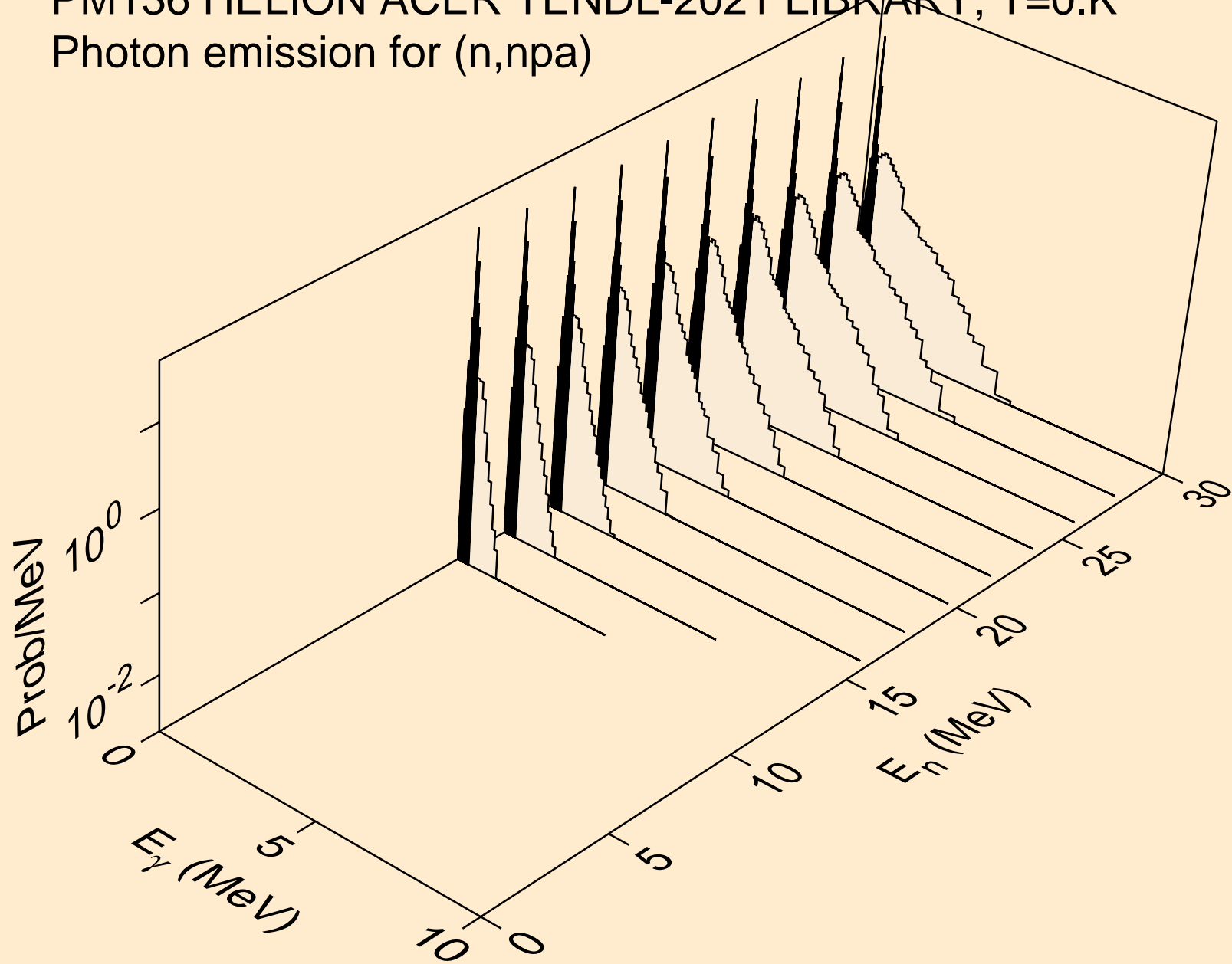

PM136 HELION ACER TENDL-2021 LIBRARY; T=0.K
Photon emission for (n,gma)

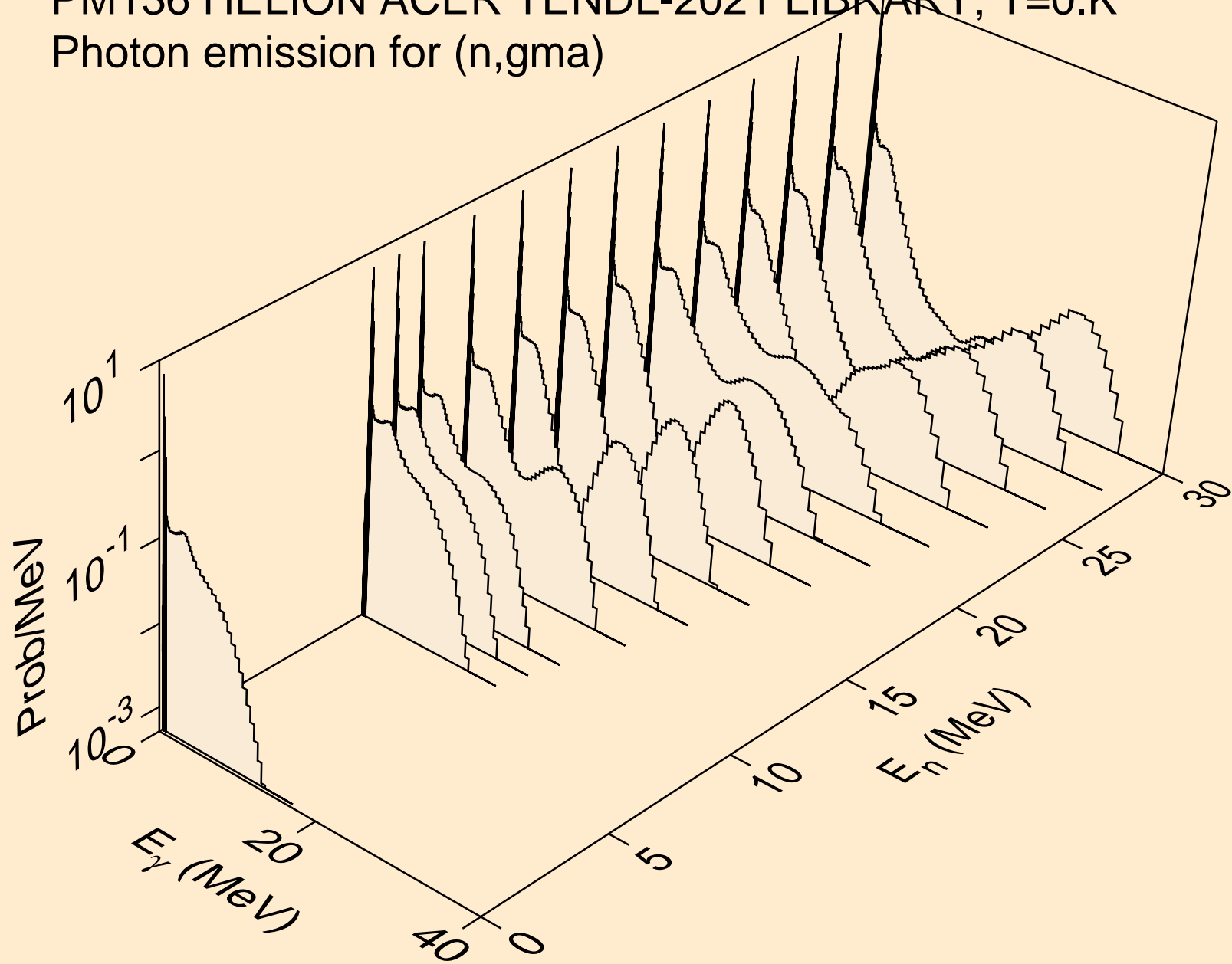

PM136 HELION ACER TENDL-2021 LIBRARY; T=0.K
Photon emission for (n,p)

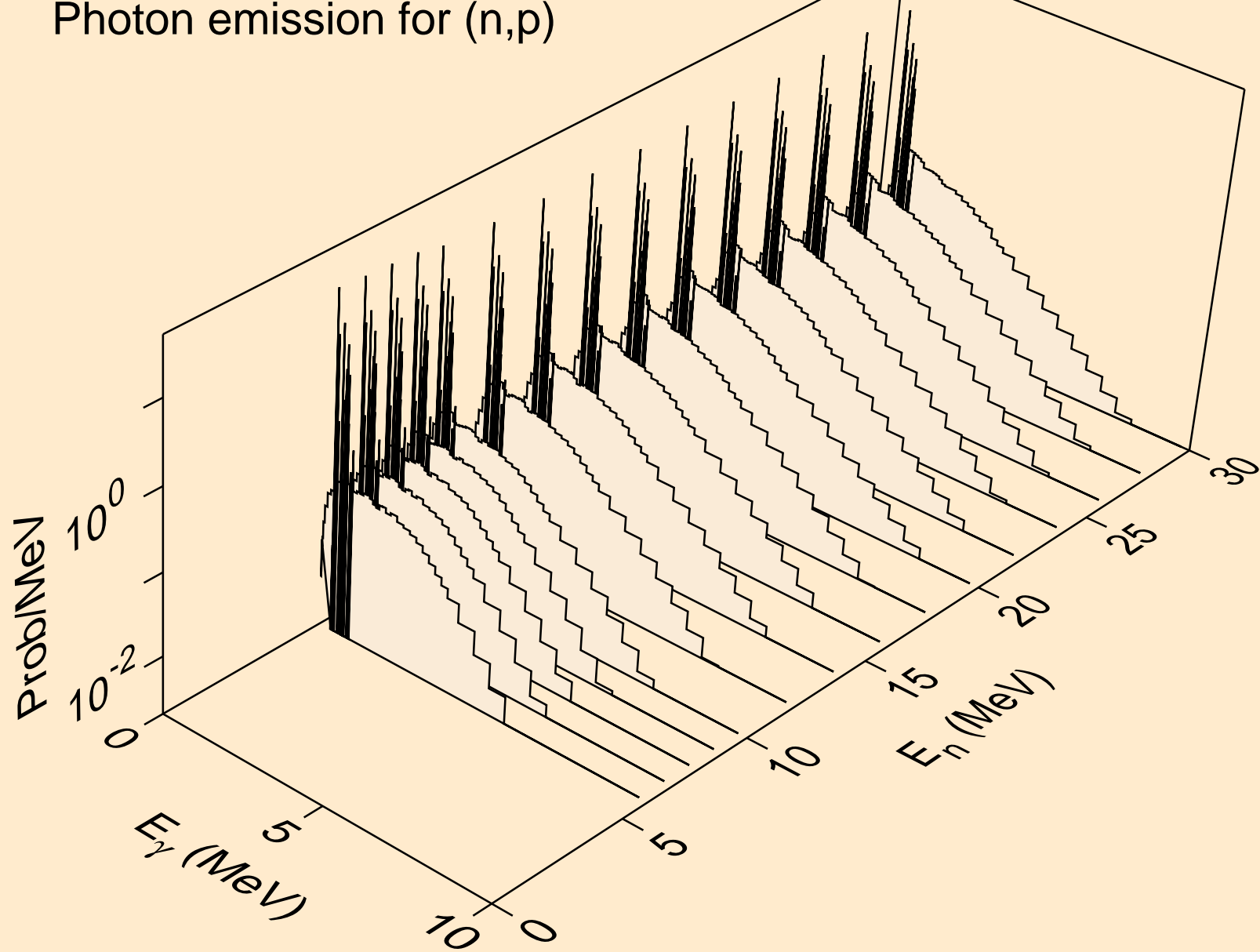

PM136 HELION ACER TENDL-2021 LIBRARY; T=0.K
Photon emission for (n,d)

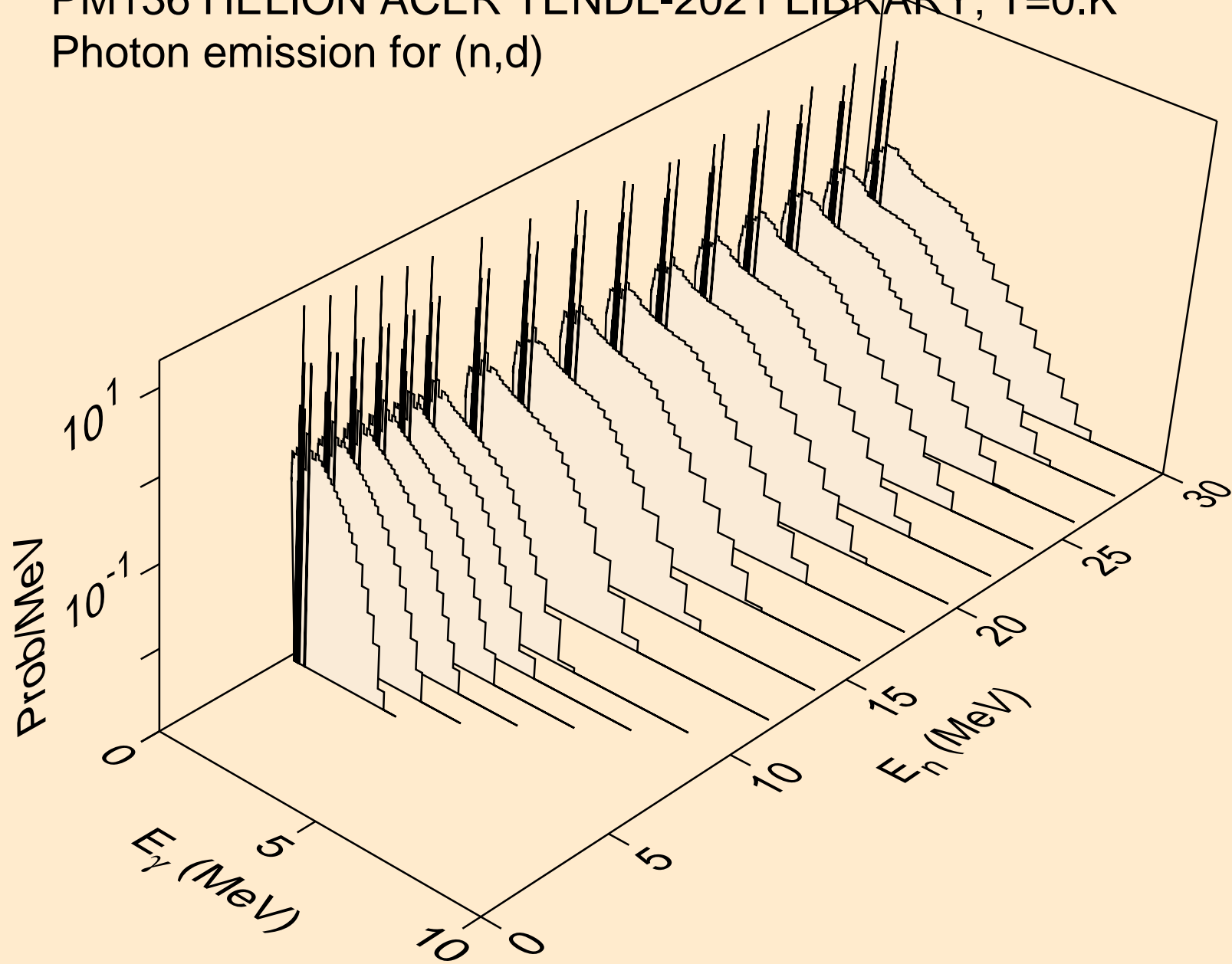

PM136 HELION ACER TENDL-2021 LIBRARY; T=0.K
Photon emission for (n,t)

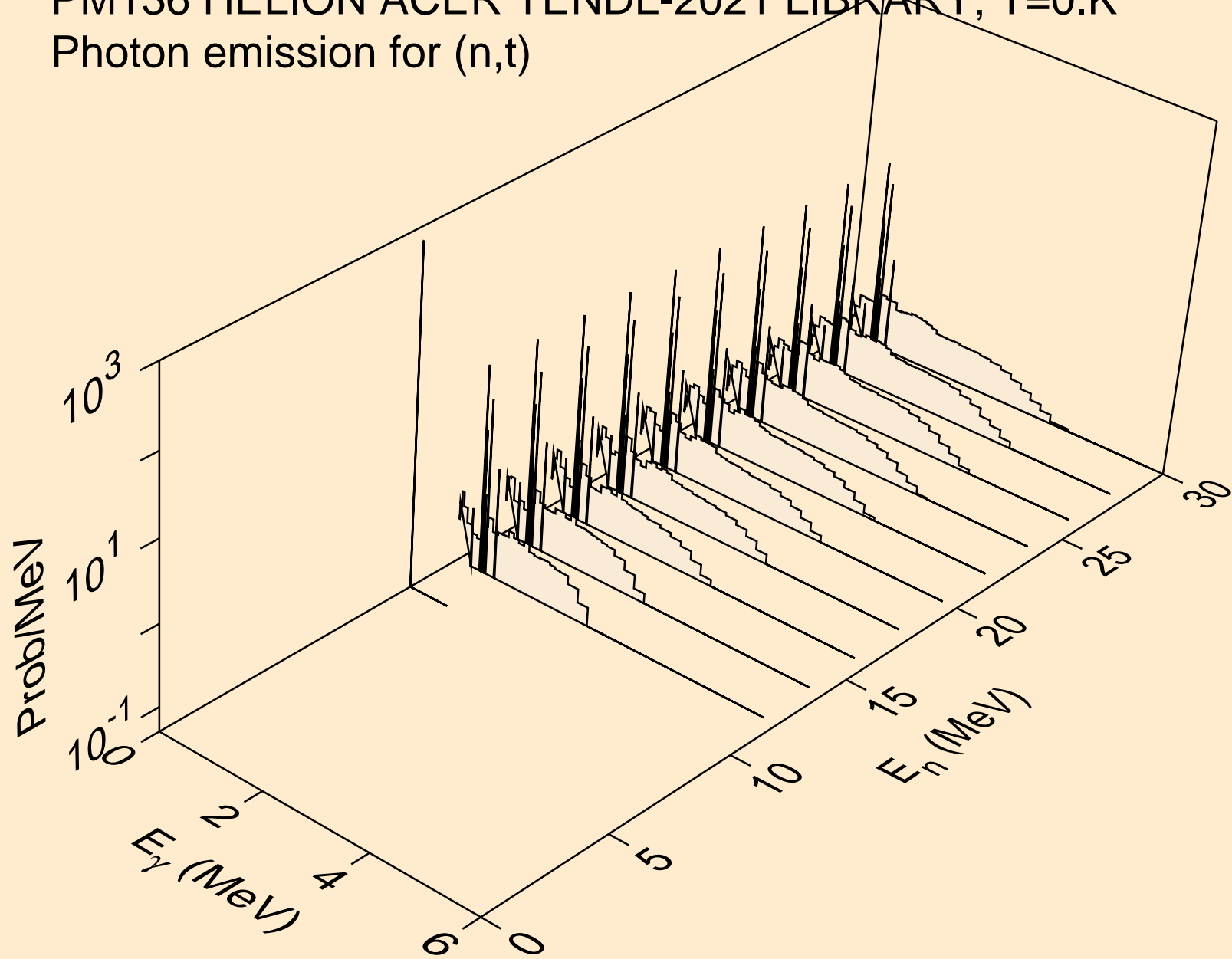

PM136 HELION ACER TENDL-2021 LIBRARY; T=0.K
Photon emission for inelastic

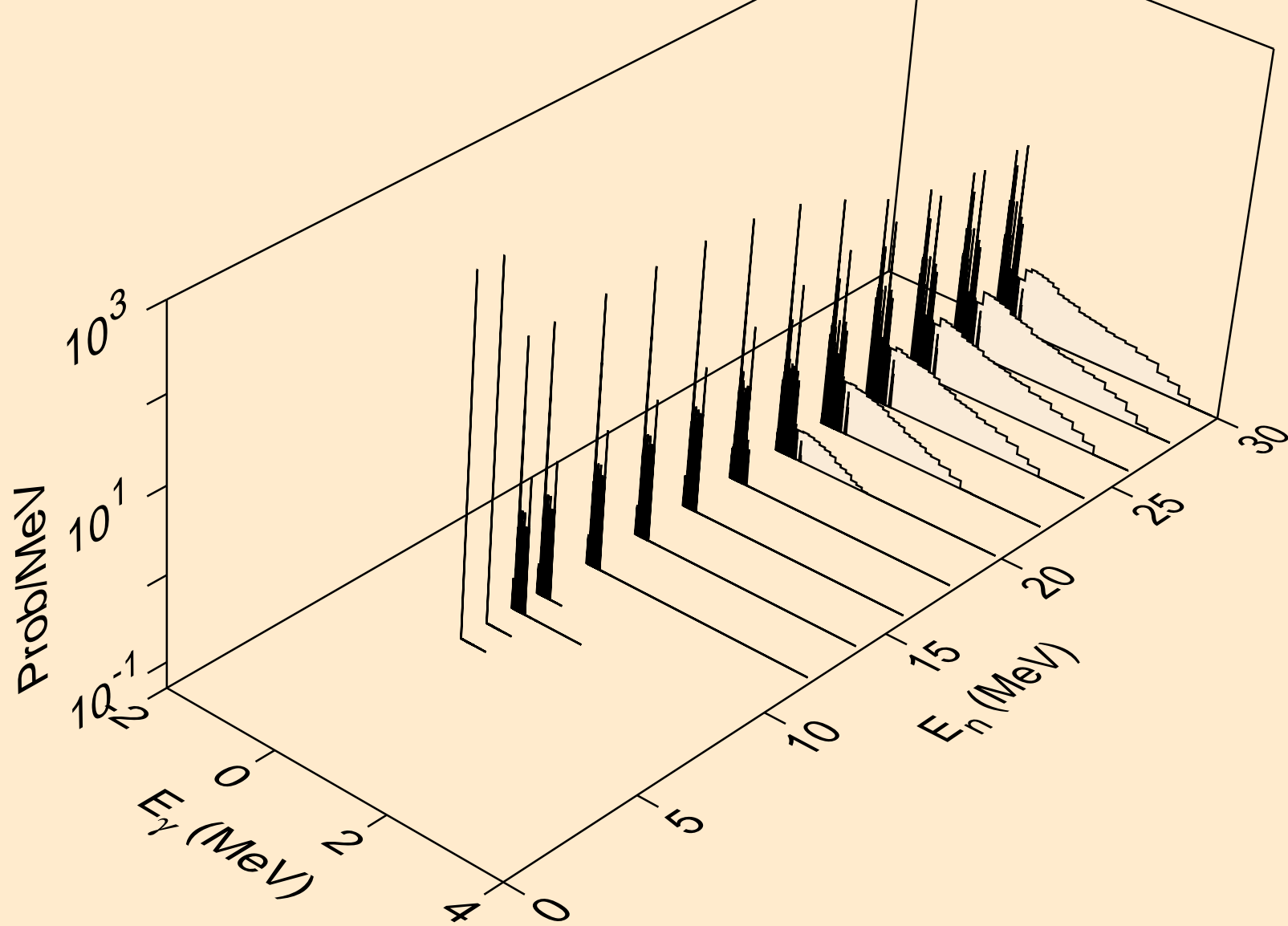

PM136 HELION ACER TENDL-2021 LIBRARY; T=0.K
Photon emission for (n,a)

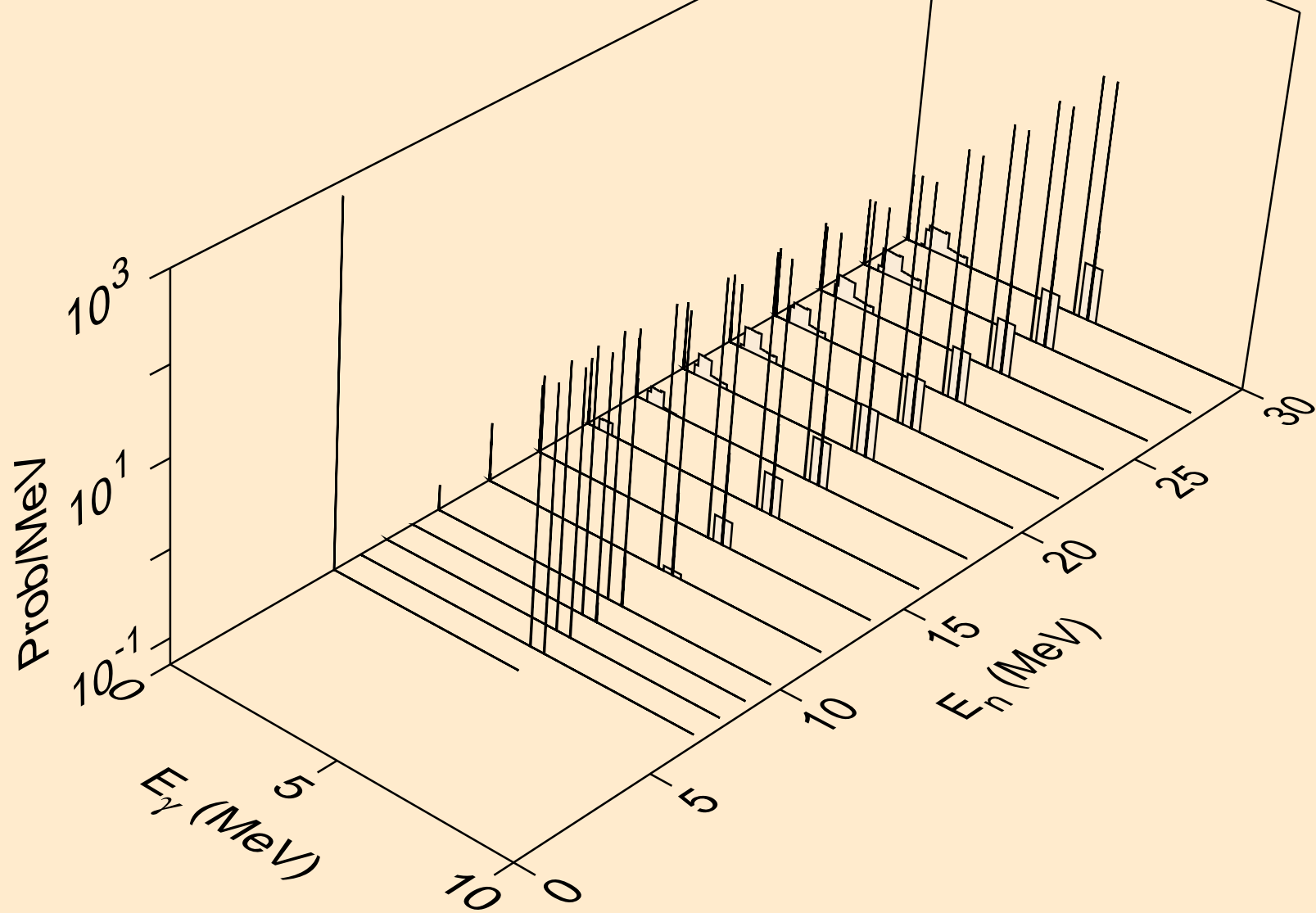

PM136 HELION ACER TENDL-2021 LIBRARY; T=0.K
Photon emission for (n,2a)

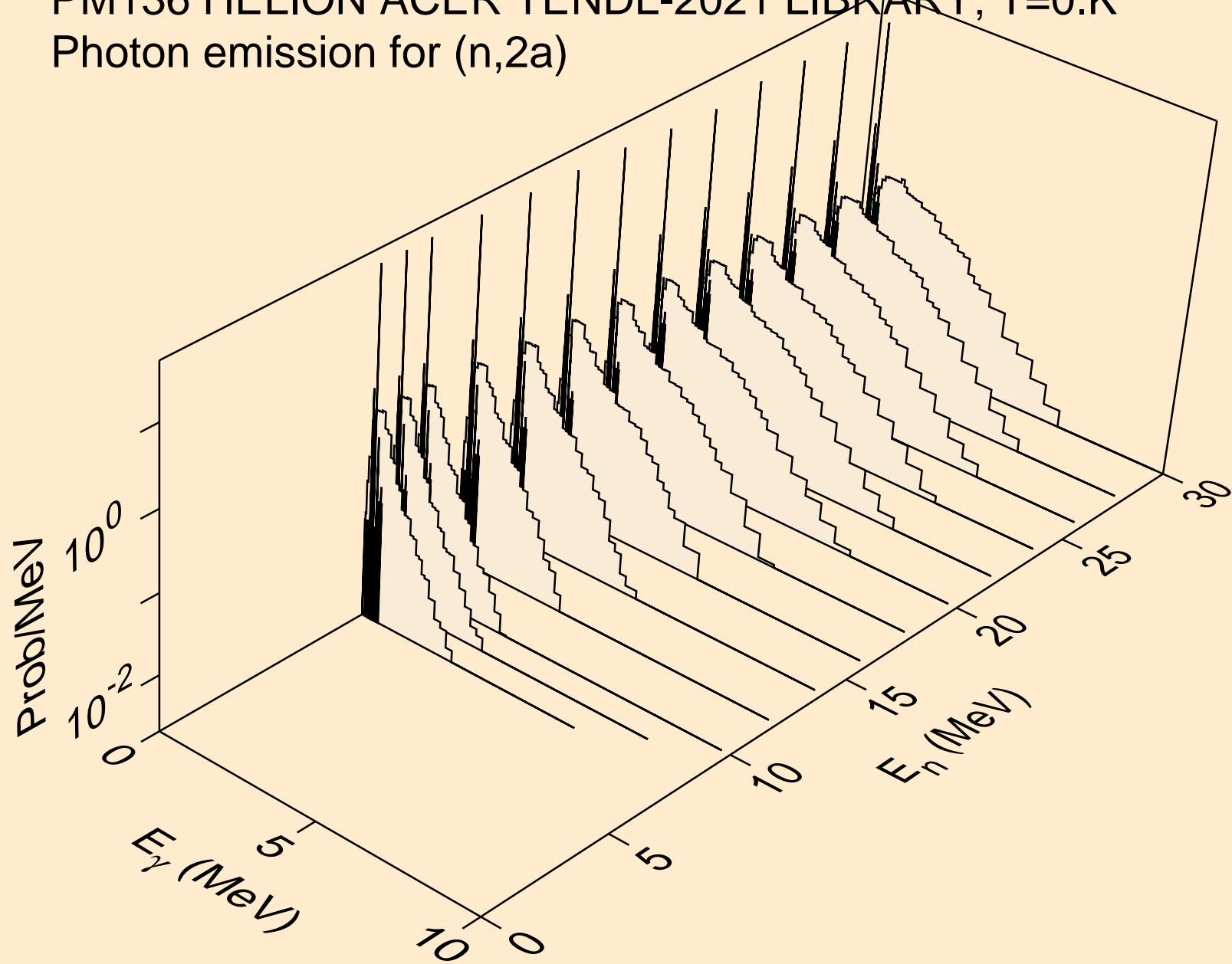

PM136 HELION ACER TENDL-2021 LIBRARY; T=0.K
Photon emission for (n,2p)

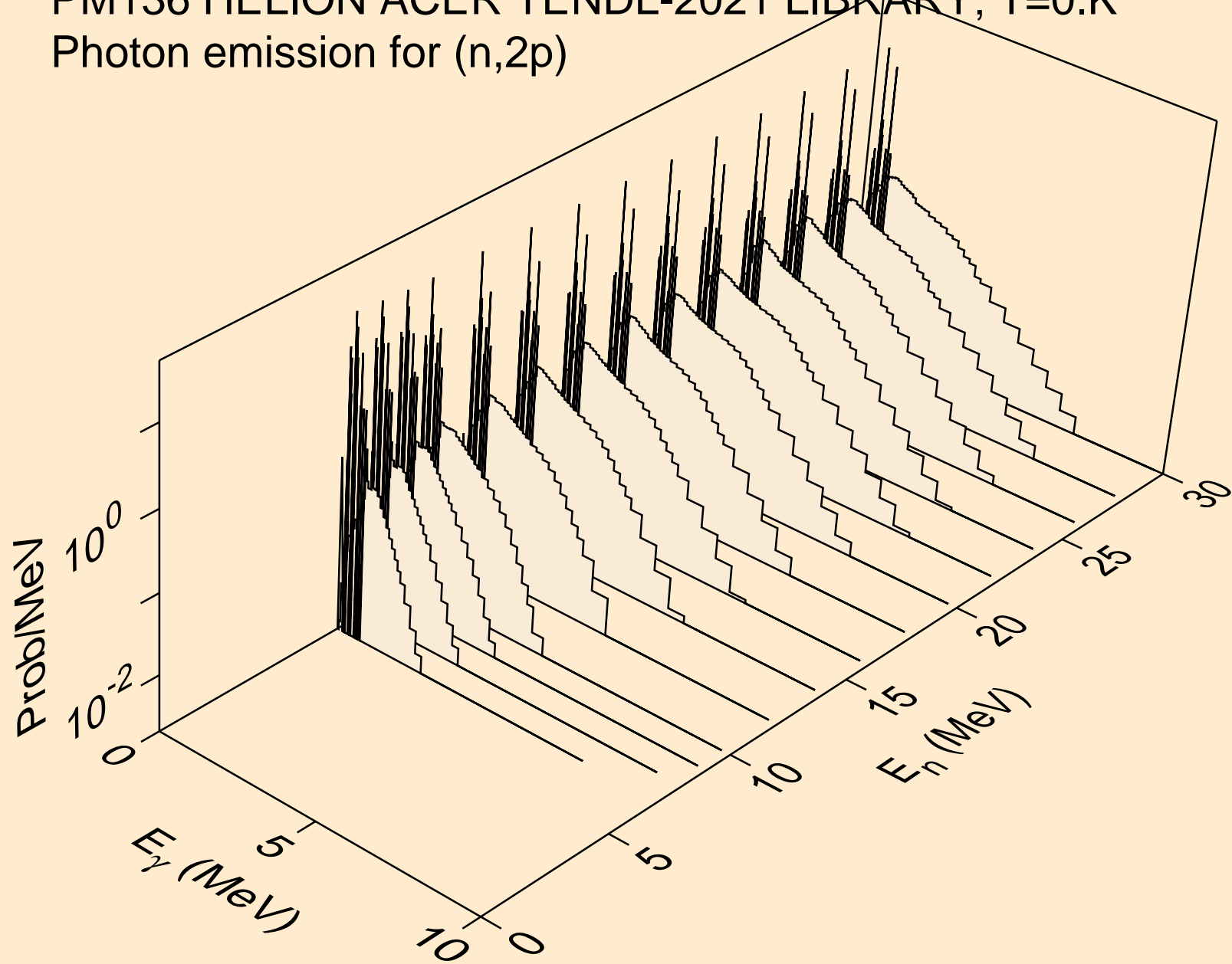

PM136 HELION ACER TENDL-2021 LIBRARY; T=0.K
Photon emission for (n,pa)

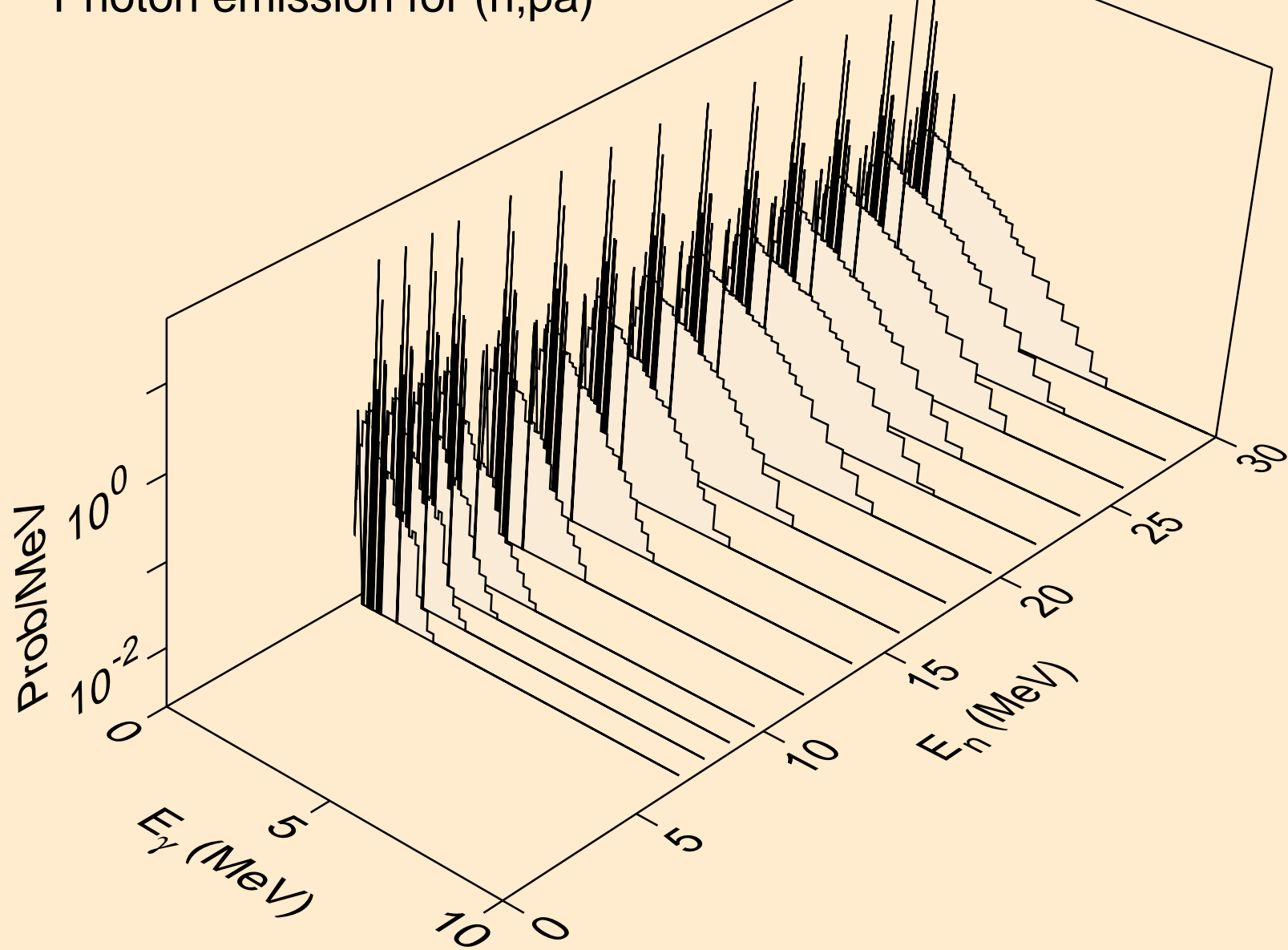

PM136 HELION ACER TENDL-2021 LIBRARY; T=0.K
Photon emission for (n,pd)

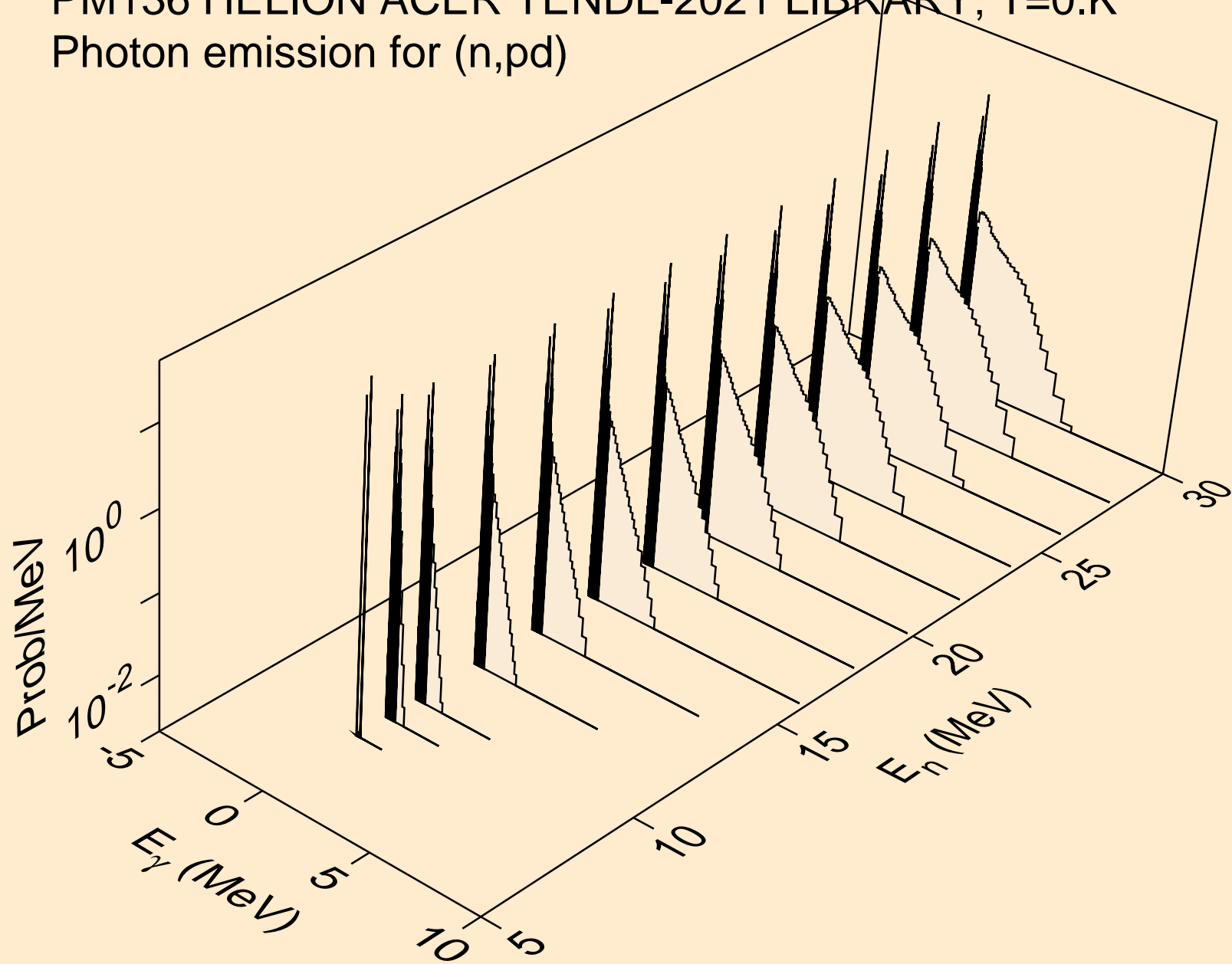

PM136 HELION ACER TENDL-2021 LIBRARY; T=0.K
Photon emission for (n,pt)

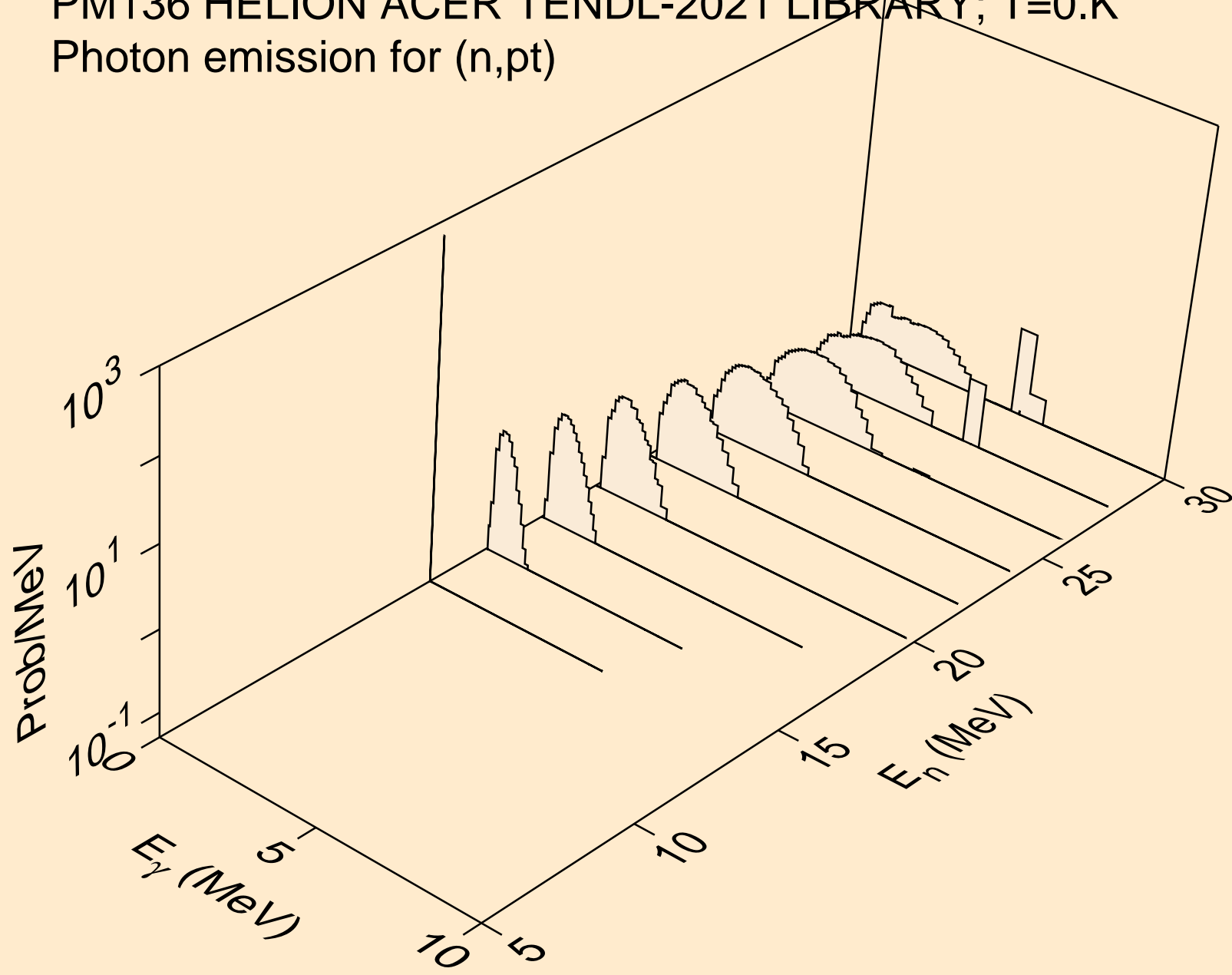

PM136 HELION ACER TENDL-2021 LIBRARY; T=0.K
Photon emission for (n,da)

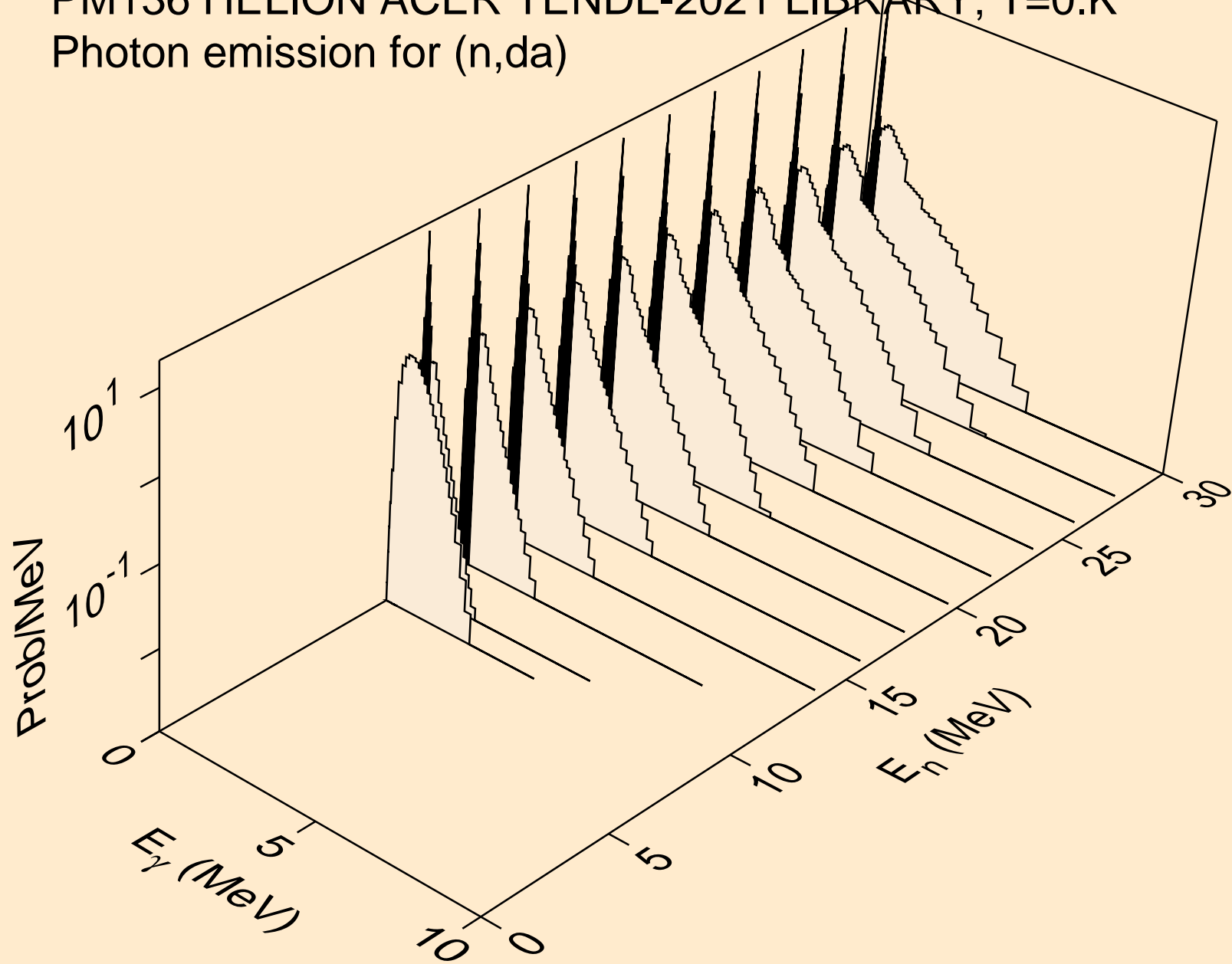

PM136 HELION ACER TENDL-2021 LIBRARY; T=0.K
Particle heating contributions

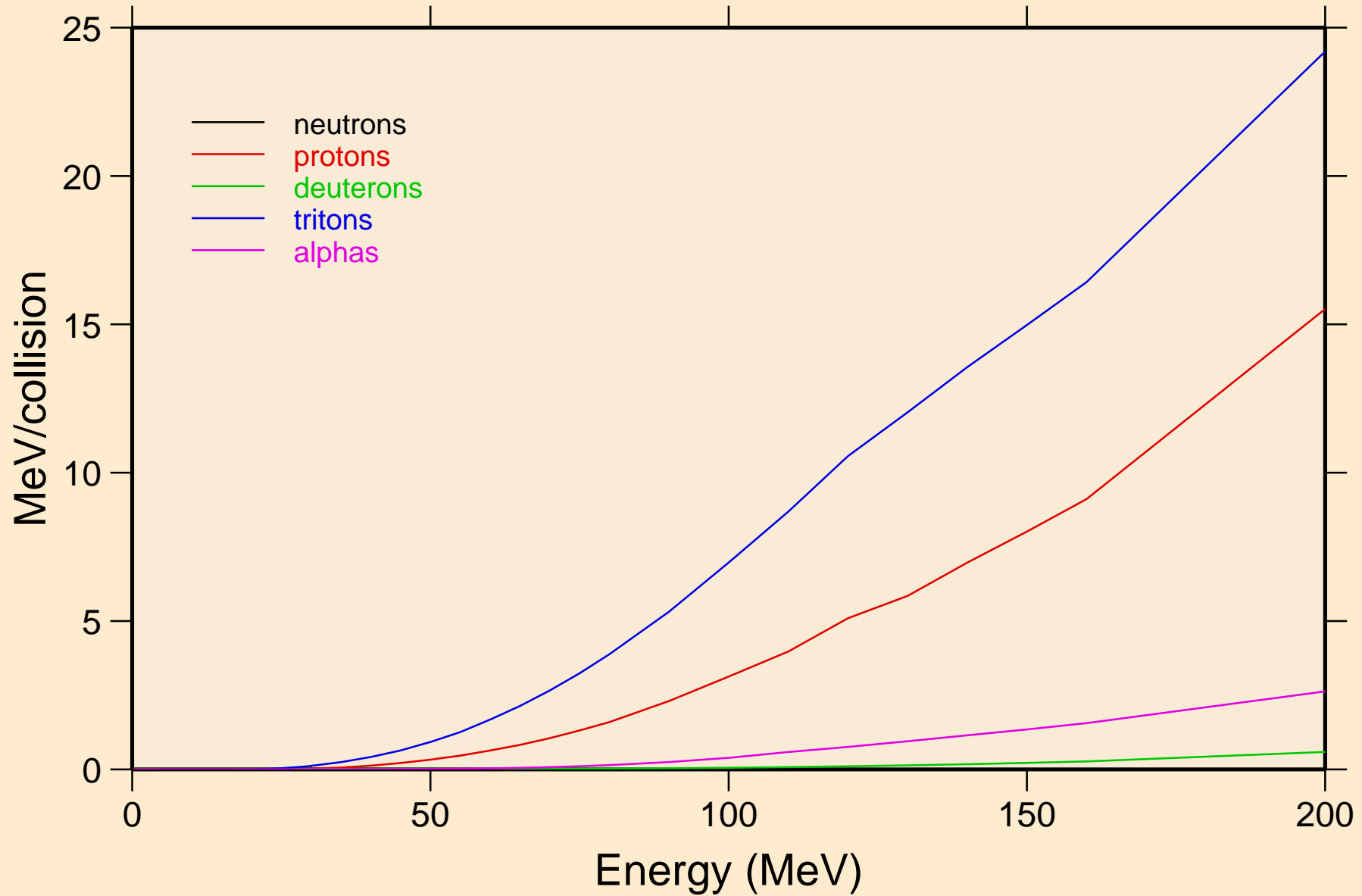

PM136 HELION ACER TENDL-2021 LIBRARY; T=0.K
Recoil Heating

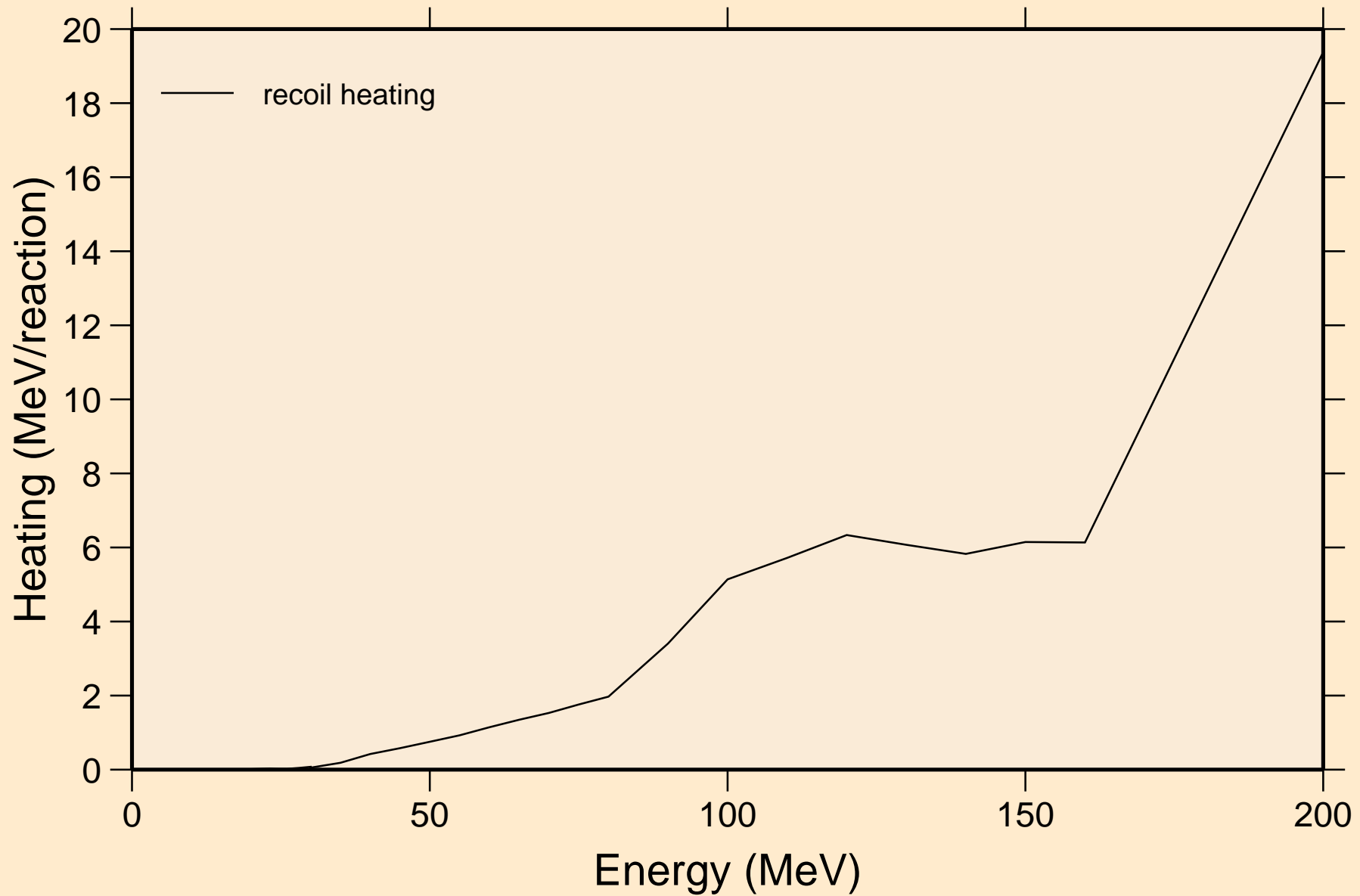

PM136 HELION ACER TENDL-2021 LIBRARY; T=0.K
Particle production cross sections

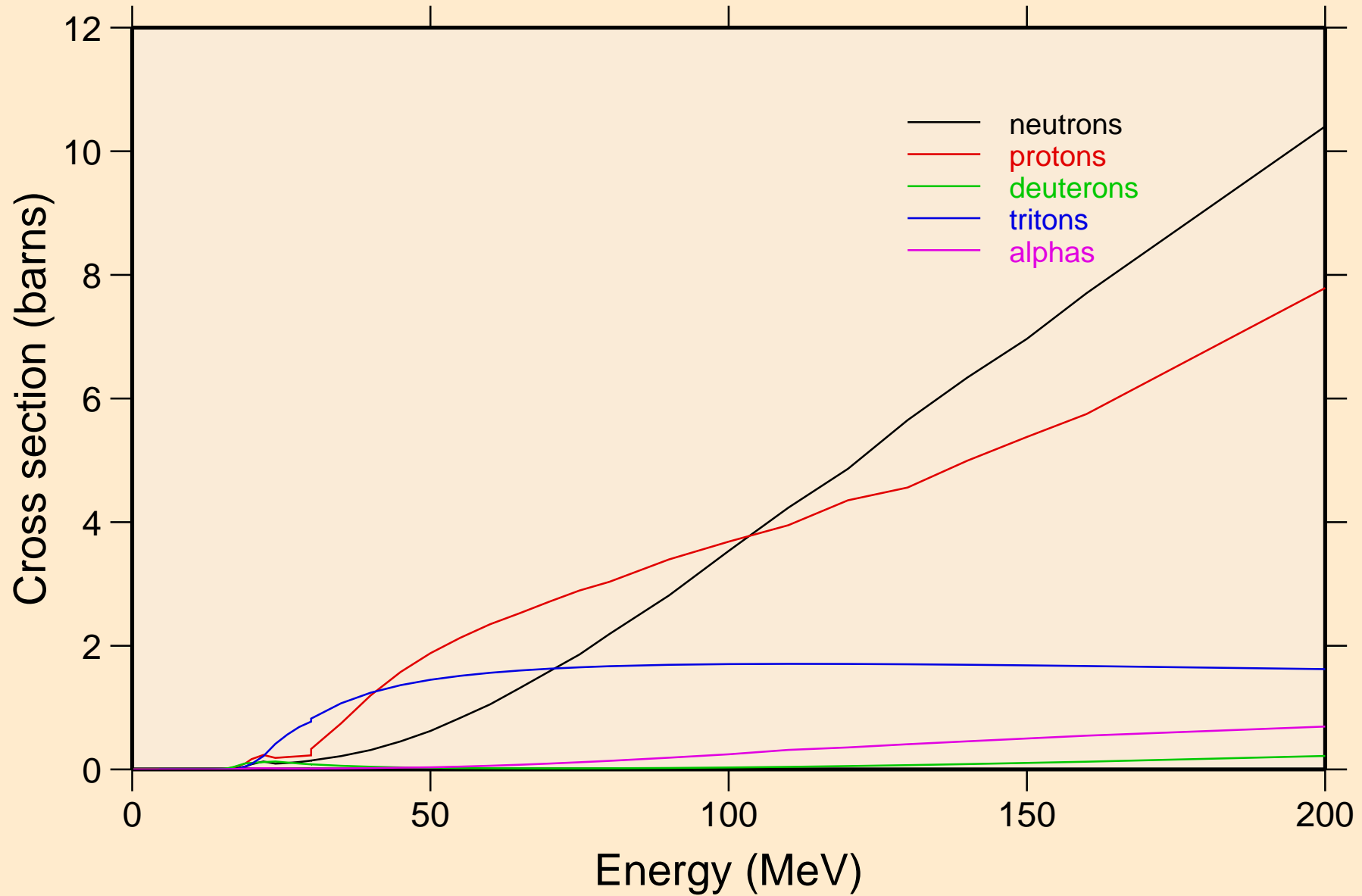

PM136 HELION ACER TENDL-2021 LIBRARY; T=0.K
neutrons from (s,n)

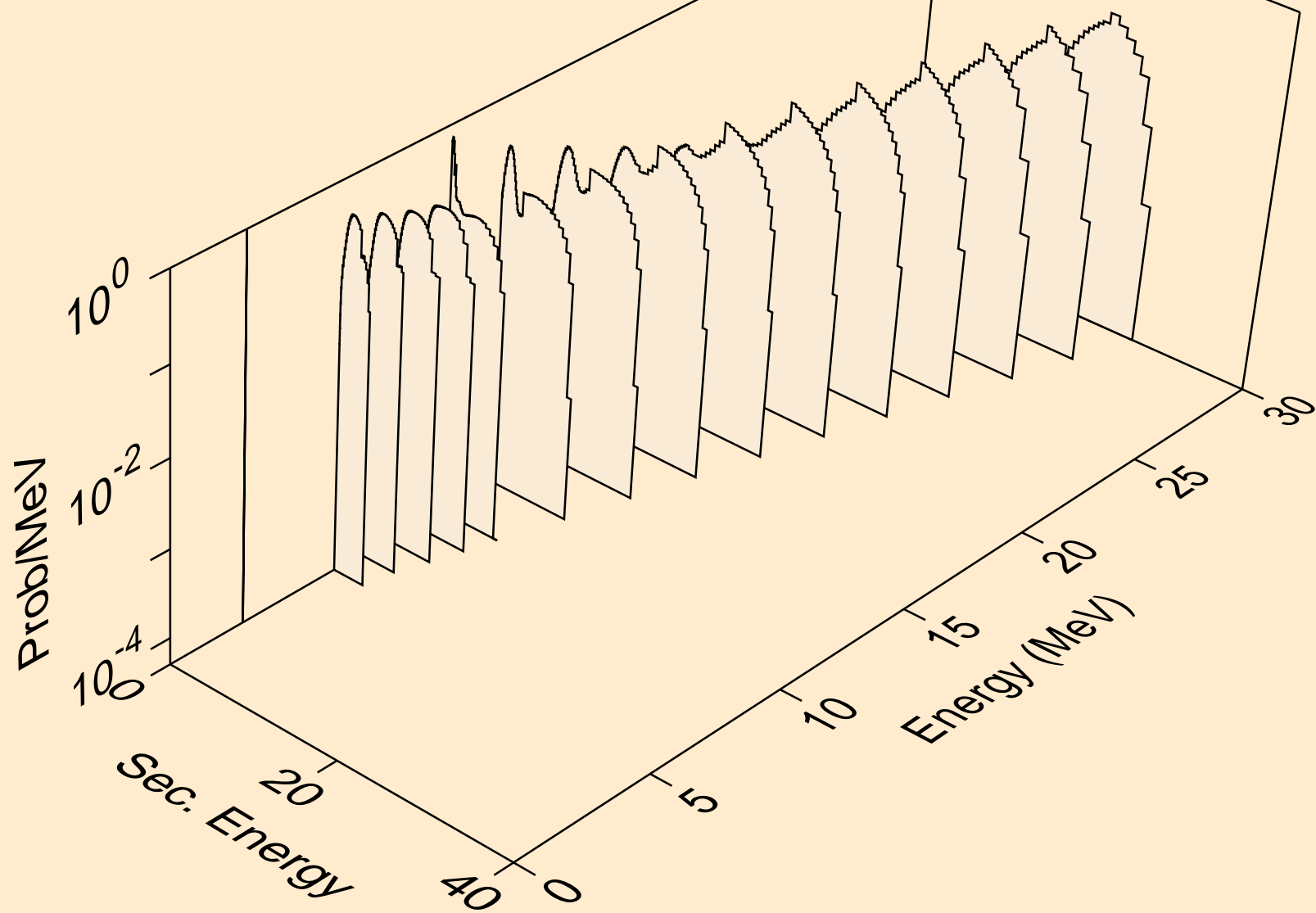

PM136 HELION ACER TENDL-2021 LIBRARY; T=0.K
neutrons from (s,x)

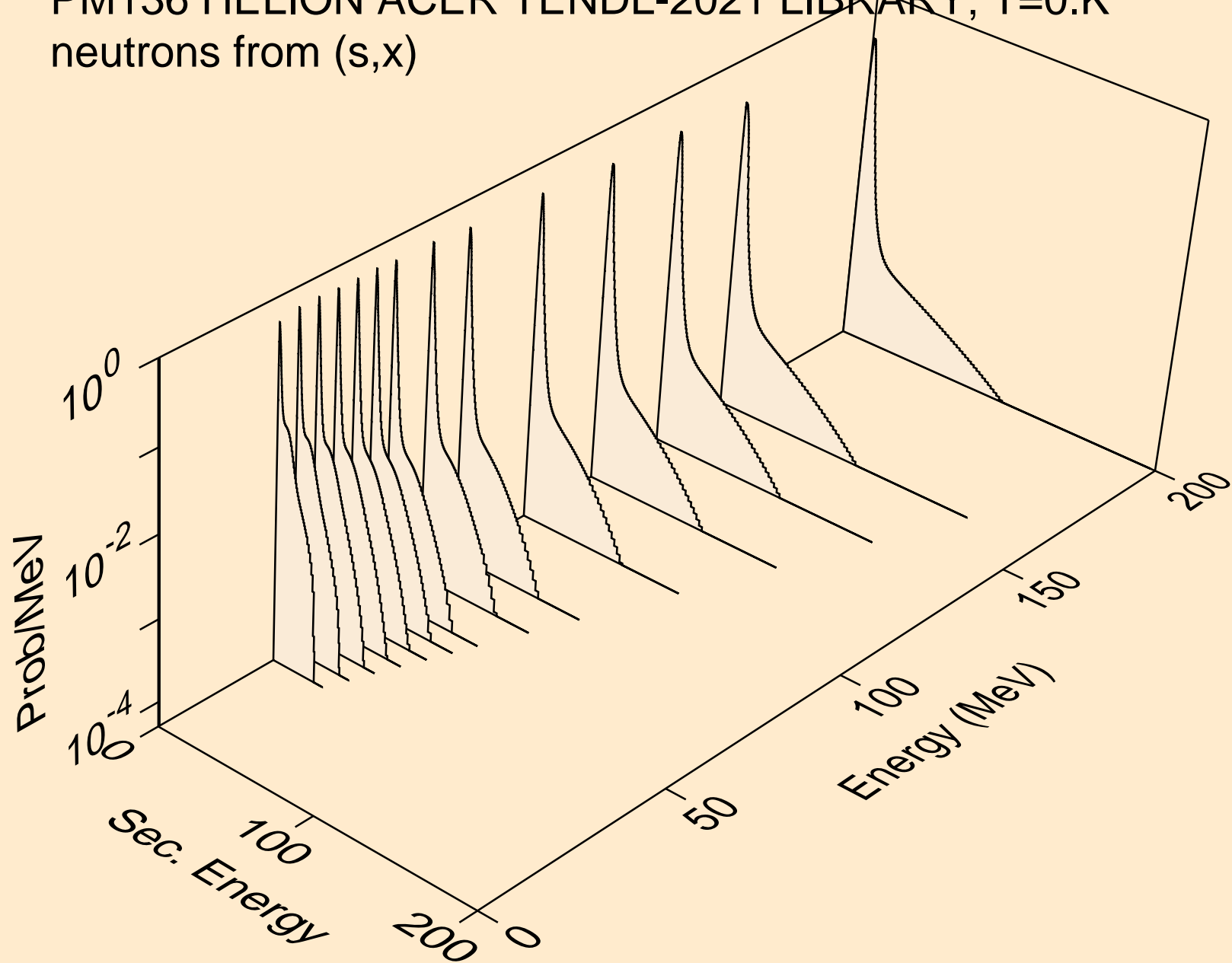

PM136 HELION ACER TENDL-2021 LIBRARY; T=0.K
neutrons from (s,2nd)

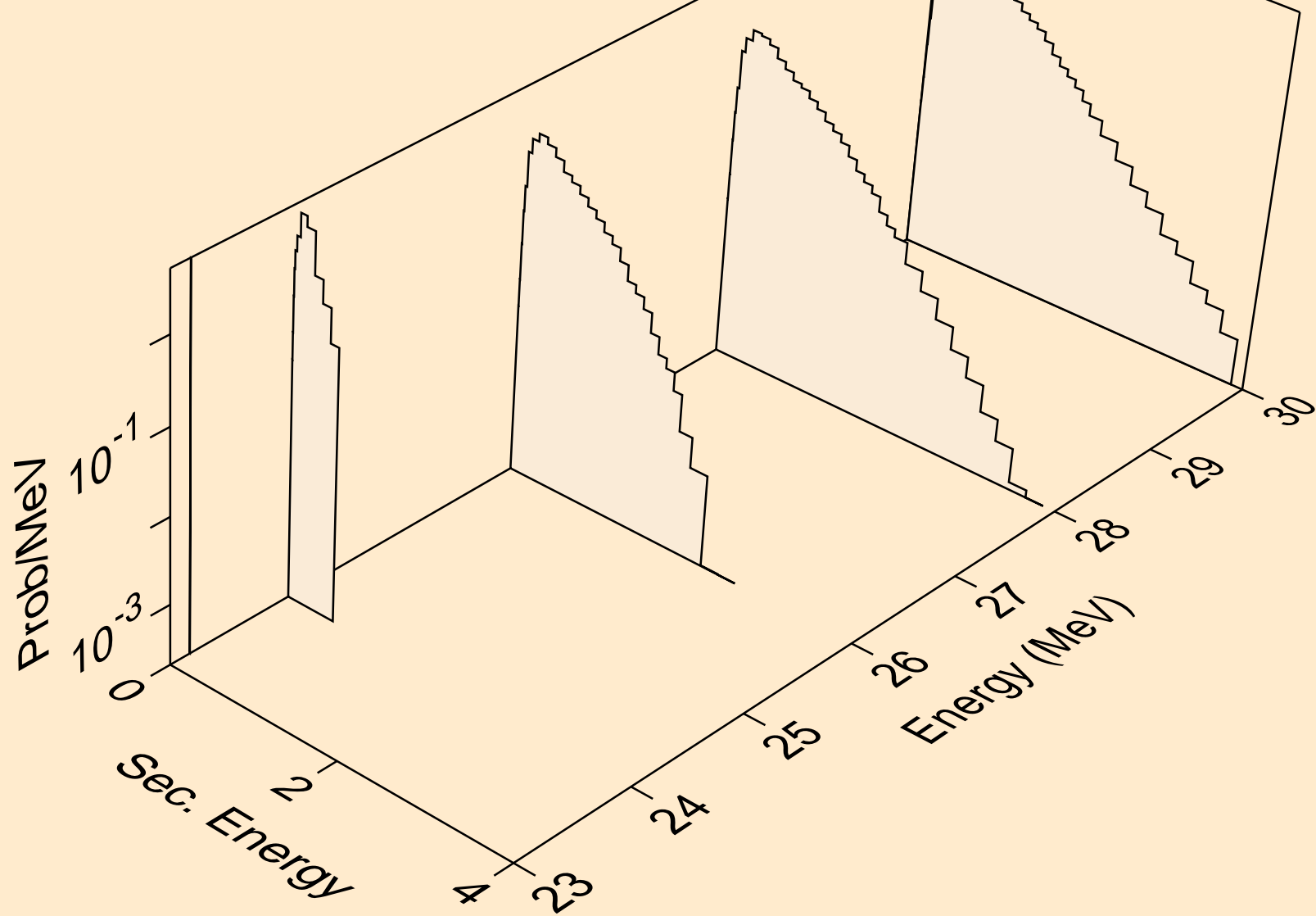

PM136 HELION ACER TENDL-2021 LIBRARY; T=0.K
neutrons from (s,2n)

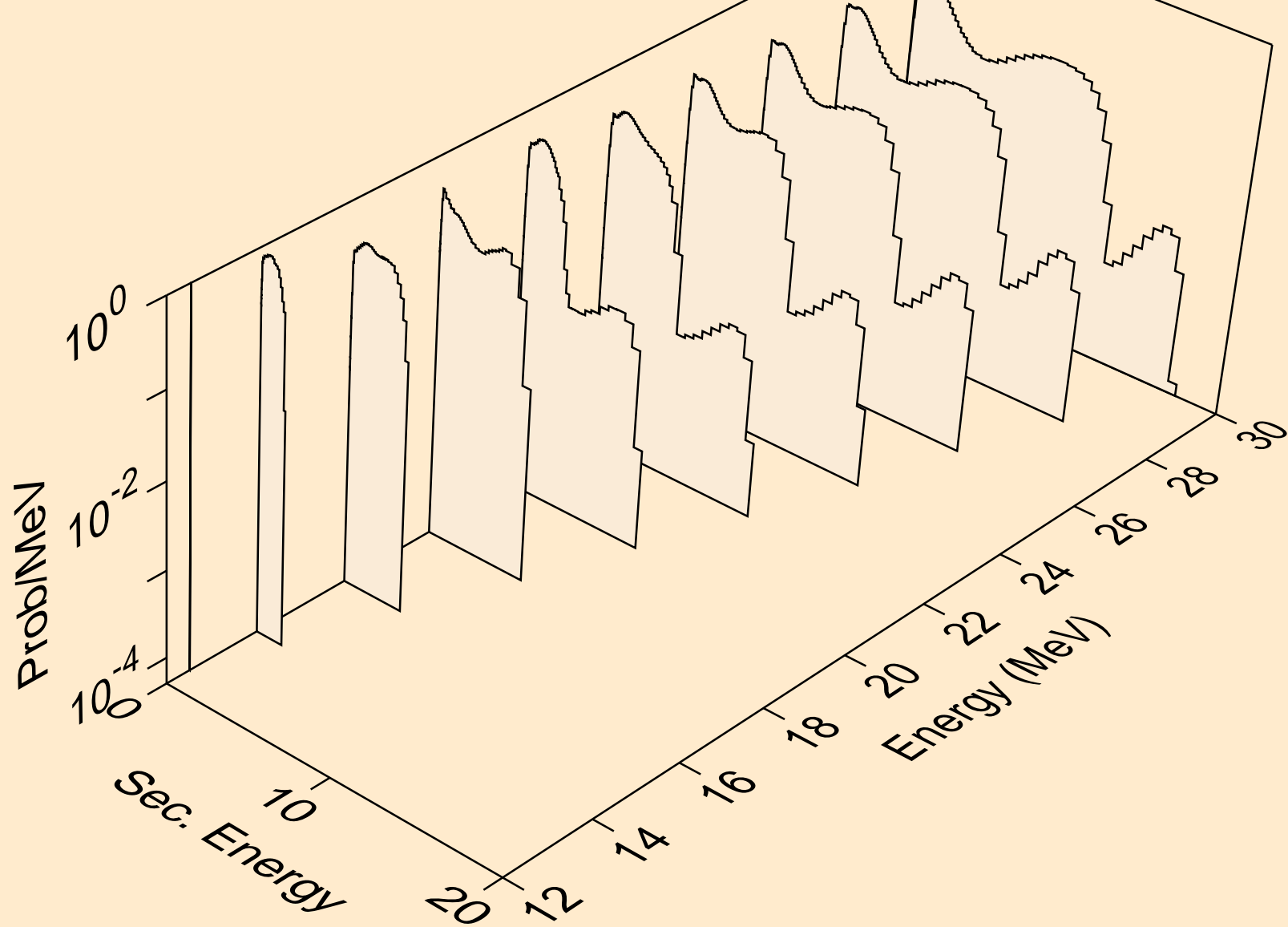

PM136 HELION ACER TENDL-2021 LIBRARY; T=0.K
neutrons from (s,3n)

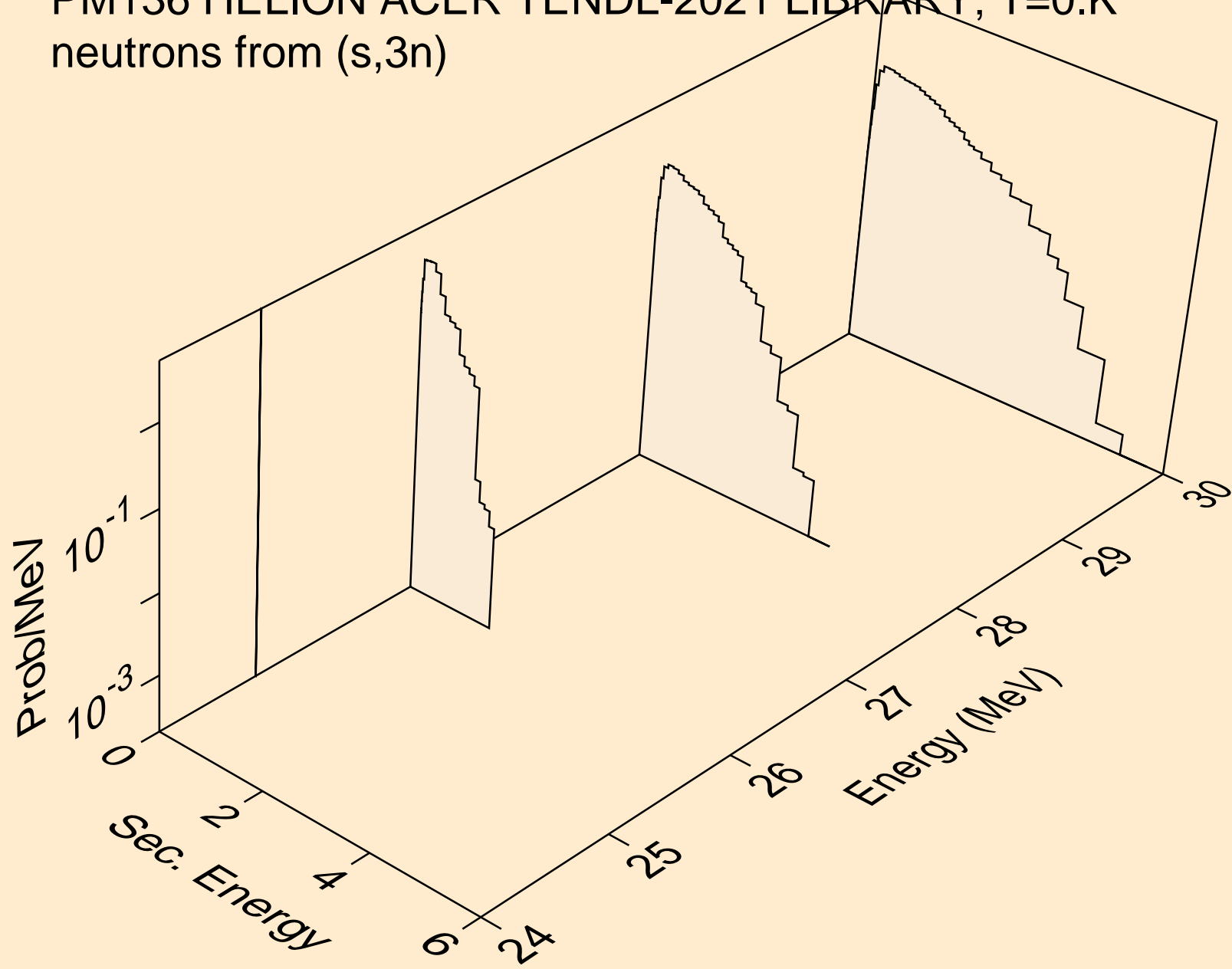

PM136 HELION ACER TENDL-2021 LIBRARY; T=0.K
neutrons from (s,n*)a

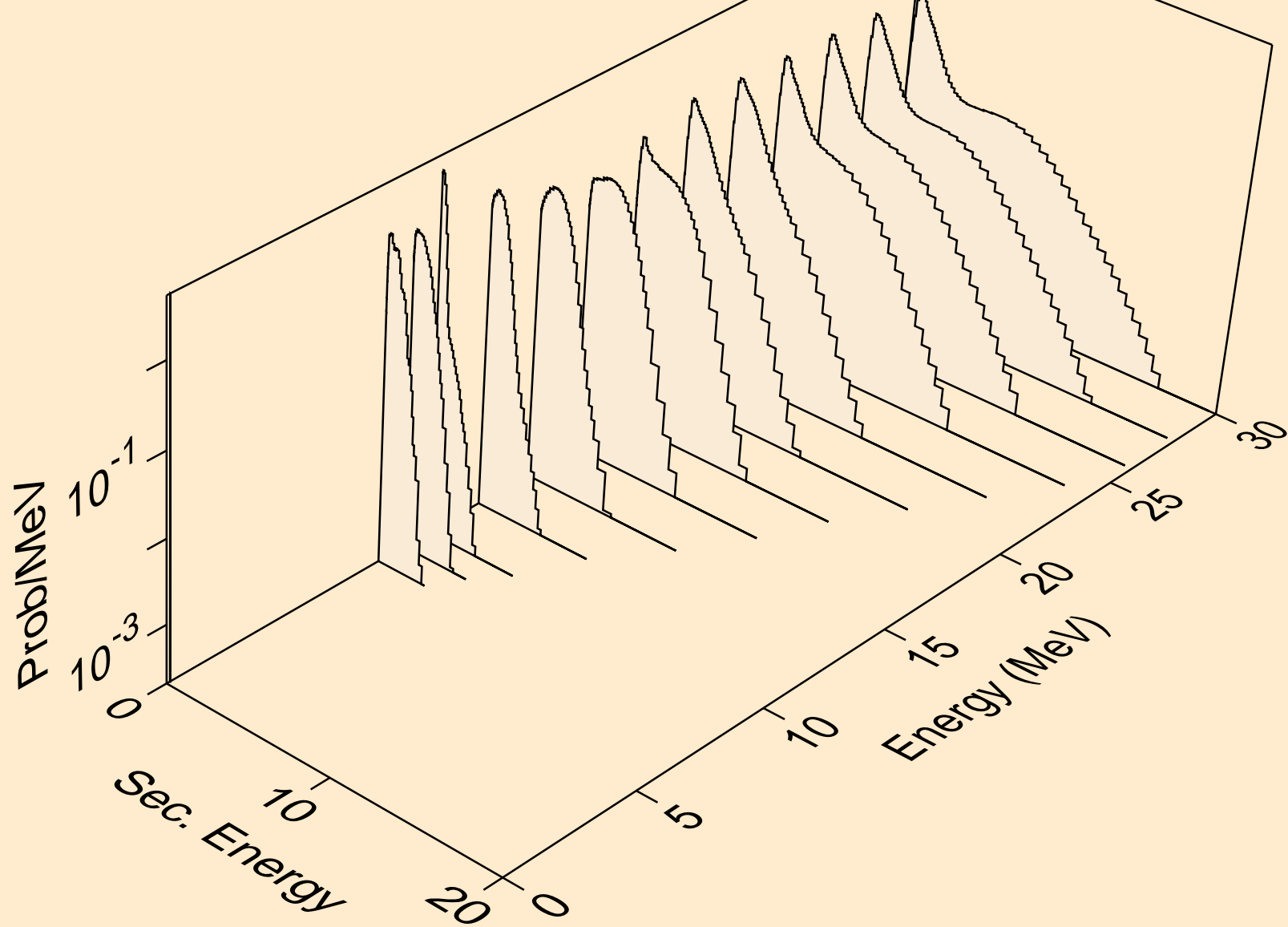

PM136 HELION ACER TENDL-2021 LIBRARY; T=0.K
neutrons from (s,2n)a

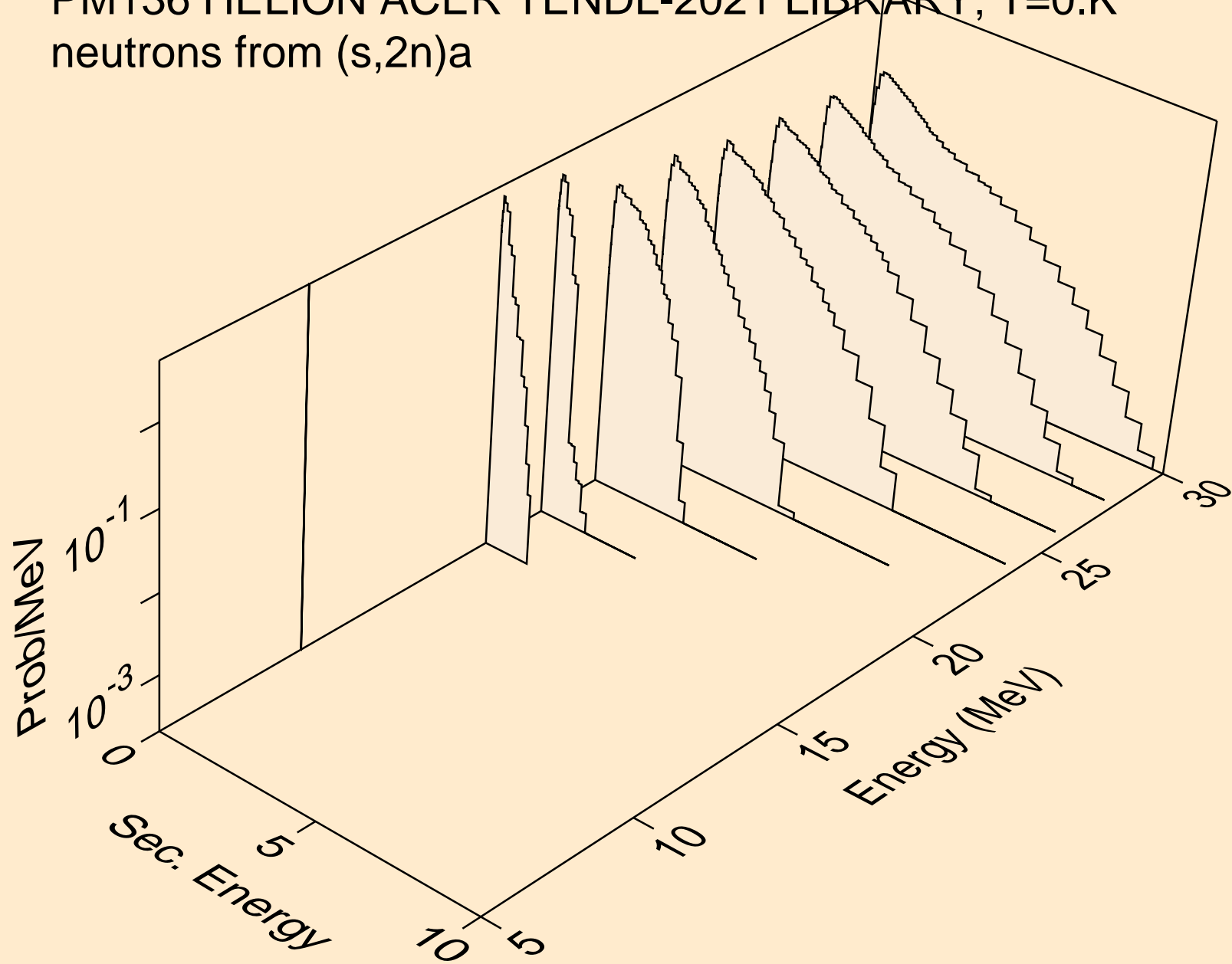

PM136 HELION ACER TENDL-2021 LIBRARY; T=0.K
neutrons from (s,n*)p

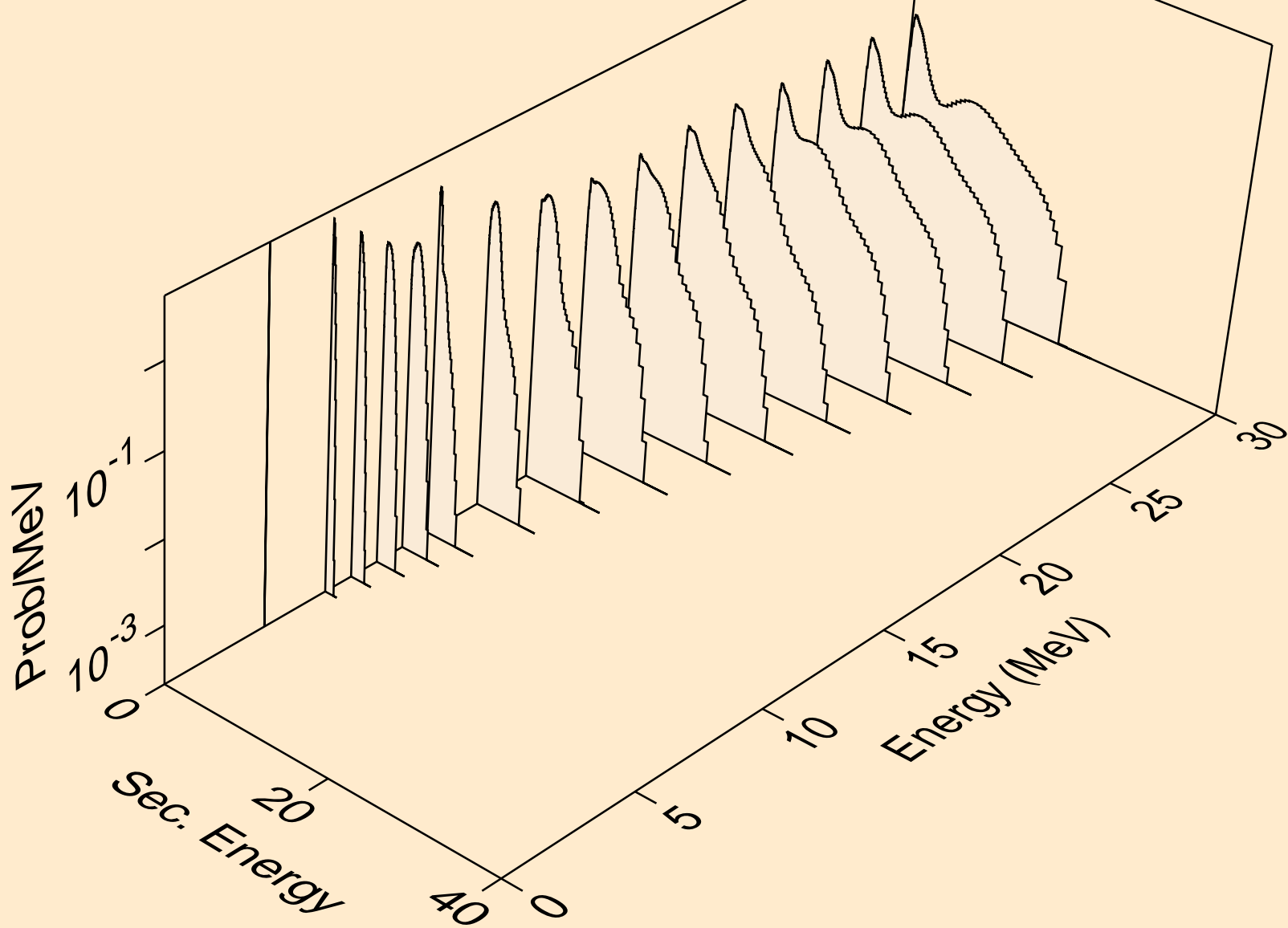

PM136 HELION ACER TENDL-2021 LIBRARY; T=0.K
neutrons from (s,n*)2a

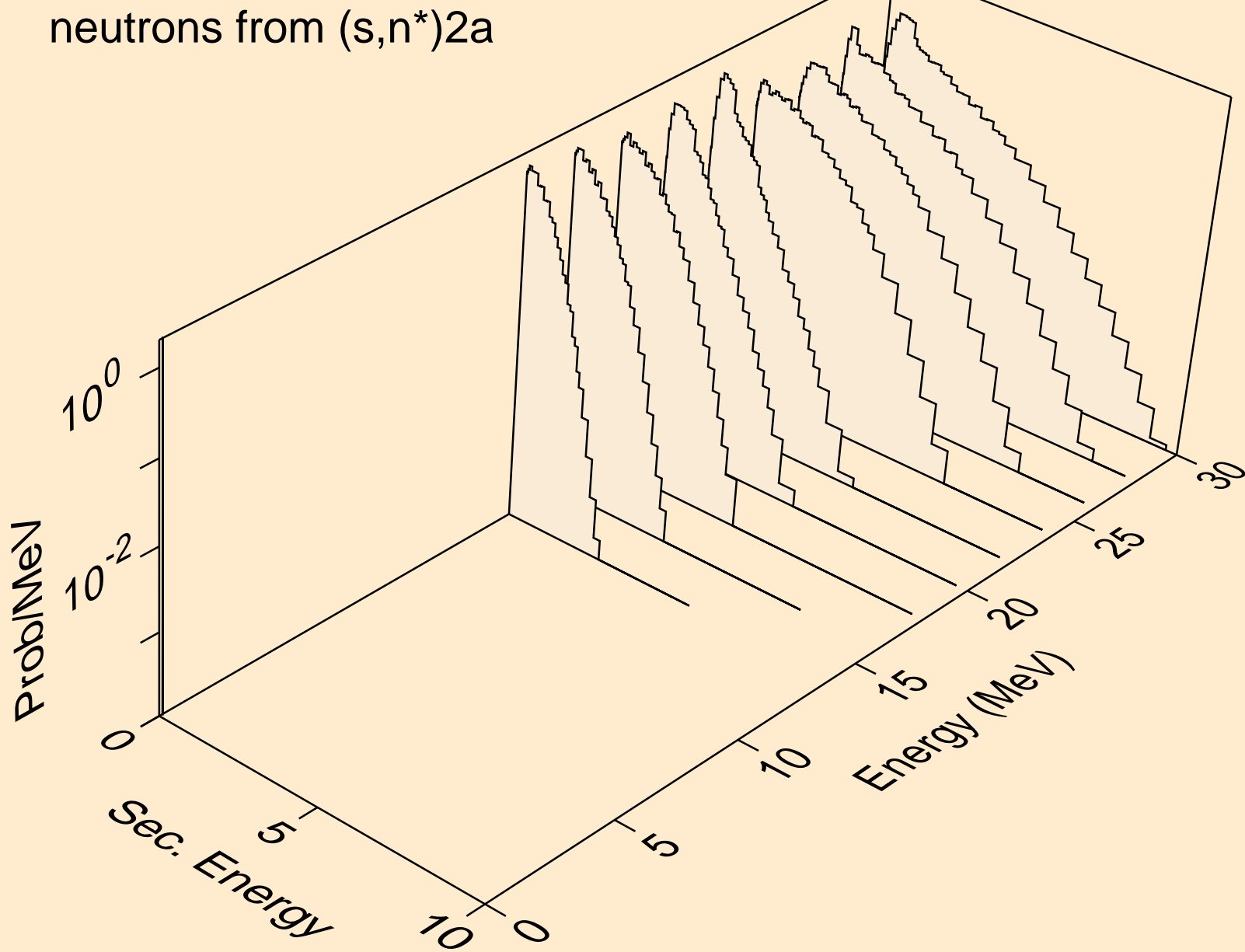

PM136 HELION ACER TENDL-2021 LIBRARY; T=0.K
neutrons from (s,n*)d

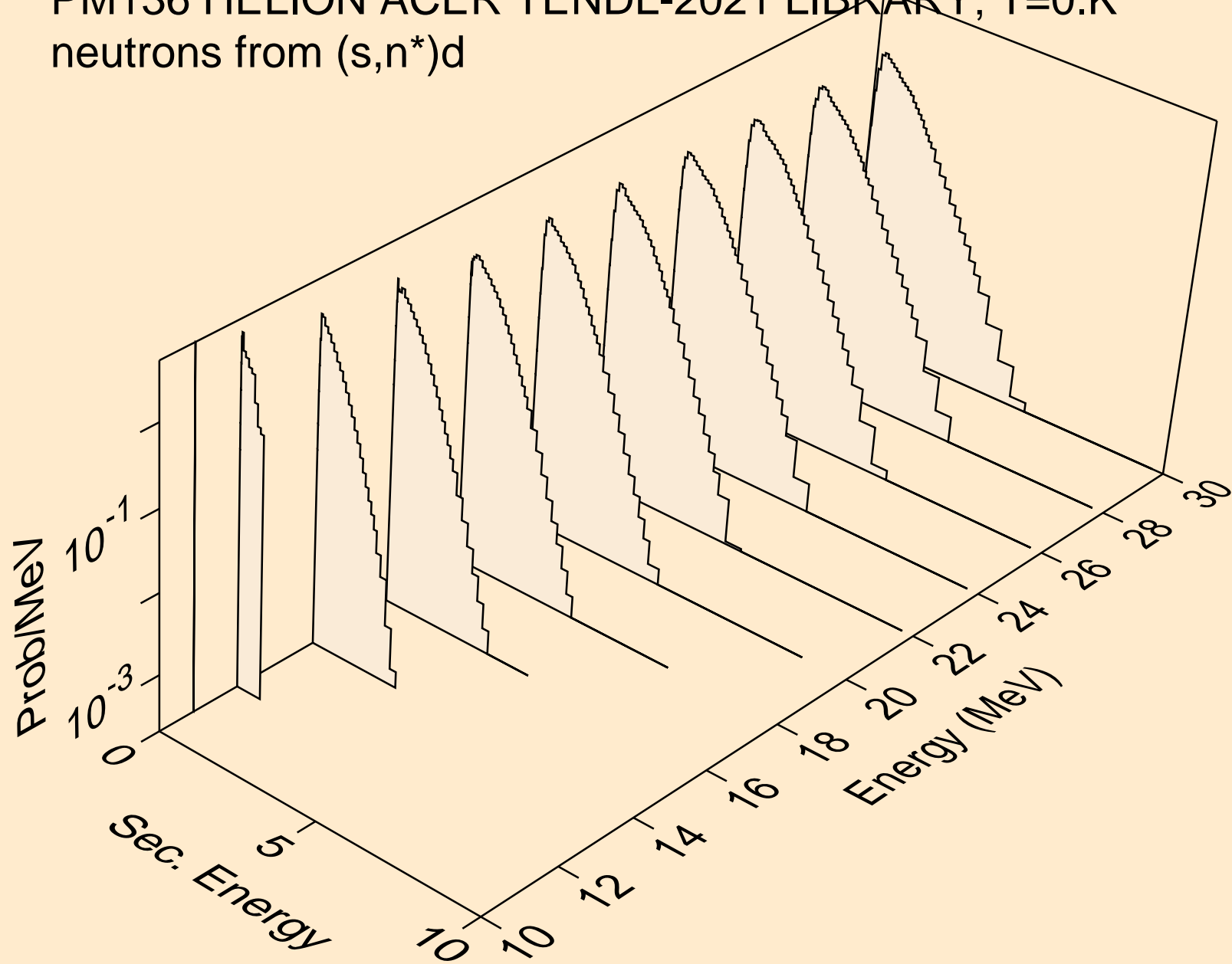

PM136 HELION ACER TENDL-2021 LIBRARY; T=0.K
neutrons from (s,n*)t

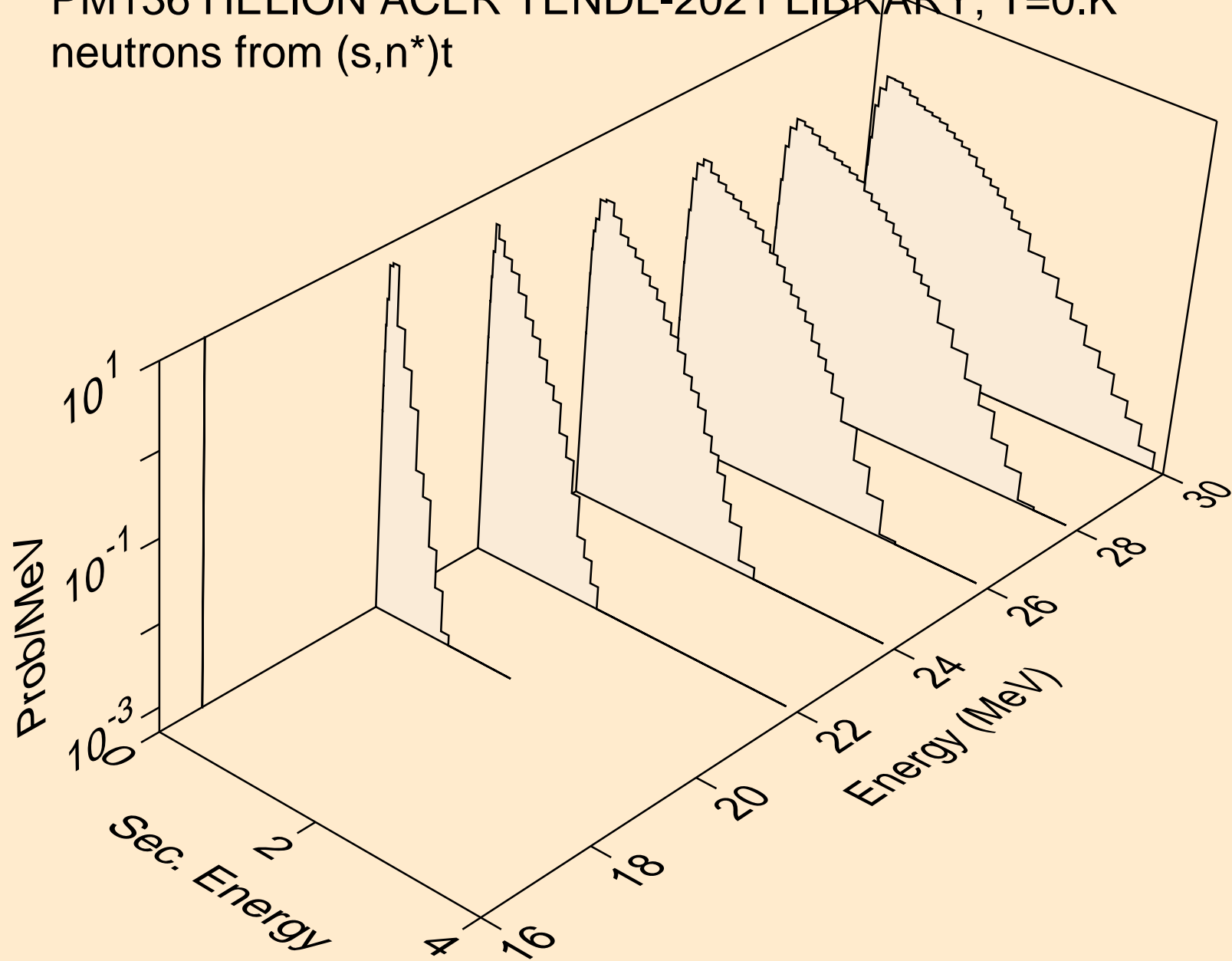

PM136 HELION ACER TENDL-2021 LIBRARY; T=0.K
neutrons from (s,n*)he3

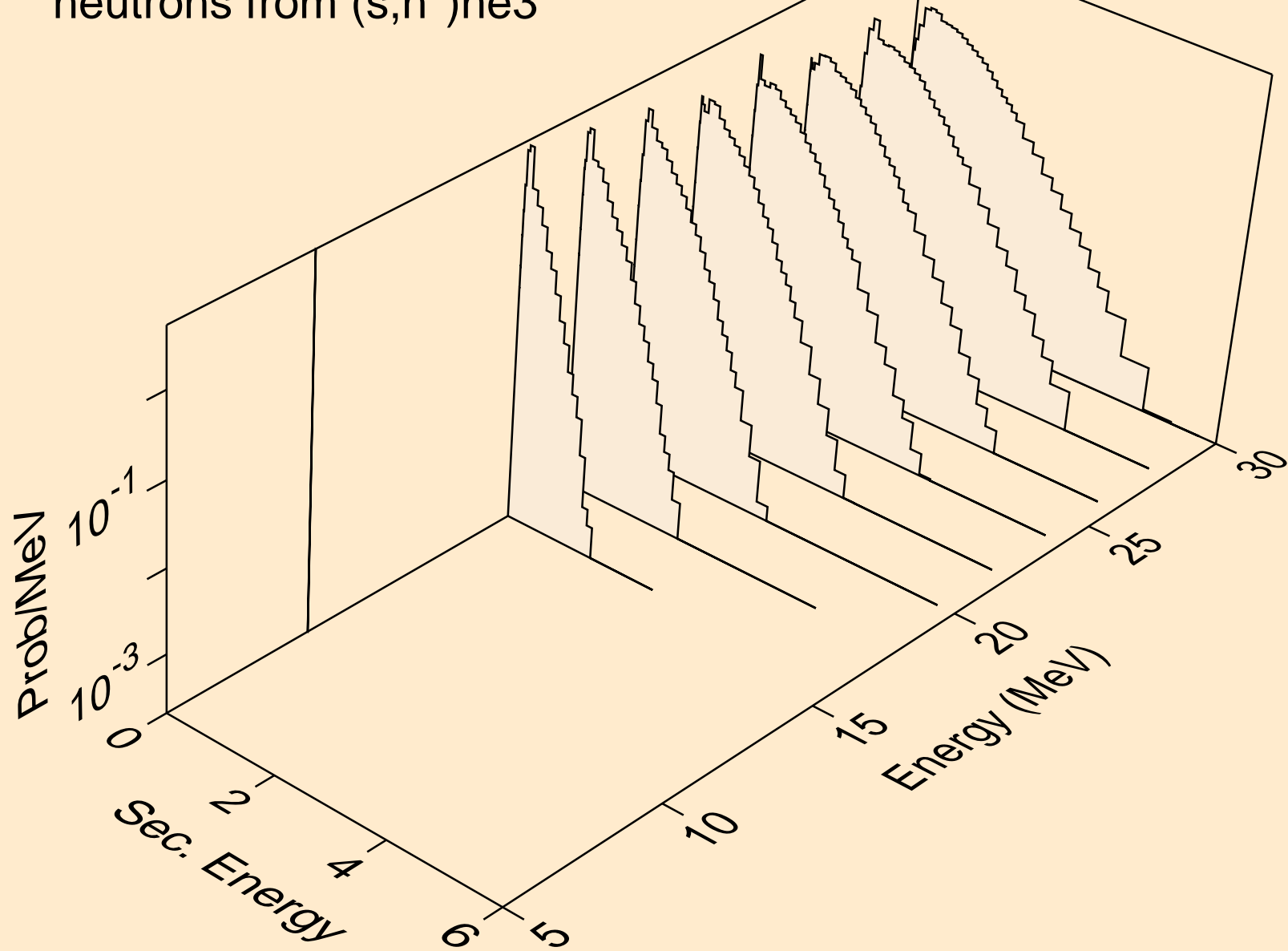

PM136 HELION ACER TENDL-2021 LIBRARY; T=0.K
neutrons from (s,2np)

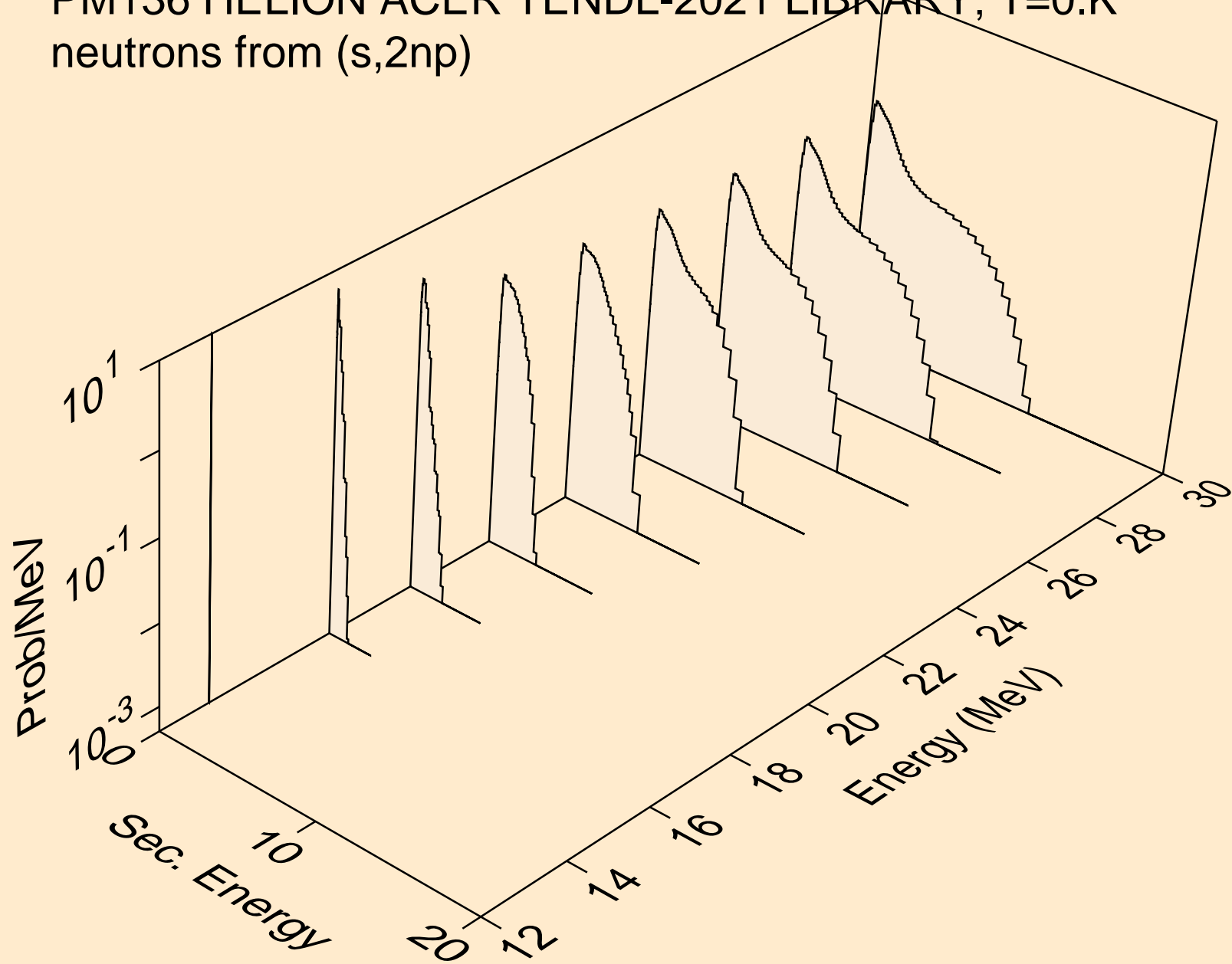

PM136 HELION ACER TENDL-2021 LIBRARY; T=0.K
neutrons from (s,3np)

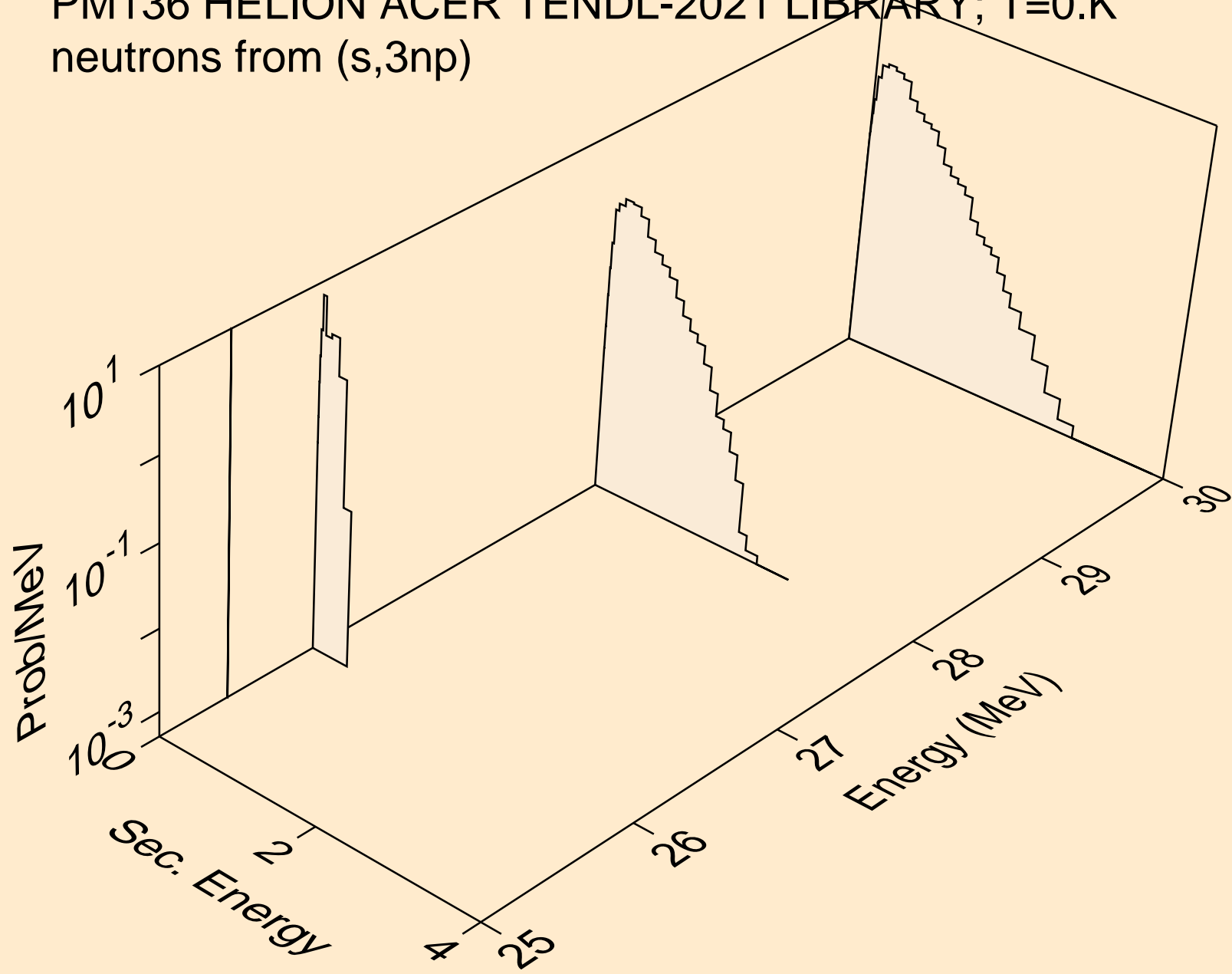

PM136 HELION ACER TENDL-2021 LIBRARY; T=0.K
neutrons from (s,2np)

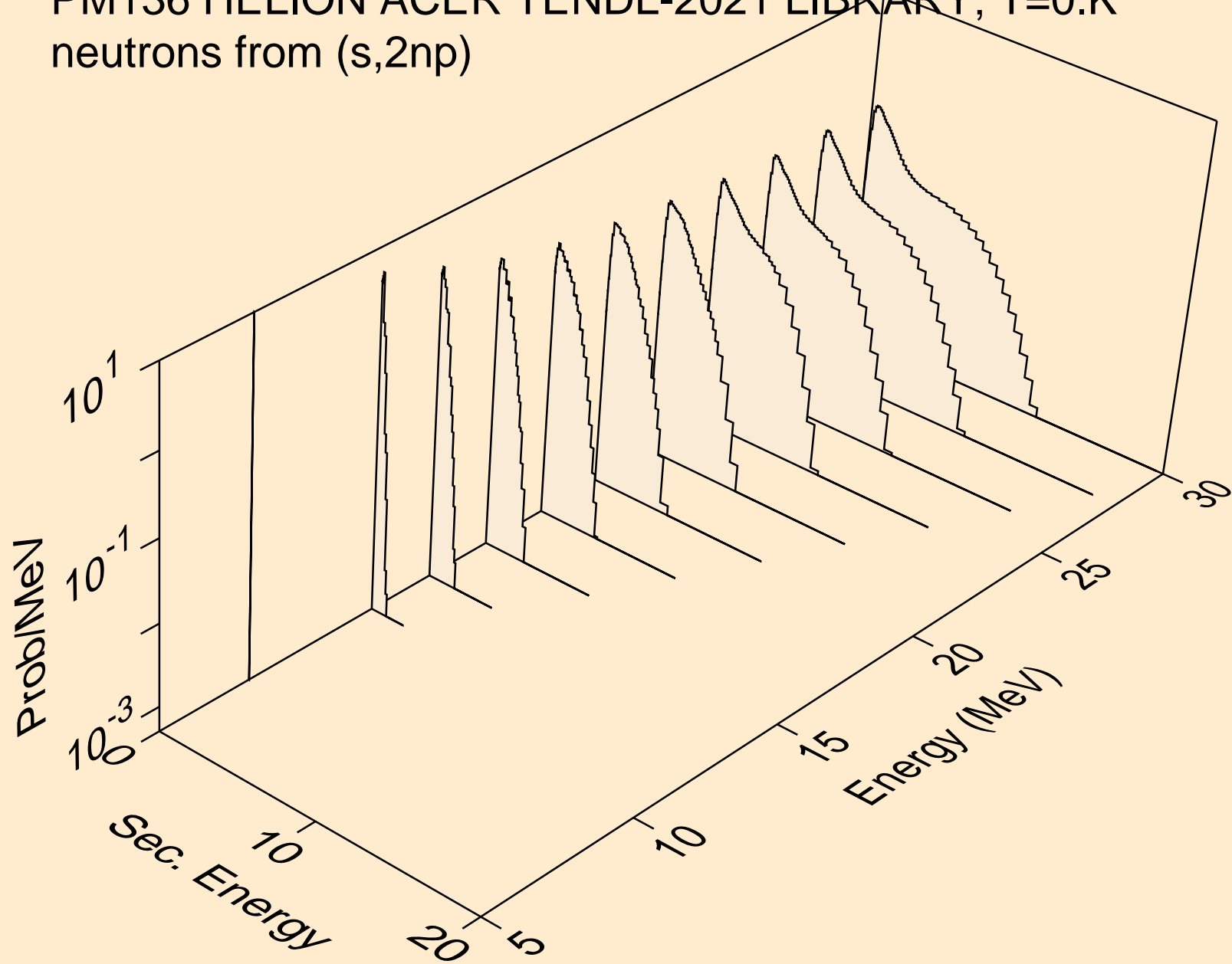

PM136 HELION ACER TENDL-2021 LIBRARY; T=0.K
neutrons from (s,npa)

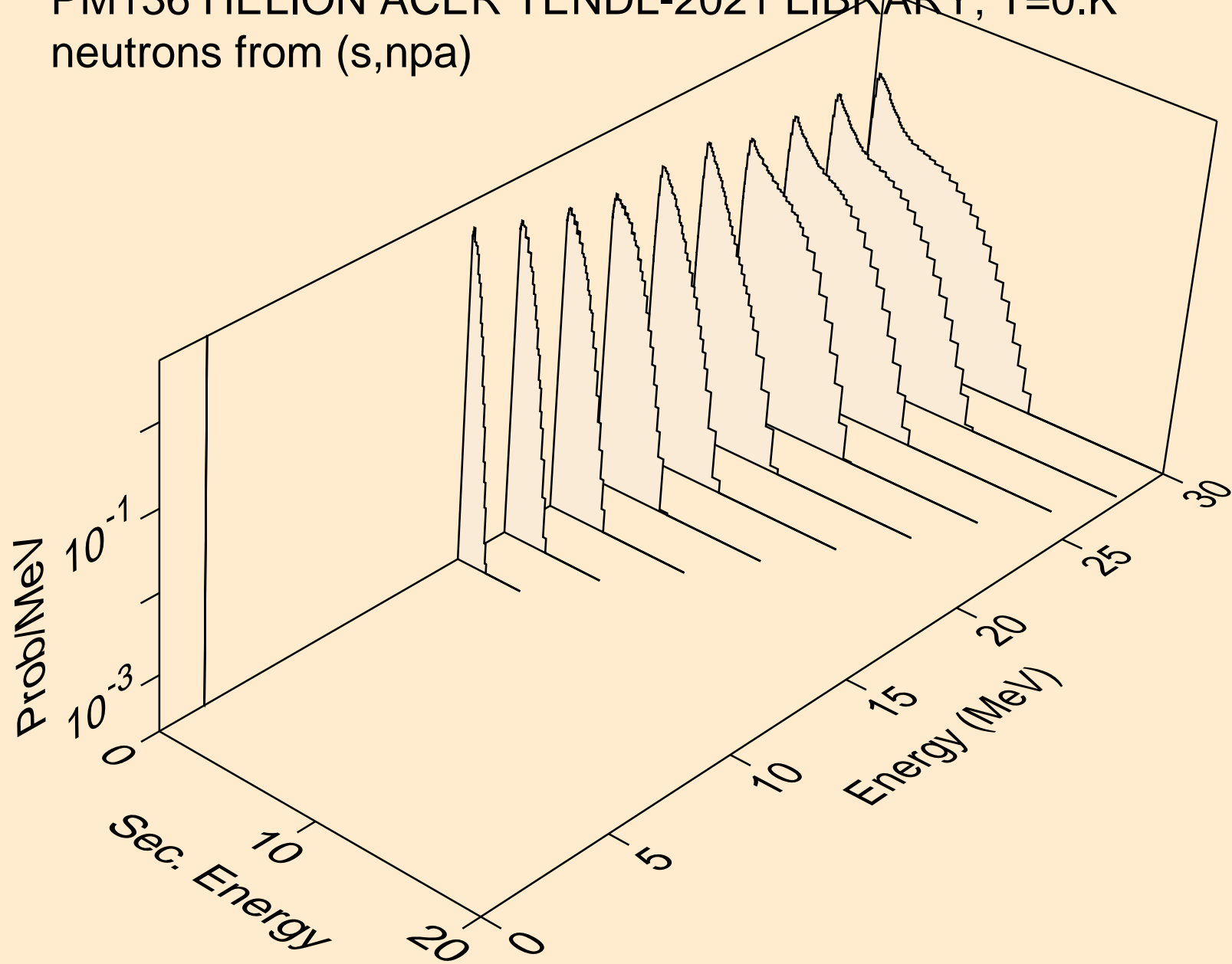

PM136 HELION ACER TENDL-2021 LIBRARY; T=0.K
protons from (s,x)

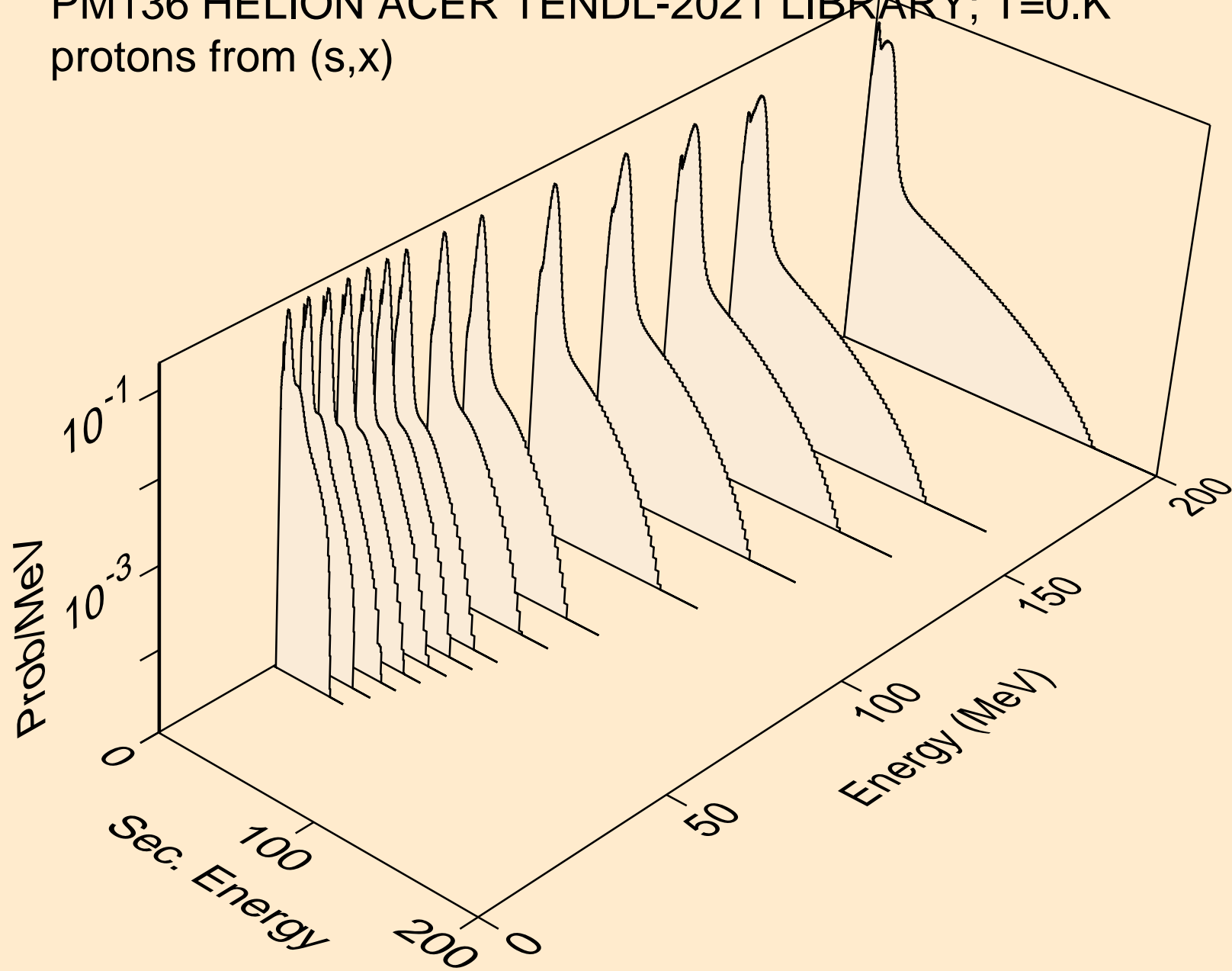

PM136 HELION ACER TENDL-2021 LIBRARY; T=0.K
protons from (s,n*)p

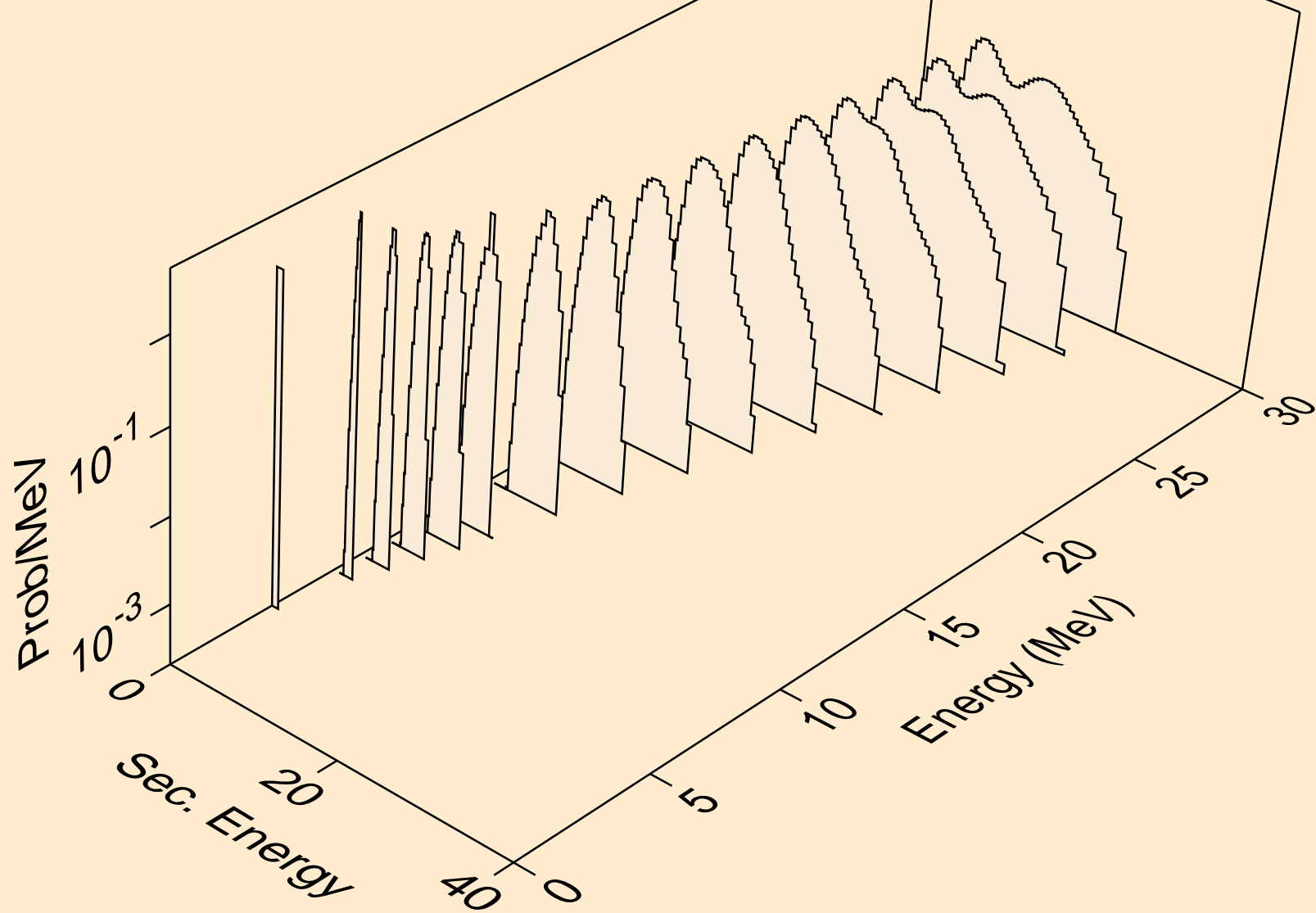

PM136 HELION ACER TENDL-2021 LIBRARY; T=0.K
protons from (s,2np)

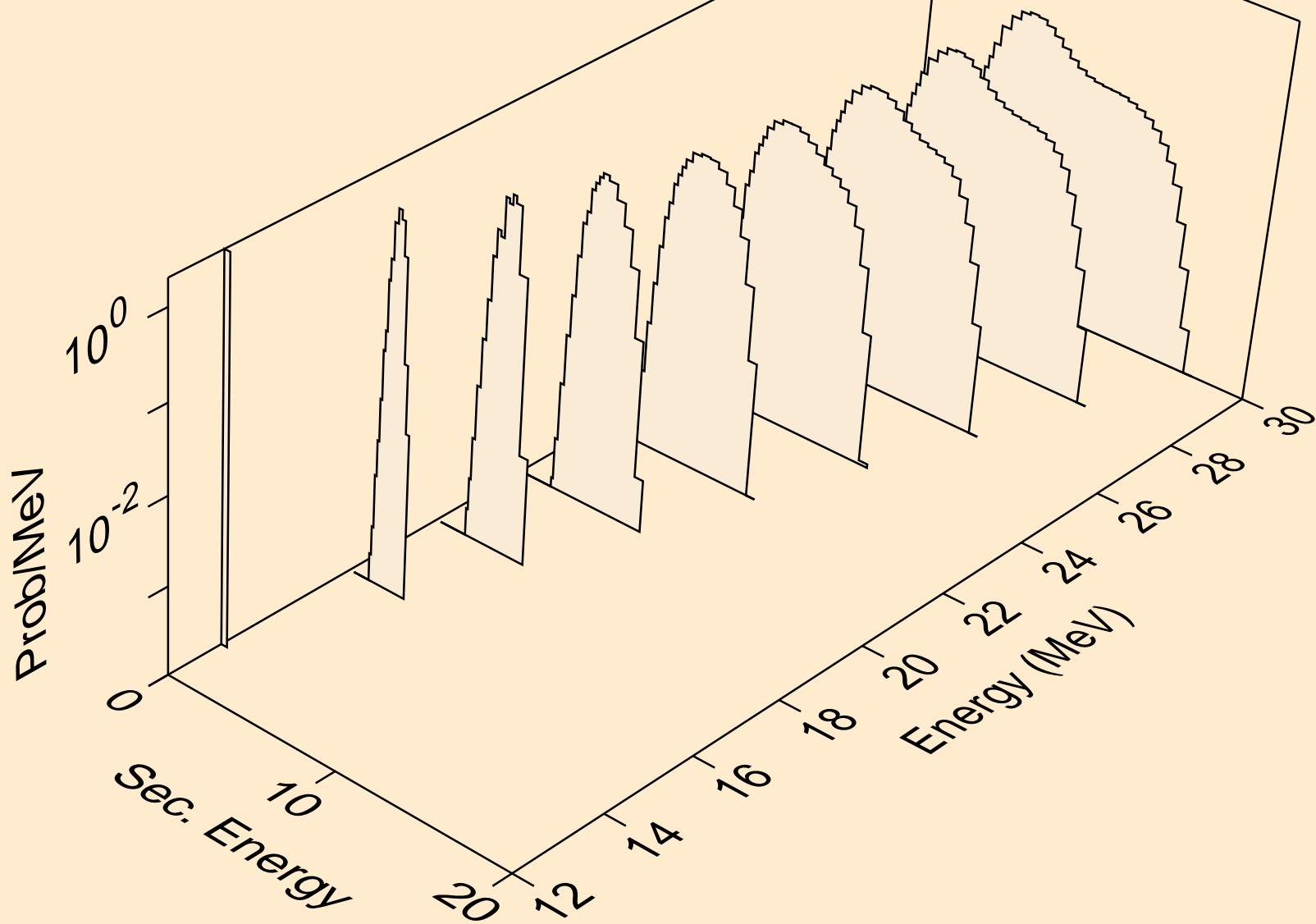

PM136 HELION ACER TENDL-2021 LIBRARY; T=0.K
protons from (s,3np)

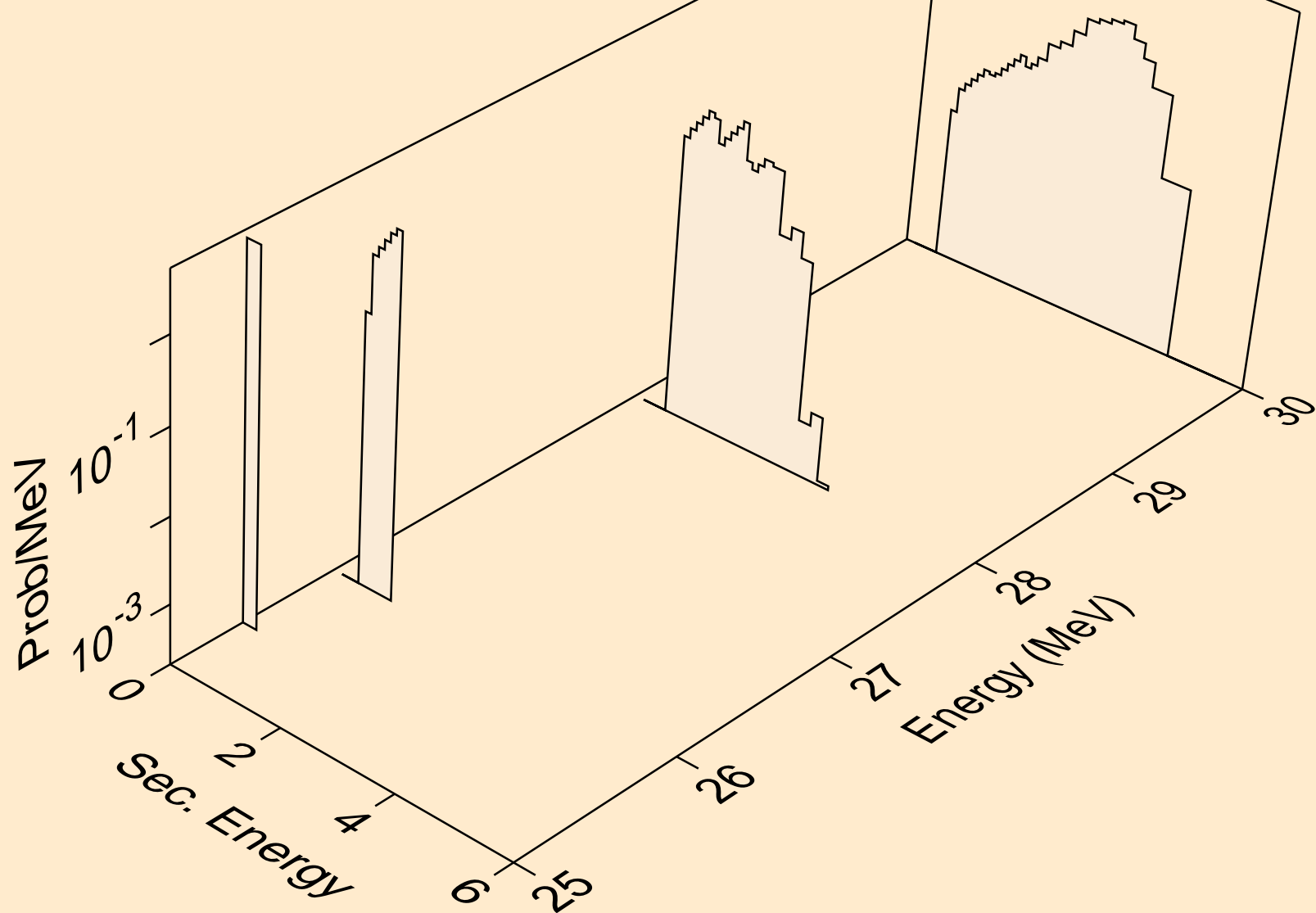

PM136 HELION ACER TENDL-2021 LIBRARY; T=0.K
protons from (s,2np)

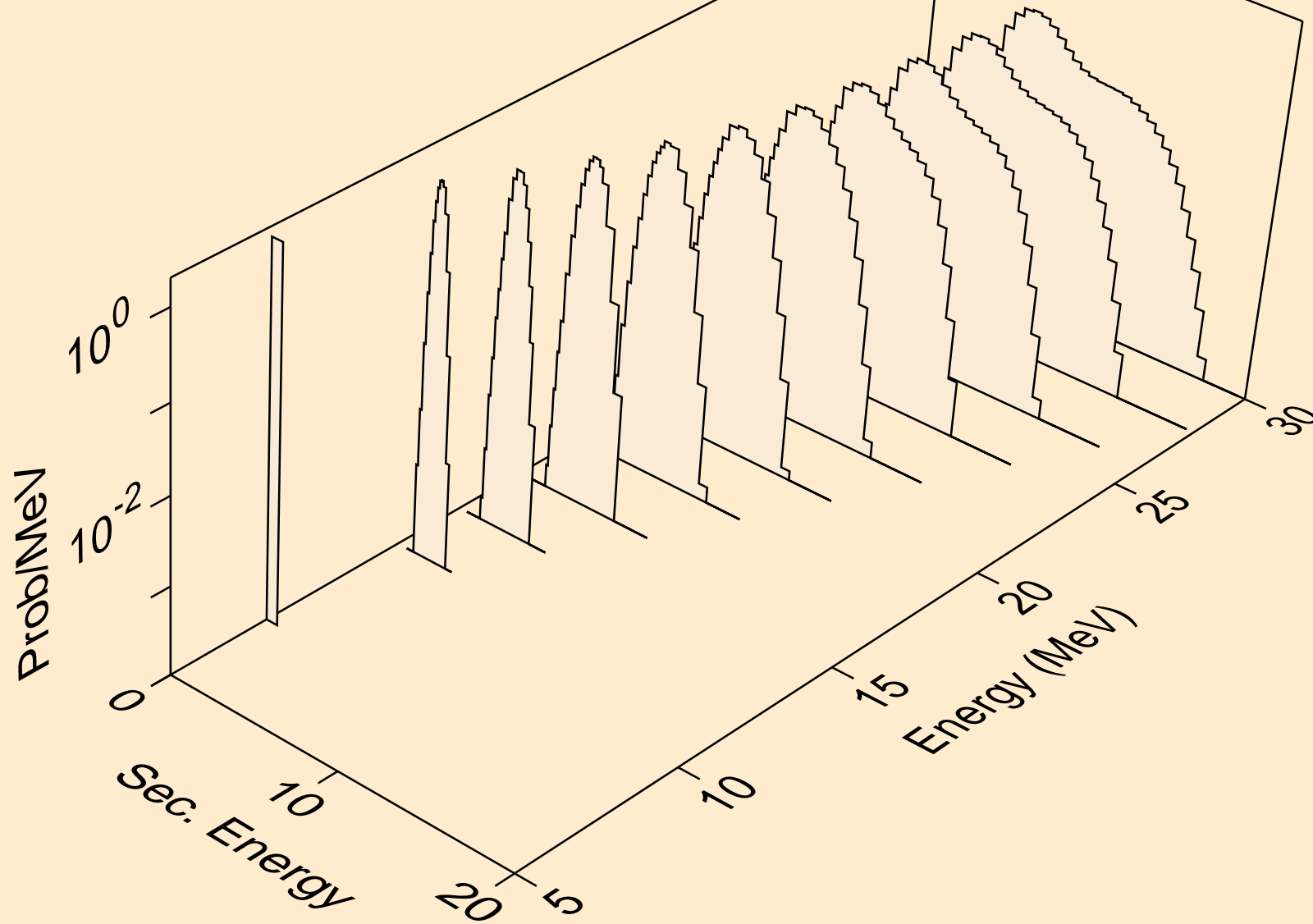

PM136 HELION ACER TENDL-2021 LIBRARY; T=0.K
protons from (s,npa)

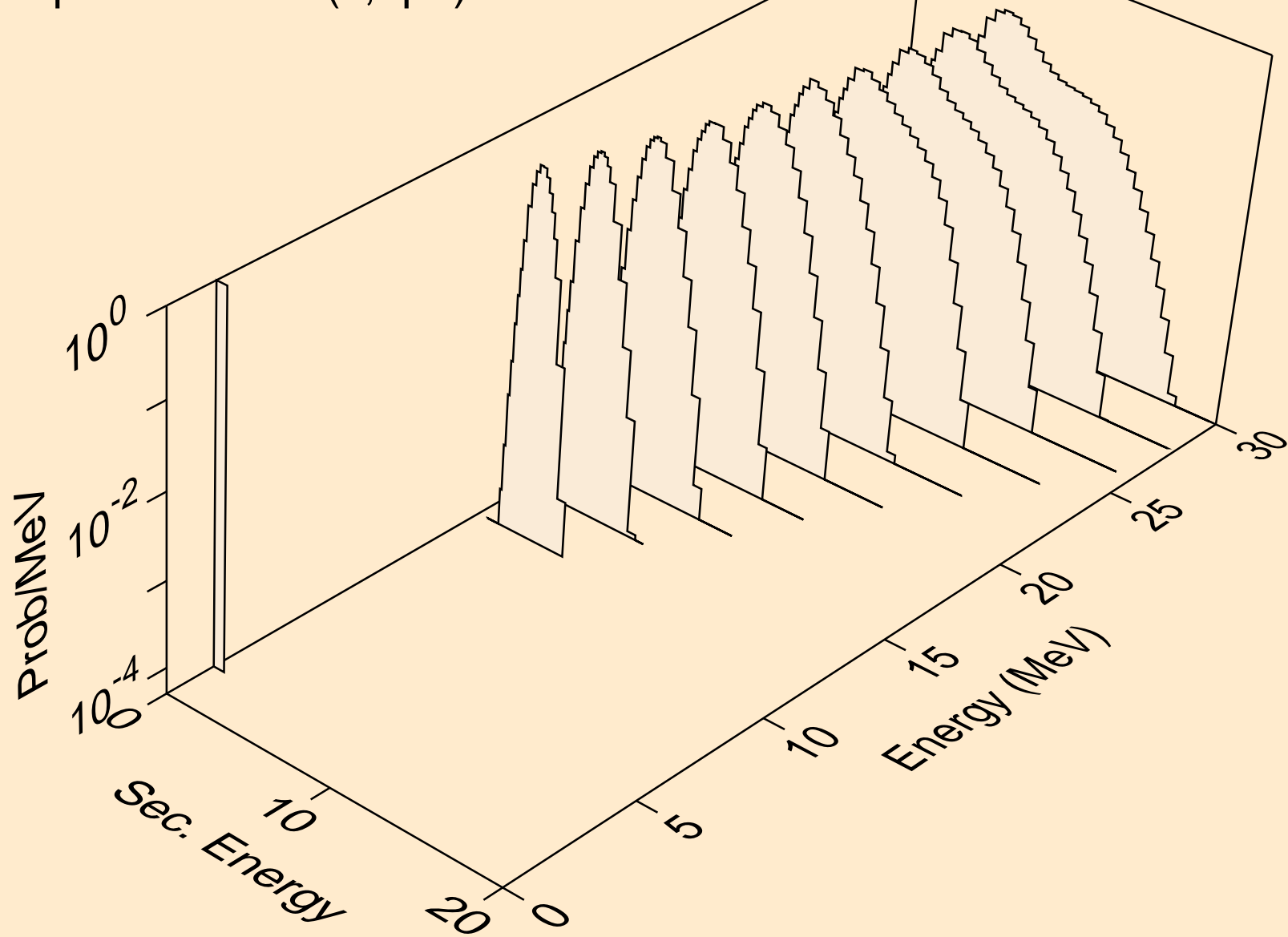

PM136 HELION ACER TENDL-2021 LIBRARY; T=0.K
protons from (s,p)

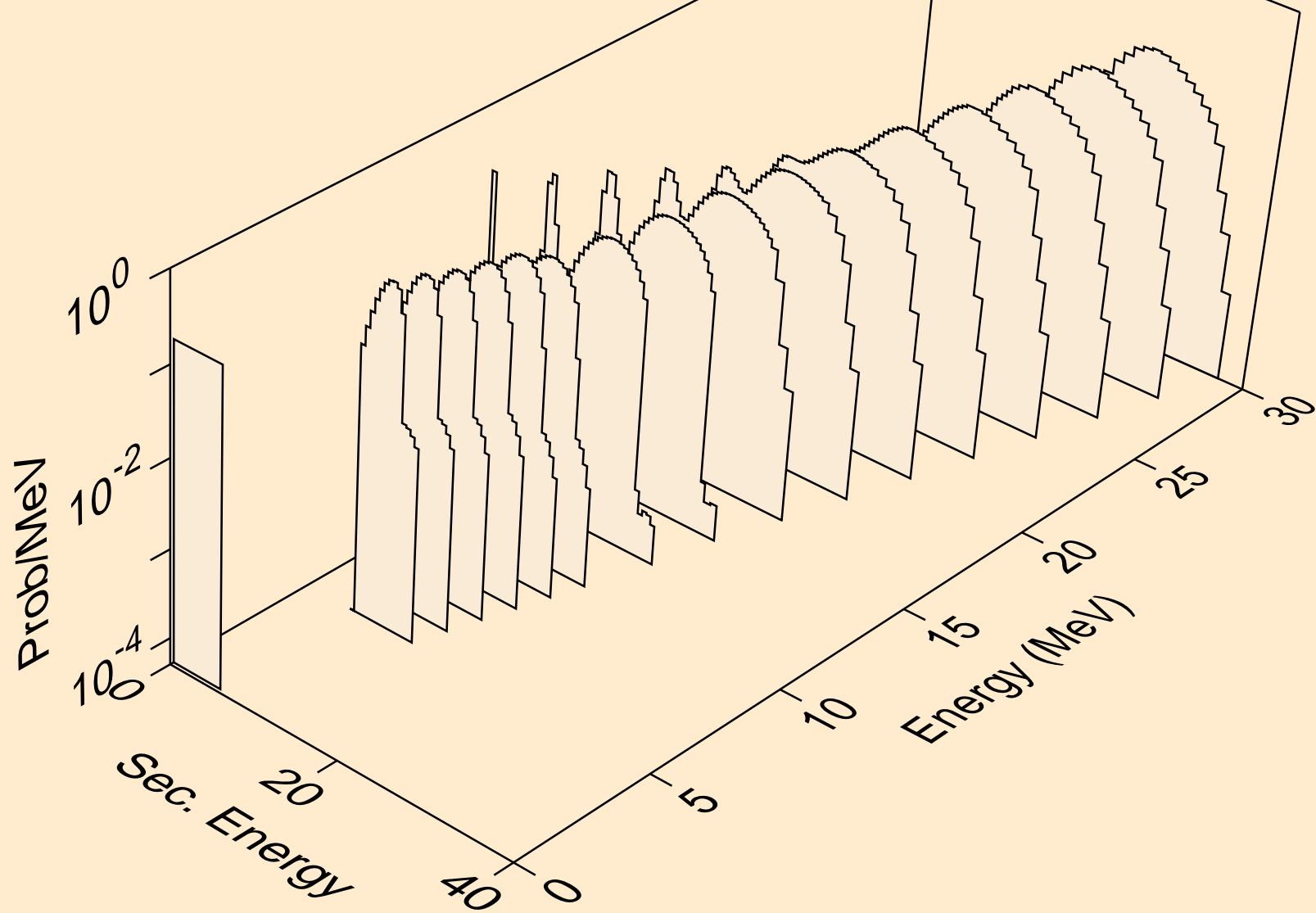

PM136 HELION ACER TENDL-2021 LIBRARY; T=0.K
protons from (s,2p)

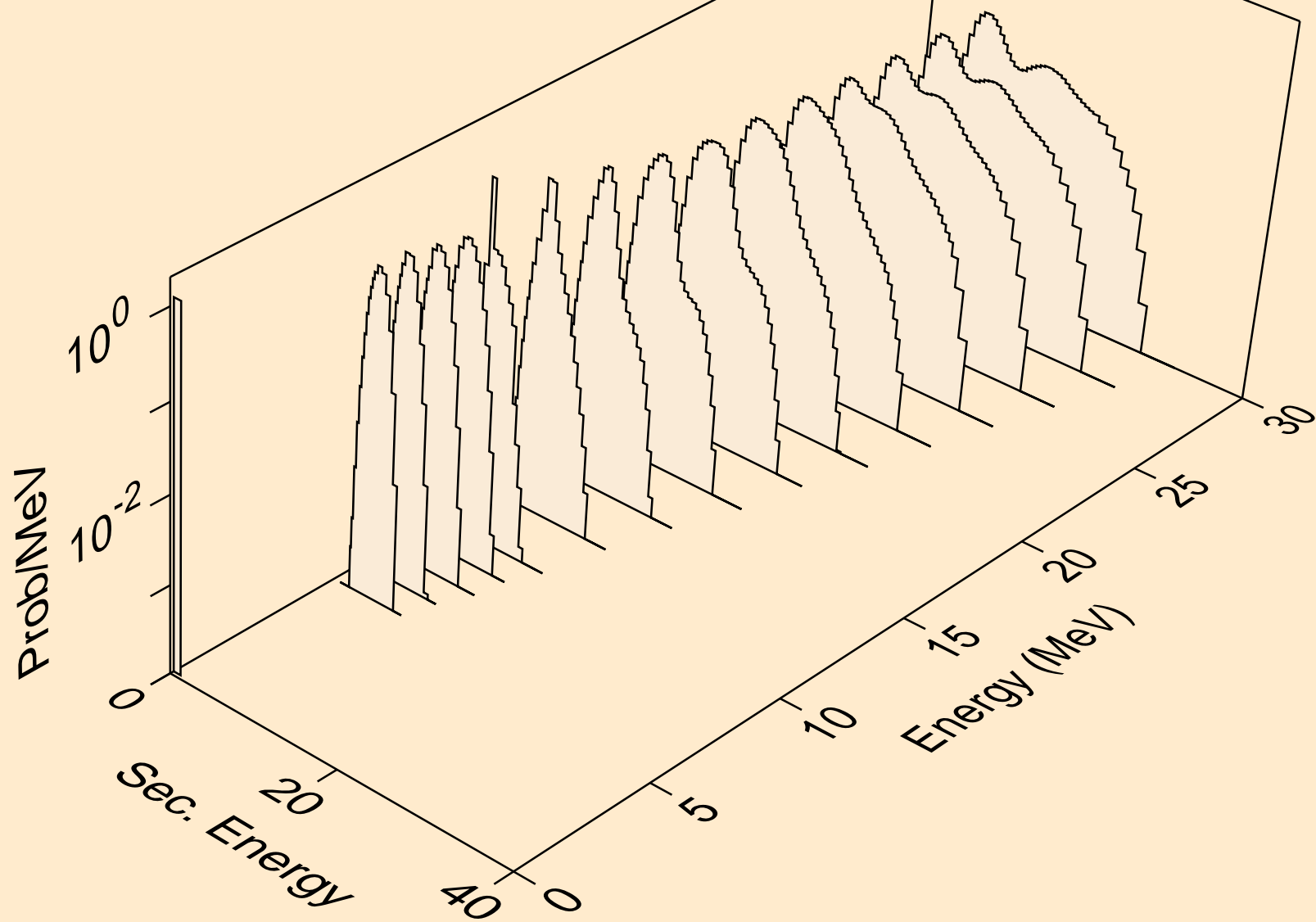

PM136 HELION ACER TENDL-2021 LIBRARY; T=0.K
protons from (s,pa)

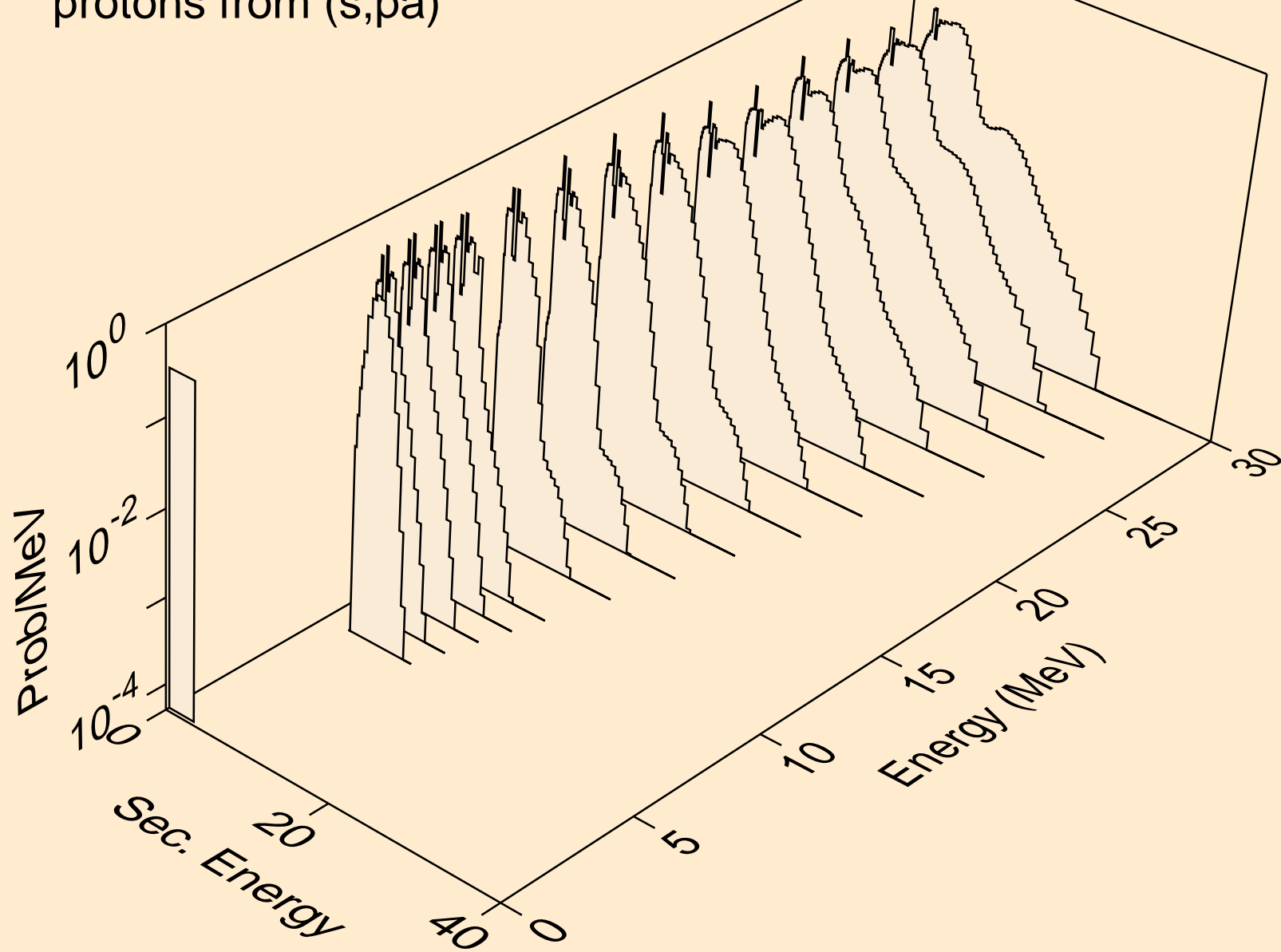

PM136 HELION ACER TENDL-2021 LIBRARY; T=0.K
protons from (s,pd)

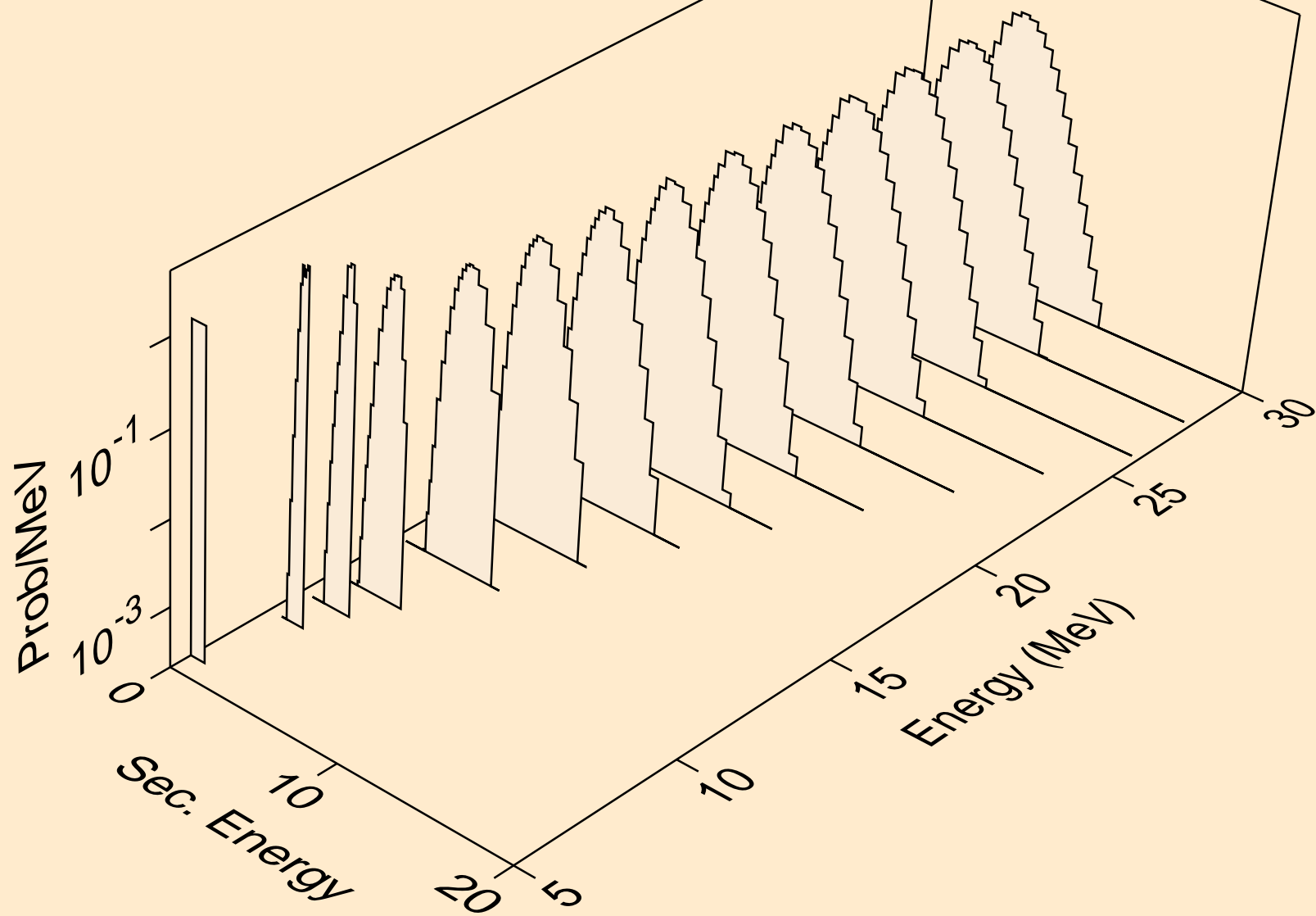

PM136 HELION ACER TENDL-2021 LIBRARY; T=0.K
protons from (s,pt)

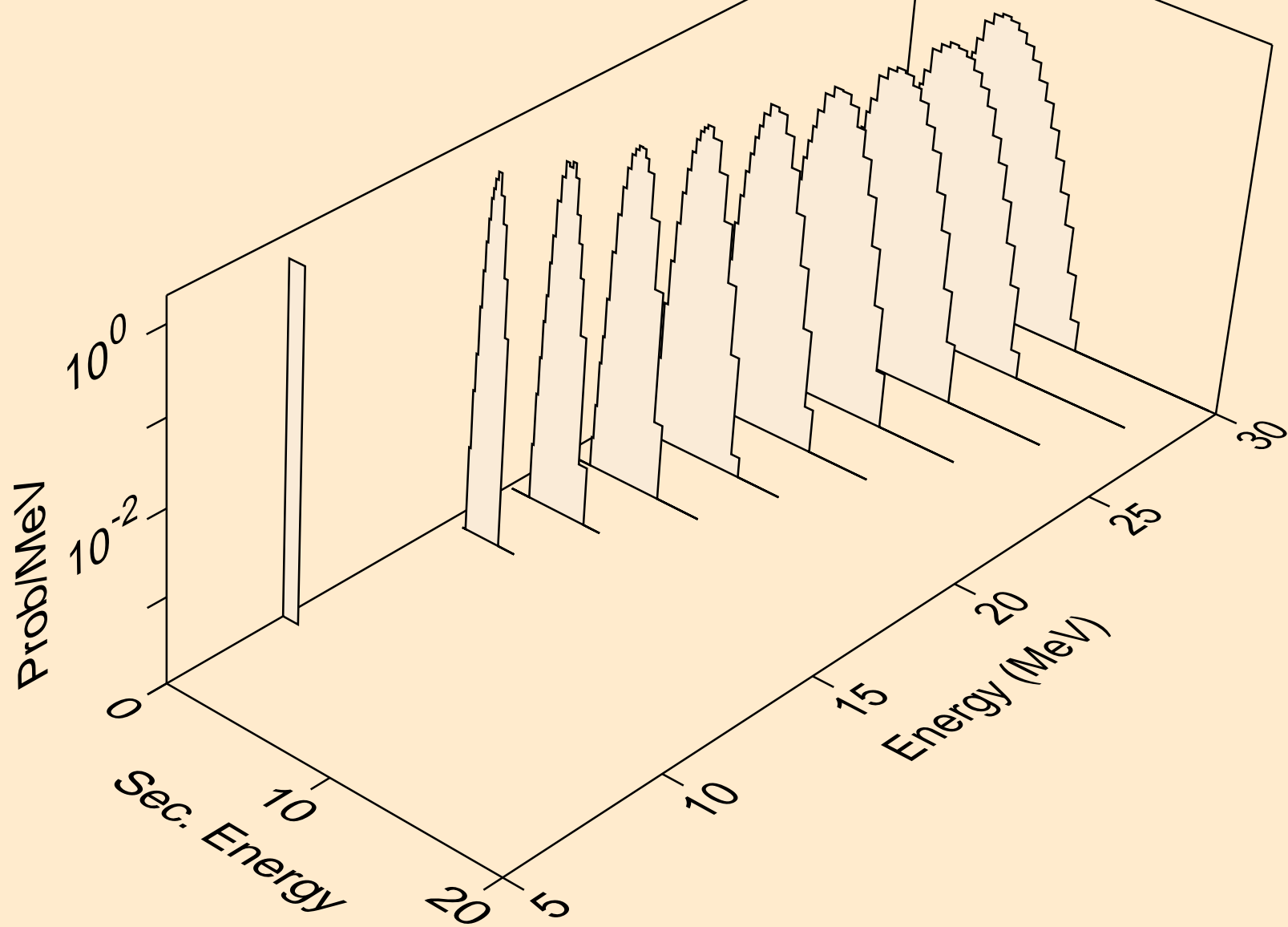

PM136 HELION ACER TENDL-2021 LIBRARY; T=0.K
deuterons from (s,x)

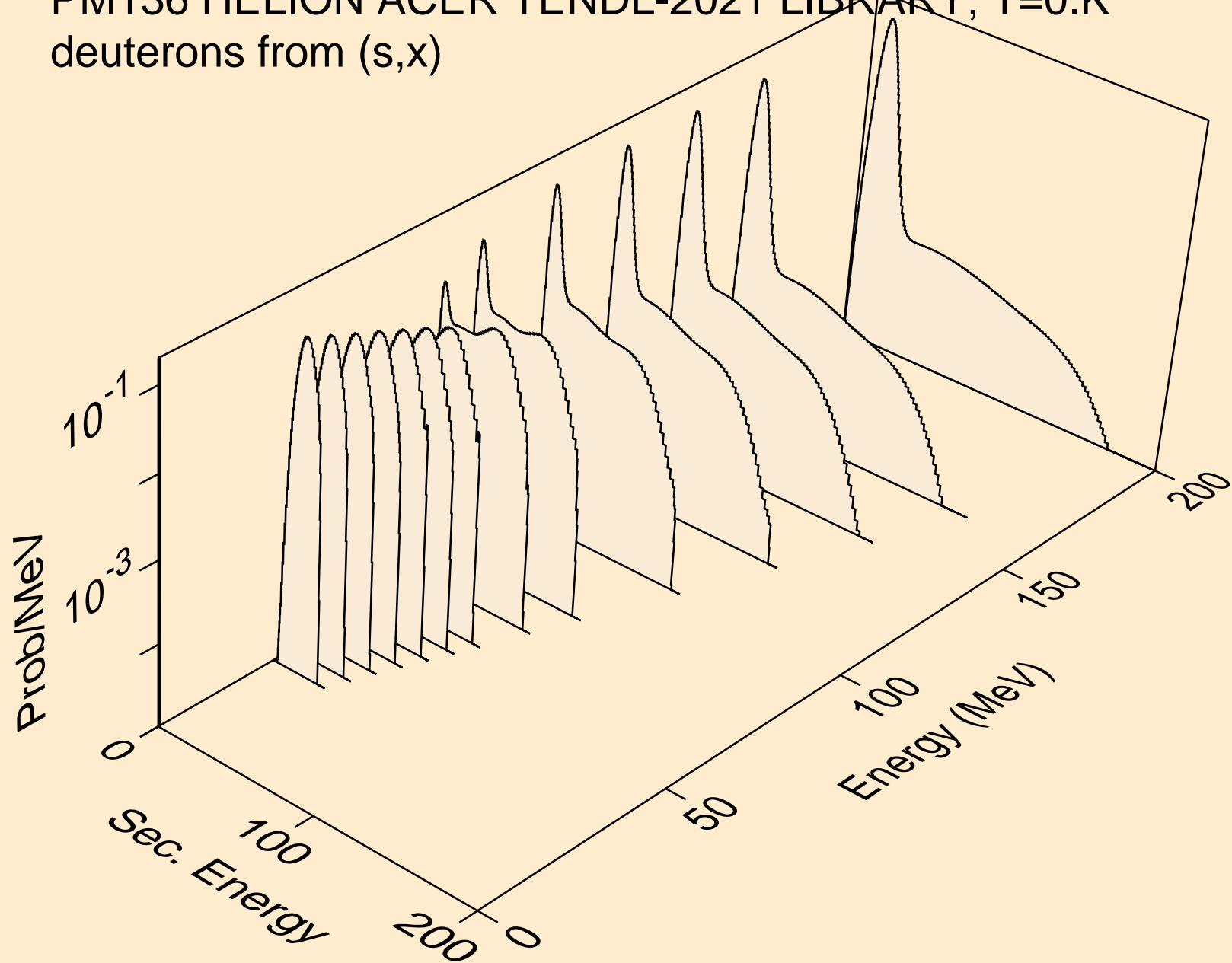

PM136 HELION ACER TENDL-2021 LIBRARY; T=0.K
deuterons from (s,2nd)

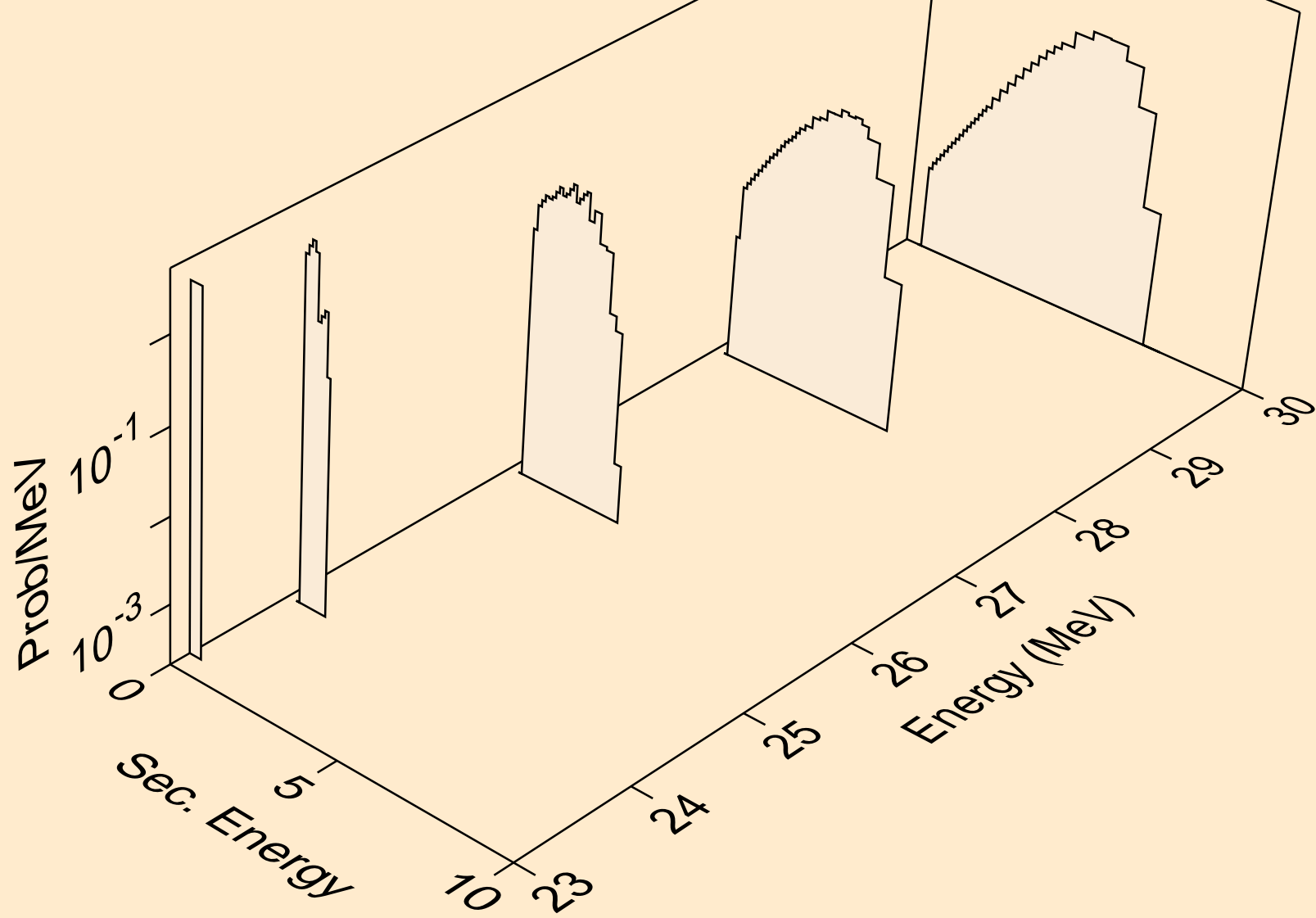

PM136 HELION ACER TENDL-2021 LIBRARY; T=0.K
deuterons from (s,n*)d

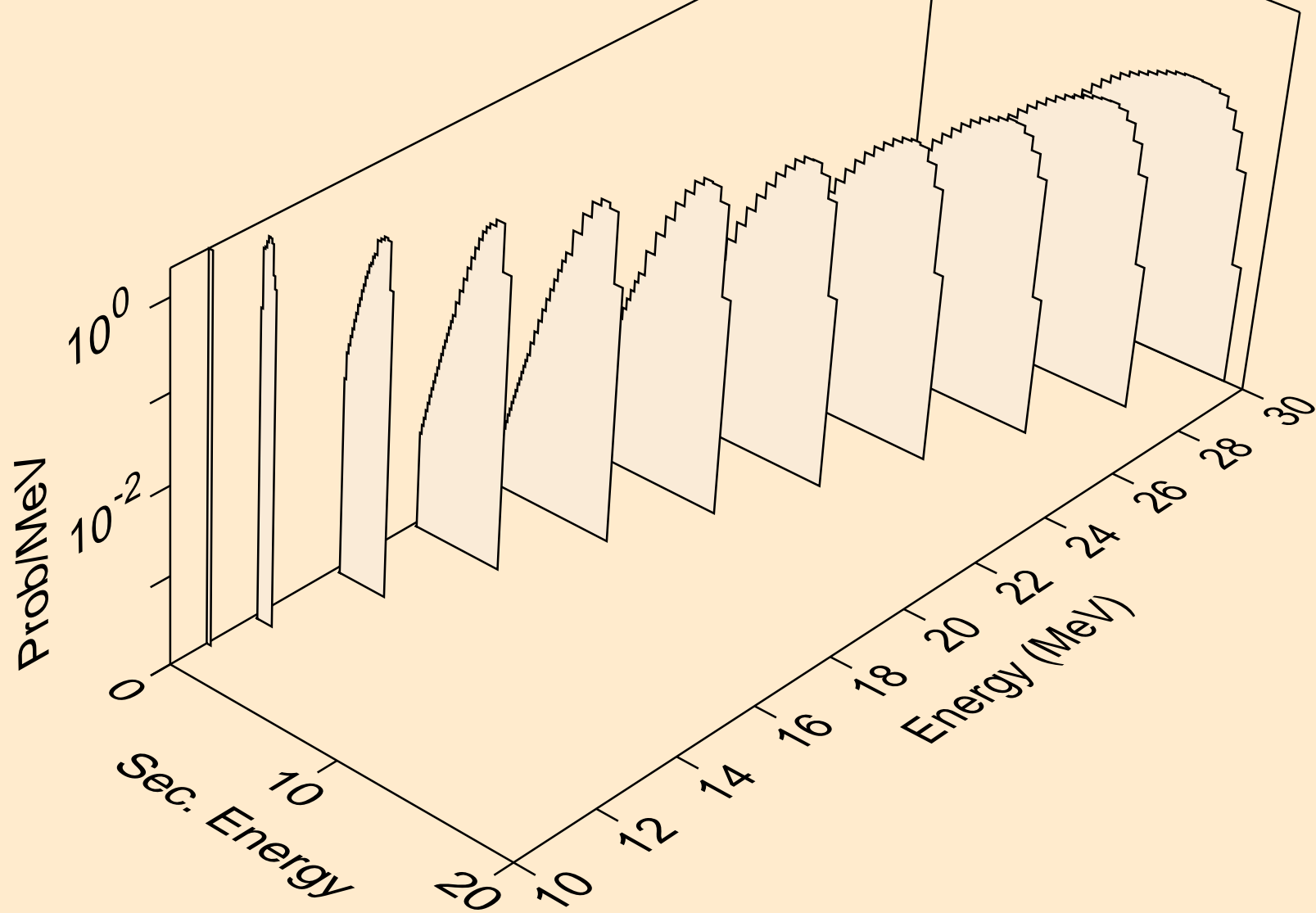

PM136 HELION ACER TENDL-2021 LIBRARY; T=0.K
deuterons from (s,d)

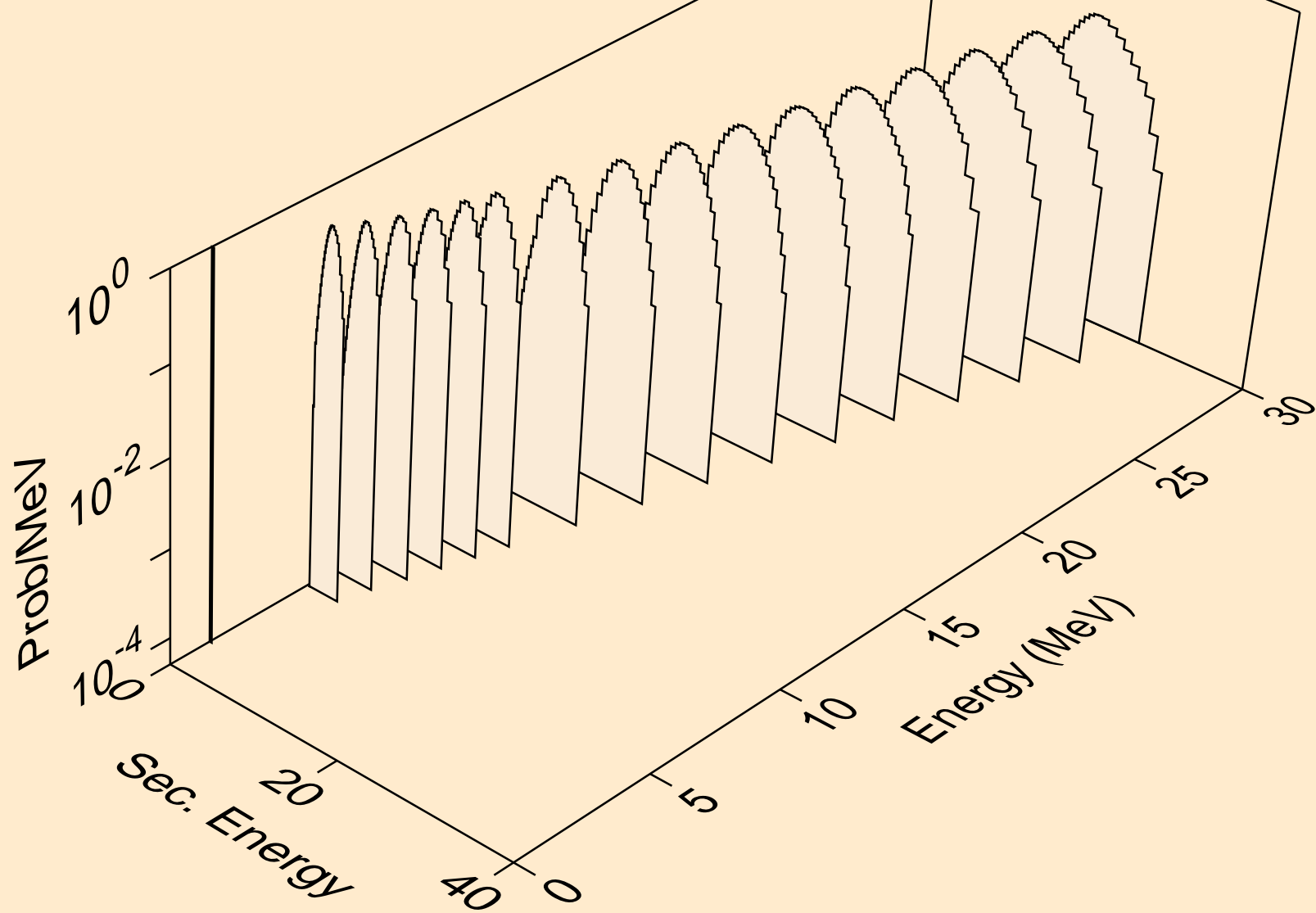

PM136 HELION ACER TENDL-2021 LIBRARY; T=0.K
deuterons from (s,pd)

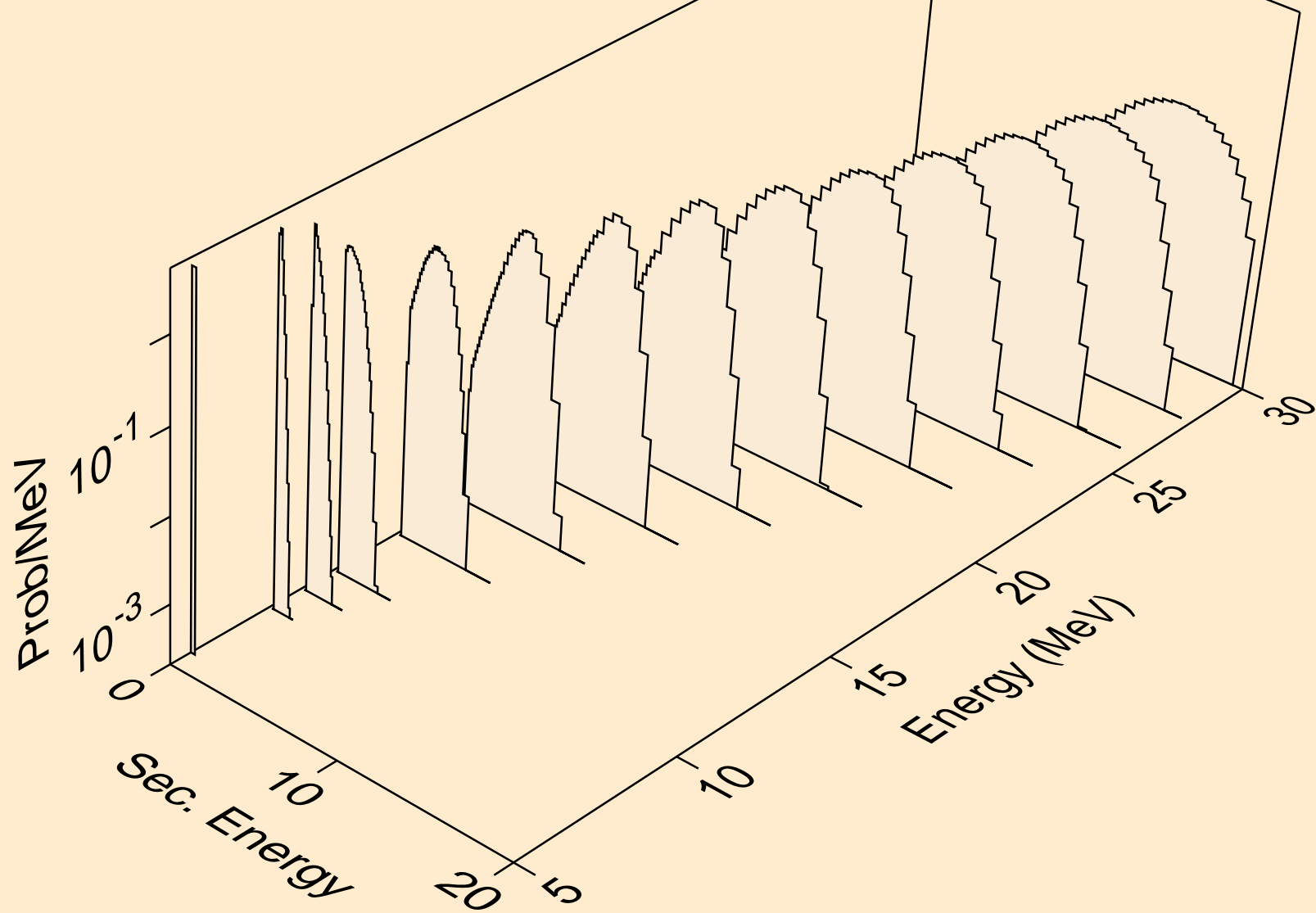

PM136 HELION ACER TENDL-2021 LIBRARY; T=0.K
deuterons from (s,da)

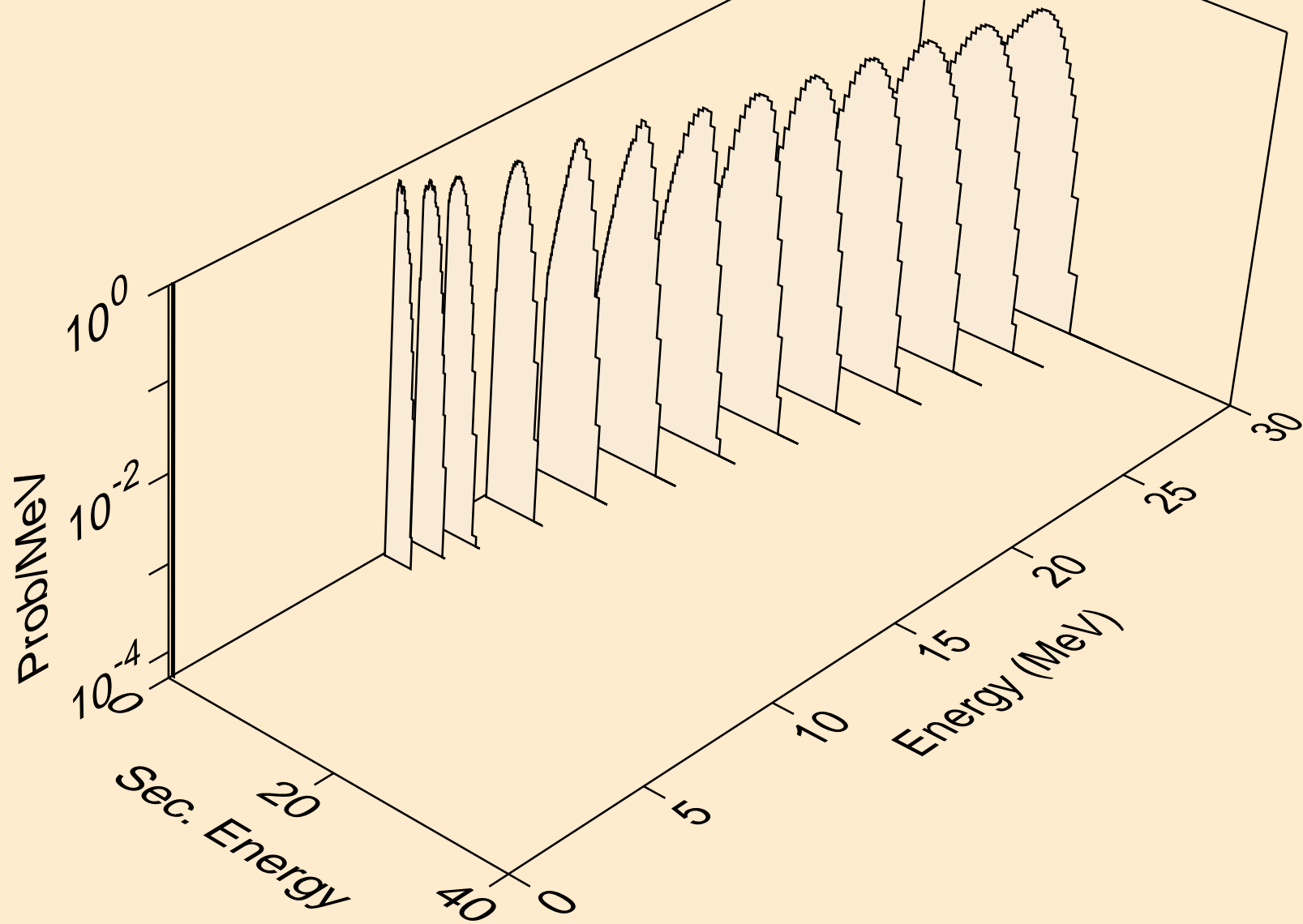

PM136 HELION ACER TENDL-2021 LIBRARY; T=0.K
tritons from (s,x)

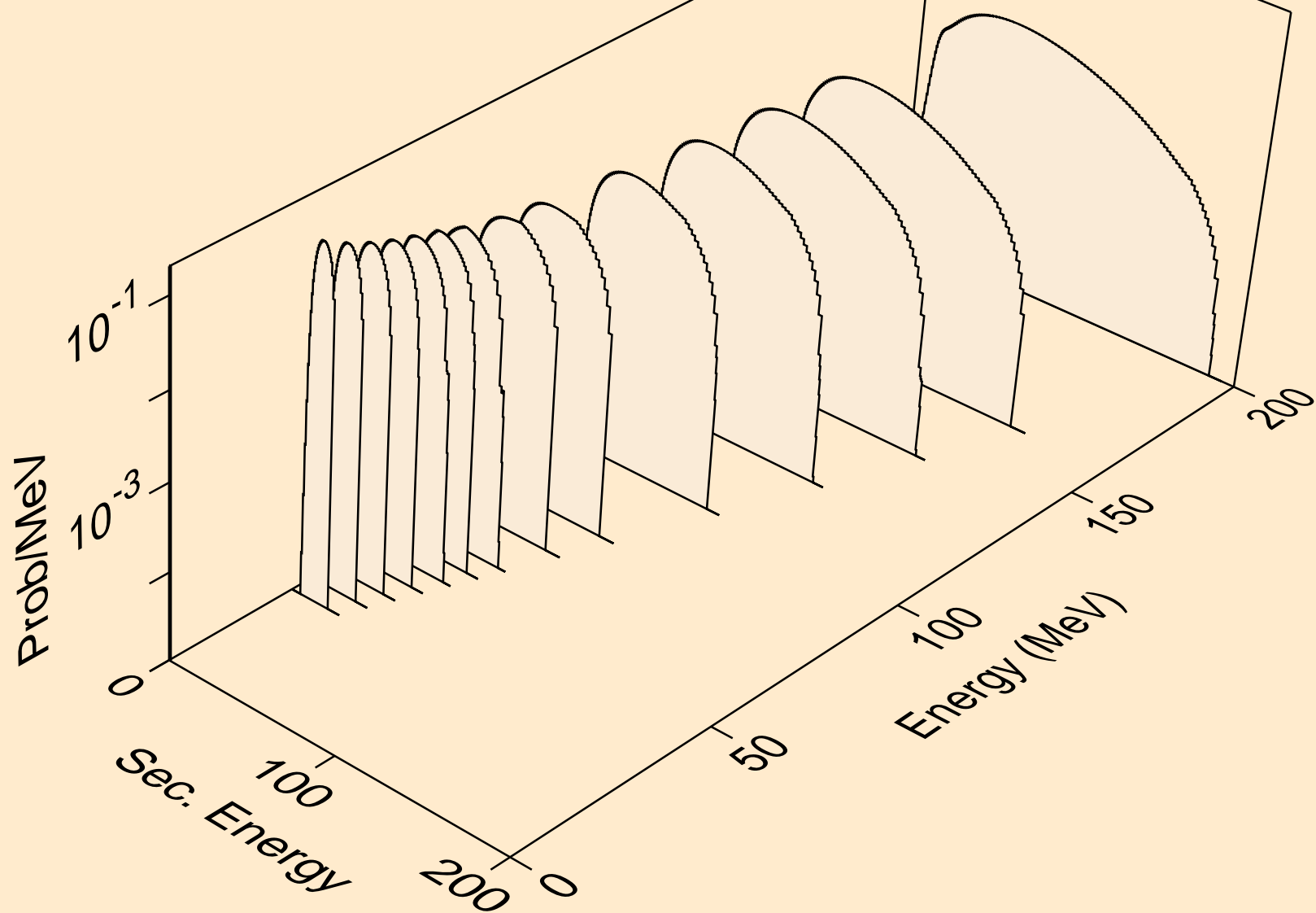

PM136 HELION ACER TENDL-2021 LIBRARY; T=0.K
tritons from (s,n*)t

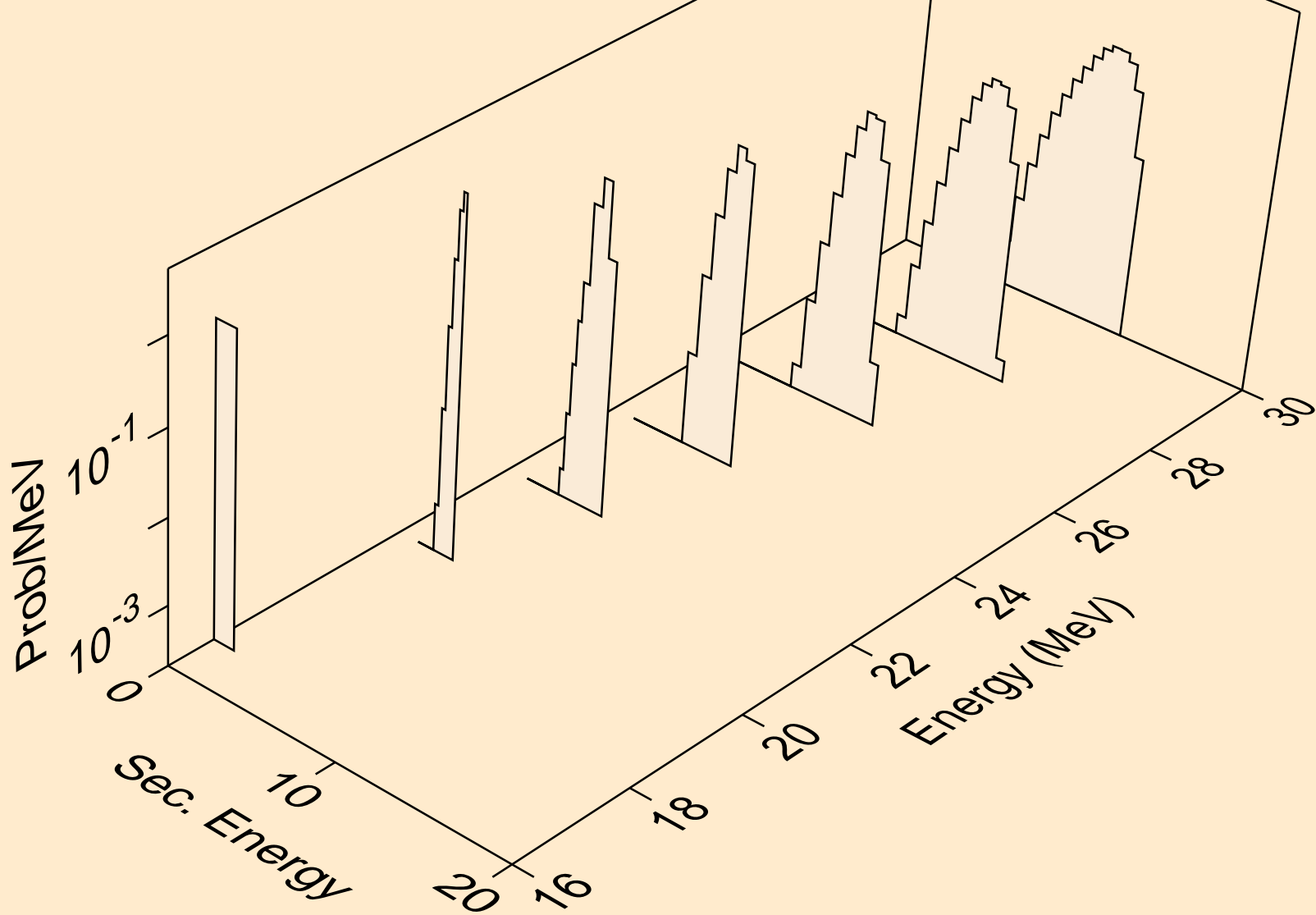

PM136 HELION ACER TENDL-2021 LIBRARY; T=0.K
tritons from (s,t)

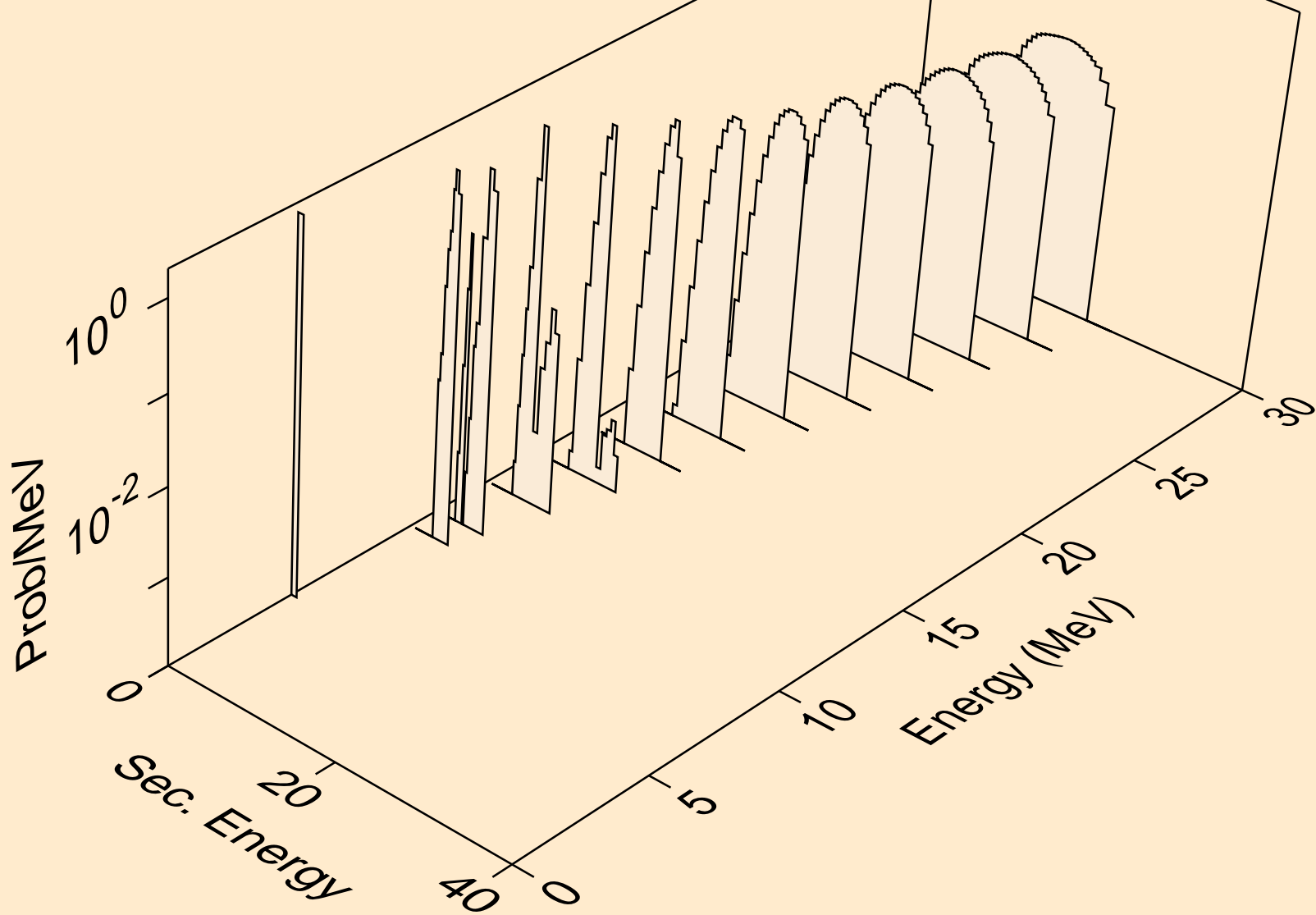

PM136 HELION ACER TENDL-2021 LIBRARY; T=0.K
tritons from (s,pt)

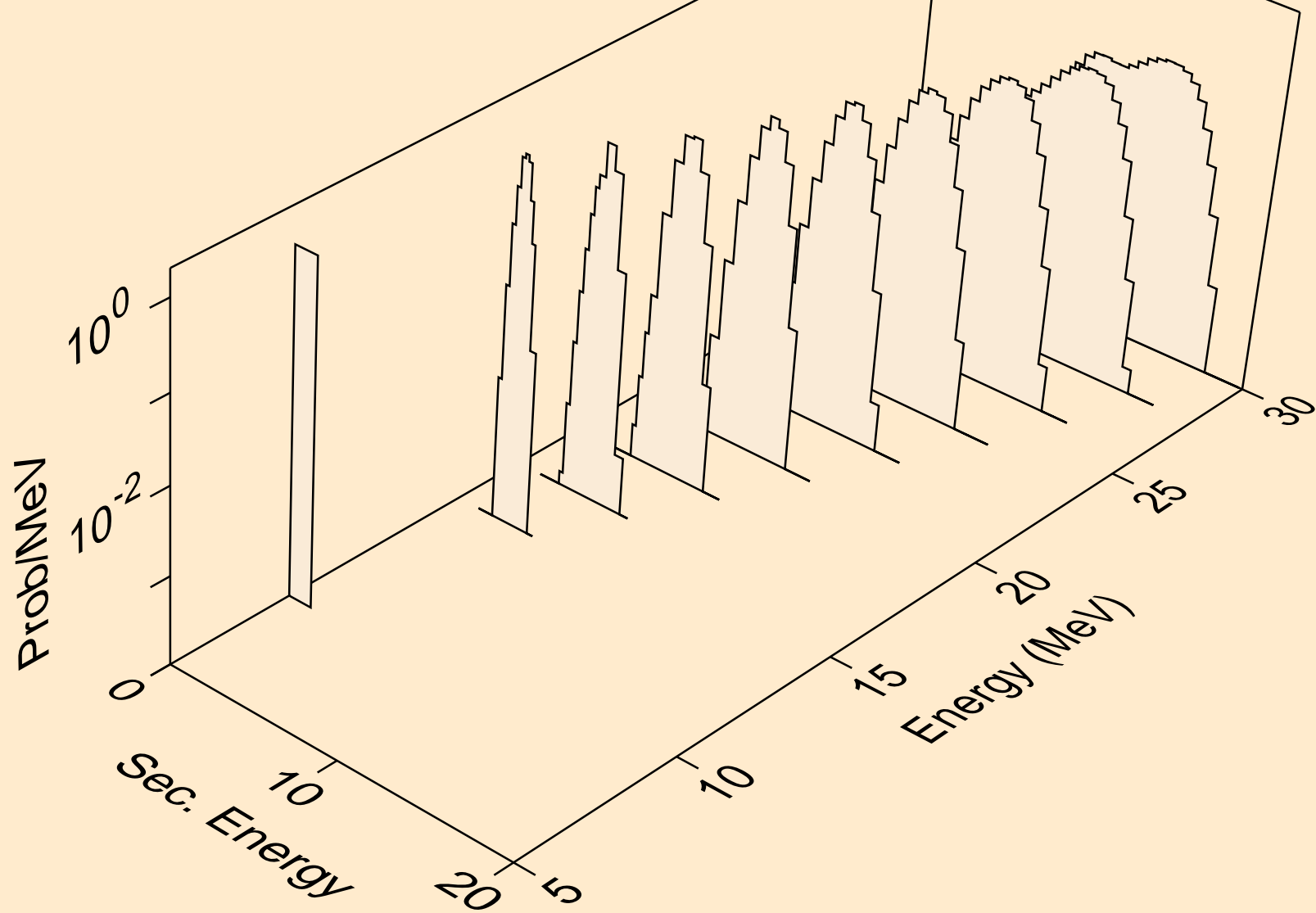

PM136 HELION ACER TENDL-2021 LIBRARY; T=0.K
alphas from (s,x)

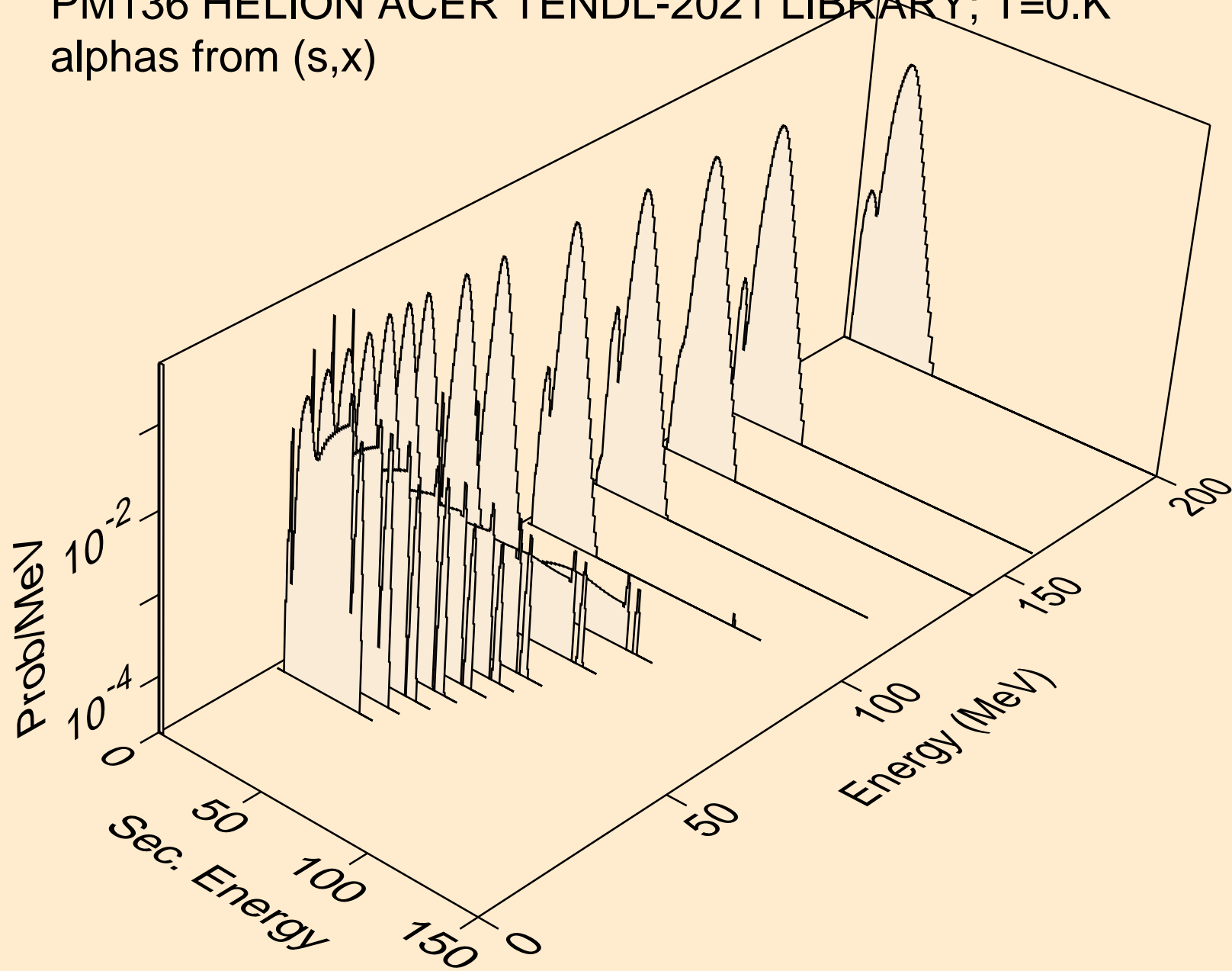

PM136 HELION ACER TENDL-2021 LIBRARY; T=0.K
alphas from (s,n*)a

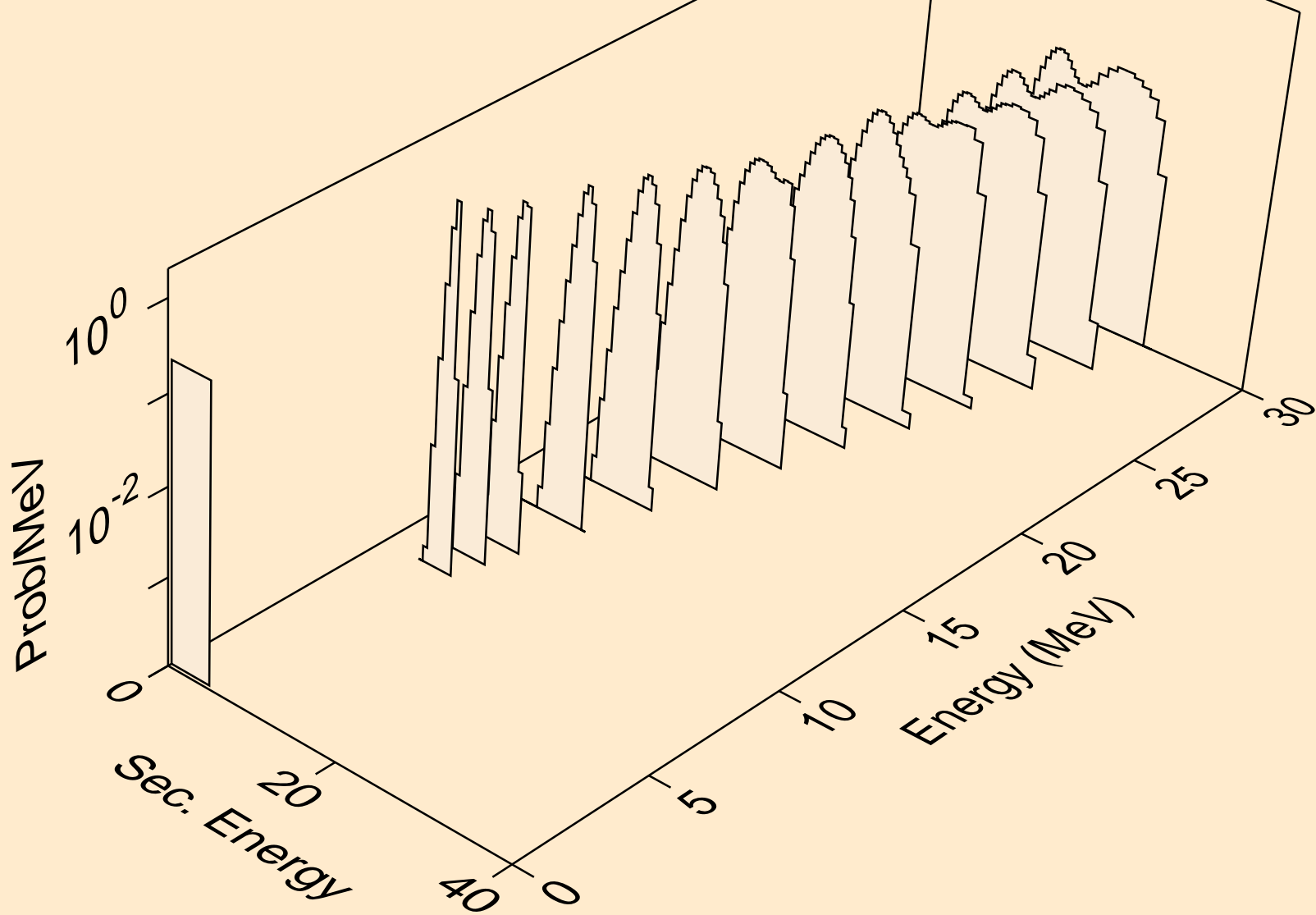

PM136 HELION ACER TENDL-2021 LIBRARY; T=0.K
alphas from (s,2n)a

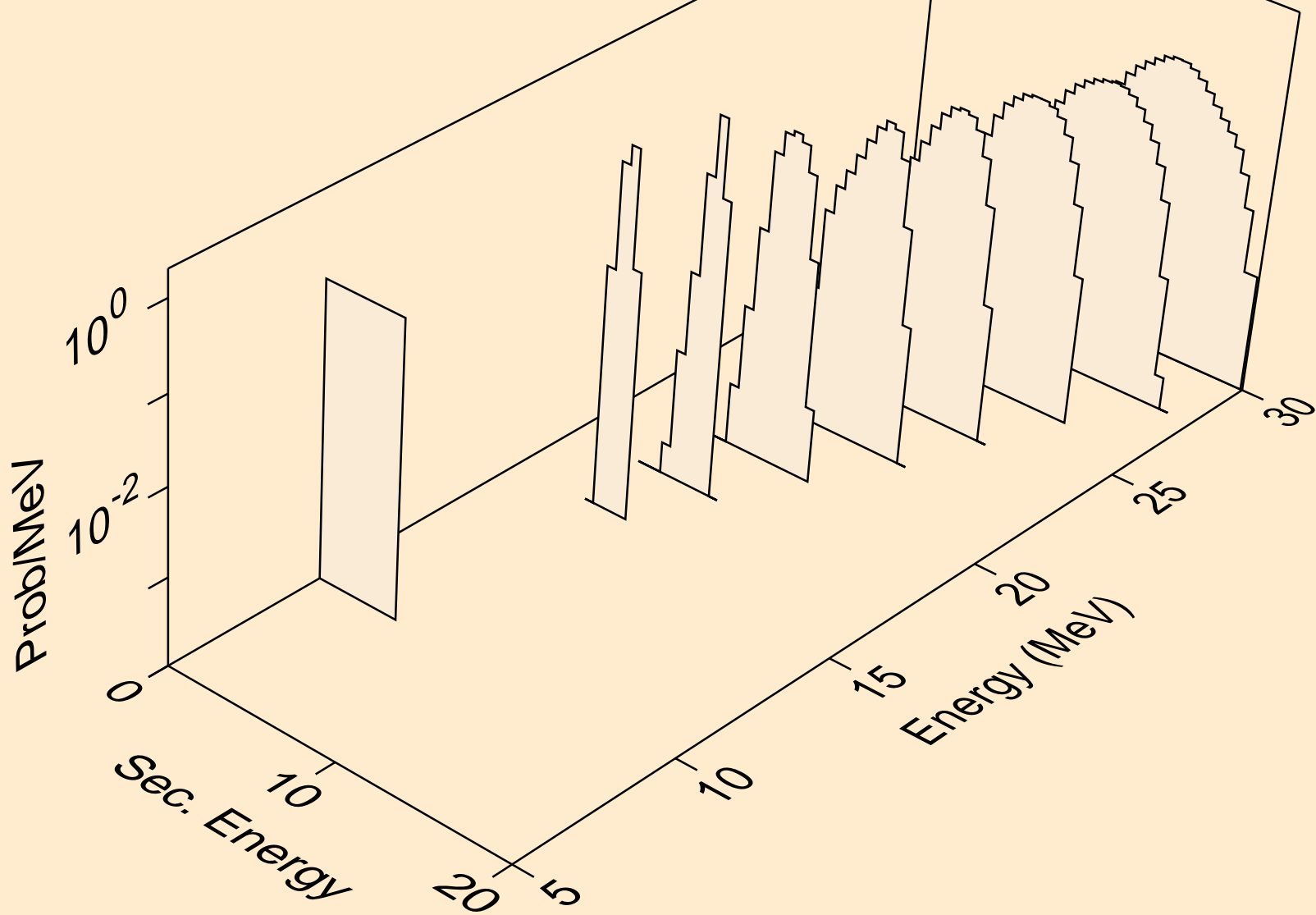

PM136 HELION ACER TENDL-2021 LIBRARY; T=0.K
alphas from (s,n*)2a

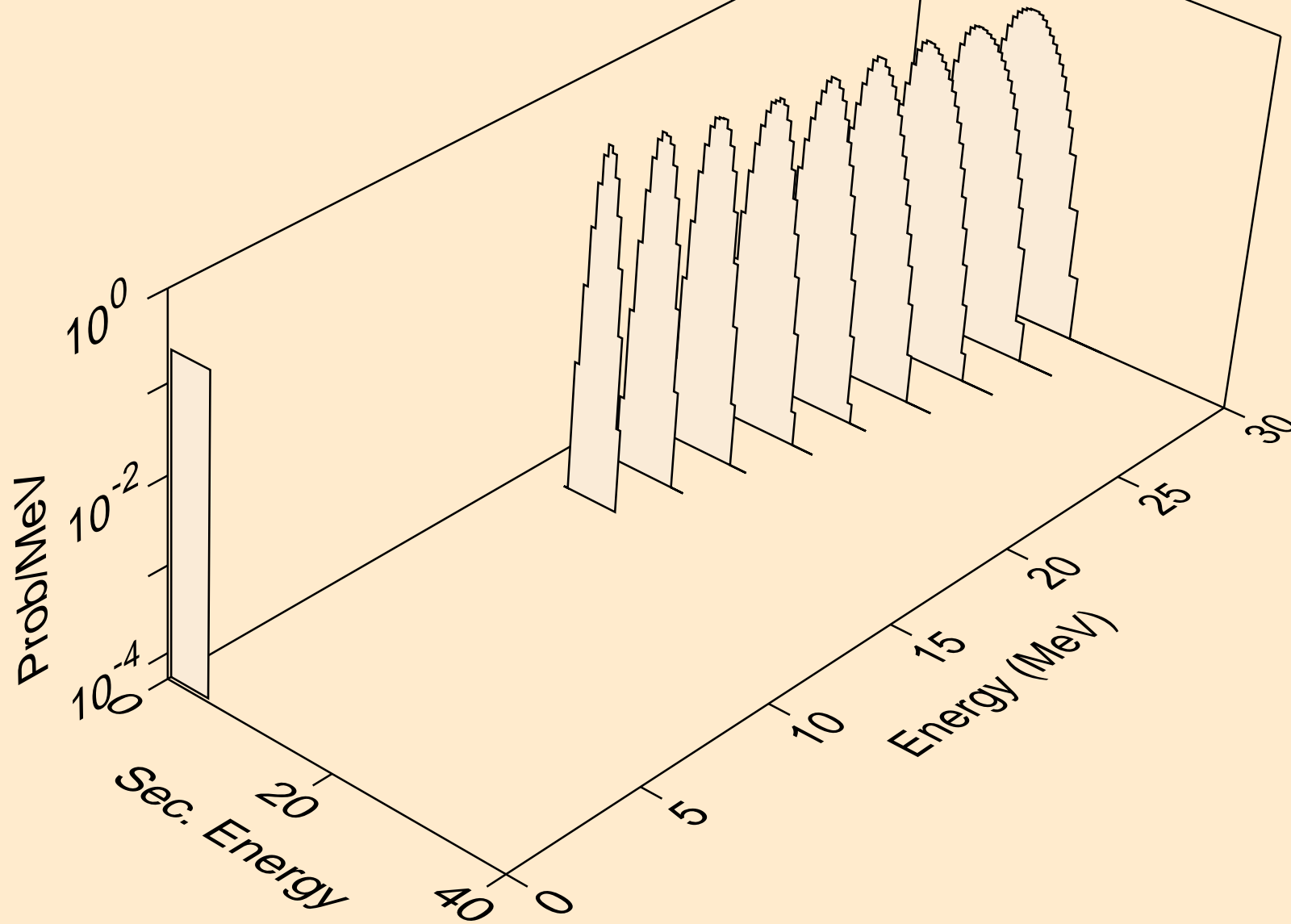

PM136 HELION ACER TENDL-2021 LIBRARY; T=0.K
alphas from (s,npa)

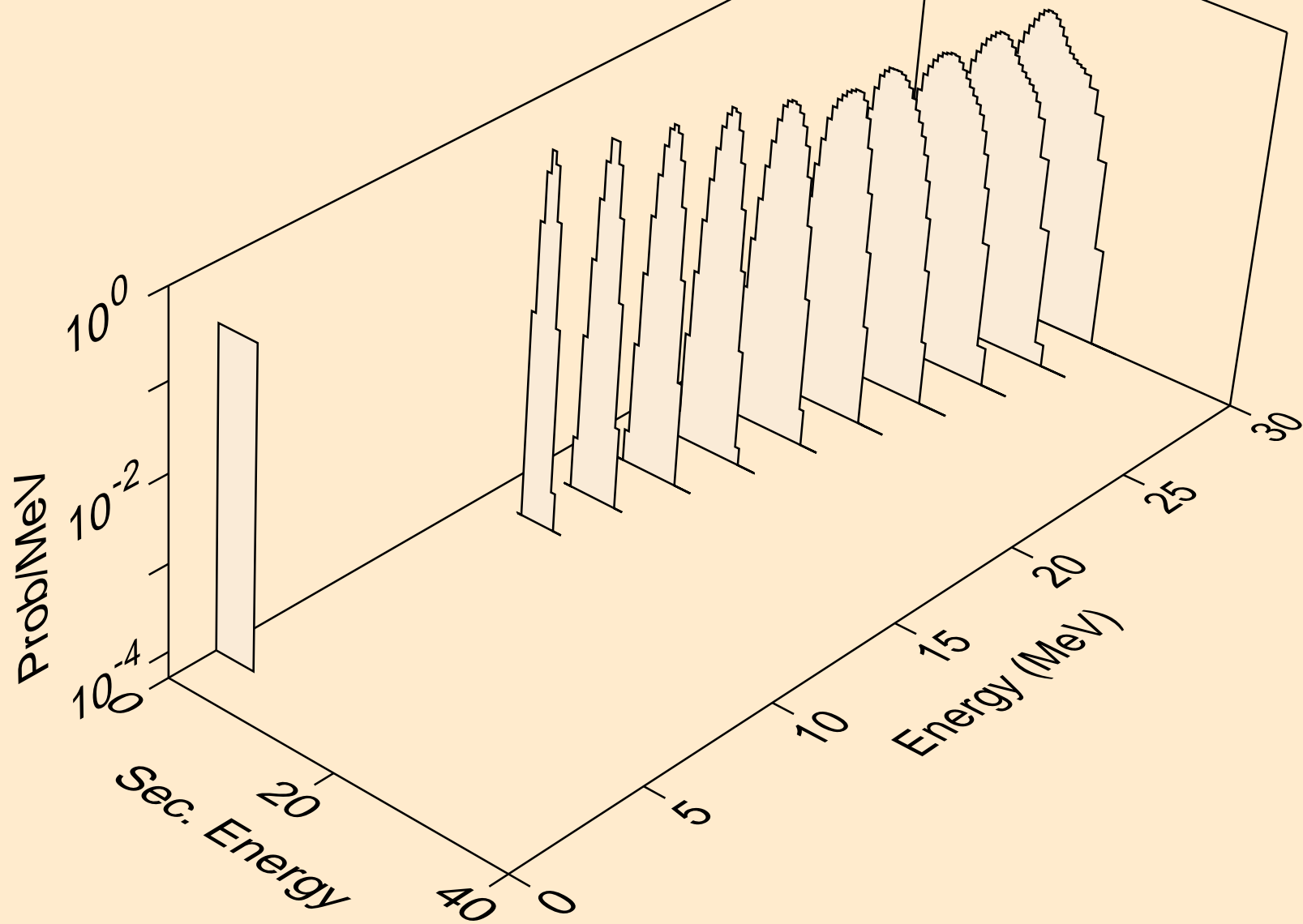

PM136 HELION ACER TENDL-2021 LIBRARY; T=0.K
alphas from (s,a)

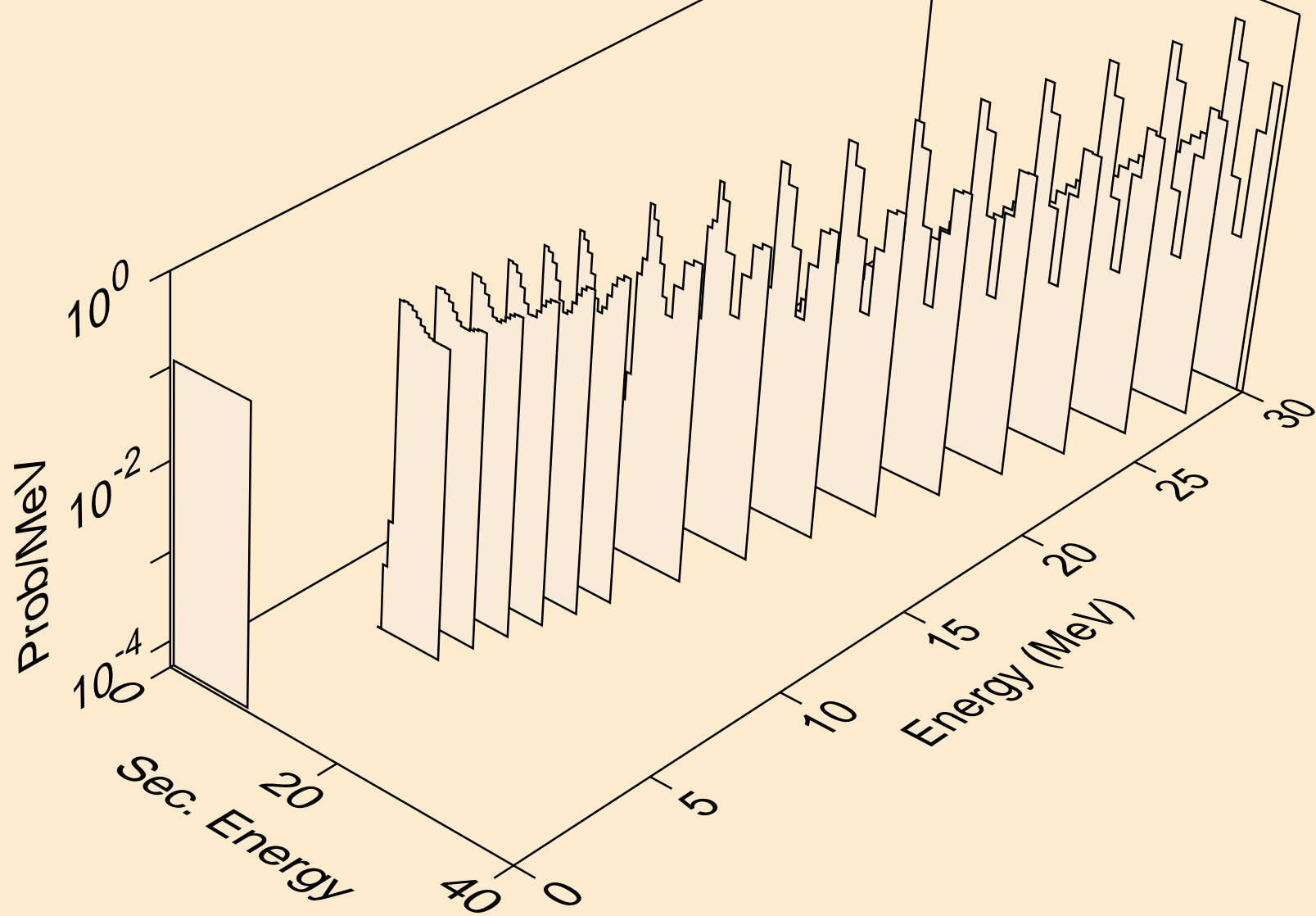

PM136 HELION ACER TENDL-2021 LIBRARY; T=0.K
alphas from (s,2a)

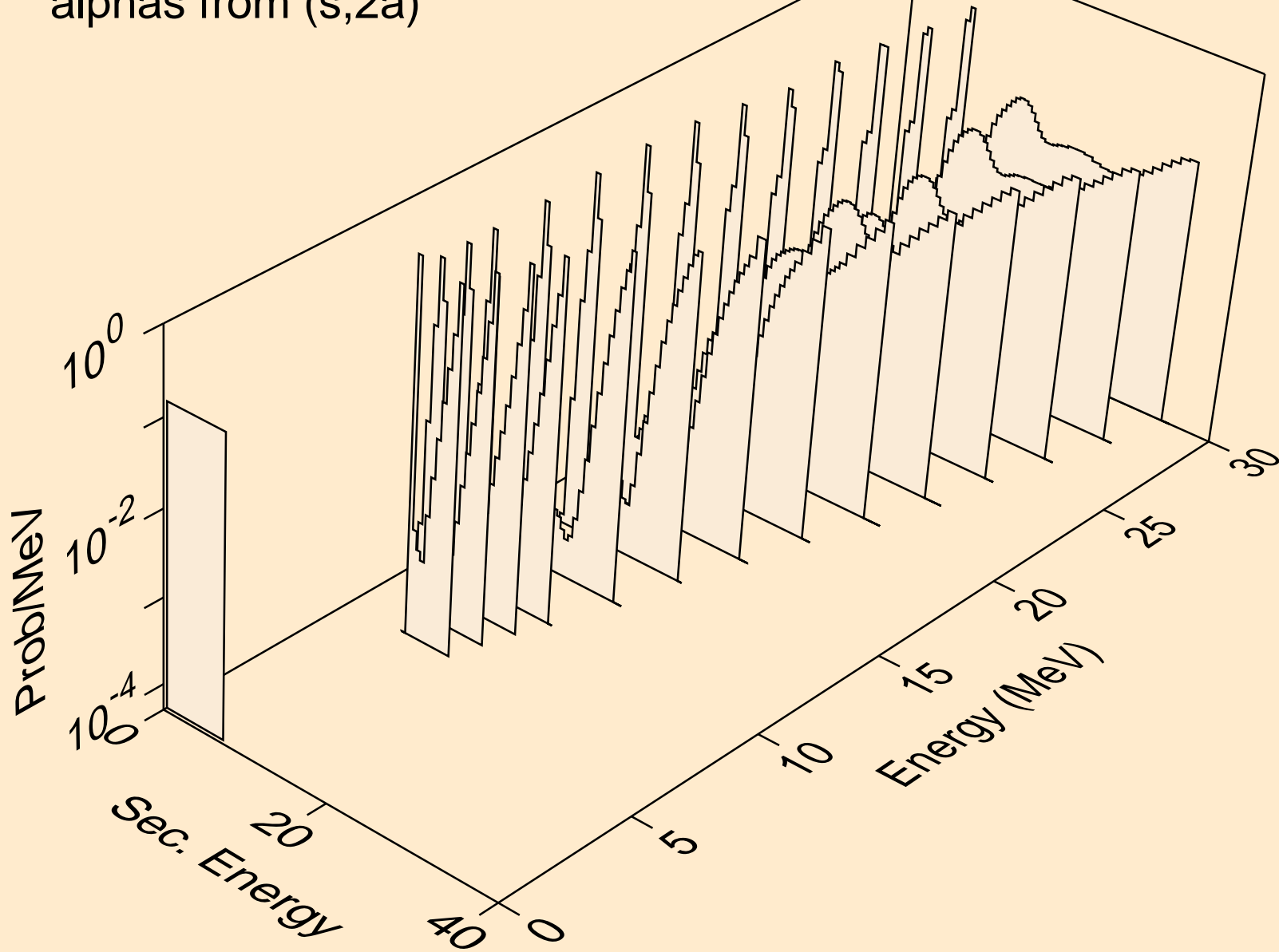

PM136 HELION ACER TENDL-2021 LIBRARY; T=0.K
alphas from (s,pa)

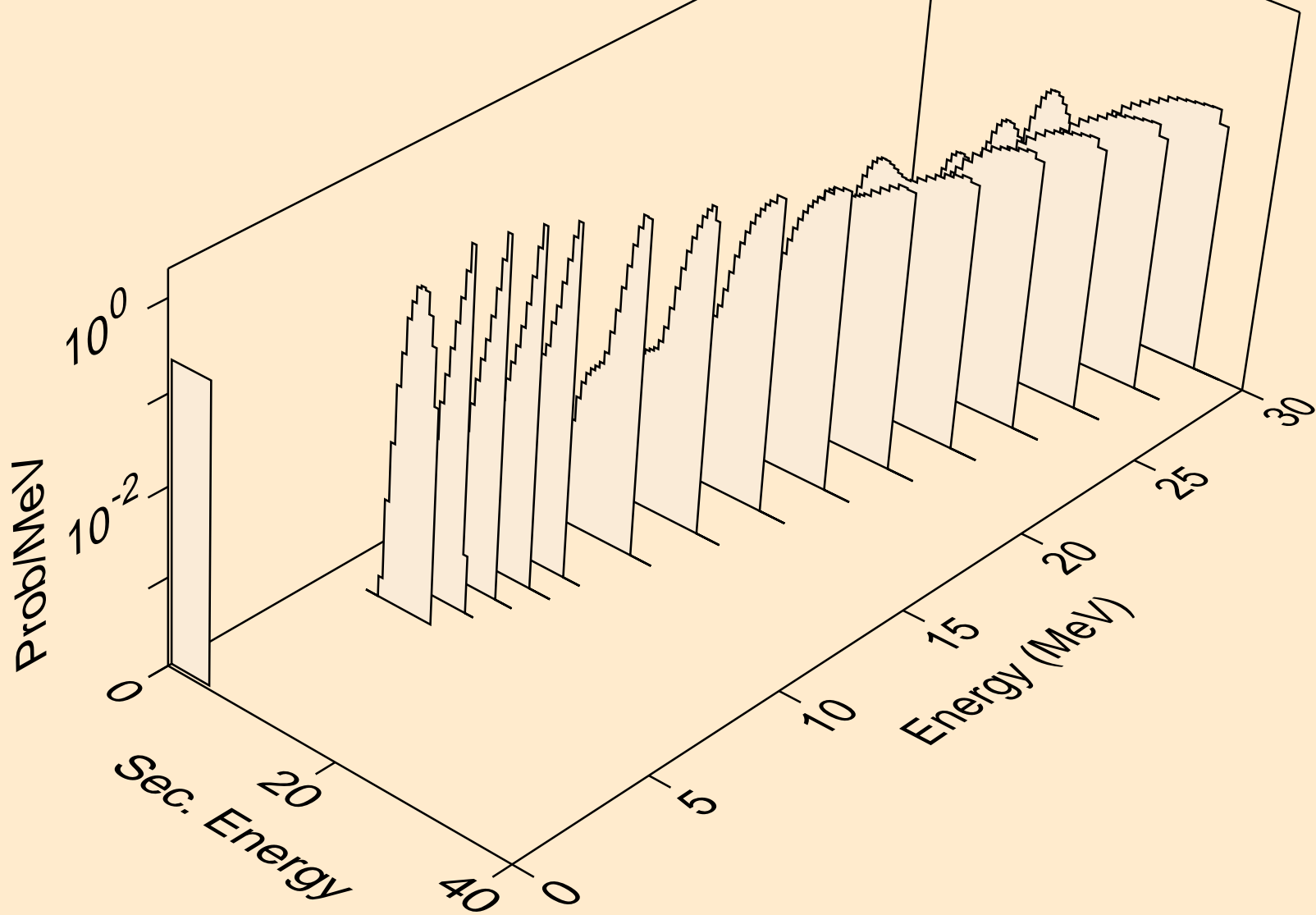

PM136 HELION ACER TENDL-2021 LIBRARY; T=0.K
alphas from (s,da)

