

PM159 HELION ACER TENDL-2021 LIBRARY; T=0.K  
Principal cross sections

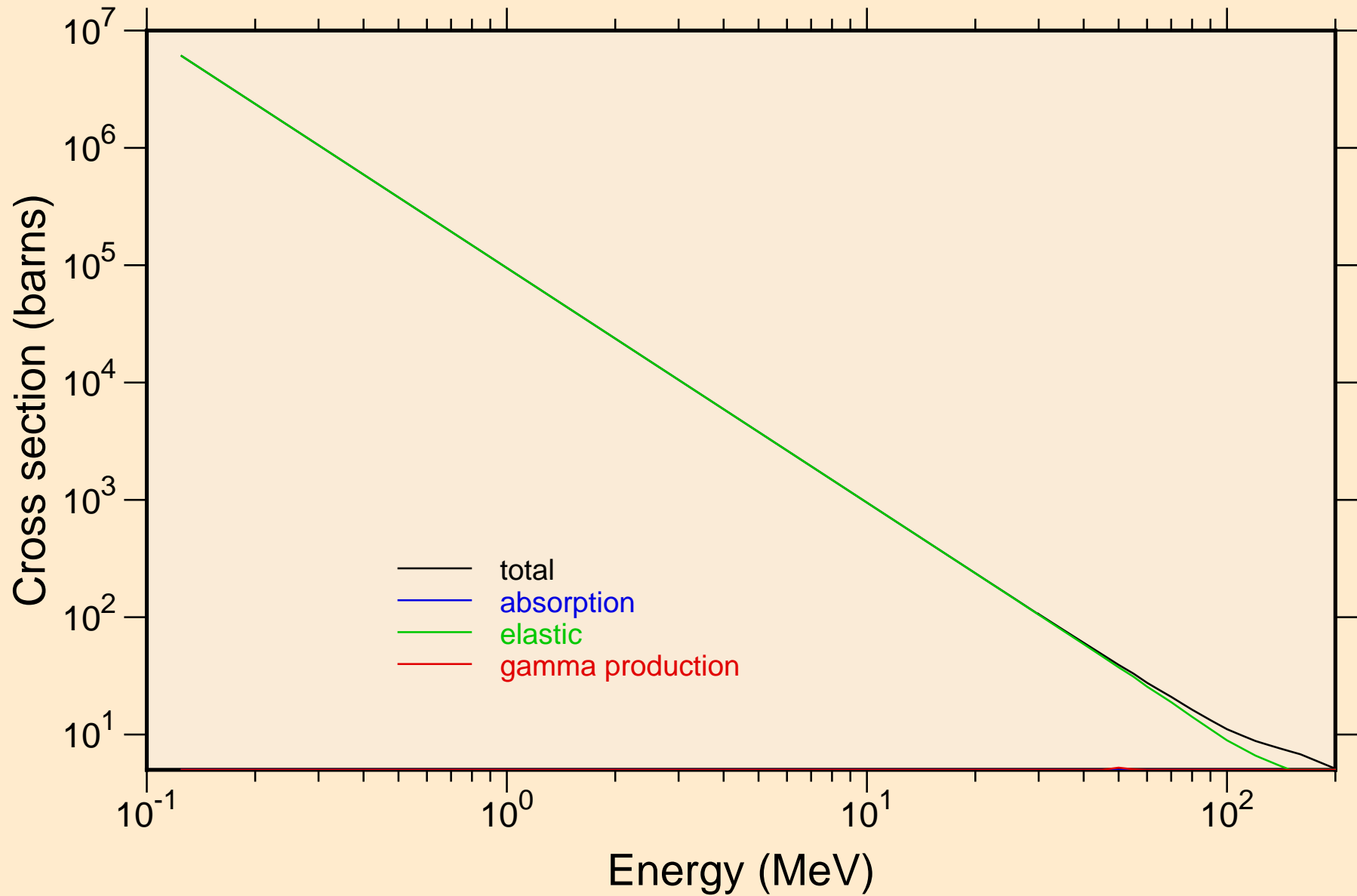

PM159 HELION ACER TENDL-2021 LIBRARY; T=0.K

Heating

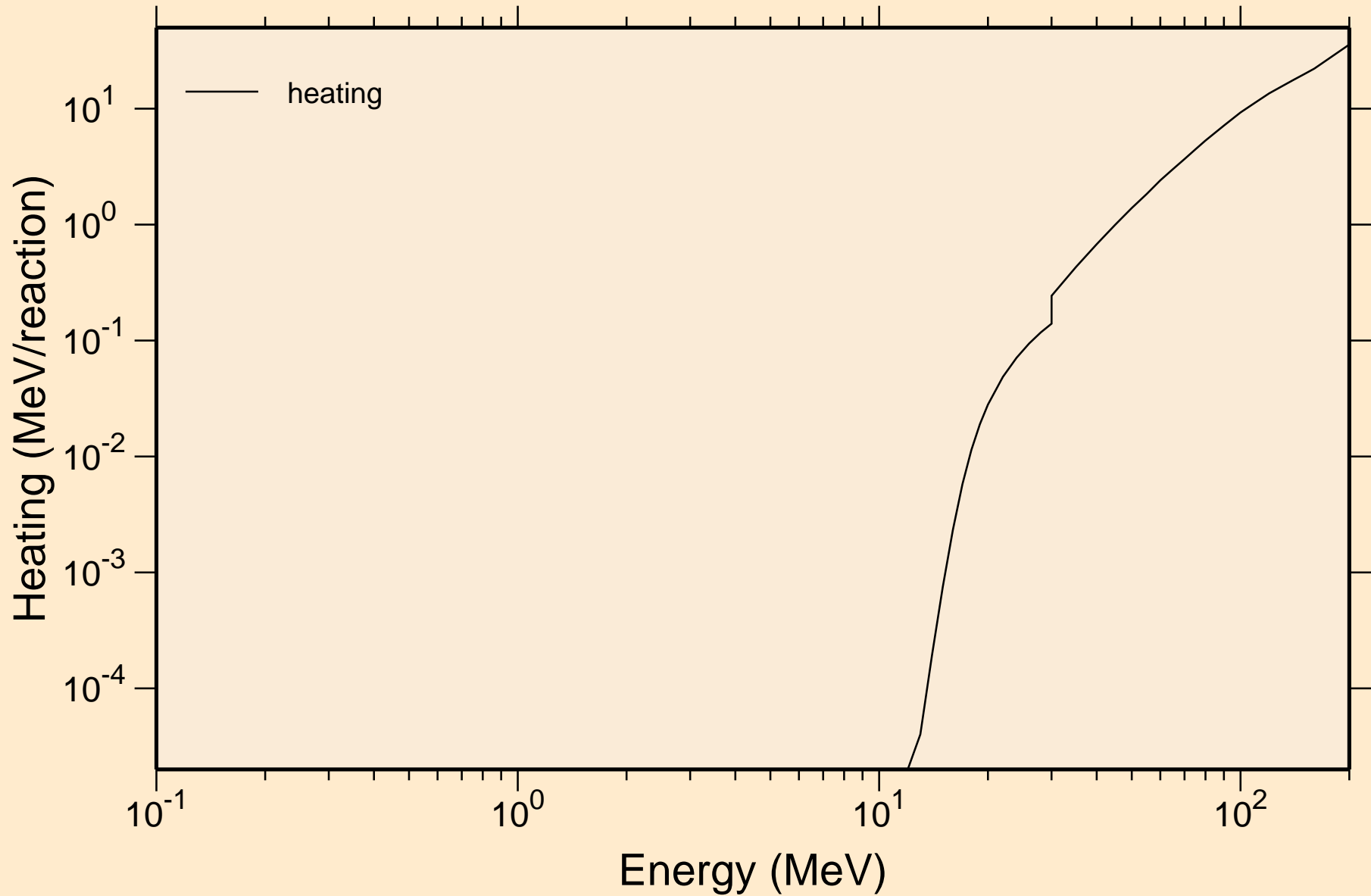

# PM159 HELION ACER TENDL-2021 LIBRARY; T=0.K

## Principal cross sections

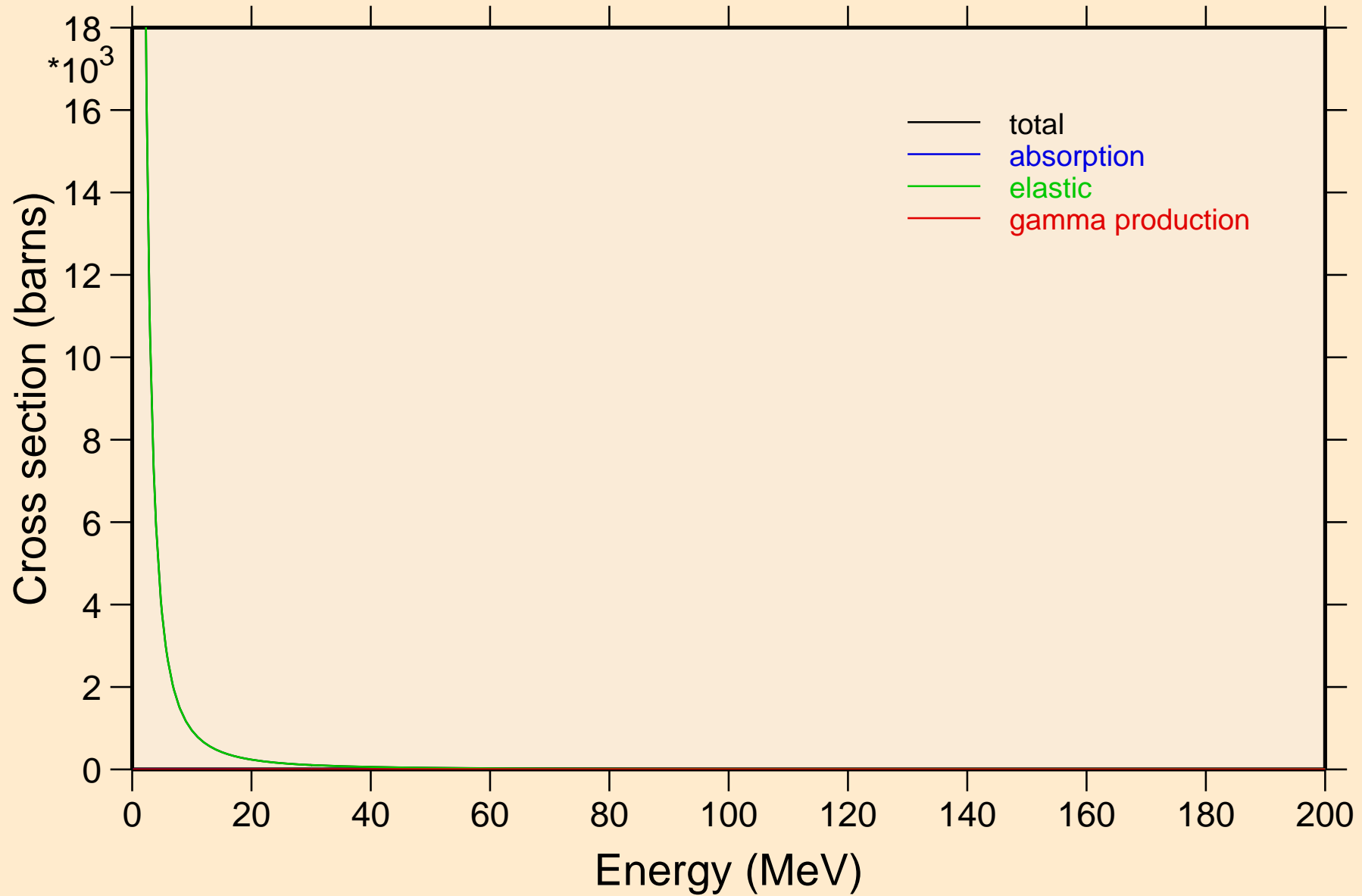

PM159 HELION ACER TENDL-2021 LIBRARY; T=0.K

Heating

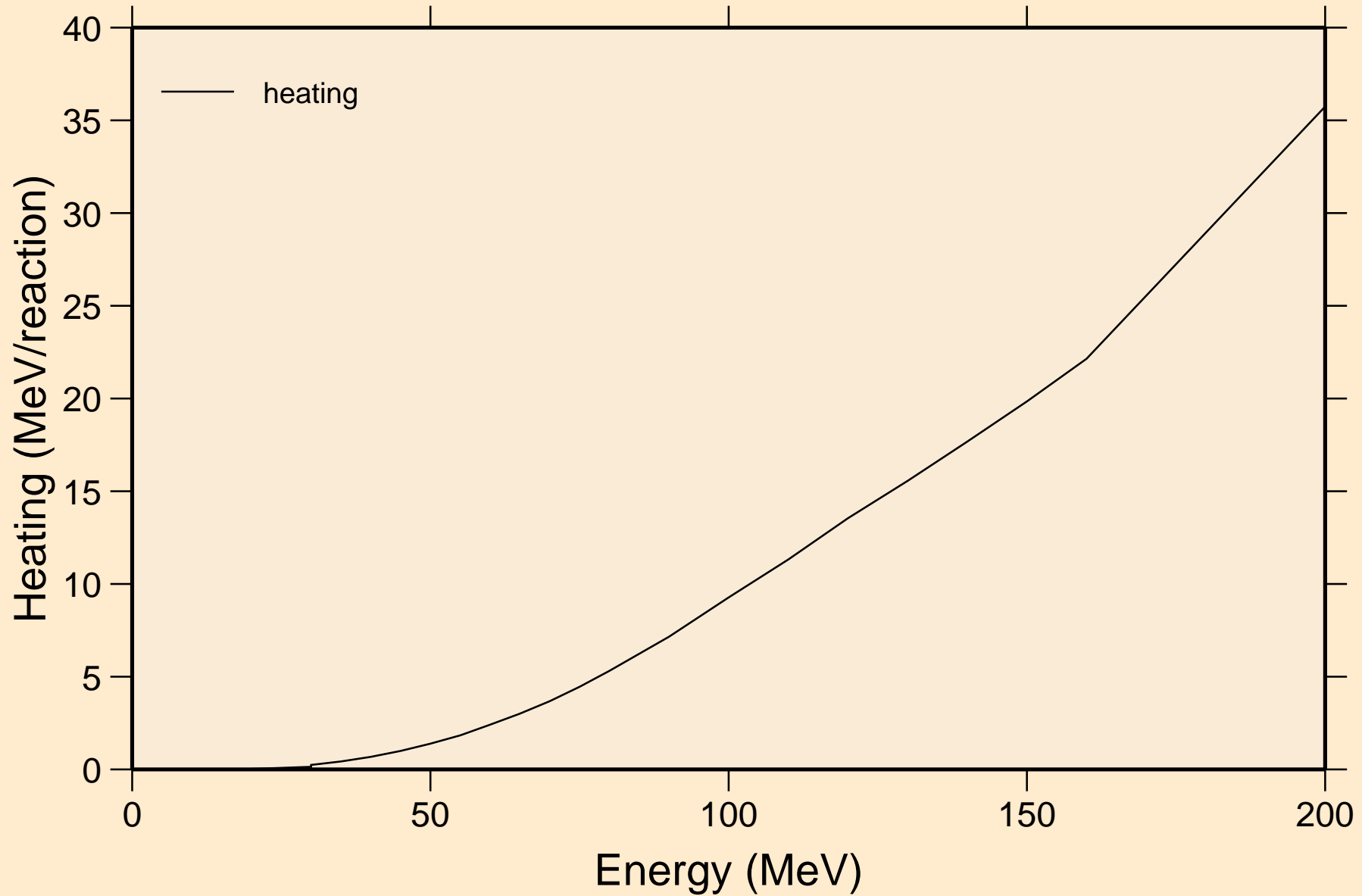

PM159 HELION ACER TENDL-2021 LIBRARY; T=0.K  
Threshold reactions

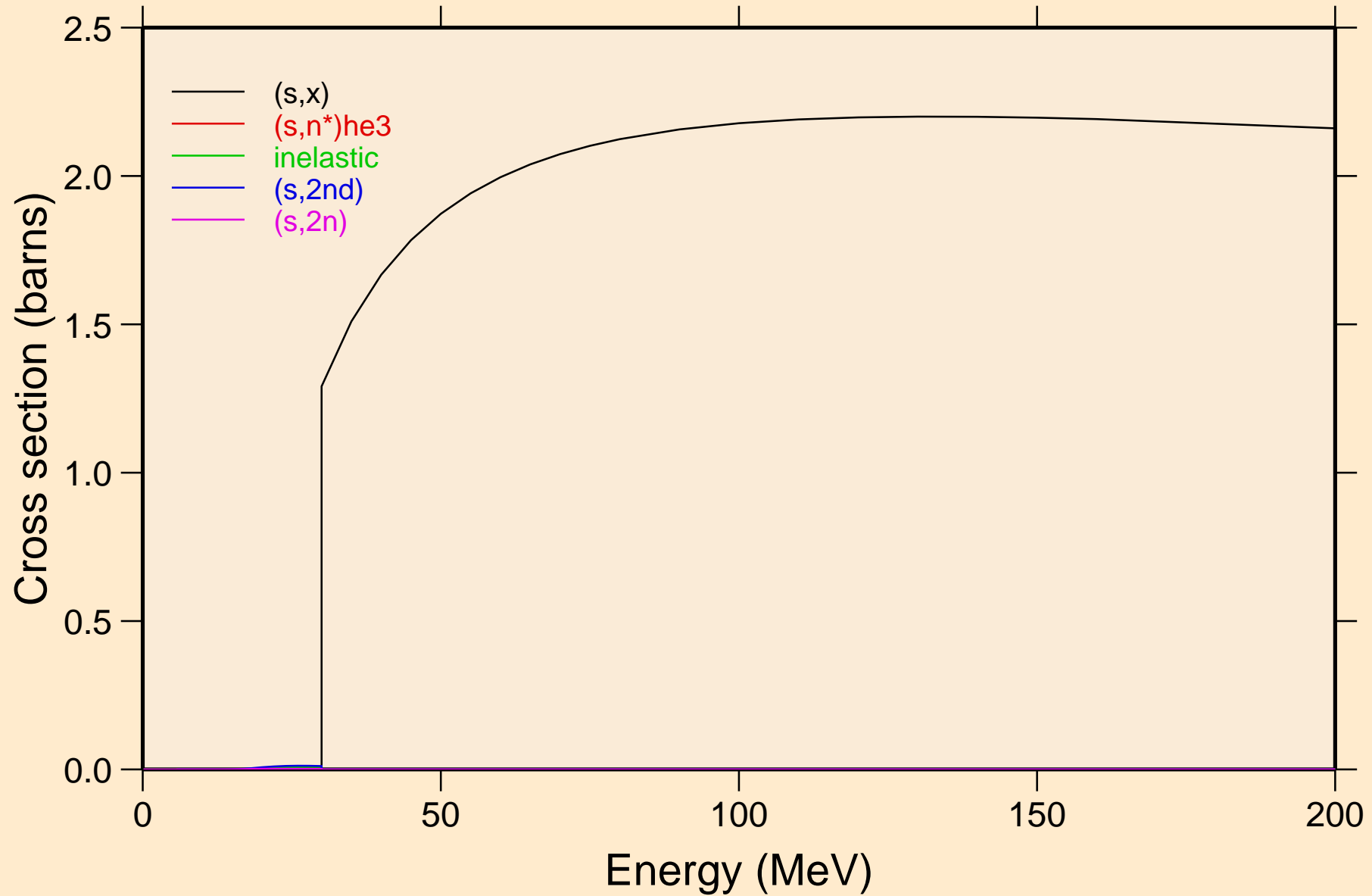

PM159 HELION ACER TENDL-2021 LIBRARY; T=0.K  
Threshold reactions

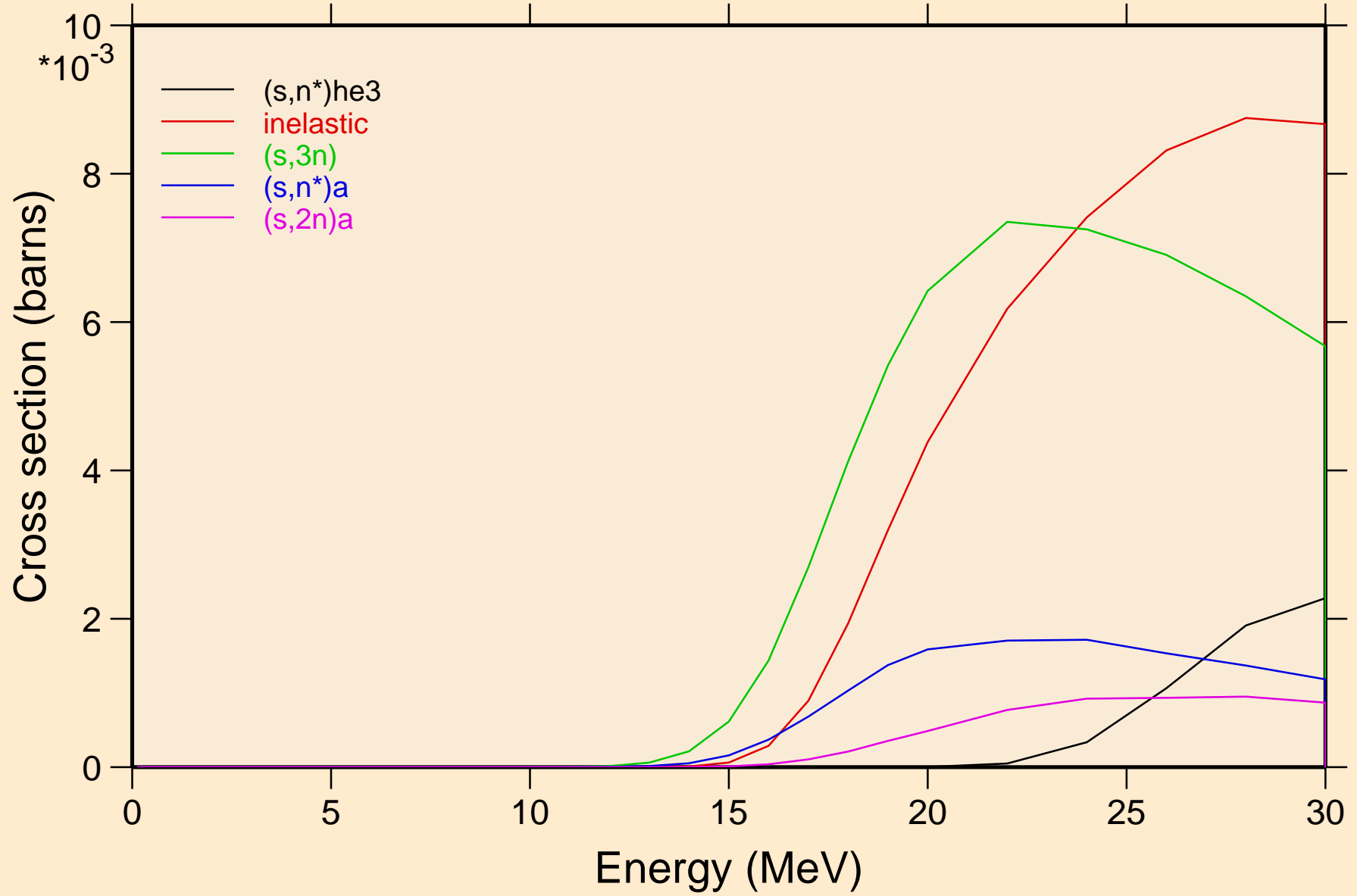

PM159 HELION ACER TENDL-2021 LIBRARY; T=0.K  
Threshold reactions

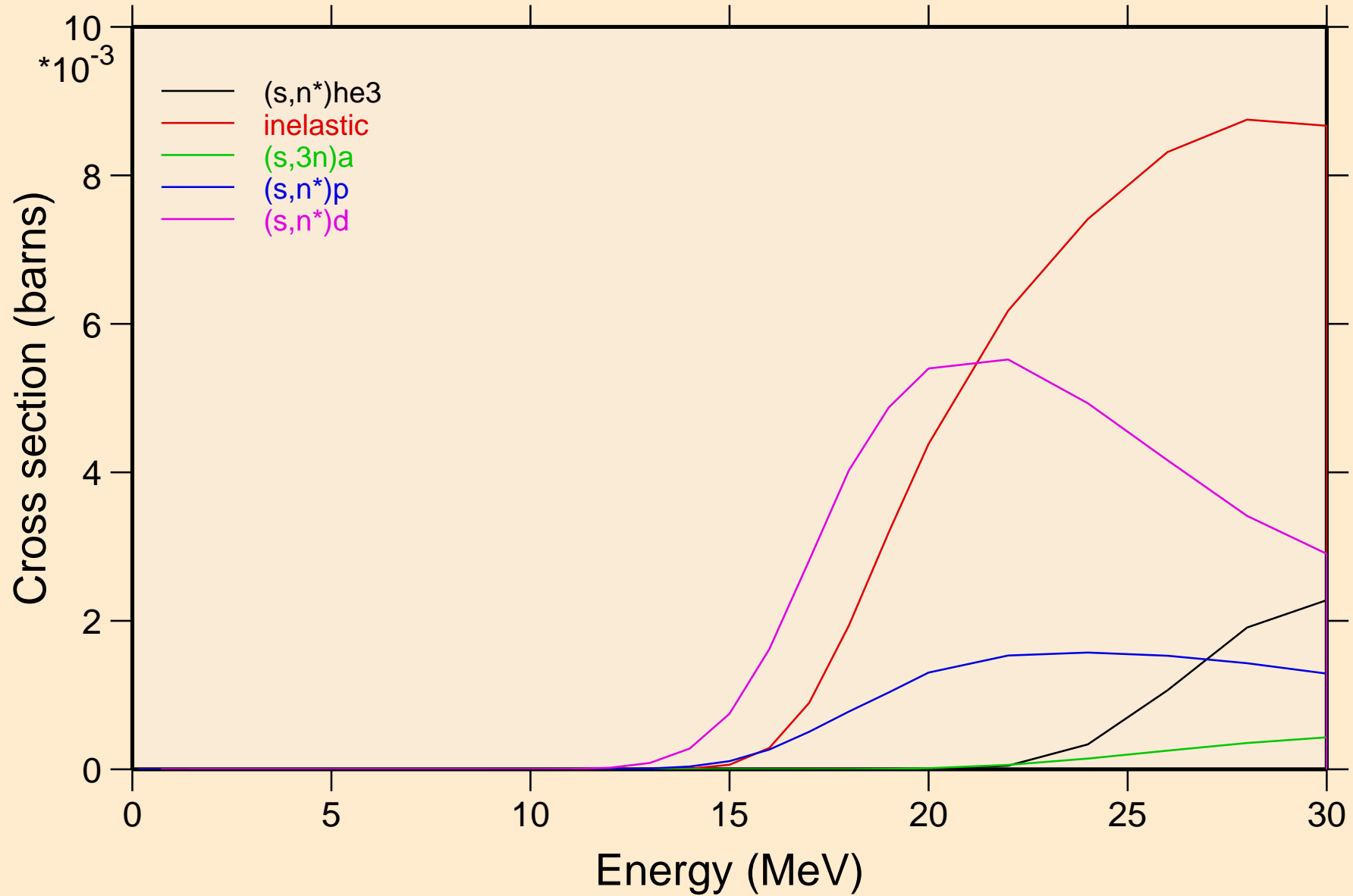

PM159 HELION ACER TENDL-2021 LIBRARY; T=0.K  
Threshold reactions

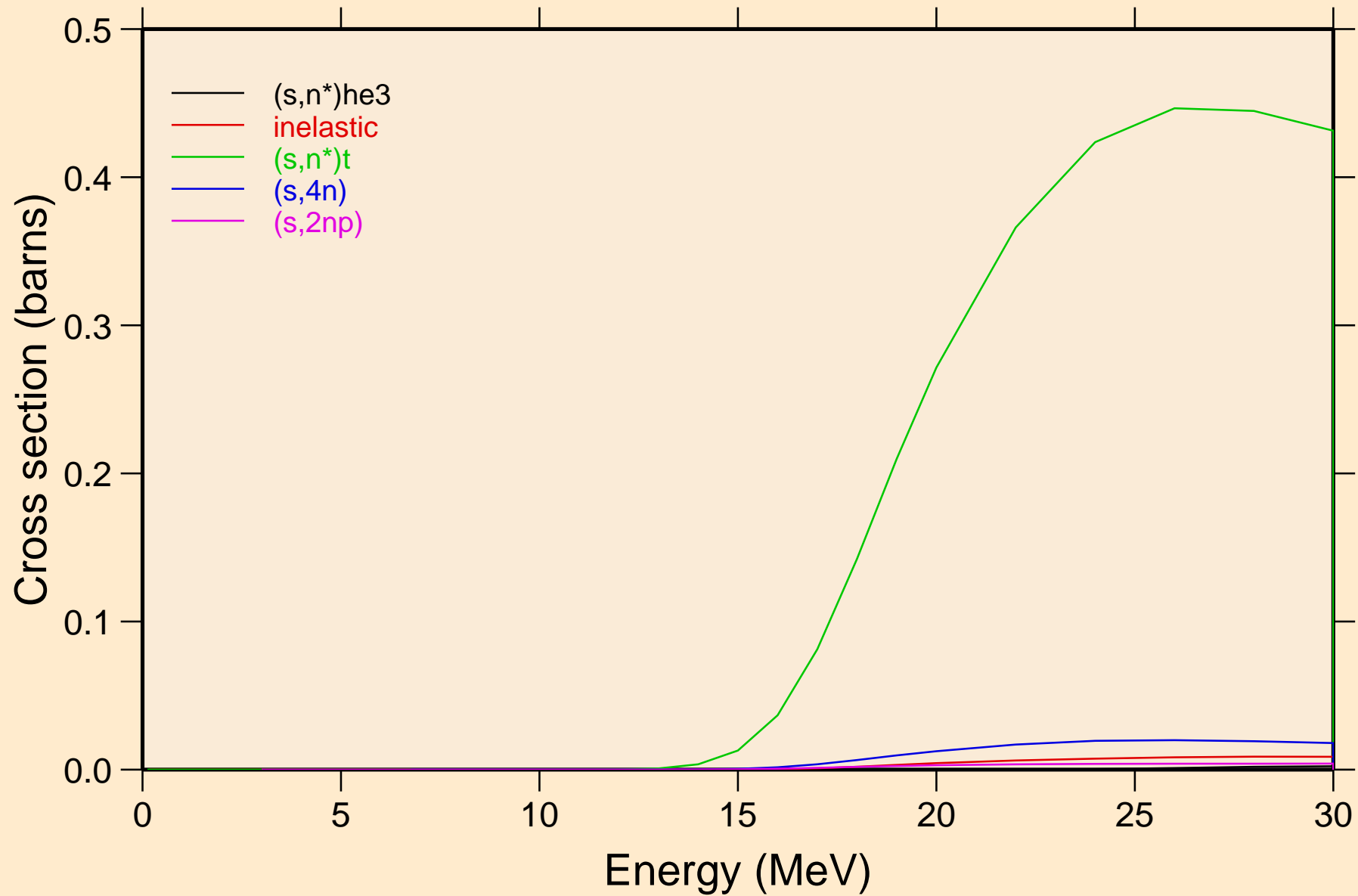



PM159 HELION ACER TENDL-2021 LIBRARY; T=0.K  
Threshold reactions

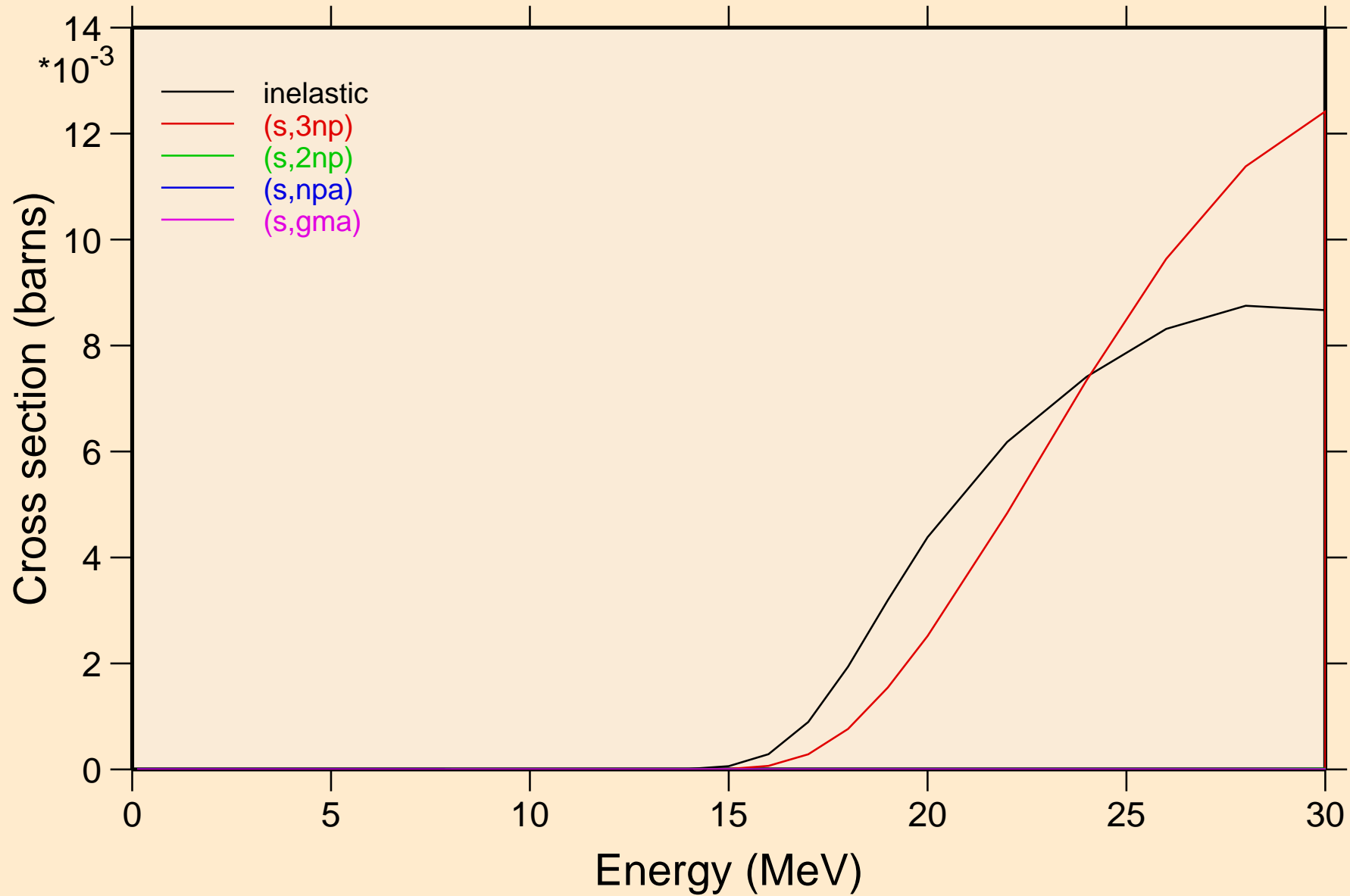

PM159 HELION ACER TENDL-2021 LIBRARY; T=0.K  
Threshold reactions

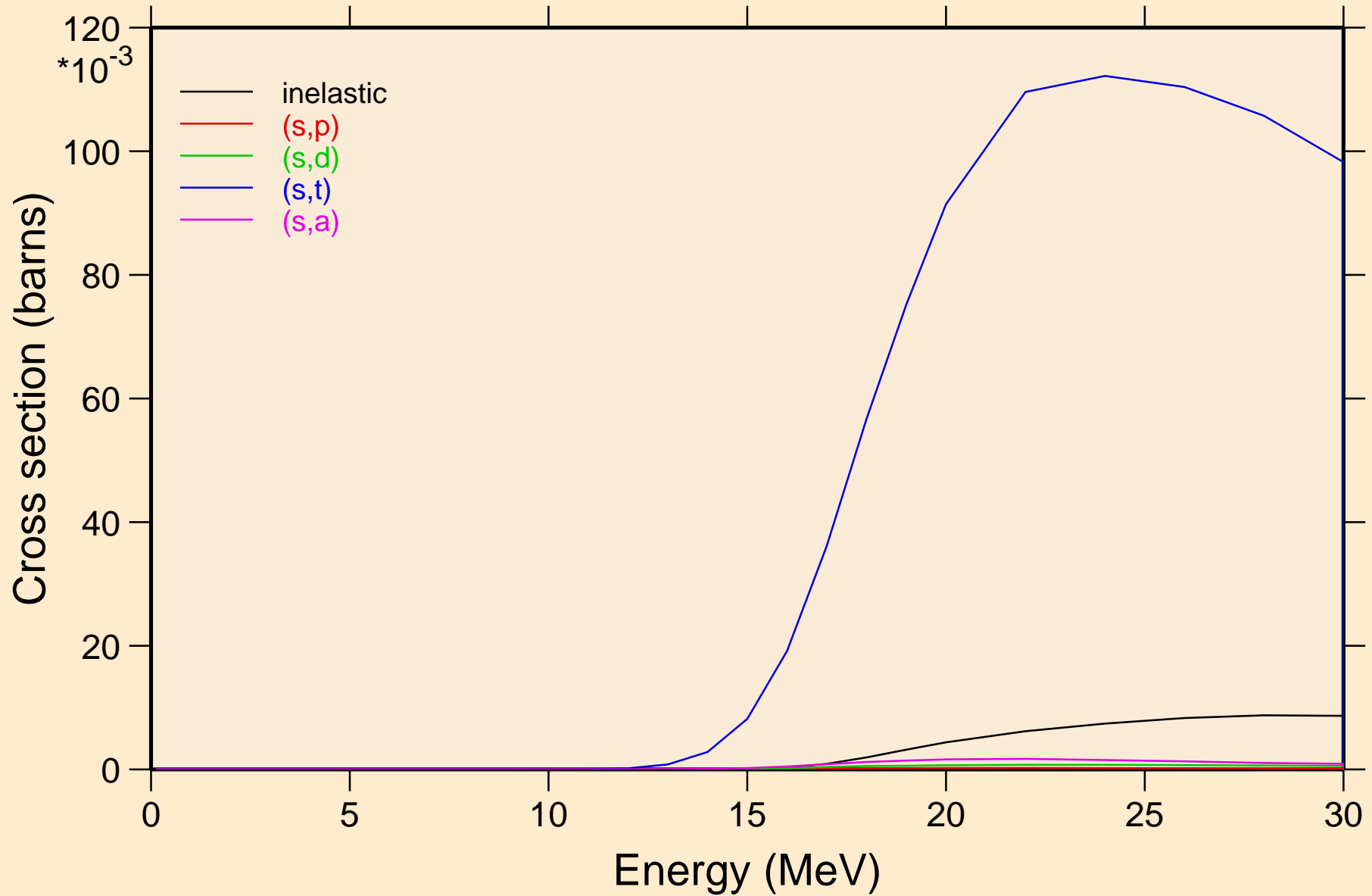

PM159 HELION ACER TENDL-2021 LIBRARY; T=0.K  
Threshold reactions

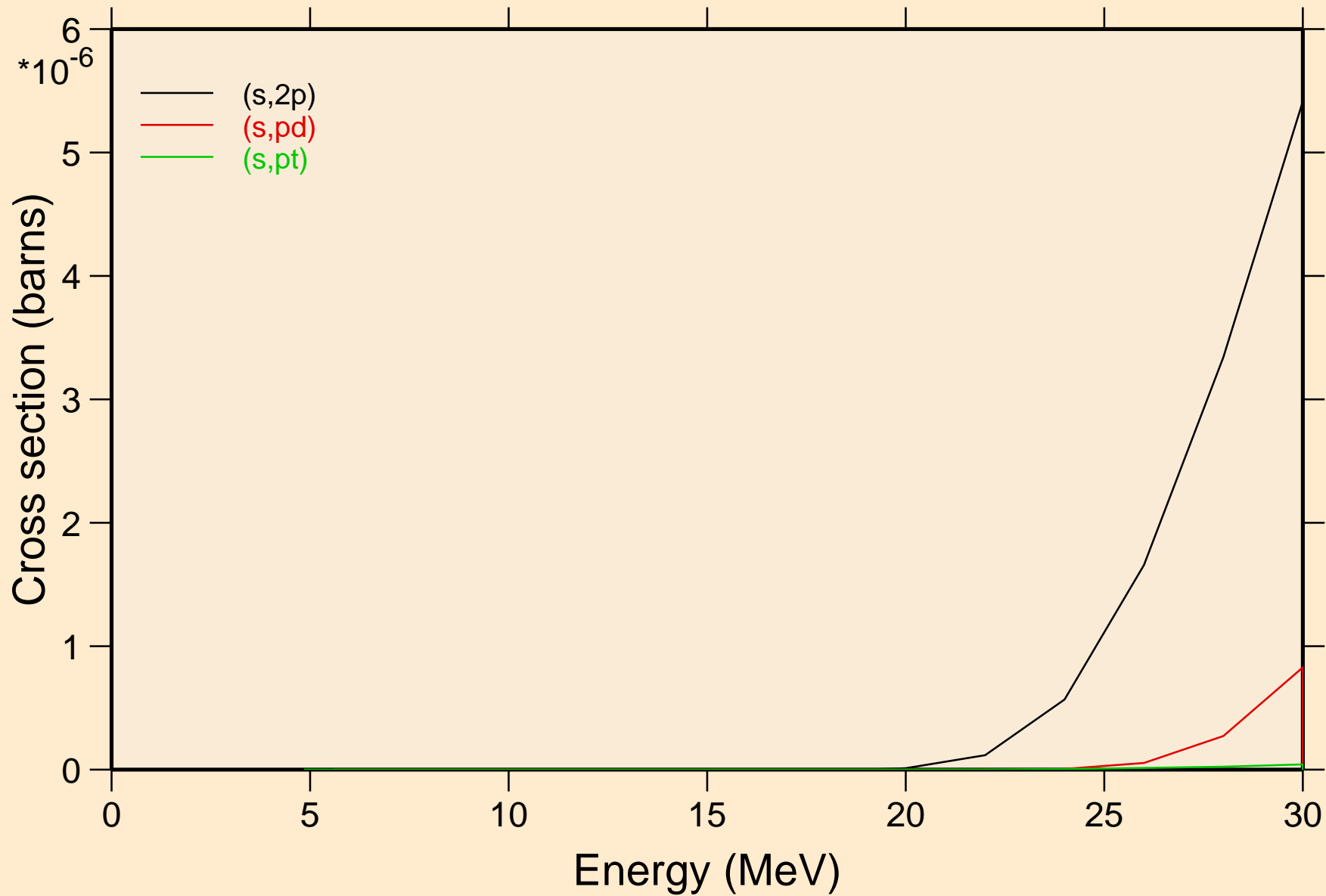

PM159 HELION ACER TENDL-2021 LIBRARY; T=0.K  
angular distribution for elastic

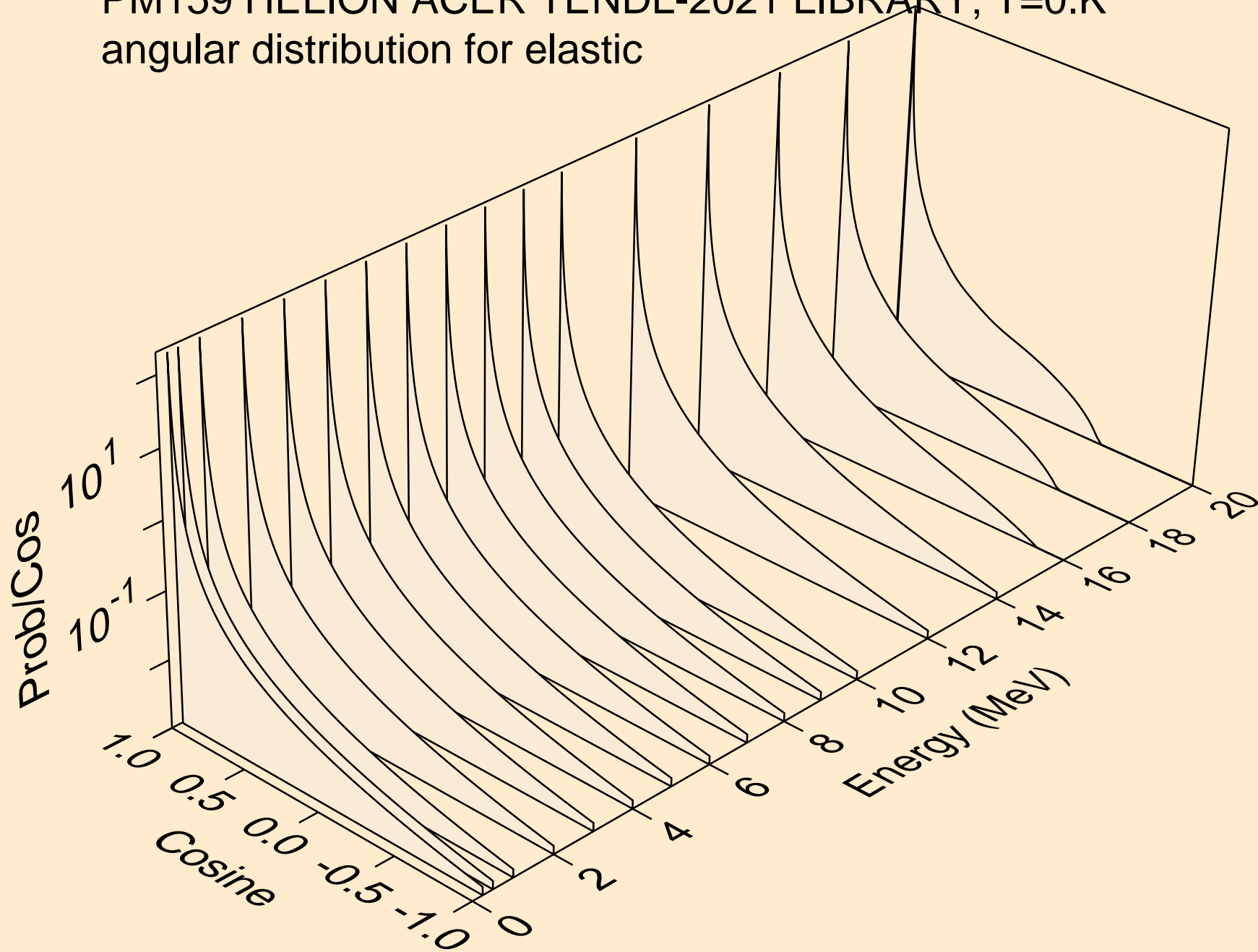

PM159 HELION ACER TENDL-2021 LIBRARY; T=0.K  
angular distribution for elastic

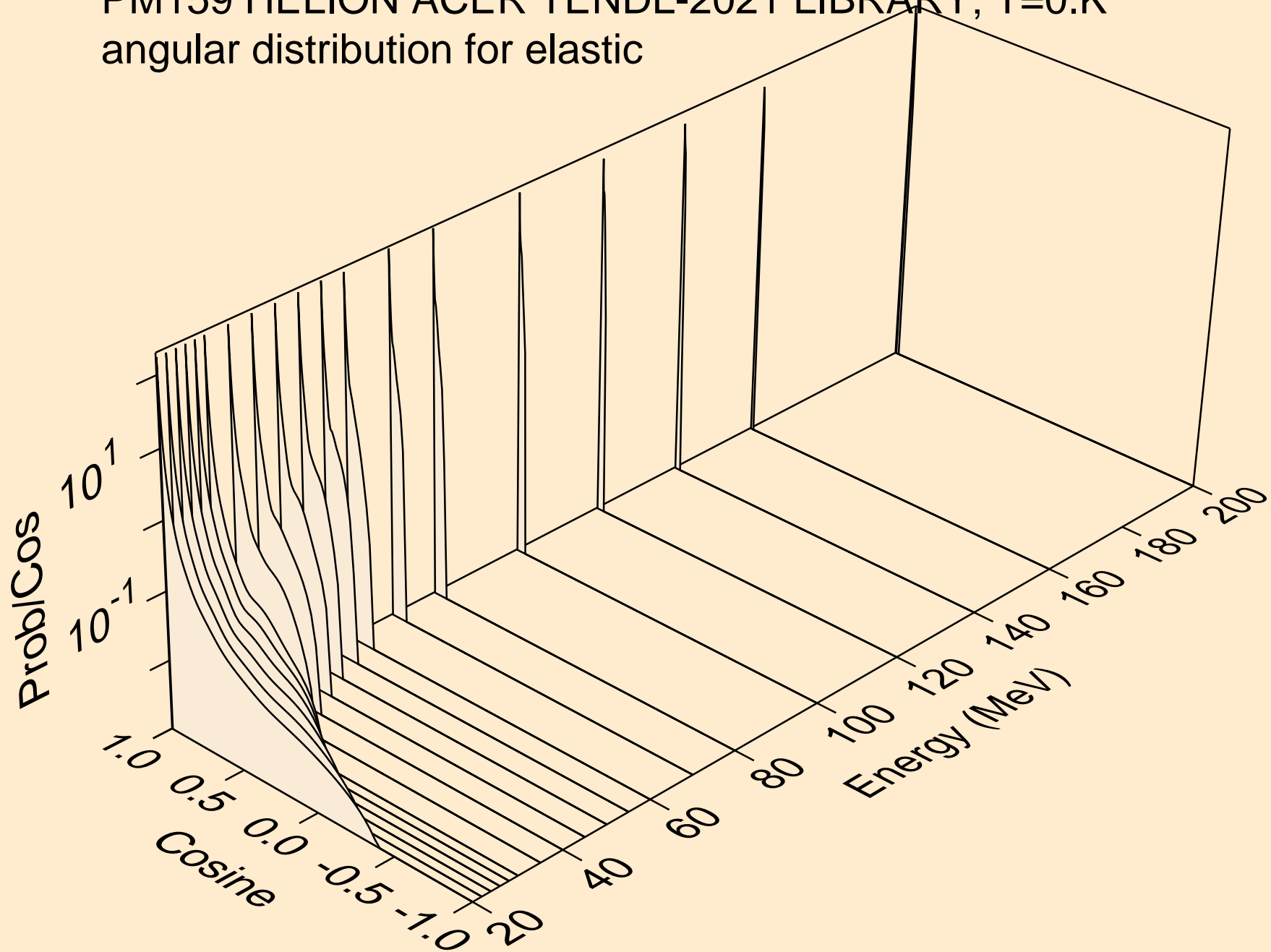

PM159 HELION ACER TENDL-2021 LIBRARY; T=0.K  
He-3 emission for (s,x)

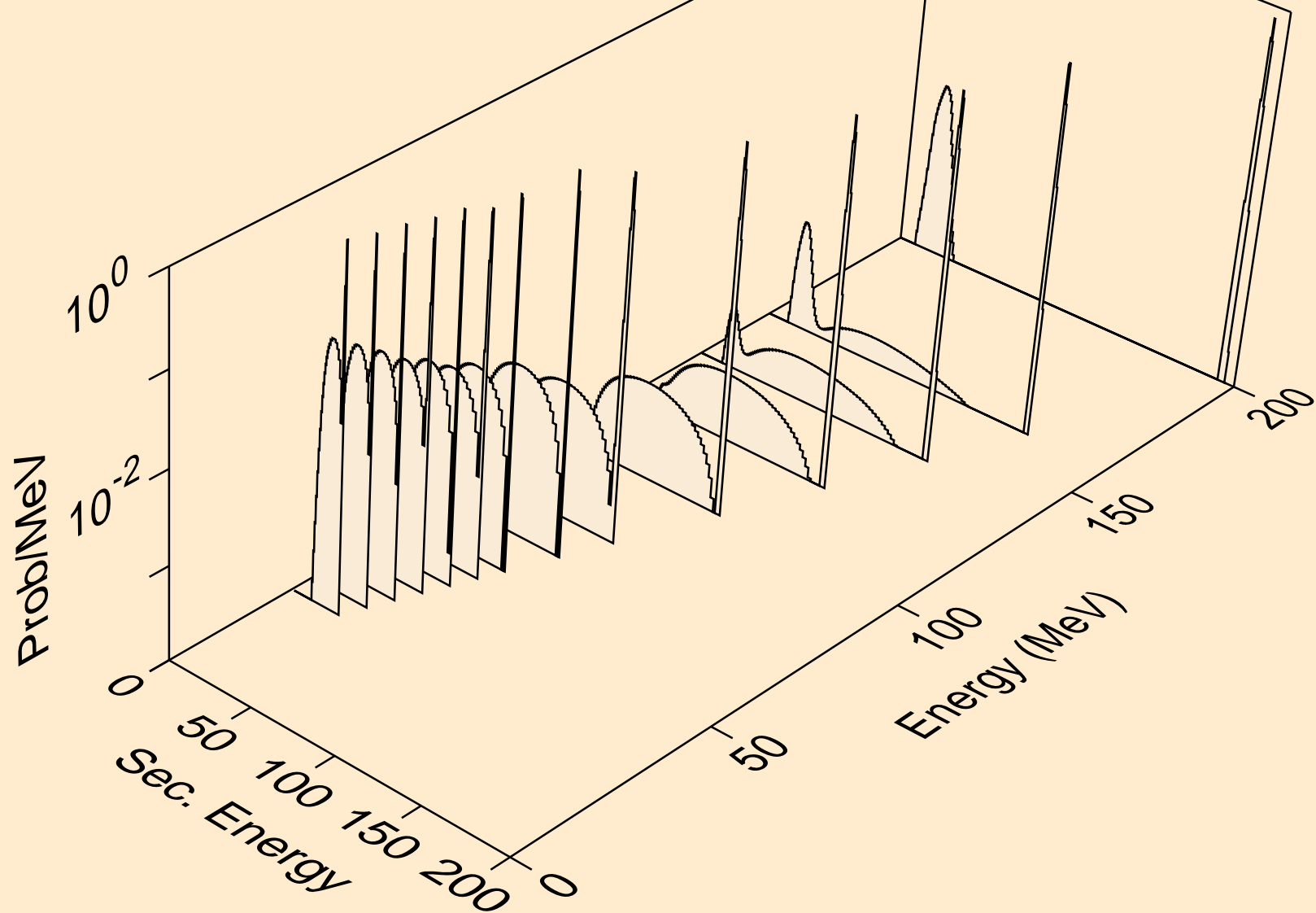

PM159 HELION ACER TENDL-2021 LIBRARY; T=0.K  
He-3 emission for (s,n\*)he3

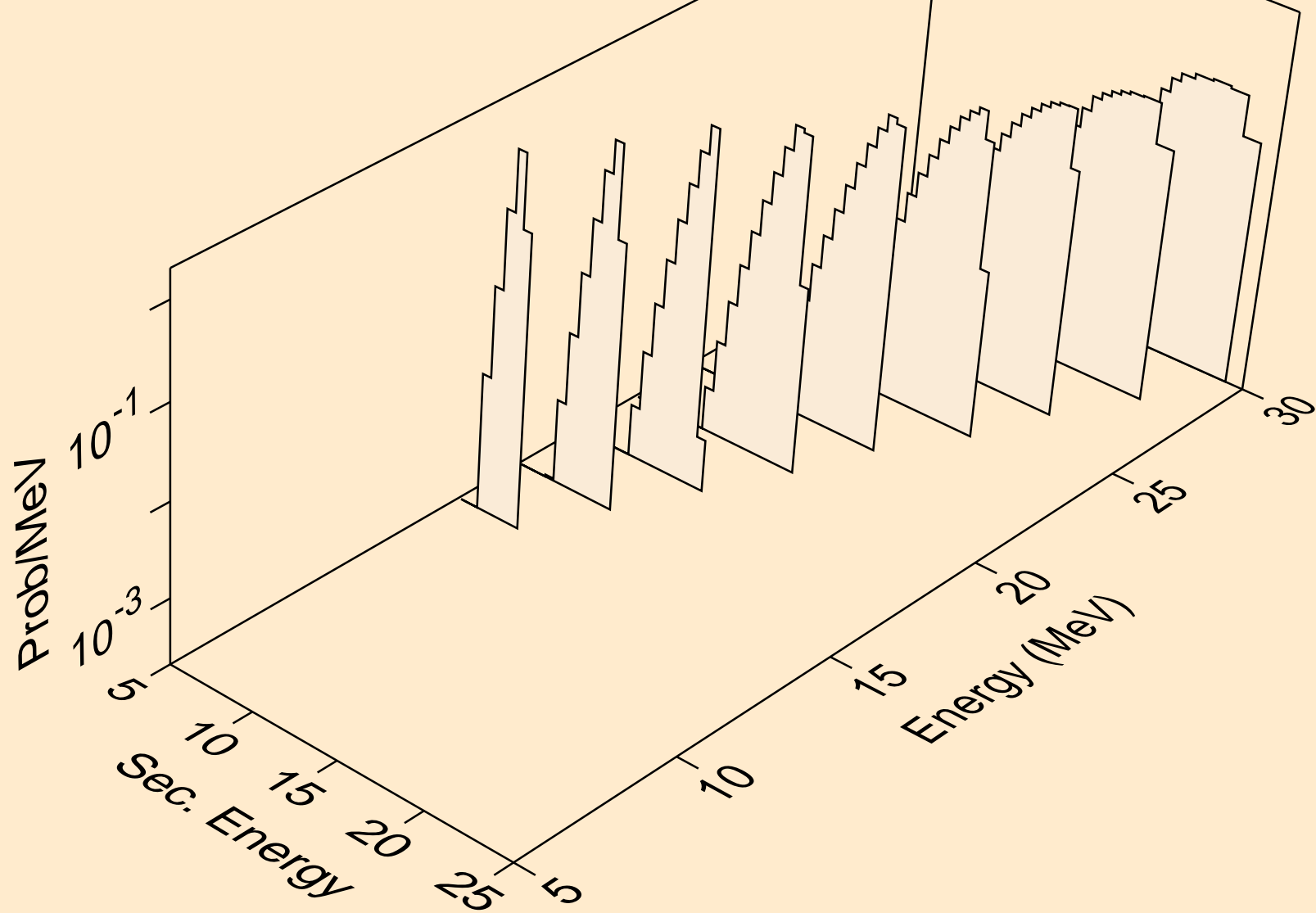

PM159 HELION ACER TENDL-2021 LIBRARY; T=0.K  
He-3 emission for inelastic

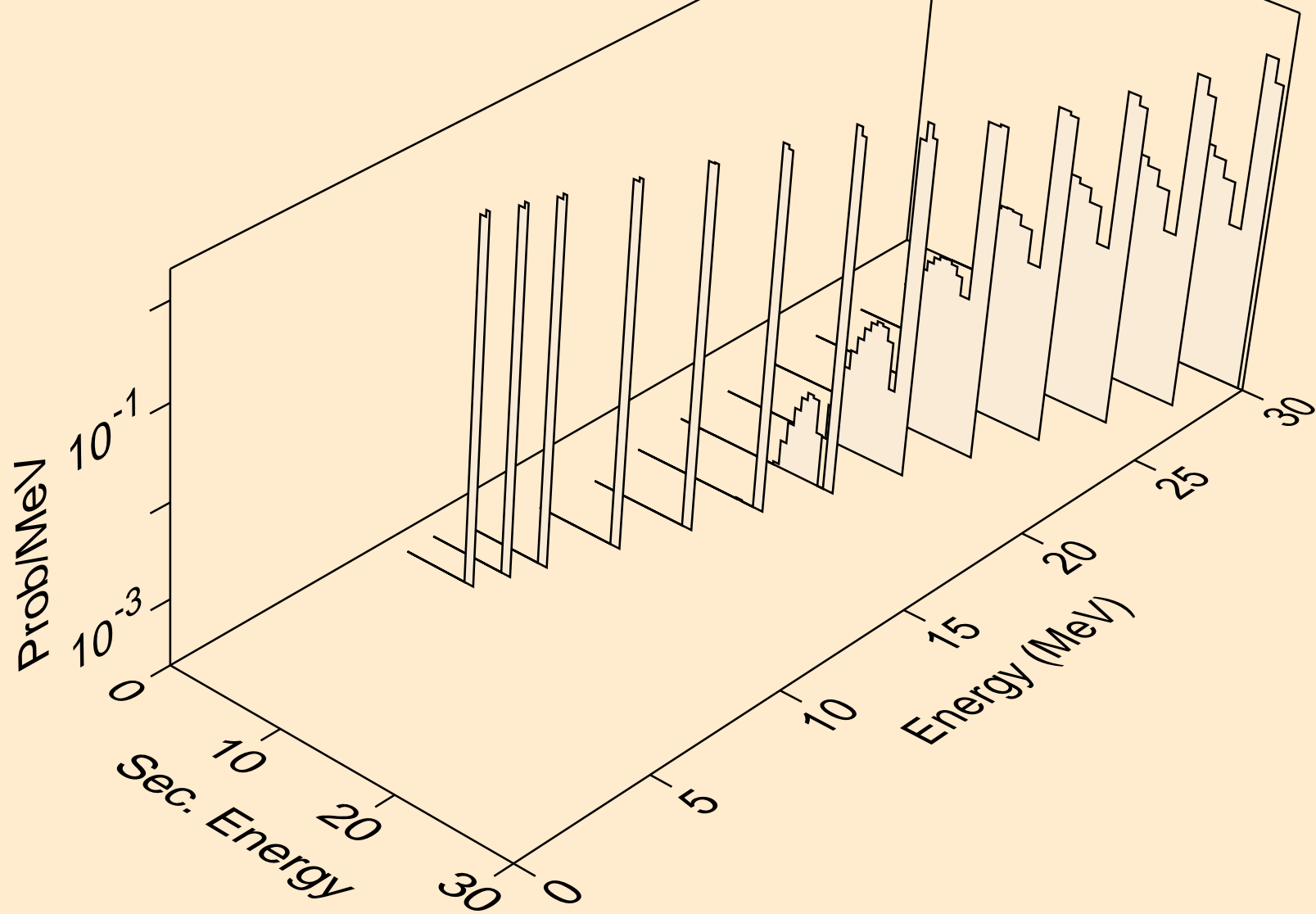



PM159 HELION ACER TENDL-2021 LIBRARY; T=0.K  
Photon emission for (z,n)

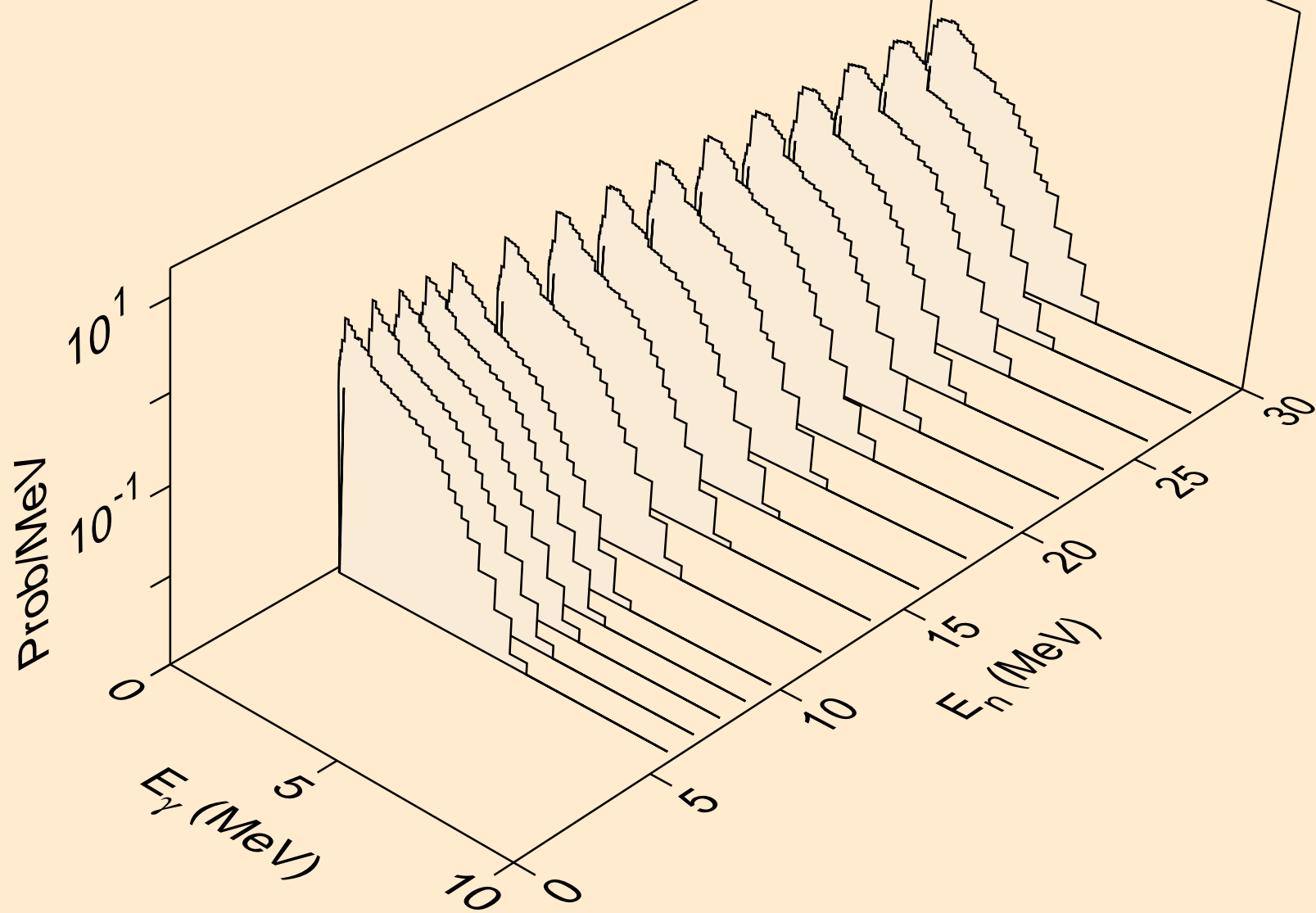

PM159 HELION ACER TENDL-2021 LIBRARY; T=0.K  
Photon emission for (n,x)

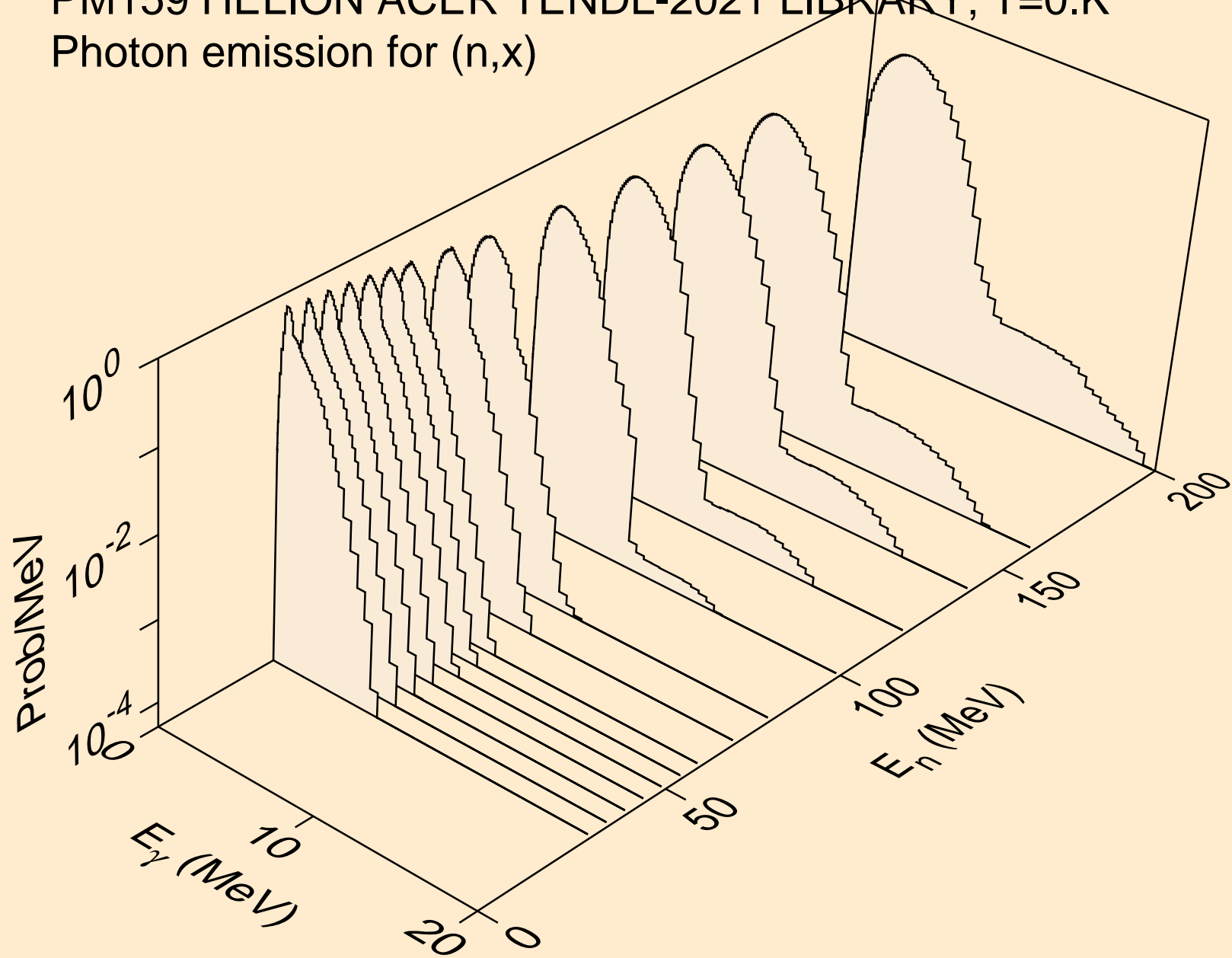

PM159 HELION ACER TENDL-2021 LIBRARY; T=0.K  
Photon emission for (n,2nd)

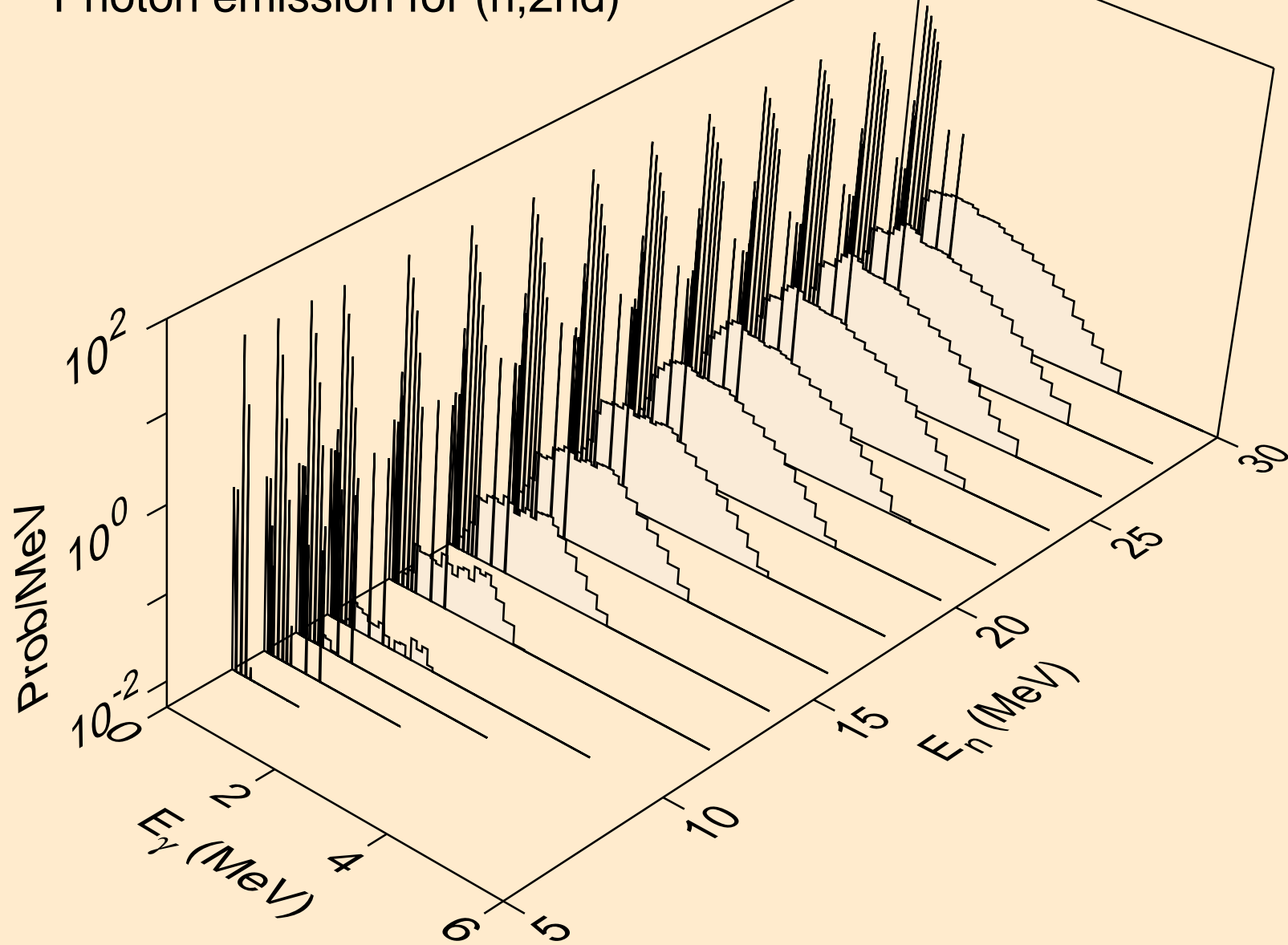

PM159 HELION ACER TENDL-2021 LIBRARY; T=0.K  
Photon emission for (n,2n)

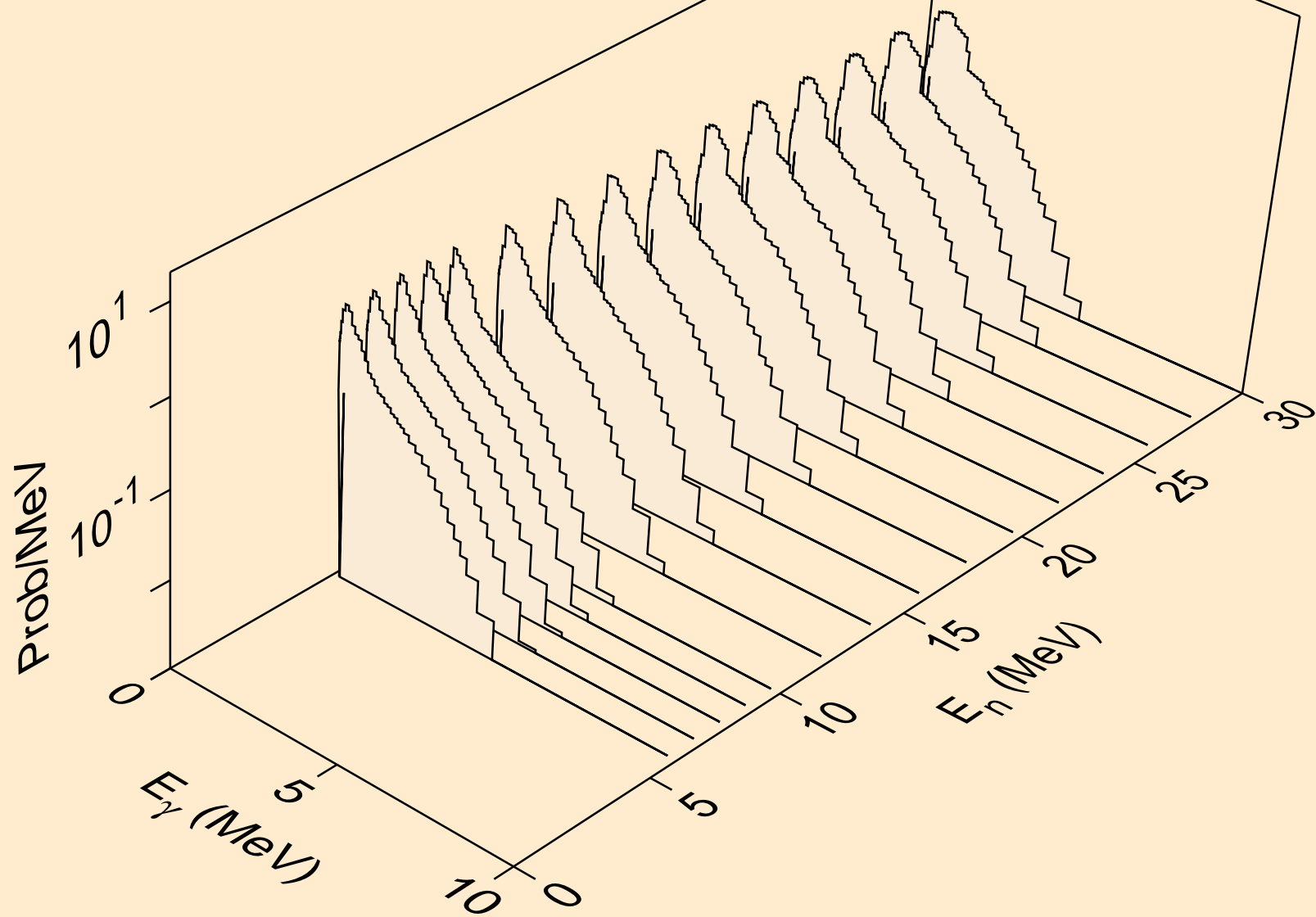

PM159 HELION ACER TENDL-2021 LIBRARY; T=0.K  
Photon emission for (n,3n)

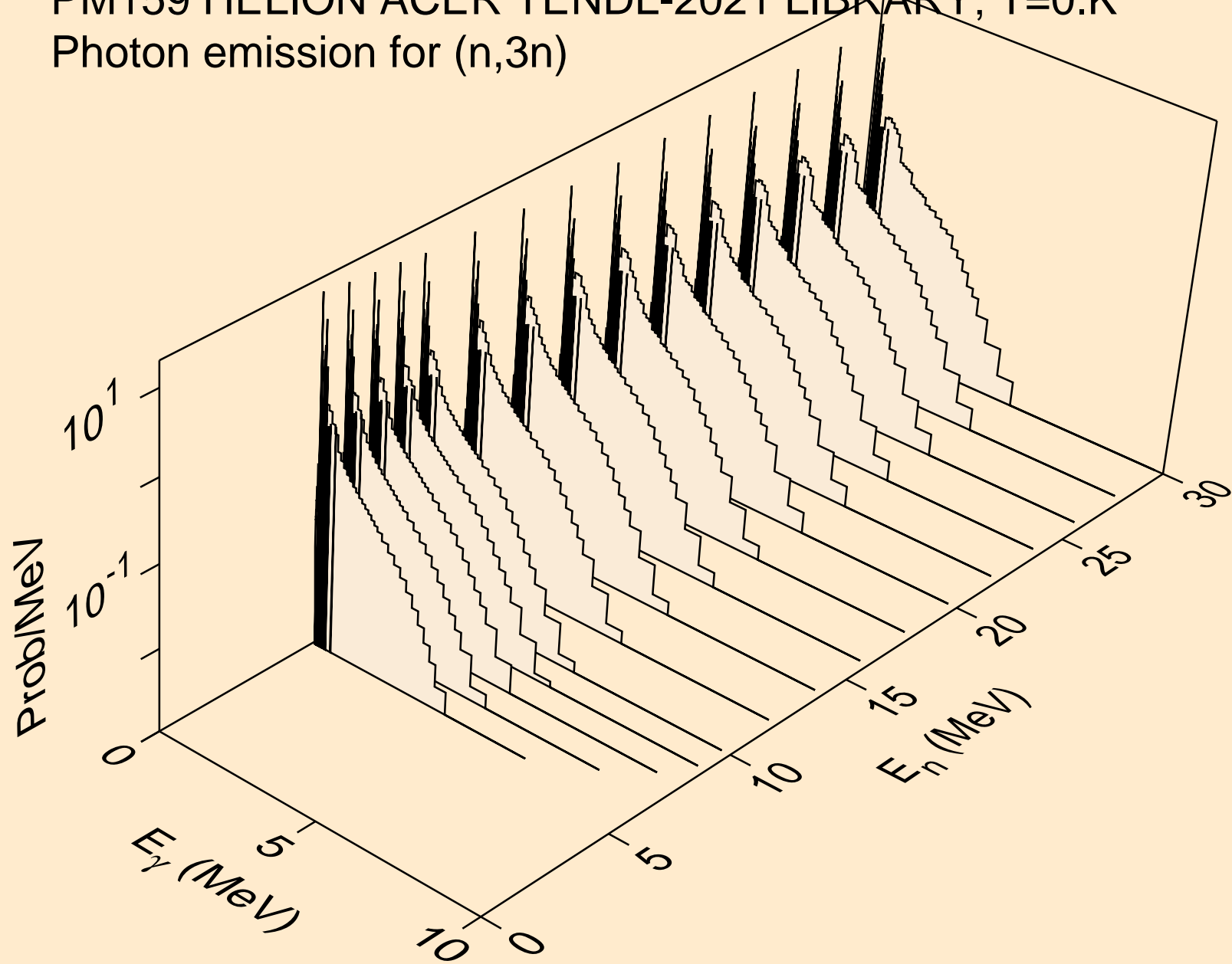

PM159 HELION ACER TENDL-2021 LIBRARY; T=0.K  
Photon emission for (n,n\*)a

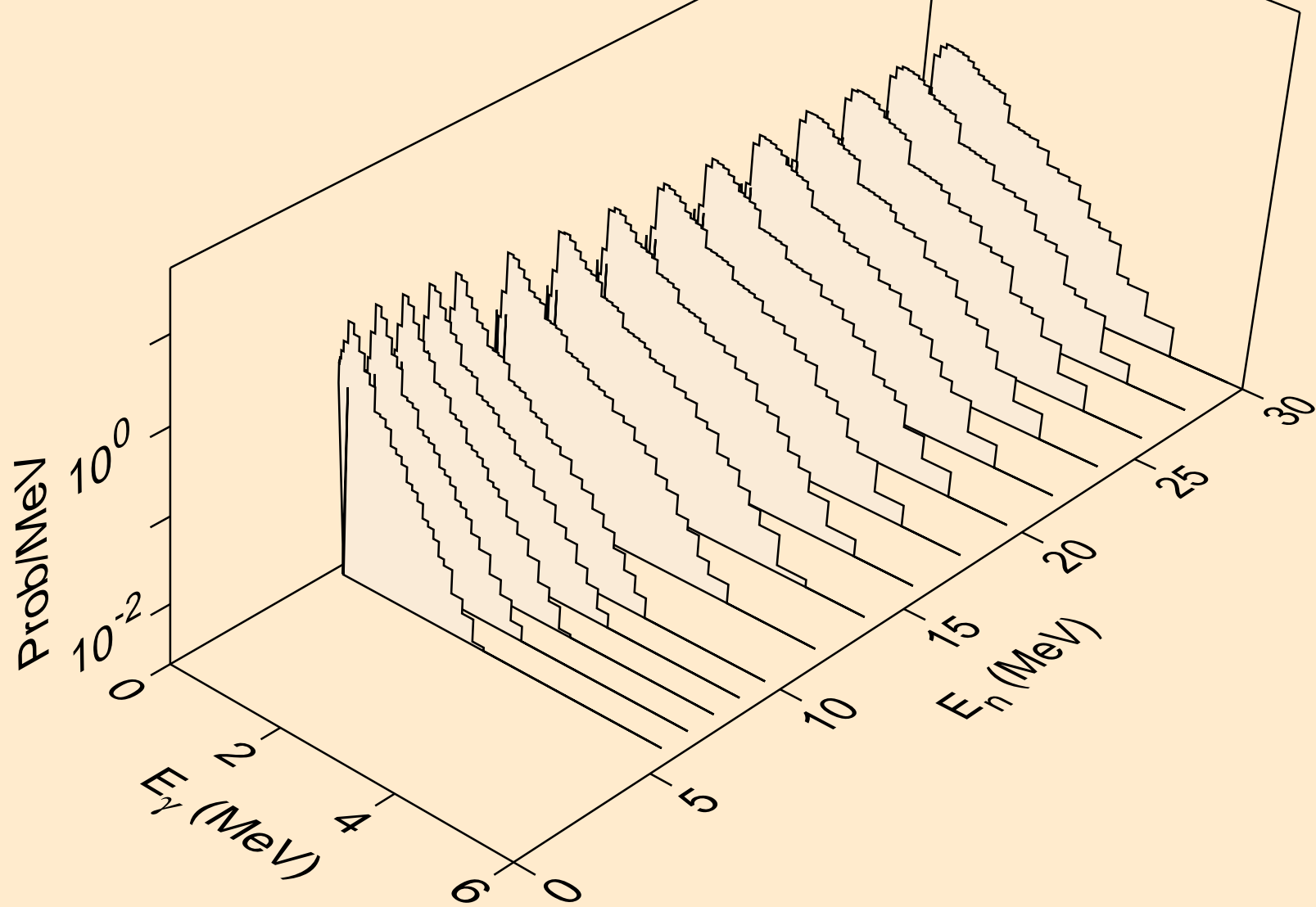

PM159 HELION ACER TENDL-2021 LIBRARY; T=0.K  
Photon emission for (n,2n)a

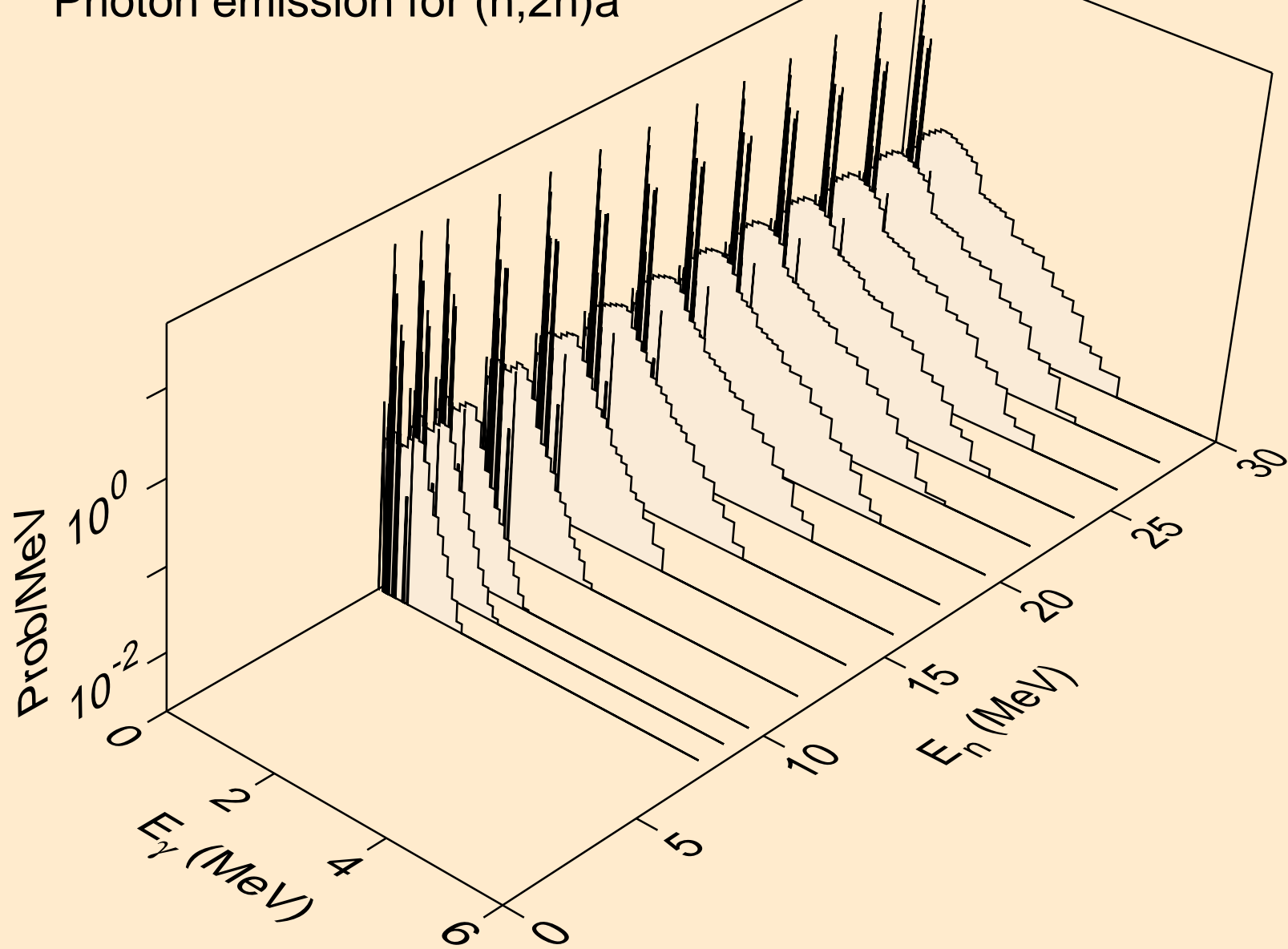

PM159 HELION ACER TENDL-2021 LIBRARY; T=0.K  
Photon emission for (n,3n)a

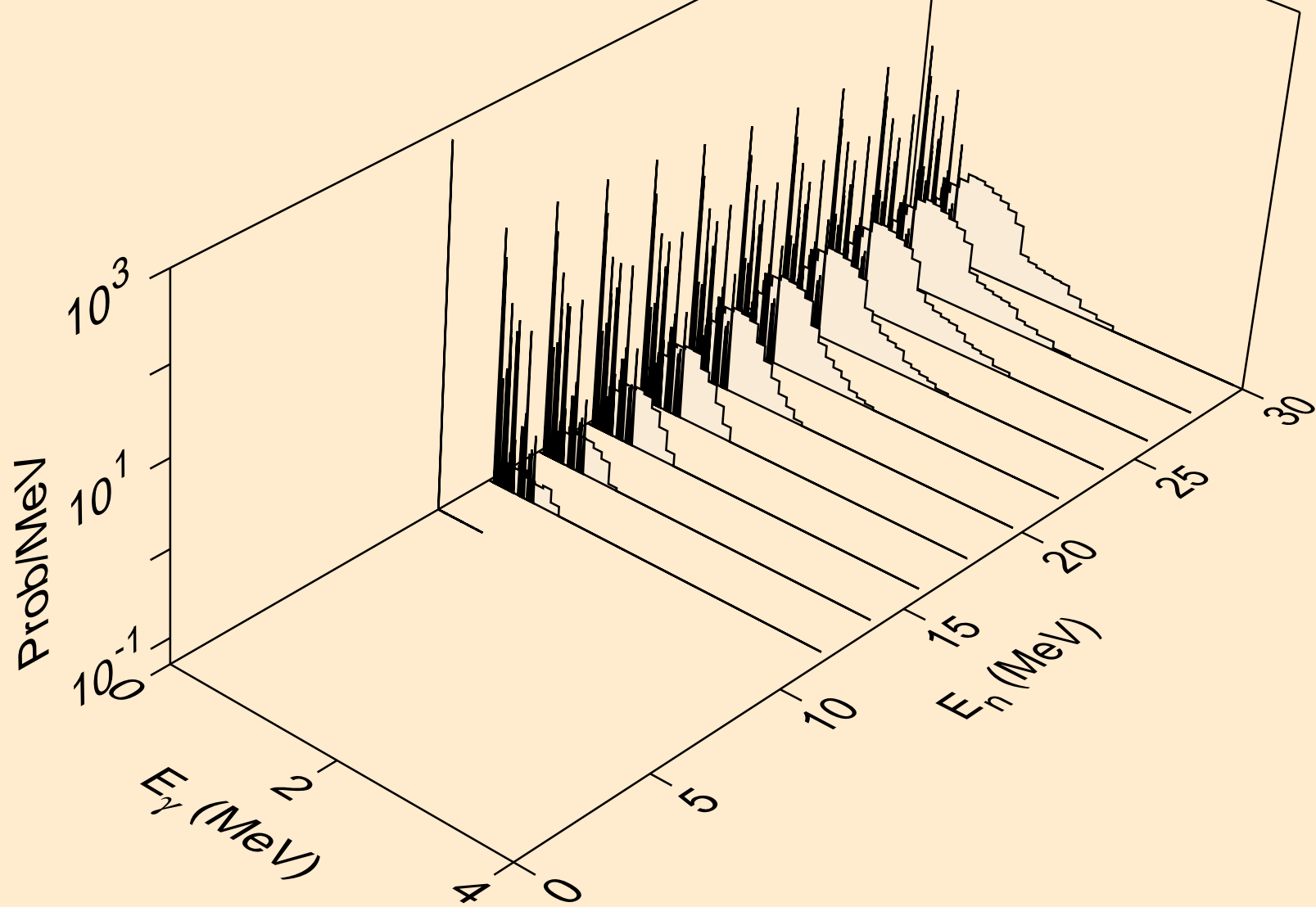



PM159 HELION ACER TENDL-2021 LIBRARY; T=0.K  
Photon emission for (n,n\*)p

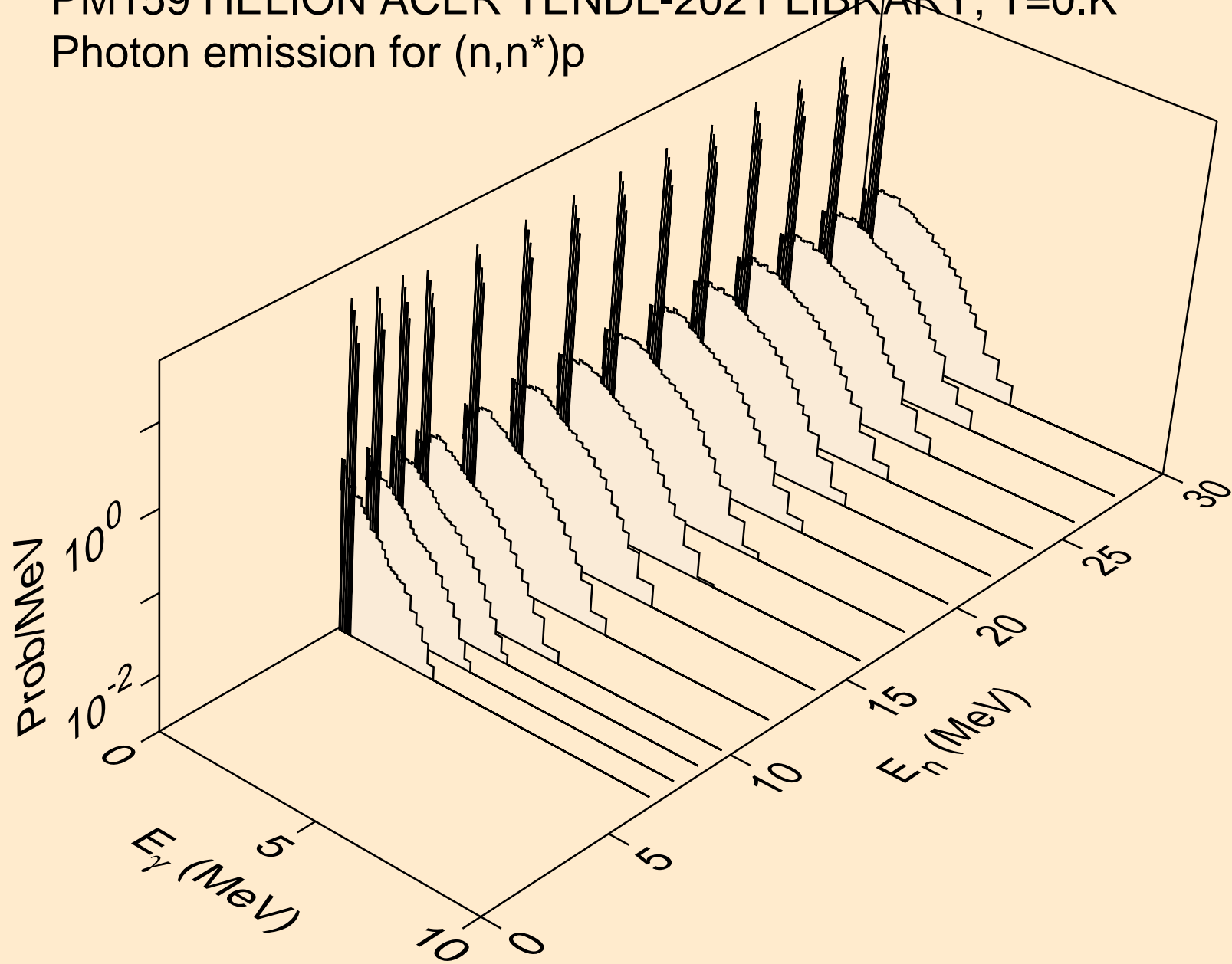

PM159 HELION ACER TENDL-2021 LIBRARY; T=0.K  
Photon emission for (n,n\*)d

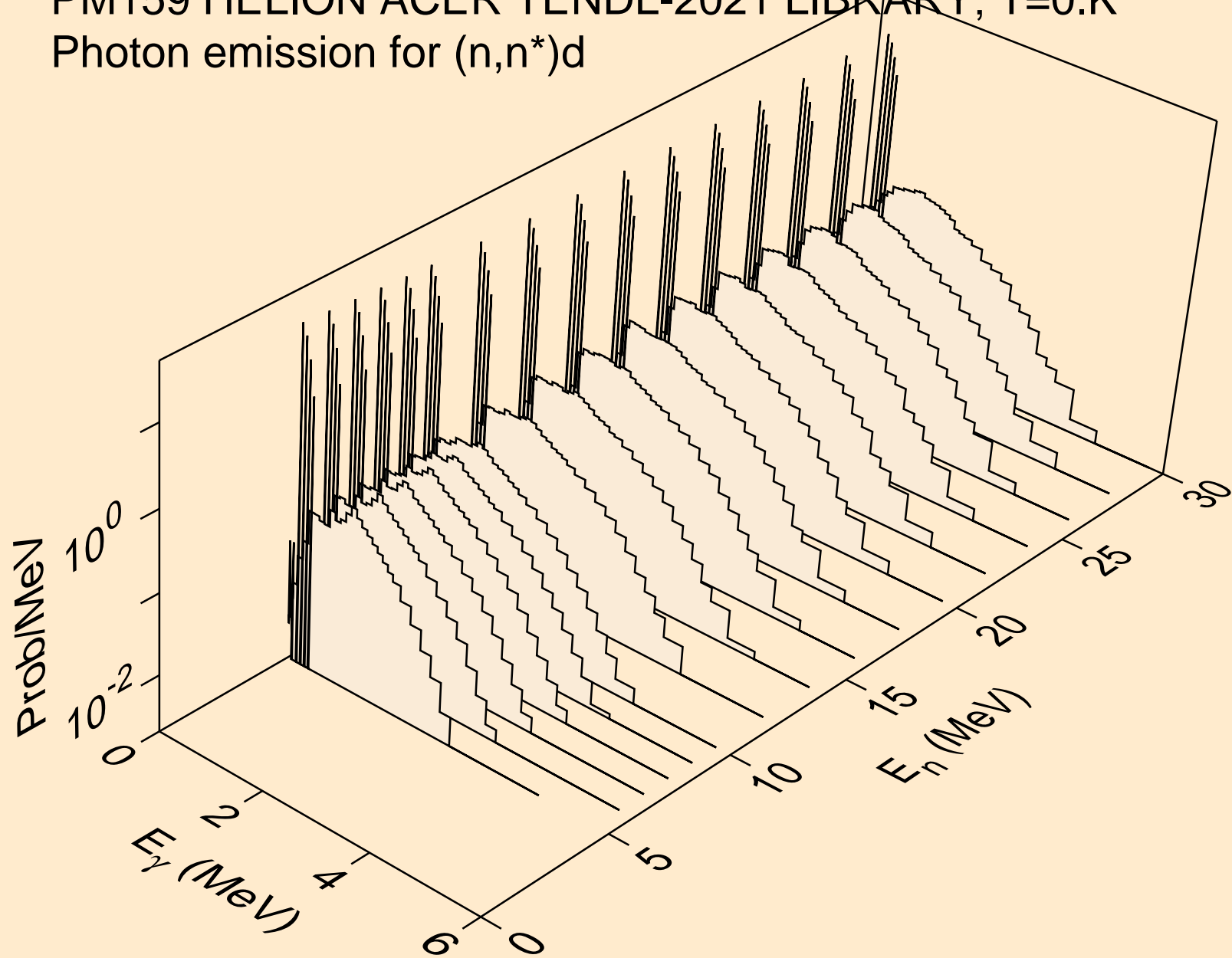

PM159 HELION ACER TENDL-2021 LIBRARY; T=0.K  
Photon emission for (n,n\*)t

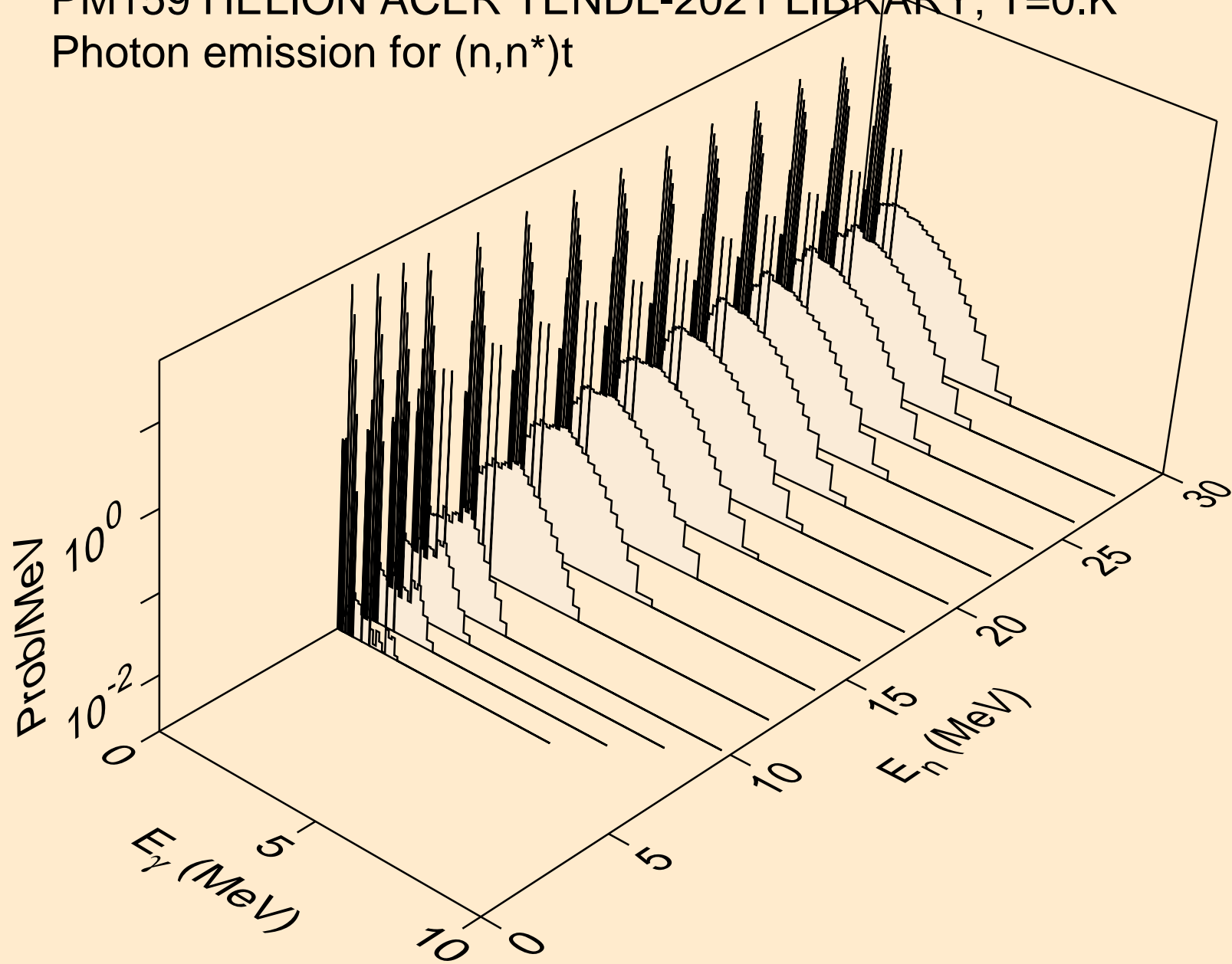

PM159 HELION ACER TENDL-2021 LIBRARY; T=0.K  
Photon emission for (n,n\*)he3

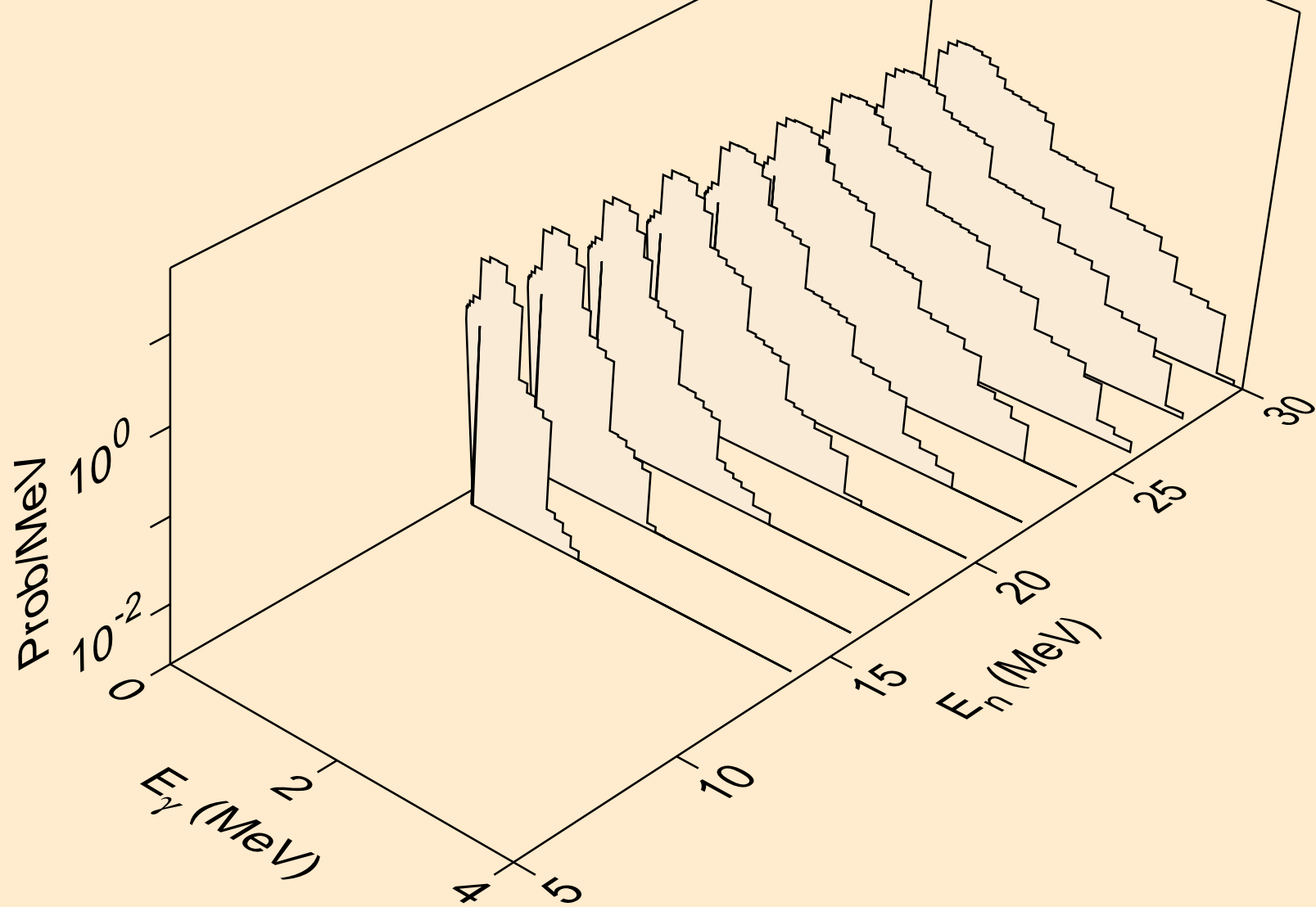

PM159 HELION ACER TENDL-2021 LIBRARY; T=0.K  
Photon emission for (n,4n)

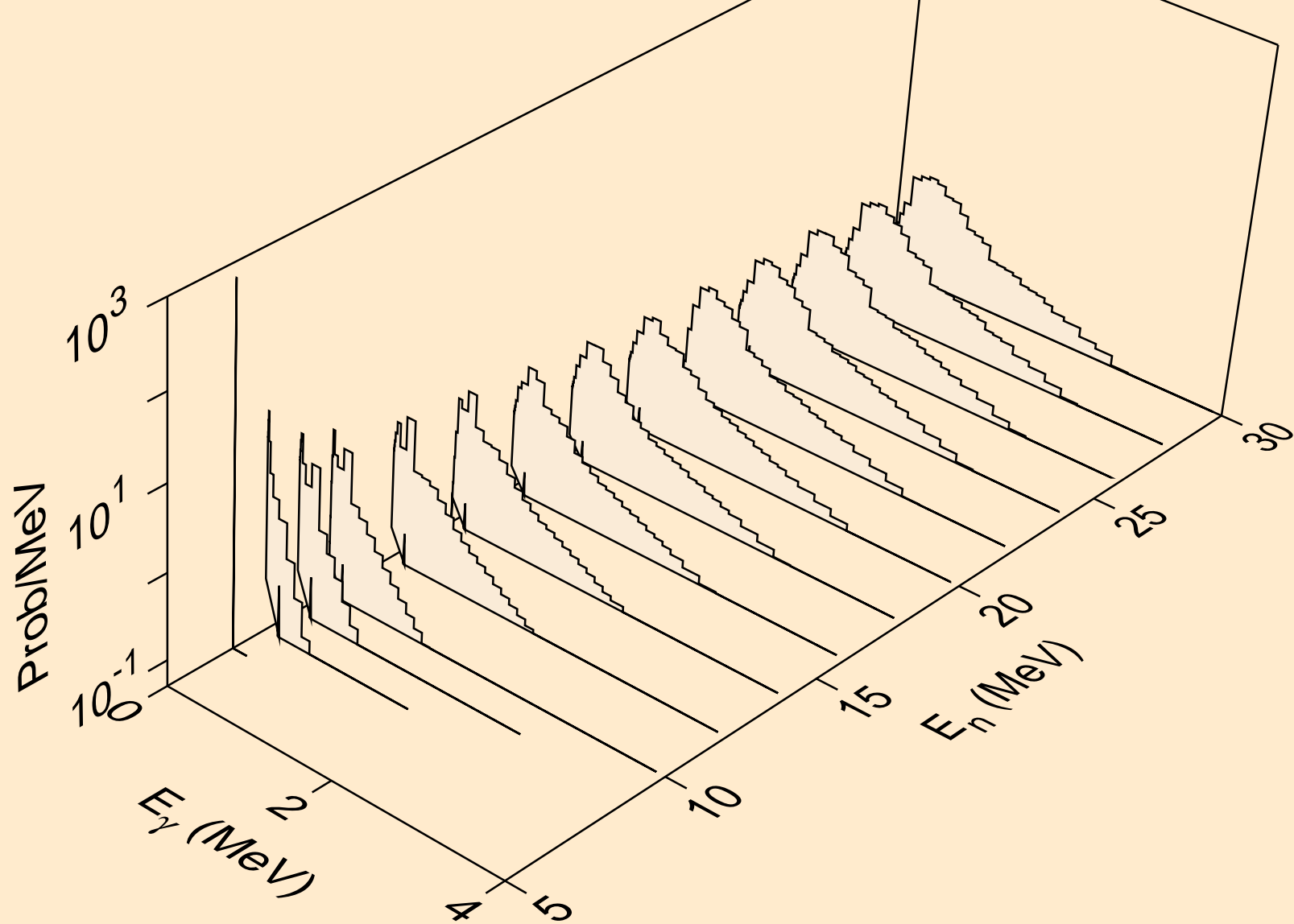

PM159 HELION ACER TENDL-2021 LIBRARY; T=0.K  
Photon emission for (n,2np)

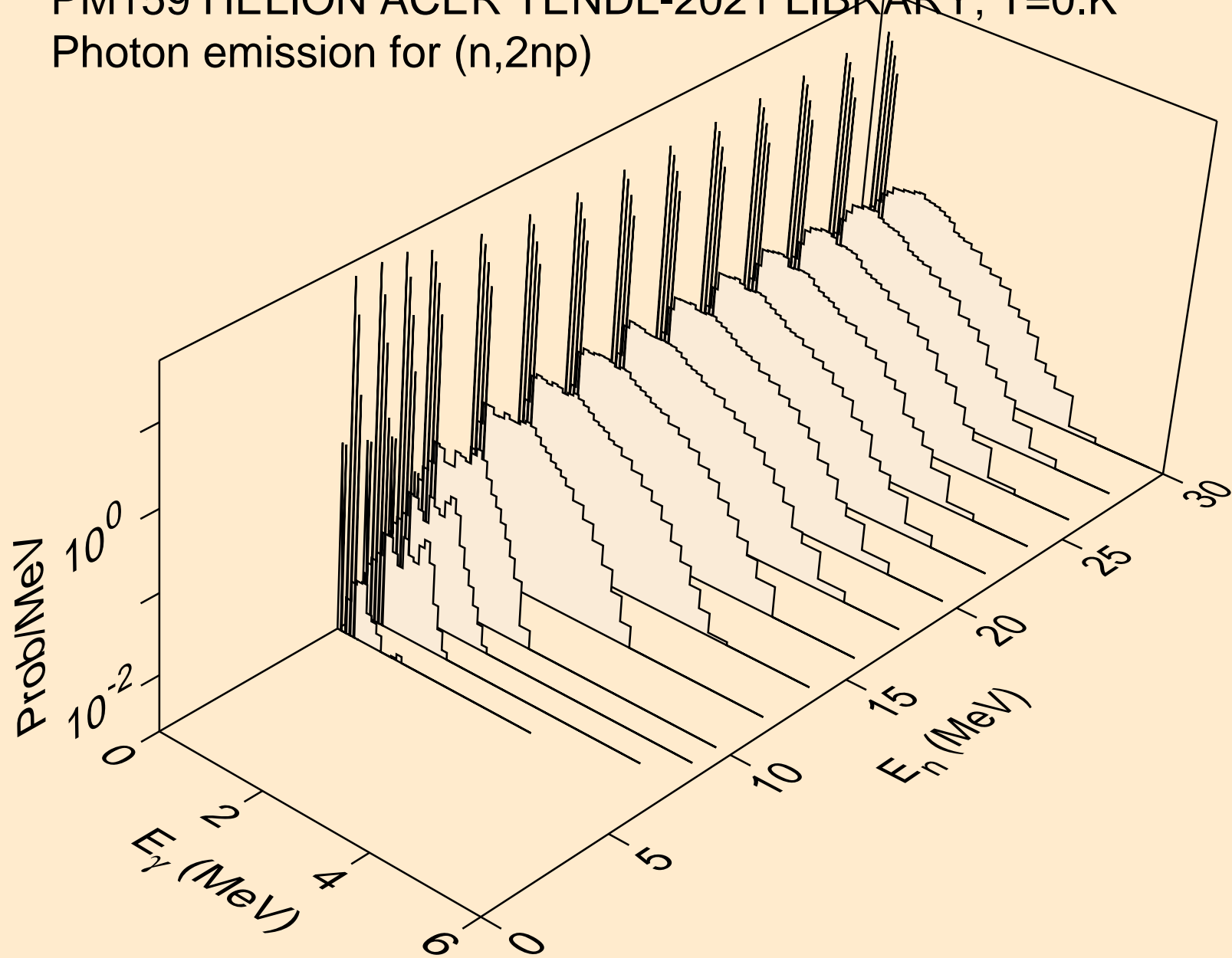

PM159 HELION ACER TENDL-2021 LIBRARY; T=0.K  
Photon emission for (n,3np)

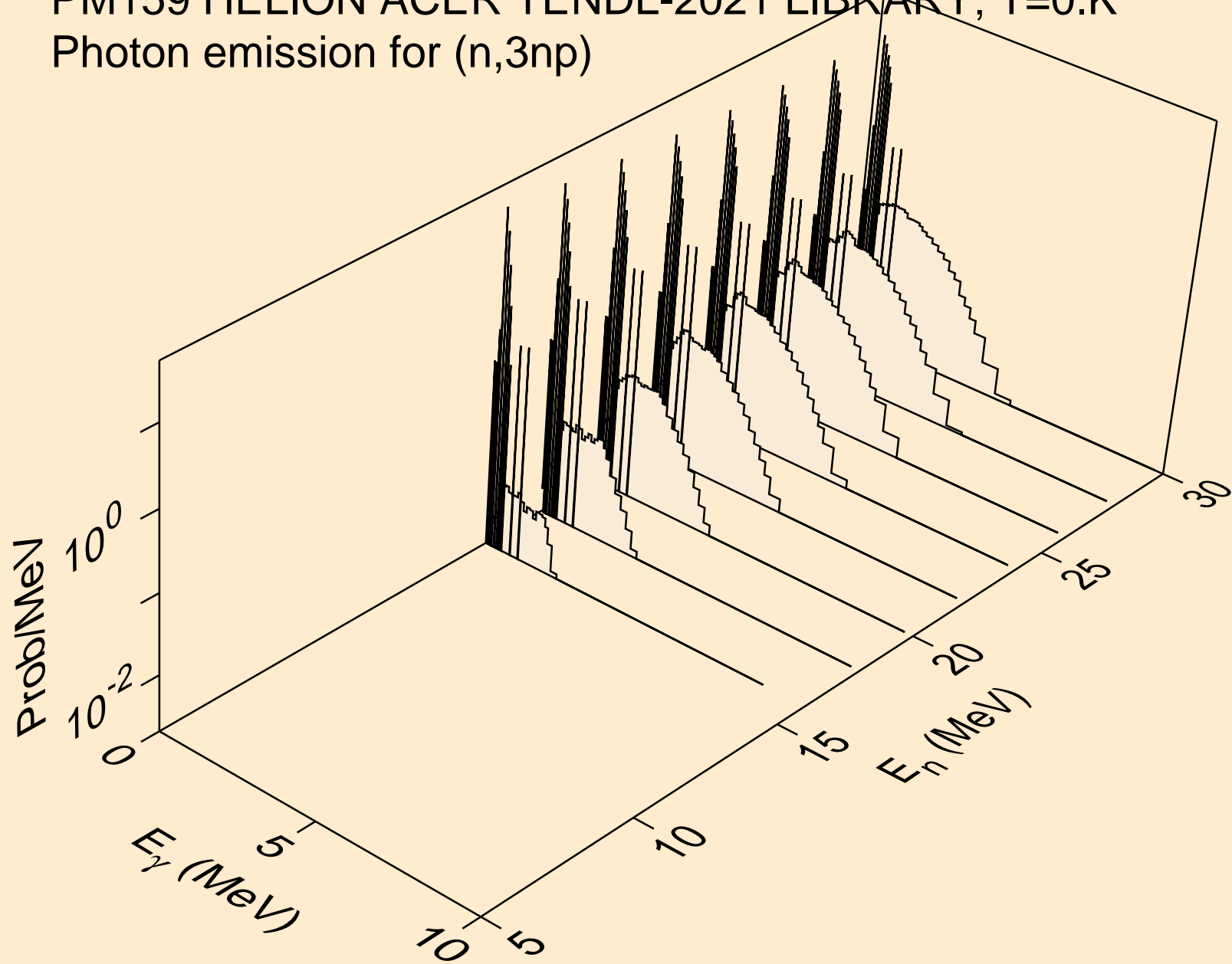

PM159 HELION ACER TENDL-2021 LIBRARY; T=0.K  
Photon emission for (n,2np)

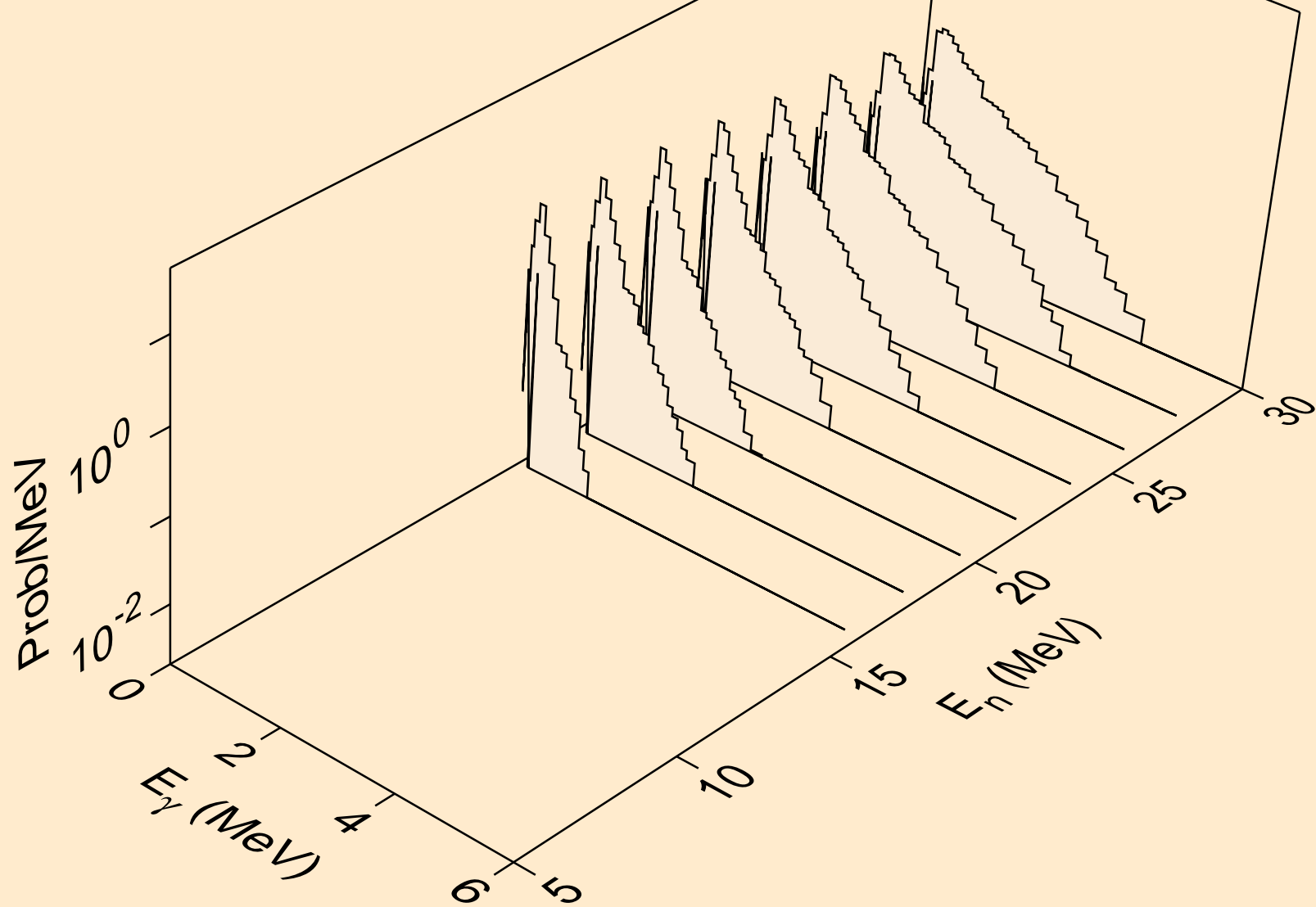



PM159 HELION ACER TENDL-2021 LIBRARY; T=0.K  
Photon emission for (n,npa)

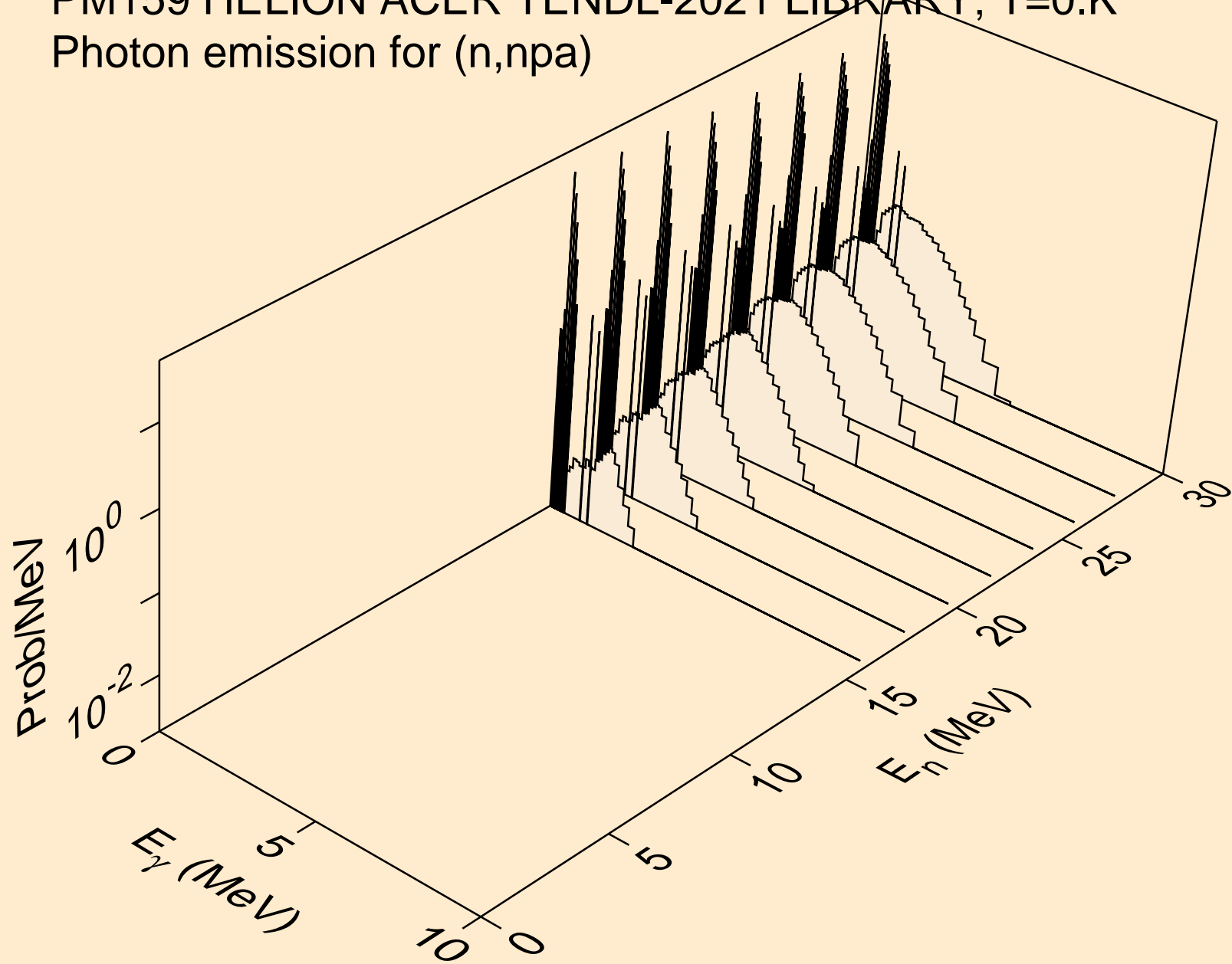

PM159 HELION ACER TENDL-2021 LIBRARY; T=0.K  
Photon emission for (n,gma)

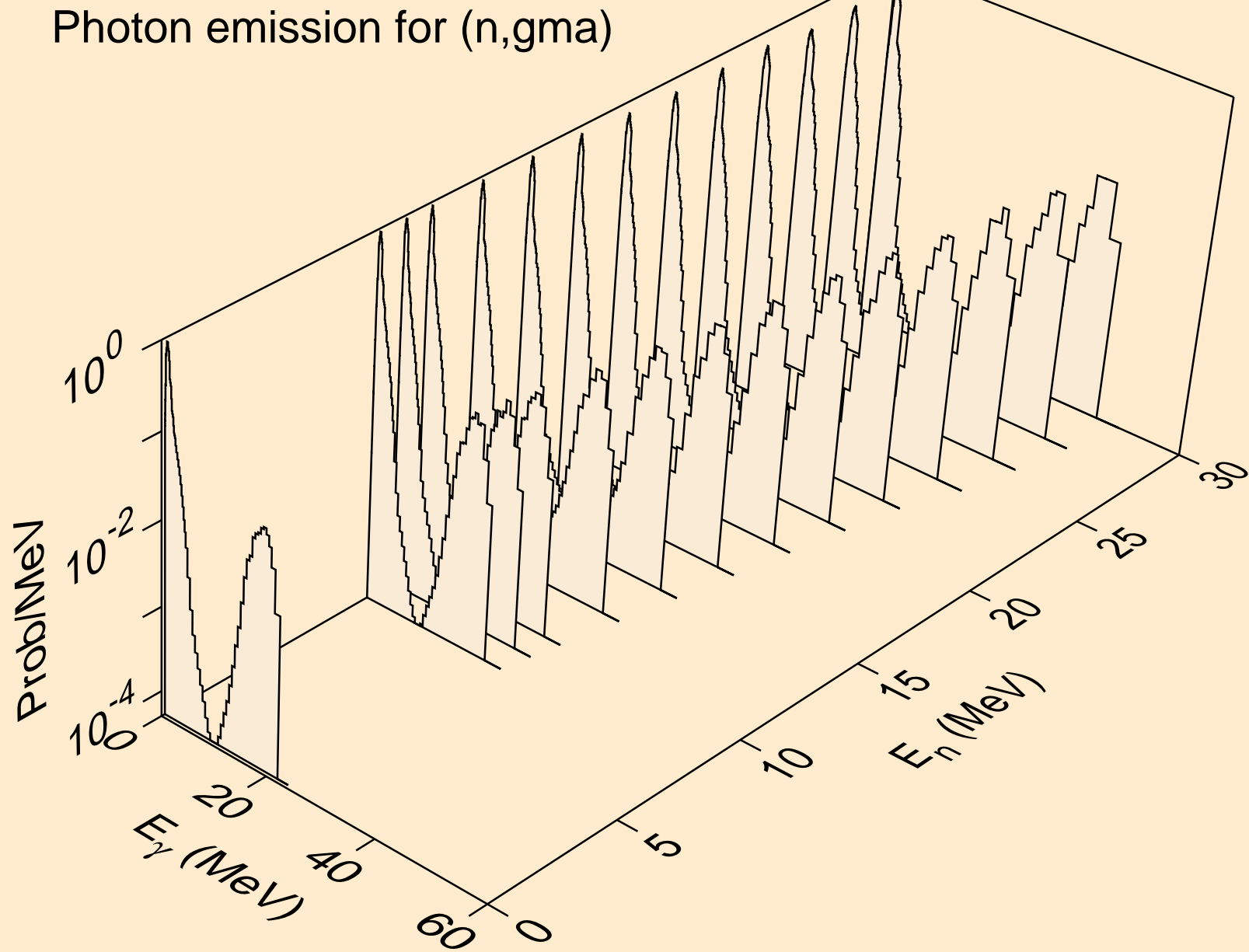

PM159 HELION ACER TENDL-2021 LIBRARY; T=0.K  
Photon emission for (n,p)

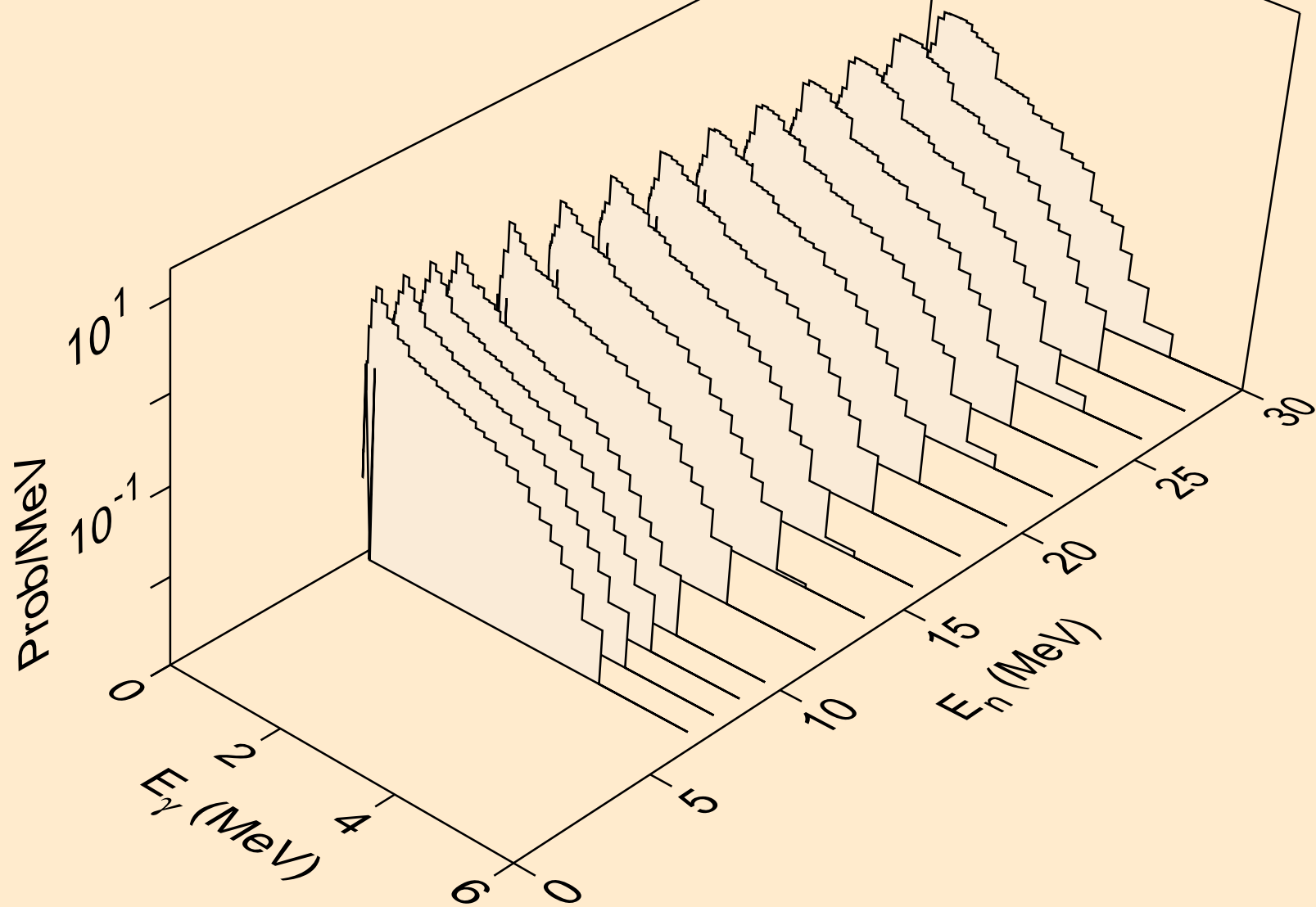

PM159 HELION ACER TENDL-2021 LIBRARY; T=0.K  
Photon emission for (n,d)

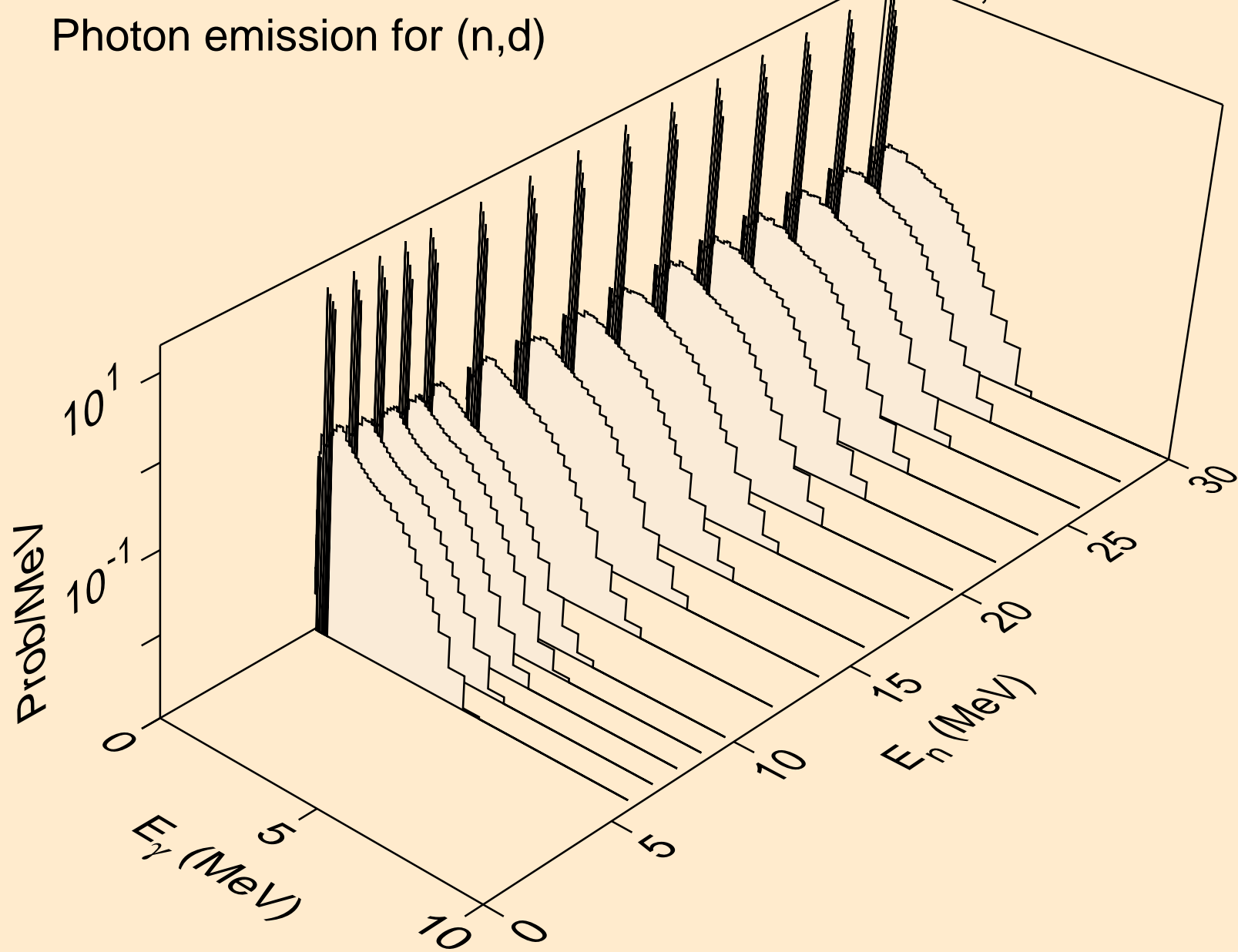

PM159 HELION ACER TENDL-2021 LIBRARY; T=0.K  
Photon emission for (n,t)

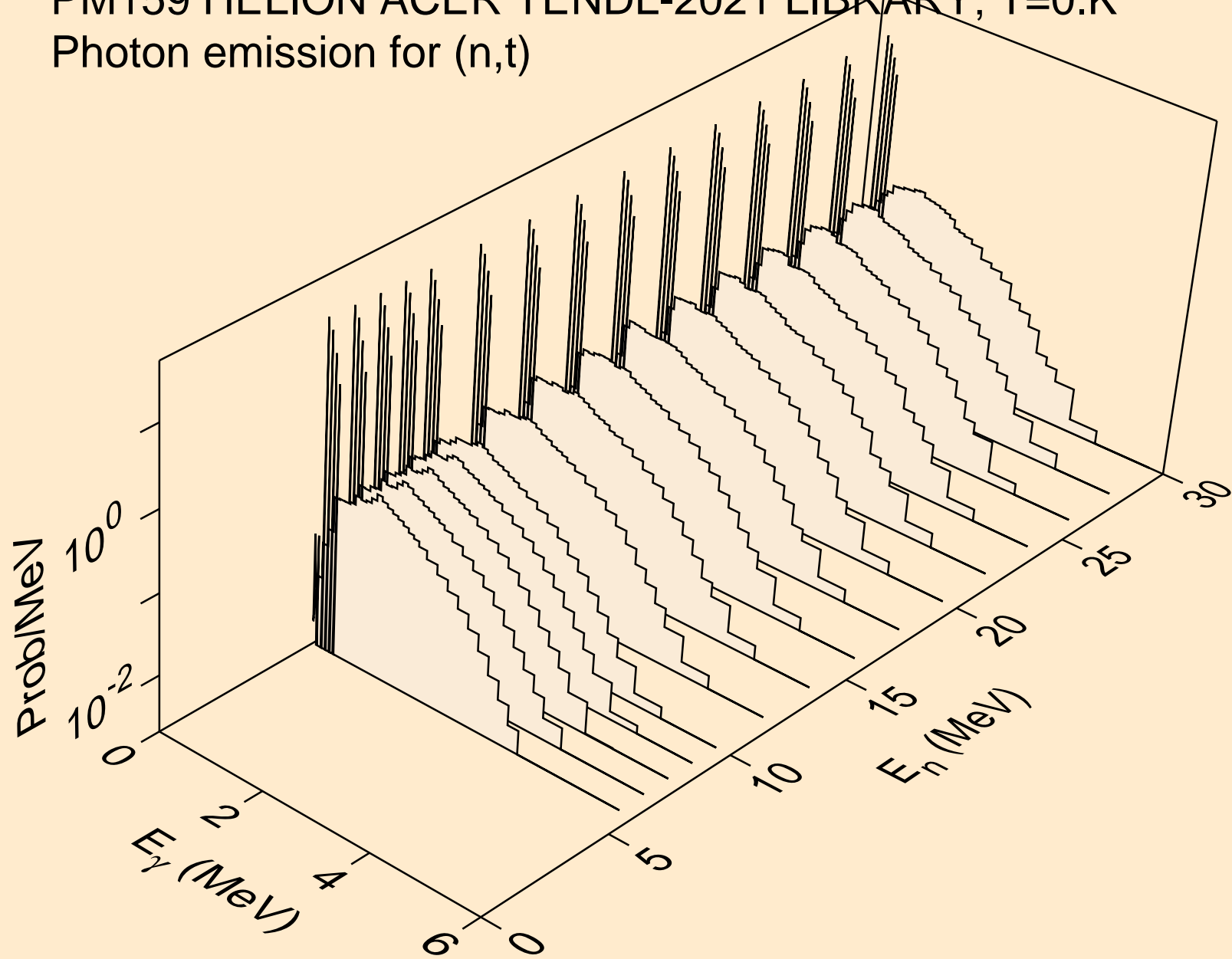

PM159 HELION ACER TENDL-2021 LIBRARY; T=0.K  
Photon emission for inelastic

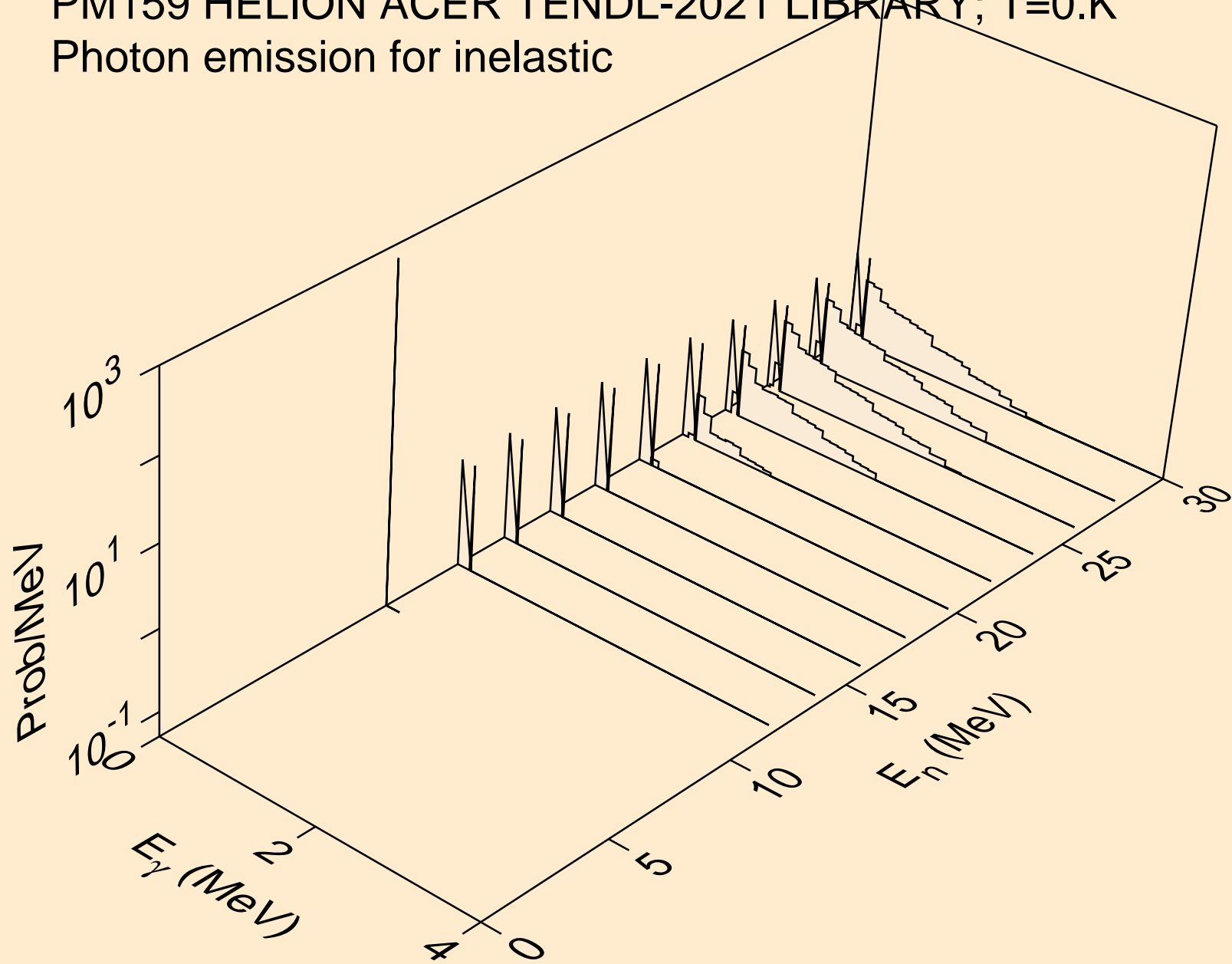

PM159 HELION ACER TENDL-2021 LIBRARY; T=0.K  
Photon emission for (n,a)

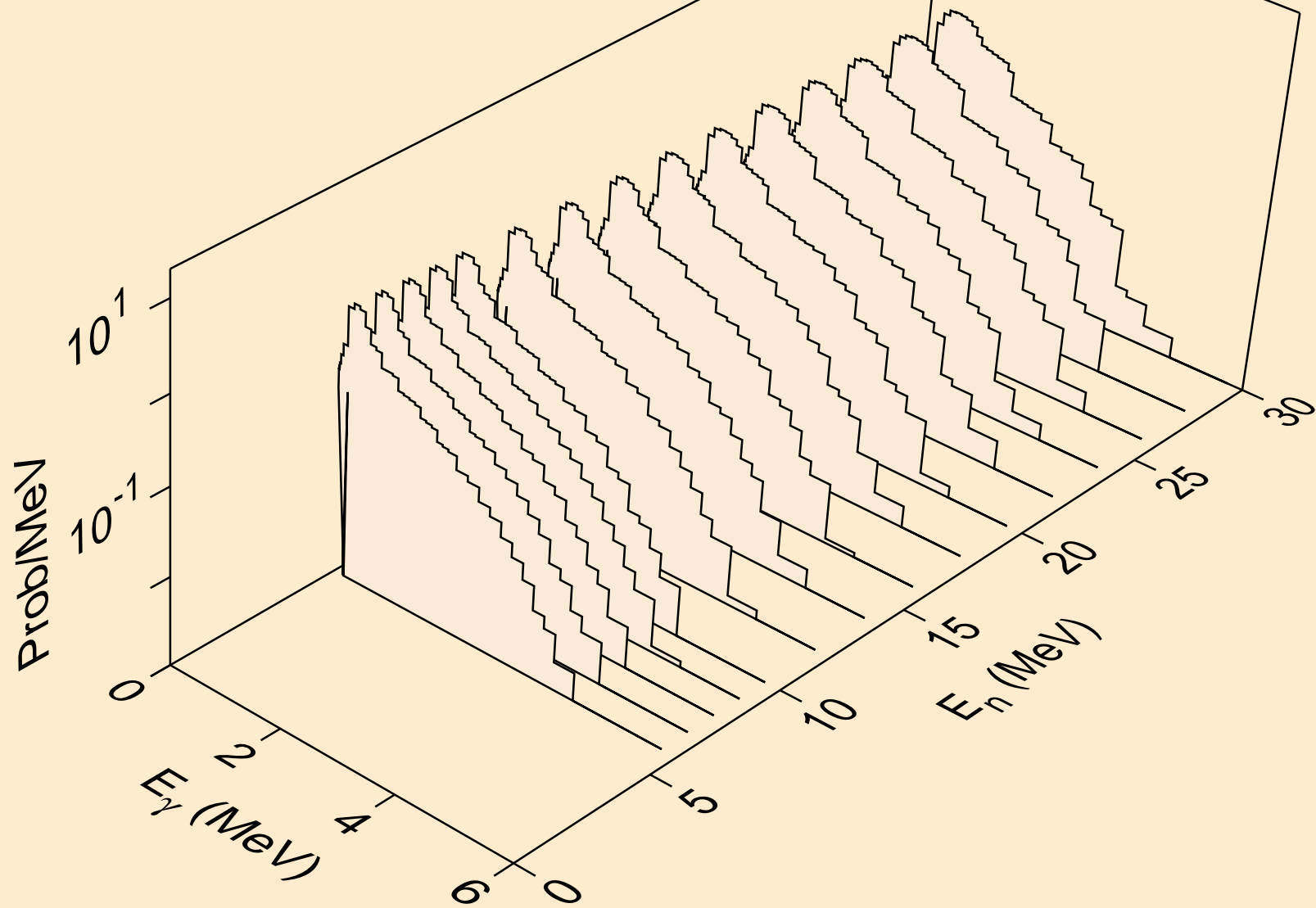

PM159 HELION ACER TENDL-2021 LIBRARY; T=0.K  
Photon emission for (n,2p)

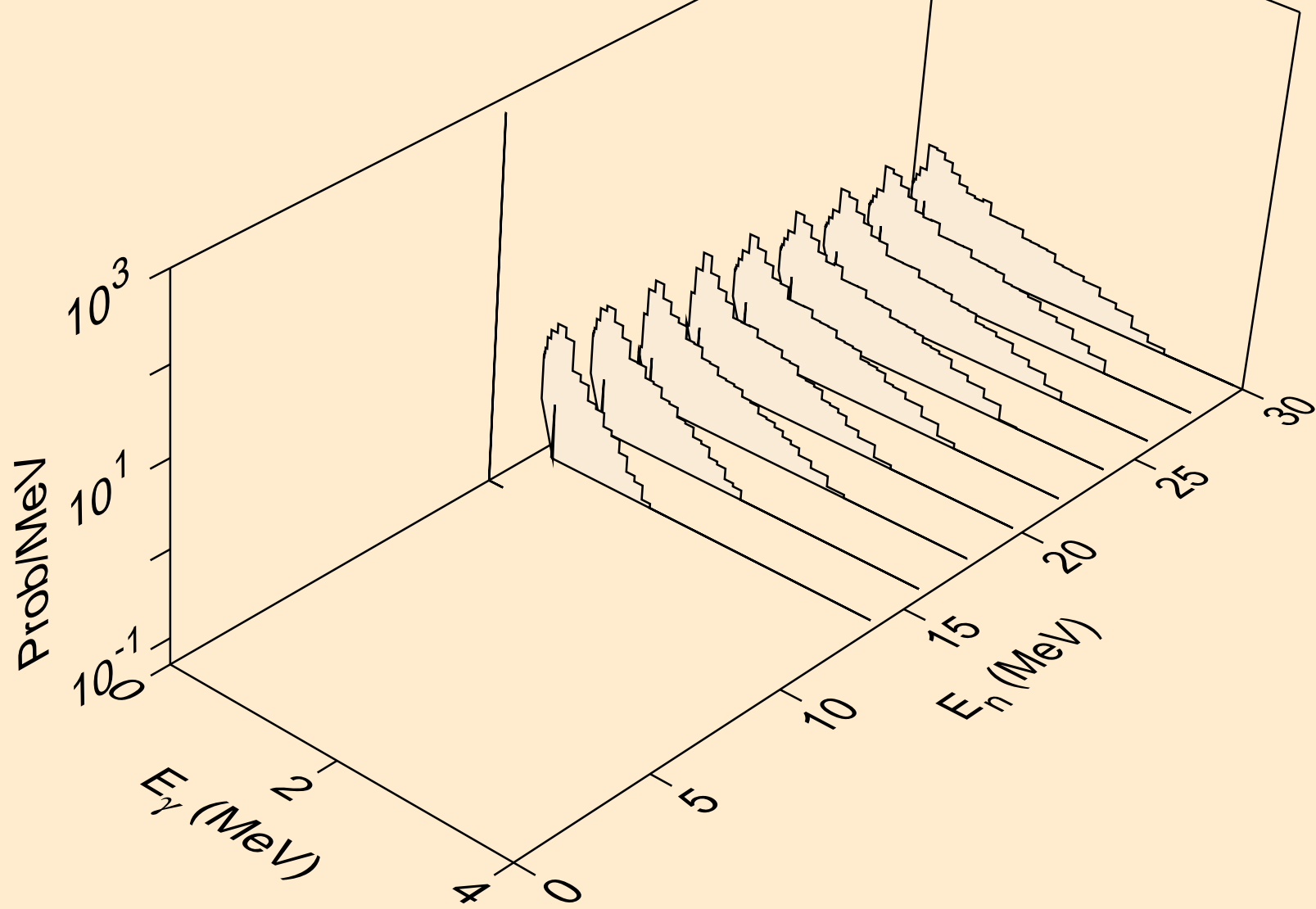



PM159 HELION ACER TENDL-2021 LIBRARY; T=0.K  
Photon emission for (n,pd)

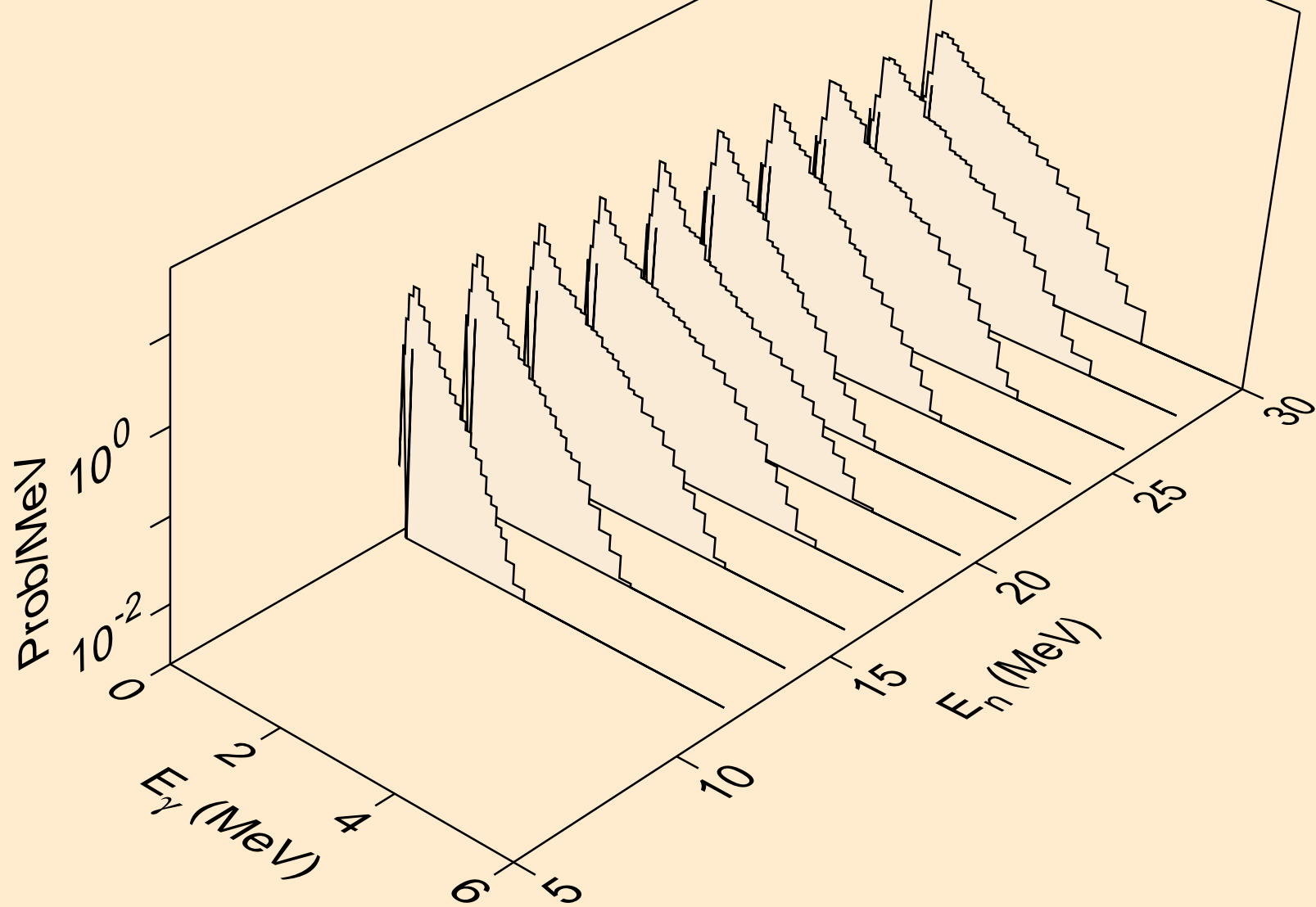

PM159 HELION ACER TENDL-2021 LIBRARY; T=0.K  
Photon emission for (n,pt)

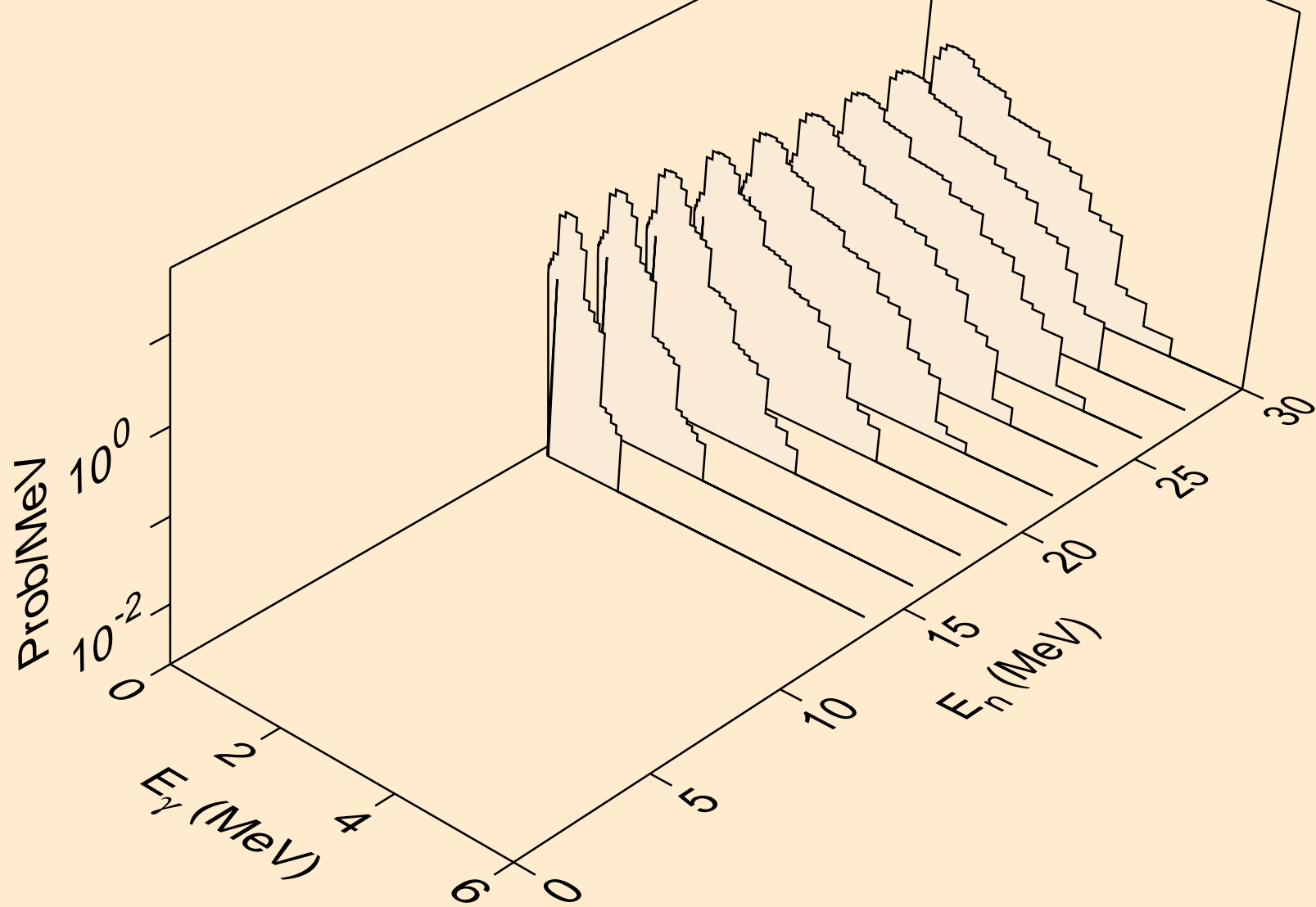

PM159 HELION ACER TENDL-2021 LIBRARY; T=0.K  
Particle heating contributions

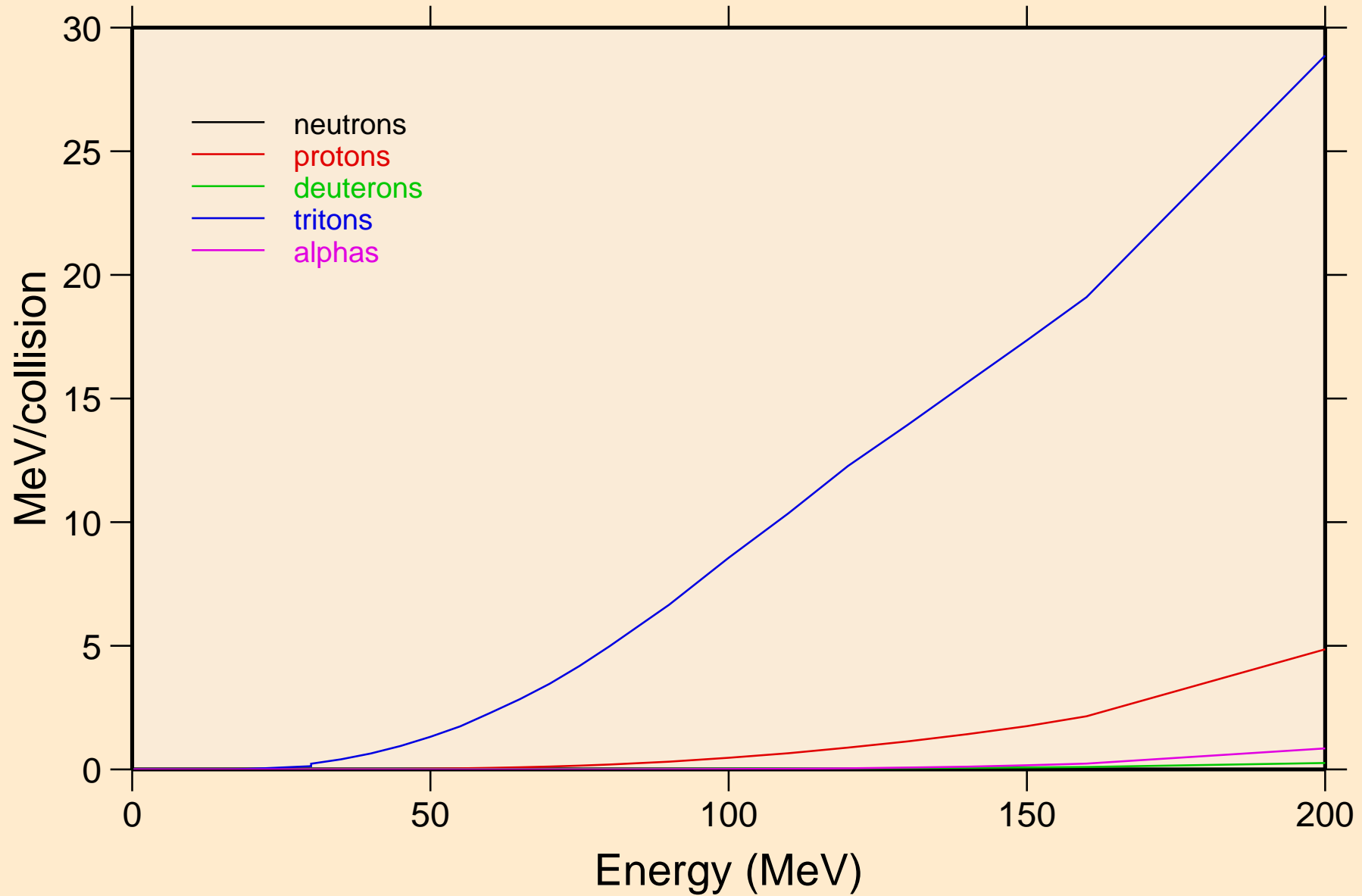

PM159 HELION ACER TENDL-2021 LIBRARY; T=0.K  
Recoil Heating

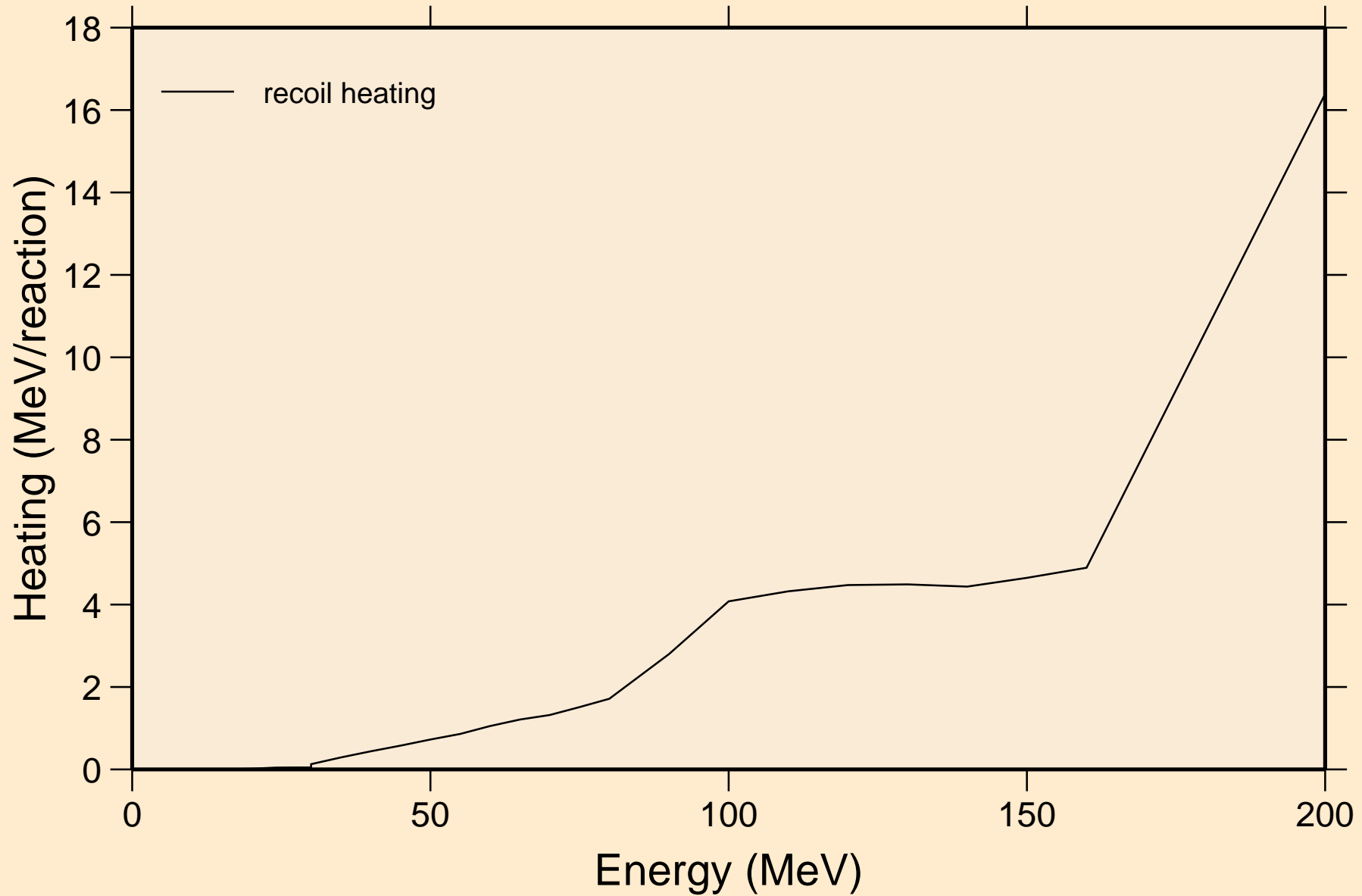

PM159 HELION ACER TENDL-2021 LIBRARY; T=0.K  
Particle production cross sections

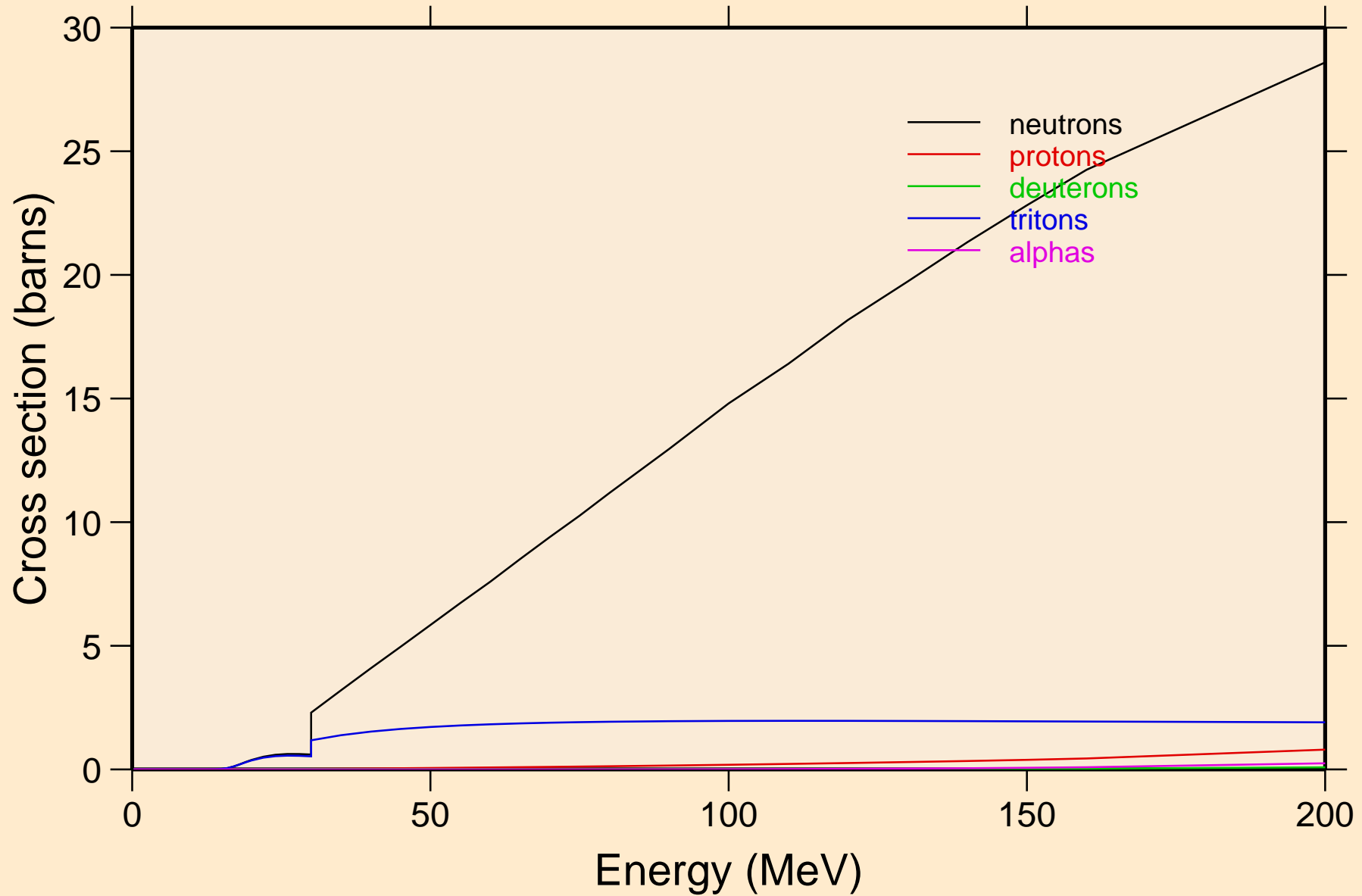

PM159 HELION ACER TENDL-2021 LIBRARY; T=0.K  
neutrons from (s,n)

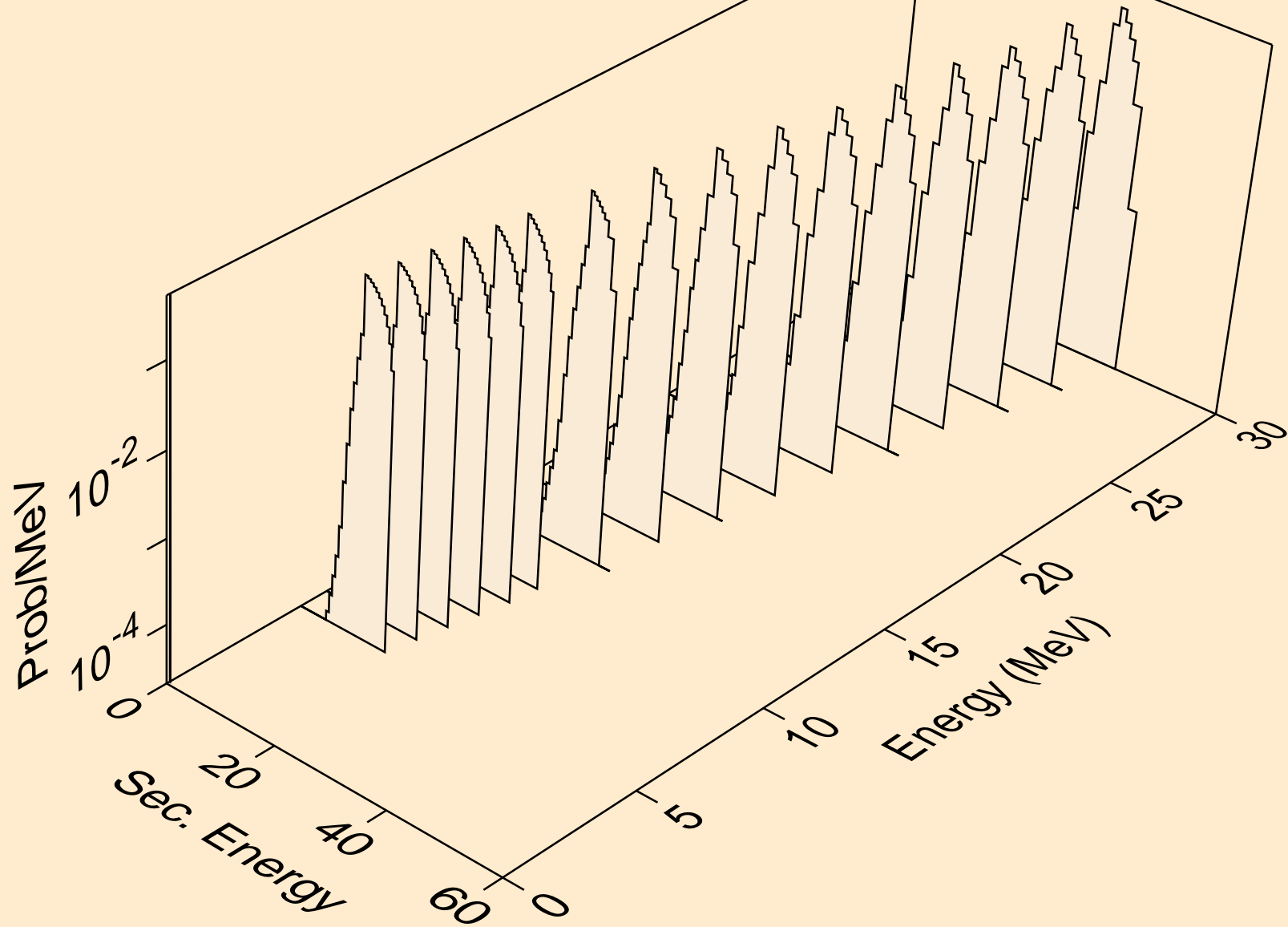

PM159 HELION ACER TENDL-2021 LIBRARY; T=0.K  
neutrons from (s,x)

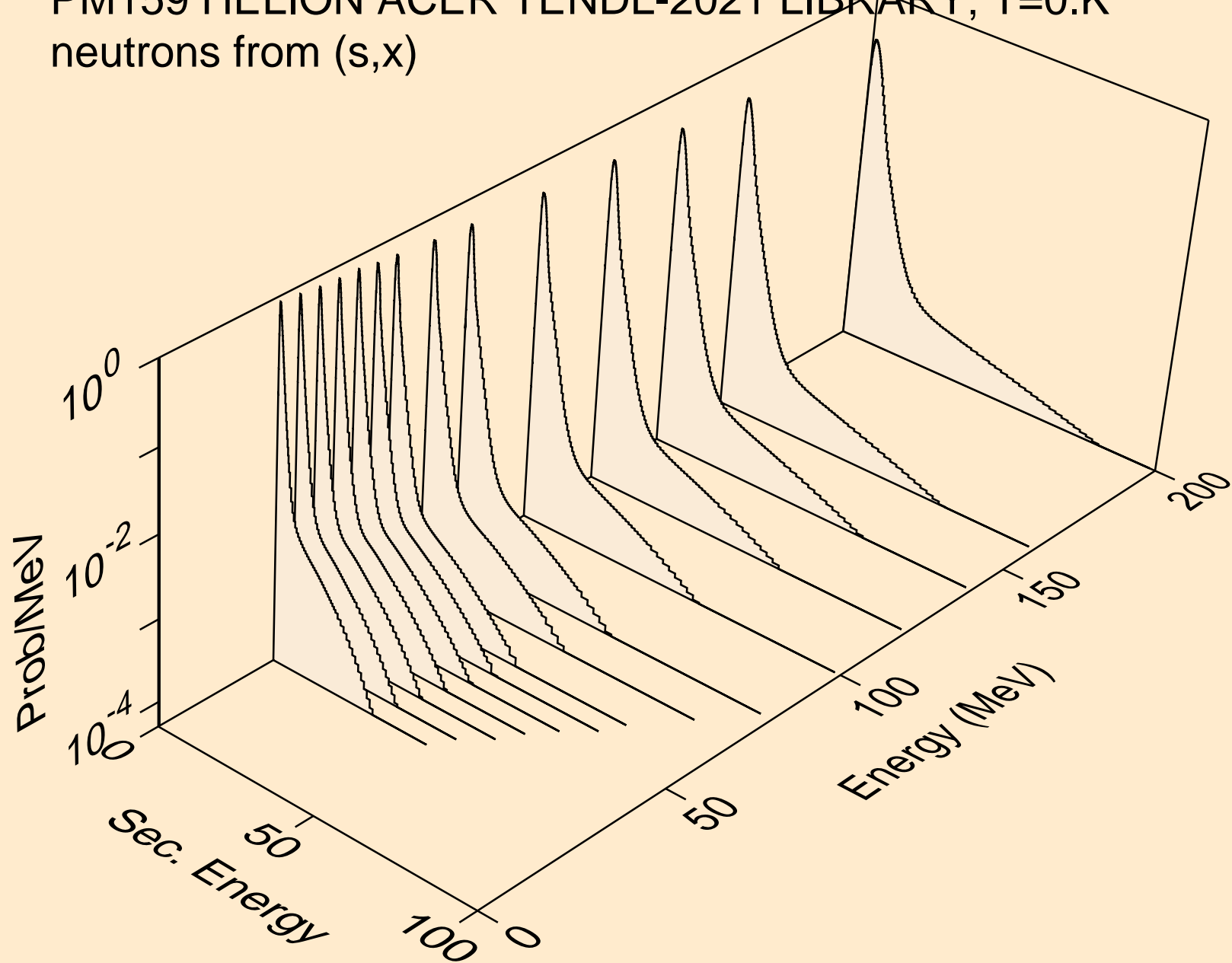

PM159 HELION ACER TENDL-2021 LIBRARY; T=0.K  
neutrons from (s,2nd)

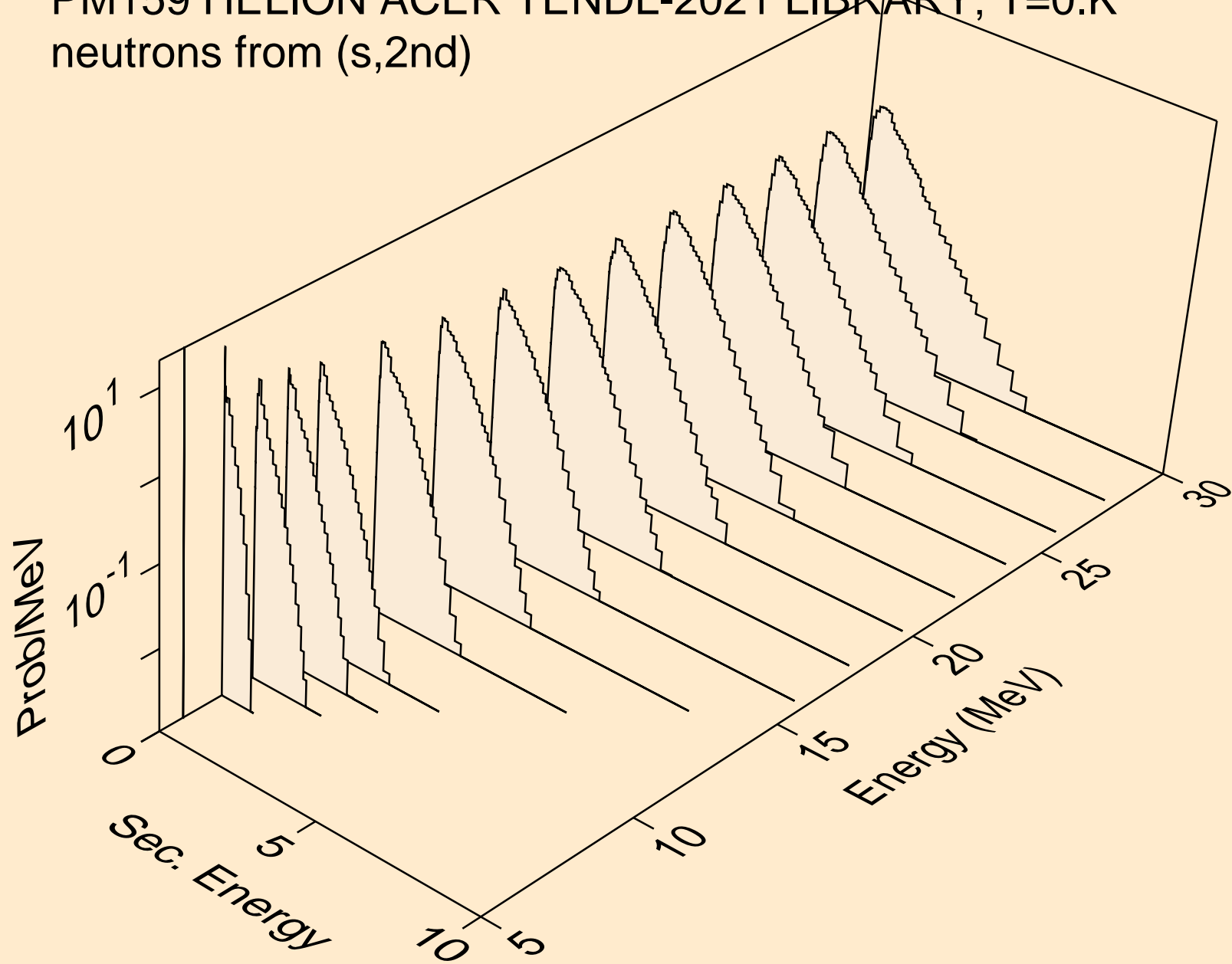



PM159 HELION ACER TENDL-2021 LIBRARY; T=0.K  
neutrons from (s,2n)

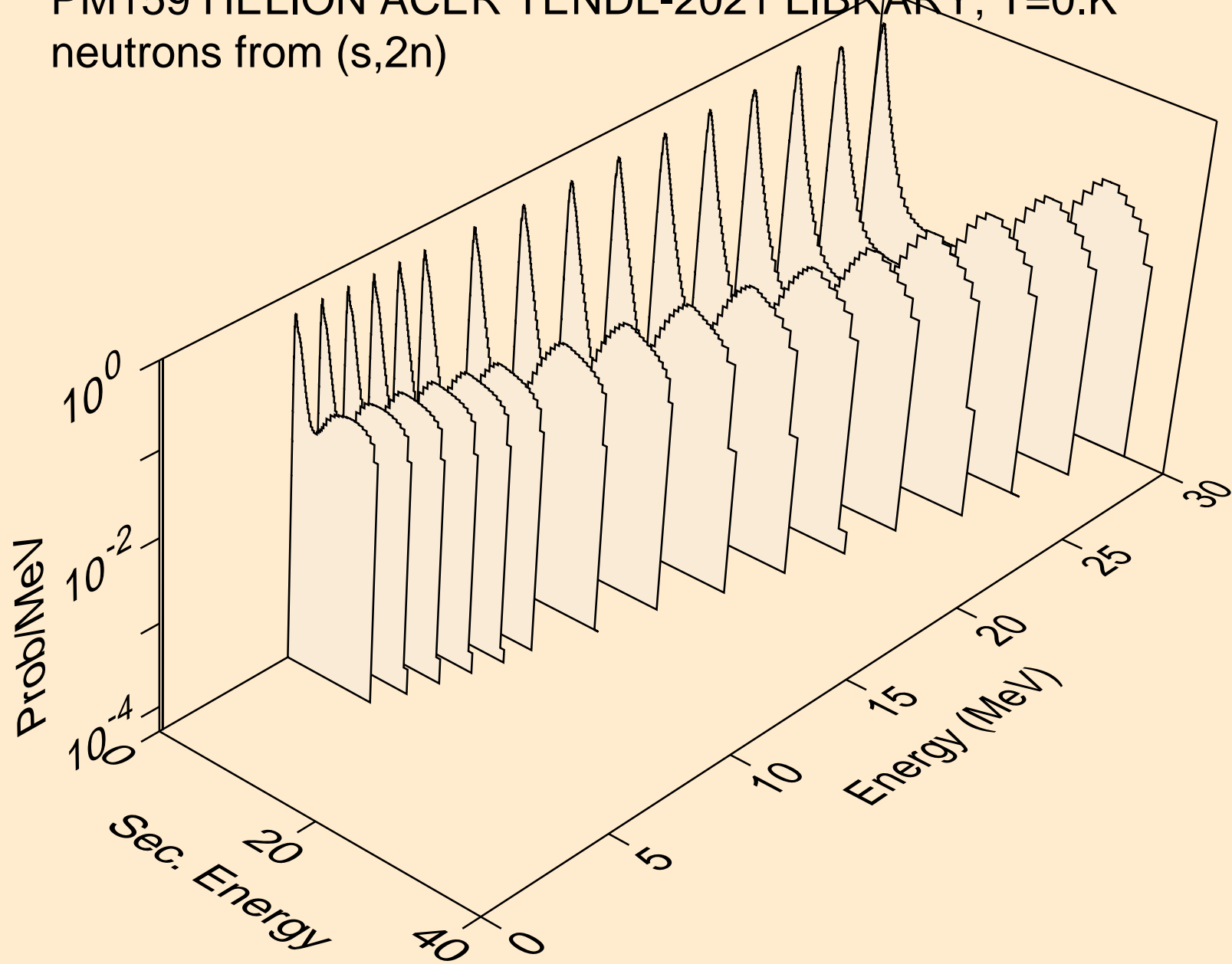

PM159 HELION ACER TENDL-2021 LIBRARY; T=0.K  
neutrons from (s,3n)

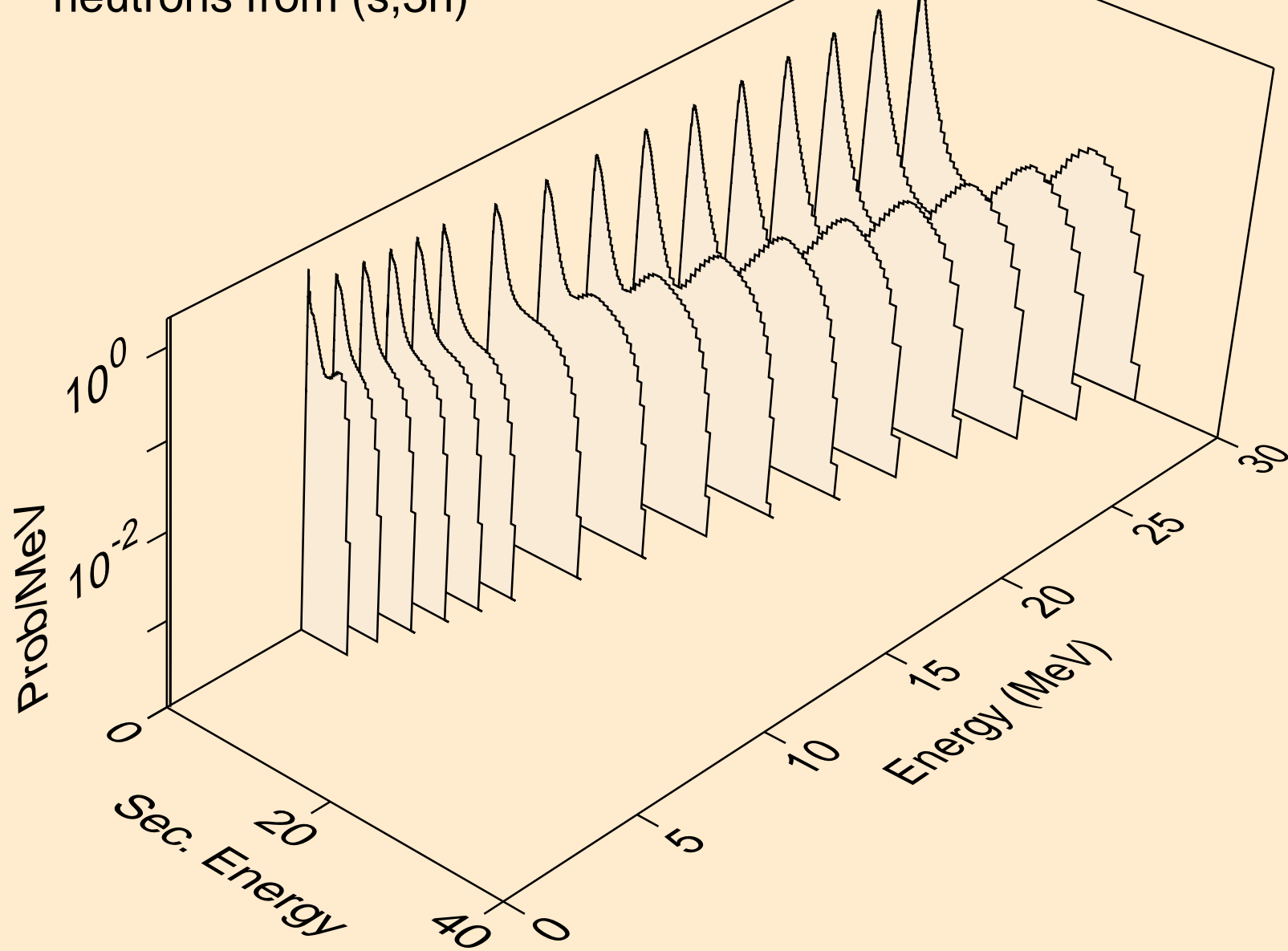

PM159 HELION ACER TENDL-2021 LIBRARY; T=0.K  
neutrons from (s,n\*)a

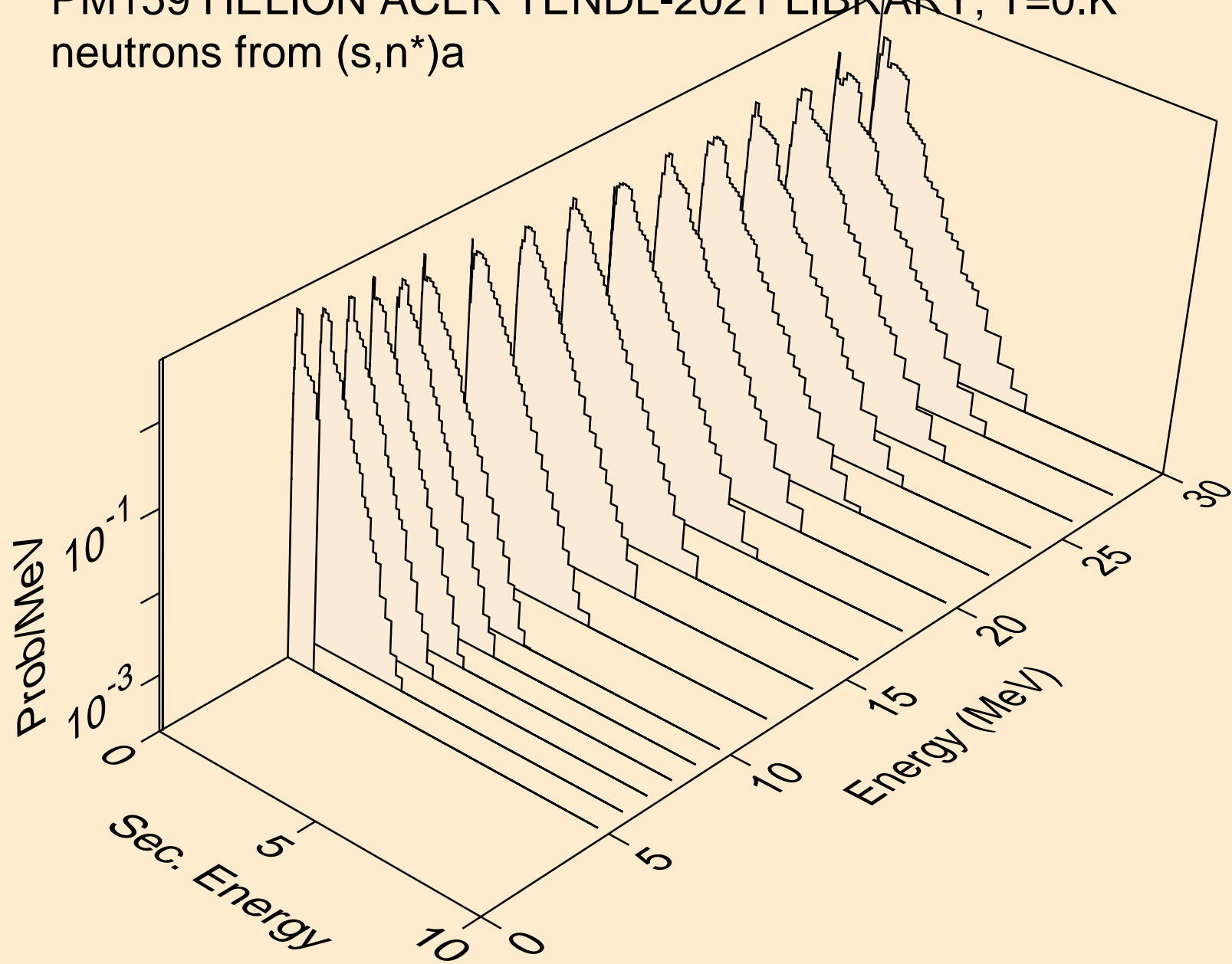

PM159 HELION ACER TENDL-2021 LIBRARY; T=0.K  
neutrons from (s,2n)a

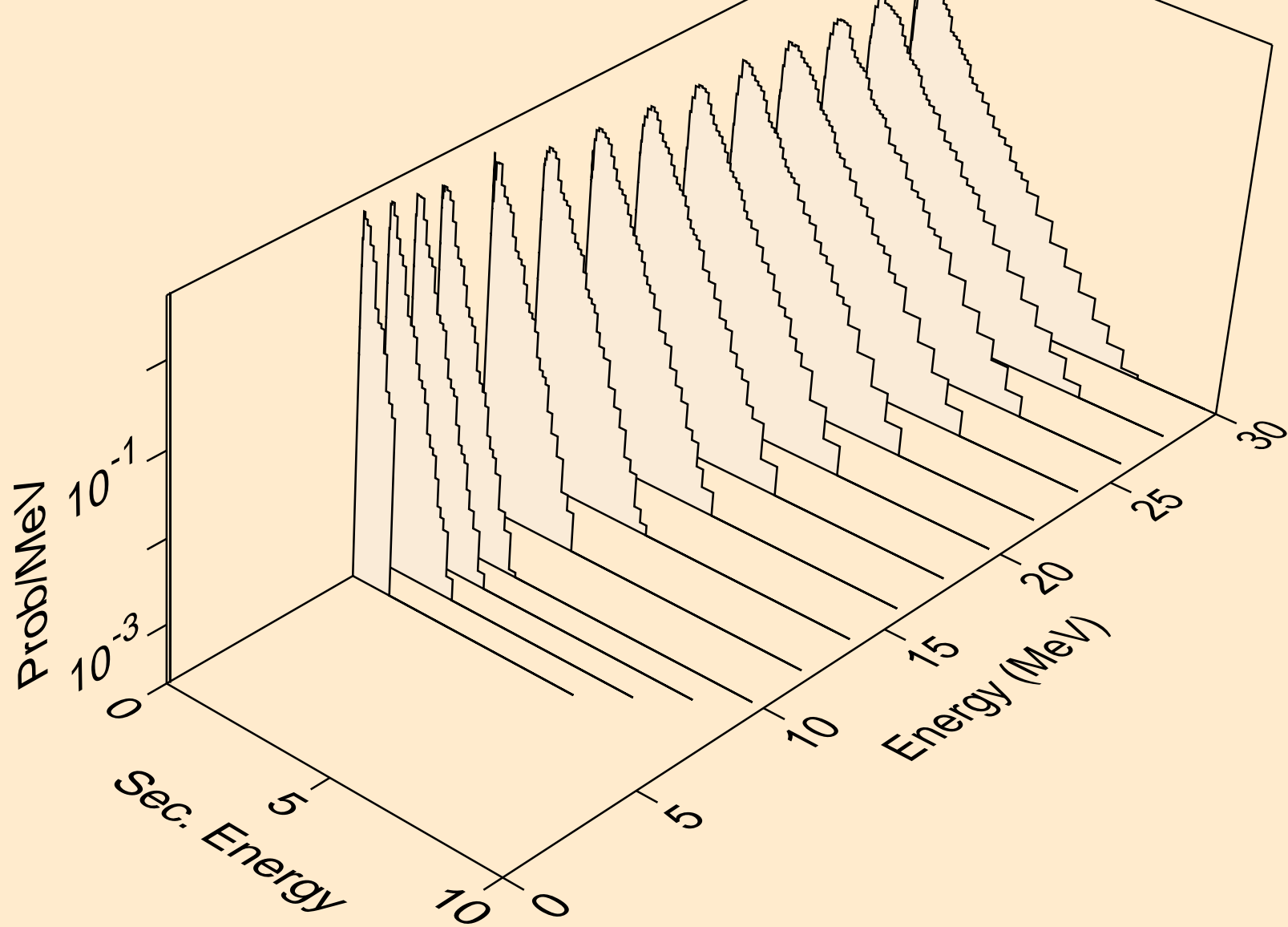

PM159 HELION ACER TENDL-2021 LIBRARY; T=0.K  
neutrons from (s,3n)a

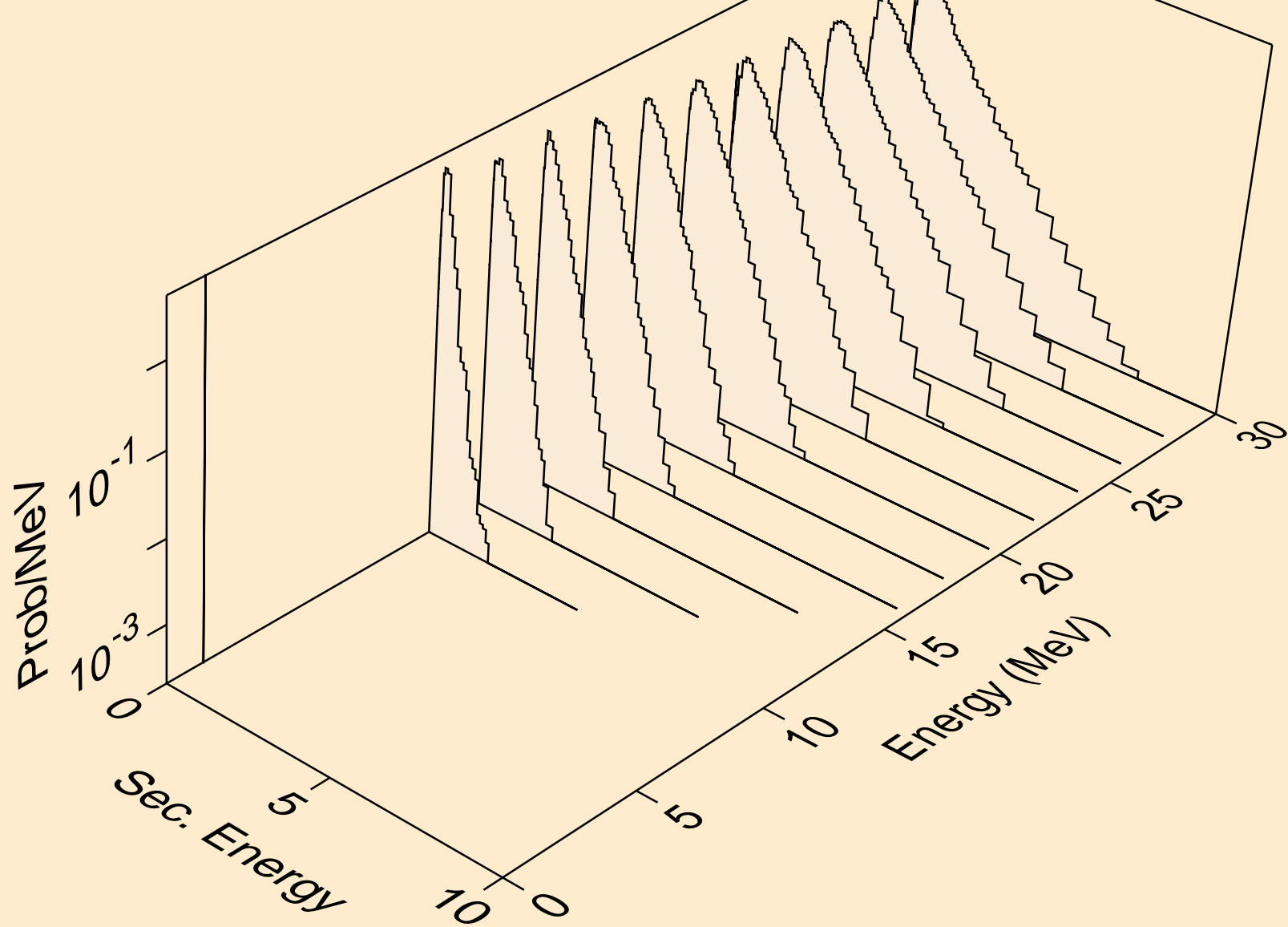

PM159 HELION ACER TENDL-2021 LIBRARY; T=0.K  
neutrons from (s,n\*)p

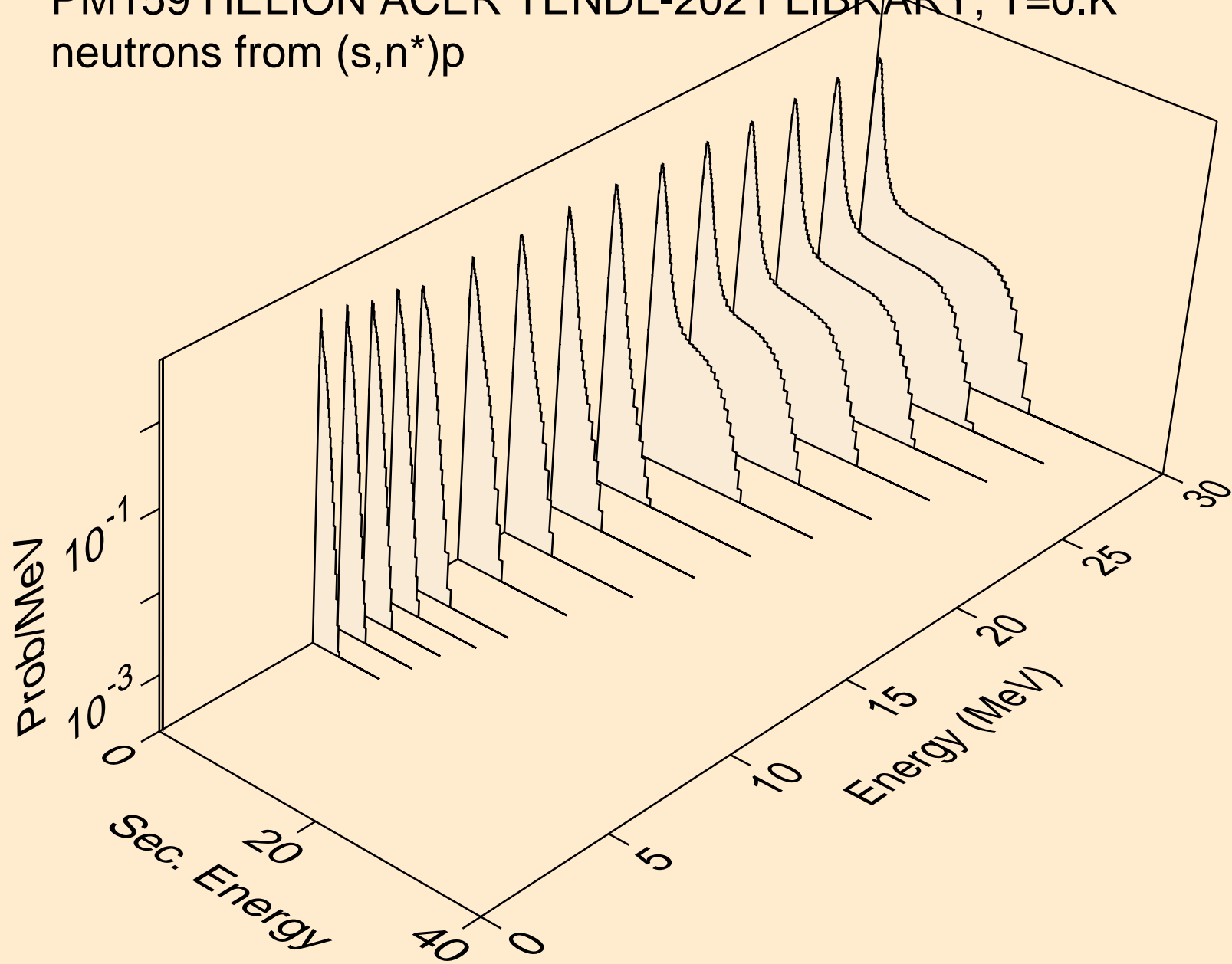

PM159 HELION ACER TENDL-2021 LIBRARY; T=0.K  
neutrons from (s,n\*)d

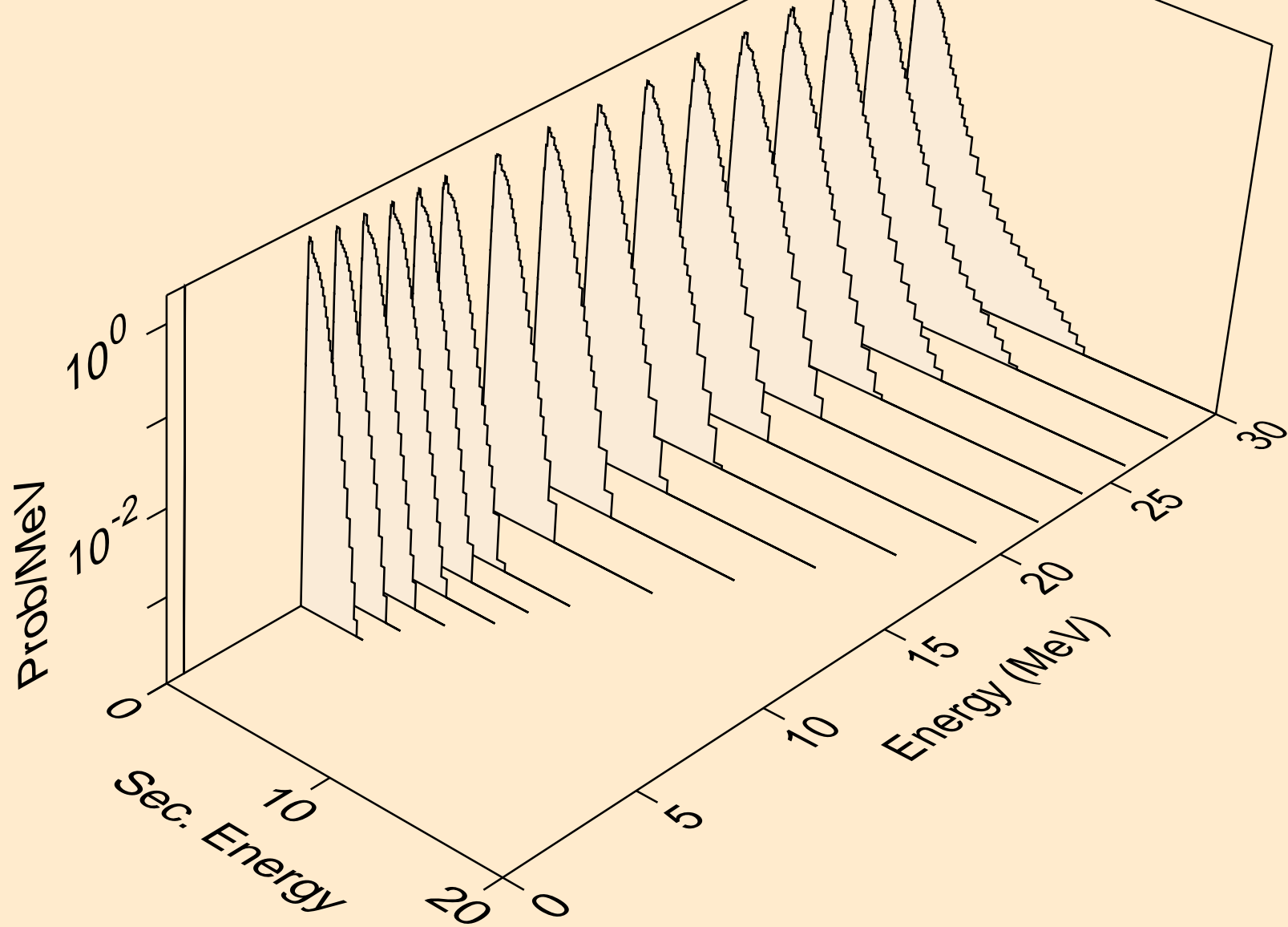

PM159 HELION ACER TENDL-2021 LIBRARY; T=0.K  
neutrons from (s,n\*)t

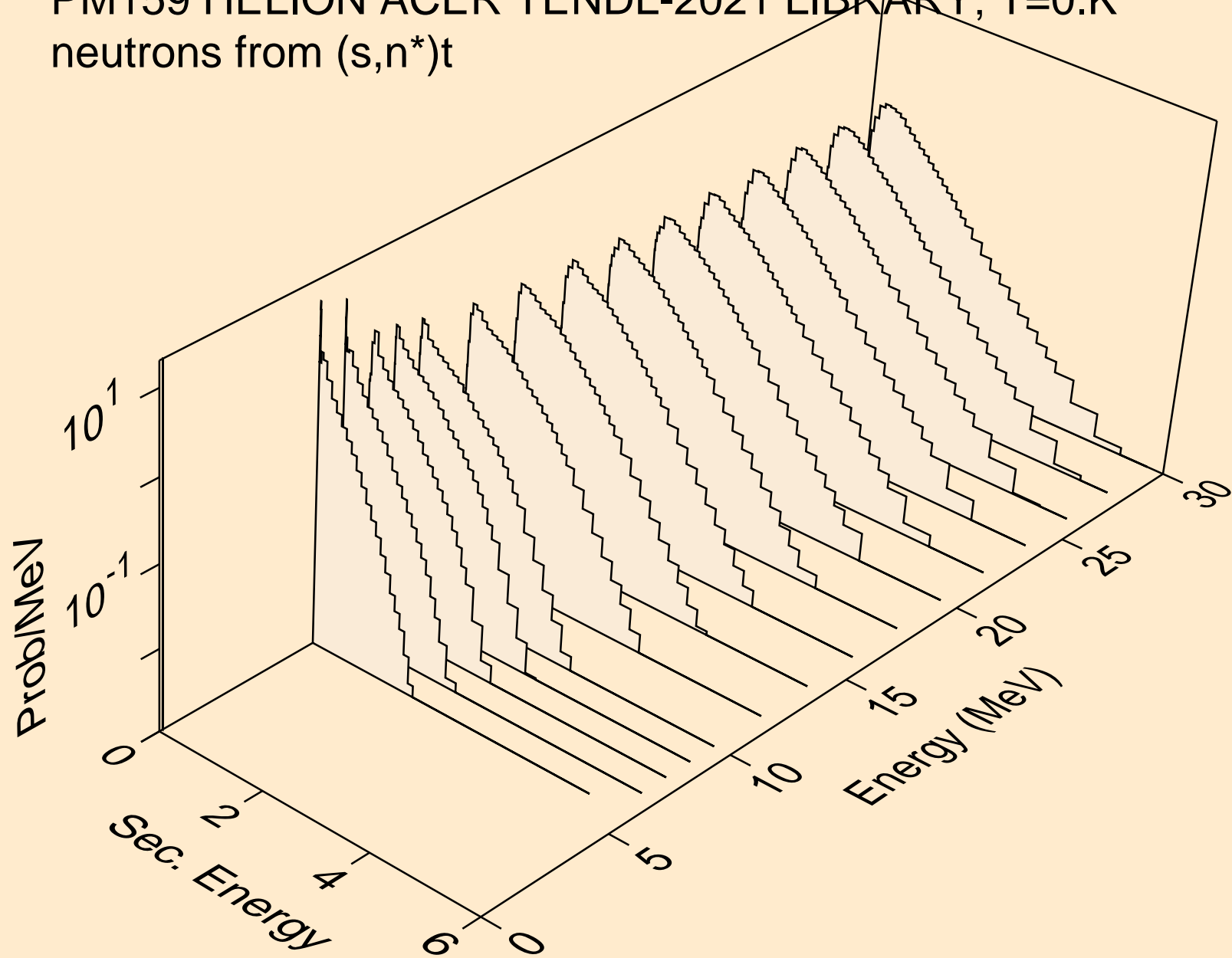



PM159 HELION ACER TENDL-2021 LIBRARY; T=0.K  
neutrons from (s,n\*)he3

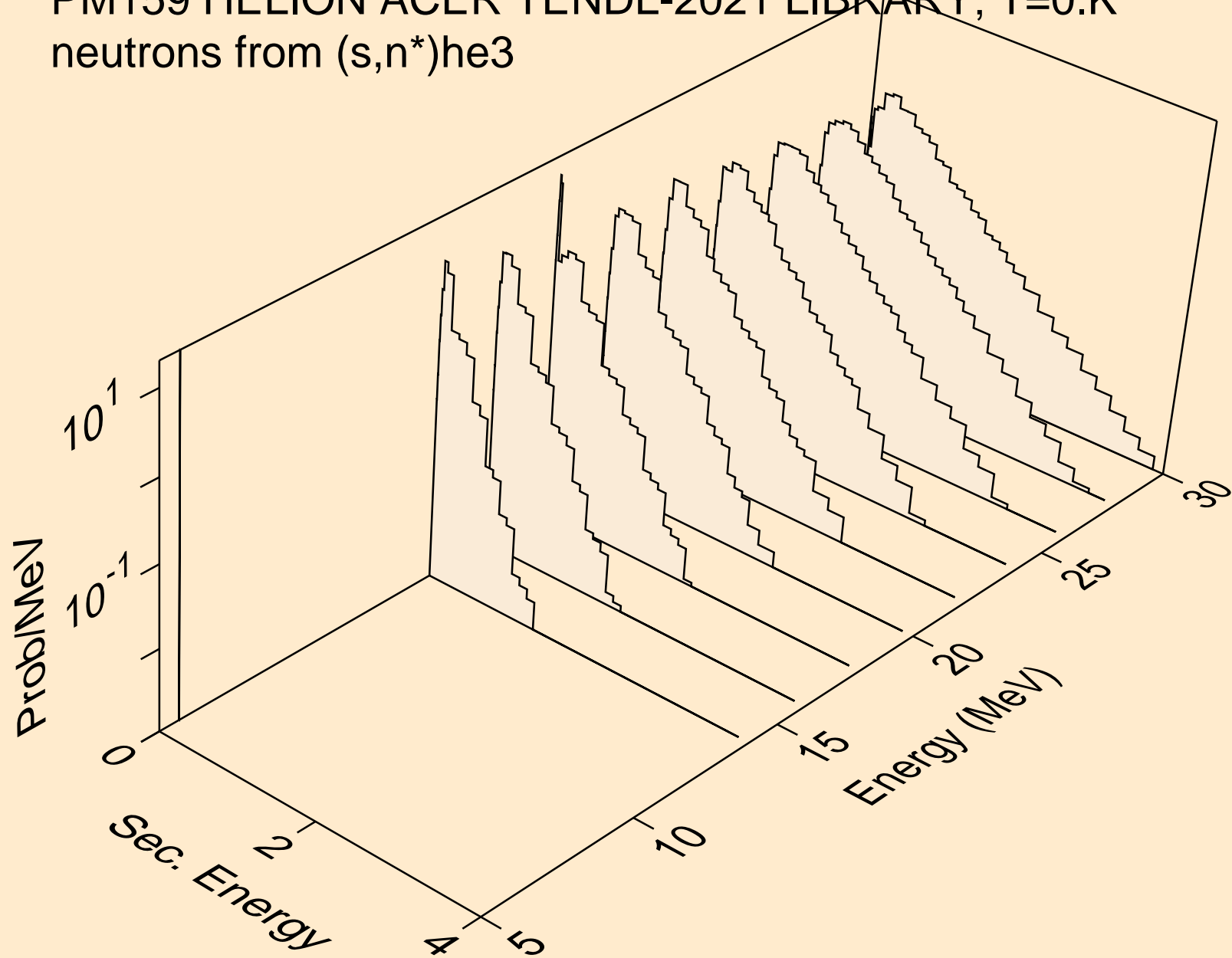

PM159 HELION ACER TENDL-2021 LIBRARY; T=0.K  
neutrons from (s,4n)

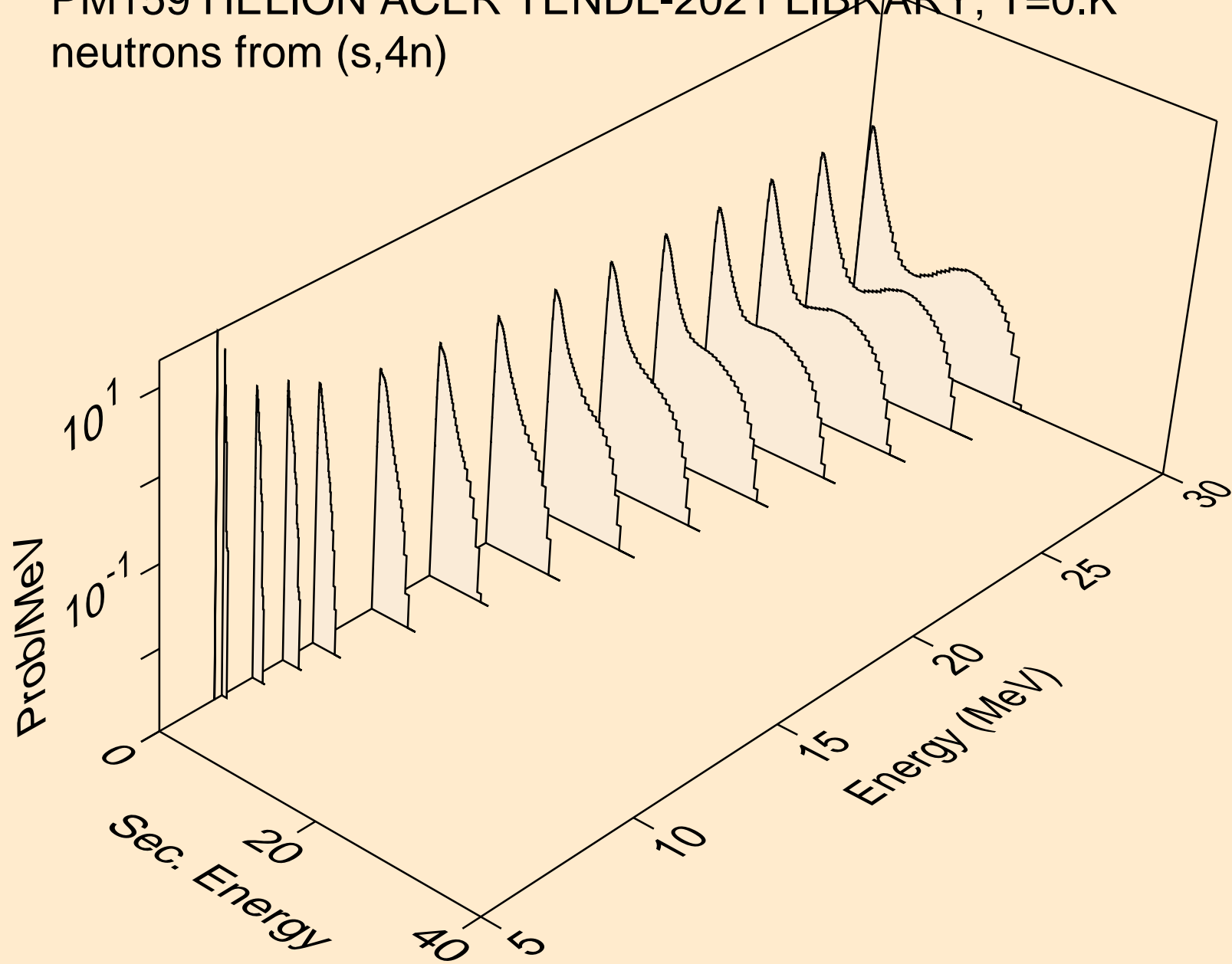

PM159 HELION ACER TENDL-2021 LIBRARY; T=0.K  
neutrons from (s,2np)

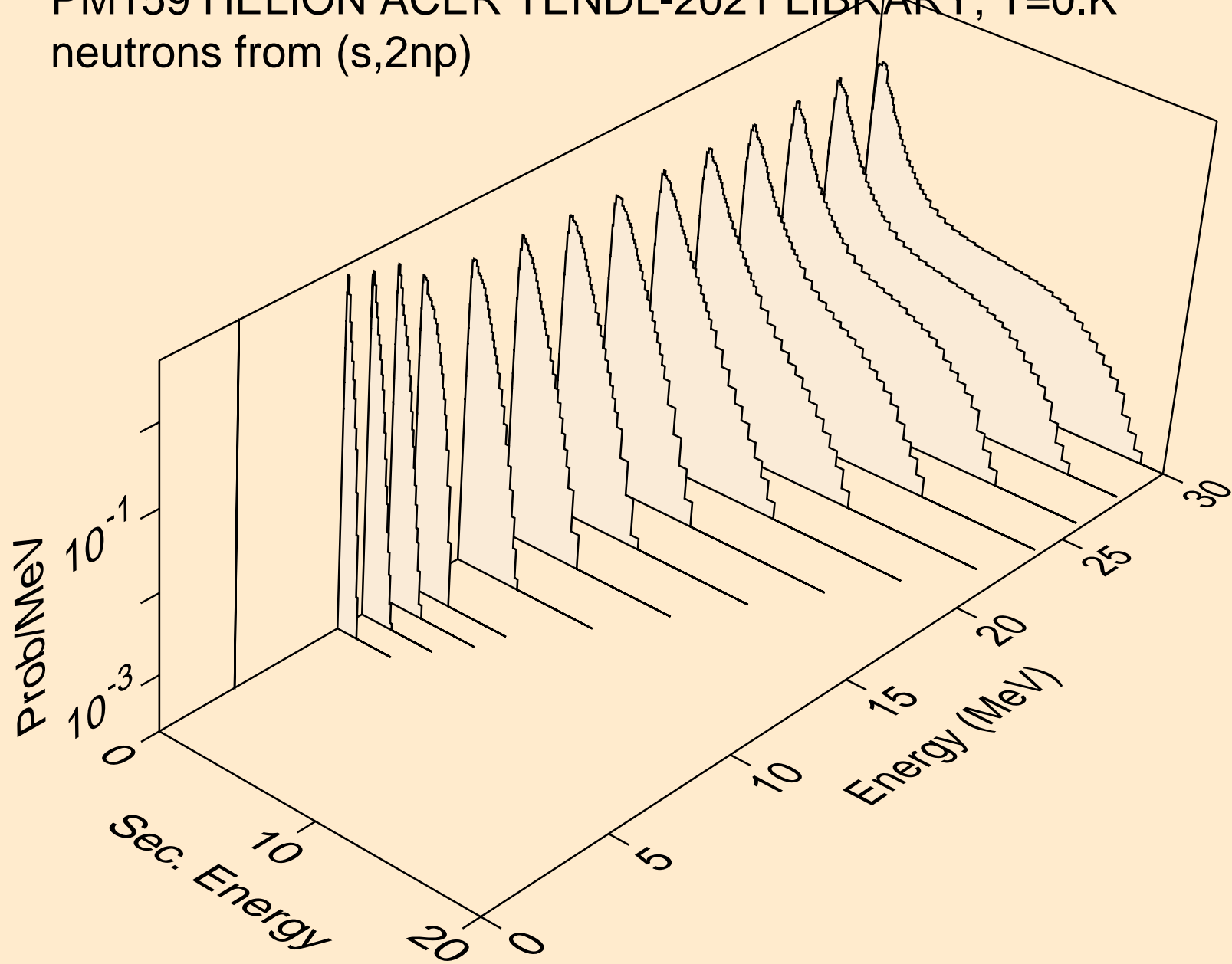

PM159 HELION ACER TENDL-2021 LIBRARY; T=0.K  
neutrons from (s,3np)

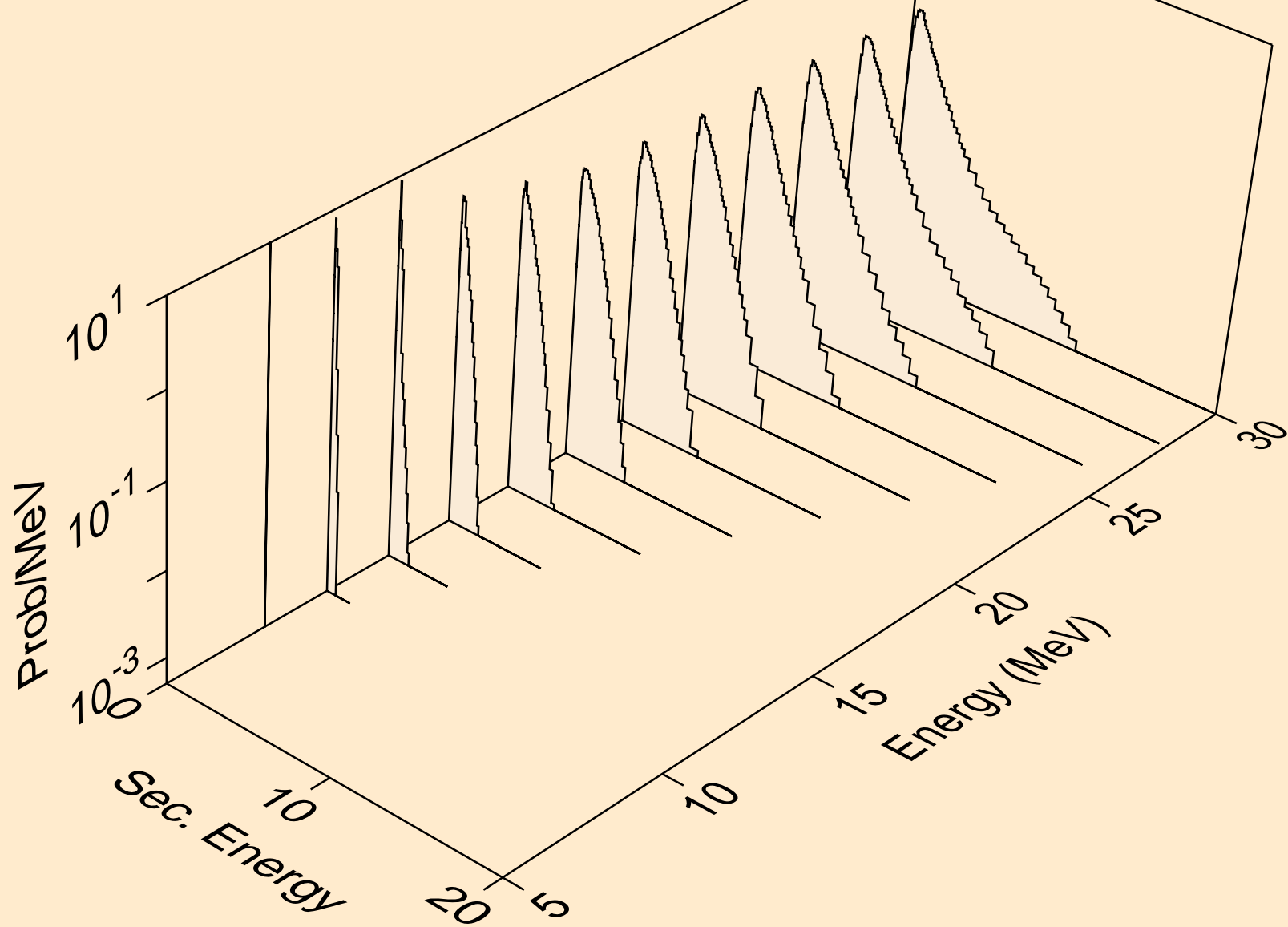

PM159 HELION ACER TENDL-2021 LIBRARY; T=0.K  
neutrons from (s,2np)

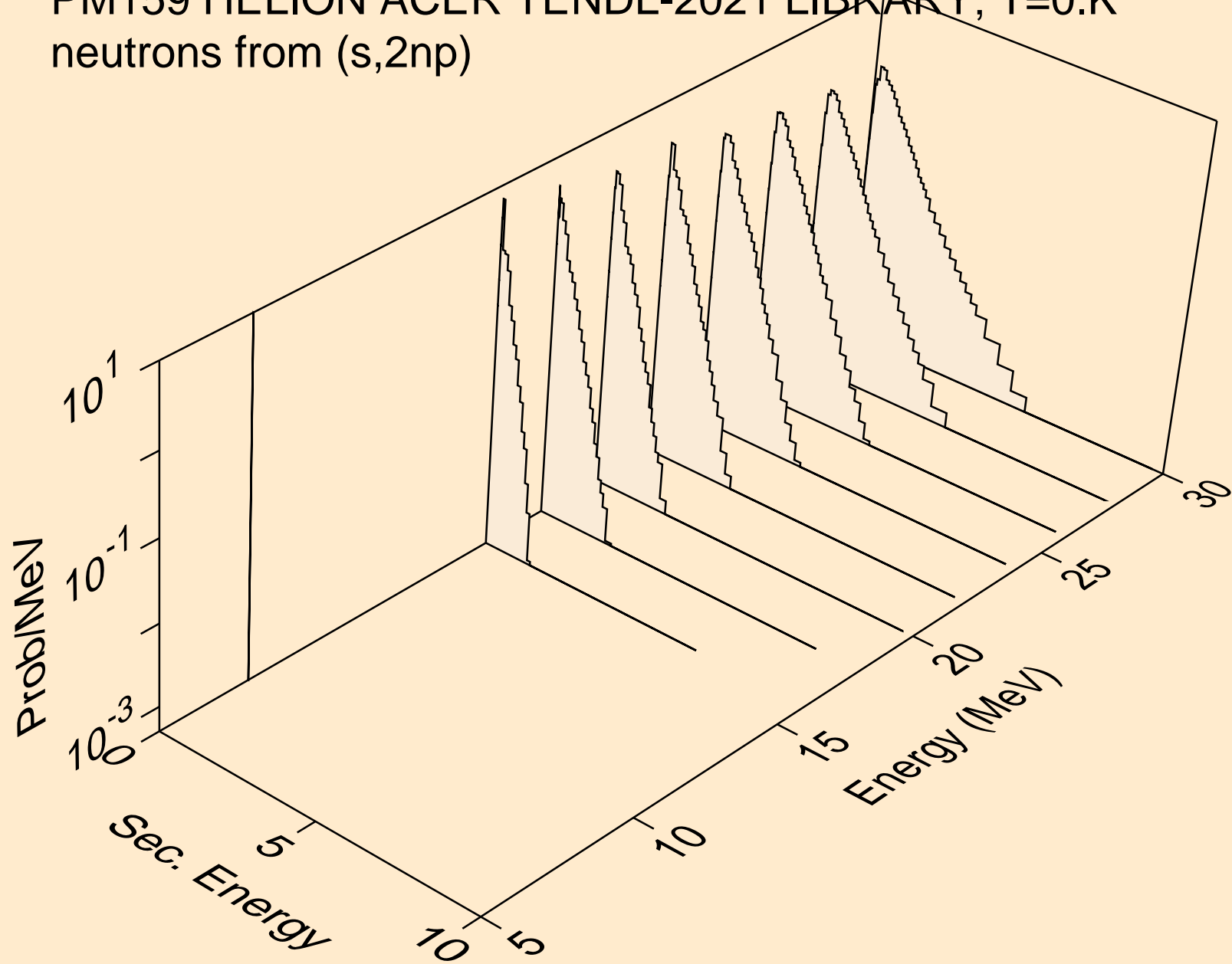

PM159 HELION ACER TENDL-2021 LIBRARY; T=0.K  
neutrons from (s,npa)

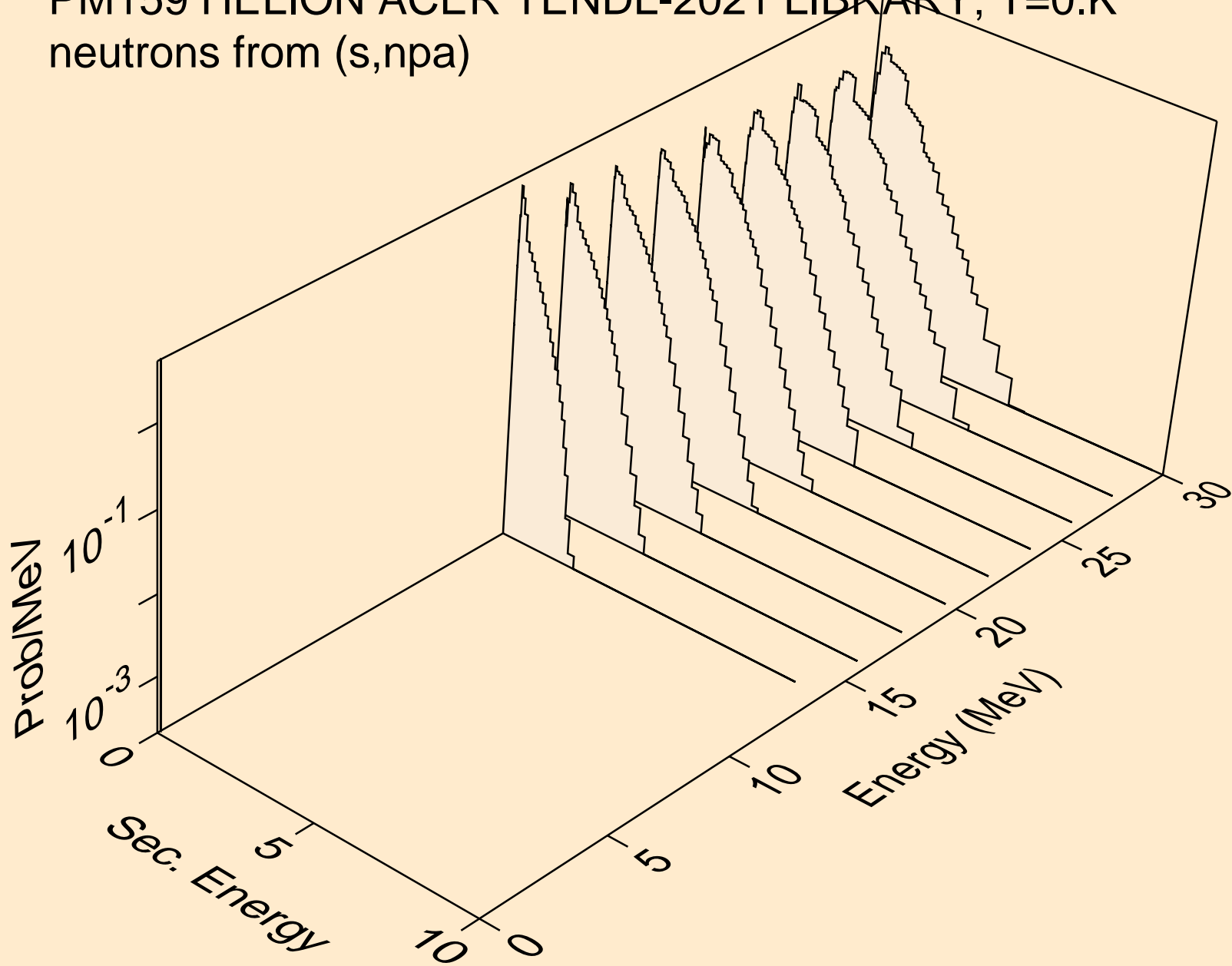

PM159 HELION ACER TENDL-2021 LIBRARY; T=0.K  
protons from (s,x)

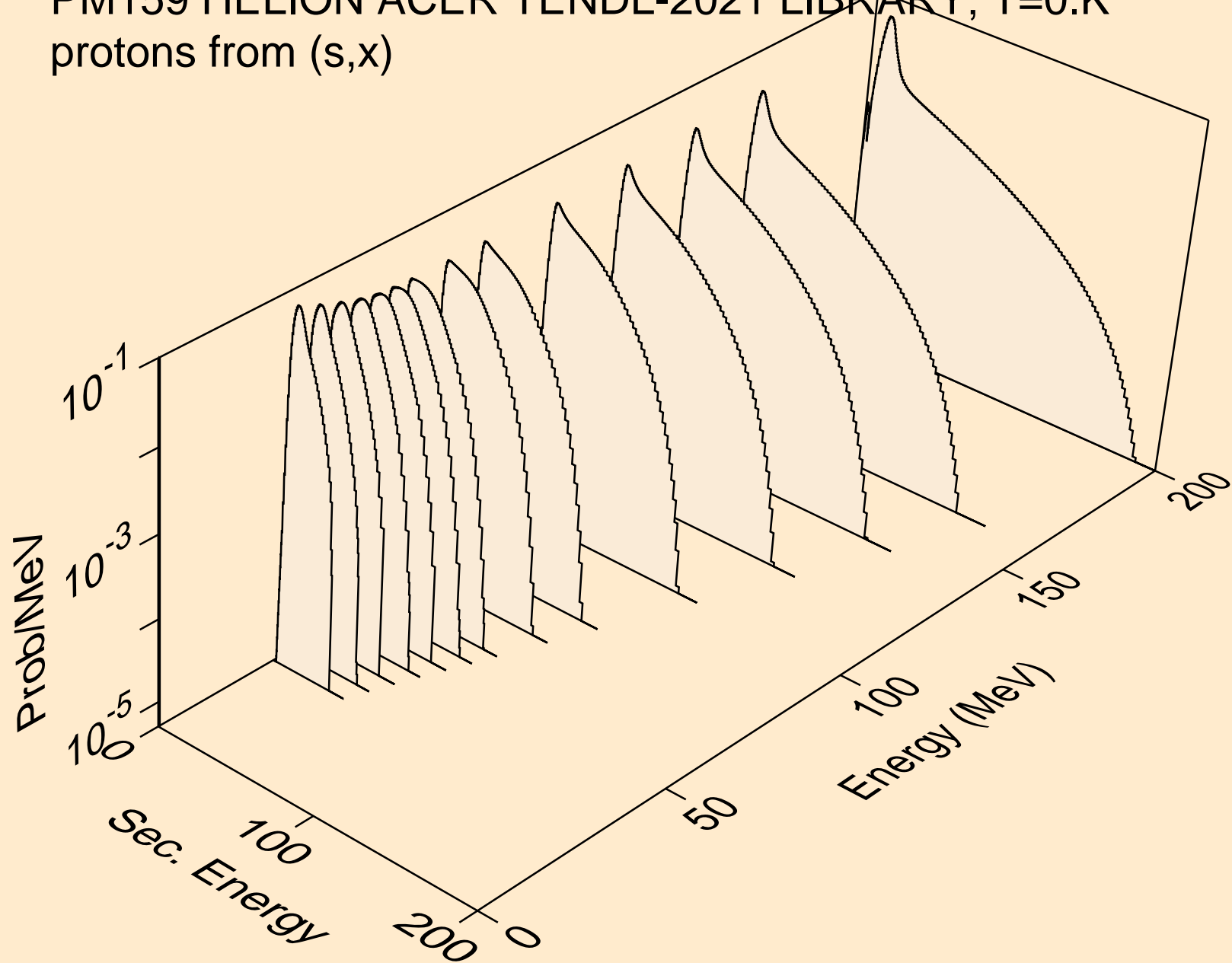

PM159 HELION ACER TENDL-2021 LIBRARY; T=0.K  
protons from (s,n\*)p

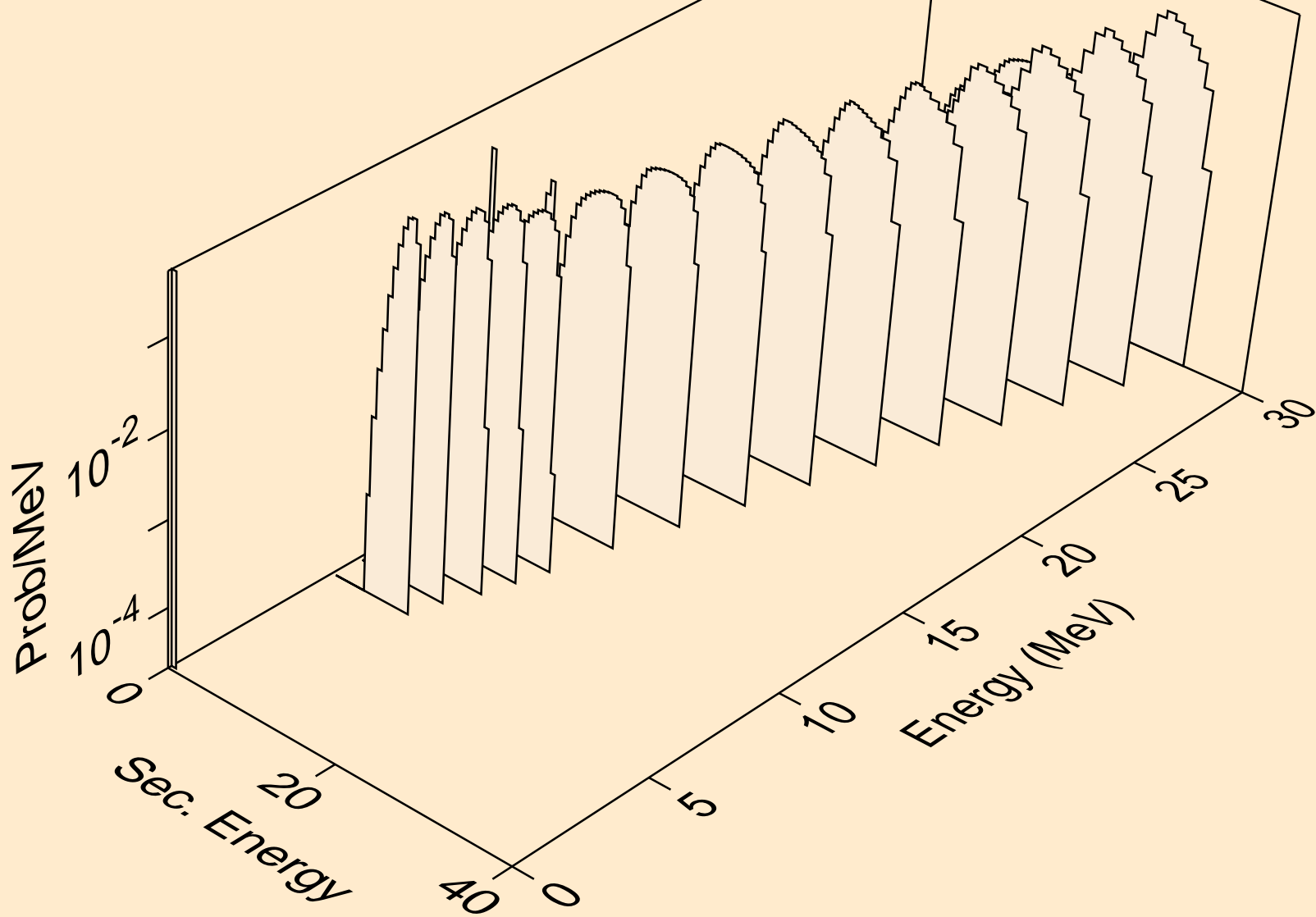



PM159 HELION ACER TENDL-2021 LIBRARY; T=0.K  
protons from (s,2np)

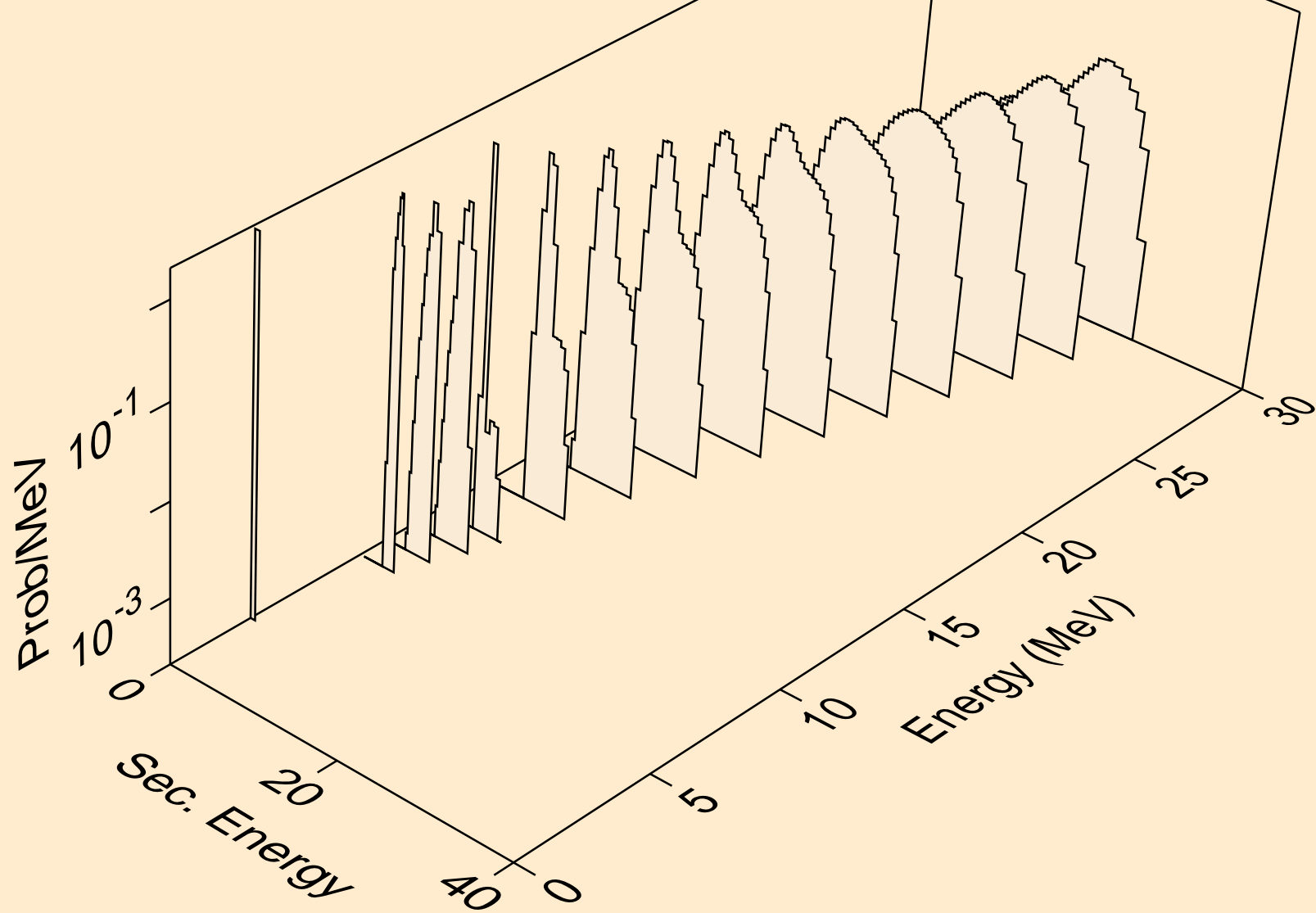

PM159 HELION ACER TENDL-2021 LIBRARY; T=0.K  
protons from (s,3np)

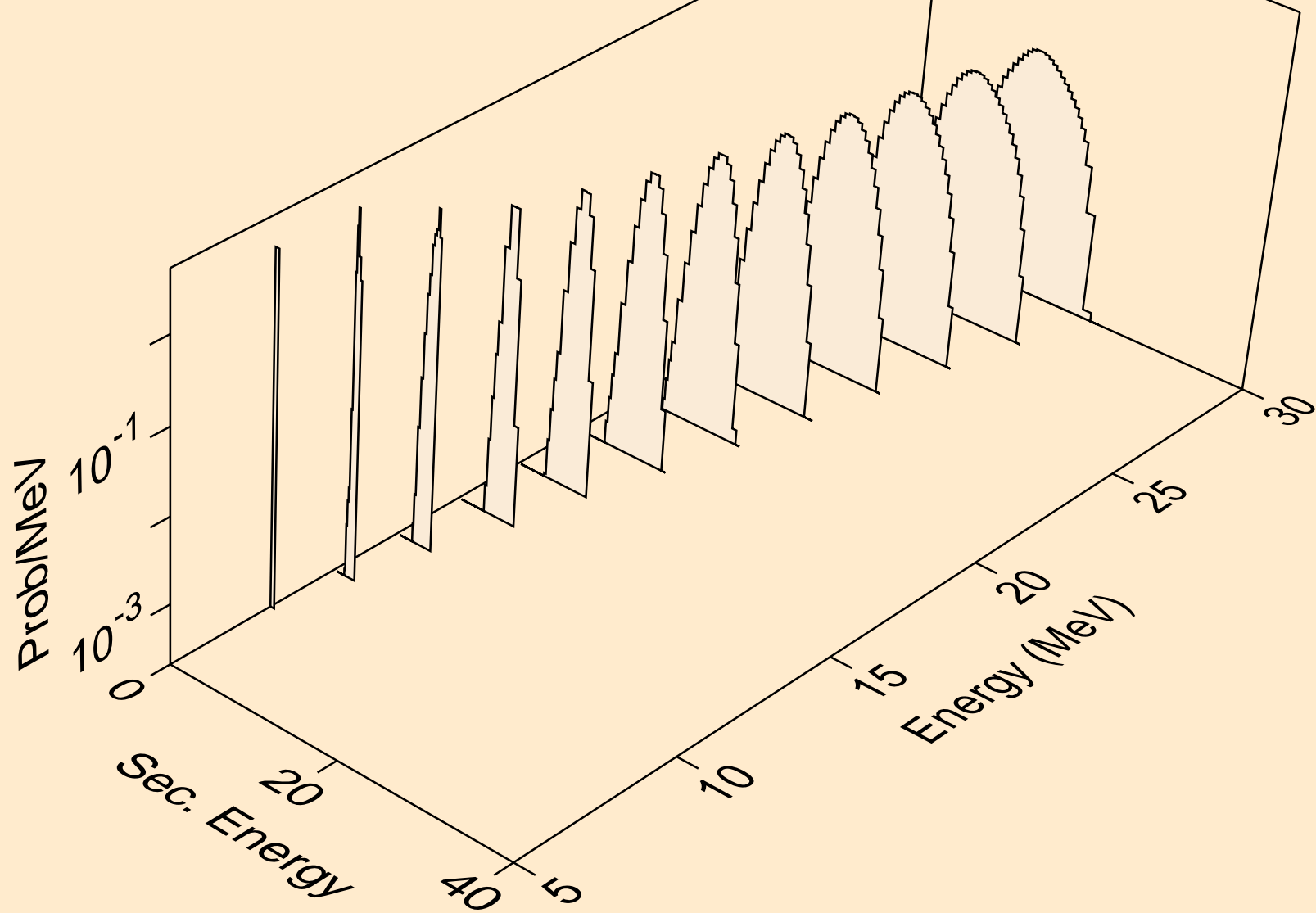

PM159 HELION ACER TENDL-2021 LIBRARY; T=0.K  
protons from (s,2np)

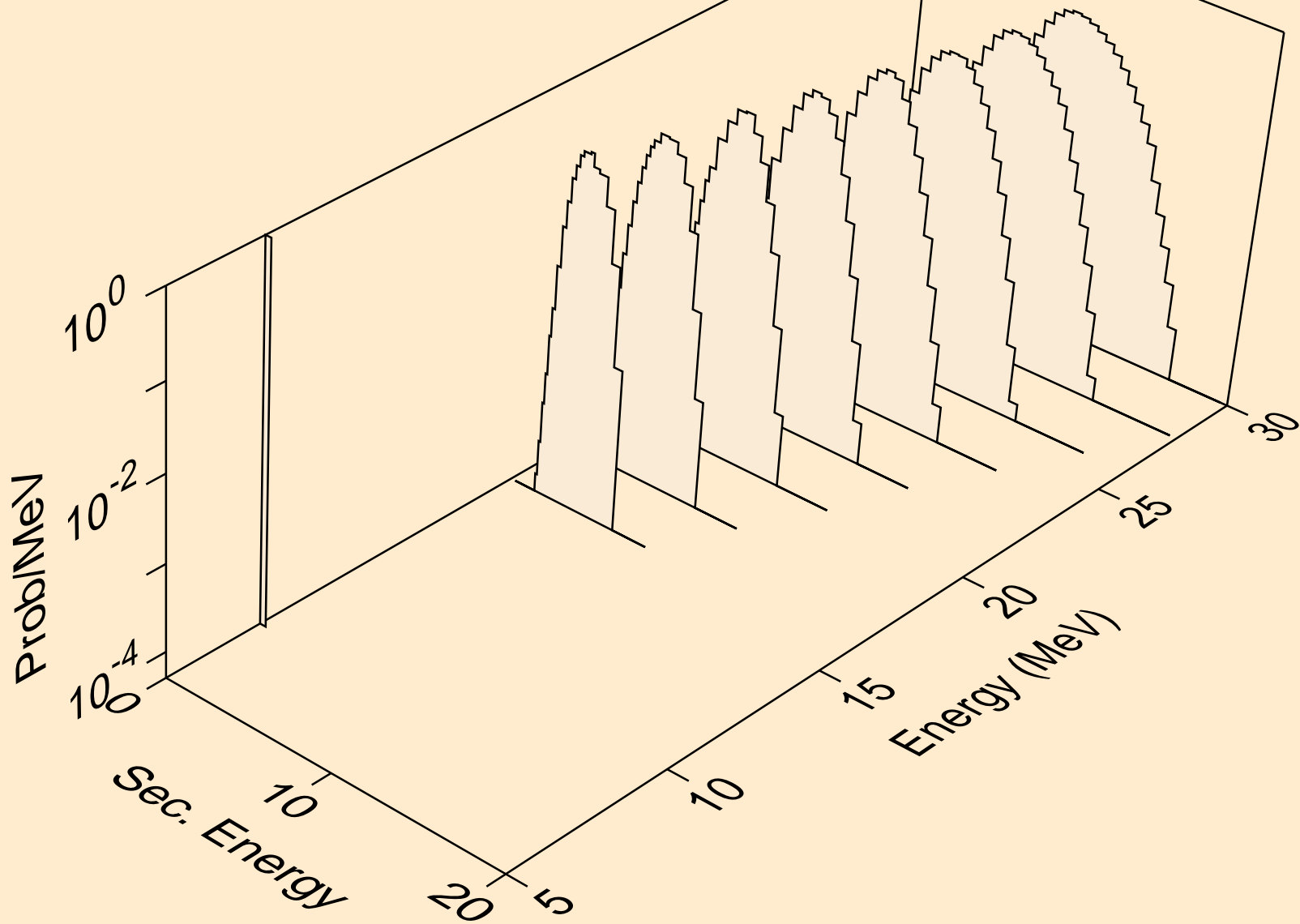

PM159 HELION ACER TENDL-2021 LIBRARY; T=0.K  
protons from (s,npa)

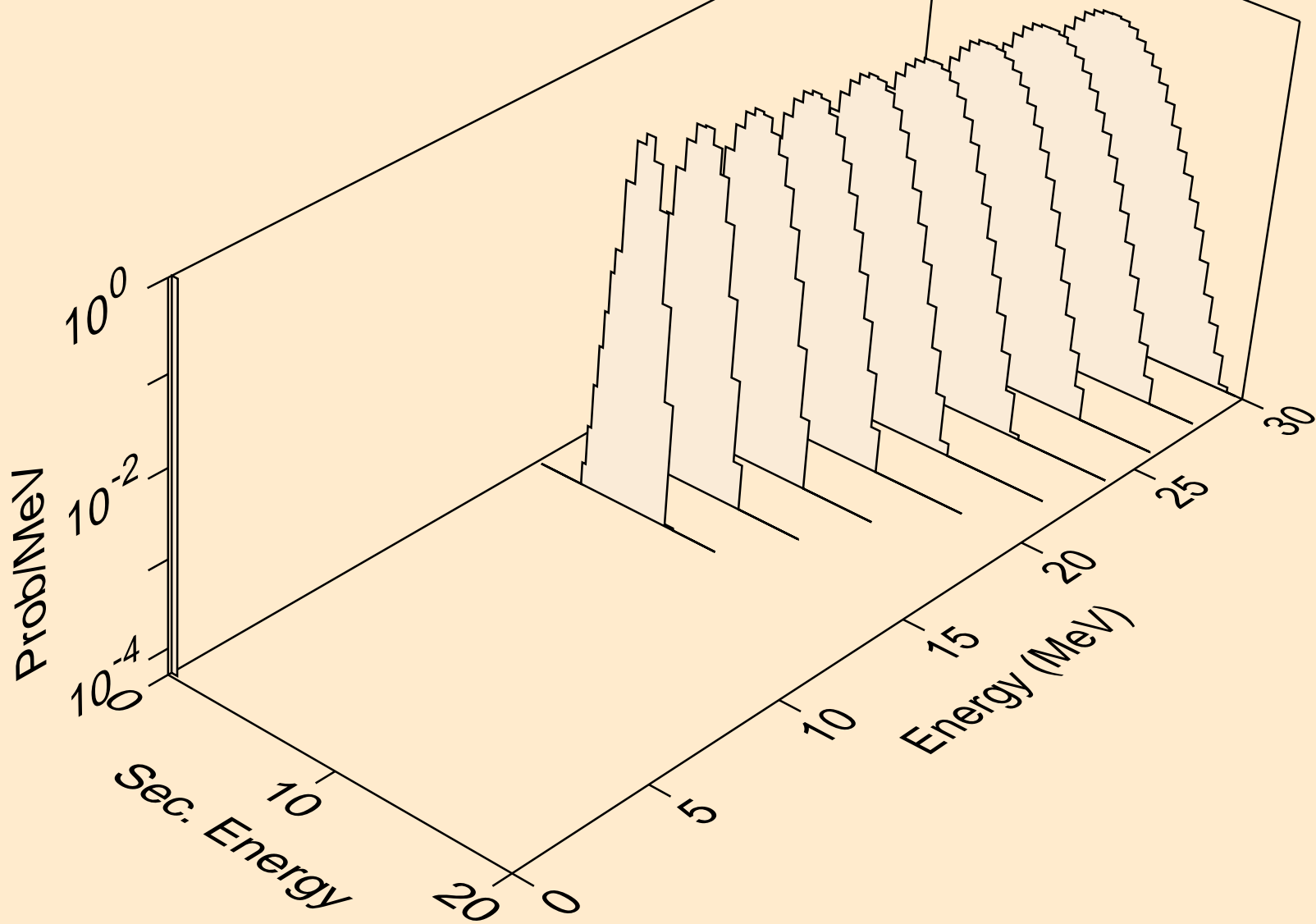

PM159 HELION ACER TENDL-2021 LIBRARY; T=0.K  
protons from (s,p)

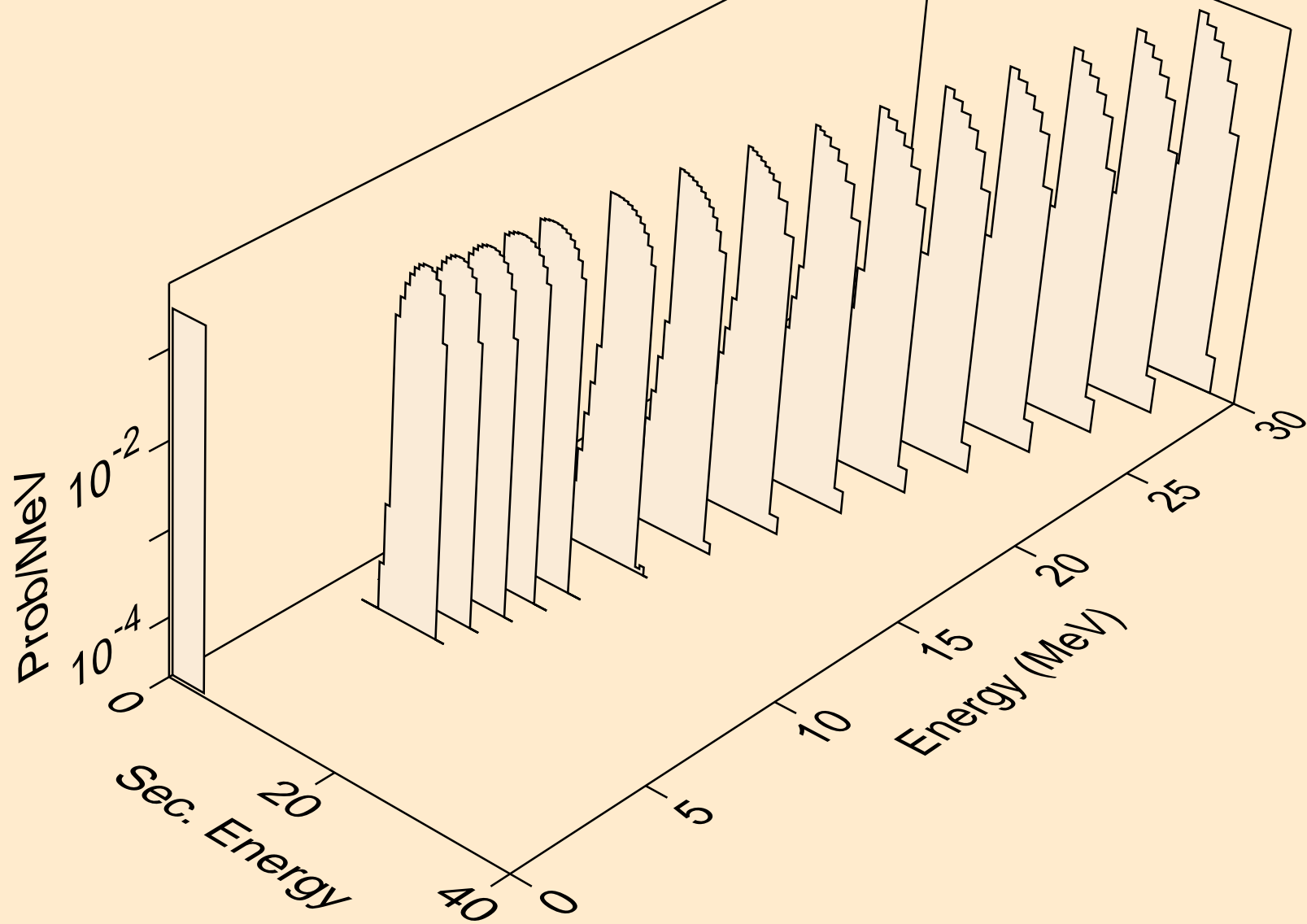

PM159 HELION ACER TENDL-2021 LIBRARY; T=0.K  
protons from (s,2p)

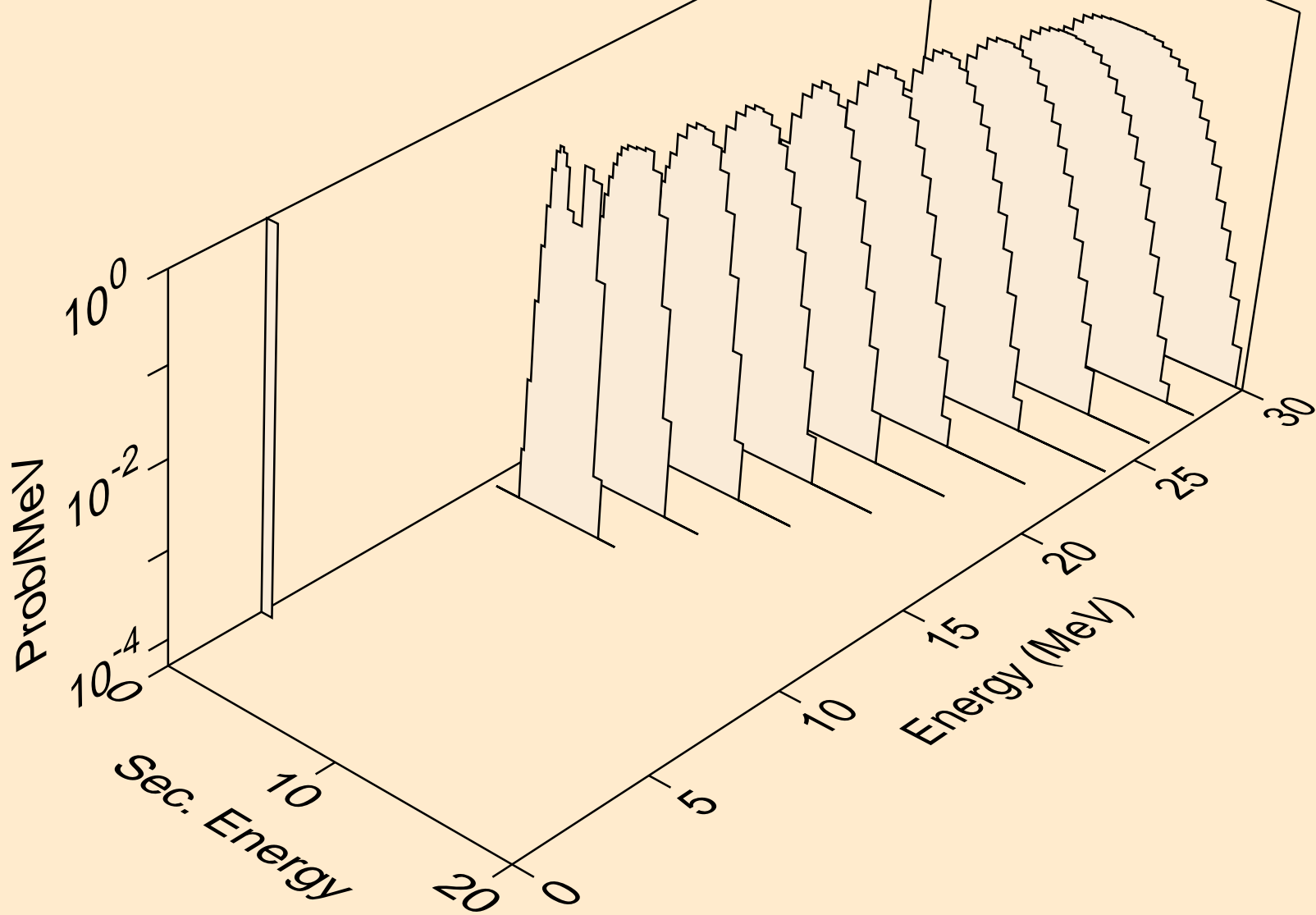

PM159 HELION ACER TENDL-2021 LIBRARY; T=0.K  
protons from (s,pd)

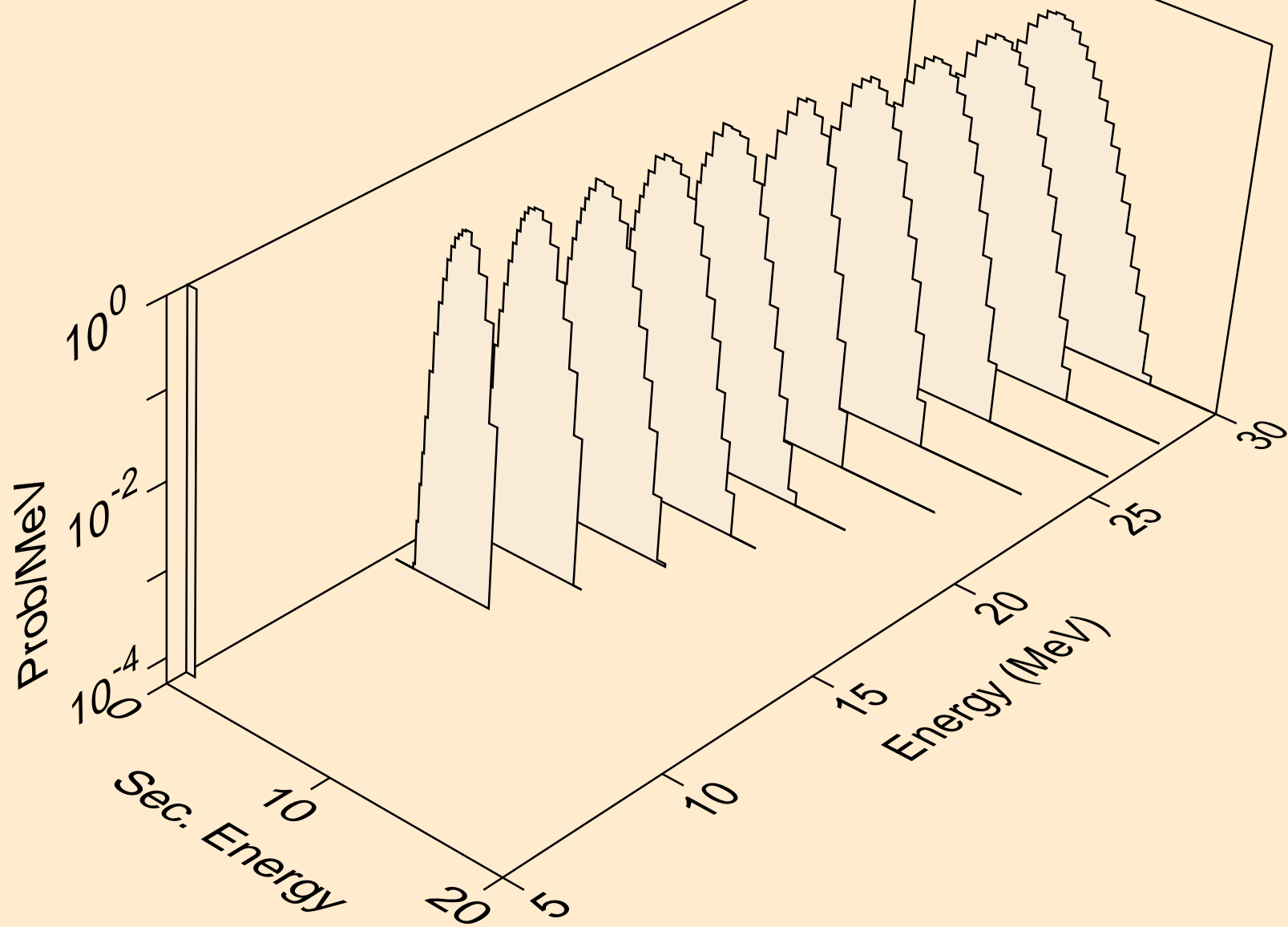

PM159 HELION ACER TENDL-2021 LIBRARY; T=0.K  
protons from (s,pt)

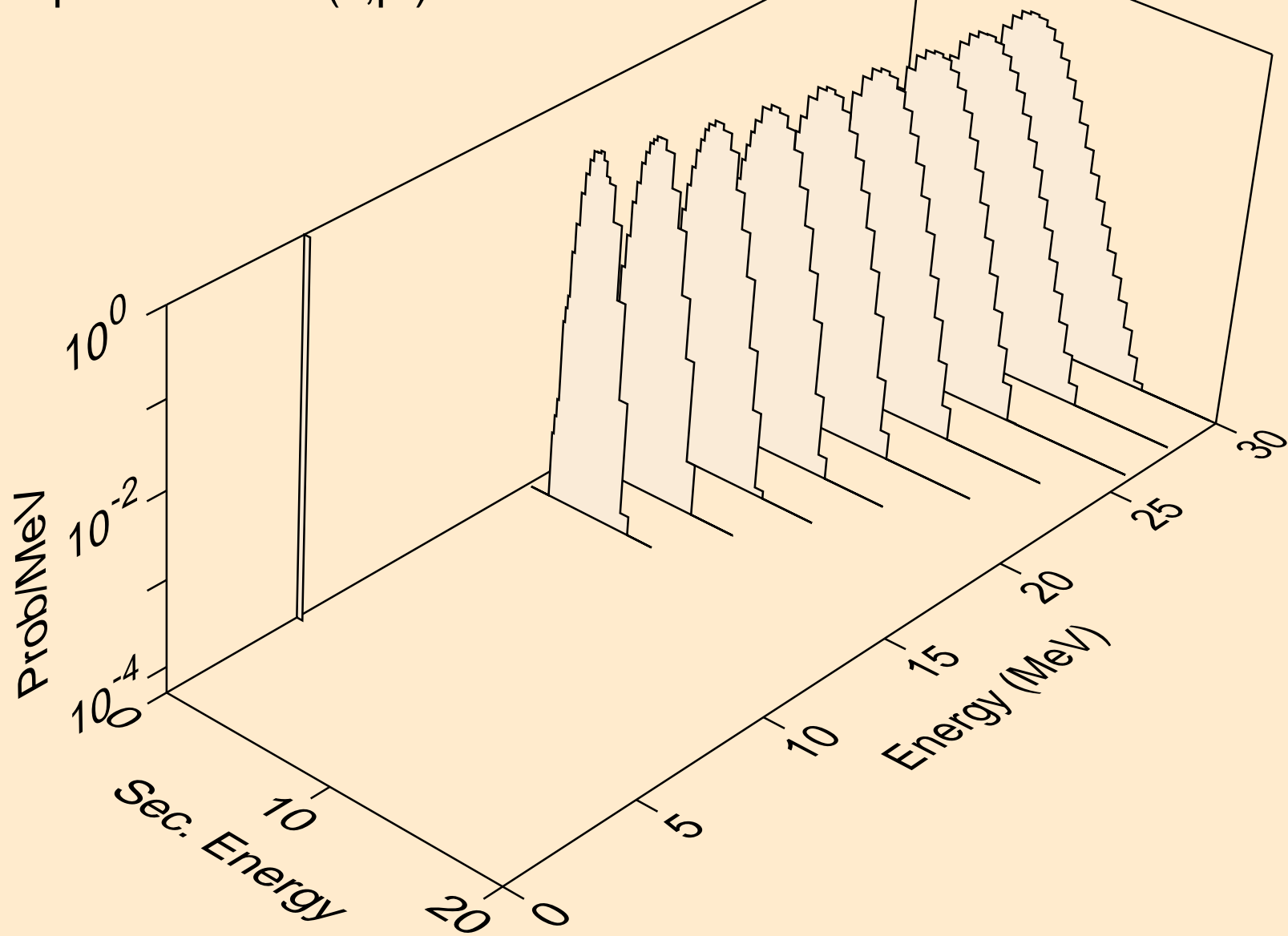



PM159 HELION ACER TENDL-2021 LIBRARY; T=0.K  
deuterons from (s,x)

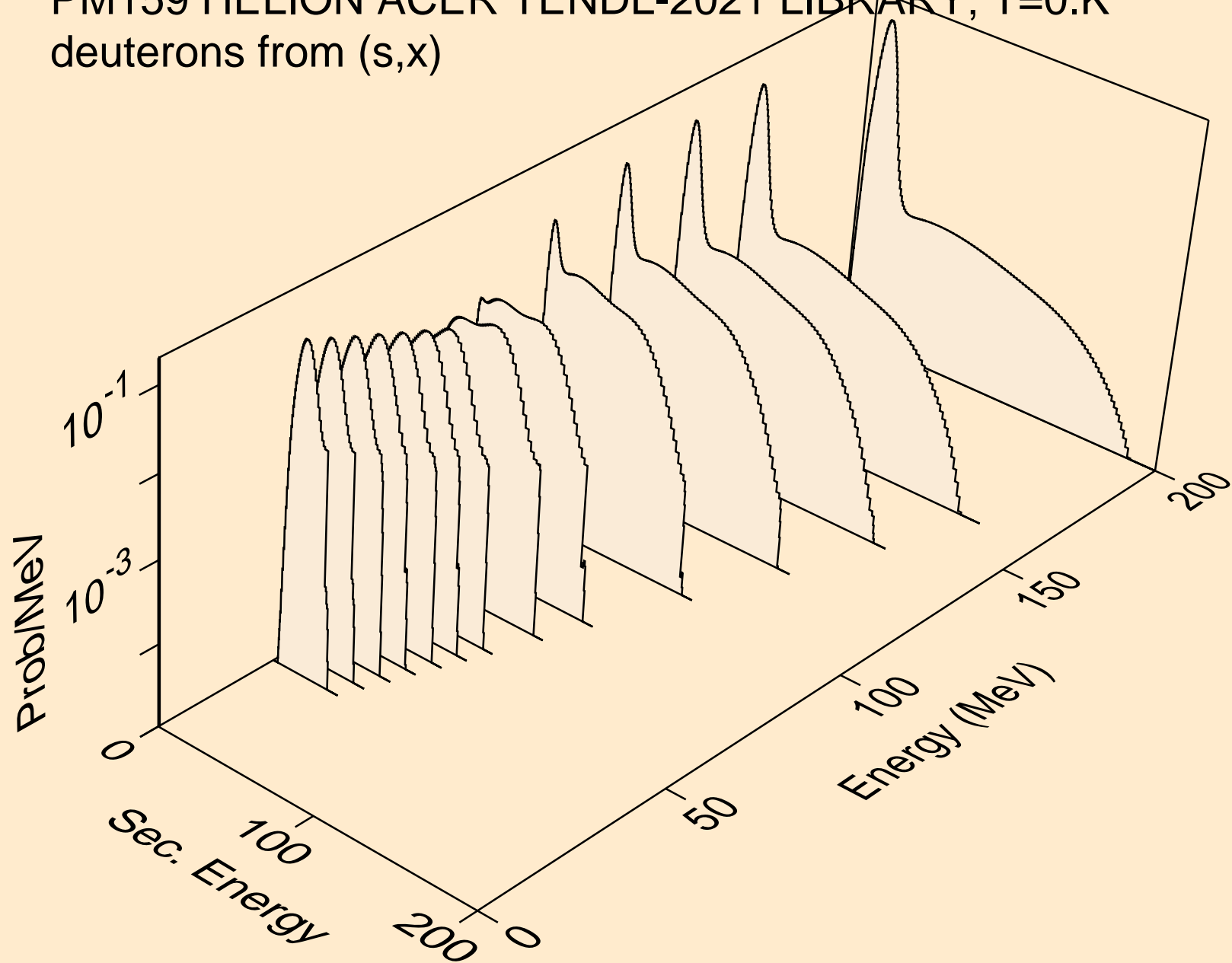

PM159 HELION ACER TENDL-2021 LIBRARY; T=0.K  
deuterons from (s,2nd)

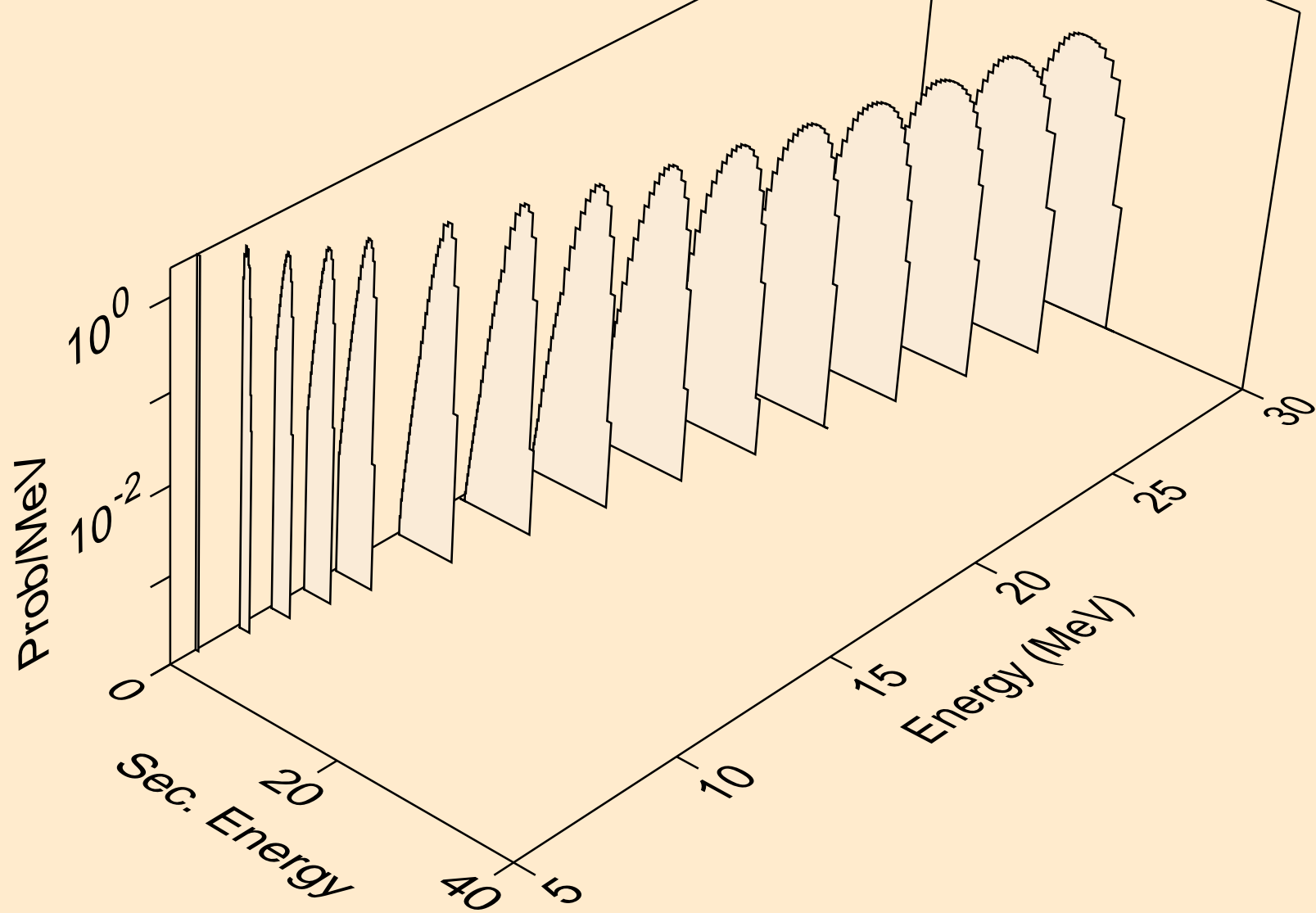

PM159 HELION ACER TENDL-2021 LIBRARY; T=0.K  
deuterons from (s,n\*)d

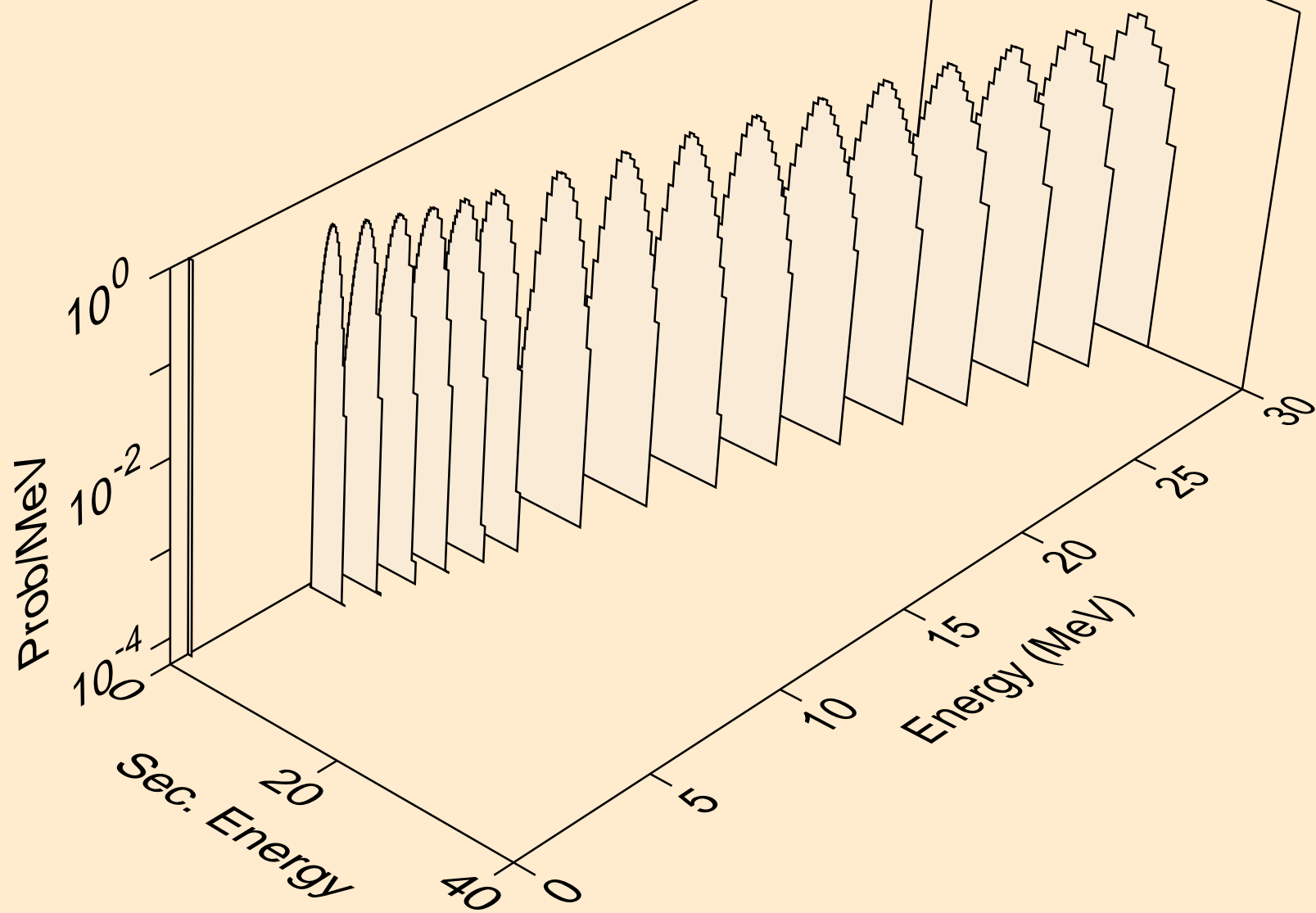

PM159 HELION ACER TENDL-2021 LIBRARY; T=0.K  
deuterons from (s,d)

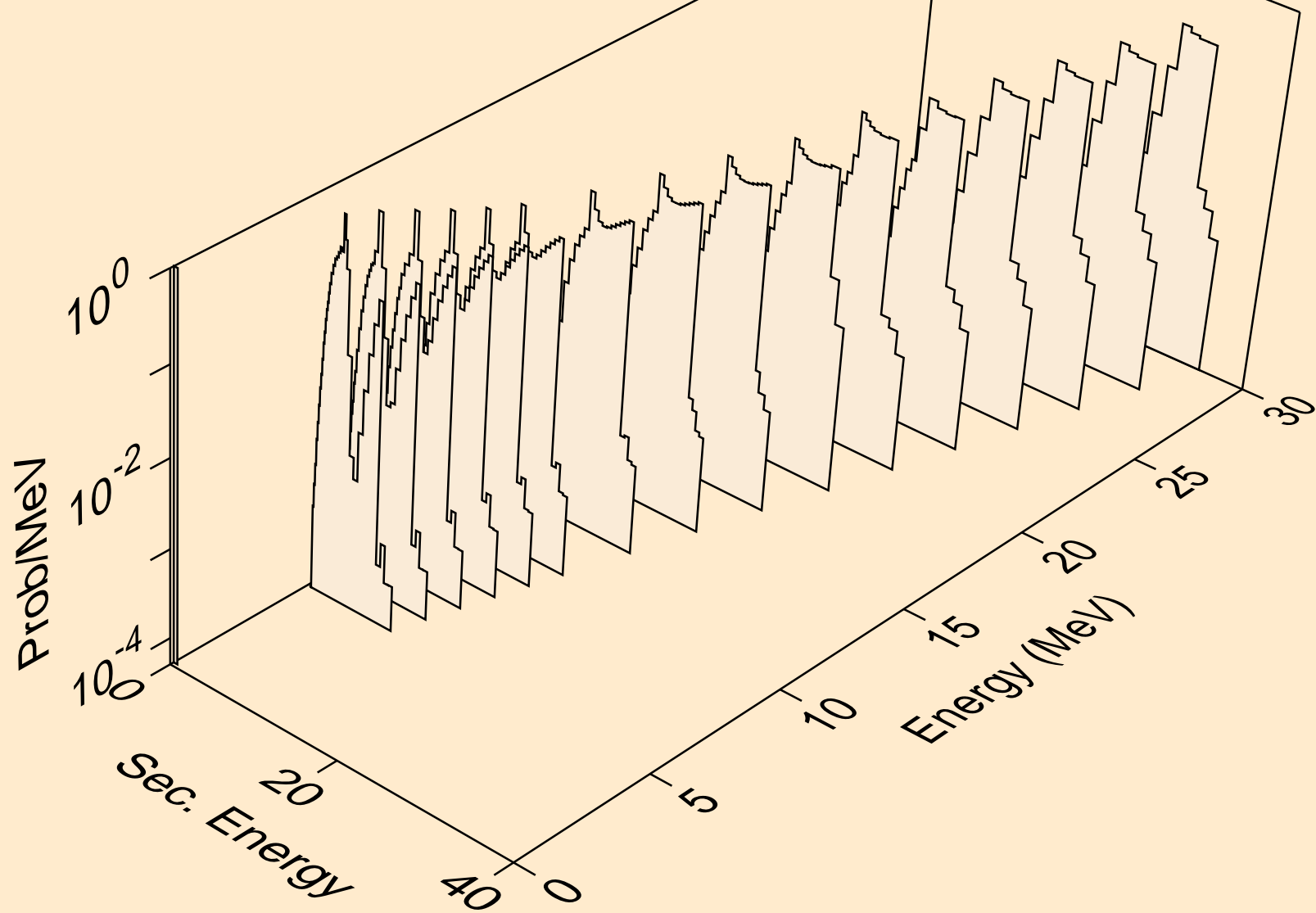

PM159 HELION ACER TENDL-2021 LIBRARY; T=0.K  
deuterons from (s,pd)

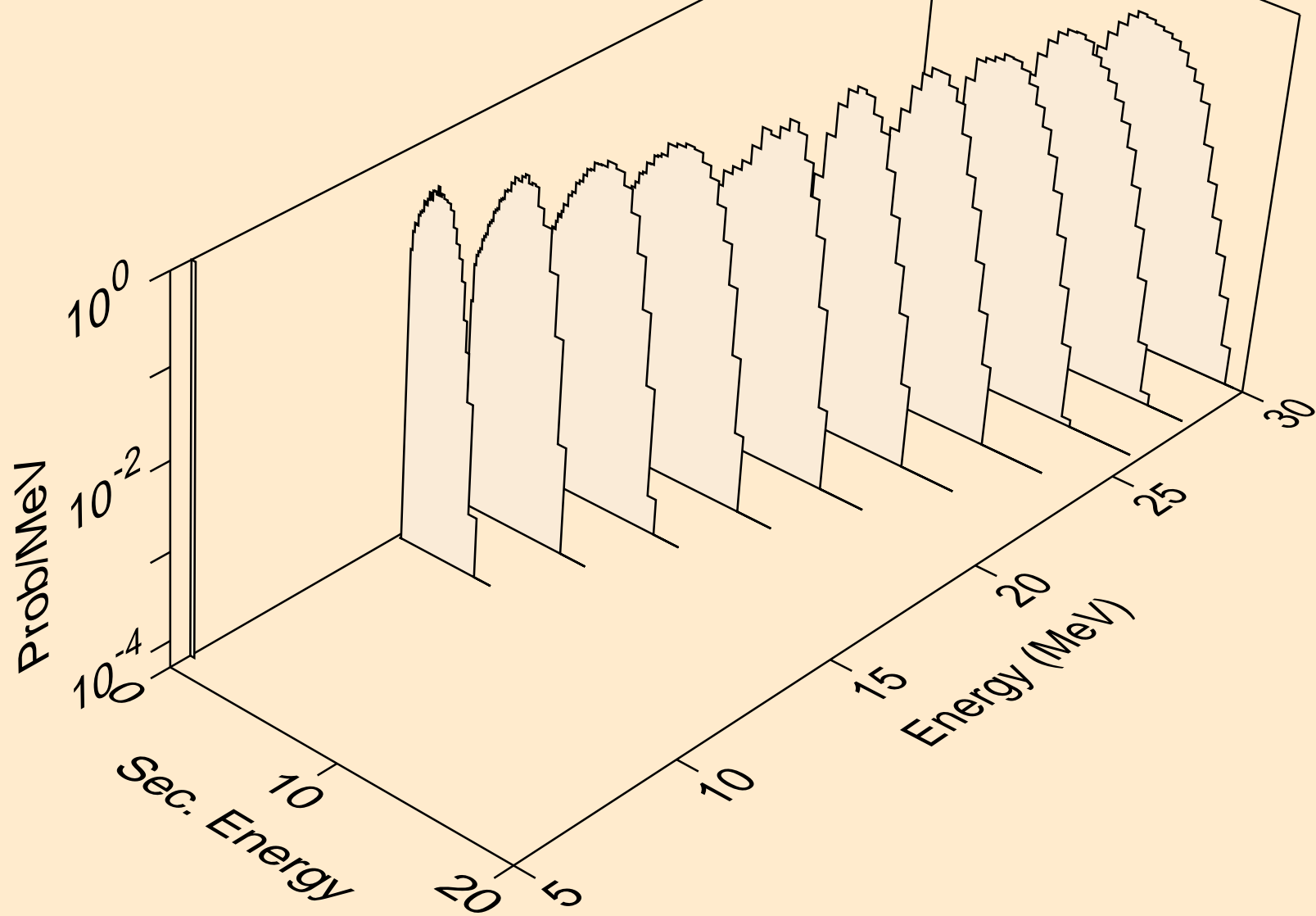

PM159 HELION ACER TENDL-2021 LIBRARY; T=0.K  
tritons from (s,x)

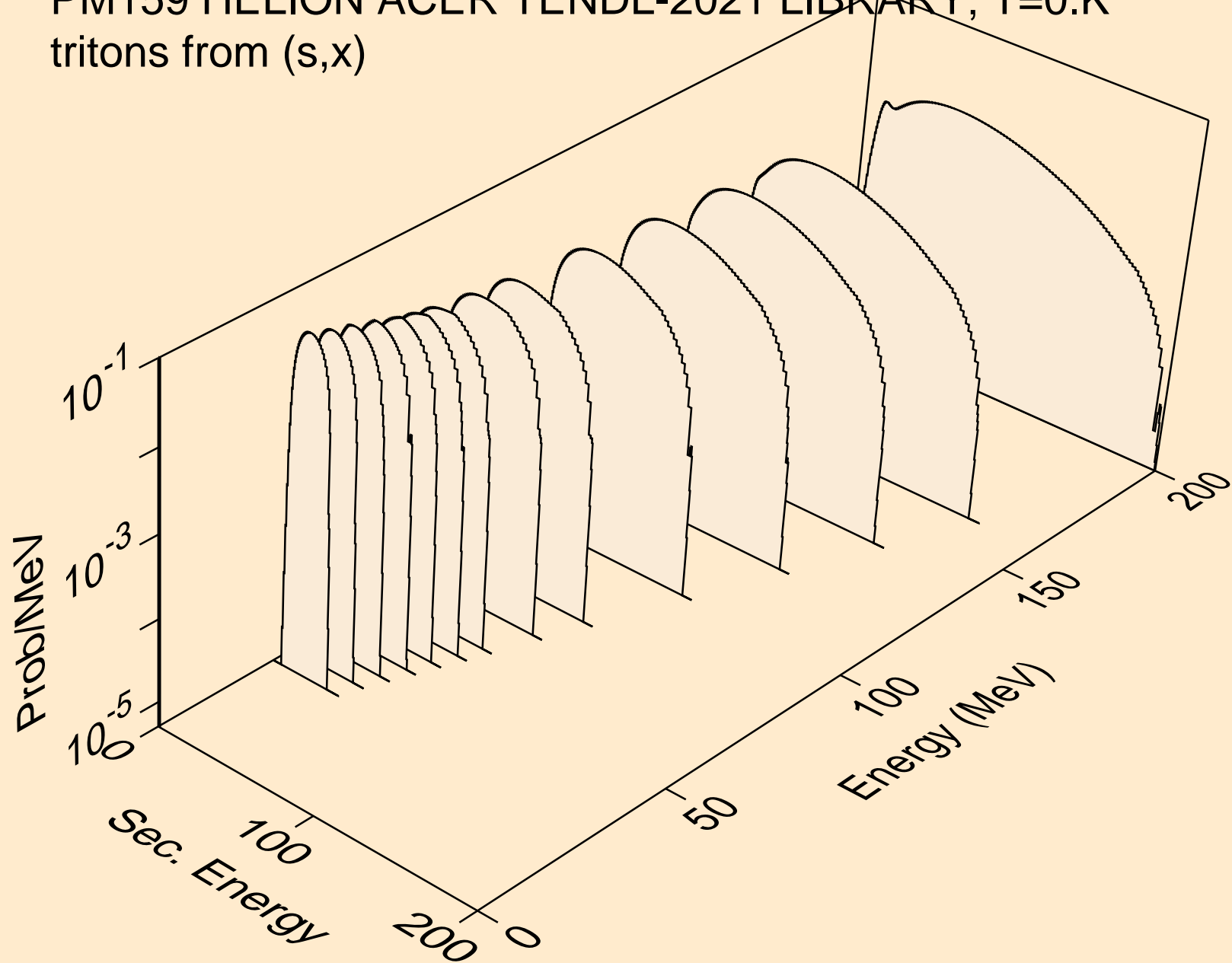

PM159 HELION ACER TENDL-2021 LIBRARY; T=0.K  
tritons from (s,n\*)t

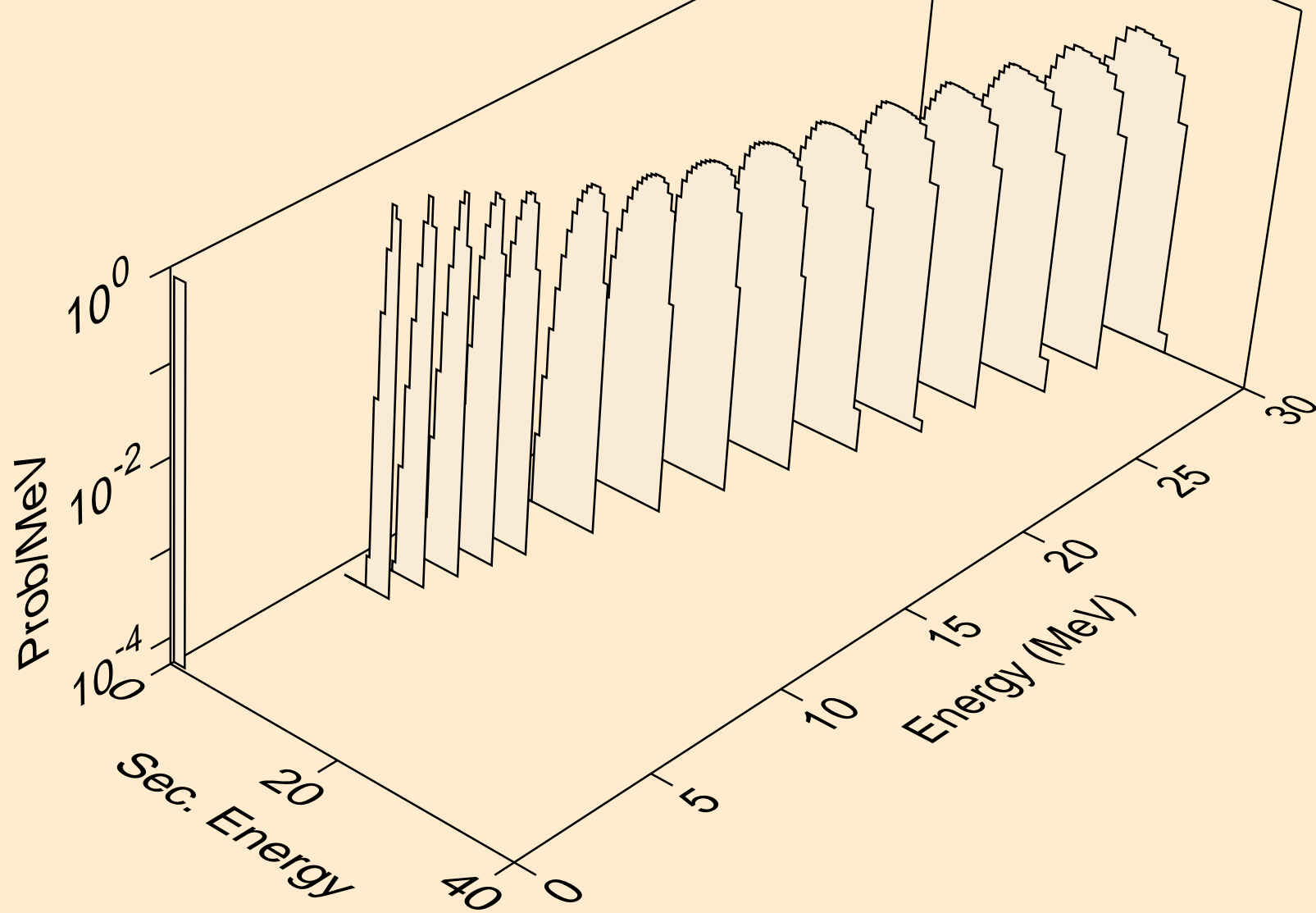

PM159 HELION ACER TENDL-2021 LIBRARY; T=0.K  
tritons from (s,t)

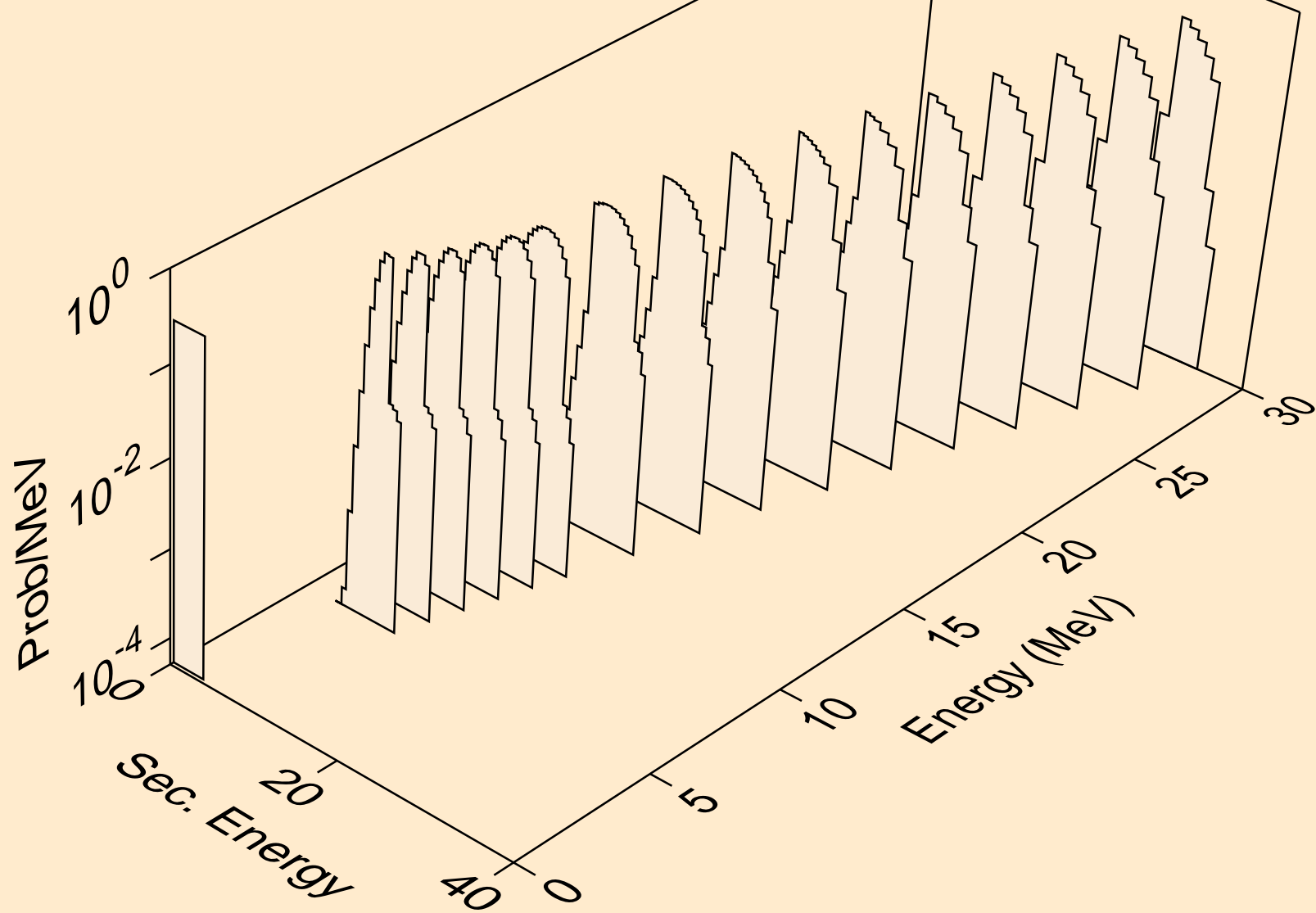



PM159 HELION ACER TENDL-2021 LIBRARY; T=0.K  
tritons from (s,pt)

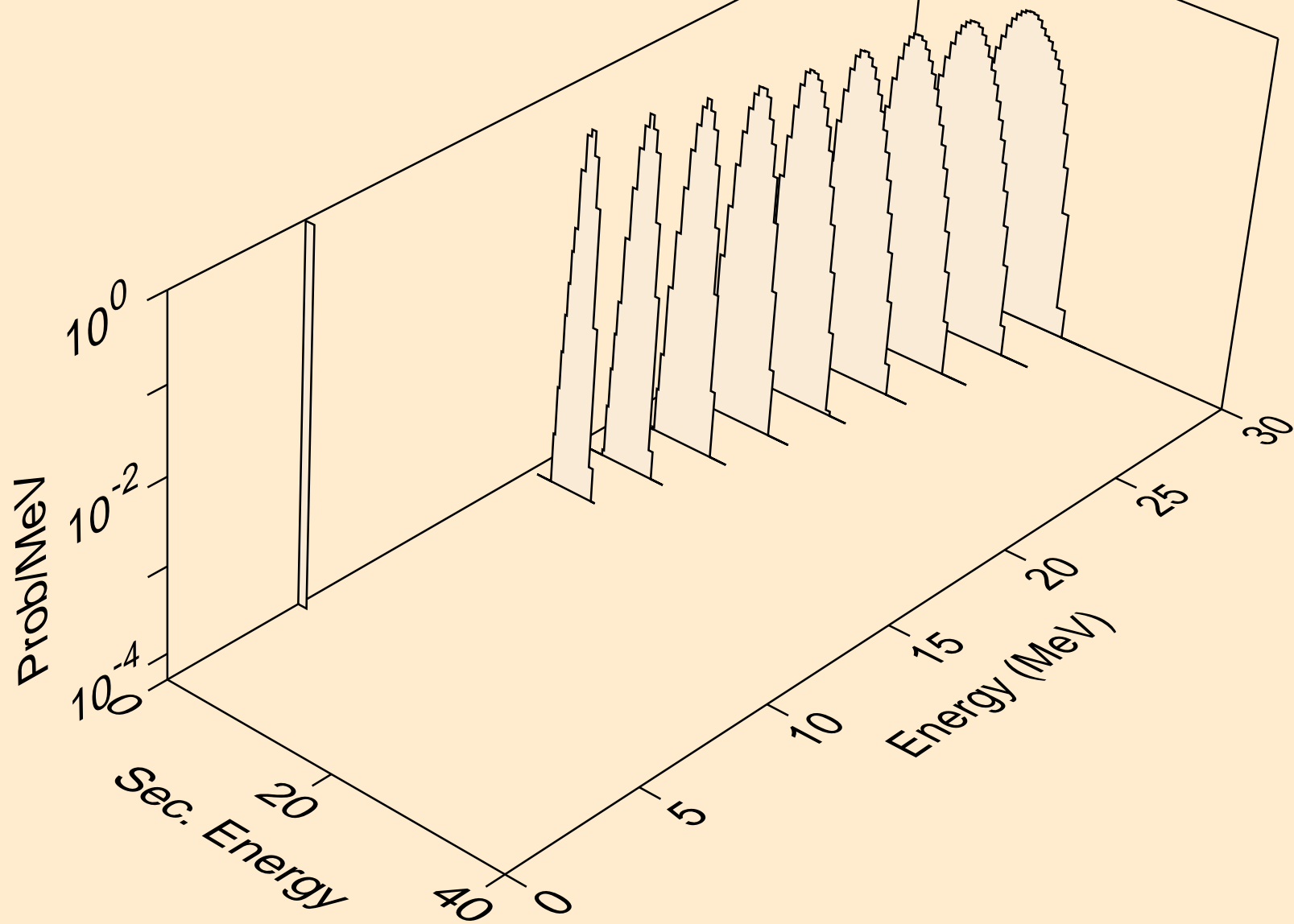

PM159 HELION ACER TENDL-2021 LIBRARY; T=0.K  
alphas from (s,x)

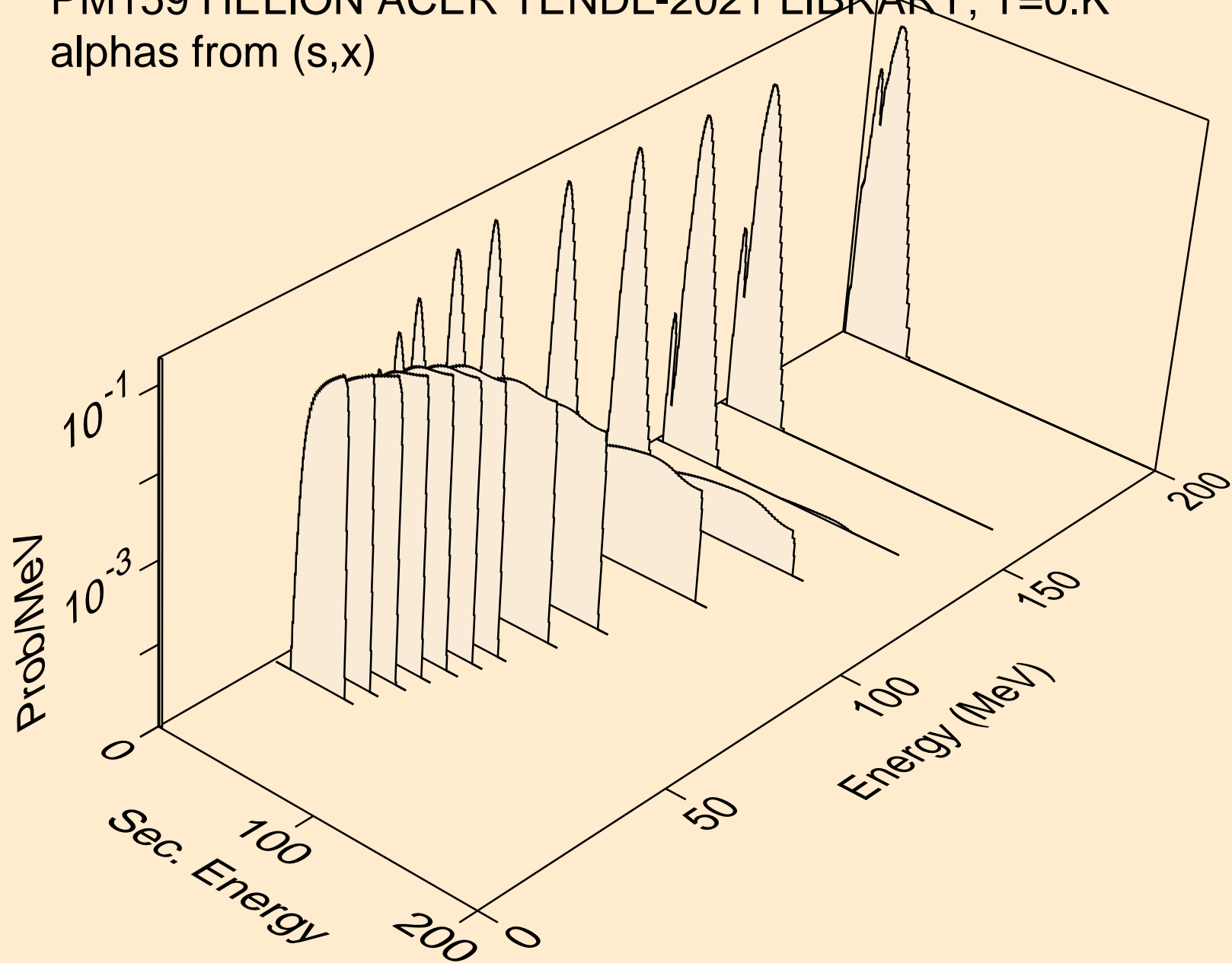

PM159 HELION ACER TENDL-2021 LIBRARY; T=0.K  
alphas from (s,n\*)a

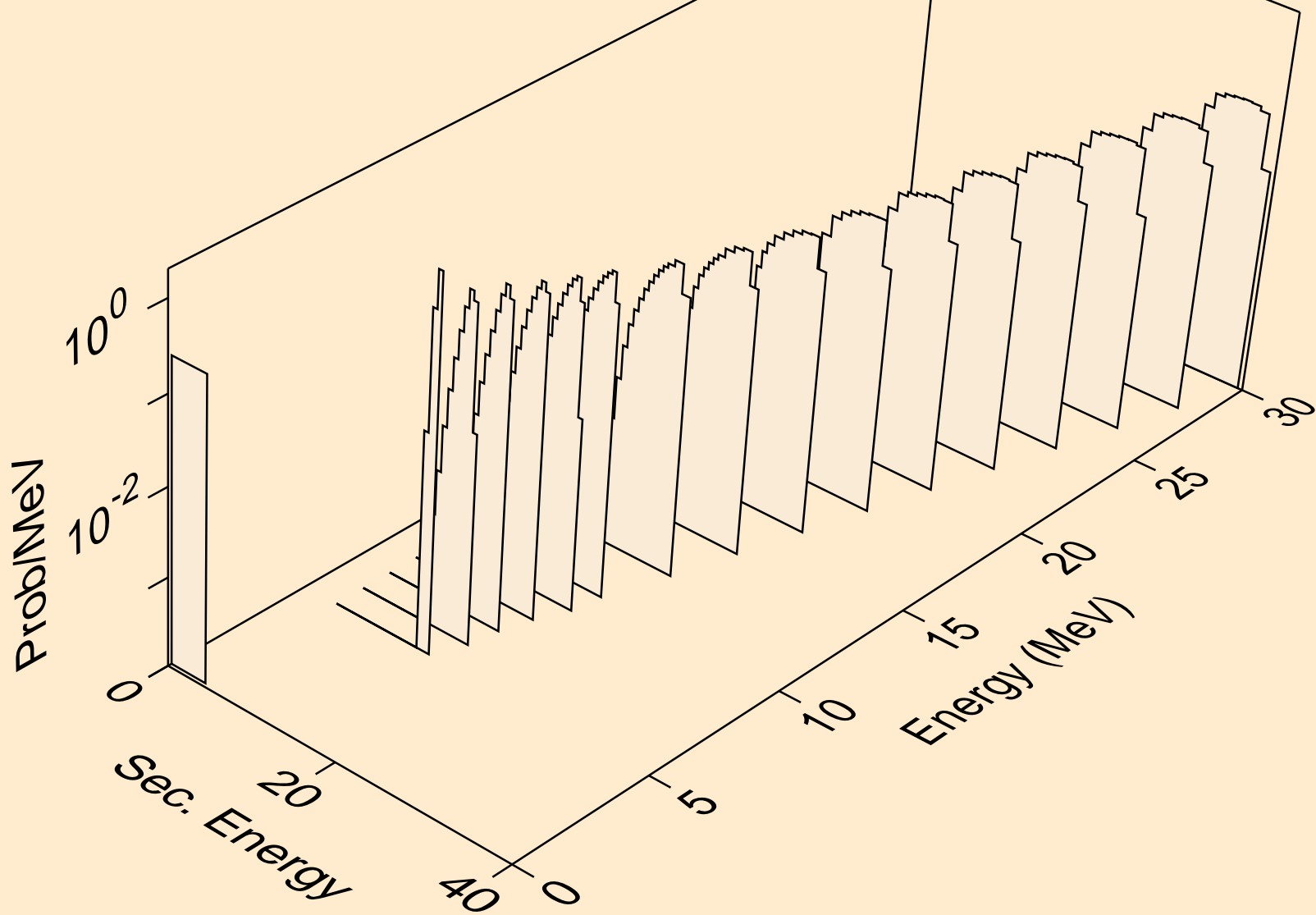

PM159 HELION ACER TENDL-2021 LIBRARY; T=0.K  
alphas from (s,2n)a

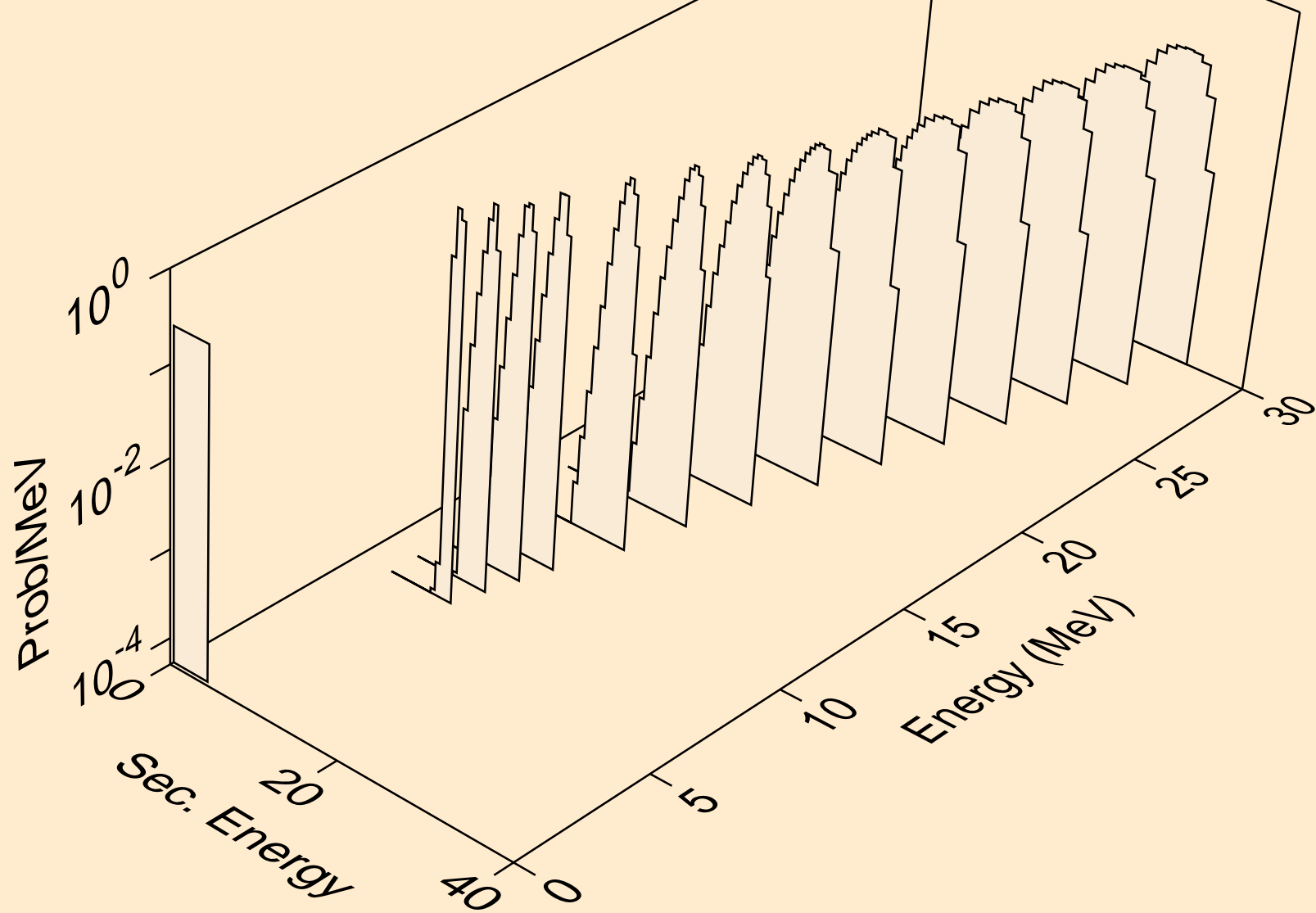

PM159 HELION ACER TENDL-2021 LIBRARY; T=0.K  
alphas from (s,3n)a

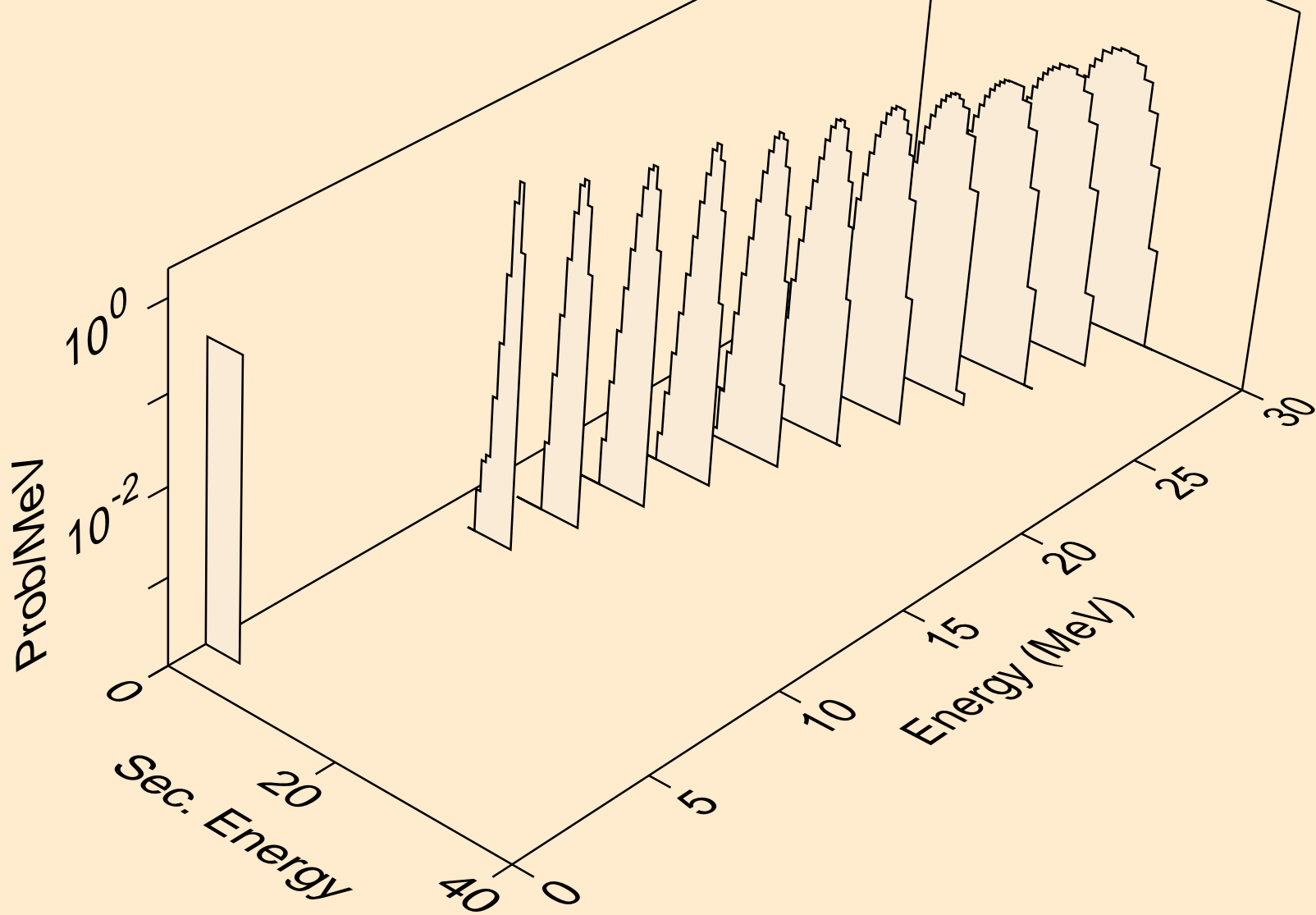

PM159 HELION ACER TENDL-2021 LIBRARY; T=0.K  
alphas from (s,npa)

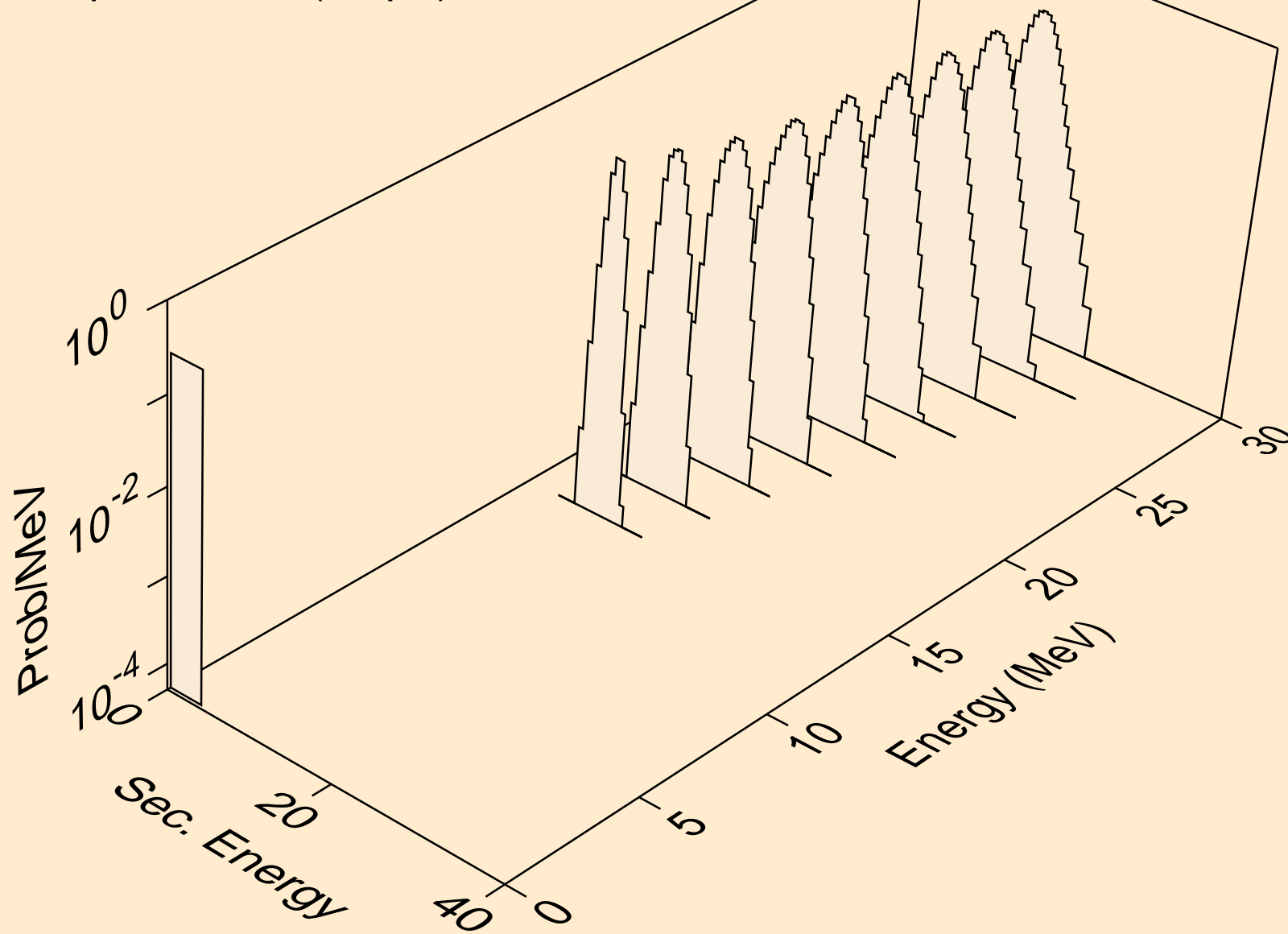

PM159 HELION ACER TENDL-2021 LIBRARY; T=0.K  
alphas from (s,a)

