

PU229 HELION ACER TENDL-2021 LIBRARY; T=0.K
Principal cross sections

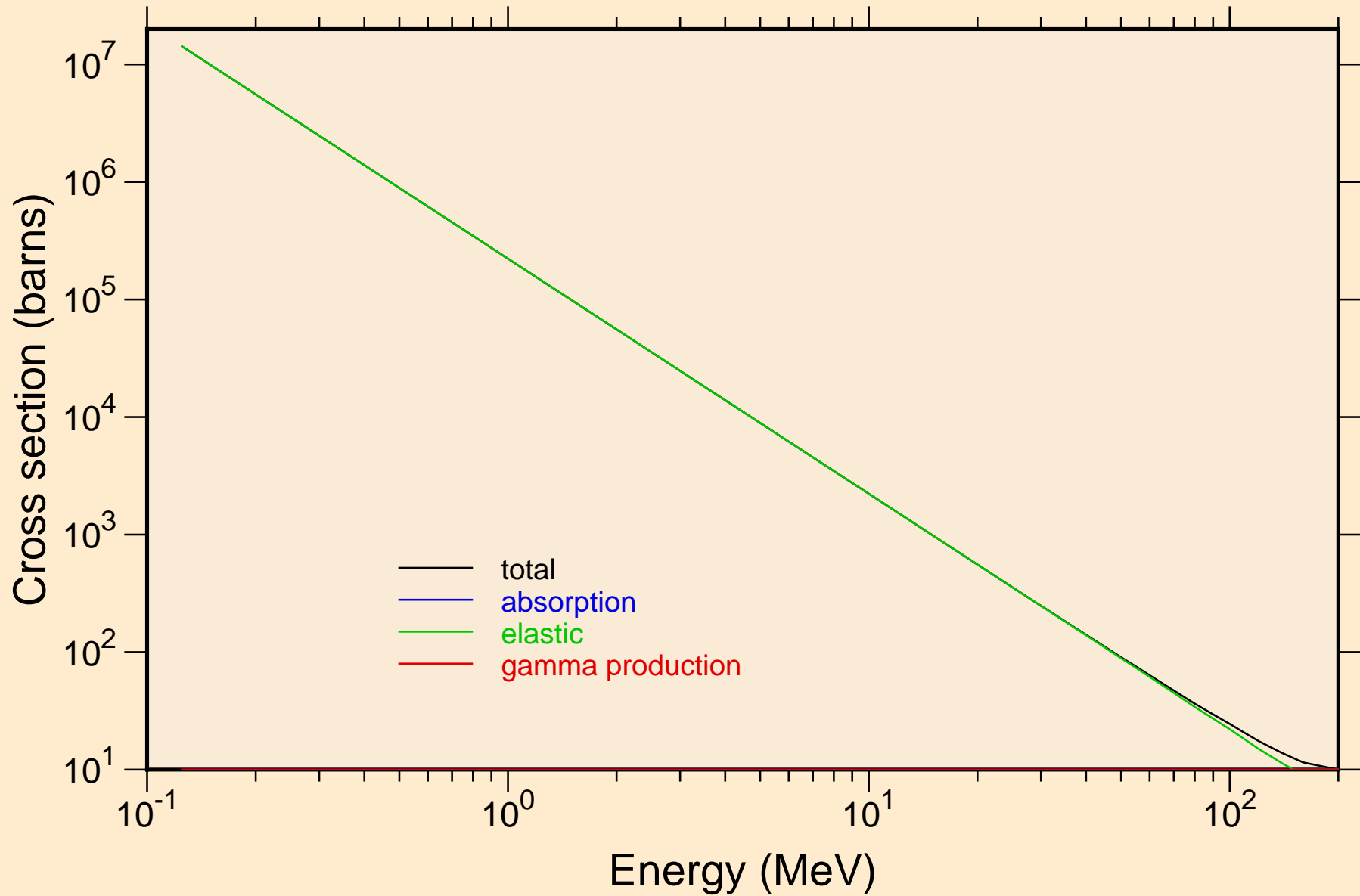

PU229 HELION ACER TENDL-2021 LIBRARY; T=0.K
Heating

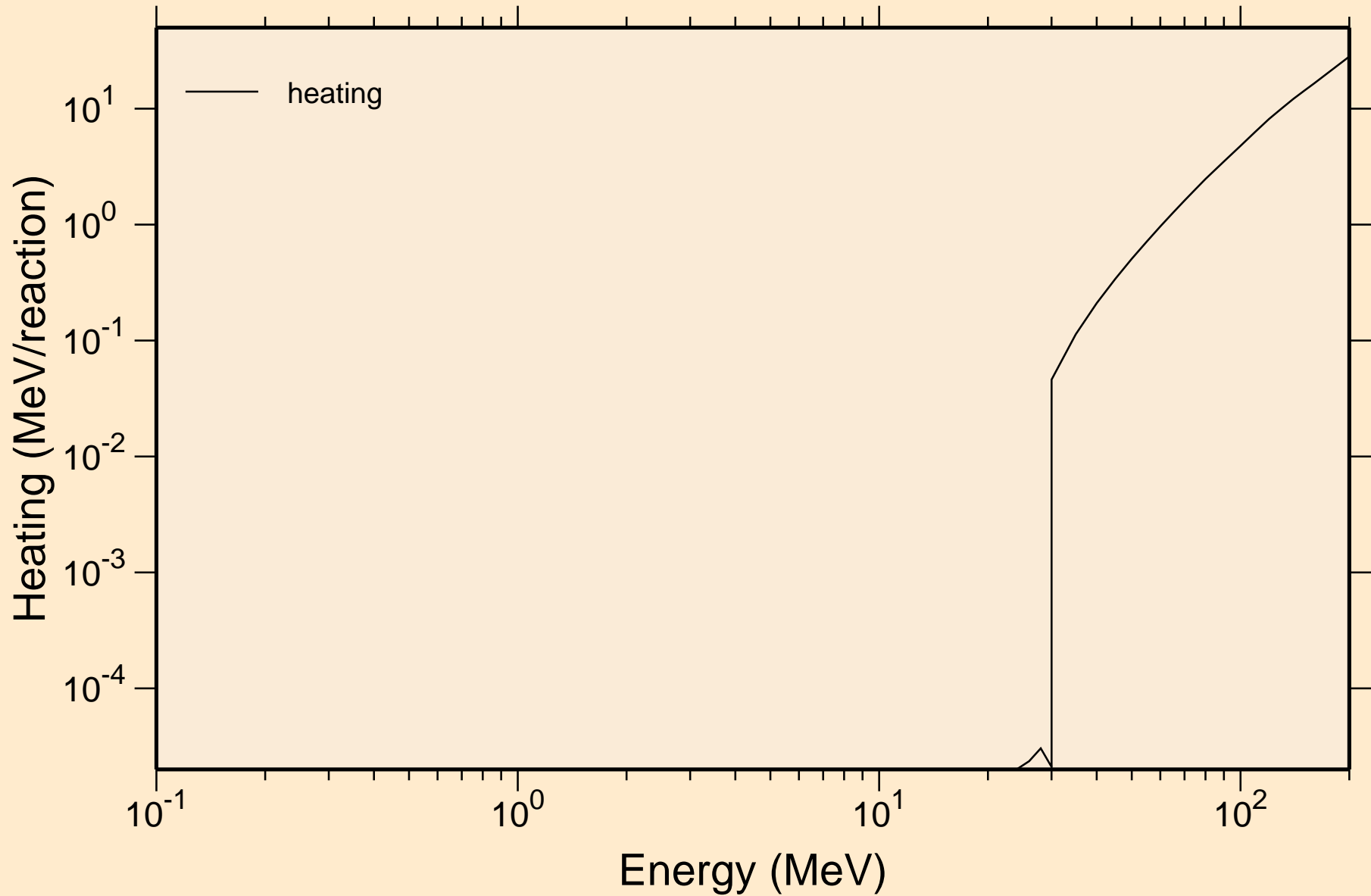

PU229 HELION ACER TENDL-2021 LIBRARY; T=0.K

Principal cross sections

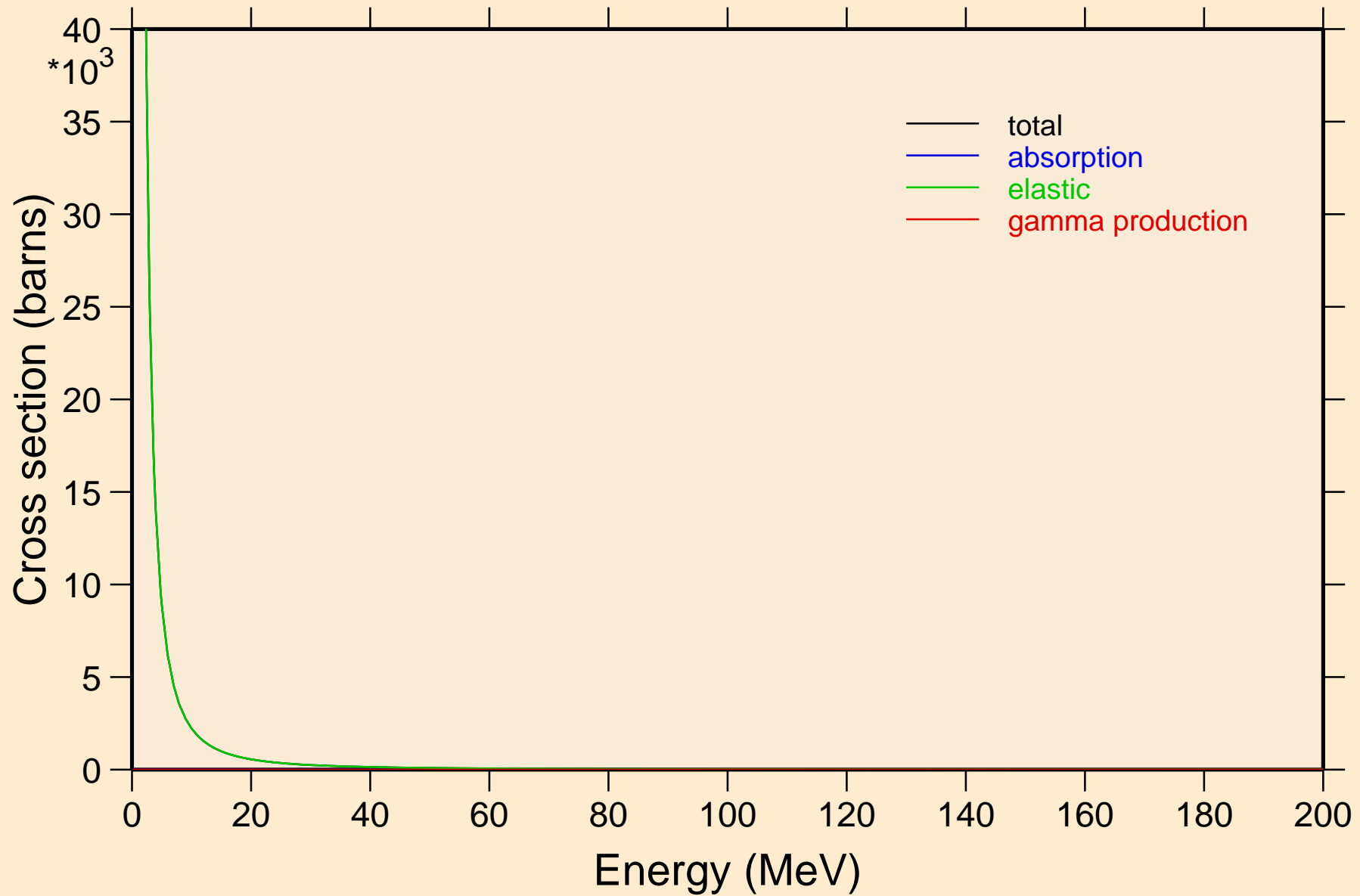

PU229 HELION ACER TENDL-2021 LIBRARY; T=0.K

Heating

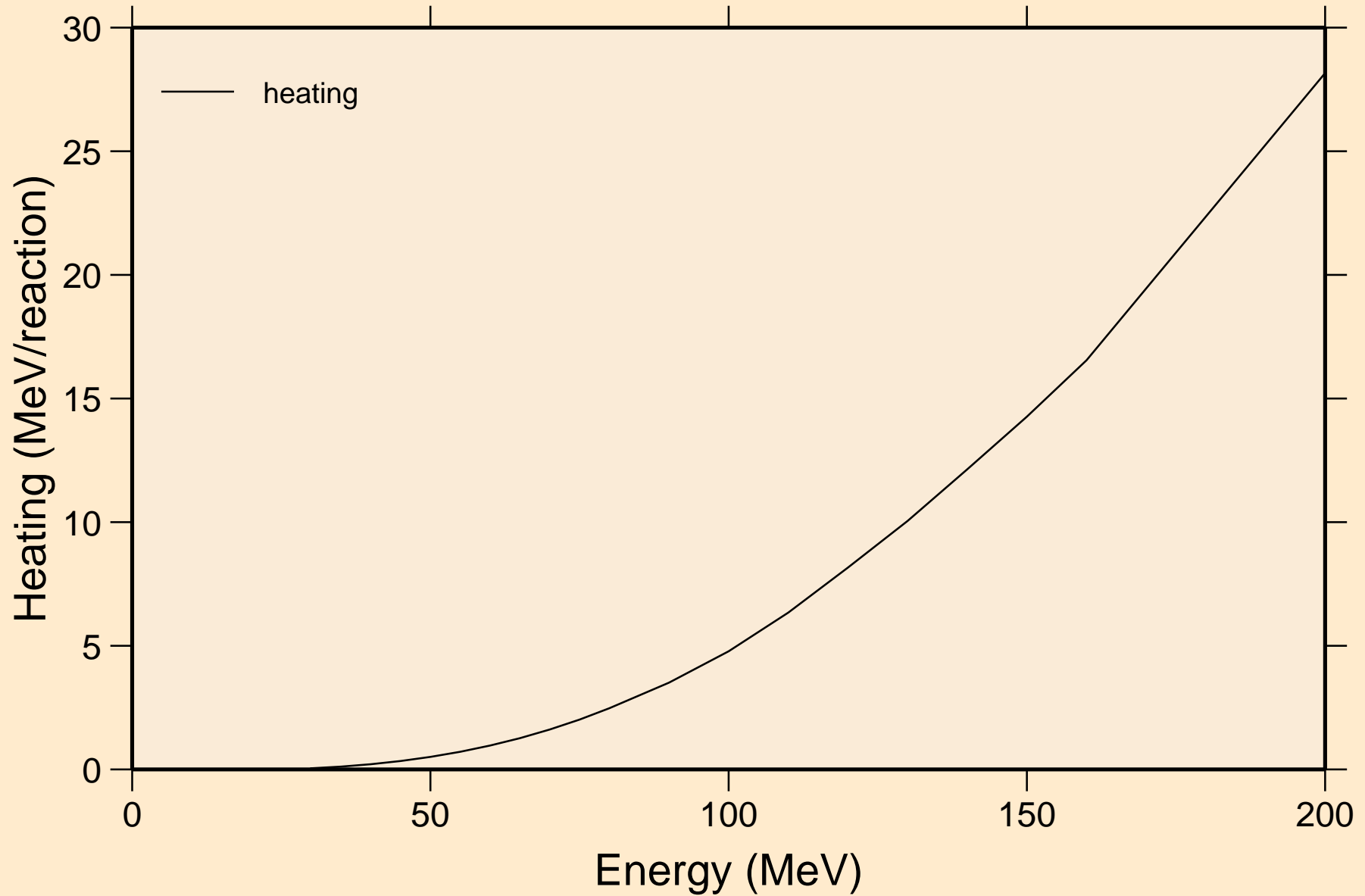

PU229 HELION ACER TENDL-2021 LIBRARY; T=0.K
Threshold reactions

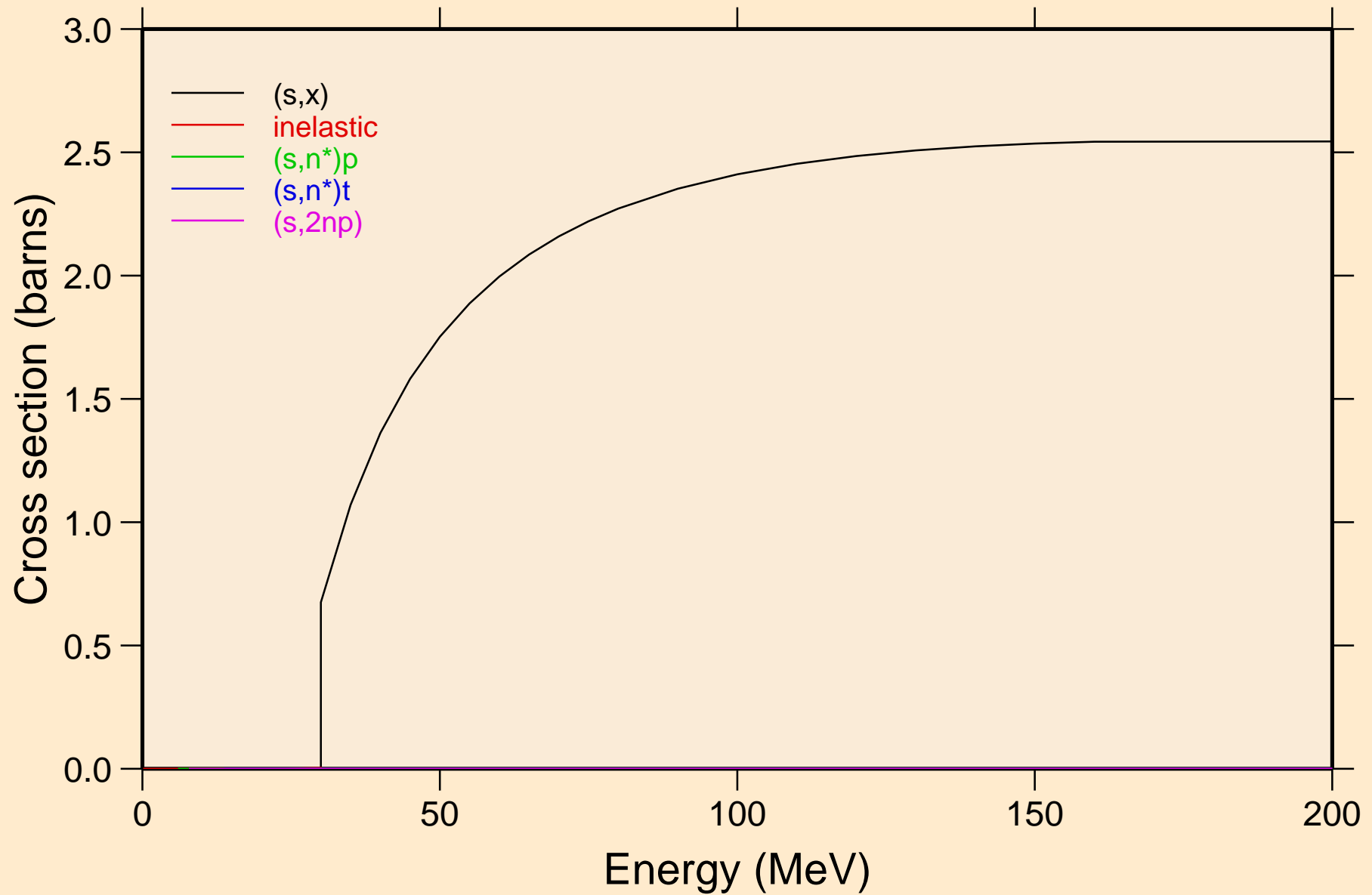

PU229 HELION ACER TENDL-2021 LIBRARY; T=0.K
Threshold reactions

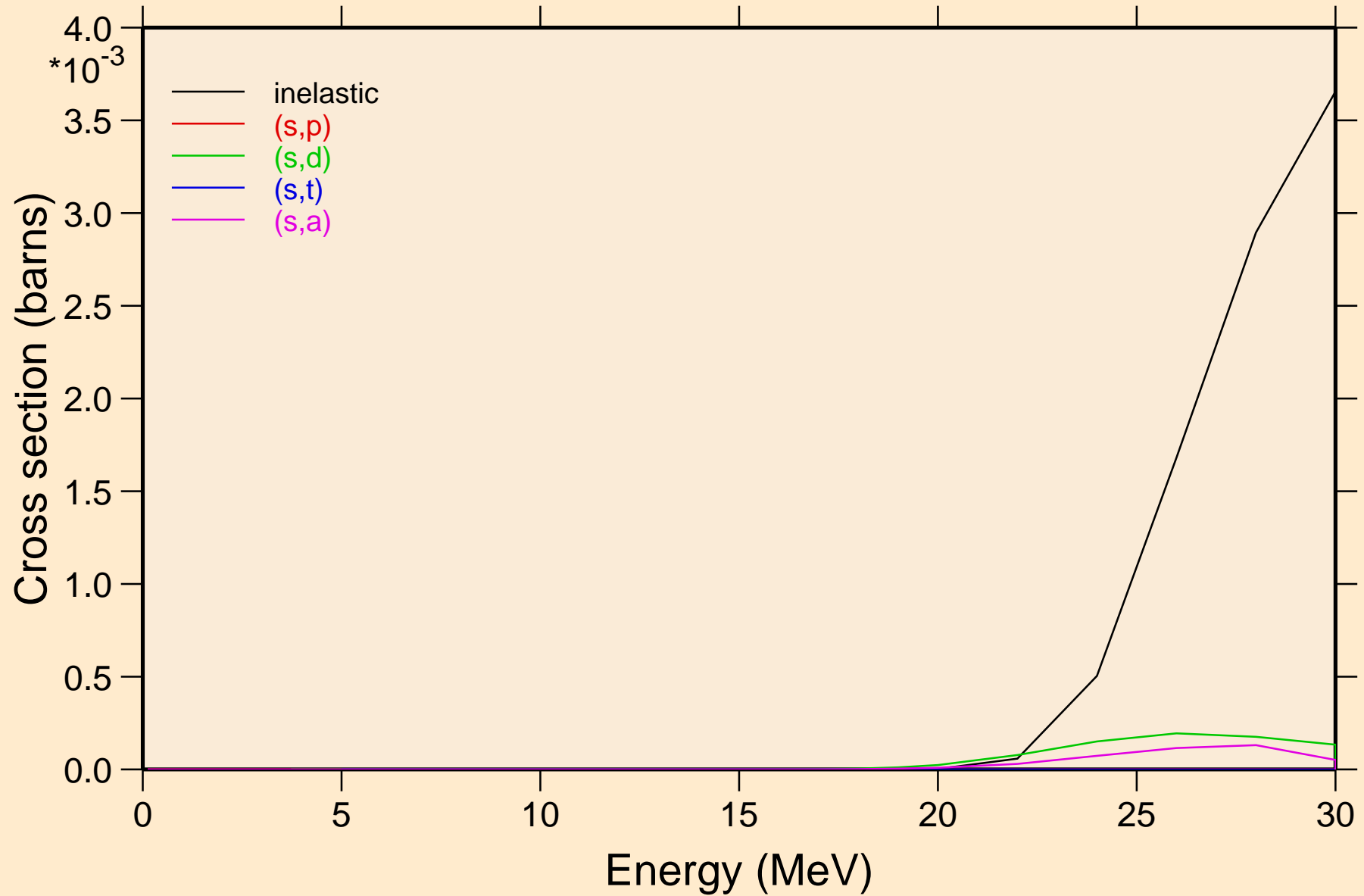

PU229 HELION ACER TENDL-2021 LIBRARY; T=0.K
Threshold reactions

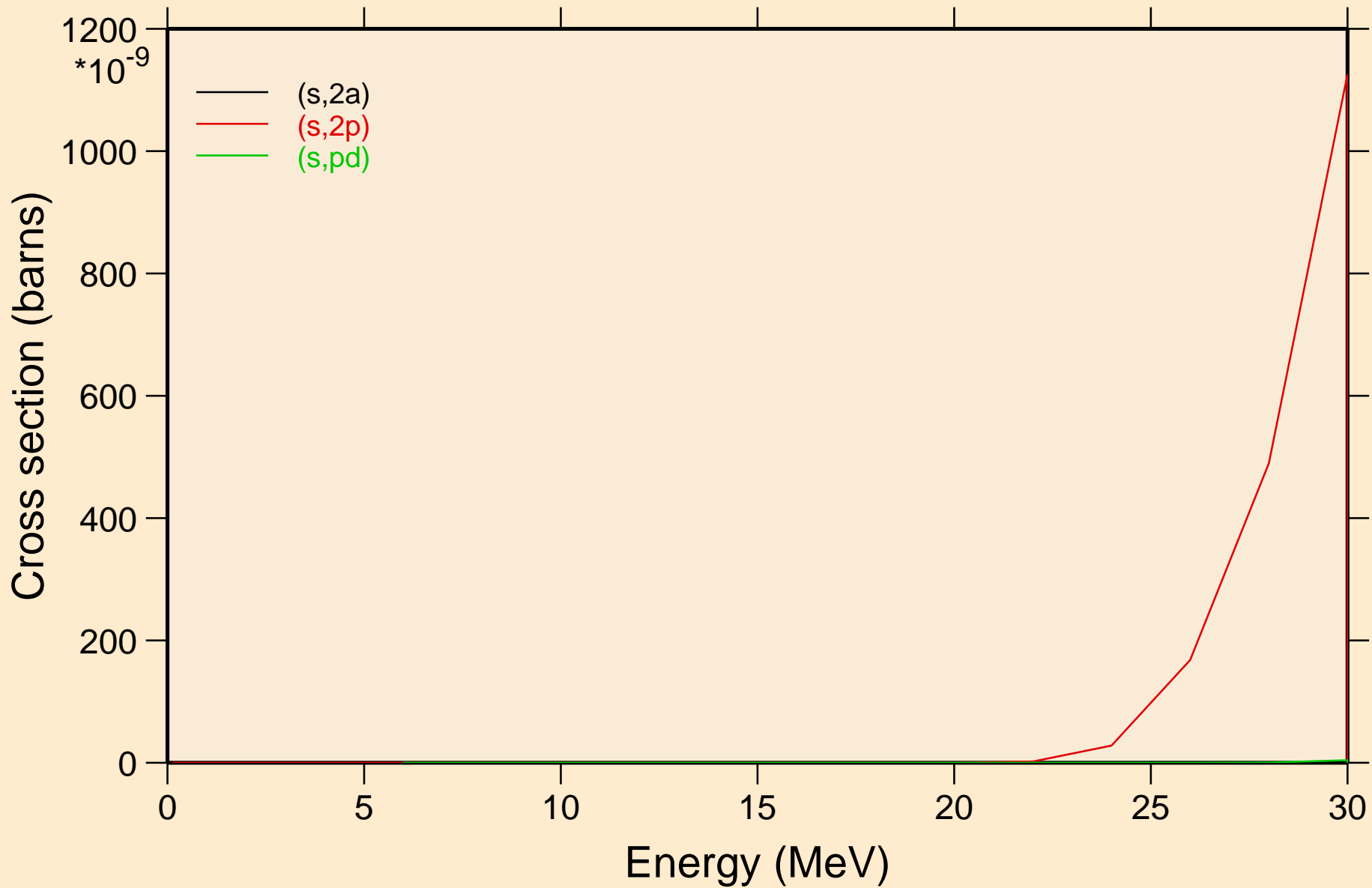

PU229 HELION ACER TENDL-2021 LIBRARY; T=0.K
angular distribution for elastic

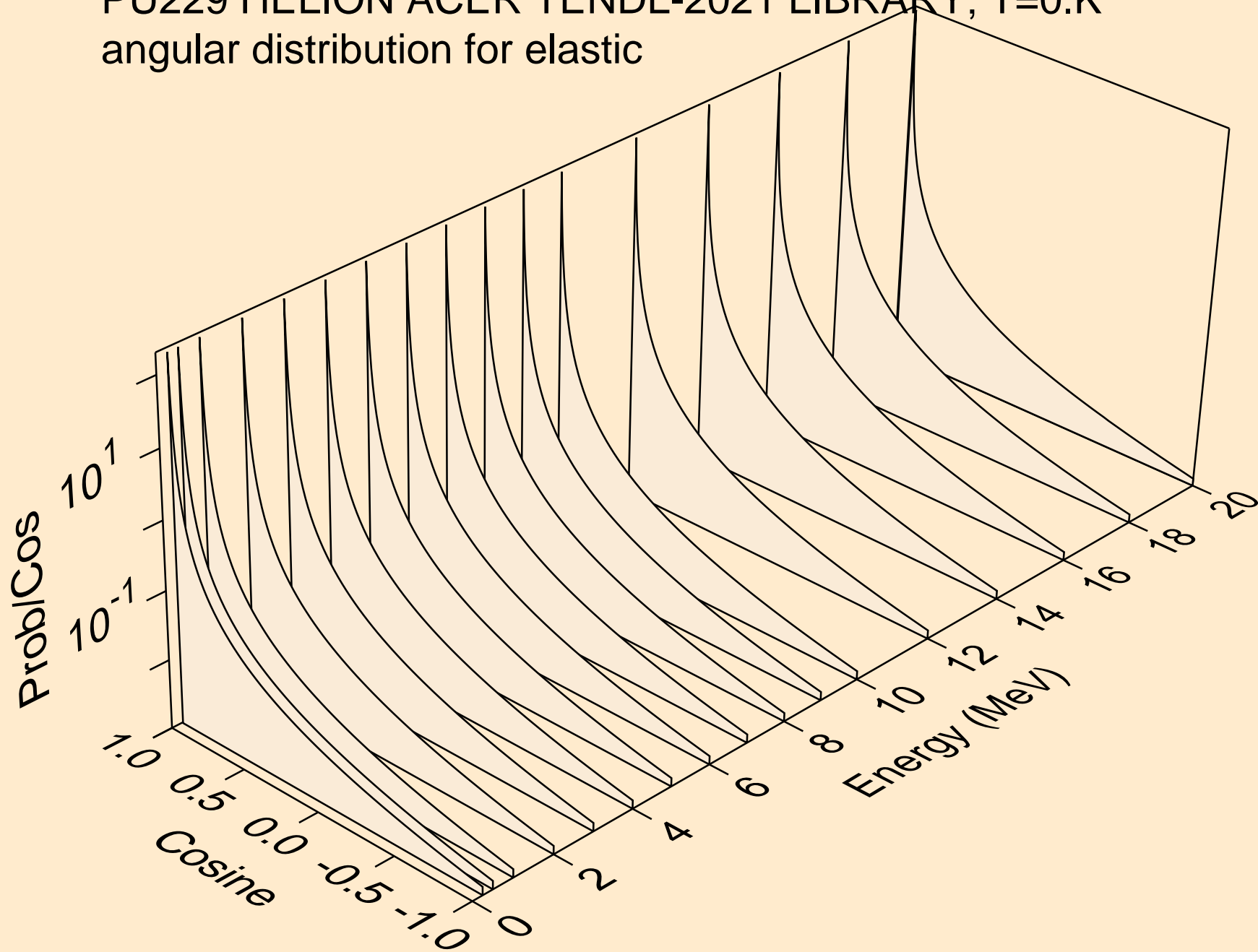

PU229 HELION ACER TENDL-2021 LIBRARY; T=0.K
angular distribution for elastic

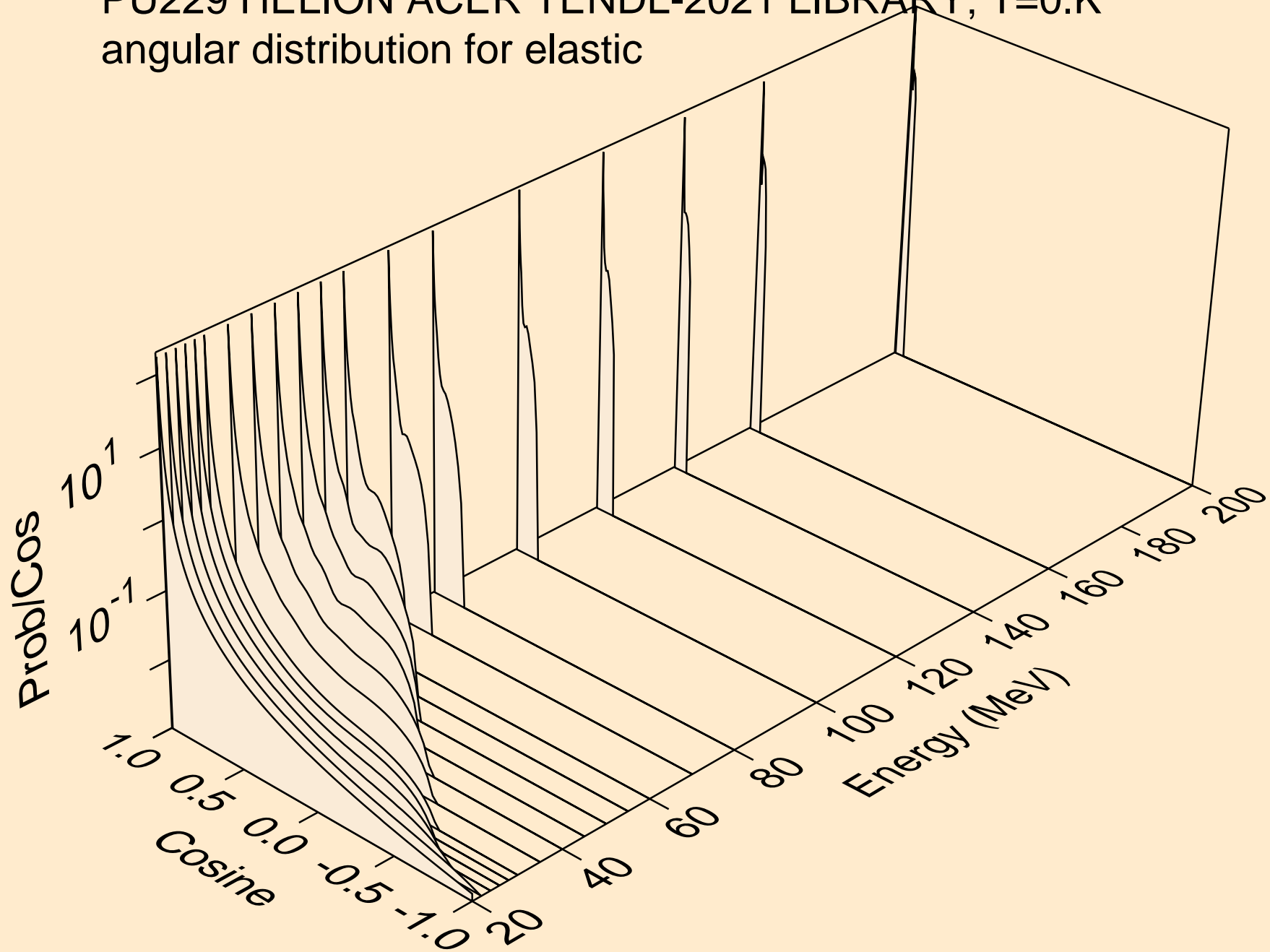

PU229 HELION ACER TENDL-2021 LIBRARY; T=0.K
He-3 emission for (s,x)

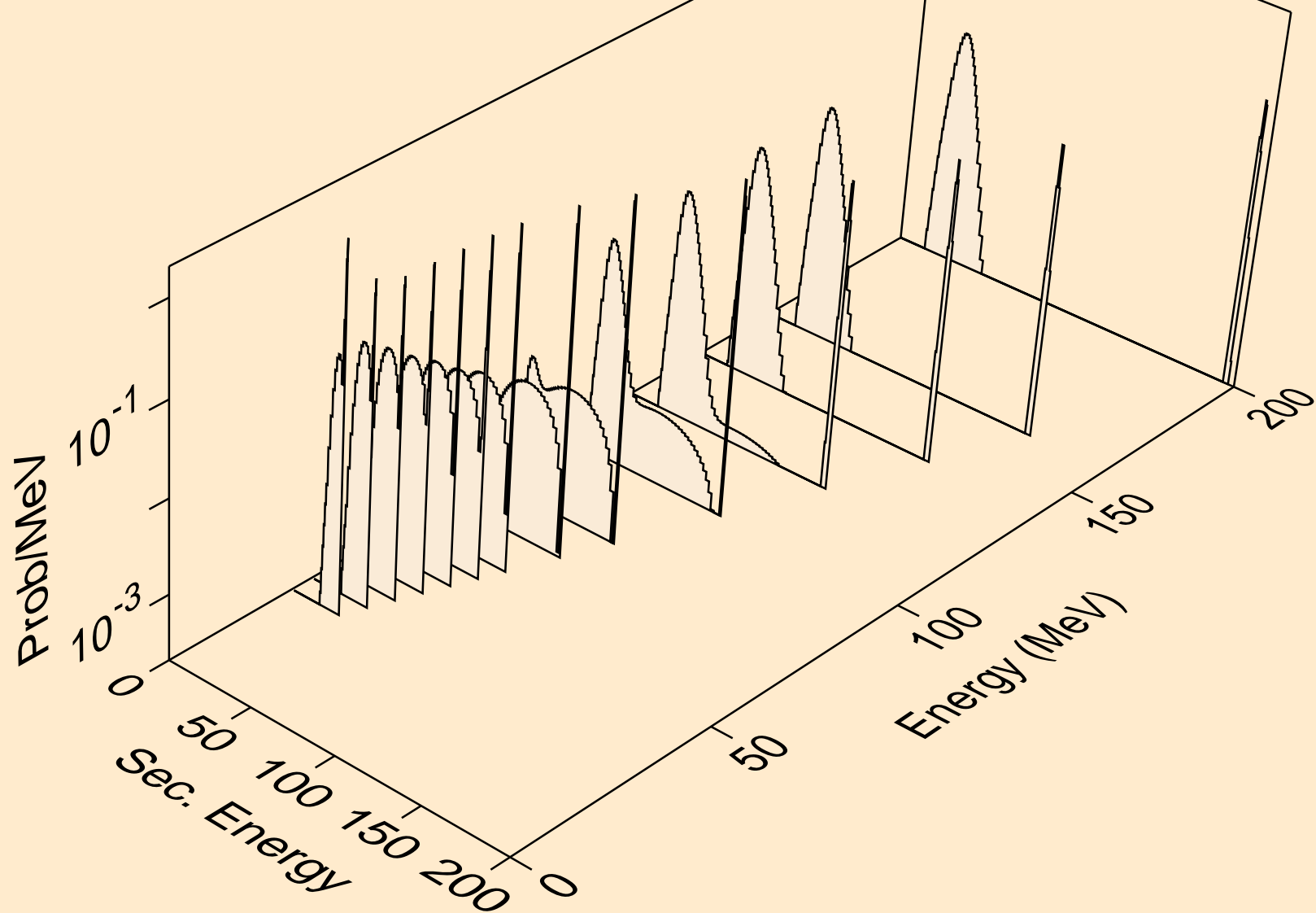

PU229 HELION ACER TENDL-2021 LIBRARY; T=0.K
He-3 emission for inelastic

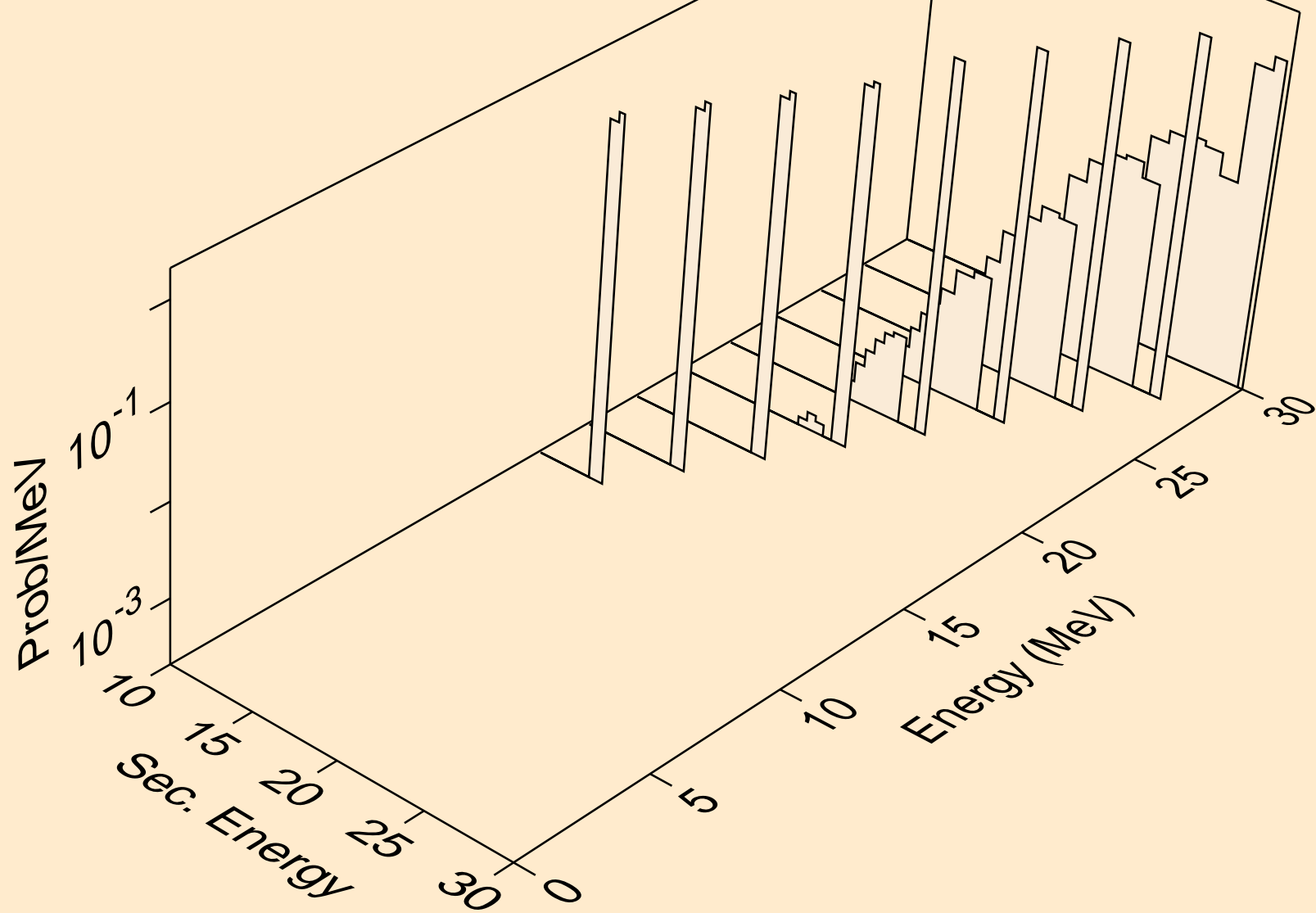

PU229 HELION ACER TENDL-2021 LIBRARY; T=0.K
Photon emission for (z,n)

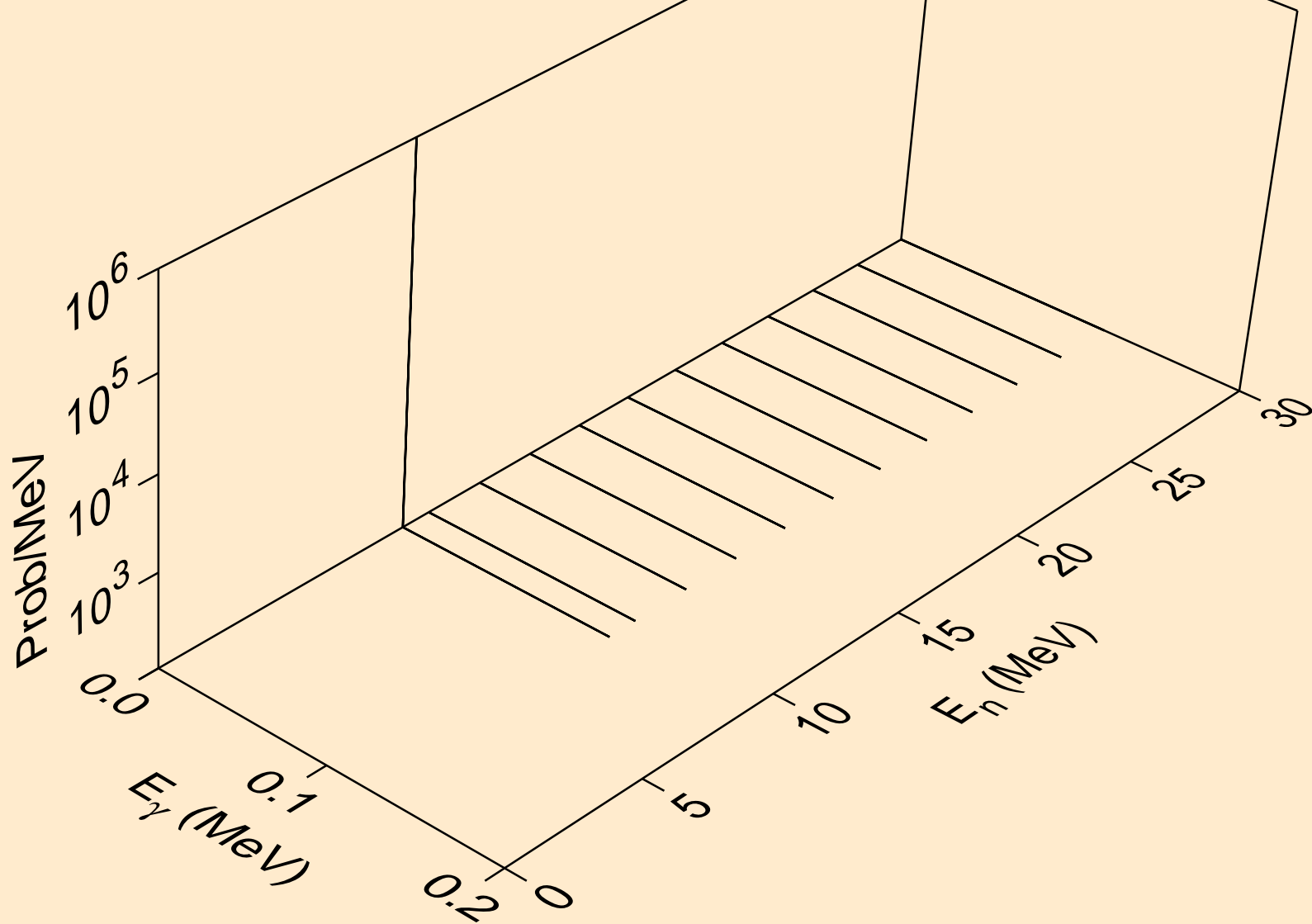

PU229 HELION ACER TENDL-2021 LIBRARY; T=0.K
Photon emission for (n,x)

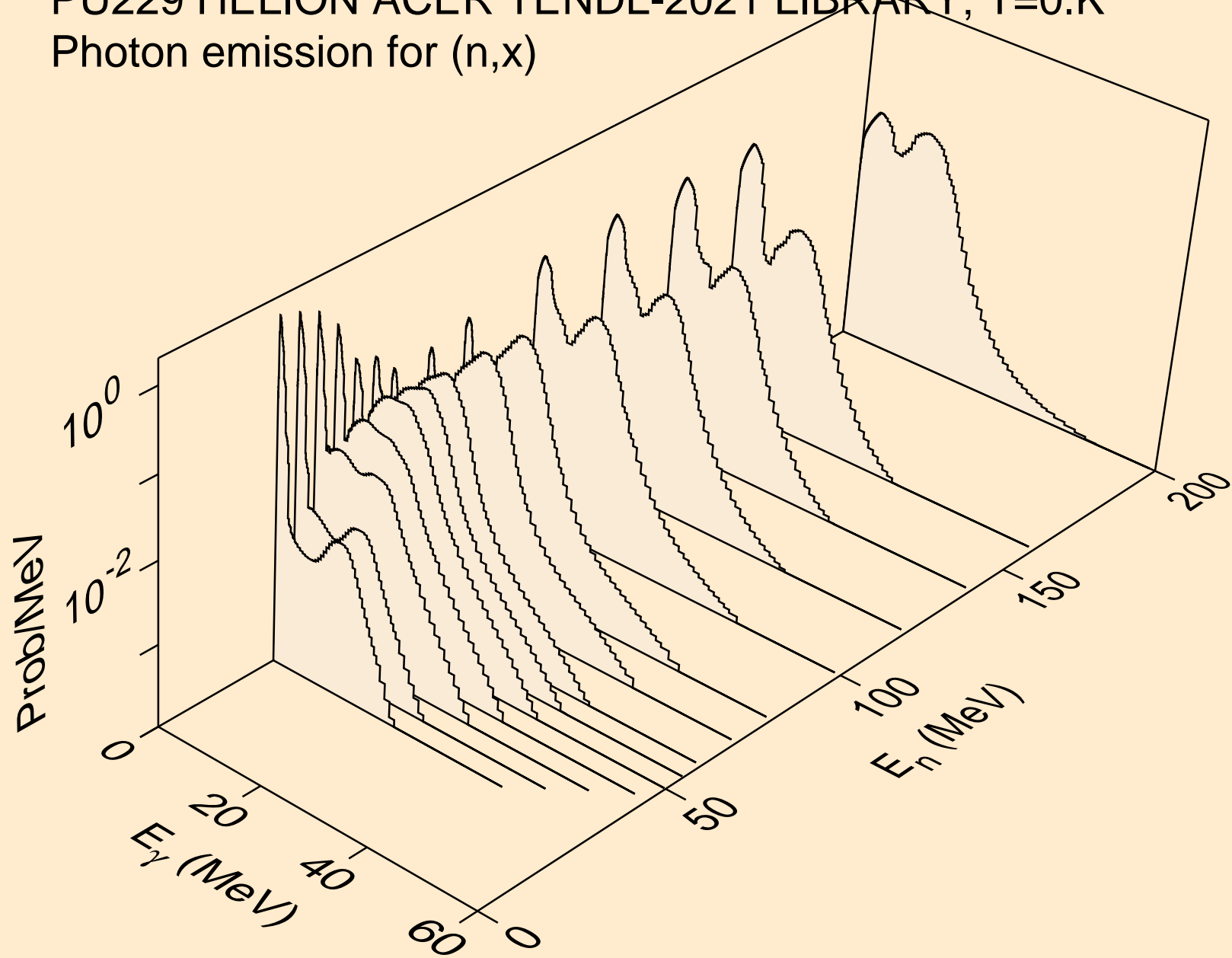

PU229 HELION ACER TENDL-2021 LIBRARY; T=0.K
Photon emission for (n,n*)p

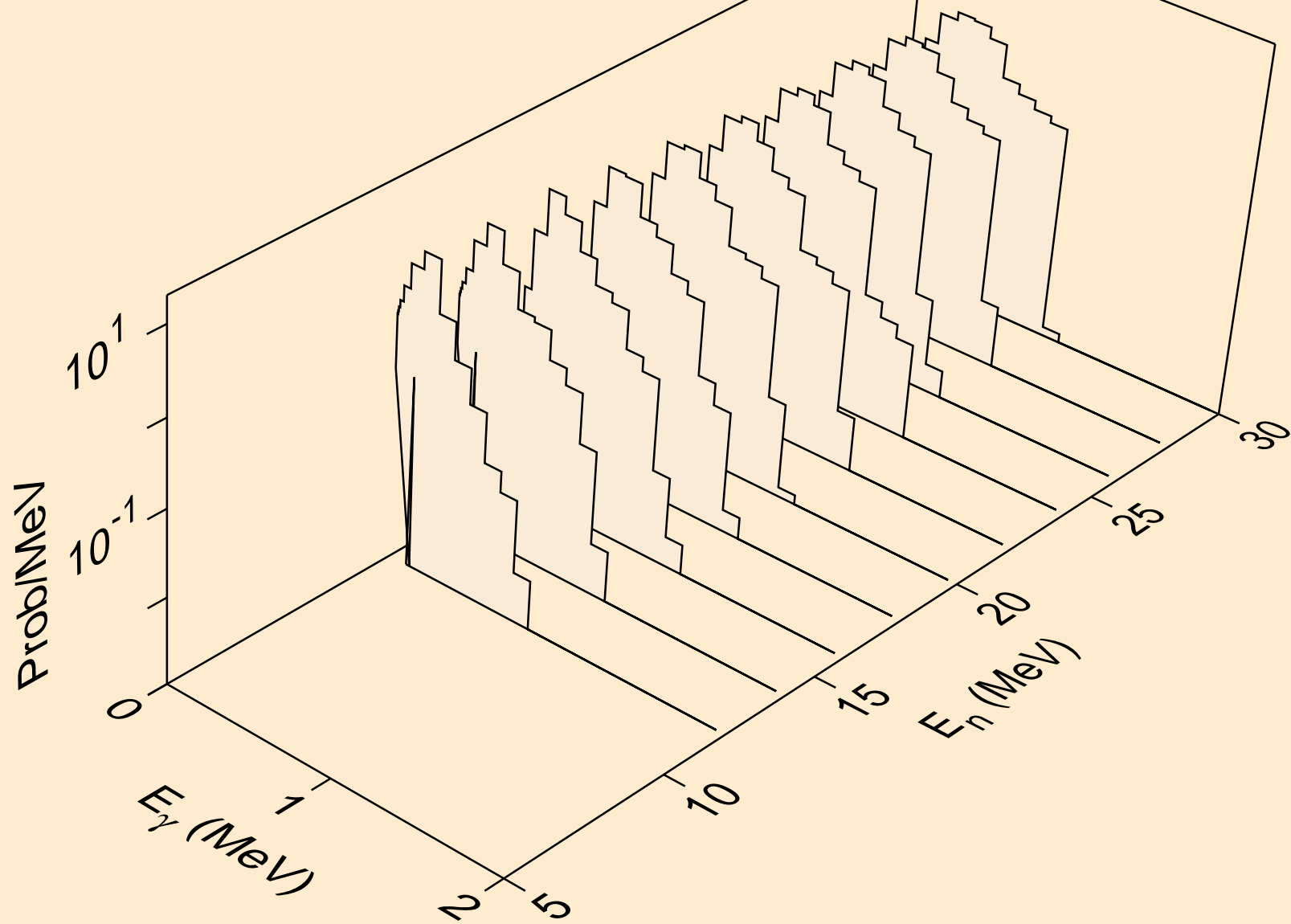

PU229 HELION ACER TENDL-2021 LIBRARY; T=0.K
Photon emission for (n,n*)t

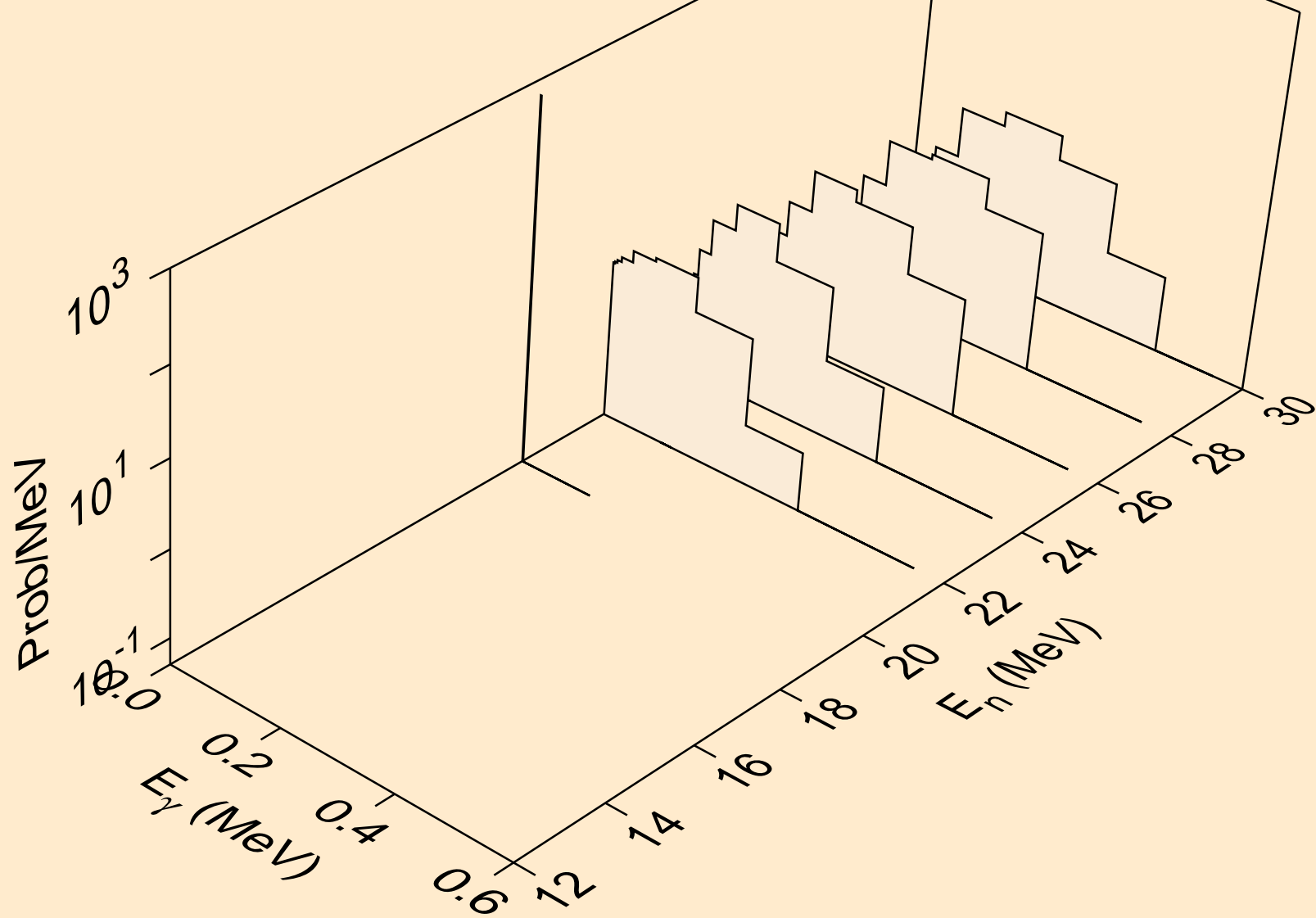

PU229 HELION ACER TENDL-2021 LIBRARY; T=0.K
Photon emission for (n,2np)

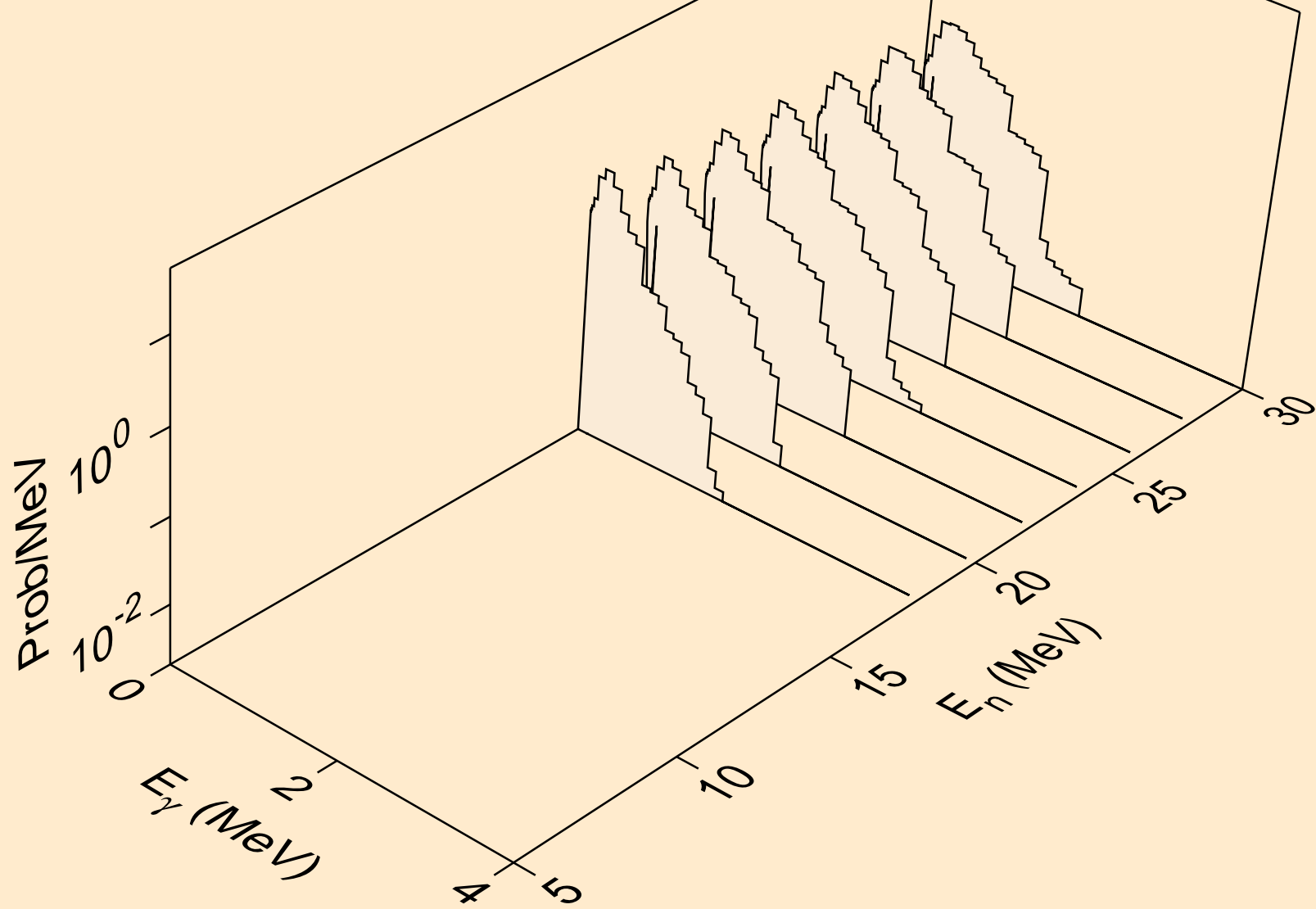

PU229 HELION ACER TENDL-2021 LIBRARY; T=0.K
Photon emission for (n,p)

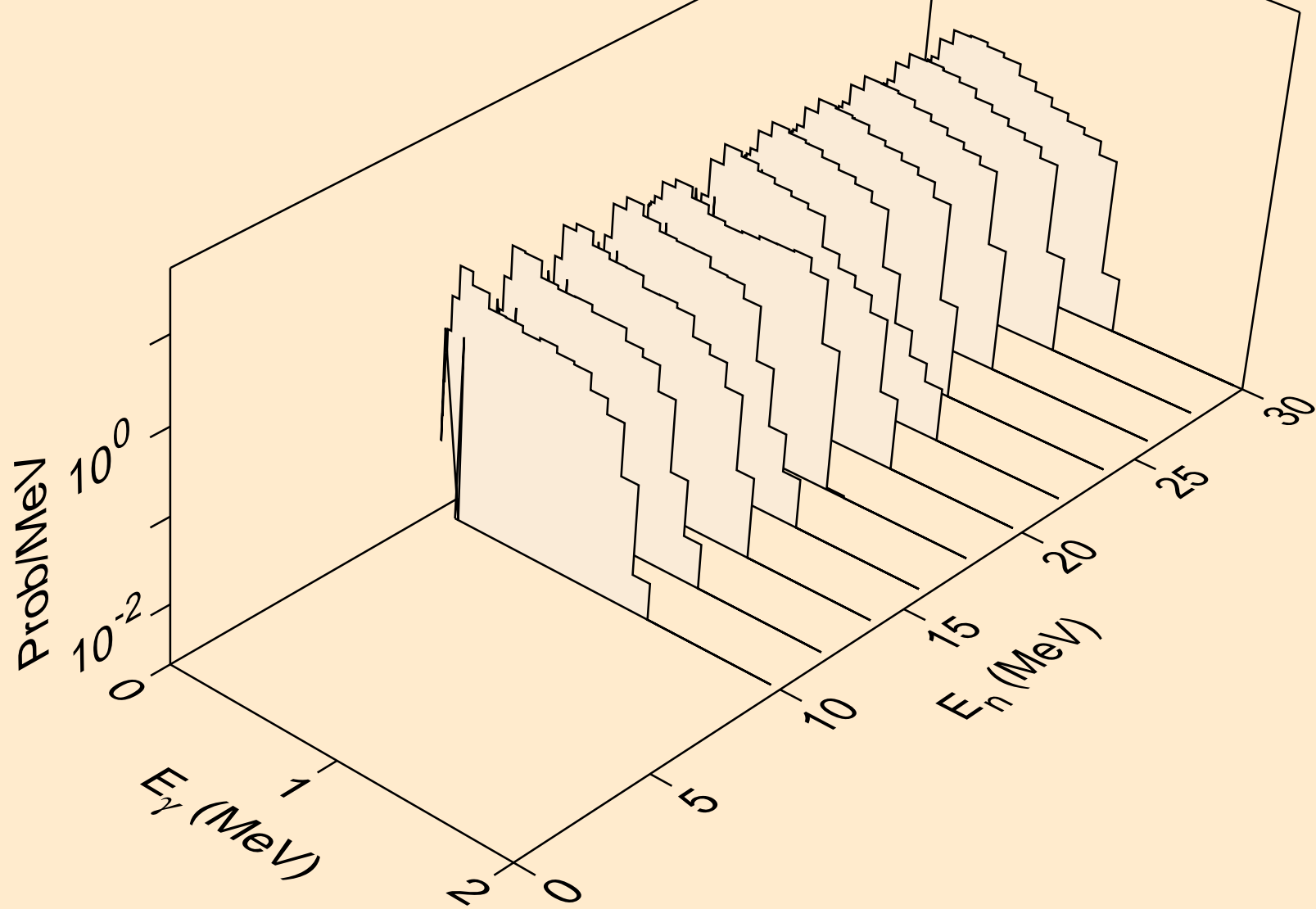

PU229 HELION ACER TENDL-2021 LIBRARY; T=0.K
Photon emission for (n,d)

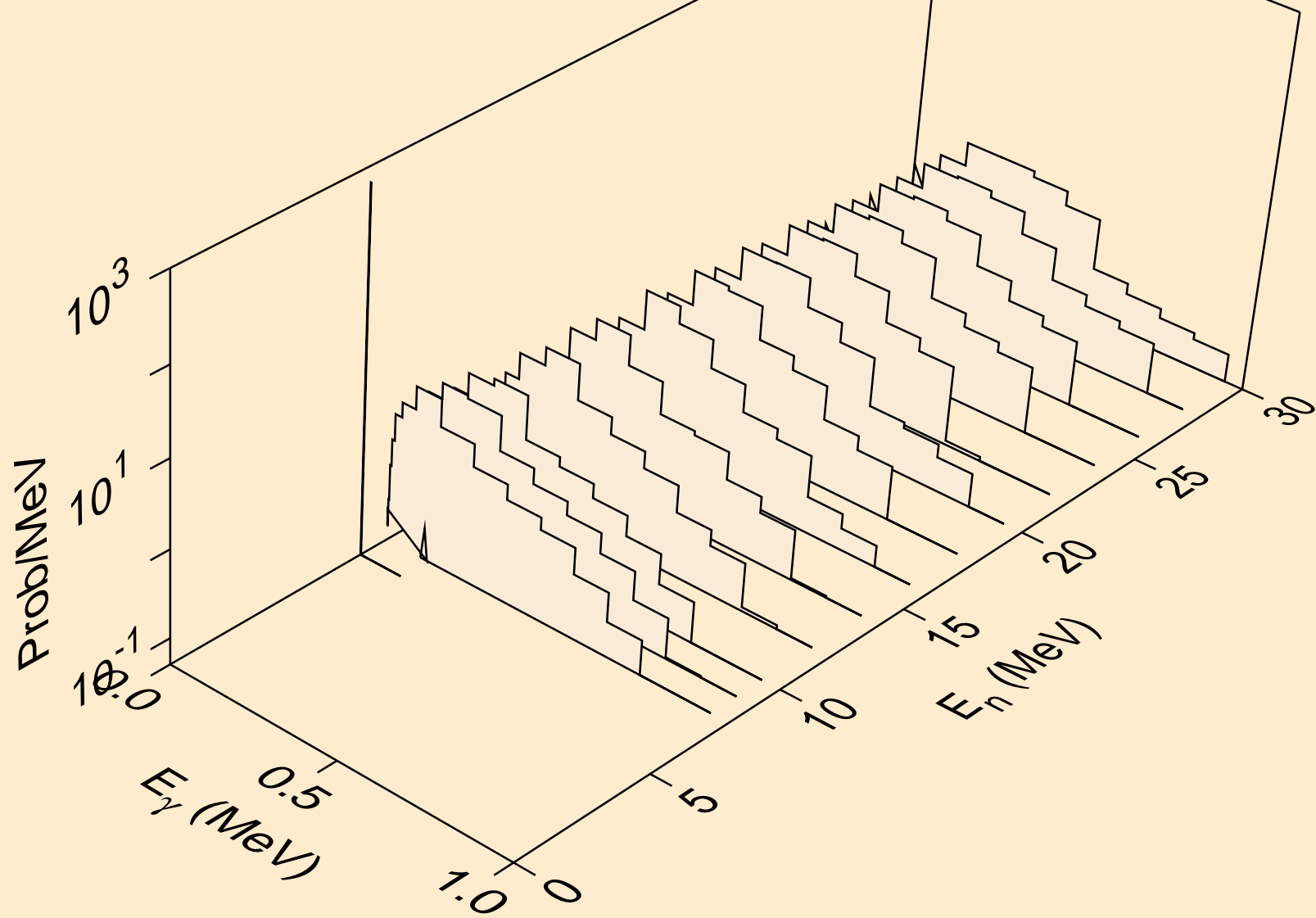

PU229 HELION ACER TENDL-2021 LIBRARY; T=0.K
Photon emission for (n,t)

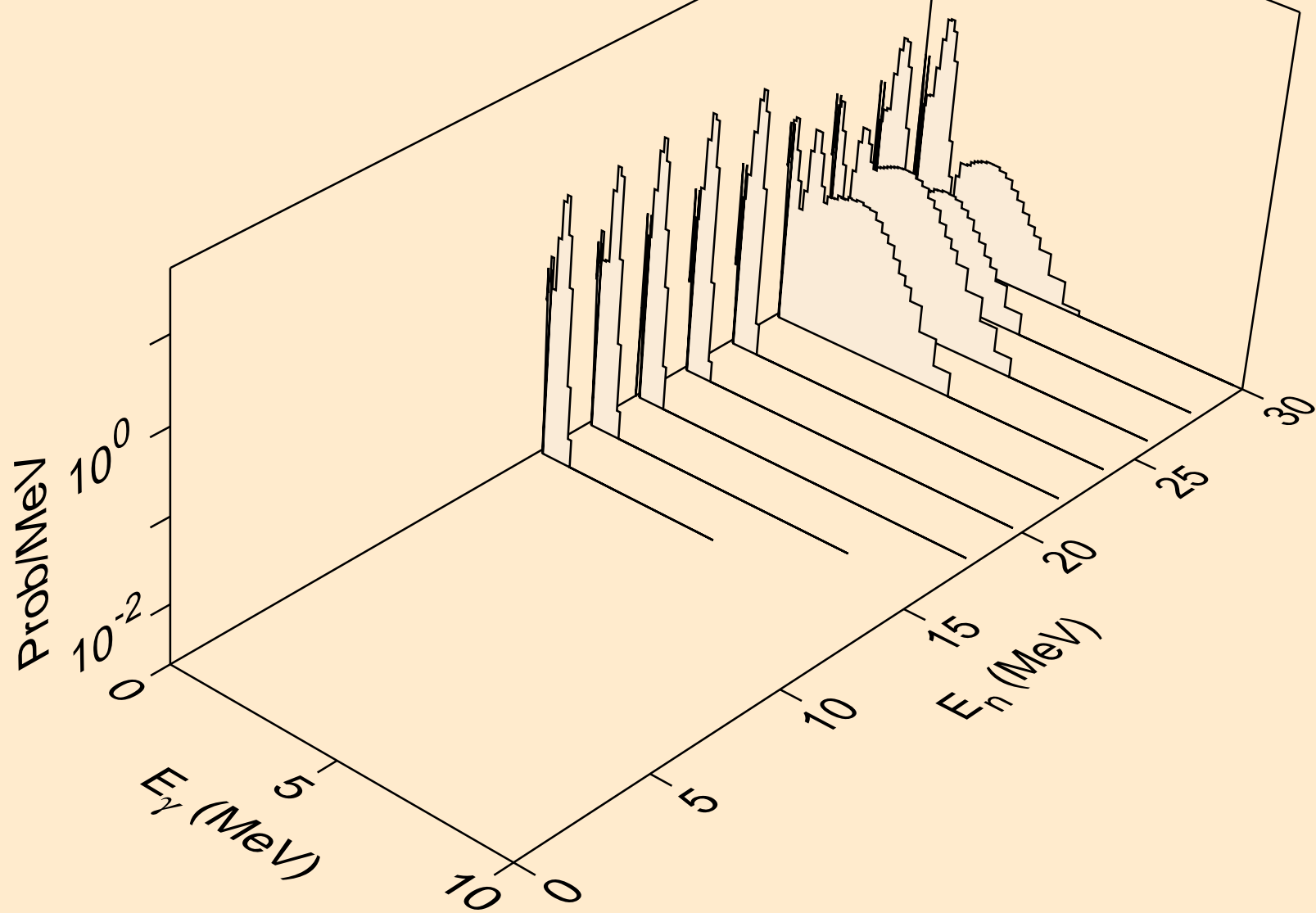

PU229 HELION ACER TENDL-2021 LIBRARY; T=0.K
Photon emission for inelastic

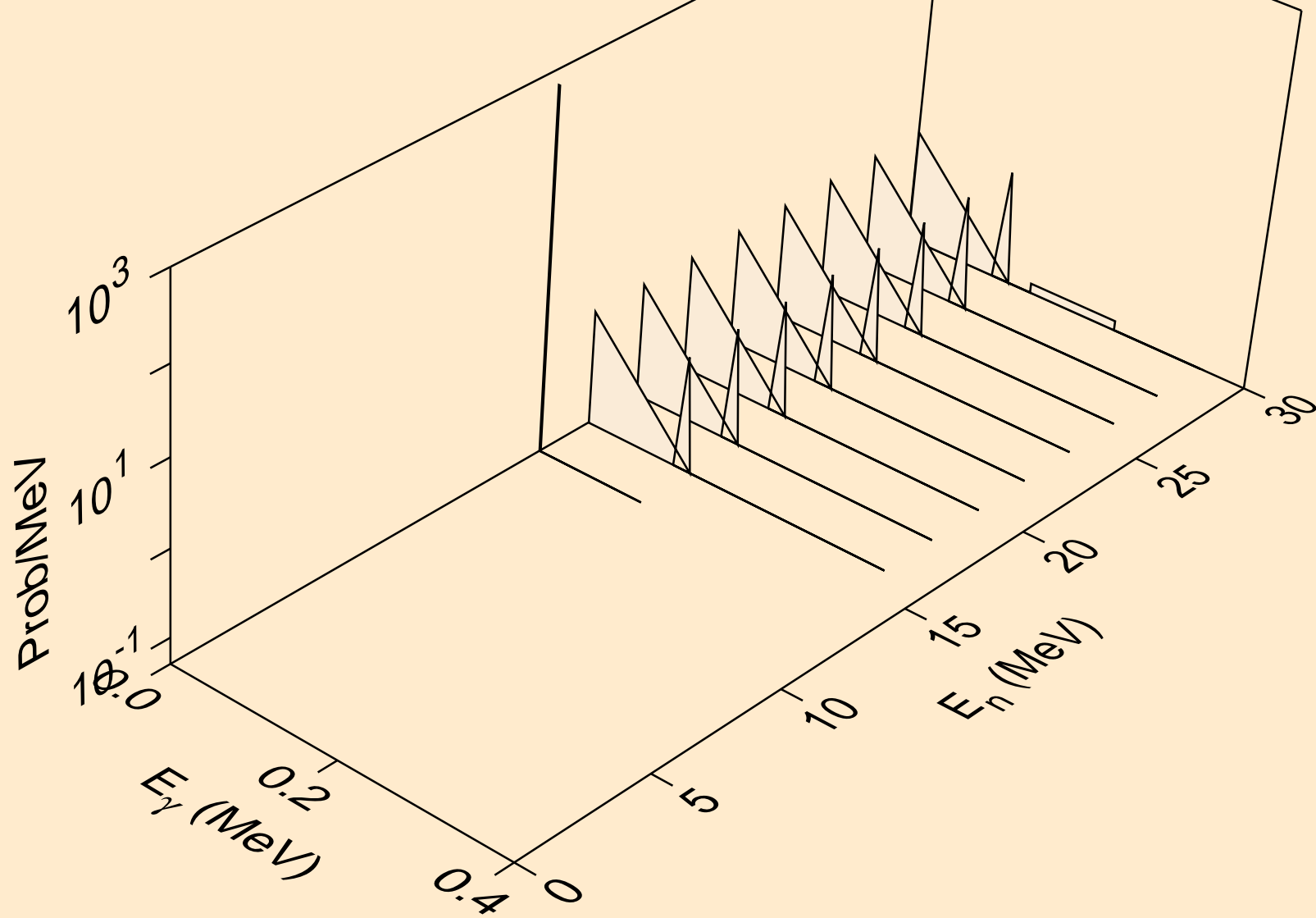

PU229 HELION ACER TENDL-2021 LIBRARY; T=0.K
Photon emission for (n,a)

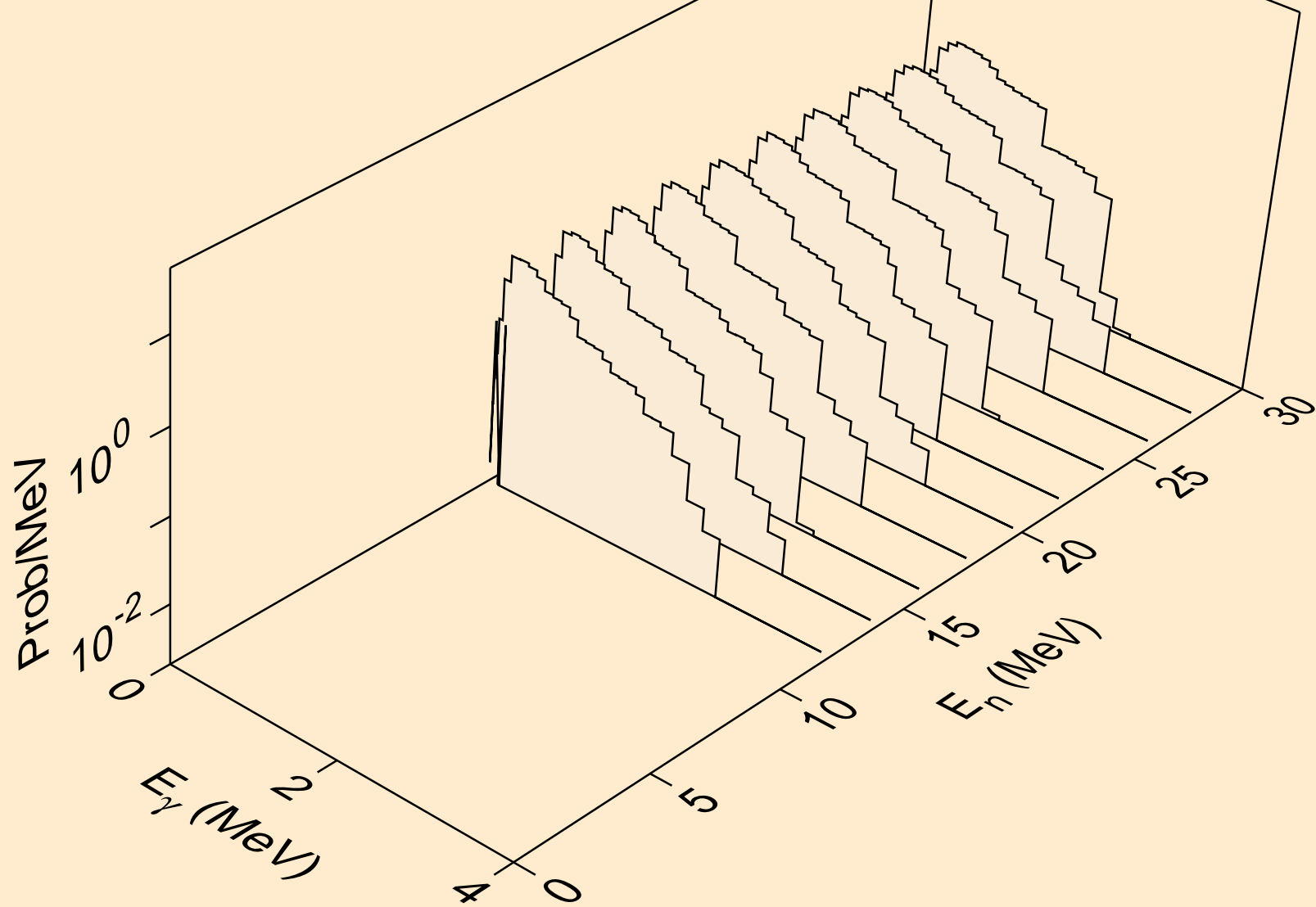

PU229 HELION ACER TENDL-2021 LIBRARY; T=0.K
Photon emission for (n,2a)

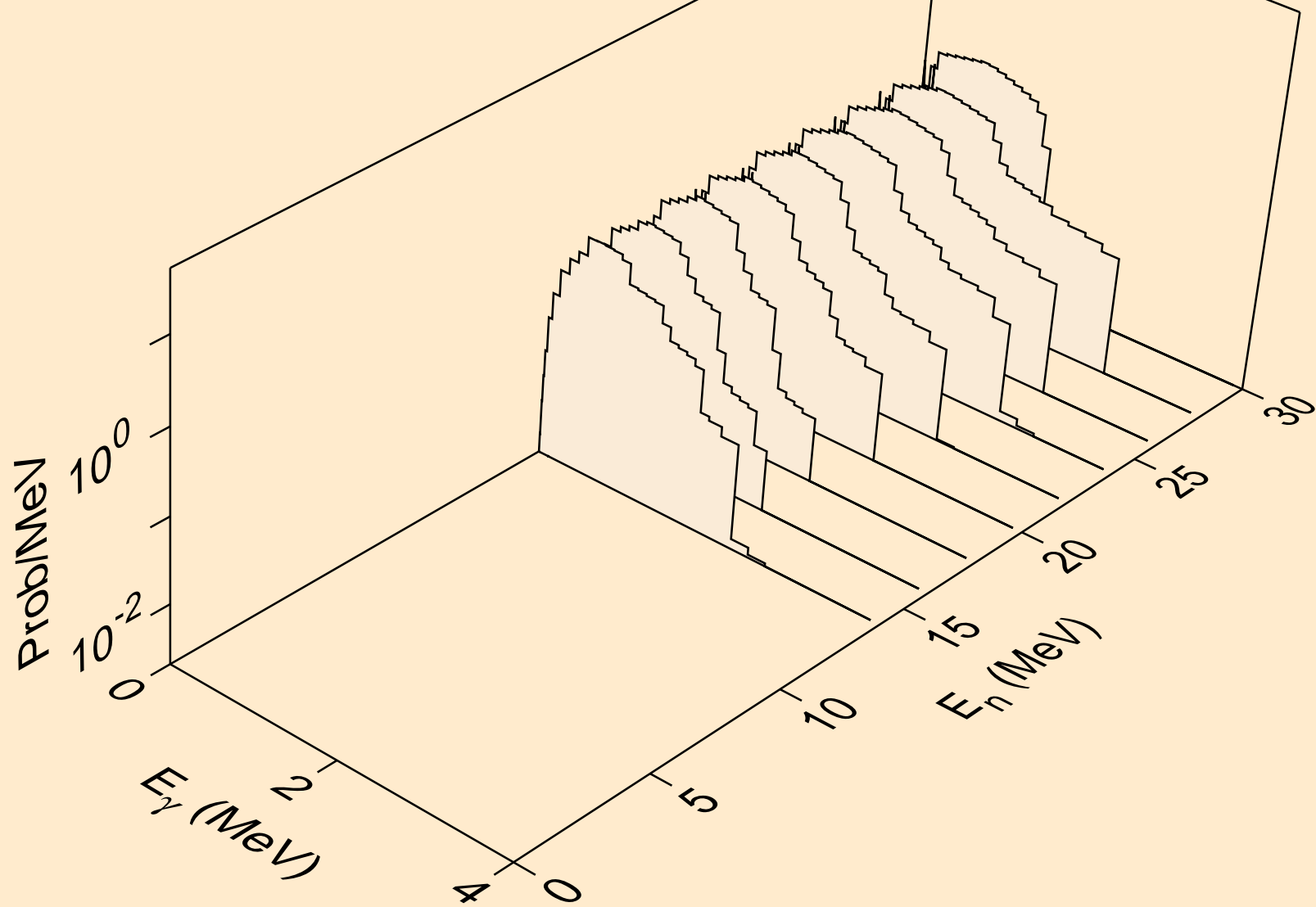

PU229 HELION ACER TENDL-2021 LIBRARY; T=0.K
Photon emission for (n,2p)

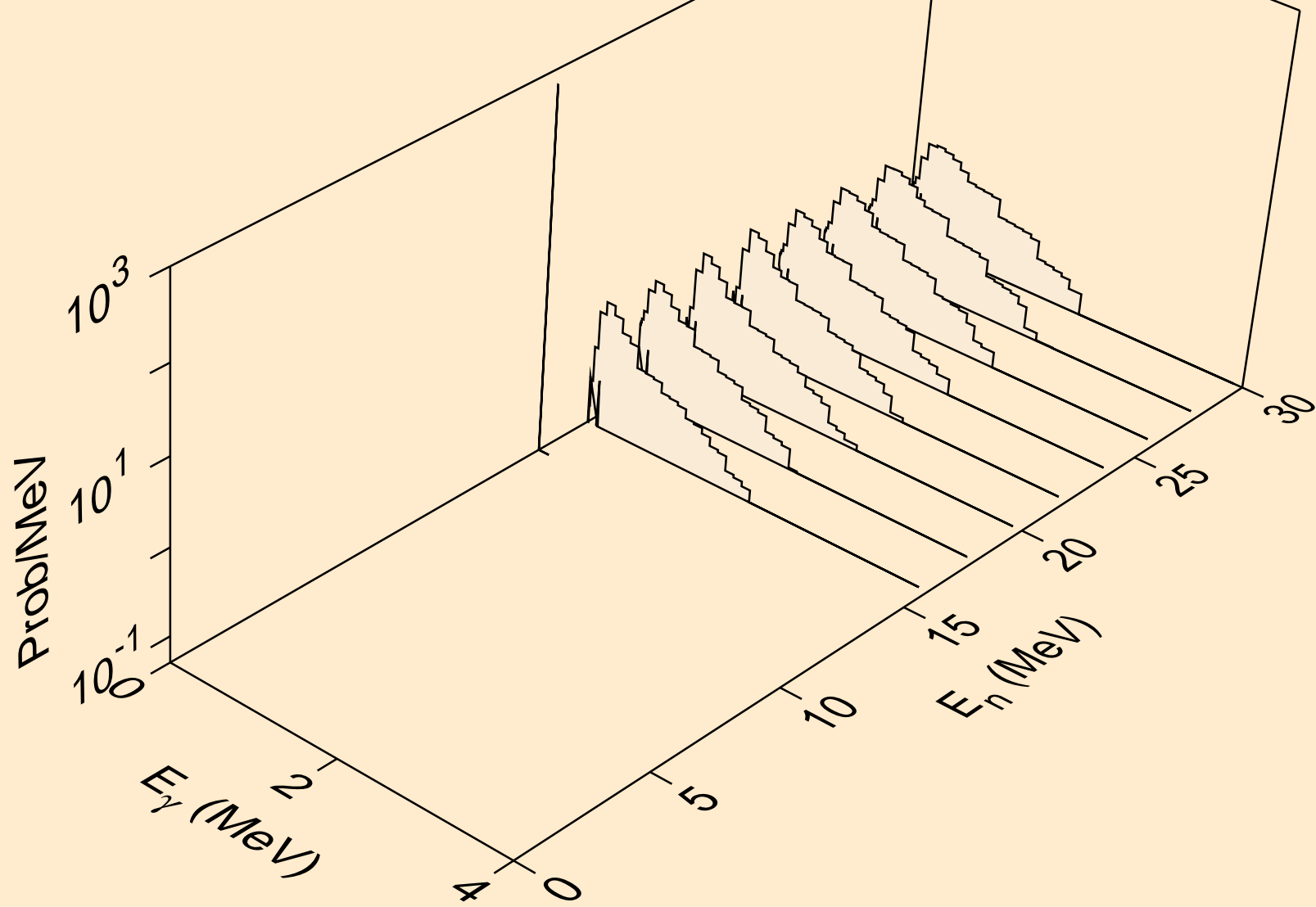

PU229 HELION ACER TENDL-2021 LIBRARY; T=0.K
Photon emission for (n,pd)

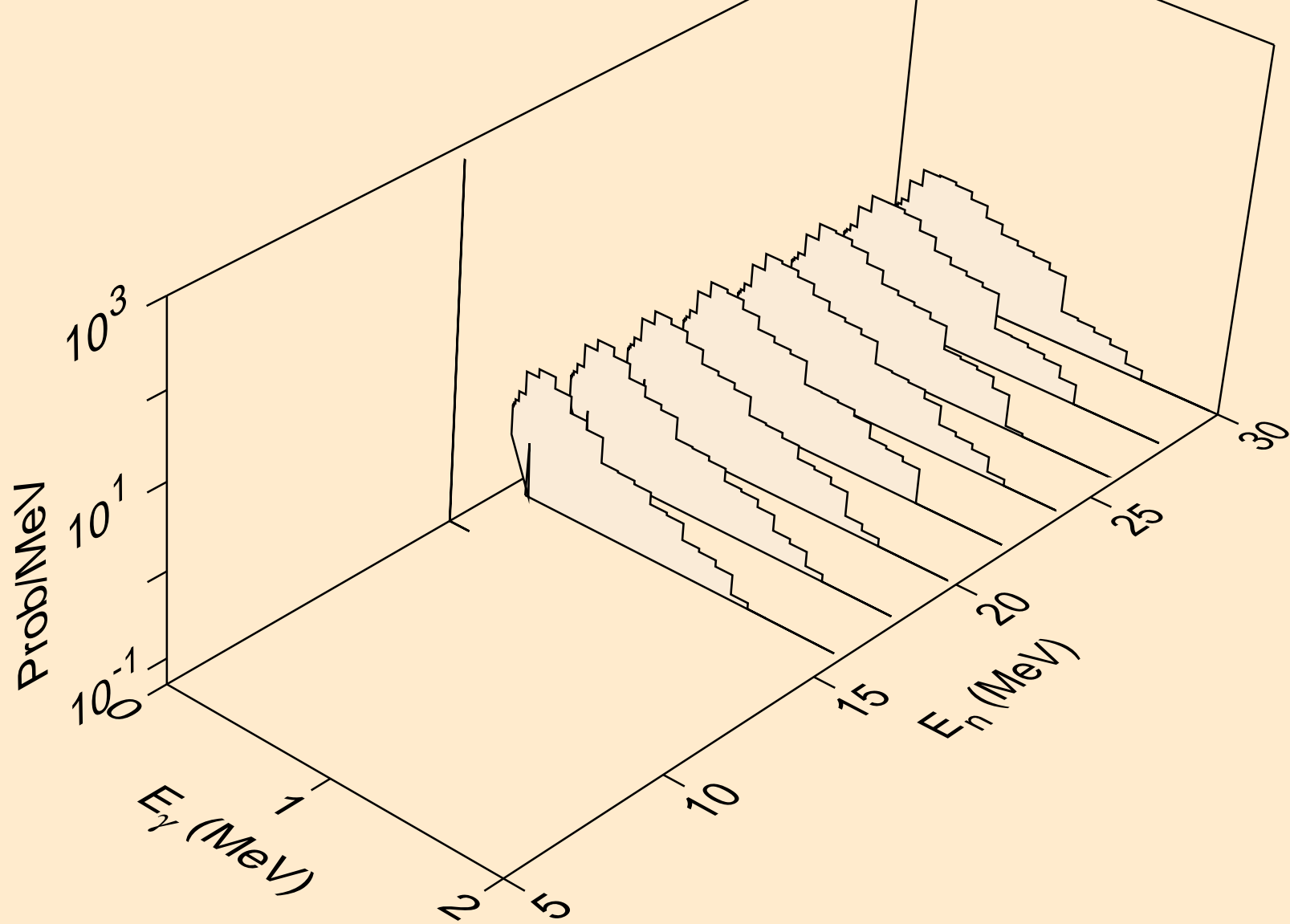

PU229 HELION ACER TENDL-2021 LIBRARY; T=0.K
Particle heating contributions

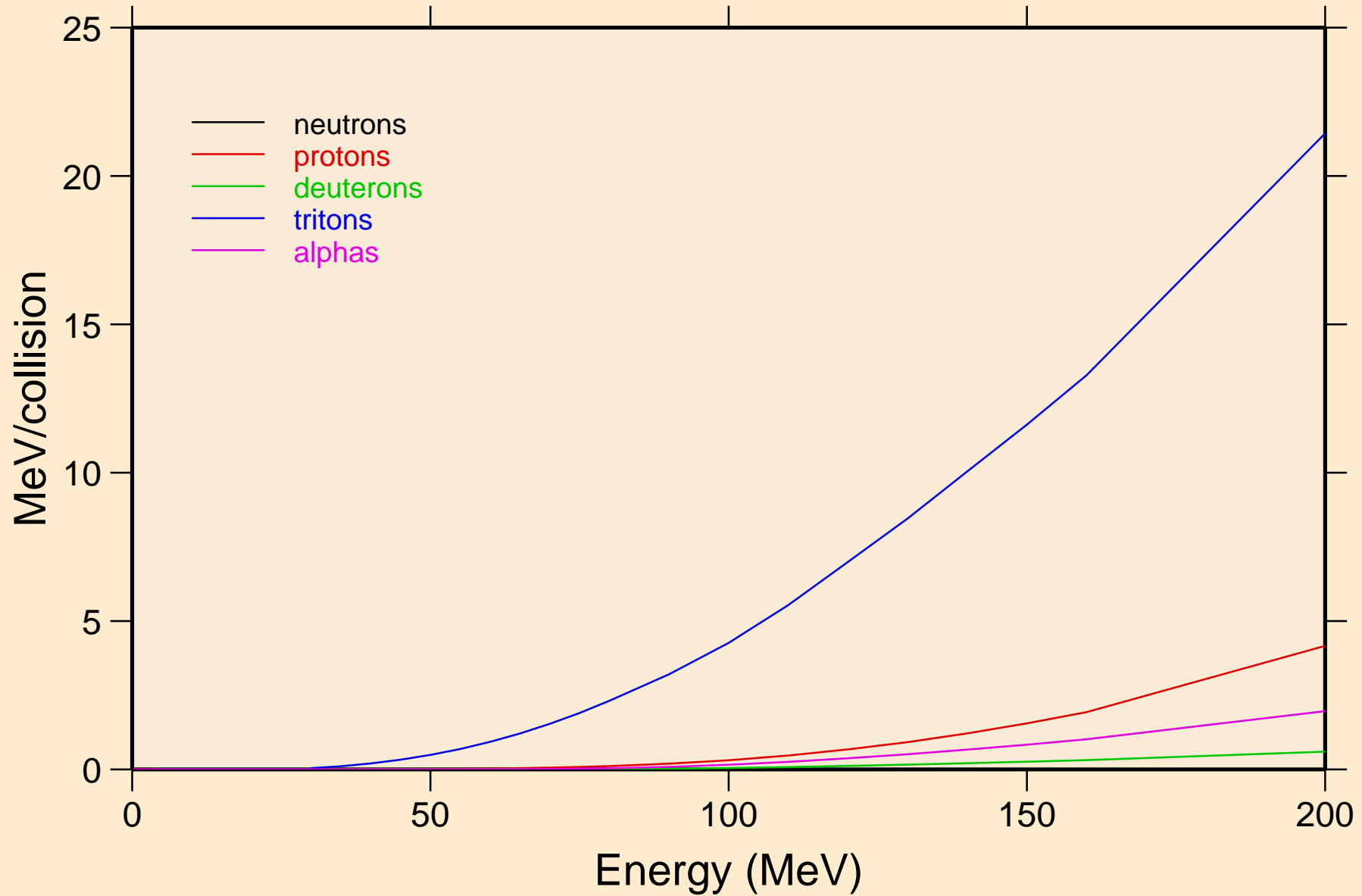

PU229 HELION ACER TENDL-2021 LIBRARY; T=0.K
Recoil Heating

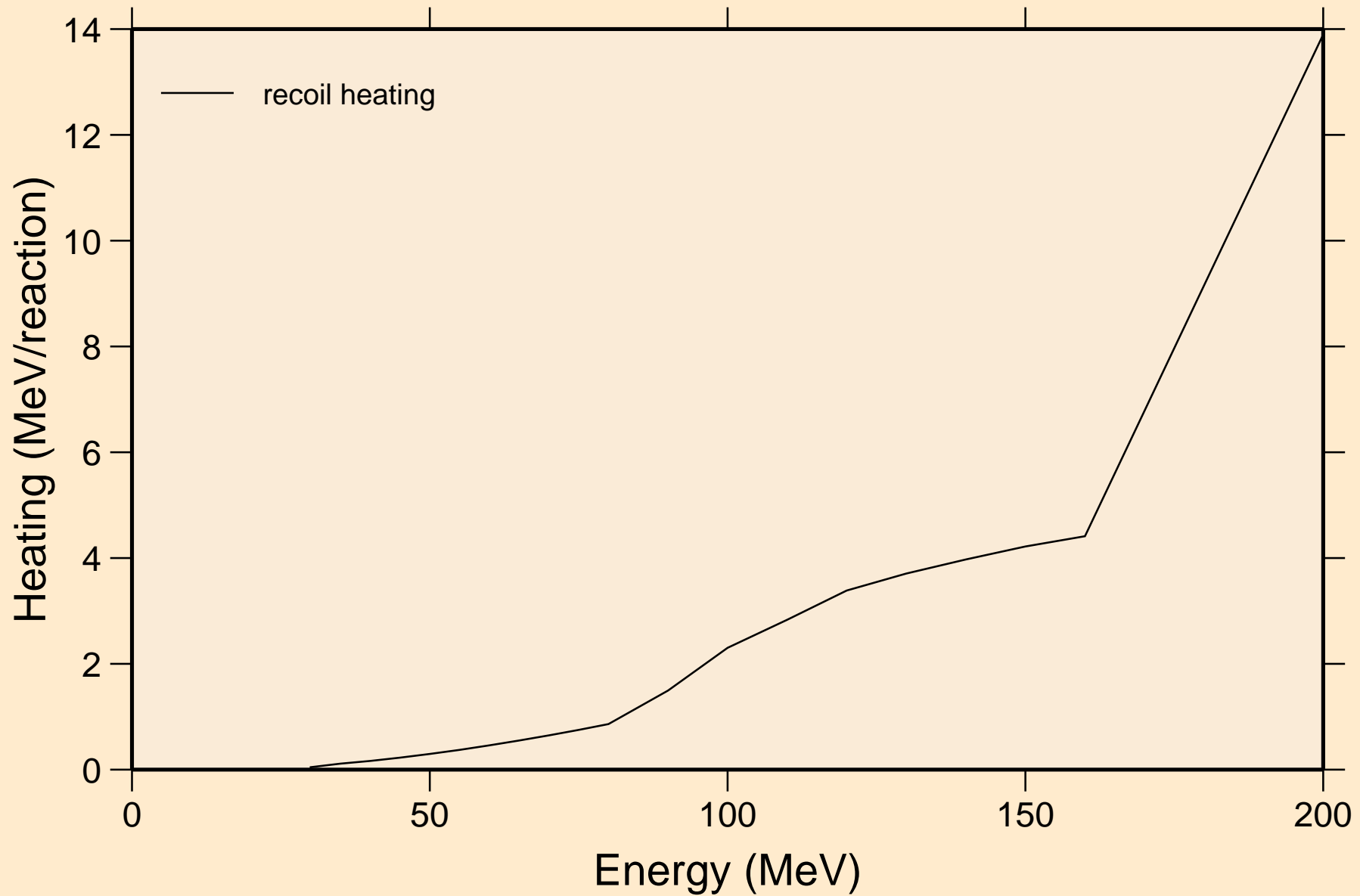

PU229 HELION ACER TENDL-2021 LIBRARY; T=0.K
Particle production cross sections

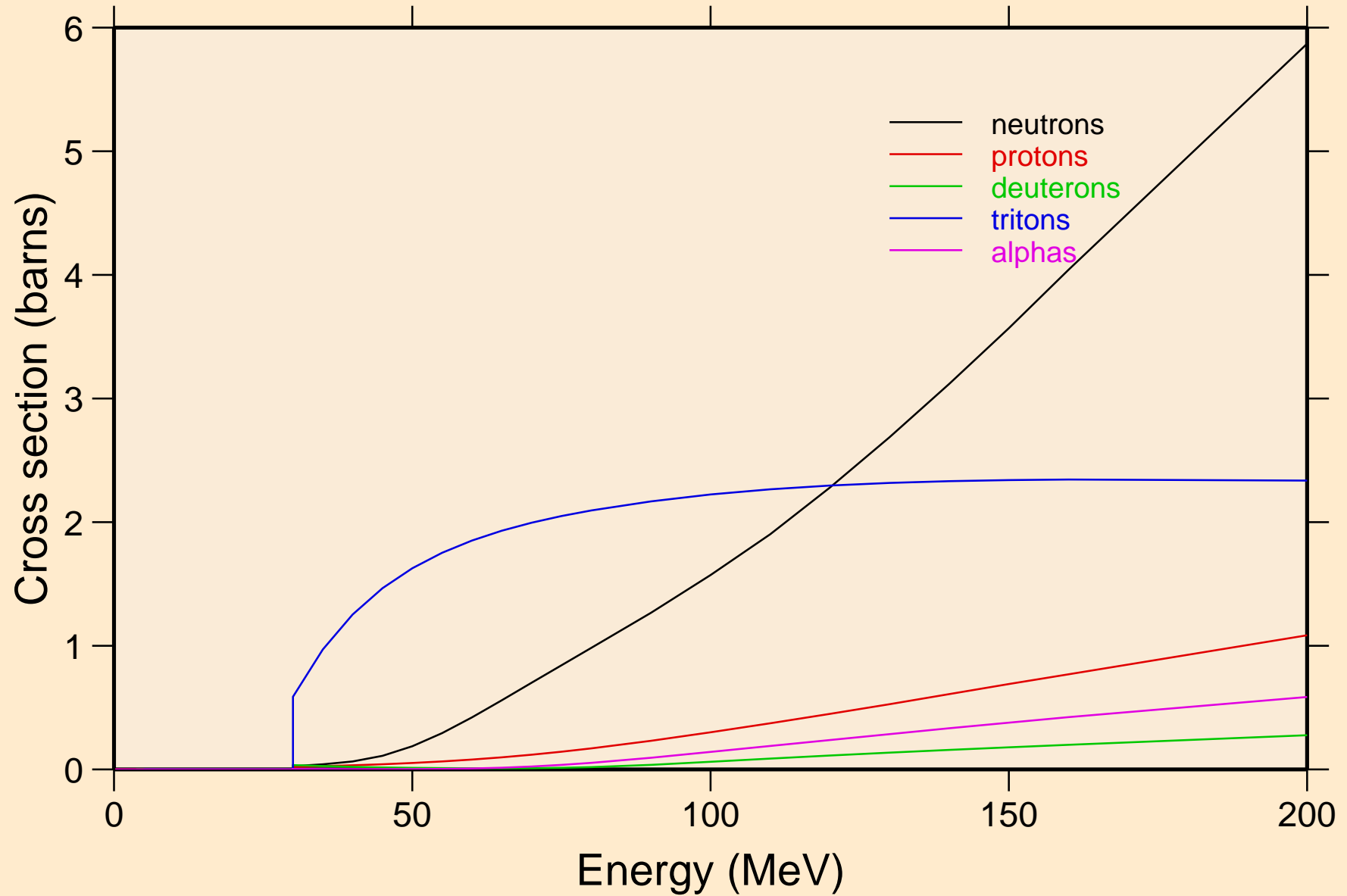

PU229 HELION ACER TENDL-2021 LIBRARY; T=0.K
neutrons from (s,n)

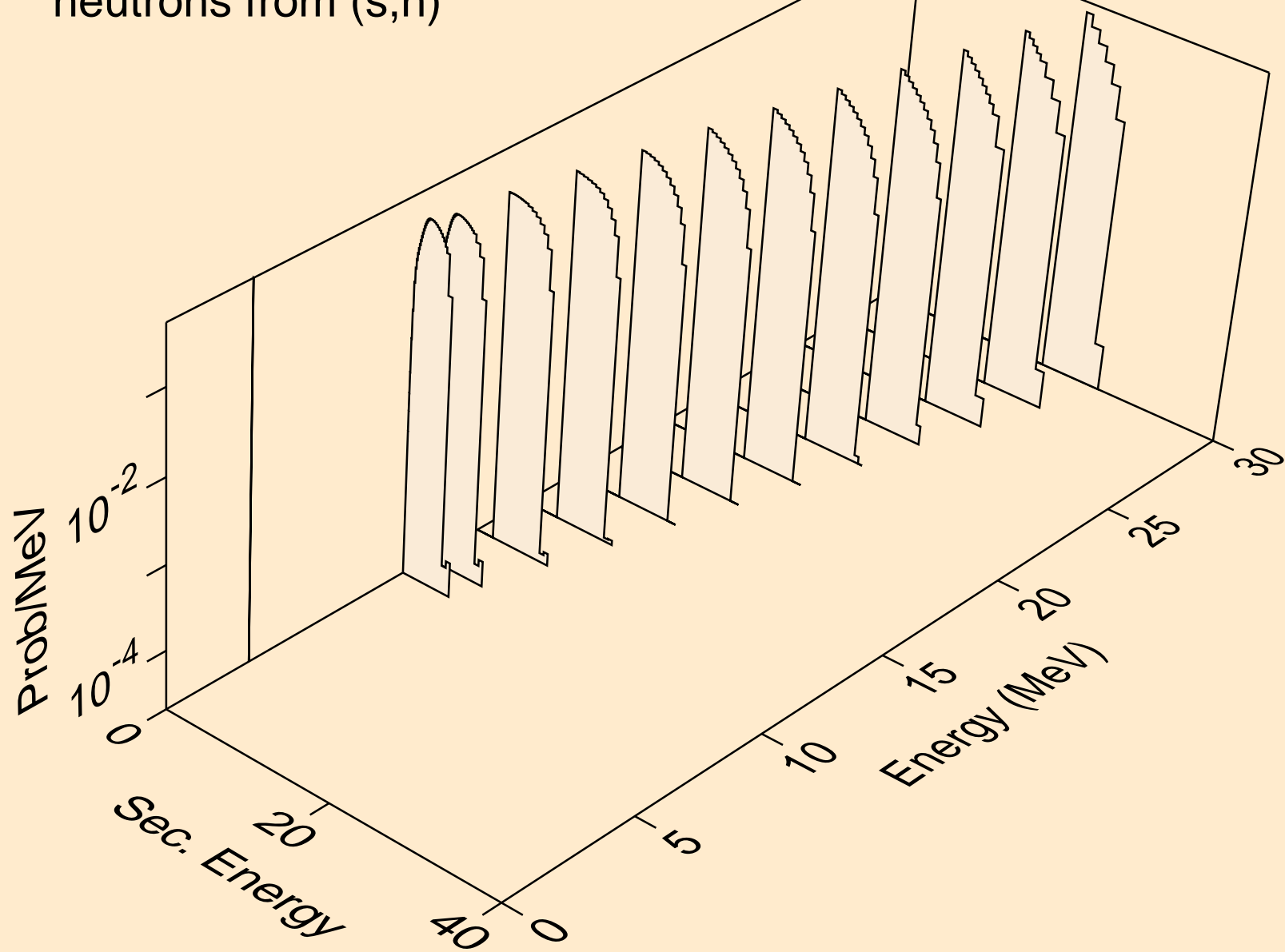

PU229 HELION ACER TENDL-2021 LIBRARY; T=0.K
neutrons from (s,x)

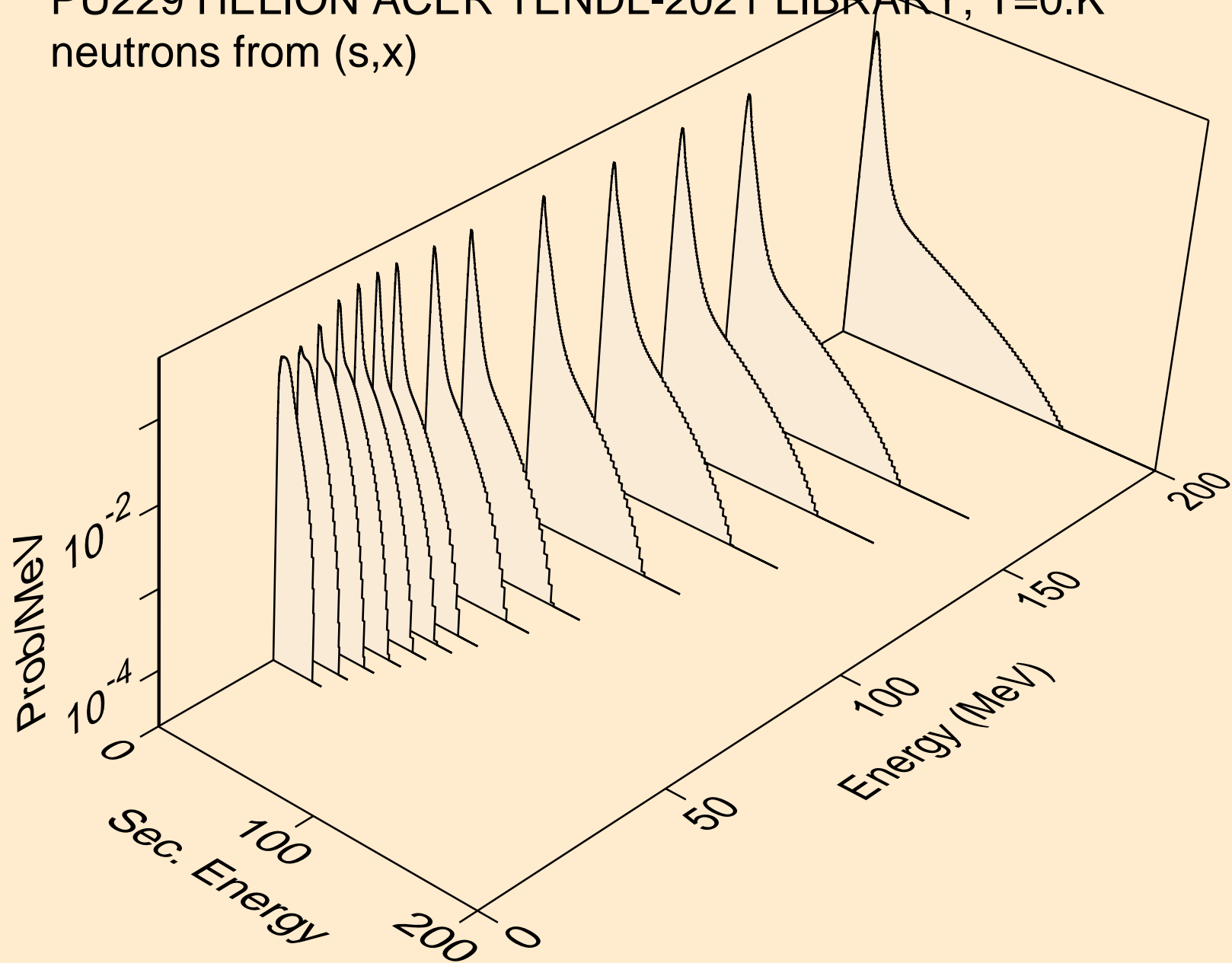

PU229 HELION ACER TENDL-2021 LIBRARY; T=0.K
neutrons from (s,n*)p

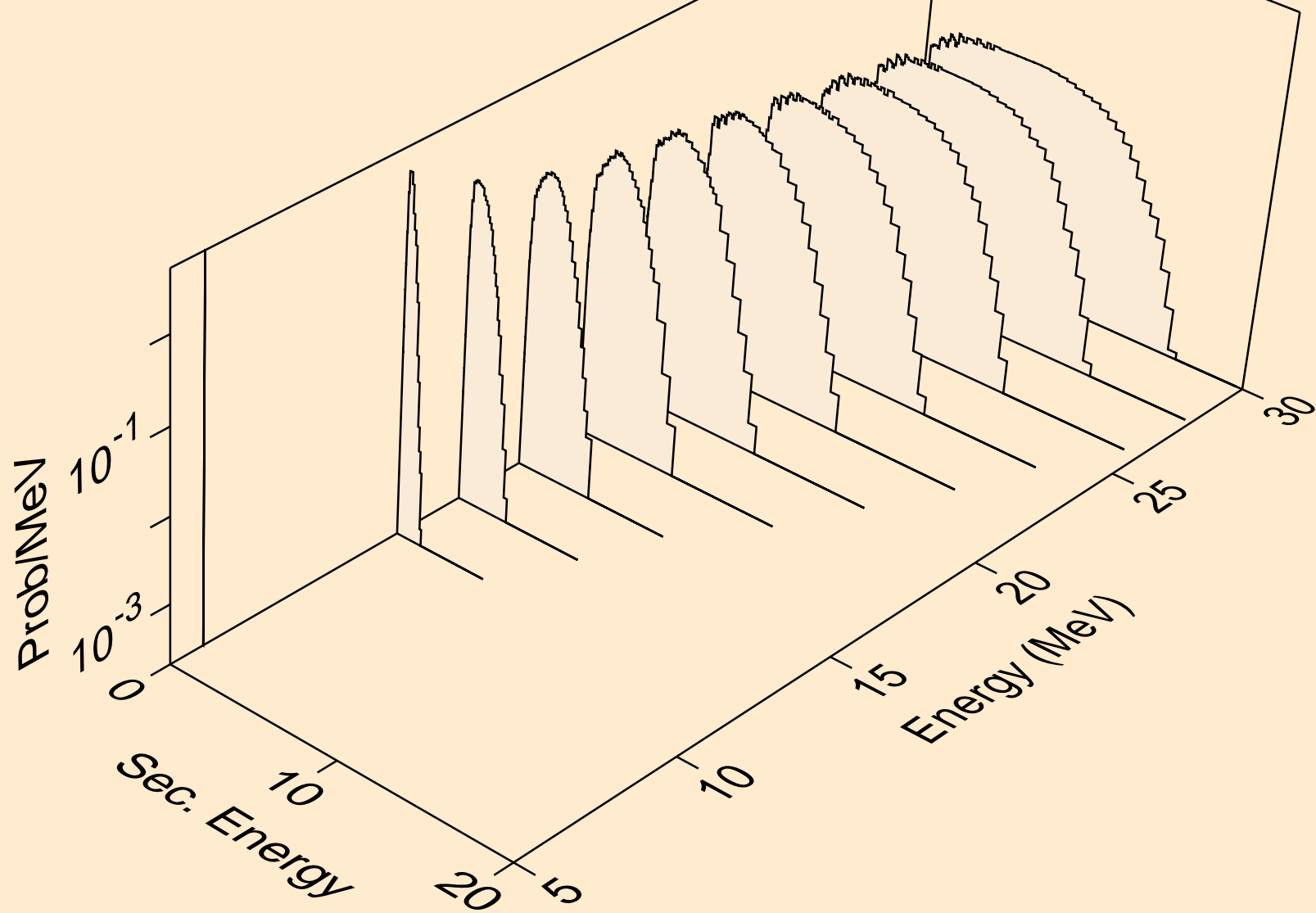

PU229 HELION ACER TENDL-2021 LIBRARY; T=0.K
neutrons from (s,n*)t

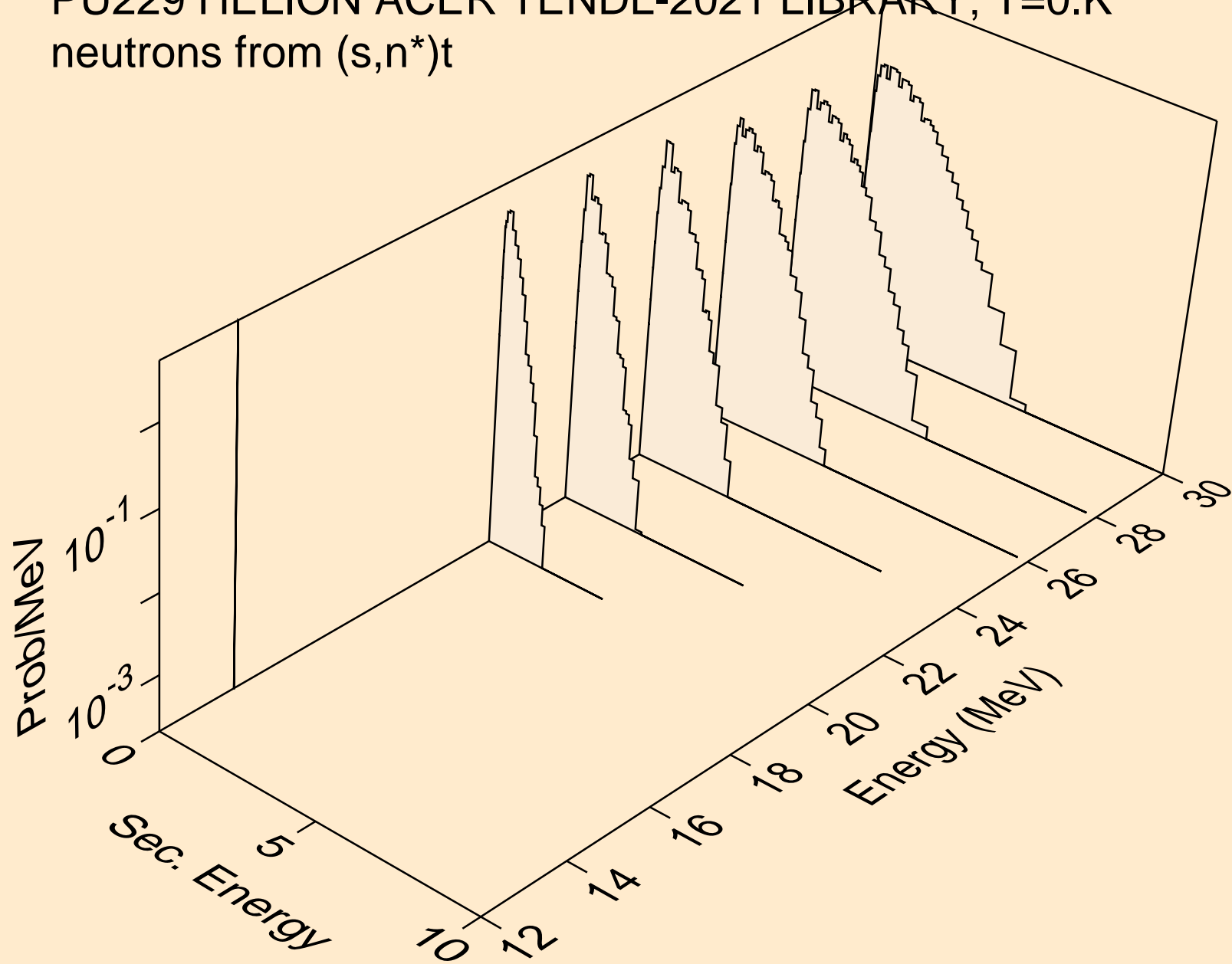

PU229 HELION ACER TENDL-2021 LIBRARY; T=0.K
neutrons from (s,2np)

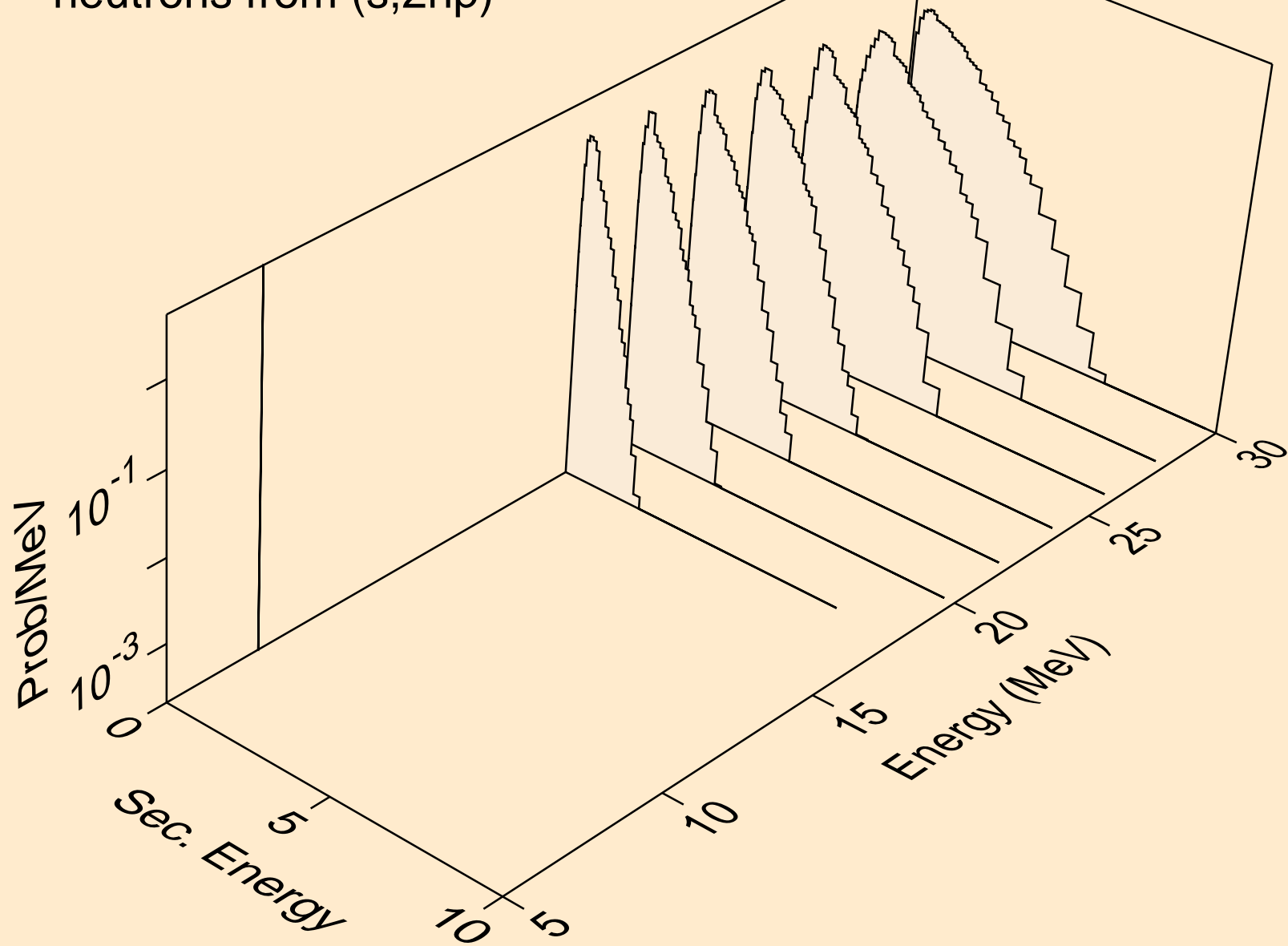

PU229 HELION ACER TENDL-2021 LIBRARY; T=0.K
protons from (s,x)

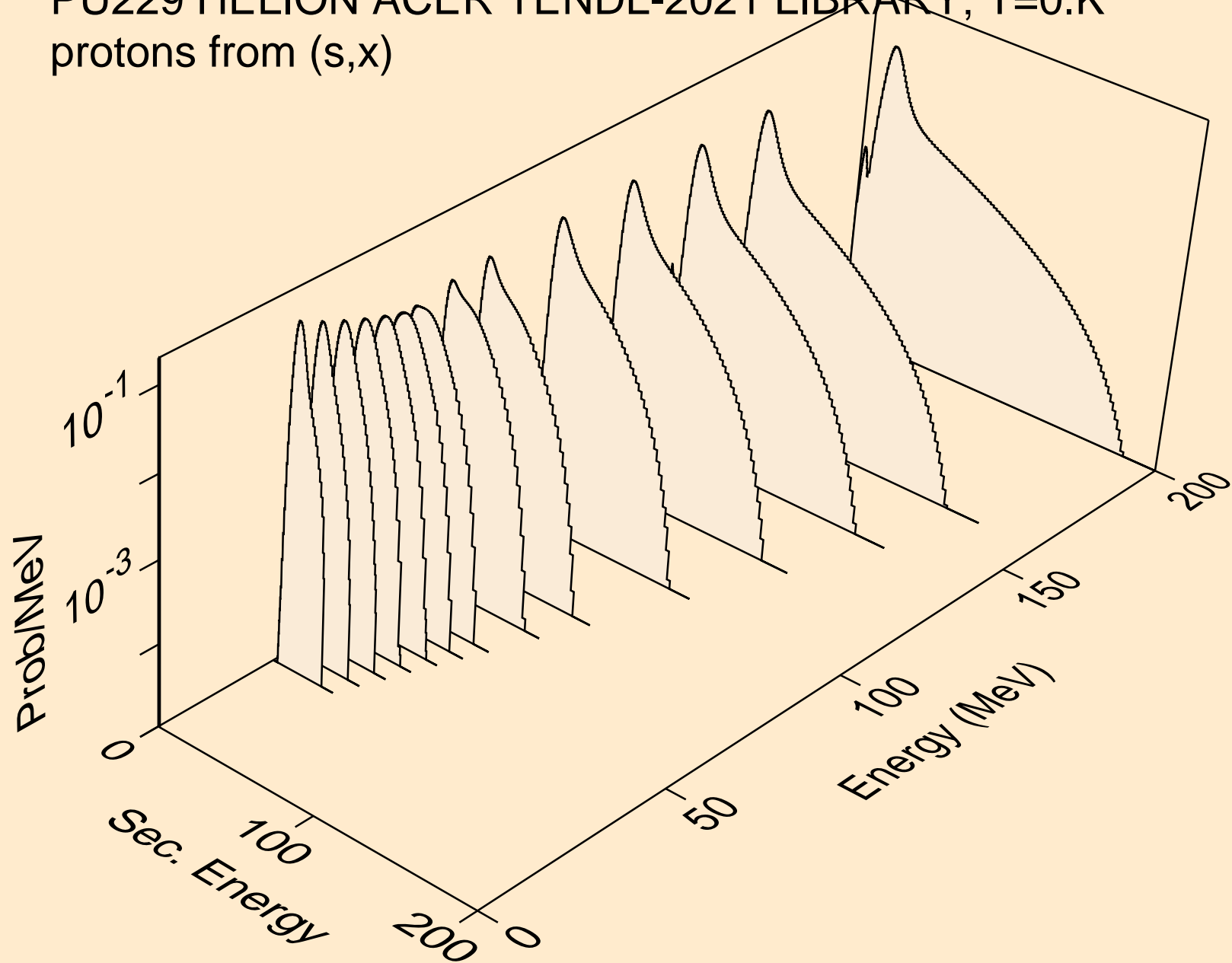

PU229 HELION ACER TENDL-2021 LIBRARY; T=0.K
protons from (s,n*)p

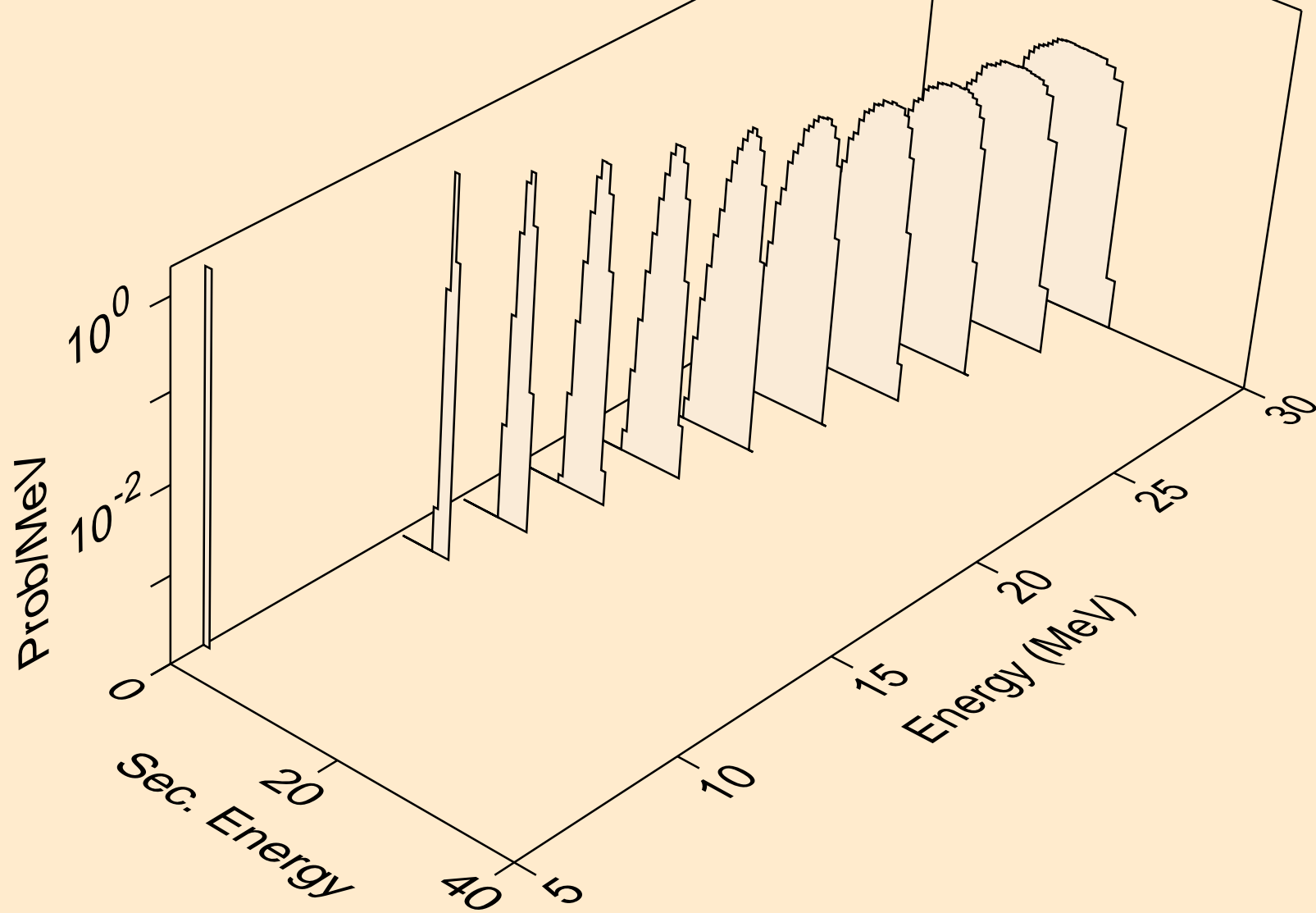

PU229 HELION ACER TENDL-2021 LIBRARY; T=0.K
protons from (s,2np)

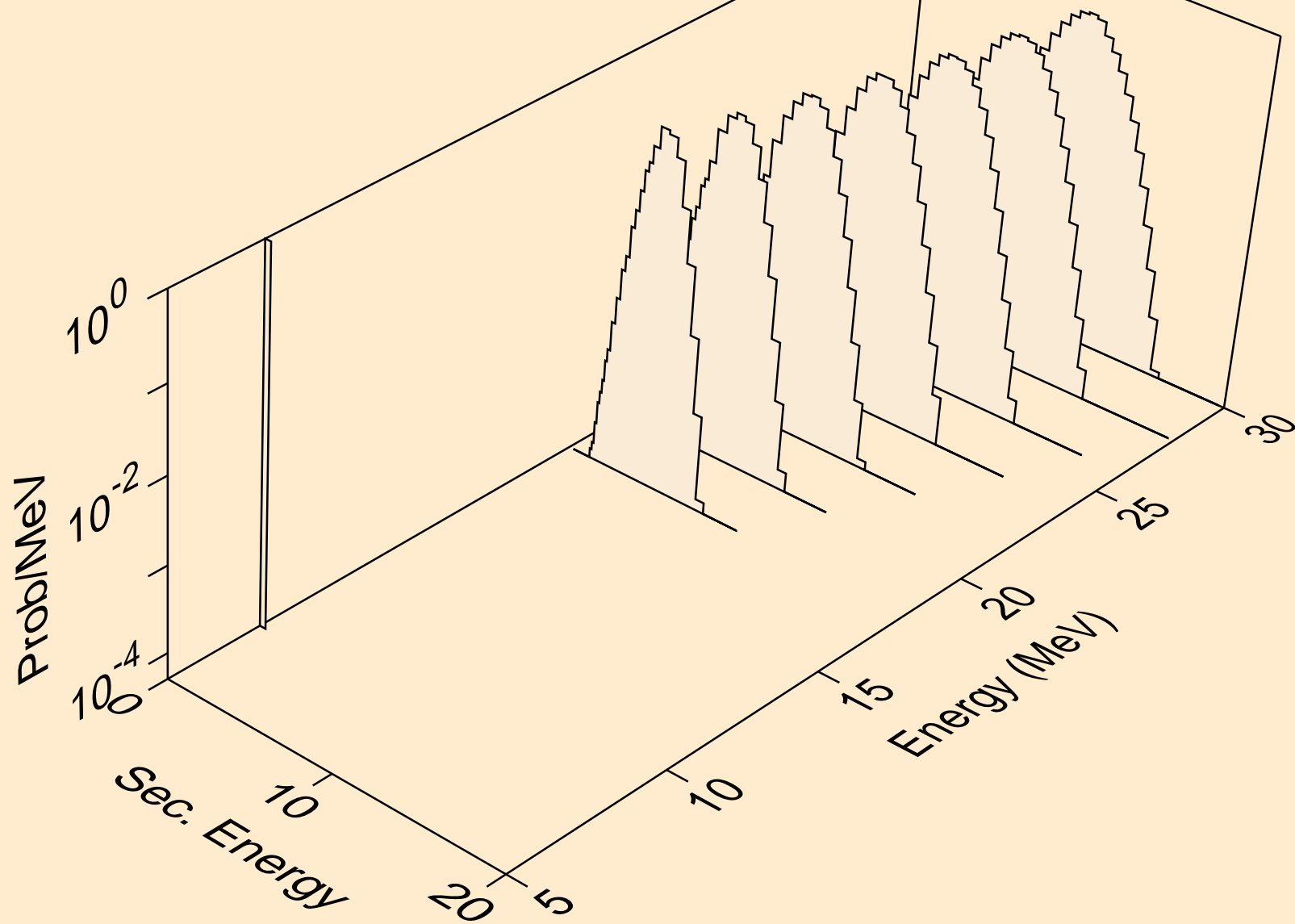

PU229 HELION ACER TENDL-2021 LIBRARY; T=0.K
protons from (s,p)

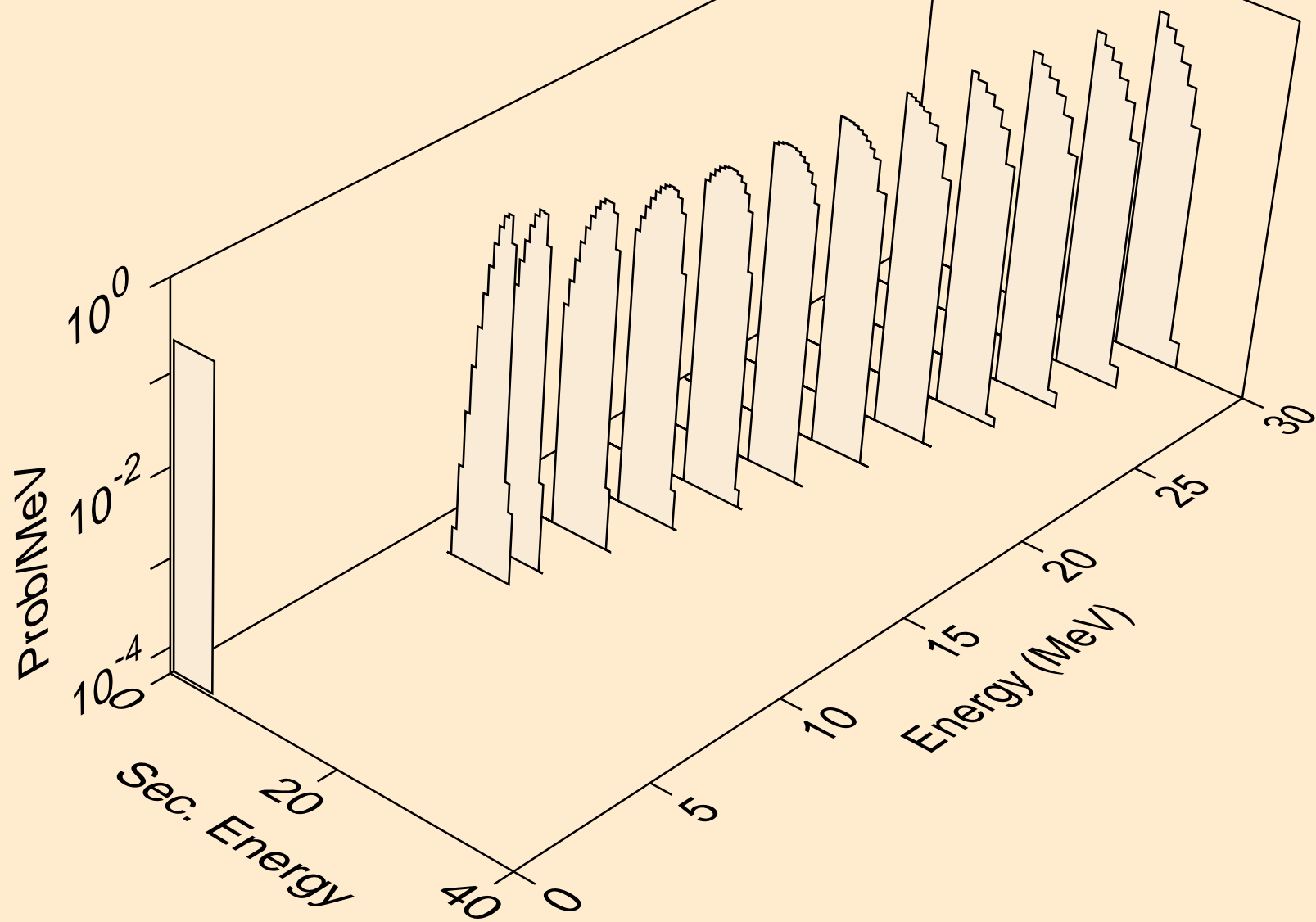

PU229 HELION ACER TENDL-2021 LIBRARY; T=0.K
protons from (s,2p)

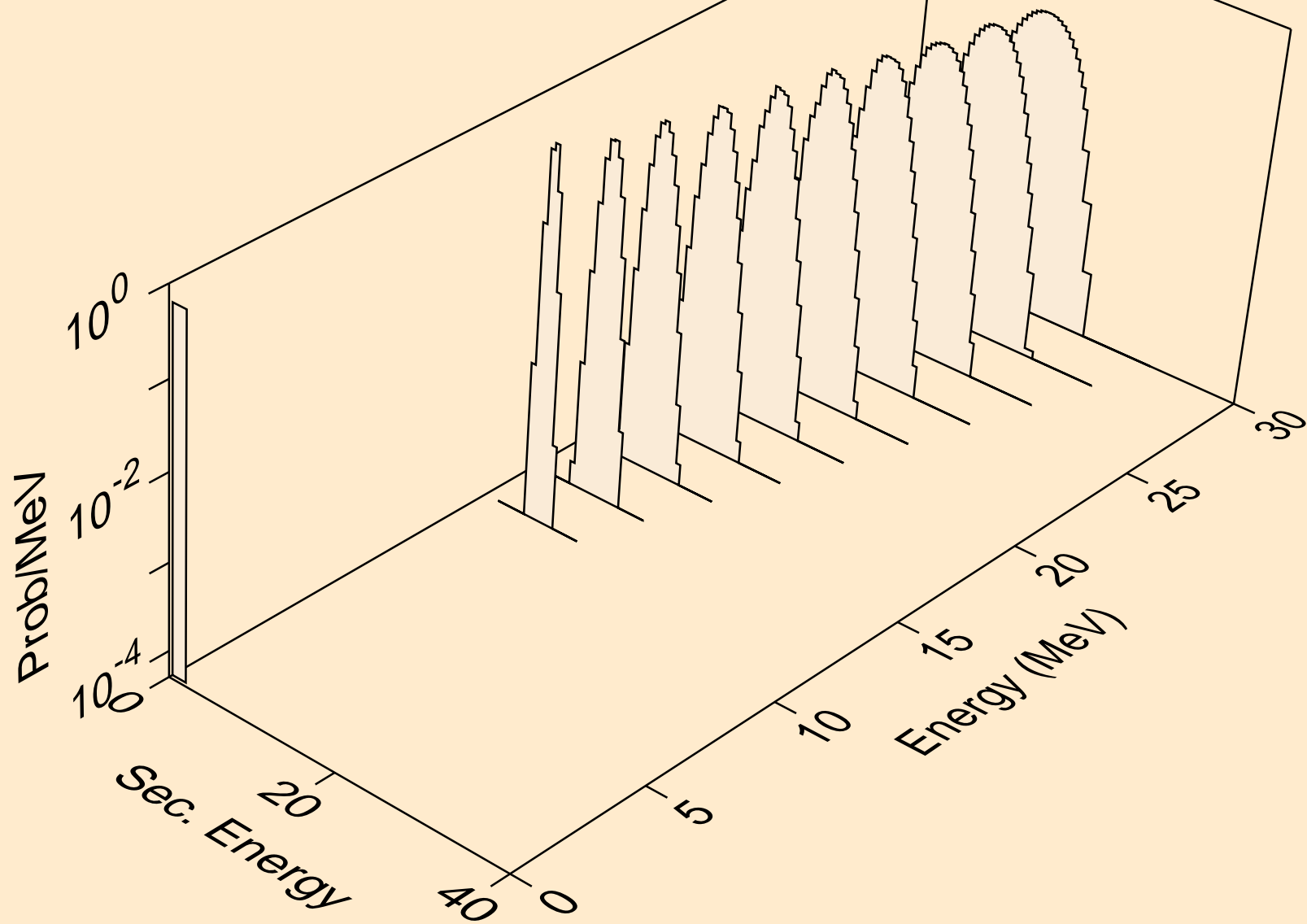

PU229 HELION ACER TENDL-2021 LIBRARY; T=0.K
protons from (s,pd)

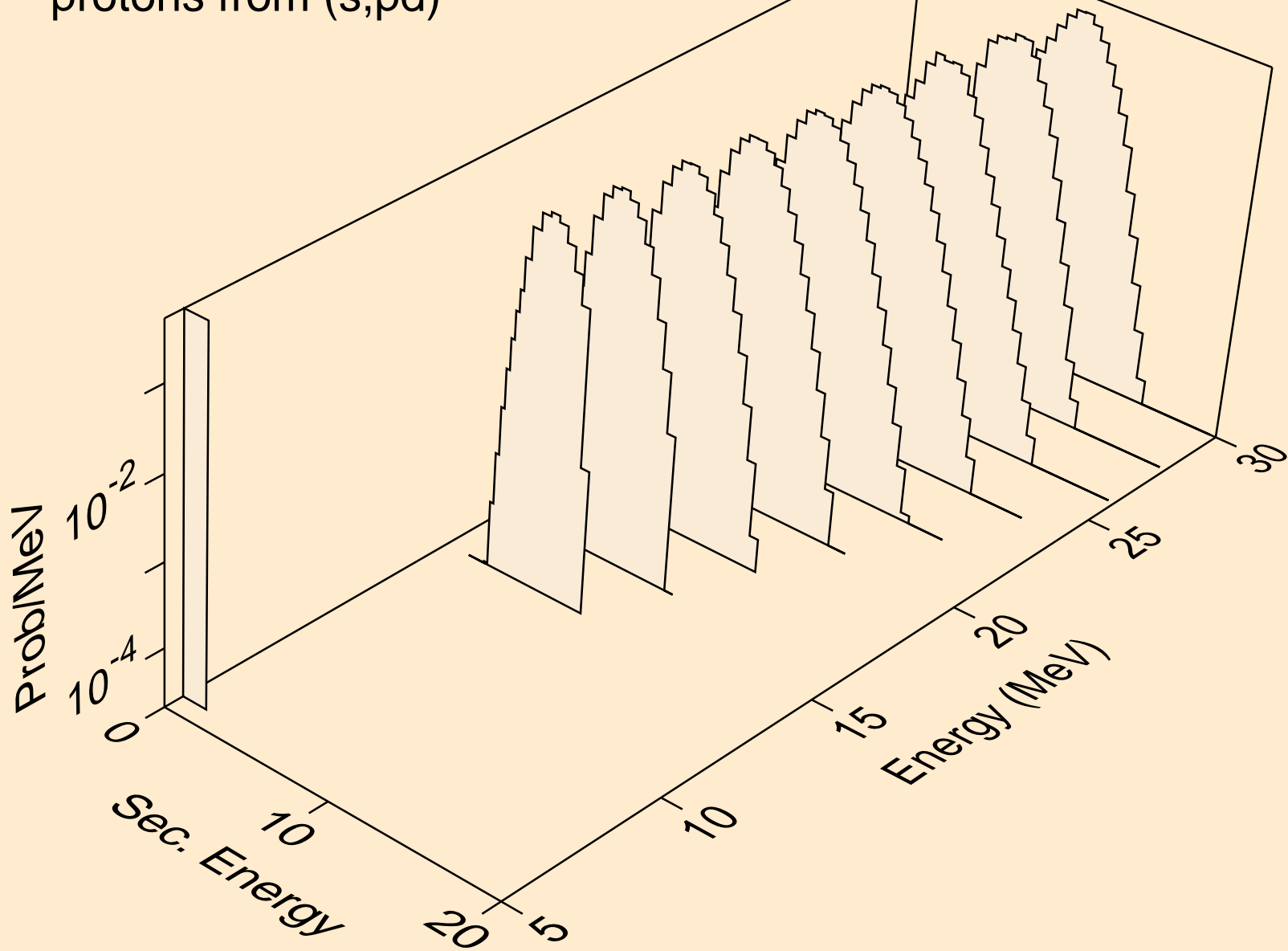

PU229 HELION ACER TENDL-2021 LIBRARY; T=0.K
deuterons from (s,x)

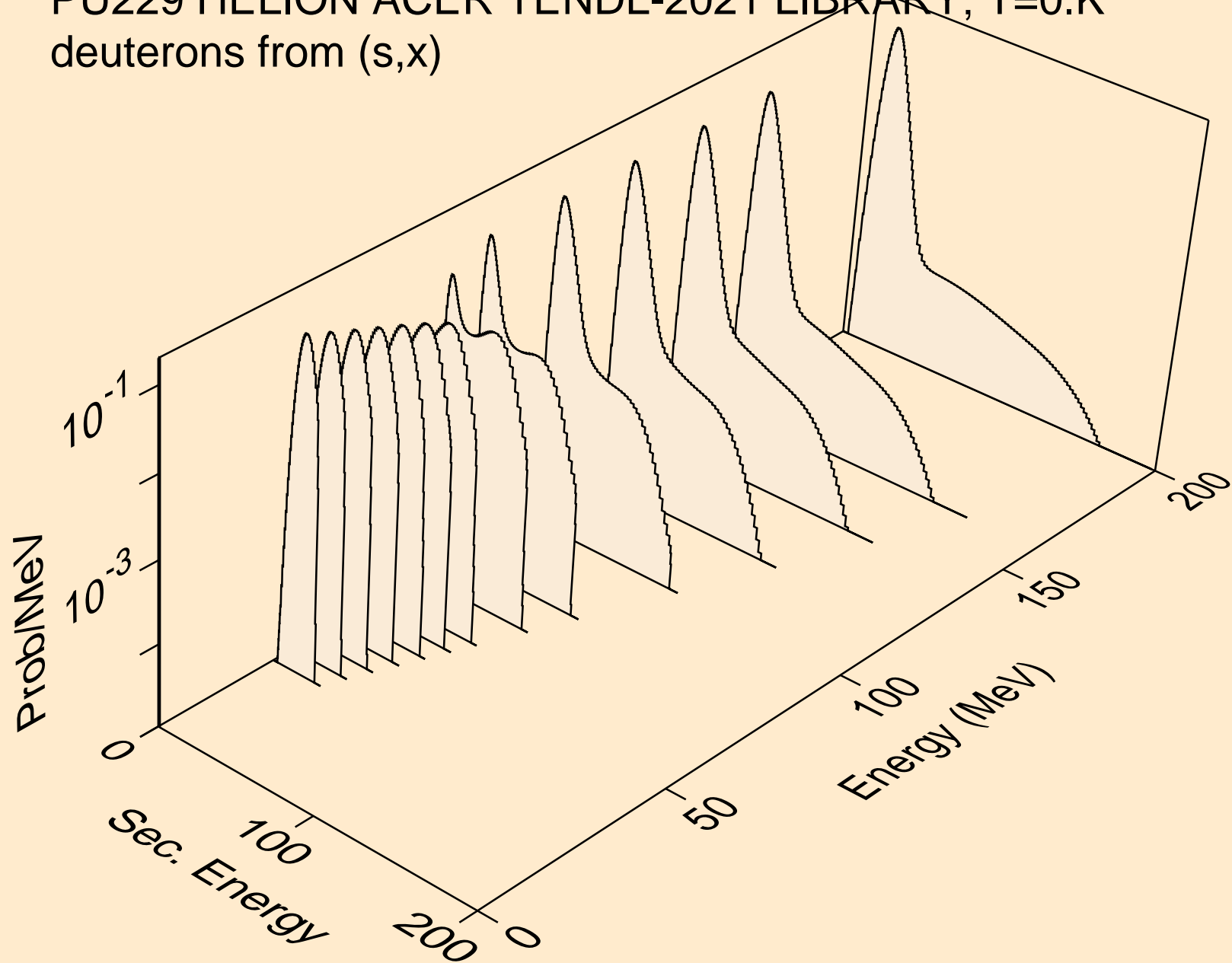

PU229 HELION ACER TENDL-2021 LIBRARY; T=0.K
deuterons from (s,d)

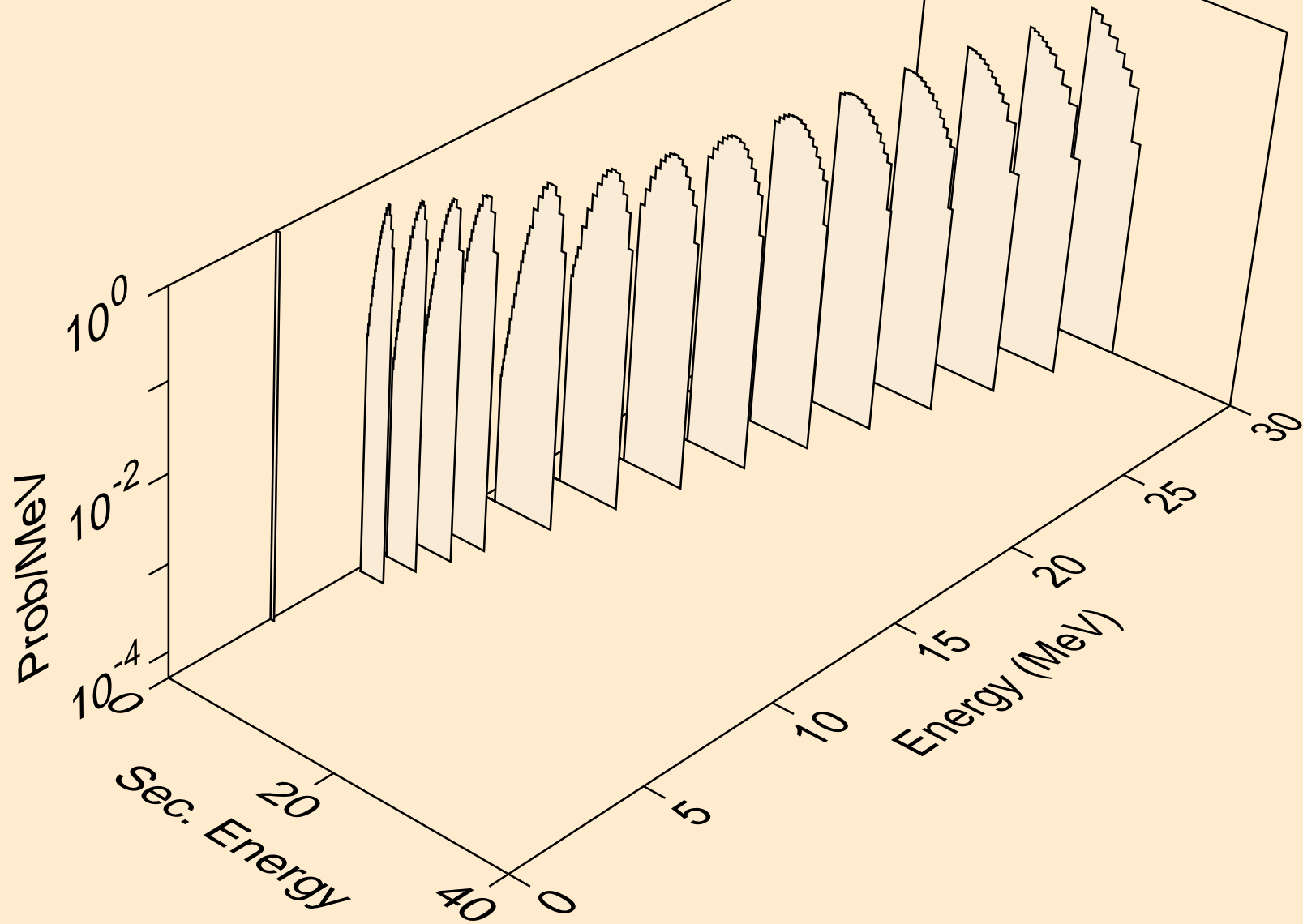

PU229 HELION ACER TENDL-2021 LIBRARY; T=0.K
deuterons from (s,pd)

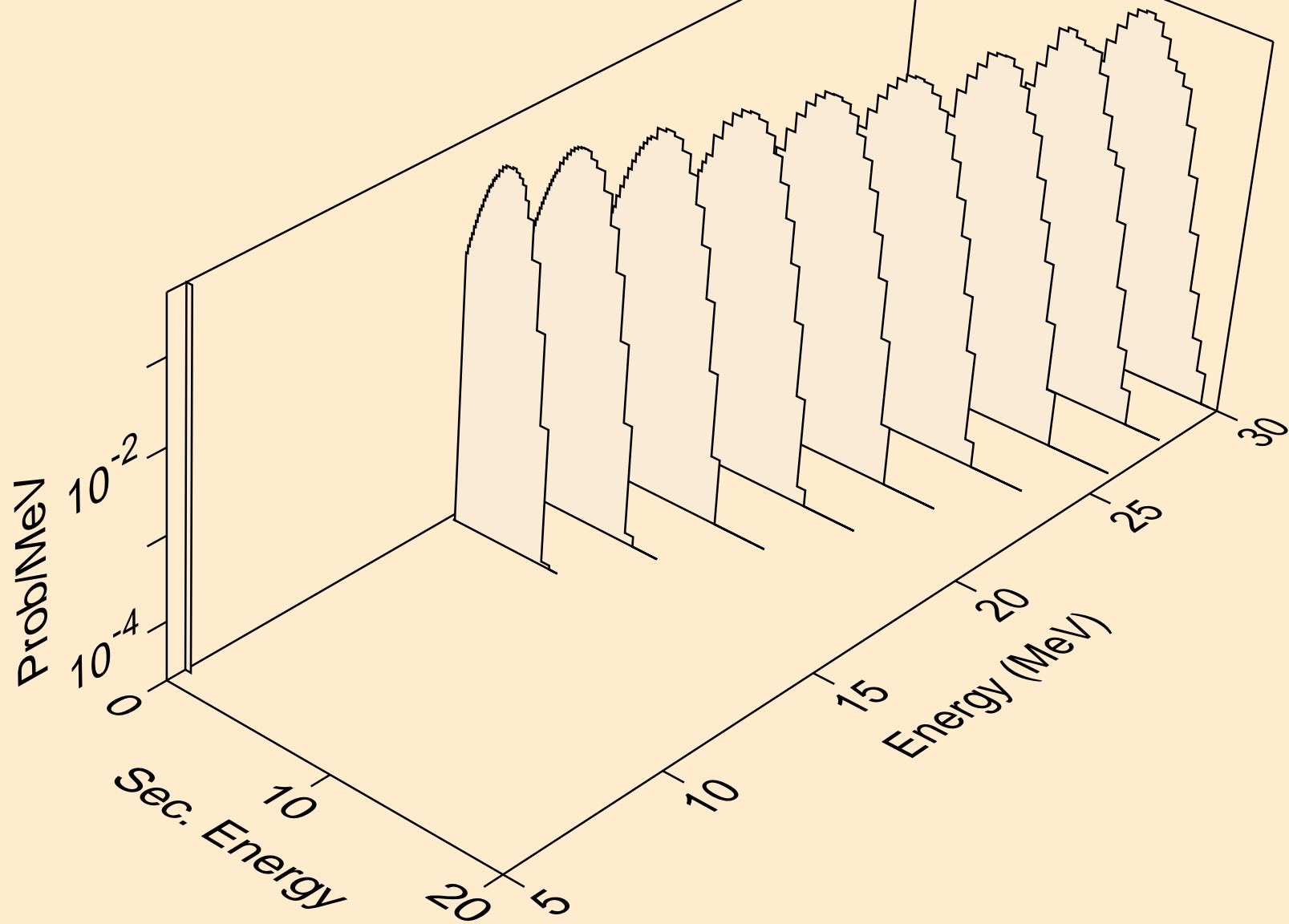

PU229 HELION ACER TENDL-2021 LIBRARY; T=0.K
tritons from (s,x)

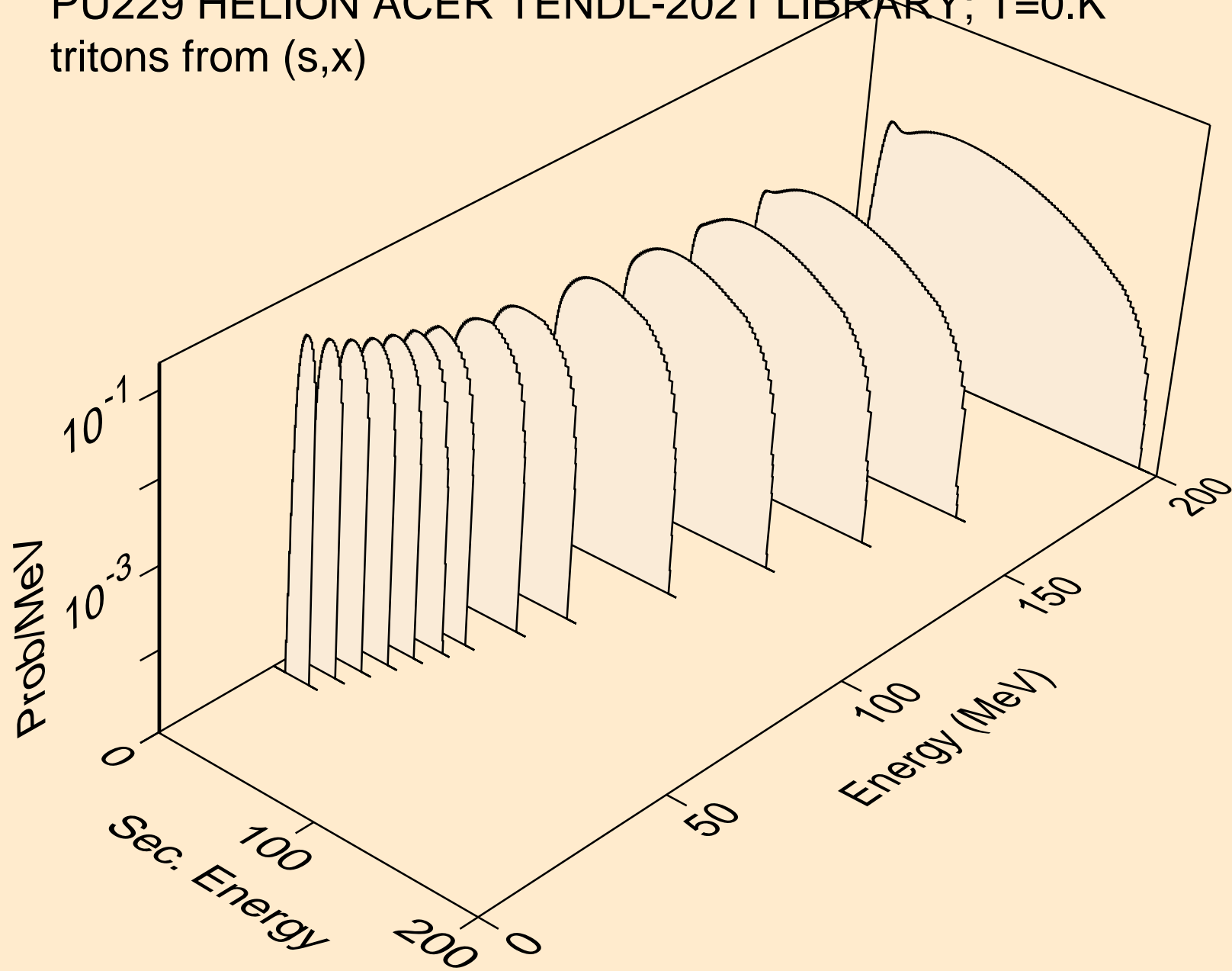

PU229 HELION ACER TENDL-2021 LIBRARY; T=0.K
tritons from (s,n*)t

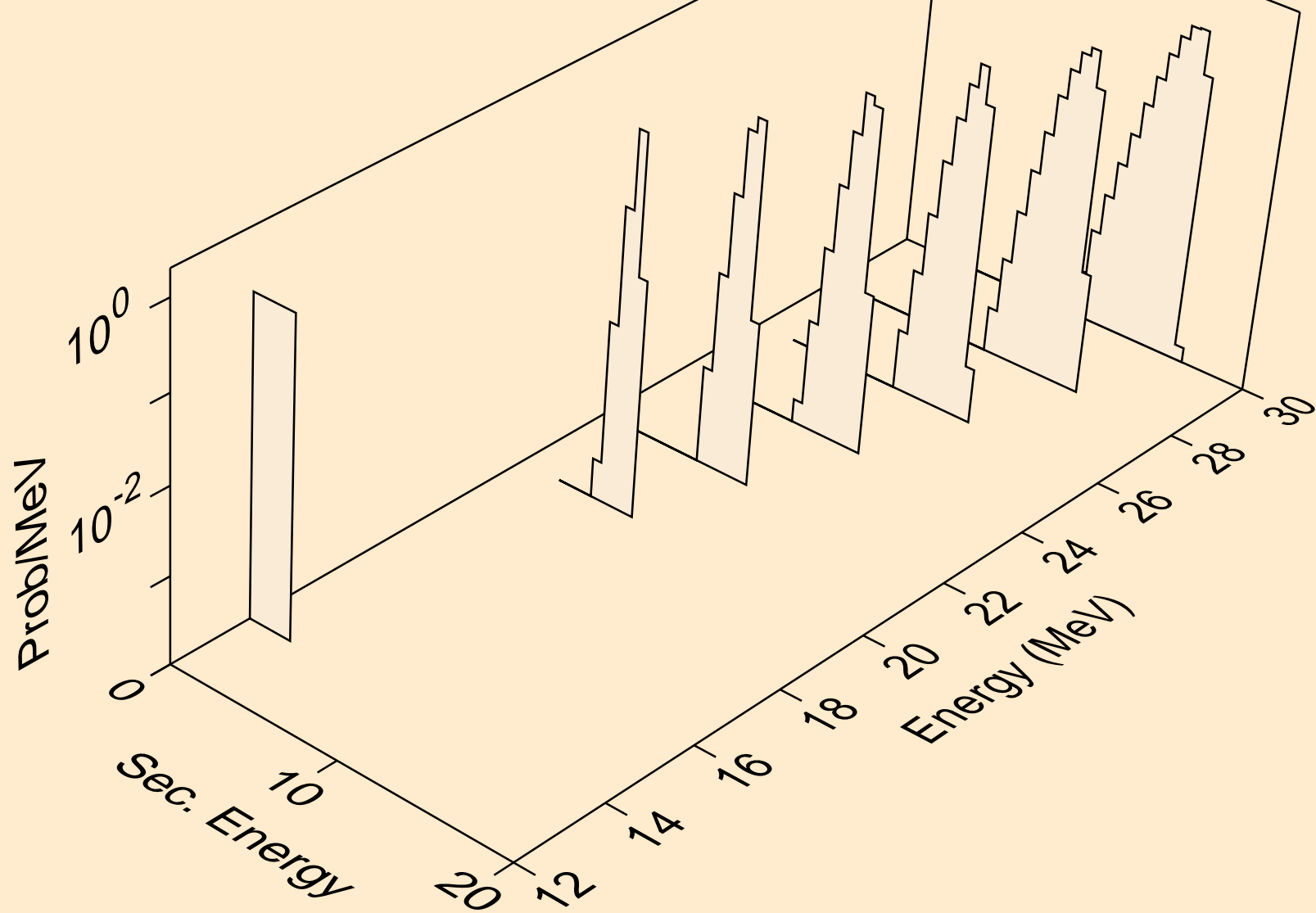

PU229 HELION ACER TENDL-2021 LIBRARY; T=0.K
tritons from (s,t)

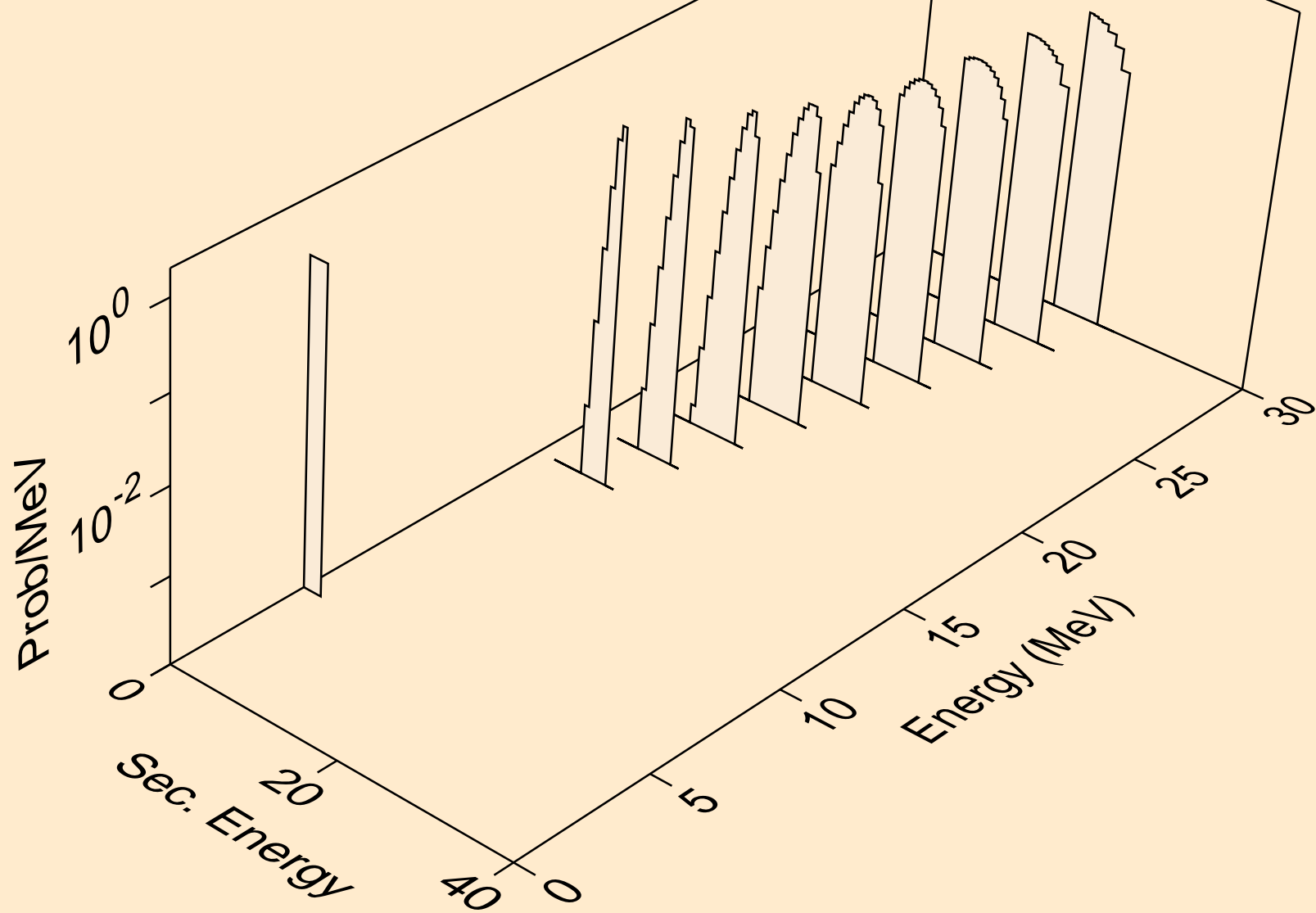

PU229 HELION ACER TENDL-2021 LIBRARY; T=0.K
alphas from (s,x)

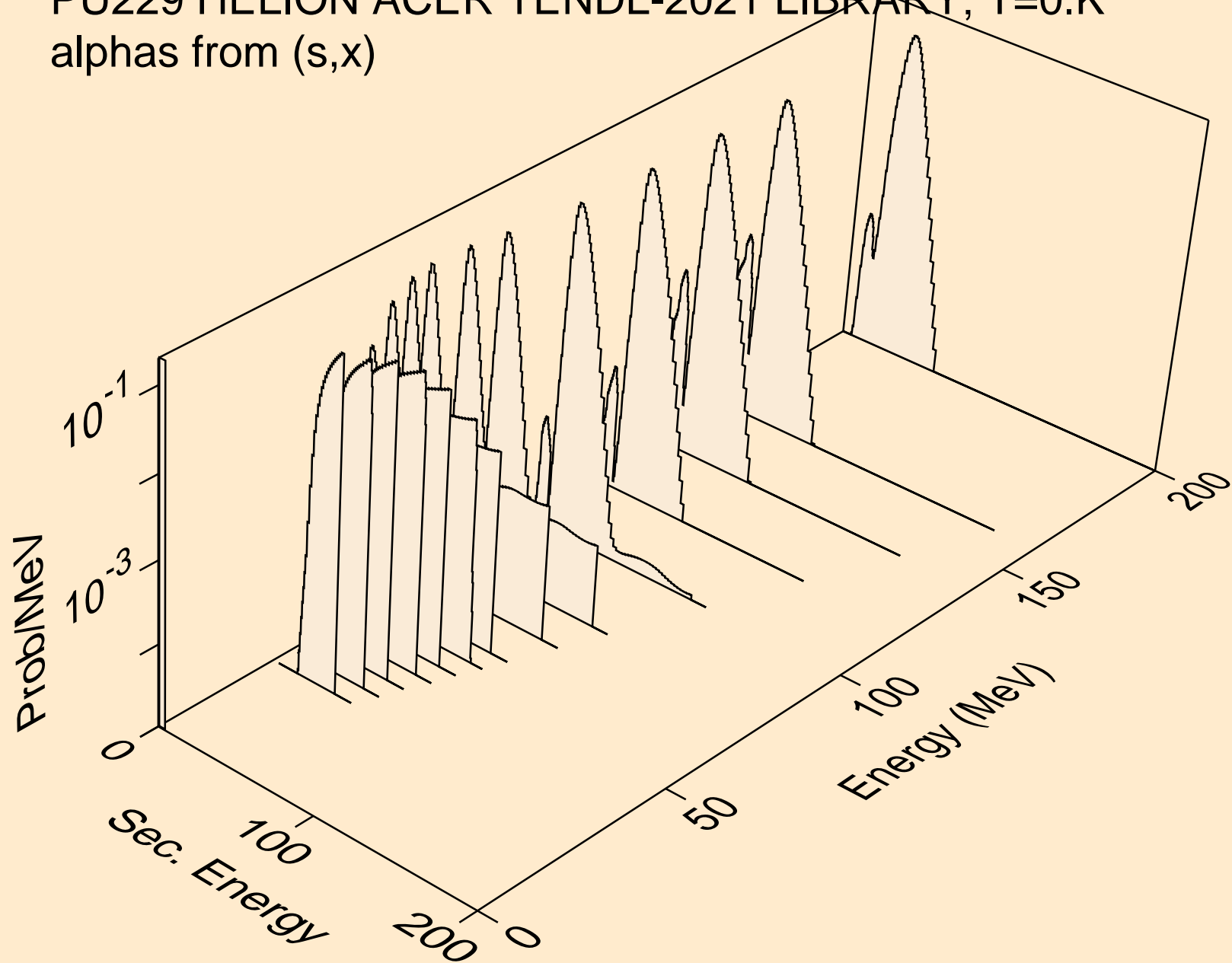

PU229 HELION ACER TENDL-2021 LIBRARY; T=0.K
alphas from (s,a)

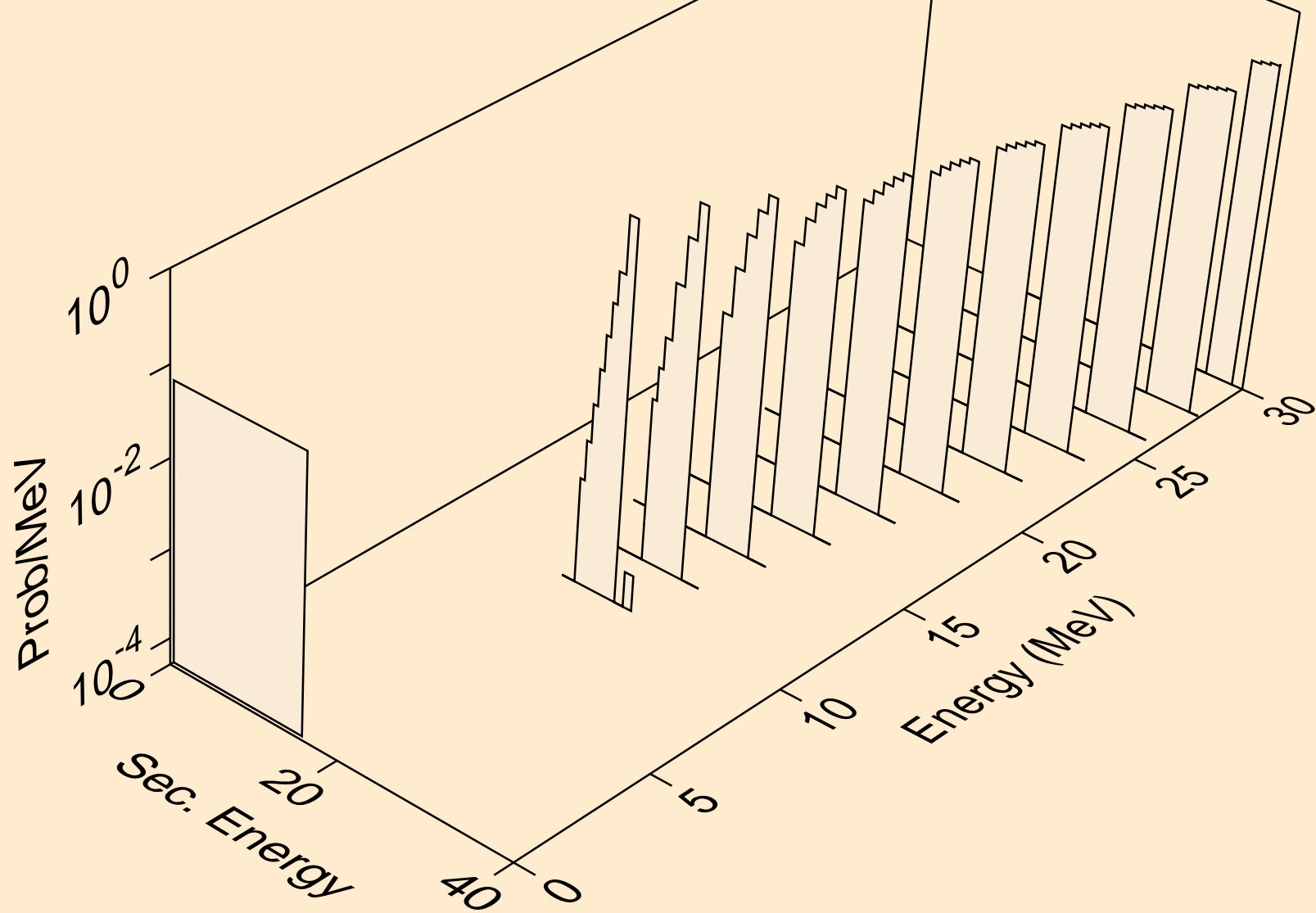

PU229 HELION ACER TENDL-2021 LIBRARY; T=0.K
alphas from (s,2a)

