

PU234 HELION ACER TENDL-2021 LIBRARY; T=0.K
Principal cross sections

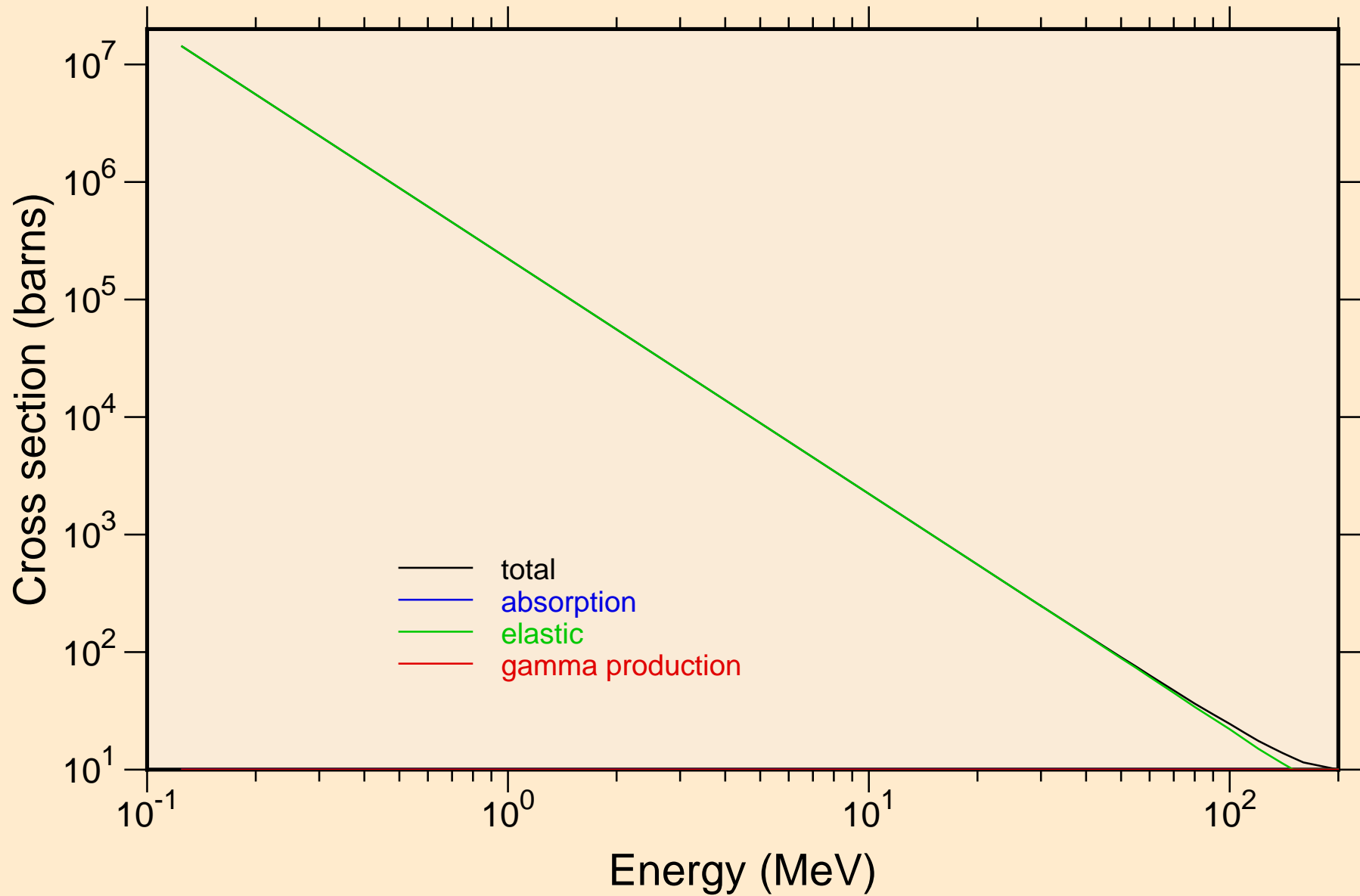

PU234 HELION ACER TENDL-2021 LIBRARY; T=0.K
Heating

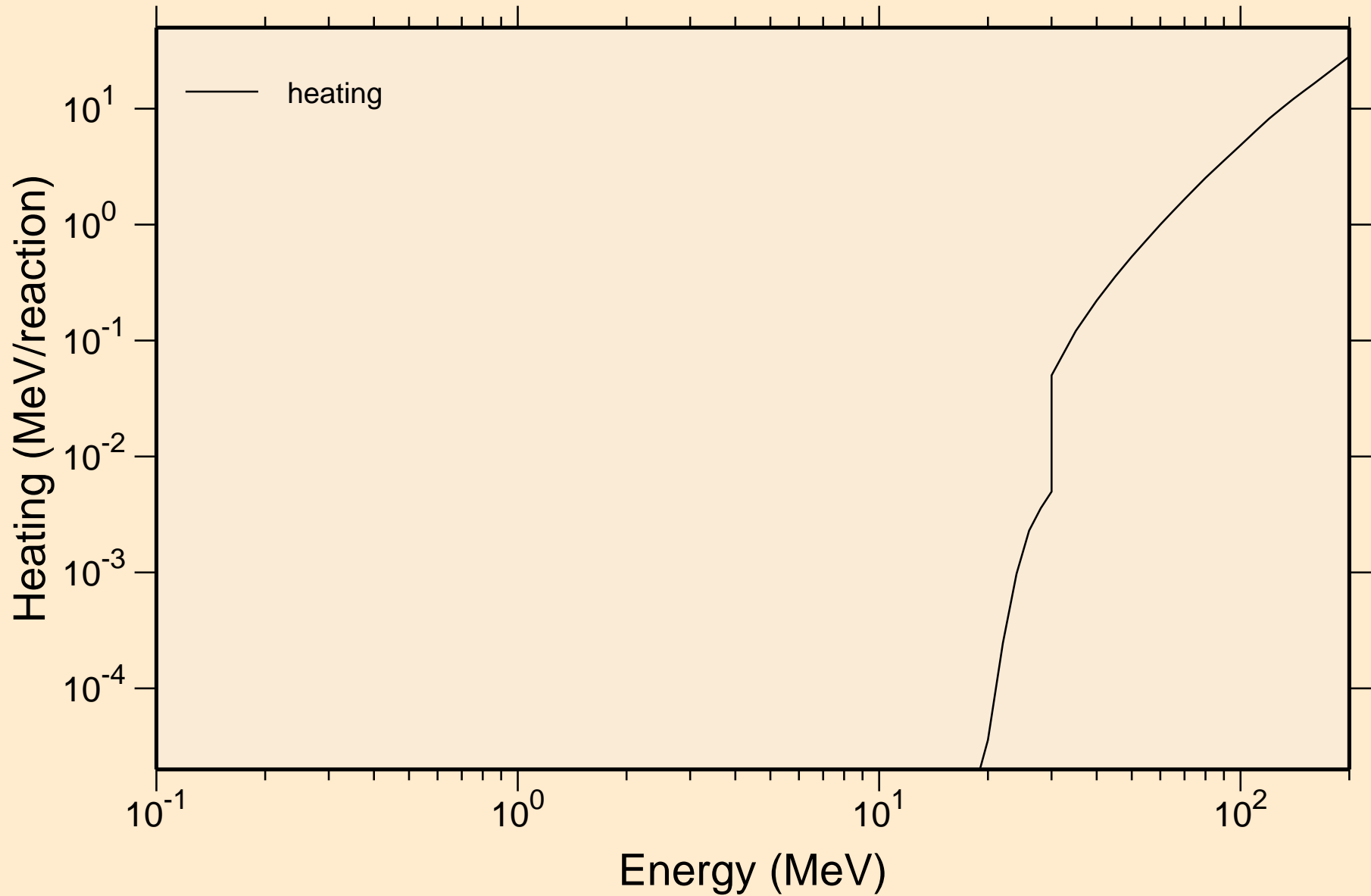

PU234 HELION ACER TENDL-2021 LIBRARY; T=0.K

Principal cross sections

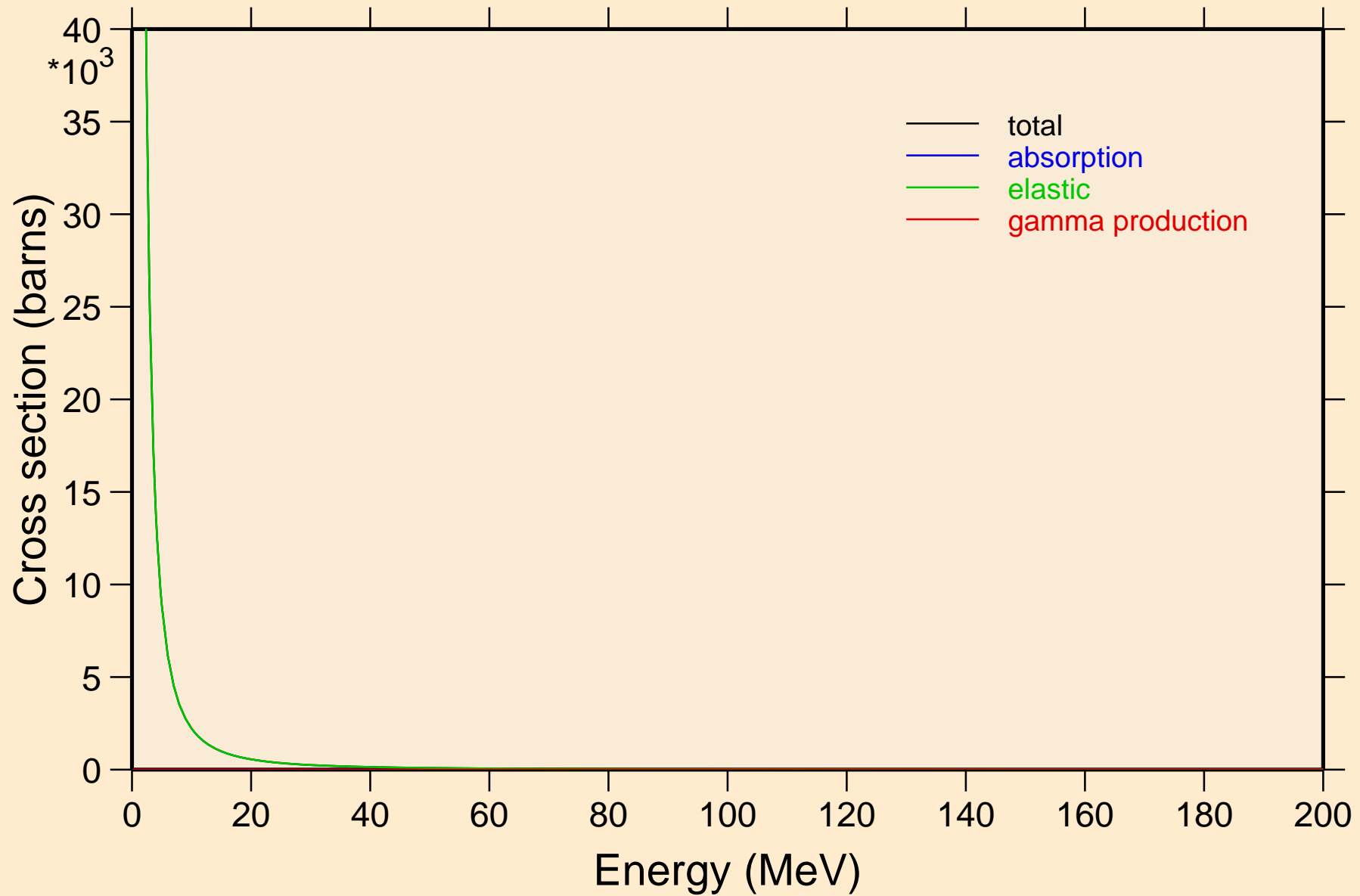

PU234 HELION ACER TENDL-2021 LIBRARY; T=0.K

Heating

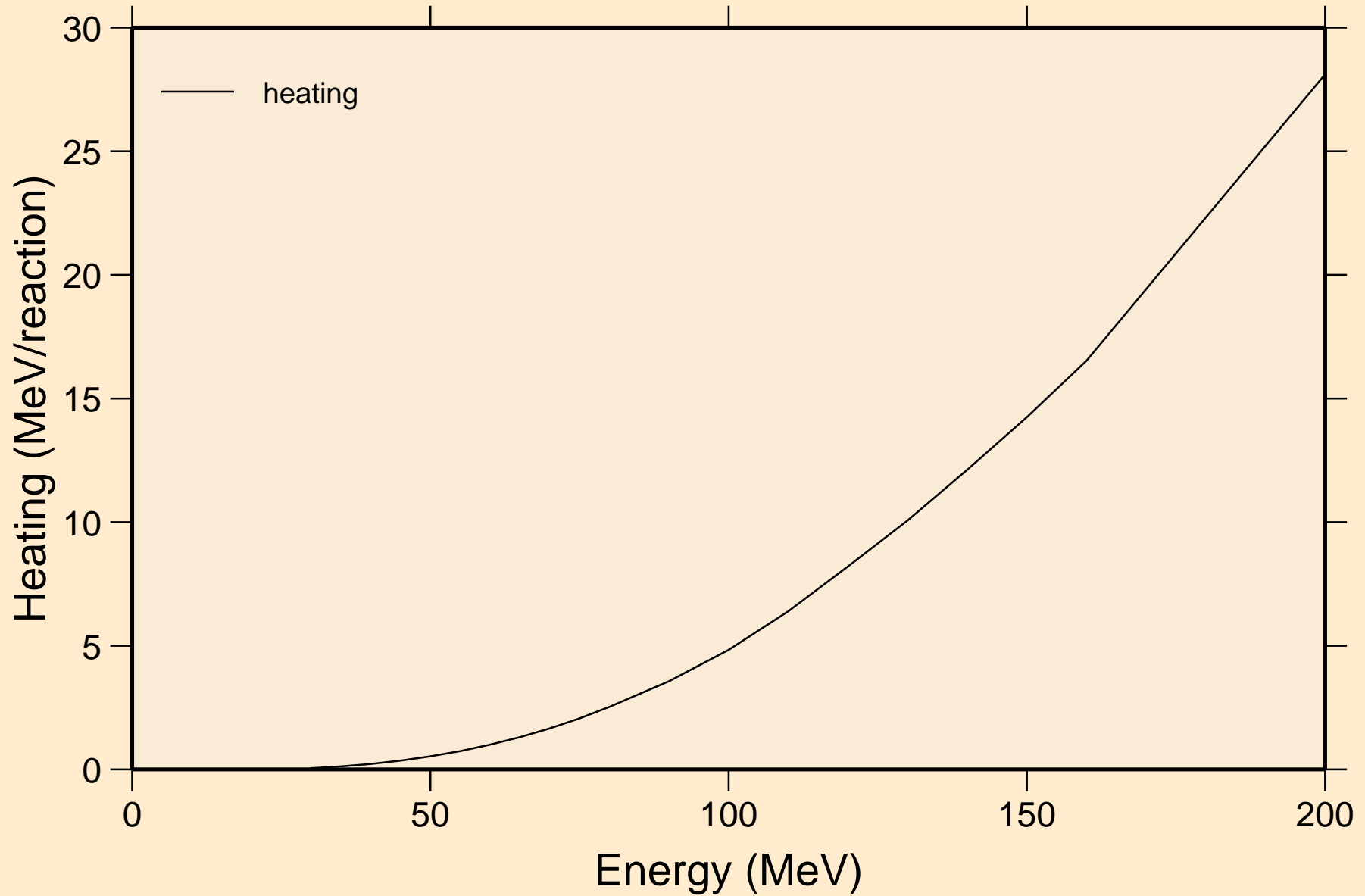

PU234 HELION ACER TENDL-2021 LIBRARY; T=0.K
Threshold reactions

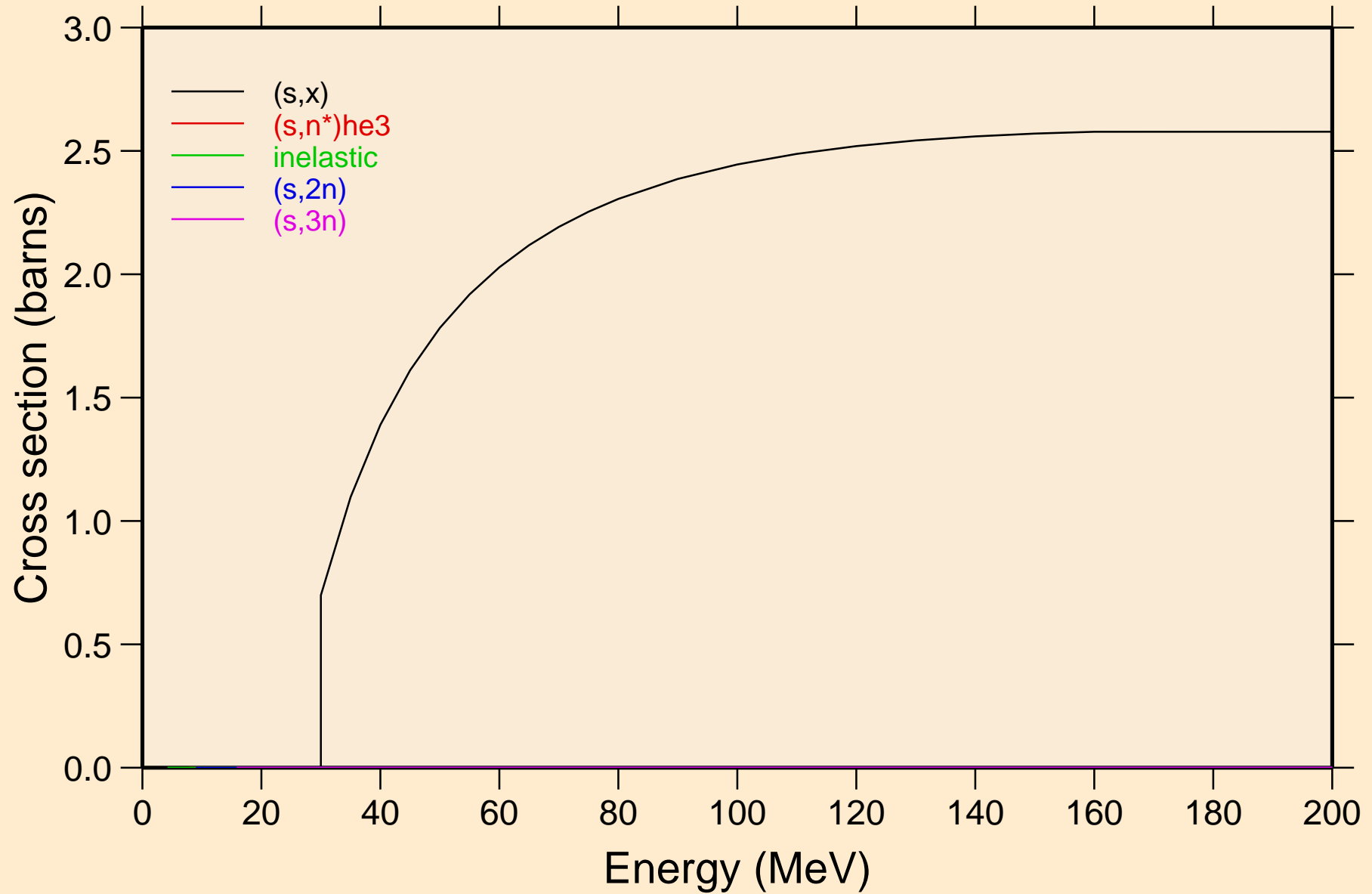

PU234 HELION ACER TENDL-2021 LIBRARY; T=0.K
Threshold reactions

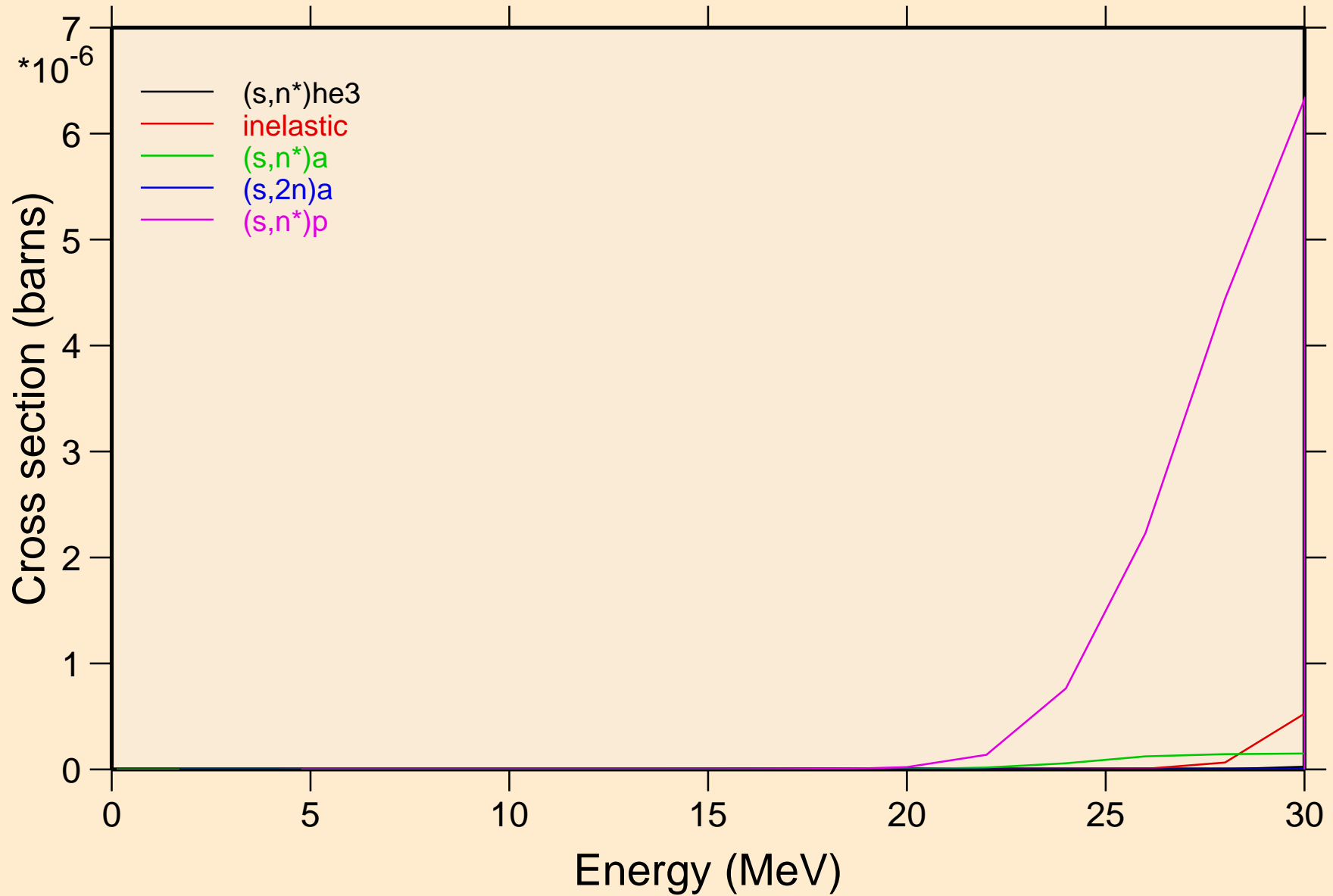

PU234 HELION ACER TENDL-2021 LIBRARY; T=0.K
Threshold reactions

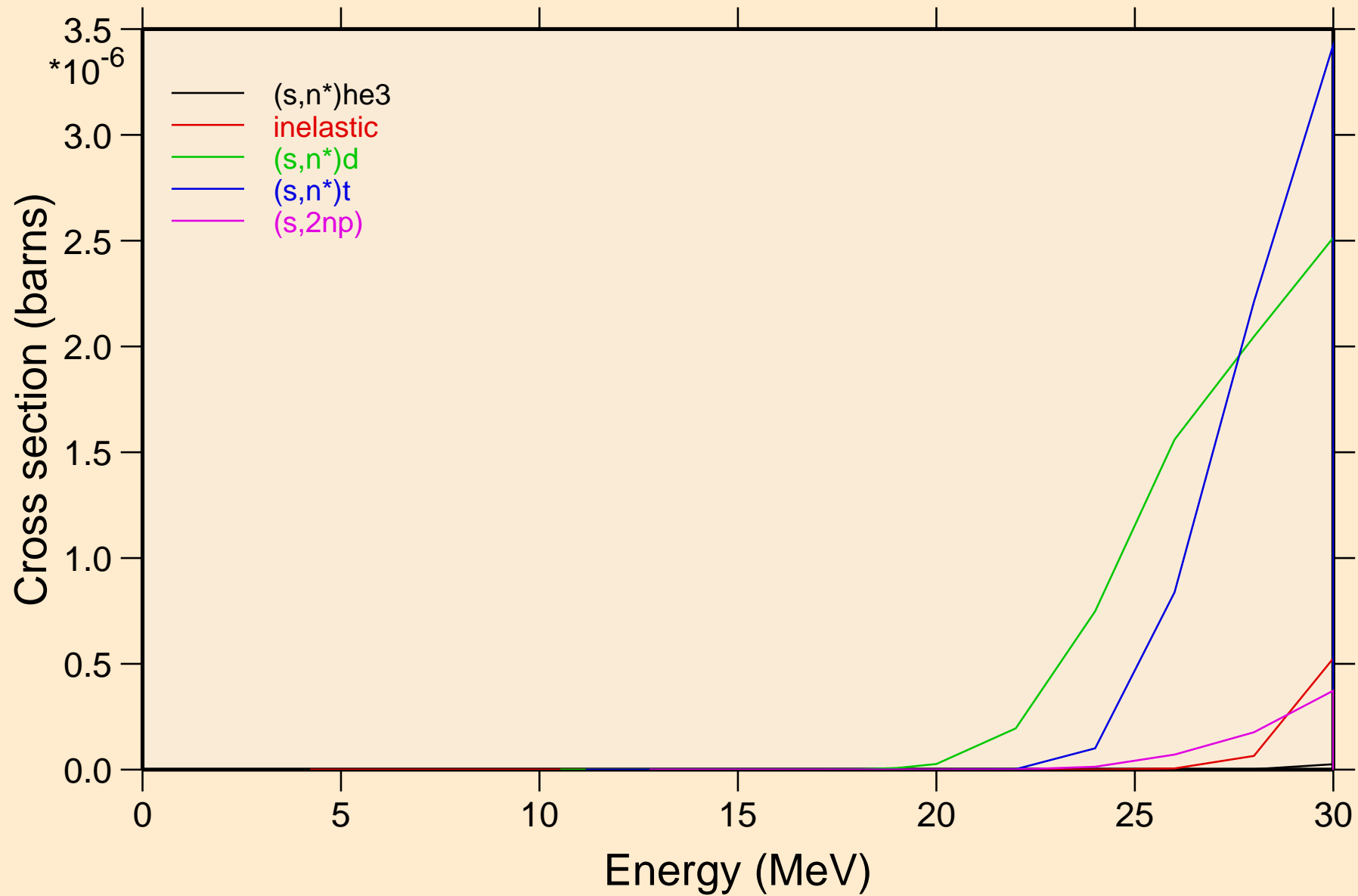

PU234 HELION ACER TENDL-2021 LIBRARY; T=0.K
Threshold reactions

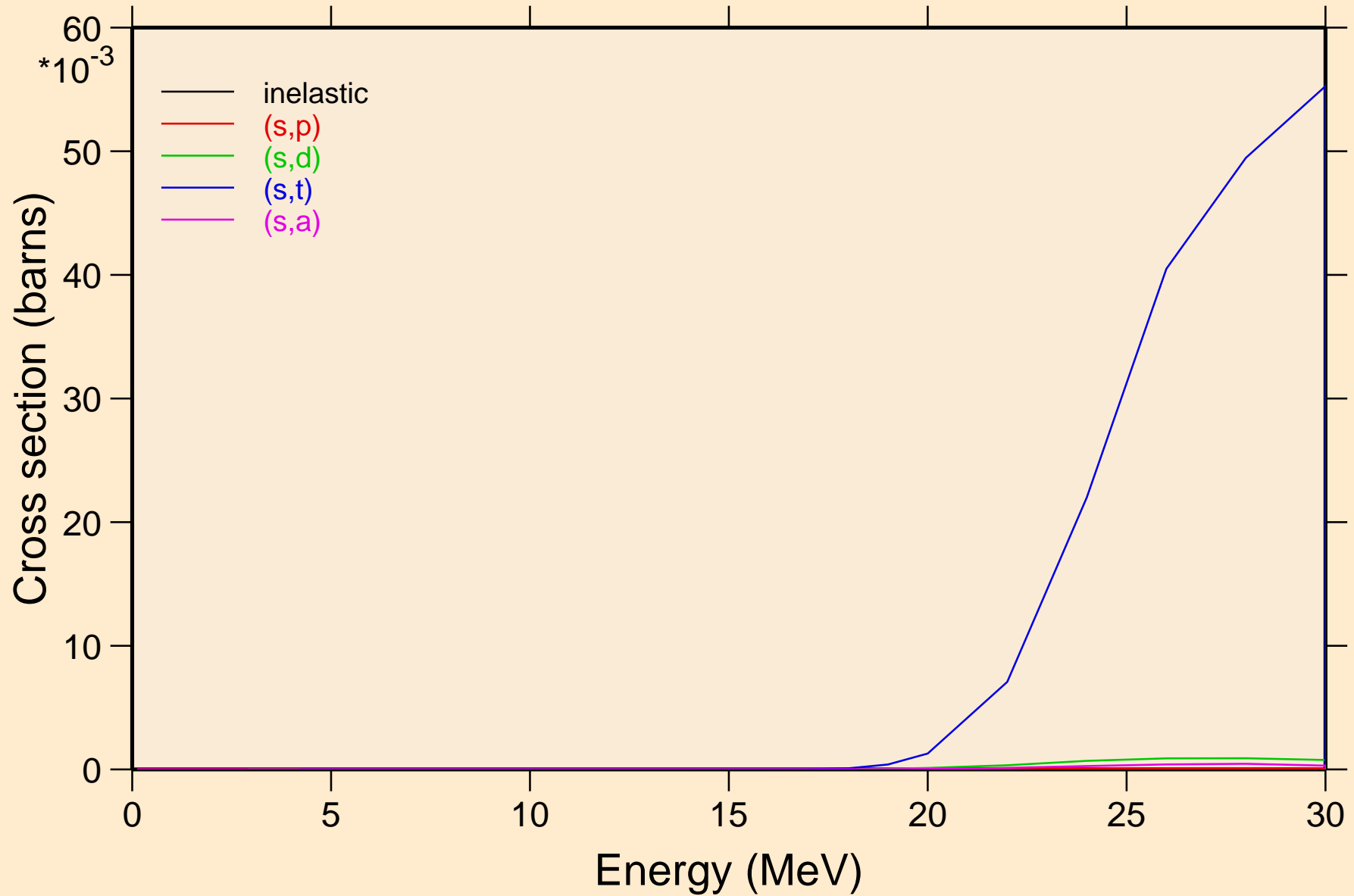

PU234 HELION ACER TENDL-2021 LIBRARY; T=0.K
Threshold reactions

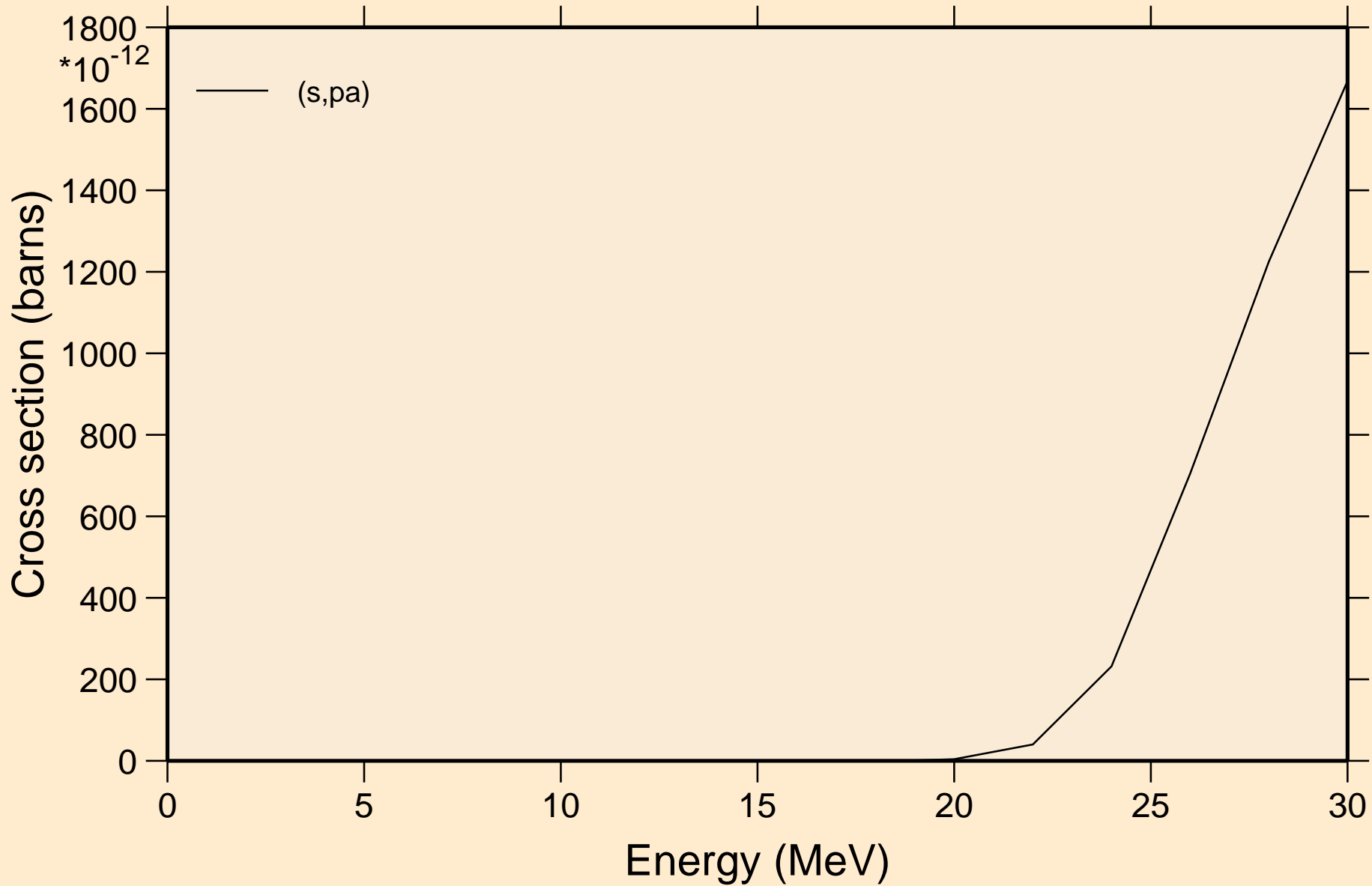

PU234 HELION ACER TENDL-2021 LIBRARY; T=0.K
angular distribution for elastic

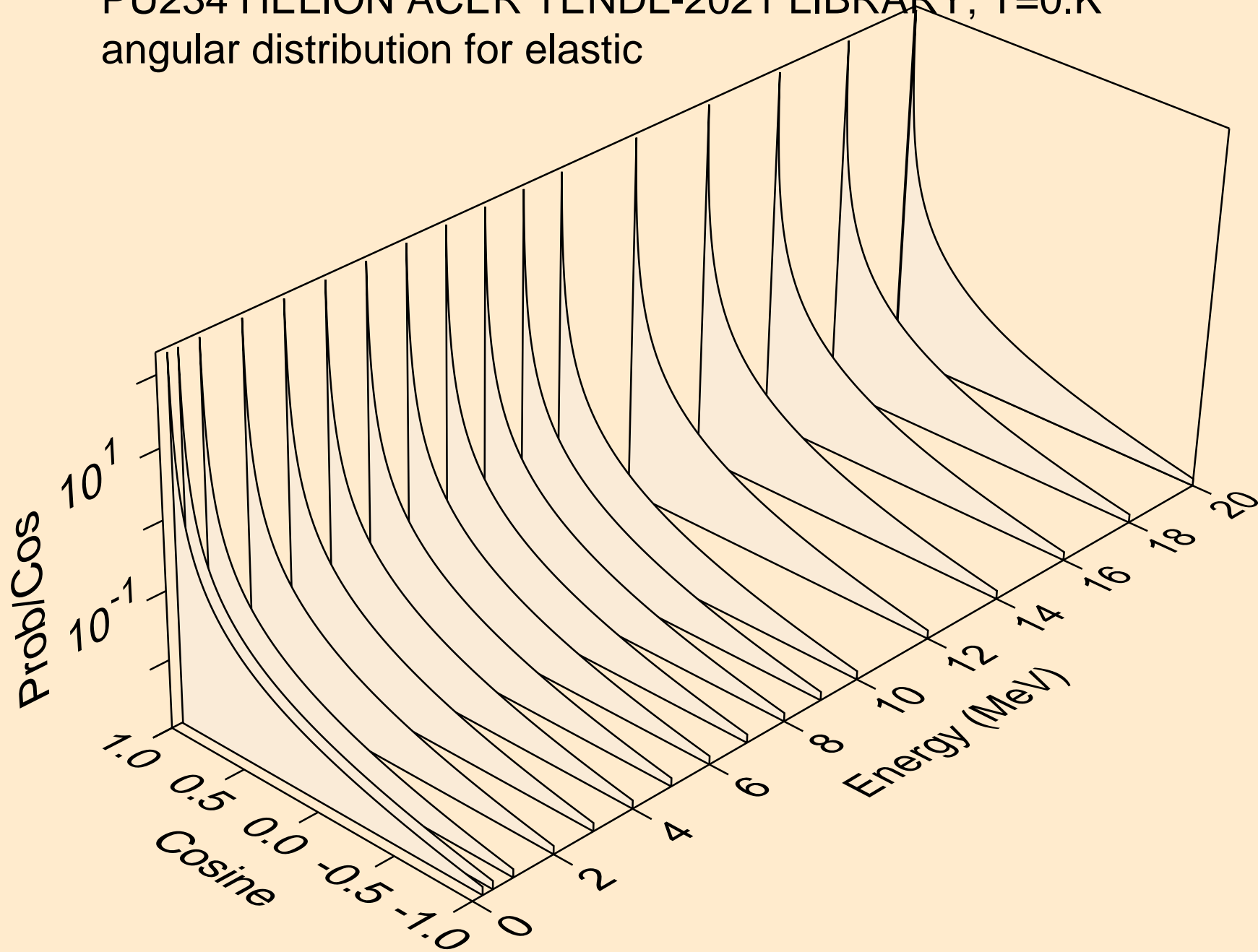

PU234 HELION ACER TENDL-2021 LIBRARY; T=0.K
angular distribution for elastic

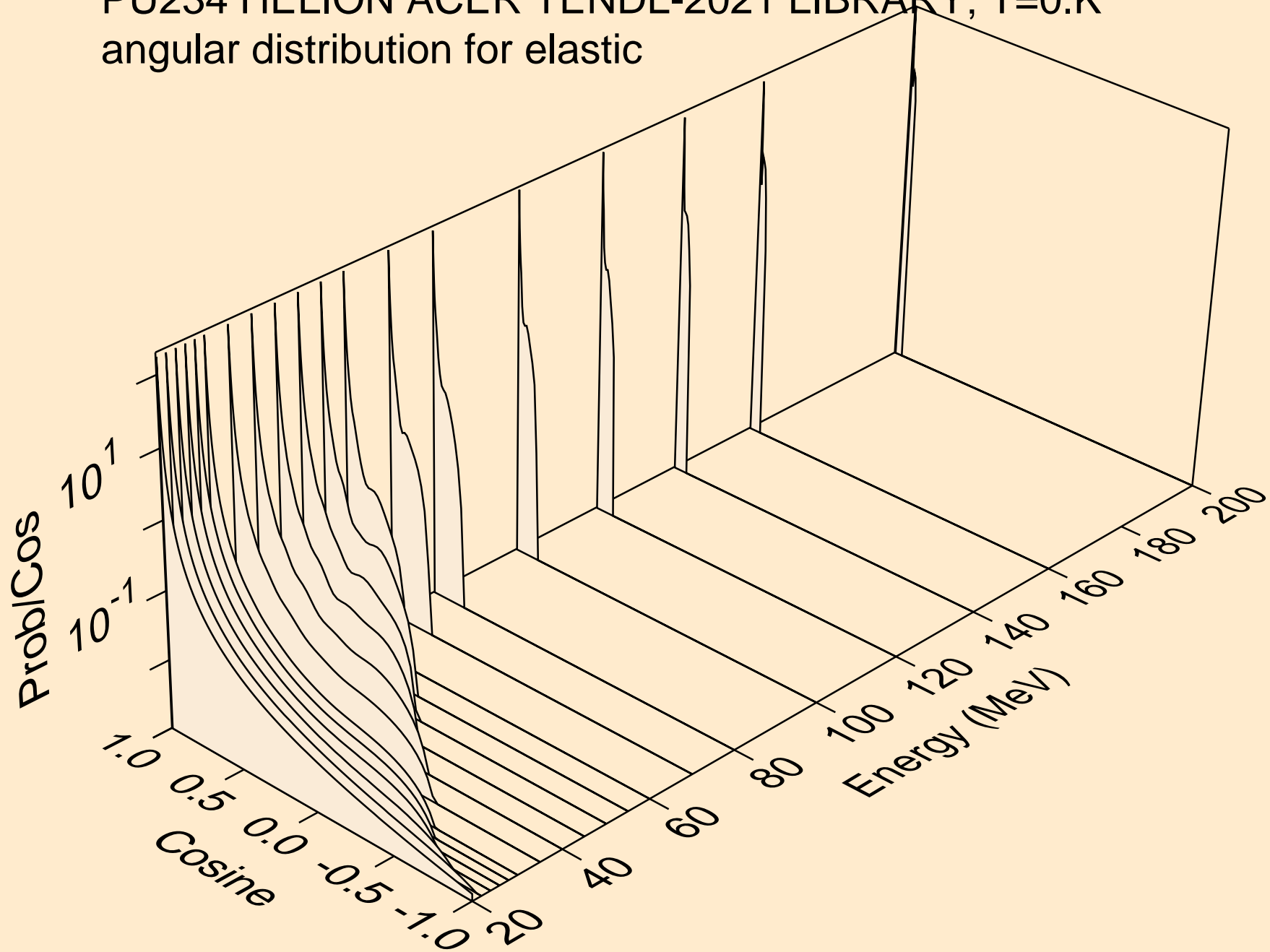

PU234 HELION ACER TENDL-2021 LIBRARY; T=0.K
He-3 emission for (s,x)

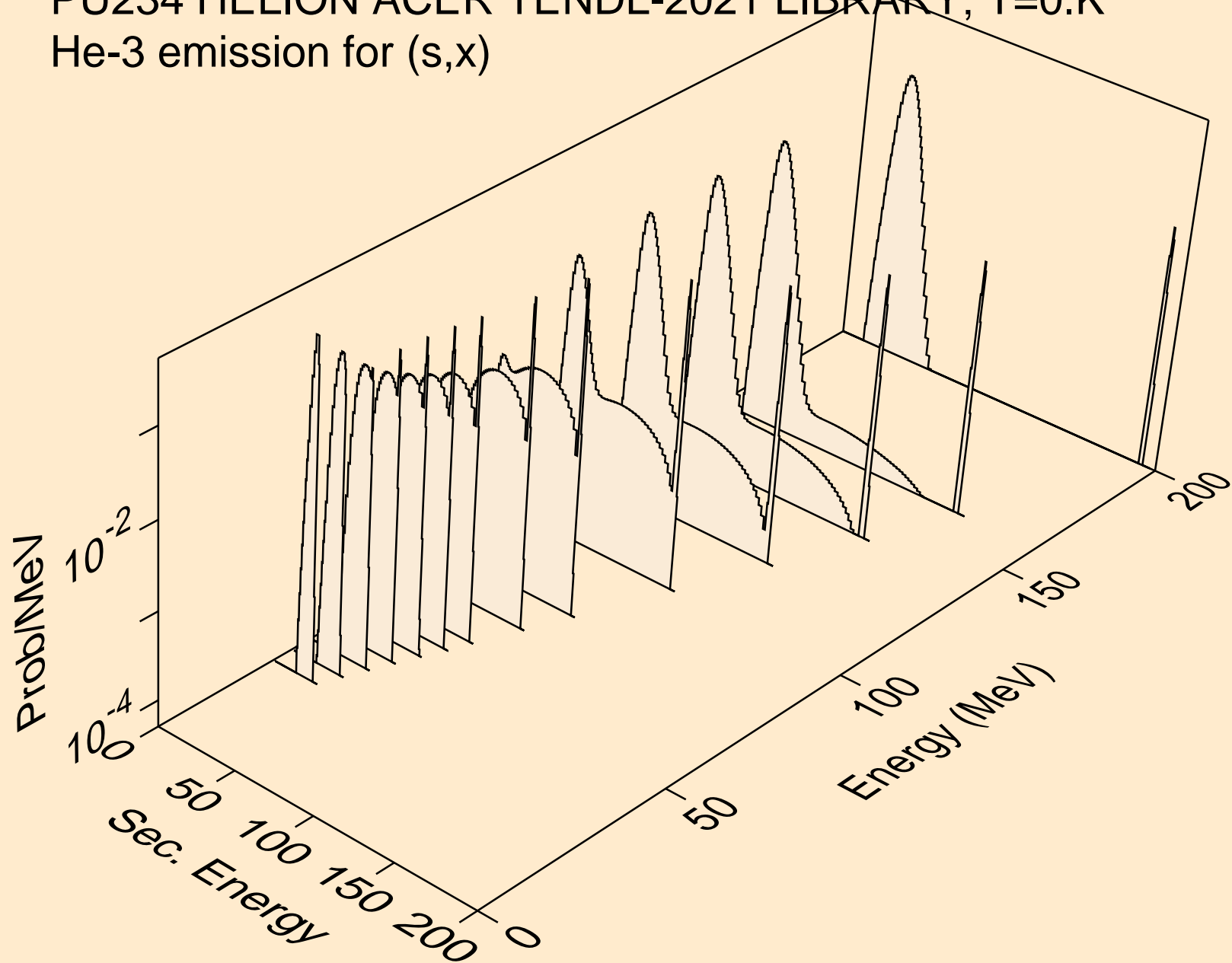

PU234 HELION ACER TENDL-2021 LIBRARY; T=0.K
He-3 emission for (s,n*)he3

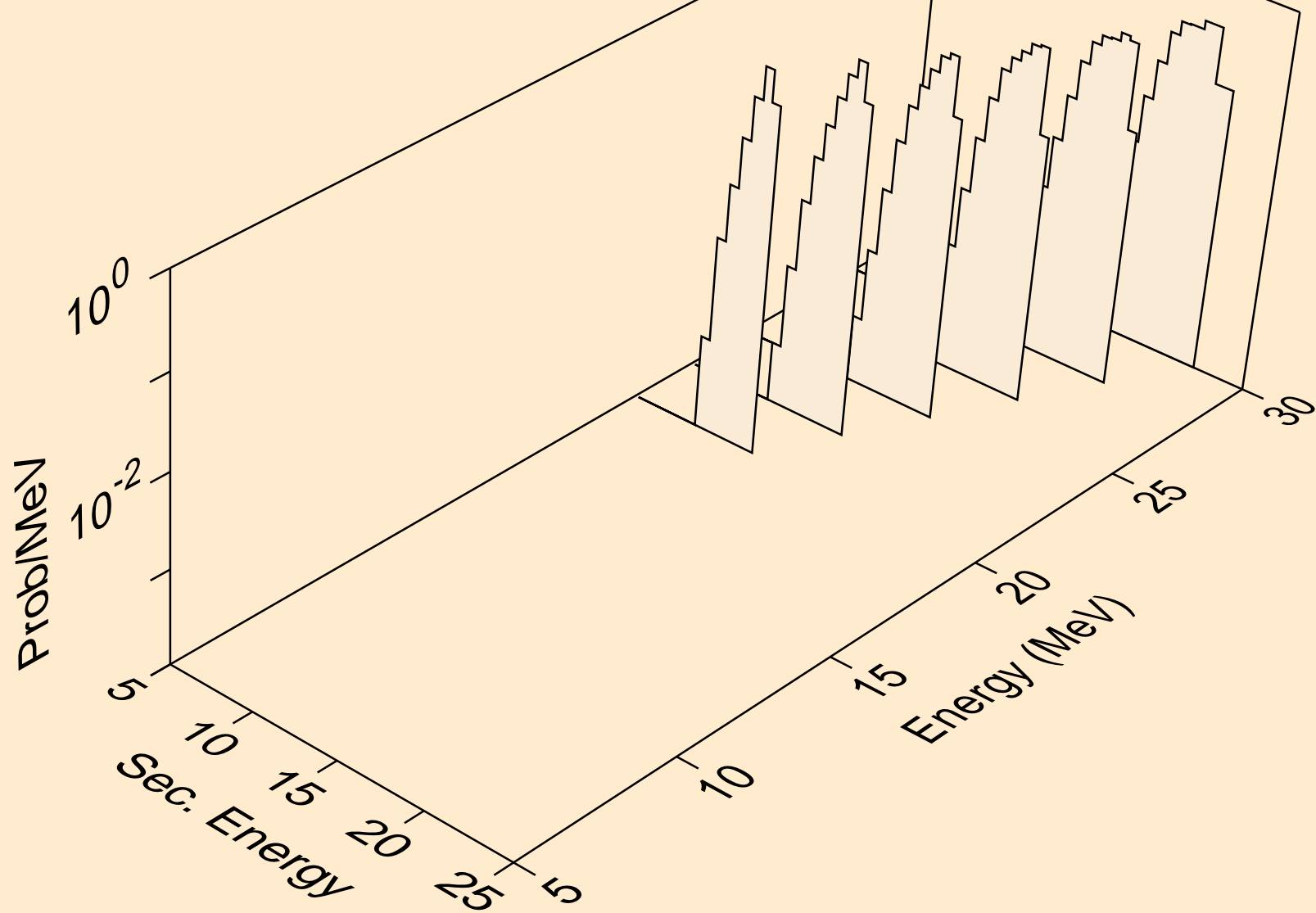

PU234 HELION ACER TENDL-2021 LIBRARY; T=0.K
He-3 emission for inelastic

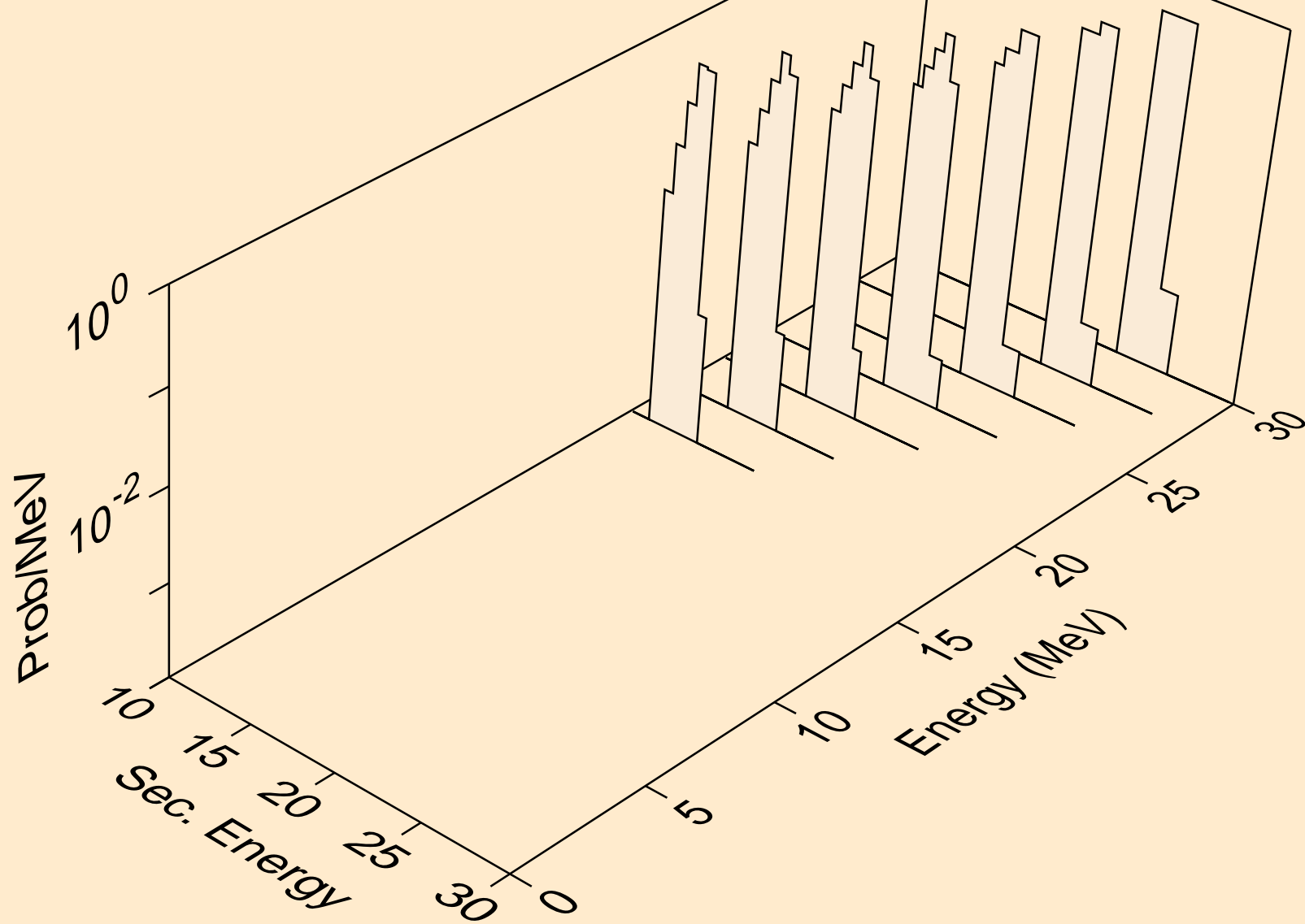

PU234 HELION ACER TENDL-2021 LIBRARY; T=0.K
Photon emission for (z,n)

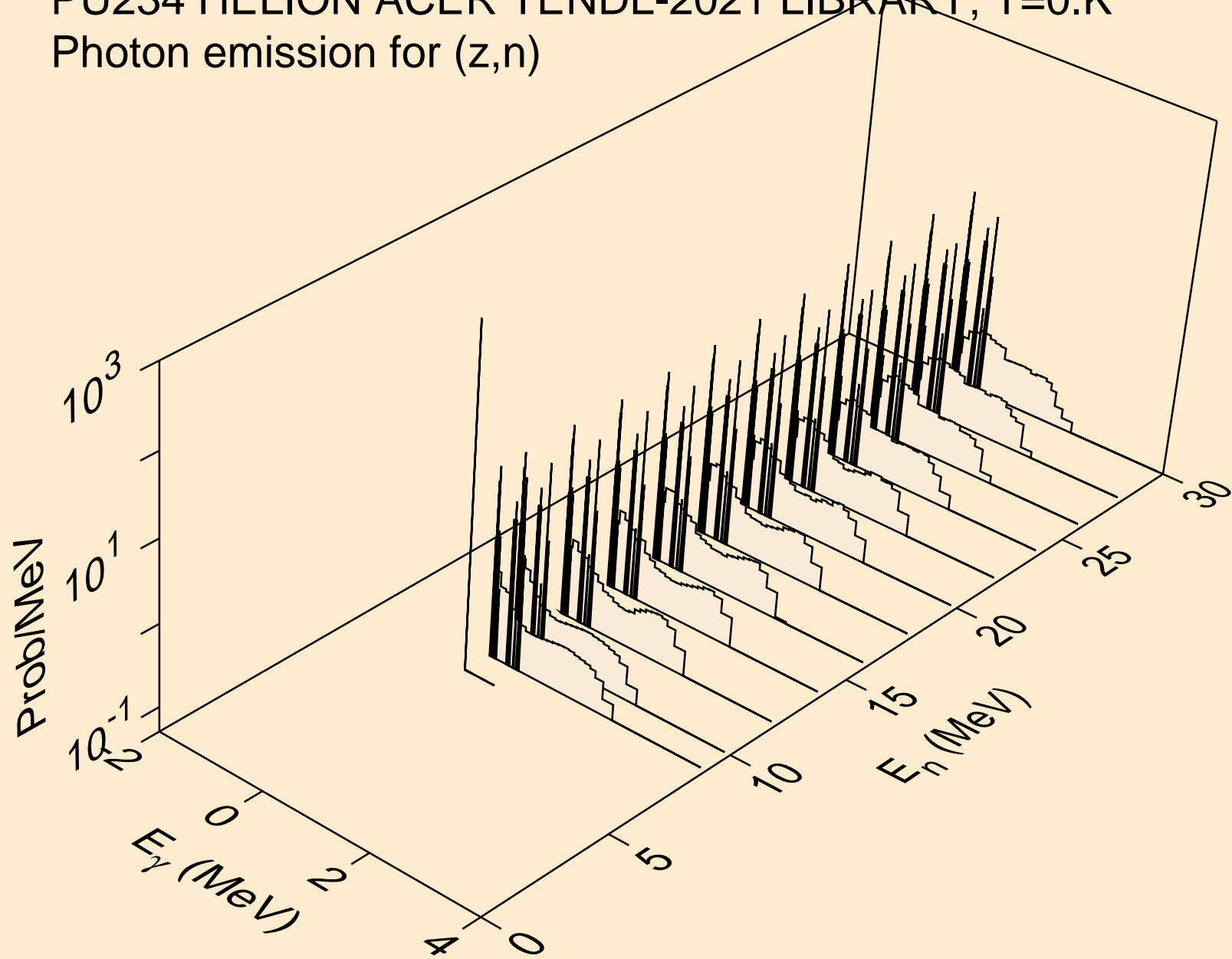

PU234 HELION ACER TENDL-2021 LIBRARY; T=0.K
Photon emission for (n,x)

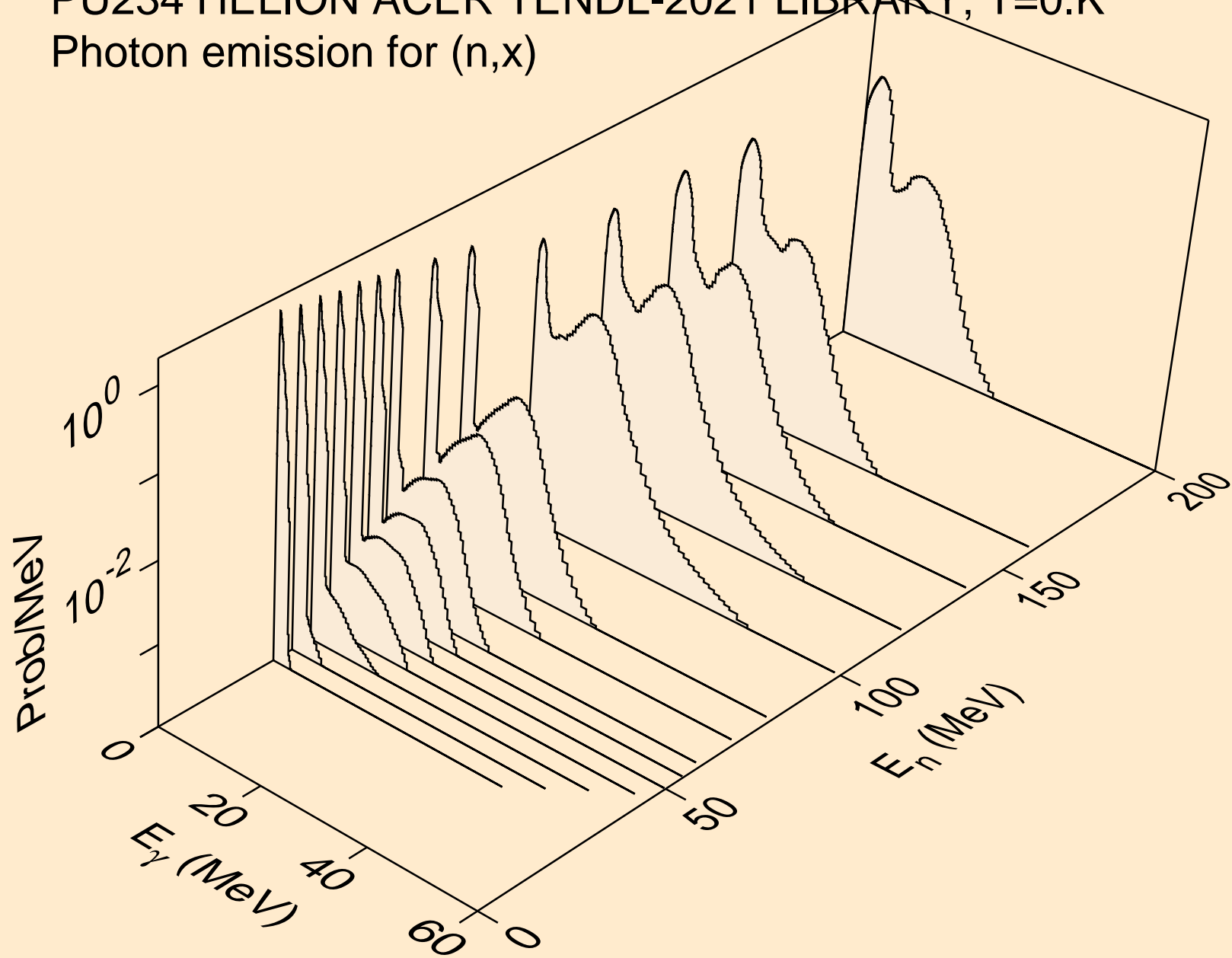

PU234 HELION ACER TENDL-2021 LIBRARY; T=0.K
Photon emission for (n,2n)

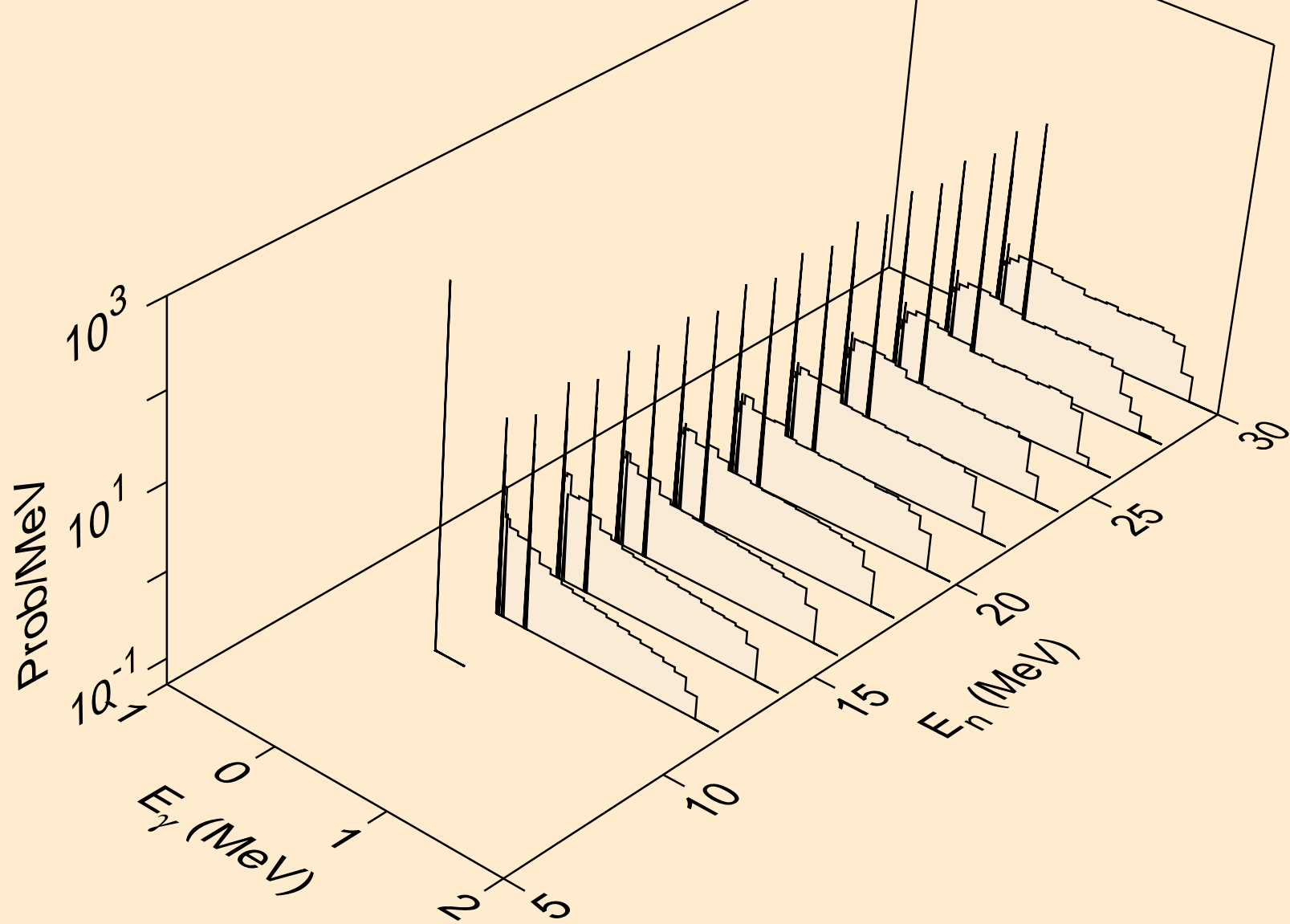

PU234 HELION ACER TENDL-2021 LIBRARY; T=0.K
Photon emission for (n,3n)

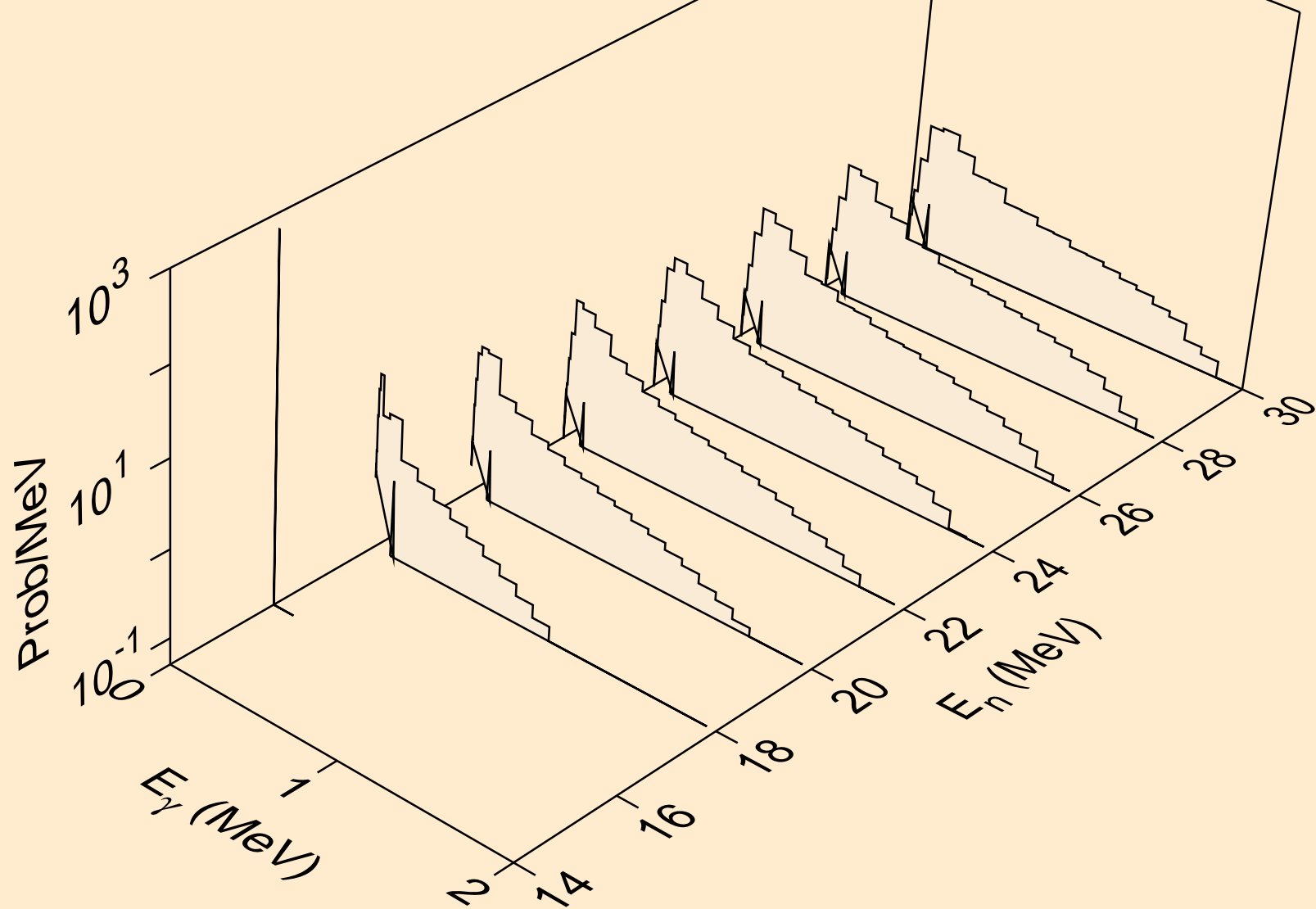

PU234 HELION ACER TENDL-2021 LIBRARY; T=0.K
Photon emission for (n,n*)a

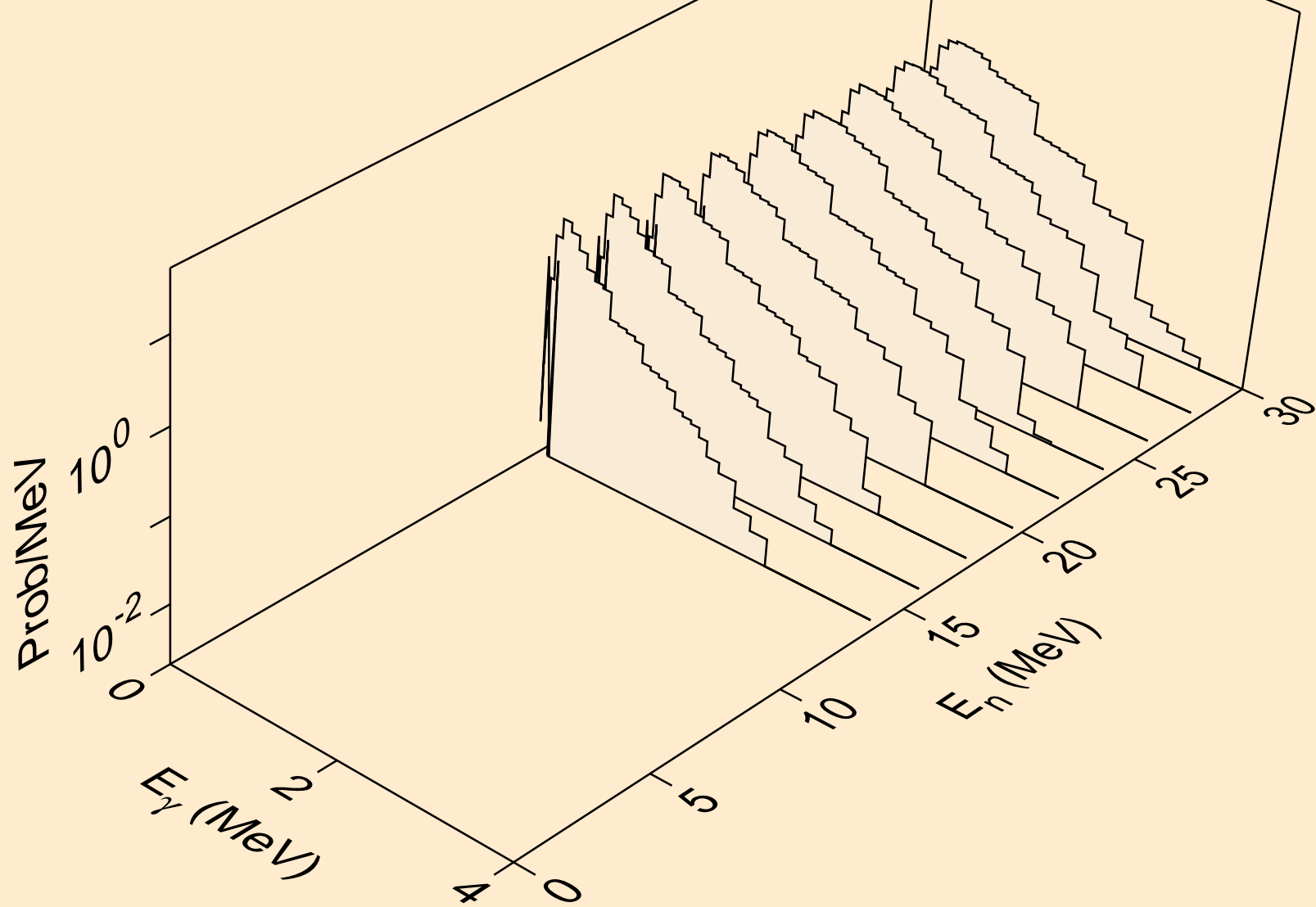

PU234 HELION ACER TENDL-2021 LIBRARY; T=0.K
Photon emission for (n,2n)a

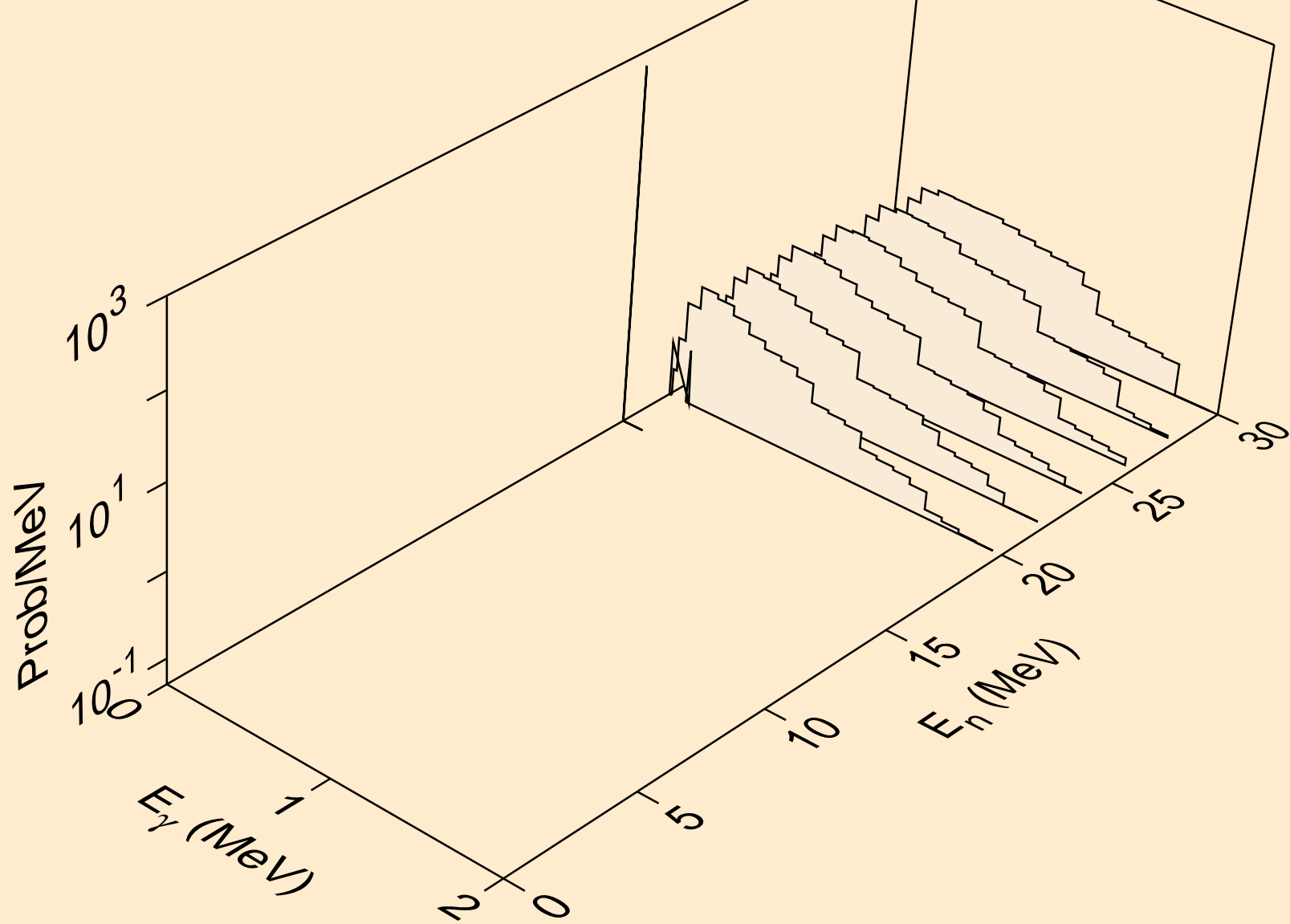

PU234 HELION ACER TENDL-2021 LIBRARY; T=0.K
Photon emission for (n,n*)p

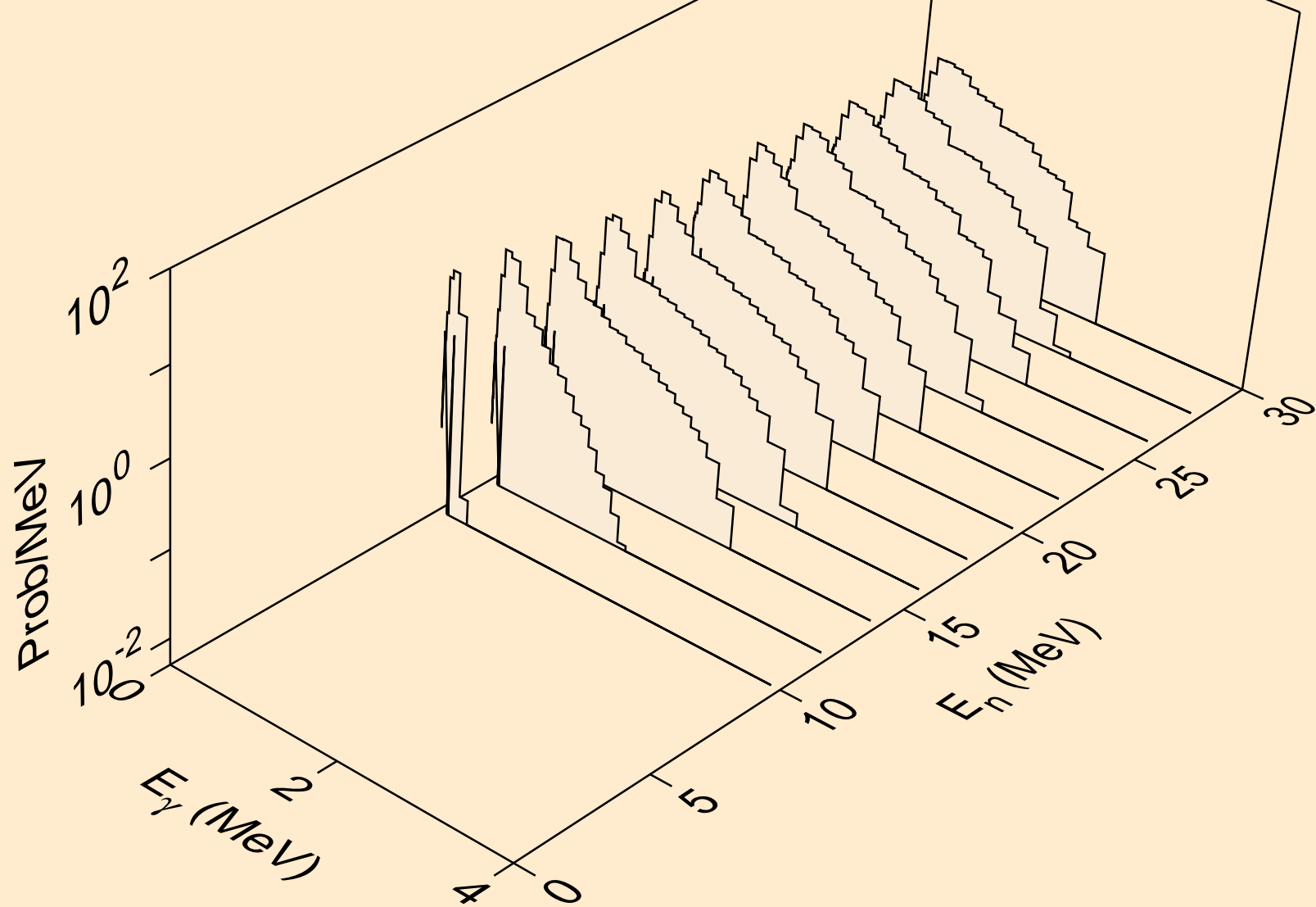

PU234 HELION ACER TENDL-2021 LIBRARY; T=0.K
Photon emission for (n,n*)d

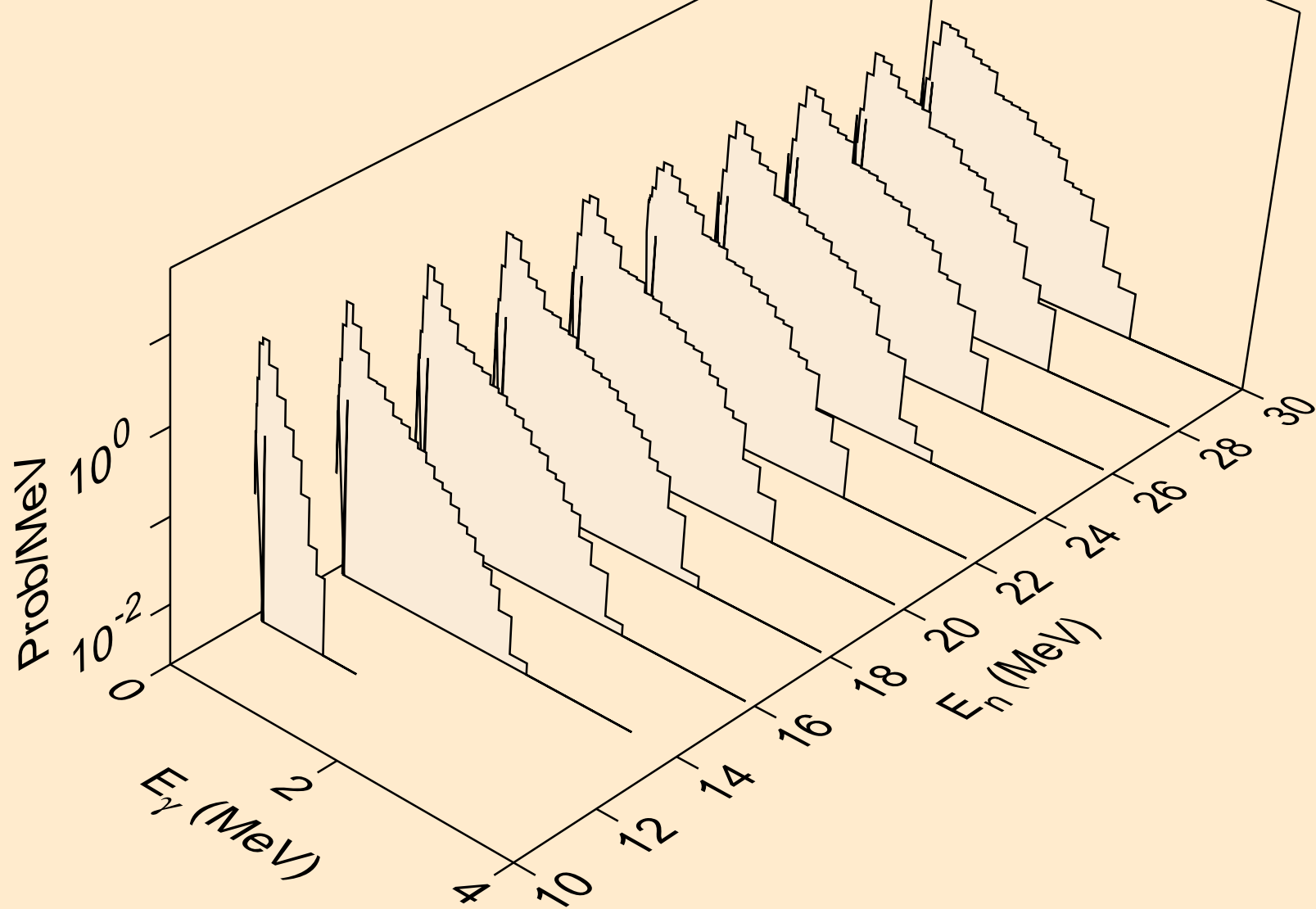

PU234 HELION ACER TENDL-2021 LIBRARY; T=0.K
Photon emission for (n,n*)t

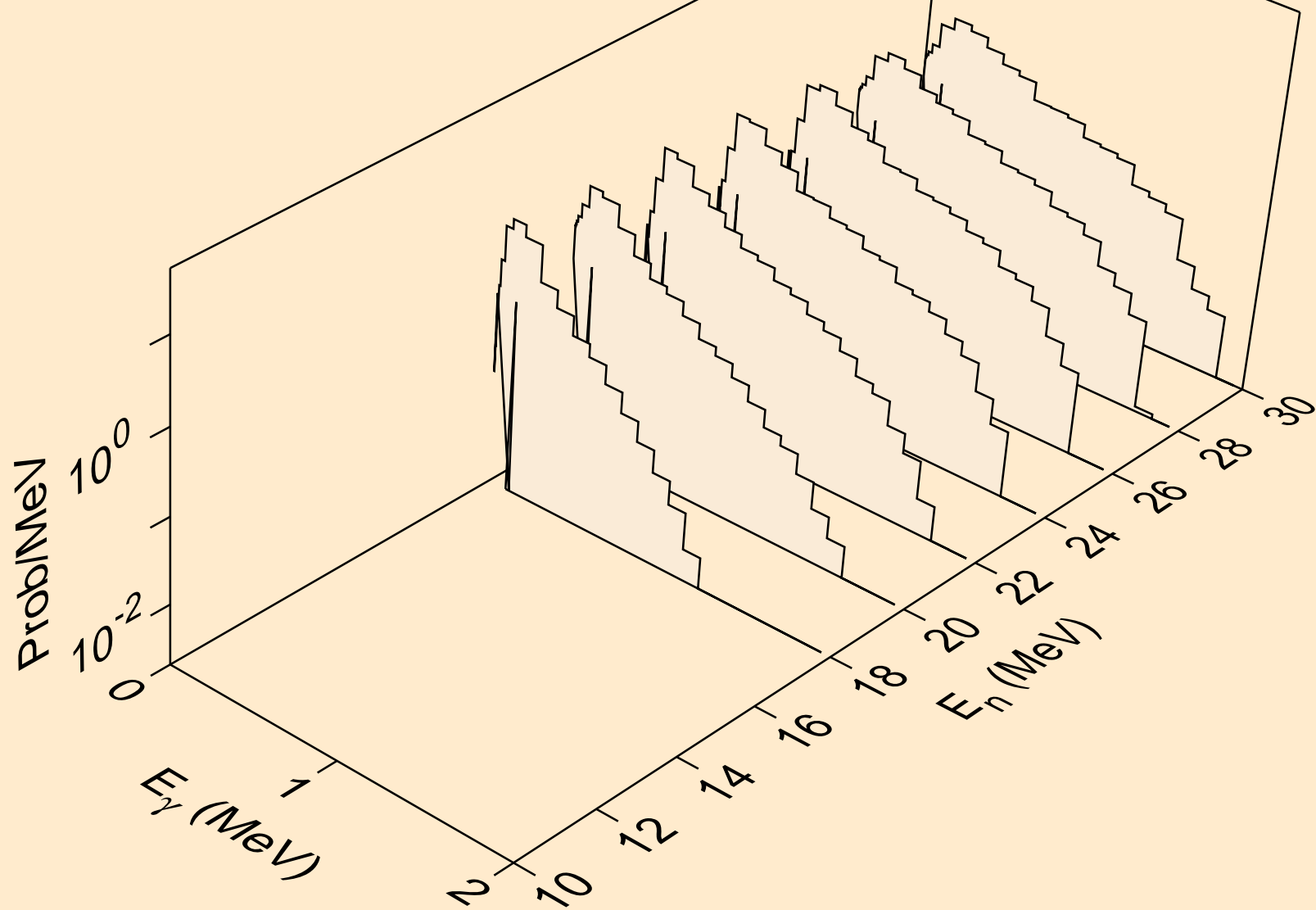

PU234 HELION ACER TENDL-2021 LIBRARY; T=0.K
Photon emission for (n,n*)he3

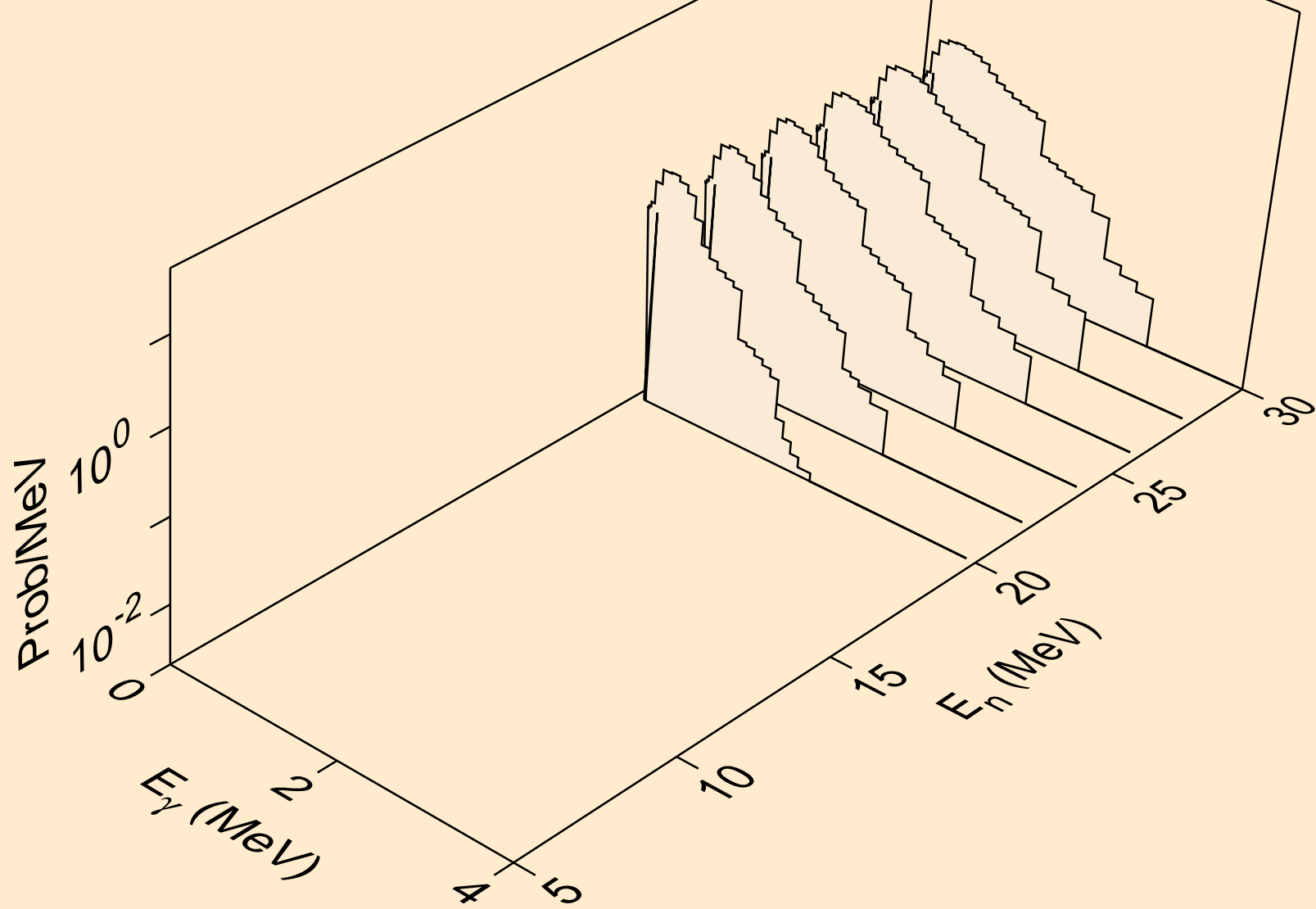

PU234 HELION ACER TENDL-2021 LIBRARY; T=0.K
Photon emission for (n,2np)

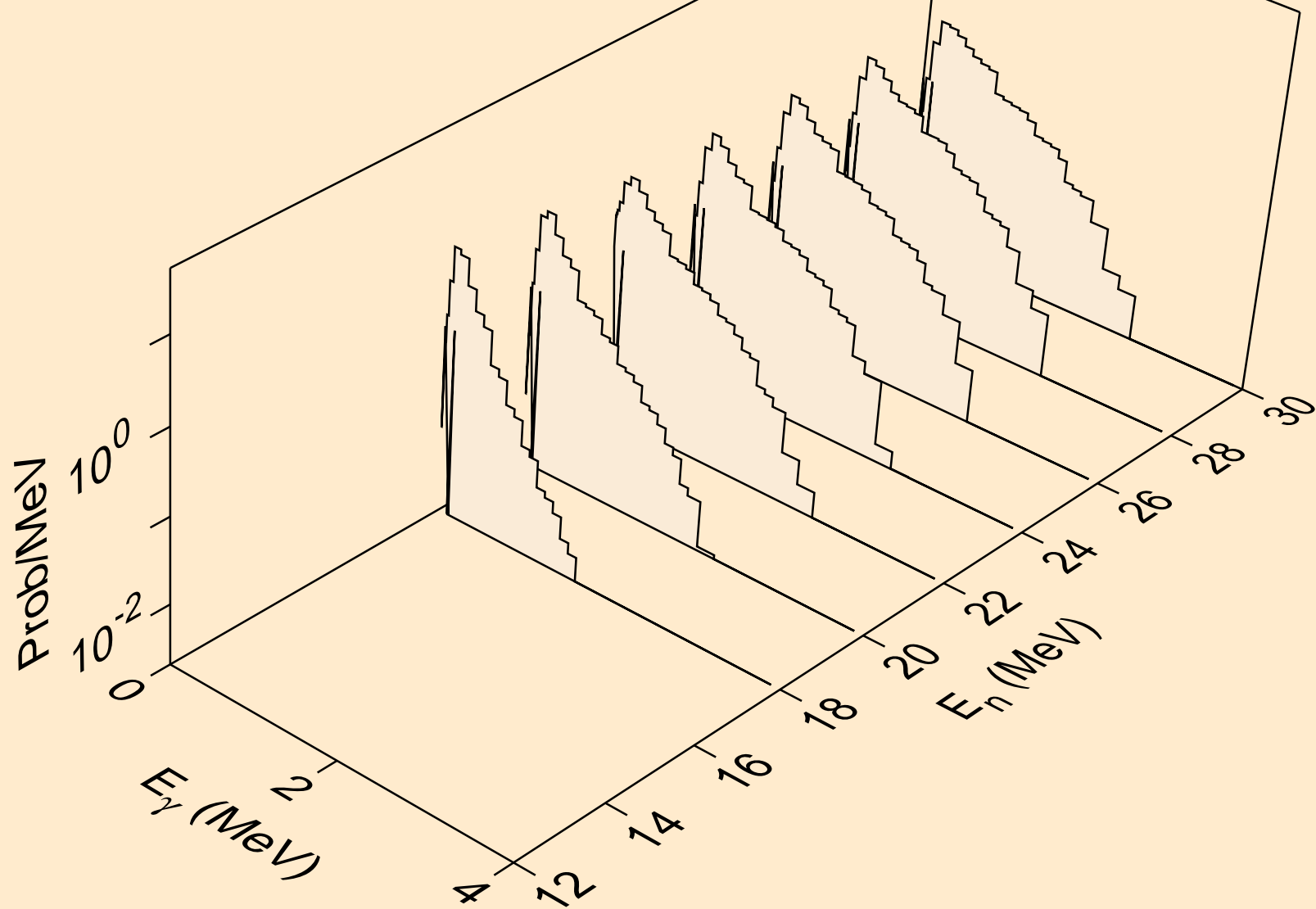

PU234 HELION ACER TENDL-2021 LIBRARY; T=0.K
Photon emission for (n,p)

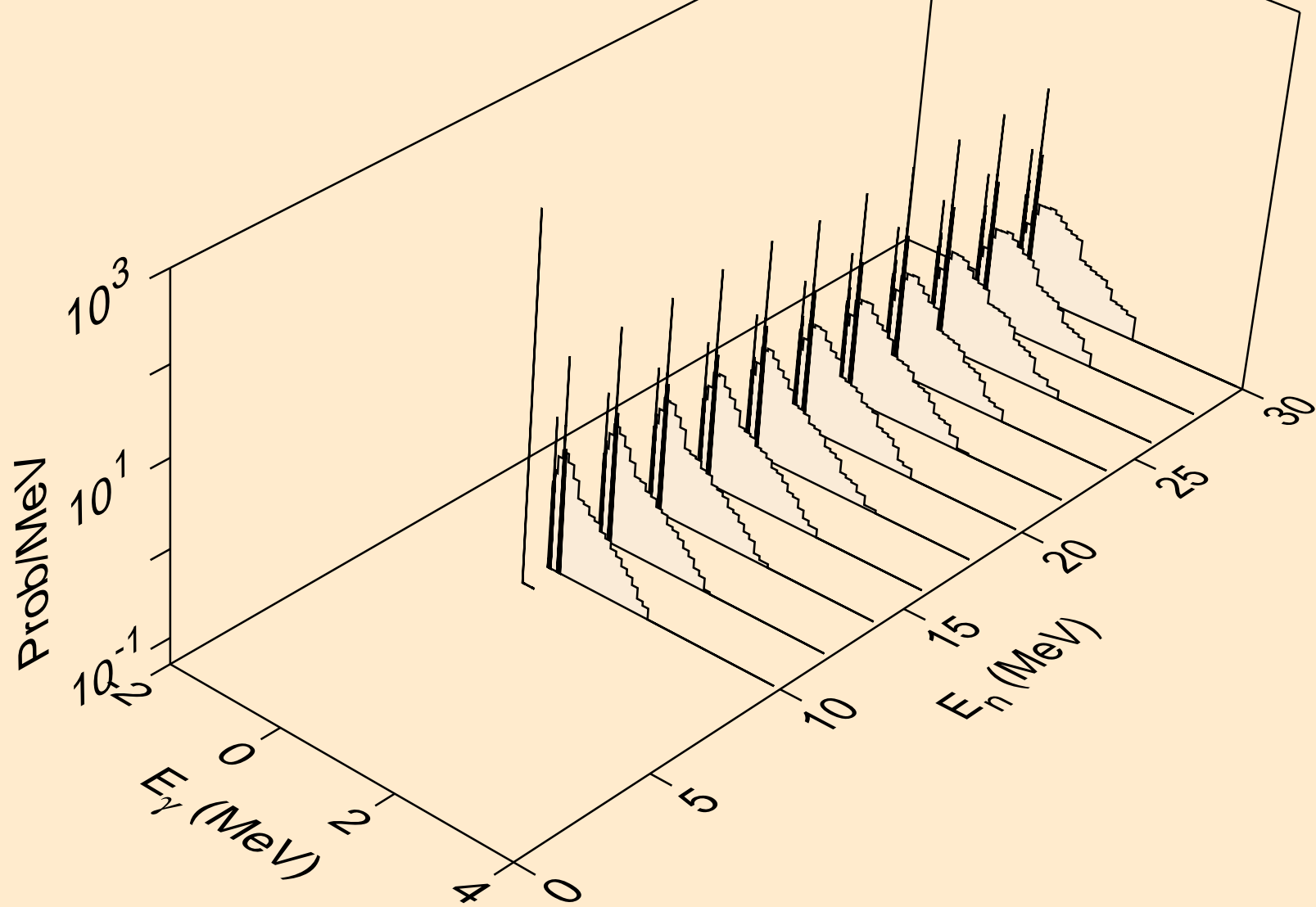

PU234 HELION ACER TENDL-2021 LIBRARY; T=0.K
Photon emission for (n,d)

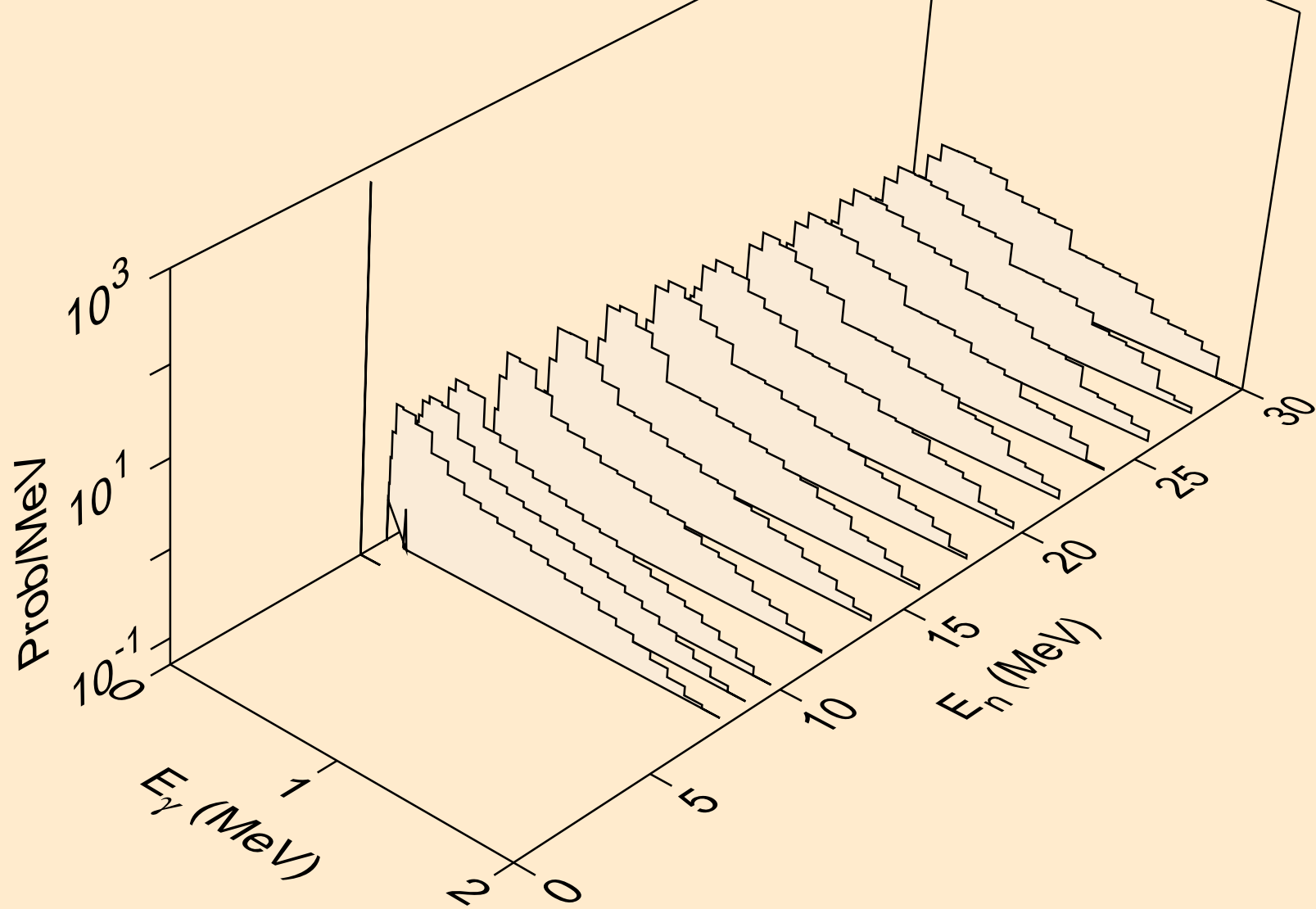

PU234 HELION ACER TENDL-2021 LIBRARY; T=0.K
Photon emission for (n,t)

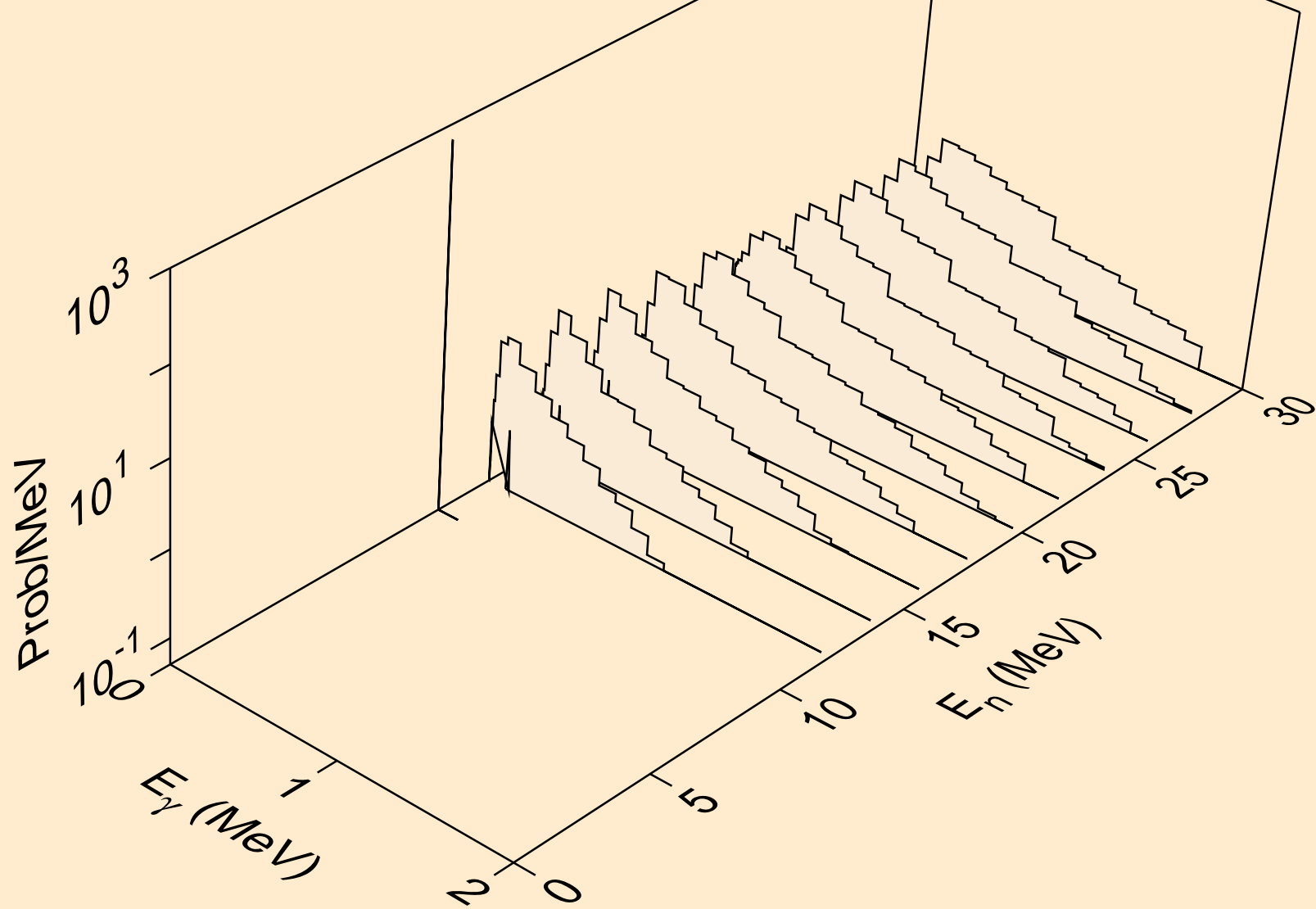

PU234 HELION ACER TENDL-2021 LIBRARY; T=0.K
Photon emission for inelastic

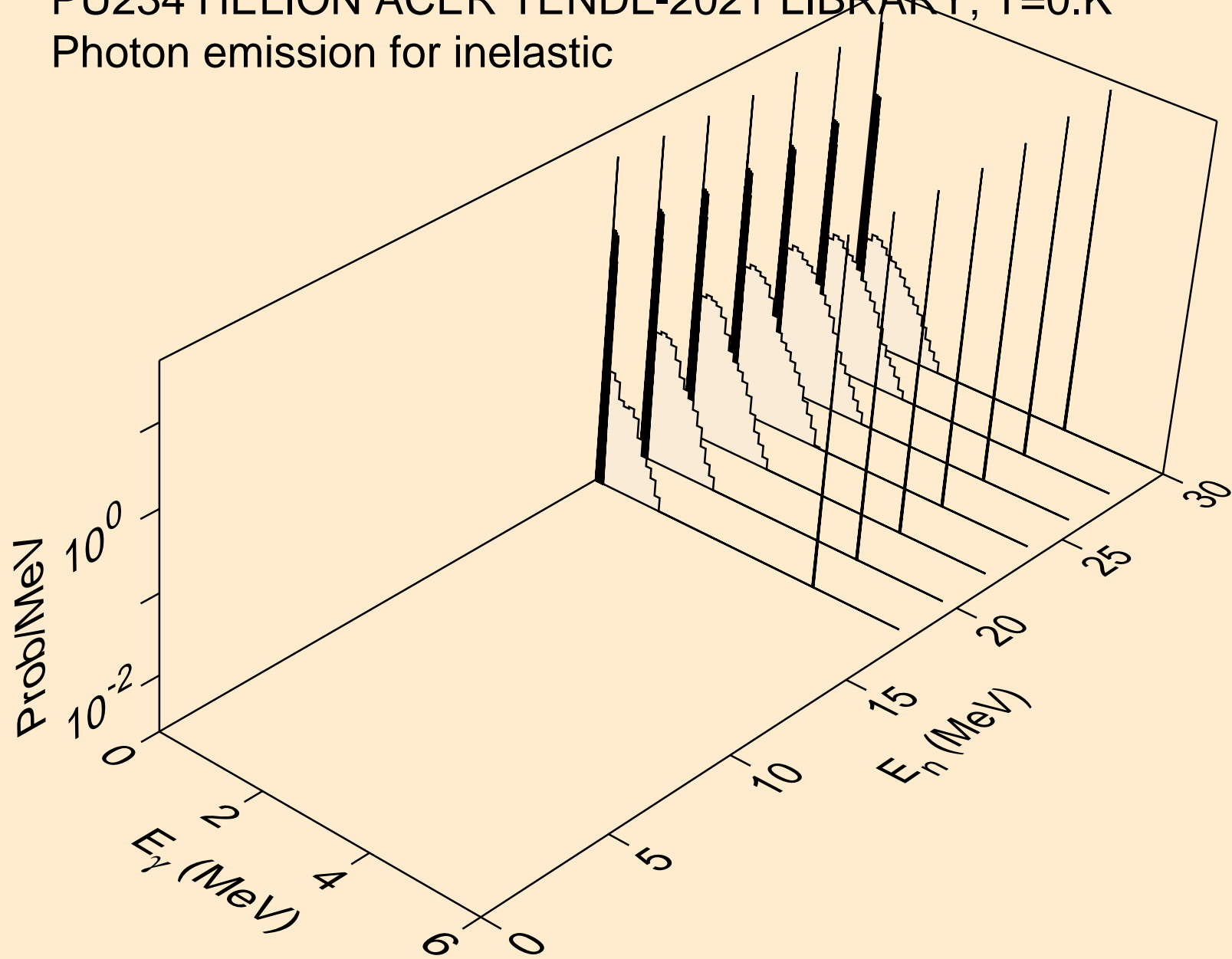

PU234 HELION ACER TENDL-2021 LIBRARY; T=0.K
Photon emission for (n,a)

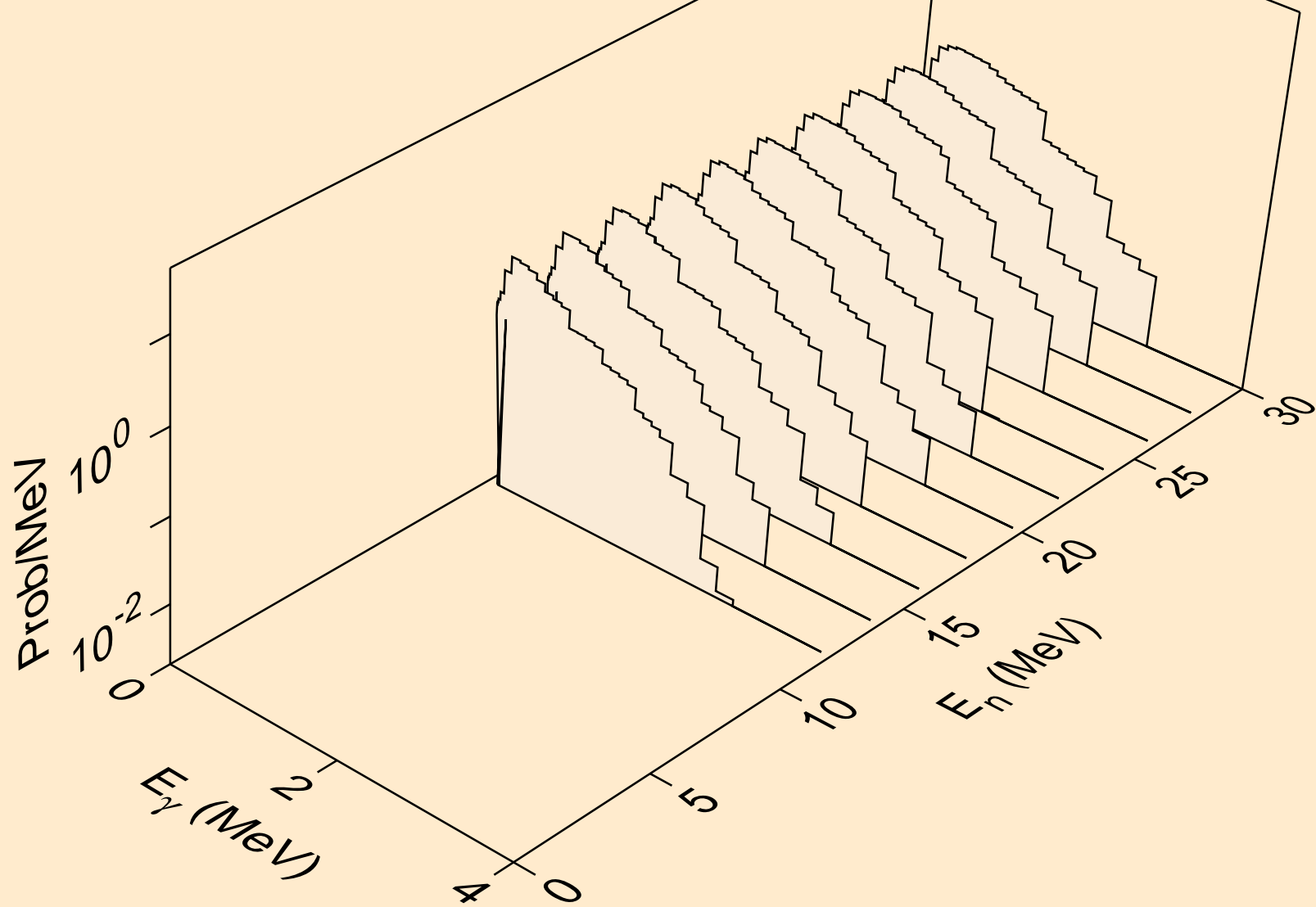

PU234 HELION ACER TENDL-2021 LIBRARY; T=0.K
Photon emission for (n,pa)

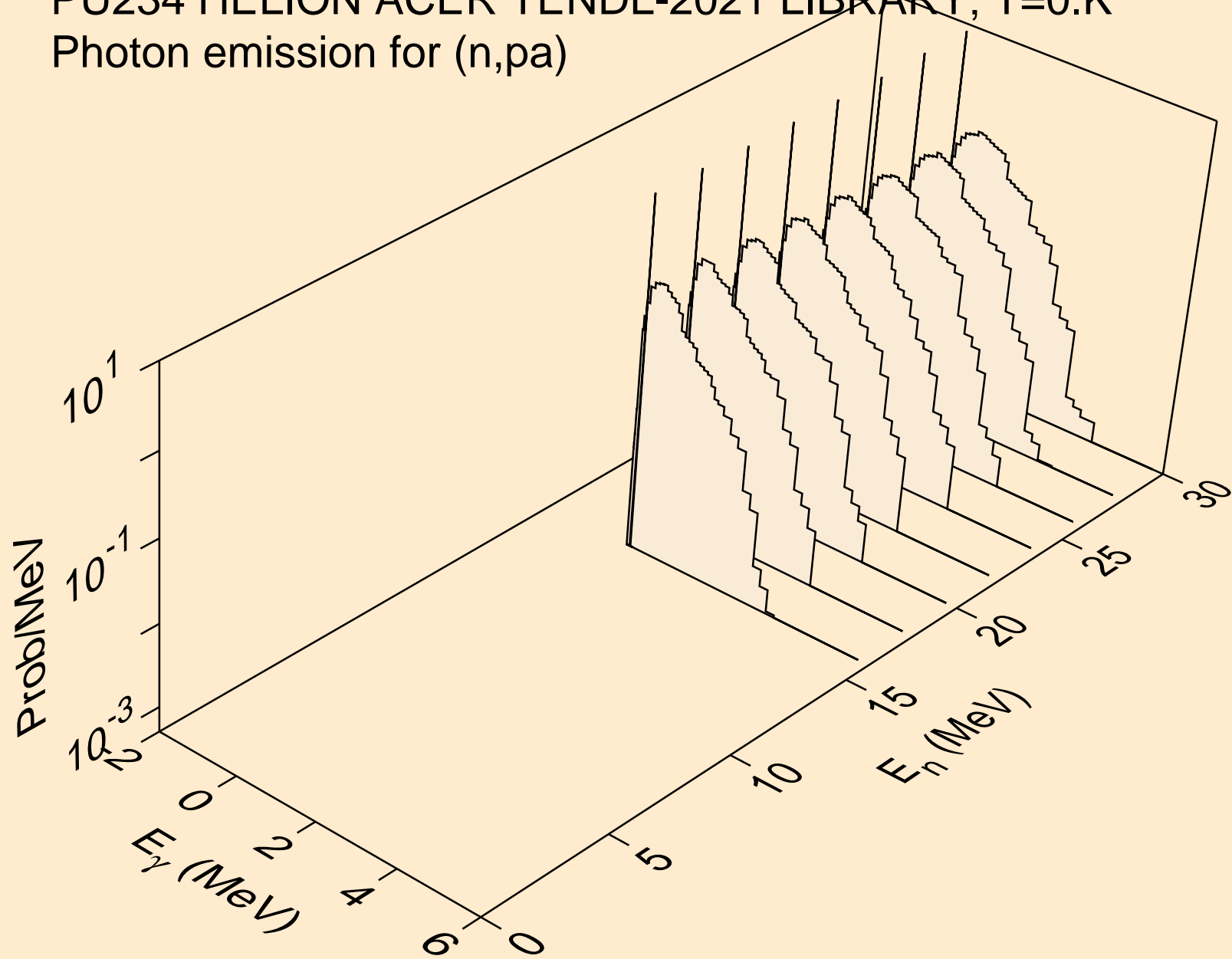

PU234 HELION ACER TENDL-2021 LIBRARY; T=0.K
Particle heating contributions

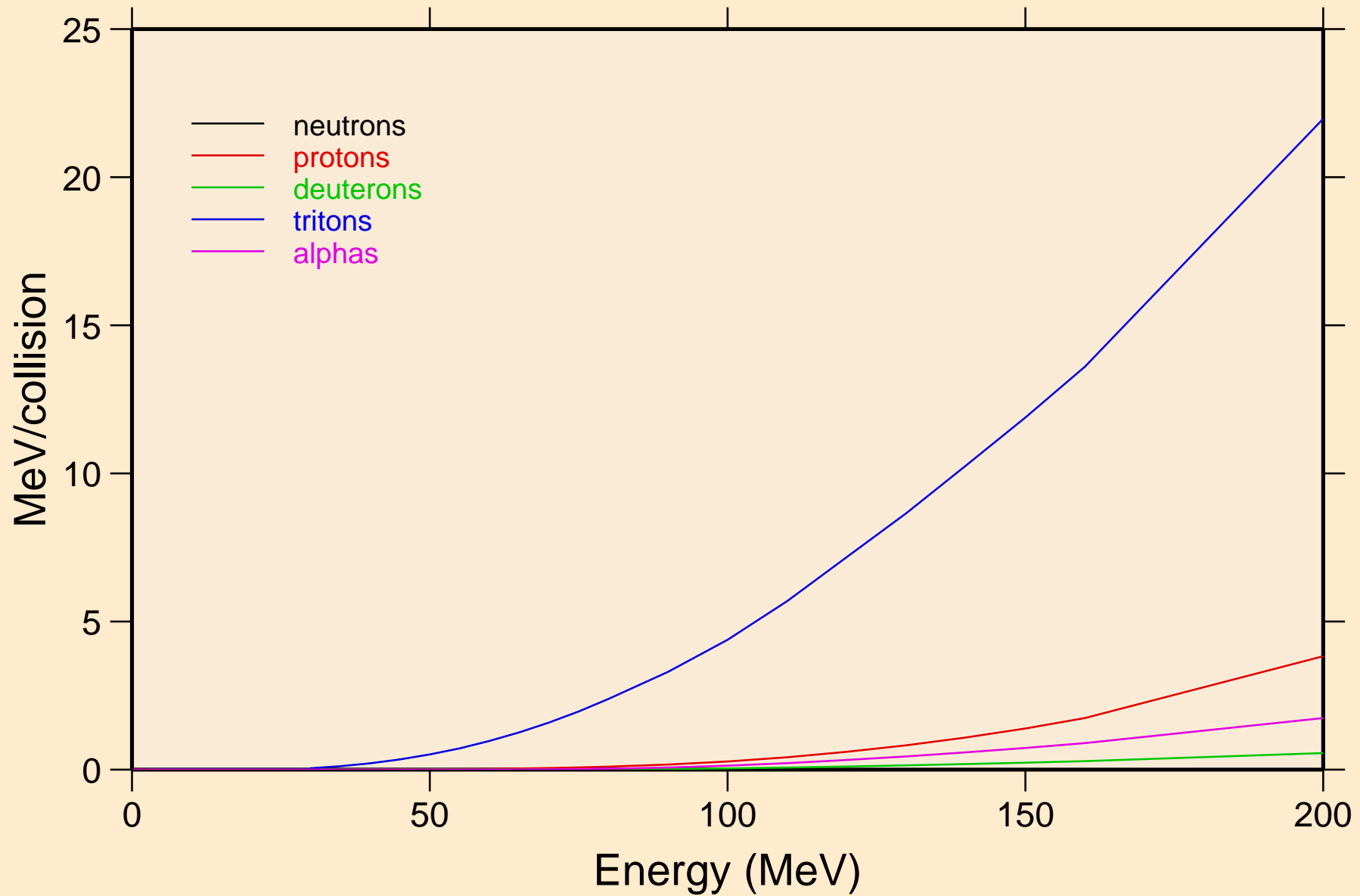

PU234 HELION ACER TENDL-2021 LIBRARY; T=0.K
Recoil Heating

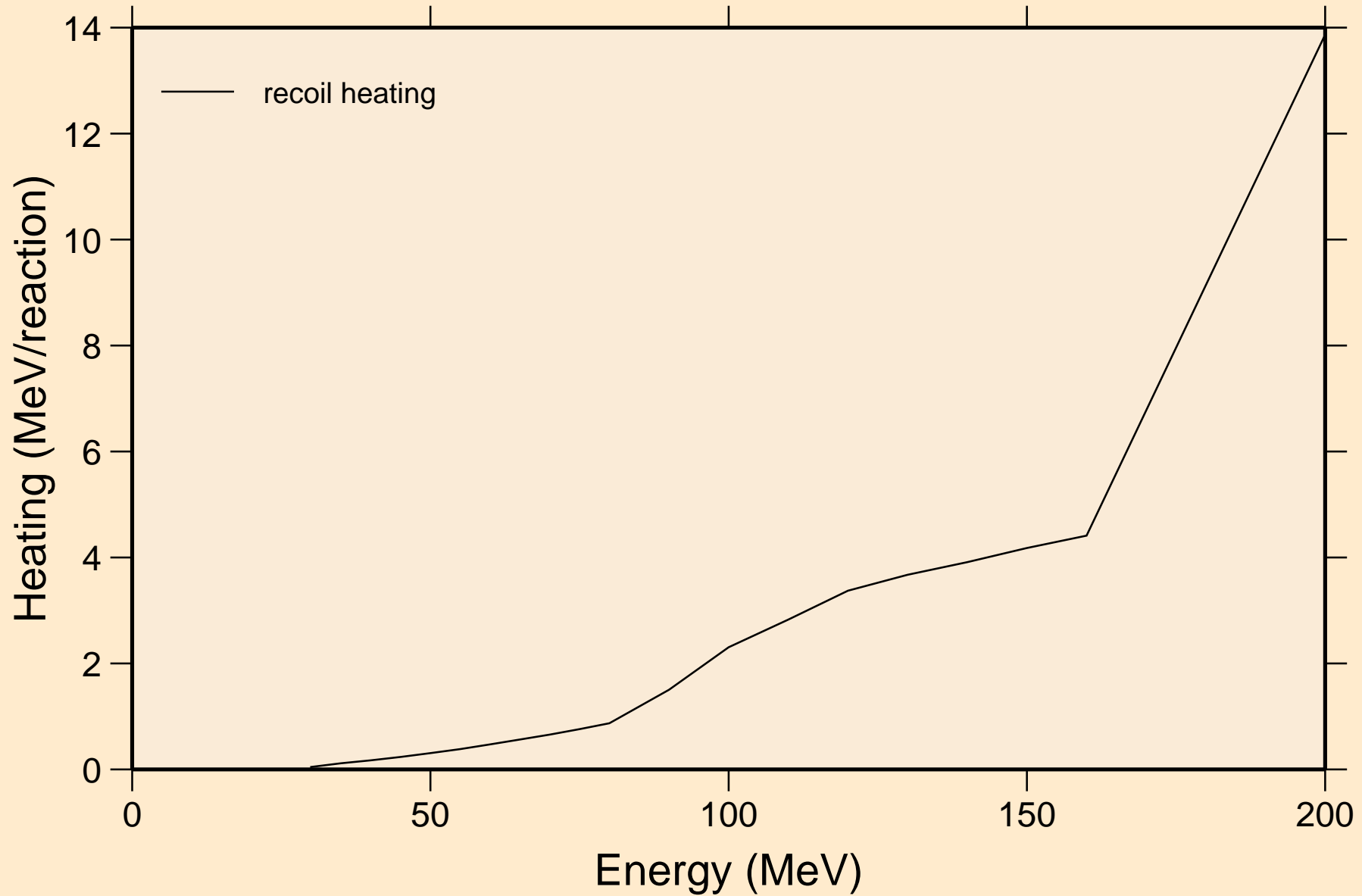

PU234 HELION ACER TENDL-2021 LIBRARY; T=0.K
Particle production cross sections

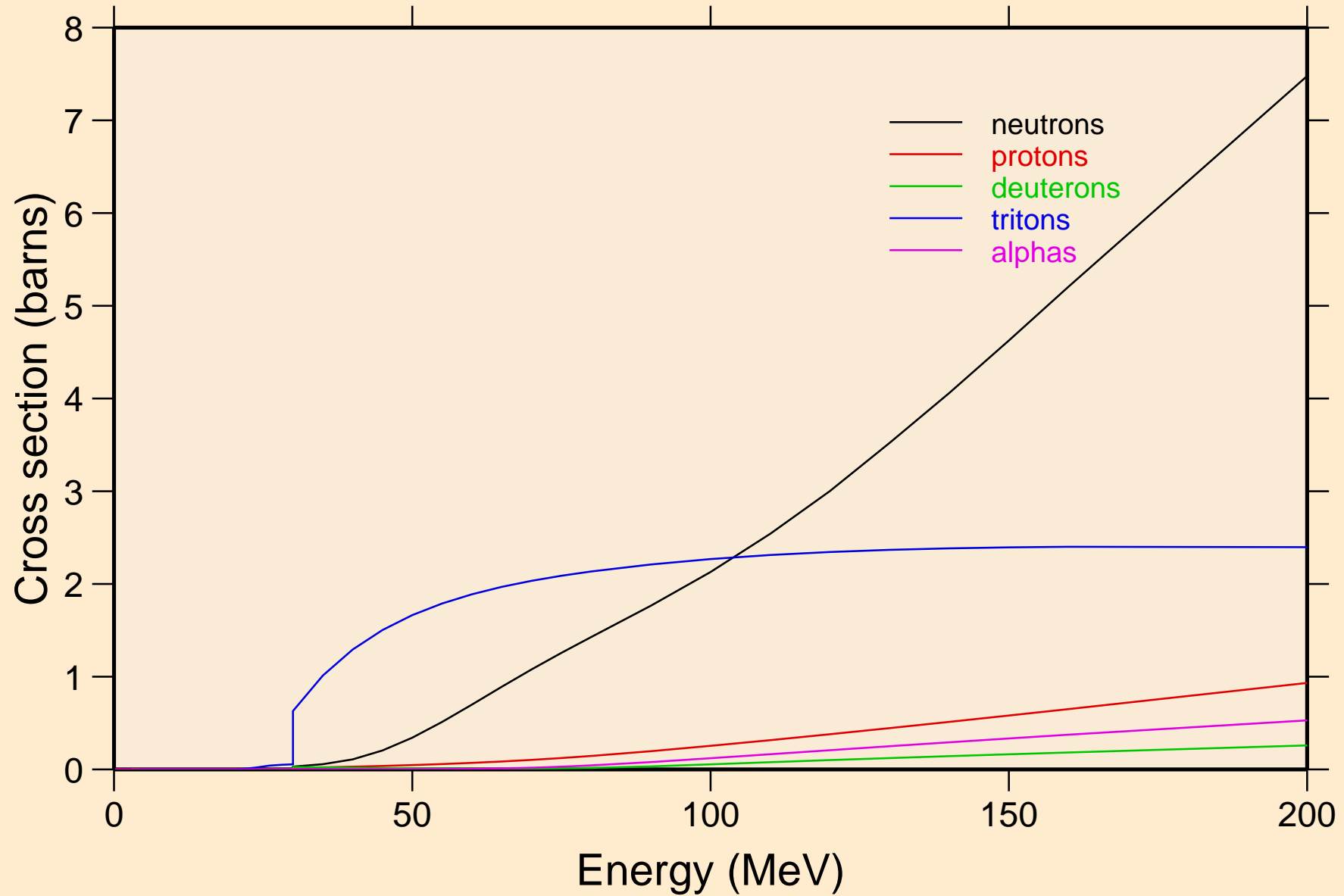

PU234 HELION ACER TENDL-2021 LIBRARY; T=0.K
neutrons from (s,n)

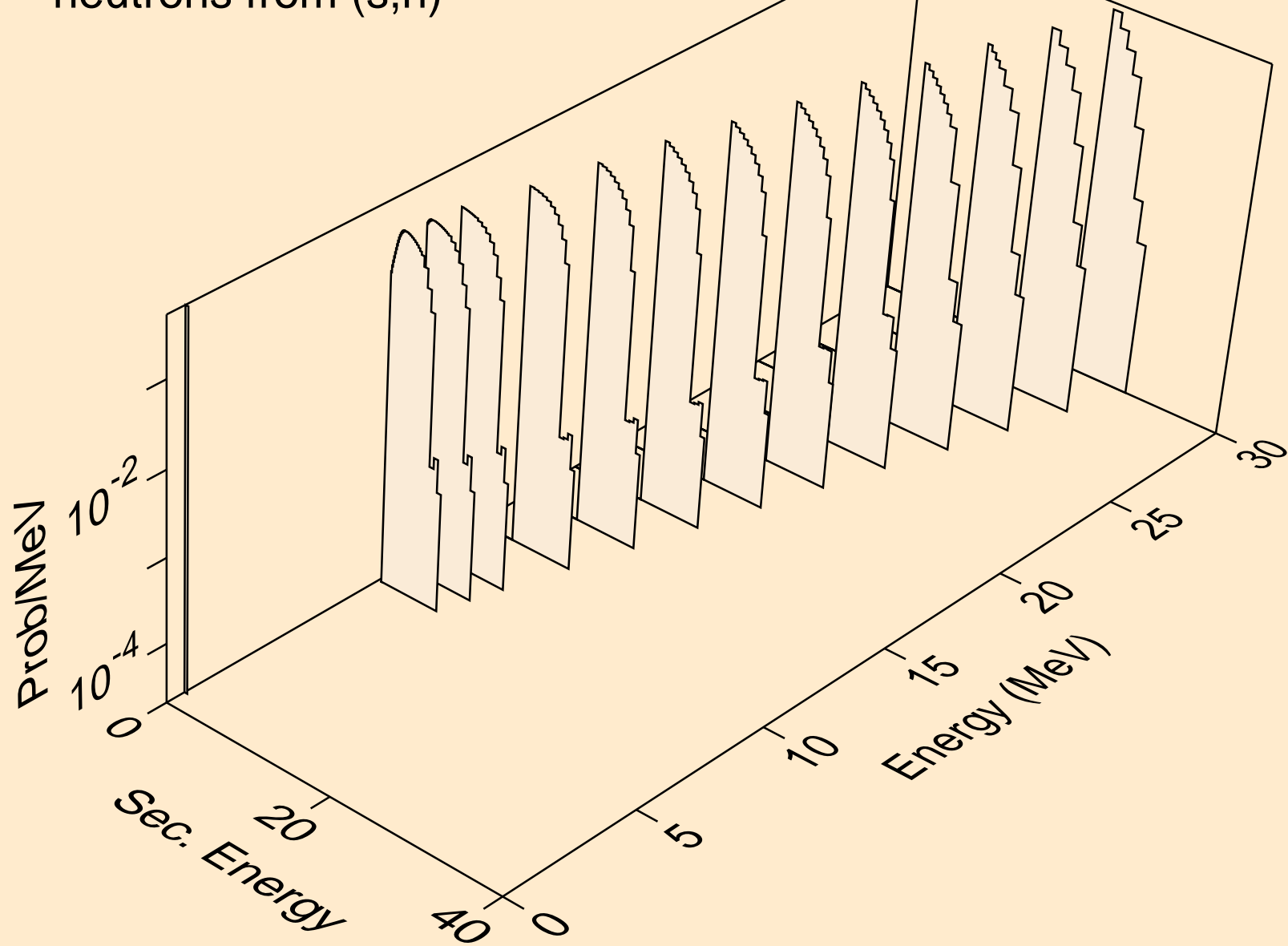

PU234 HELION ACER TENDL-2021 LIBRARY; T=0.K
neutrons from (s,x)

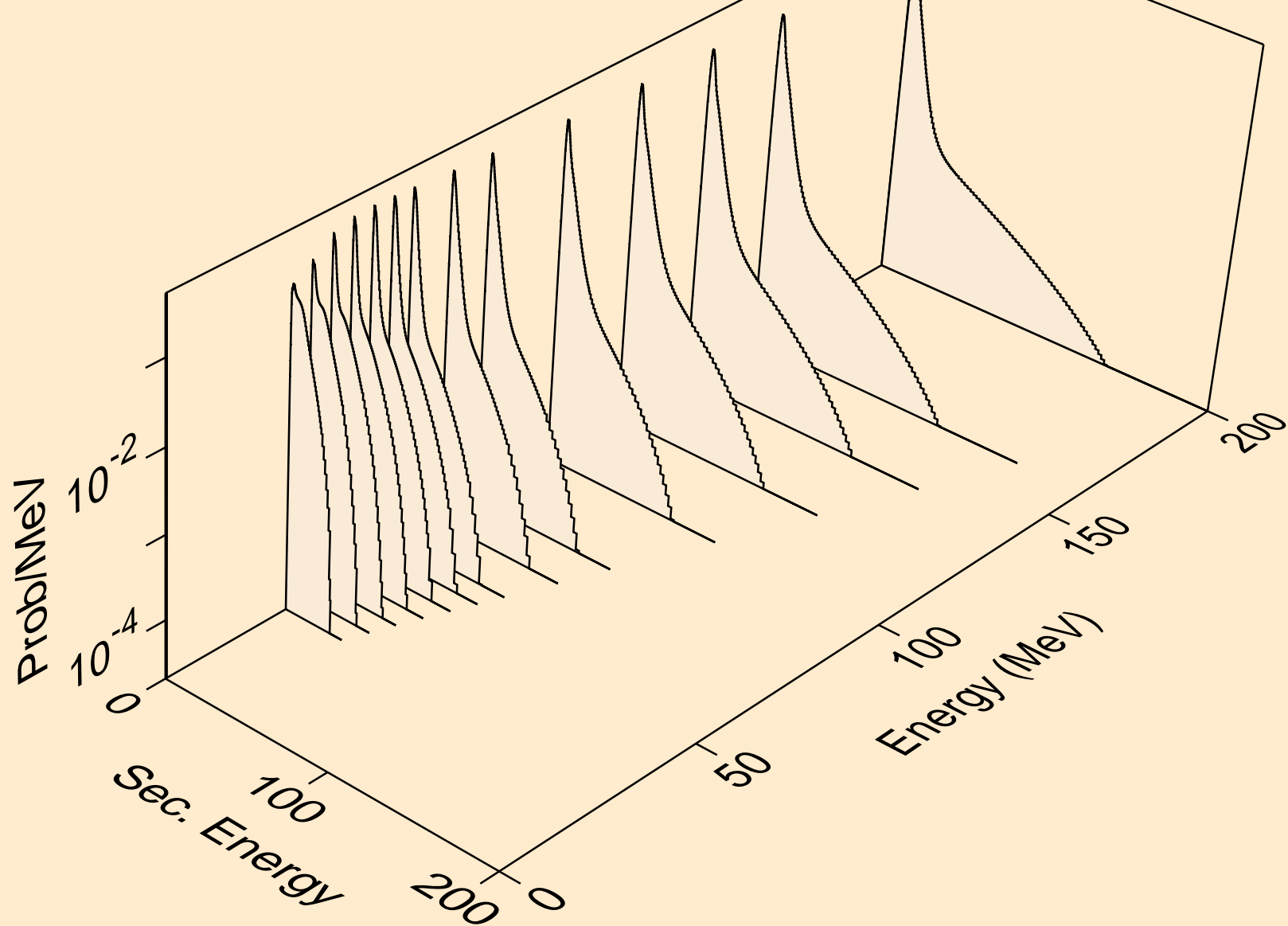

PU234 HELION ACER TENDL-2021 LIBRARY; T=0.K
neutrons from (s,2n)

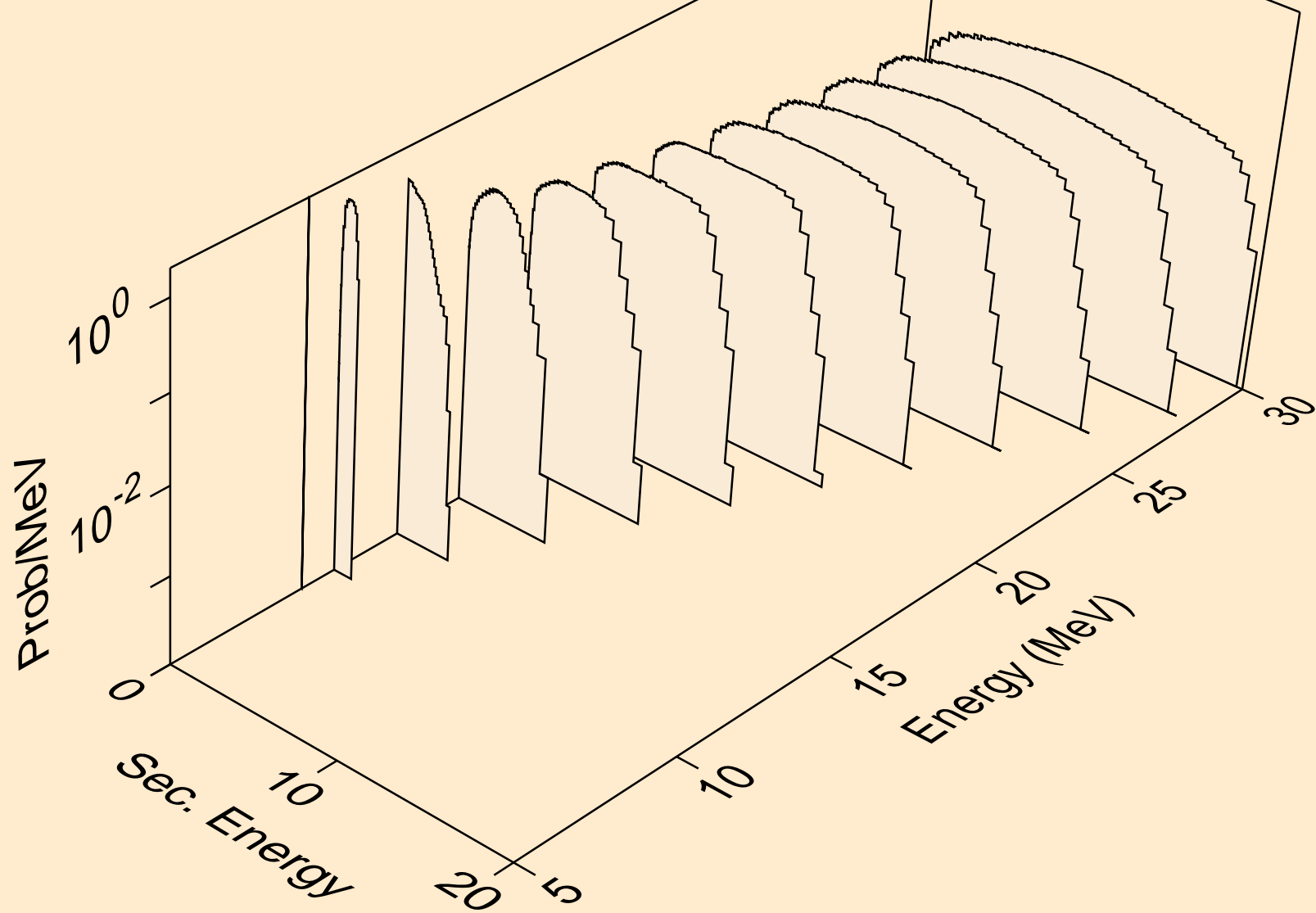

PU234 HELION ACER TENDL-2021 LIBRARY; T=0.K
neutrons from (s,3n)

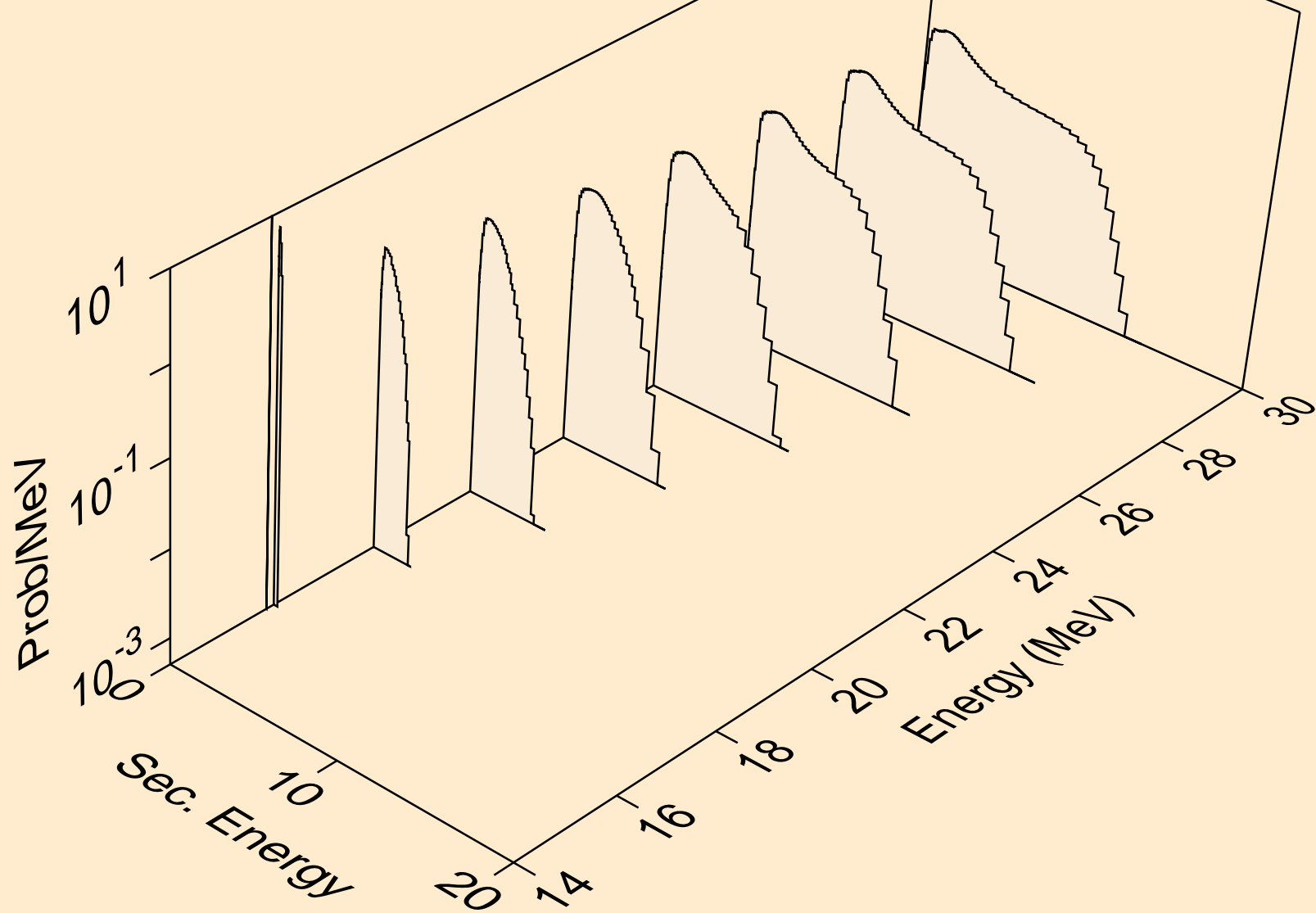

PU234 HELION ACER TENDL-2021 LIBRARY; T=0.K
neutrons from (s,n*)a

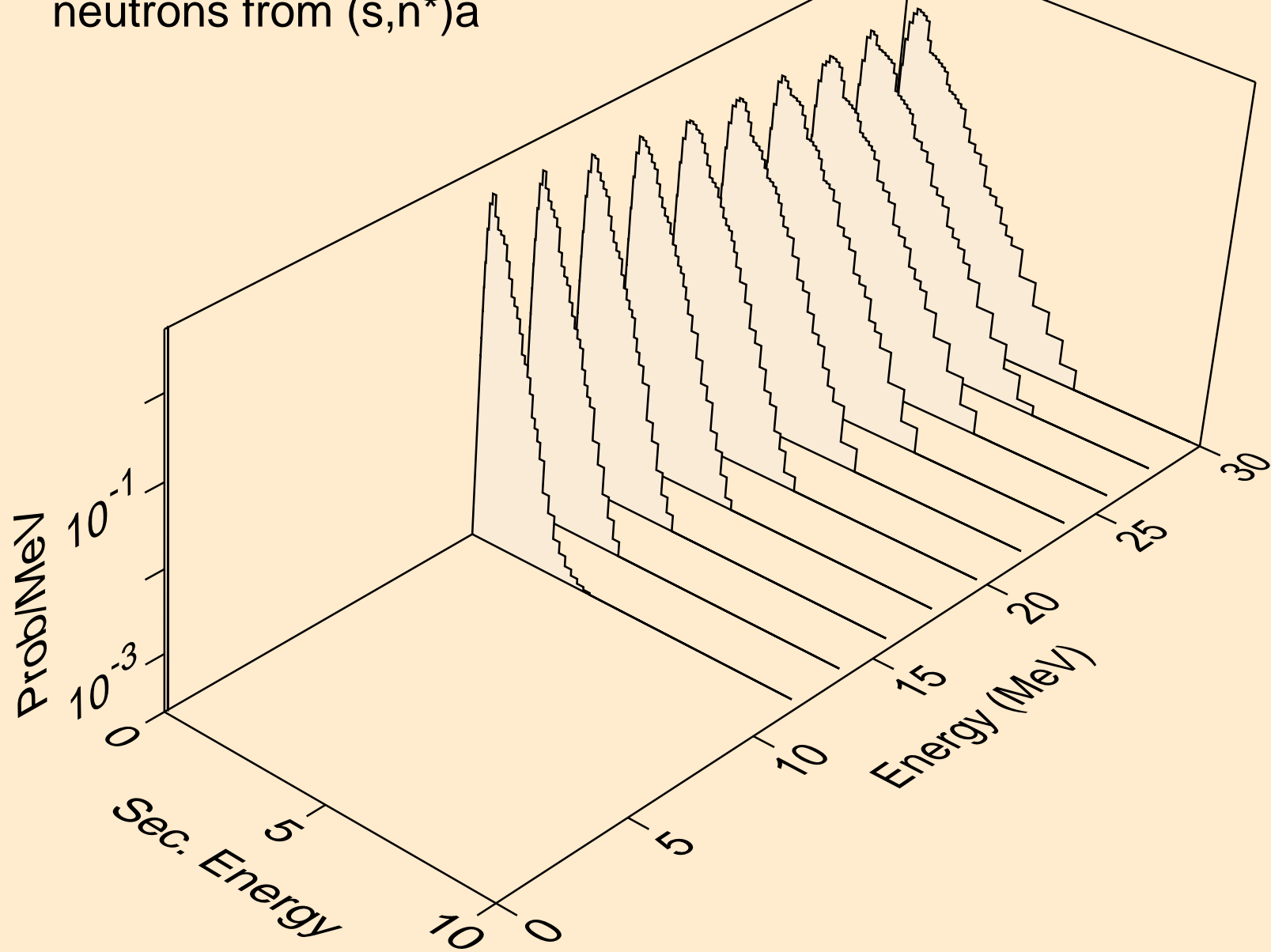

PU234 HELION ACER TENDL-2021 LIBRARY; T=0.K
neutrons from (s,2n)a

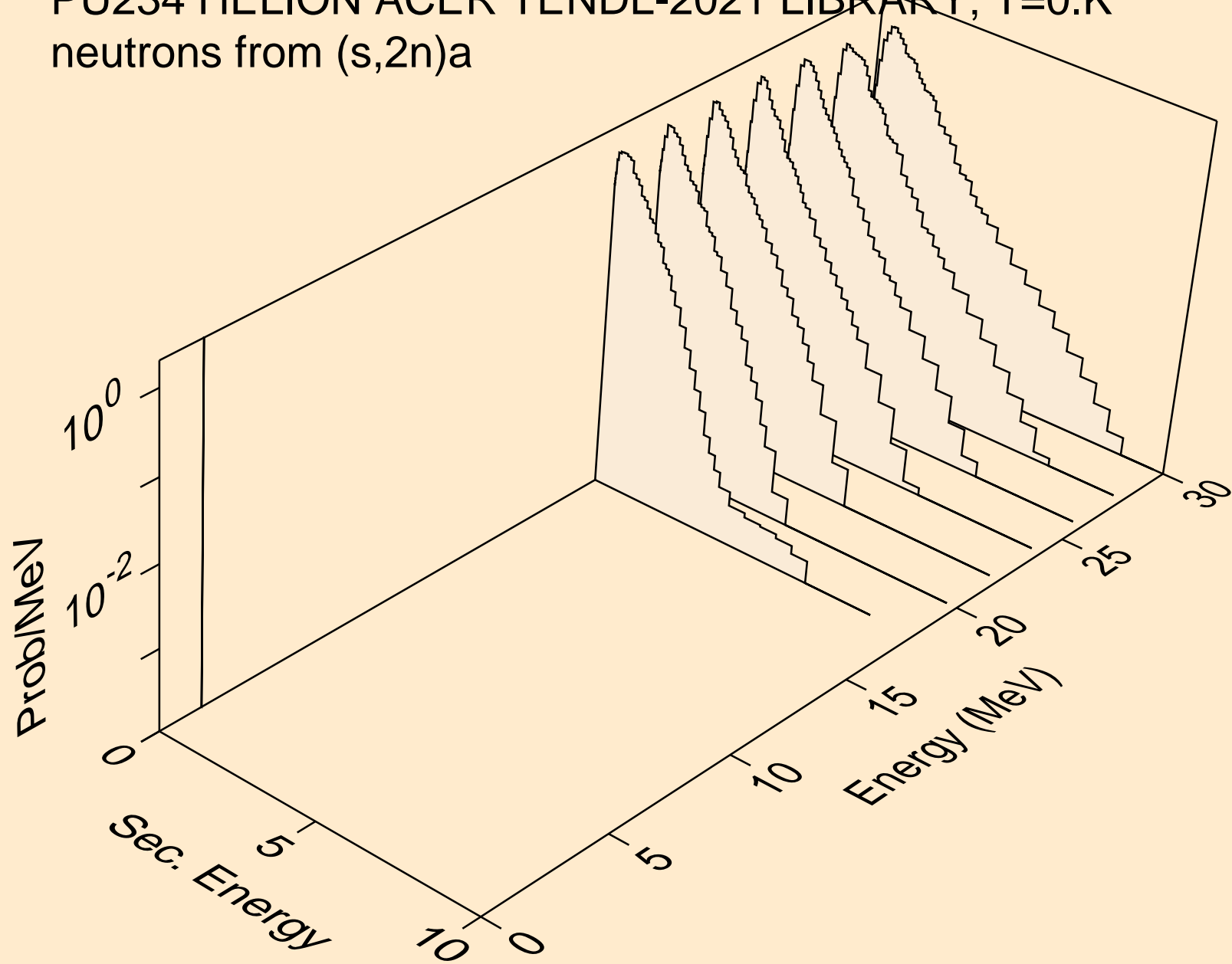

PU234 HELION ACER TENDL-2021 LIBRARY; T=0.K
neutrons from (s,n*)p

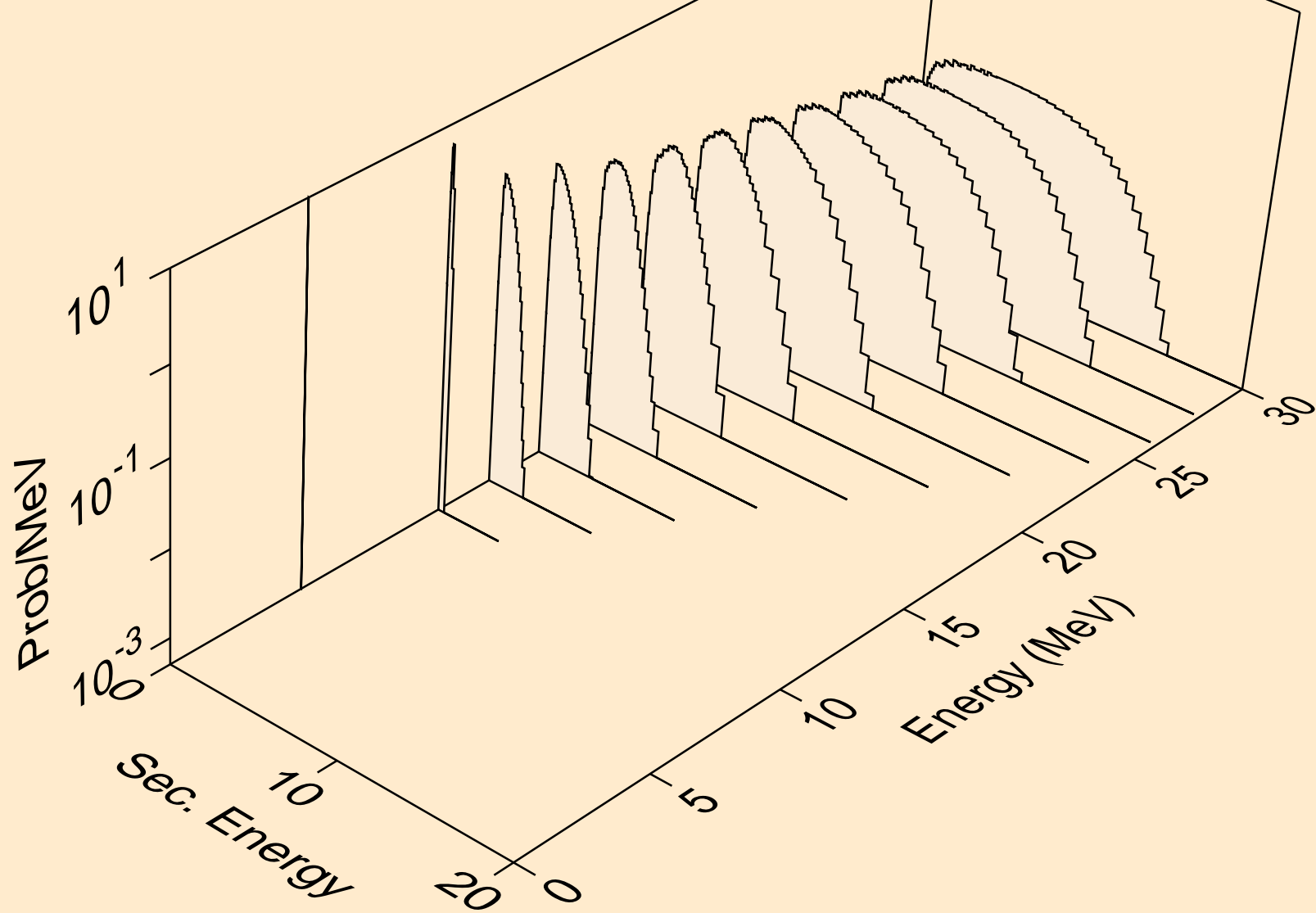

PU234 HELION ACER TENDL-2021 LIBRARY; T=0.K
neutrons from (s,n*)d

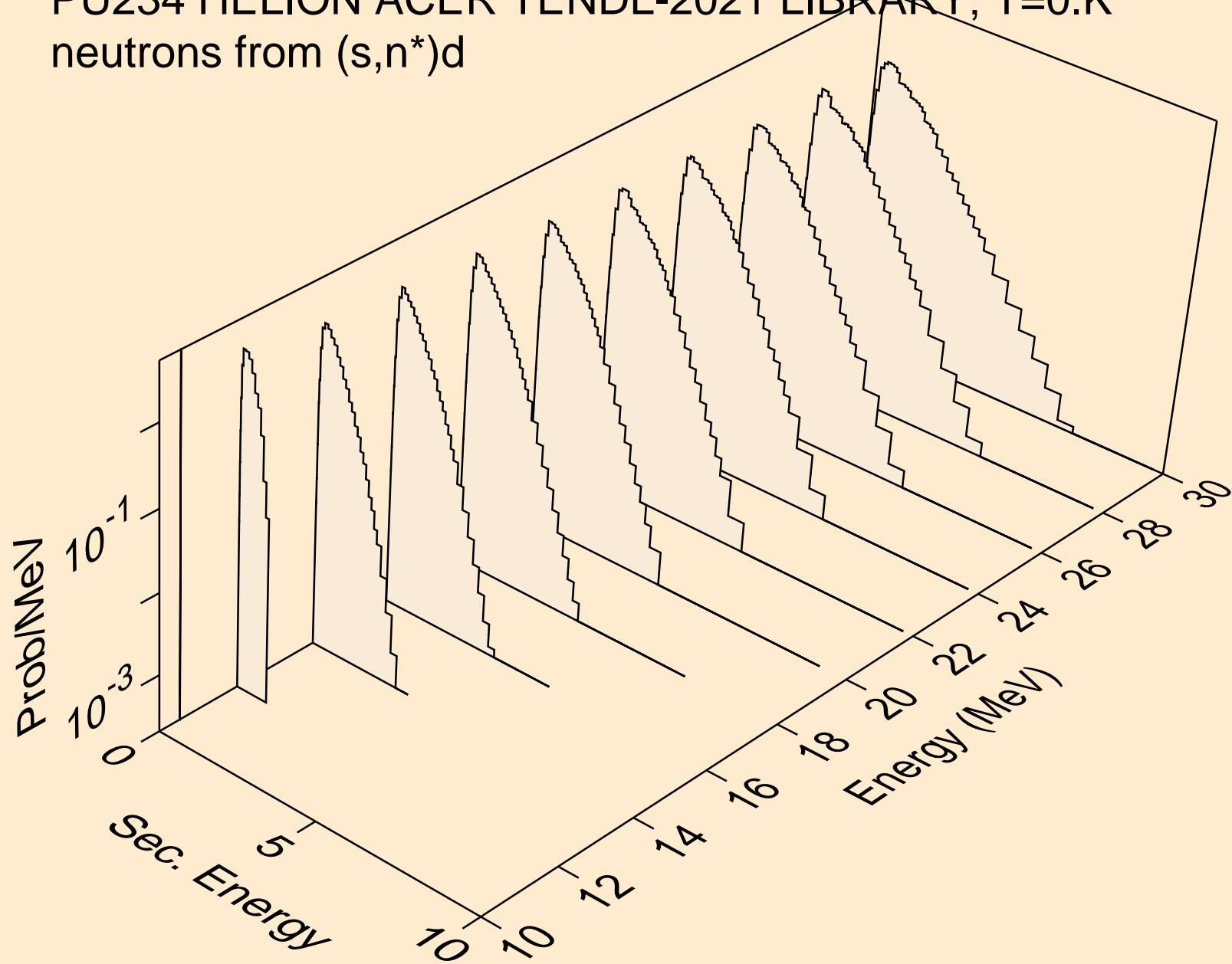

PU234 HELION ACER TENDL-2021 LIBRARY; T=0.K
neutrons from (s,n*)t

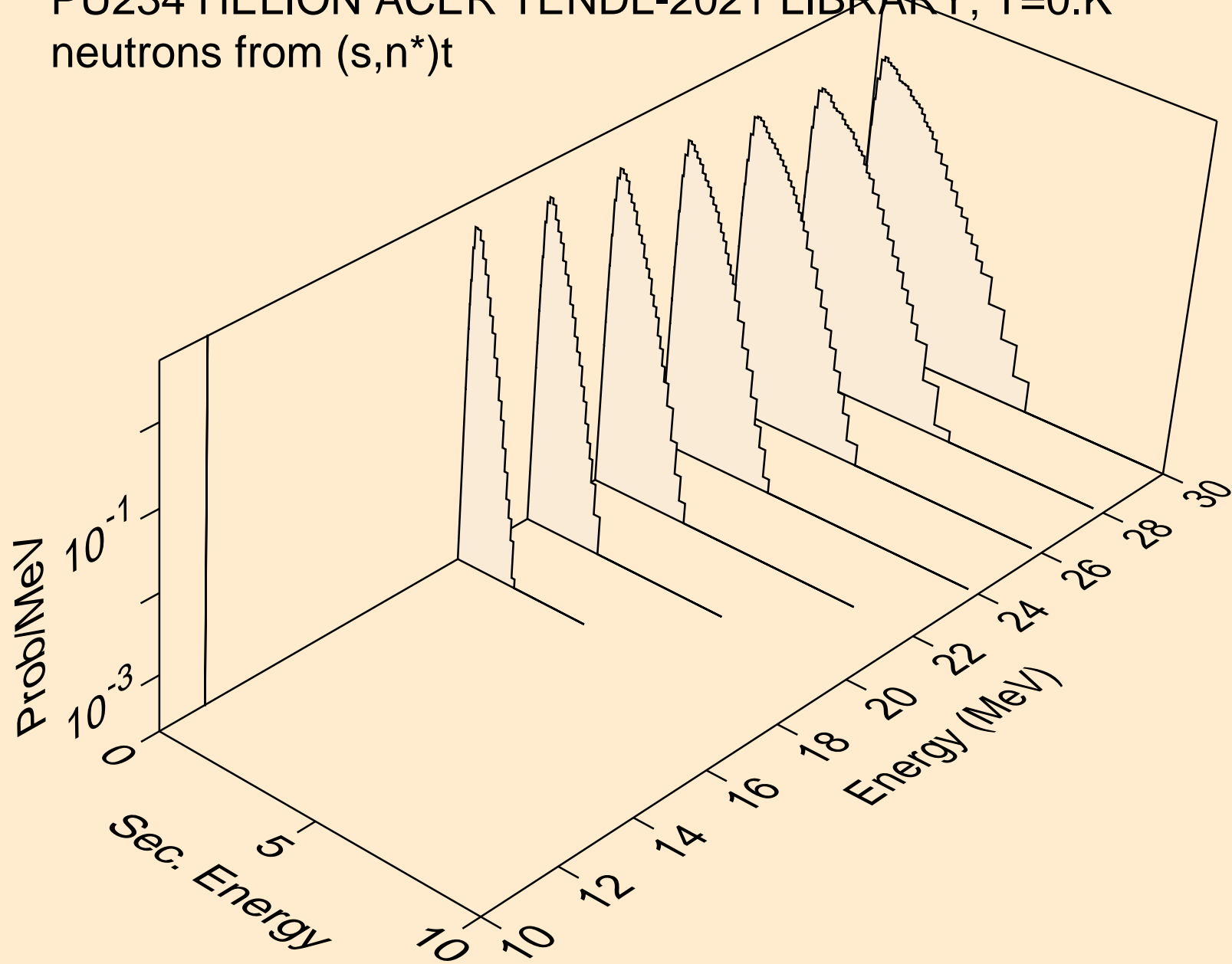

PU234 HELION ACER TENDL-2021 LIBRARY; T=0.K
neutrons from (s,n*)he3

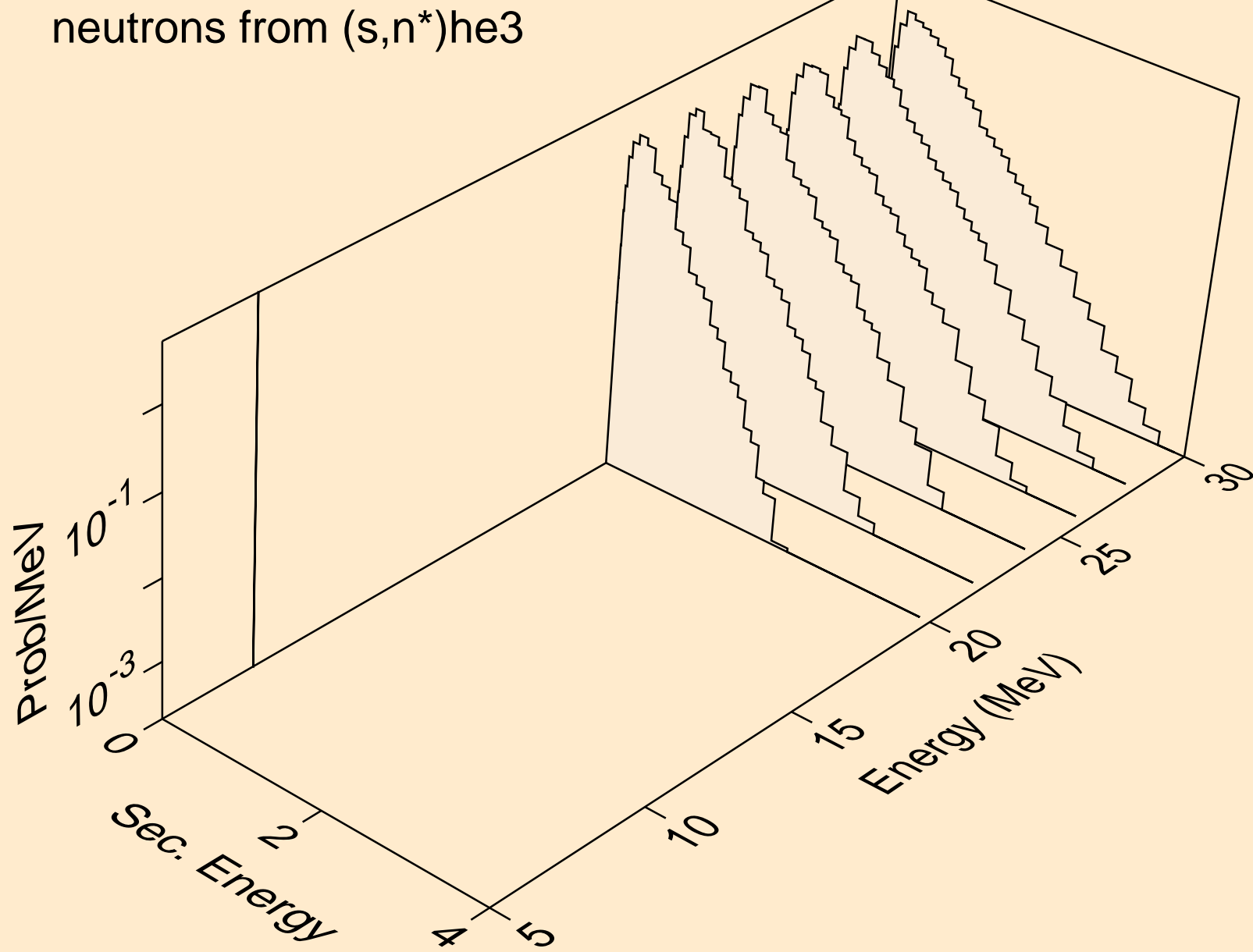

PU234 HELION ACER TENDL-2021 LIBRARY; T=0.K
neutrons from (s,2np)

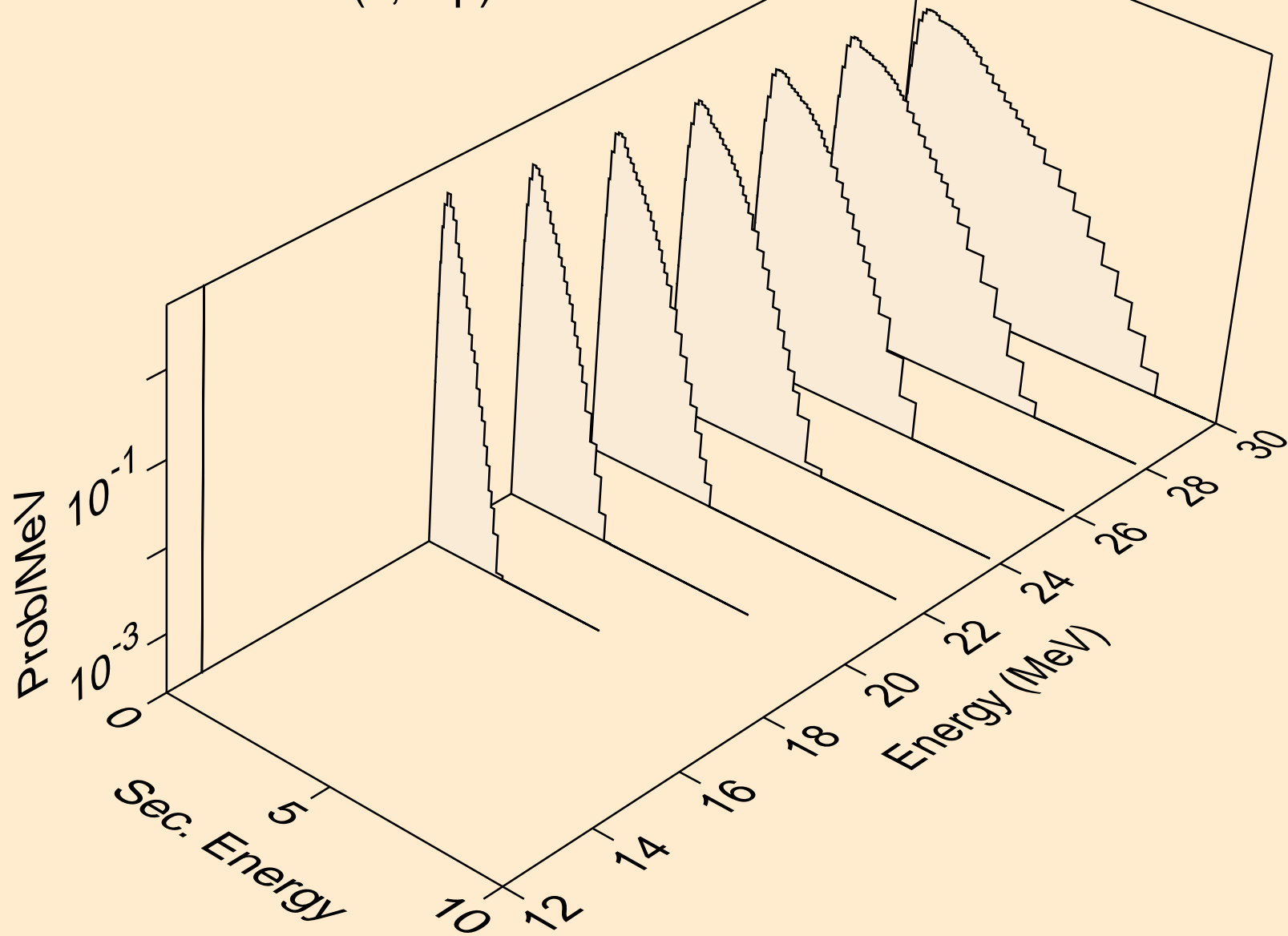

PU234 HELION ACER TENDL-2021 LIBRARY; T=0.K
protons from (s,x)

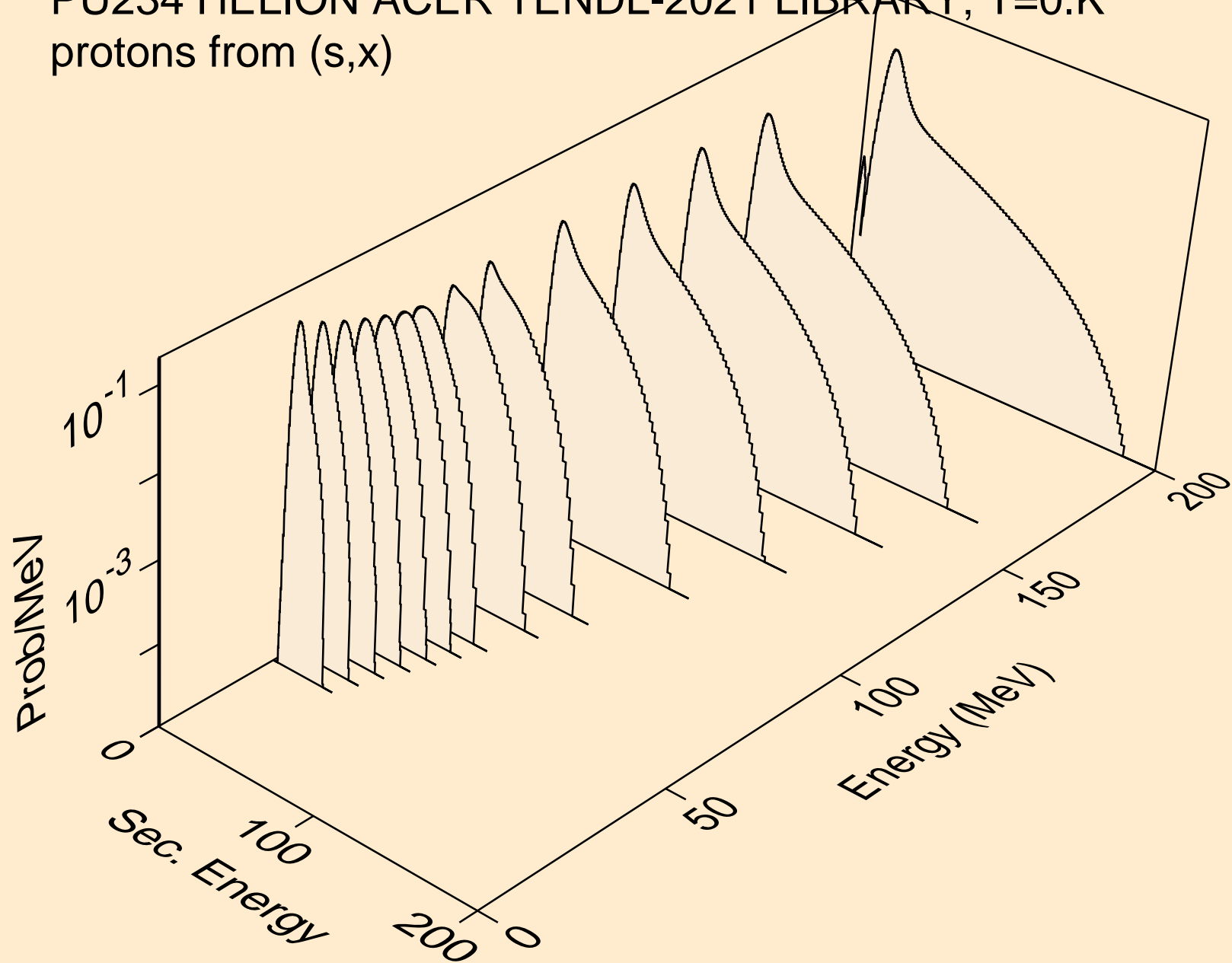

PU234 HELION ACER TENDL-2021 LIBRARY; T=0.K
protons from (s,n*)p

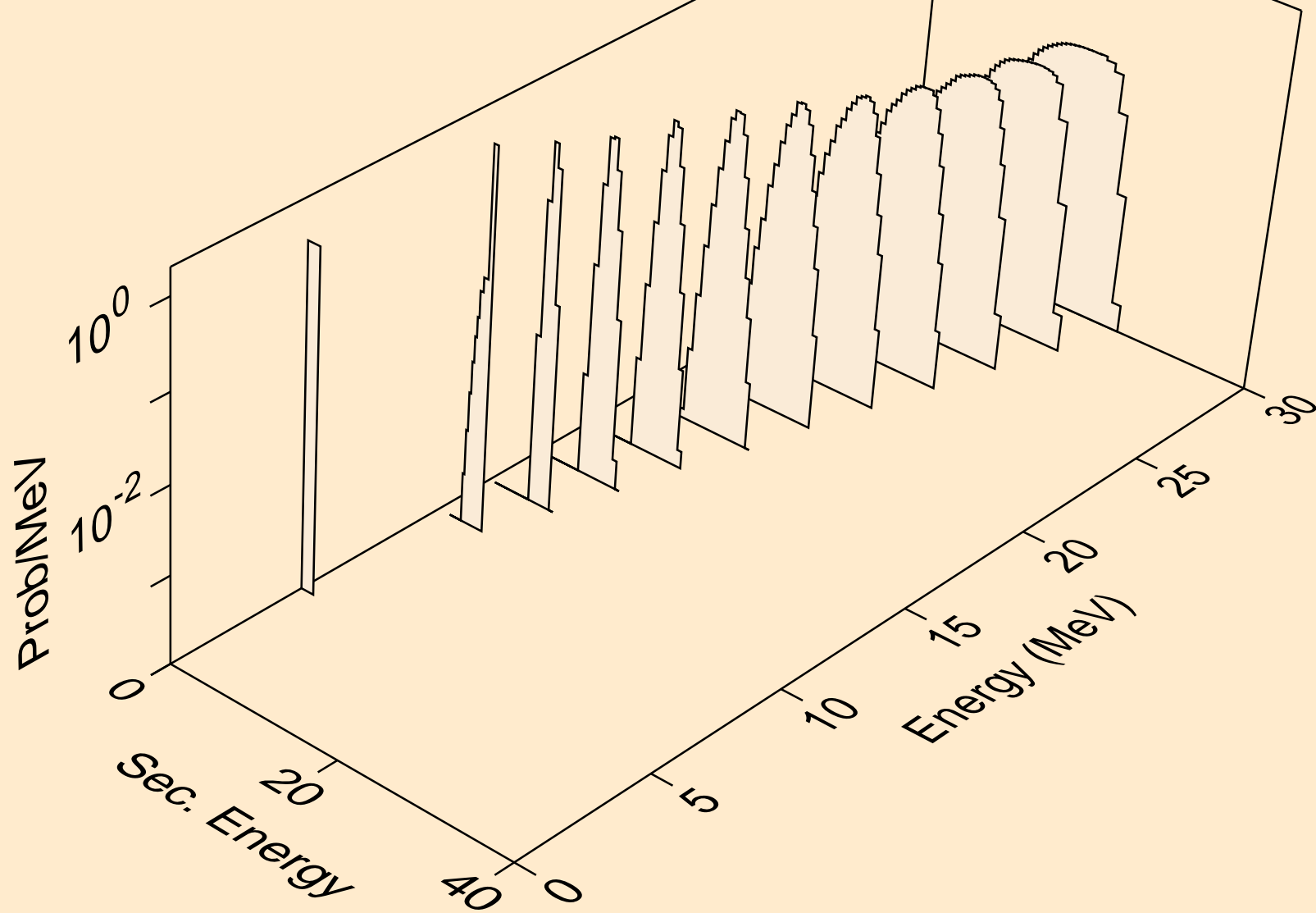

PU234 HELION ACER TENDL-2021 LIBRARY; T=0.K
protons from (s,2np)

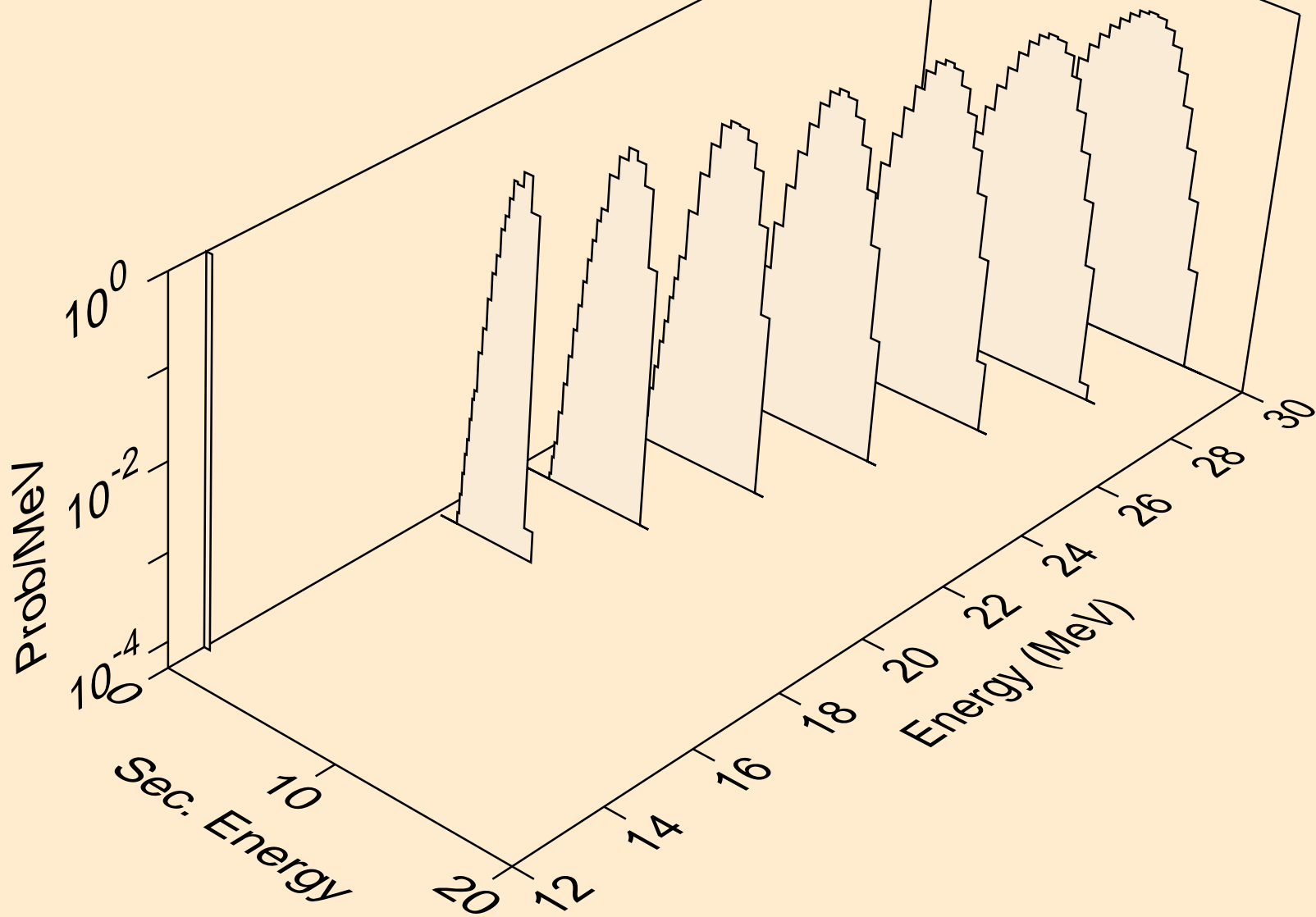

PU234 HELION ACER TENDL-2021 LIBRARY; T=0.K
protons from (s,p)

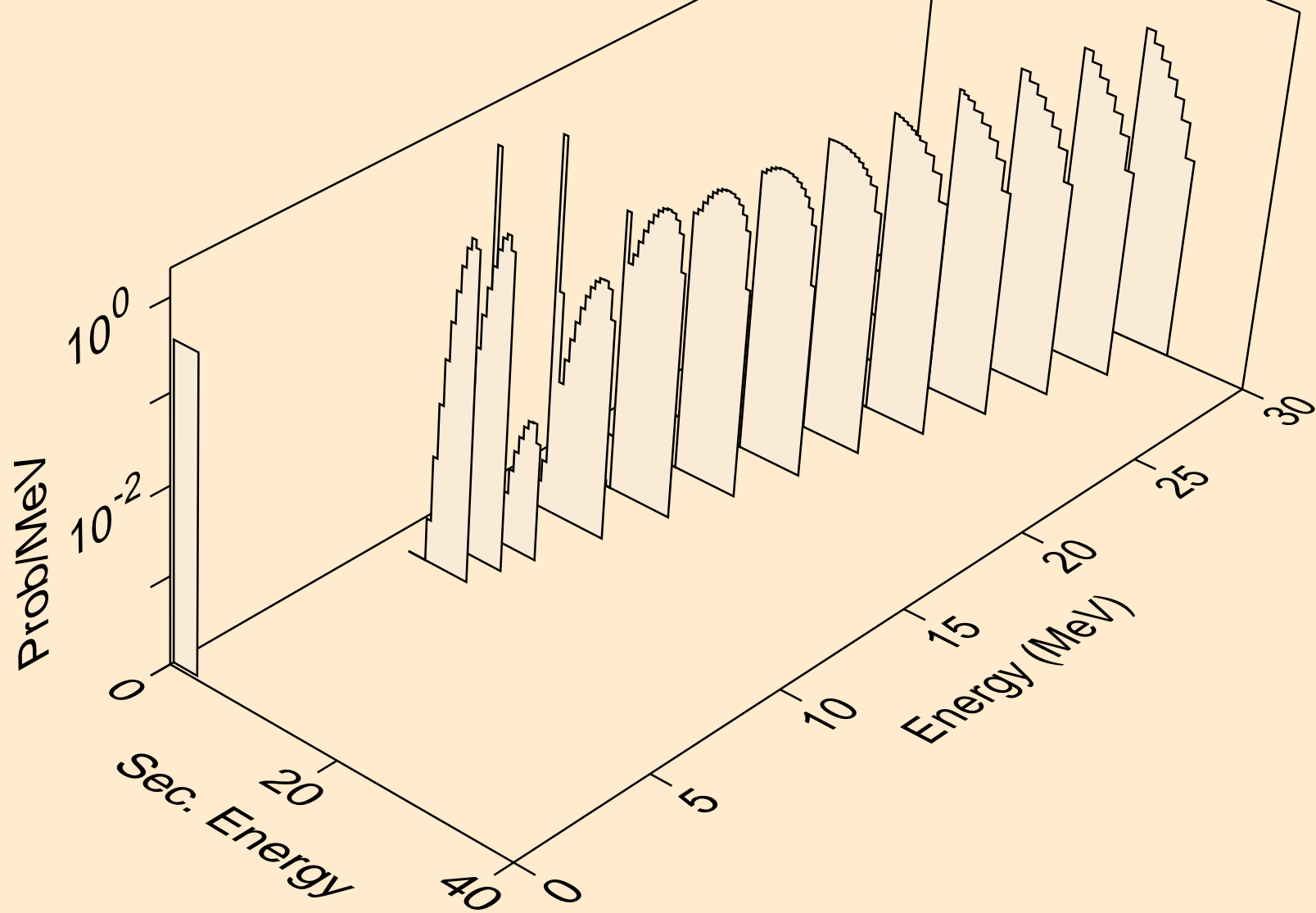

PU234 HELION ACER TENDL-2021 LIBRARY; T=0.K
protons from (s,pa)

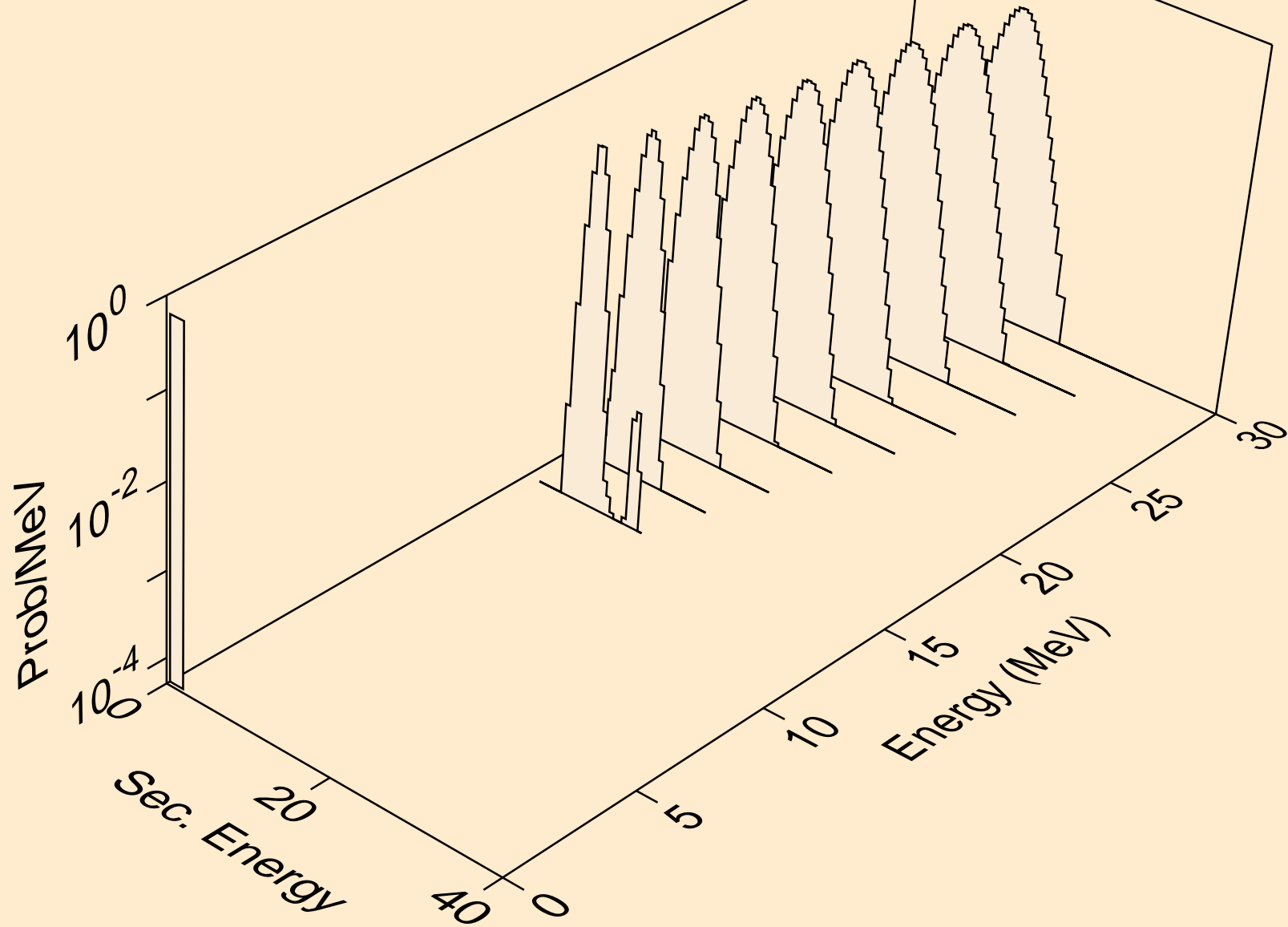

PU234 HELION ACER TENDL-2021 LIBRARY; T=0.K
deuterons from (s,x)

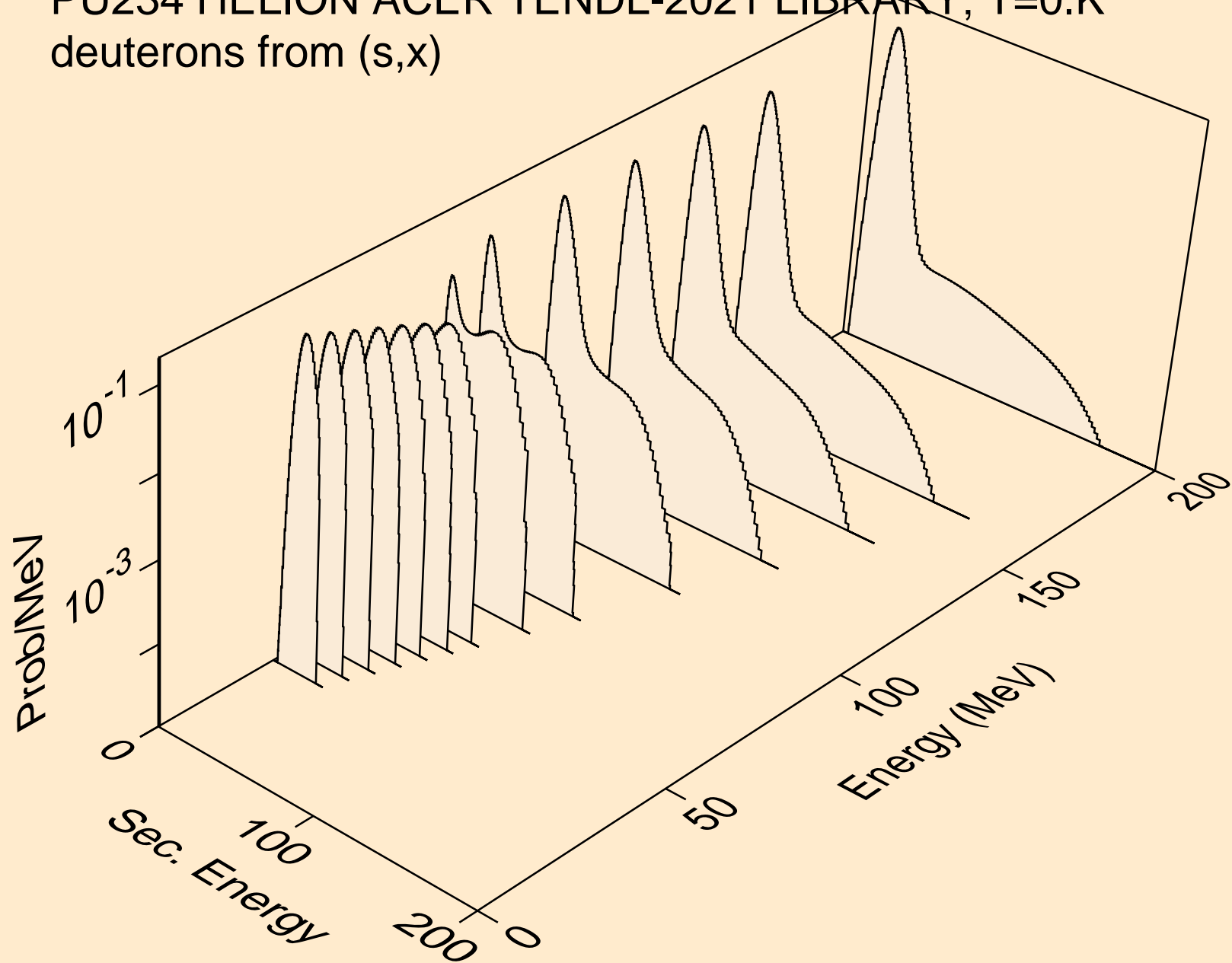

PU234 HELION ACER TENDL-2021 LIBRARY; T=0.K
deuterons from (s,n*)d

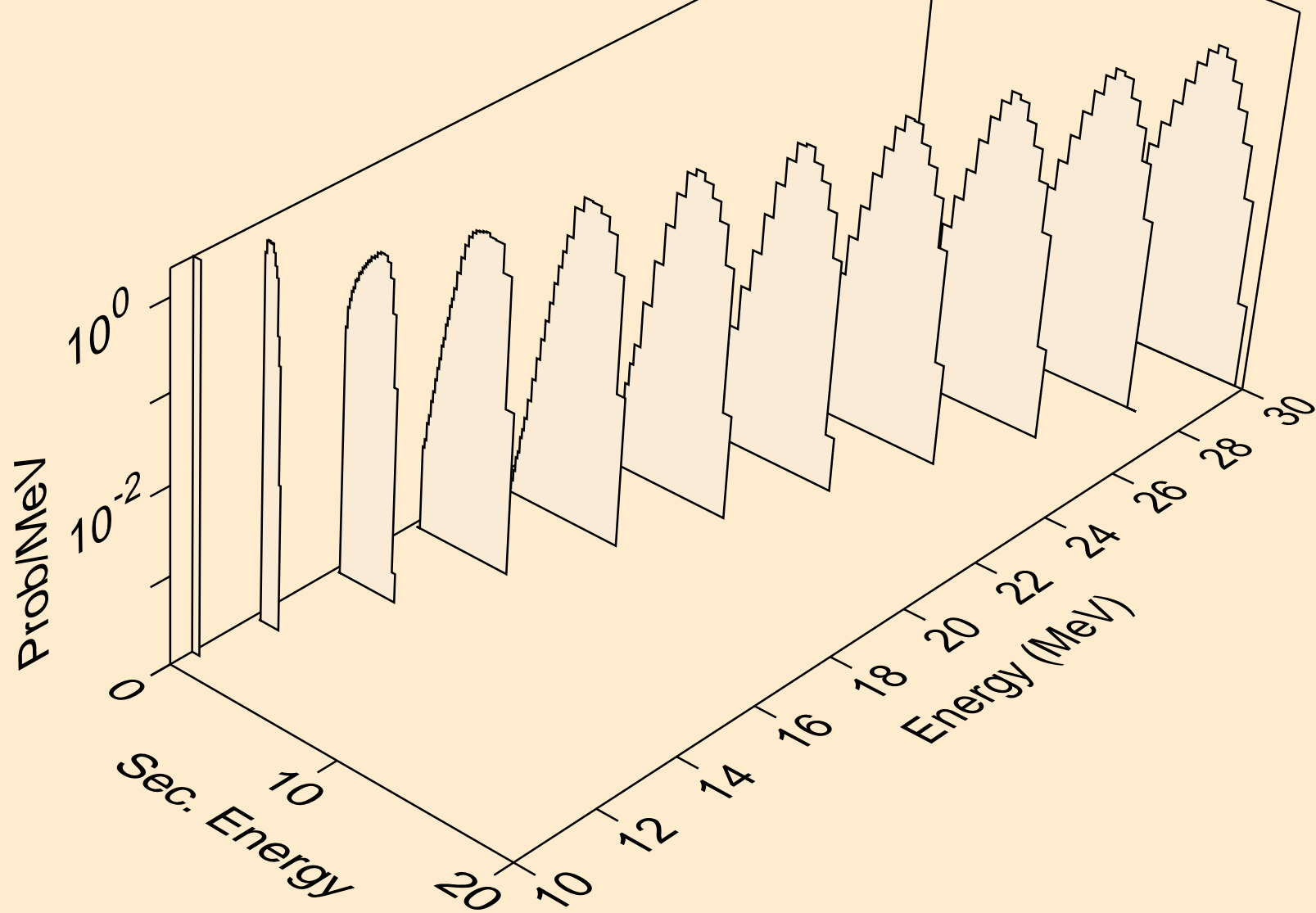

PU234 HELION ACER TENDL-2021 LIBRARY; T=0.K
deuterons from (s,d)

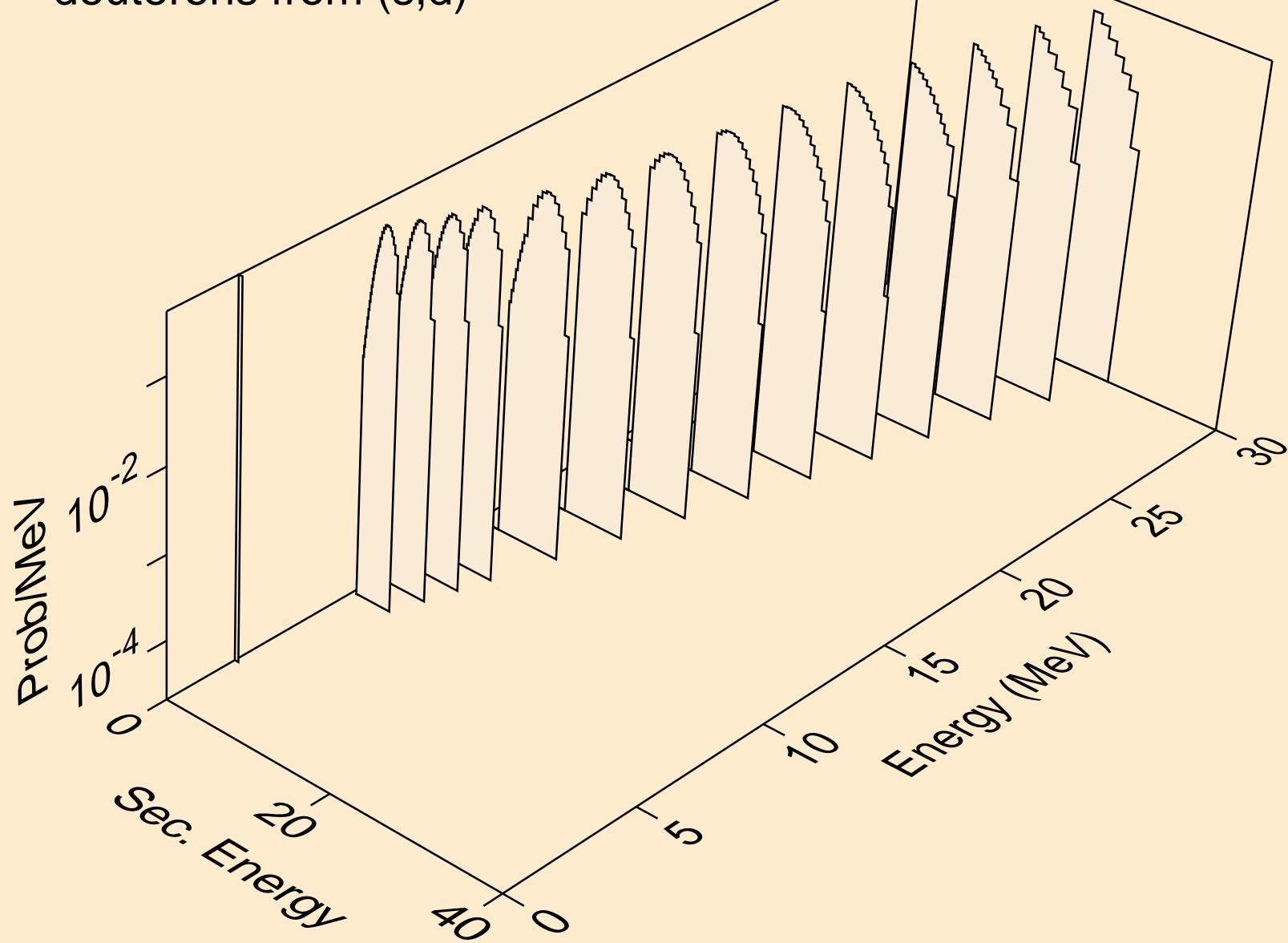

PU234 HELION ACER TENDL-2021 LIBRARY; T=0.K
tritons from (s,x)

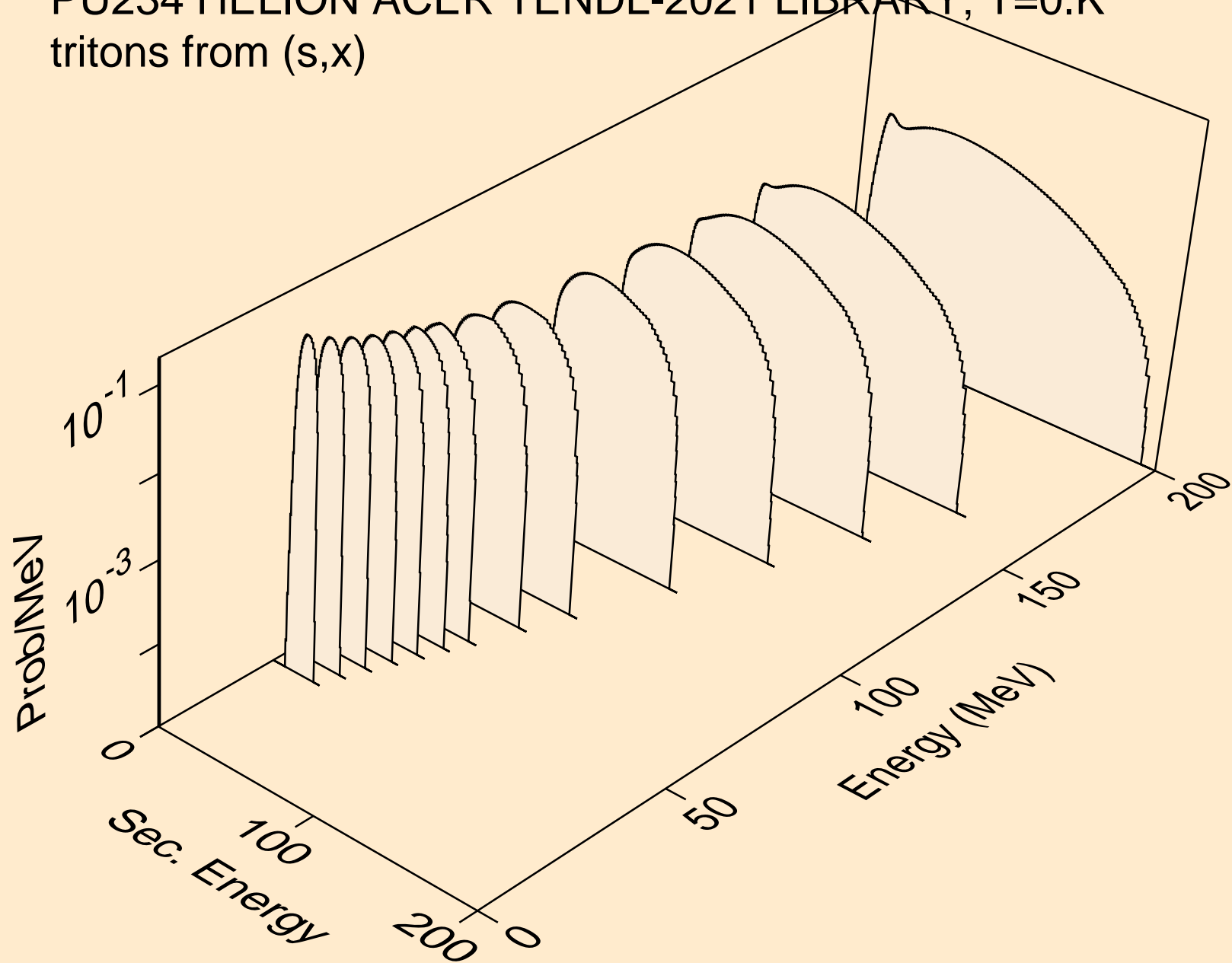

PU234 HELION ACER TENDL-2021 LIBRARY; T=0.K
tritons from (s,n*)t

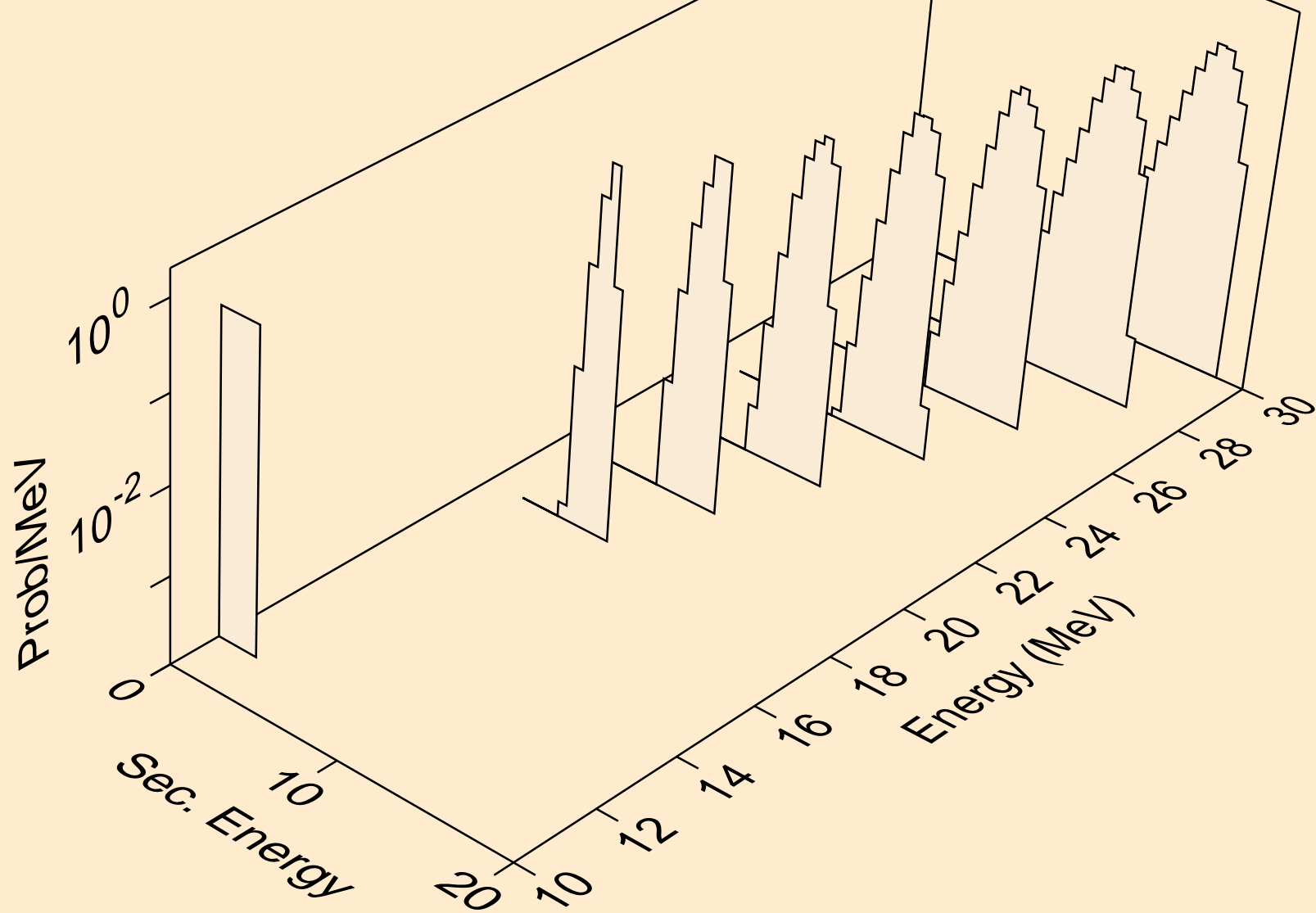

PU234 HELION ACER TENDL-2021 LIBRARY; T=0.K
tritons from (s,t)

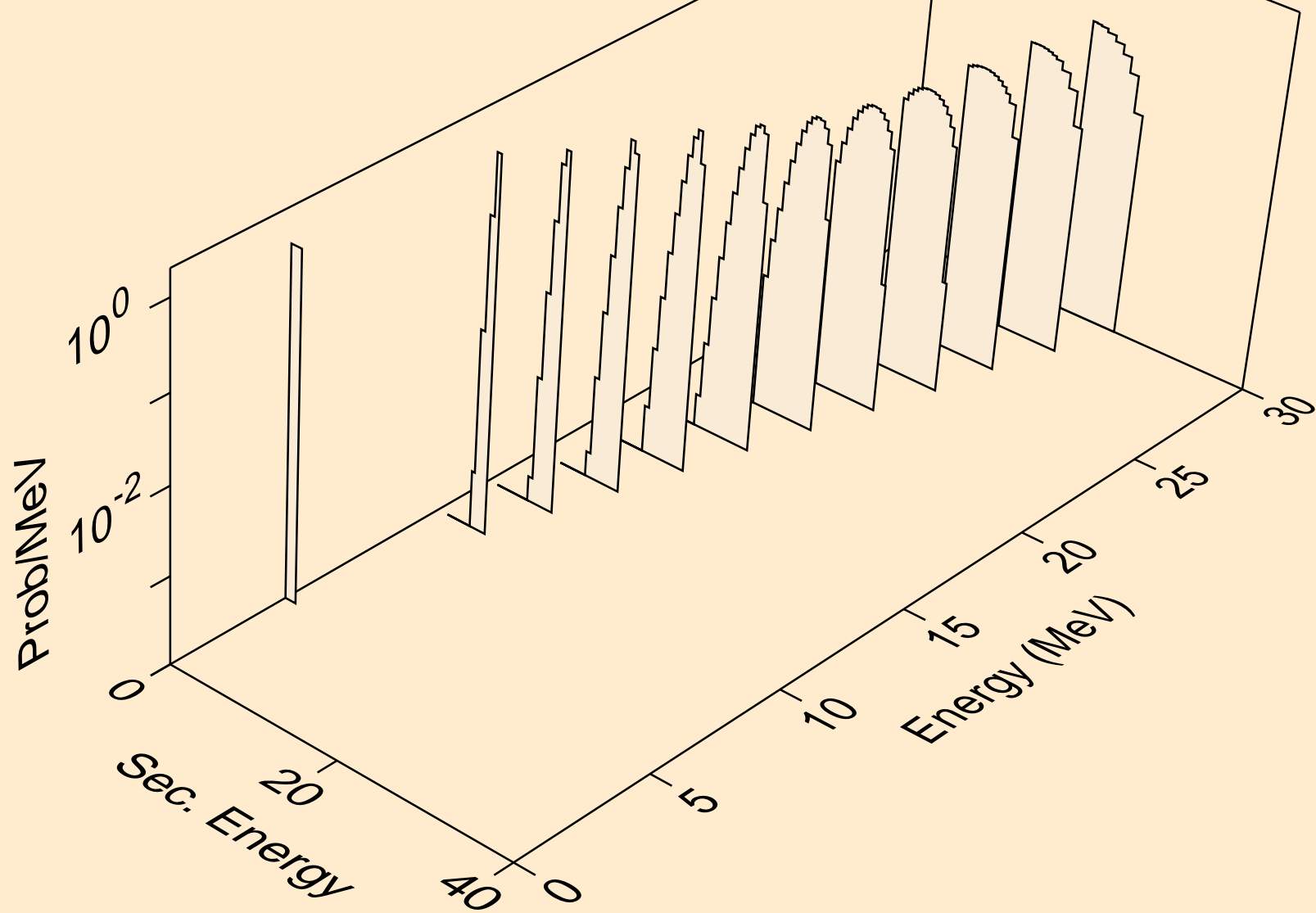

PU234 HELION ACER TENDL-2021 LIBRARY; T=0.K
alphas from (s,x)

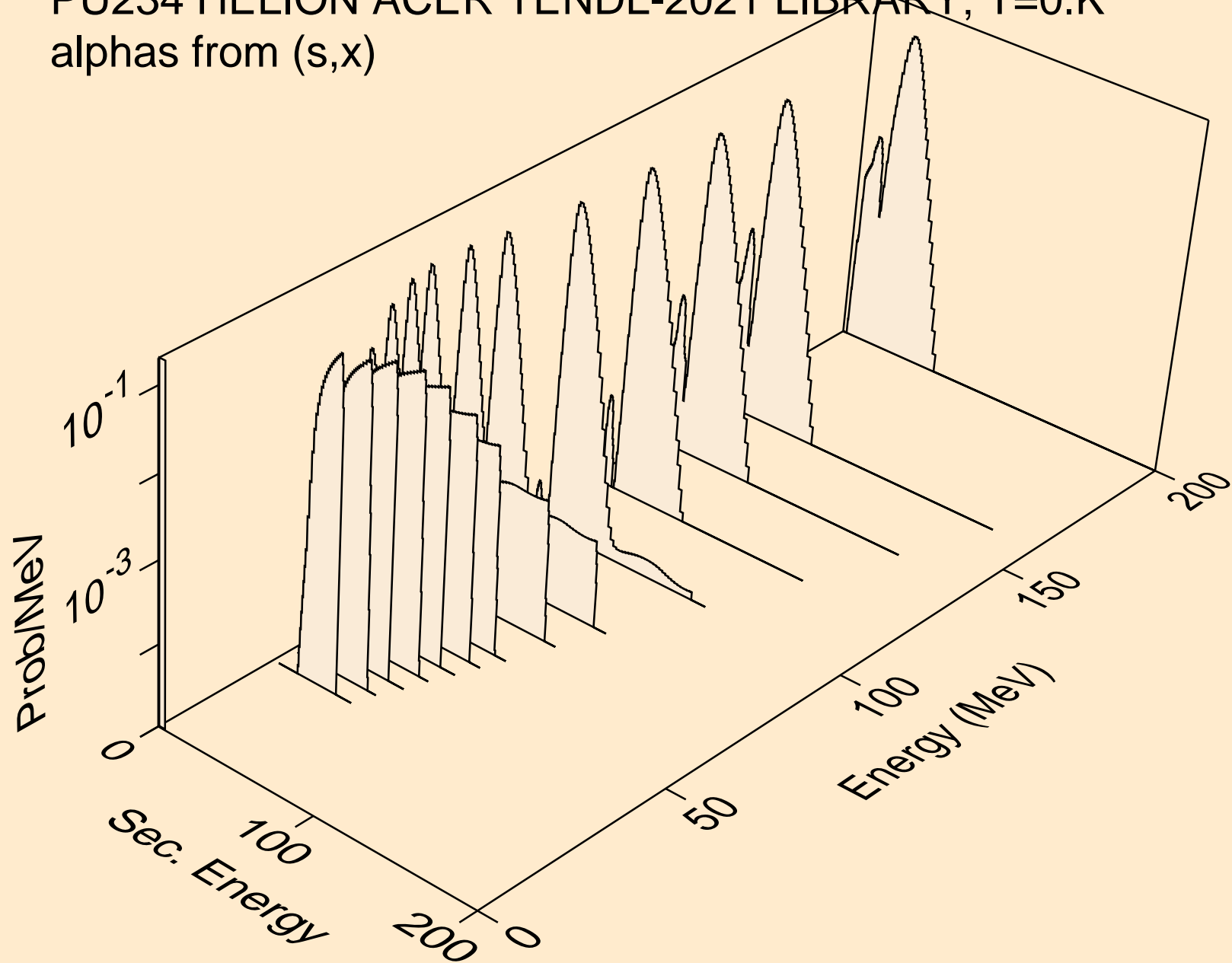

PU234 HELION ACER TENDL-2021 LIBRARY; T=0.K
alphas from (s,n*)a

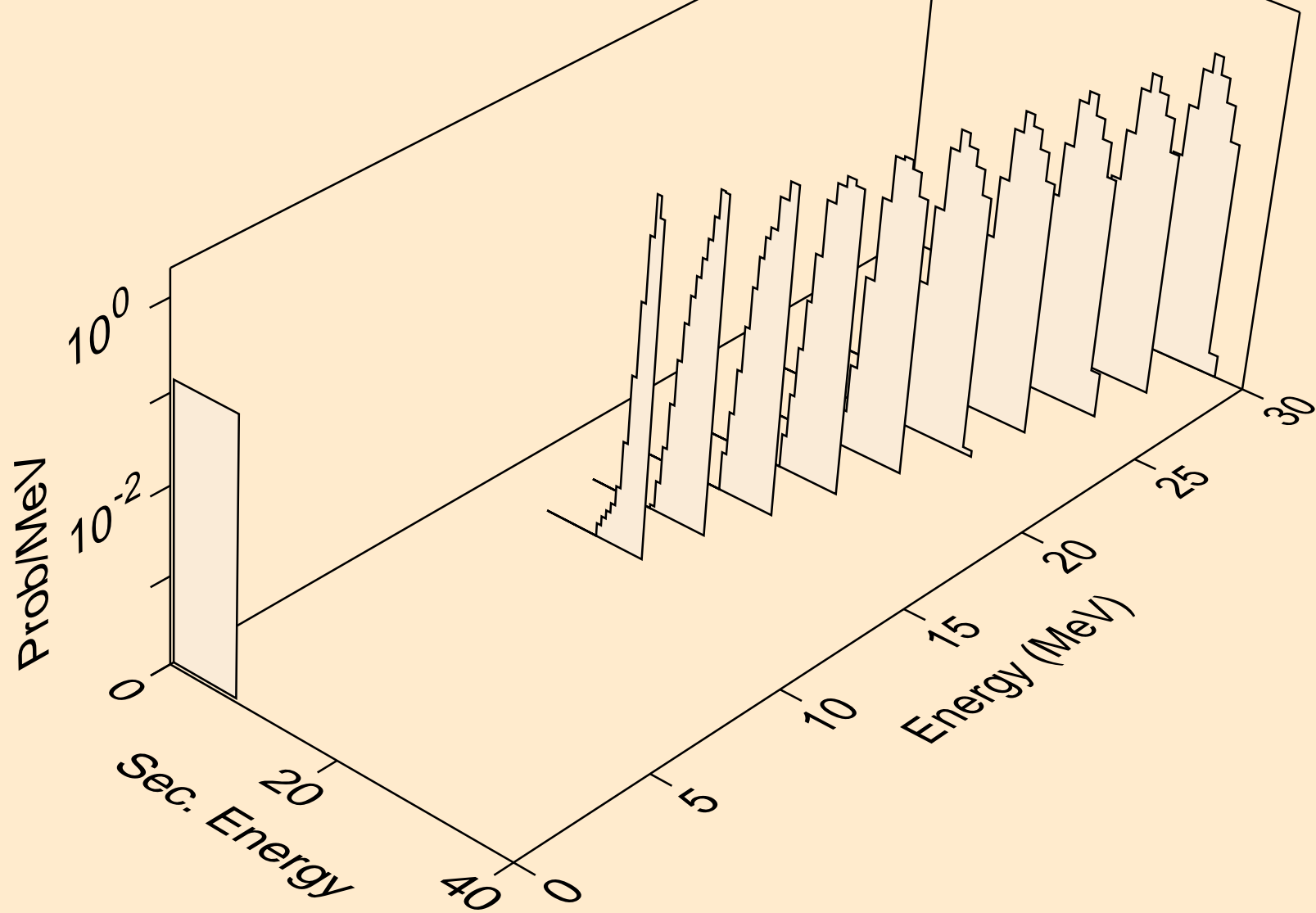

PU234 HELION ACER TENDL-2021 LIBRARY; T=0.K
alphas from (s,2n)a

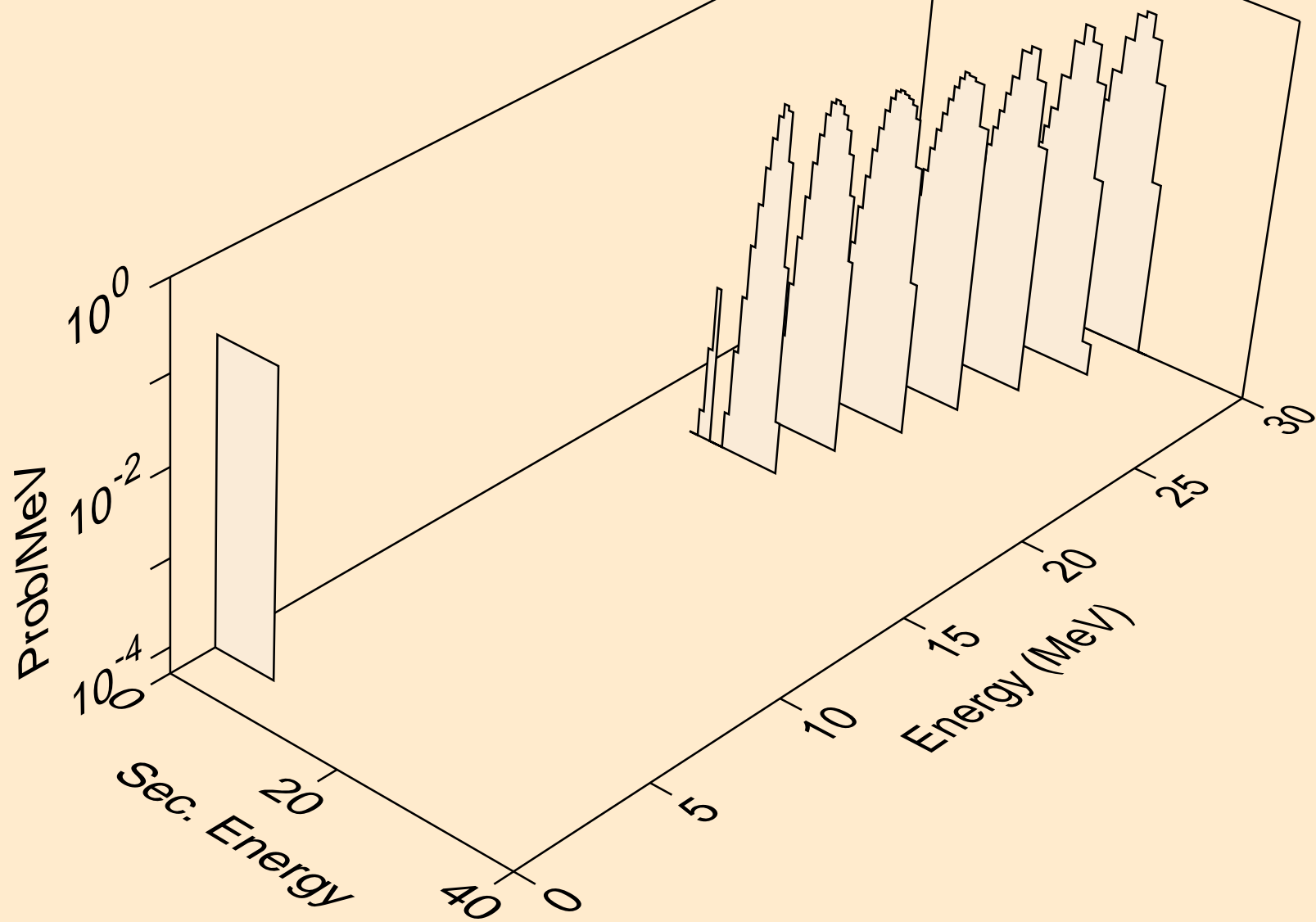

PU234 HELION ACER TENDL-2021 LIBRARY; T=0.K
alphas from (s,a)

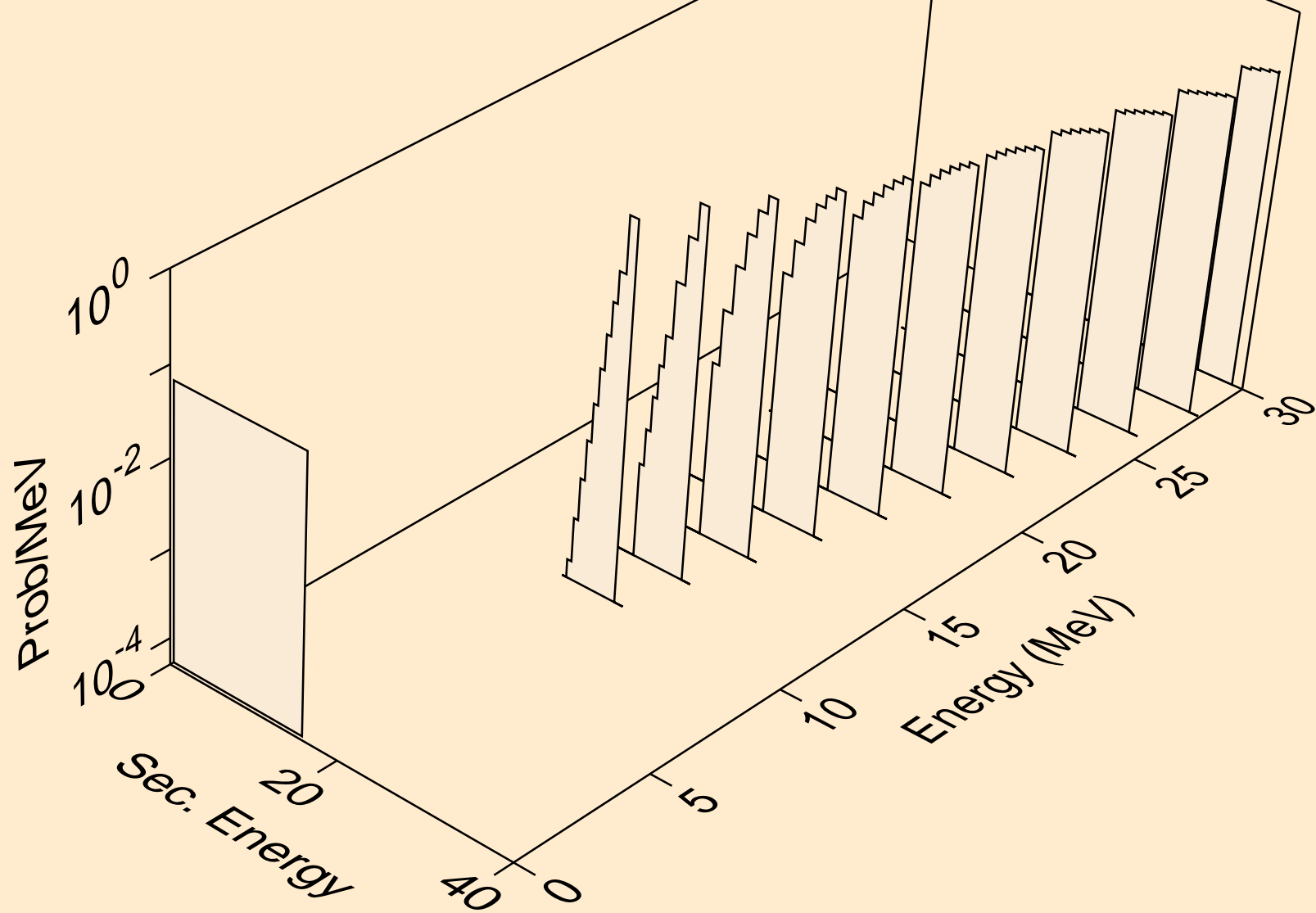

PU234 HELION ACER TENDL-2021 LIBRARY; T=0.K
alphas from (s,pa)

