

PU237 HELION ACER TENDL-2021 LIBRARY; T=0.K  
Principal cross sections

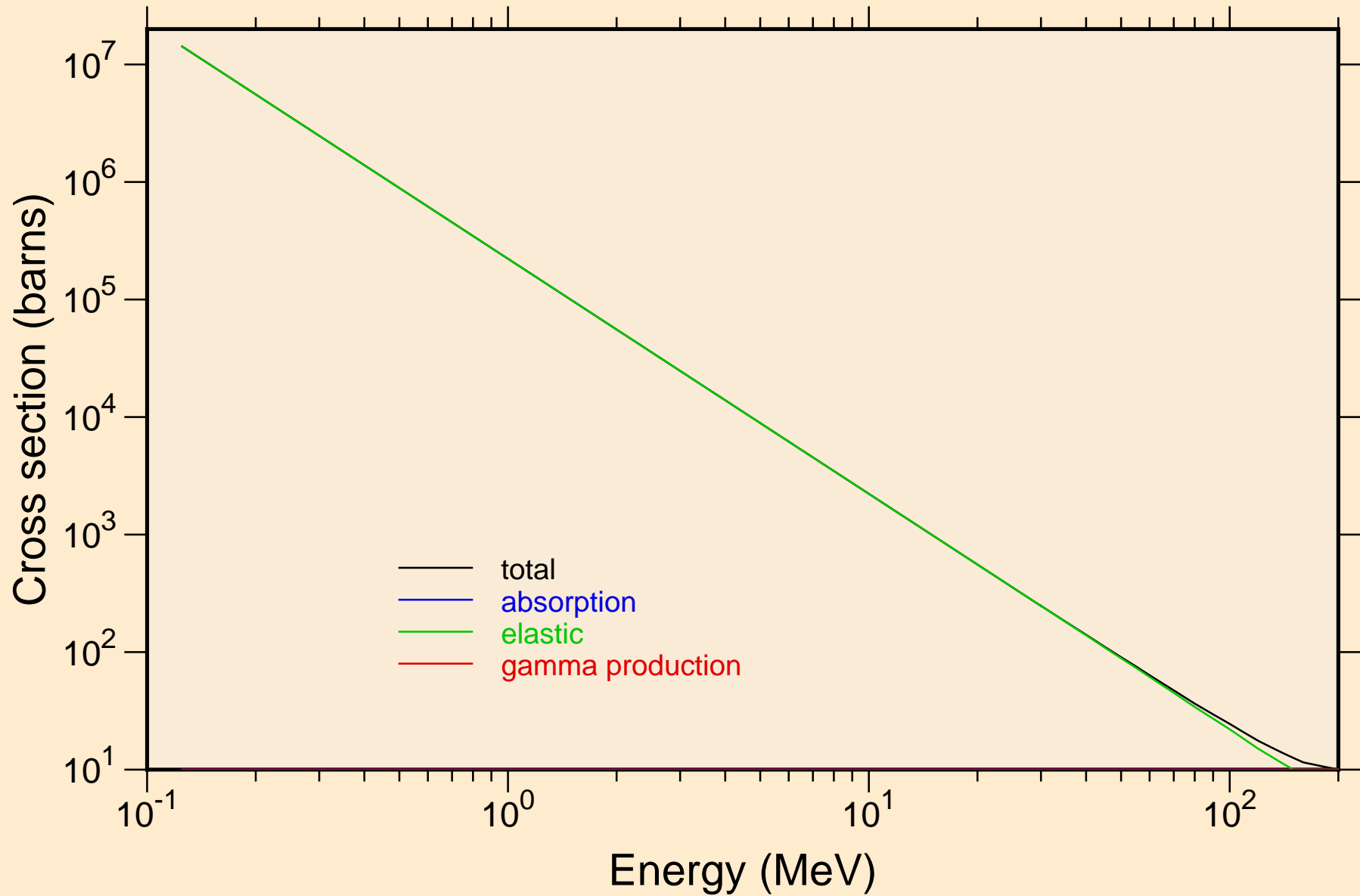

PU237 HELION ACER TENDL-2021 LIBRARY; T=0.K  
Heating

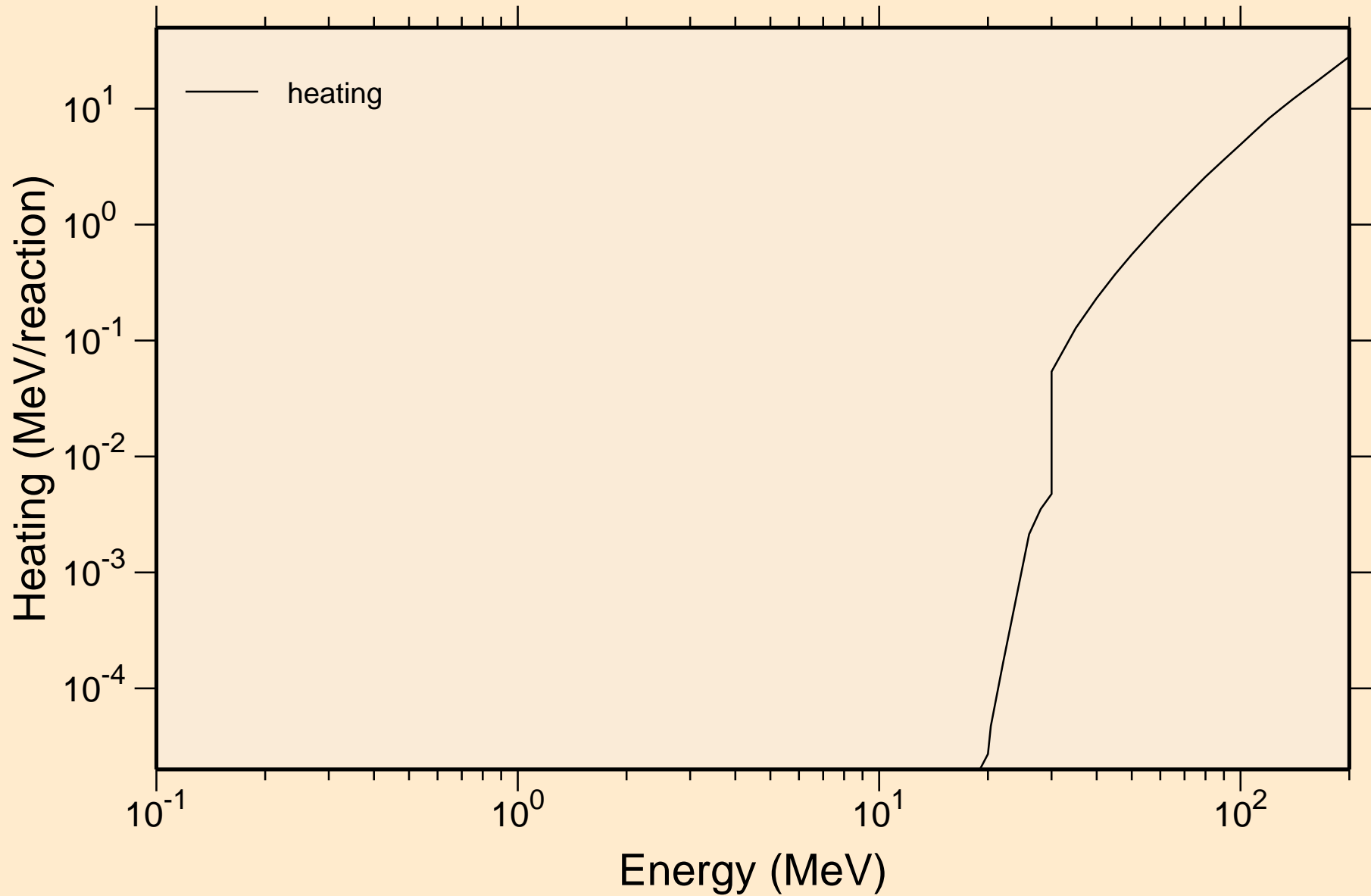

# PU237 HELION ACER TENDL-2021 LIBRARY; T=0.K

## Principal cross sections

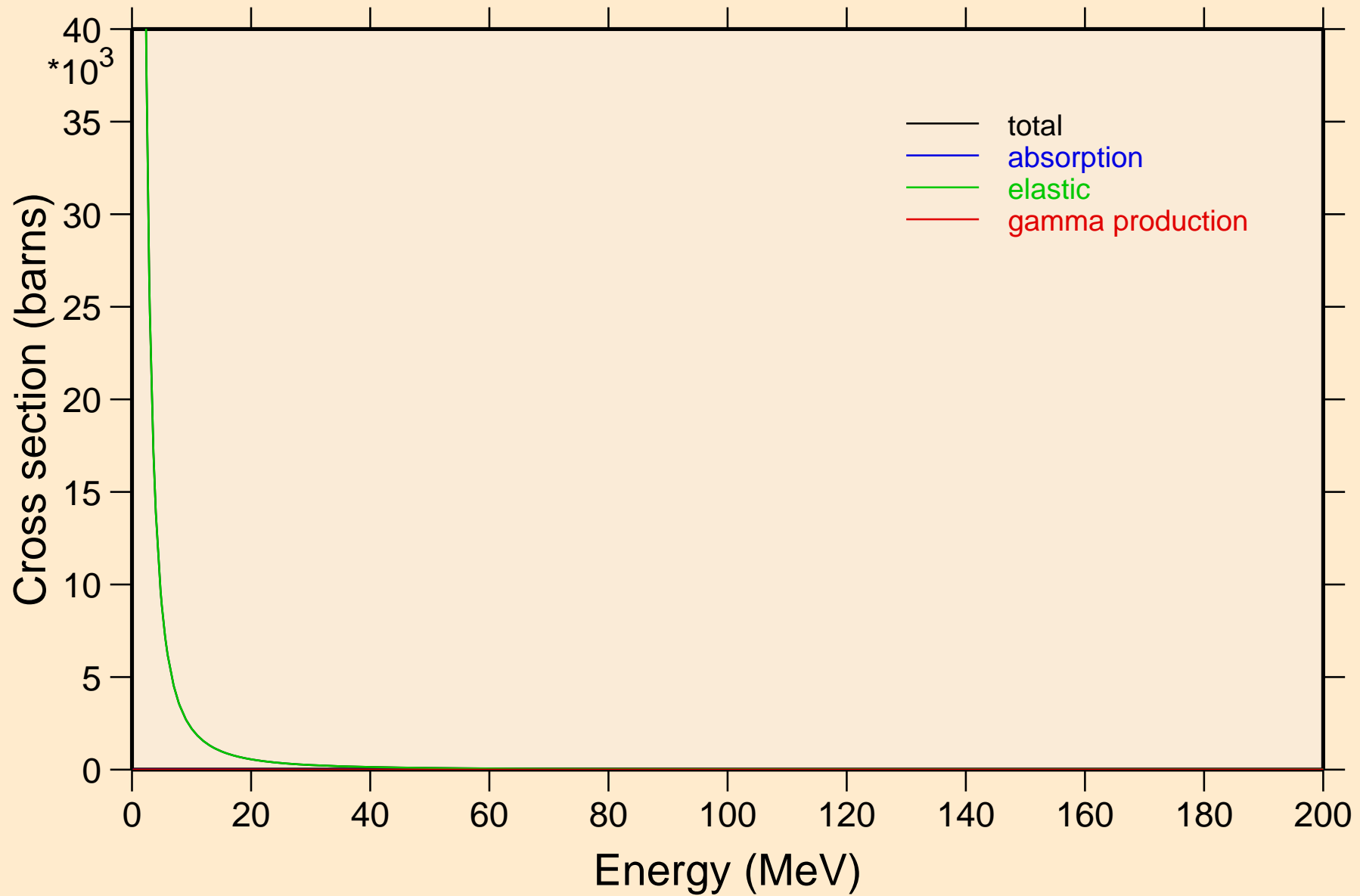

PU237 HELION ACER TENDL-2021 LIBRARY; T=0.K

Heating

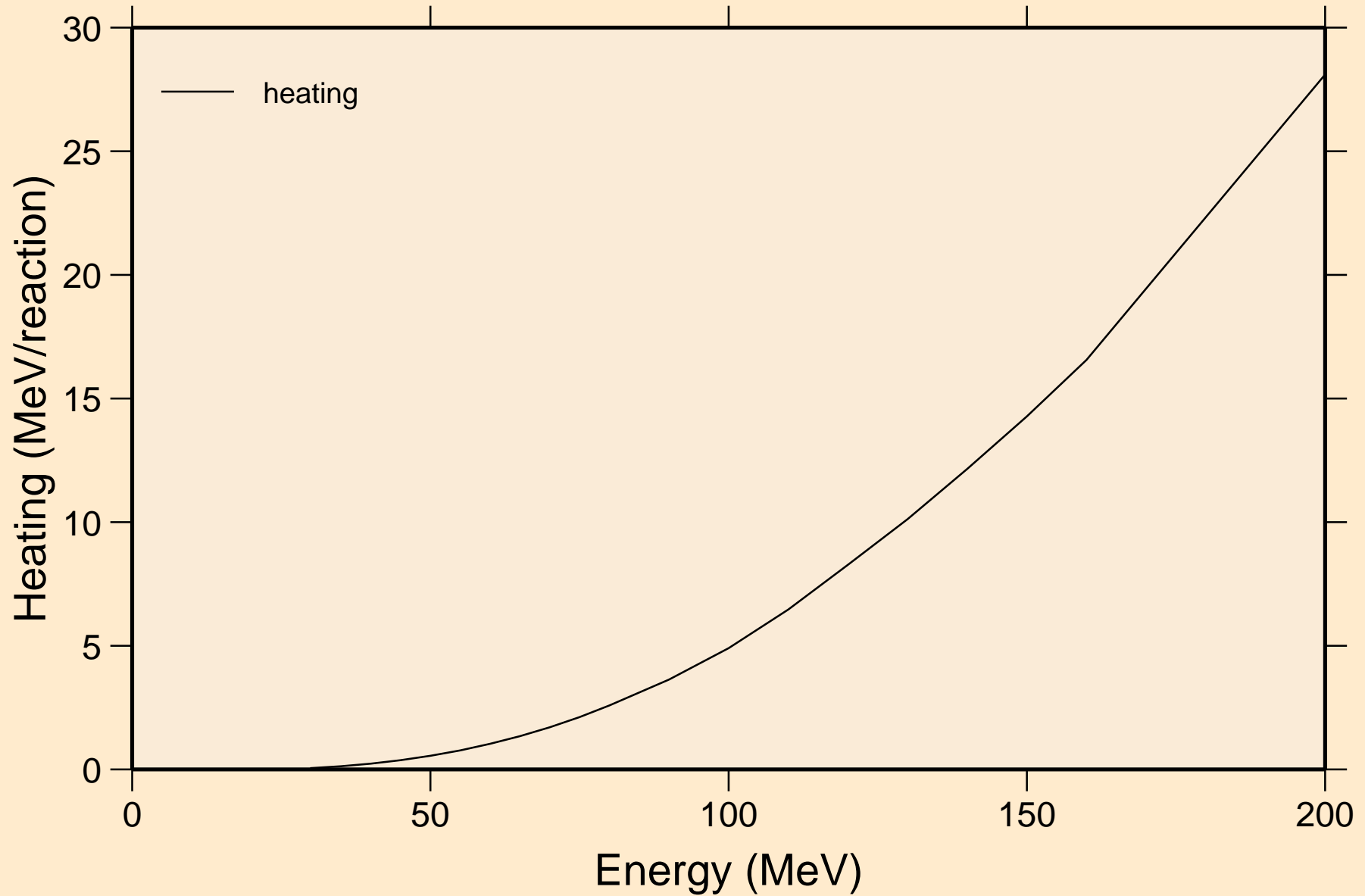

PU237 HELION ACER TENDL-2021 LIBRARY; T=0.K  
Threshold reactions

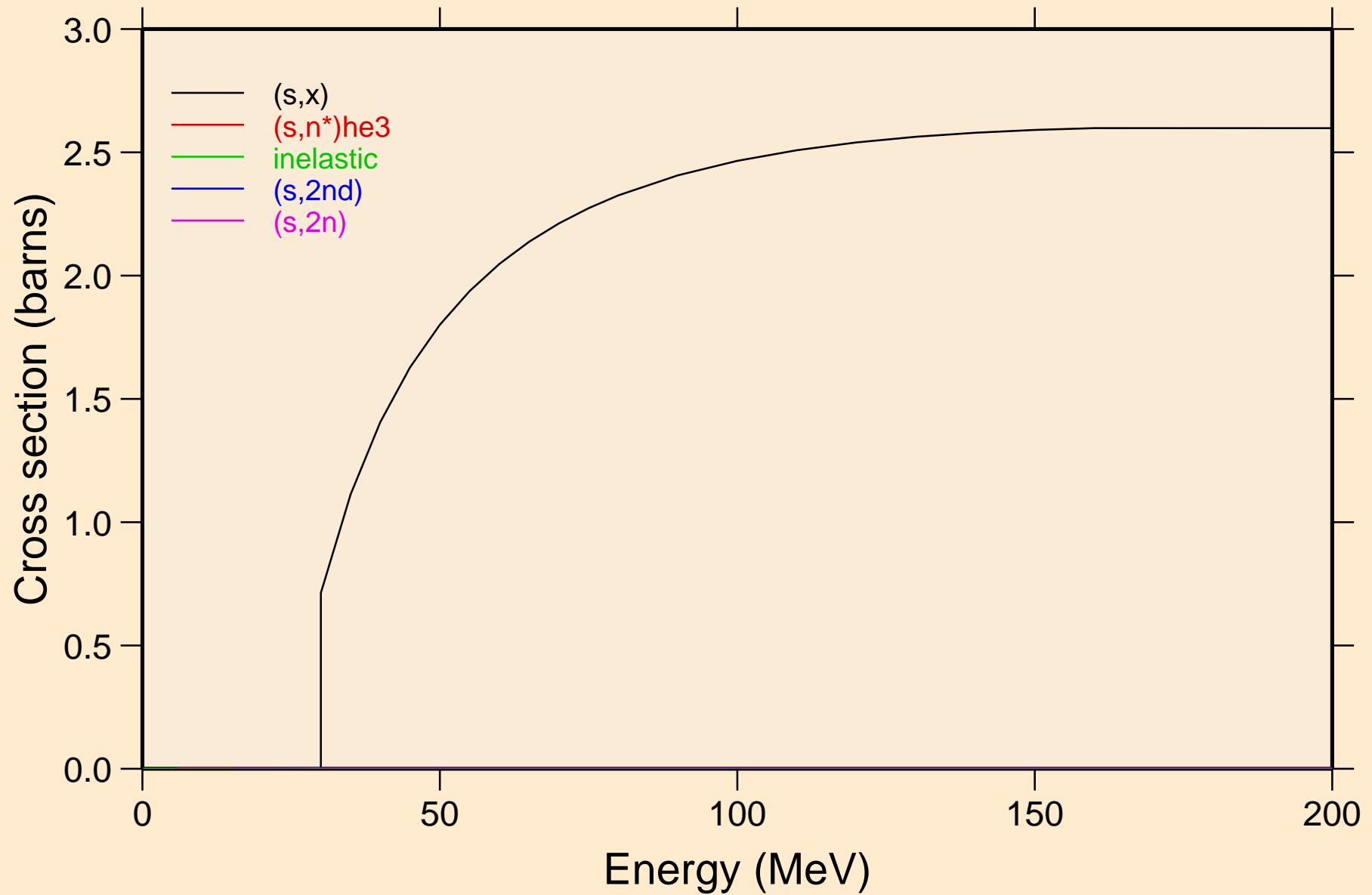

PU237 HELION ACER TENDL-2021 LIBRARY; T=0.K  
Threshold reactions

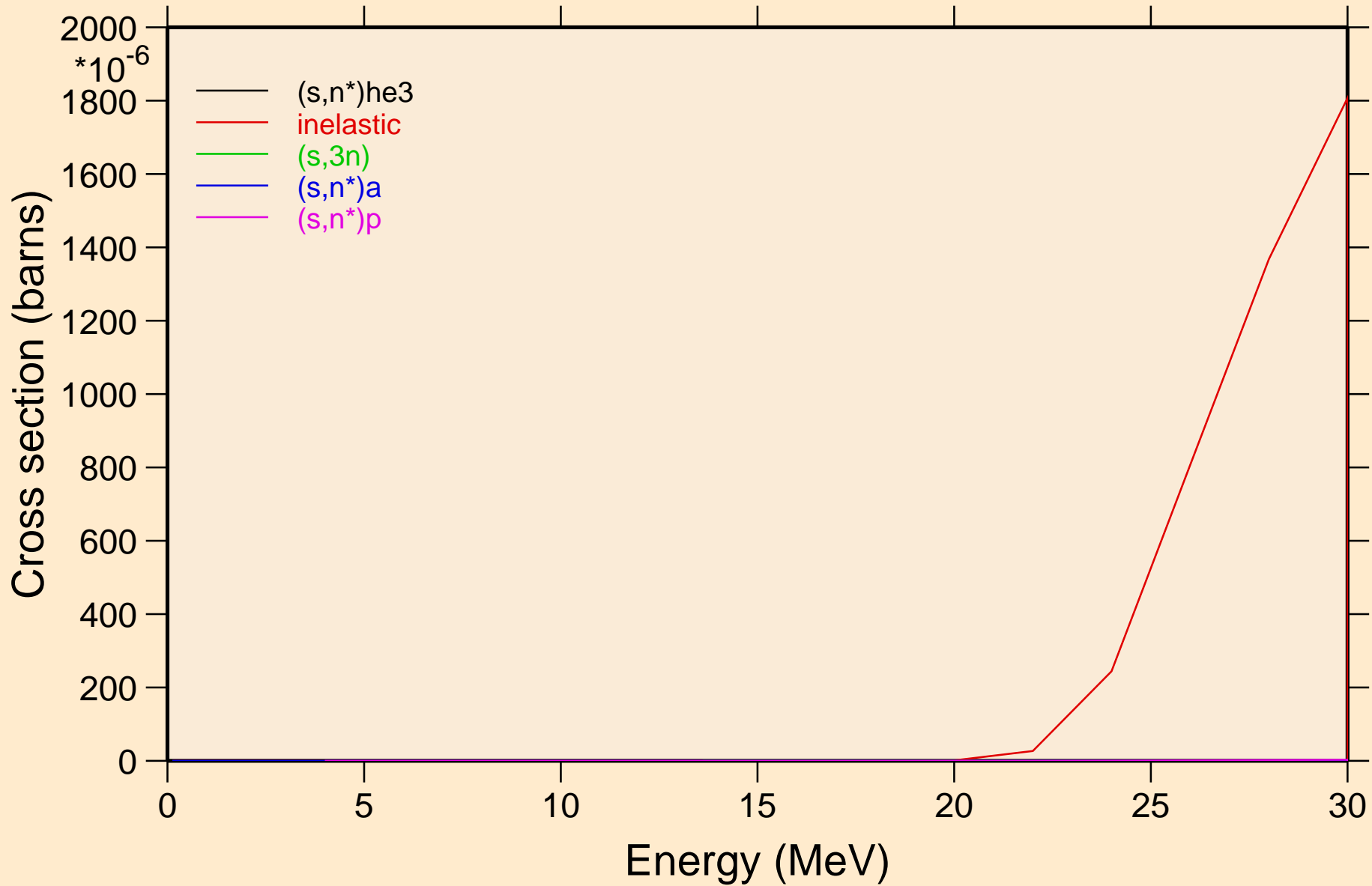

PU237 HELION ACER TENDL-2021 LIBRARY; T=0.K  
Threshold reactions

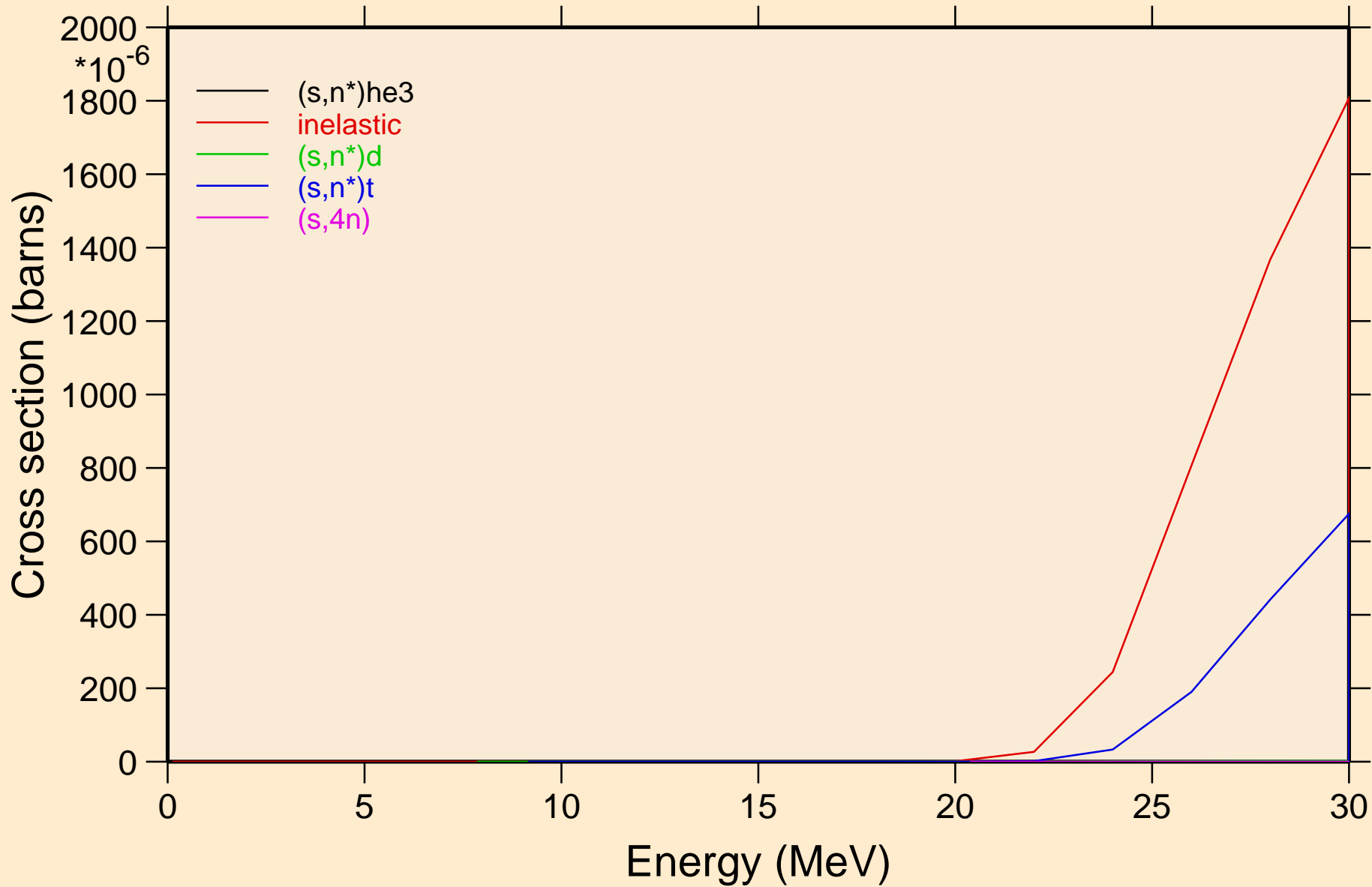

PU237 HELION ACER TENDL-2021 LIBRARY; T=0.K  
Threshold reactions

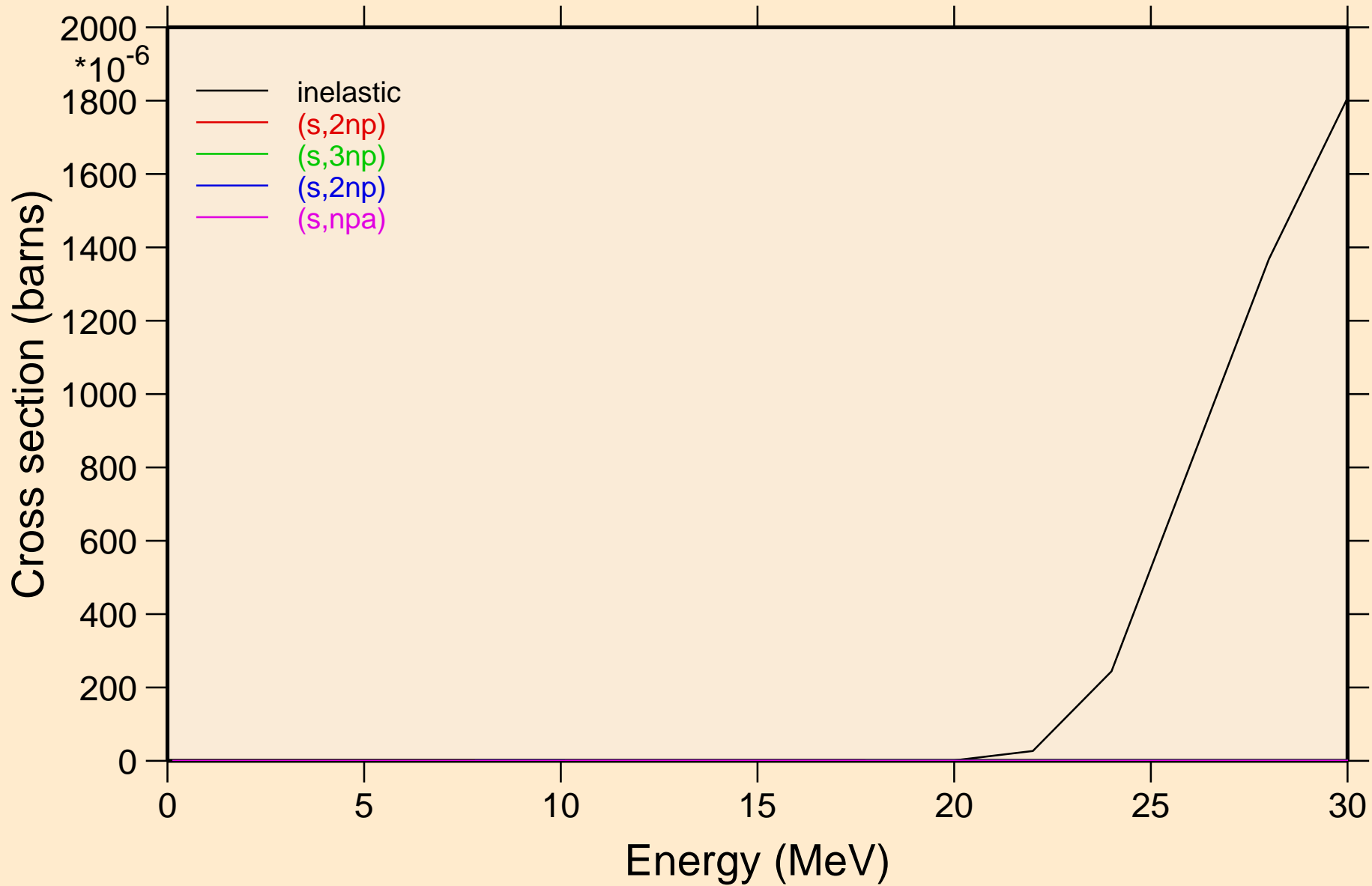



PU237 HELION ACER TENDL-2021 LIBRARY; T=0.K  
Threshold reactions

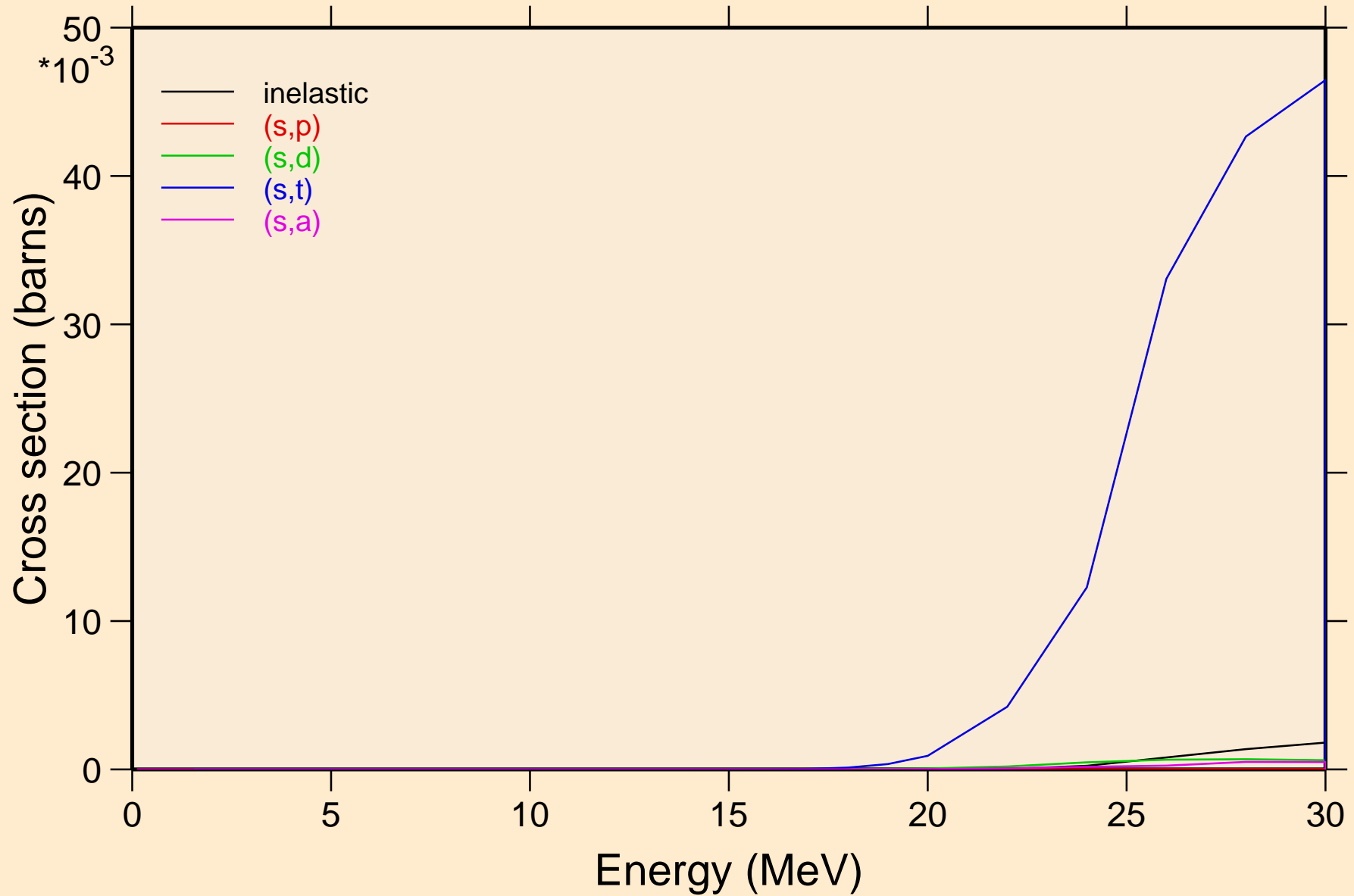

PU237 HELION ACER TENDL-2021 LIBRARY; T=0.K  
Threshold reactions

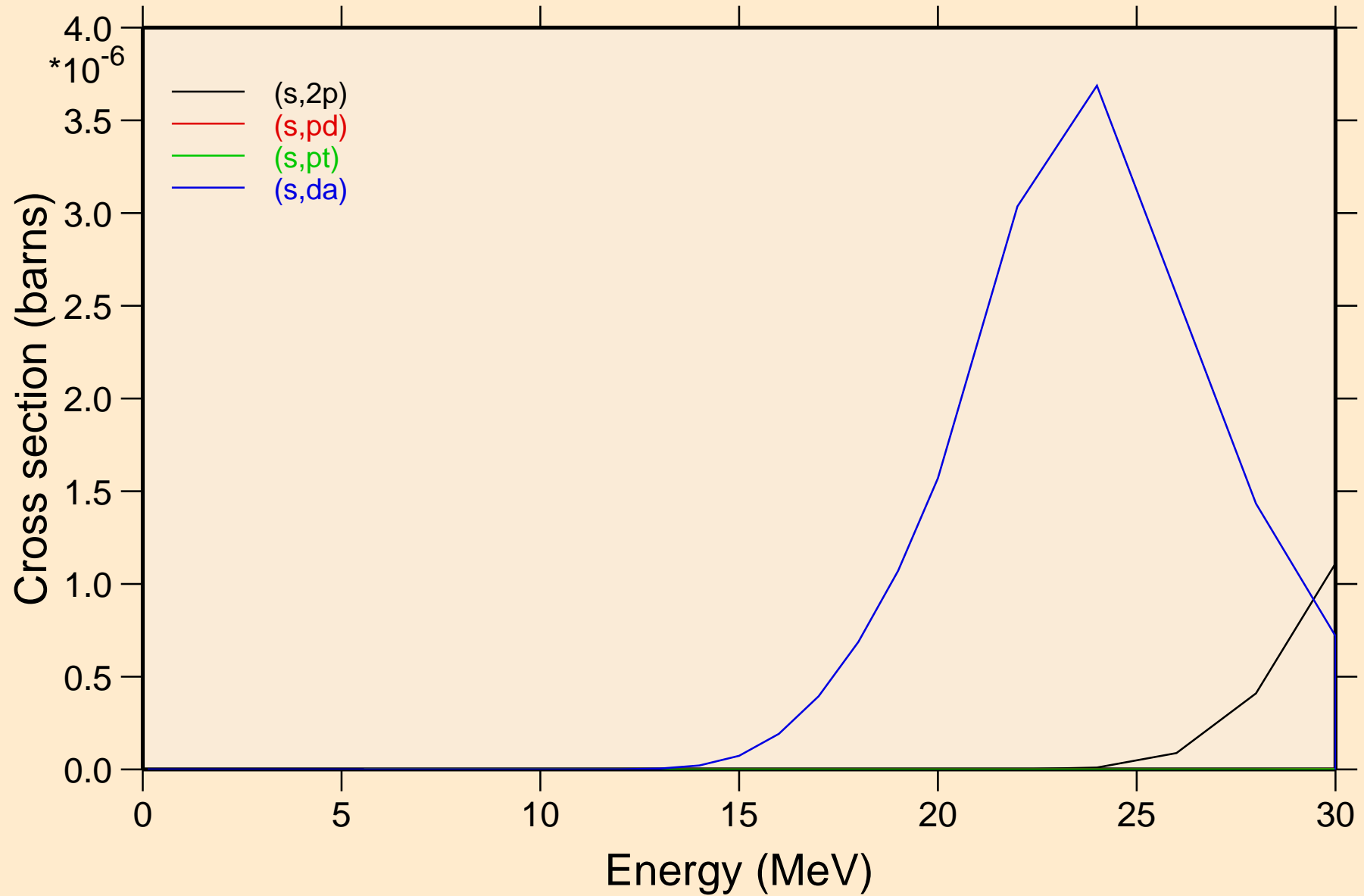

PU237 HELION ACER TENDL-2021 LIBRARY; T=0.K  
angular distribution for elastic

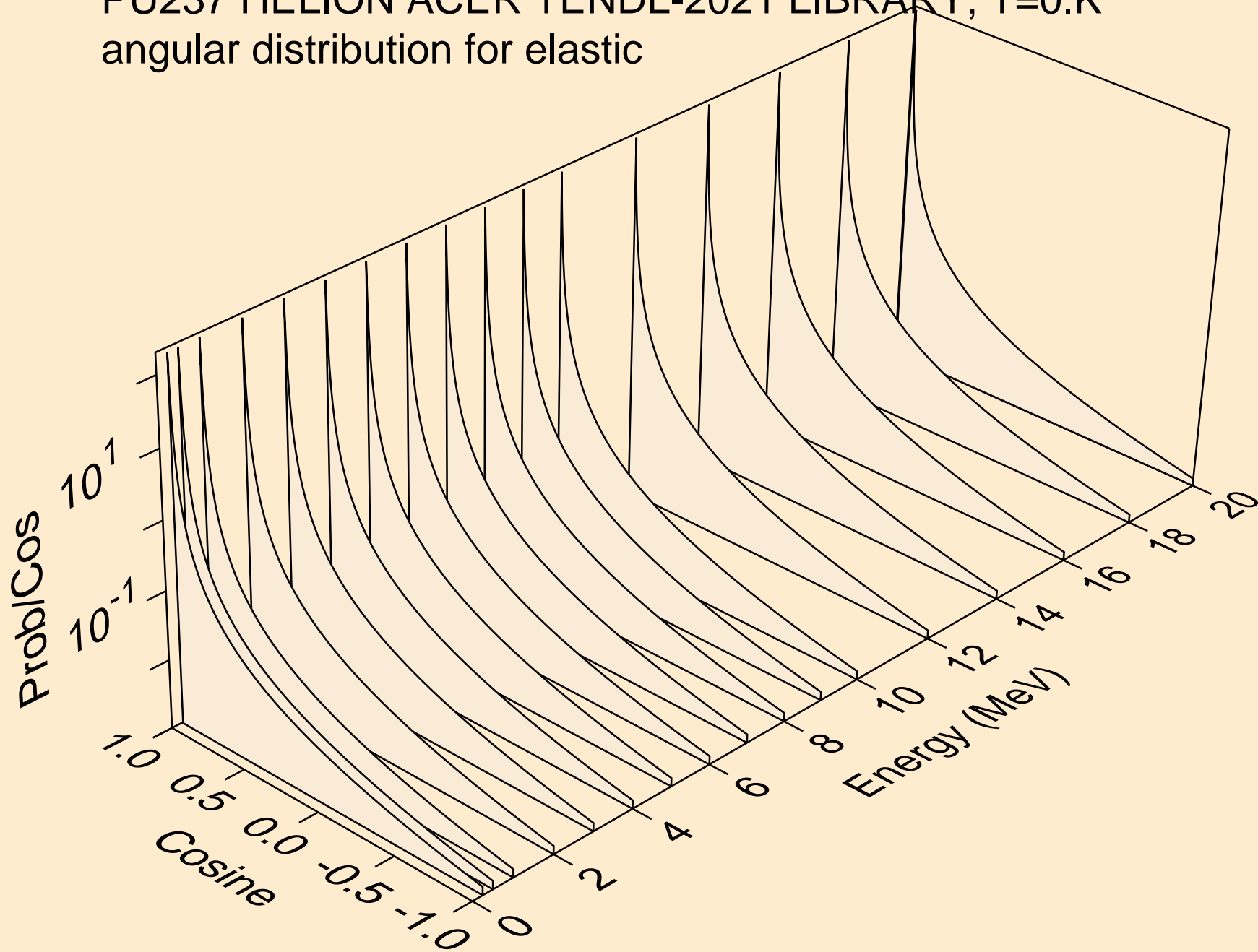

PU237 HELION ACER TENDL-2021 LIBRARY; T=0.K  
angular distribution for elastic

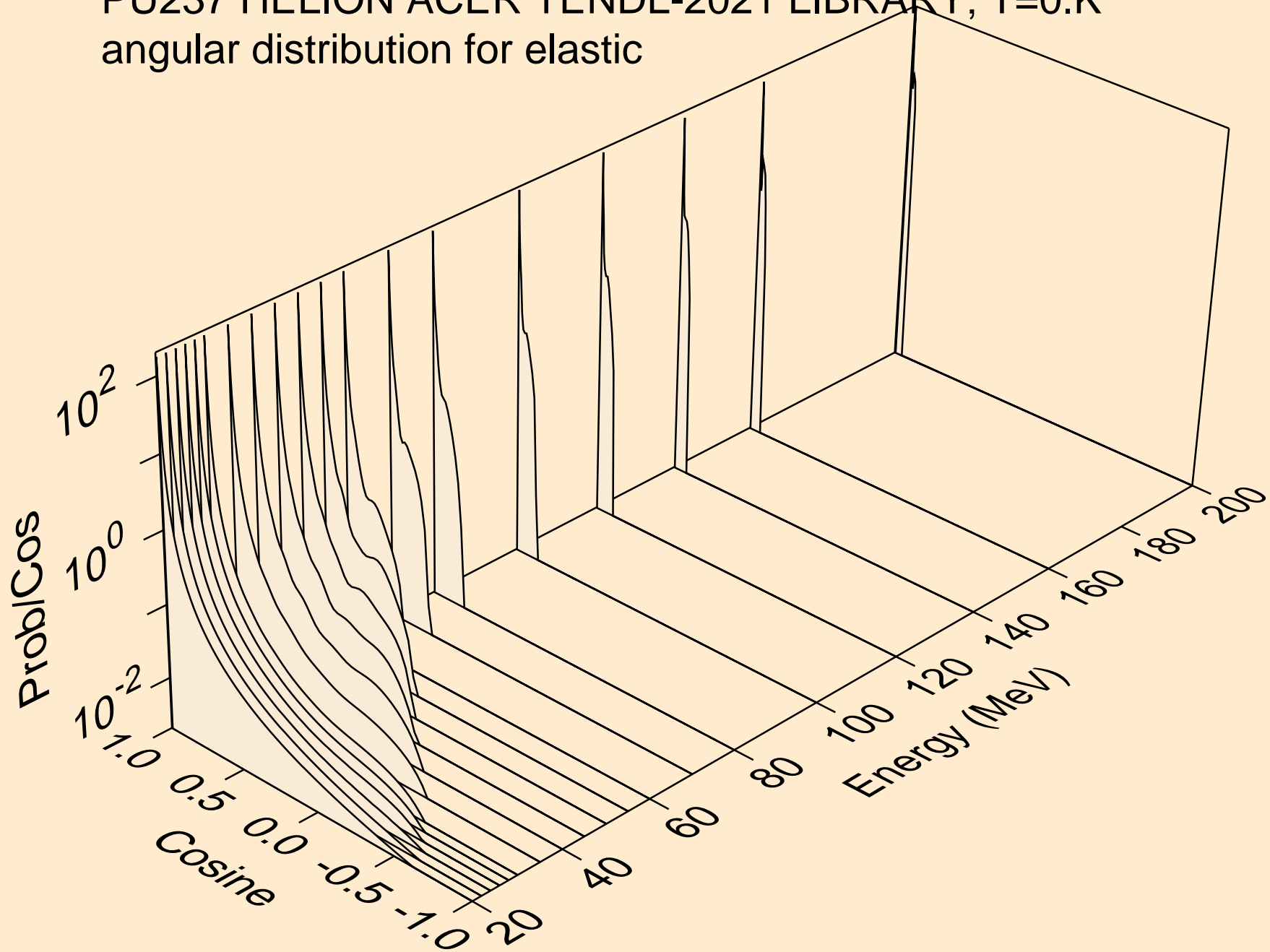

PU237 HELION ACER TENDL-2021 LIBRARY; T=0.K  
He-3 emission for (s,x)

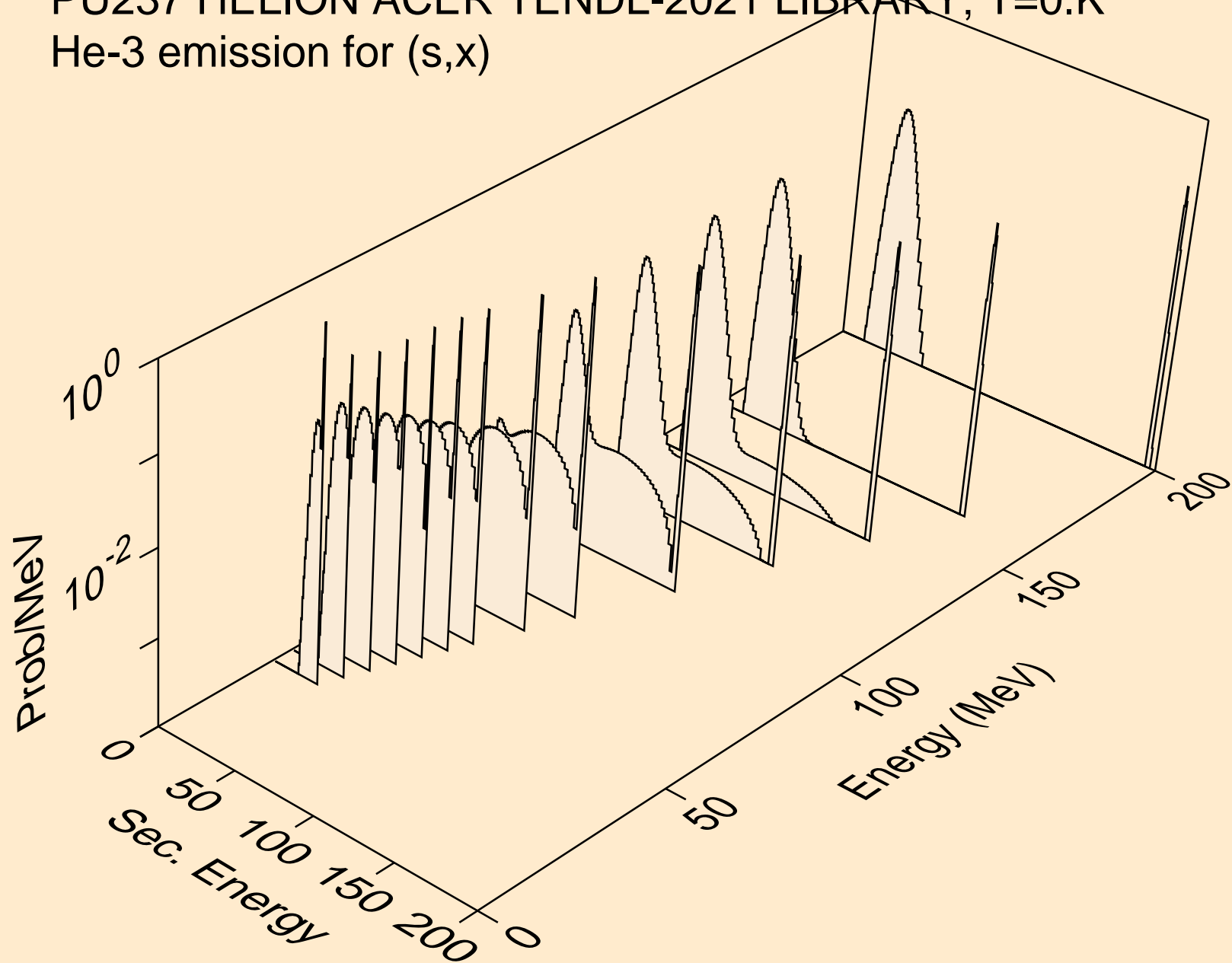

PU237 HELION ACER TENDL-2021 LIBRARY; T=0.K  
He-3 emission for (s,n\*)he3

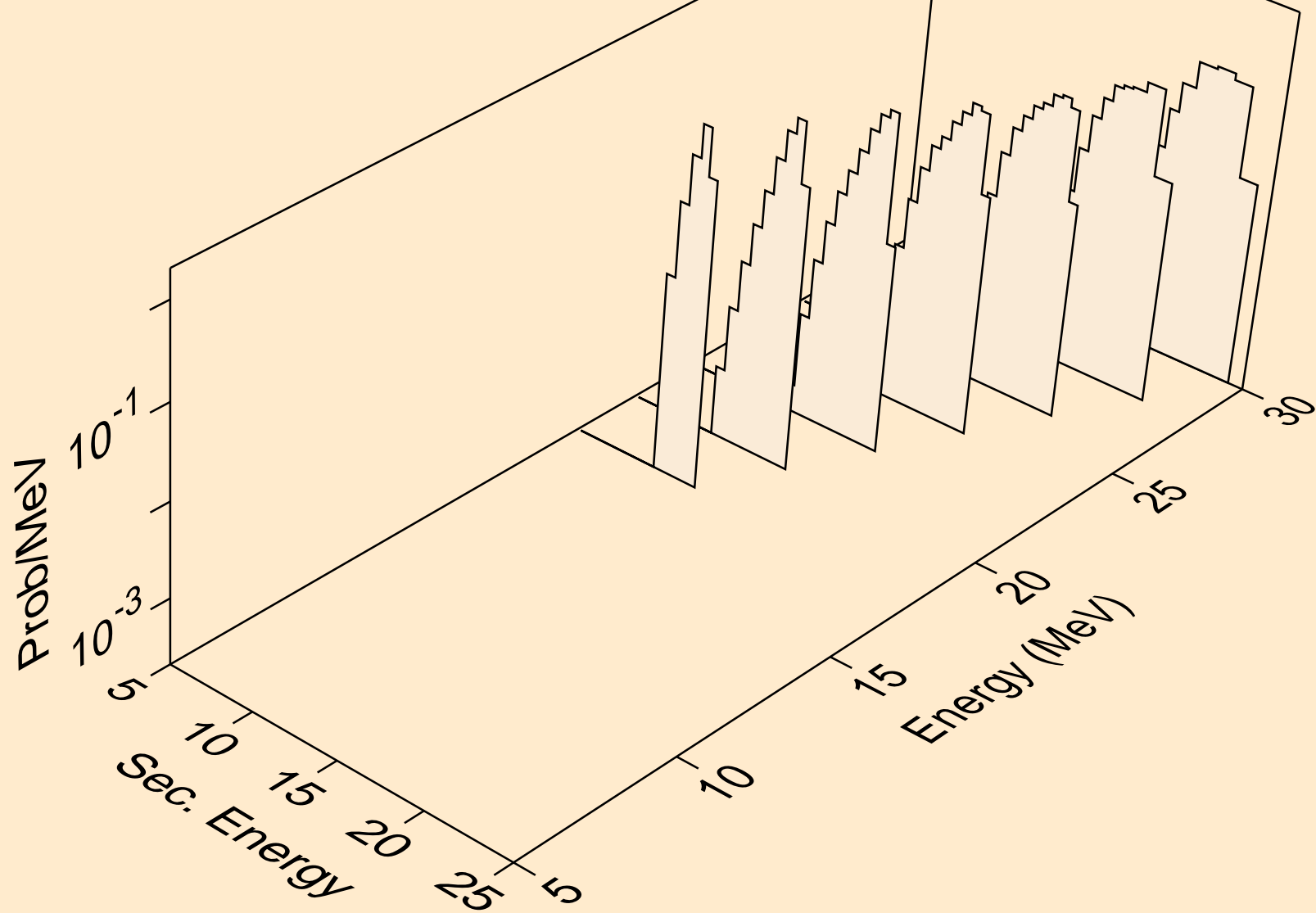

PU237 HELION ACER TENDL-2021 LIBRARY; T=0.K  
He-3 emission for inelastic

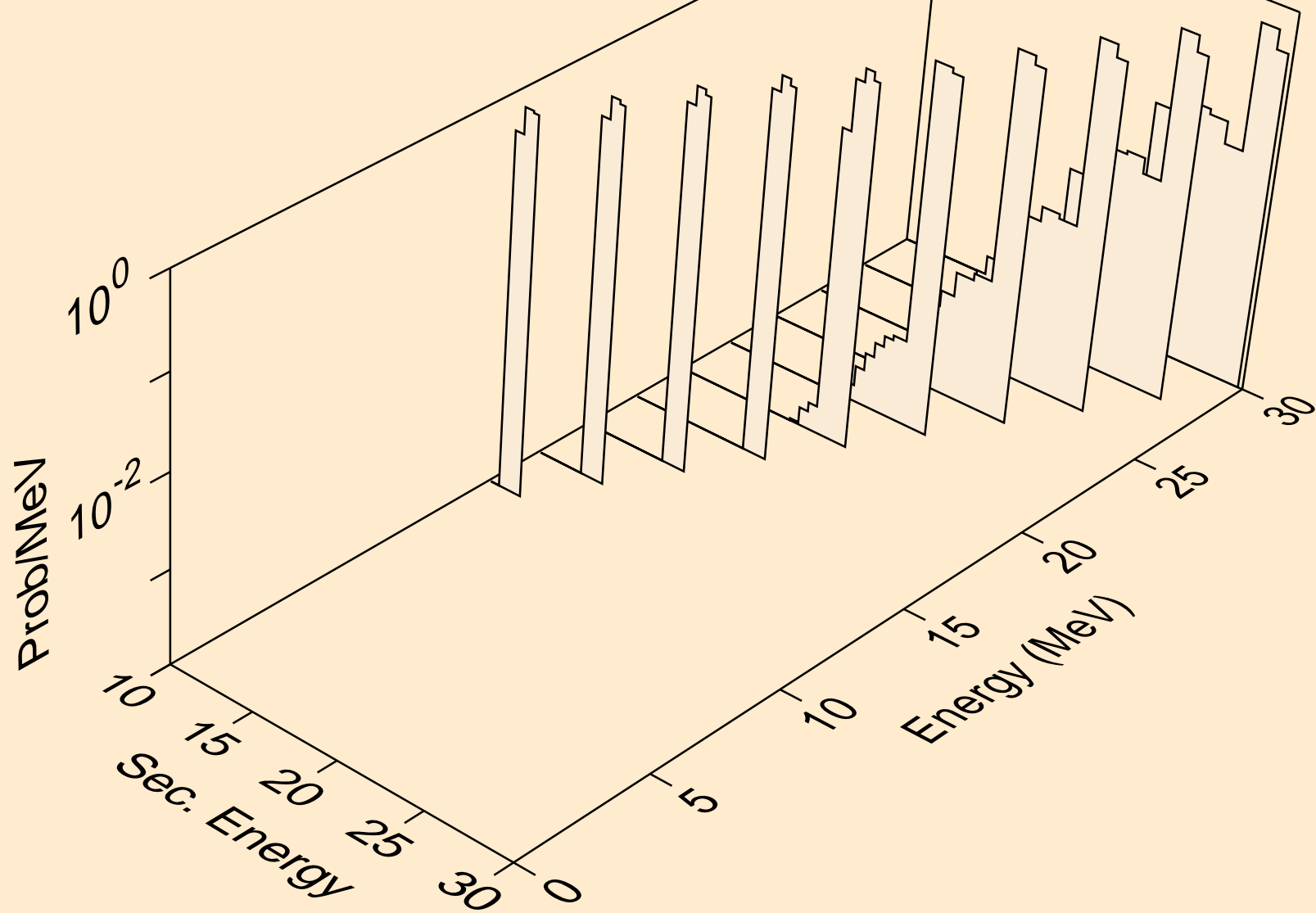

PU237 HELION ACER TENDL-2021 LIBRARY; T=0.K  
Photon emission for (z,n)

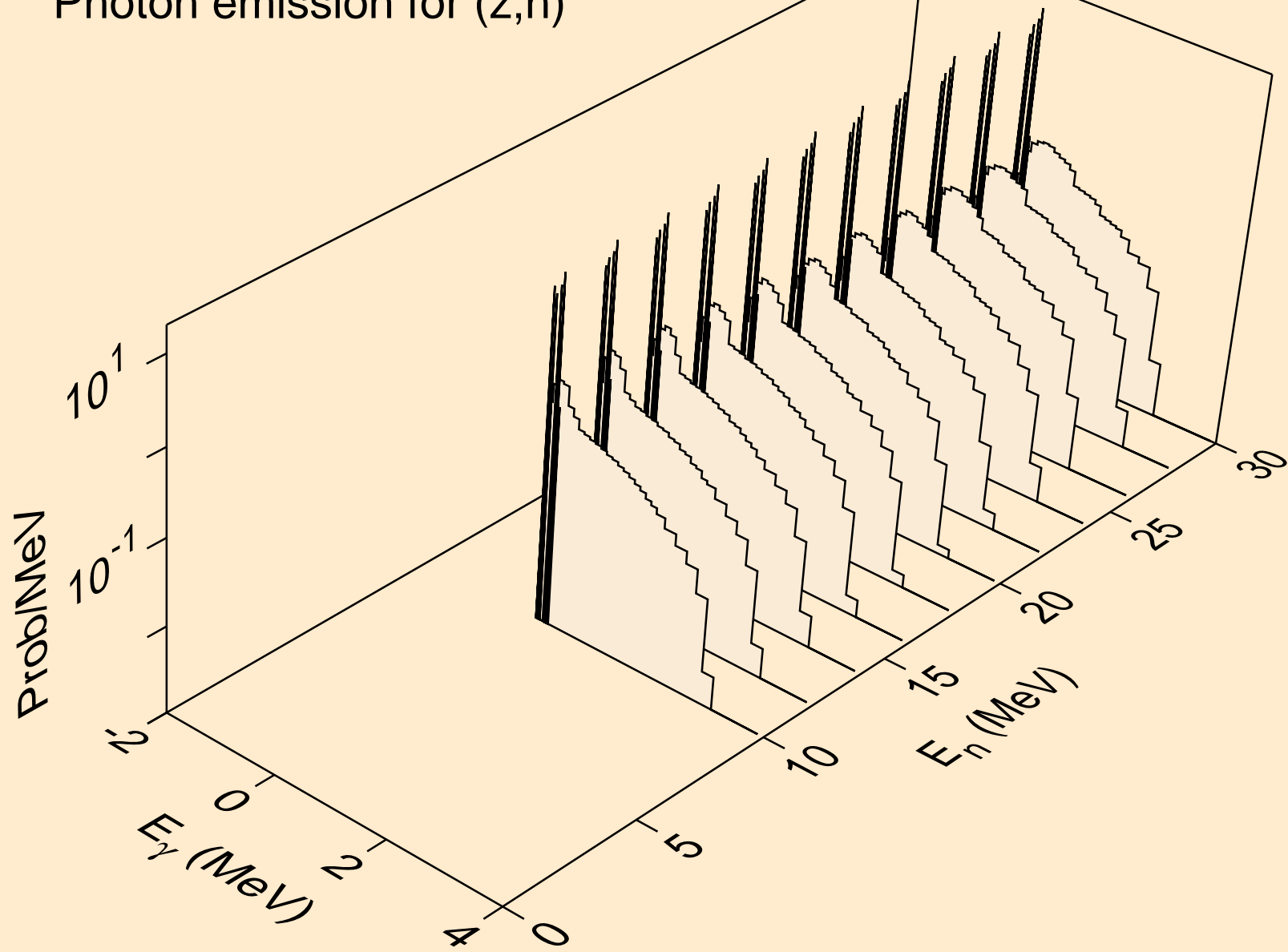



PU237 HELION ACER TENDL-2021 LIBRARY; T=0.K  
Photon emission for (n,x)

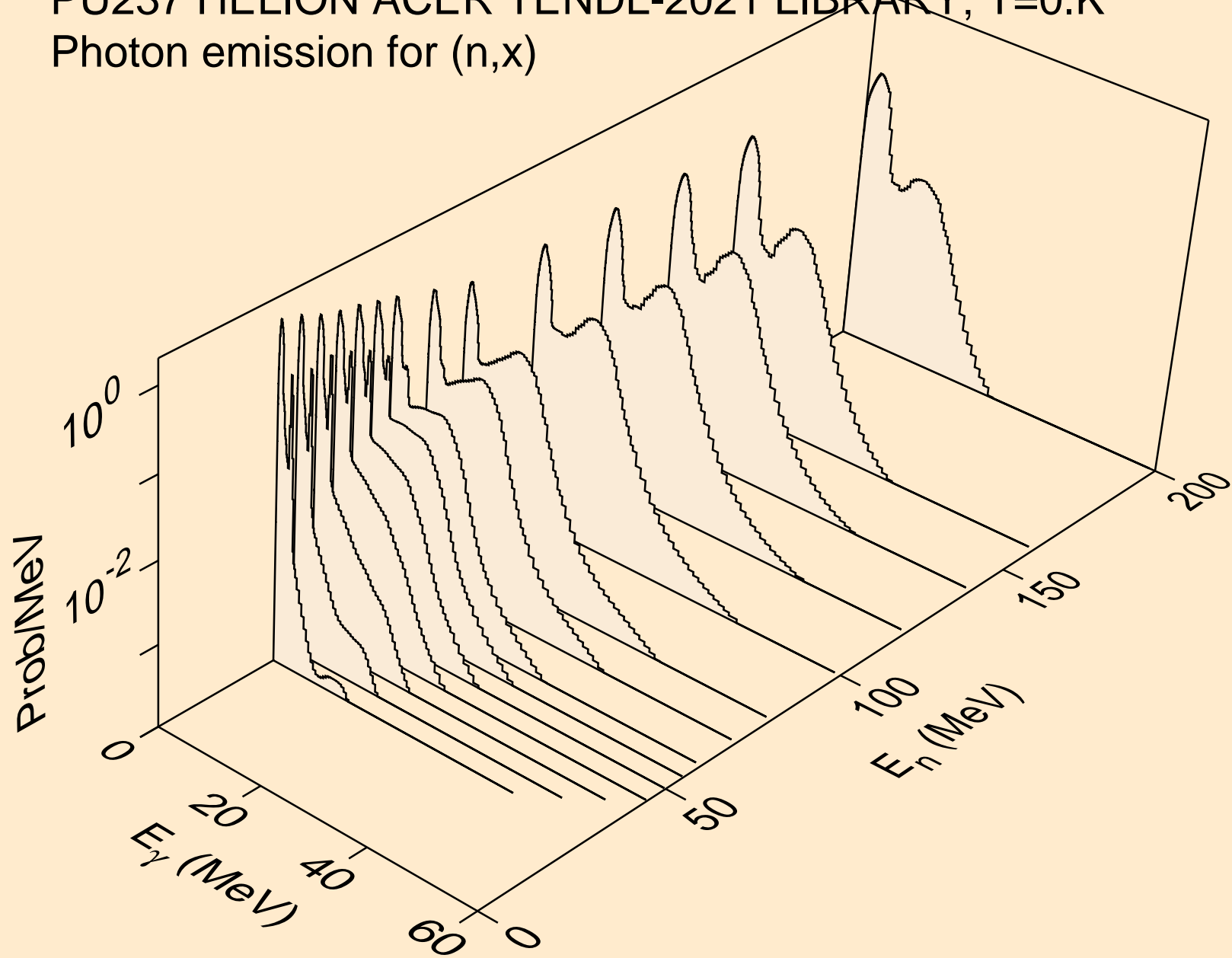

PU237 HELION ACER TENDL-2021 LIBRARY; T=0.K  
Photon emission for (n,2nd)

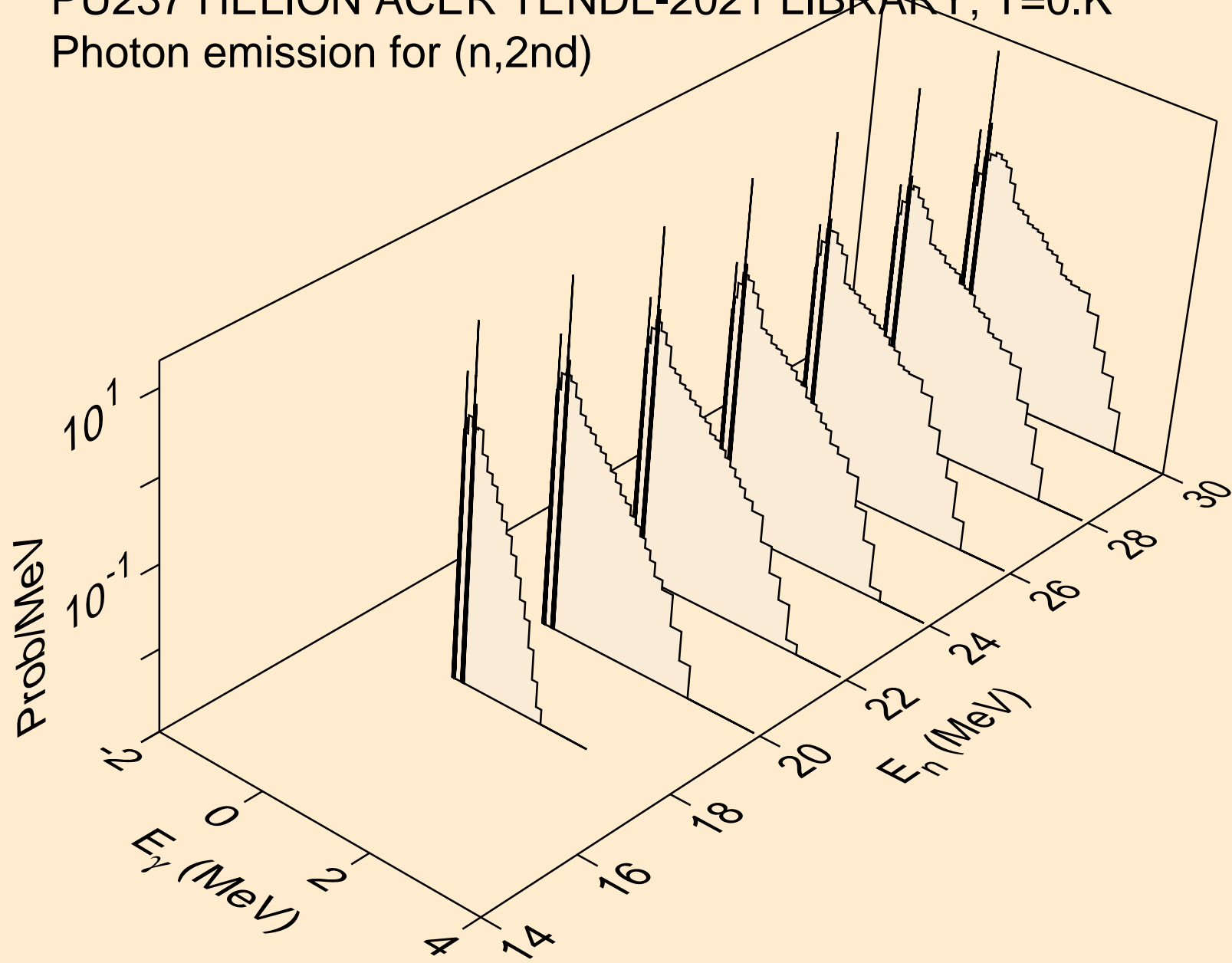

PU237 HELION ACER TENDL-2021 LIBRARY; T=0.K  
Photon emission for (n,2n)

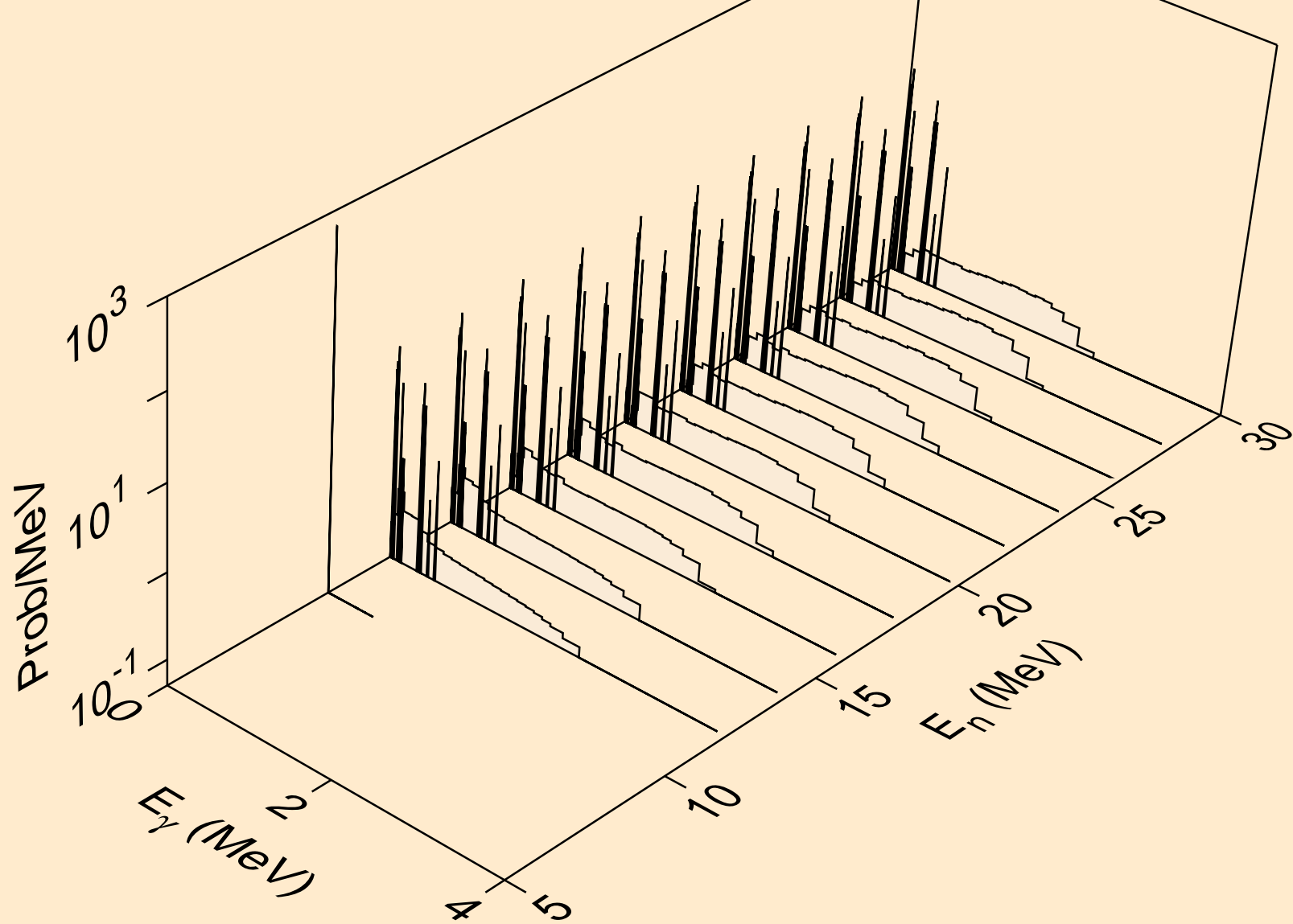

PU237 HELION ACER TENDL-2021 LIBRARY; T=0.K  
Photon emission for (n,3n)

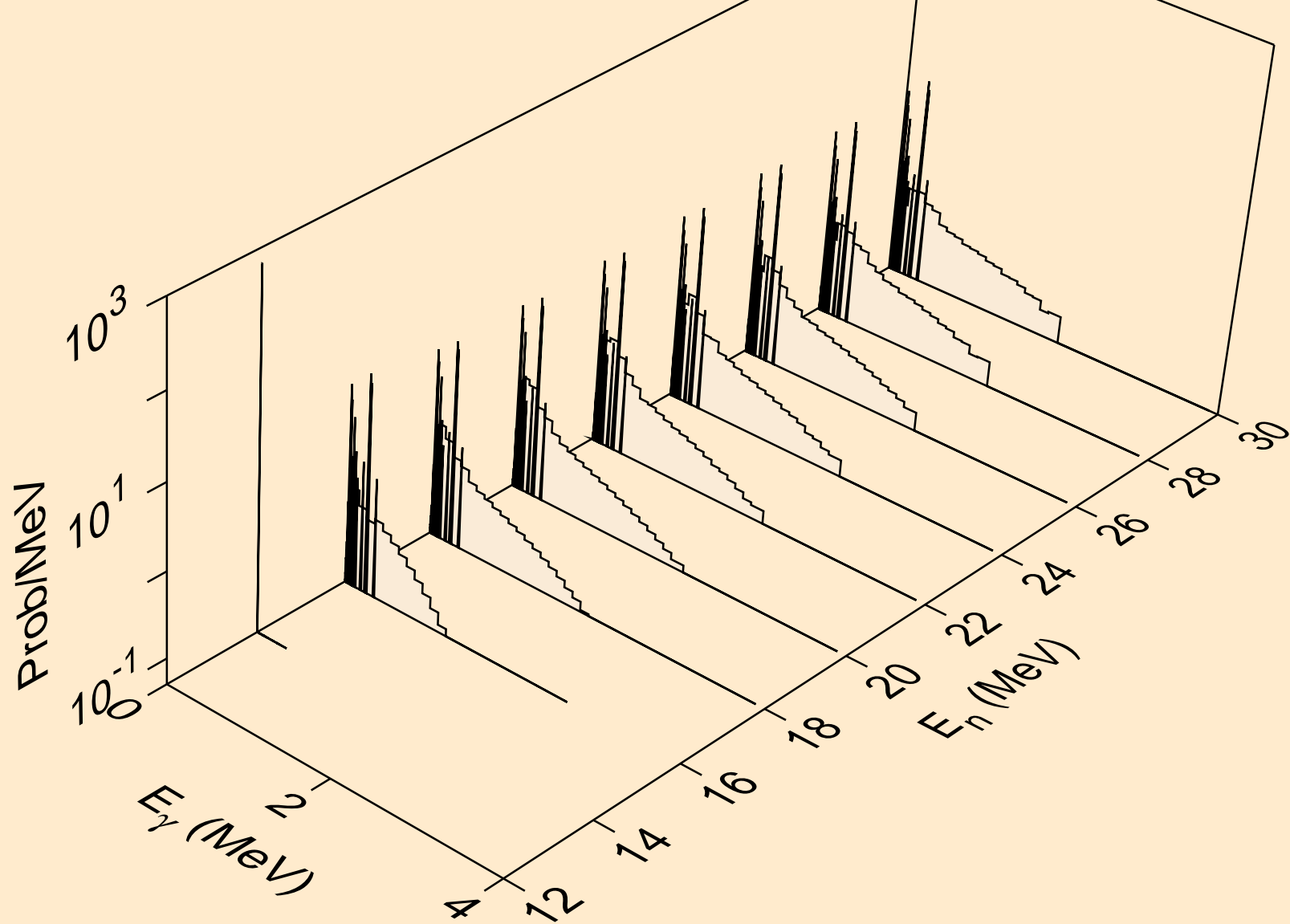

PU237 HELION ACER TENDL-2021 LIBRARY; T=0.K  
Photon emission for (n,n\*)a

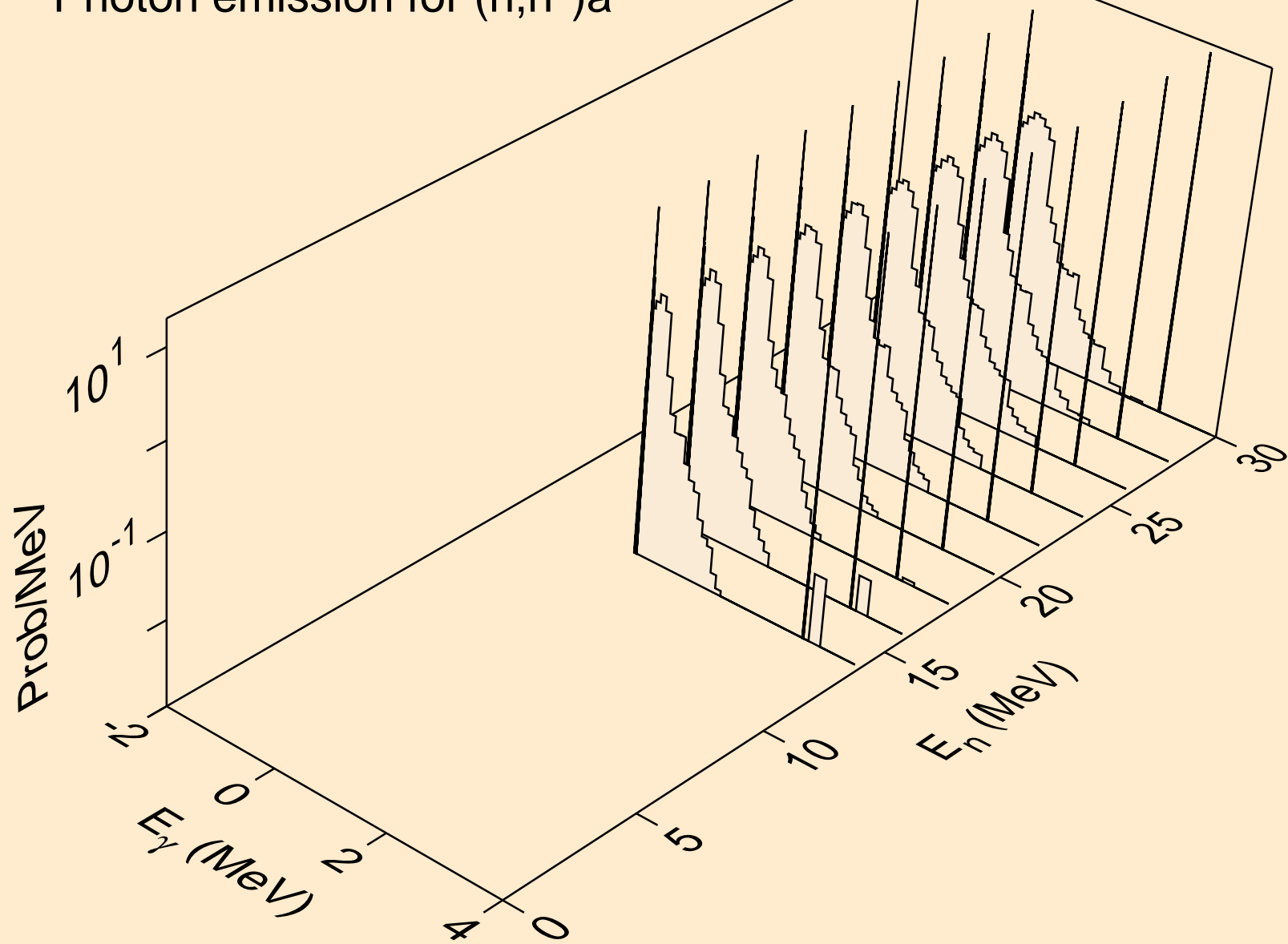

PU237 HELION ACER TENDL-2021 LIBRARY; T=0.K  
Photon emission for (n,n\*)p

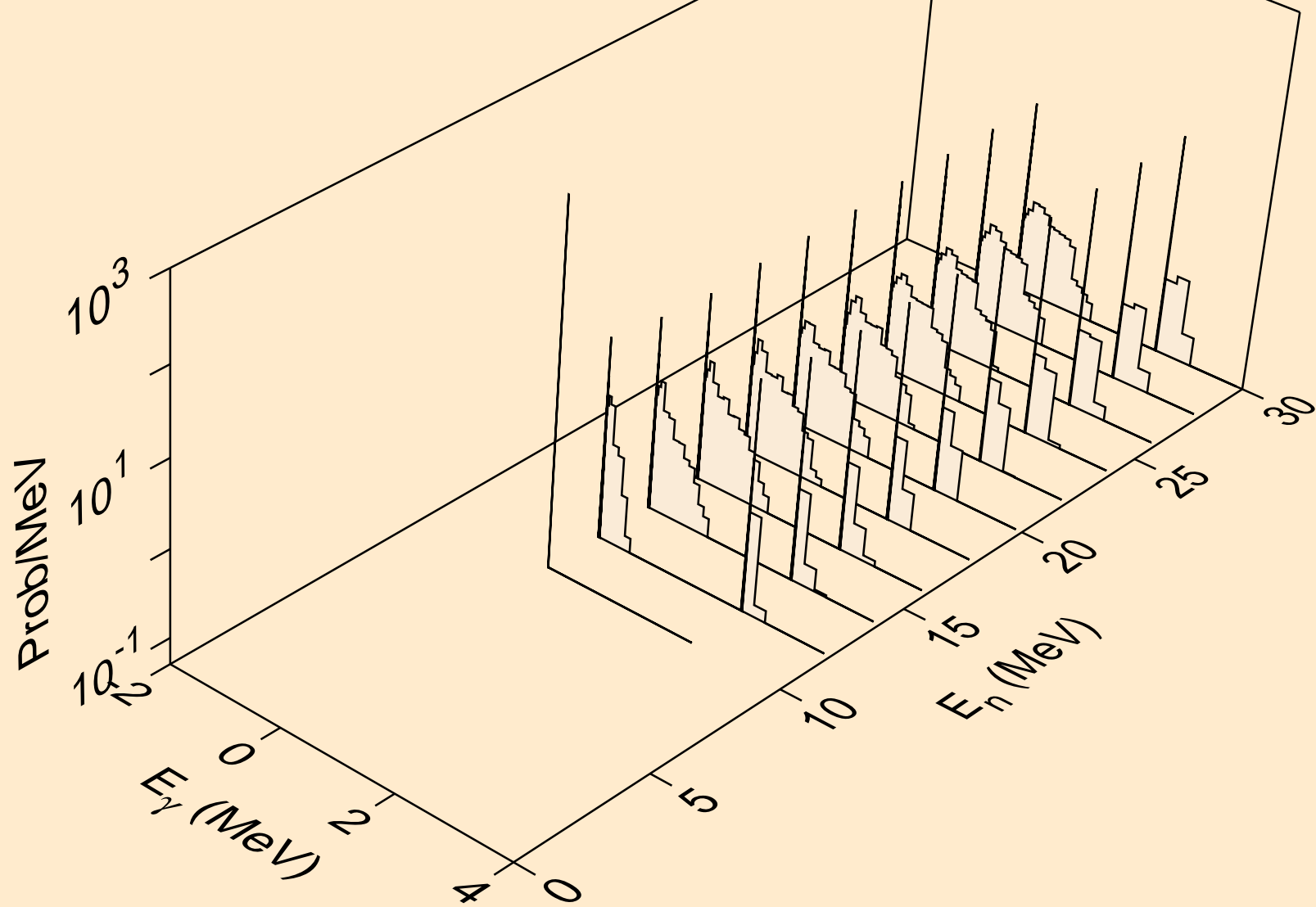

PU237 HELION ACER TENDL-2021 LIBRARY; T=0.K  
Photon emission for (n,n\*)d

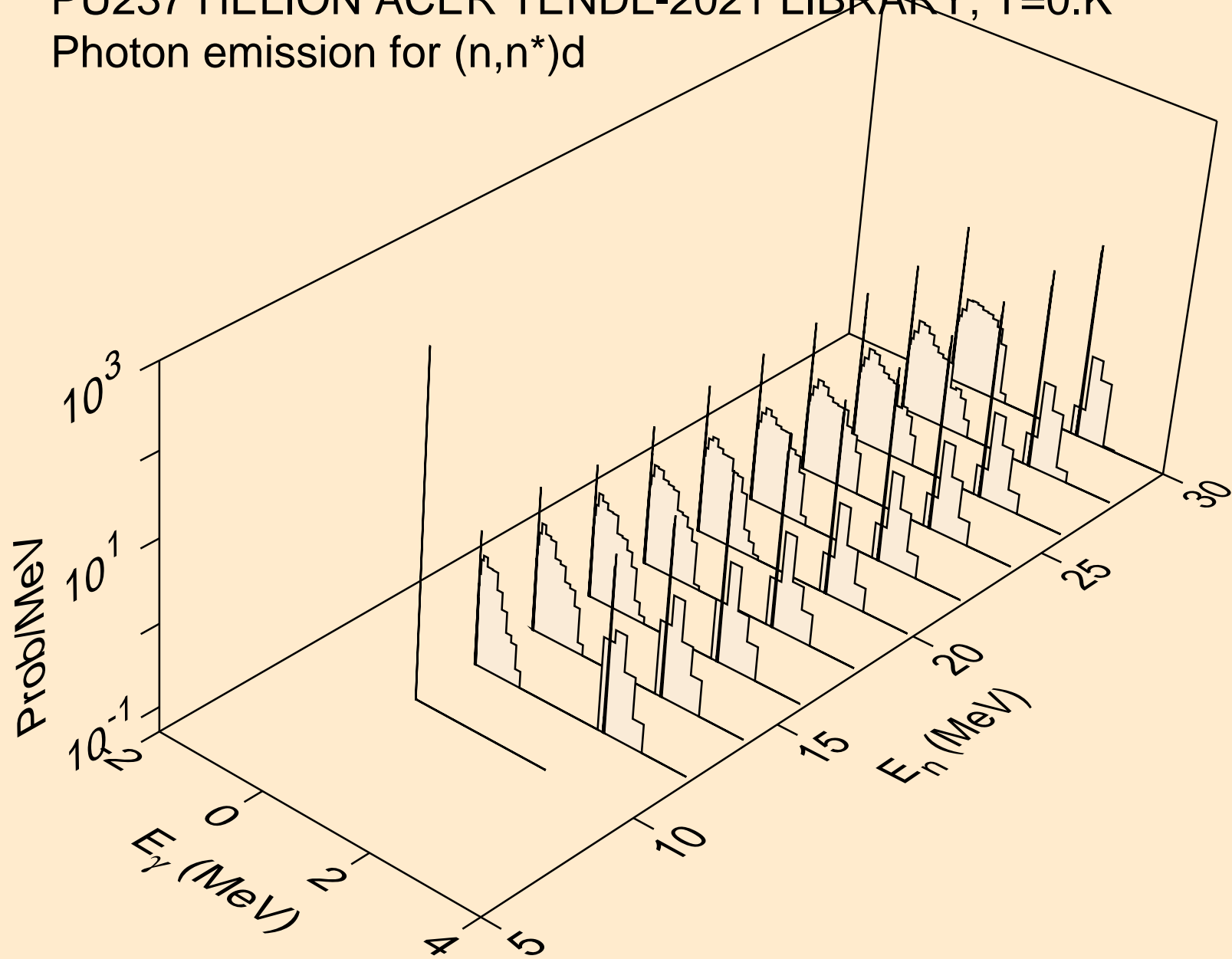

PU237 HELION ACER TENDL-2021 LIBRARY; T=0.K  
Photon emission for (n,n\*)t

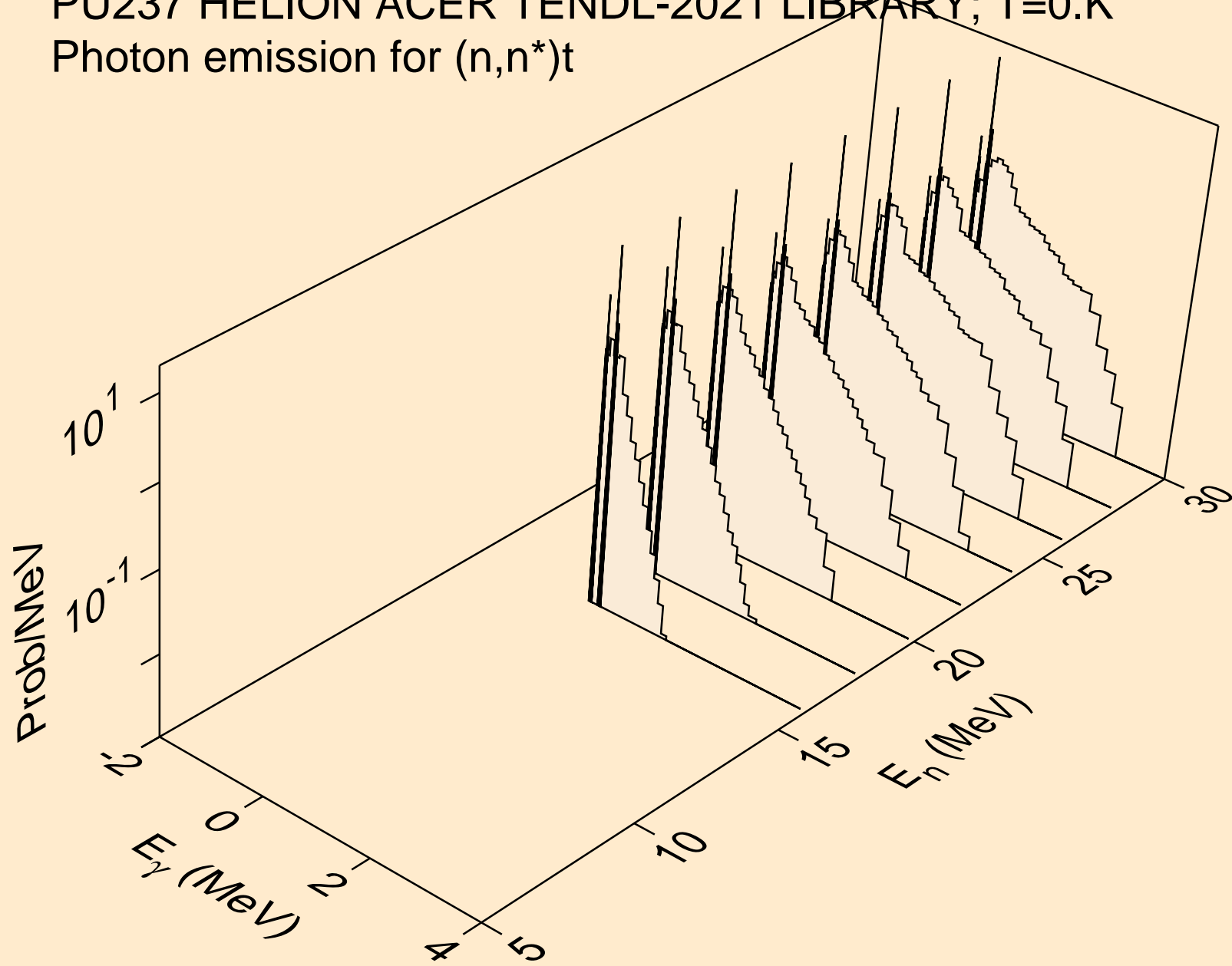



PU237 HELION ACER TENDL-2021 LIBRARY; T=0.K  
Photon emission for (n,n\*)he3

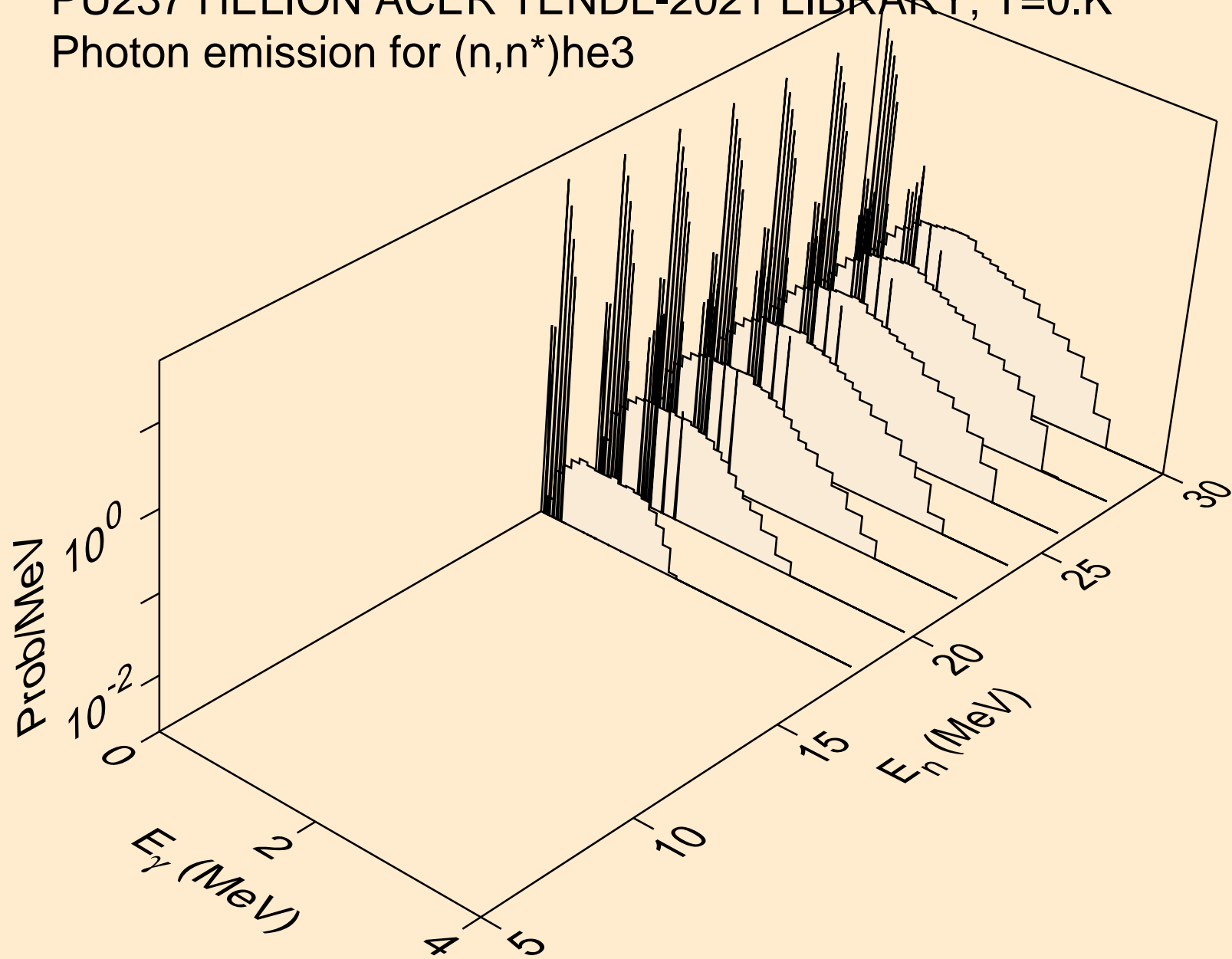

PU237 HELION ACER TENDL-2021 LIBRARY; T=0.K  
Photon emission for (n,4n)

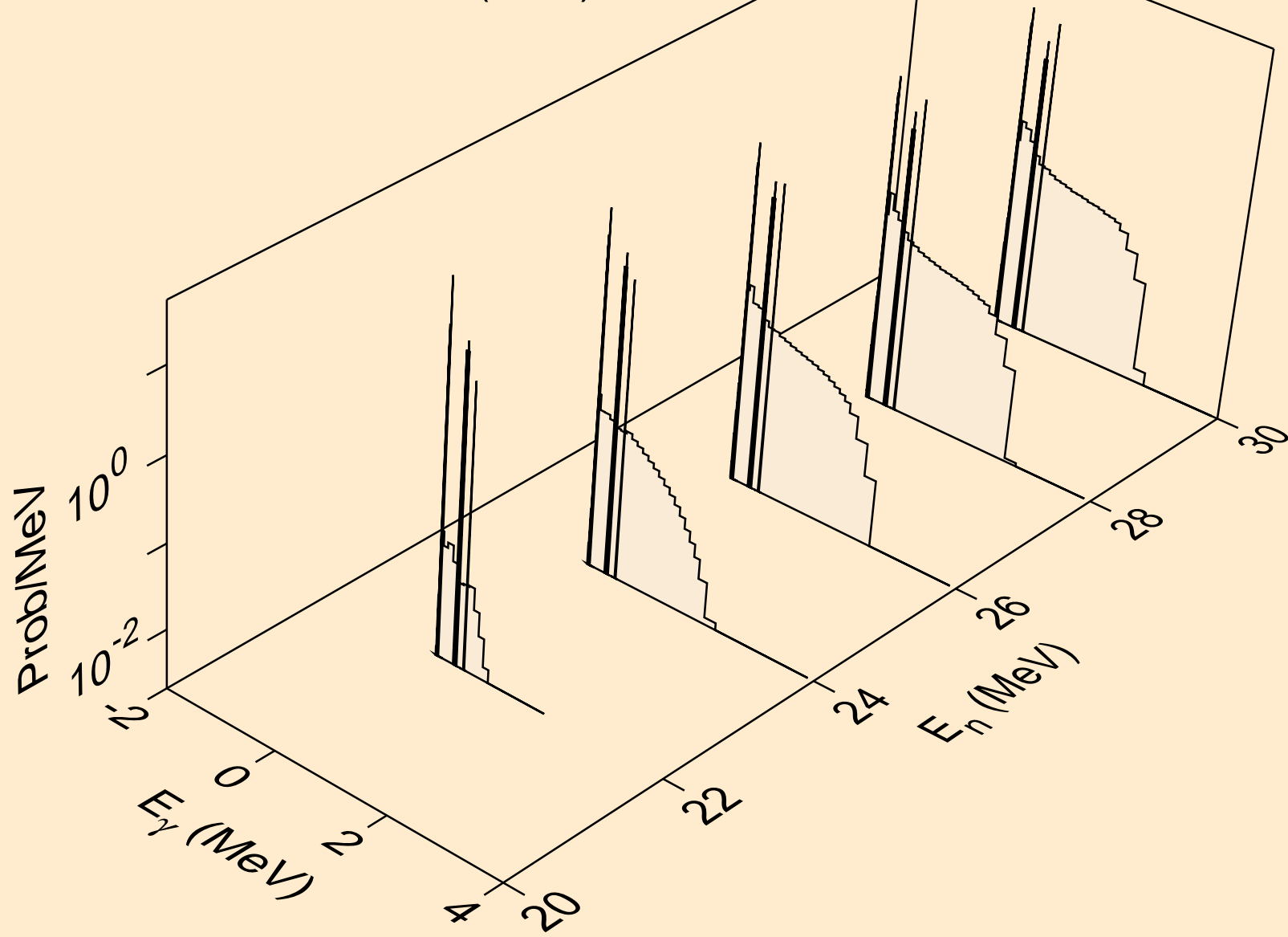

PU237 HELION ACER TENDL-2021 LIBRARY; T=0.K  
Photon emission for (n,2np)

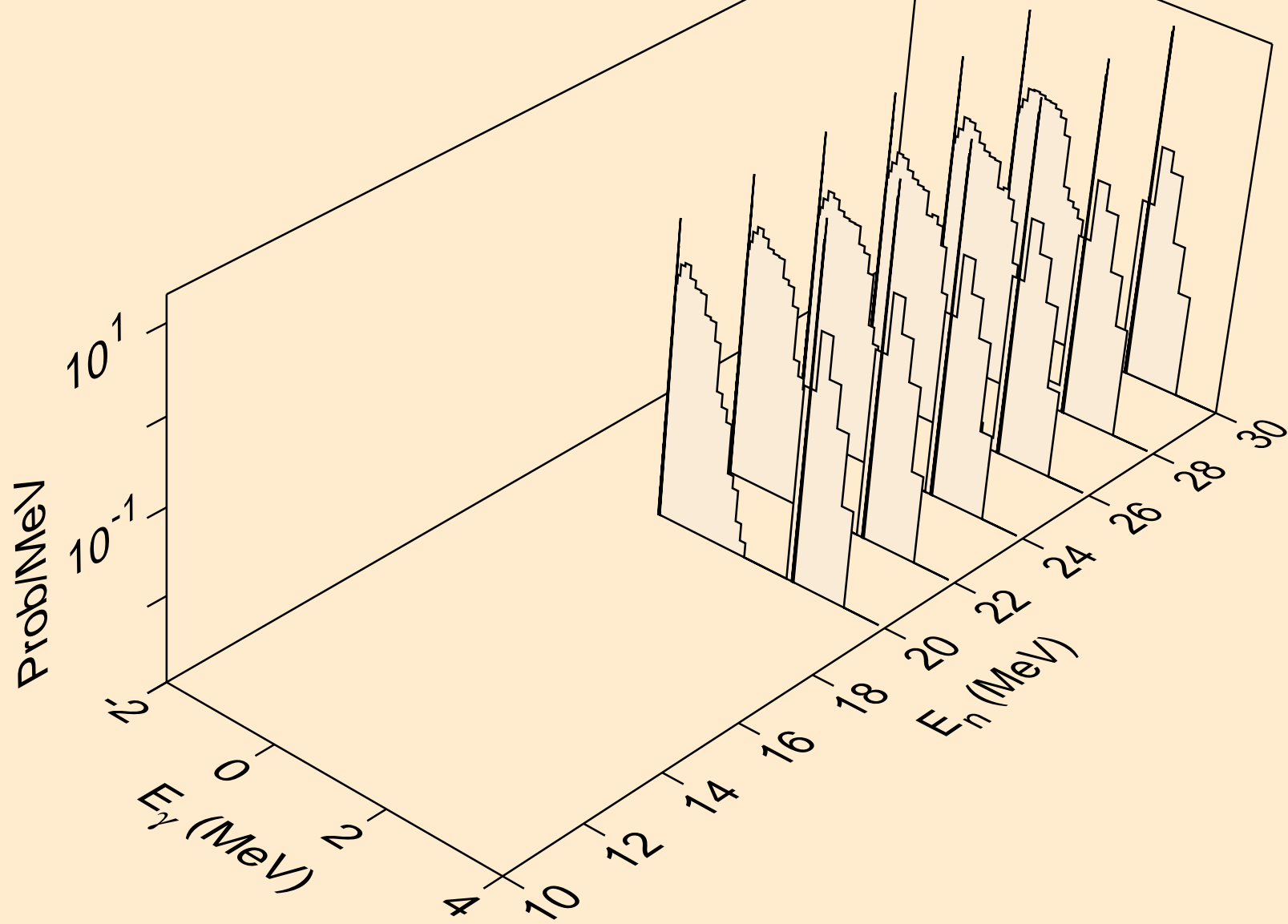

PU237 HELION ACER TENDL-2021 LIBRARY; T=0.K  
Photon emission for (n,3np)

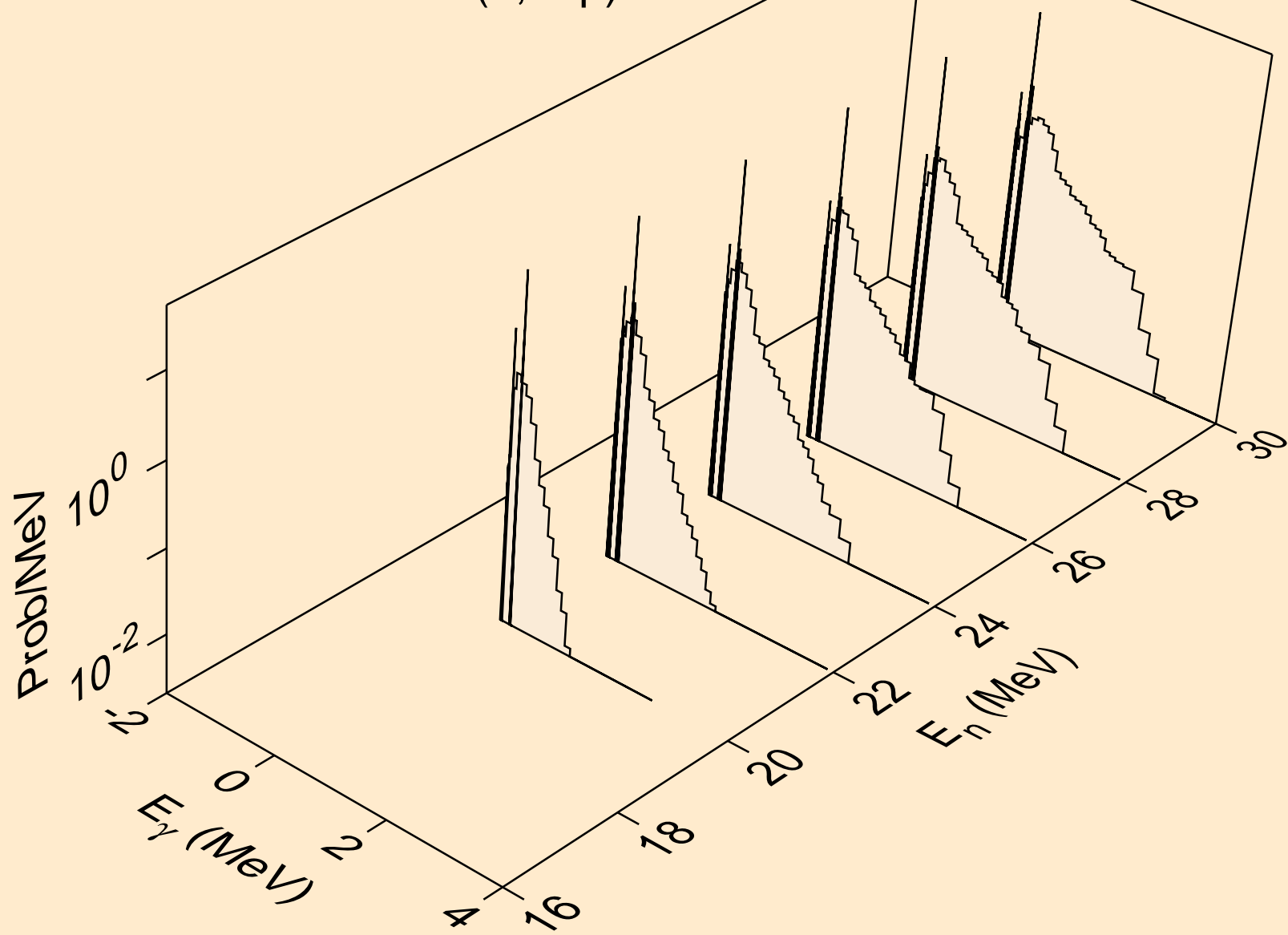

PU237 HELION ACER TENDL-2021 LIBRARY; T=0.K  
Photon emission for (n,2np)

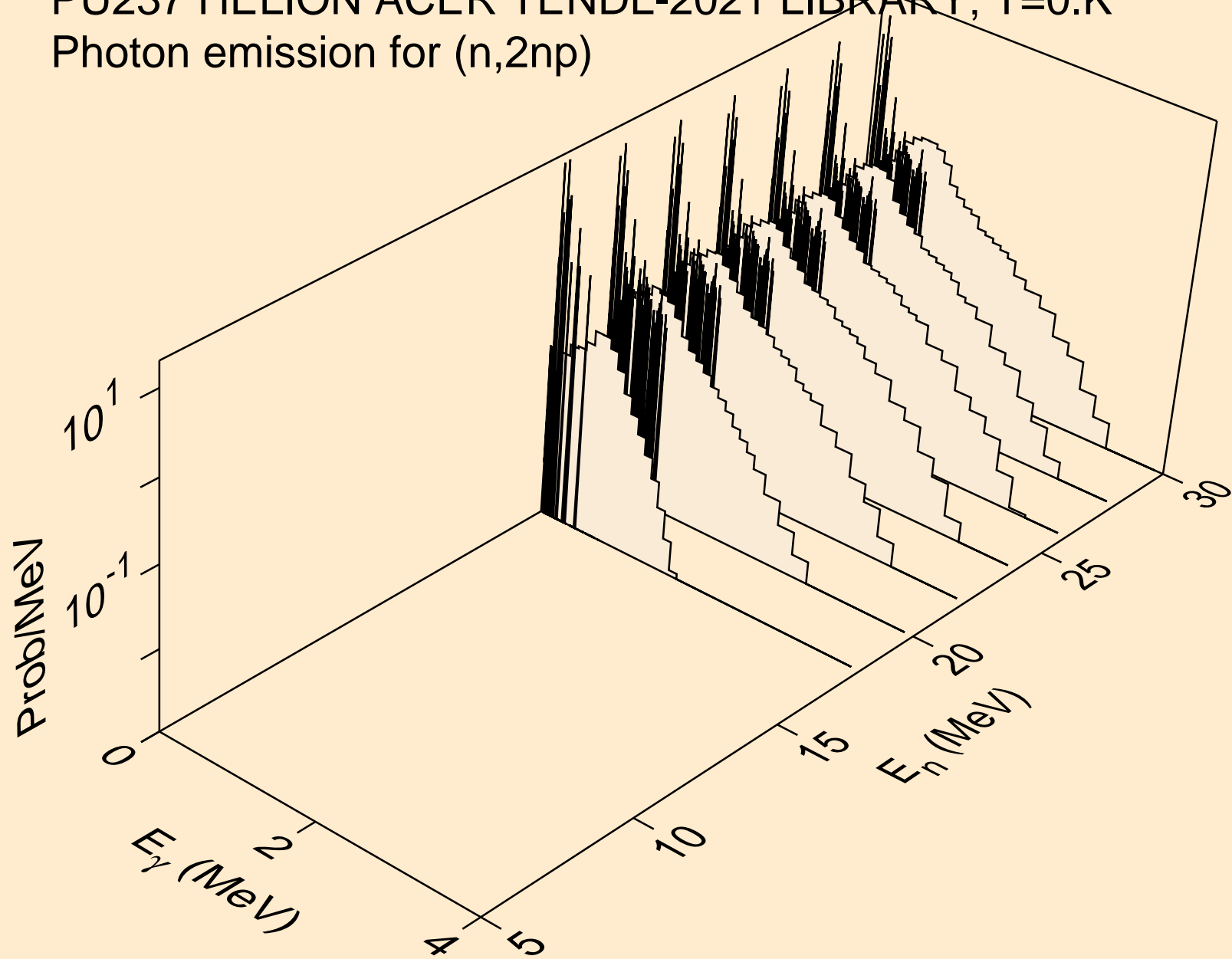

PU237 HELION ACER TENDL-2021 LIBRARY; T=0.K  
Photon emission for (n,npa)

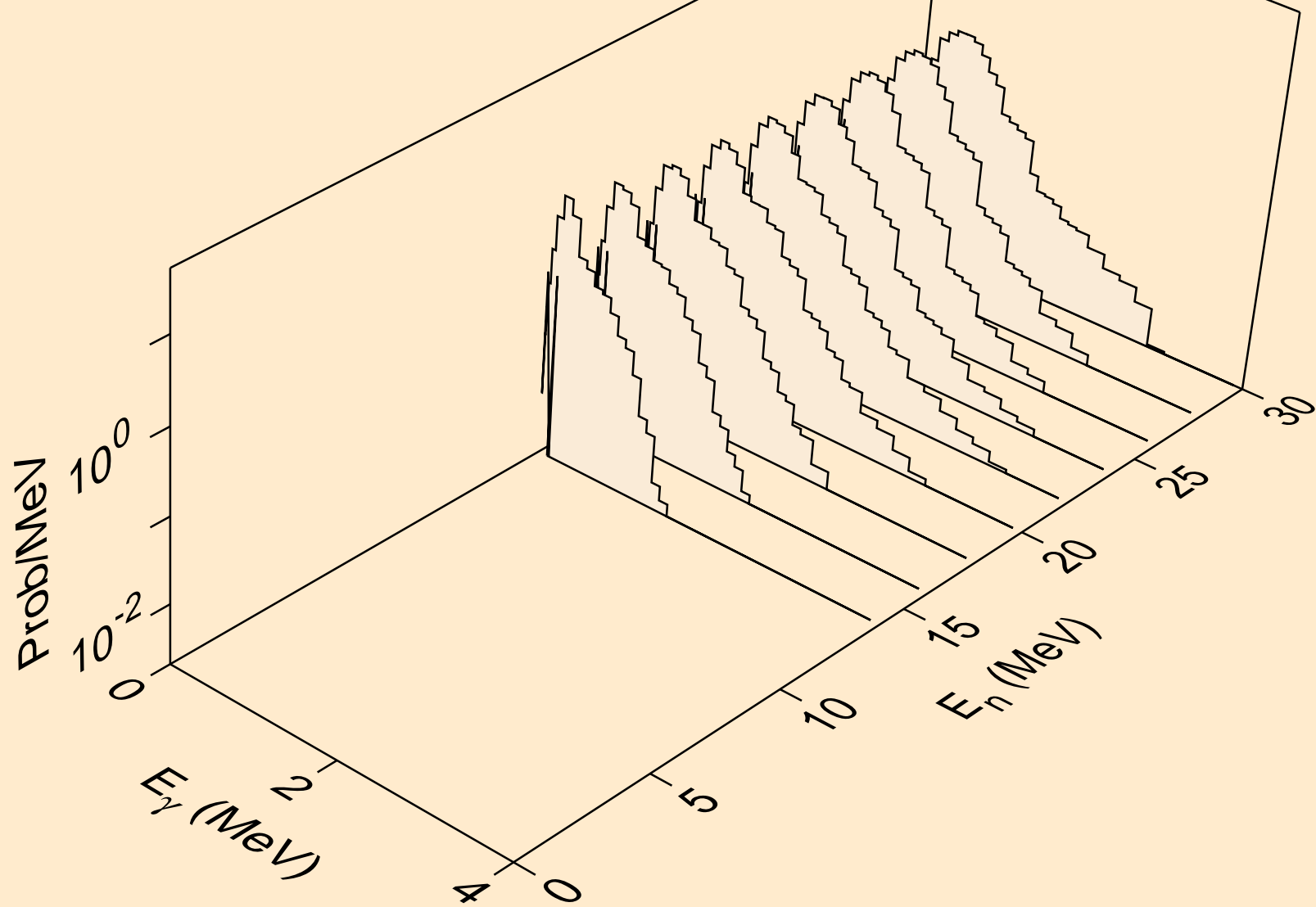

PU237 HELION ACER TENDL-2021 LIBRARY; T=0.K  
Photon emission for (n,p)

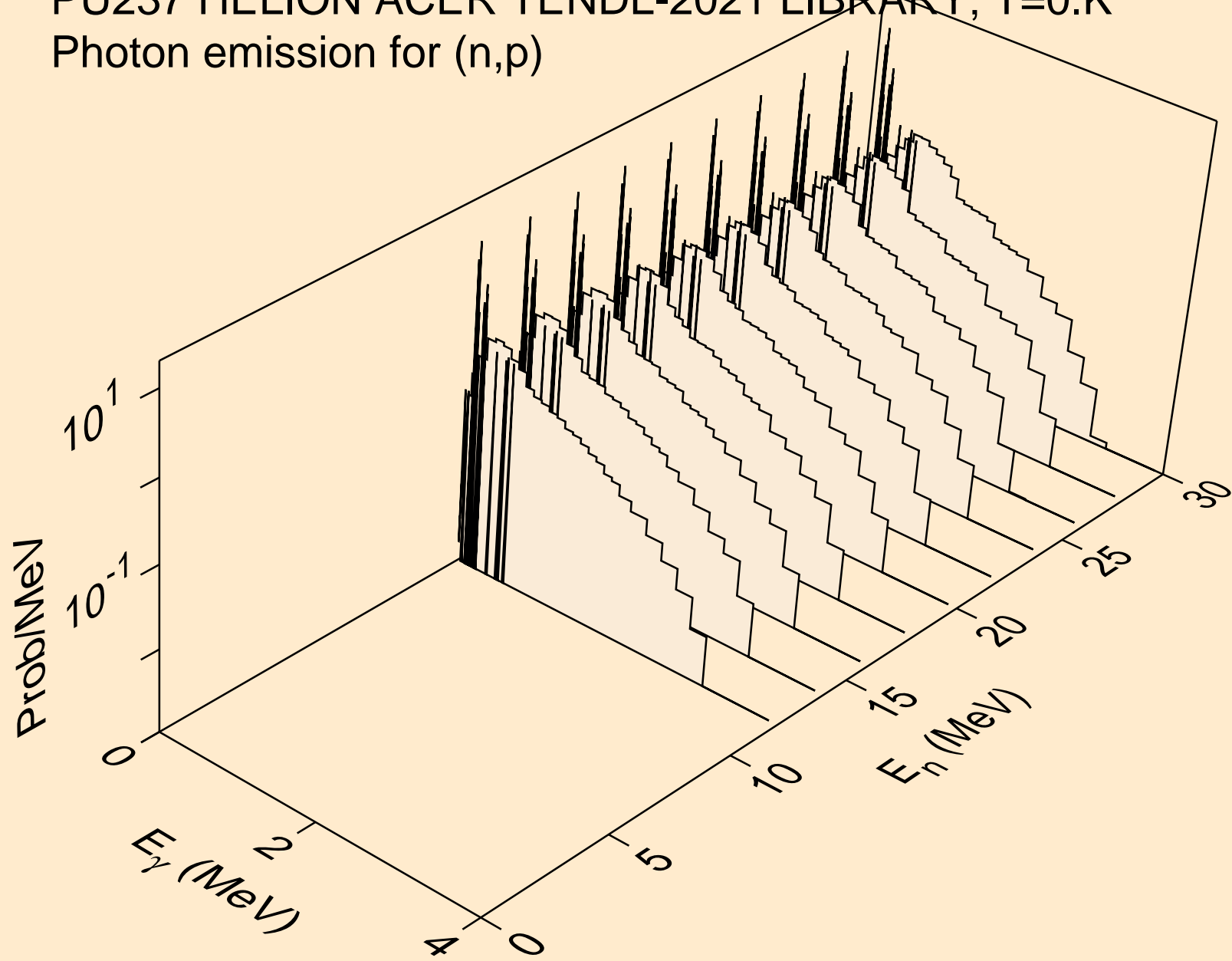

PU237 HELION ACER TENDL-2021 LIBRARY; T=0.K  
Photon emission for (n,d)

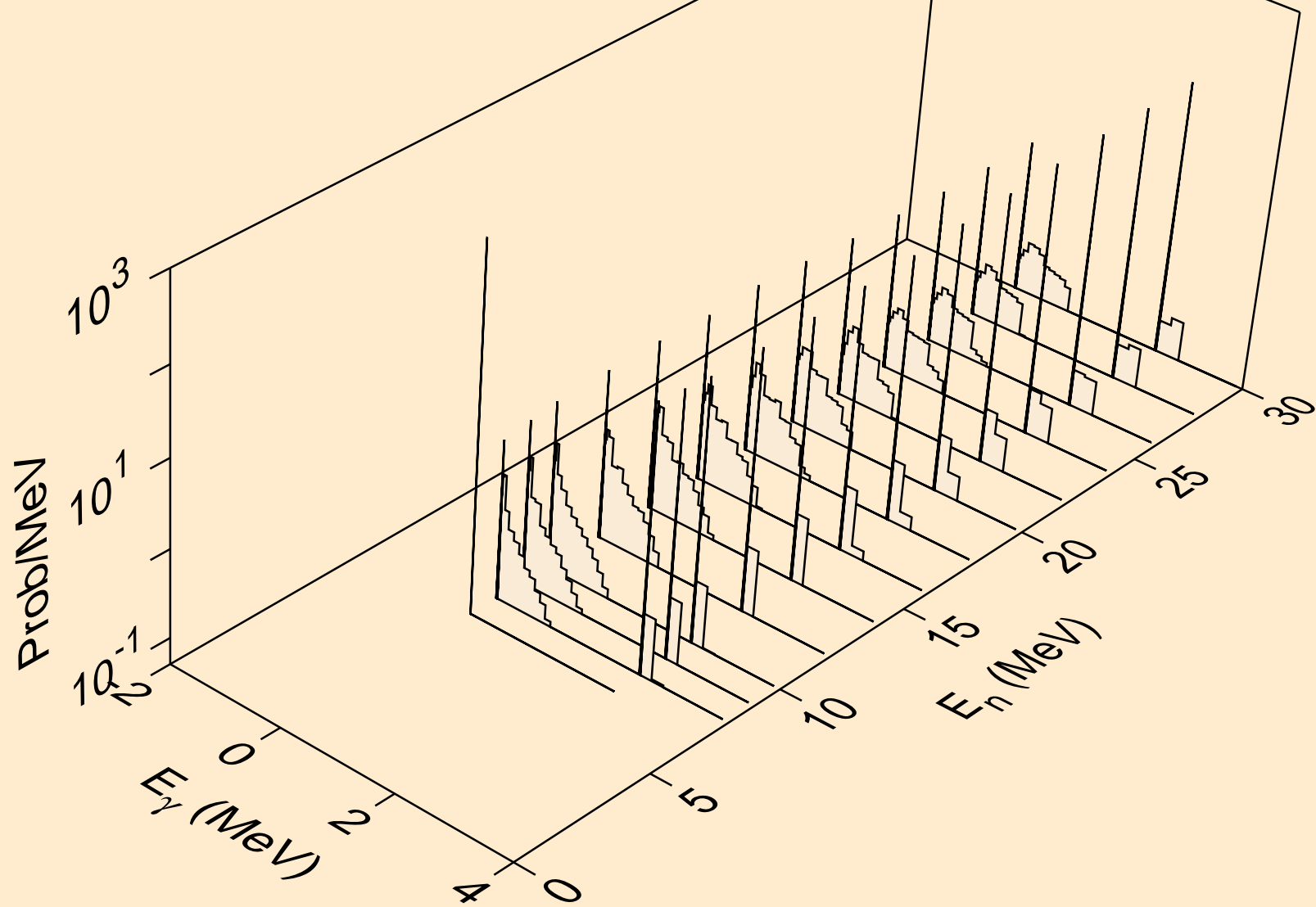



PU237 HELION ACER TENDL-2021 LIBRARY; T=0.K  
Photon emission for (n,t)

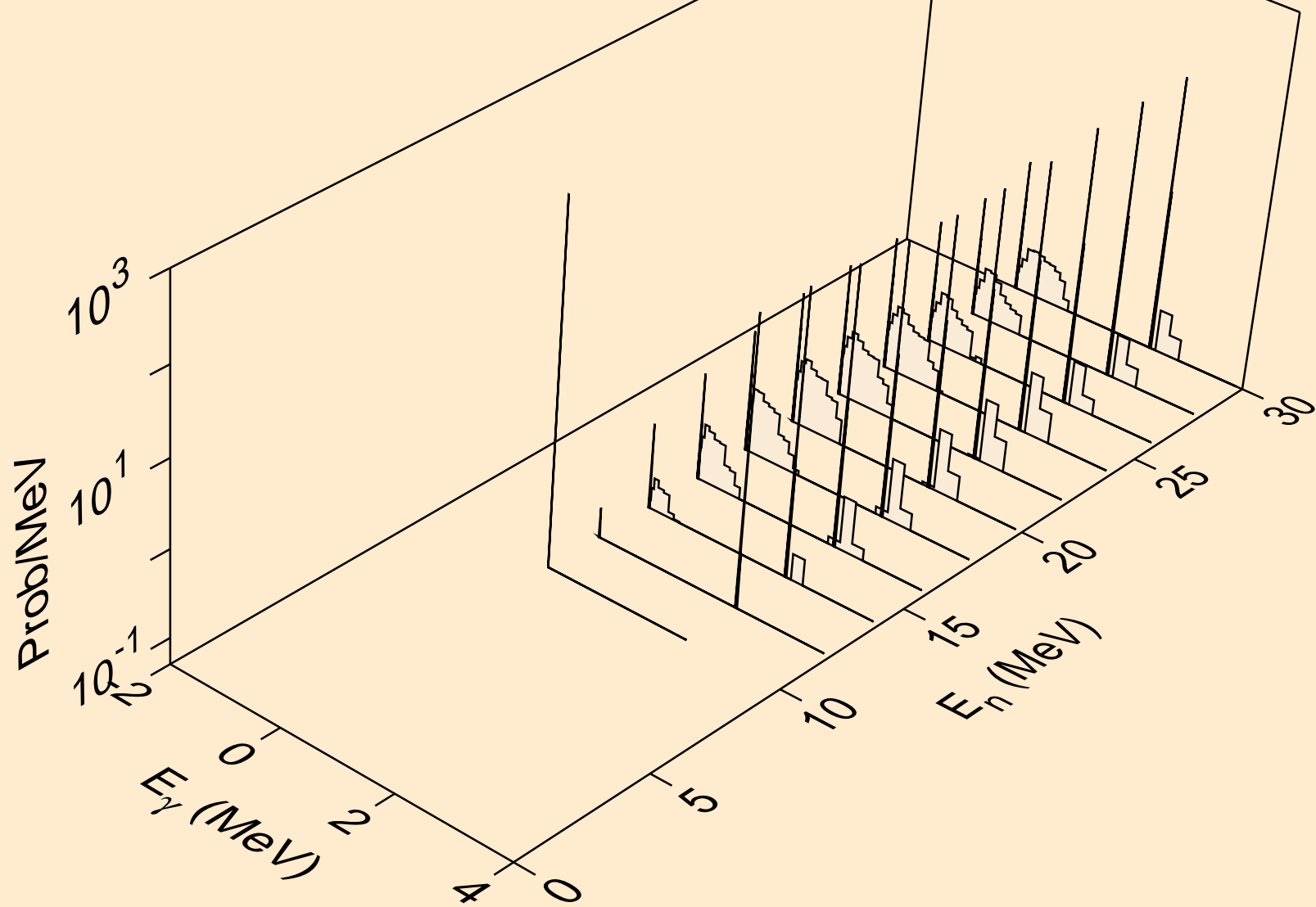

PU237 HELION ACER TENDL-2021 LIBRARY; T=0.K  
Photon emission for inelastic

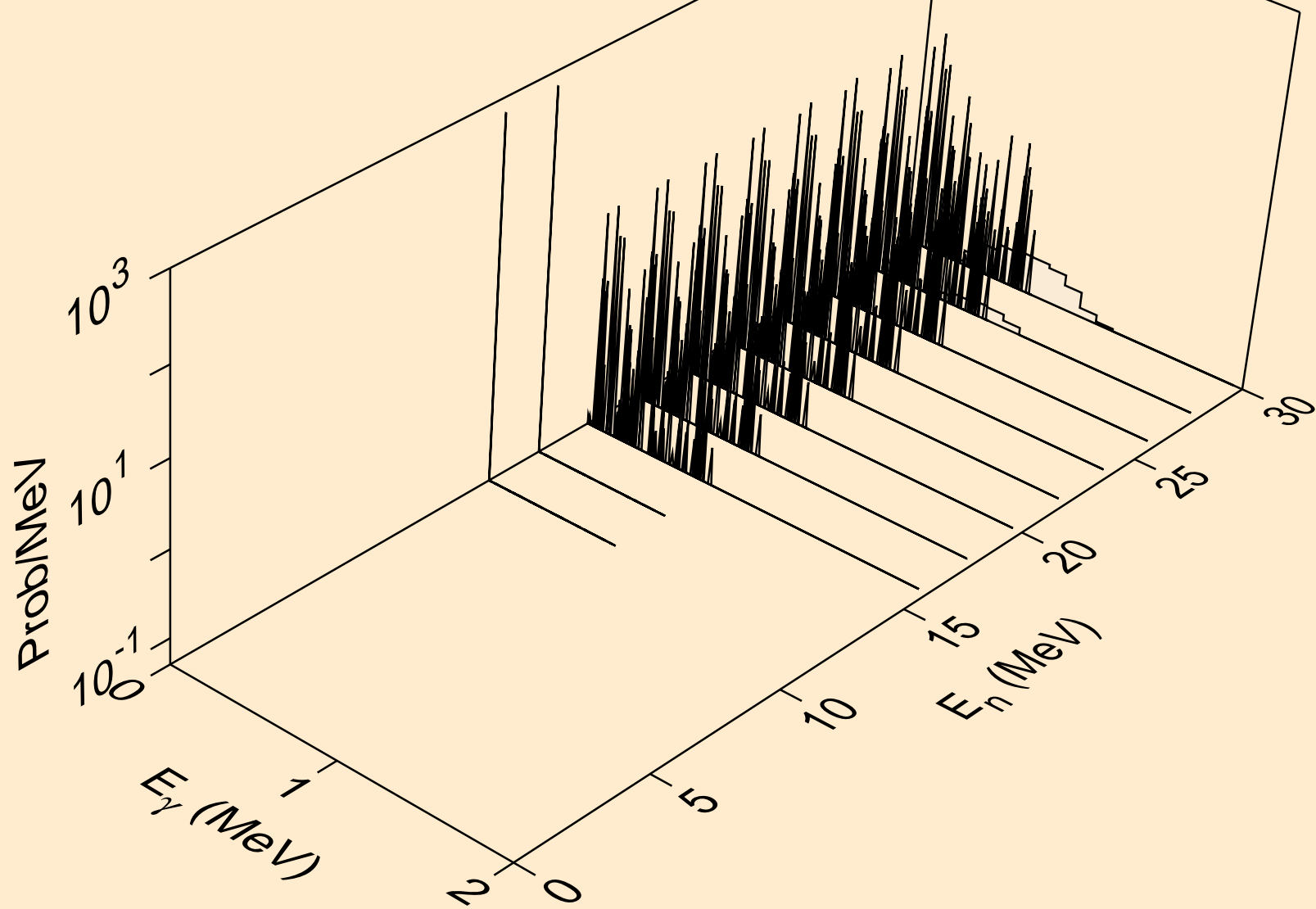

PU237 HELION ACER TENDL-2021 LIBRARY; T=0.K  
Photon emission for (n,a)

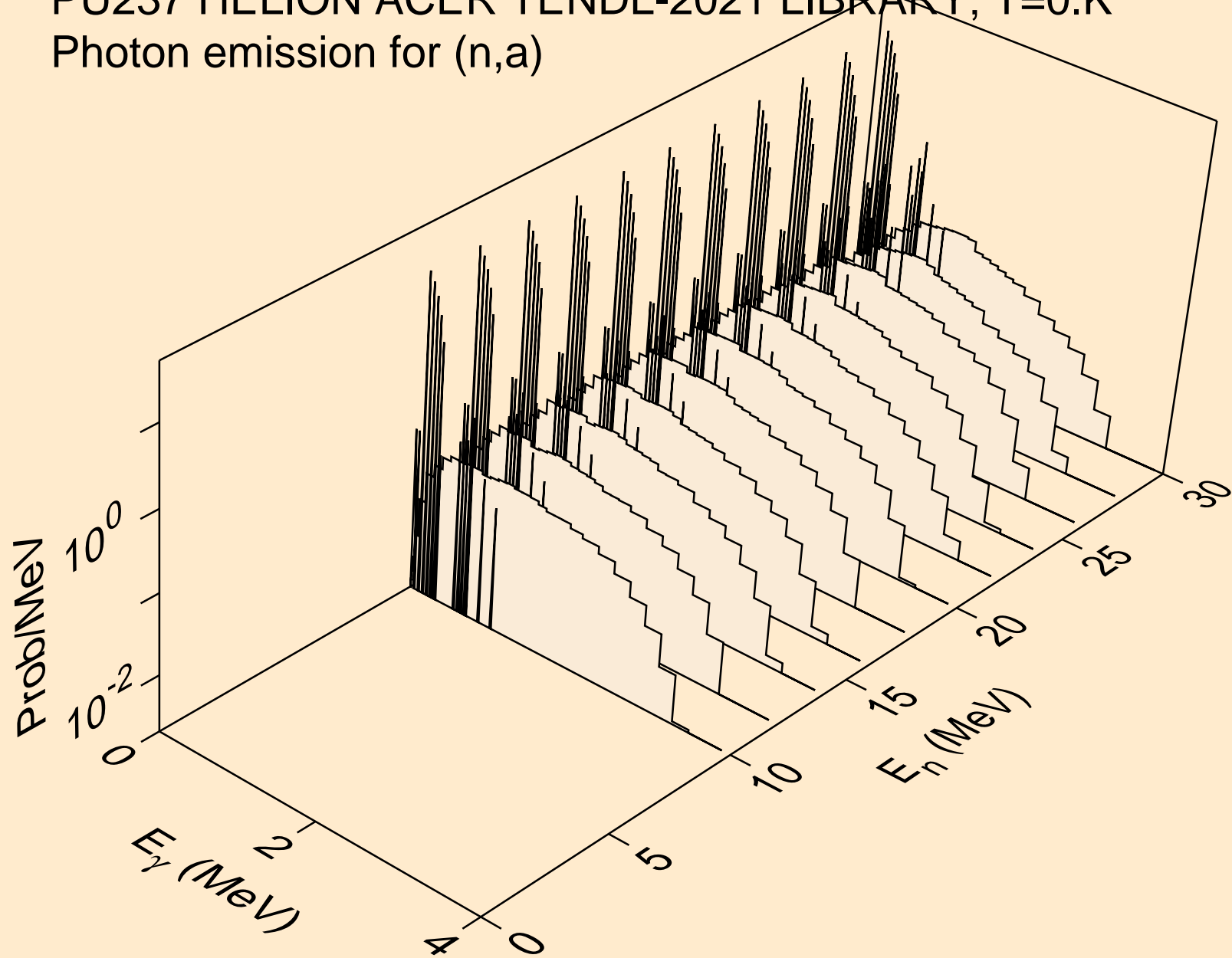

PU237 HELION ACER TENDL-2021 LIBRARY; T=0.K  
Photon emission for (n,2p)

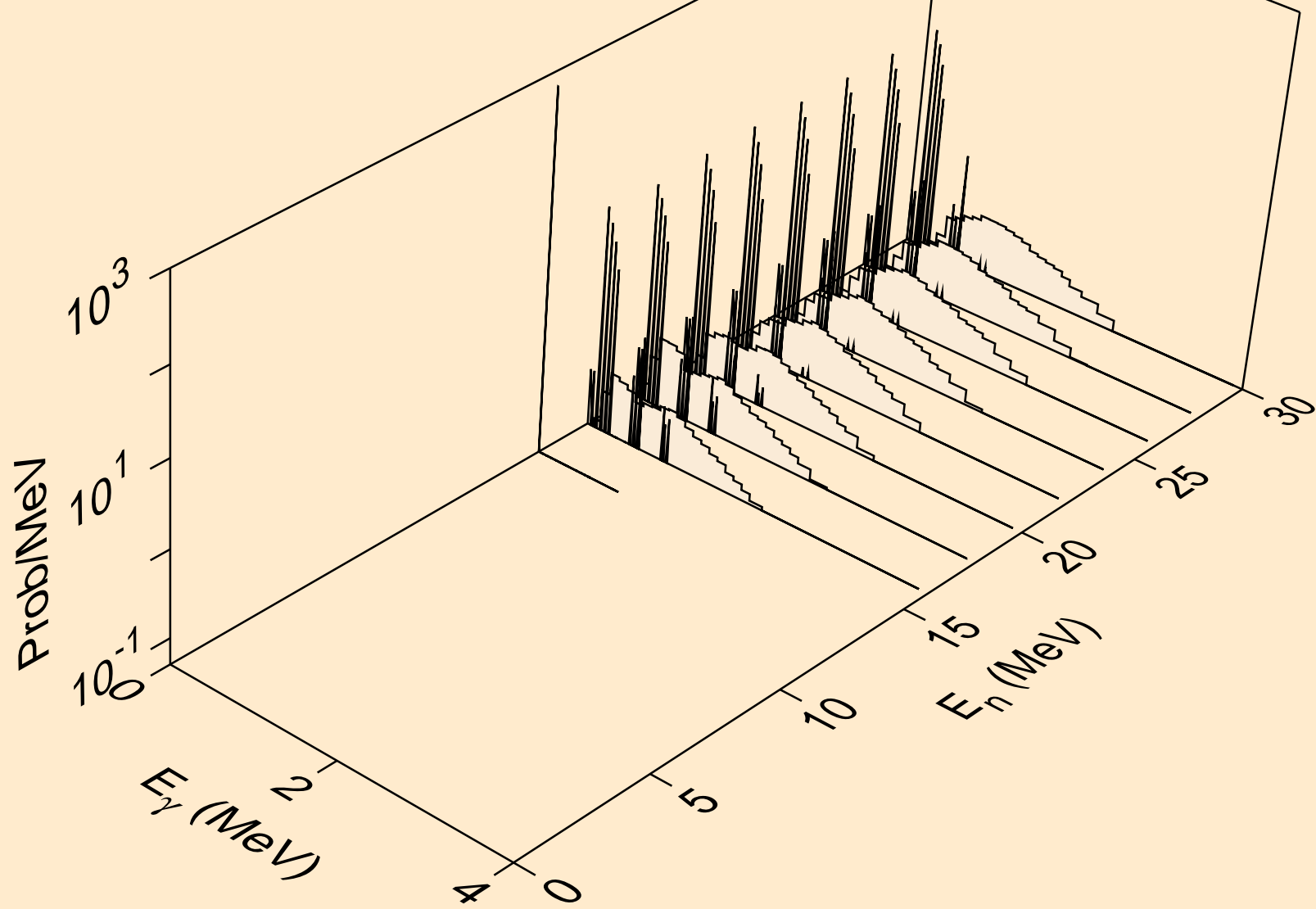

PU237 HELION ACER TENDL-2021 LIBRARY; T=0.K  
Photon emission for (n,pd)

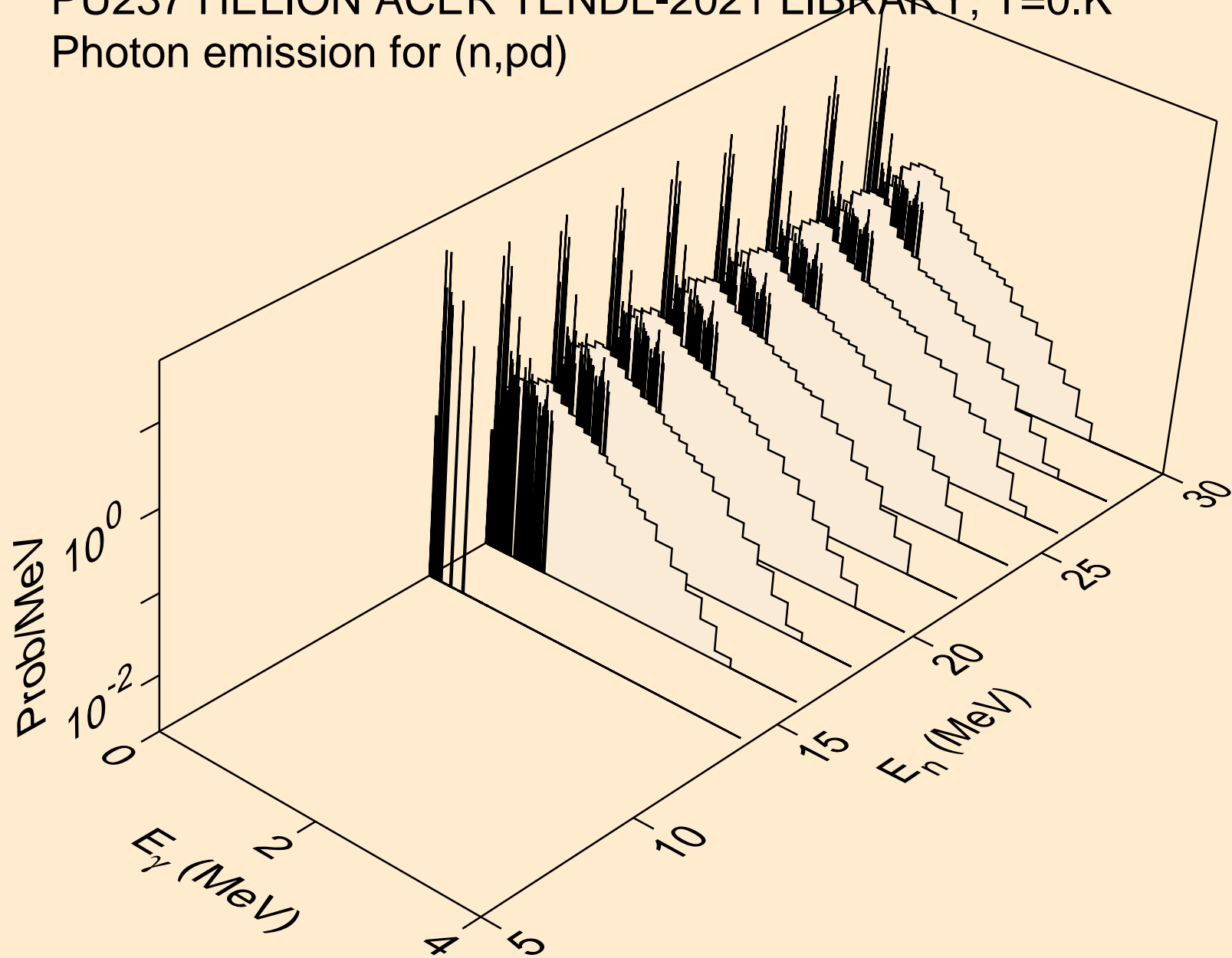

PU237 HELION ACER TENDL-2021 LIBRARY; T=0.K  
Photon emission for (n,pt)

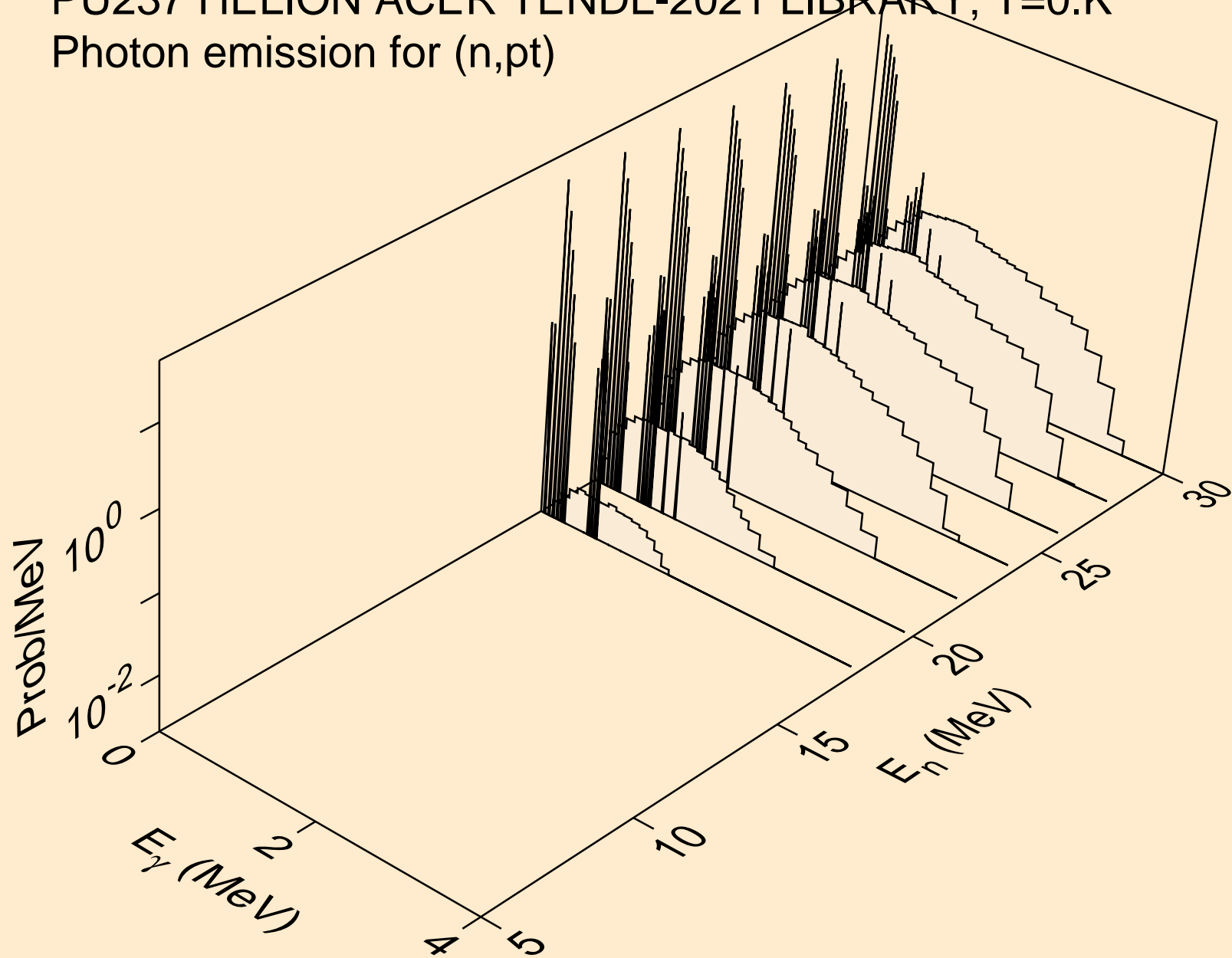

PU237 HELION ACER TENDL-2021 LIBRARY; T=0.K  
Photon emission for (n,da)

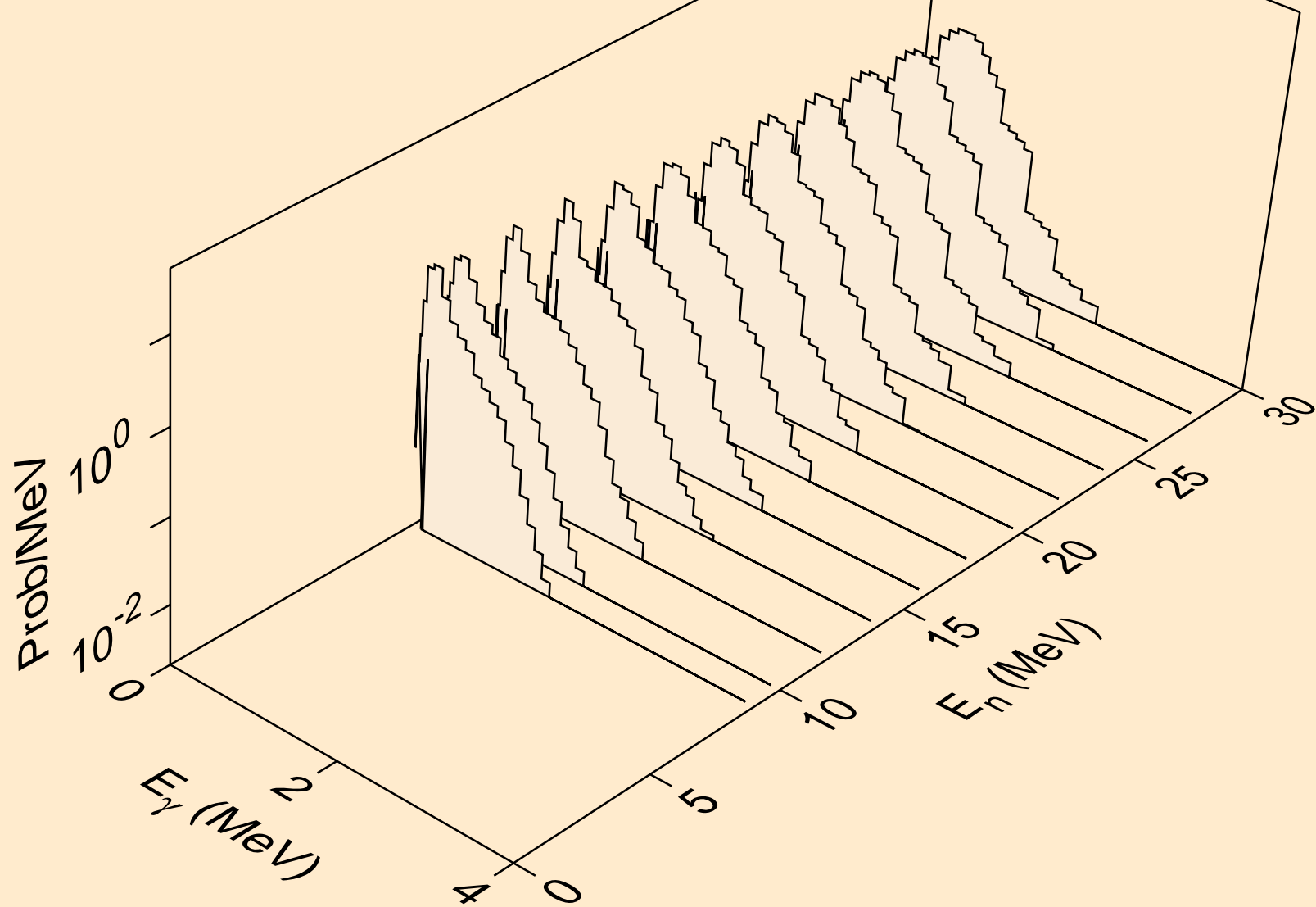

PU237 HELION ACER TENDL-2021 LIBRARY; T=0.K  
Particle heating contributions

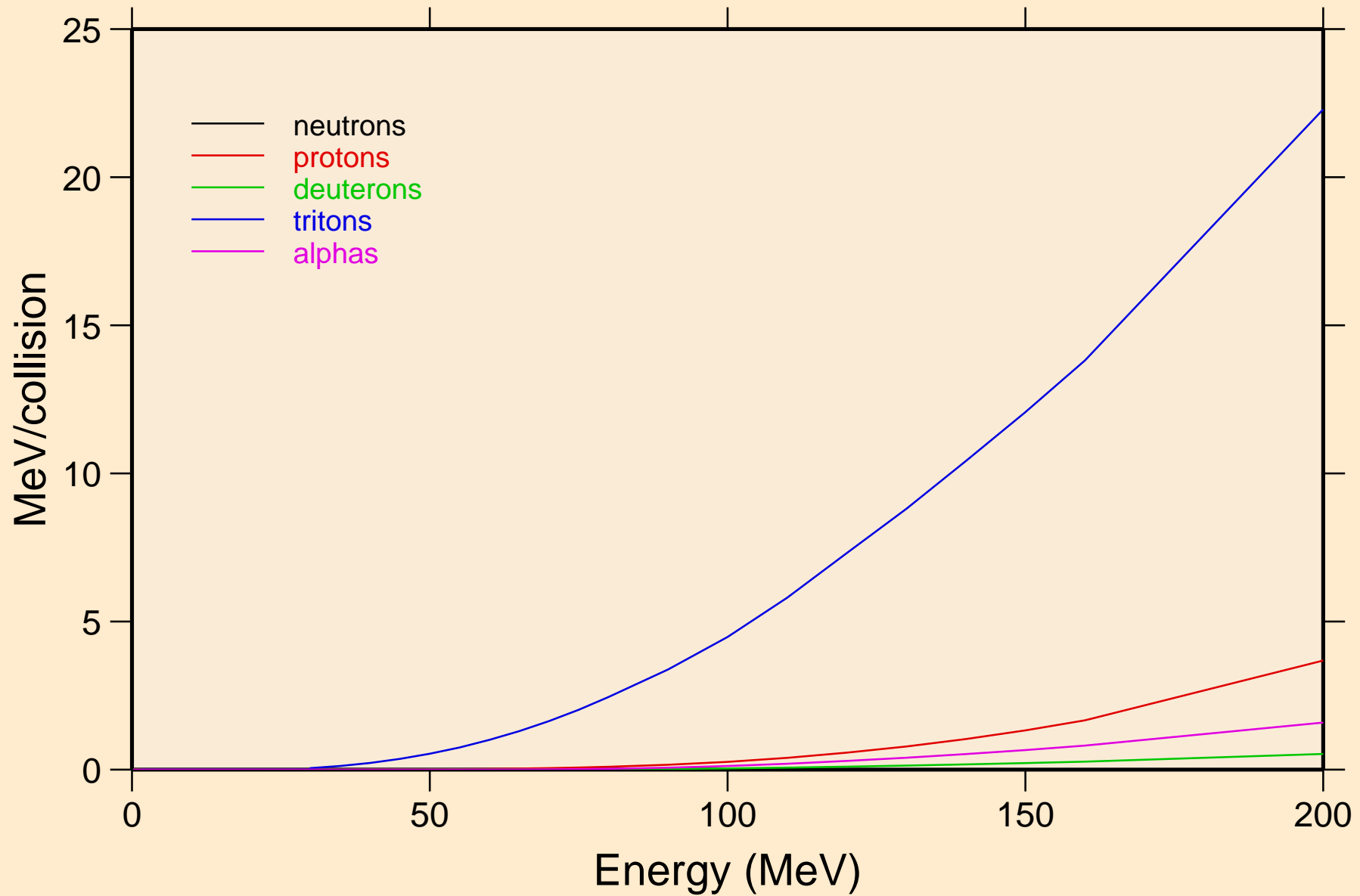



PU237 HELION ACER TENDL-2021 LIBRARY; T=0.K  
Recoil Heating

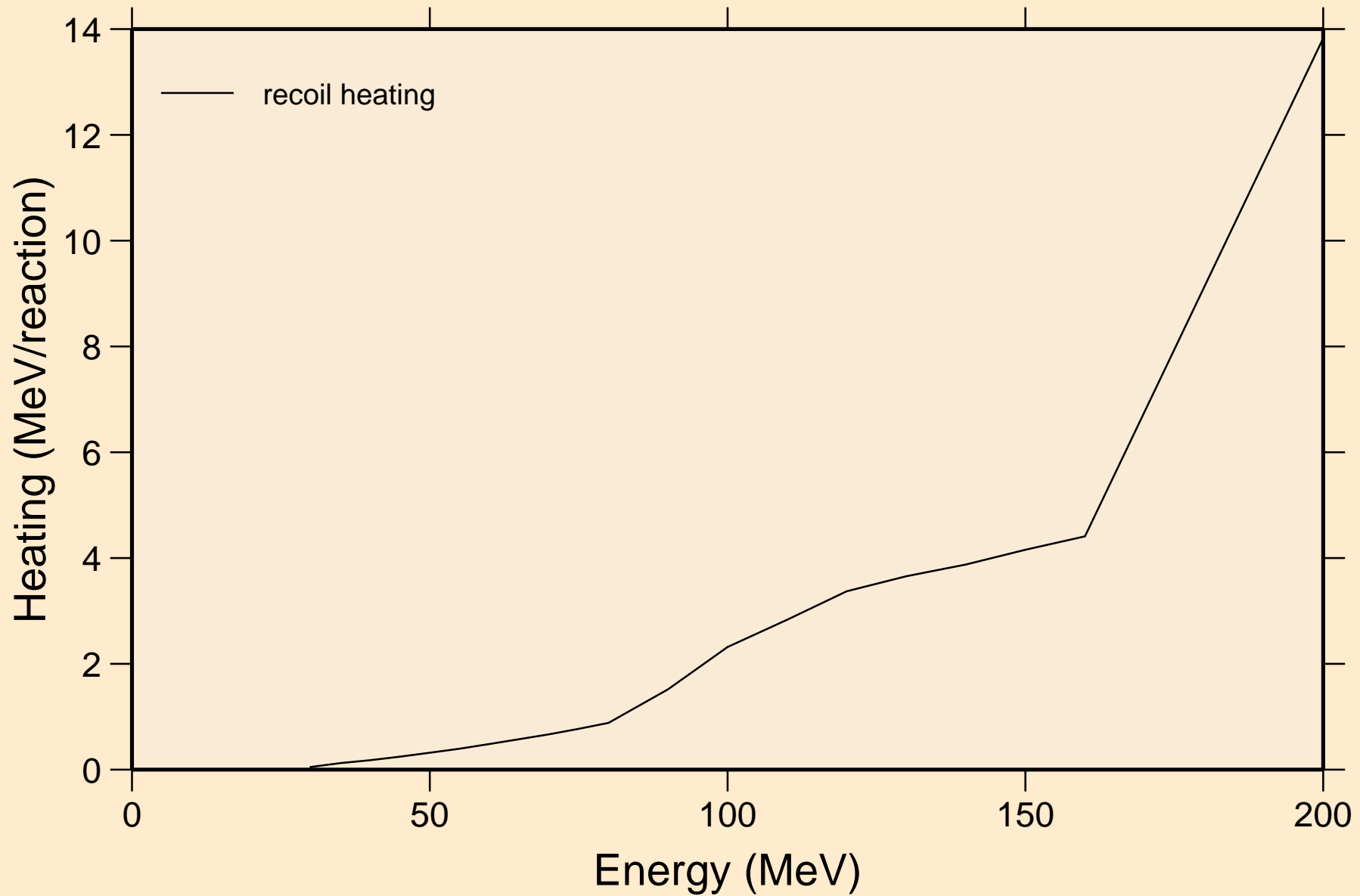

PU237 HELION ACER TENDL-2021 LIBRARY; T=0.K  
Particle production cross sections

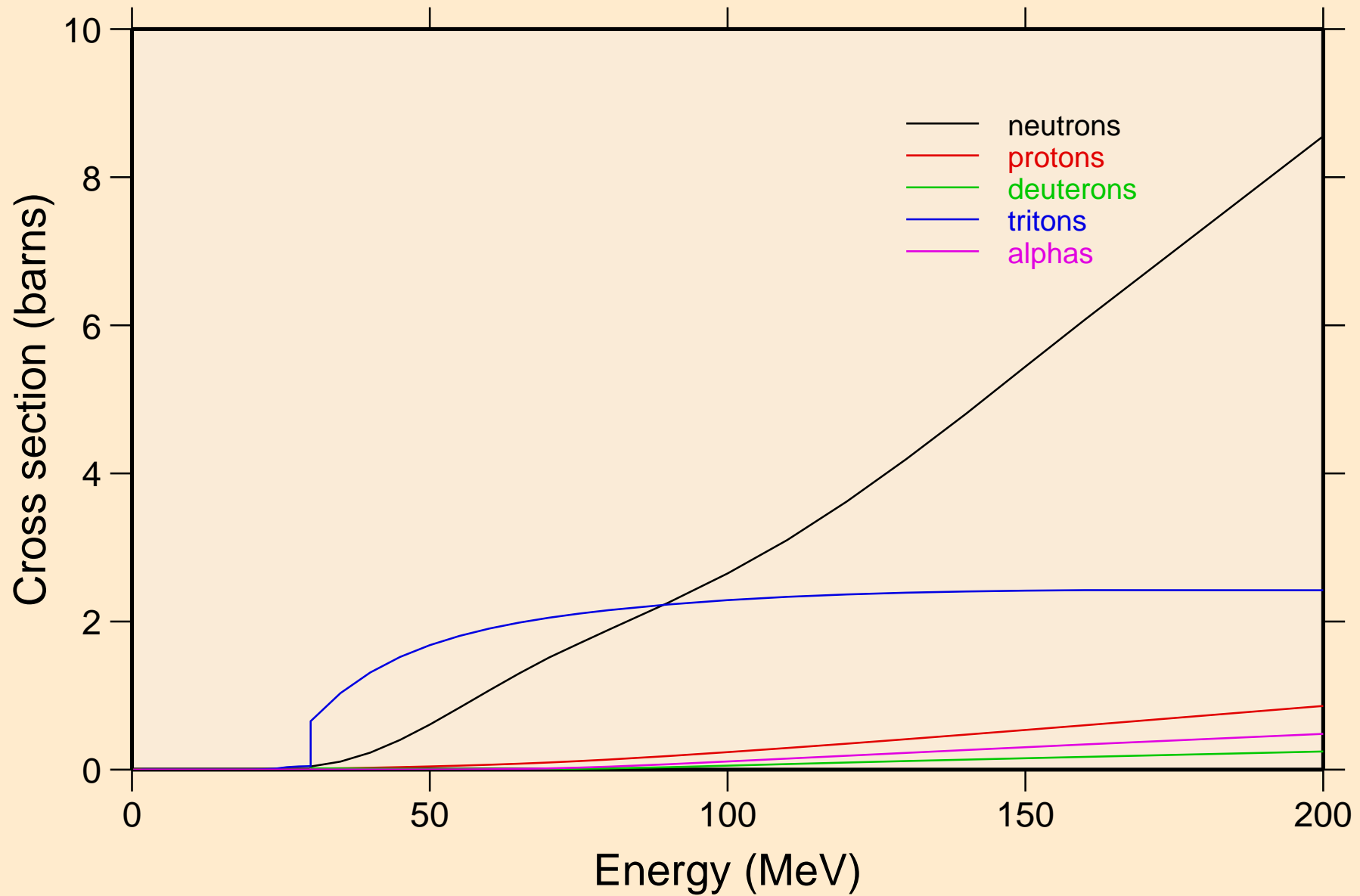

PU237 HELION ACER TENDL-2021 LIBRARY; T=0.K  
neutrons from (s,n)

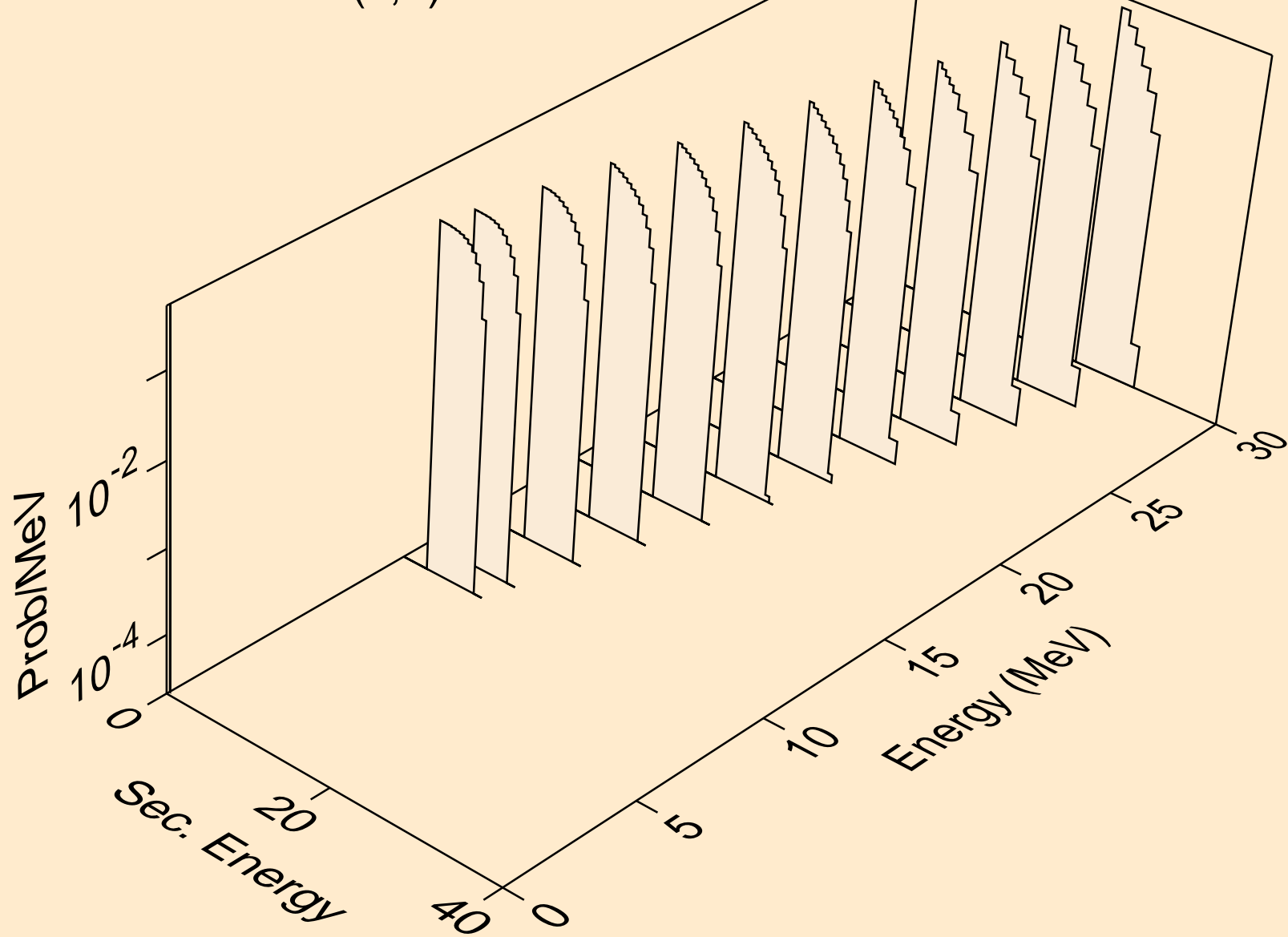

PU237 HELION ACER TENDL-2021 LIBRARY; T=0.K  
neutrons from (s,x)

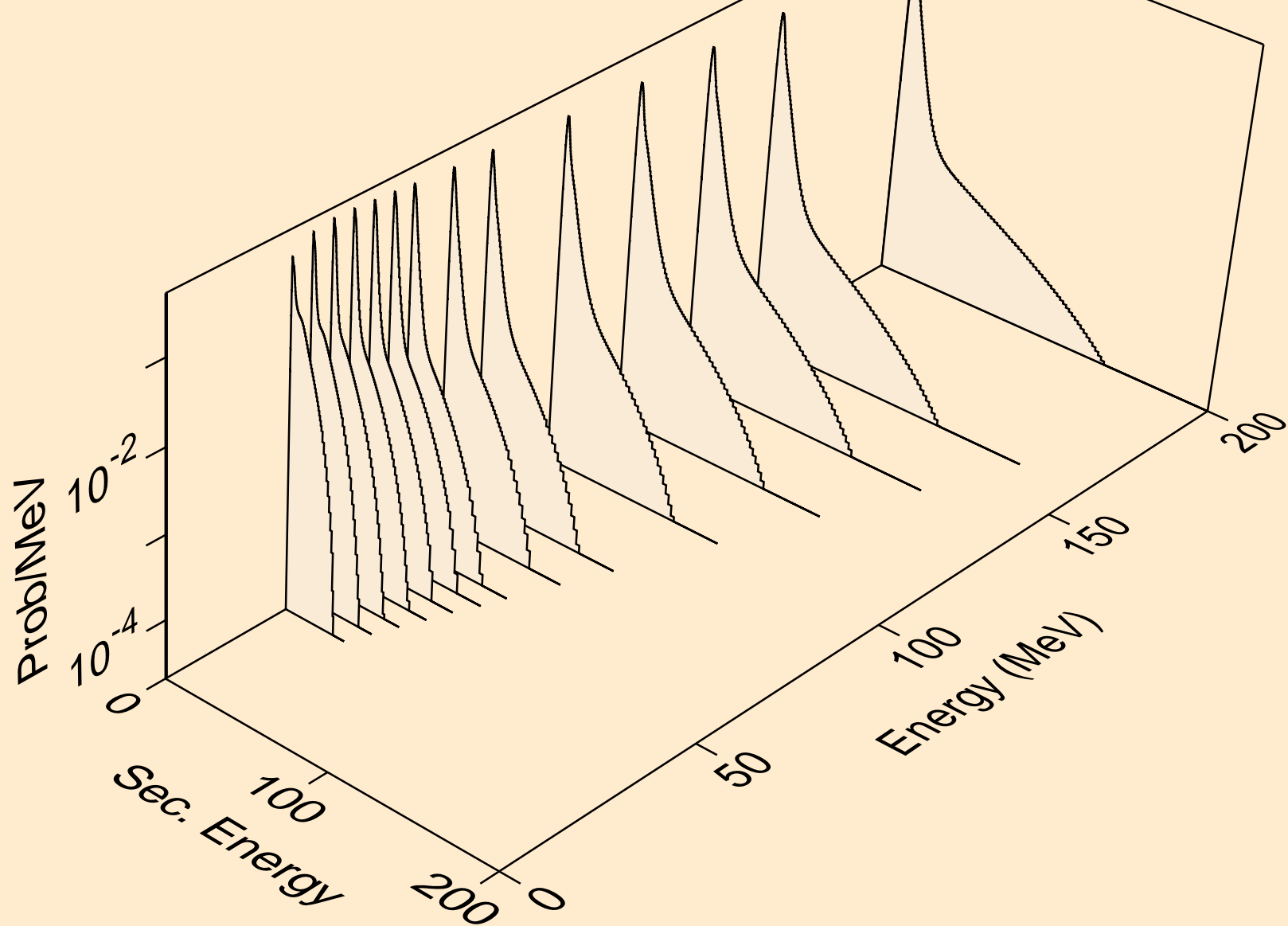

PU237 HELION ACER TENDL-2021 LIBRARY; T=0.K  
neutrons from (s,2nd)

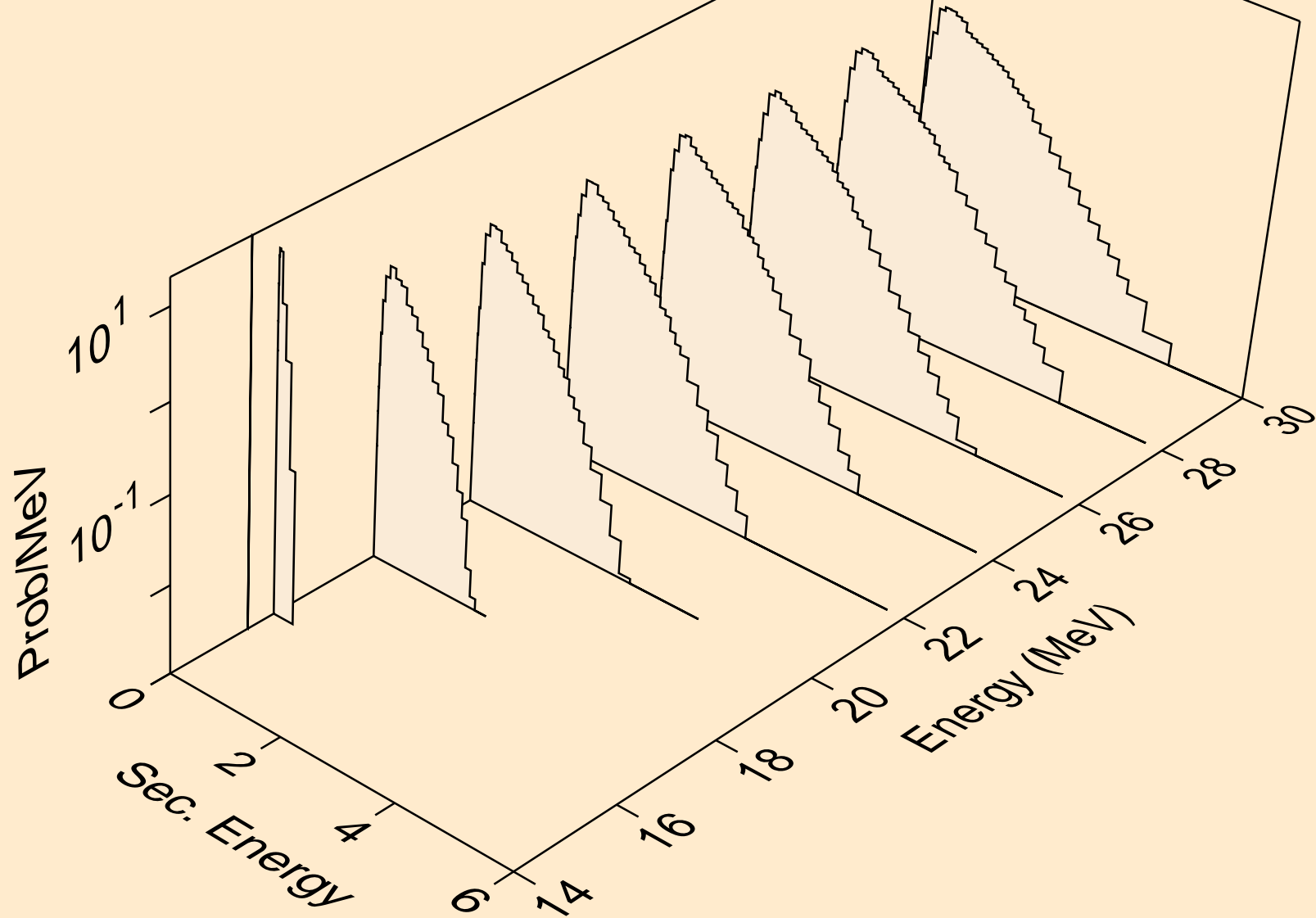

PU237 HELION ACER TENDL-2021 LIBRARY; T=0.K  
neutrons from (s,2n)

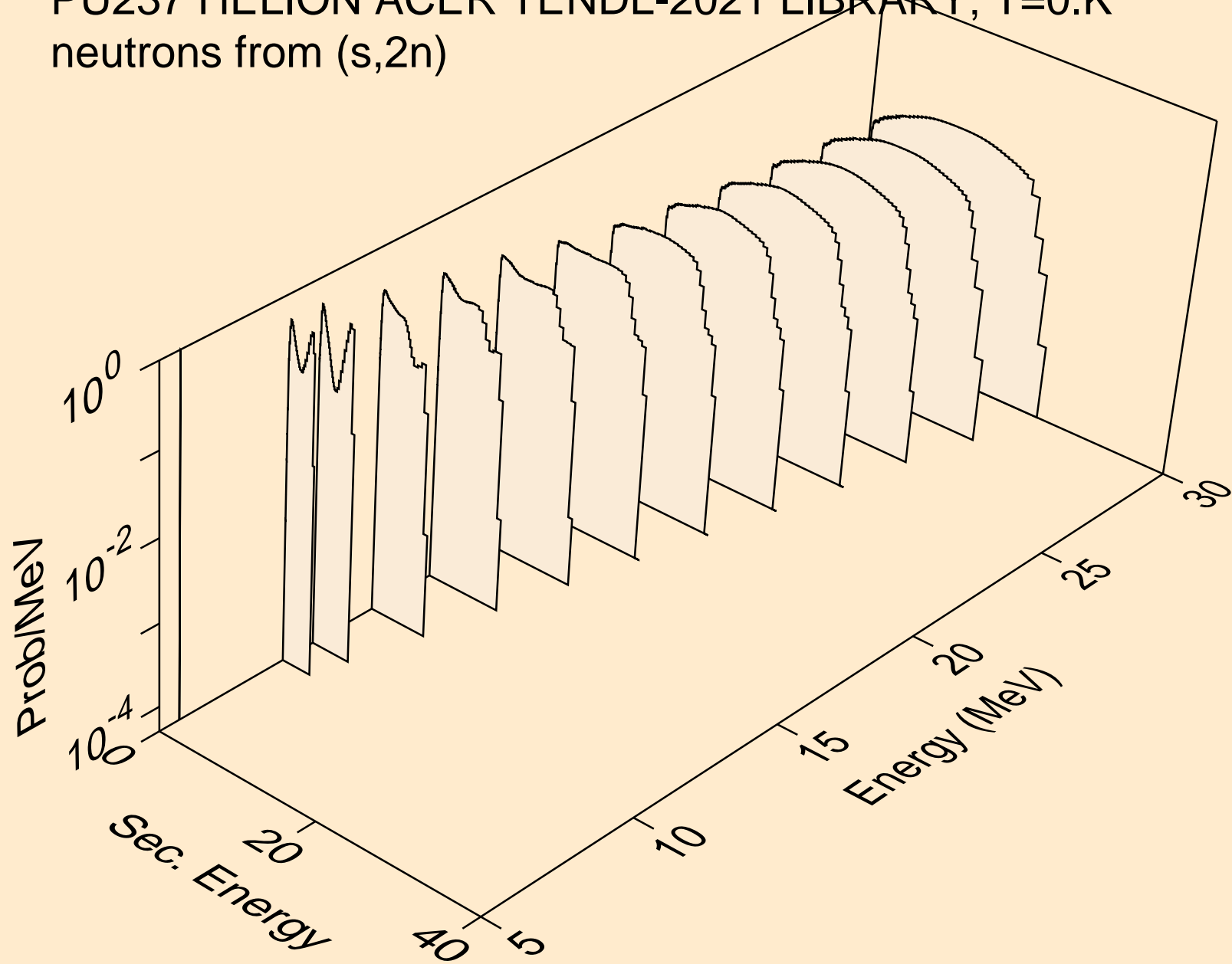

PU237 HELION ACER TENDL-2021 LIBRARY; T=0.K  
neutrons from (s,3n)

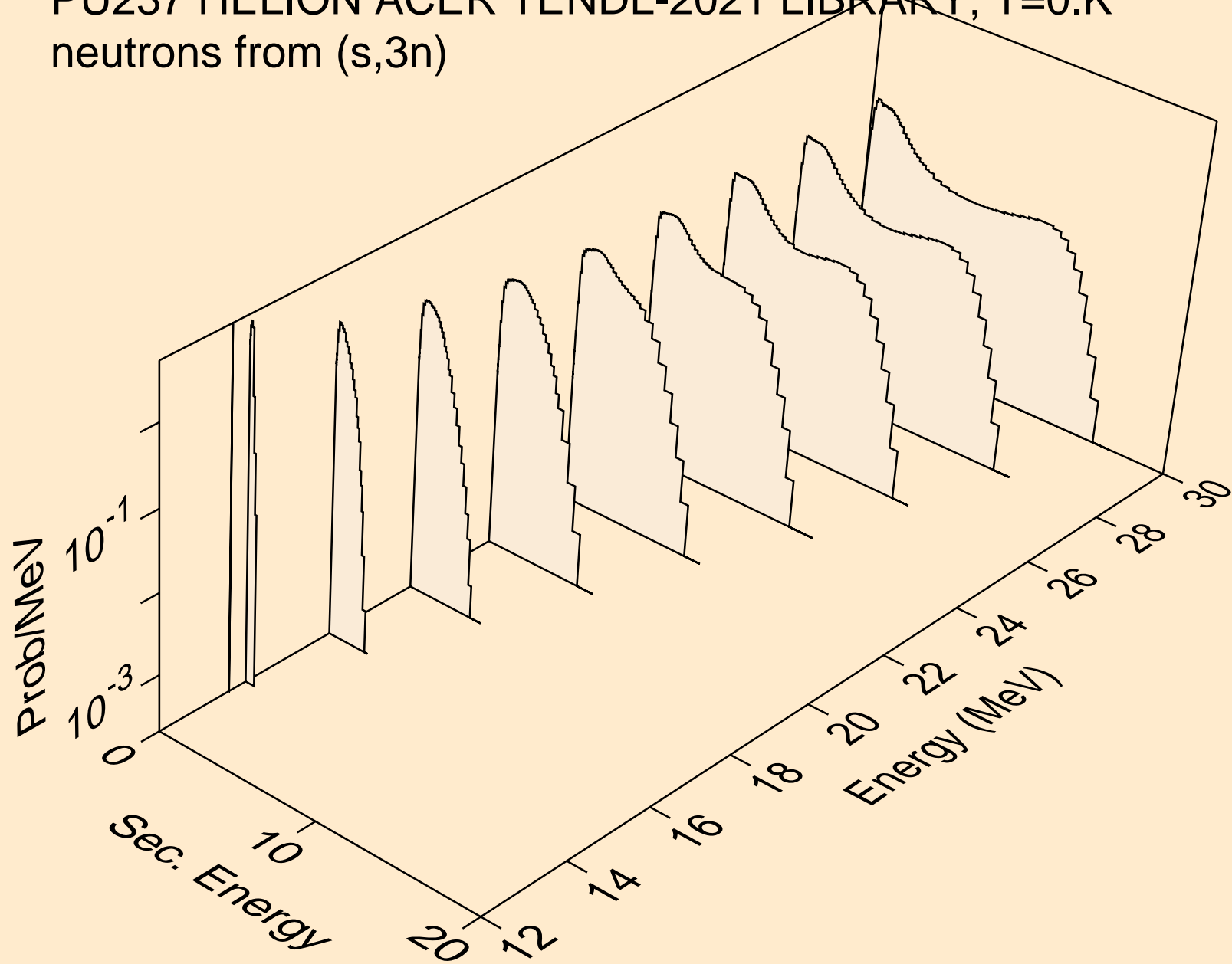

PU237 HELION ACER TENDL-2021 LIBRARY; T=0.K  
neutrons from (s,n\*)a

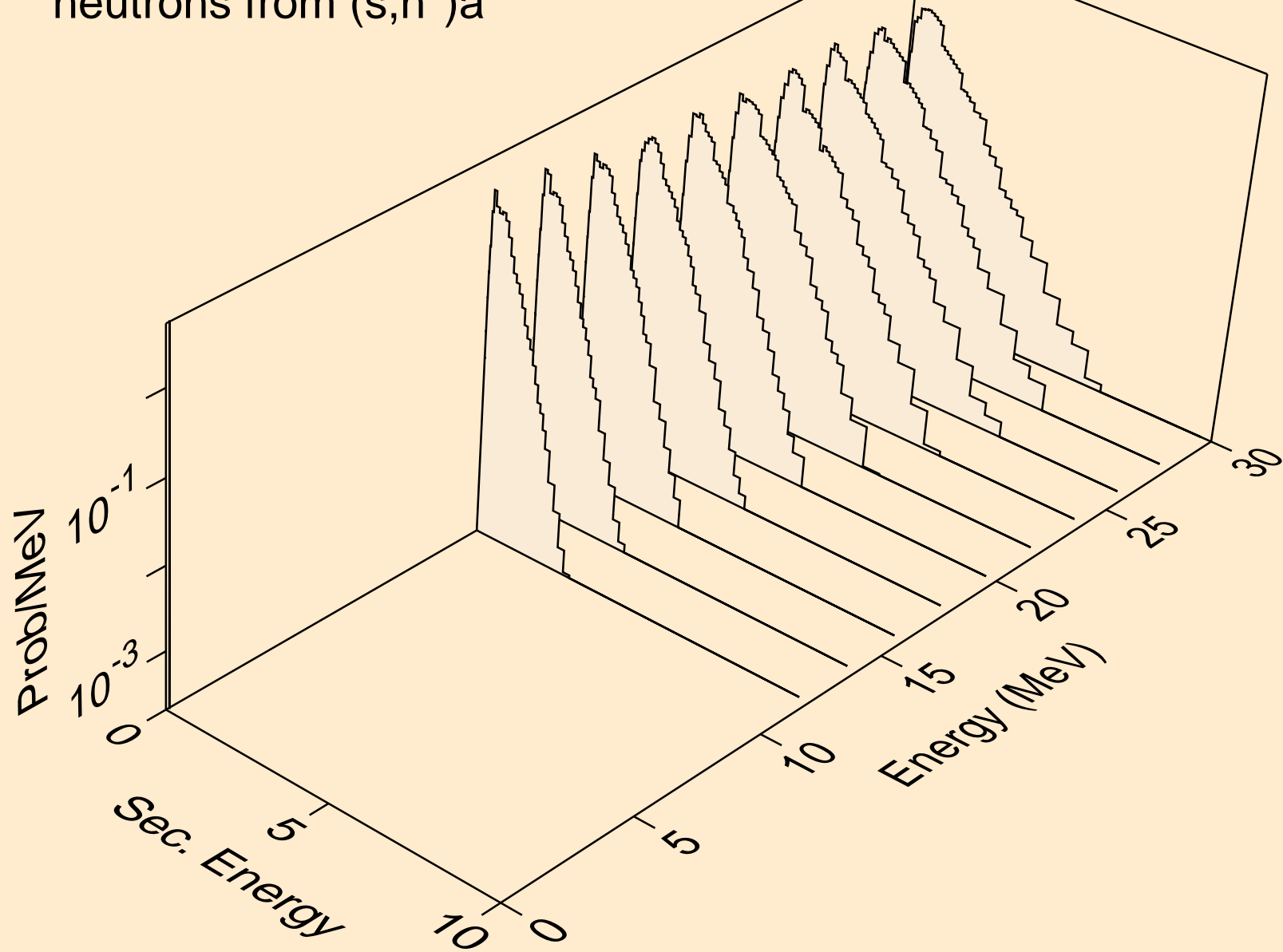



PU237 HELION ACER TENDL-2021 LIBRARY; T=0.K  
neutrons from (s,n\*)p

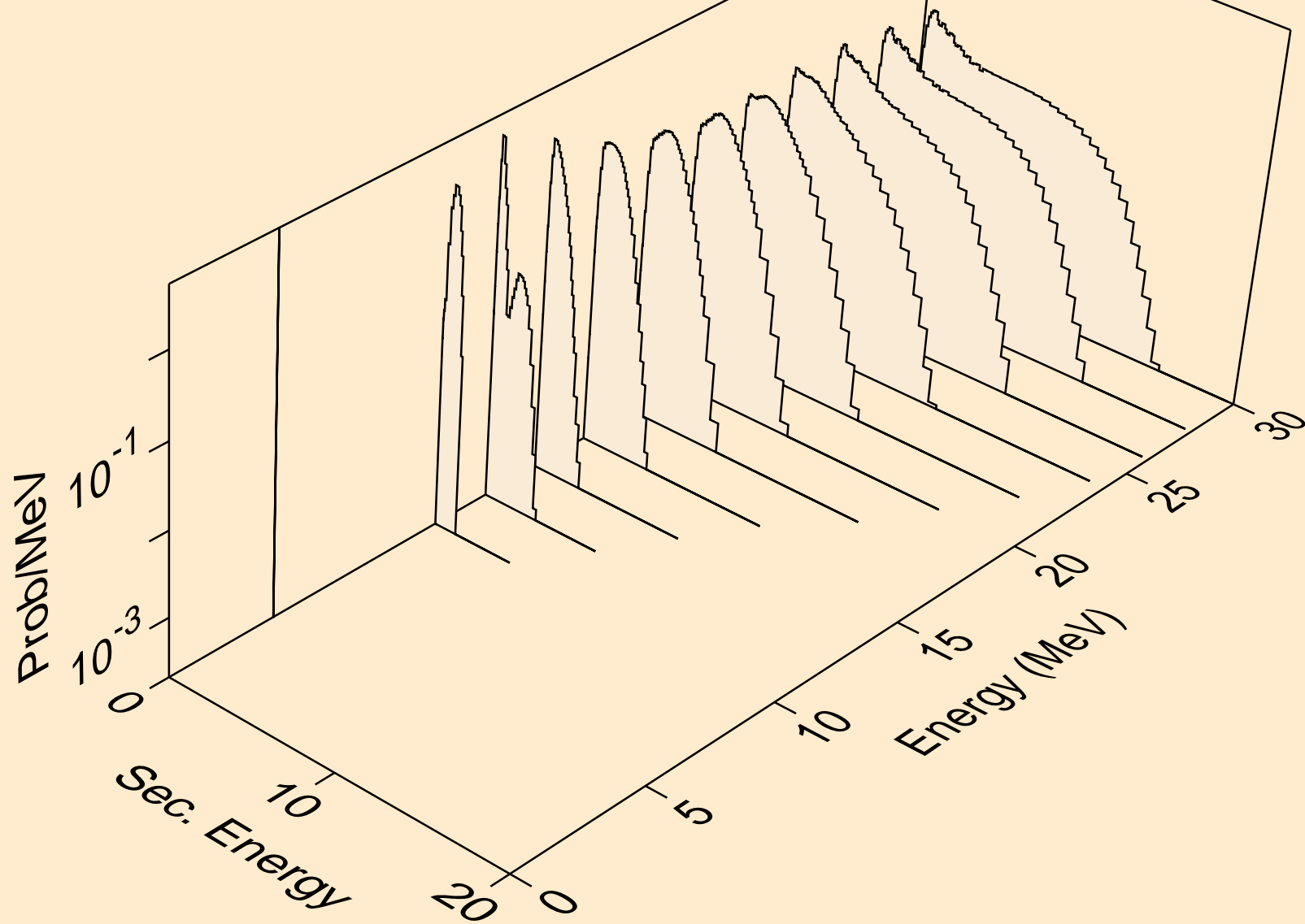

PU237 HELION ACER TENDL-2021 LIBRARY; T=0.K  
neutrons from (s,n\*)d

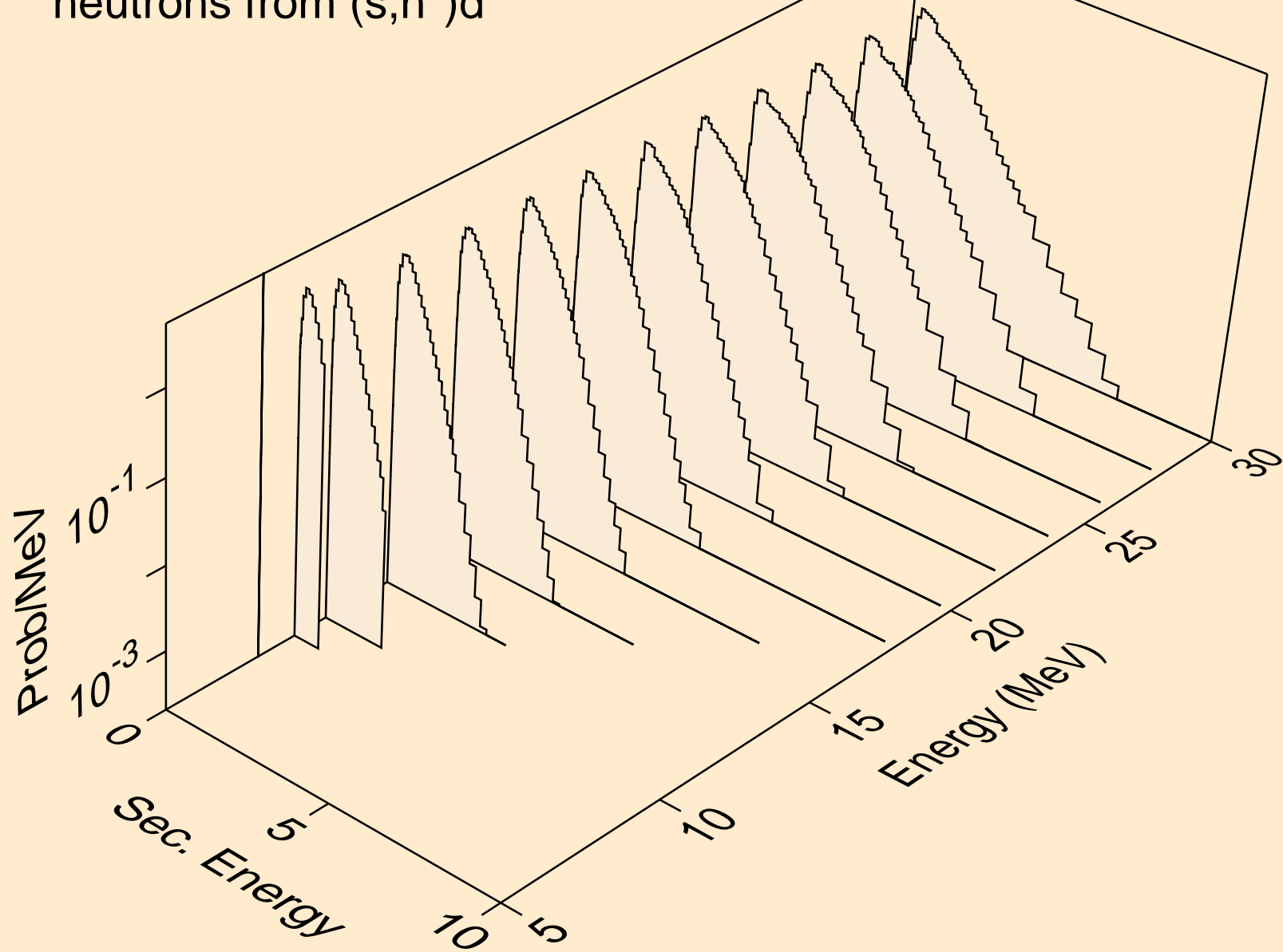

PU237 HELION ACER TENDL-2021 LIBRARY; T=0.K  
neutrons from (s,n\*)t

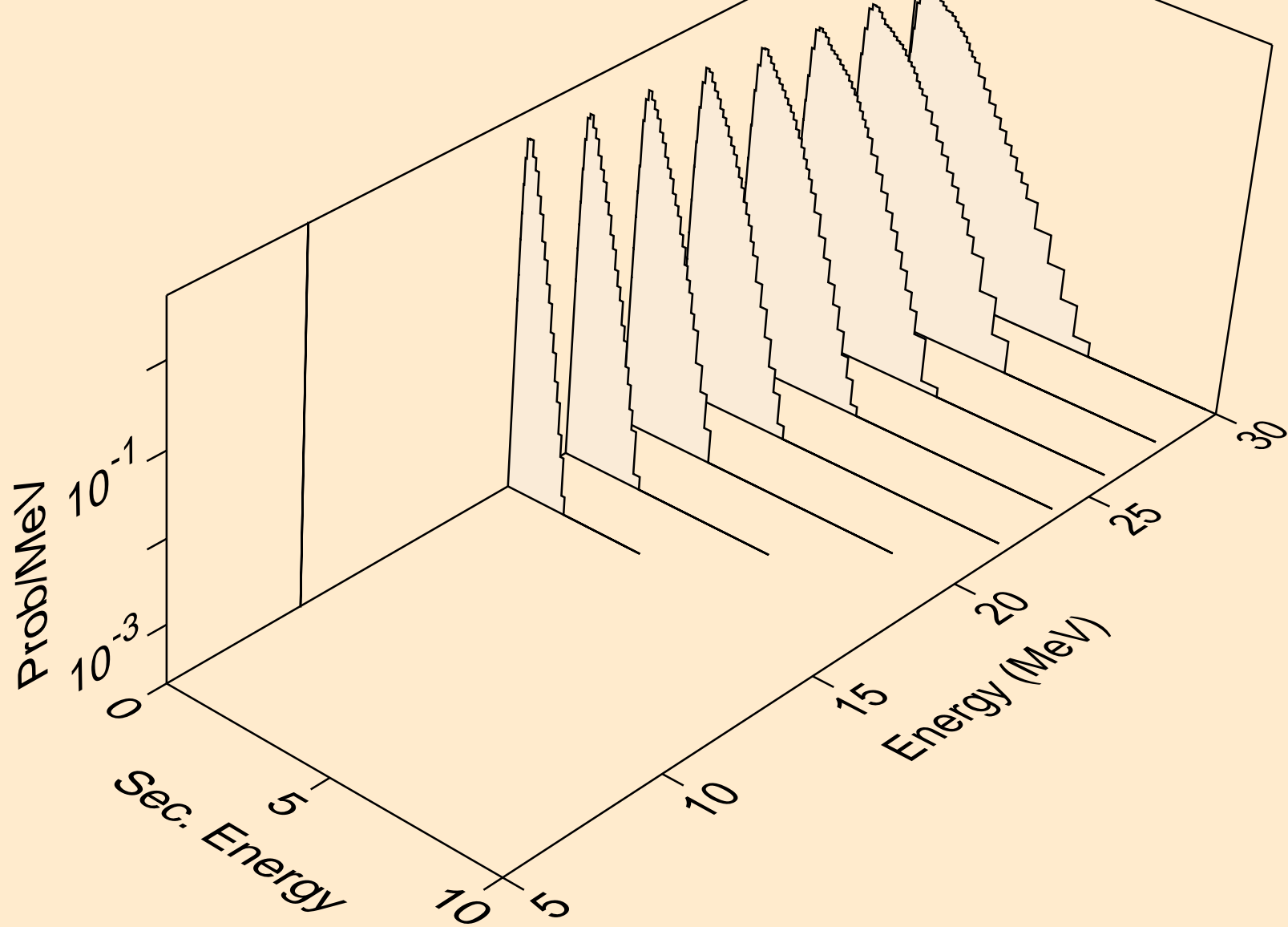

PU237 HELION ACER TENDL-2021 LIBRARY; T=0.K  
neutrons from (s,n\*)he3

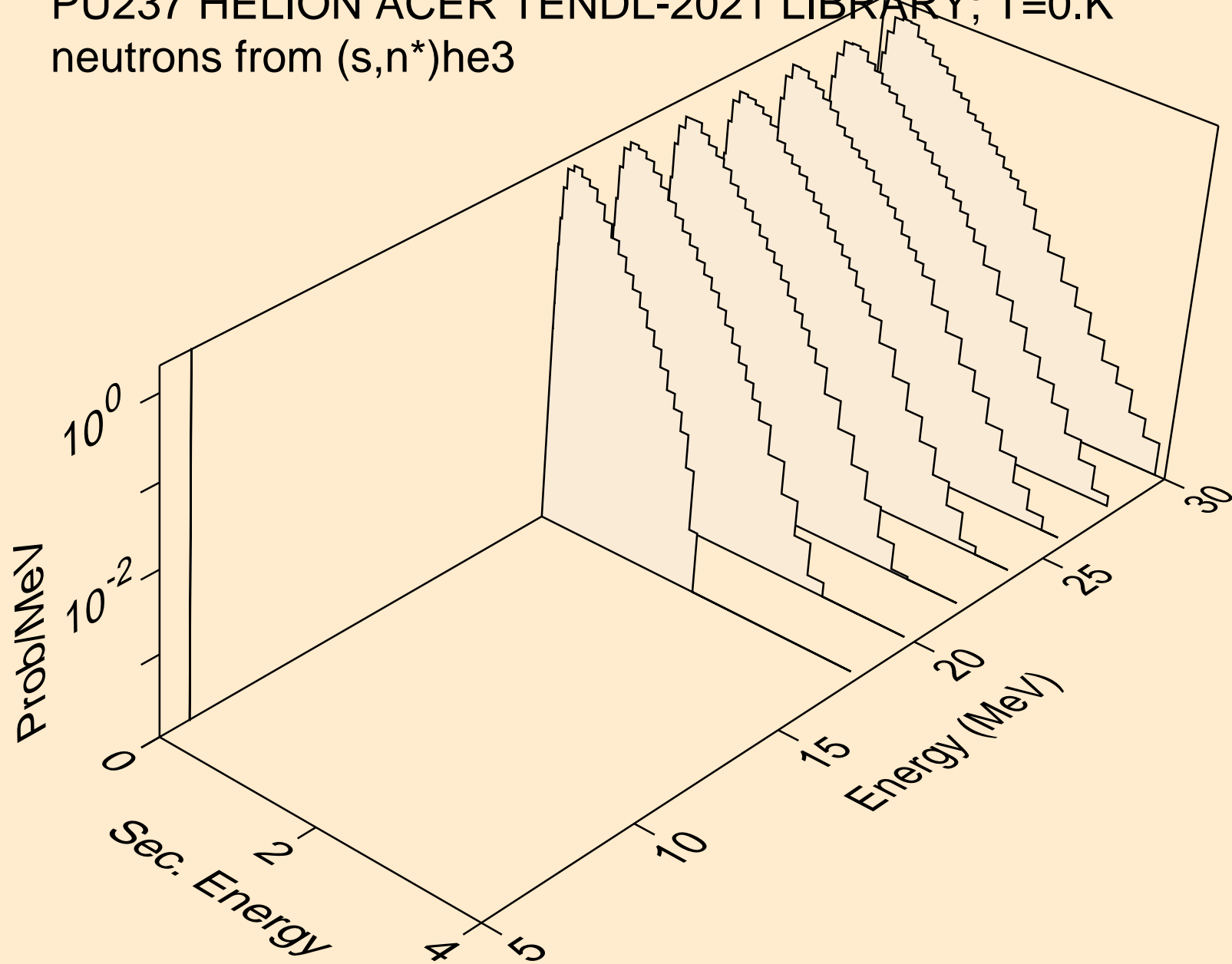

PU237 HELION ACER TENDL-2021 LIBRARY; T=0.K  
neutrons from (s,4n)

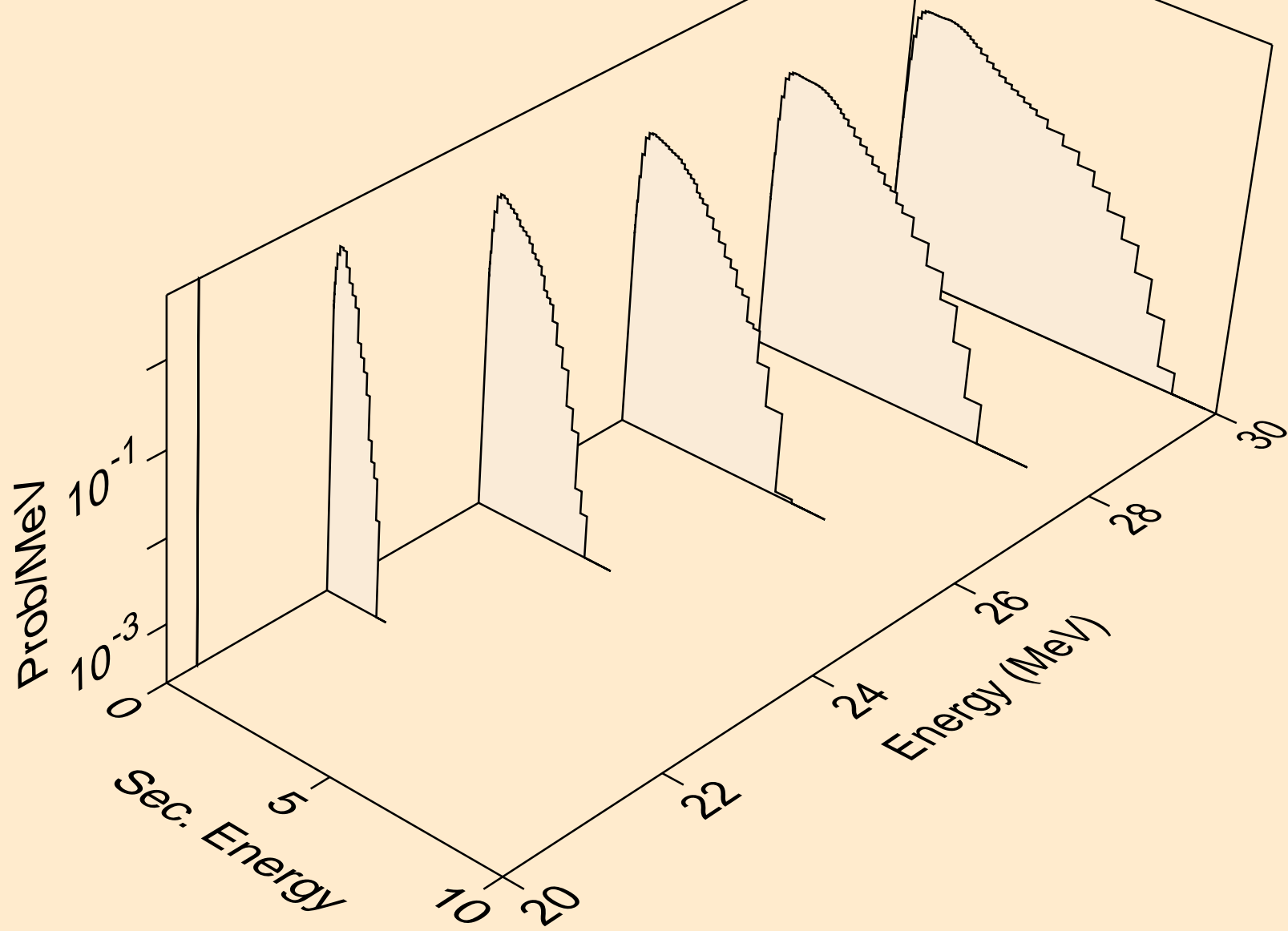

PU237 HELION ACER TENDL-2021 LIBRARY; T=0.K  
neutrons from (s,2np)

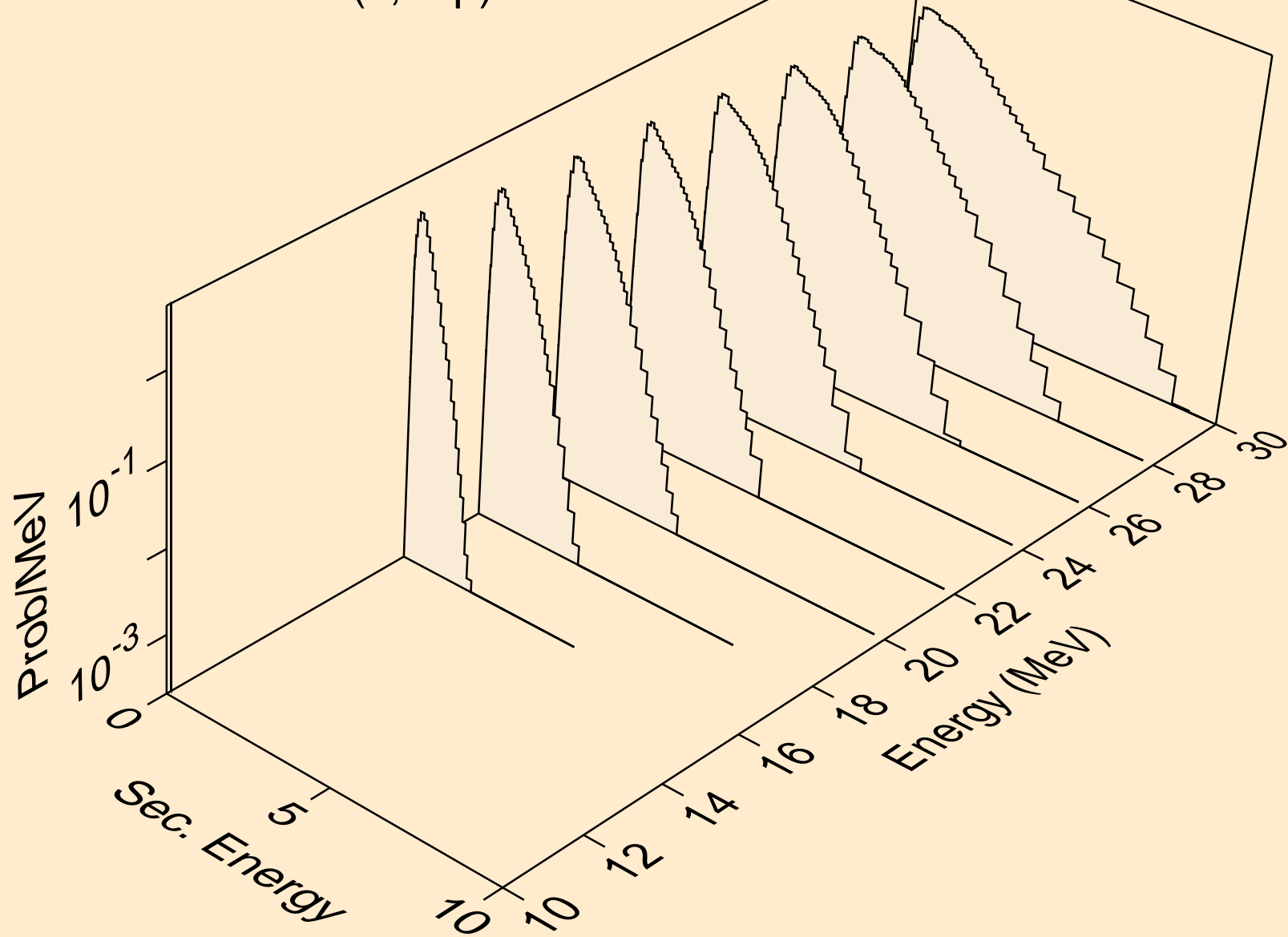

PU237 HELION ACER TENDL-2021 LIBRARY; T=0.K  
neutrons from (s,3np)

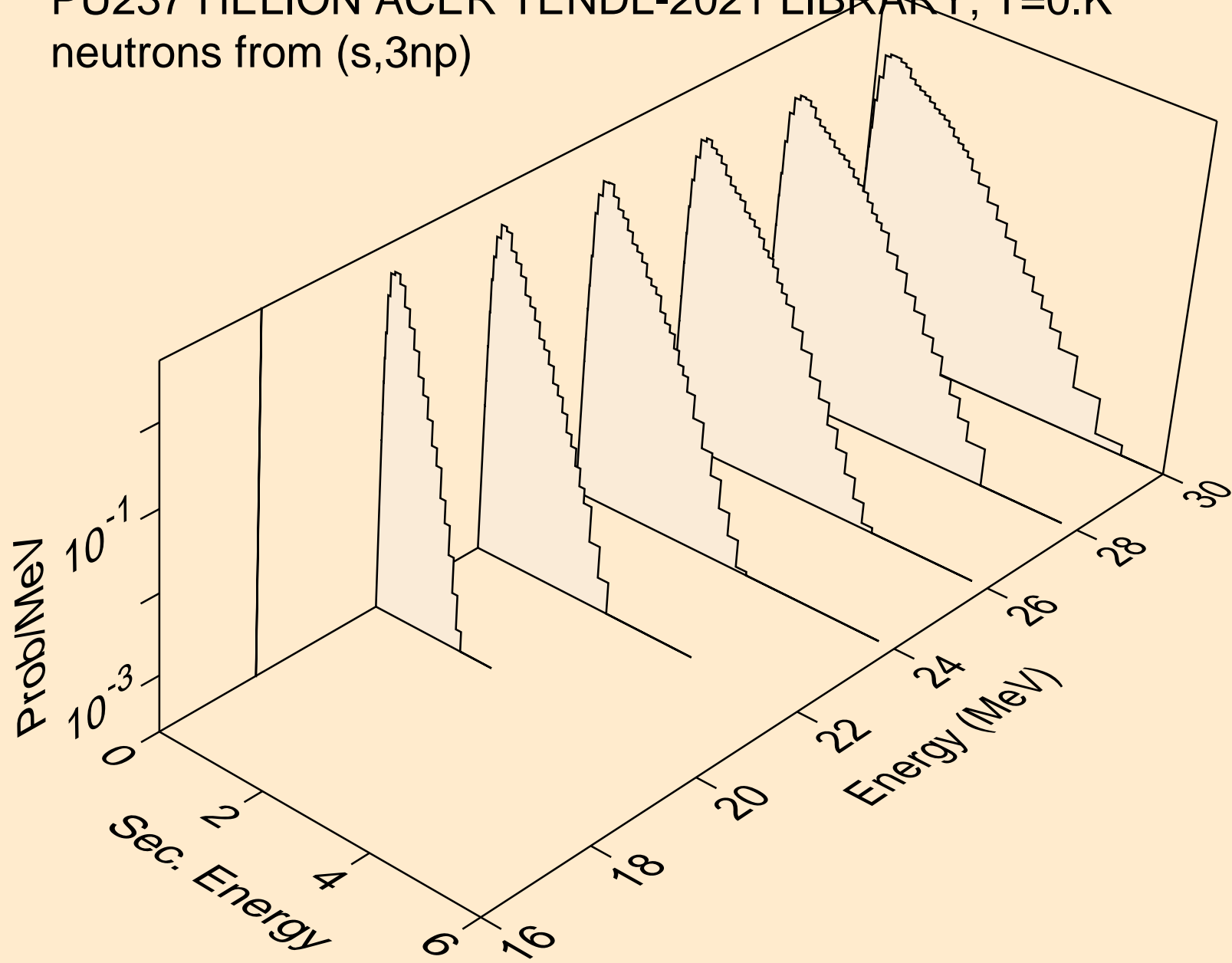

PU237 HELION ACER TENDL-2021 LIBRARY; T=0.K  
neutrons from (s,2np)

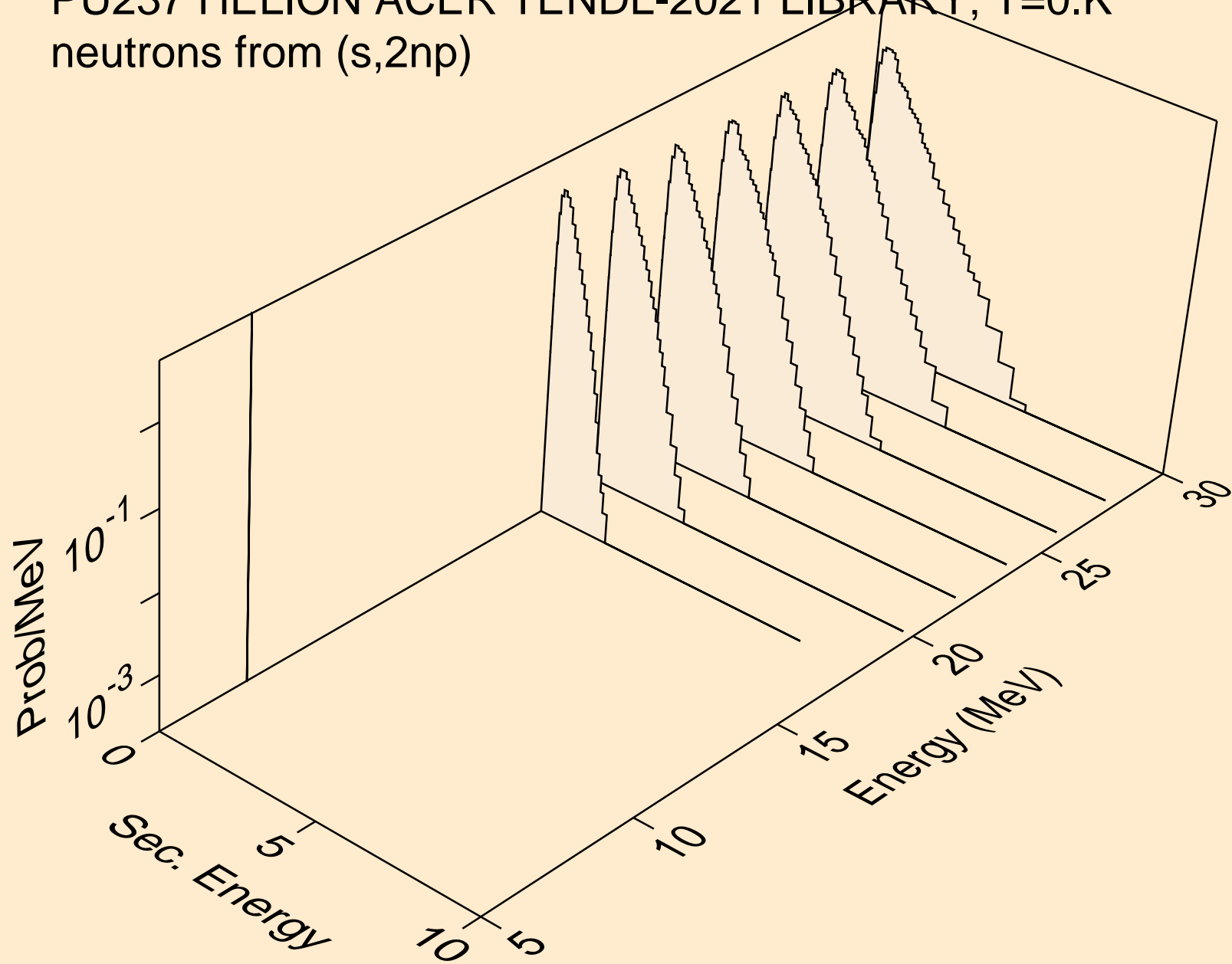



PU237 HELION ACER TENDL-2021 LIBRARY; T=0.K  
neutrons from (s,npa)

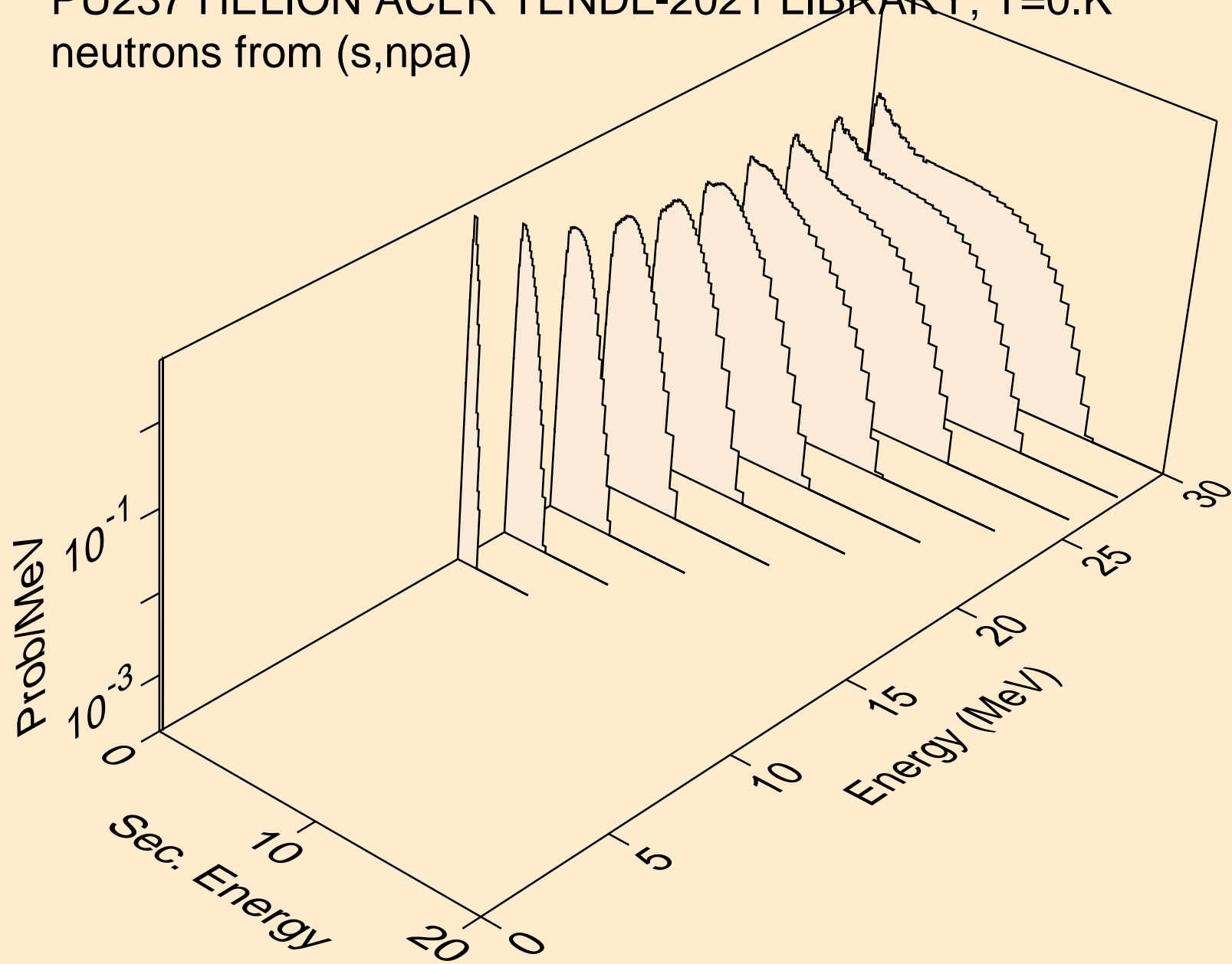

PU237 HELION ACER TENDL-2021 LIBRARY; T=0.K  
protons from (s,x)

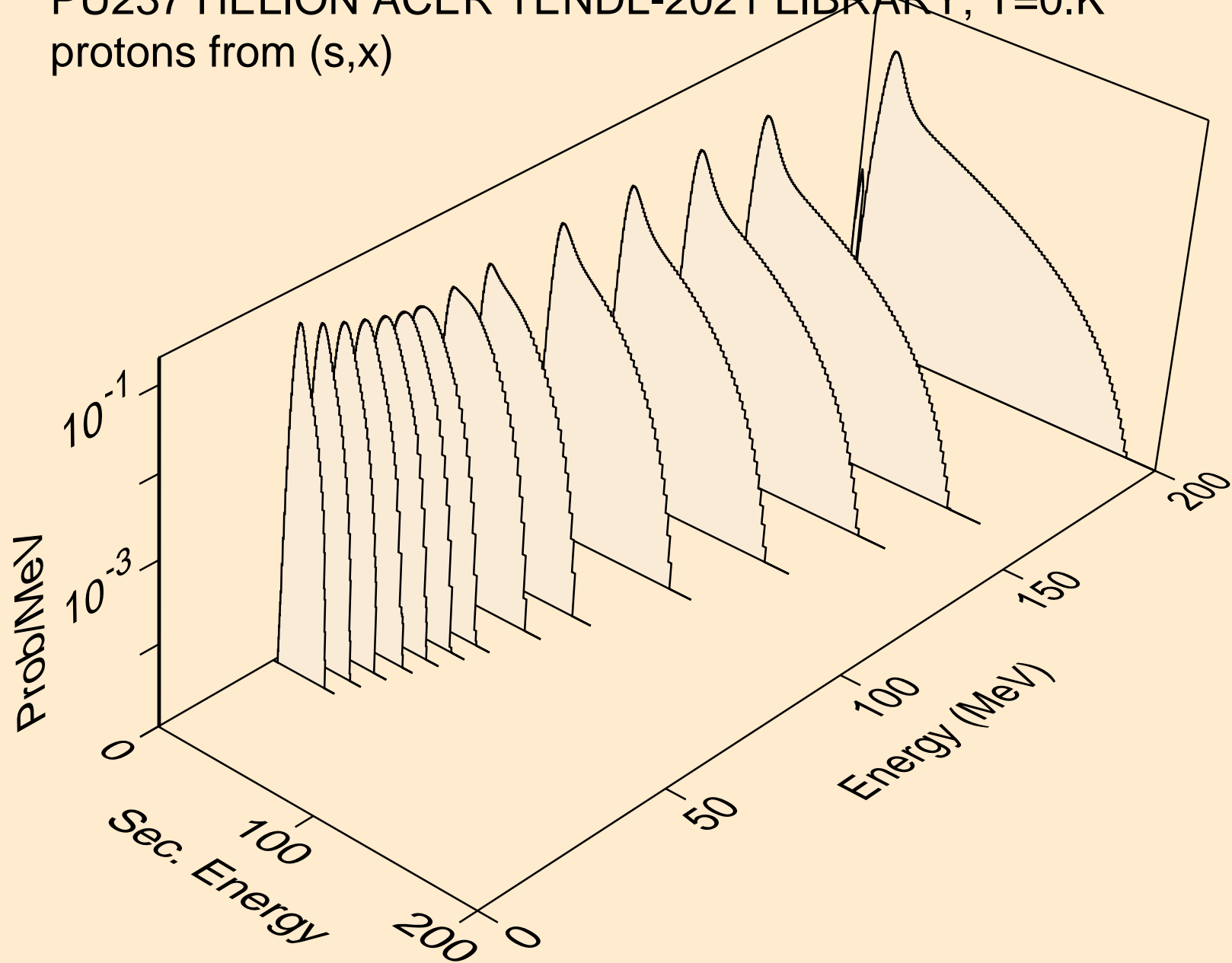

PU237 HELION ACER TENDL-2021 LIBRARY; T=0.K  
protons from (s,n\*)p

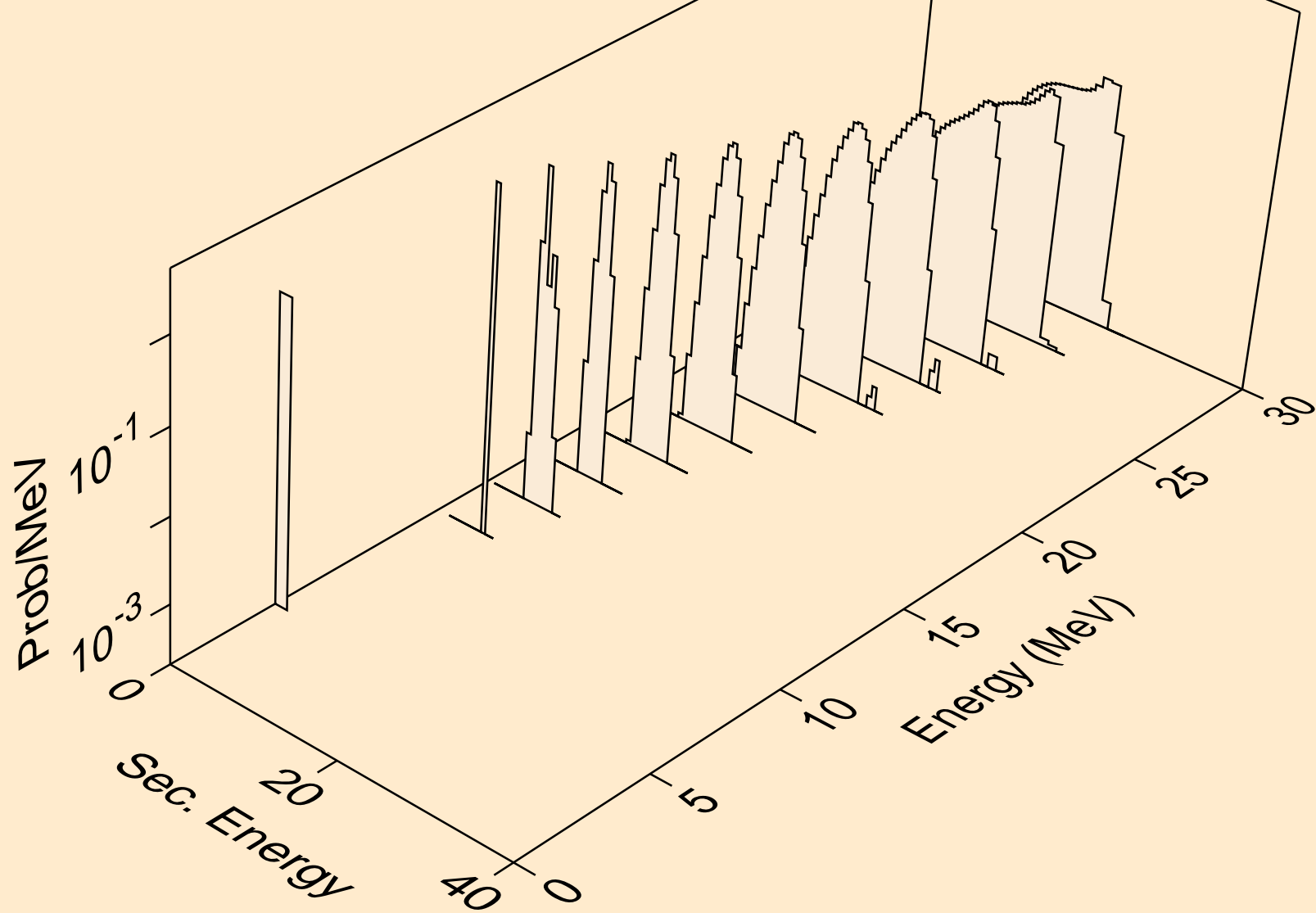

PU237 HELION ACER TENDL-2021 LIBRARY; T=0.K  
protons from (s,2np)

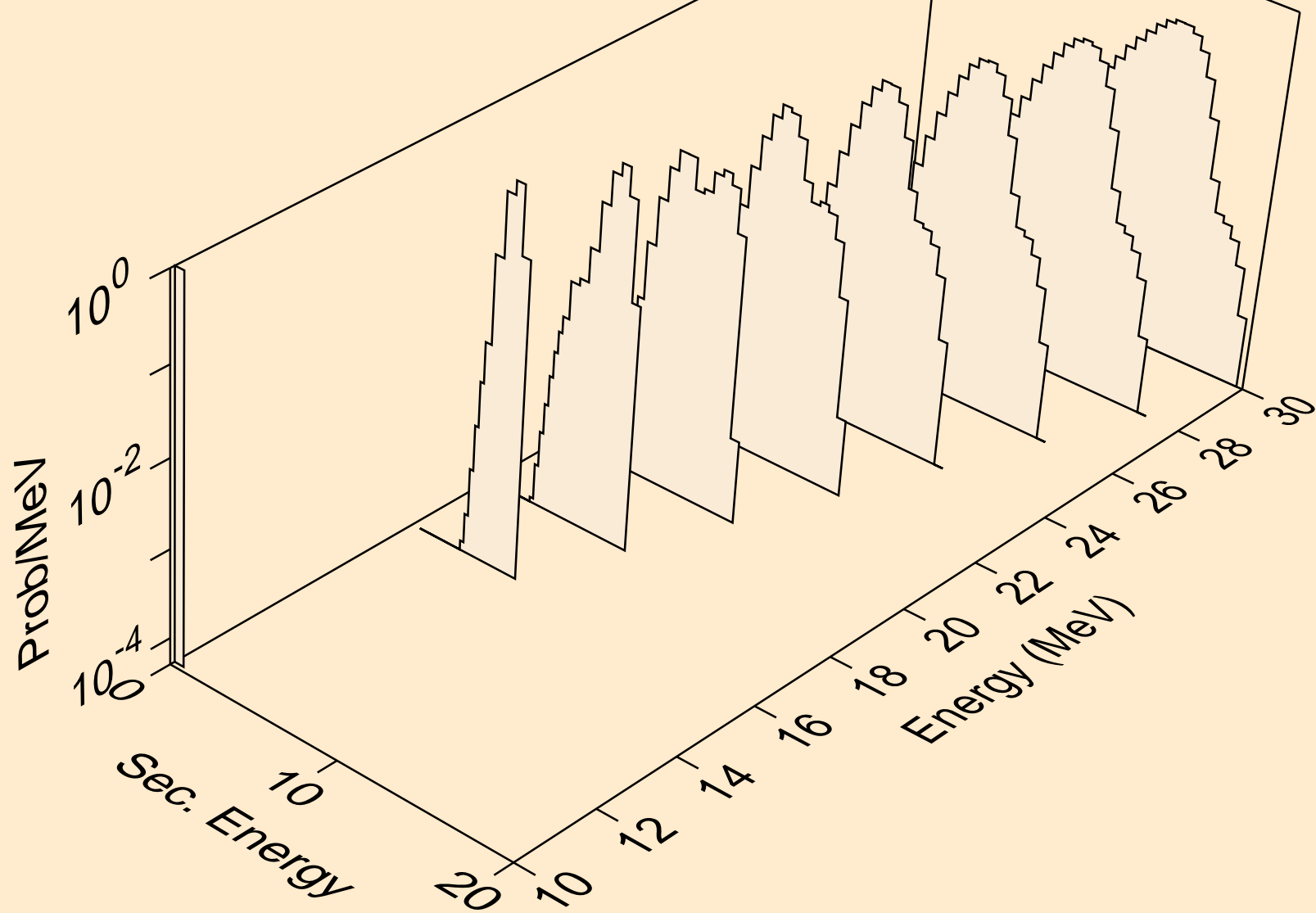

PU237 HELION ACER TENDL-2021 LIBRARY; T=0.K  
protons from (s,3np)

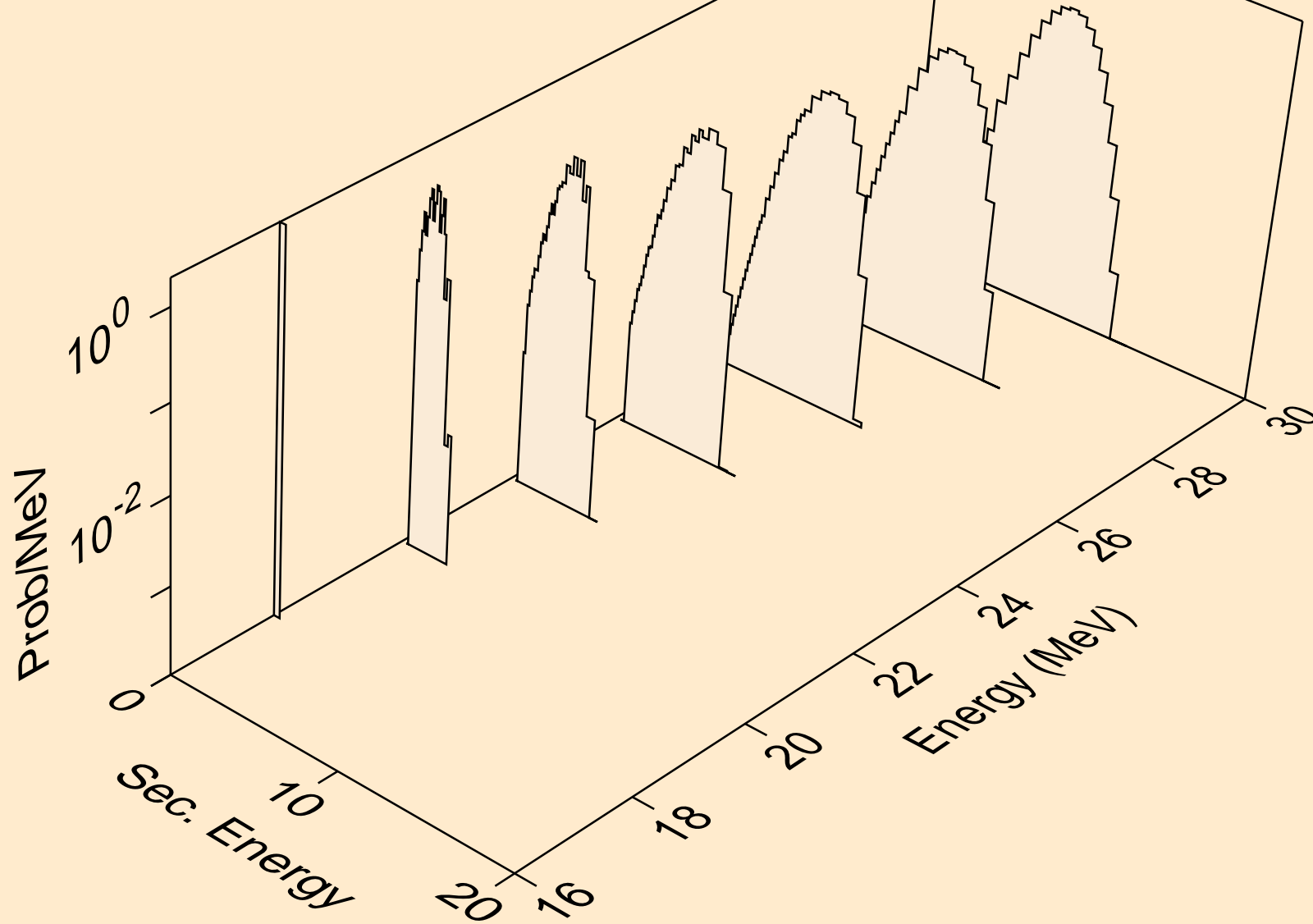

PU237 HELION ACER TENDL-2021 LIBRARY; T=0.K  
protons from (s,2np)

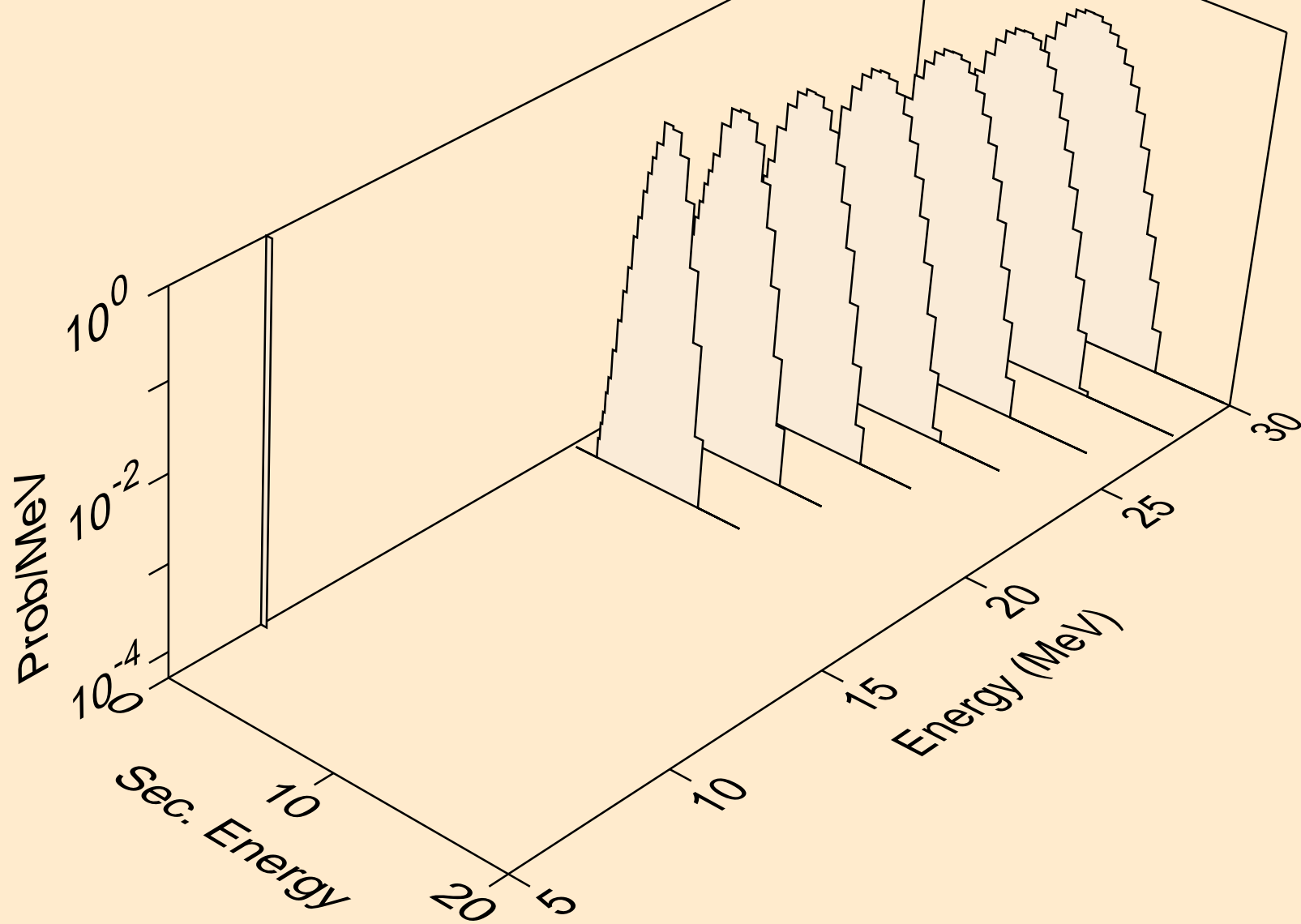

PU237 HELION ACER TENDL-2021 LIBRARY; T=0.K  
protons from (s,npa)

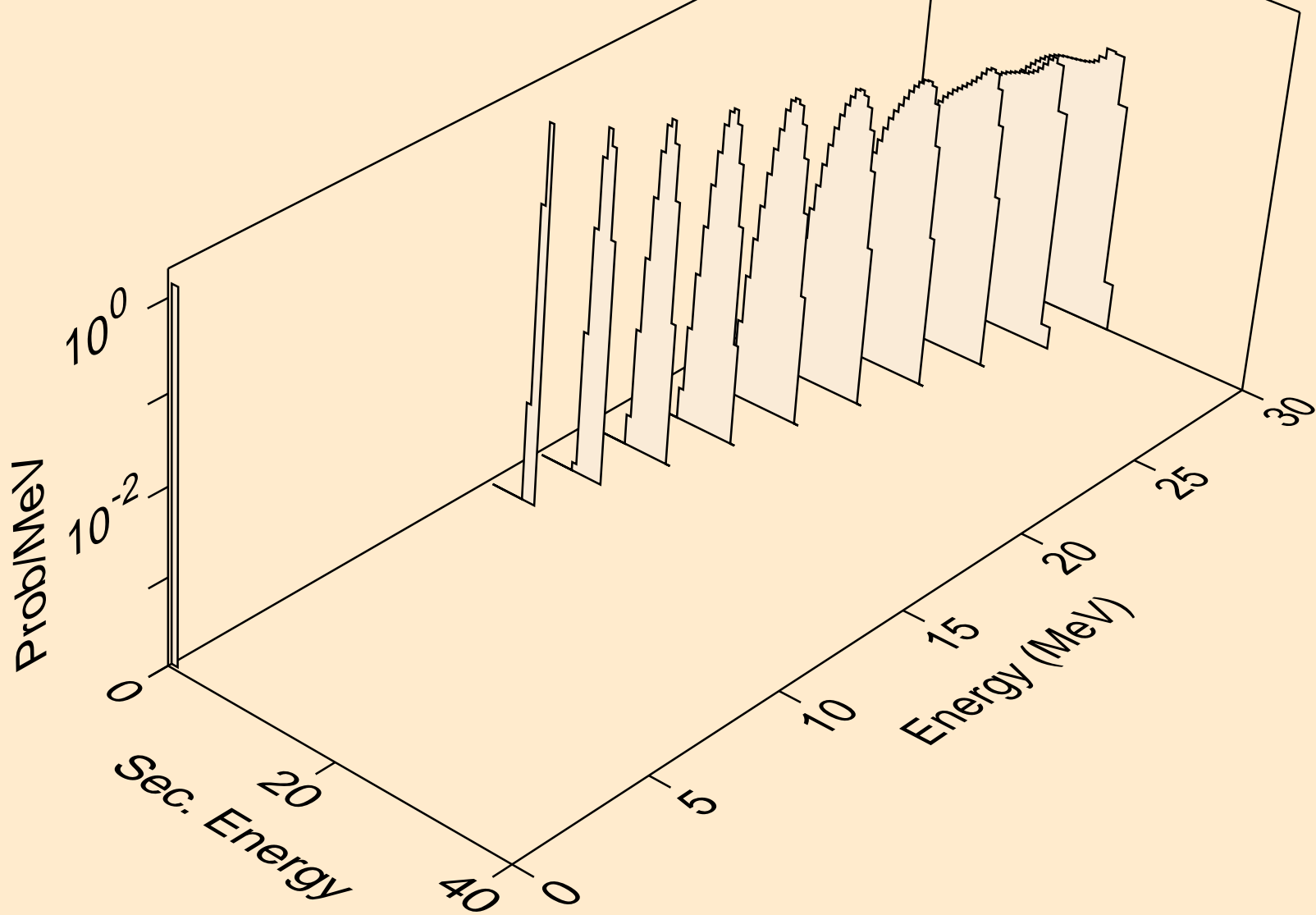

PU237 HELION ACER TENDL-2021 LIBRARY; T=0.K  
protons from (s,p)

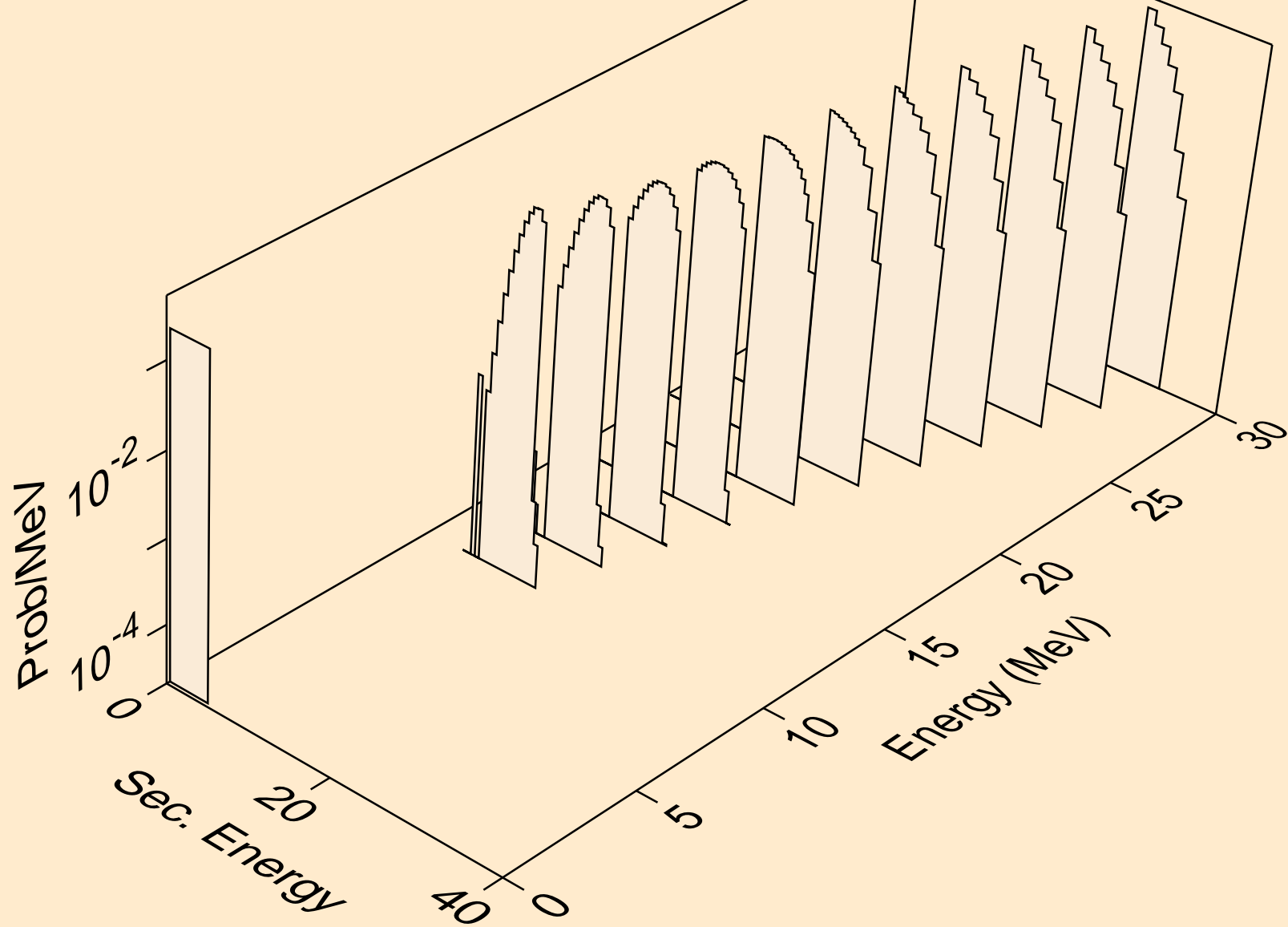



PU237 HELION ACER TENDL-2021 LIBRARY; T=0.K  
protons from (s,2p)

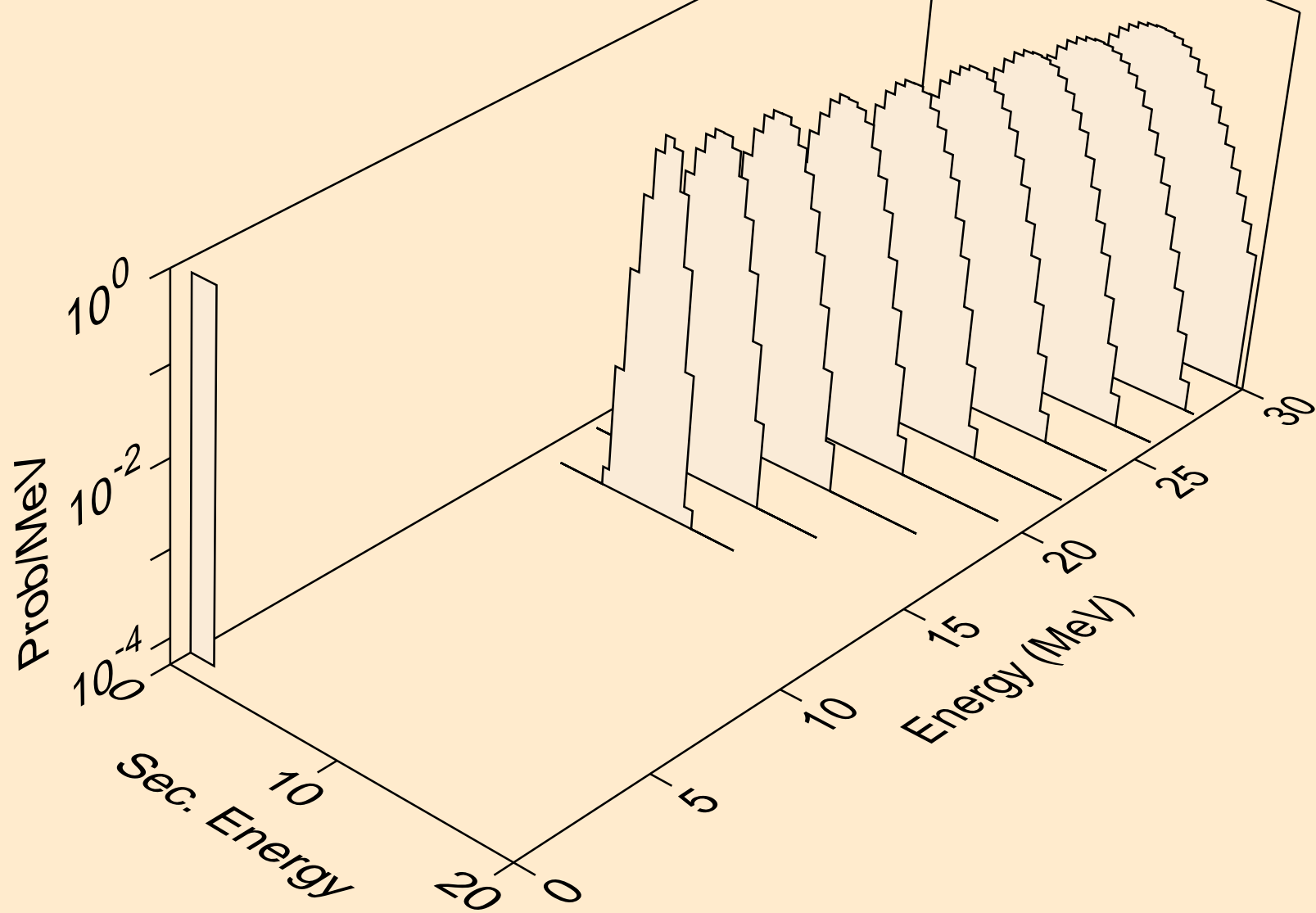

PU237 HELION ACER TENDL-2021 LIBRARY; T=0.K  
protons from (s,pd)

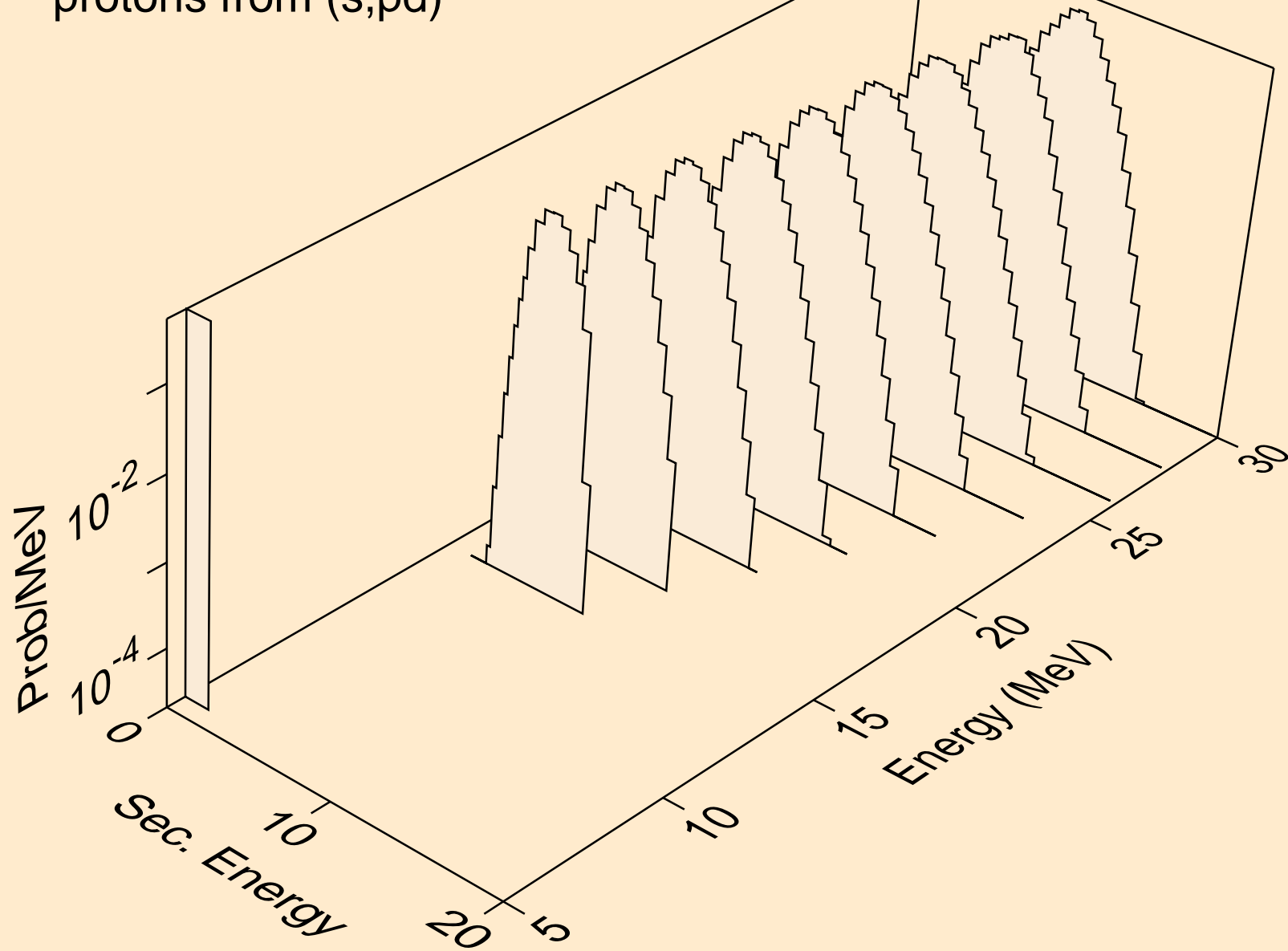

PU237 HELION ACER TENDL-2021 LIBRARY; T=0.K  
protons from (s,pt)

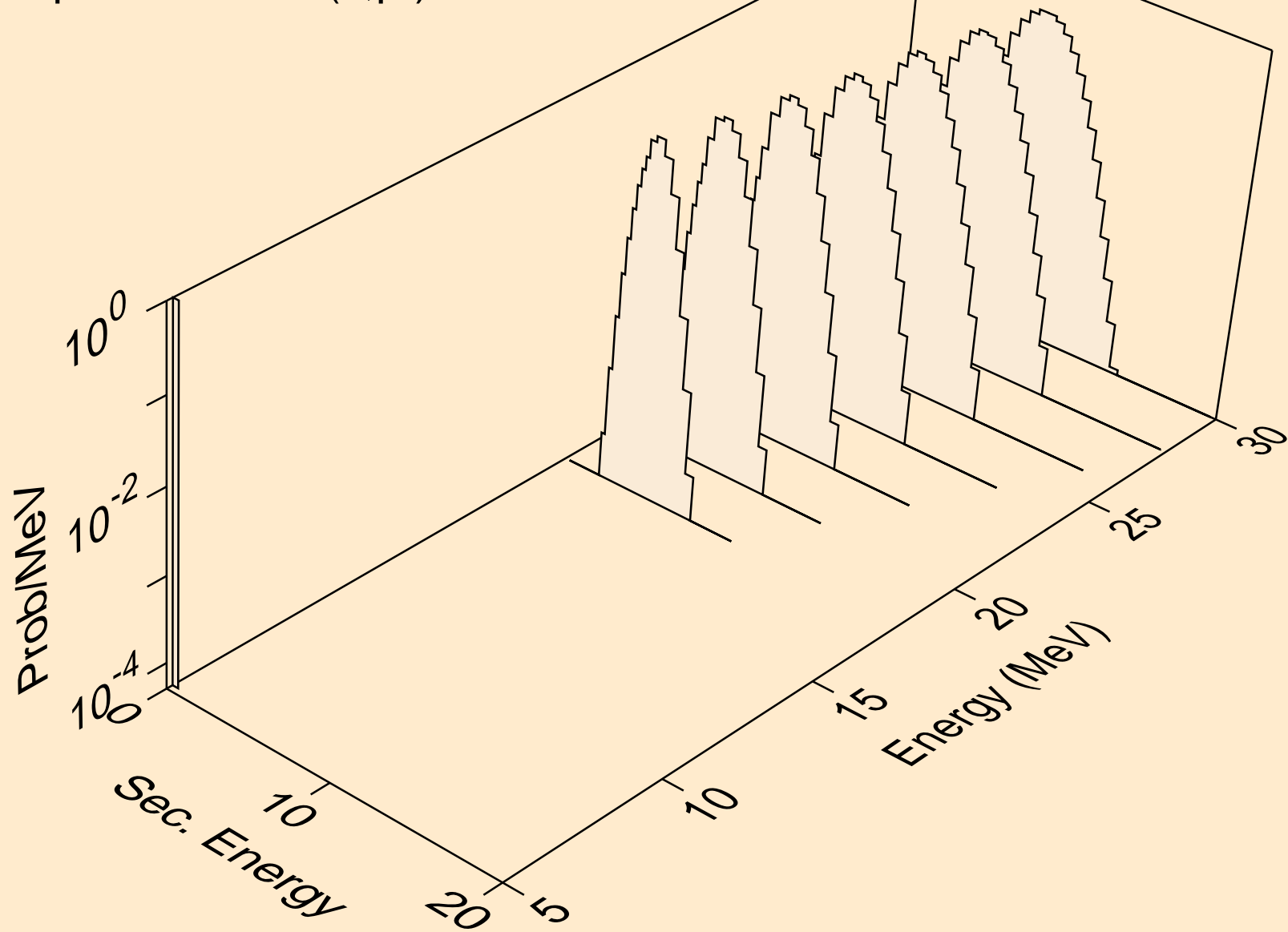

PU237 HELION ACER TENDL-2021 LIBRARY; T=0.K  
deuterons from (s,x)

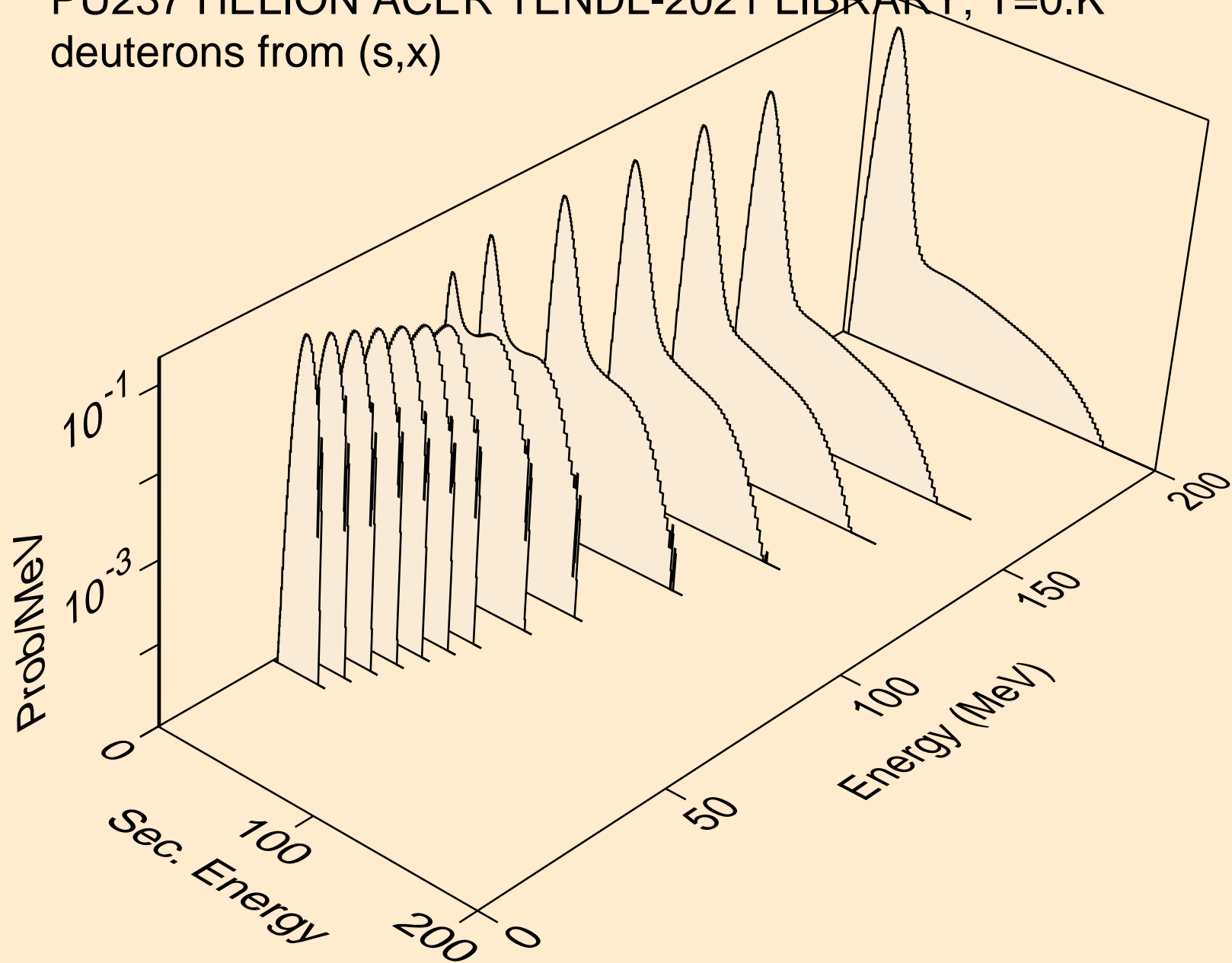

PU237 HELION ACER TENDL-2021 LIBRARY; T=0.K  
deuterons from (s,2nd)

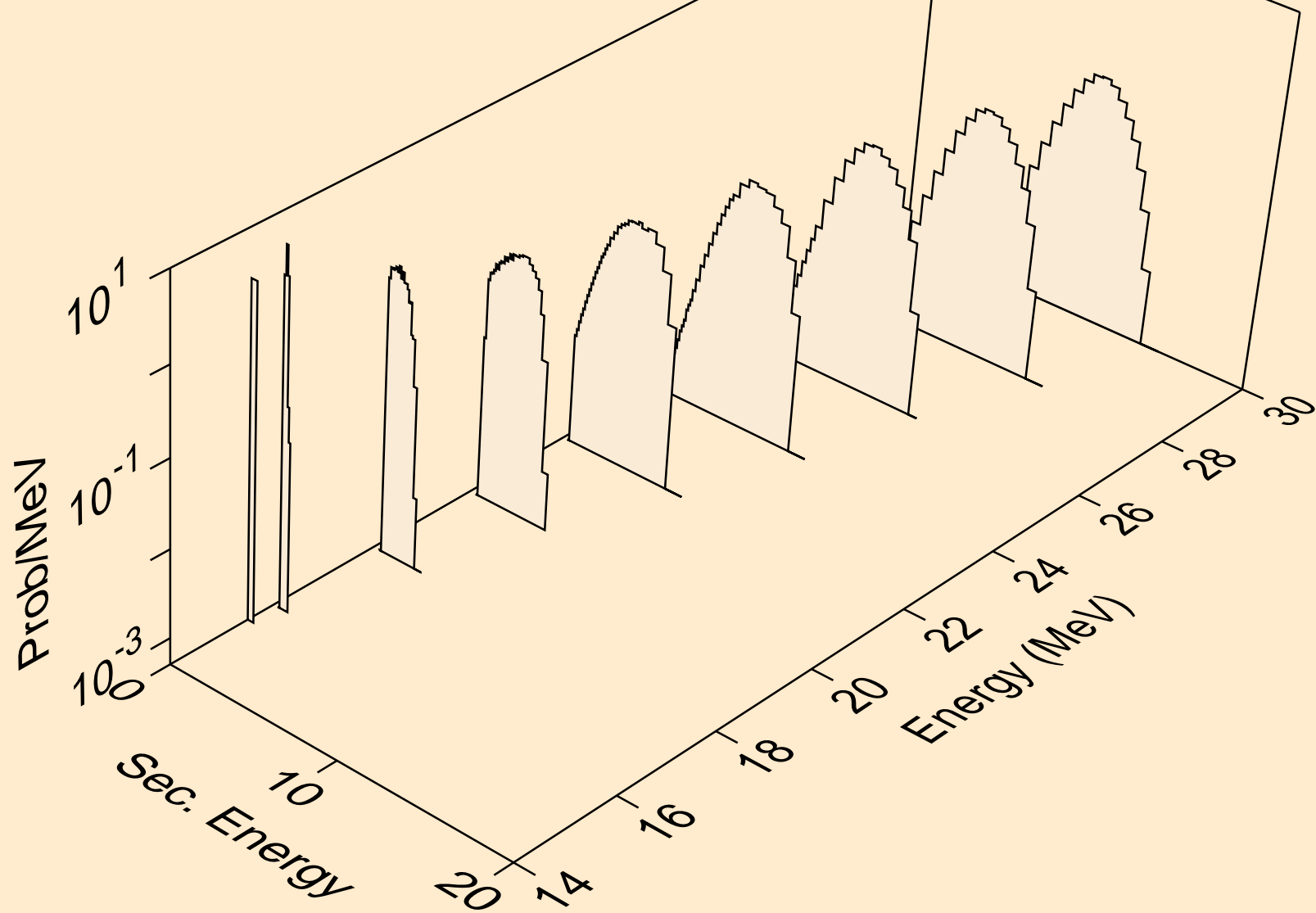

PU237 HELION ACER TENDL-2021 LIBRARY; T=0.K  
deuterons from (s,n\*)d

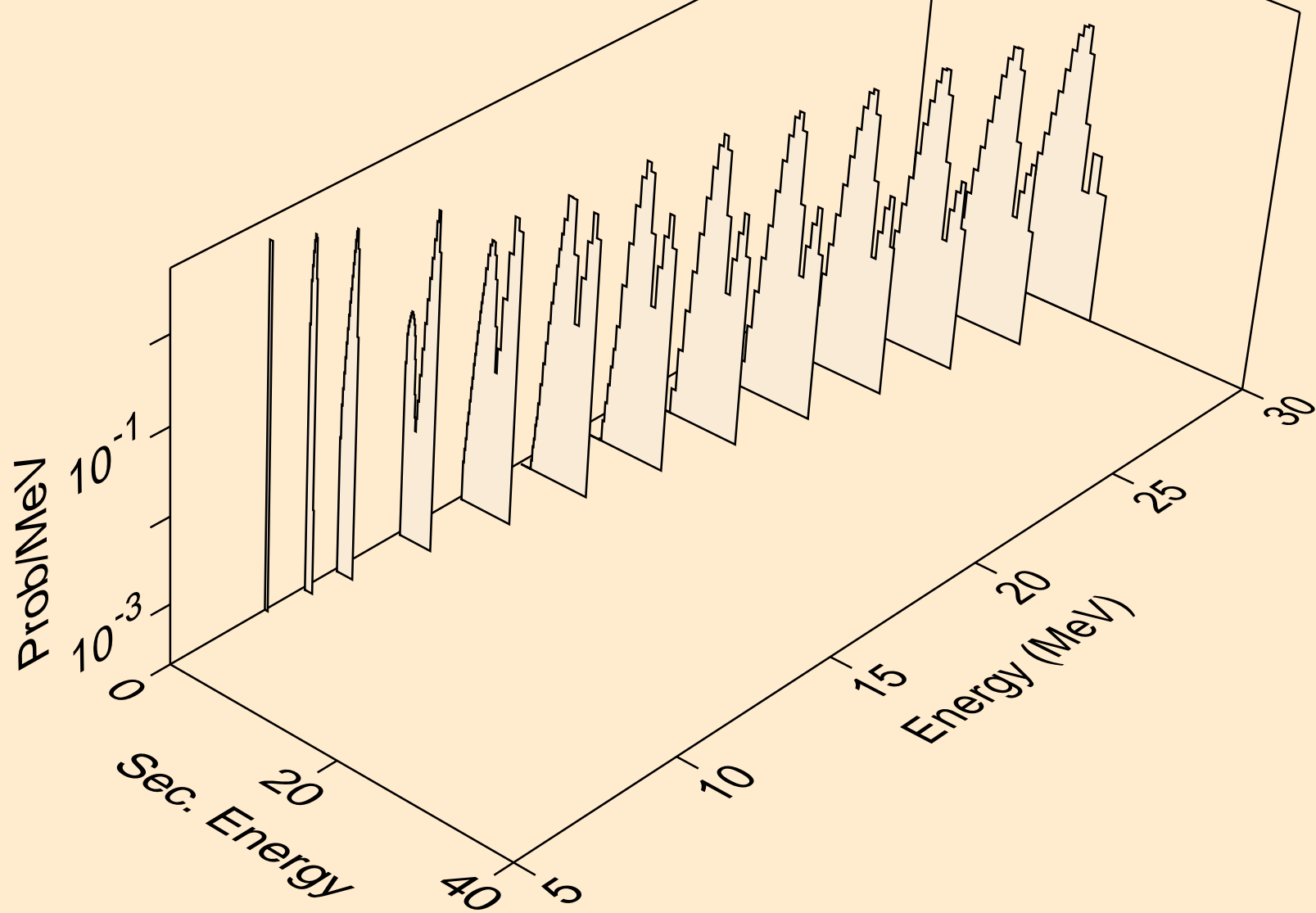

PU237 HELION ACER TENDL-2021 LIBRARY; T=0.K  
deuterons from (s,d)

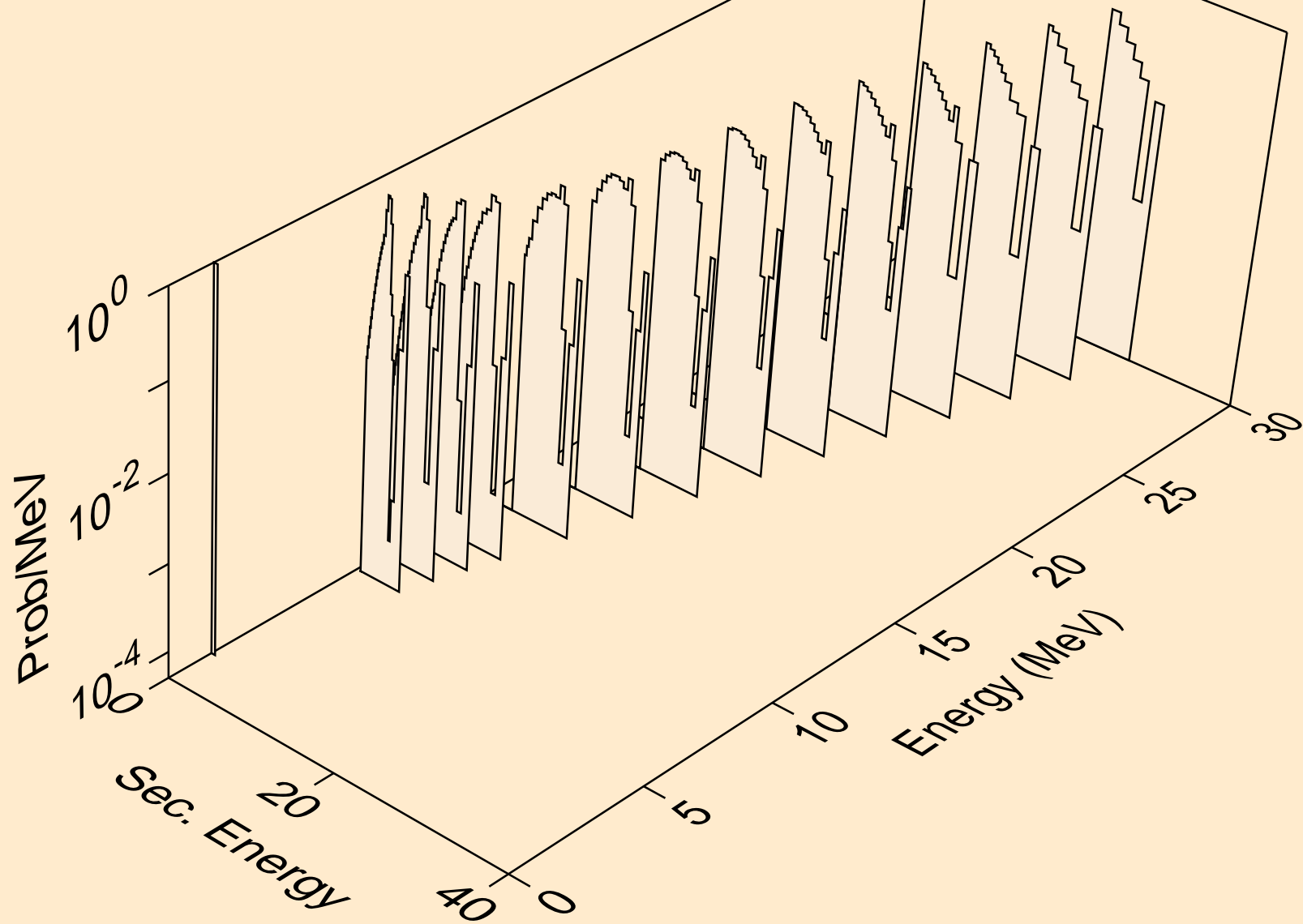

PU237 HELION ACER TENDL-2021 LIBRARY; T=0.K  
deuterons from (s,pd)

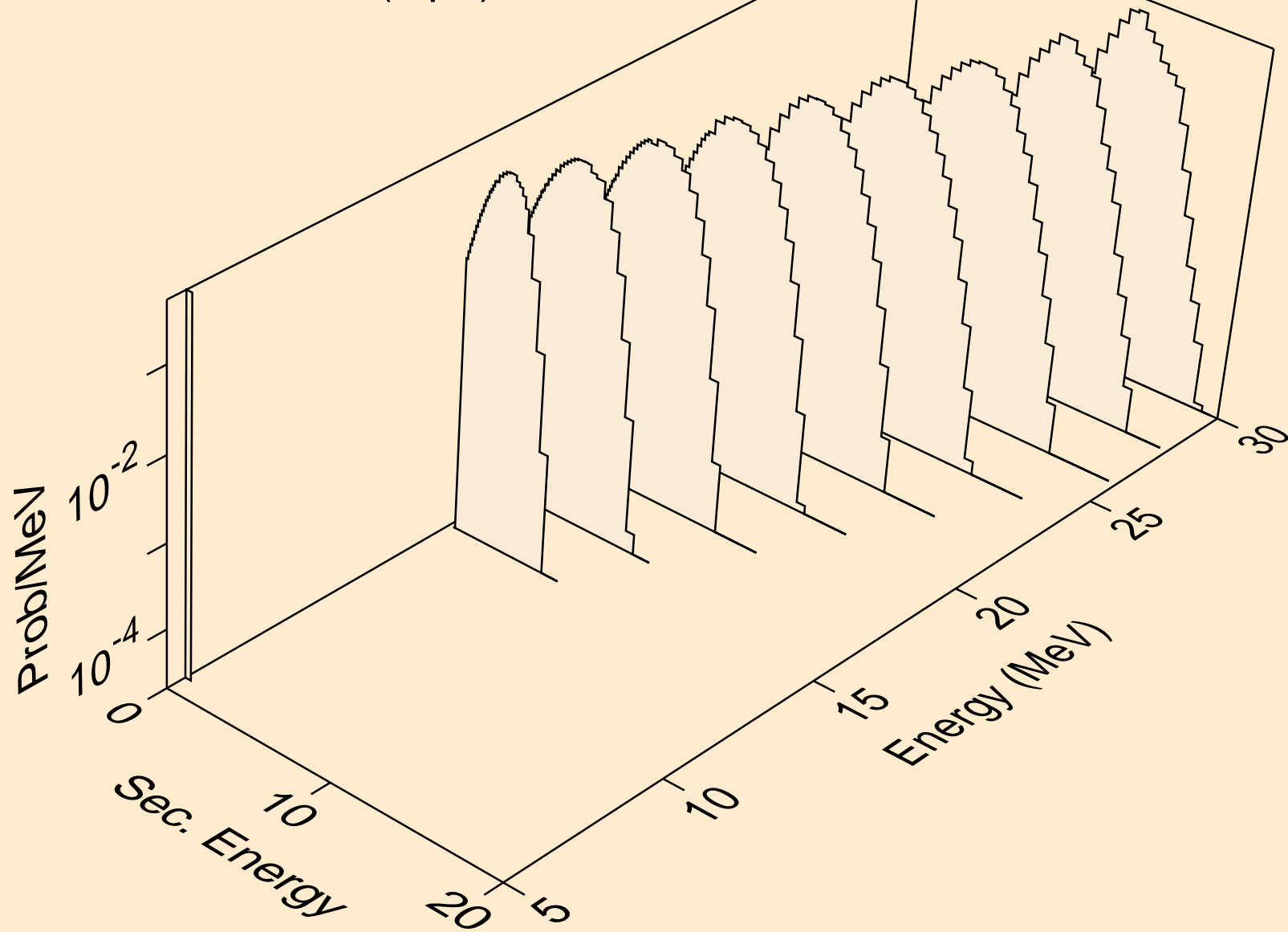



PU237 HELION ACER TENDL-2021 LIBRARY; T=0.K  
deuterons from (s,da)

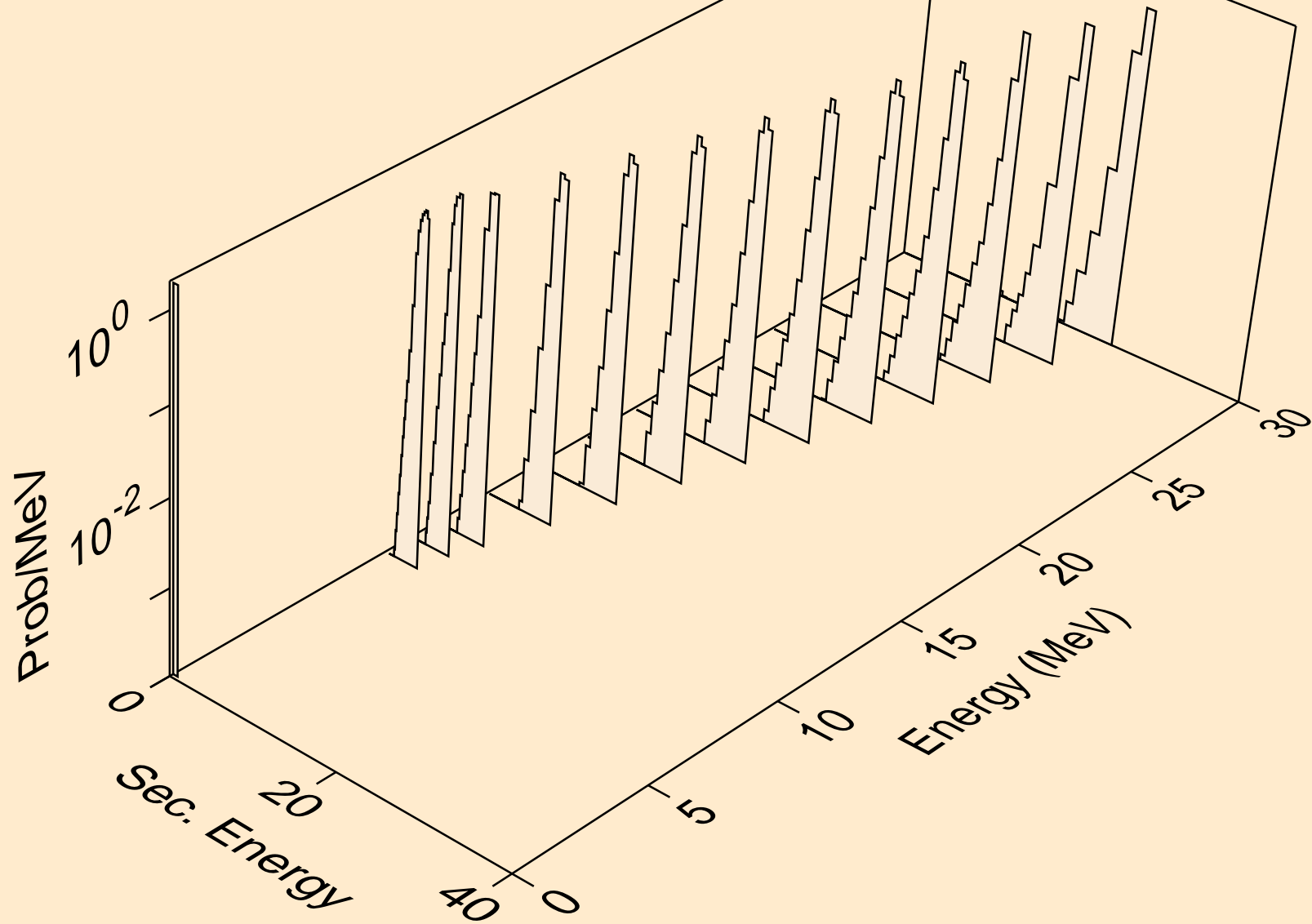

PU237 HELION ACER TENDL-2021 LIBRARY; T=0.K  
tritons from (s,x)

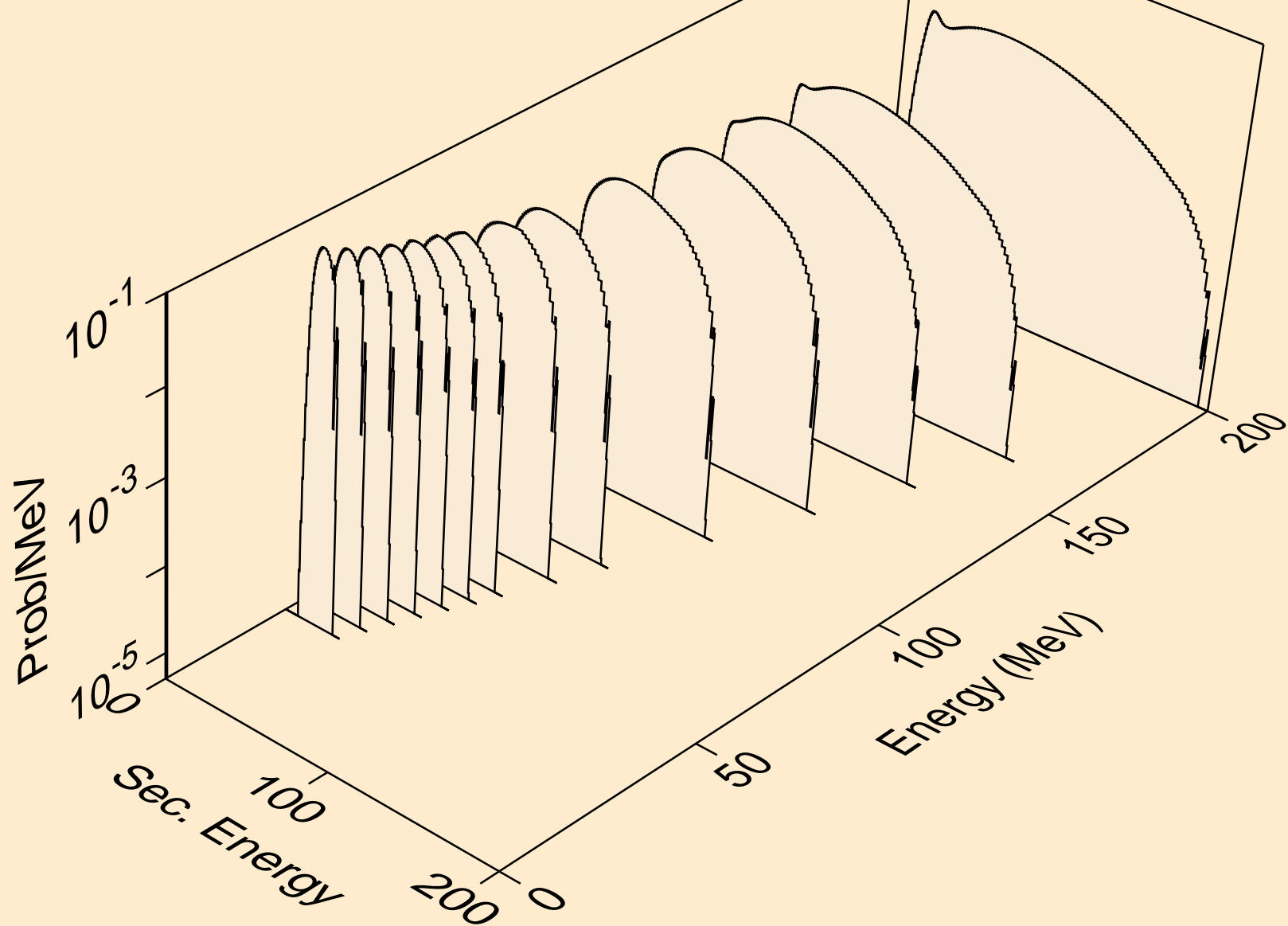

PU237 HELION ACER TENDL-2021 LIBRARY; T=0.K  
tritons from (s,n\*)t

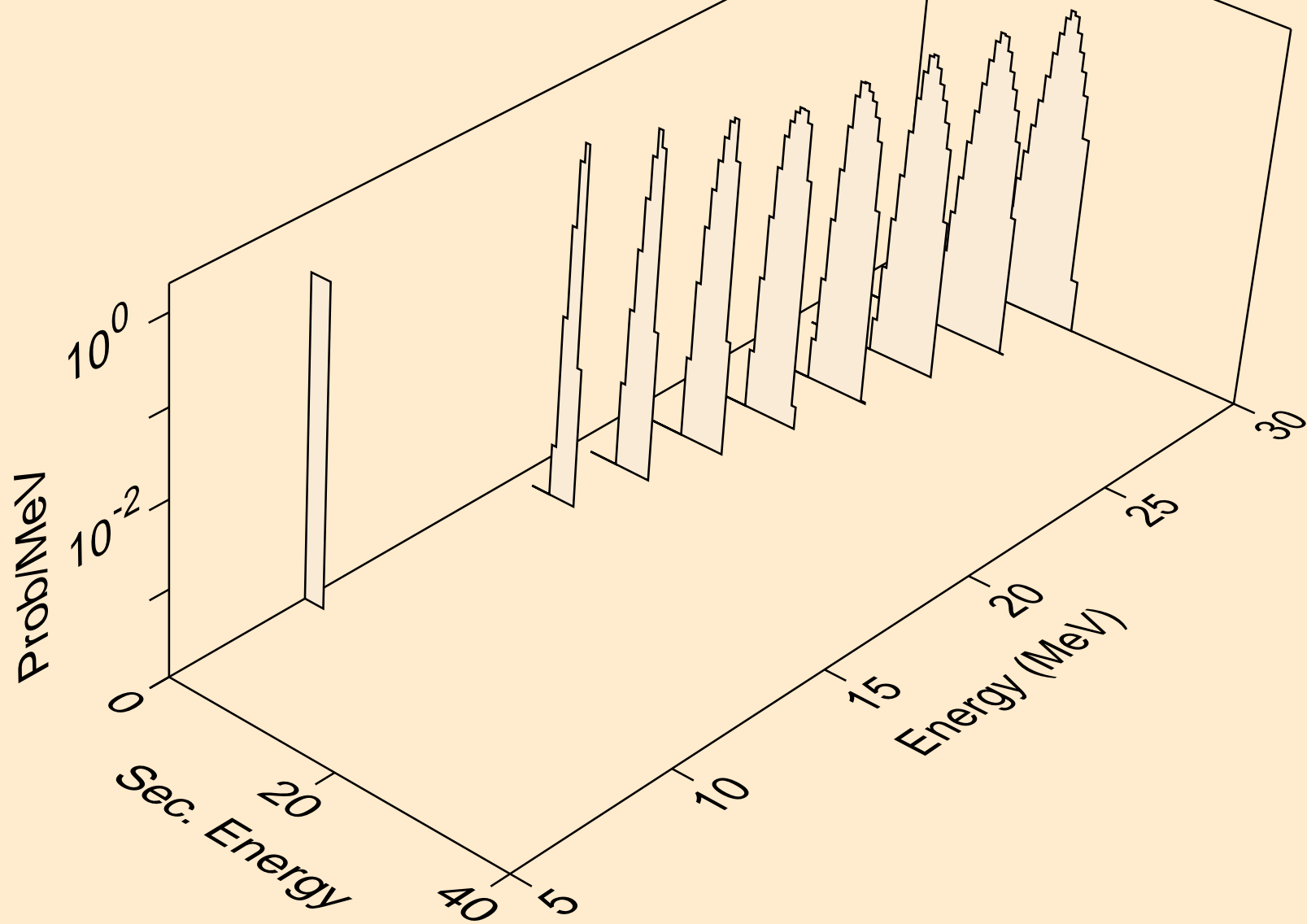

PU237 HELION ACER TENDL-2021 LIBRARY; T=0.K  
tritons from (s,t)

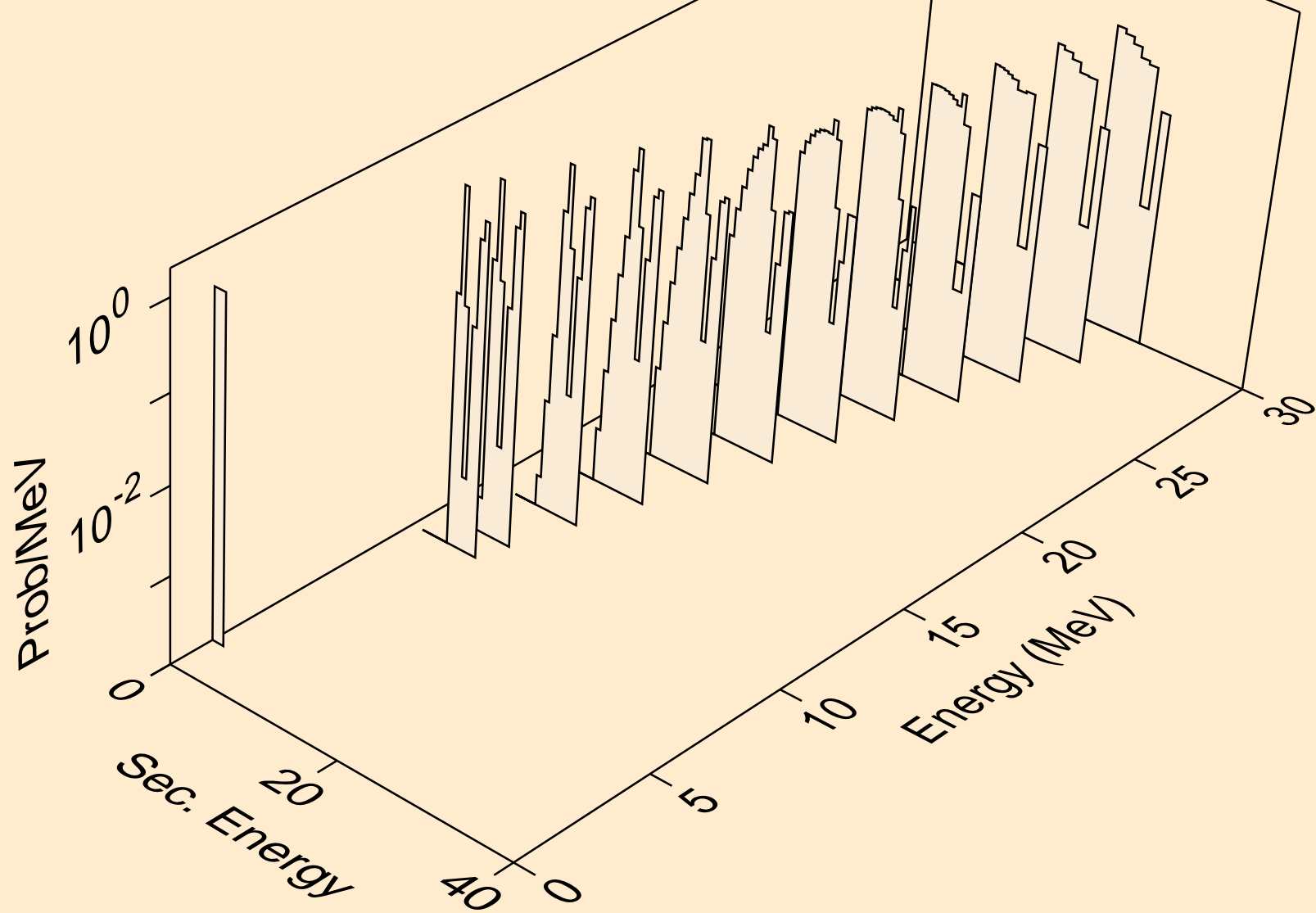

PU237 HELION ACER TENDL-2021 LIBRARY; T=0.K  
tritons from (s,pt)

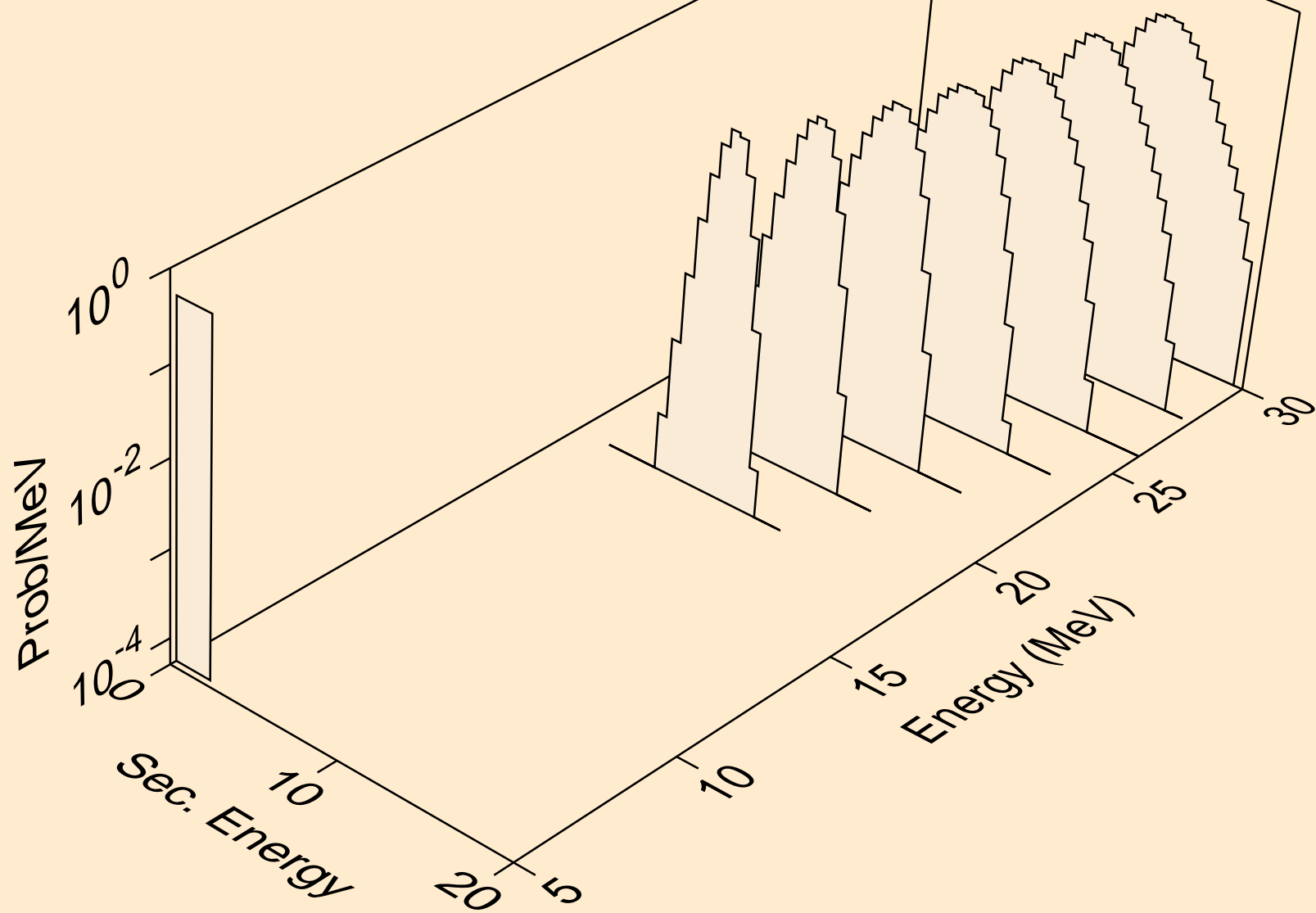

PU237 HELION ACER TENDL-2021 LIBRARY; T=0.K  
alphas from (s,x)

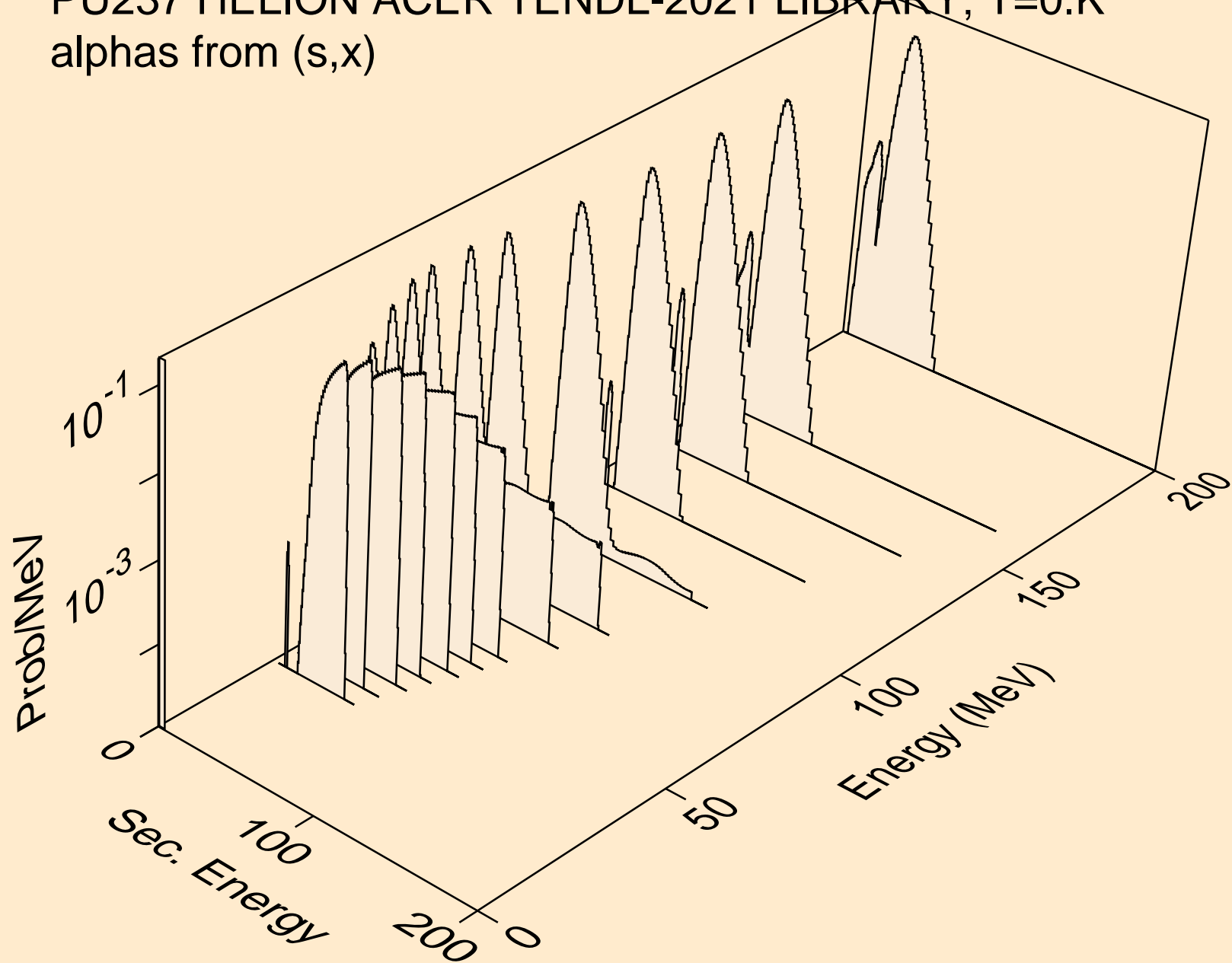

PU237 HELION ACER TENDL-2021 LIBRARY; T=0.K  
alphas from (s,n\*)a

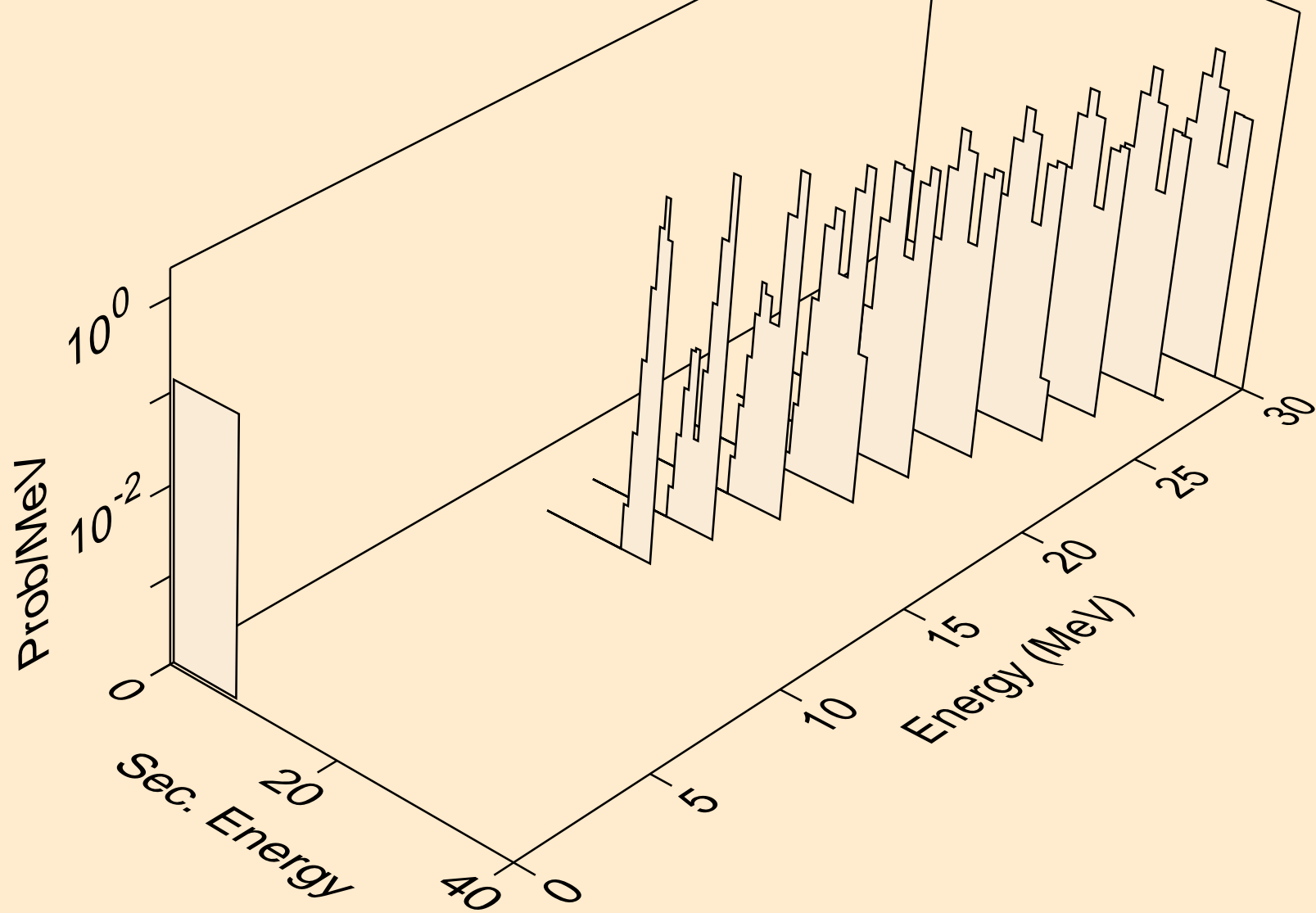

PU237 HELION ACER TENDL-2021 LIBRARY; T=0.K  
alphas from (s,npa)

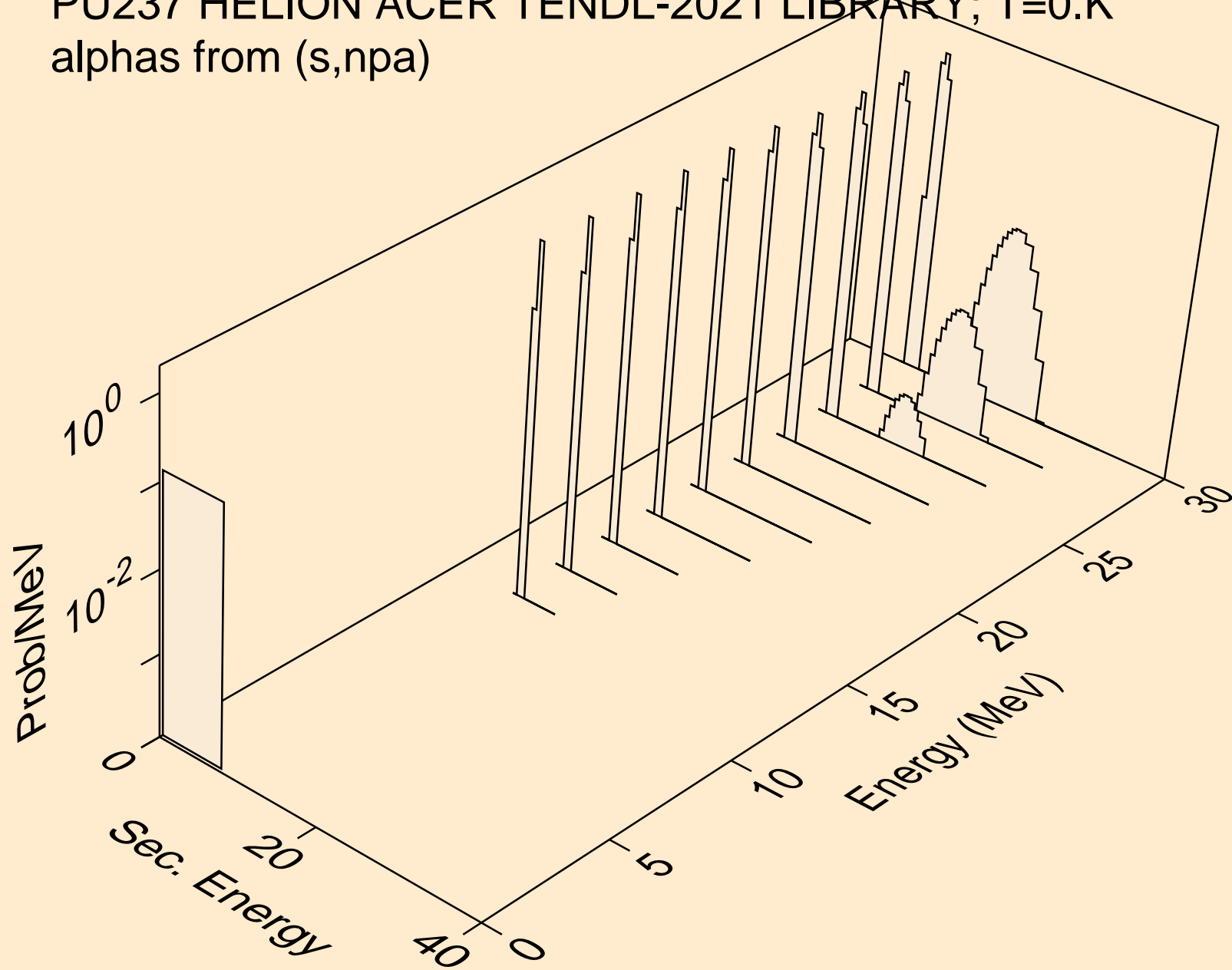



PU237 HELION ACER TENDL-2021 LIBRARY; T=0.K  
alphas from (s,a)

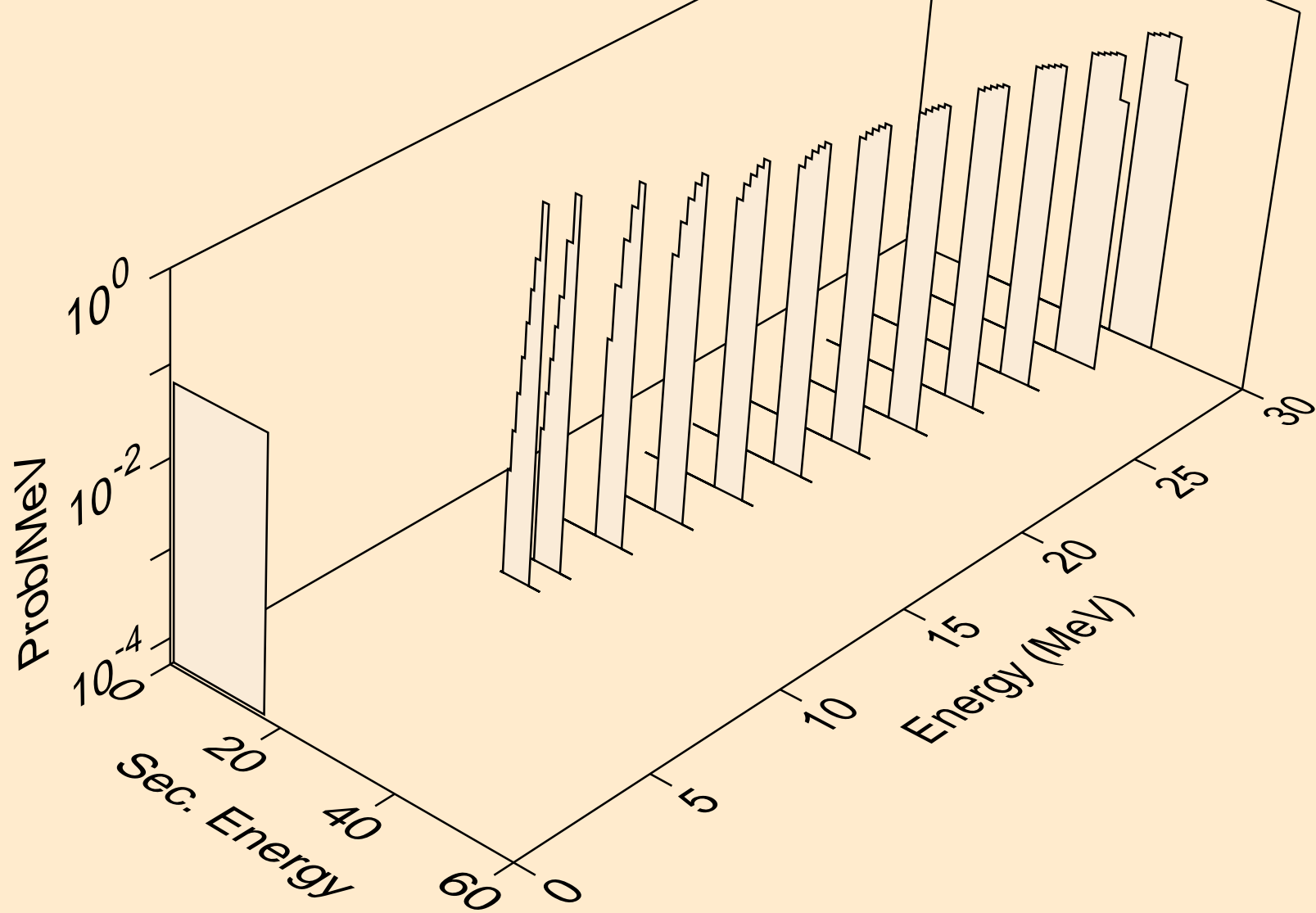

PU237 HELION ACER TENDL-2021 LIBRARY; T=0.K  
alphas from (s,da)

