

RB092 HELION ACER TENDL-2021 LIBRARY; T=0.K  
Principal cross sections

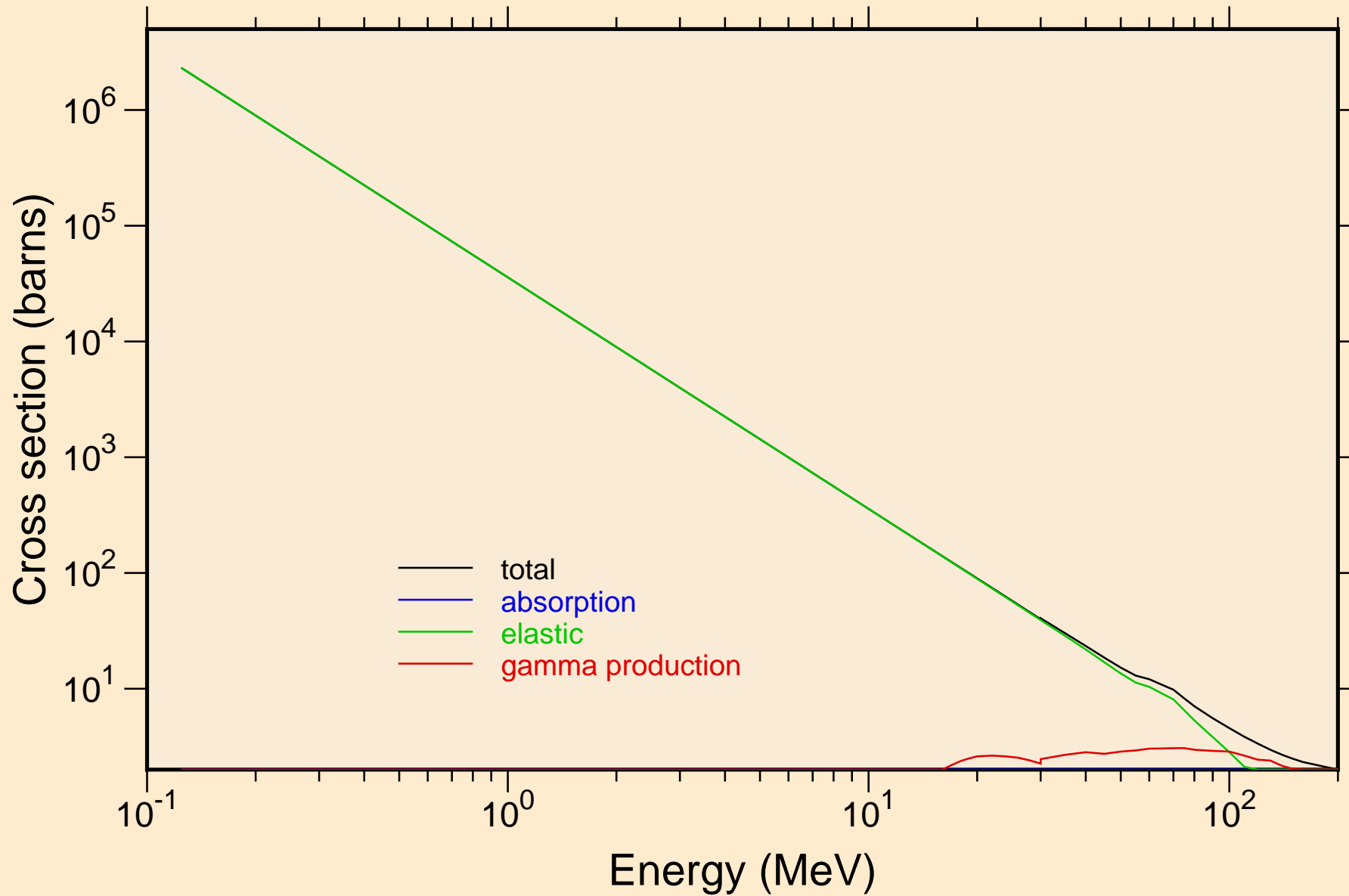

RB092 HELION ACER TENDL-2021 LIBRARY; T=0.K

Heating

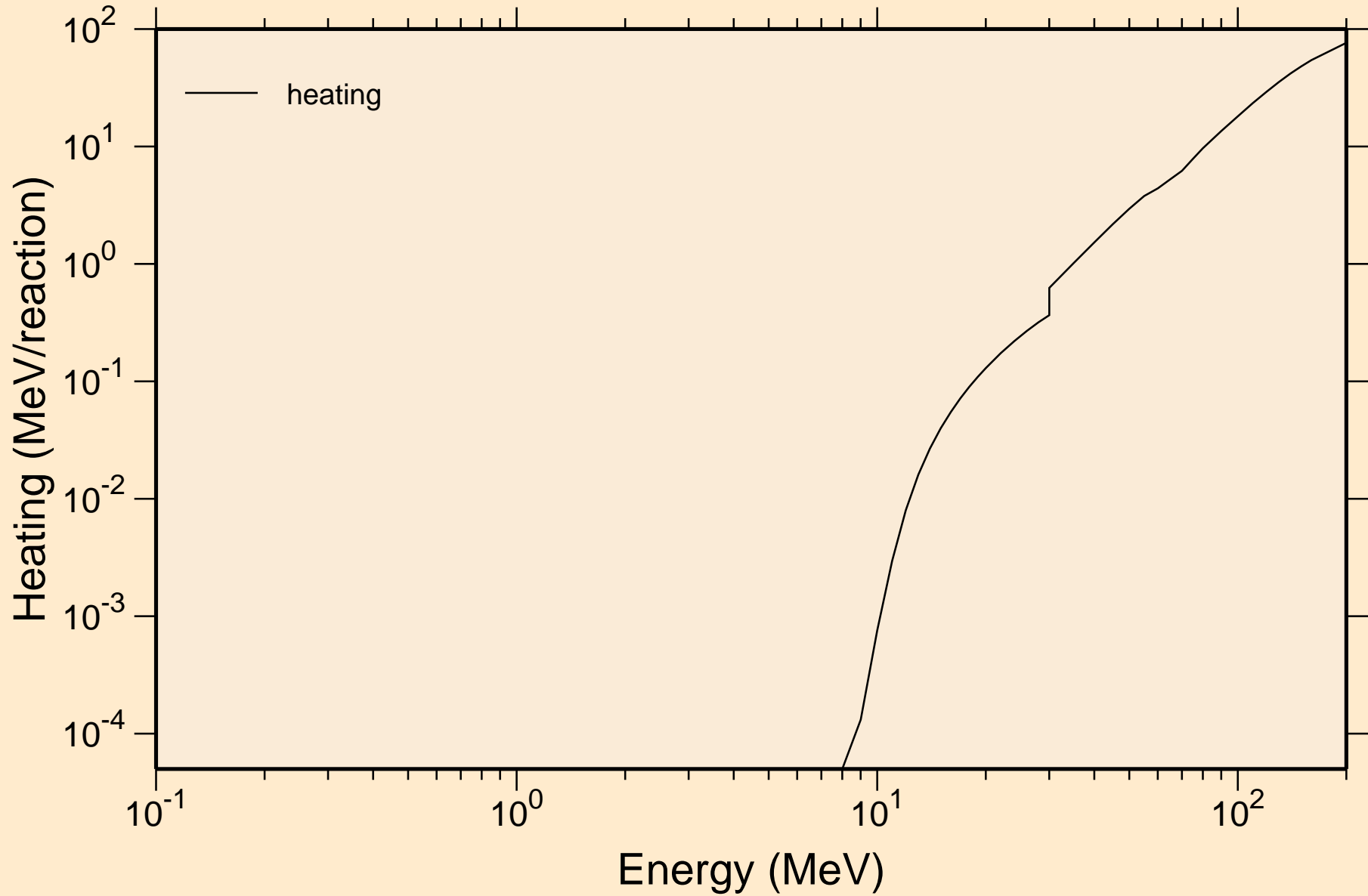

# RB092 HELION ACER TENDL-2021 LIBRARY; T=0.K

## Principal cross sections

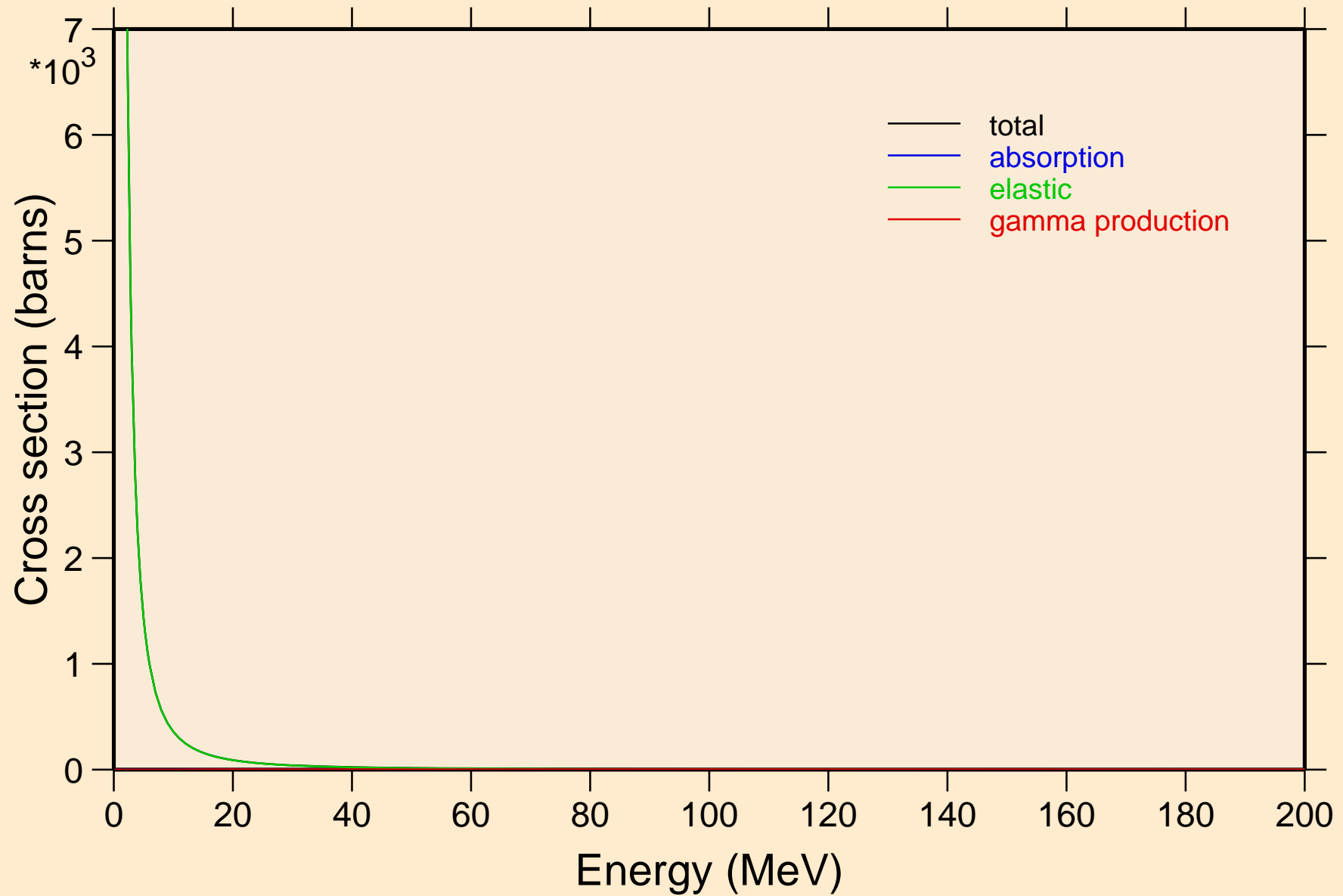

RB092 HELION ACER TENDL-2021 LIBRARY; T=0.K

Heating

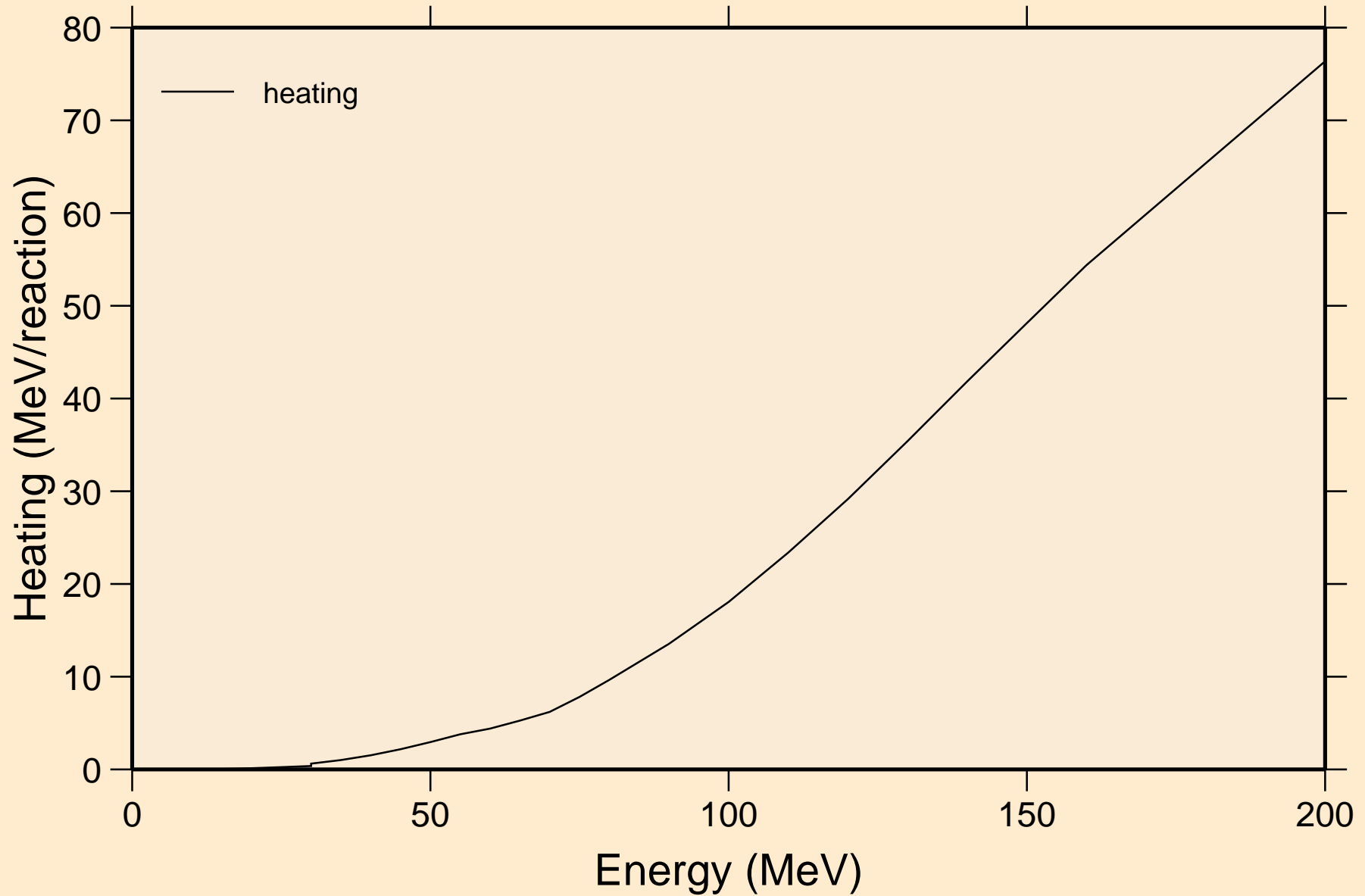

RB092 HELION ACER TENDL-2021 LIBRARY; T=0.K  
Threshold reactions

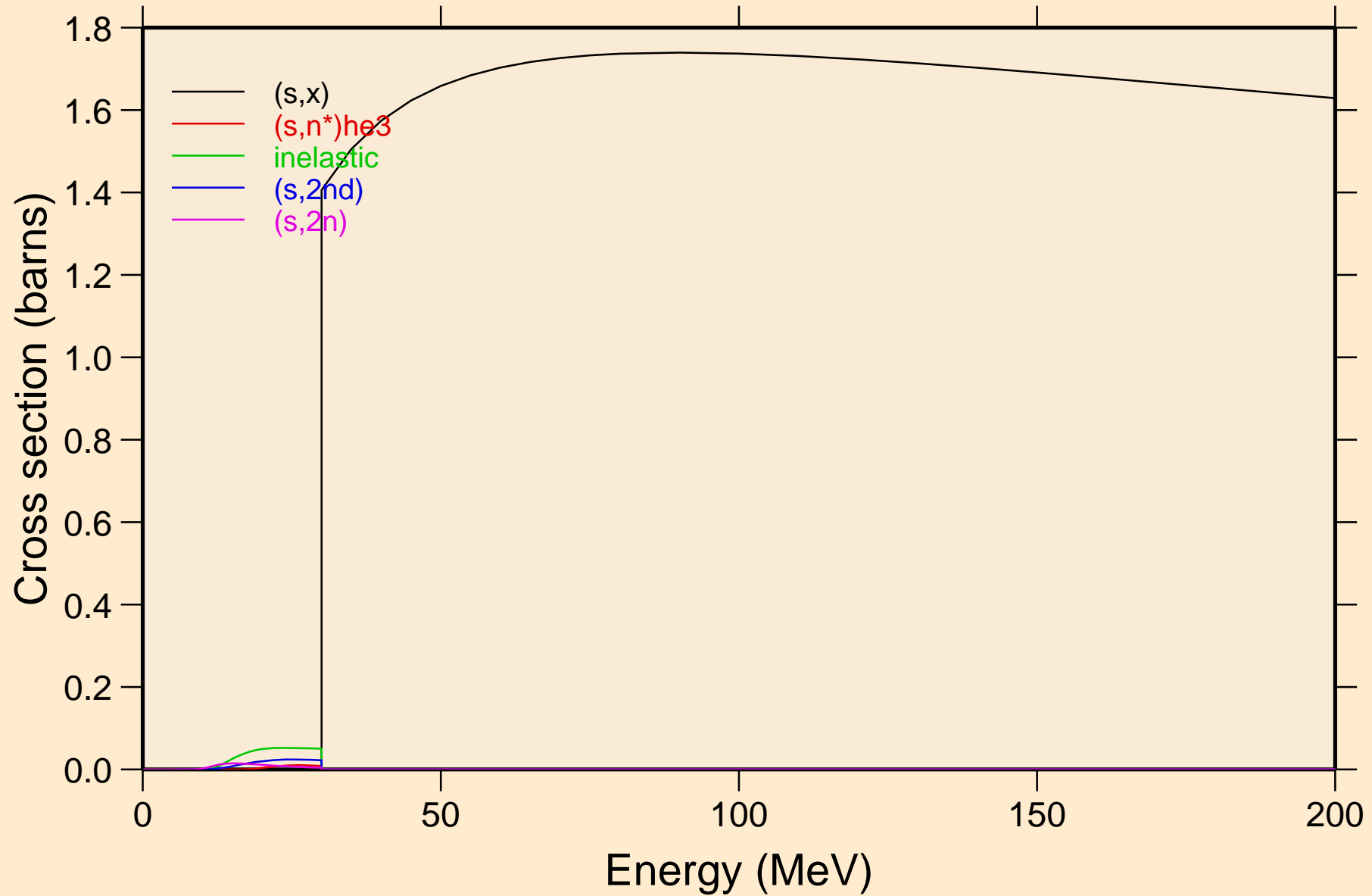

RB092 HELION ACER TENDL-2021 LIBRARY; T=0.K  
Threshold reactions

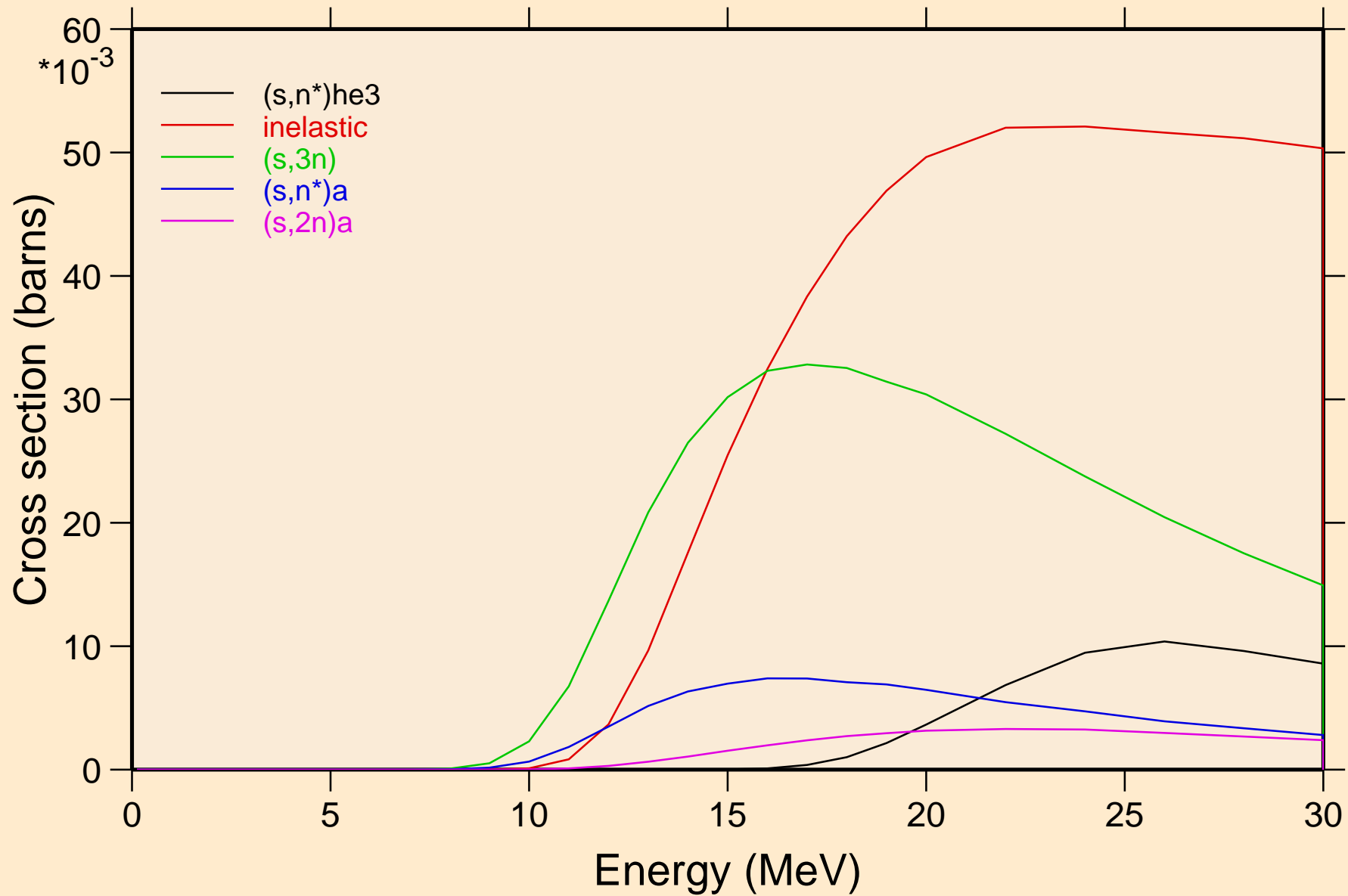

RB092 HELION ACER TENDL-2021 LIBRARY; T=0.K  
Threshold reactions

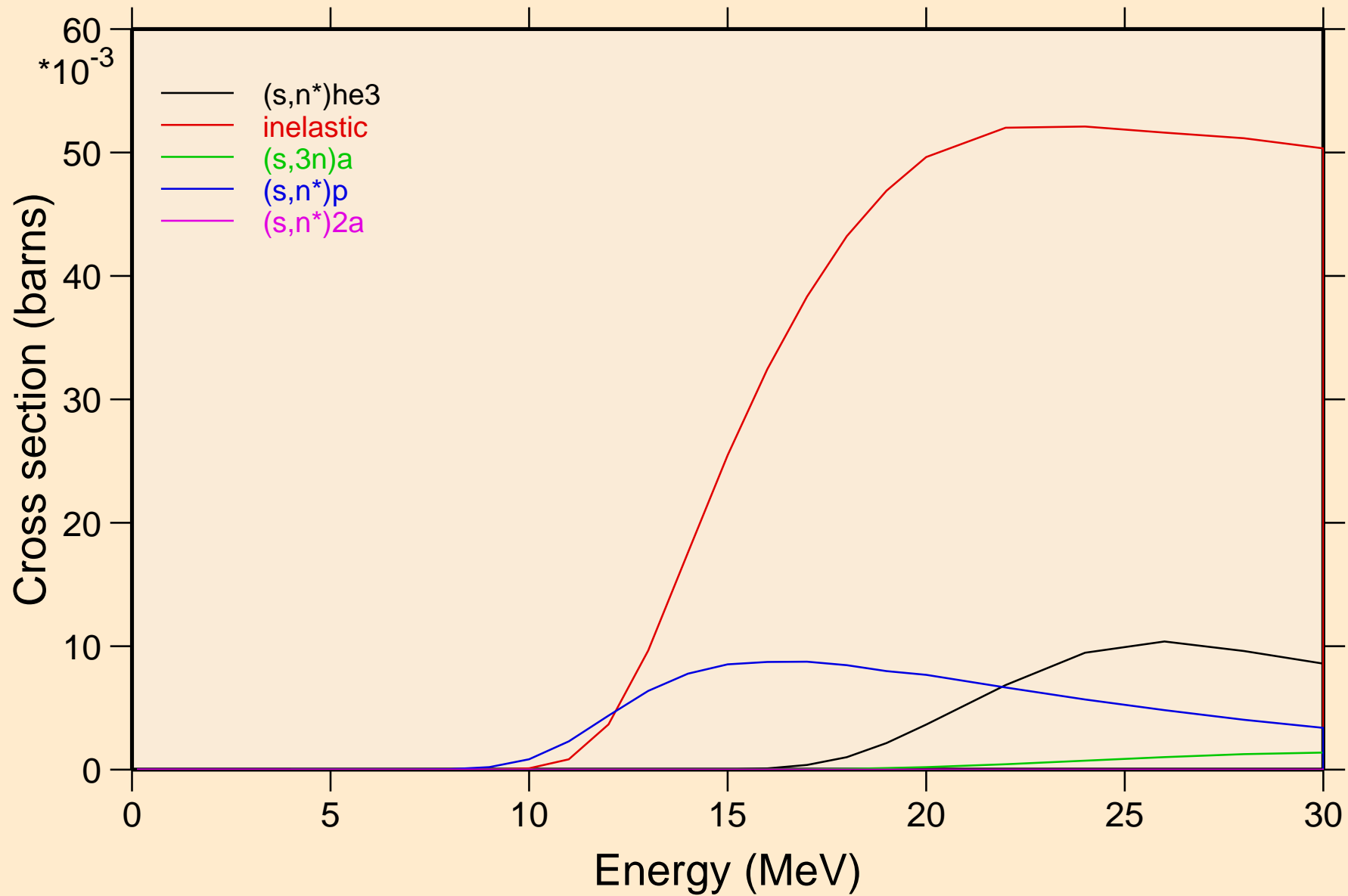

RB092 HELION ACER TENDL-2021 LIBRARY; T=0.K  
Threshold reactions

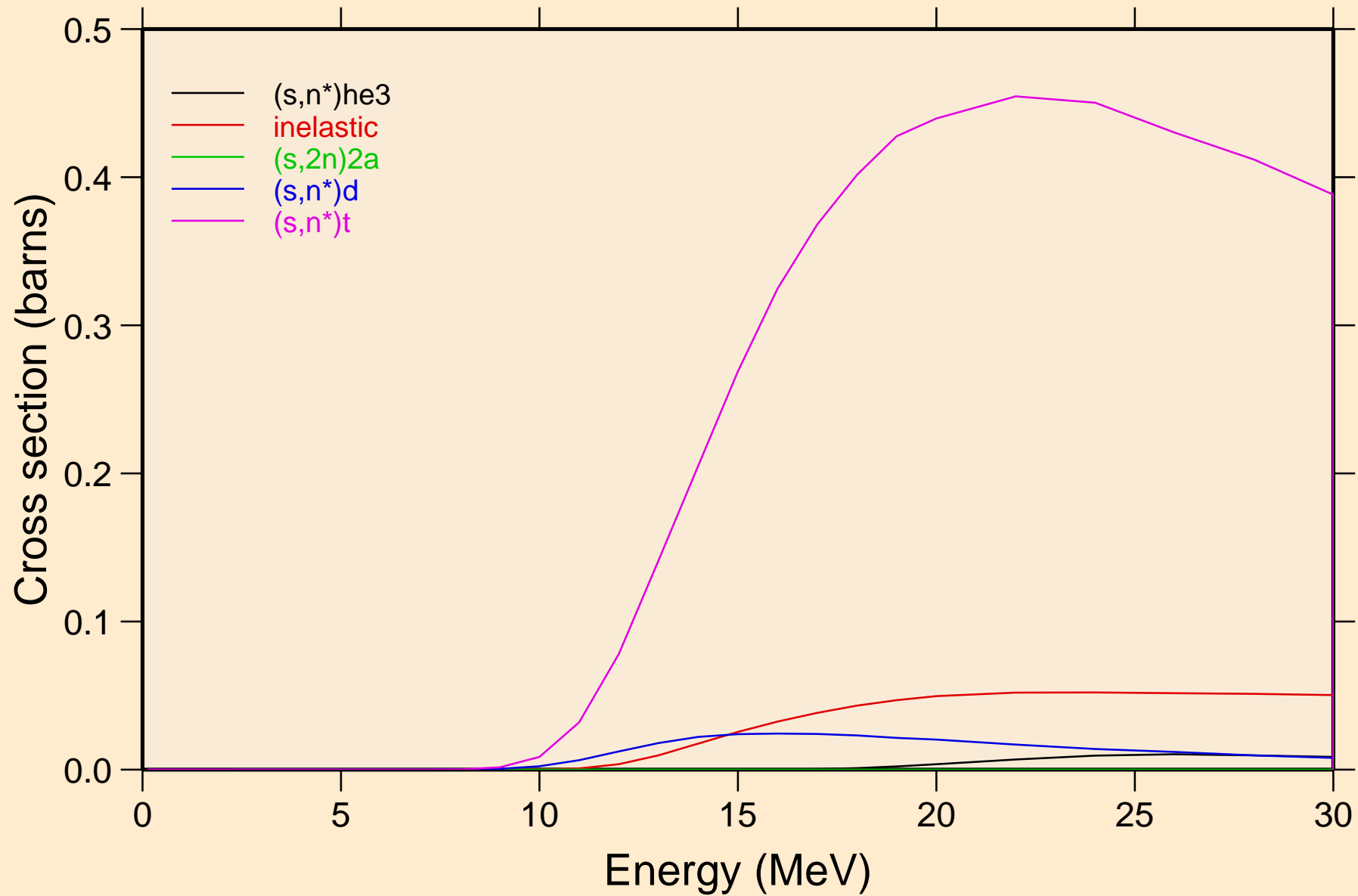



RB092 HELION ACER TENDL-2021 LIBRARY; T=0.K  
Threshold reactions

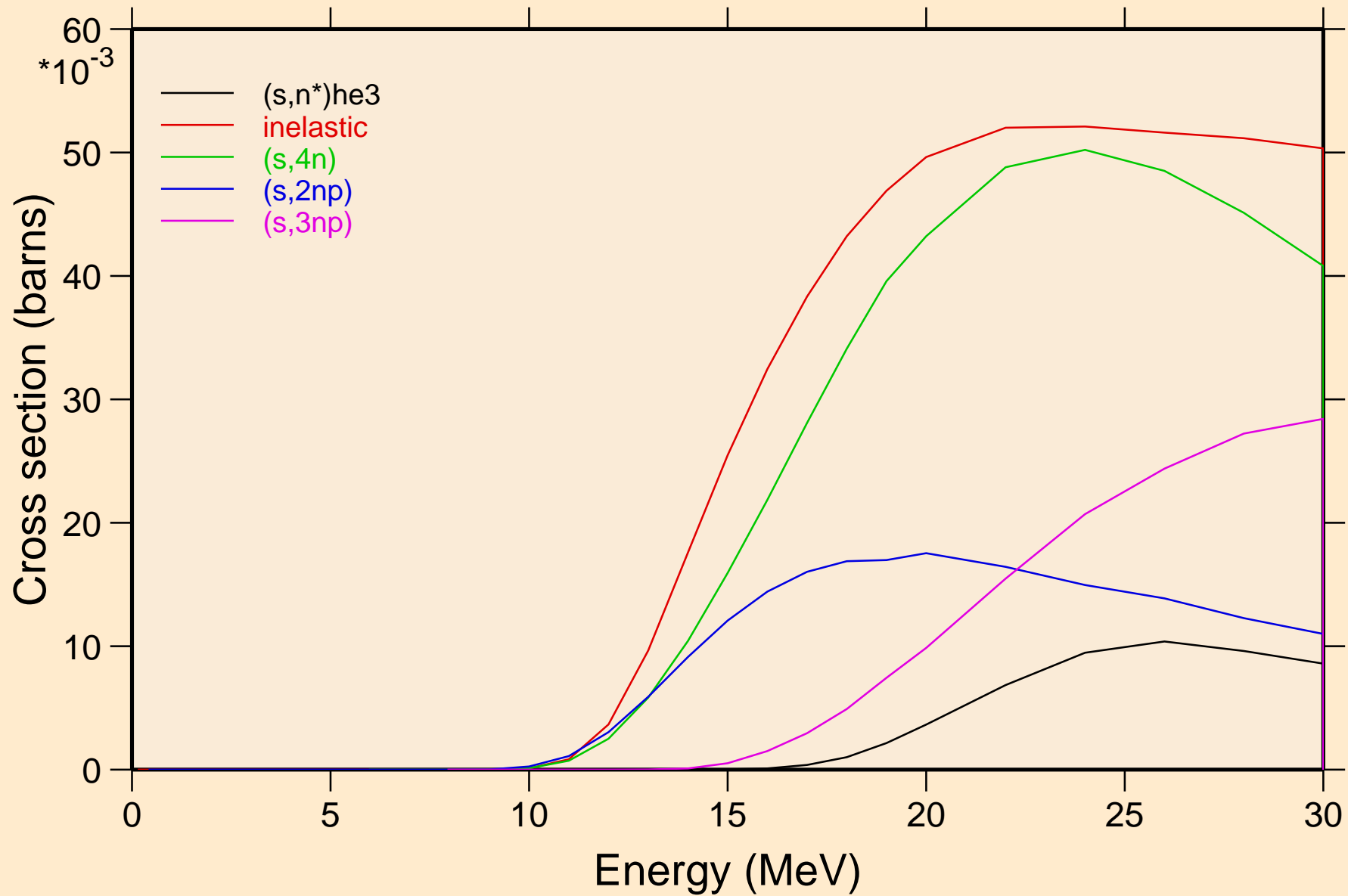

RB092 HELION ACER TENDL-2021 LIBRARY; T=0.K  
Threshold reactions

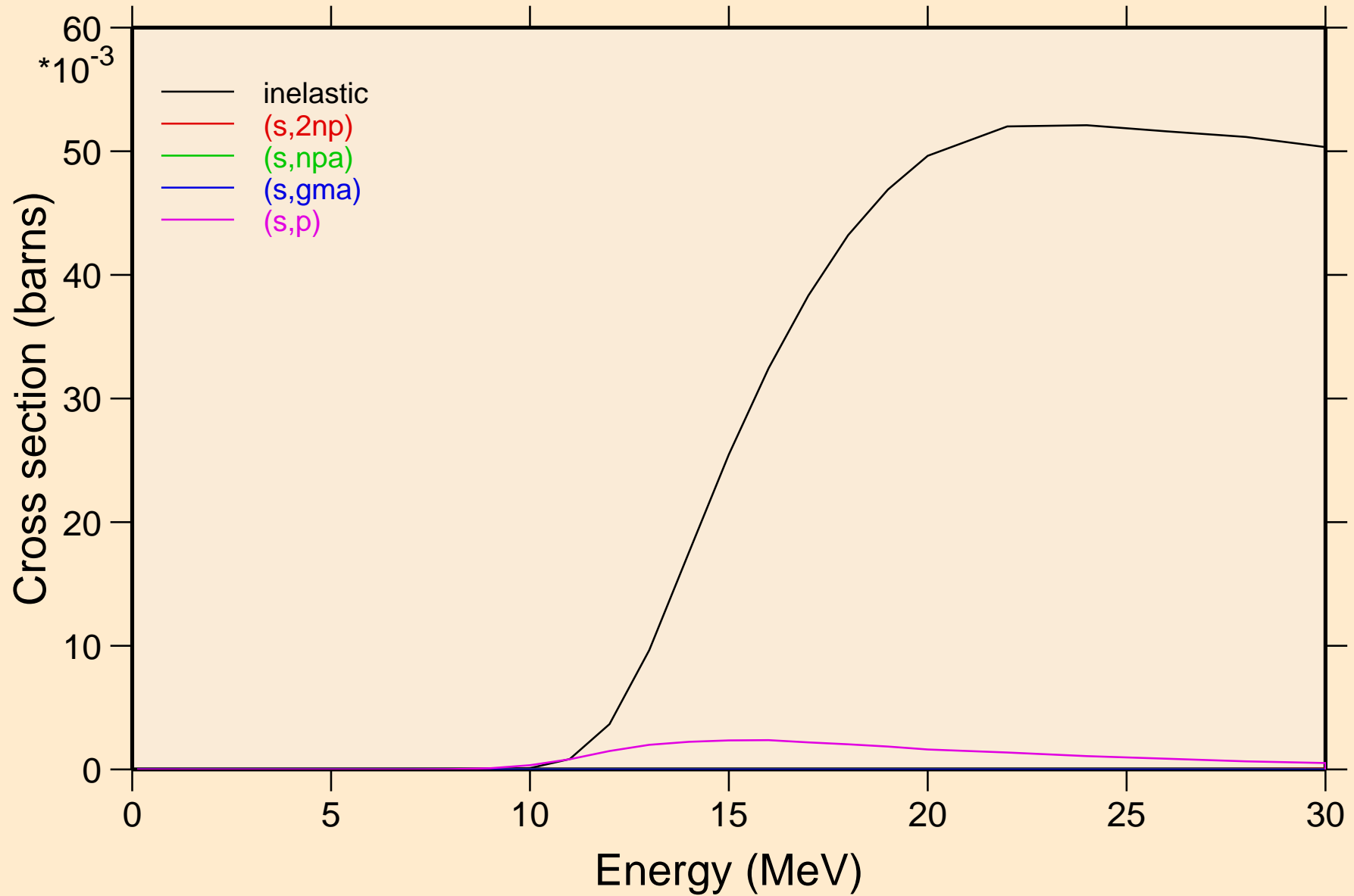

RB092 HELION ACER TENDL-2021 LIBRARY; T=0.K  
Threshold reactions

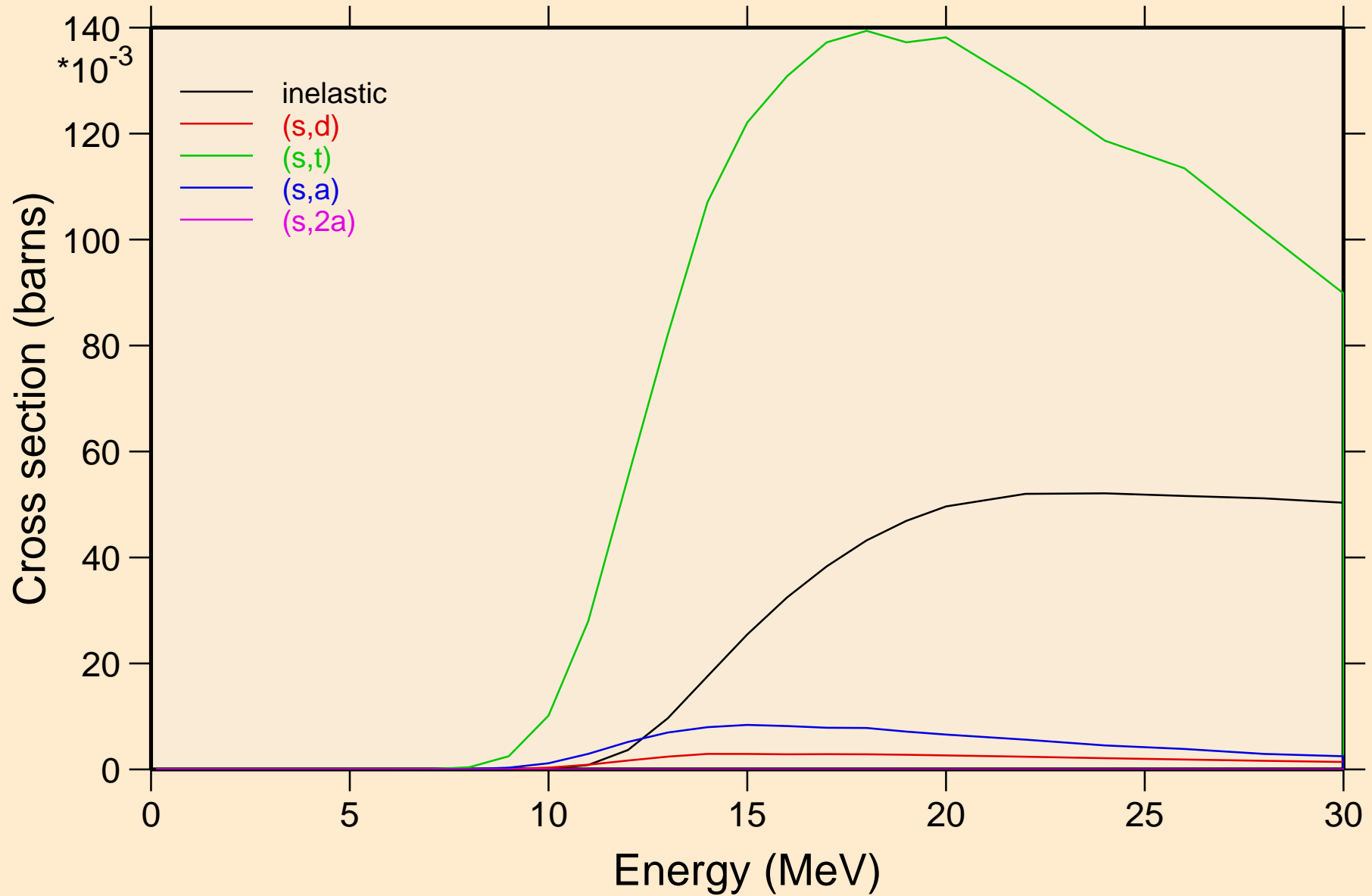

RB092 HELION ACER TENDL-2021 LIBRARY; T=0.K  
Threshold reactions

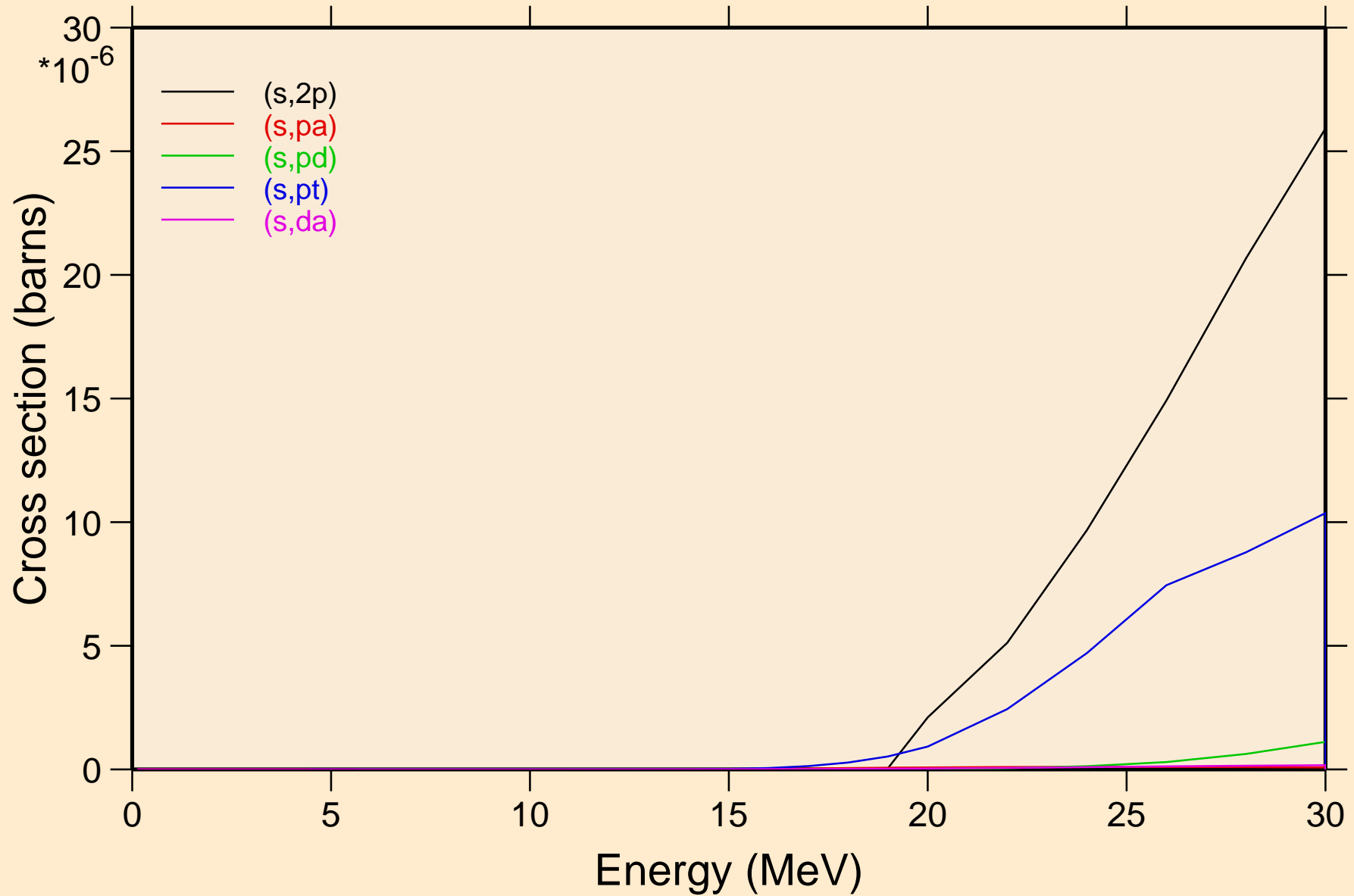

RB092 HELION ACER TENDL-2021 LIBRARY; T=0.K  
angular distribution for elastic

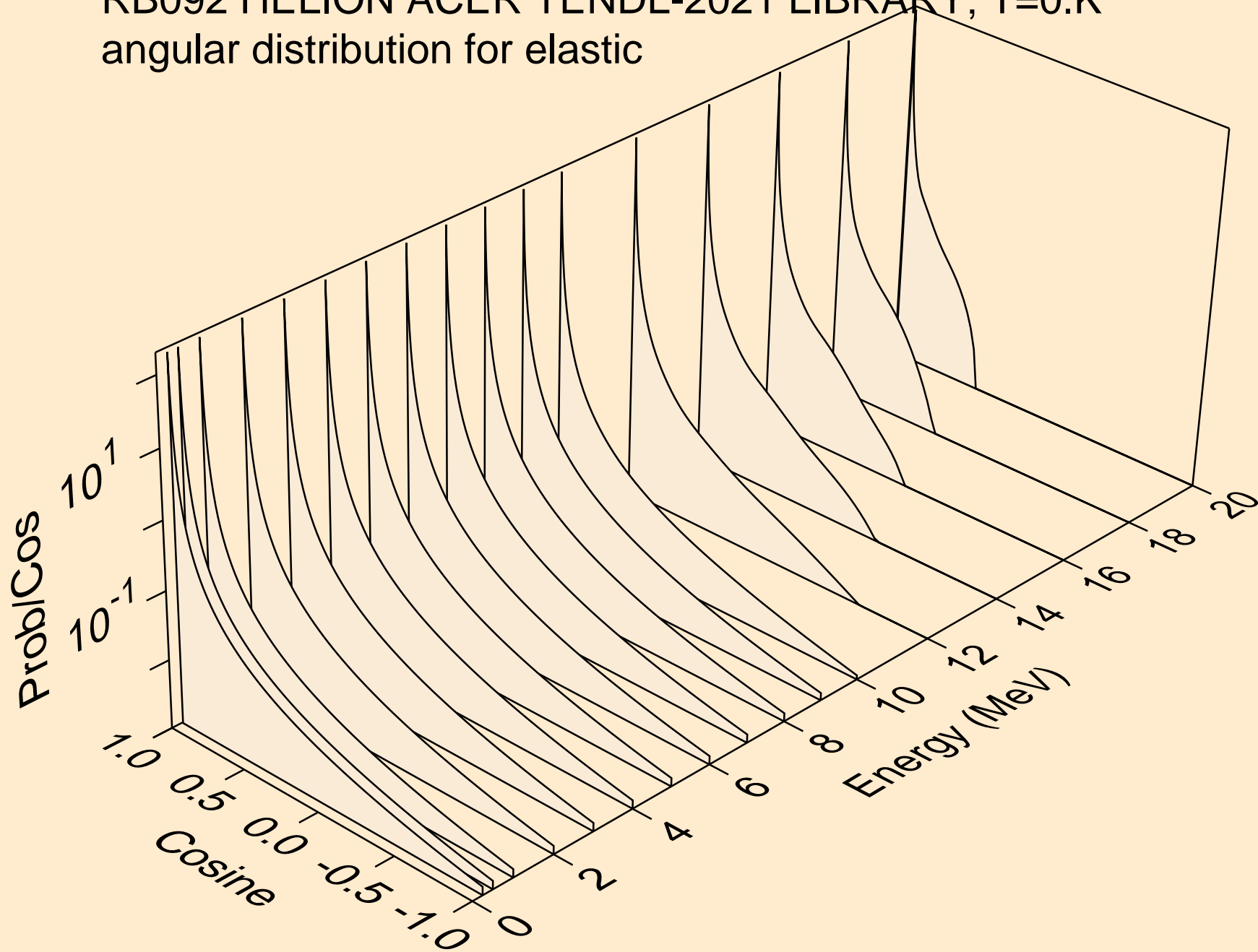

RB092 HELION ACER TENDL-2021 LIBRARY; T=0.K  
angular distribution for elastic

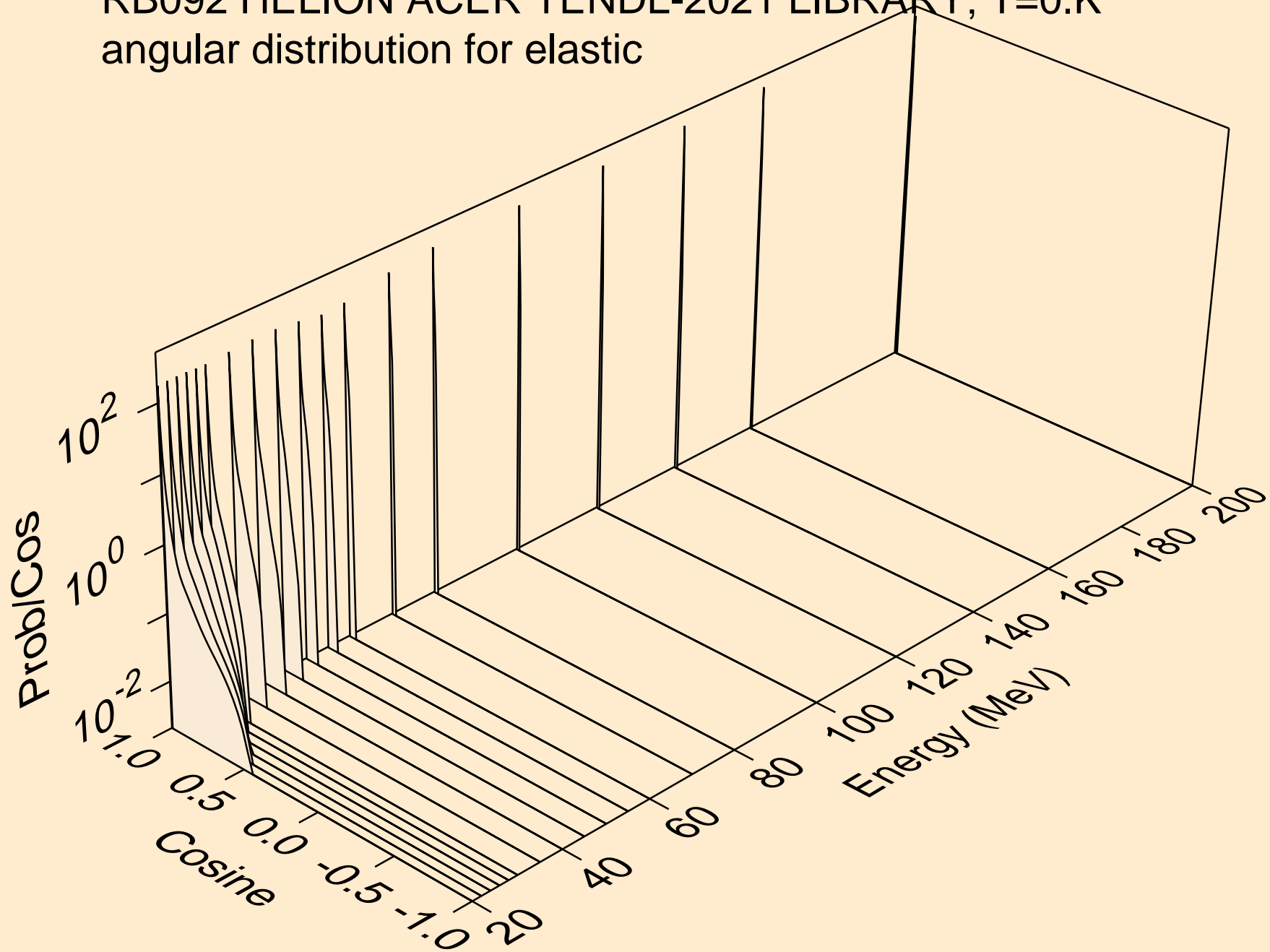

RB092 HELION ACER TENDL-2021 LIBRARY; T=0.K  
He-3 emission for (s,x)

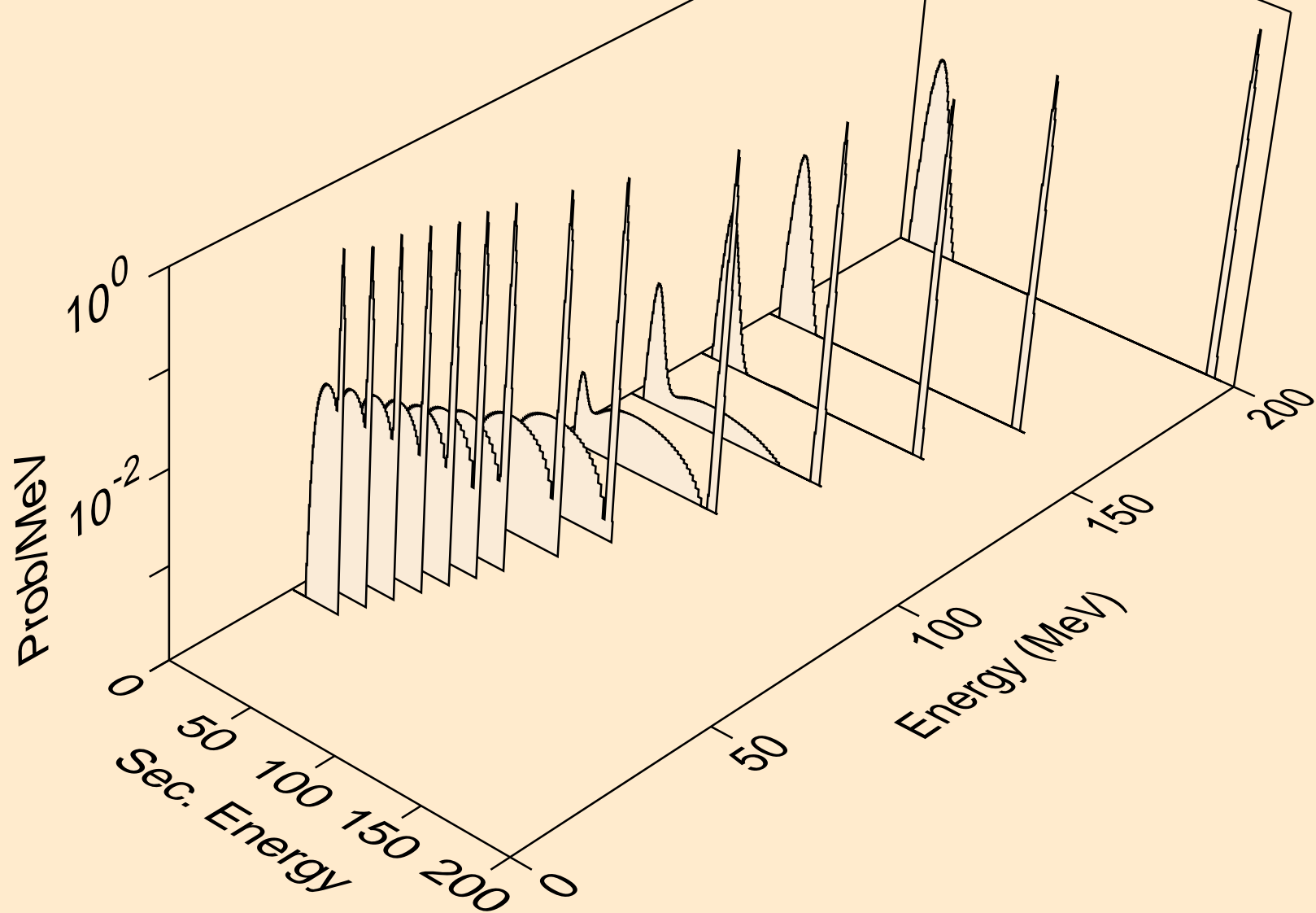

RB092 HELION ACER TENDL-2021 LIBRARY; T=0.K  
He-3 emission for (s,n\*)he3

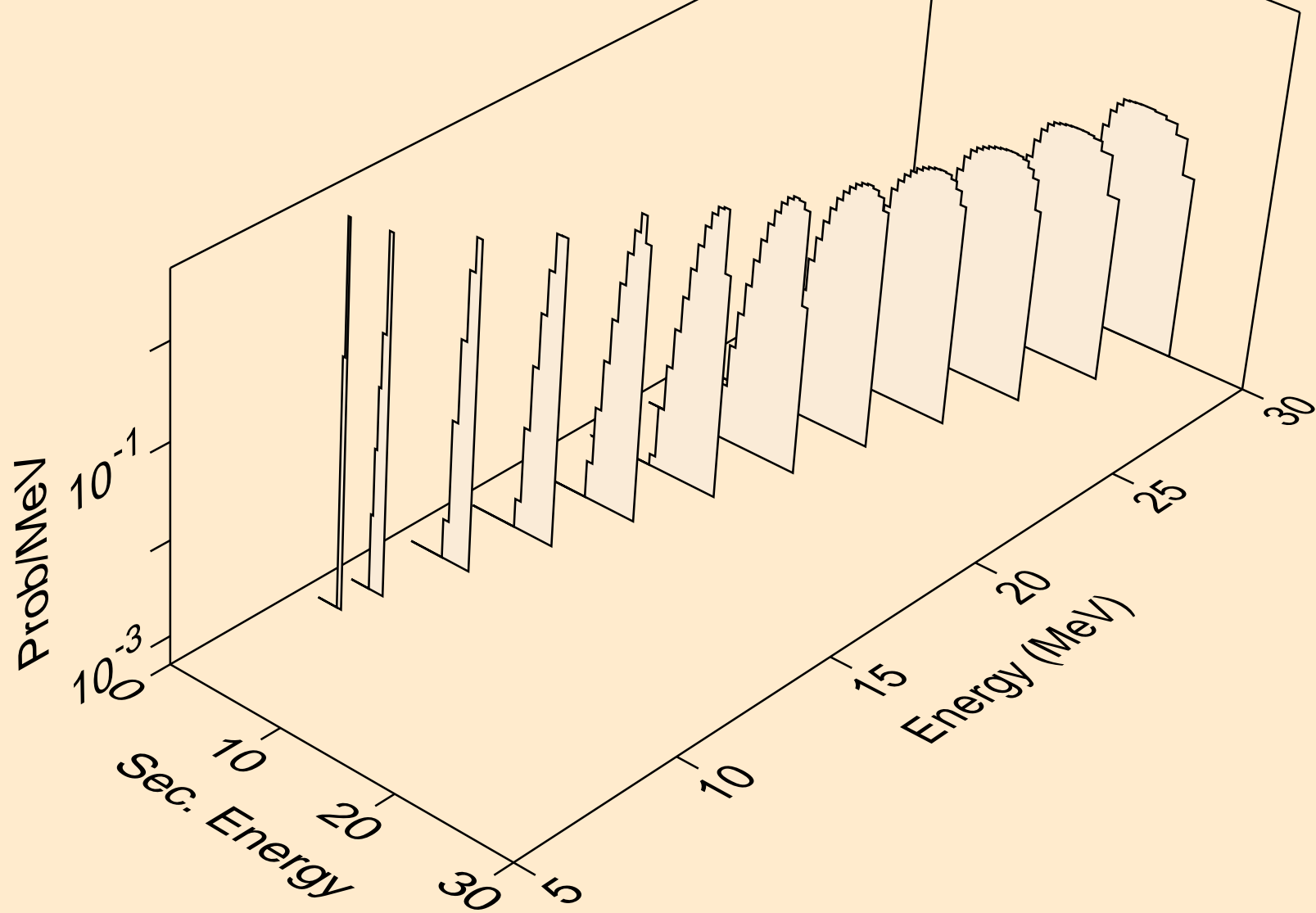



RB092 HELION ACER TENDL-2021 LIBRARY; T=0.K  
He-3 emission for inelastic

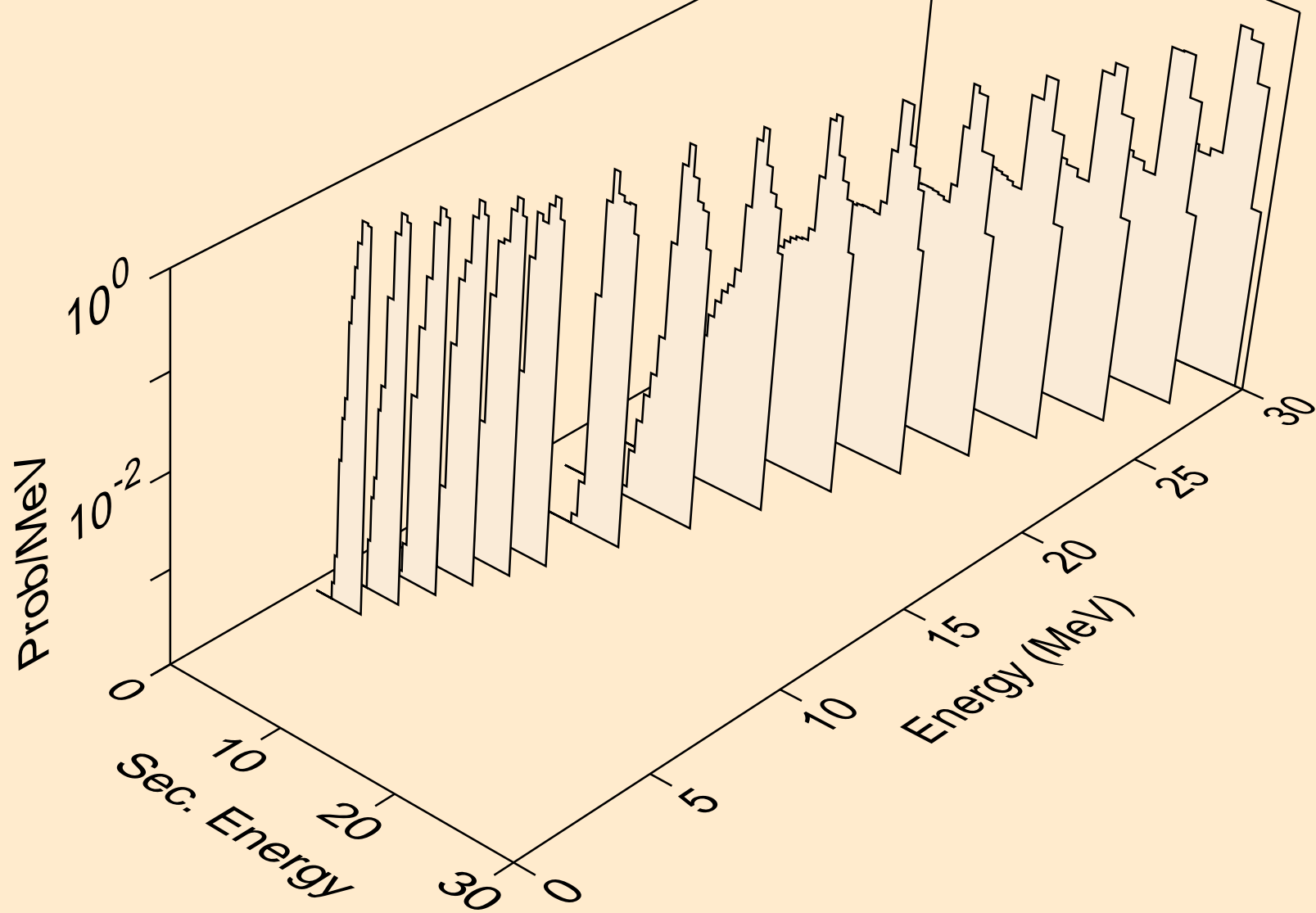

RB092 HELION ACER TENDL-2021 LIBRARY; T=0.K  
Photon emission for (z,n)

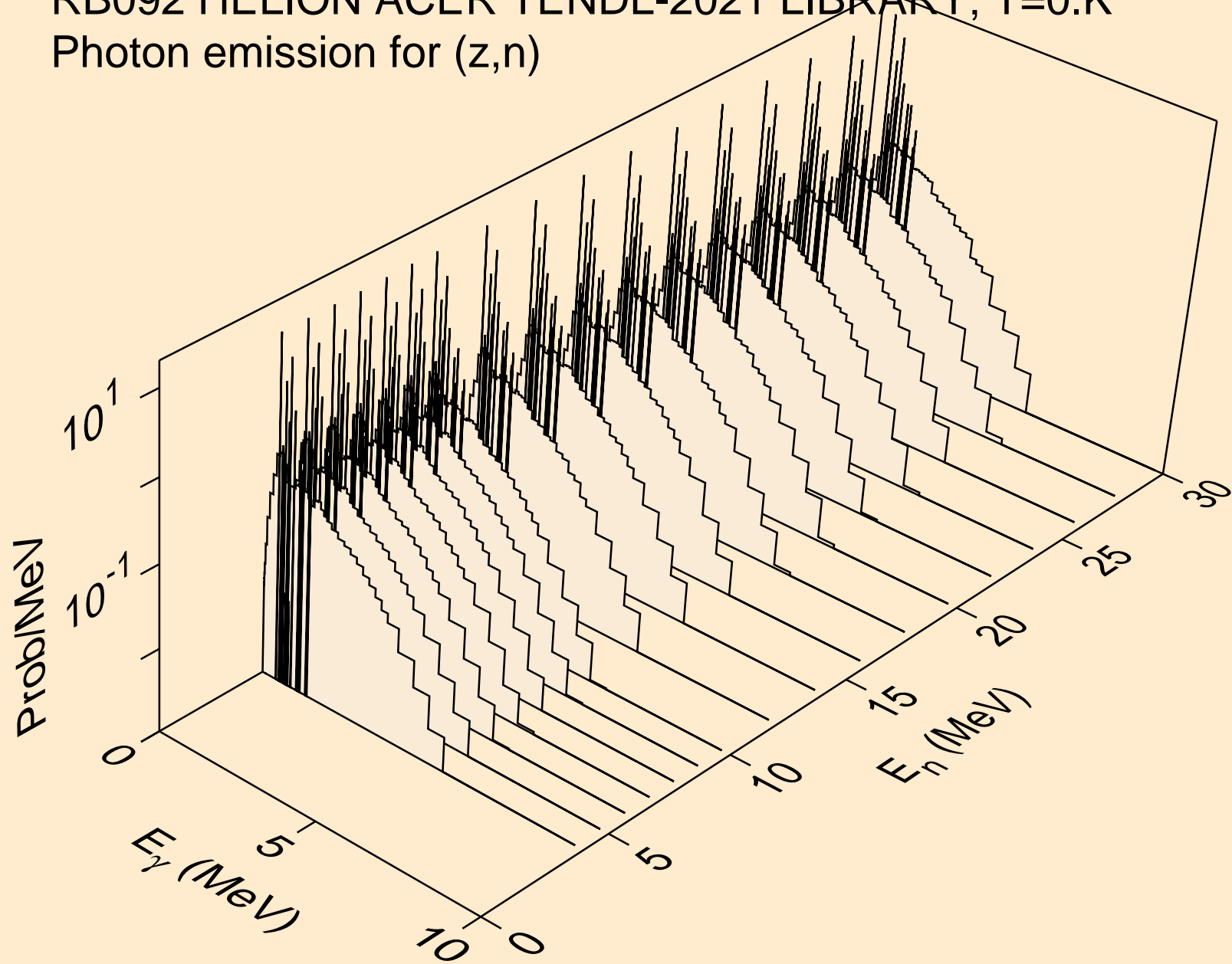

RB092 HELION ACER TENDL-2021 LIBRARY; T=0.K  
Photon emission for (n,x)

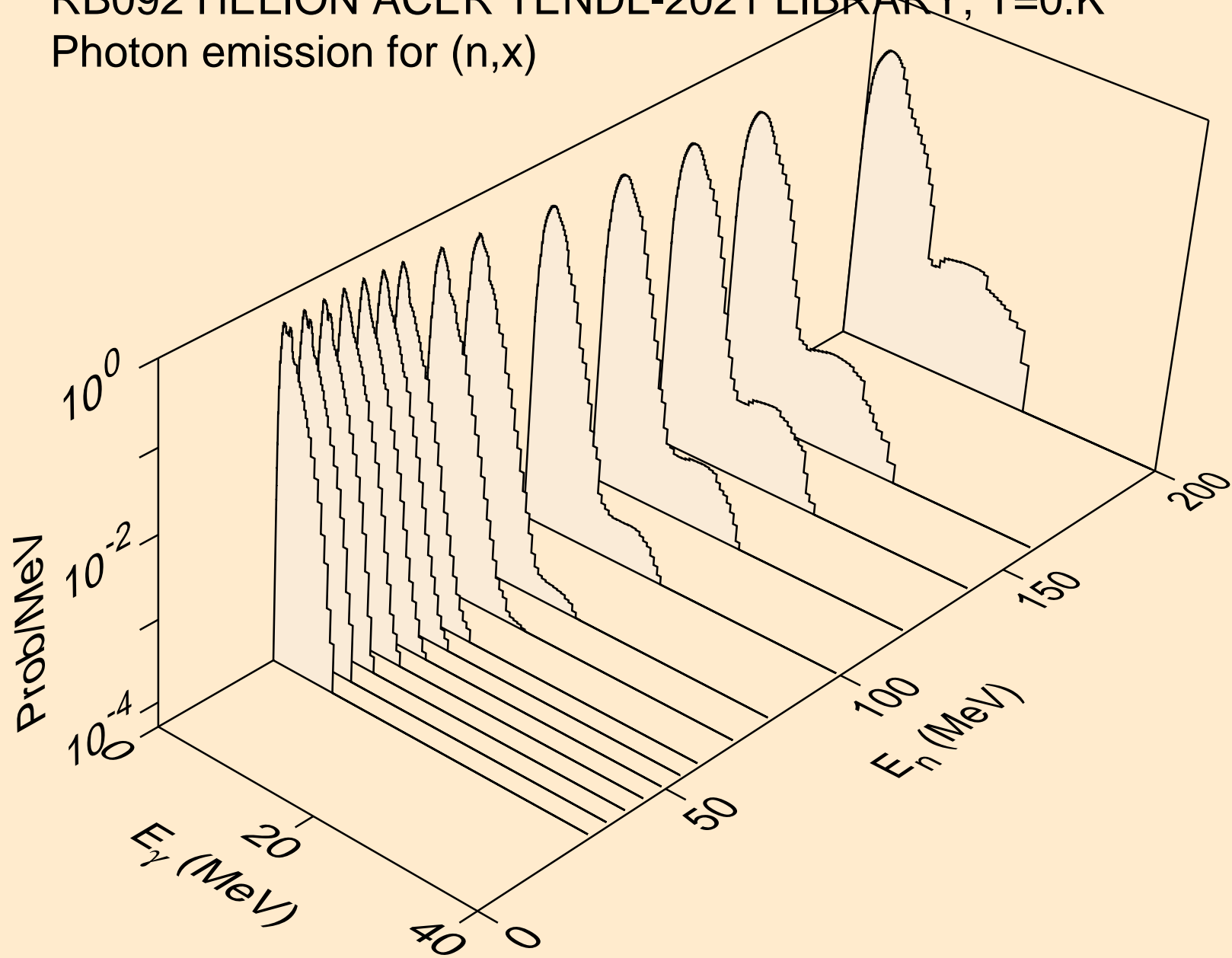

RB092 HELION ACER TENDL-2021 LIBRARY; T=0.K  
Photon emission for (n,2nd)

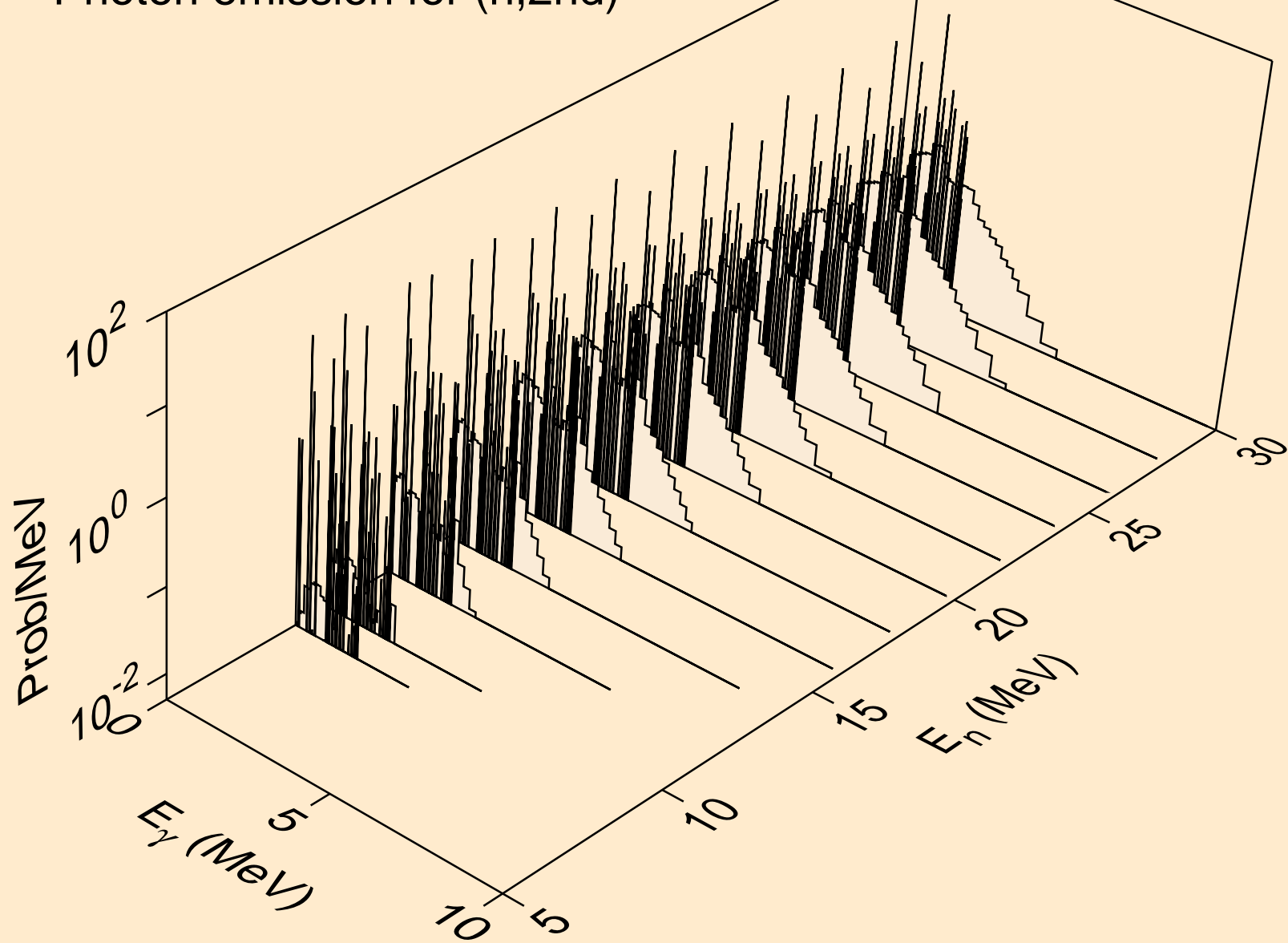

RB092 HELION ACER TENDL-2021 LIBRARY; T=0.K  
Photon emission for (n,2n)

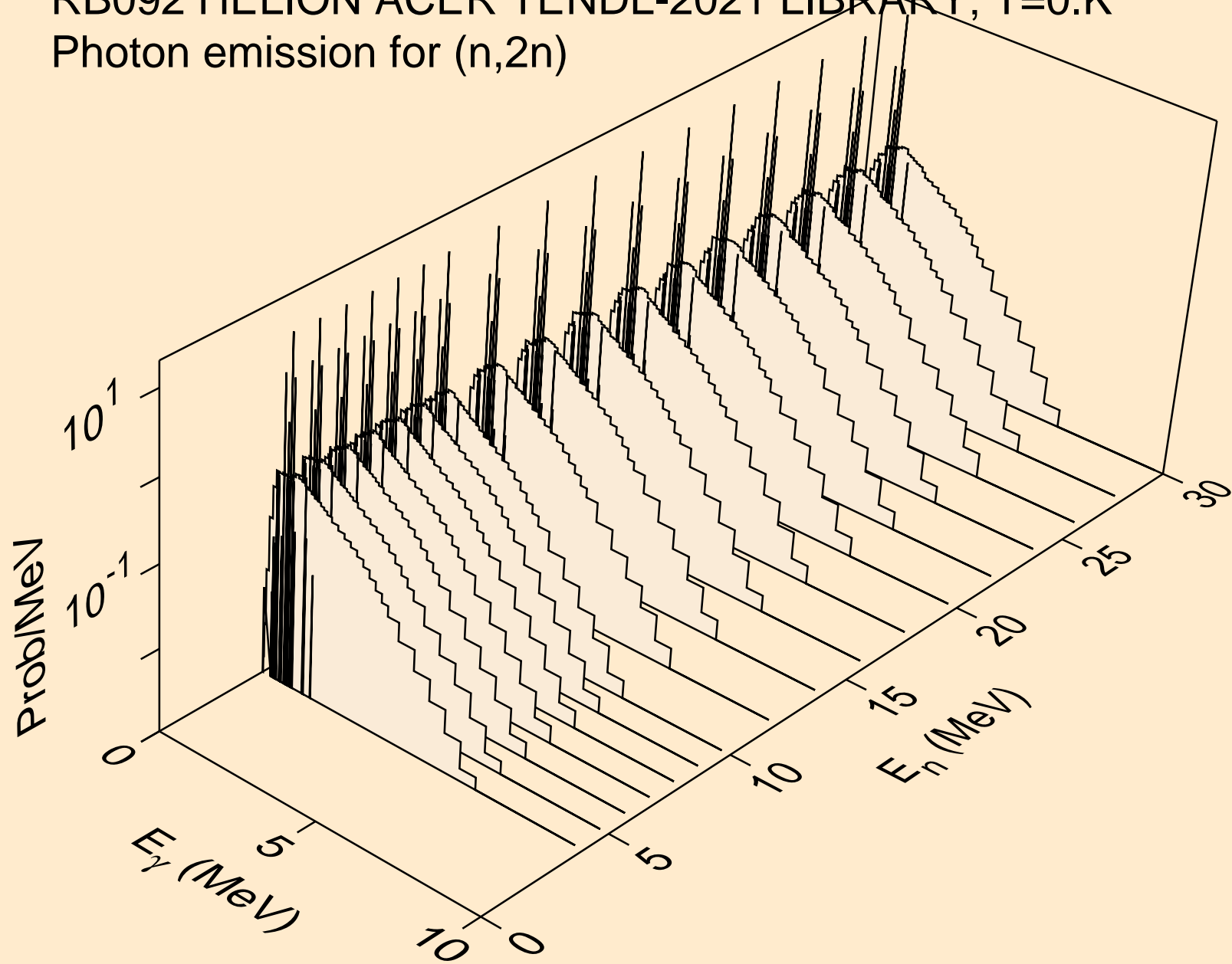

RB092 HELION ACER TENDL-2021 LIBRARY; T=0.K  
Photon emission for (n,3n)

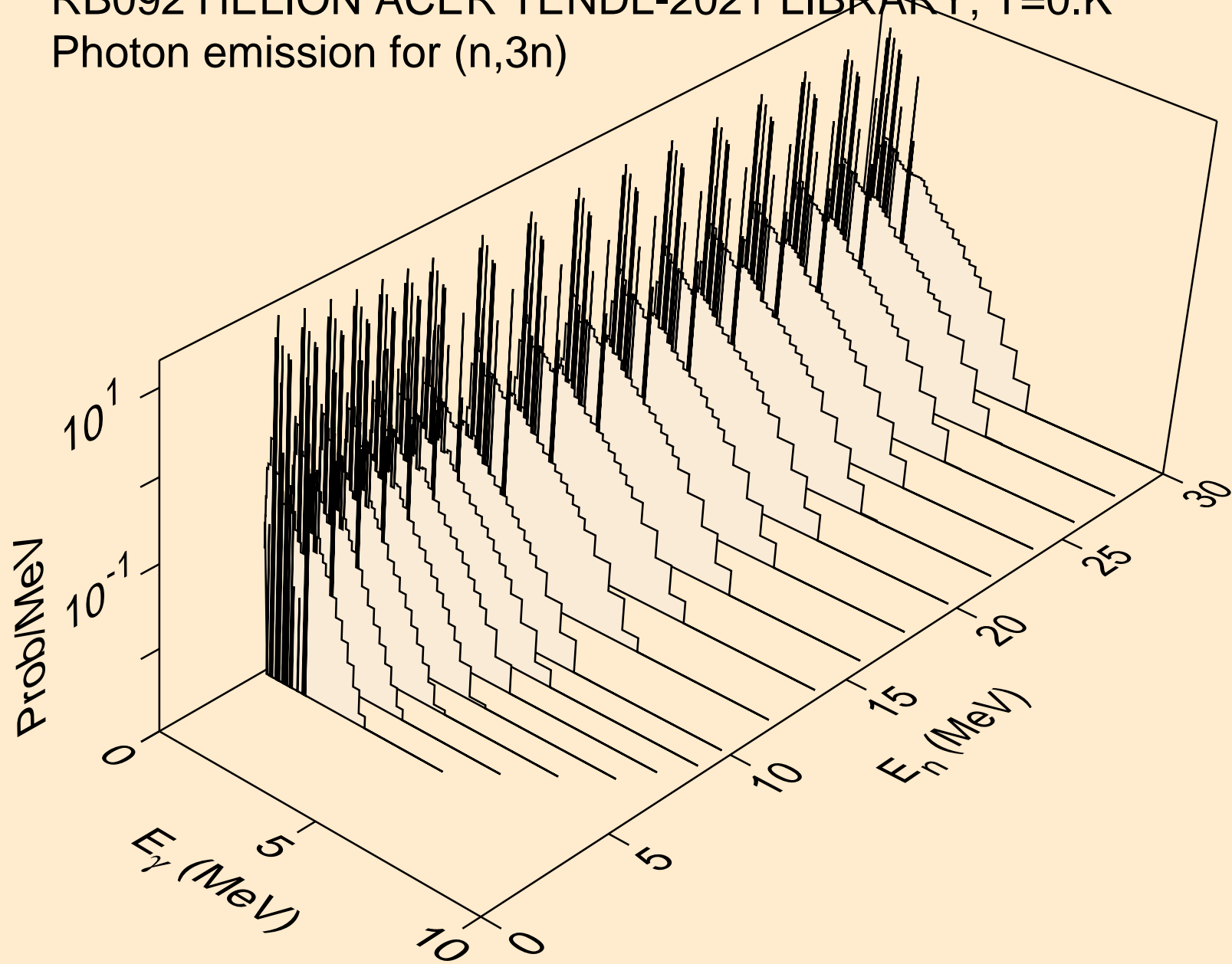

RB092 HELION ACER TENDL-2021 LIBRARY; T=0.K  
Photon emission for (n,n\*)a

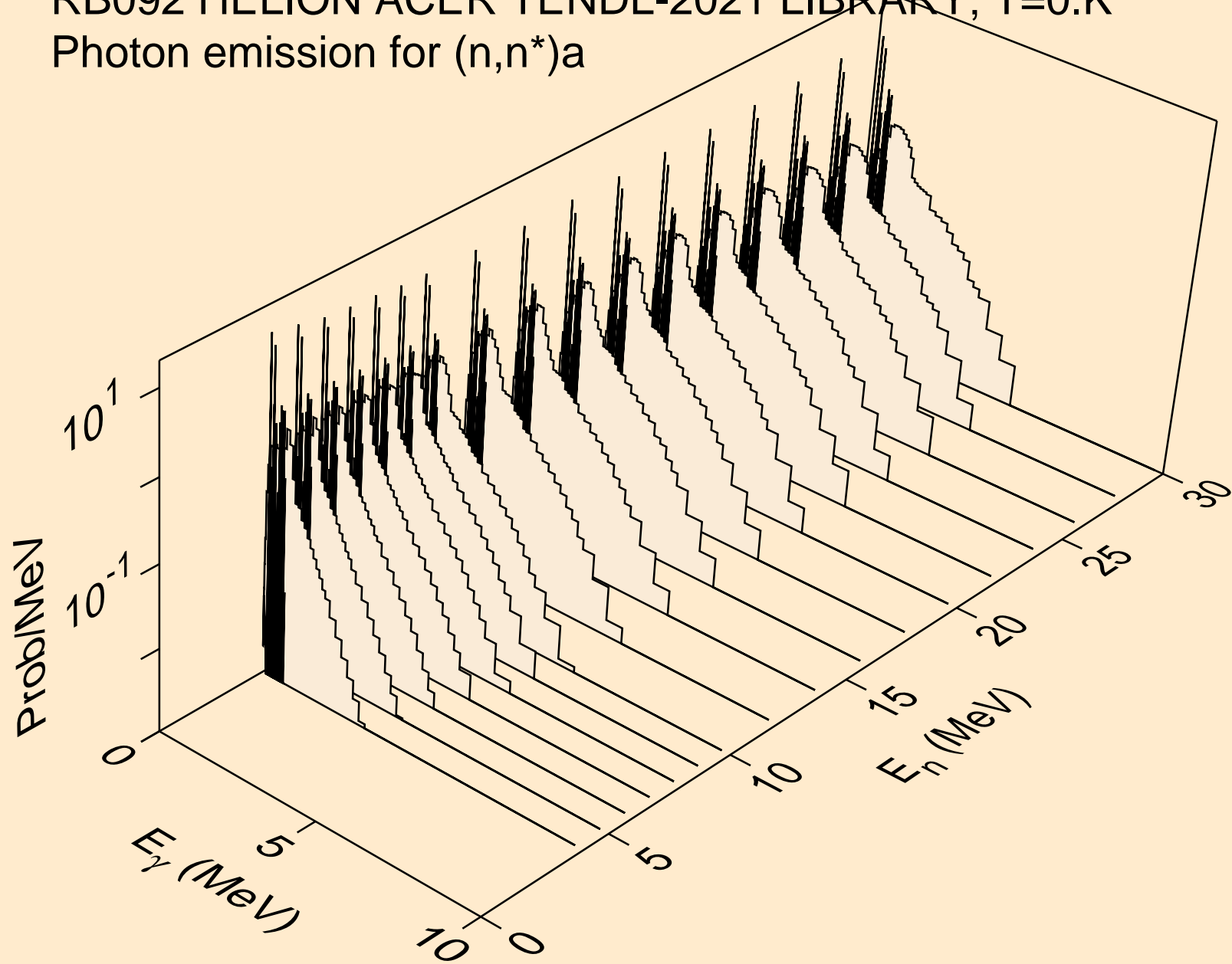

RB092 HELION ACER TENDL-2021 LIBRARY; T=0.K  
Photon emission for (n,2n)a

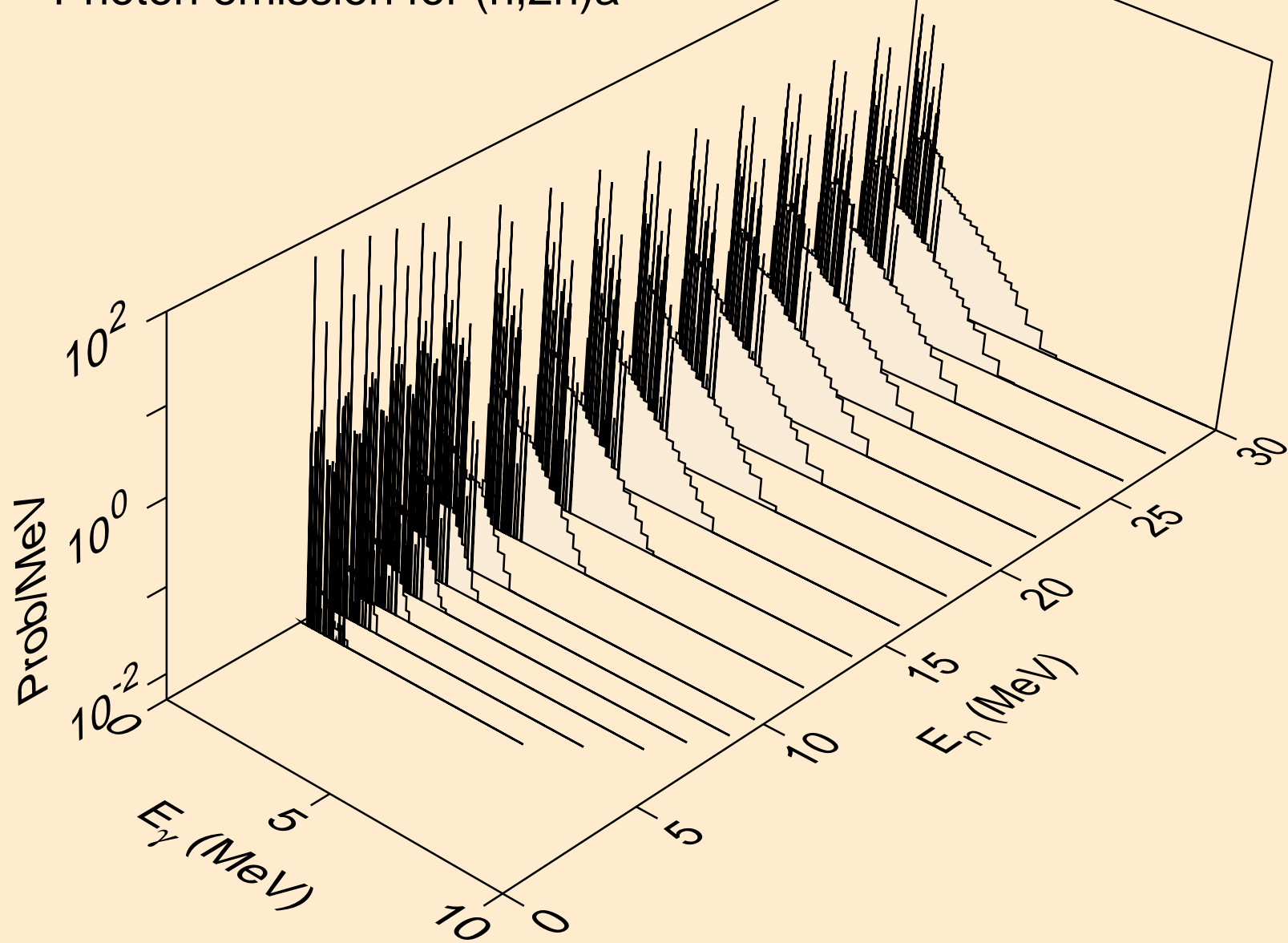



RB092 HELION ACER TENDL-2021 LIBRARY; T=0.K  
Photon emission for (n,3n)a

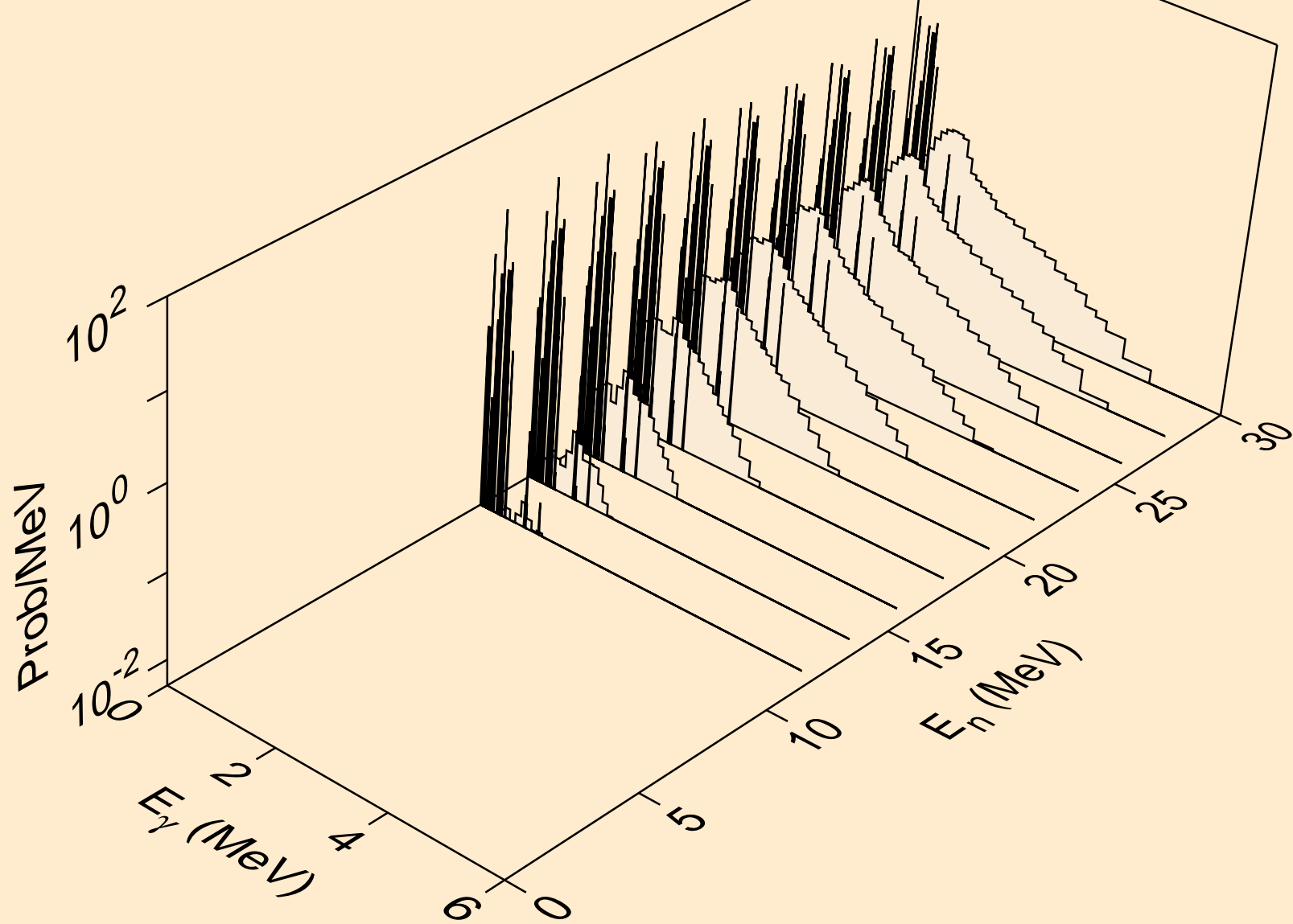

RB092 HELION ACER TENDL-2021 LIBRARY; T=0.K  
Photon emission for (n,n\*)p

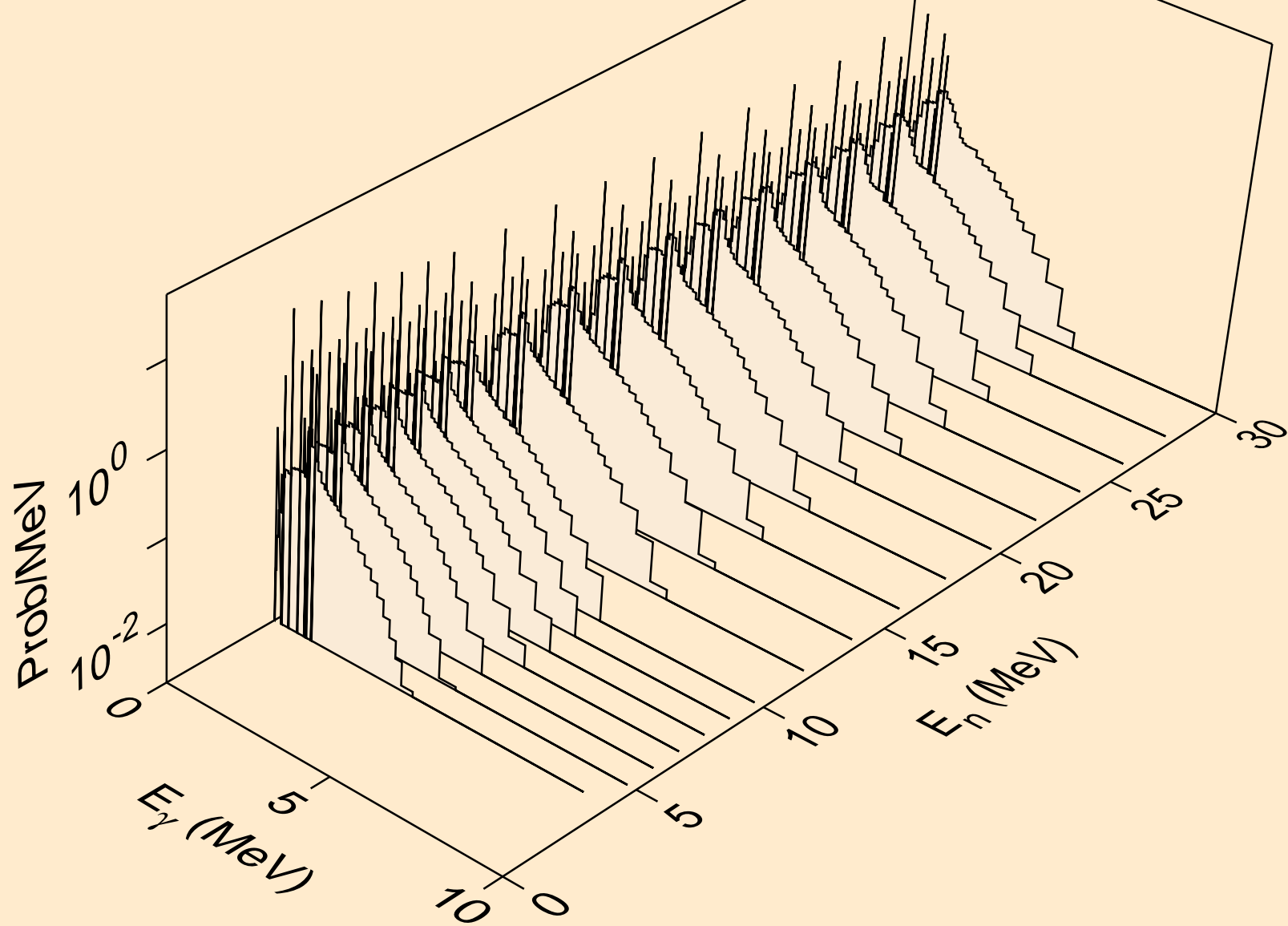

RB092 HELION ACER TENDL-2021 LIBRARY; T=0.K  
Photon emission for (n,n\*)2a

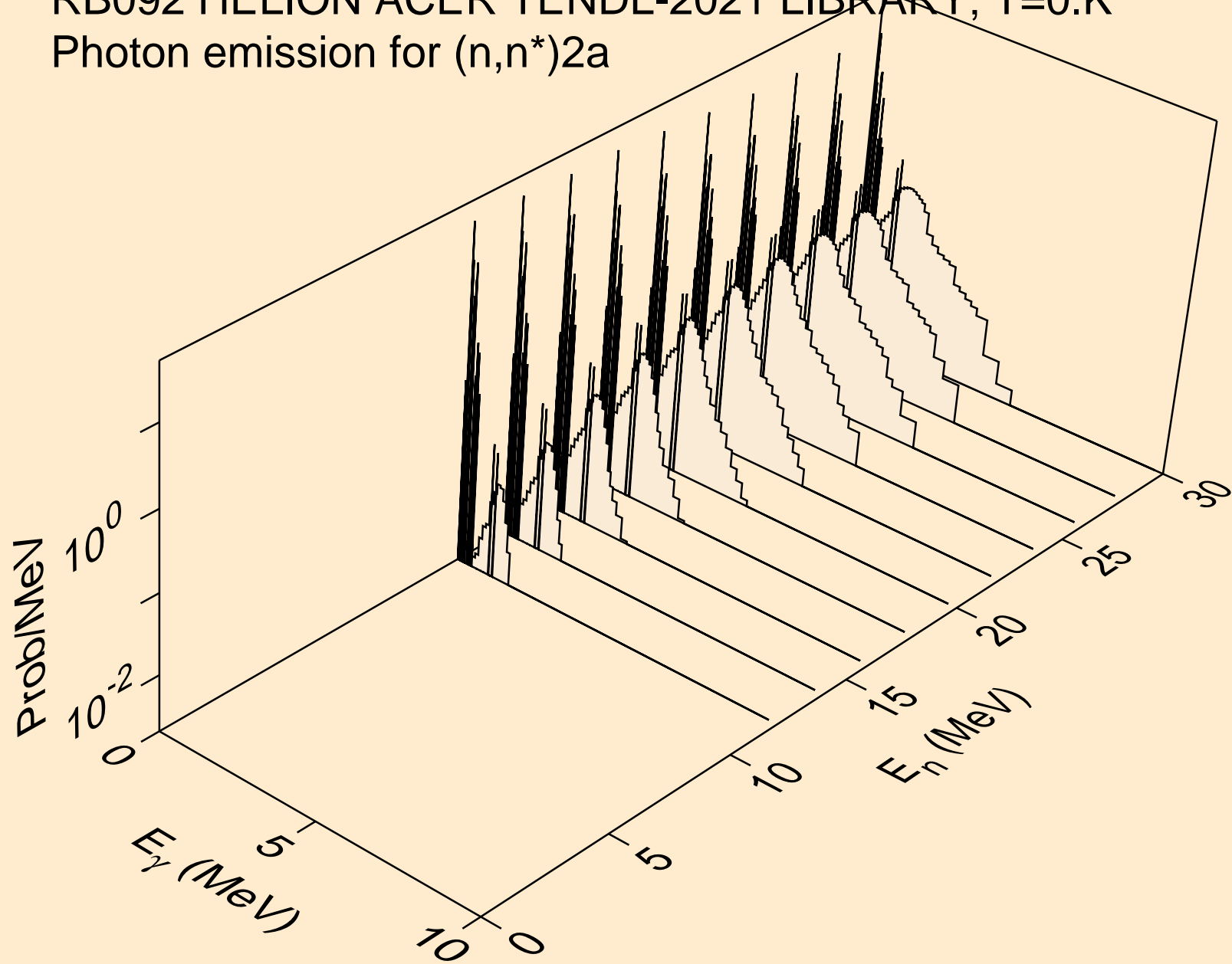

RB092 HELION ACER TENDL-2021 LIBRARY; T=0.K  
Photon emission for (n,2n)2a

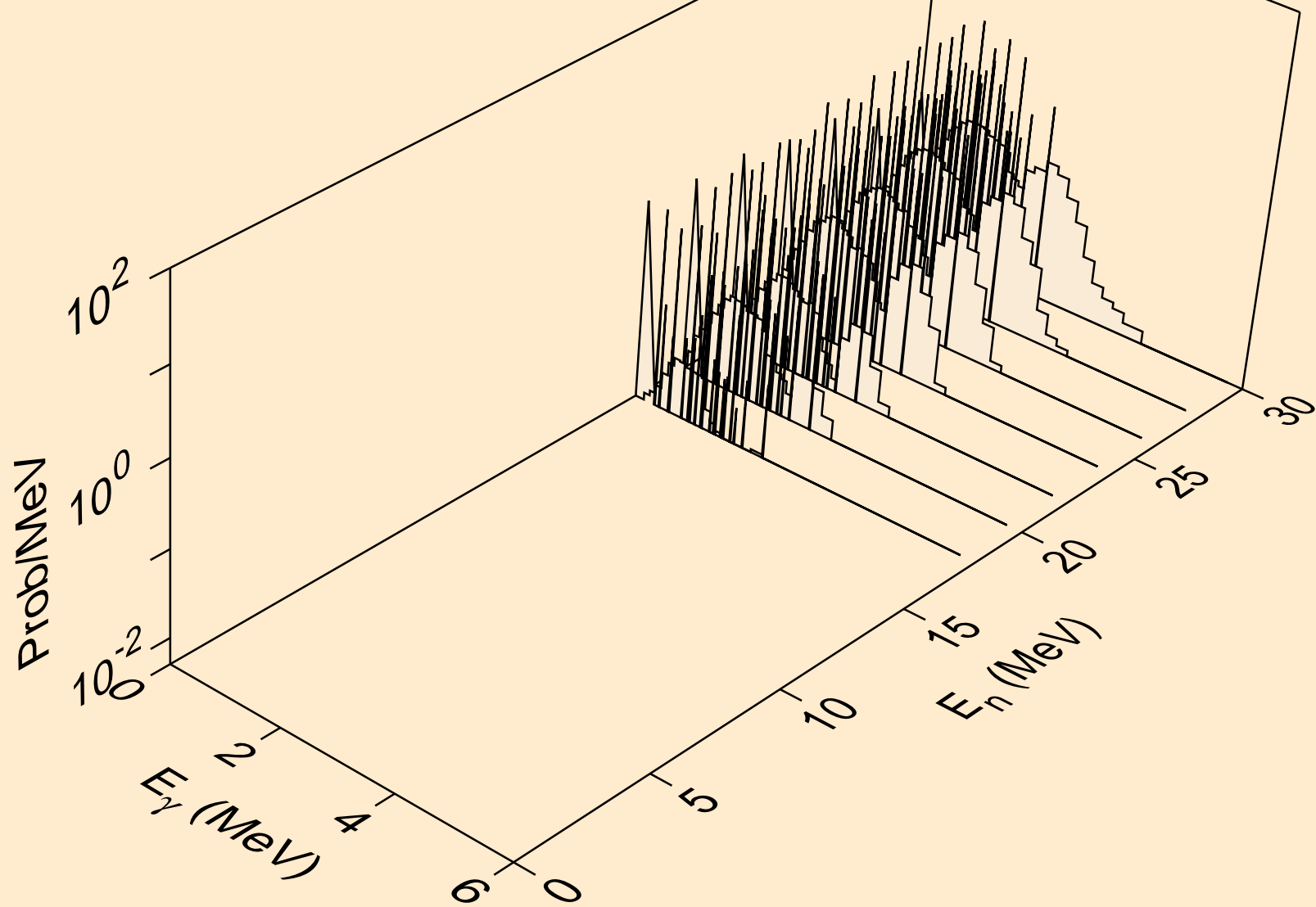

RB092 HELION ACER TENDL-2021 LIBRARY; T=0.K  
Photon emission for (n,n\*)d

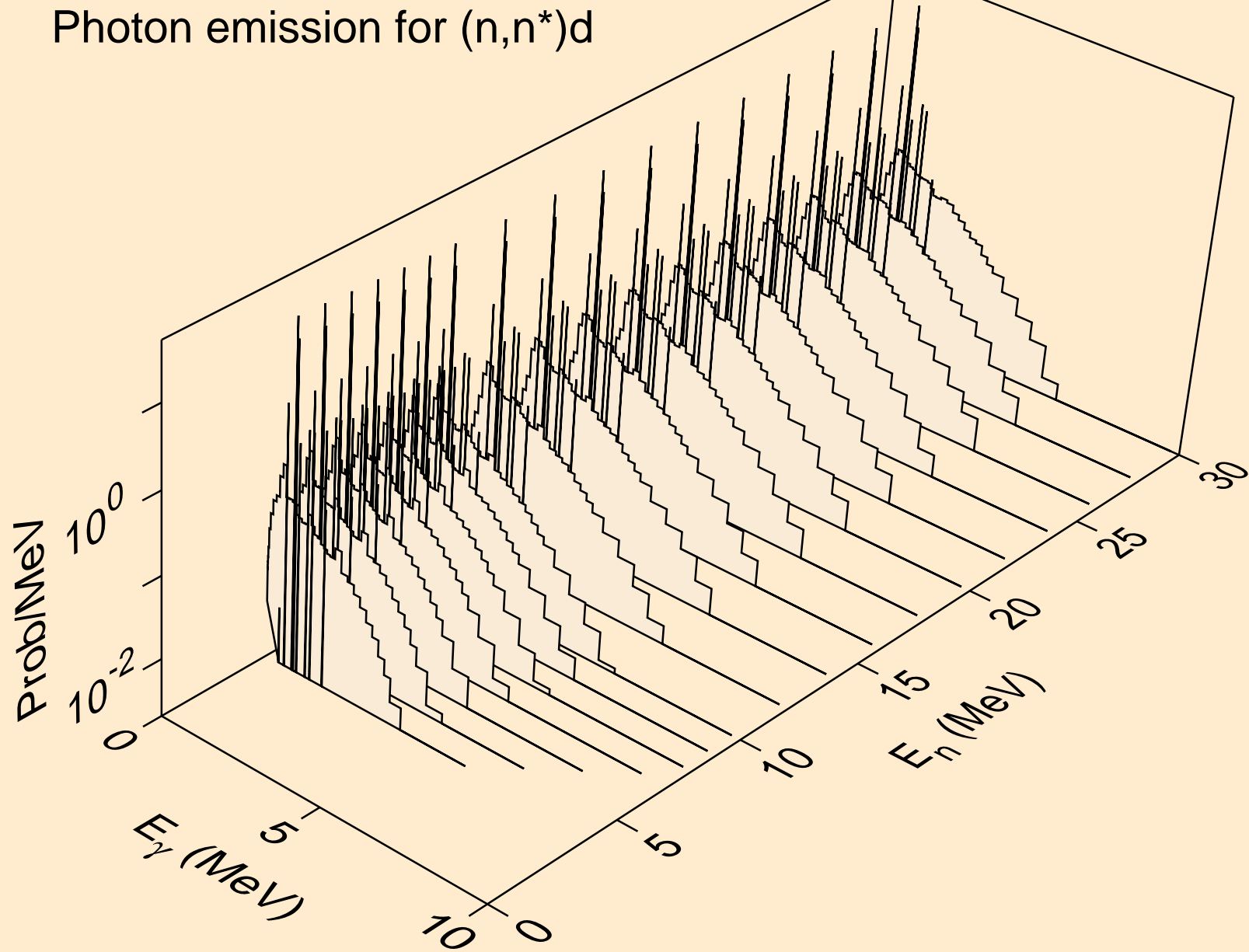

RB092 HELION ACER TENDL-2021 LIBRARY; T=0.K  
Photon emission for (n,n\*)t

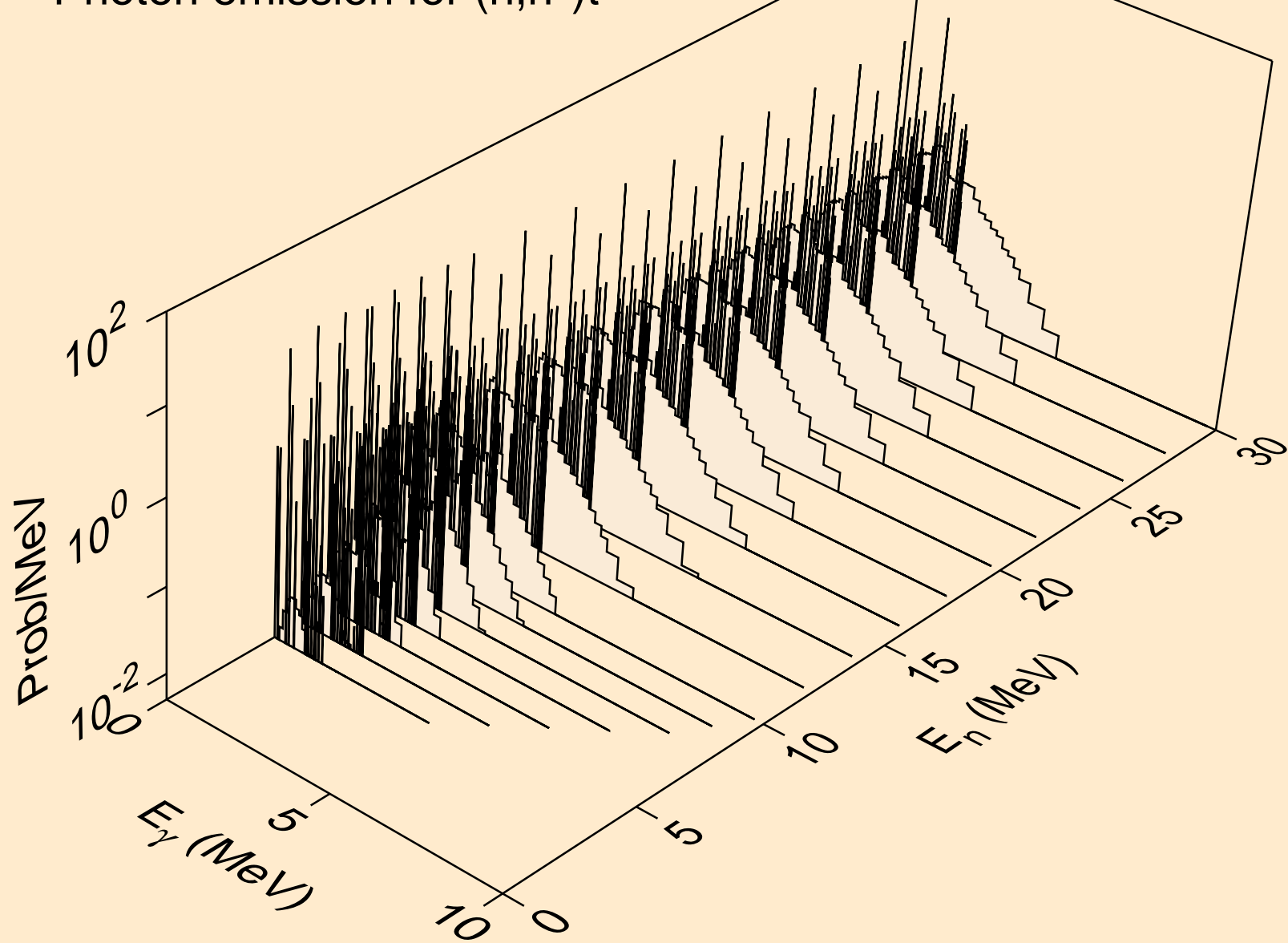

RB092 HELION ACER TENDL-2021 LIBRARY; T=0.K  
Photon emission for (n,n\*)he3

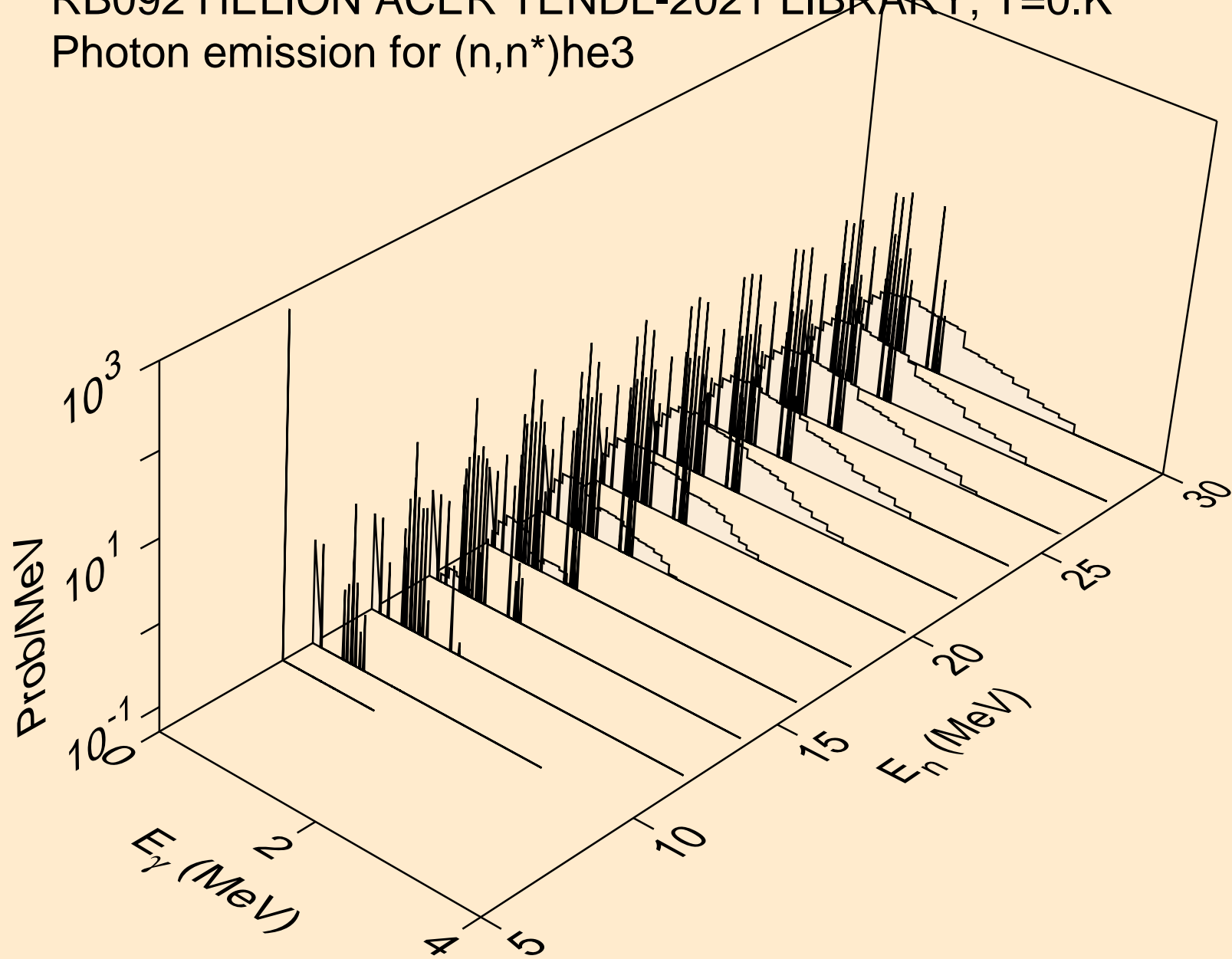

RB092 HELION ACER TENDL-2021 LIBRARY; T=0.K  
Photon emission for (n,4n)

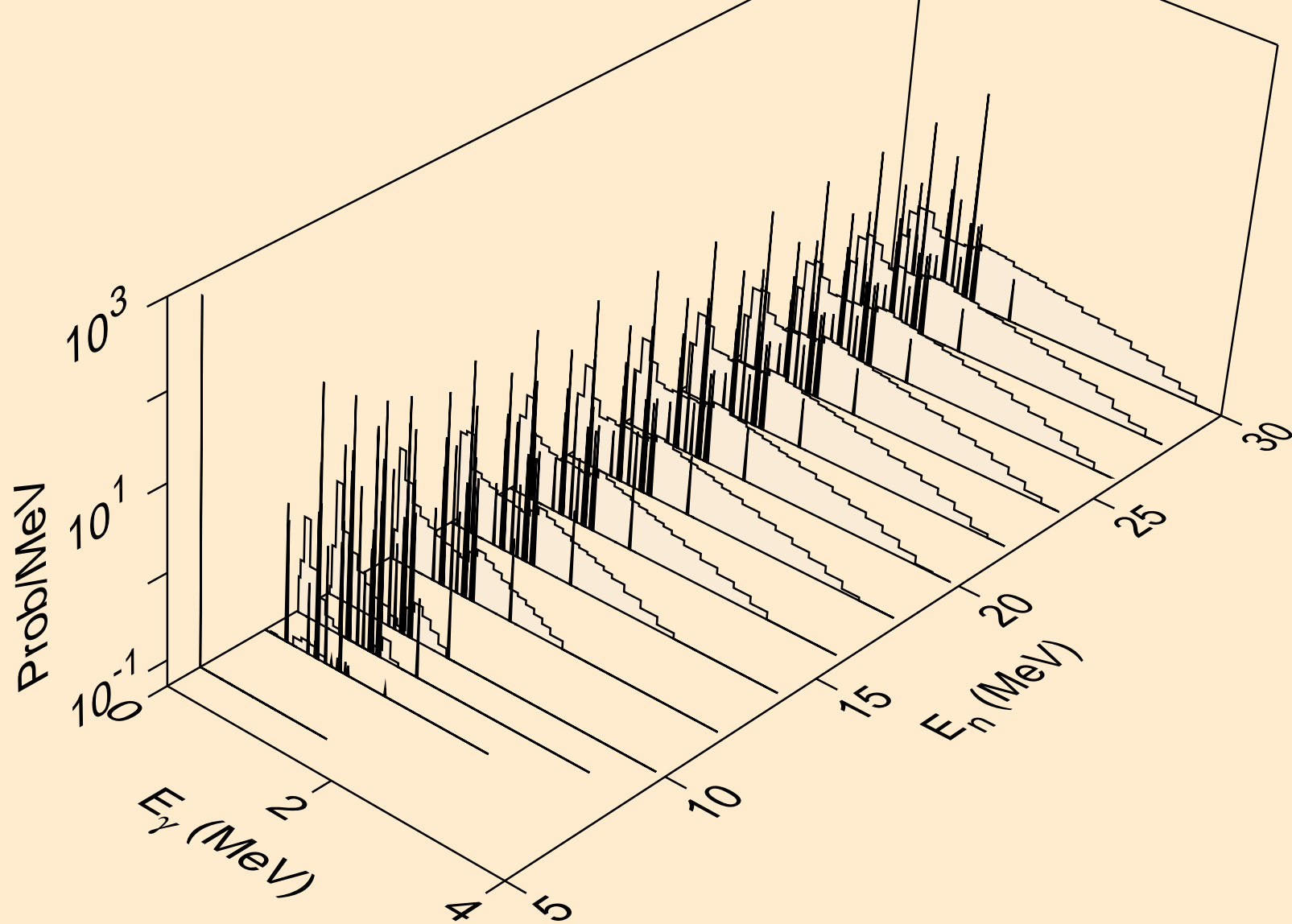



RB092 HELION ACER TENDL-2021 LIBRARY; T=0.K  
Photon emission for (n,2np)

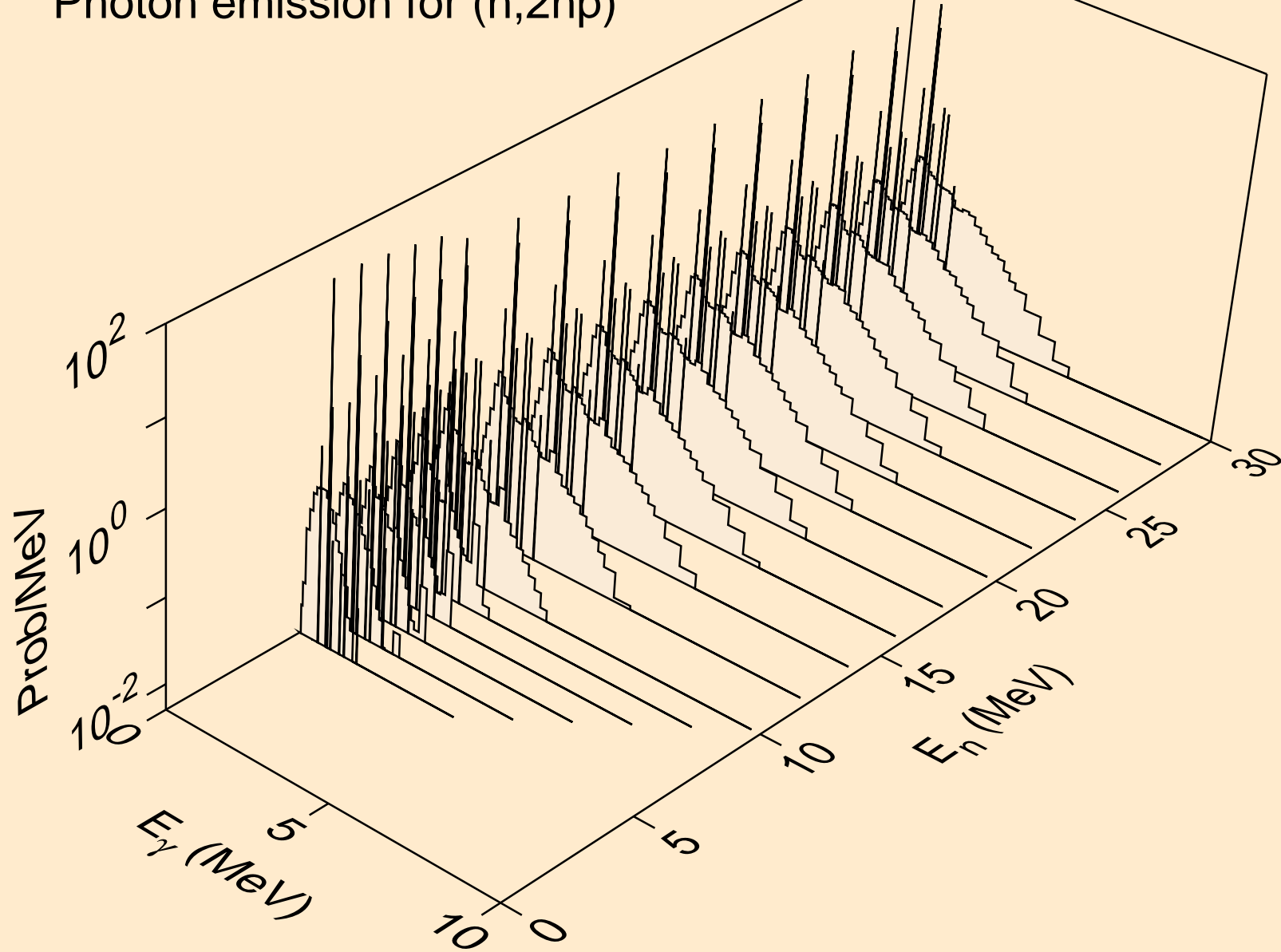

RB092 HELION ACER TENDL-2021 LIBRARY; T=0.K  
Photon emission for (n,3np)

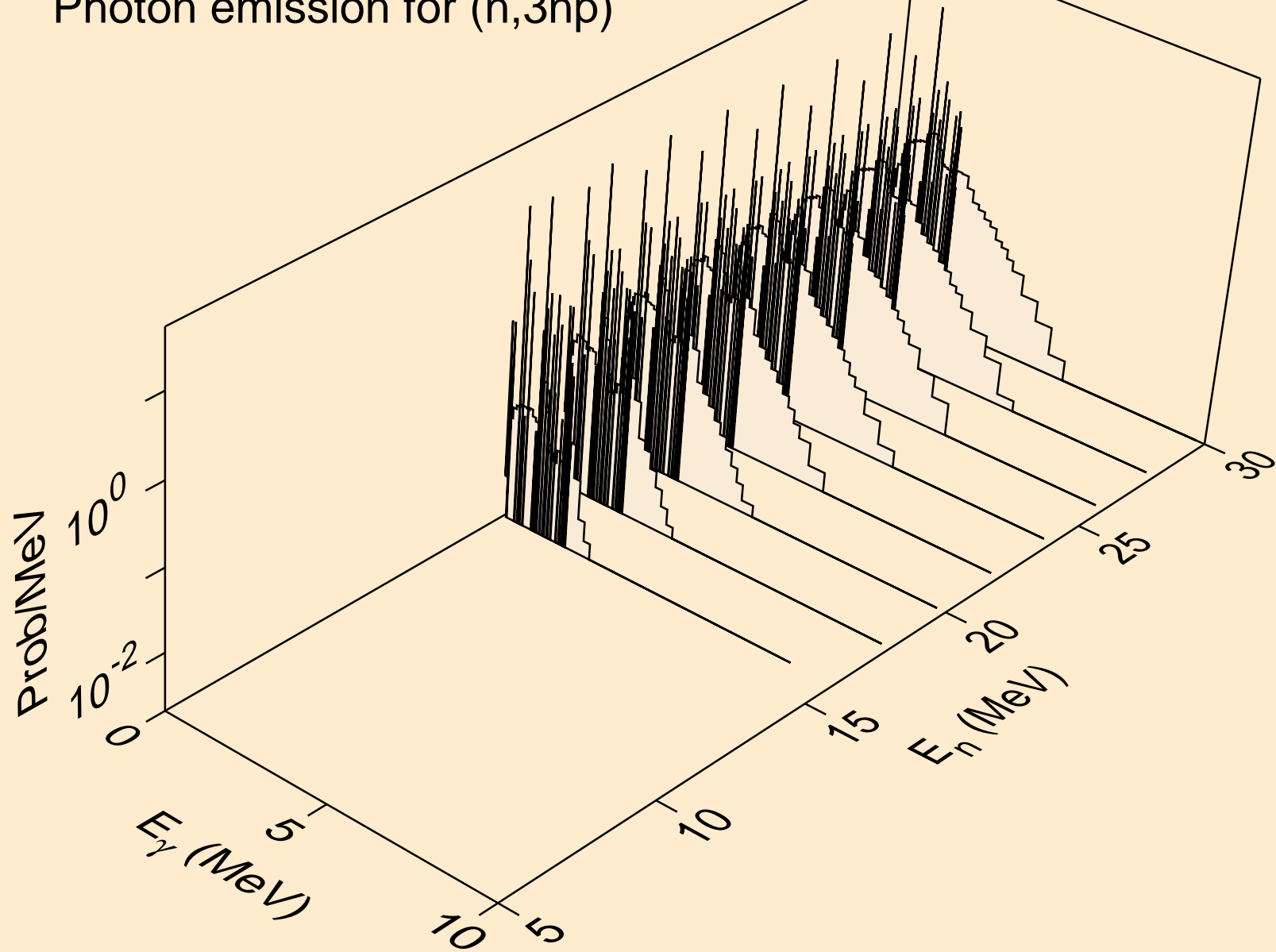

RB092 HELION ACER TENDL-2021 LIBRARY; T=0.K  
Photon emission for (n,2np)

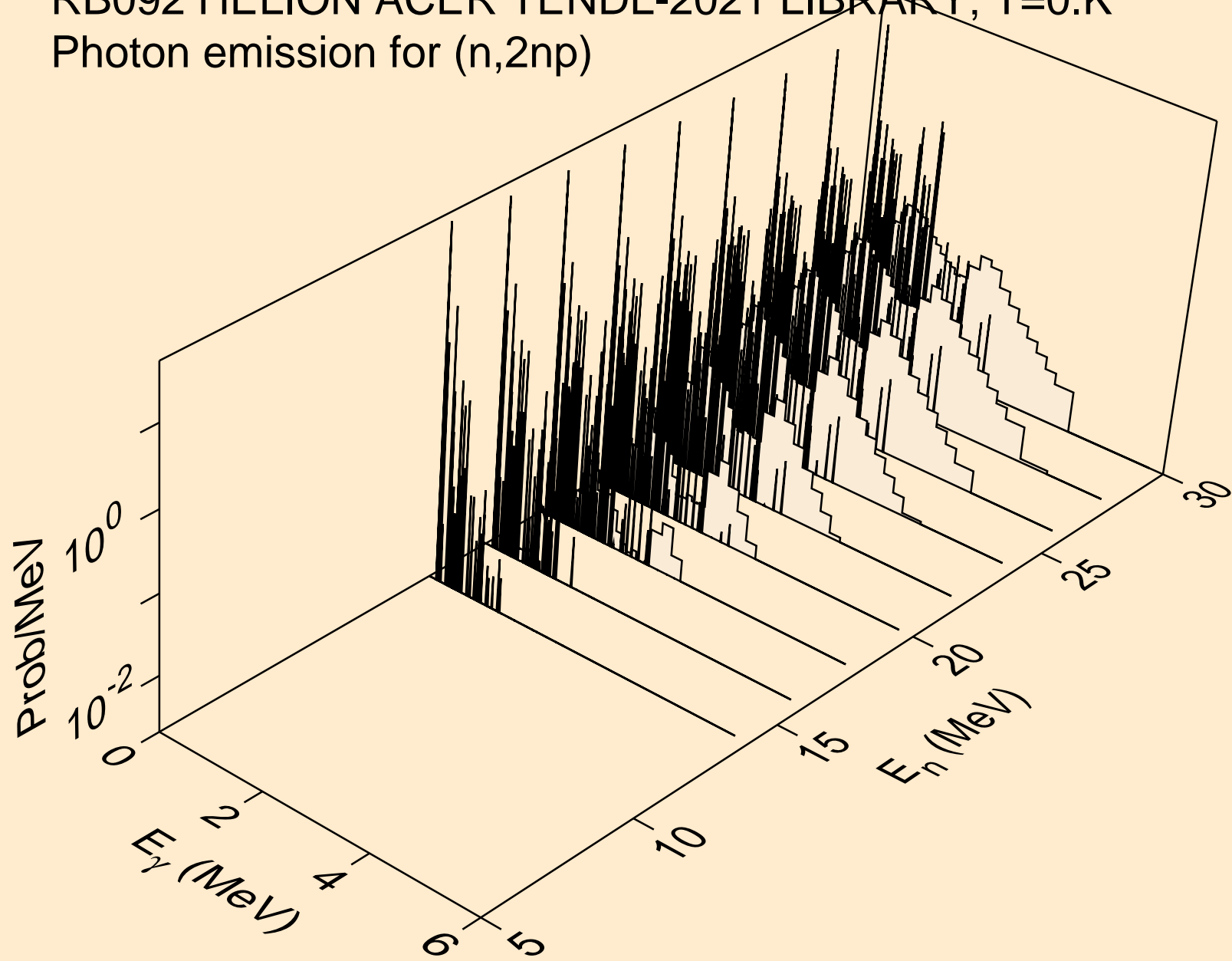

RB092 HELION ACER TENDL-2021 LIBRARY; T=0.K  
Photon emission for (n,npa)

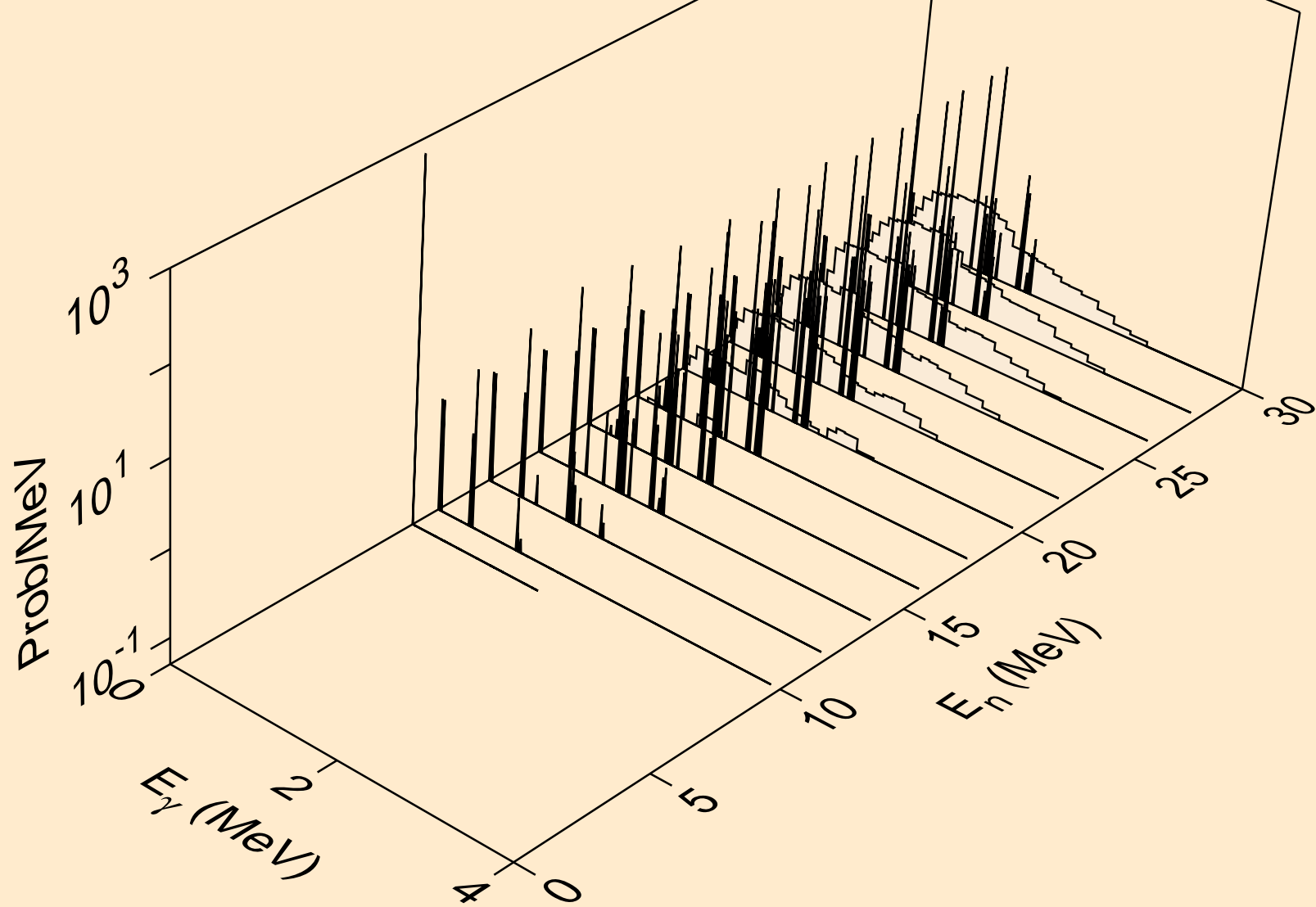

RB092 HELION ACER TENDL-2021 LIBRARY; T=0.K  
Photon emission for (n,gma)

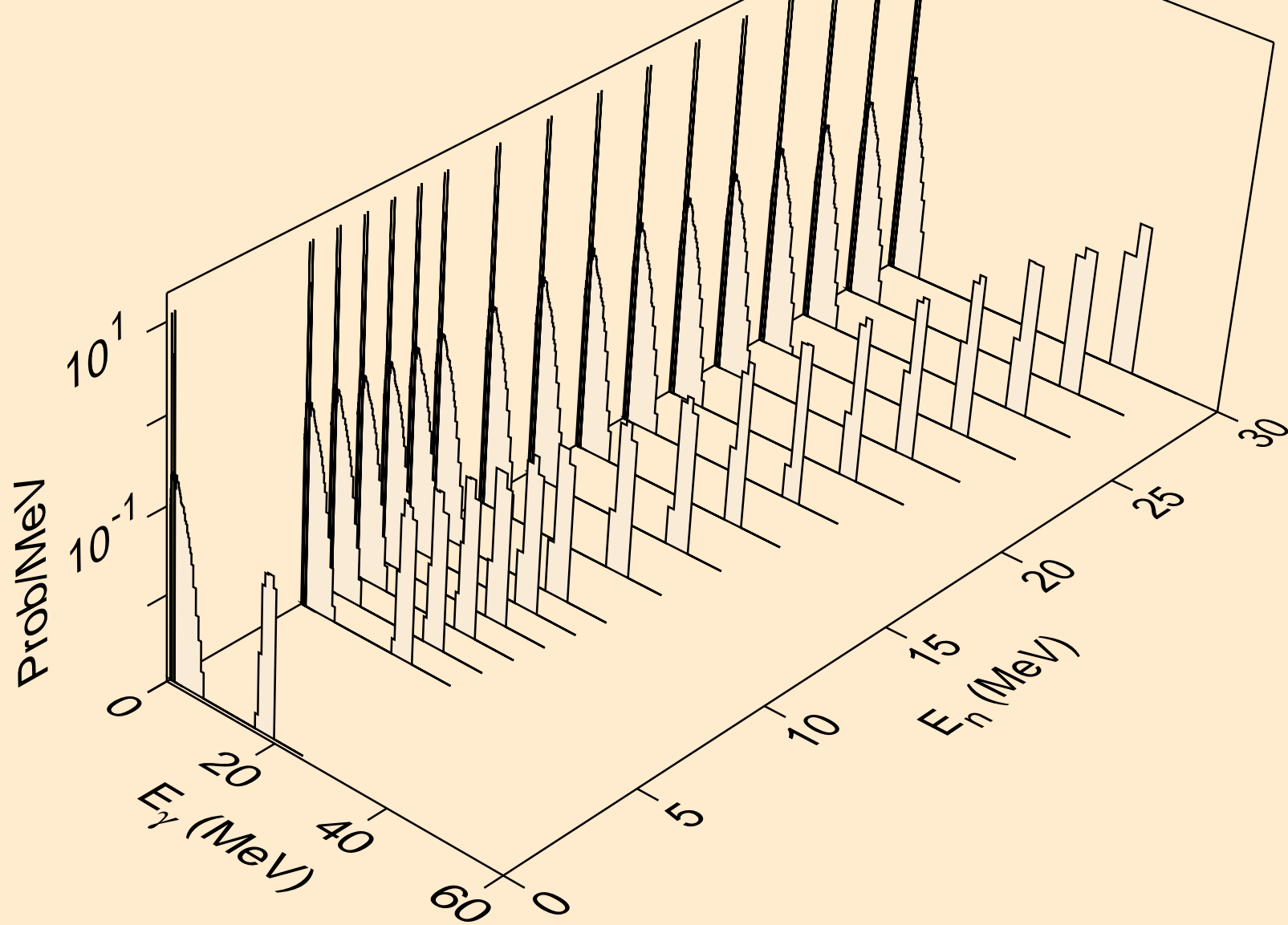

RB092 HELION ACER TENDL-2021 LIBRARY; T=0.K  
Photon emission for (n,p)

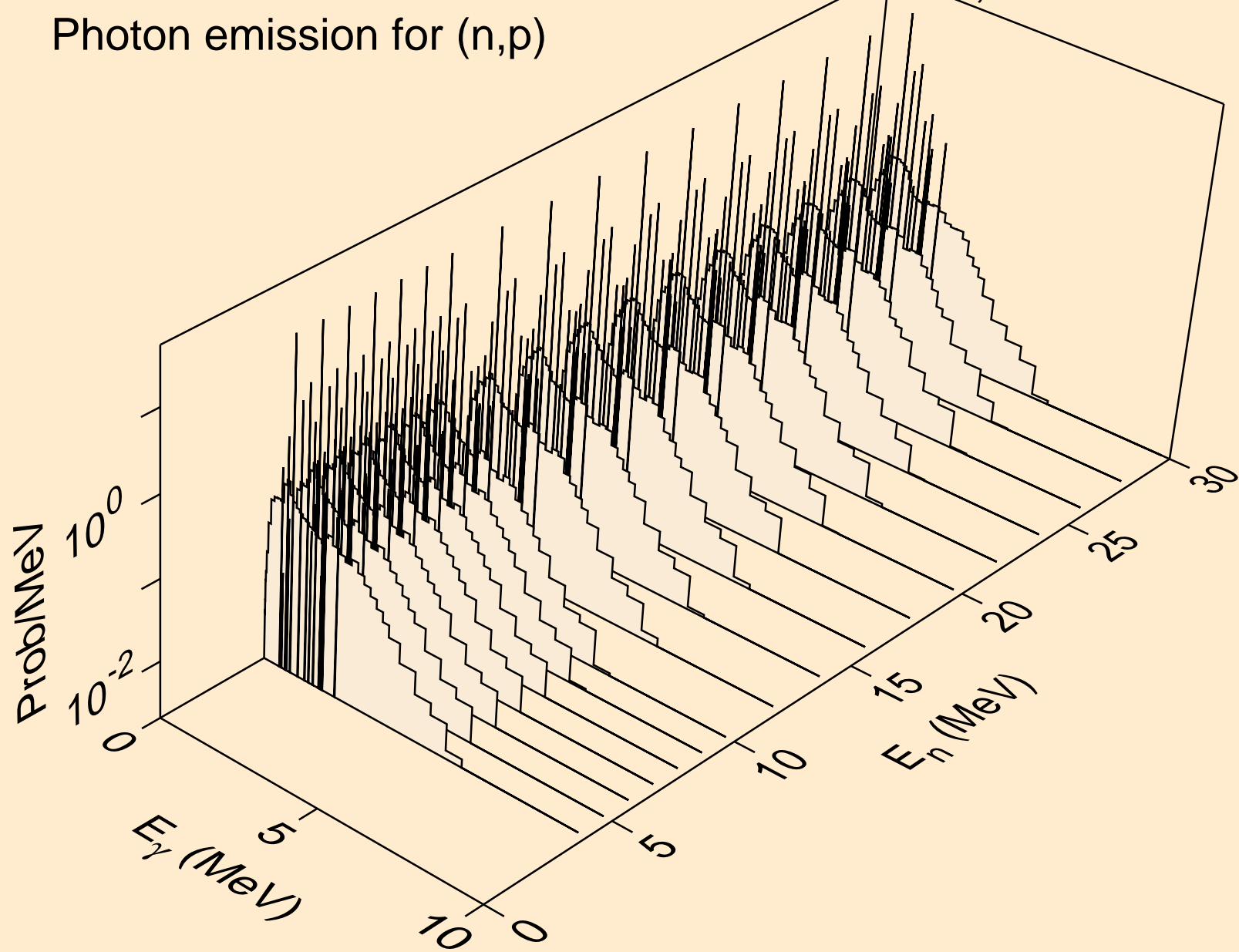

RB092 HELION ACER TENDL-2021 LIBRARY; T=0.K  
Photon emission for (n,d)

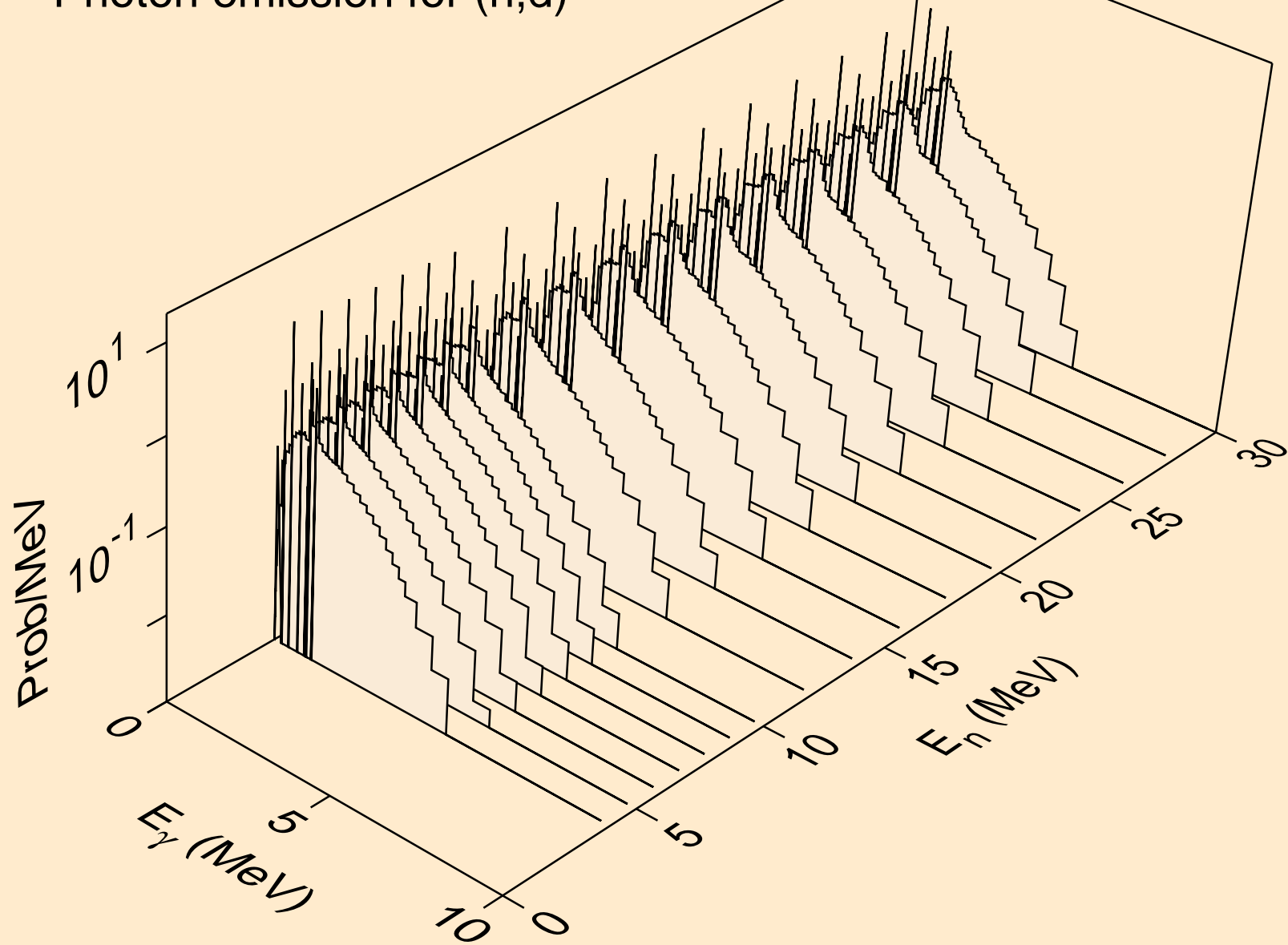

RB092 HELION ACER TENDL-2021 LIBRARY; T=0.K  
Photon emission for (n,t)

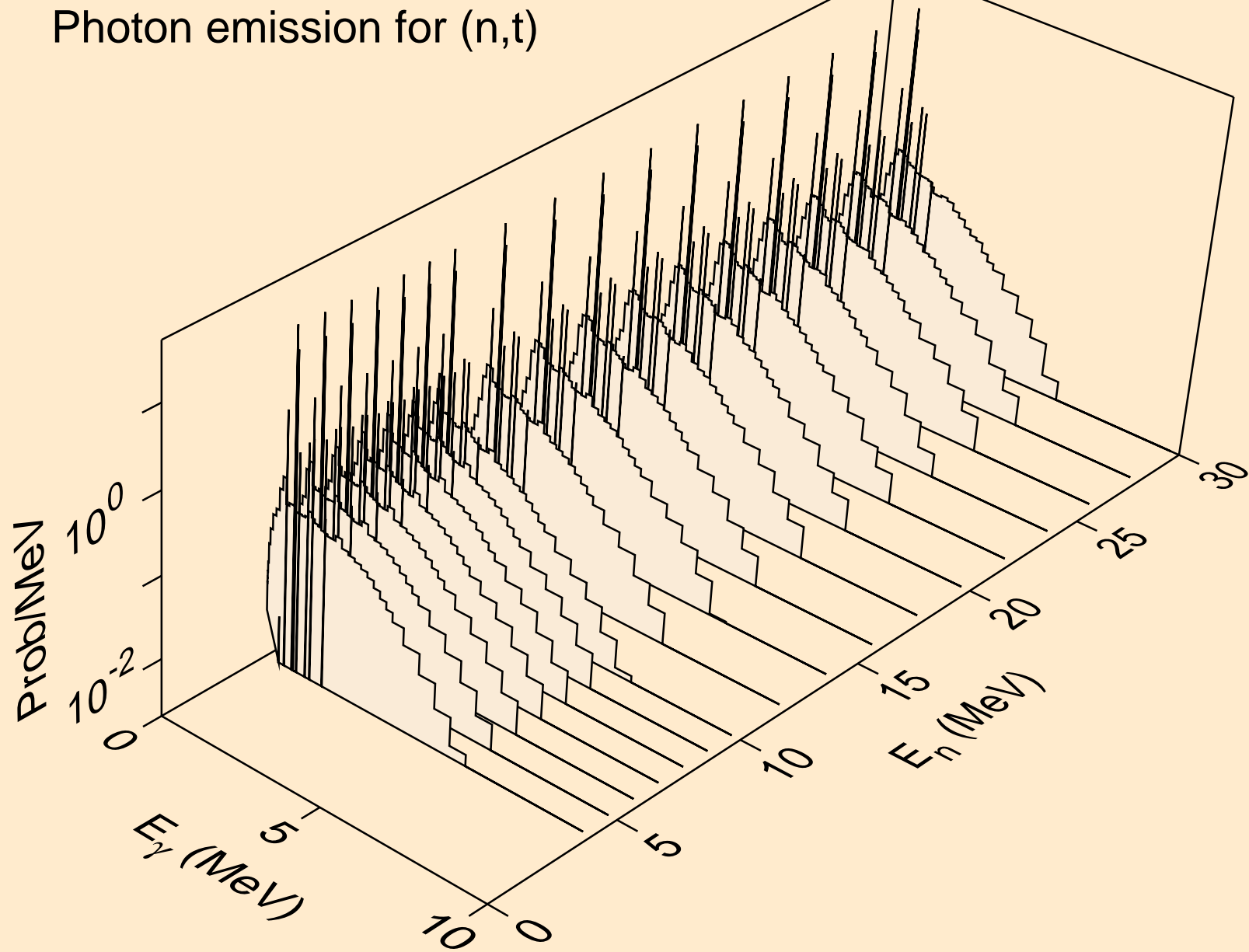



RB092 HELION ACER TENDL-2021 LIBRARY; T=0.K  
Photon emission for inelastic

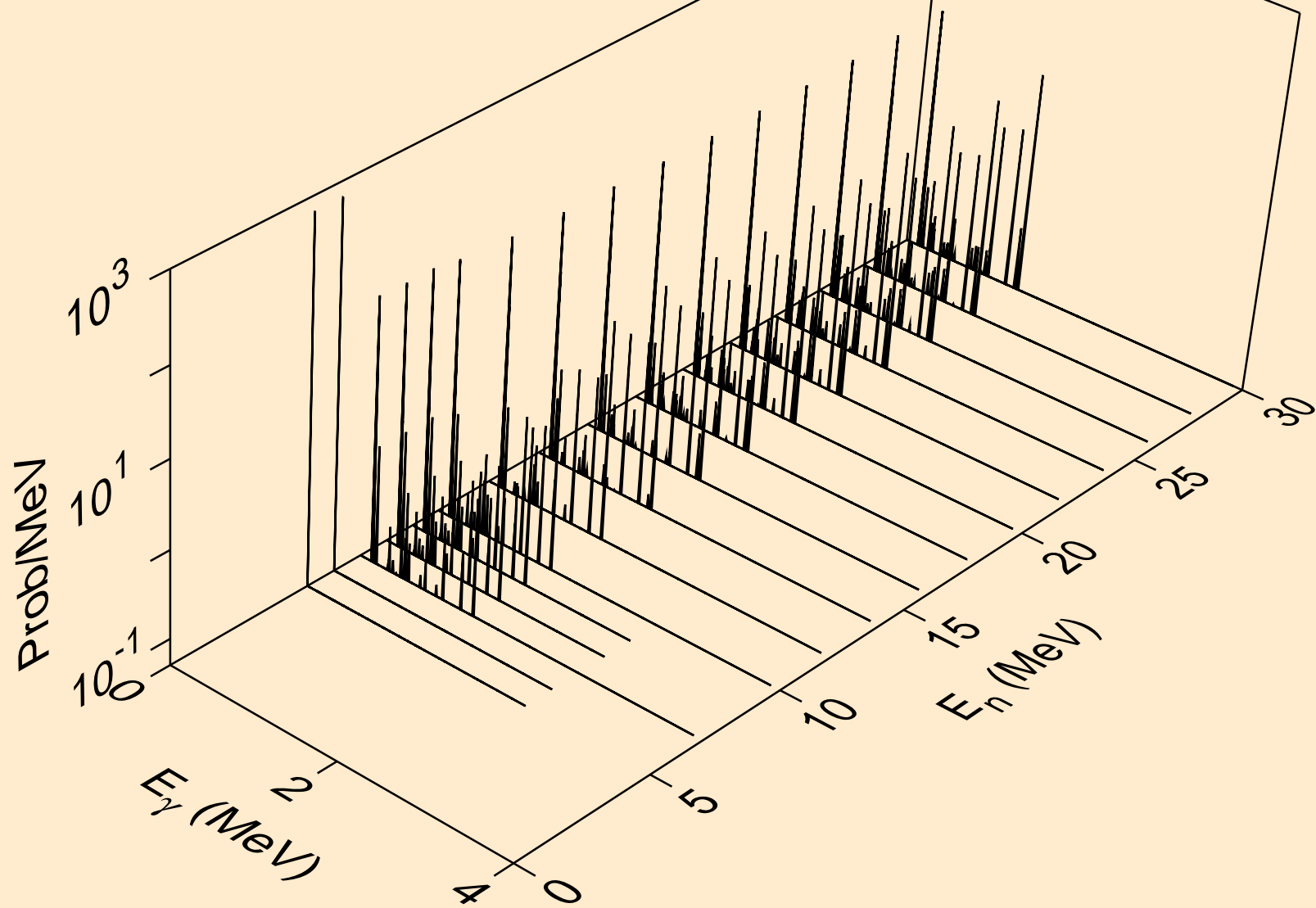

RB092 HELION ACER TENDL-2021 LIBRARY; T=0.K  
Photon emission for (n,a)

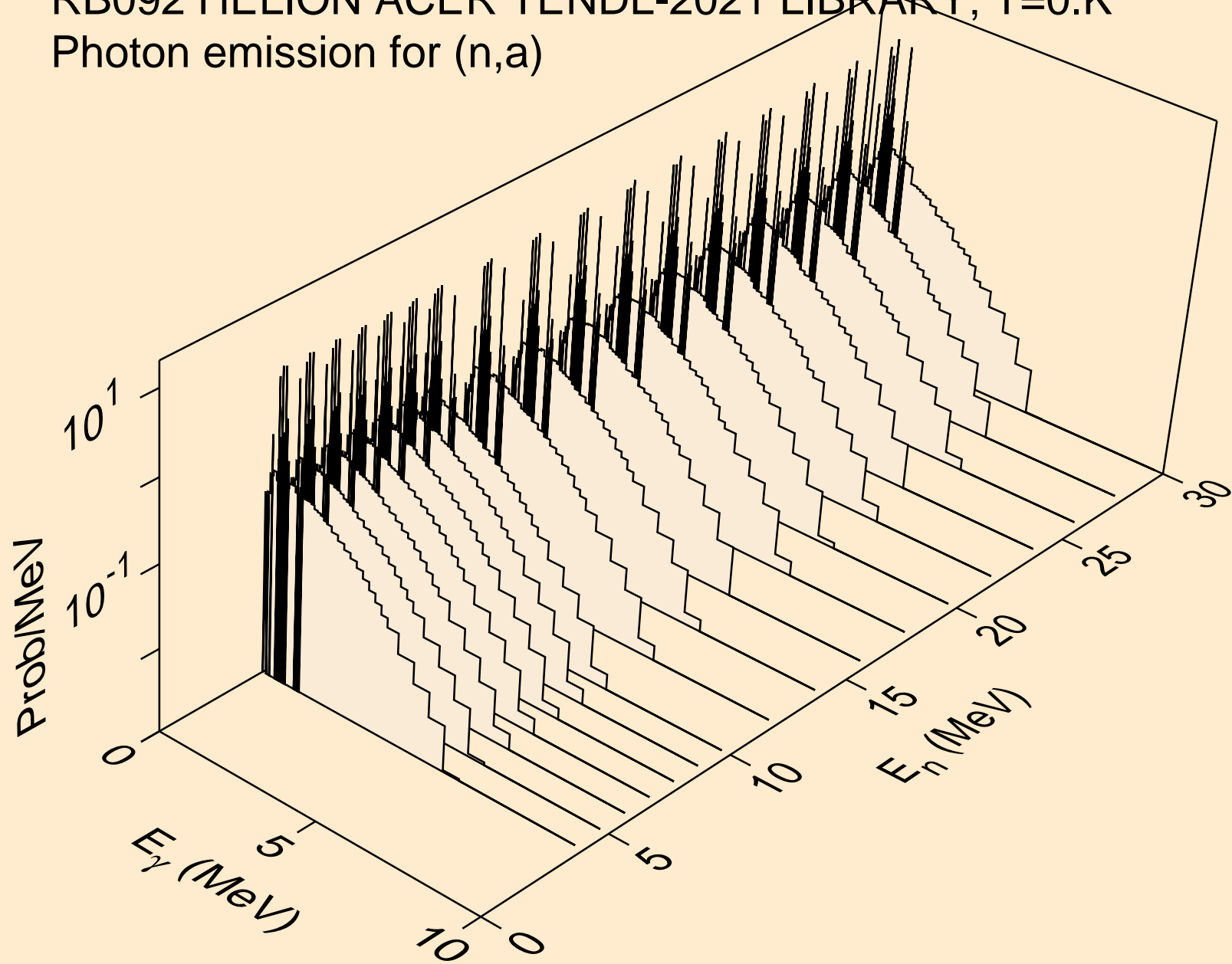

RB092 HELION ACER TENDL-2021 LIBRARY; T=0.K  
Photon emission for (n,2a)

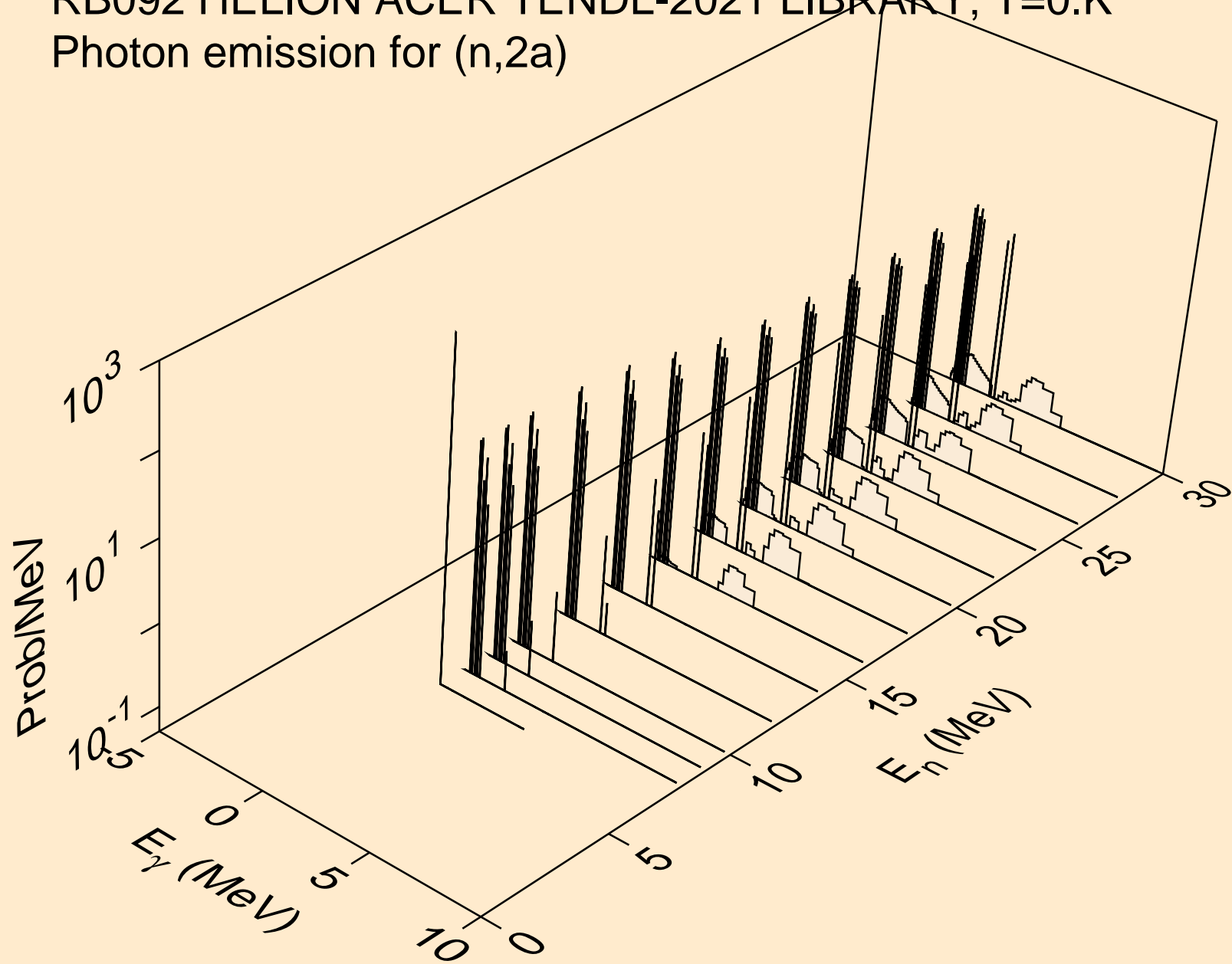

RB092 HELION ACER TENDL-2021 LIBRARY; T=0.K  
Photon emission for (n,2p)

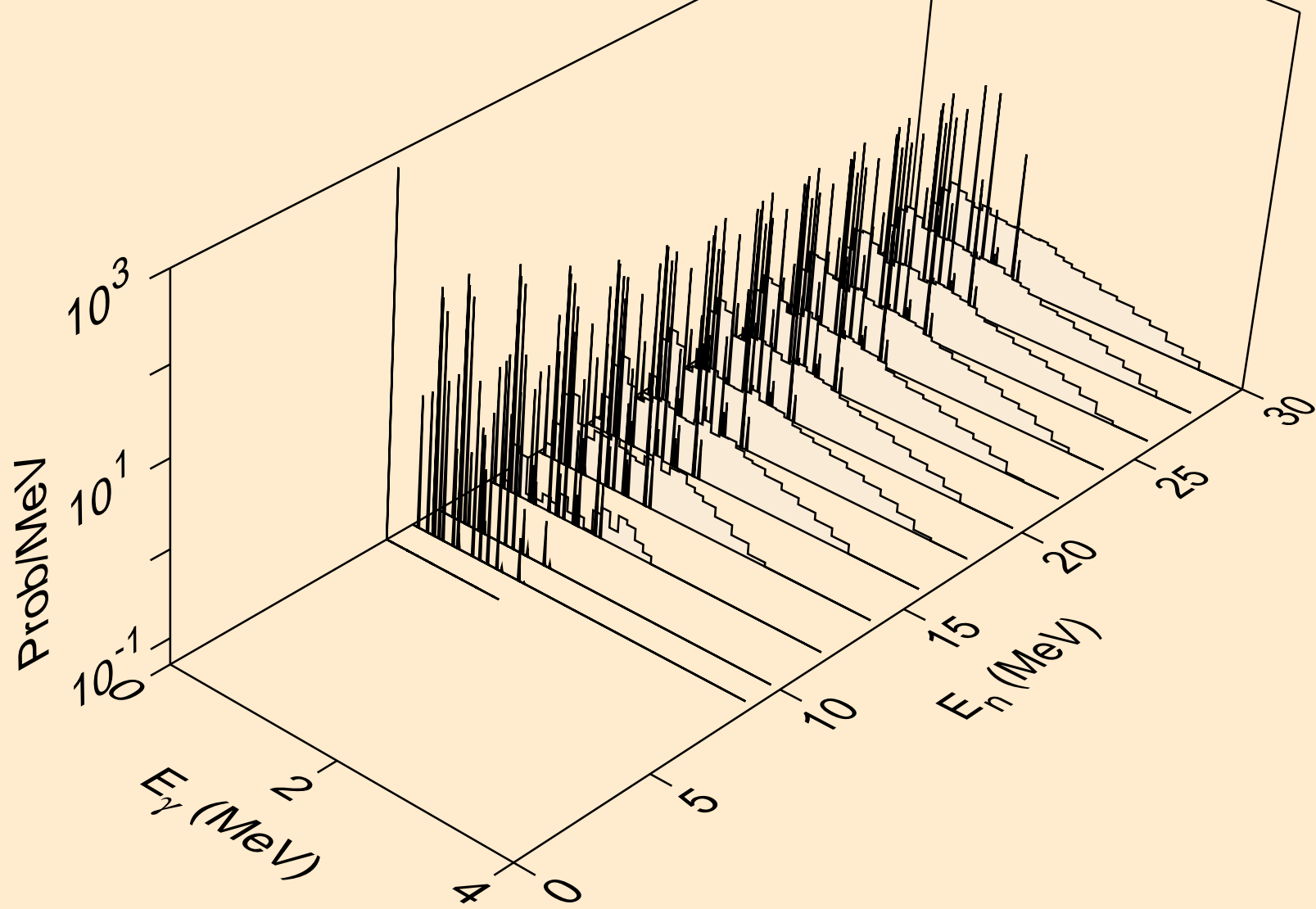

RB092 HELION ACER TENDL-2021 LIBRARY; T=0.K  
Photon emission for (n,pa)

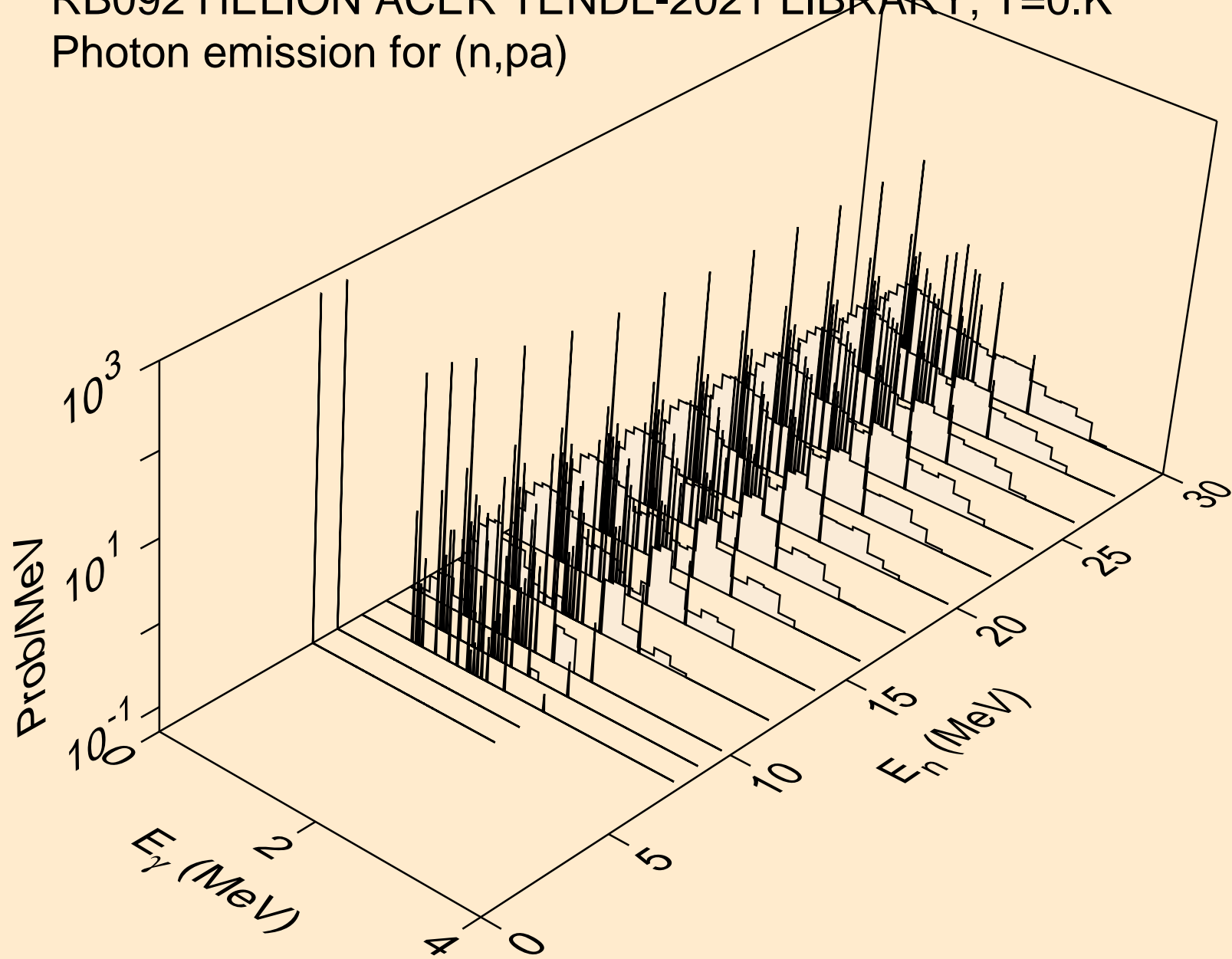

RB092 HELION ACER TENDL-2021 LIBRARY; T=0.K  
Photon emission for (n,pd)

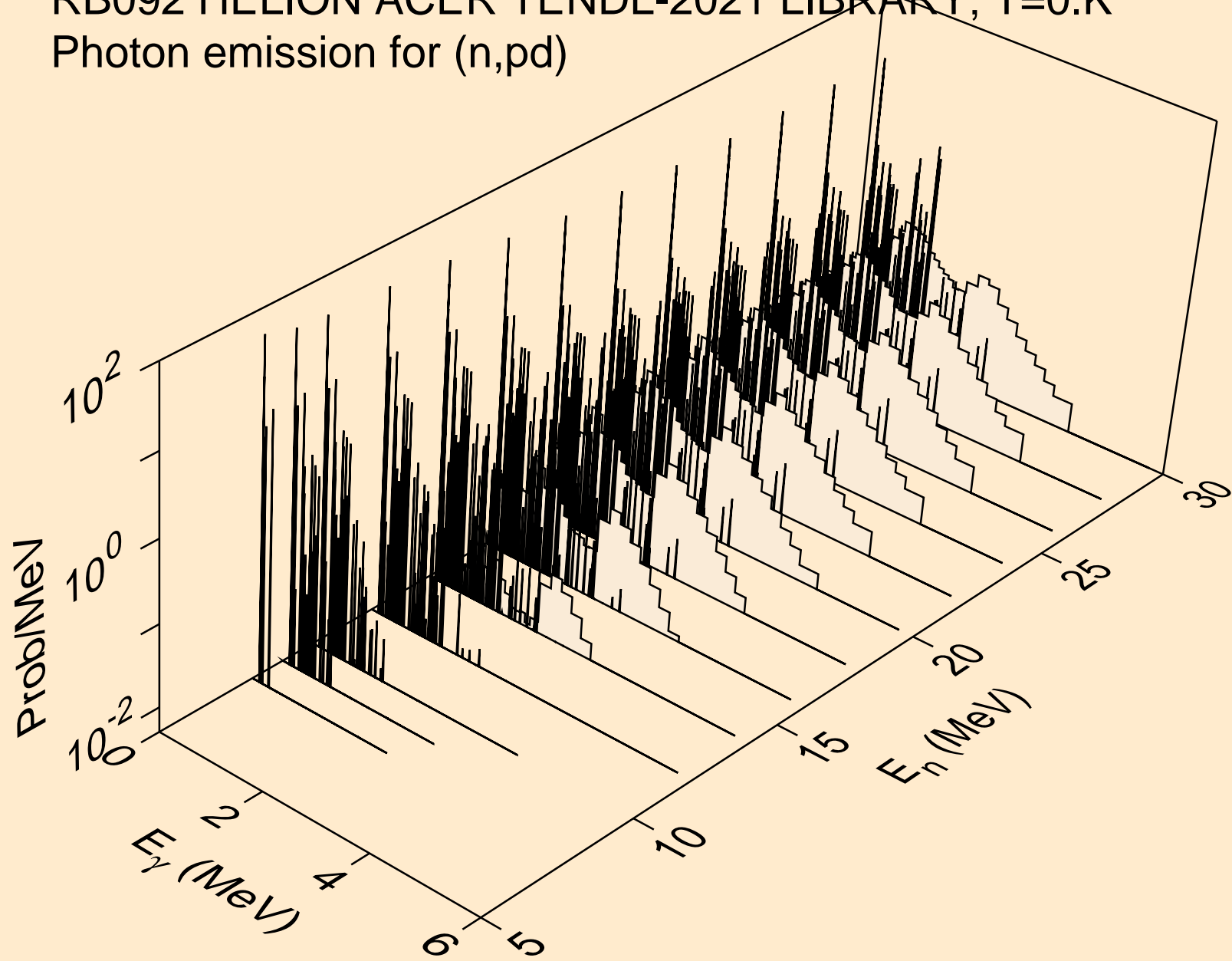

RB092 HELION ACER TENDL-2021 LIBRARY; T=0.K  
Photon emission for (n,pt)

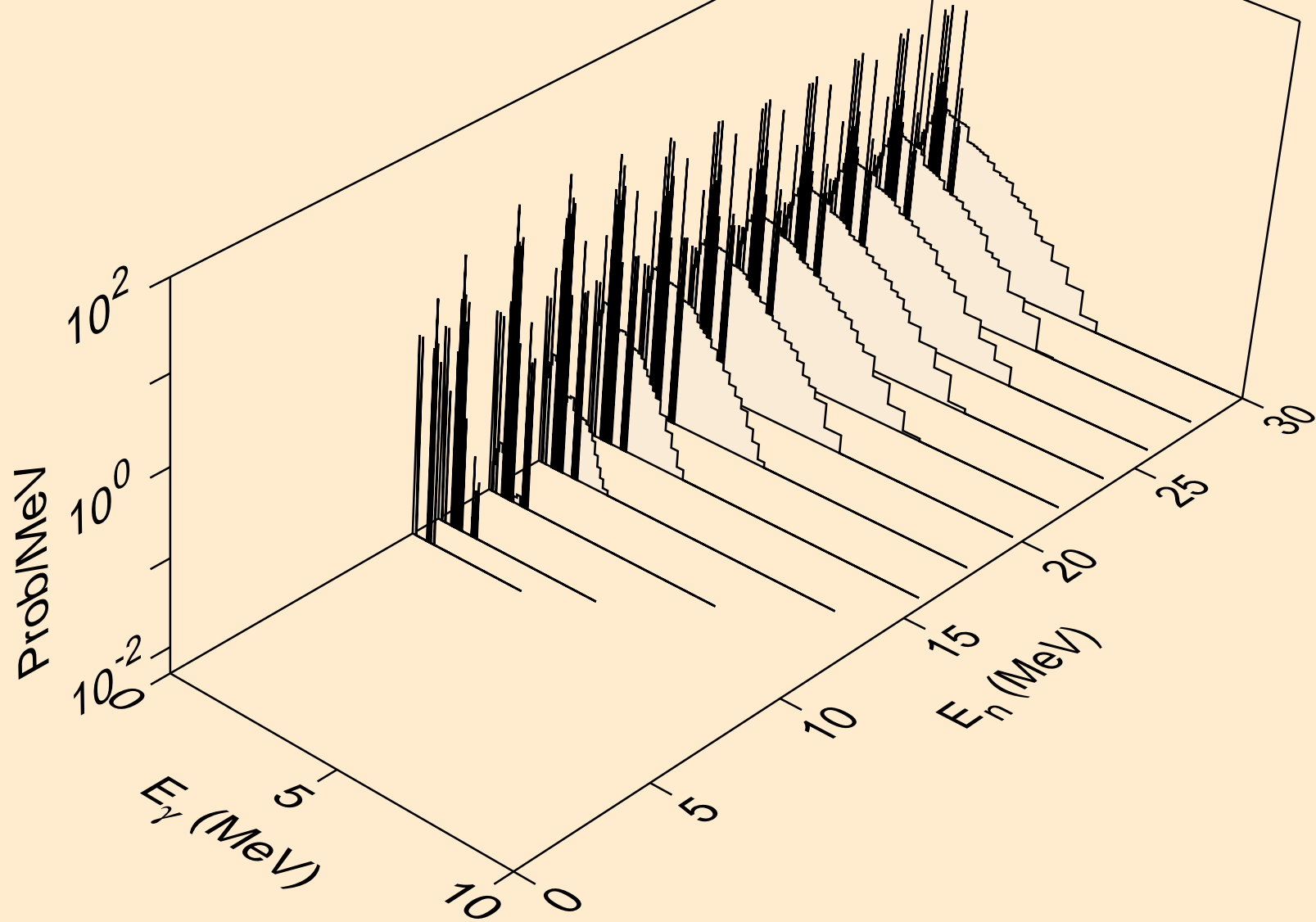

RB092 HELION ACER TENDL-2021 LIBRARY; T=0.K  
Photon emission for (n,da)

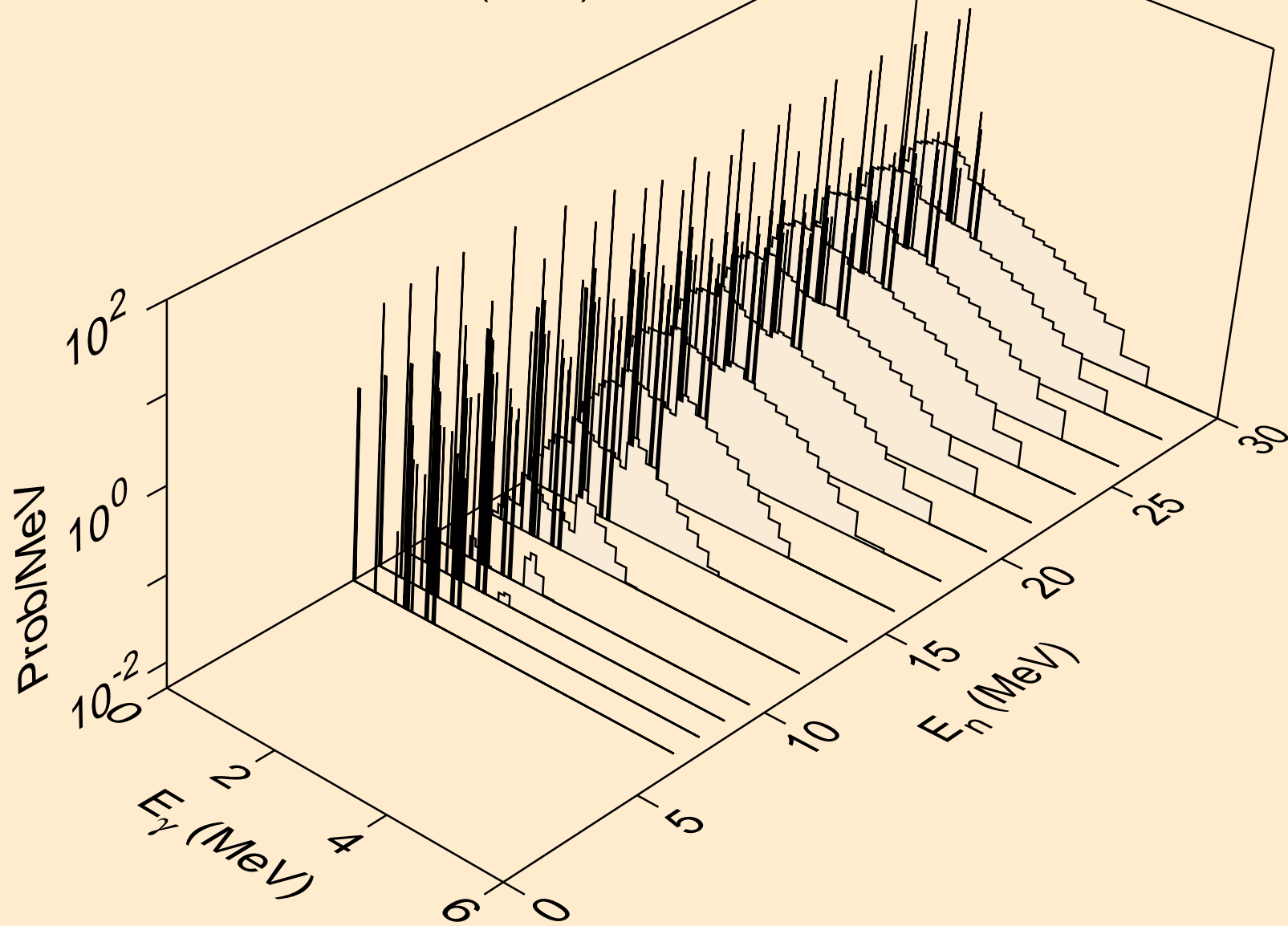



RB092 HELION ACER TENDL-2021 LIBRARY; T=0.K  
Particle heating contributions

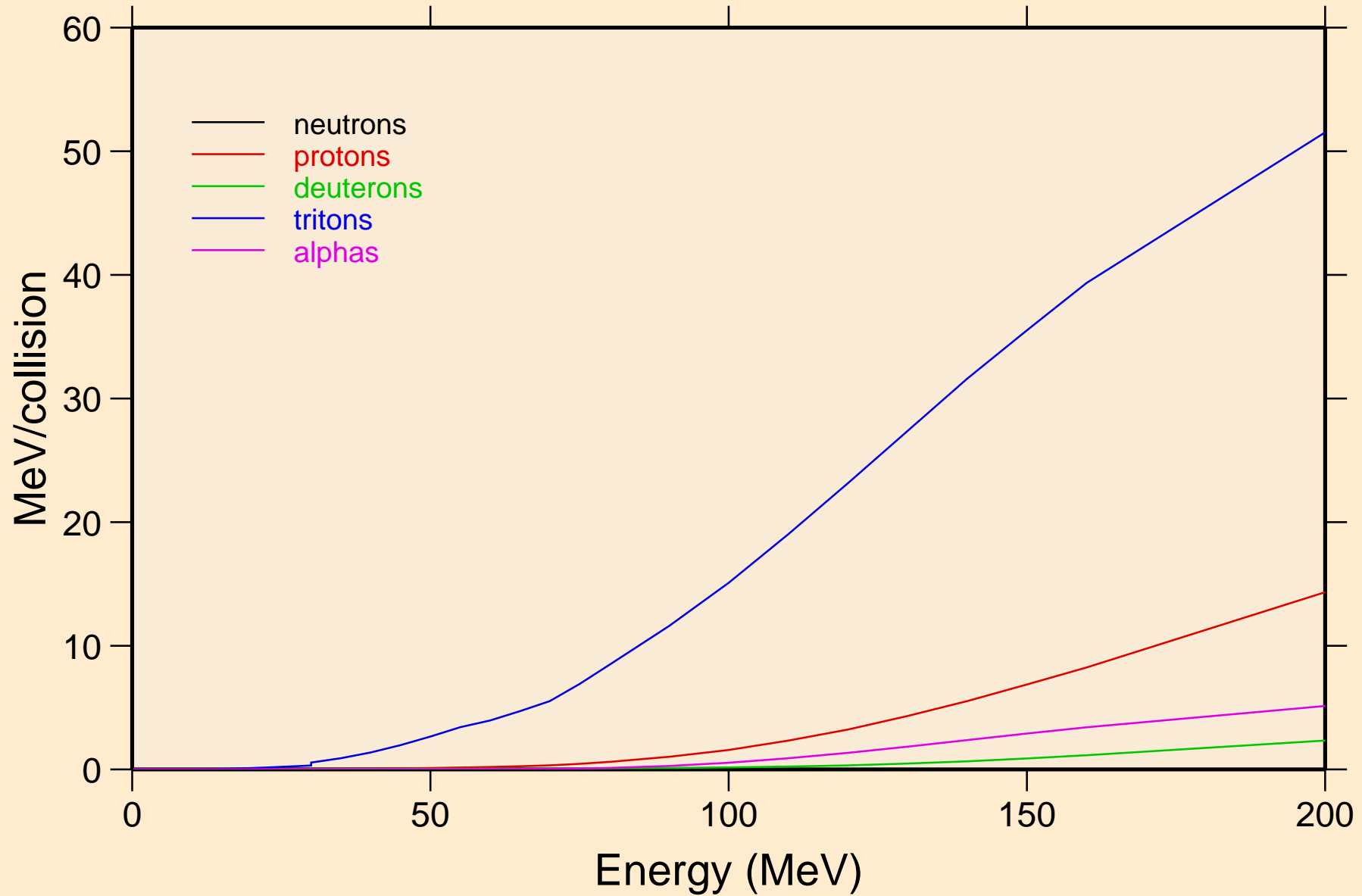

RB092 HELION ACER TENDL-2021 LIBRARY; T=0.K  
Recoil Heating

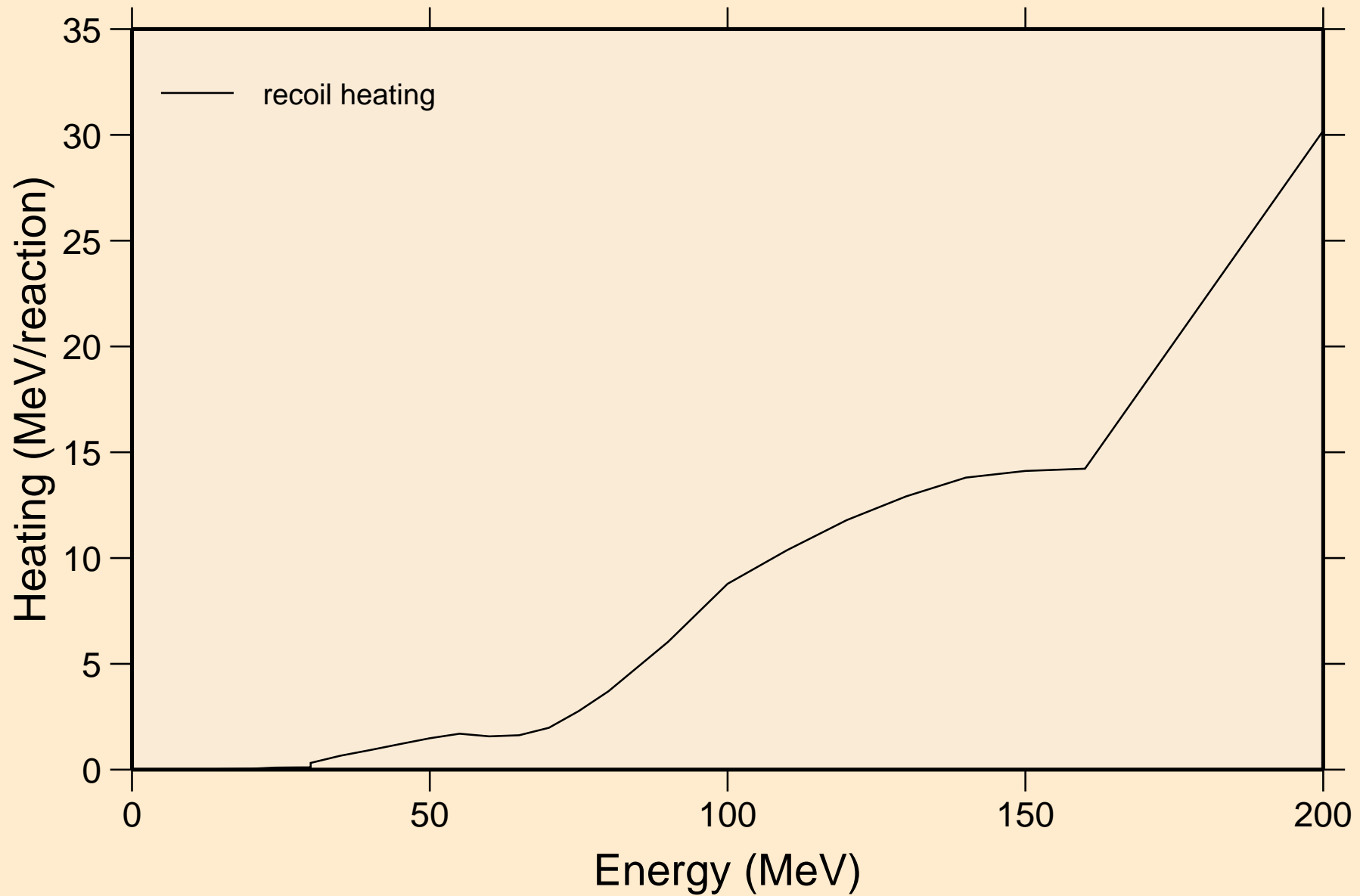

RB092 HELION ACER TENDL-2021 LIBRARY; T=0.K  
Particle production cross sections

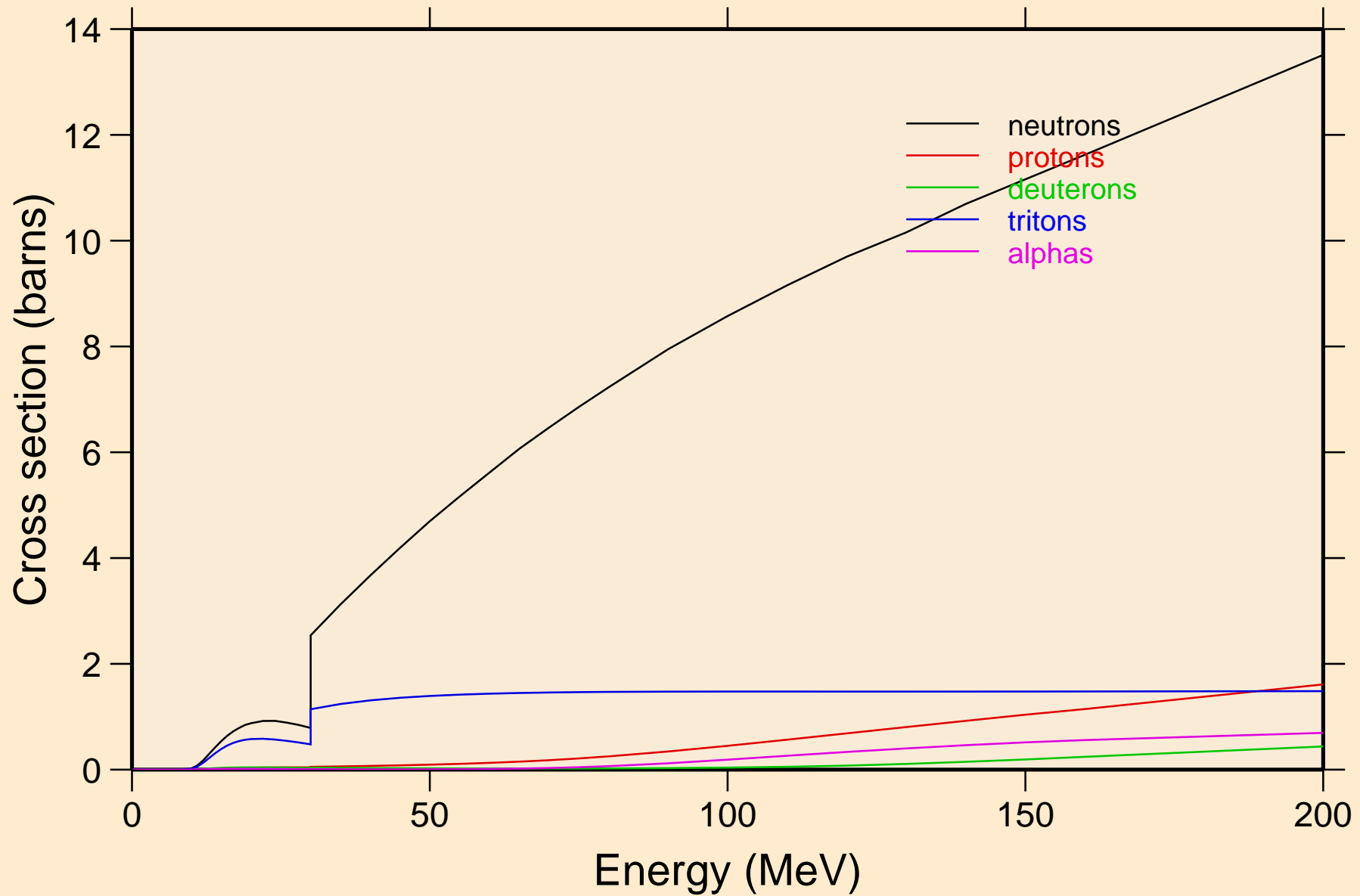

RB092 HELION ACER TENDL-2021 LIBRARY; T=0.K  
neutrons from (s,n)

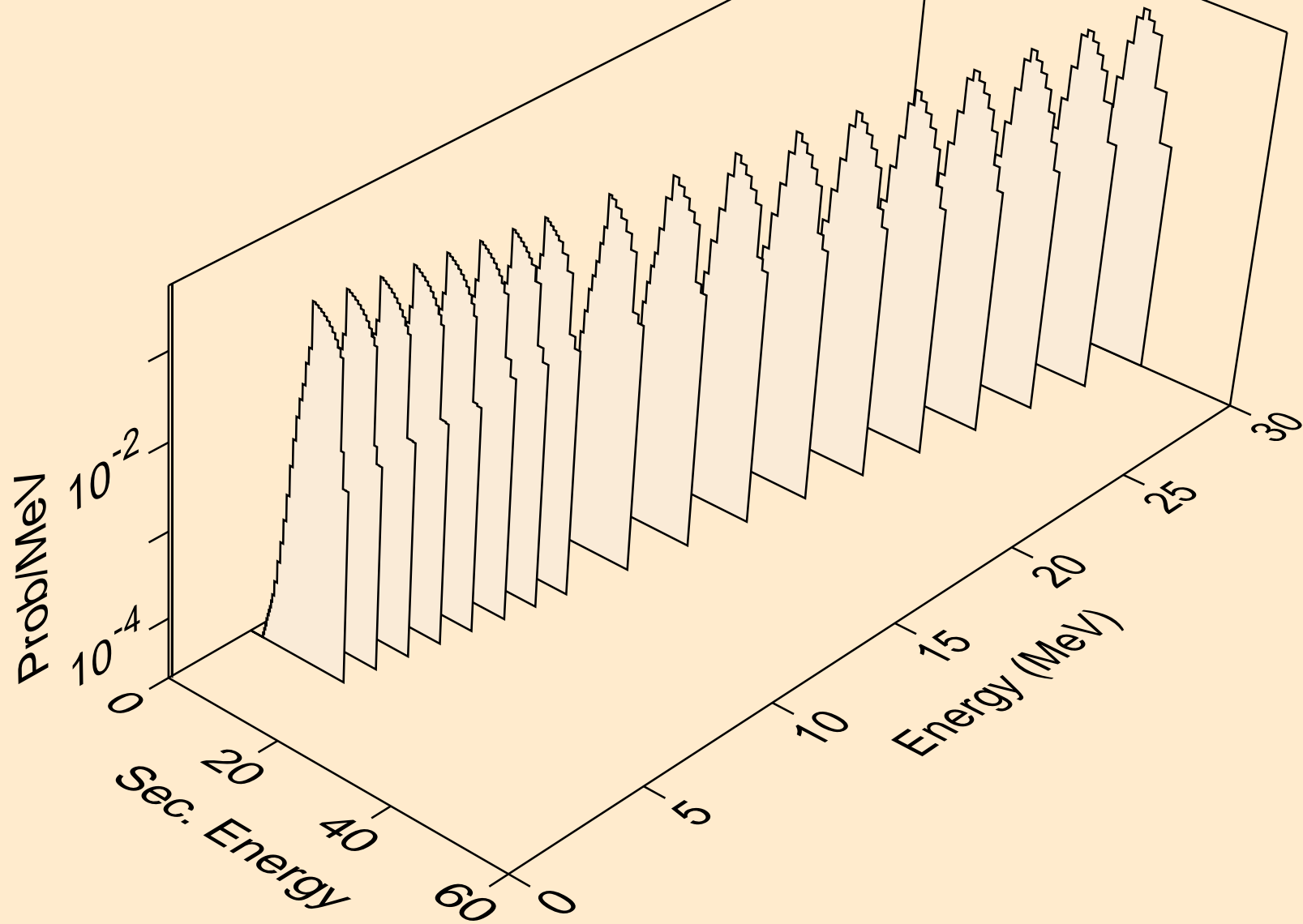

RB092 HELION ACER TENDL-2021 LIBRARY; T=0.K  
neutrons from (s,x)

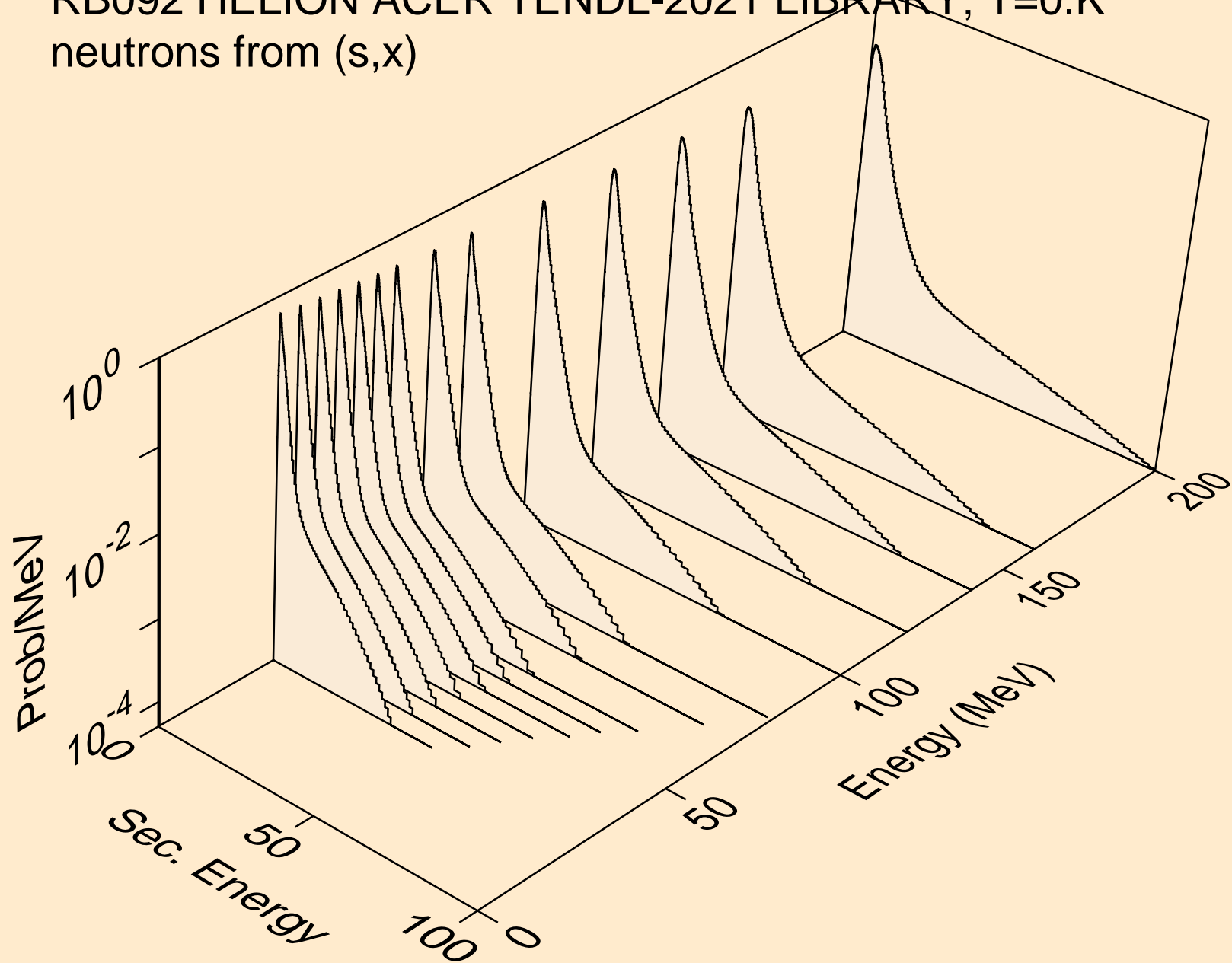

RB092 HELION ACER TENDL-2021 LIBRARY; T=0.K  
neutrons from (s,2nd)

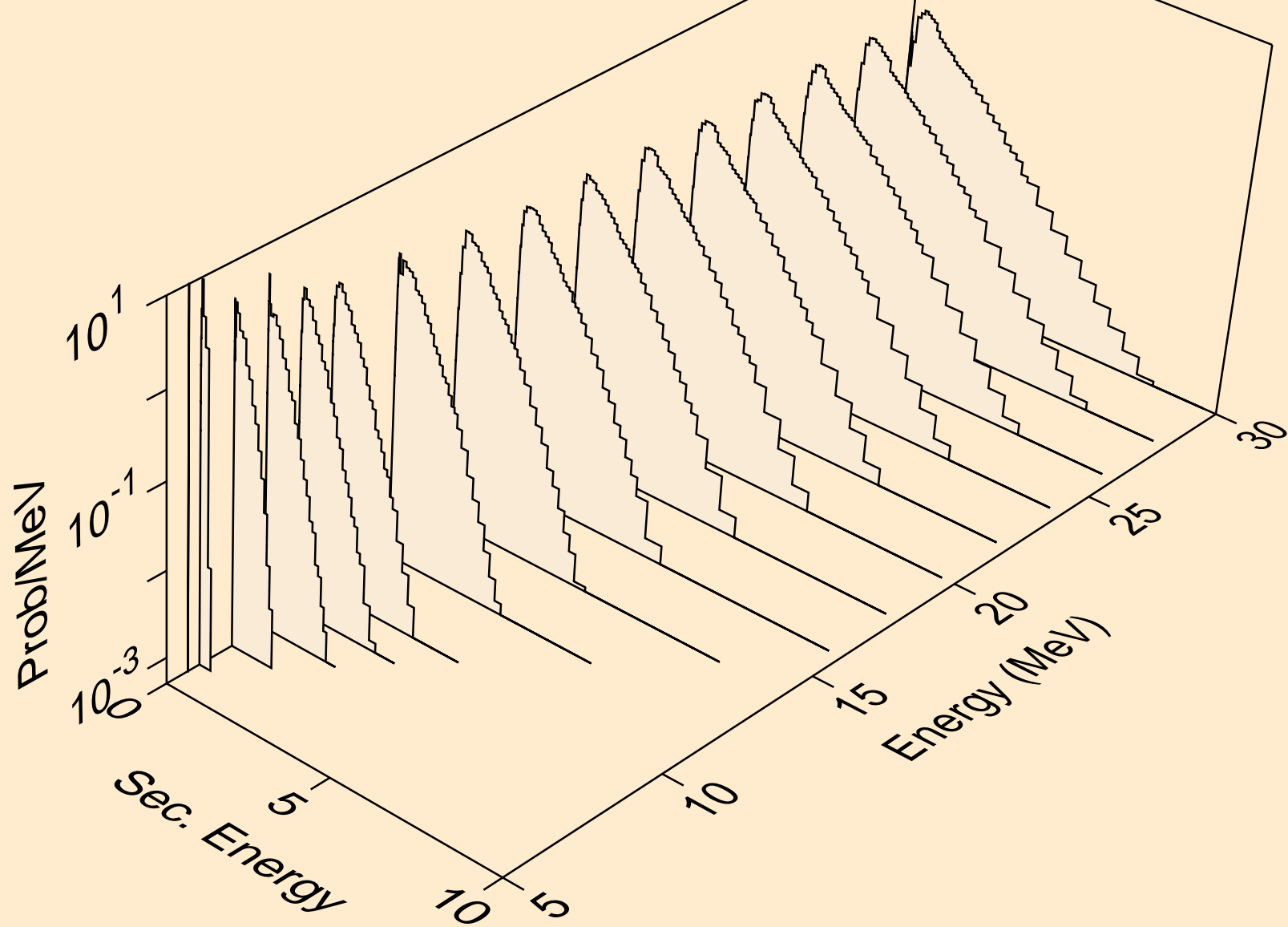

RB092 HELION ACER TENDL-2021 LIBRARY; T=0.K  
neutrons from (s,2n)

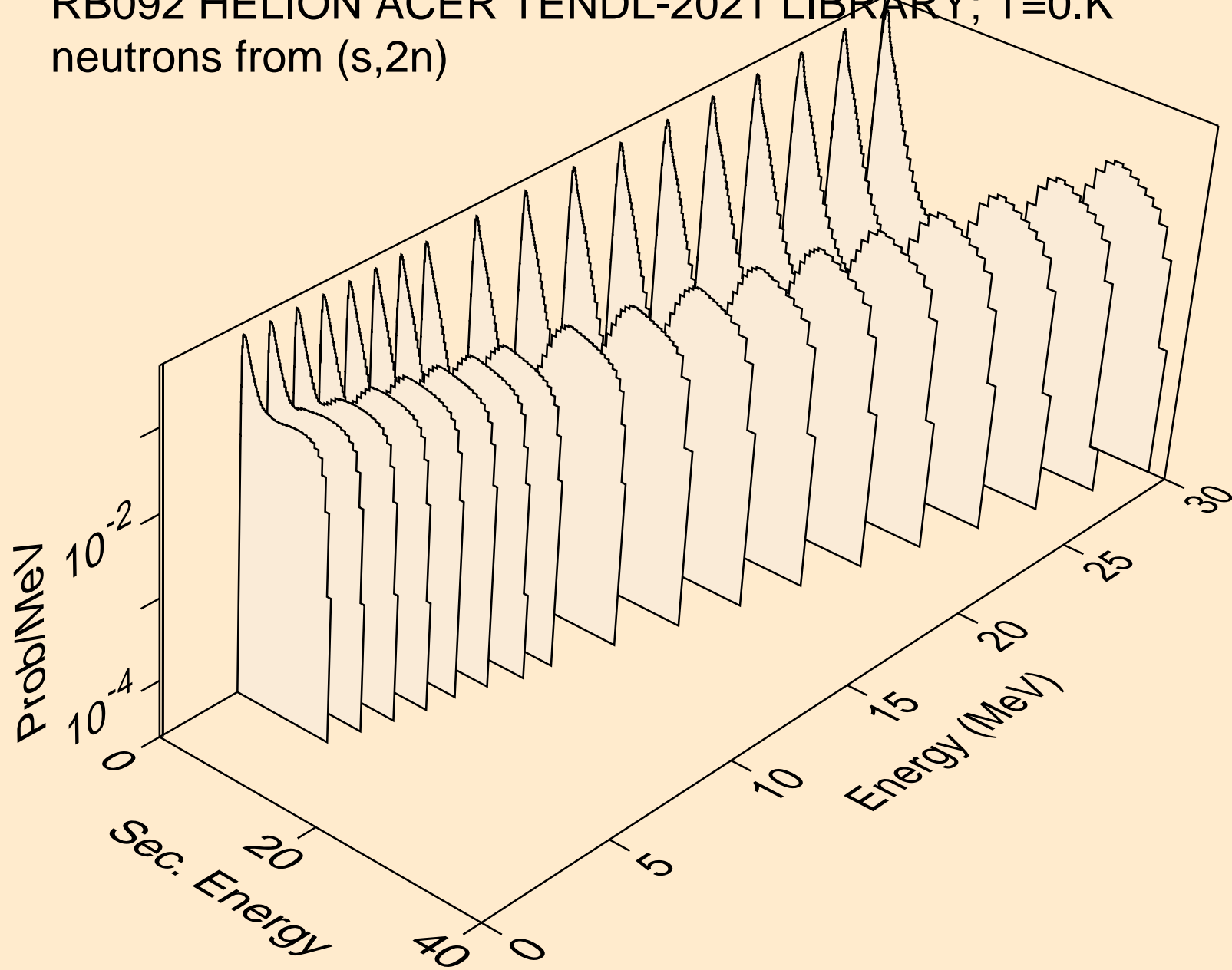

RB092 HELION ACER TENDL-2021 LIBRARY; T=0.K  
neutrons from (s,3n)

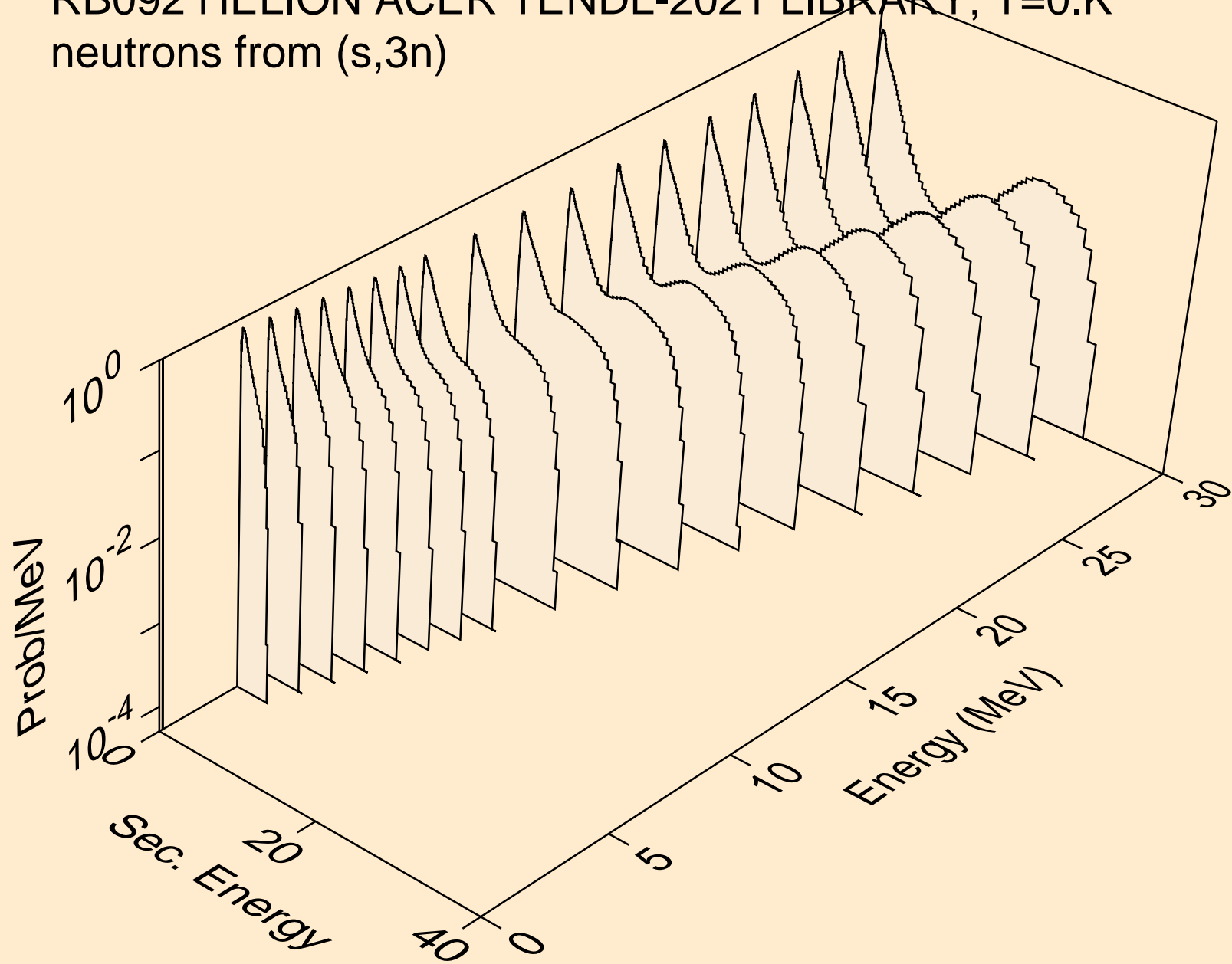



RB092 HELION ACER TENDL-2021 LIBRARY; T=0.K  
neutrons from (s,n\*)a

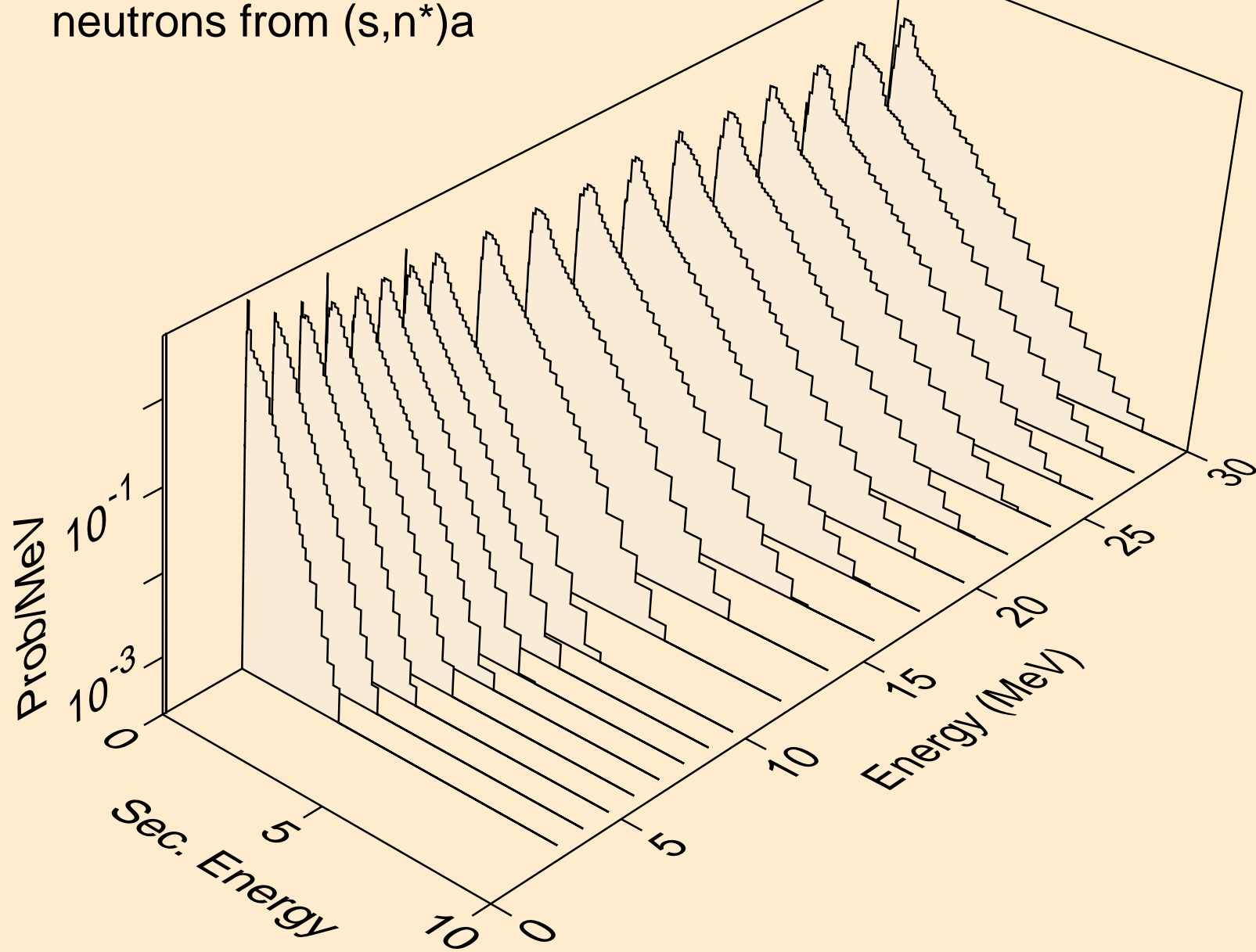

RB092 HELION ACER TENDL-2021 LIBRARY; T=0.K  
neutrons from (s,2n)a

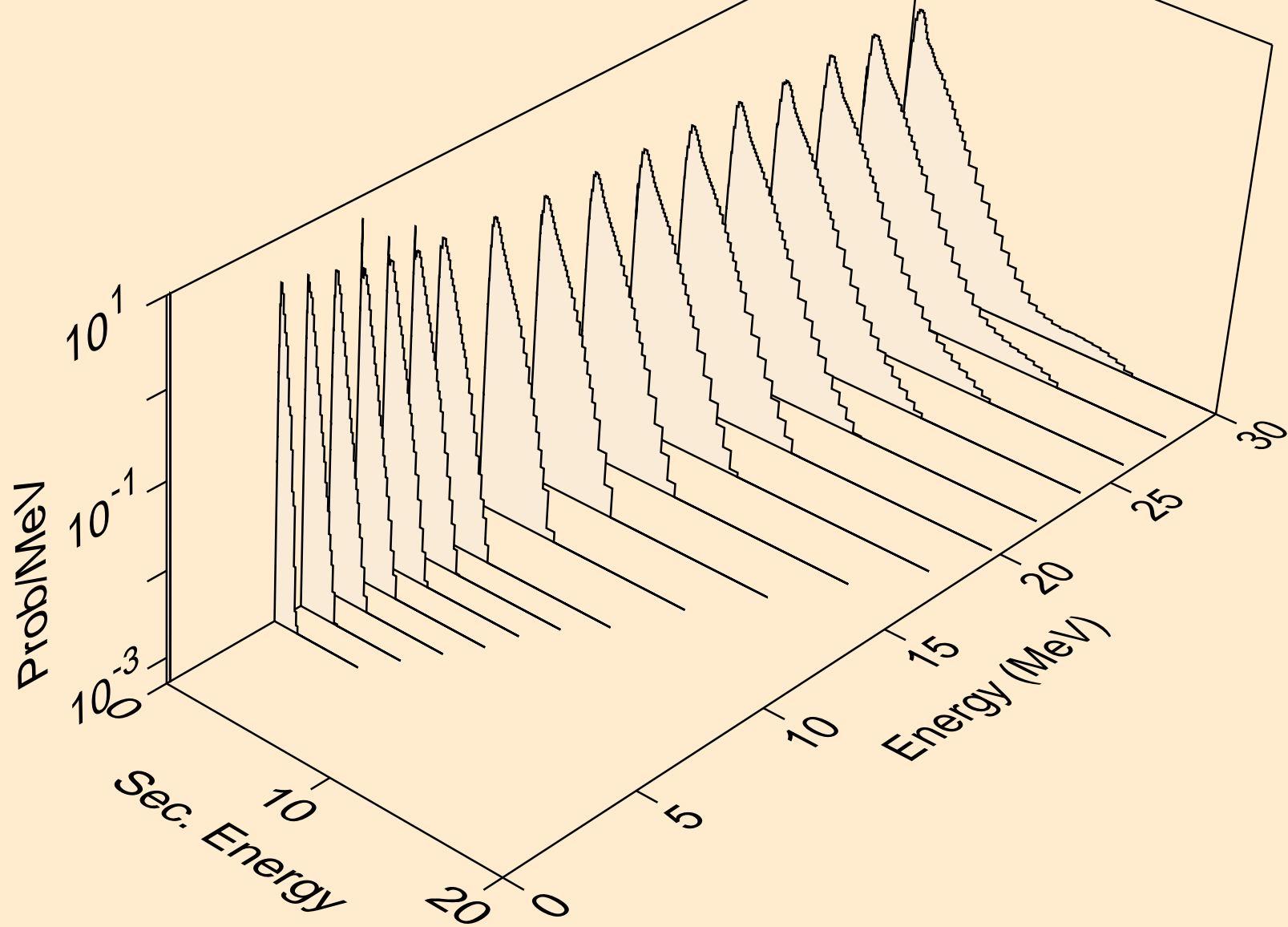

RB092 HELION ACER TENDL-2021 LIBRARY; T=0.K  
neutrons from (s,3n)a

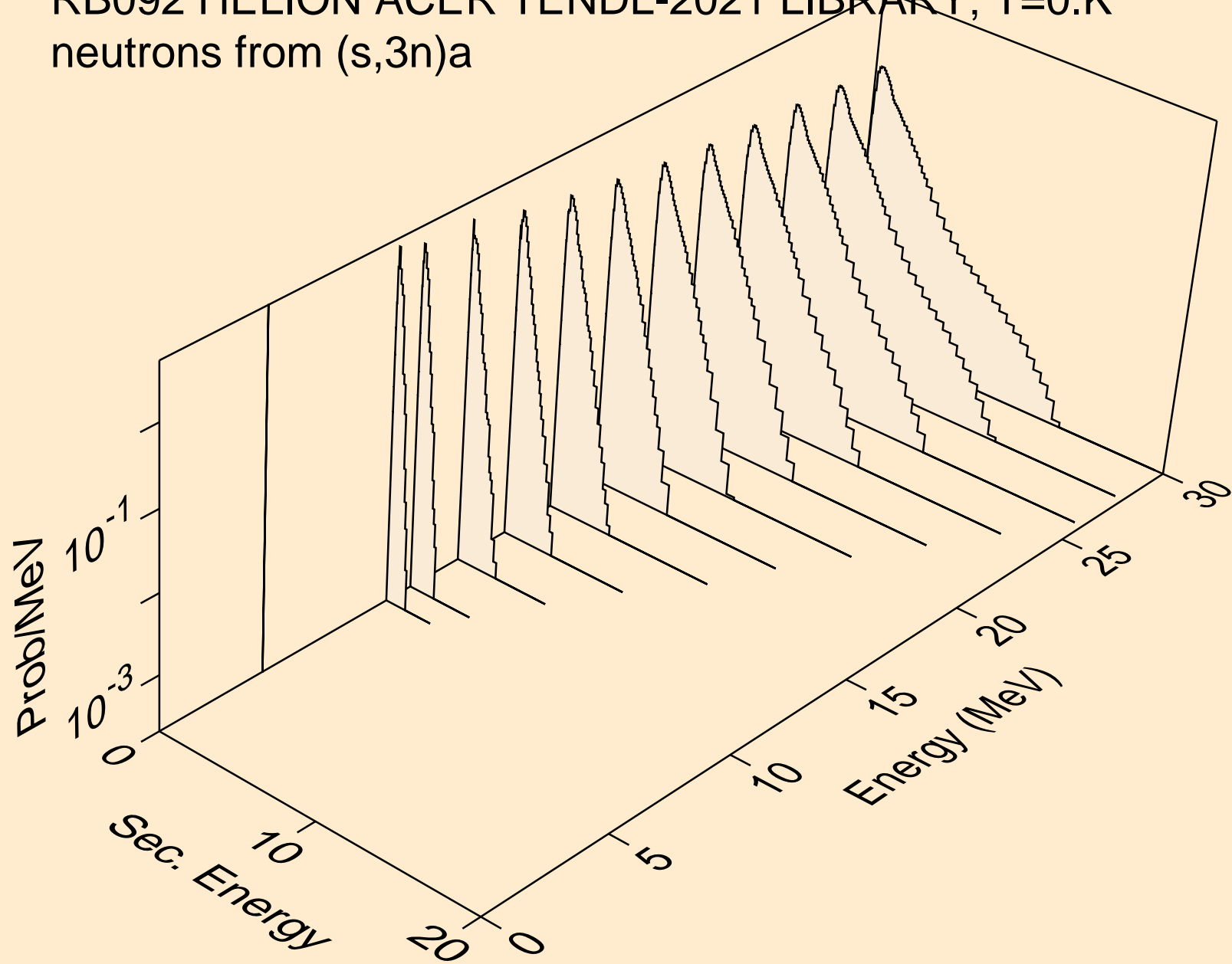

RB092 HELION ACER TENDL-2021 LIBRARY; T=0.K  
neutrons from (s,n\*)p

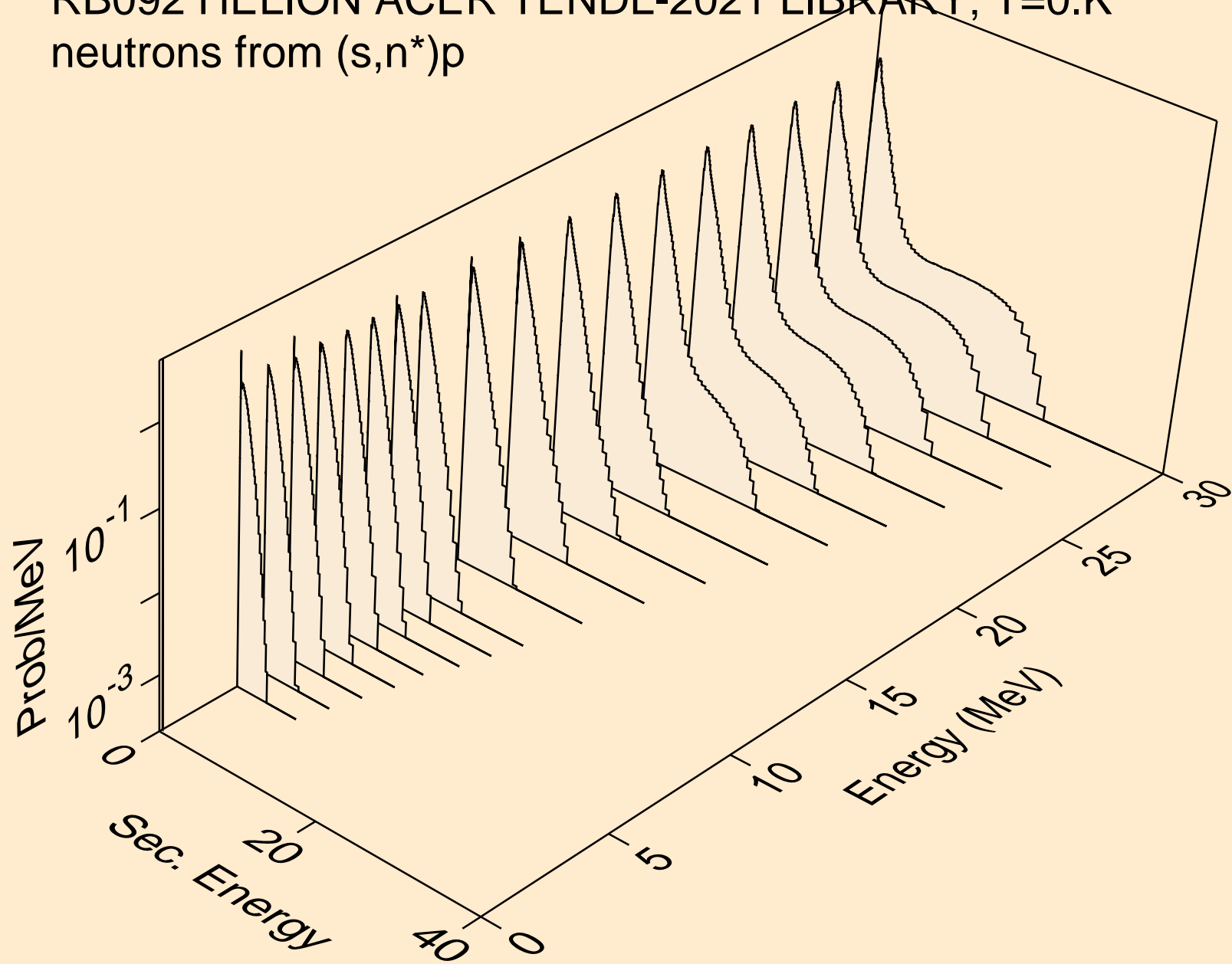

RB092 HELION ACER TENDL-2021 LIBRARY; T=0.K  
neutrons from (s,n\*)2a

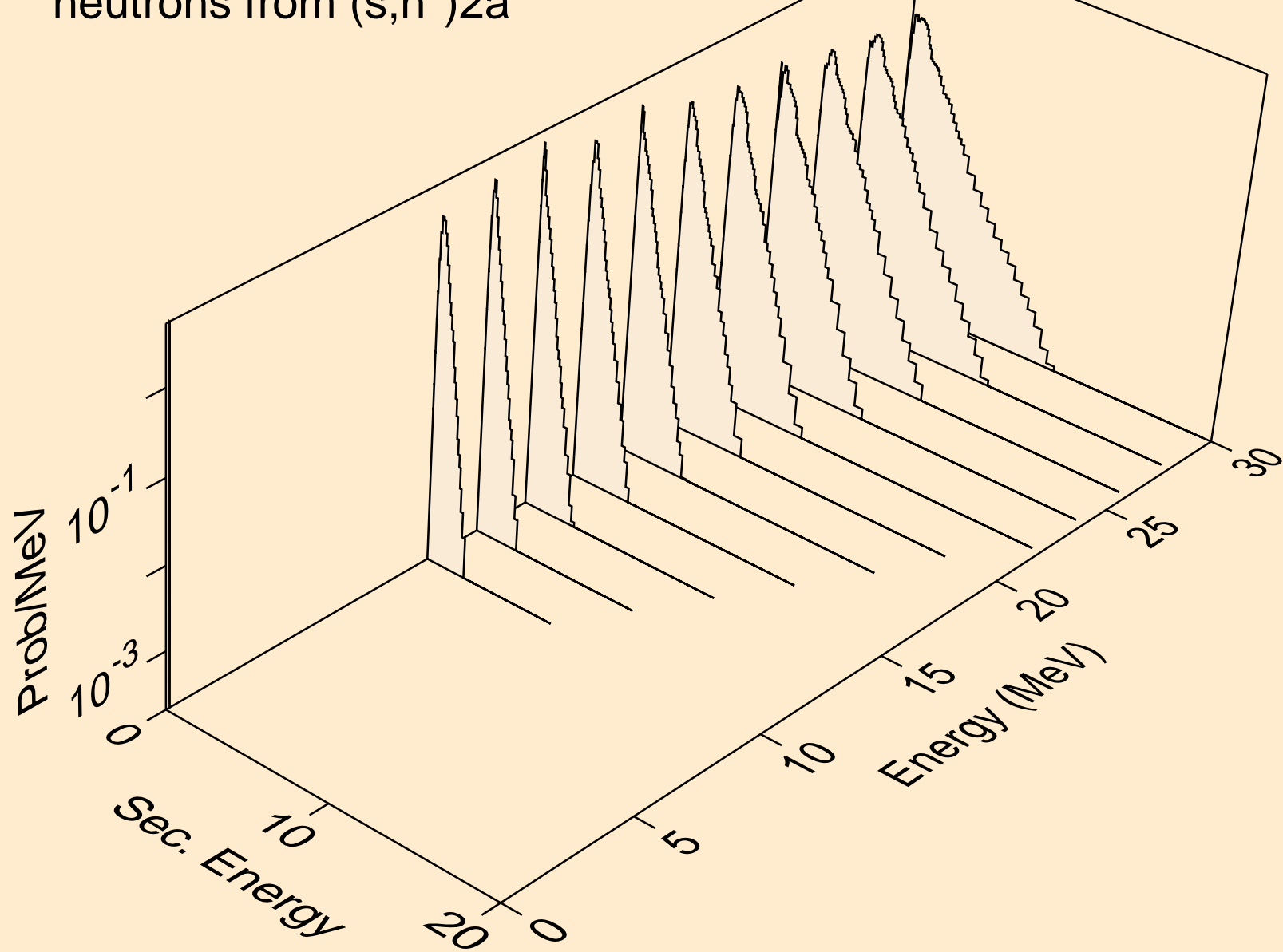

RB092 HELION ACER TENDL-2021 LIBRARY; T=0.K  
neutrons from (s,2n)2a

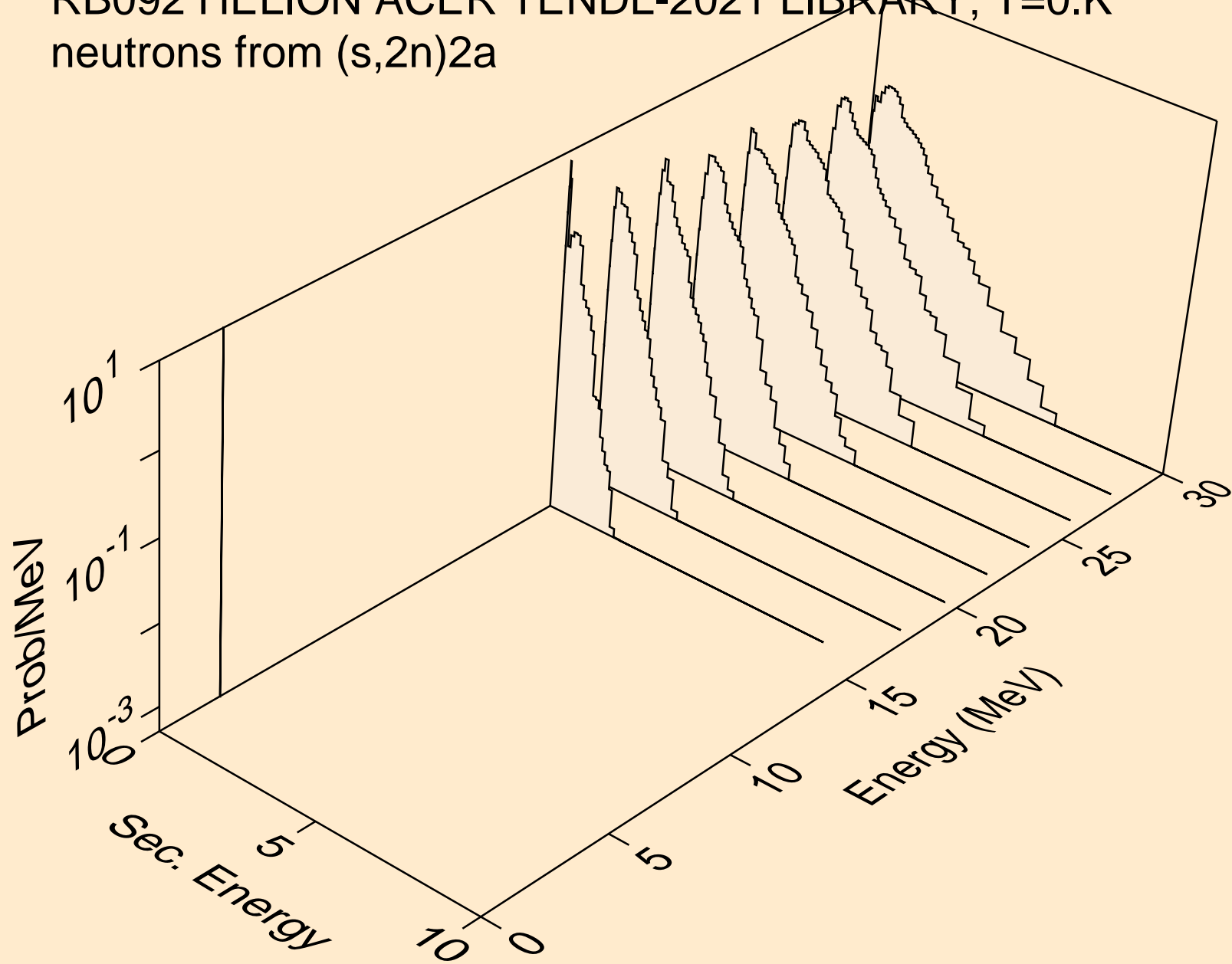

RB092 HELION ACER TENDL-2021 LIBRARY; T=0.K  
neutrons from (s,n\*)d

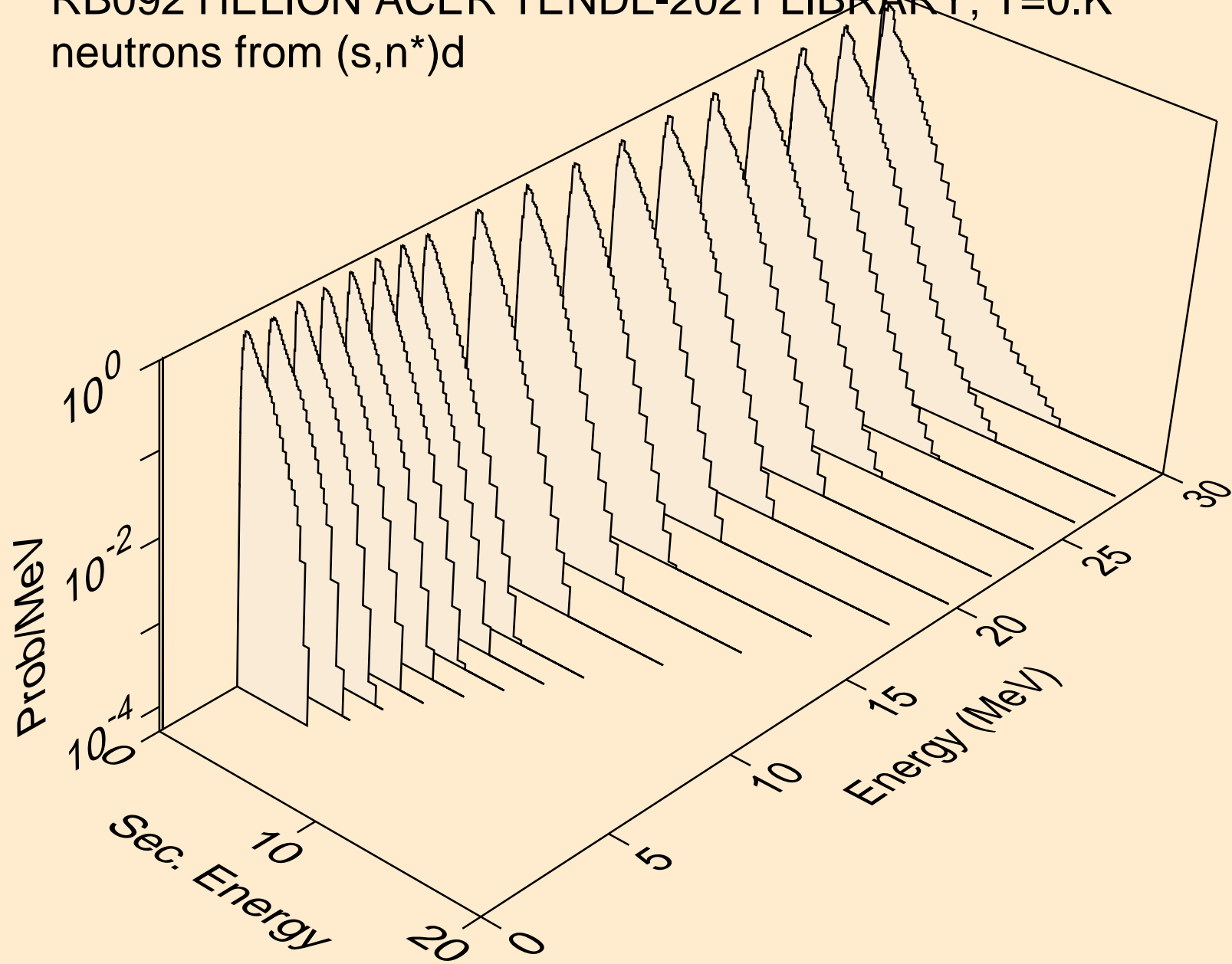

RB092 HELION ACER TENDL-2021 LIBRARY; T=0.K  
neutrons from (s,n\*)t

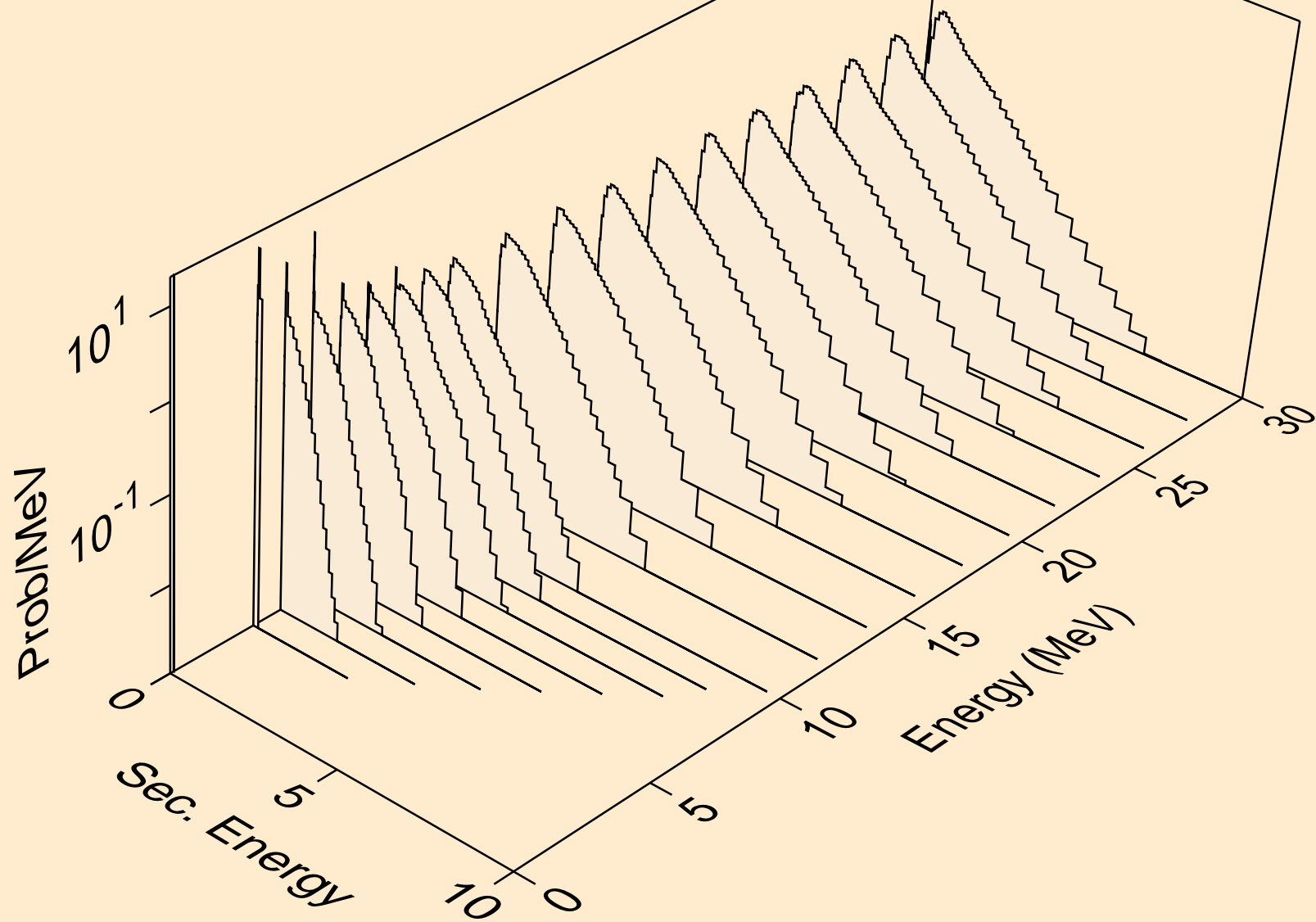



RB092 HELION ACER TENDL-2021 LIBRARY; T=0.K  
neutrons from (s,n\*)he3

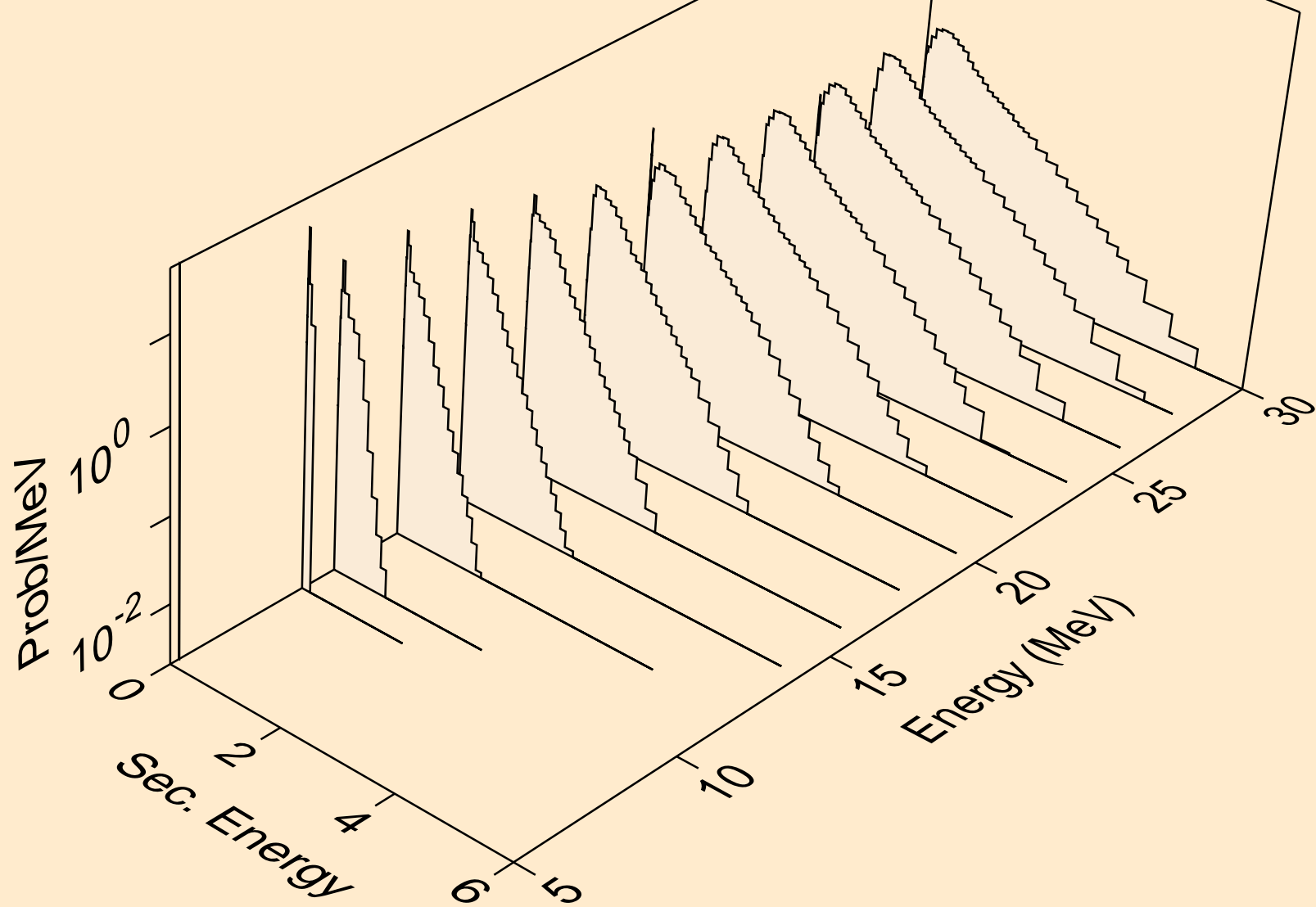

RB092 HELION ACER TENDL-2021 LIBRARY; T=0.K  
neutrons from (s,4n)

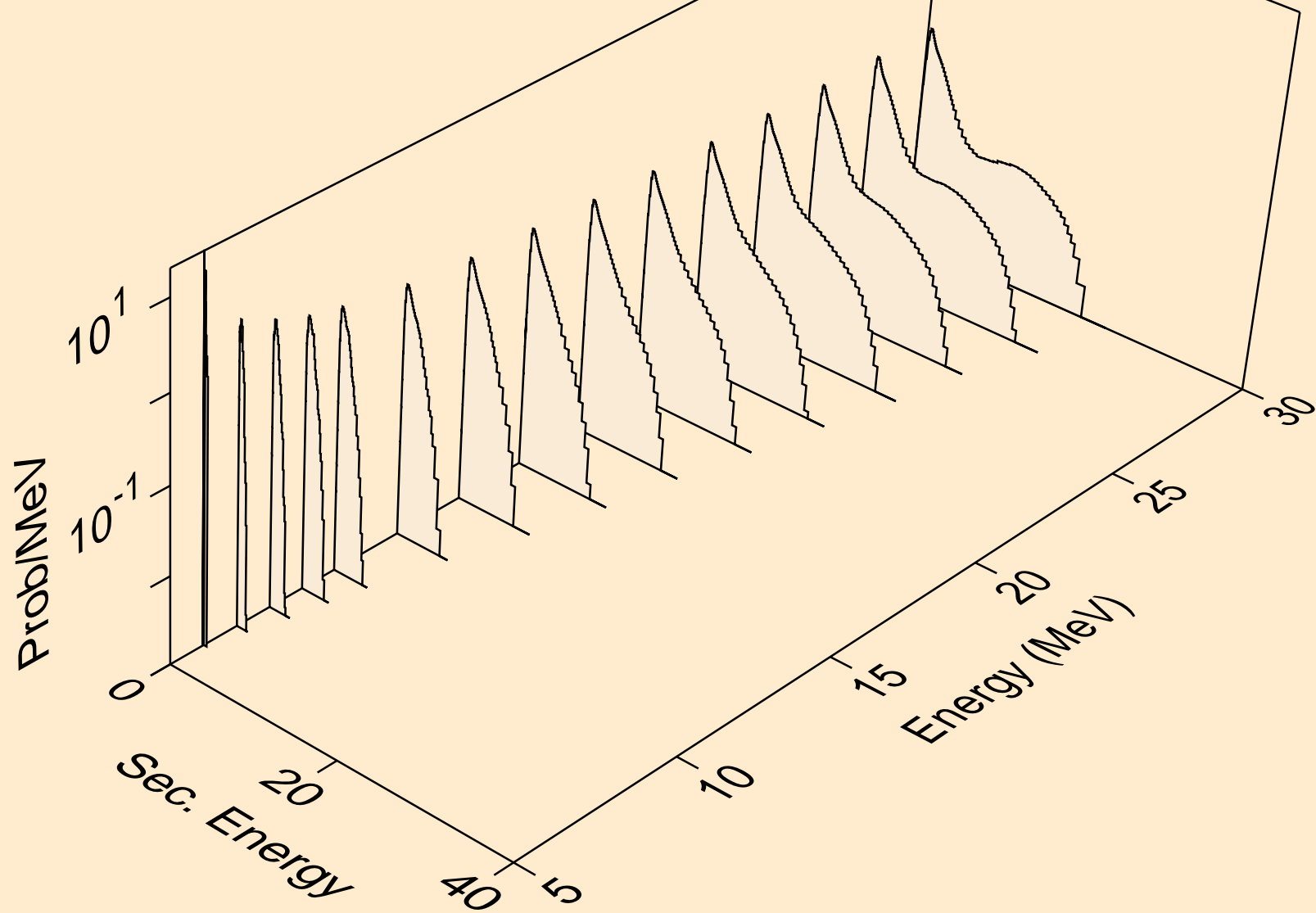

RB092 HELION ACER TENDL-2021 LIBRARY; T=0.K  
neutrons from (s,2np)

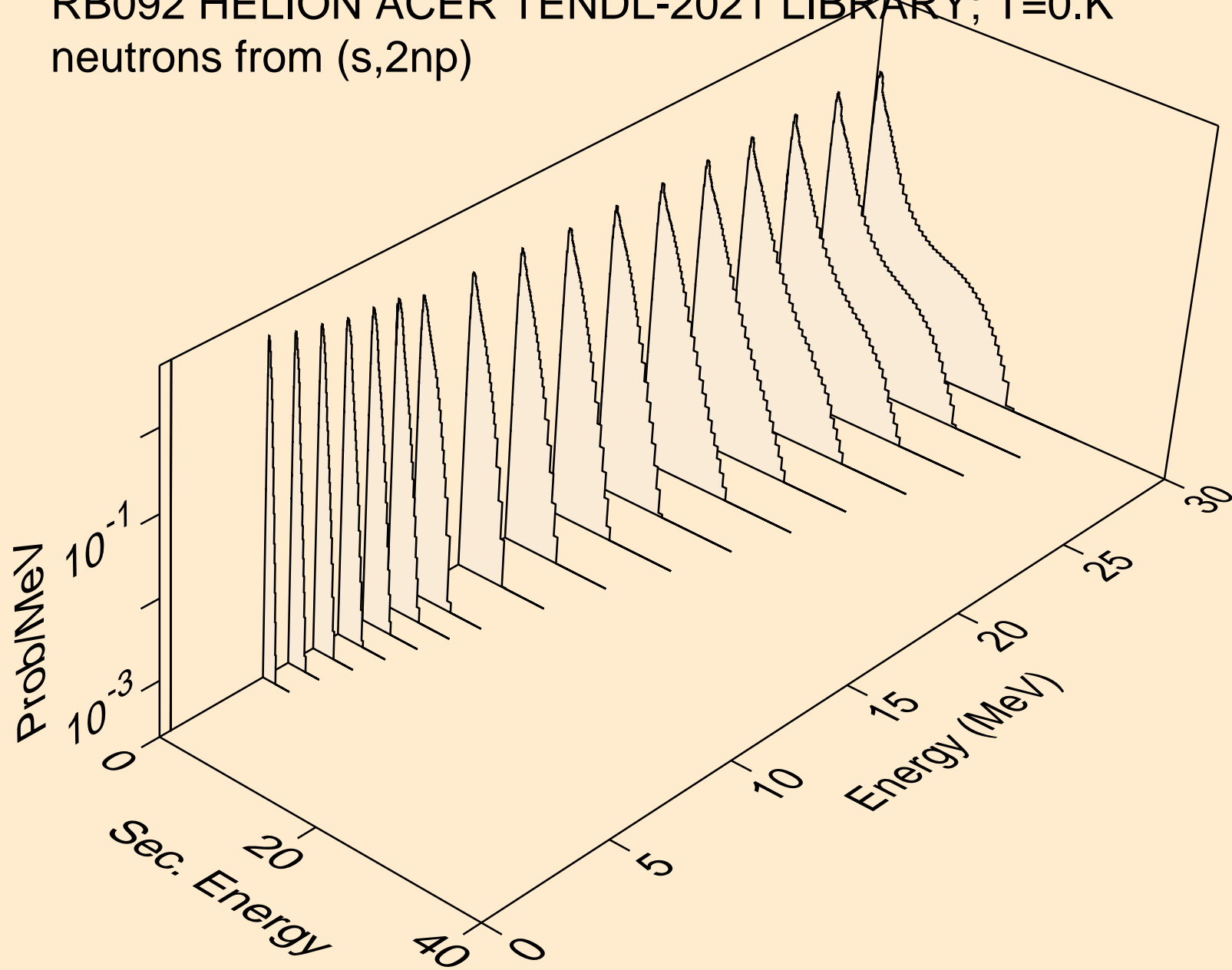

RB092 HELION ACER TENDL-2021 LIBRARY; T=0.K  
neutrons from (s,3np)

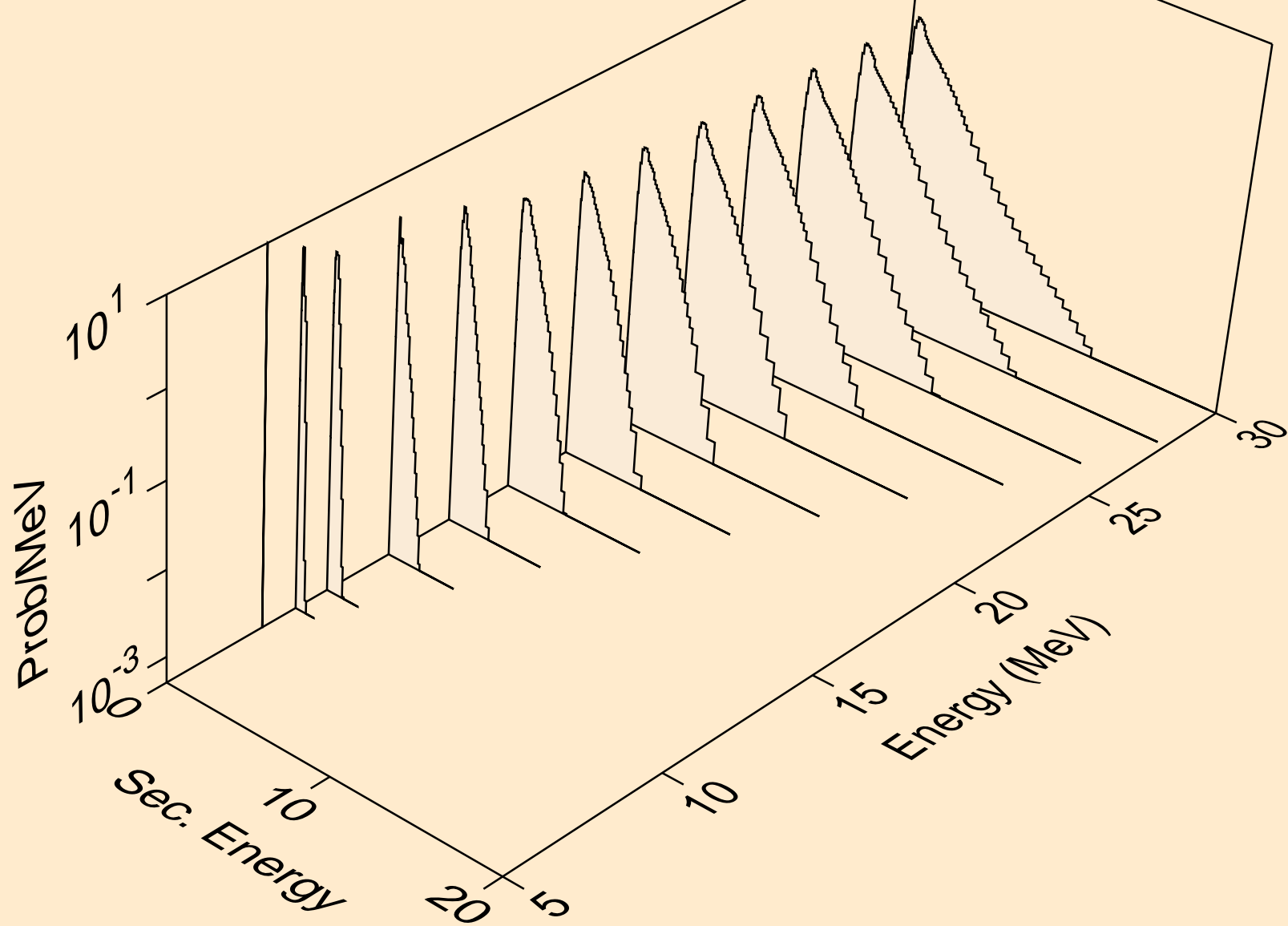

RB092 HELION ACER TENDL-2021 LIBRARY; T=0.K  
neutrons from (s,2np)

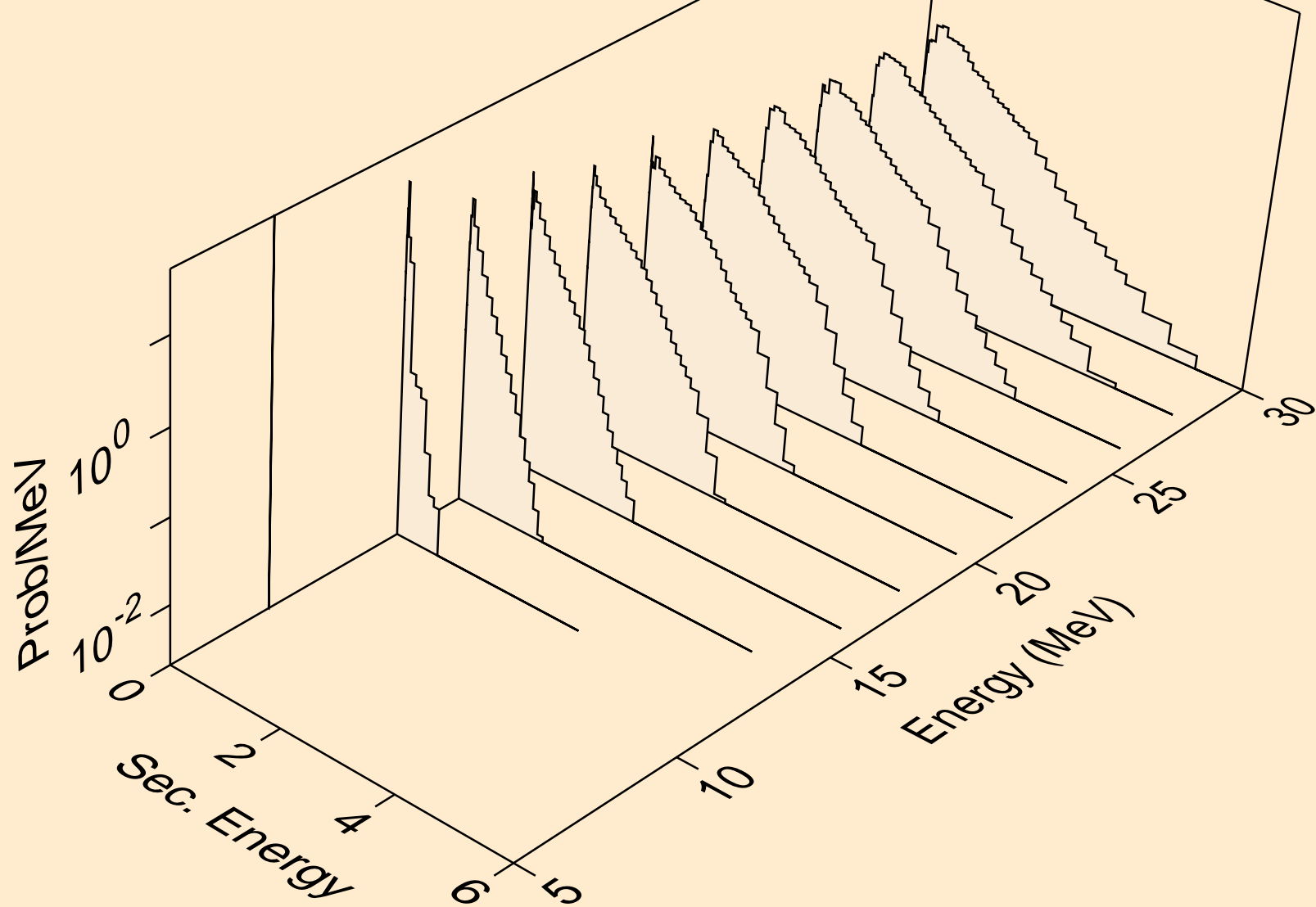

RB092 HELION ACER TENDL-2021 LIBRARY; T=0.K  
neutrons from (s,npa)

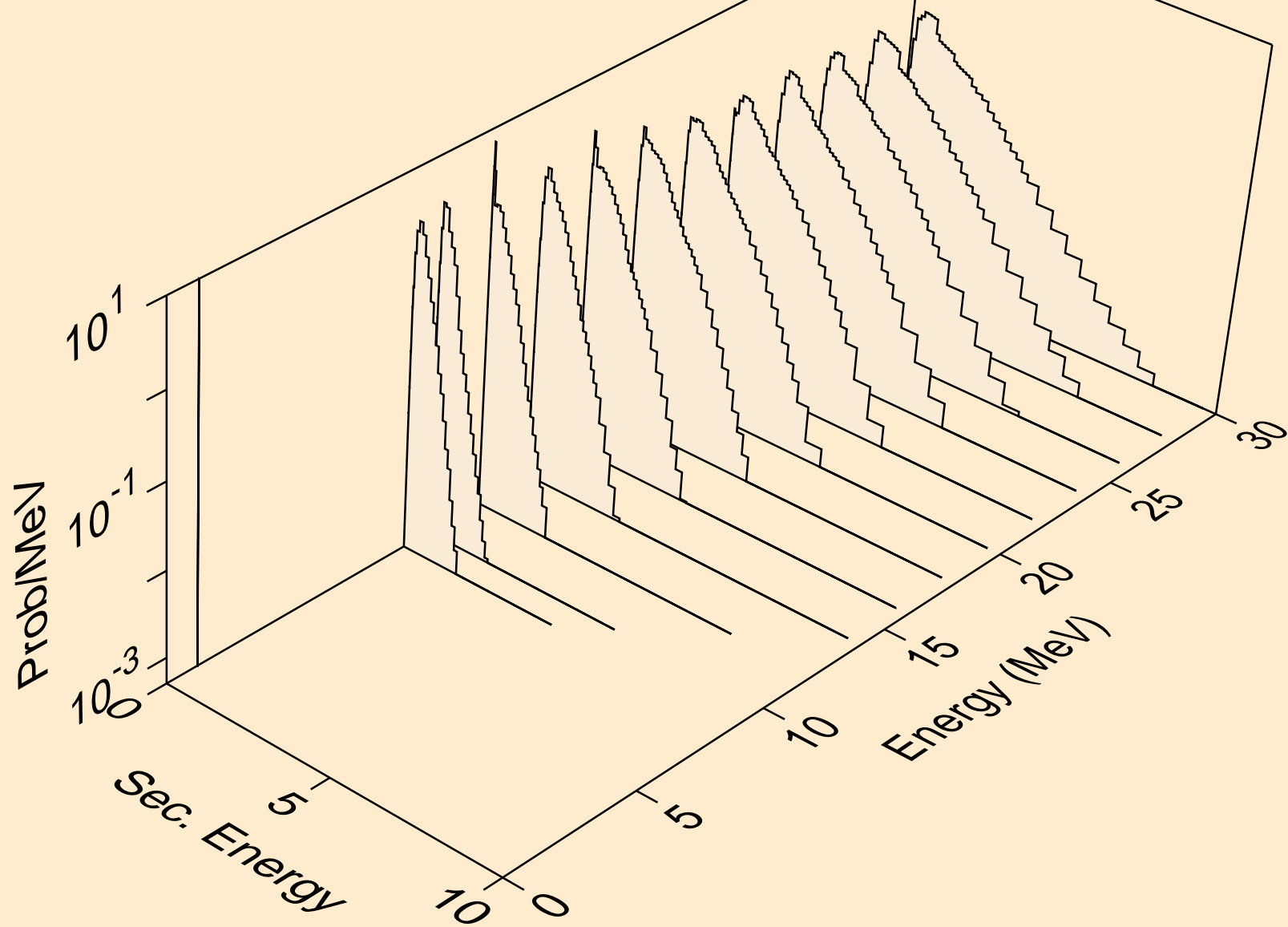

RB092 HELION ACER TENDL-2021 LIBRARY; T=0.K  
protons from (s,x)

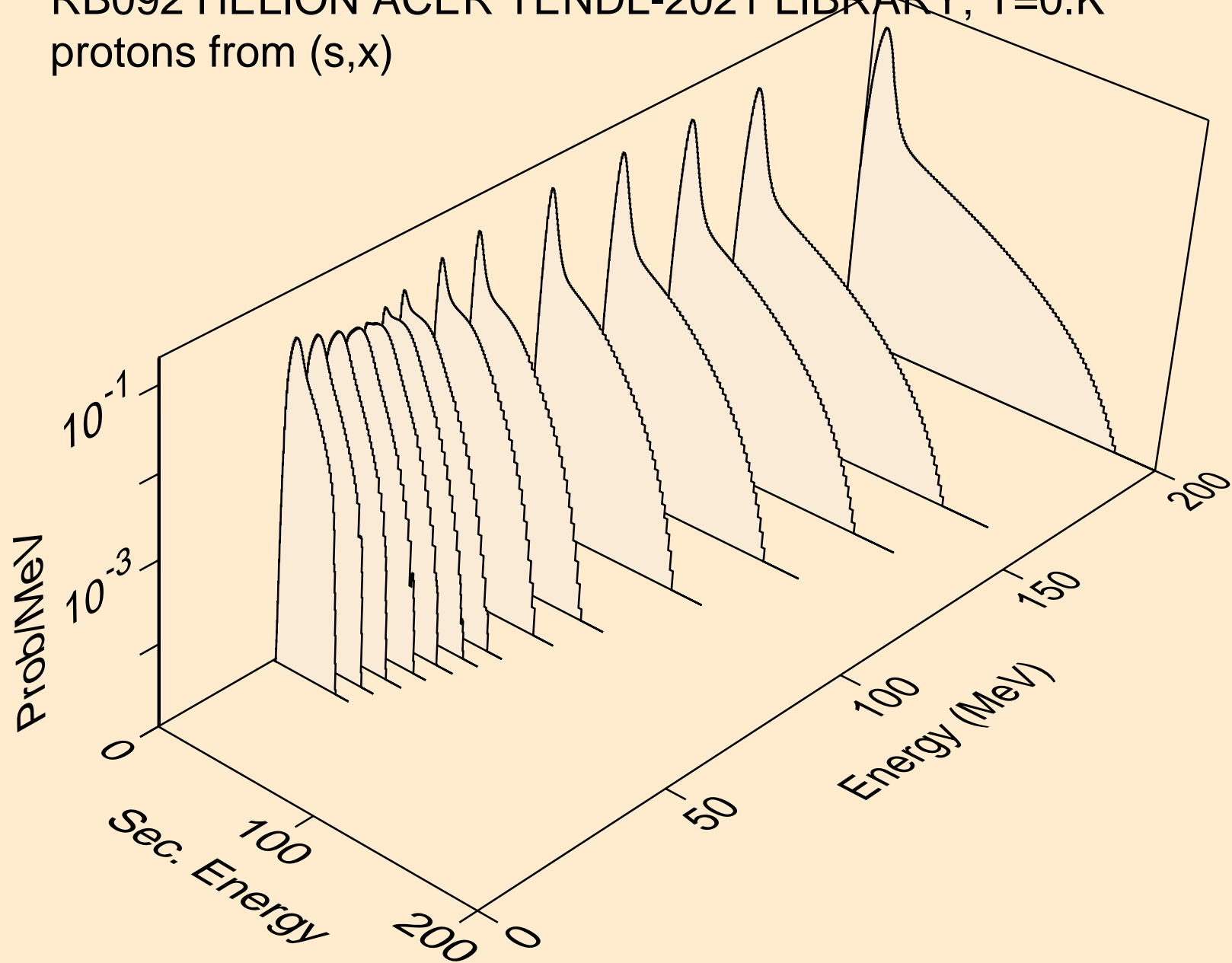

RB092 HELION ACER TENDL-2021 LIBRARY; T=0.K  
protons from (s,n\*)p

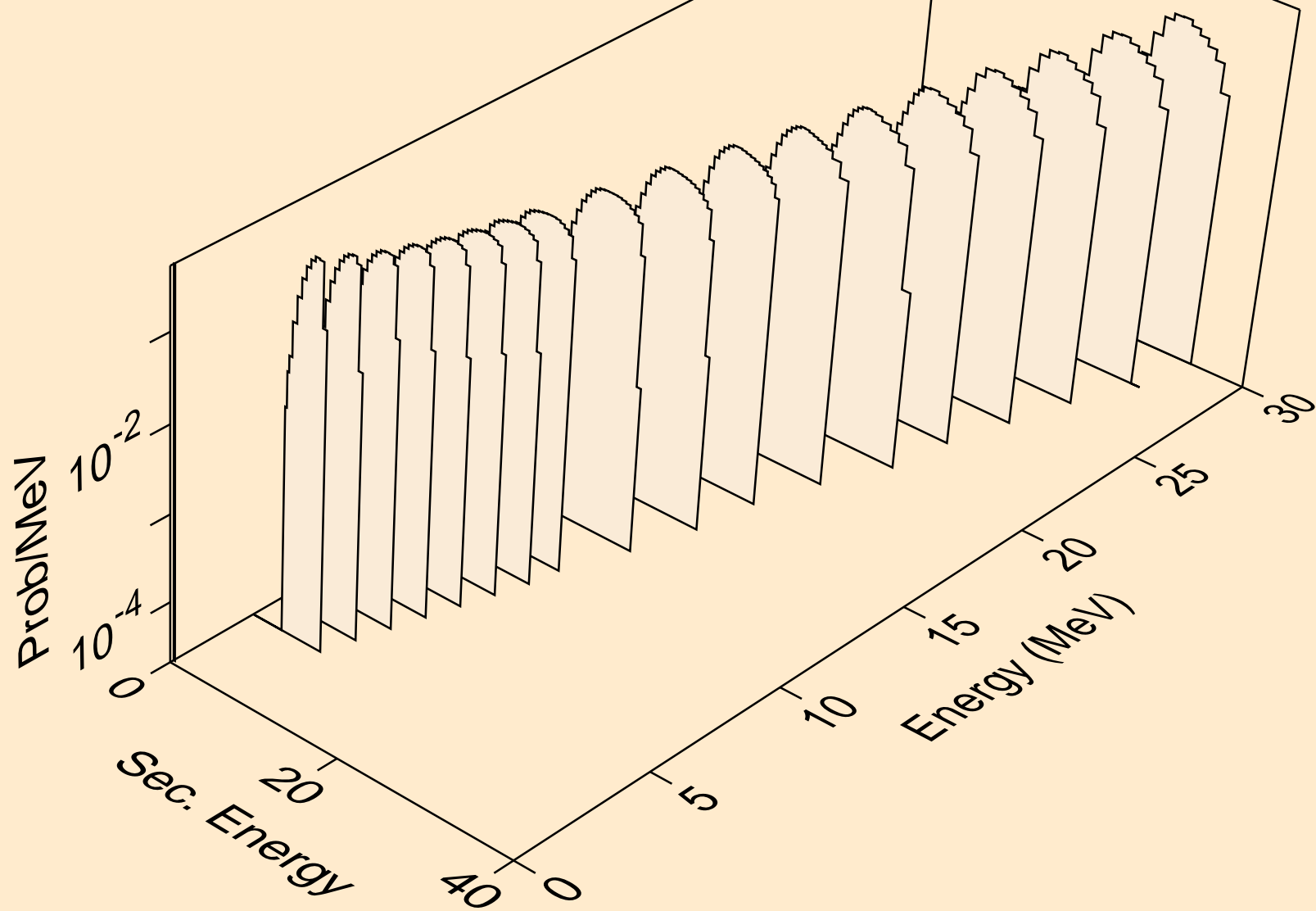



RB092 HELION ACER TENDL-2021 LIBRARY; T=0.K  
protons from (s,2np)

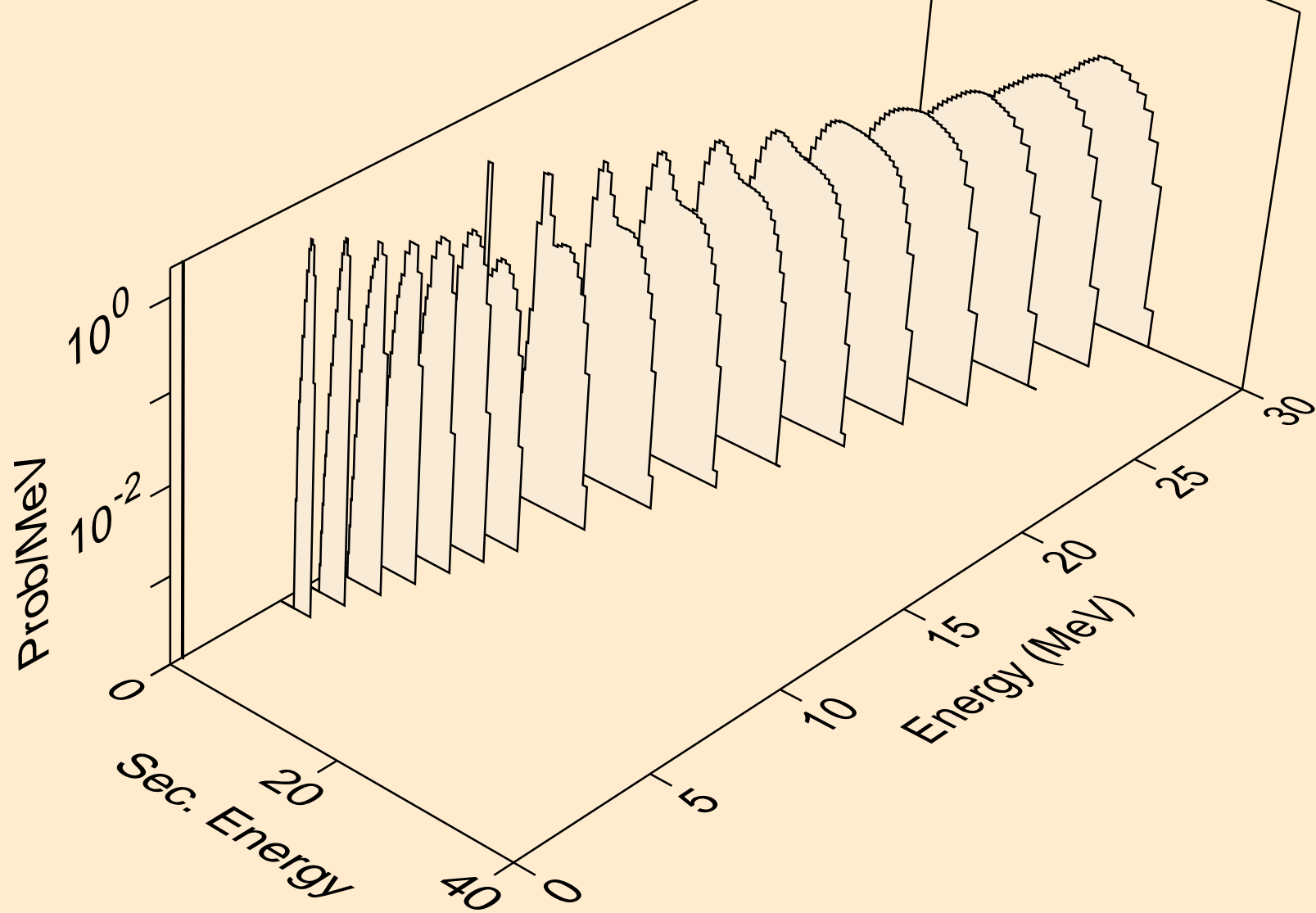

RB092 HELION ACER TENDL-2021 LIBRARY; T=0.K  
protons from (s,3np)

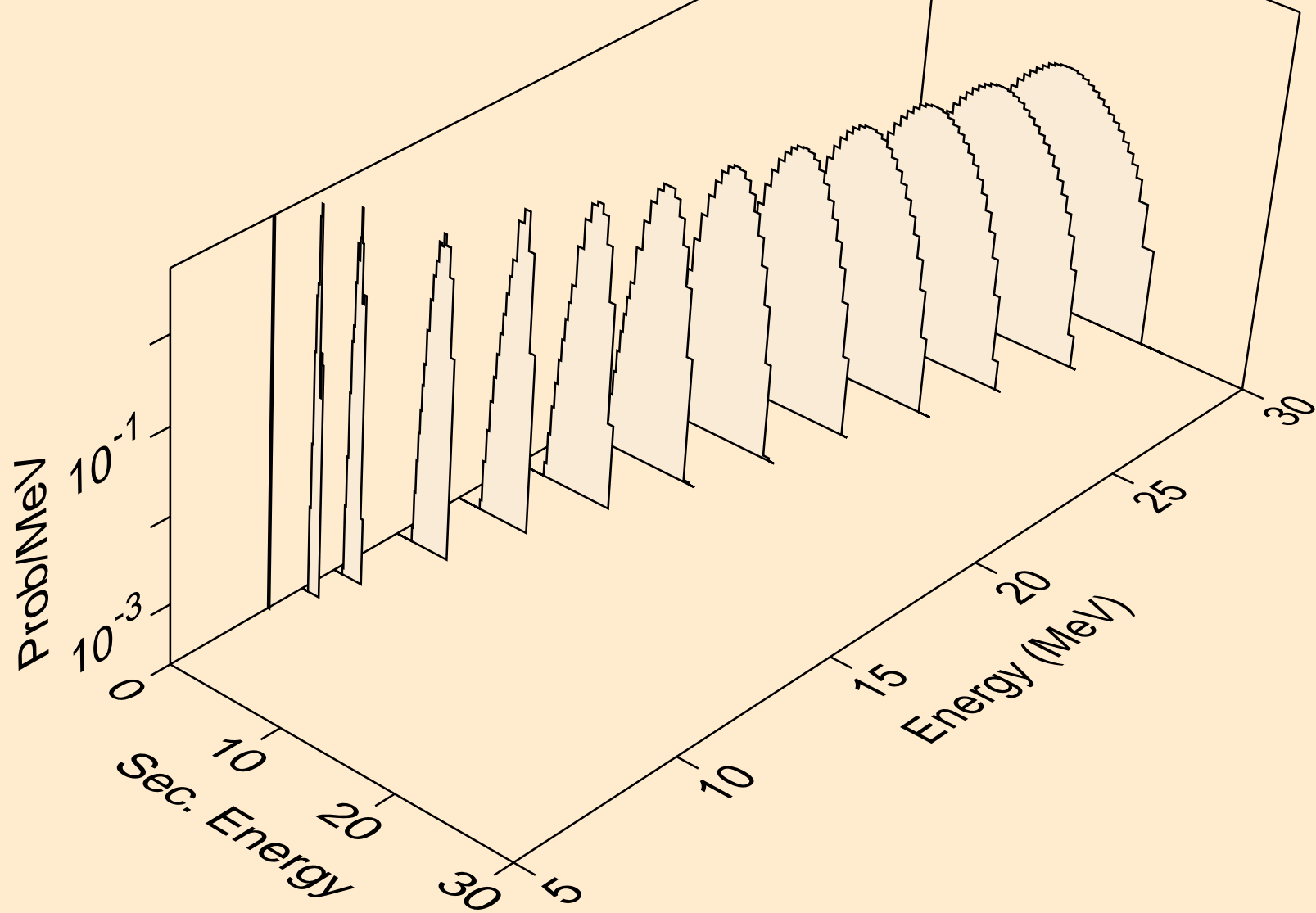

RB092 HELION ACER TENDL-2021 LIBRARY; T=0.K  
protons from (s,2np)

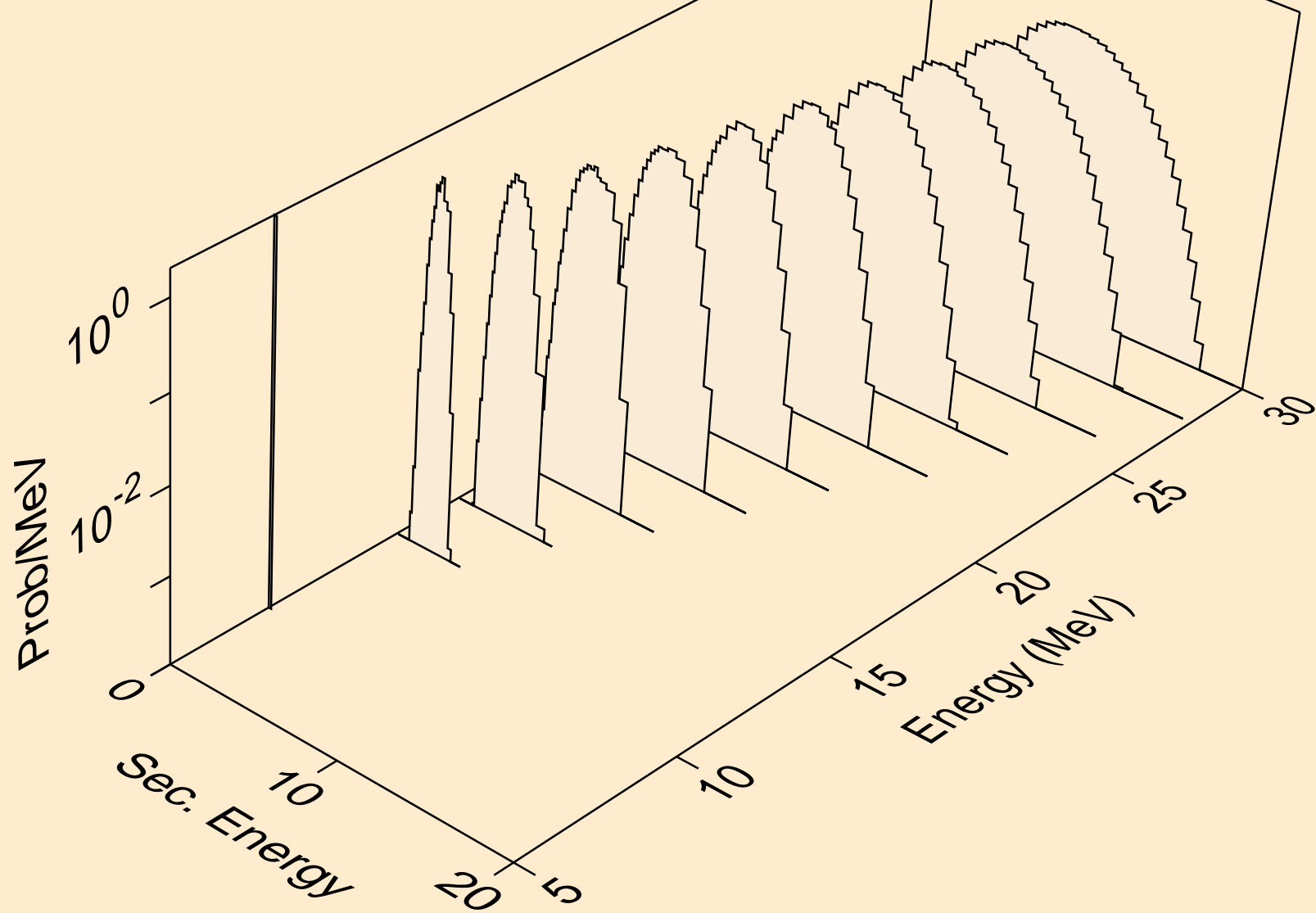

RB092 HELION ACER TENDL-2021 LIBRARY; T=0.K  
protons from (s,npa)

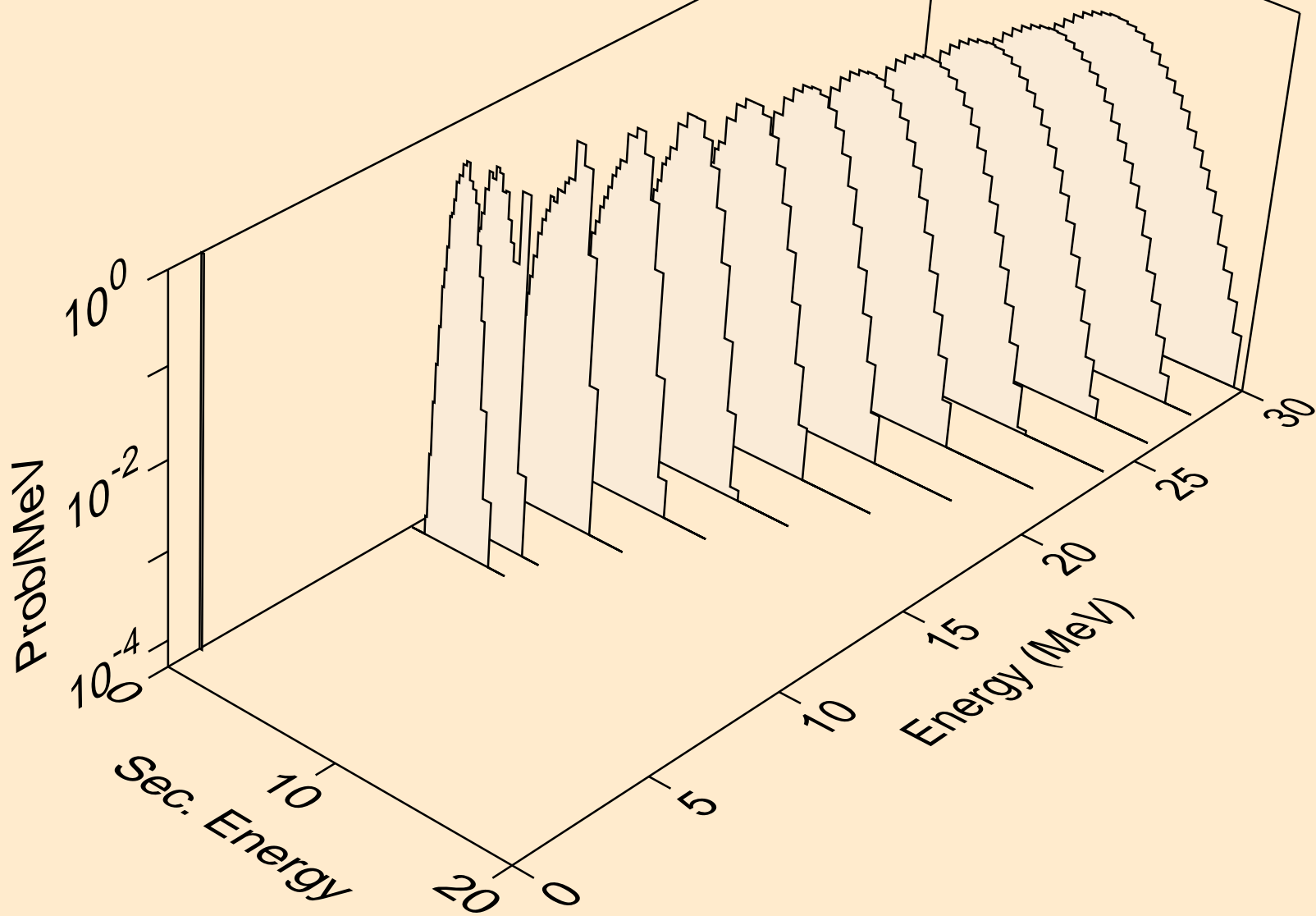

RB092 HELION ACER TENDL-2021 LIBRARY; T=0.K  
protons from (s,p)

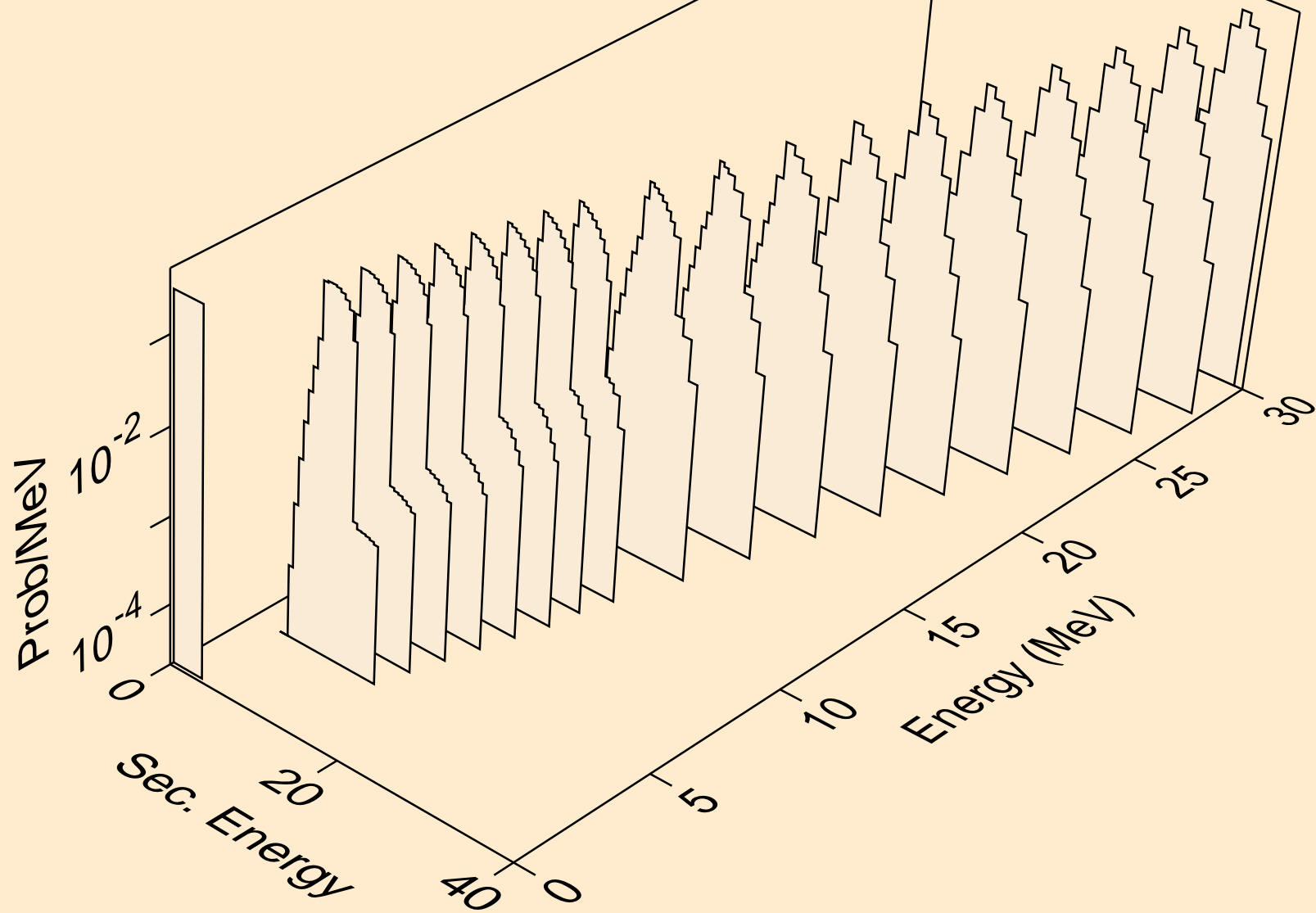

RB092 HELION ACER TENDL-2021 LIBRARY; T=0.K  
protons from (s,2p)

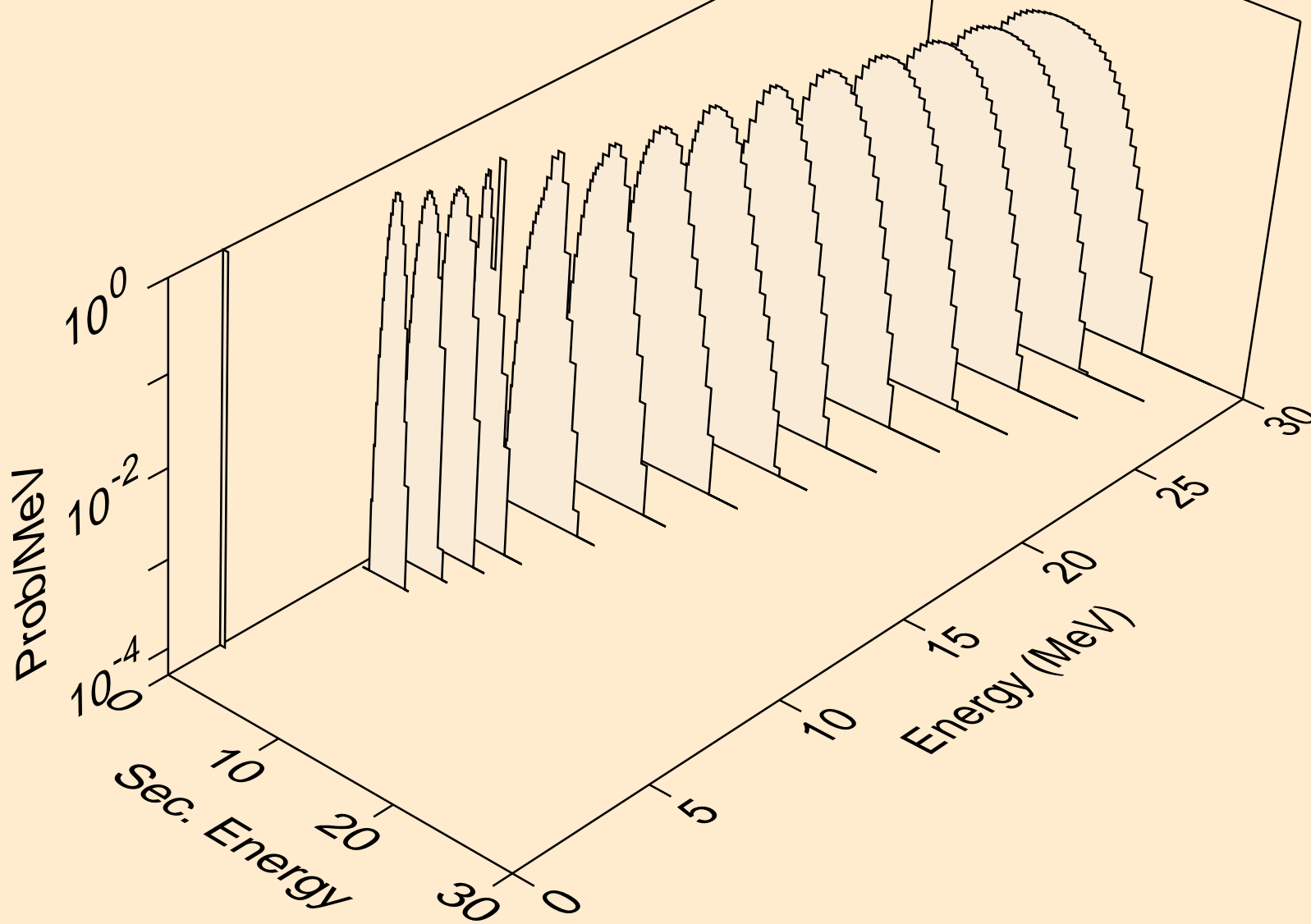

RB092 HELION ACER TENDL-2021 LIBRARY; T=0.K  
protons from (s,pa)

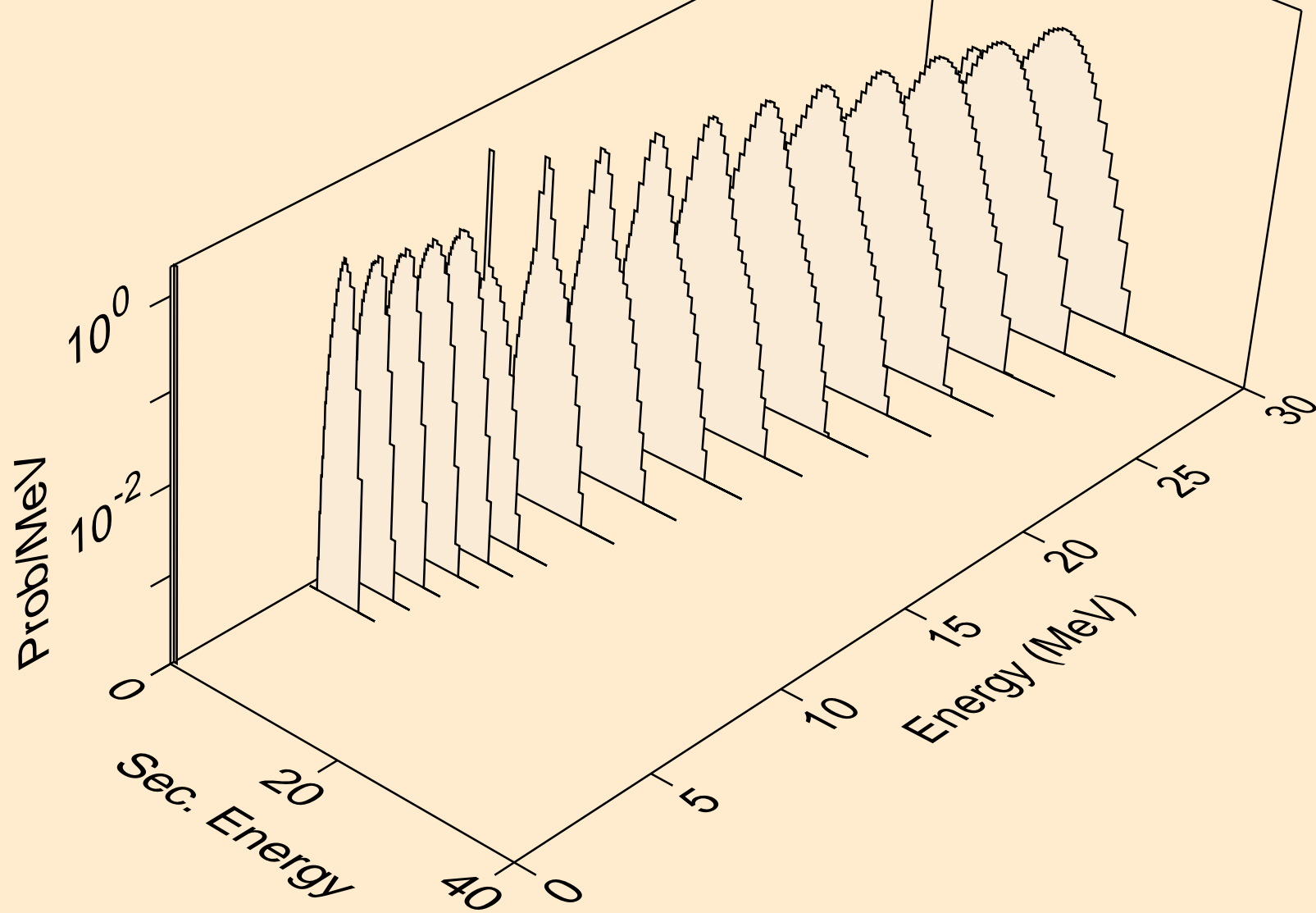

RB092 HELION ACER TENDL-2021 LIBRARY; T=0.K  
protons from (s,pd)

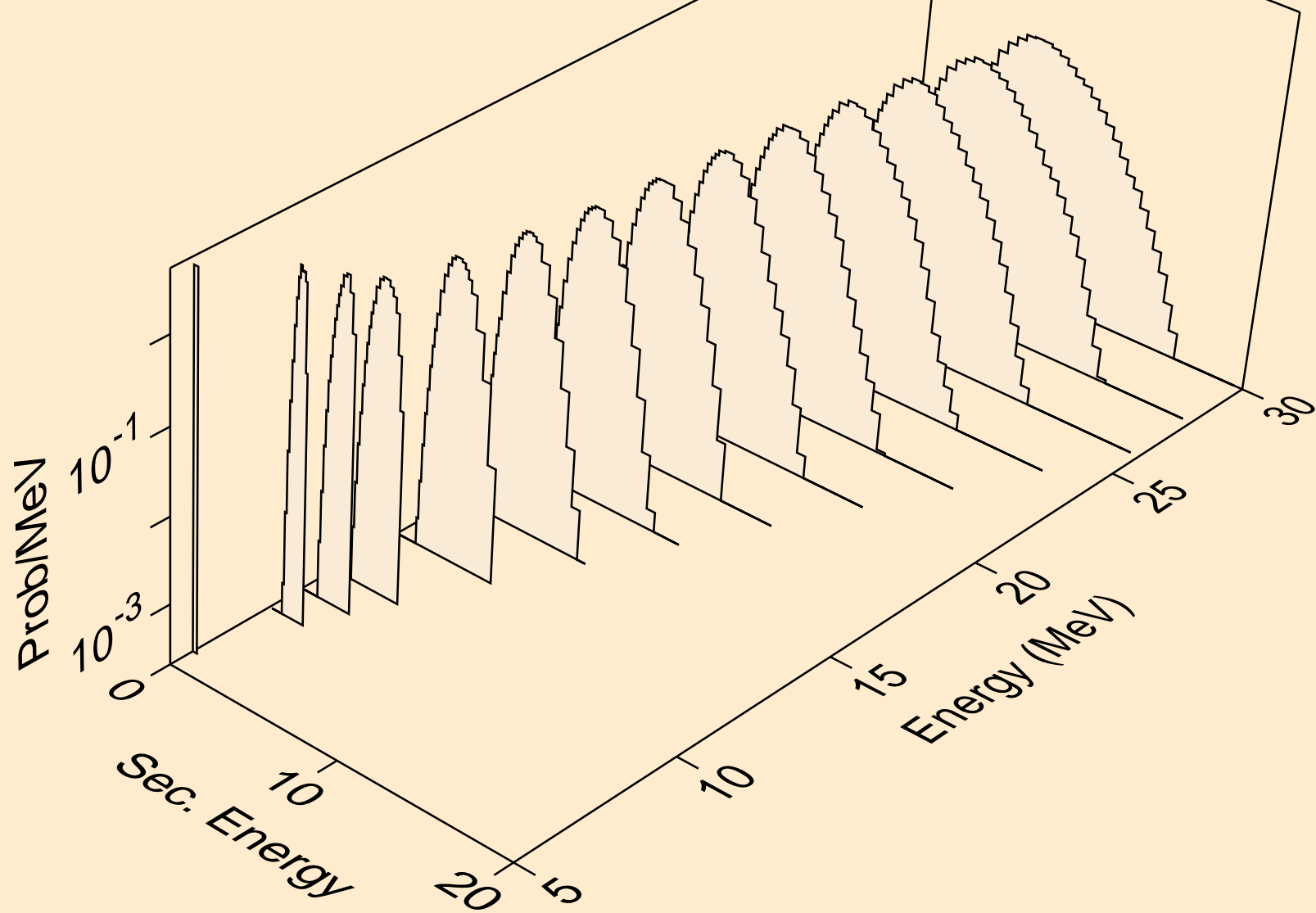



RB092 HELION ACER TENDL-2021 LIBRARY; T=0.K  
protons from (s,pt)

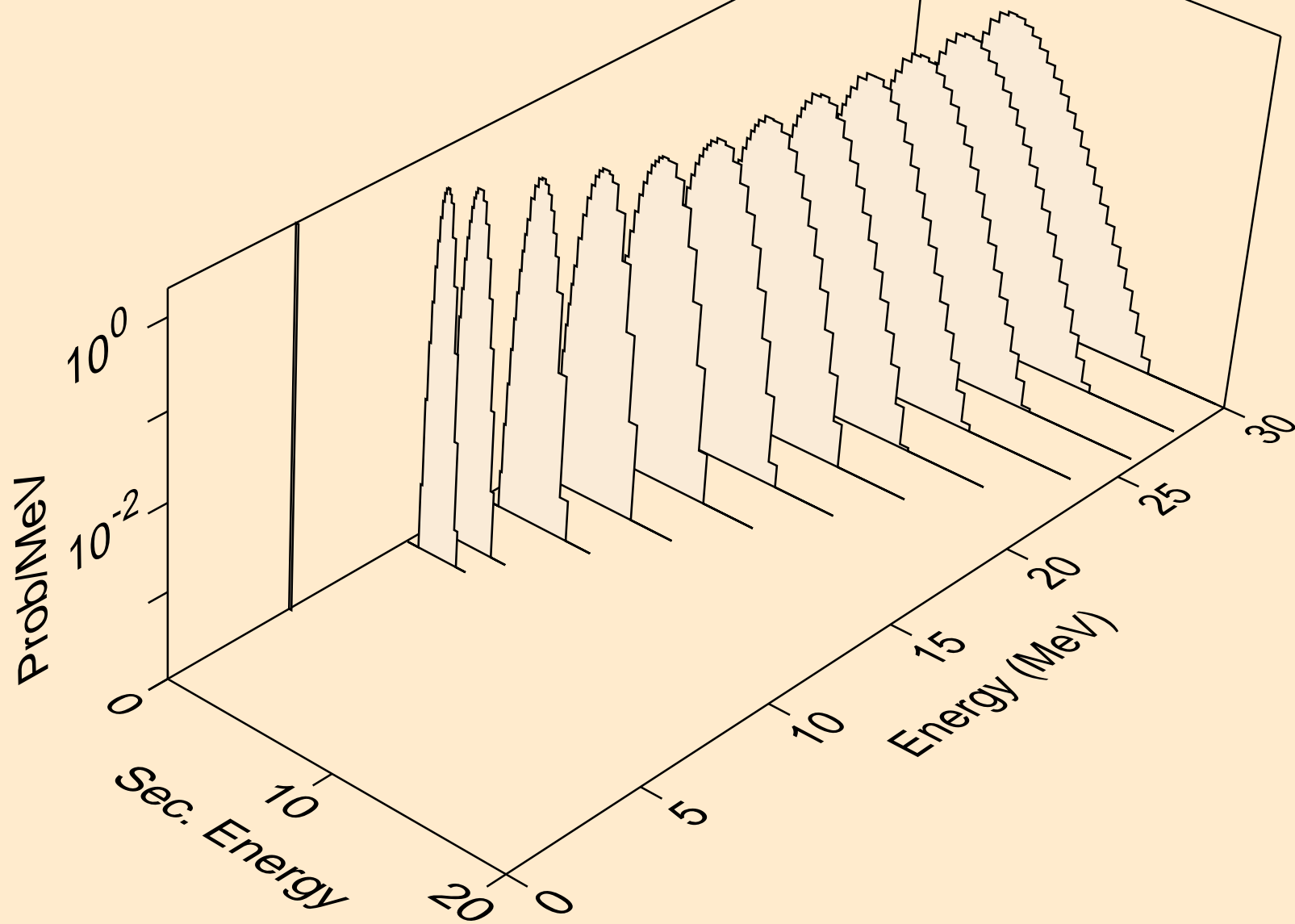

RB092 HELION ACER TENDL-2021 LIBRARY; T=0.K  
deuterons from (s,x)

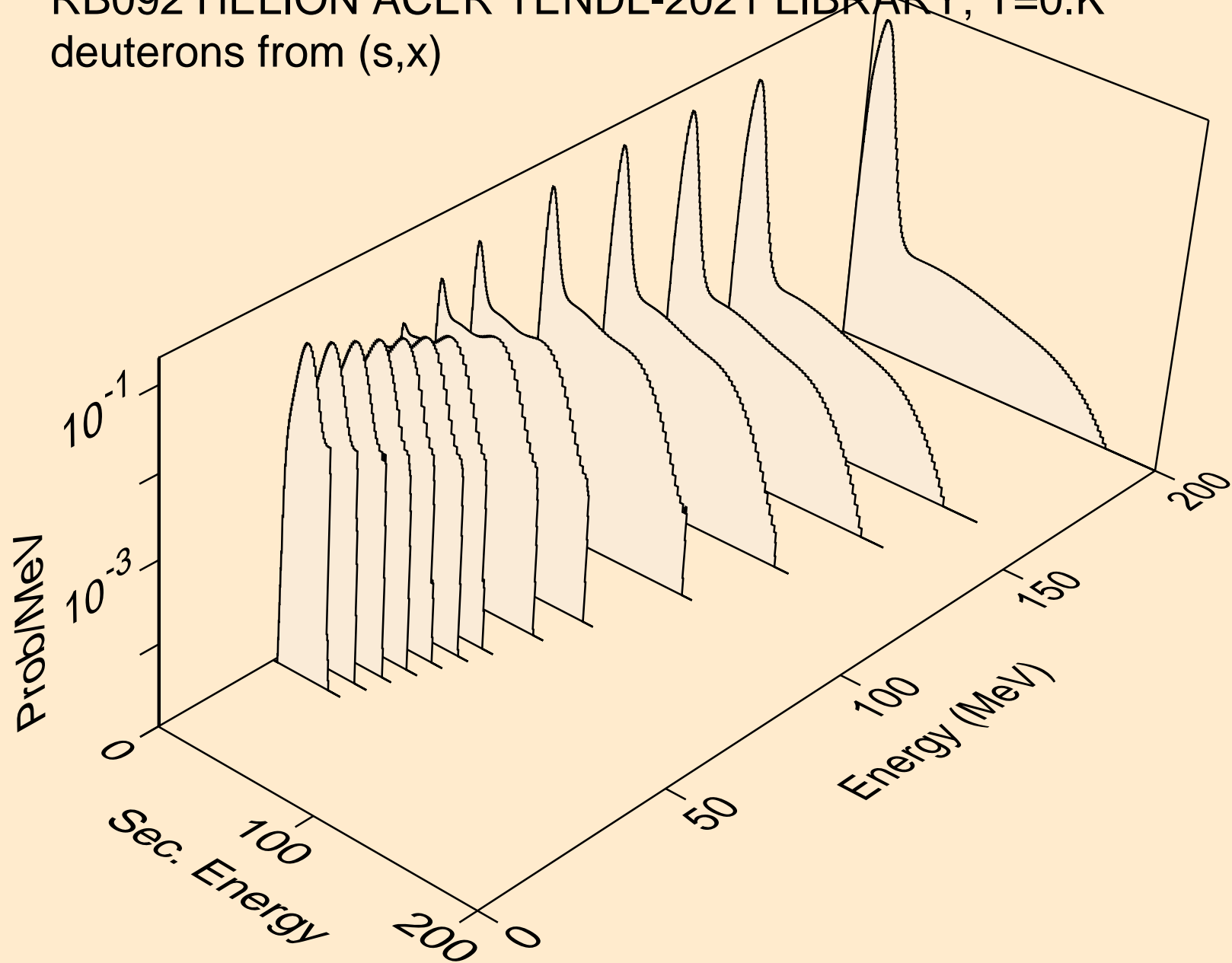

RB092 HELION ACER TENDL-2021 LIBRARY; T=0.K  
deuterons from (s,2nd)

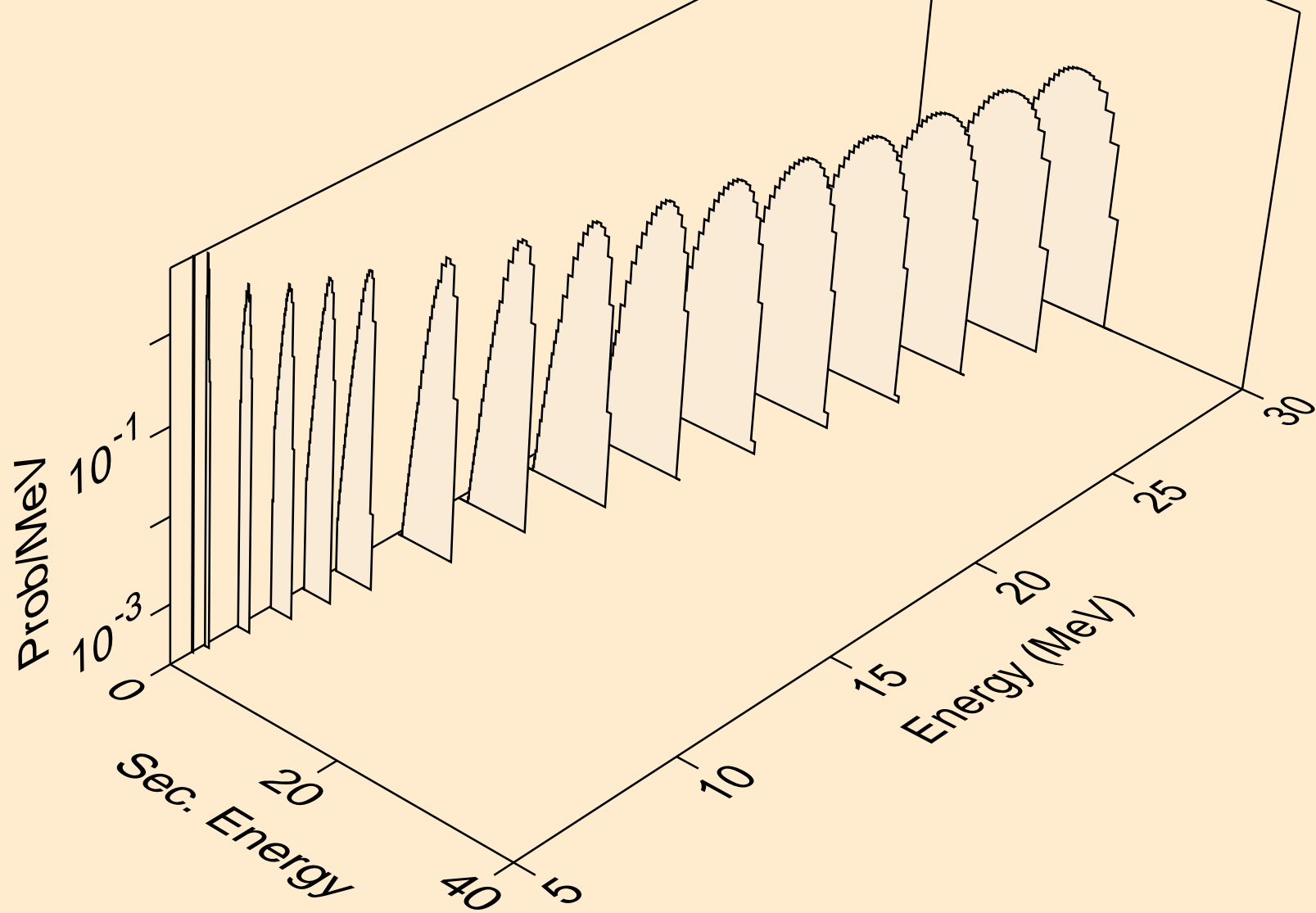

RB092 HELION ACER TENDL-2021 LIBRARY; T=0.K  
deuterons from (s,n\*)d

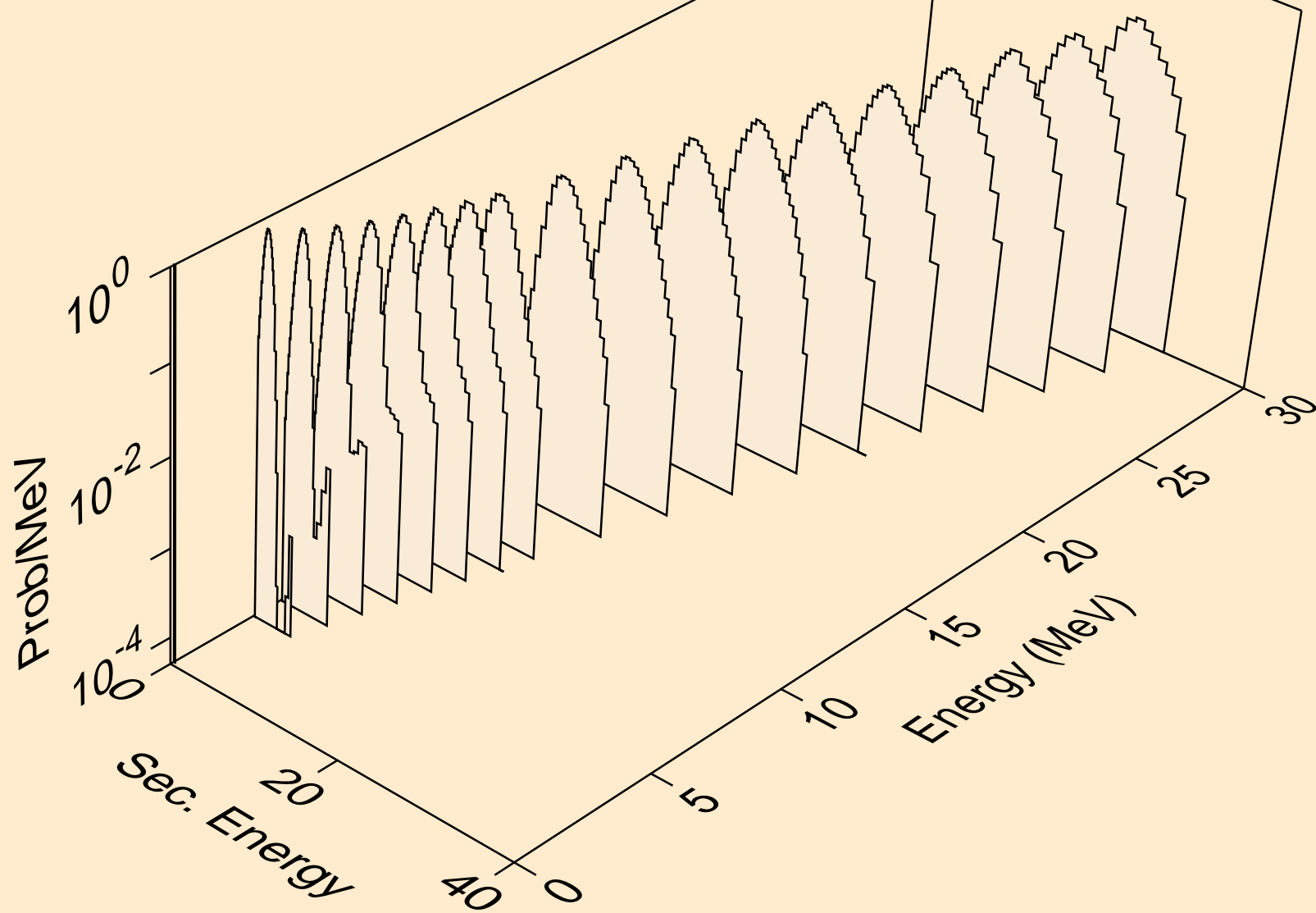

RB092 HELION ACER TENDL-2021 LIBRARY; T=0.K  
deuterons from (s,d)

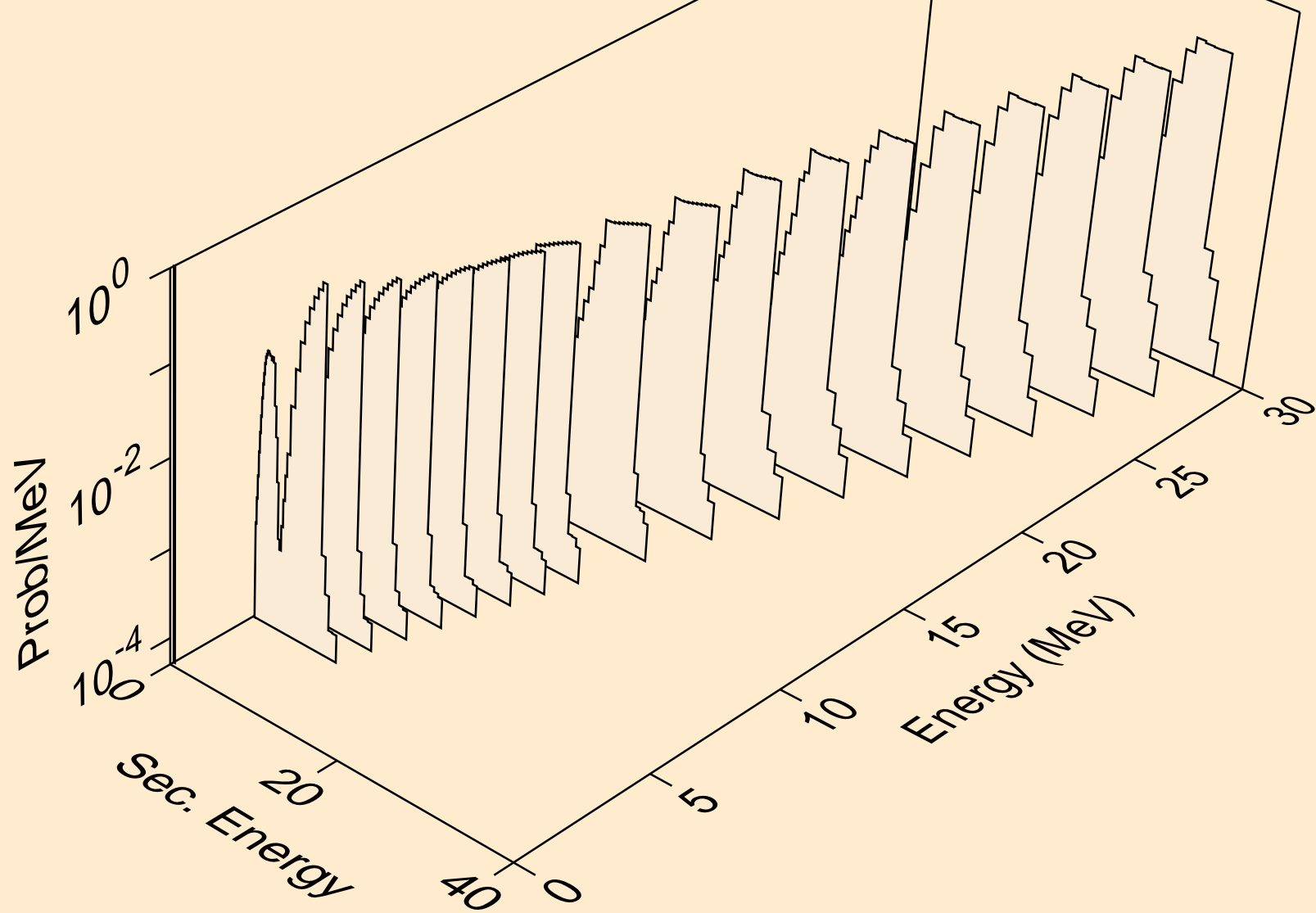

RB092 HELION ACER TENDL-2021 LIBRARY; T=0.K  
deuterons from (s,pd)

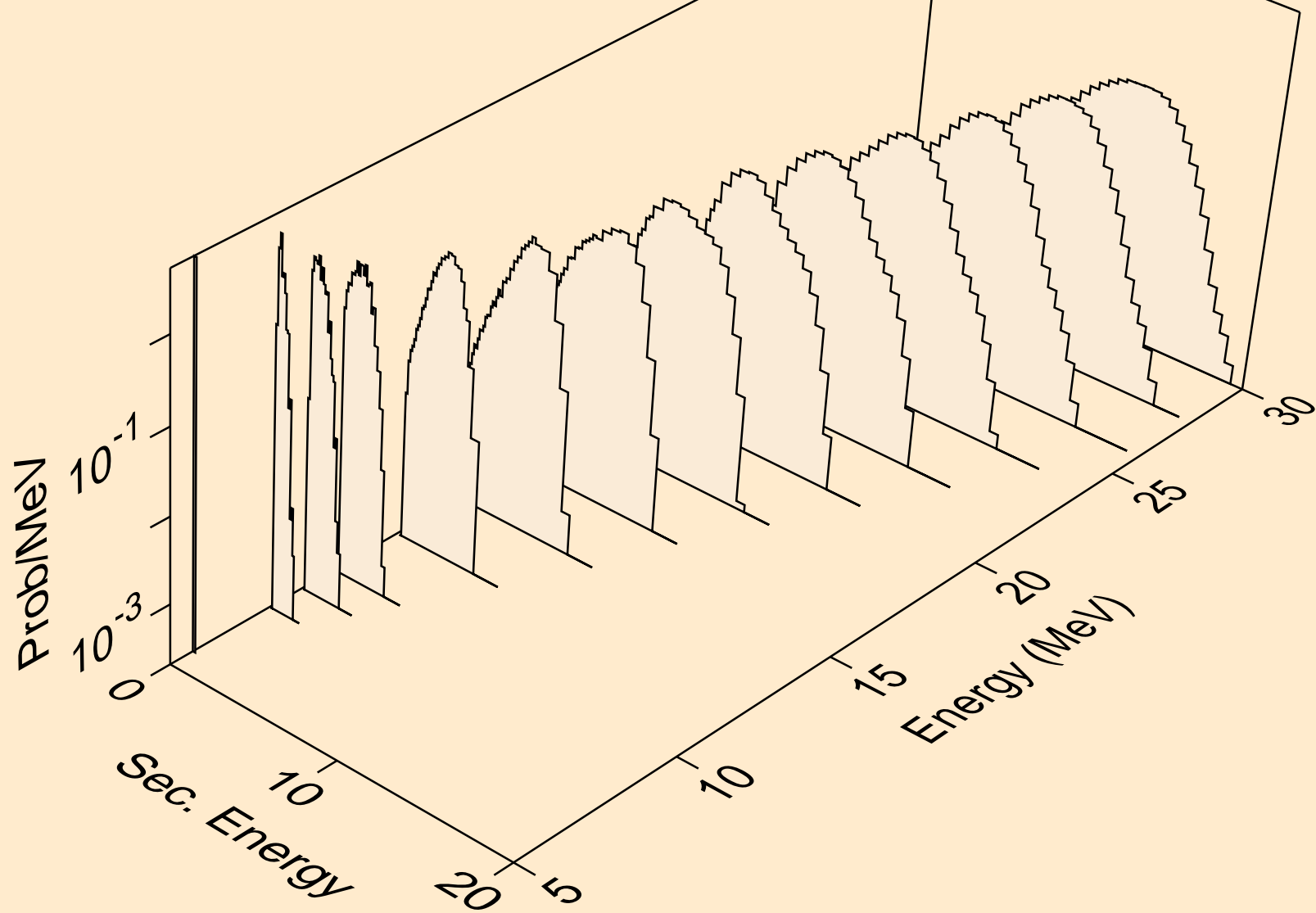

RB092 HELION ACER TENDL-2021 LIBRARY; T=0.K  
deuterons from (s,da)

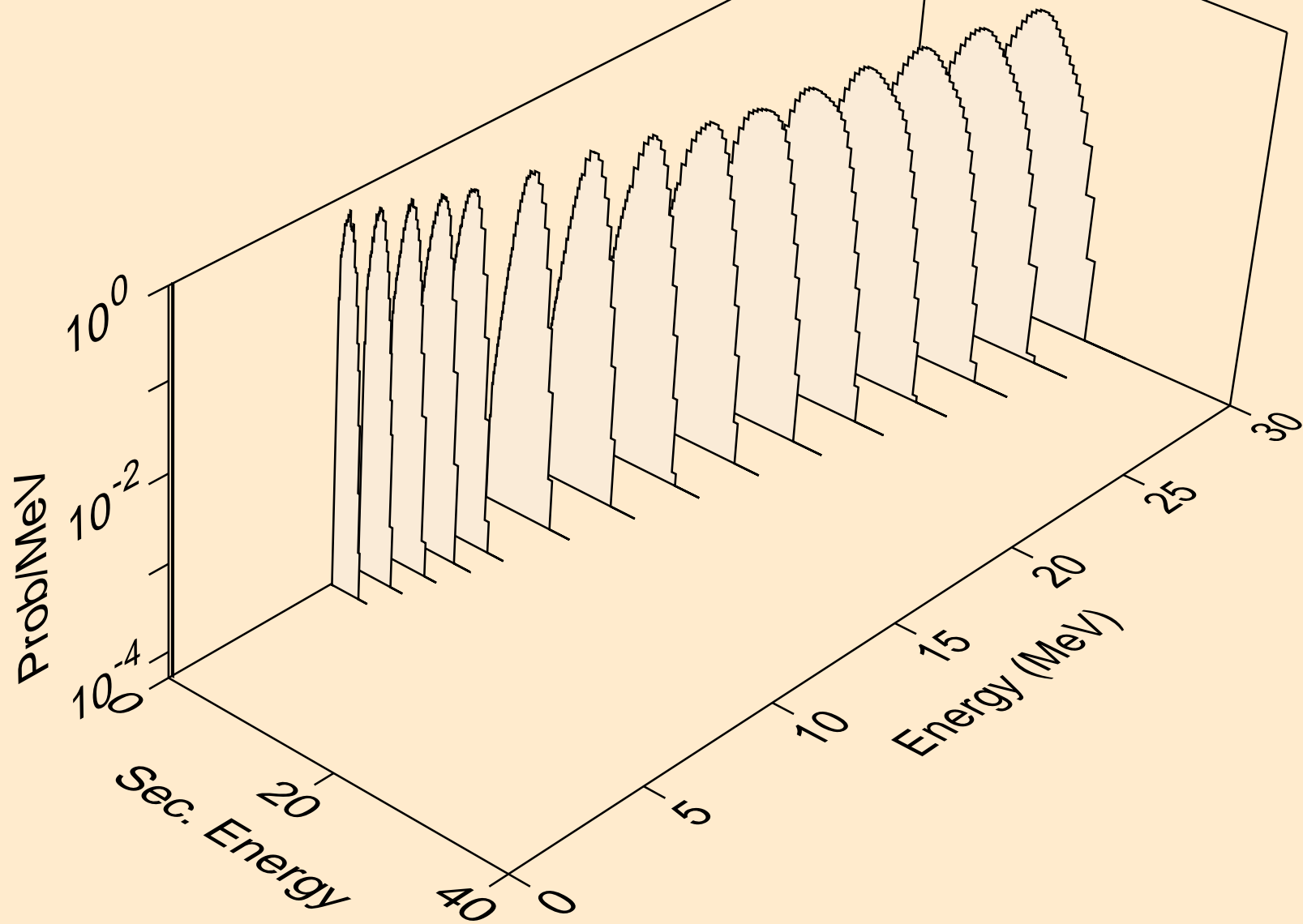

RB092 HELION ACER TENDL-2021 LIBRARY; T=0.K  
tritons from (s,x)

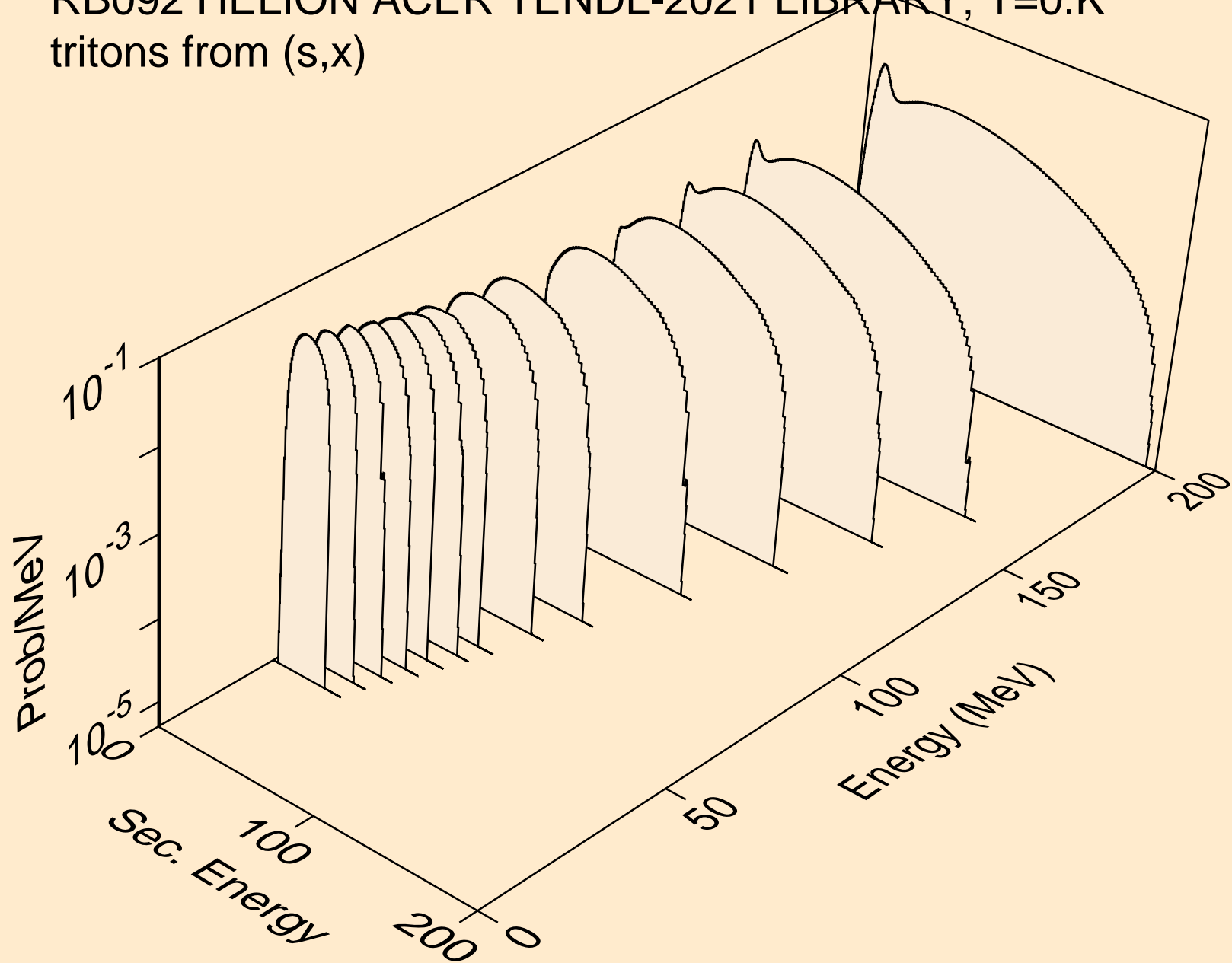



RB092 HELION ACER TENDL-2021 LIBRARY; T=0.K  
tritons from (s,n\*)t

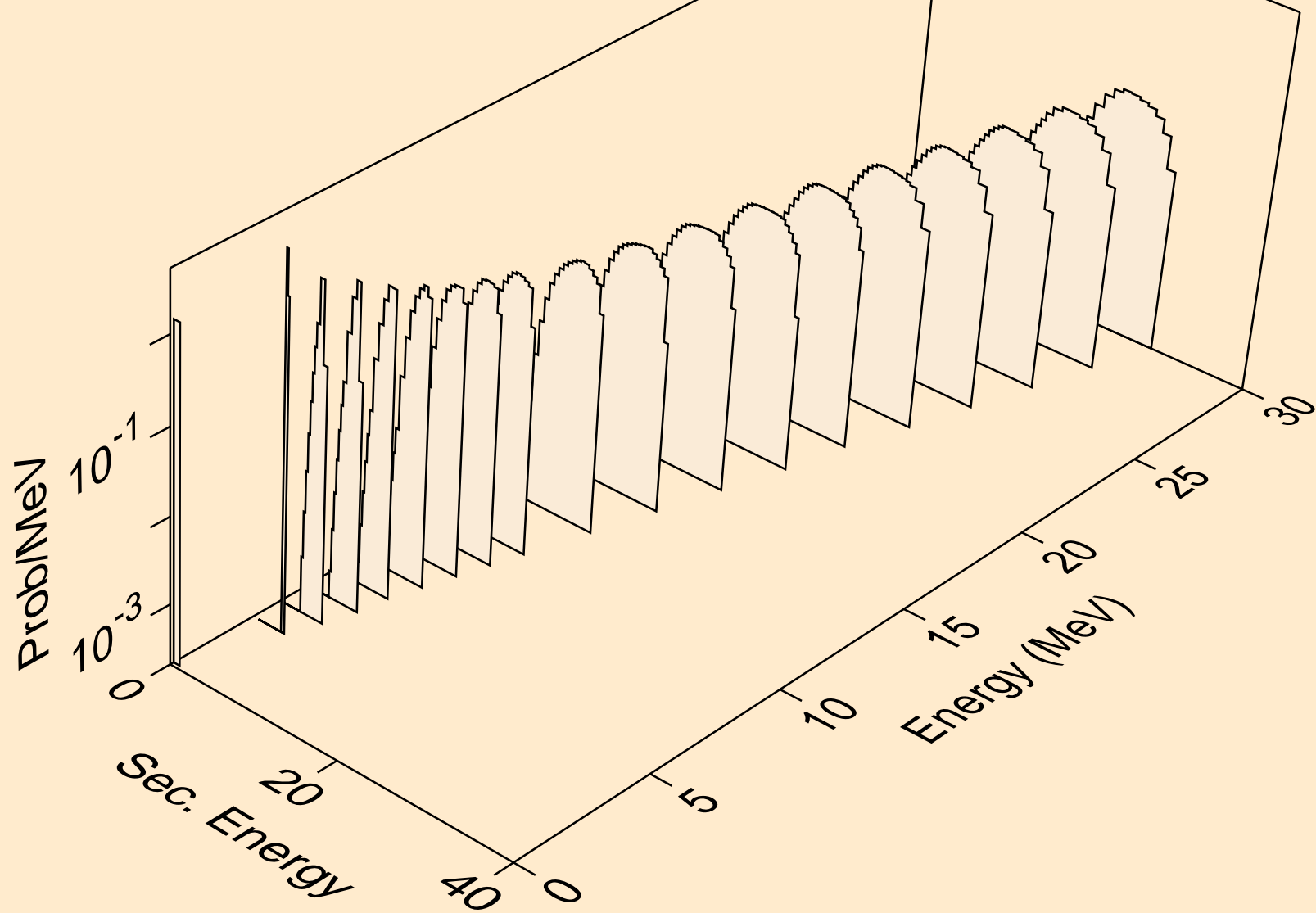

RB092 HELION ACER TENDL-2021 LIBRARY; T=0.K  
tritons from (s,t)

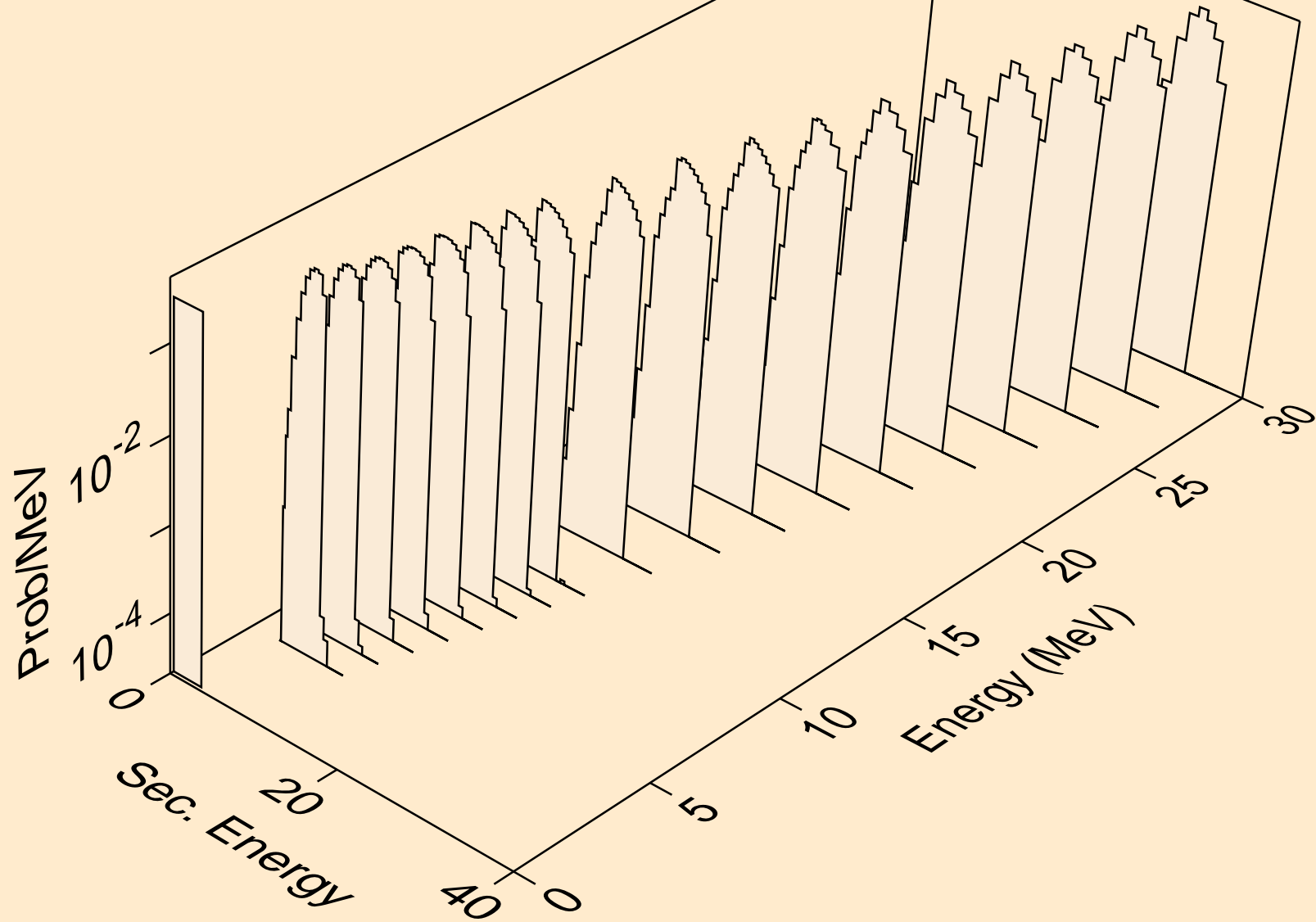

RB092 HELION ACER TENDL-2021 LIBRARY; T=0.K  
tritons from (s,pt)

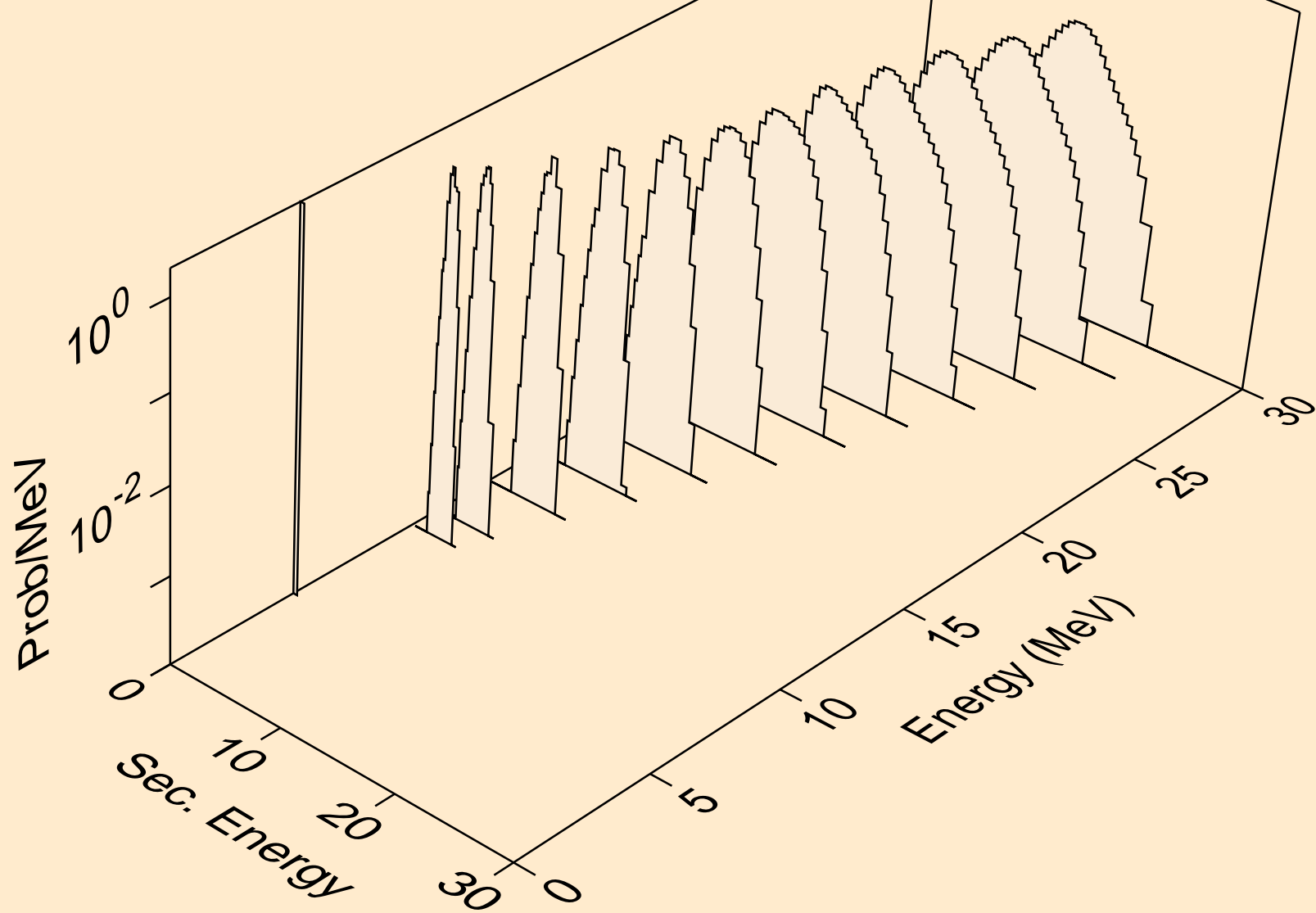

RB092 HELION ACER TENDL-2021 LIBRARY; T=0.K  
alphas from (s,x)

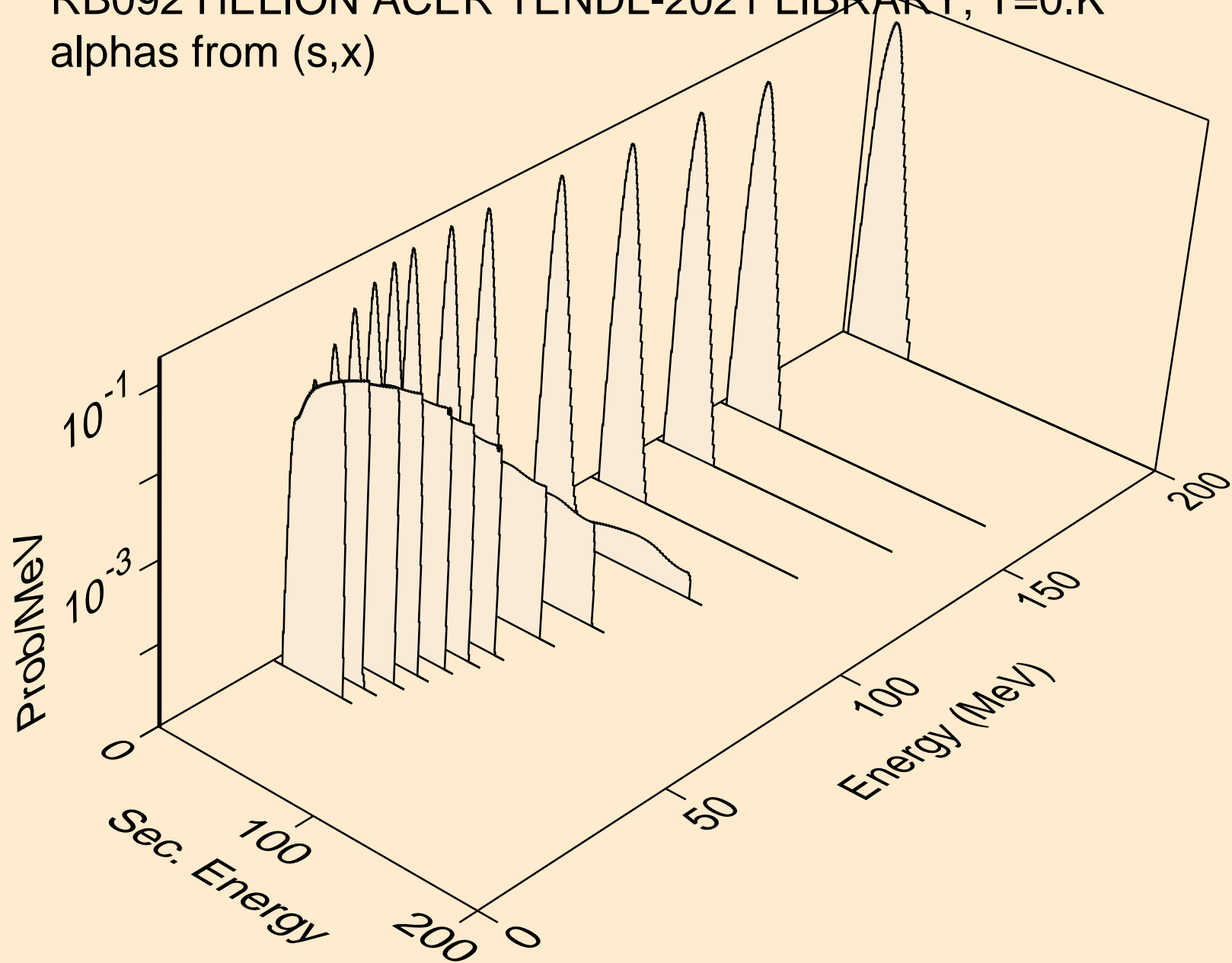

RB092 HELION ACER TENDL-2021 LIBRARY; T=0.K  
alphas from (s,n\*)a

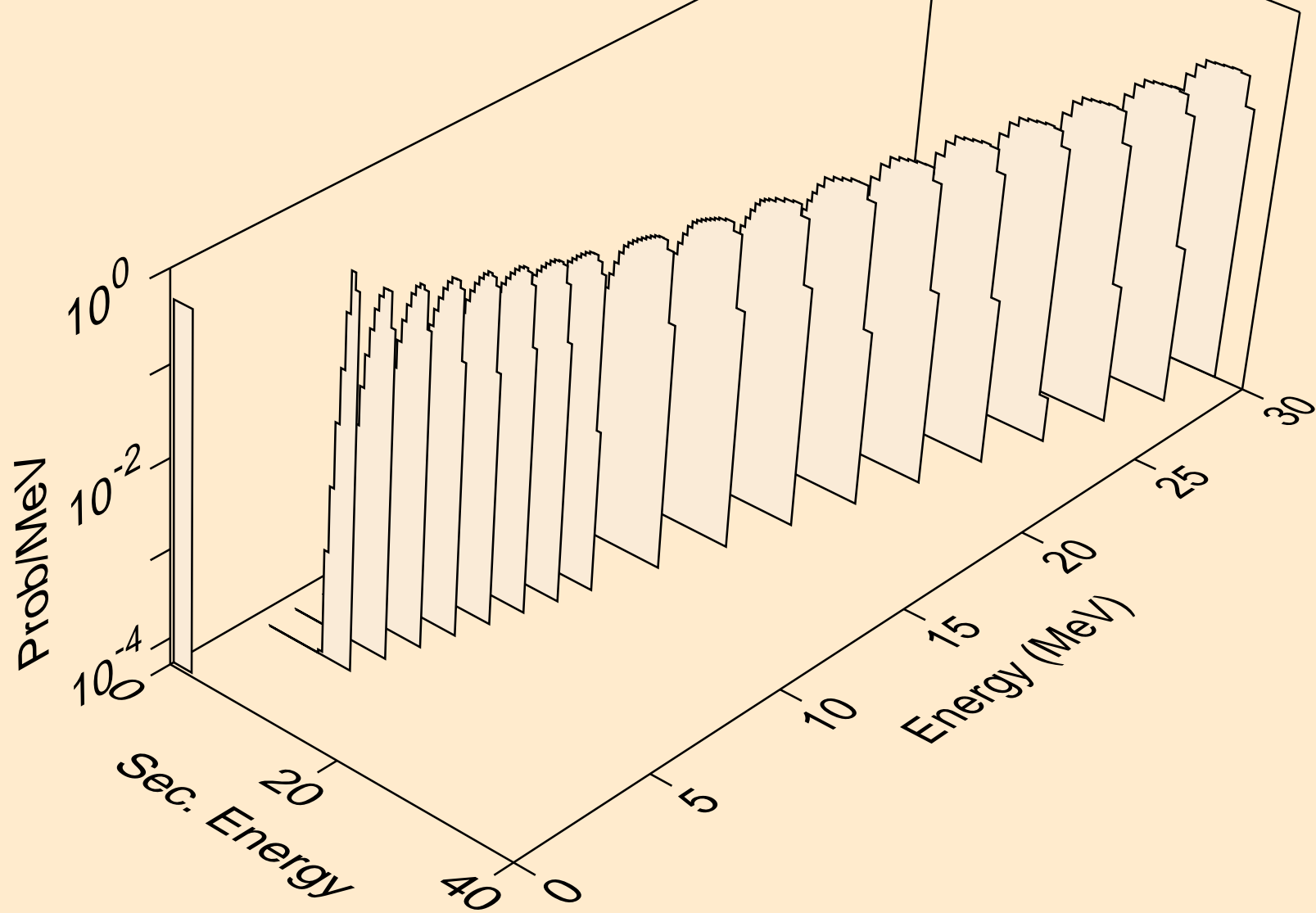

RB092 HELION ACER TENDL-2021 LIBRARY; T=0.K  
alphas from (s,2n)a

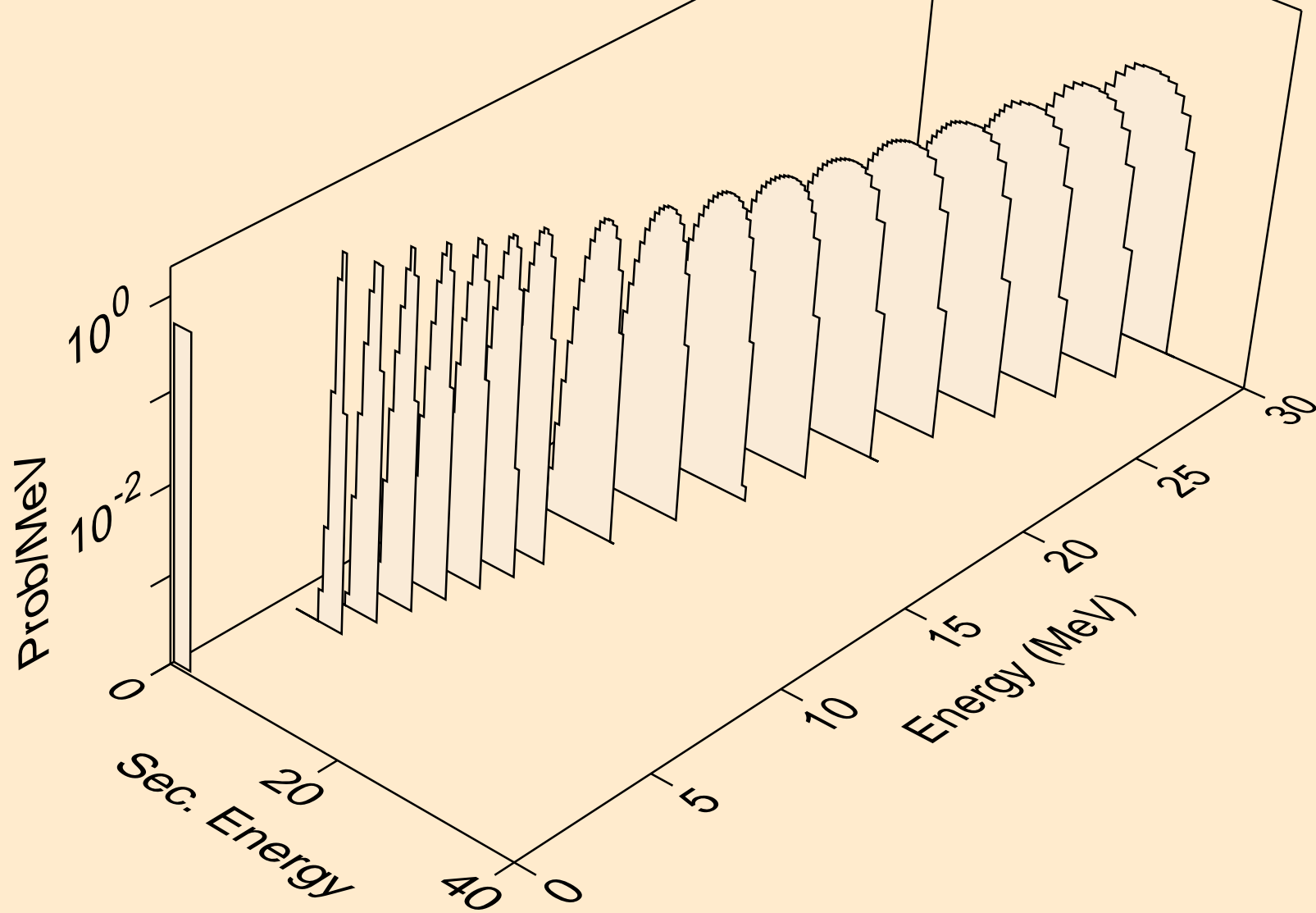

RB092 HELION ACER TENDL-2021 LIBRARY; T=0.K  
alphas from (s,3n)a

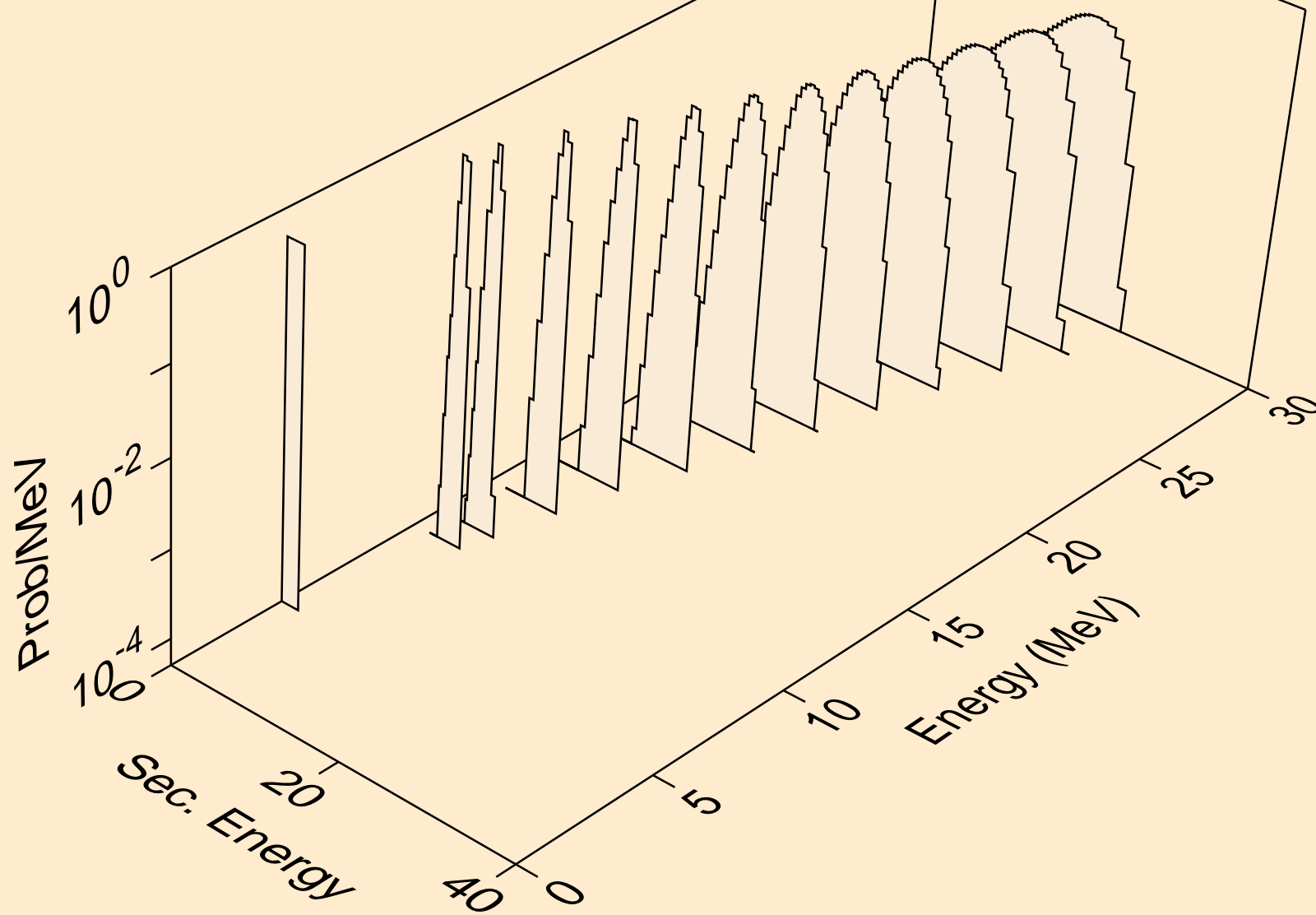

RB092 HELION ACER TENDL-2021 LIBRARY; T=0.K  
alphas from (s,n\*)2a

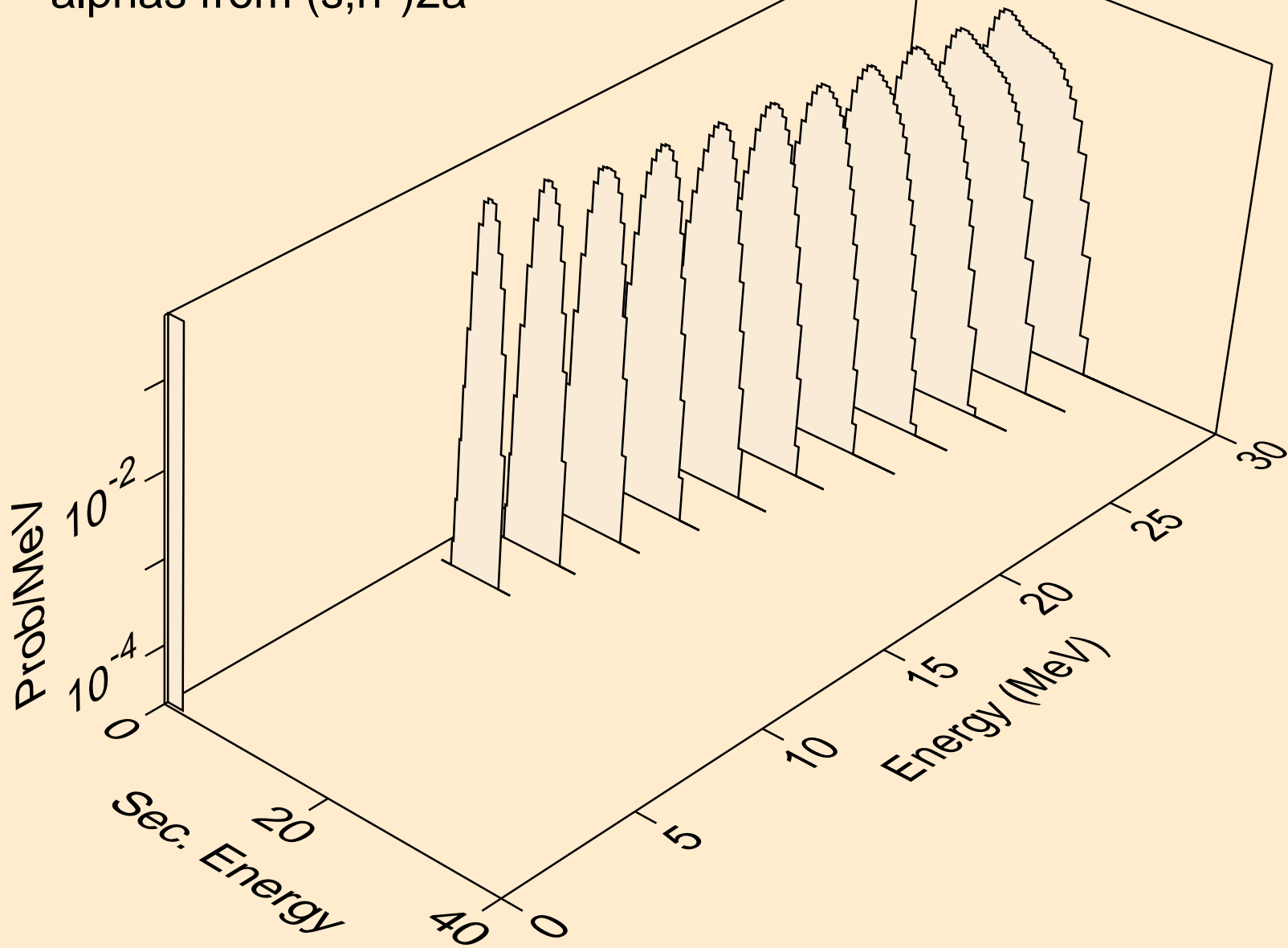



RB092 HELION ACER TENDL-2021 LIBRARY; T=0.K  
alphas from (s,2n)2a

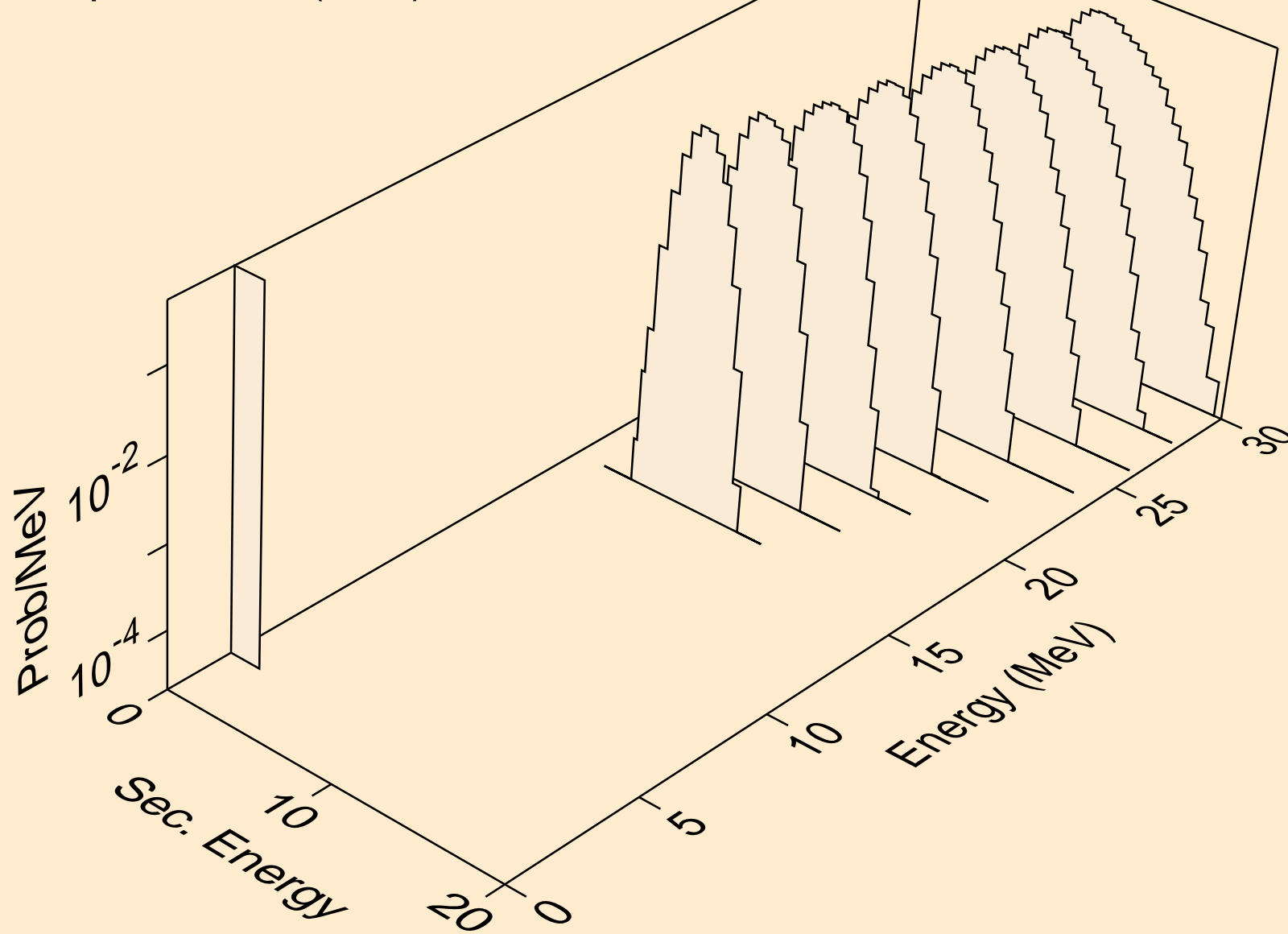

RB092 HELION ACER TENDL-2021 LIBRARY; T=0.K  
alphas from (s,npa)

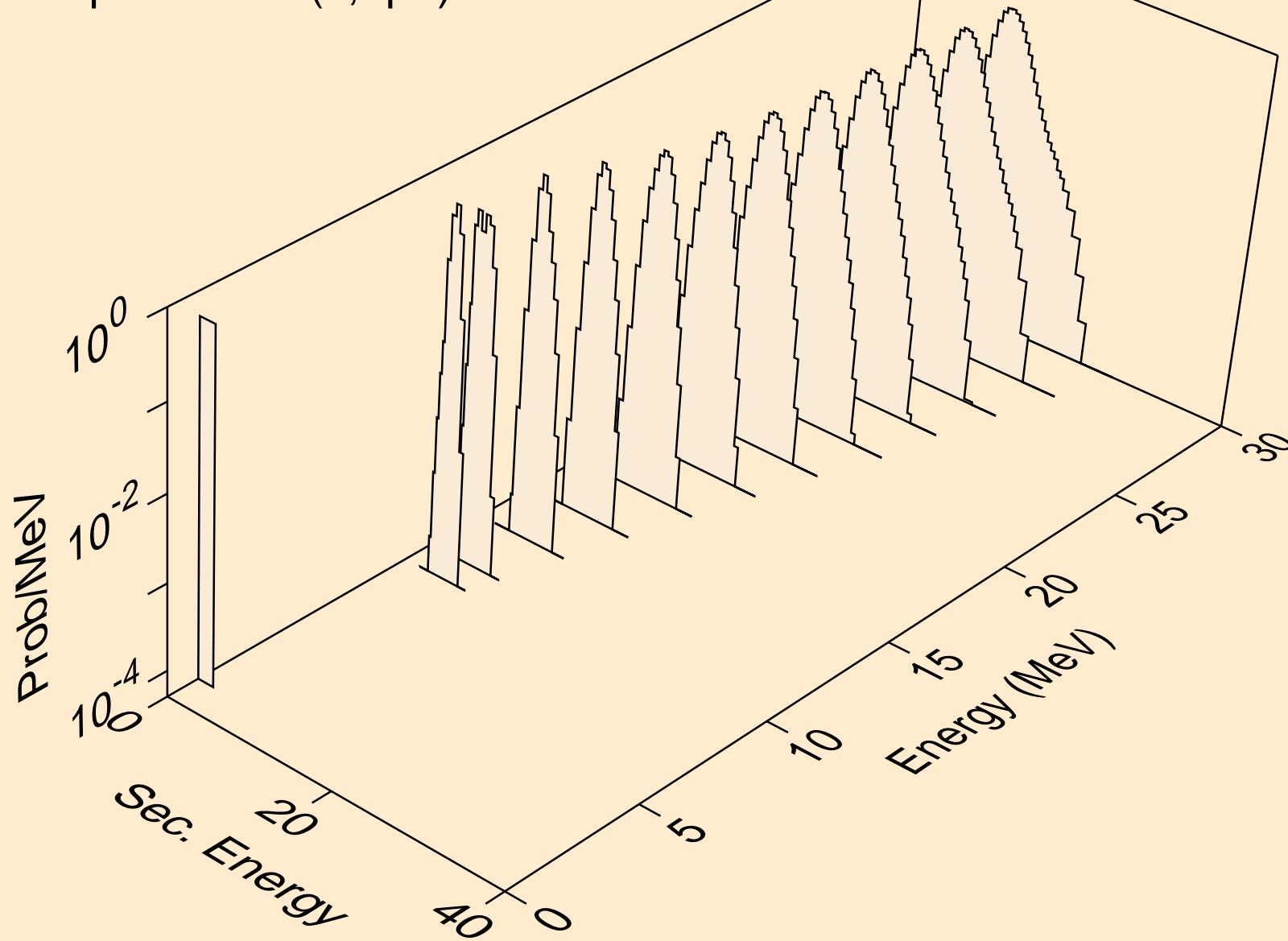

RB092 HELION ACER TENDL-2021 LIBRARY; T=0.K  
alphas from (s,a)

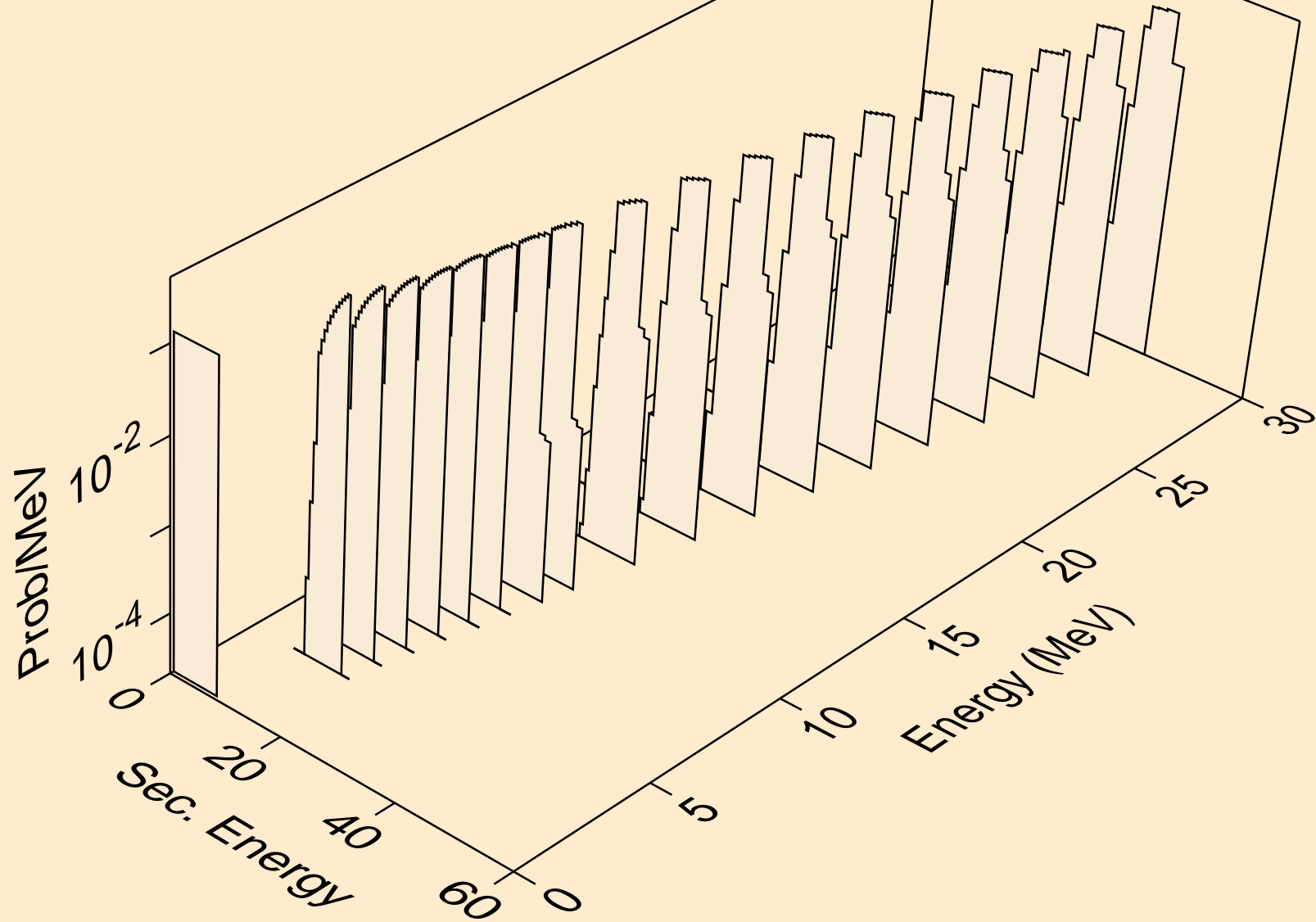

RB092 HELION ACER TENDL-2021 LIBRARY; T=0.K  
alphas from (s,2a)

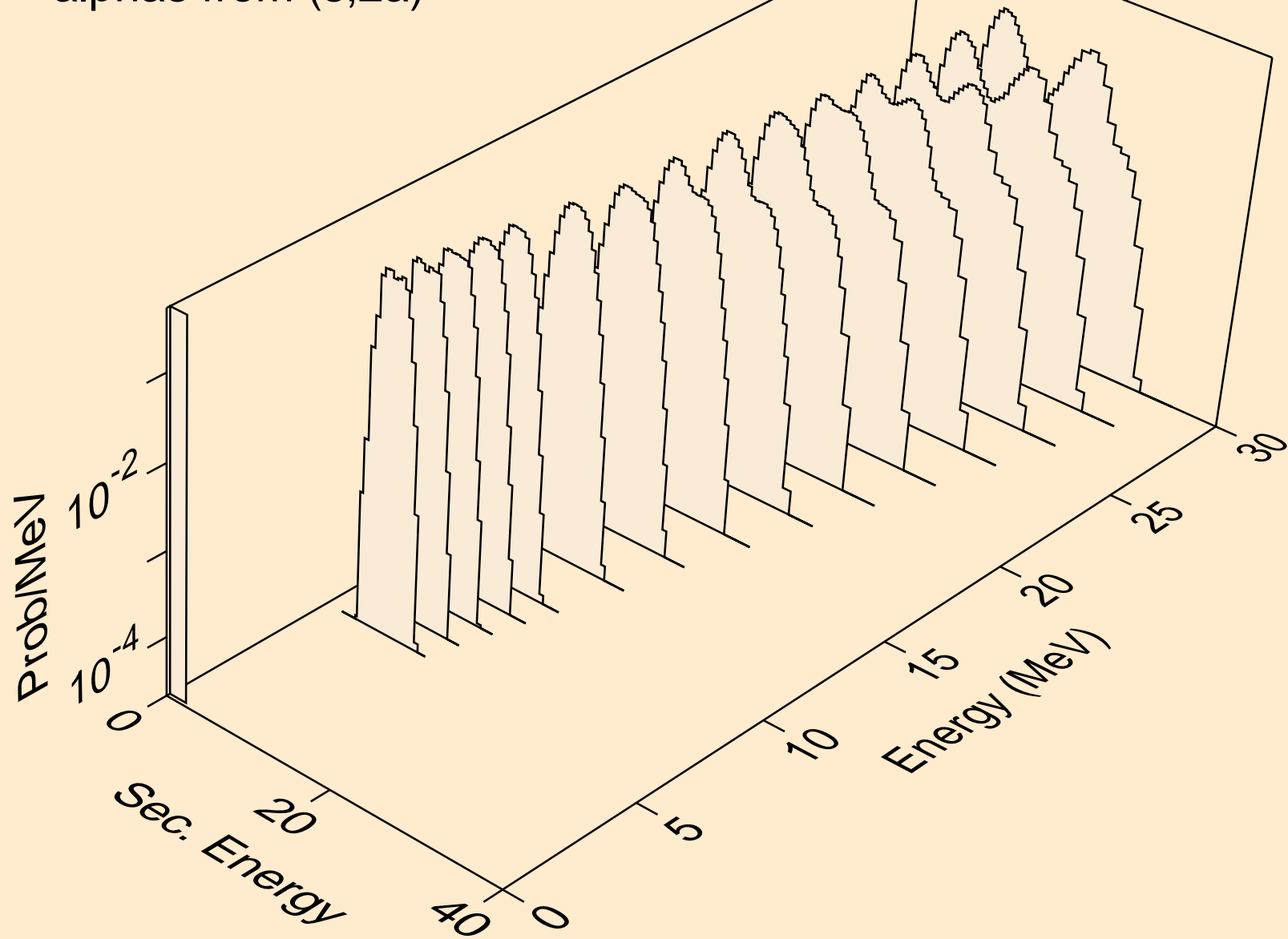

RB092 HELION ACER TENDL-2021 LIBRARY; T=0.K  
alphas from (s,pa)

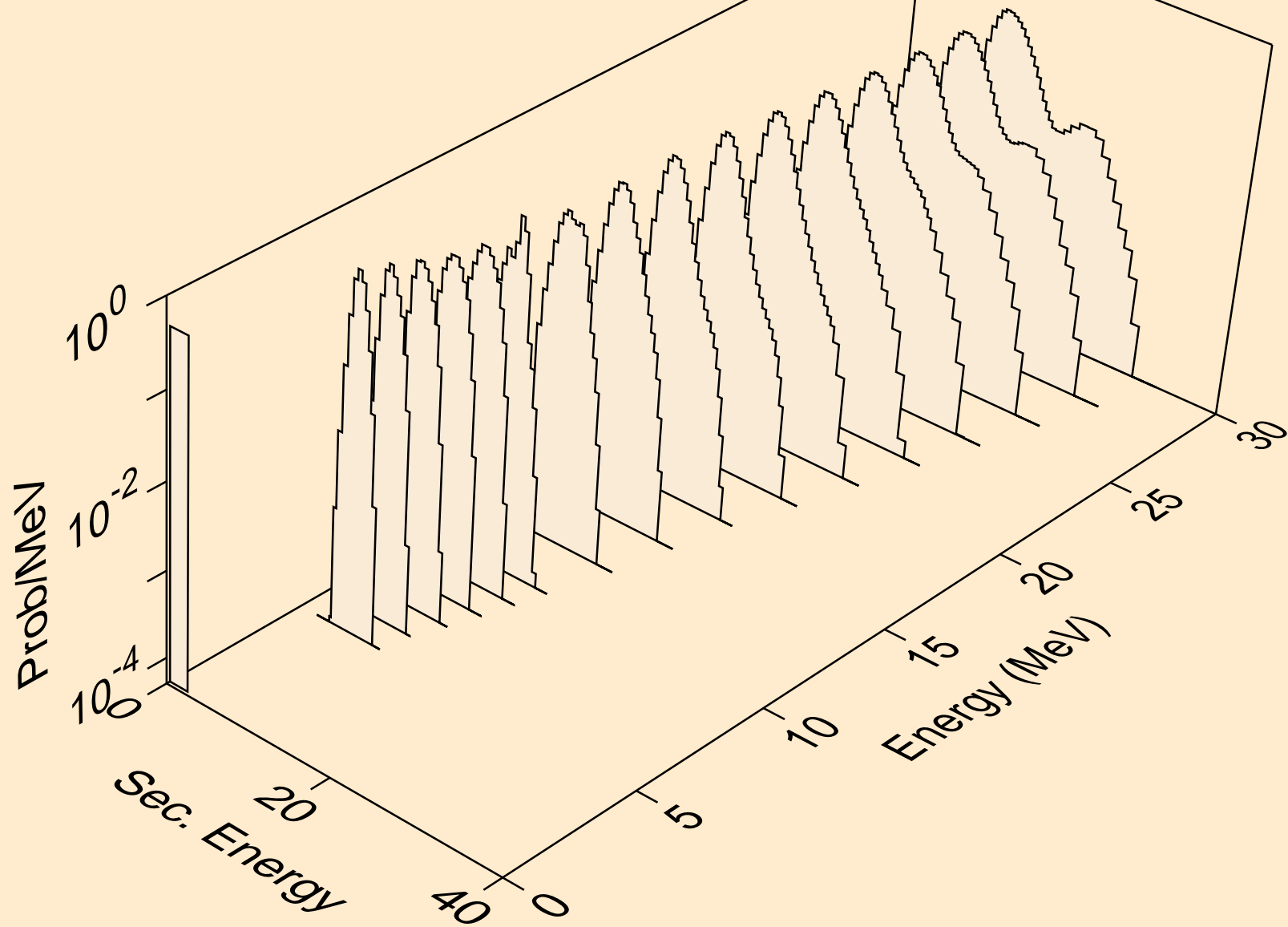

RB092 HELION ACER TENDL-2021 LIBRARY; T=0.K  
alphas from (s,da)

