

RF259 HELION ACER TENDL-2021 LIBRARY; T=0.K  
Principal cross sections

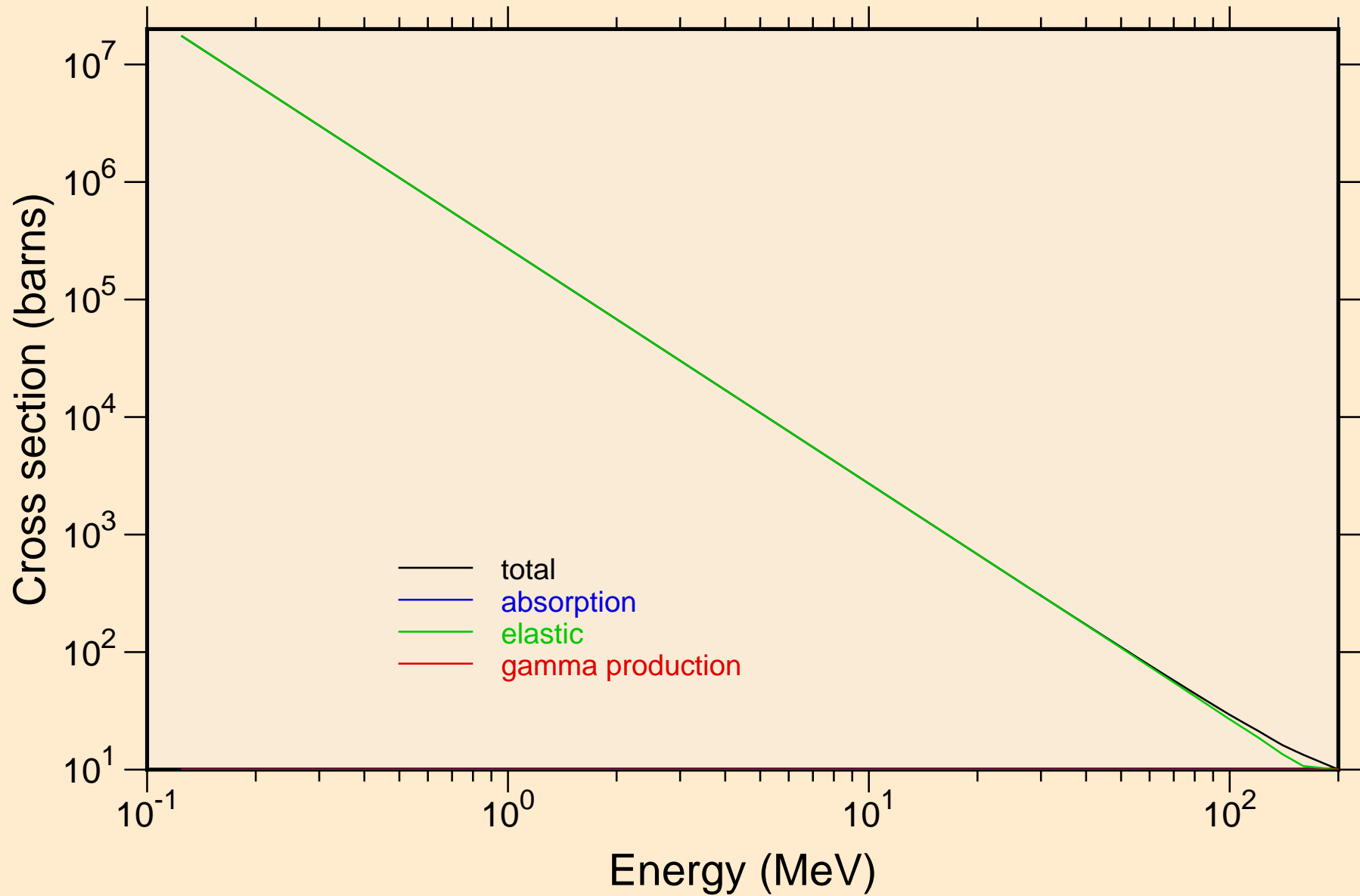

RF259 HELION ACER TENDL-2021 LIBRARY; T=0.K

Heating

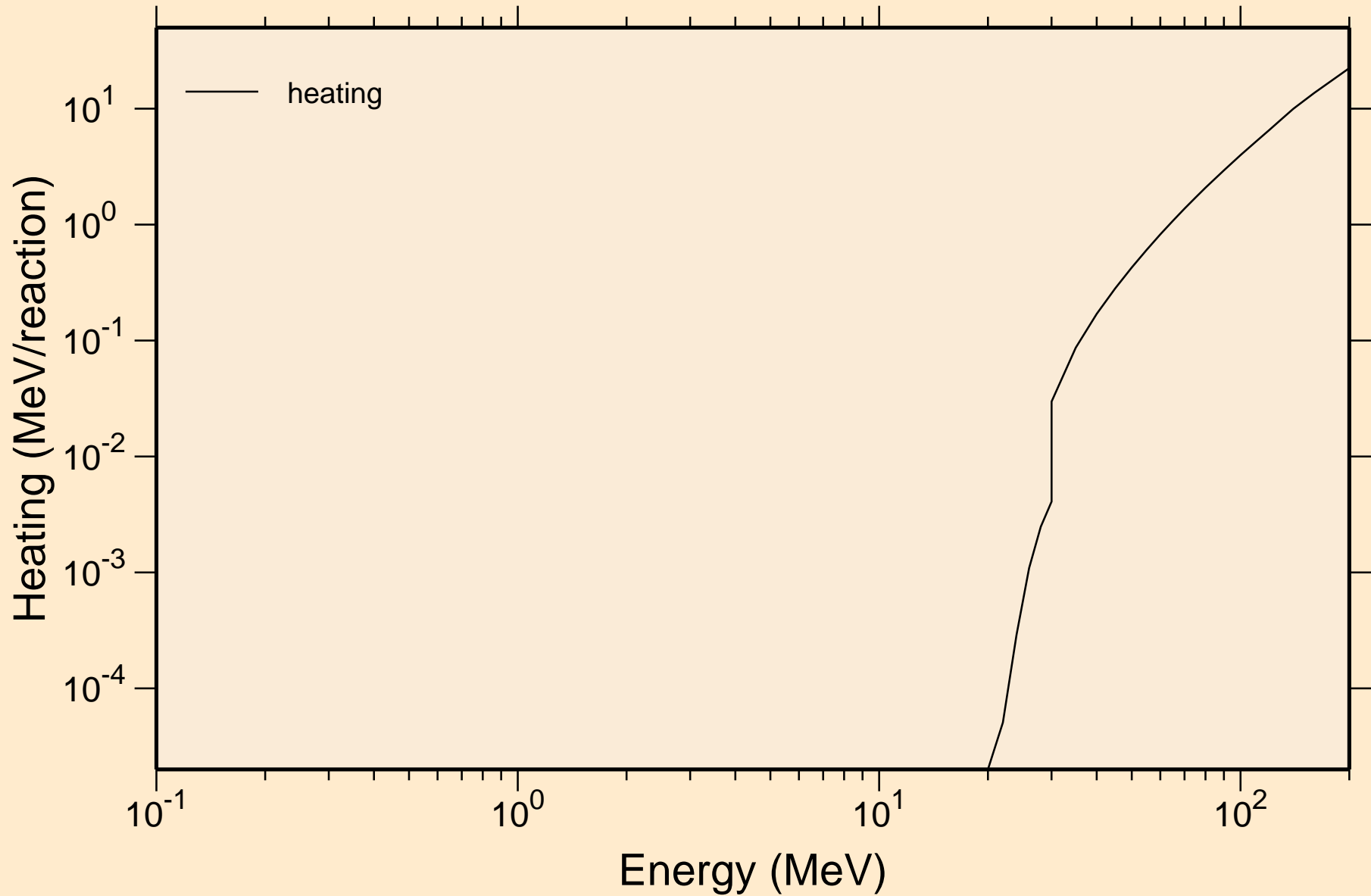

# RF259 HELION ACER TENDL-2021 LIBRARY; T=0.K

## Principal cross sections

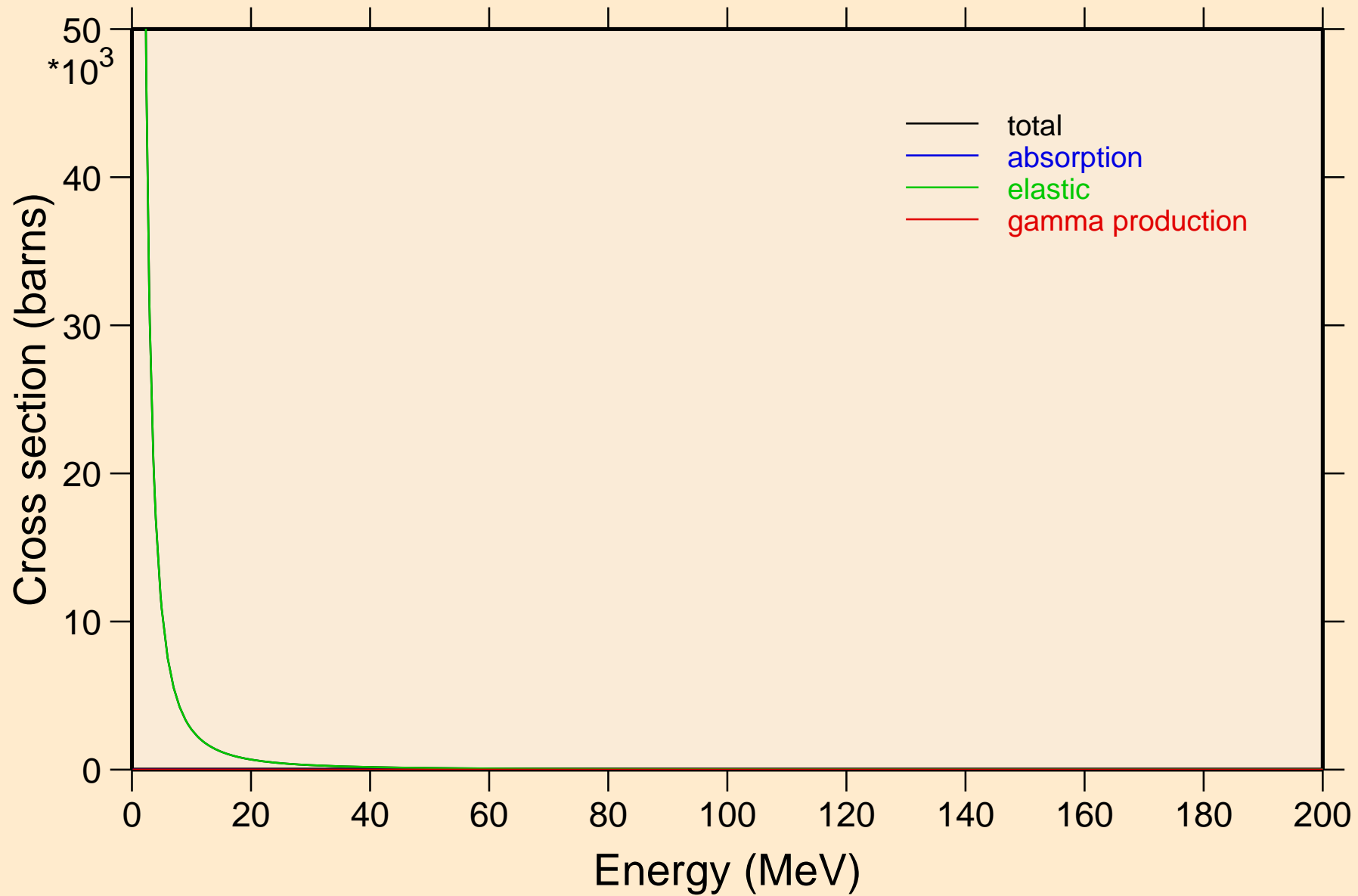

RF259 HELION ACER TENDL-2021 LIBRARY; T=0.K

Heating

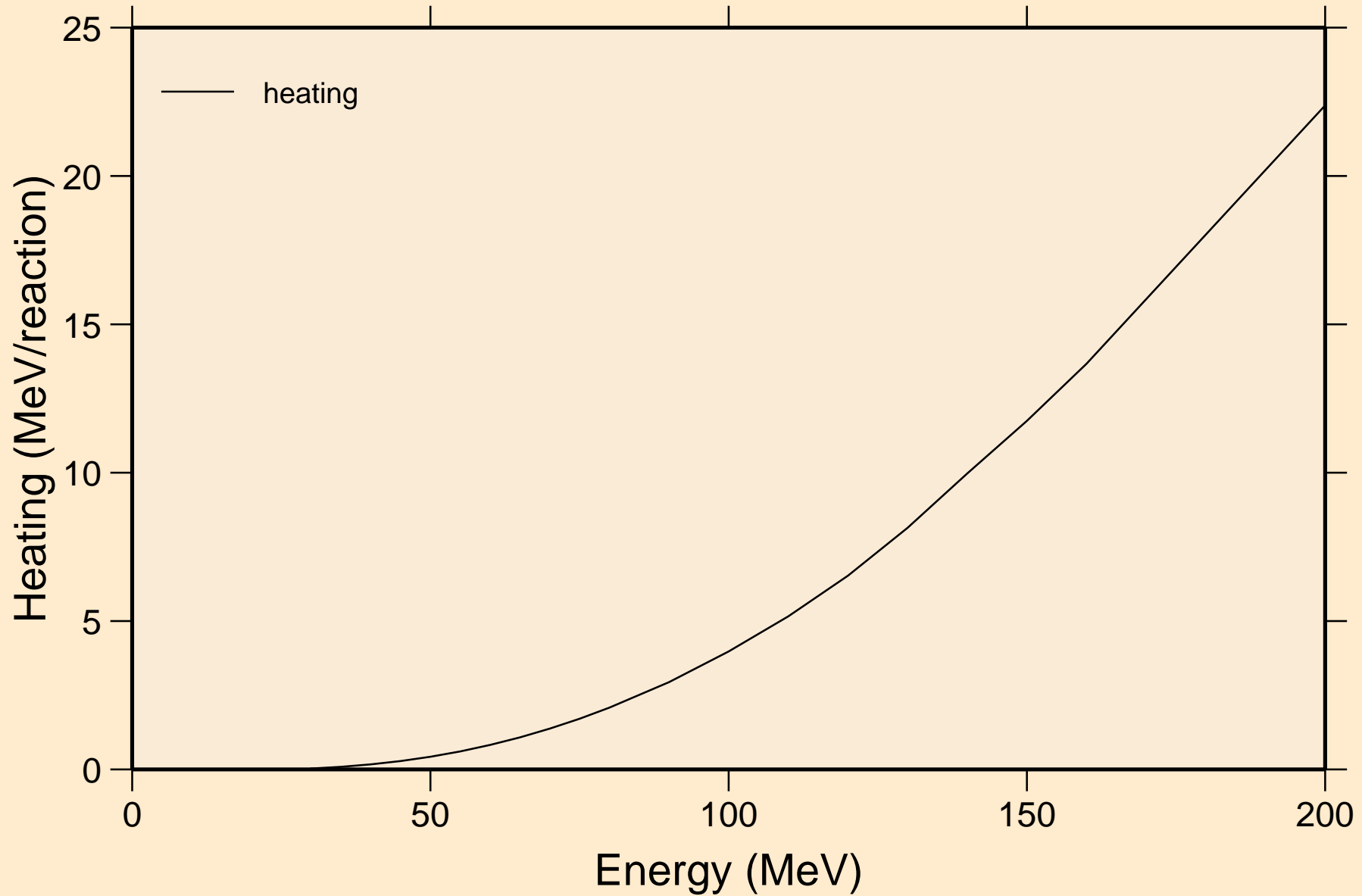

RF259 HELION ACER TENDL-2021 LIBRARY; T=0.K  
Threshold reactions

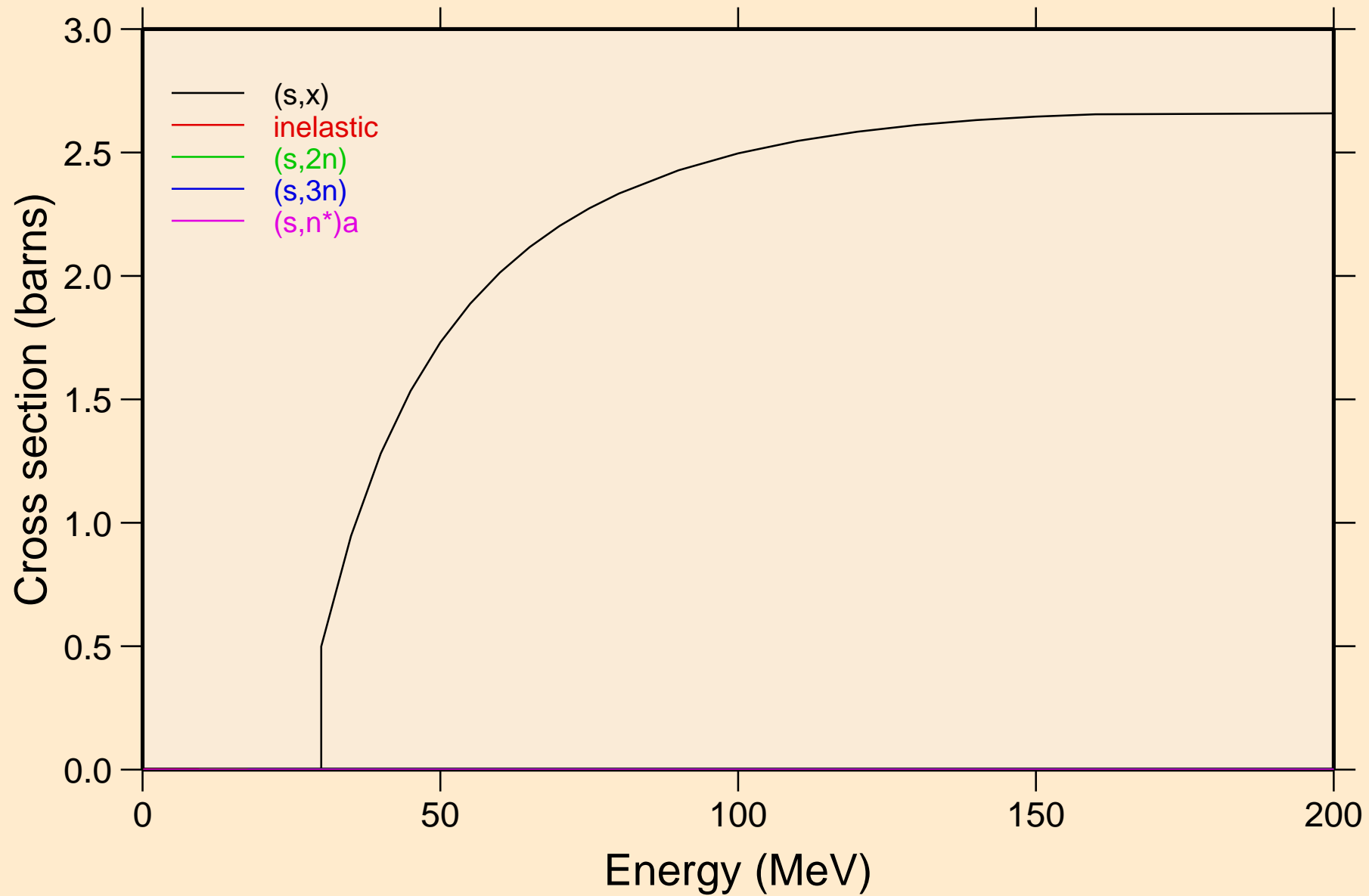

RF259 HELION ACER TENDL-2021 LIBRARY; T=0.K  
Threshold reactions

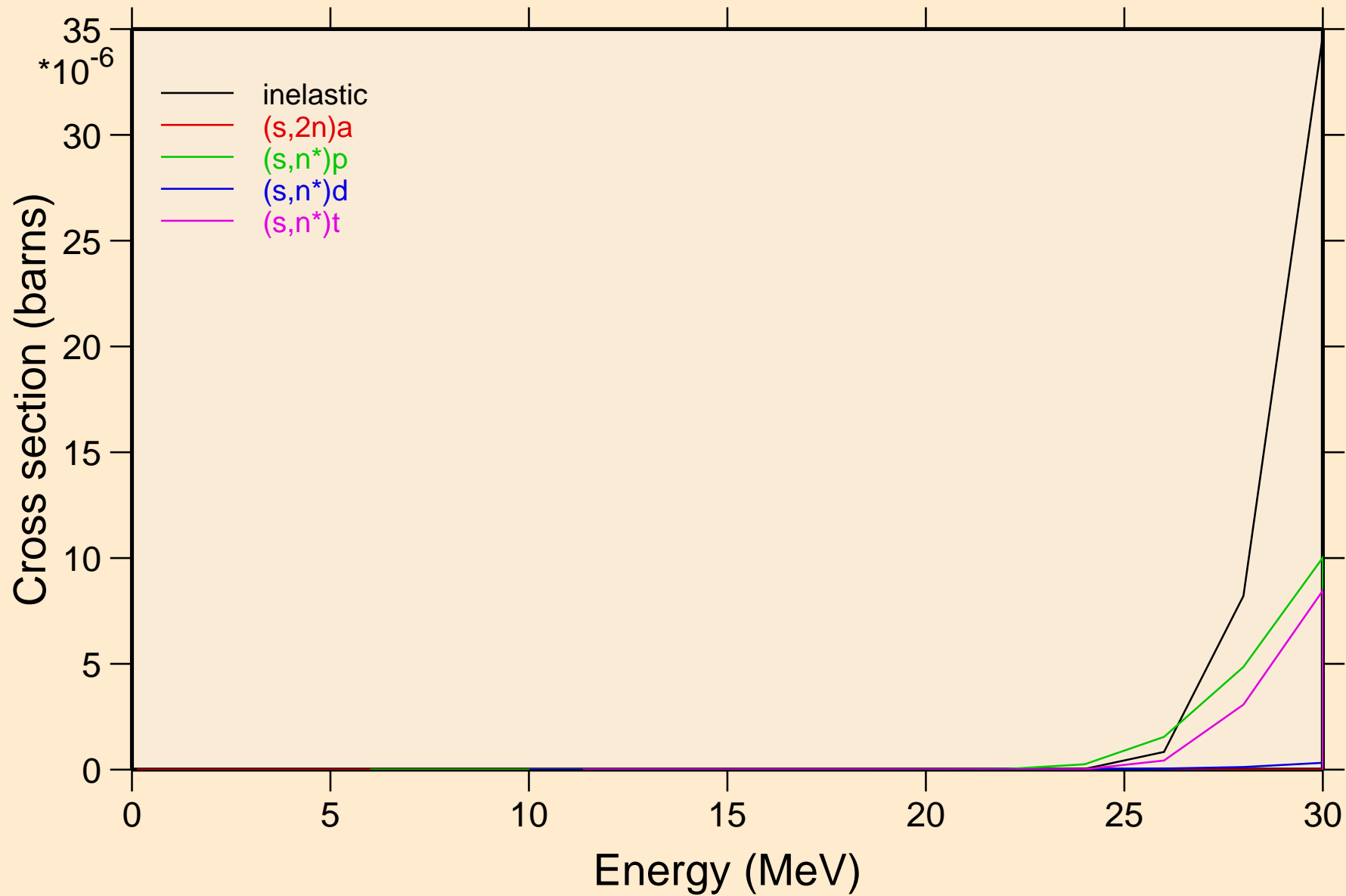

RF259 HELION ACER TENDL-2021 LIBRARY; T=0.K  
Threshold reactions

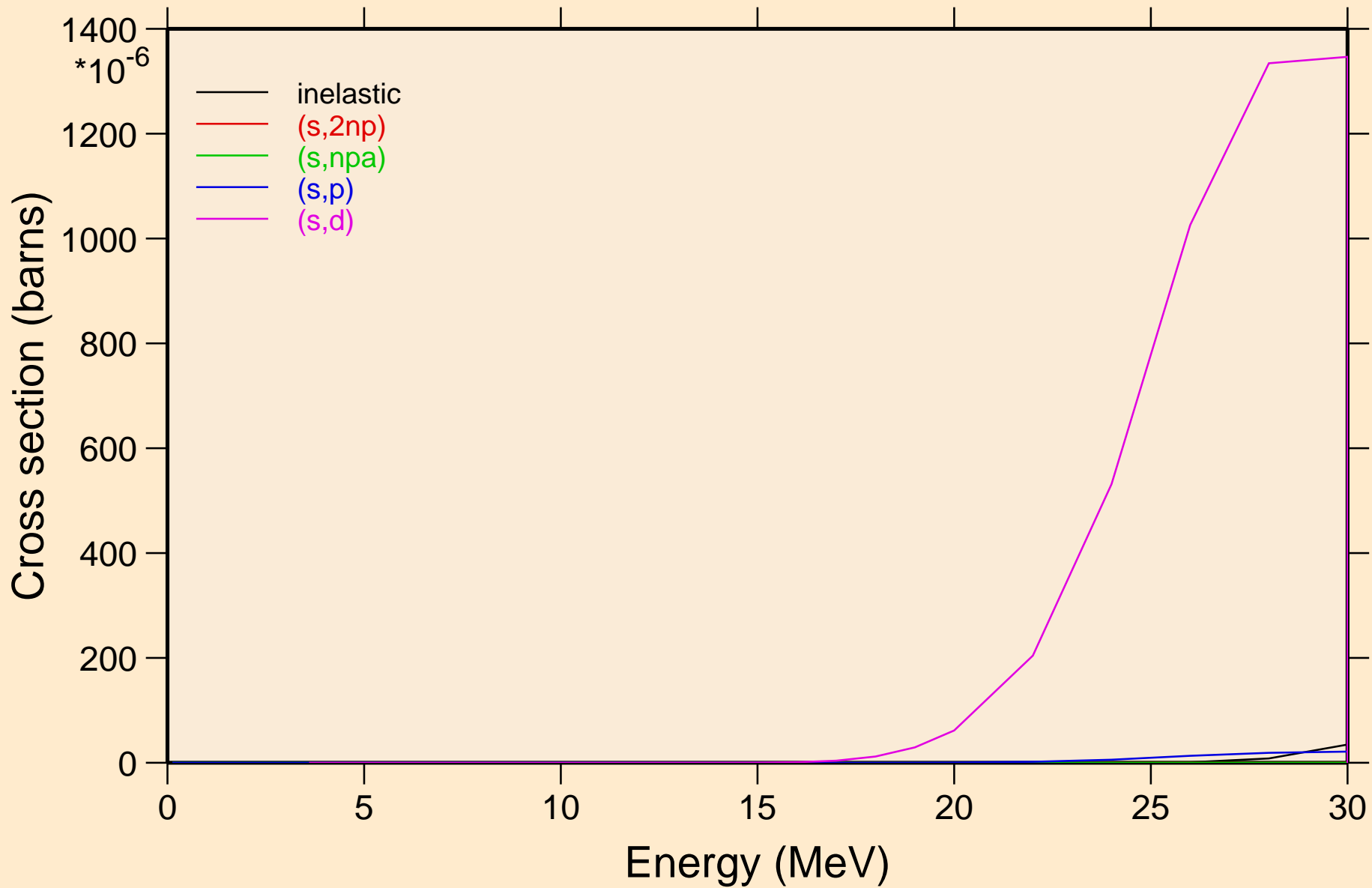

RF259 HELION ACER TENDL-2021 LIBRARY; T=0.K  
Threshold reactions

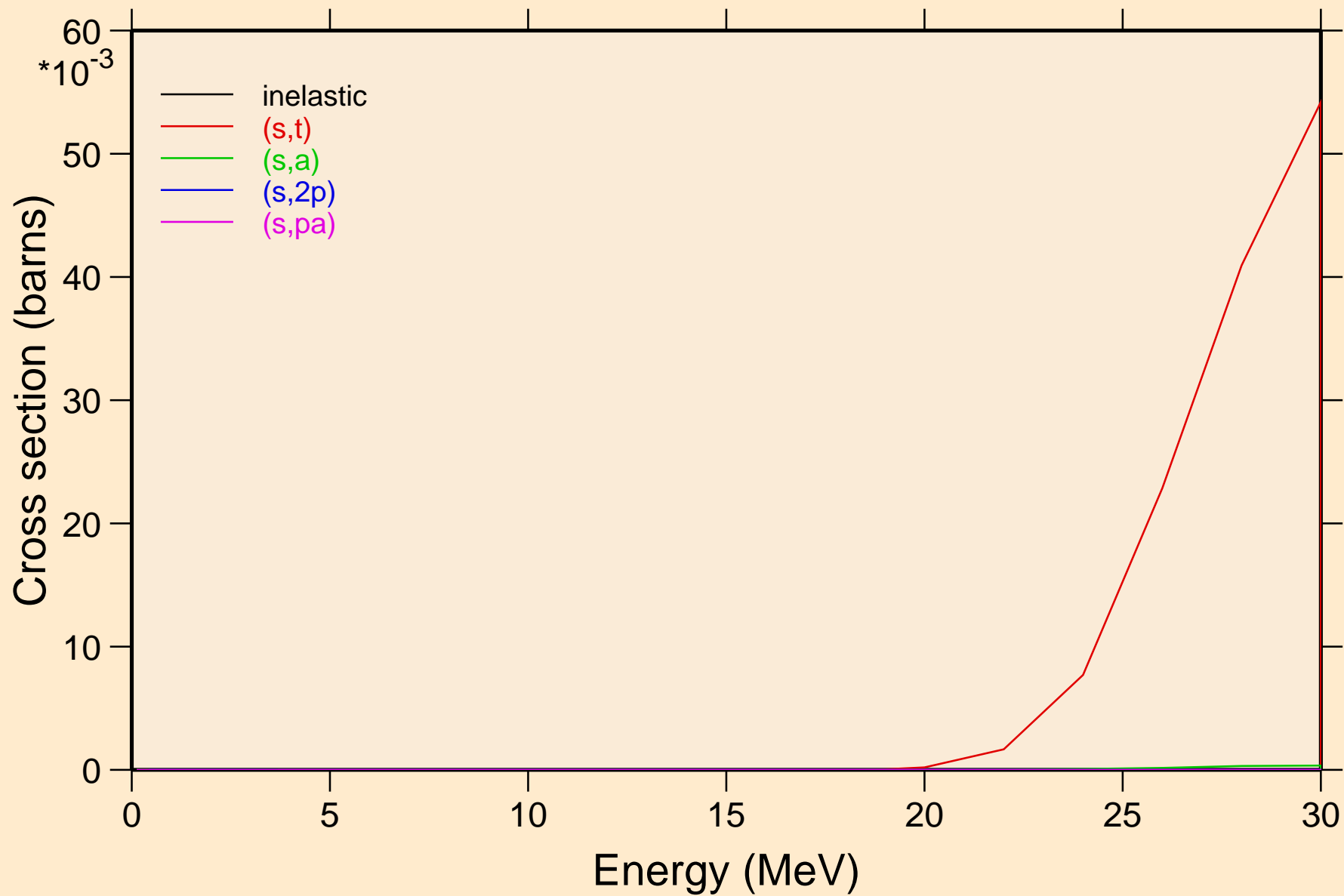



RF259 HELION ACER TENDL-2021 LIBRARY; T=0.K  
Threshold reactions

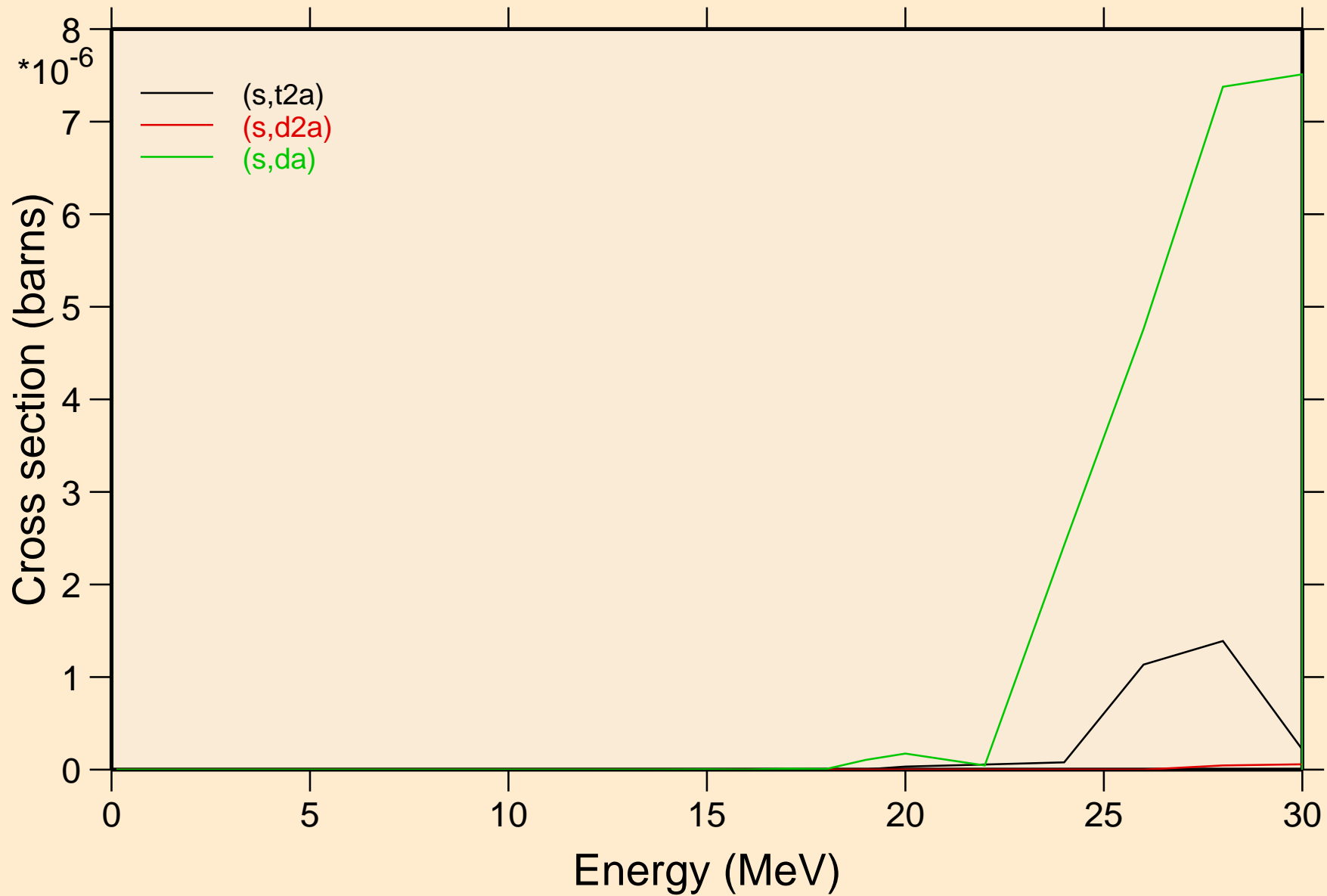

RF259 HELION ACER TENDL-2021 LIBRARY; T=0.K  
angular distribution for elastic

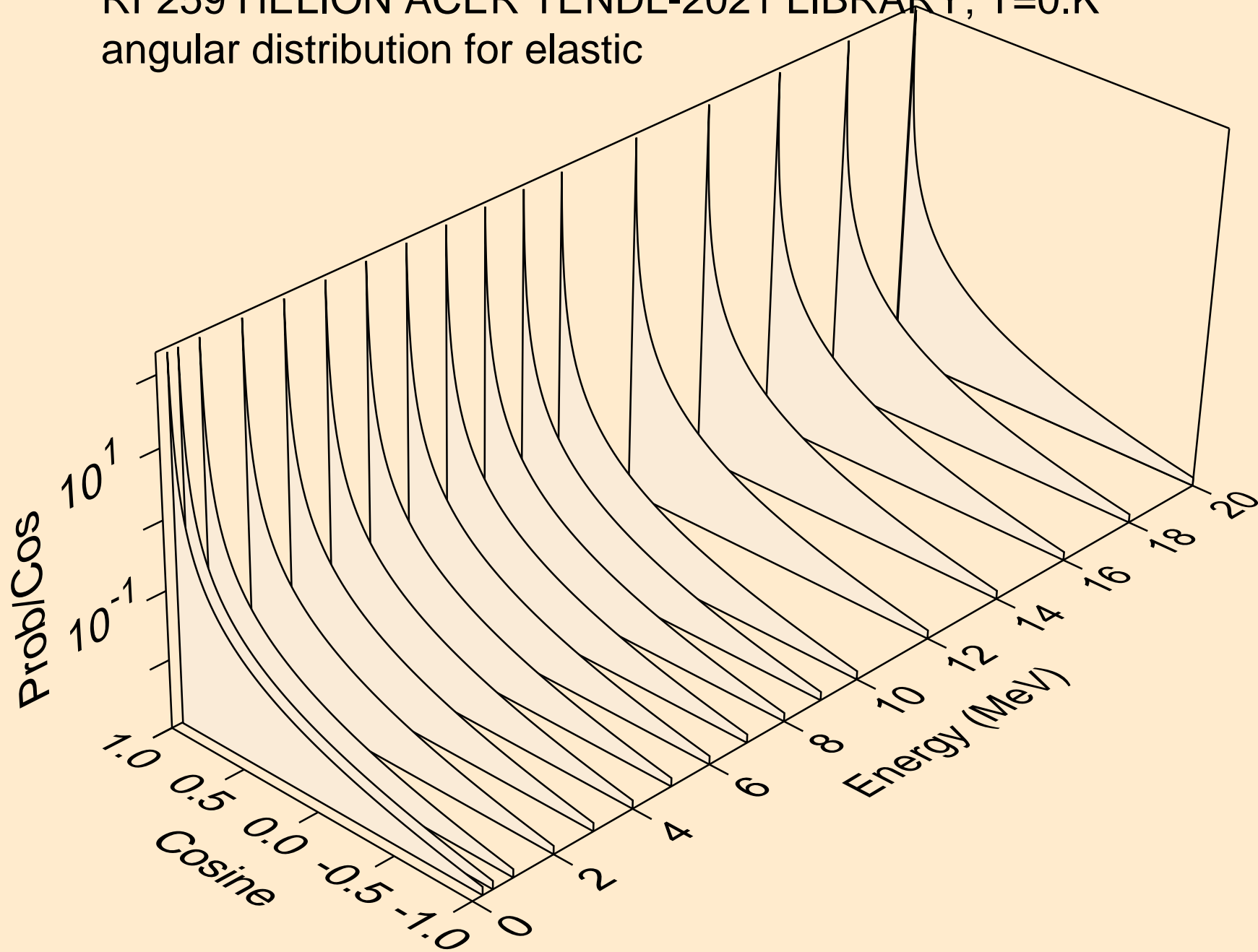

RF259 HELION ACER TENDL-2021 LIBRARY; T=0.K  
angular distribution for elastic

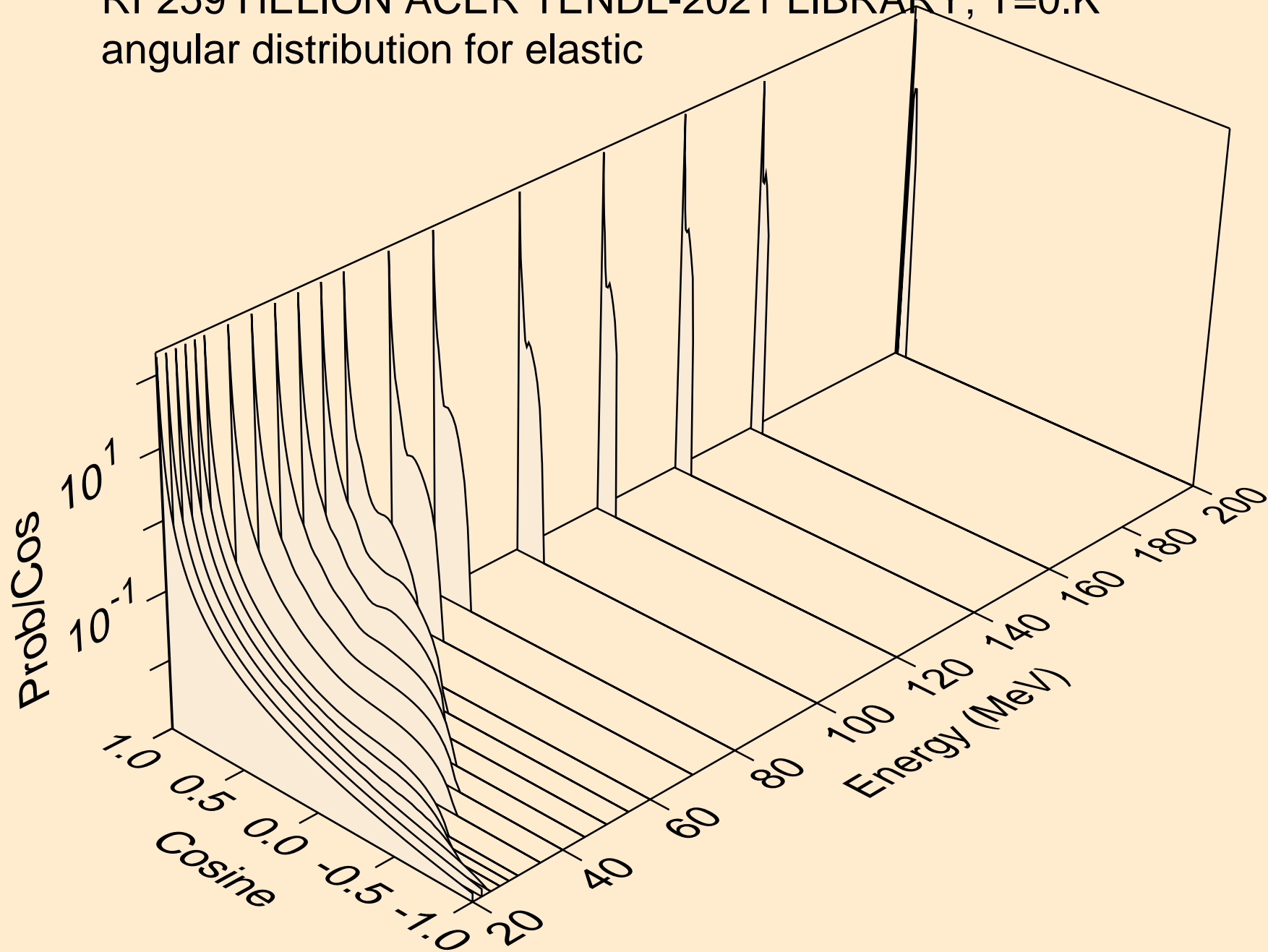

RF259 HELION ACER TENDL-2021 LIBRARY; T=0.K  
He-3 emission for (s,x)

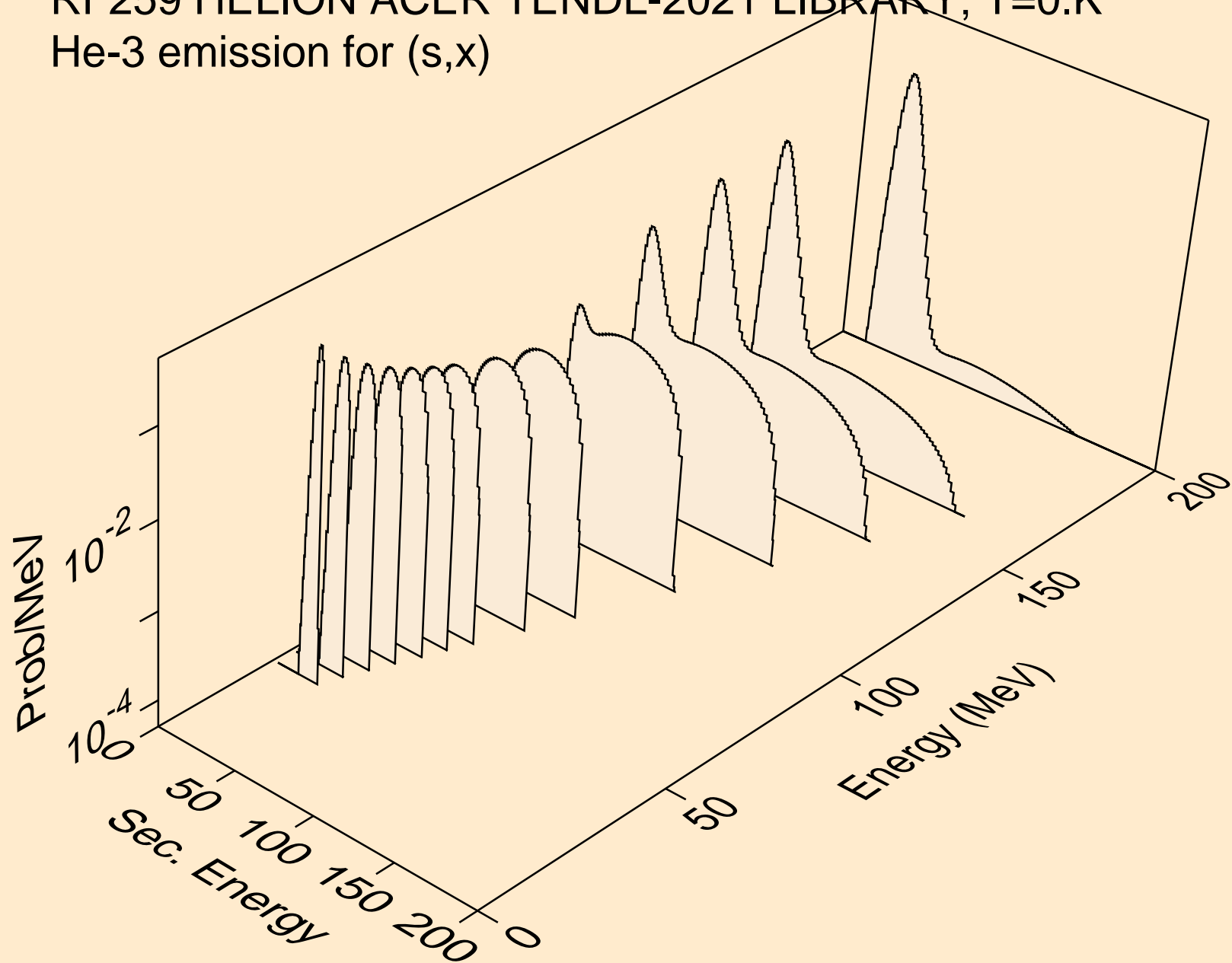

RF259 HELION ACER TENDL-2021 LIBRARY; T=0.K  
He-3 emission for inelastic

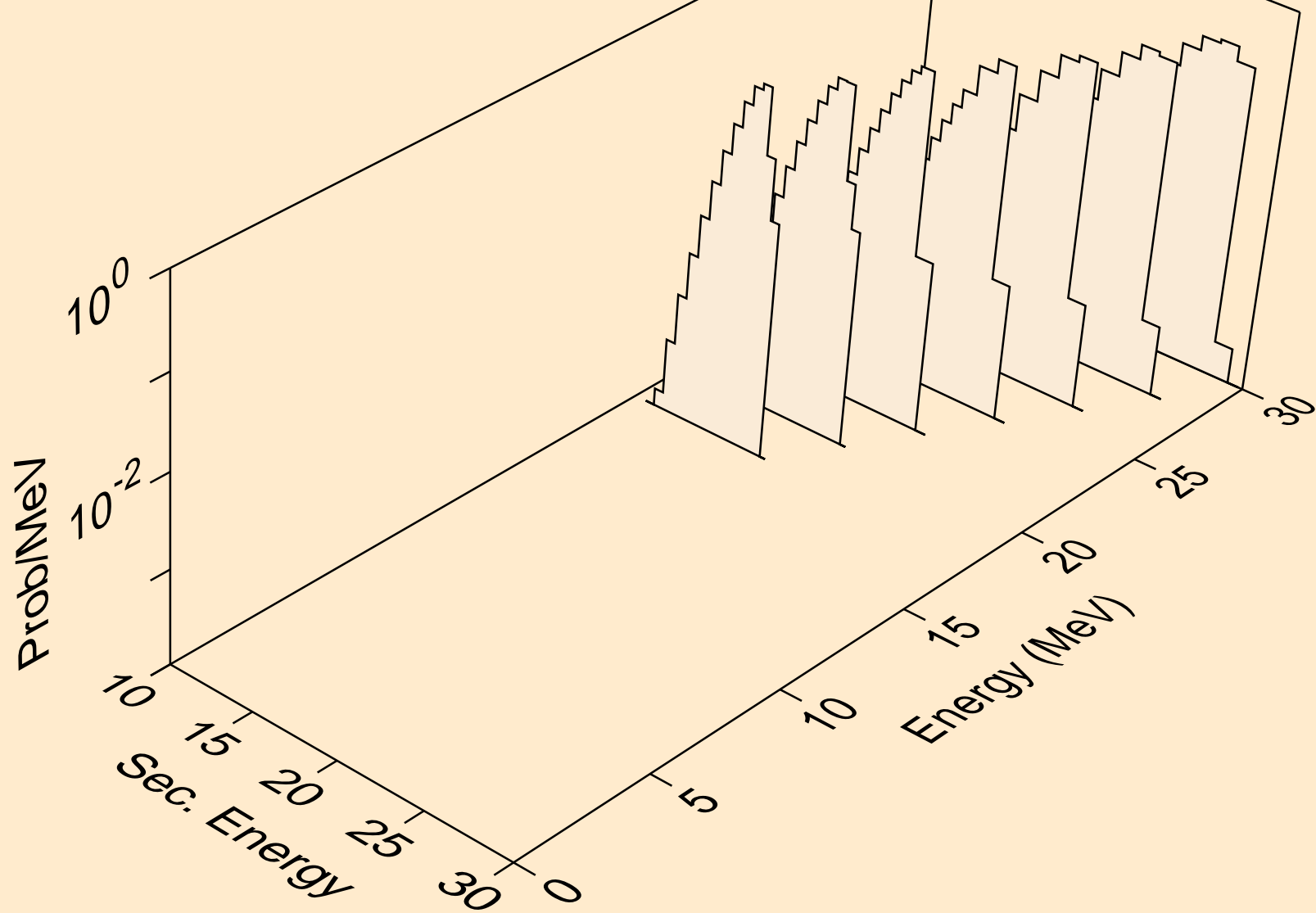

RF259 HELION ACER TENDL-2021 LIBRARY; T=0.K  
Photon emission for (z,n)

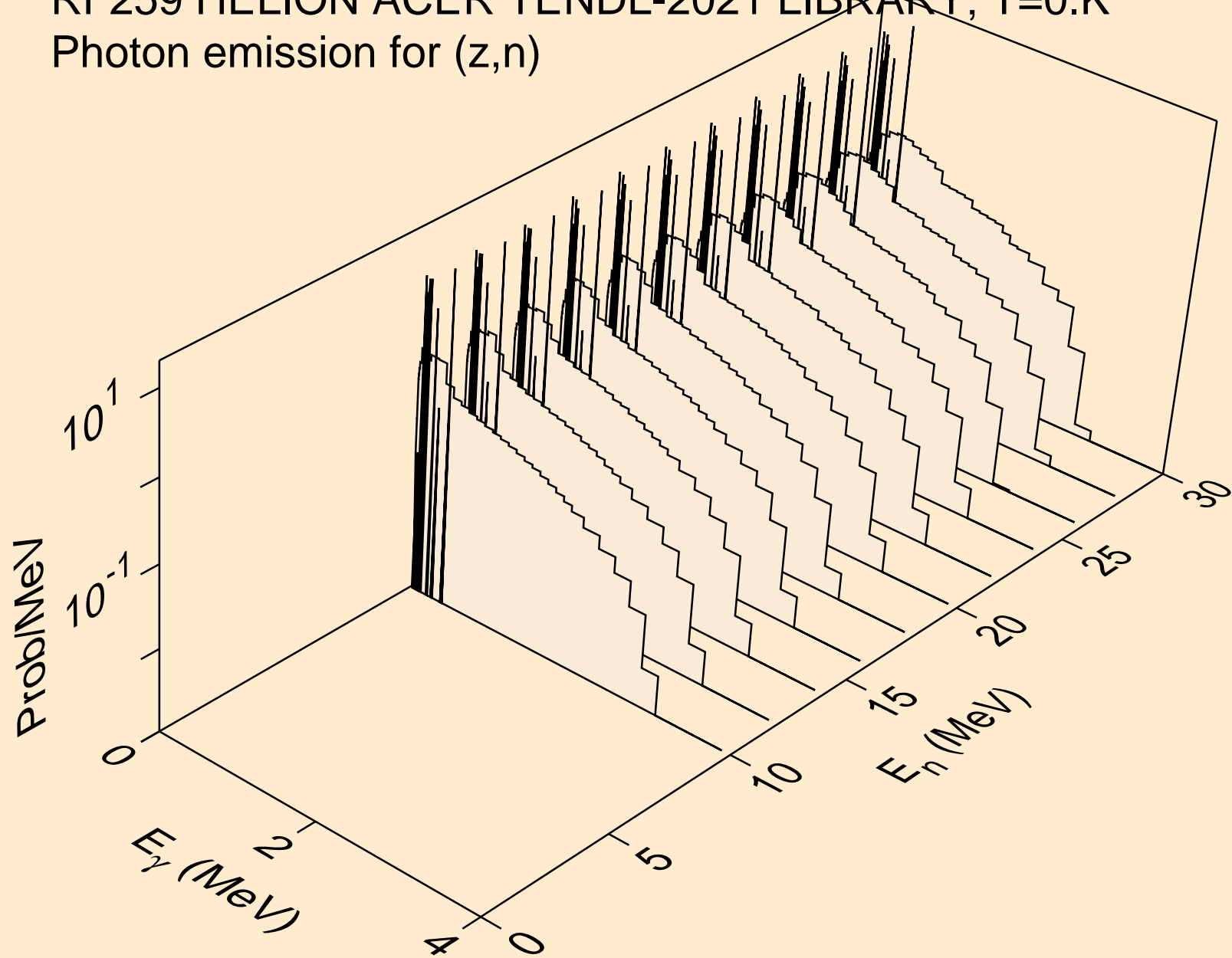

RF259 HELION ACER TENDL-2021 LIBRARY; T=0.K  
Photon emission for (n,x)

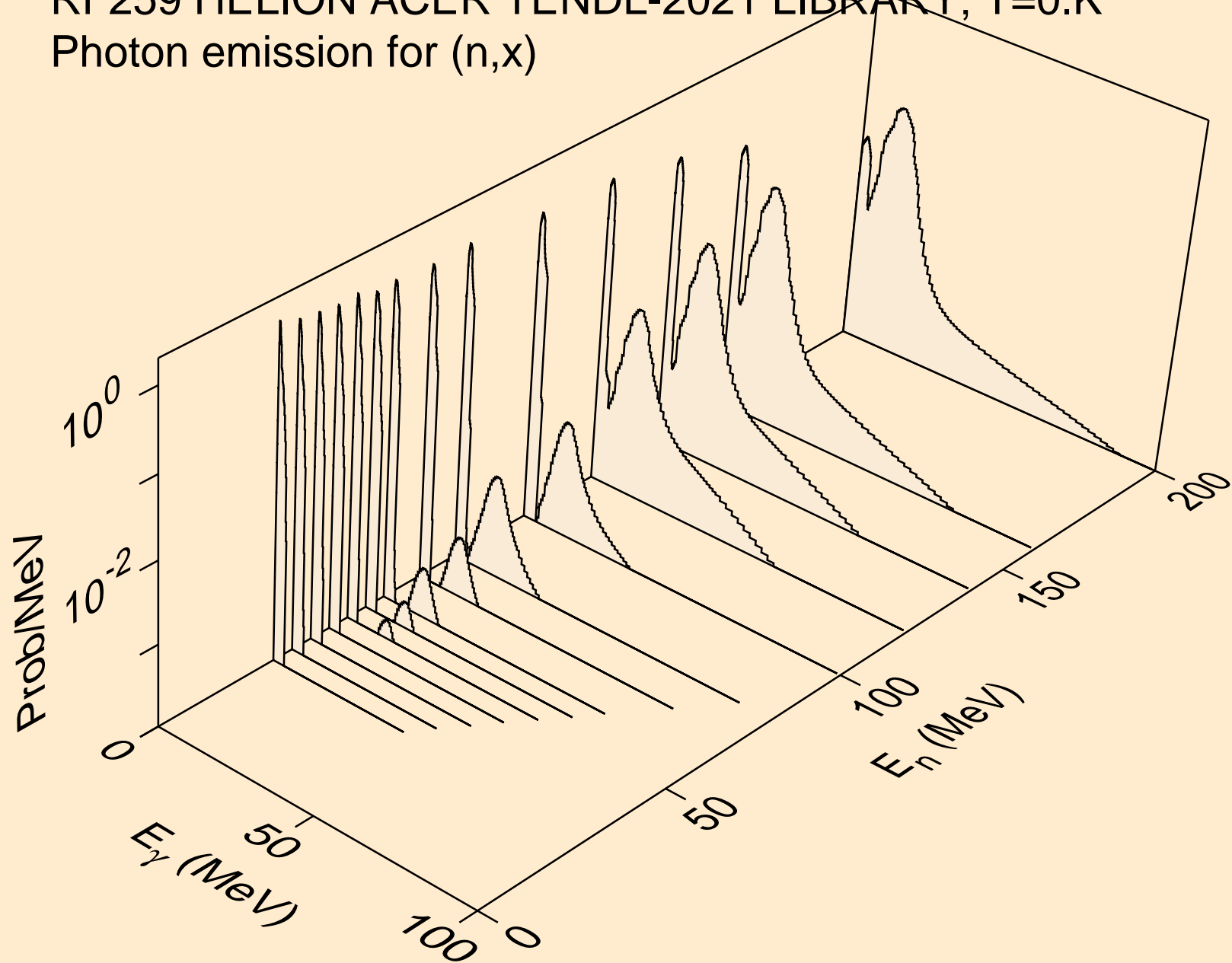

RF259 HELION ACER TENDL-2021 LIBRARY; T=0.K  
Photon emission for (n,2n)

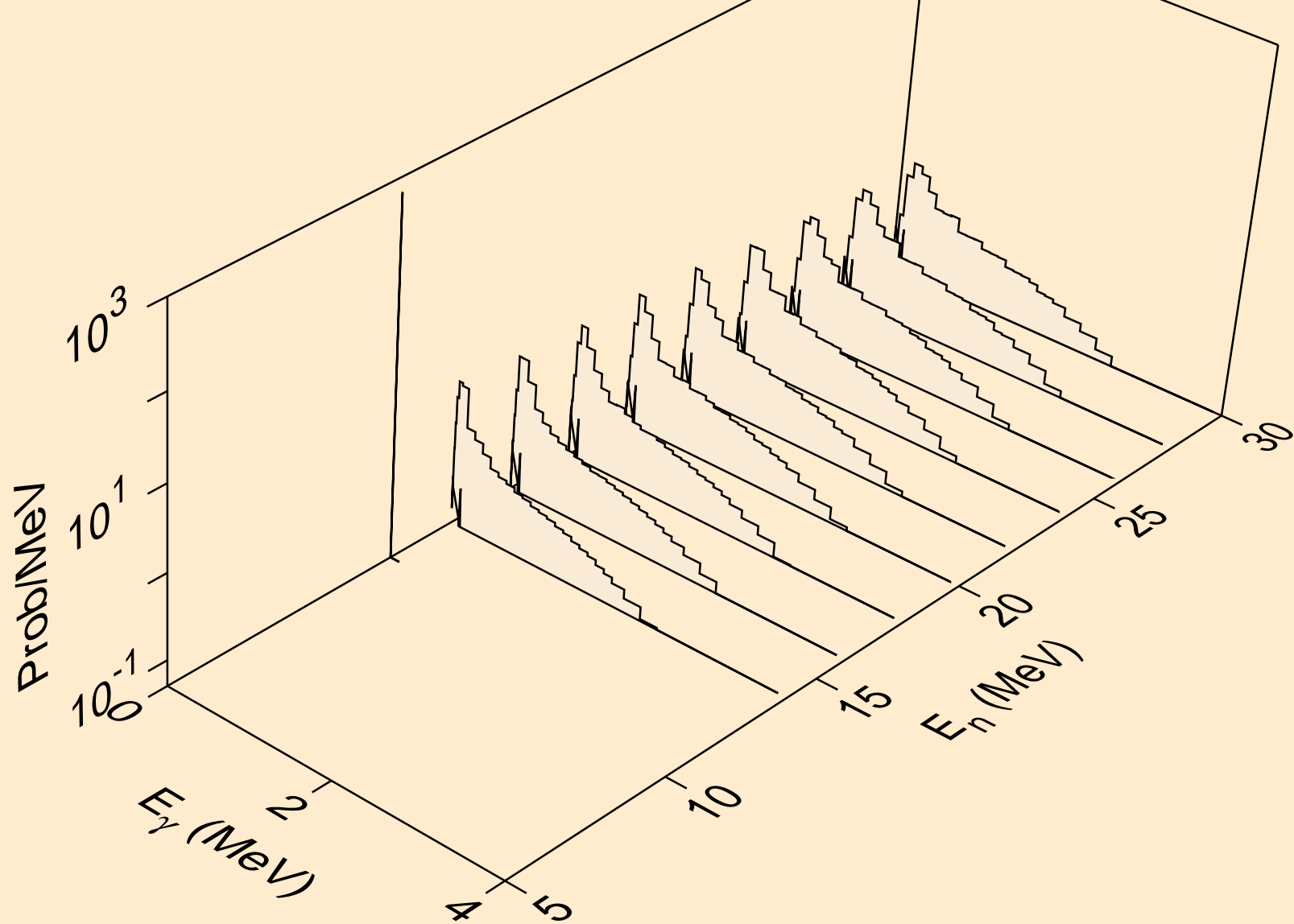



RF259 HELION ACER TENDL-2021 LIBRARY; T=0.K  
Photon emission for (n,3n)

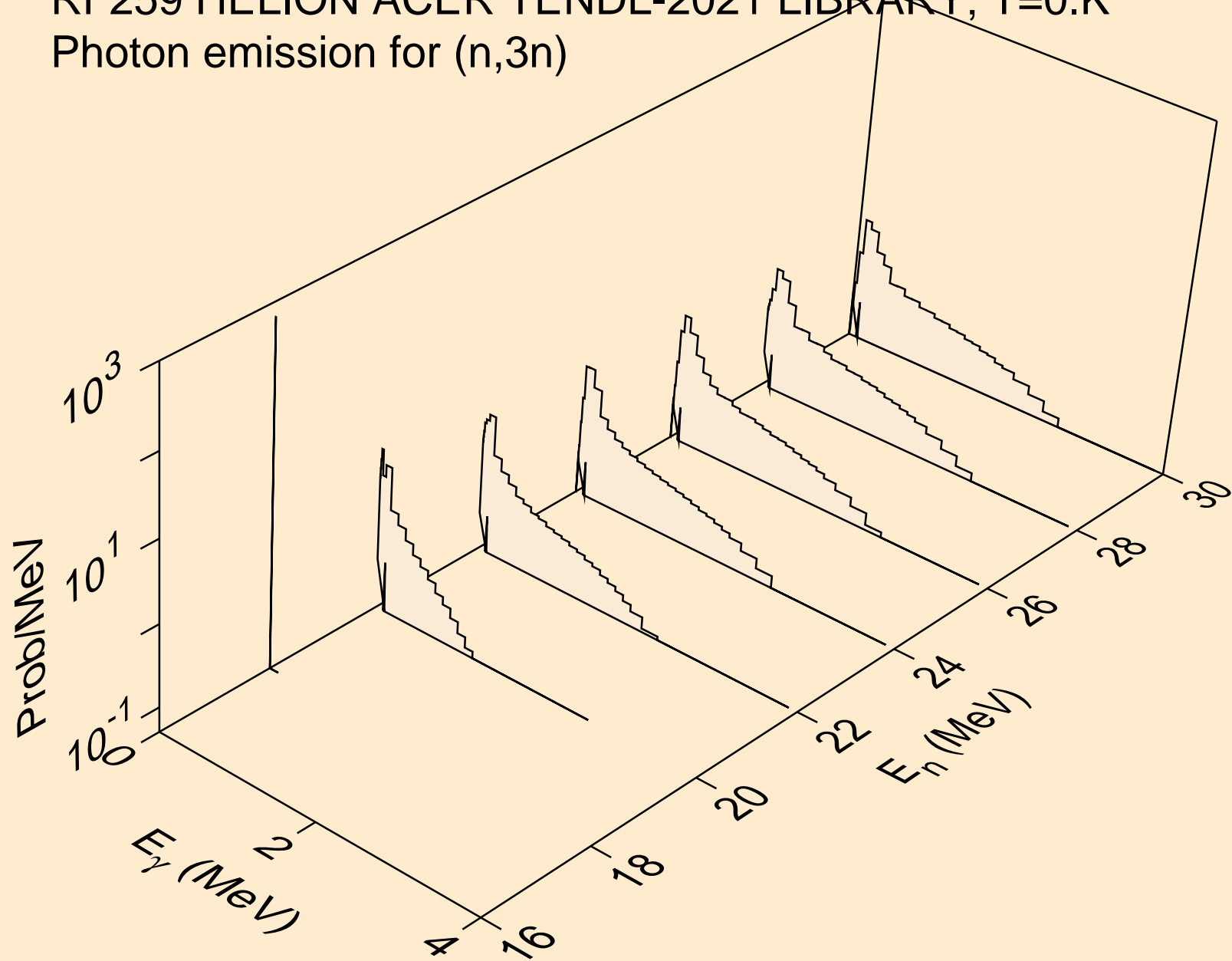

RF259 HELION ACER TENDL-2021 LIBRARY; T=0.K  
Photon emission for (n,n\*)a

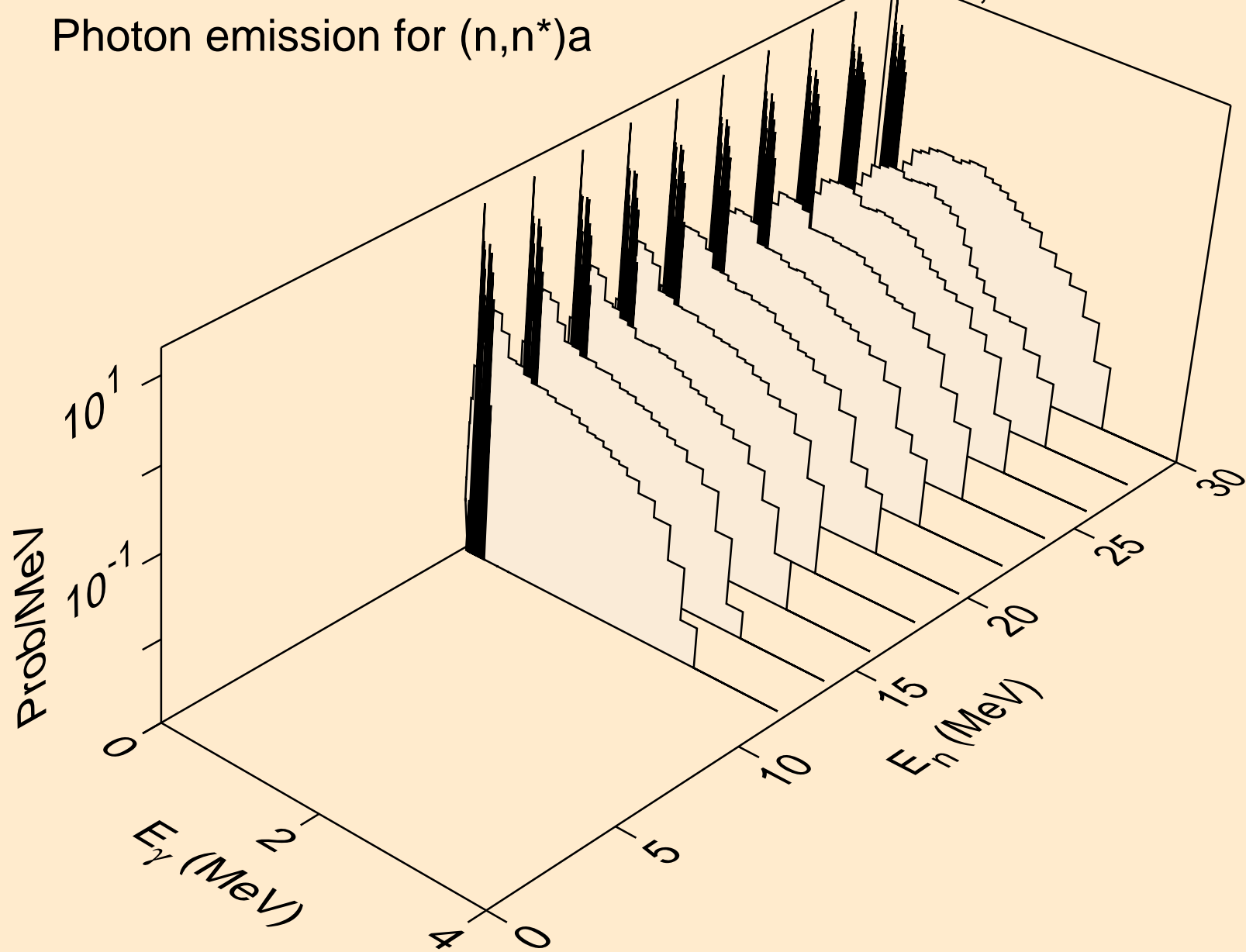

RF259 HELION ACER TENDL-2021 LIBRARY; T=0.K  
Photon emission for (n,2n)a

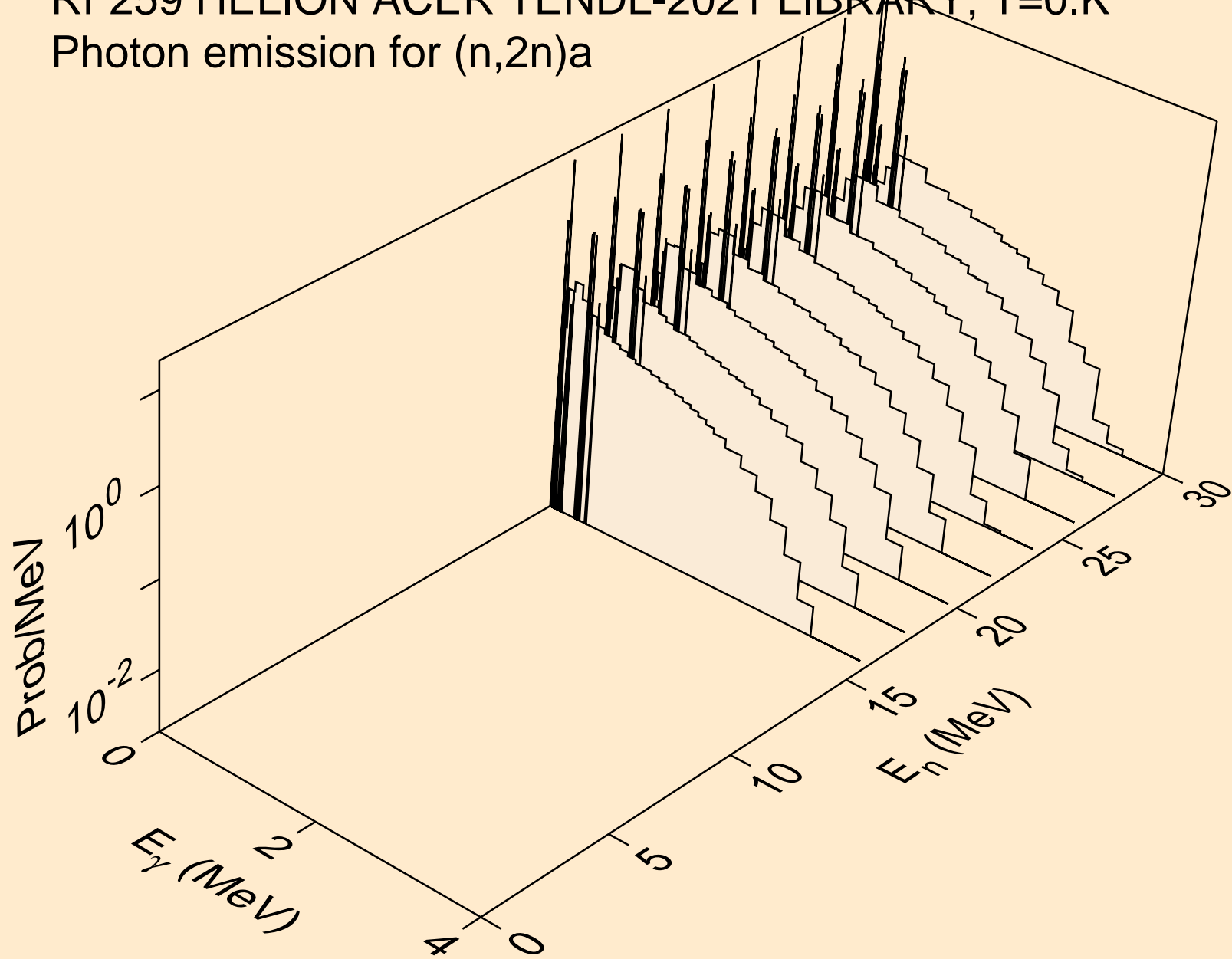

RF259 HELION ACER TENDL-2021 LIBRARY; T=0.K  
Photon emission for (n,n\*)p

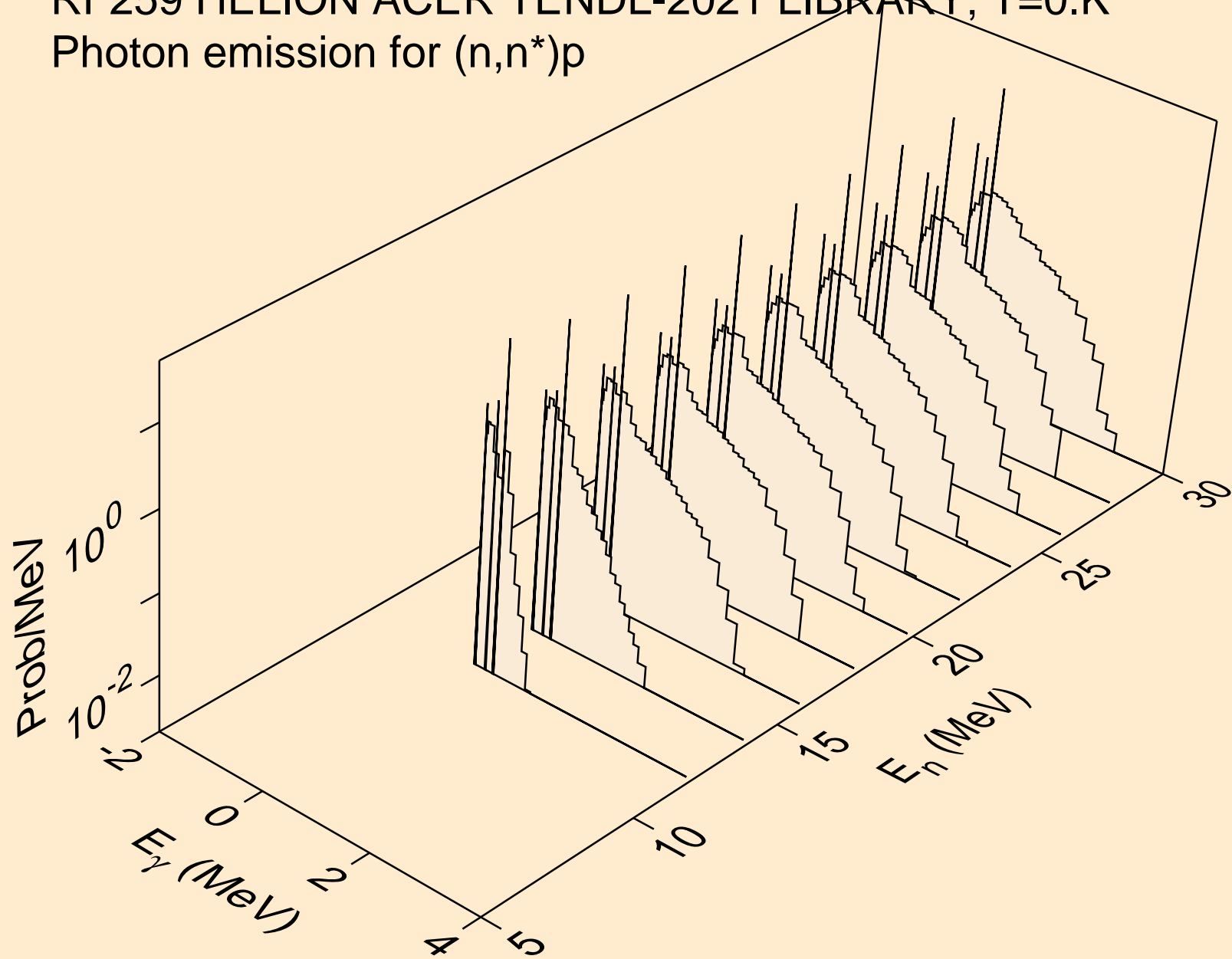

RF259 HELION ACER TENDL-2021 LIBRARY; T=0.K  
Photon emission for (n,n\*)d

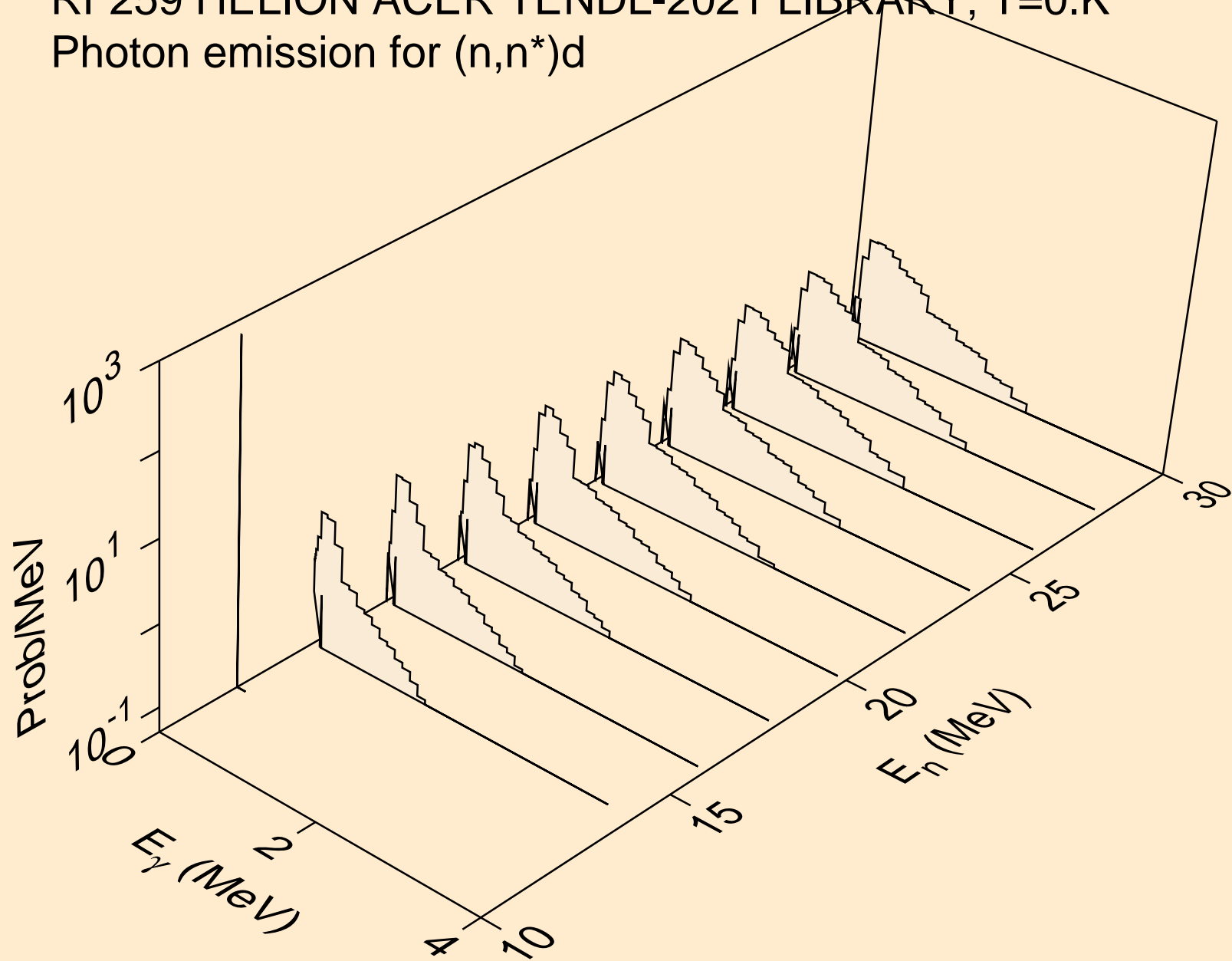

RF259 HELION ACER TENDL-2021 LIBRARY; T=0.K  
Photon emission for (n,n\*)t

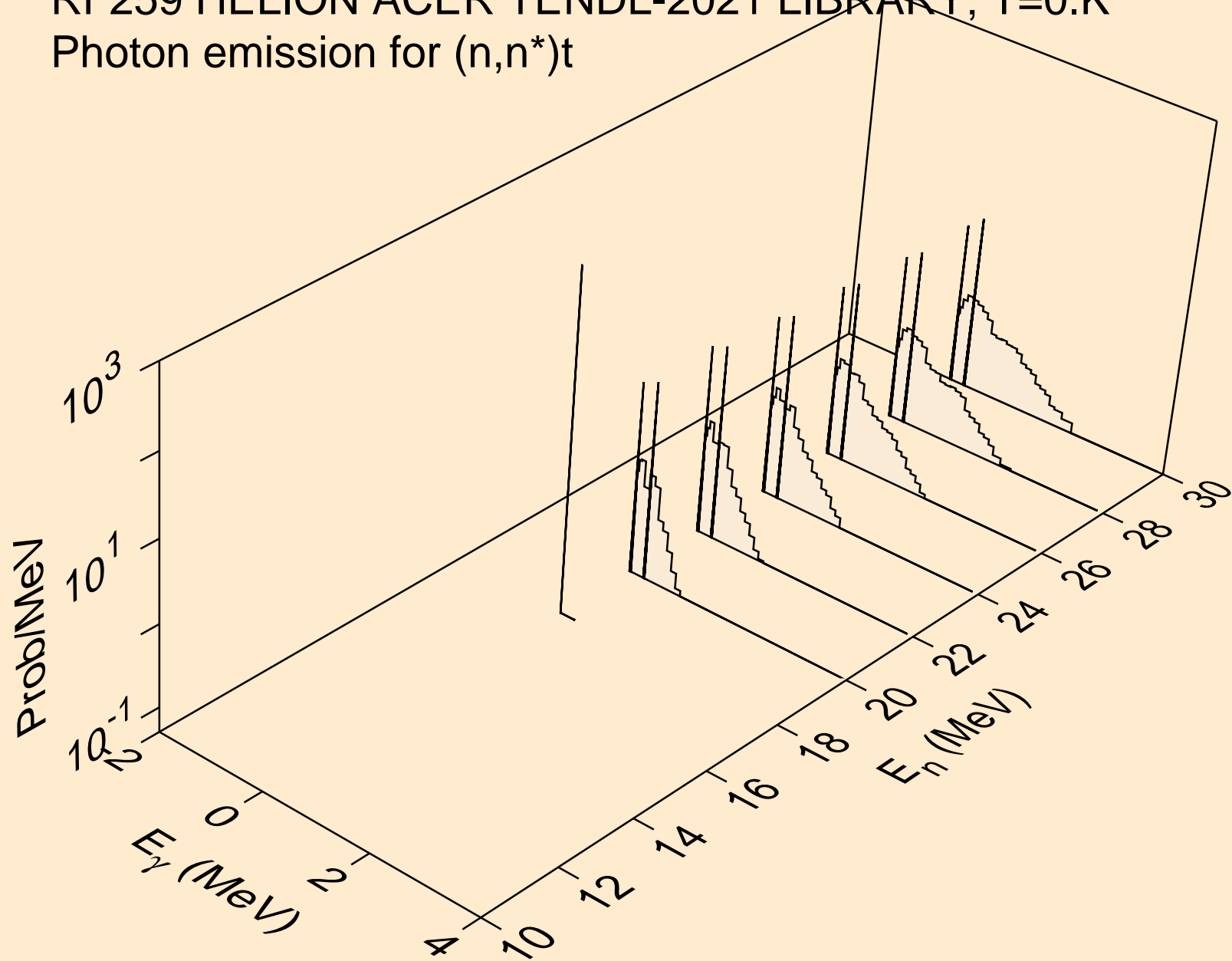

RF259 HELION ACER TENDL-2021 LIBRARY; T=0.K  
Photon emission for (n,2np)

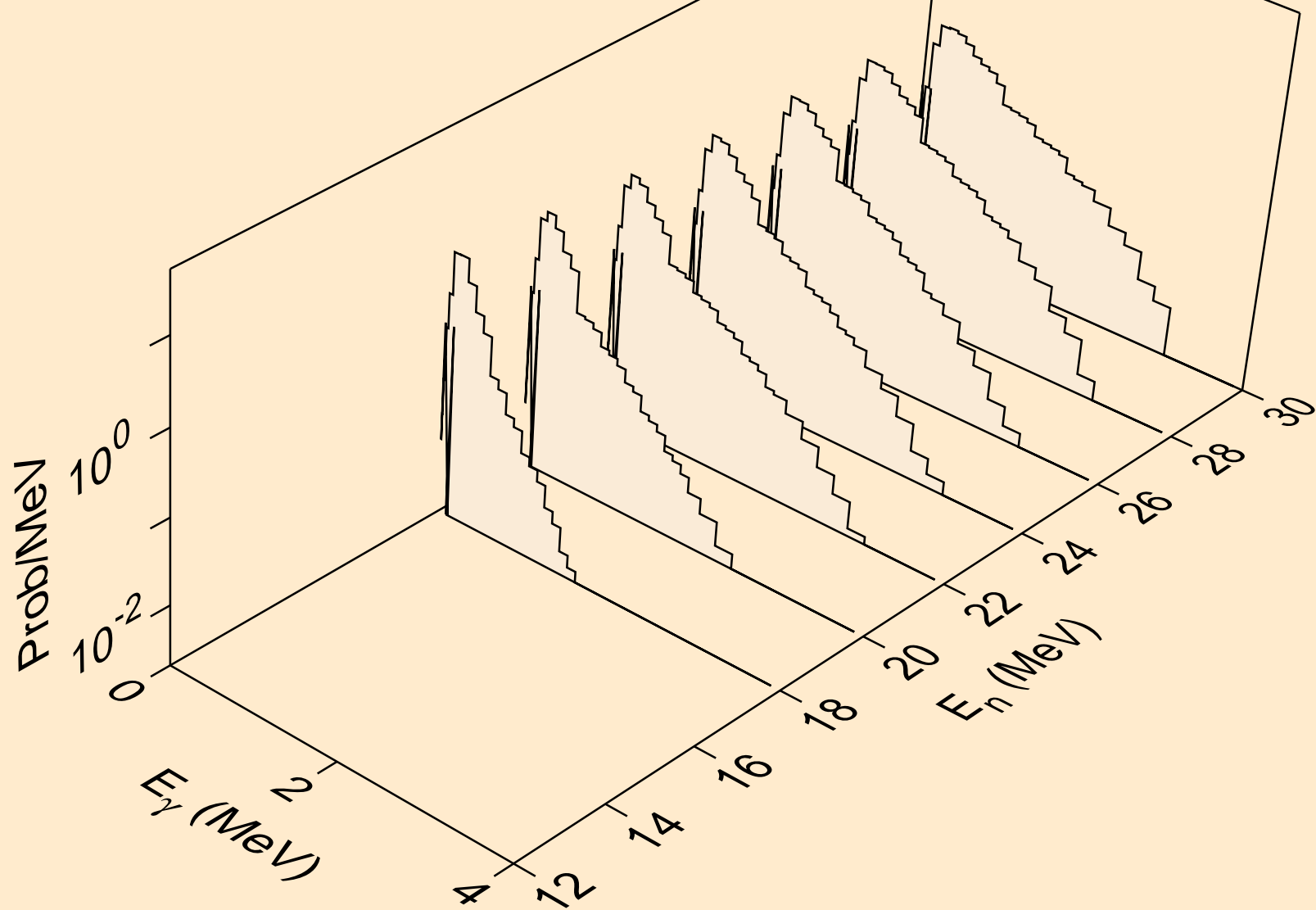

RF259 HELION ACER TENDL-2021 LIBRARY; T=0.K  
Photon emission for (n,npa)

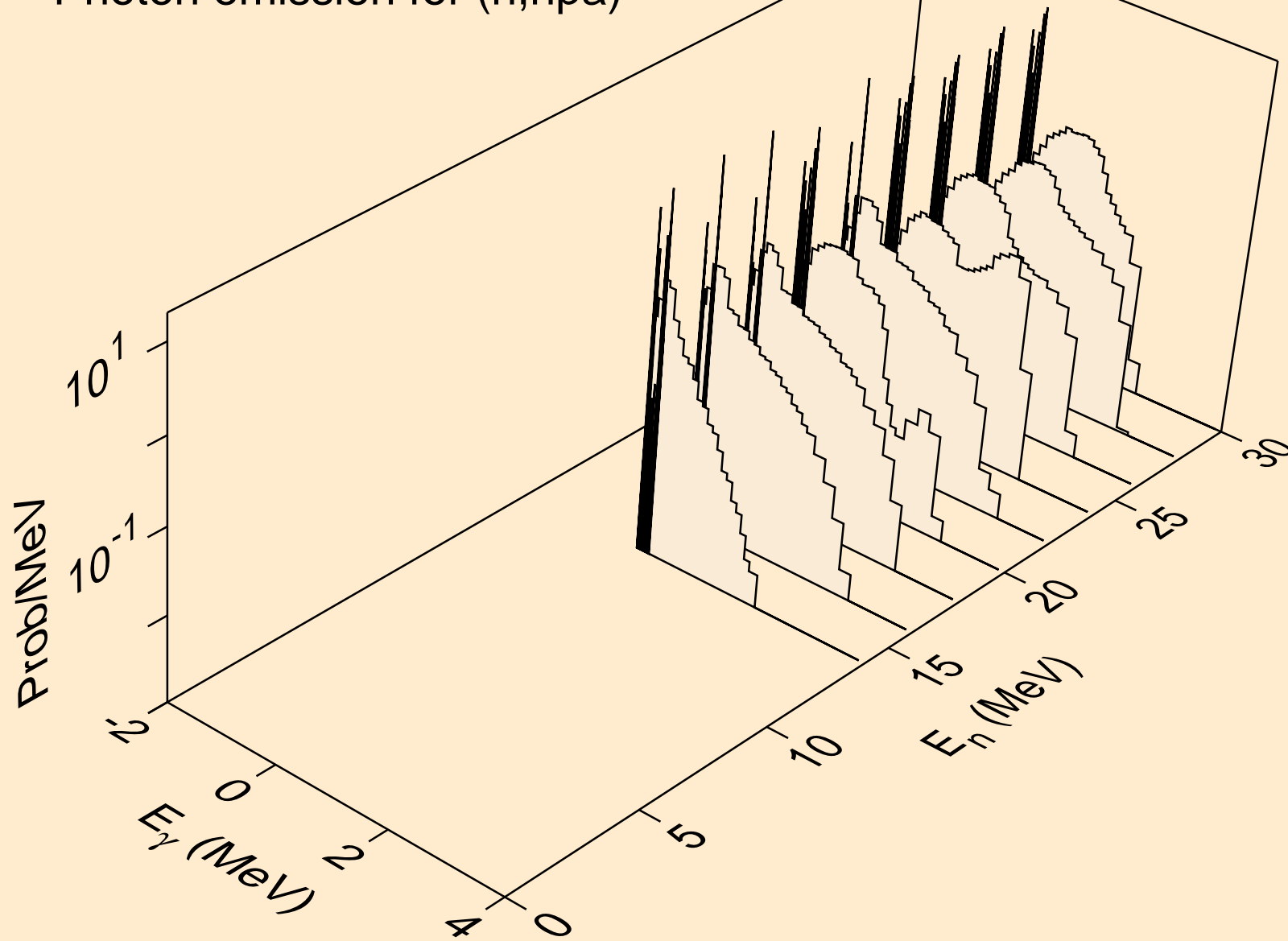



RF259 HELION ACER TENDL-2021 LIBRARY; T=0.K  
Photon emission for (n,p)

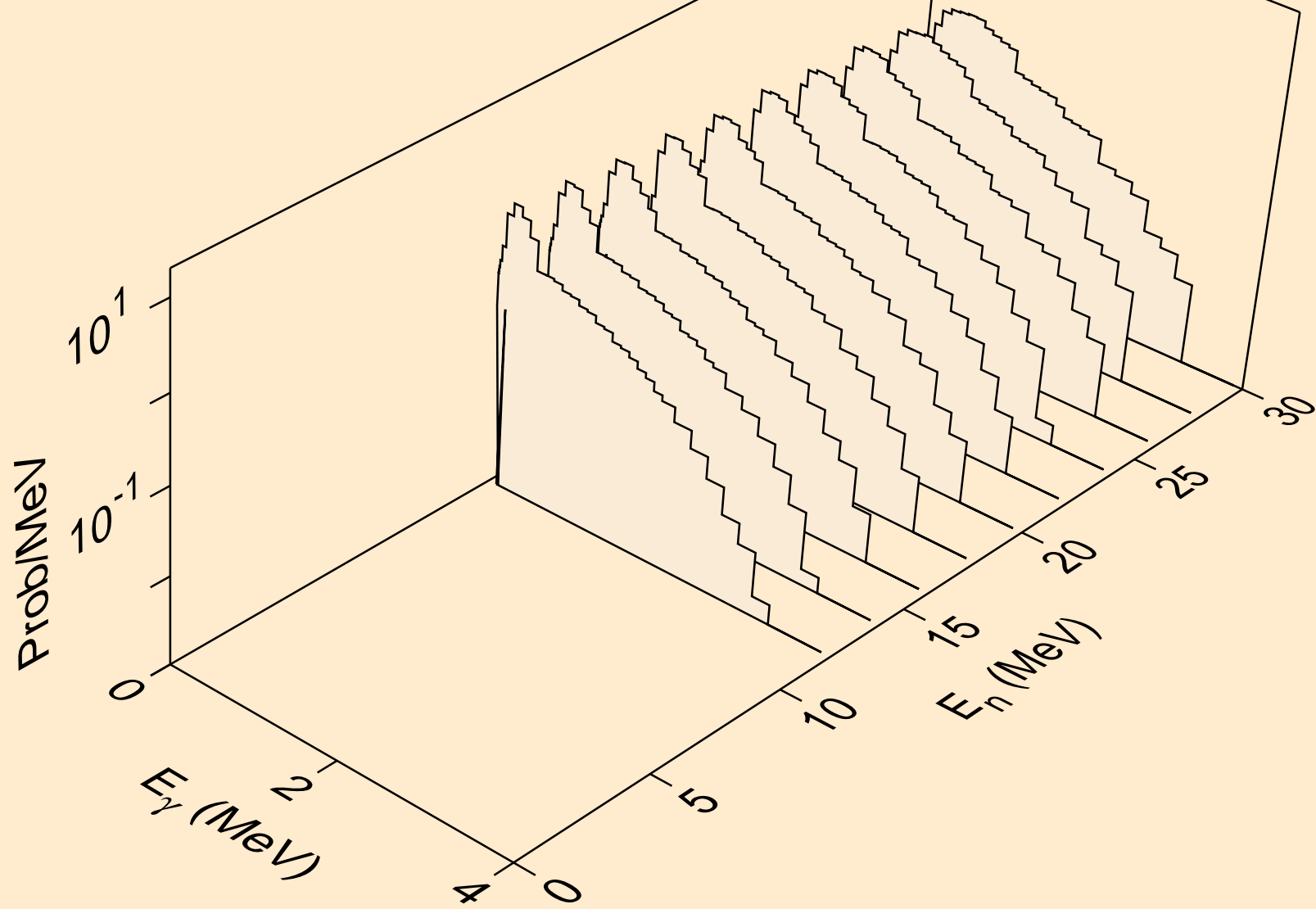

RF259 HELION ACER TENDL-2021 LIBRARY; T=0.K  
Photon emission for (n,d)

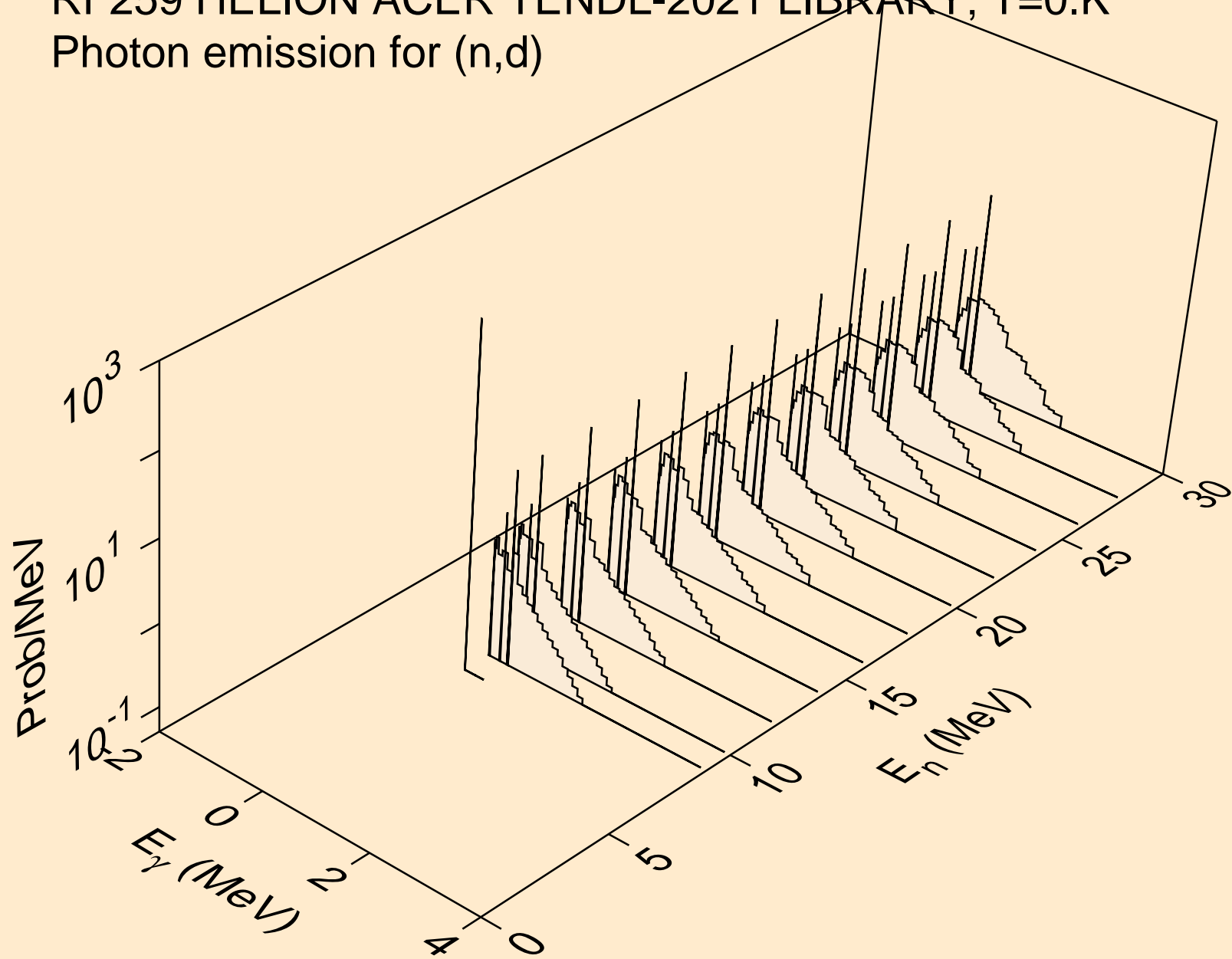

RF259 HELION ACER TENDL-2021 LIBRARY; T=0.K  
Photon emission for (n,t)

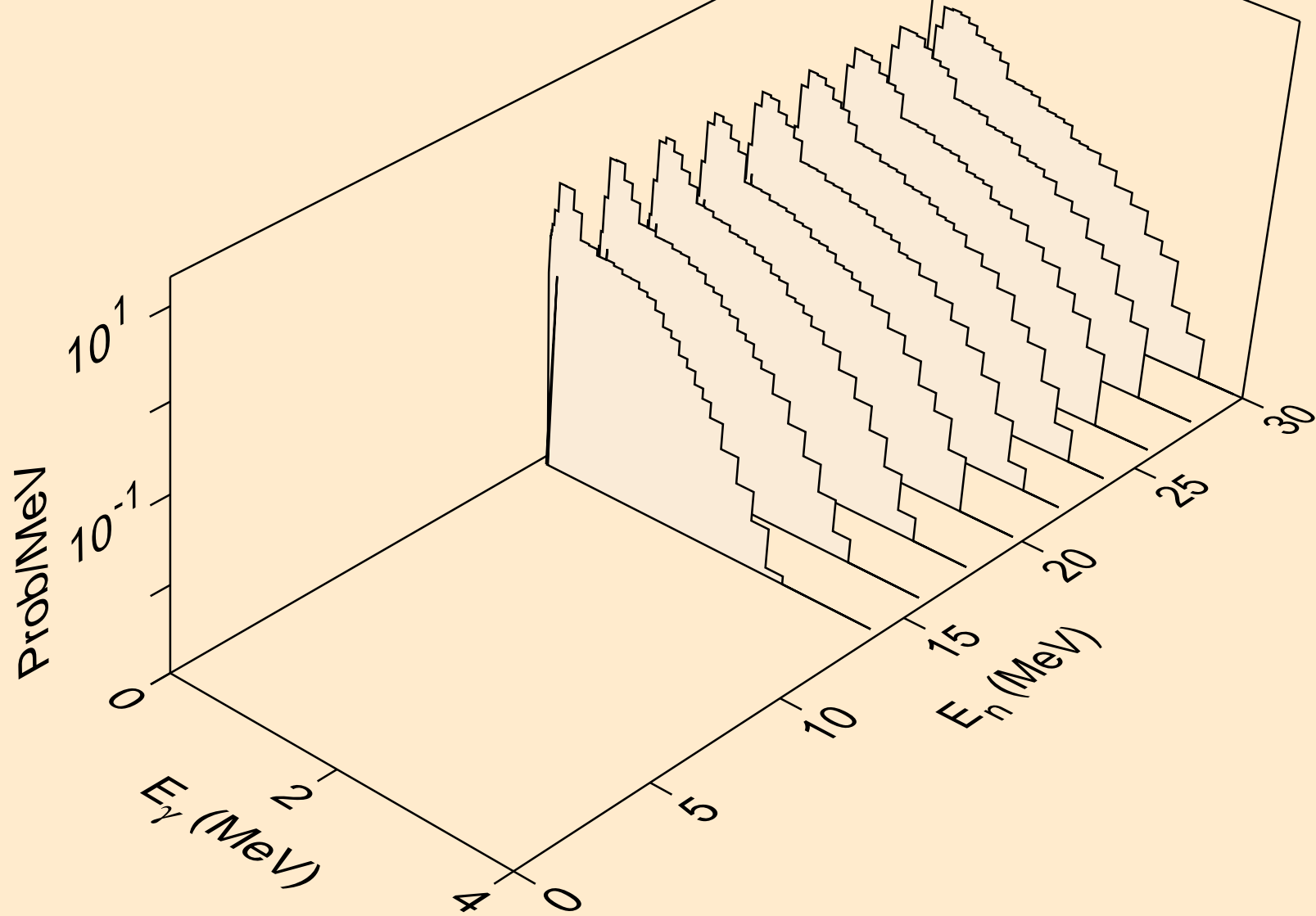

RF259 HELION ACER TENDL-2021 LIBRARY; T=0.K  
Photon emission for inelastic

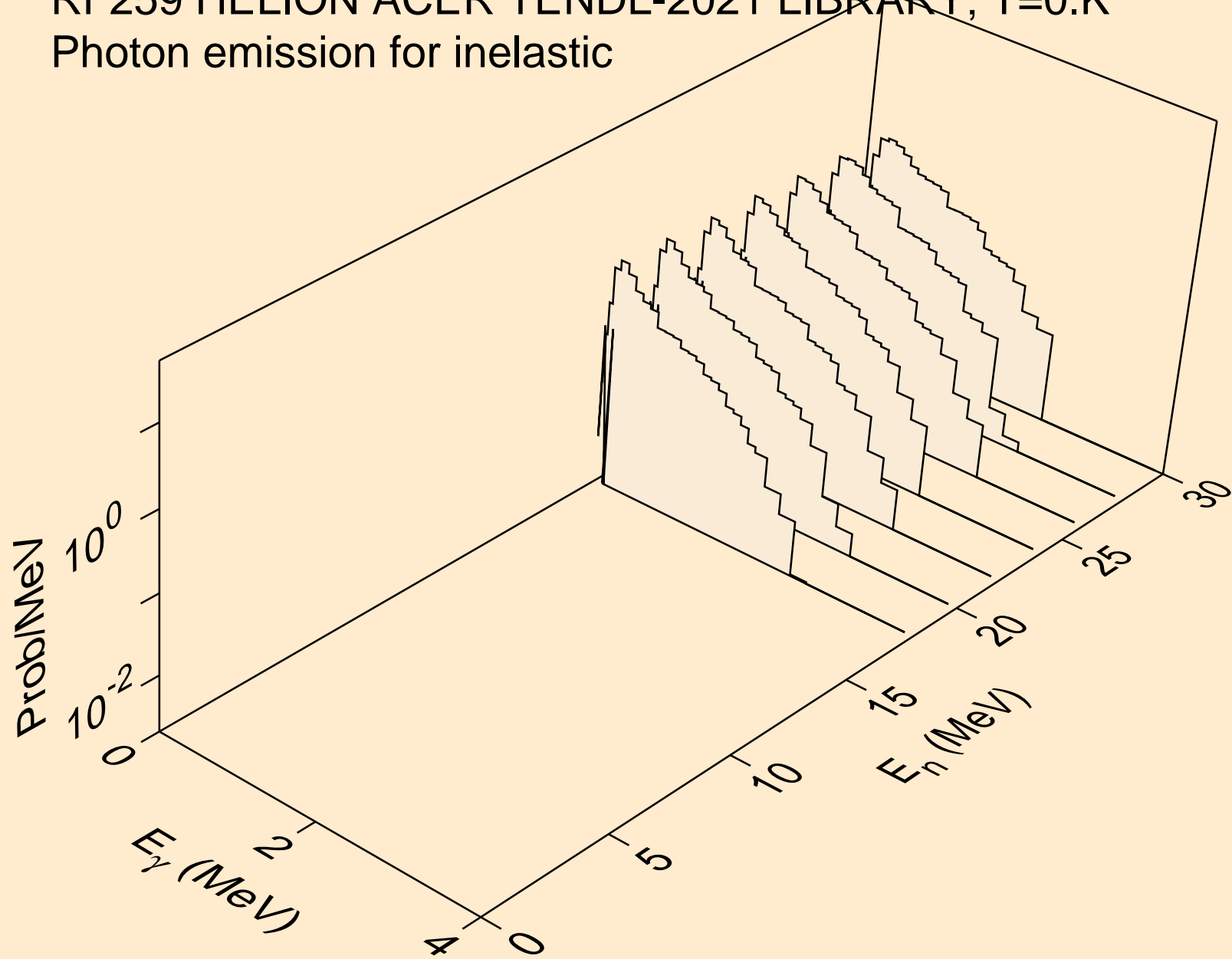

RF259 HELION ACER TENDL-2021 LIBRARY; T=0.K  
Photon emission for (n,a)

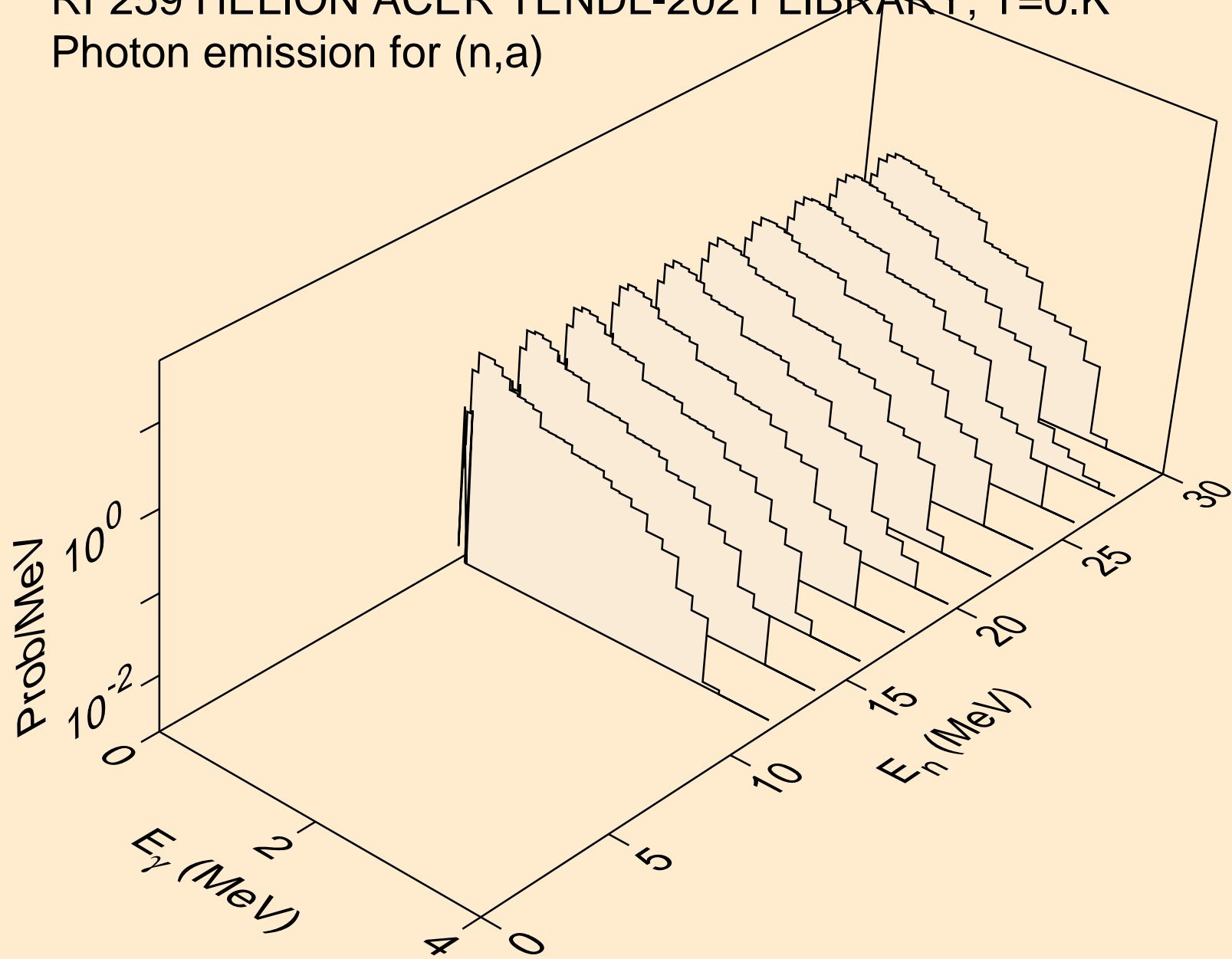

RF259 HELION ACER TENDL-2021 LIBRARY; T=0.K  
Photon emission for (n,2p)

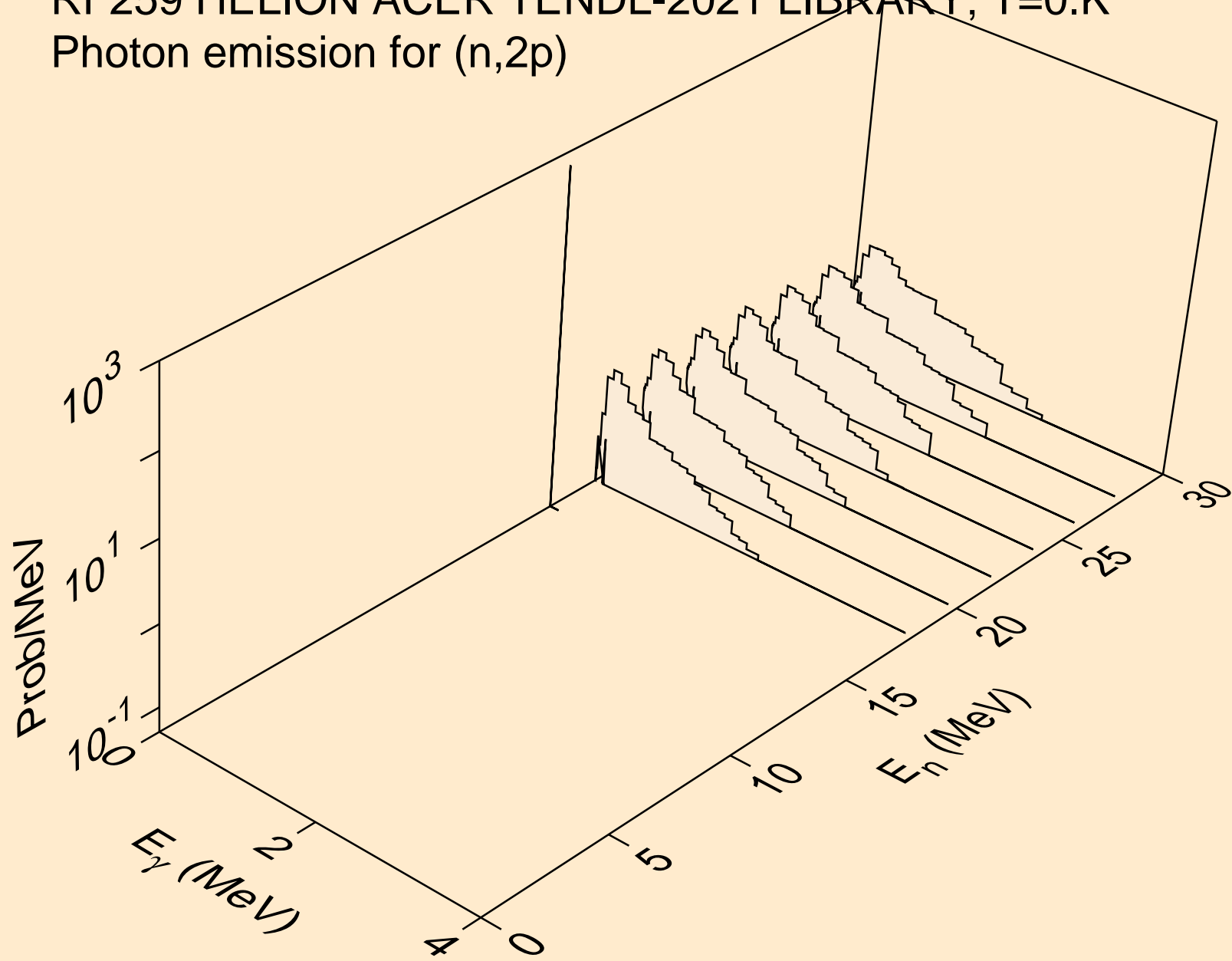

RF259 HELION ACER TENDL-2021 LIBRARY; T=0.K  
Photon emission for (n,pa)

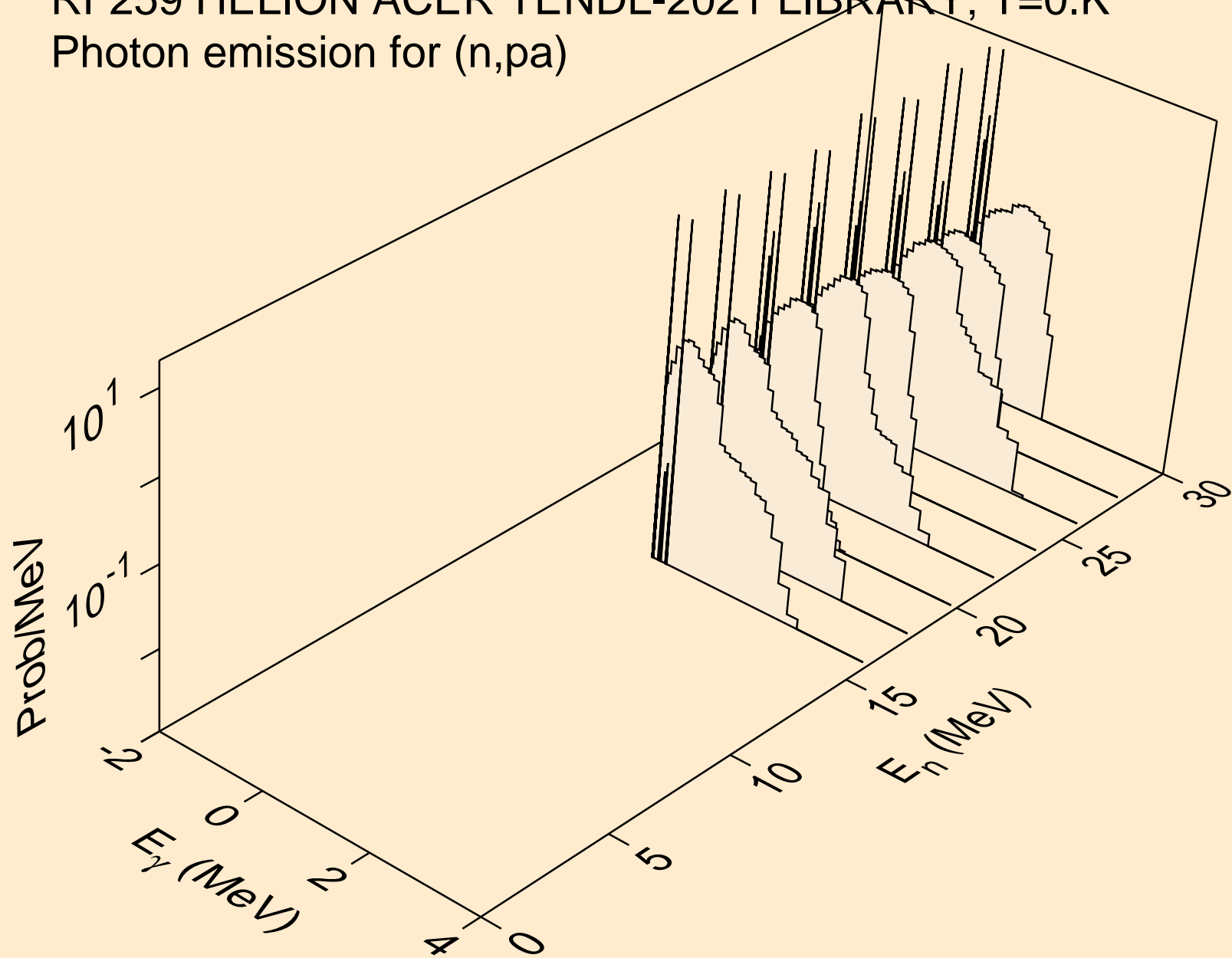

RF259 HELION ACER TENDL-2021 LIBRARY; T=0.K  
Photon emission for (n,t2a)

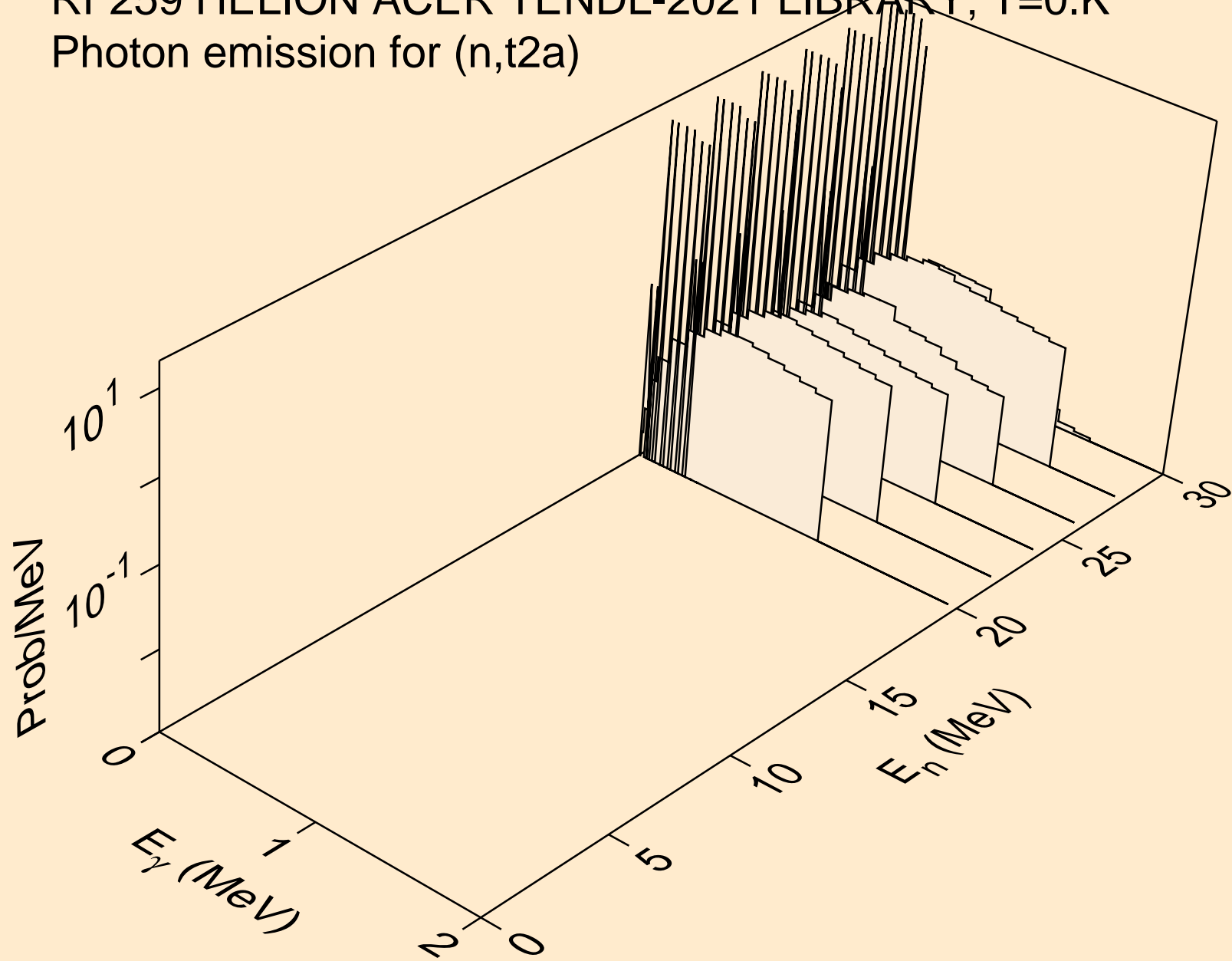



RF259 HELION ACER TENDL-2021 LIBRARY; T=0.K  
Photon emission for (n,d2a)

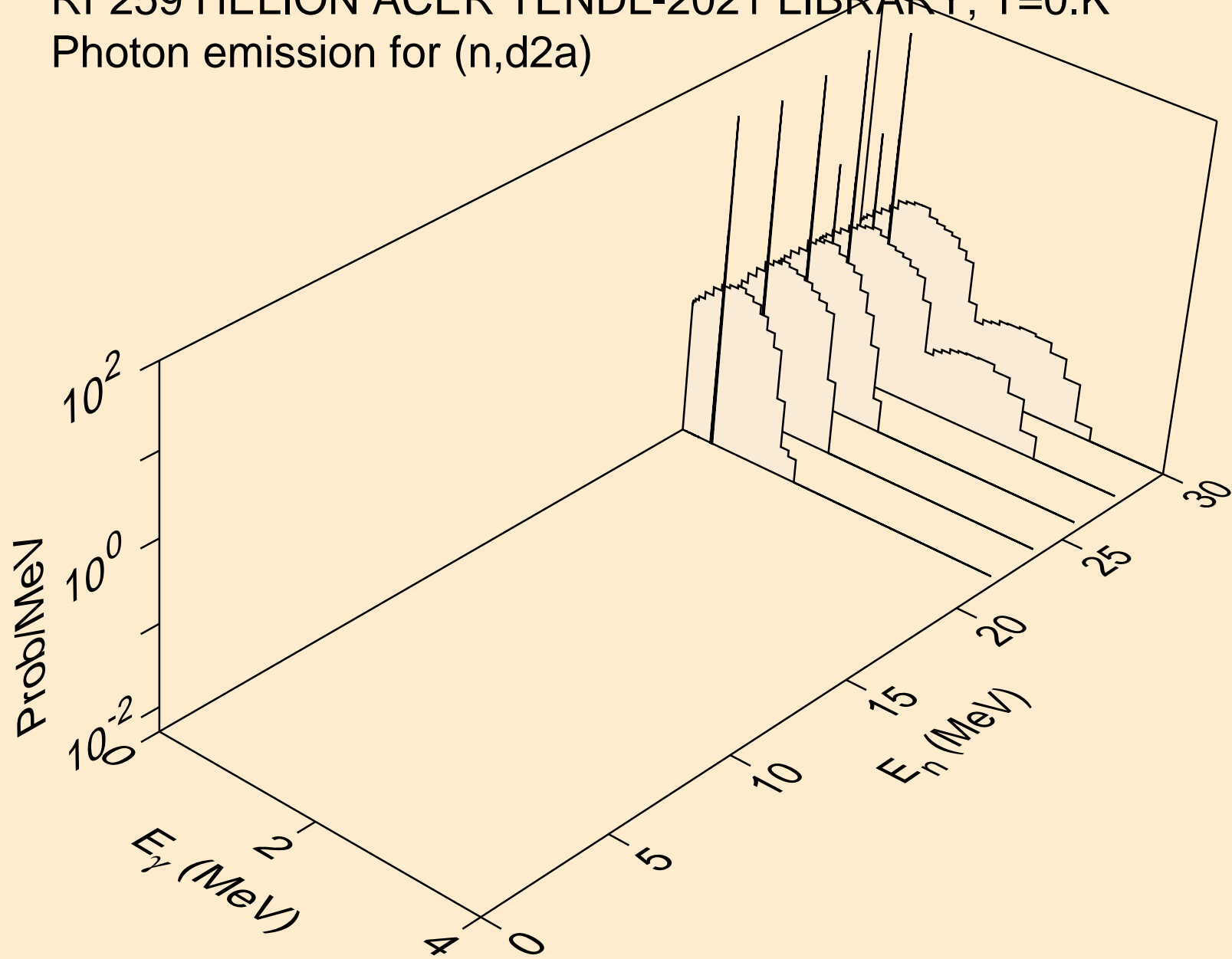

RF259 HELION ACER TENDL-2021 LIBRARY; T=0.K  
Photon emission for (n,da)

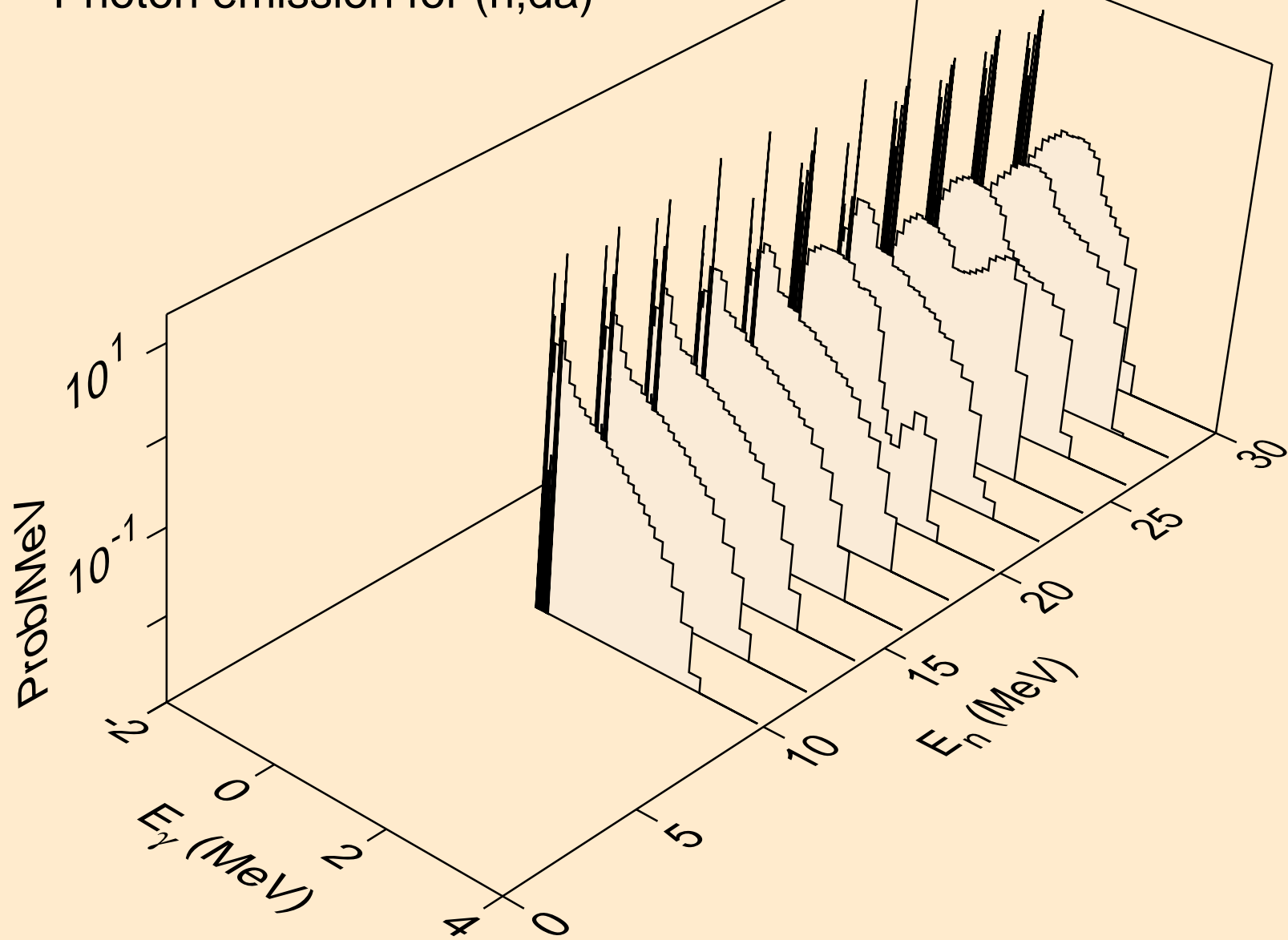

RF259 HELION ACER TENDL-2021 LIBRARY; T=0.K  
Particle heating contributions

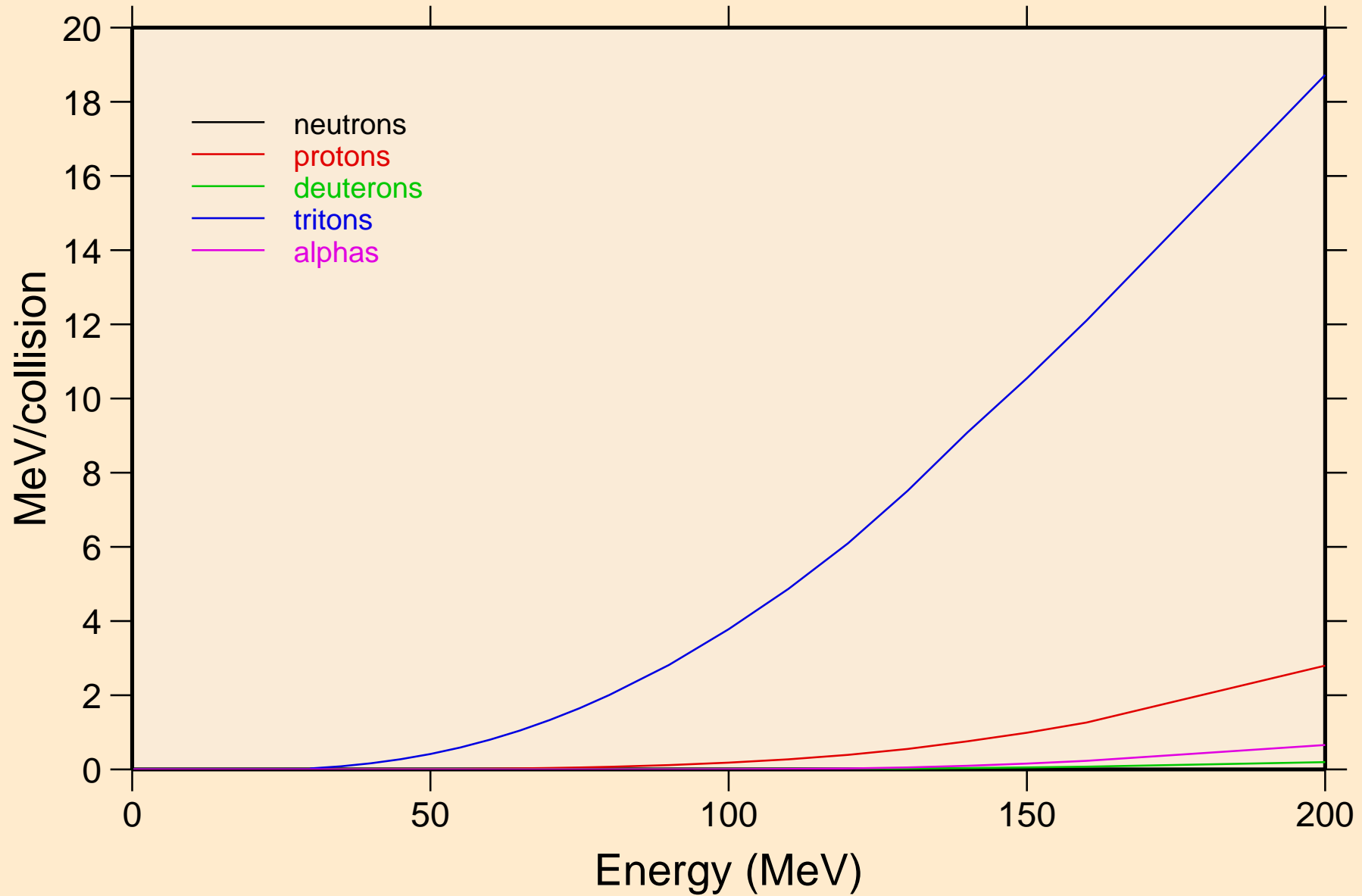

RF259 HELION ACER TENDL-2021 LIBRARY; T=0.K  
Recoil Heating

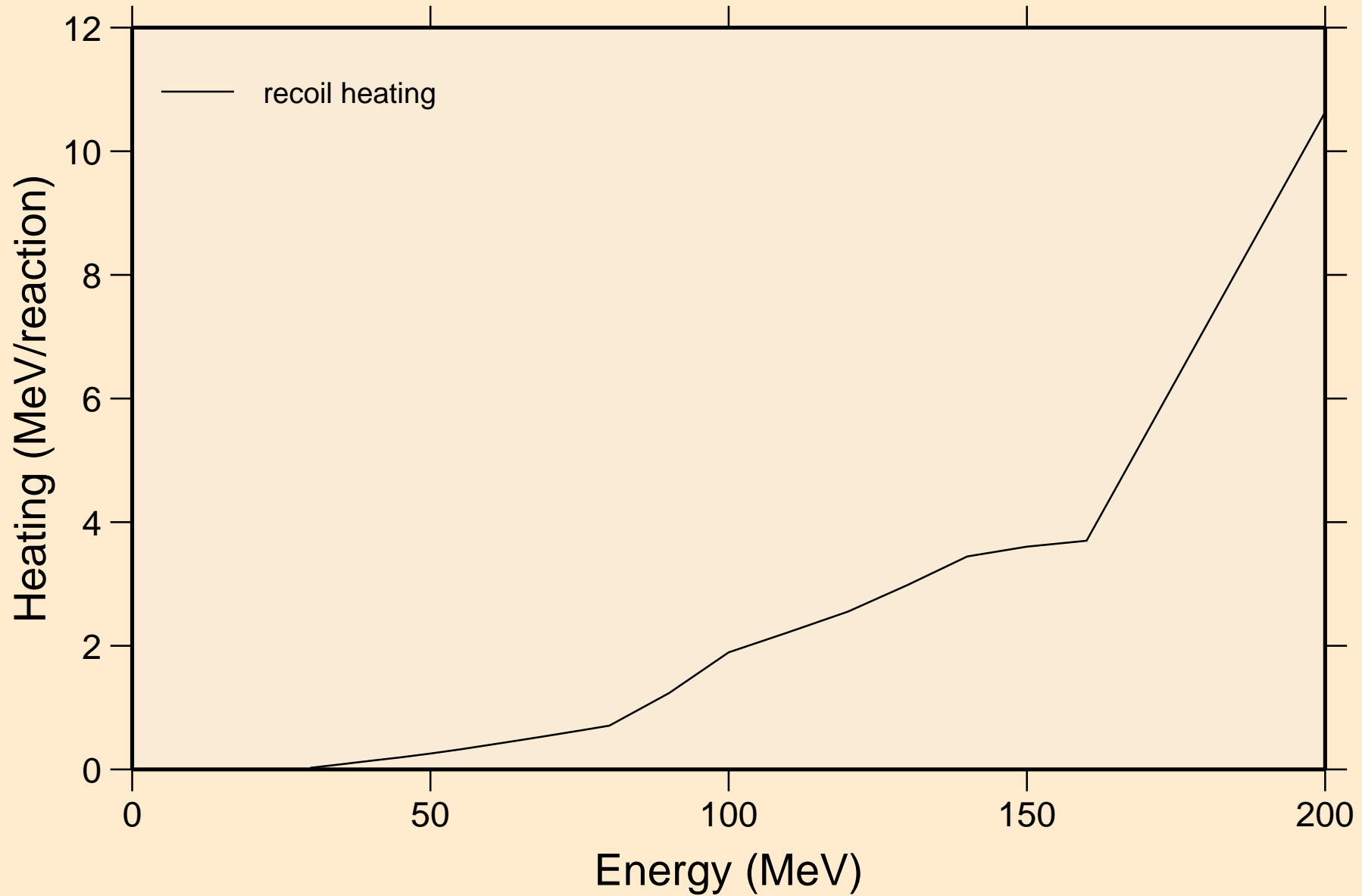

RF259 HELION ACER TENDL-2021 LIBRARY; T=0.K  
Particle production cross sections

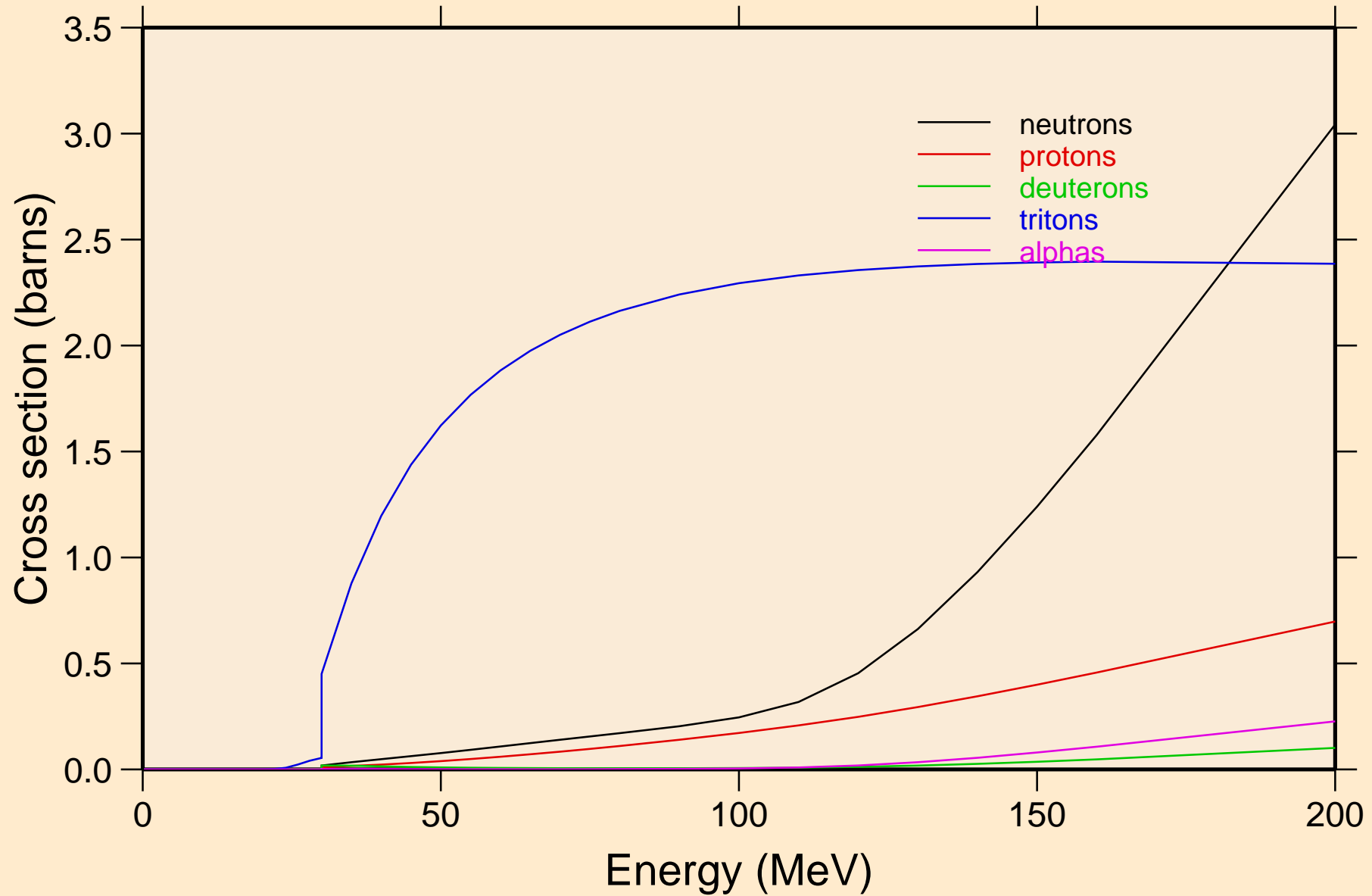

RF259 HELION ACER TENDL-2021 LIBRARY; T=0.K  
neutrons from (s,n)

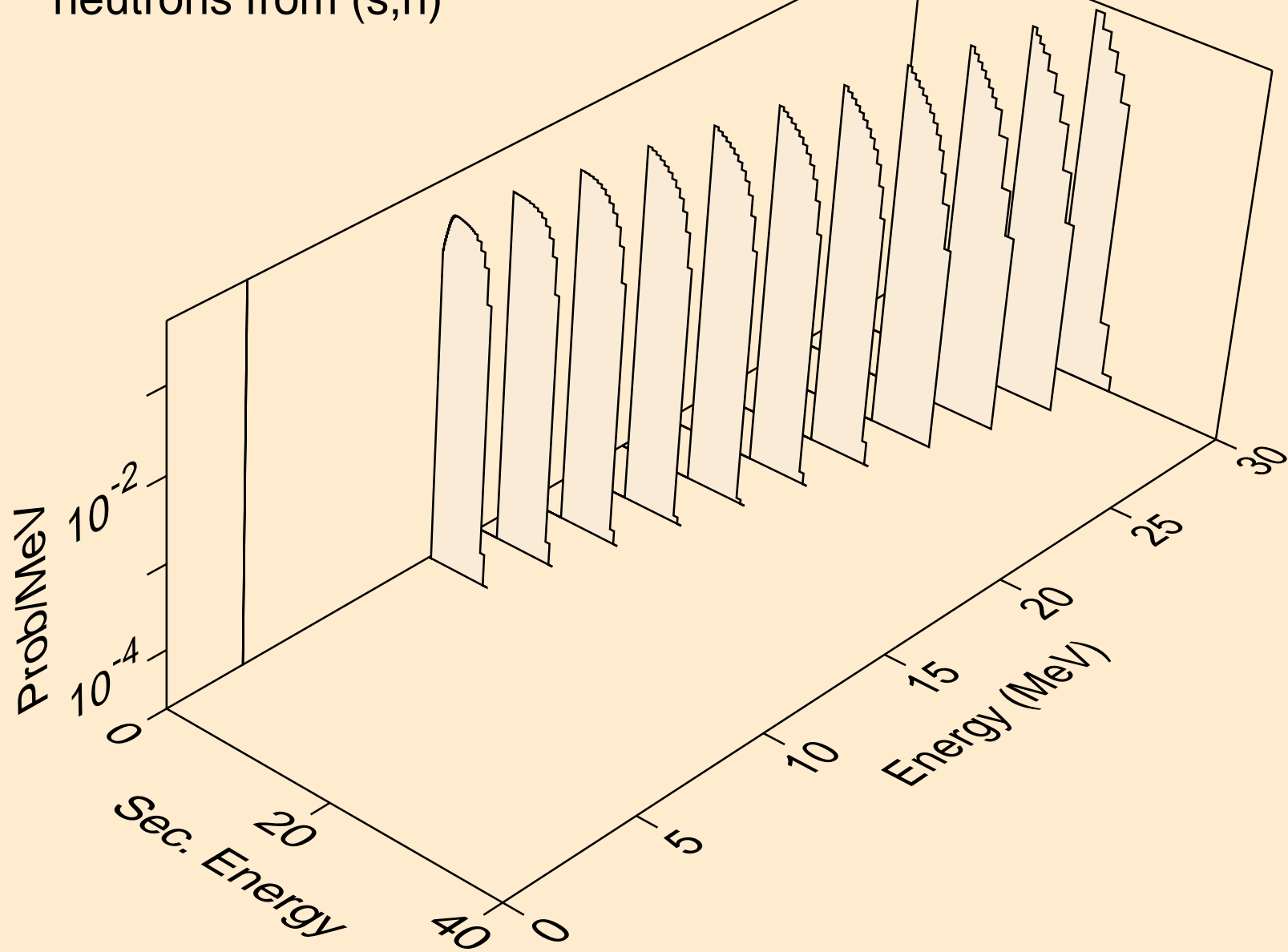

RF259 HELION ACER TENDL-2021 LIBRARY; T=0.K  
neutrons from (s,x)

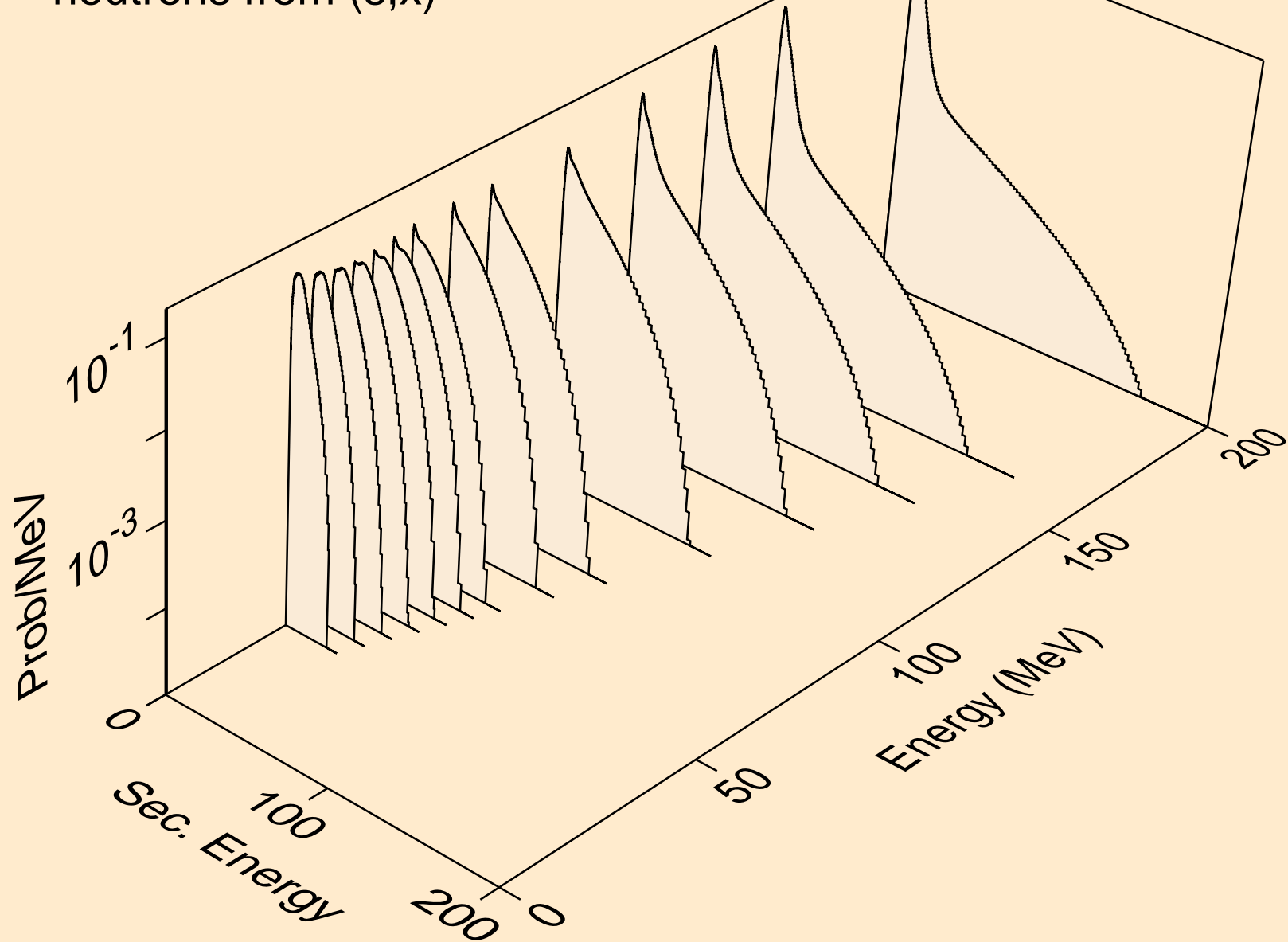

RF259 HELION ACER TENDL-2021 LIBRARY; T=0.K  
neutrons from (s,2n)

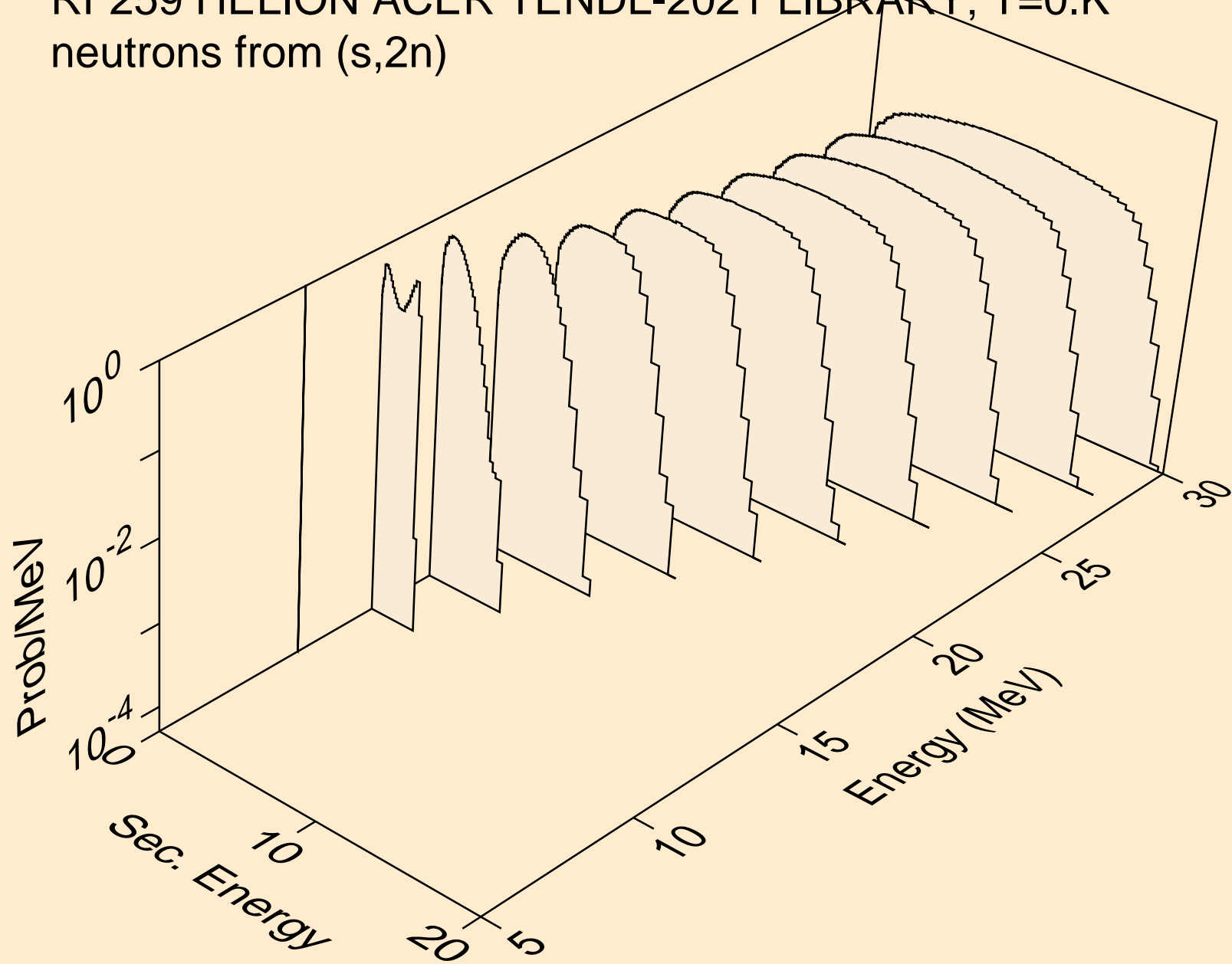



RF259 HELION ACER TENDL-2021 LIBRARY; T=0.K  
neutrons from (s,3n)

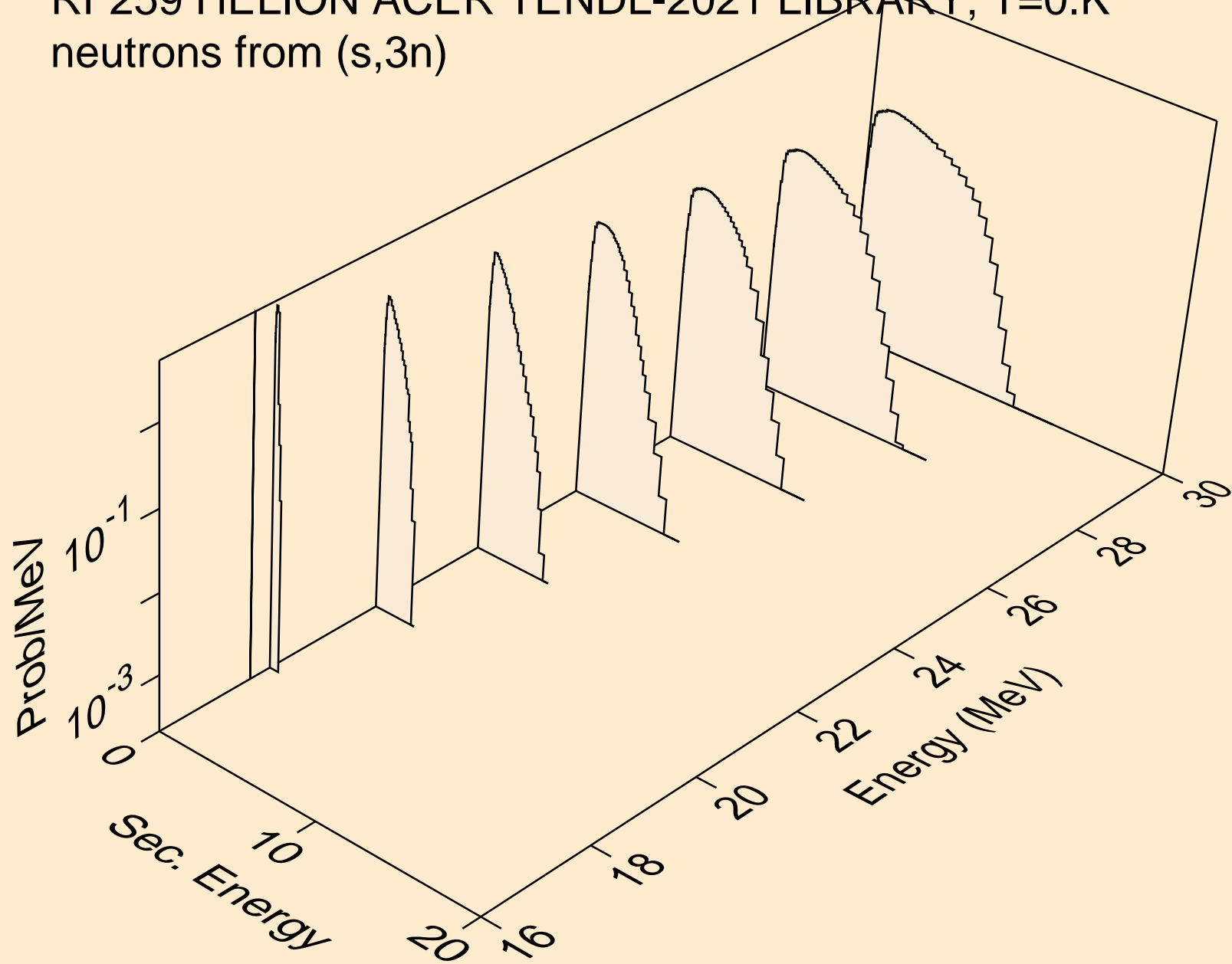

RF259 HELION ACER TENDL-2021 LIBRARY; T=0.K  
neutrons from (s,n\*)a

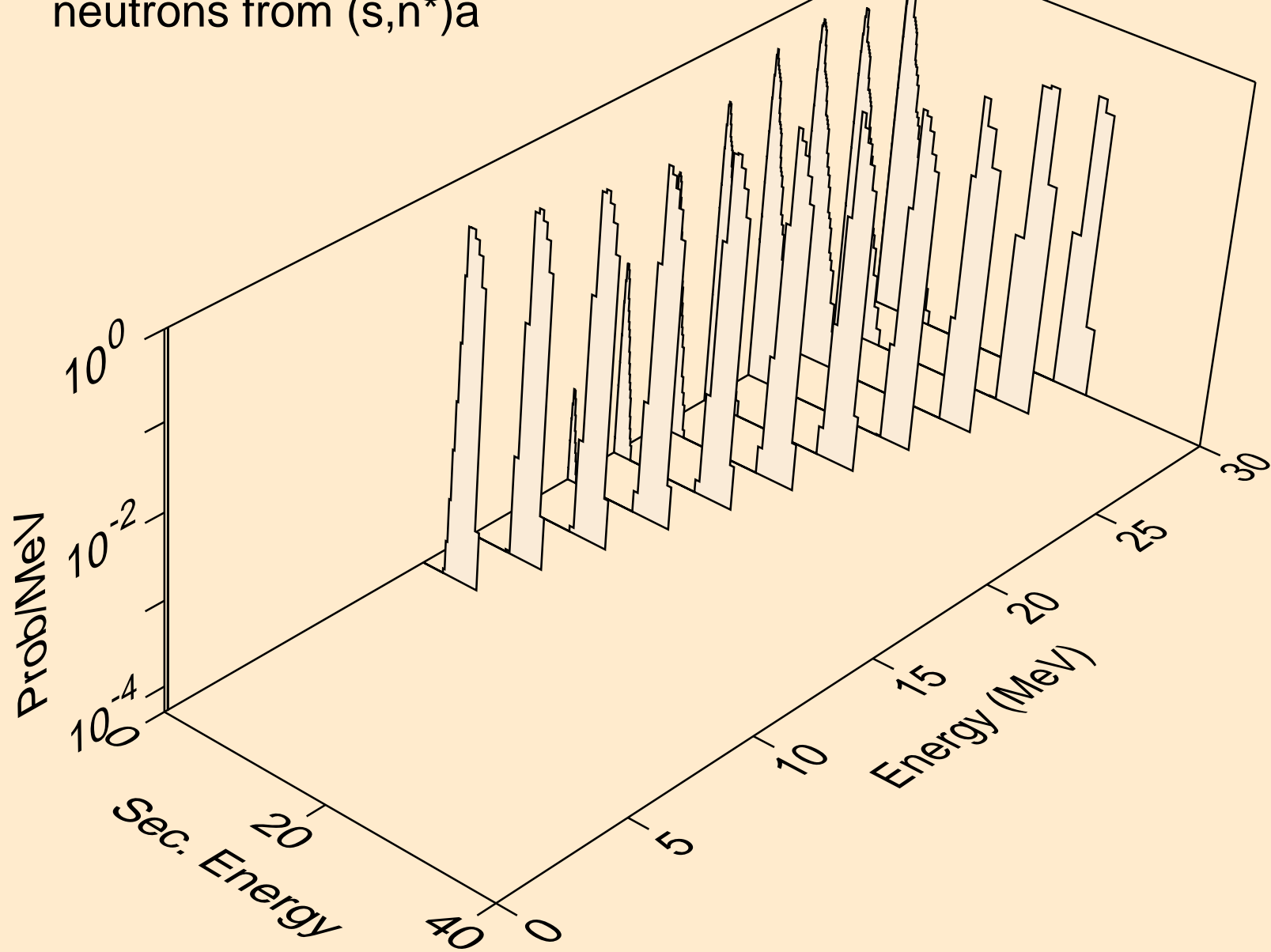

RF259 HELION ACER TENDL-2021 LIBRARY; T=0.K  
neutrons from (s,2n)a

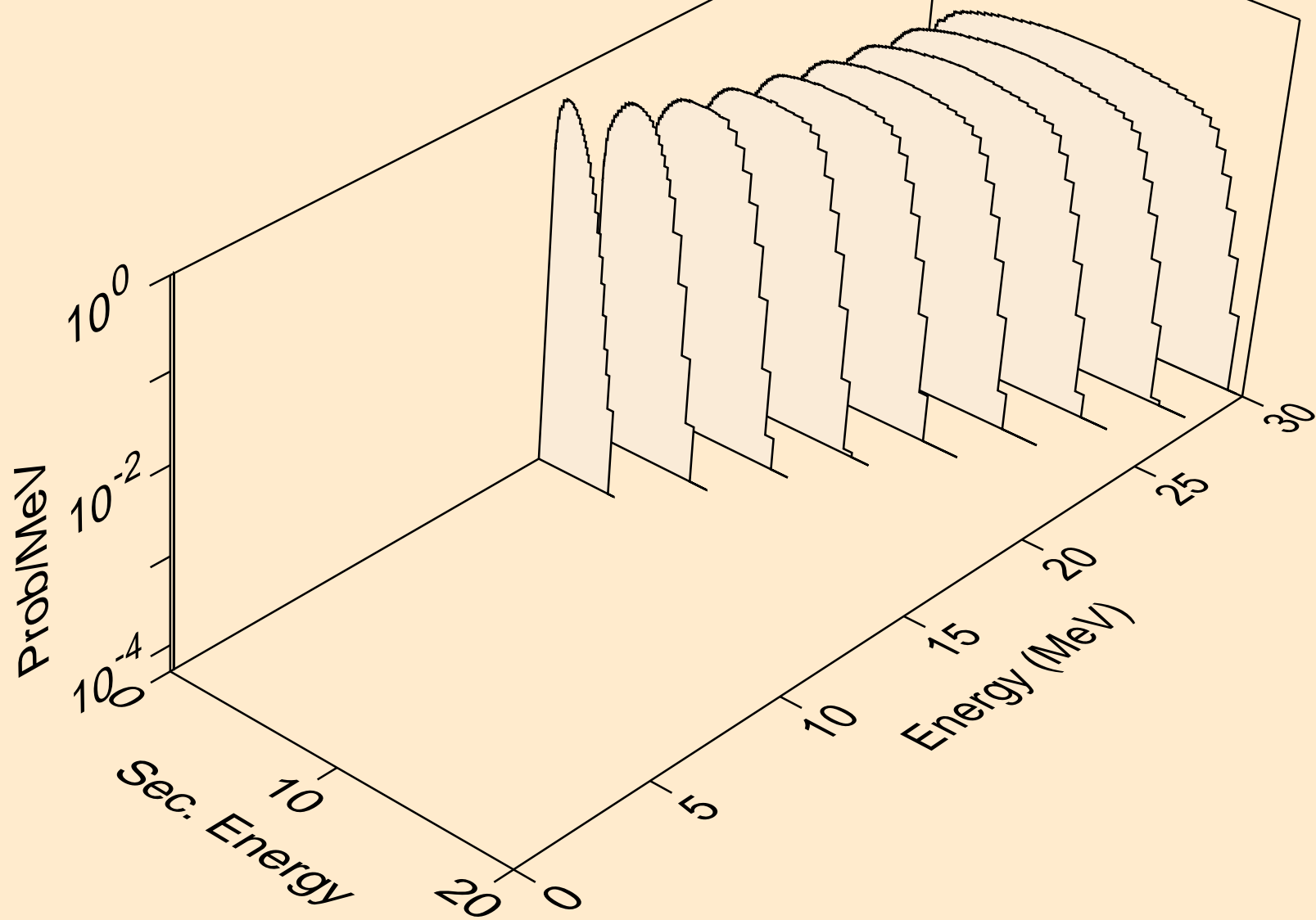

RF259 HELION ACER TENDL-2021 LIBRARY; T=0.K  
neutrons from (s,n\*)p

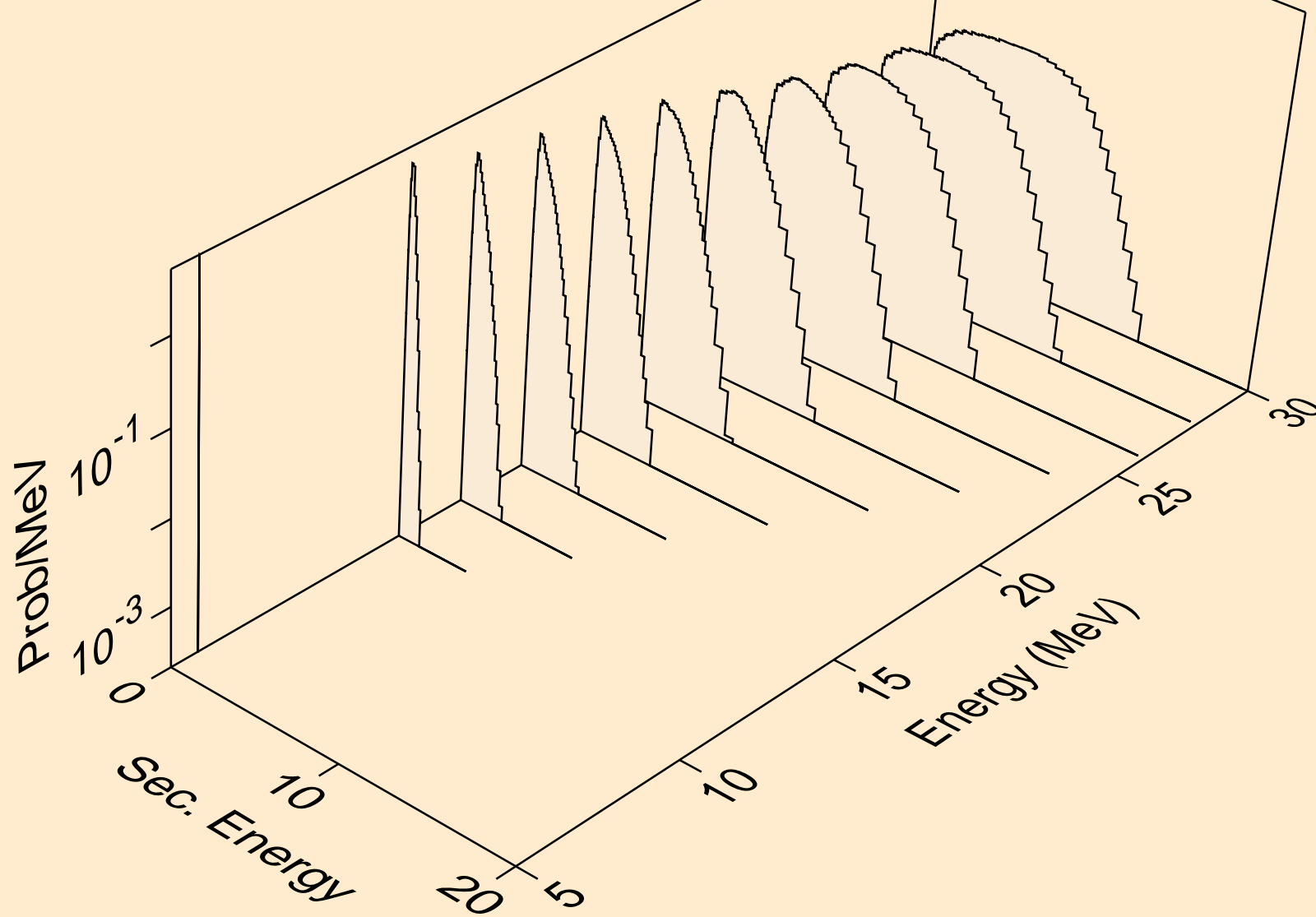

RF259 HELION ACER TENDL-2021 LIBRARY; T=0.K  
neutrons from (s,n\*)d

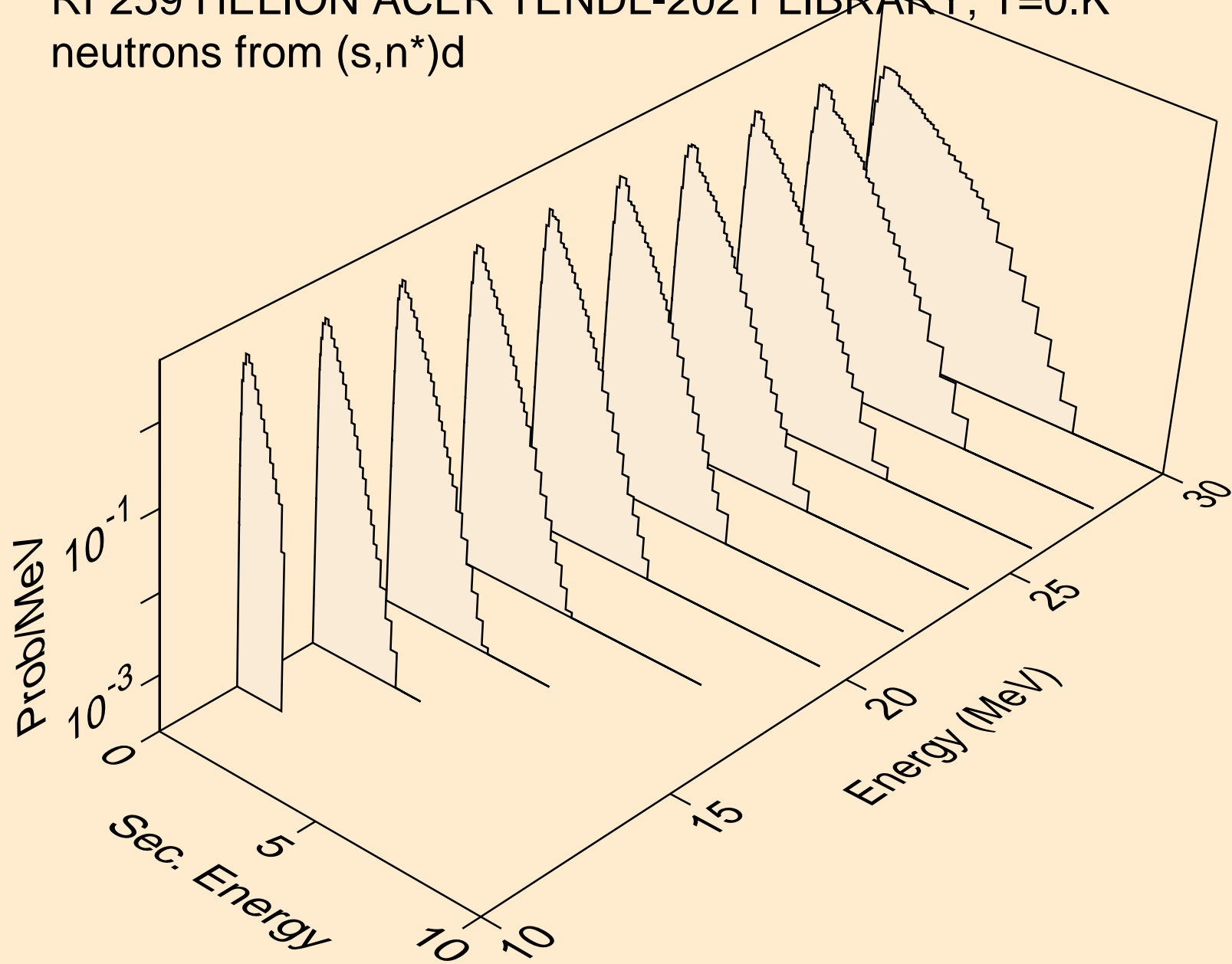

RF259 HELION ACER TENDL-2021 LIBRARY; T=0.K  
neutrons from (s,n\*)t

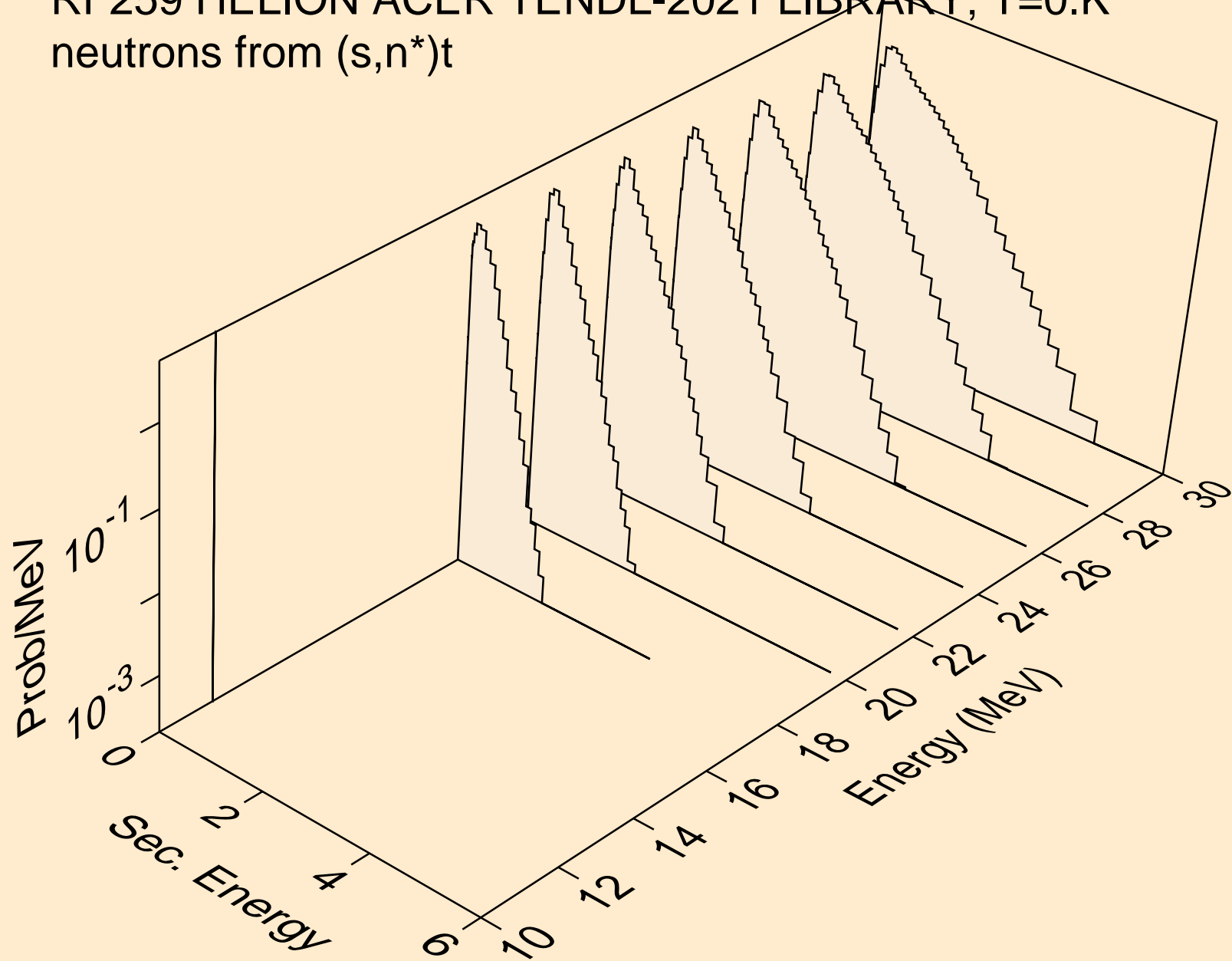

RF259 HELION ACER TENDL-2021 LIBRARY; T=0.K  
neutrons from (s,2np)

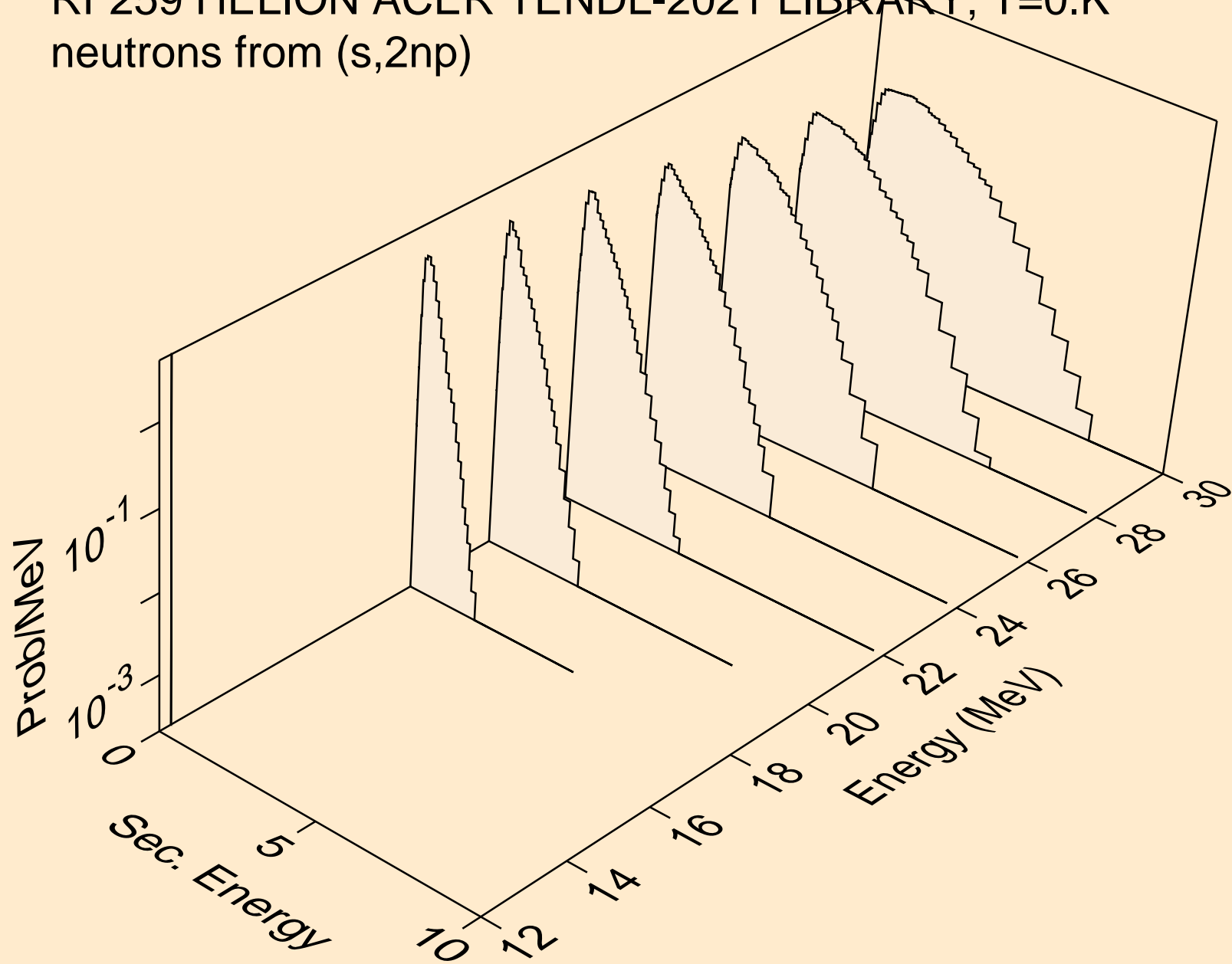

RF259 HELION ACER TENDL-2021 LIBRARY; T=0.K  
neutrons from (s,npa)

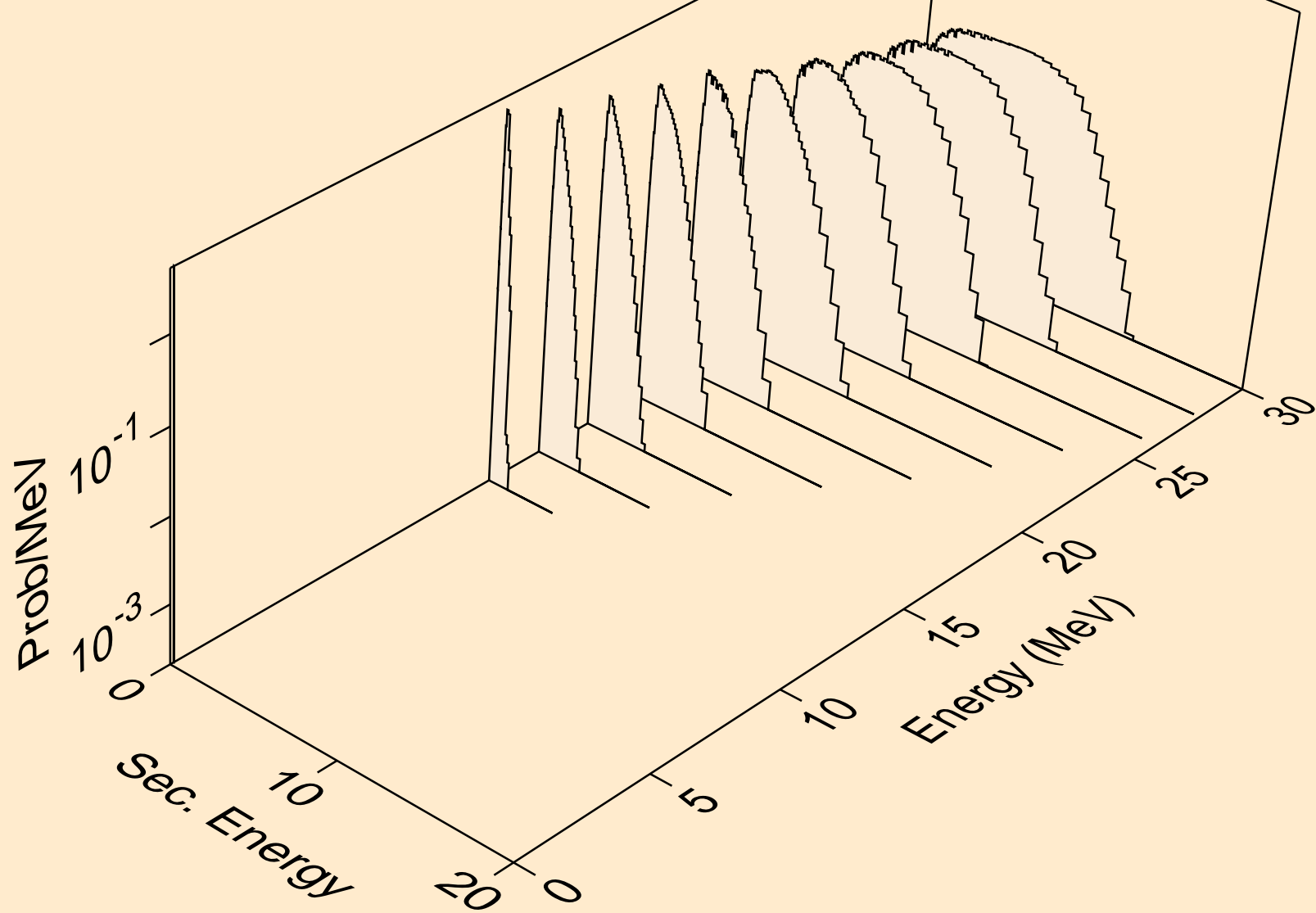



RF259 HELION ACER TENDL-2021 LIBRARY; T=0.K  
protons from (s,x)

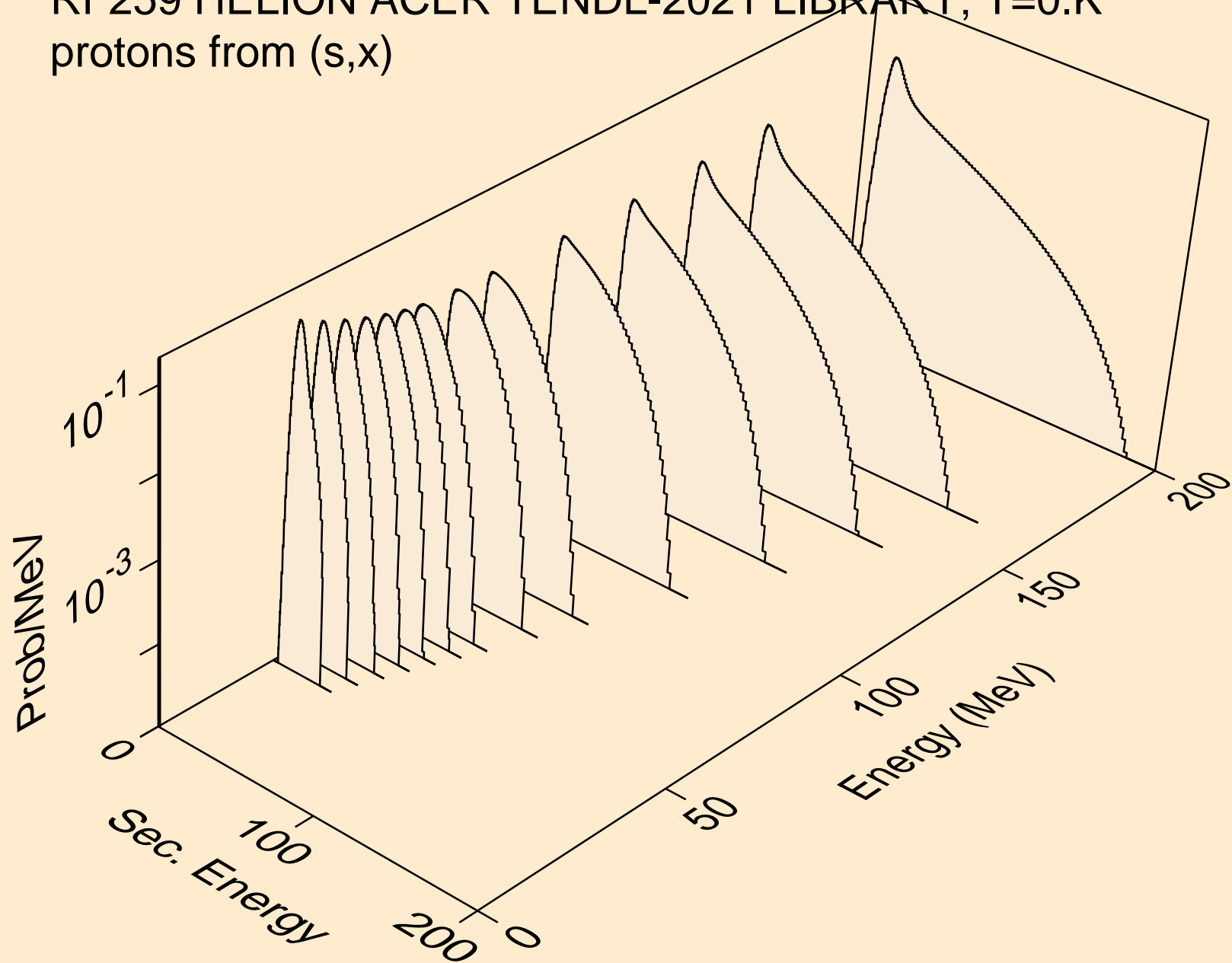

RF259 HELION ACER TENDL-2021 LIBRARY; T=0.K  
protons from (s,n\*)p

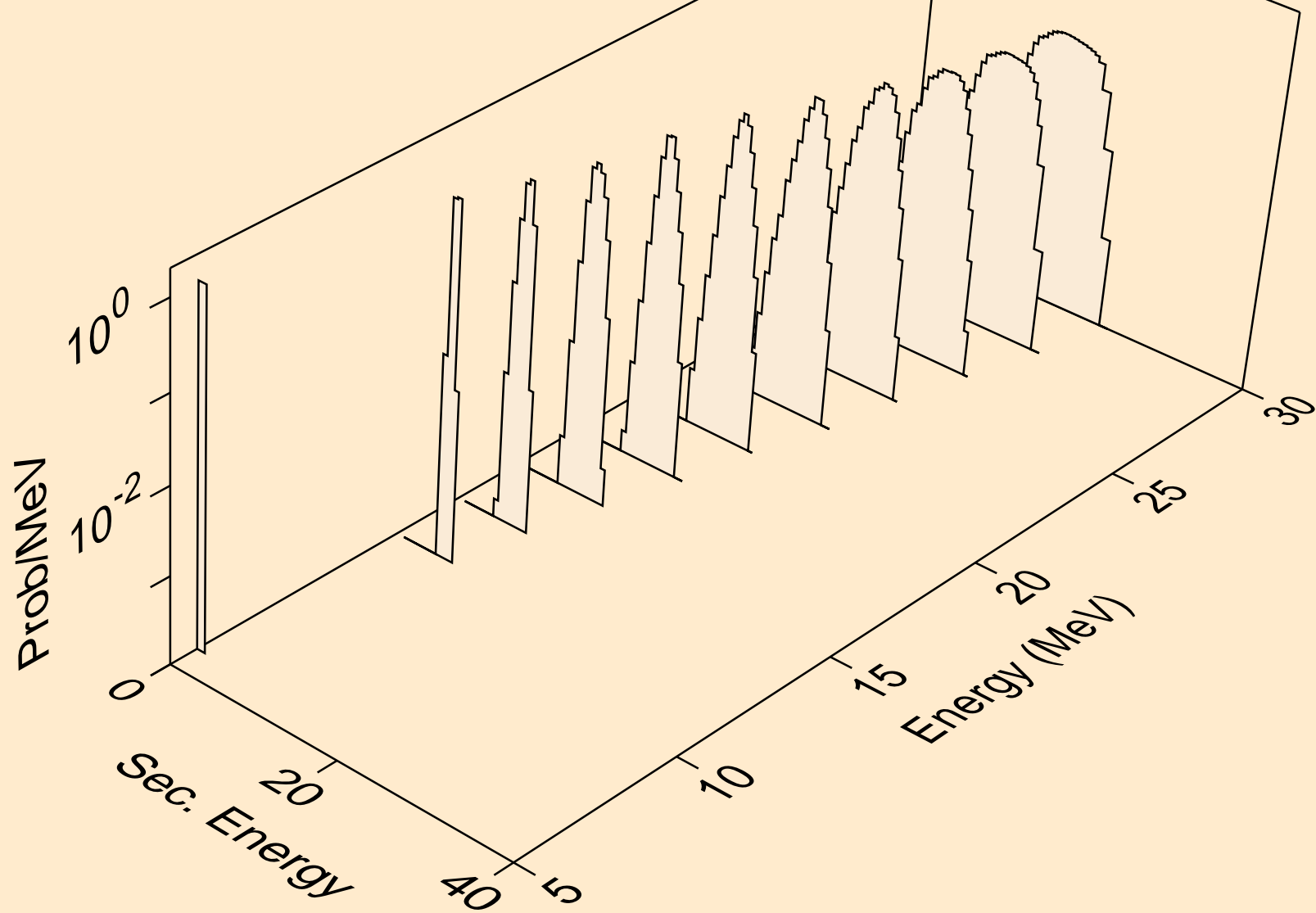

RF259 HELION ACER TENDL-2021 LIBRARY; T=0.K  
protons from (s,2np)

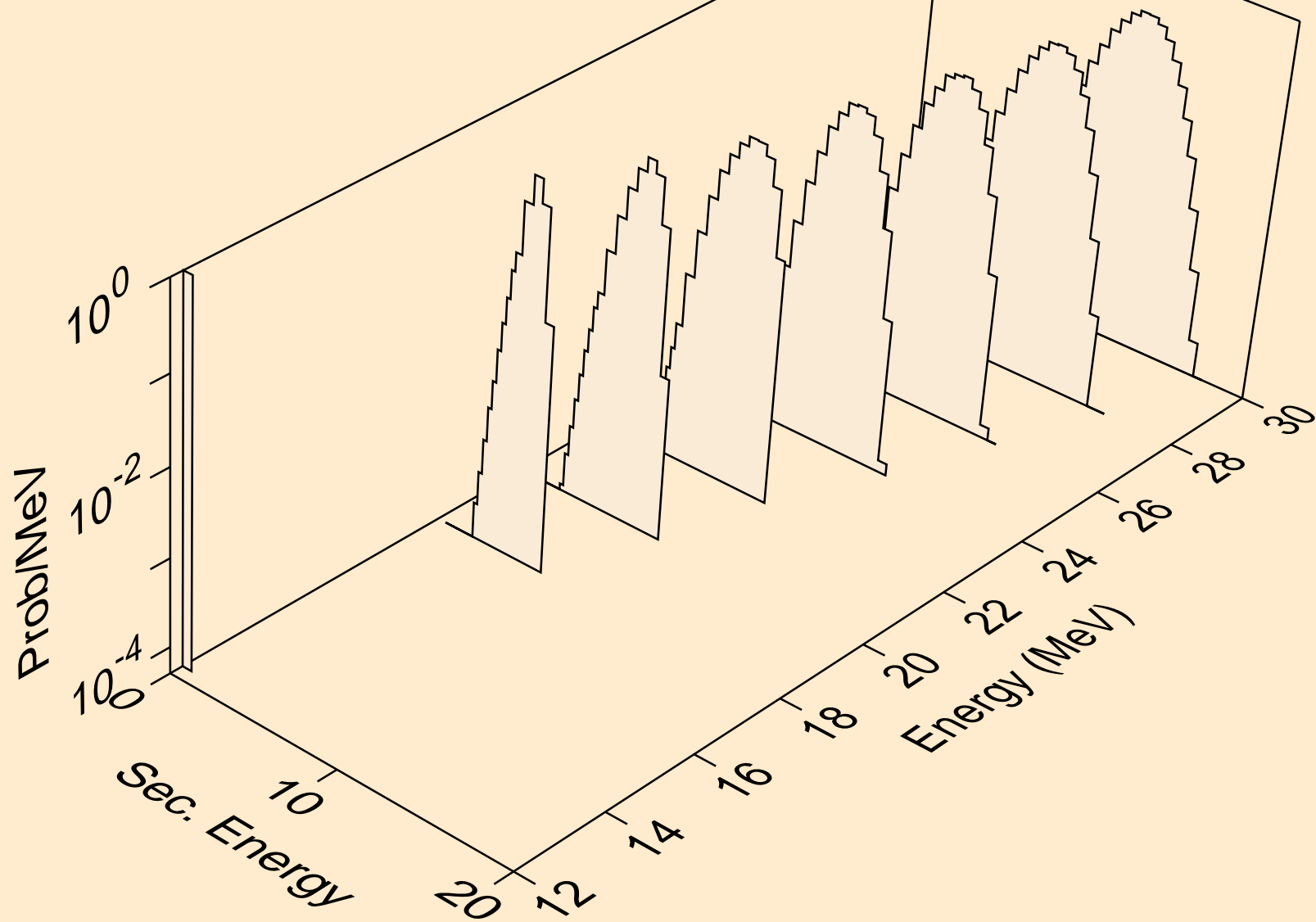

RF259 HELION ACER TENDL-2021 LIBRARY; T=0.K  
protons from (s,npa)

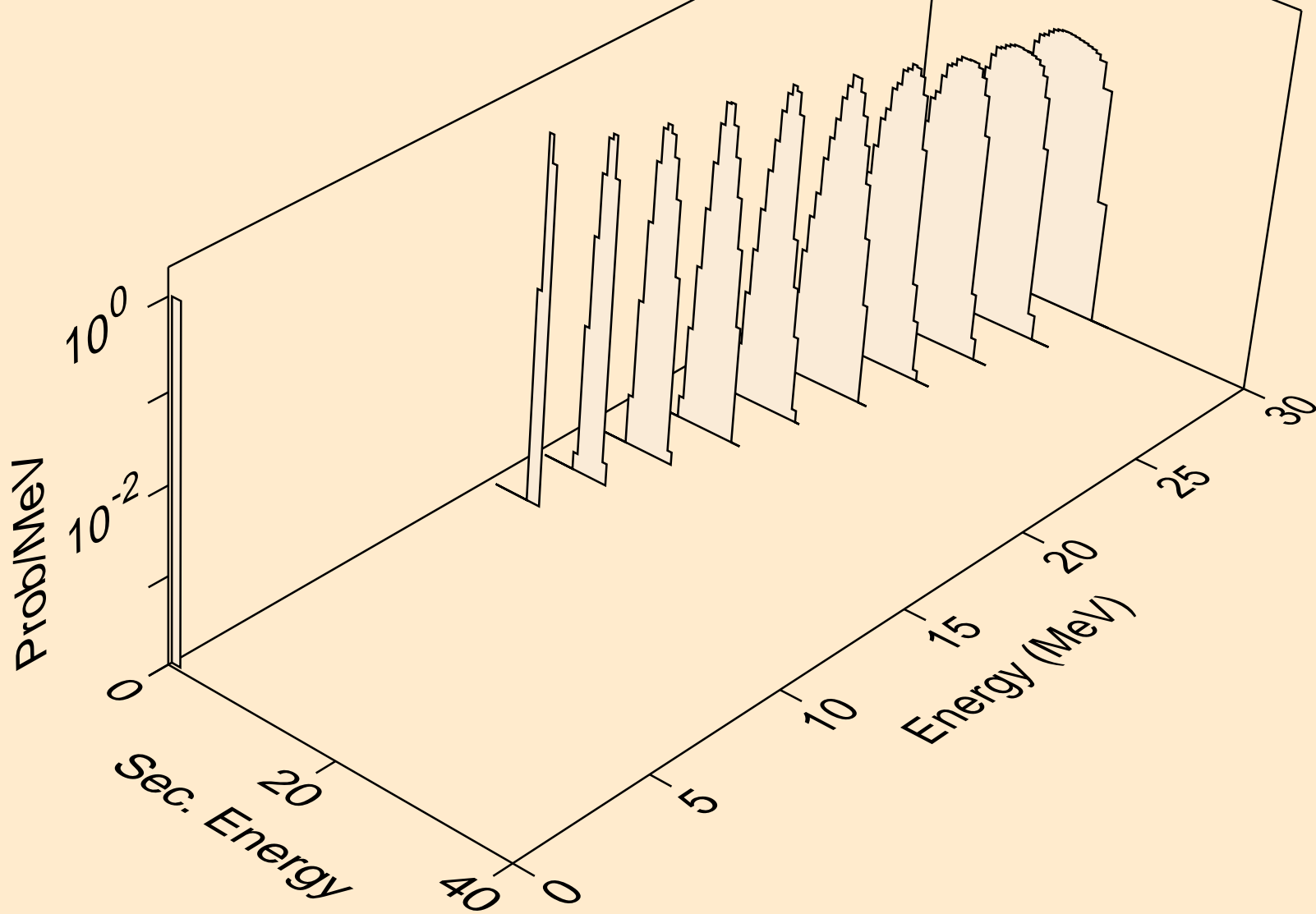

RF259 HELION ACER TENDL-2021 LIBRARY; T=0.K  
protons from (s,p)

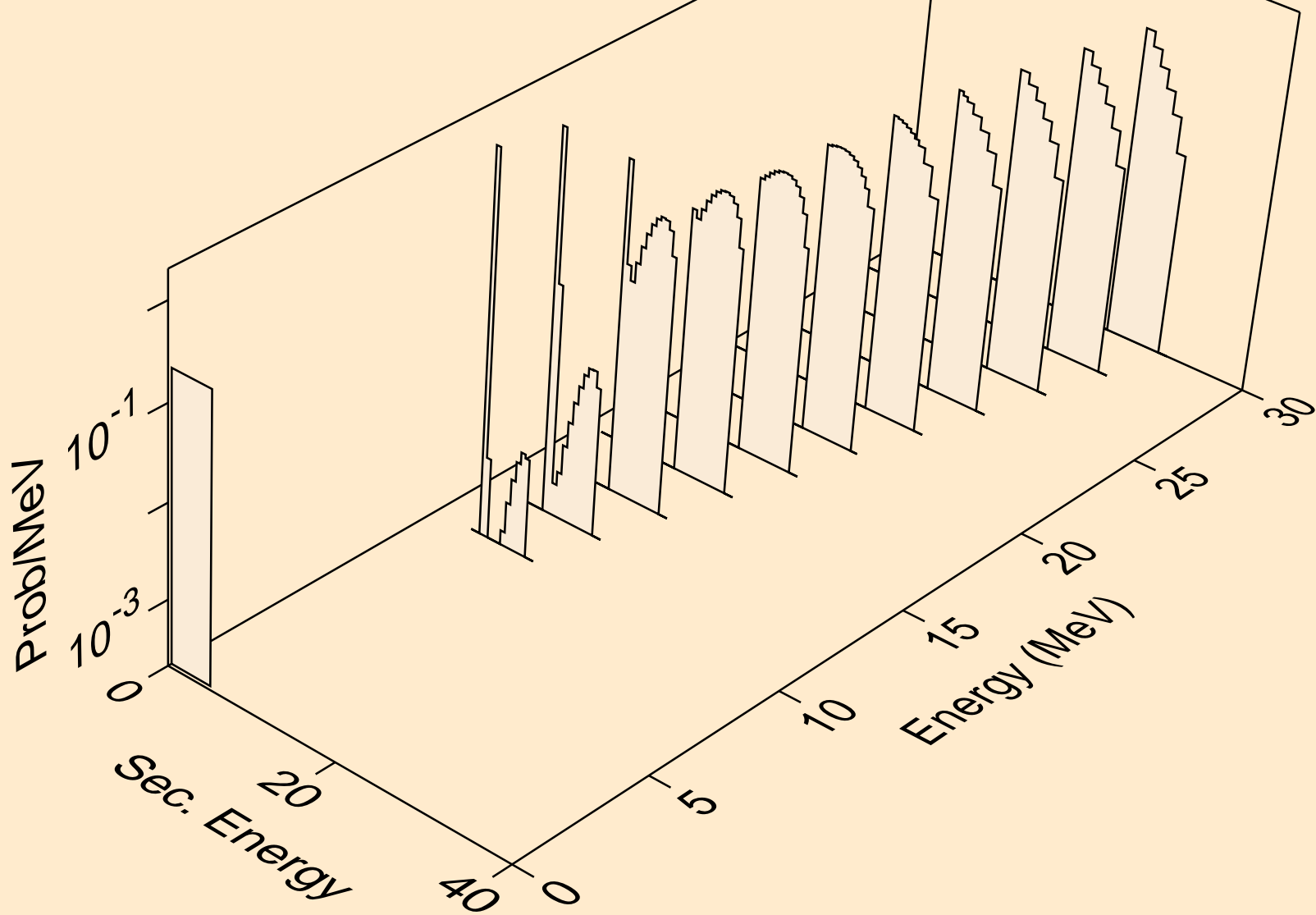

RF259 HELION ACER TENDL-2021 LIBRARY; T=0.K  
protons from (s,2p)

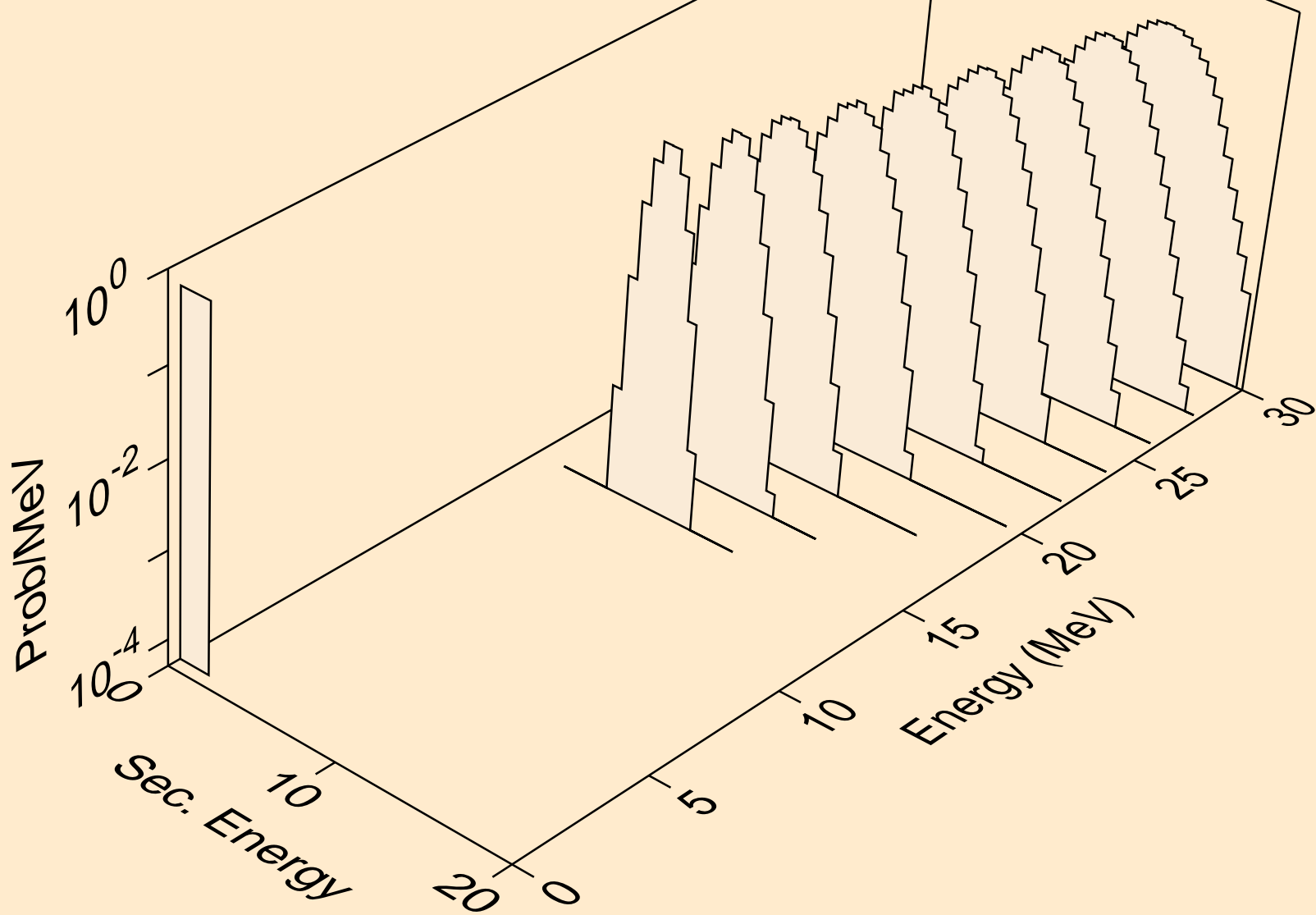

RF259 HELION ACER TENDL-2021 LIBRARY; T=0.K  
protons from (s,pa)

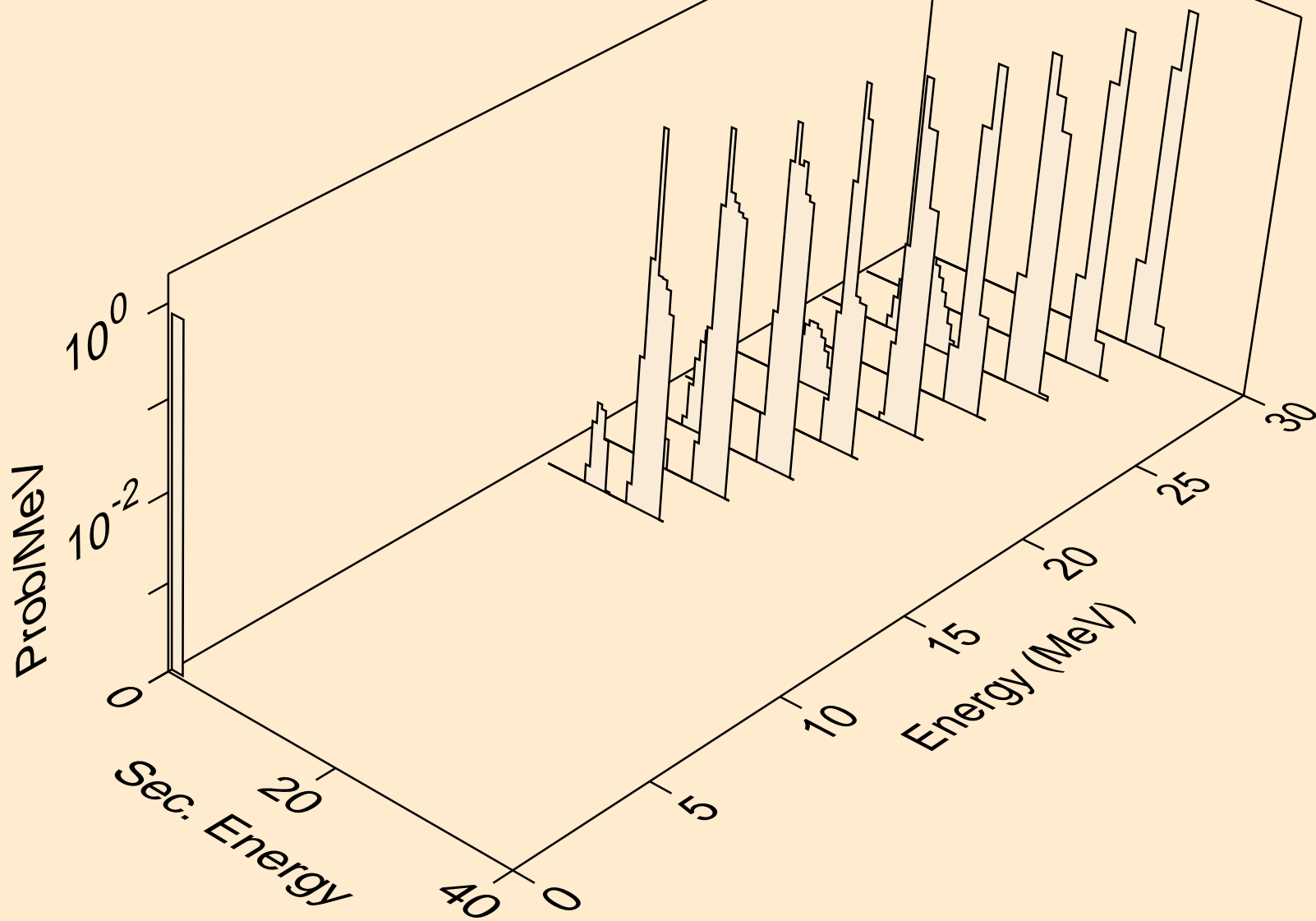

RF259 HELION ACER TENDL-2021 LIBRARY; T=0.K  
deuterons from (s,x)

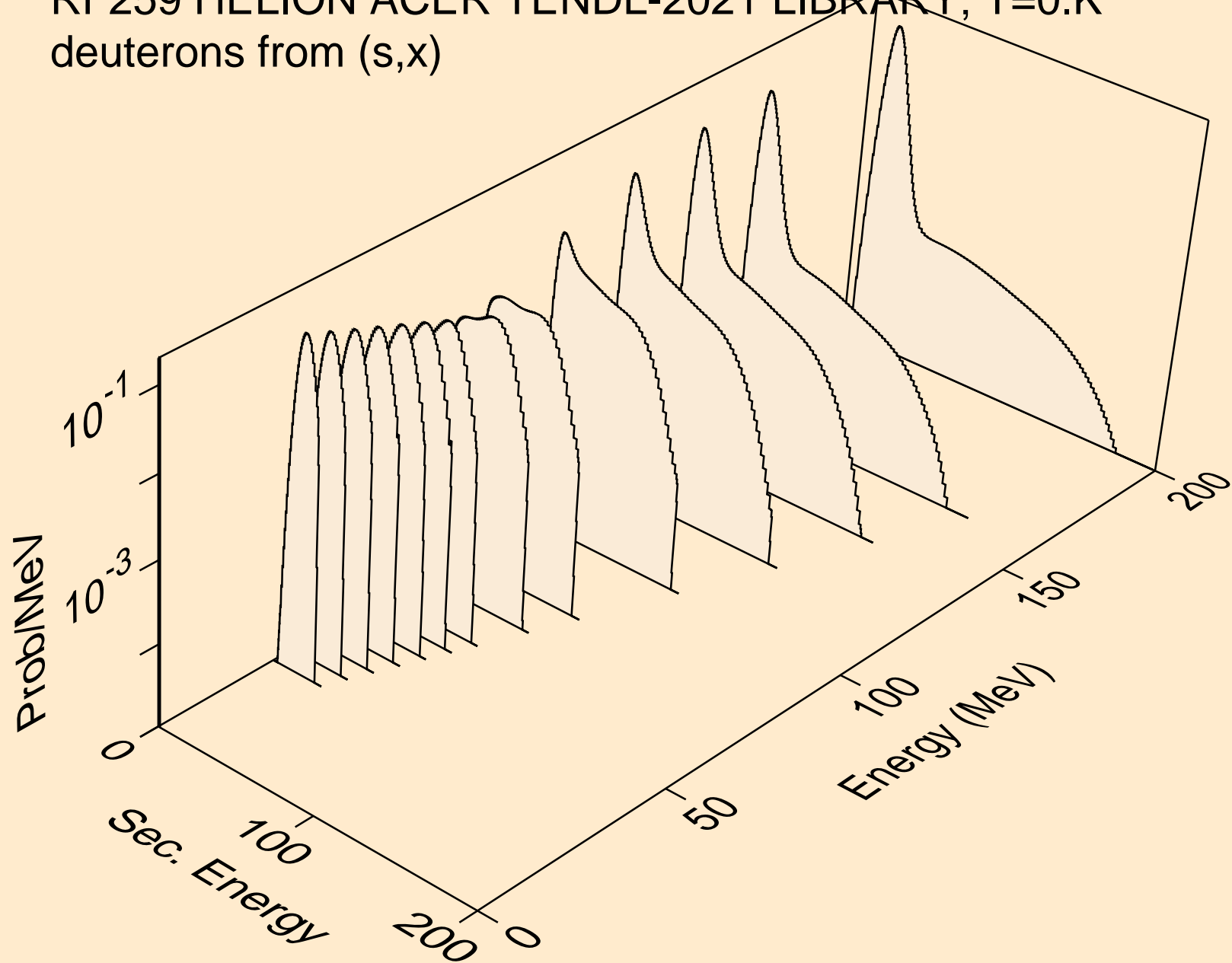



RF259 HELION ACER TENDL-2021 LIBRARY; T=0.K  
deuterons from (s,n\*)d

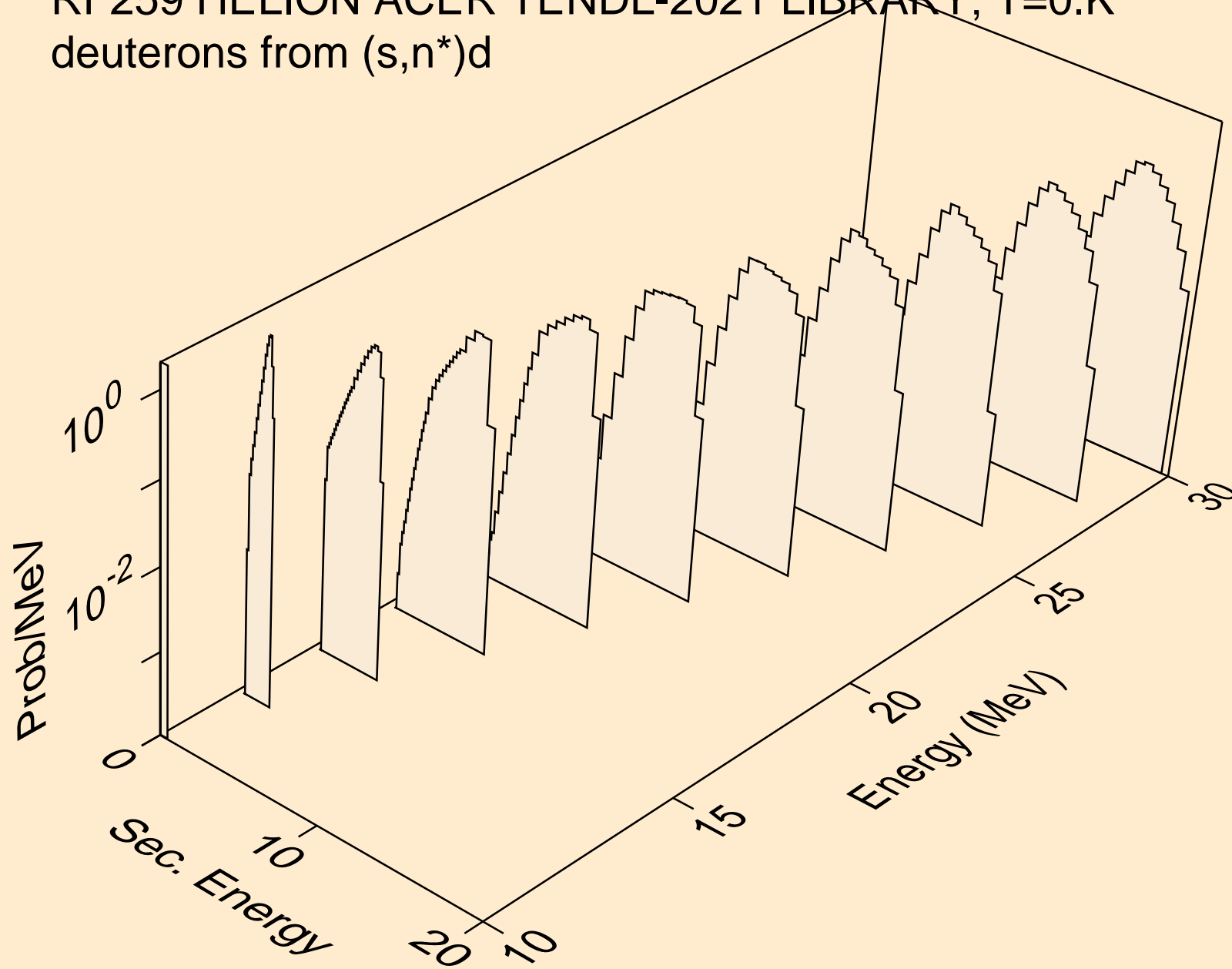

RF259 HELION ACER TENDL-2021 LIBRARY; T=0.K  
deuterons from (s,d)

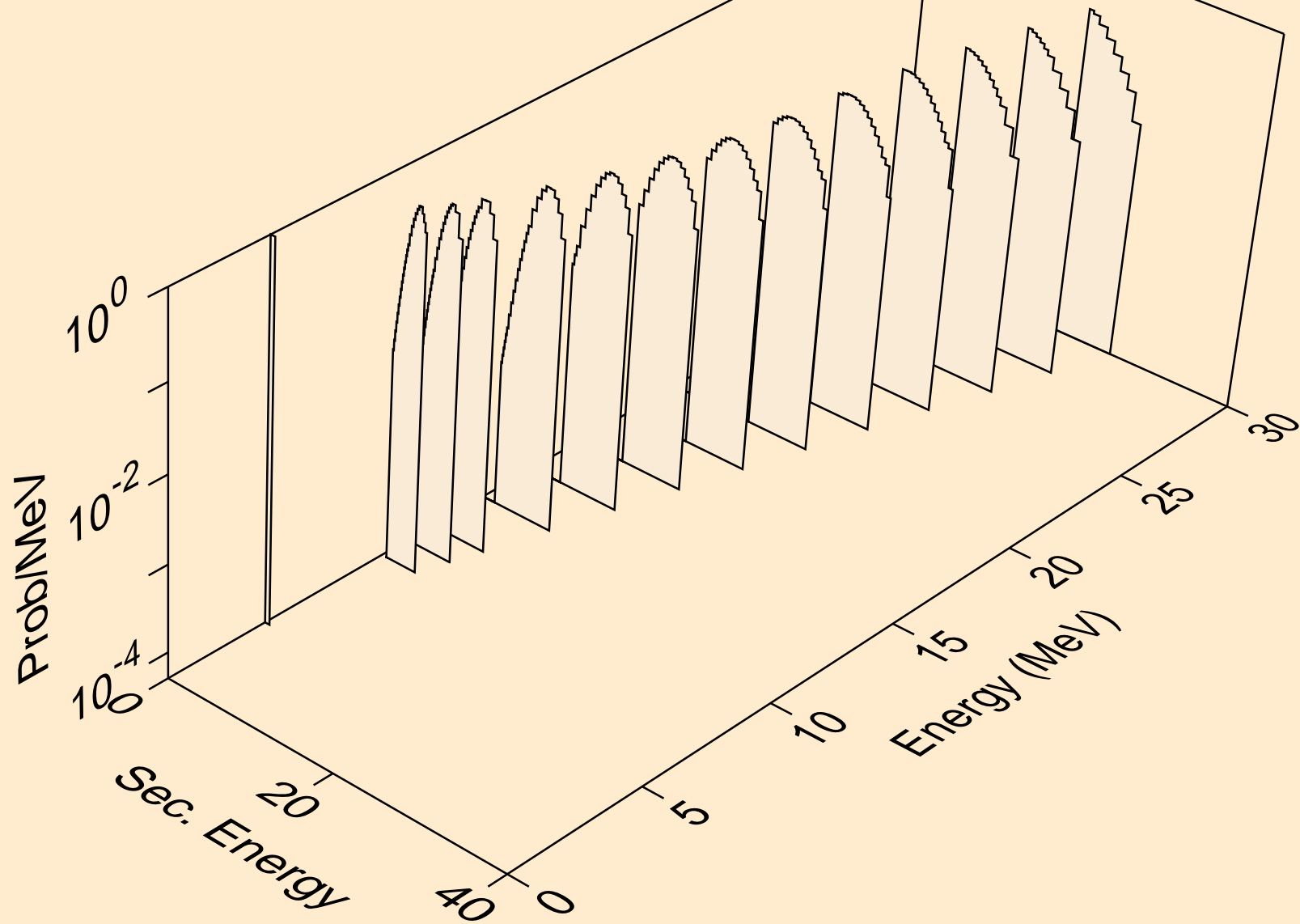

RF259 HELION ACER TENDL-2021 LIBRARY; T=0.K  
deuterons from (s,d2a)

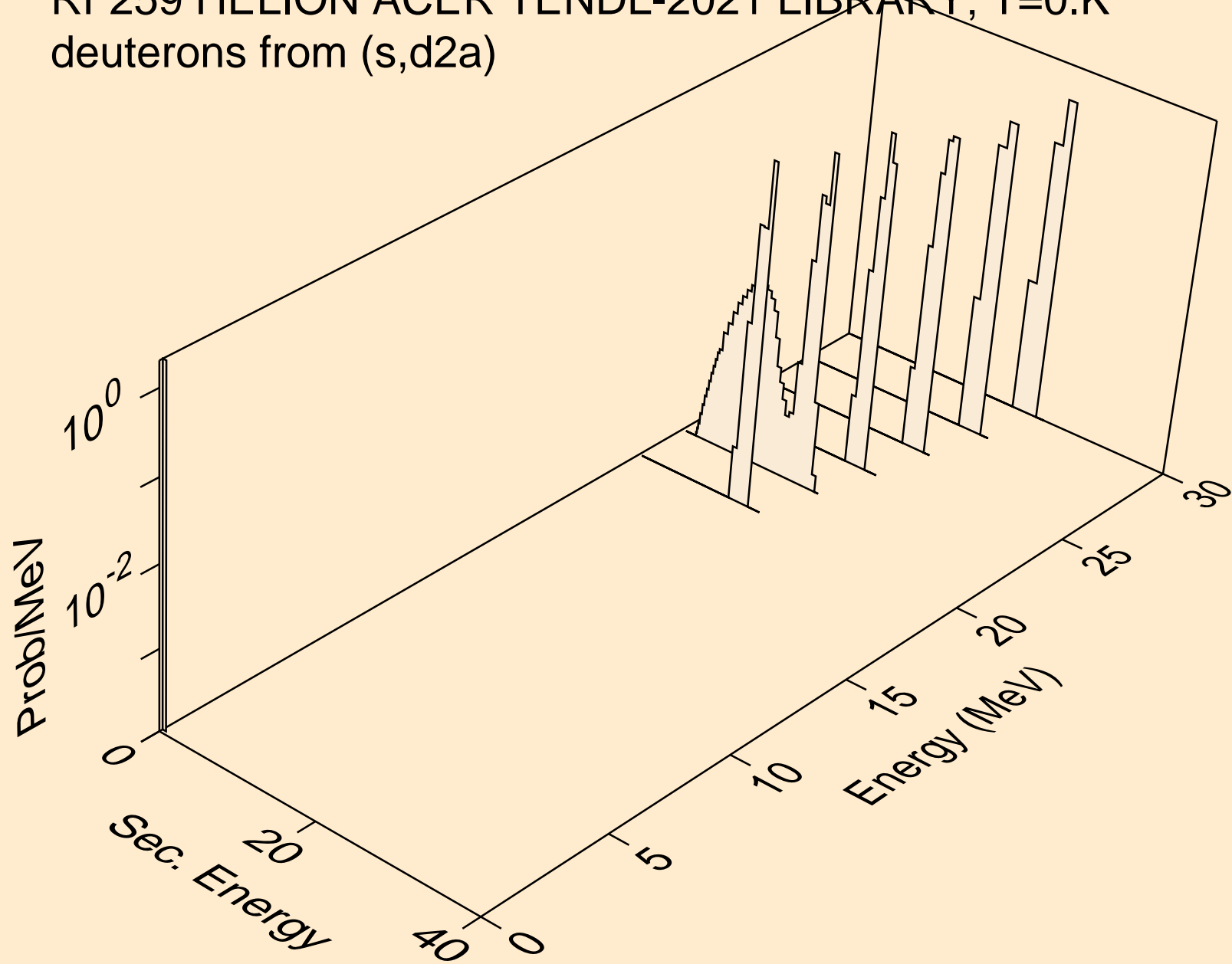

RF259 HELION ACER TENDL-2021 LIBRARY; T=0.K  
deuterons from (s,da)

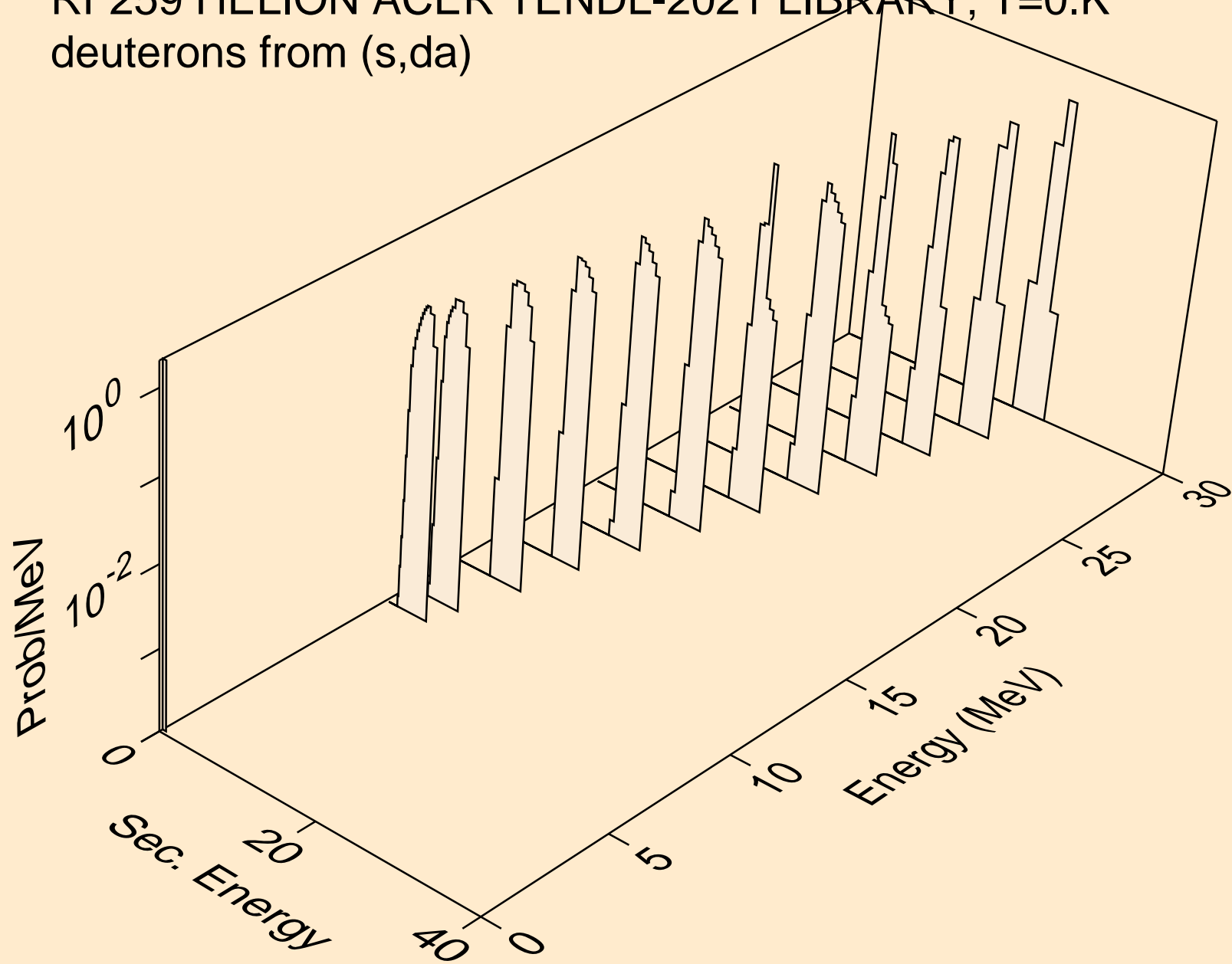

RF259 HELION ACER TENDL-2021 LIBRARY; T=0.K  
tritons from (s,x)

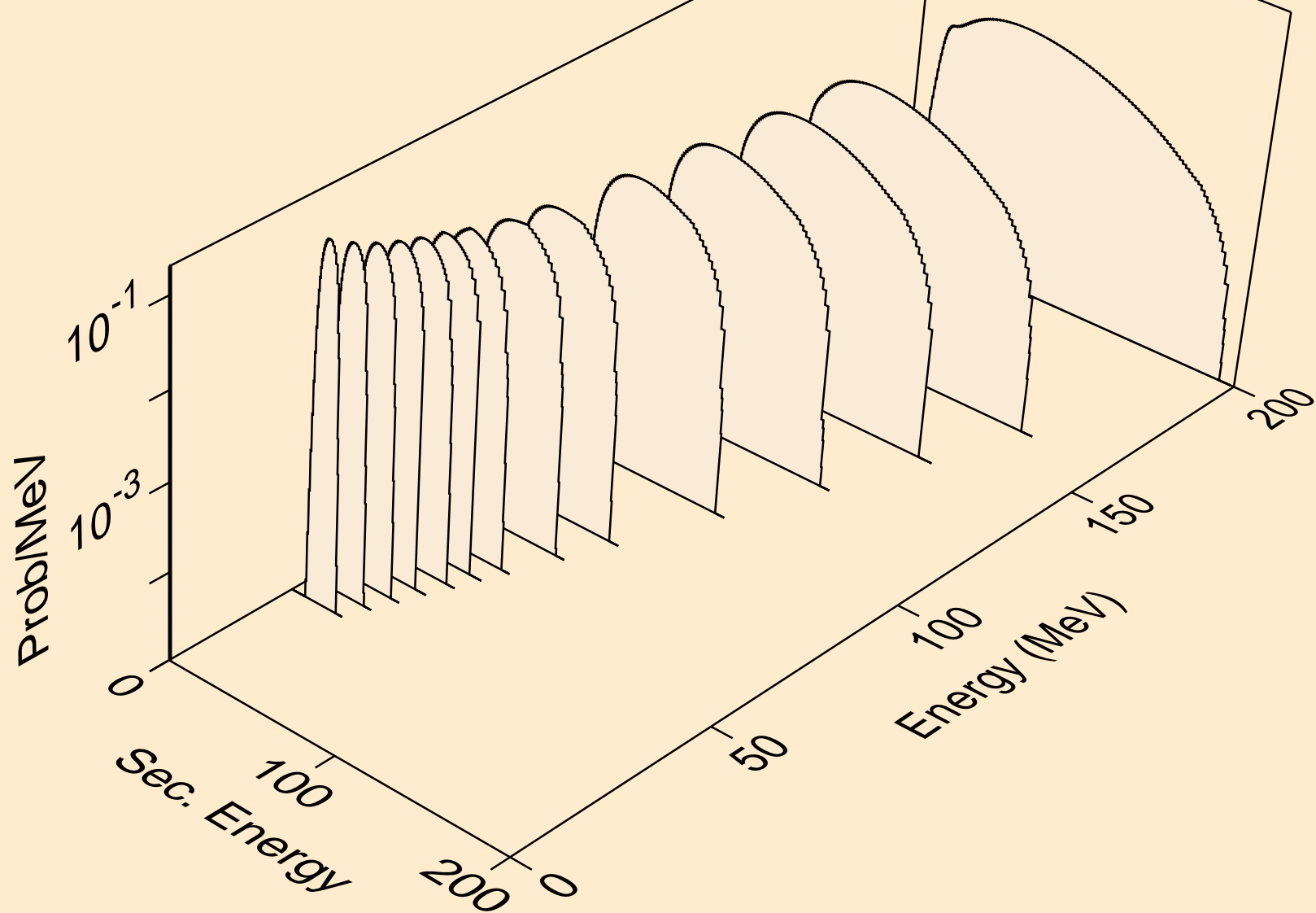

RF259 HELION ACER TENDL-2021 LIBRARY; T=0.K  
tritons from (s,n\*)t

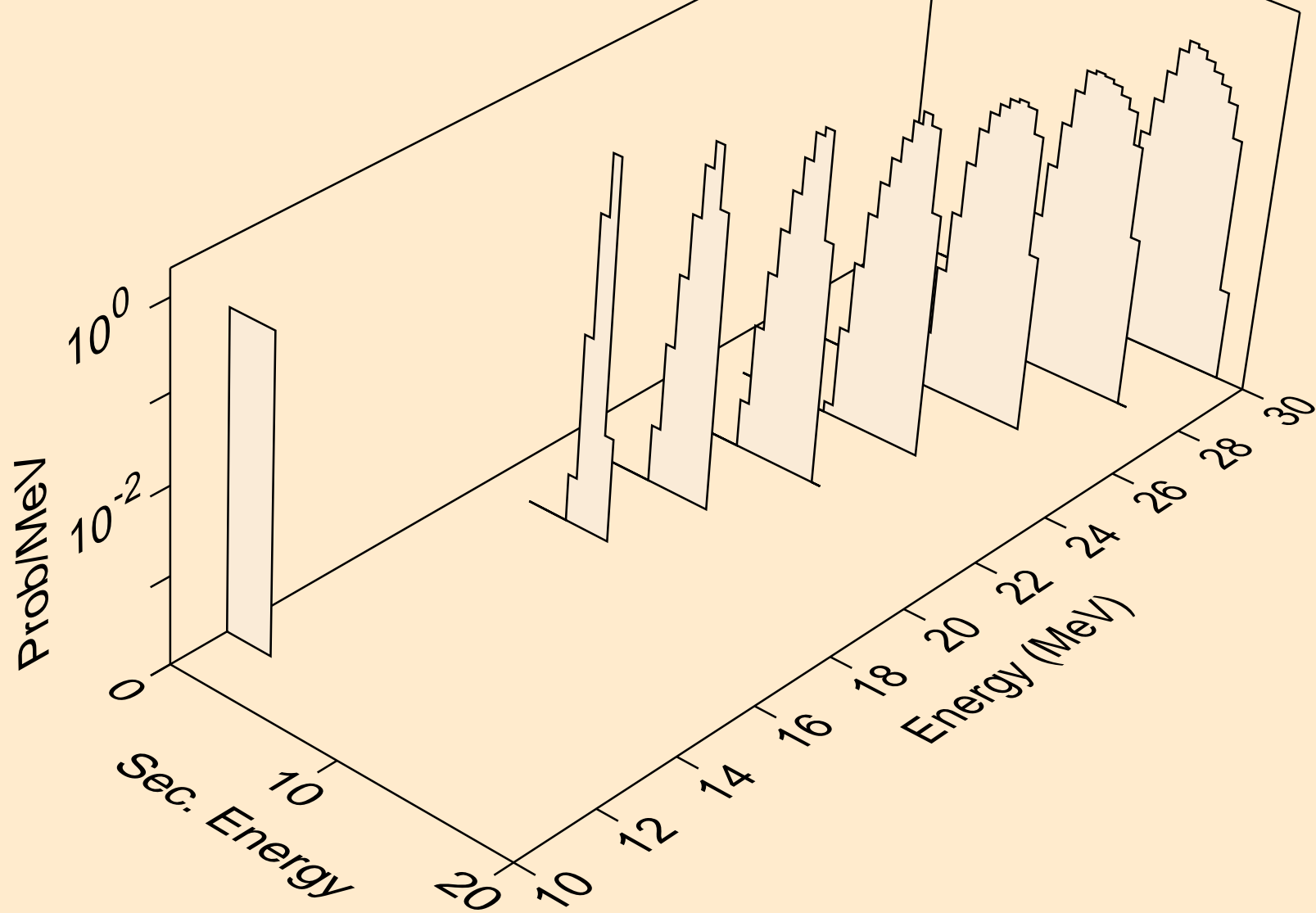

RF259 HELION ACER TENDL-2021 LIBRARY; T=0.K  
tritons from (s,t)

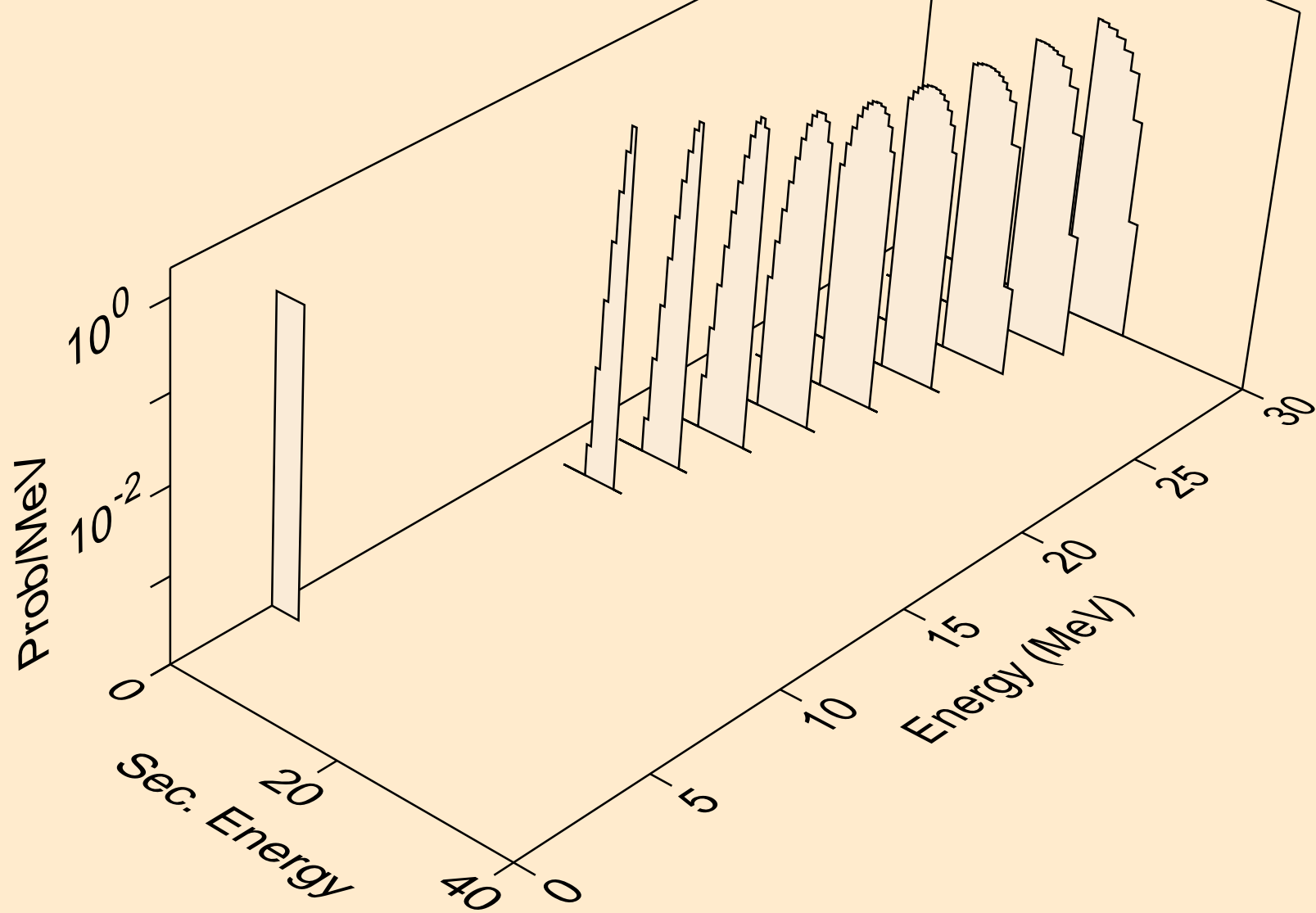

RF259 HELION ACER TENDL-2021 LIBRARY; T=0.K  
tritons from (s,t2a)

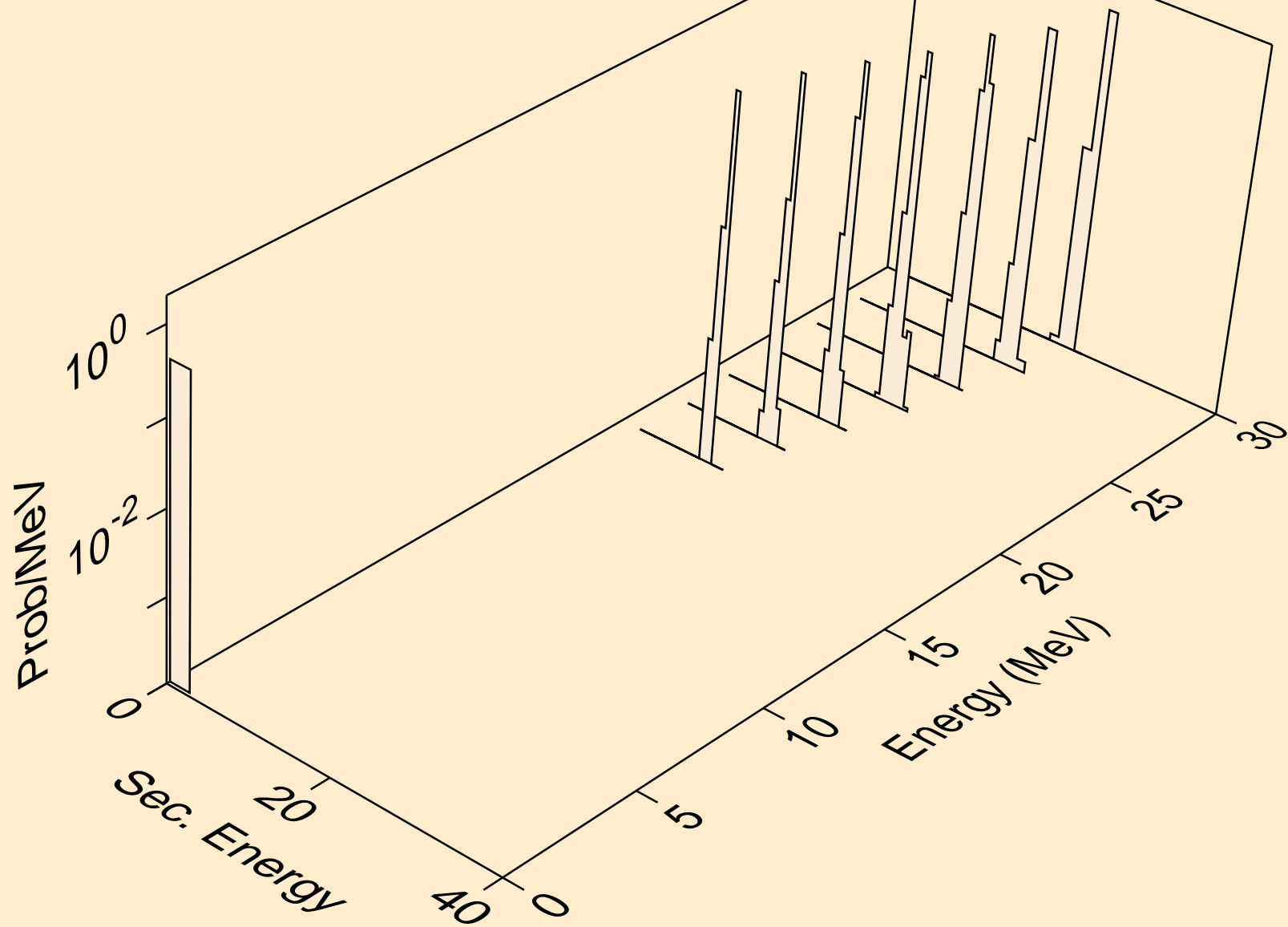



RF259 HELION ACER TENDL-2021 LIBRARY; T=0.K  
alphas from (s,x)

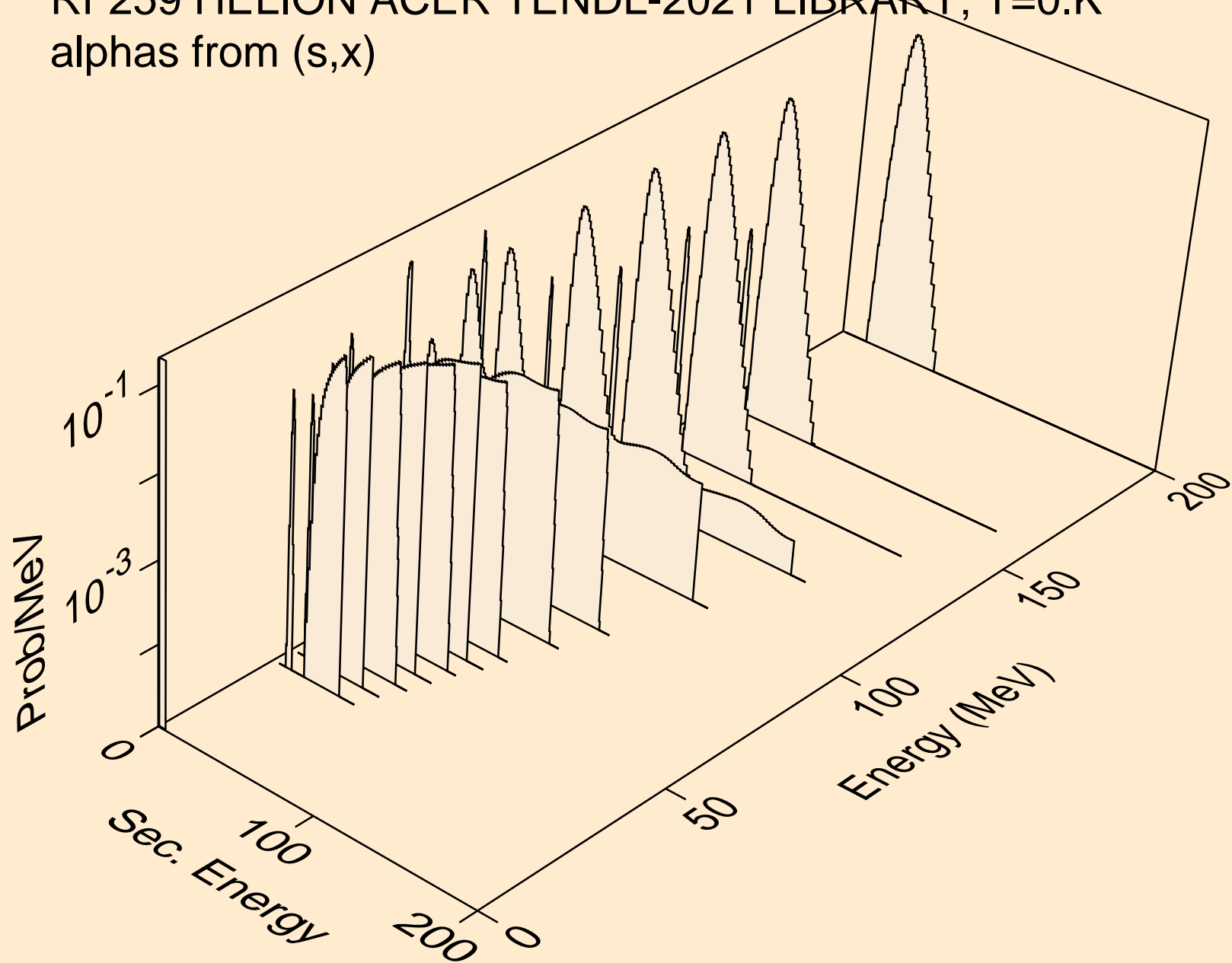

RF259 HELION ACER TENDL-2021 LIBRARY; T=0.K  
alphas from (s,n\*)a

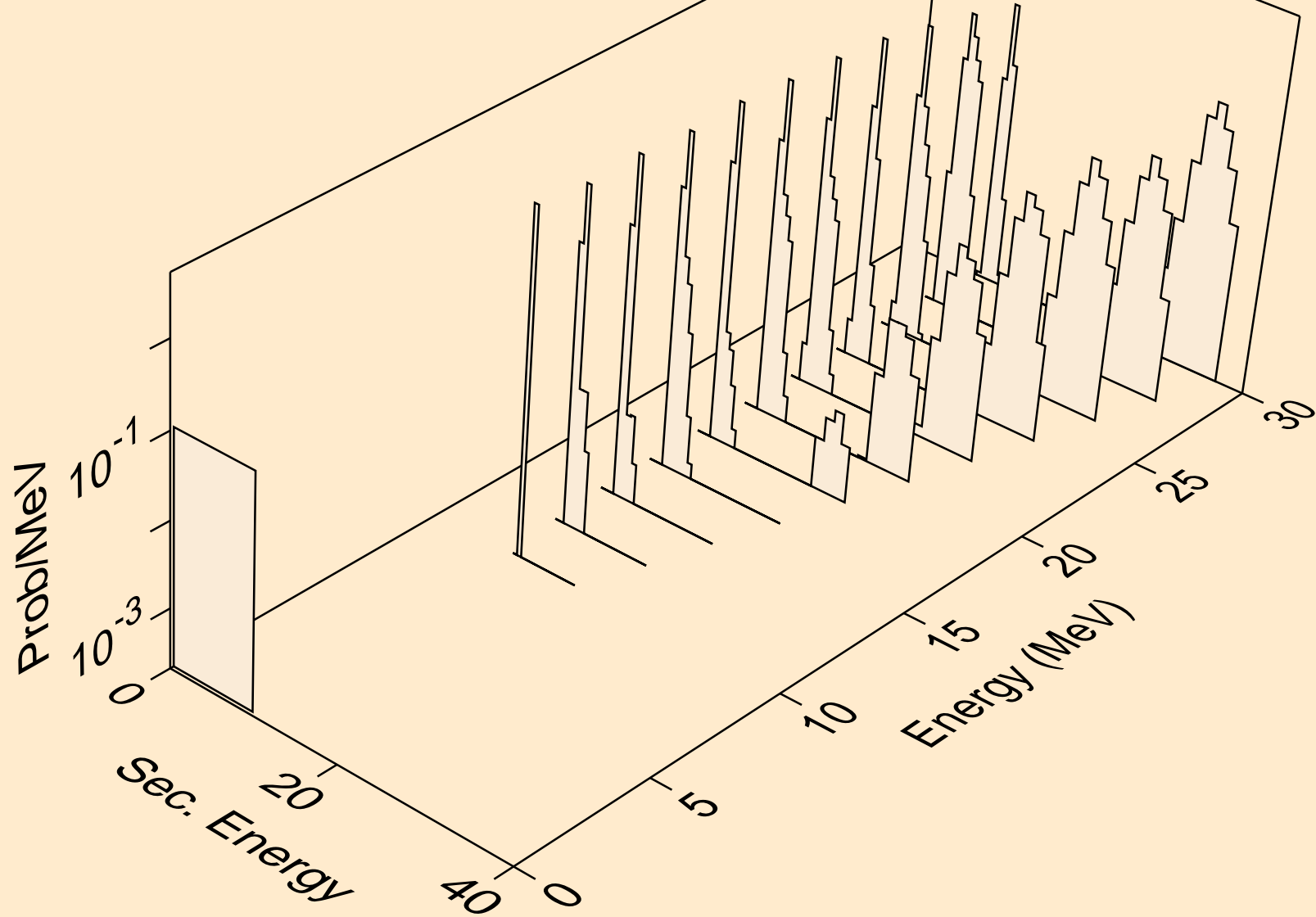

RF259 HELION ACER TENDL-2021 LIBRARY; T=0.K  
alphas from (s,2n)a

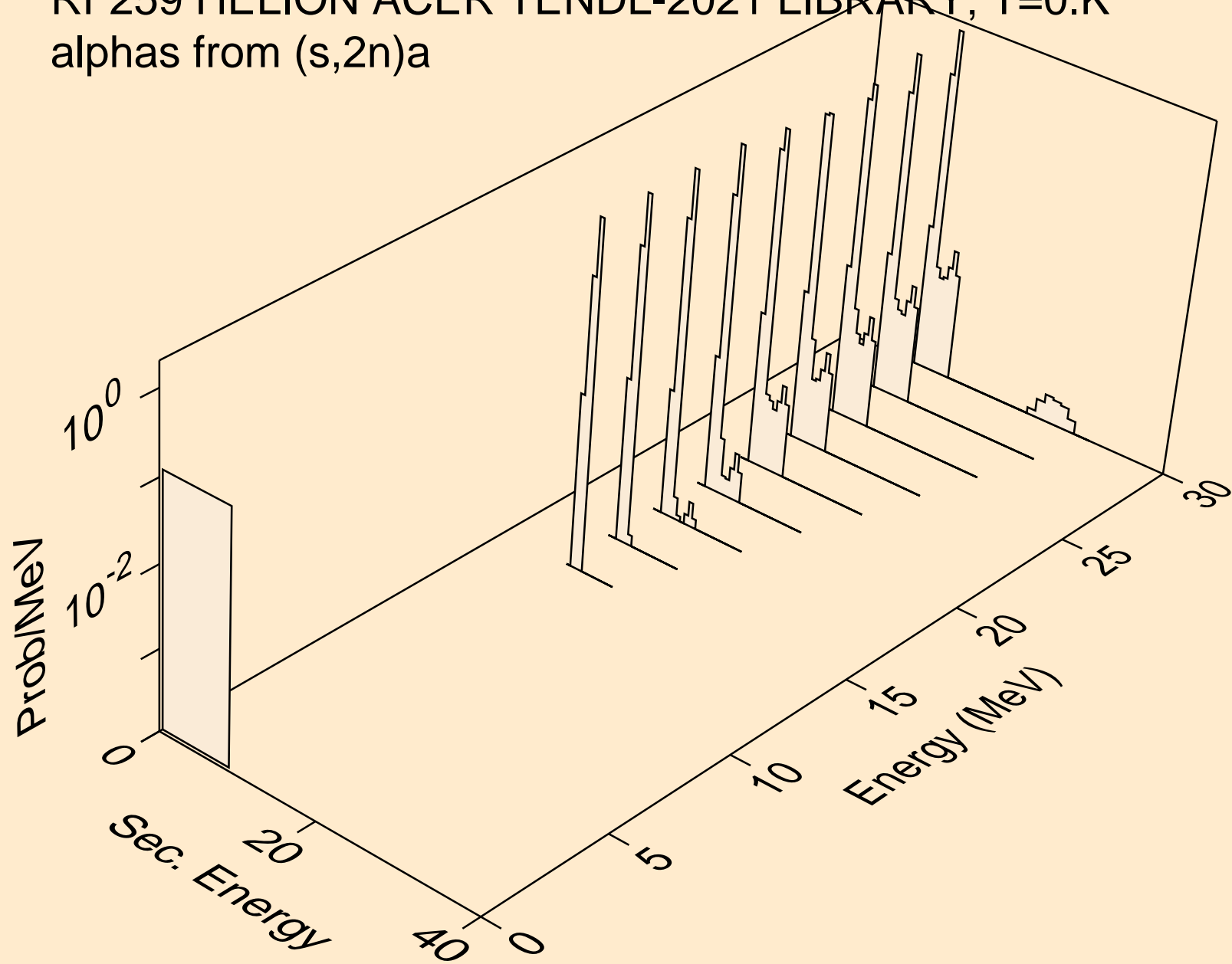

RF259 HELION ACER TENDL-2021 LIBRARY; T=0.K  
alphas from (s,npa)

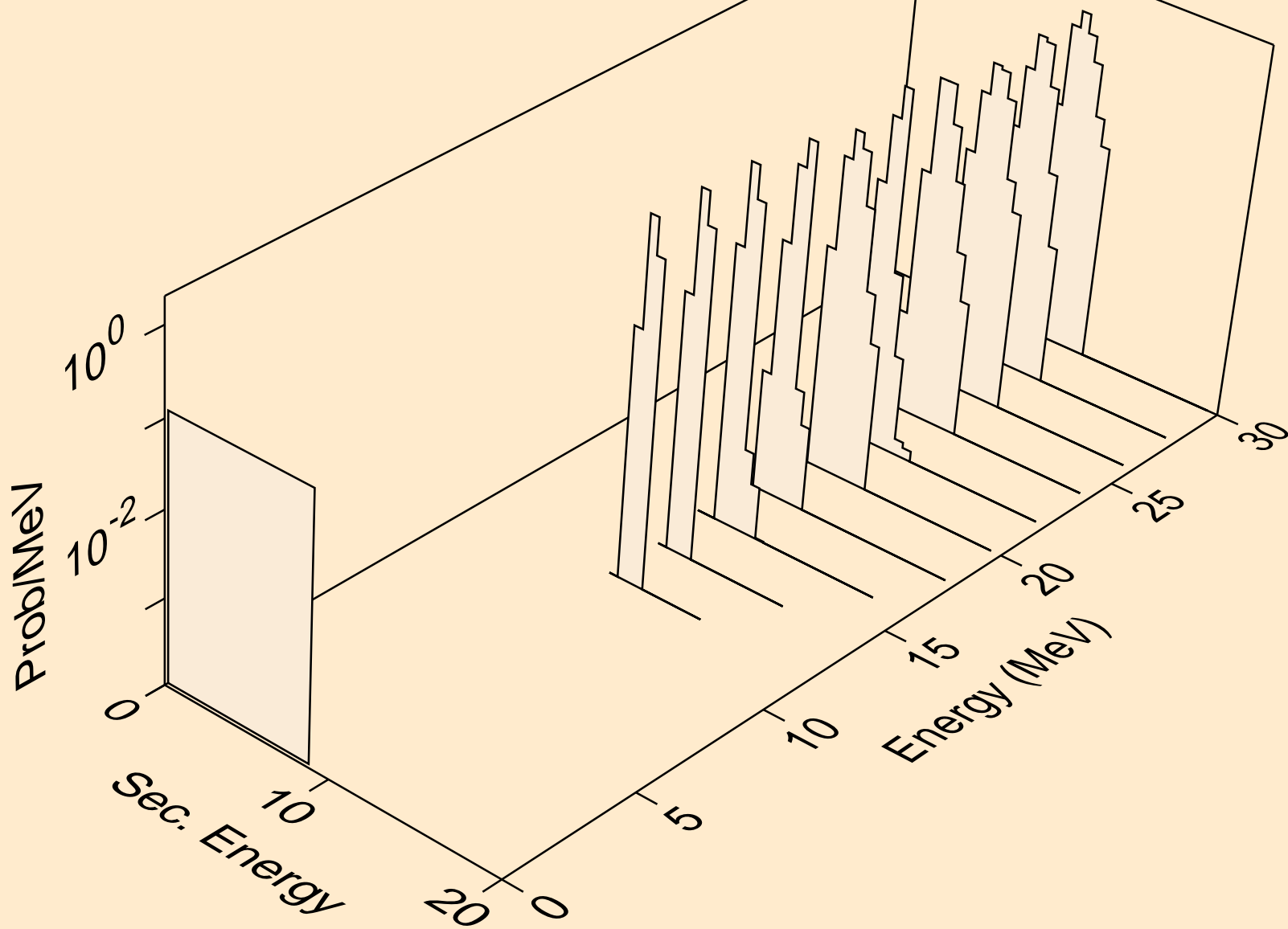

RF259 HELION ACER TENDL-2021 LIBRARY; T=0.K  
alphas from (s,a)

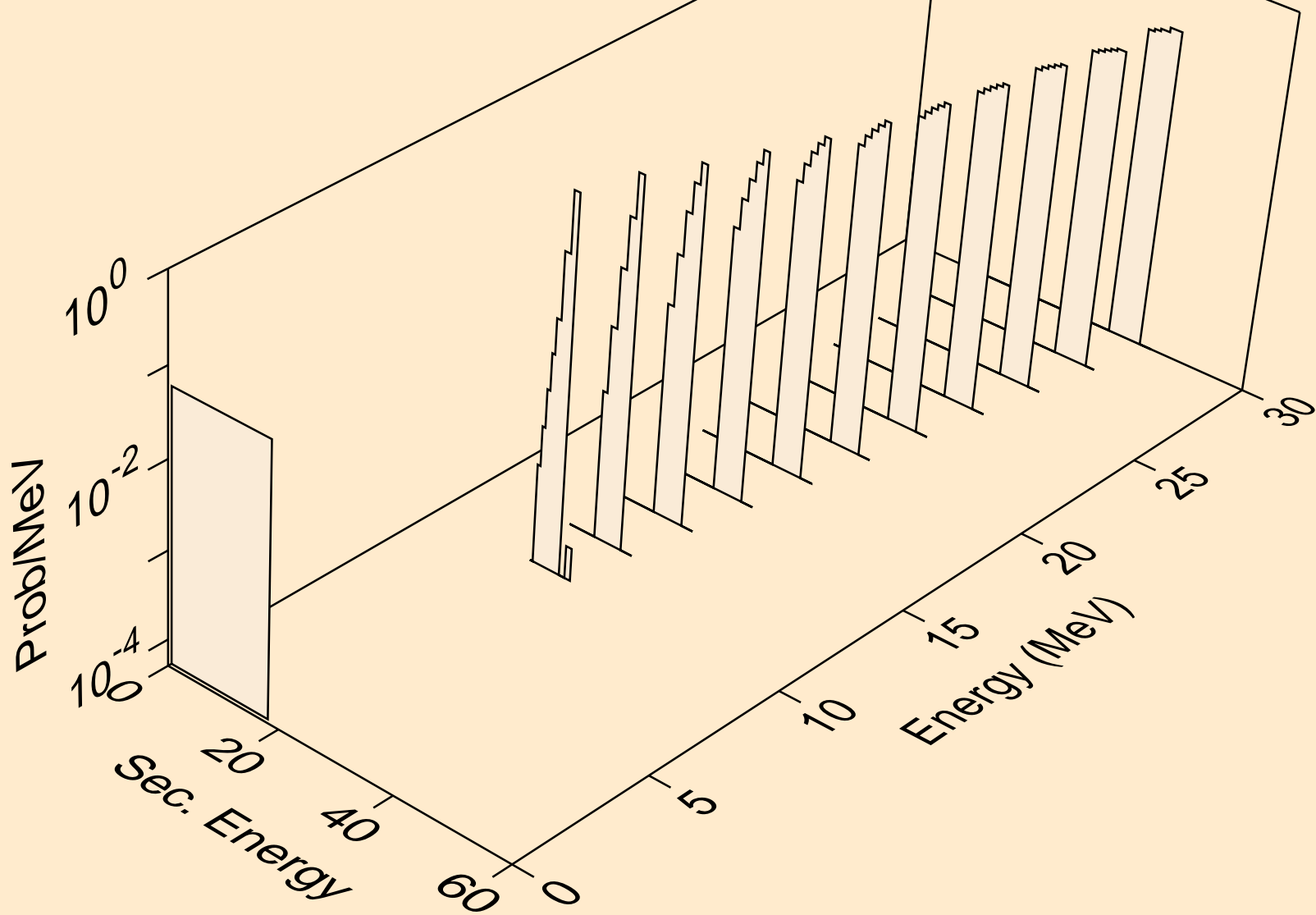

RF259 HELION ACER TENDL-2021 LIBRARY; T=0.K  
alphas from (s,pa)

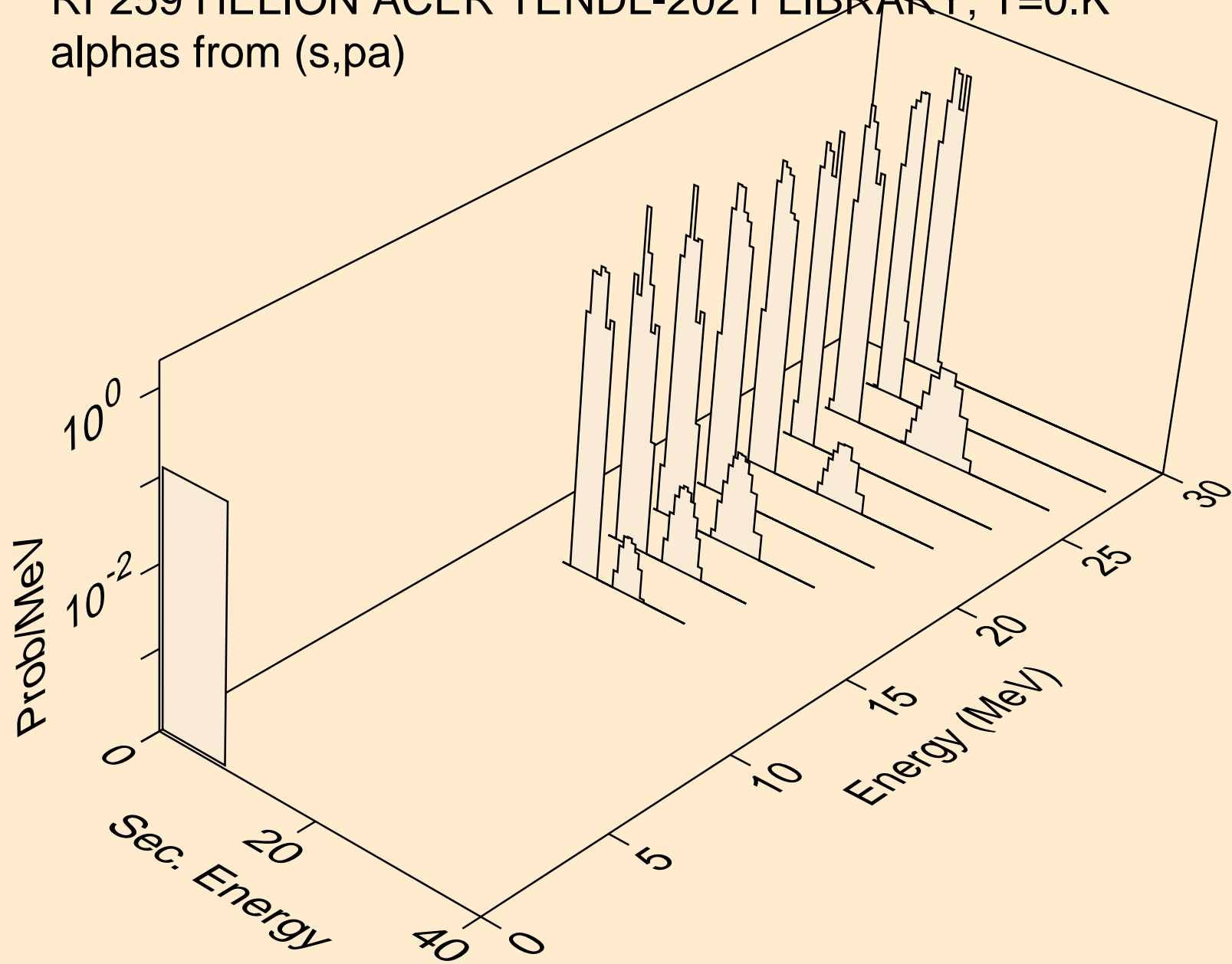

RF259 HELION ACER TENDL-2021 LIBRARY; T=0.K  
alphas from (s,t2a)

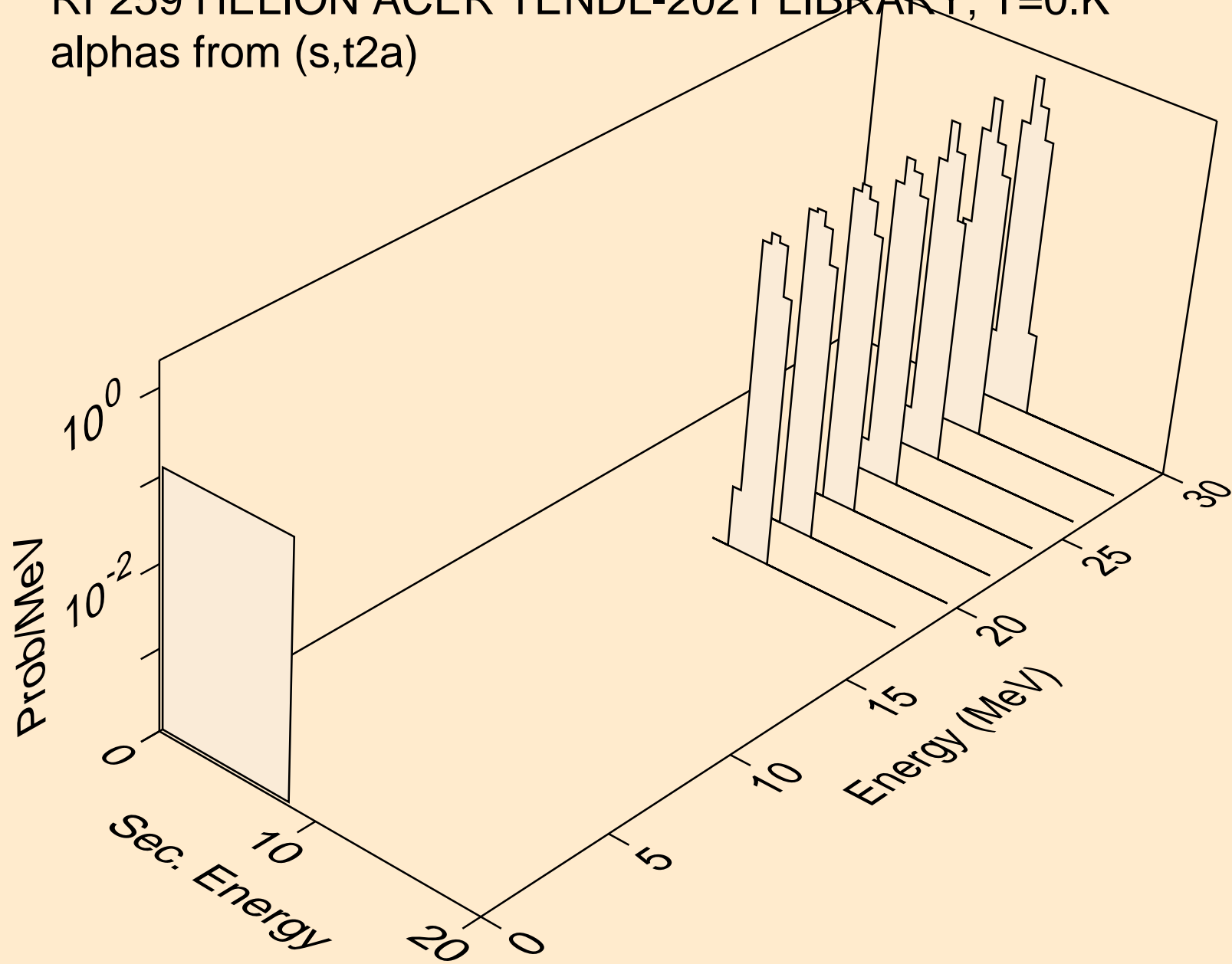

RF259 HELION ACER TENDL-2021 LIBRARY; T=0.K  
alphas from (s,d2a)

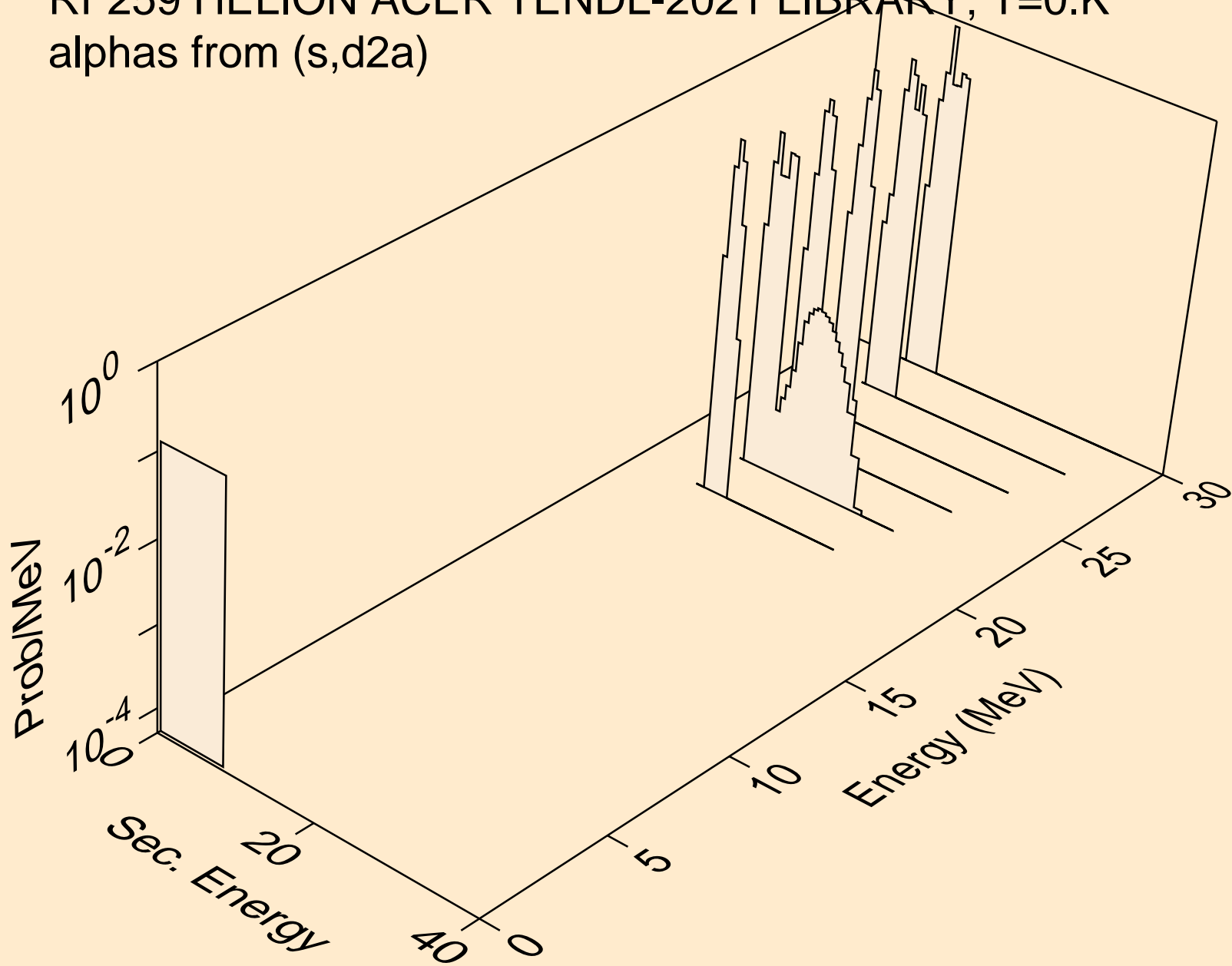



RF259 HELION ACER TENDL-2021 LIBRARY; T=0.K  
alphas from (s,da)

