

RF266 HELION ACER TENDL-2021 LIBRARY; T=0.K  
Principal cross sections

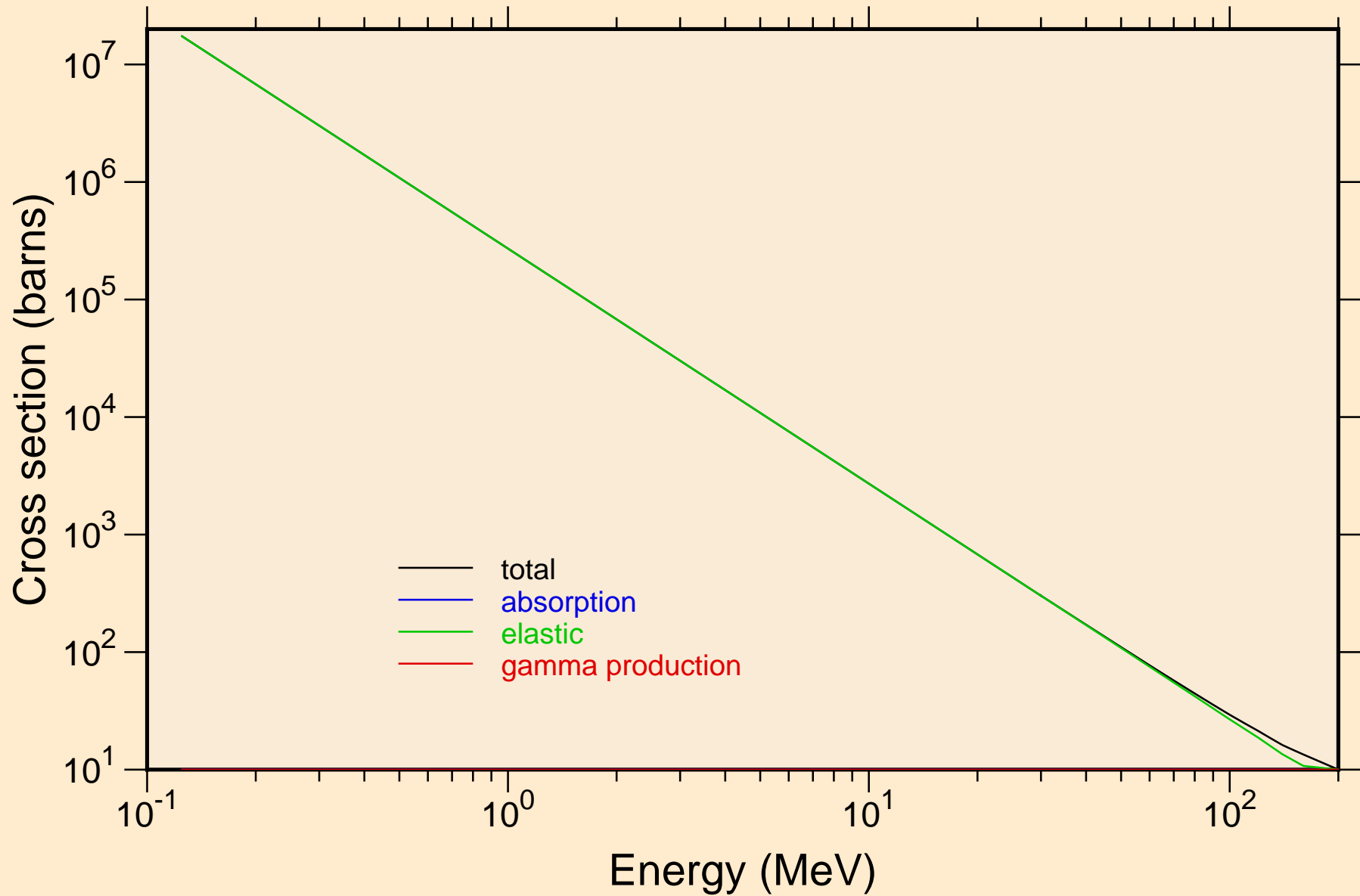

RF266 HELION ACER TENDL-2021 LIBRARY; T=0.K  
Heating

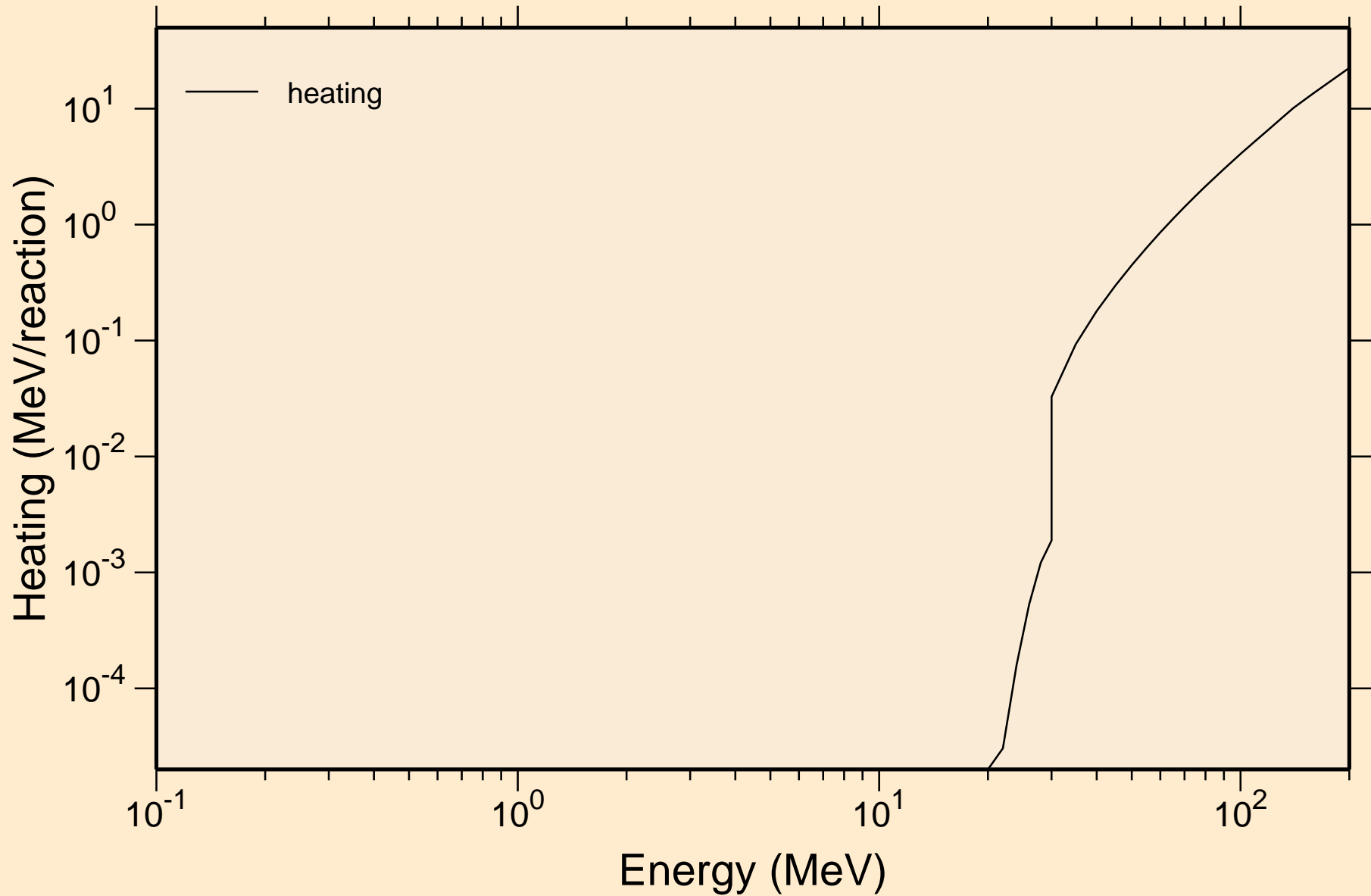

RF266 HELION ACER TENDL-2021 LIBRARY; T=0.K

Principal cross sections

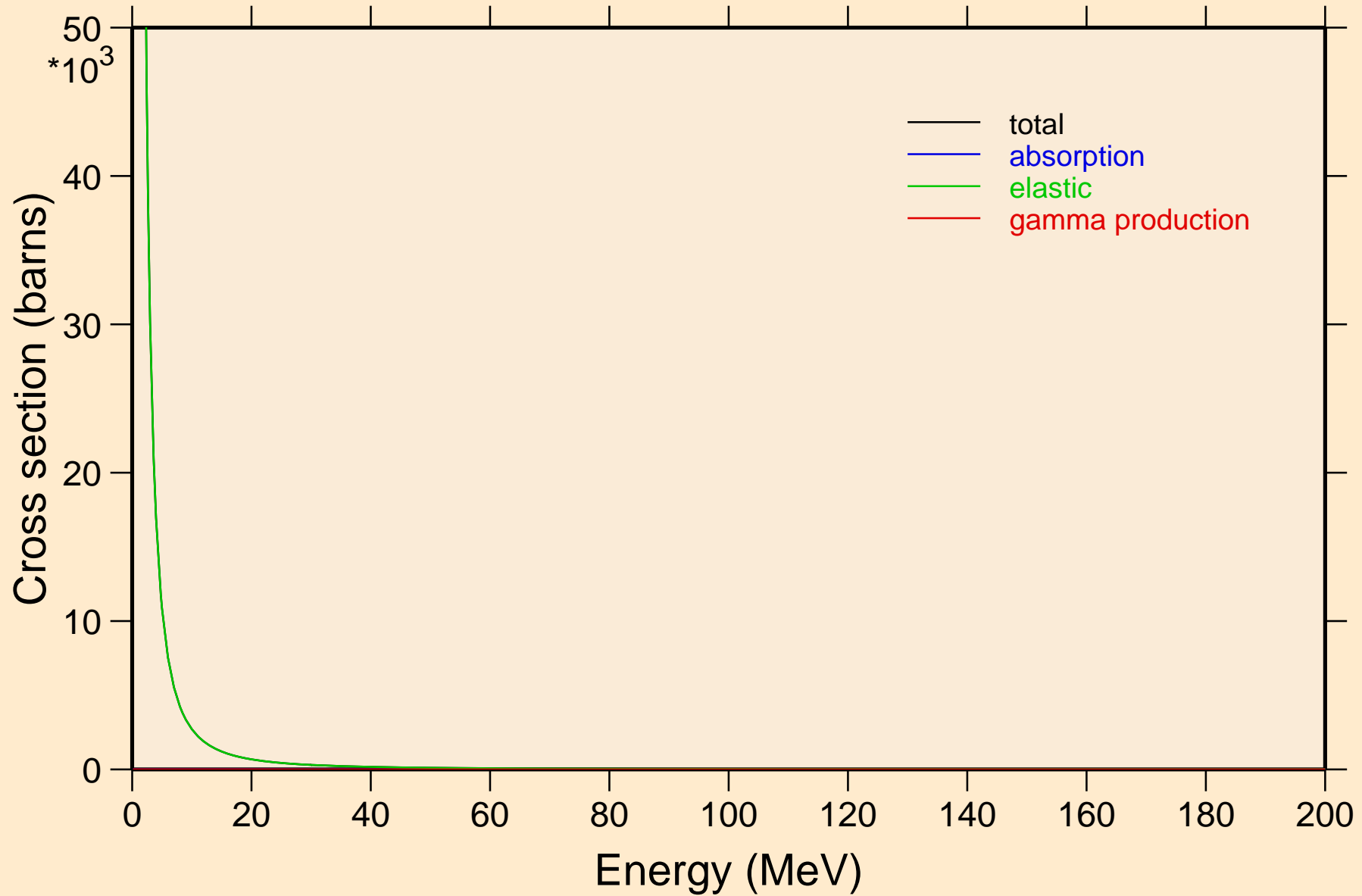

RF266 HELION ACER TENDL-2021 LIBRARY; T=0.K

Heating

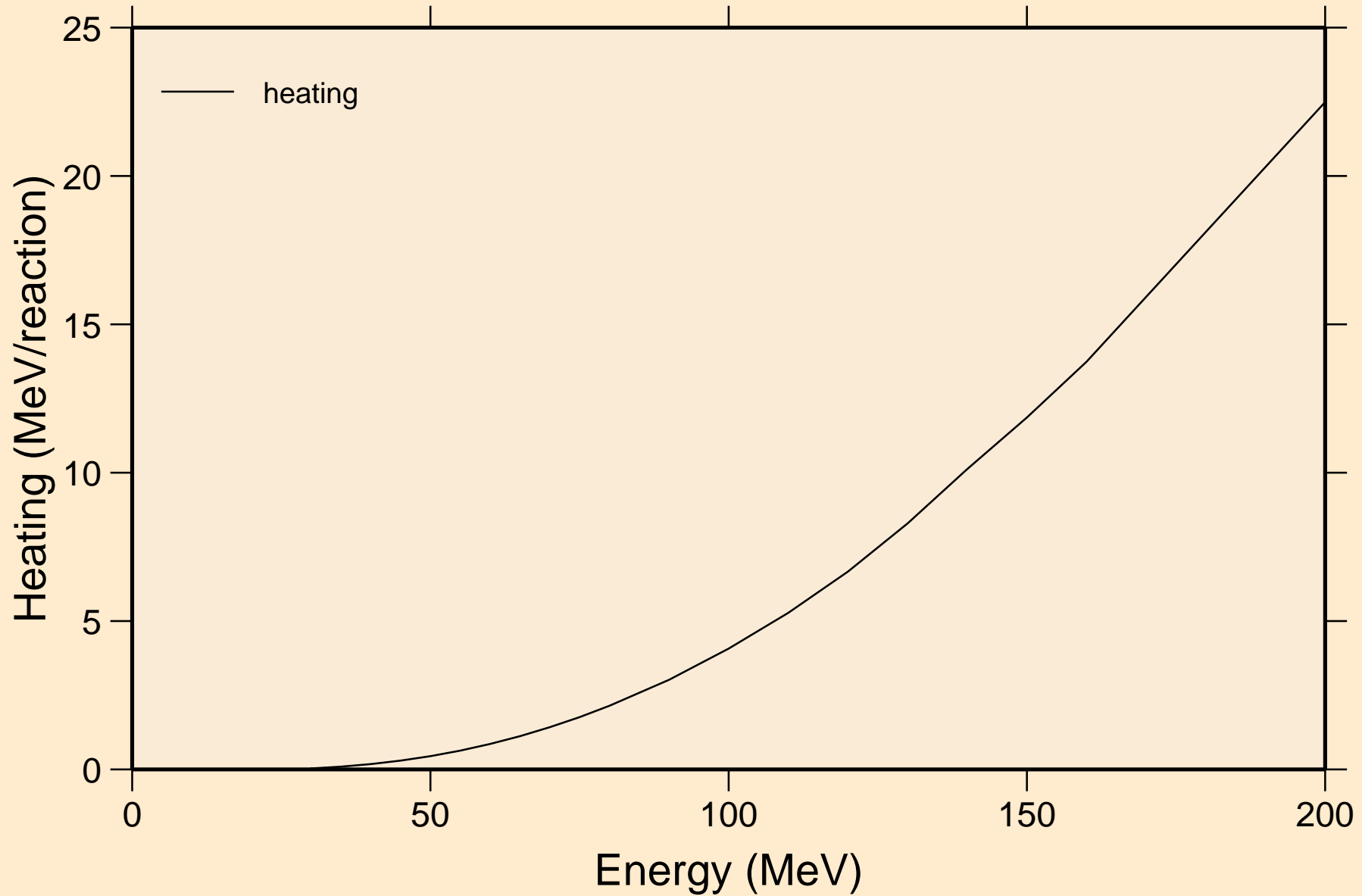

RF266 HELION ACER TENDL-2021 LIBRARY; T=0.K  
Threshold reactions

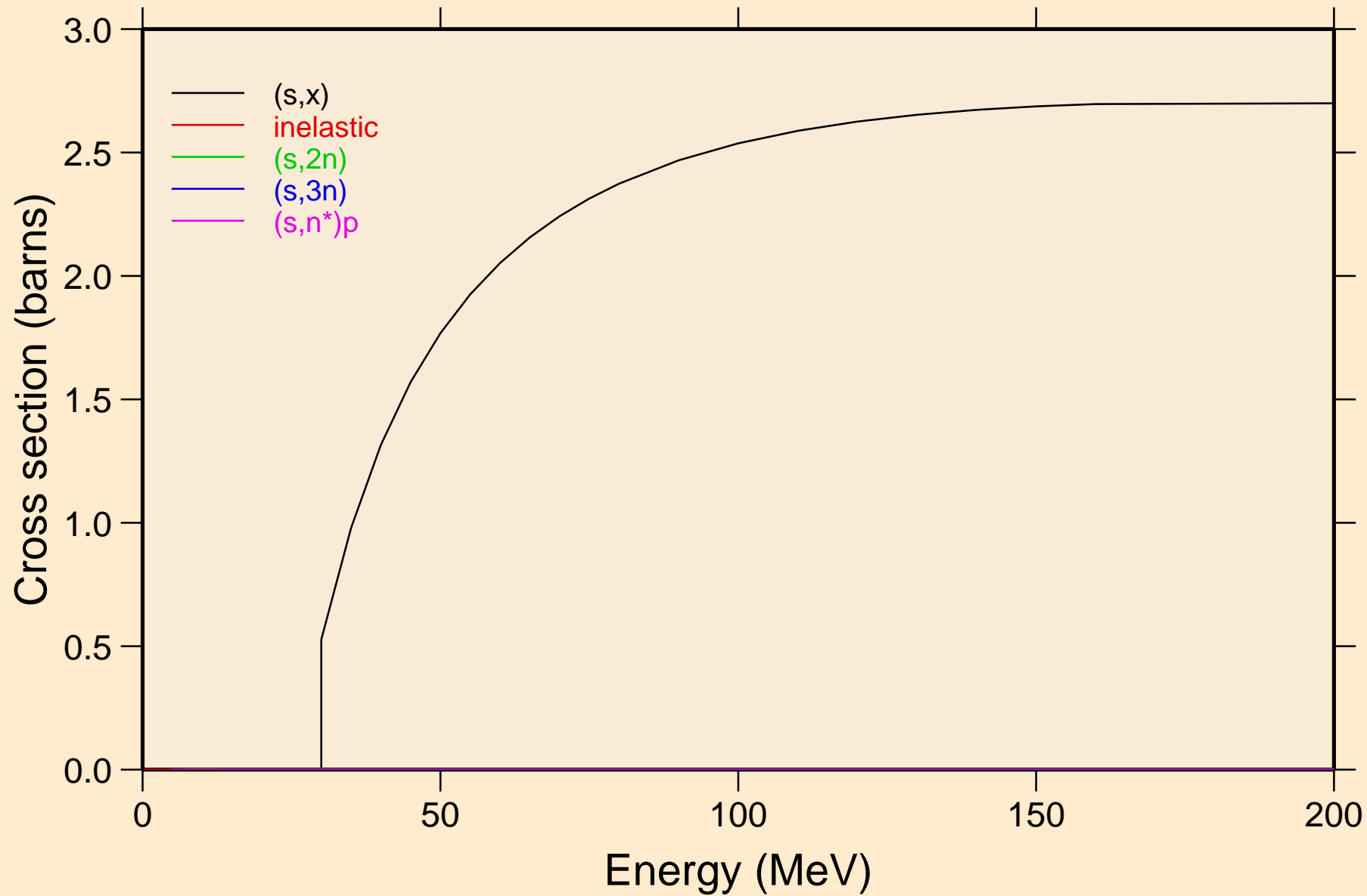

RF266 HELION ACER TENDL-2021 LIBRARY; T=0.K  
Threshold reactions

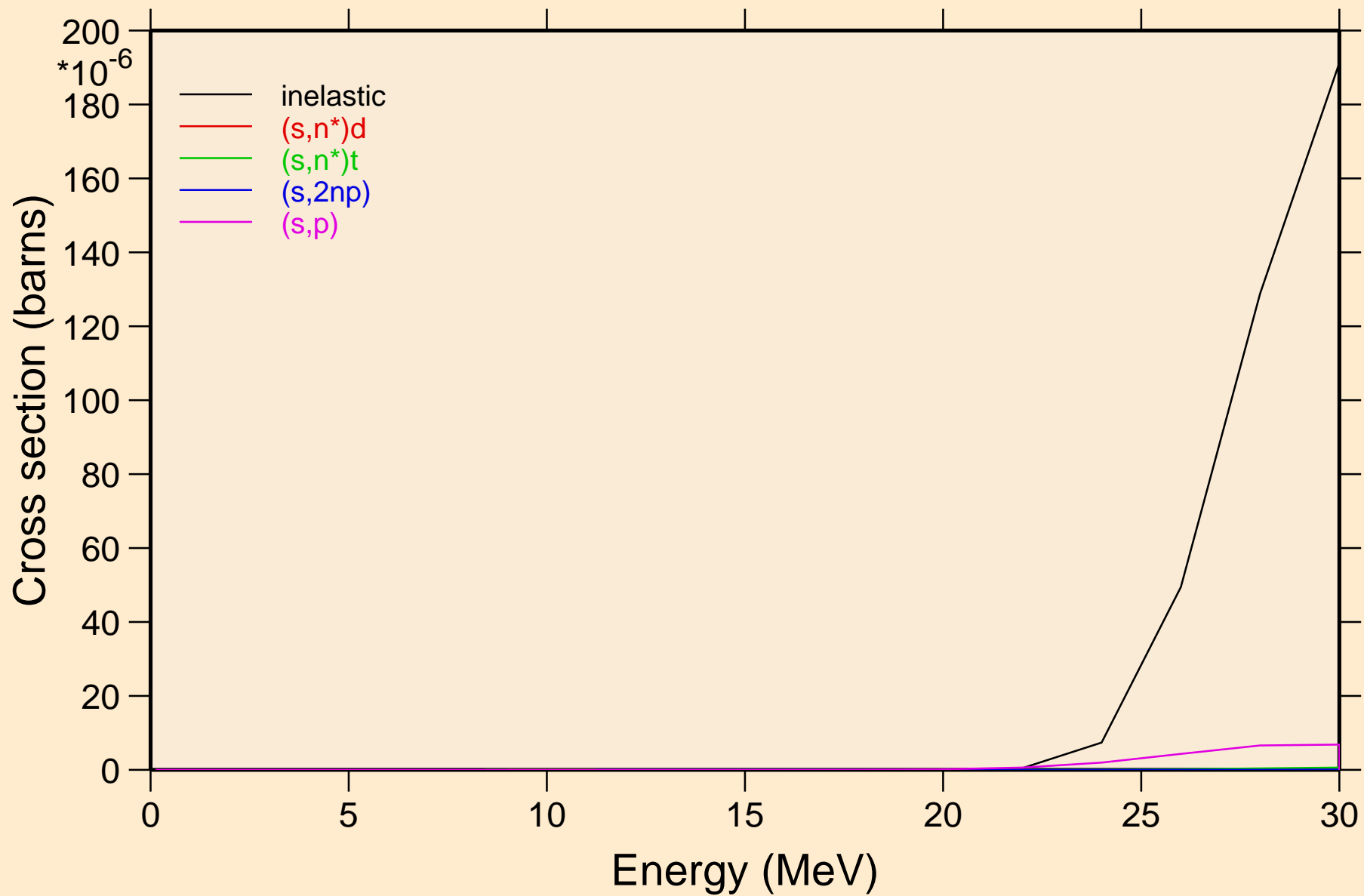

RF266 HELION ACER TENDL-2021 LIBRARY; T=0.K  
Threshold reactions

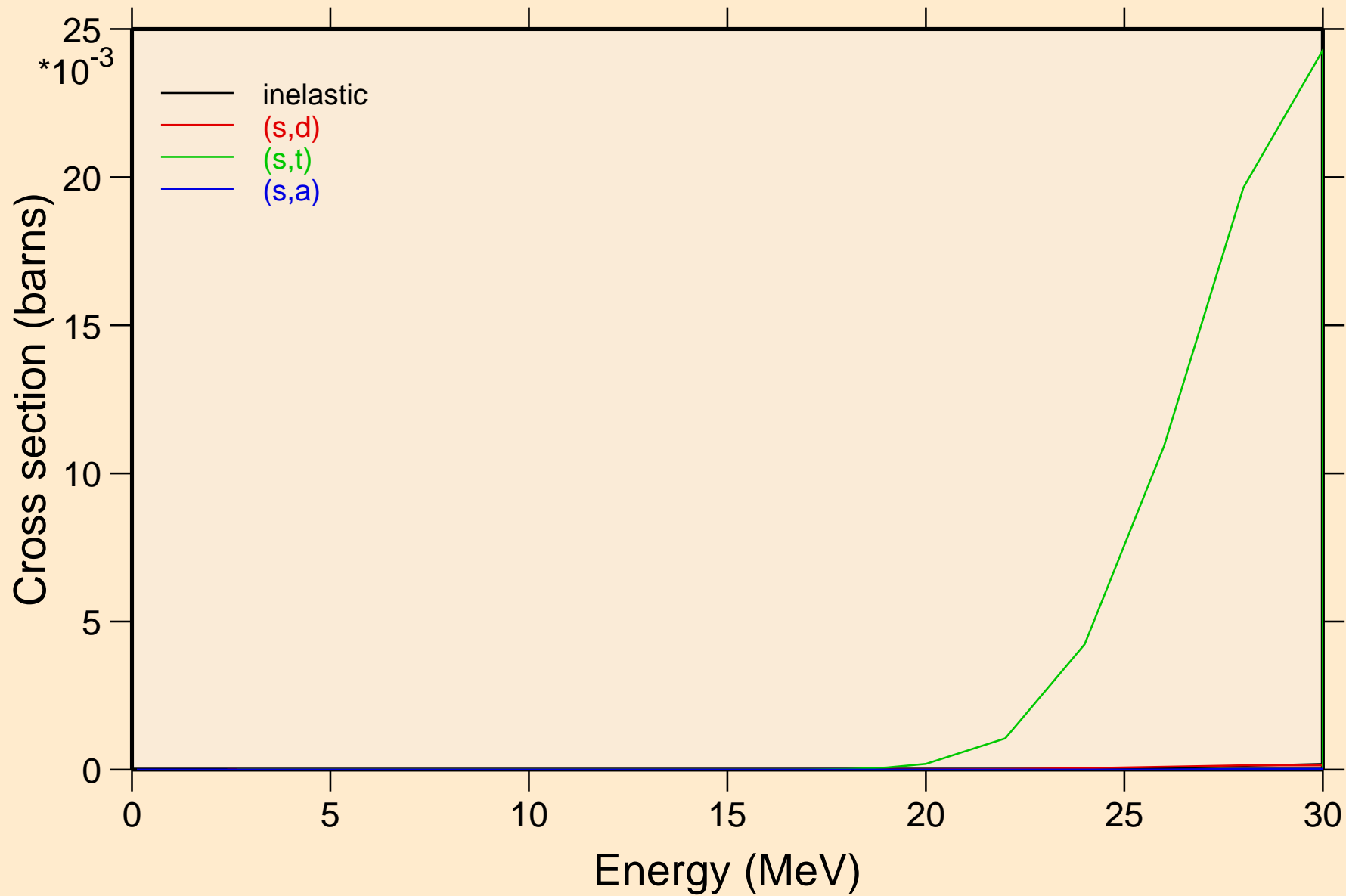

RF266 HELION ACER TENDL-2021 LIBRARY; T=0.K  
angular distribution for elastic

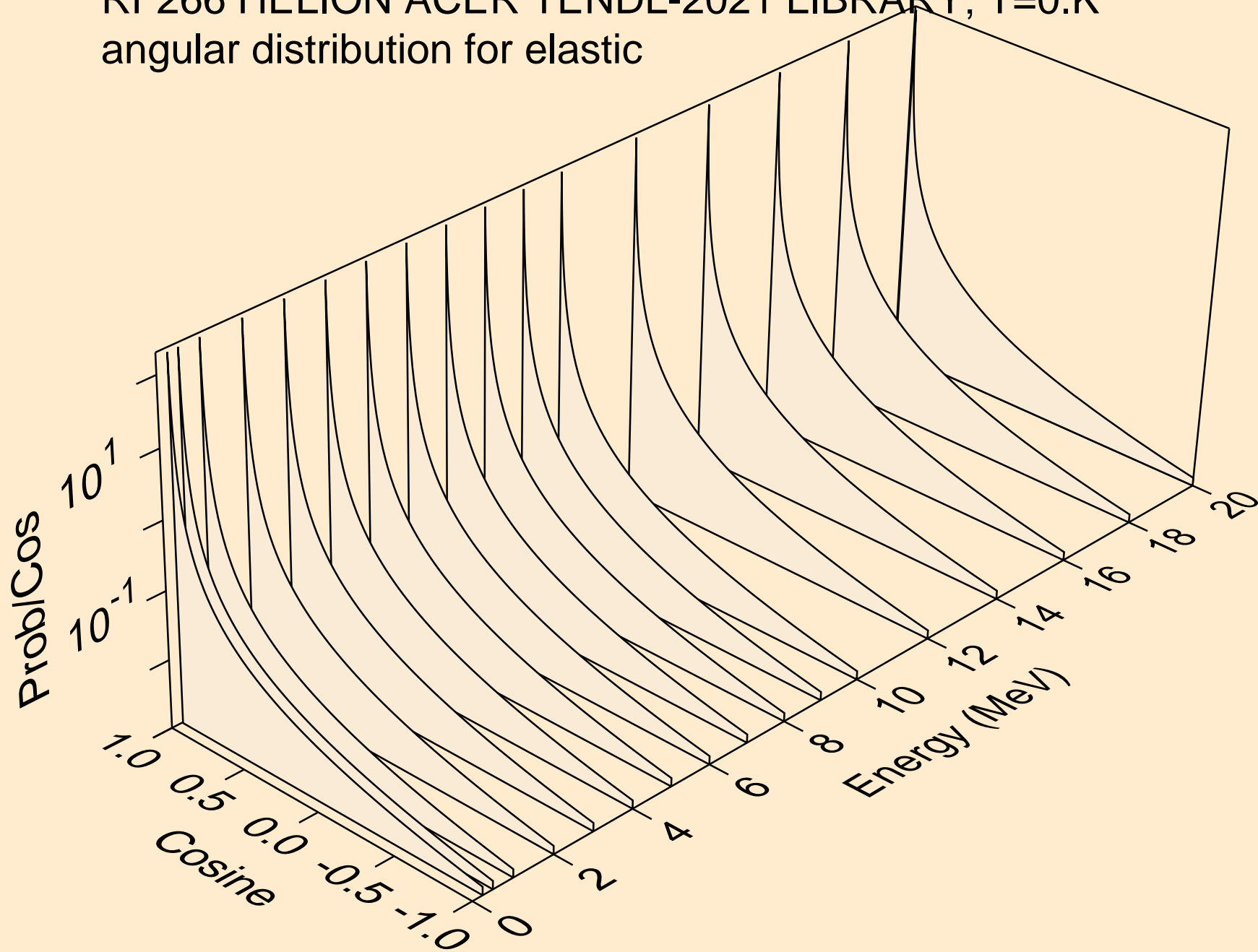



RF266 HELION ACER TENDL-2021 LIBRARY; T=0.K  
angular distribution for elastic

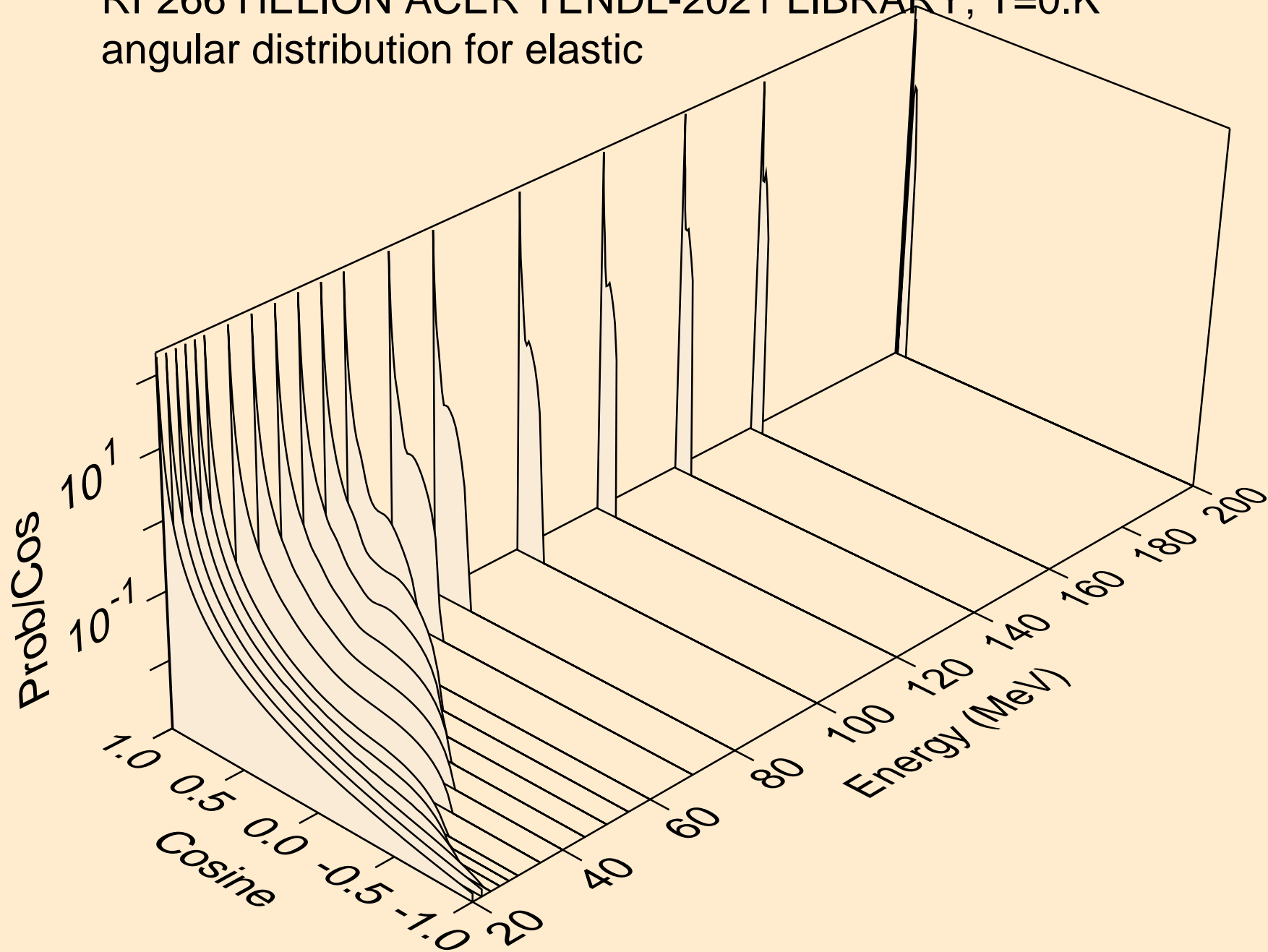

RF266 HELION ACER TENDL-2021 LIBRARY; T=0.K  
He-3 emission for (s,x)

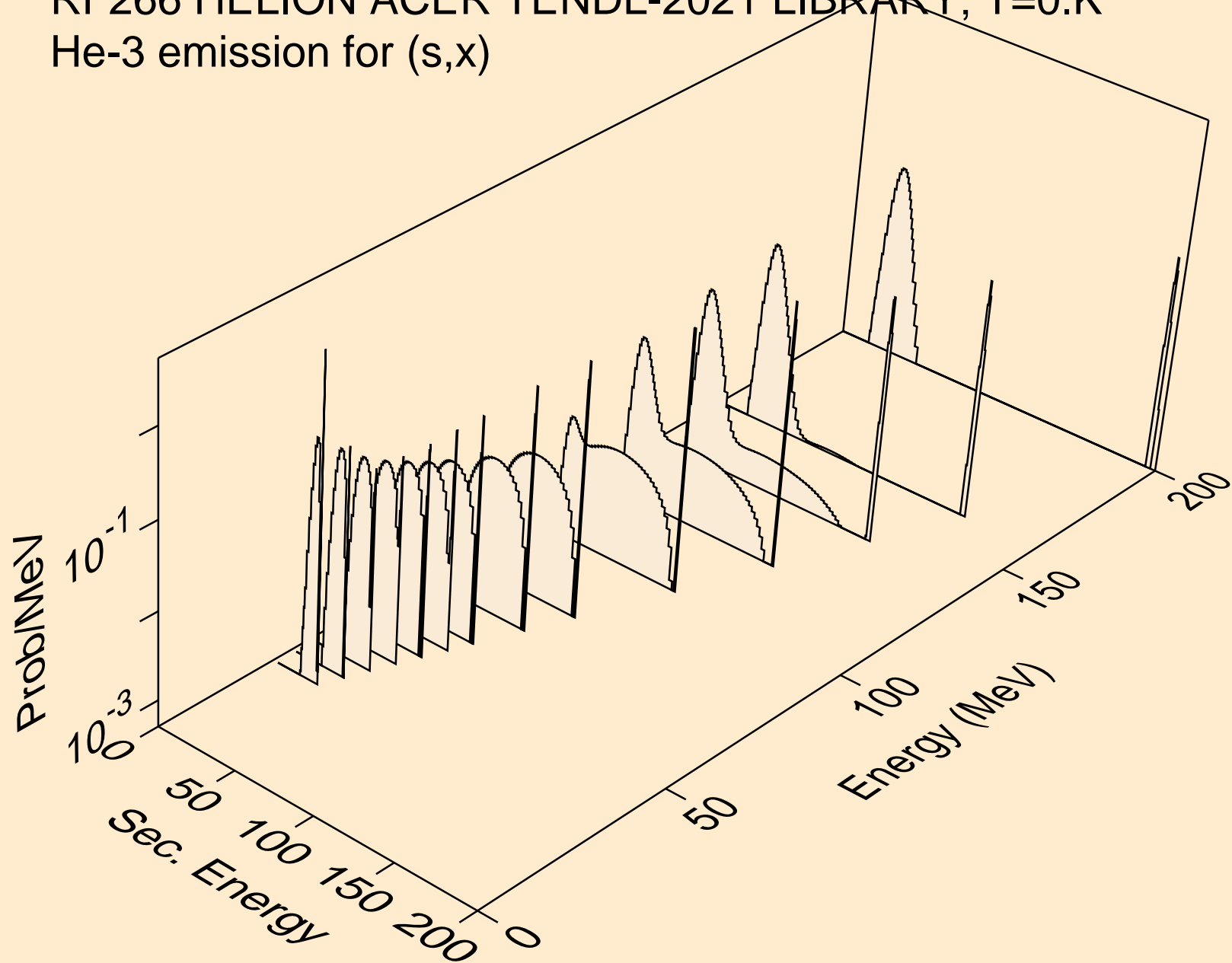

RF266 HELION ACER TENDL-2021 LIBRARY; T=0.K  
He-3 emission for inelastic

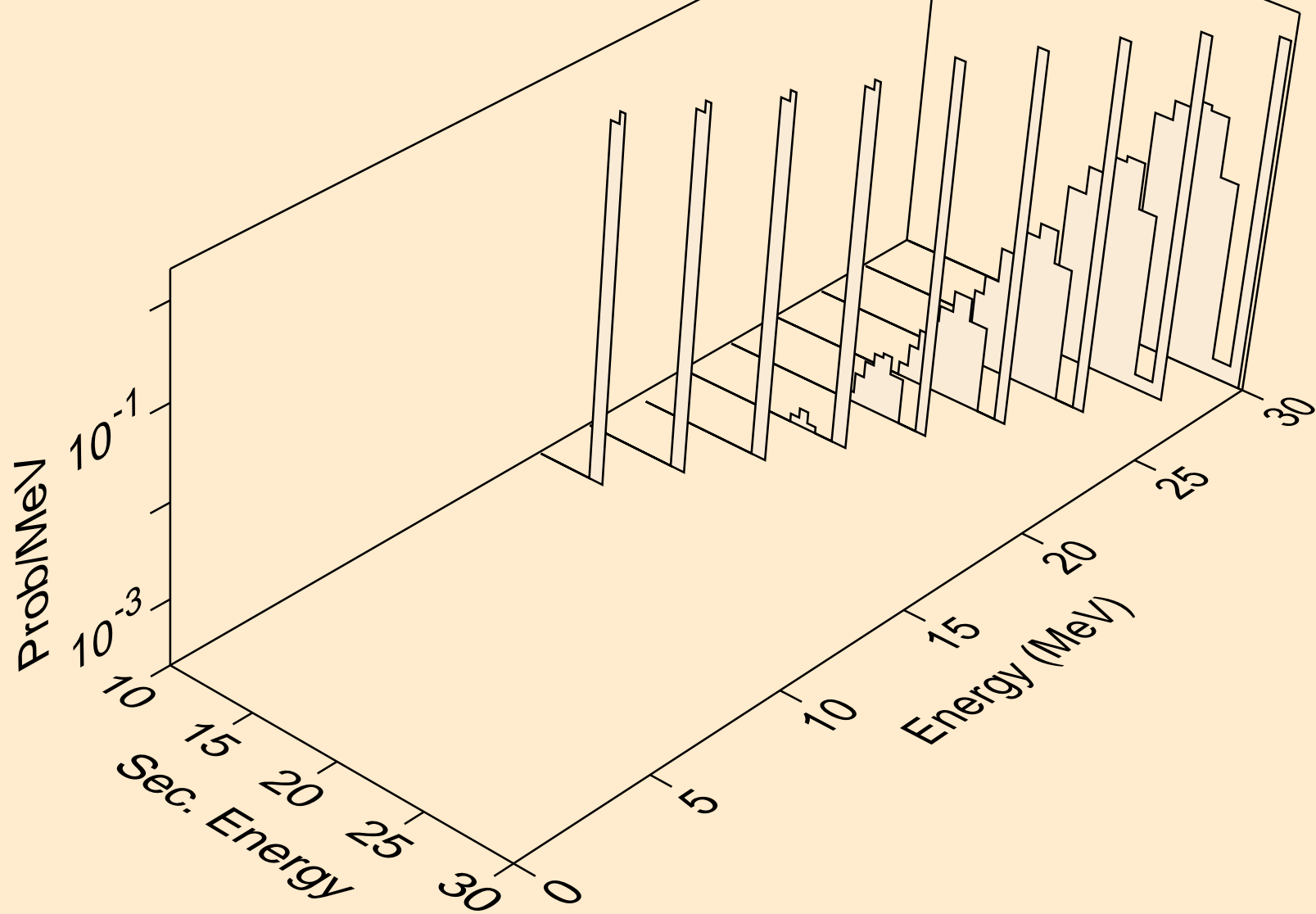

RF266 HELION ACER TENDL-2021 LIBRARY; T=0.K  
Photon emission for (z,n)

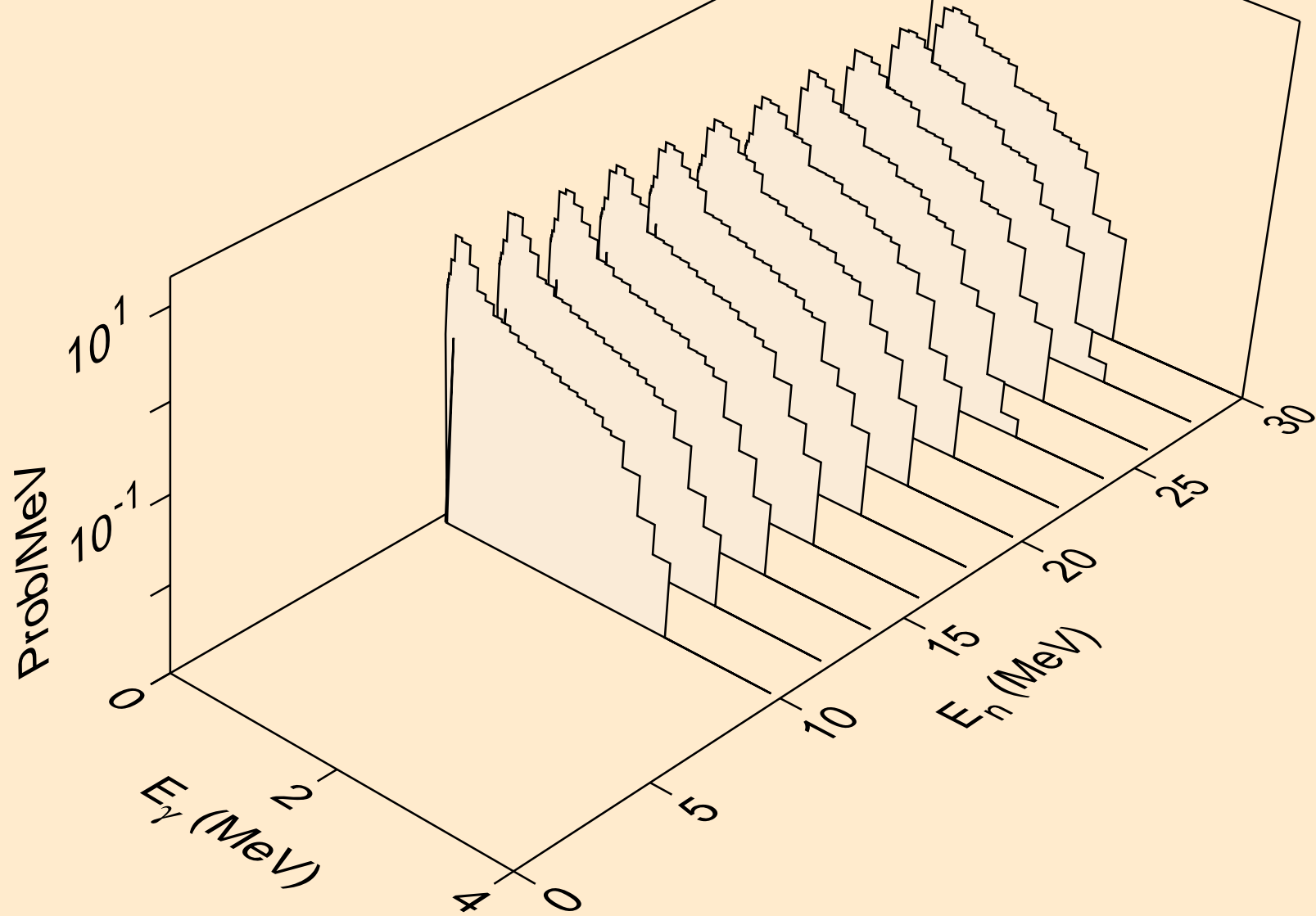

RF266 HELION ACER TENDL-2021 LIBRARY; T=0.K  
Photon emission for (n,x)

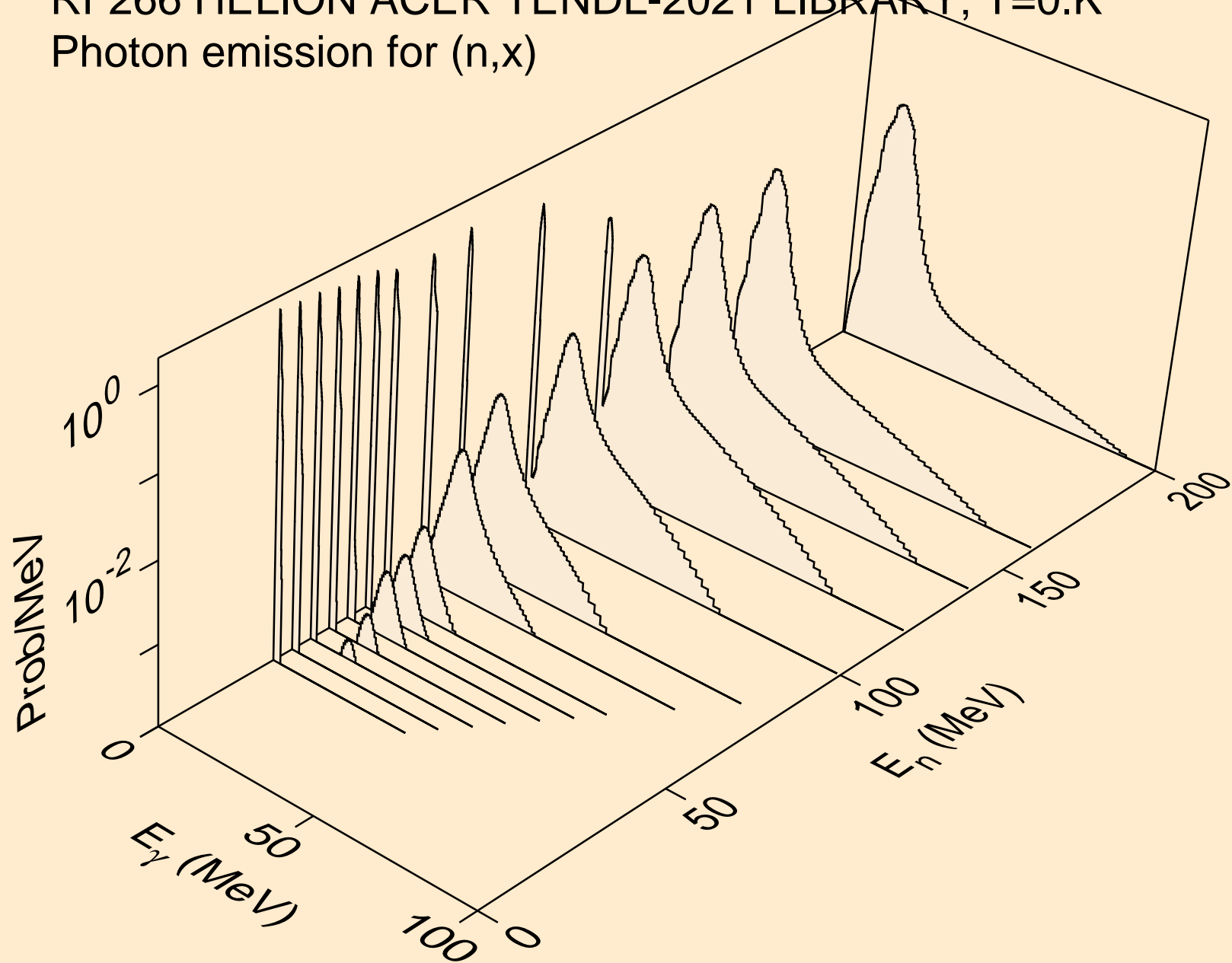

RF266 HELION ACER TENDL-2021 LIBRARY; T=0.K  
Photon emission for (n,2n)

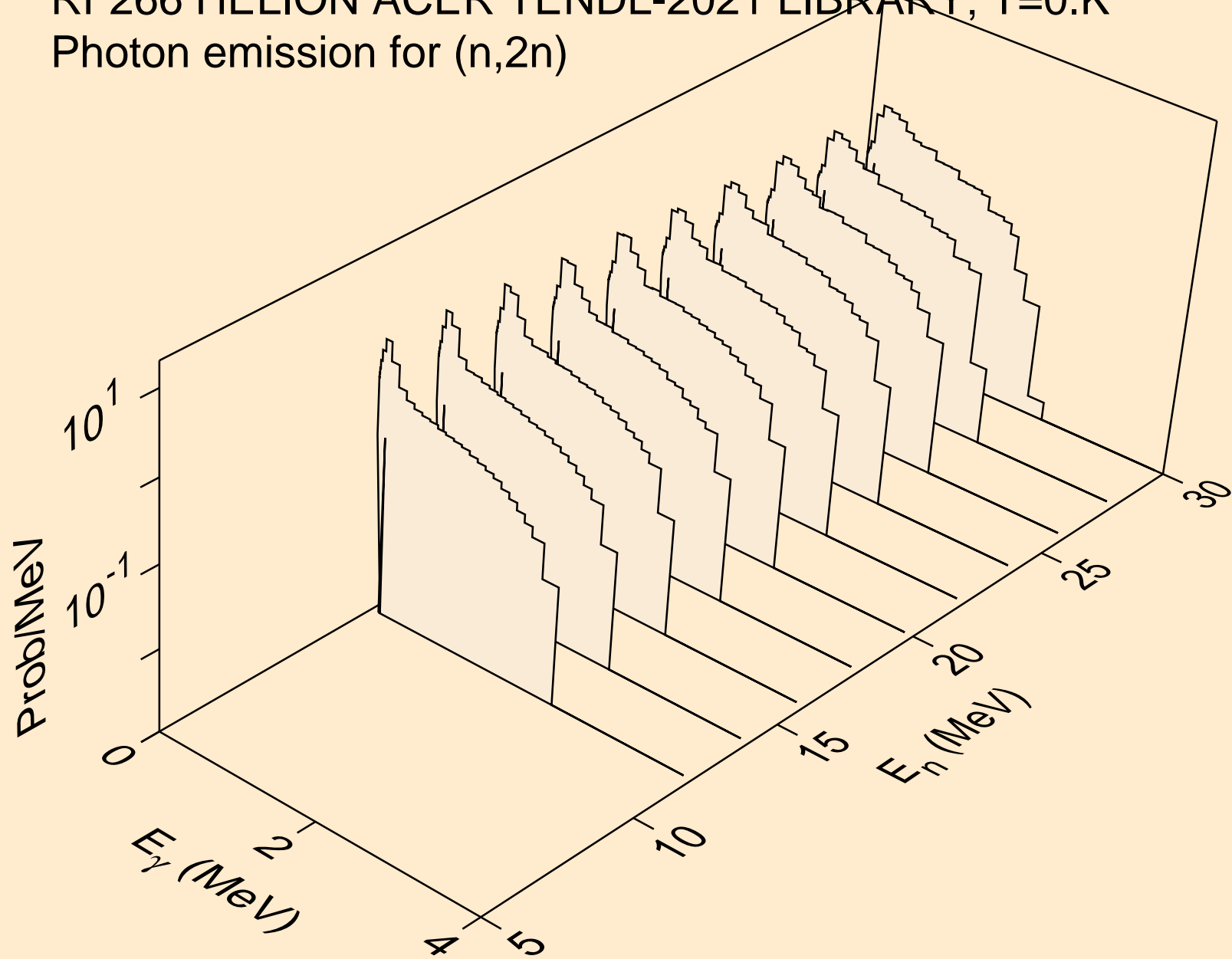

RF266 HELION ACER TENDL-2021 LIBRARY; T=0.K  
Photon emission for (n,3n)

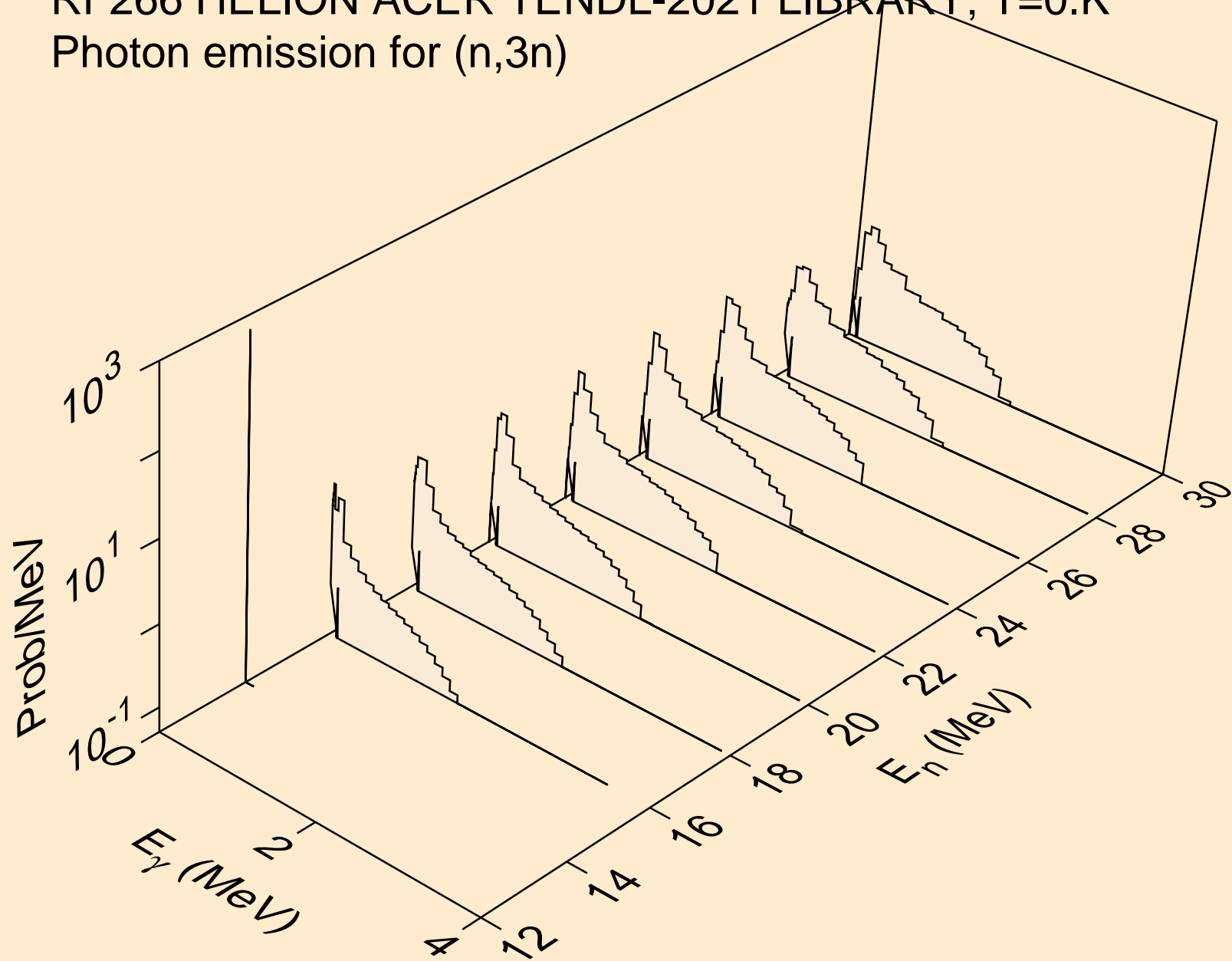

RF266 HELION ACER TENDL-2021 LIBRARY; T=0.K  
Photon emission for (n,n\*)p

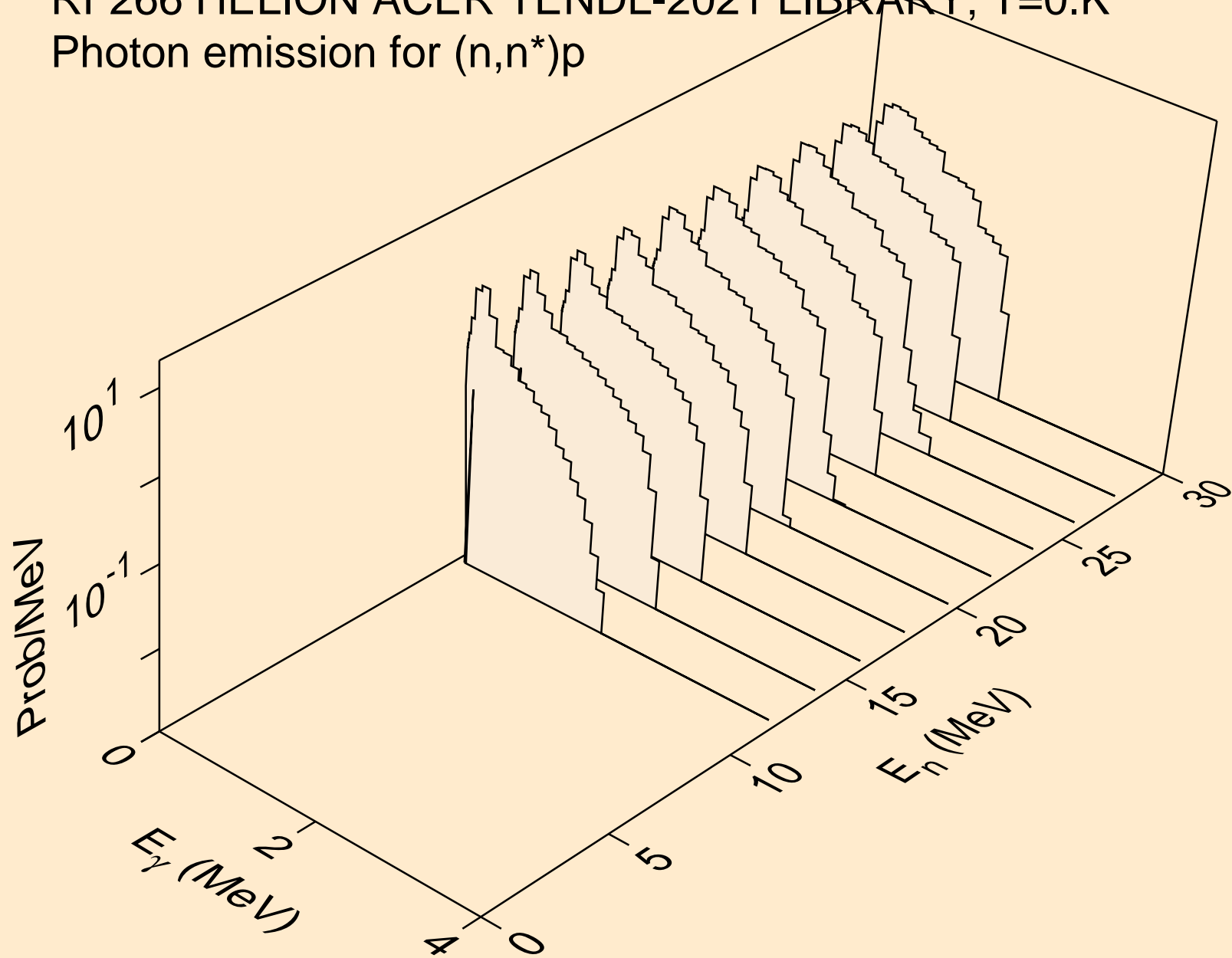



RF266 HELION ACER TENDL-2021 LIBRARY; T=0.K  
Photon emission for (n,n\*)d

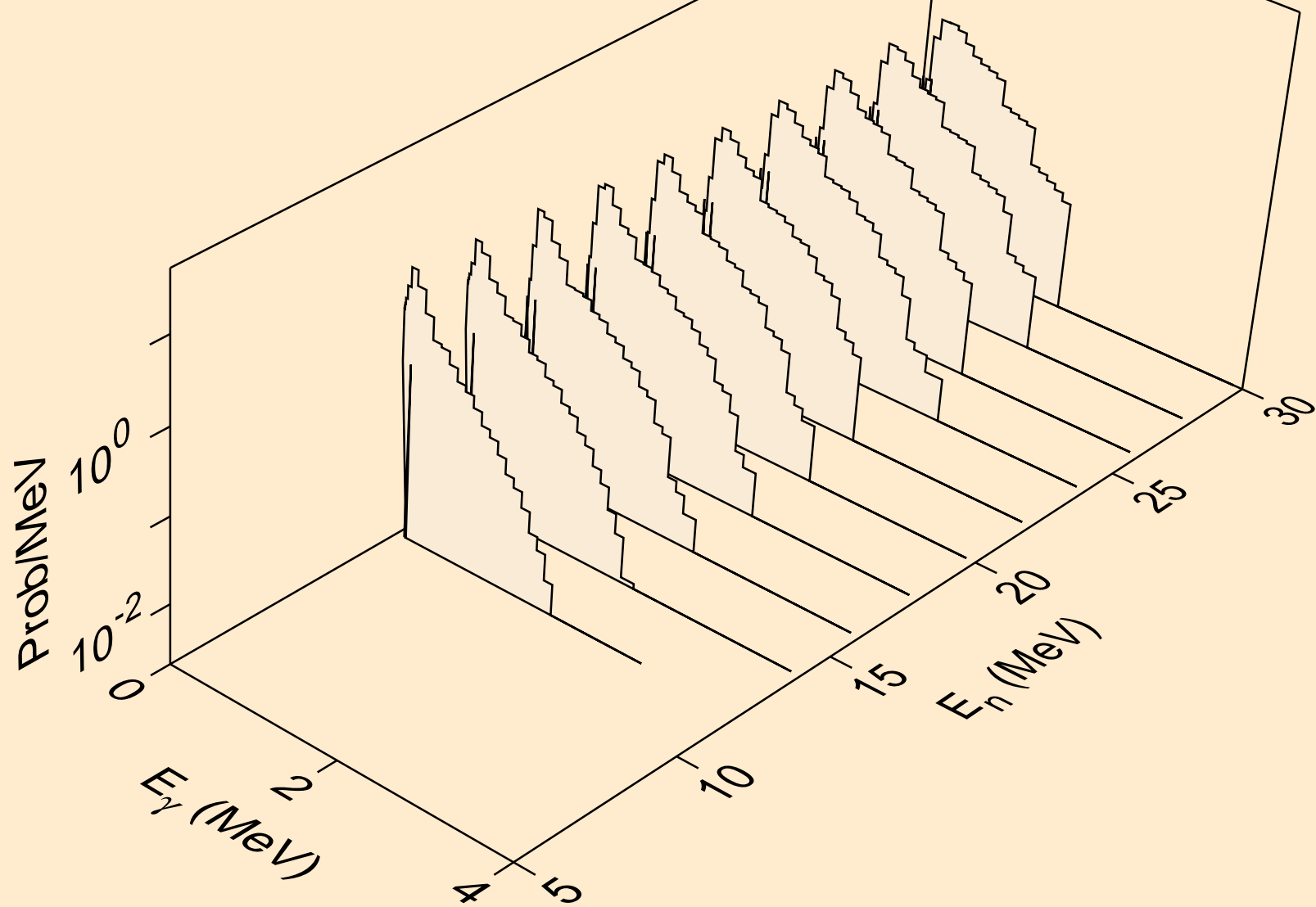

RF266 HELION ACER TENDL-2021 LIBRARY; T=0.K  
Photon emission for (n,n\*)t

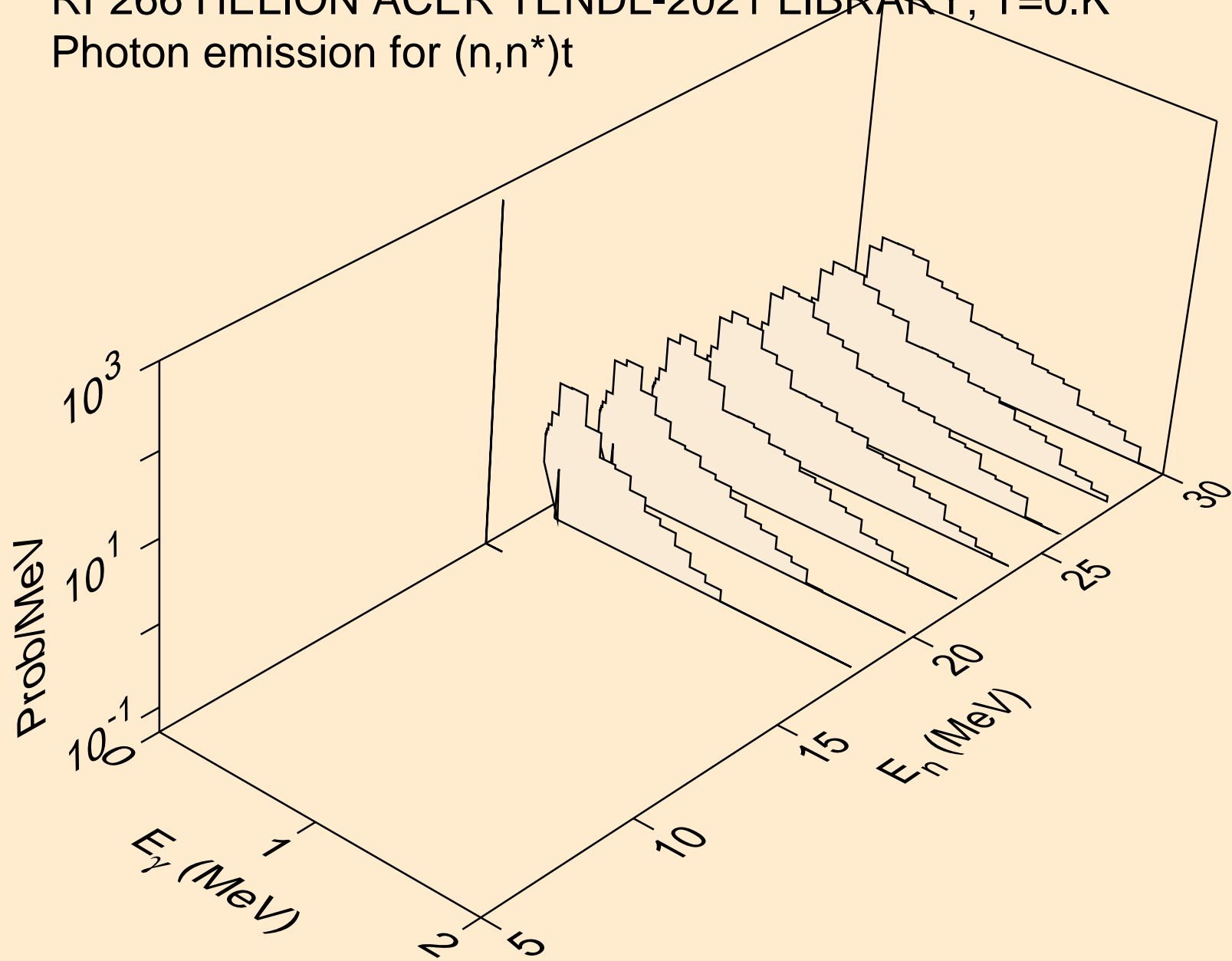

RF266 HELION ACER TENDL-2021 LIBRARY; T=0.K  
Photon emission for (n,2np)

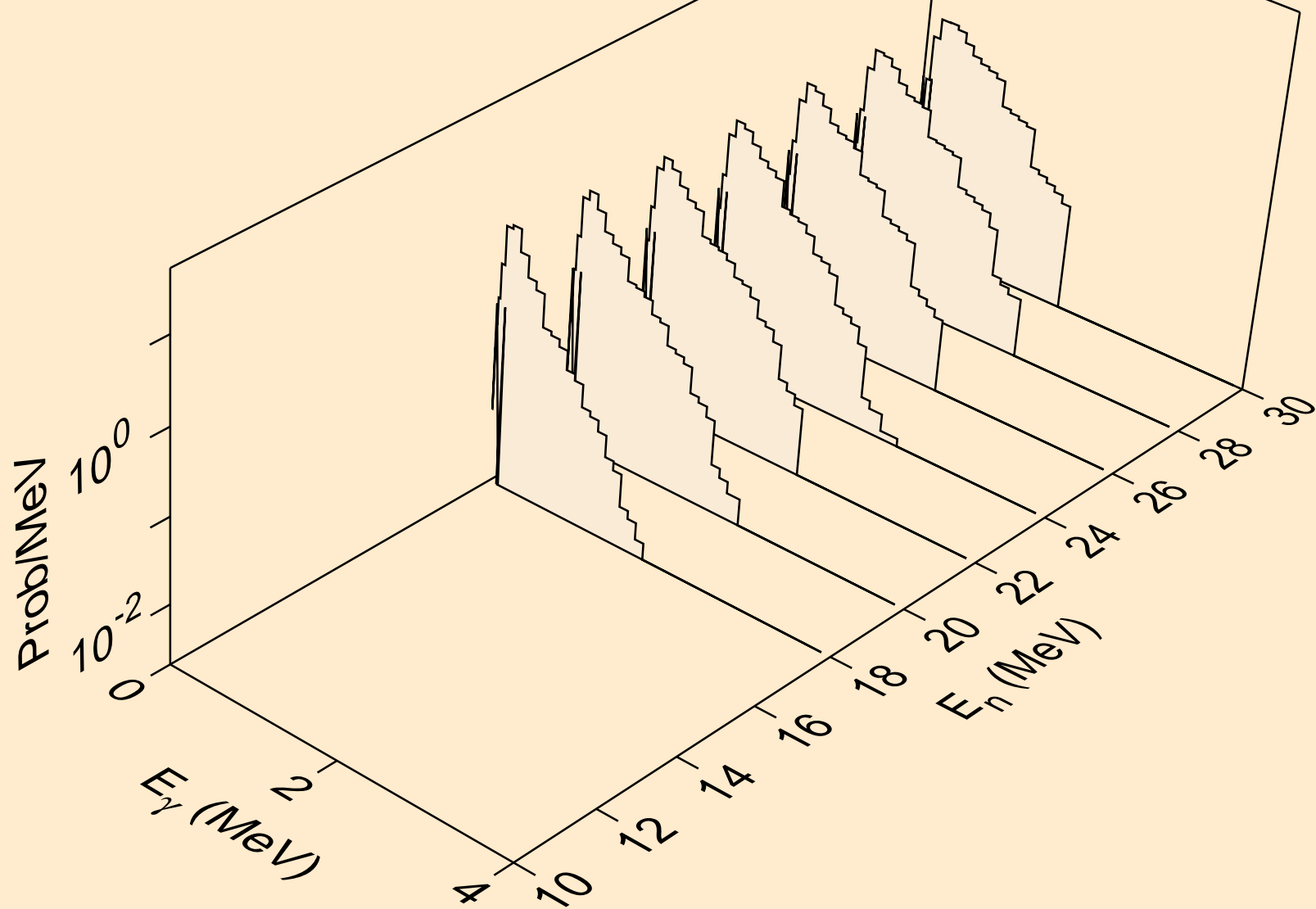

RF266 HELION ACER TENDL-2021 LIBRARY; T=0.K  
Photon emission for (n,p)

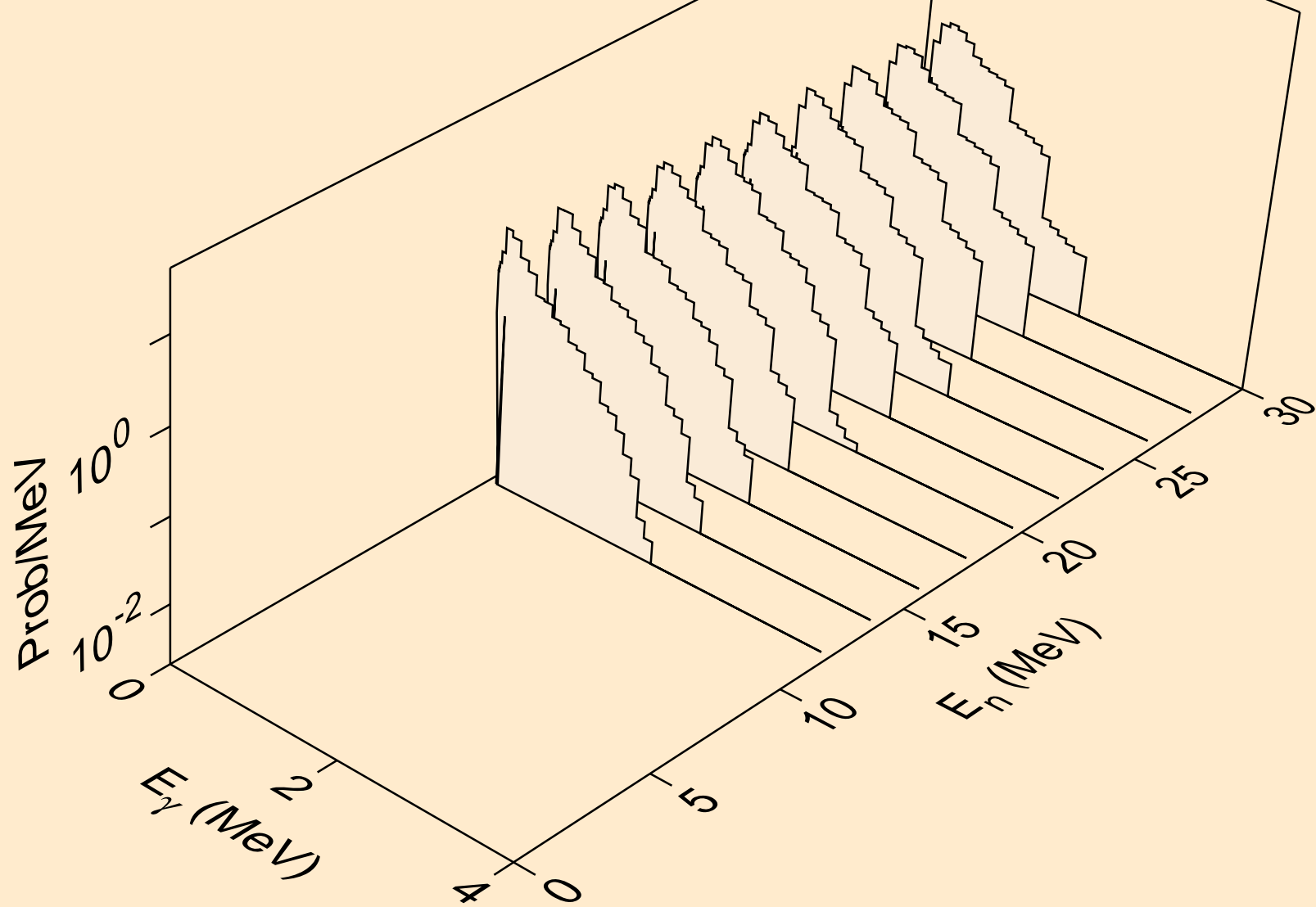

RF266 HELION ACER TENDL-2021 LIBRARY; T=0.K  
Photon emission for (n,d)

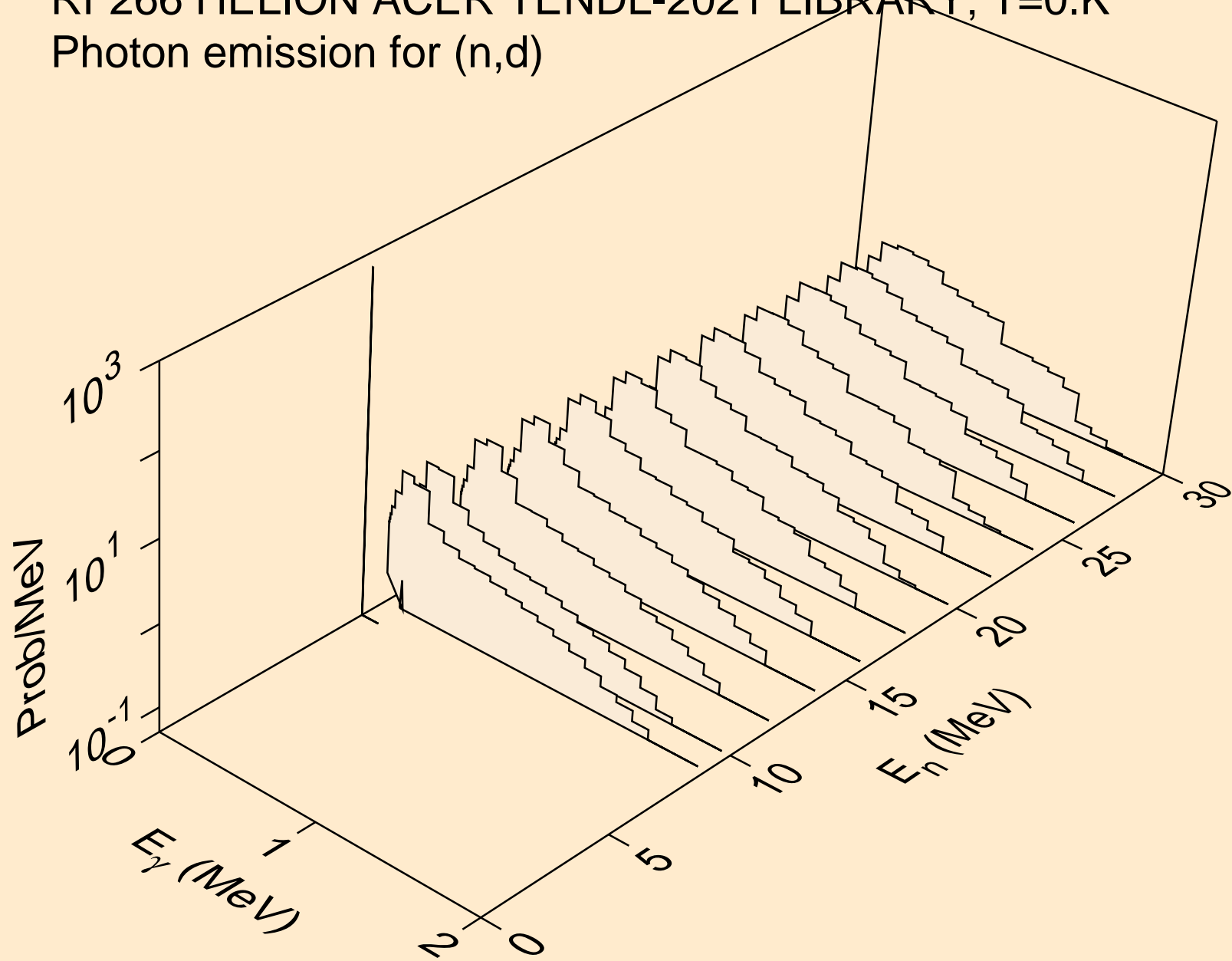

RF266 HELION ACER TENDL-2021 LIBRARY; T=0.K  
Photon emission for (n,t)

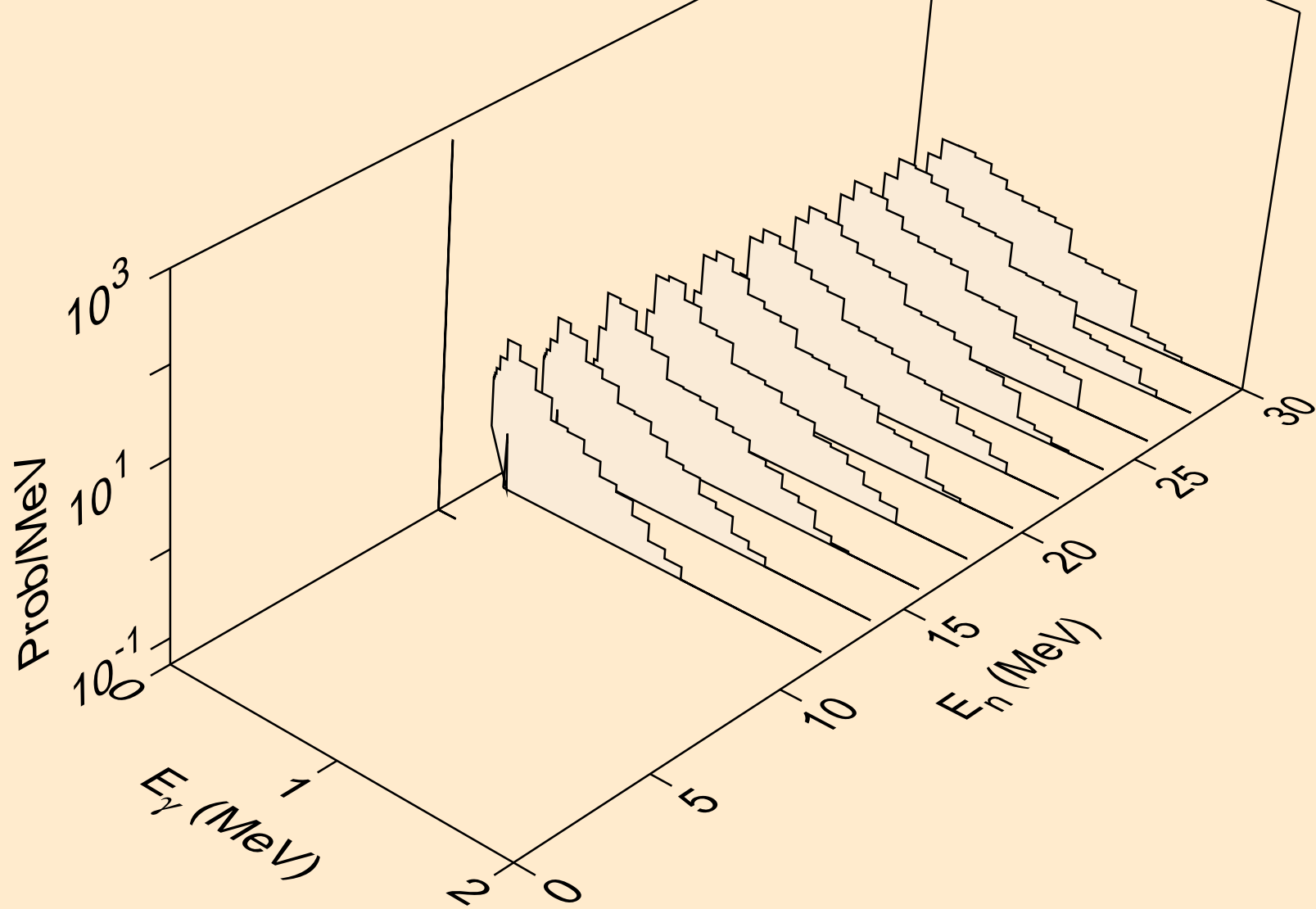

RF266 HELION ACER TENDL-2021 LIBRARY; T=0.K  
Photon emission for inelastic

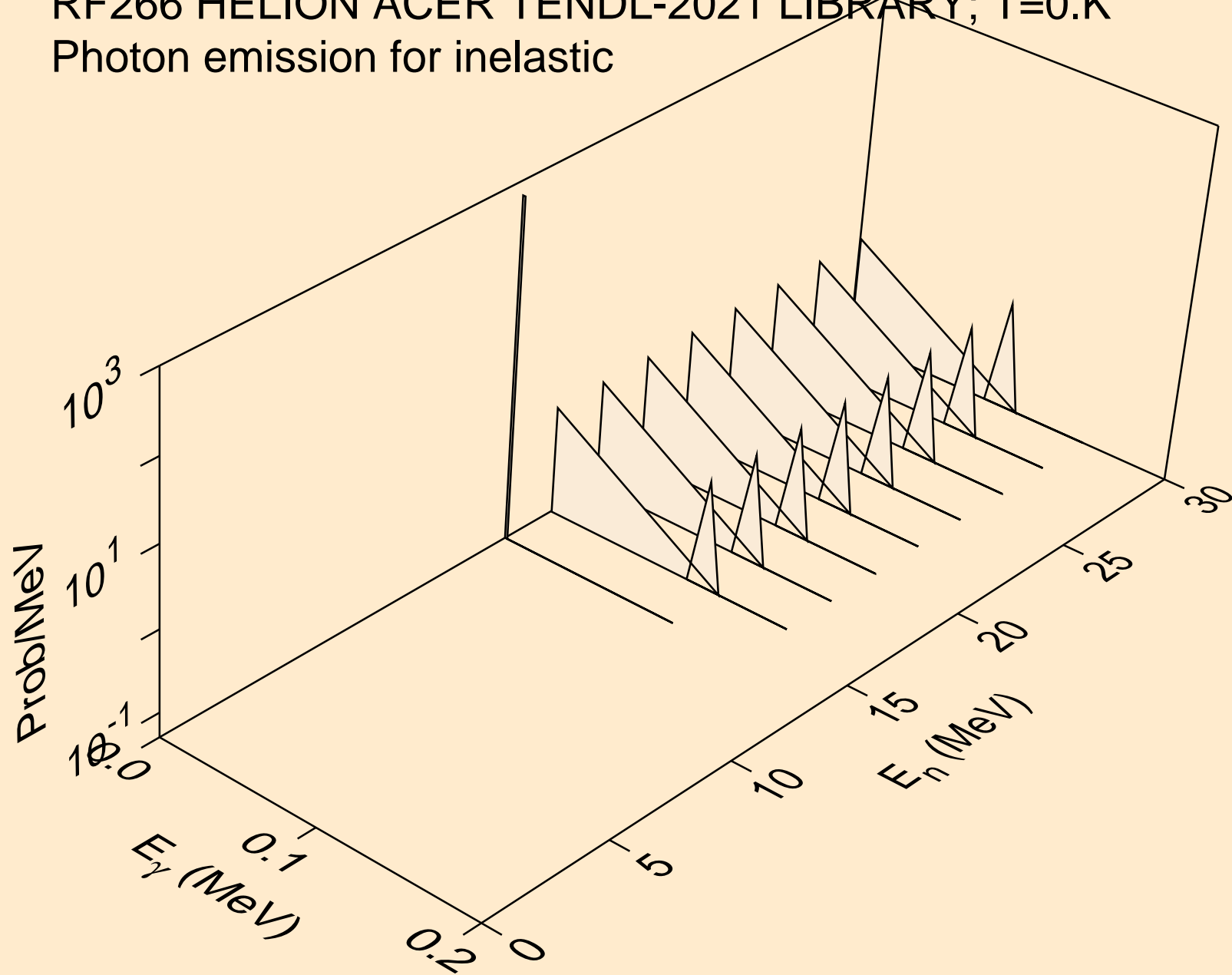

RF266 HELION ACER TENDL-2021 LIBRARY; T=0.K  
Photon emission for (n,a)

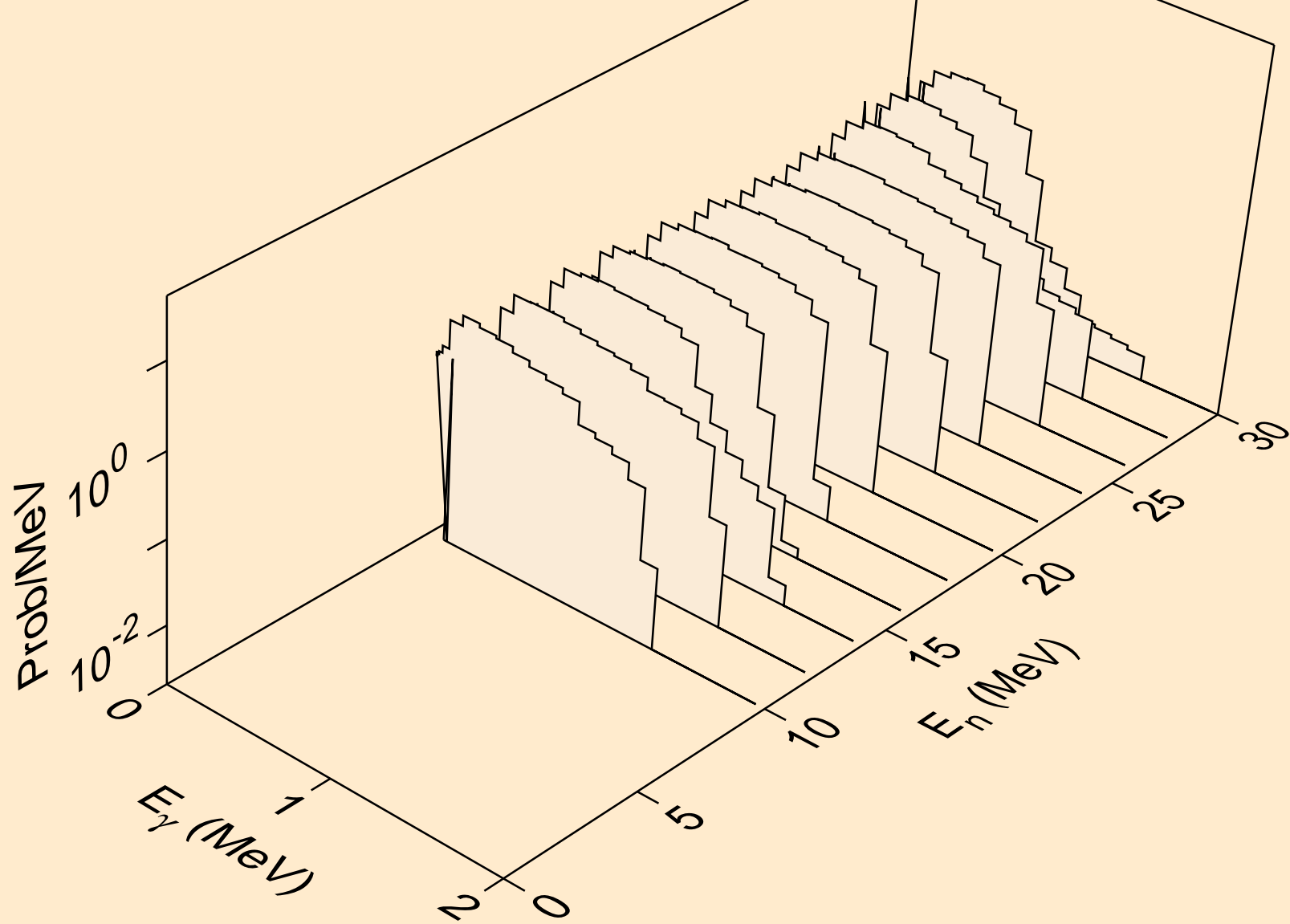



RF266 HELION ACER TENDL-2021 LIBRARY; T=0.K  
Particle heating contributions

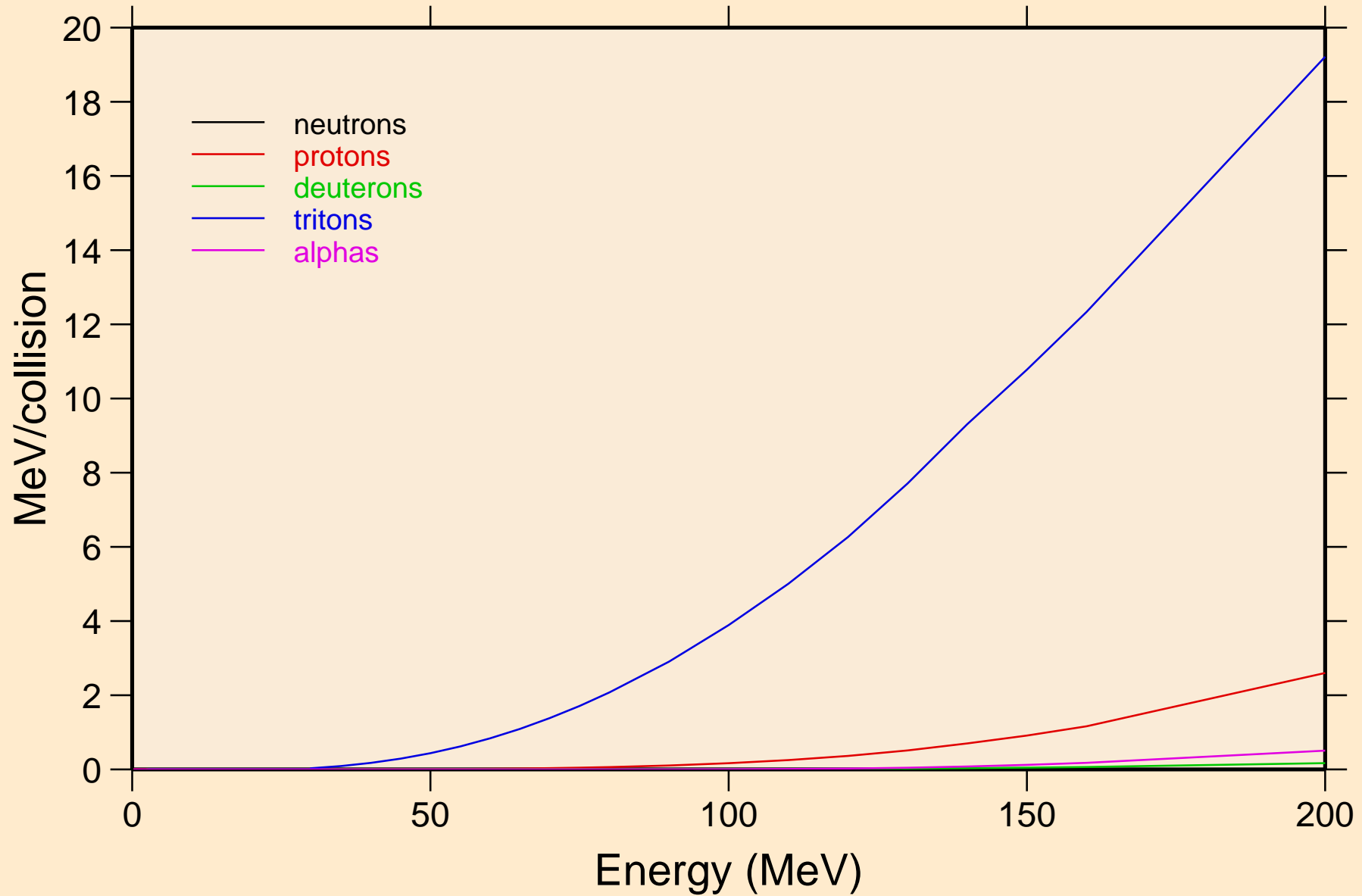

RF266 HELION ACER TENDL-2021 LIBRARY; T=0.K  
Recoil Heating

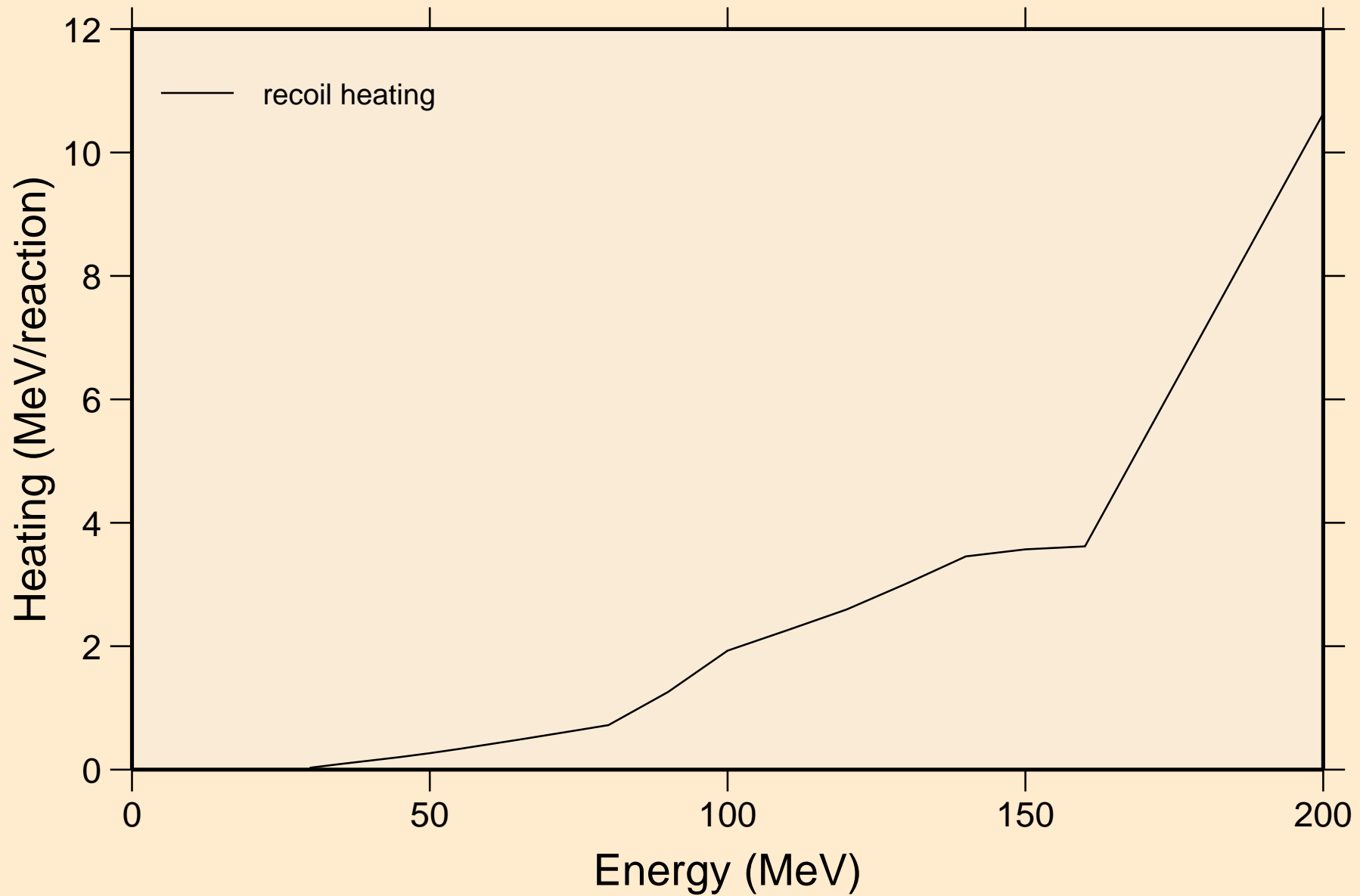

RF266 HELION ACER TENDL-2021 LIBRARY; T=0.K  
Particle production cross sections

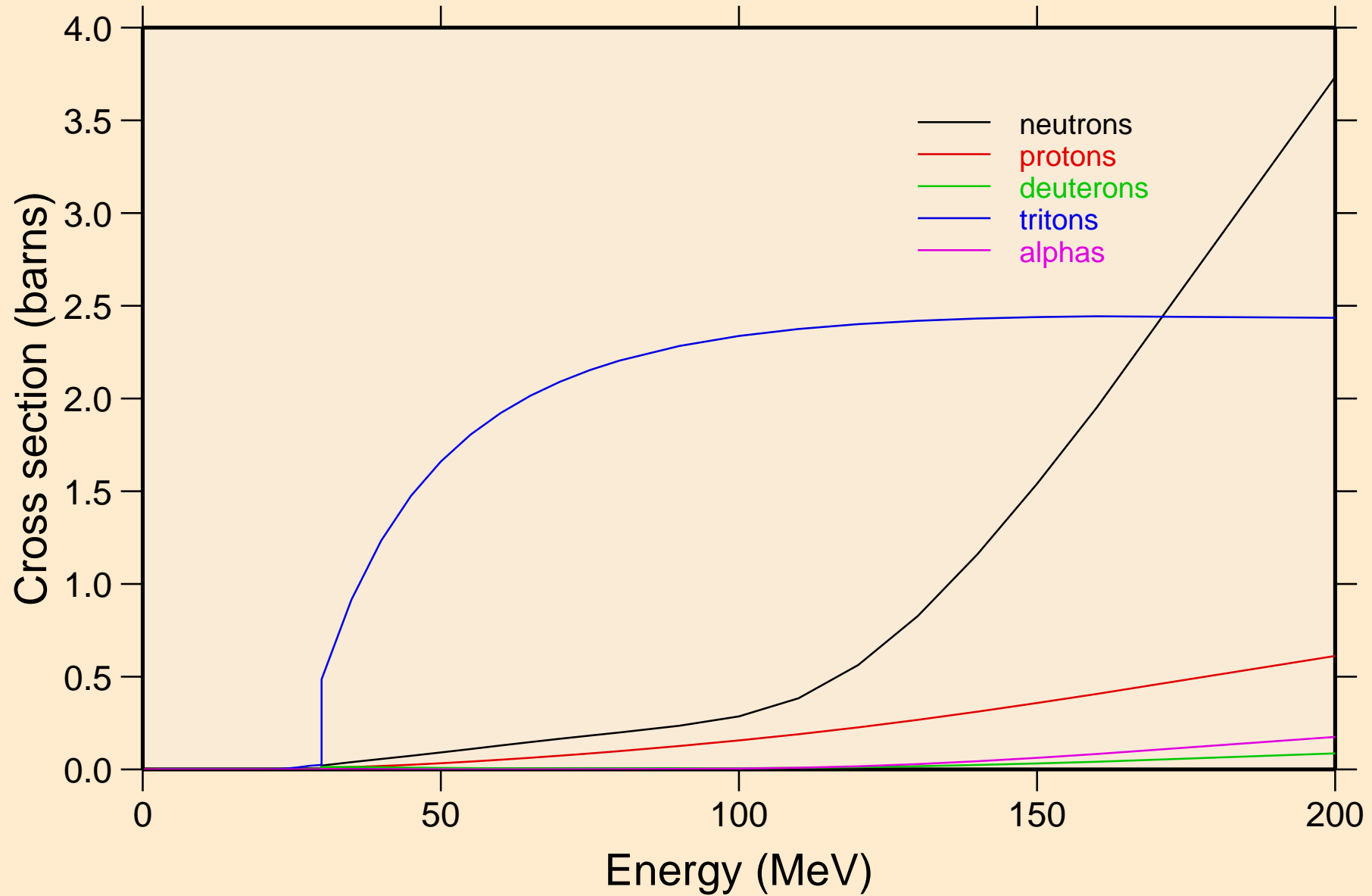

RF266 HELION ACER TENDL-2021 LIBRARY; T=0.K  
neutrons from (s,n)

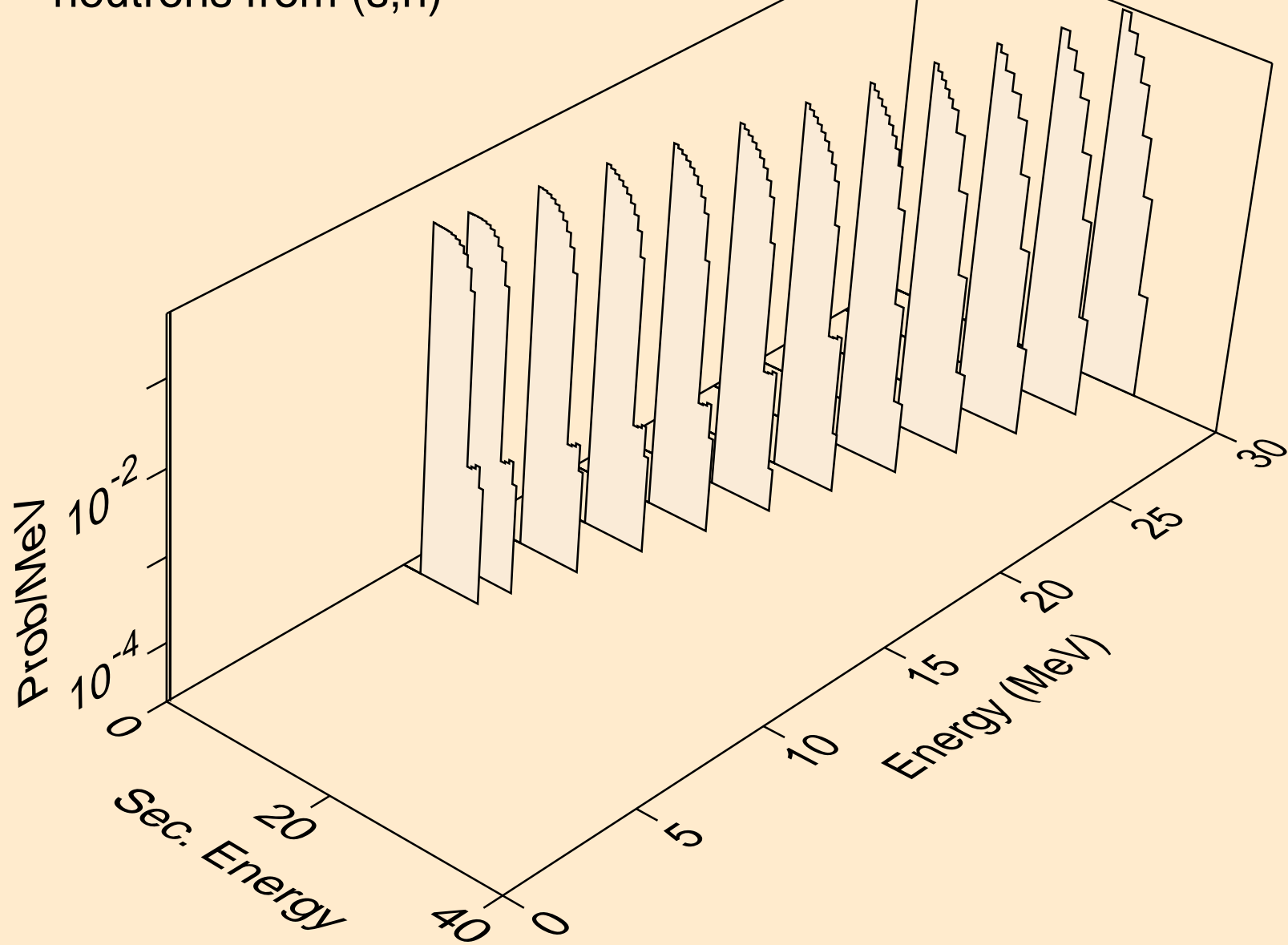

RF266 HELION ACER TENDL-2021 LIBRARY; T=0.K  
neutrons from (s,x)

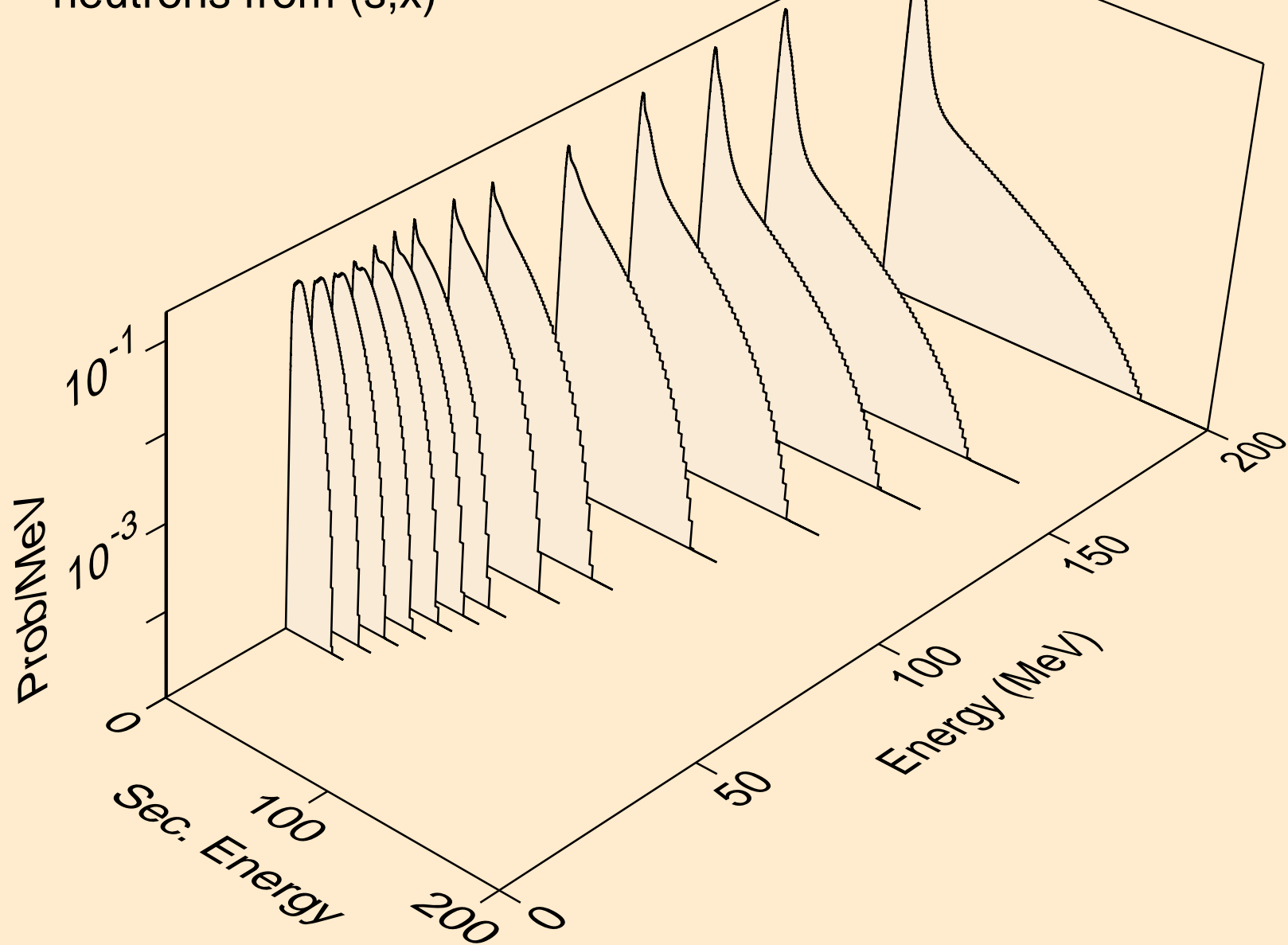

RF266 HELION ACER TENDL-2021 LIBRARY; T=0.K  
neutrons from (s,2n)

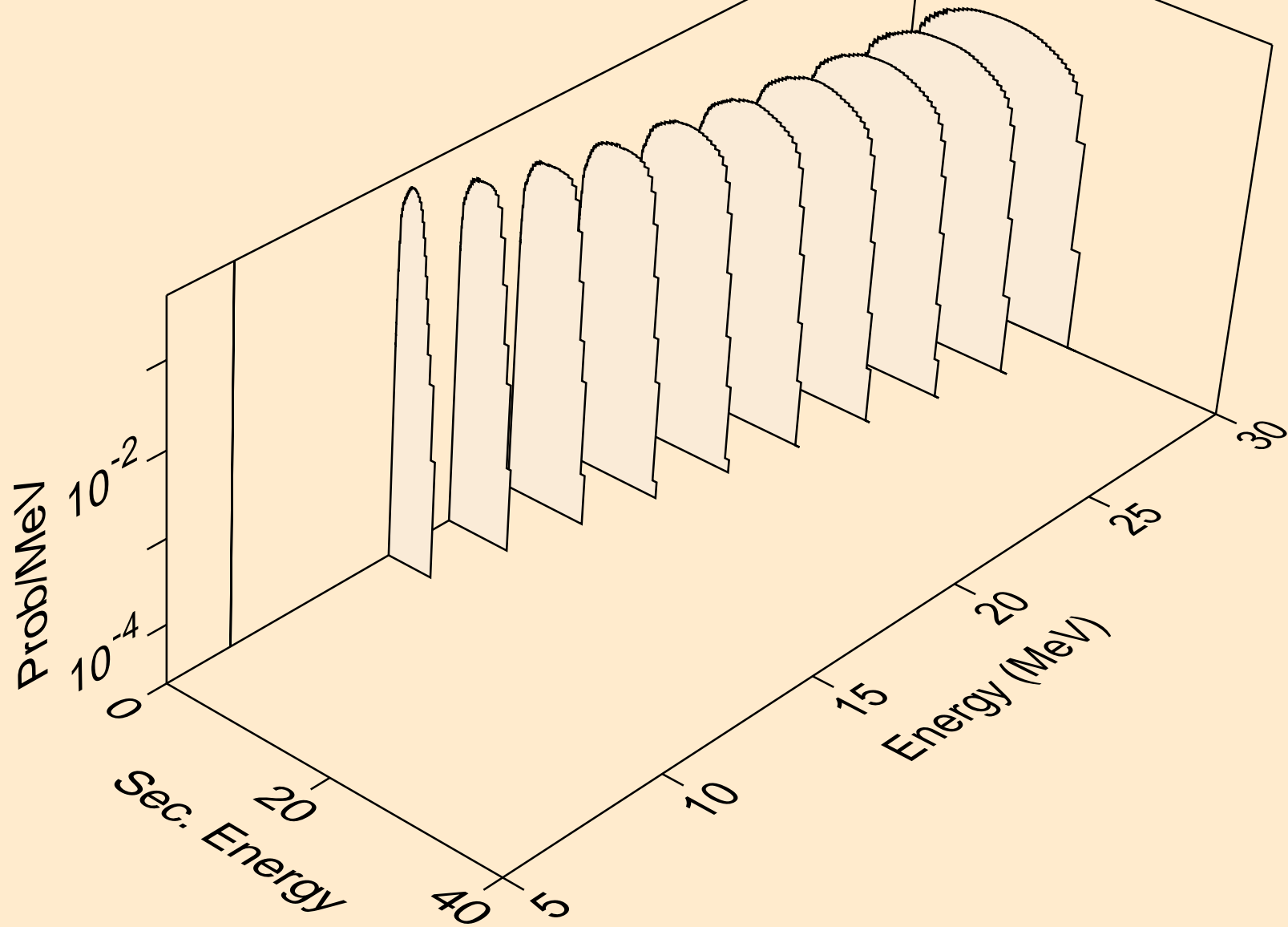

RF266 HELION ACER TENDL-2021 LIBRARY; T=0.K  
neutrons from (s,3n)

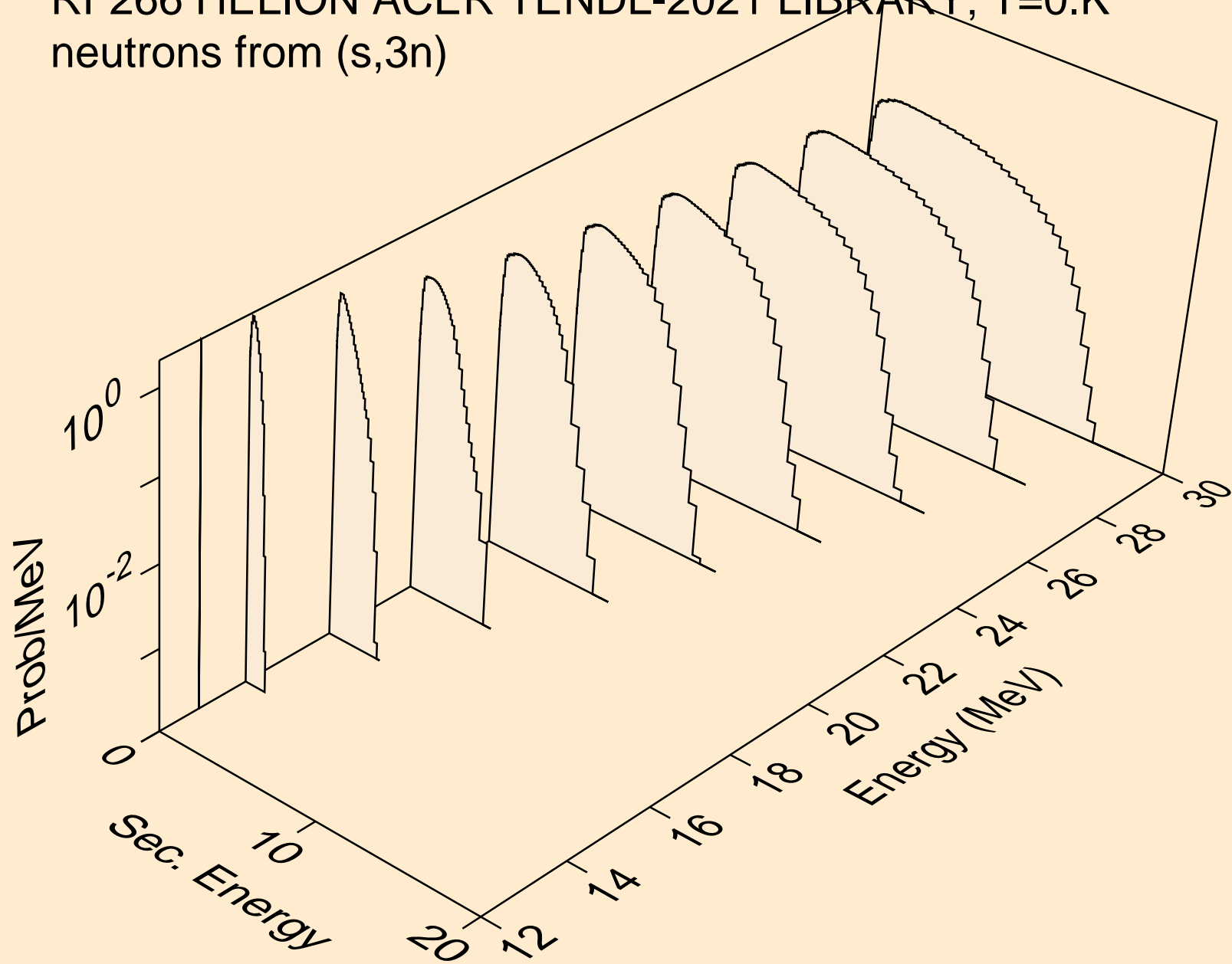

RF266 HELION ACER TENDL-2021 LIBRARY; T=0.K  
neutrons from (s,n\*)p

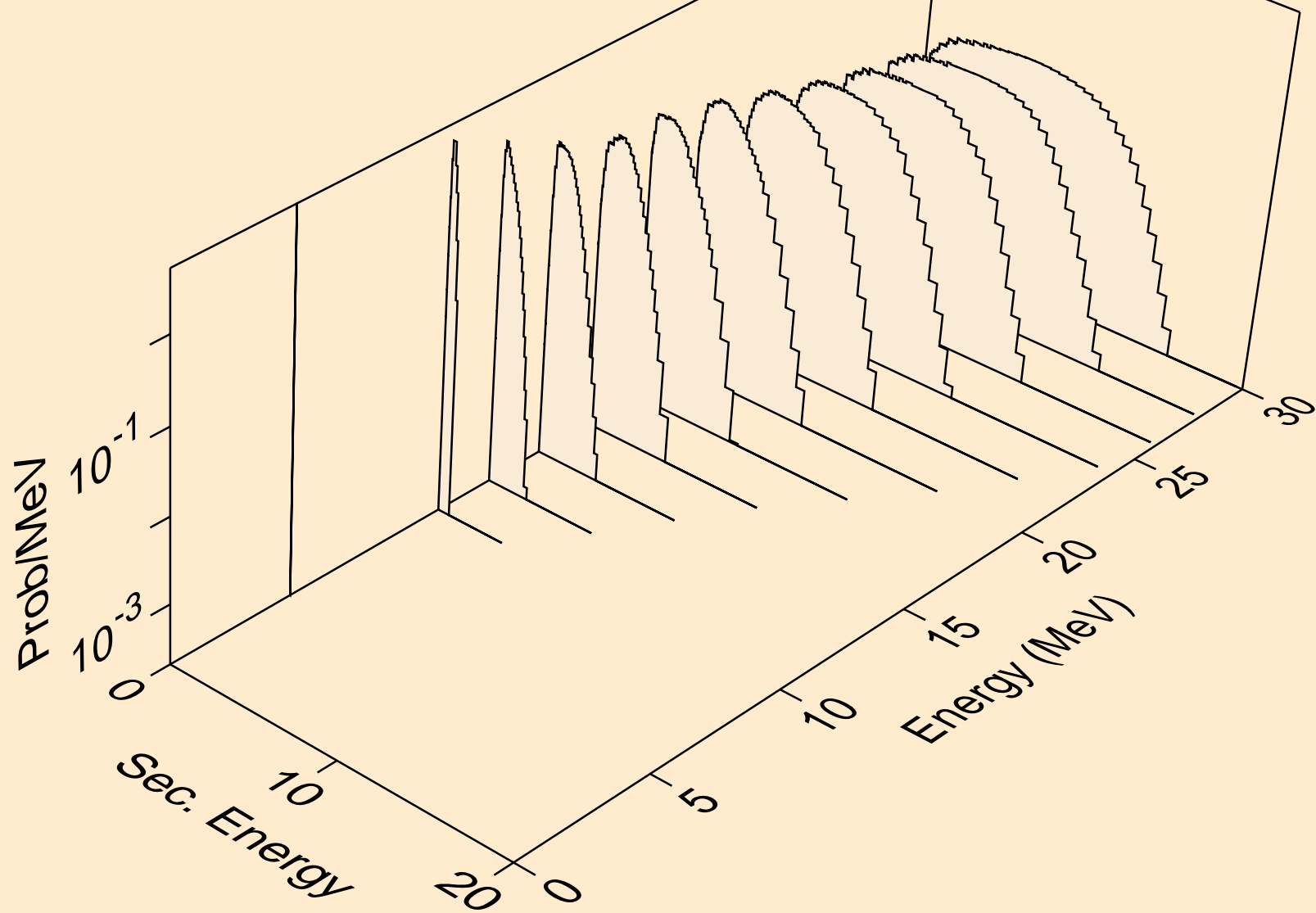



RF266 HELION ACER TENDL-2021 LIBRARY; T=0.K  
neutrons from (s,n\*)d

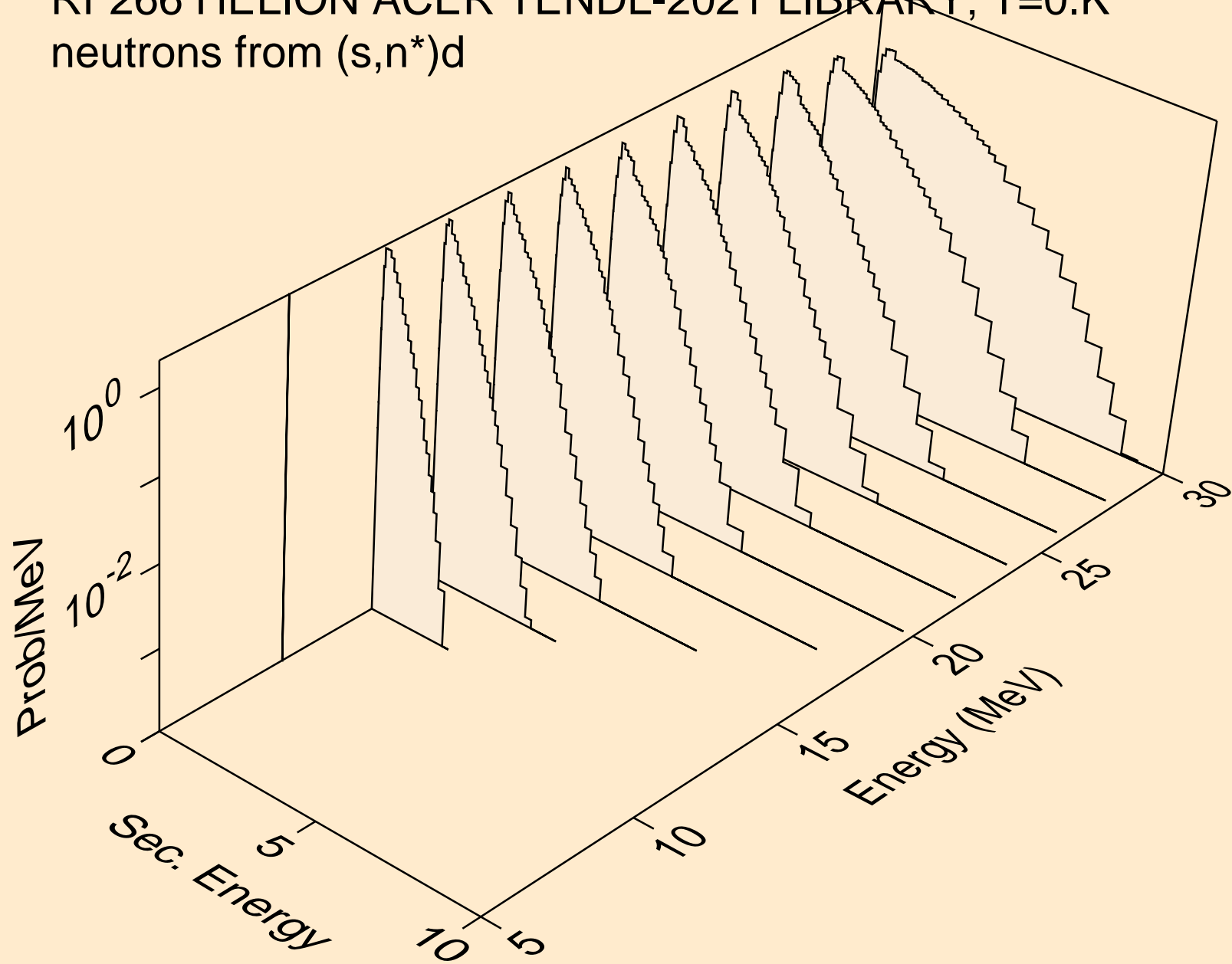

RF266 HELION ACER TENDL-2021 LIBRARY; T=0.K  
neutrons from (s,n\*)t

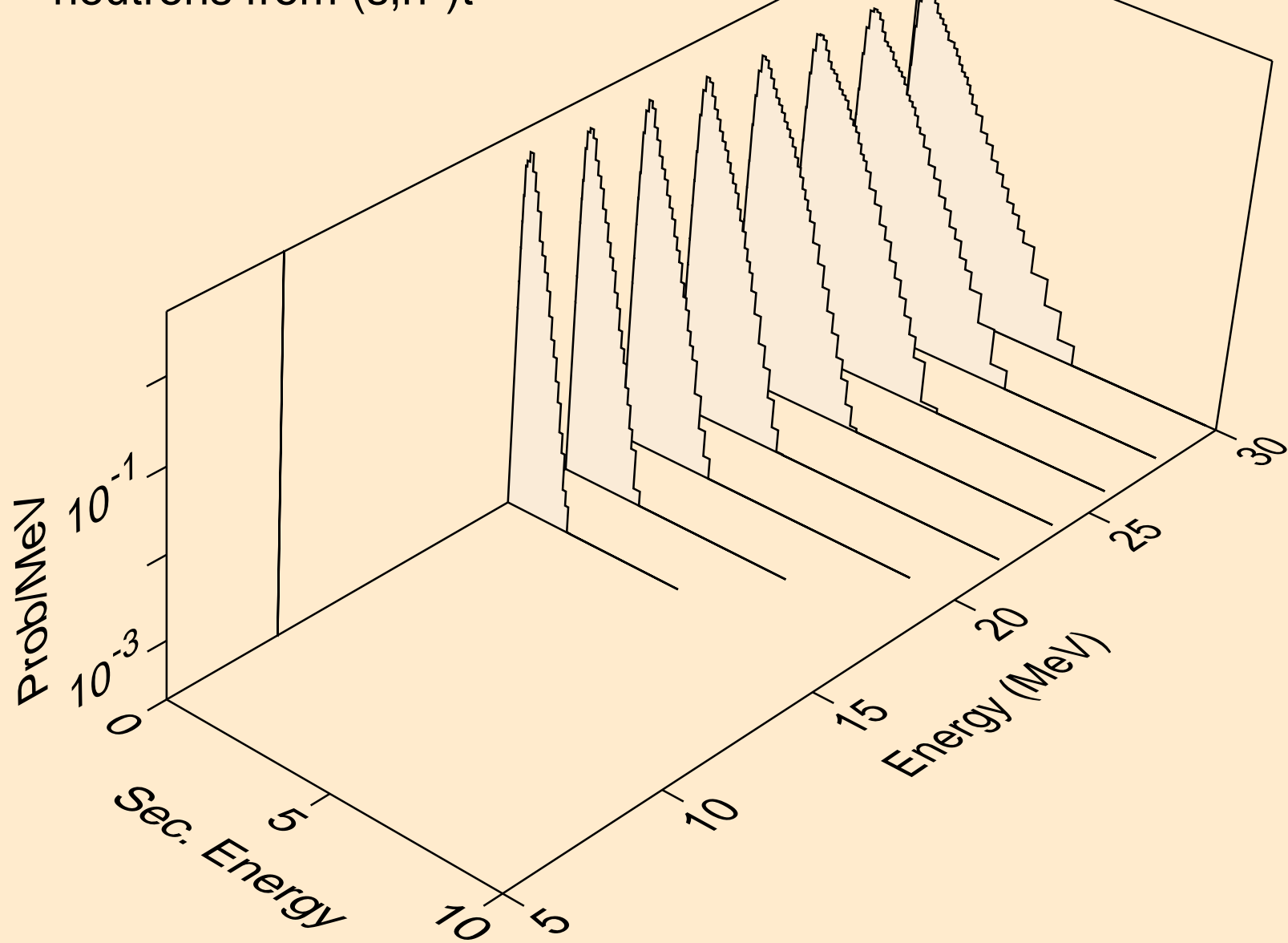

RF266 HELION ACER TENDL-2021 LIBRARY; T=0.K  
neutrons from (s,2np)

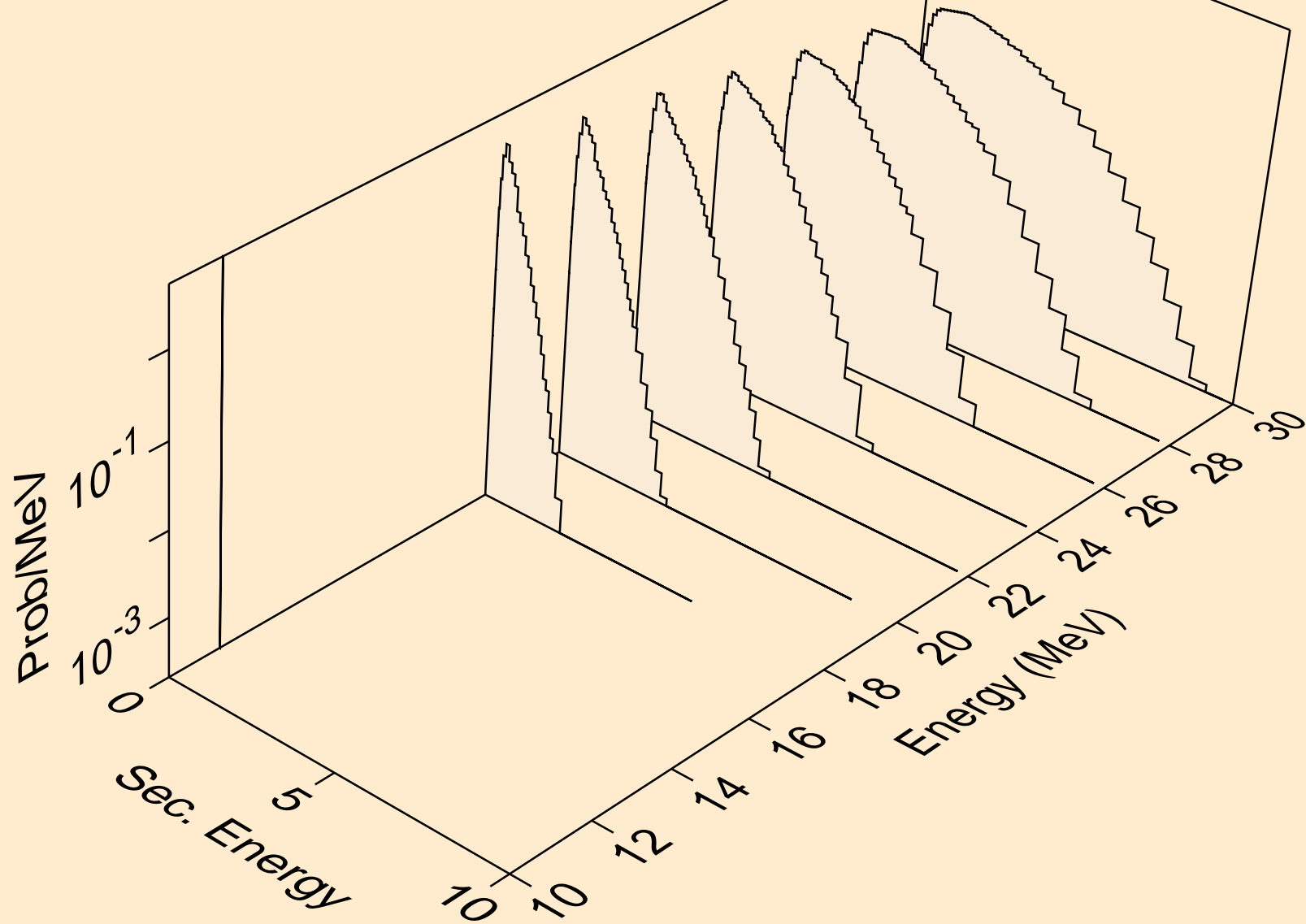

RF266 HELION ACER TENDL-2021 LIBRARY; T=0.K  
protons from (s,x)

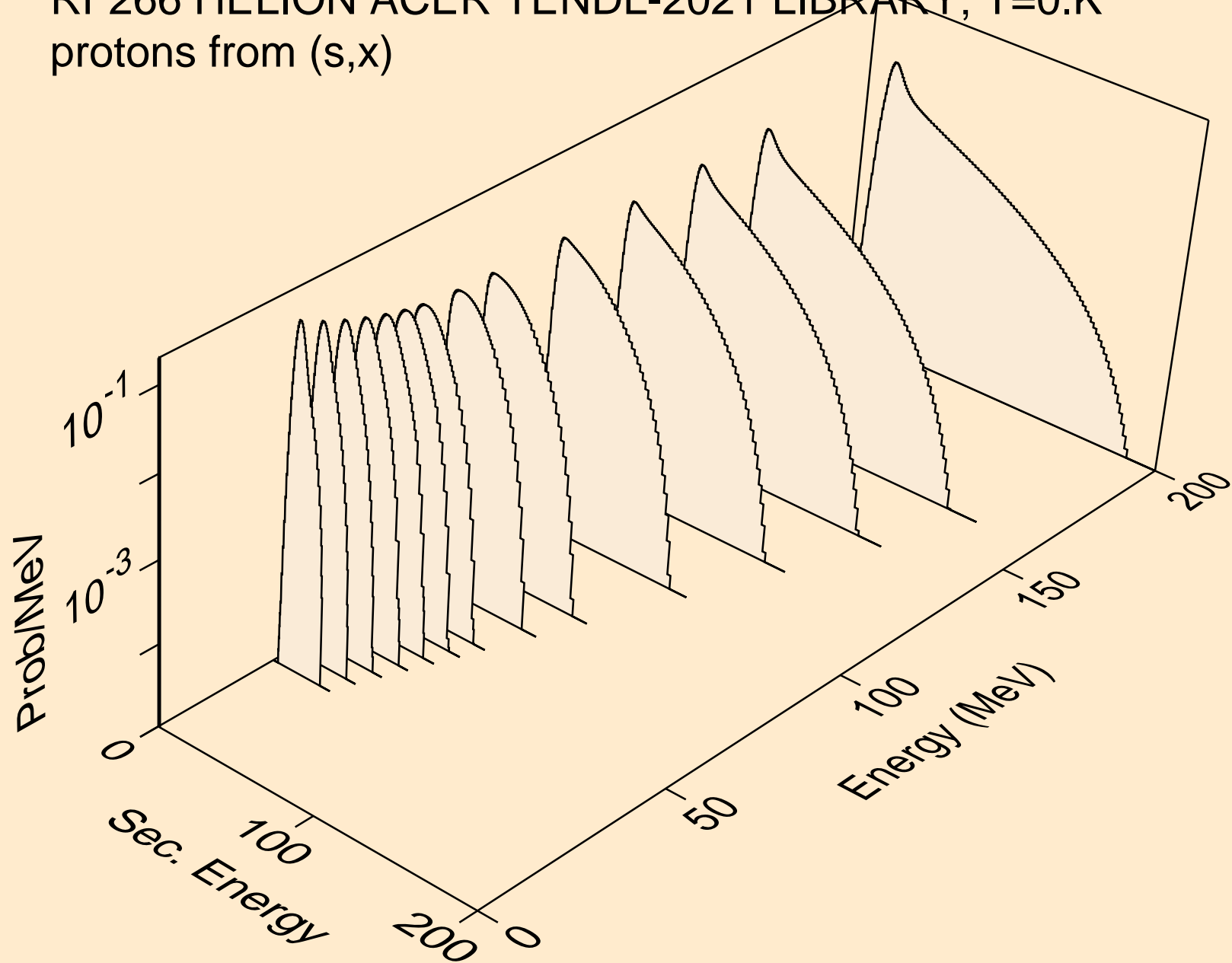

RF266 HELION ACER TENDL-2021 LIBRARY; T=0.K  
protons from (s,n\*)p

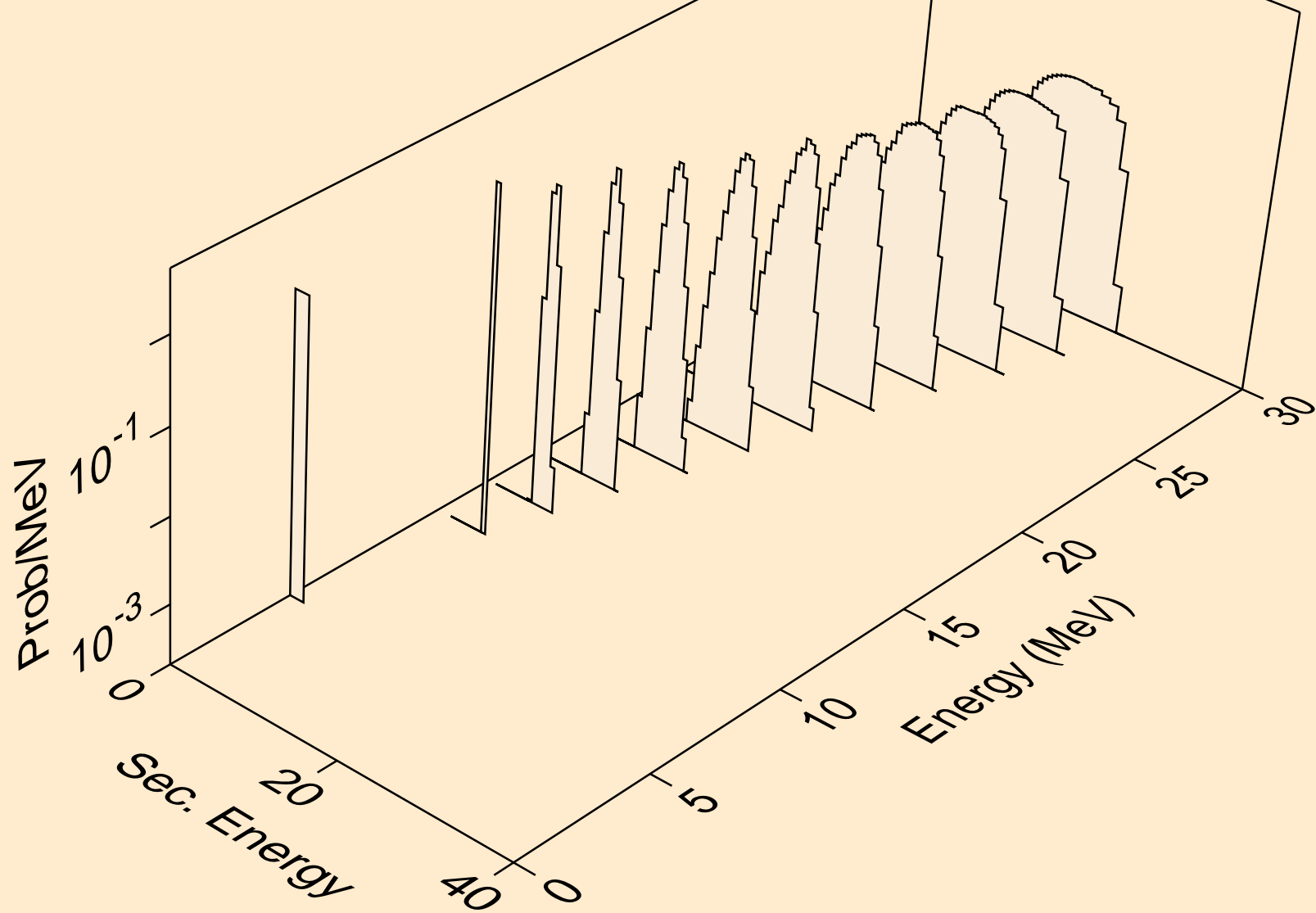

RF266 HELION ACER TENDL-2021 LIBRARY; T=0.K  
protons from (s,2np)

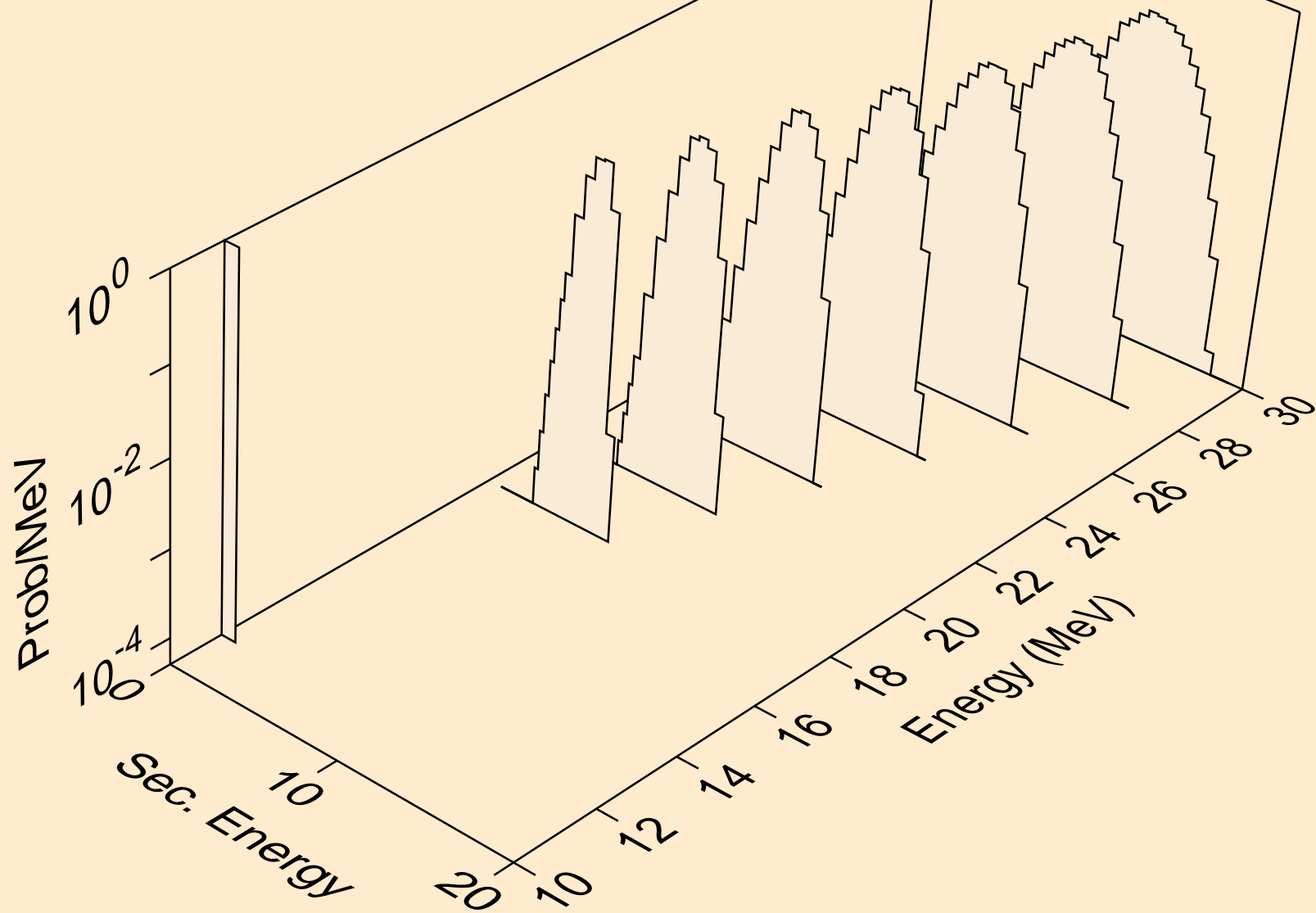

RF266 HELION ACER TENDL-2021 LIBRARY; T=0.K  
protons from (s,p)

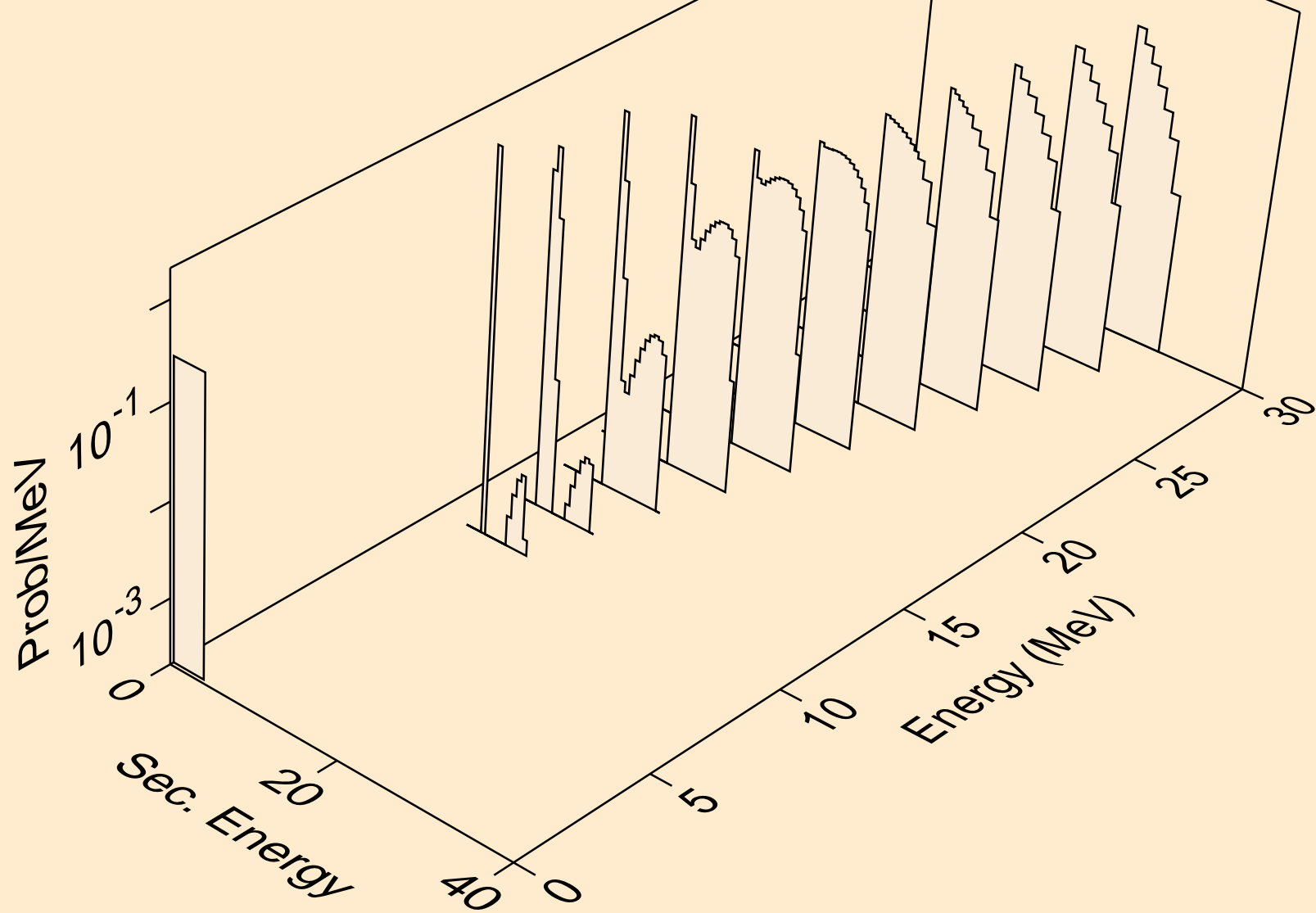

RF266 HELION ACER TENDL-2021 LIBRARY; T=0.K  
deuterons from (s,x)

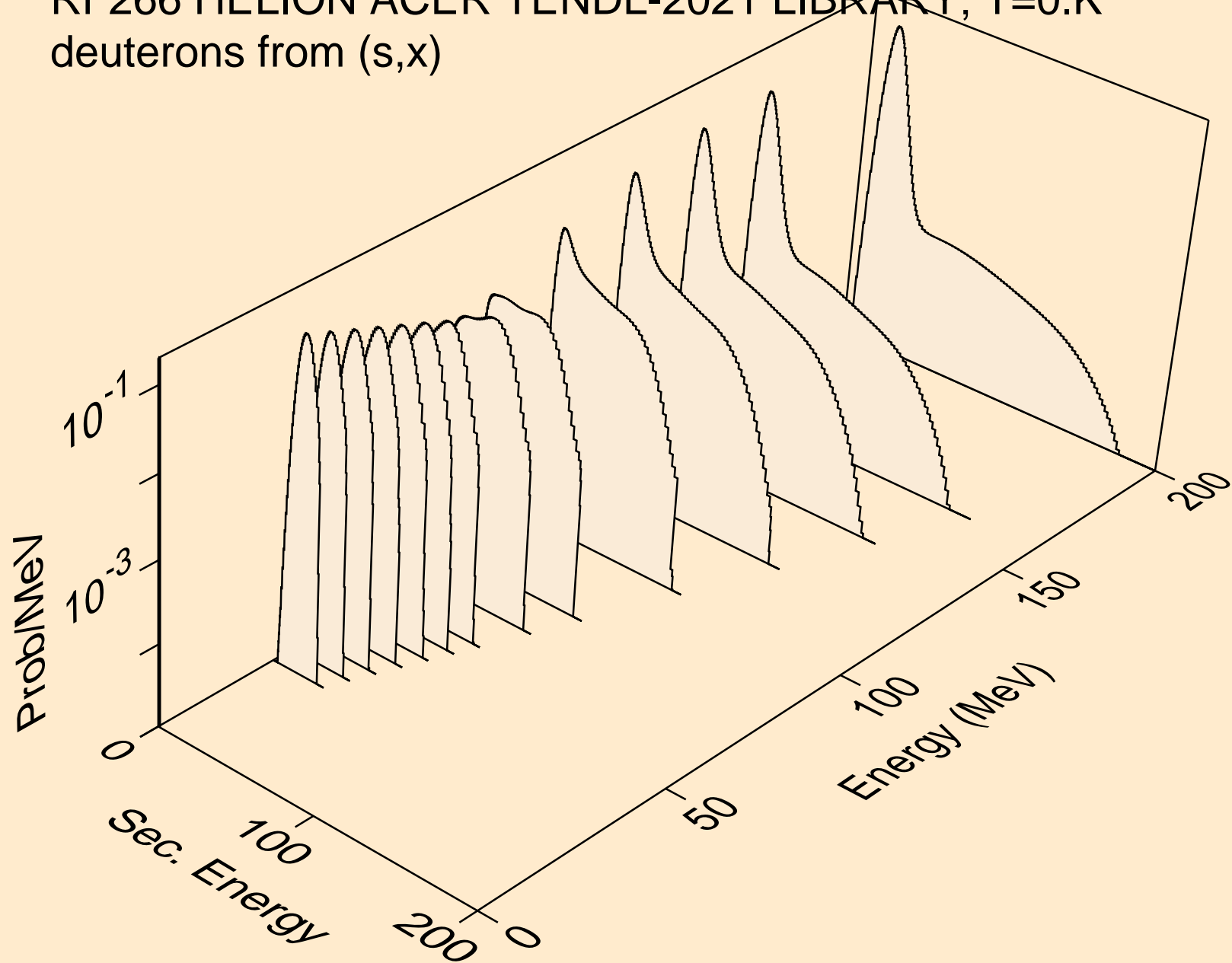



RF266 HELION ACER TENDL-2021 LIBRARY; T=0.K  
deuterons from (s,n\*)d

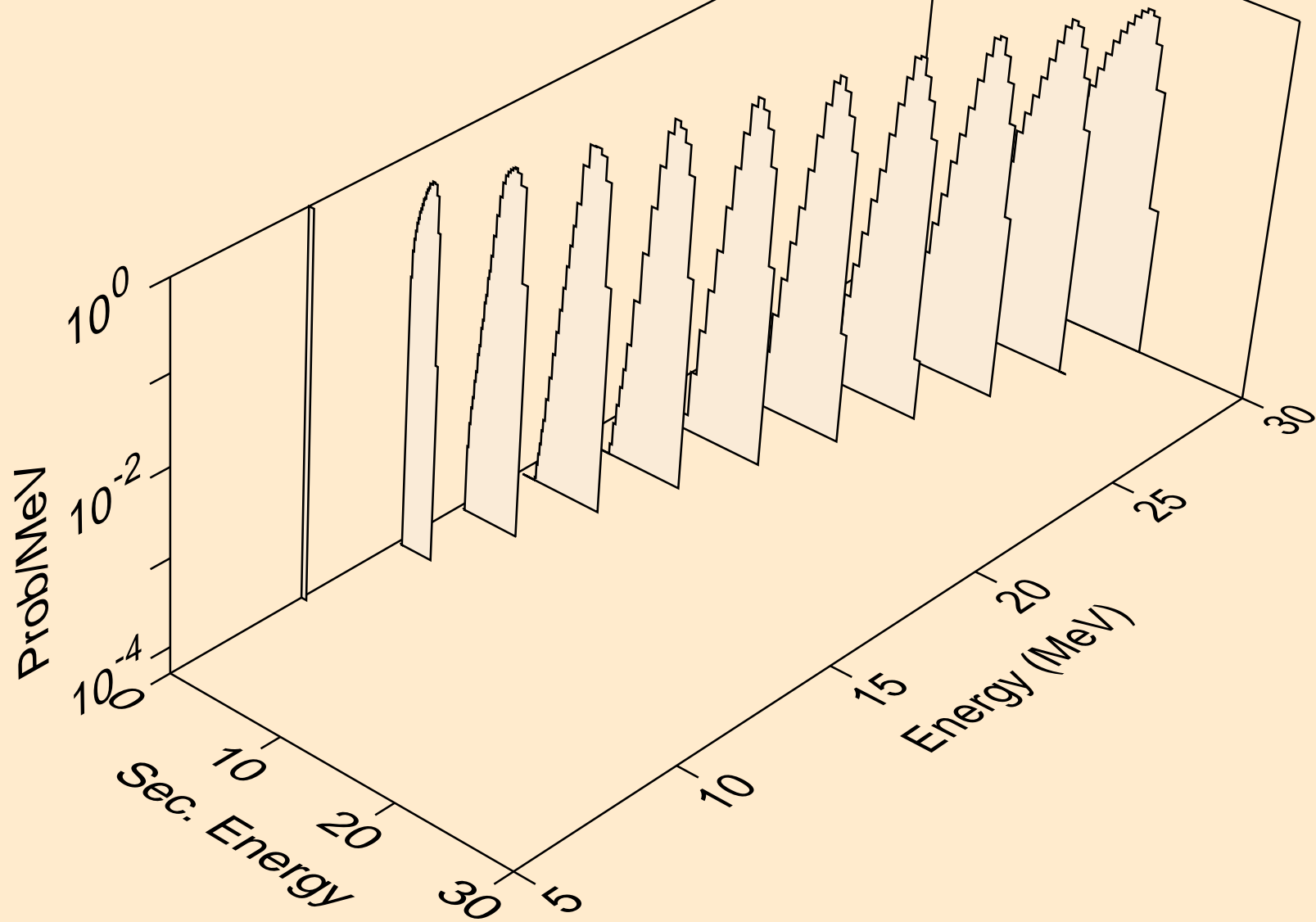

RF266 HELION ACER TENDL-2021 LIBRARY; T=0.K  
deuterons from (s,d)

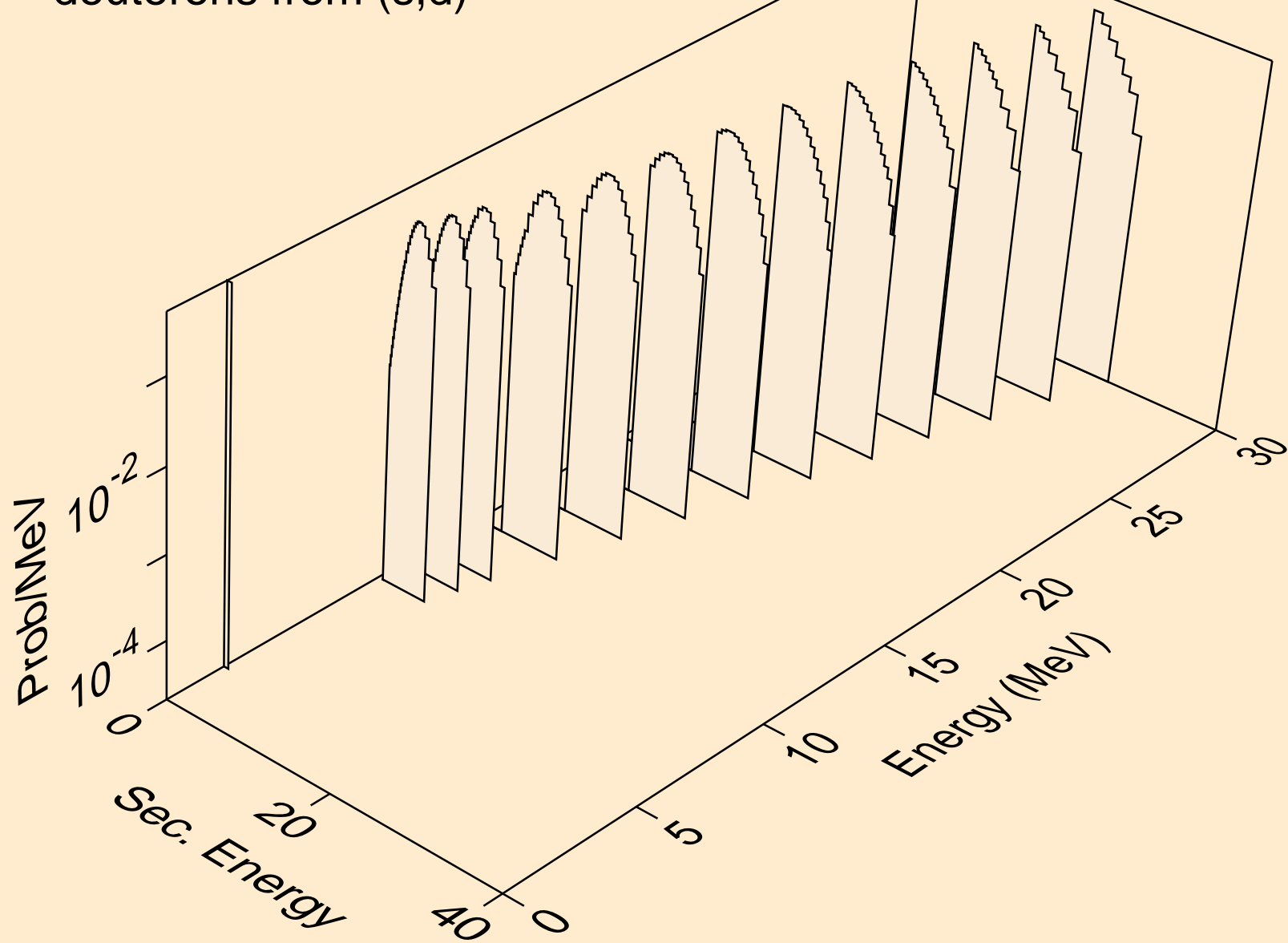

RF266 HELION ACER TENDL-2021 LIBRARY; T=0.K  
tritons from (s,x)

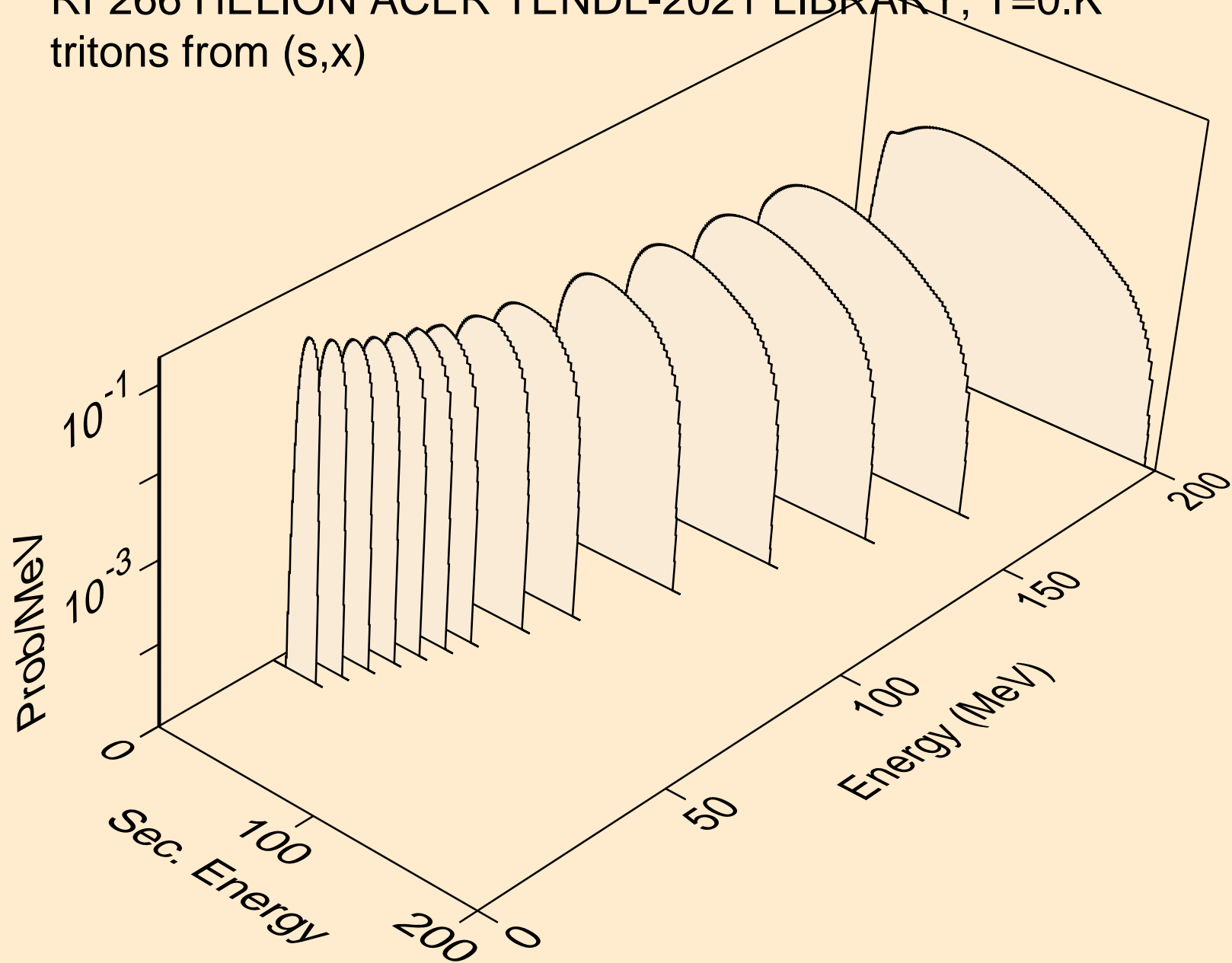

RF266 HELION ACER TENDL-2021 LIBRARY; T=0.K  
tritons from (s,n\*)t

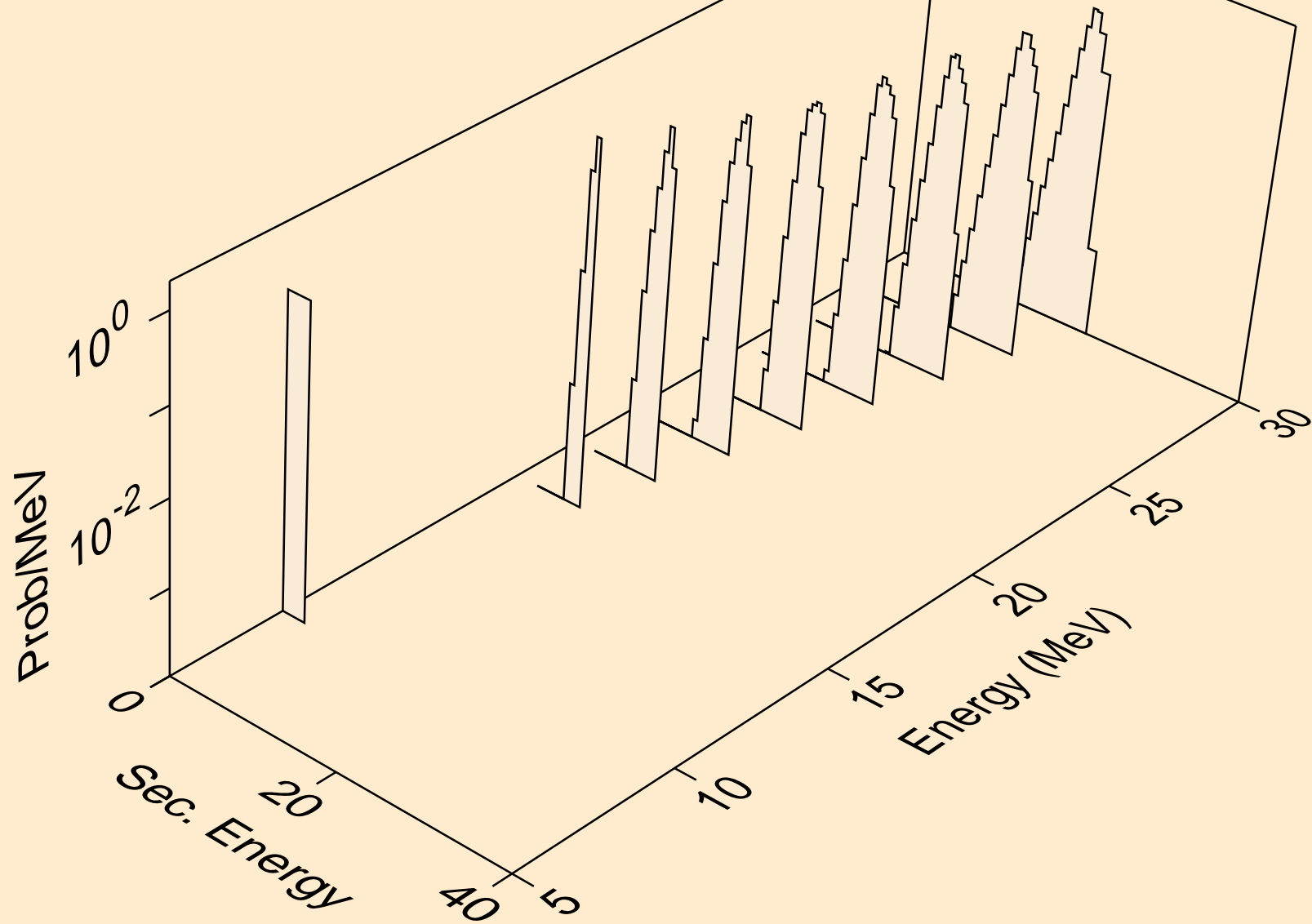

RF266 HELION ACER TENDL-2021 LIBRARY; T=0.K  
tritons from (s,t)

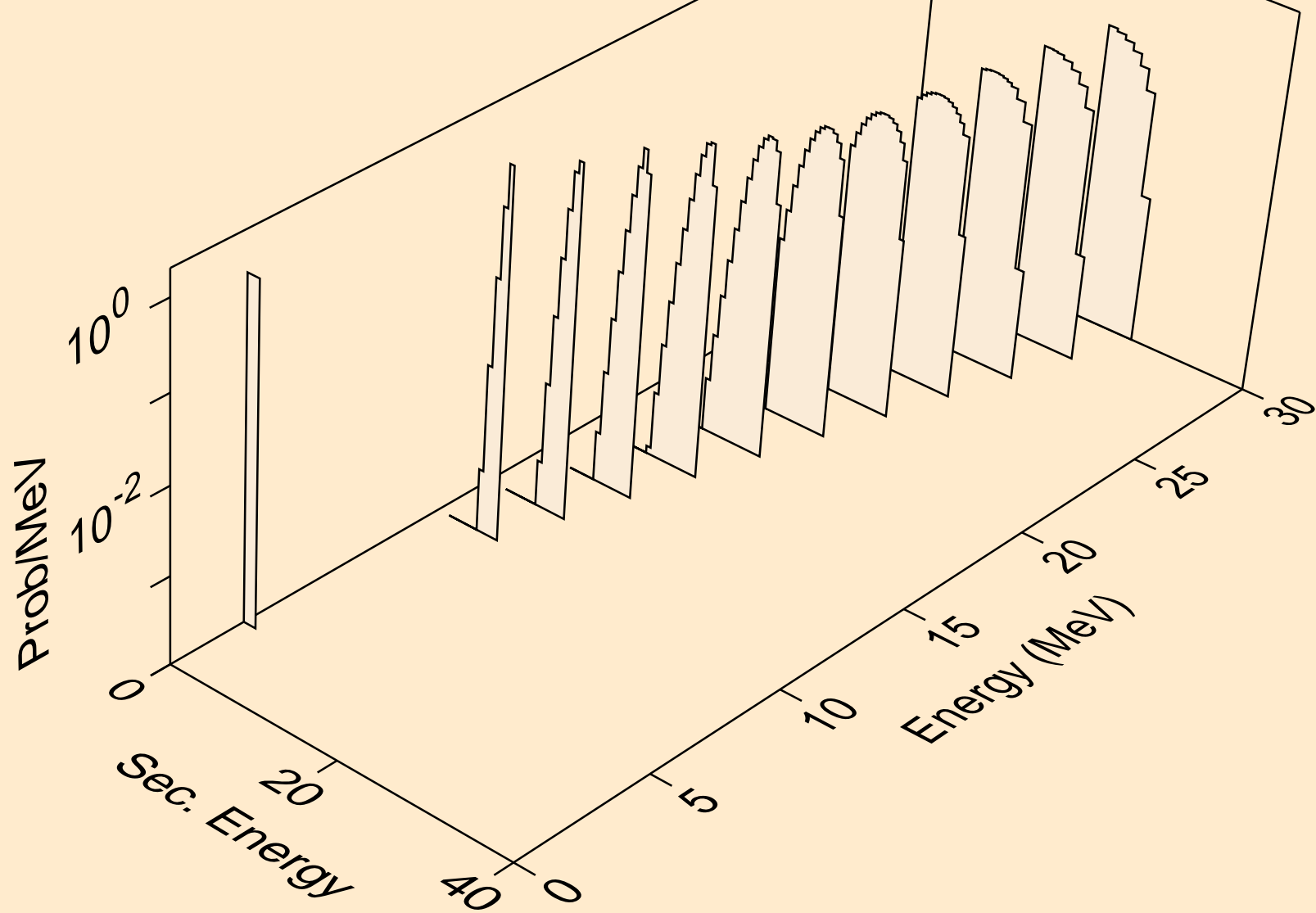

RF266 HELION ACER TENDL-2021 LIBRARY; T=0.K  
alphas from (s,x)

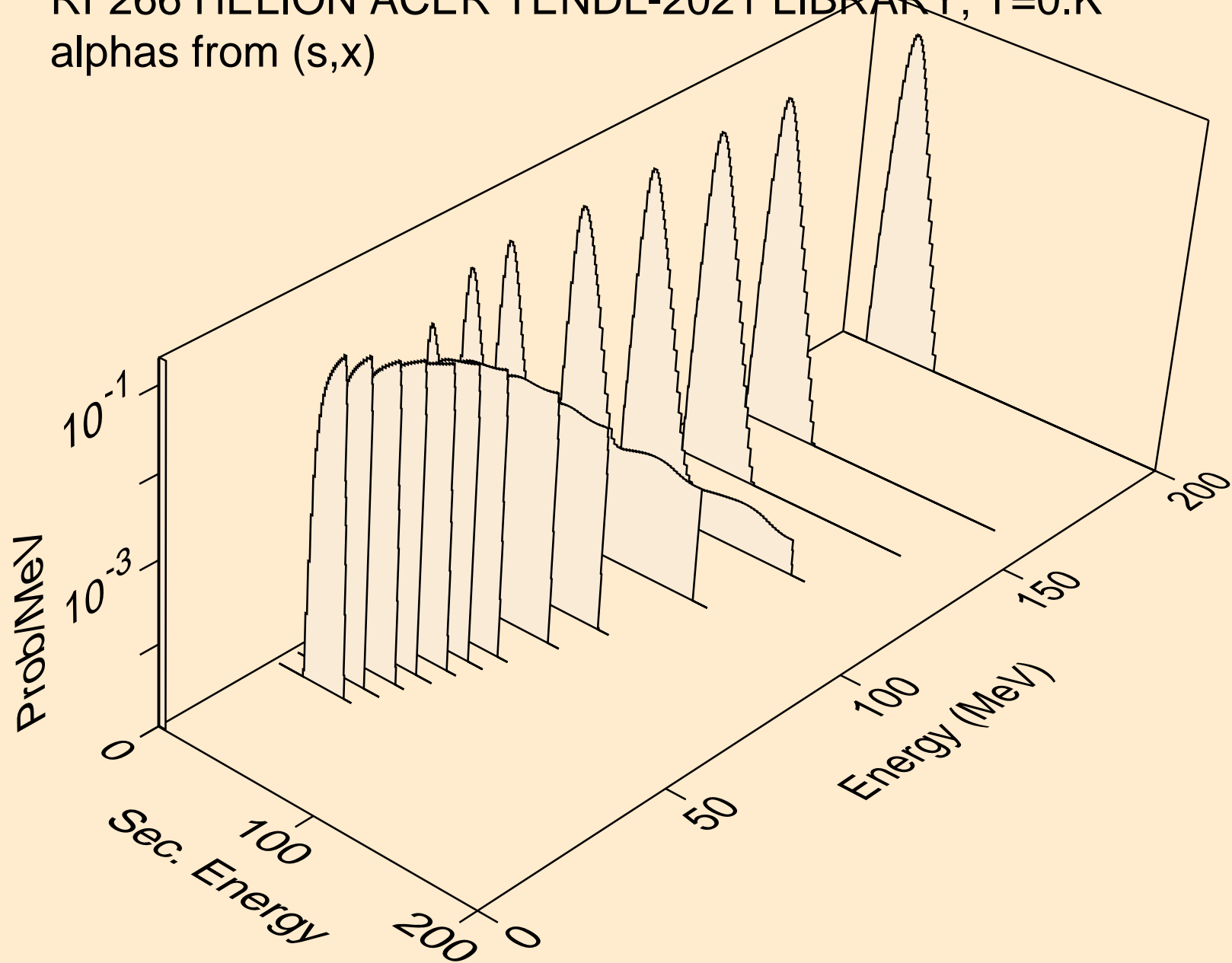

RF266 HELION ACER TENDL-2021 LIBRARY; T=0.K  
alphas from (s,a)

