

RF267 HELION ACER TENDL-2021 LIBRARY; T=0.K
Principal cross sections

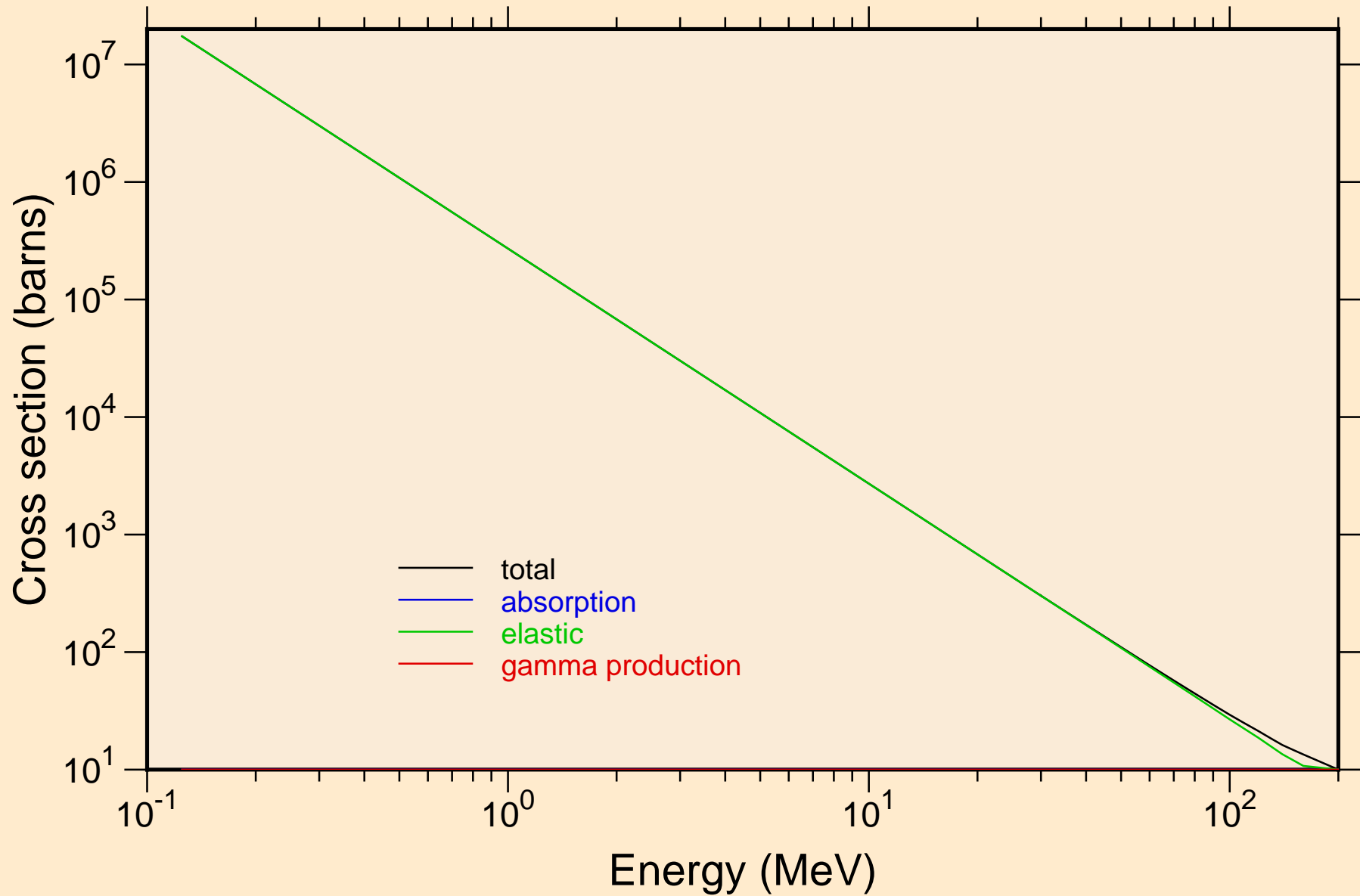

RF267 HELION ACER TENDL-2021 LIBRARY; T=0.K

Heating

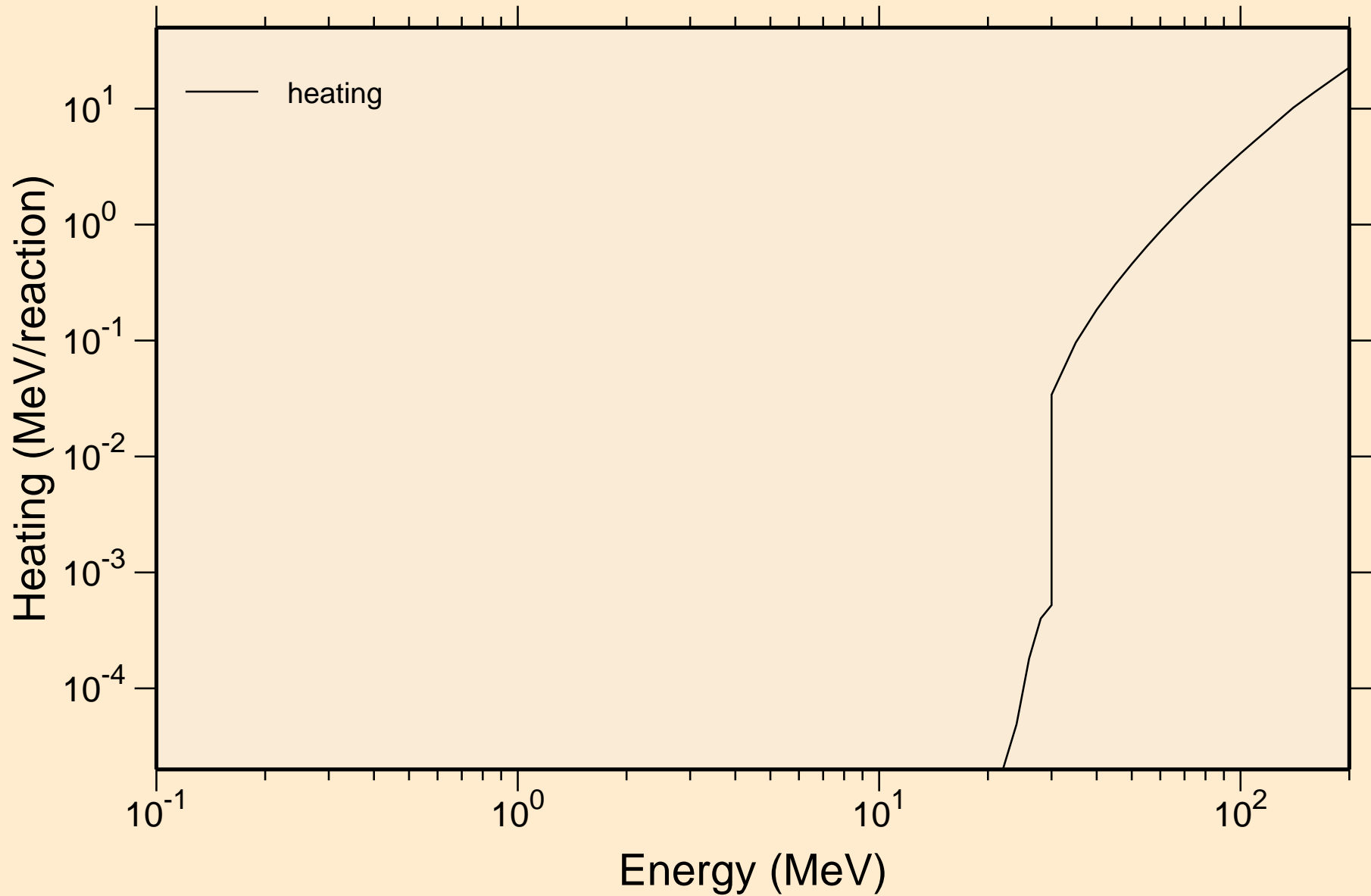

RF267 HELION ACER TENDL-2021 LIBRARY; T=0.K

Principal cross sections

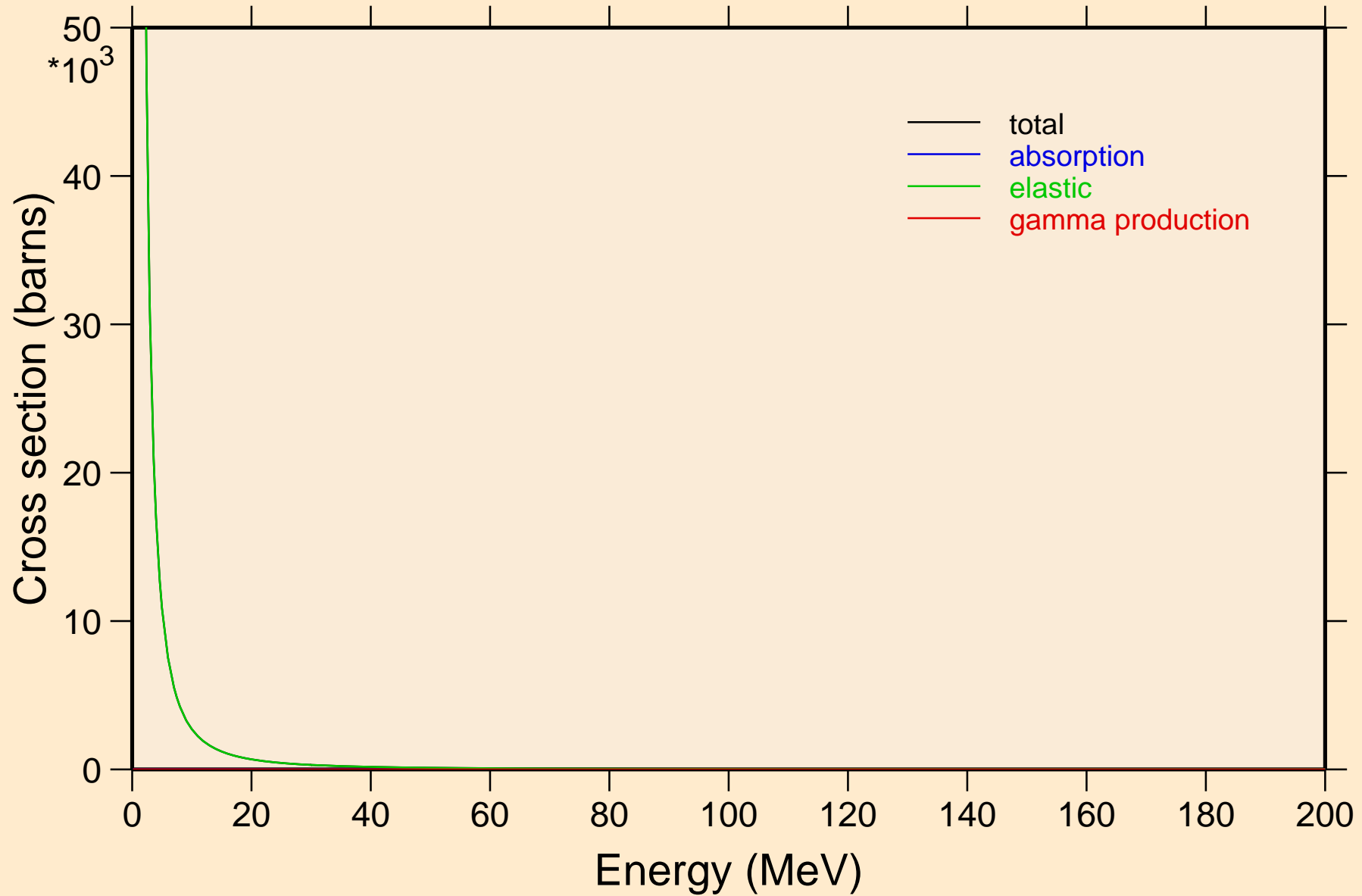

RF267 HELION ACER TENDL-2021 LIBRARY; T=0.K

Heating

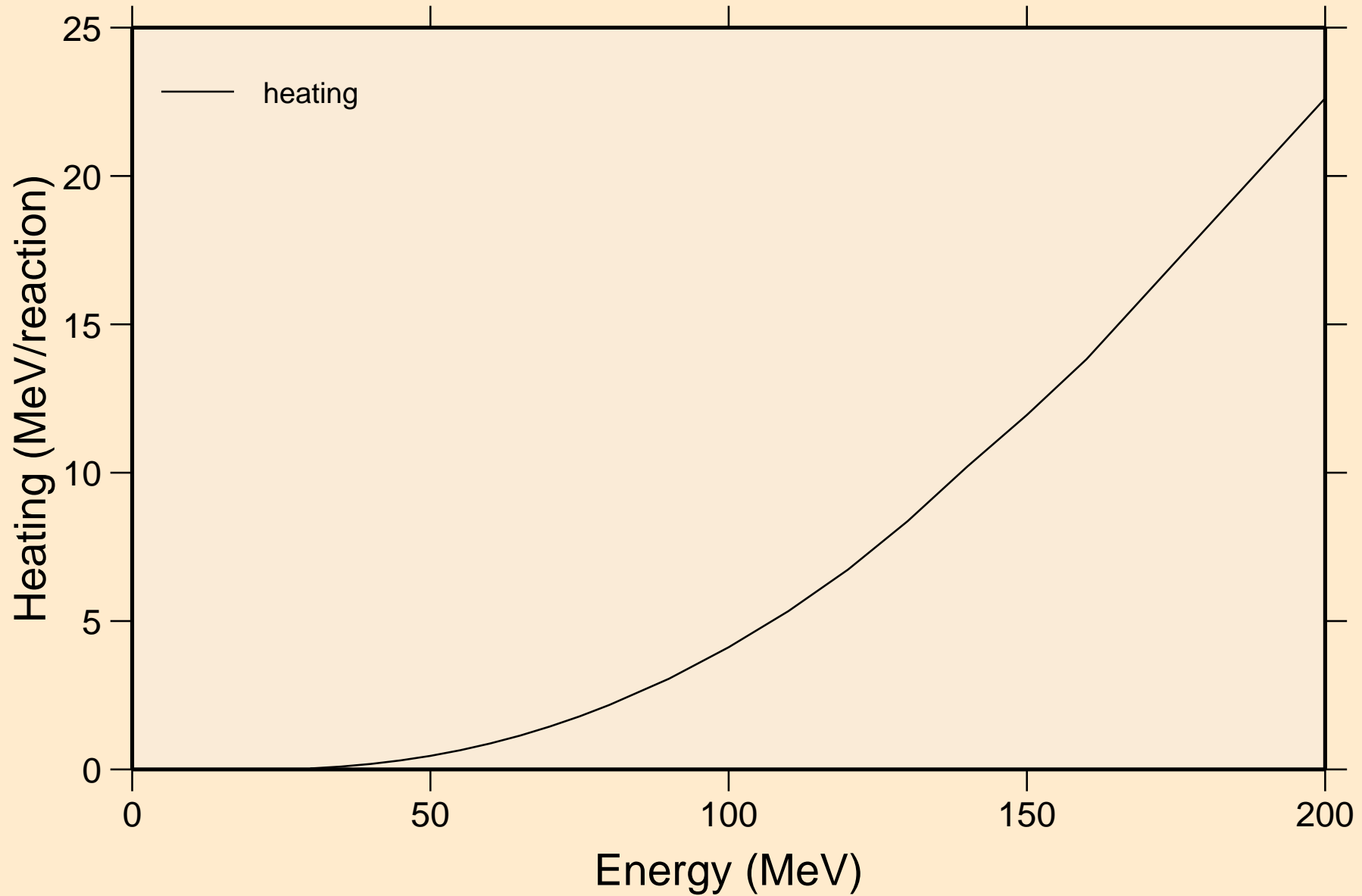

RF267 HELION ACER TENDL-2021 LIBRARY; T=0.K
Threshold reactions

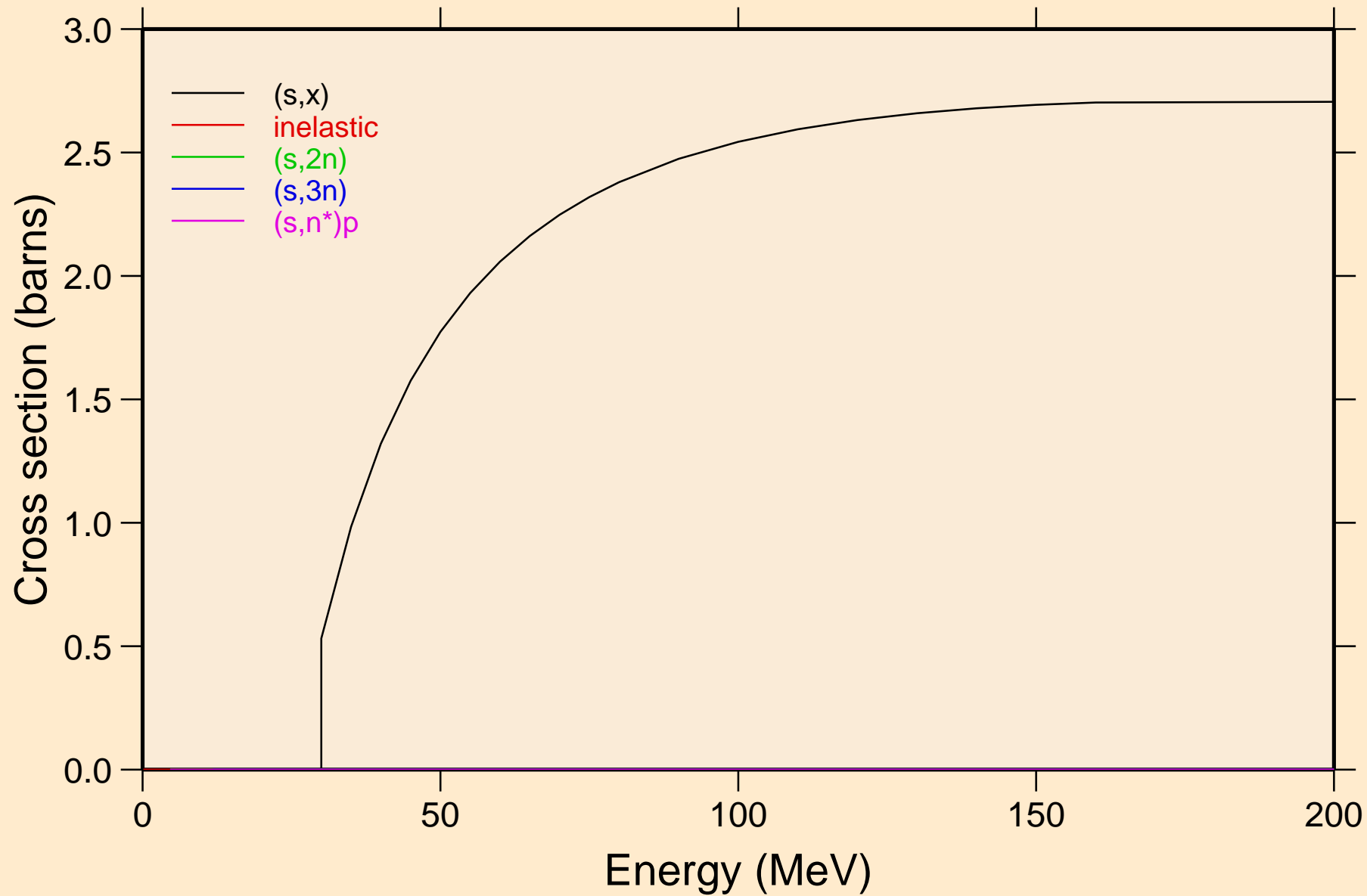

RF267 HELION ACER TENDL-2021 LIBRARY; T=0.K
Threshold reactions

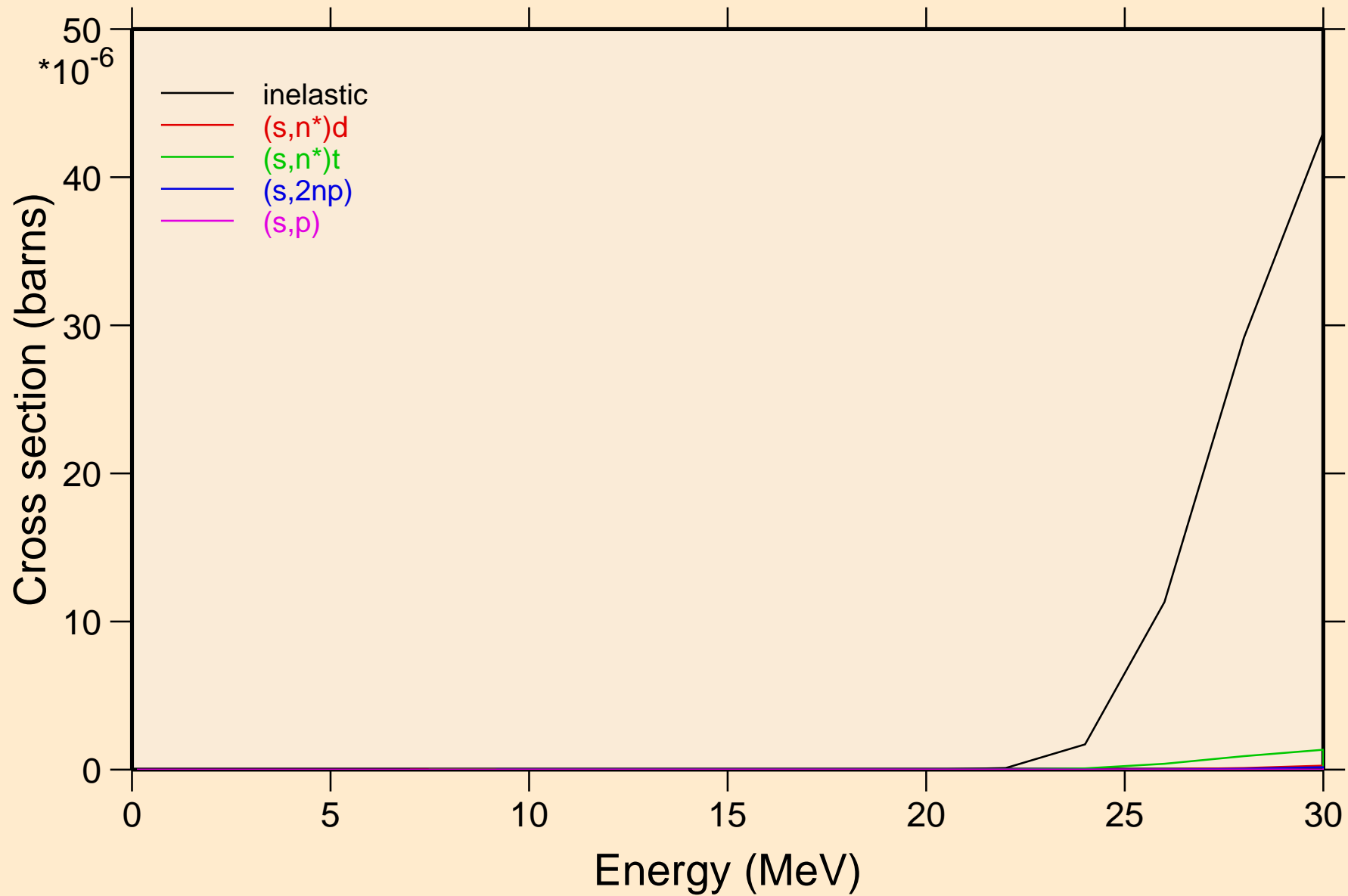

RF267 HELION ACER TENDL-2021 LIBRARY; T=0.K
Threshold reactions

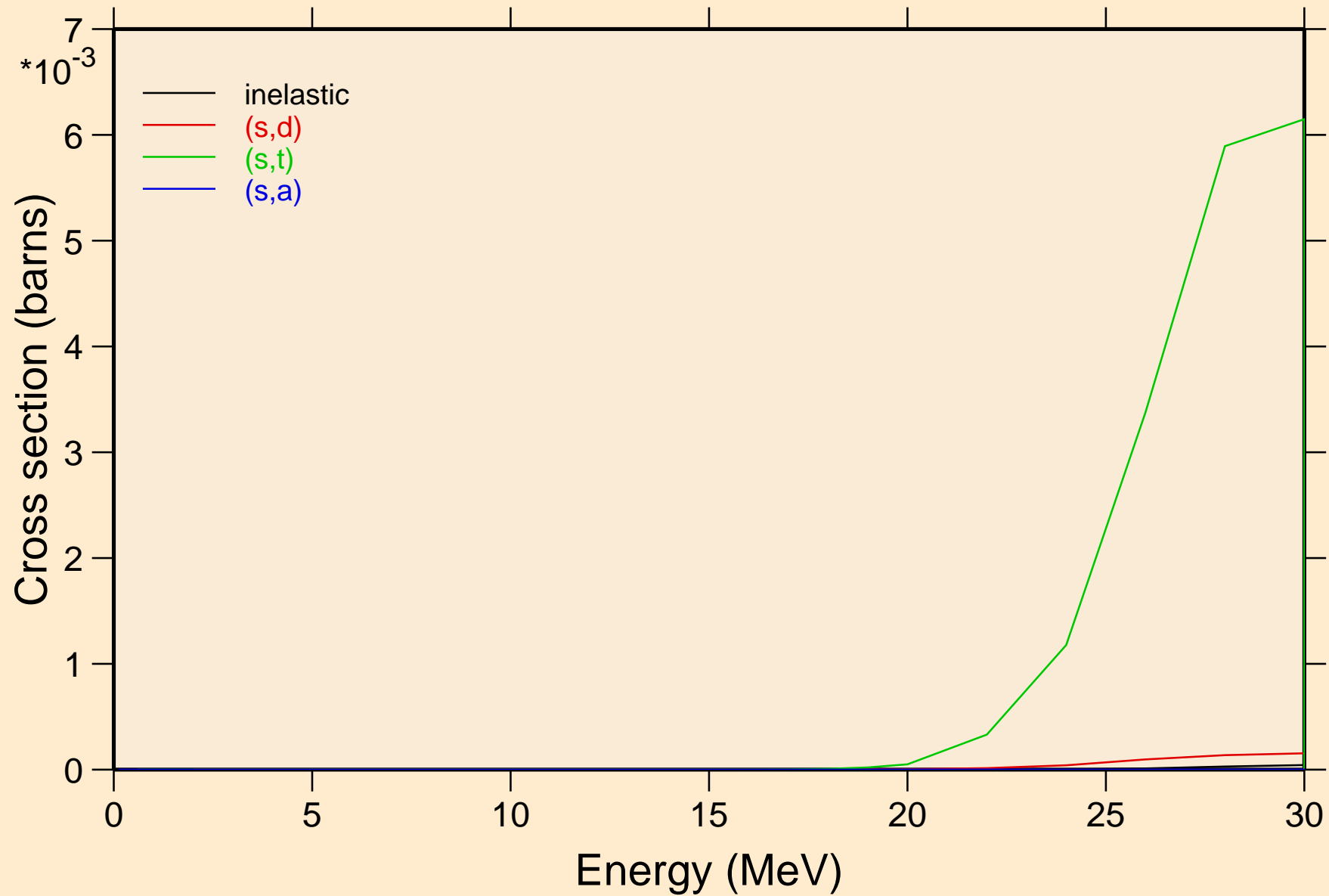

RF267 HELION ACER TENDL-2021 LIBRARY; T=0.K
angular distribution for elastic

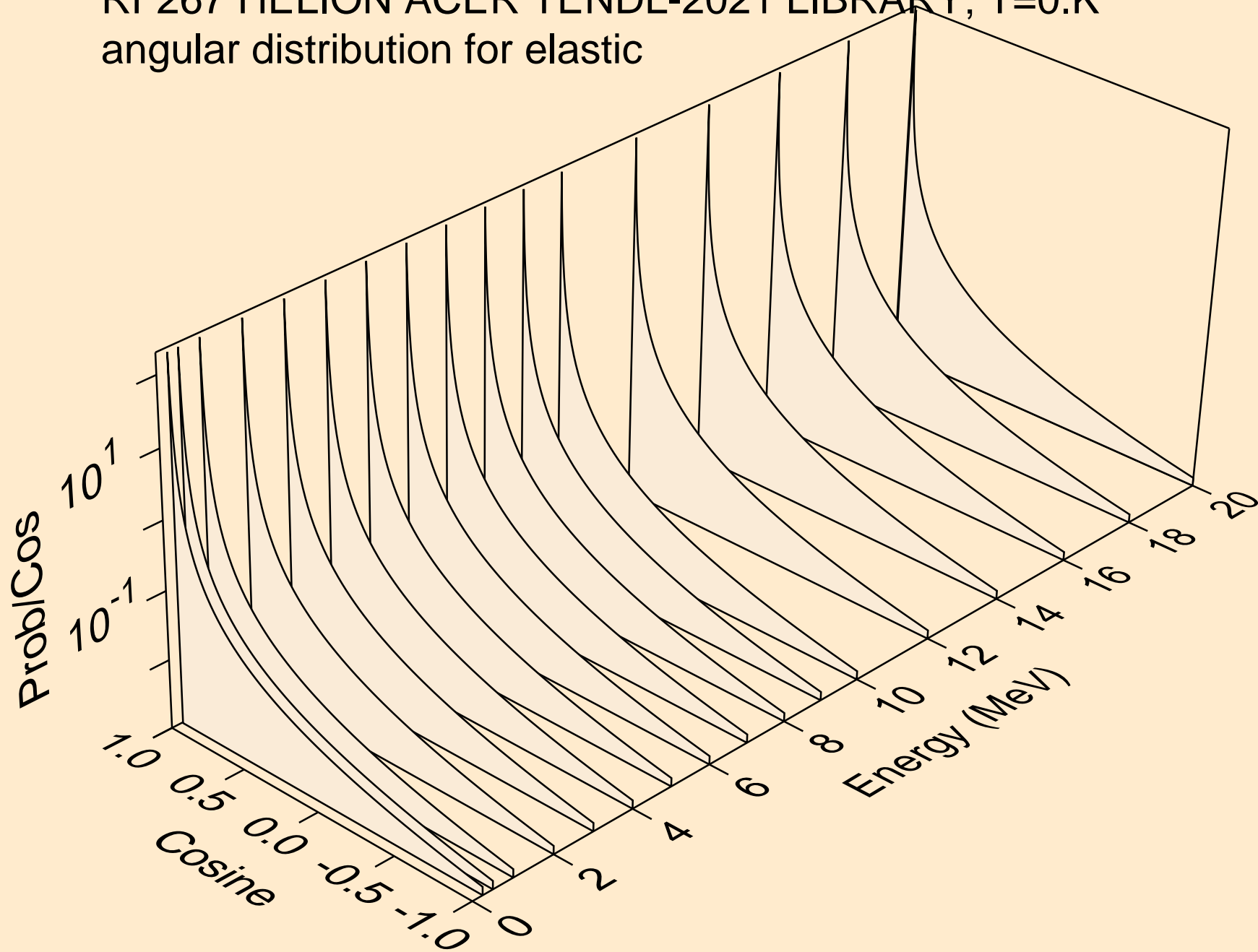

RF267 HELION ACER TENDL-2021 LIBRARY; T=0.K
angular distribution for elastic

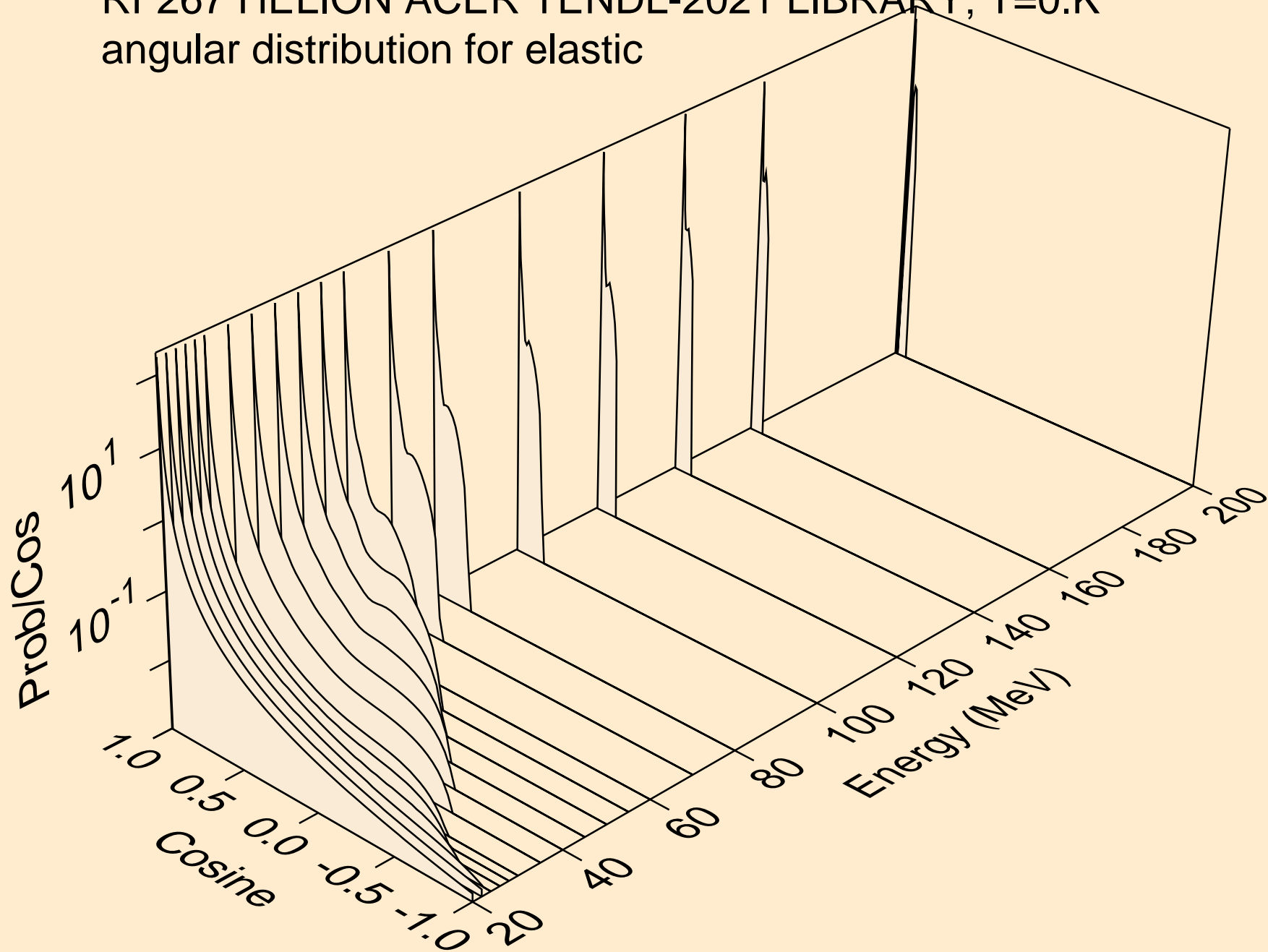

RF267 HELION ACER TENDL-2021 LIBRARY; T=0.K
He-3 emission for (s,x)

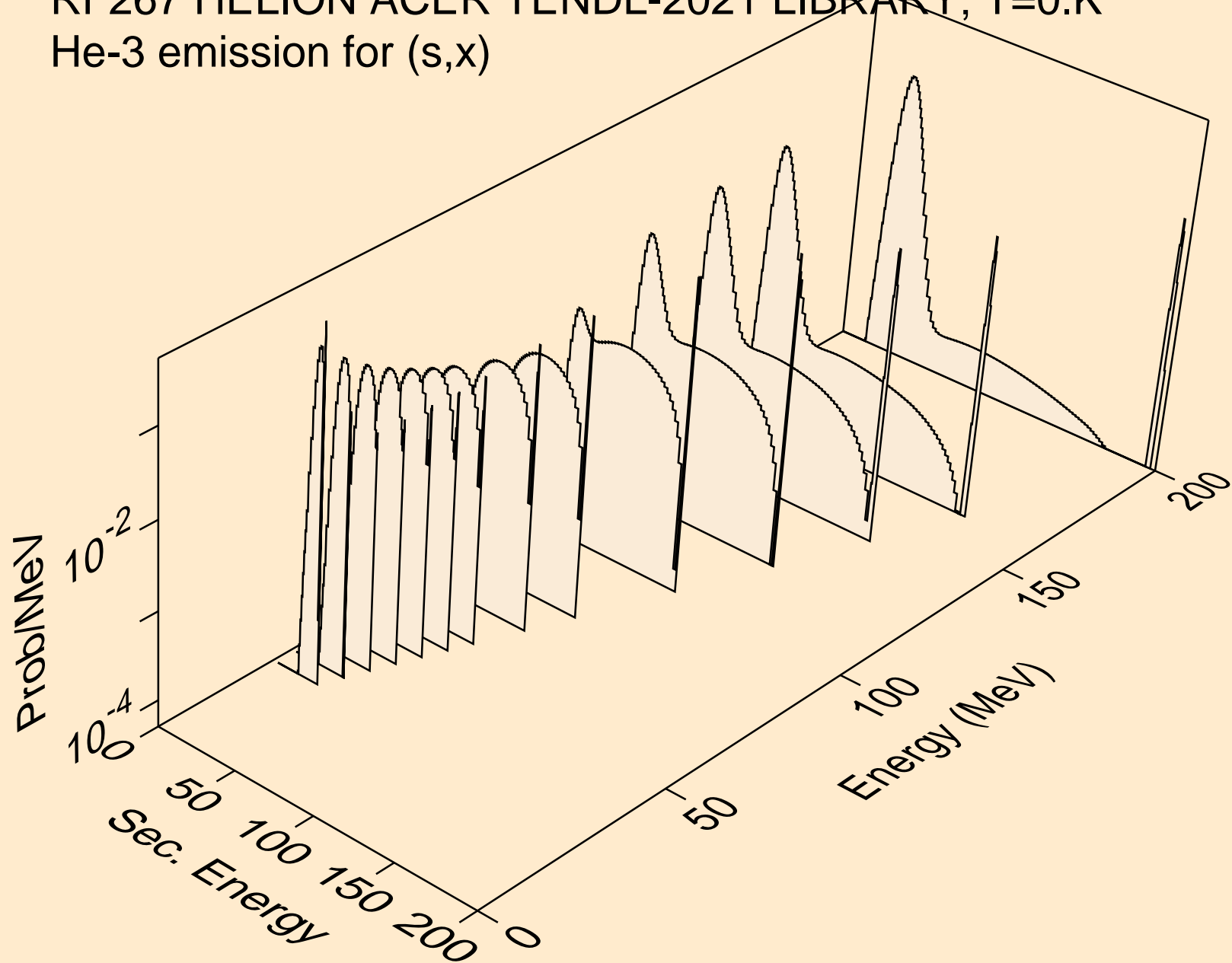

RF267 HELION ACER TENDL-2021 LIBRARY; T=0.K
He-3 emission for inelastic

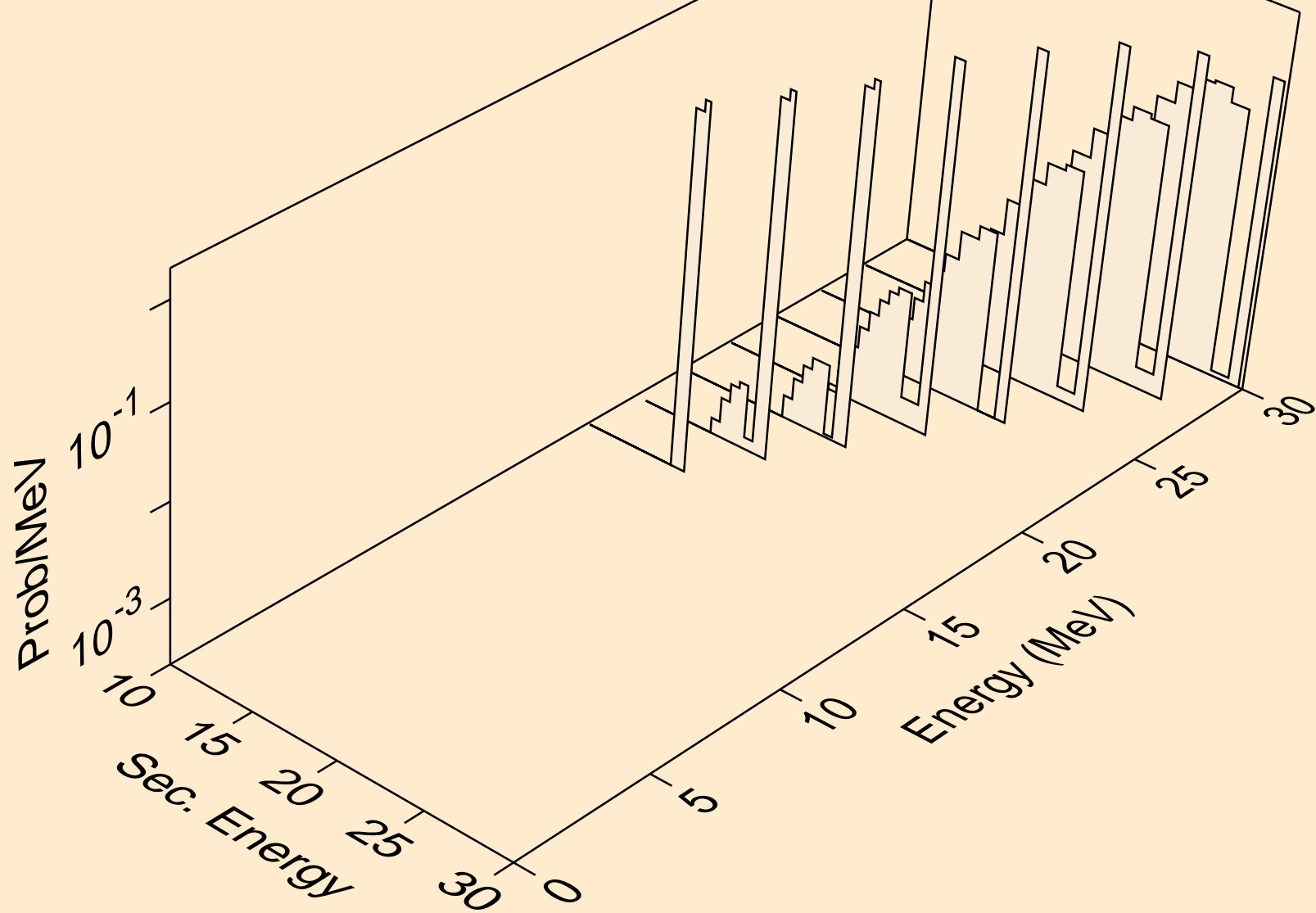

RF267 HELION ACER TENDL-2021 LIBRARY; T=0.K
Photon emission for (z,n)

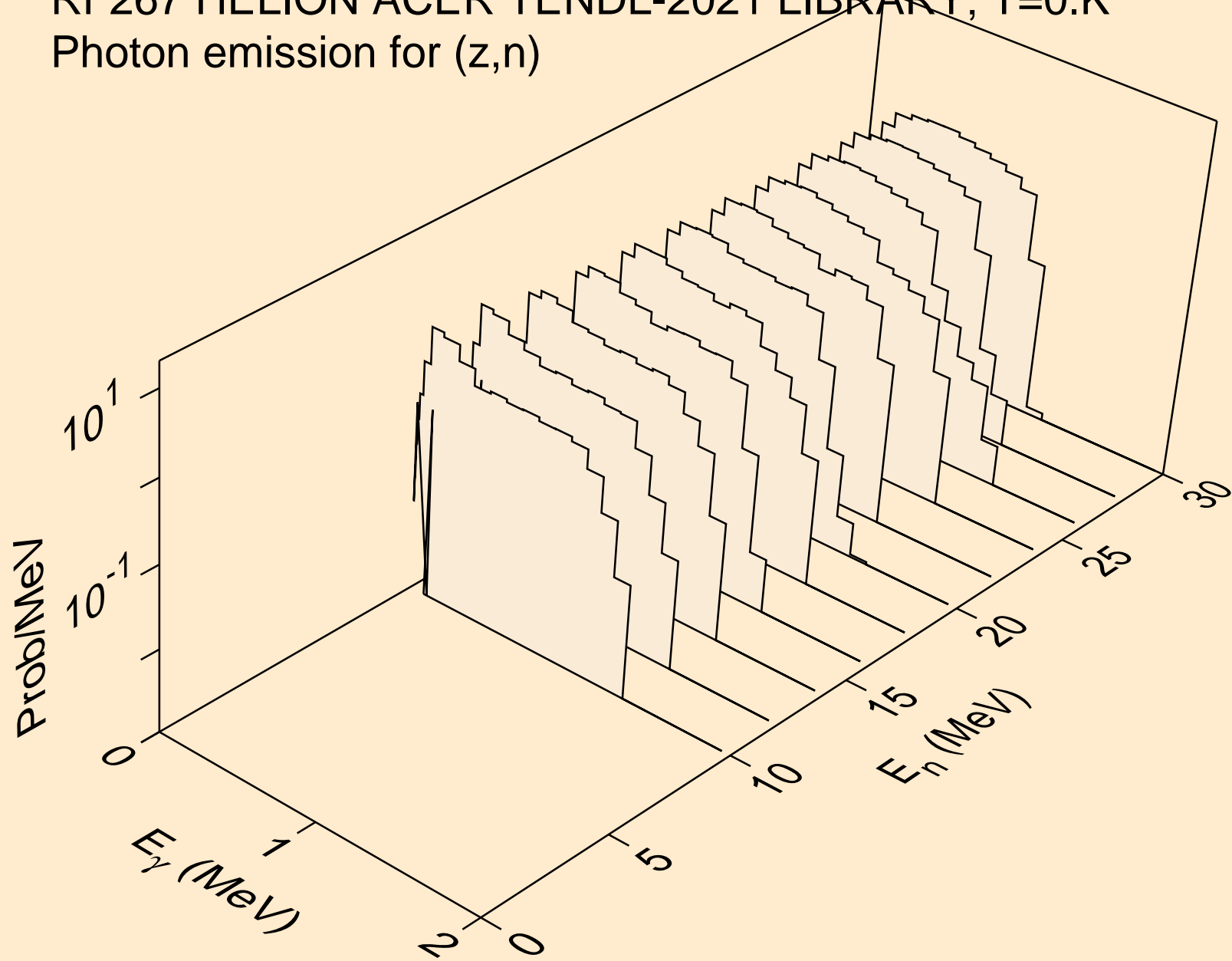

RF267 HELION ACER TENDL-2021 LIBRARY; T=0.K
Photon emission for (n,x)

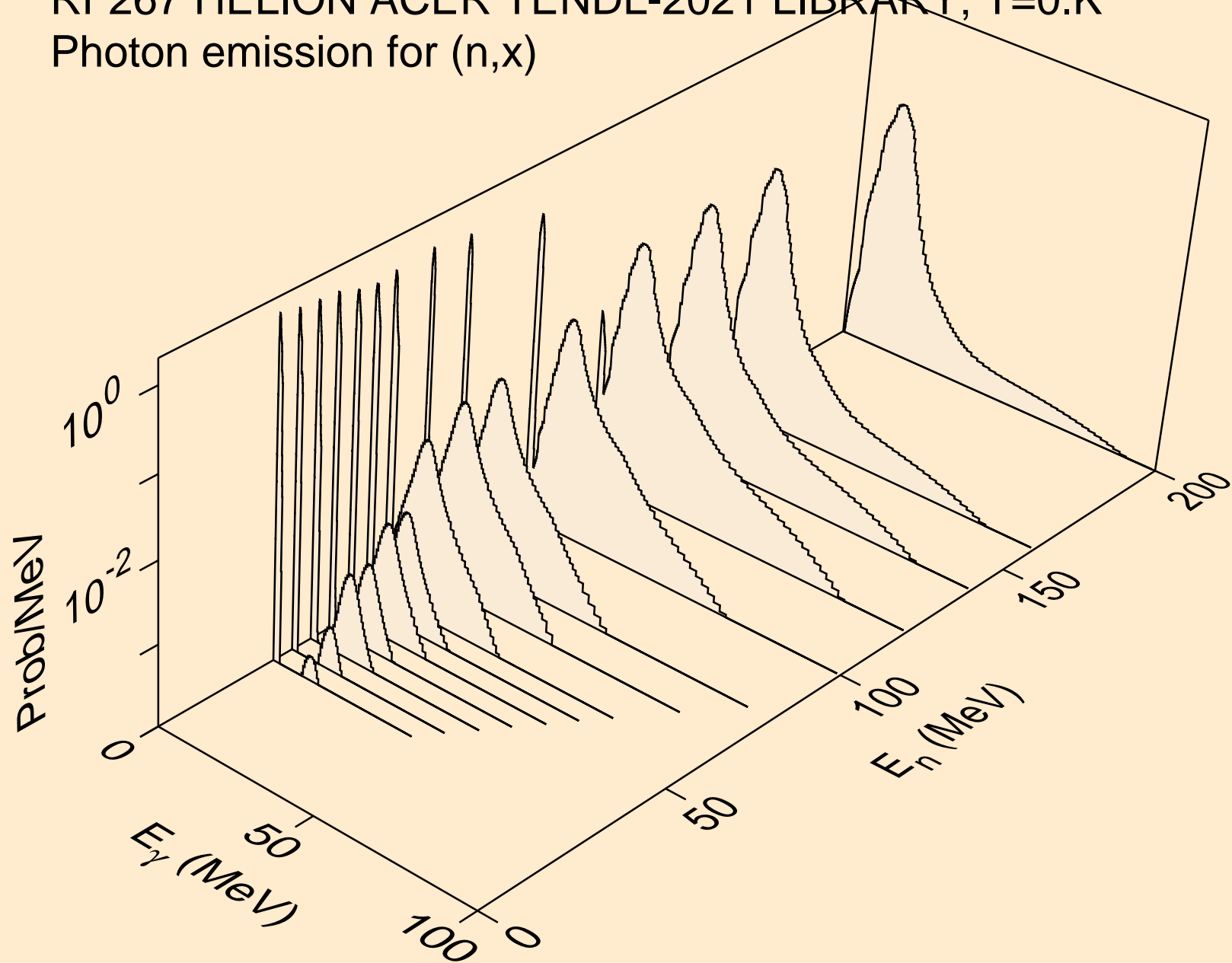

RF267 HELION ACER TENDL-2021 LIBRARY; T=0.K
Photon emission for (n,2n)

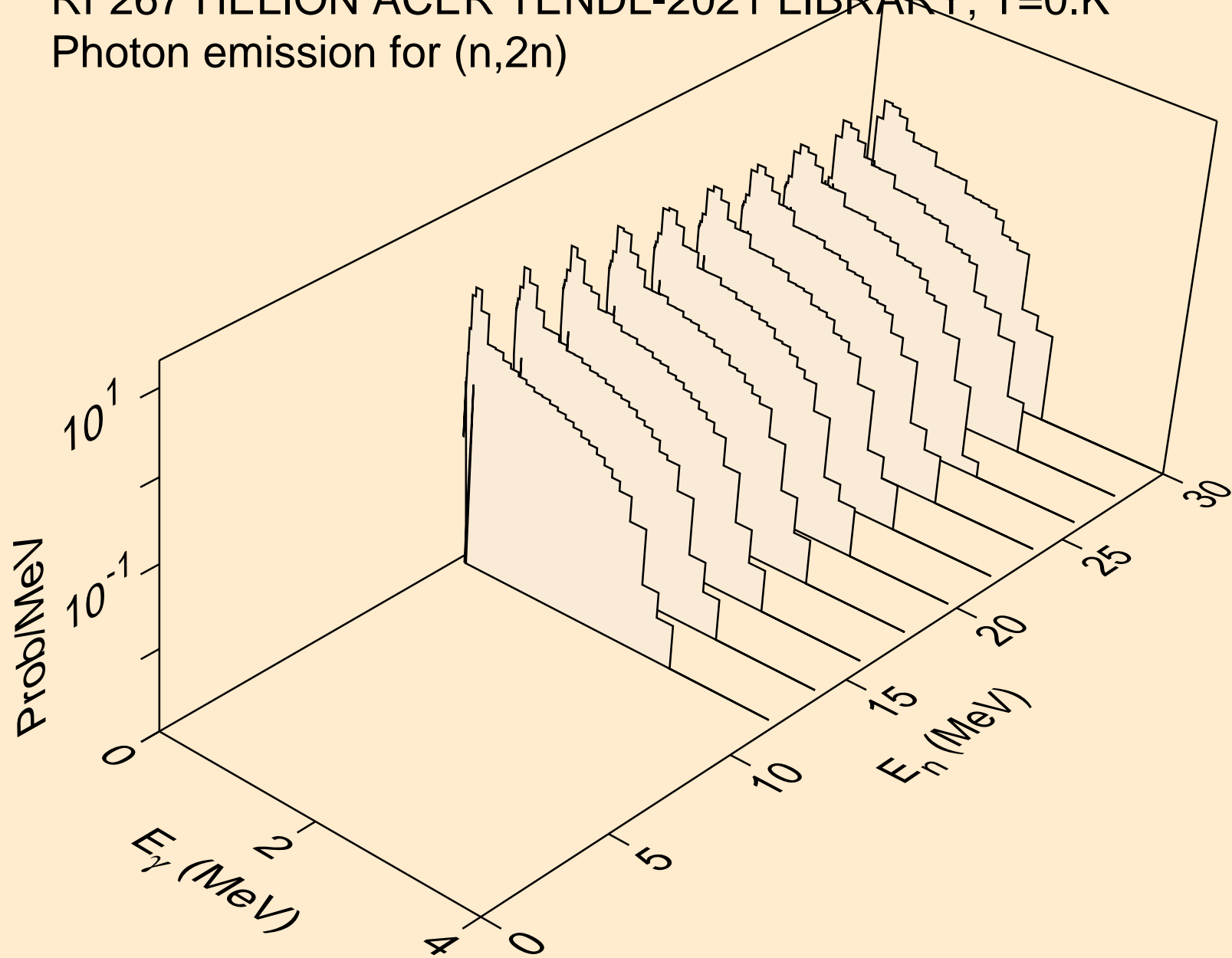

RF267 HELION ACER TENDL-2021 LIBRARY; T=0.K
Photon emission for (n,3n)

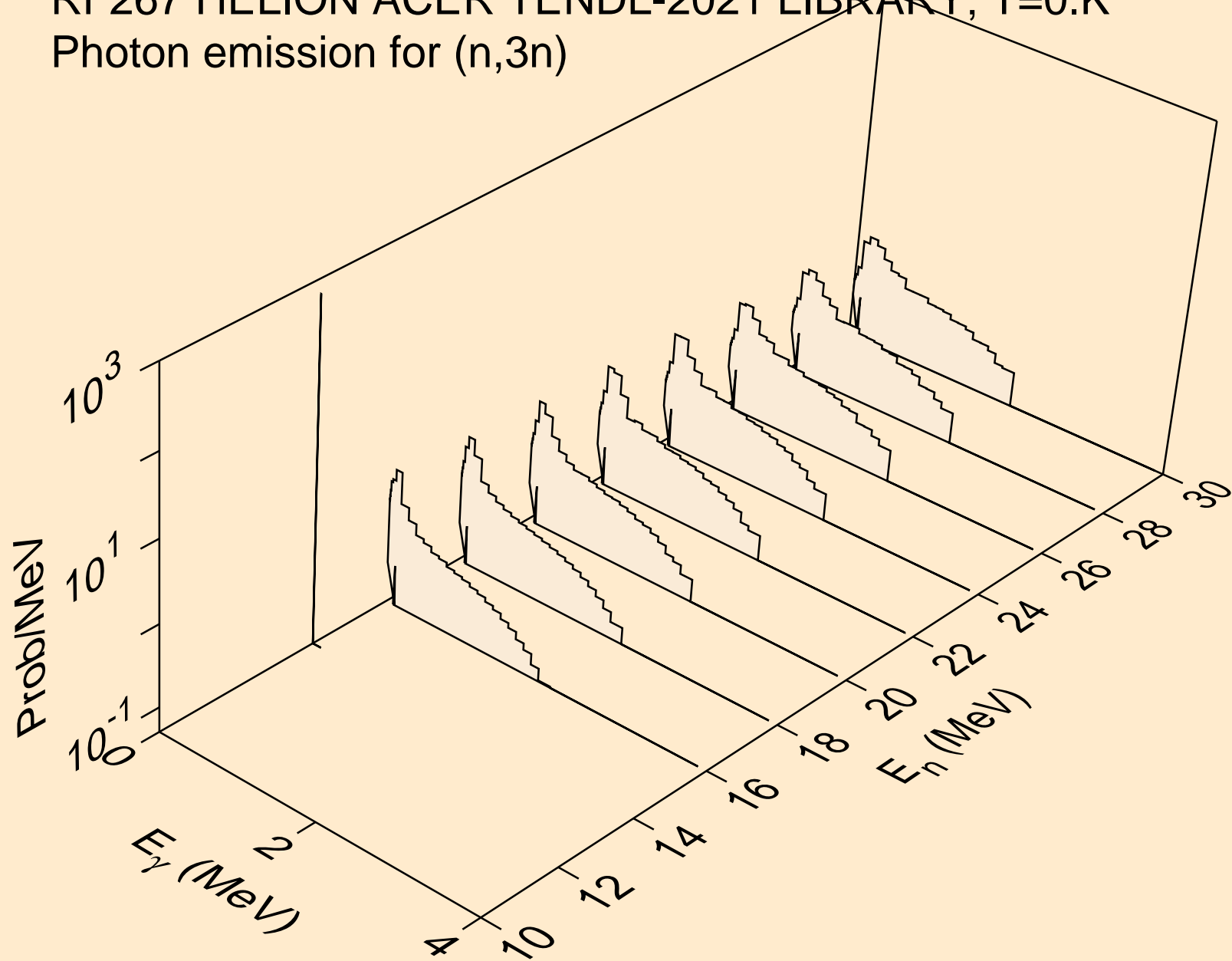

RF267 HELION ACER TENDL-2021 LIBRARY; T=0.K
Photon emission for (n,n*)p

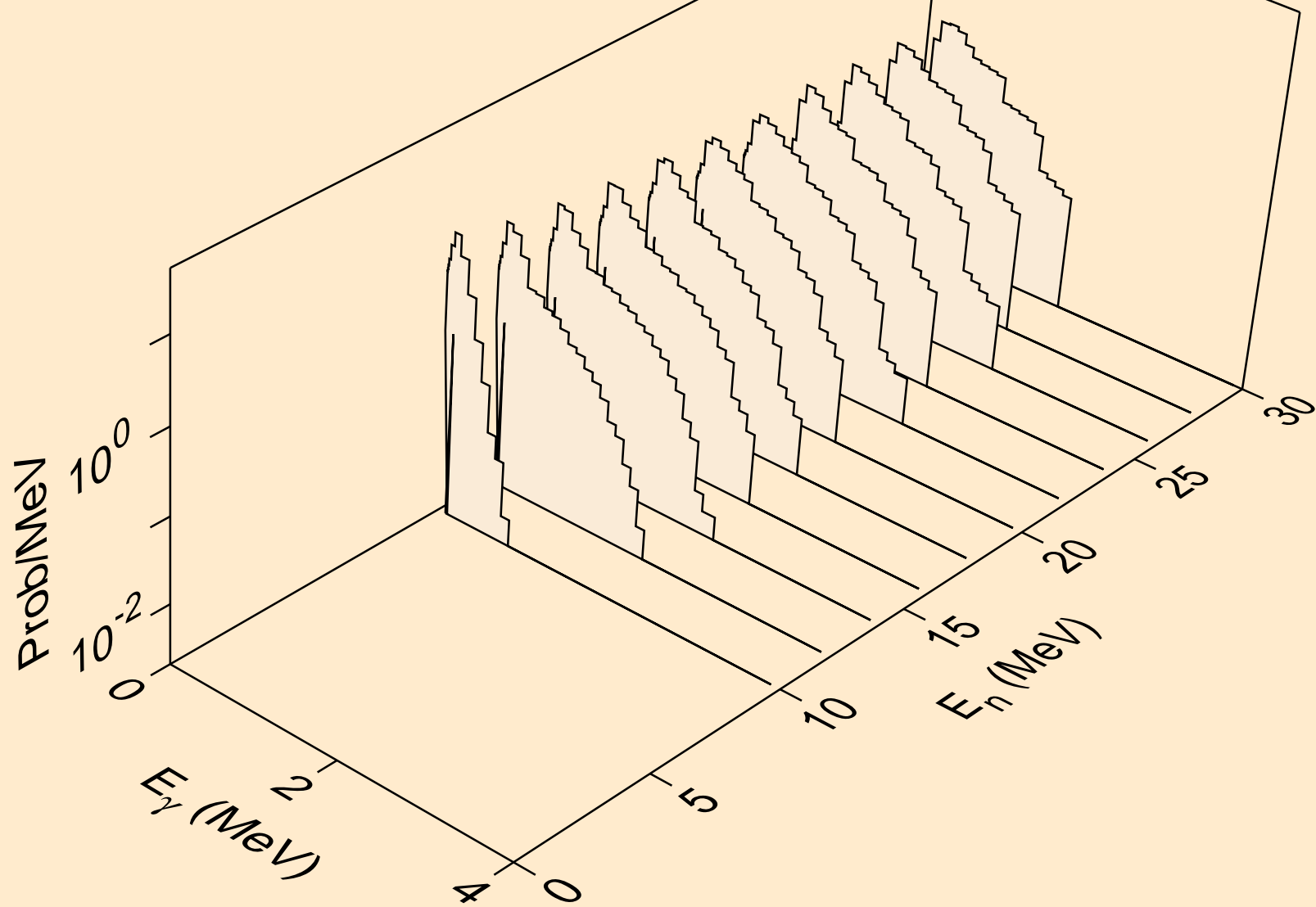

RF267 HELION ACER TENDL-2021 LIBRARY; T=0.K
Photon emission for (n,n*)d

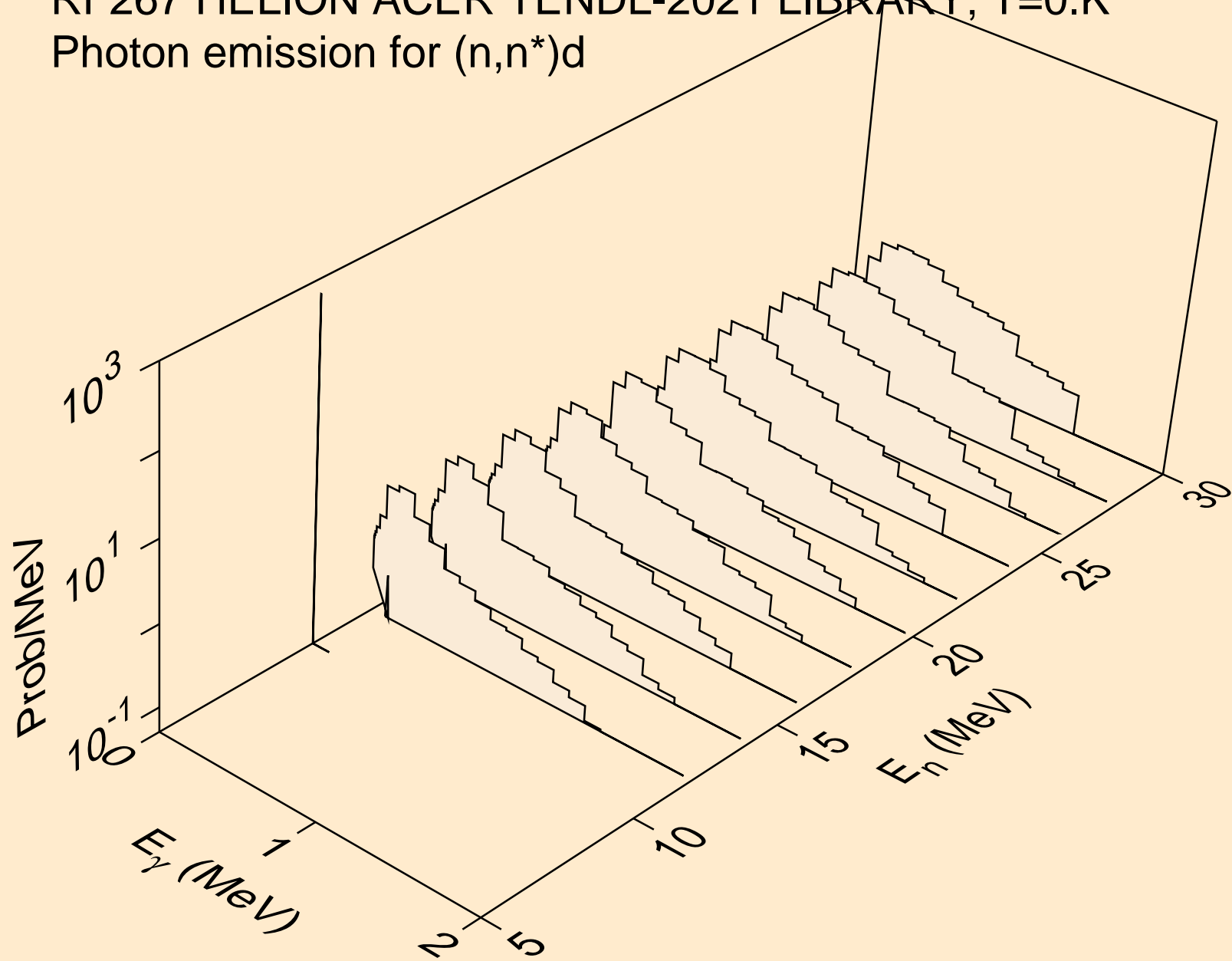

RF267 HELION ACER TENDL-2021 LIBRARY; T=0.K
Photon emission for (n,n*)t

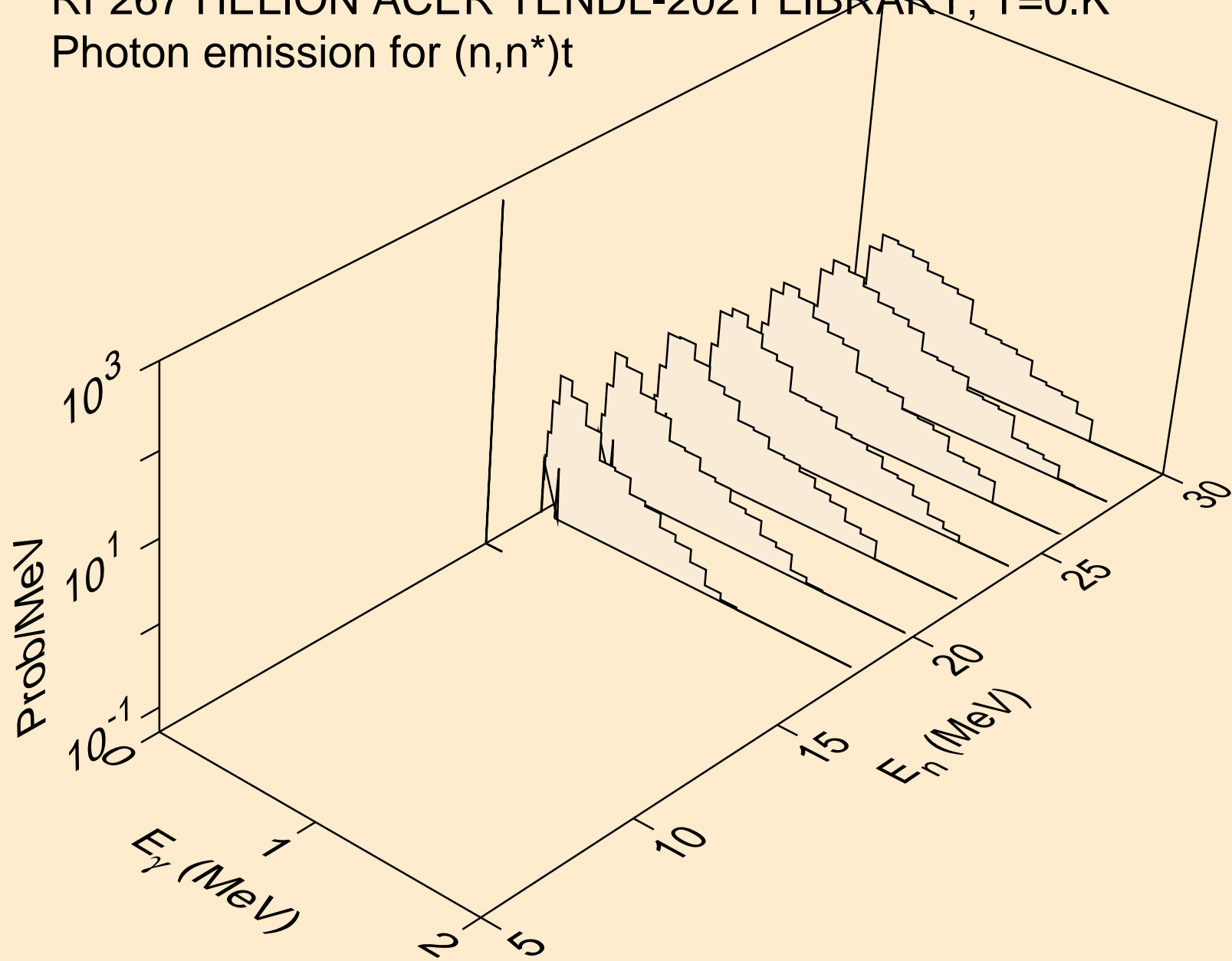

RF267 HELION ACER TENDL-2021 LIBRARY; T=0.K
Photon emission for (n,2np)

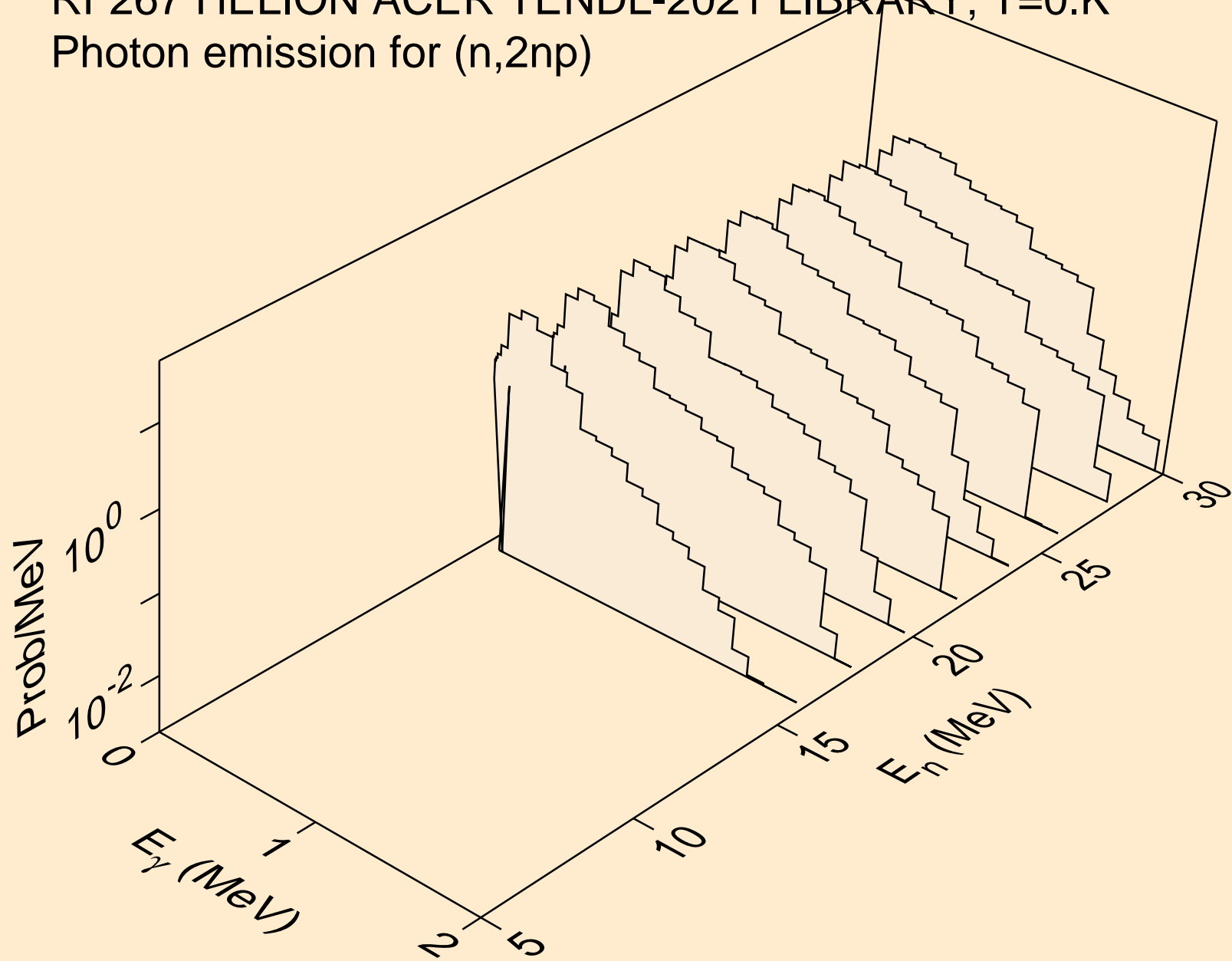

RF267 HELION ACER TENDL-2021 LIBRARY; T=0.K
Photon emission for (n,p)

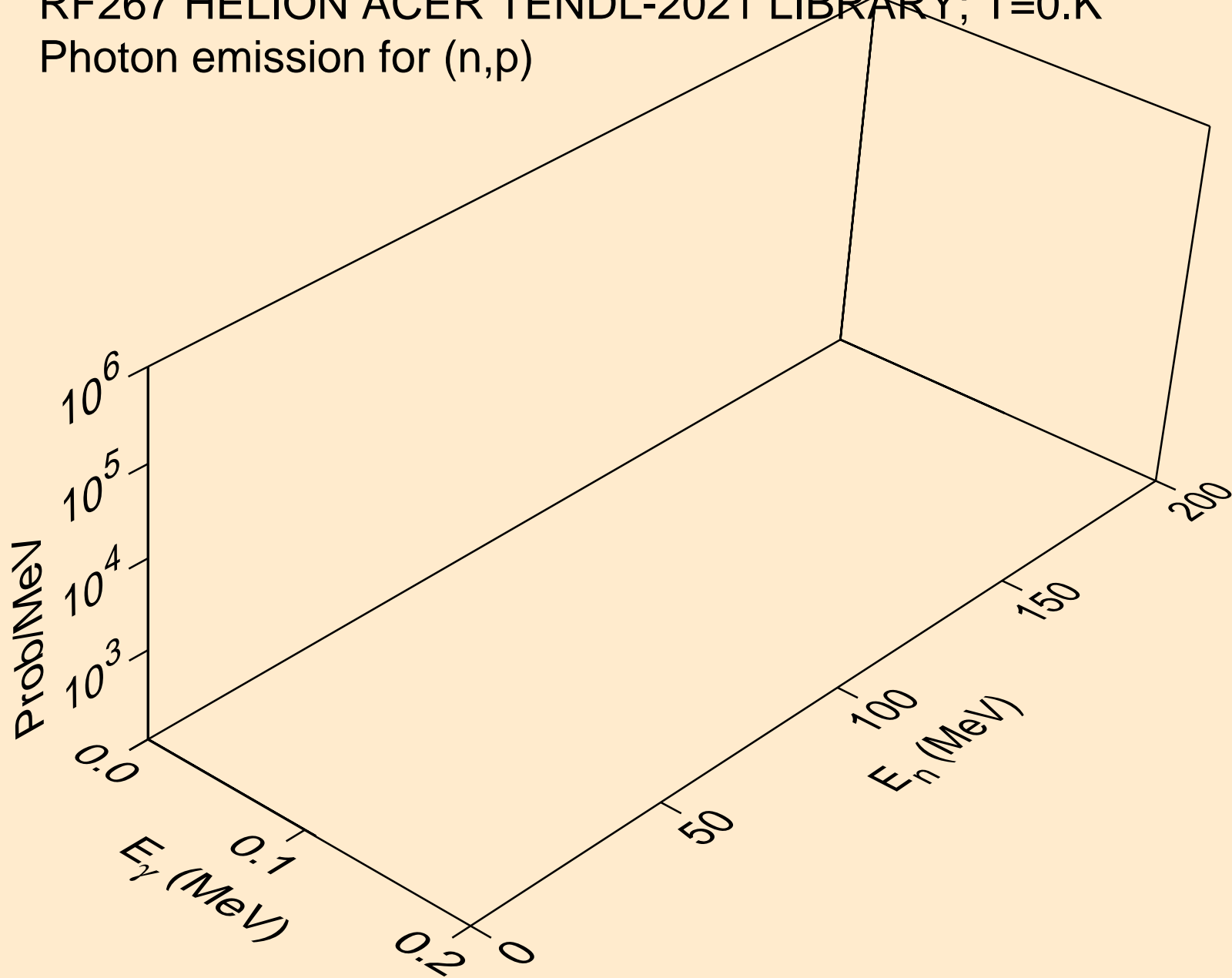

RF267 HELION ACER TENDL-2021 LIBRARY; T=0.K
Photon emission for (n,d)

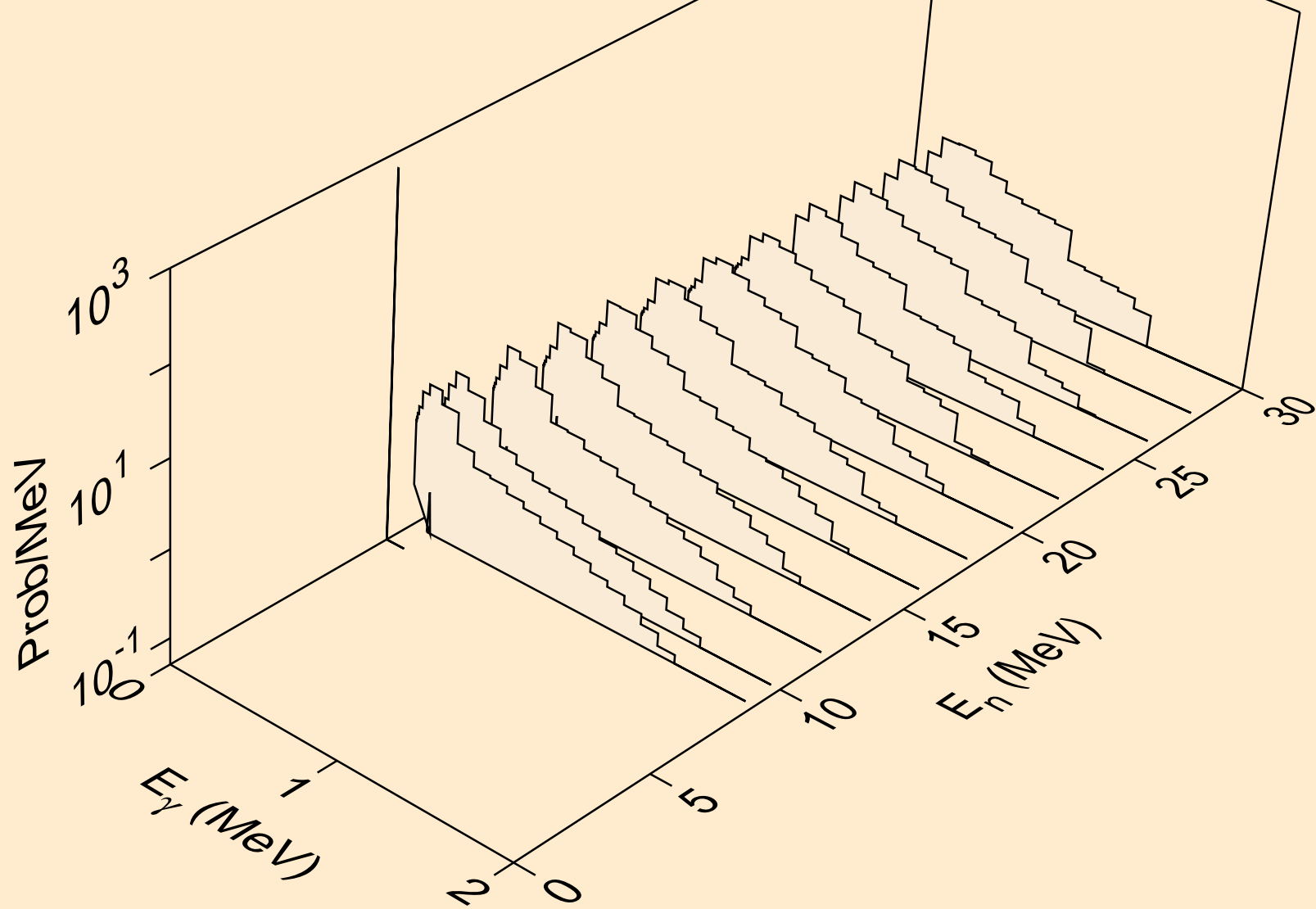

RF267 HELION ACER TENDL-2021 LIBRARY; T=0.K
Photon emission for (n,t)

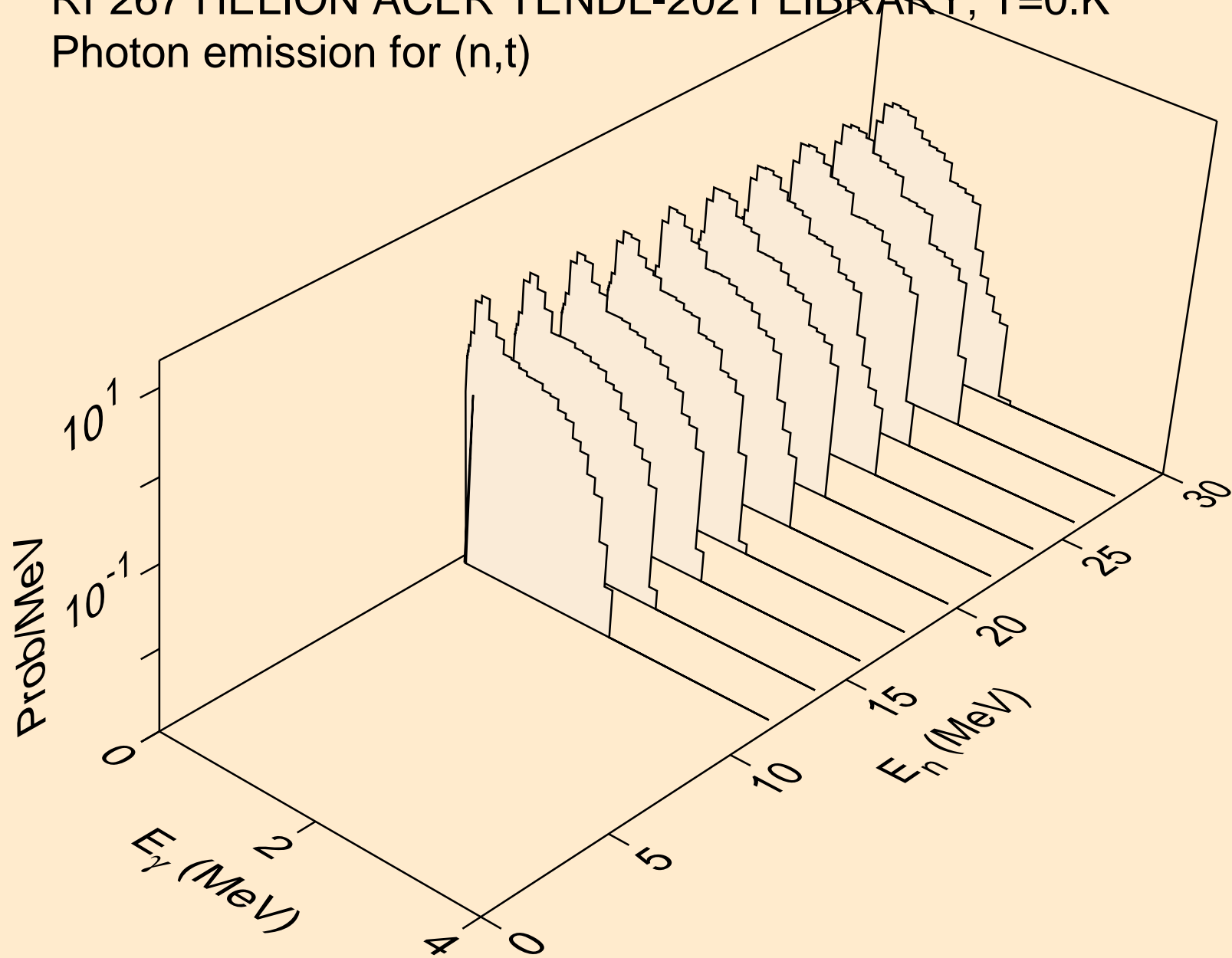

RF267 HELION ACER TENDL-2021 LIBRARY; T=0.K
Photon emission for inelastic

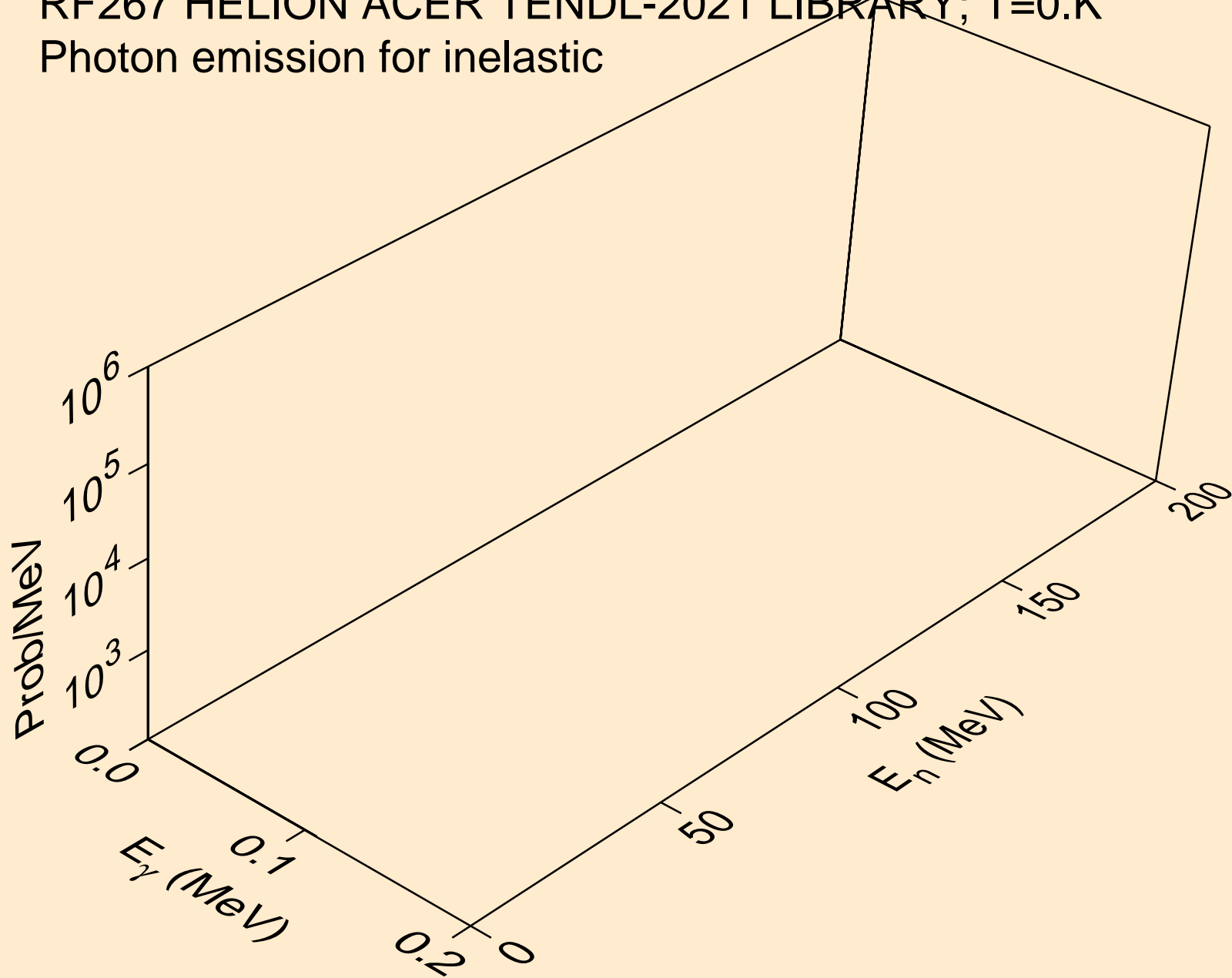

RF267 HELION ACER TENDL-2021 LIBRARY; T=0.K
Photon emission for (n,a)

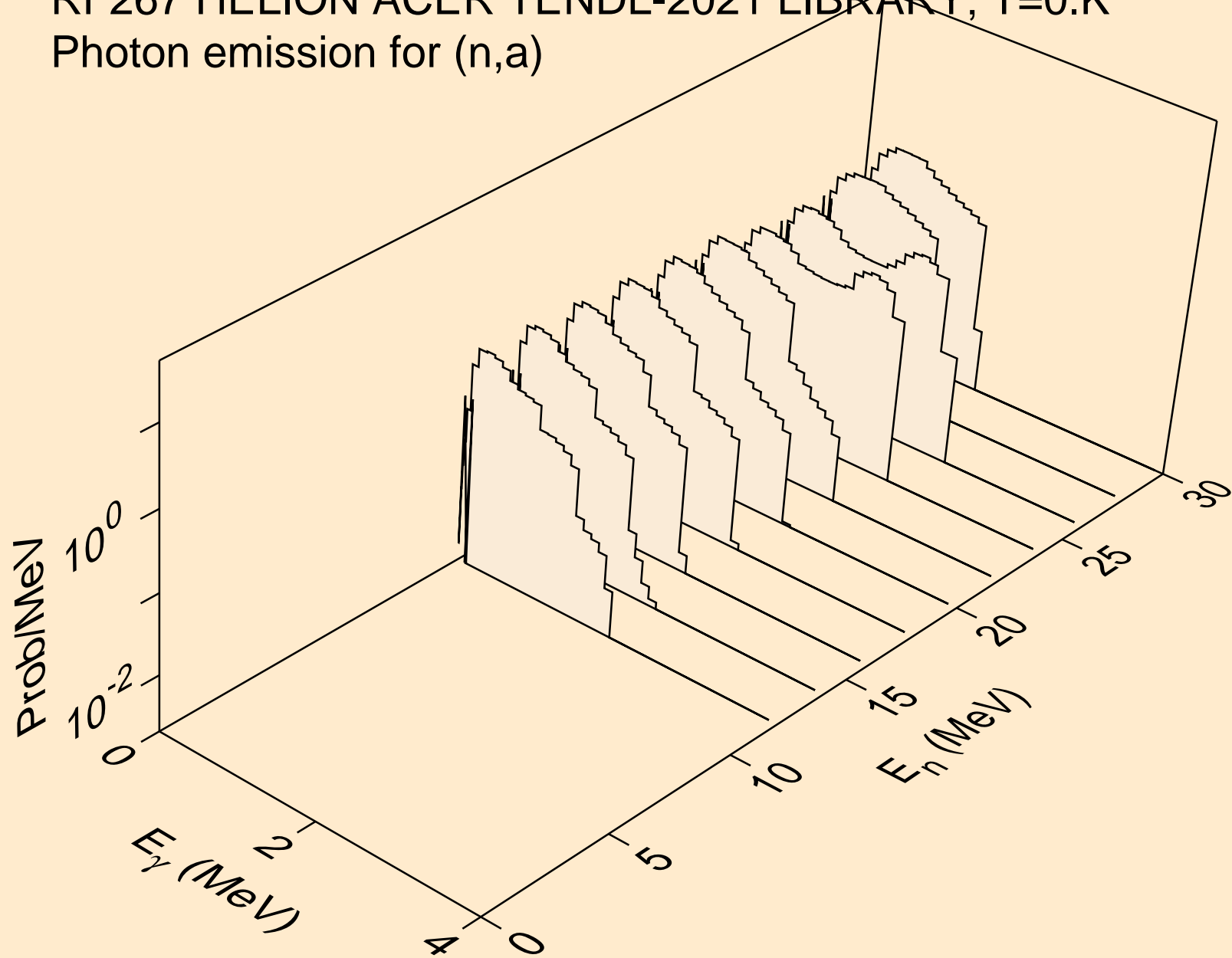

RF267 HELION ACER TENDL-2021 LIBRARY; T=0.K
Particle heating contributions

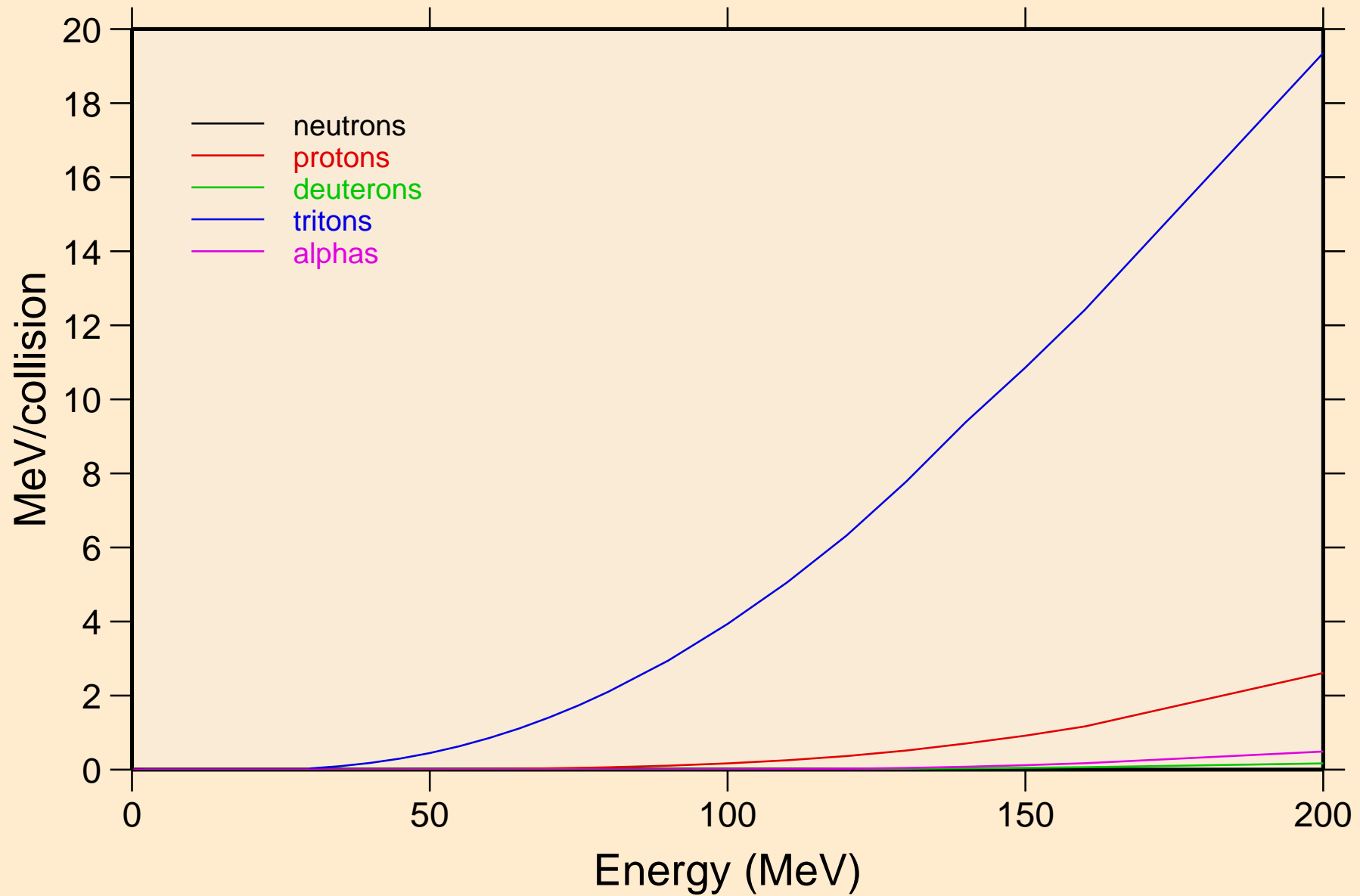

RF267 HELION ACER TENDL-2021 LIBRARY; T=0.K
Recoil Heating

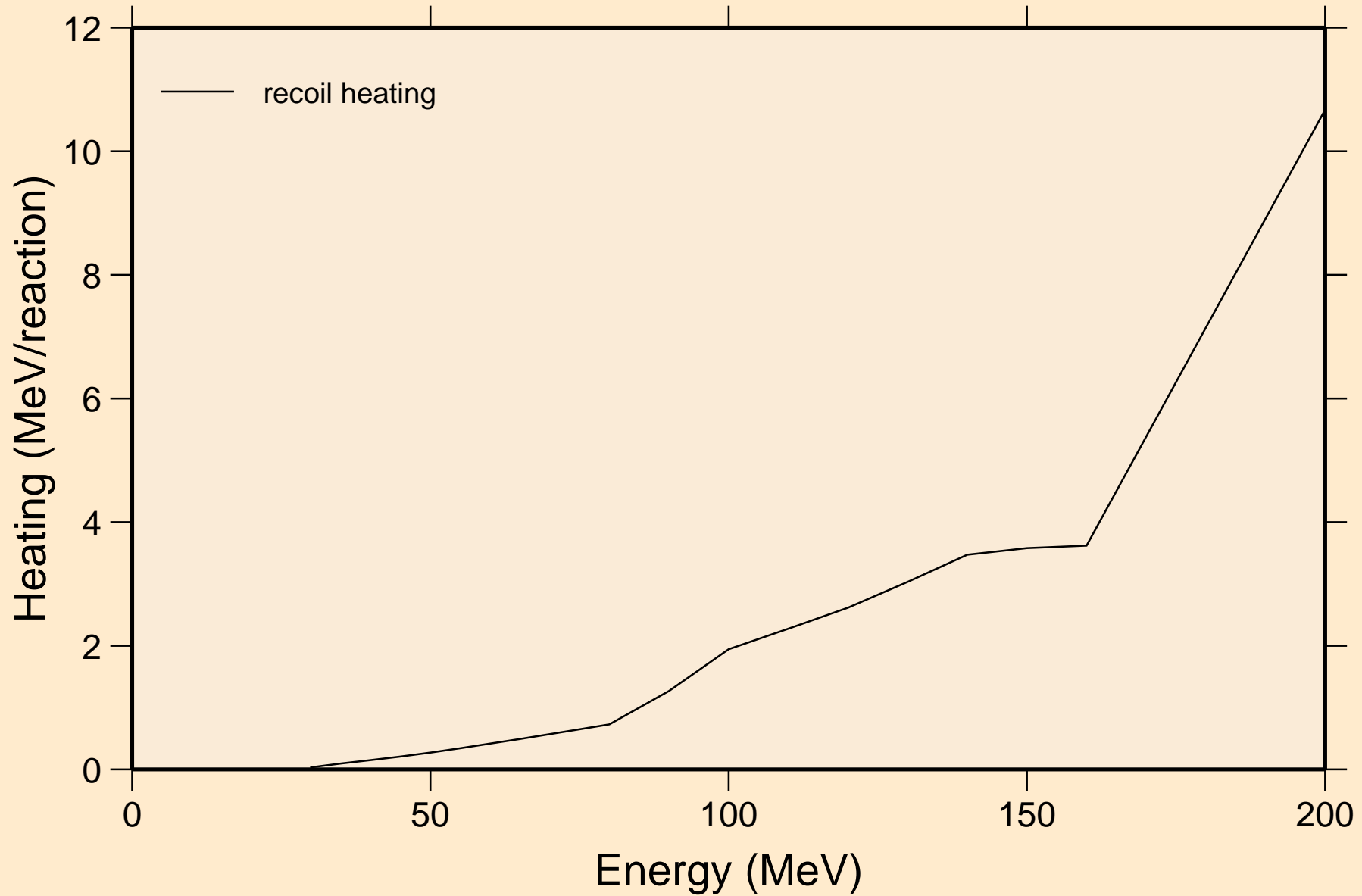

RF267 HELION ACER TENDL-2021 LIBRARY; T=0.K
Particle production cross sections

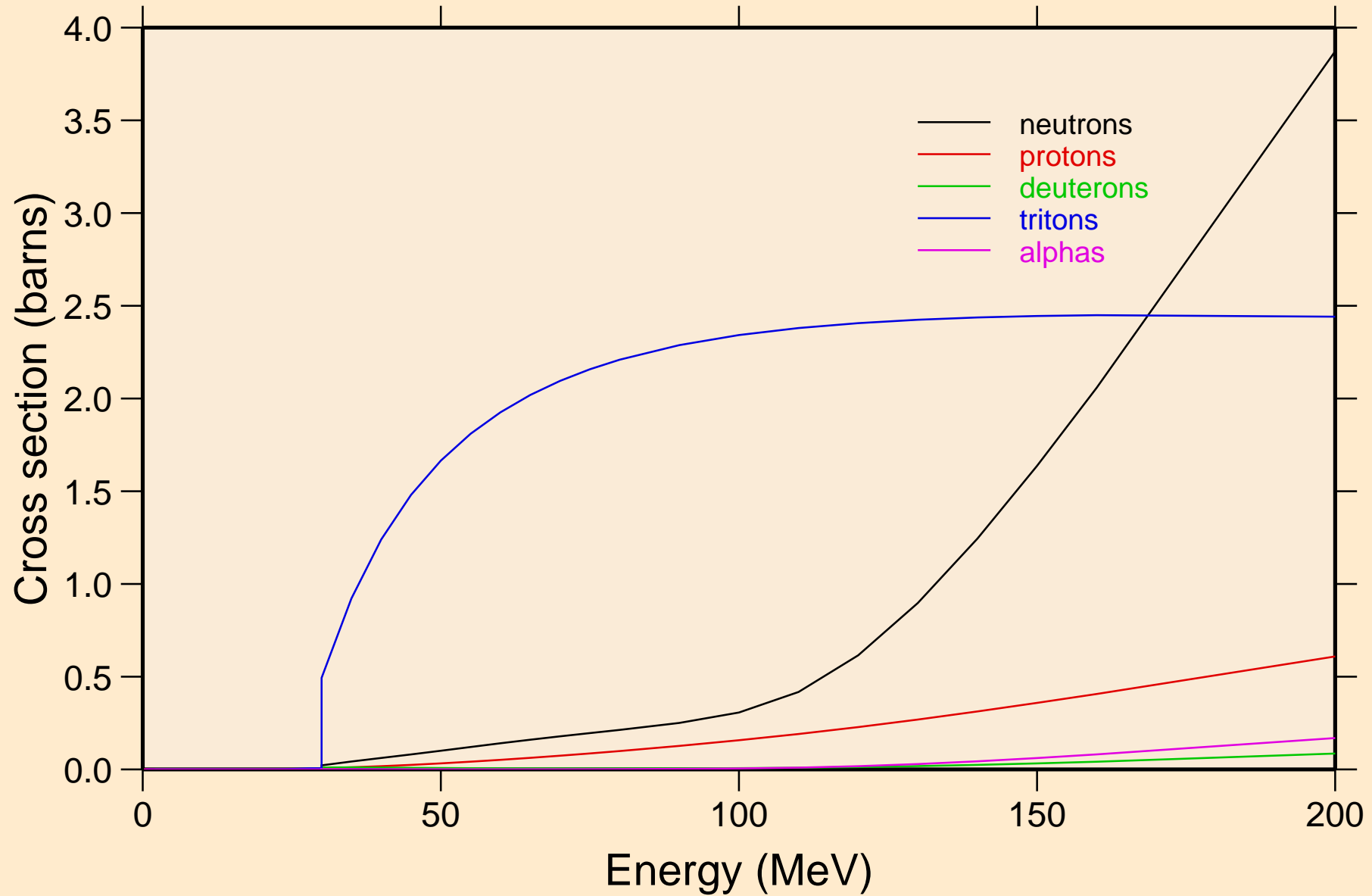

RF267 HELION ACER TENDL-2021 LIBRARY; T=0.K
neutrons from (s,n)

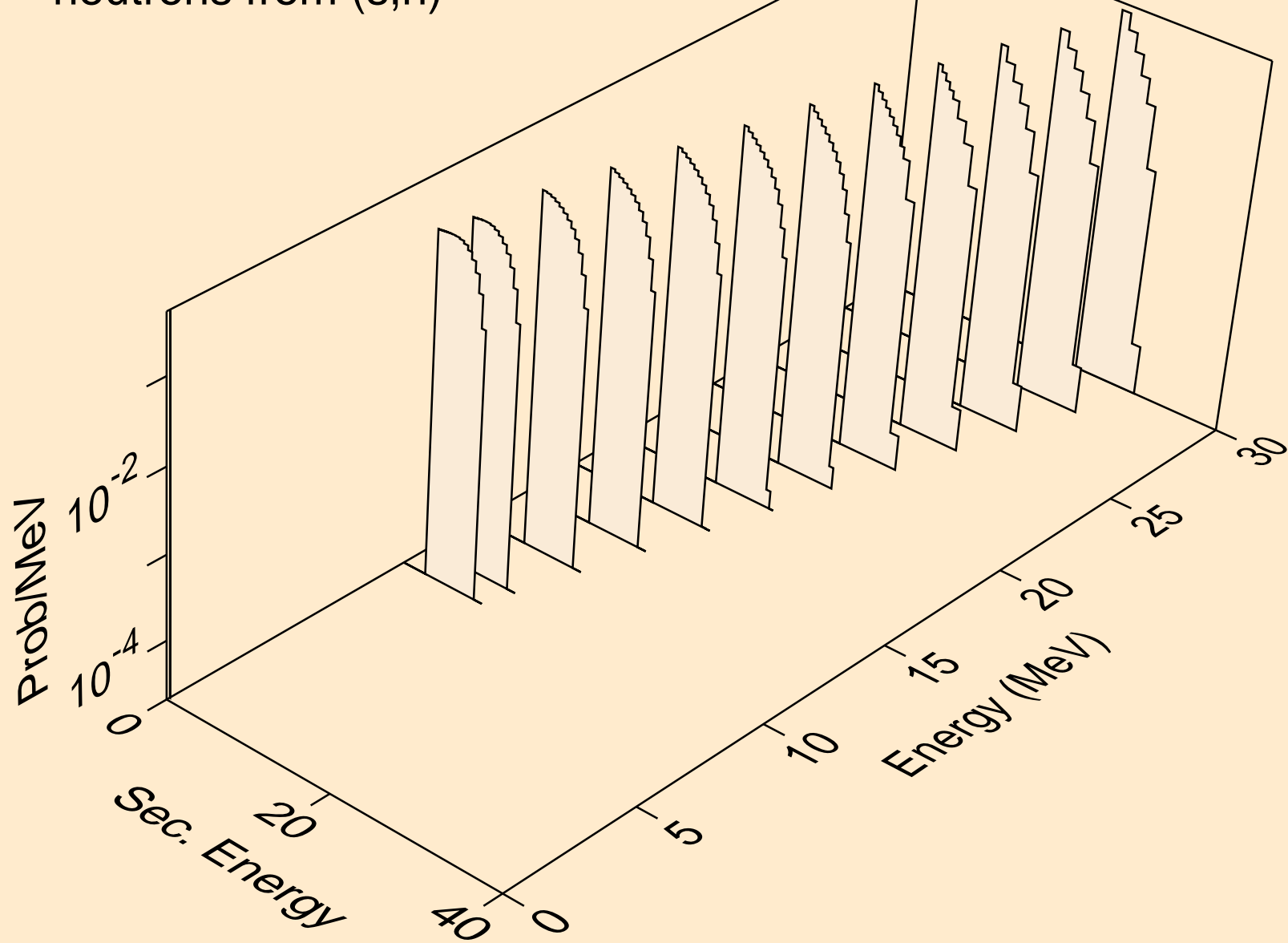

RF267 HELION ACER TENDL-2021 LIBRARY; T=0.K
neutrons from (s,x)

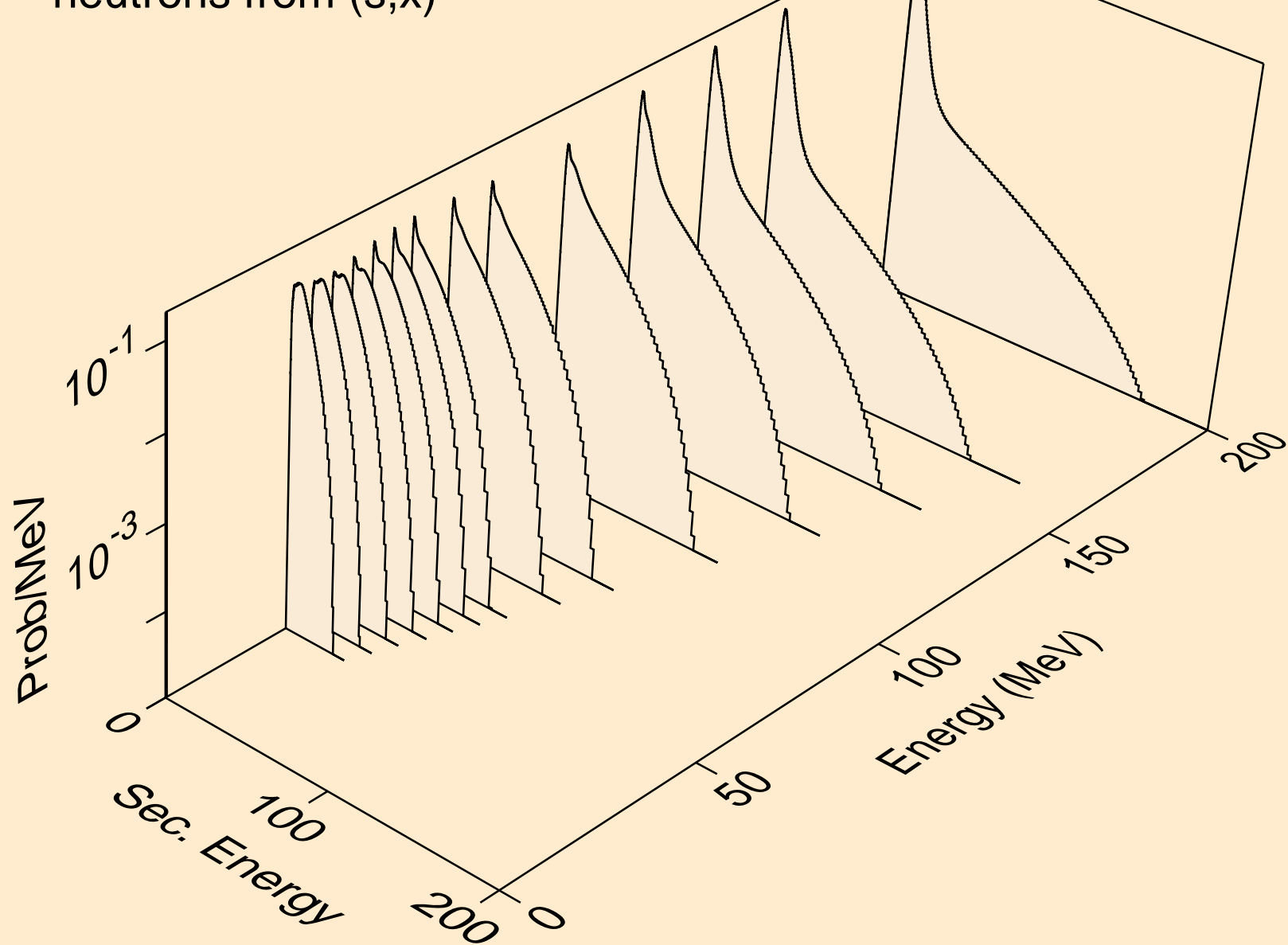

RF267 HELION ACER TENDL-2021 LIBRARY; T=0.K
neutrons from (s,2n)

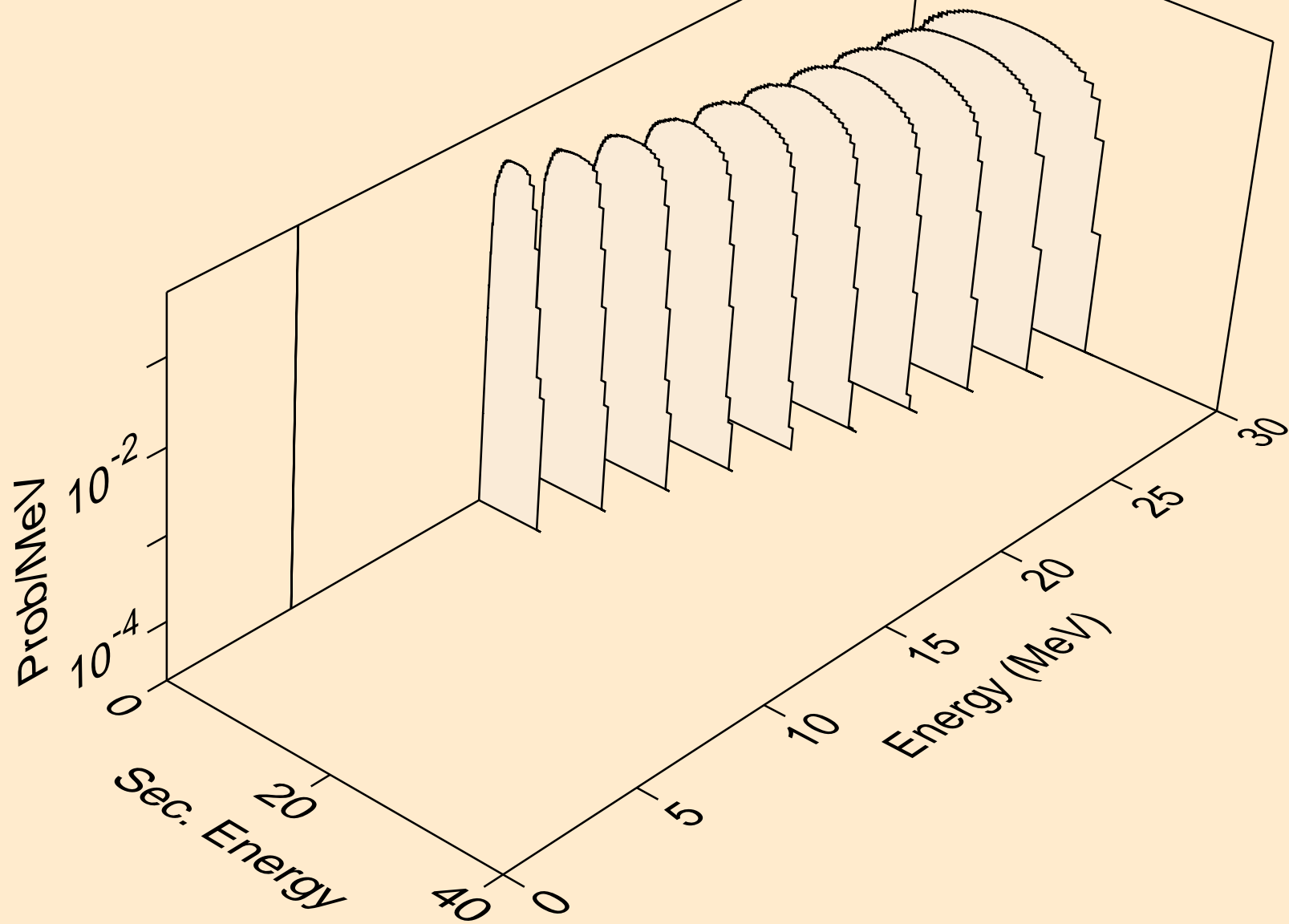

RF267 HELION ACER TENDL-2021 LIBRARY; T=0.K
neutrons from (s,3n)

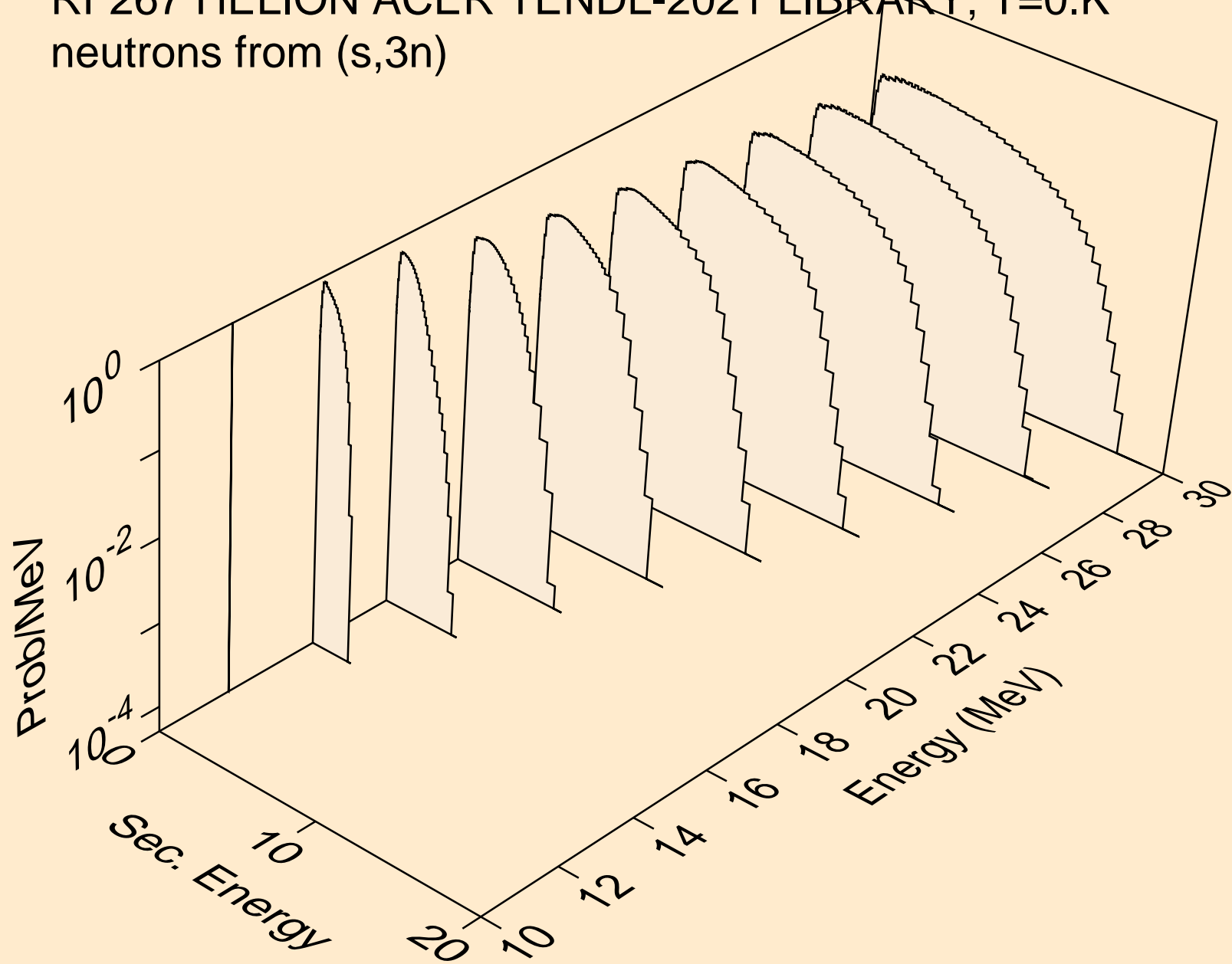

RF267 HELION ACER TENDL-2021 LIBRARY; T=0.K
neutrons from (s,n*)p

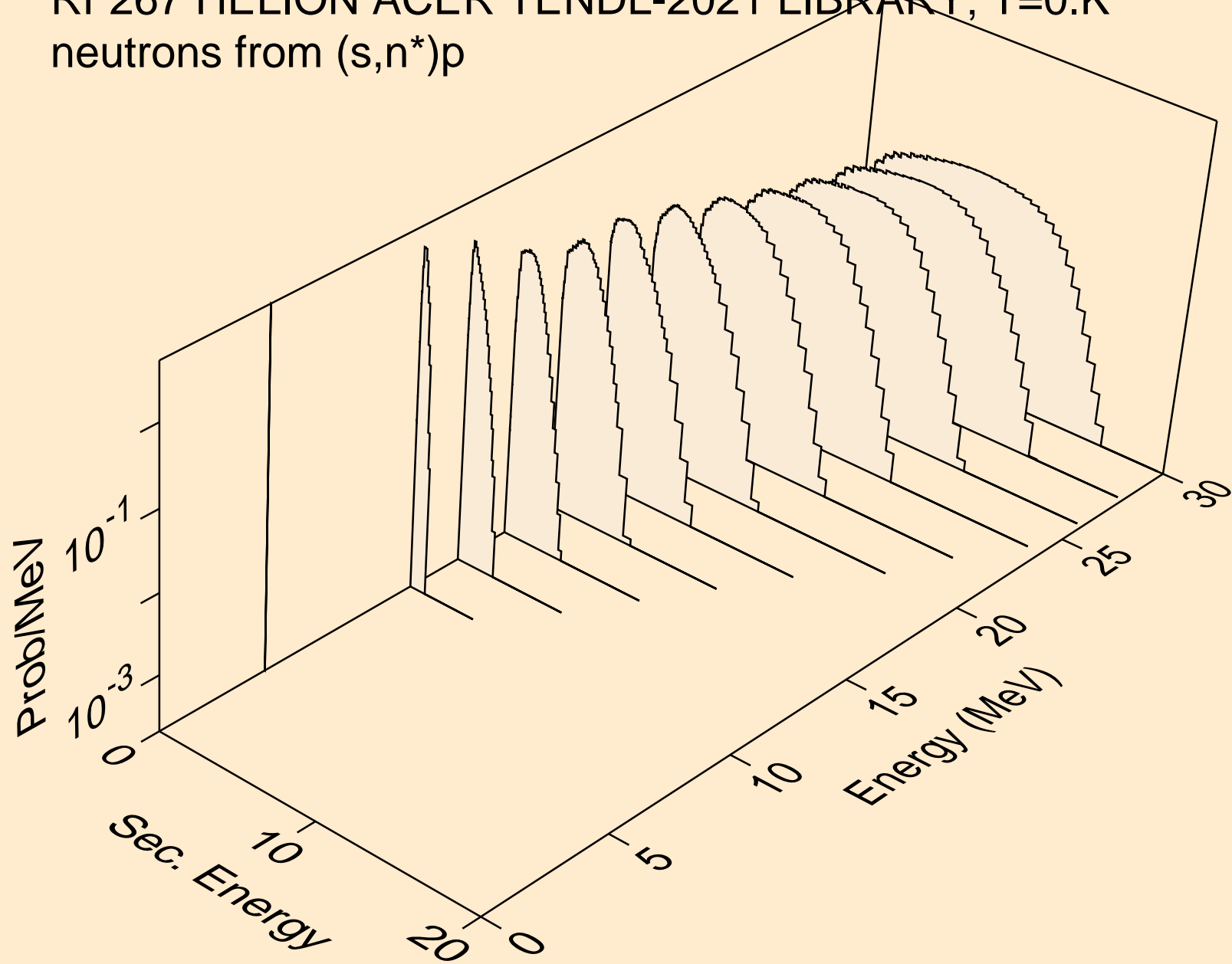

RF267 HELION ACER TENDL-2021 LIBRARY; T=0.K
neutrons from (s,n*)d

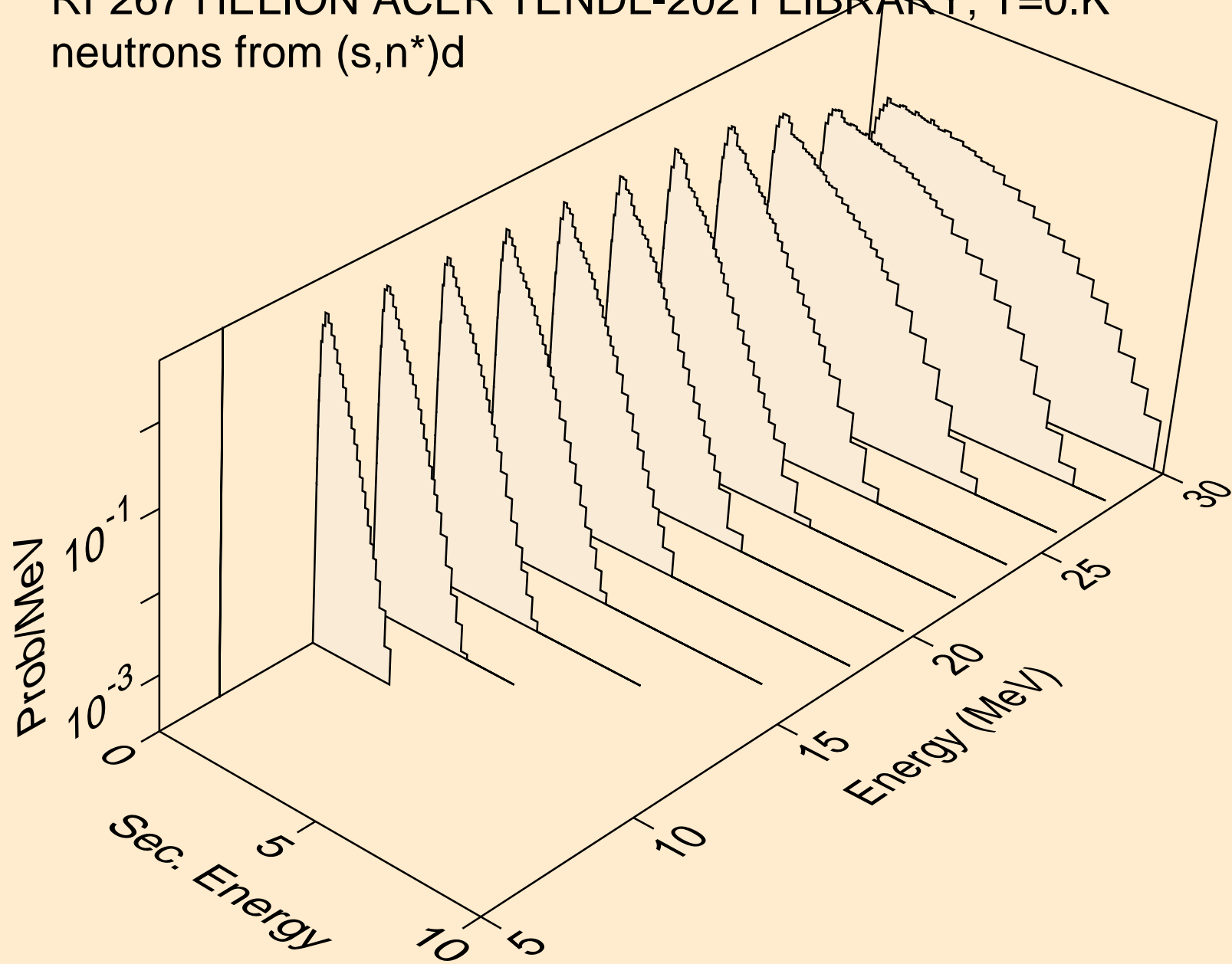

RF267 HELION ACER TENDL-2021 LIBRARY; T=0.K
neutrons from (s,n*)t

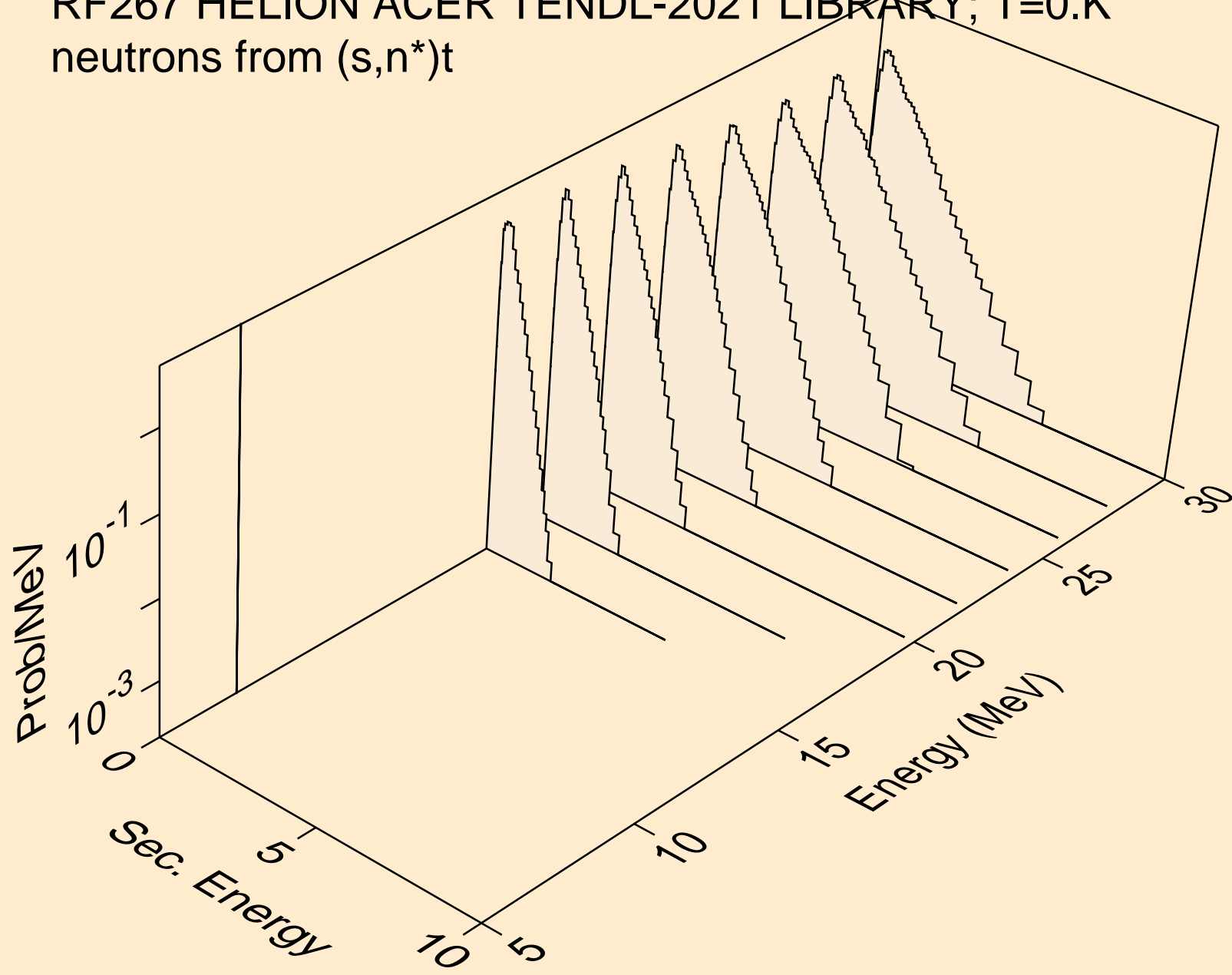

RF267 HELION ACER TENDL-2021 LIBRARY; T=0.K
neutrons from (s,2np)

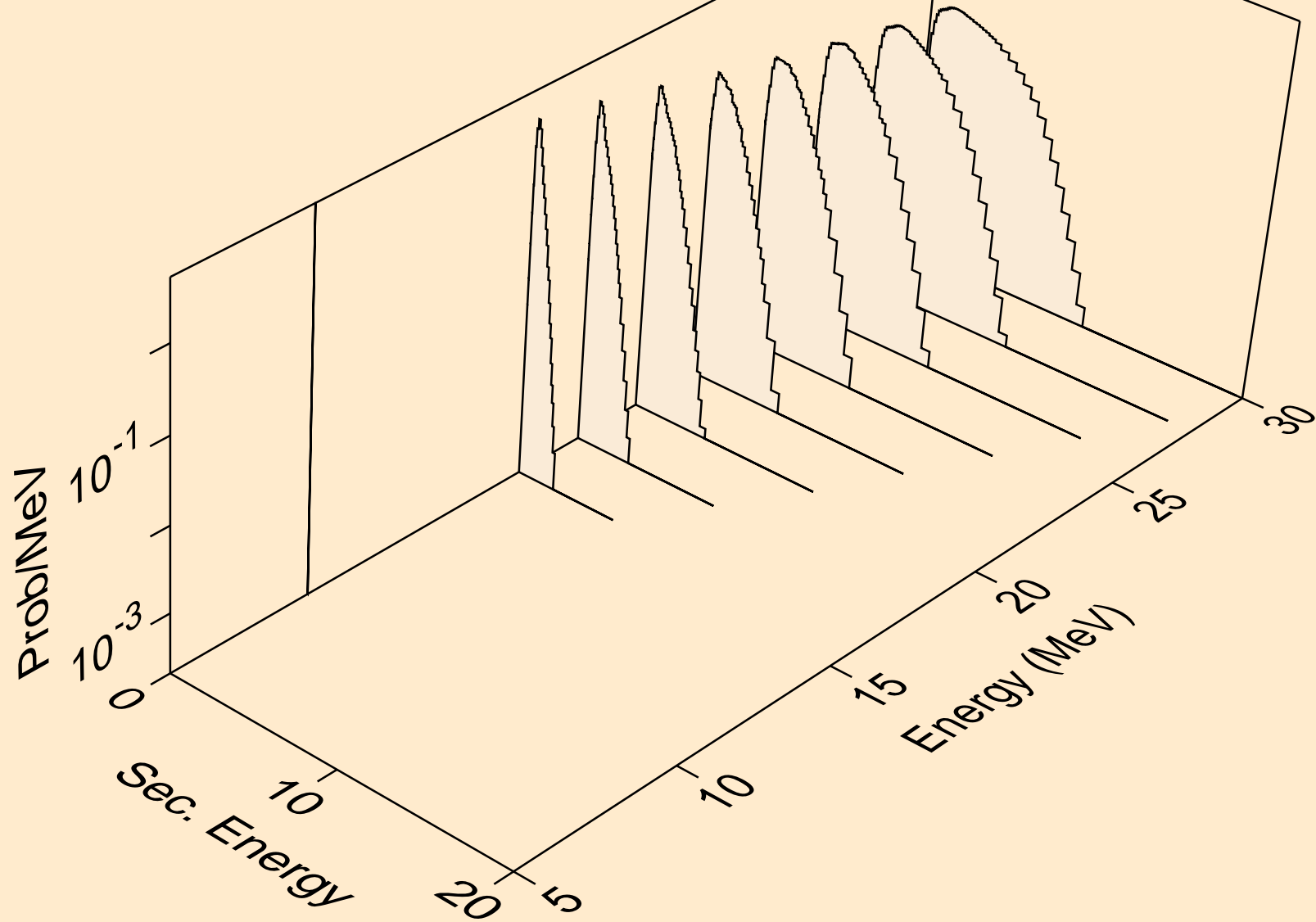

RF267 HELION ACER TENDL-2021 LIBRARY; T=0.K
protons from (s,x)

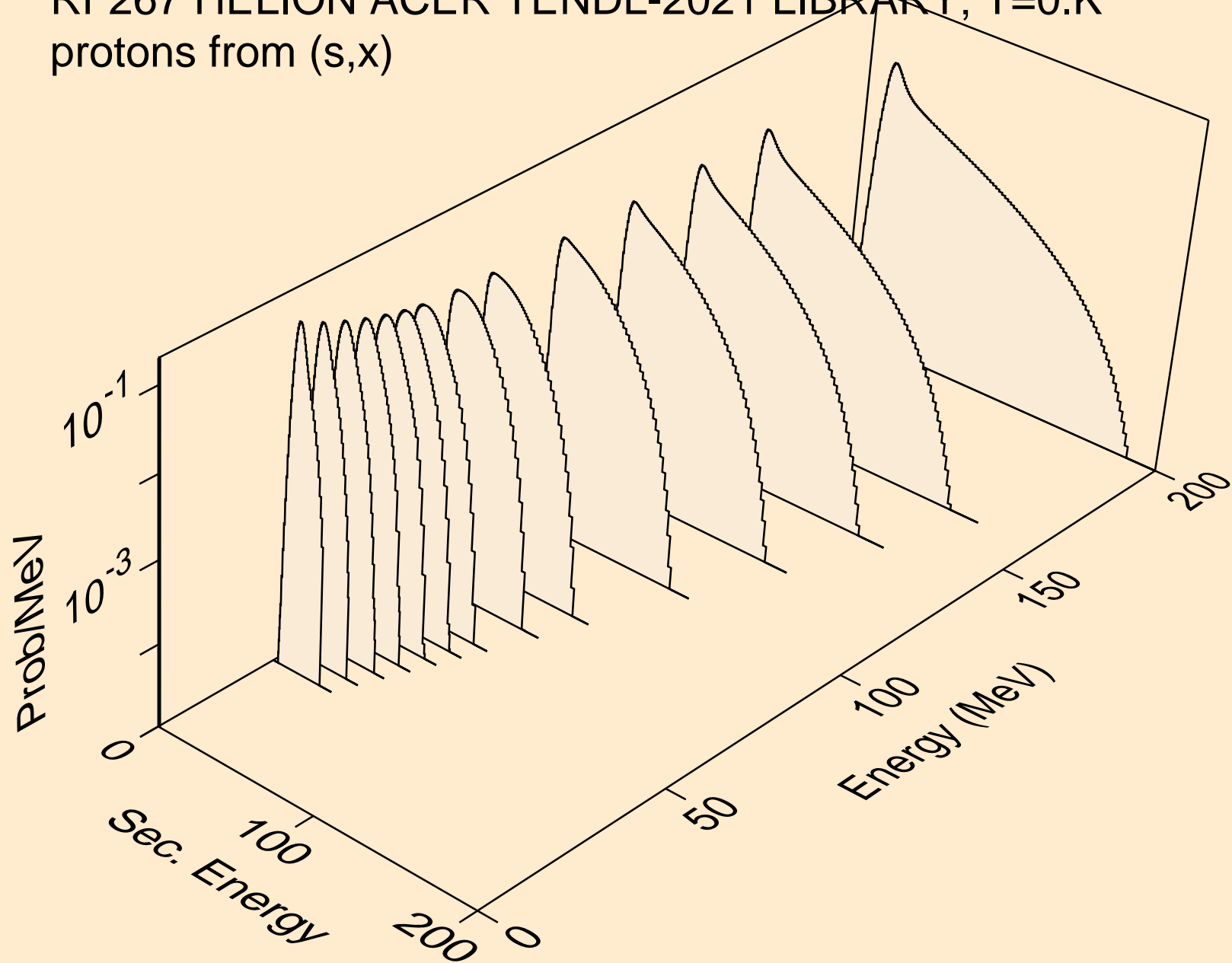

RF267 HELION ACER TENDL-2021 LIBRARY; T=0.K
protons from (s,n*)p

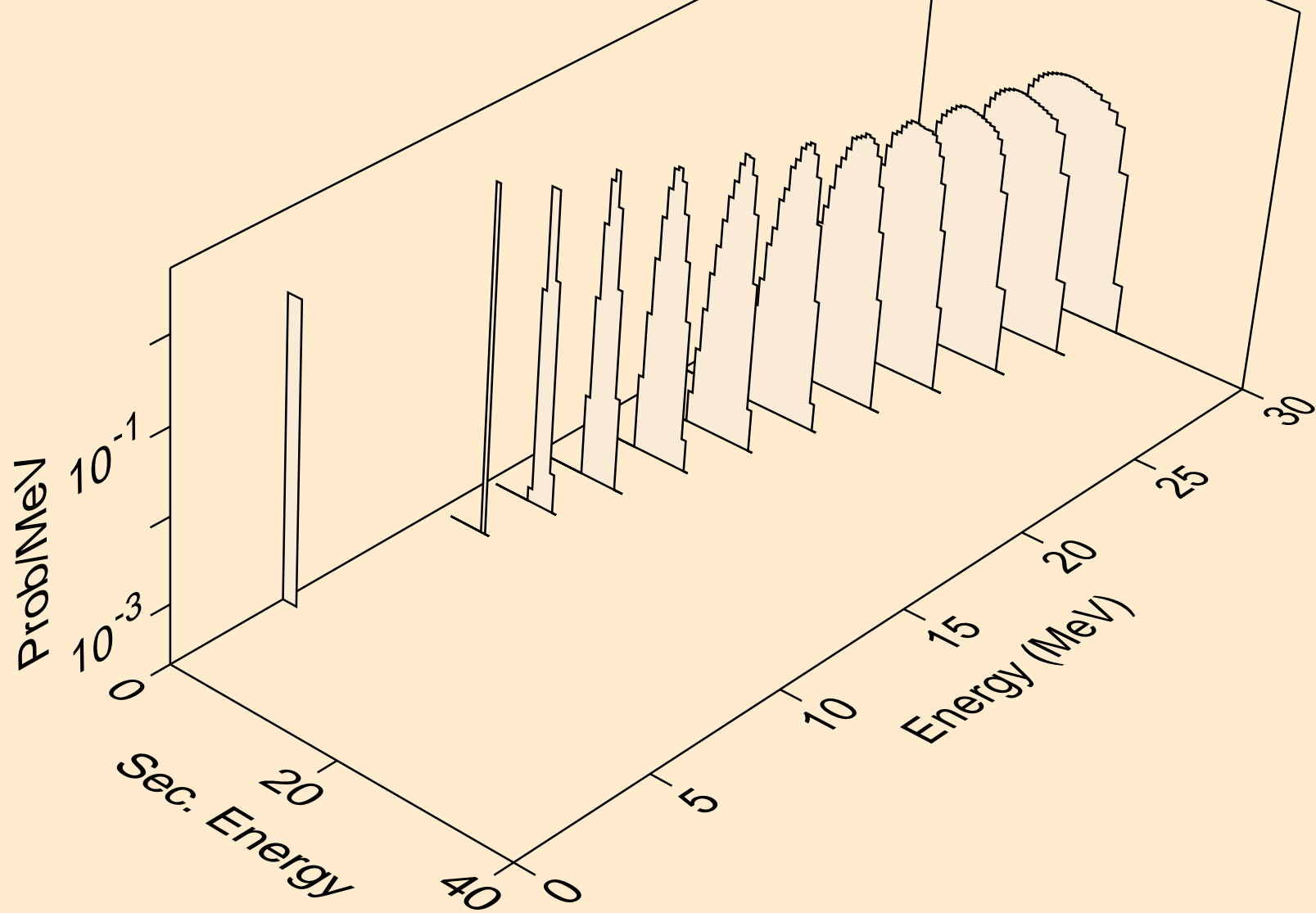

RF267 HELION ACER TENDL-2021 LIBRARY; T=0.K
protons from (s,2np)

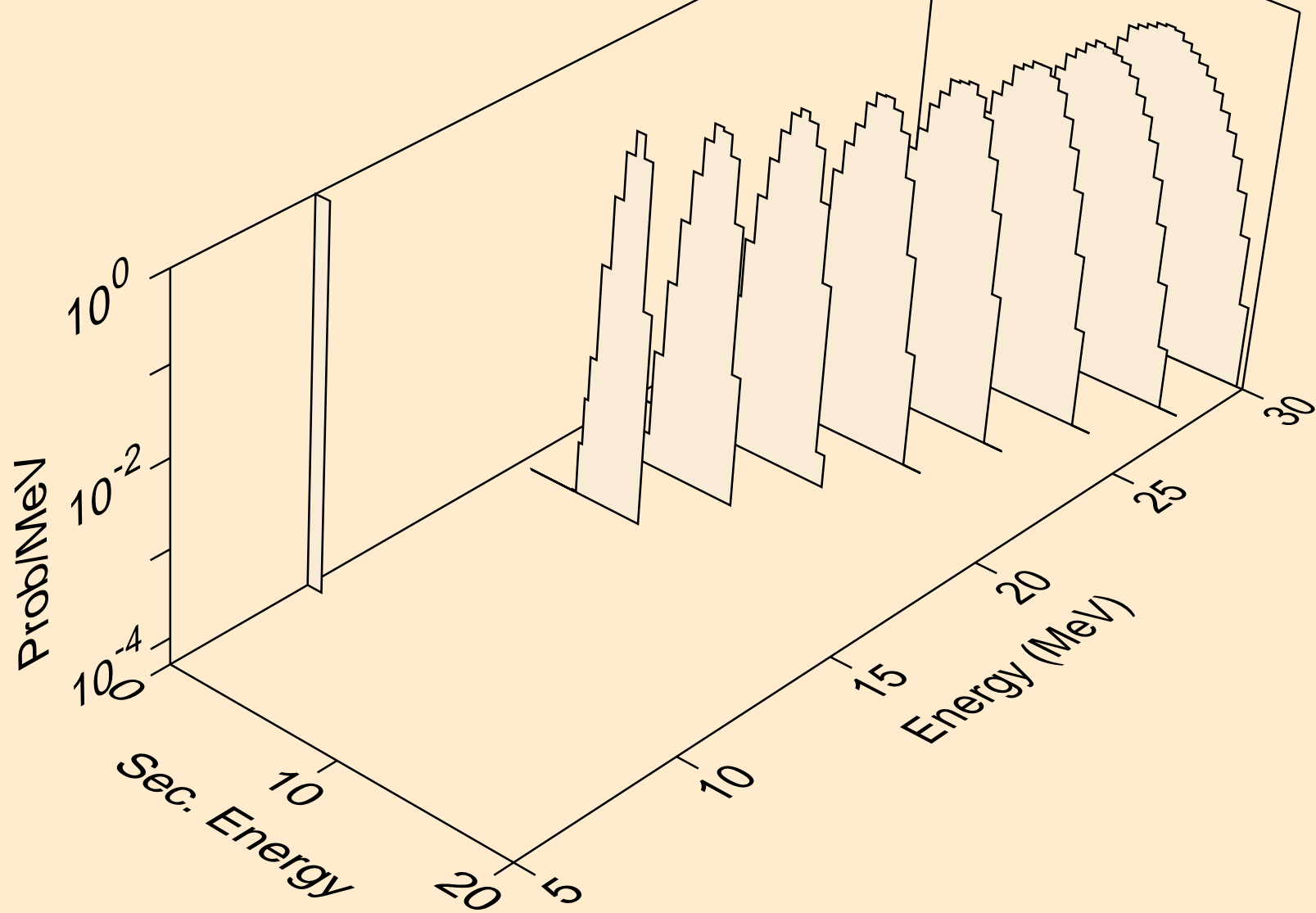

RF267 HELION ACER TENDL-2021 LIBRARY; T=0.K
protons from (s,p)

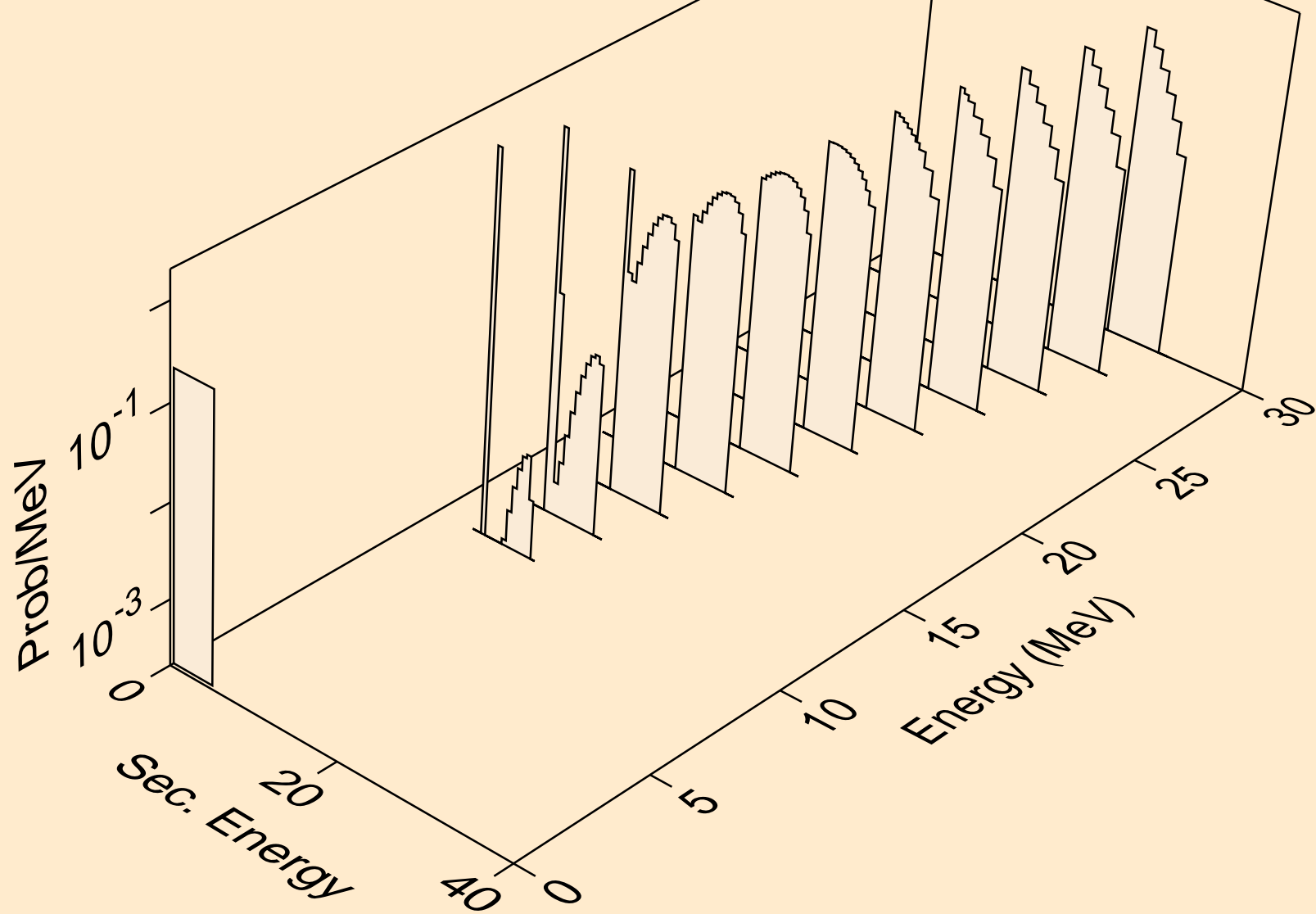

RF267 HELION ACER TENDL-2021 LIBRARY; T=0.K
deuterons from (s,x)

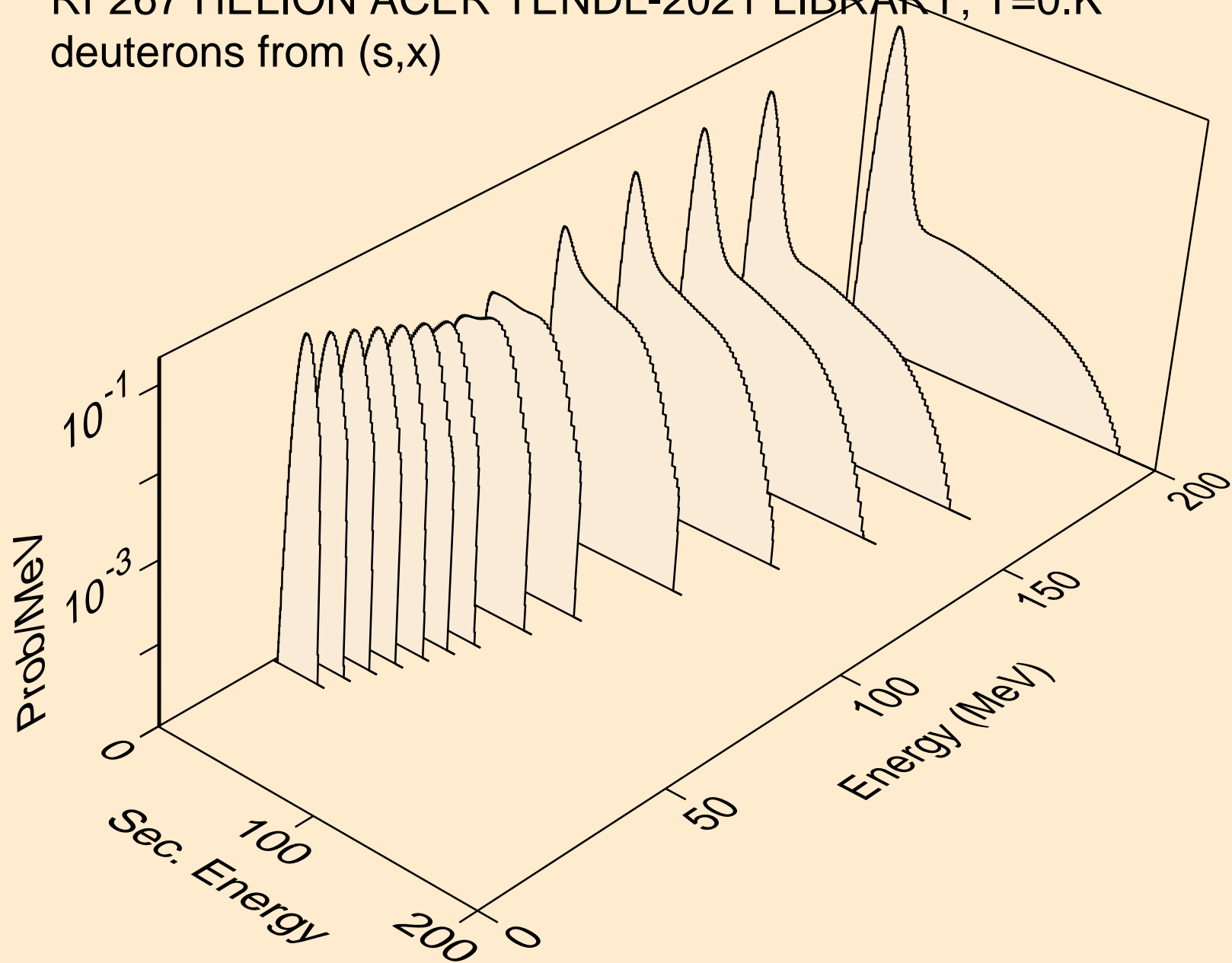

RF267 HELION ACER TENDL-2021 LIBRARY; T=0.K
deuterons from (s,n*)d

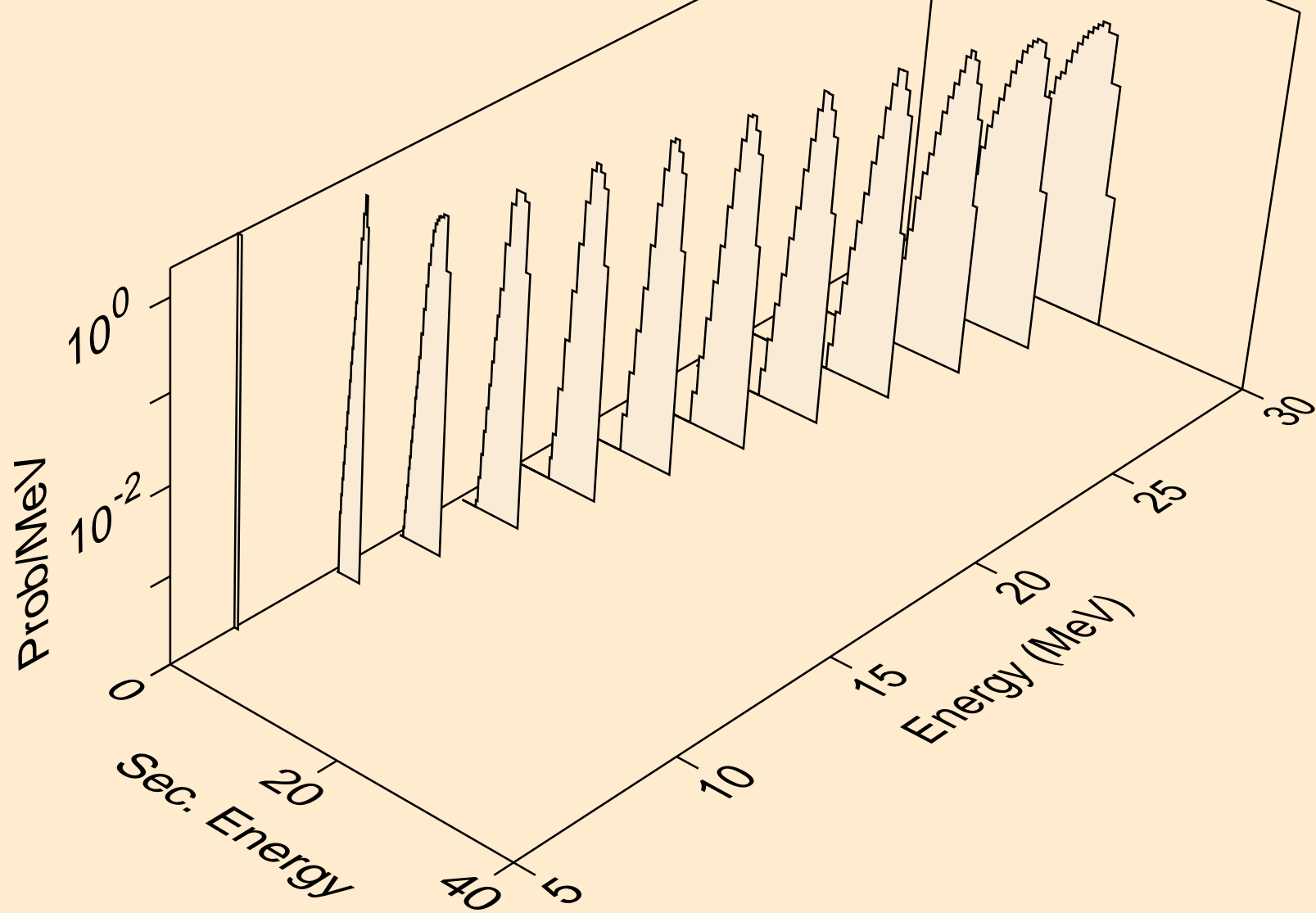

RF267 HELION ACER TENDL-2021 LIBRARY; T=0.K
deuterons from (s,d)

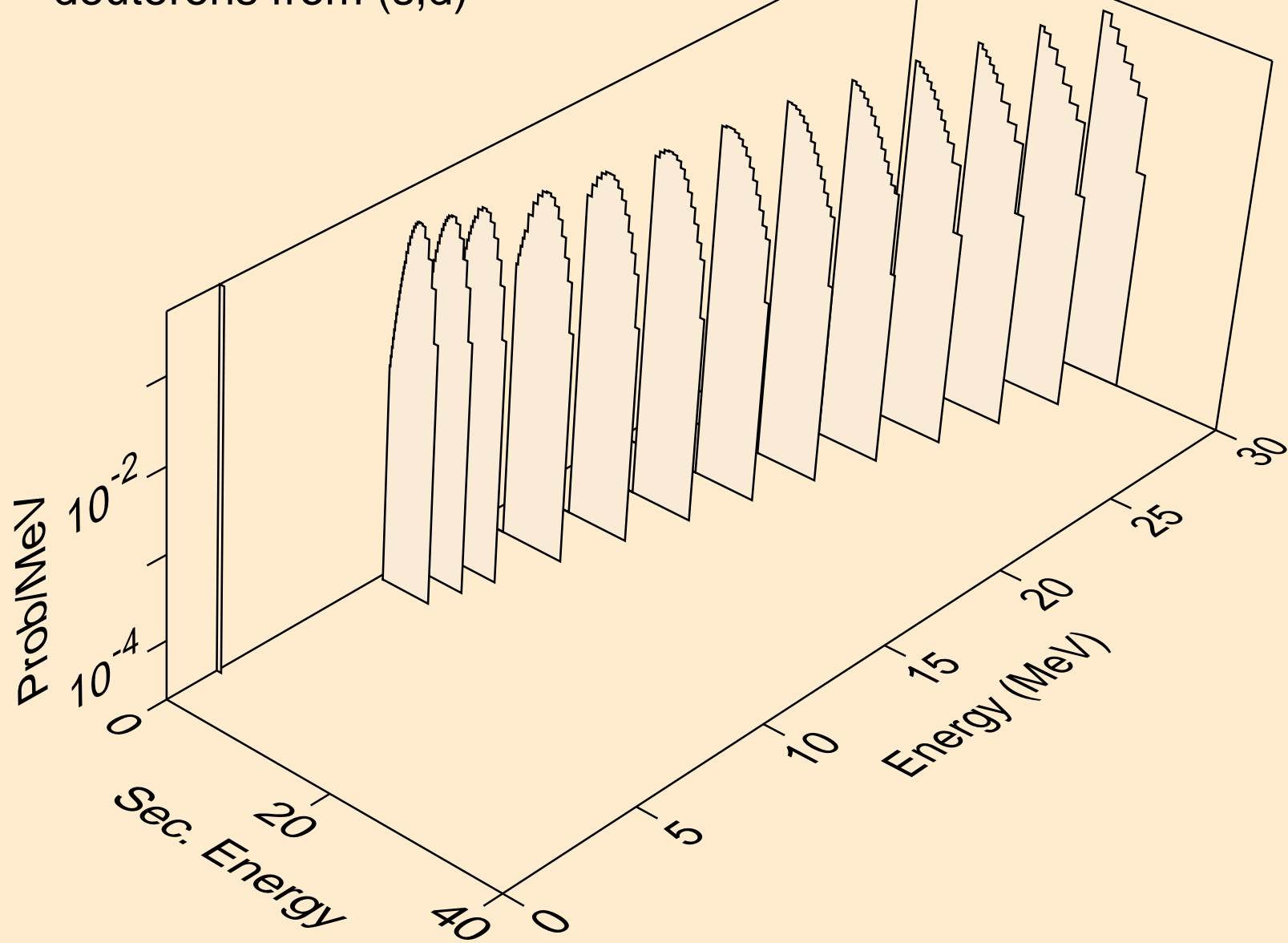

RF267 HELION ACER TENDL-2021 LIBRARY; T=0.K
tritons from (s,x)

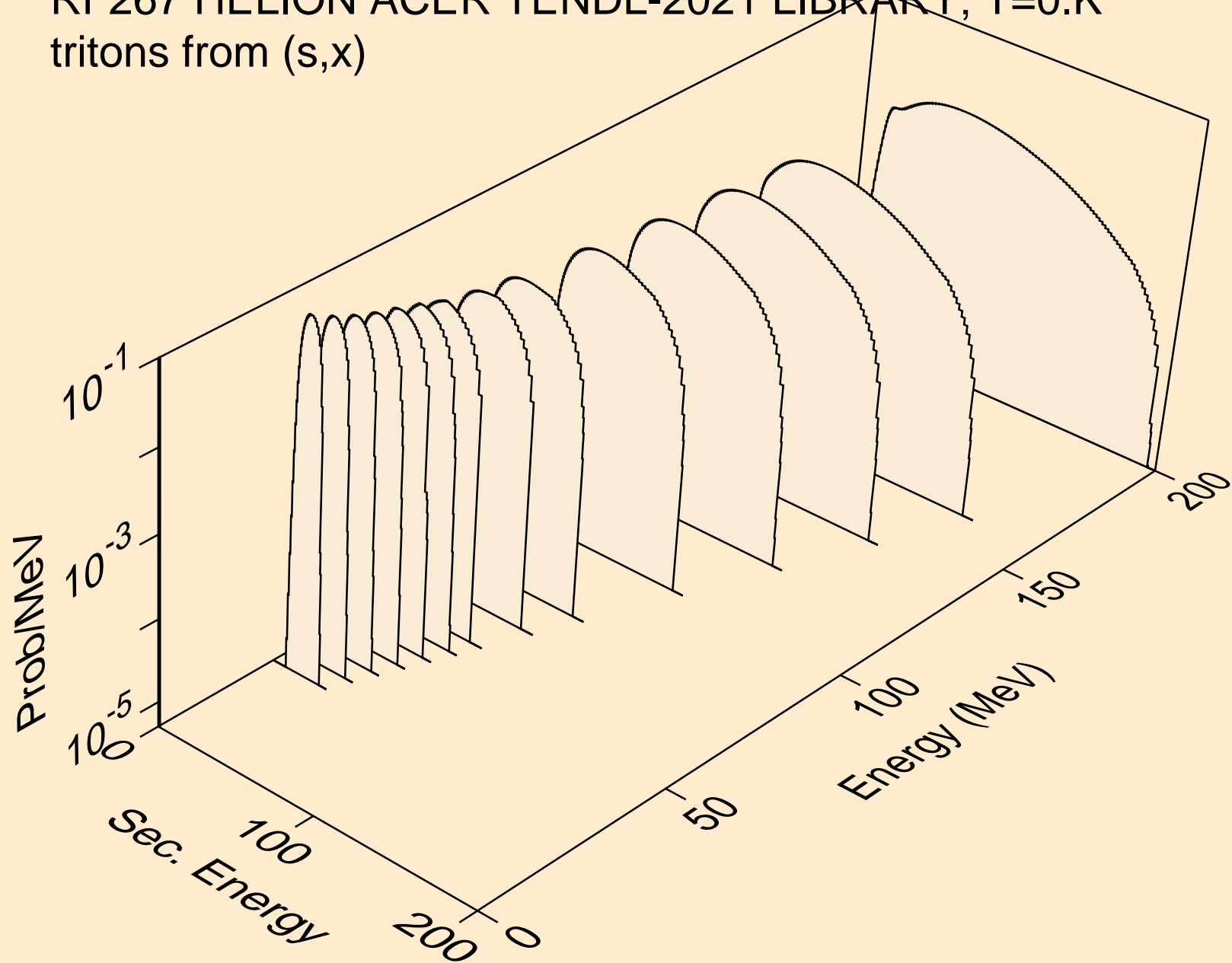

RF267 HELION ACER TENDL-2021 LIBRARY; T=0.K
tritons from (s,n*)t

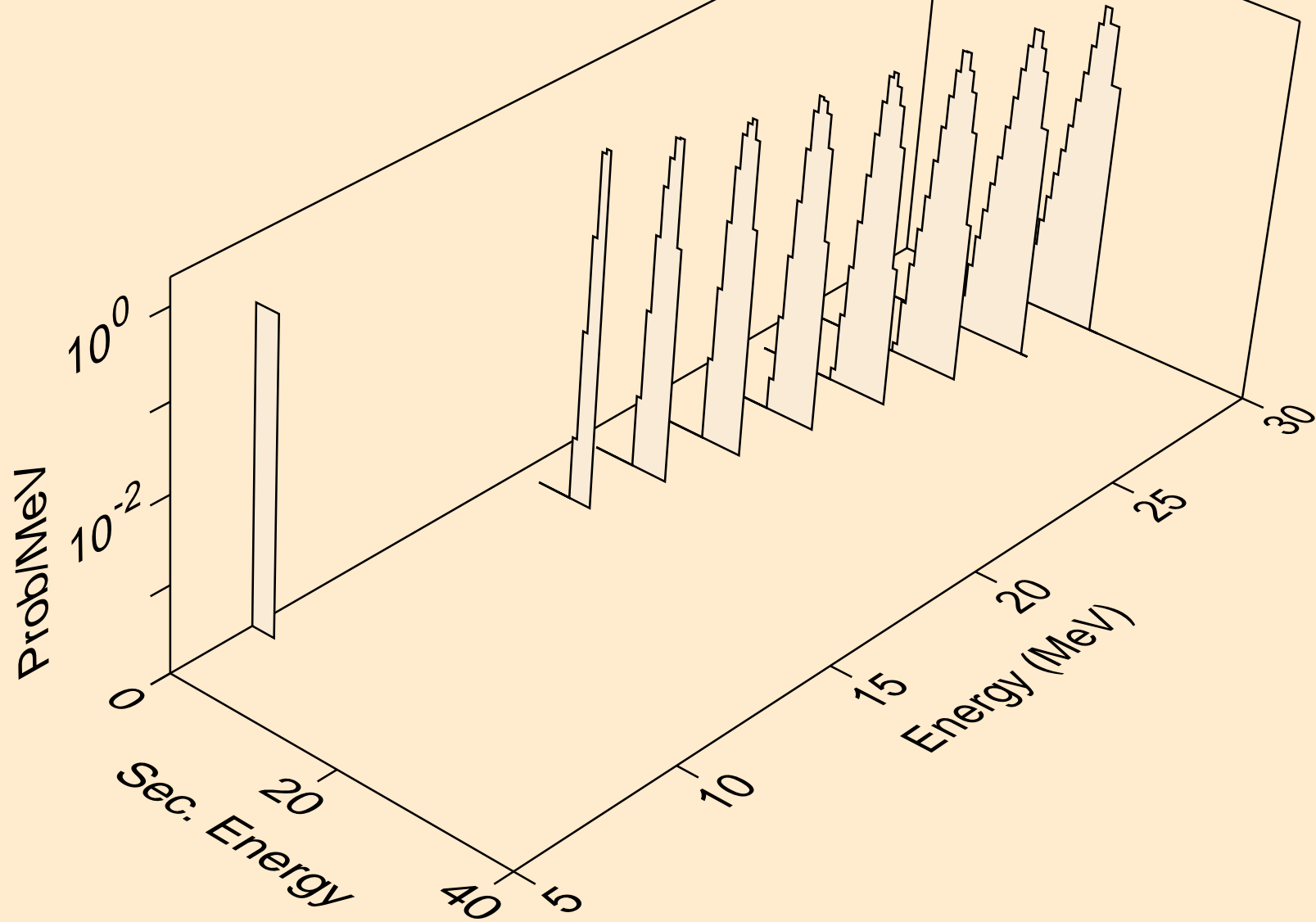

RF267 HELION ACER TENDL-2021 LIBRARY; T=0.K
tritons from (s,t)

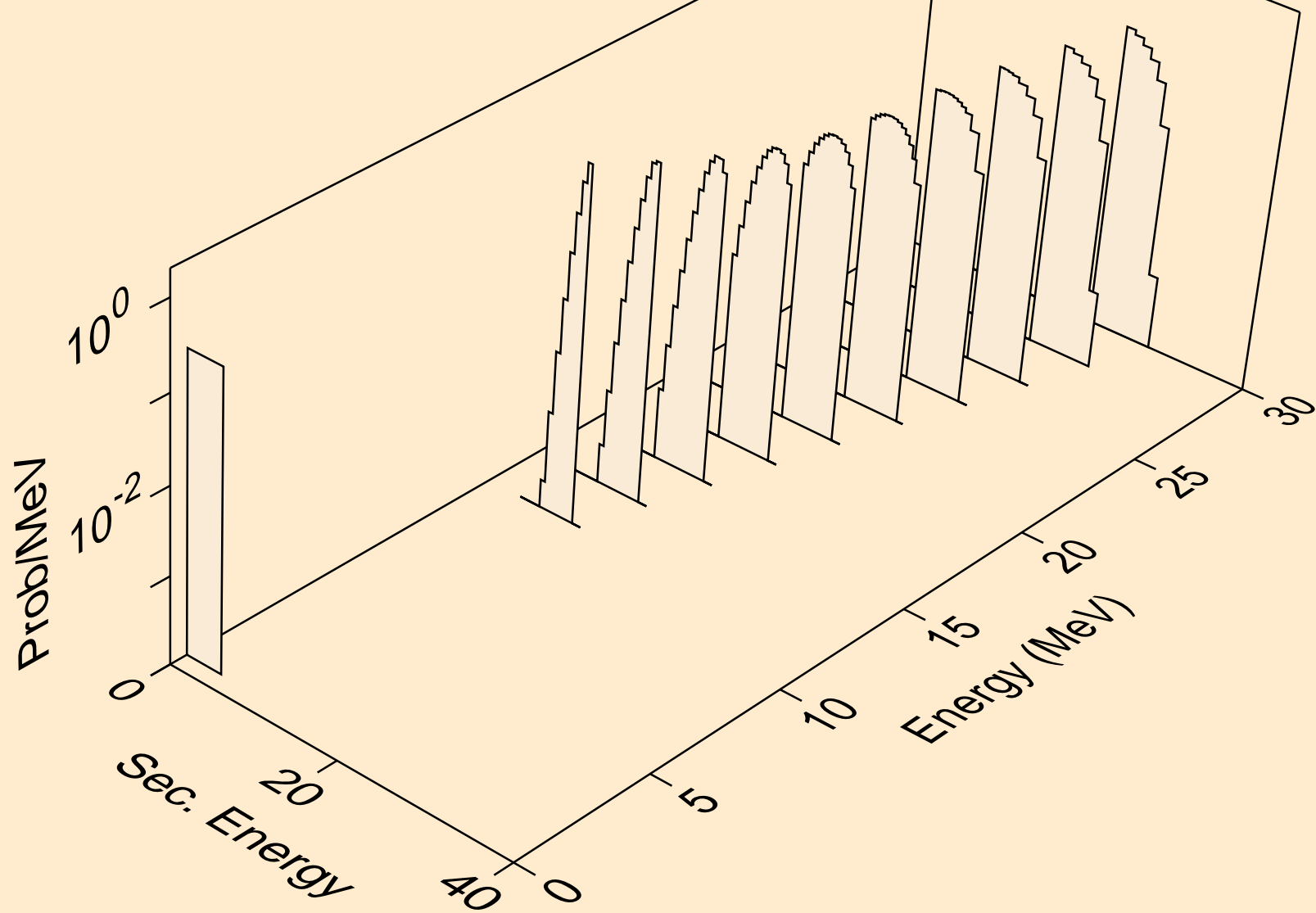

RF267 HELION ACER TENDL-2021 LIBRARY; T=0.K
alphas from (s,x)

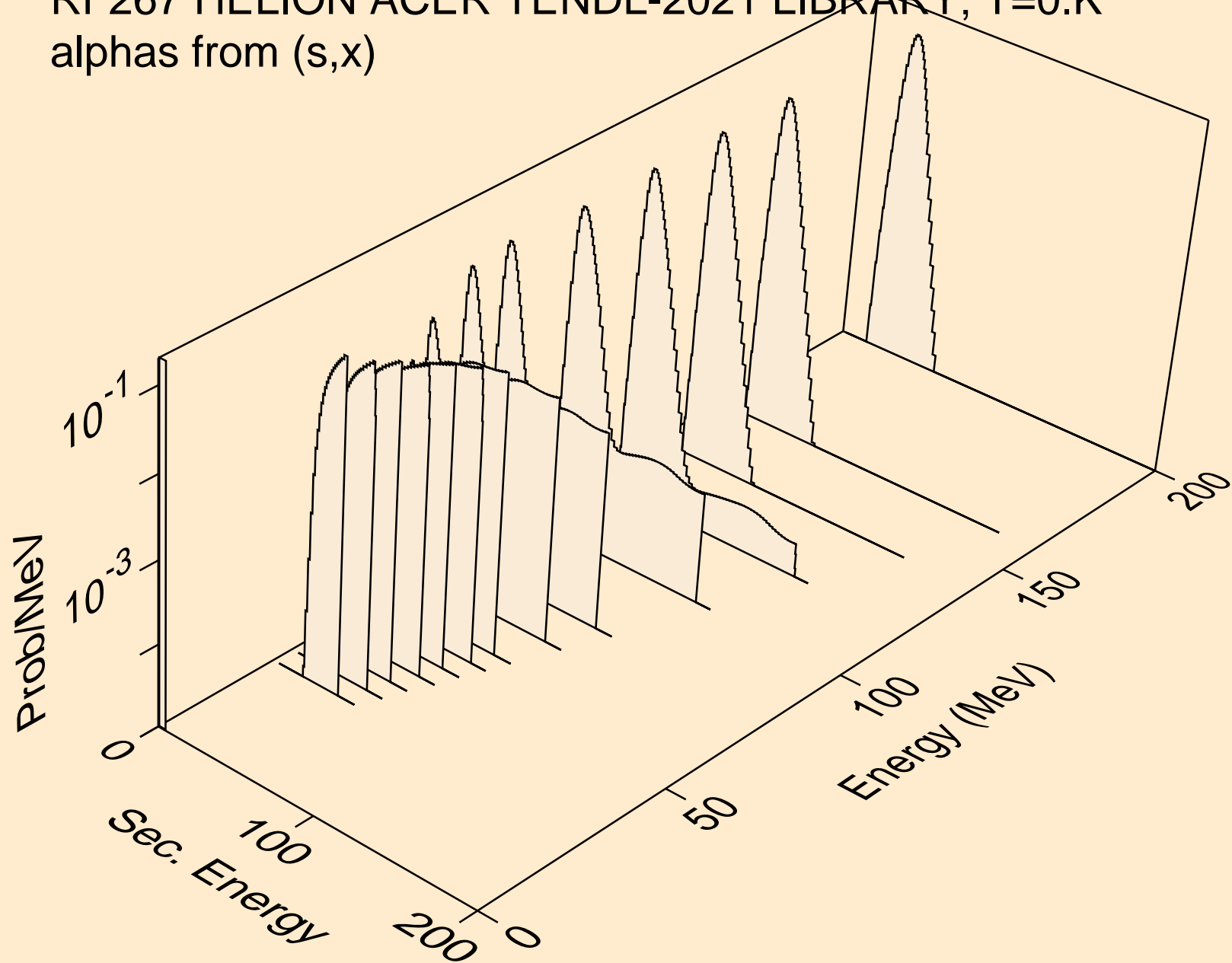

RF267 HELION ACER TENDL-2021 LIBRARY; T=0.K
alphas from (s,a)

