

SN120 HELION ACER TENDL-2021 LIBRARY; T=0.K

Principal cross sections

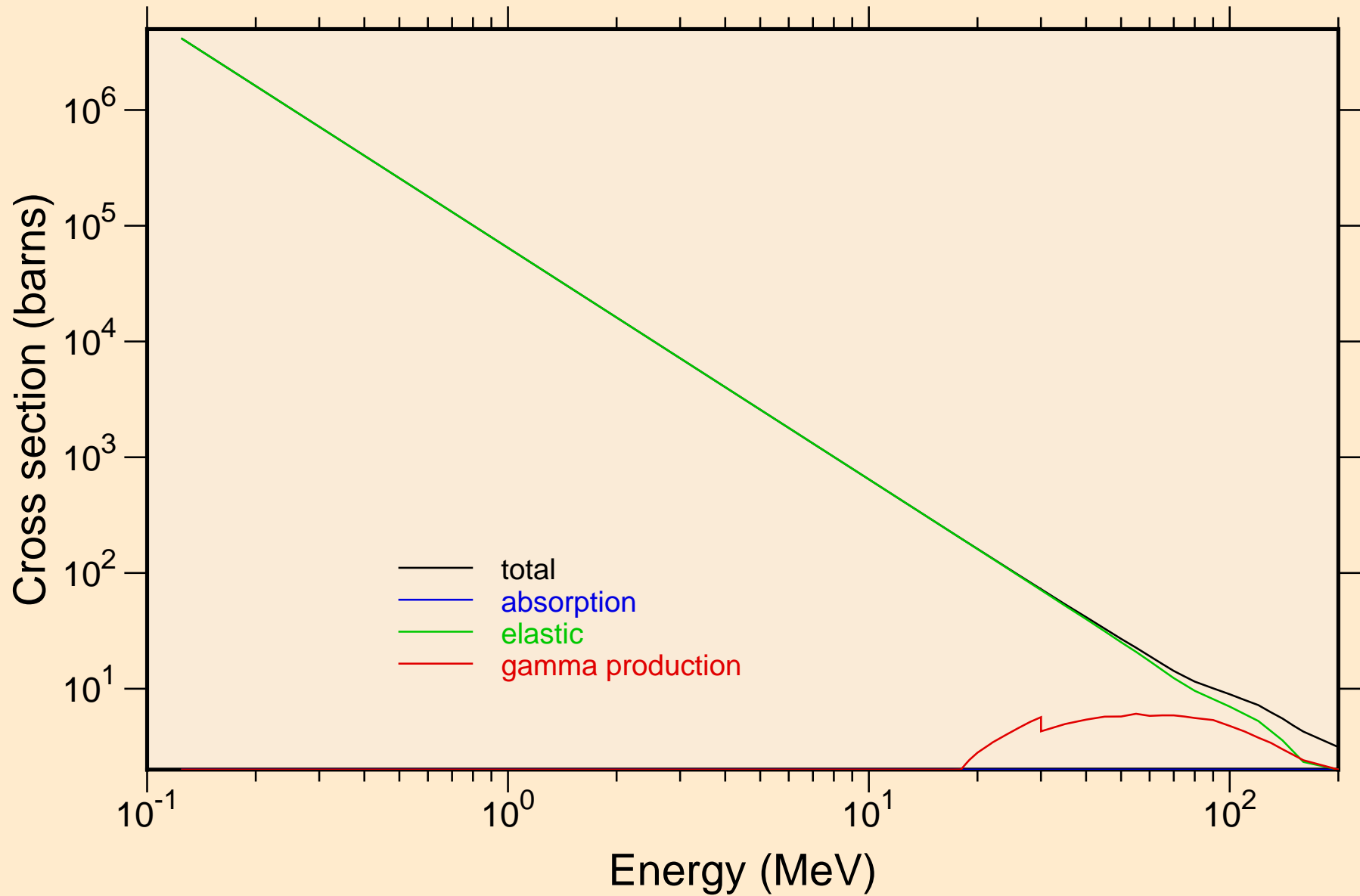

SN120 HELION ACER TENDL-2021 LIBRARY; T=0.K

Heating

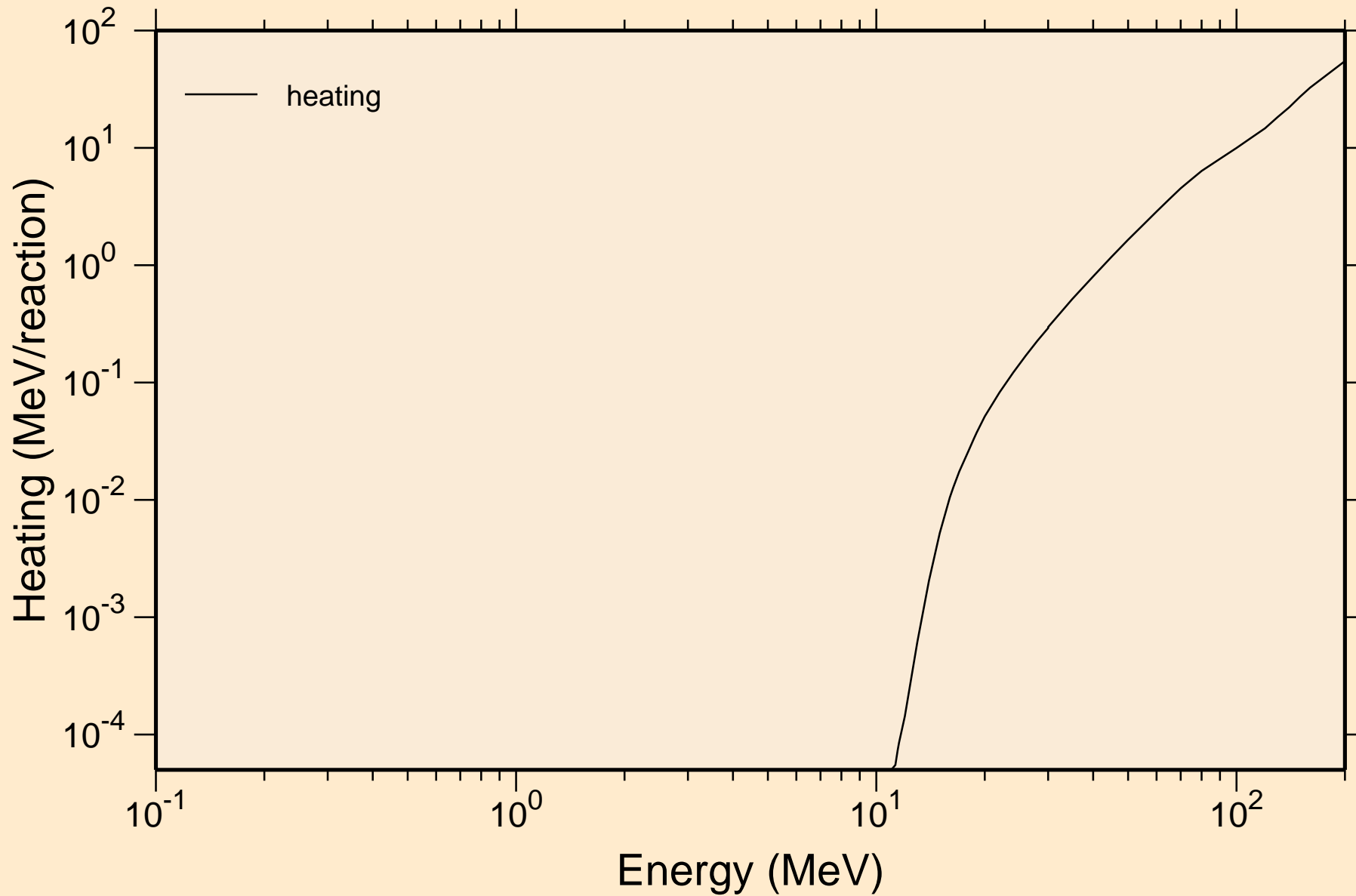

SN120 HELION ACER TENDL-2021 LIBRARY; T=0.K

Principal cross sections

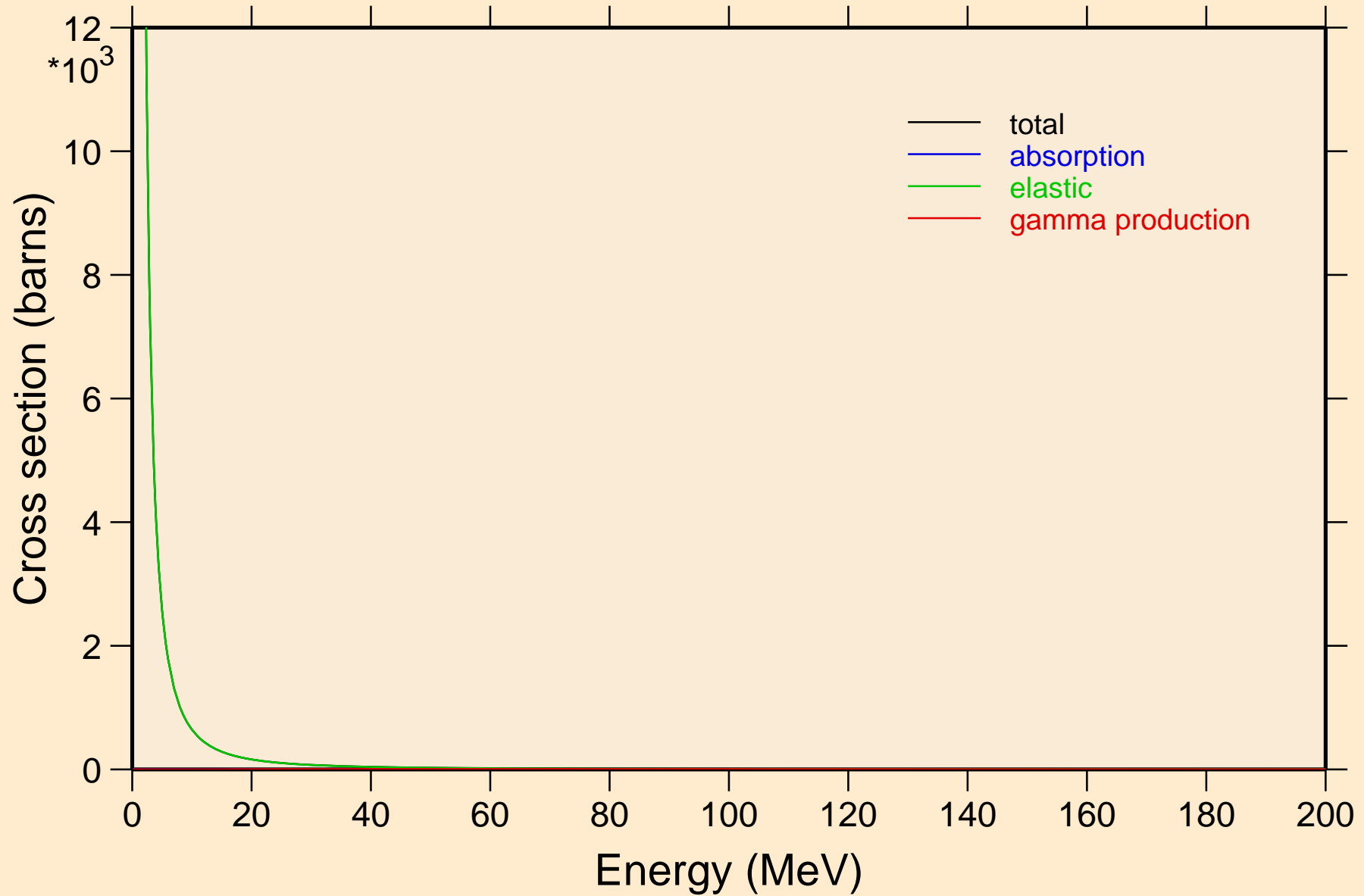

SN120 HELION ACER TENDL-2021 LIBRARY; T=0.K

Heating

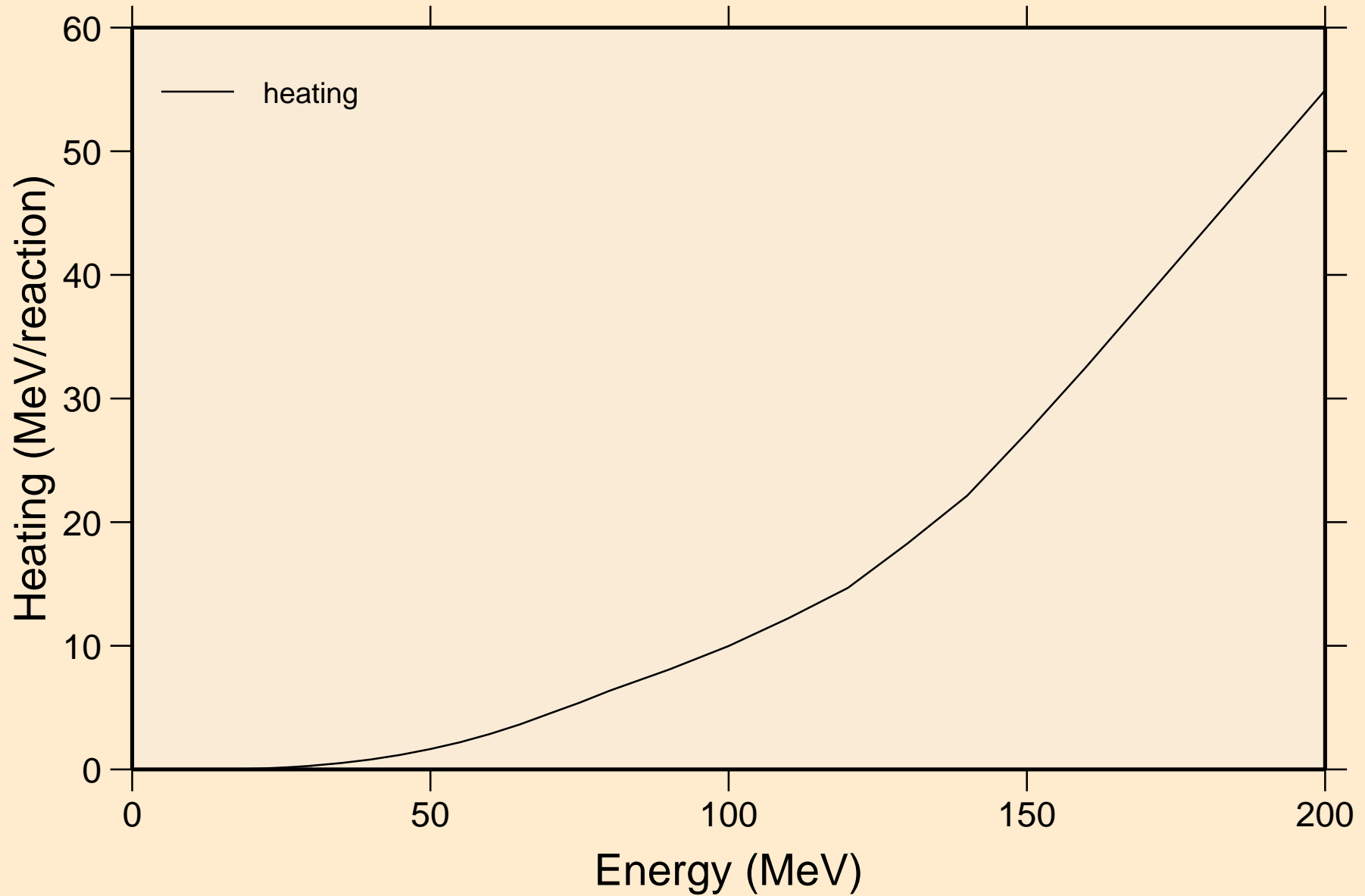

SN120 HELION ACER TENDL-2021 LIBRARY; T=0.K

Threshold reactions

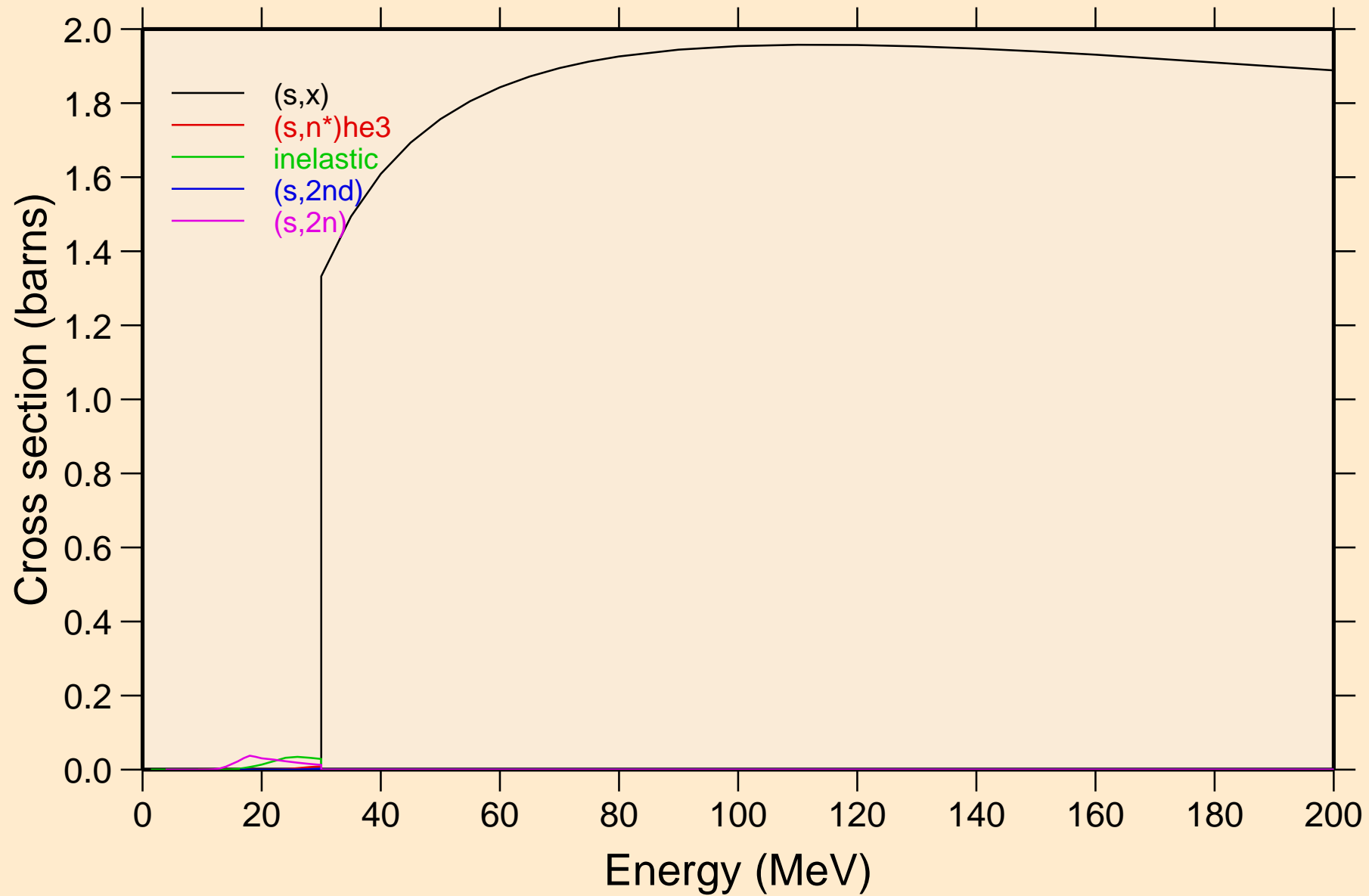

SN120 HELION ACER TENDL-2021 LIBRARY; T=0.K

Threshold reactions

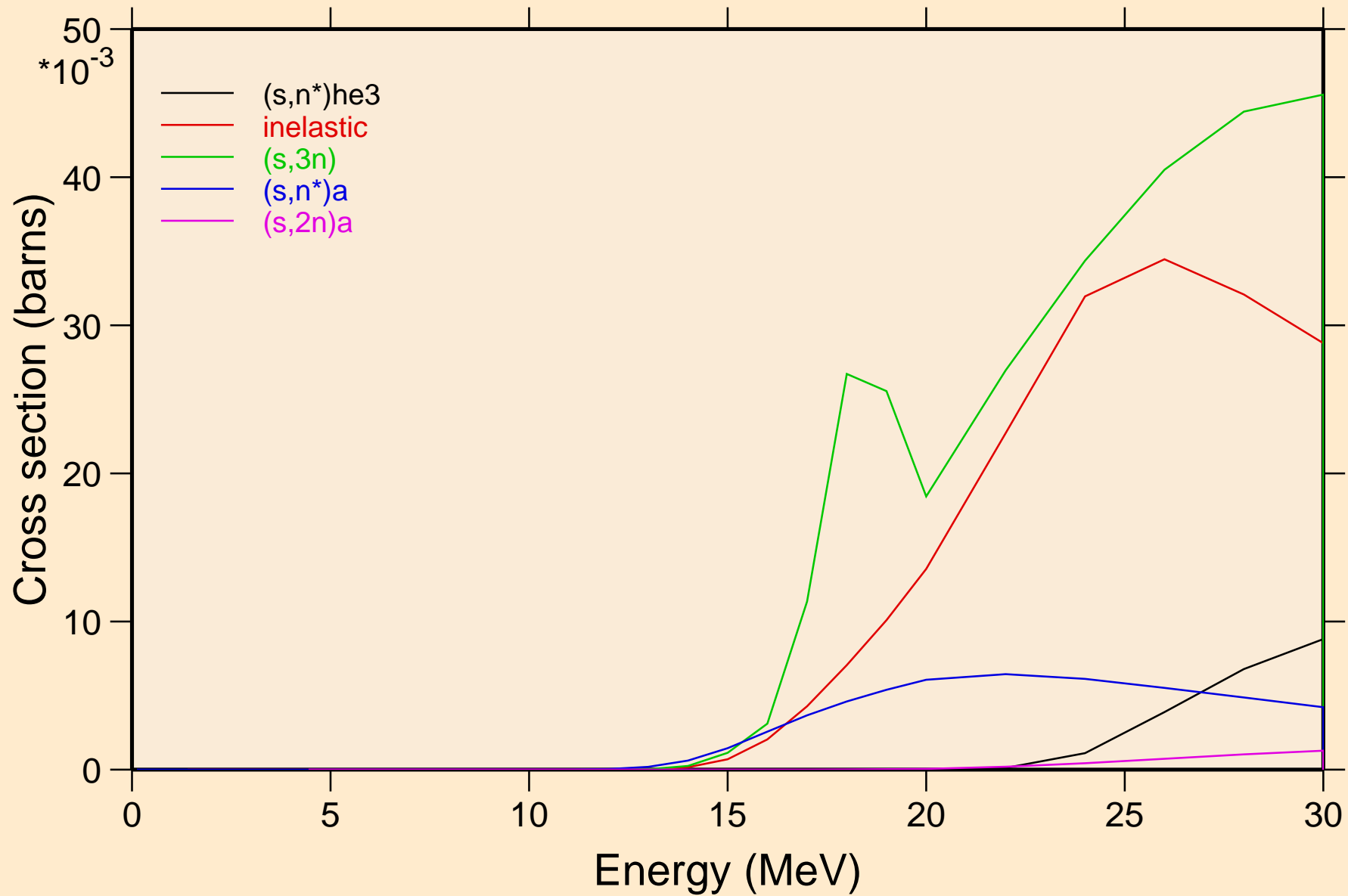

SN120 HELION ACER TENDL-2021 LIBRARY; T=0.K

Threshold reactions

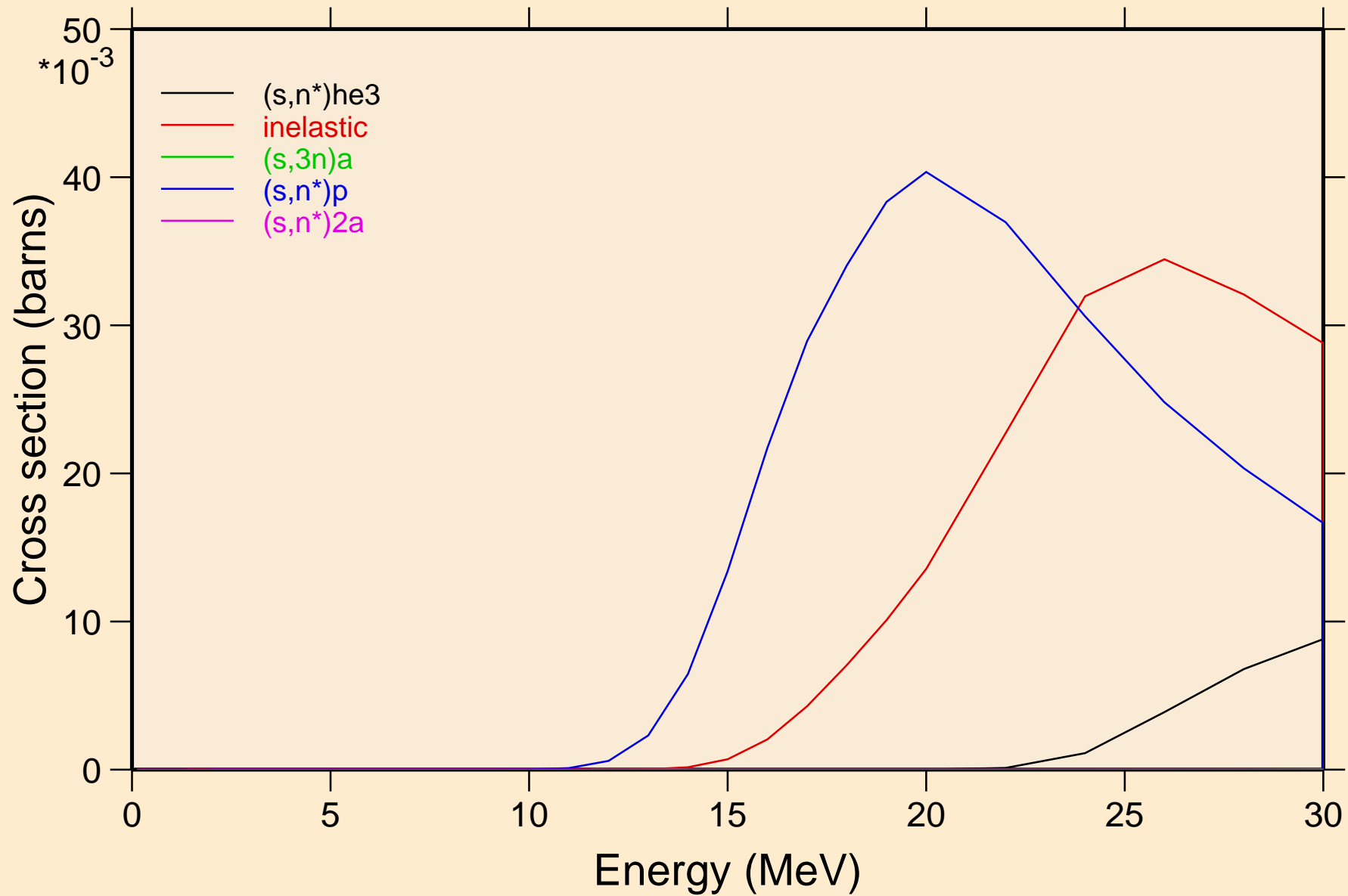

SN120 HELION ACER TENDL-2021 LIBRARY; T=0.K

Threshold reactions

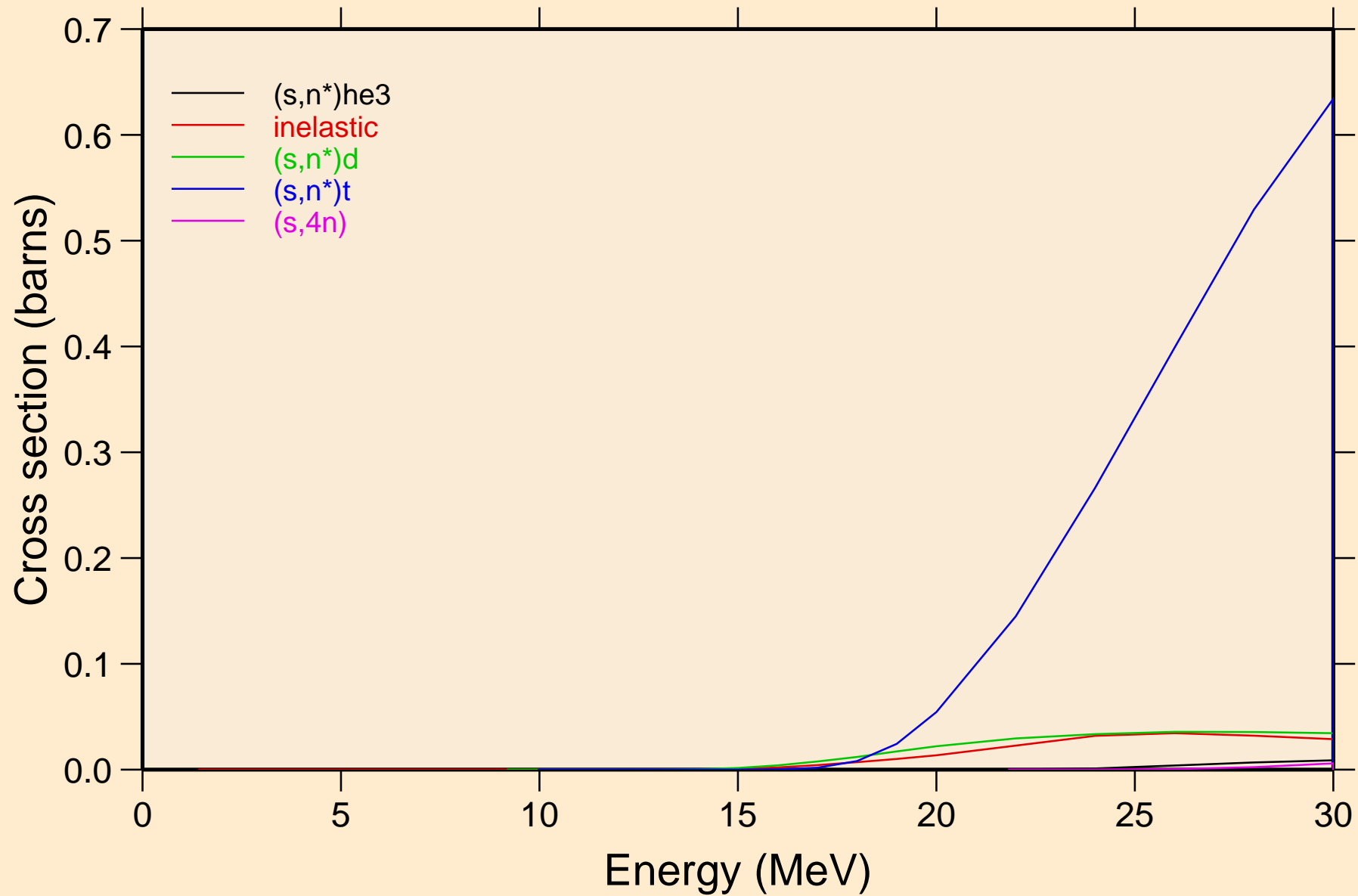

SN120 HELION ACER TENDL-2021 LIBRARY; T=0.K

Threshold reactions

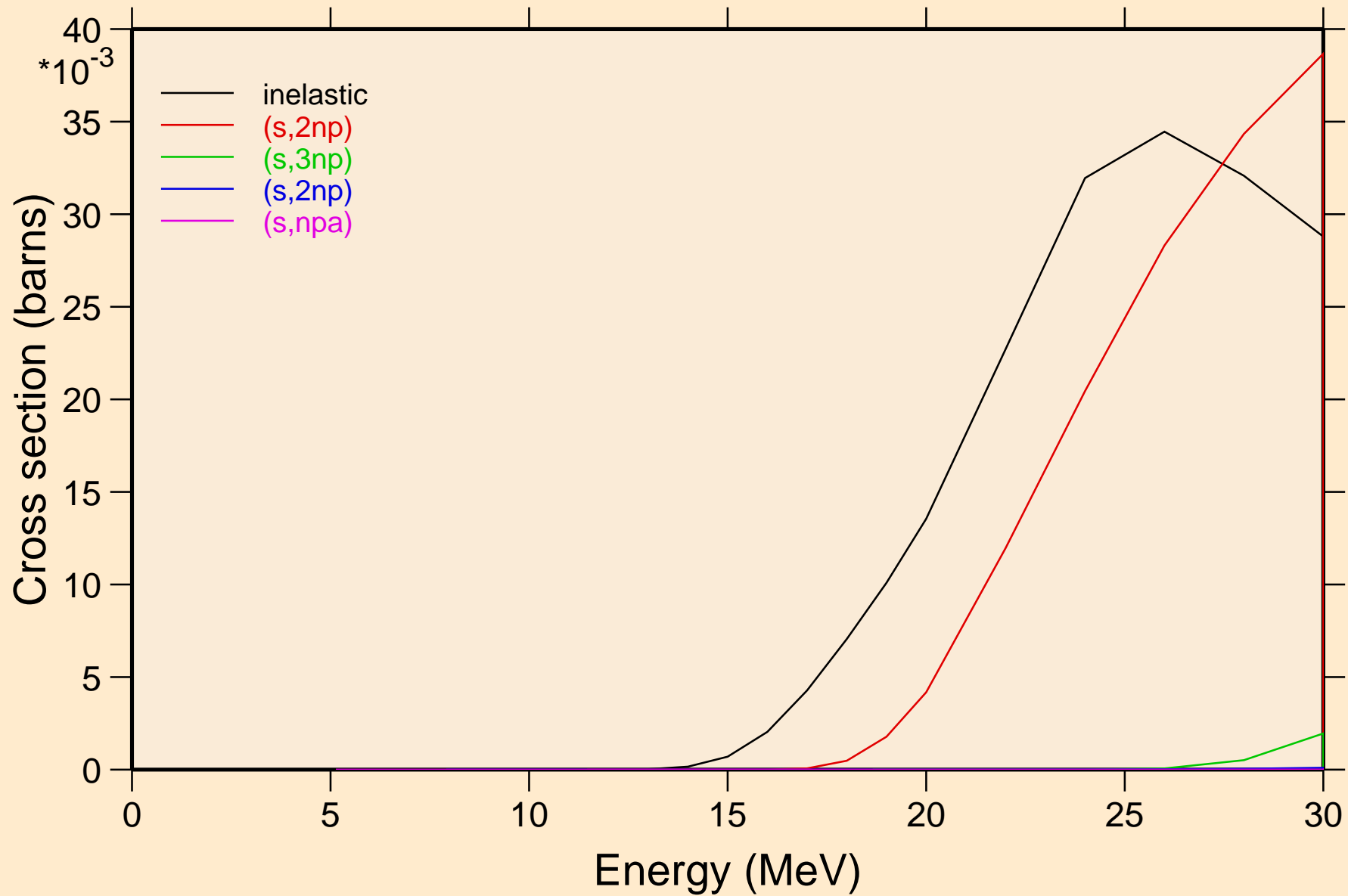

SN120 HELION ACER TENDL-2021 LIBRARY; T=0.K

Threshold reactions

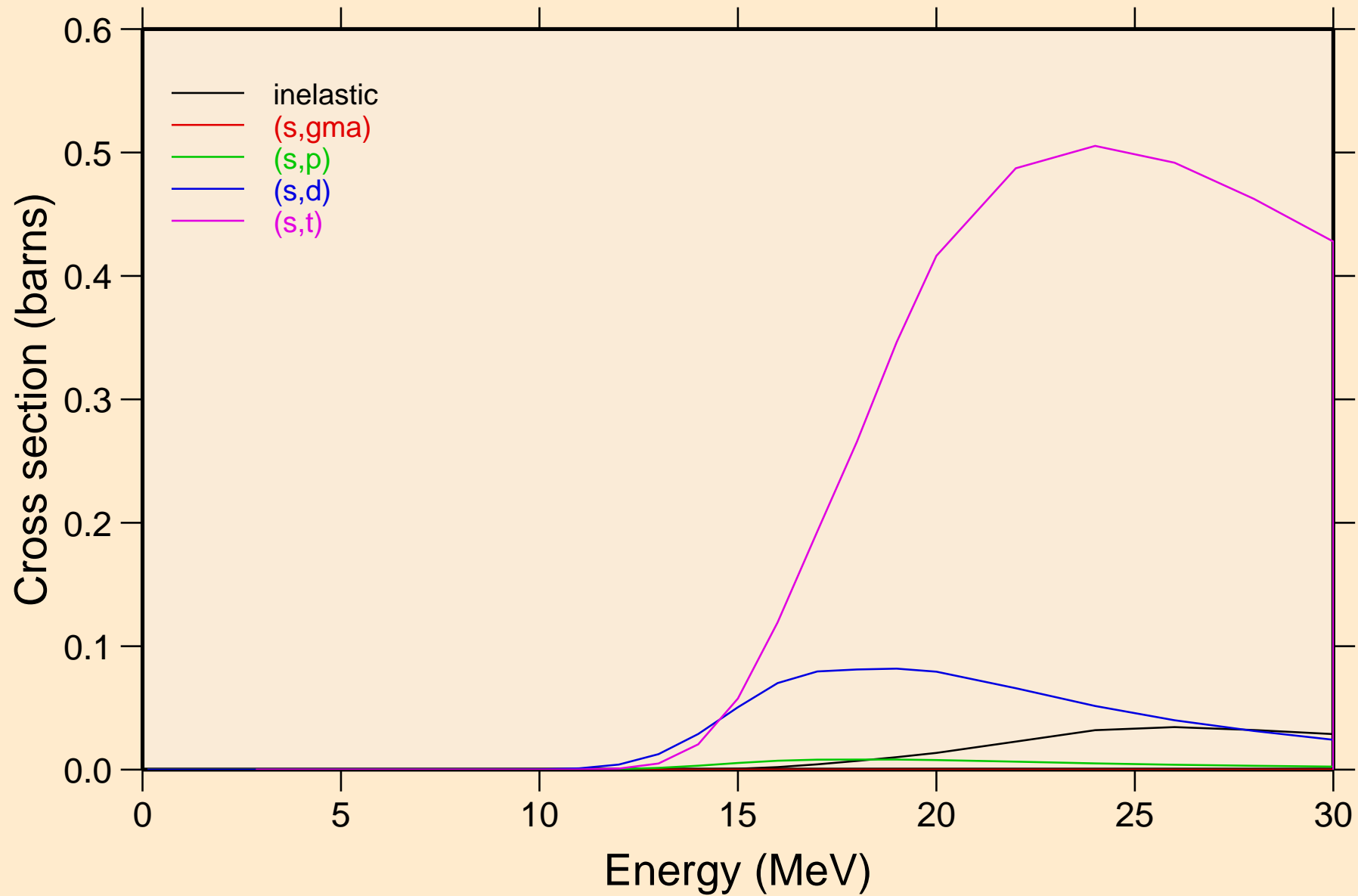

SN120 HELION ACER TENDL-2021 LIBRARY; T=0.K
Threshold reactions

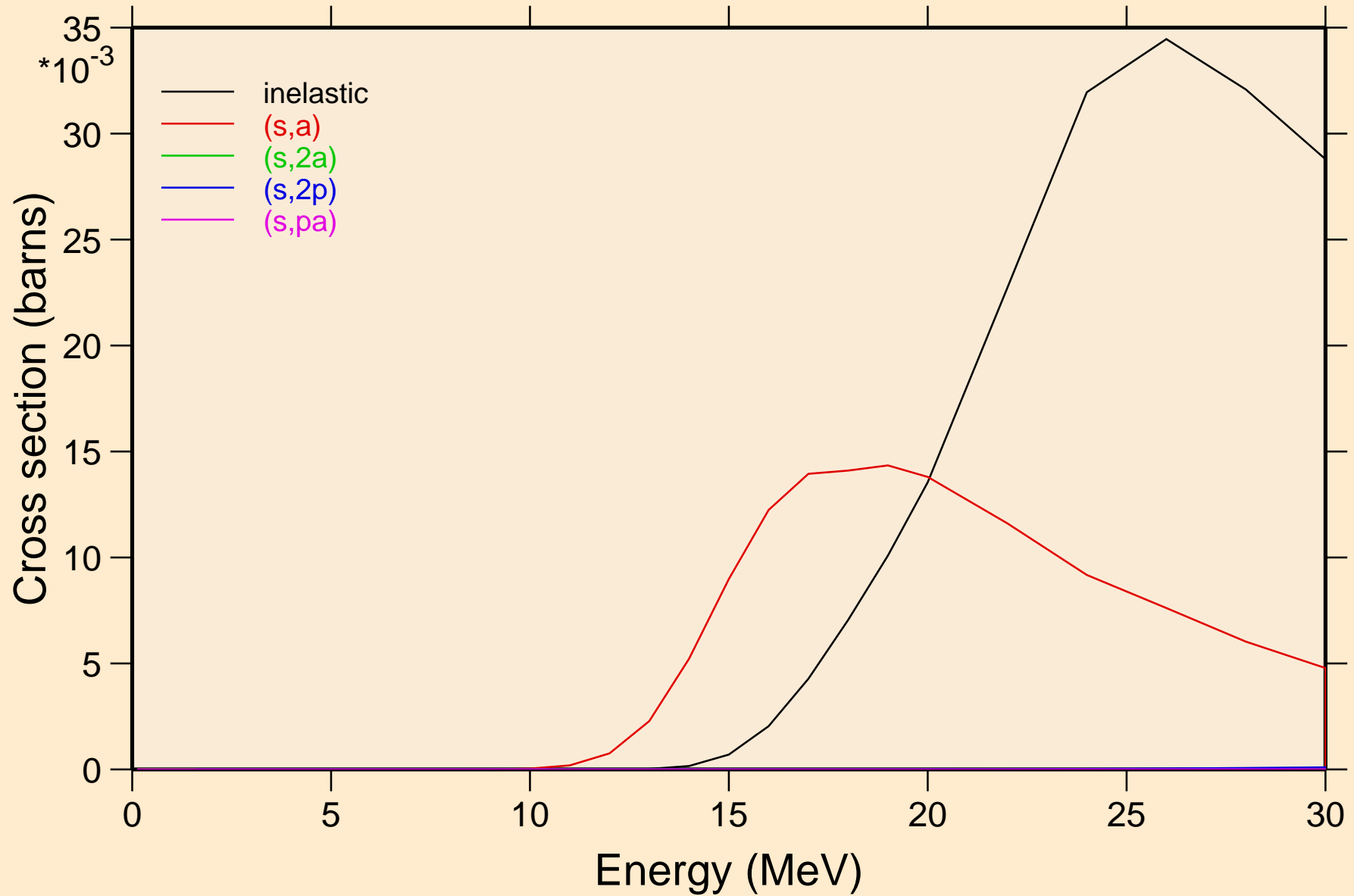

SN120 HELION ACER TENDL-2021 LIBRARY; T=0.K
Threshold reactions

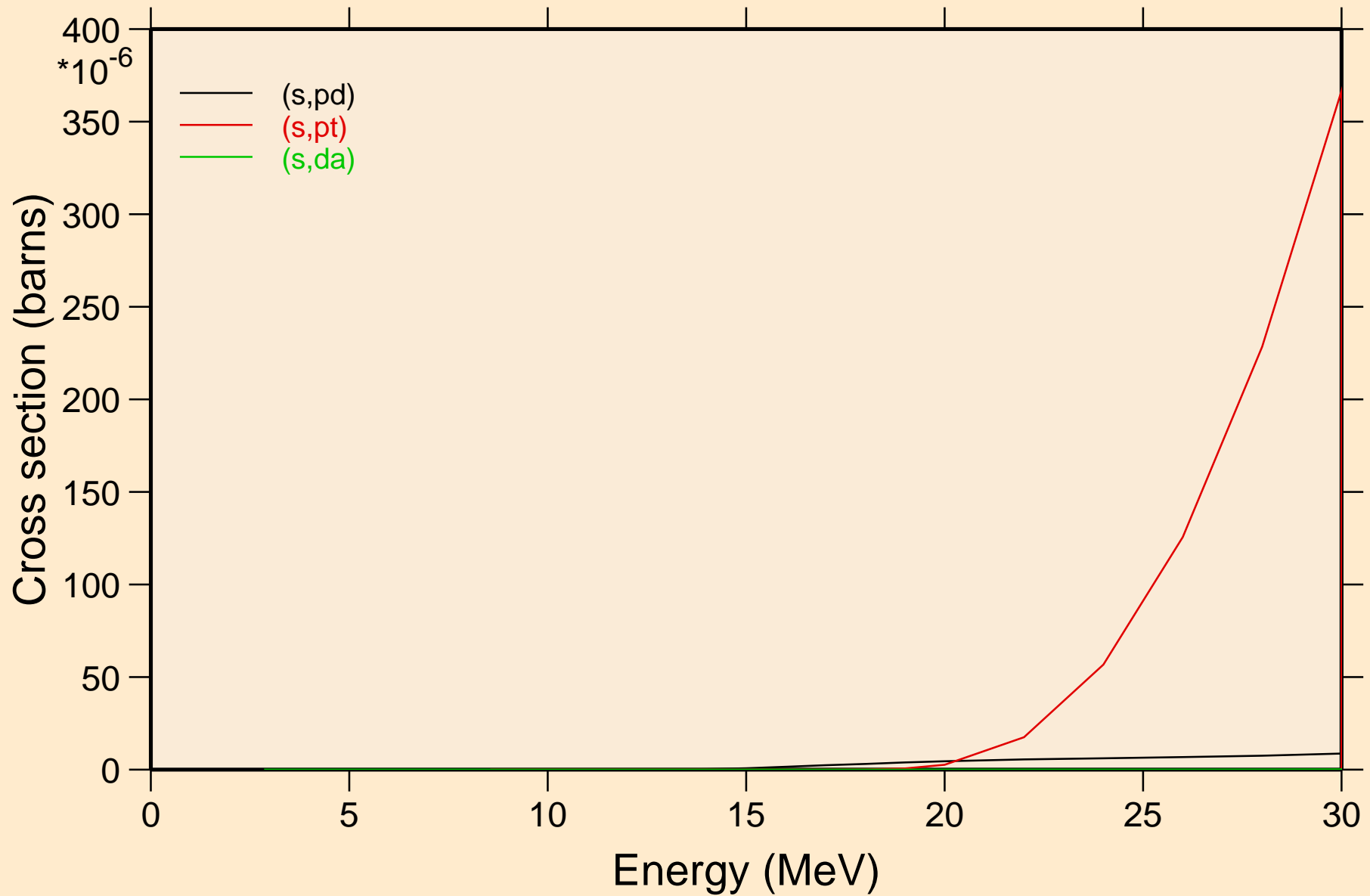

SN120 HELION ACER TENDL-2021 LIBRARY; T=0.K
angular distribution for elastic

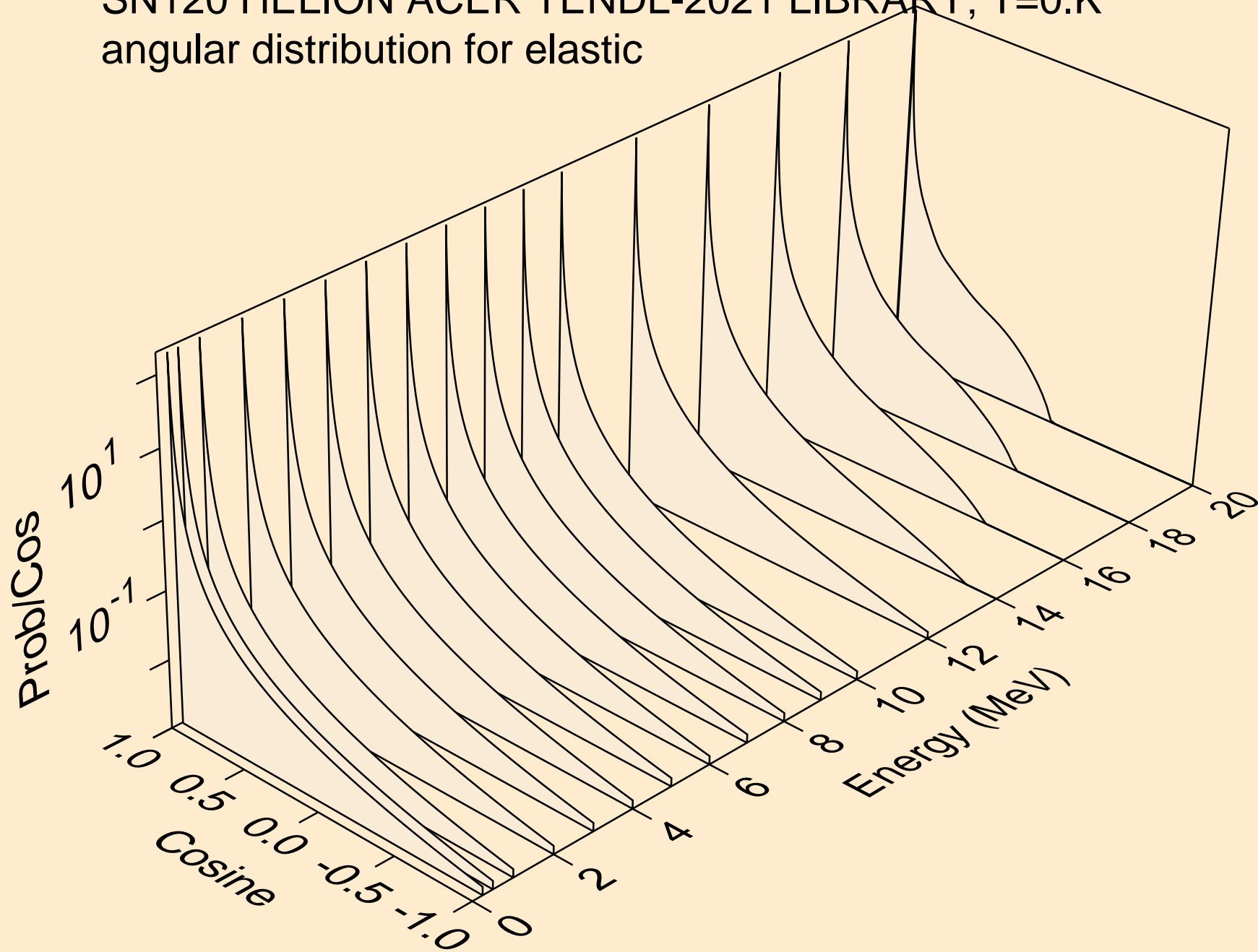

SN120 HELION ACER TENDL-2021 LIBRARY; T=0.K
angular distribution for elastic

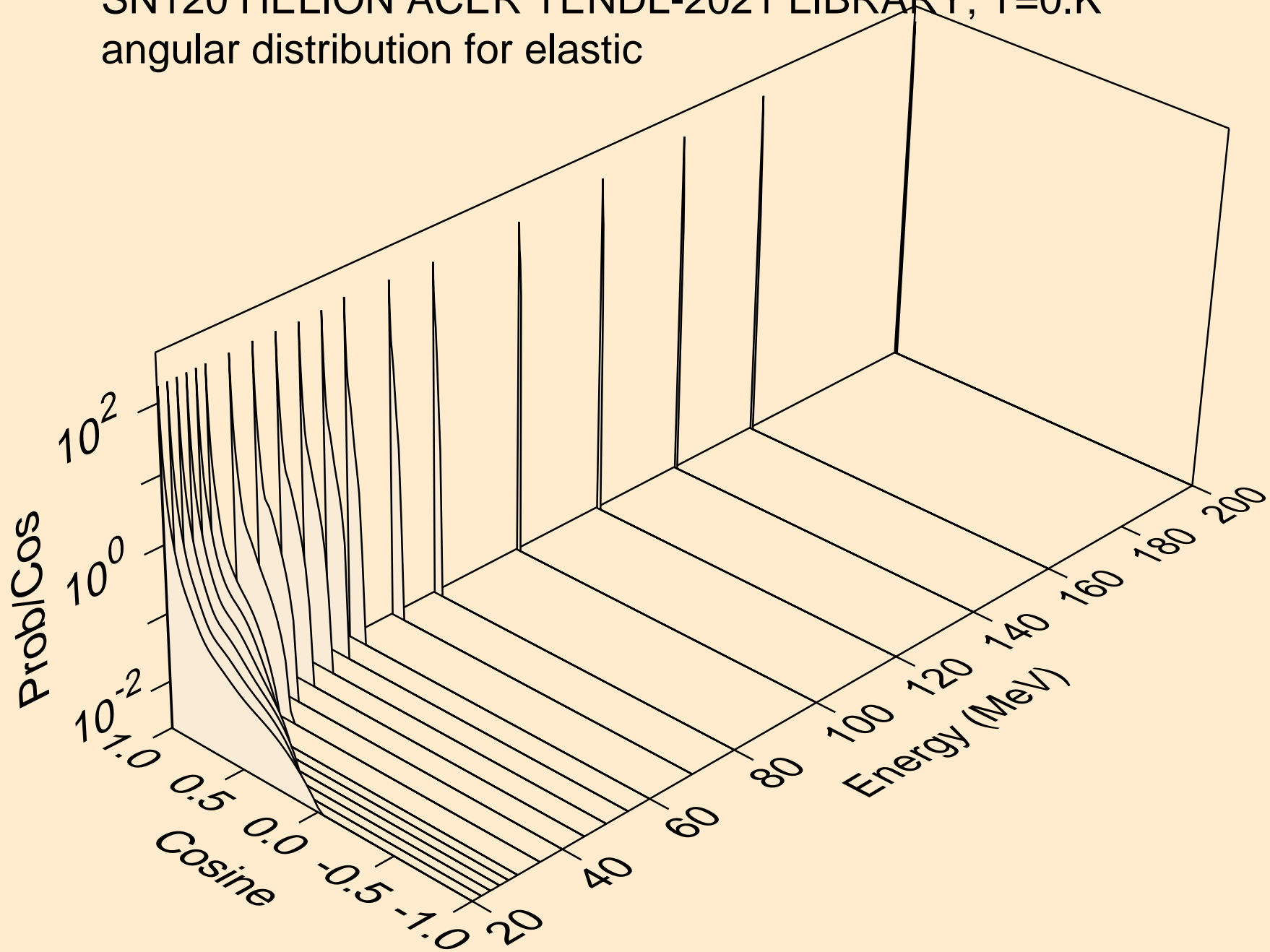

SN120 HELION ACER TENDL-2021 LIBRARY; T=0.K
He-3 emission for (s,x)

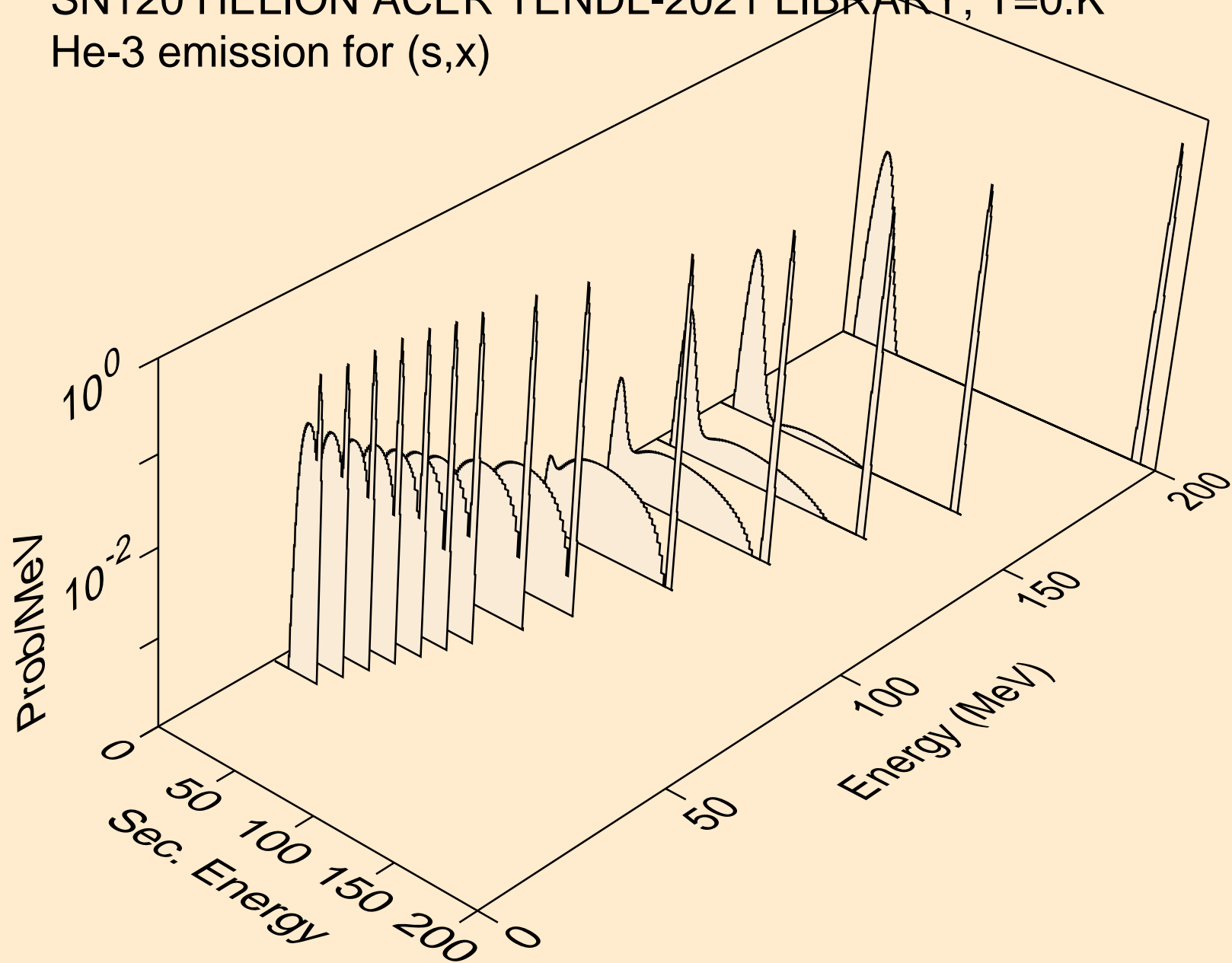

SN120 HELION ACER TENDL-2021 LIBRARY; T=0.K
He-3 emission for (s,n*)he3

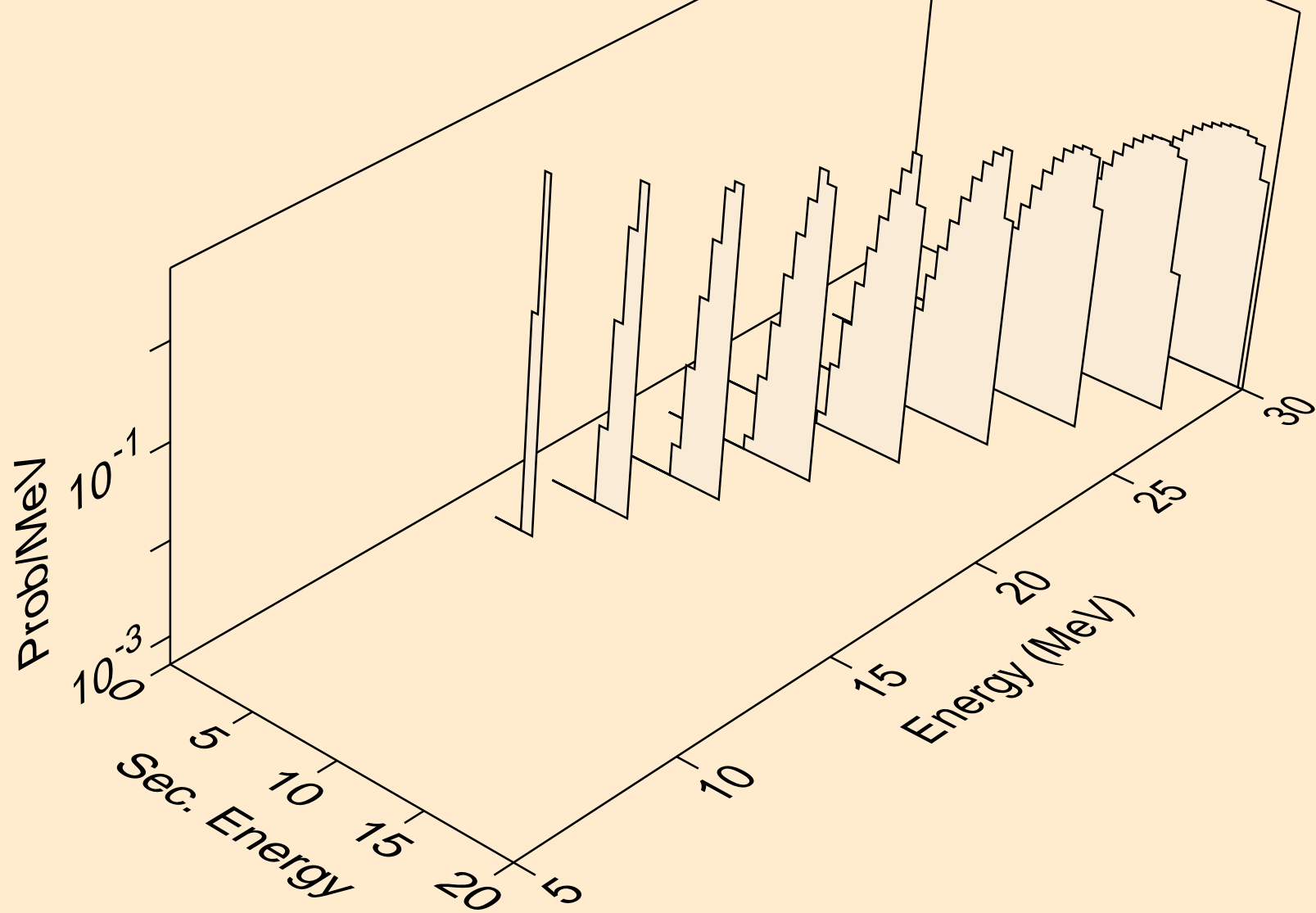

SN120 HELION ACER TENDL-2021 LIBRARY; T=0.K
He-3 emission for inelastic

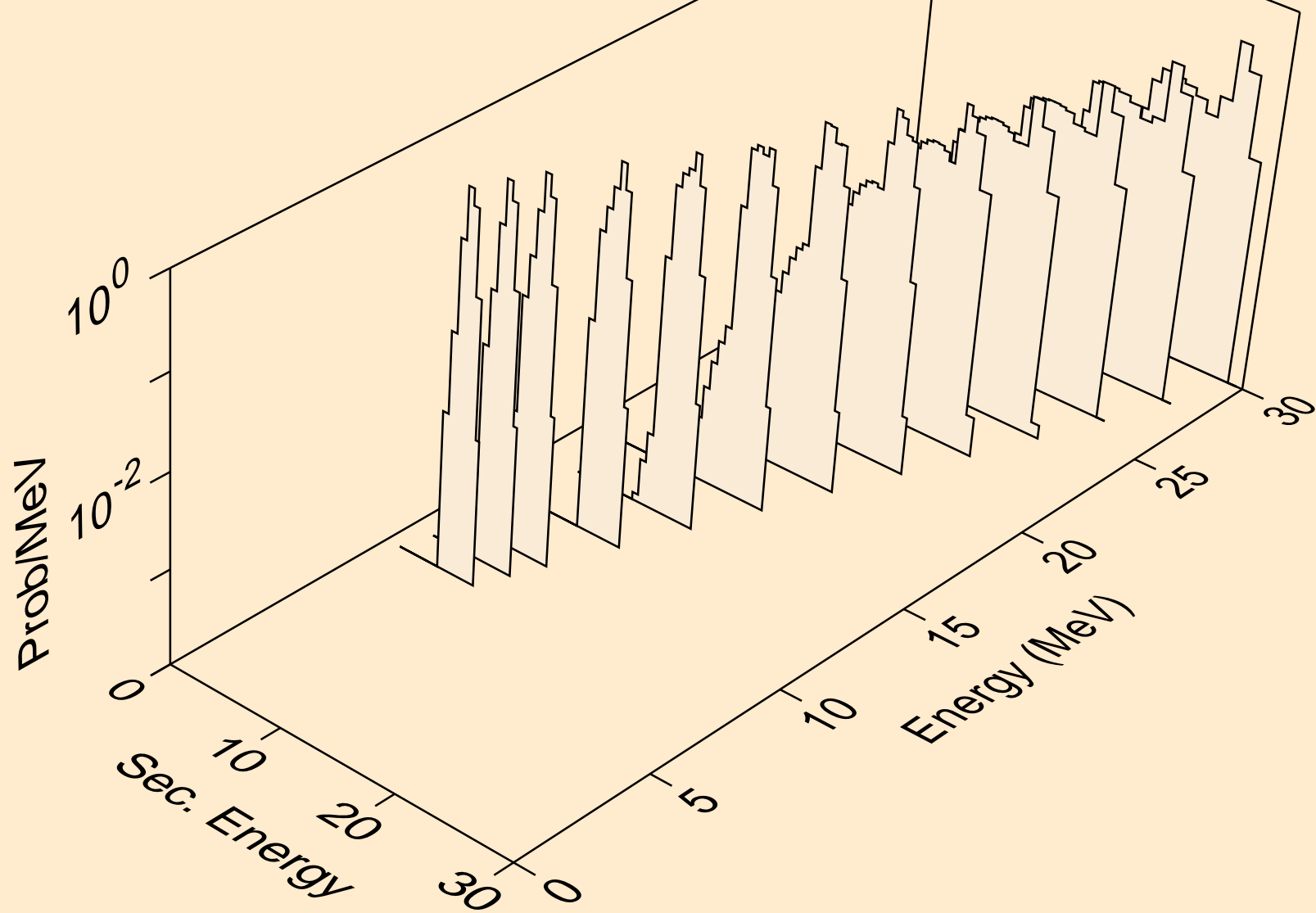

SN120 HELION ACER TENDL-2021 LIBRARY; T=0.K
Photon emission for (z,n)

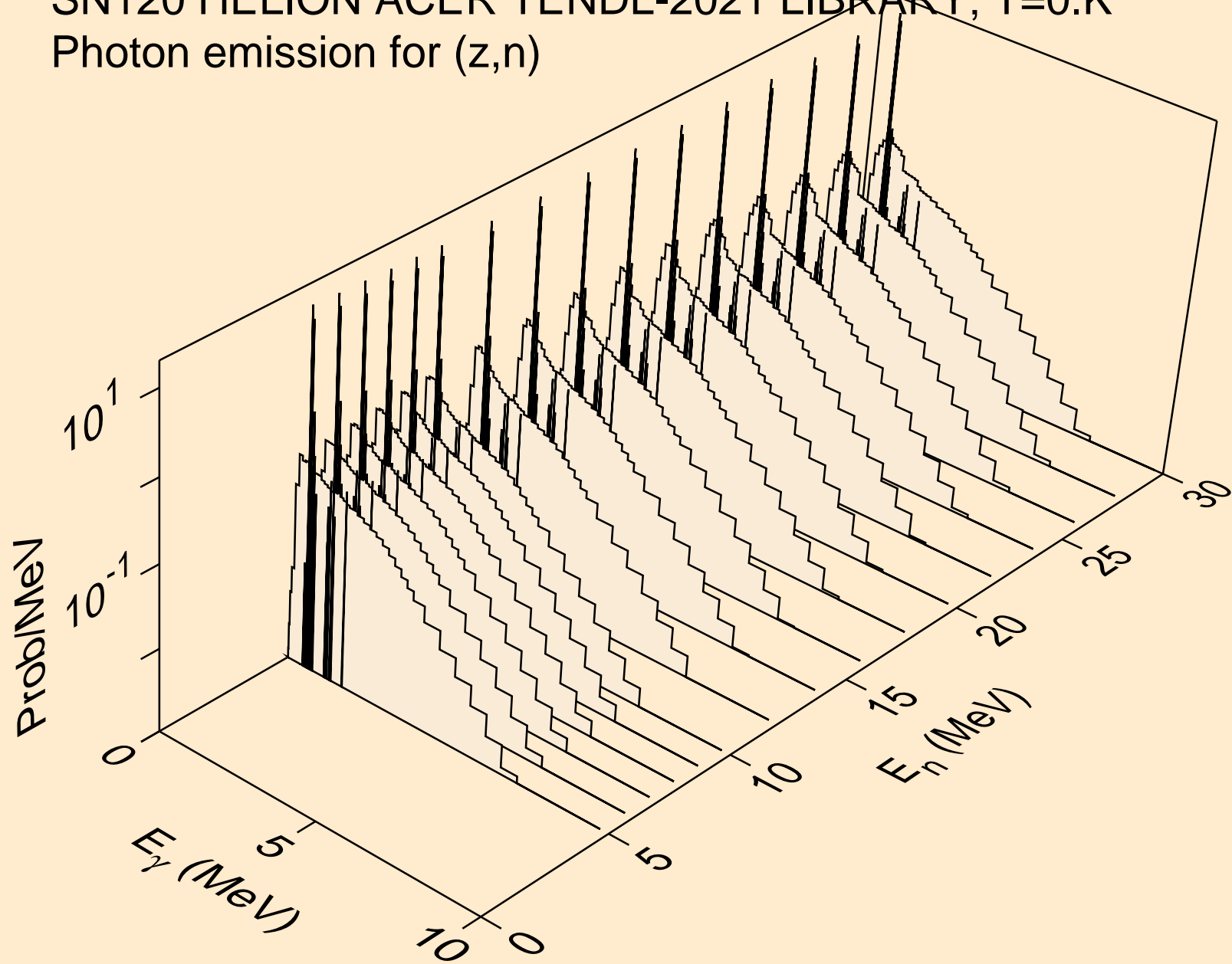

SN120 HELION ACER TENDL-2021 LIBRARY; T=0.K
Photon emission for (n,x)

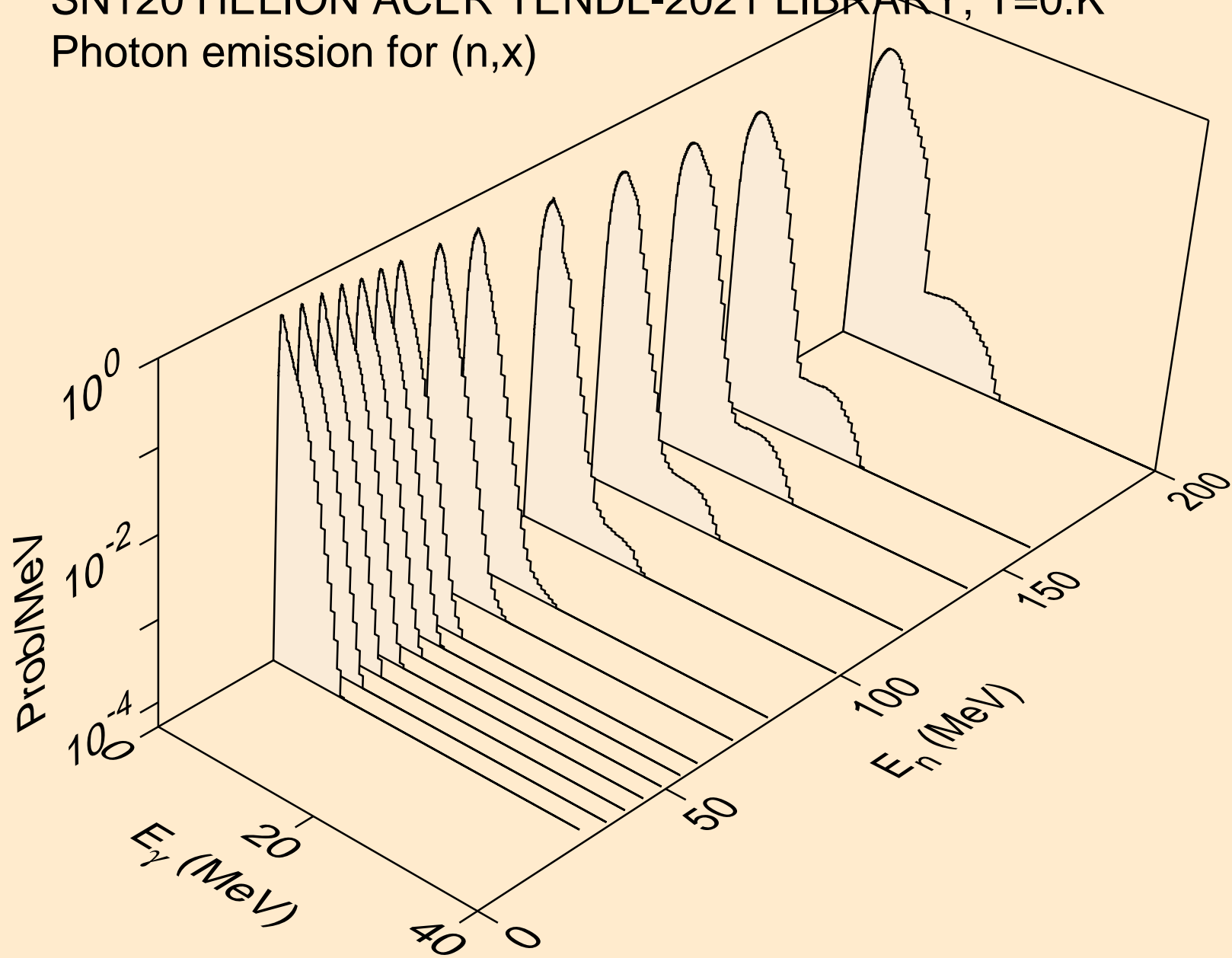

SN120 HELION ACER TENDL-2021 LIBRARY; T=0.K
Photon emission for (n,2nd)

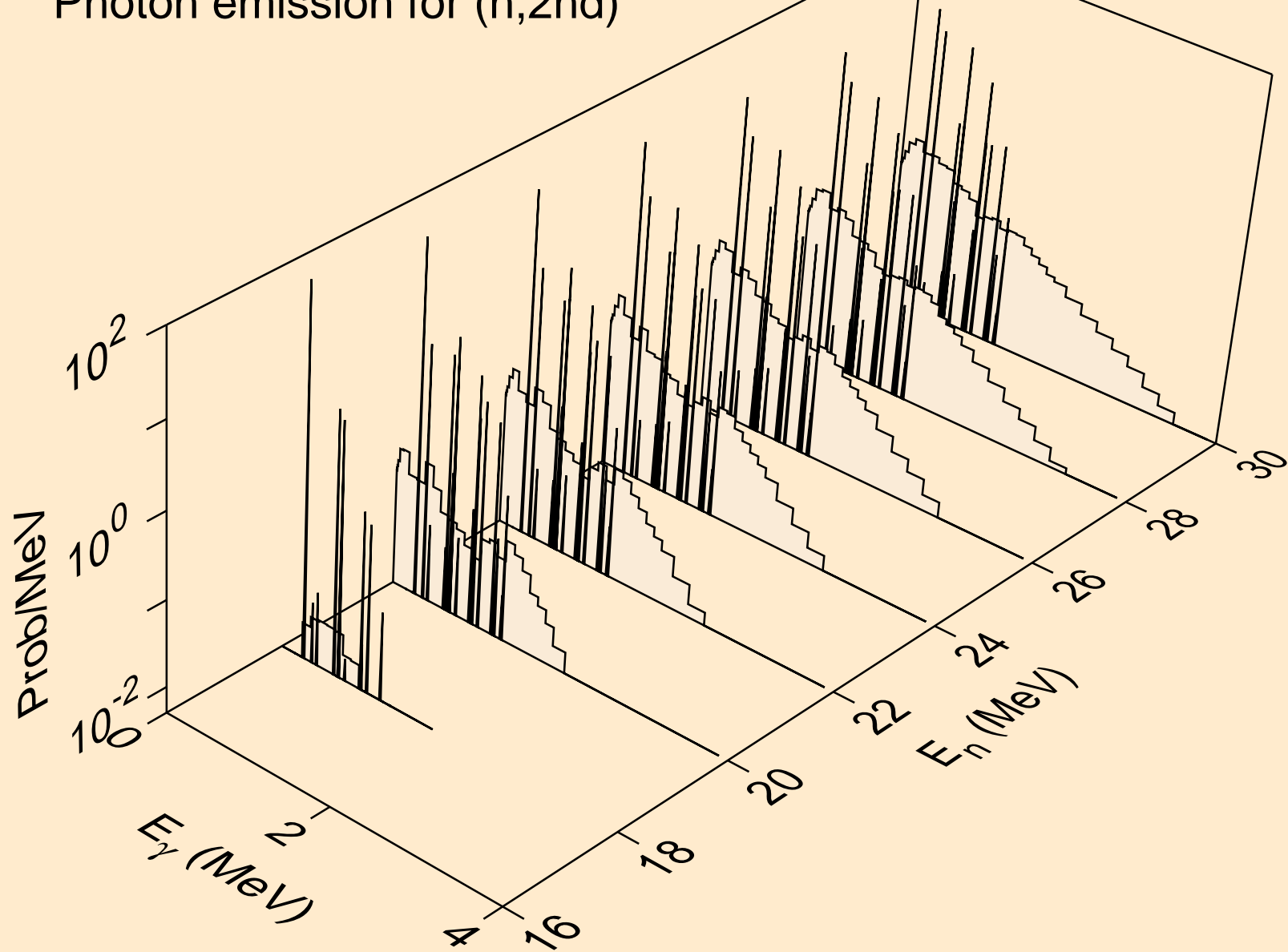

SN120 HELION ACER TENDL-2021 LIBRARY; T=0.K
Photon emission for (n,2n)

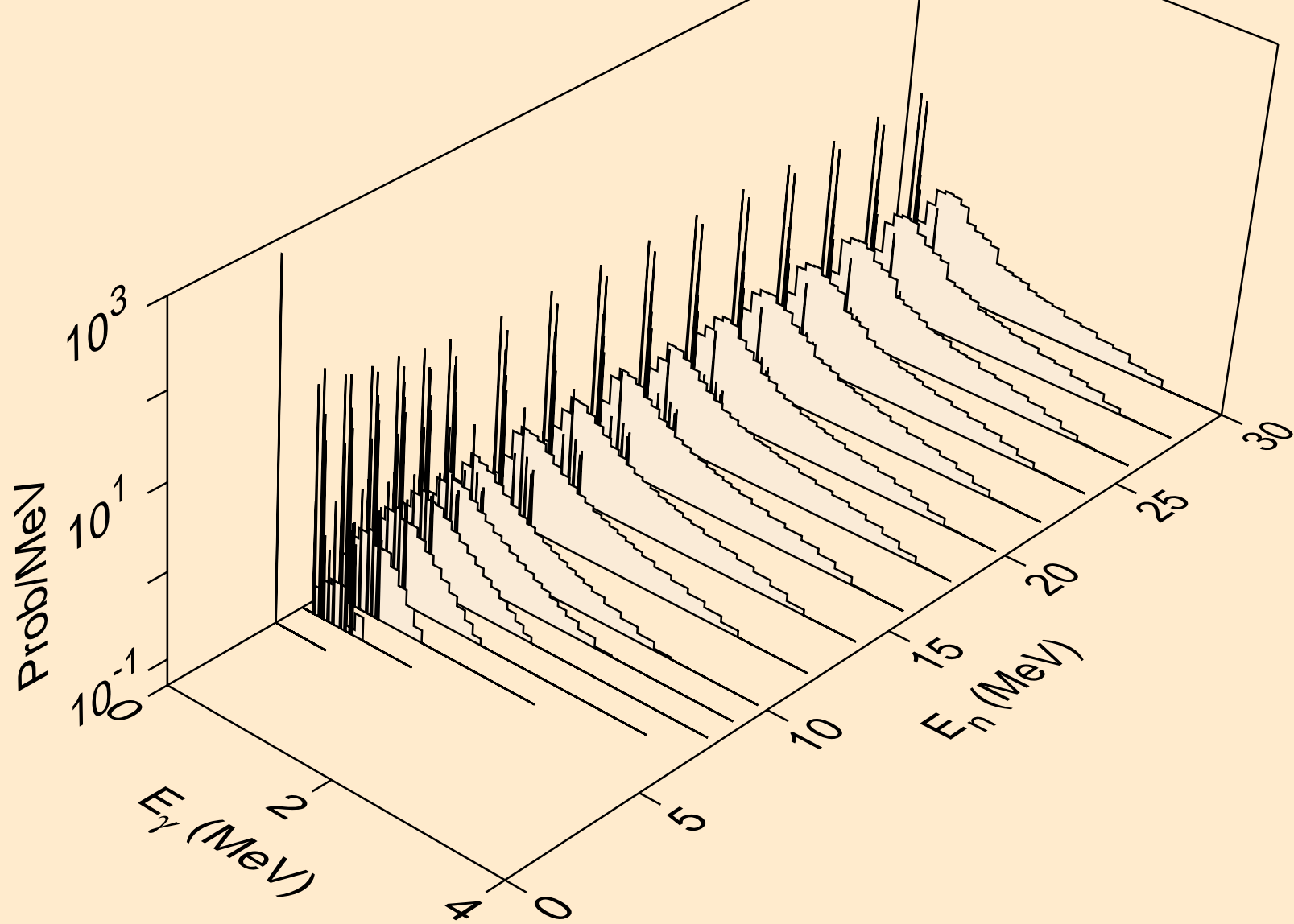

SN120 HELION ACER TENDL-2021 LIBRARY; T=0.K
Photon emission for (n,3n)

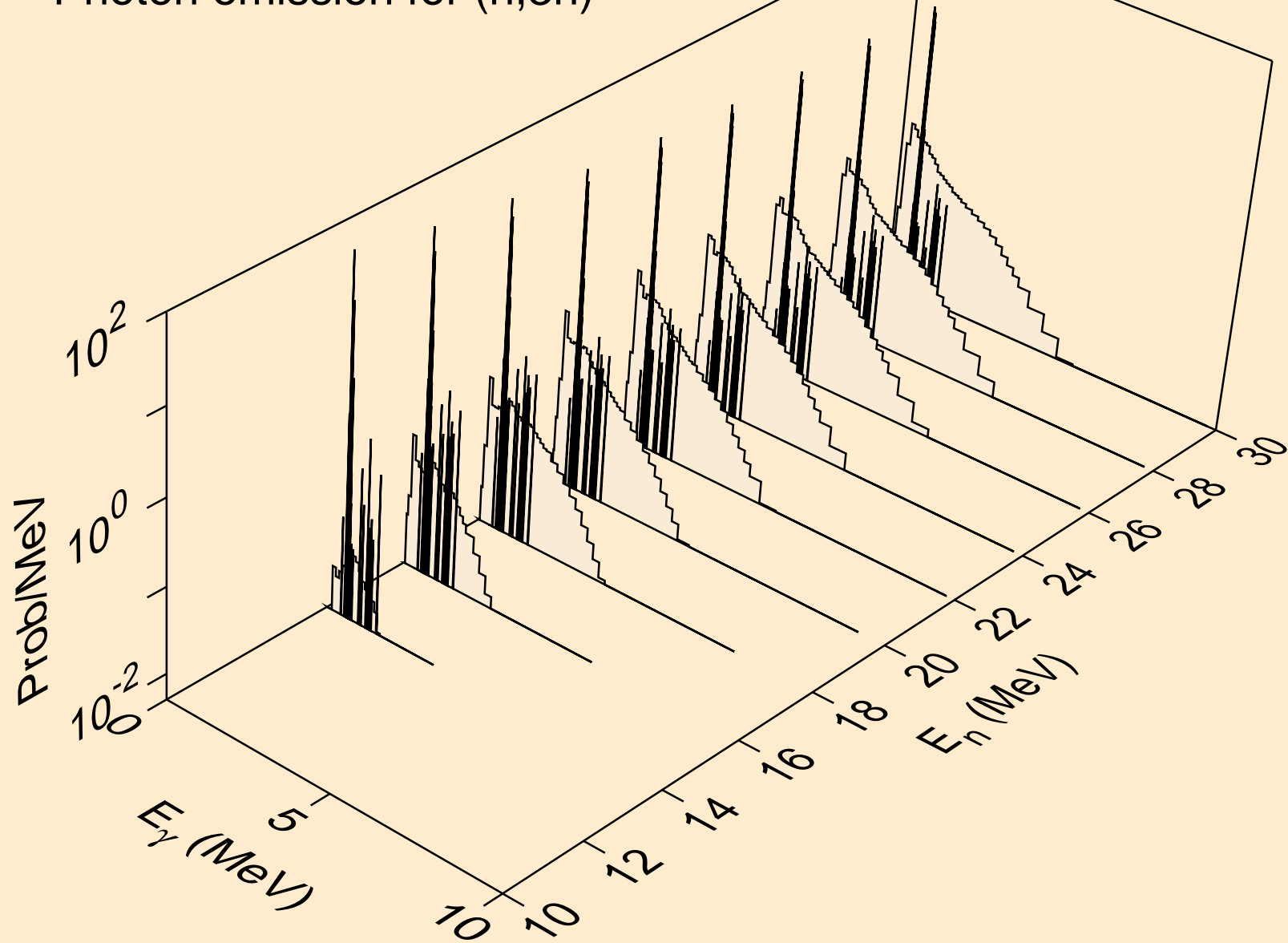

SN120 HELION ACER TENDL-2021 LIBRARY; T=0.K
Photon emission for (n,n*)a

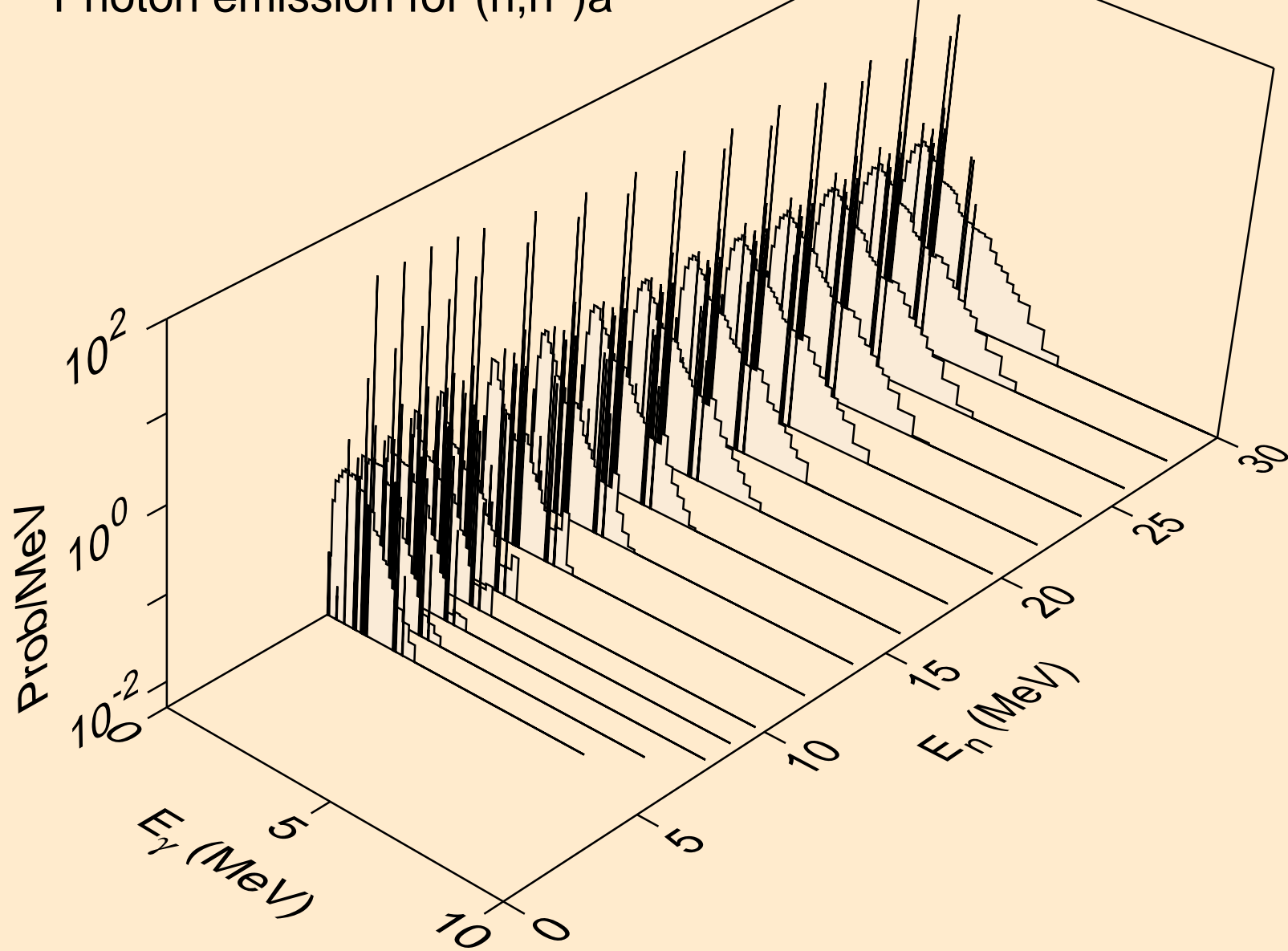

SN120 HELION ACER TENDL-2021 LIBRARY; T=0.K
Photon emission for (n,2n)a

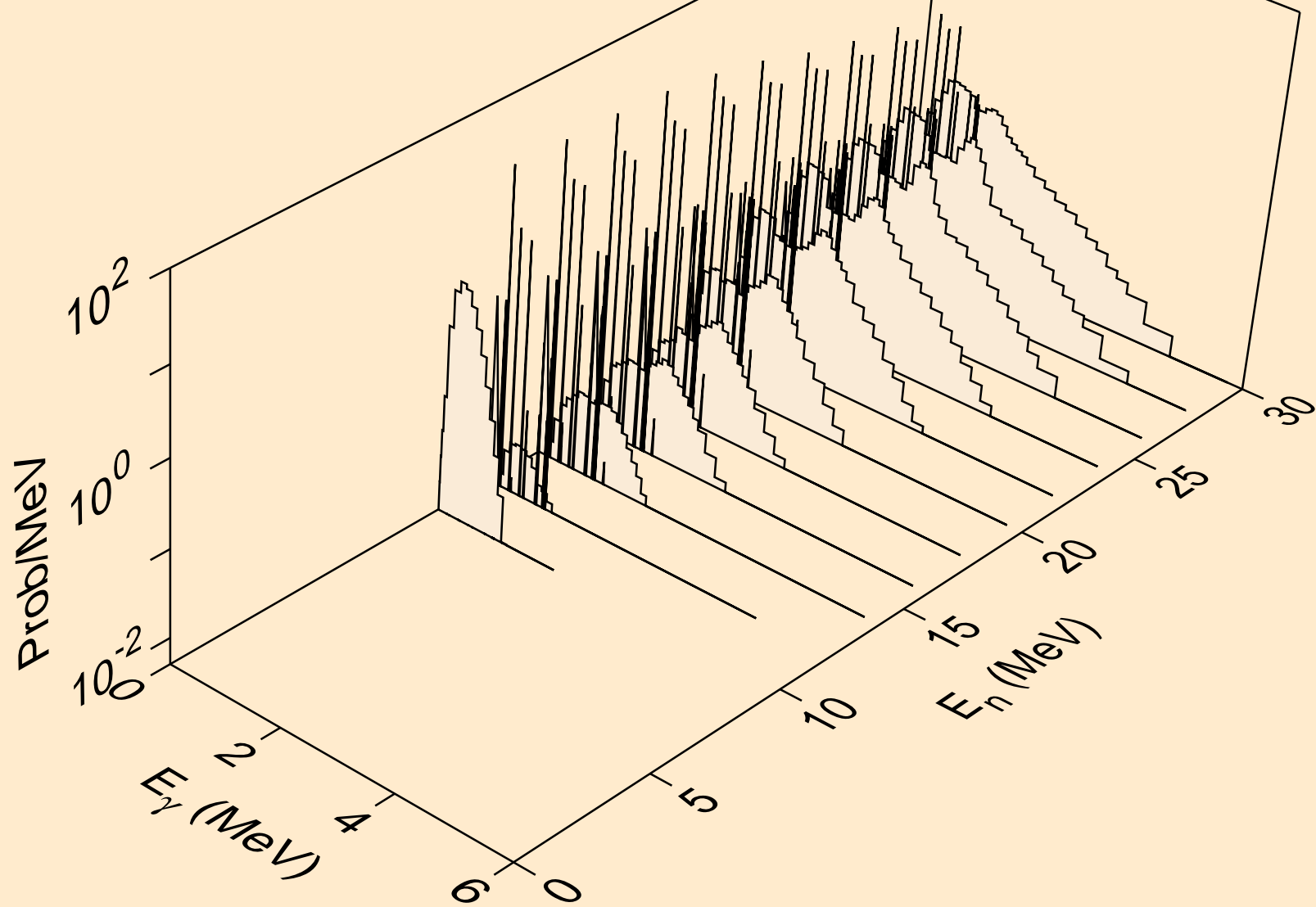

SN120 HELION ACER TENDL-2021 LIBRARY; T=0.K
Photon emission for (n,3n)a

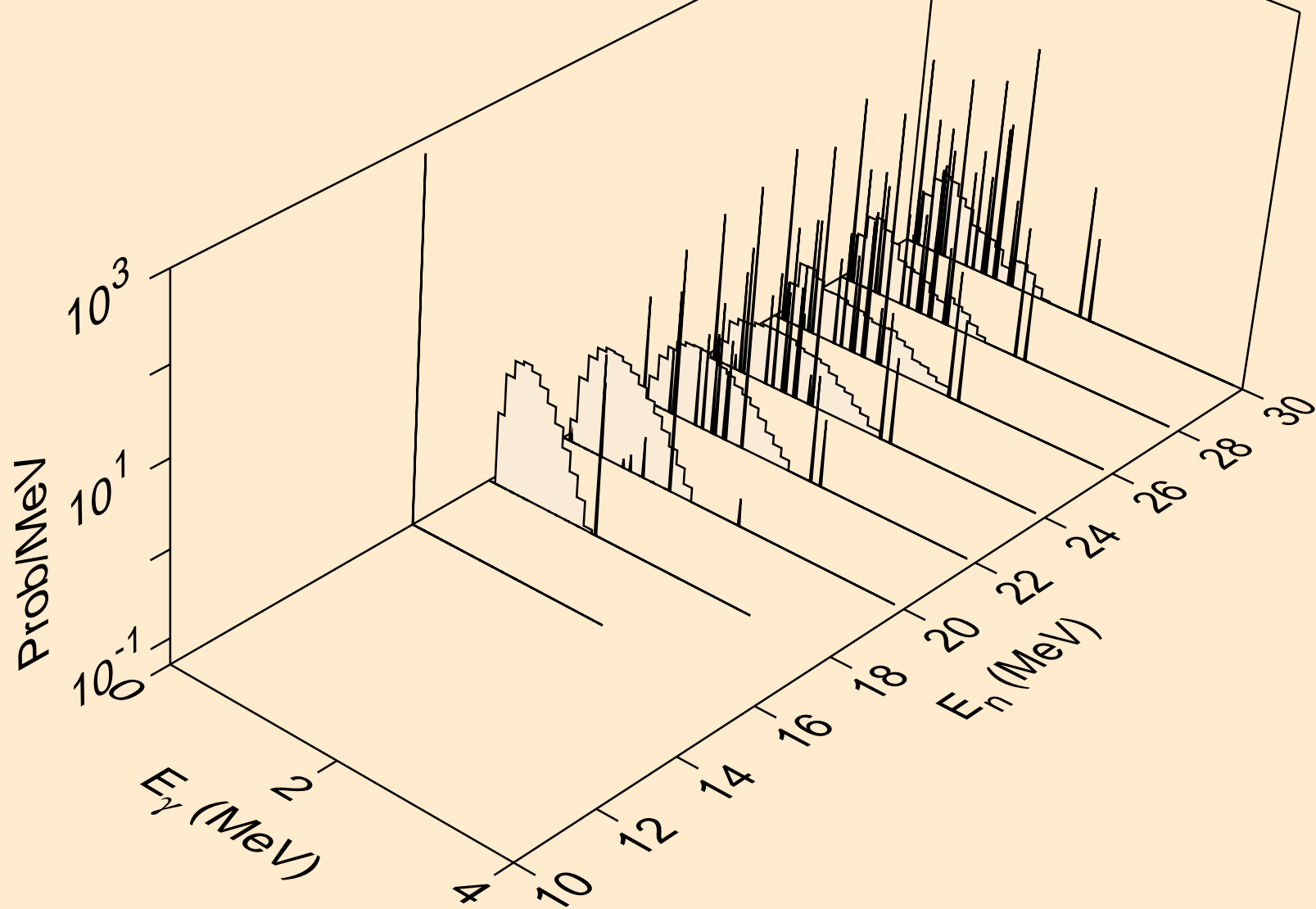

SN120 HELION ACER TENDL-2021 LIBRARY; T=0.K
Photon emission for (n,n*)p

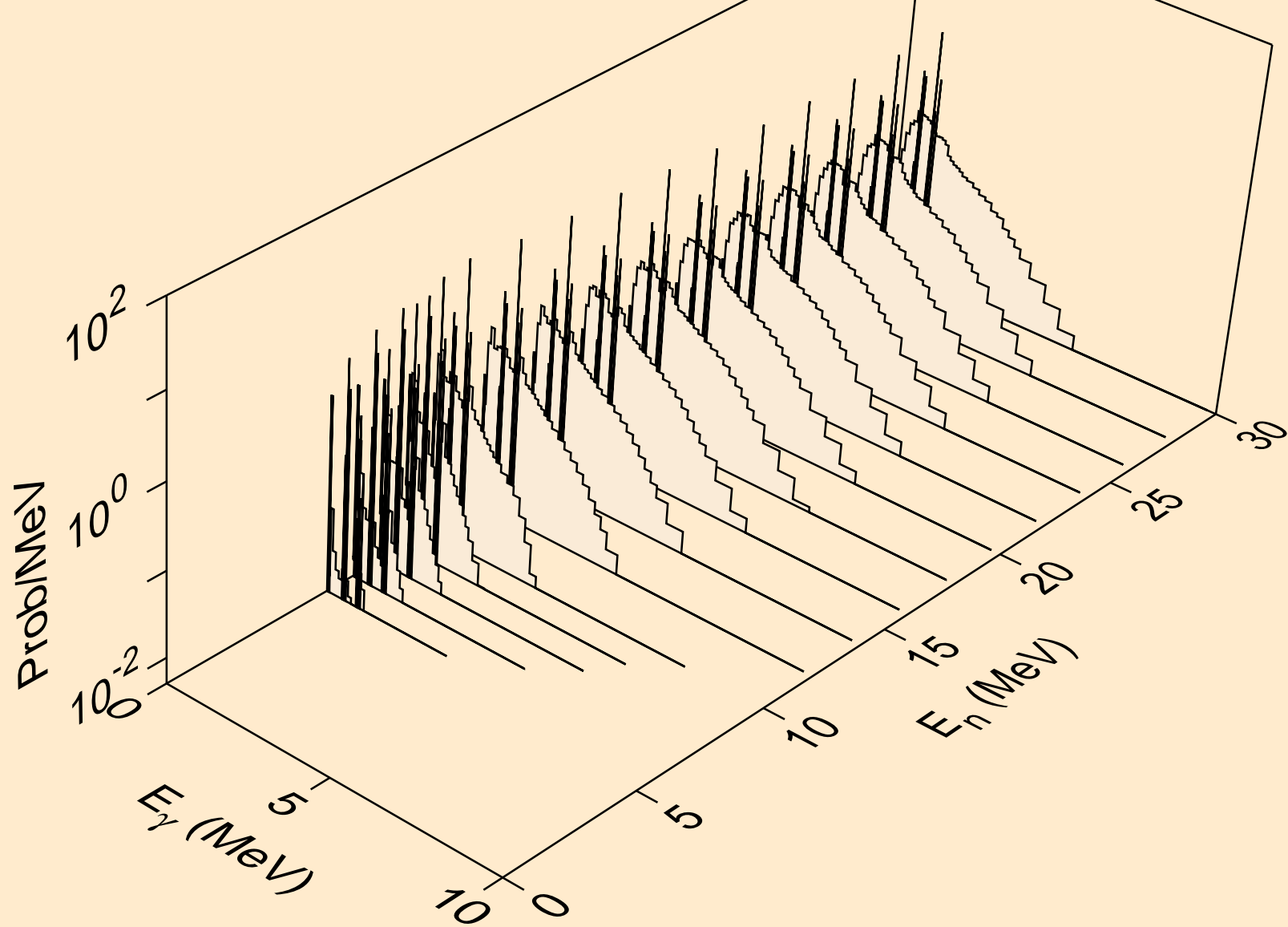

SN120 HELION ACER TENDL-2021 LIBRARY; T=0.K
Photon emission for (n,n*)2a

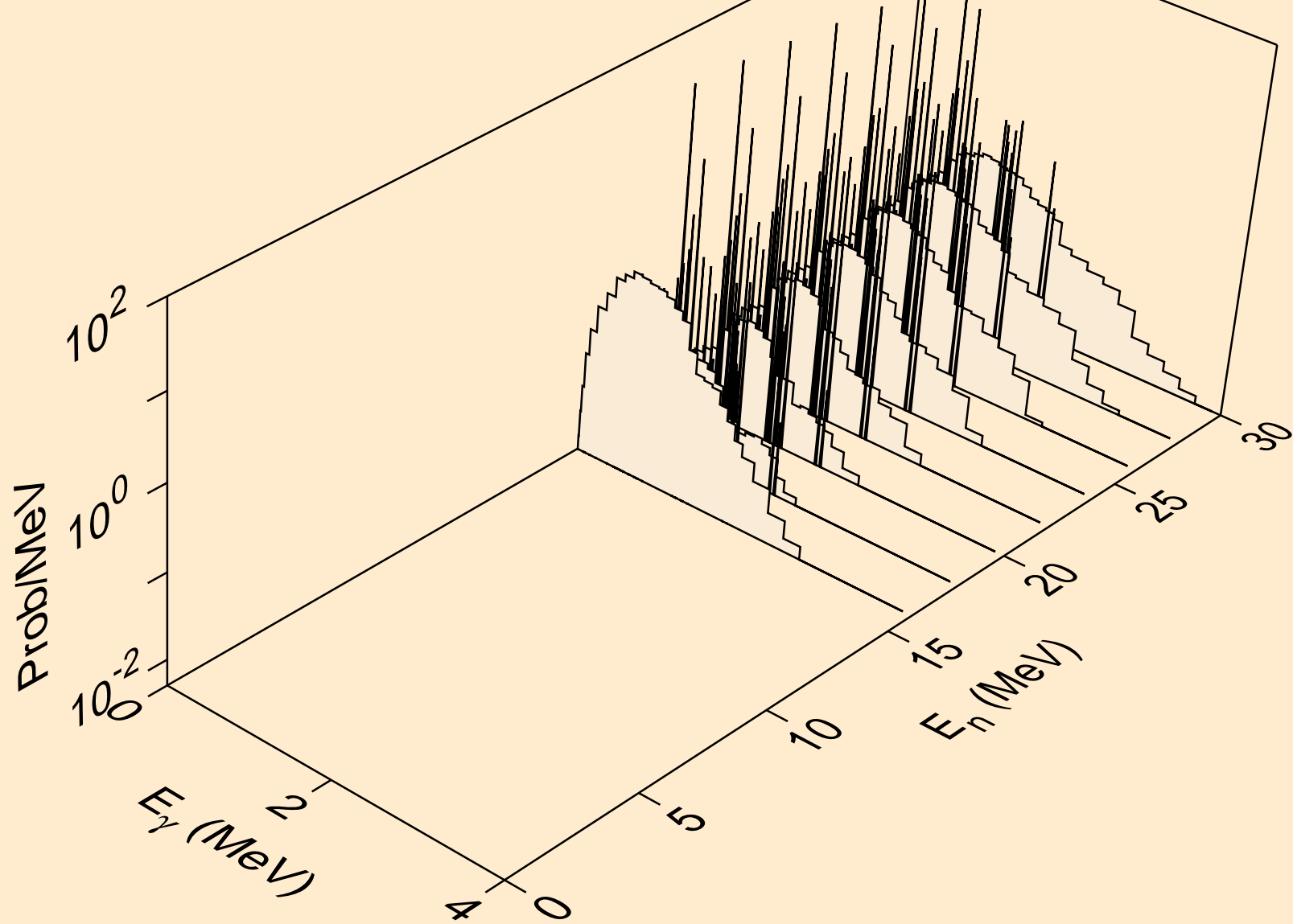

SN120 HELION ACER TENDL-2021 LIBRARY; T=0.K
Photon emission for (n,n*)d

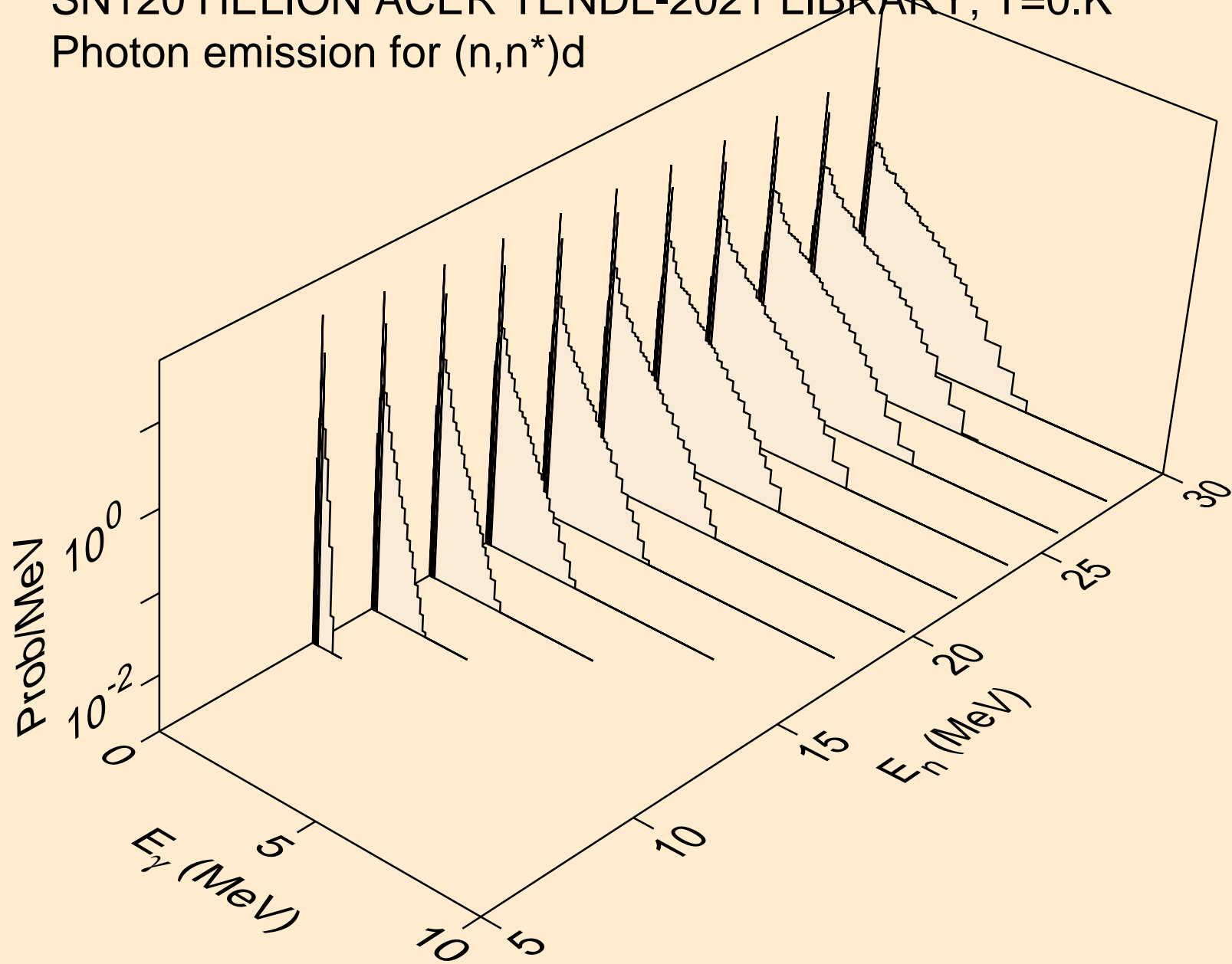

SN120 HELION ACER TENDL-2021 LIBRARY; T=0.K
Photon emission for (n,n*)t

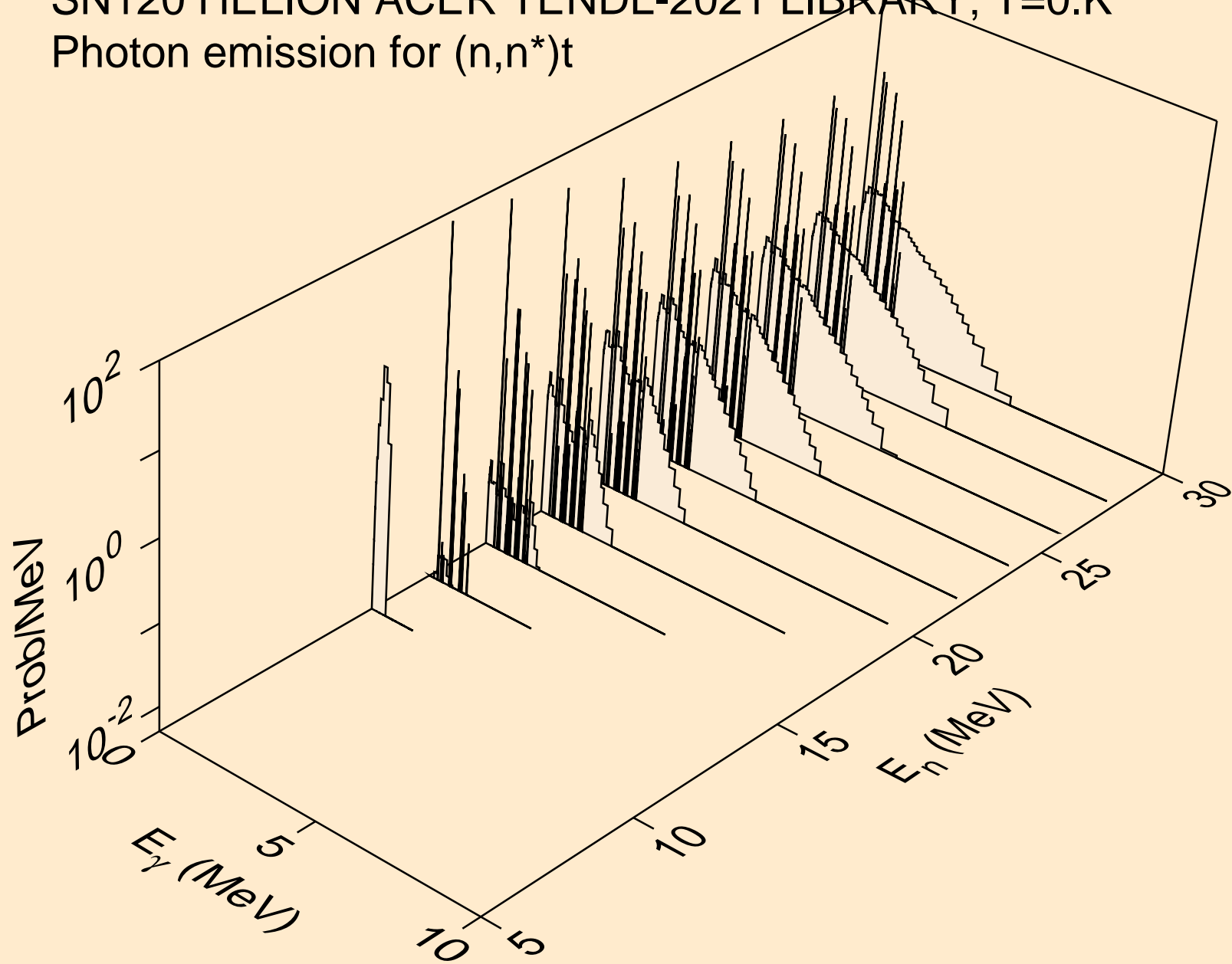

SN120 HELION ACER TENDL-2021 LIBRARY; T=0.K
Photon emission for (n,n*)he3

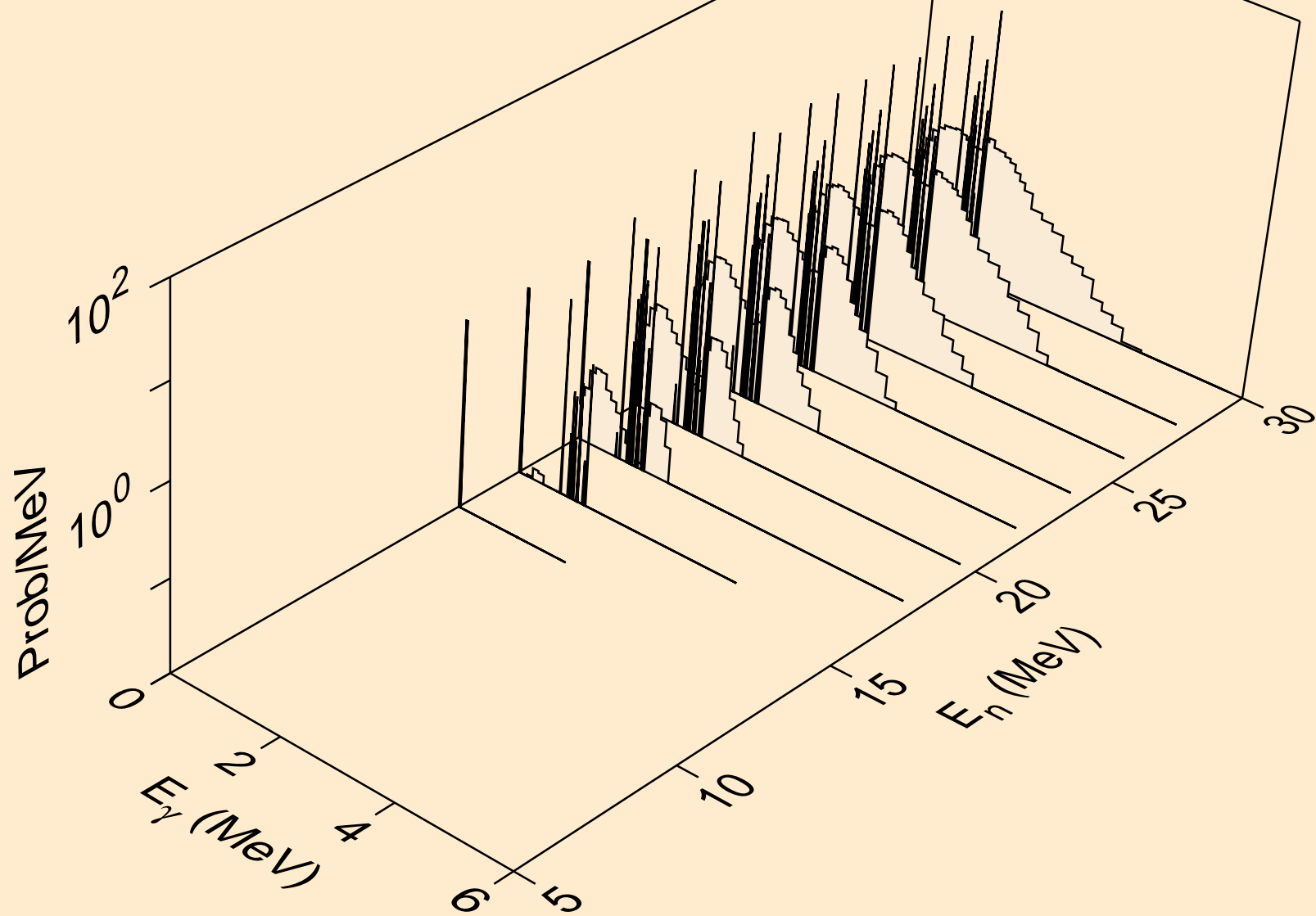

SN120 HELION ACER TENDL-2021 LIBRARY; T=0.K
Photon emission for (n,4n)

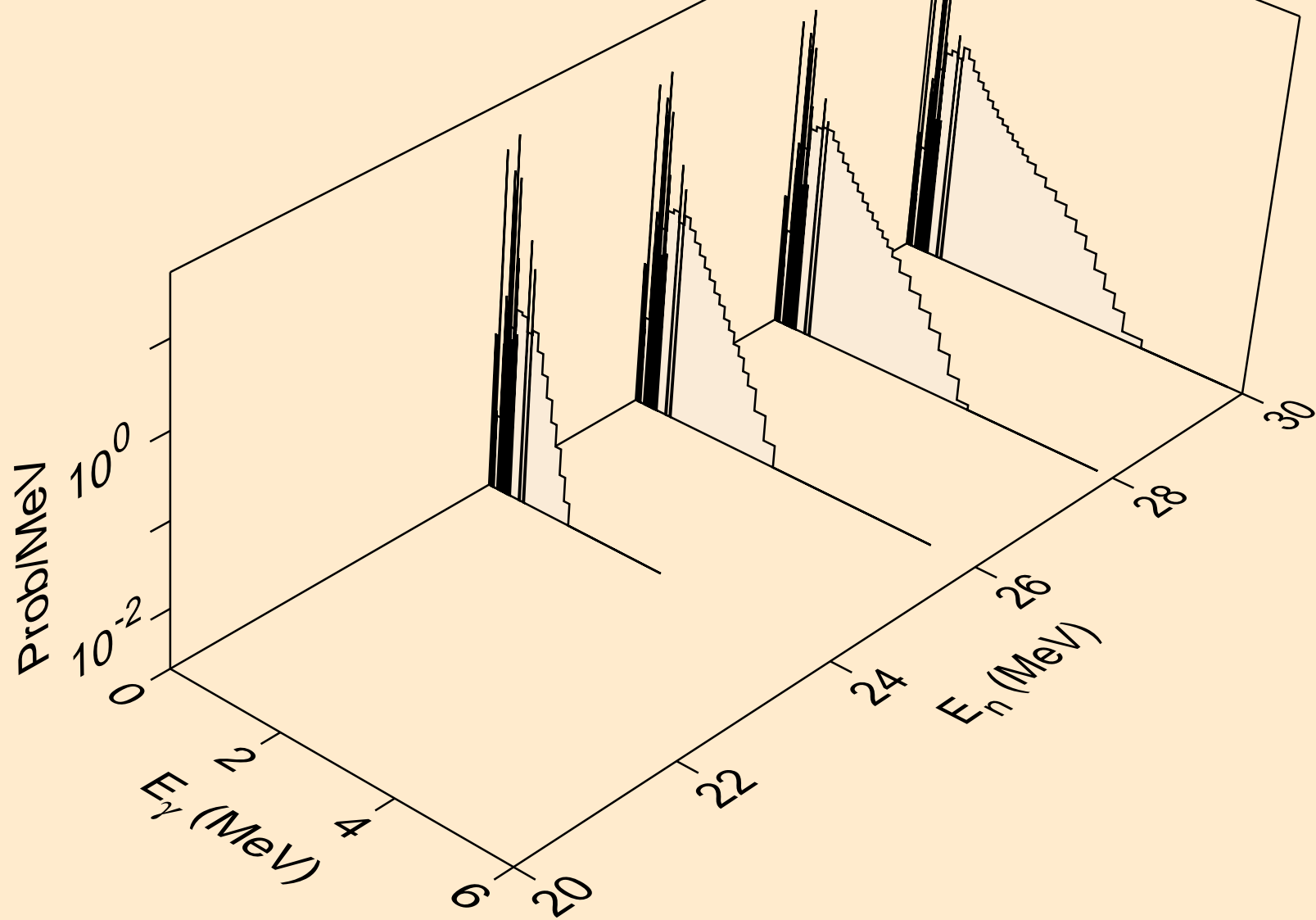

SN120 HELION ACER TENDL-2021 LIBRARY; T=0.K
Photon emission for (n,2np)

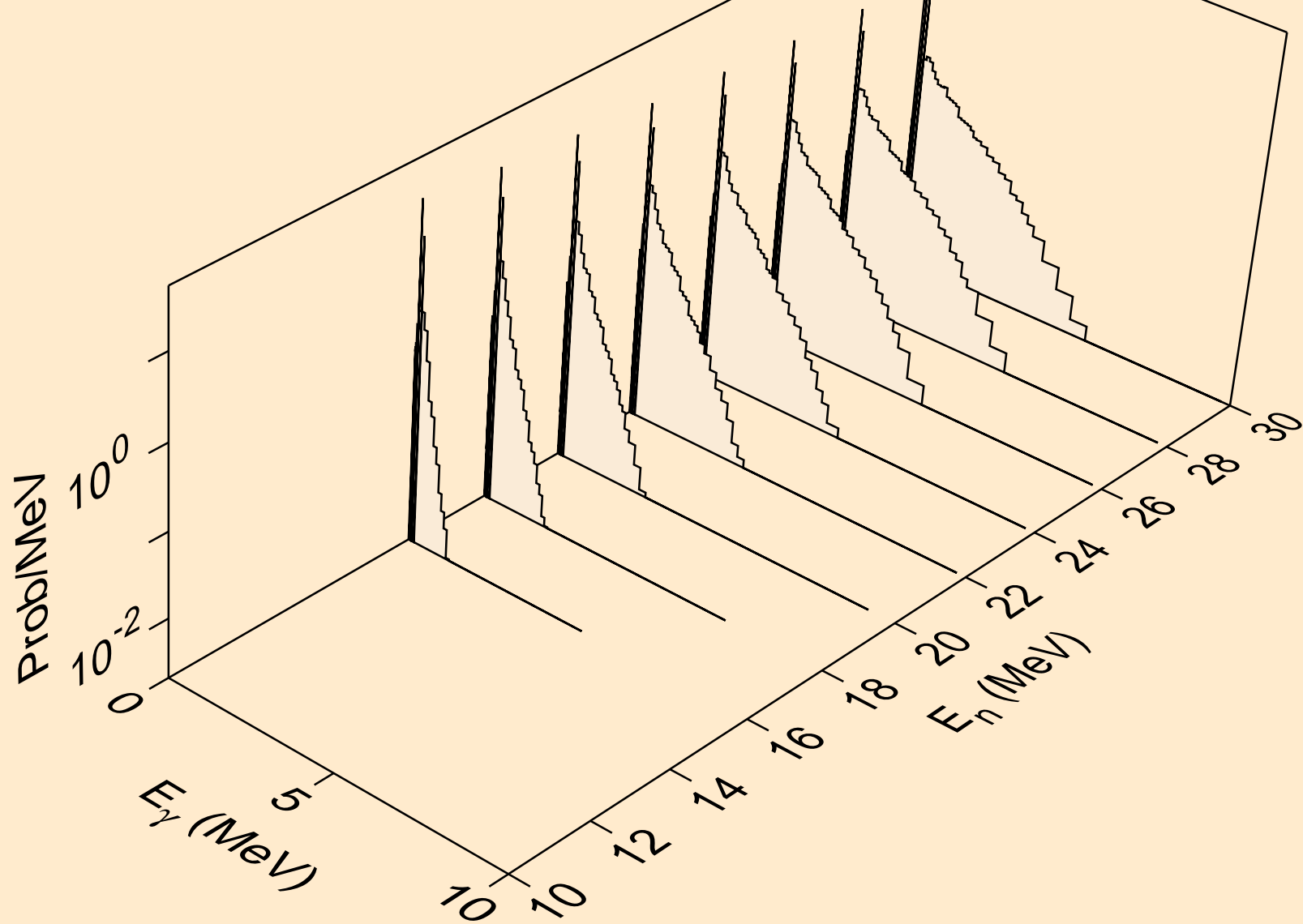

SN120 HELION ACER TENDL-2021 LIBRARY; T=0.K
Photon emission for (n,3np)

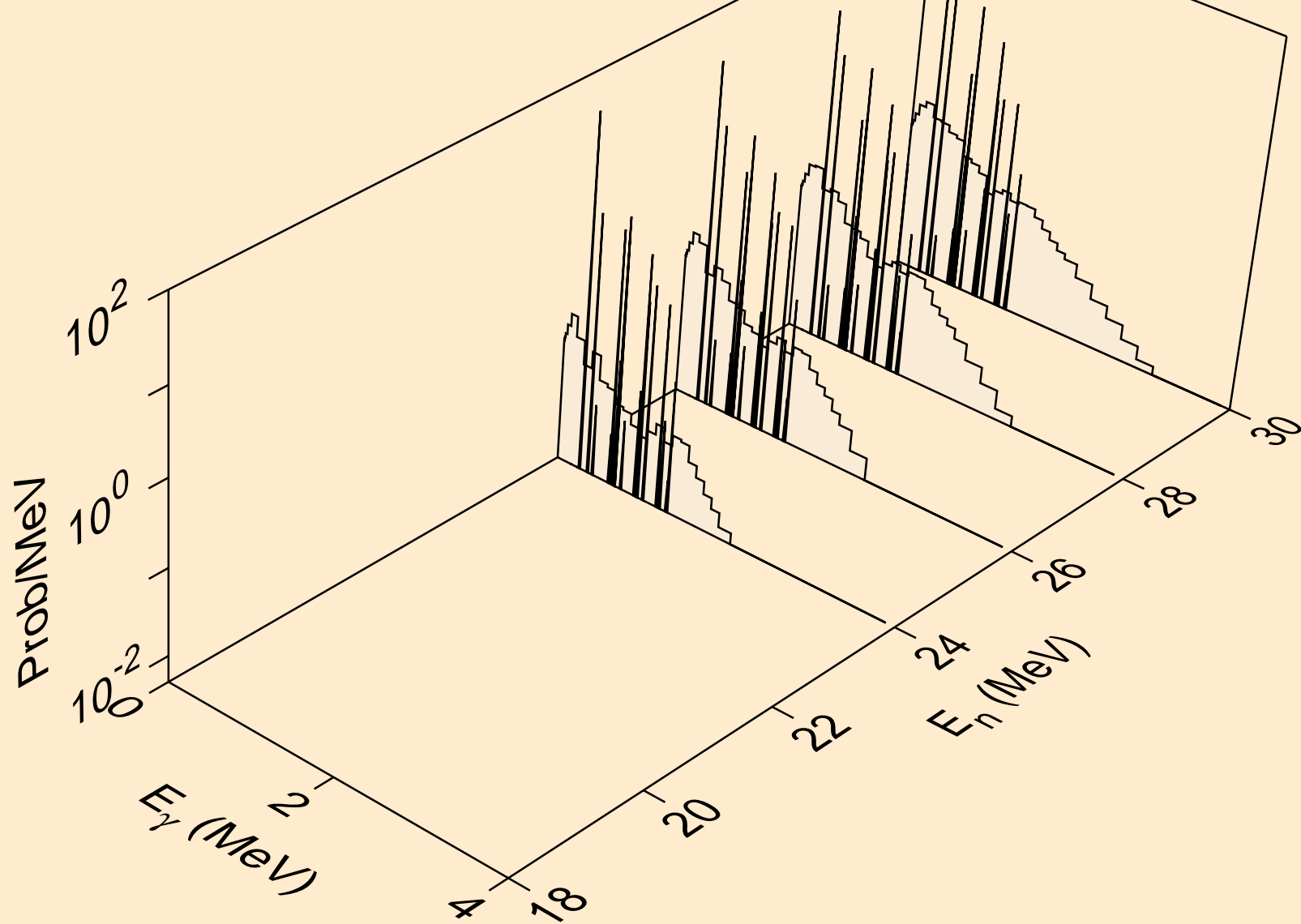

SN120 HELION ACER TENDL-2021 LIBRARY; T=0.K
Photon emission for (n,2np)

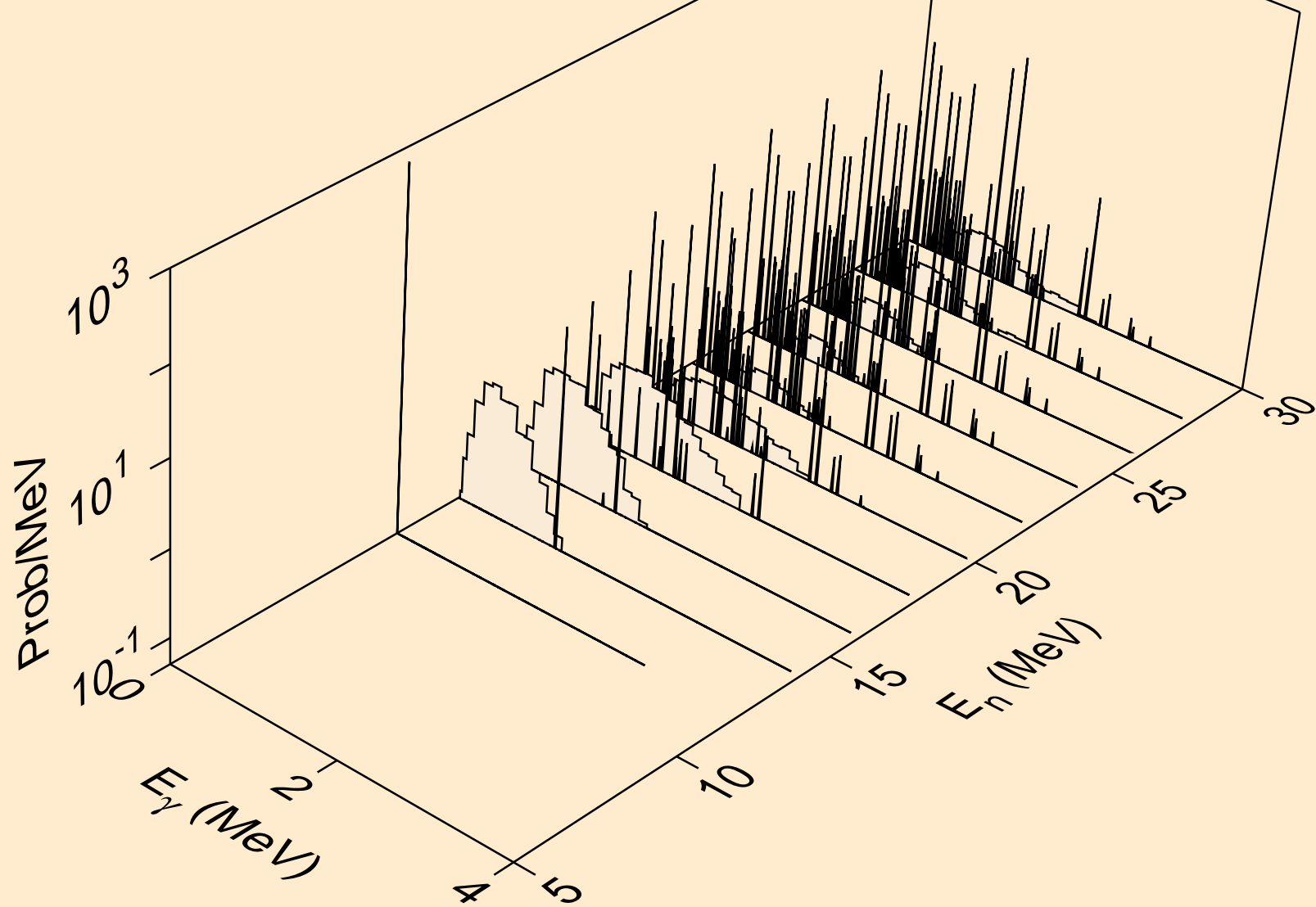

SN120 HELION ACER TENDL-2021 LIBRARY; T=0.K
Photon emission for (n,npa)

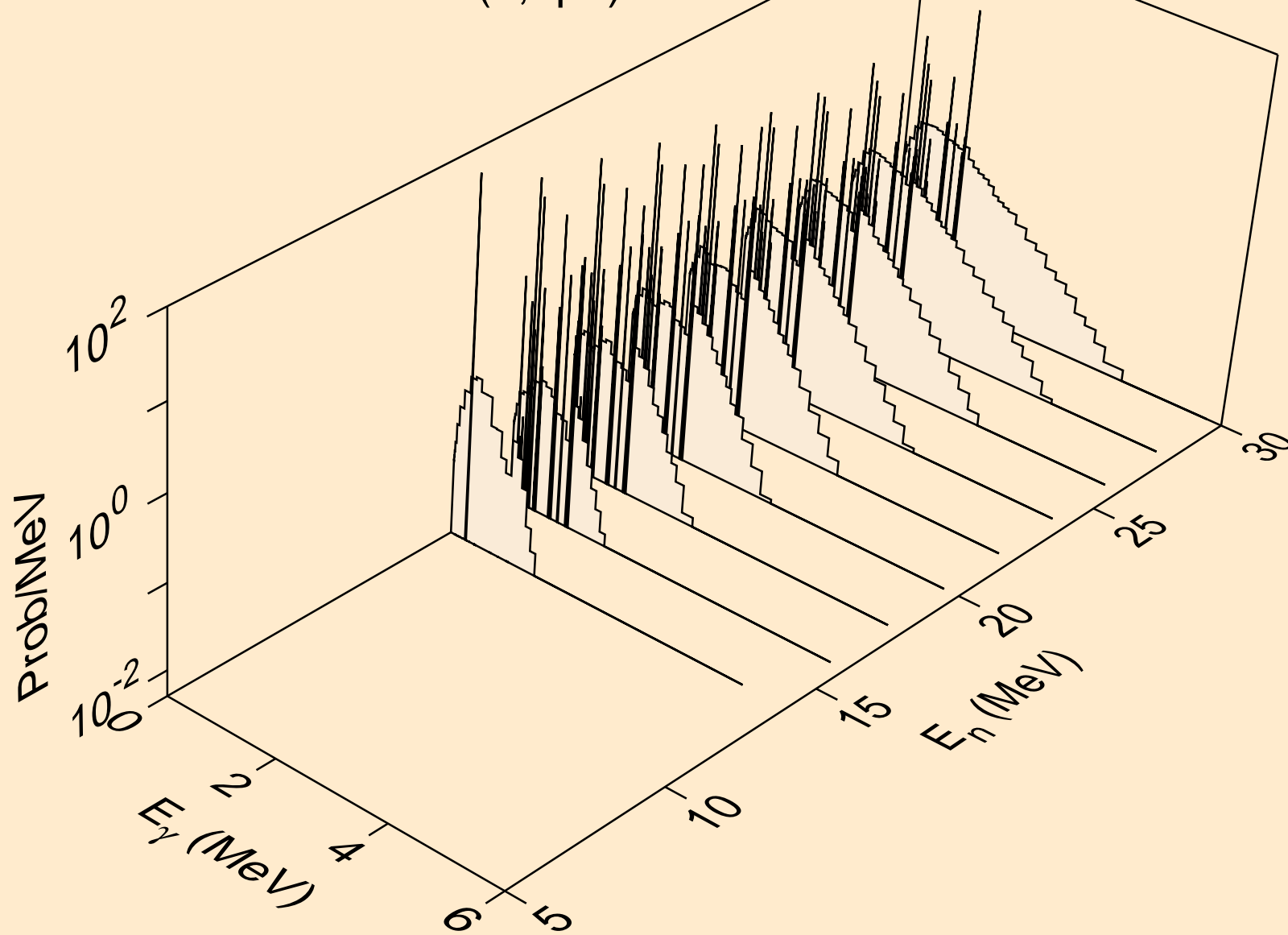

SN120 HELION ACER TENDL-2021 LIBRARY; T=0.K
Photon emission for (n,gma)

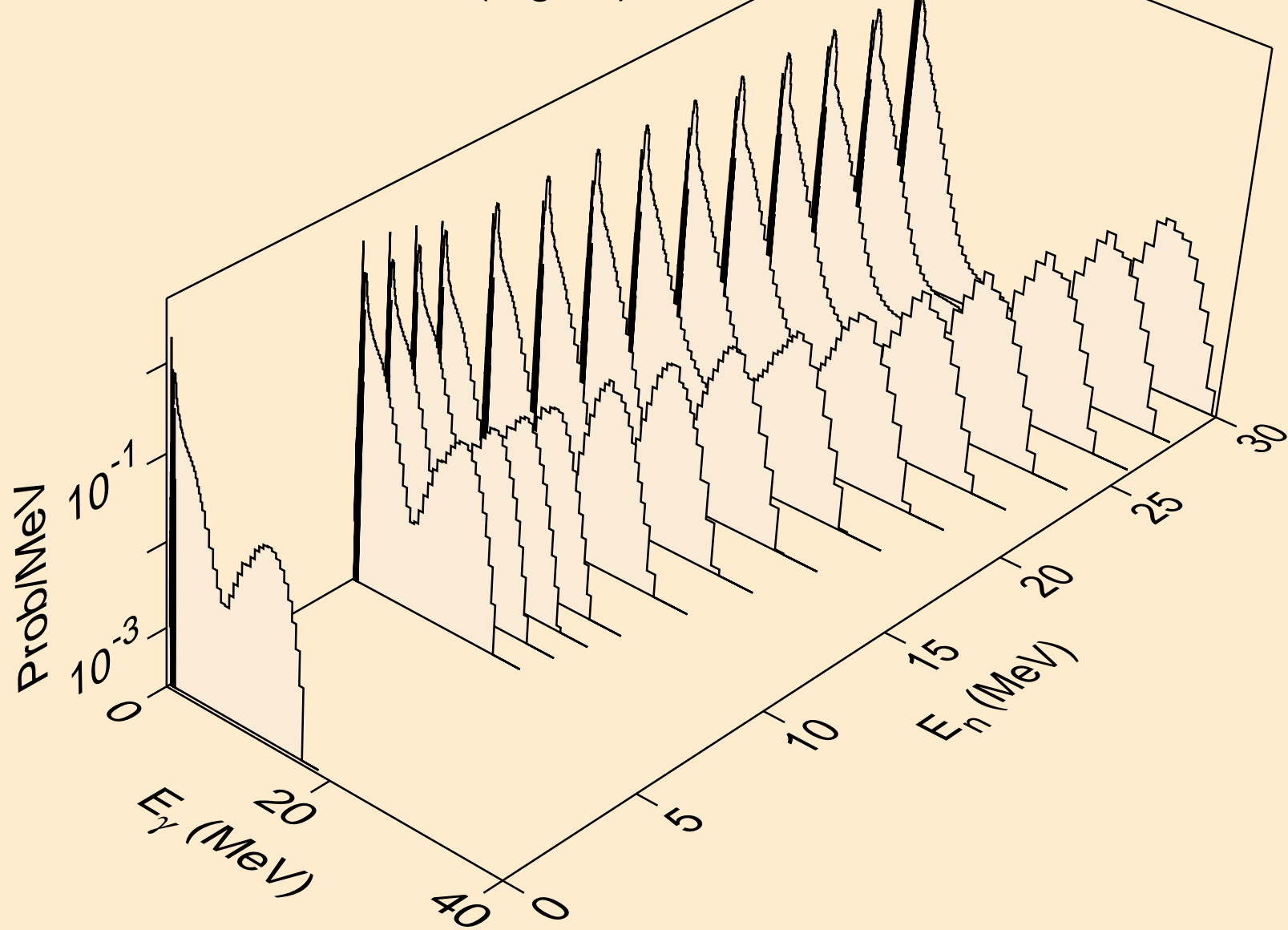

SN120 HELION ACER TENDL-2021 LIBRARY; T=0.K
Photon emission for (n,p)

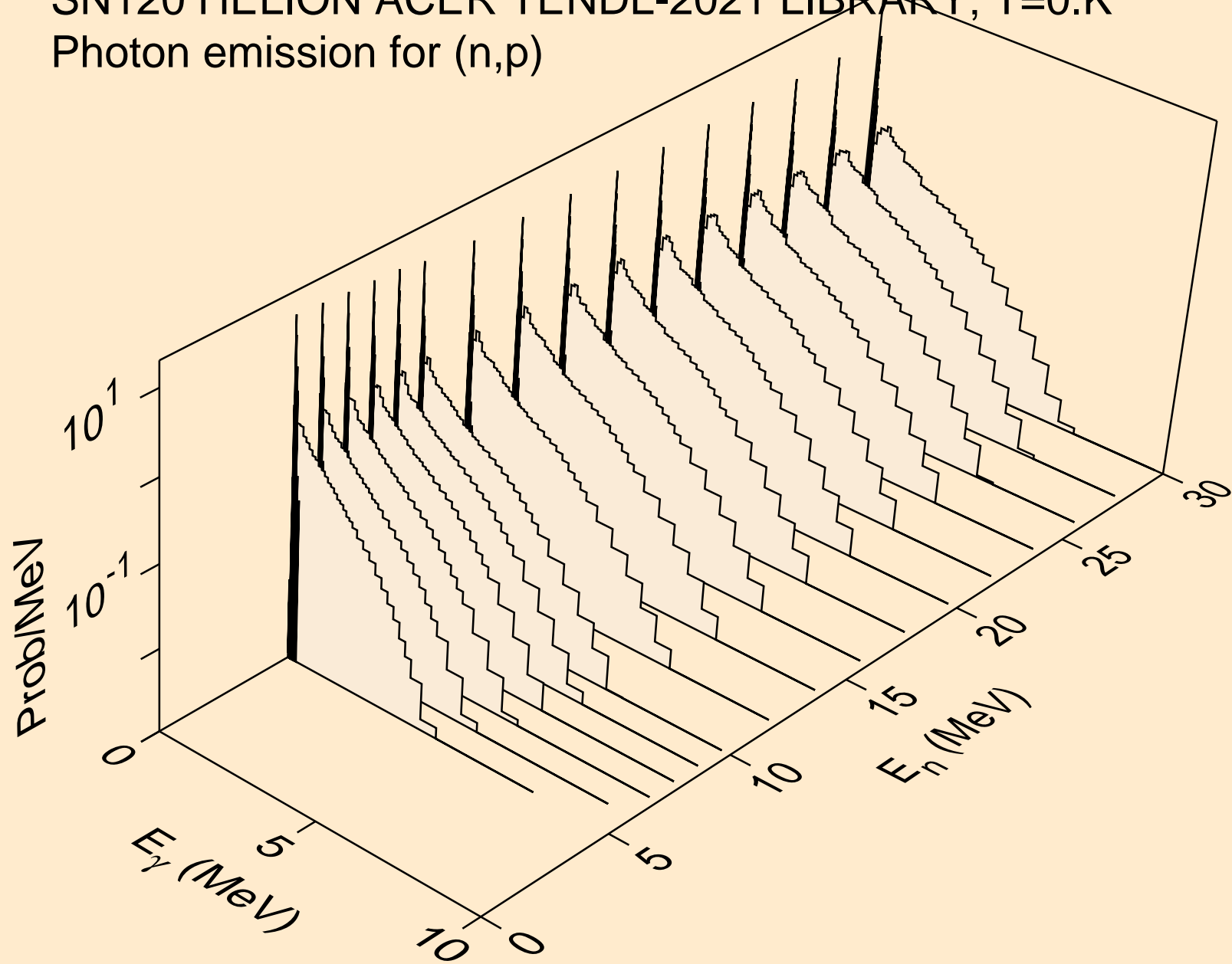

SN120 HELION ACER TENDL-2021 LIBRARY; T=0.K
Photon emission for (n,d)

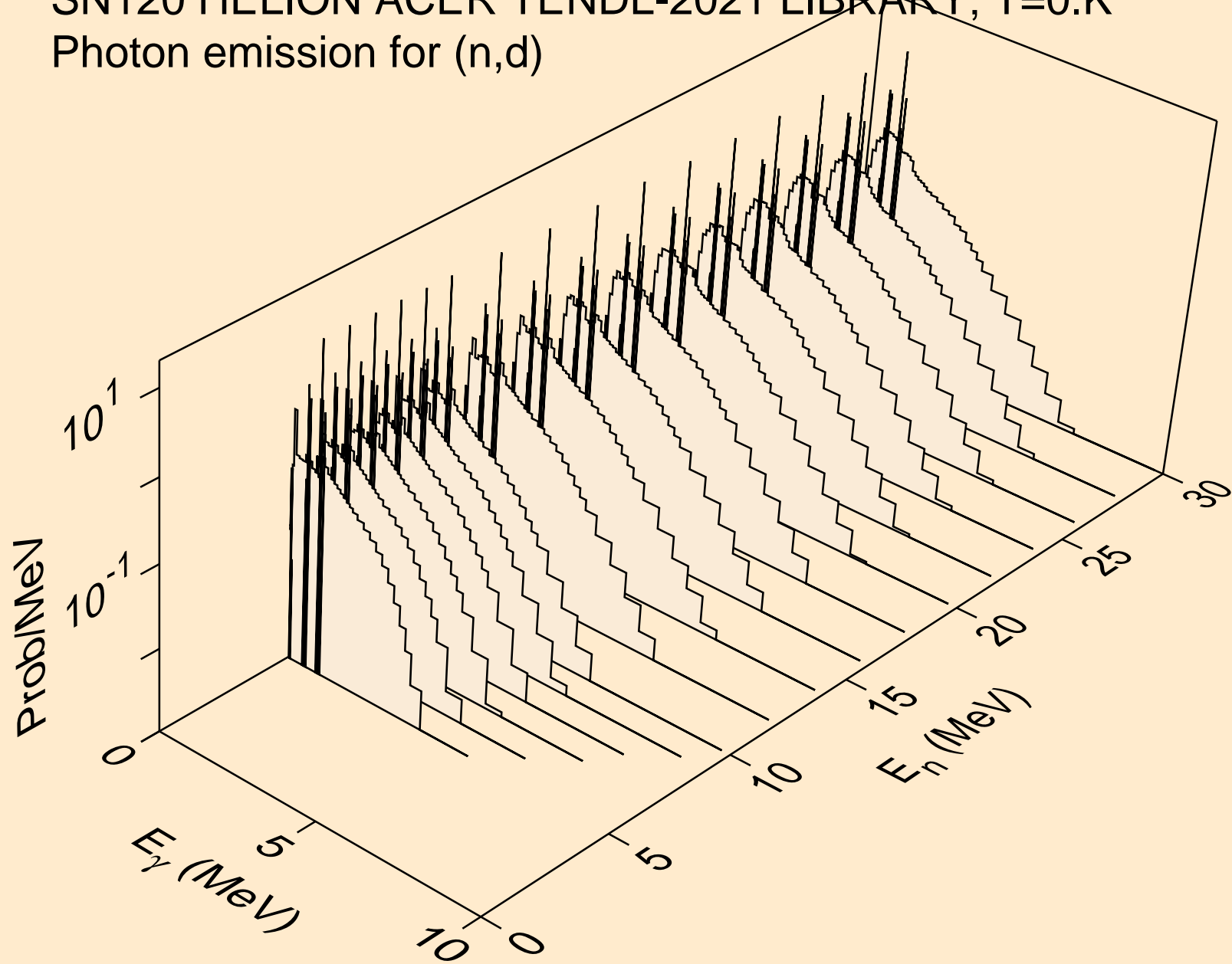

SN120 HELION ACER TENDL-2021 LIBRARY; T=0.K
Photon emission for (n,t)

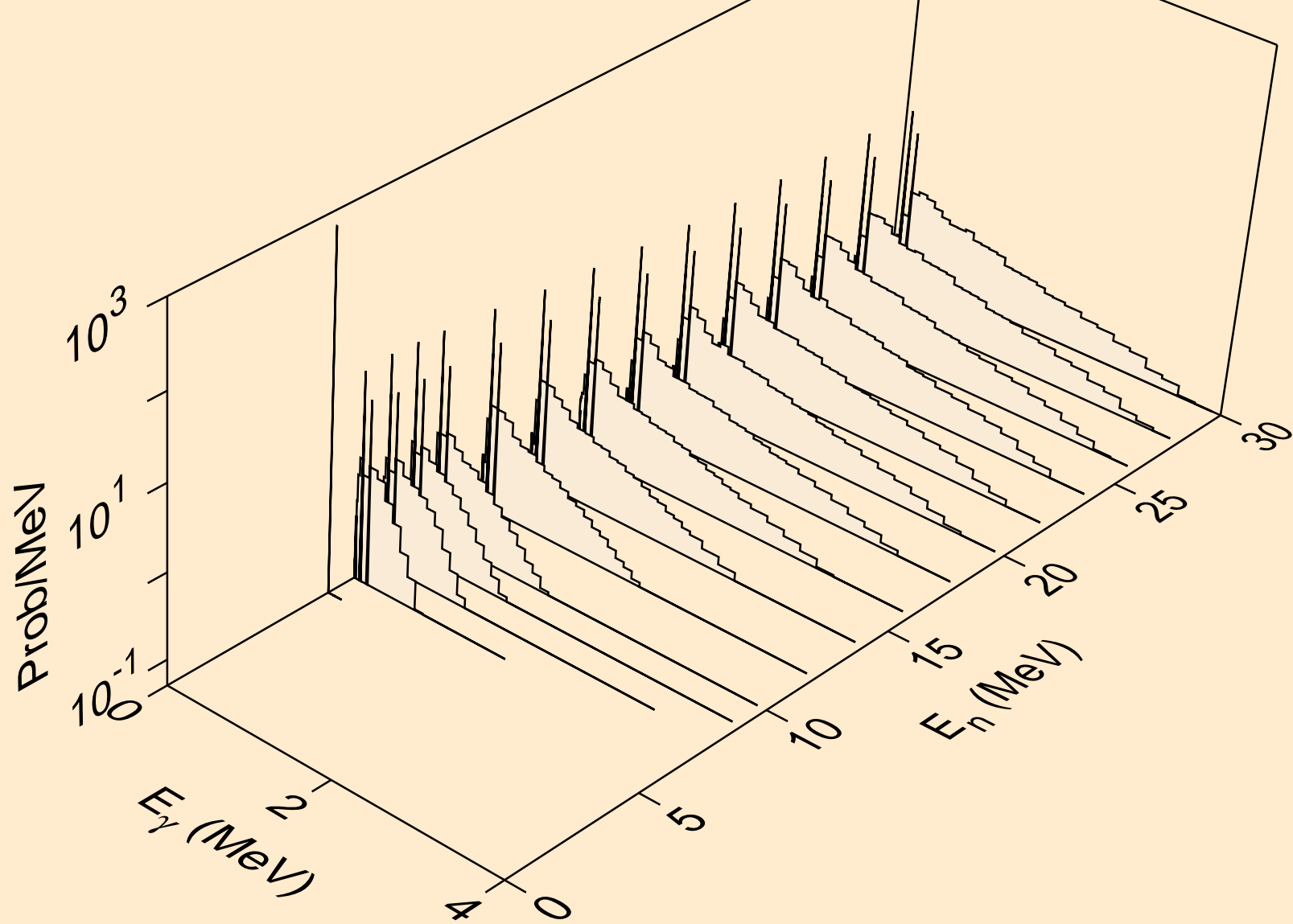

SN120 HELION ACER TENDL-2021 LIBRARY; T=0.K
Photon emission for inelastic

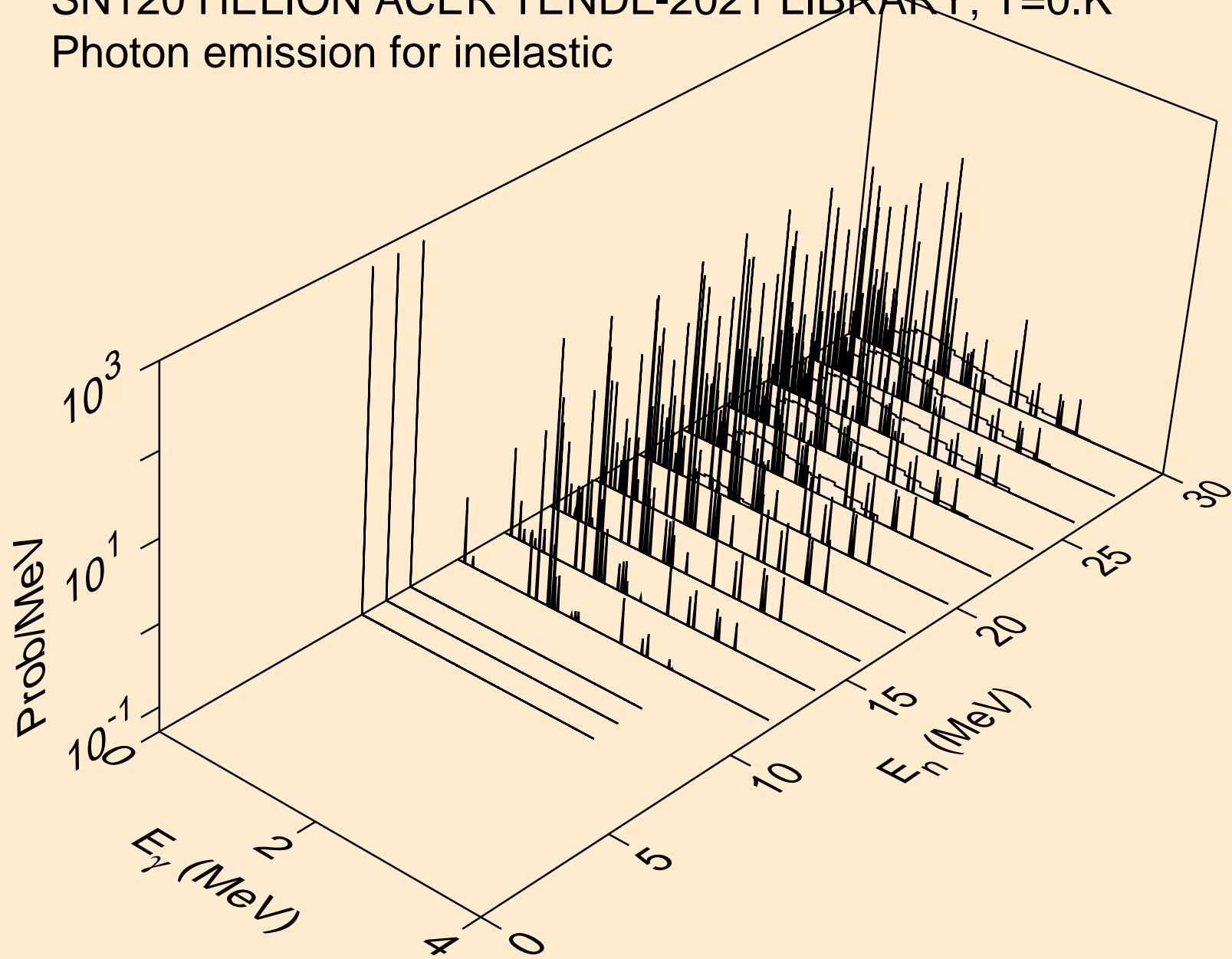

SN120 HELION ACER TENDL-2021 LIBRARY; T=0.K
Photon emission for (n,a)

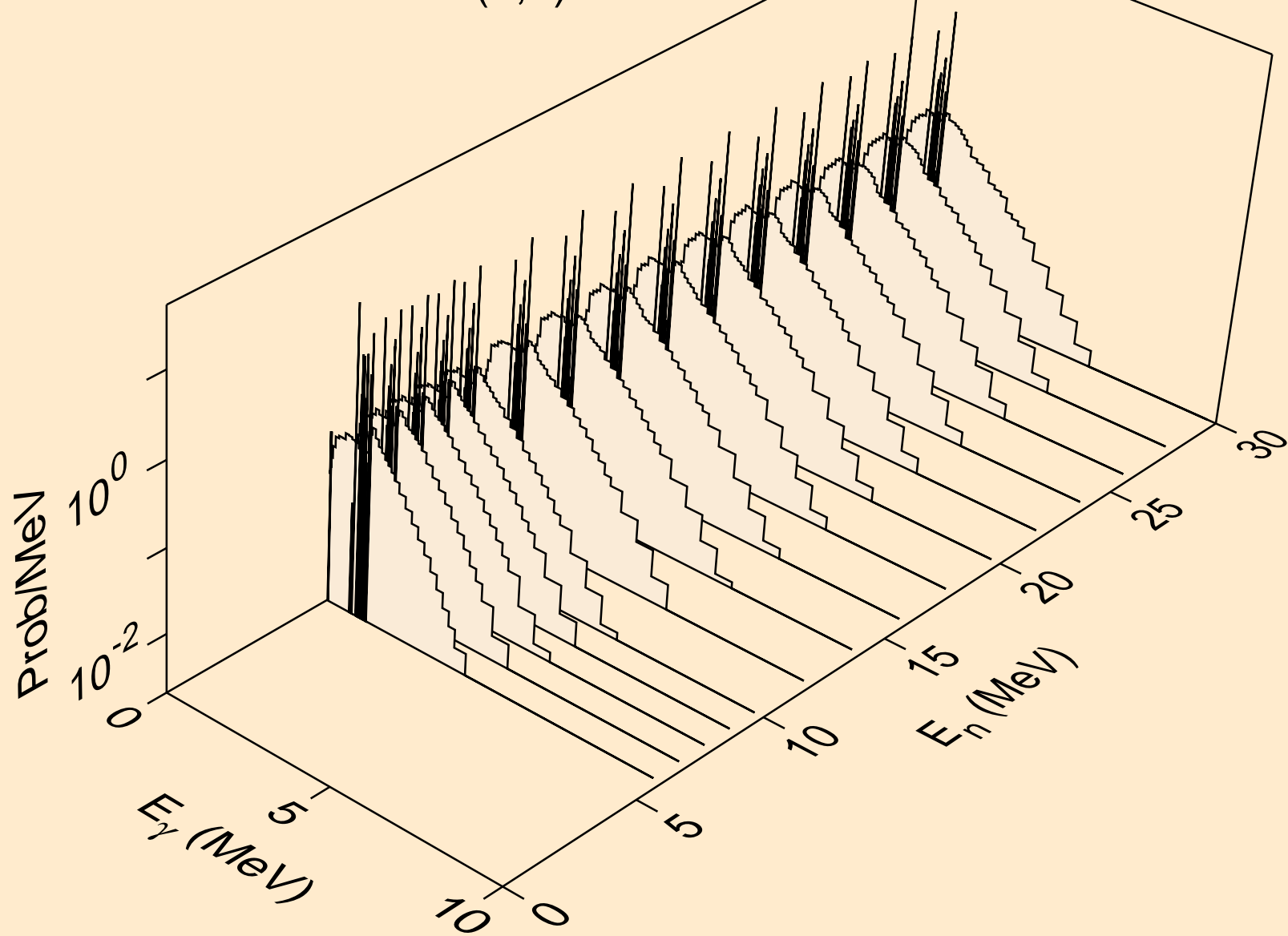

SN120 HELION ACER TENDL-2021 LIBRARY; T=0.K
Photon emission for (n,2a)

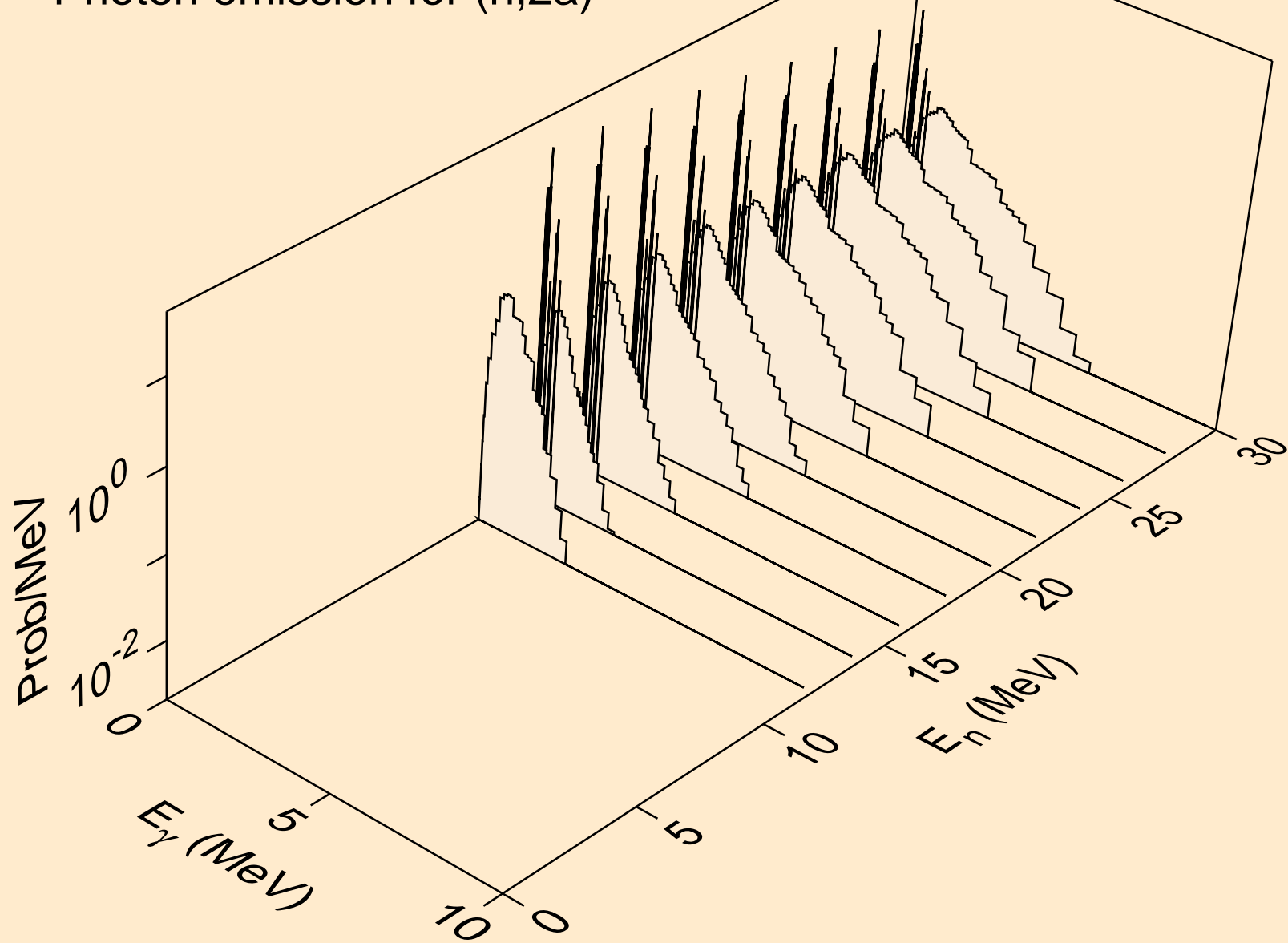

SN120 HELION ACER TENDL-2021 LIBRARY; T=0.K
Photon emission for (n,2p)

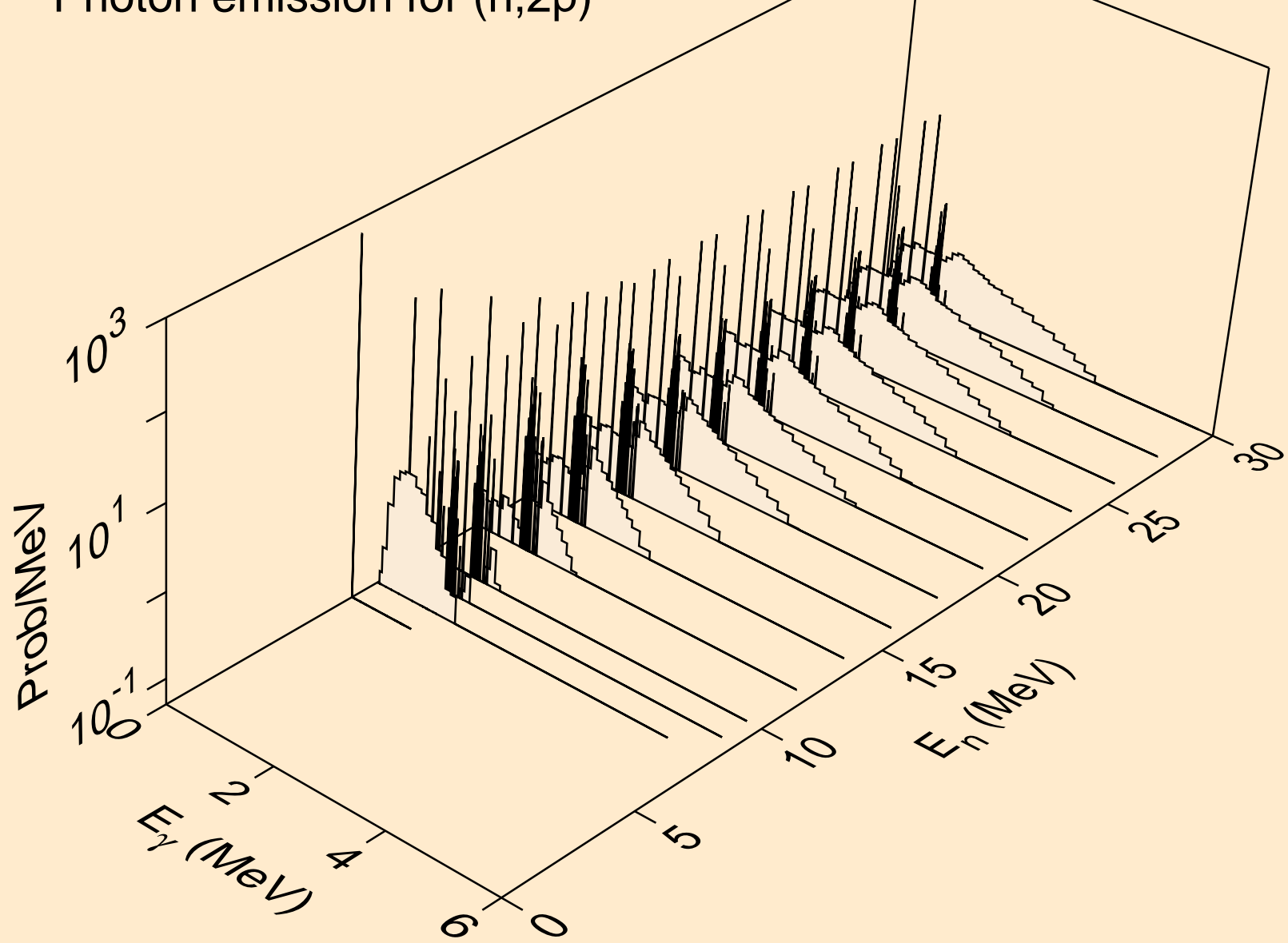

SN120 HELION ACER TENDL-2021 LIBRARY; T=0.K
Photon emission for (n,pa)

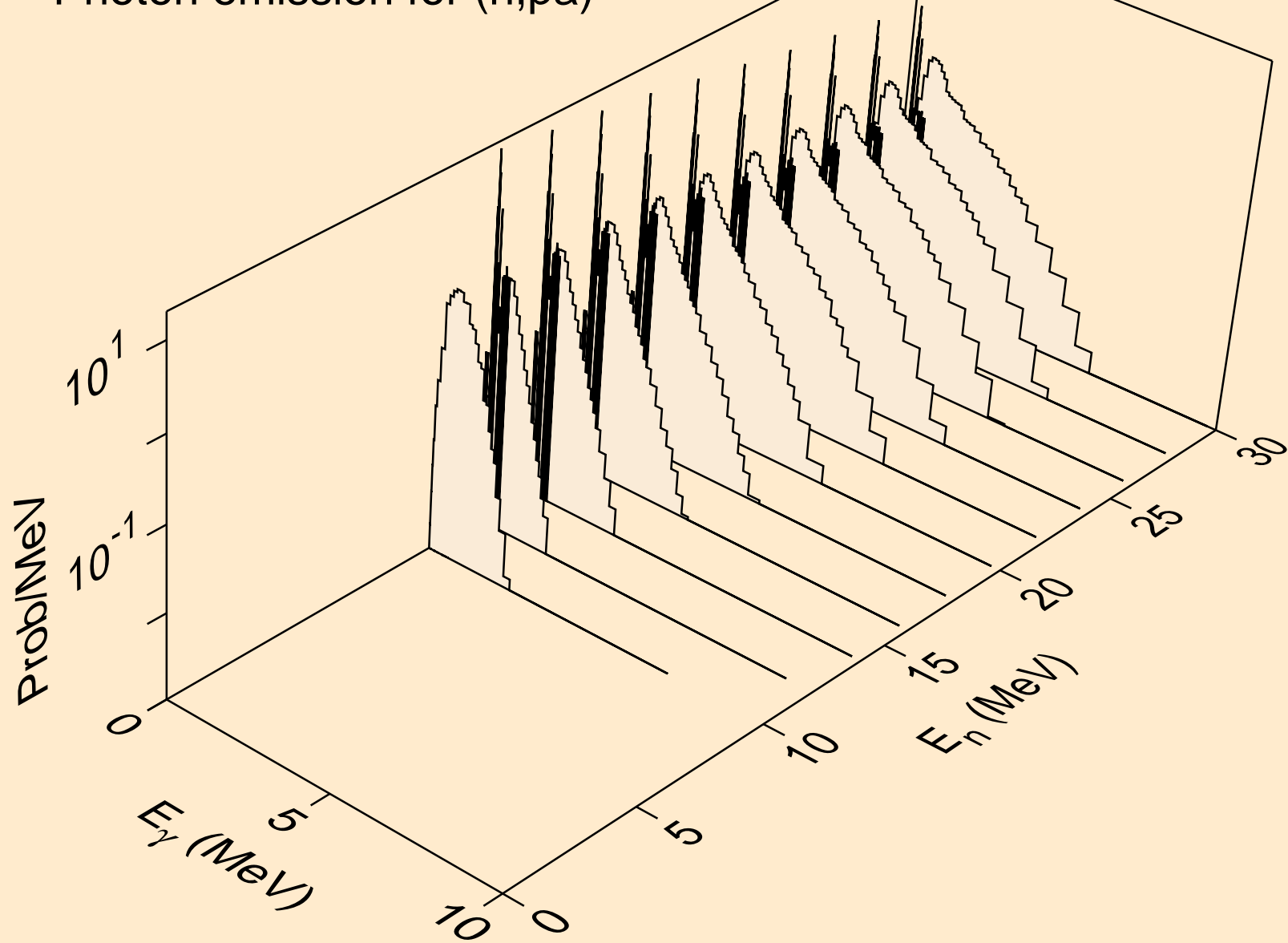

SN120 HELION ACER TENDL-2021 LIBRARY; T=0.K
Photon emission for (n,pd)

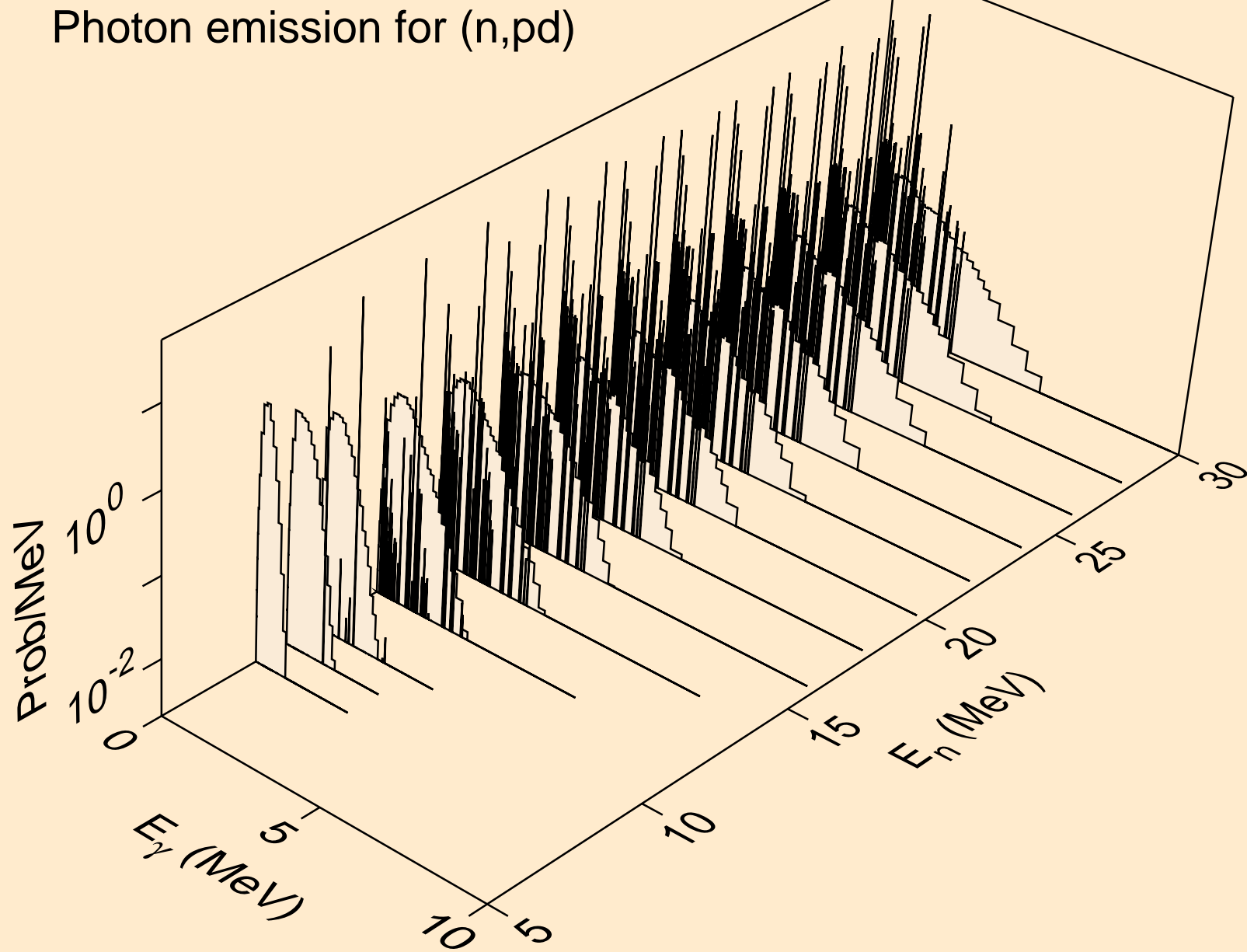

SN120 HELION ACER TENDL-2021 LIBRARY; T=0.K
Photon emission for (n,pt)

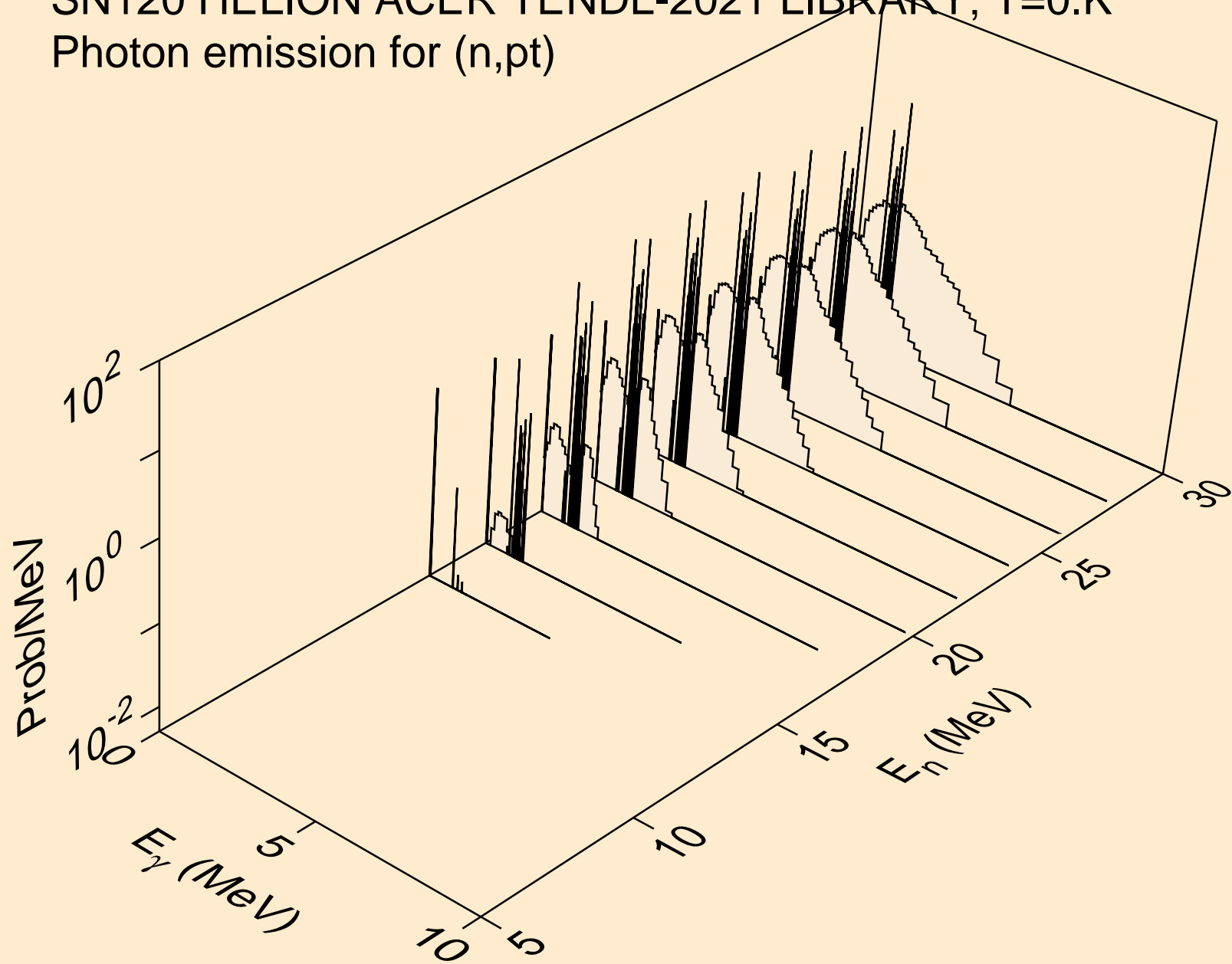

SN120 HELION ACER TENDL-2021 LIBRARY; T=0.K
Photon emission for (n,da)

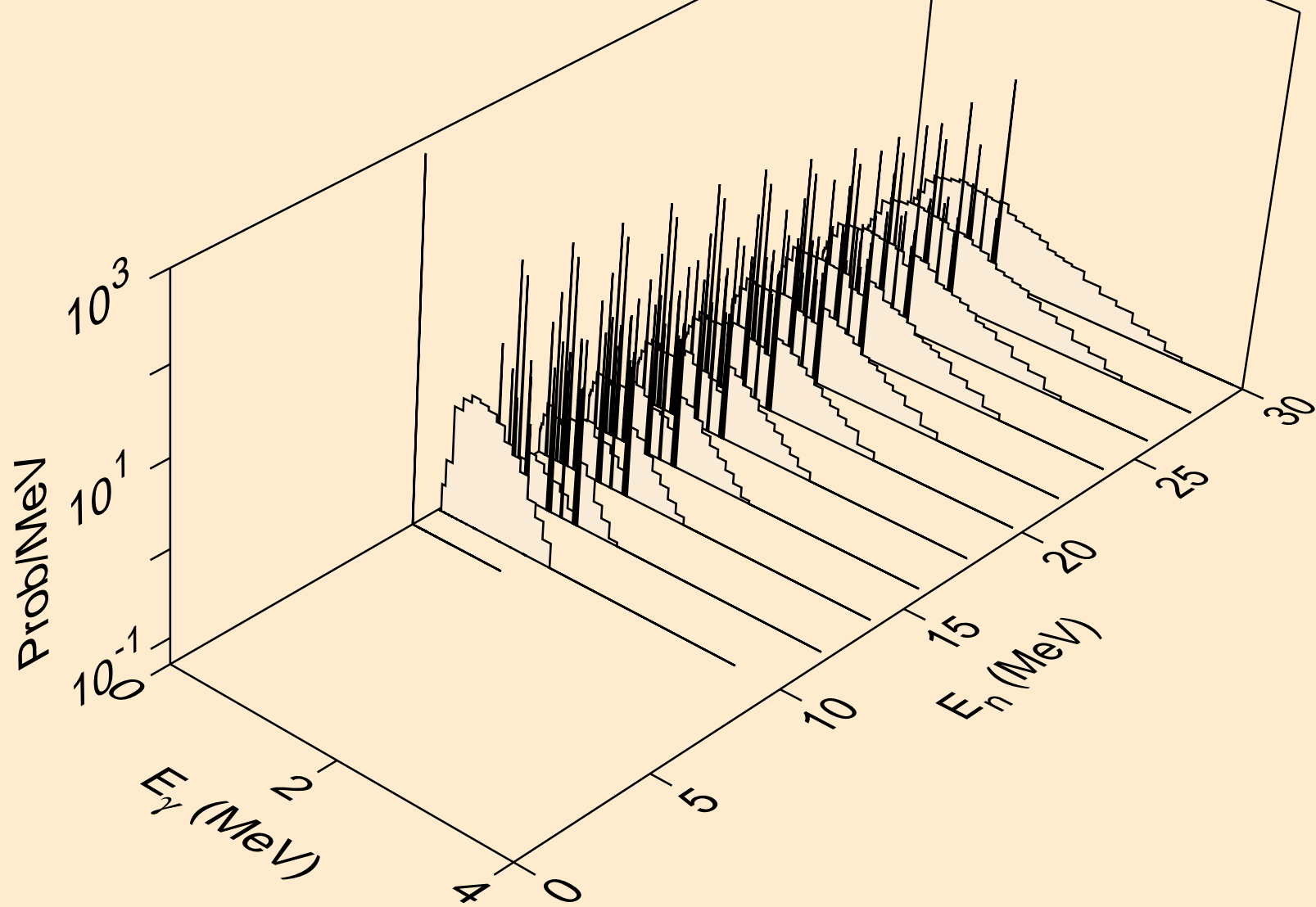

SN120 HELION ACER TENDL-2021 LIBRARY; T=0.K

Particle heating contributions

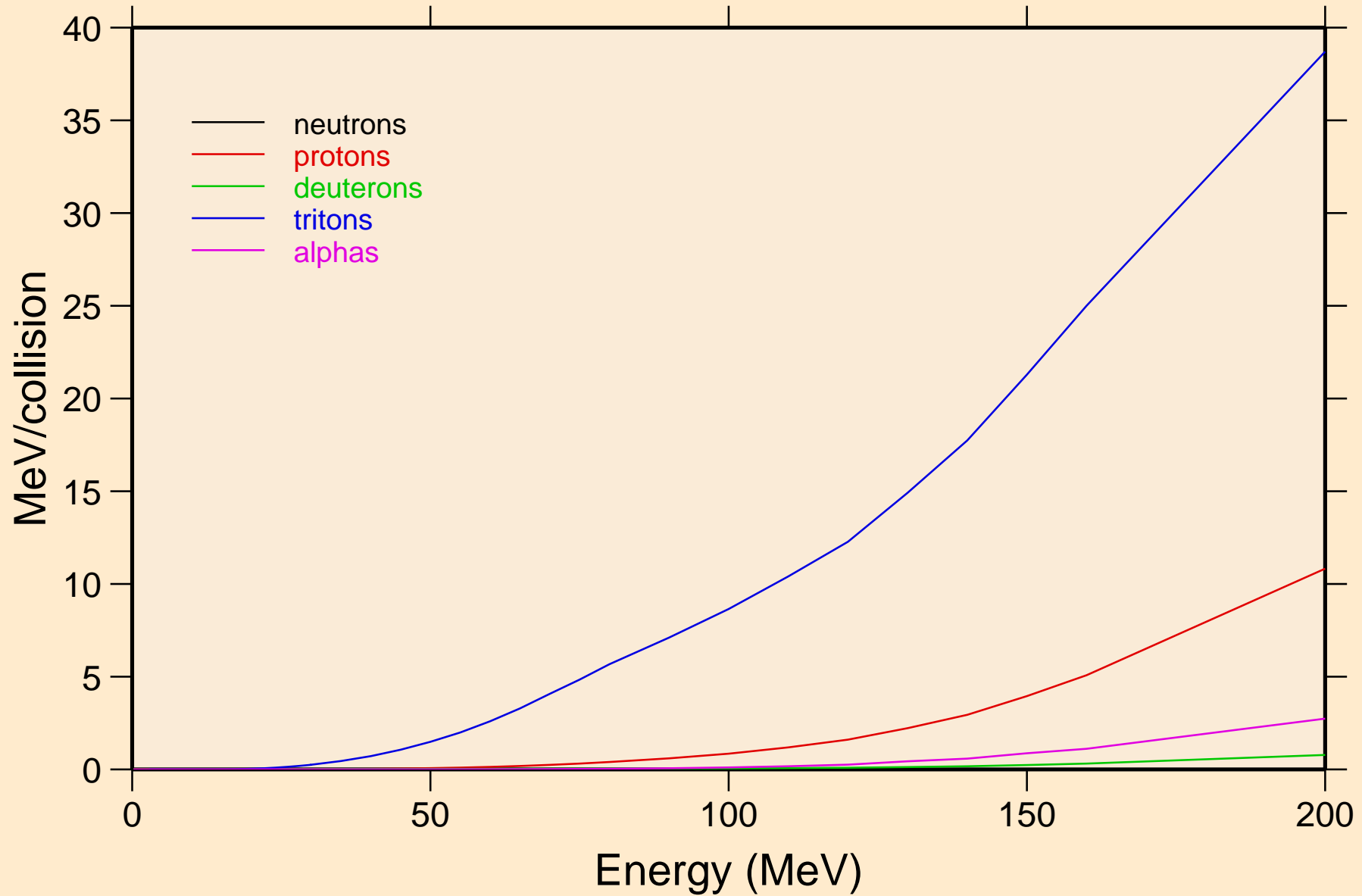

SN120 HELION ACER TENDL-2021 LIBRARY; T=0.K
Recoil Heating

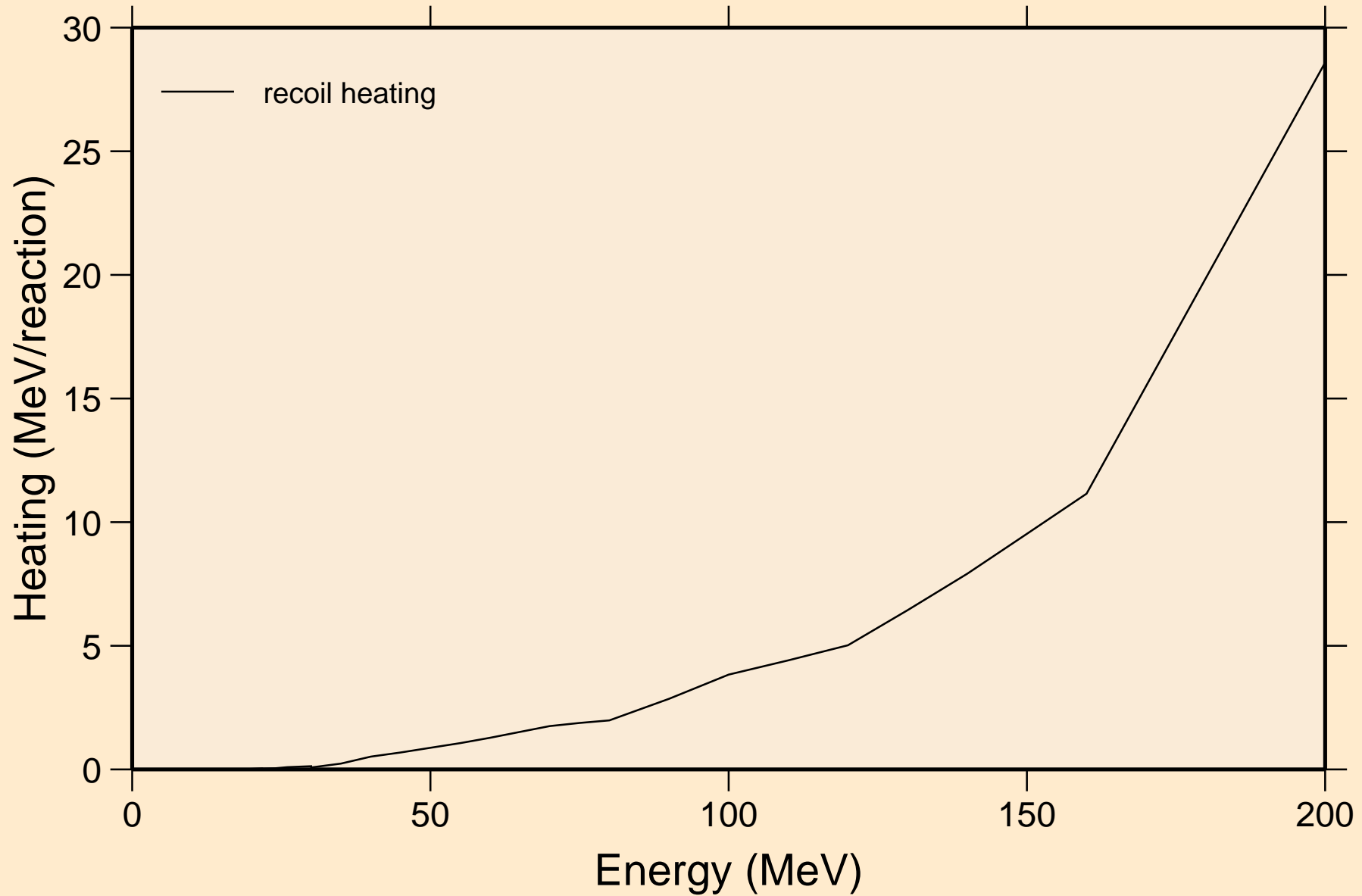

SN120 HELION ACER TENDL-2021 LIBRARY; T=0.K

Particle production cross sections

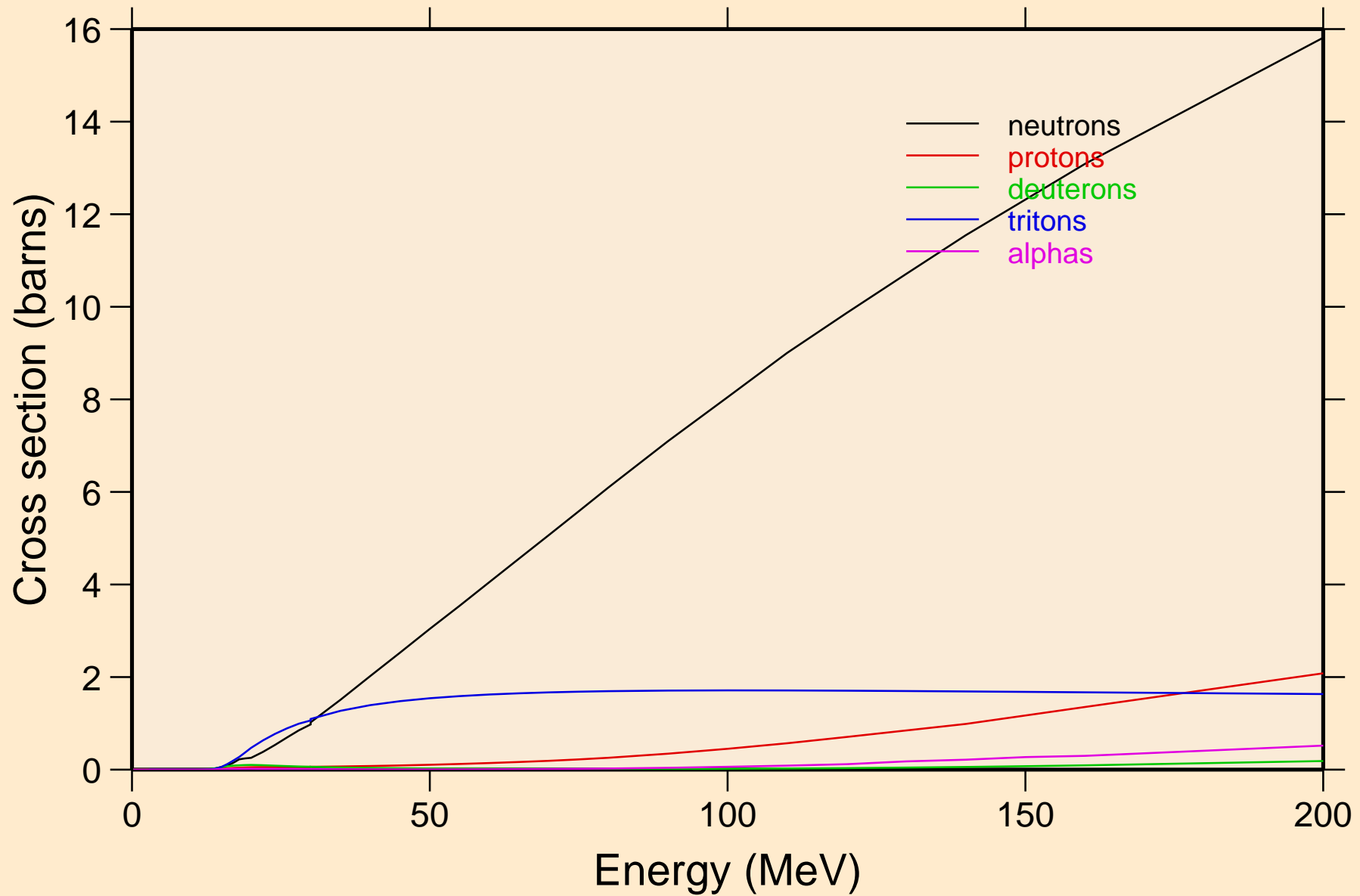

SN120 HELION ACER TENDL-2021 LIBRARY; T=0.K
neutrons from (s,n)

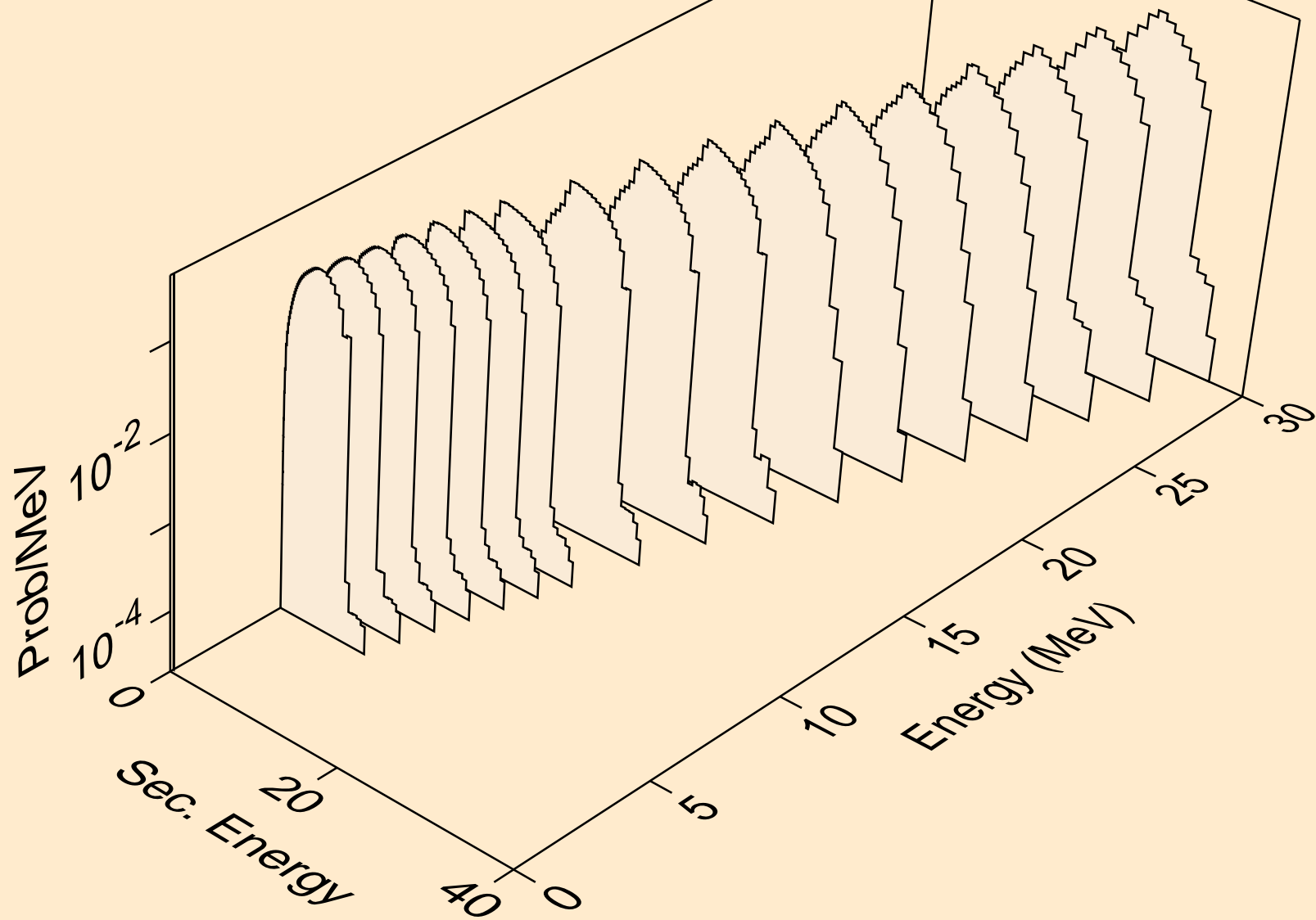

SN120 HELION ACER TENDL-2021 LIBRARY; T=0.K
neutrons from (s,x)

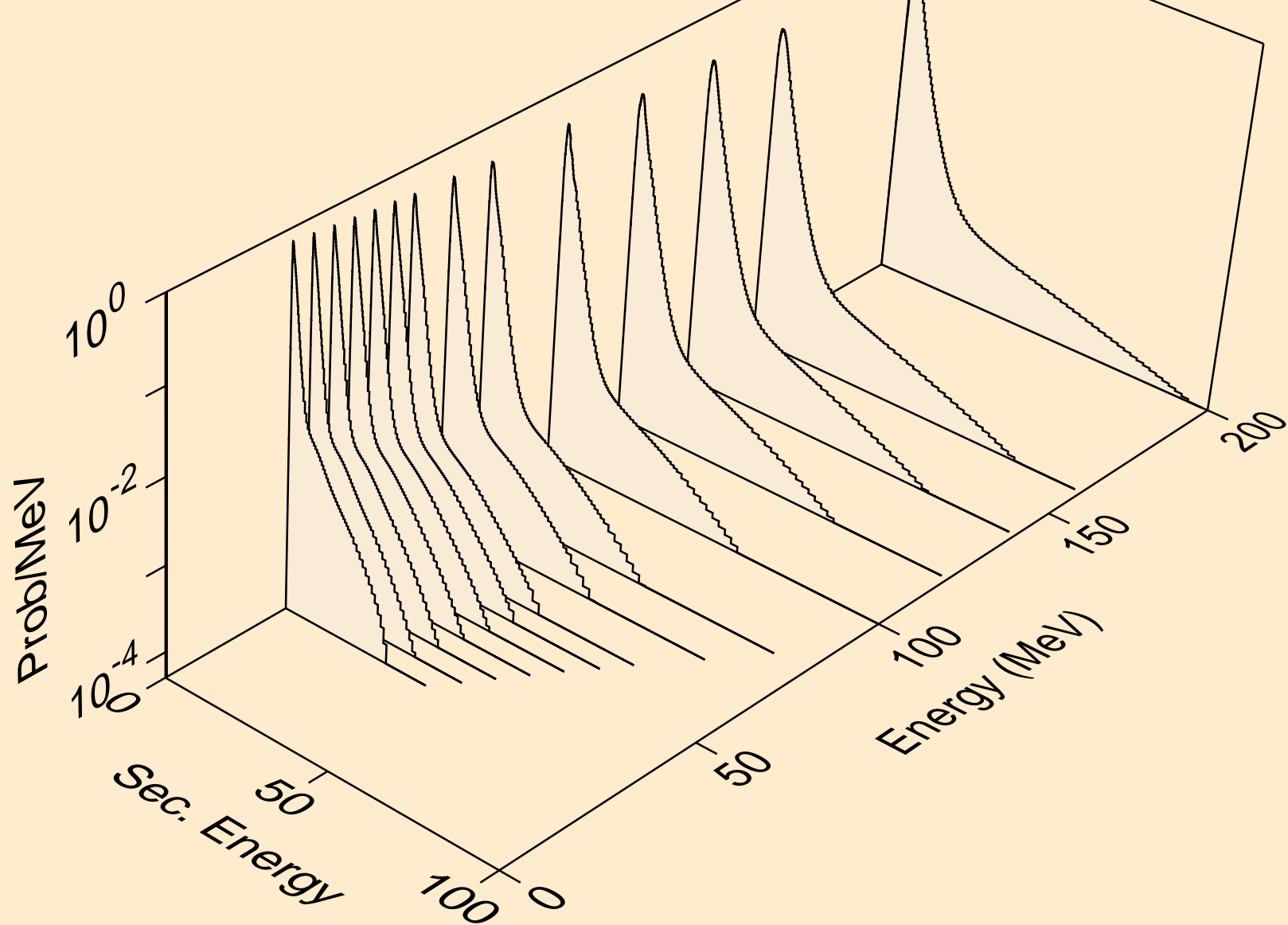

SN120 HELION ACER TENDL-2021 LIBRARY; T=0.K
neutrons from (s,2nd)

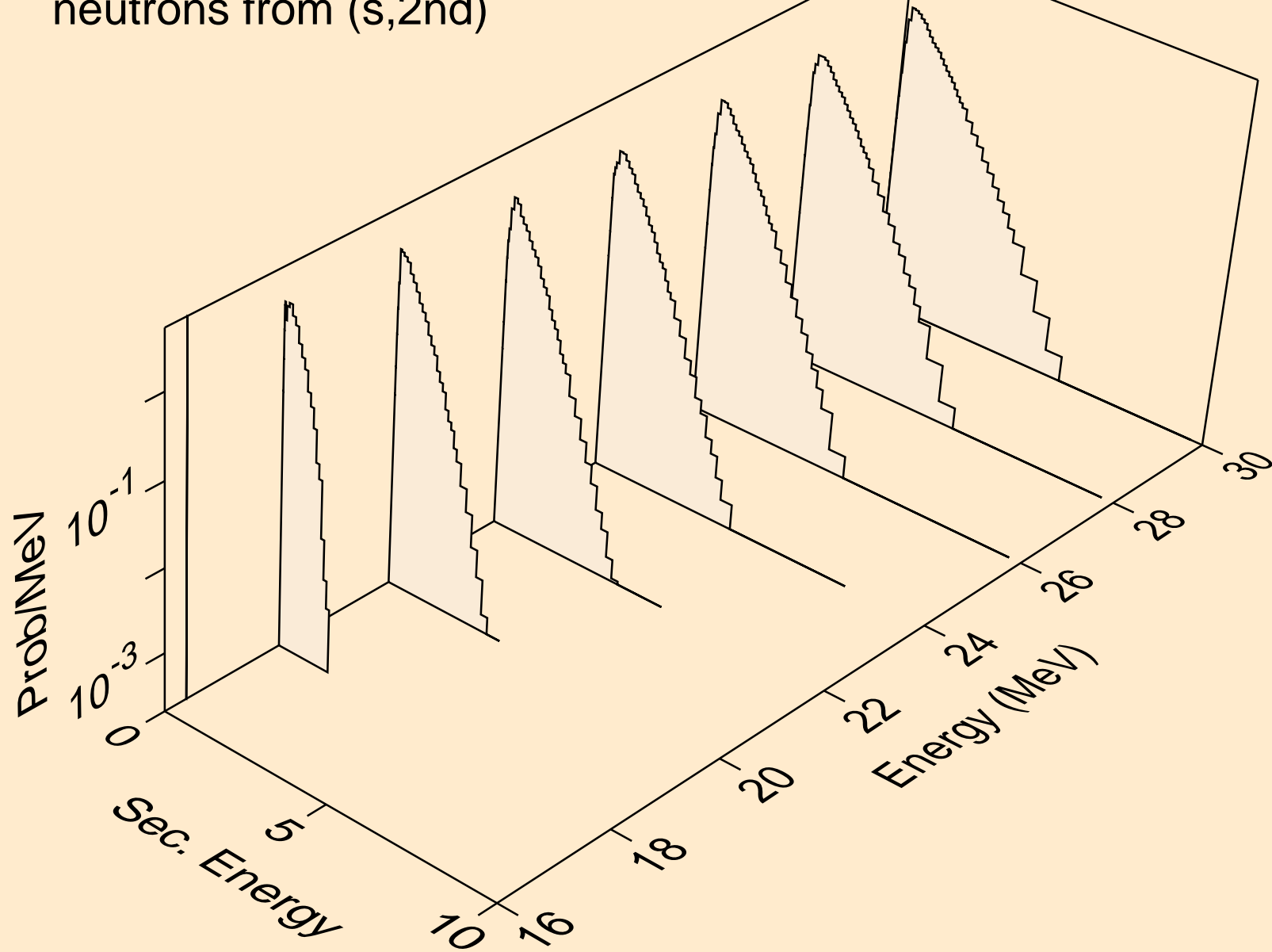

SN120 HELION ACER TENDL-2021 LIBRARY; T=0.K
neutrons from (s,2n)

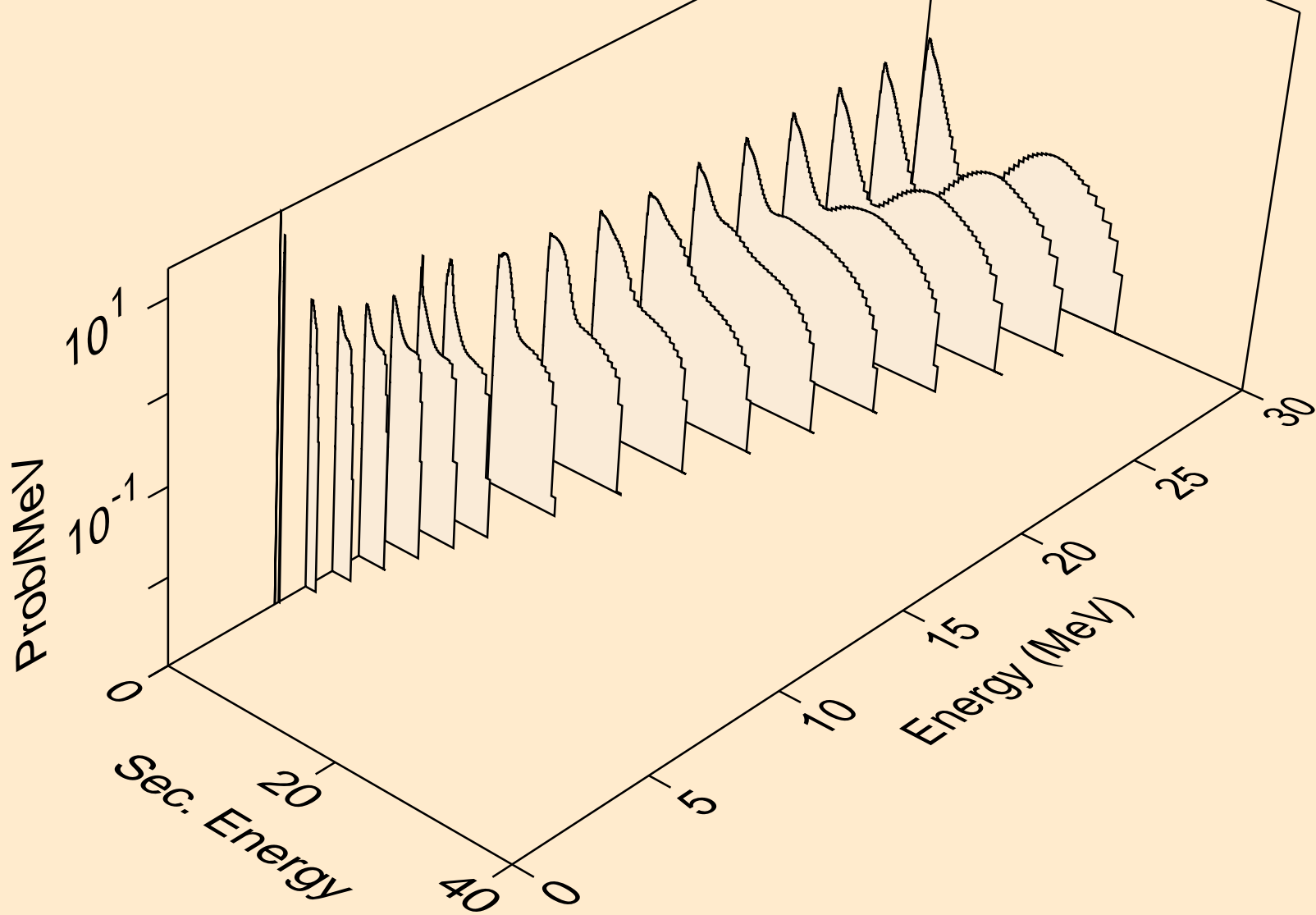

SN120 HELION ACER TENDL-2021 LIBRARY; T=0.K
neutrons from (s,3n)

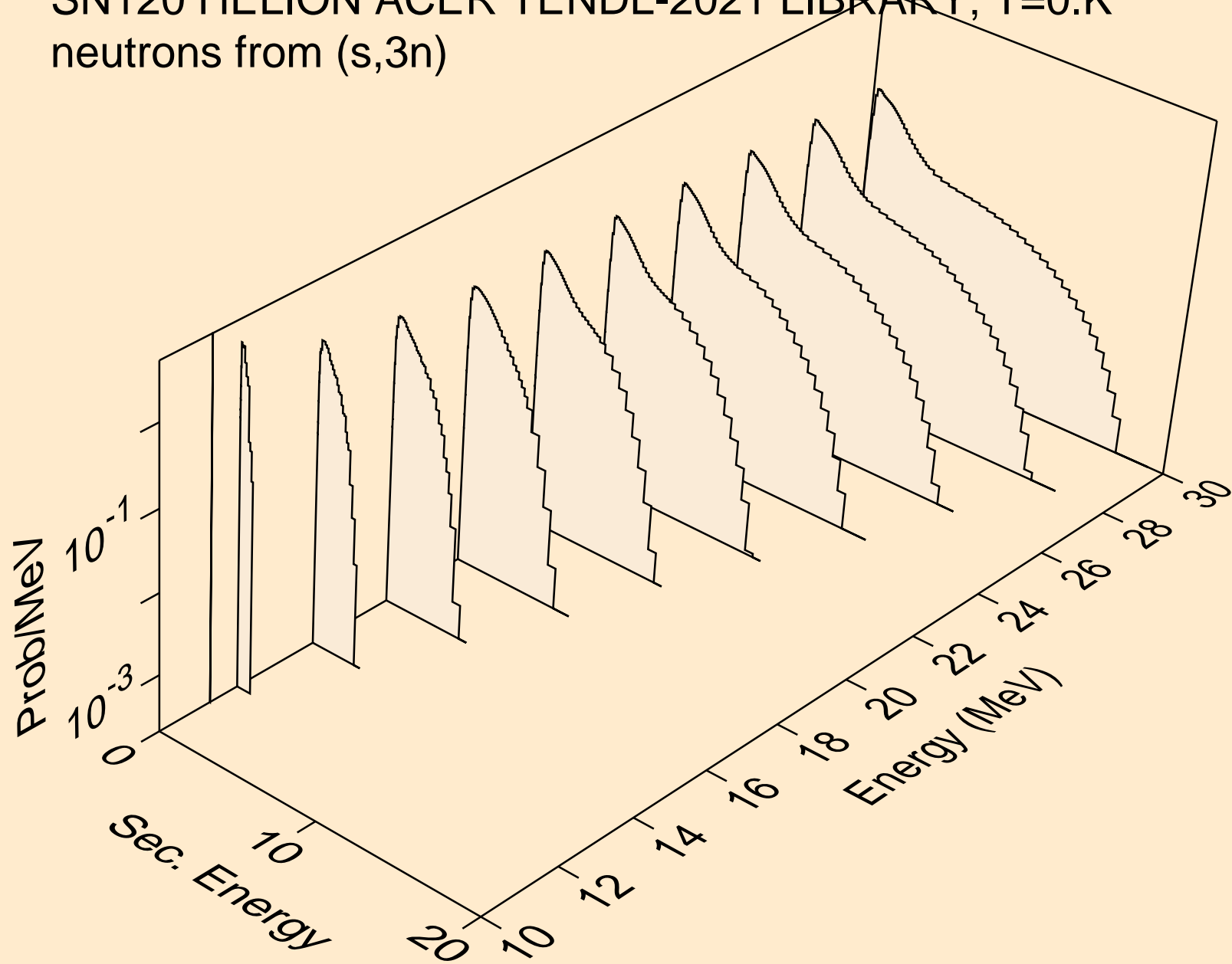

SN120 HELION ACER TENDL-2021 LIBRARY; T=0.K
neutrons from (s,n*)a

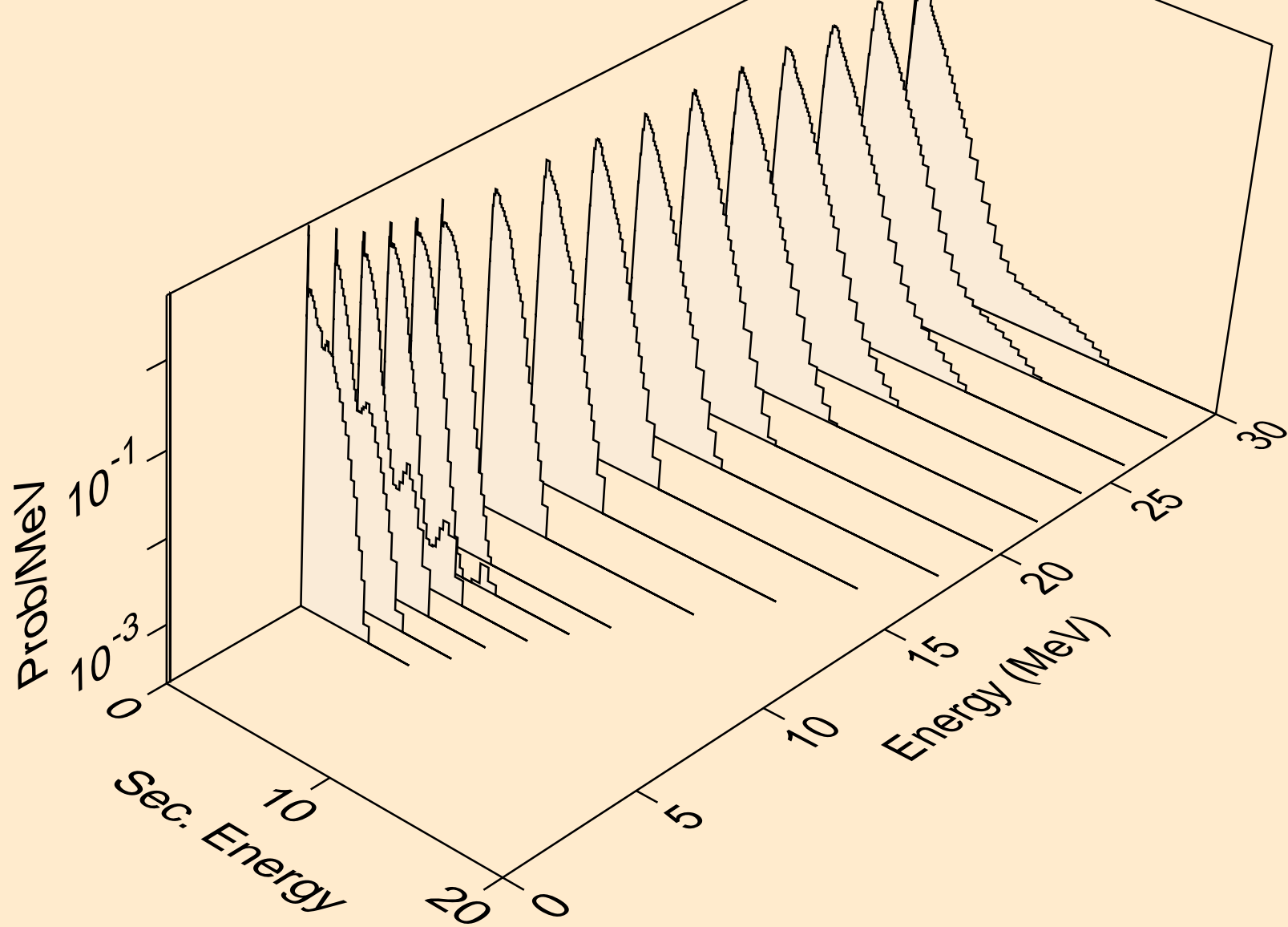

SN120 HELION ACER TENDL-2021 LIBRARY; T=0.K
neutrons from (s,2n)a

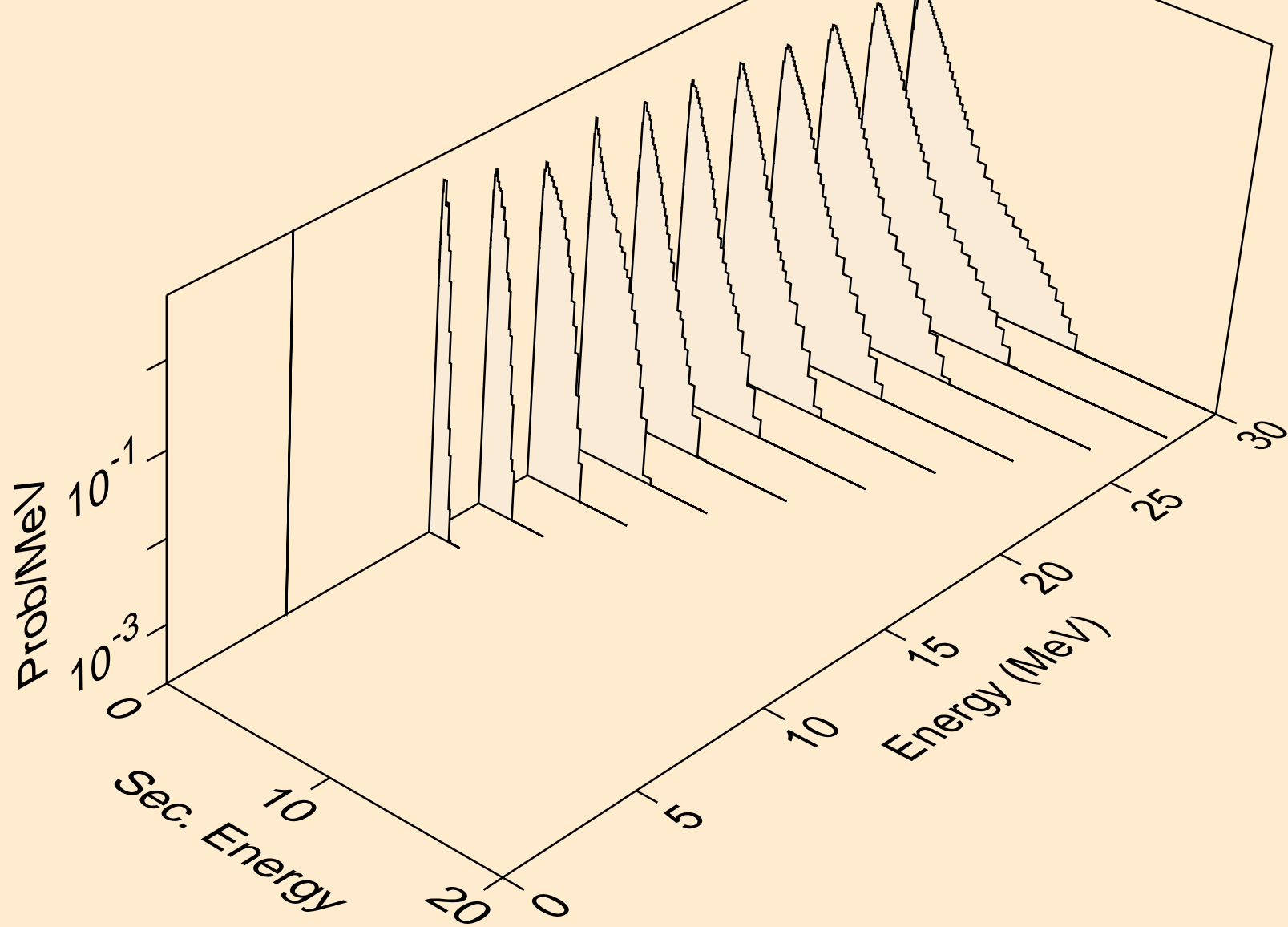

SN120 HELION ACER TENDL-2021 LIBRARY; T=0.K
neutrons from (s,3n)a

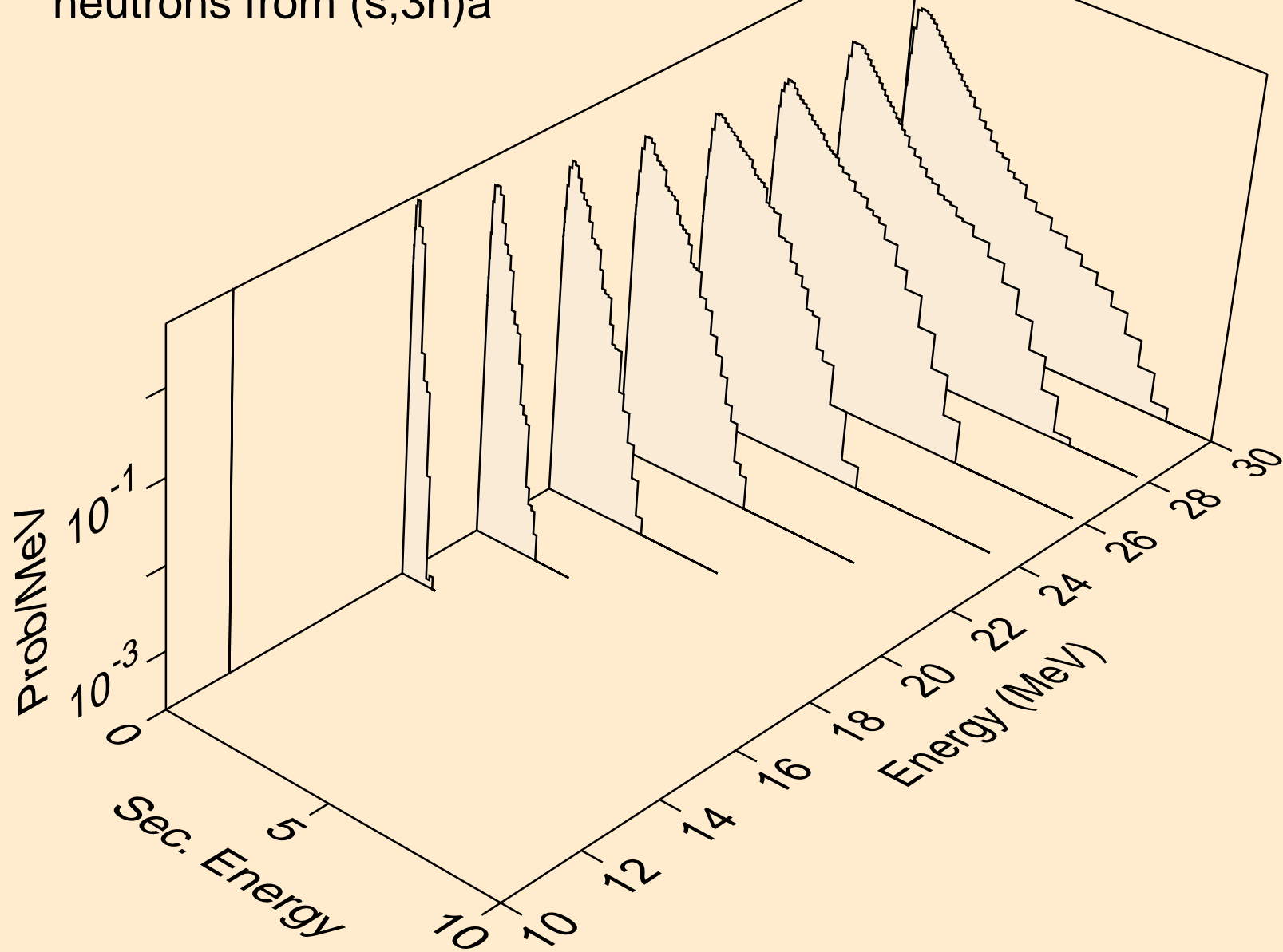

SN120 HELION ACER TENDL-2021 LIBRARY; T=0.K
neutrons from (s,n*)p

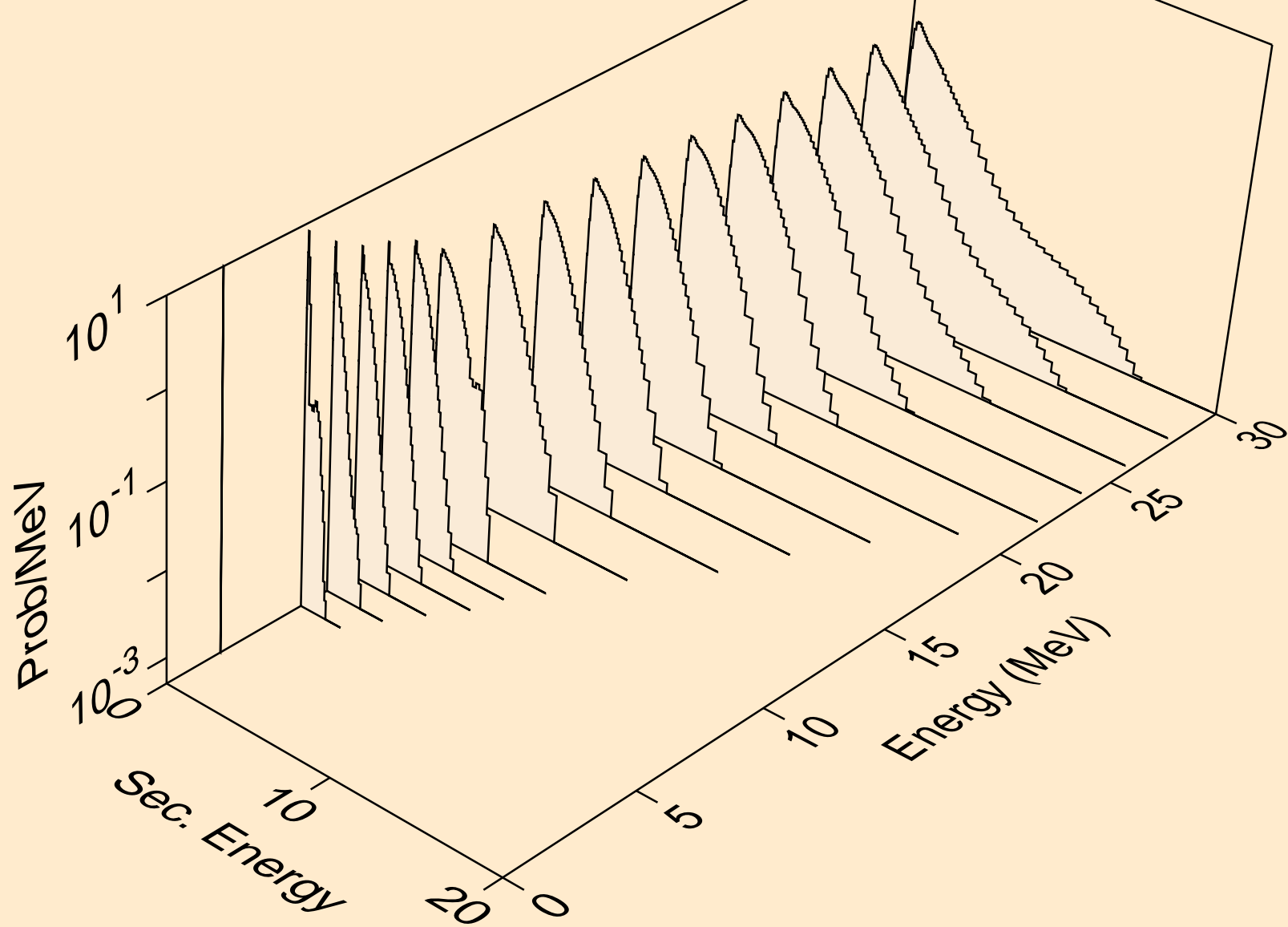

SN120 HELION ACER TENDL-2021 LIBRARY; T=0.K
neutrons from (s,n*)2a

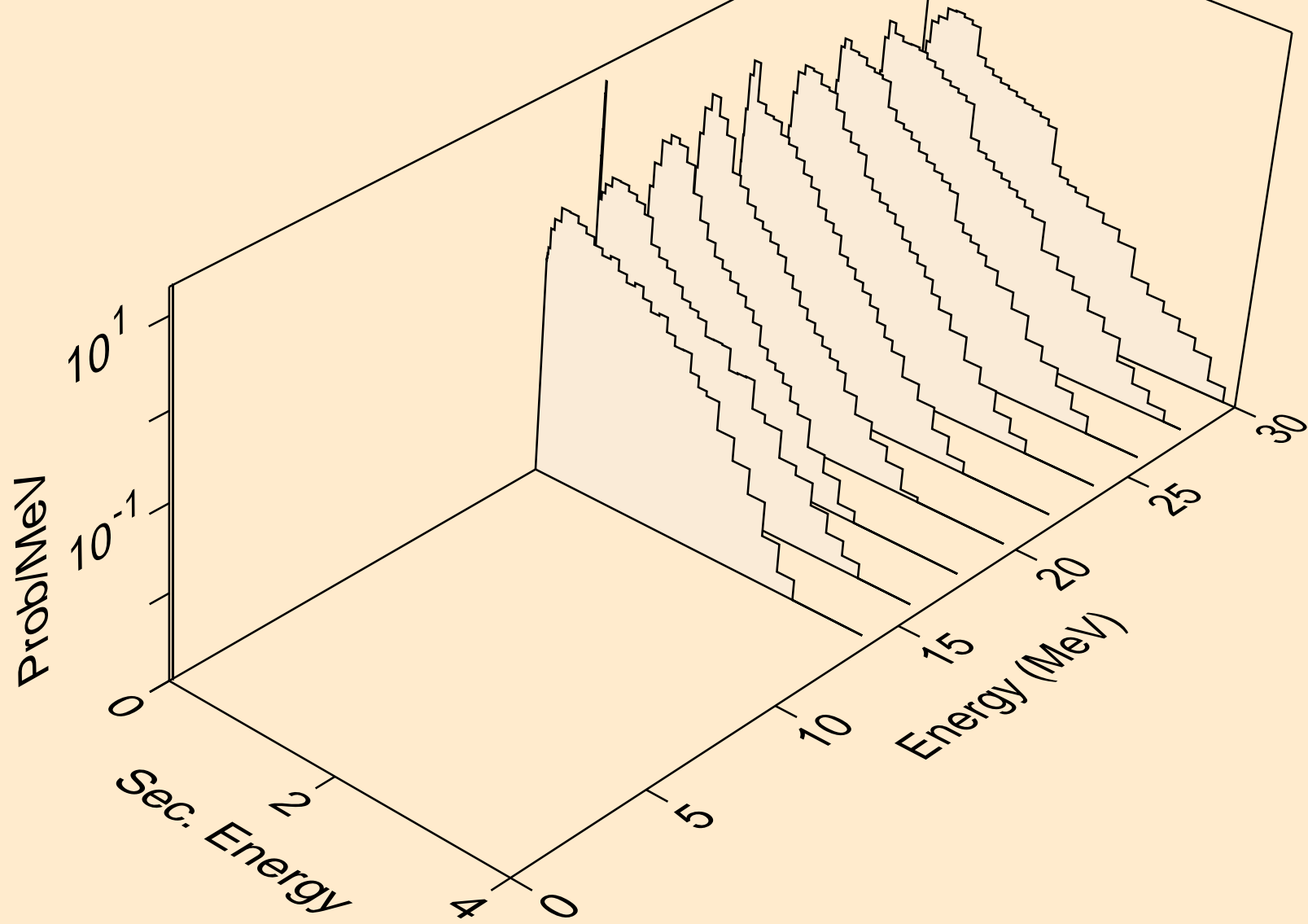

SN120 HELION ACER TENDL-2021 LIBRARY; T=0.K
neutrons from (s,n*)d

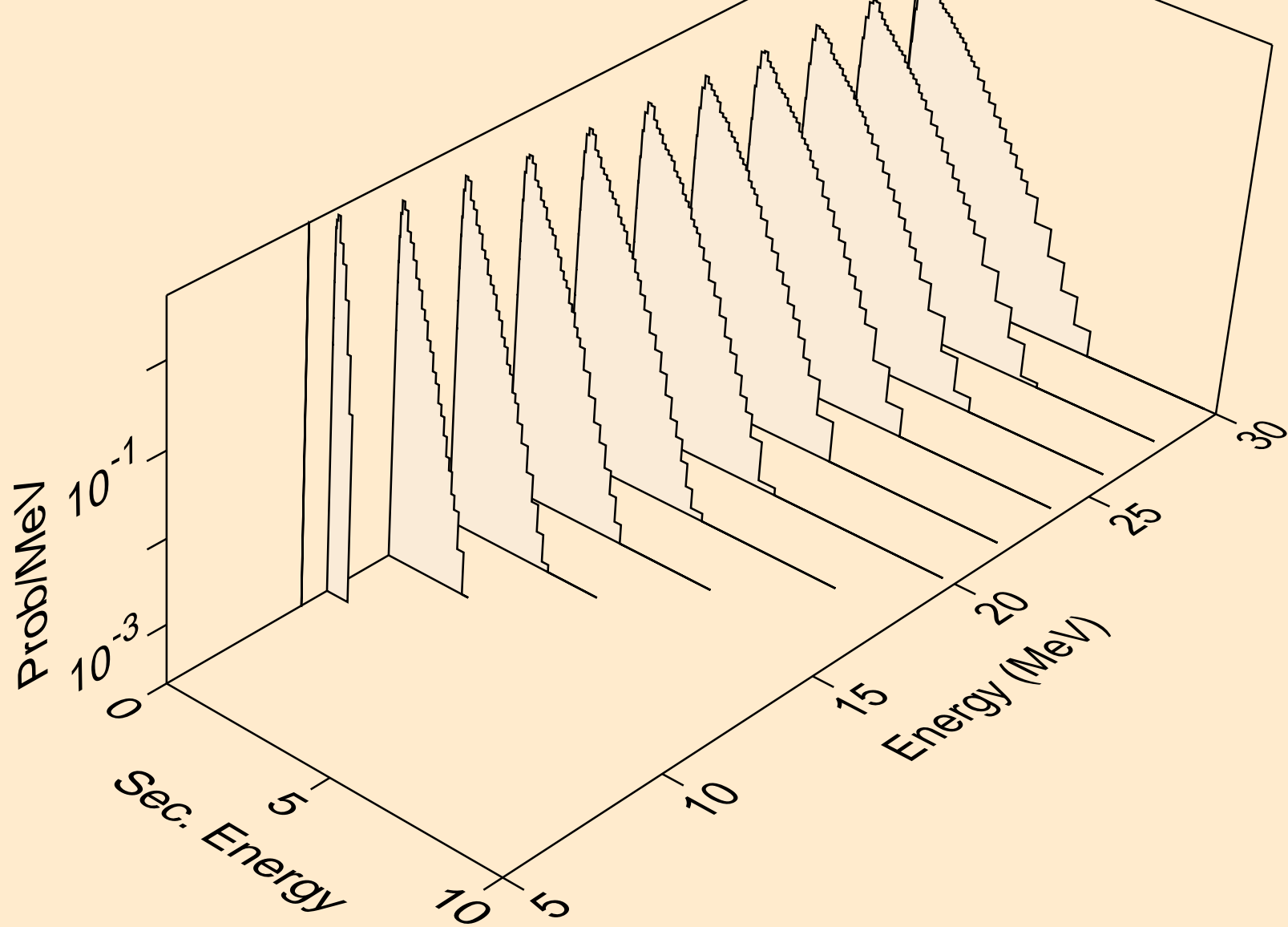

SN120 HELION ACER TENDL-2021 LIBRARY; T=0.K
neutrons from (s,n*)t

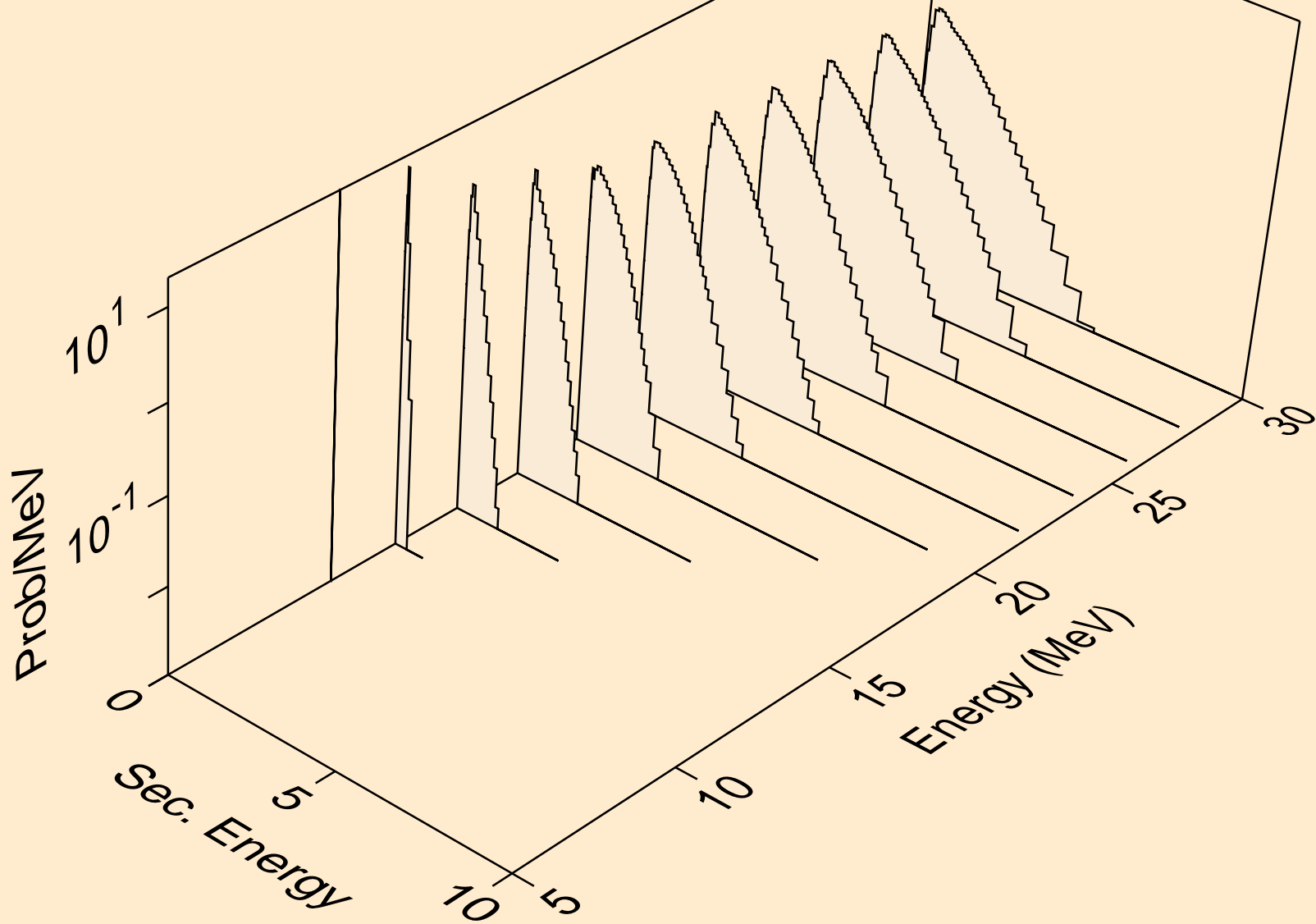

SN120 HELION ACER TENDL-2021 LIBRARY; T=0.K
neutrons from (s,n*)he3

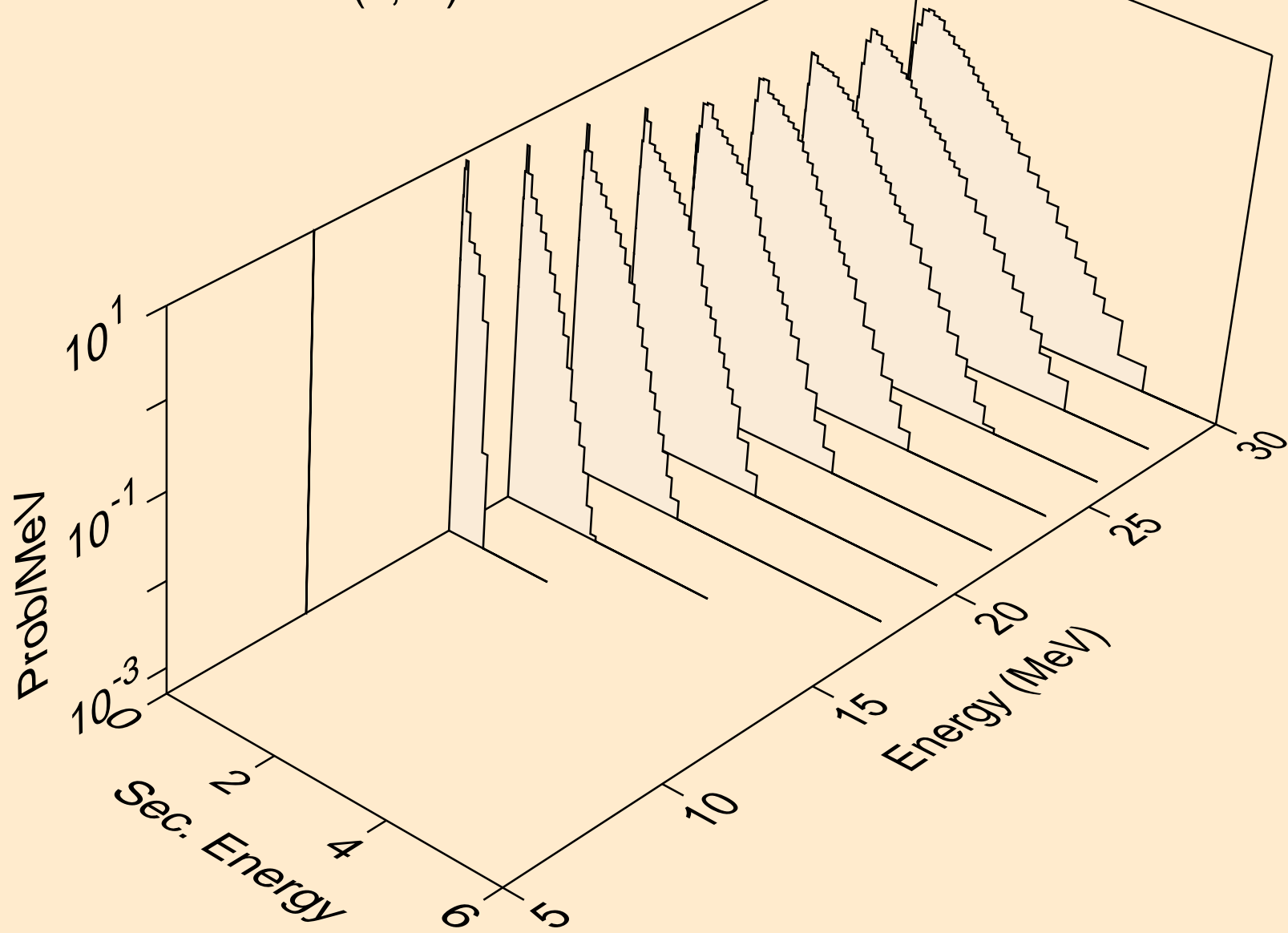

SN120 HELION ACER TENDL-2021 LIBRARY; T=0.K
neutrons from (s,4n)

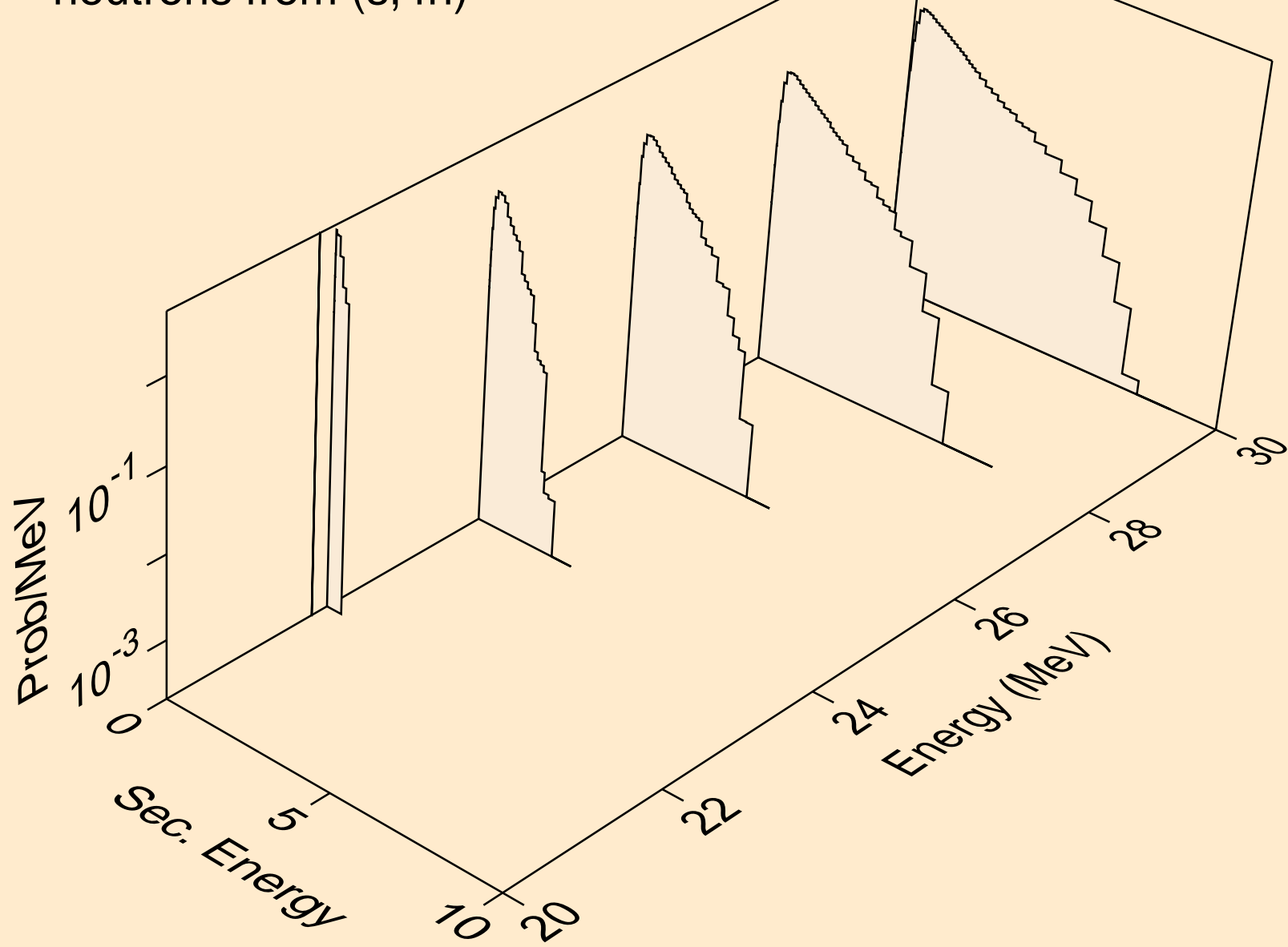

SN120 HELION ACER TENDL-2021 LIBRARY; T=0.K
neutrons from (s,2np)

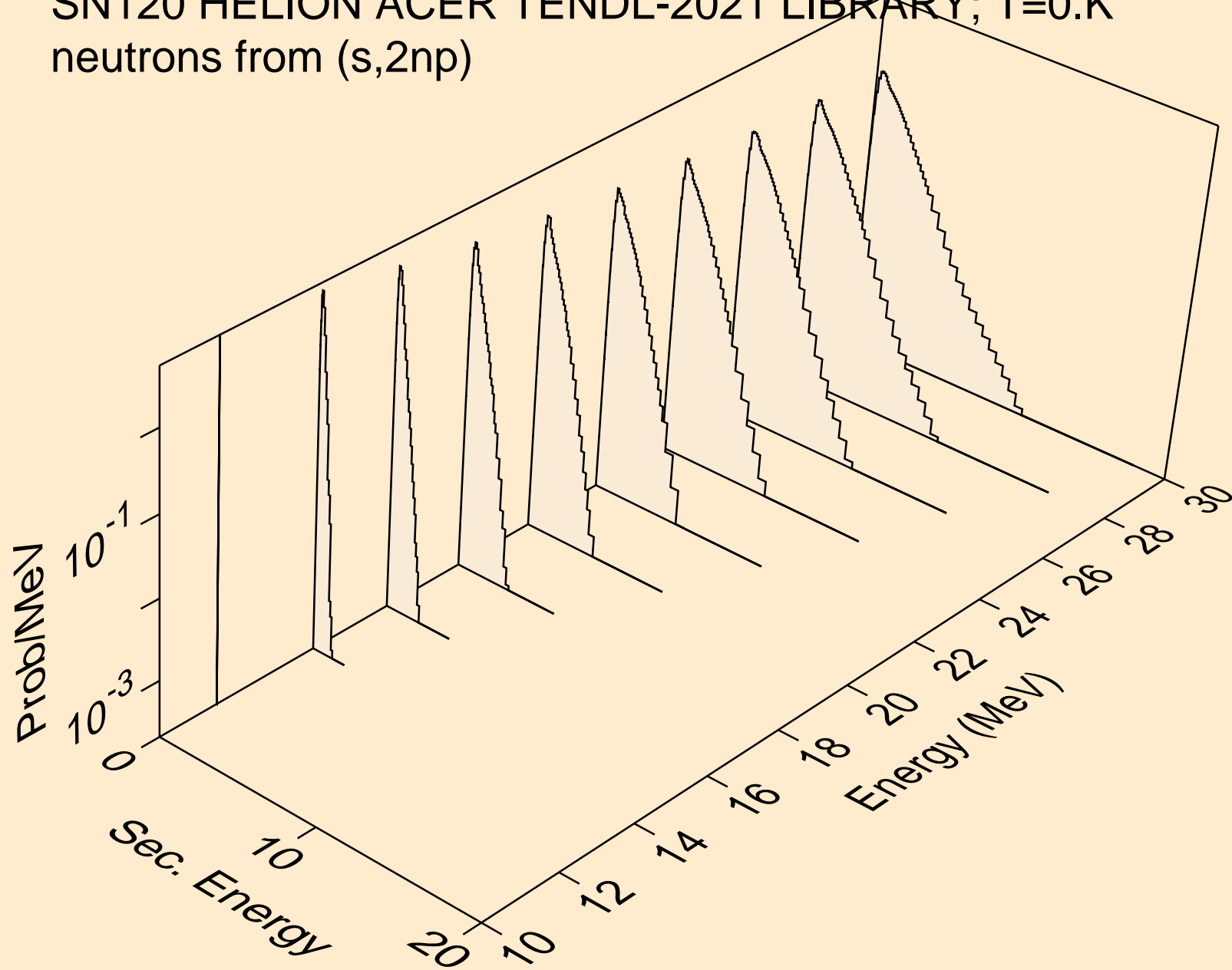

SN120 HELION ACER TENDL-2021 LIBRARY; T=0.K
neutrons from (s,3np)

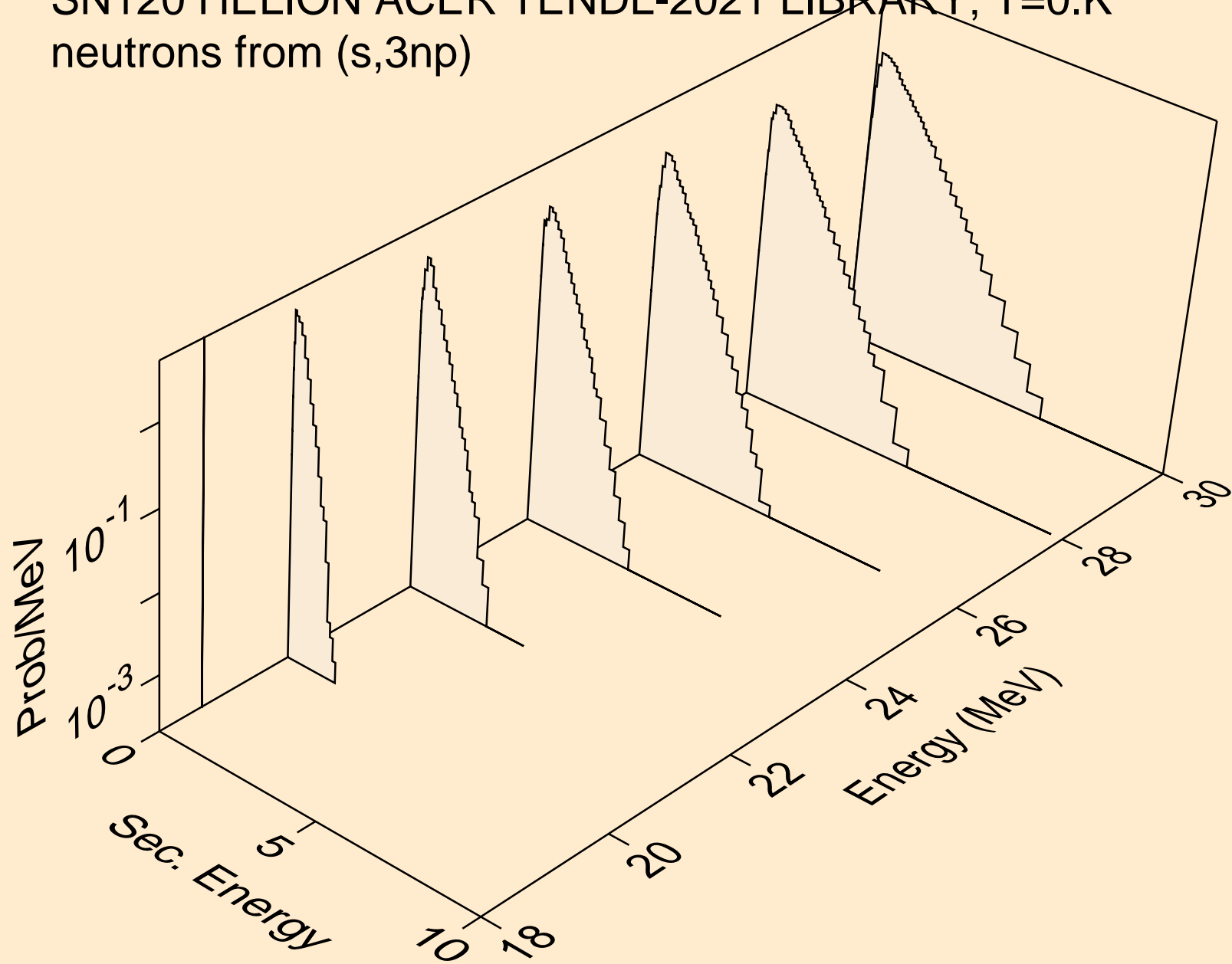

SN120 HELION ACER TENDL-2021 LIBRARY; T=0.K
neutrons from (s,2np)

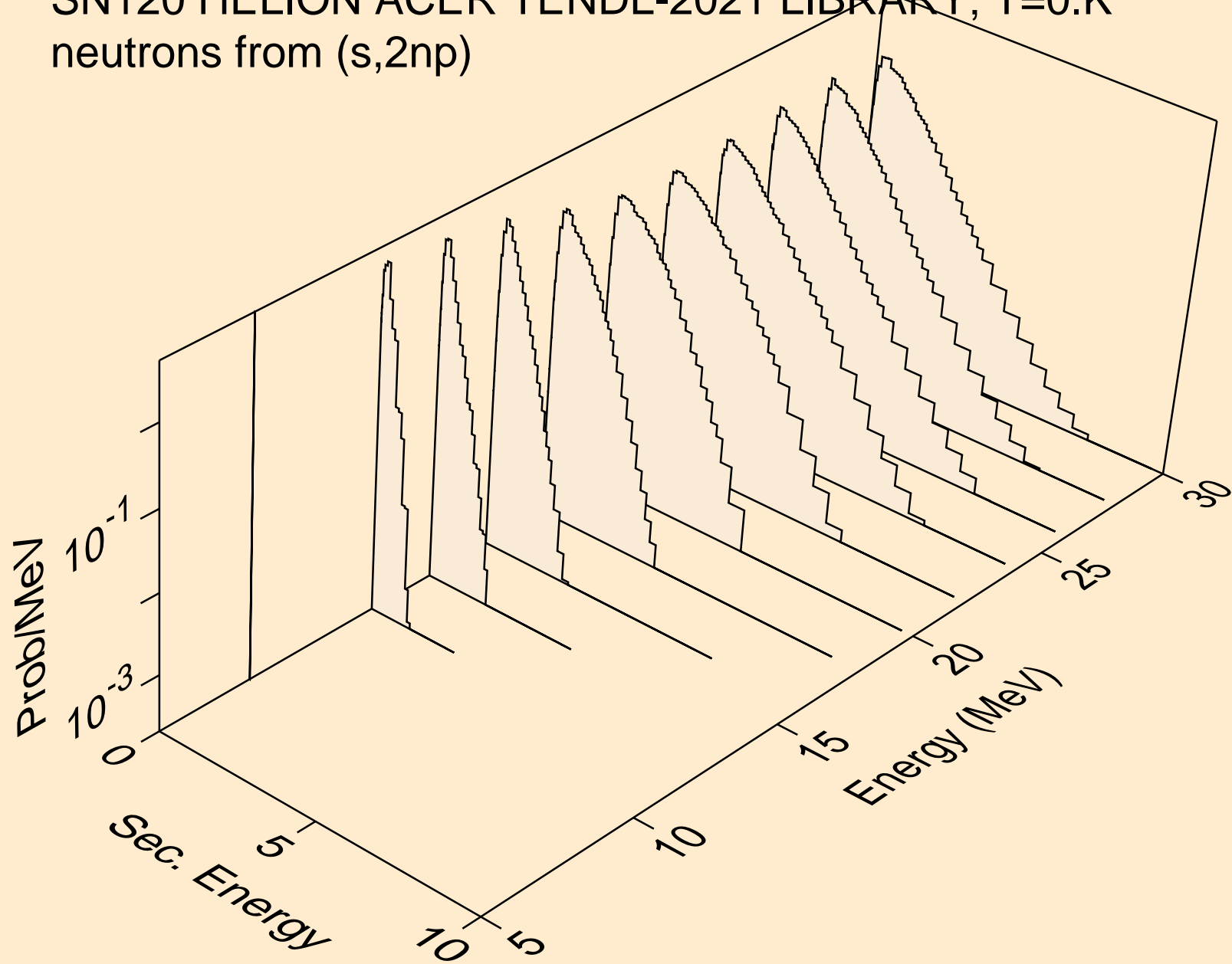

SN120 HELION ACER TENDL-2021 LIBRARY; T=0.K
neutrons from (s,npa)

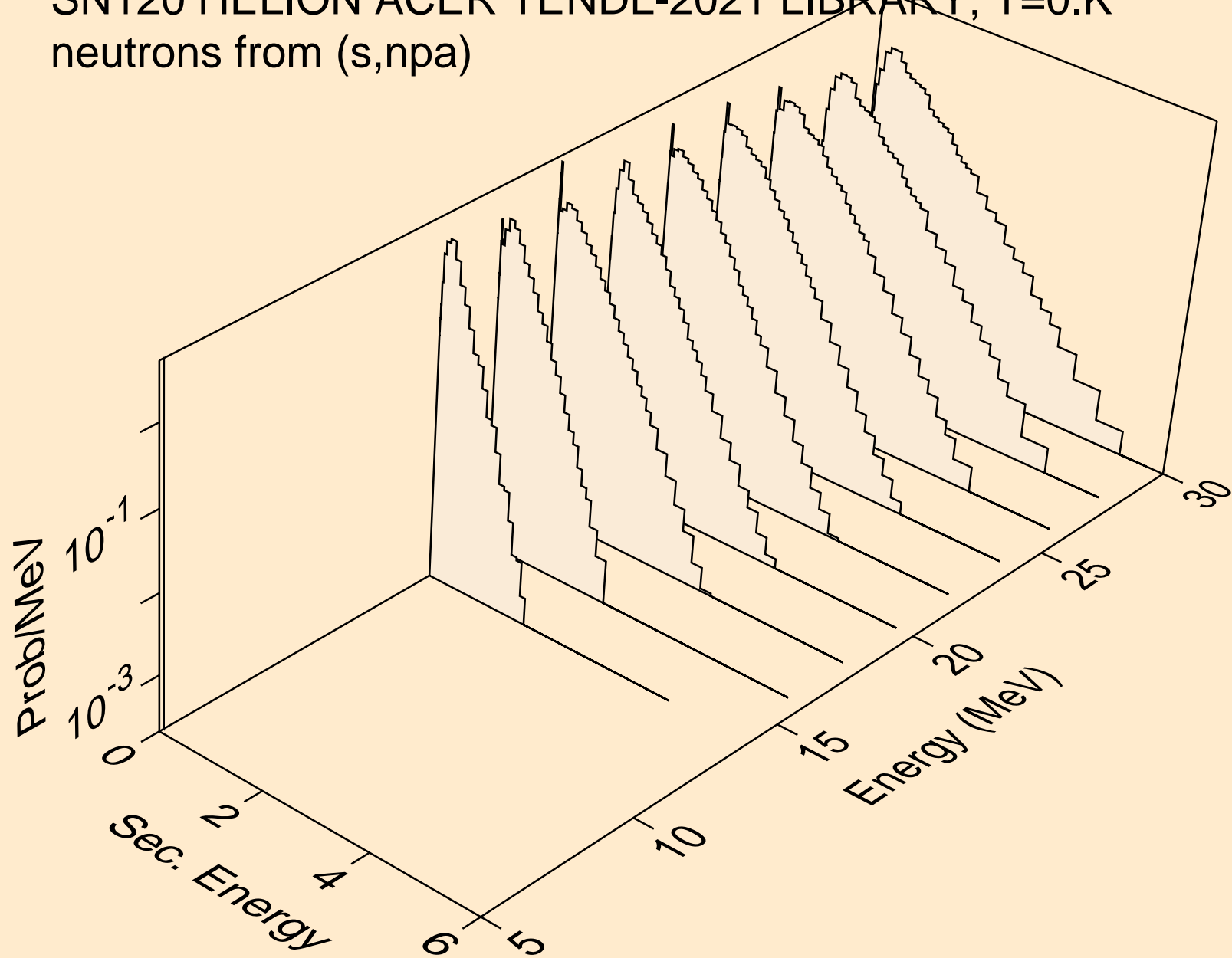

SN120 HELION ACER TENDL-2021 LIBRARY; T=0.K
protons from (s,x)

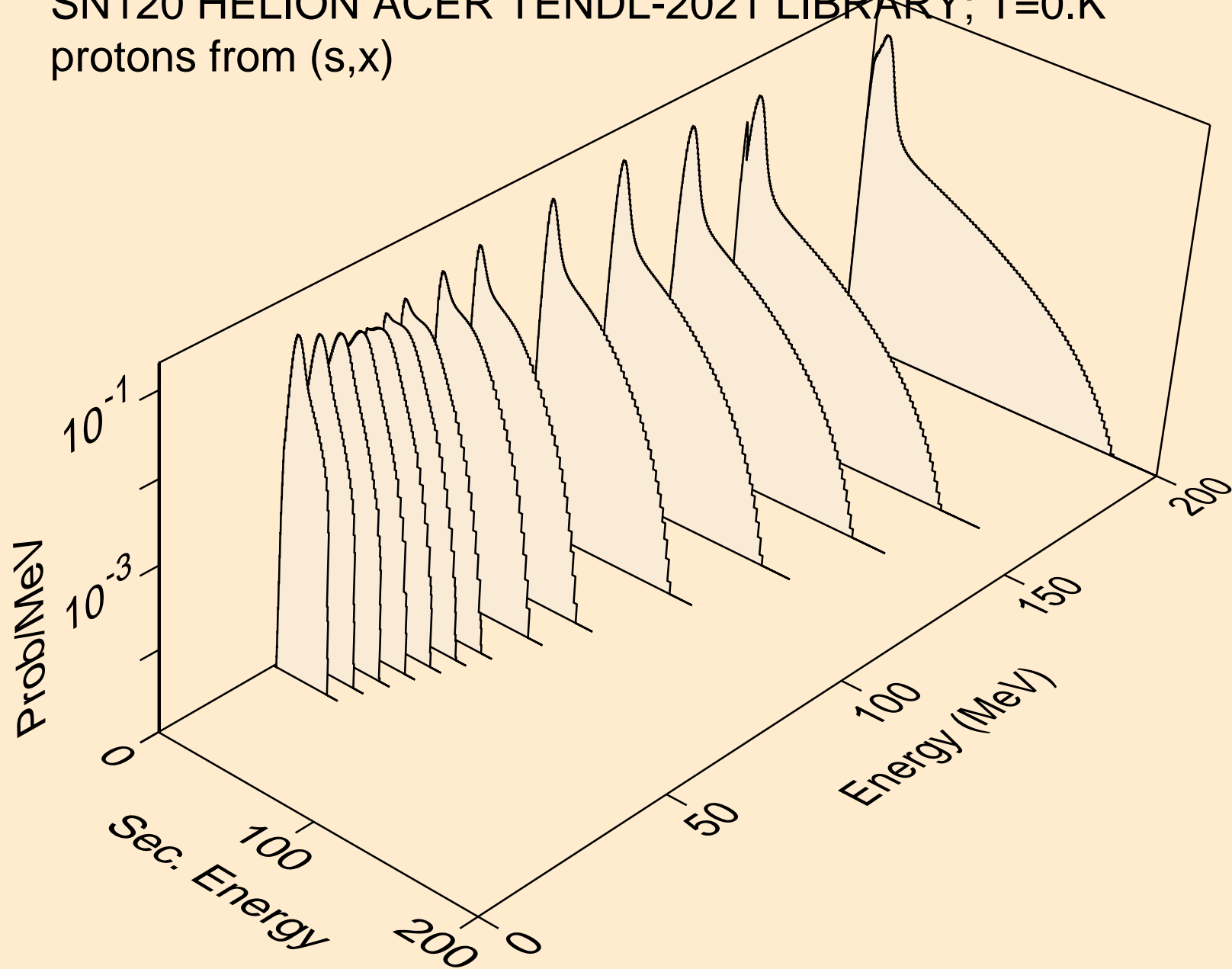

SN120 HELION ACER TENDL-2021 LIBRARY; T=0.K
protons from (s,n*)p

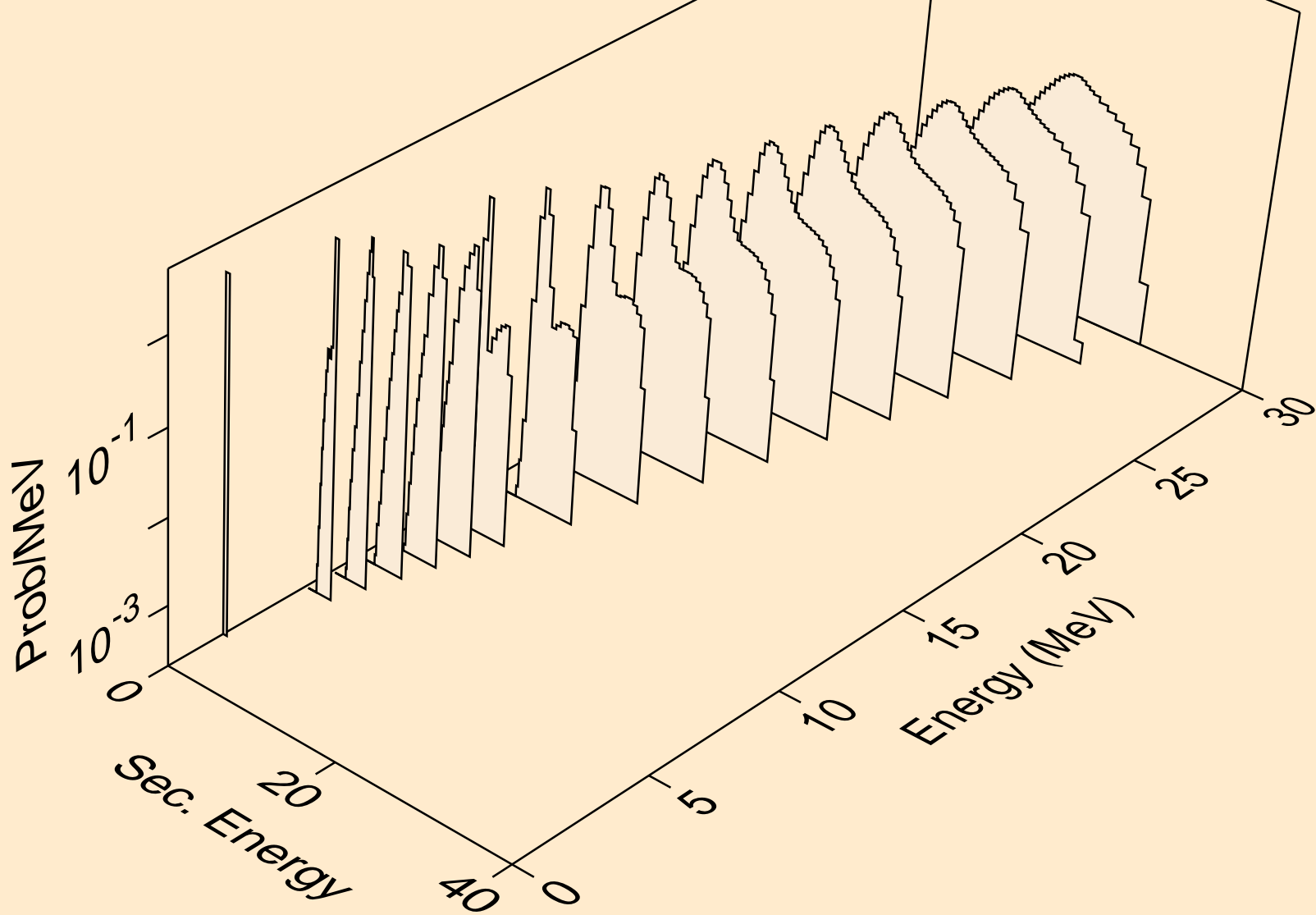

SN120 HELION ACER TENDL-2021 LIBRARY; T=0.K
protons from (s,2np)

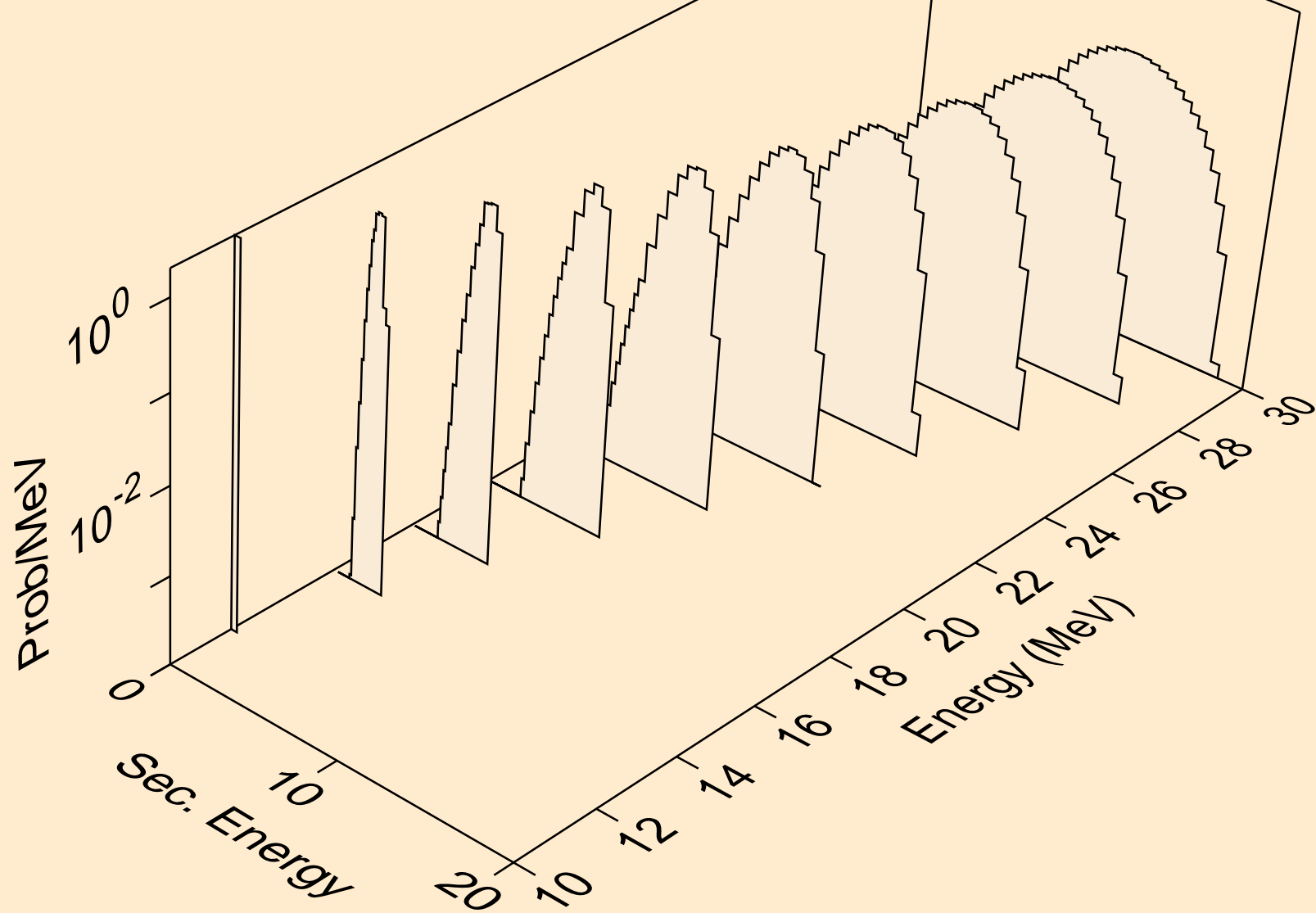

SN120 HELION ACER TENDL-2021 LIBRARY; T=0.K
protons from (s,3np)

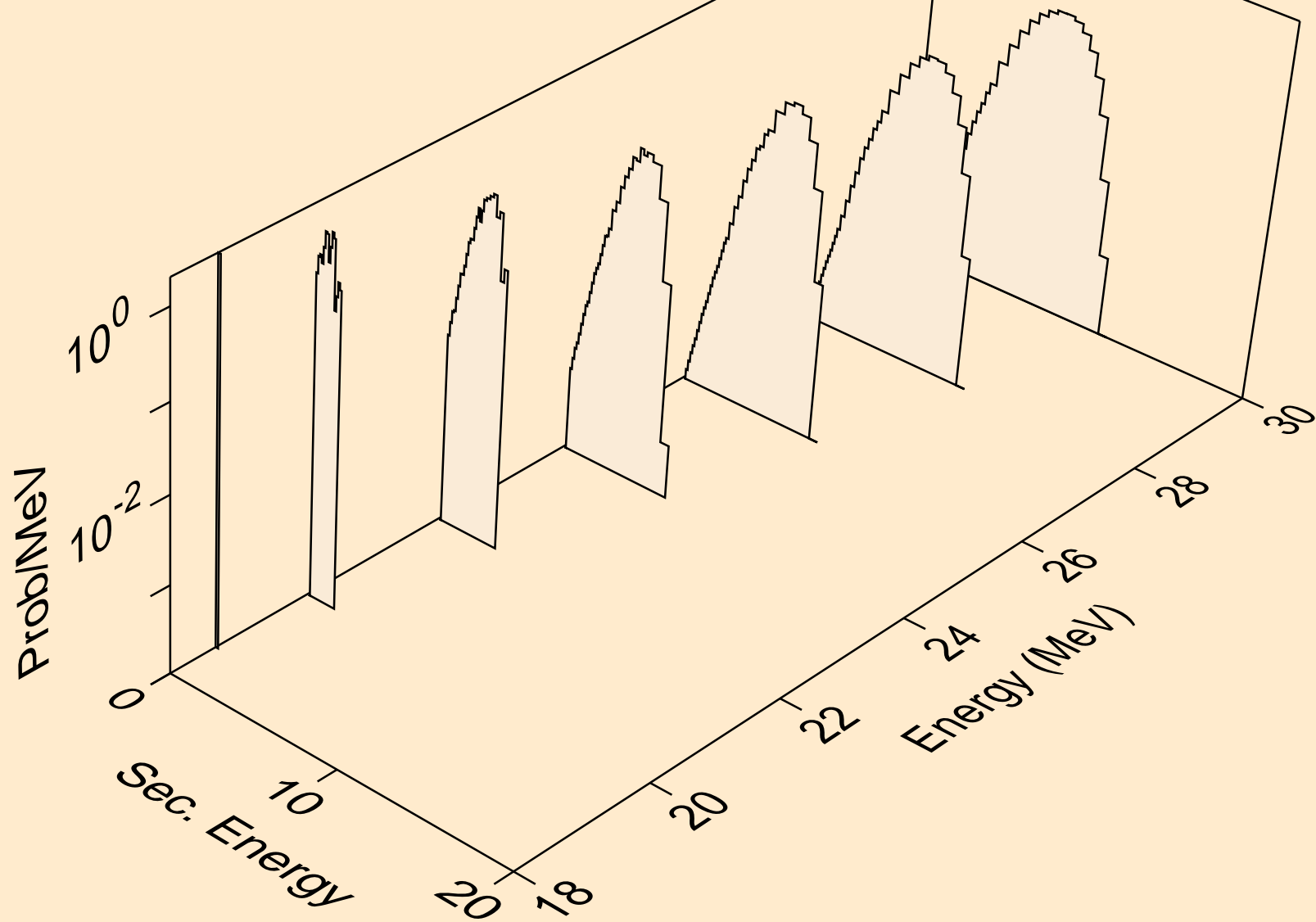

SN120 HELION ACER TENDL-2021 LIBRARY; T=0.K
protons from (s,2np)

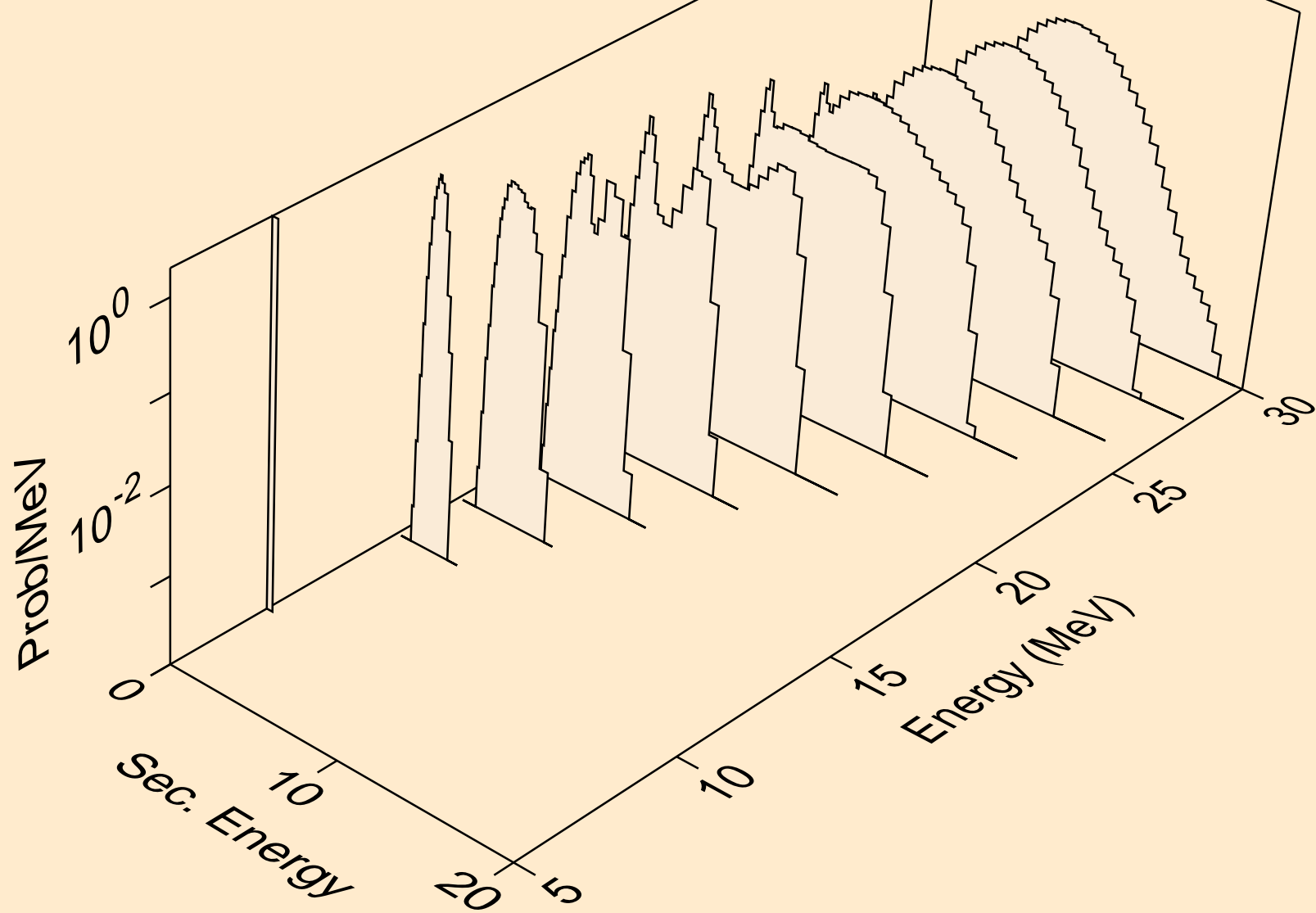

SN120 HELION ACER TENDL-2021 LIBRARY; T=0.K
protons from (s,npa)

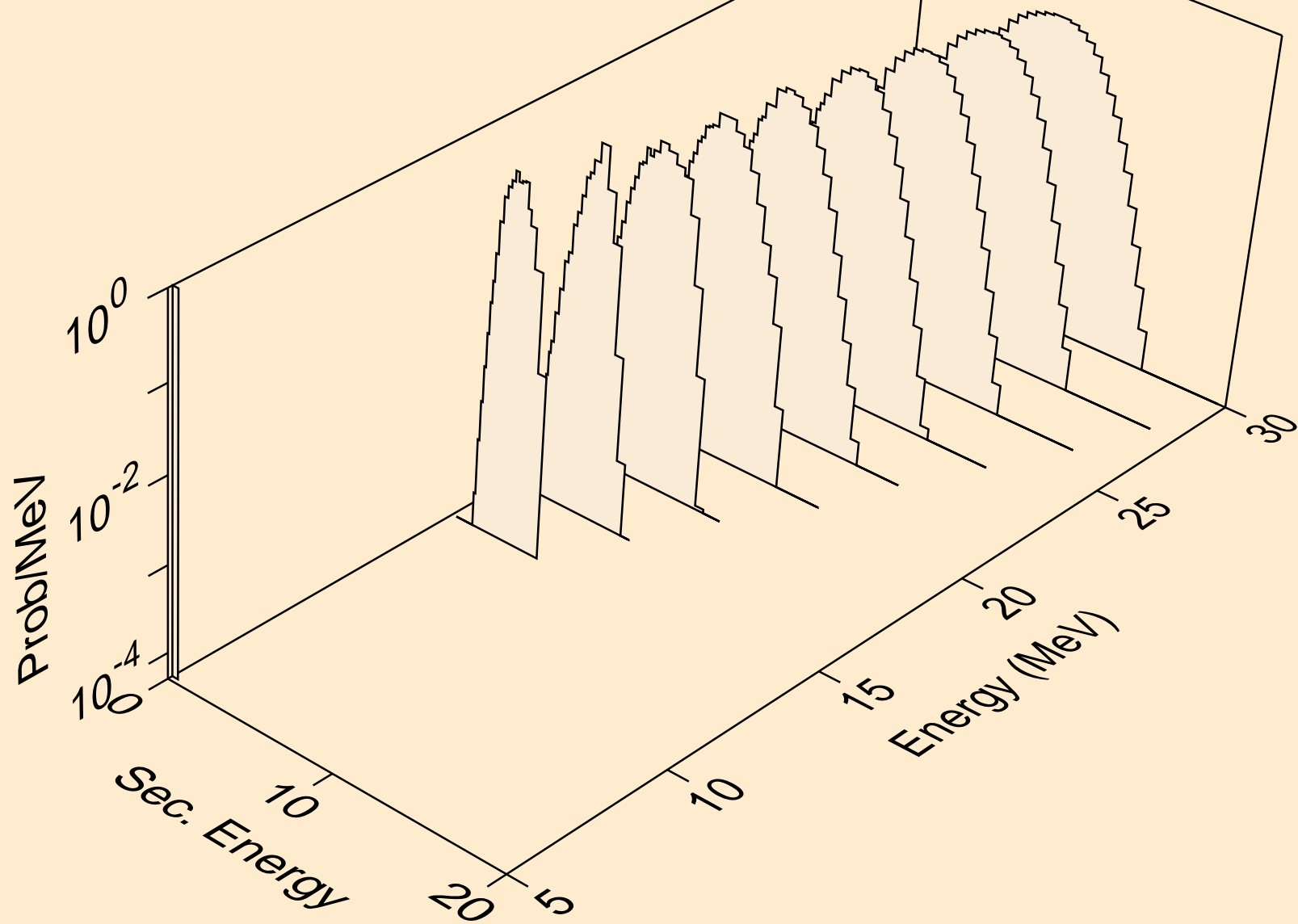

SN120 HELION ACER TENDL-2021 LIBRARY; T=0.K
protons from (s,p)

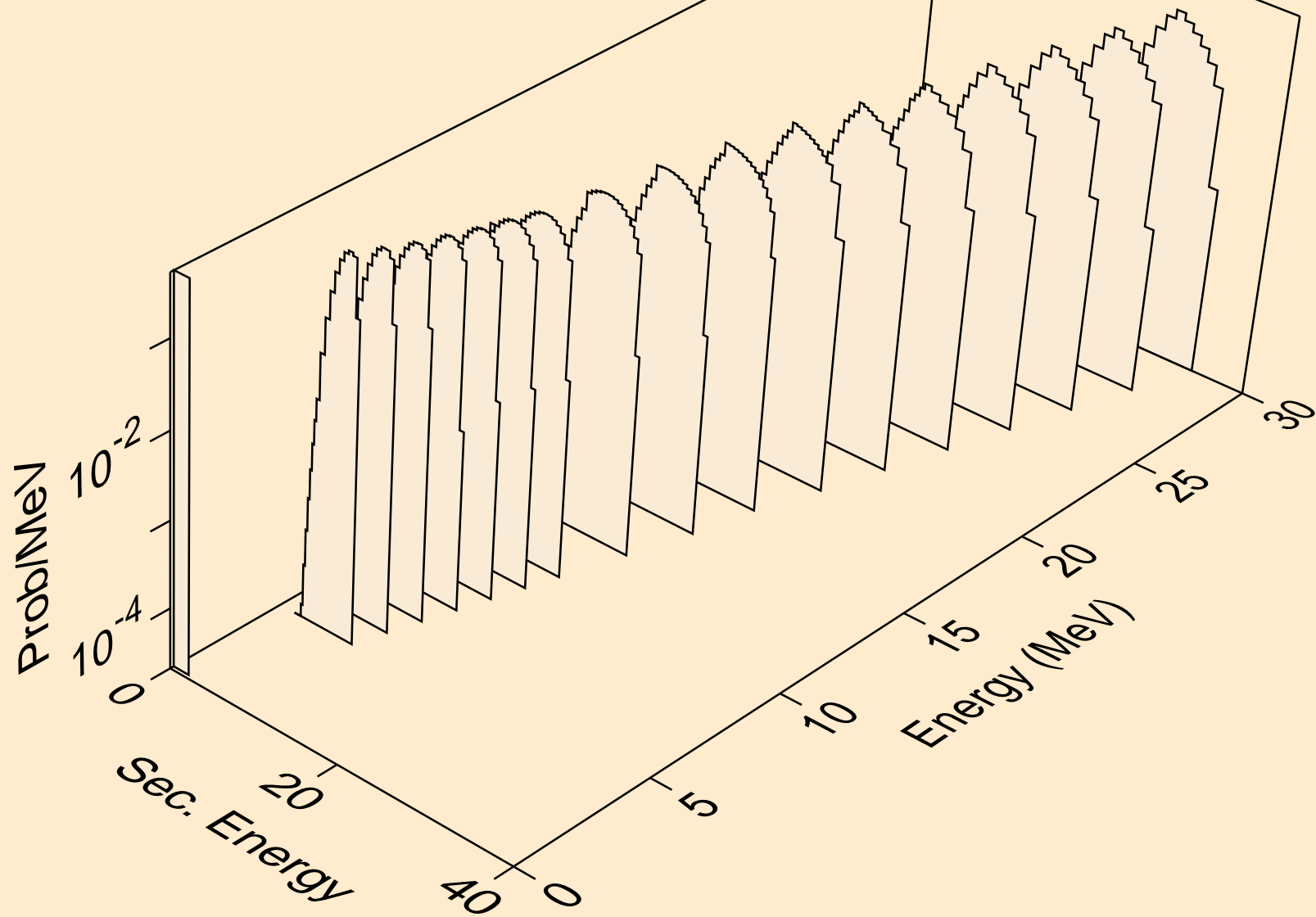

SN120 HELION ACER TENDL-2021 LIBRARY; T=0.K
protons from (s,2p)

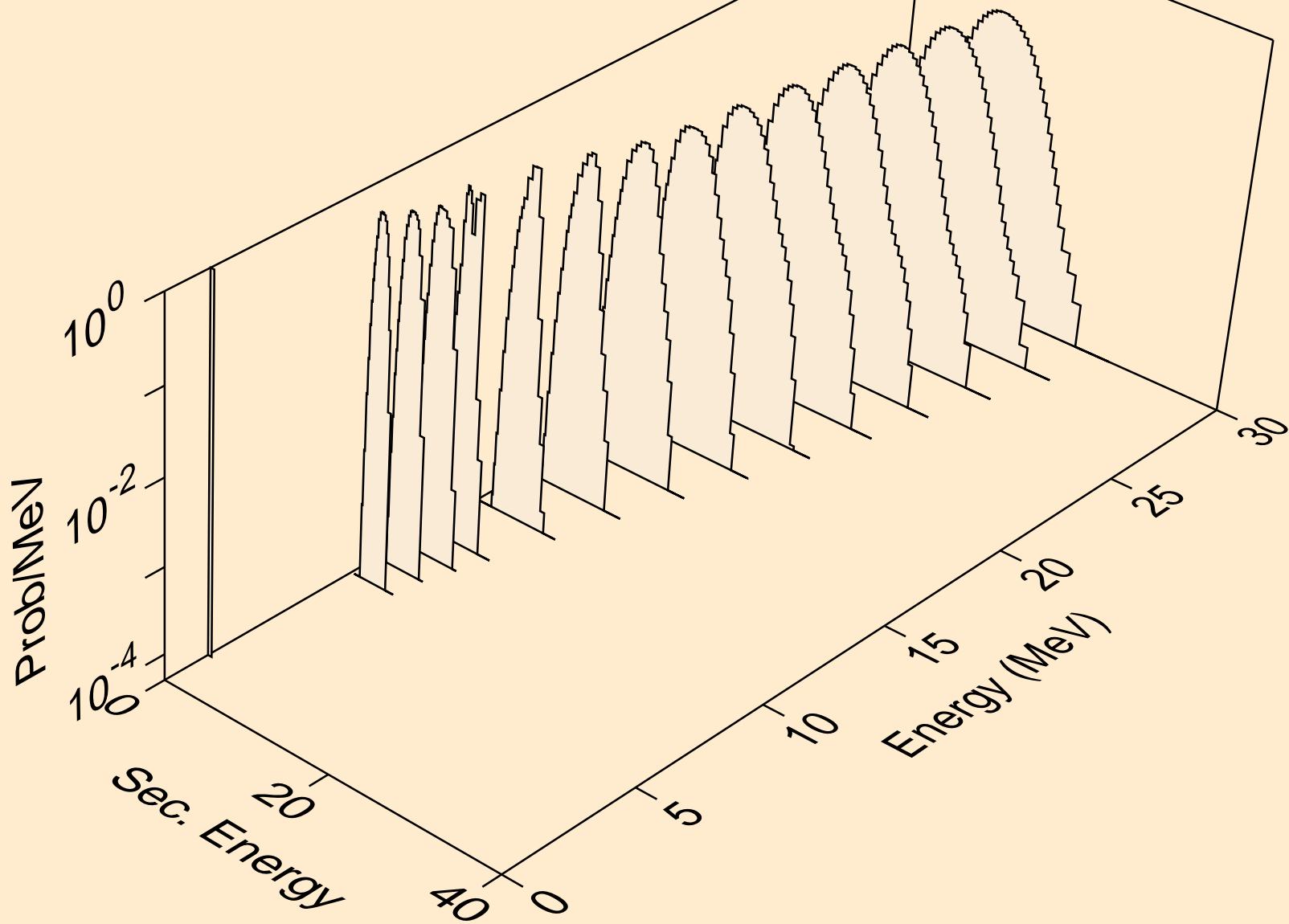

SN120 HELION ACER TENDL-2021 LIBRARY; T=0.K
protons from (s,pa)

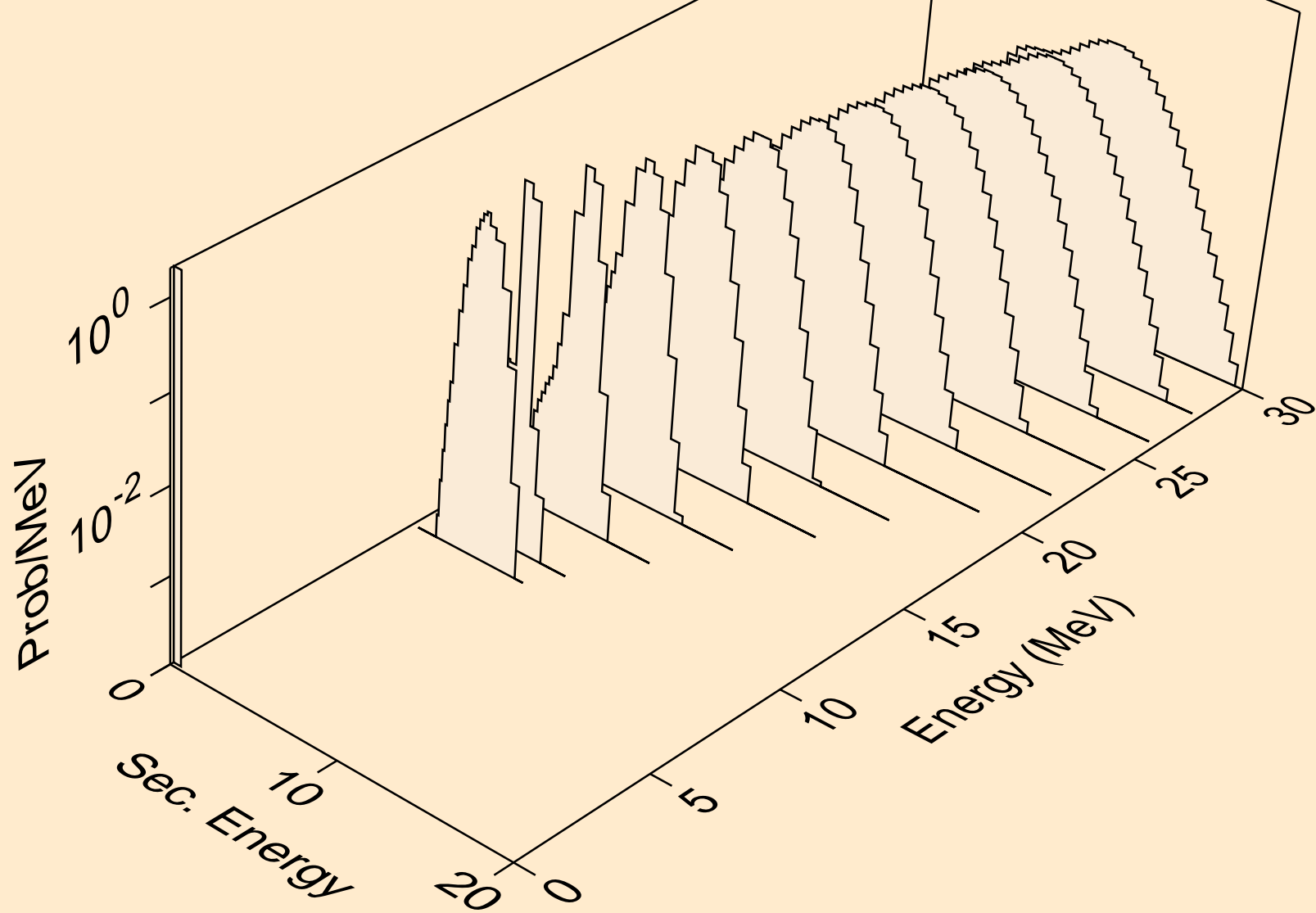

SN120 HELION ACER TENDL-2021 LIBRARY; T=0.K
protons from (s,pd)

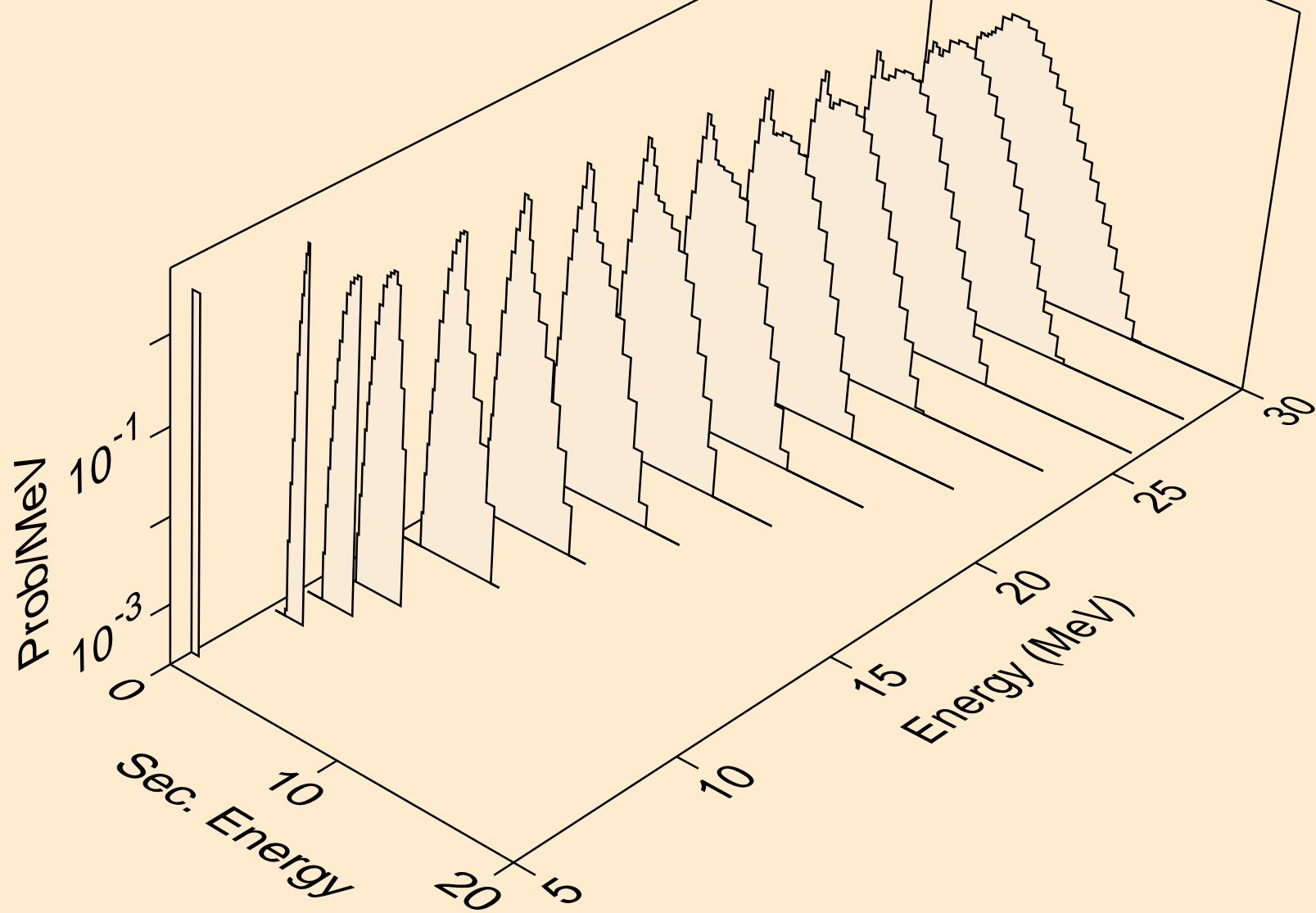

SN120 HELION ACER TENDL-2021 LIBRARY; T=0.K
protons from (s,pt)

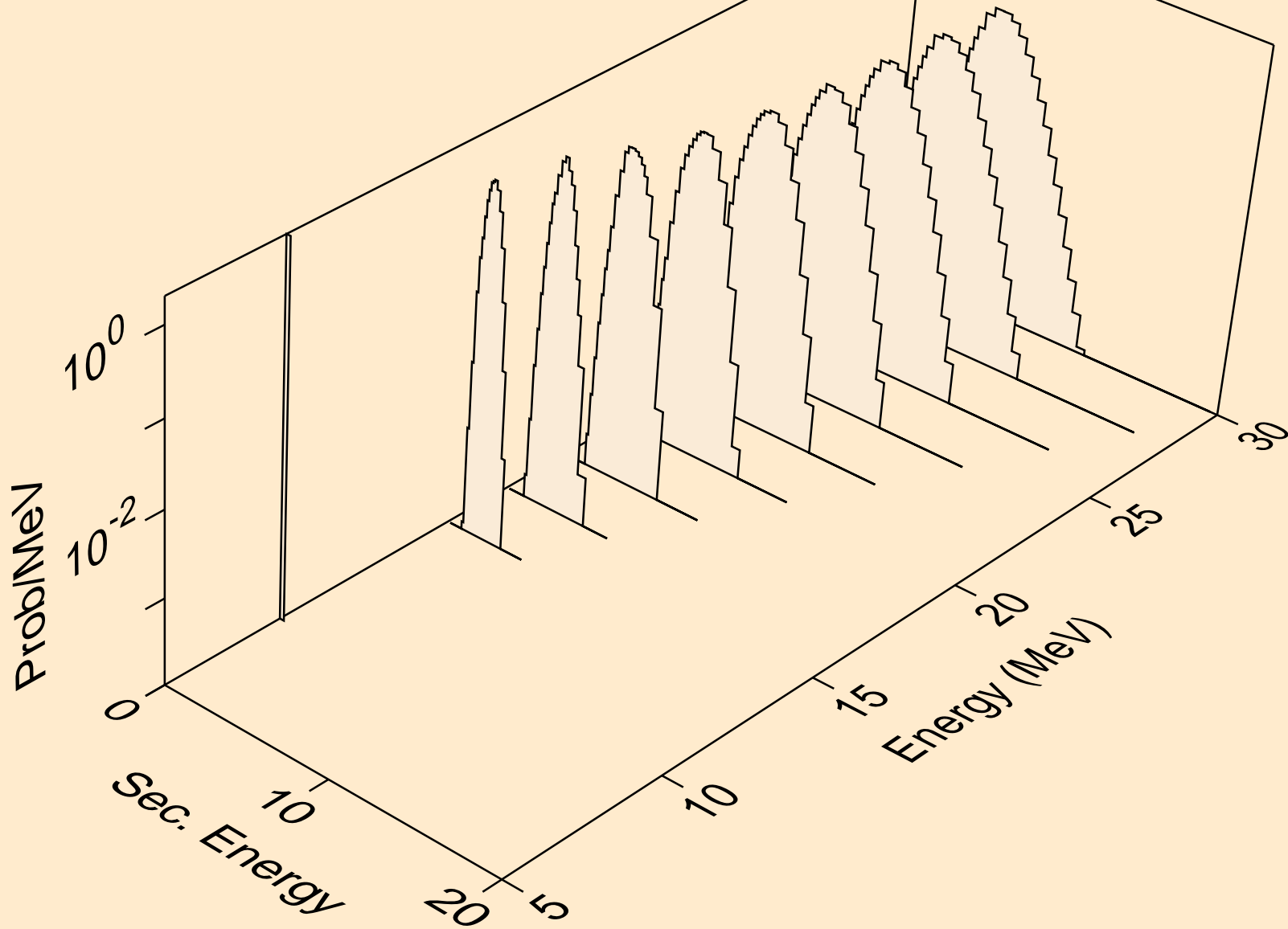

SN120 HELION ACER TENDL-2021 LIBRARY; T=0.K
deuterons from (s,x)

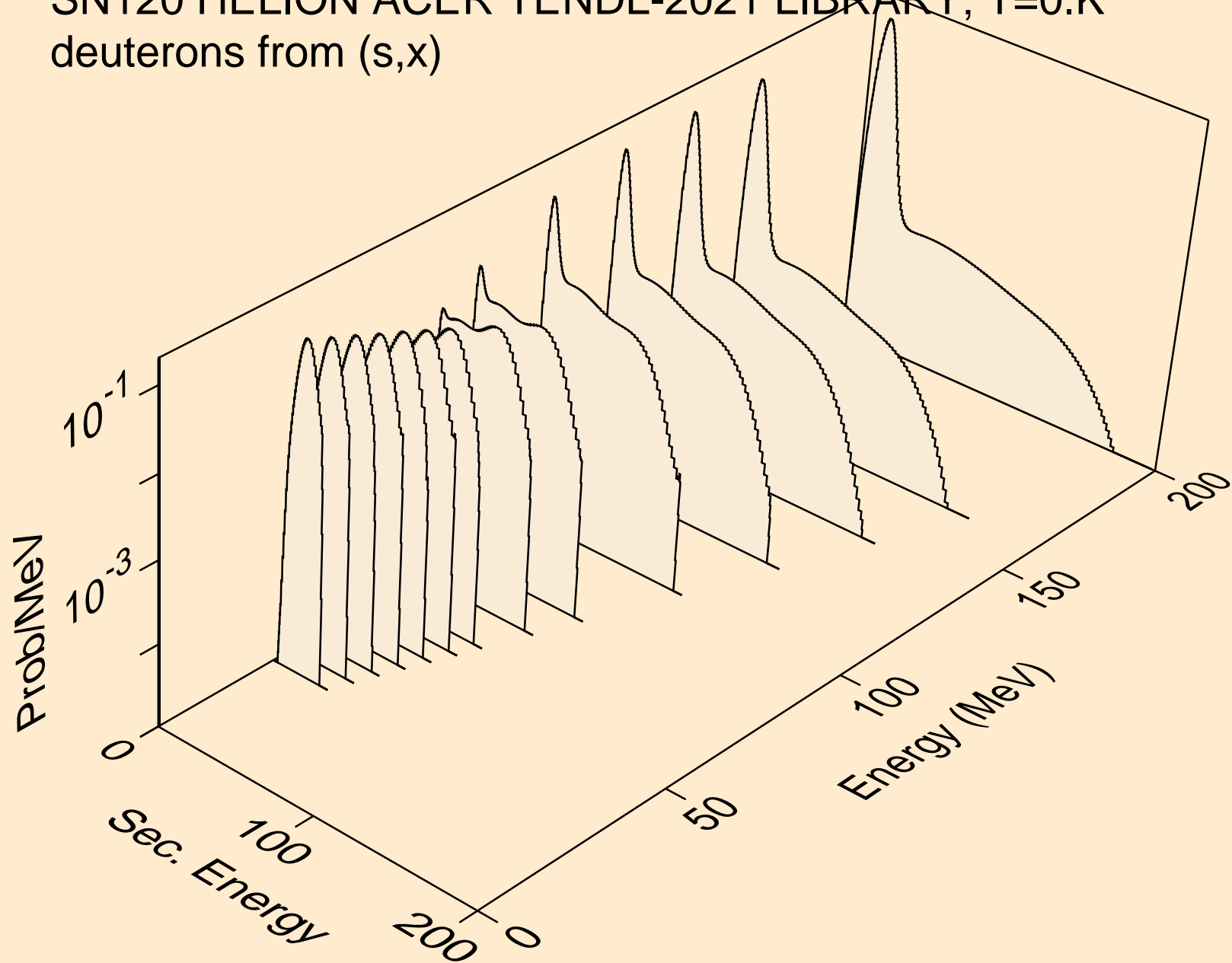

SN120 HELION ACER TENDL-2021 LIBRARY; T=0.K
deuterons from (s,2nd)

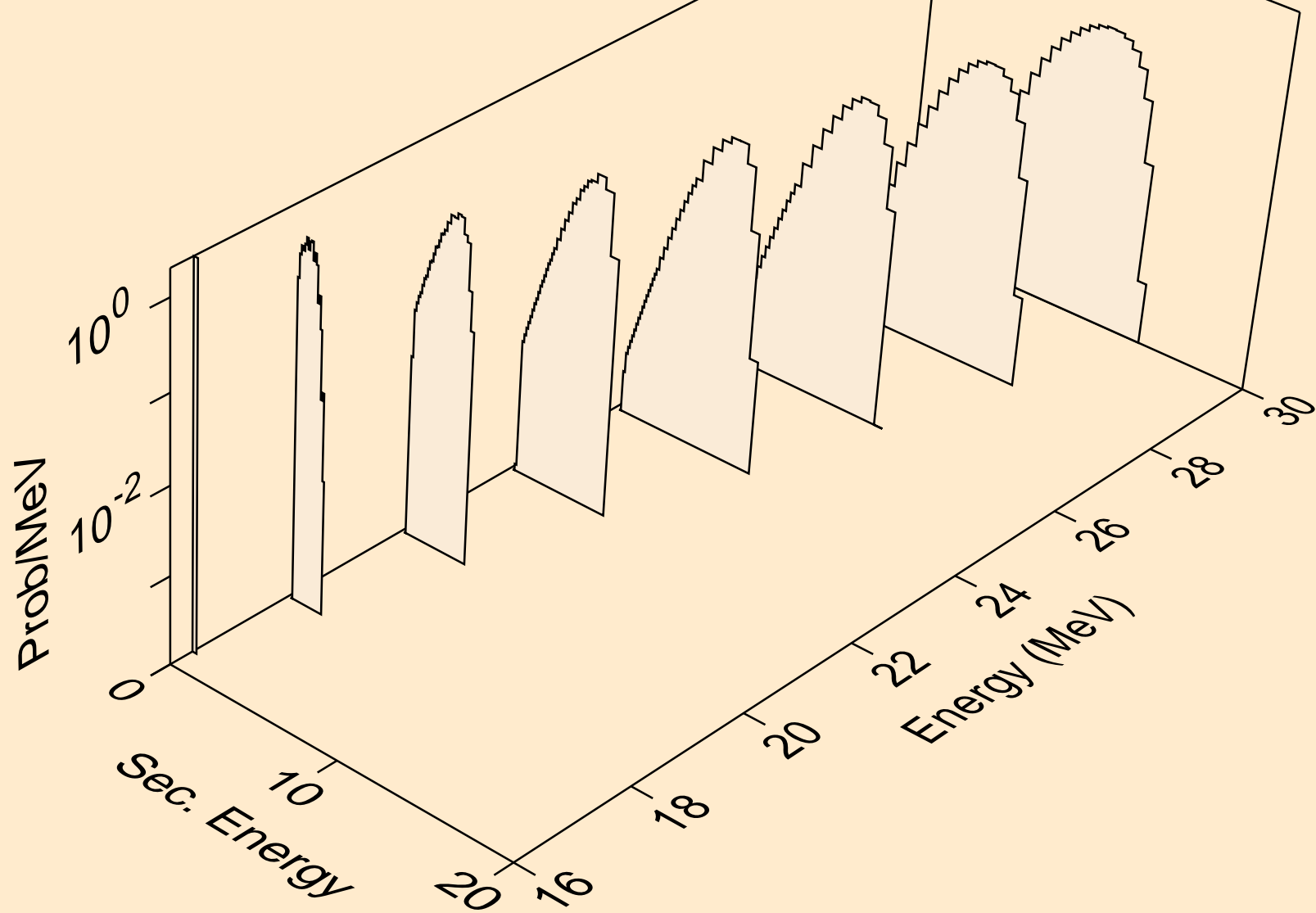

SN120 HELION ACER TENDL-2021 LIBRARY; T=0.K
deuterons from (s,n*)d

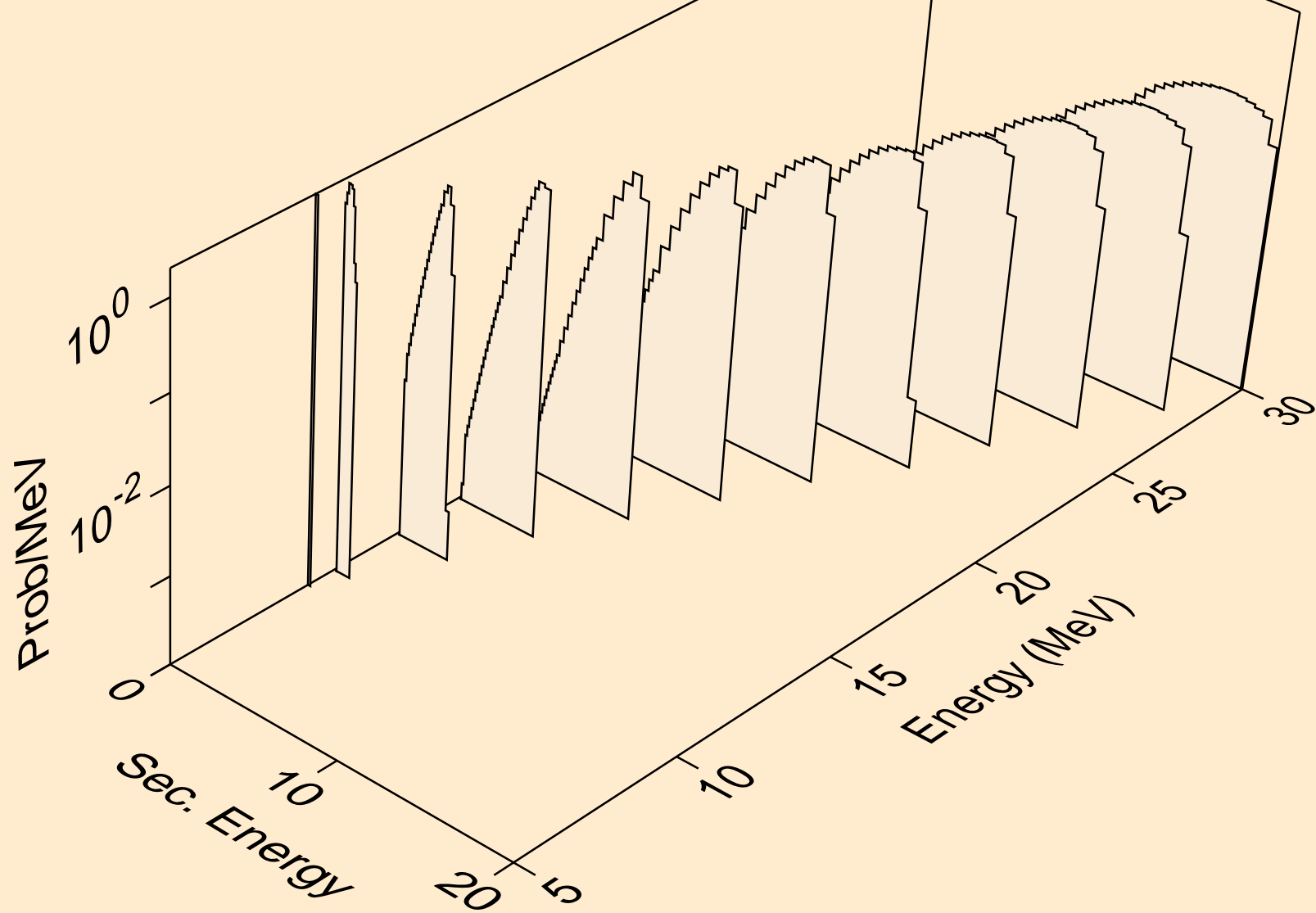

SN120 HELION ACER TENDL-2021 LIBRARY; T=0.K
deuterons from (s,d)

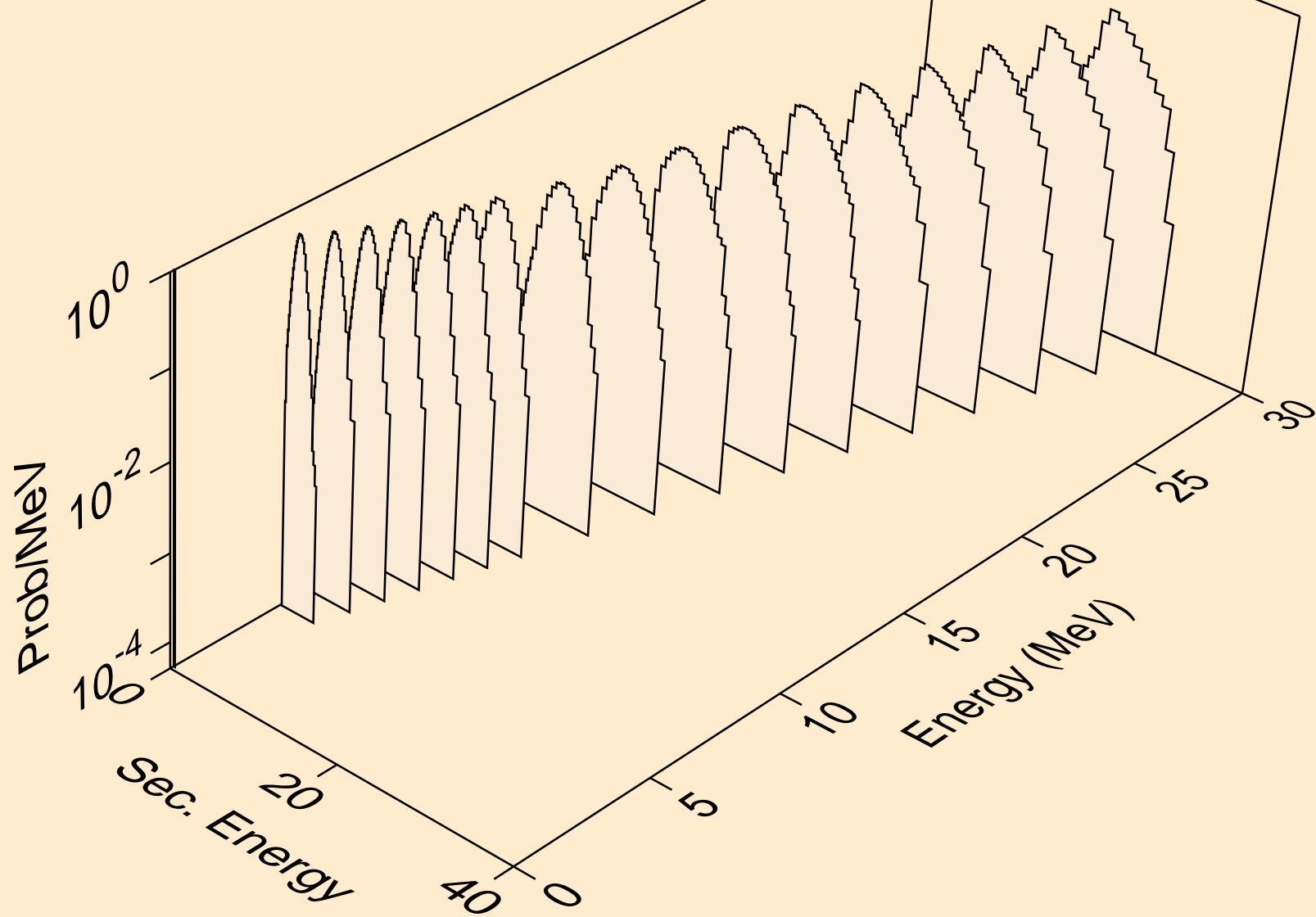

SN120 HELION ACER TENDL-2021 LIBRARY; T=0.K
deuterons from (s,pd)

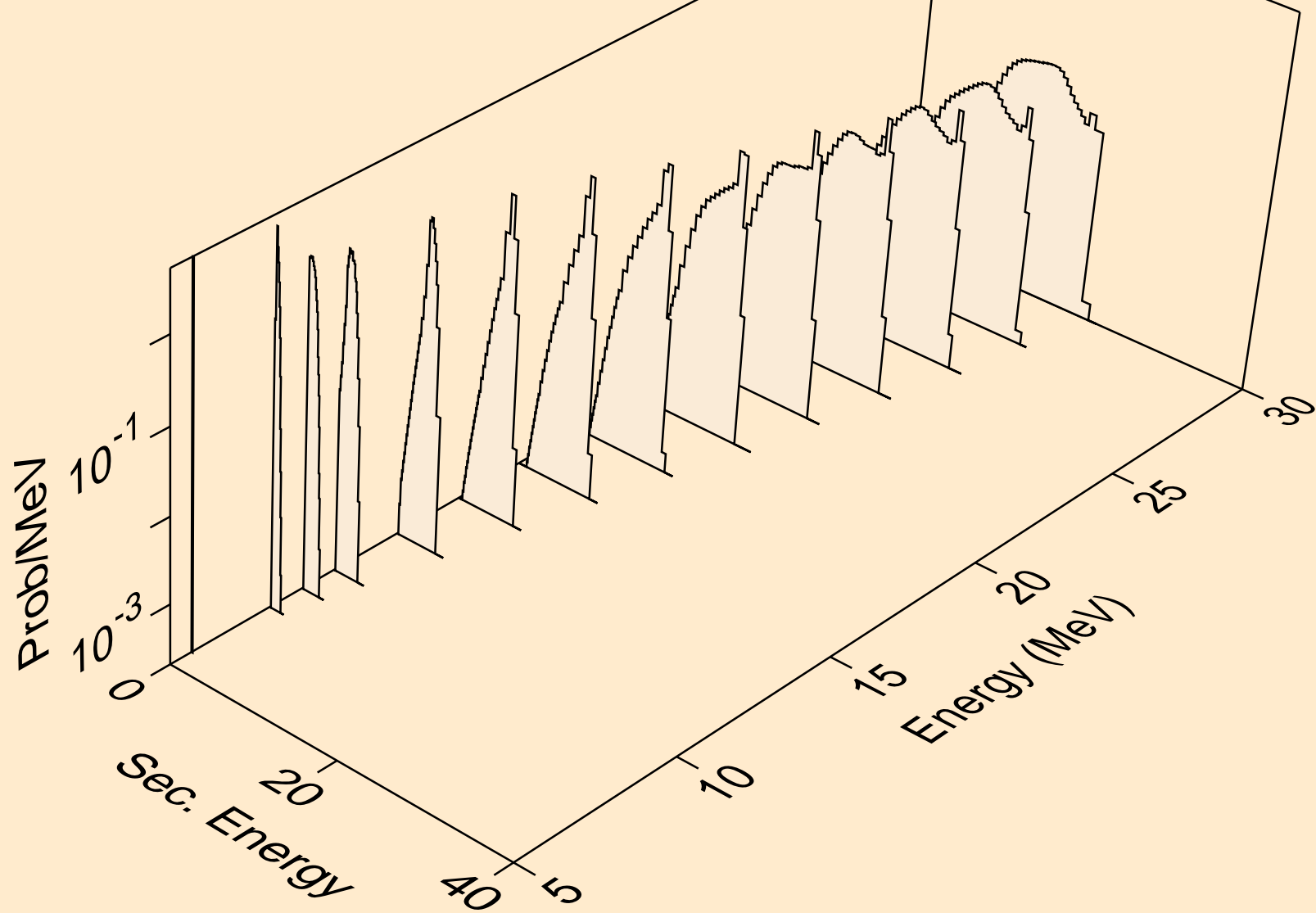

SN120 HELION ACER TENDL-2021 LIBRARY; T=0.K
deuterons from (s,da)

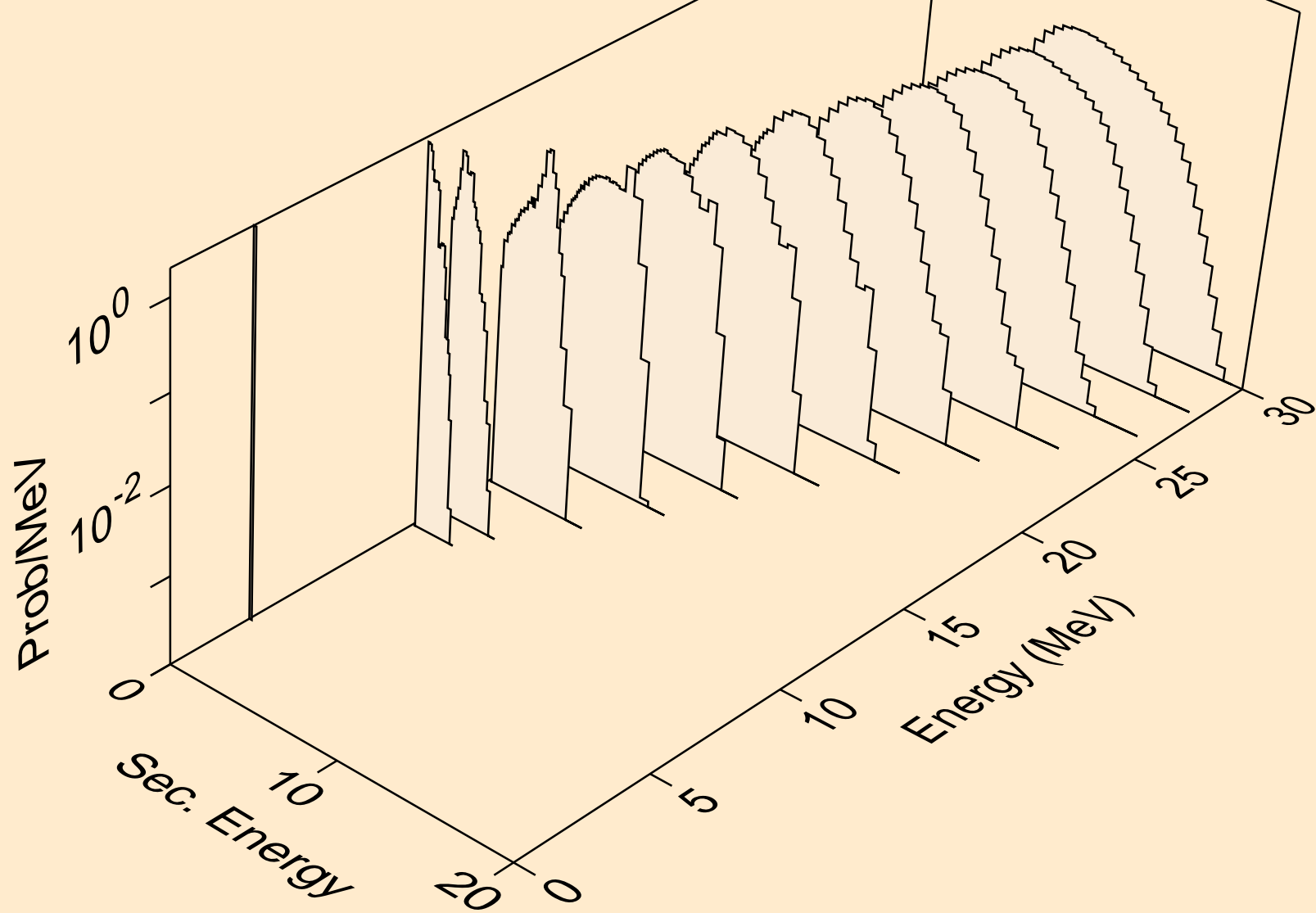

SN120 HELION ACER TENDL-2021 LIBRARY; T=0.K
tritons from (s,x)

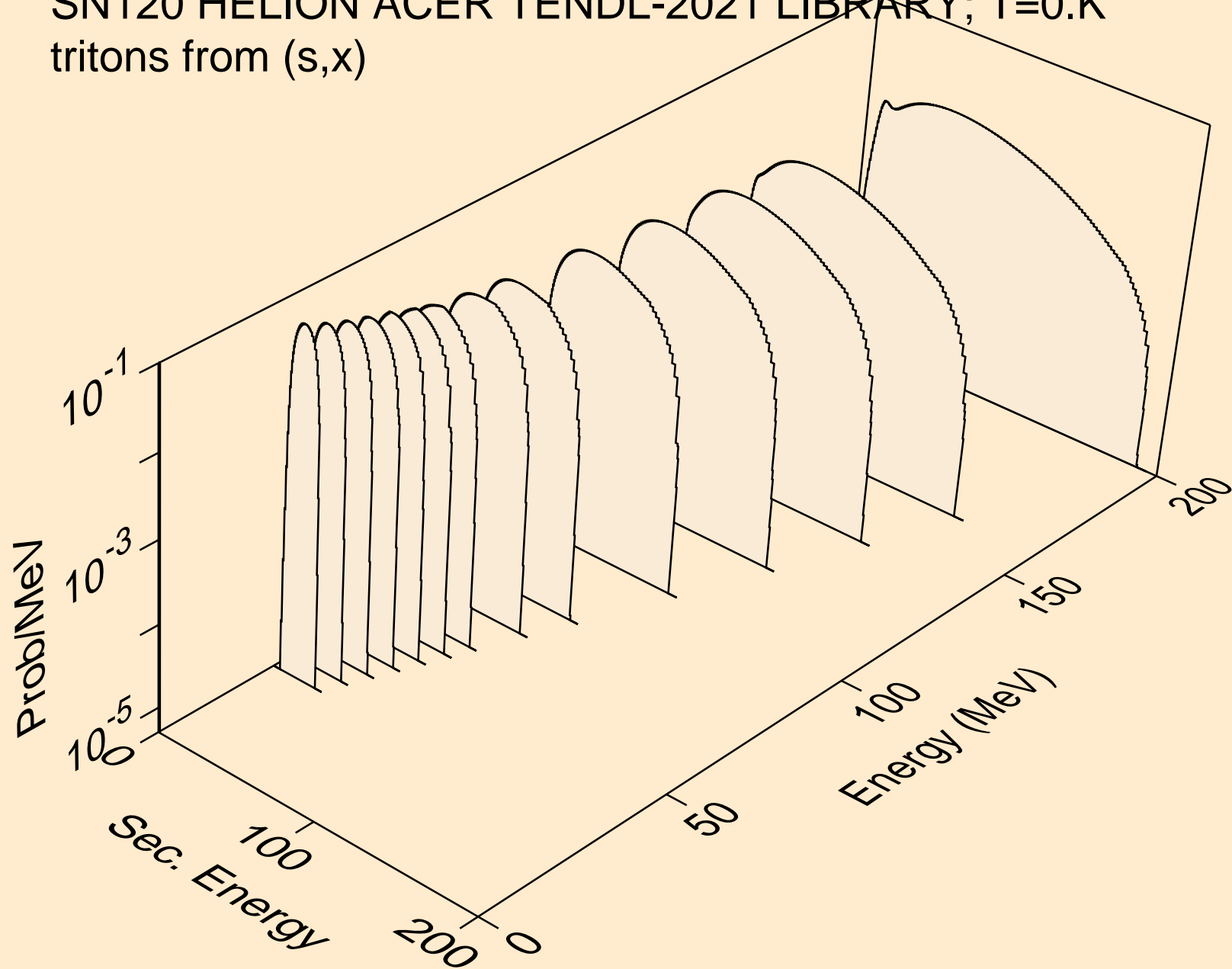

SN120 HELION ACER TENDL-2021 LIBRARY; T=0.K
tritons from (s,n*)t

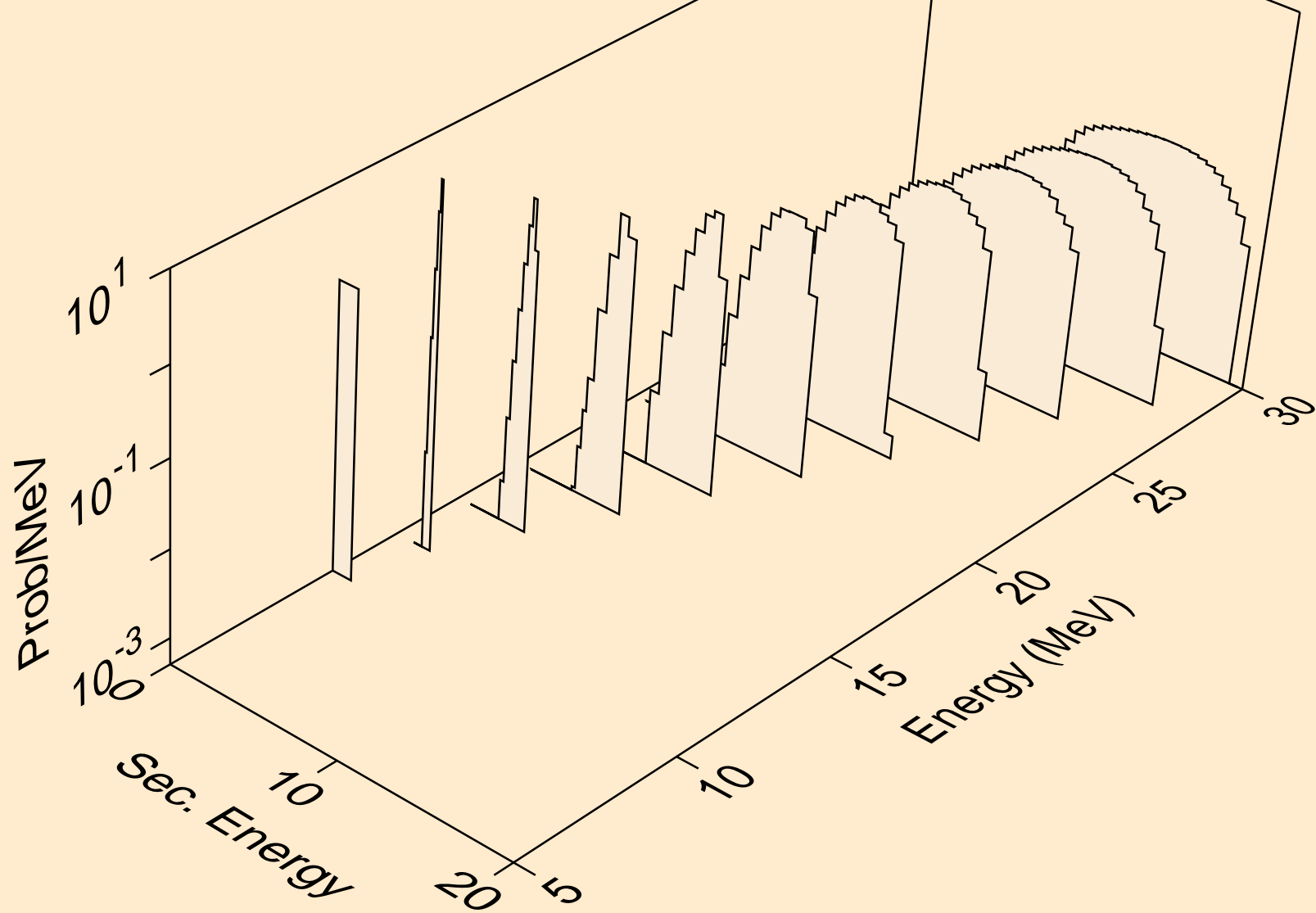

SN120 HELION ACER TENDL-2021 LIBRARY; T=0.K
tritons from (s,t)

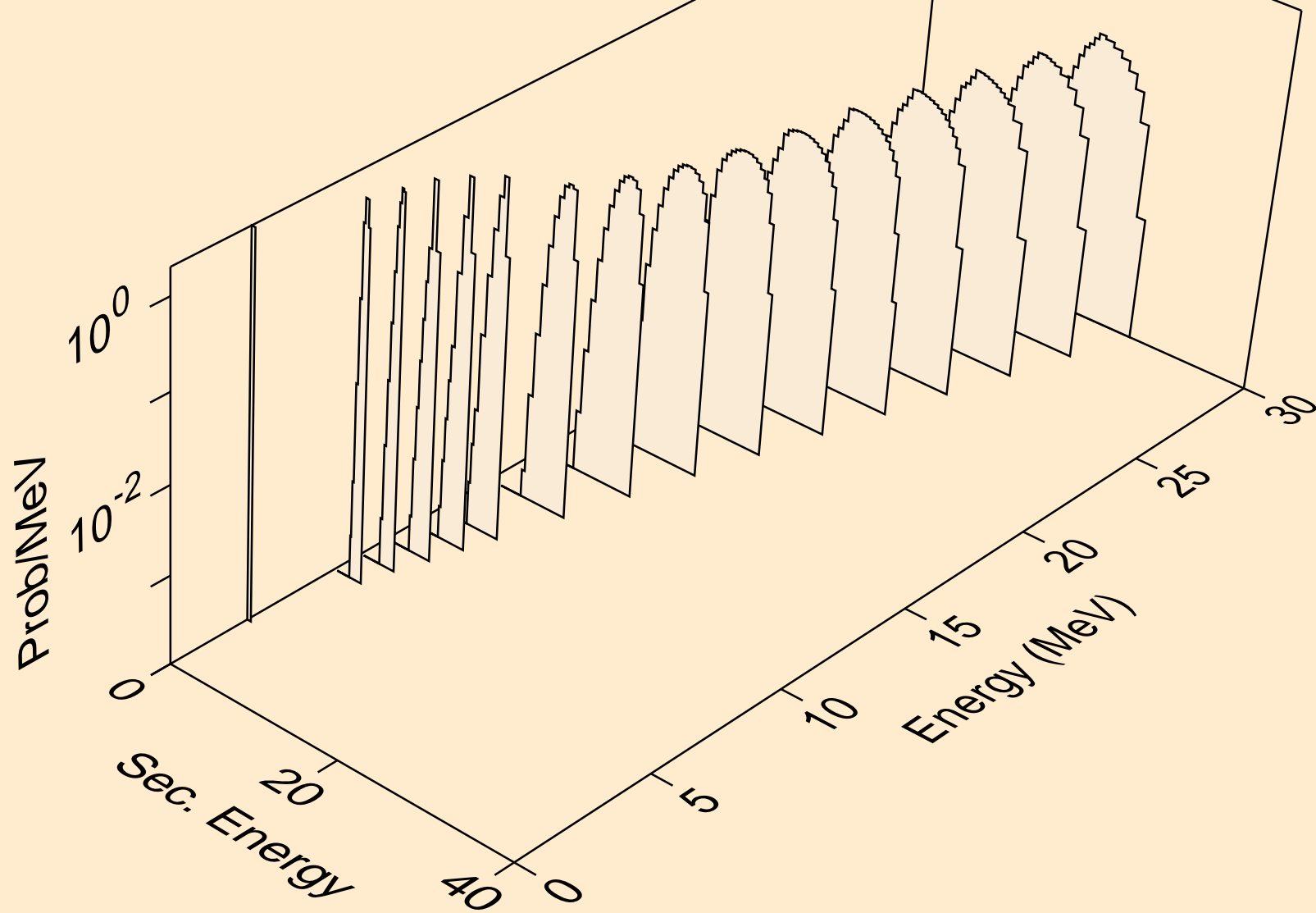

SN120 HELION ACER TENDL-2021 LIBRARY; T=0.K
tritons from (s,pt)

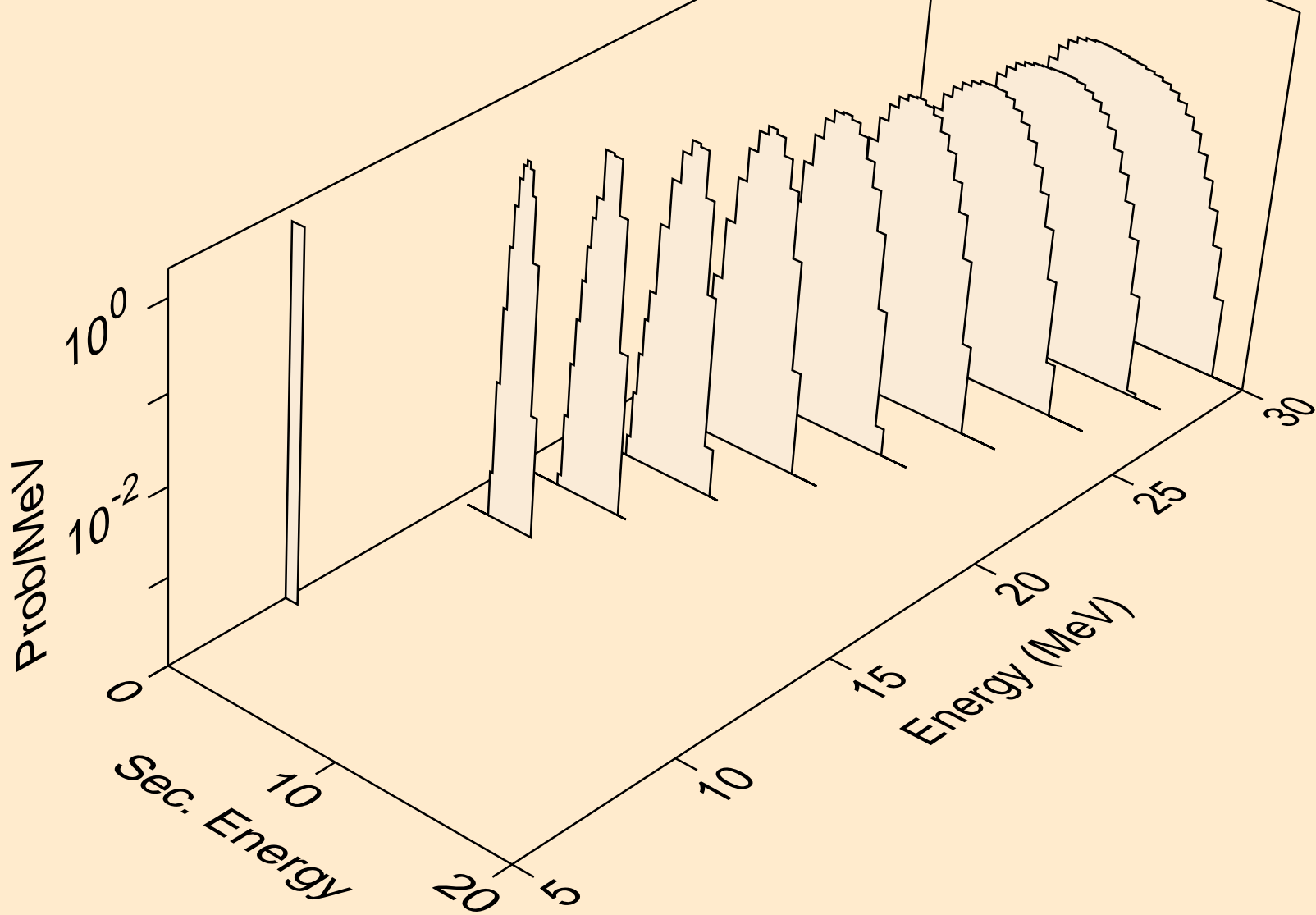

SN120 HELION ACER TENDL-2021 LIBRARY; T=0.K
alphas from (s,x)

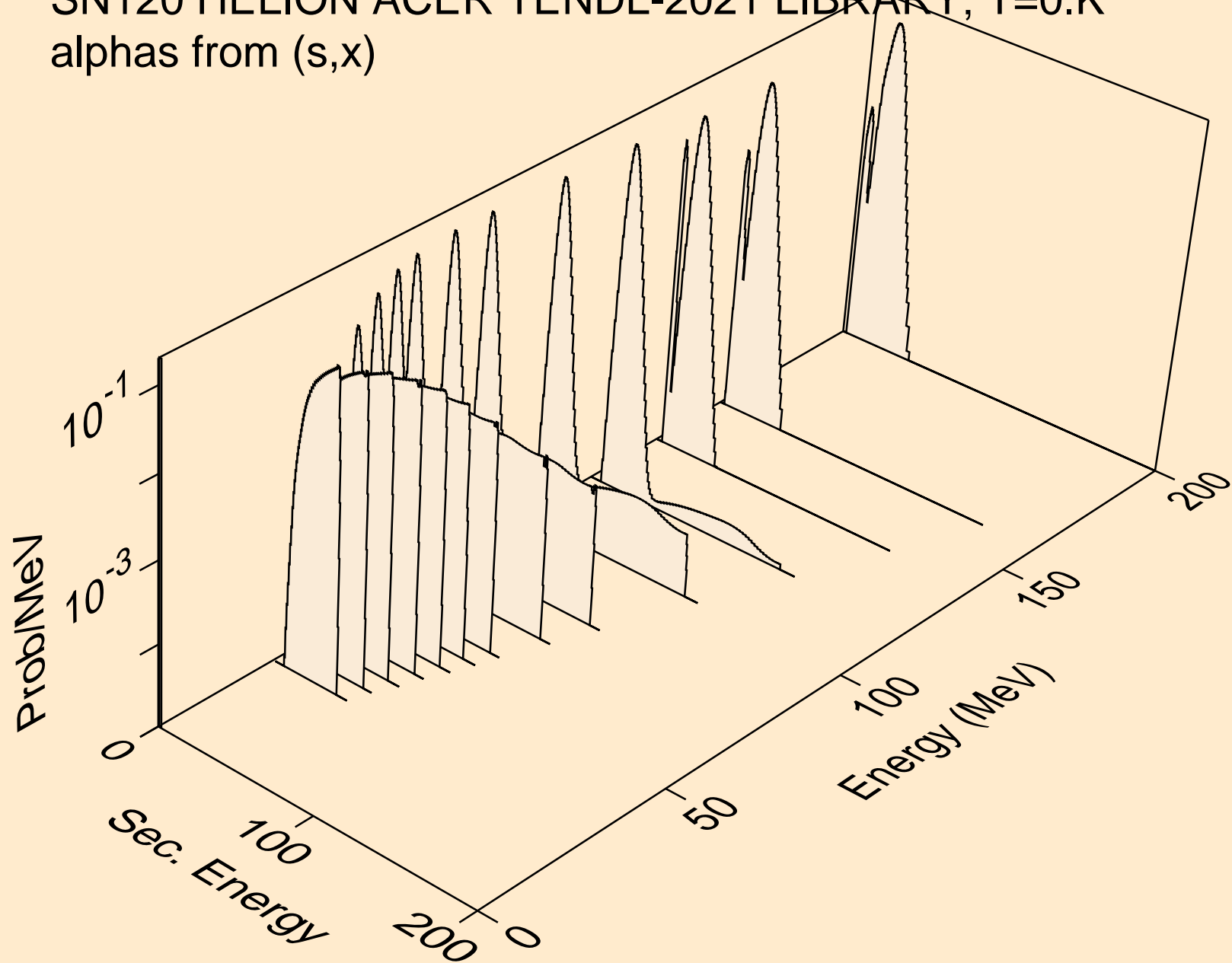

SN120 HELION ACER TENDL-2021 LIBRARY; T=0.K
alphas from (s,n*)a

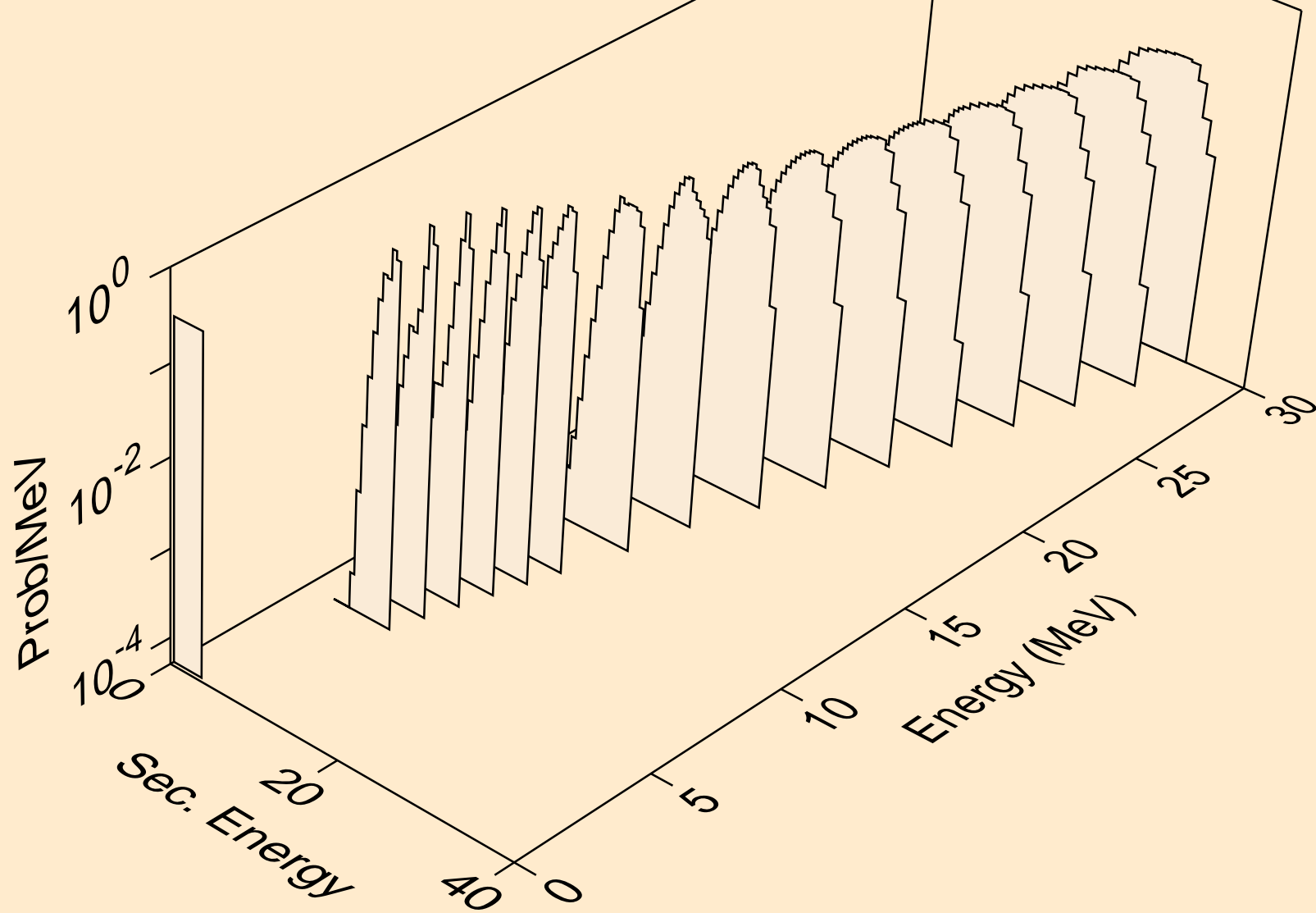

SN120 HELION ACER TENDL-2021 LIBRARY; T=0.K
alphas from (s,2n)a

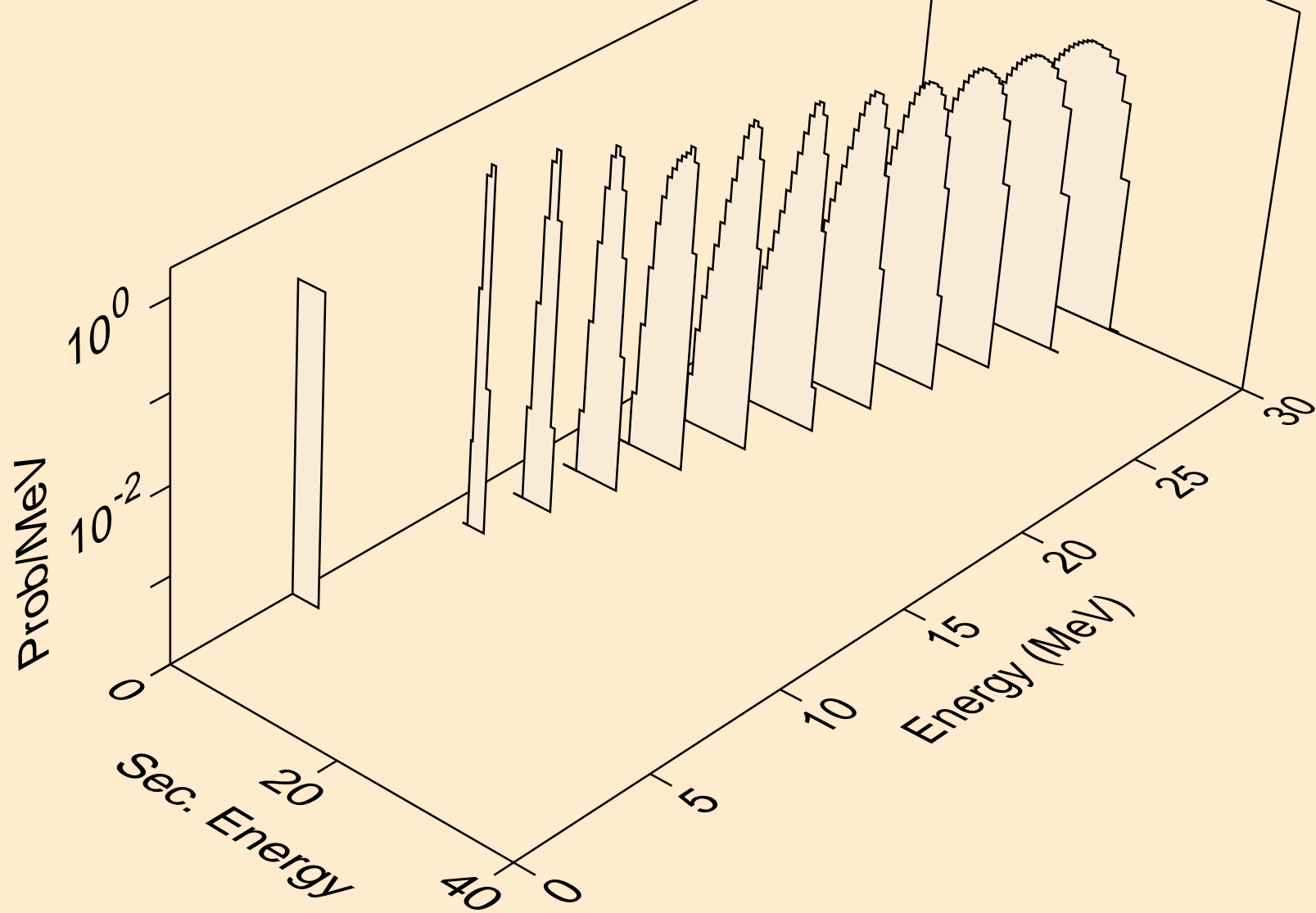

SN120 HELION ACER TENDL-2021 LIBRARY; T=0.K
alphas from (s,3n)a

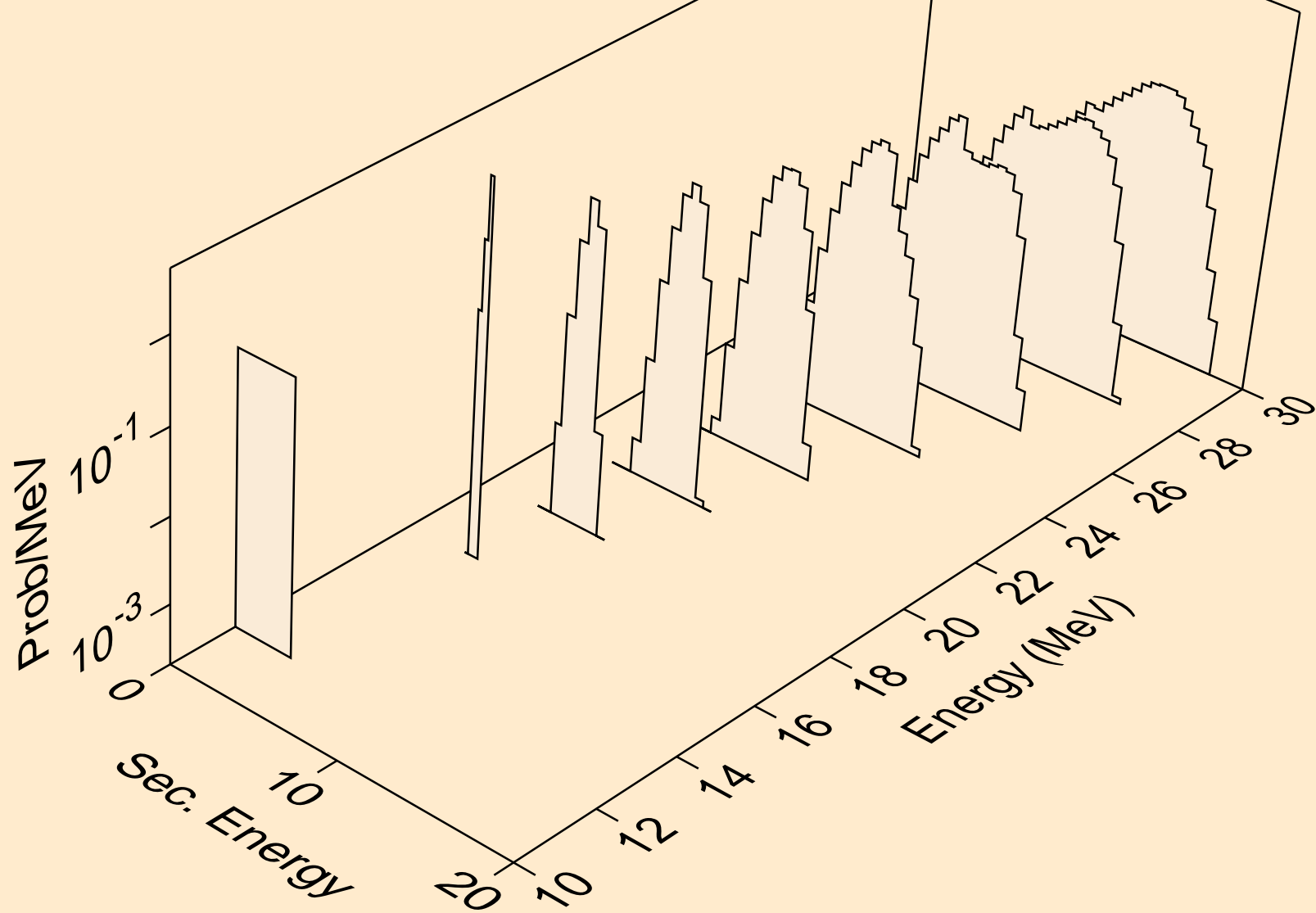

SN120 HELION ACER TENDL-2021 LIBRARY; T=0.K
alphas from (s,n*)2a

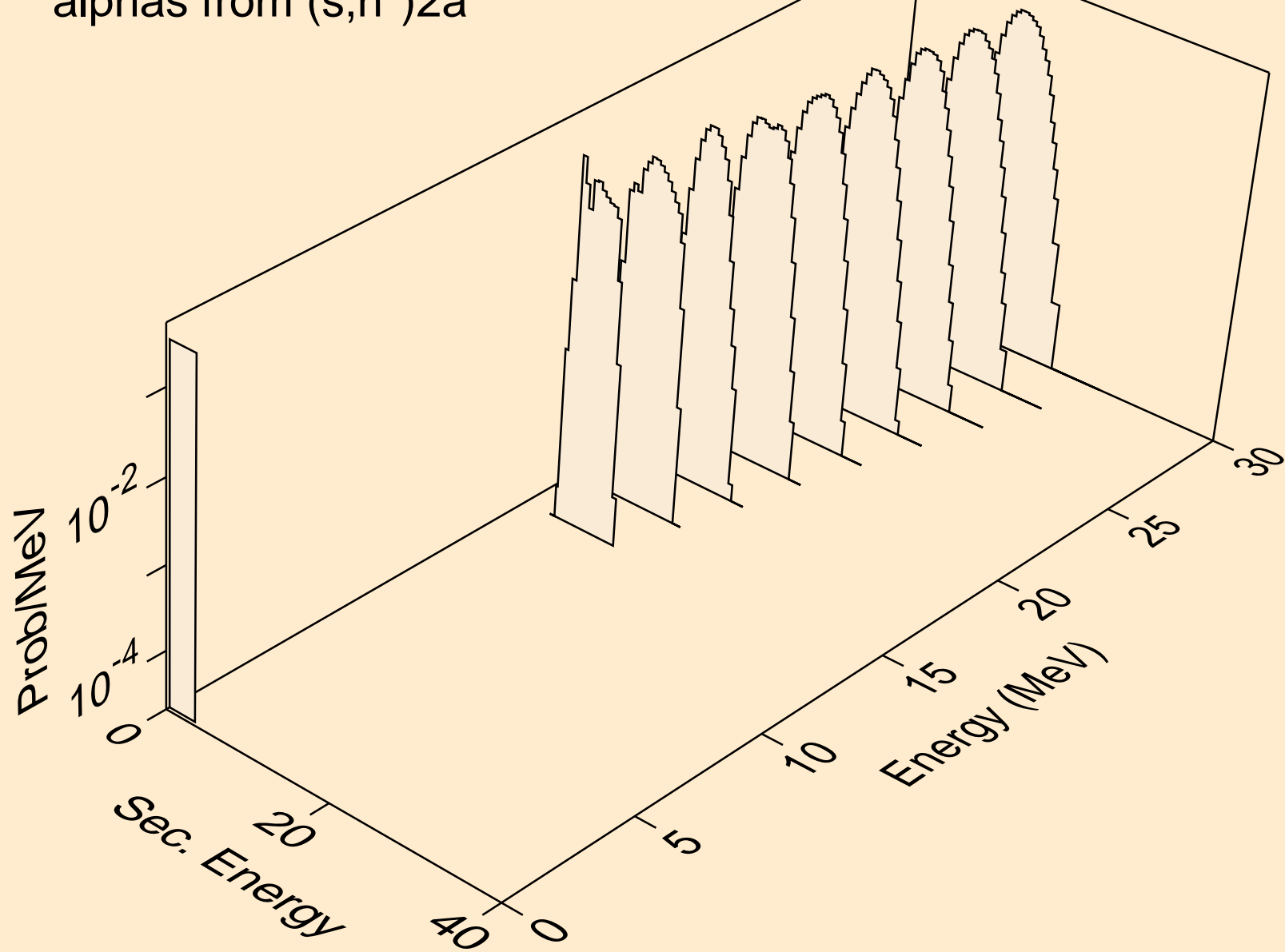

SN120 HELION ACER TENDL-2021 LIBRARY; T=0.K
alphas from (s,npa)

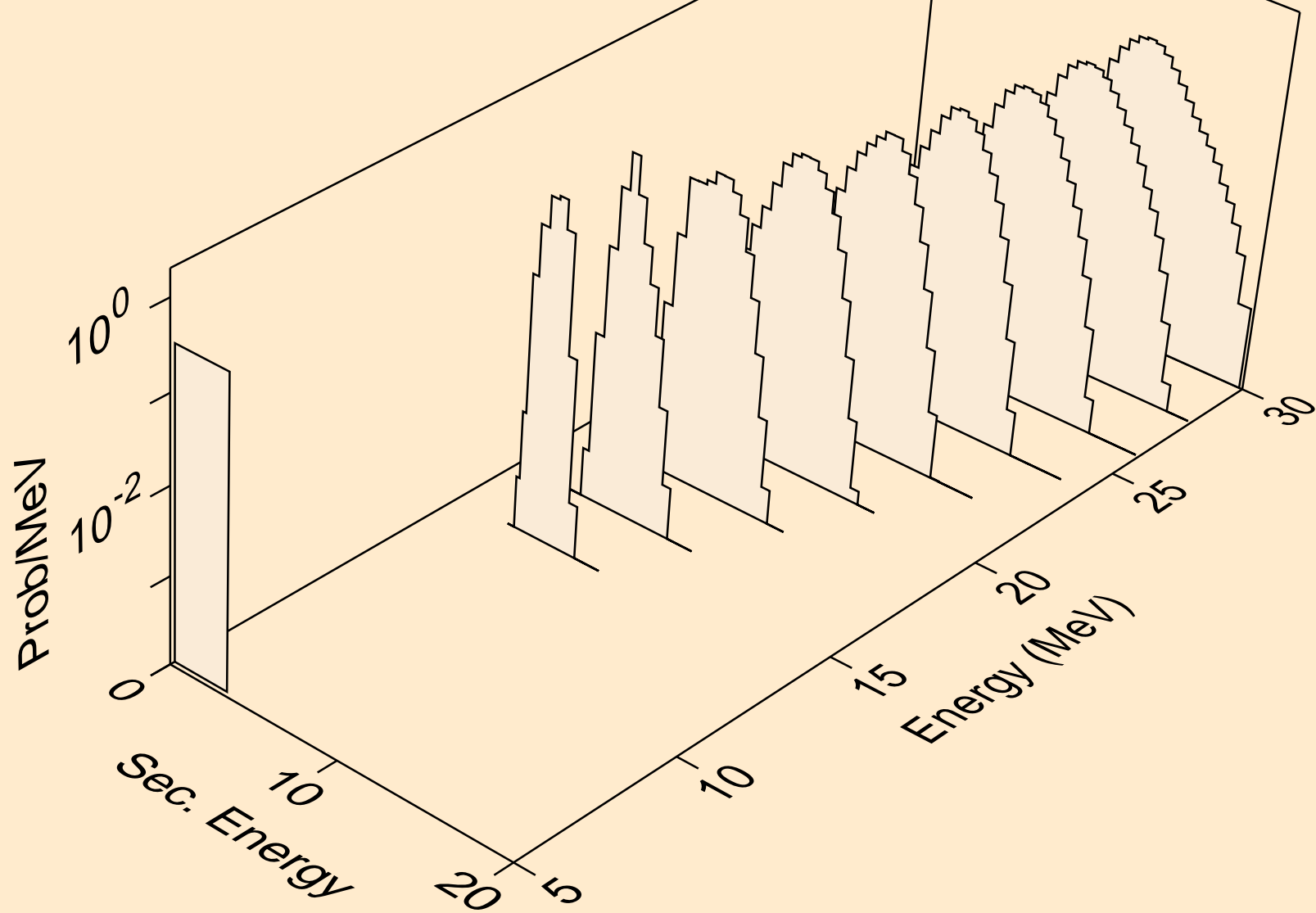

SN120 HELION ACER TENDL-2021 LIBRARY; T=0.K
alphas from (s,a)

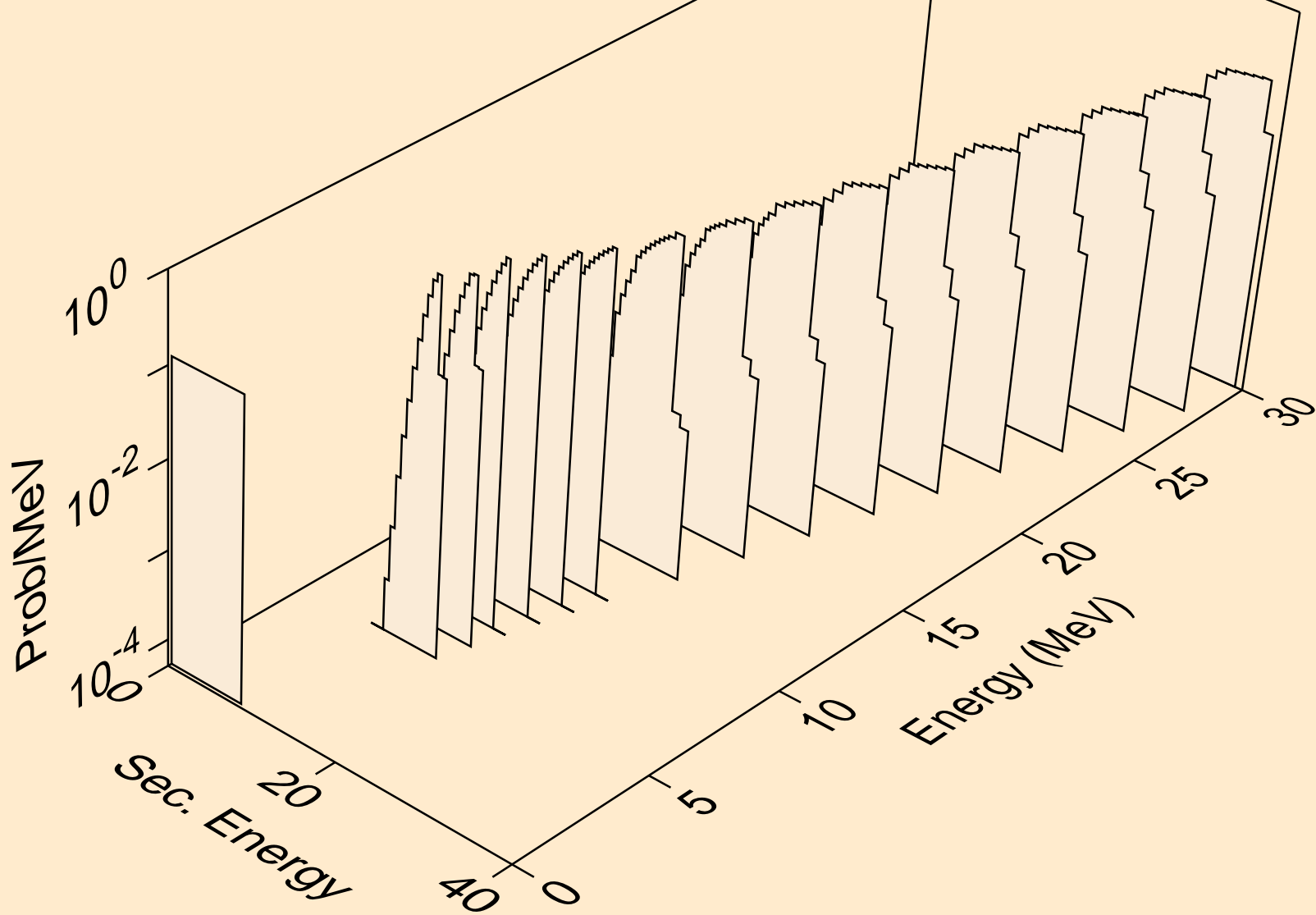

SN120 HELION ACER TENDL-2021 LIBRARY; T=0.K
alphas from (s,2a)

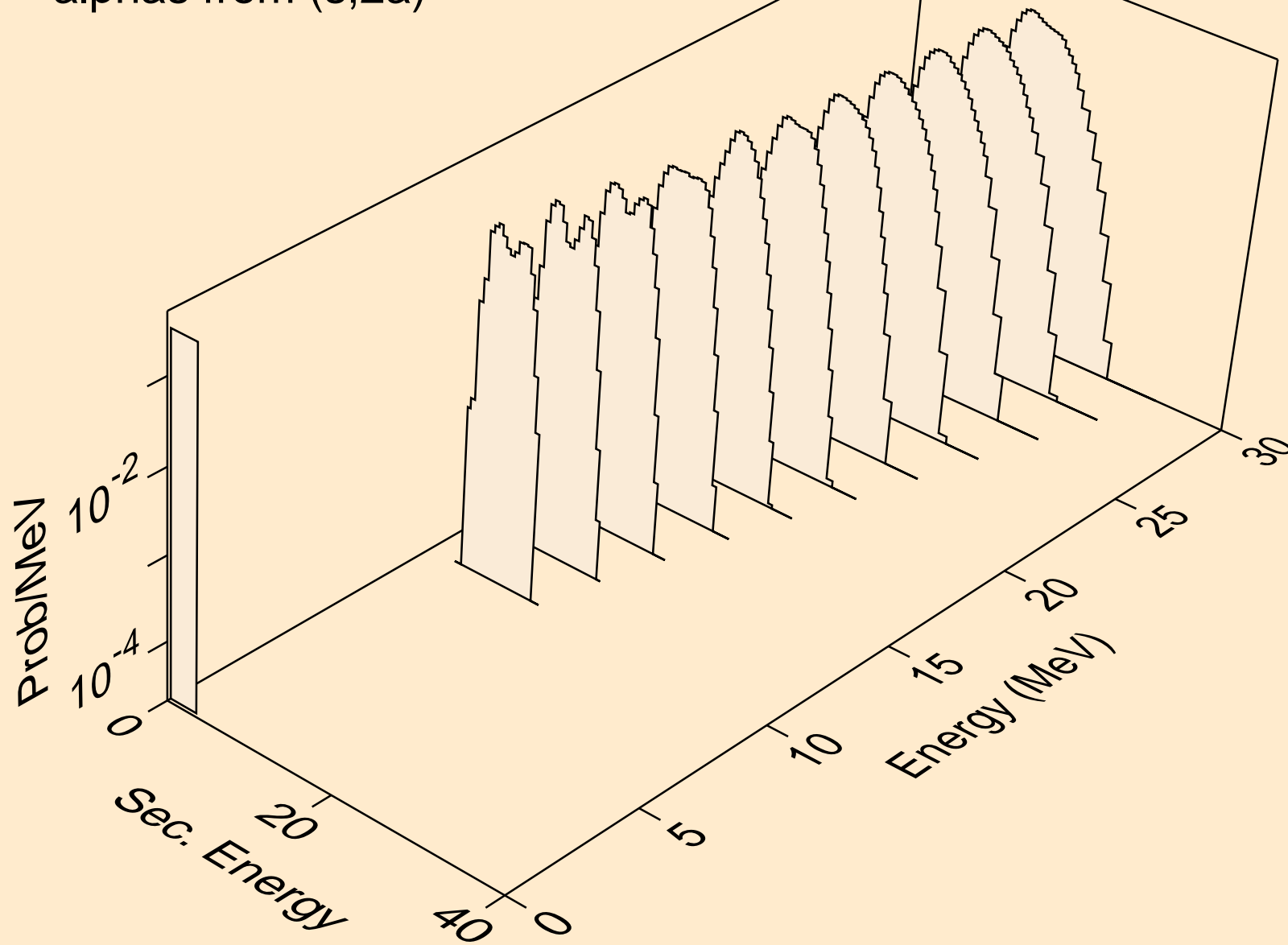

SN120 HELION ACER TENDL-2021 LIBRARY; T=0.K
alphas from (s,pa)

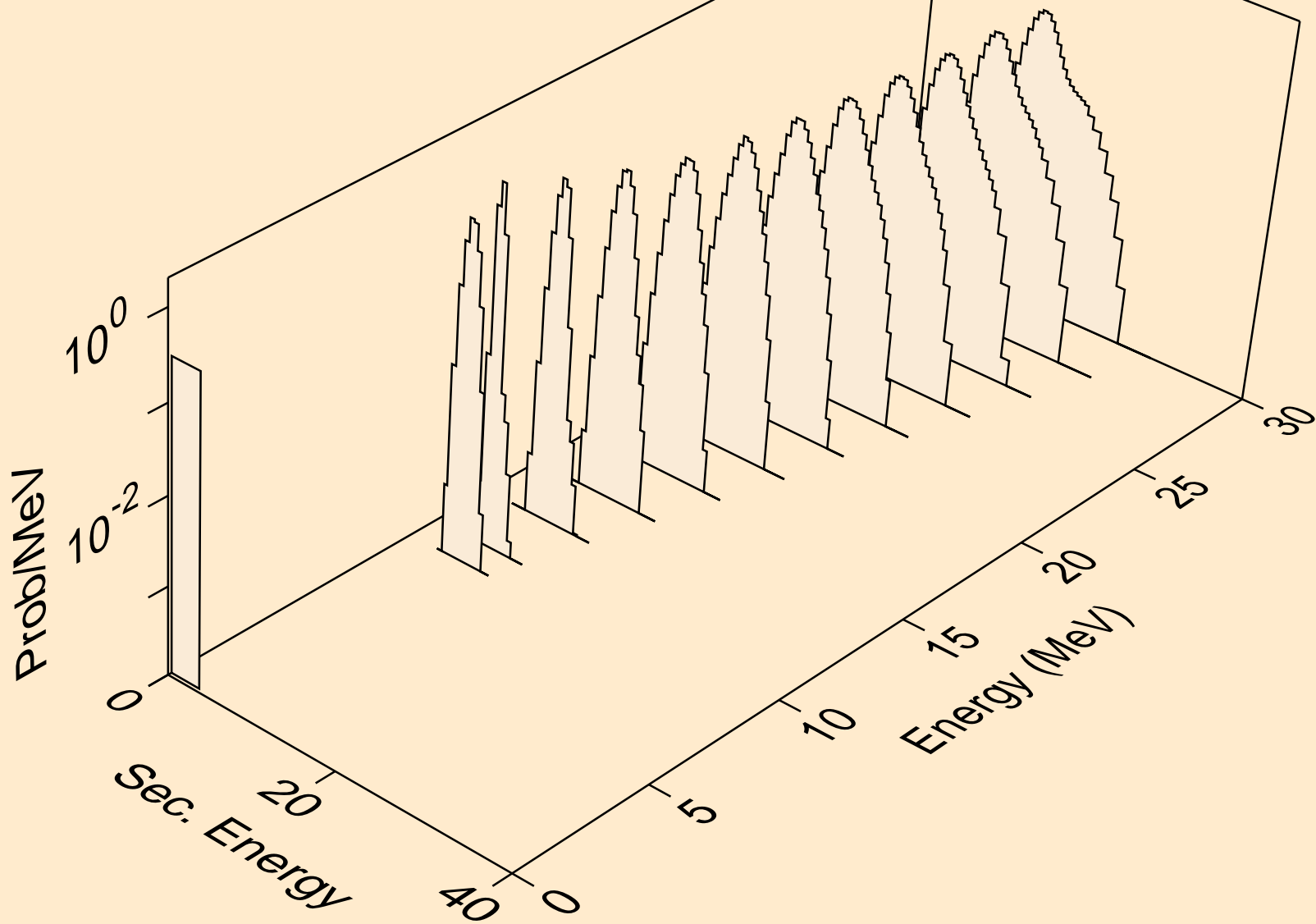

SN120 HELION ACER TENDL-2021 LIBRARY; T=0.K
alphas from (s,da)

