

# SN134 HELION ACER TENDL-2021 LIBRARY; T=0.K

## Principal cross sections

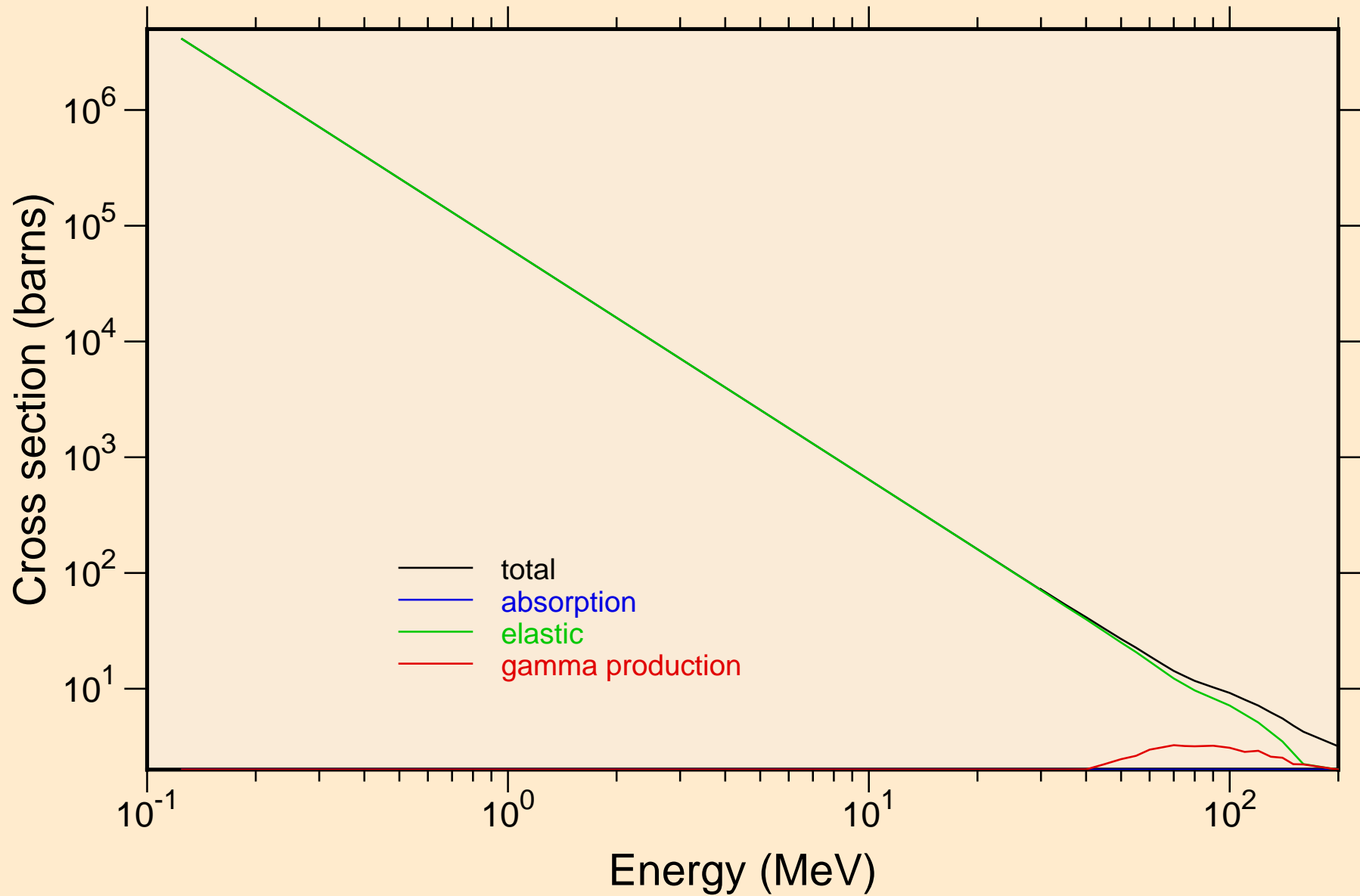

# SN134 HELION ACER TENDL-2021 LIBRARY; T=0.K

## Heating

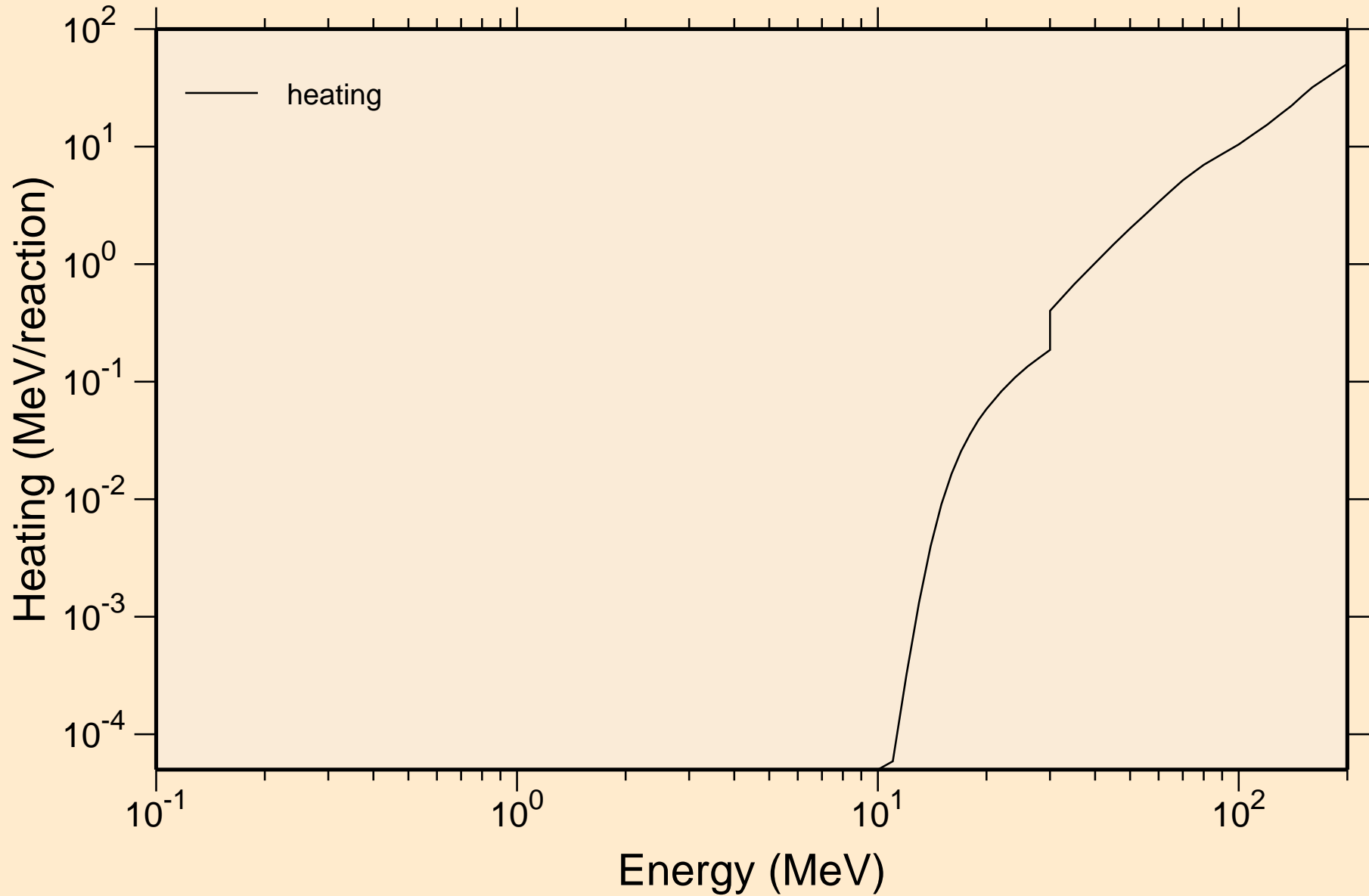

# SN134 HELION ACER TENDL-2021 LIBRARY; T=0.K

## Principal cross sections

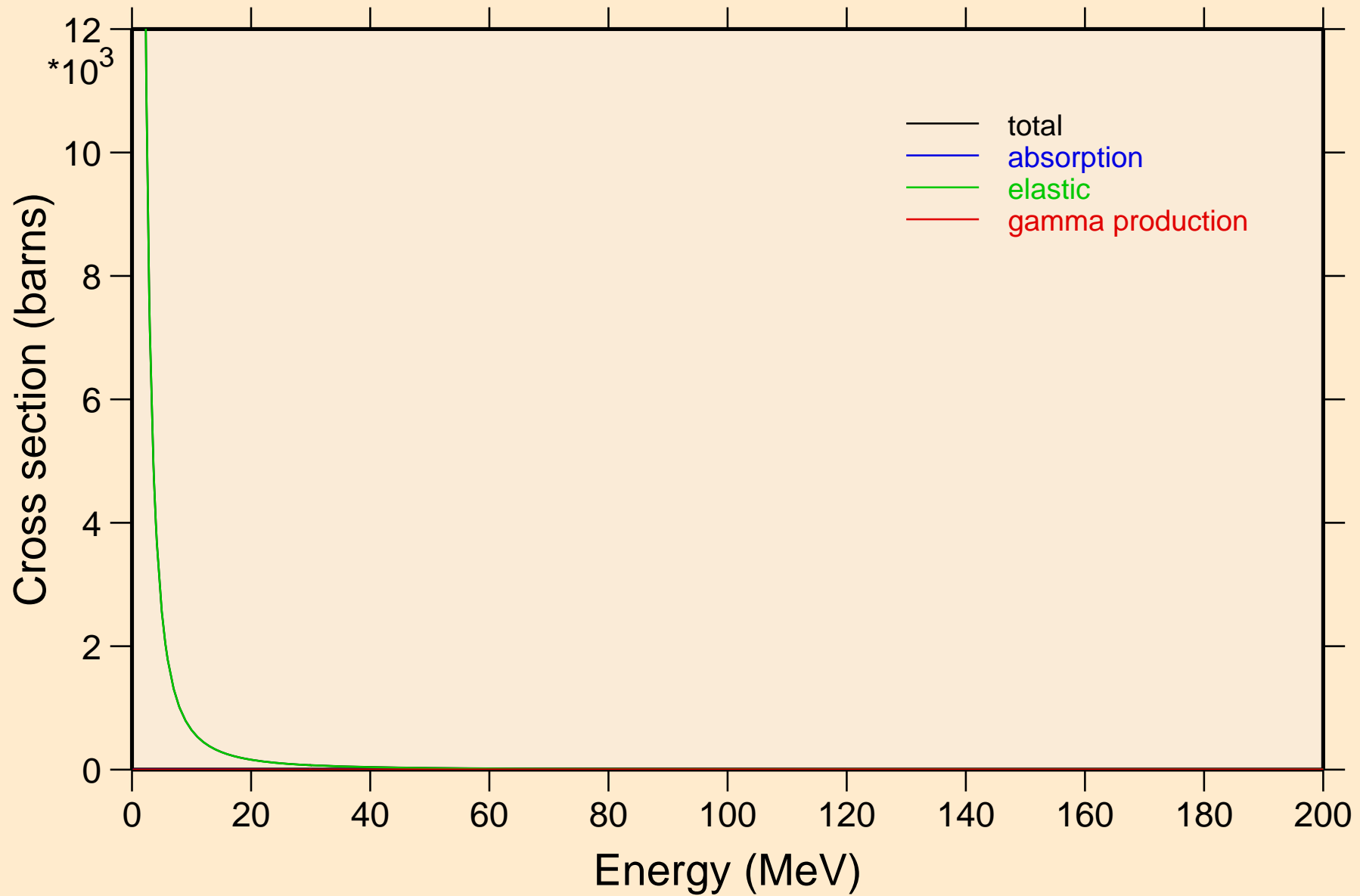

# SN134 HELION ACER TENDL-2021 LIBRARY; T=0.K

## Heating

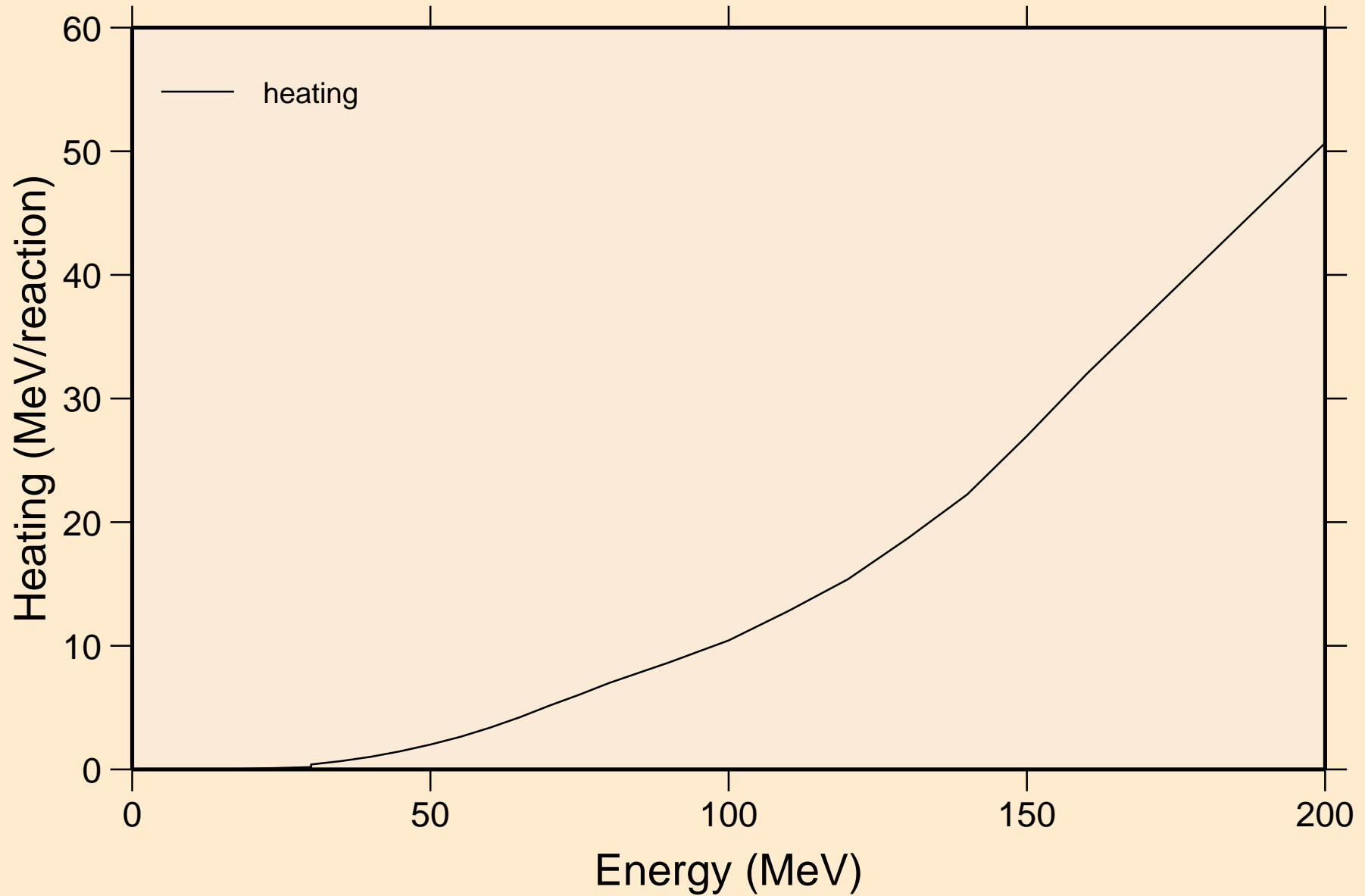

# SN134 HELION ACER TENDL-2021 LIBRARY; T=0.K

## Threshold reactions

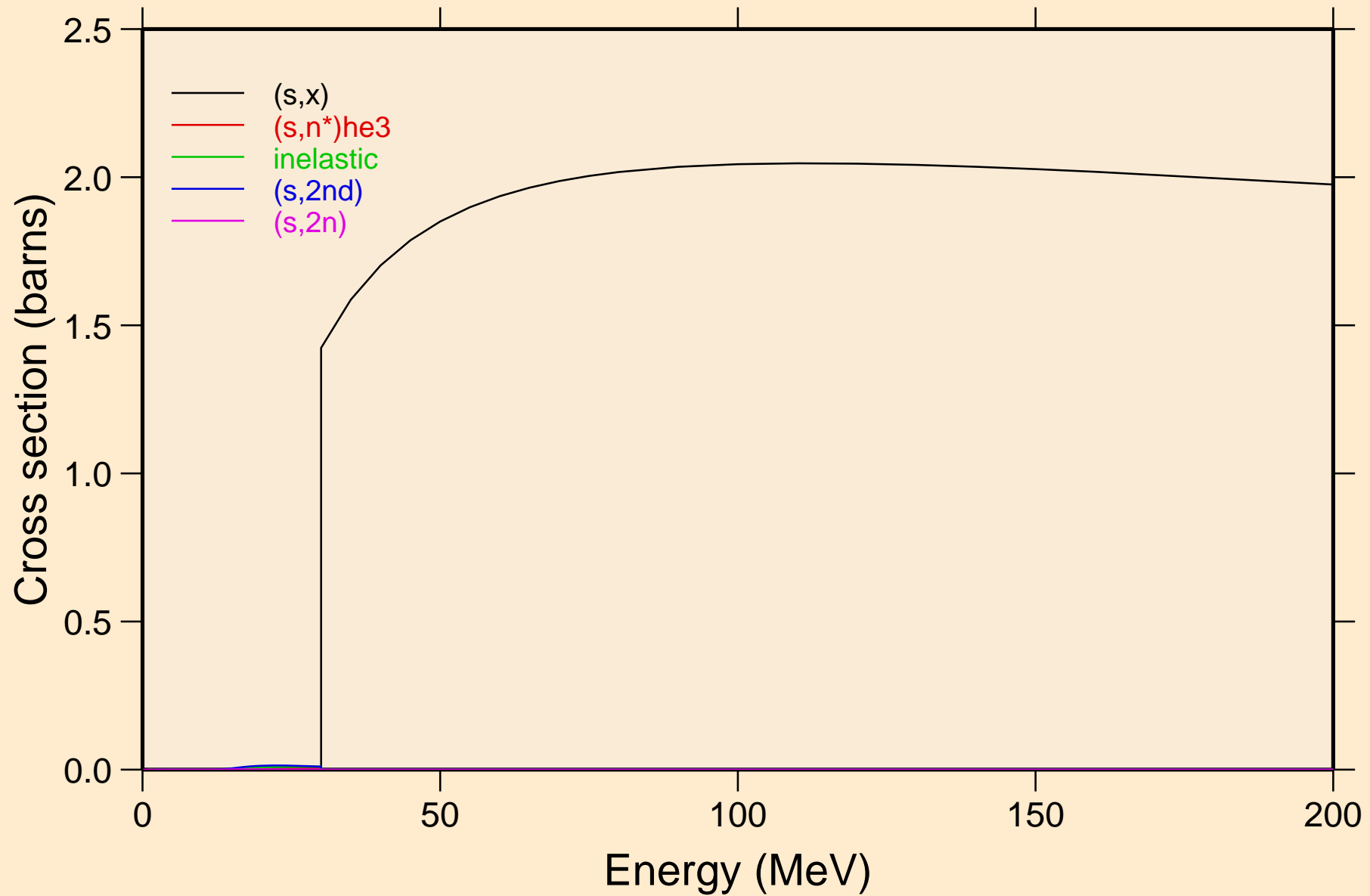

# SN134 HELION ACER TENDL-2021 LIBRARY; T=0.K

## Threshold reactions

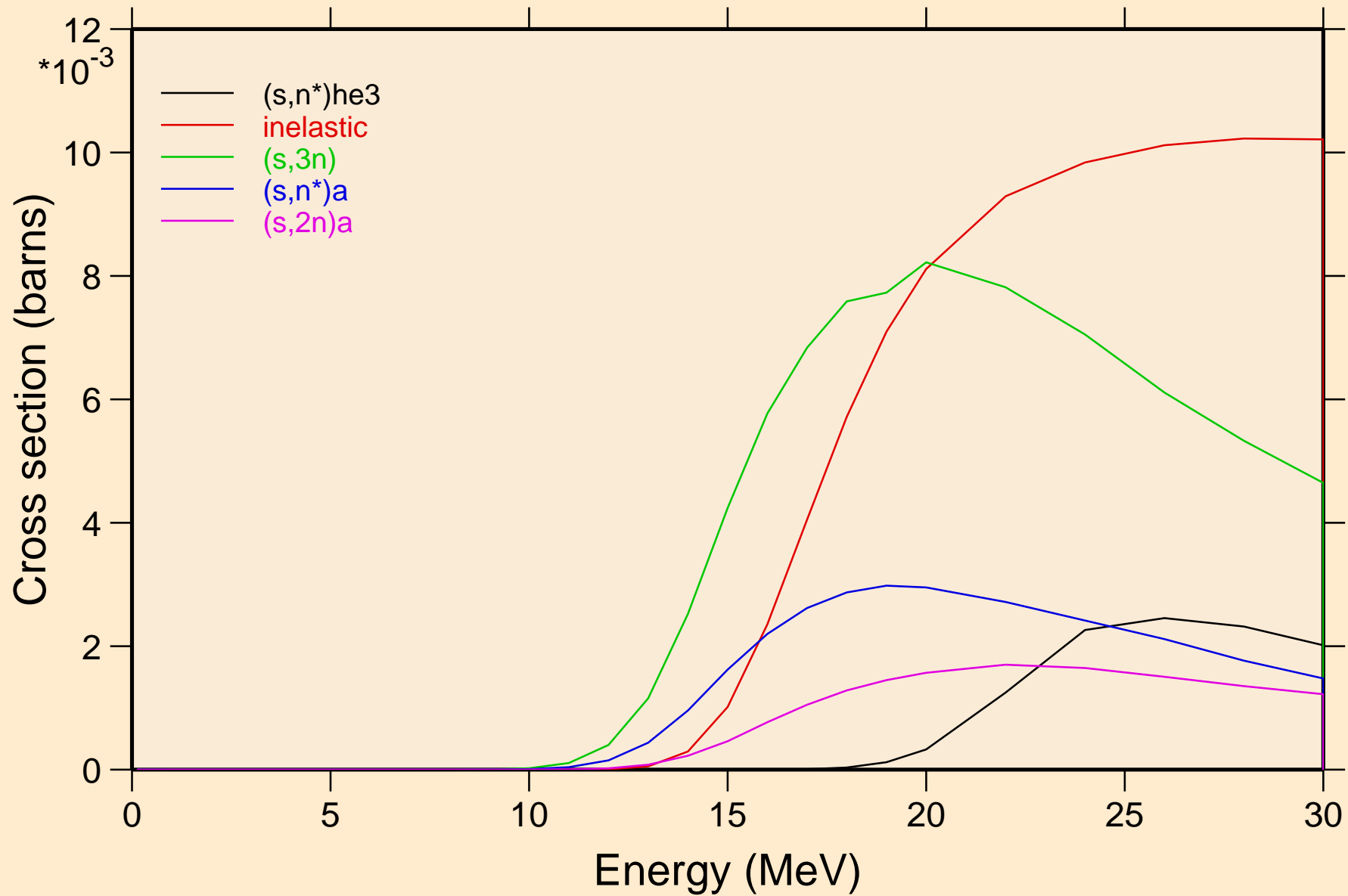

SN134 HELION ACER TENDL-2021 LIBRARY; T=0.K  
Threshold reactions

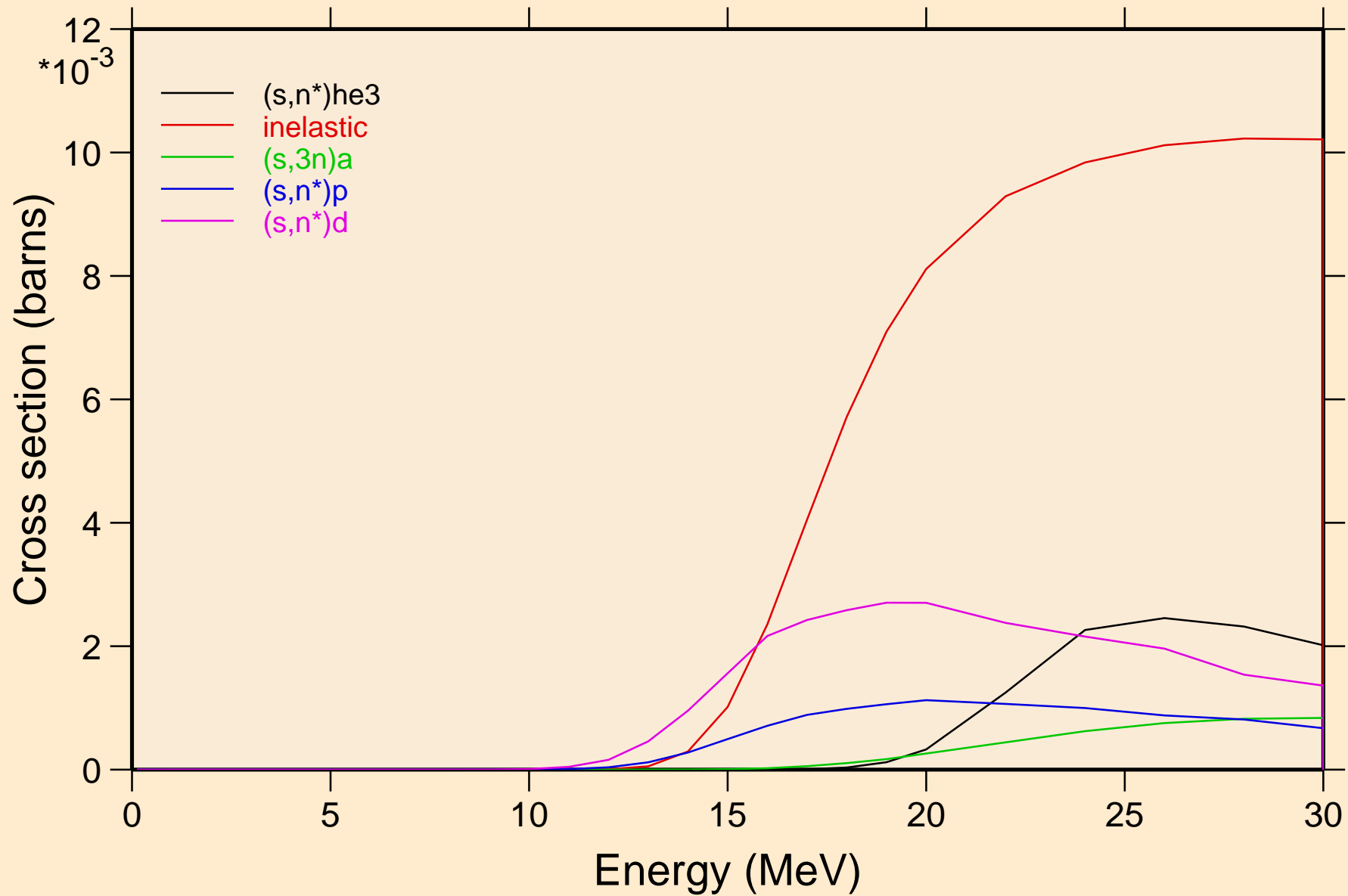

# SN134 HELION ACER TENDL-2021 LIBRARY; T=0.K

## Threshold reactions

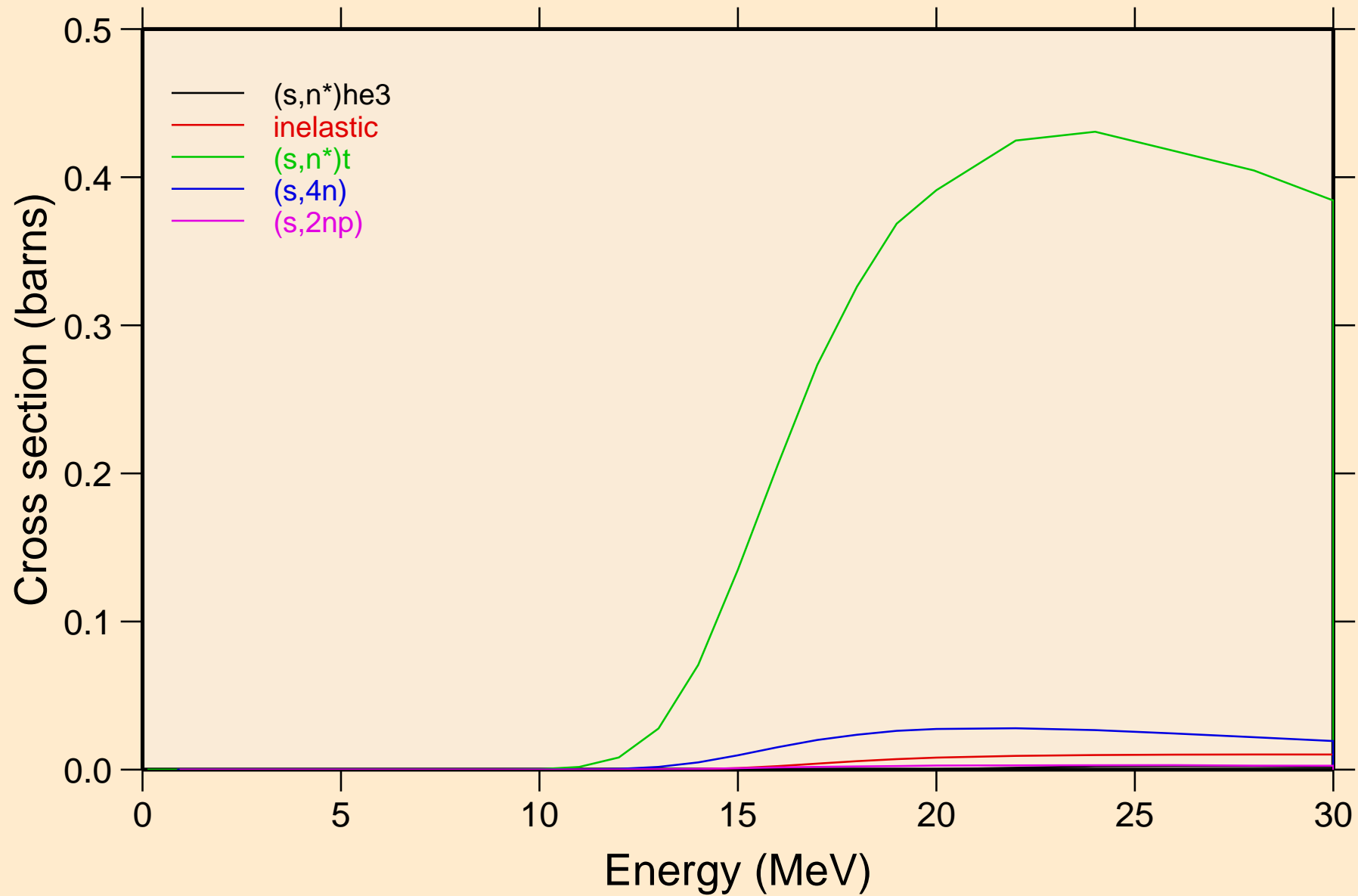



# SN134 HELION ACER TENDL-2021 LIBRARY; T=0.K

## Threshold reactions

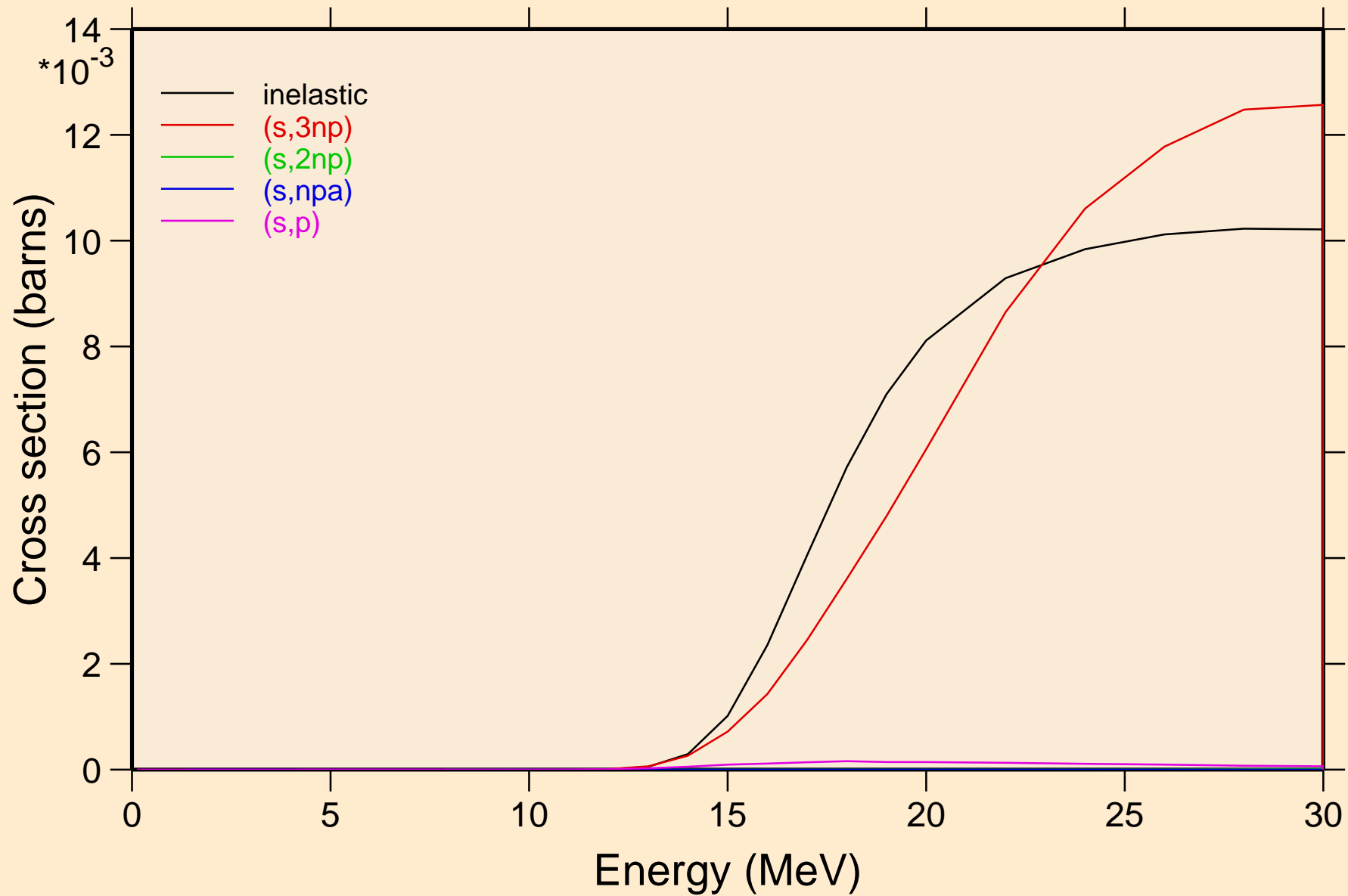

# SN134 HELION ACER TENDL-2021 LIBRARY; T=0.K

## Threshold reactions

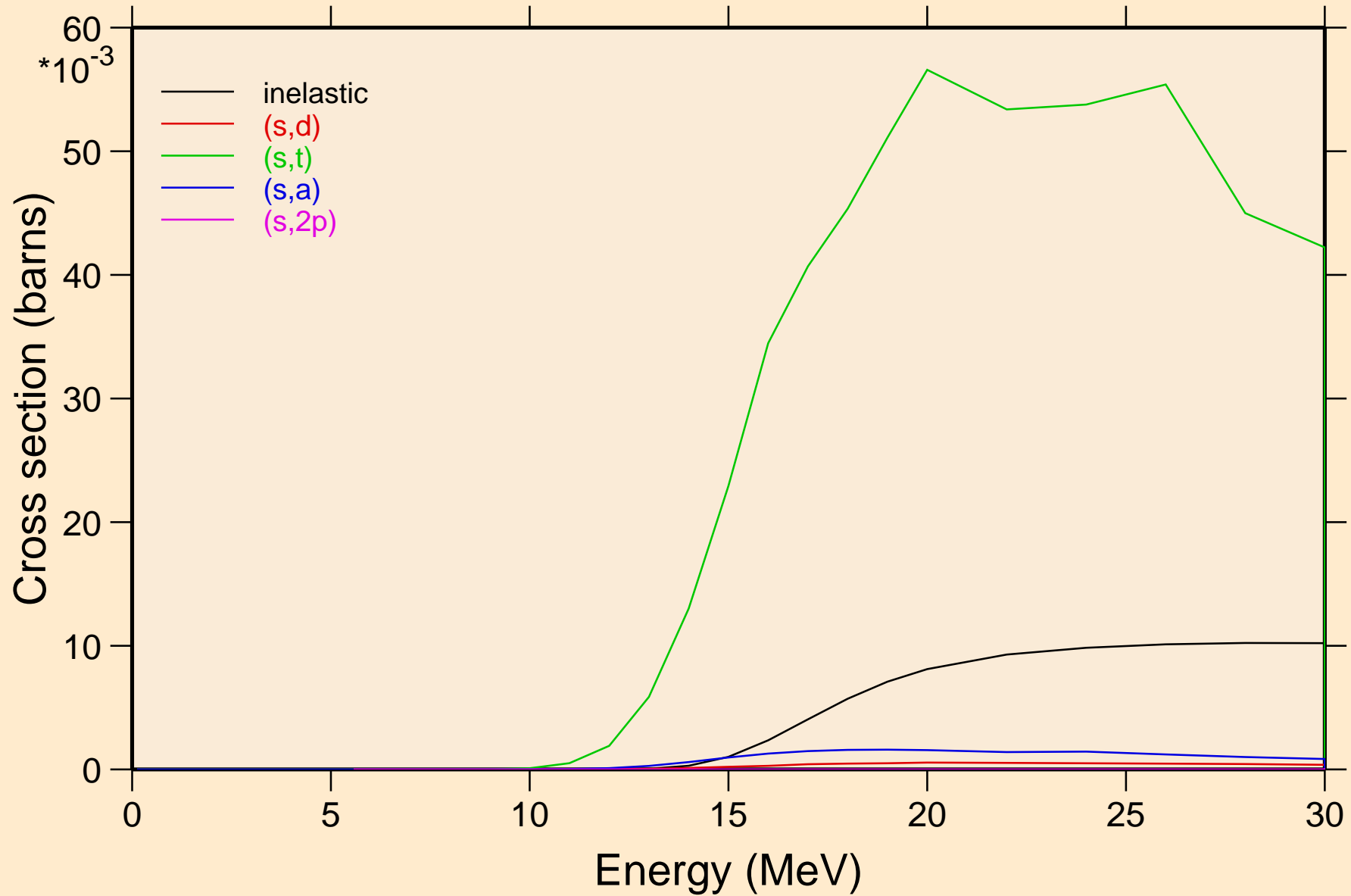

# SN134 HELION ACER TENDL-2021 LIBRARY; T=0.K

## Threshold reactions

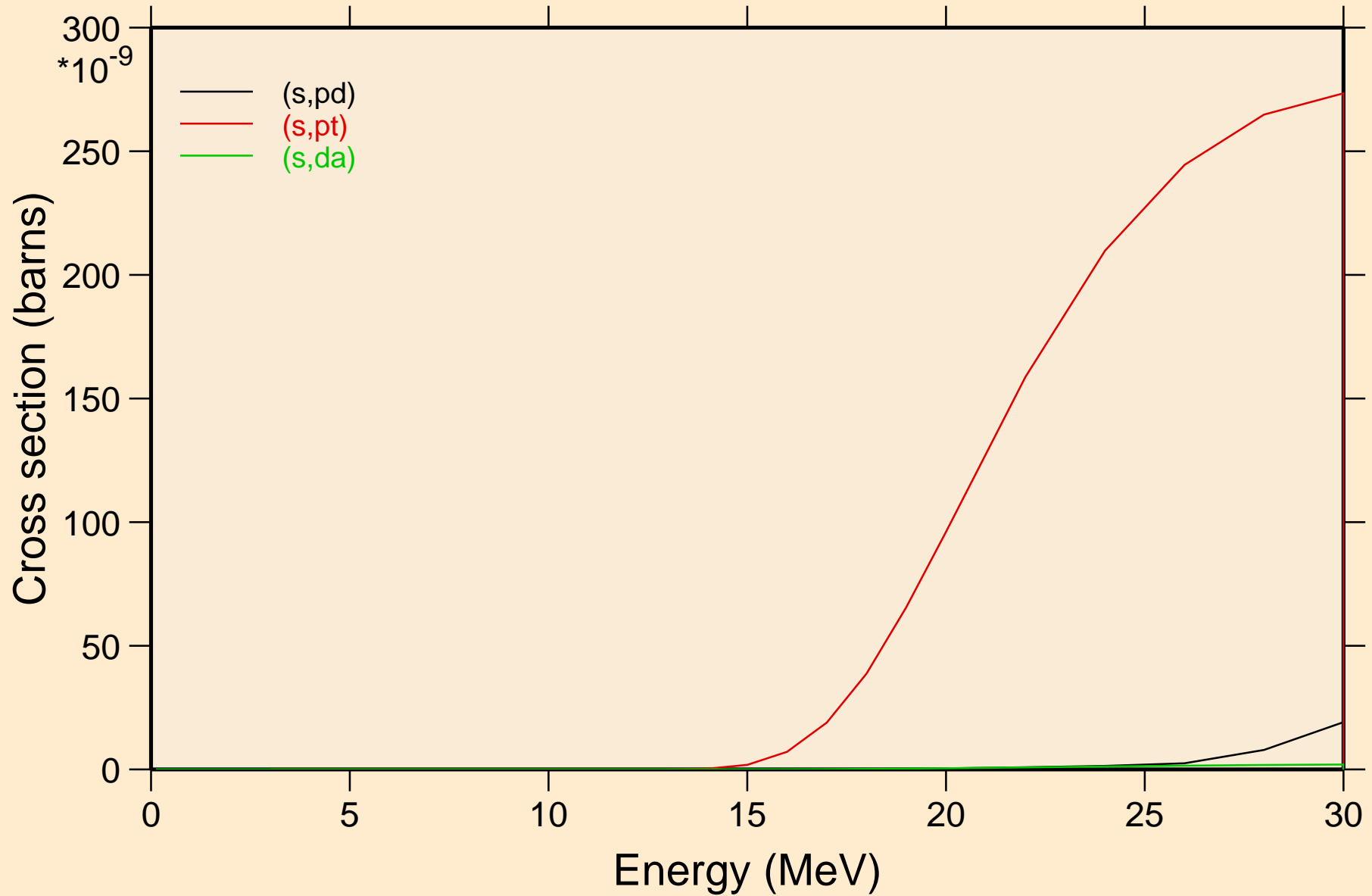

SN134 HELION ACER TENDL-2021 LIBRARY; T=0.K  
angular distribution for elastic

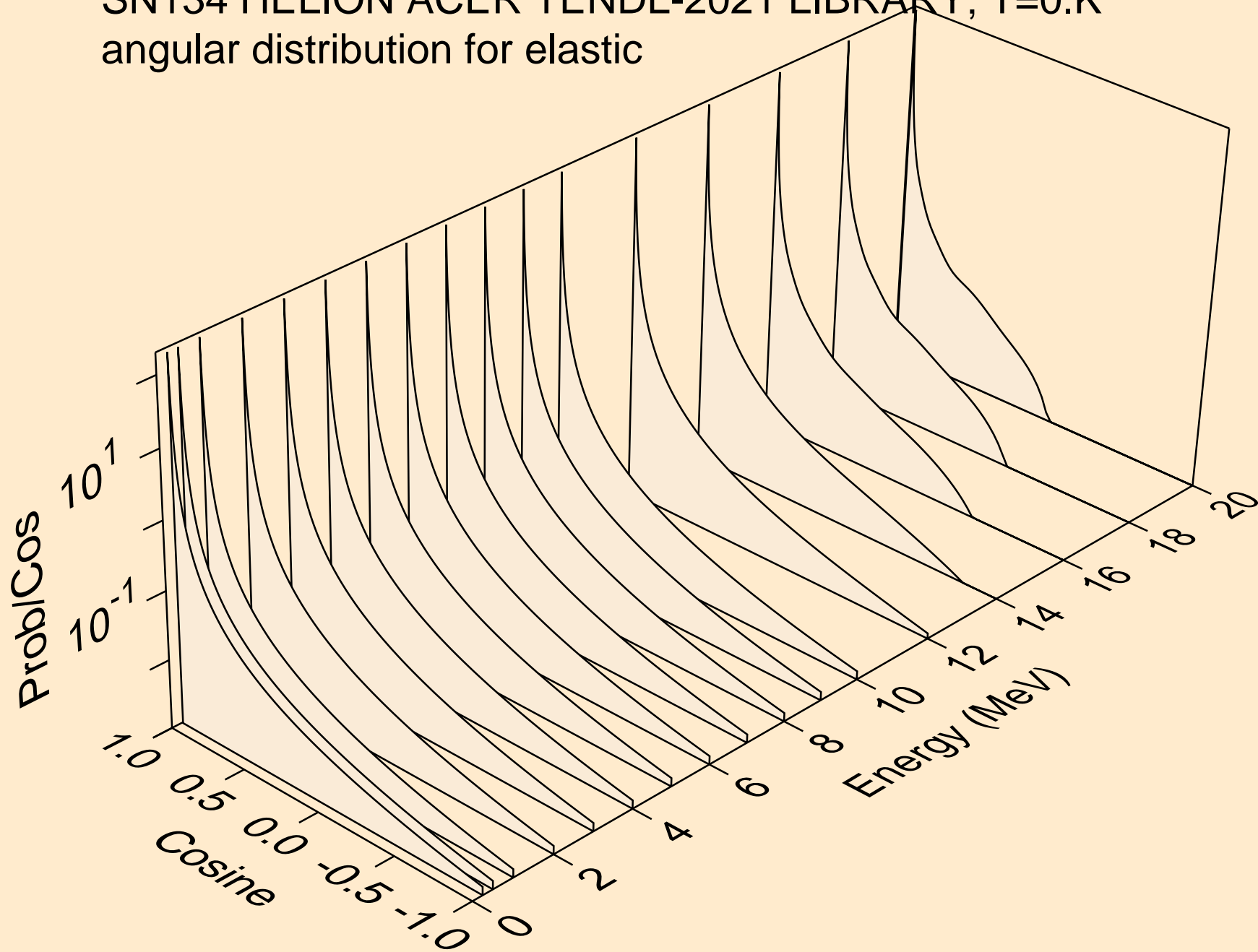

SN134 HELION ACER TENDL-2021 LIBRARY; T=0.K  
angular distribution for elastic

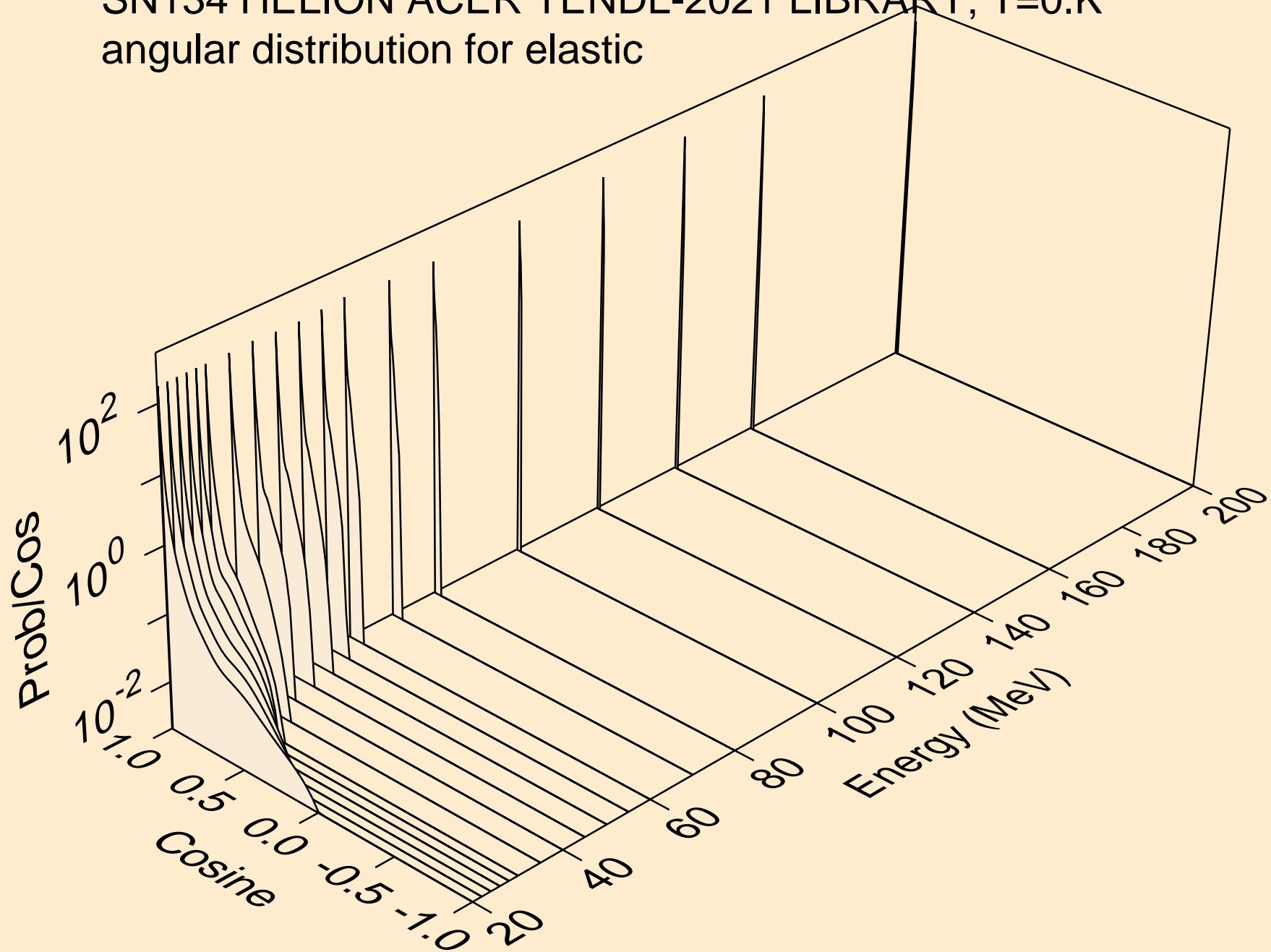

SN134 HELION ACER TENDL-2021 LIBRARY; T=0.K  
He-3 emission for (s,x)

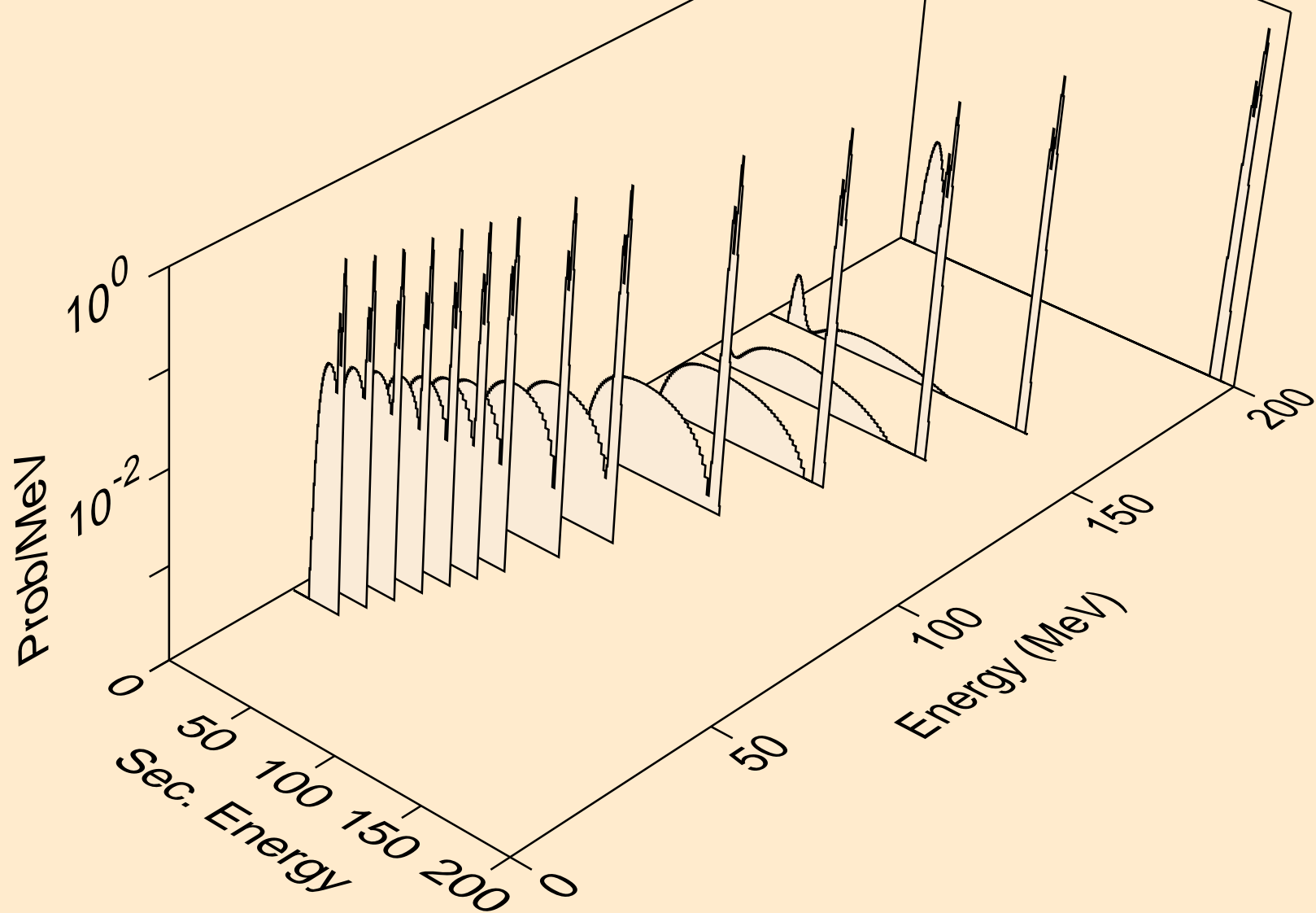

SN134 HELION ACER TENDL-2021 LIBRARY; T=0.K  
He-3 emission for (s,n\*)he3

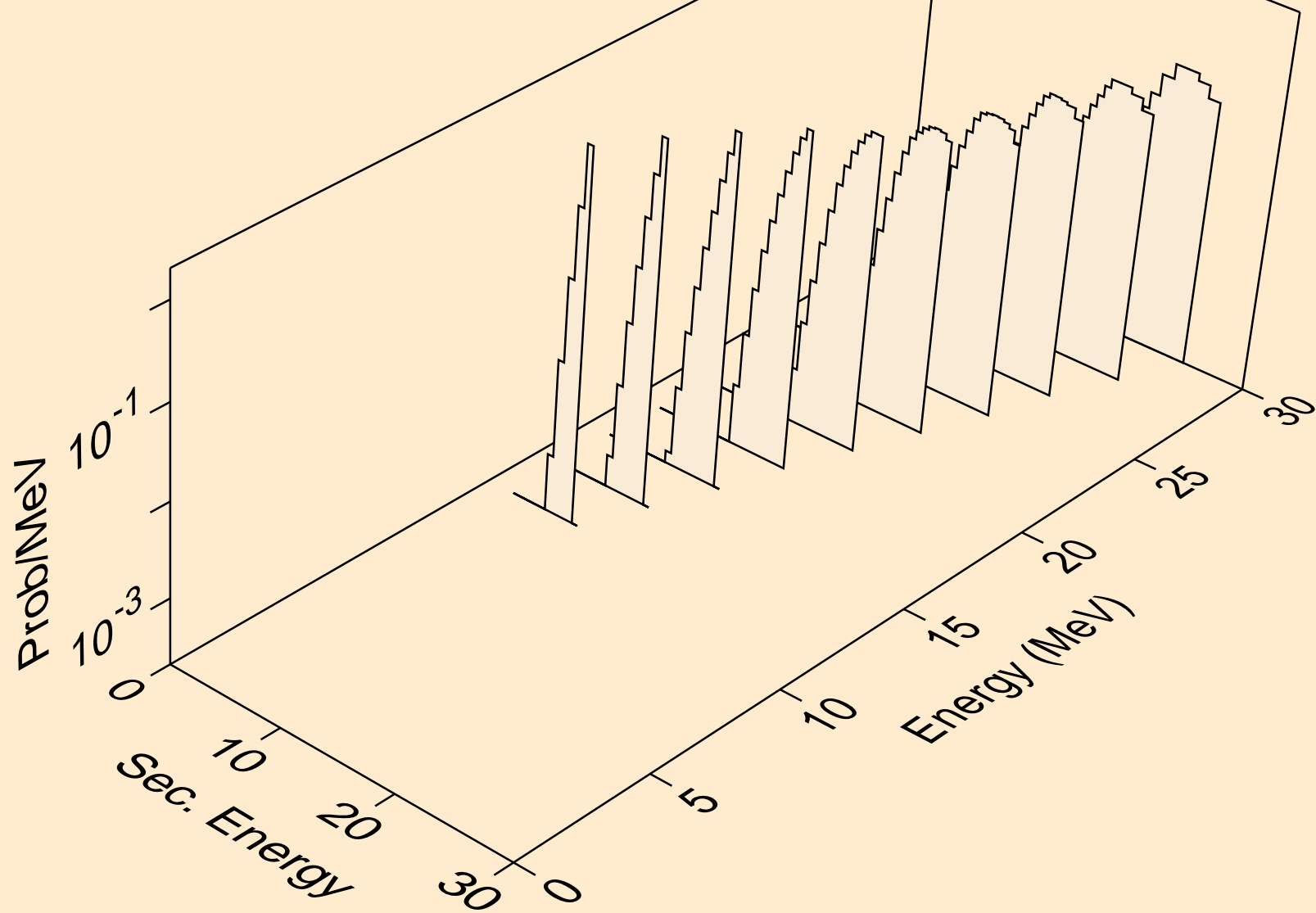

SN134 HELION ACER TENDL-2021 LIBRARY; T=0.K  
He-3 emission for inelastic

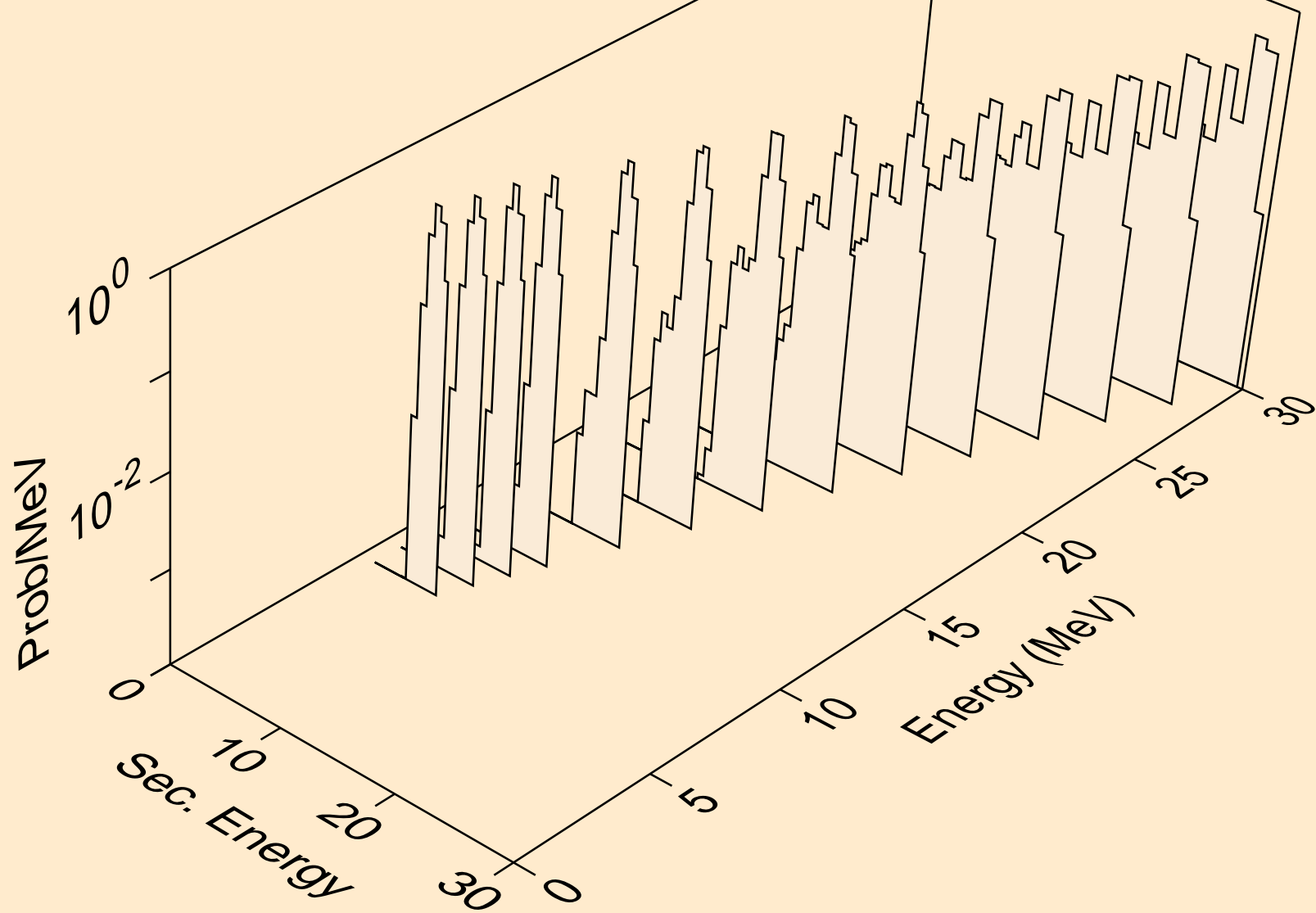



SN134 HELION ACER TENDL-2021 LIBRARY; T=0.K  
Photon emission for (z,n)

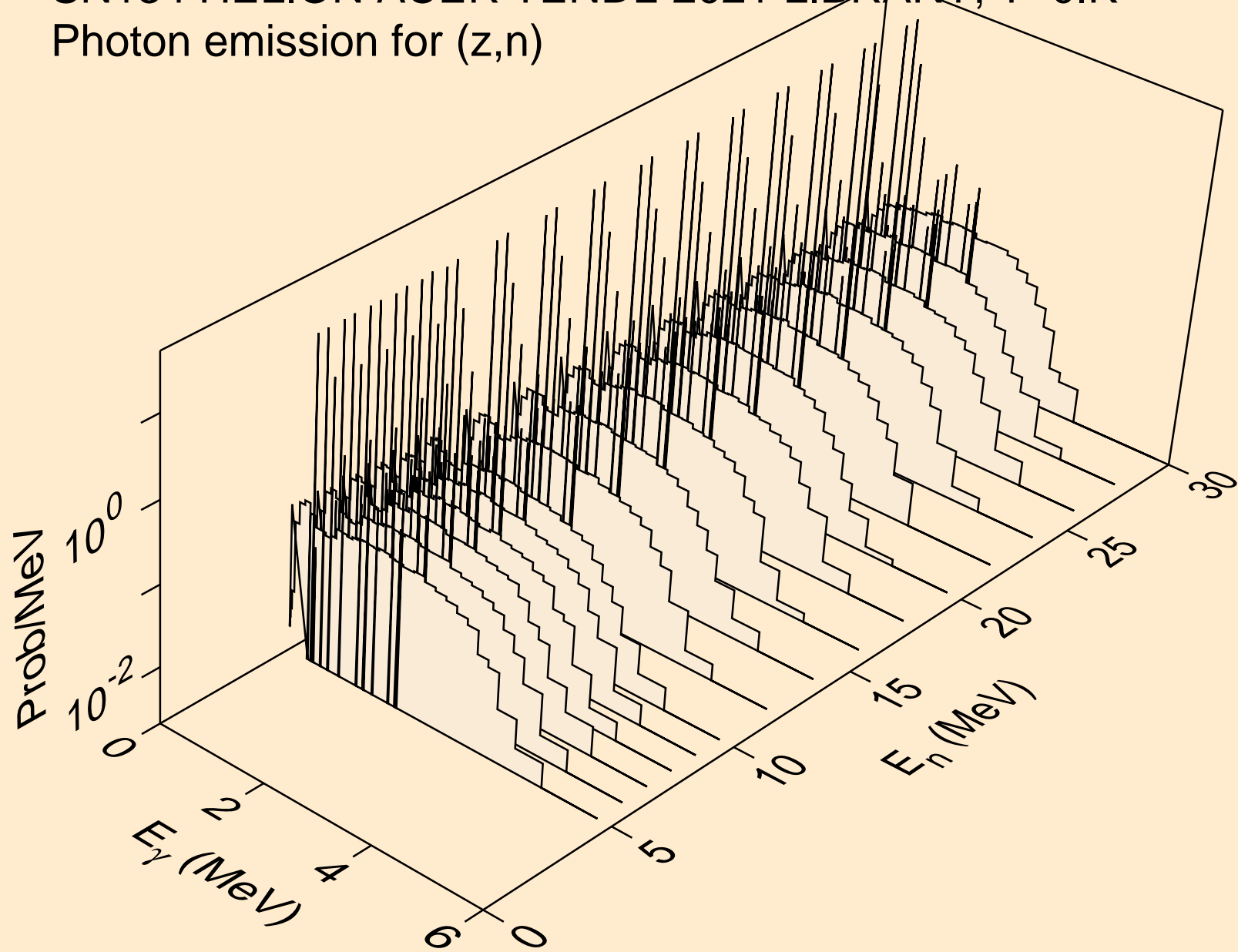

SN134 HELION ACER TENDL-2021 LIBRARY; T=0.K  
Photon emission for (n,x)

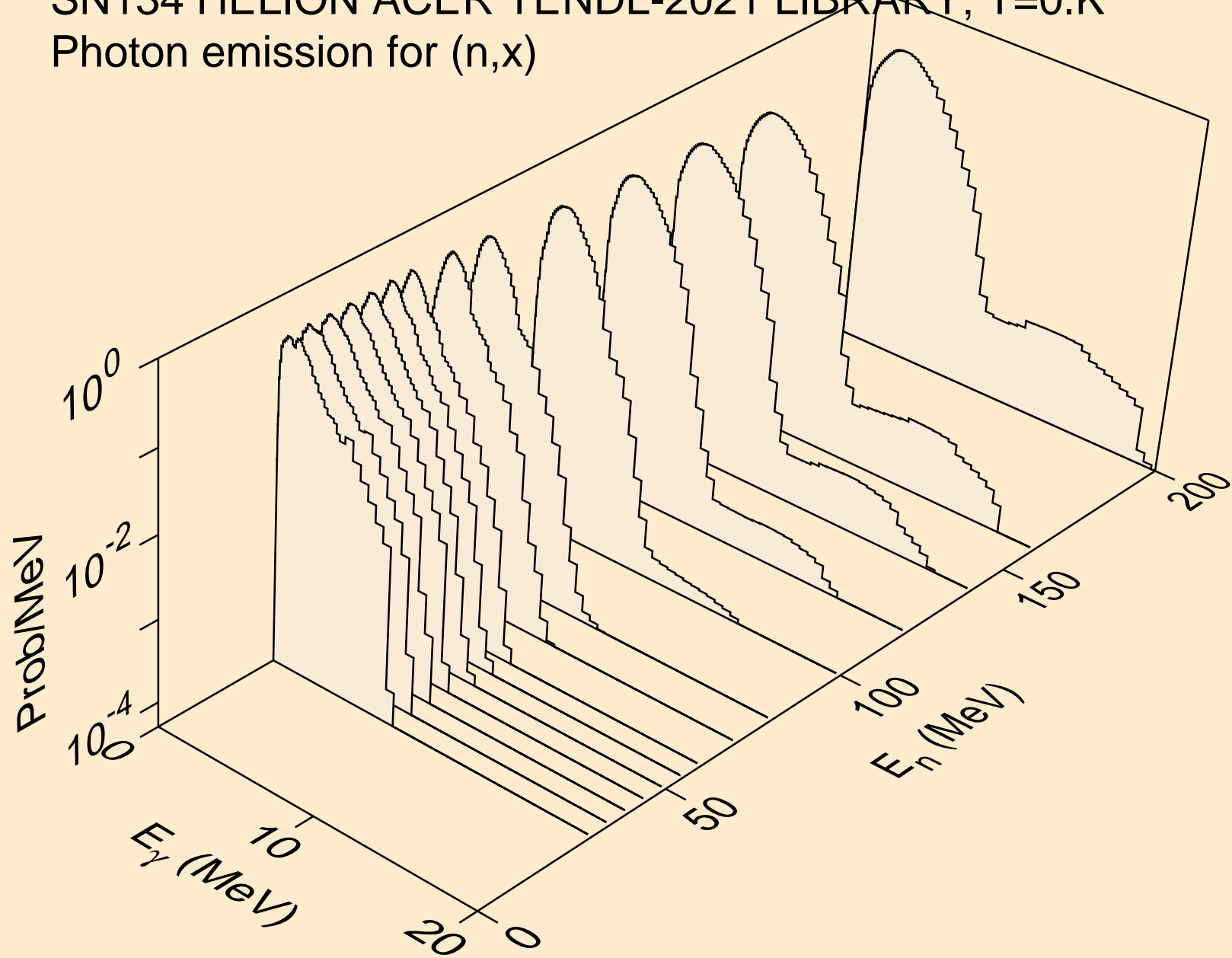

SN134 HELION ACER TENDL-2021 LIBRARY; T=0.K  
Photon emission for (n,2nd)

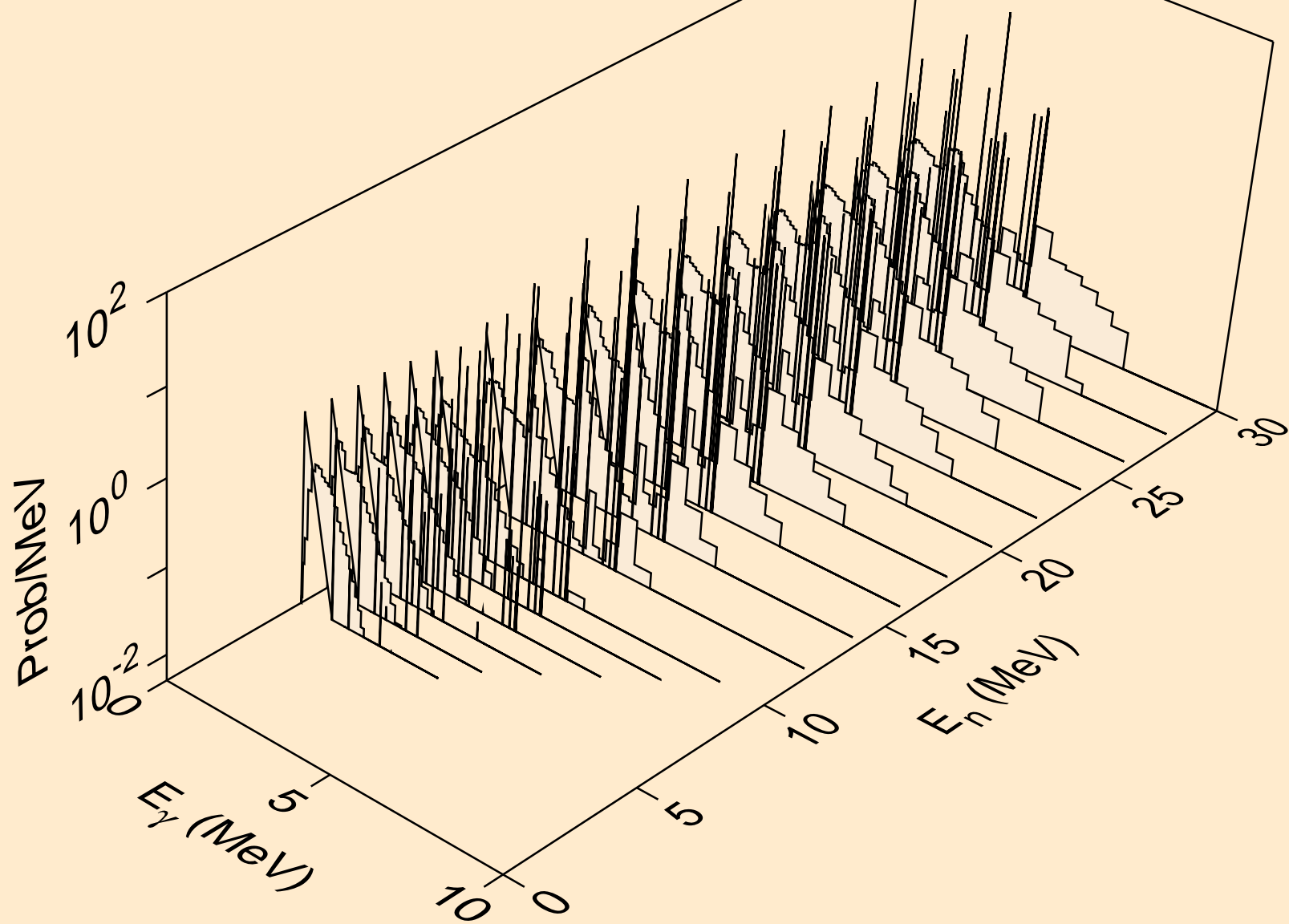

SN134 HELION ACER TENDL-2021 LIBRARY; T=0.K  
Photon emission for (n,2n)

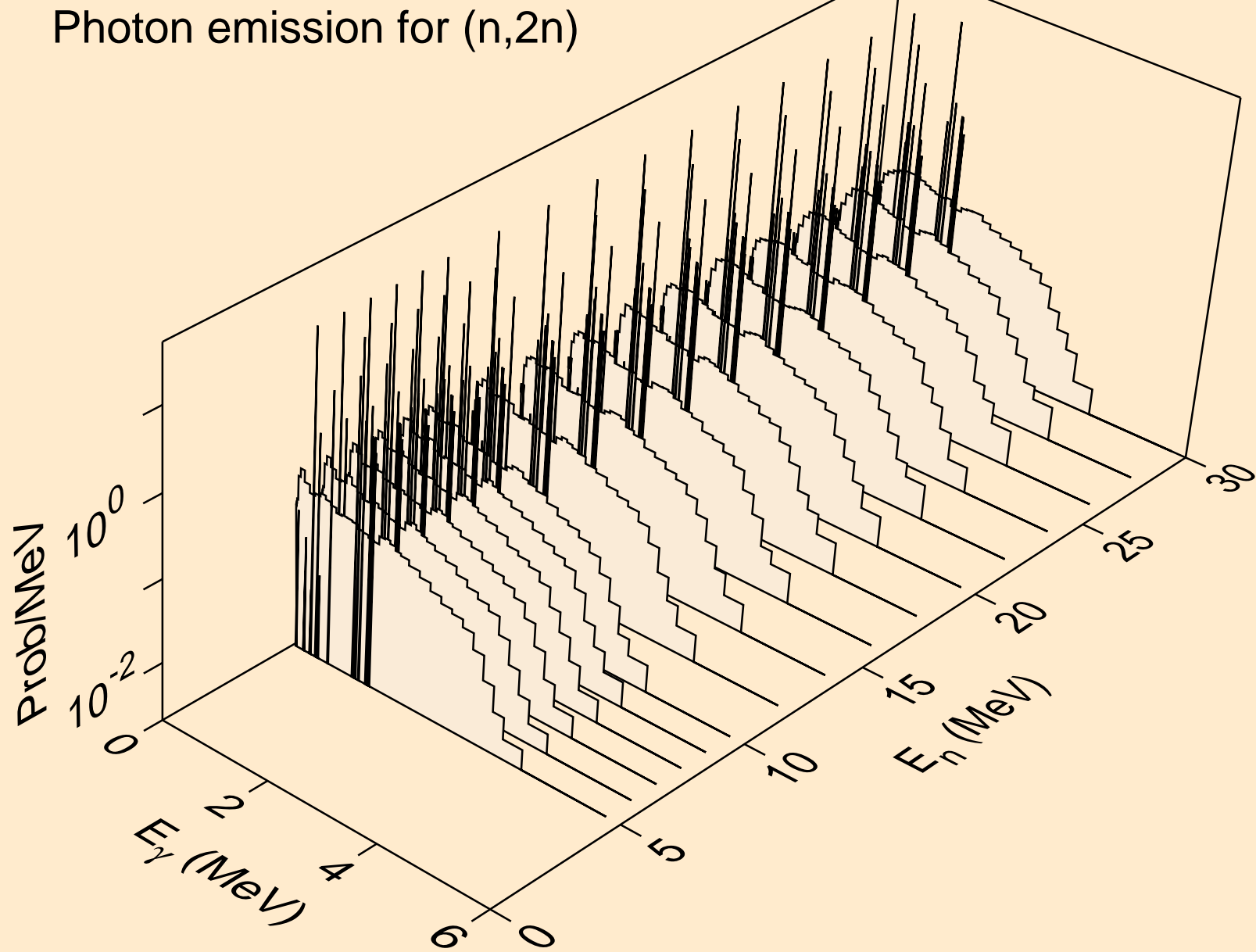

SN134 HELION ACER TENDL-2021 LIBRARY; T=0.K  
Photon emission for (n,3n)

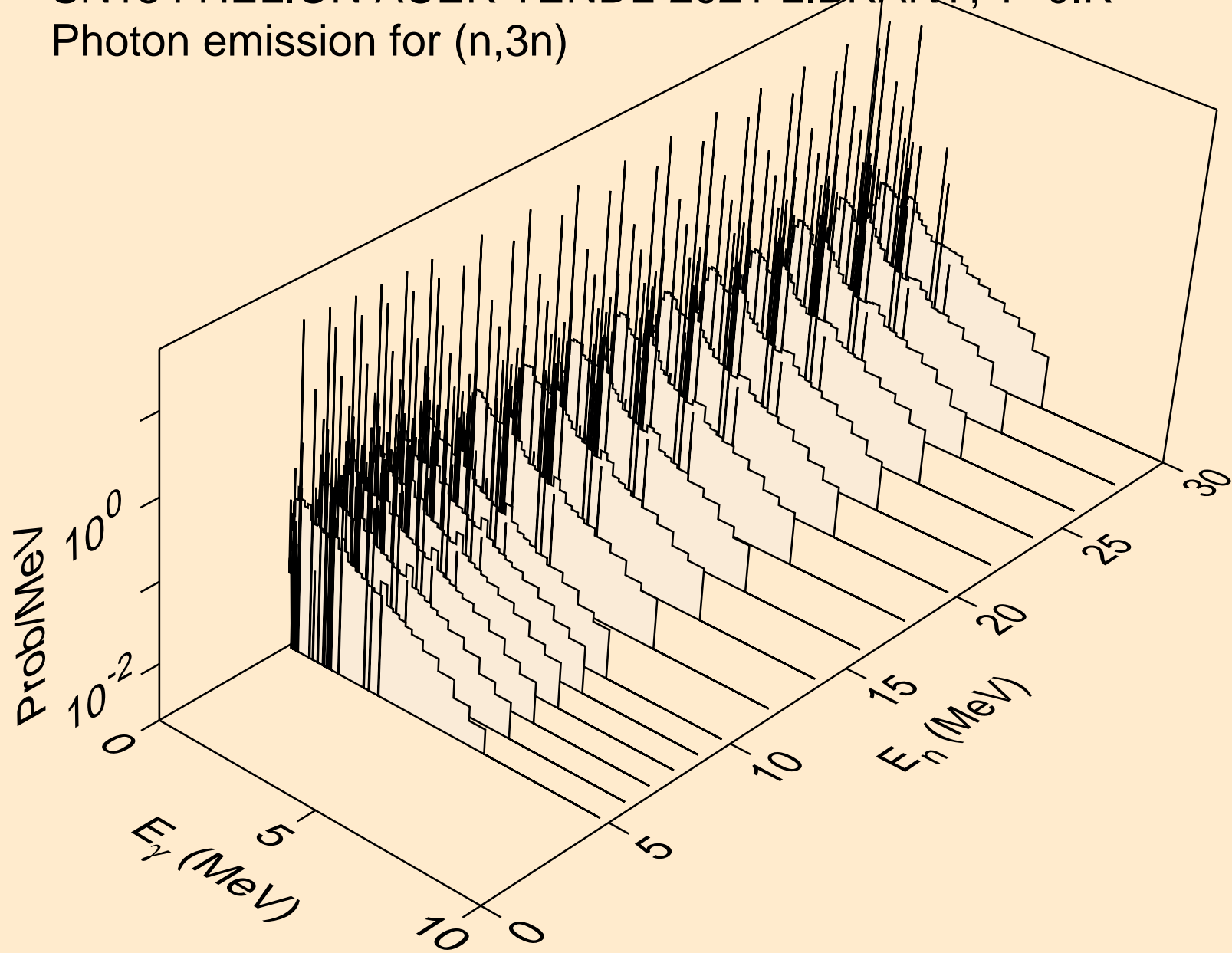

SN134 HELION ACER TENDL-2021 LIBRARY; T=0.K  
Photon emission for (n,n\*)a

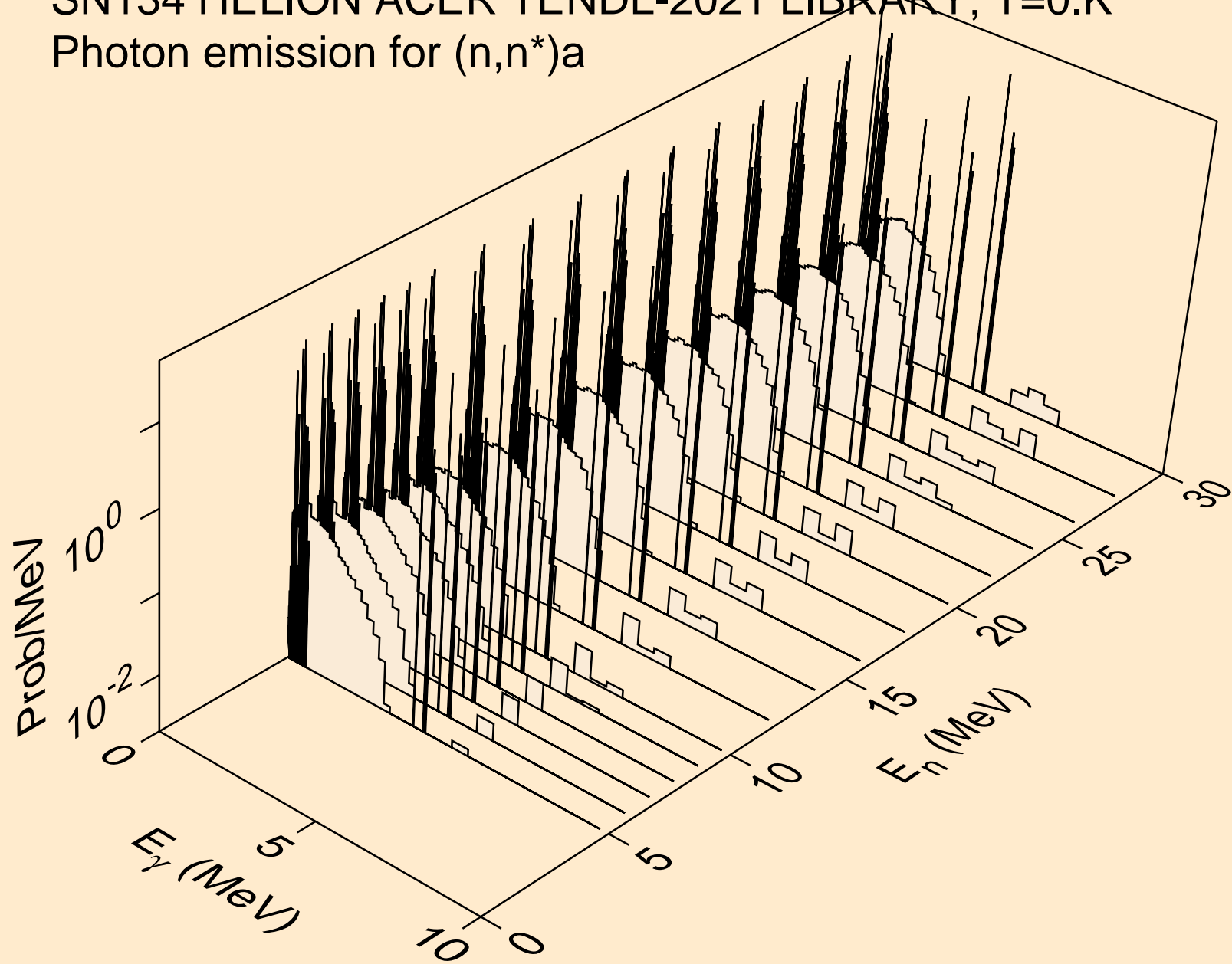

SN134 HELION ACER TENDL-2021 LIBRARY; T=0.K  
Photon emission for (n,2n)a

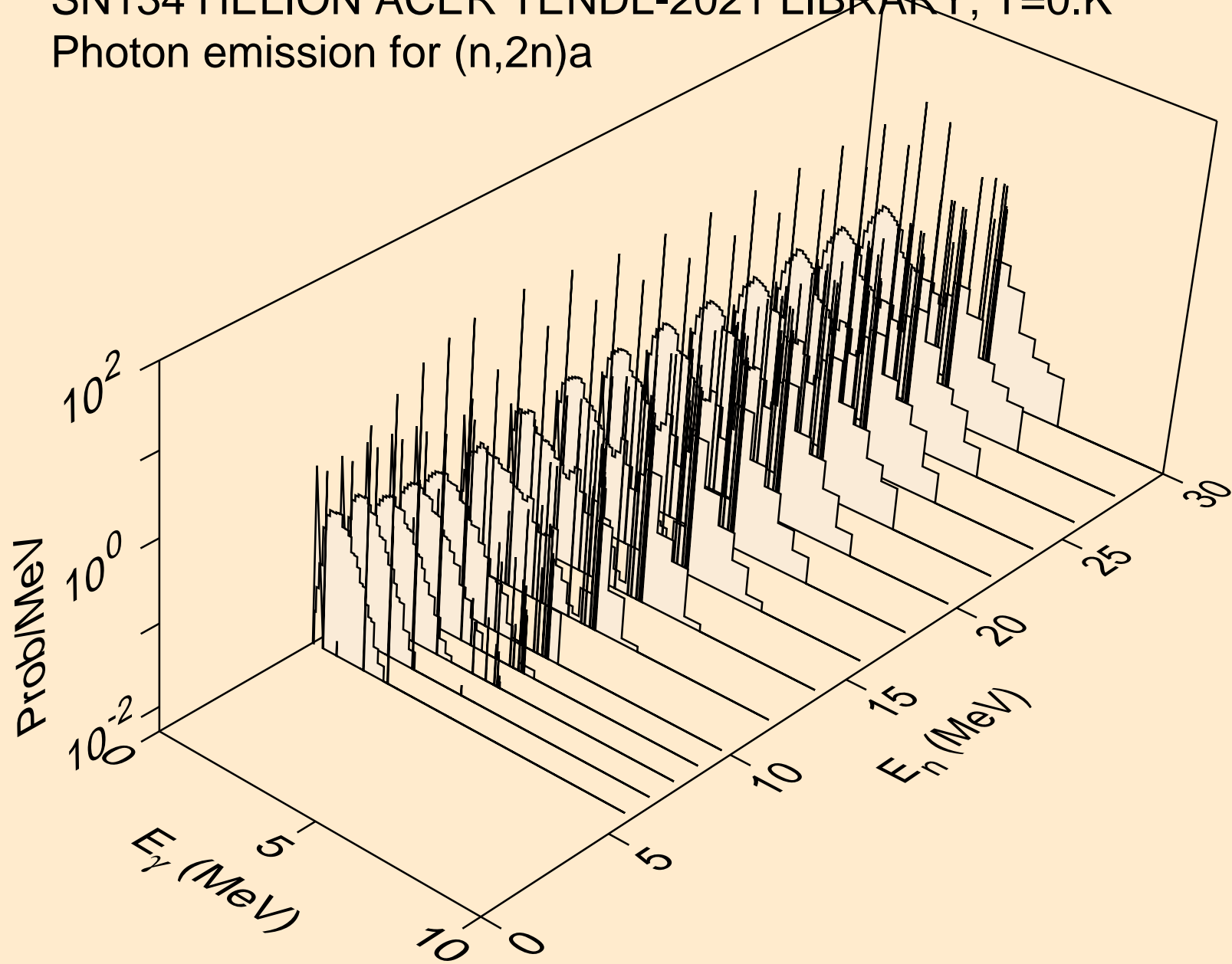

SN134 HELION ACER TENDL-2021 LIBRARY; T=0.K  
Photon emission for (n,3n)a

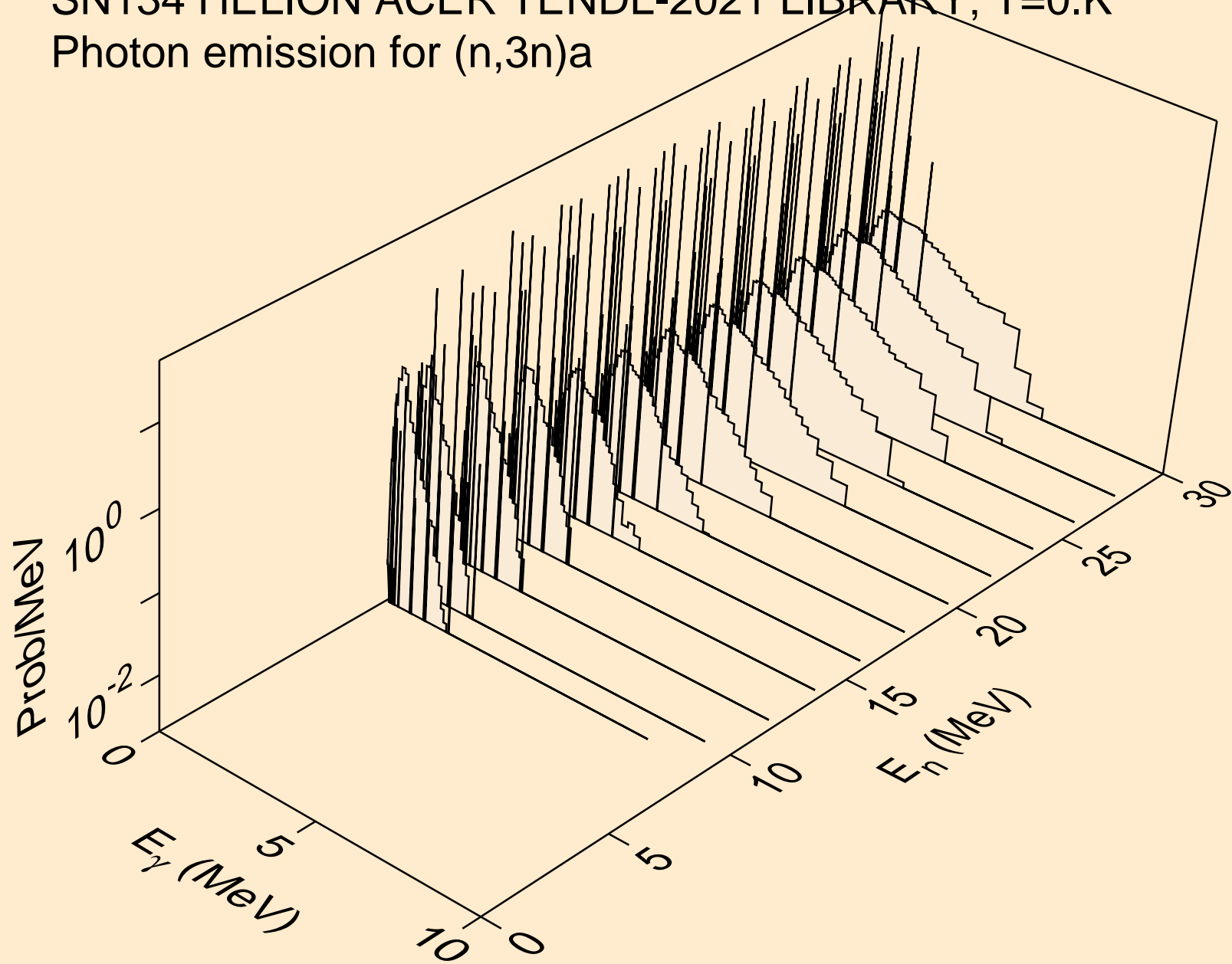



SN134 HELION ACER TENDL-2021 LIBRARY; T=0.K  
Photon emission for (n,n\*)p

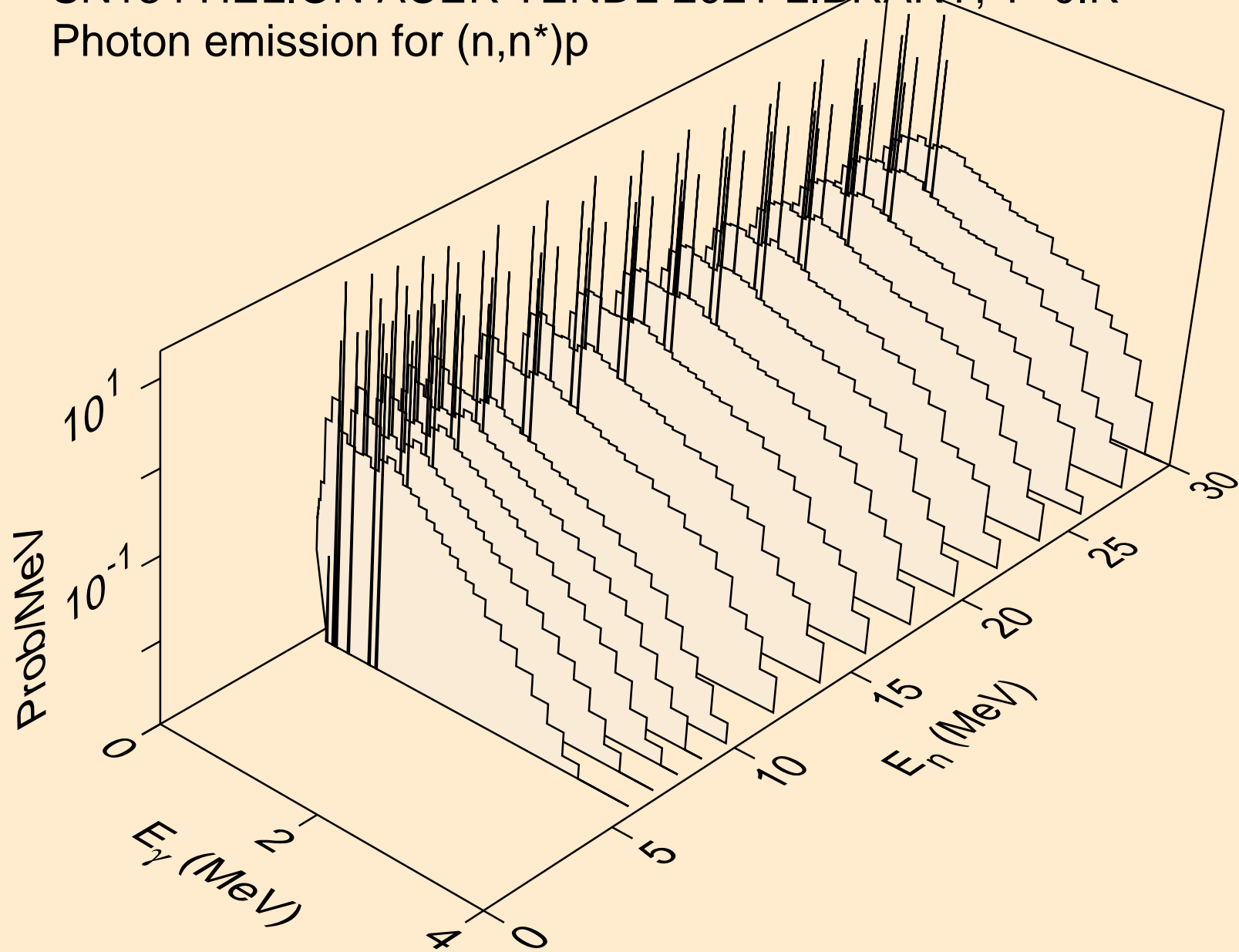

SN134 HELION ACER TENDL-2021 LIBRARY; T=0.K  
Photon emission for (n,n\*)d

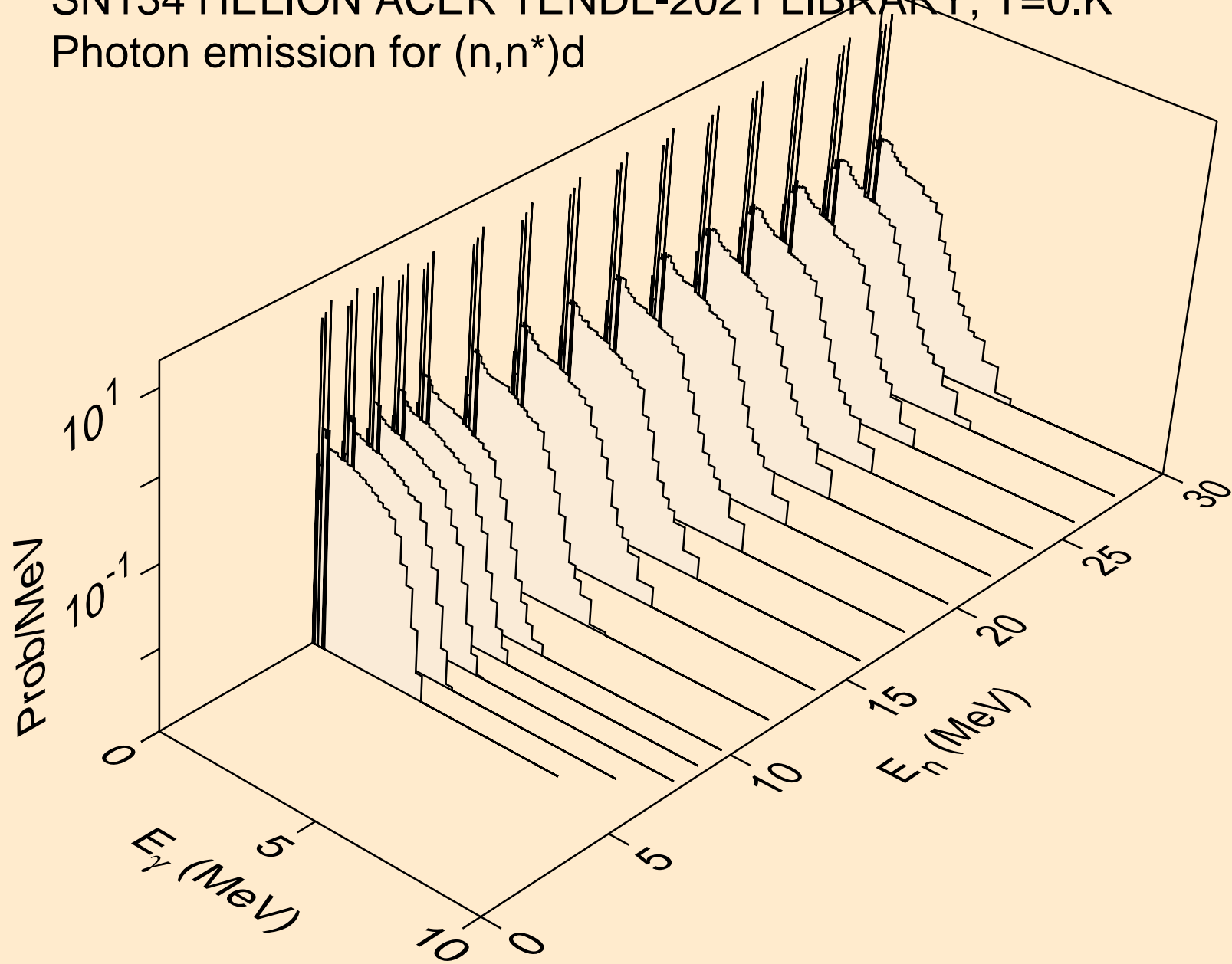

SN134 HELION ACER TENDL-2021 LIBRARY; T=0.K  
Photon emission for (n,n\*)t

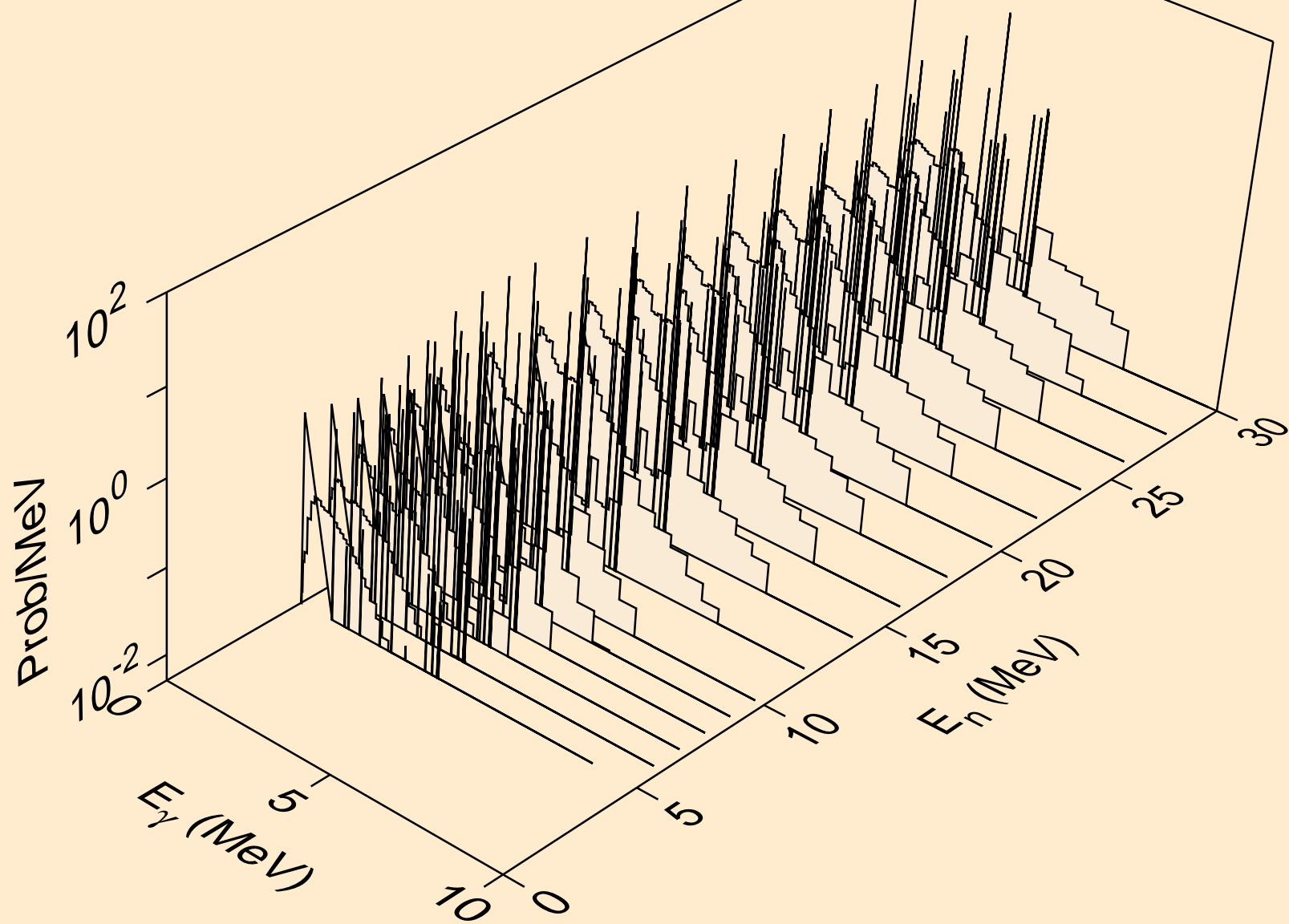

SN134 HELION ACER TENDL-2021 LIBRARY; T=0.K  
Photon emission for (n,n\*)he3

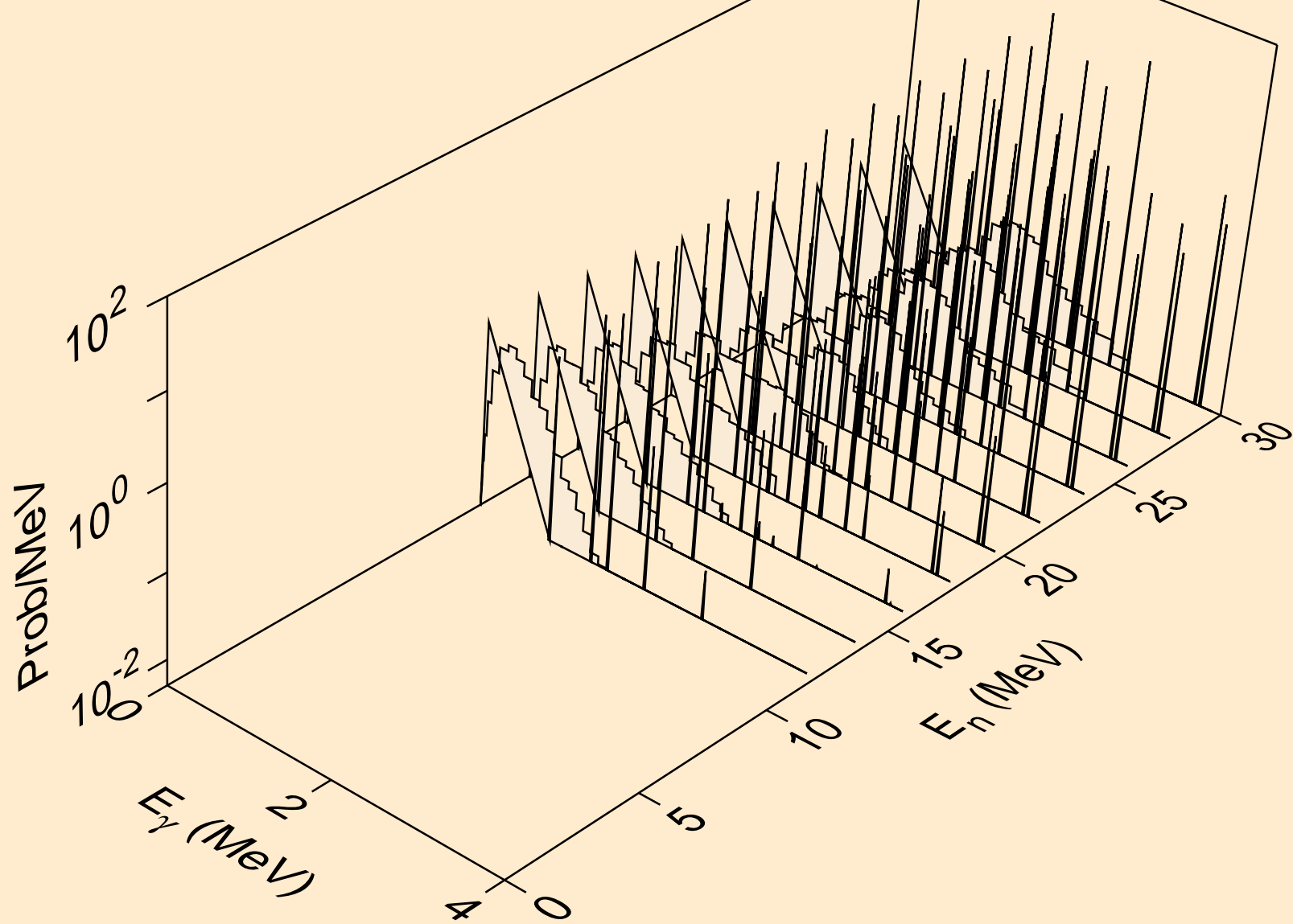

SN134 HELION ACER TENDL-2021 LIBRARY; T=0.K  
Photon emission for (n,4n)

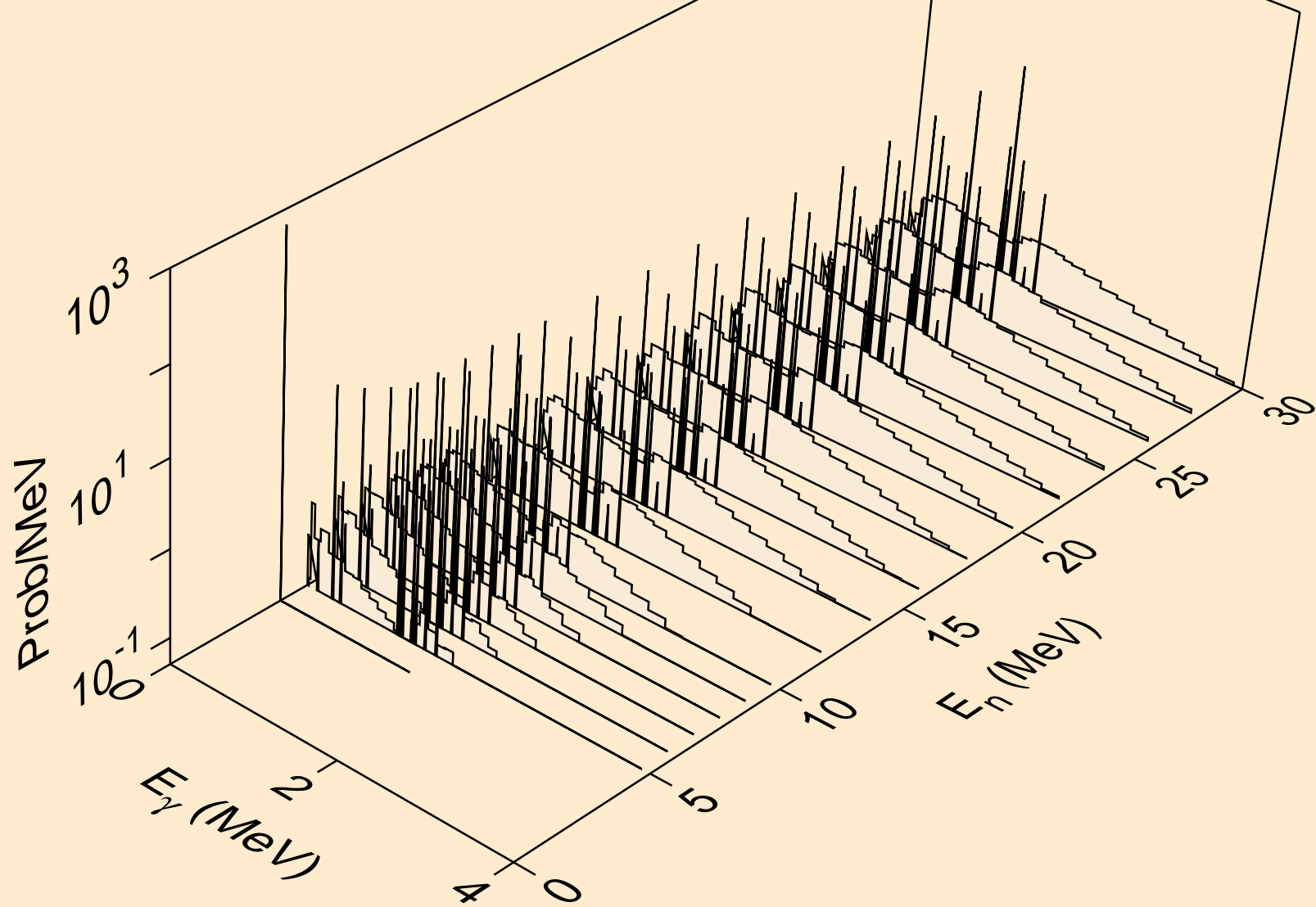

SN134 HELION ACER TENDL-2021 LIBRARY; T=0.K  
Photon emission for (n,2np)

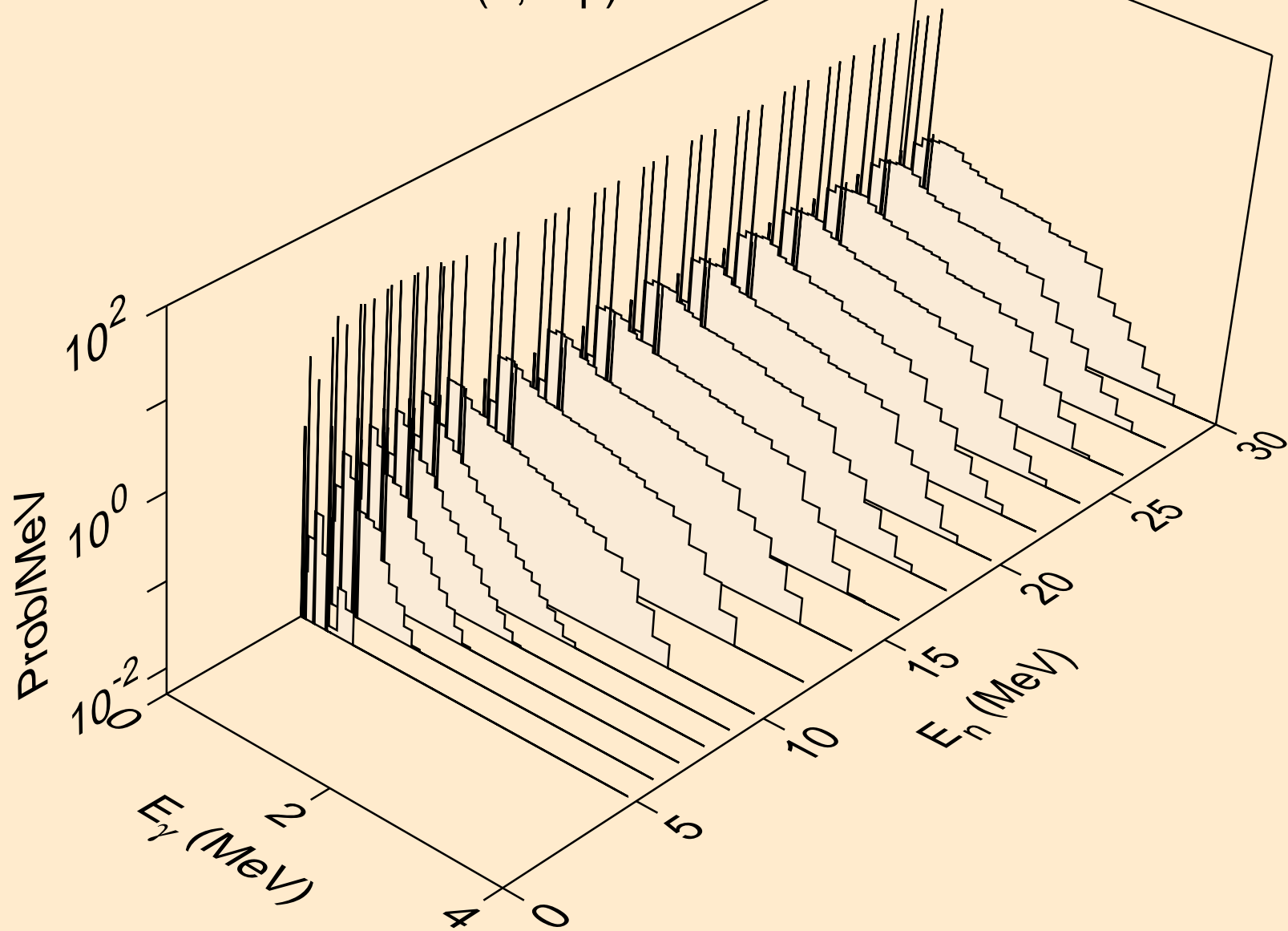

SN134 HELION ACER TENDL-2021 LIBRARY; T=0.K  
Photon emission for (n,3np)

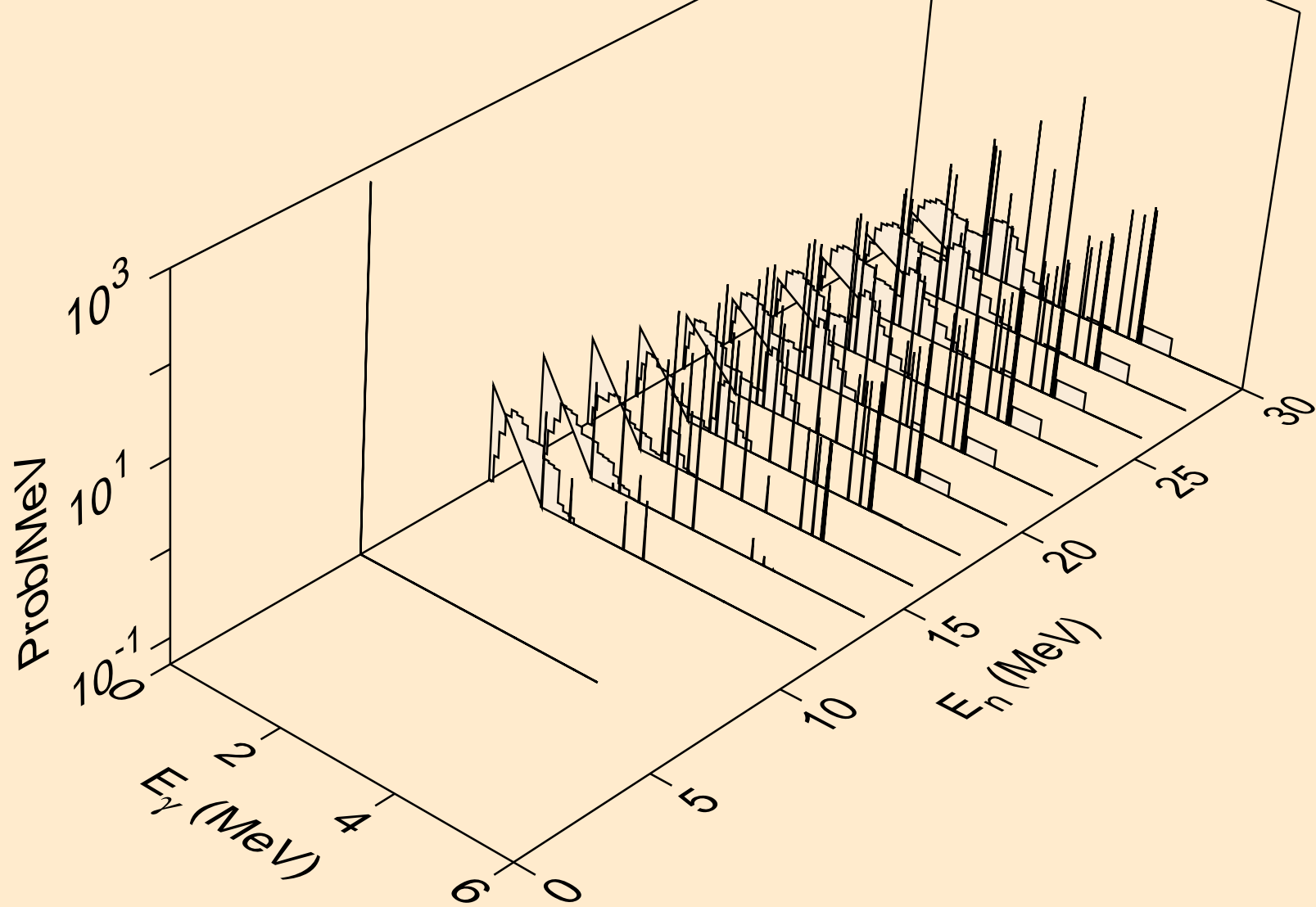

SN134 HELION ACER TENDL-2021 LIBRARY; T=0.K  
Photon emission for (n,2np)

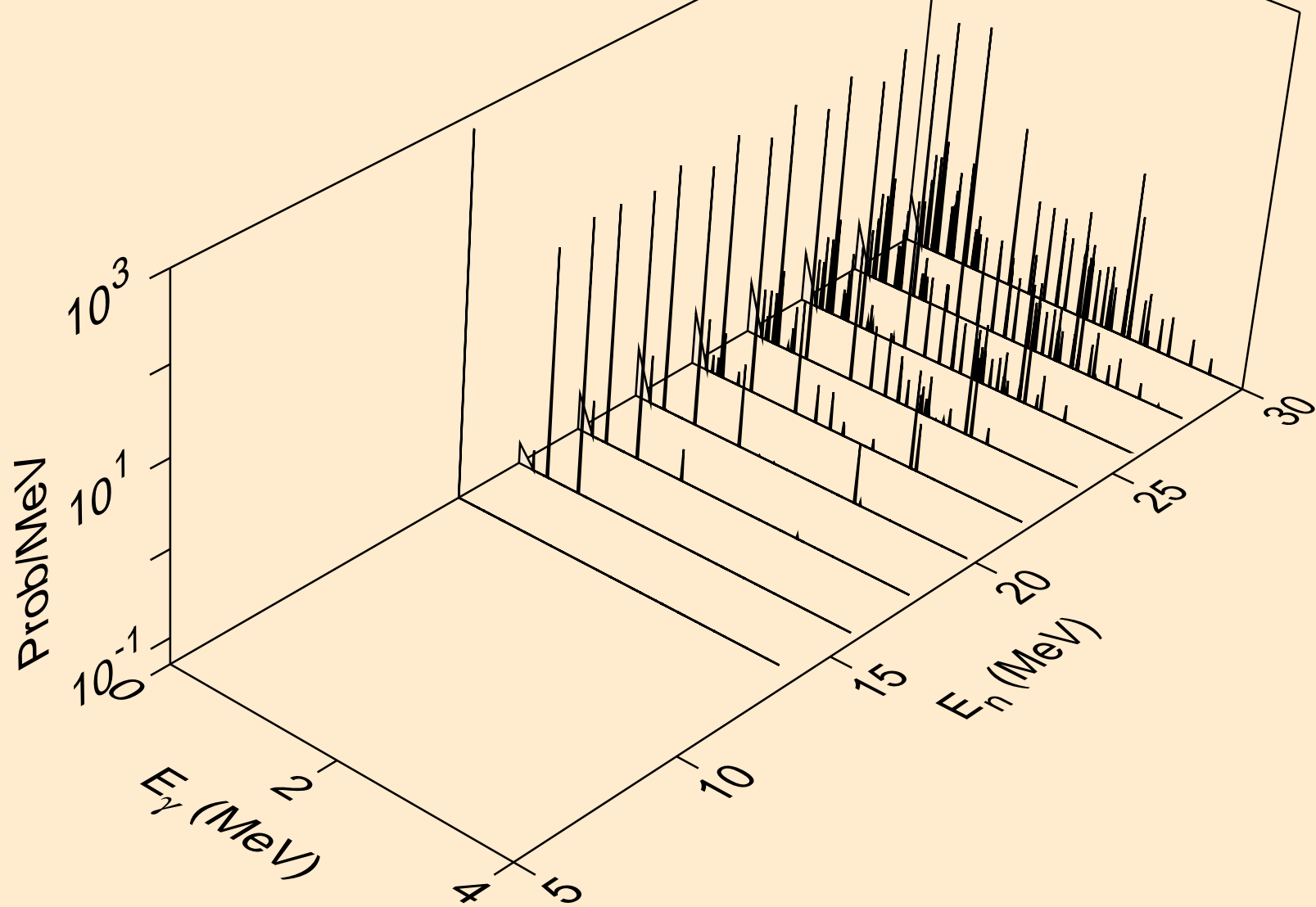



SN134 HELION ACER TENDL-2021 LIBRARY; T=0.K  
Photon emission for (n,npa)

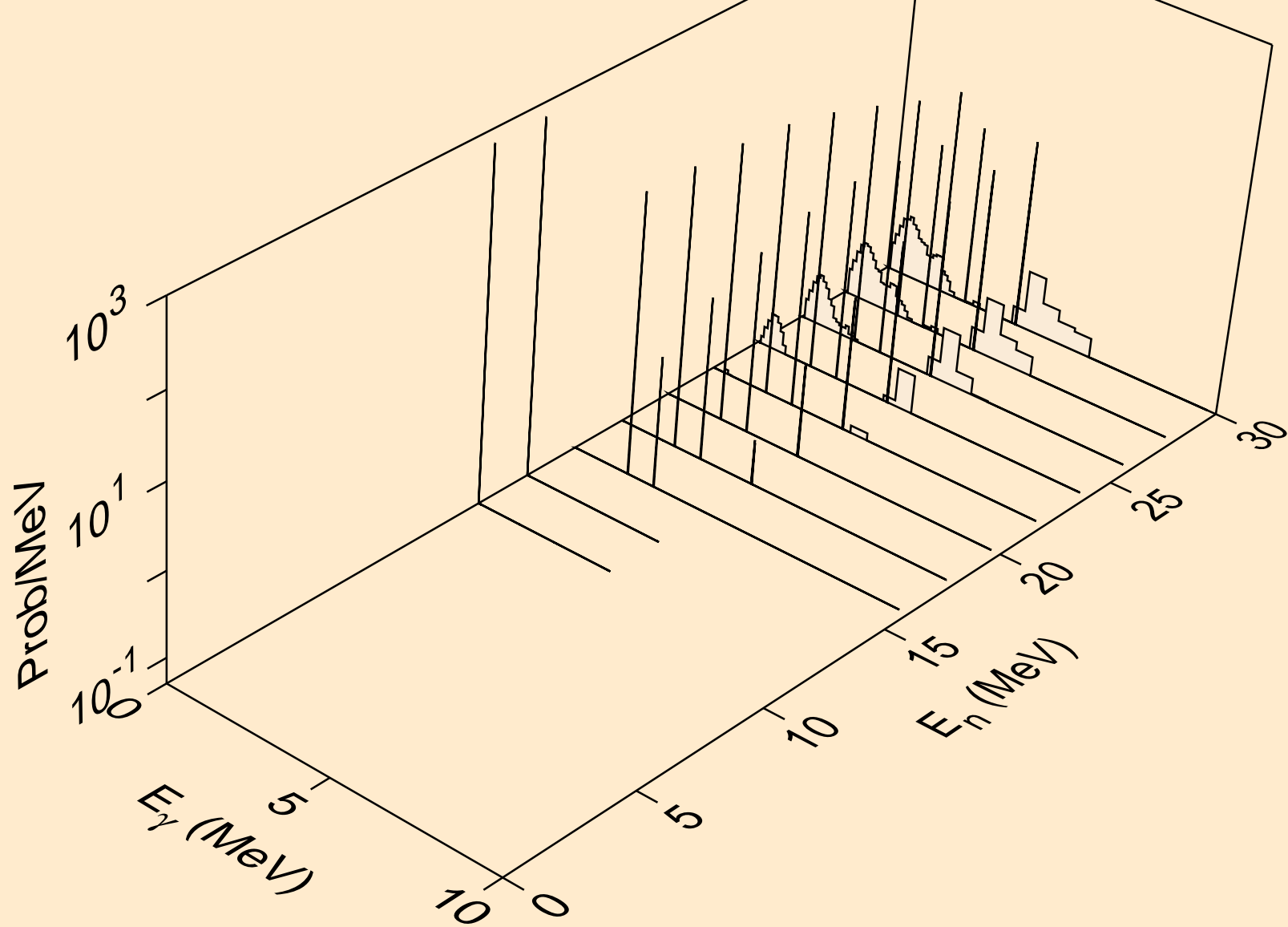

SN134 HELION ACER TENDL-2021 LIBRARY; T=0.K  
Photon emission for (n,p)

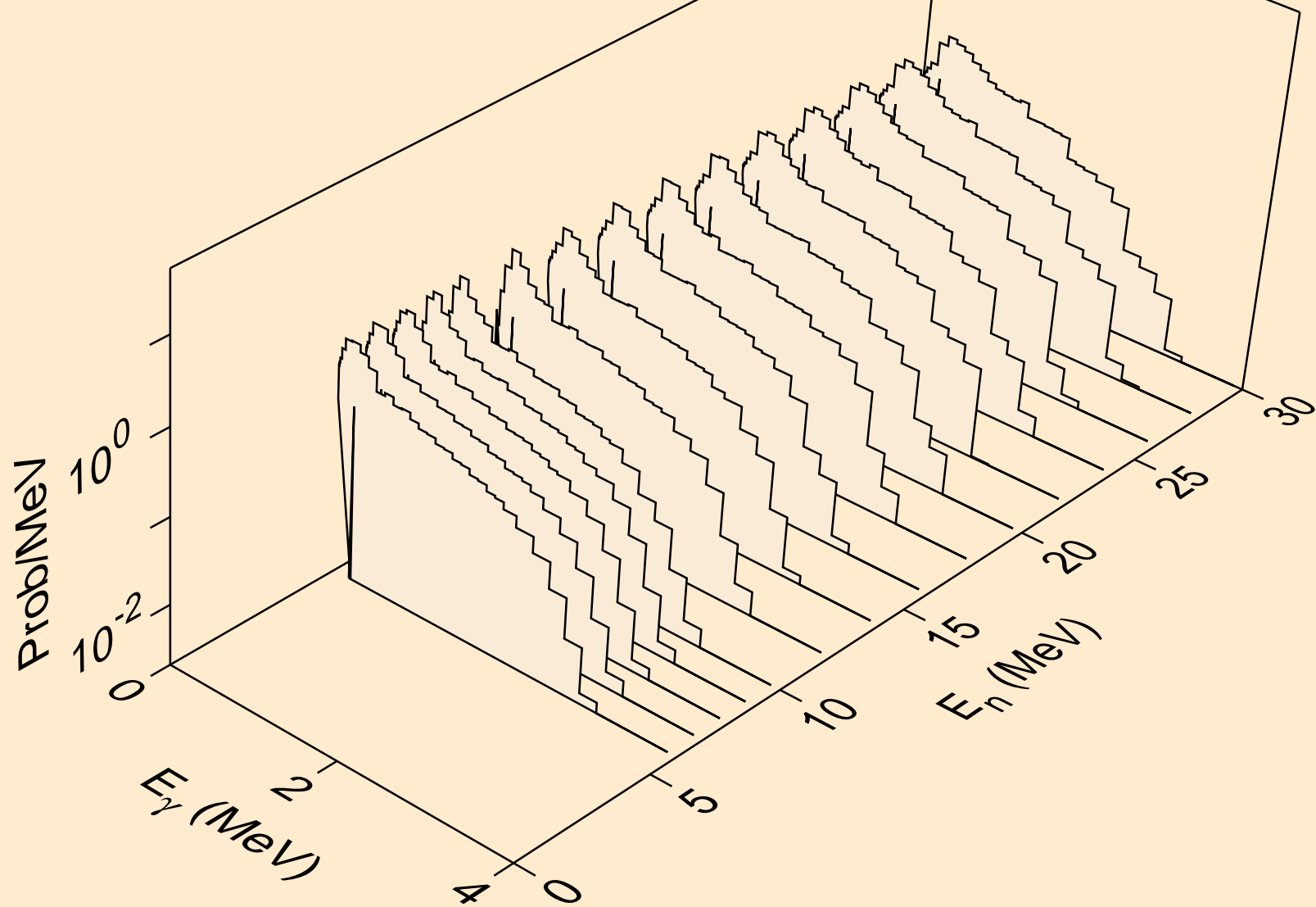

SN134 HELION ACER TENDL-2021 LIBRARY; T=0.K  
Photon emission for (n,d)

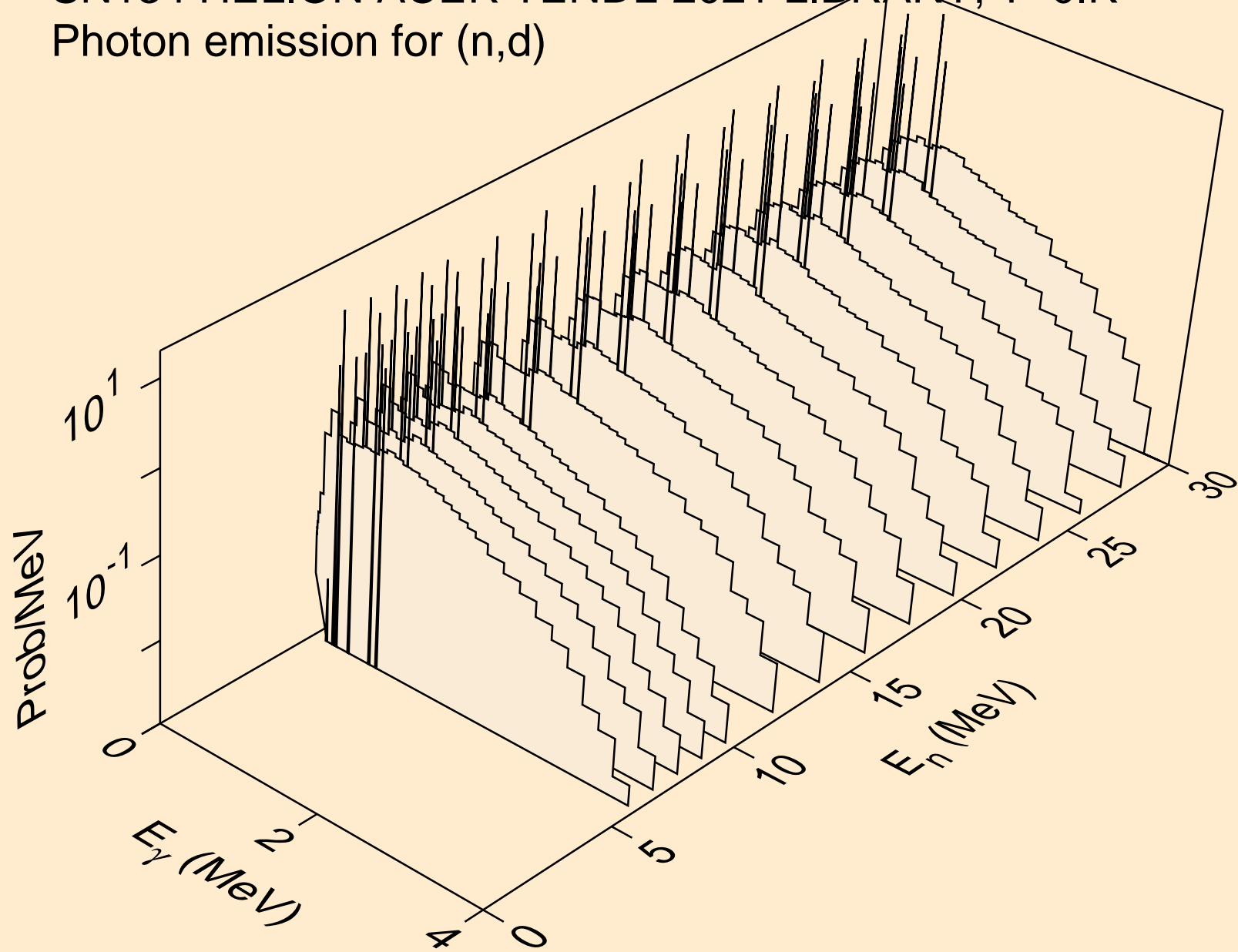

SN134 HELION ACER TENDL-2021 LIBRARY; T=0.K  
Photon emission for (n,t)

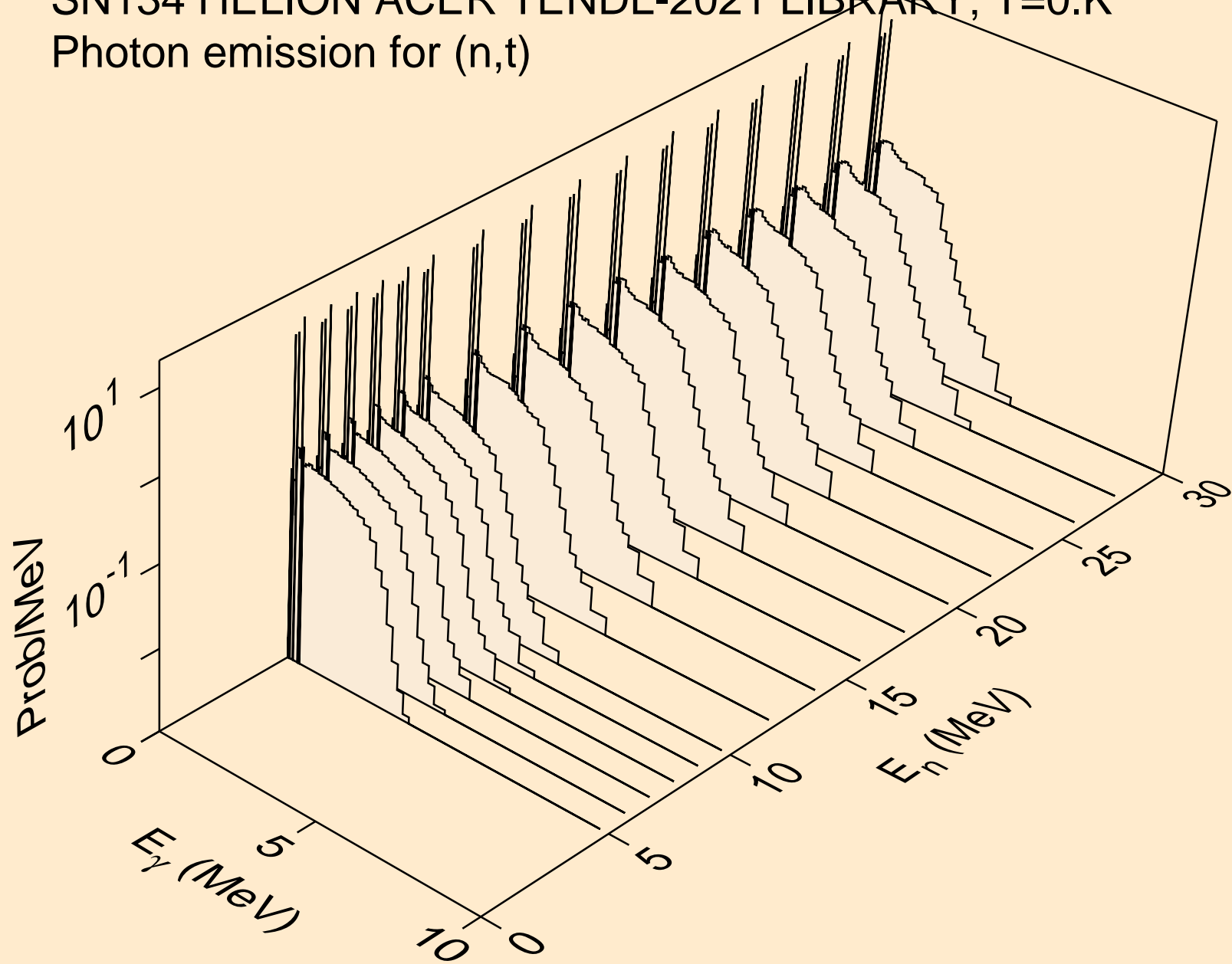

SN134 HELION ACER TENDL-2021 LIBRARY; T=0.K  
Photon emission for inelastic

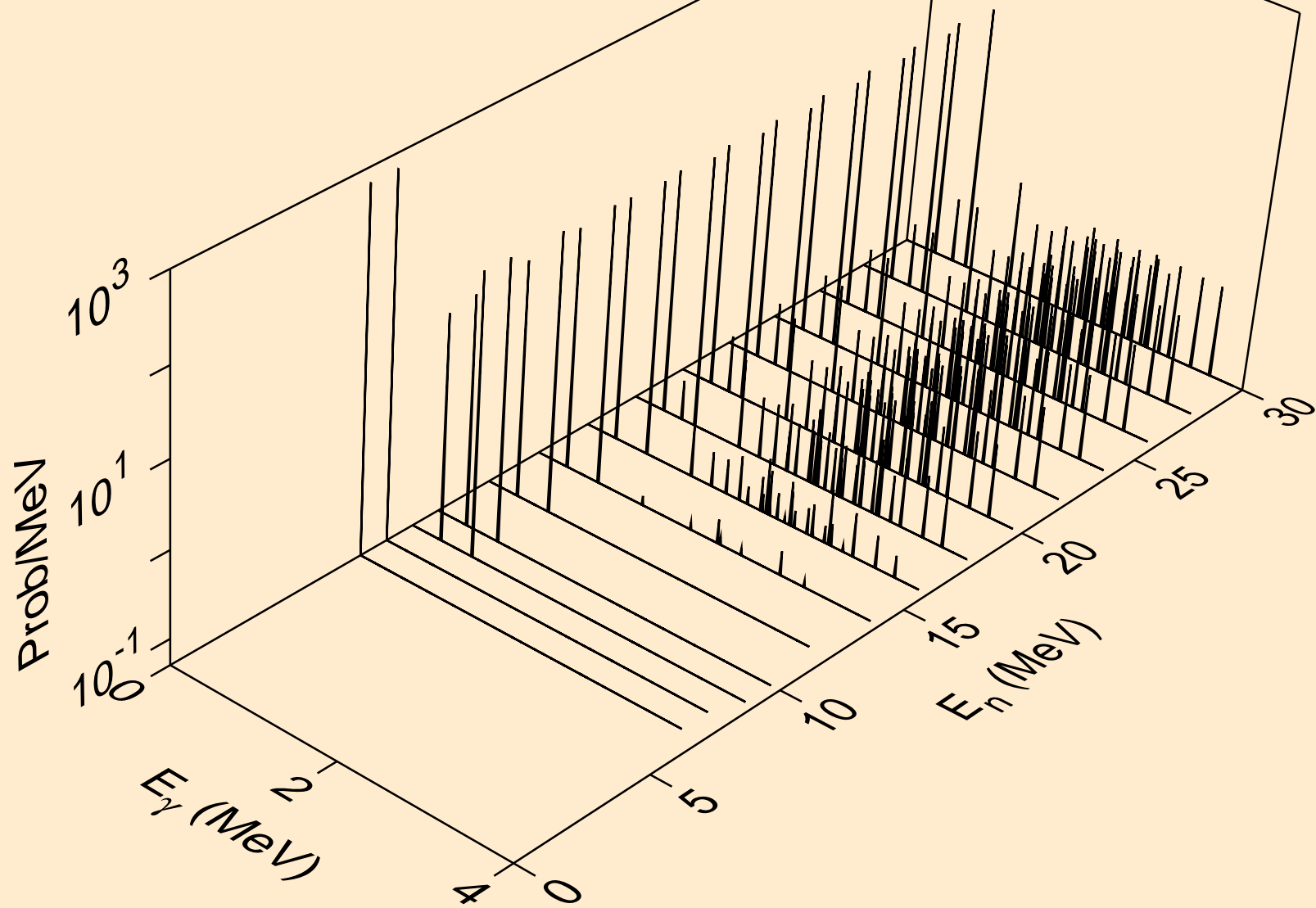

SN134 HELION ACER TENDL-2021 LIBRARY; T=0.K  
Photon emission for (n,a)

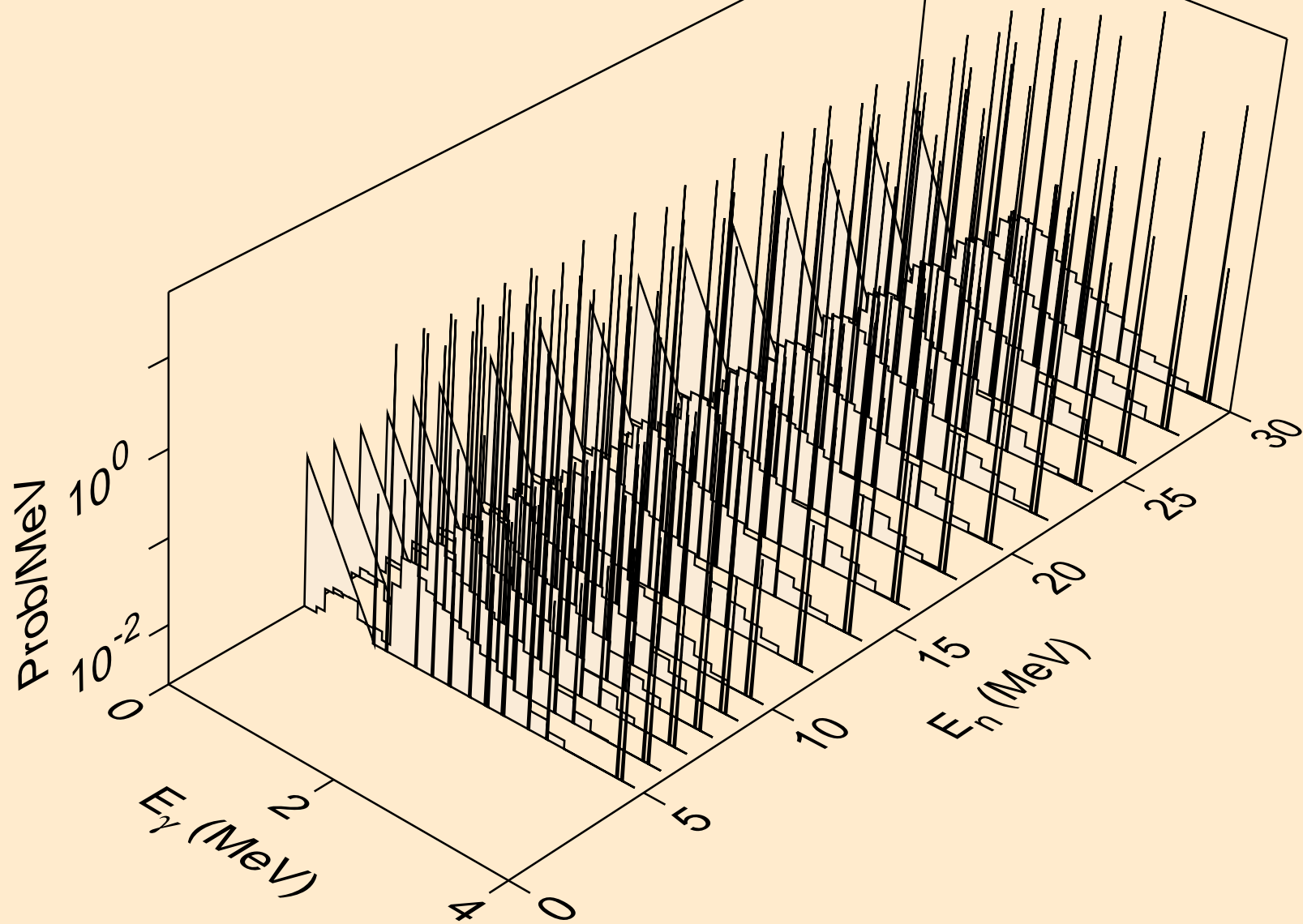

SN134 HELION ACER TENDL-2021 LIBRARY; T=0.K  
Photon emission for (n,2p)

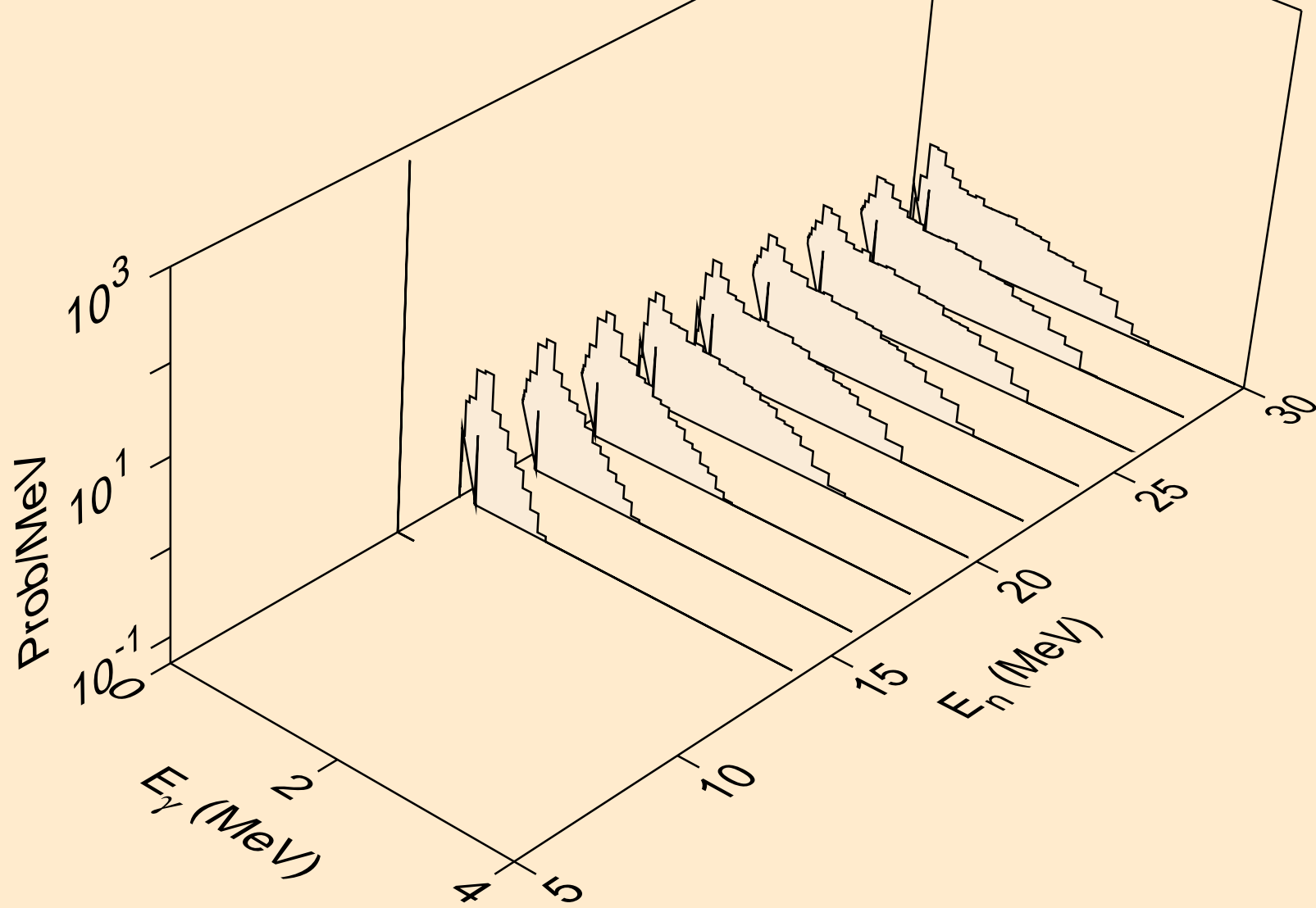

SN134 HELION ACER TENDL-2021 LIBRARY; T=0.K  
Photon emission for (n,pd)

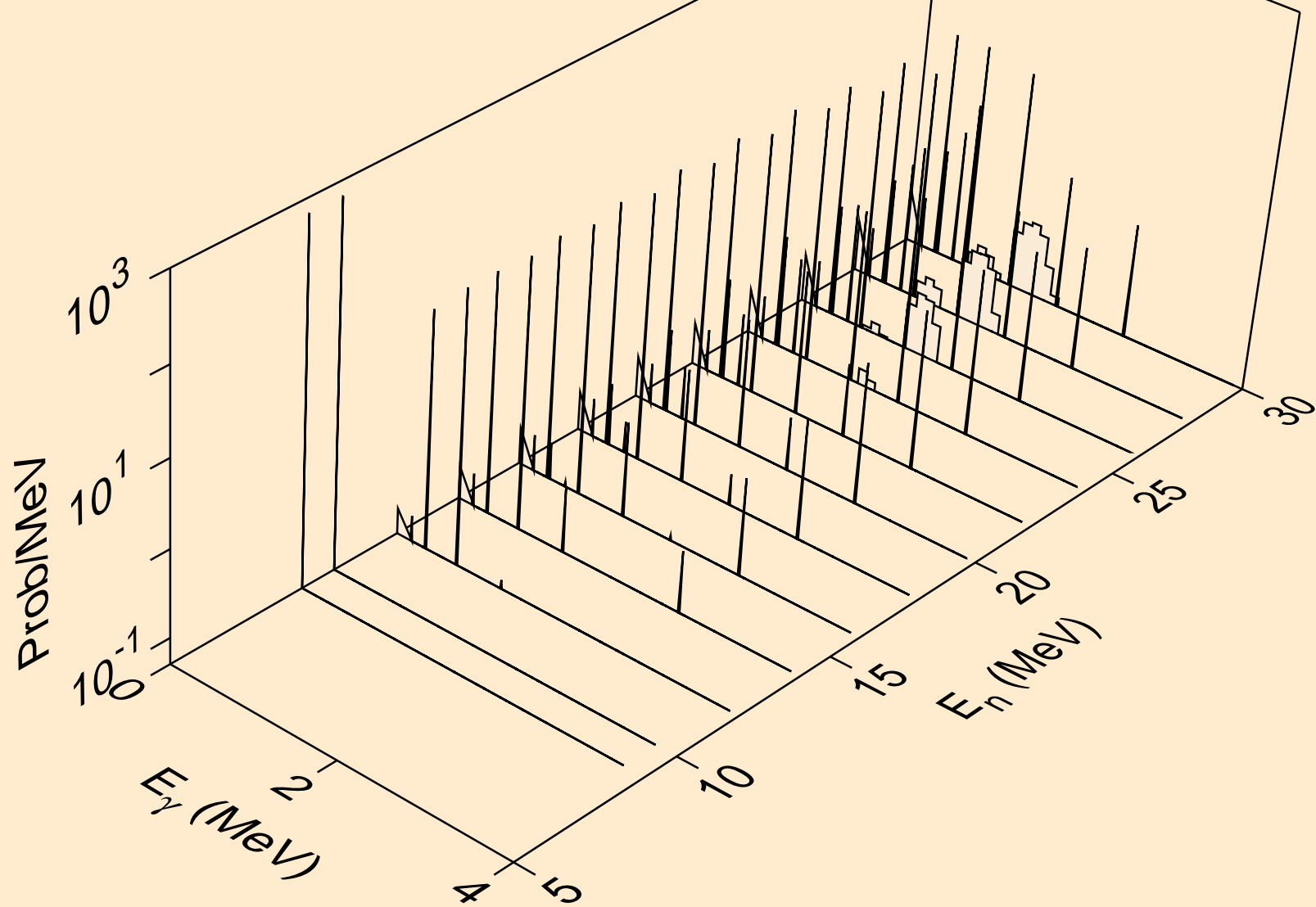



SN134 HELION ACER TENDL-2021 LIBRARY; T=0.K  
Photon emission for (n,pt)

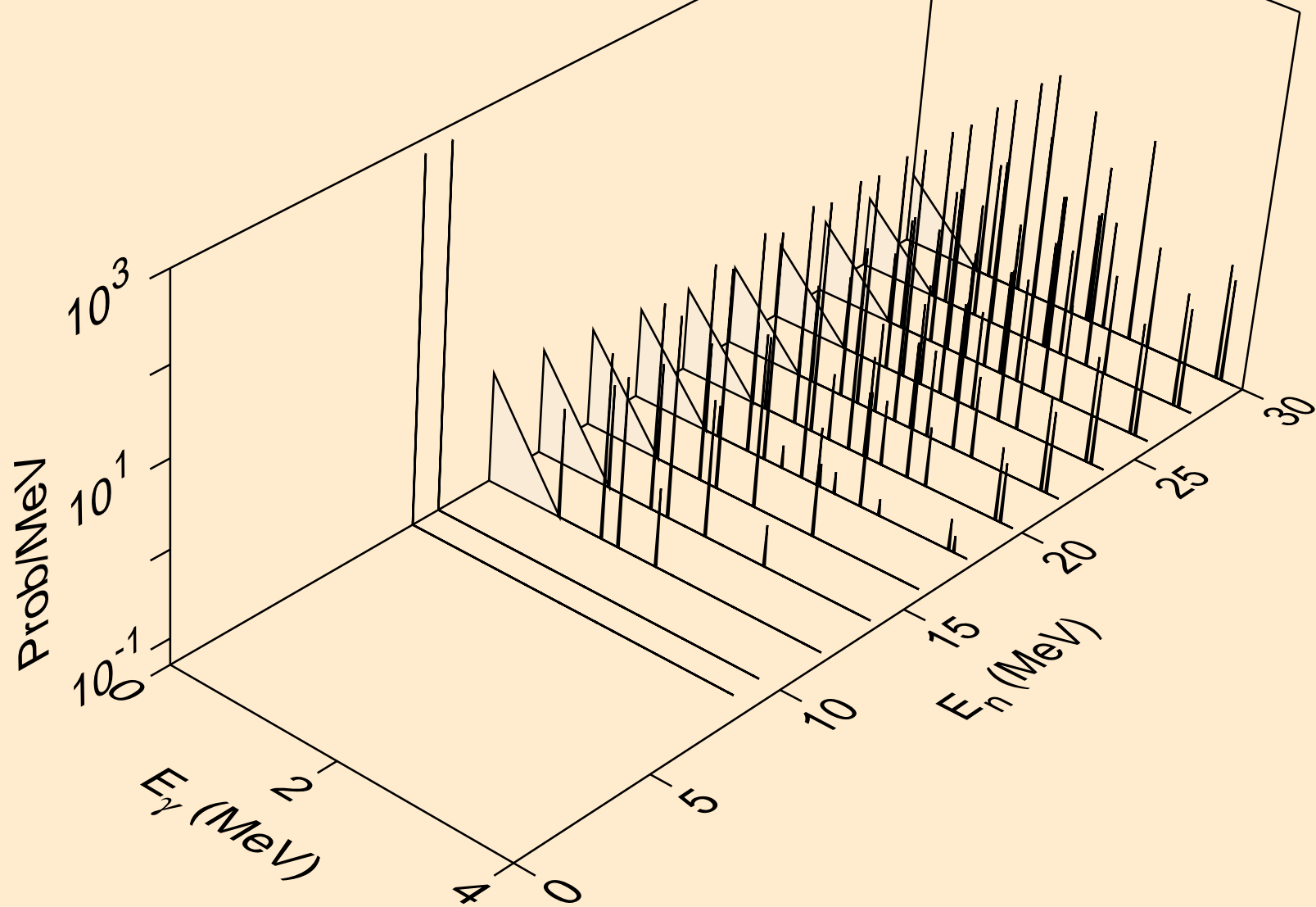

SN134 HELION ACER TENDL-2021 LIBRARY; T=0.K  
Photon emission for (n,da)

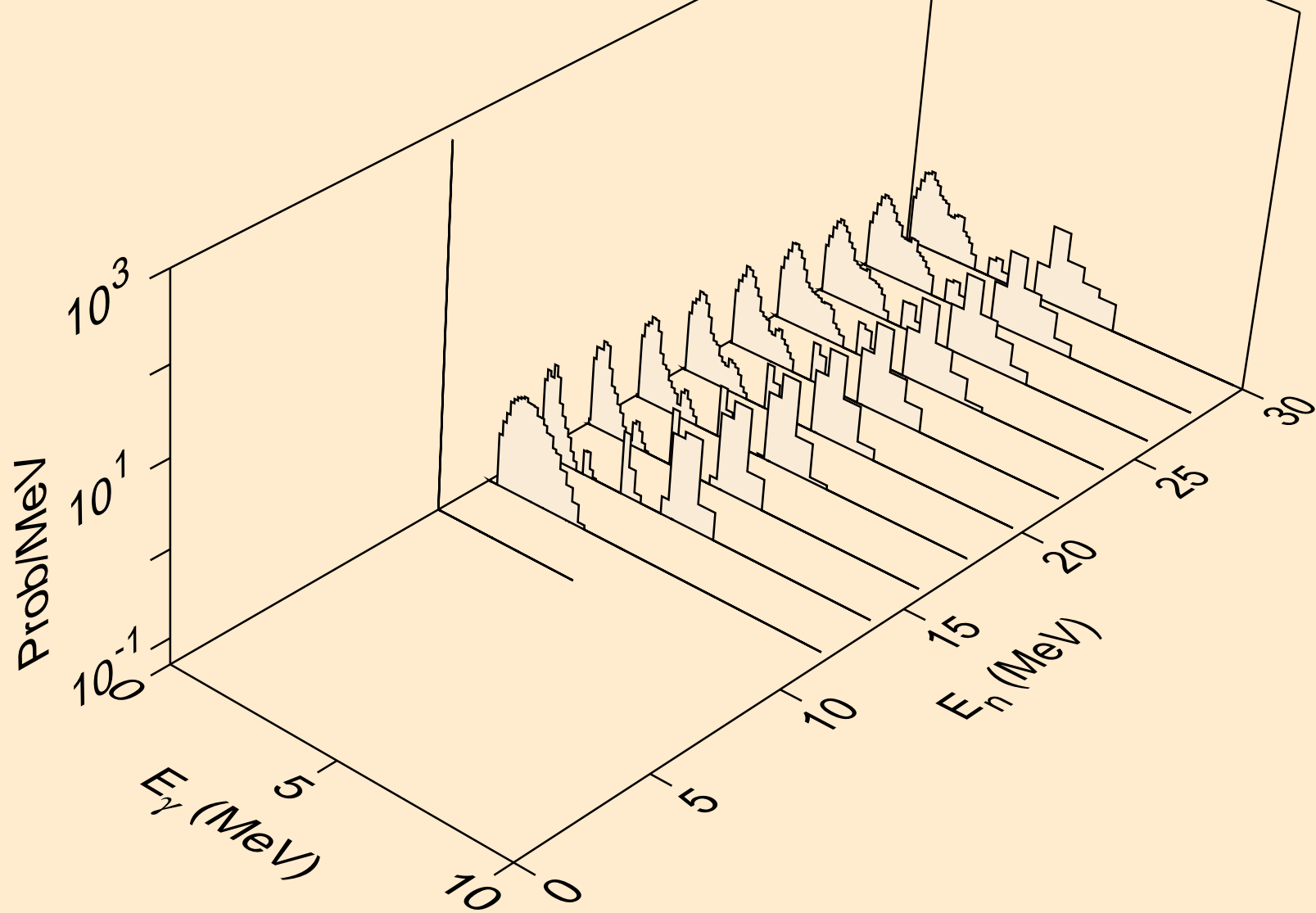

# SN134 HELION ACER TENDL-2021 LIBRARY; T=0.K

## Particle heating contributions

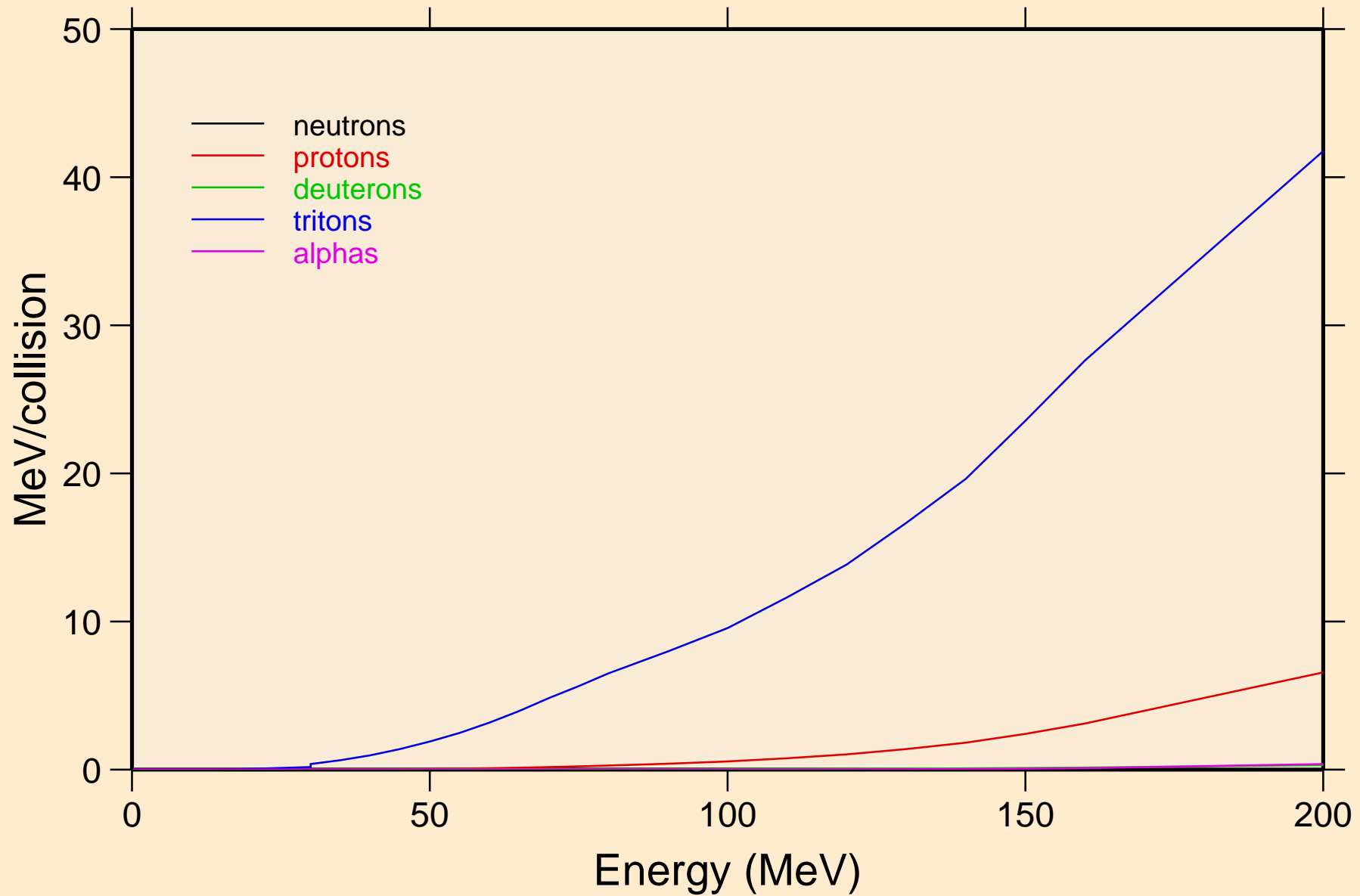

SN134 HELION ACER TENDL-2021 LIBRARY; T=0.K  
Recoil Heating

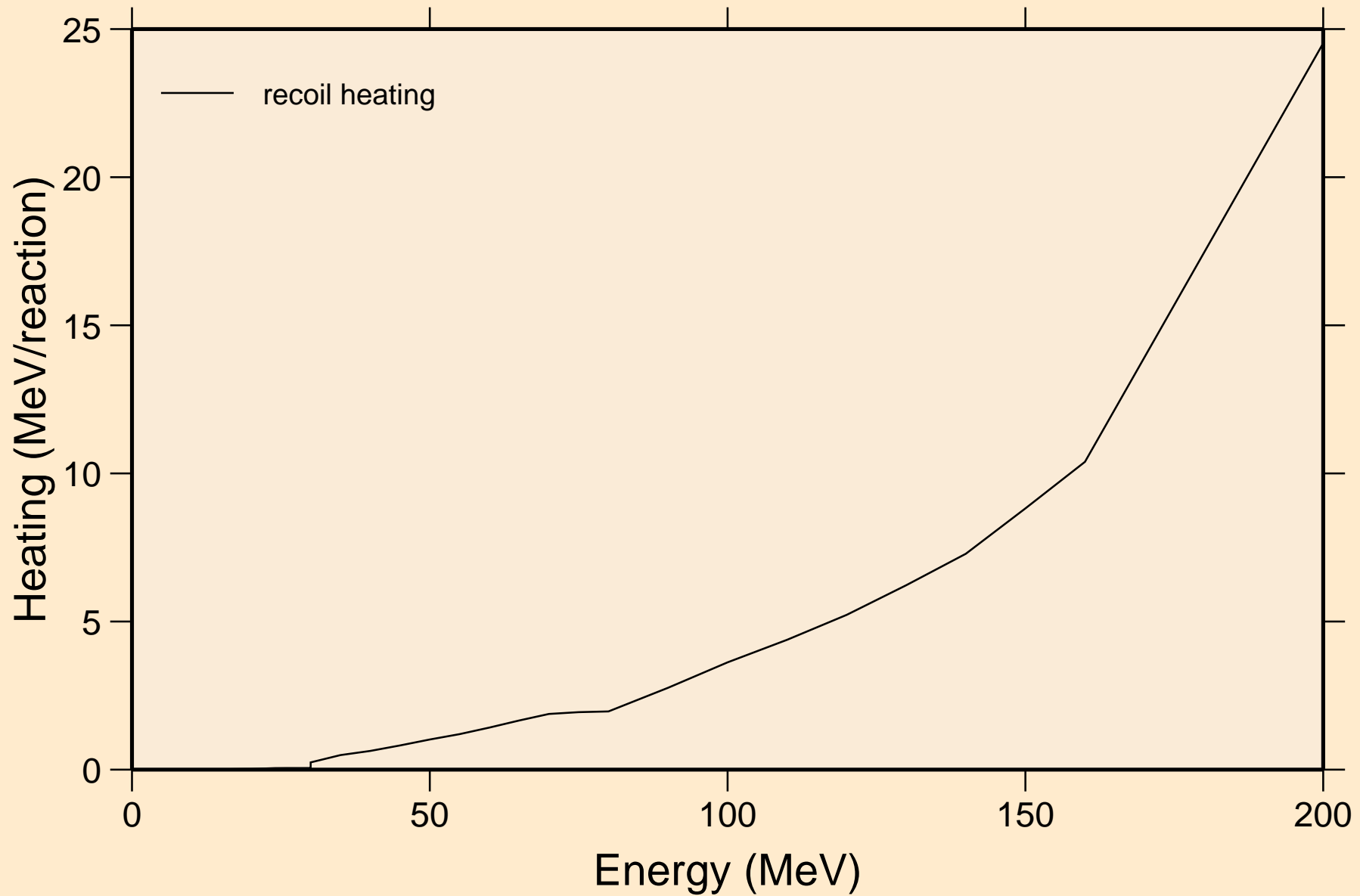

SN134 HELION ACER TENDL-2021 LIBRARY; T=0.K  
Particle production cross sections

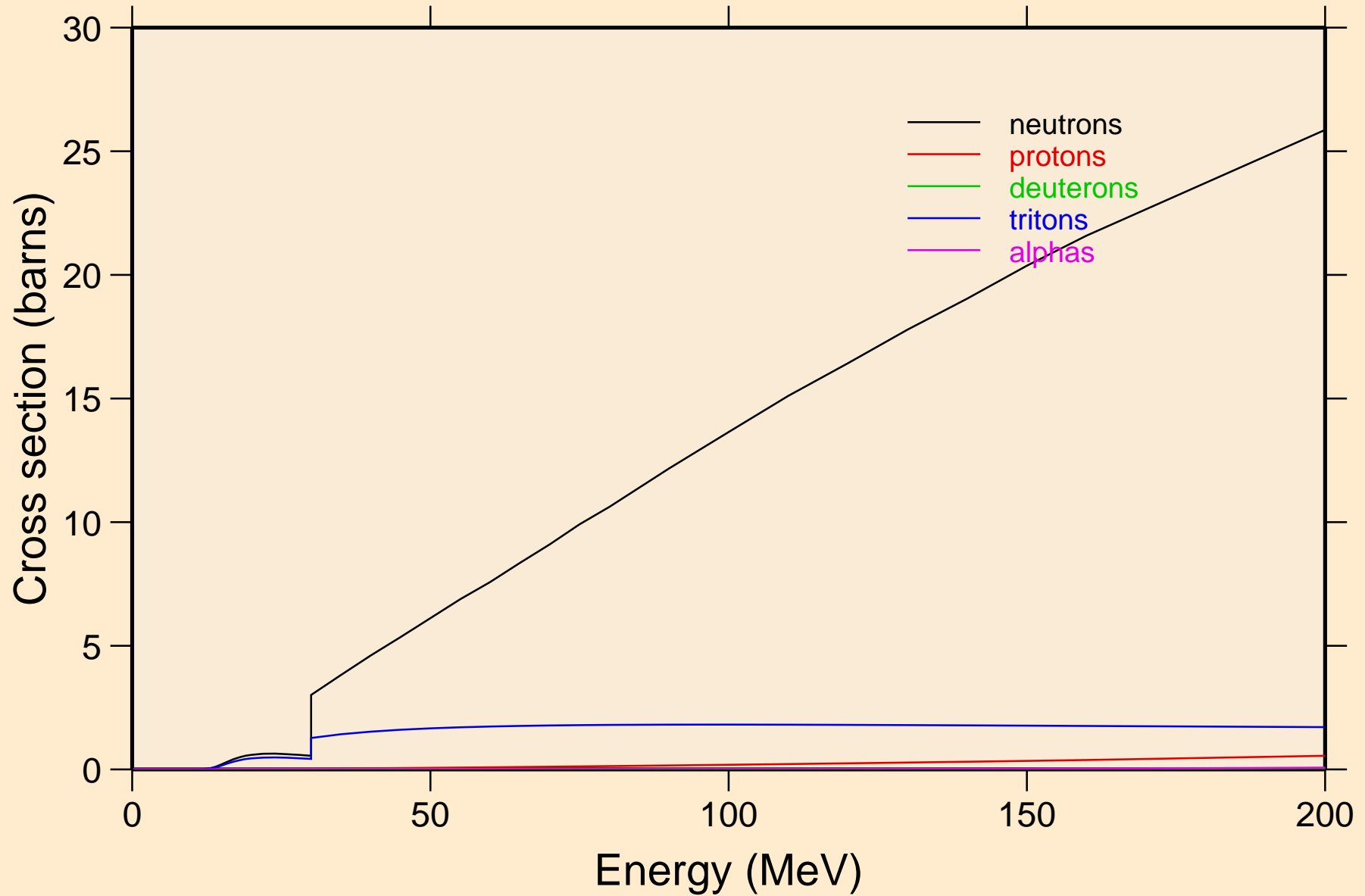

SN134 HELION ACER TENDL-2021 LIBRARY; T=0.K  
neutrons from (s,n)

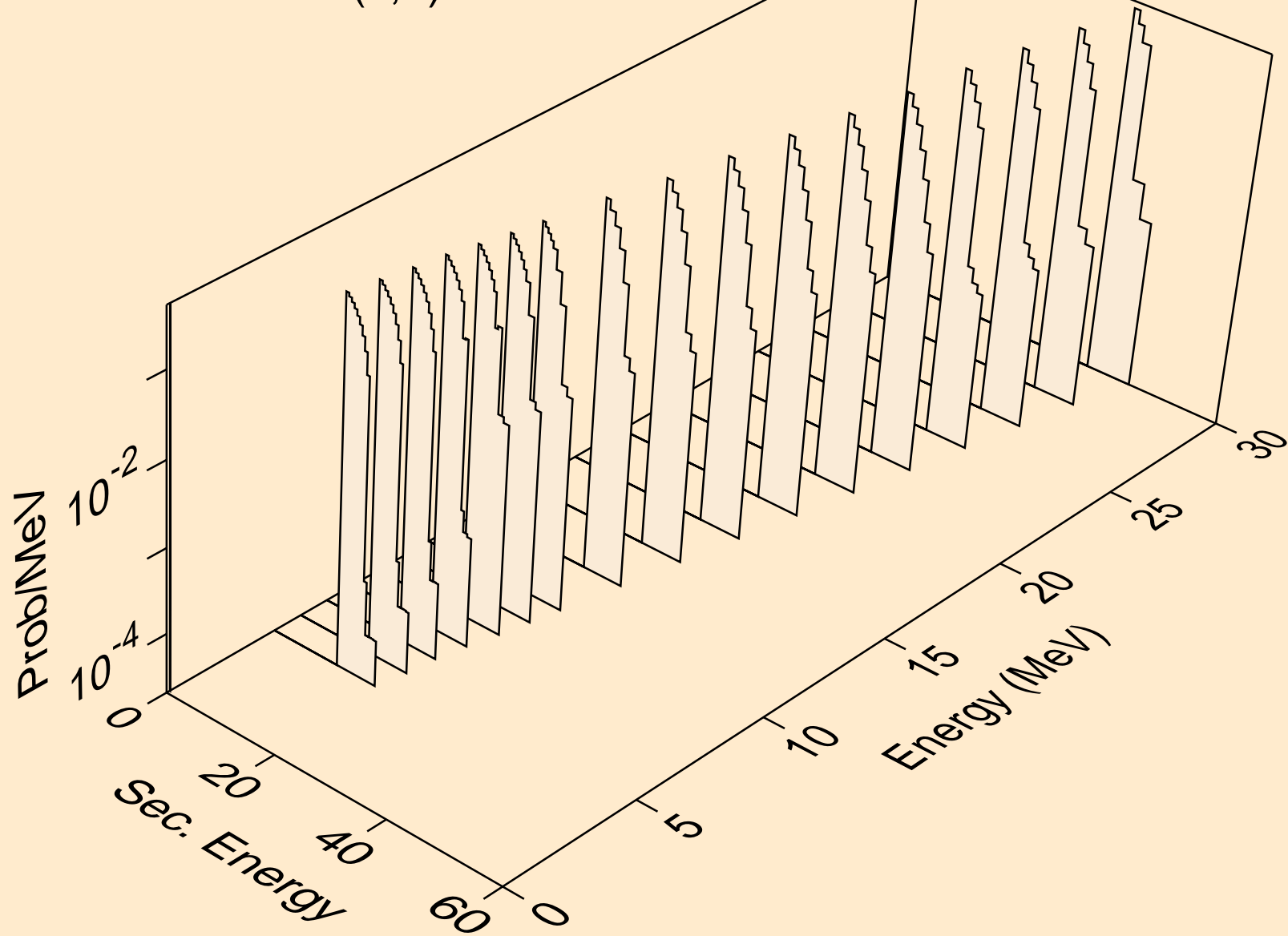

SN134 HELION ACER TENDL-2021 LIBRARY; T=0.K  
neutrons from (s,x)

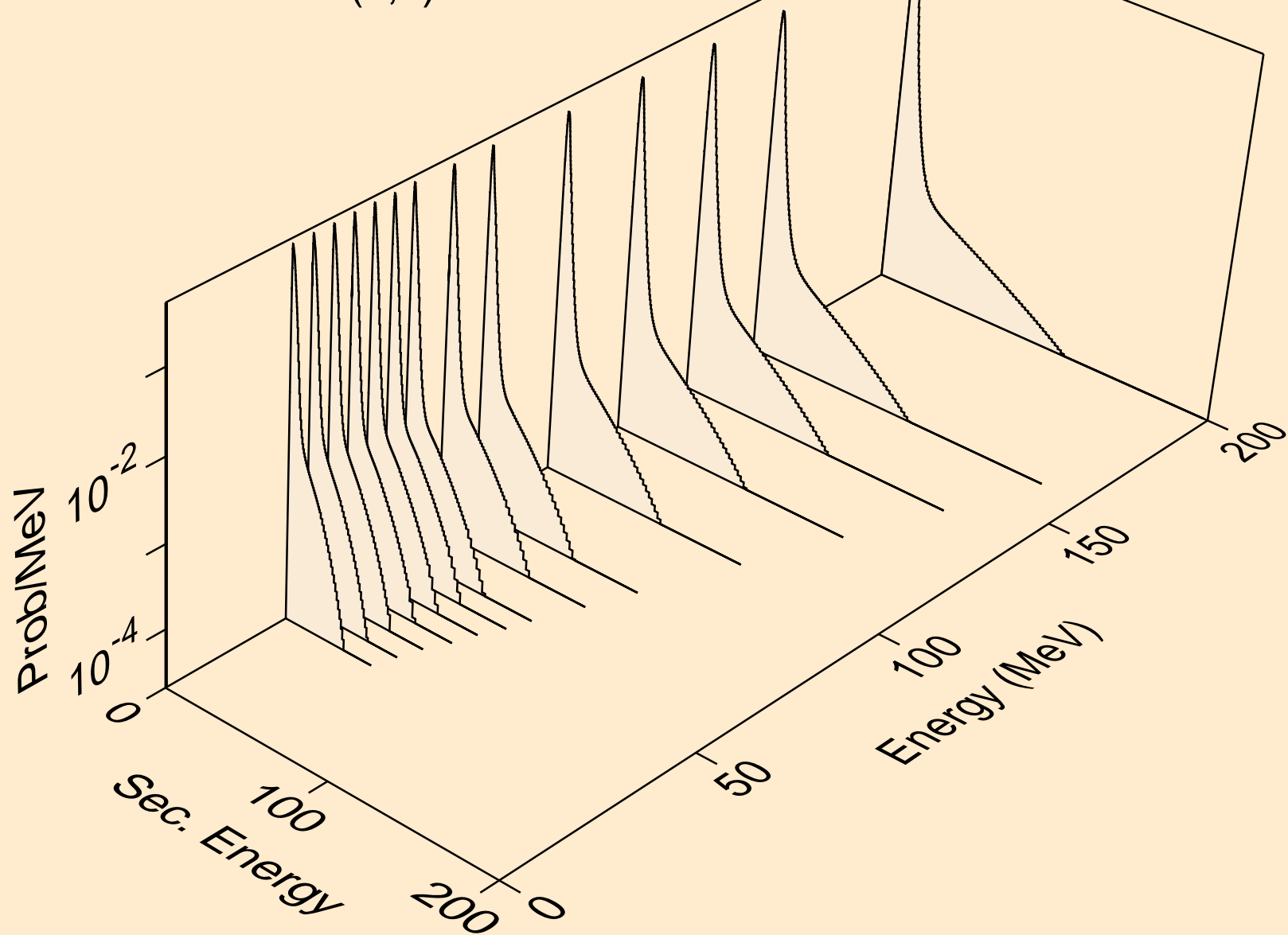

SN134 HELION ACER TENDL-2021 LIBRARY; T=0.K  
neutrons from (s,2nd)

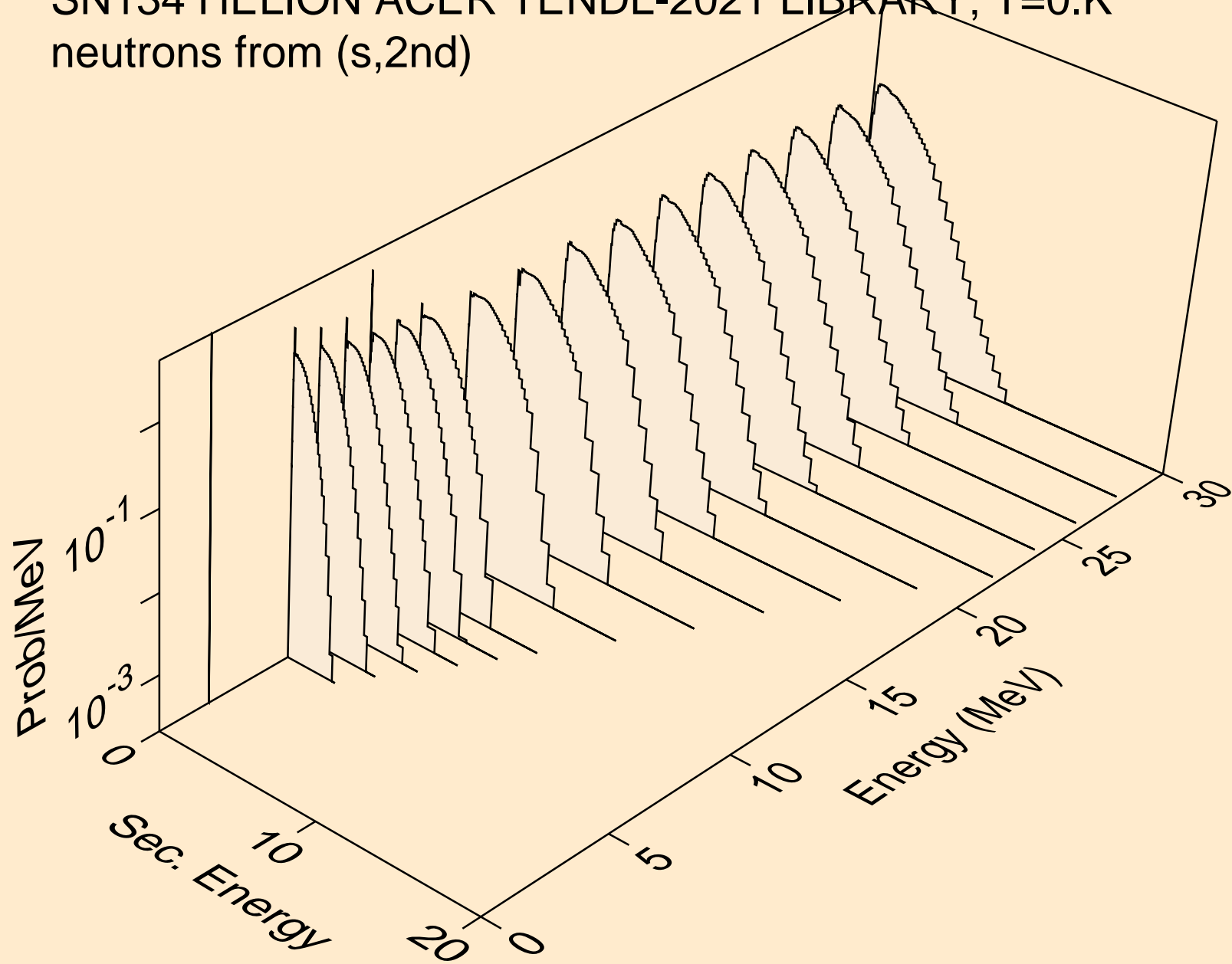



SN134 HELION ACER TENDL-2021 LIBRARY; T=0.K  
neutrons from (s,2n)

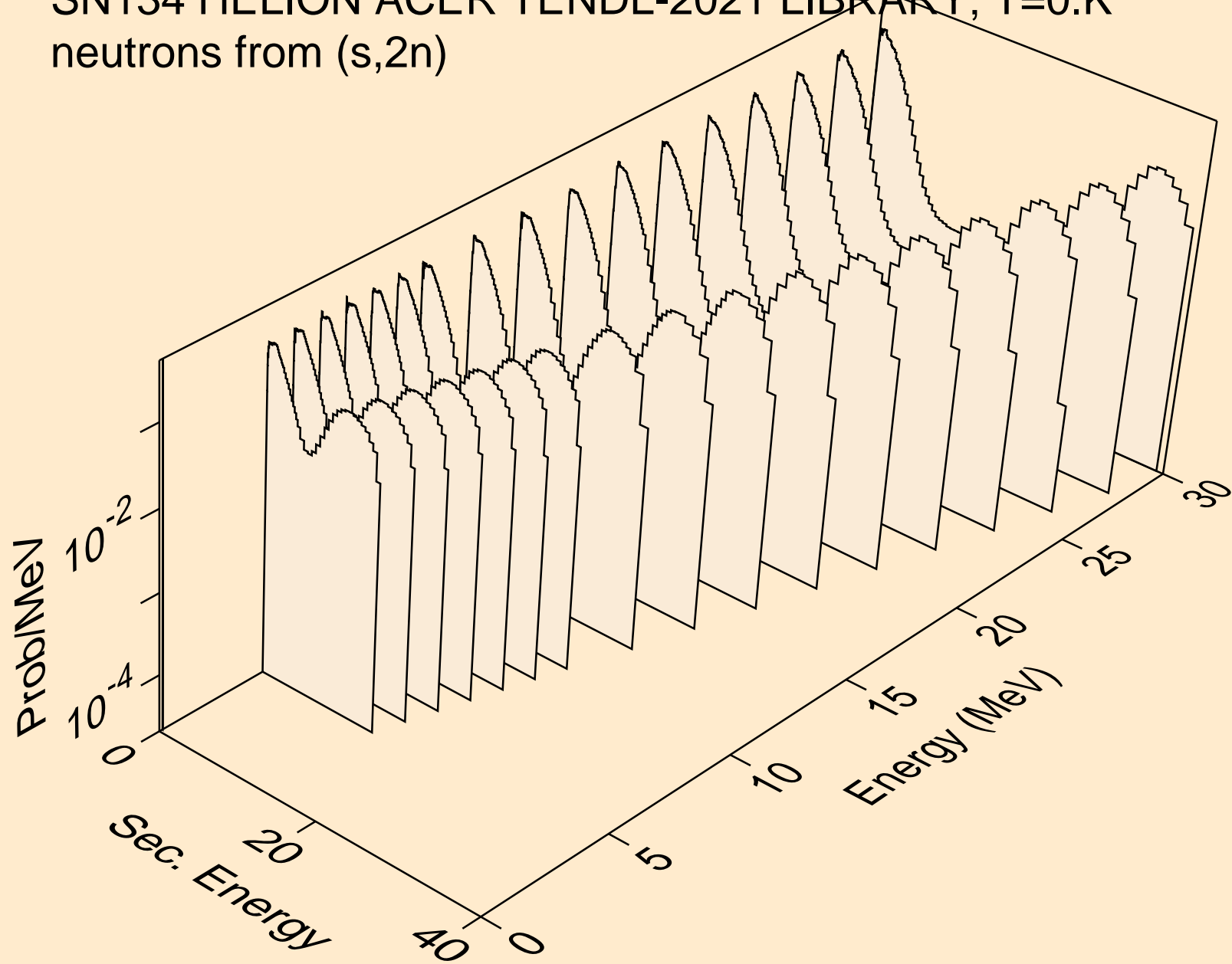

SN134 HELION ACER TENDL-2021 LIBRARY; T=0.K  
neutrons from (s,3n)

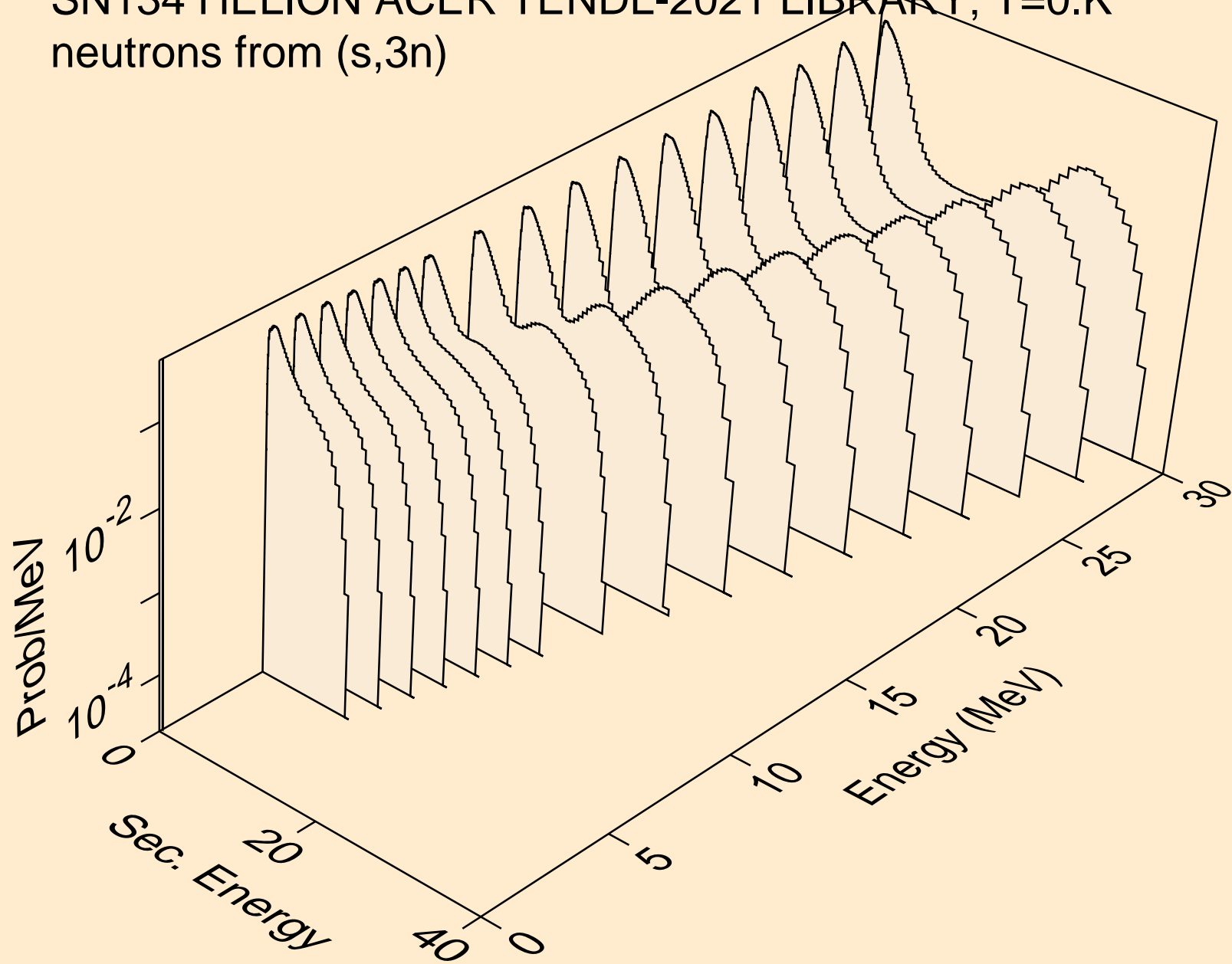

SN134 HELION ACER TENDL-2021 LIBRARY; T=0.K  
neutrons from (s,n\*)a

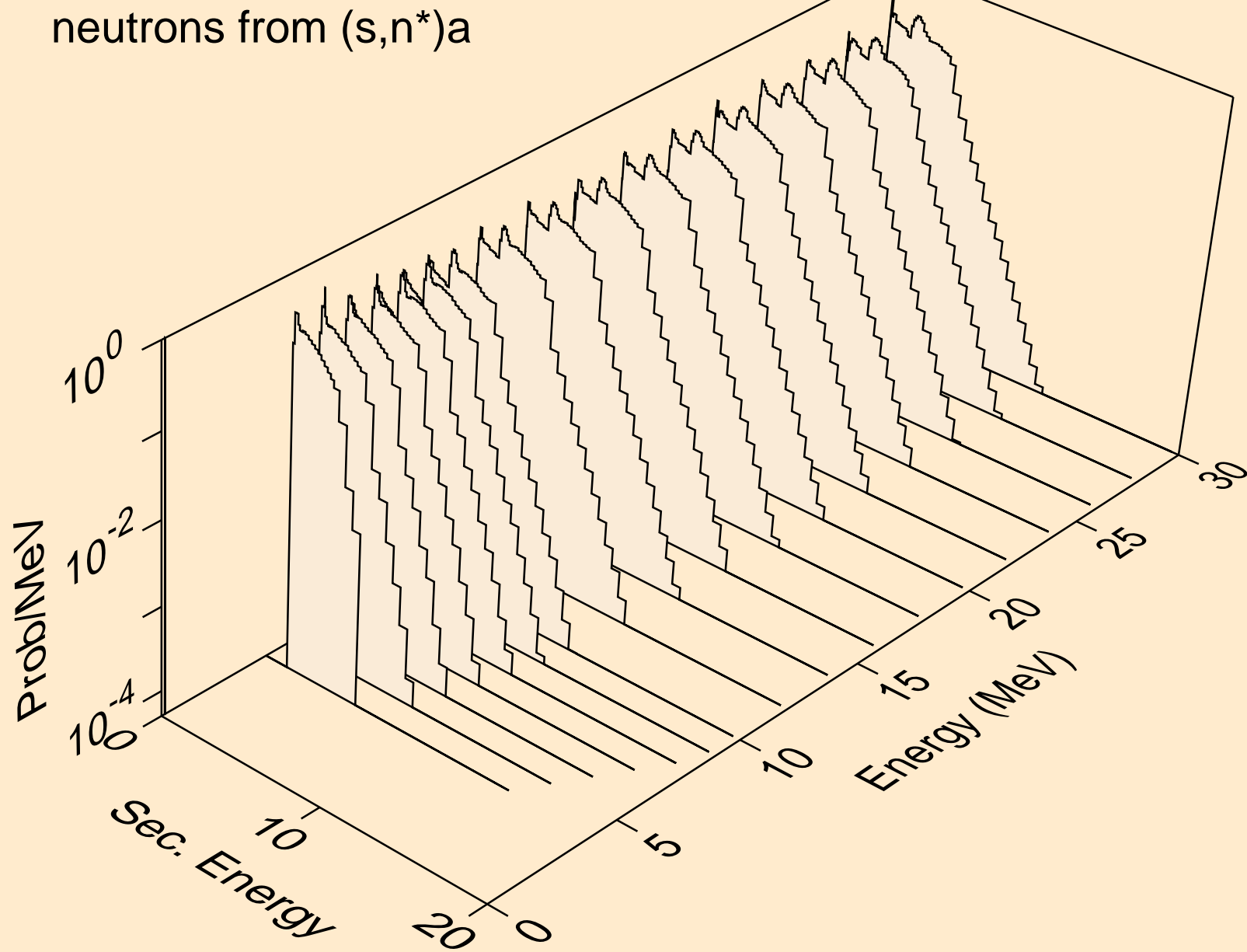

SN134 HELION ACER TENDL-2021 LIBRARY; T=0.K  
neutrons from (s,2n)a

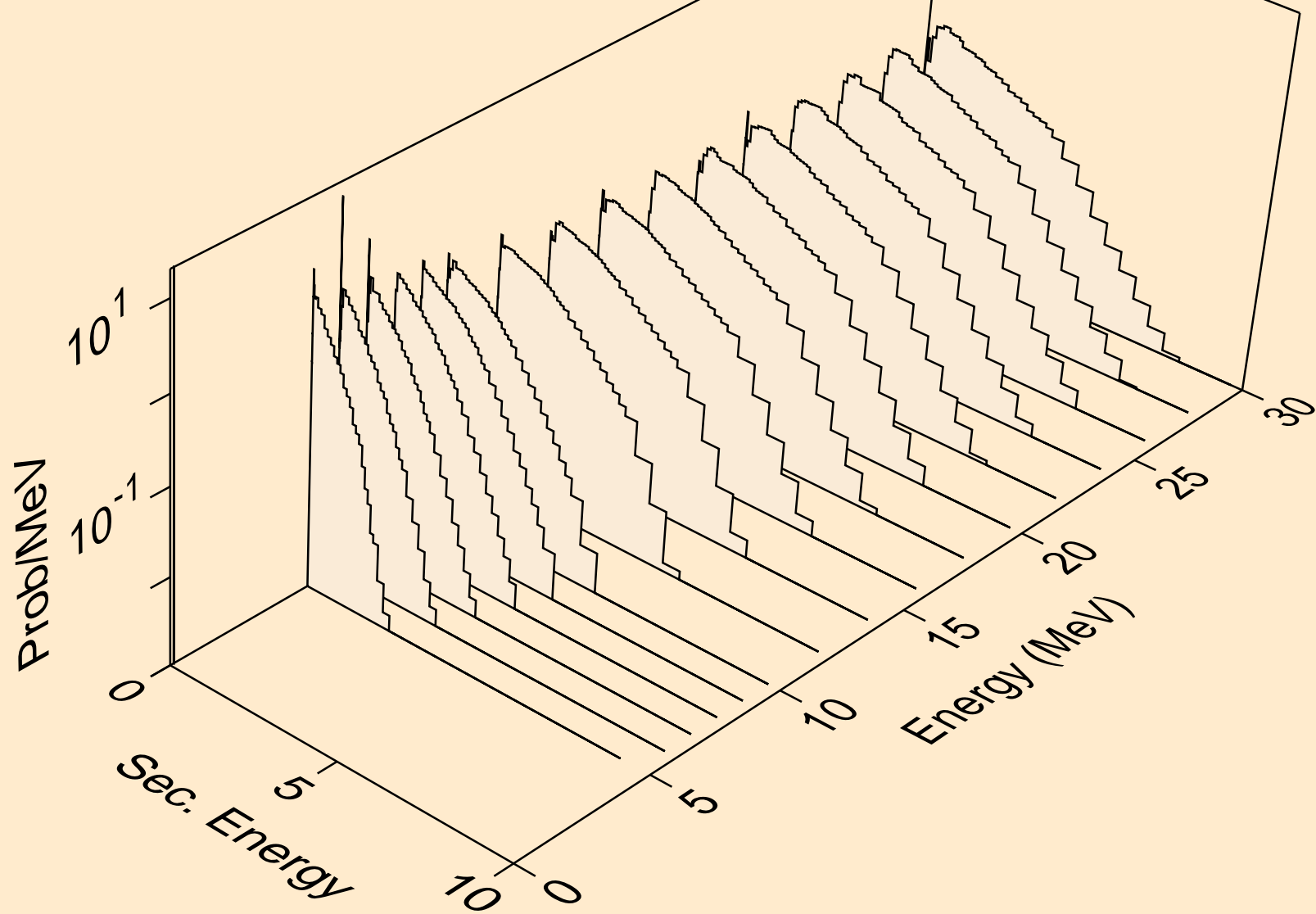

SN134 HELION ACER TENDL-2021 LIBRARY; T=0.K  
neutrons from (s,3n)a

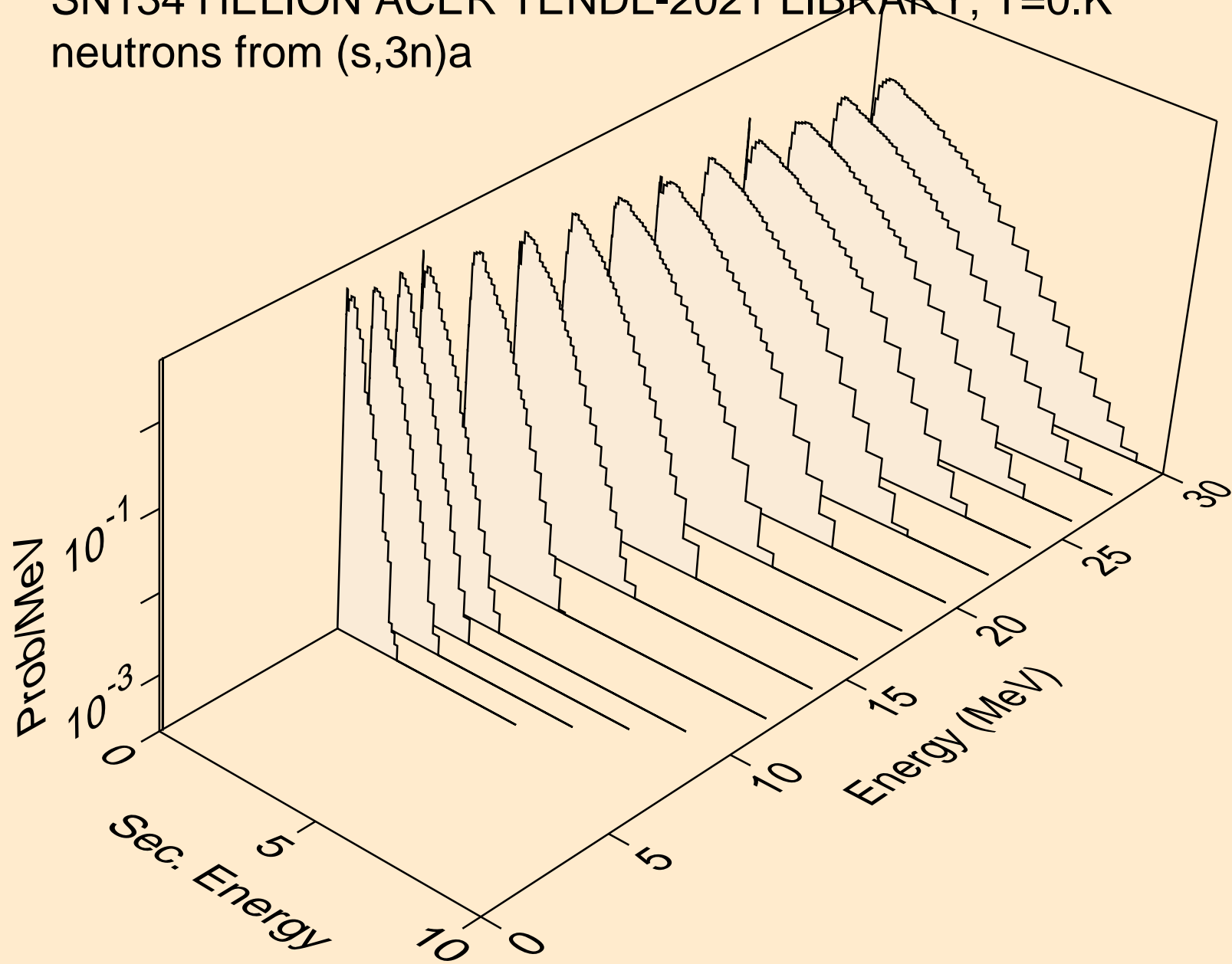

SN134 HELION ACER TENDL-2021 LIBRARY; T=0.K  
neutrons from (s,n\*)p

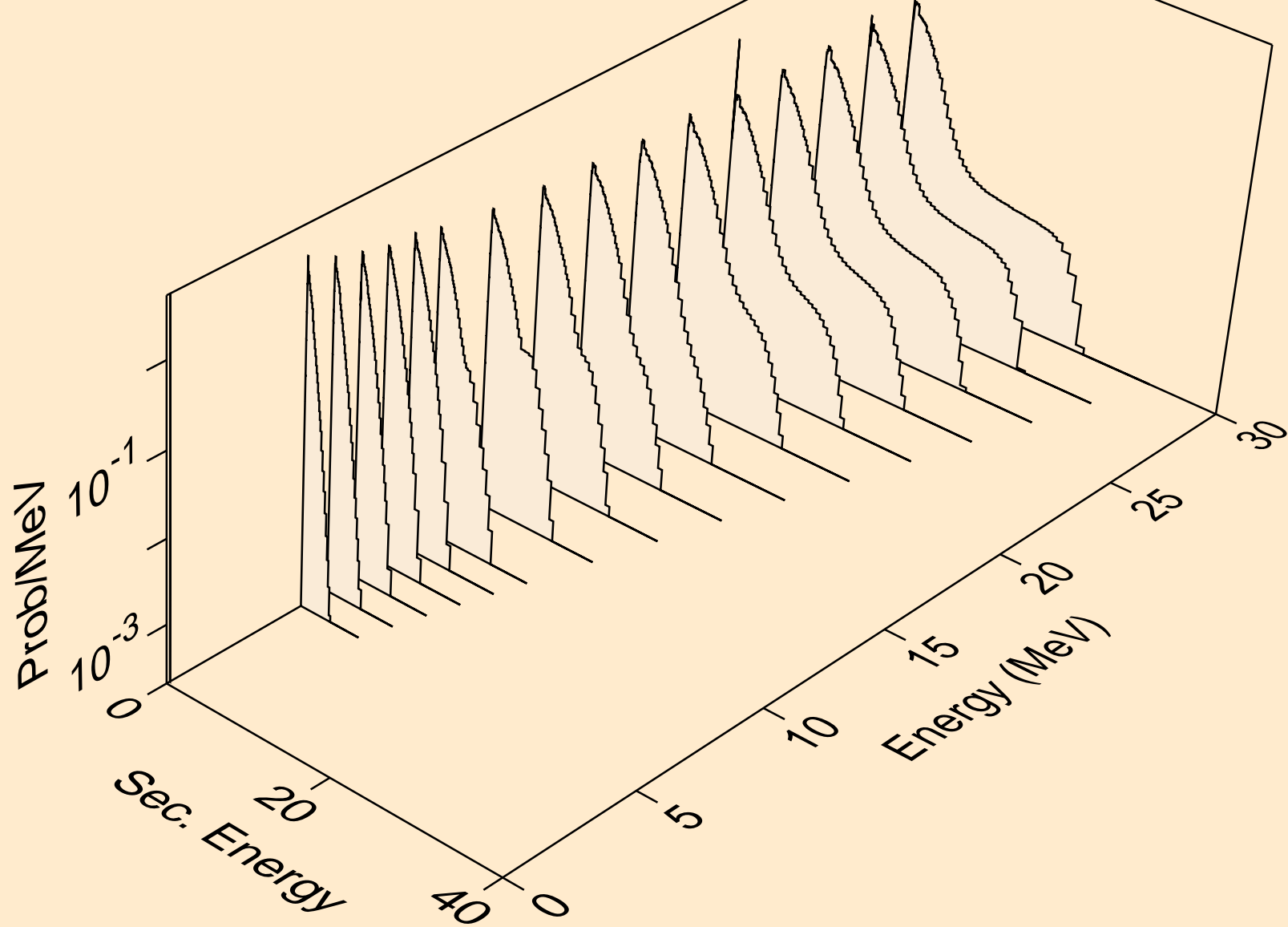

SN134 HELION ACER TENDL-2021 LIBRARY; T=0.K  
neutrons from (s,n\*)d

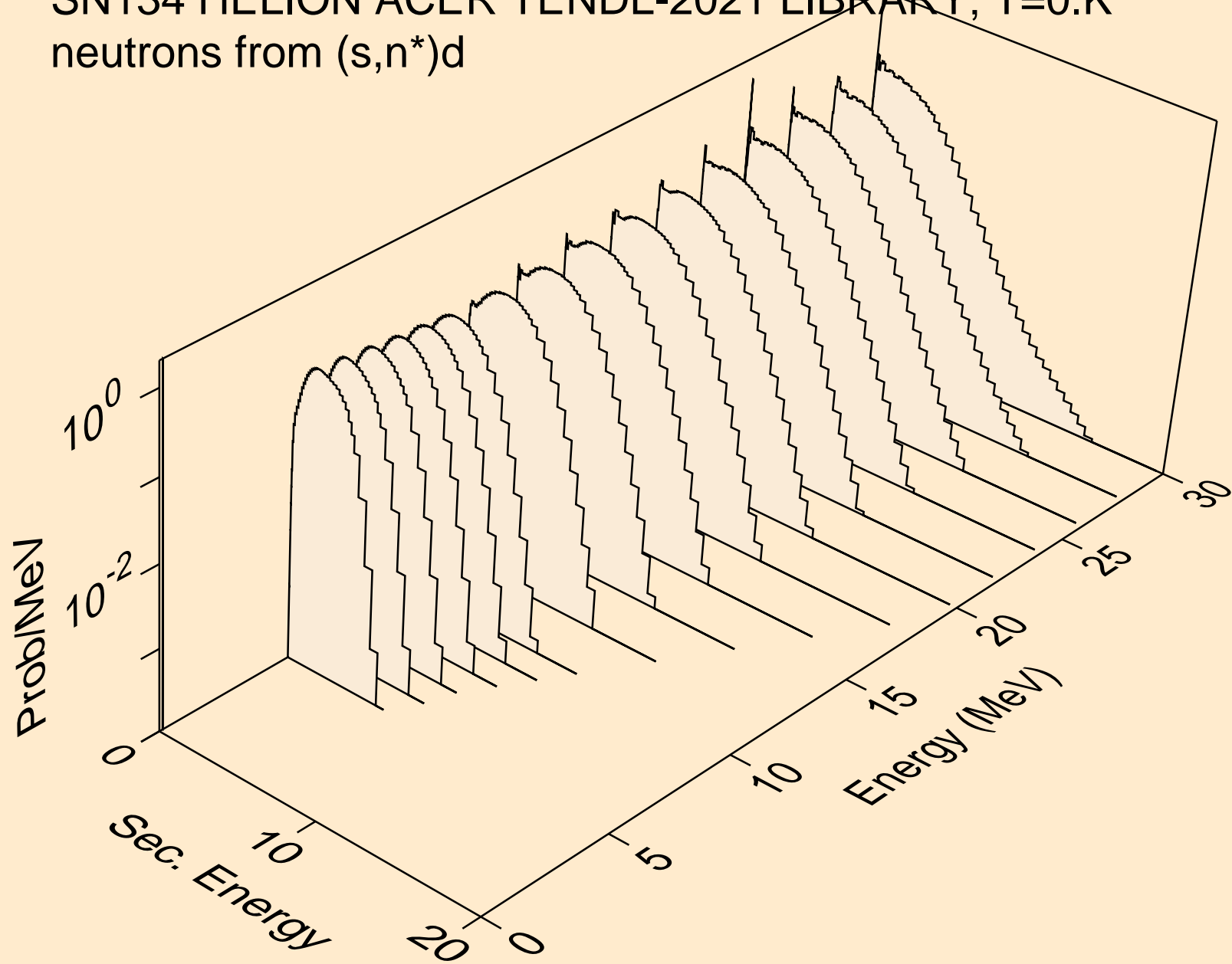

SN134 HELION ACER TENDL-2021 LIBRARY; T=0.K  
neutrons from (s,n\*)t

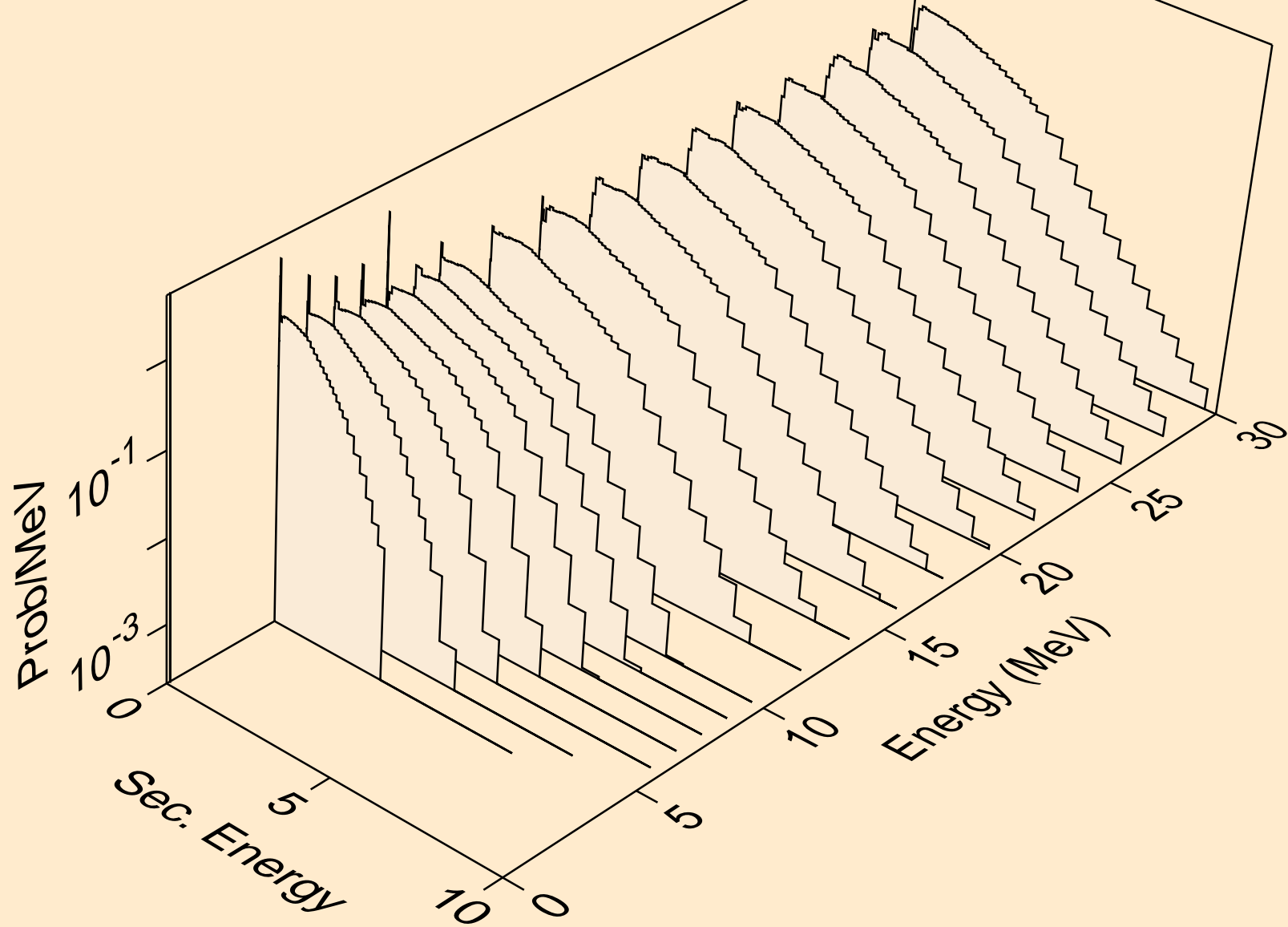



SN134 HELION ACER TENDL-2021 LIBRARY; T=0.K  
neutrons from (s,n\*)he3

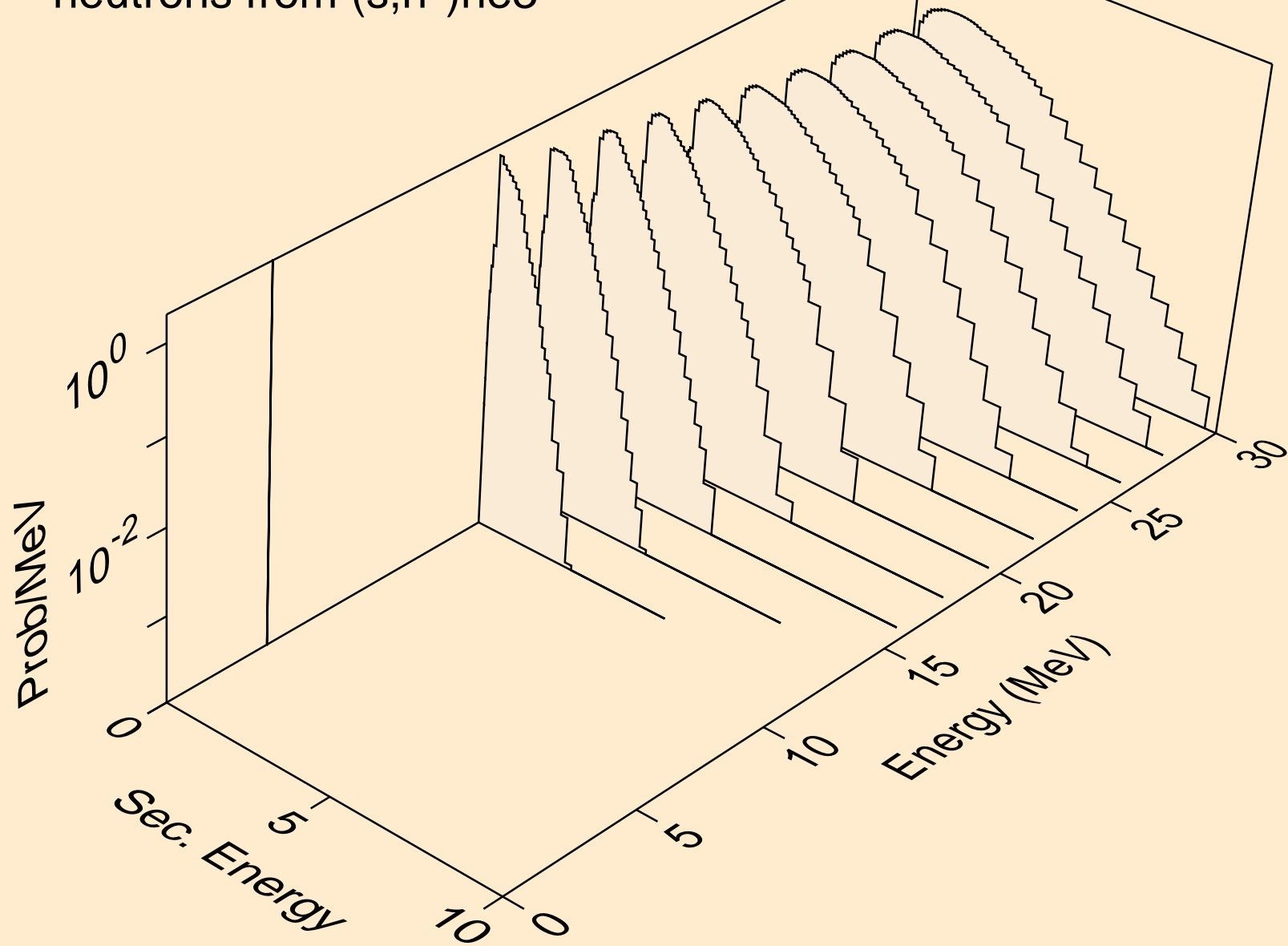

SN134 HELION ACER TENDL-2021 LIBRARY; T=0.K  
neutrons from (s,4n)

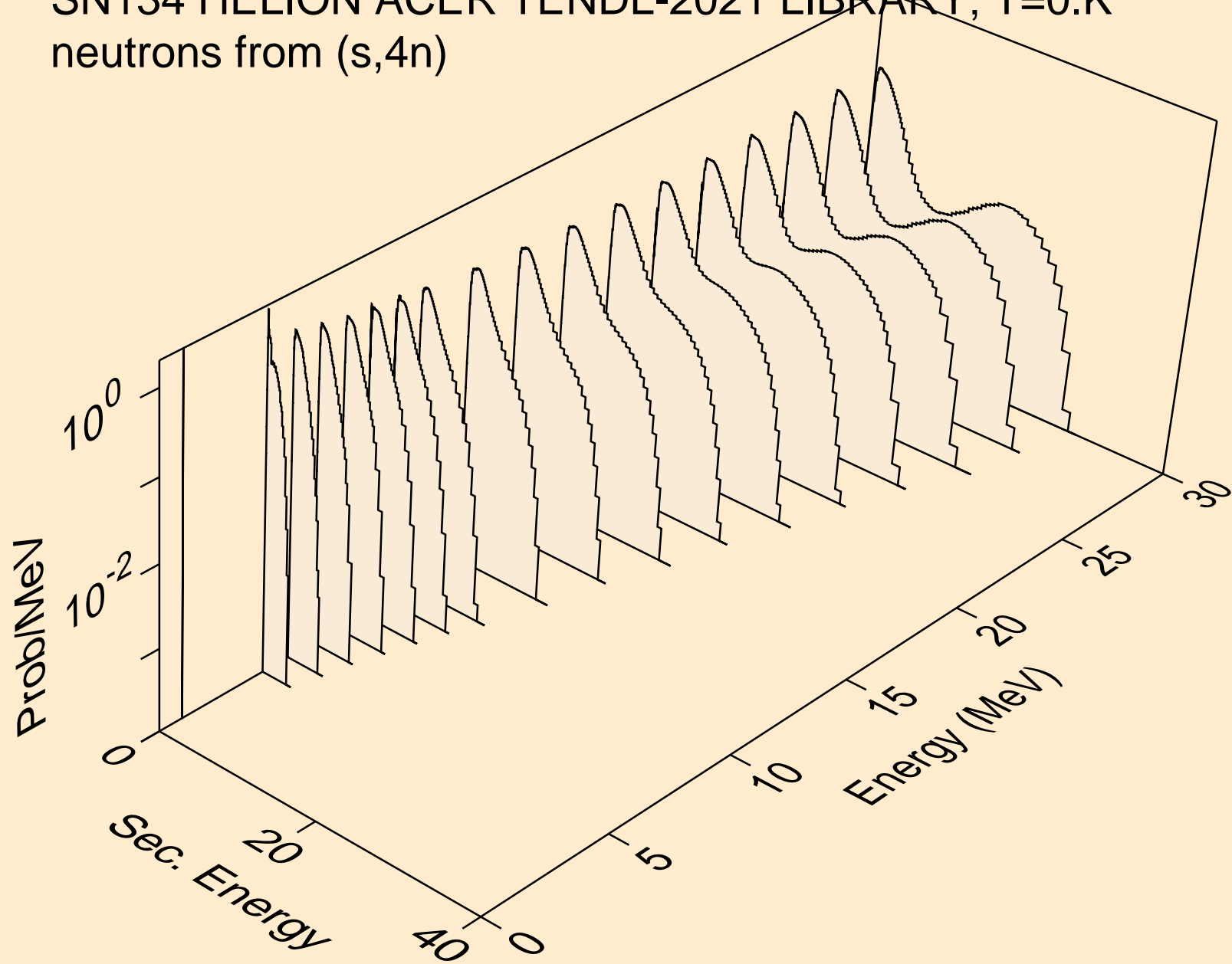

SN134 HELION ACER TENDL-2021 LIBRARY; T=0.K  
neutrons from (s,2np)

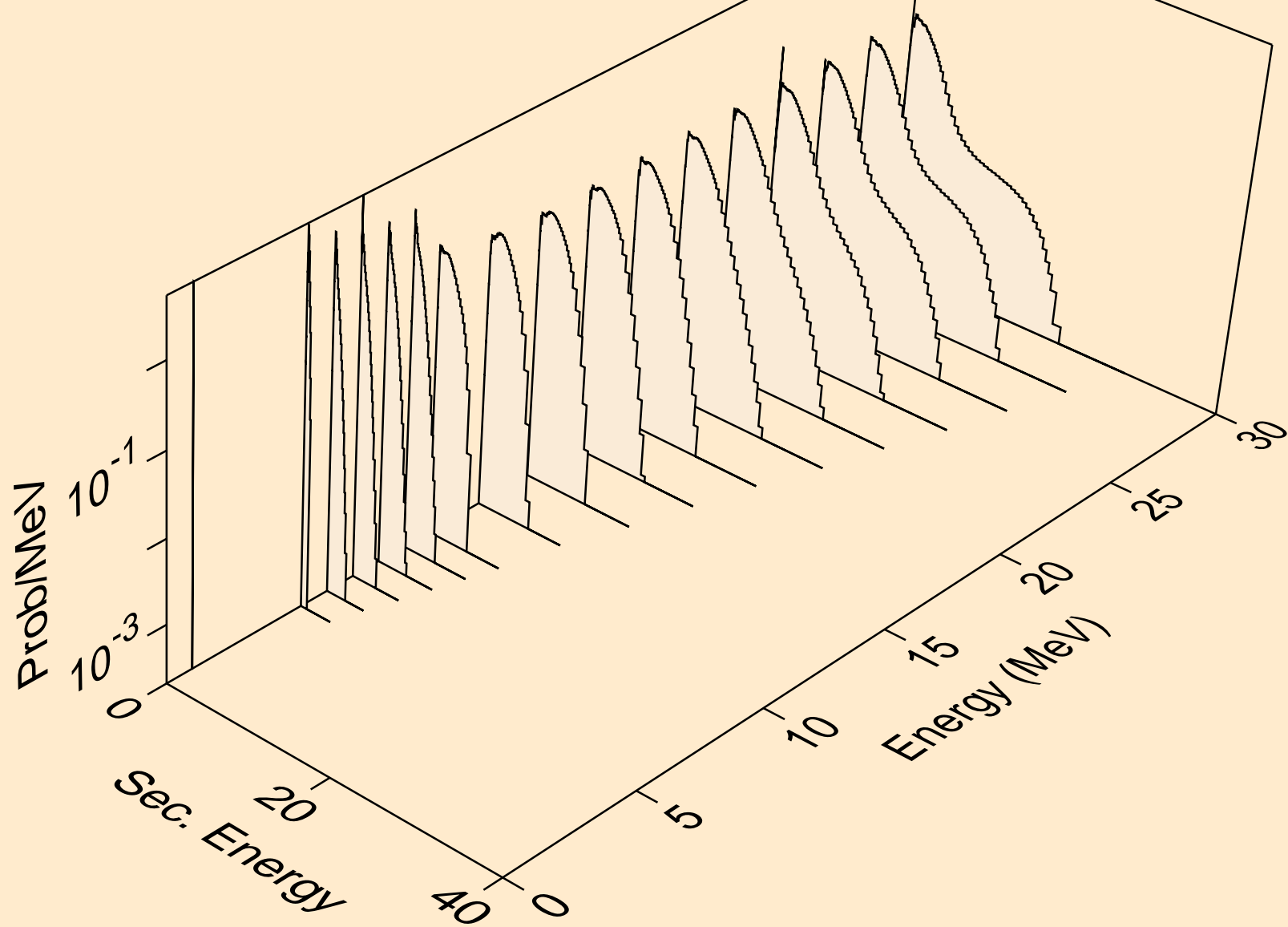

SN134 HELION ACER TENDL-2021 LIBRARY; T=0.K  
neutrons from (s,3np)

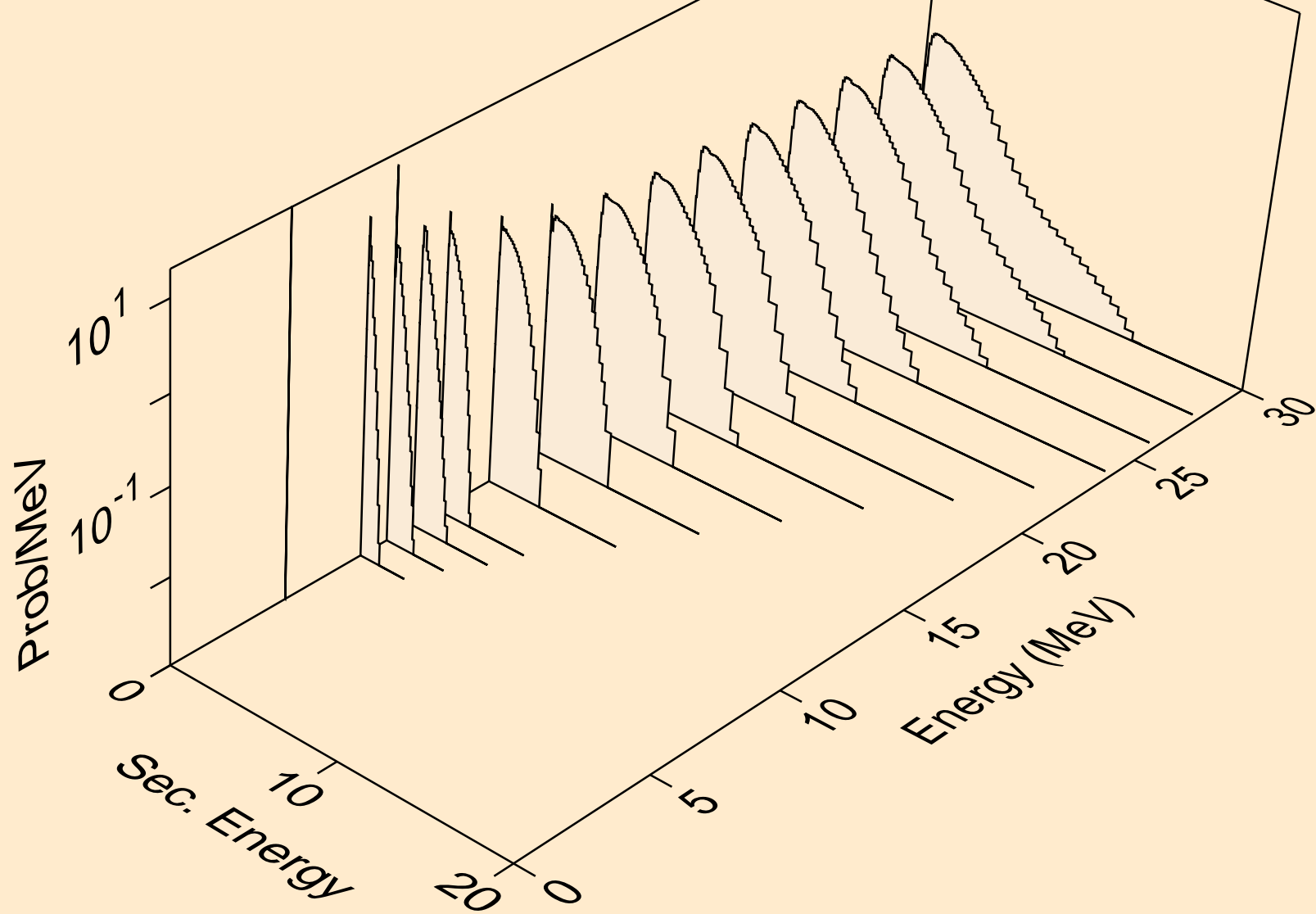

SN134 HELION ACER TENDL-2021 LIBRARY; T=0.K  
neutrons from (s,2np)

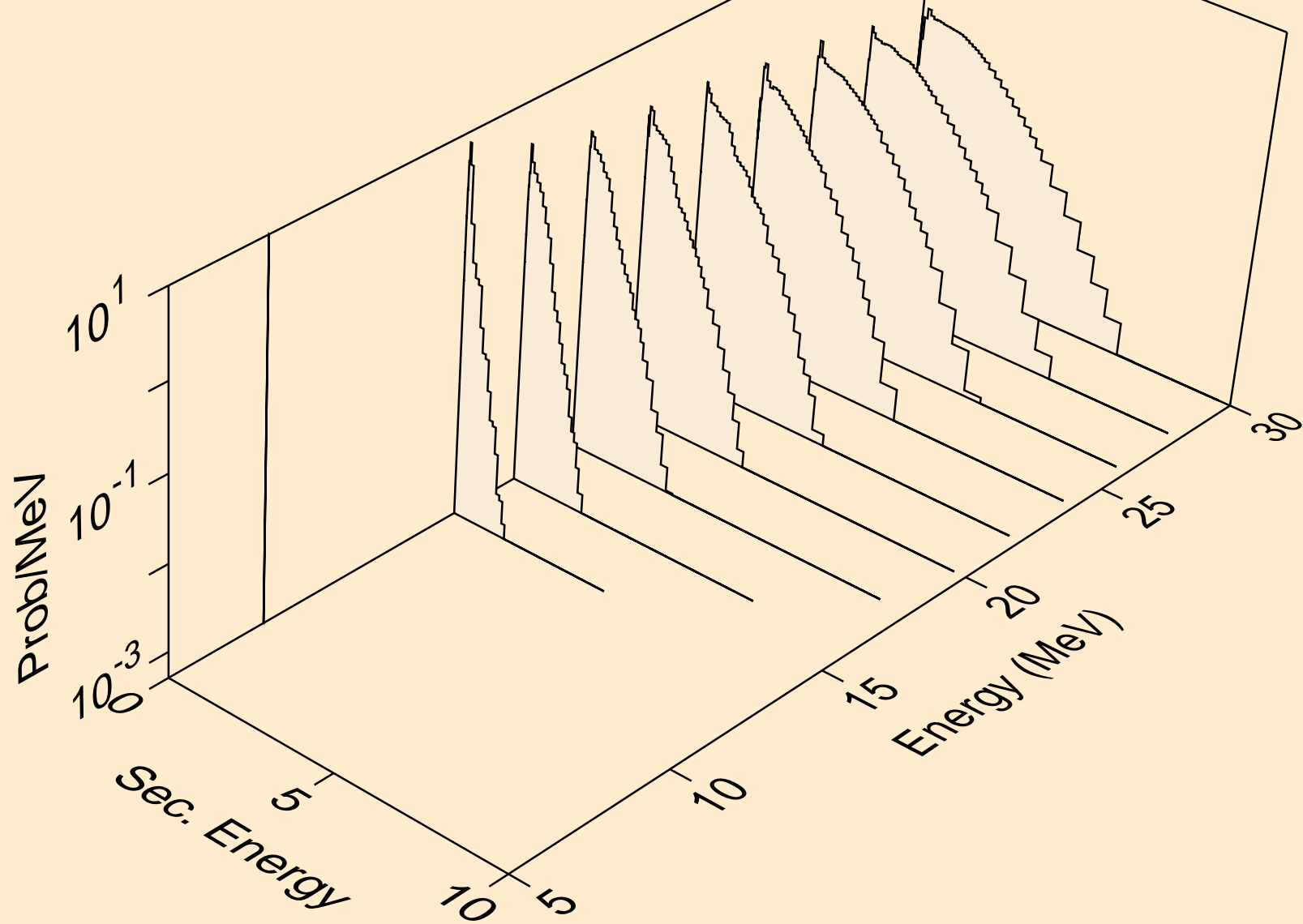

SN134 HELION ACER TENDL-2021 LIBRARY; T=0.K  
neutrons from (s,npa)

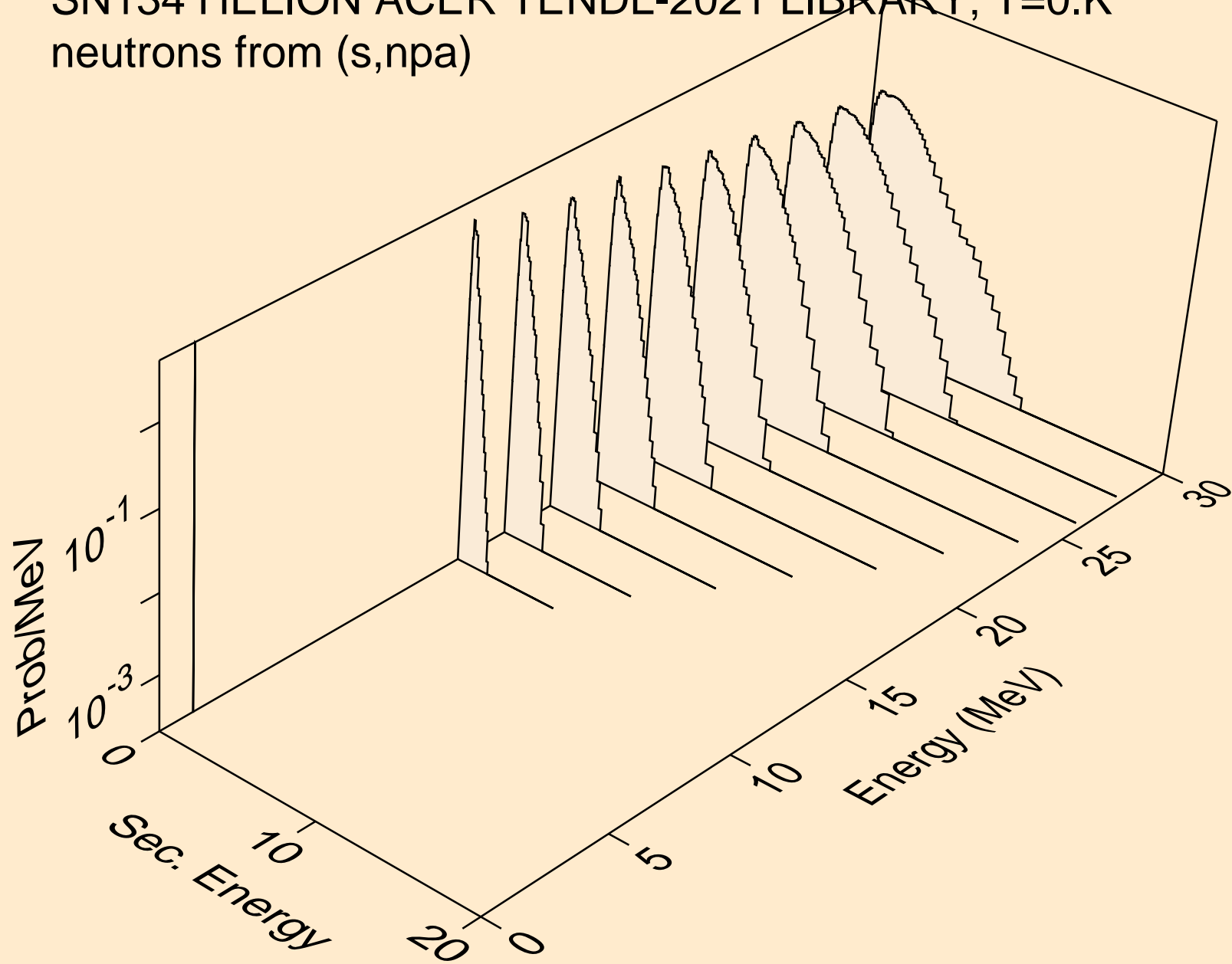

SN134 HELION ACER TENDL-2021 LIBRARY; T=0.K  
protons from (s,x)

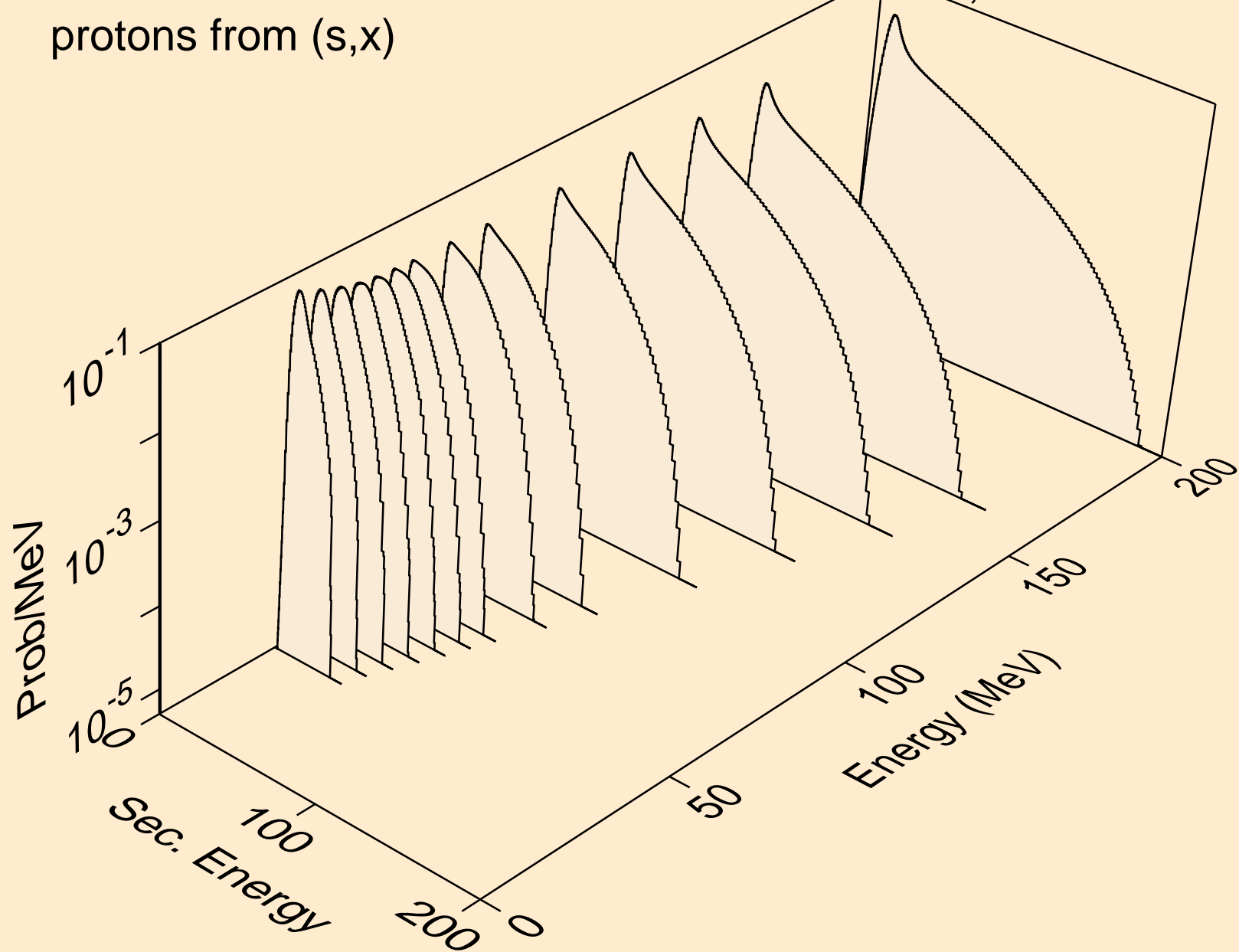

SN134 HELION ACER TENDL-2021 LIBRARY; T=0.K  
protons from (s,n\*)p

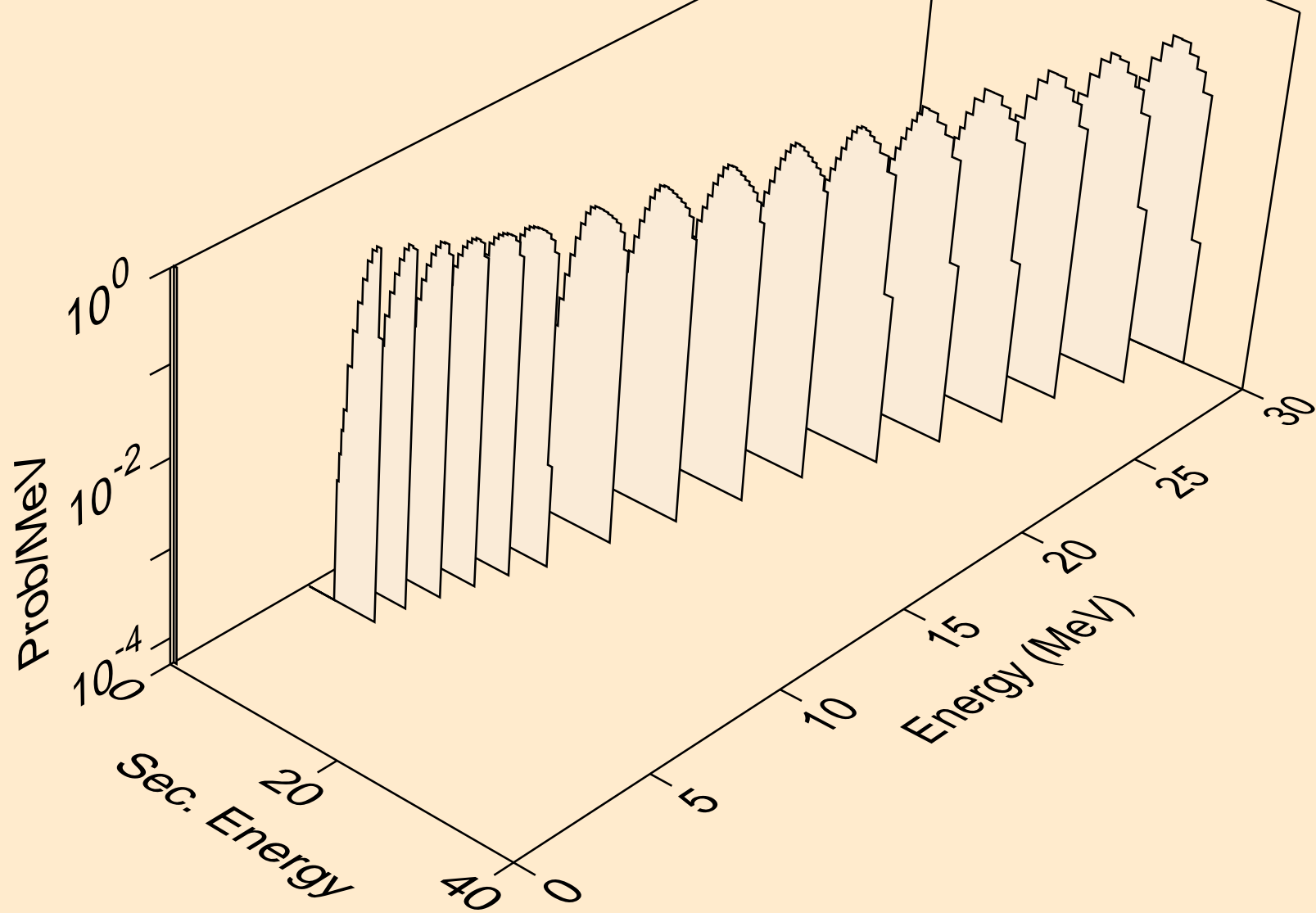



SN134 HELION ACER TENDL-2021 LIBRARY; T=0.K  
protons from (s,2np)

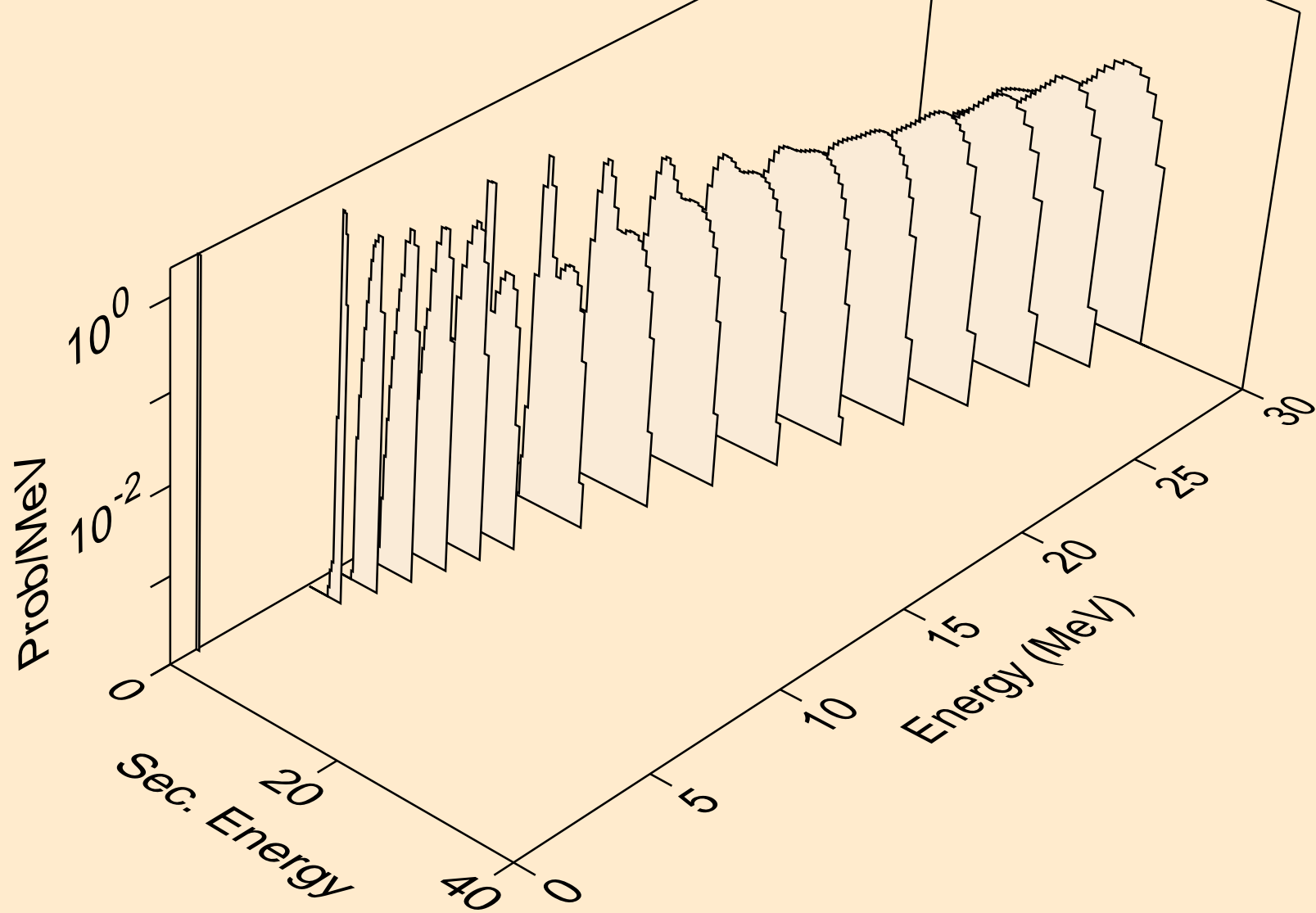

SN134 HELION ACER TENDL-2021 LIBRARY; T=0.K  
protons from (s,3np)

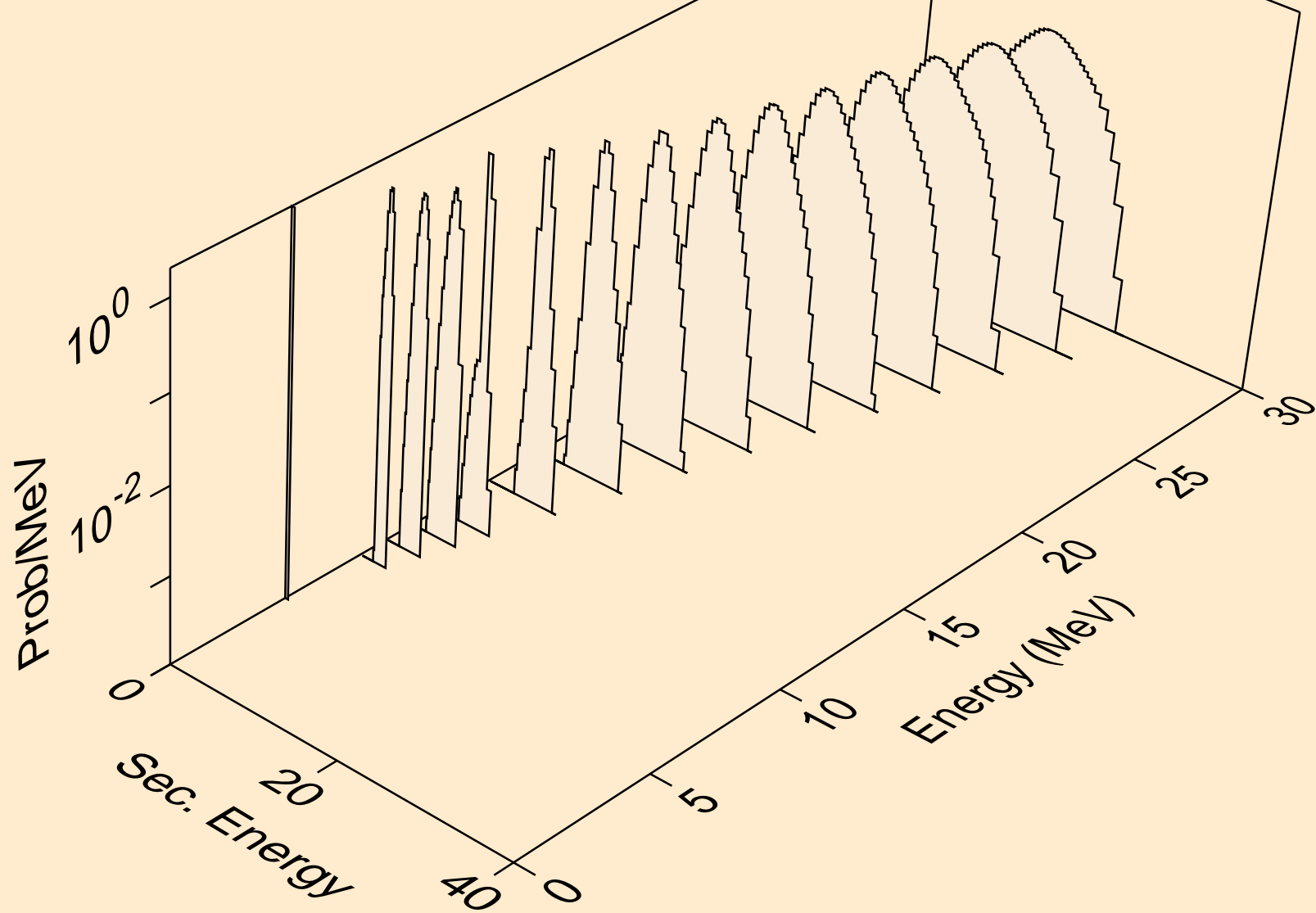

SN134 HELION ACER TENDL-2021 LIBRARY; T=0.K  
protons from (s,2np)

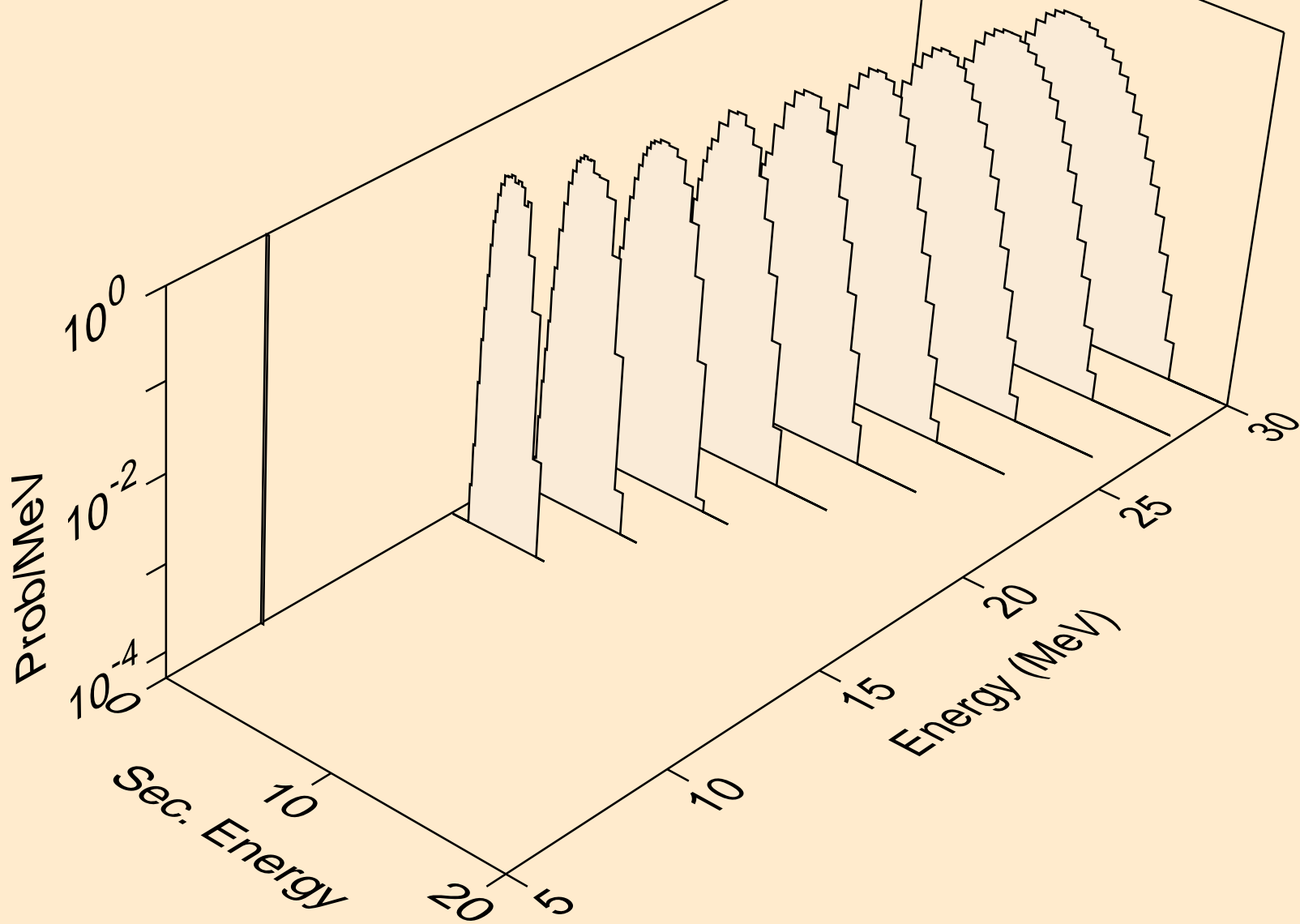

SN134 HELION ACER TENDL-2021 LIBRARY; T=0.K  
protons from (s,npa)

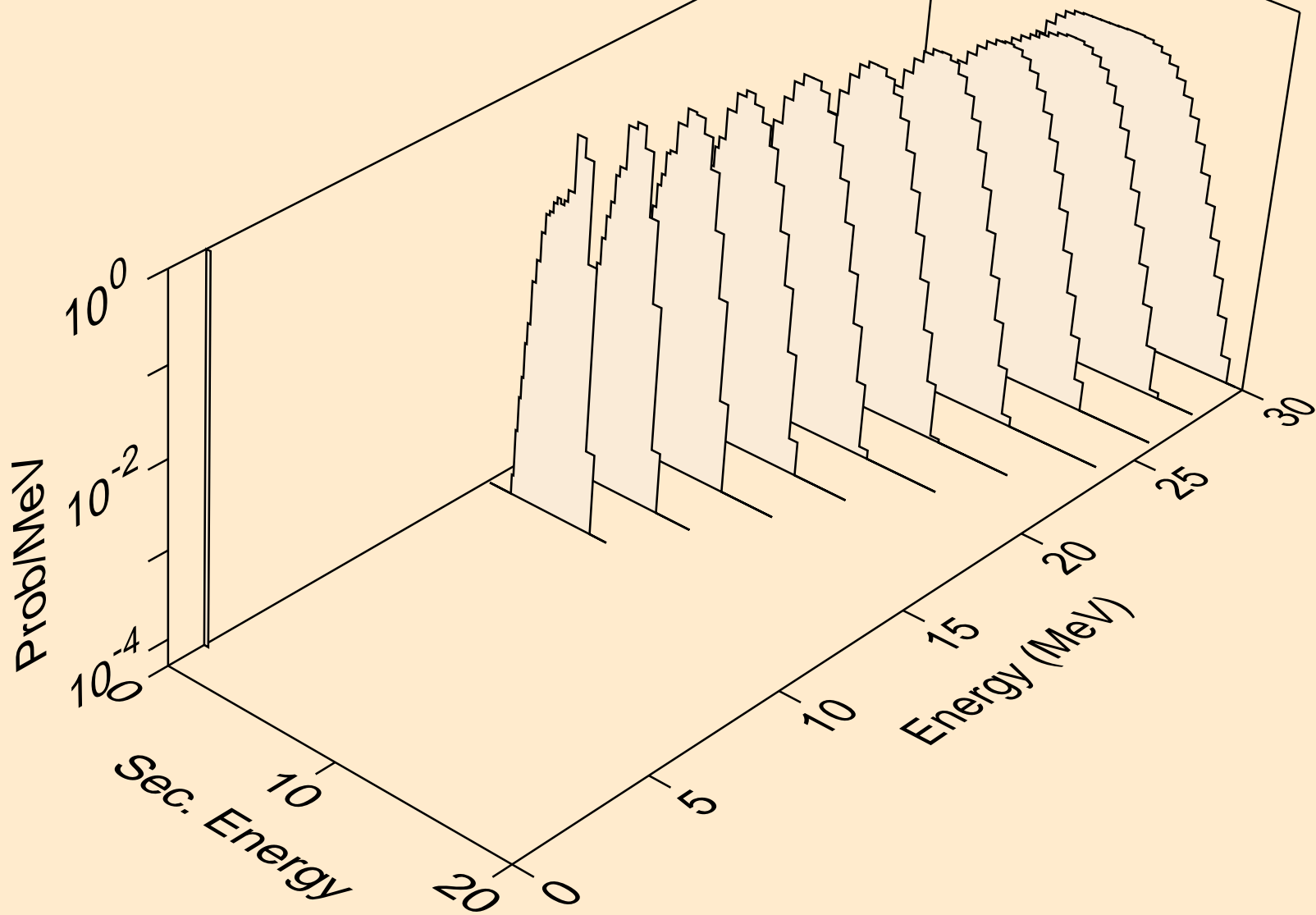

SN134 HELION ACER TENDL-2021 LIBRARY; T=0.K  
protons from (s,p)

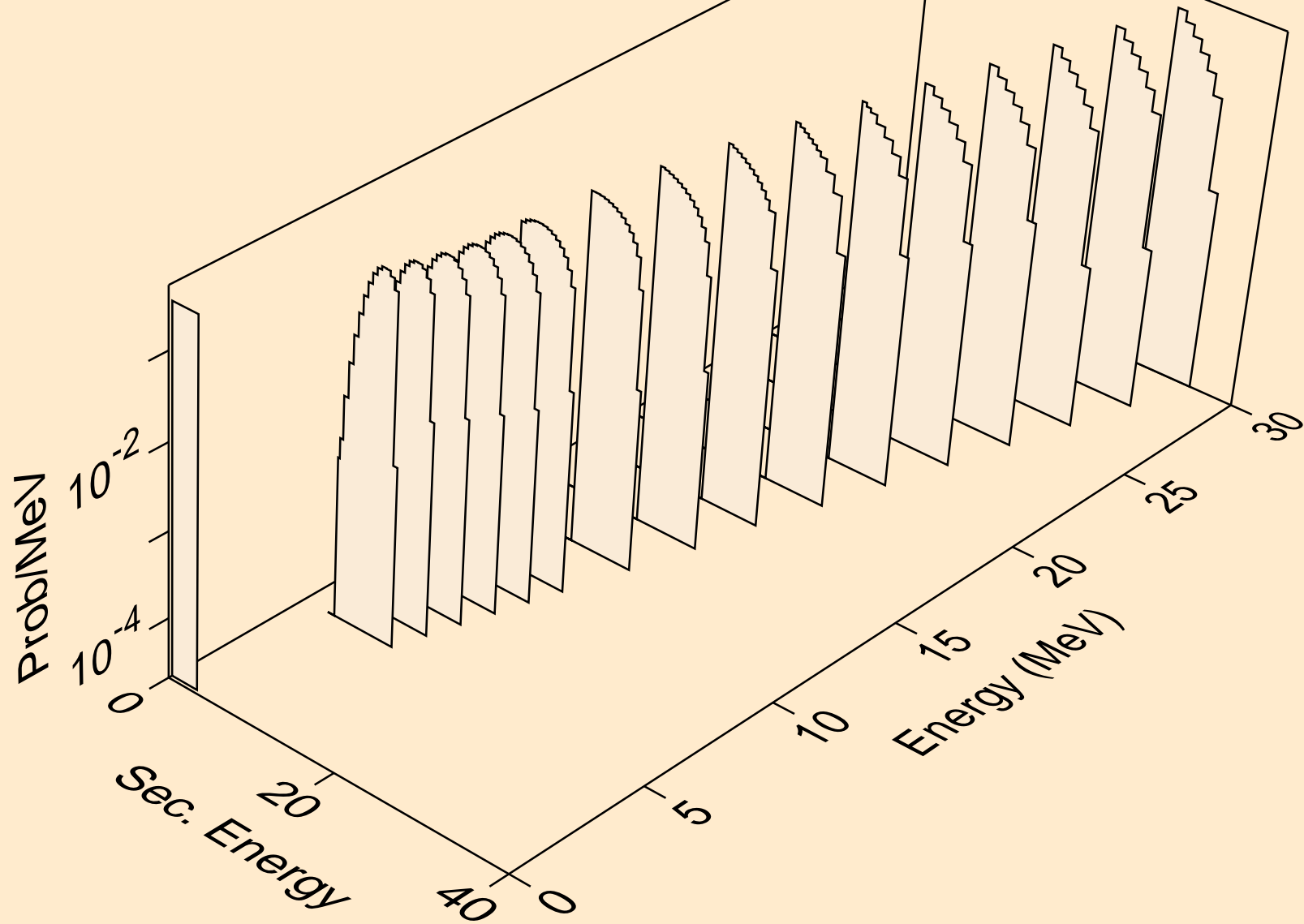

SN134 HELION ACER TENDL-2021 LIBRARY; T=0.K  
protons from (s,2p)

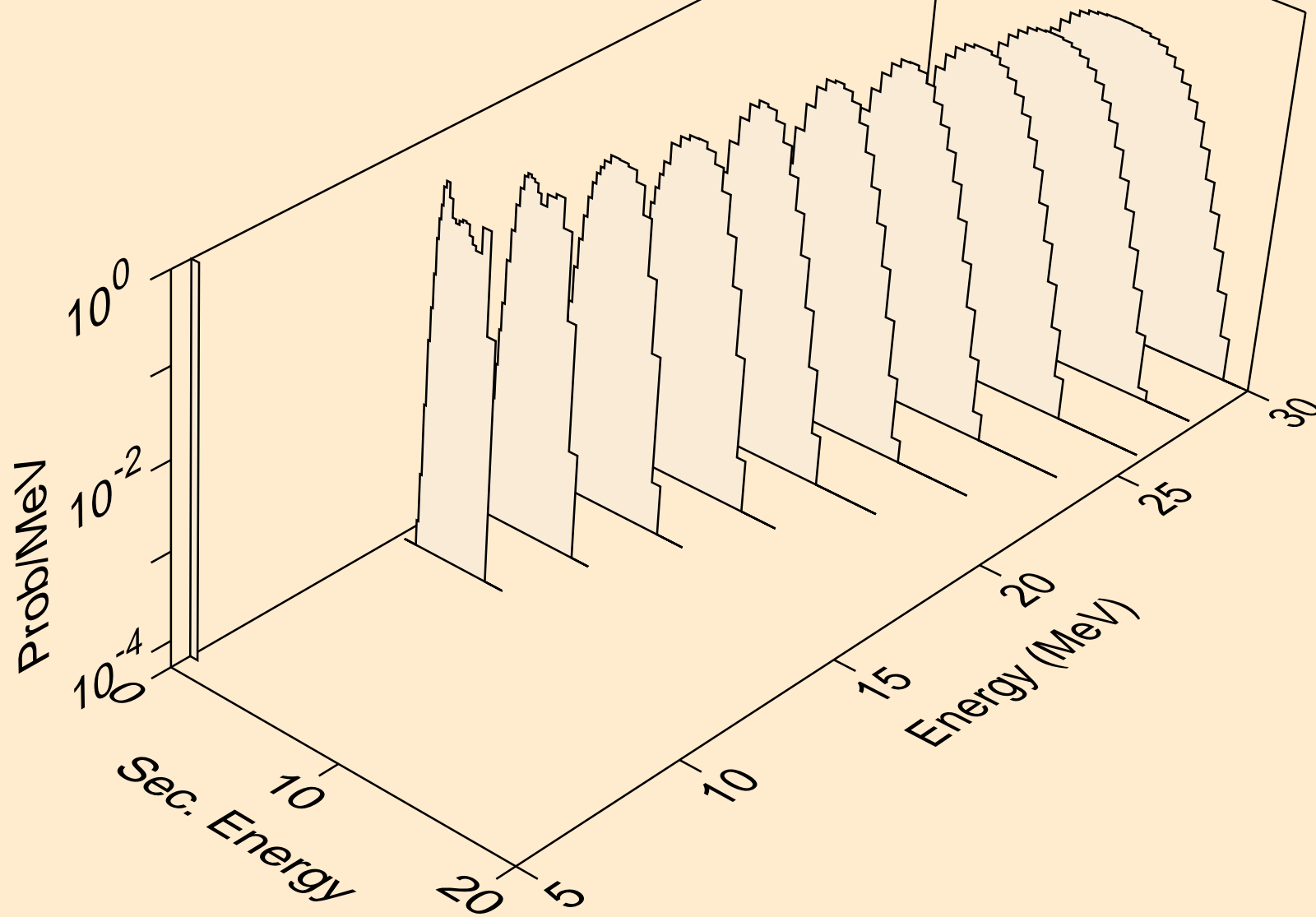

SN134 HELION ACER TENDL-2021 LIBRARY; T=0.K  
protons from (s,pd)

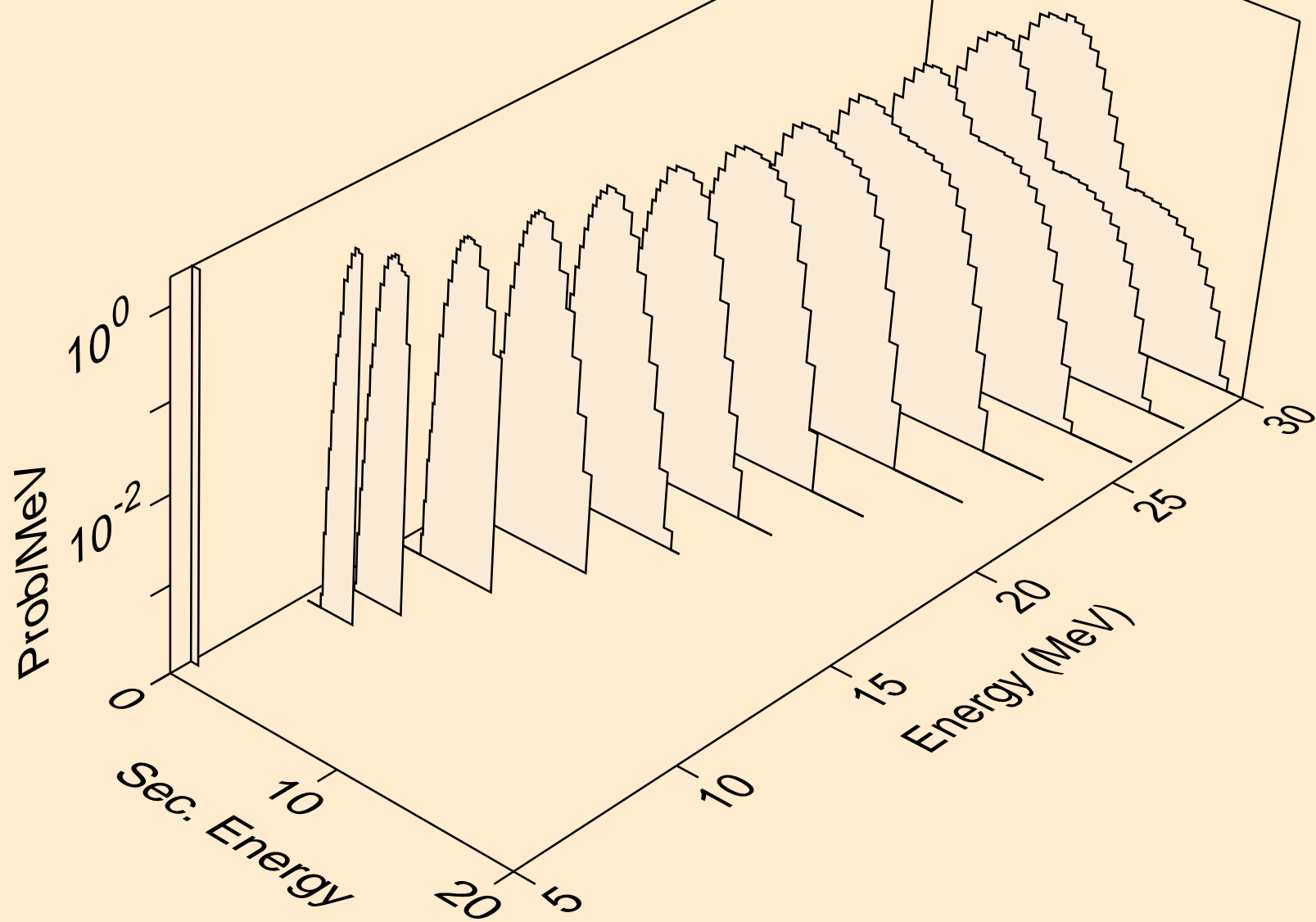

SN134 HELION ACER TENDL-2021 LIBRARY; T=0.K  
protons from (s,pt)

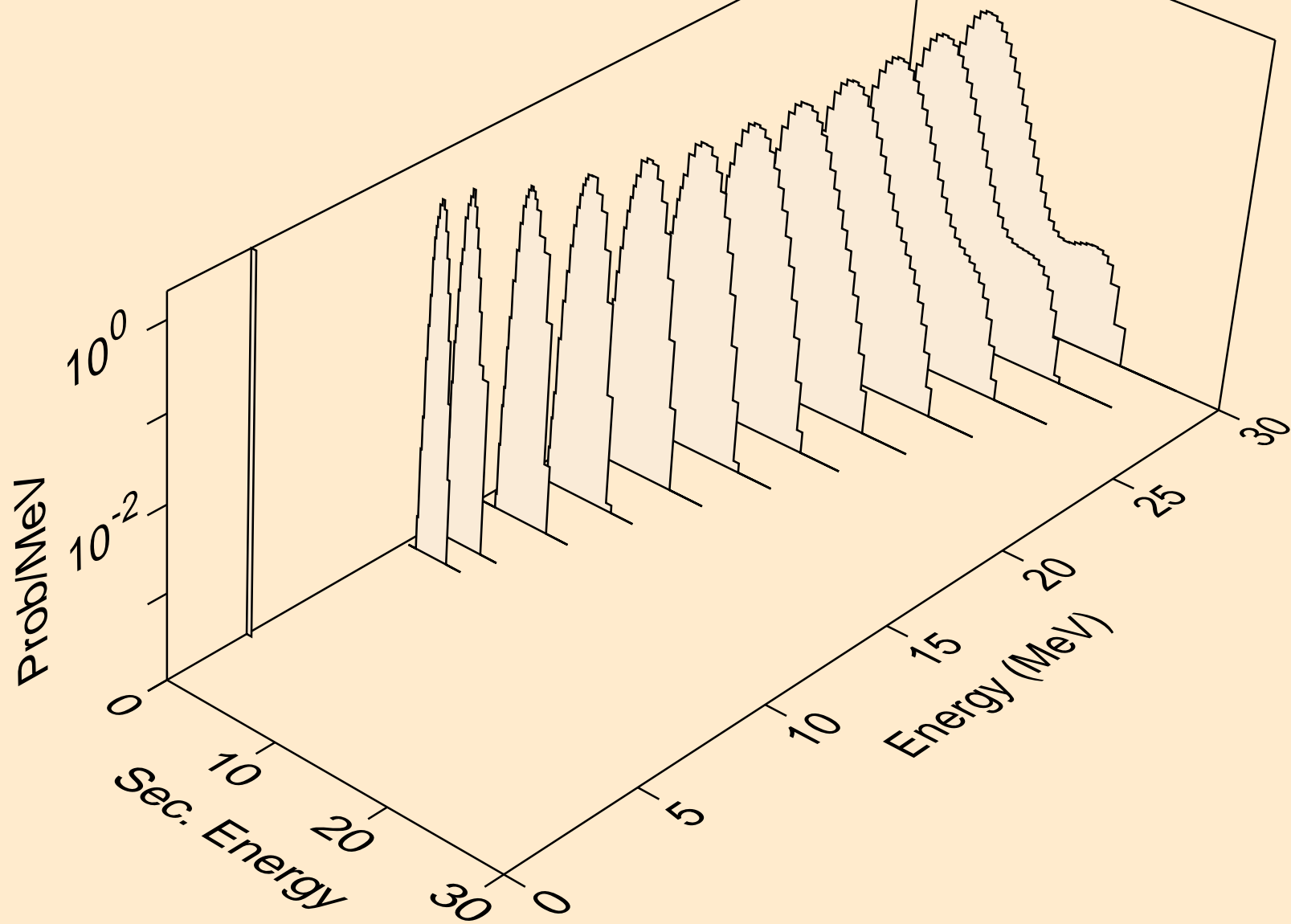



SN134 HELION ACER TENDL-2021 LIBRARY; T=0.K  
deuterons from (s,x)

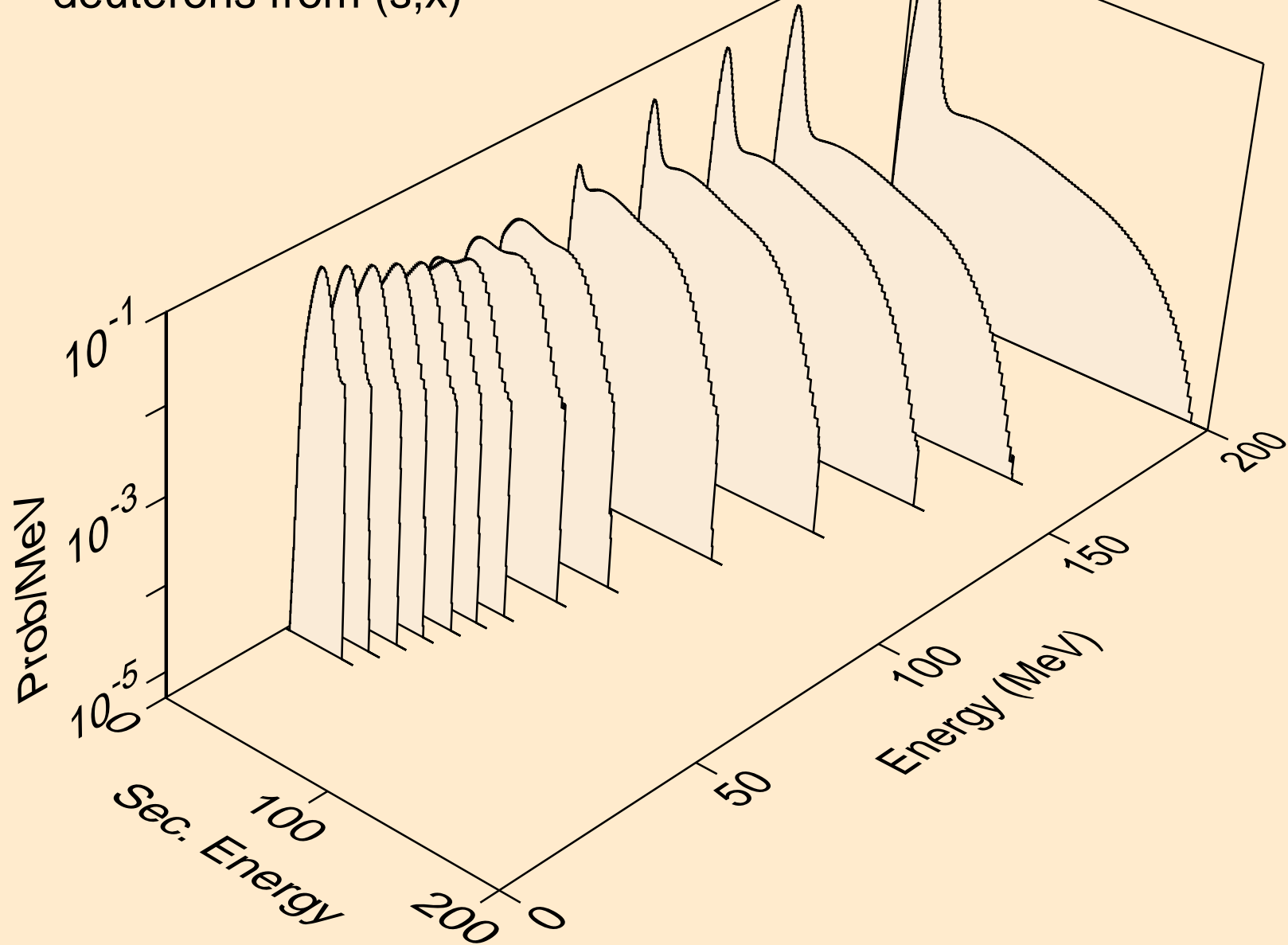

SN134 HELION ACER TENDL-2021 LIBRARY; T=0.K  
deuterons from (s,2nd)

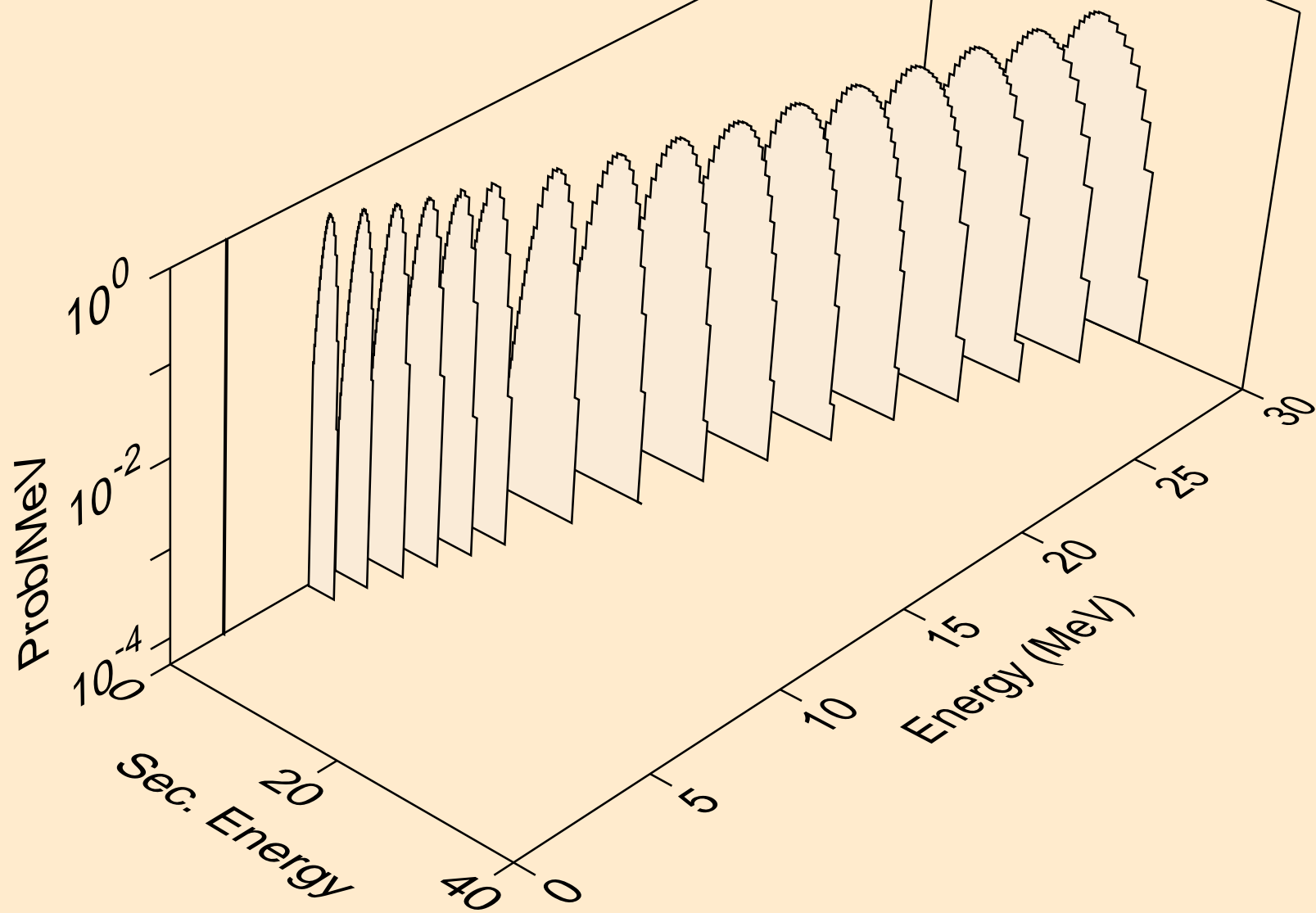

SN134 HELION ACER TENDL-2021 LIBRARY; T=0.K  
deuterons from (s,n\*)d

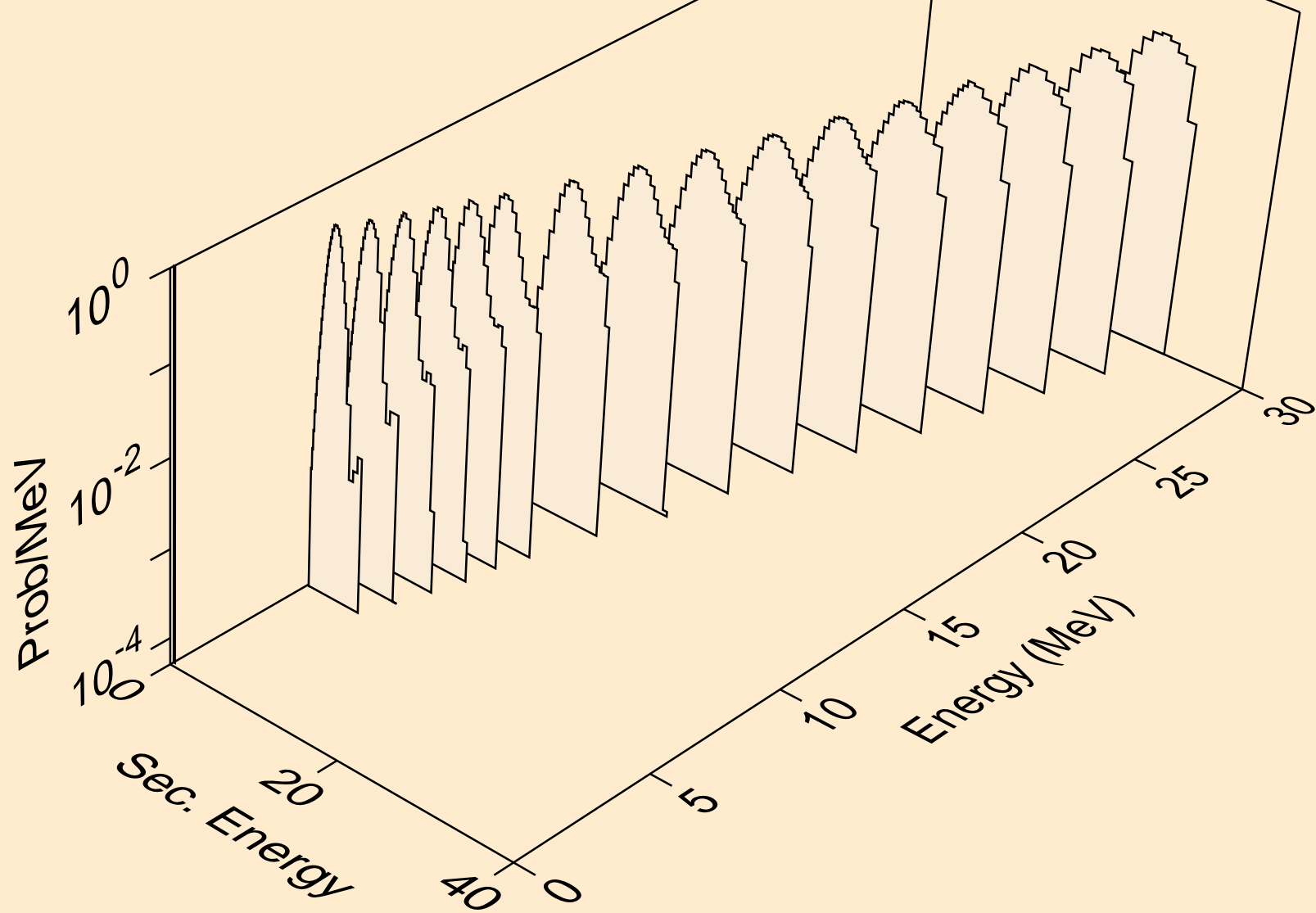

SN134 HELION ACER TENDL-2021 LIBRARY; T=0.K  
deuterons from (s,d)

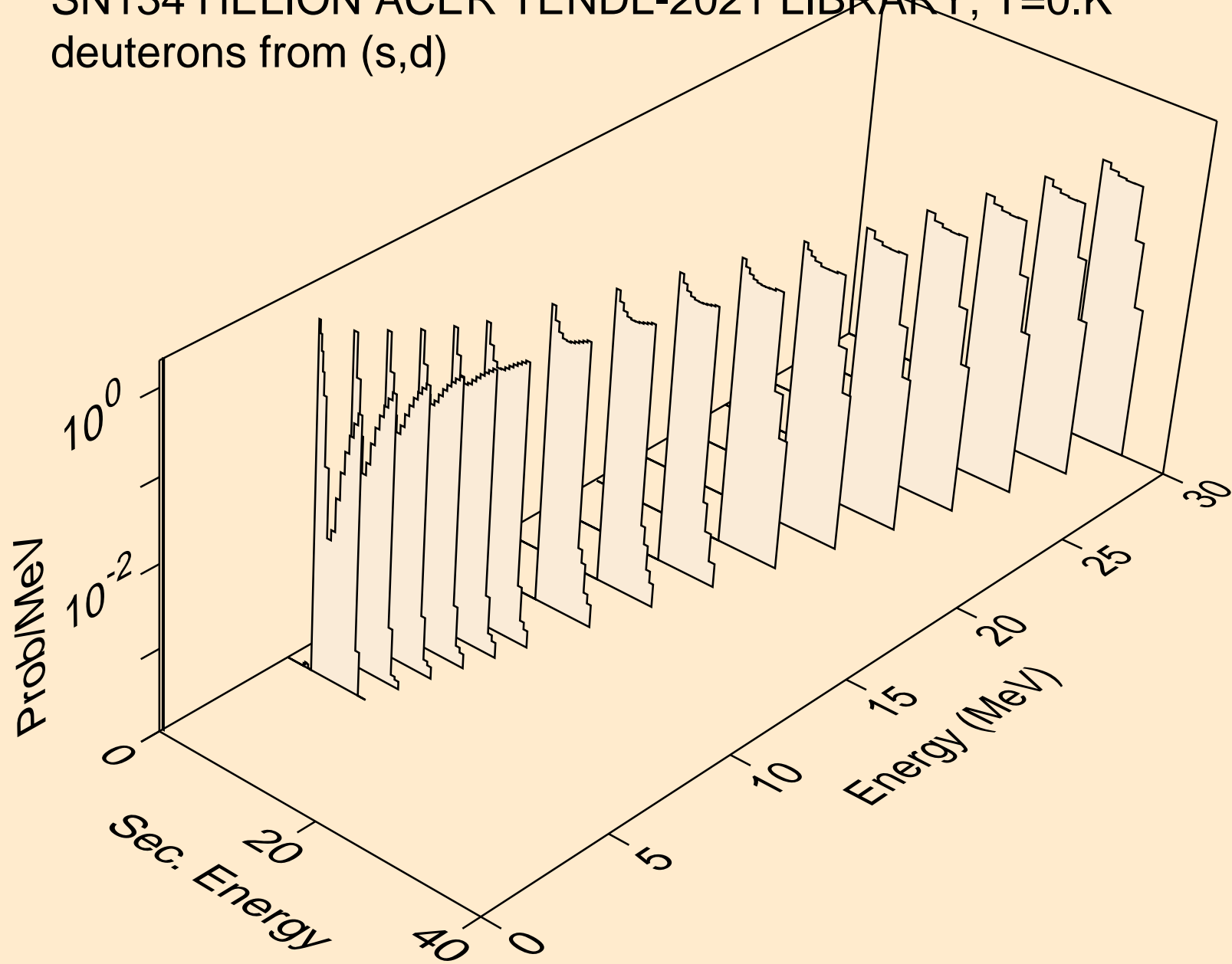

SN134 HELION ACER TENDL-2021 LIBRARY; T=0.K  
deuterons from (s,pd)

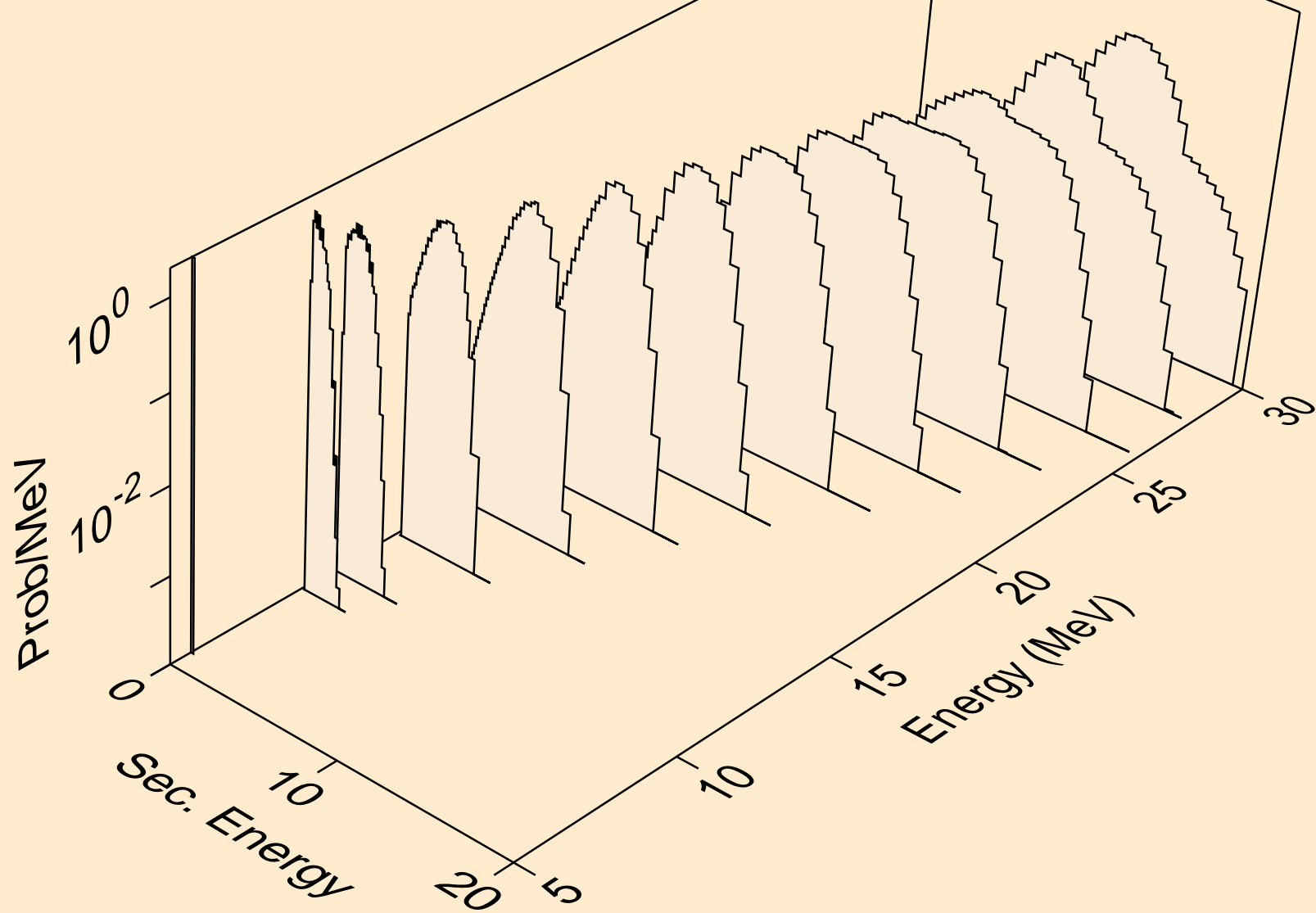

SN134 HELION ACER TENDL-2021 LIBRARY; T=0.K  
deuterons from (s,da)

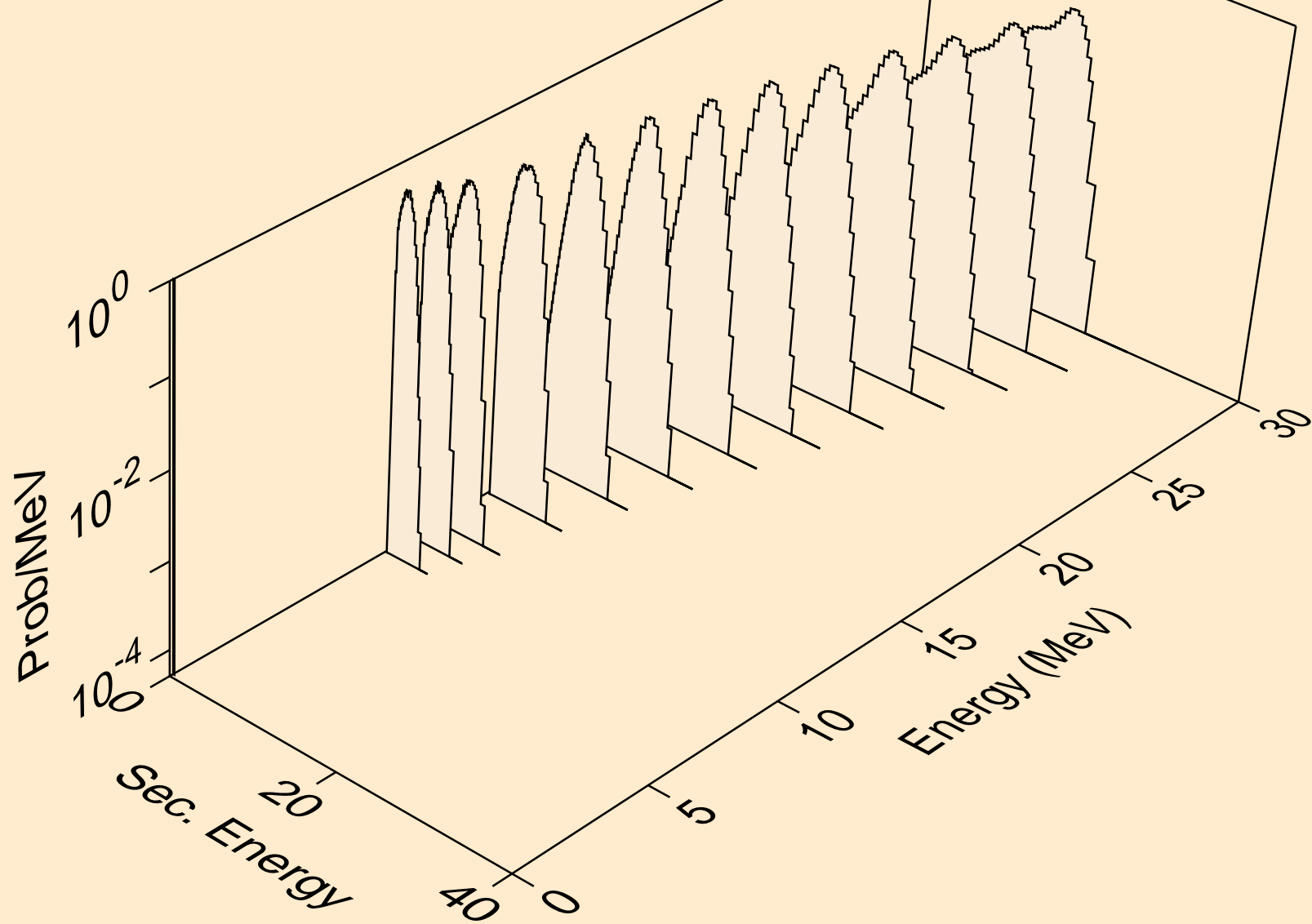

SN134 HELION ACER TENDL-2021 LIBRARY; T=0.K  
tritons from (s,x)

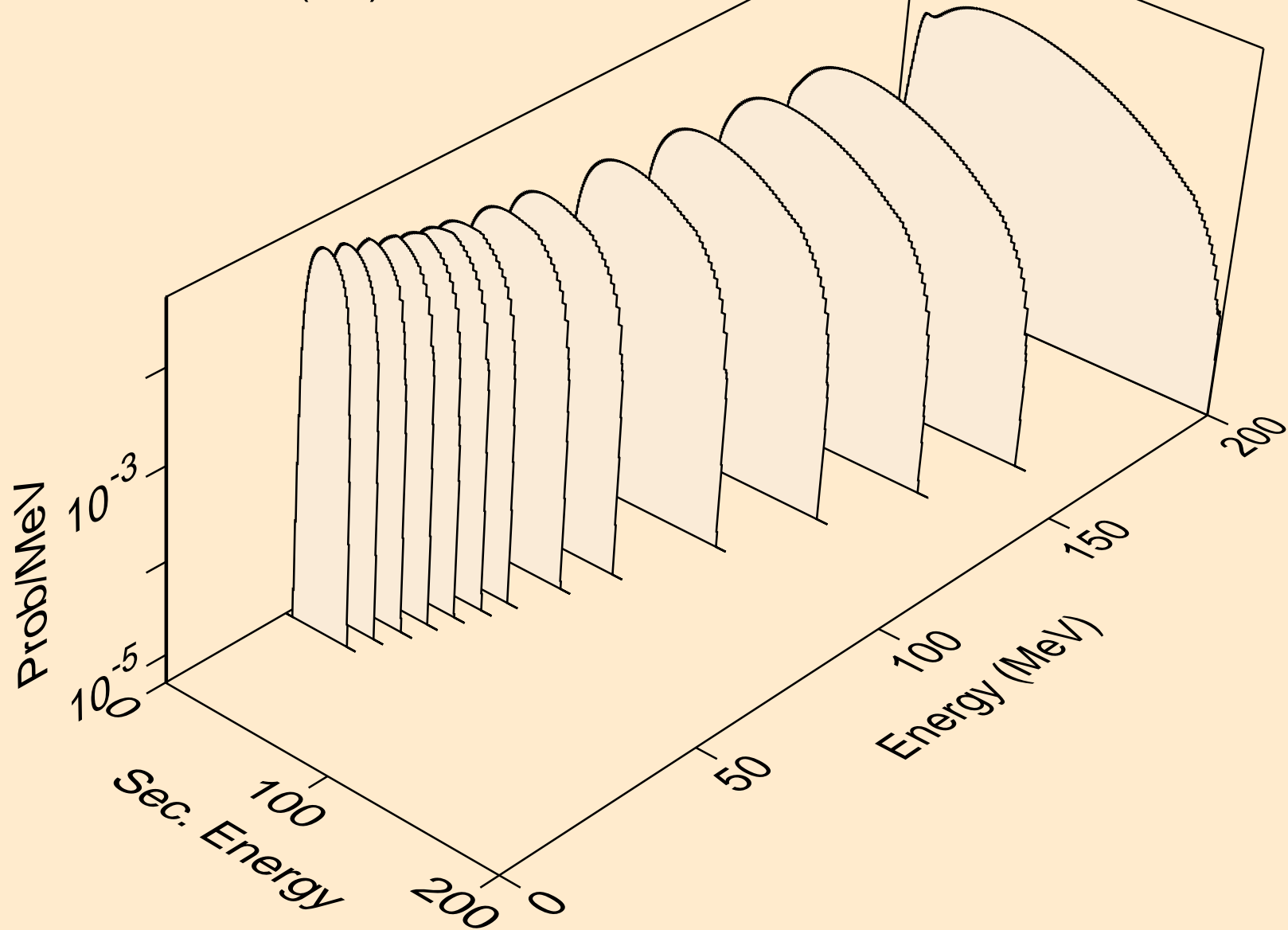

SN134 HELION ACER TENDL-2021 LIBRARY; T=0.K  
tritons from (s,n\*)t

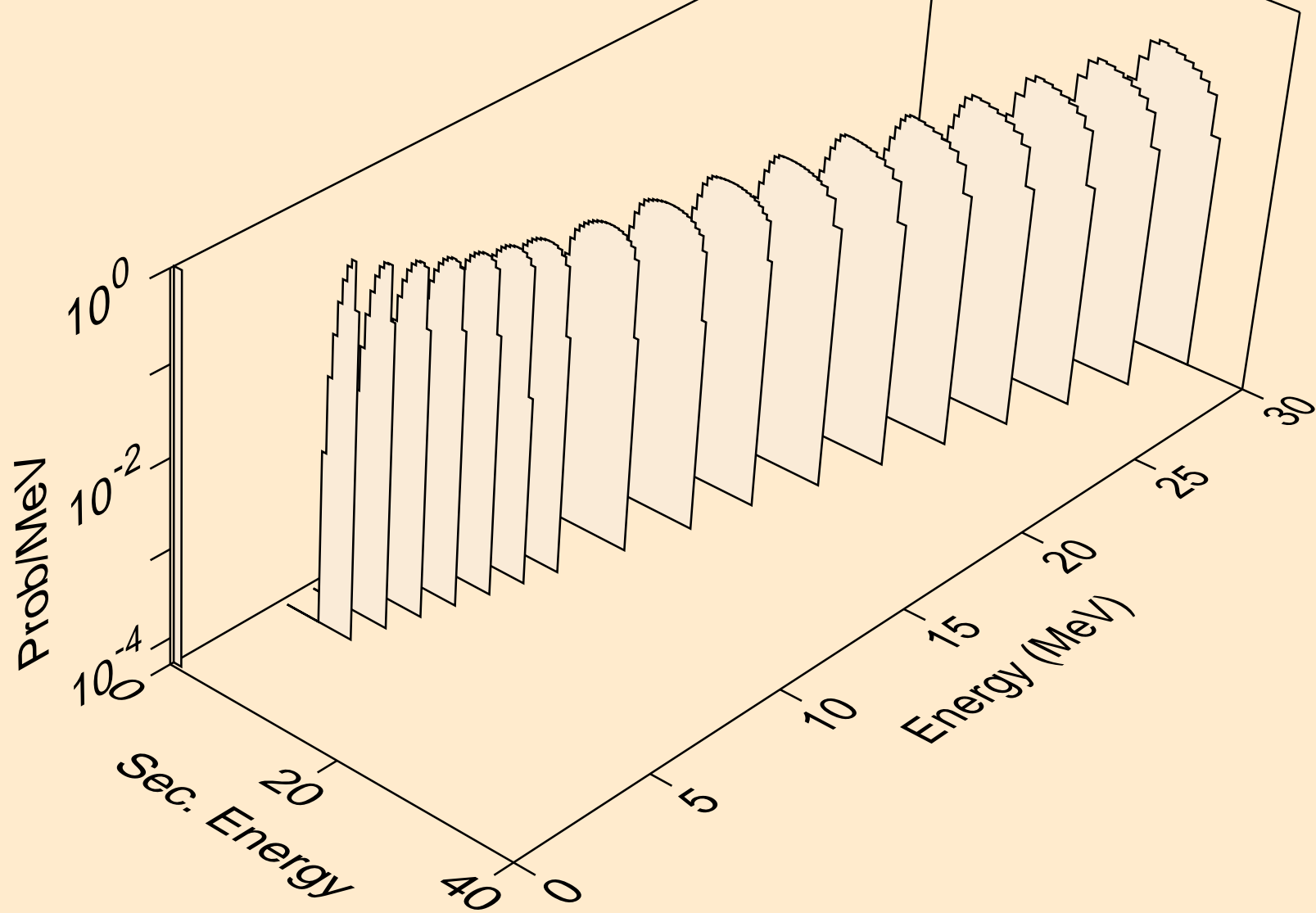



SN134 HELION ACER TENDL-2021 LIBRARY; T=0.K  
tritons from (s,t)

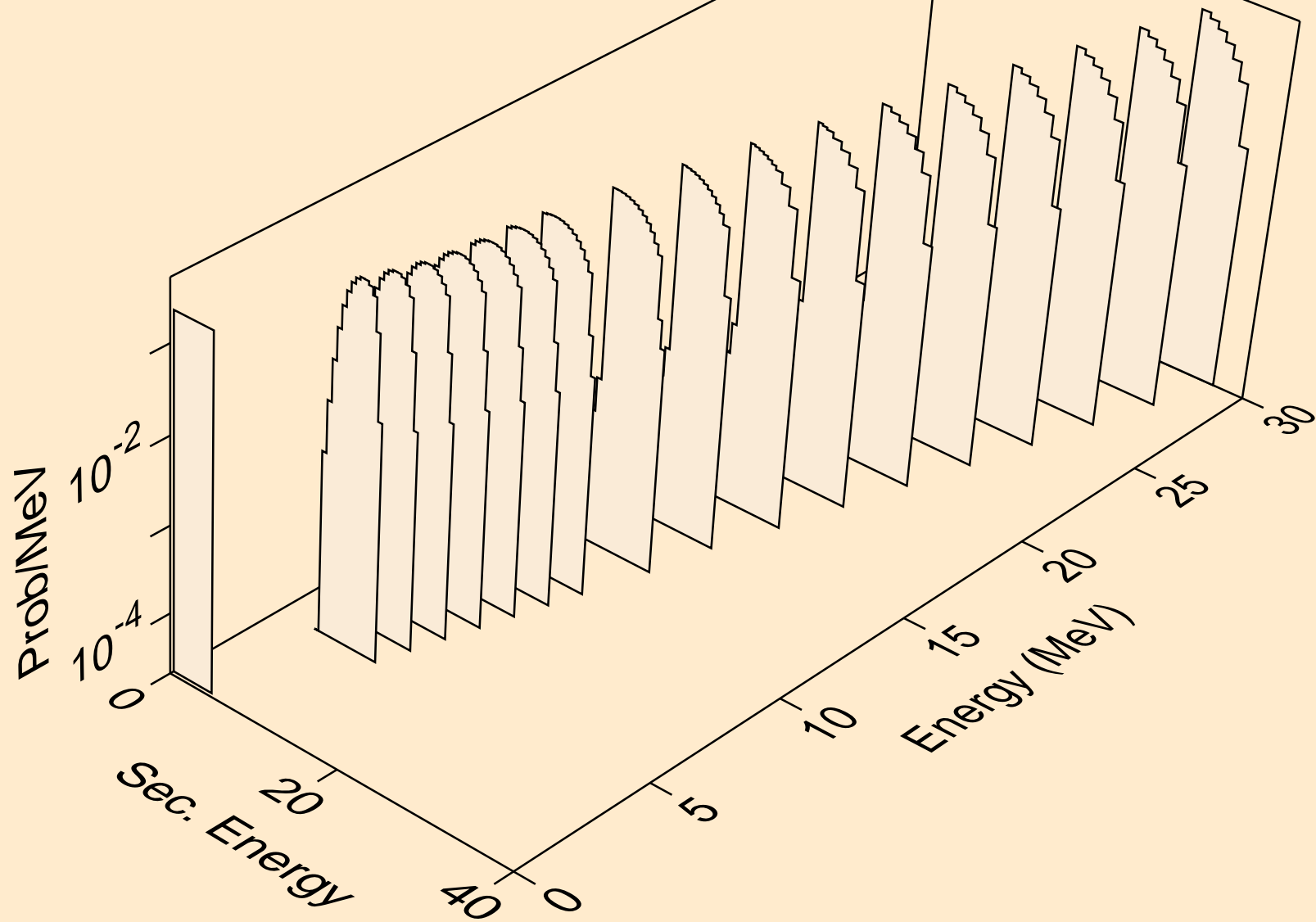

SN134 HELION ACER TENDL-2021 LIBRARY; T=0.K  
tritons from (s,pt)

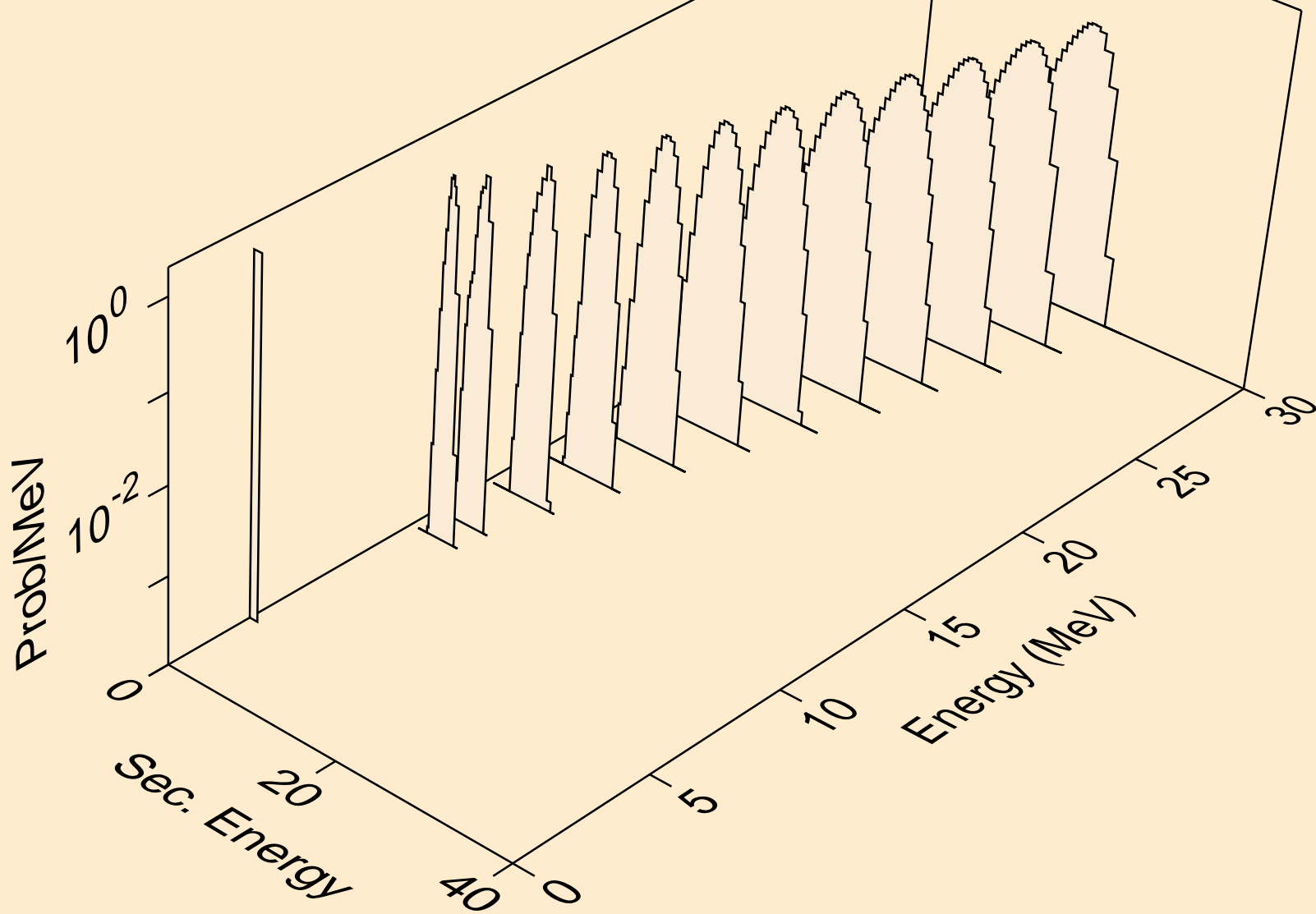

SN134 HELION ACER TENDL-2021 LIBRARY; T=0.K  
alphas from (s,x)

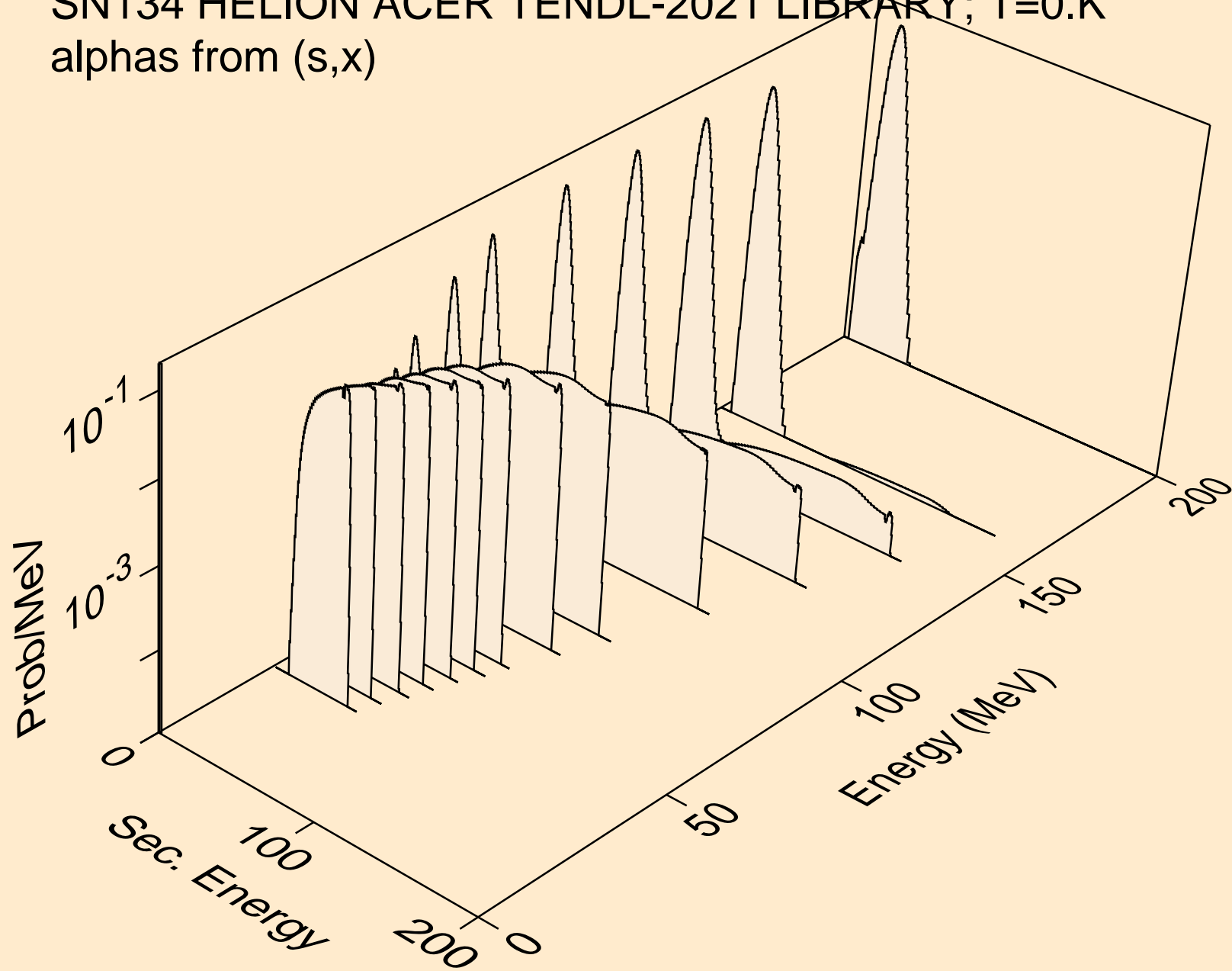

SN134 HELION ACER TENDL-2021 LIBRARY; T=0.K  
alphas from (s,n\*)a

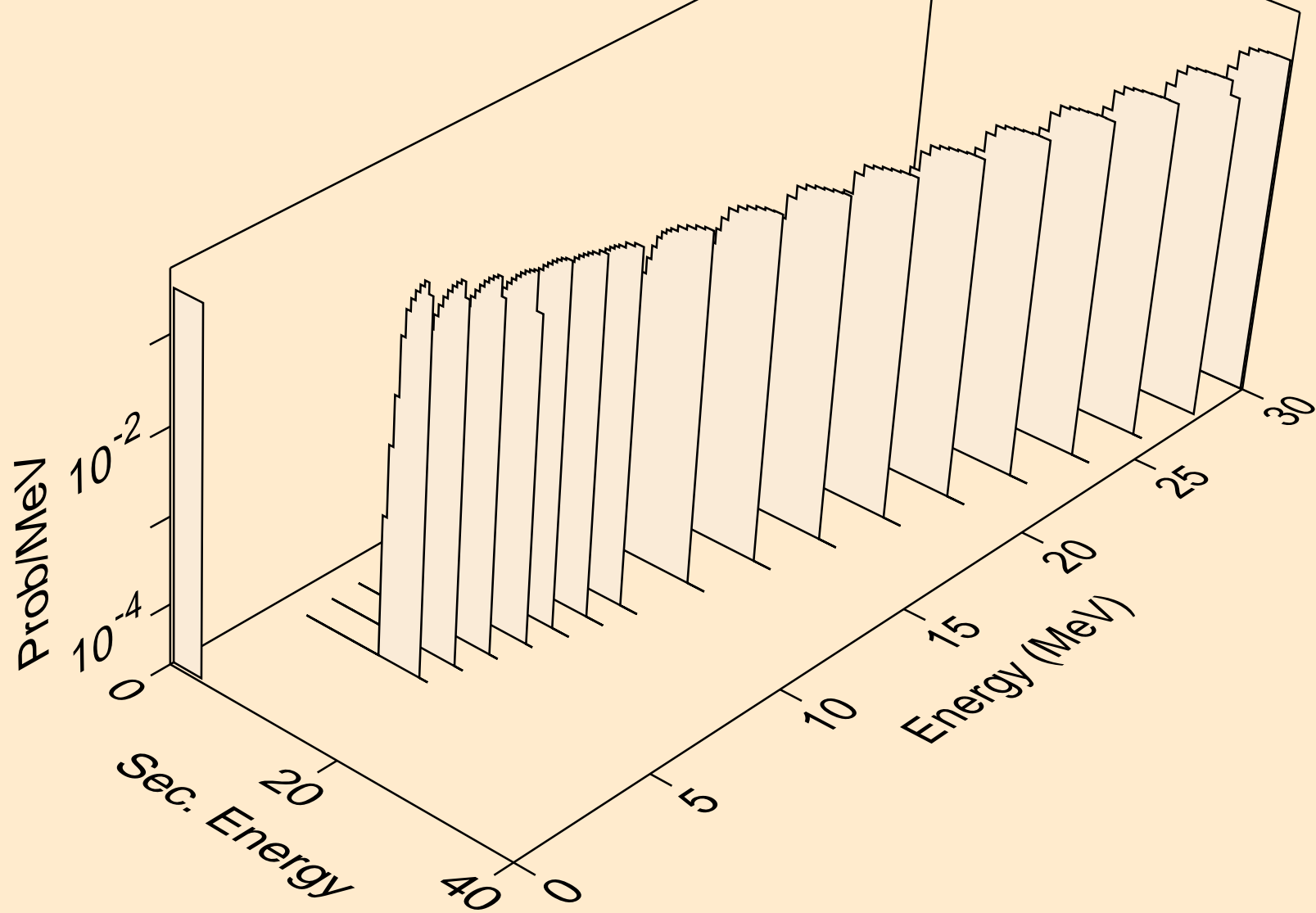

SN134 HELION ACER TENDL-2021 LIBRARY; T=0.K  
alphas from (s,2n)a

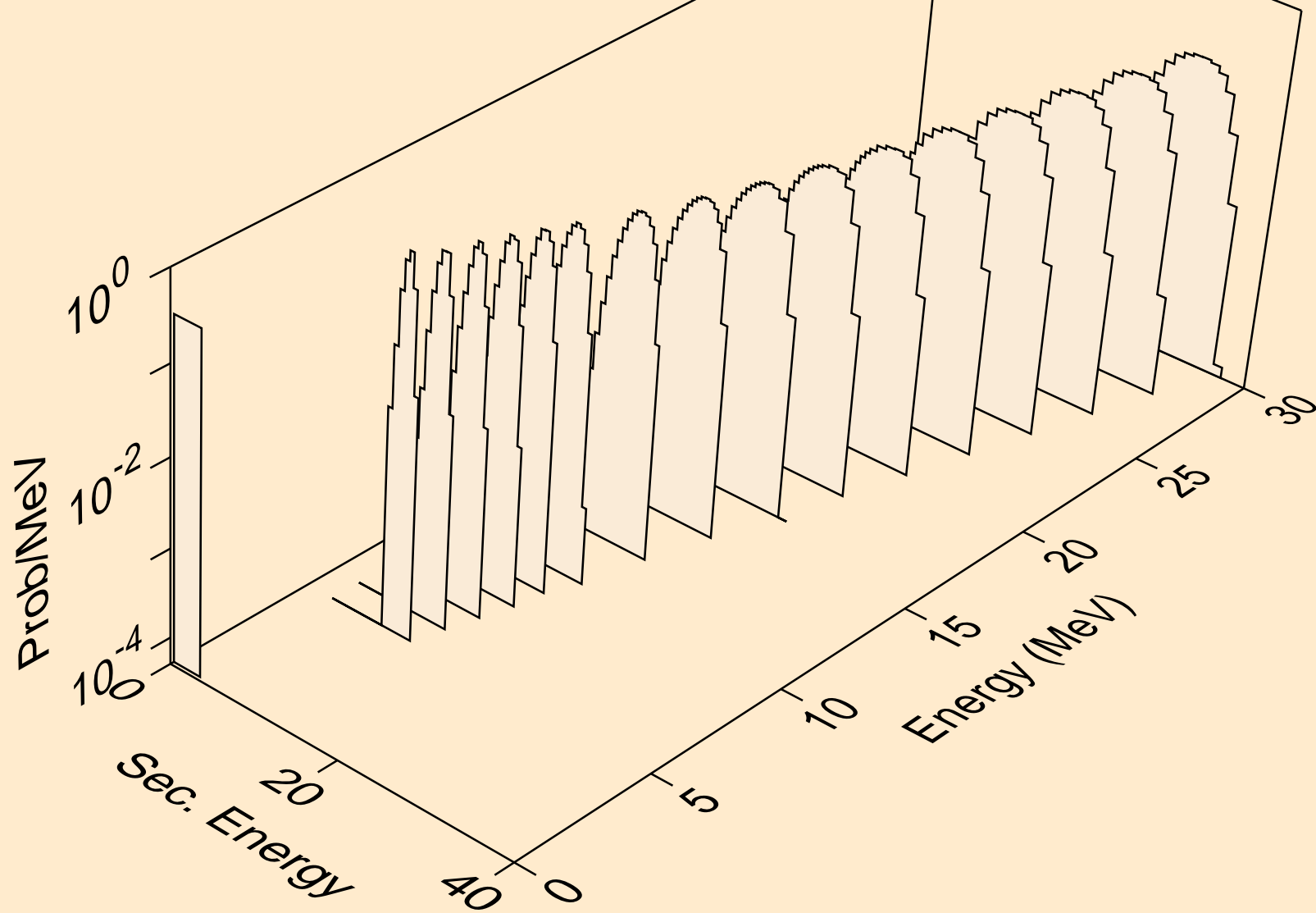

SN134 HELION ACER TENDL-2021 LIBRARY; T=0.K  
alphas from (s,3n)a

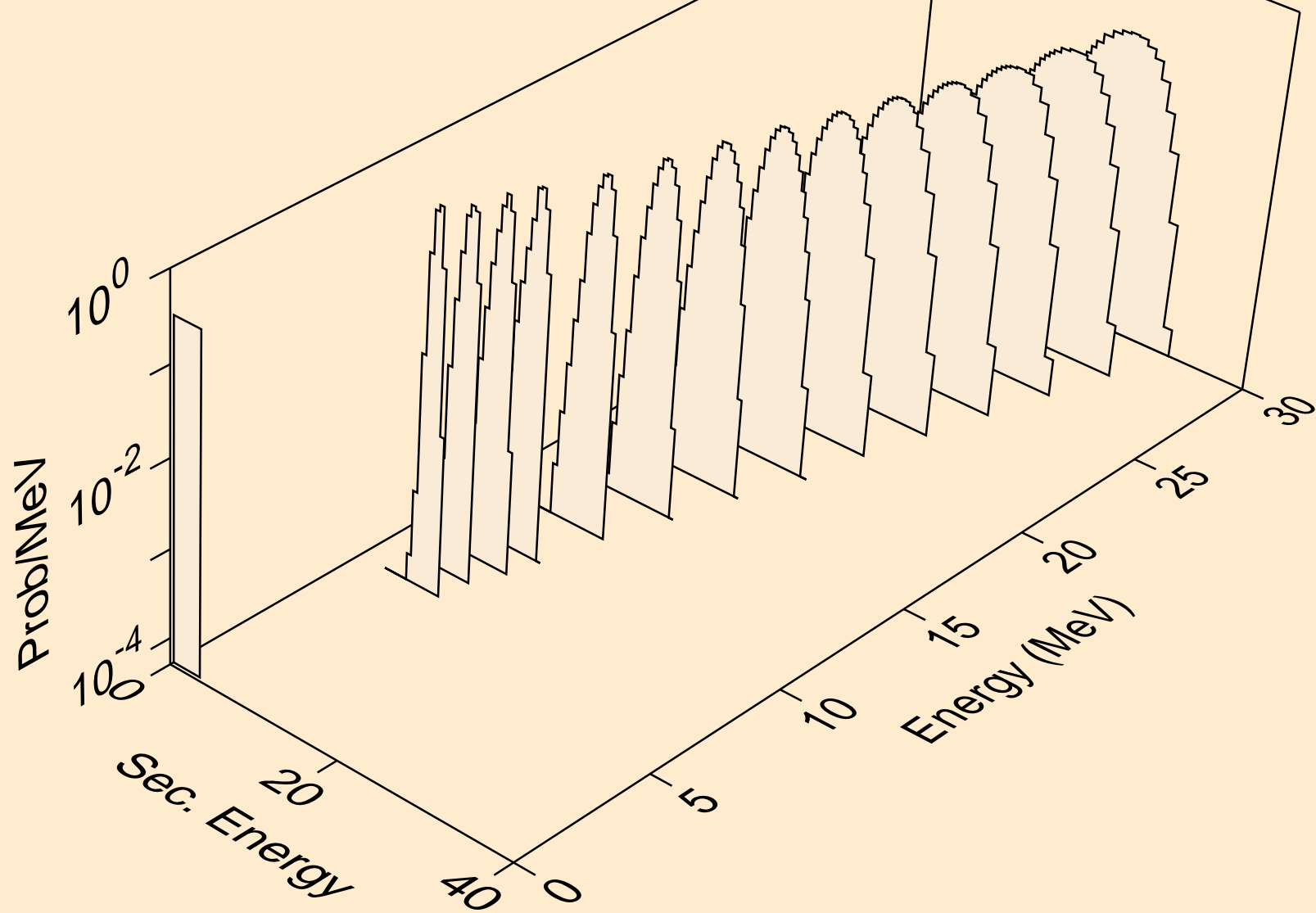

SN134 HELION ACER TENDL-2021 LIBRARY; T=0.K  
alphas from (s,npa)

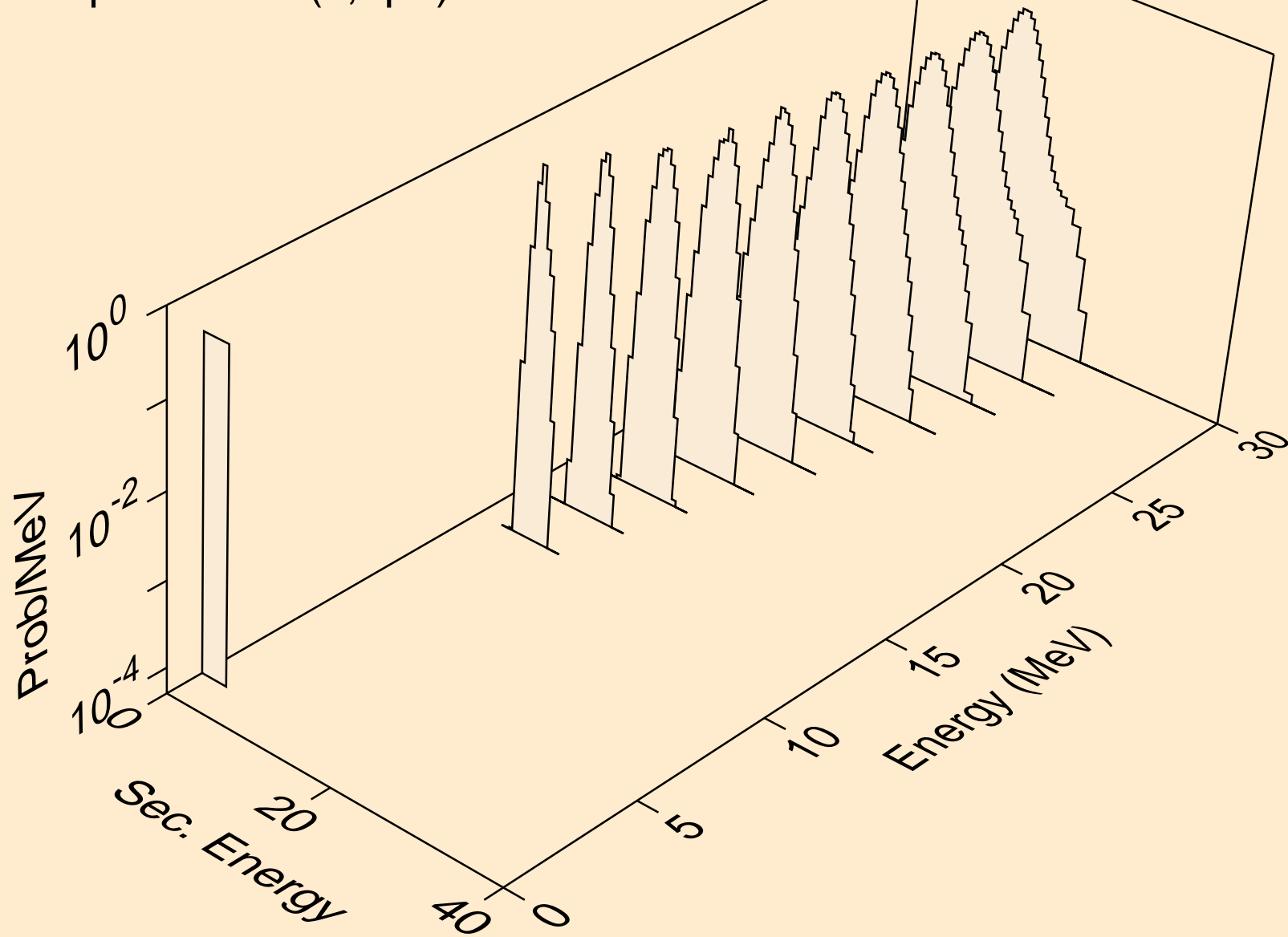

SN134 HELION ACER TENDL-2021 LIBRARY; T=0.K  
alphas from (s,a)

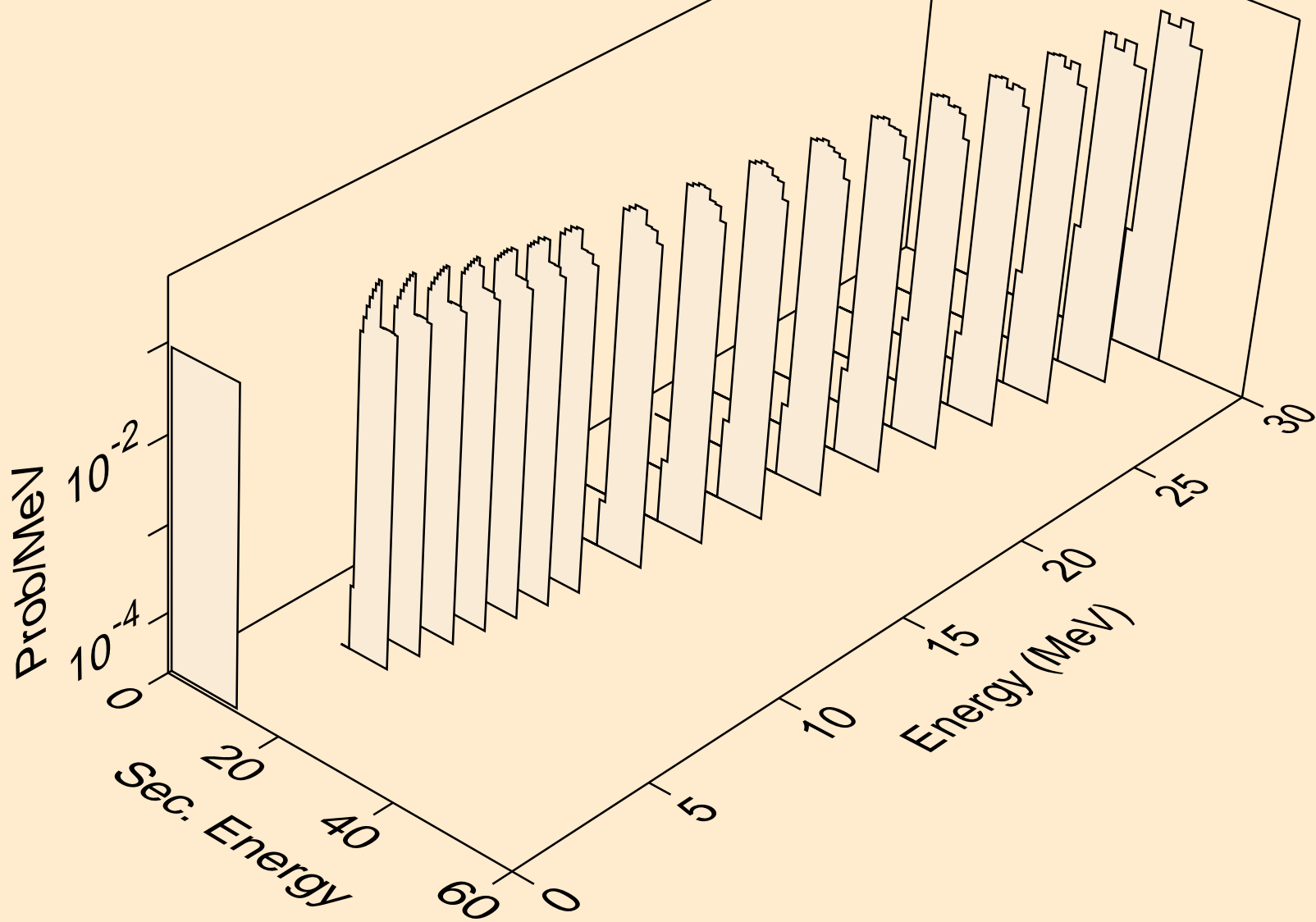



SN134 HELION ACER TENDL-2021 LIBRARY; T=0.K  
alphas from (s,da)

