

SR080 HELION ACER TENDL-2021 LIBRARY; T=0.K  
Principal cross sections

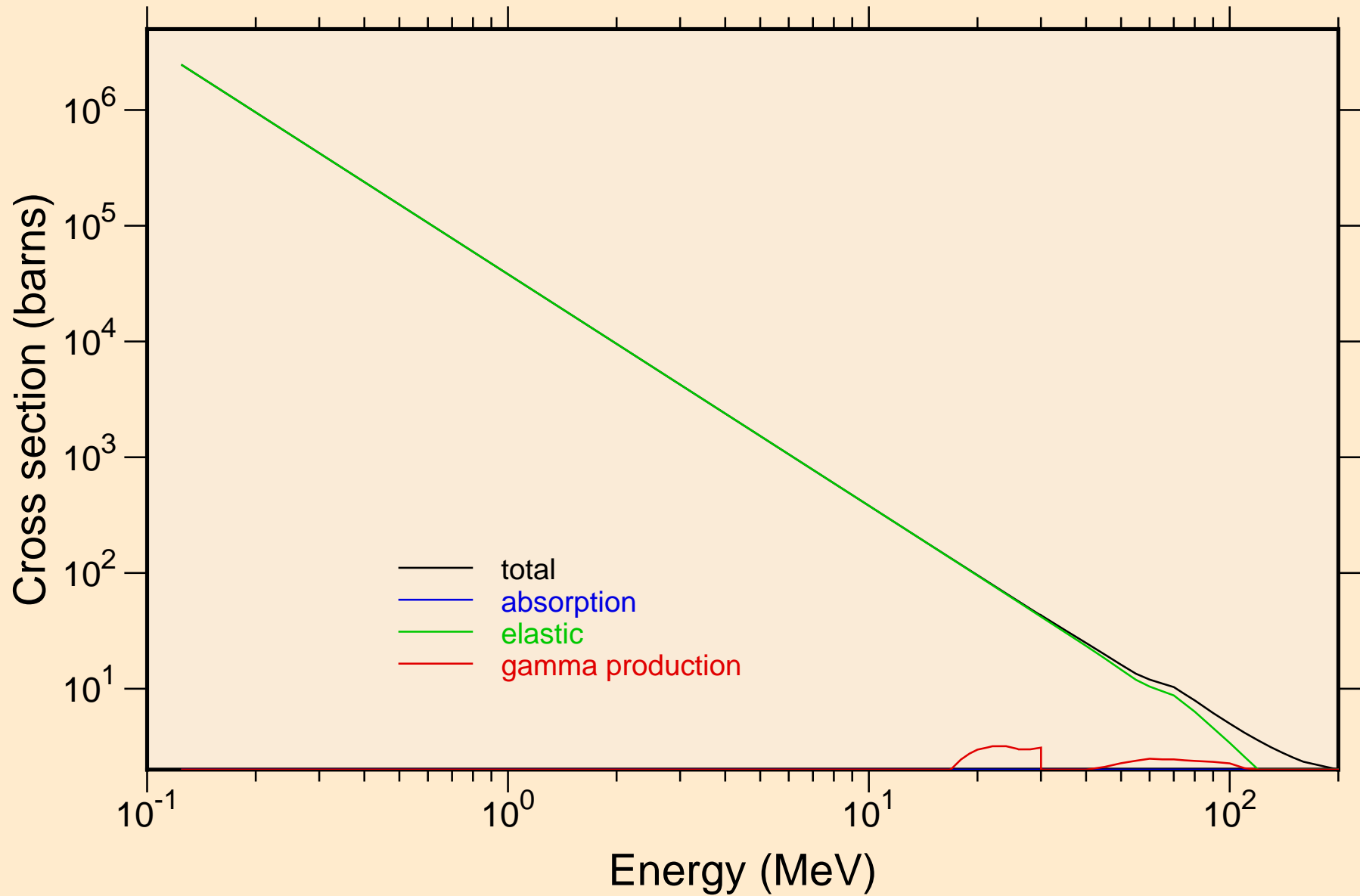

SR080 HELION ACER TENDL-2021 LIBRARY; T=0.K

Heating

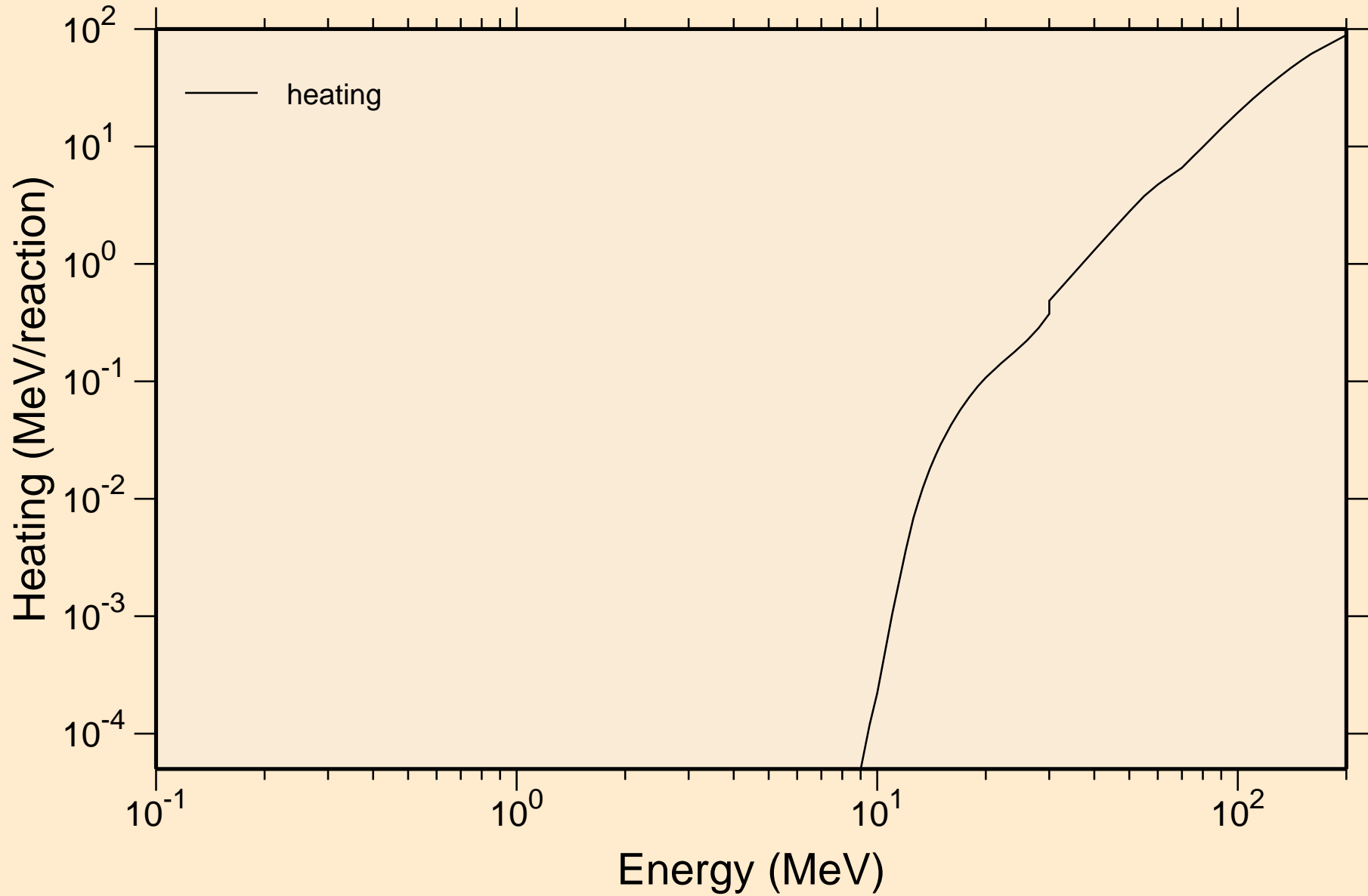

# SR080 HELION ACER TENDL-2021 LIBRARY; T=0.K

## Principal cross sections

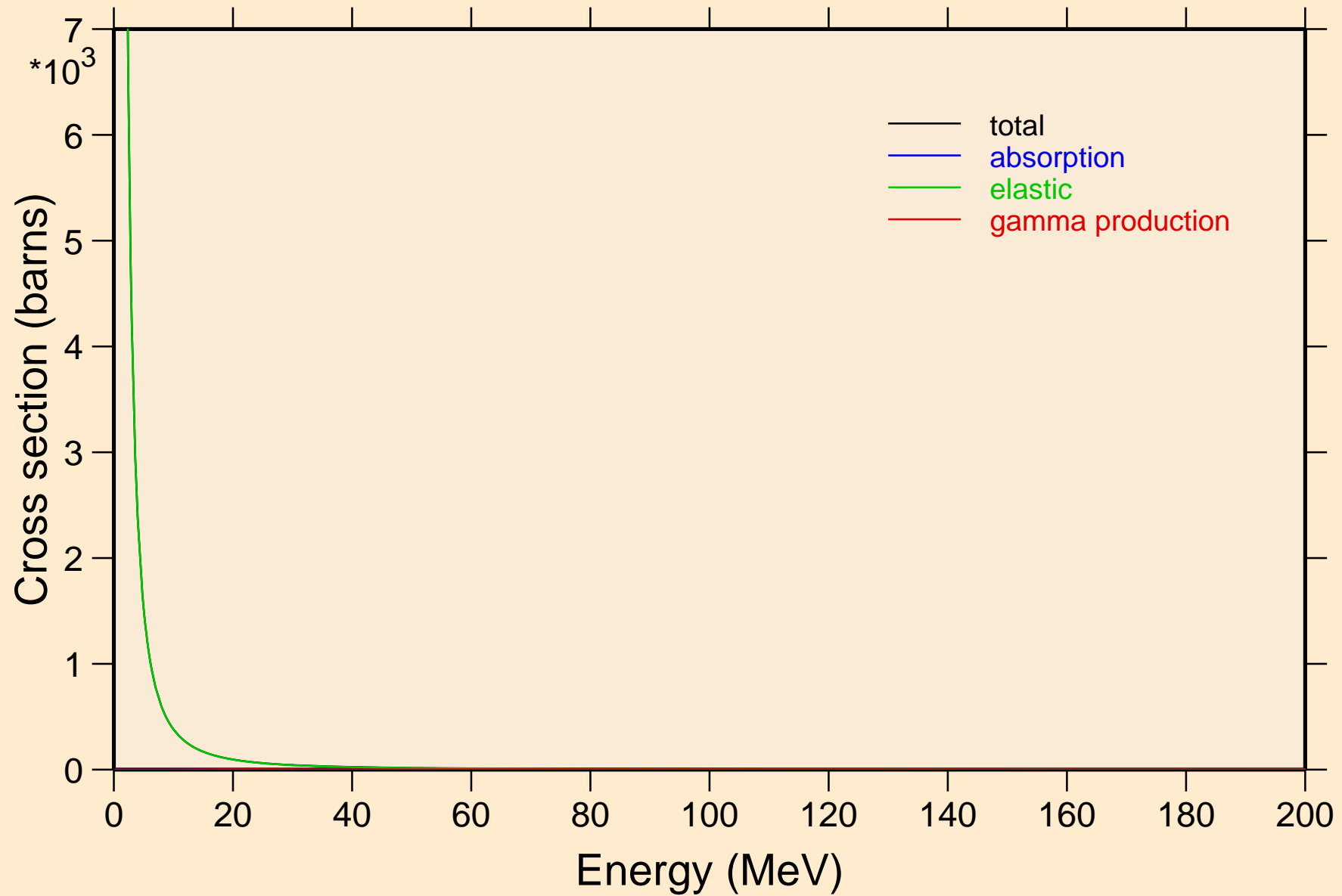

SR080 HELION ACER TENDL-2021 LIBRARY; T=0.K

Heating

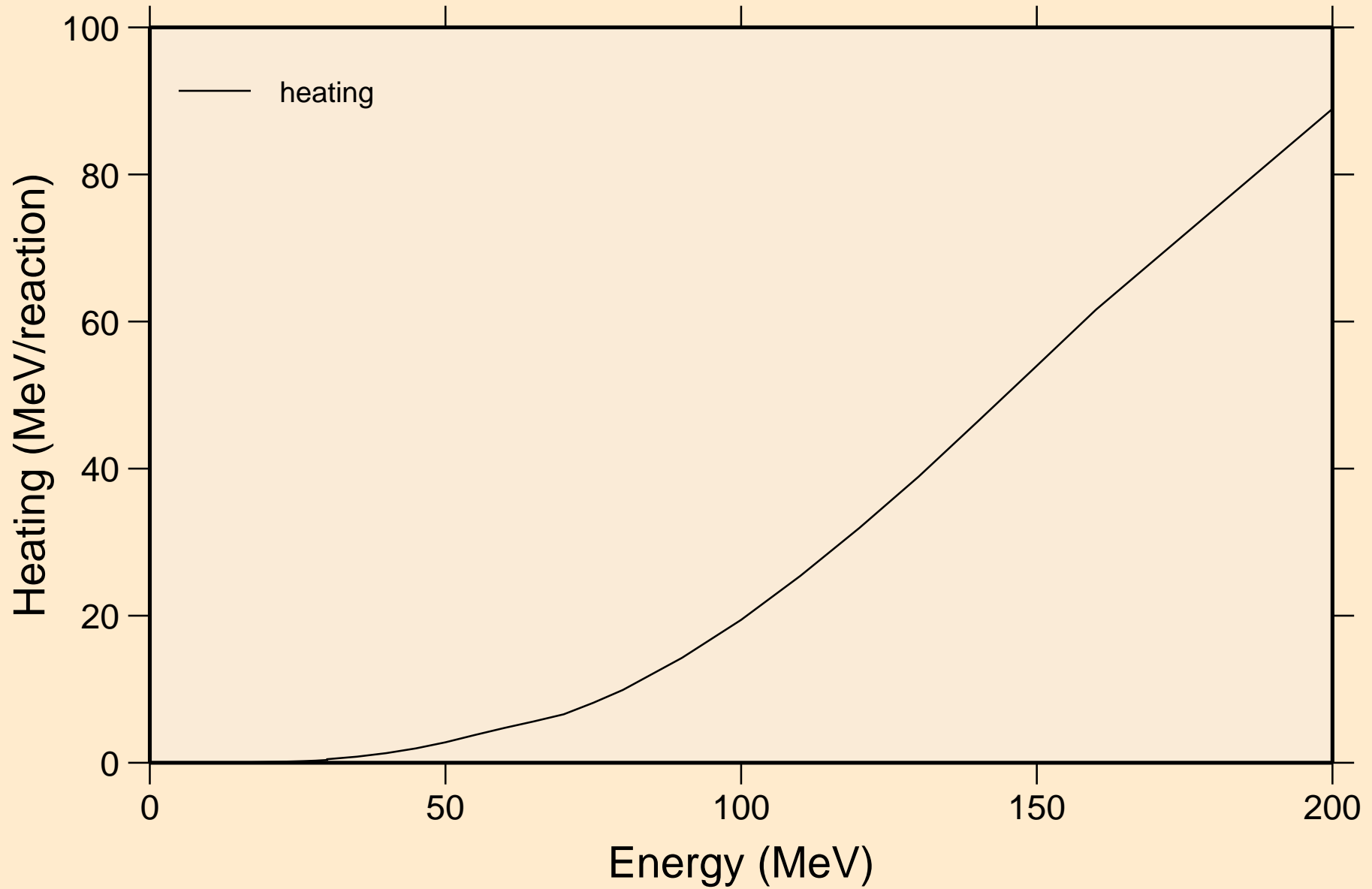

SR080 HELION ACER TENDL-2021 LIBRARY; T=0.K  
Threshold reactions

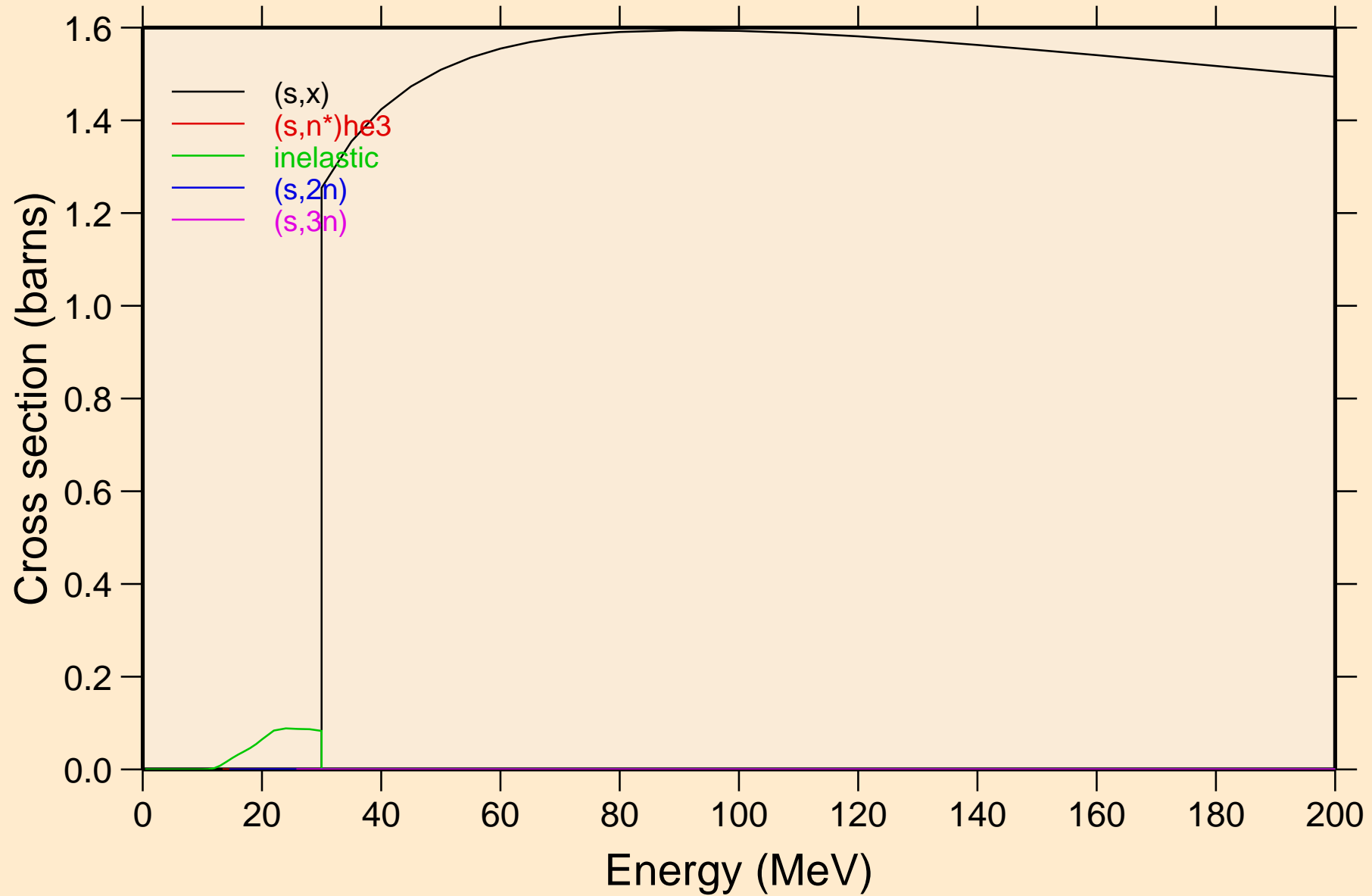

SR080 HELION ACER TENDL-2021 LIBRARY; T=0.K  
Threshold reactions

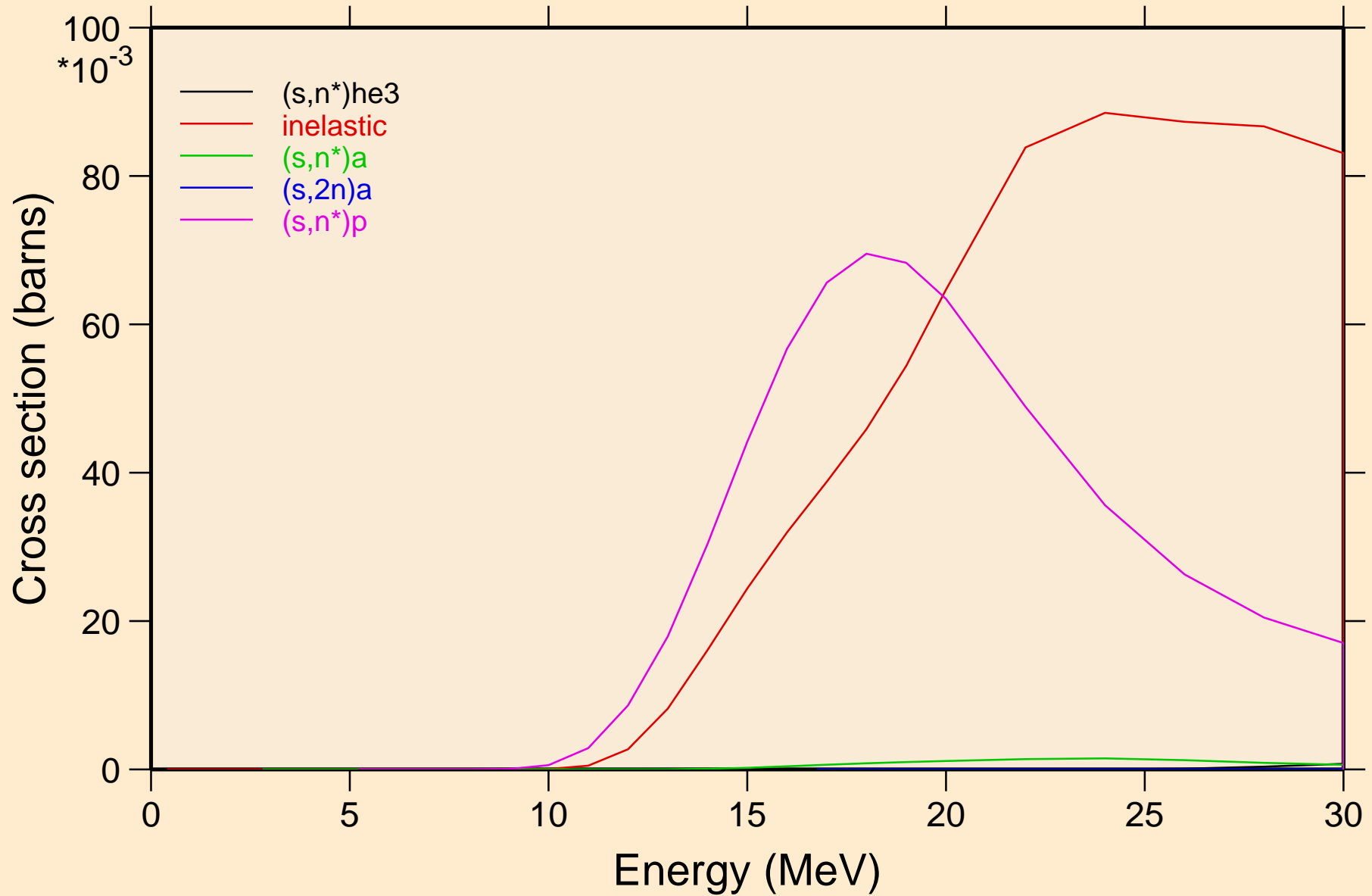

SR080 HELION ACER TENDL-2021 LIBRARY; T=0.K  
Threshold reactions

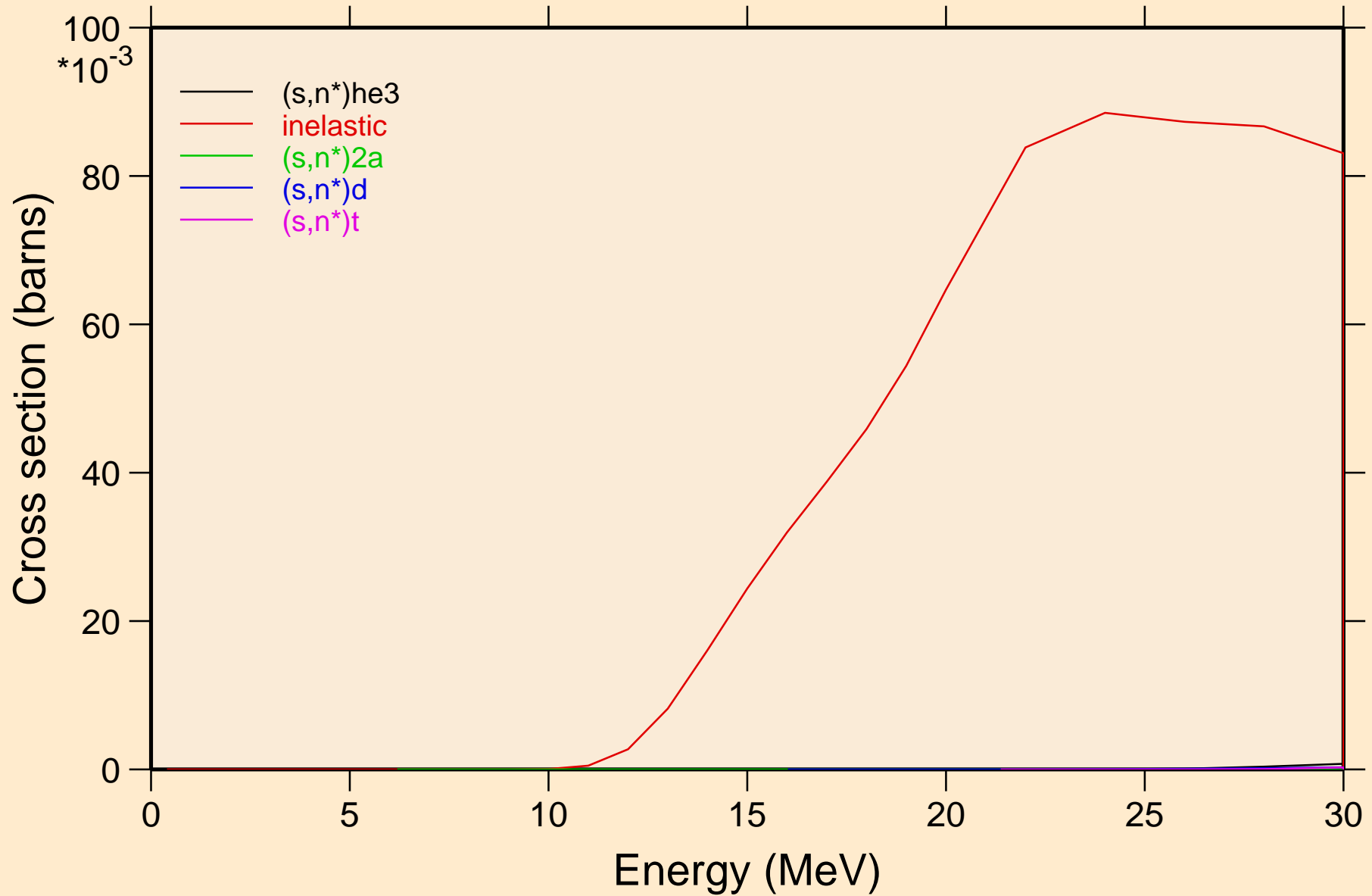

SR080 HELION ACER TENDL-2021 LIBRARY; T=0.K  
Threshold reactions

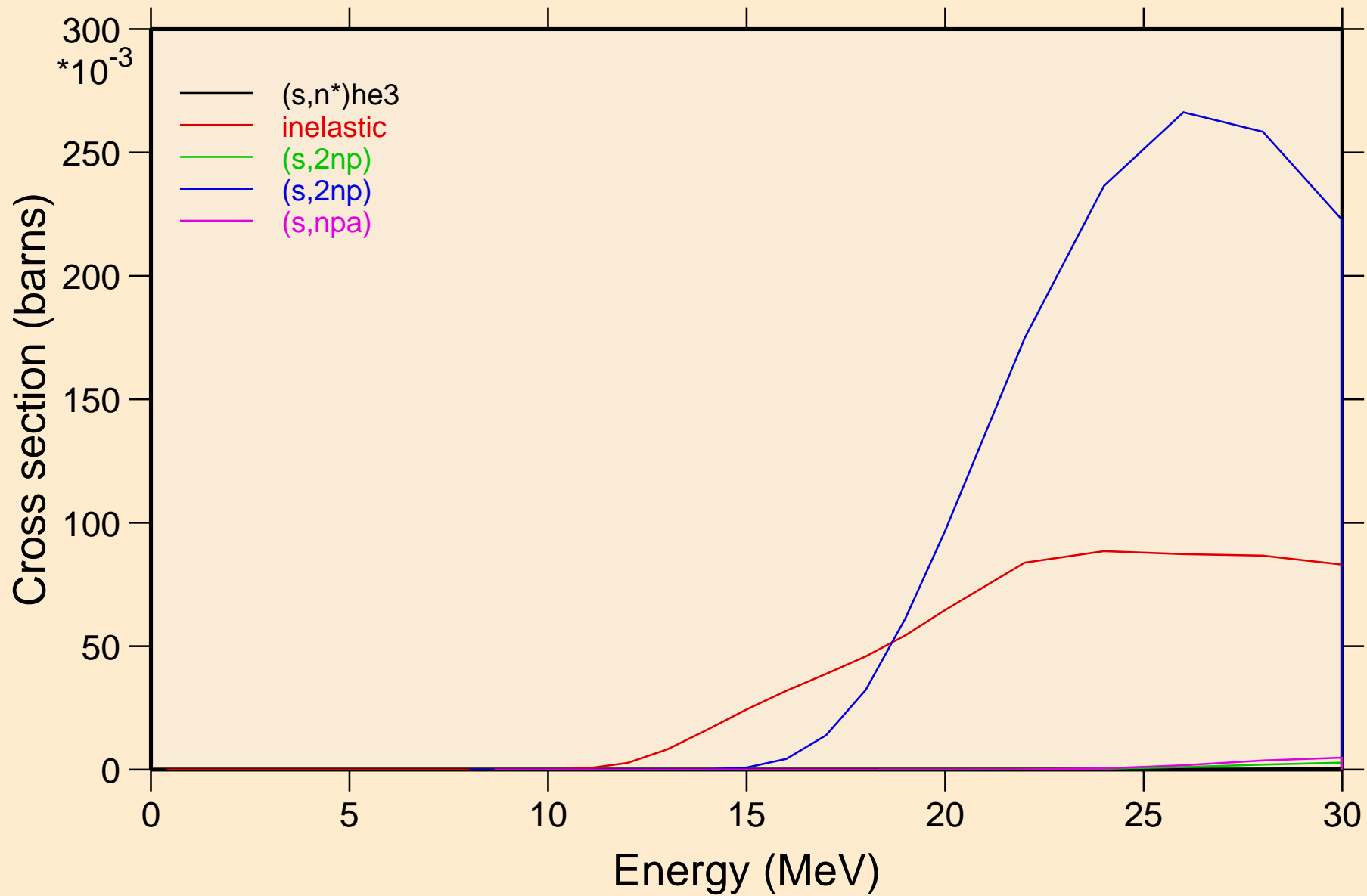



# SR080 HELION ACER TENDL-2021 LIBRARY; T=0.K

## Threshold reactions

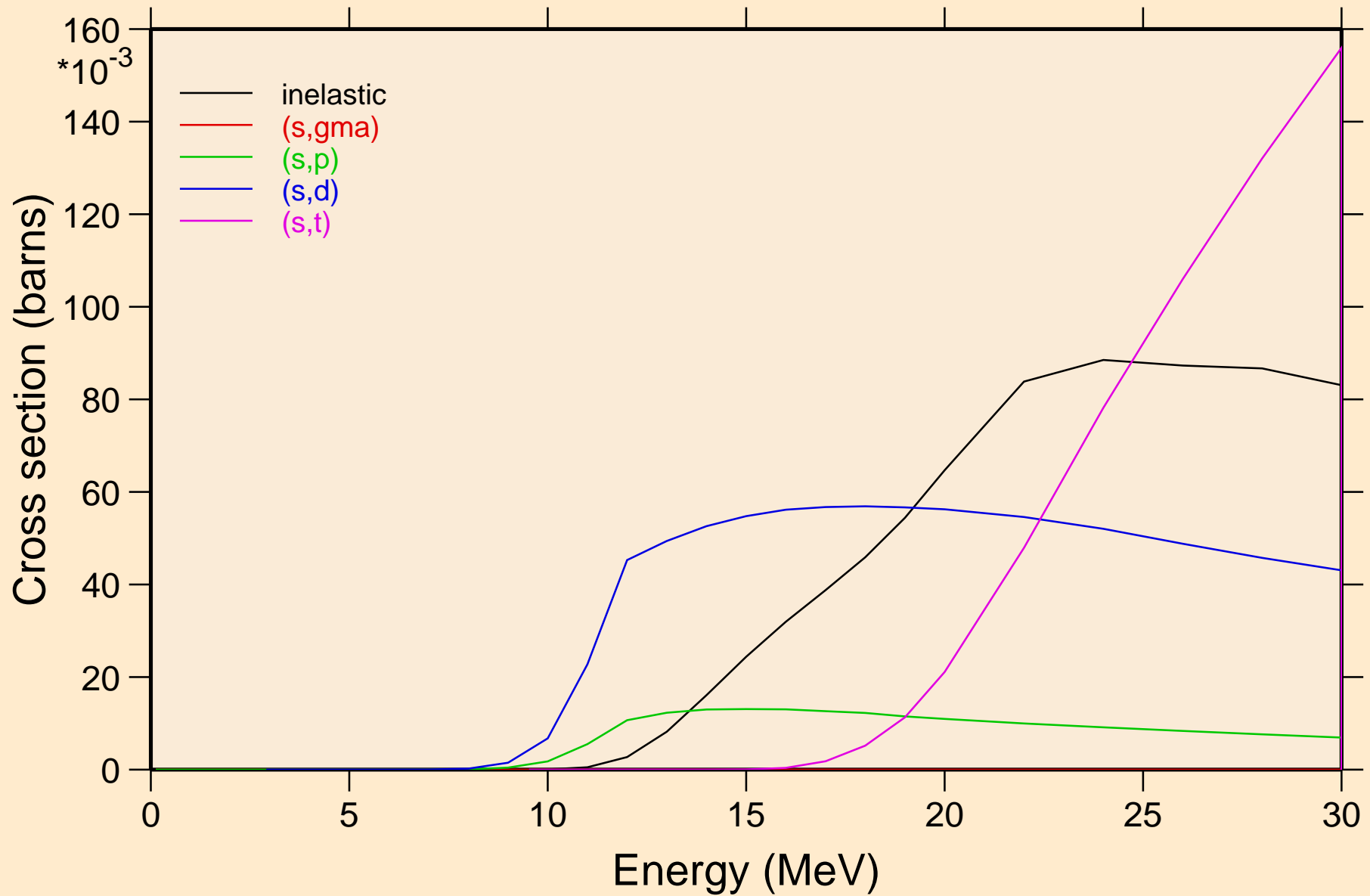

SR080 HELION ACER TENDL-2021 LIBRARY; T=0.K  
Threshold reactions

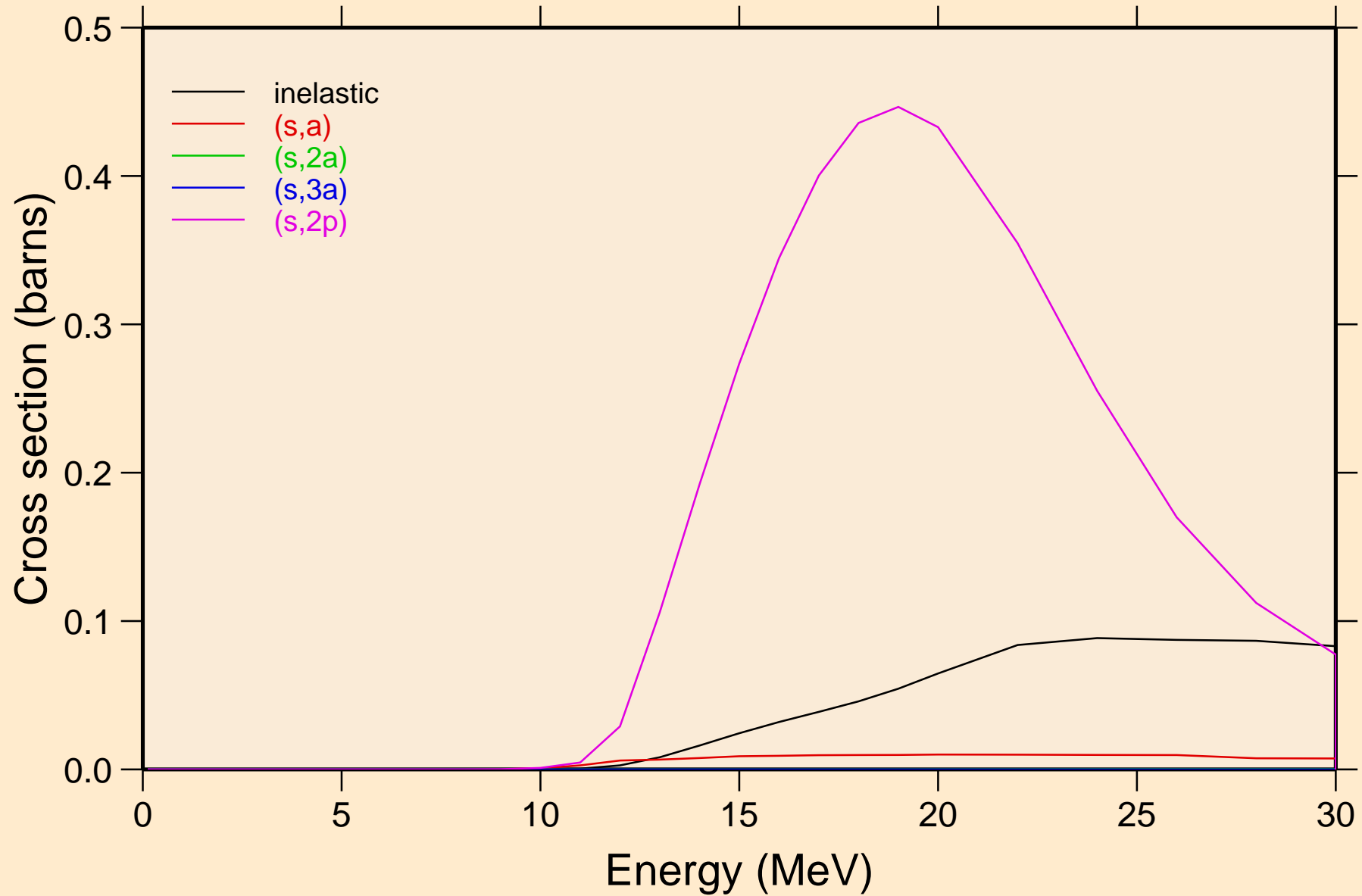

SR080 HELION ACER TENDL-2021 LIBRARY; T=0.K  
Threshold reactions

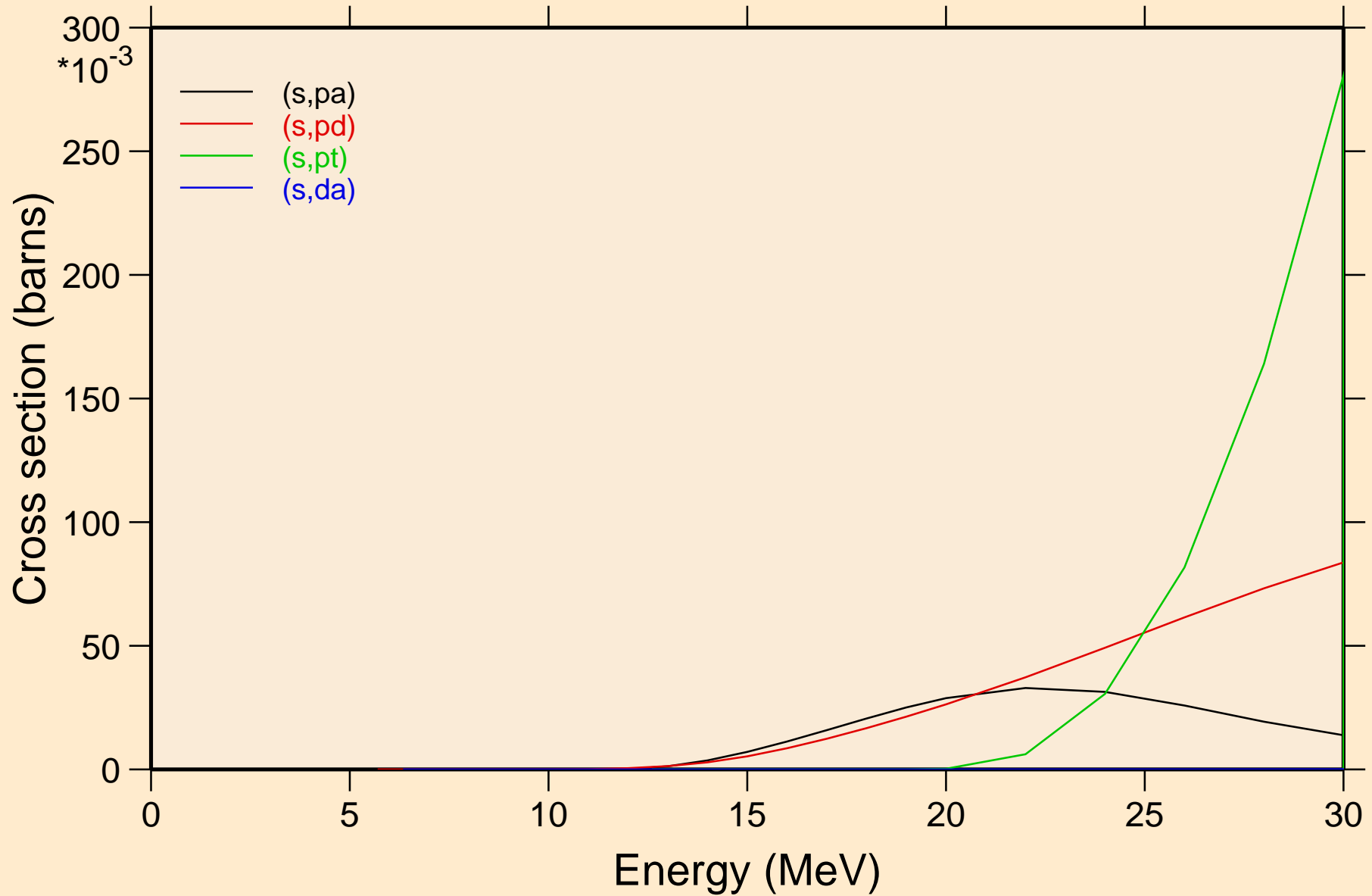

SR080 HELION ACER TENDL-2021 LIBRARY; T=0.K  
angular distribution for elastic

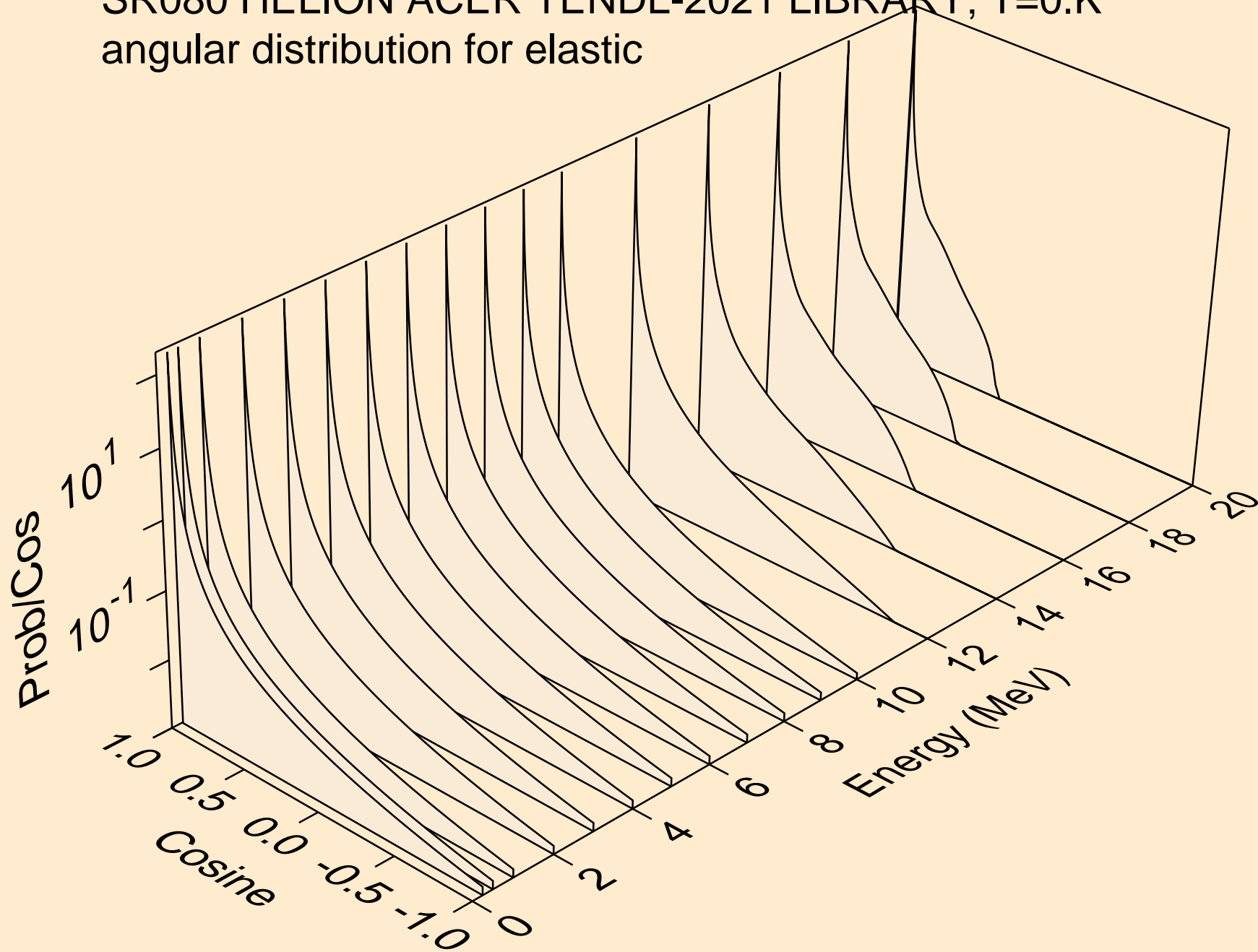

SR080 HELION ACER TENDL-2021 LIBRARY; T=0.K  
angular distribution for elastic

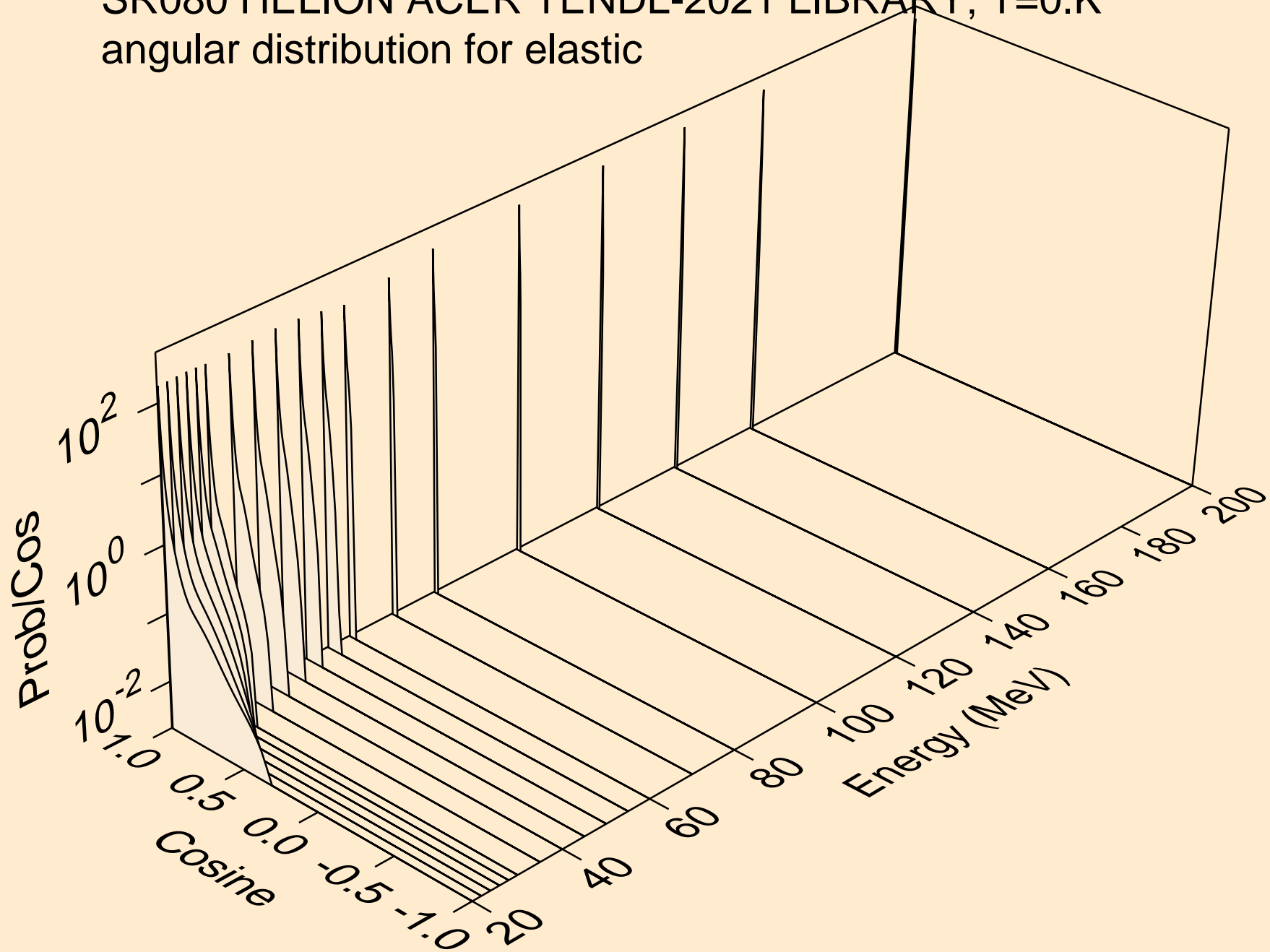

SR080 HELION ACER TENDL-2021 LIBRARY; T=0.K  
He-3 emission for (s,x)

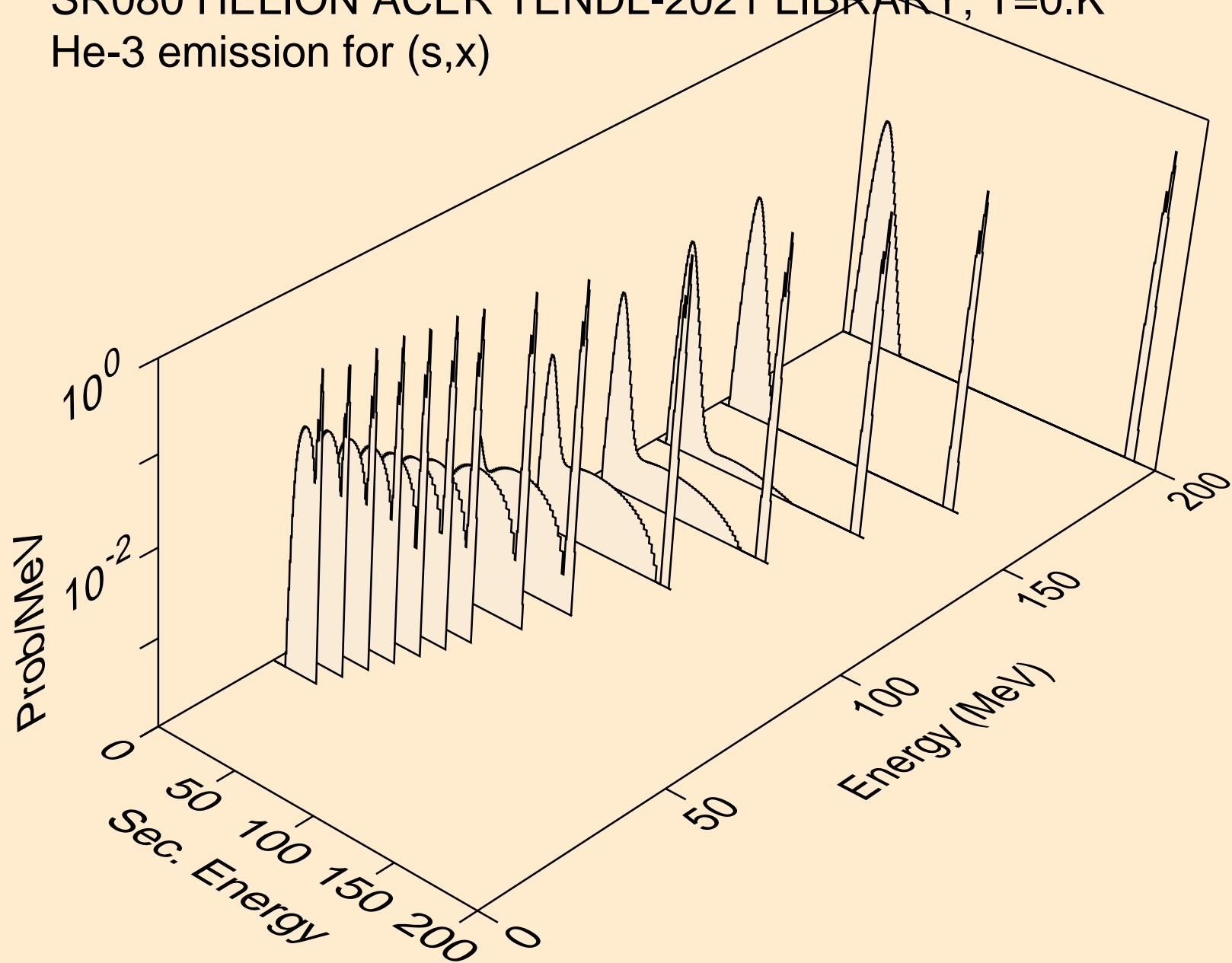

SR080 HELION ACER TENDL-2021 LIBRARY; T=0.K  
He-3 emission for (s,n\*)he3

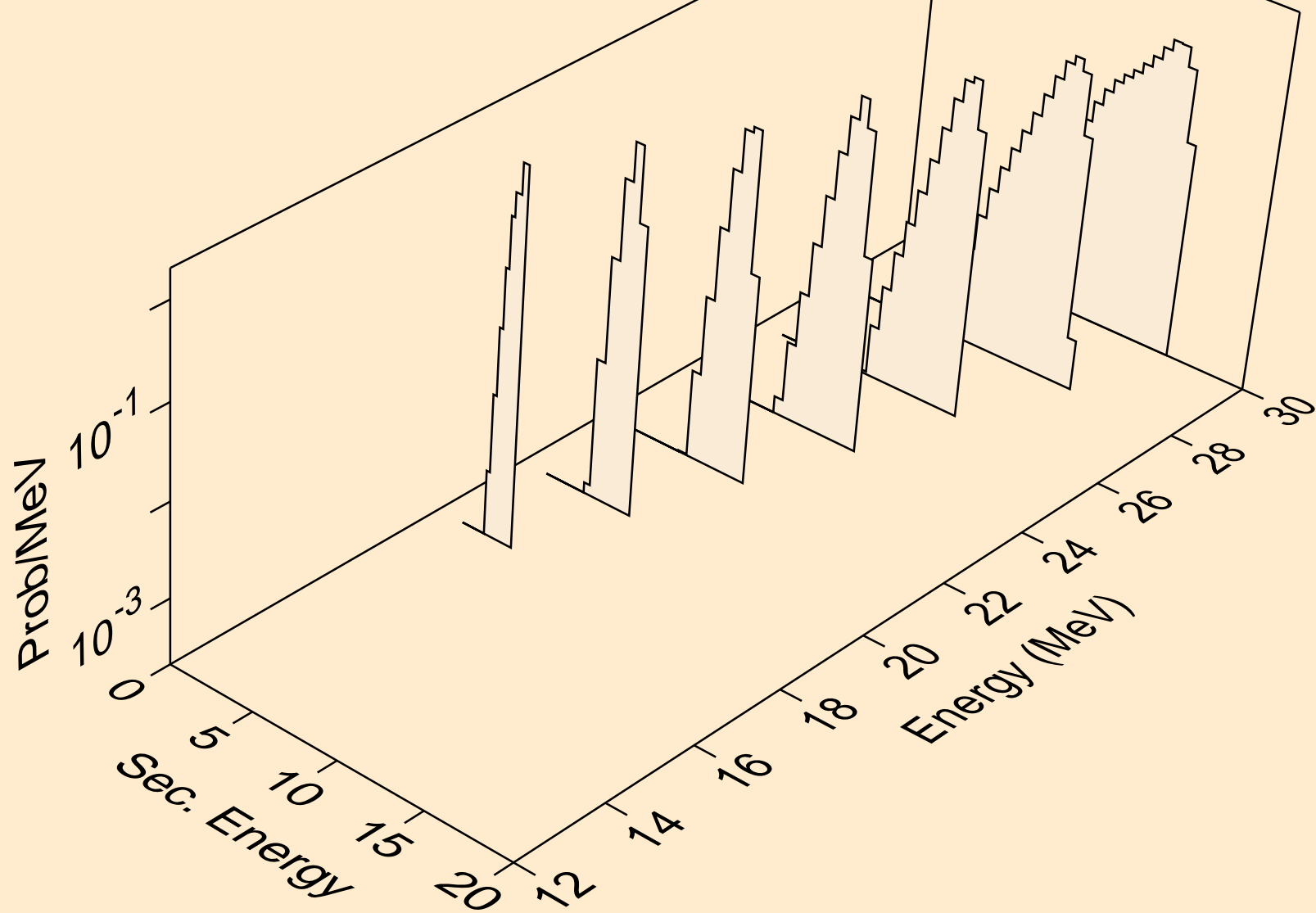

SR080 HELION ACER TENDL-2021 LIBRARY; T=0.K  
He-3 emission for inelastic

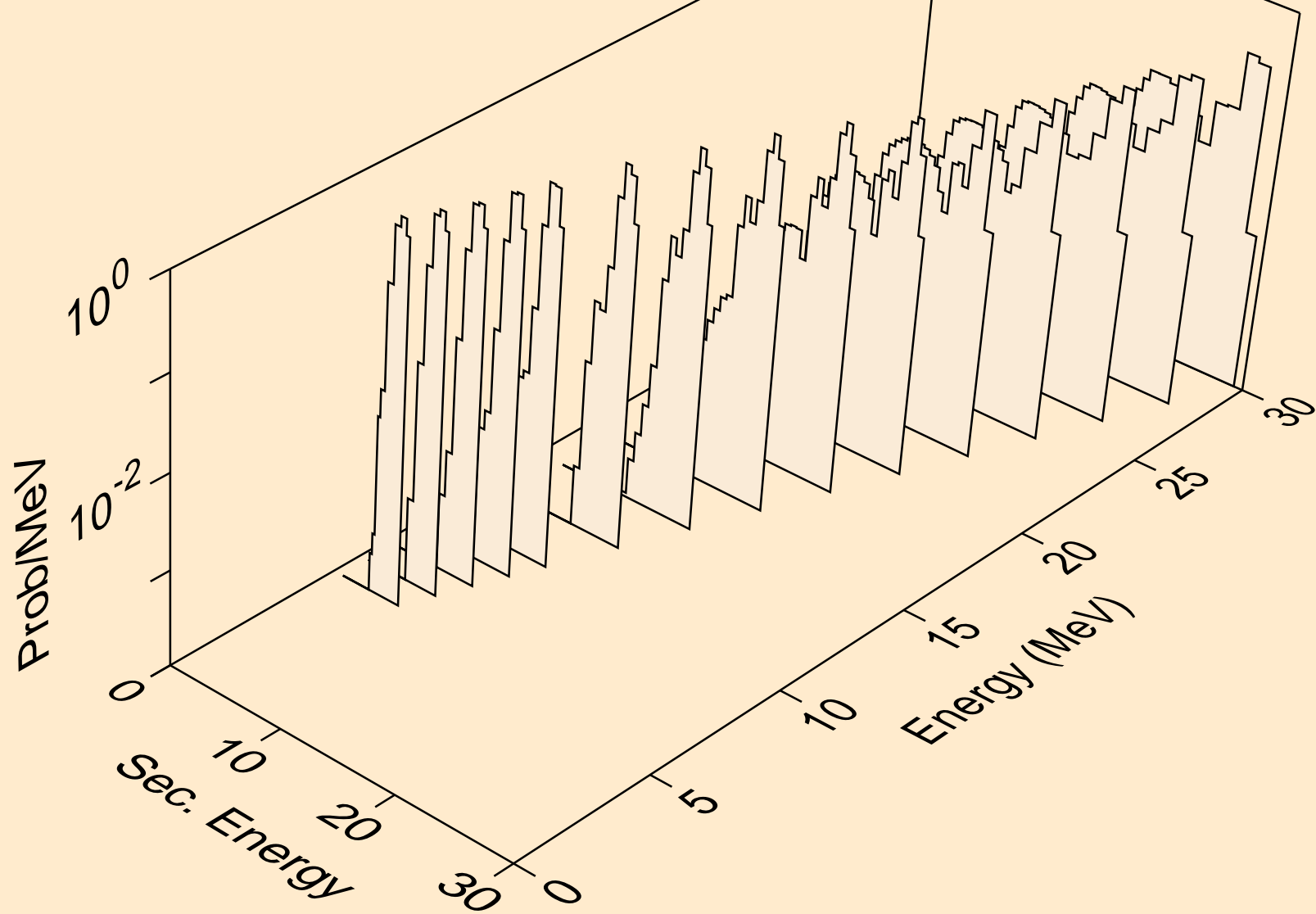



SR080 HELION ACER TENDL-2021 LIBRARY; T=0.K  
Photon emission for (z,n)

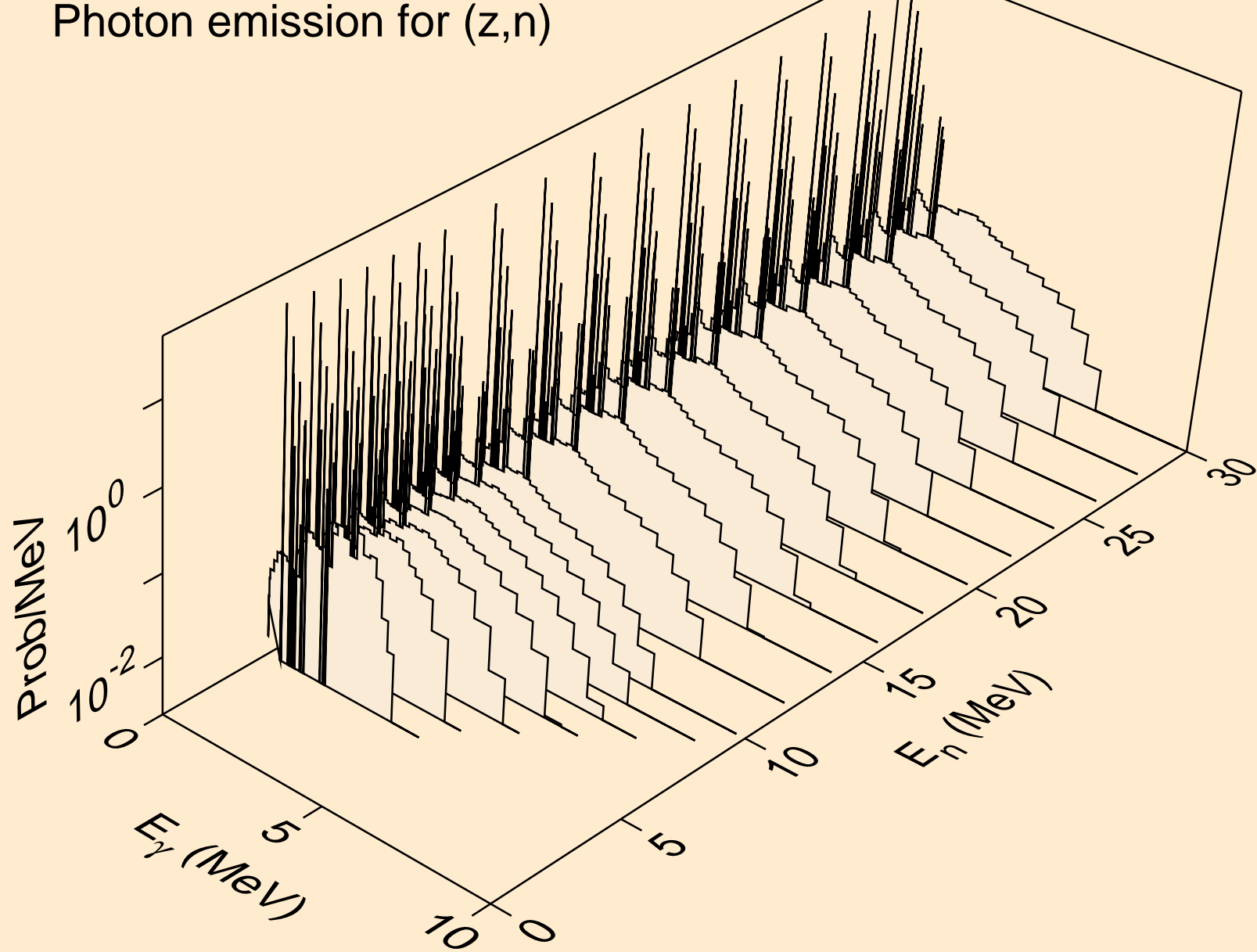

SR080 HELION ACER TENDL-2021 LIBRARY; T=0.K  
Photon emission for (n,x)

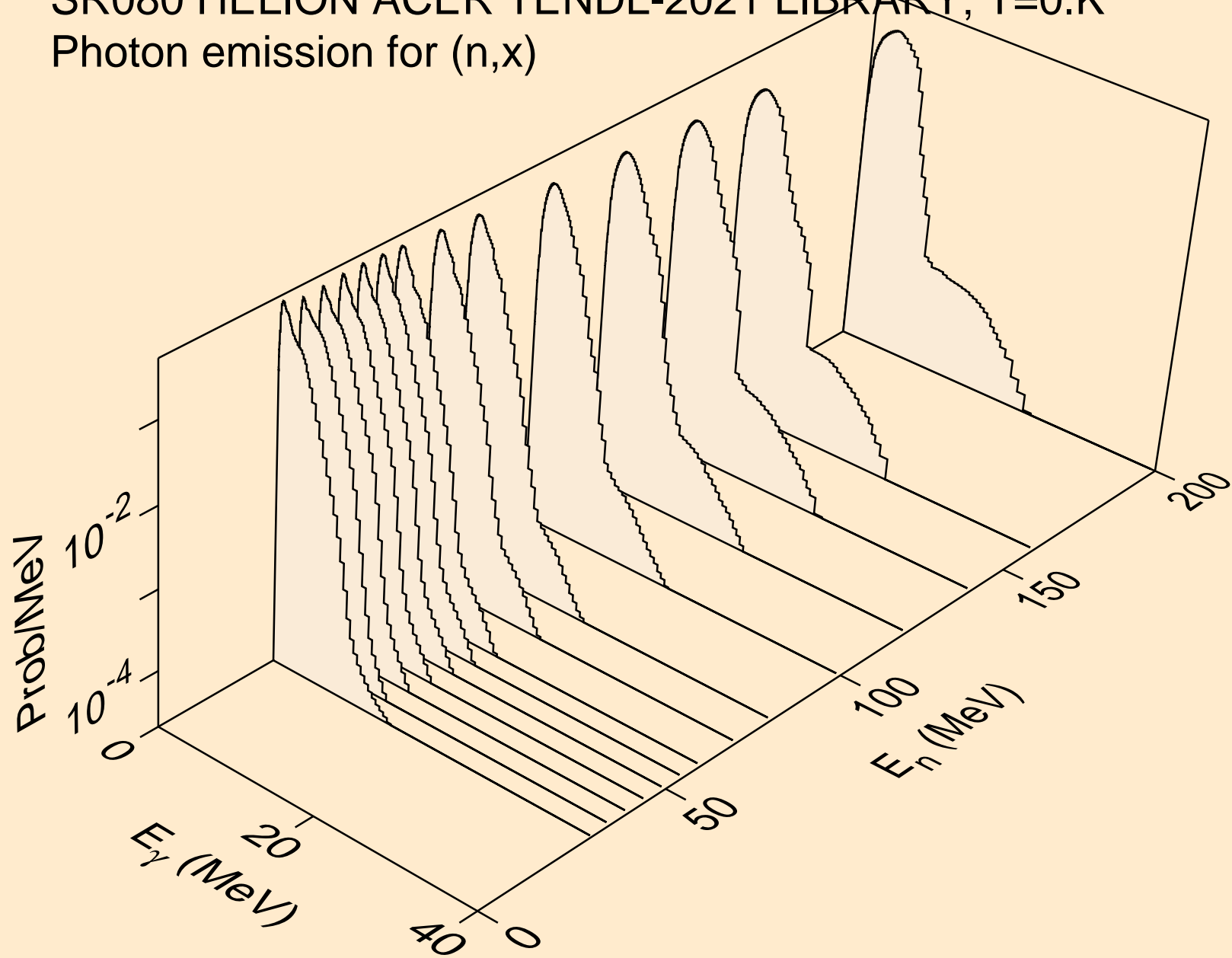

SR080 HELION ACER TENDL-2021 LIBRARY; T=0.K  
Photon emission for (n,2n)

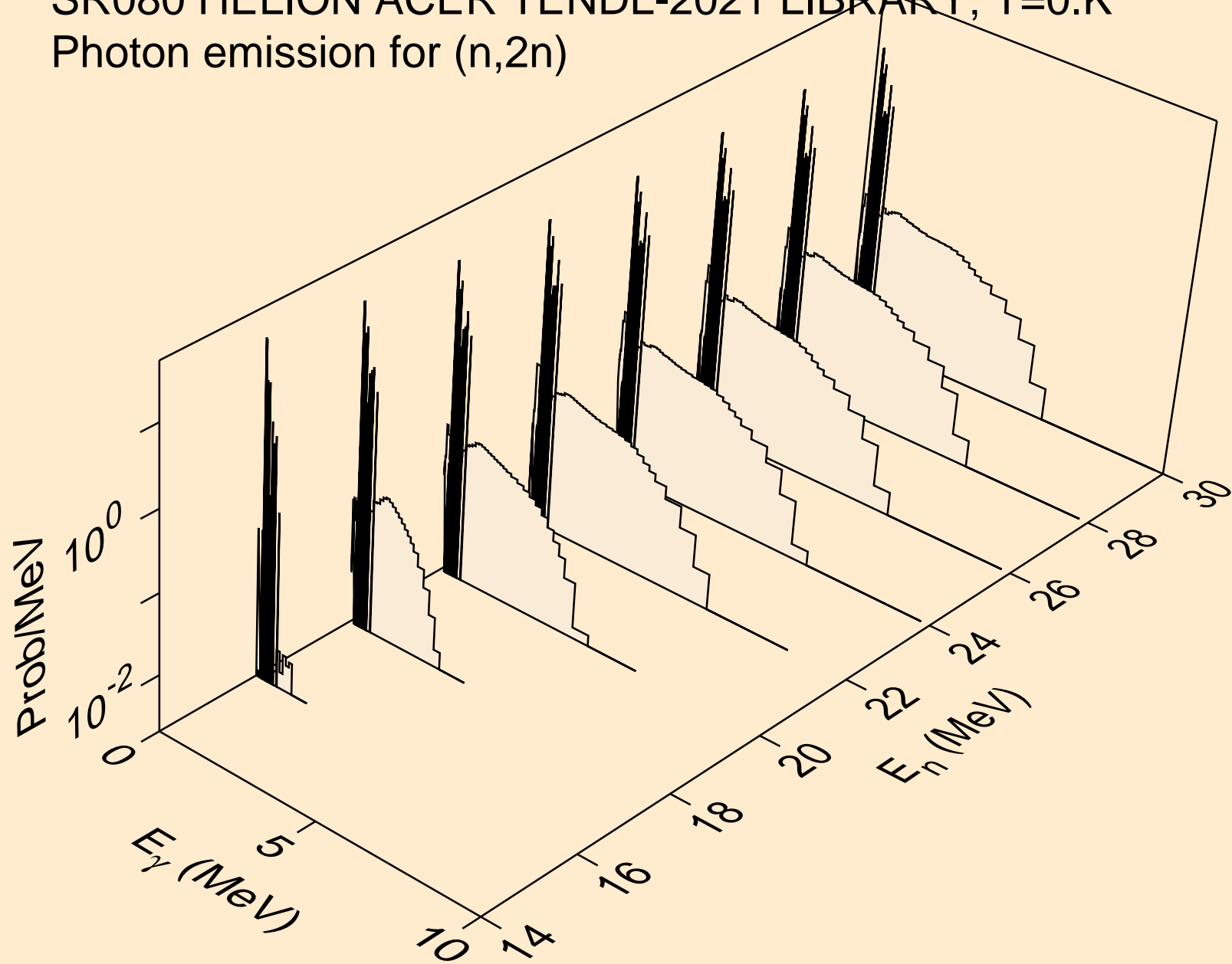

SR080 HELION ACER TENDL-2021 LIBRARY; T=0.K  
Photon emission for (n,3n)

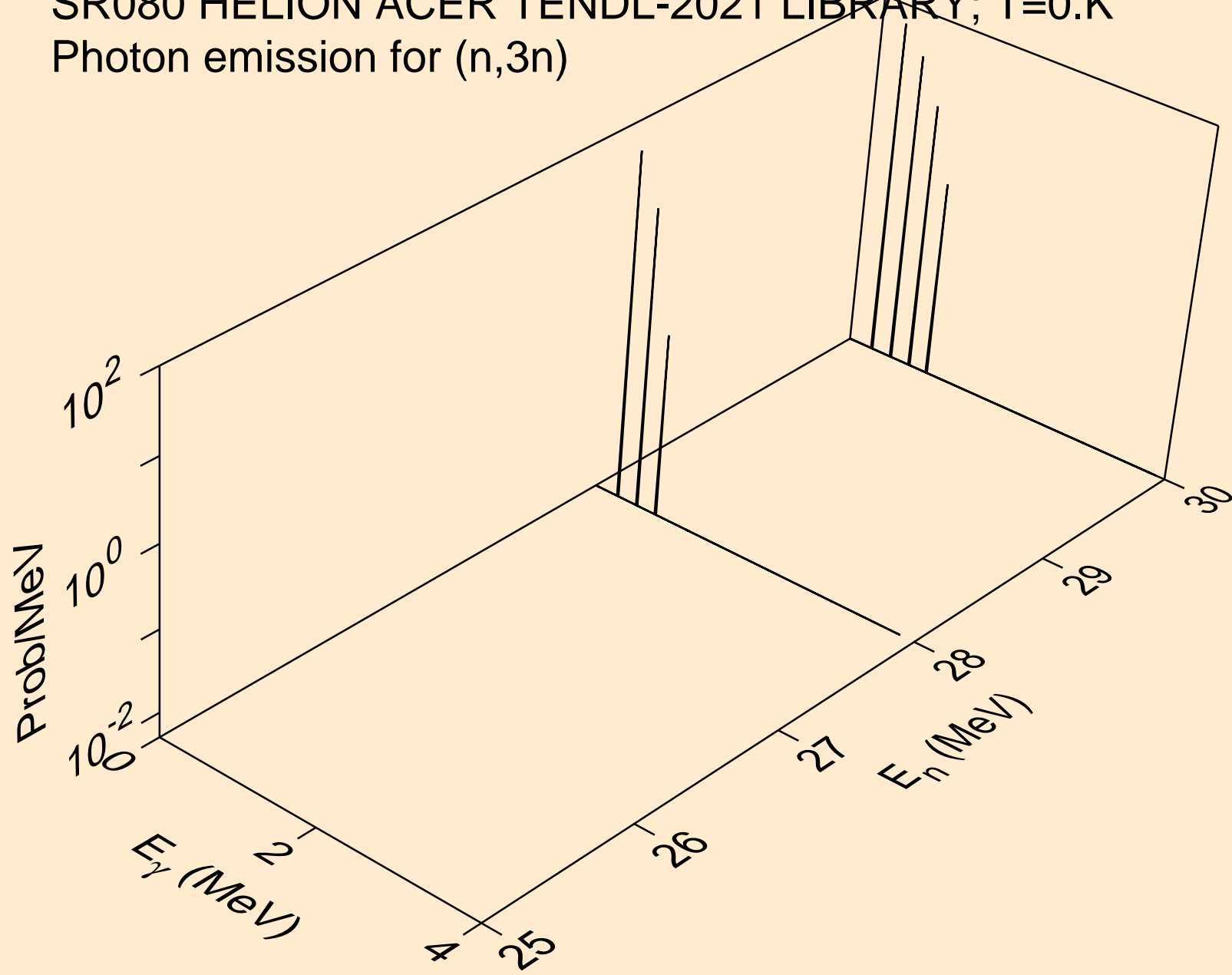

SR080 HELION ACER TENDL-2021 LIBRARY; T=0.K  
Photon emission for (n,n\*)a

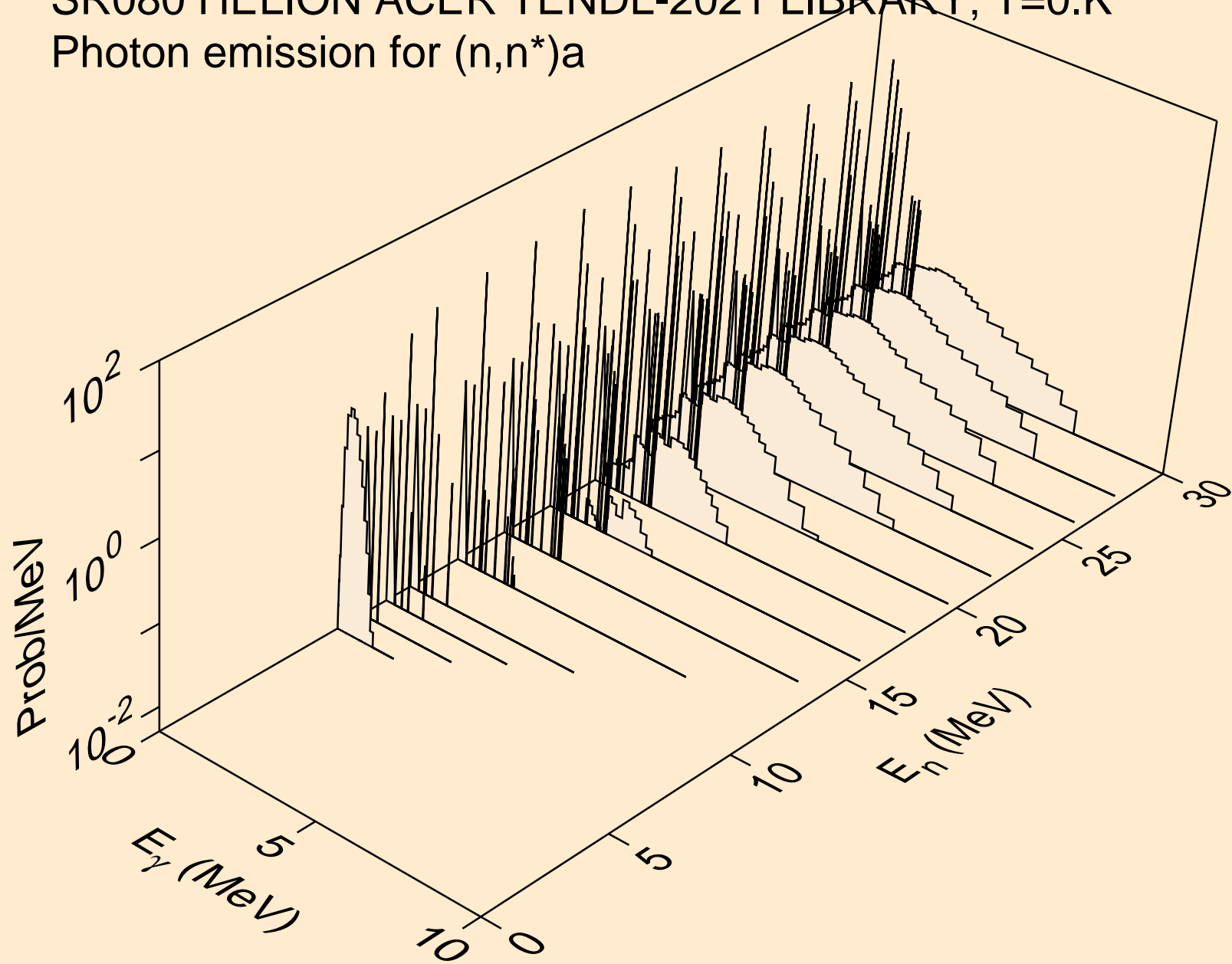

SR080 HELION ACER TENDL-2021 LIBRARY; T=0.K  
Photon emission for (n,2n)a

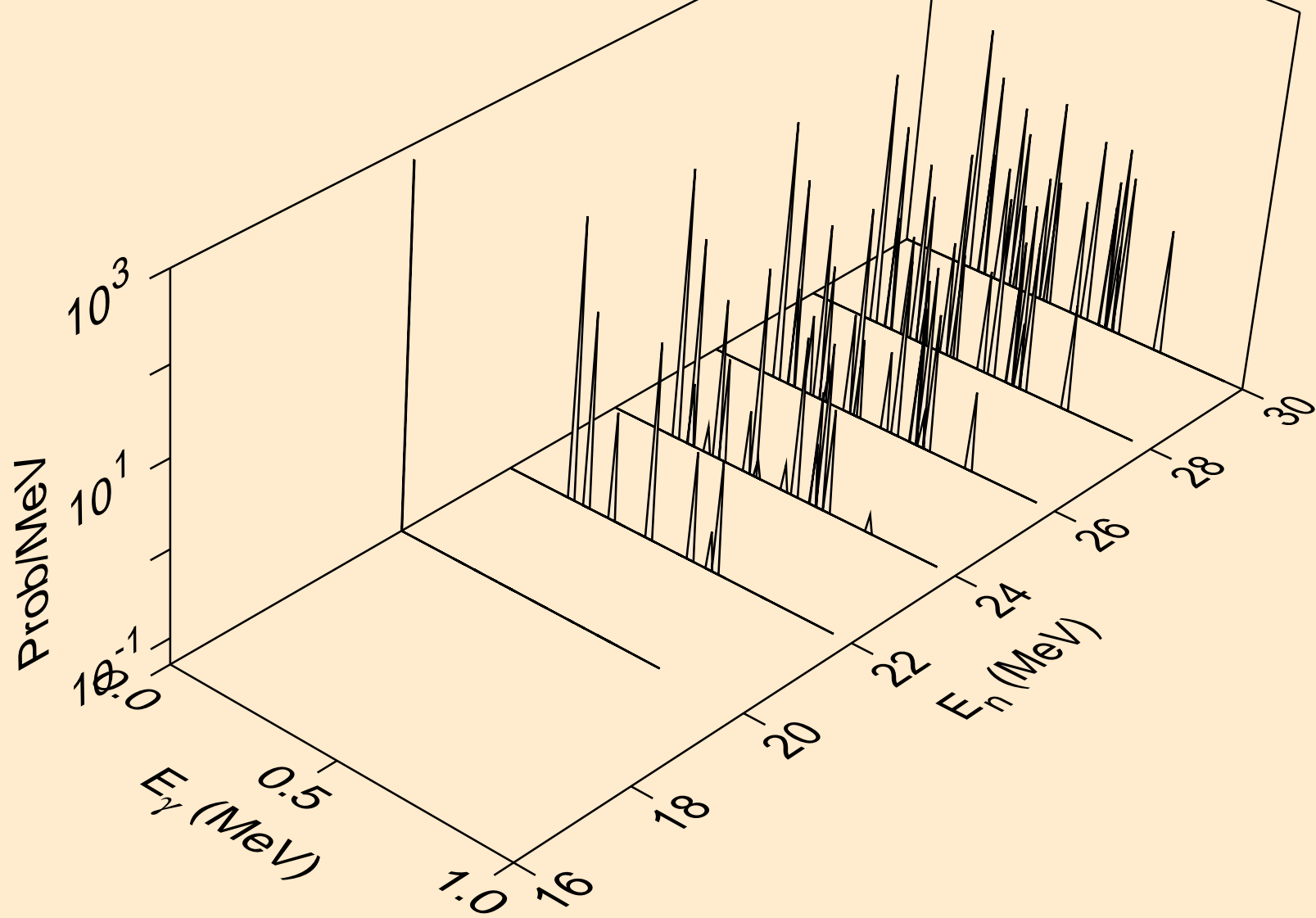

SR080 HELION ACER TENDL-2021 LIBRARY; T=0.K  
Photon emission for (n,n\*)p

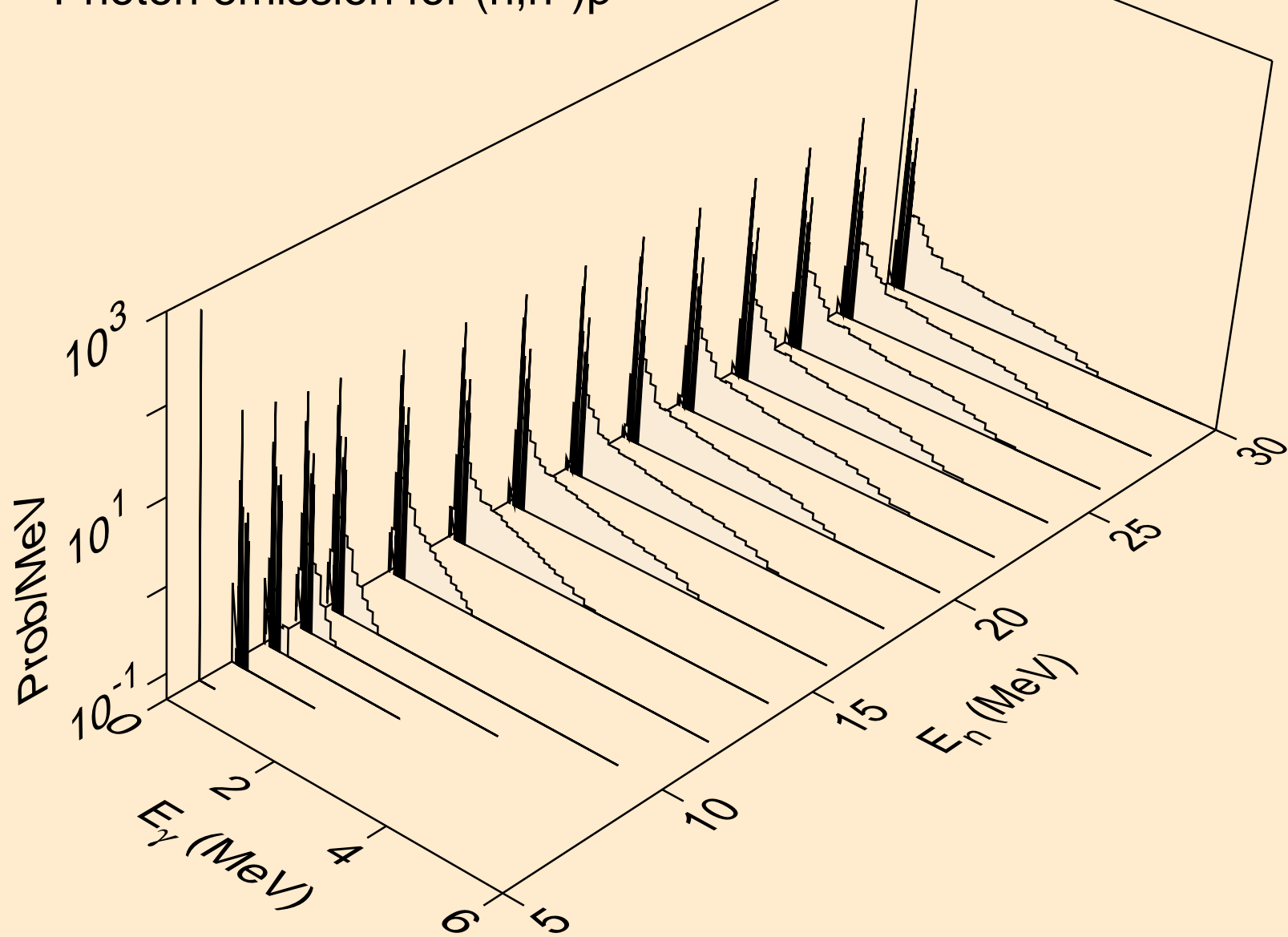

SR080 HELION ACER TENDL-2021 LIBRARY; T=0.K  
Photon emission for (n,n\*)2a

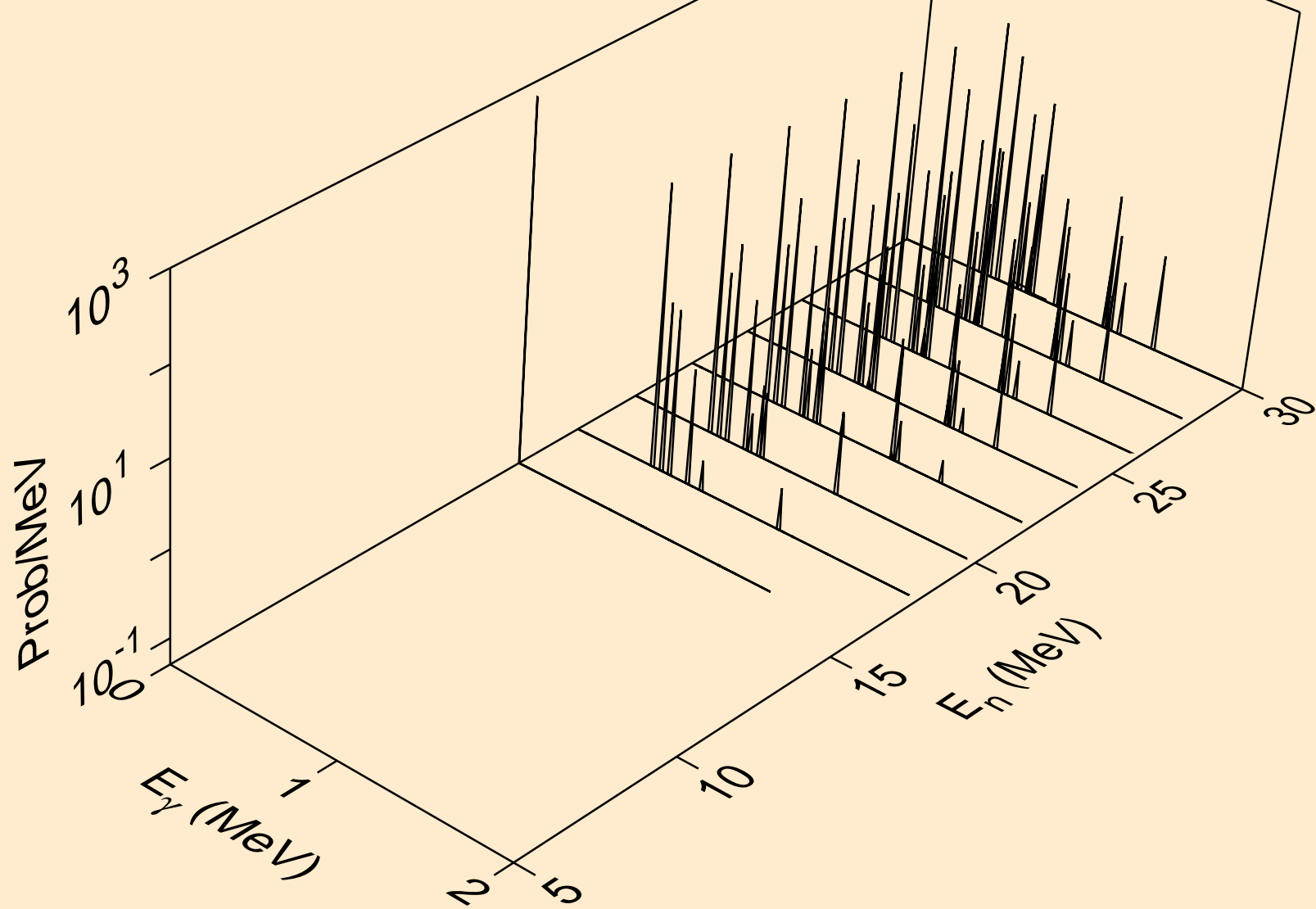



SR080 HELION ACER TENDL-2021 LIBRARY; T=0.K  
Photon emission for (n,n\*)d

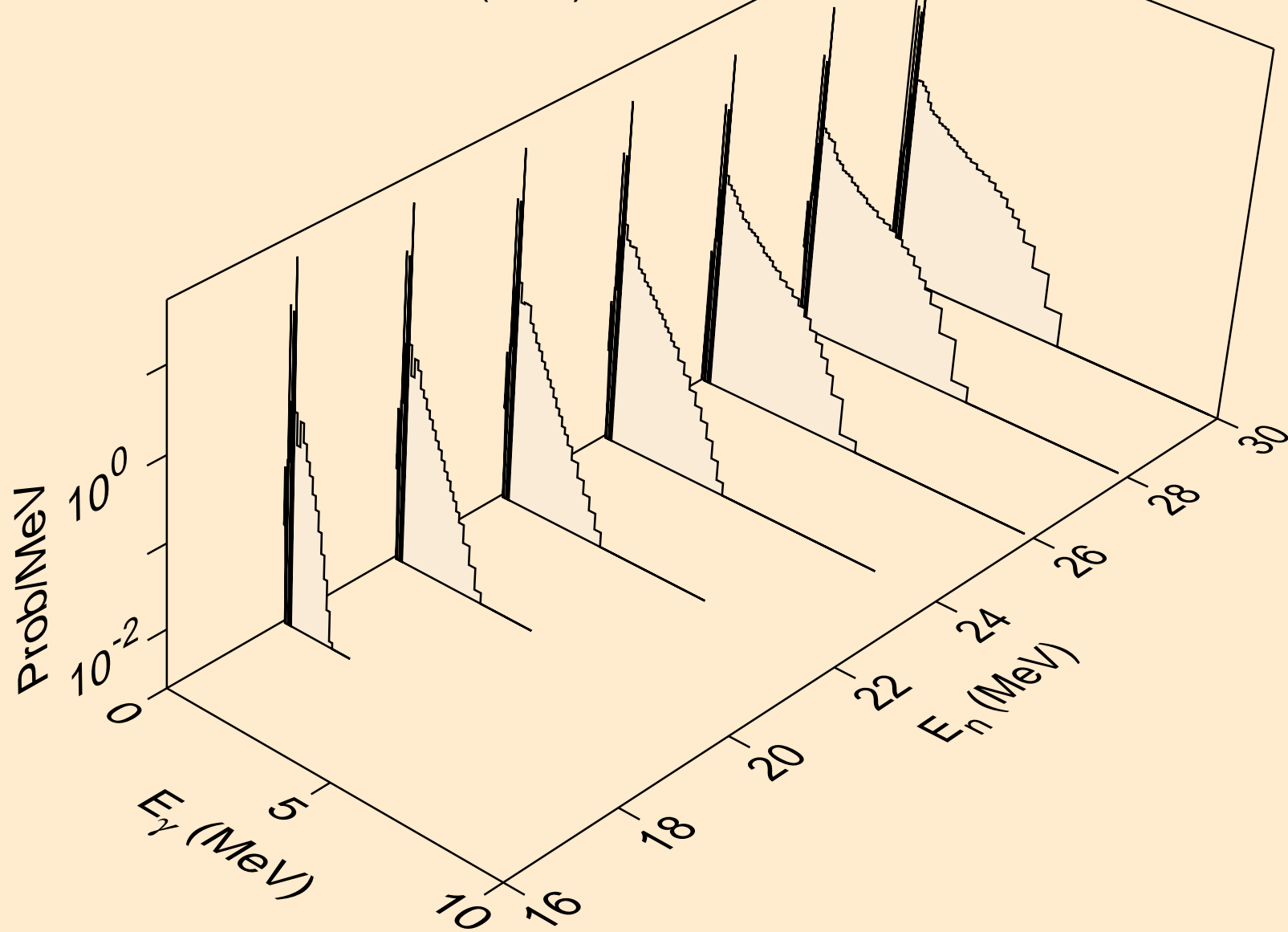

SR080 HELION ACER TENDL-2021 LIBRARY; T=0.K  
Photon emission for (n,n\*)t

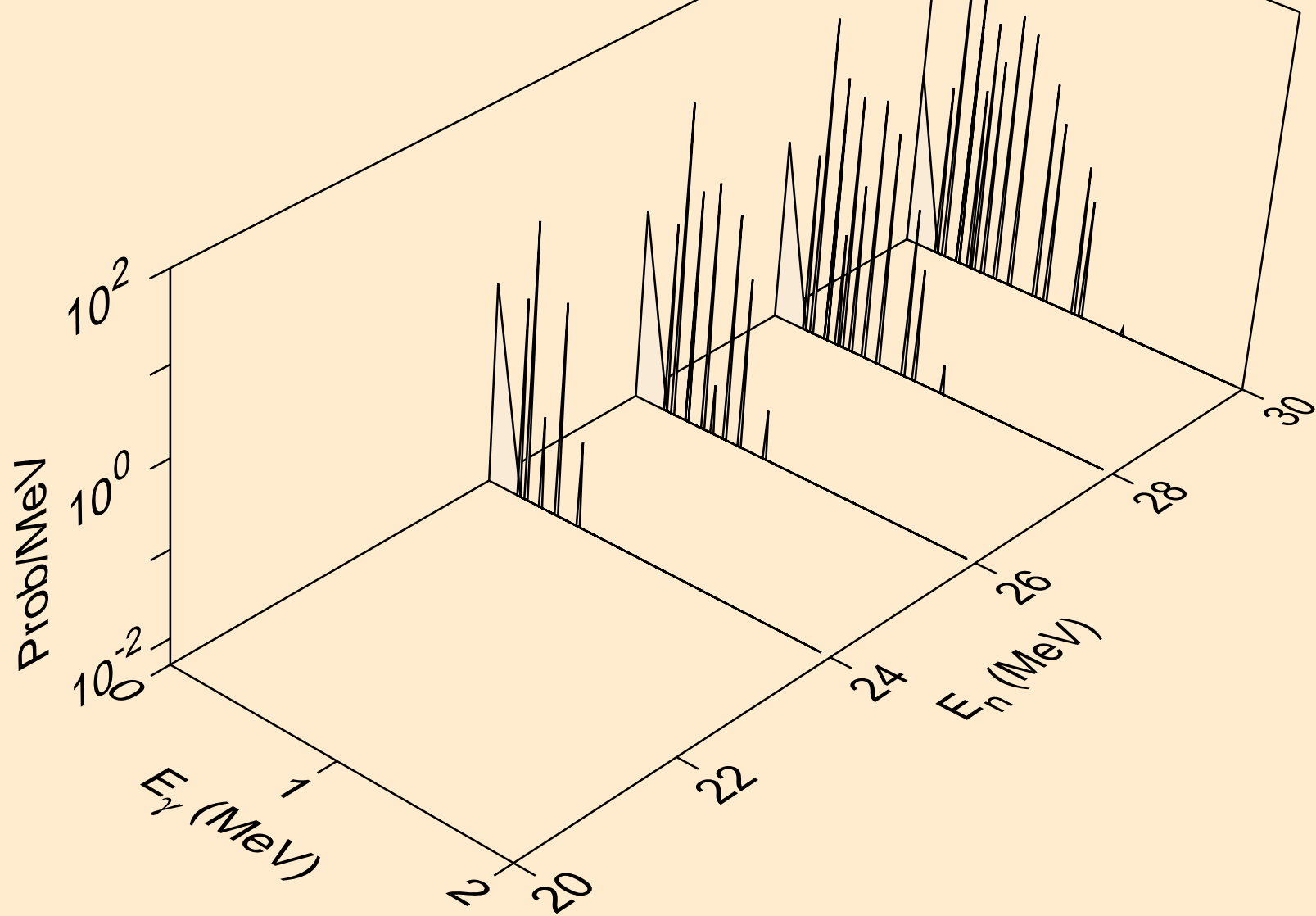

SR080 HELION ACER TENDL-2021 LIBRARY; T=0.K  
Photon emission for (n,n\*)he3

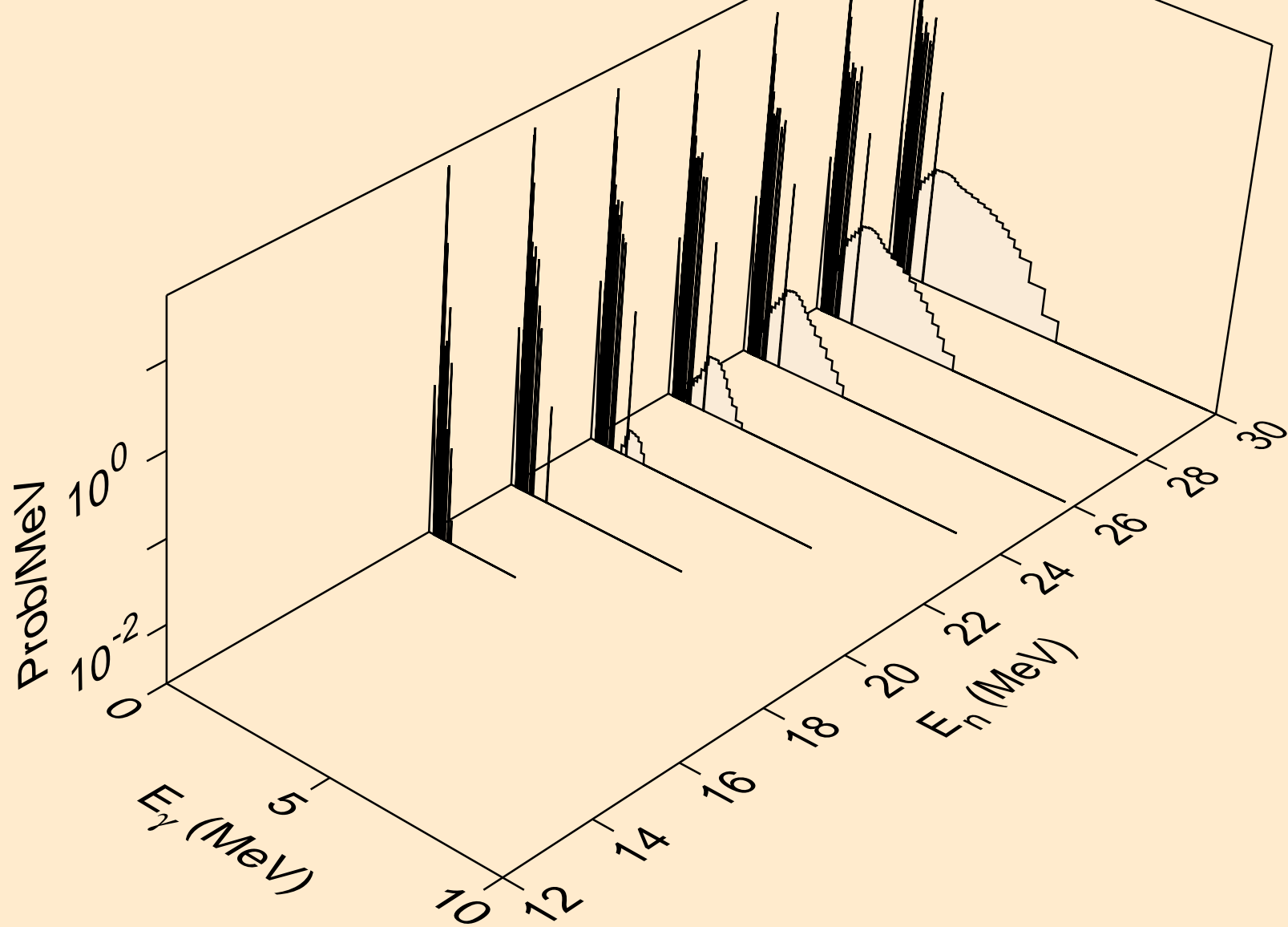

SR080 HELION ACER TENDL-2021 LIBRARY; T=0.K  
Photon emission for (n,2np)

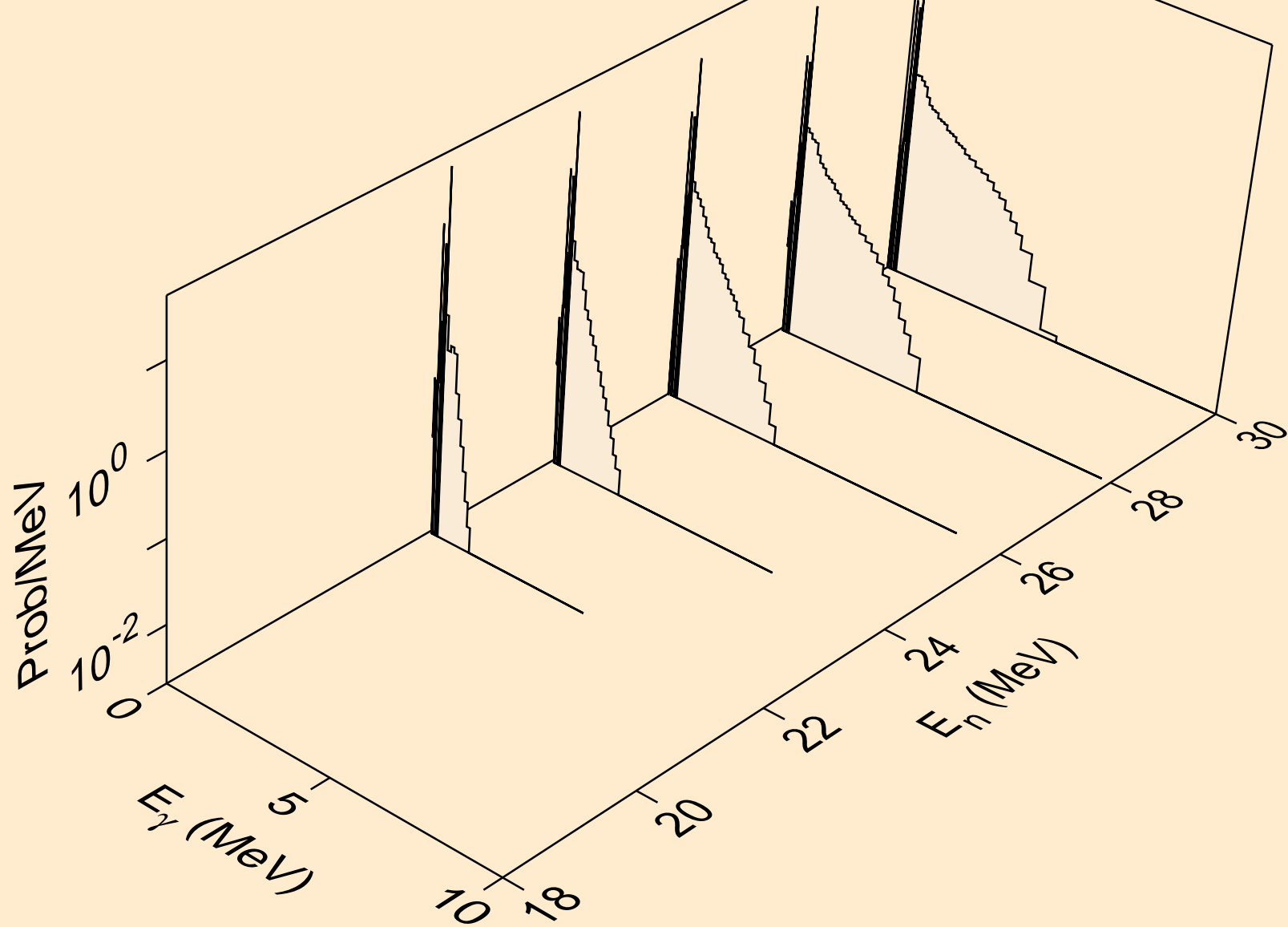

SR080 HELION ACER TENDL-2021 LIBRARY; T=0.K  
Photon emission for (n,2np)

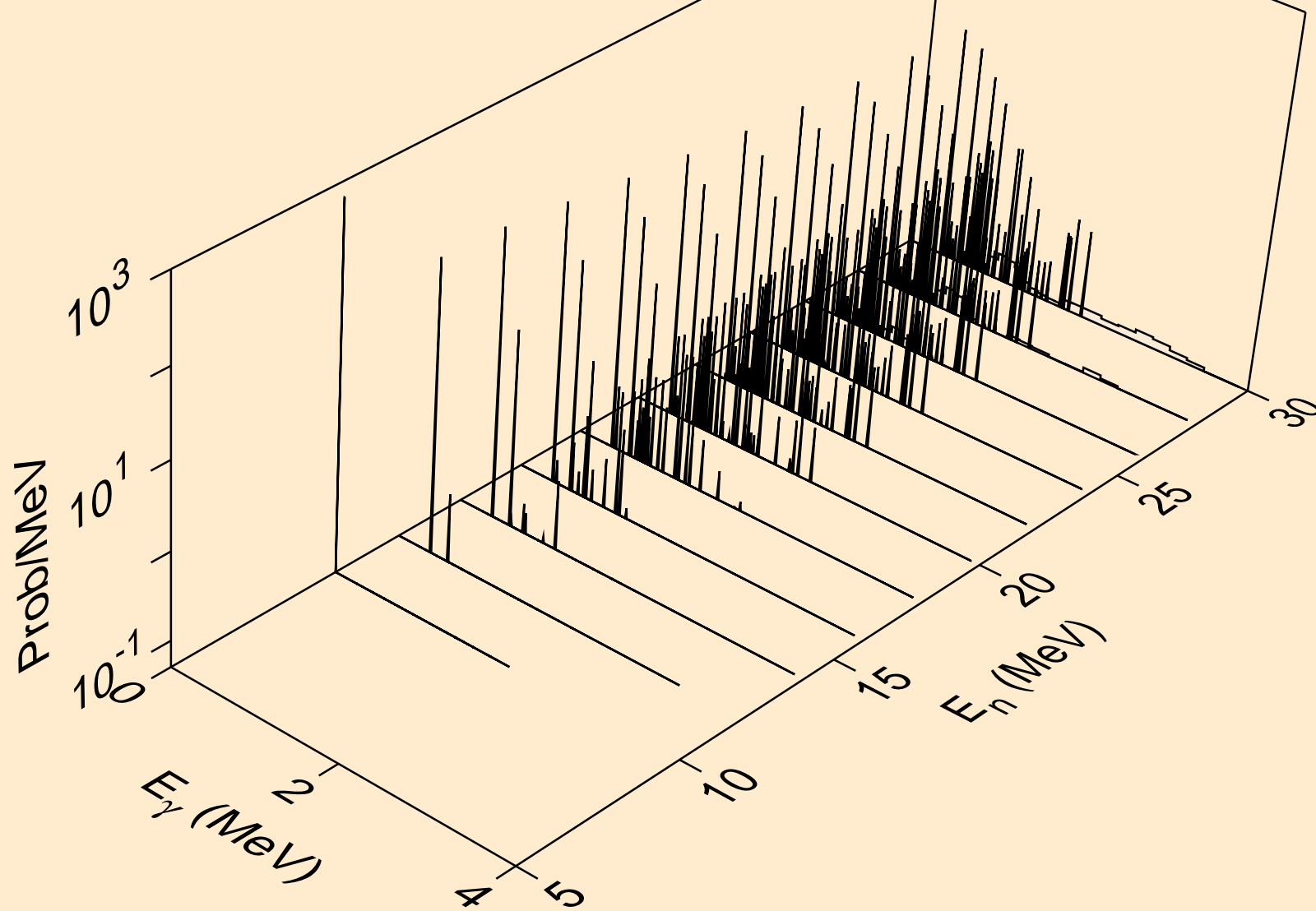

SR080 HELION ACER TENDL-2021 LIBRARY; T=0.K  
Photon emission for (n,npa)

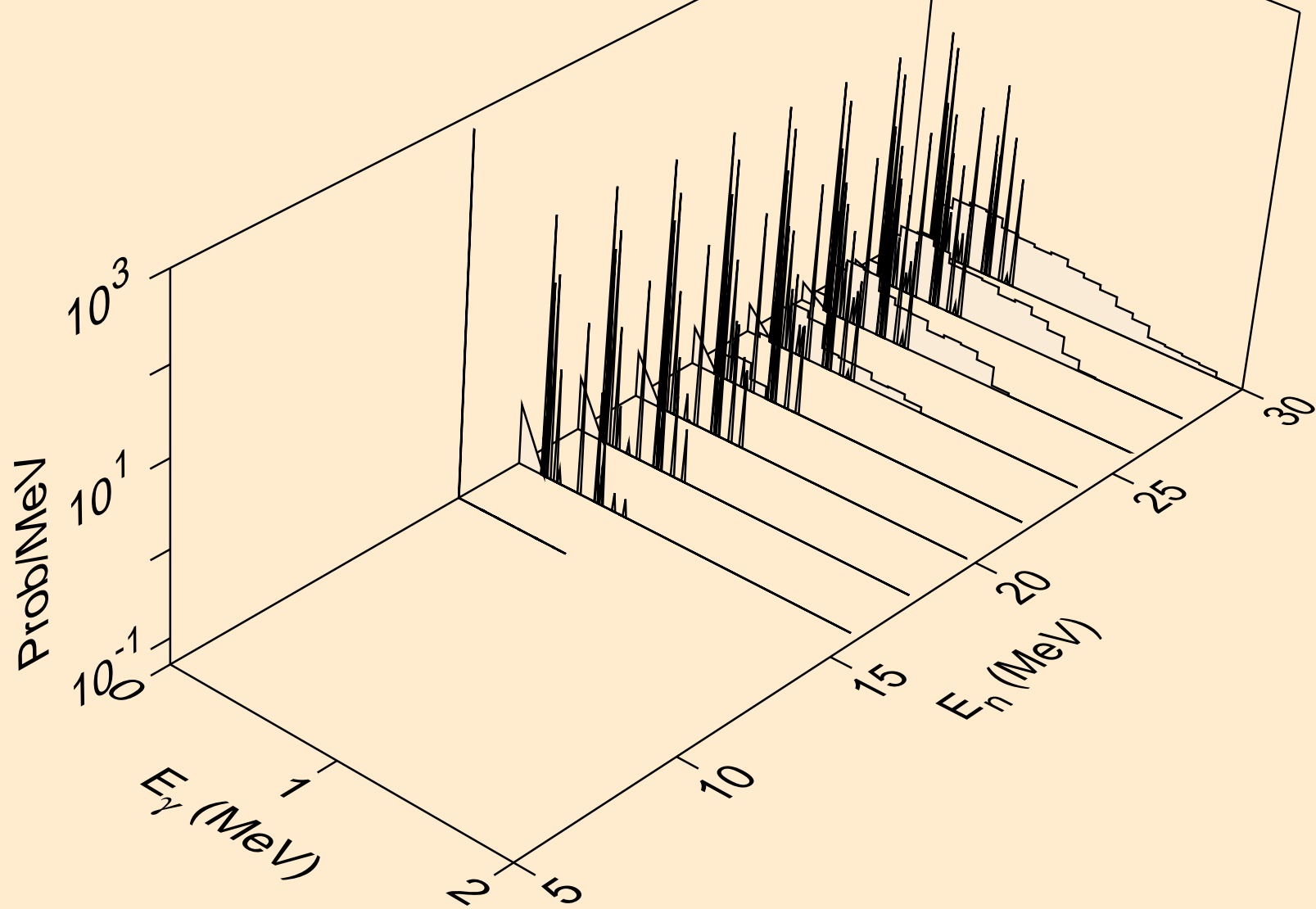

SR080 HELION ACER TENDL-2021 LIBRARY; T=0.K  
Photon emission for (n,gma)

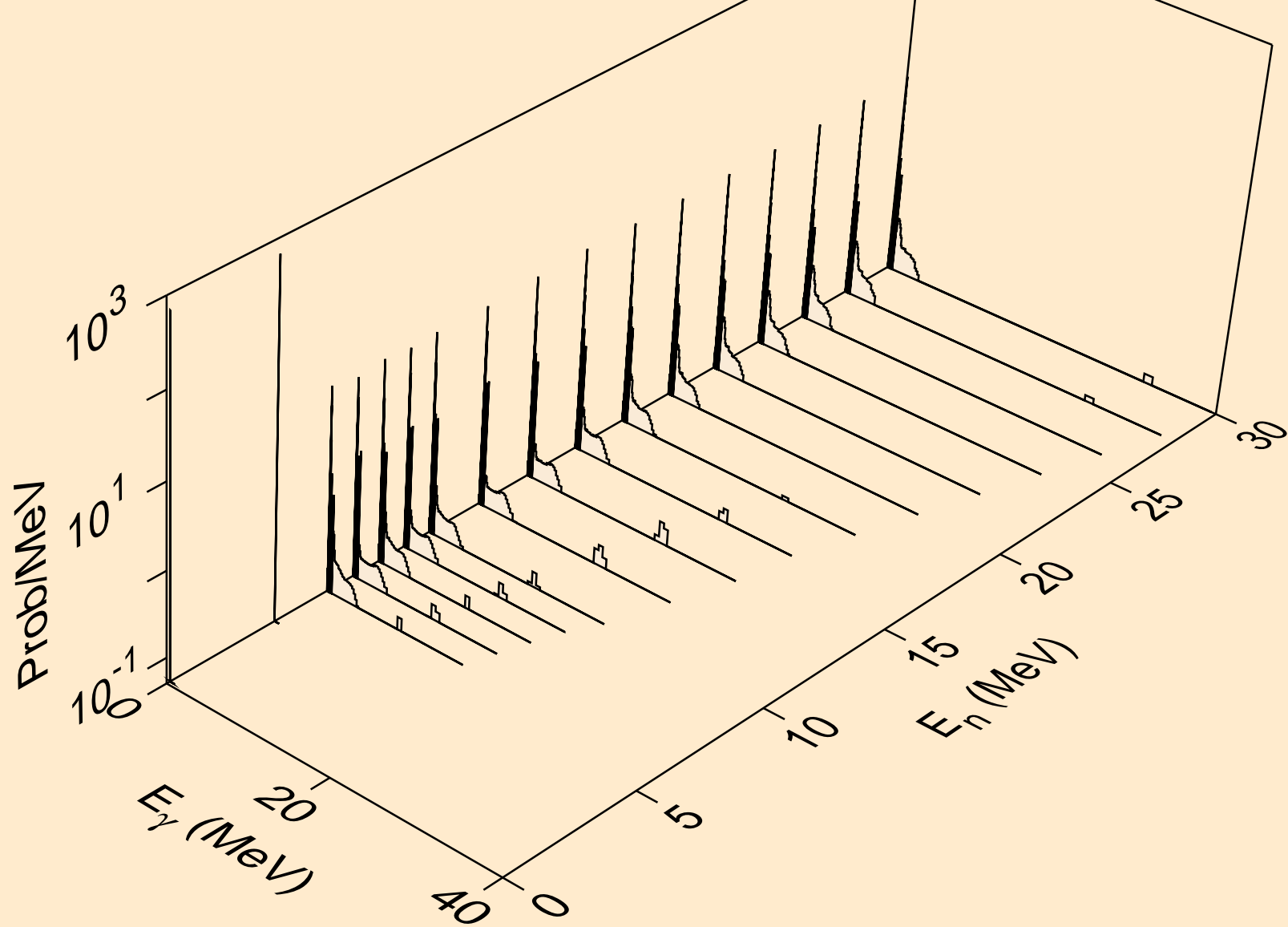

SR080 HELION ACER TENDL-2021 LIBRARY; T=0.K  
Photon emission for (n,p)

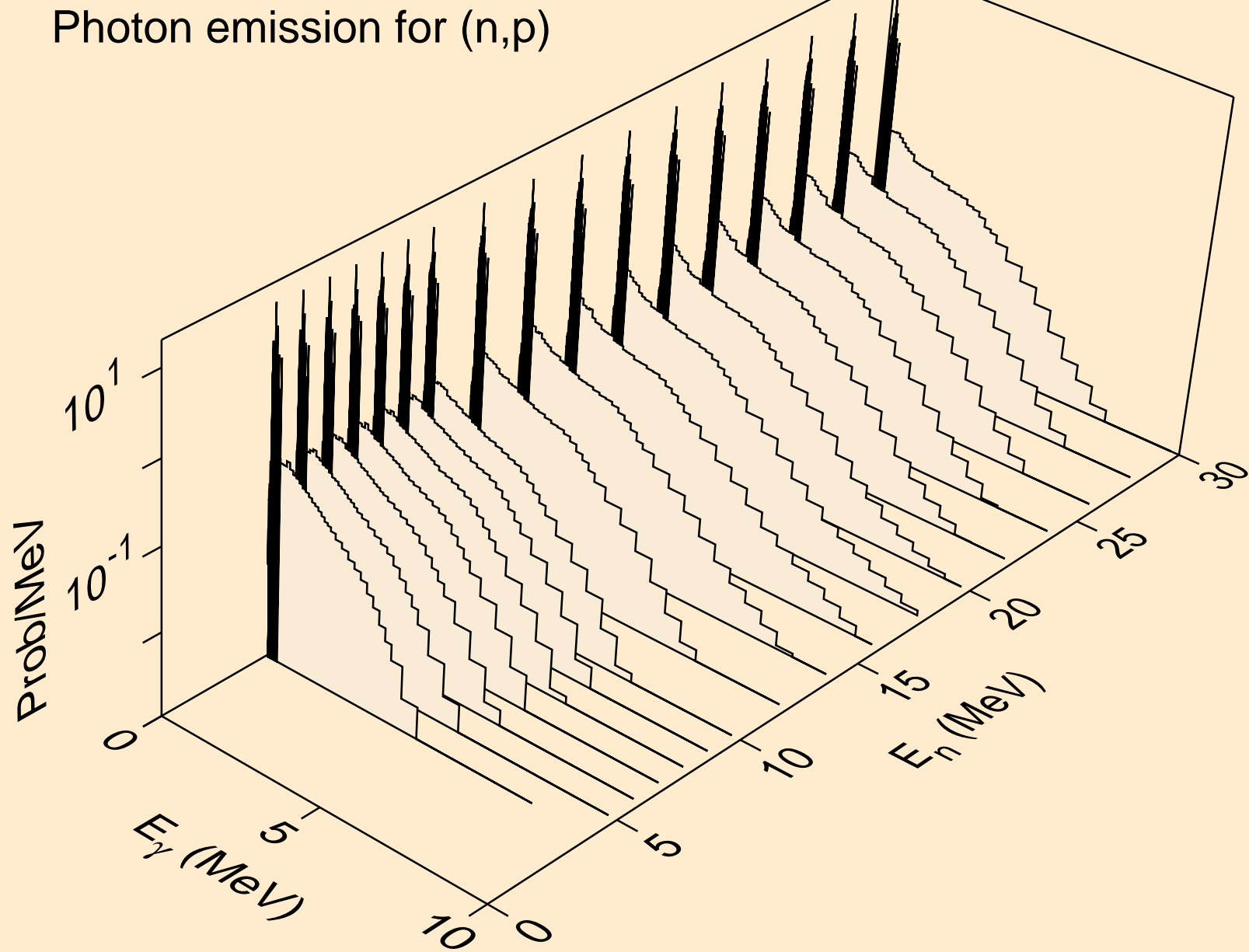



SR080 HELION ACER TENDL-2021 LIBRARY; T=0.K  
Photon emission for (n,d)

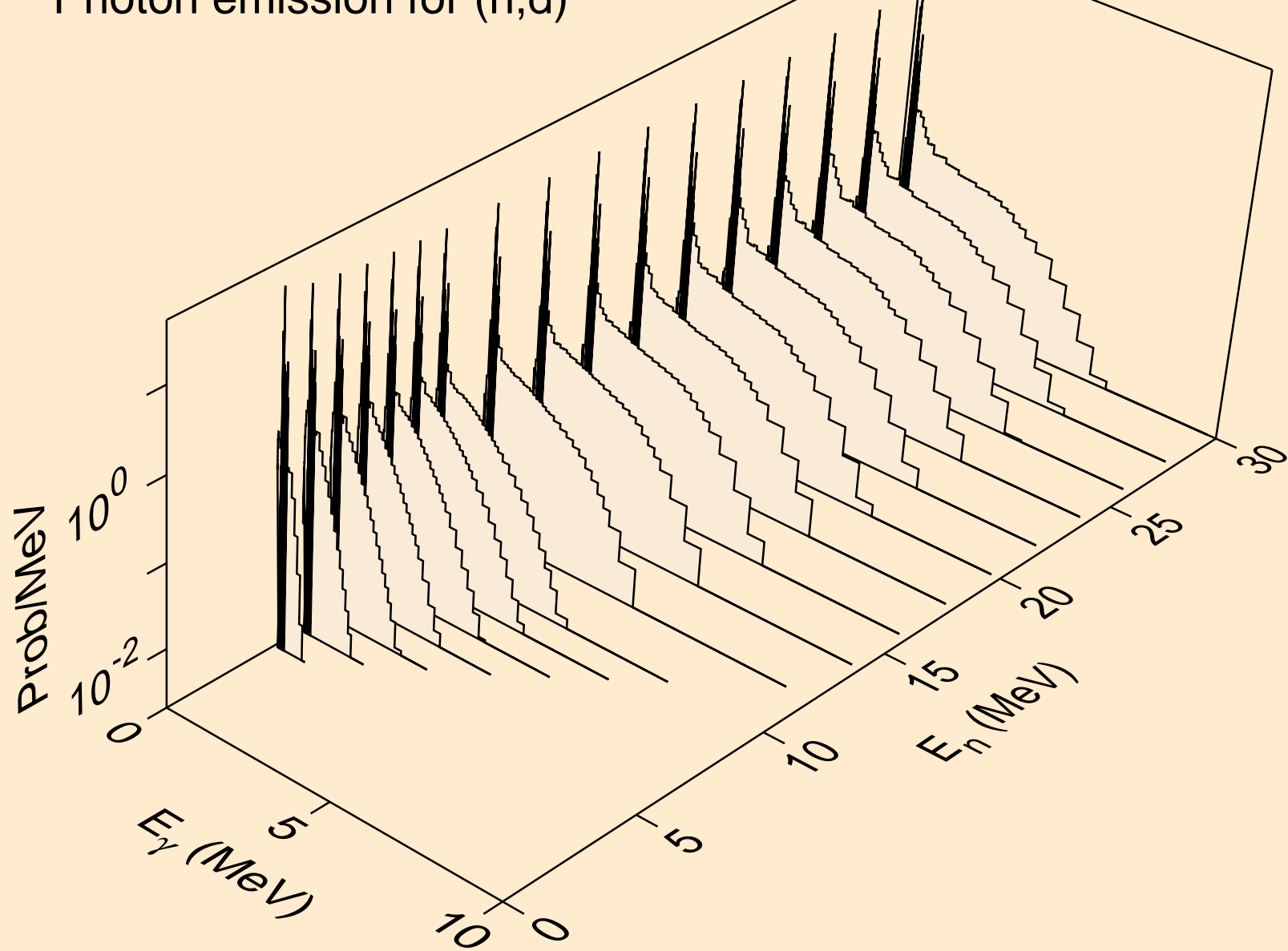

SR080 HELION ACER TENDL-2021 LIBRARY; T=0.K  
Photon emission for (n,t)

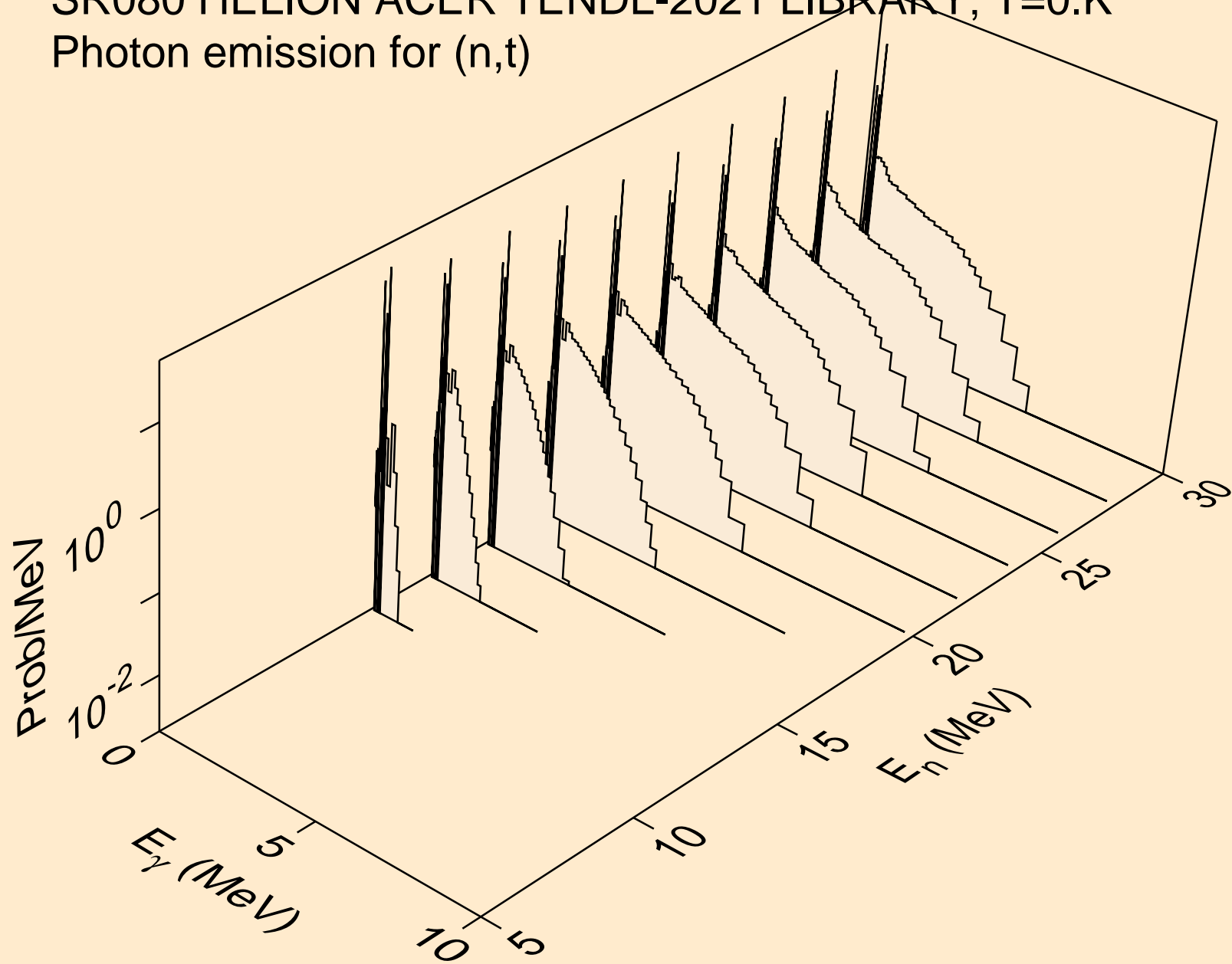

SR080 HELION ACER TENDL-2021 LIBRARY; T=0.K  
Photon emission for inelastic

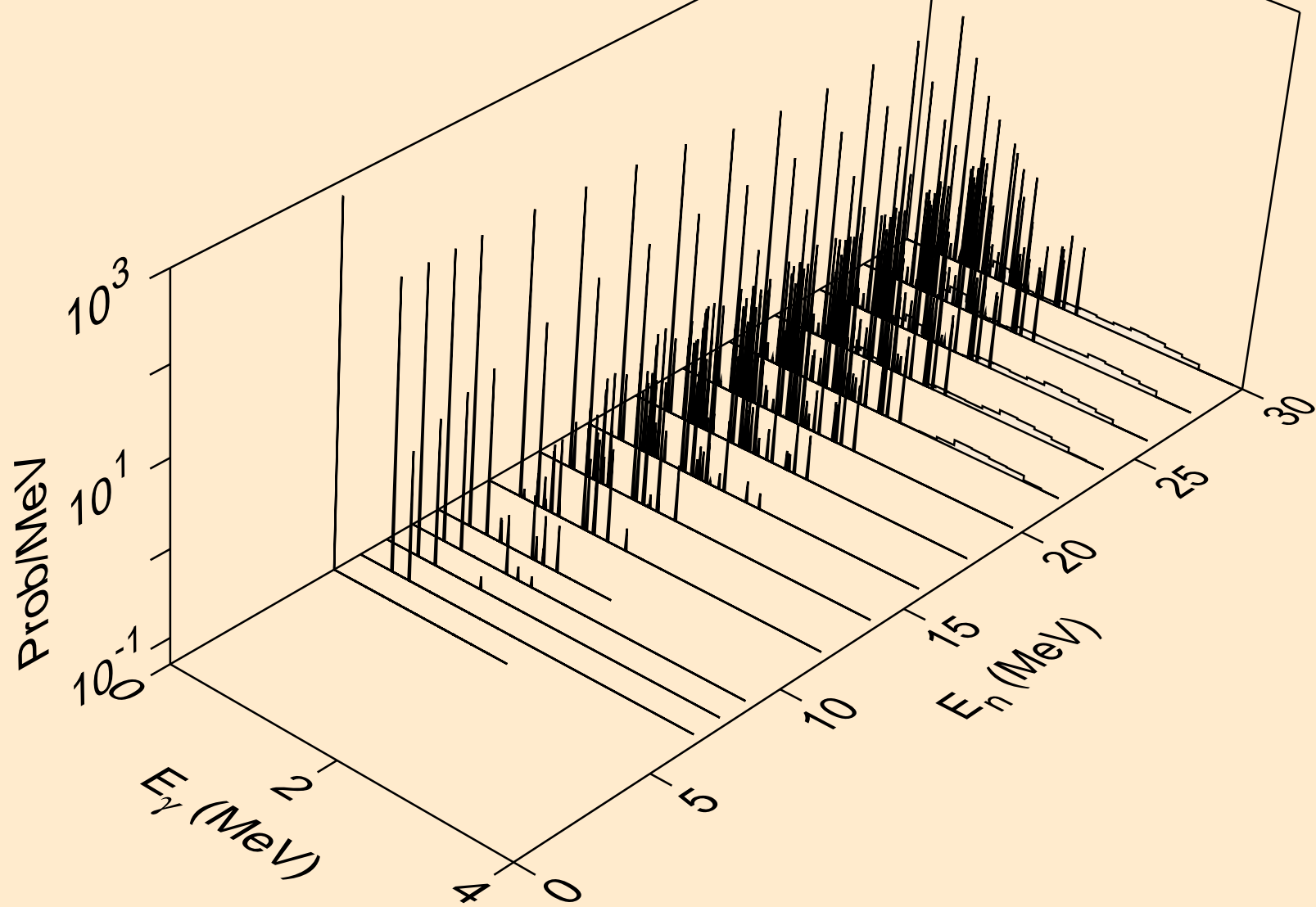

SR080 HELION ACER TENDL-2021 LIBRARY; T=0.K  
Photon emission for (n,a)

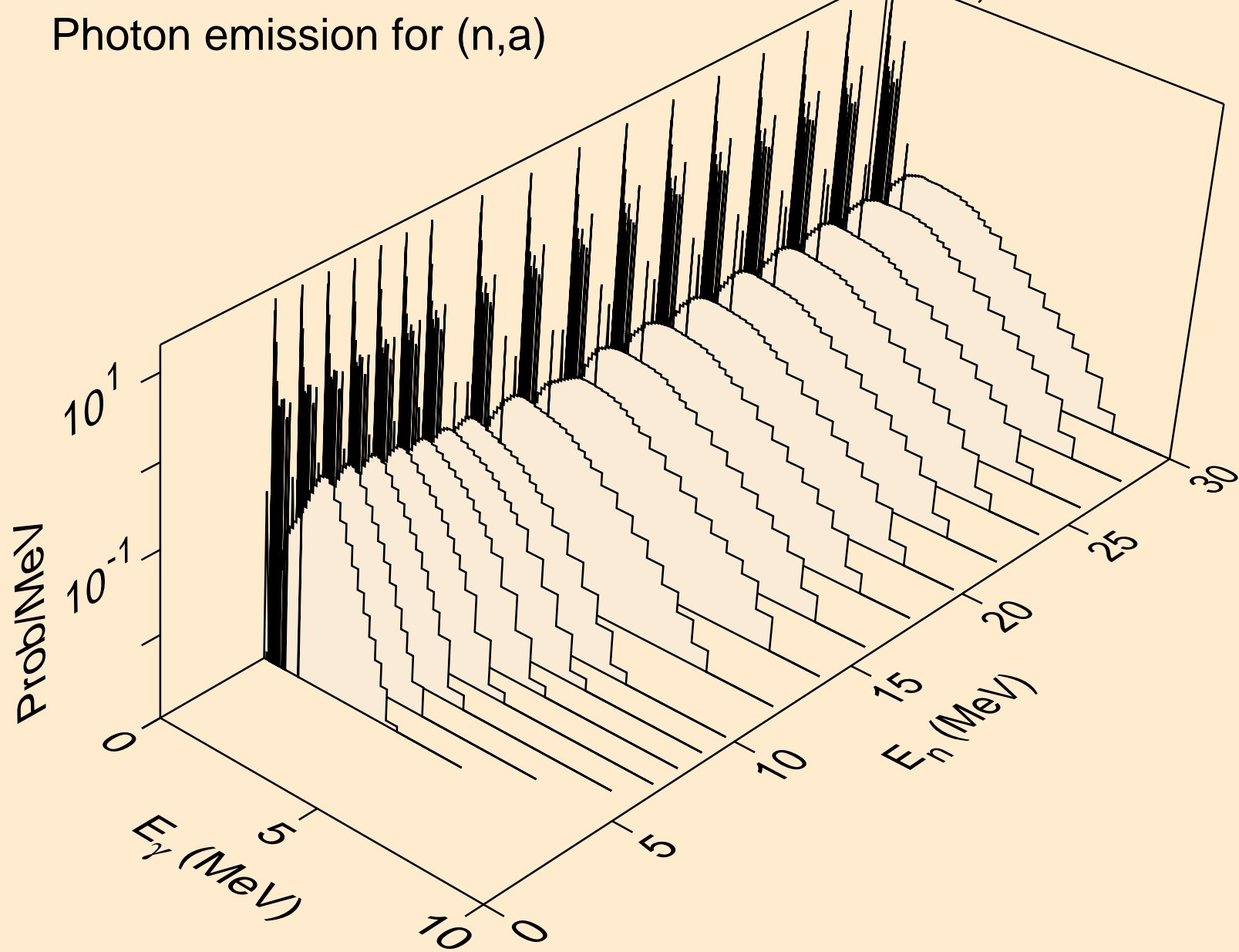

SR080 HELION ACER TENDL-2021 LIBRARY; T=0.K  
Photon emission for (n,2a)

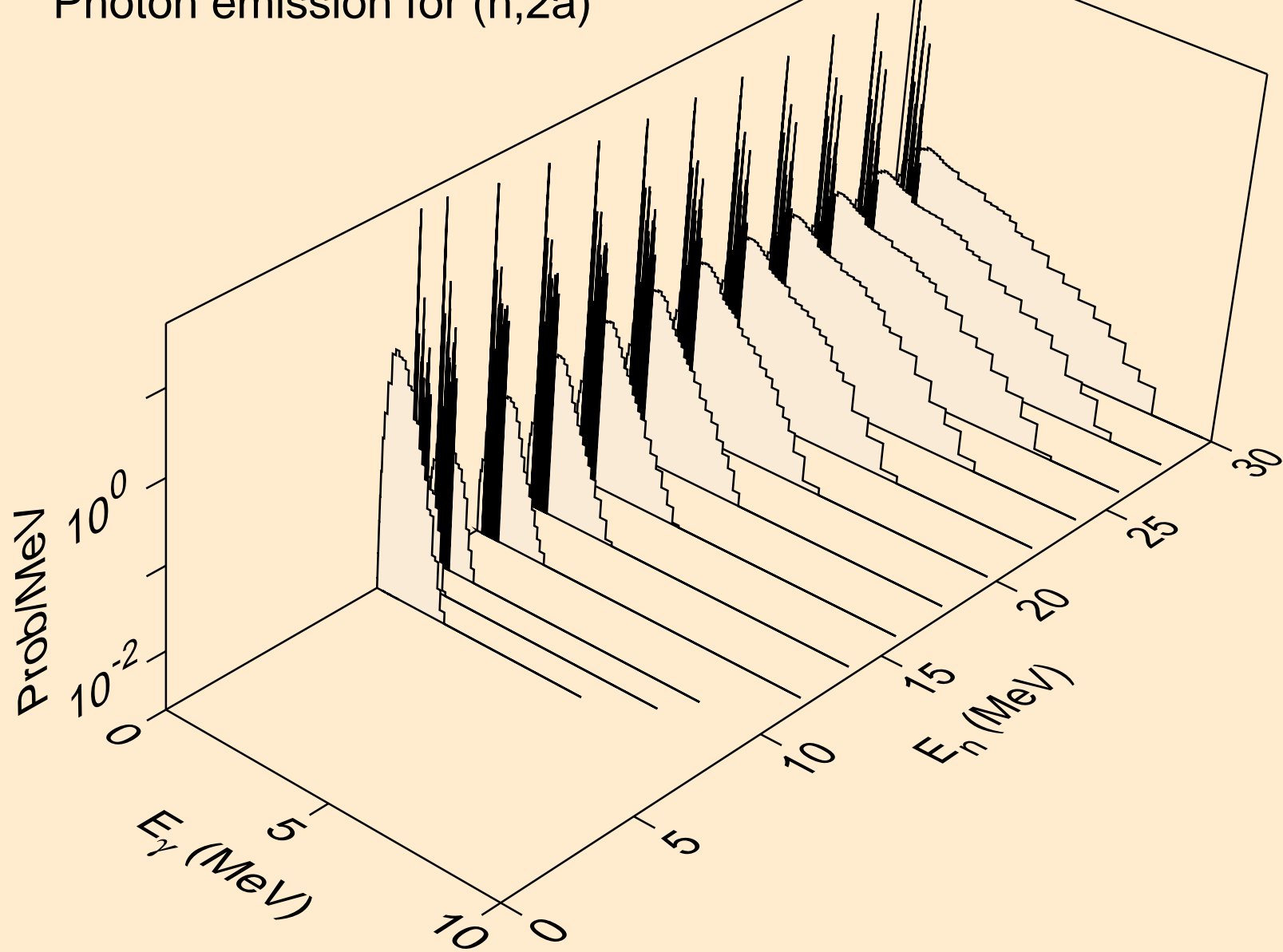

SR080 HELION ACER TENDL-2021 LIBRARY; T=0.K  
Photon emission for (n,3a)

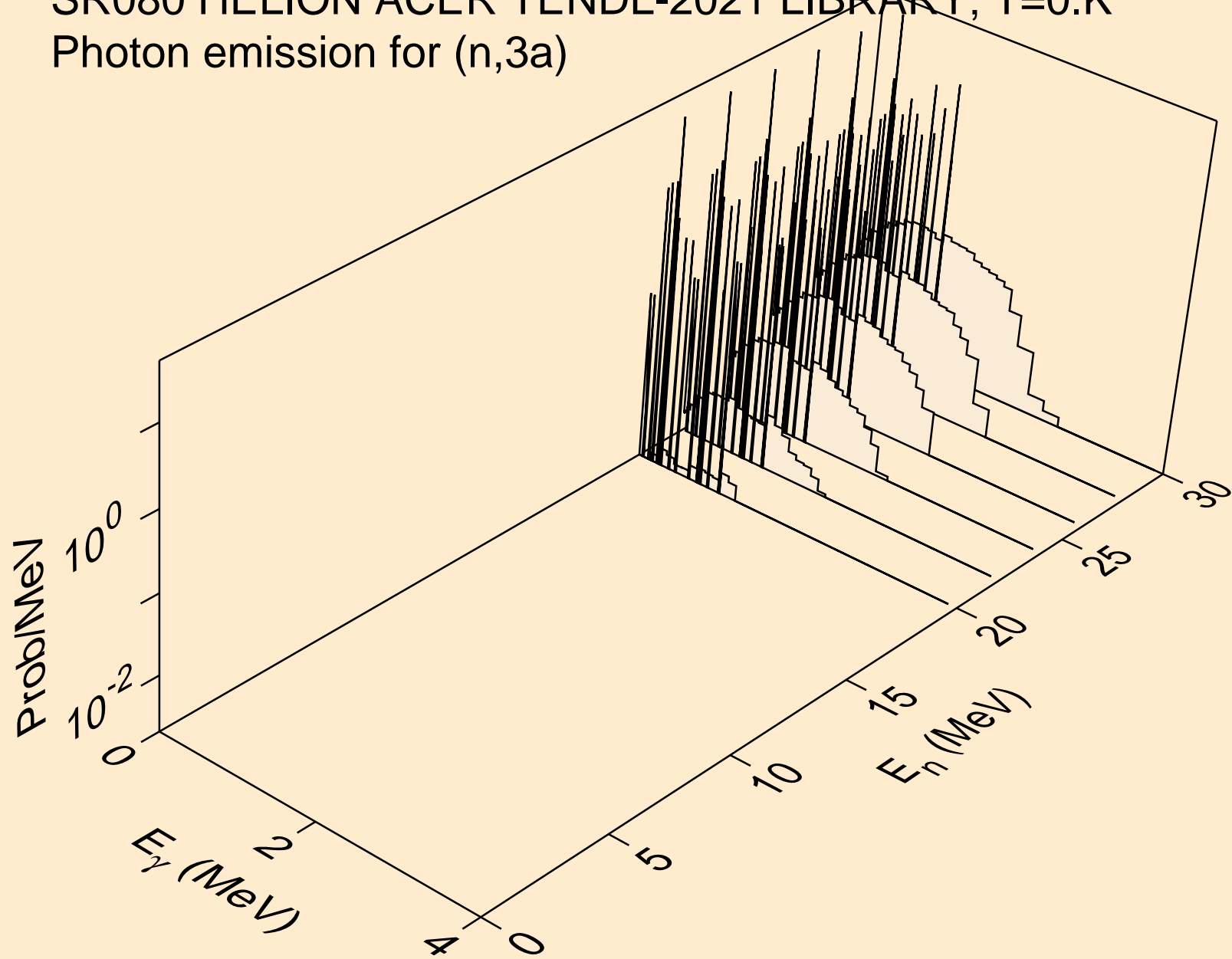

SR080 HELION ACER TENDL-2021 LIBRARY; T=0.K  
Photon emission for (n,2p)

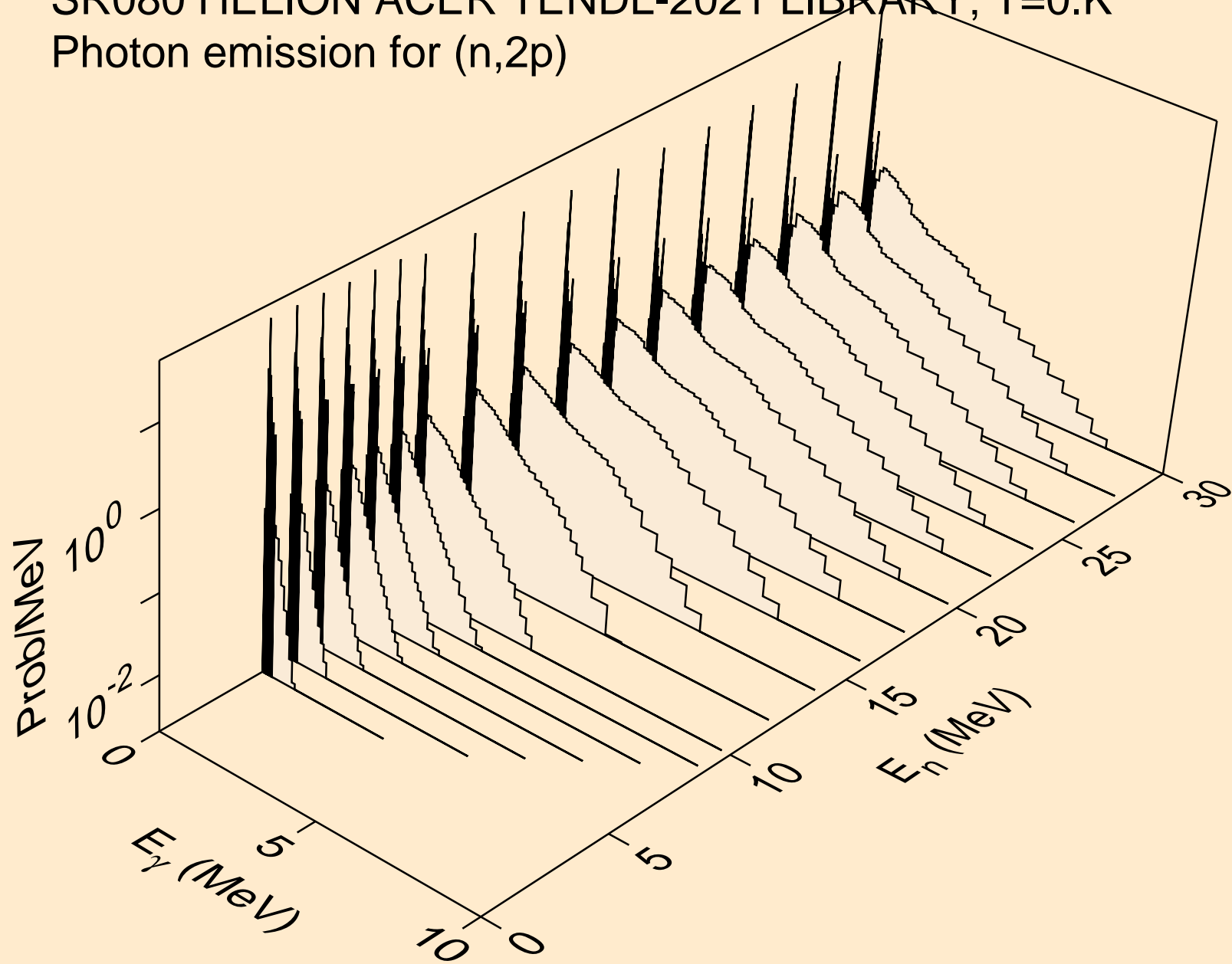

SR080 HELION ACER TENDL-2021 LIBRARY; T=0.K  
Photon emission for (n,pa)

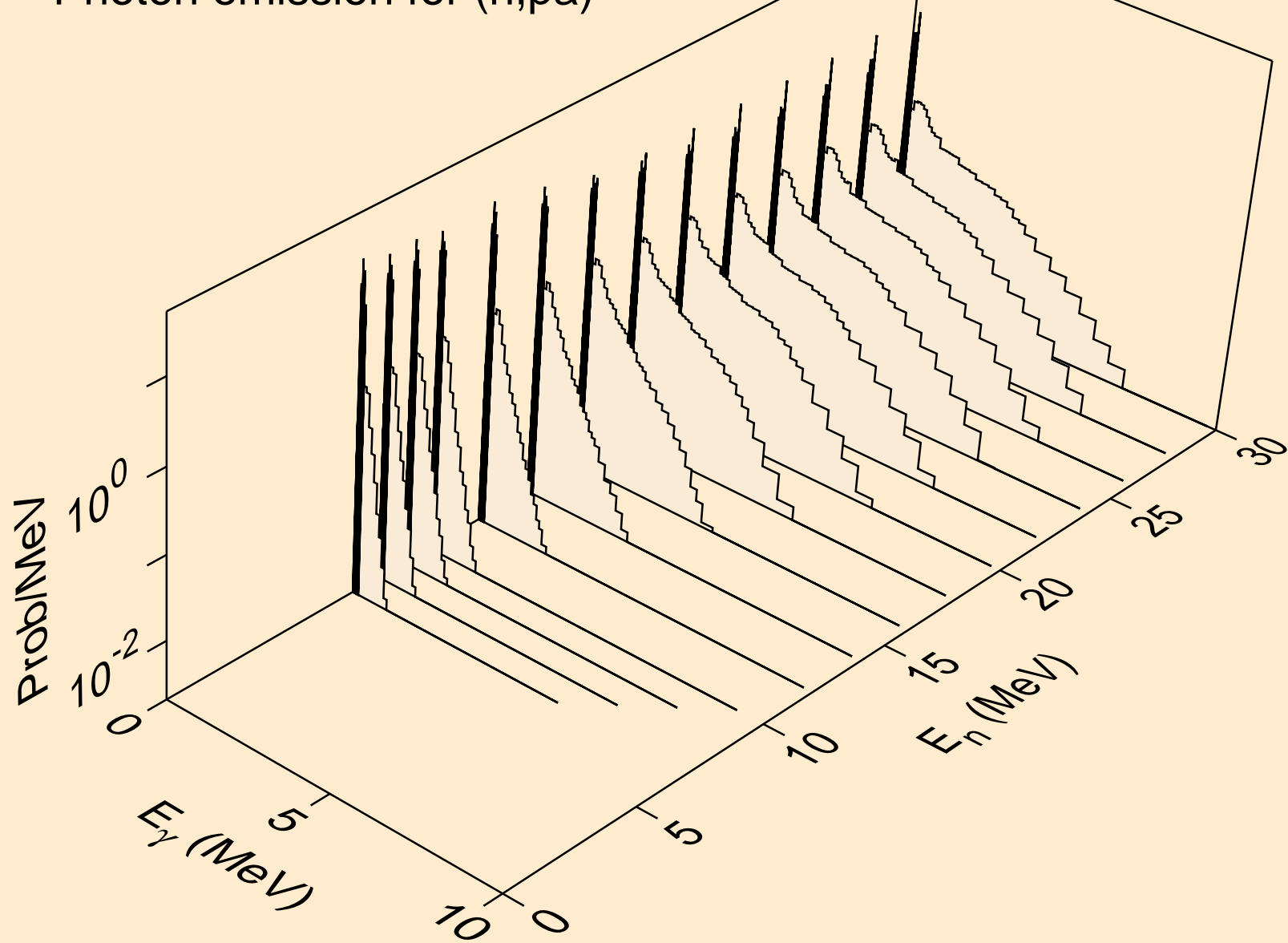



SR080 HELION ACER TENDL-2021 LIBRARY; T=0.K  
Photon emission for (n,pd)

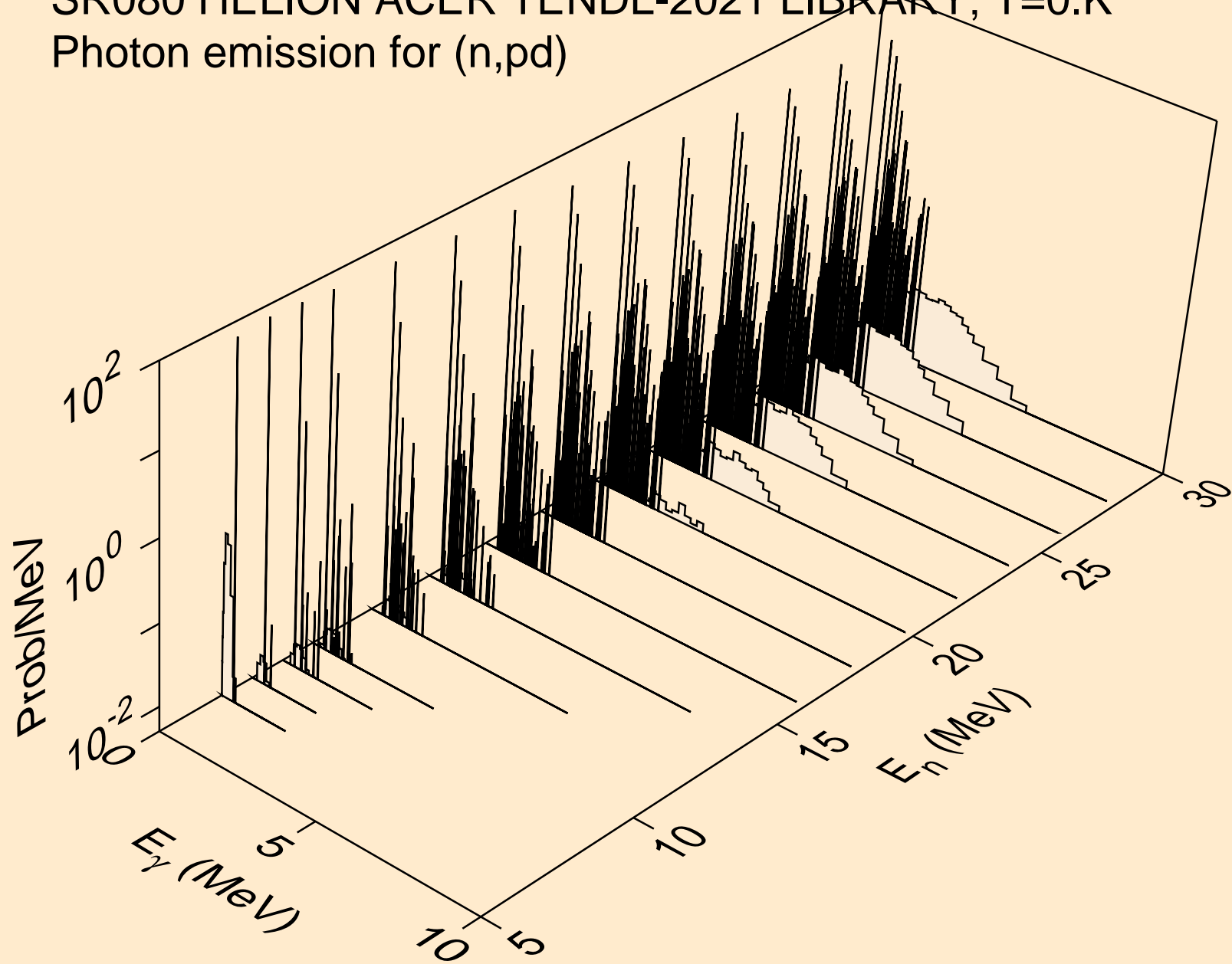

SR080 HELION ACER TENDL-2021 LIBRARY; T=0.K  
Photon emission for (n,pt)

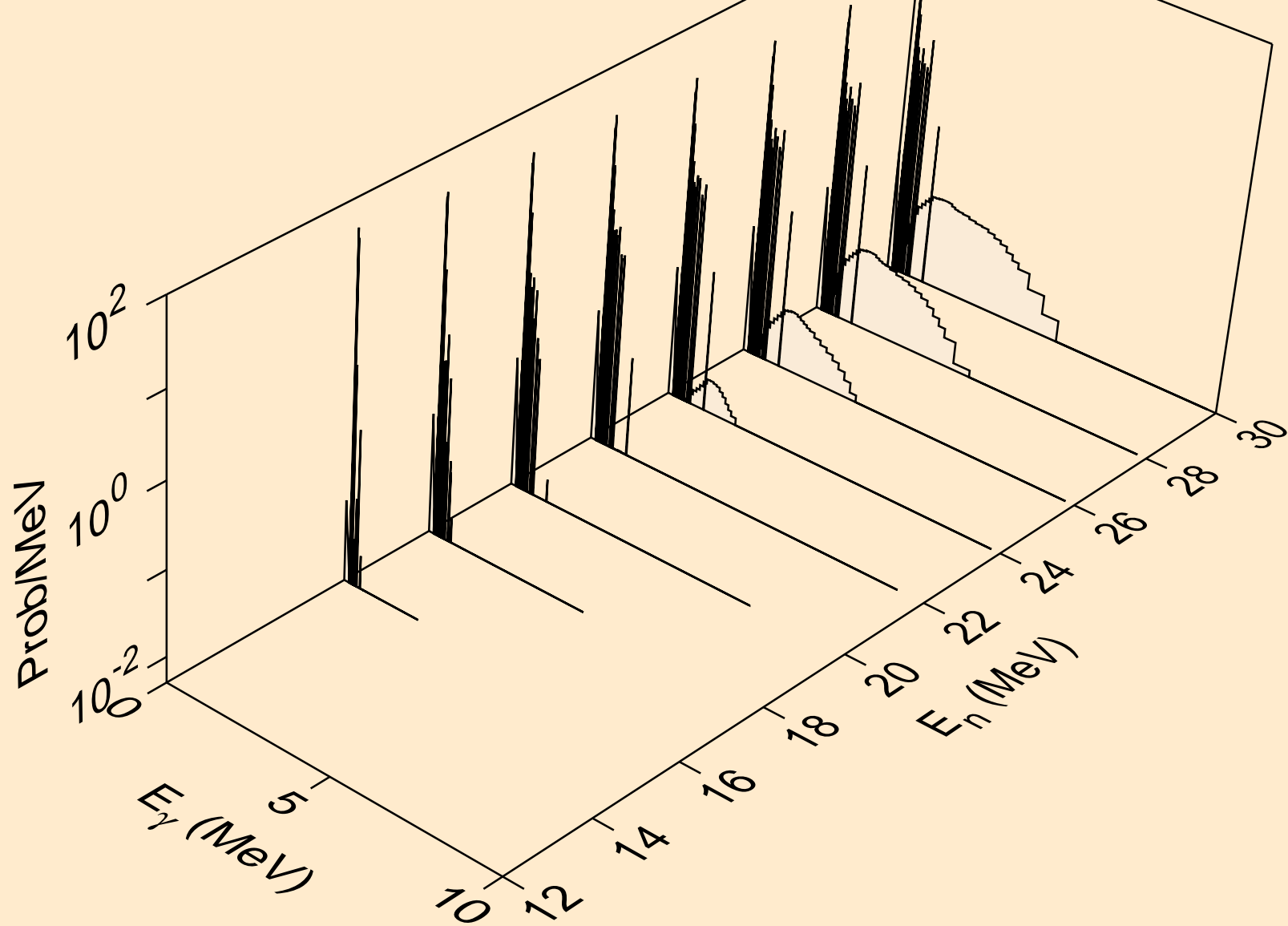

SR080 HELION ACER TENDL-2021 LIBRARY; T=0.K  
Photon emission for (n,da)

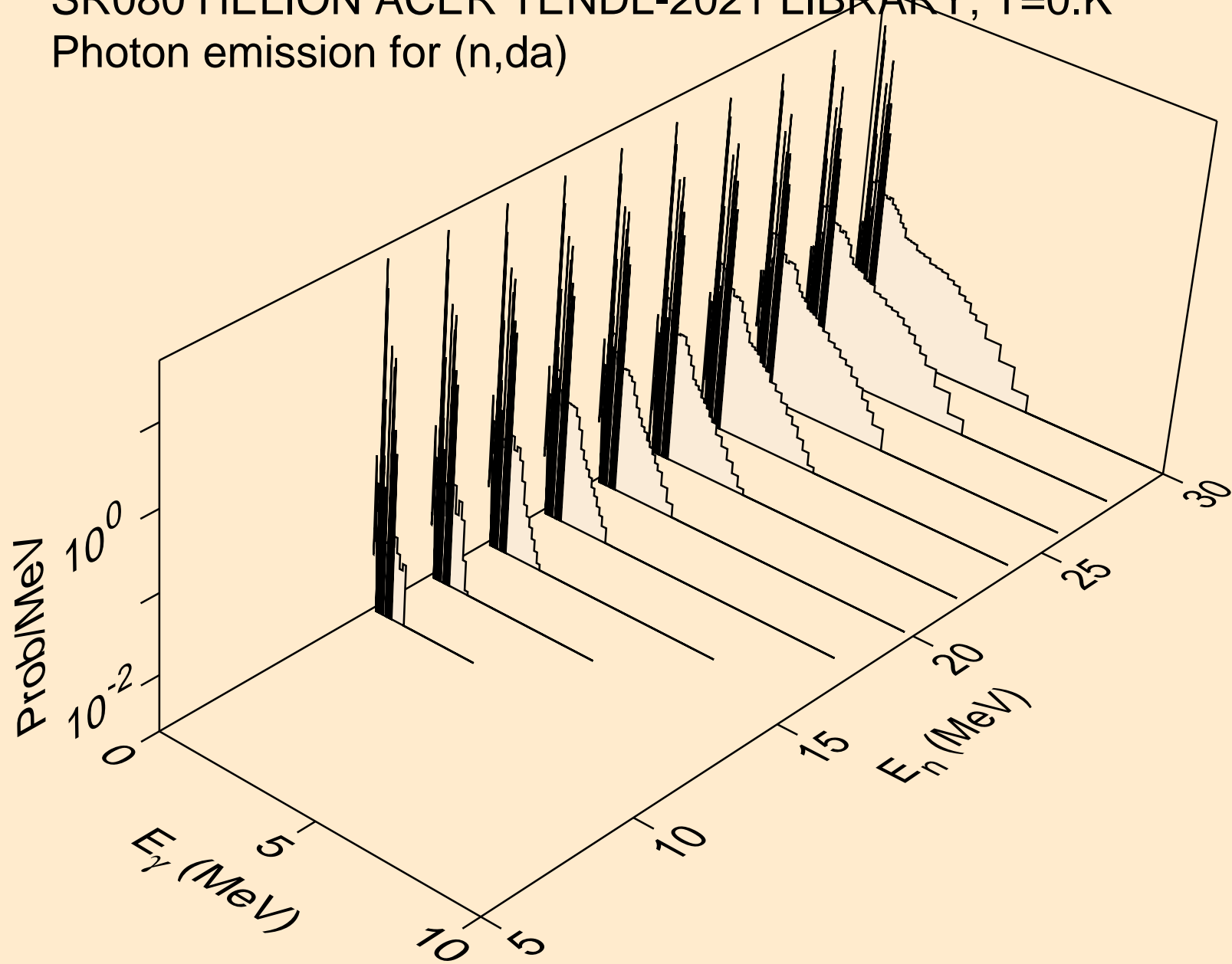

SR080 HELION ACER TENDL-2021 LIBRARY; T=0.K  
Particle heating contributions

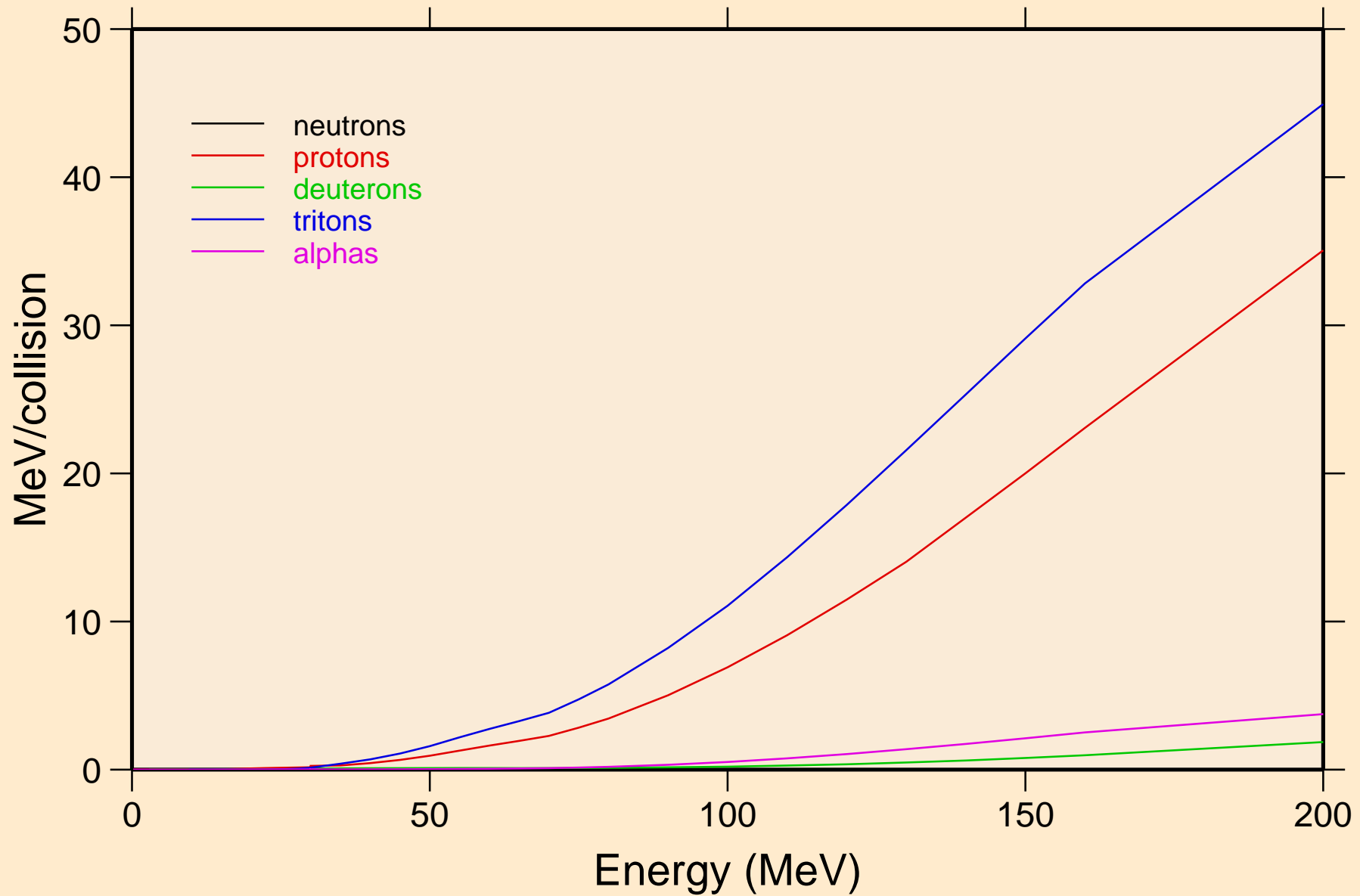

SR080 HELION ACER TENDL-2021 LIBRARY; T=0.K  
Recoil Heating

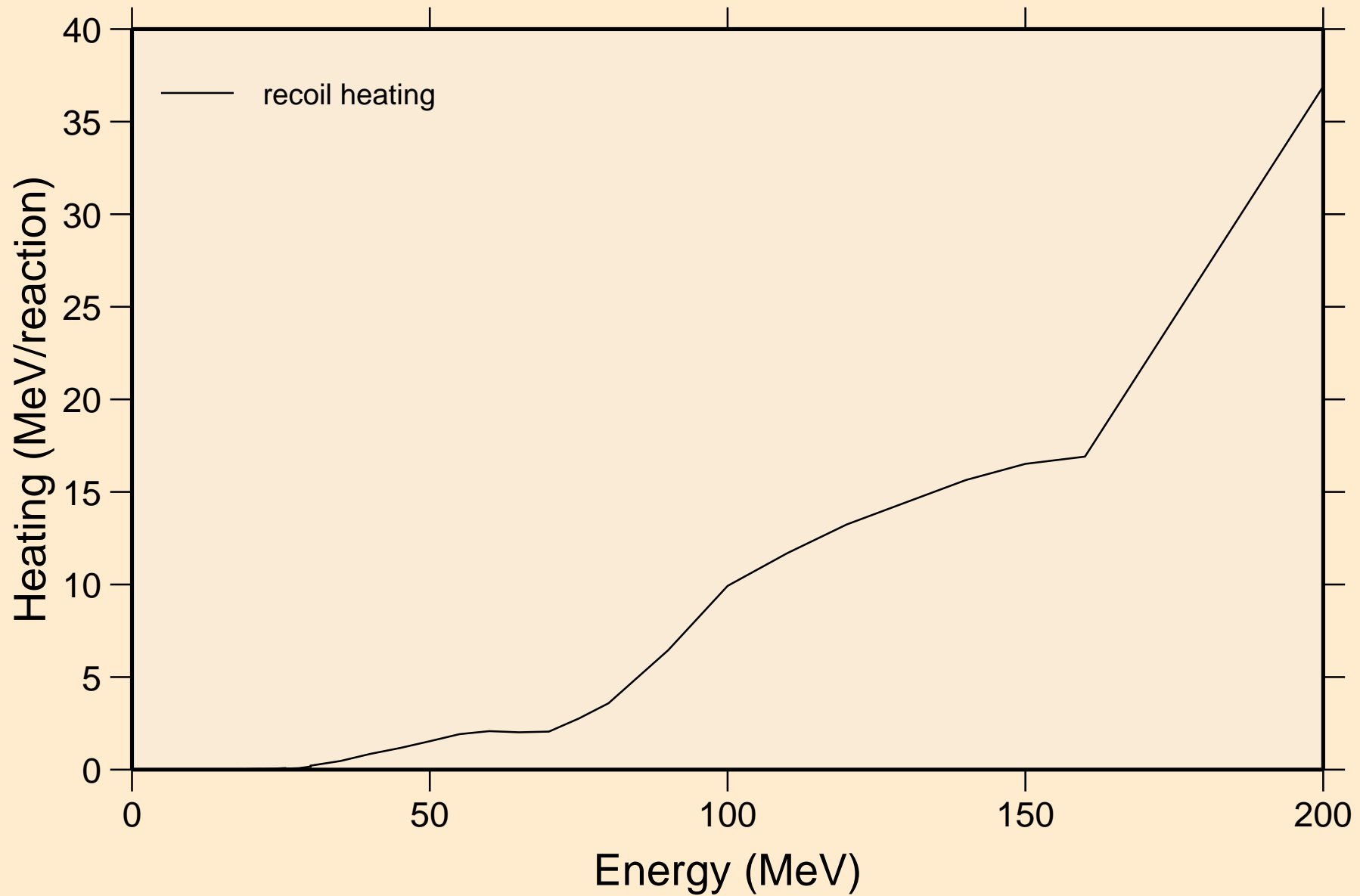

SR080 HELION ACER TENDL-2021 LIBRARY; T=0.K  
Particle production cross sections

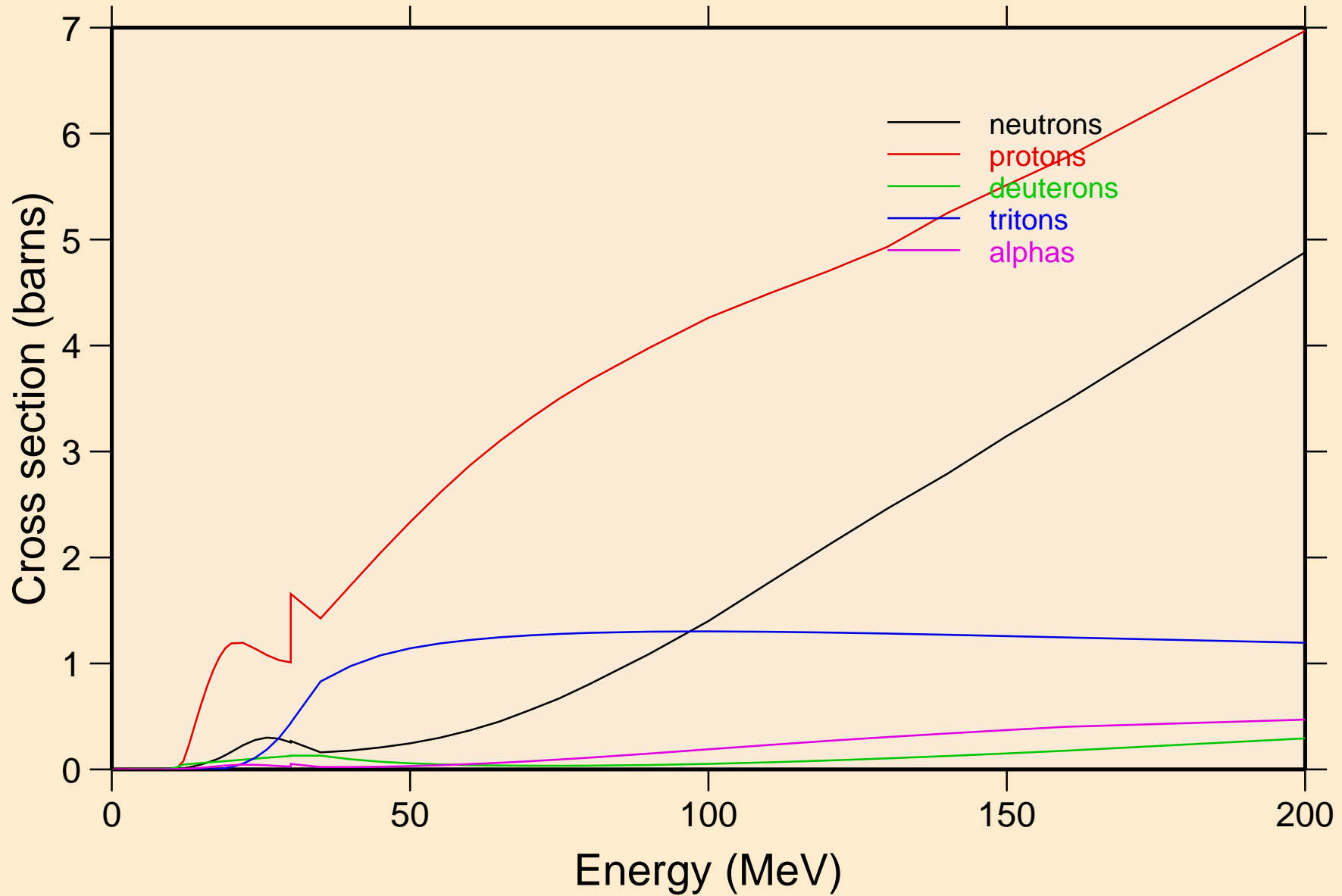

SR080 HELION ACER TENDL-2021 LIBRARY; T=0.K  
neutrons from (s,n)

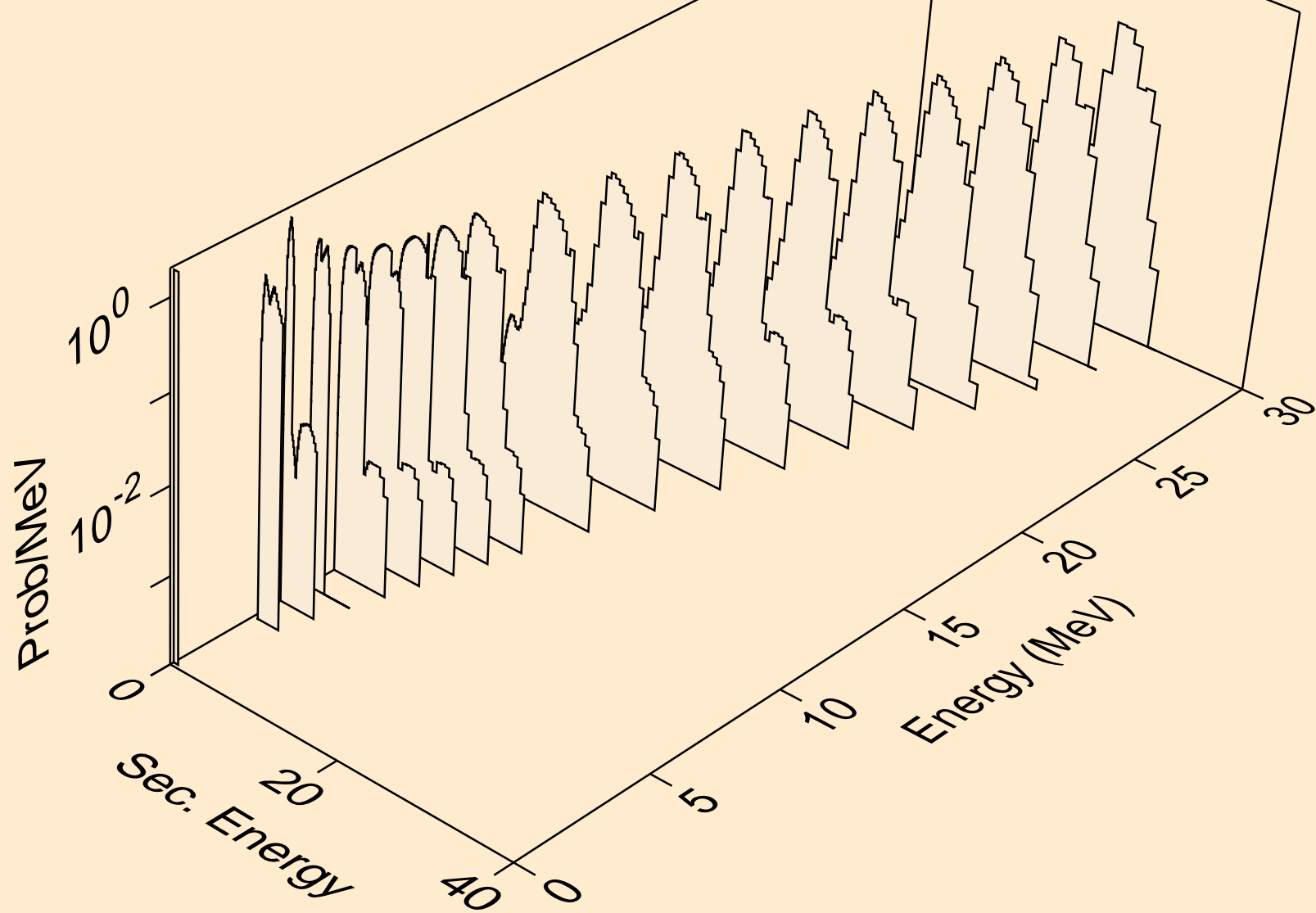

SR080 HELION ACER TENDL-2021 LIBRARY; T=0.K  
neutrons from (s,x)

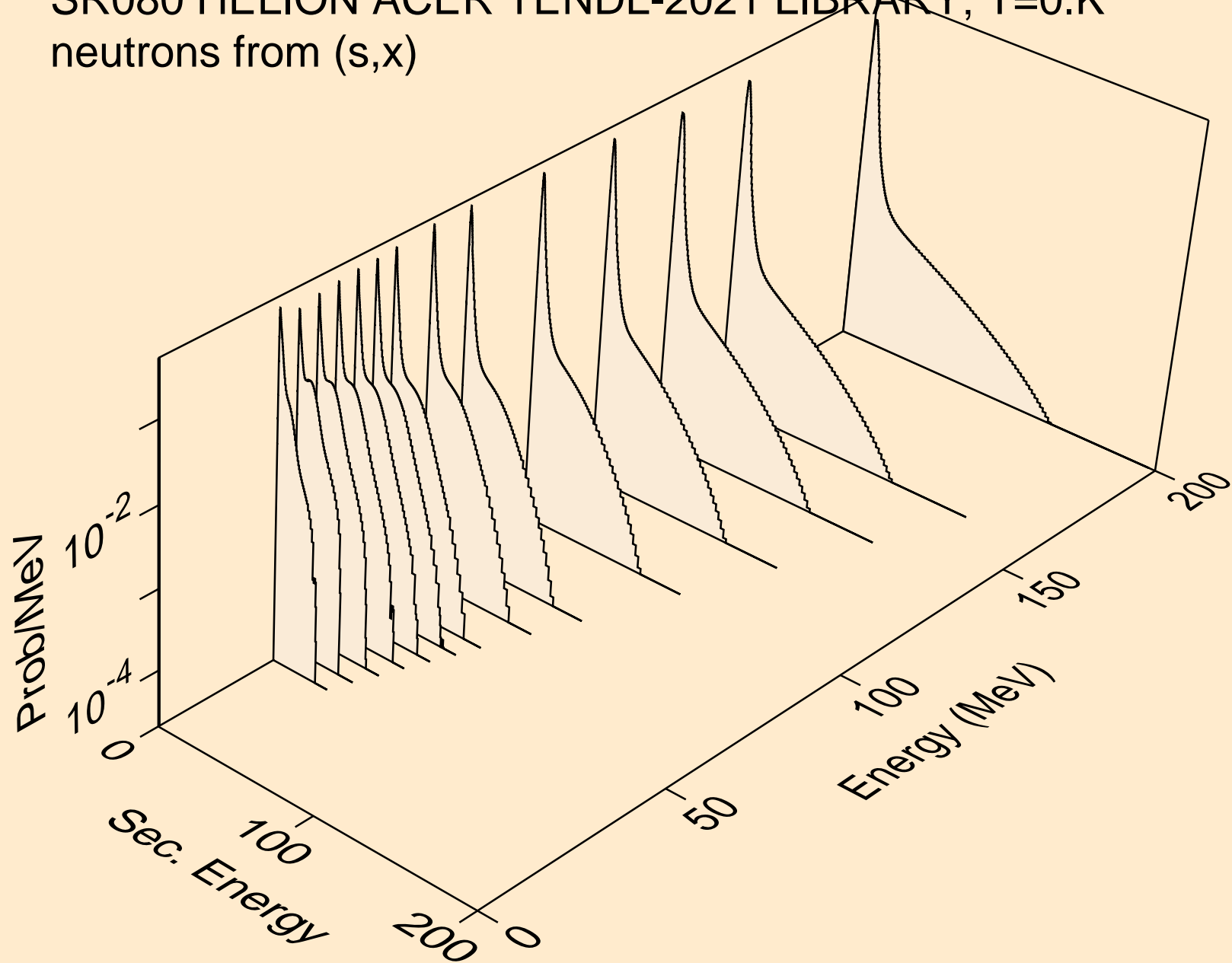



SR080 HELION ACER TENDL-2021 LIBRARY; T=0.K  
neutrons from (s,2n)

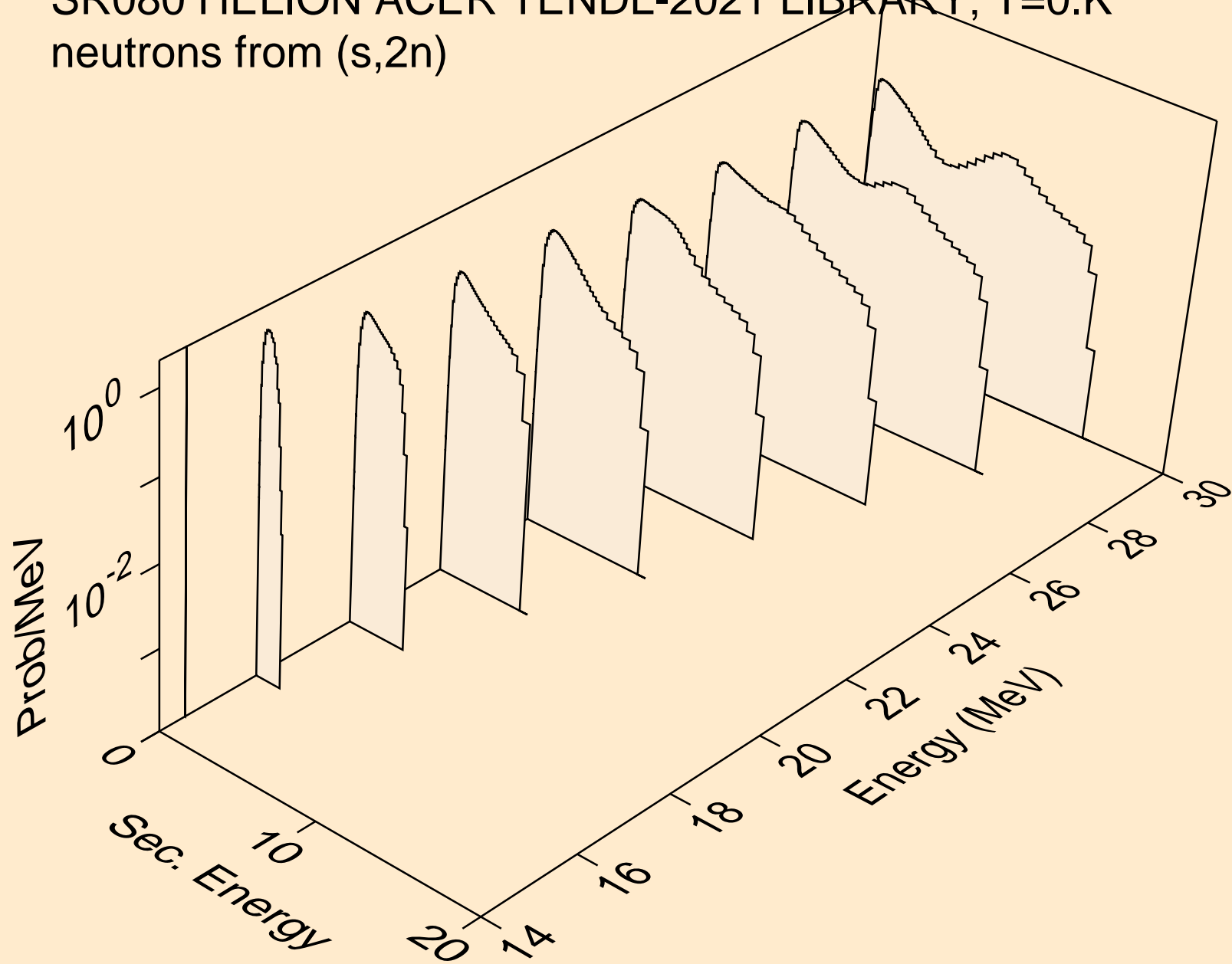

SR080 HELION ACER TENDL-2021 LIBRARY; T=0.K  
neutrons from (s,3n)

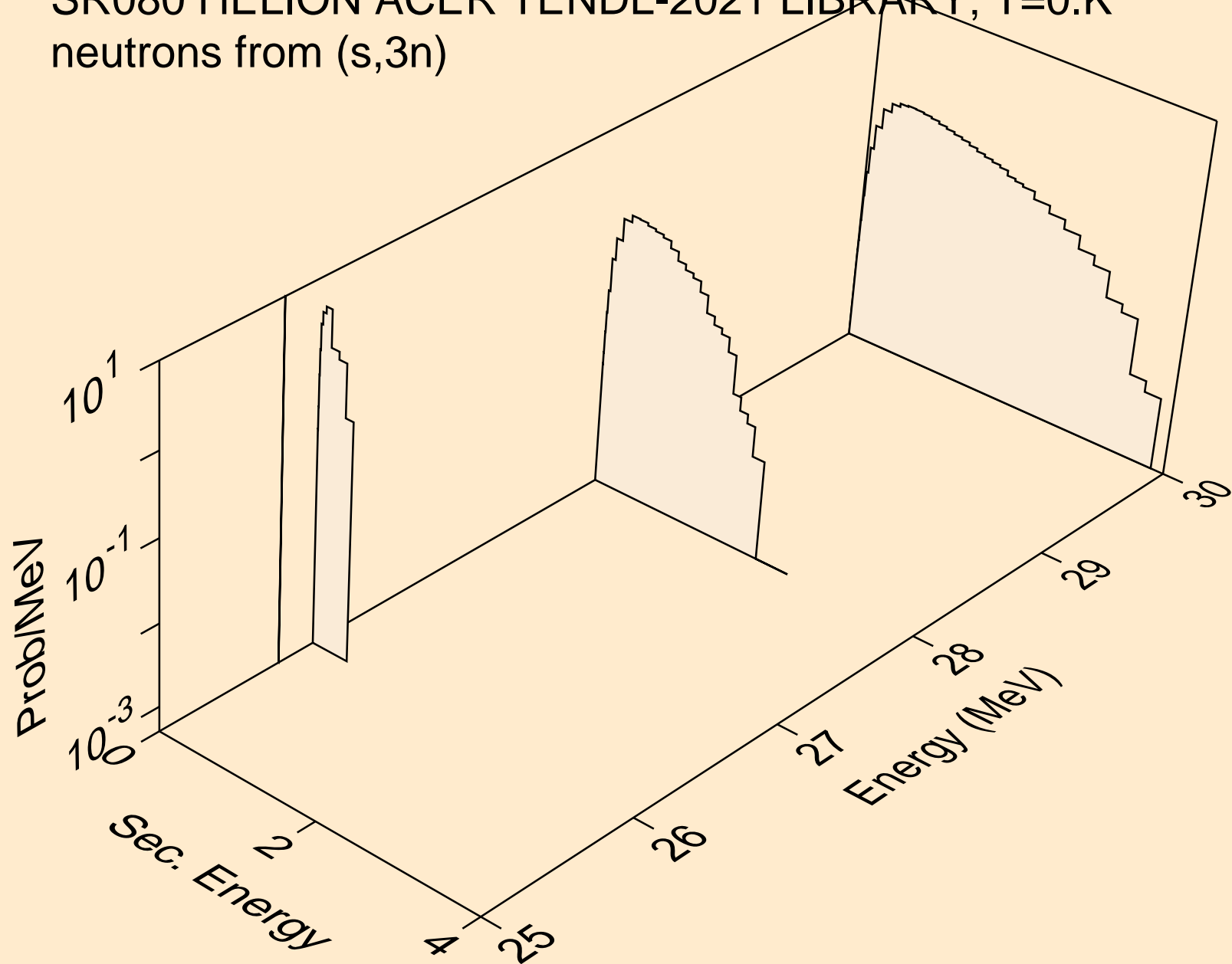

SR080 HELION ACER TENDL-2021 LIBRARY; T=0.K  
neutrons from (s,n\*)a

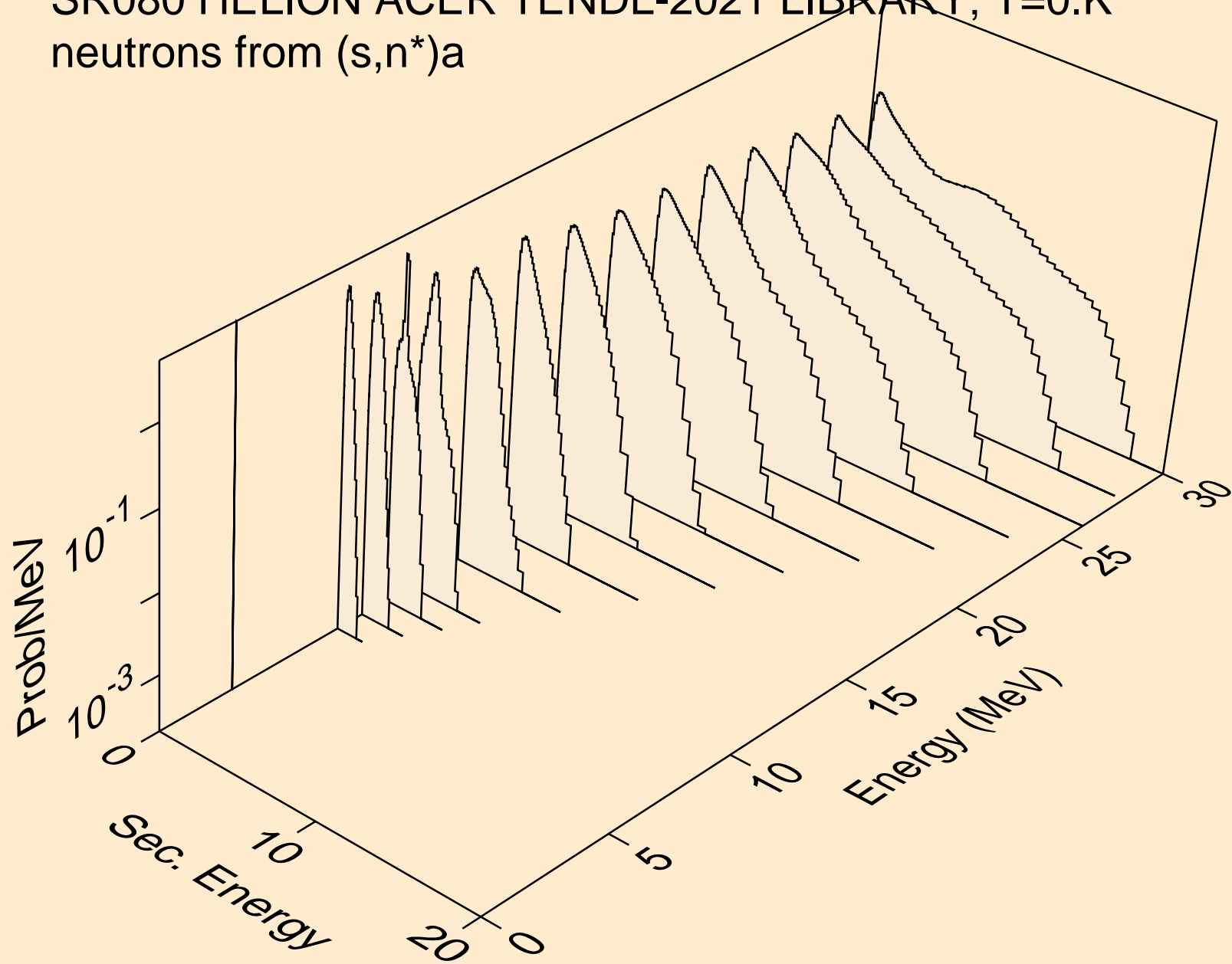

SR080 HELION ACER TENDL-2021 LIBRARY; T=0.K  
neutrons from (s,2n)a

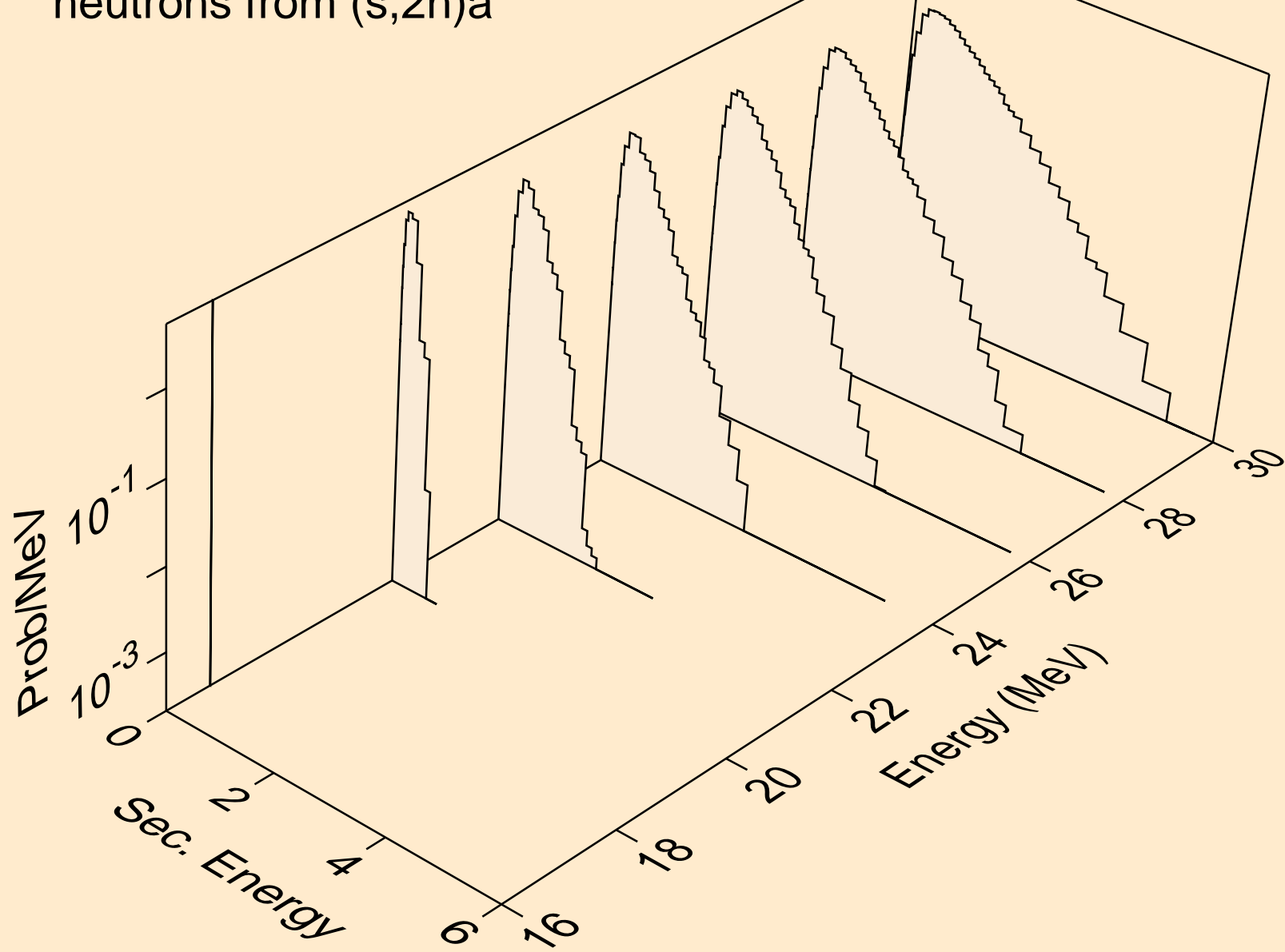

SR080 HELION ACER TENDL-2021 LIBRARY; T=0.K  
neutrons from (s,n\*)p

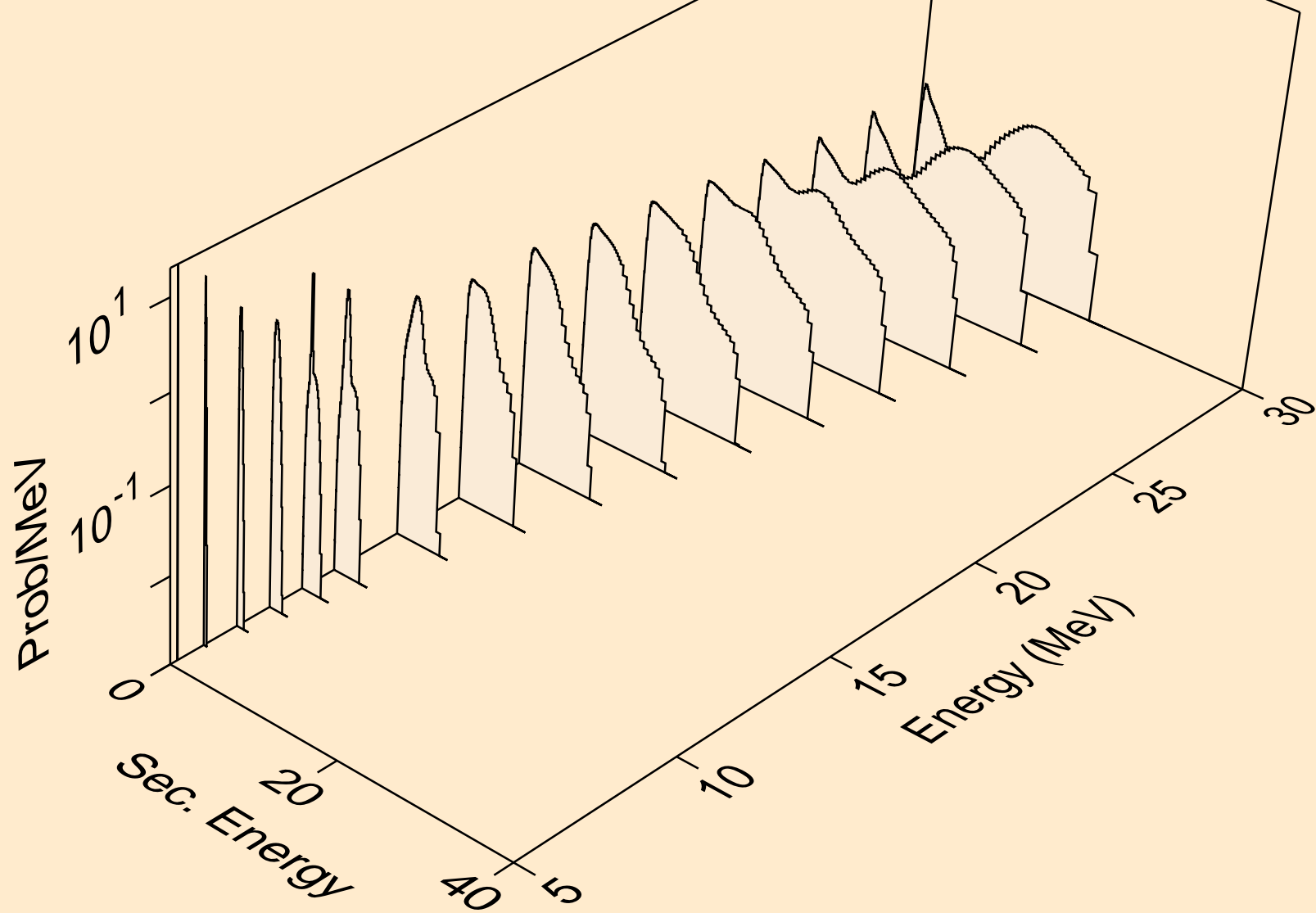

SR080 HELION ACER TENDL-2021 LIBRARY; T=0.K  
neutrons from (s,n\*)2a

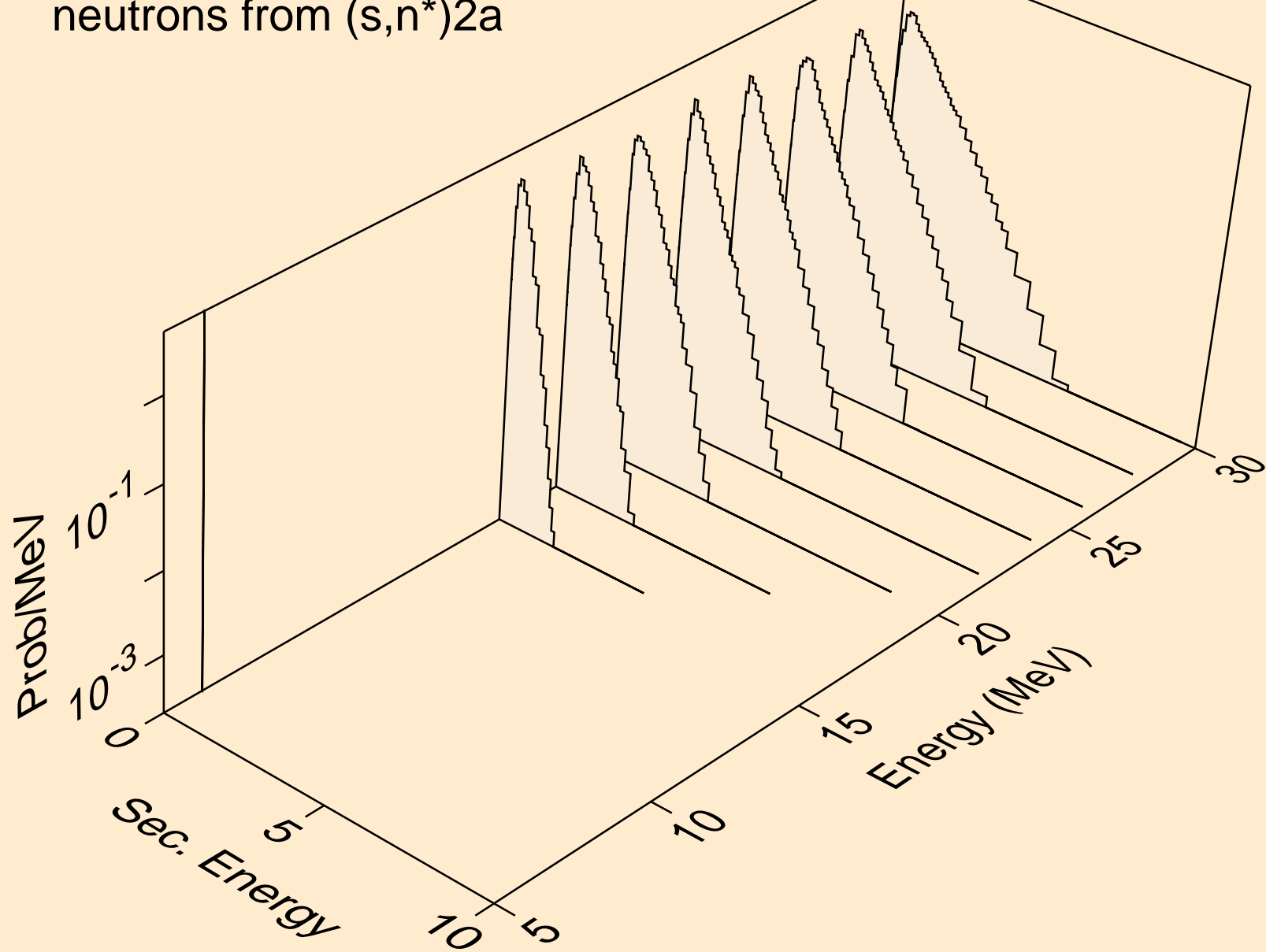

SR080 HELION ACER TENDL-2021 LIBRARY; T=0.K  
neutrons from (s,n\*)d

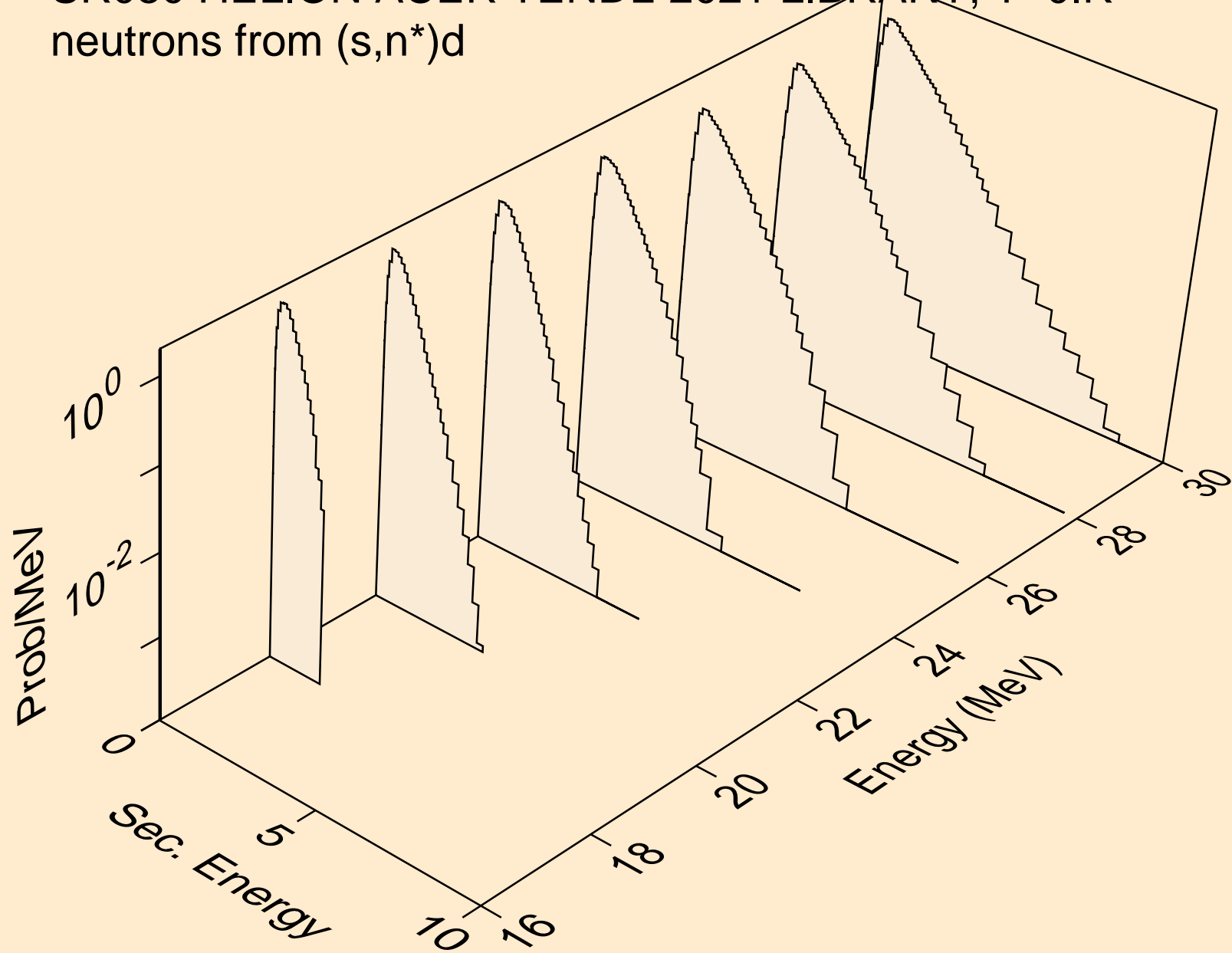

SR080 HELION ACER TENDL-2021 LIBRARY; T=0.K  
neutrons from (s,n\*)t

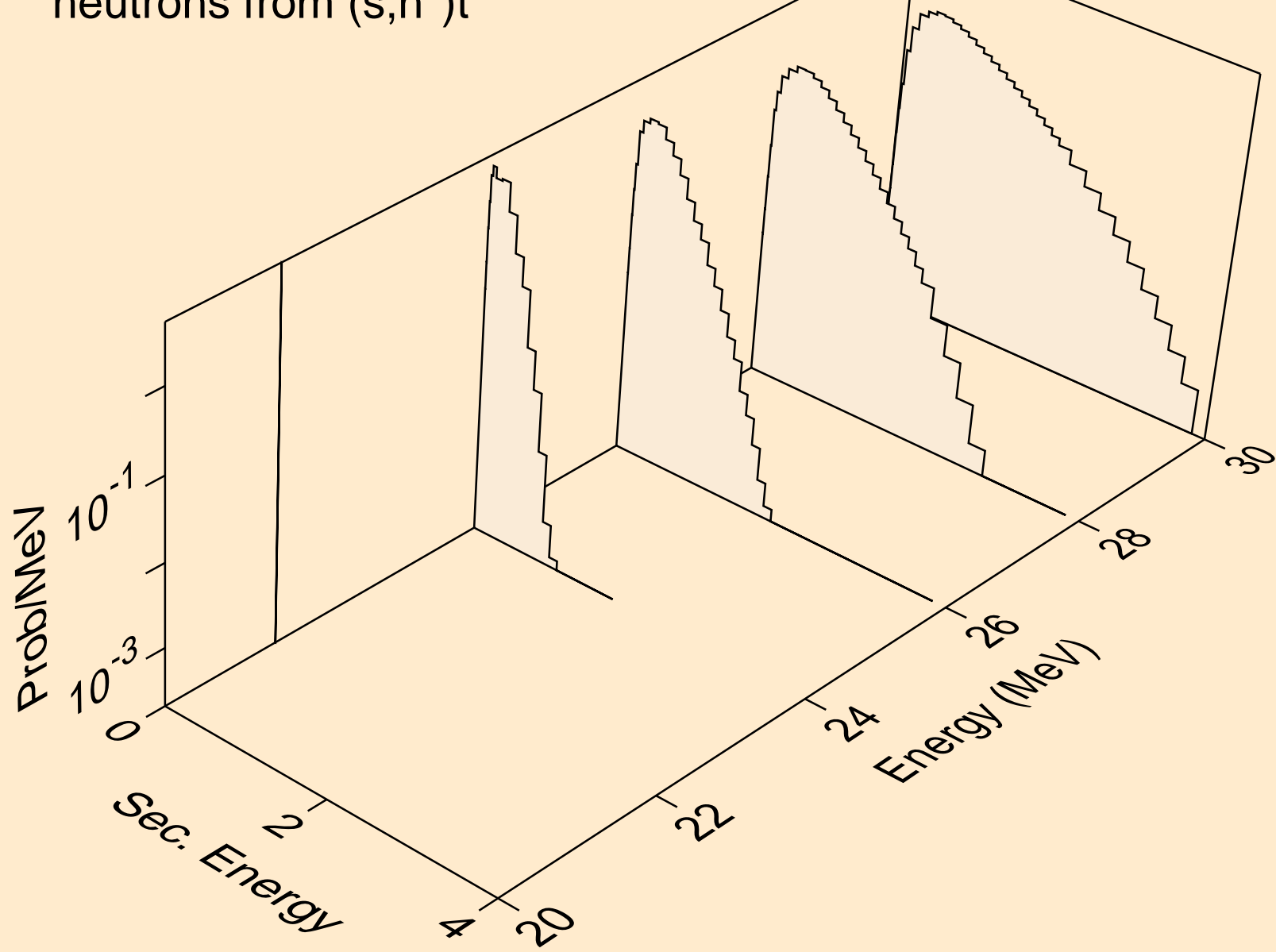



SR080 HELION ACER TENDL-2021 LIBRARY; T=0.K  
neutrons from (s,n\*)he3

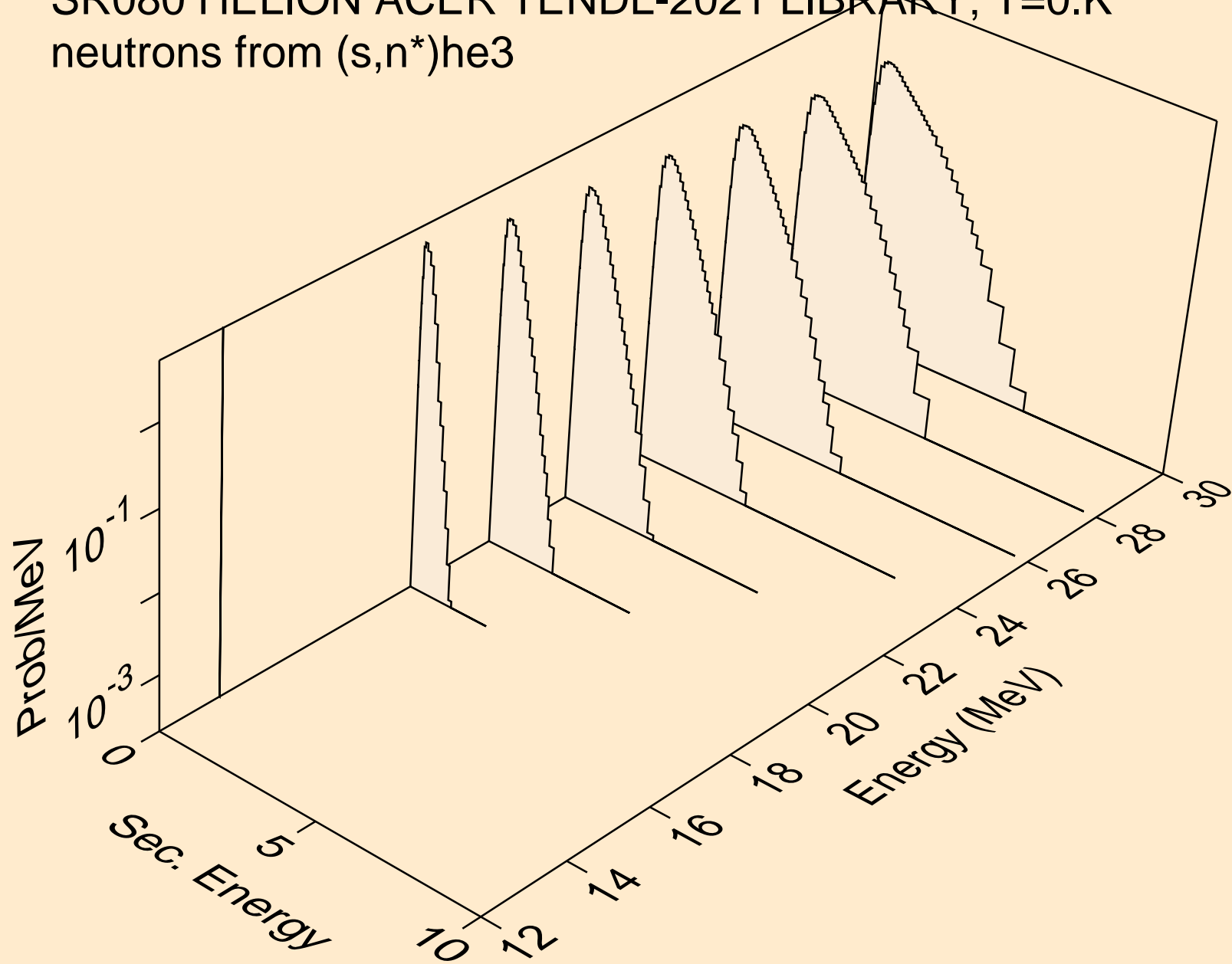

SR080 HELION ACER TENDL-2021 LIBRARY; T=0.K  
neutrons from (s,2np)

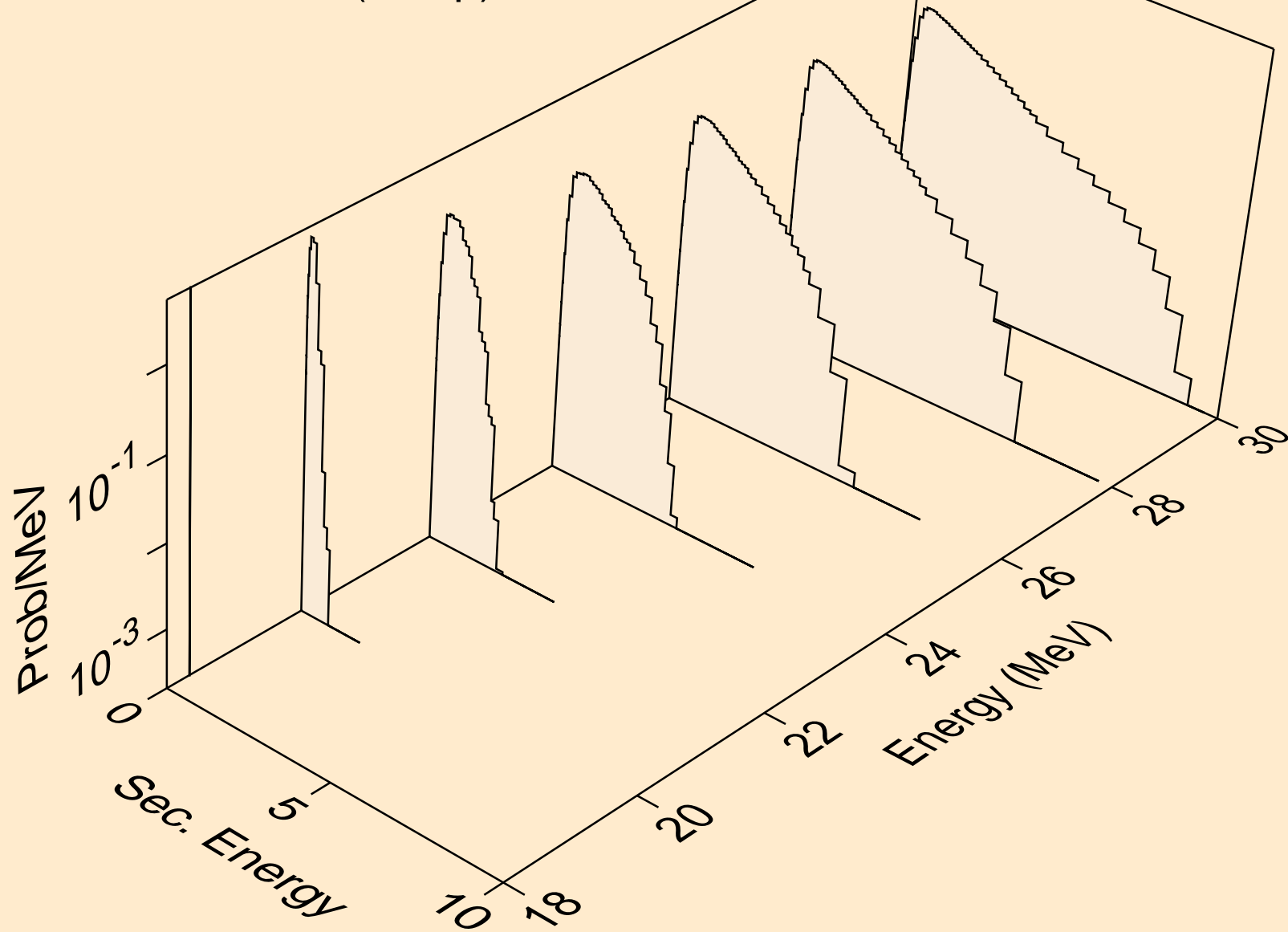

SR080 HELION ACER TENDL-2021 LIBRARY; T=0.K  
neutrons from (s,2np)

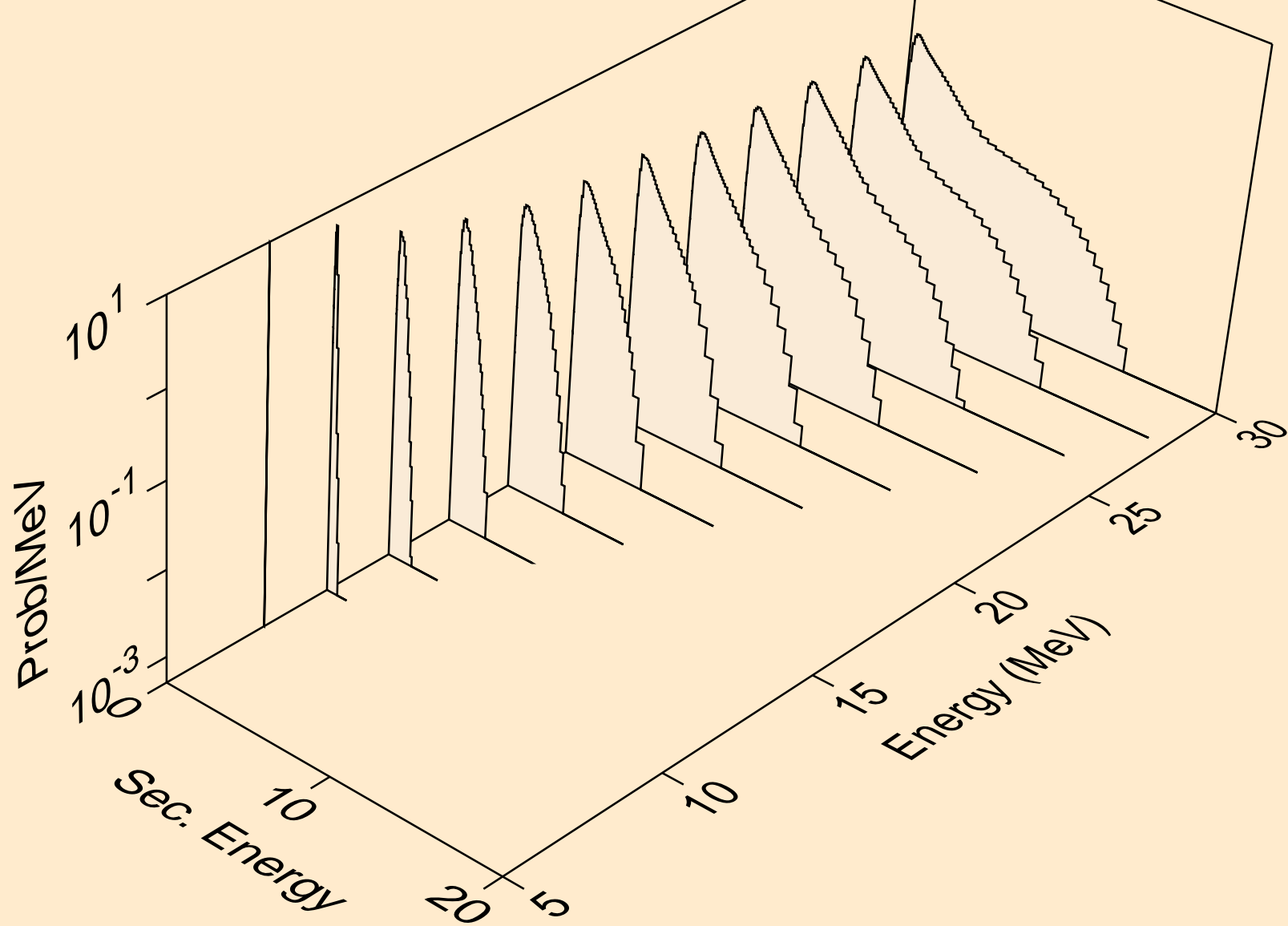

SR080 HELION ACER TENDL-2021 LIBRARY; T=0.K  
neutrons from (s,npa)

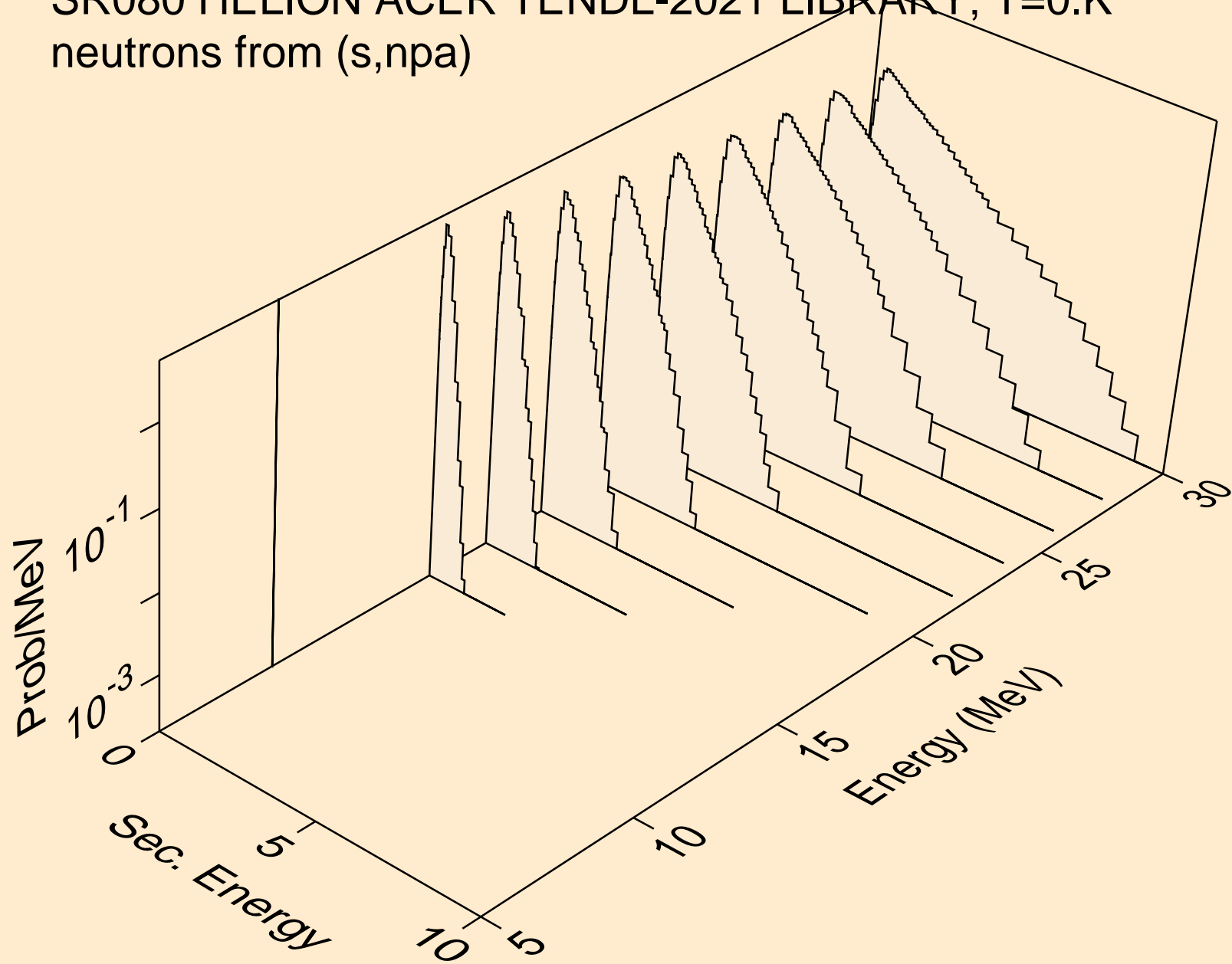

SR080 HELION ACER TENDL-2021 LIBRARY; T=0.K  
protons from (s,x)

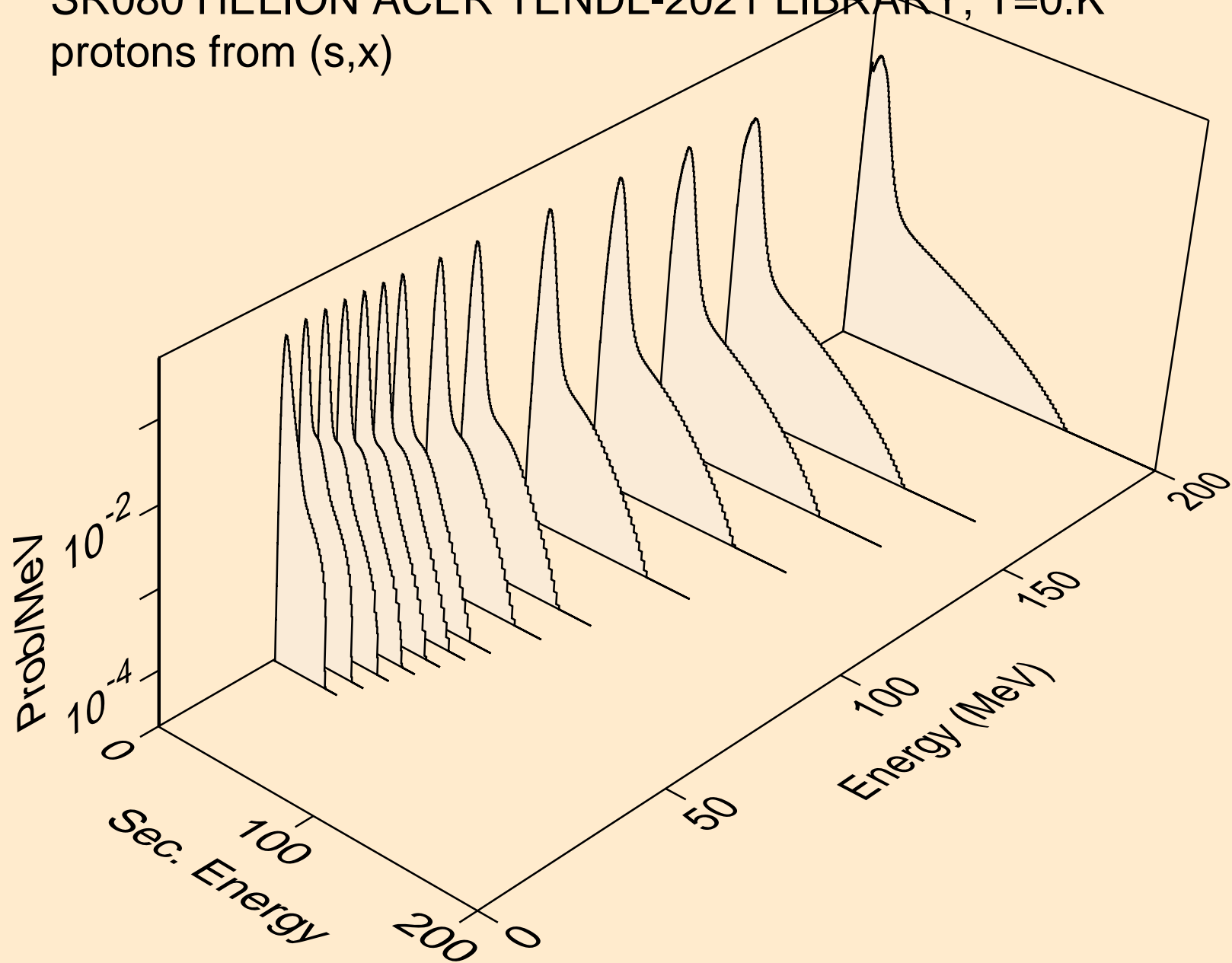

SR080 HELION ACER TENDL-2021 LIBRARY; T=0.K  
protons from (s,n\*)p

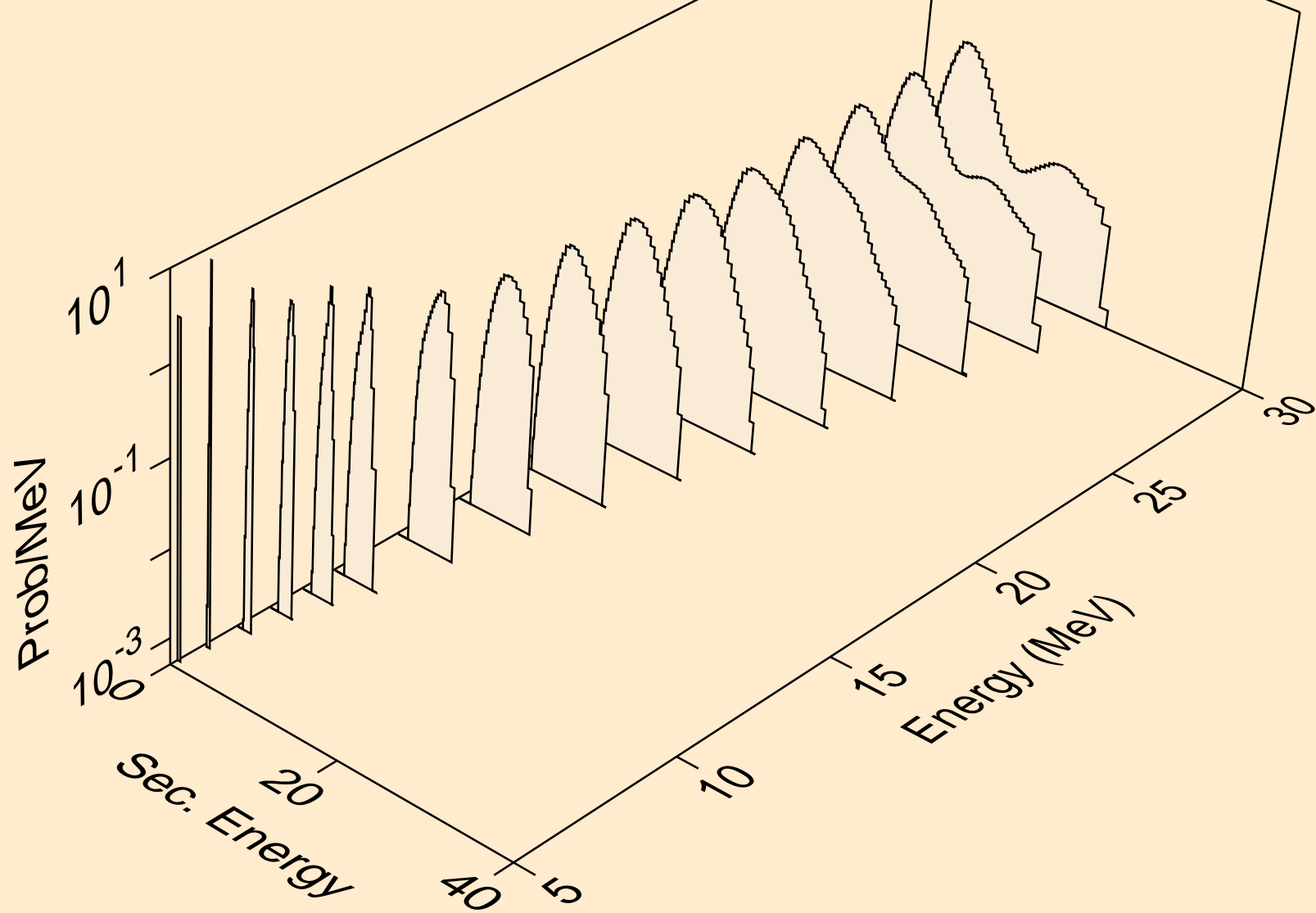

SR080 HELION ACER TENDL-2021 LIBRARY; T=0.K  
protons from (s,2np)

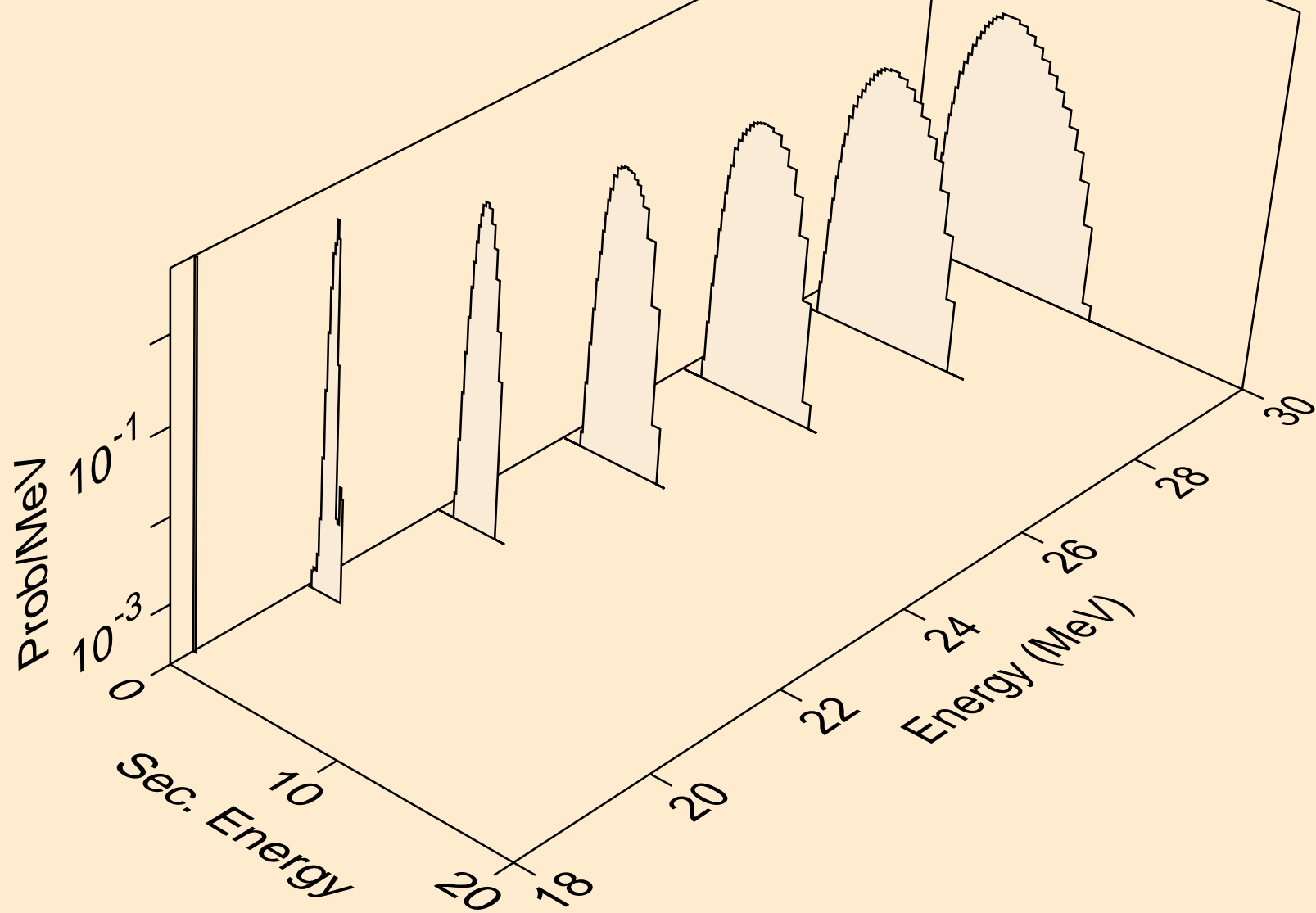

SR080 HELION ACER TENDL-2021 LIBRARY; T=0.K  
protons from (s,2np)

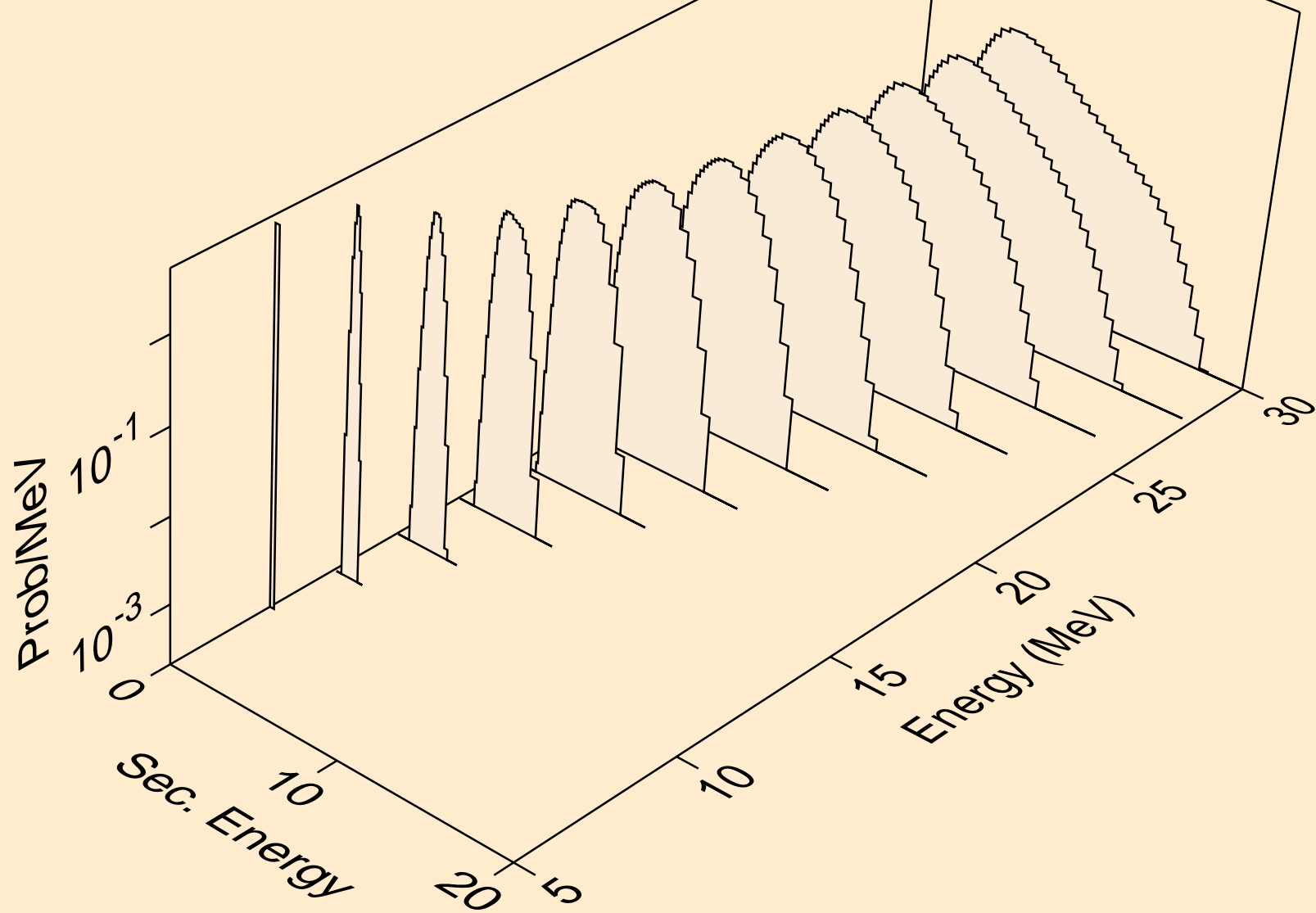



SR080 HELION ACER TENDL-2021 LIBRARY; T=0.K  
protons from (s,npa)

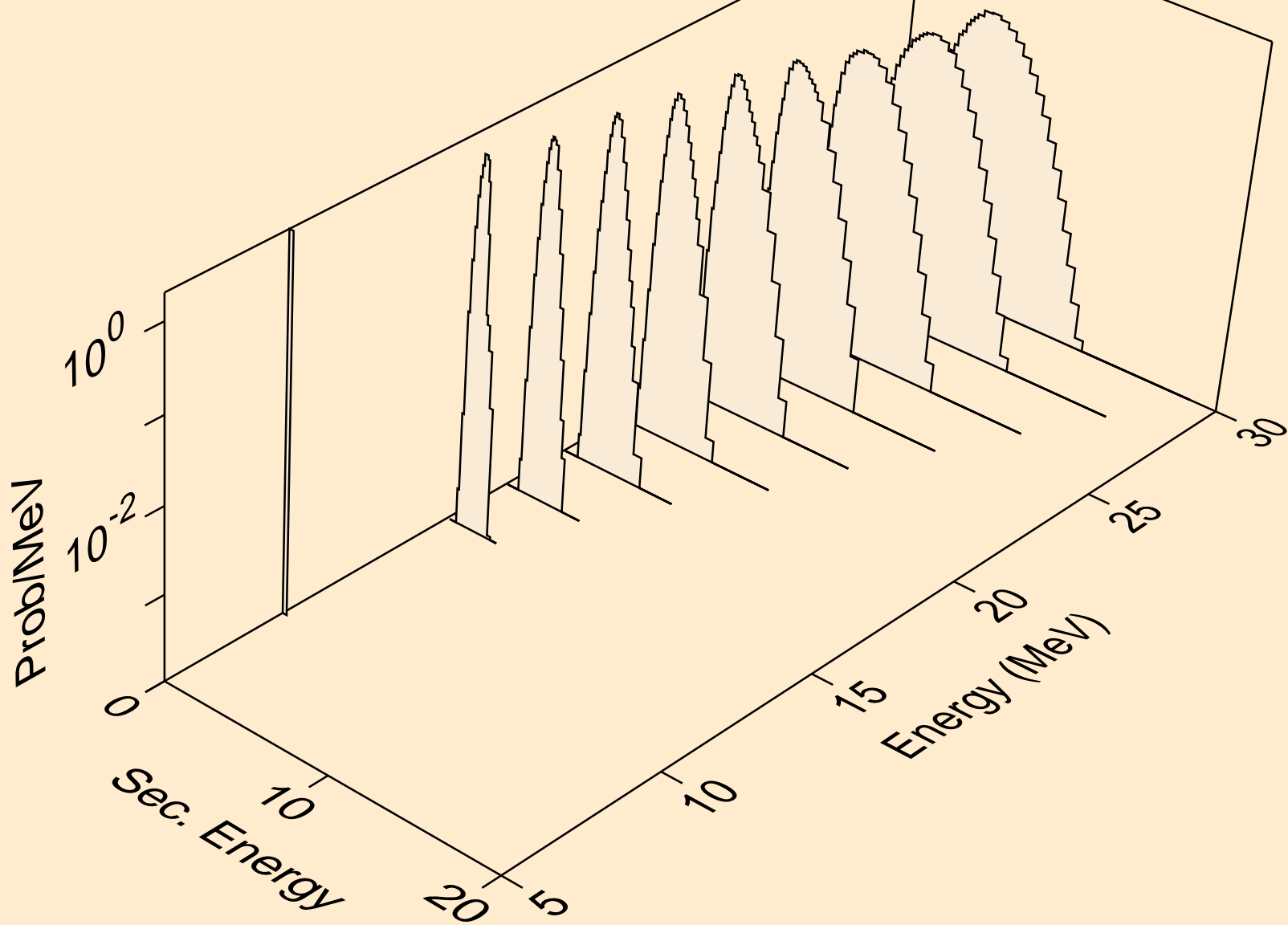

SR080 HELION ACER TENDL-2021 LIBRARY; T=0.K  
protons from (s,p)

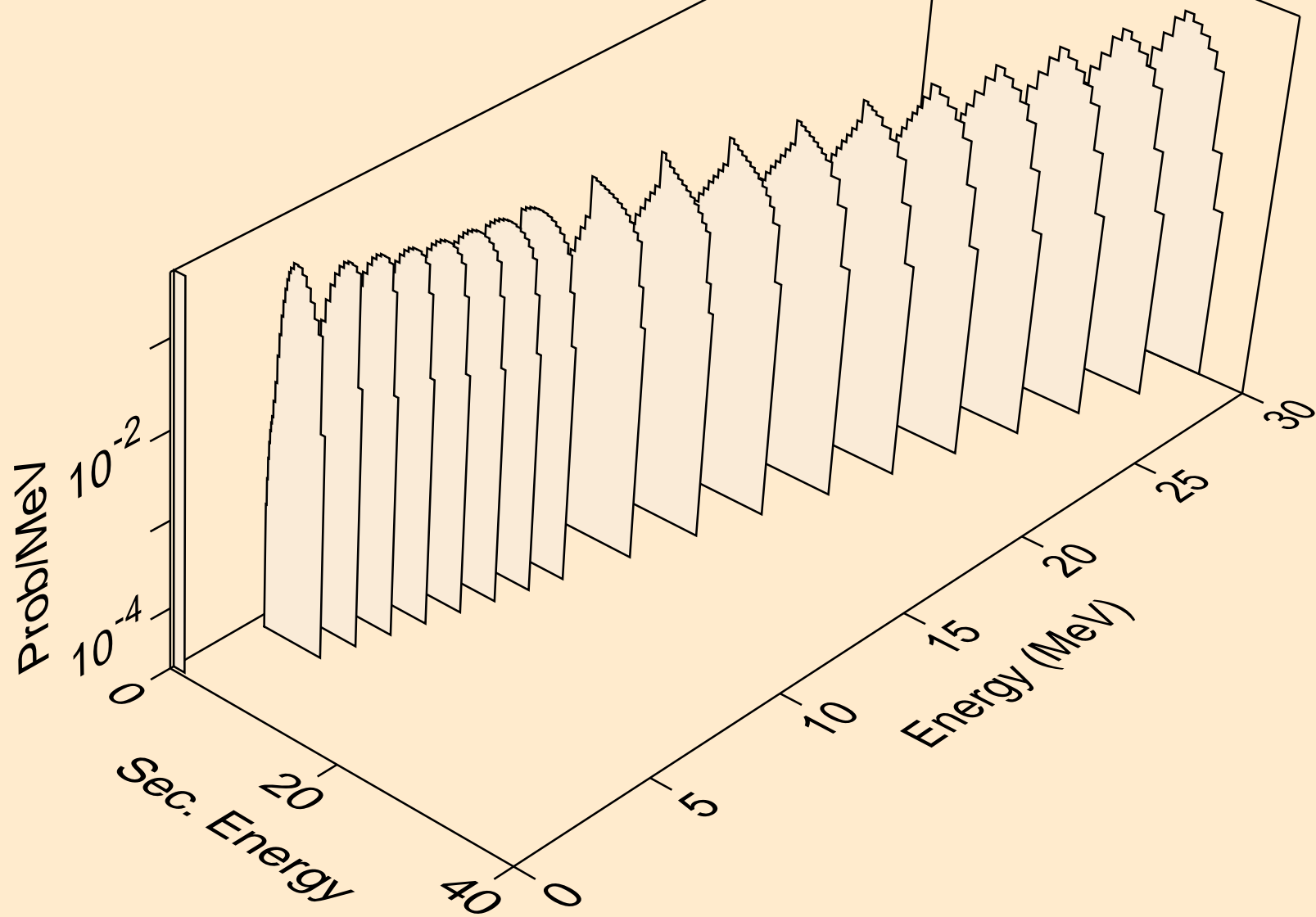

SR080 HELION ACER TENDL-2021 LIBRARY; T=0.K  
protons from (s,2p)

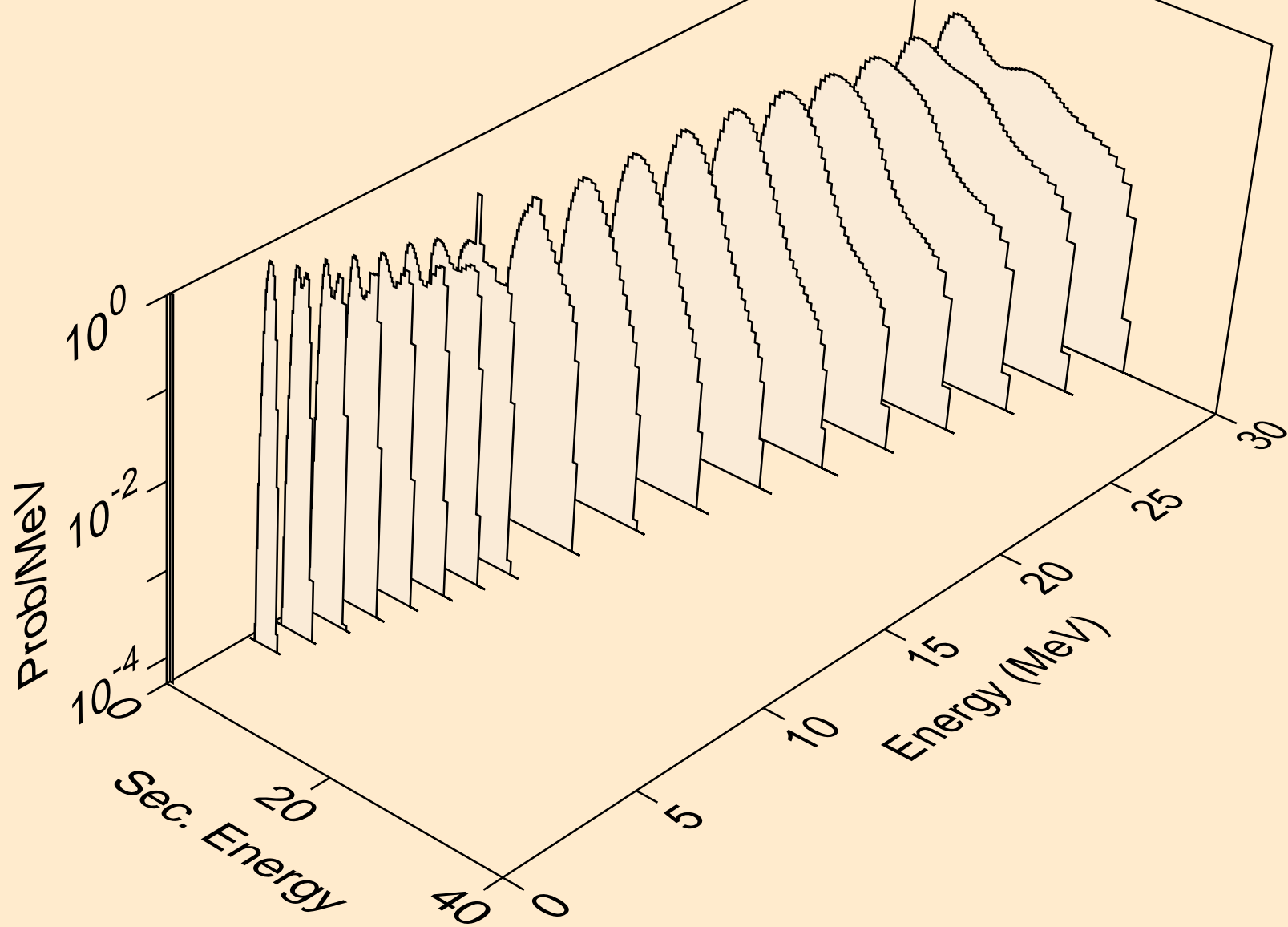

SR080 HELION ACER TENDL-2021 LIBRARY; T=0.K  
protons from (s,pa)

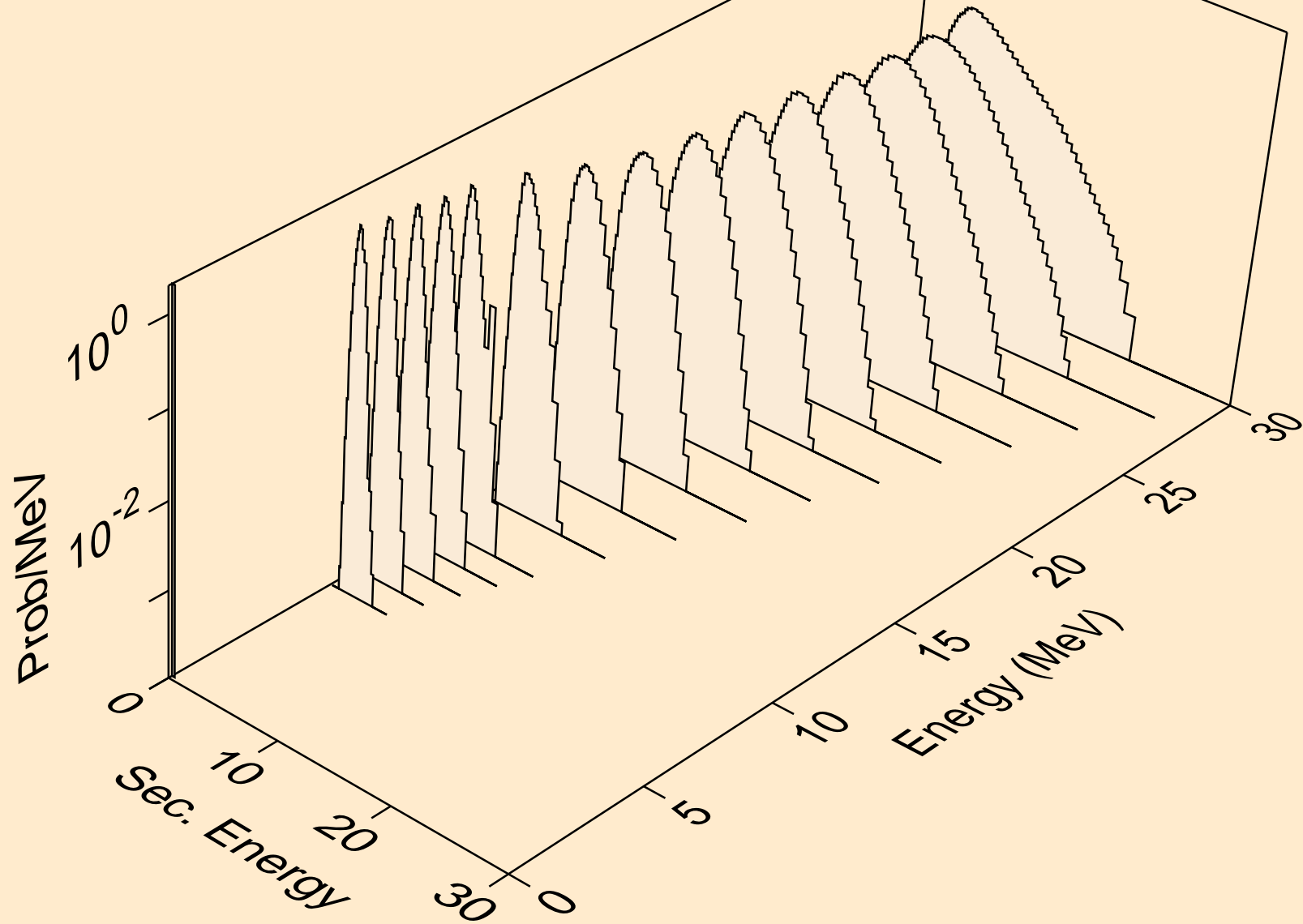

SR080 HELION ACER TENDL-2021 LIBRARY; T=0.K  
protons from (s,pd)

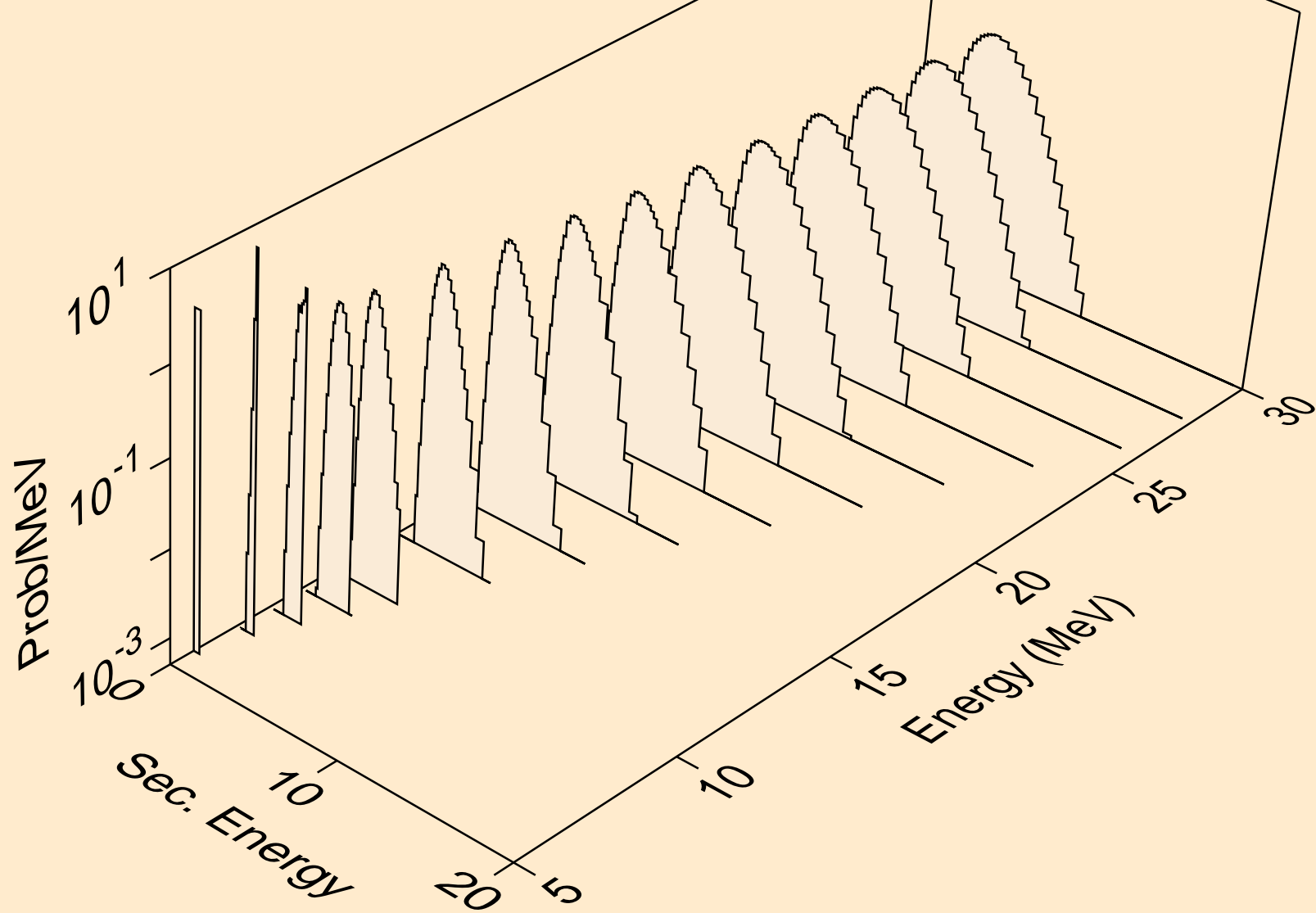

SR080 HELION ACER TENDL-2021 LIBRARY; T=0.K  
protons from (s,pt)

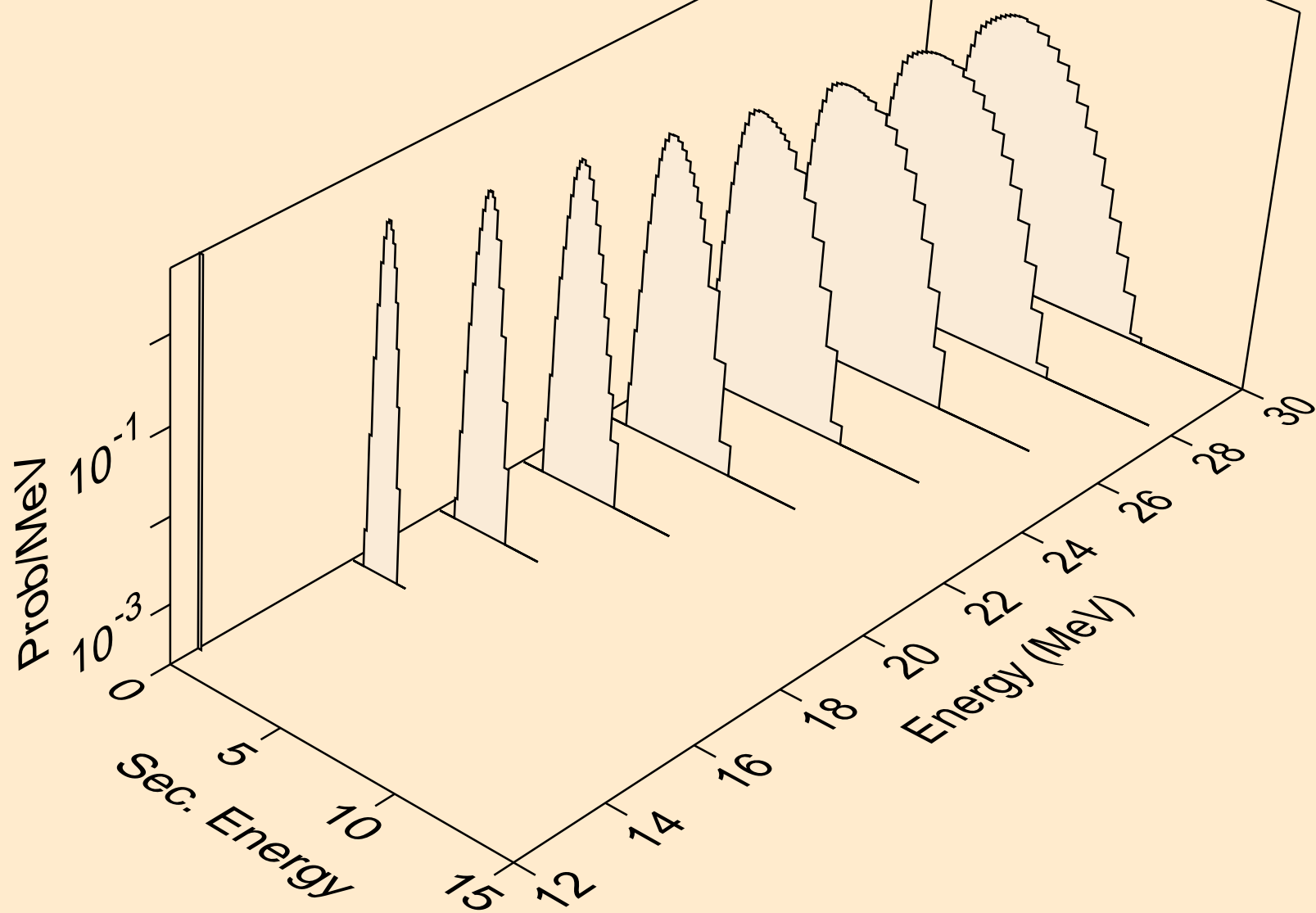

SR080 HELION ACER TENDL-2021 LIBRARY; T=0.K  
deuterons from (s,x)

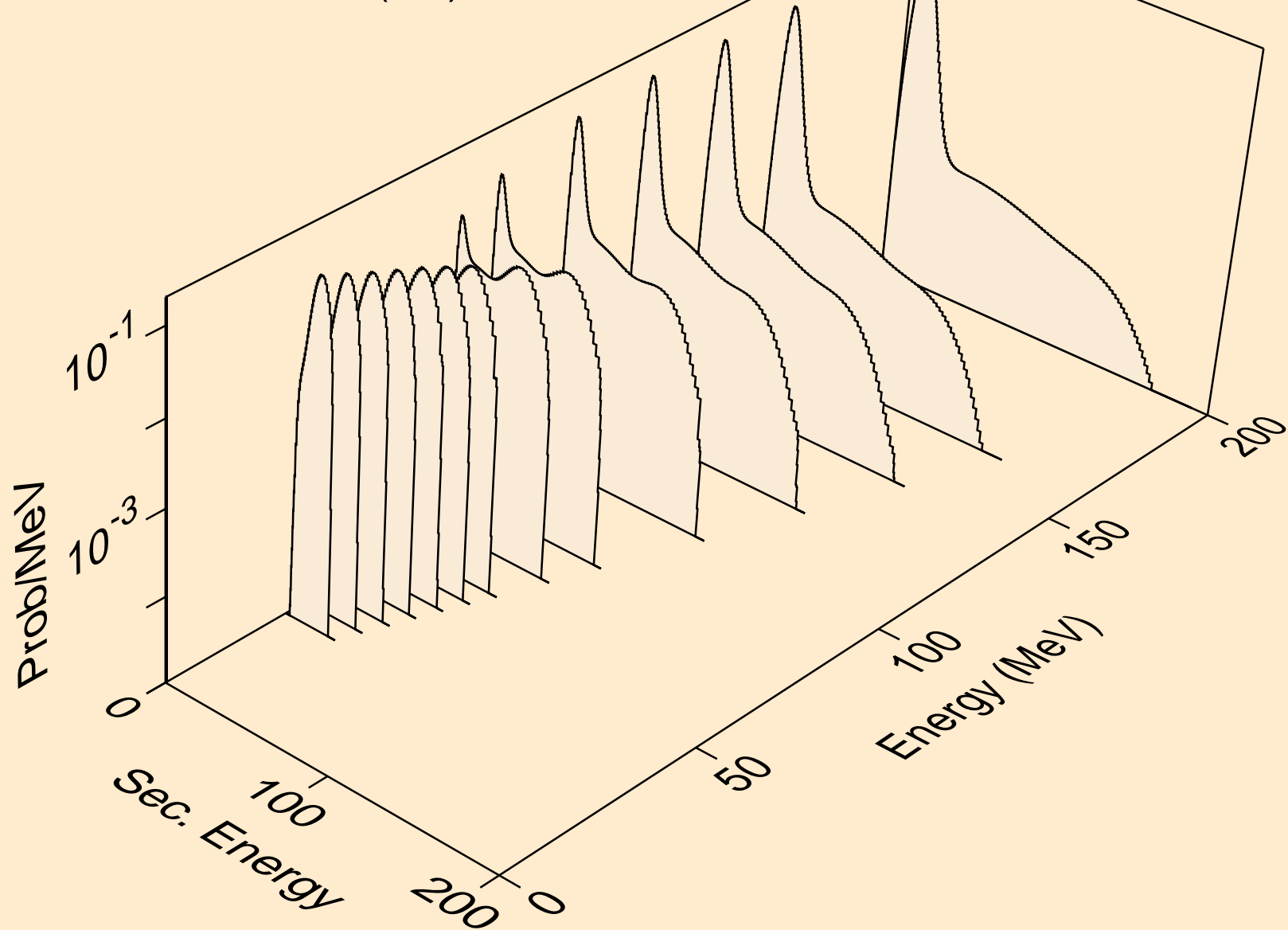

SR080 HELION ACER TENDL-2021 LIBRARY; T=0.K  
deuterons from (s,n\*)d

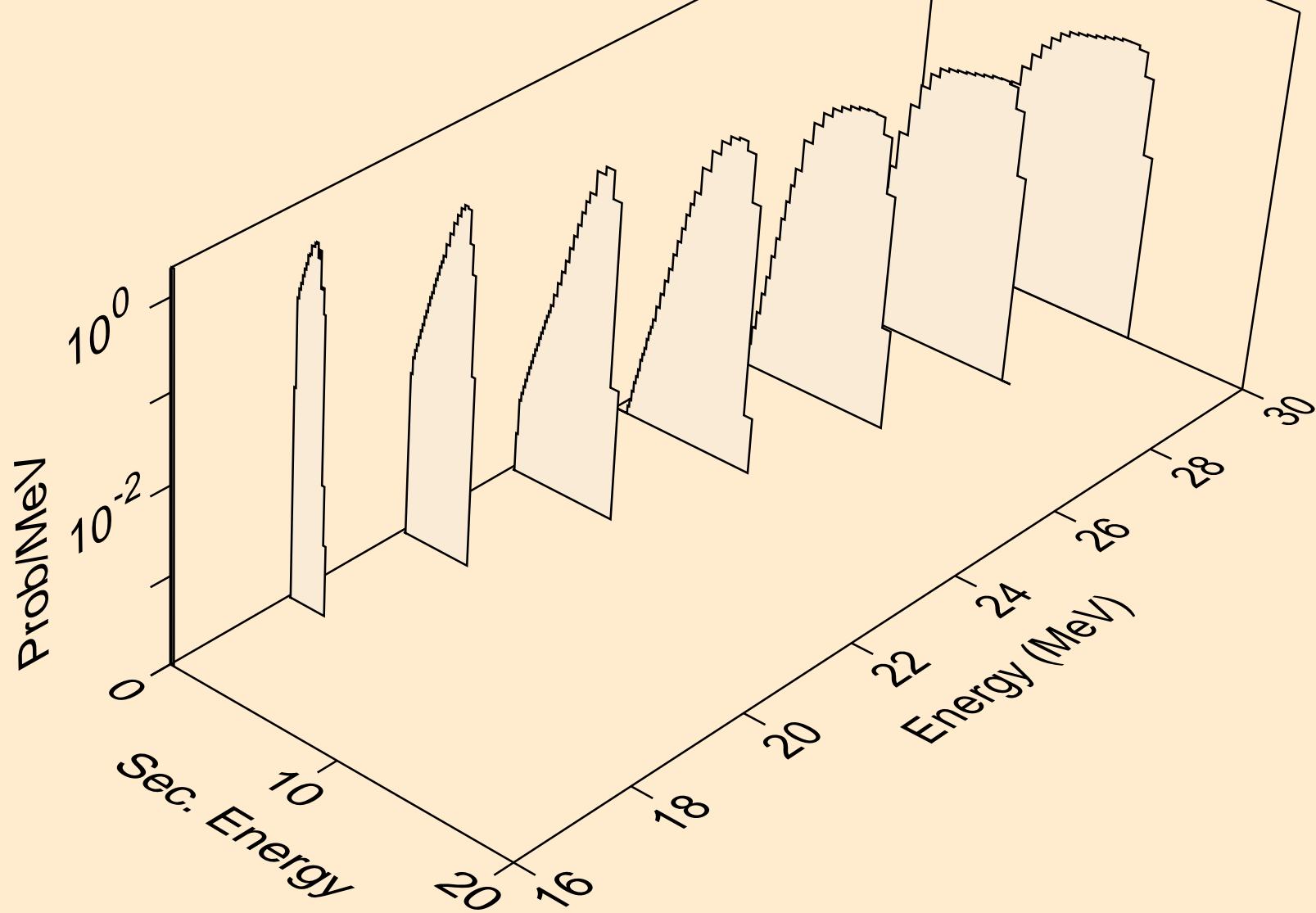



SR080 HELION ACER TENDL-2021 LIBRARY; T=0.K  
deuterons from (s,d)

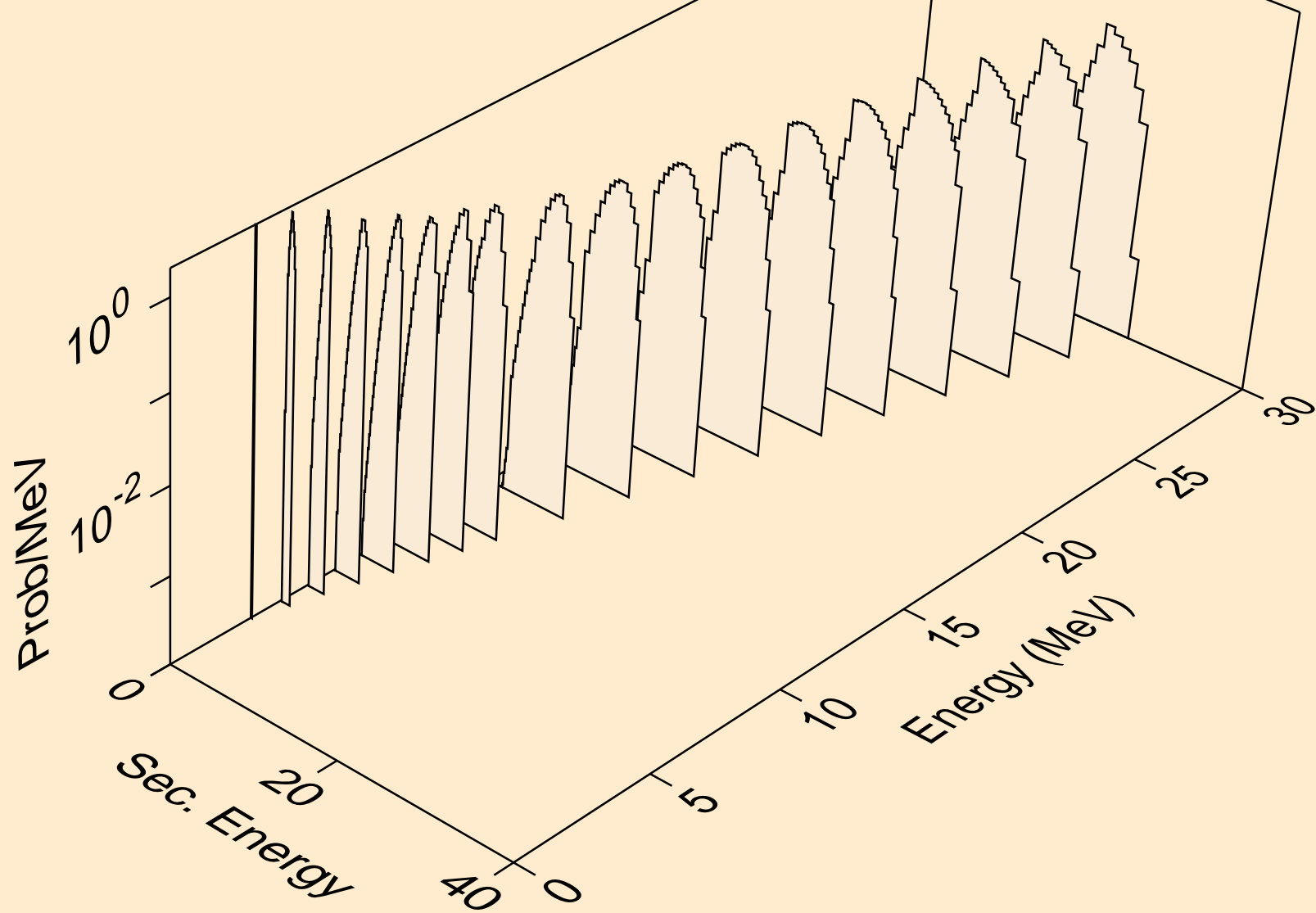

SR080 HELION ACER TENDL-2021 LIBRARY; T=0.K  
deuterons from (s,pd)

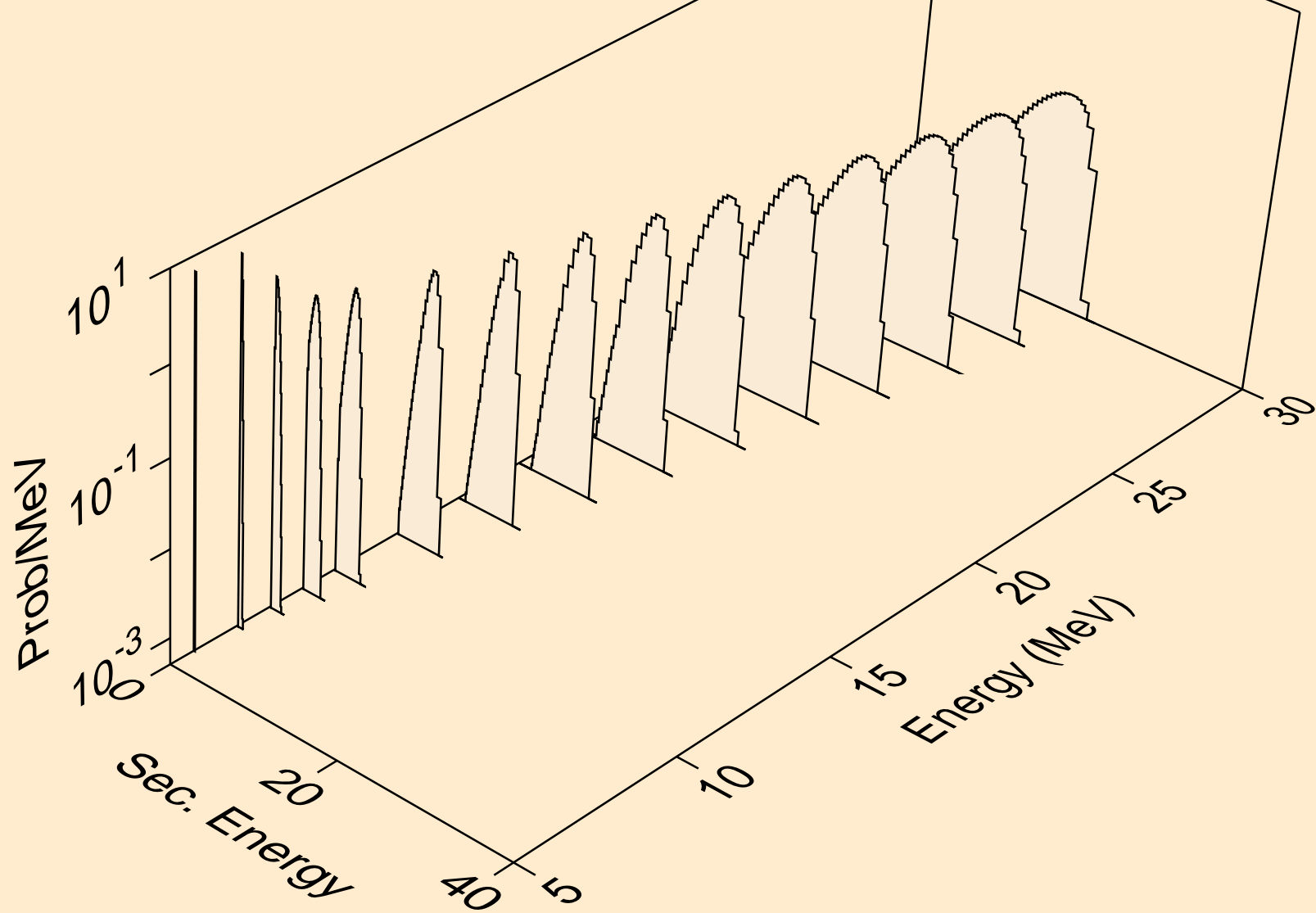

SR080 HELION ACER TENDL-2021 LIBRARY; T=0.K  
deuterons from (s,da)

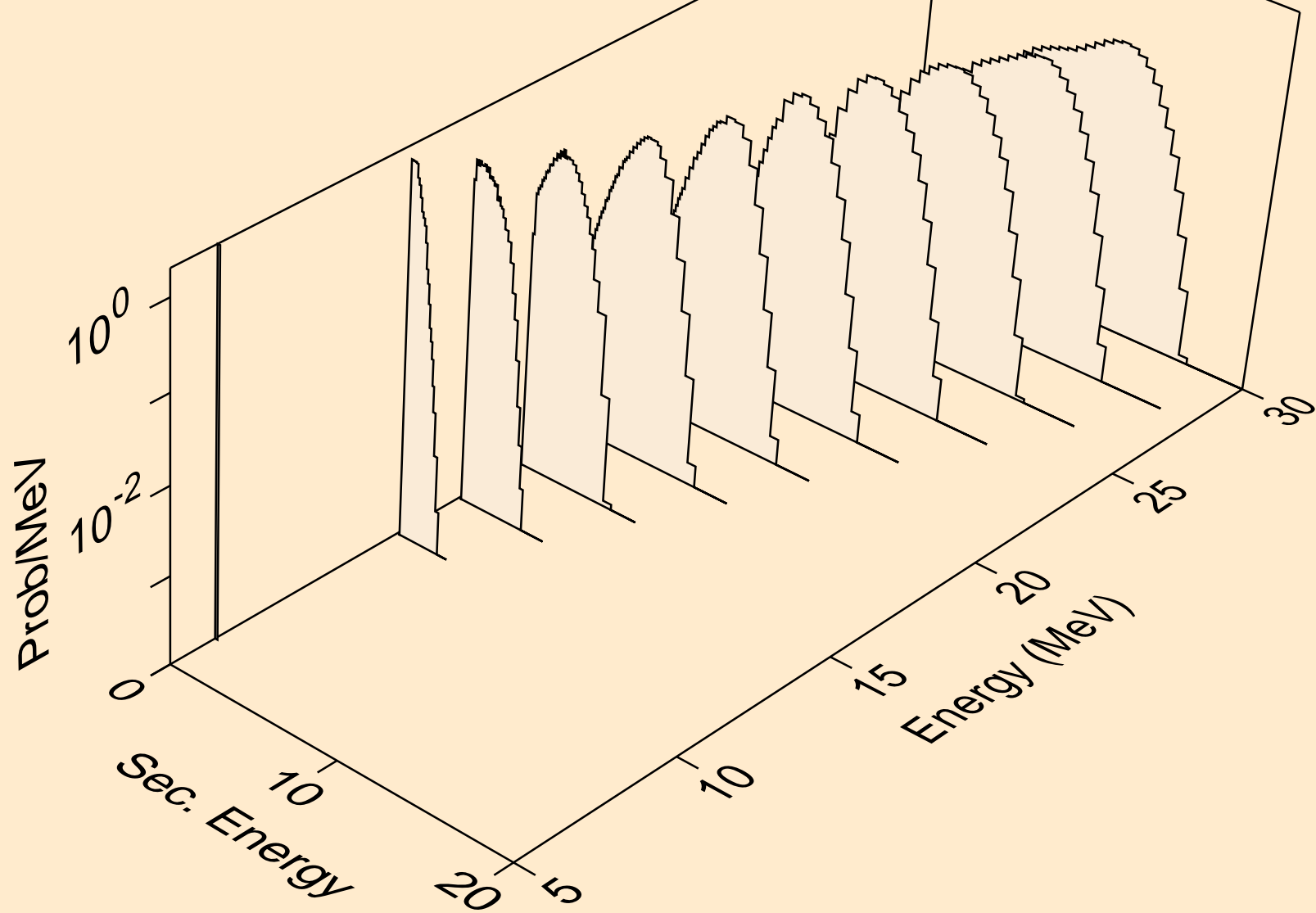

SR080 HELION ACER TENDL-2021 LIBRARY; T=0.K  
tritons from (s,x)

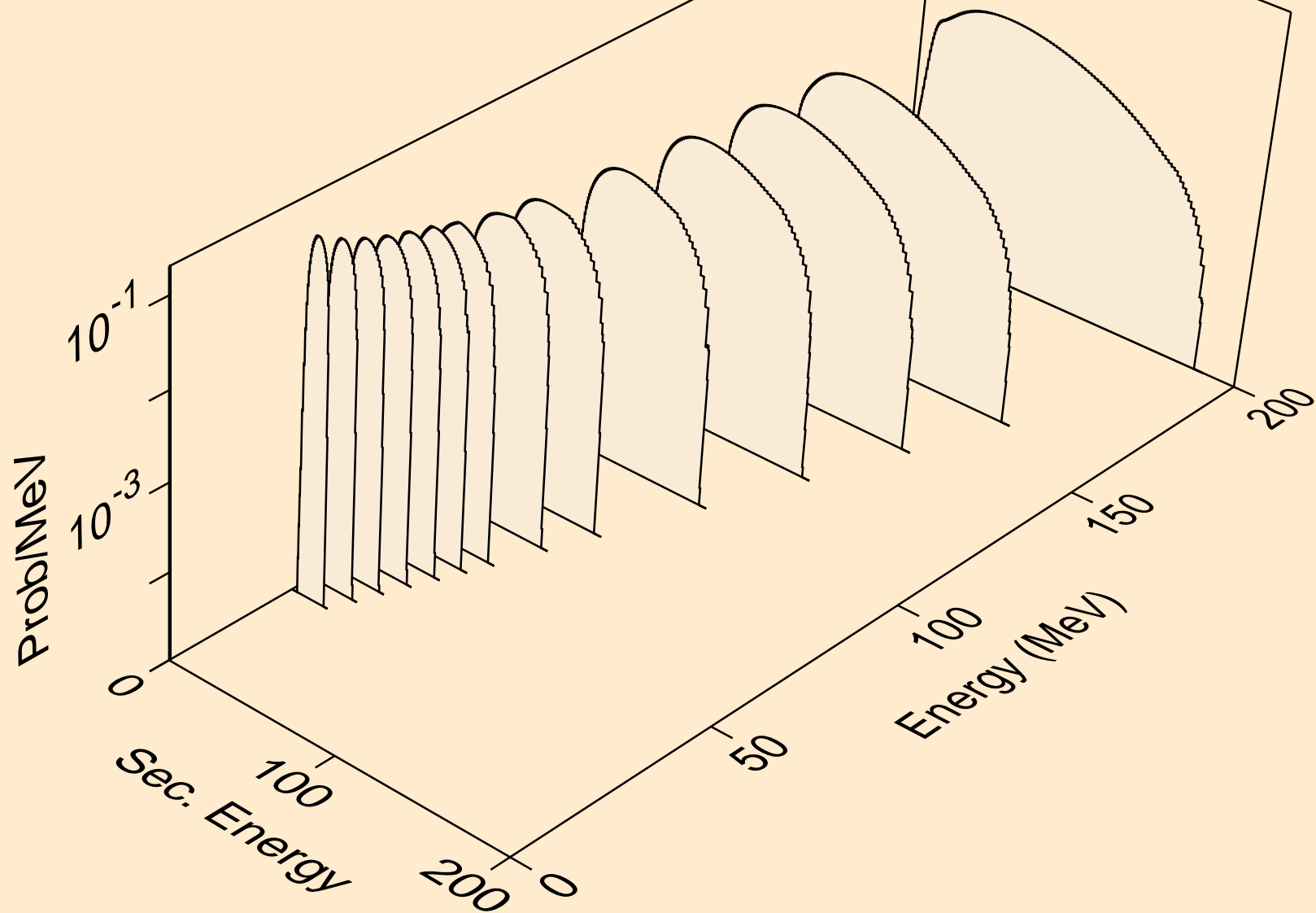

SR080 HELION ACER TENDL-2021 LIBRARY; T=0.K  
tritons from (s,n\*)t

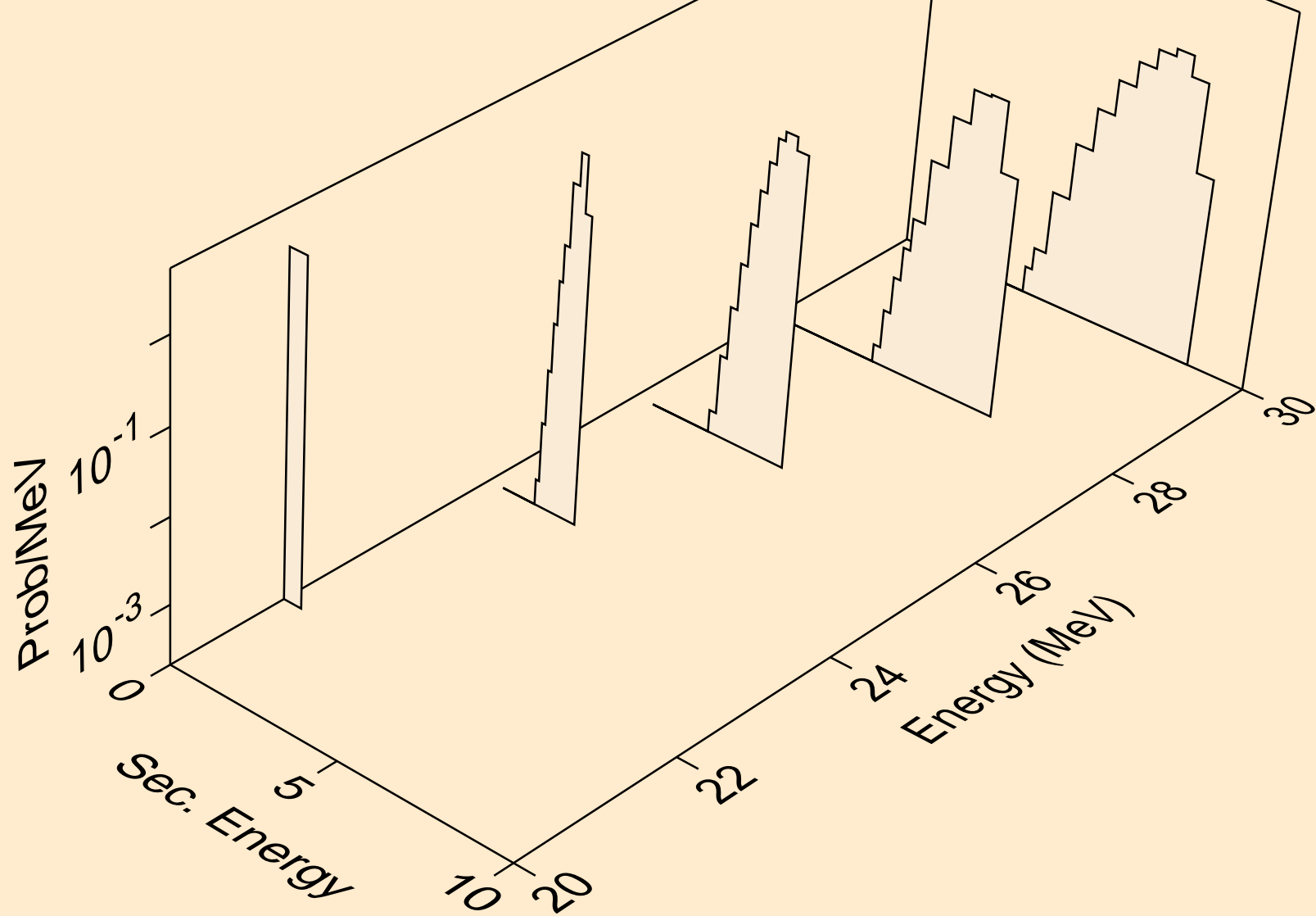

SR080 HELION ACER TENDL-2021 LIBRARY; T=0.K  
tritons from (s,t)

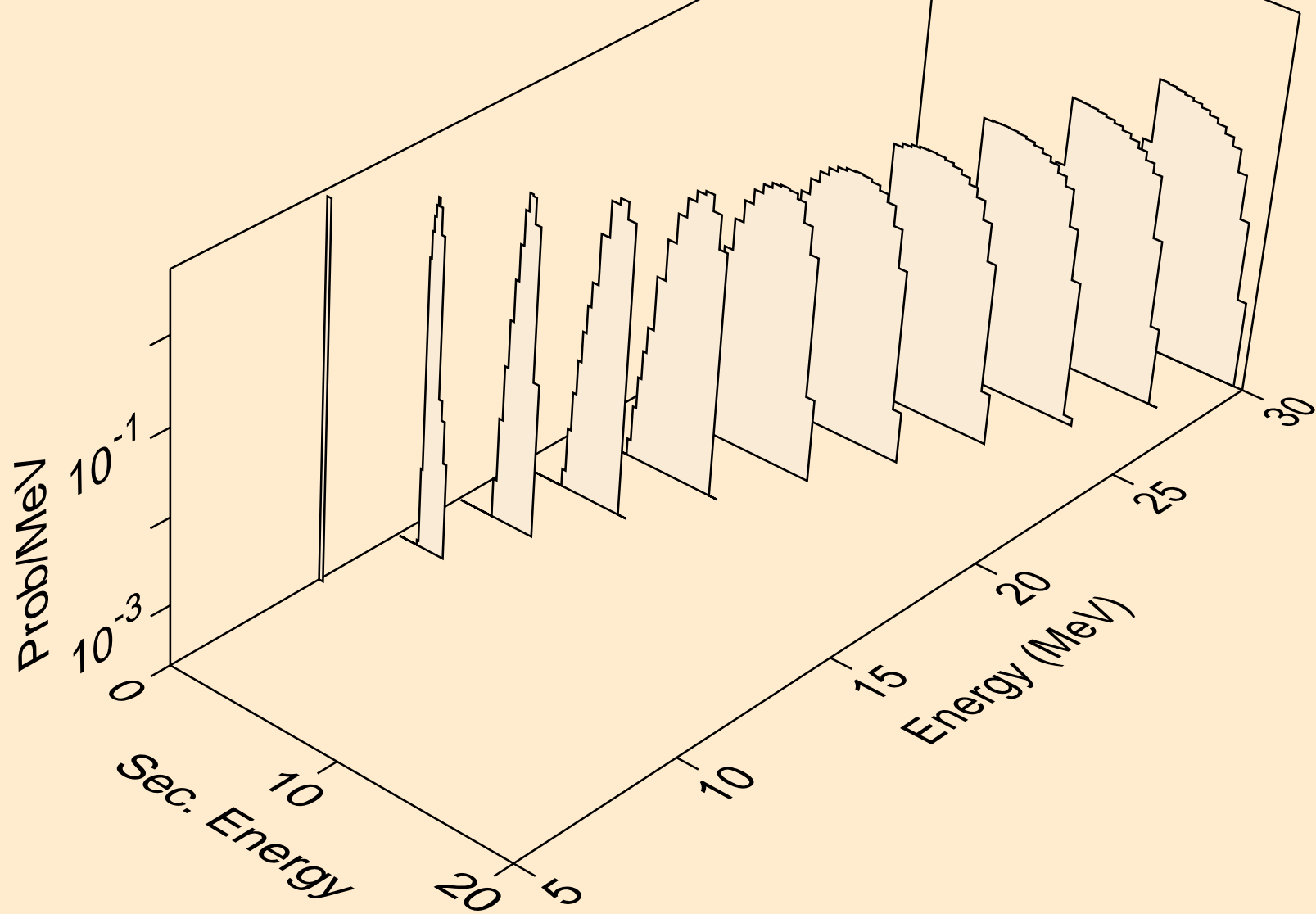

SR080 HELION ACER TENDL-2021 LIBRARY; T=0.K  
tritons from (s,pt)

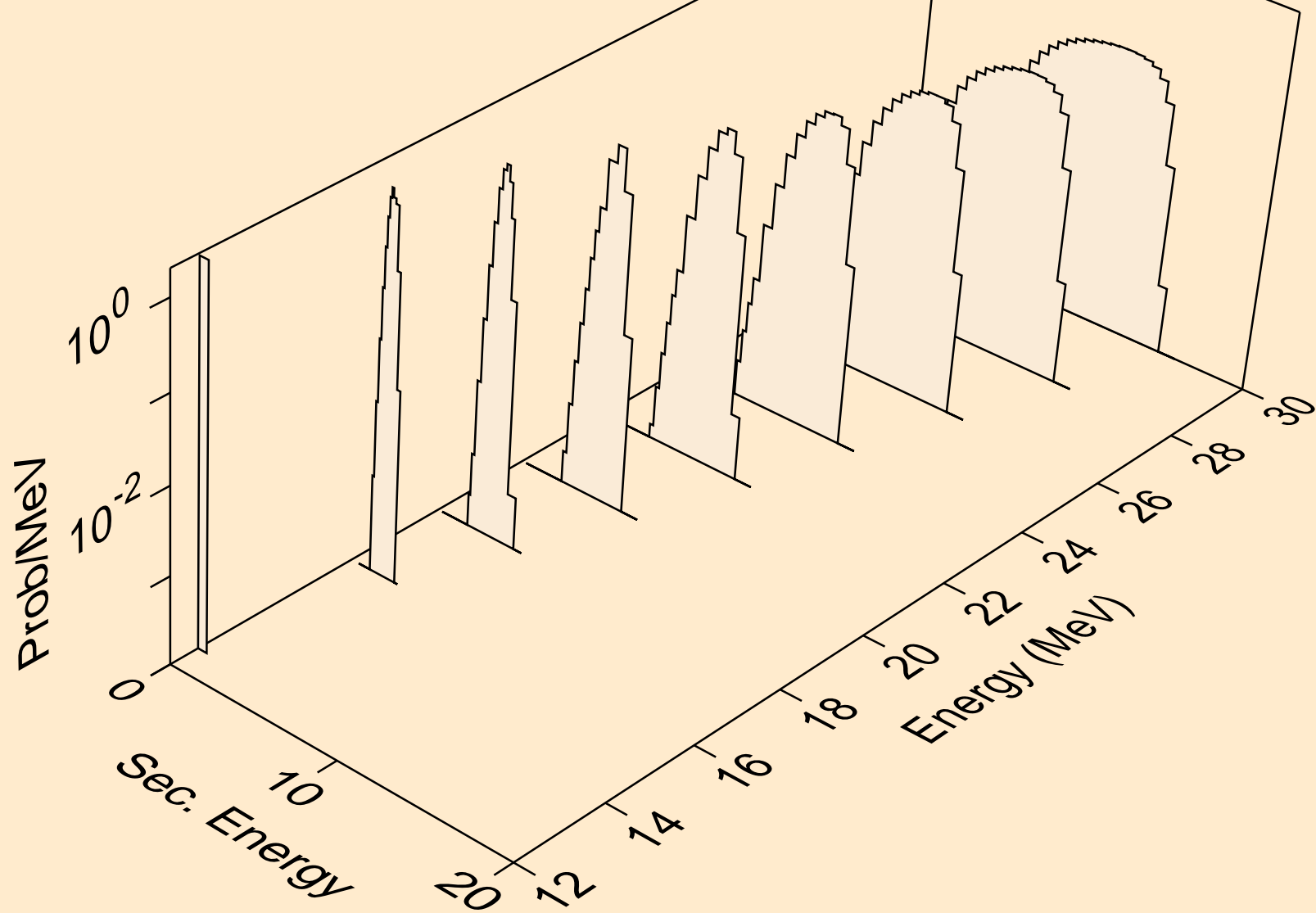

SR080 HELION ACER TENDL-2021 LIBRARY; T=0.K  
alphas from (s,x)

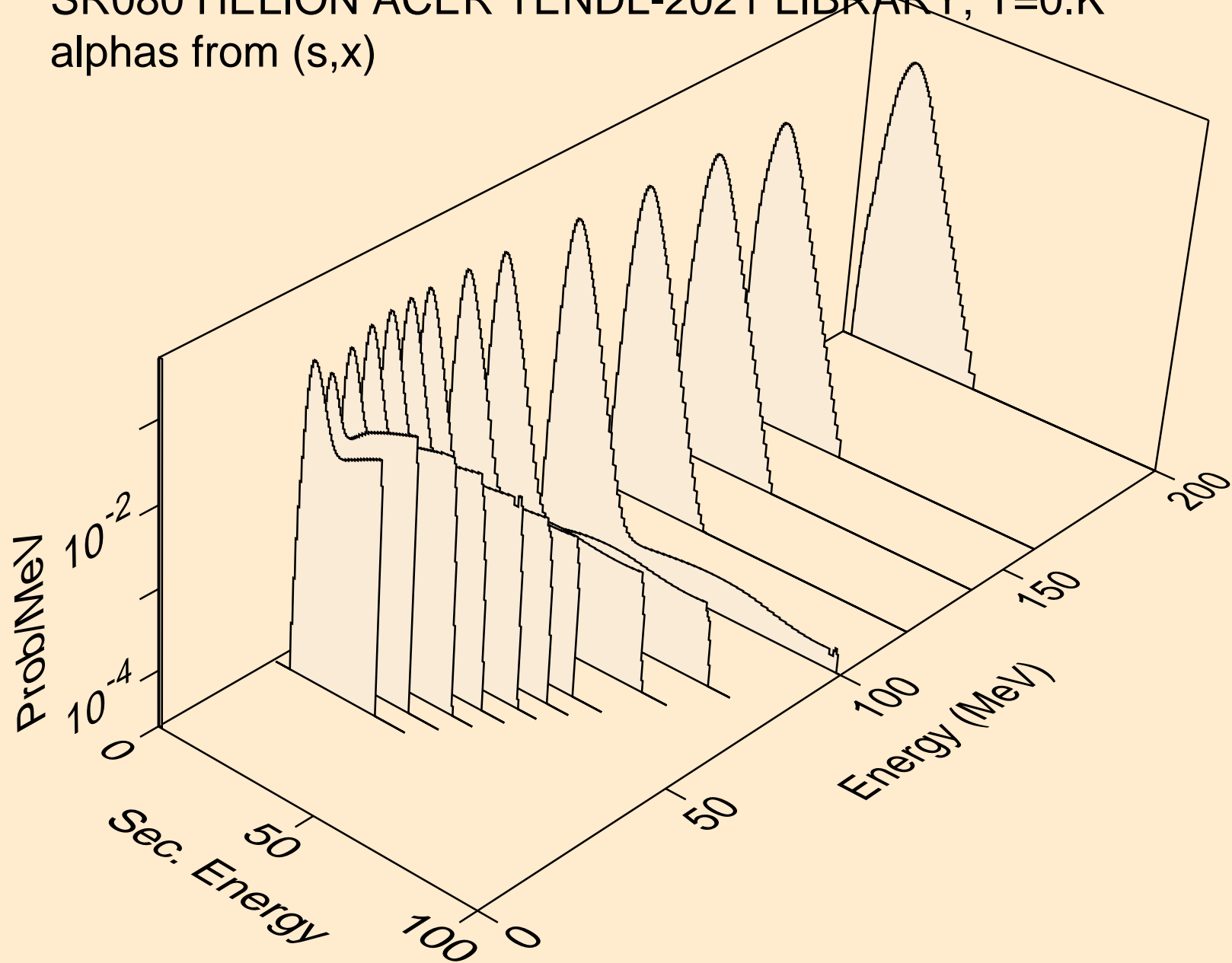



SR080 HELION ACER TENDL-2021 LIBRARY; T=0.K  
alphas from (s,n\*)a

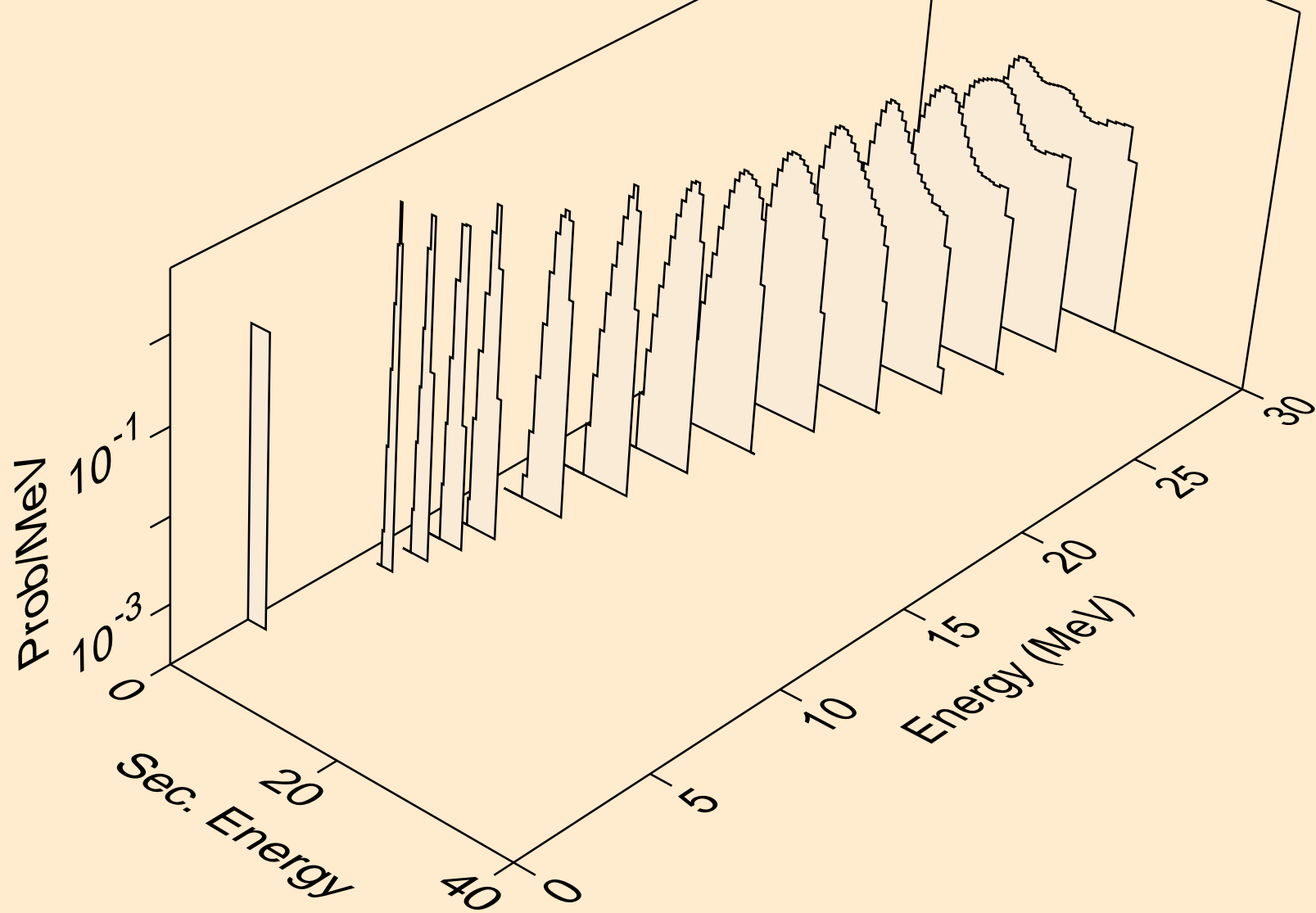

SR080 HELION ACER TENDL-2021 LIBRARY; T=0.K  
alphas from (s,2n)a

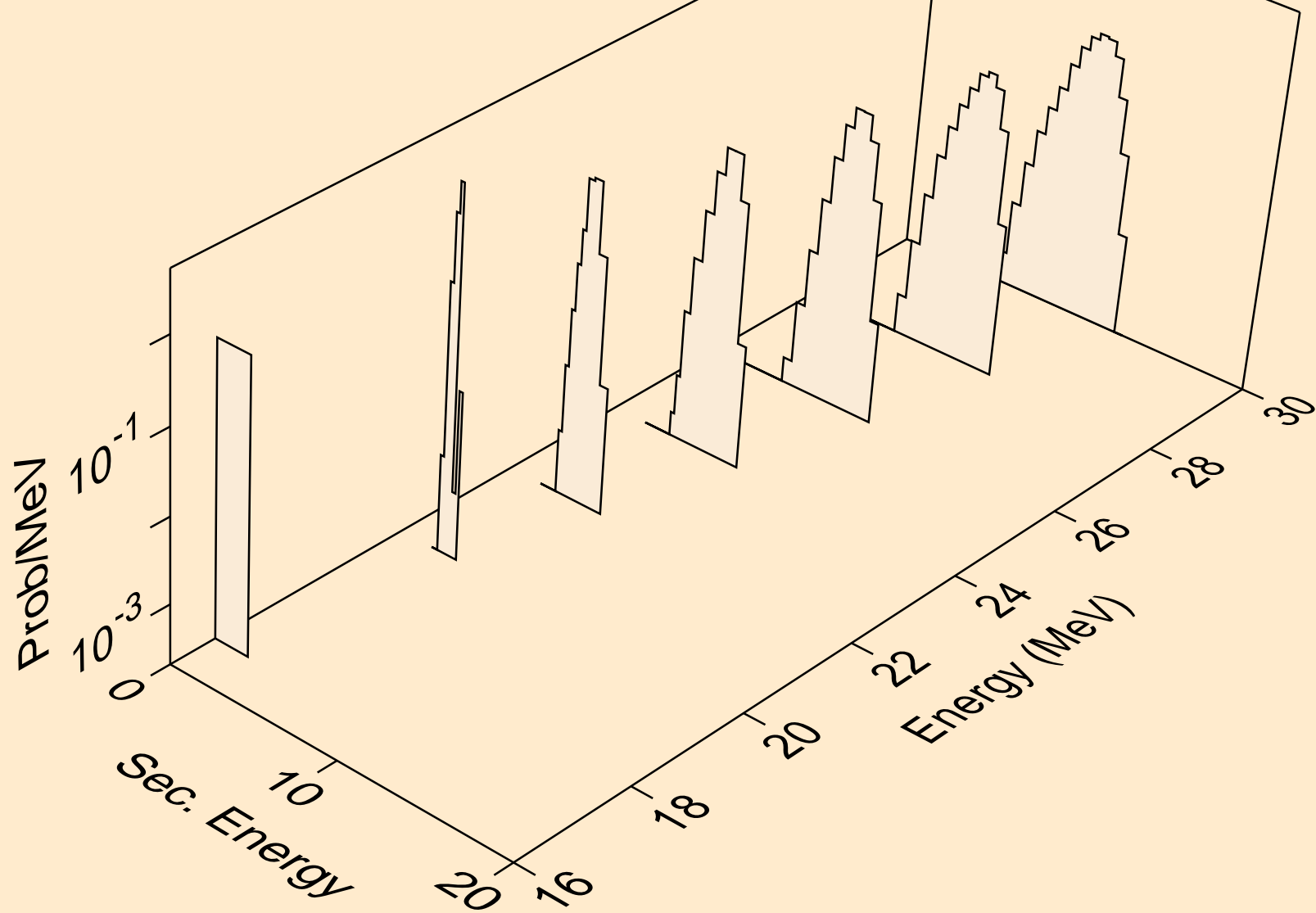

SR080 HELION ACER TENDL-2021 LIBRARY; T=0.K  
alphas from (s,n\*)2a

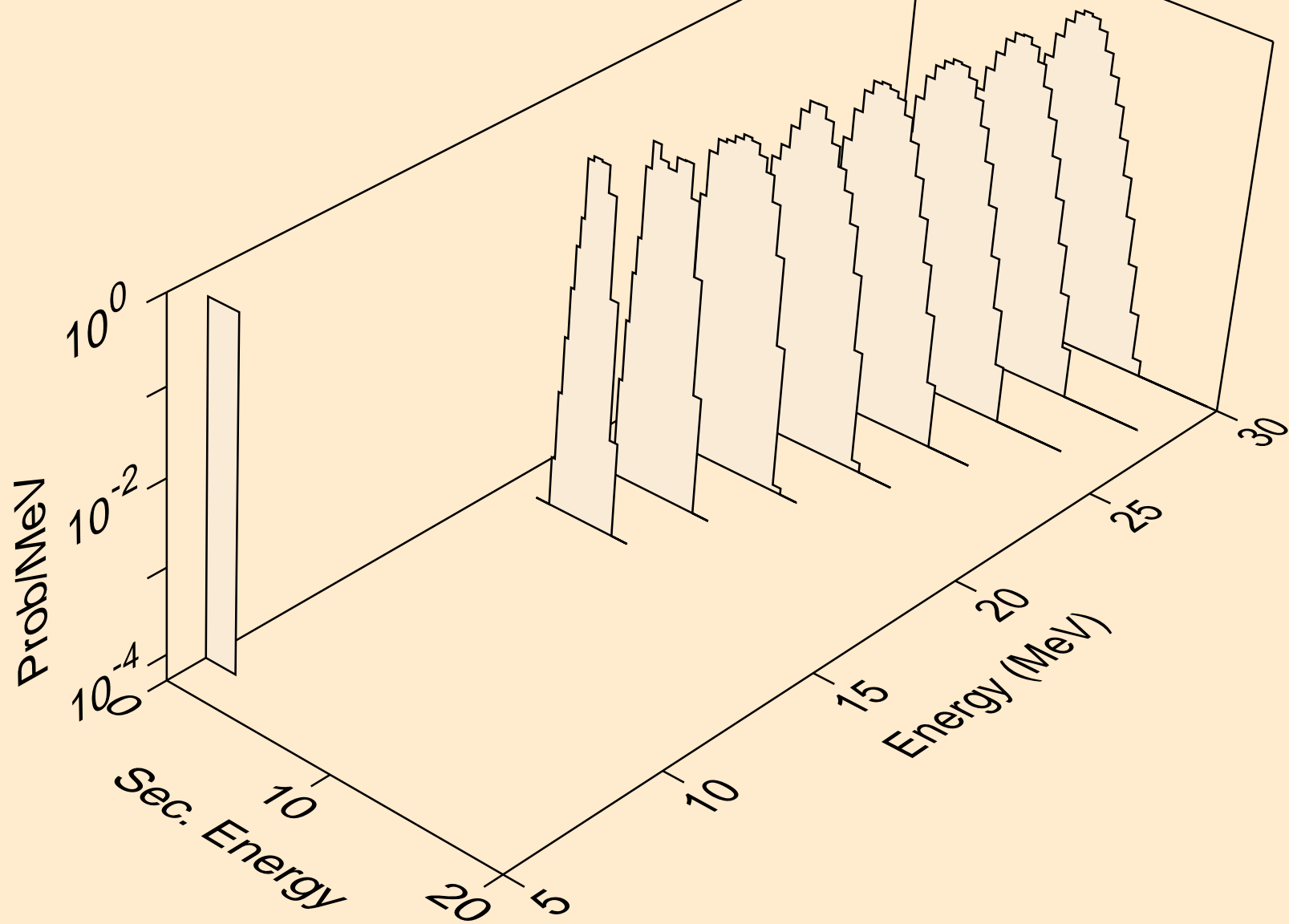

SR080 HELION ACER TENDL-2021 LIBRARY; T=0.K  
alphas from (s,npa)

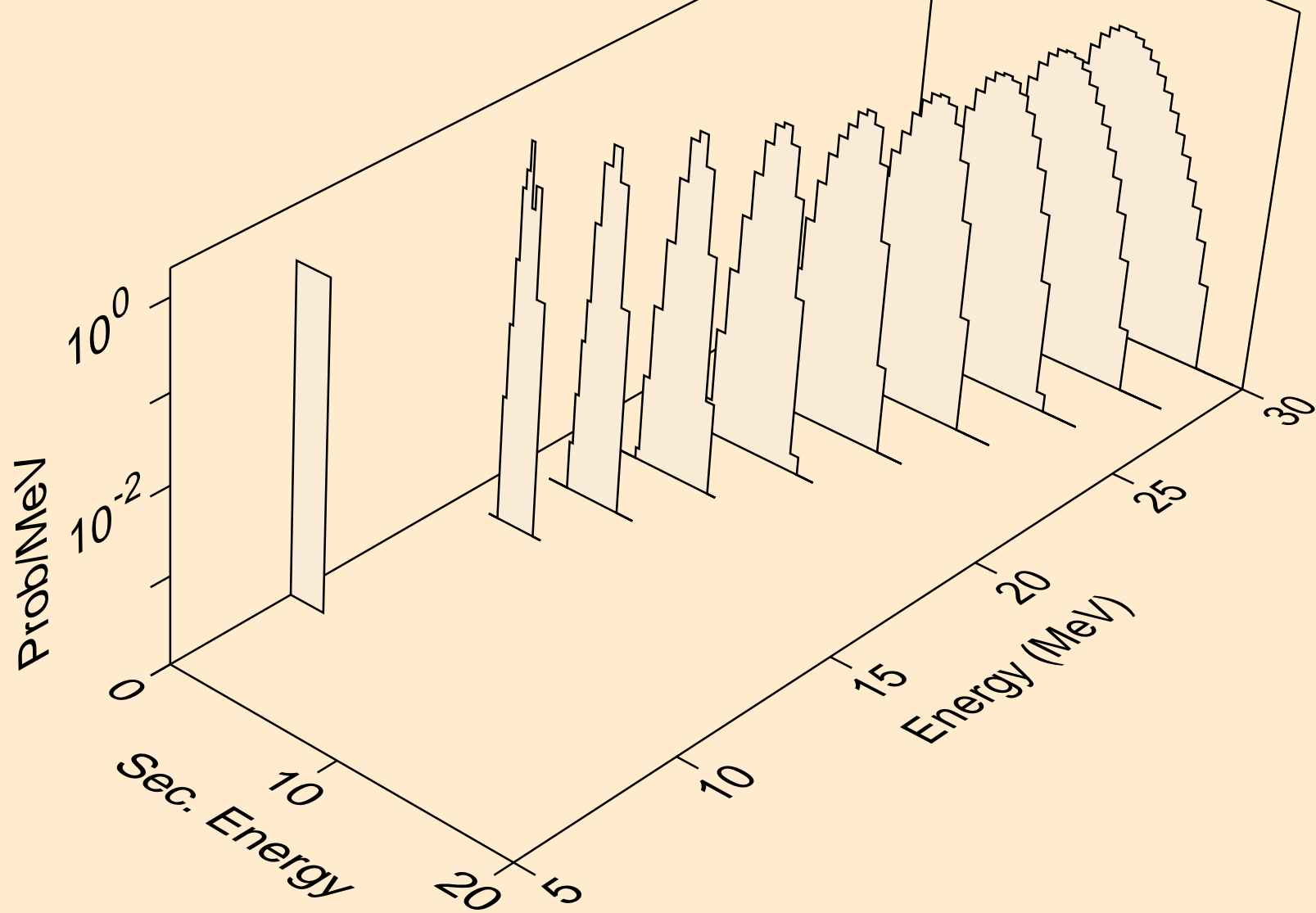

SR080 HELION ACER TENDL-2021 LIBRARY; T=0.K  
alphas from (s,a)

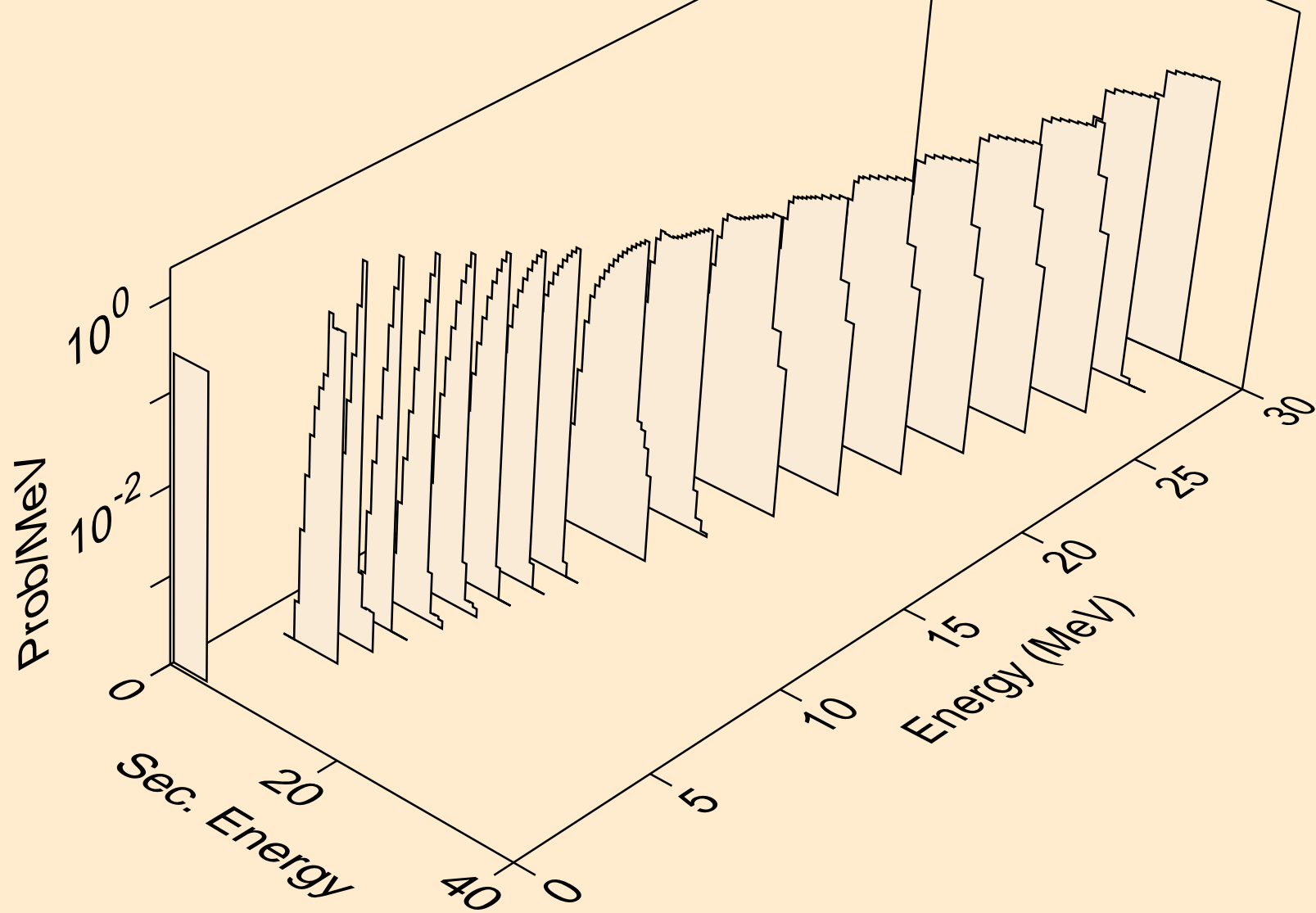

SR080 HELION ACER TENDL-2021 LIBRARY; T=0.K  
alphas from (s,2a)

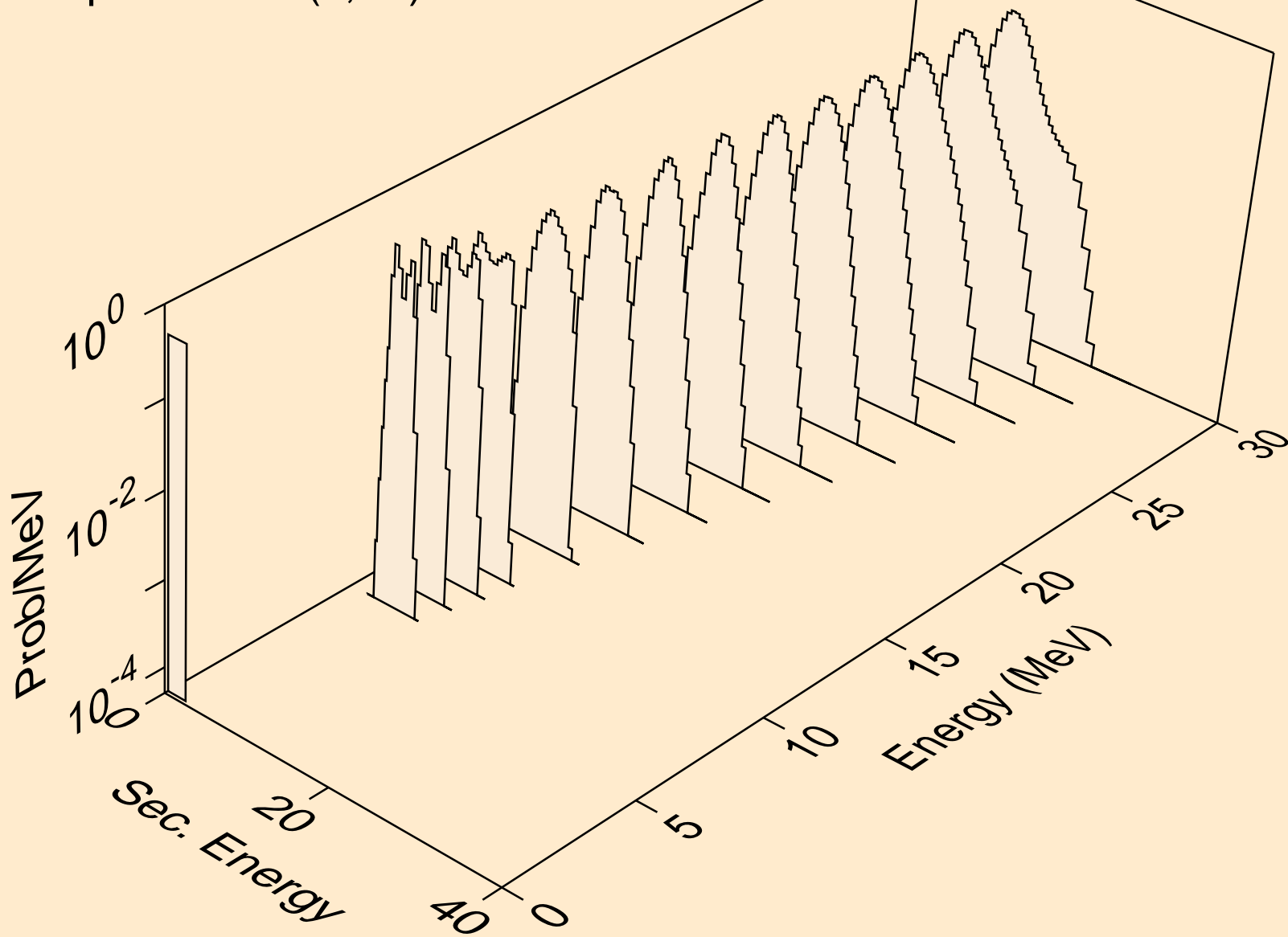

SR080 HELION ACER TENDL-2021 LIBRARY; T=0.K  
alphas from (s,3a)

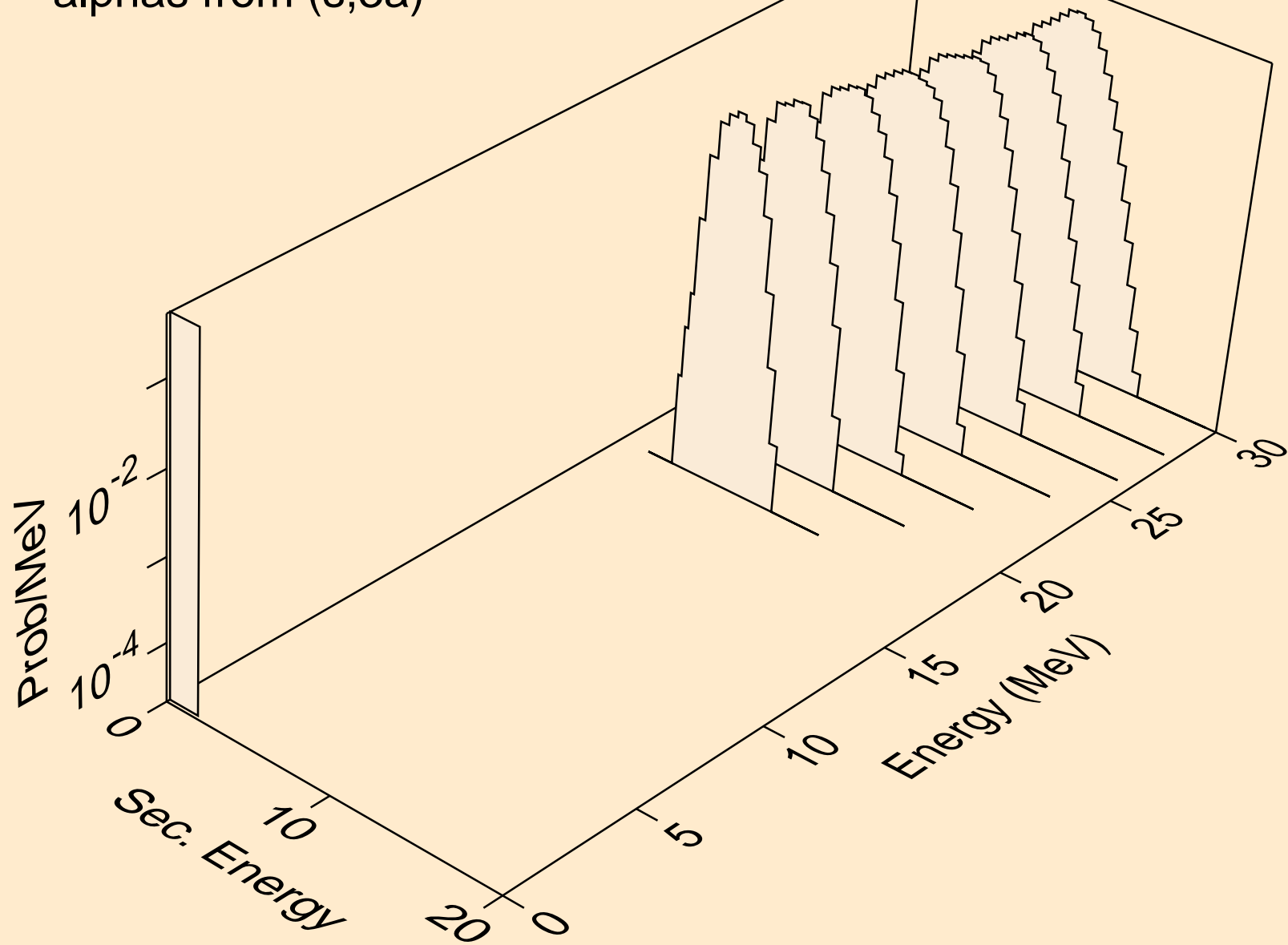

SR080 HELION ACER TENDL-2021 LIBRARY; T=0.K  
alphas from (s,pa)

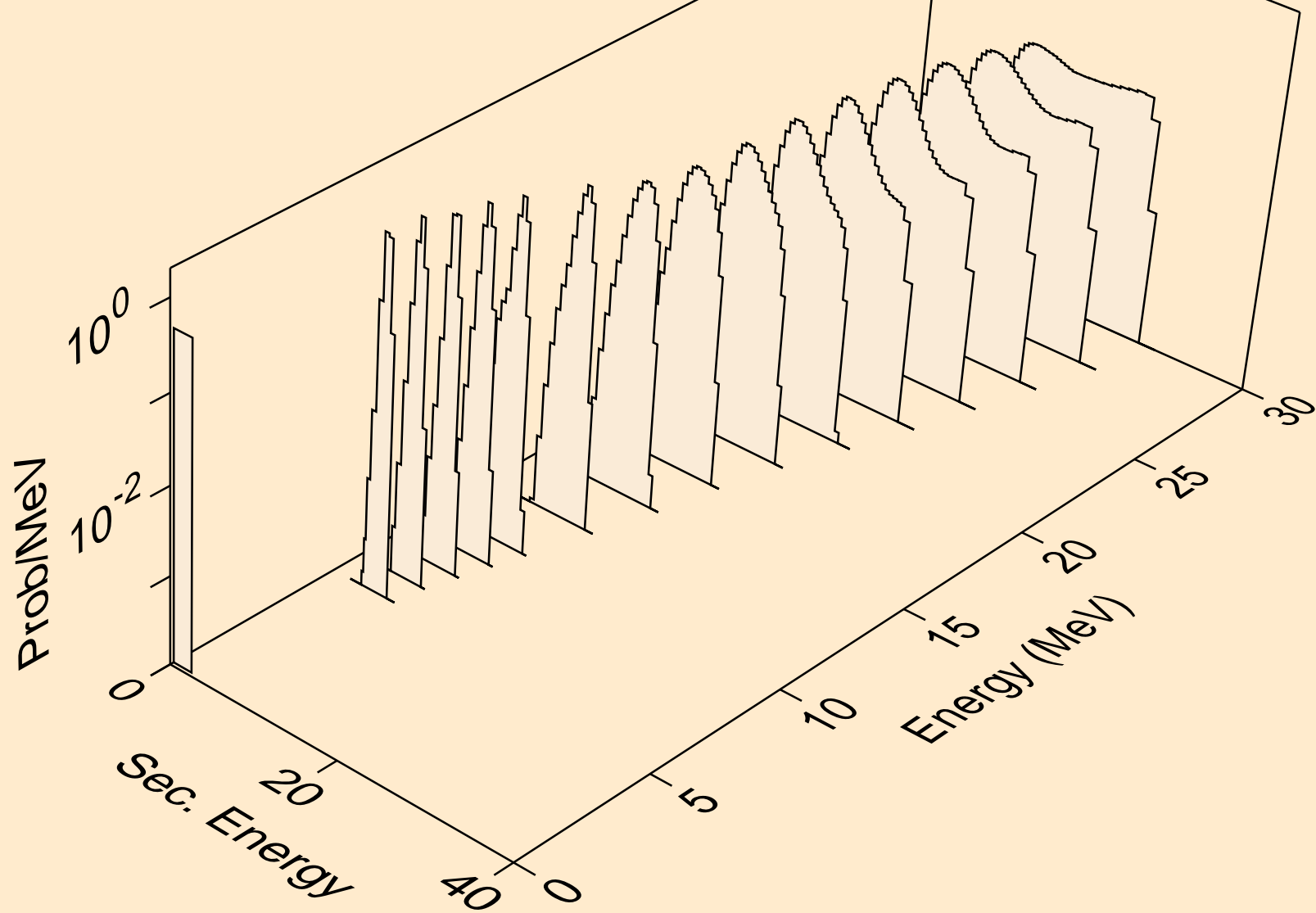



SR080 HELION ACER TENDL-2021 LIBRARY; T=0.K  
alphas from (s,da)

