

TA162 HELION ACER TENDL-2021 LIBRARY; T=0.K

Principal cross sections

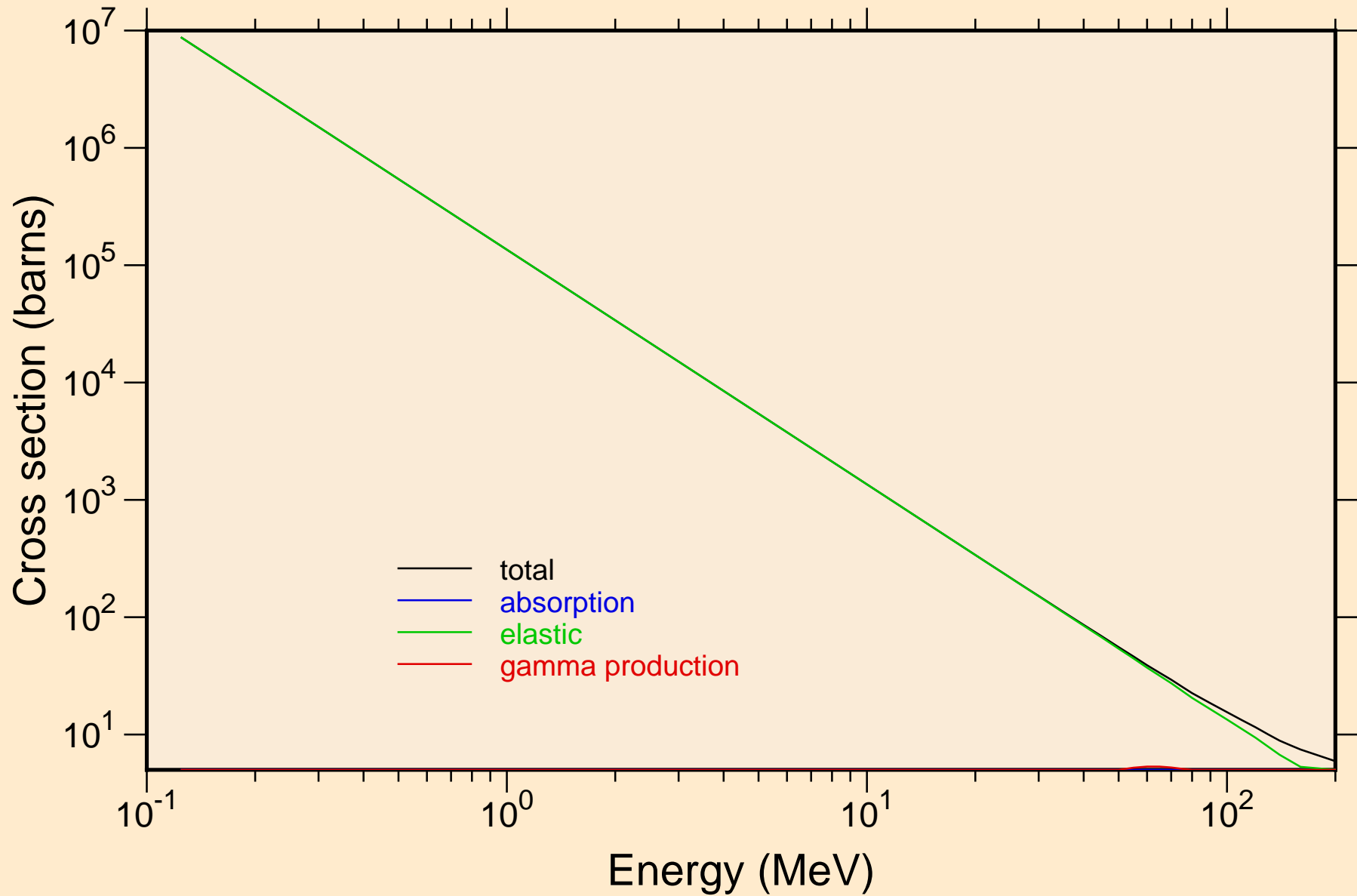

TA162 HELION ACER TENDL-2021 LIBRARY; T=0.K

Heating

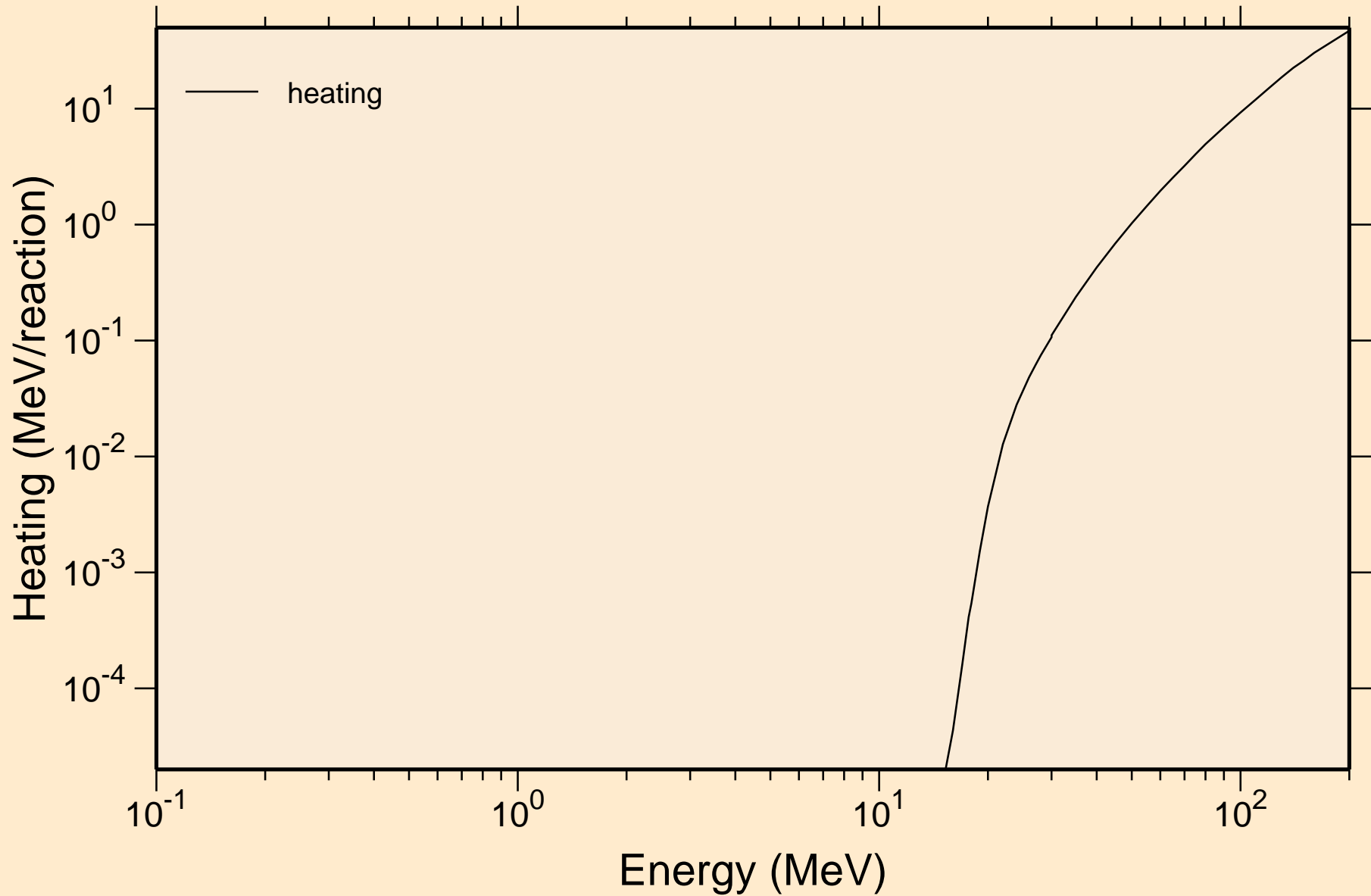

TA162 HELION ACER TENDL-2021 LIBRARY; T=0.K

Principal cross sections

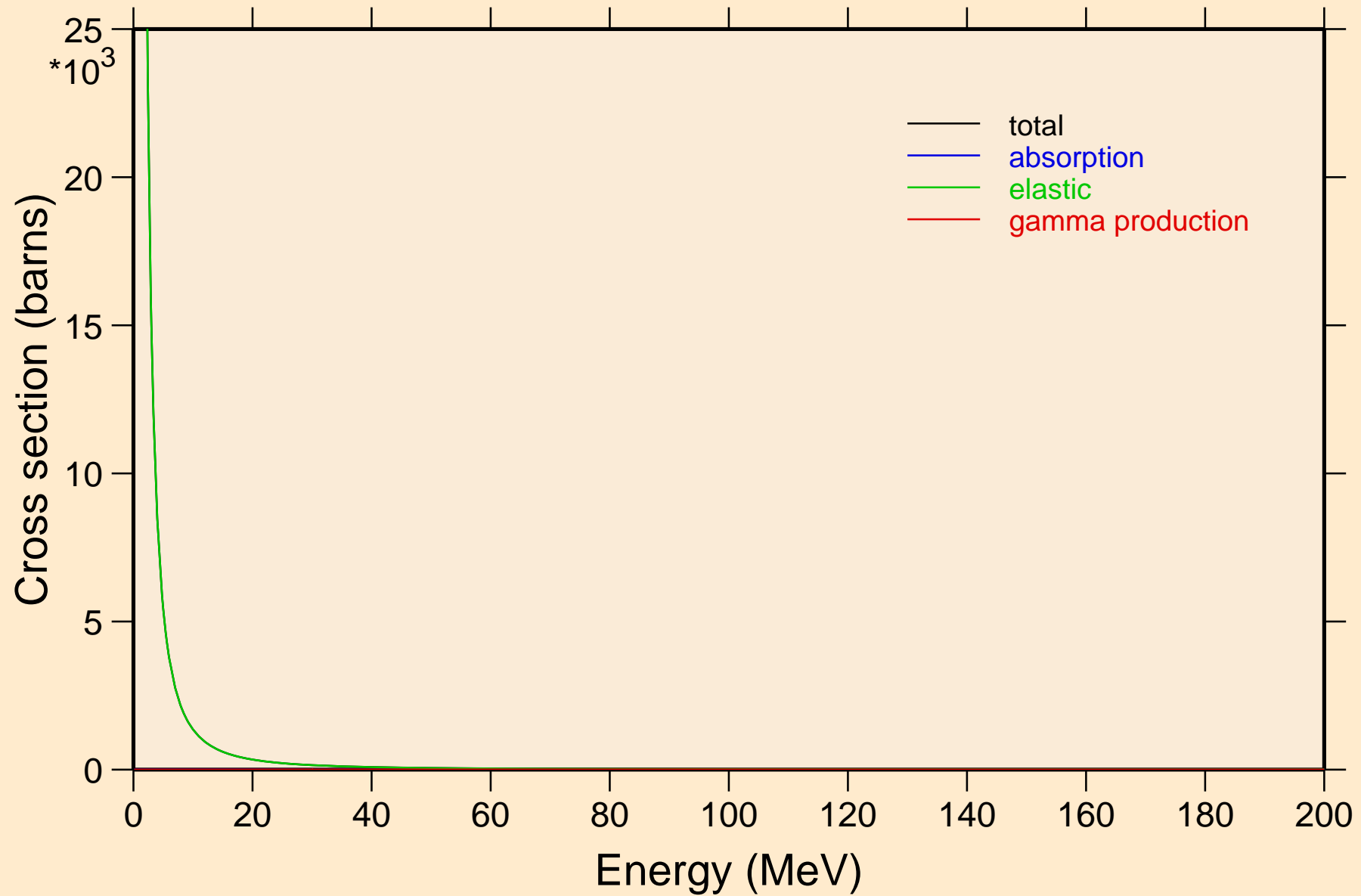

TA162 HELION ACER TENDL-2021 LIBRARY; T=0.K

Heating

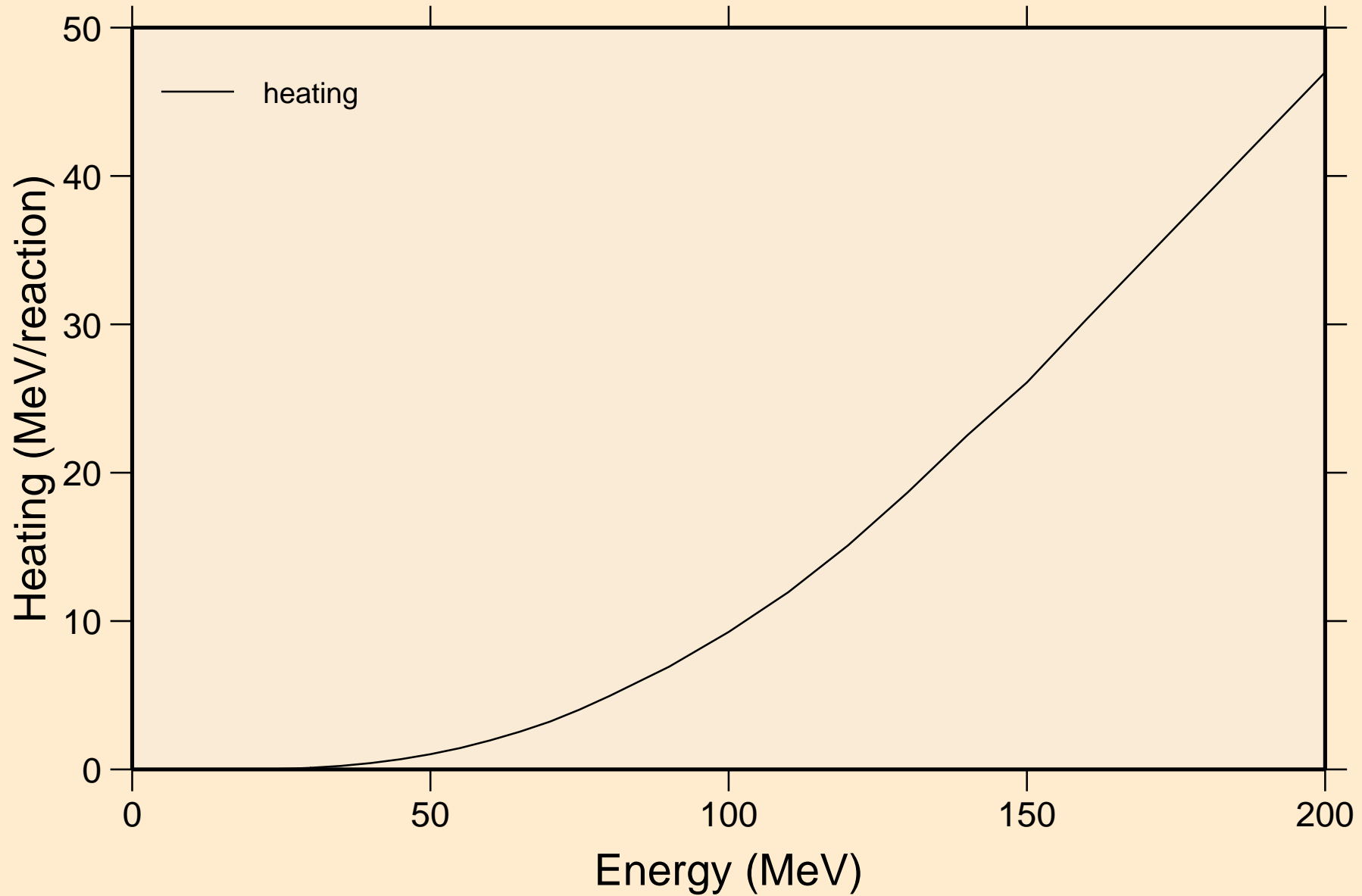

TA162 HELION ACER TENDL-2021 LIBRARY; T=0.K
Threshold reactions

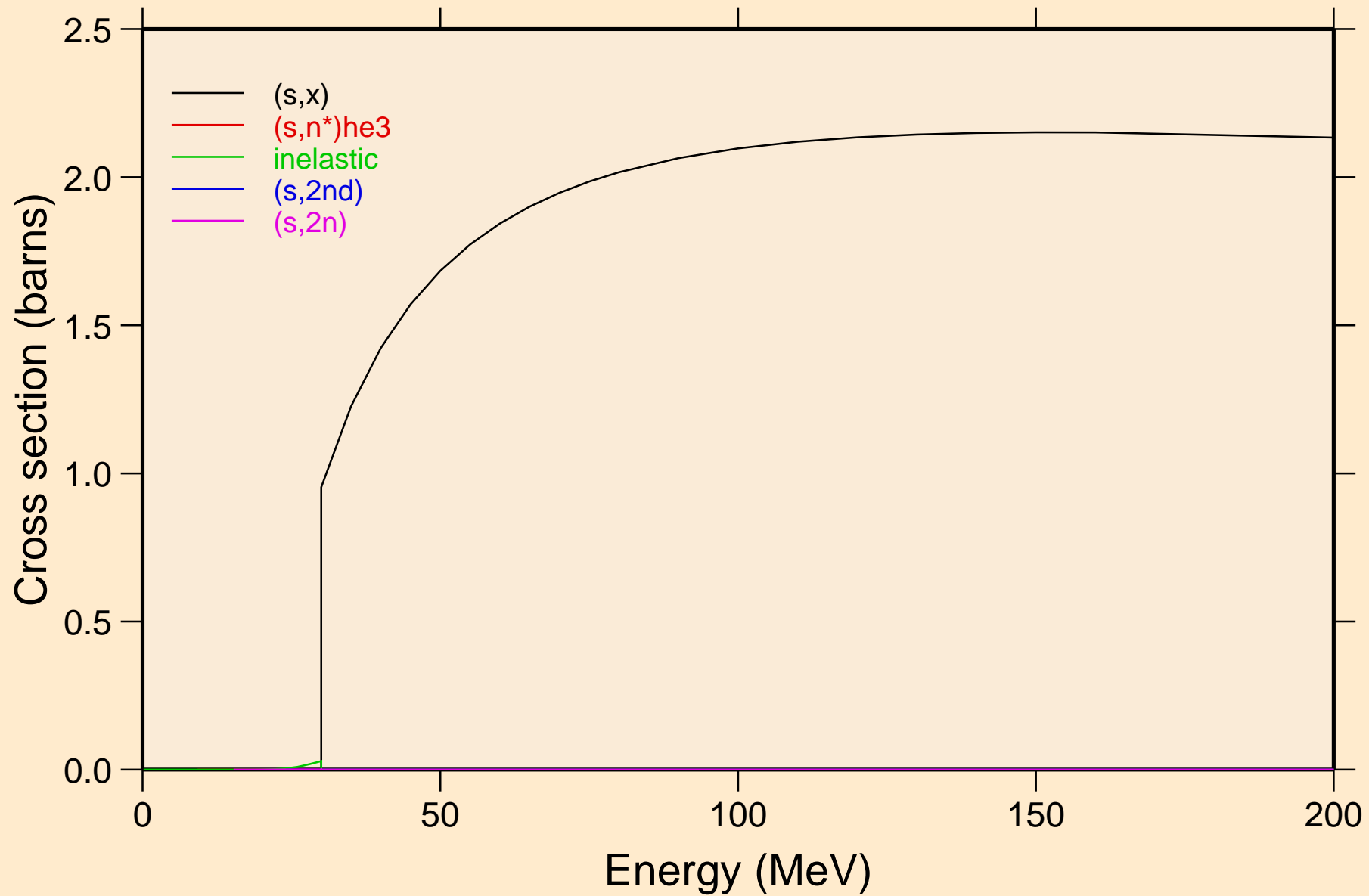

TA162 HELION ACER TENDL-2021 LIBRARY; T=0.K
Threshold reactions

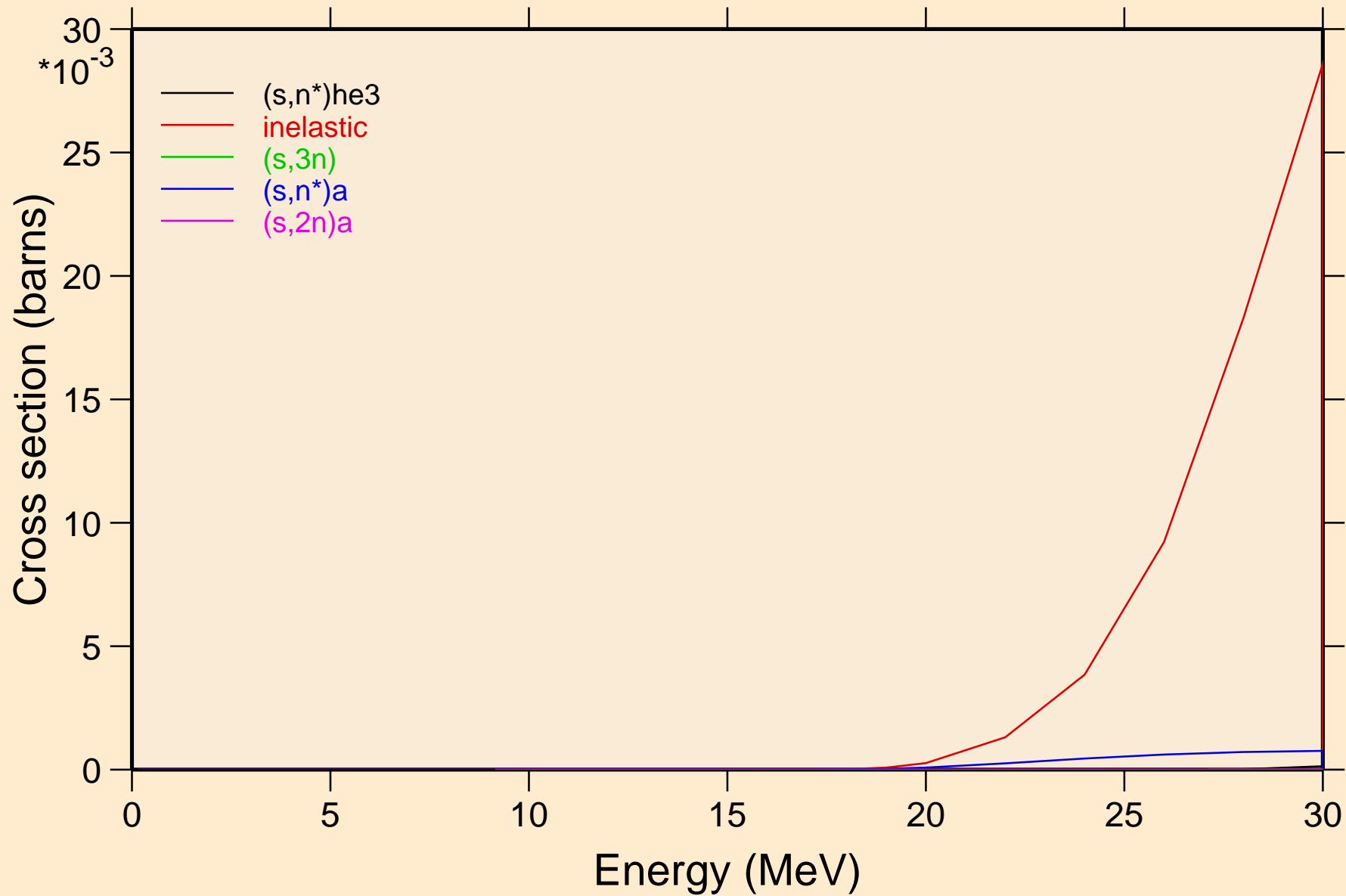

TA162 HELION ACER TENDL-2021 LIBRARY; T=0.K
Threshold reactions

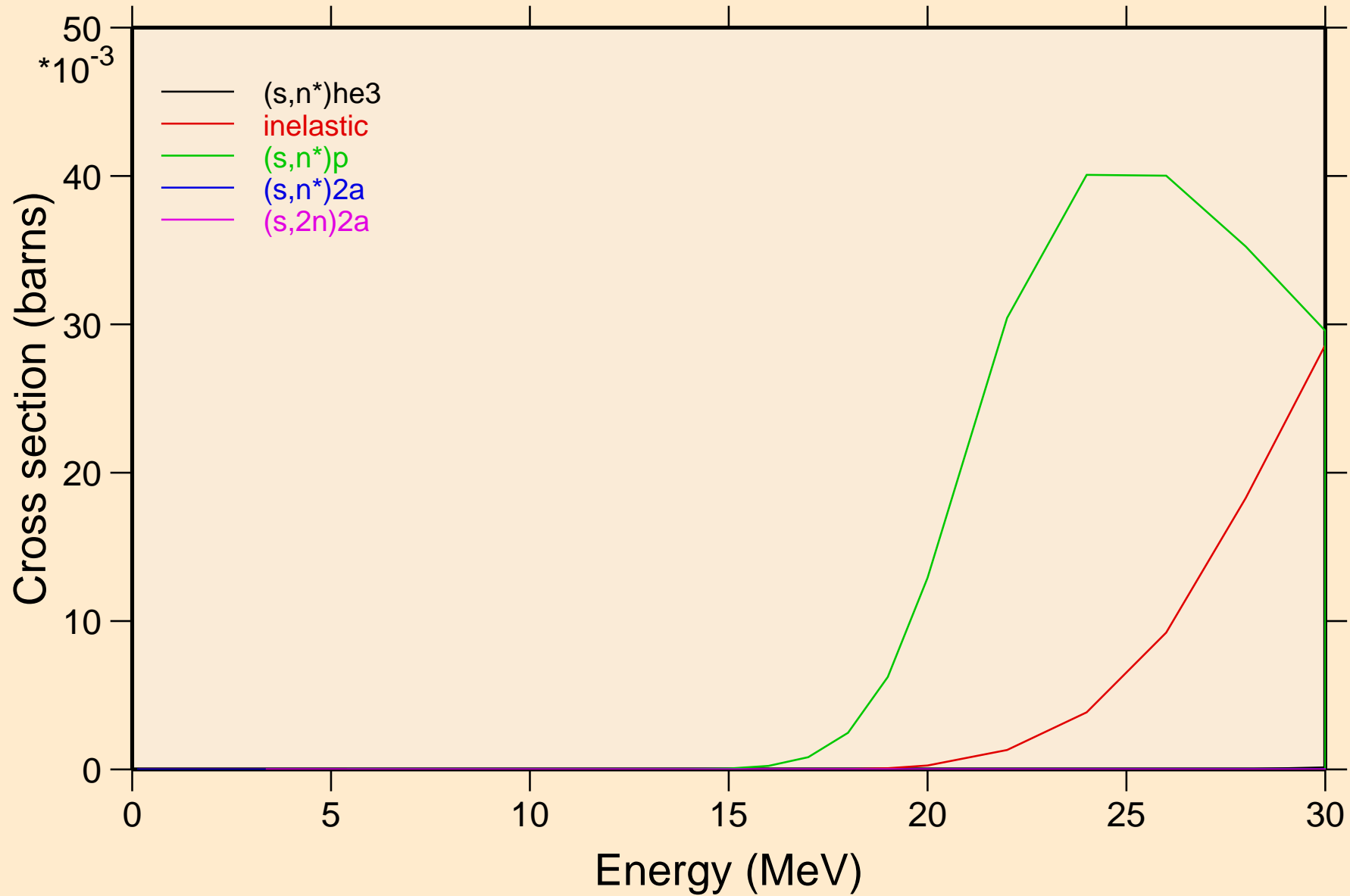

TA162 HELION ACER TENDL-2021 LIBRARY; T=0.K
Threshold reactions

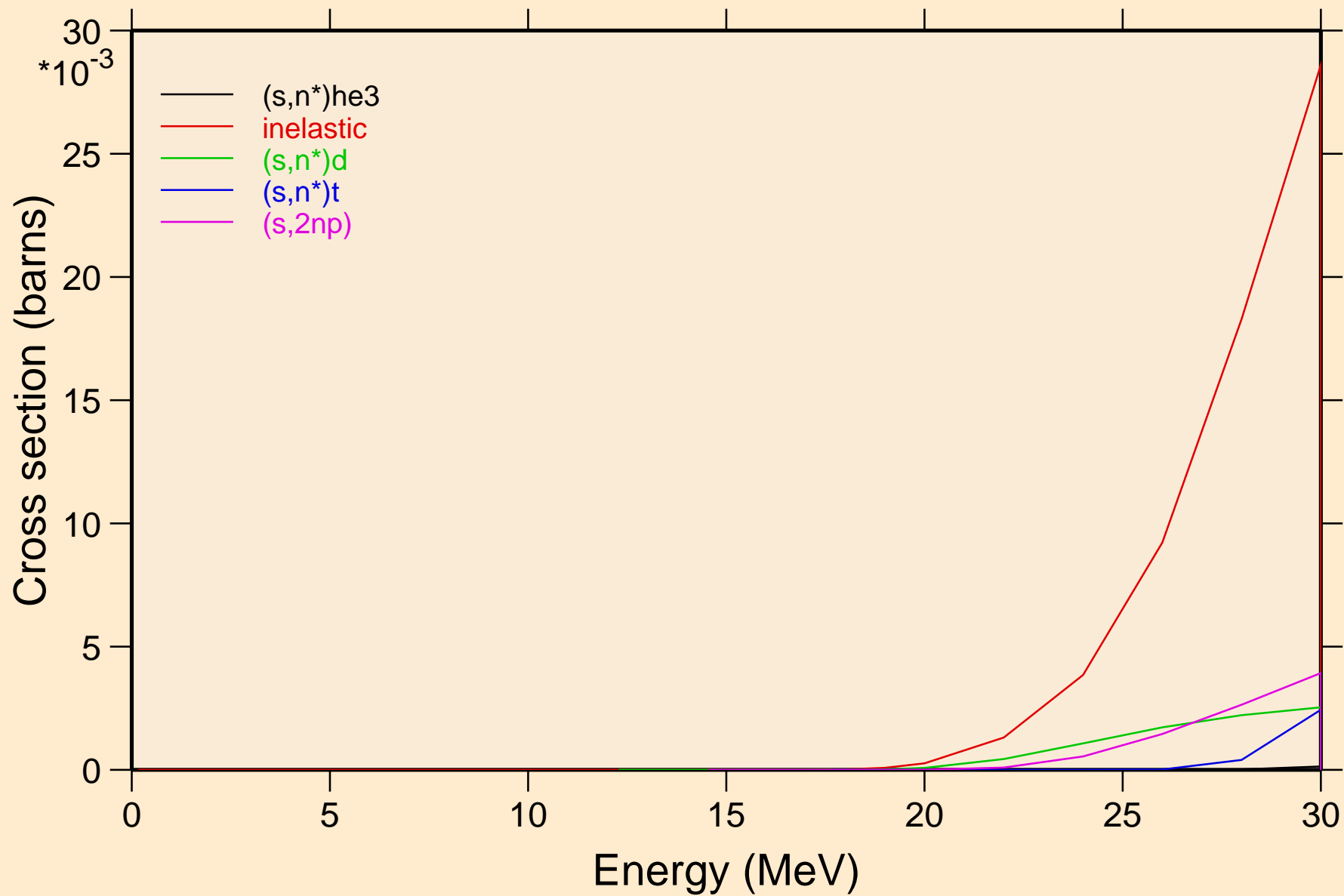

TA162 HELION ACER TENDL-2021 LIBRARY; T=0.K
Threshold reactions

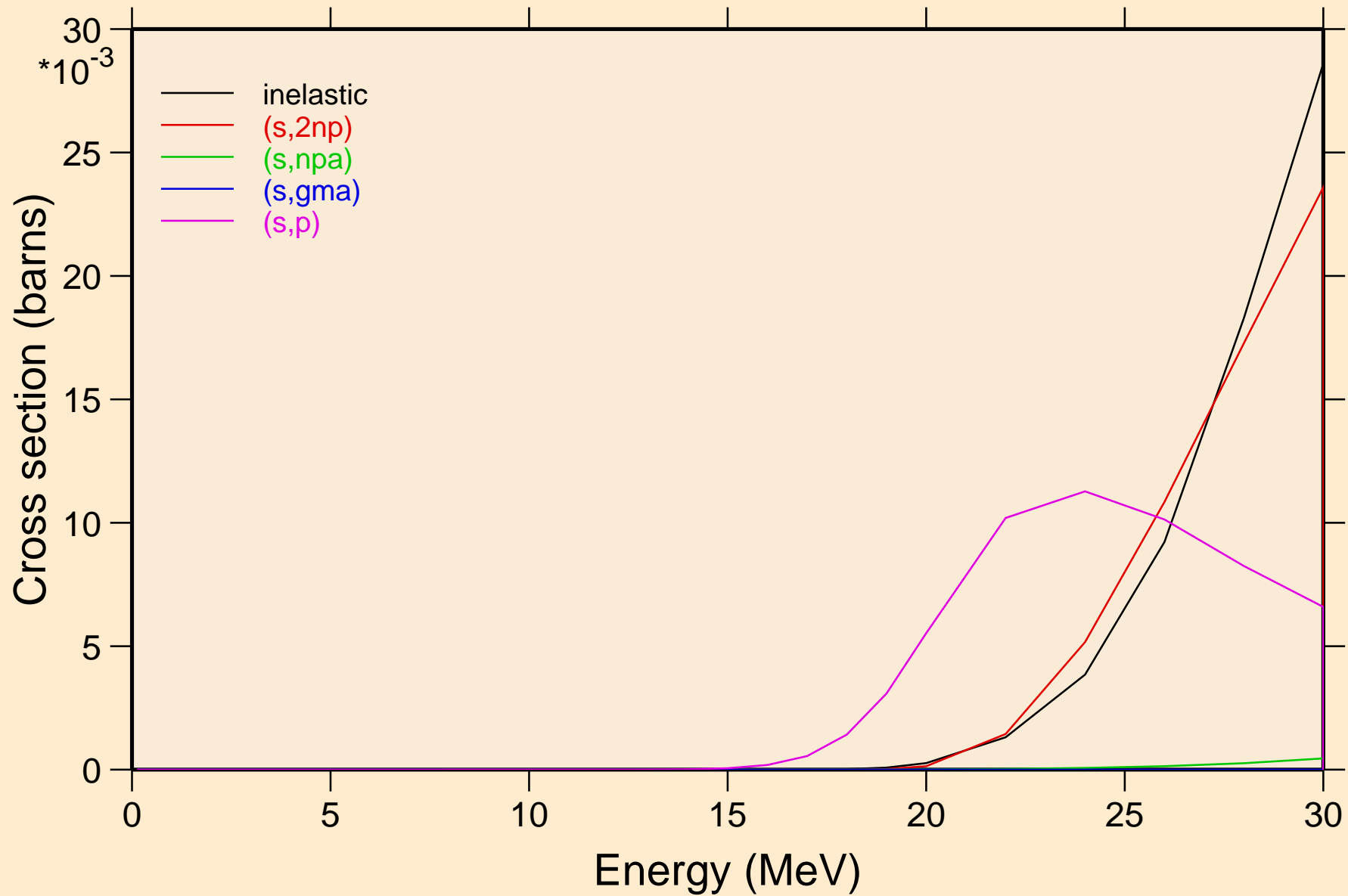

TA162 HELION ACER TENDL-2021 LIBRARY; T=0.K
Threshold reactions

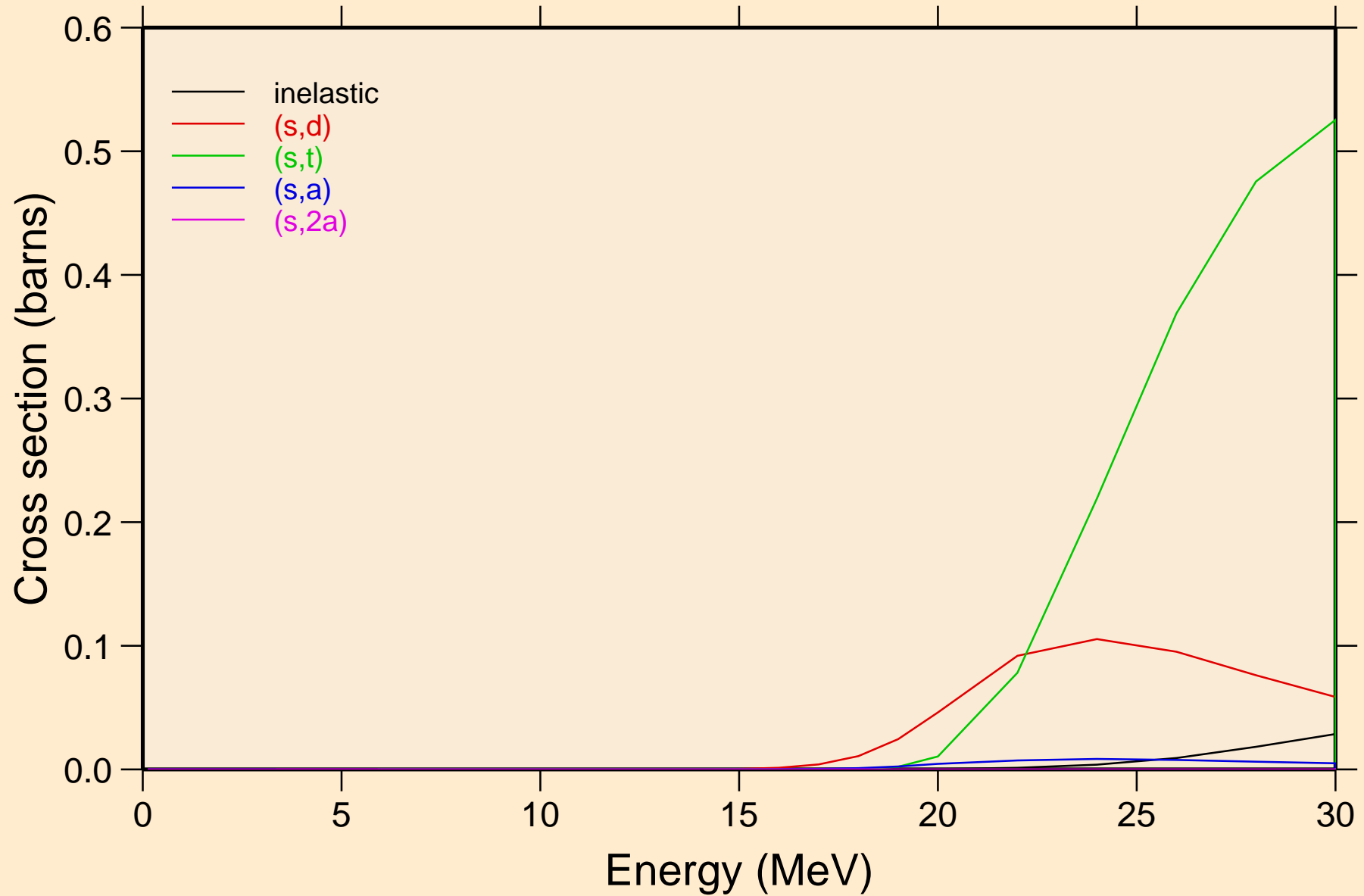

TA162 HELION ACER TENDL-2021 LIBRARY; T=0.K
Threshold reactions

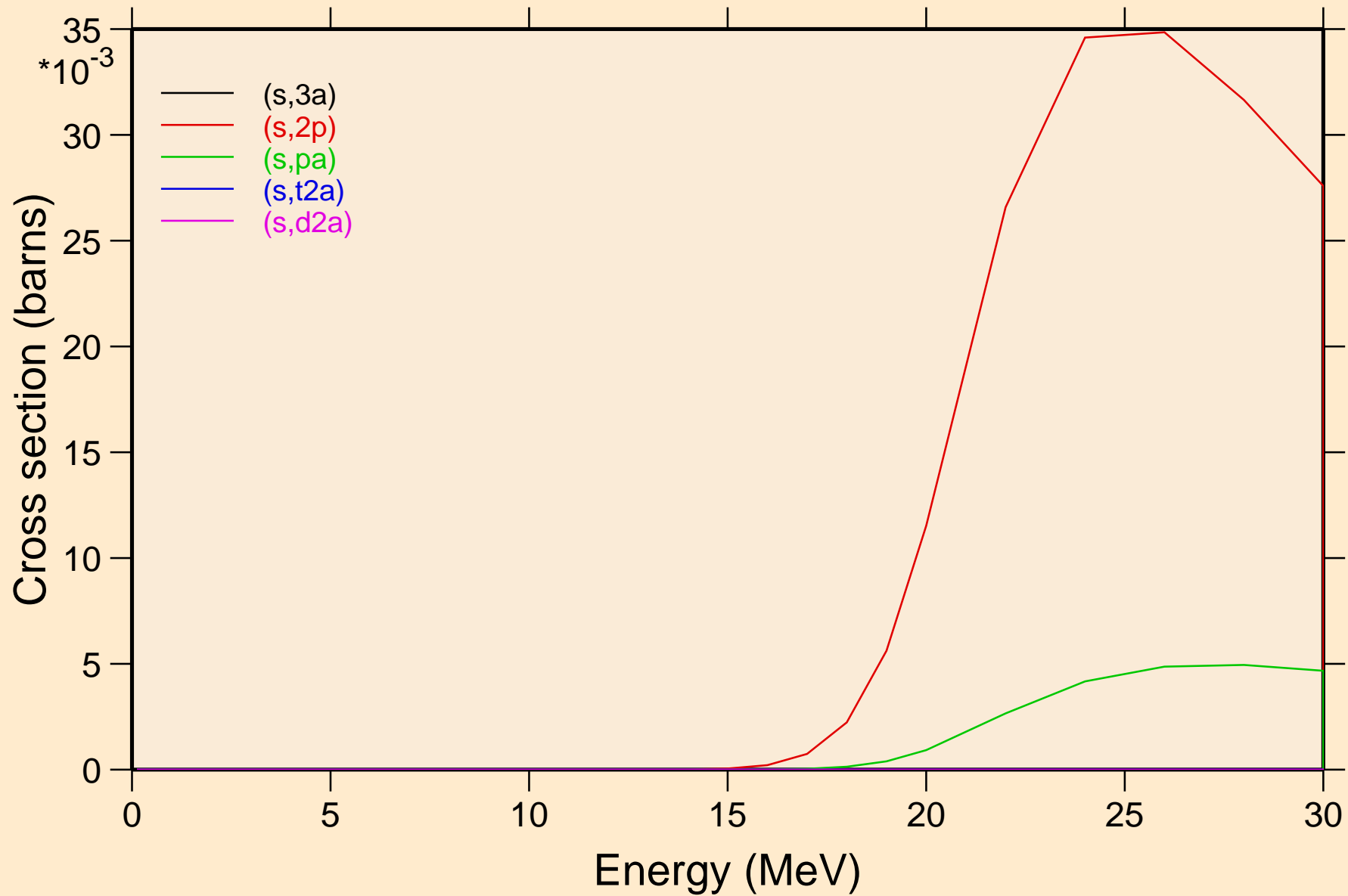

TA162 HELION ACER TENDL-2021 LIBRARY; T=0.K
Threshold reactions

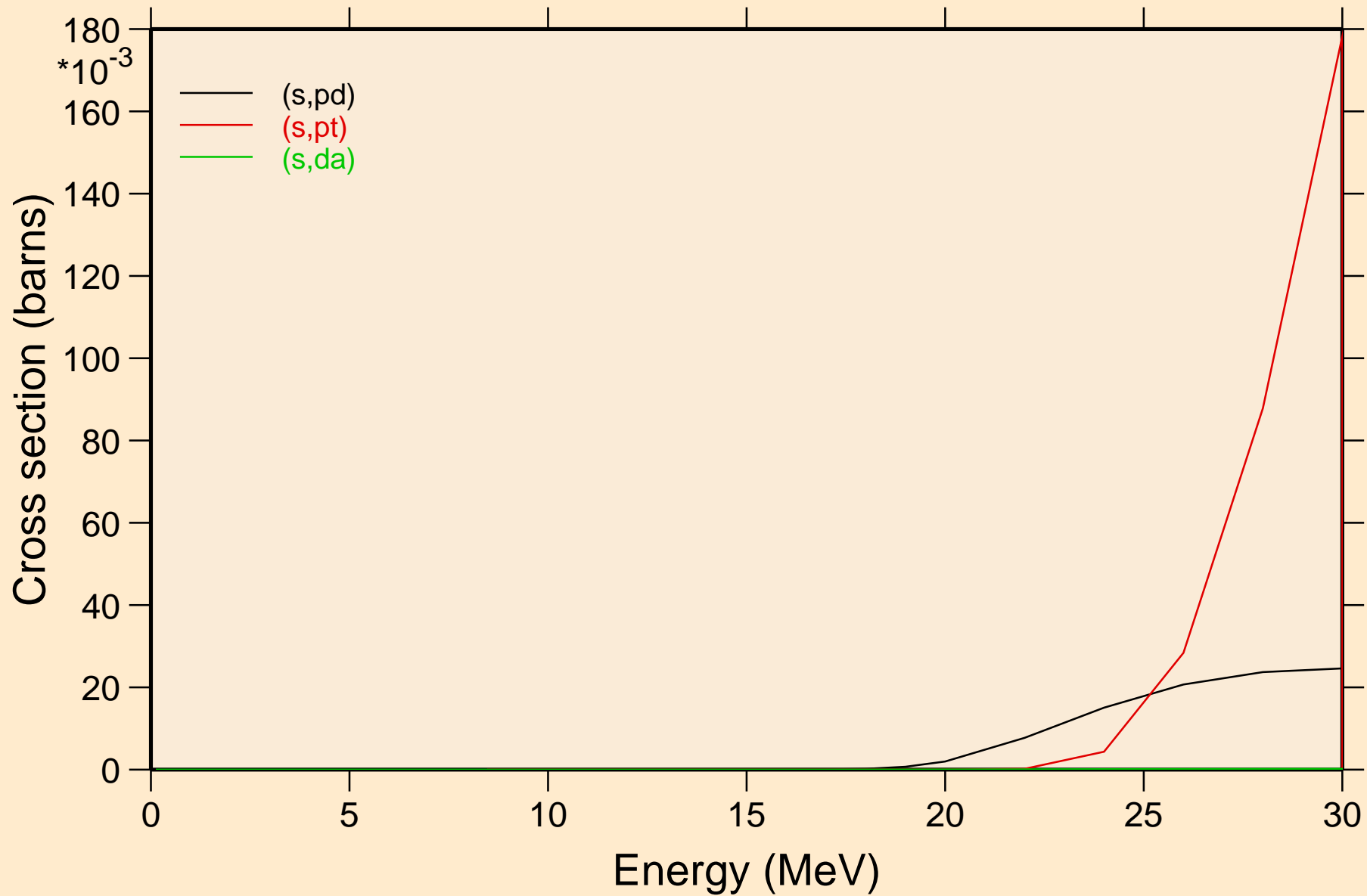

TA162 HELION ACER TENDL-2021 LIBRARY; T=0.K
angular distribution for elastic

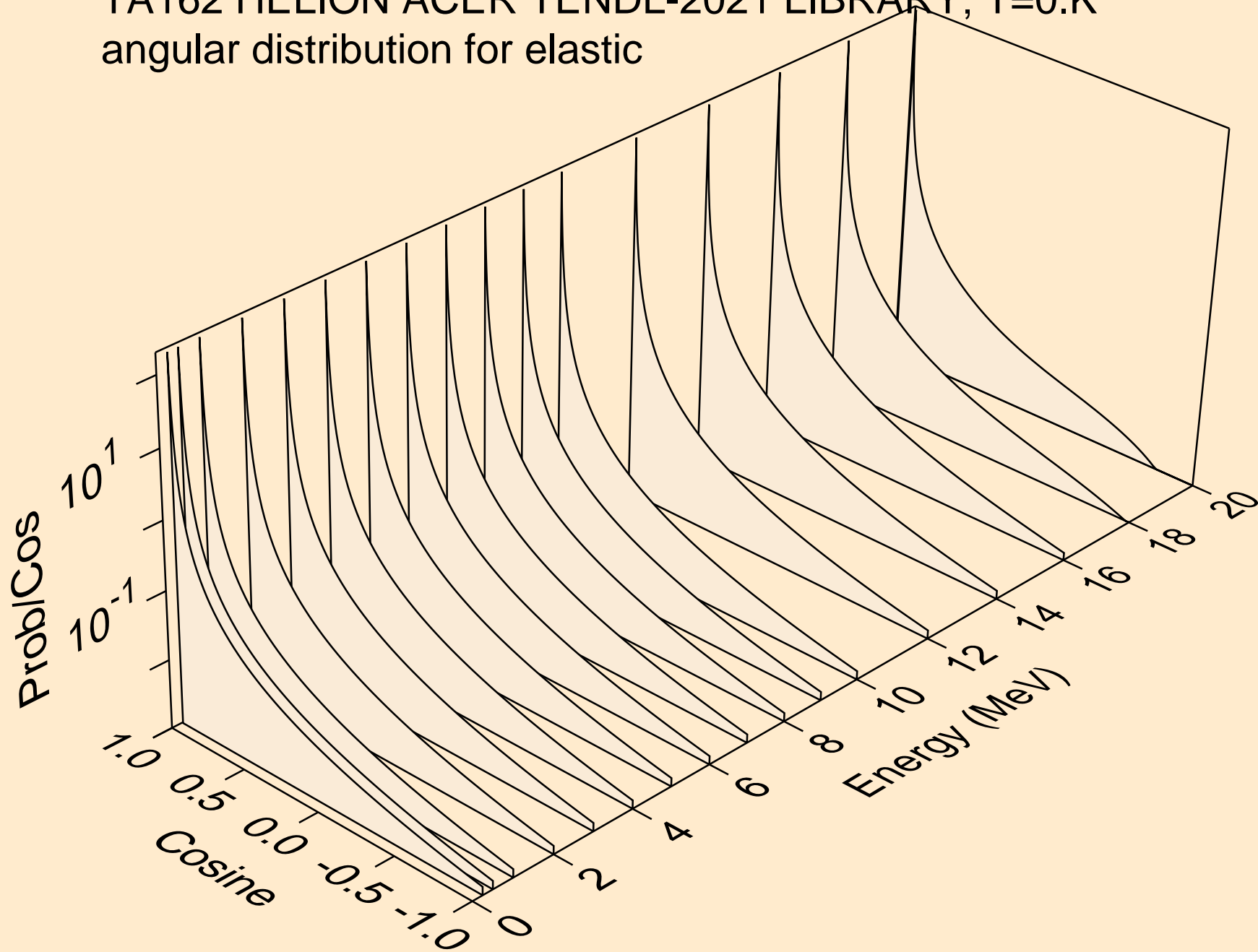

TA162 HELION ACER TENDL-2021 LIBRARY; T=0.K
angular distribution for elastic

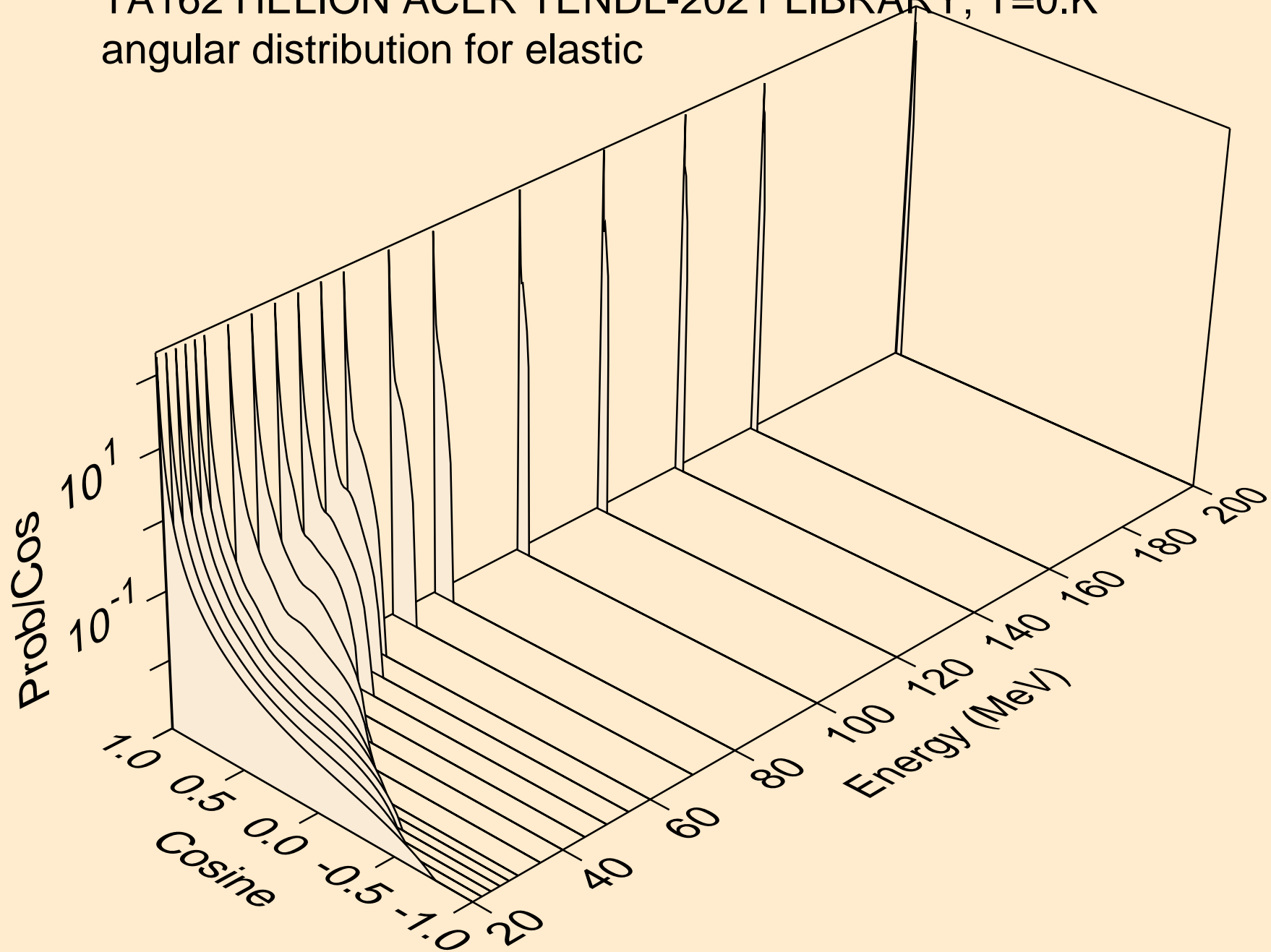

TA162 HELION ACER TENDL-2021 LIBRARY; T=0.K
He-3 emission for (s,x)

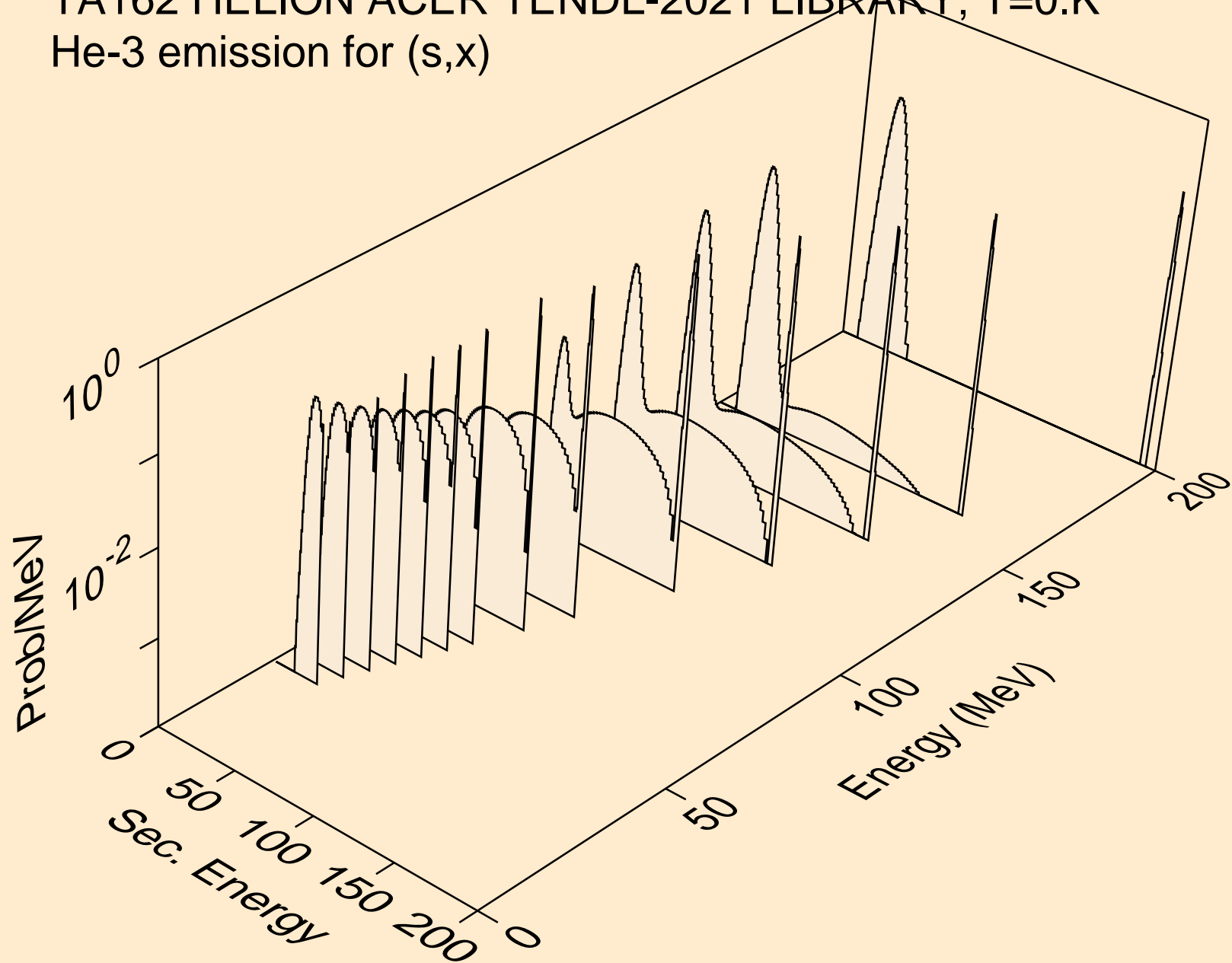

TA162 HELION ACER TENDL-2021 LIBRARY; T=0.K
He-3 emission for (s,n*)he3

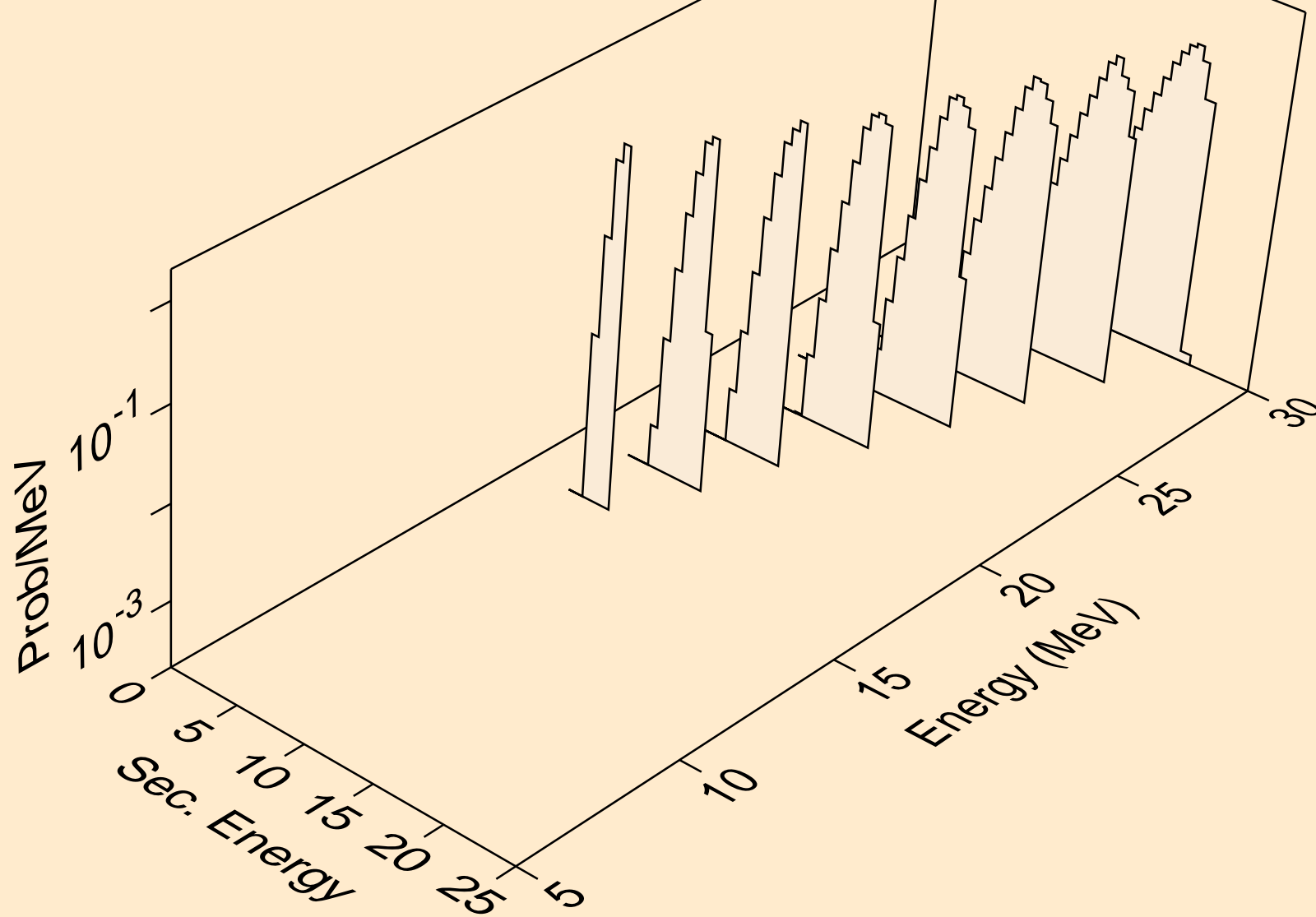

TA162 HELION ACER TENDL-2021 LIBRARY; T=0.K
He-3 emission for inelastic

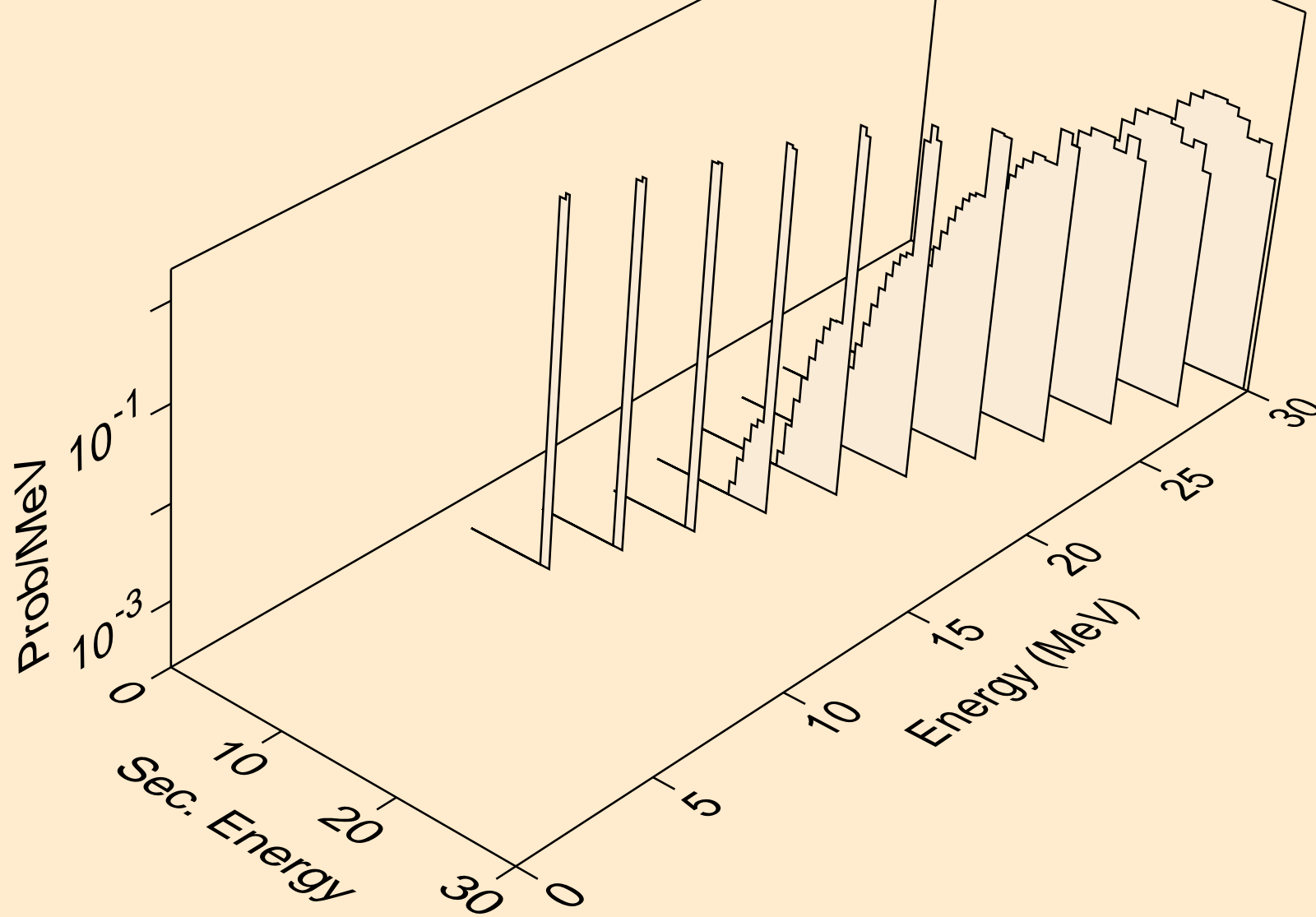

TA162 HELION ACER TENDL-2021 LIBRARY; T=0.K
Photon emission for (z,n)

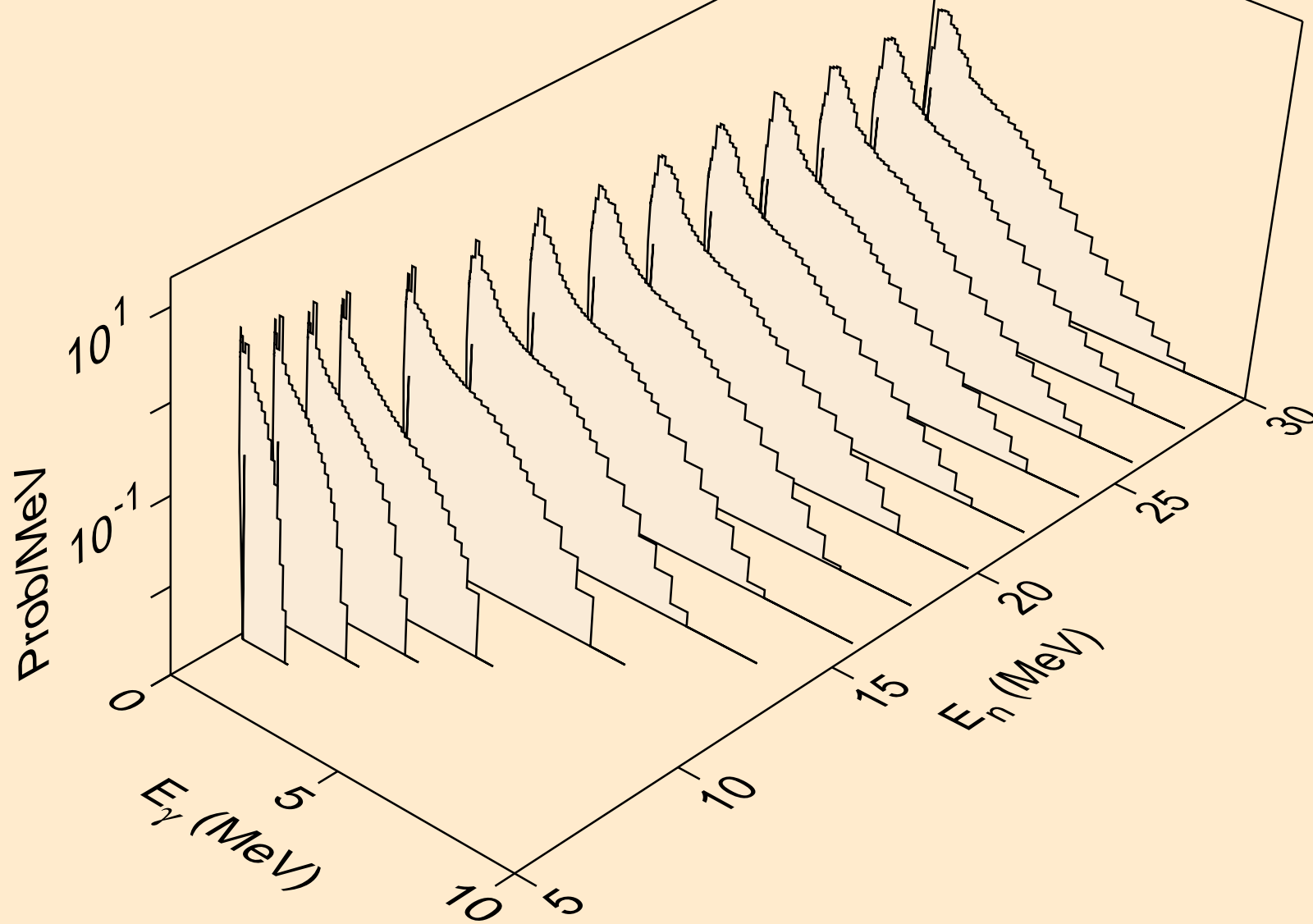

TA162 HELION ACER TENDL-2021 LIBRARY; T=0.K
Photon emission for (n,x)

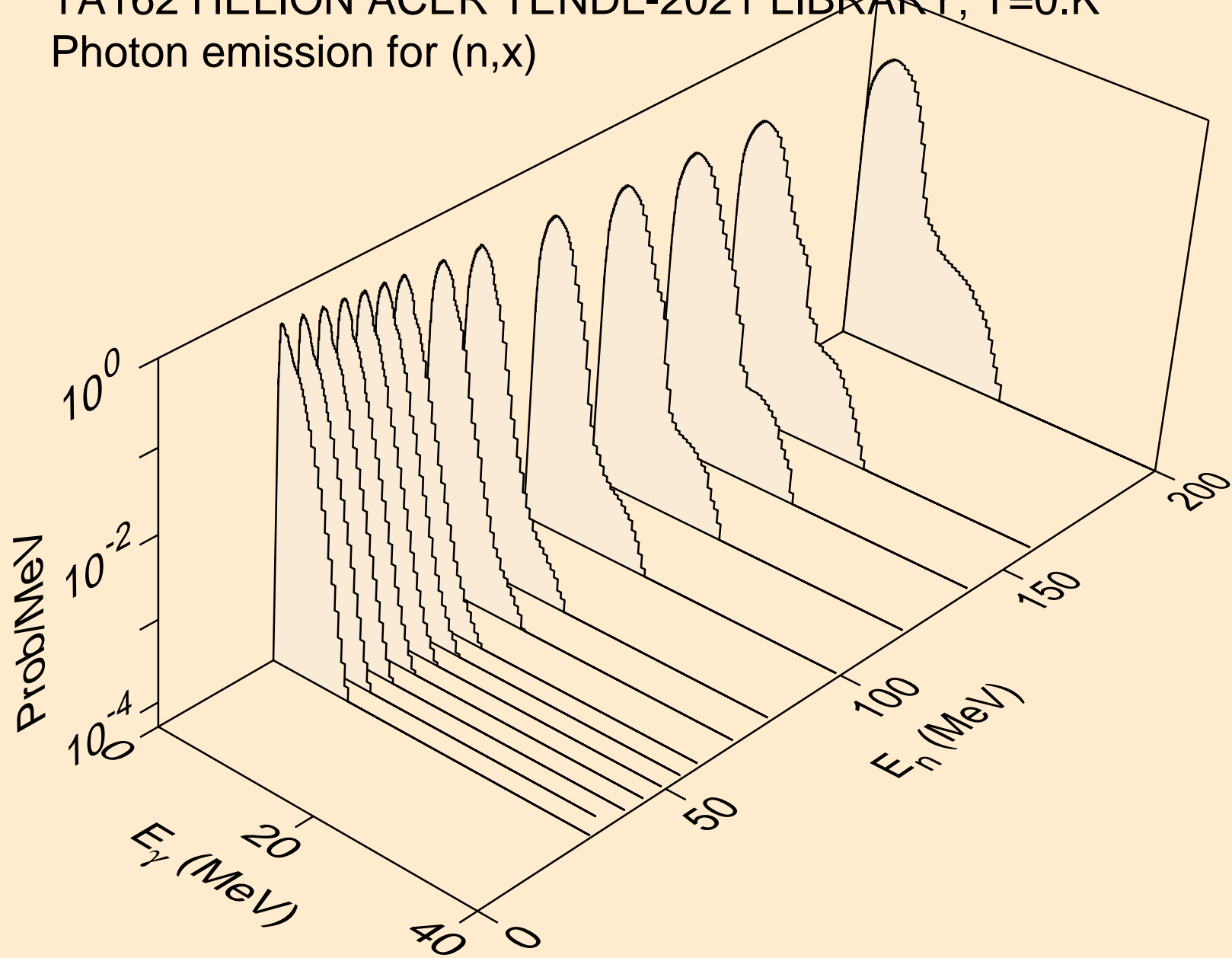

TA162 HELION ACER TENDL-2021 LIBRARY; T=0.K
Photon emission for (n,2nd)

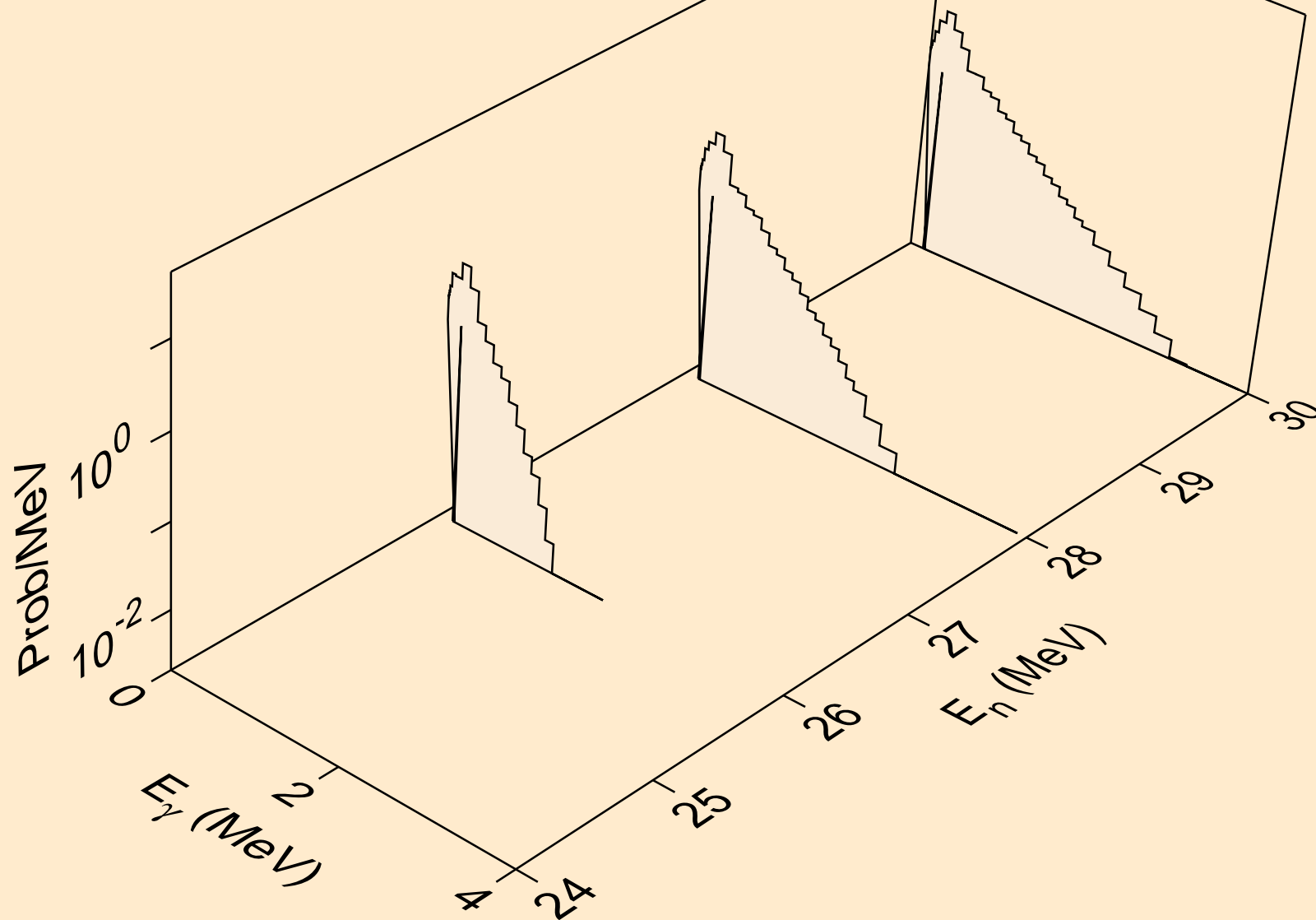

TA162 HELION ACER TENDL-2021 LIBRARY; T=0.K
Photon emission for (n,2n)

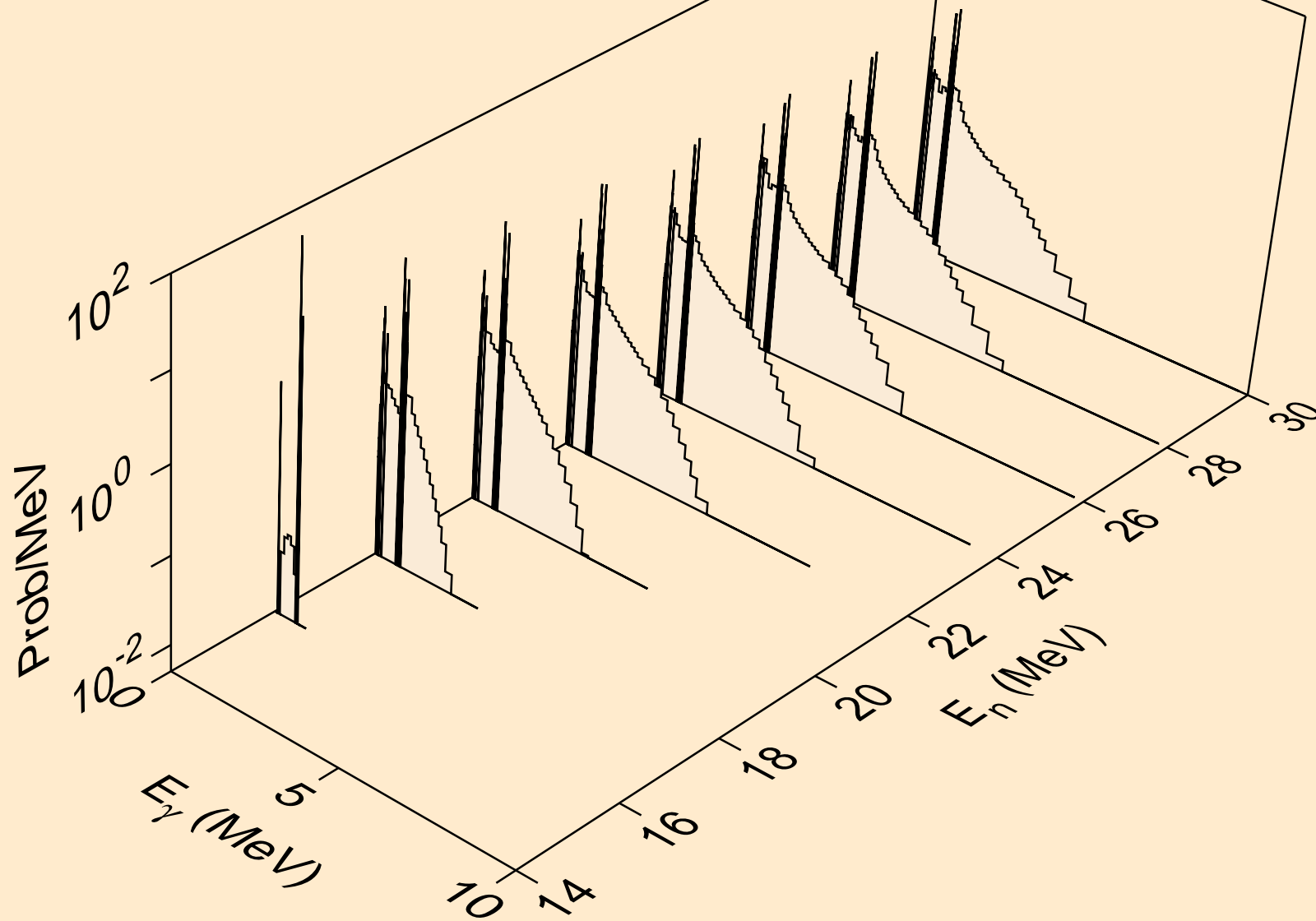

TA162 HELION ACER TENDL-2021 LIBRARY; T=0.K
Photon emission for (n,3n)

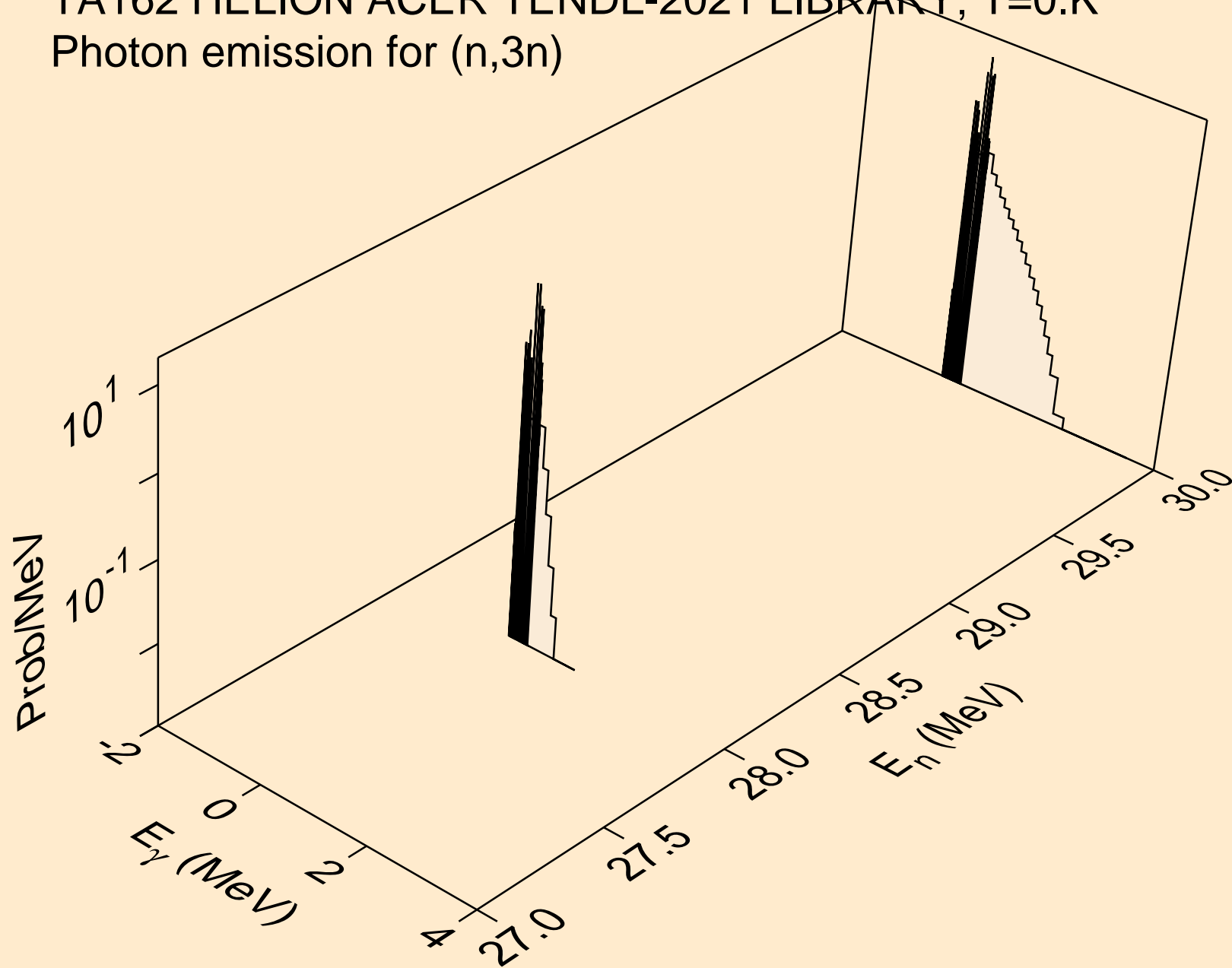

TA162 HELION ACER TENDL-2021 LIBRARY; T=0.K
Photon emission for (n,n*)a

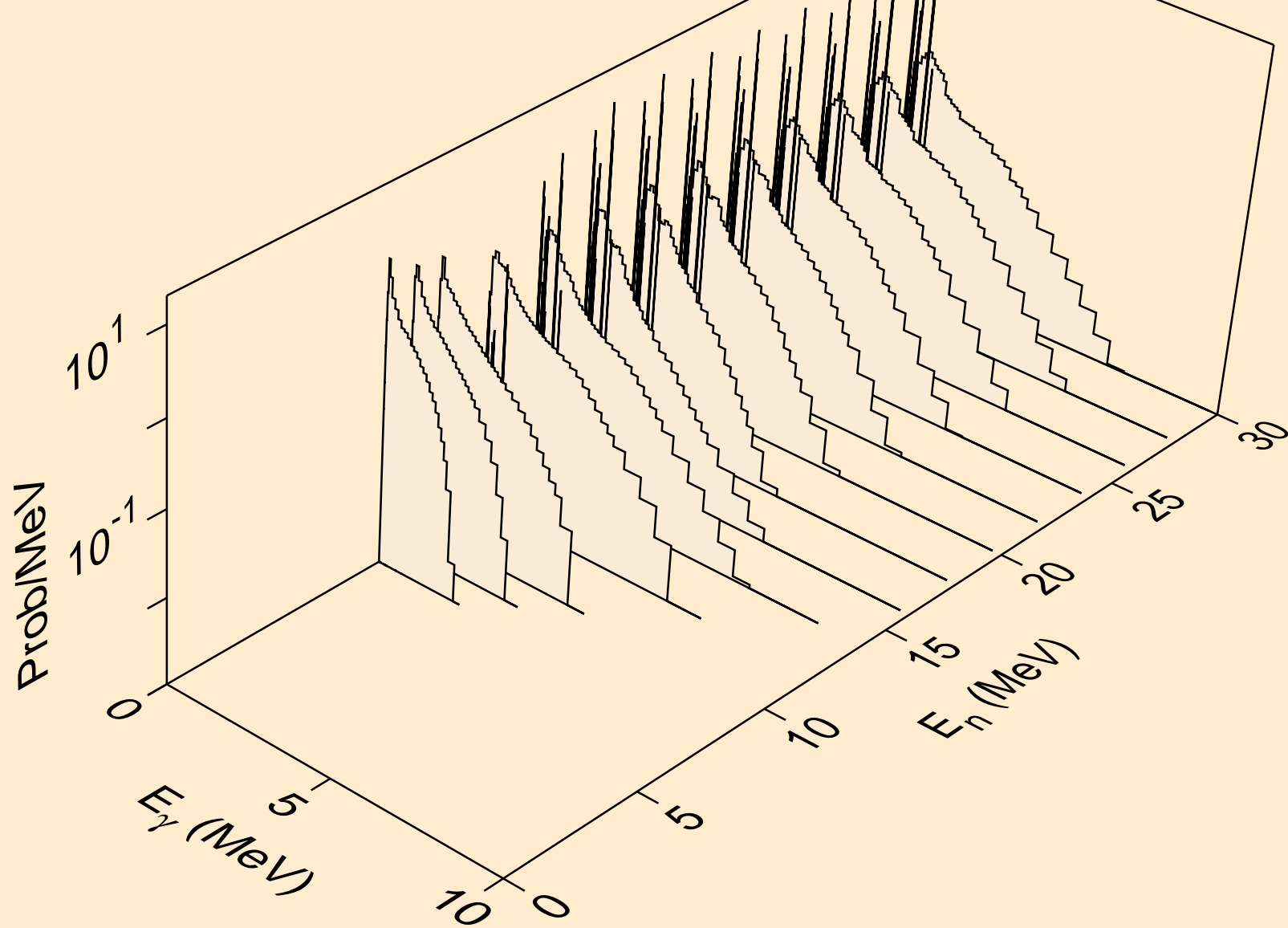

TA162 HELION ACER TENDL-2021 LIBRARY; T=0.K
Photon emission for (n,2n)a

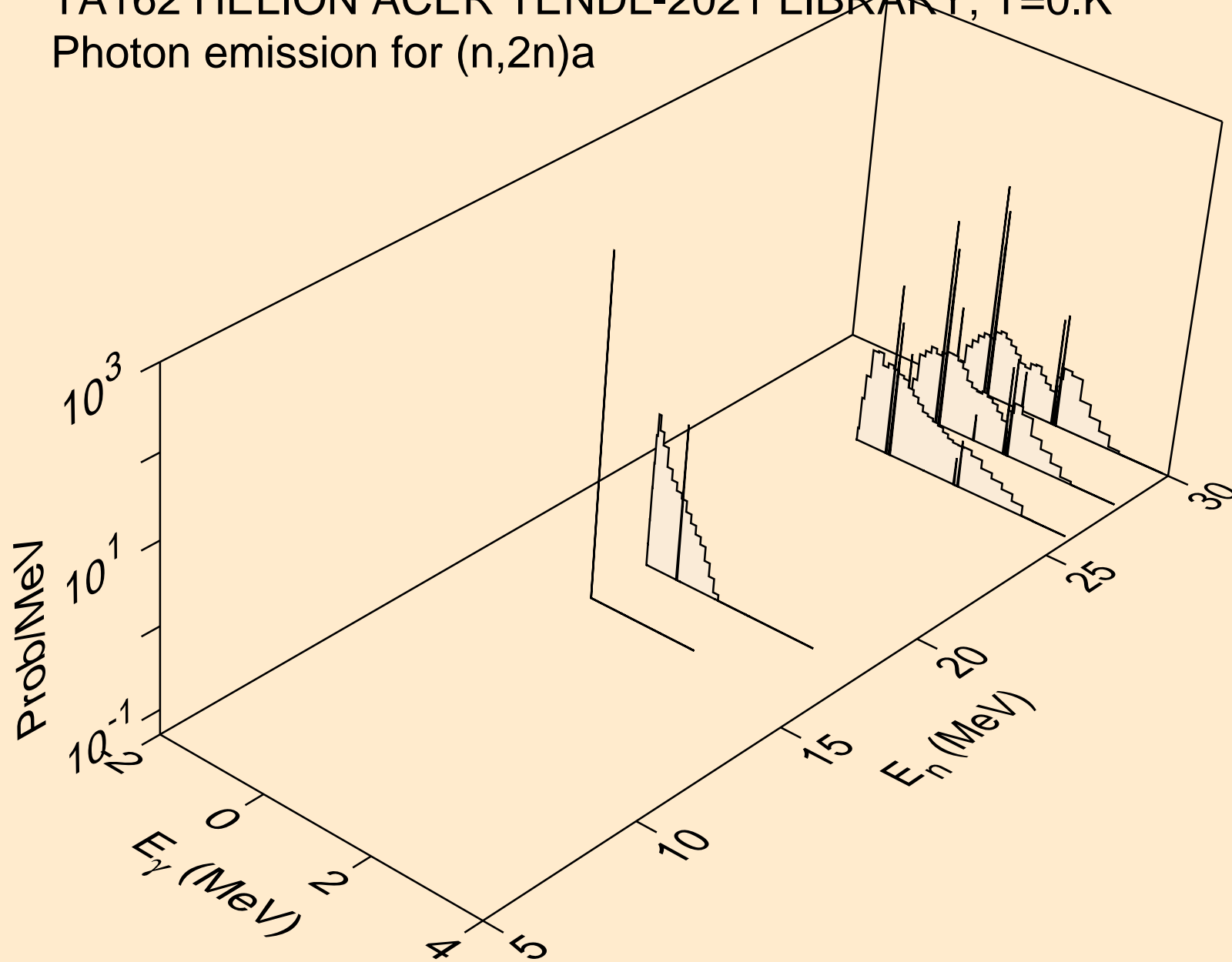

TA162 HELION ACER TENDL-2021 LIBRARY; T=0.K
Photon emission for (n,n*)p

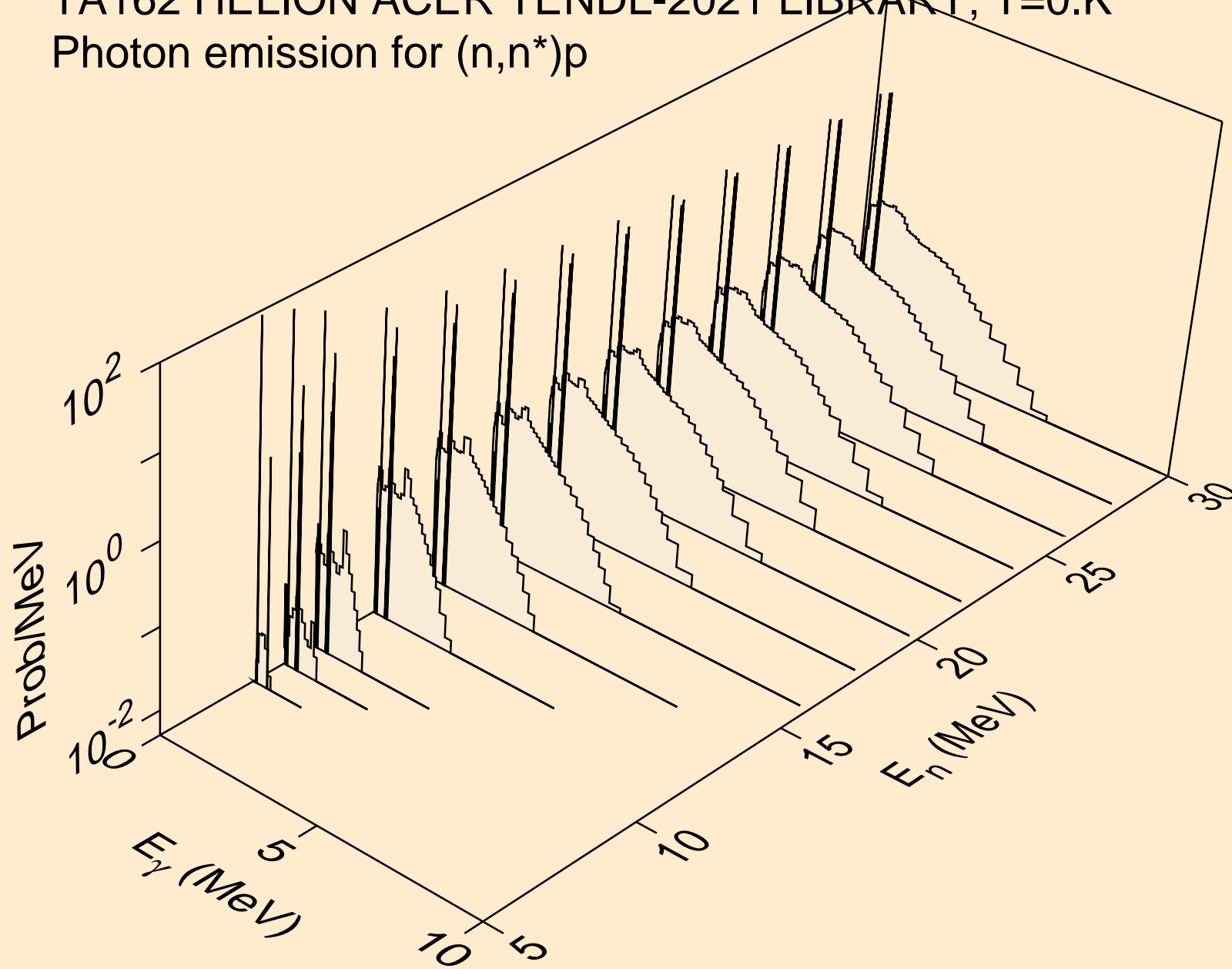

TA162 HELION ACER TENDL-2021 LIBRARY; T=0.K
Photon emission for (n,n*)2a

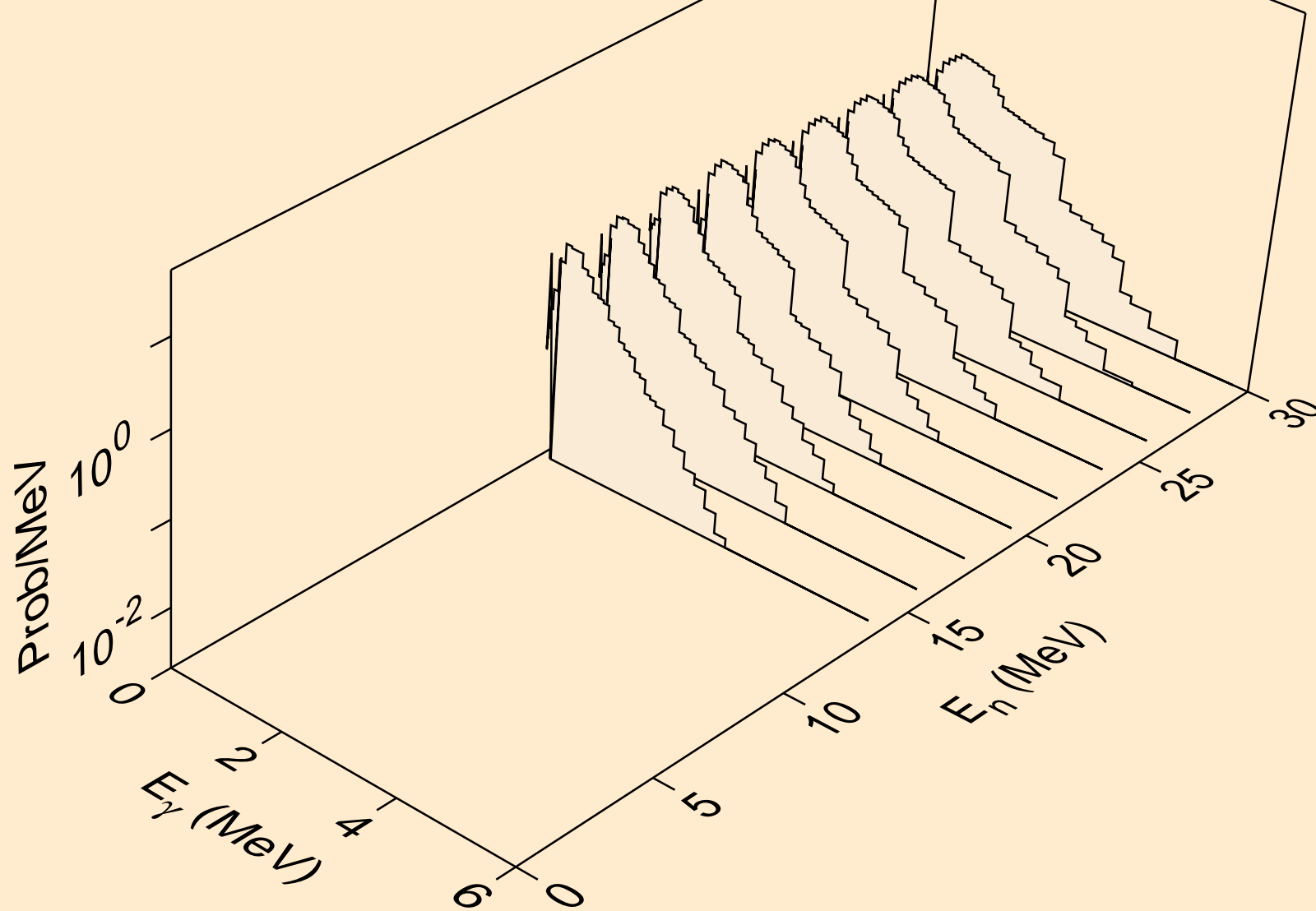

TA162 HELION ACER TENDL-2021 LIBRARY; T=0.K
Photon emission for (n,2n)2a

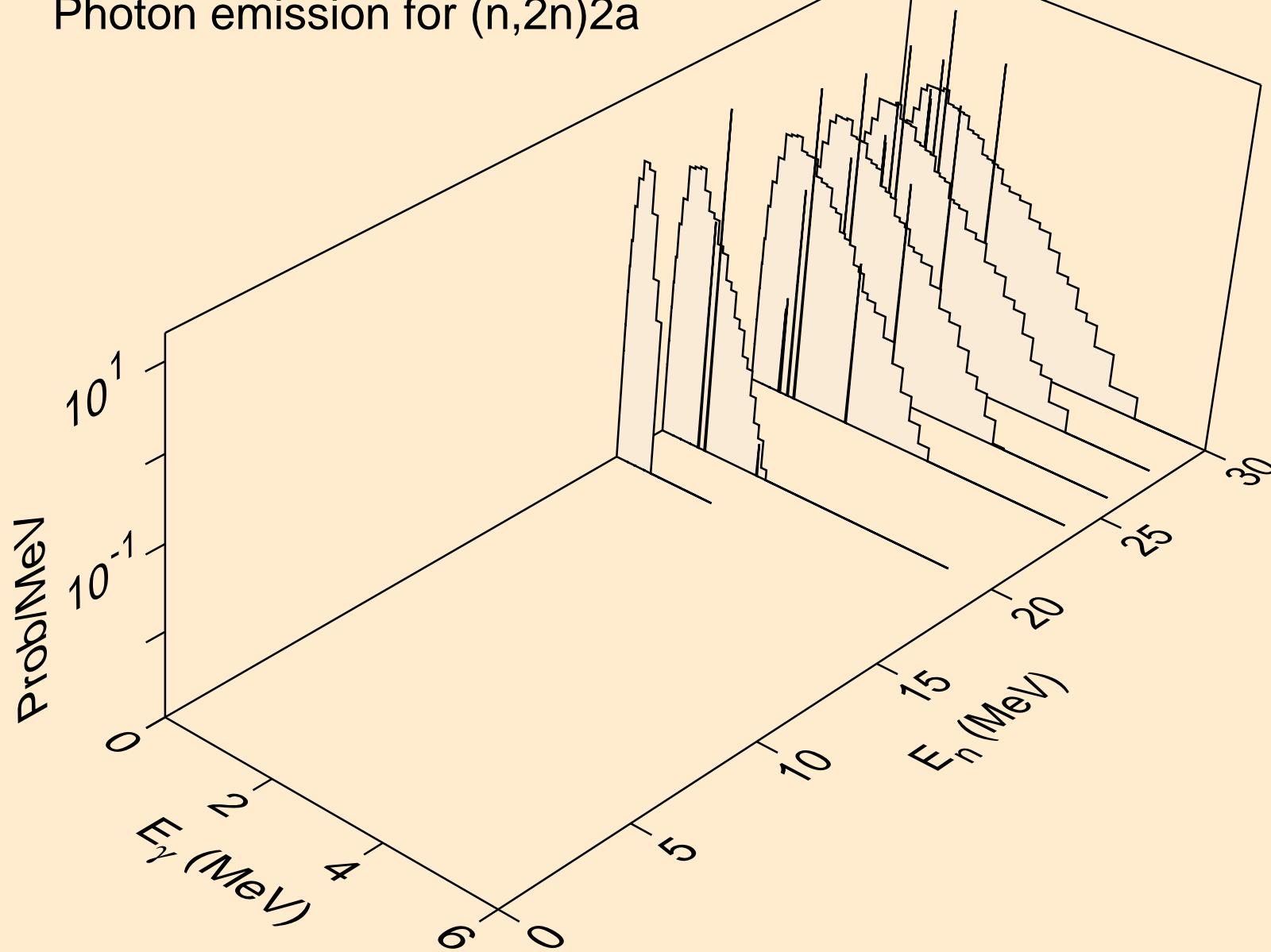

TA162 HELION ACER TENDL-2021 LIBRARY; T=0.K
Photon emission for (n,n*)d

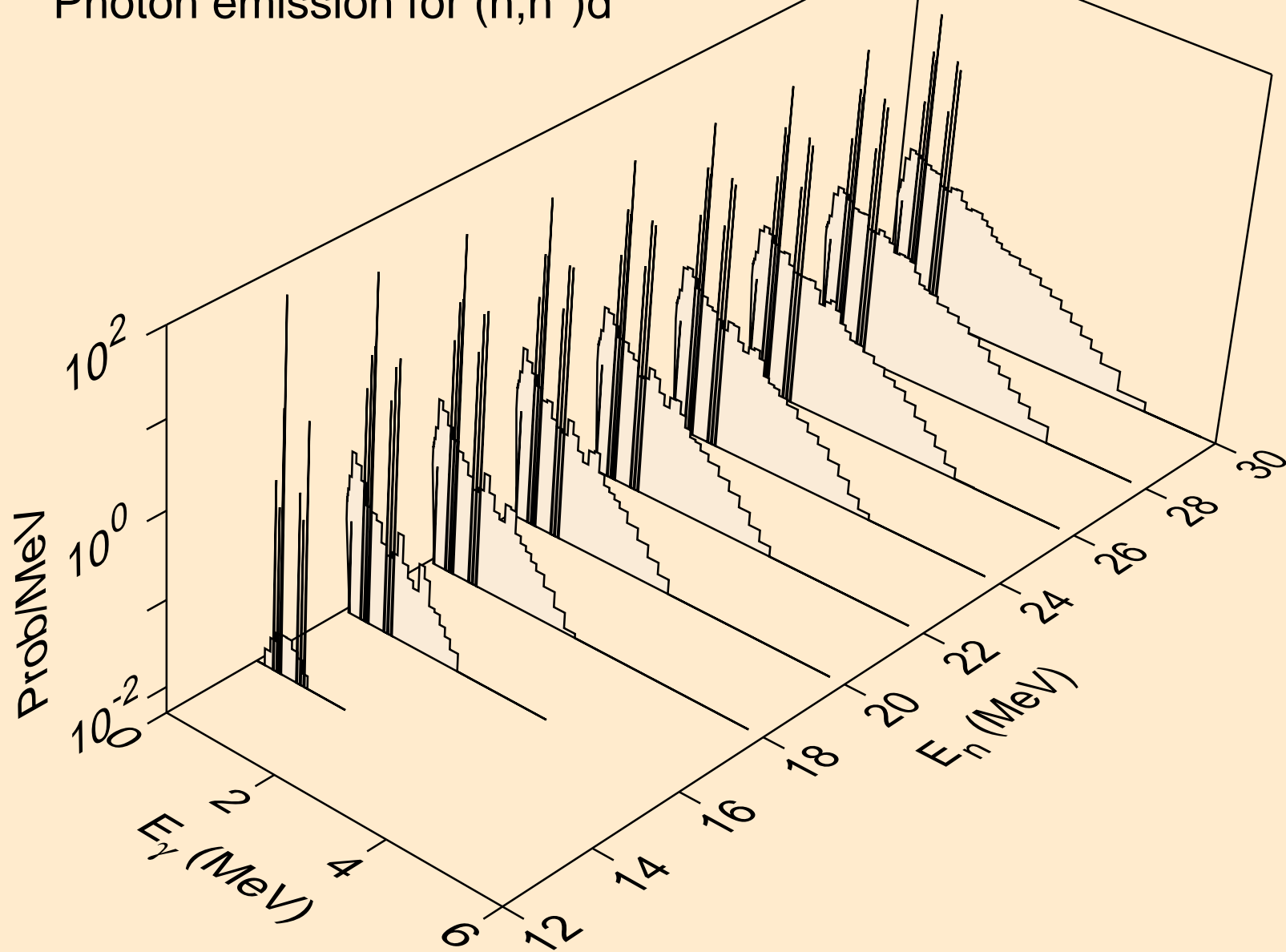

TA162 HELION ACER TENDL-2021 LIBRARY; T=0.K
Photon emission for (n,n*)t

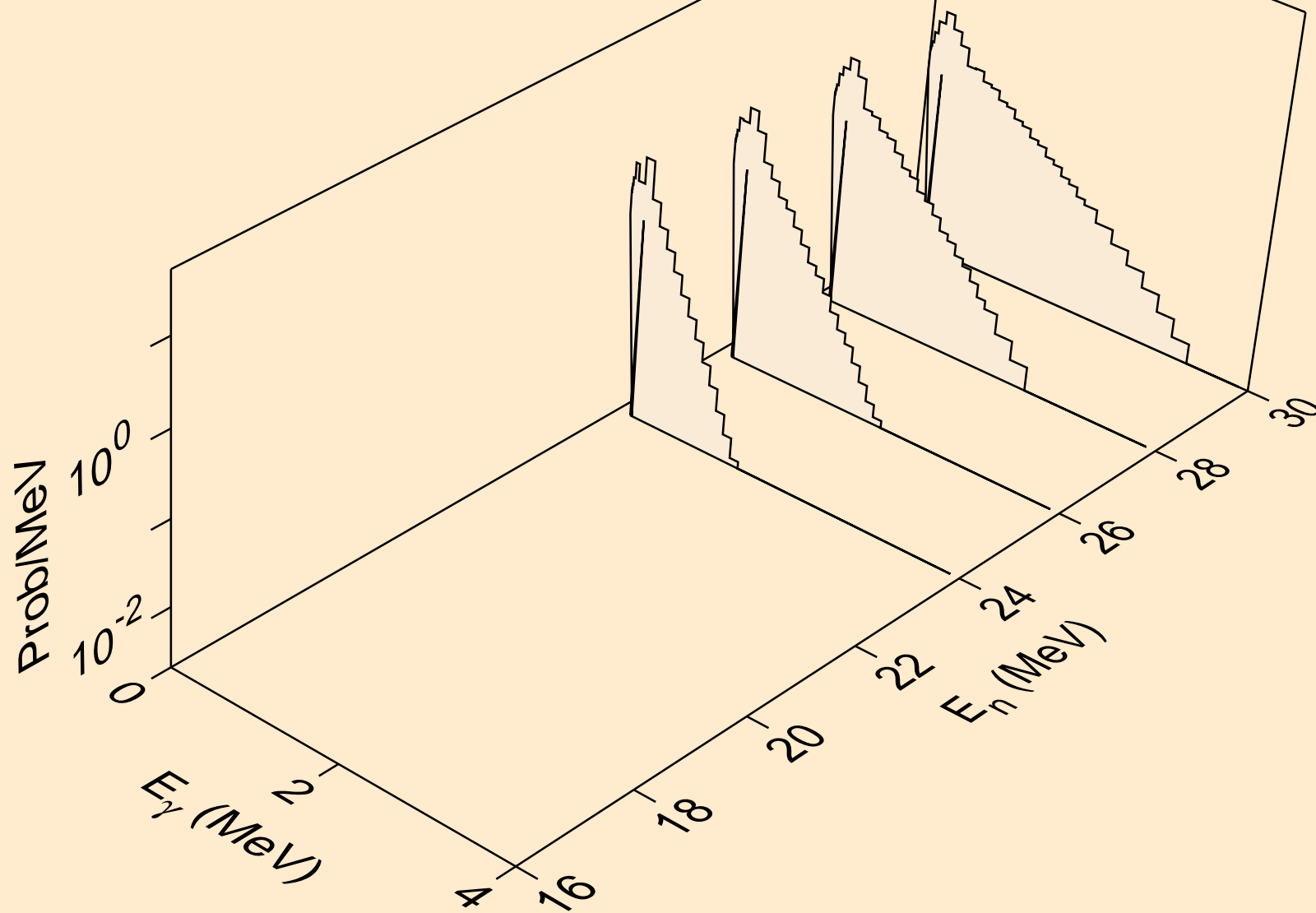

TA162 HELION ACER TENDL-2021 LIBRARY; T=0.K
Photon emission for (n,n*)he3

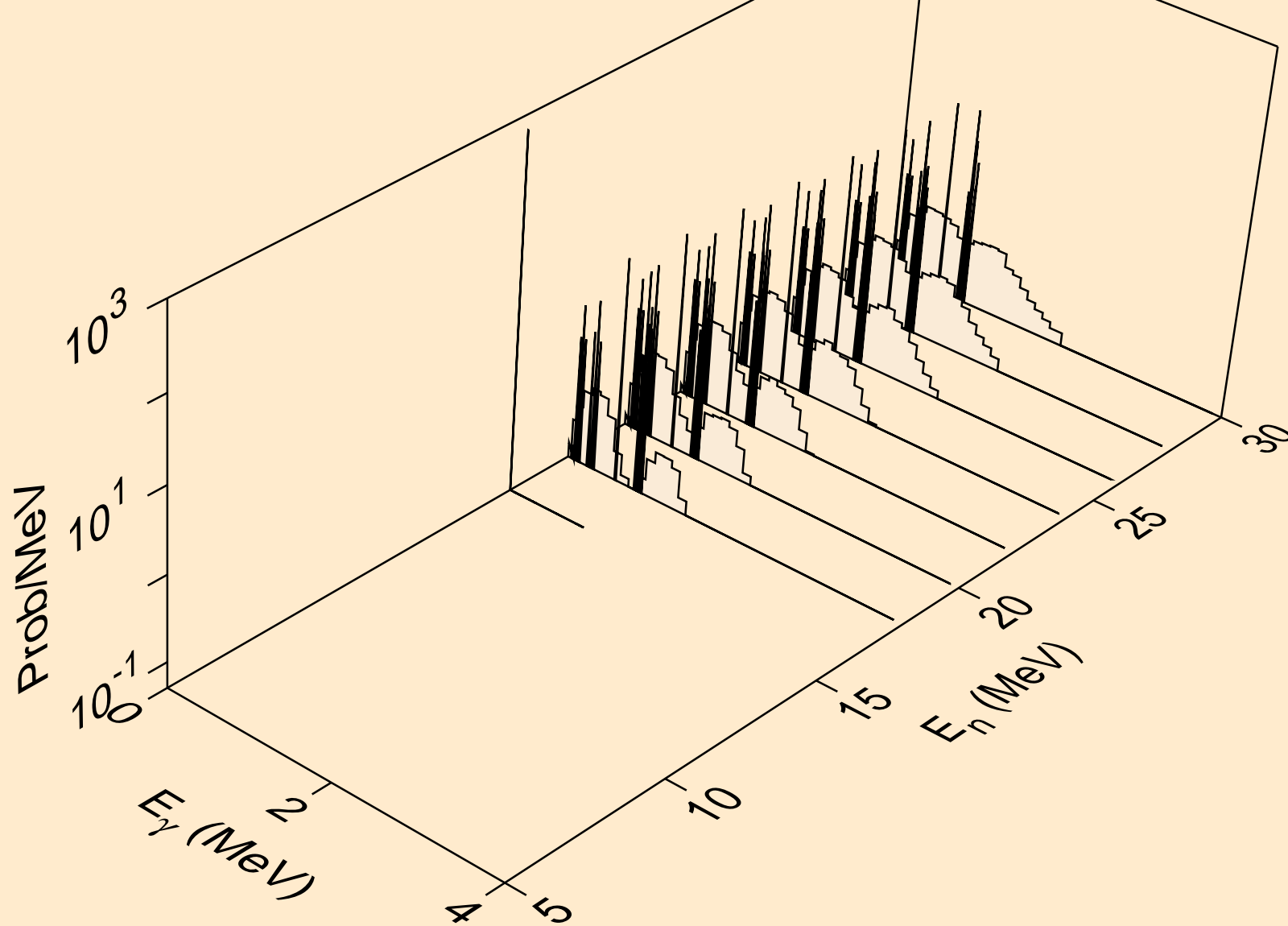

TA162 HELION ACER TENDL-2021 LIBRARY; T=0.K
Photon emission for (n,2np)

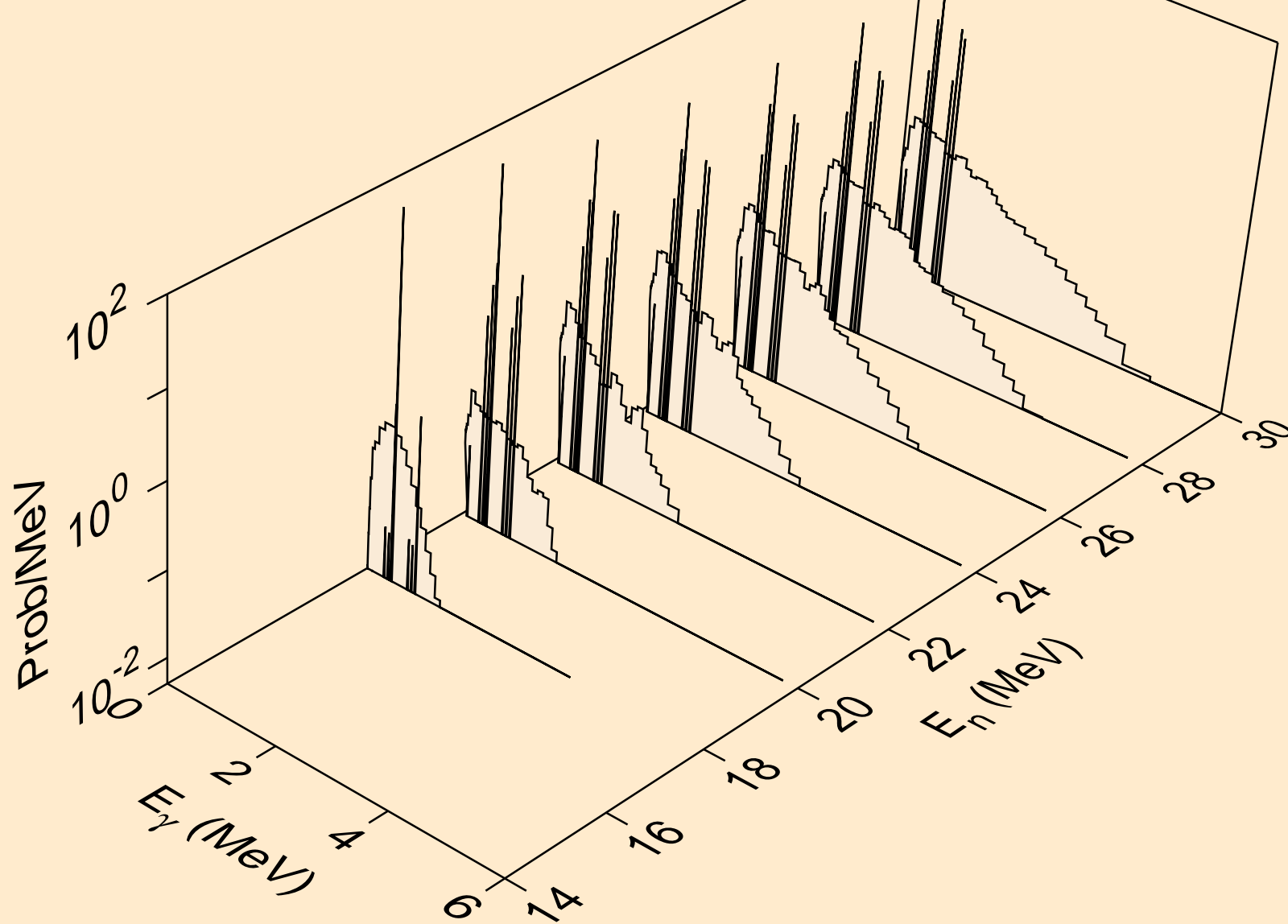

TA162 HELION ACER TENDL-2021 LIBRARY; T=0.K
Photon emission for (n,2np)

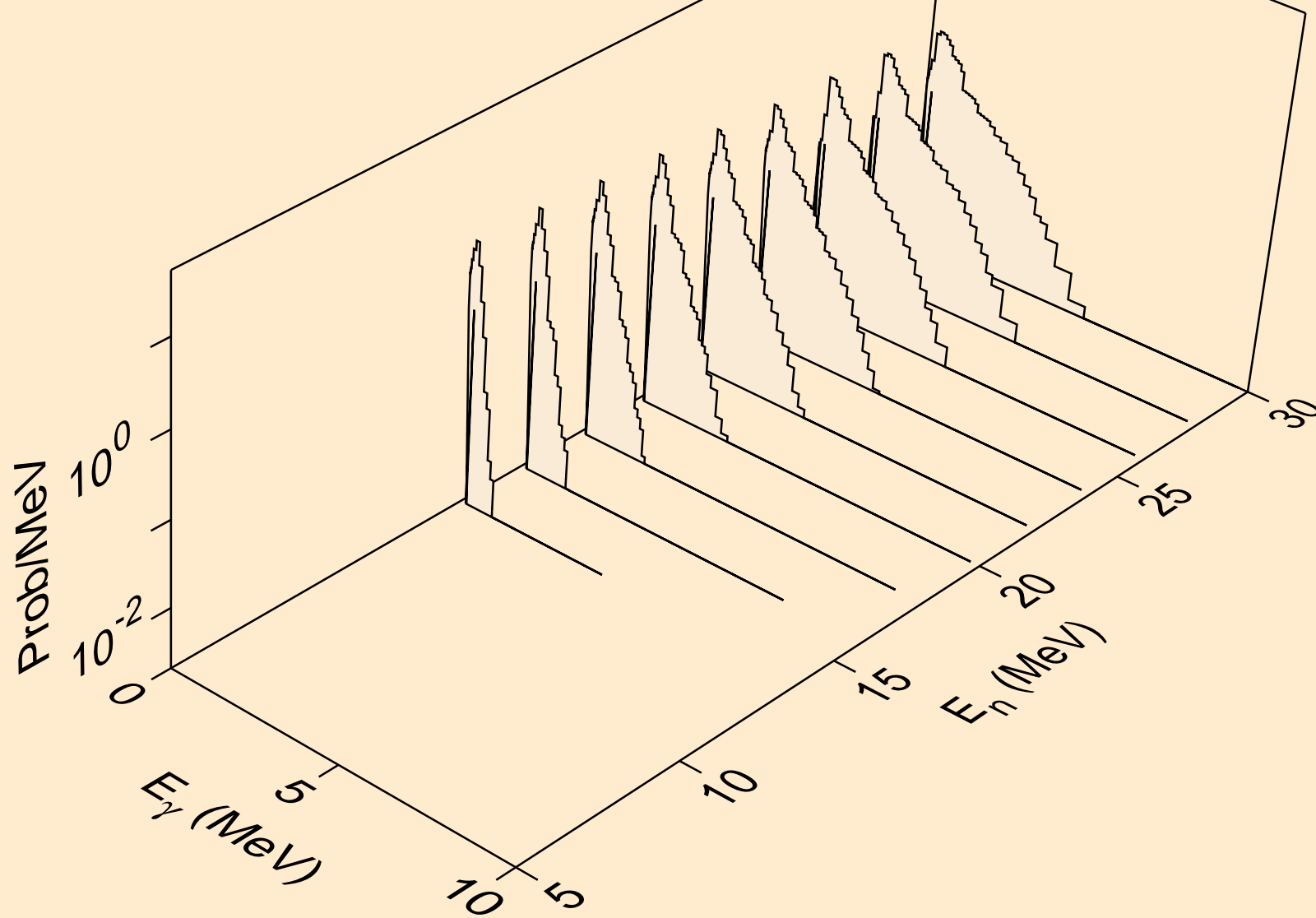

TA162 HELION ACER TENDL-2021 LIBRARY; T=0.K
Photon emission for (n,npa)

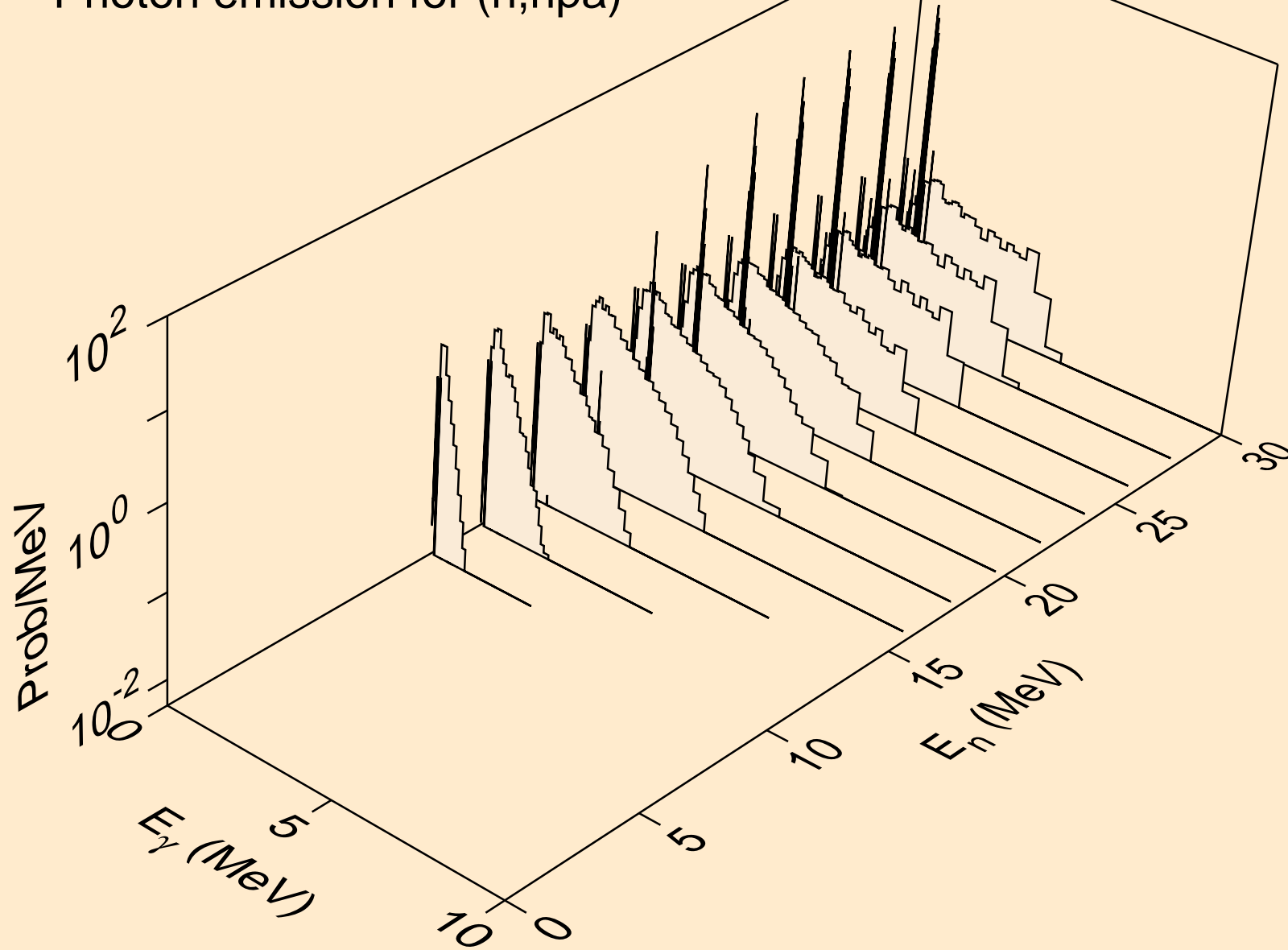

TA162 HELION ACER TENDL-2021 LIBRARY; T=0.K
Photon emission for (n,gma)

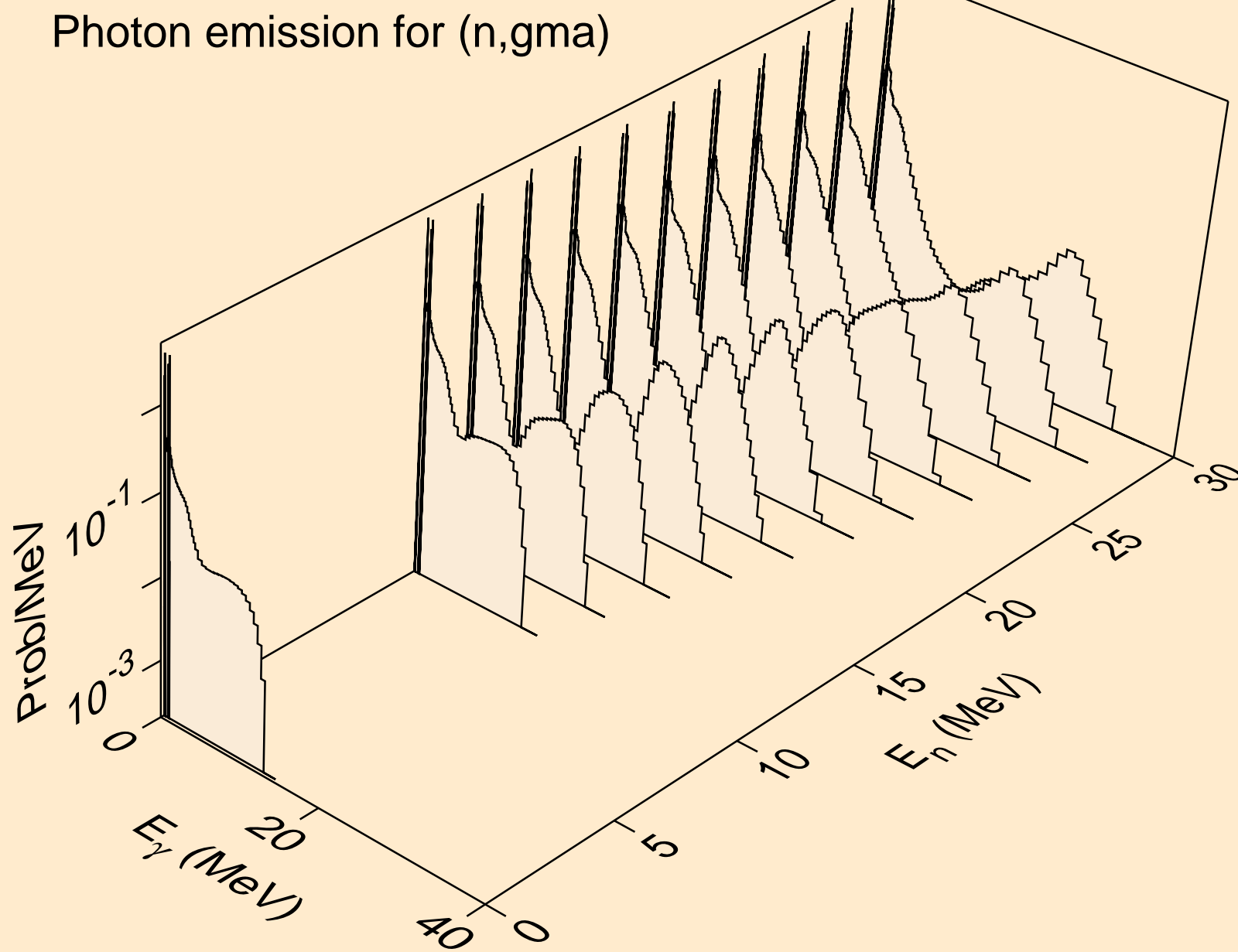

TA162 HELION ACER TENDL-2021 LIBRARY; T=0.K
Photon emission for (n,p)

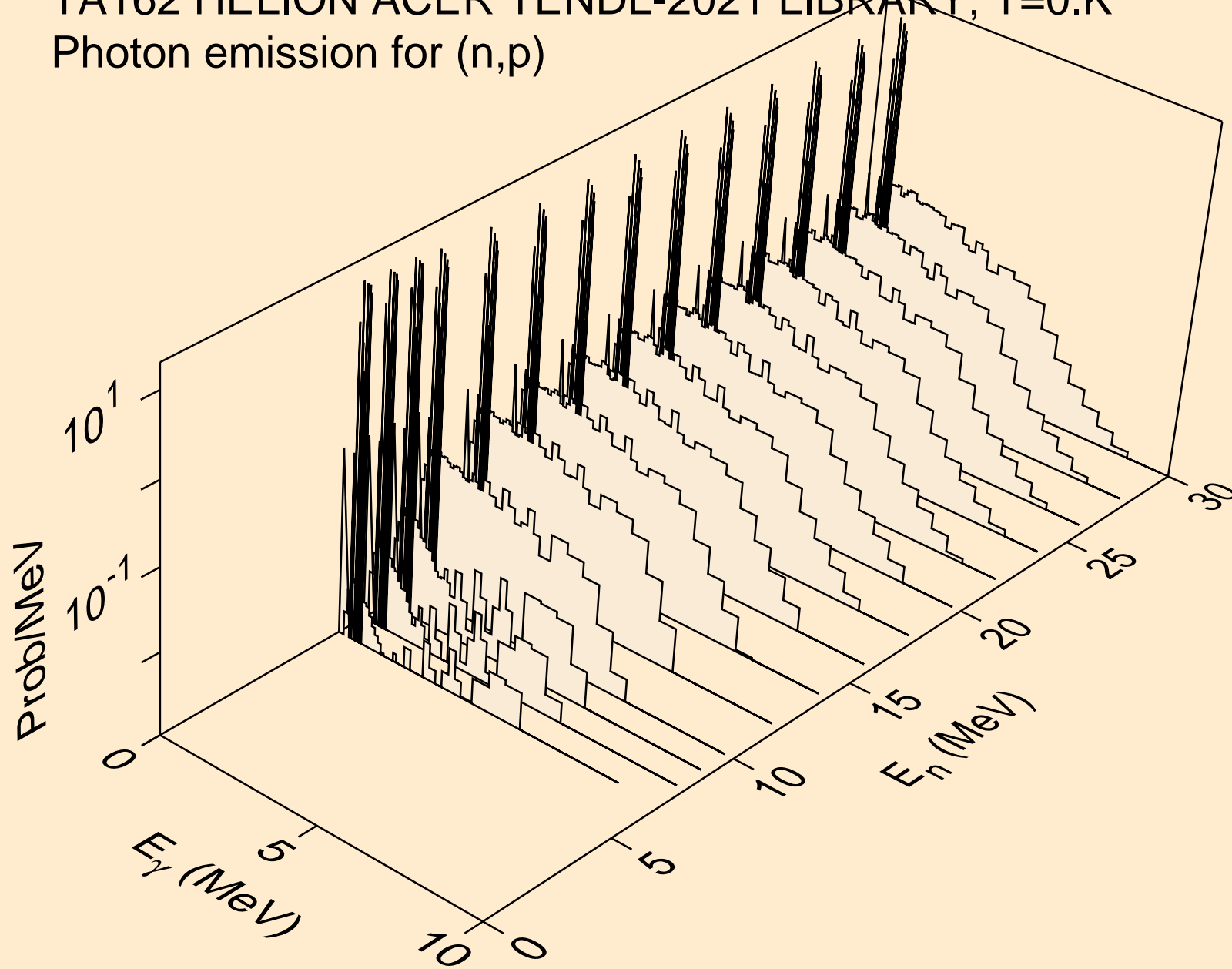

TA162 HELION ACER TENDL-2021 LIBRARY; T=0.K
Photon emission for (n,d)

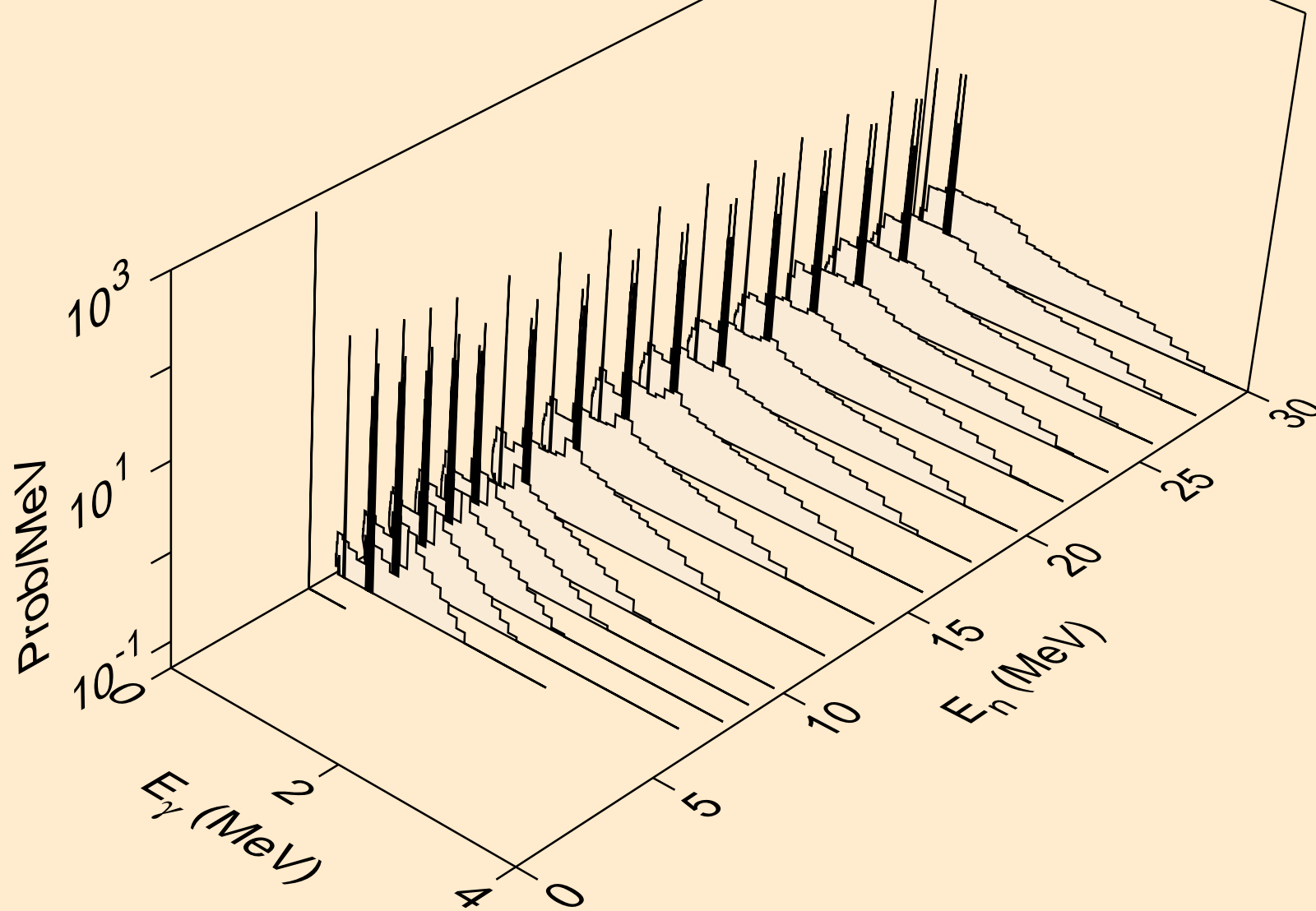

TA162 HELION ACER TENDL-2021 LIBRARY; T=0.K
Photon emission for (n,t)

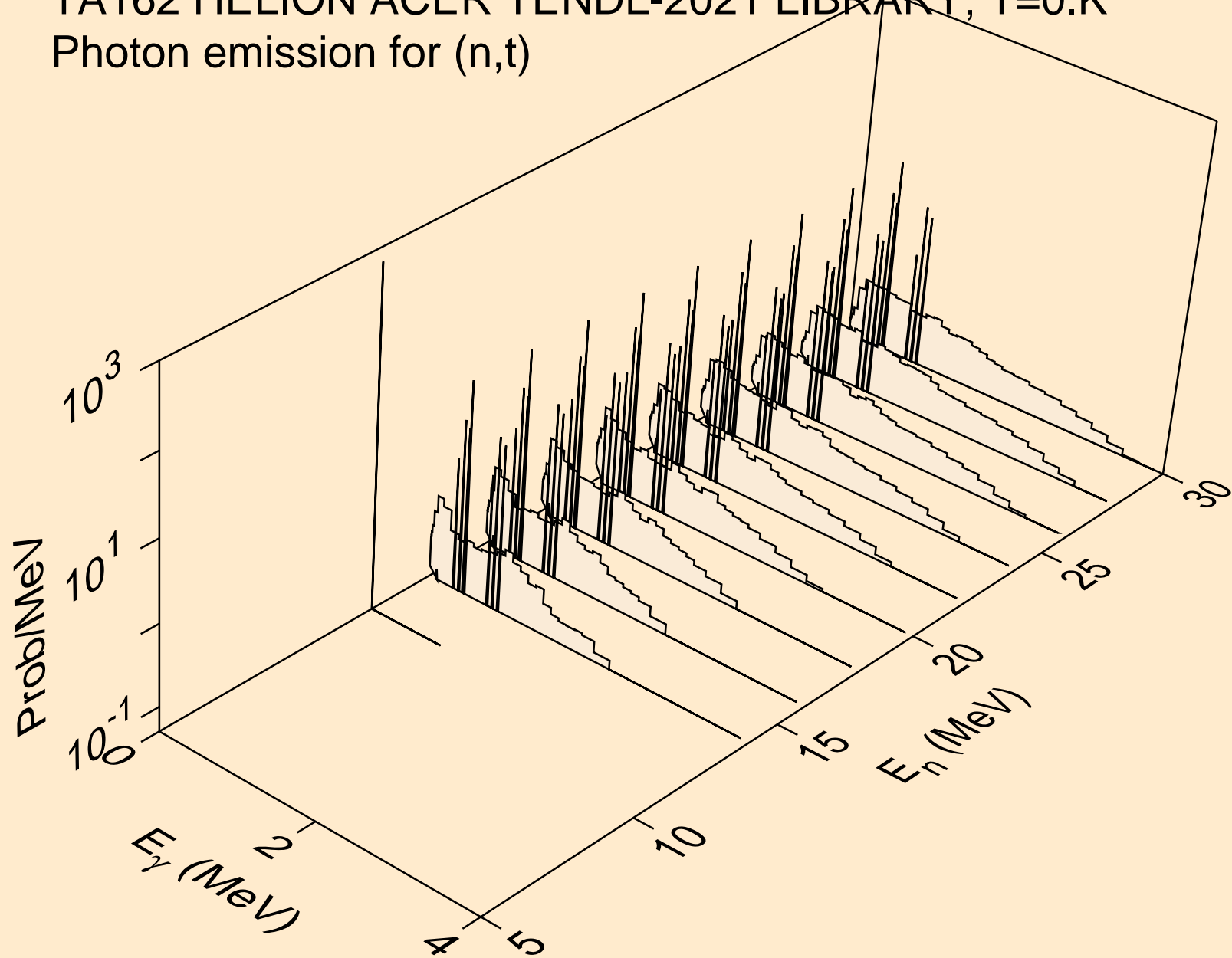

TA162 HELION ACER TENDL-2021 LIBRARY; T=0.K
Photon emission for inelastic

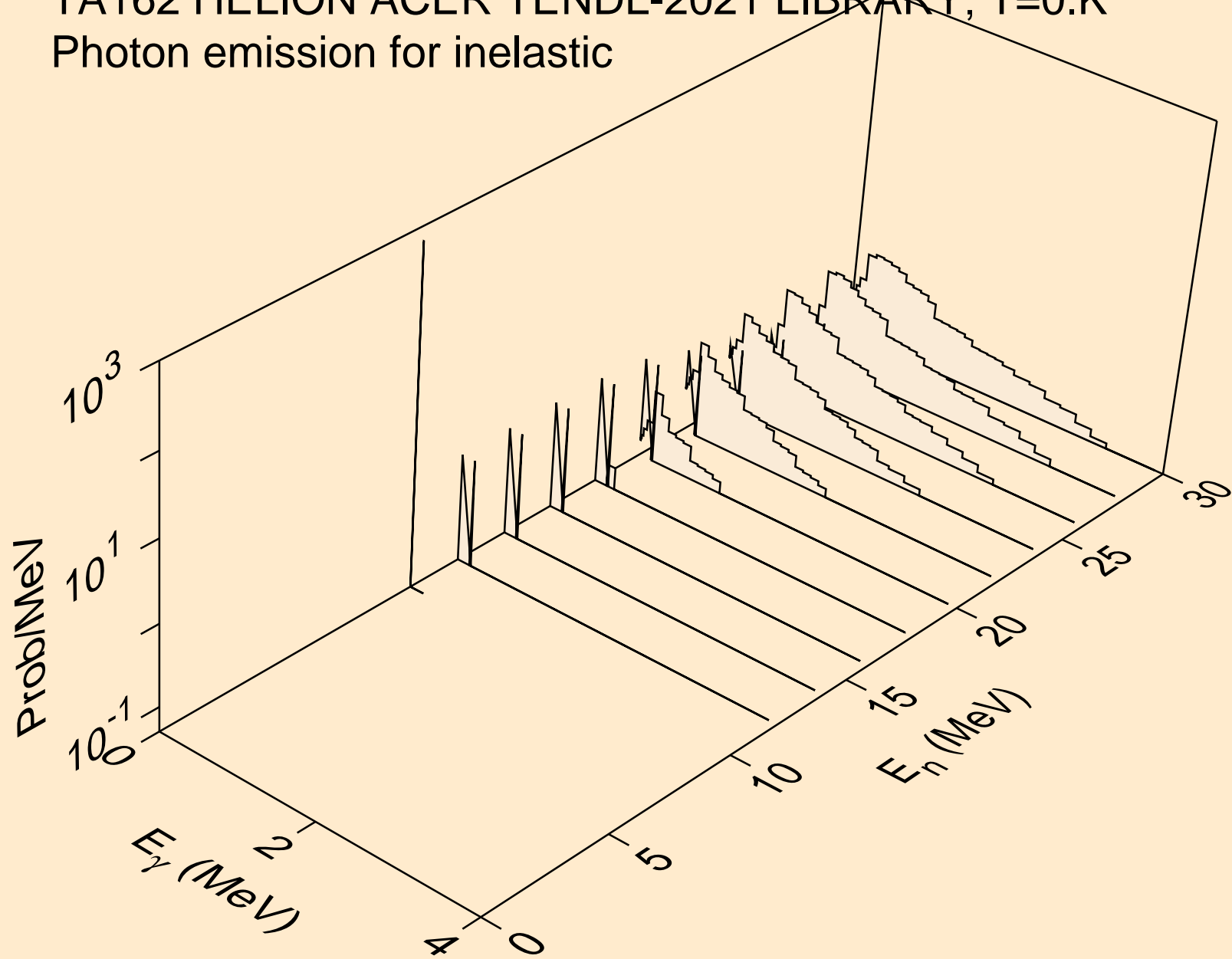

TA162 HELION ACER TENDL-2021 LIBRARY; T=0.K
Photon emission for (n,a)

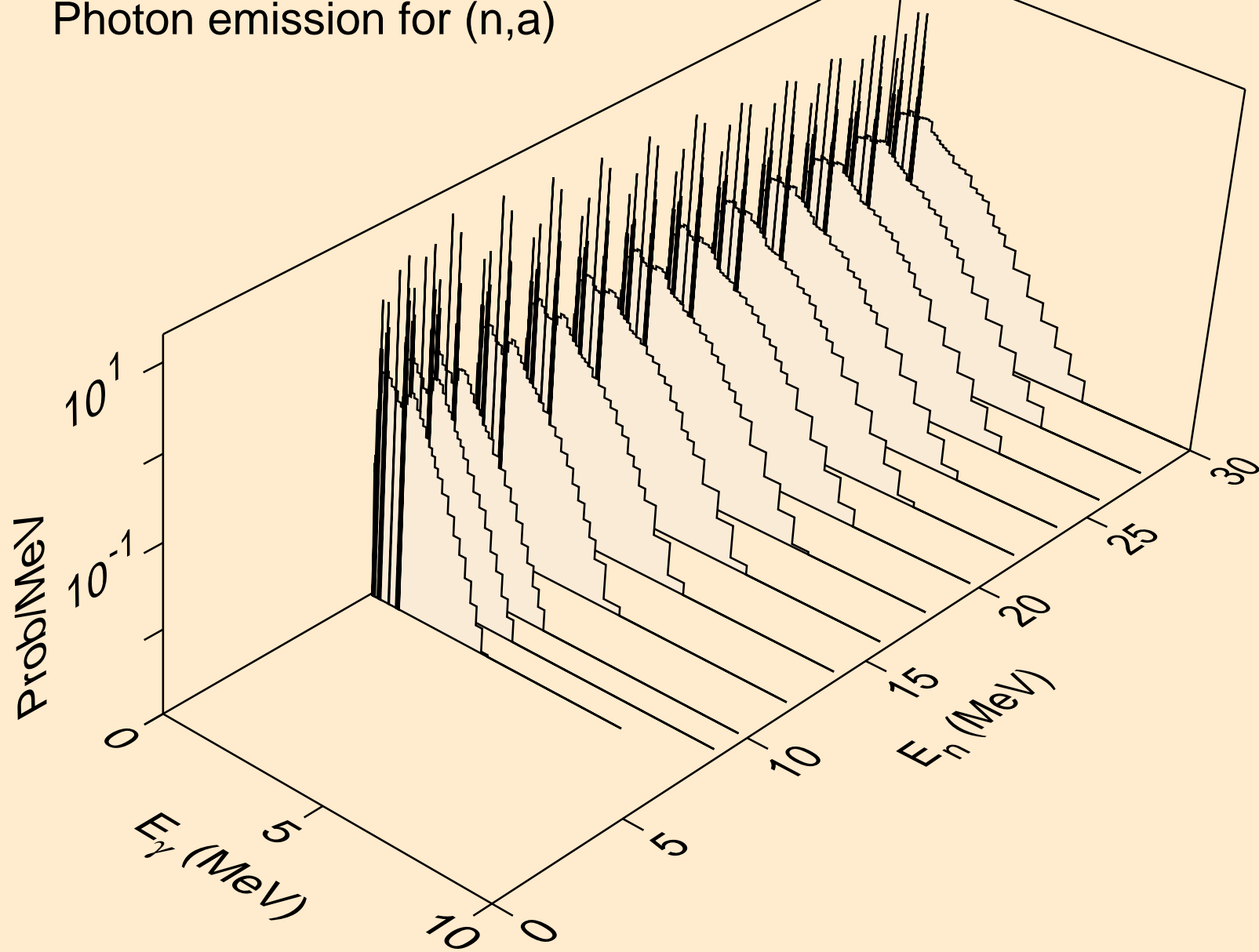

TA162 HELION ACER TENDL-2021 LIBRARY; T=0.K
Photon emission for (n,2a)

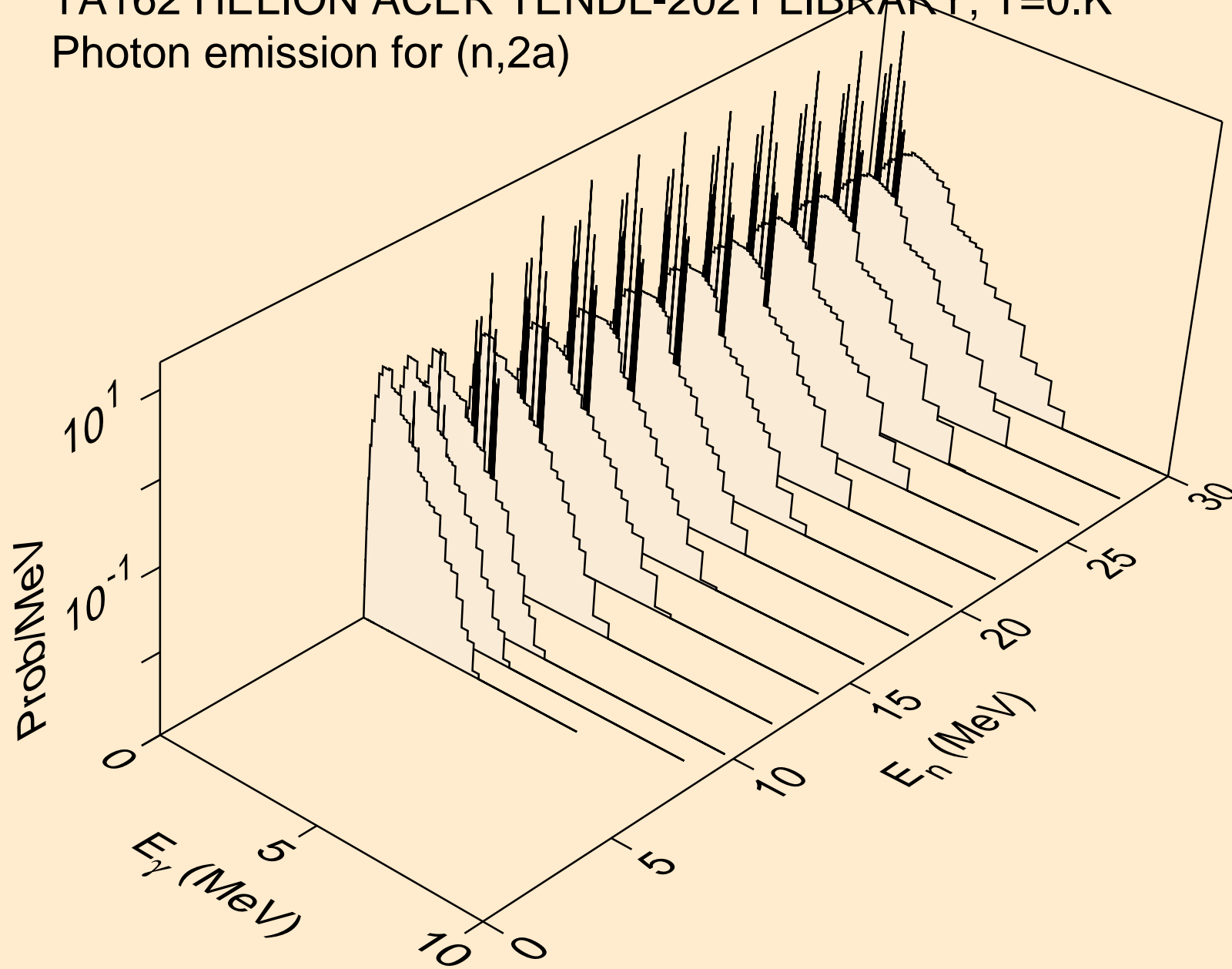

TA162 HELION ACER TENDL-2021 LIBRARY; T=0.K
Photon emission for (n,3a)

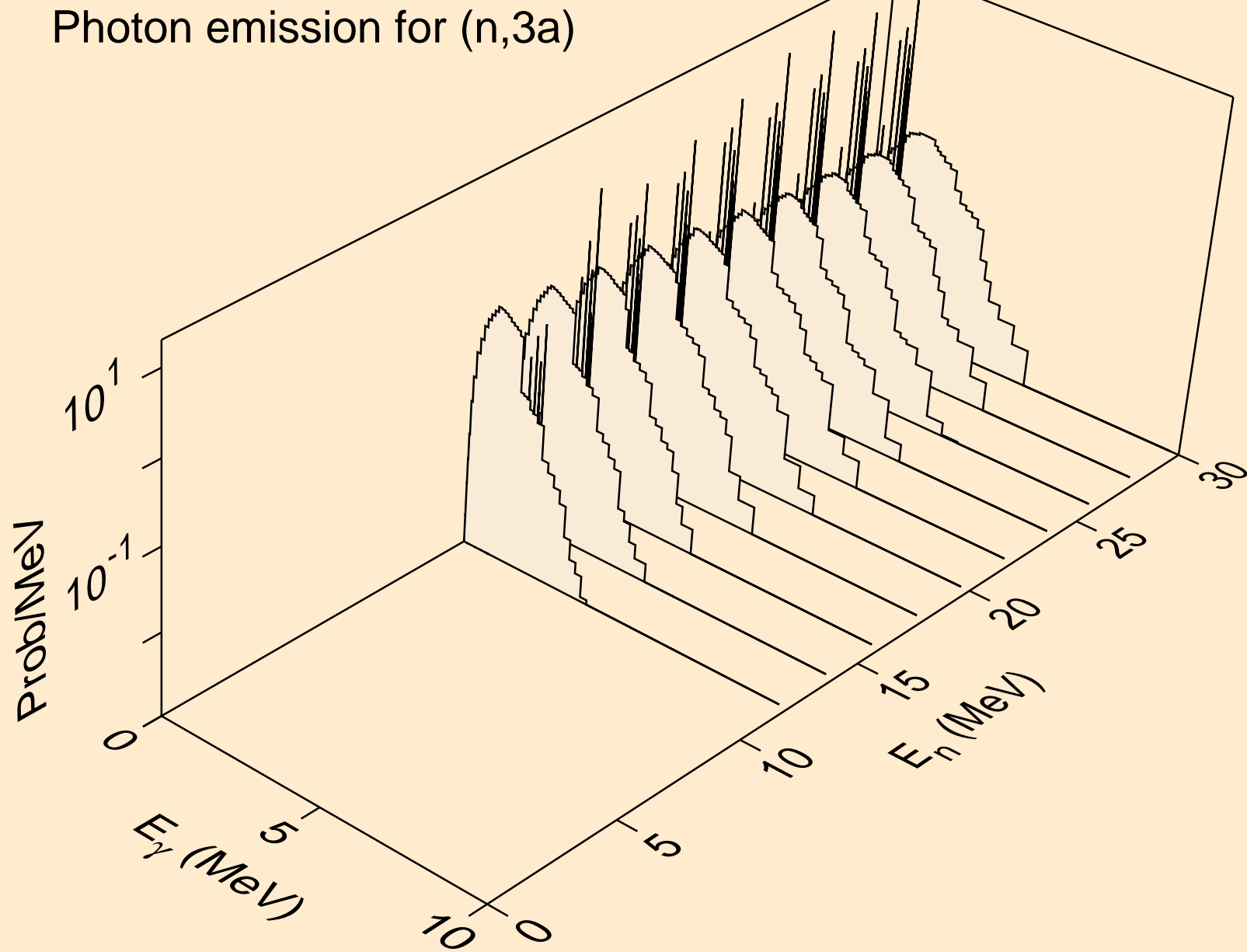

TA162 HELION ACER TENDL-2021 LIBRARY; T=0.K
Photon emission for (n,2p)

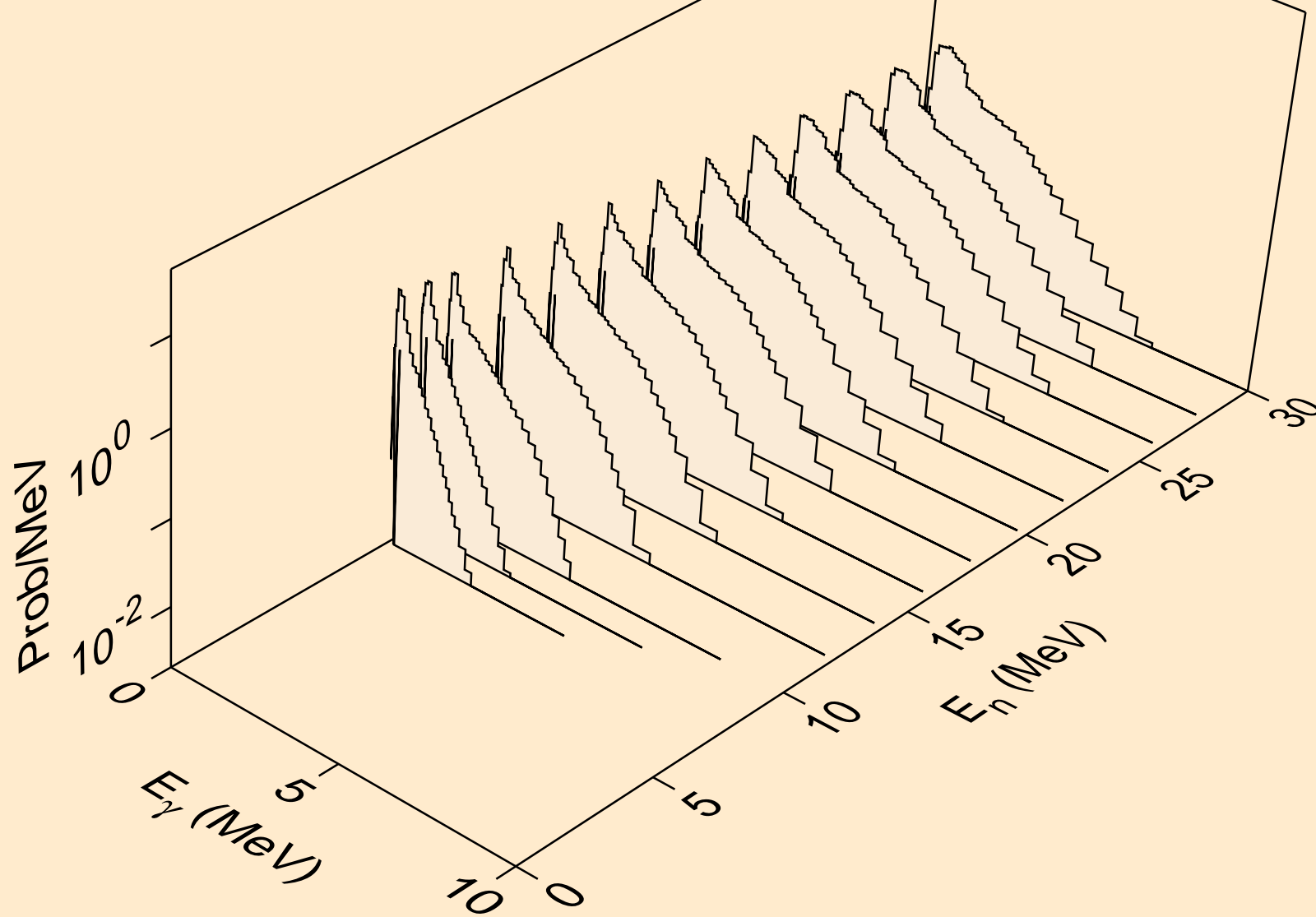

TA162 HELION ACER TENDL-2021 LIBRARY; T=0.K
Photon emission for (n,pa)

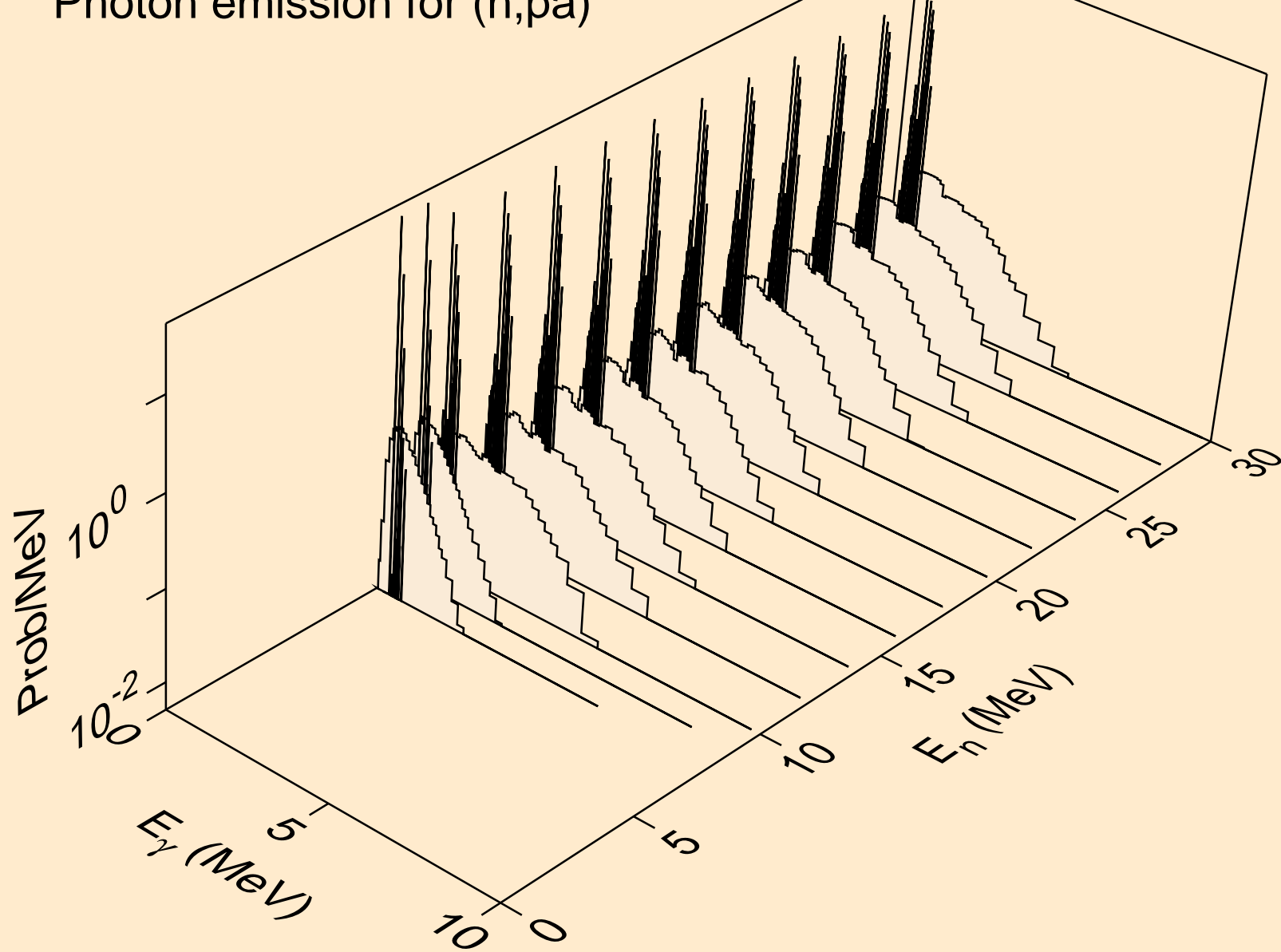

TA162 HELION ACER TENDL-2021 LIBRARY; T=0.K
Photon emission for (n,t2a)

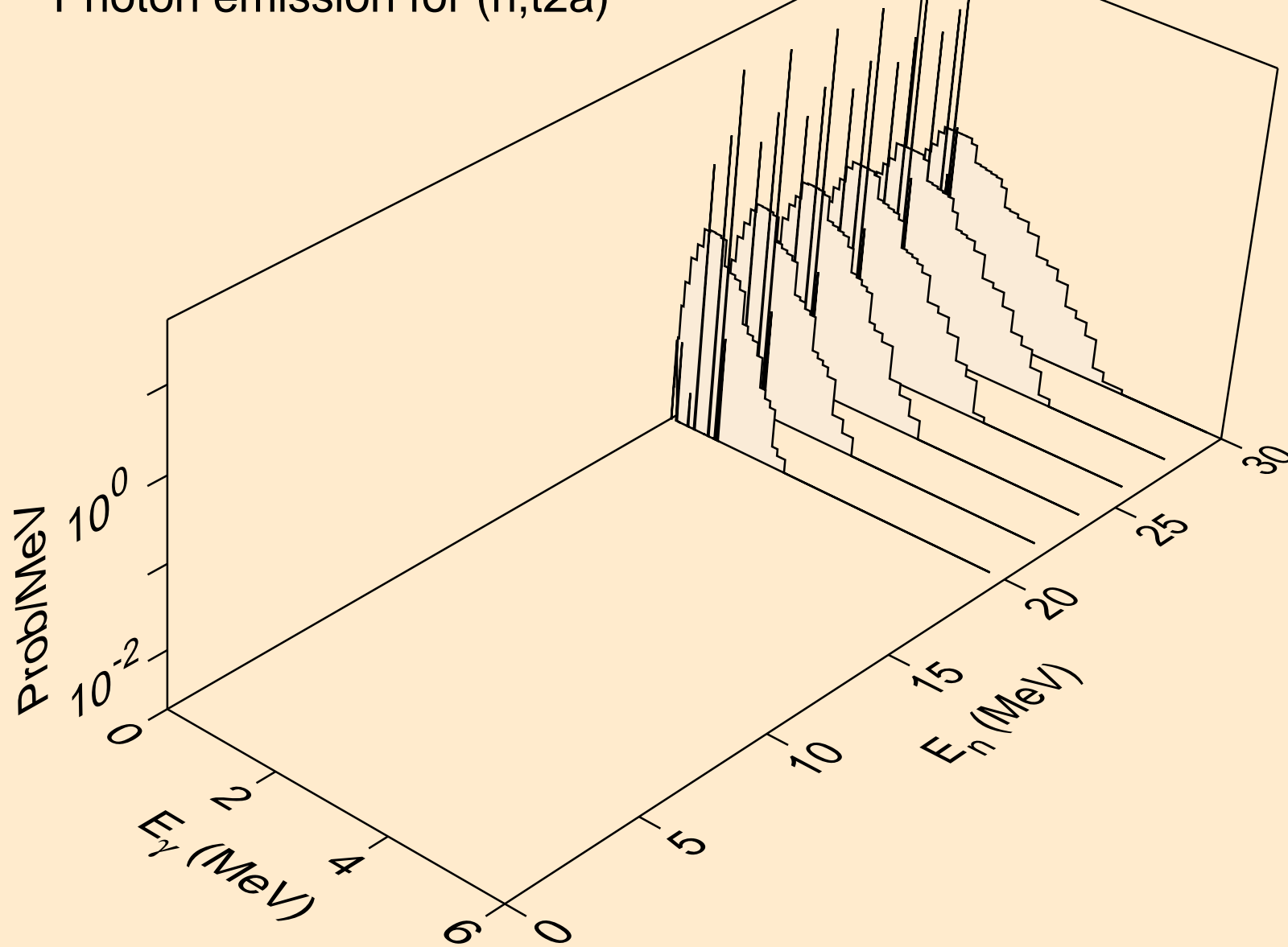

TA162 HELION ACER TENDL-2021 LIBRARY; T=0.K
Photon emission for (n,d2a)

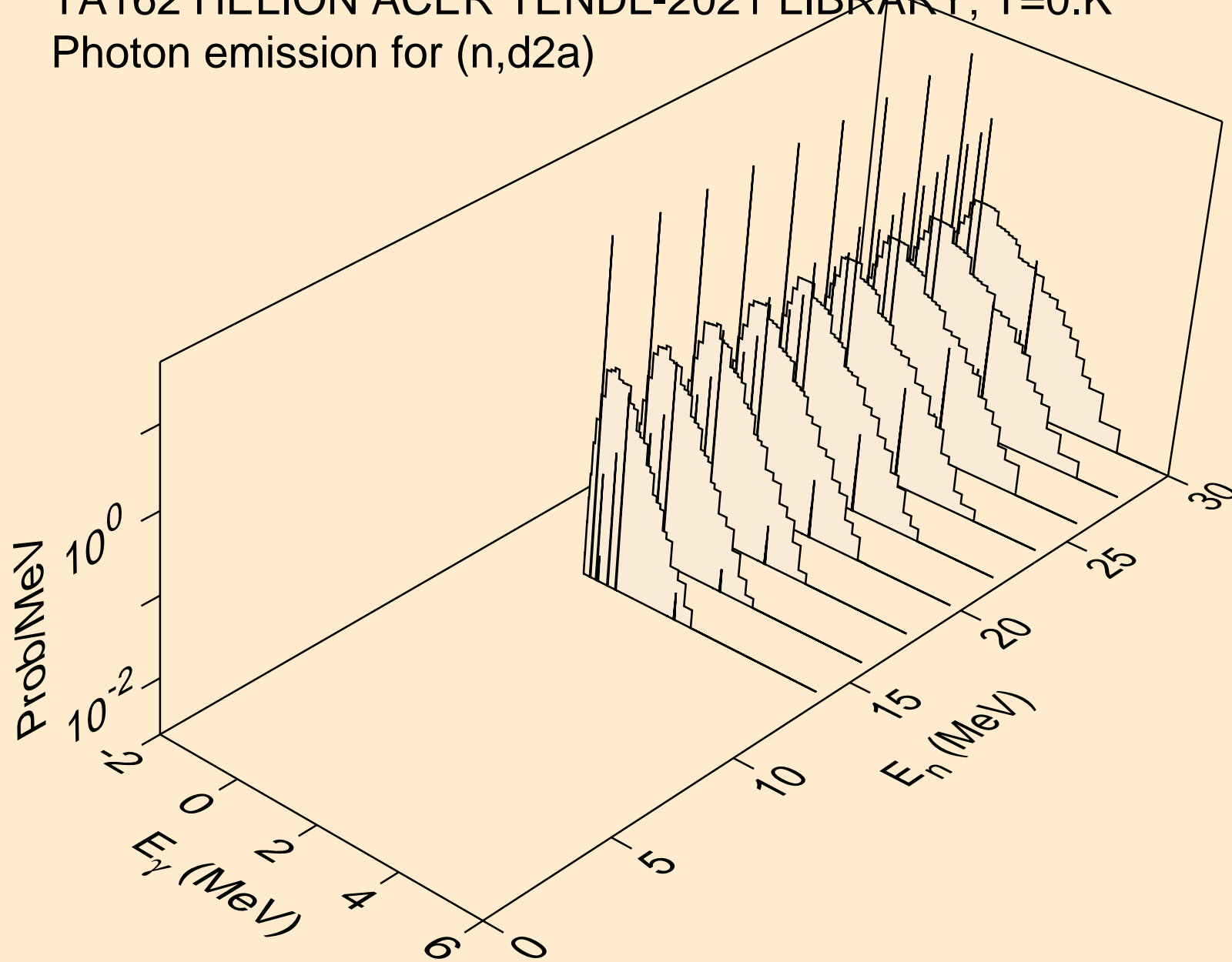

TA162 HELION ACER TENDL-2021 LIBRARY; T=0.K
Photon emission for (n,pd)

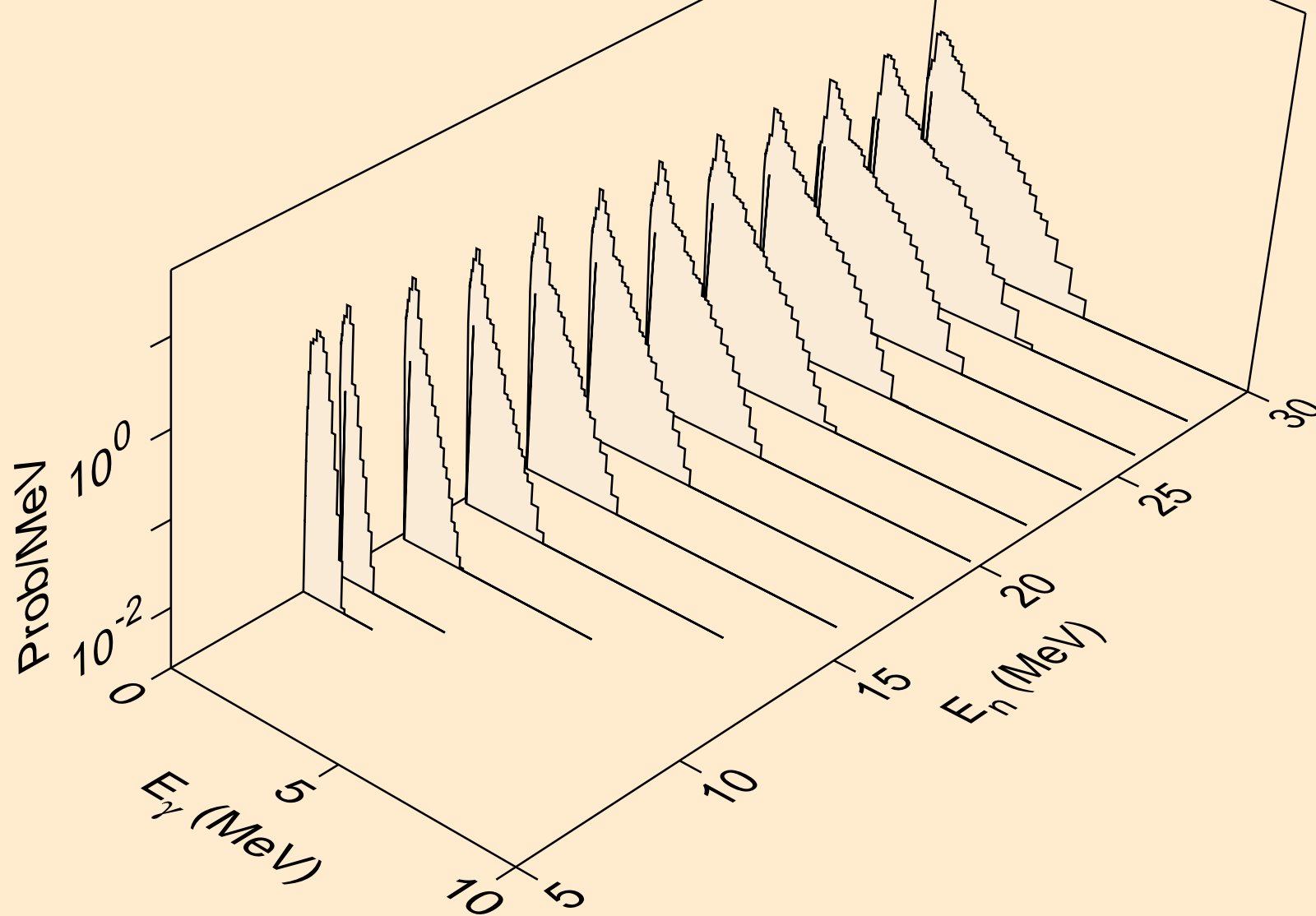

TA162 HELION ACER TENDL-2021 LIBRARY; T=0.K
Photon emission for (n,pt)

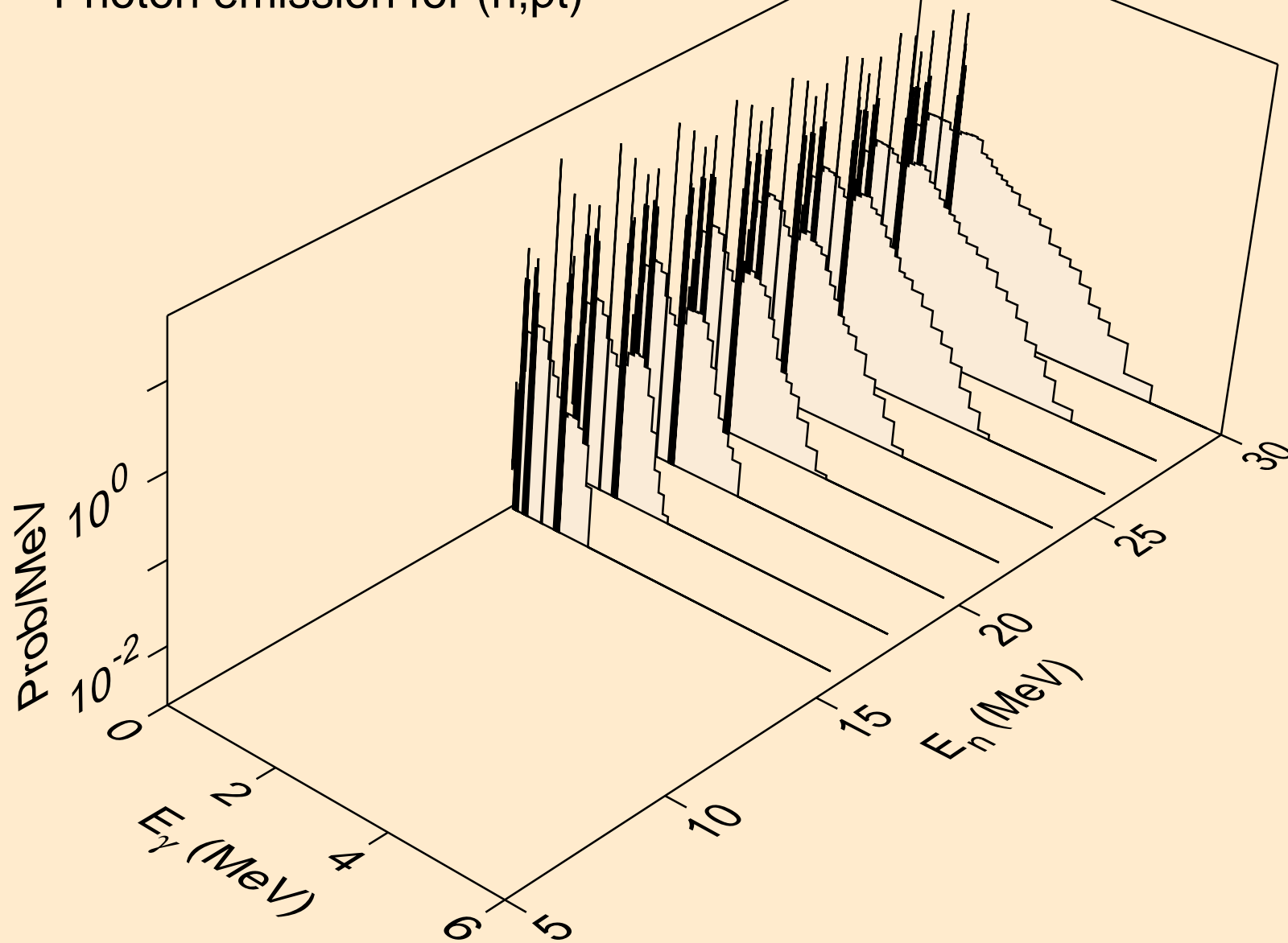

TA162 HELION ACER TENDL-2021 LIBRARY; T=0.K
Photon emission for (n,da)

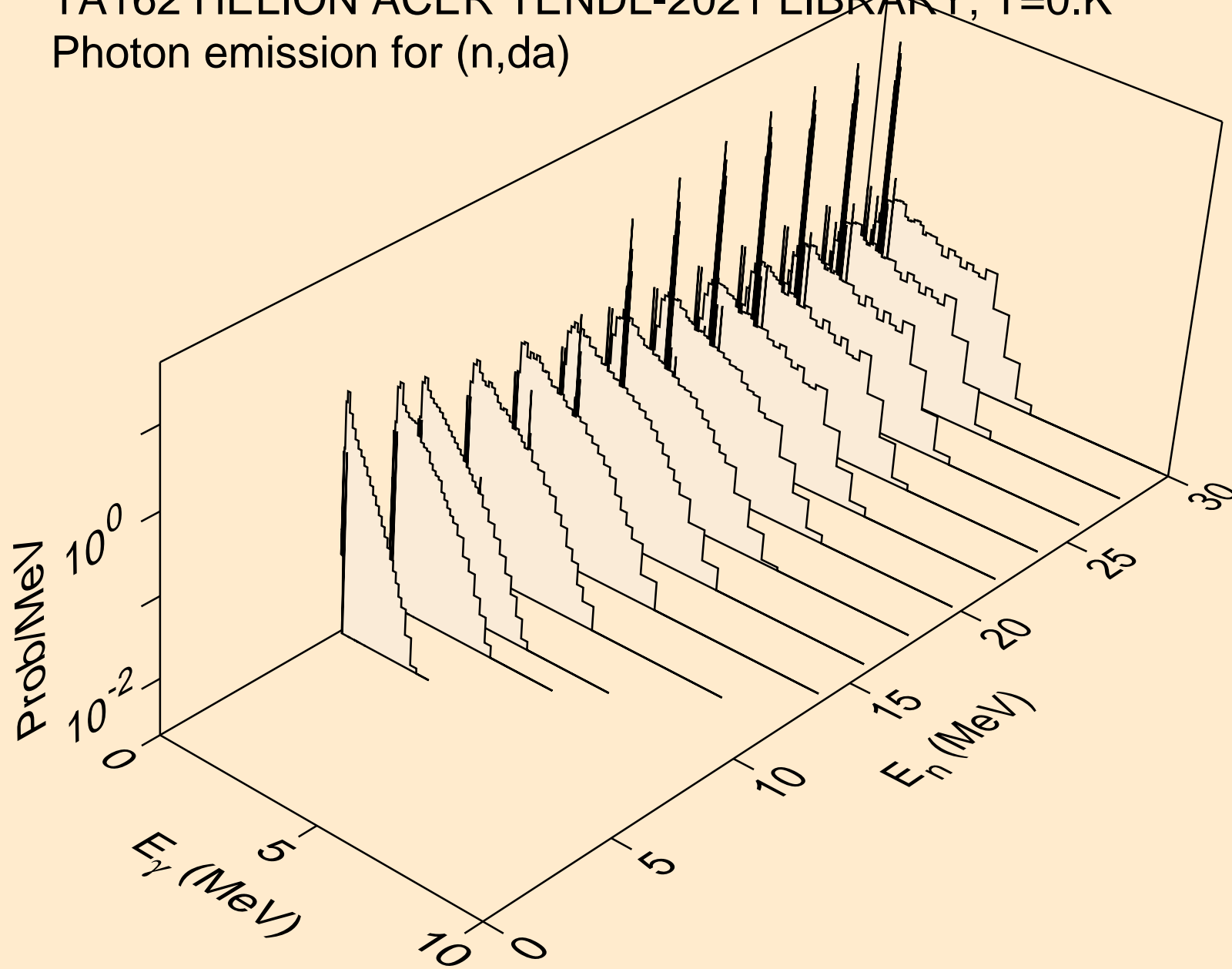

TA162 HELION ACER TENDL-2021 LIBRARY; T=0.K
Particle heating contributions

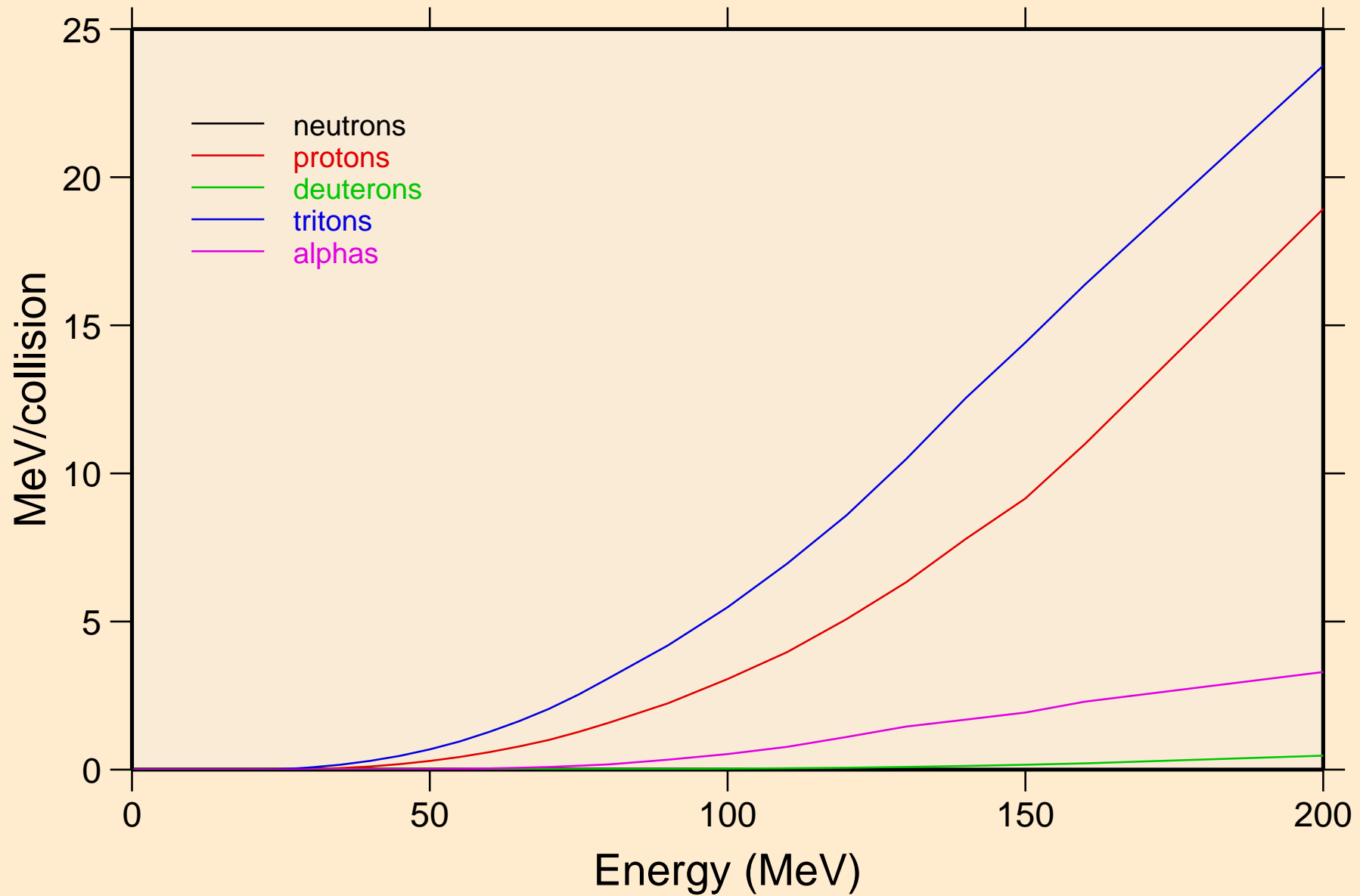

TA162 HELION ACER TENDL-2021 LIBRARY; T=0.K
Recoil Heating

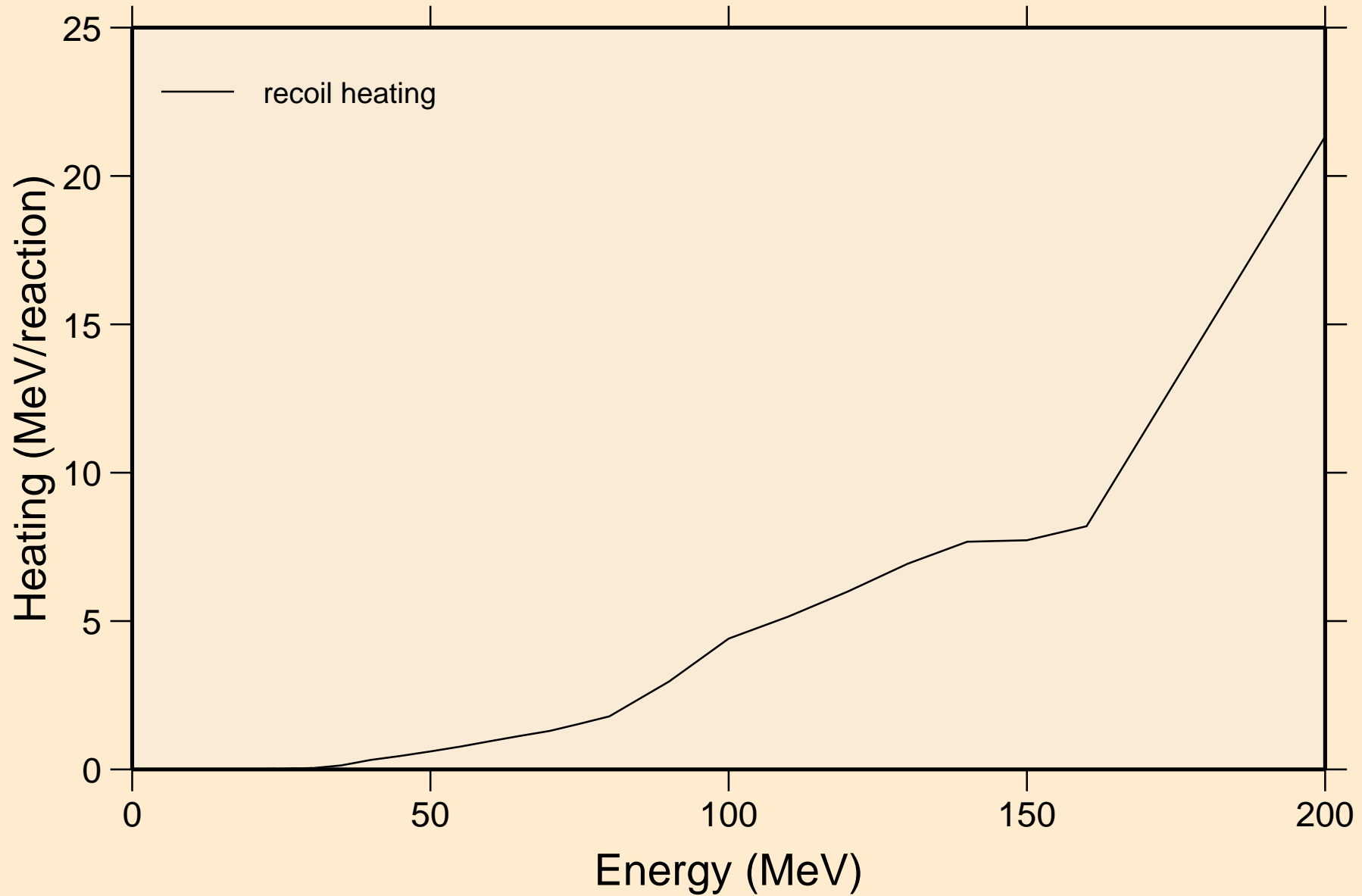

TA162 HELION ACER TENDL-2021 LIBRARY; T=0.K
Particle production cross sections

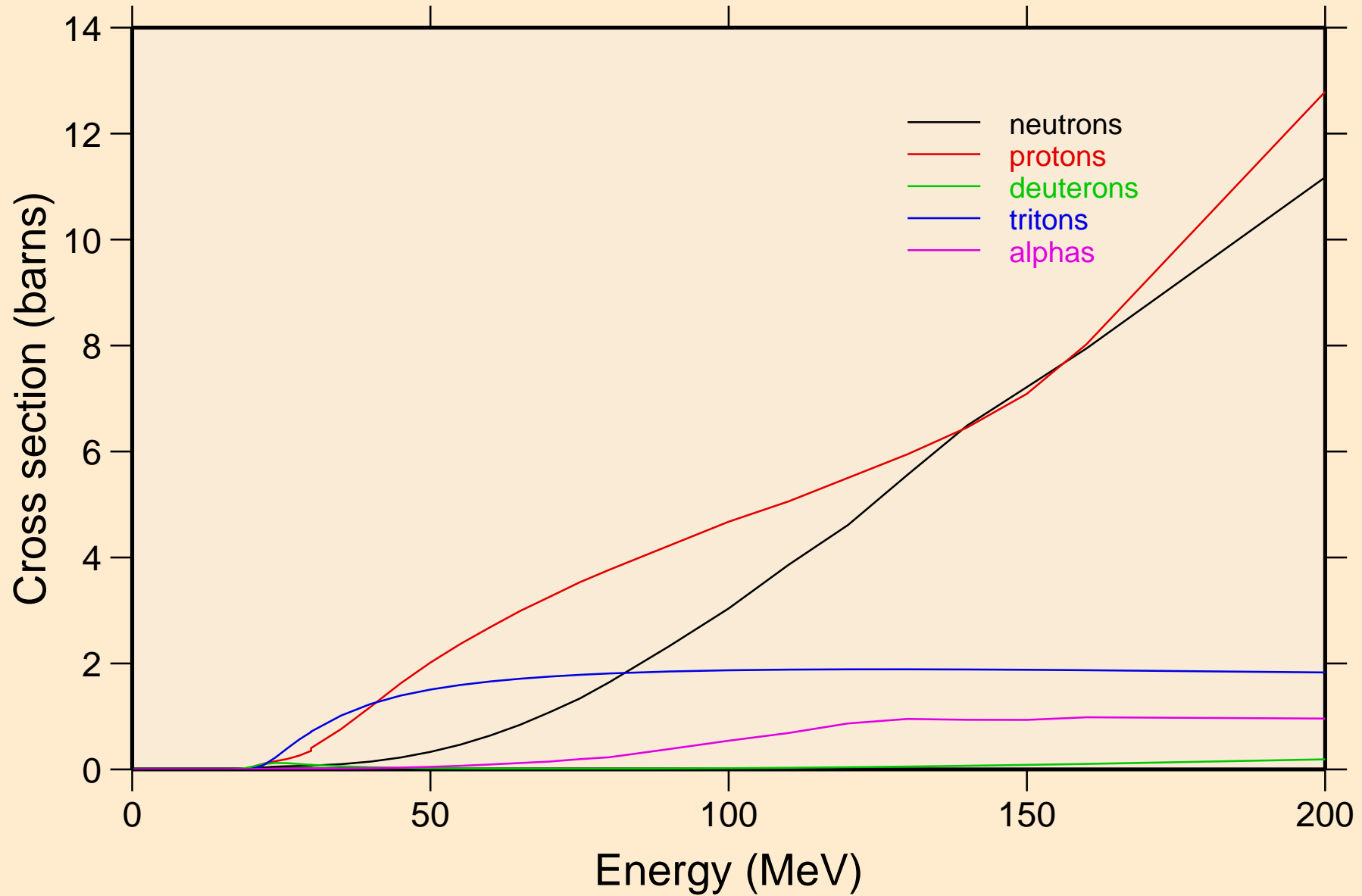

TA162 HELION ACER TENDL-2021 LIBRARY; T=0.K
neutrons from (s,n)

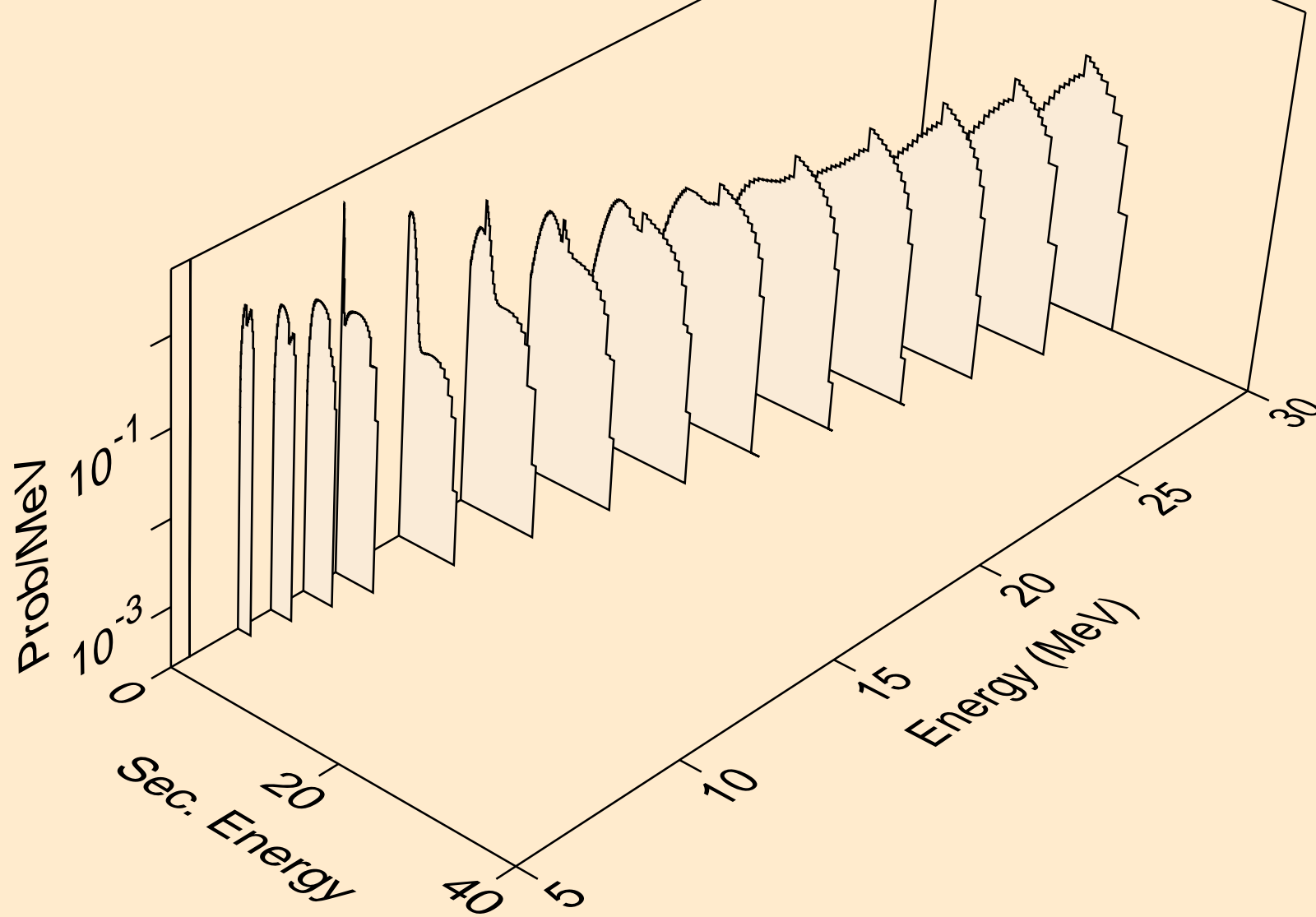

TA162 HELION ACER TENDL-2021 LIBRARY; T=0.K
neutrons from (s,x)

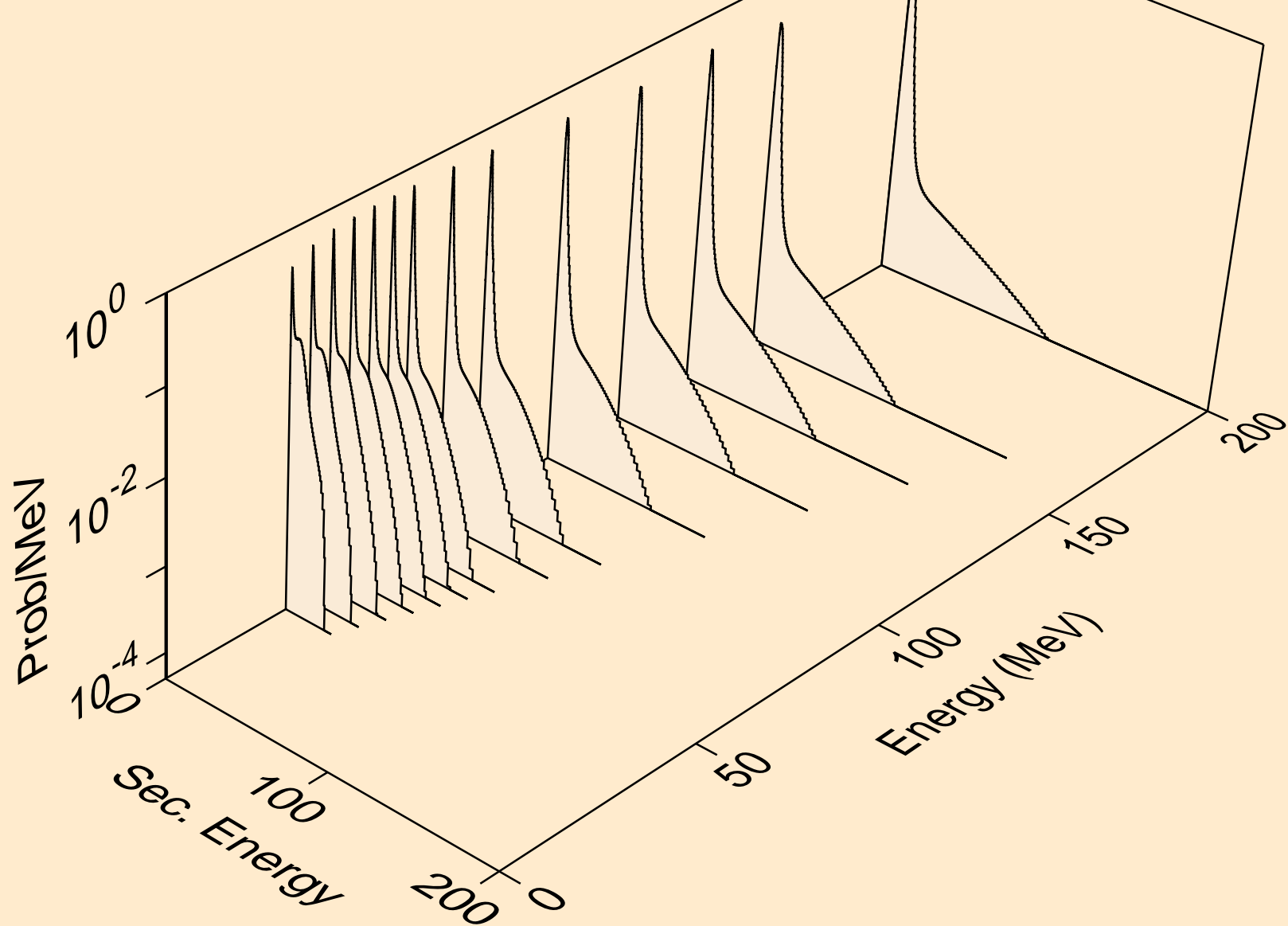

TA162 HELION ACER TENDL-2021 LIBRARY; T=0.K
neutrons from (s,2nd)

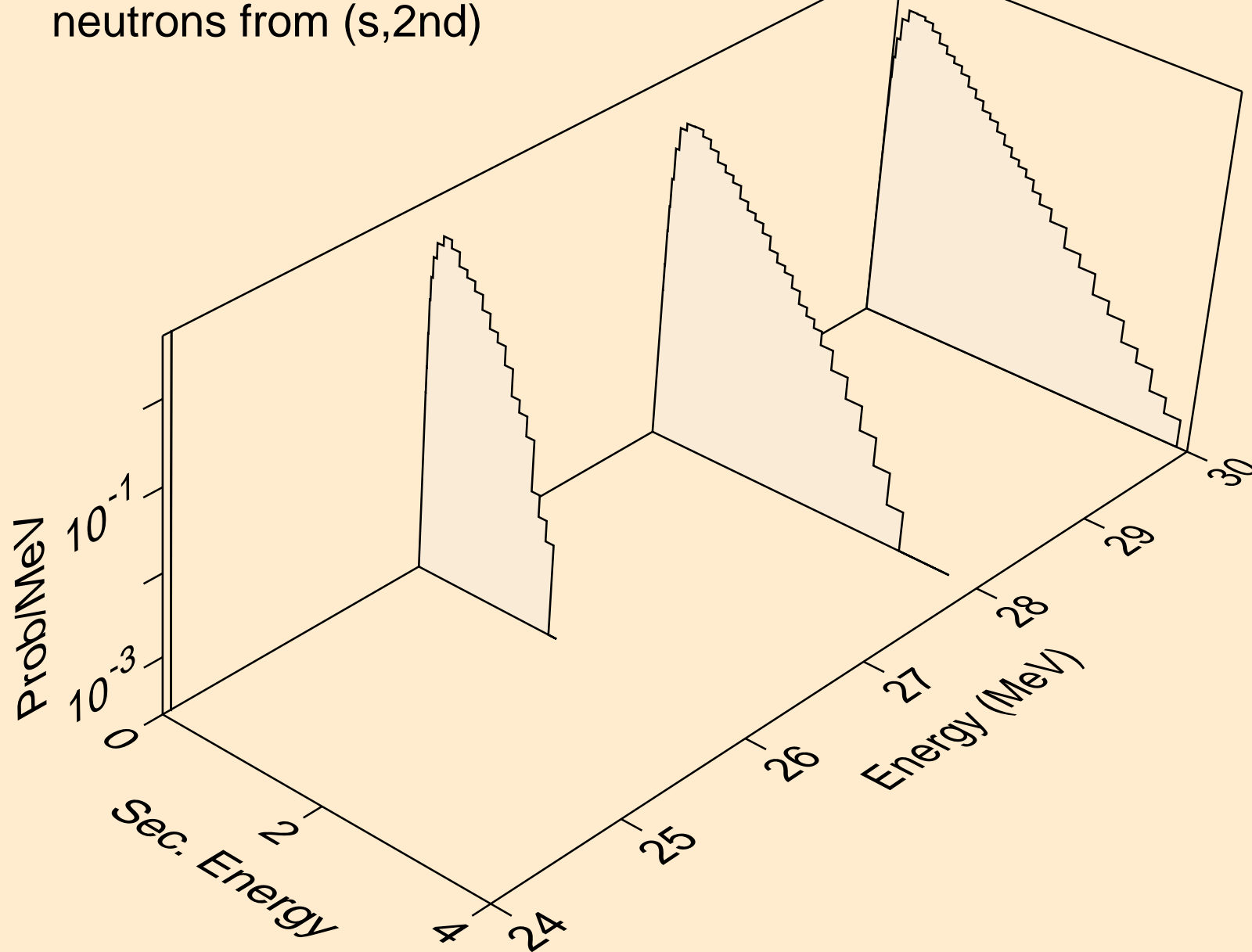

TA162 HELION ACER TENDL-2021 LIBRARY; T=0.K
neutrons from (s,2n)

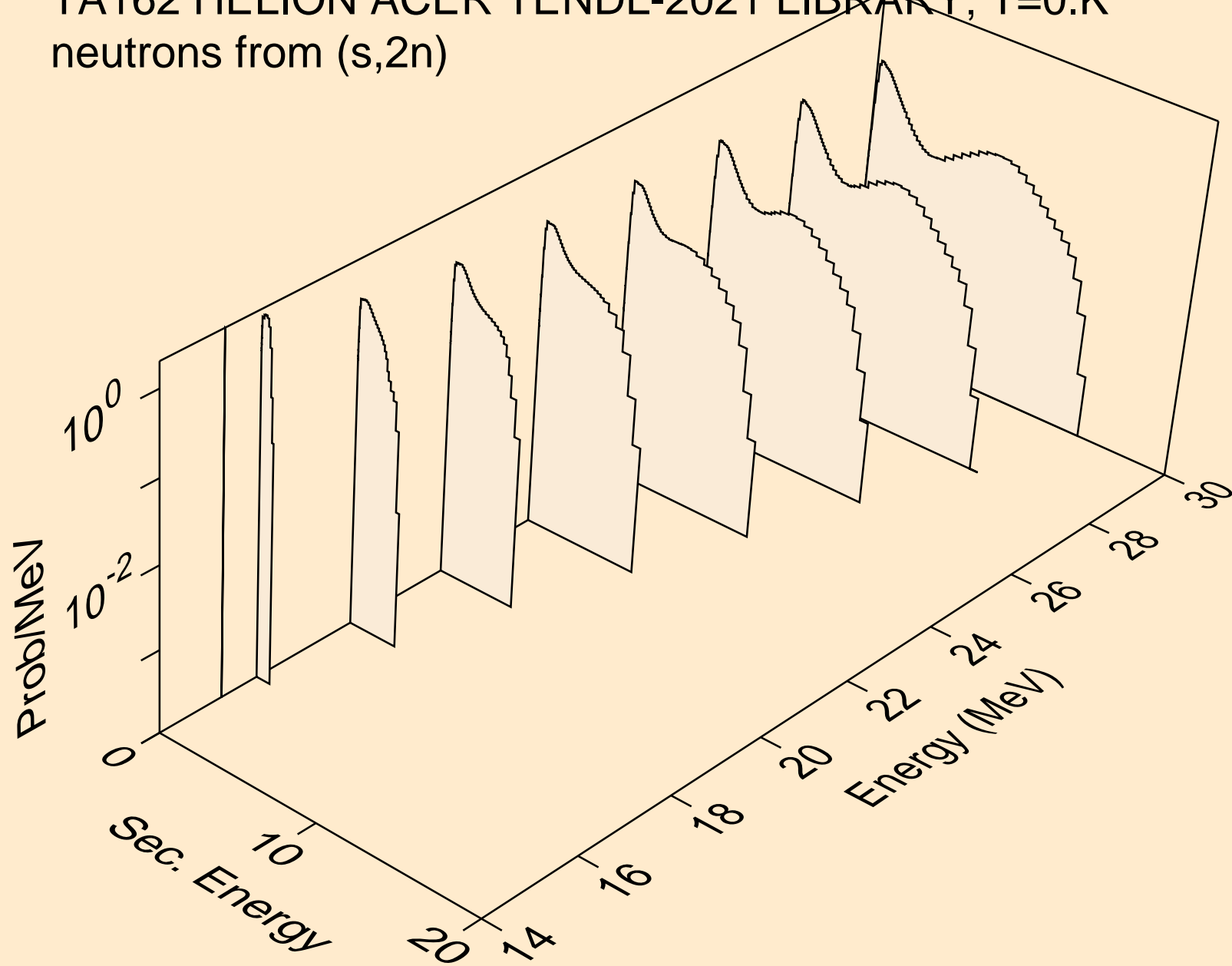

TA162 HELION ACER TENDL-2021 LIBRARY; T=0.K
neutrons from (s,3n)

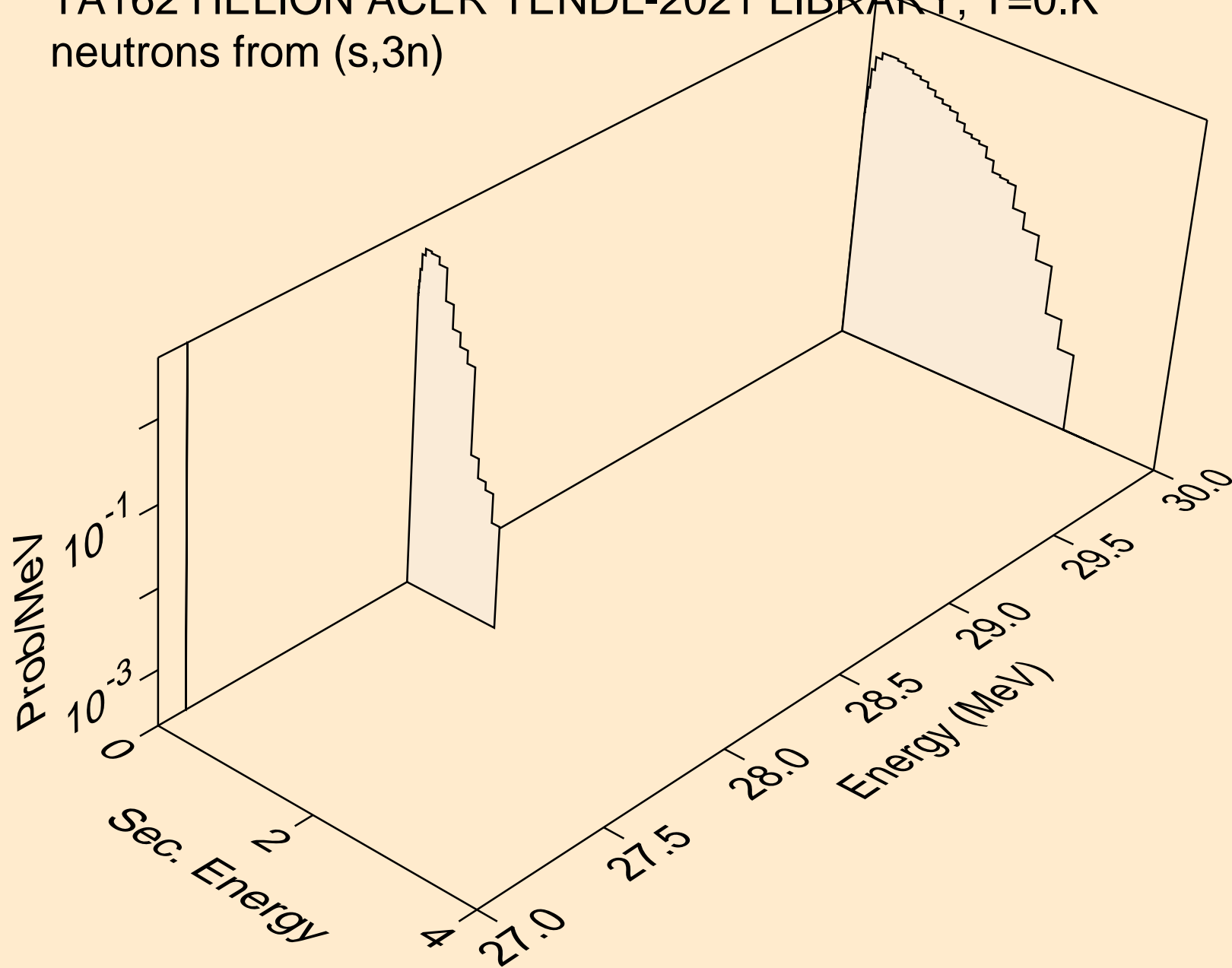

TA162 HELION ACER TENDL-2021 LIBRARY; T=0.K
neutrons from (s,n*)a

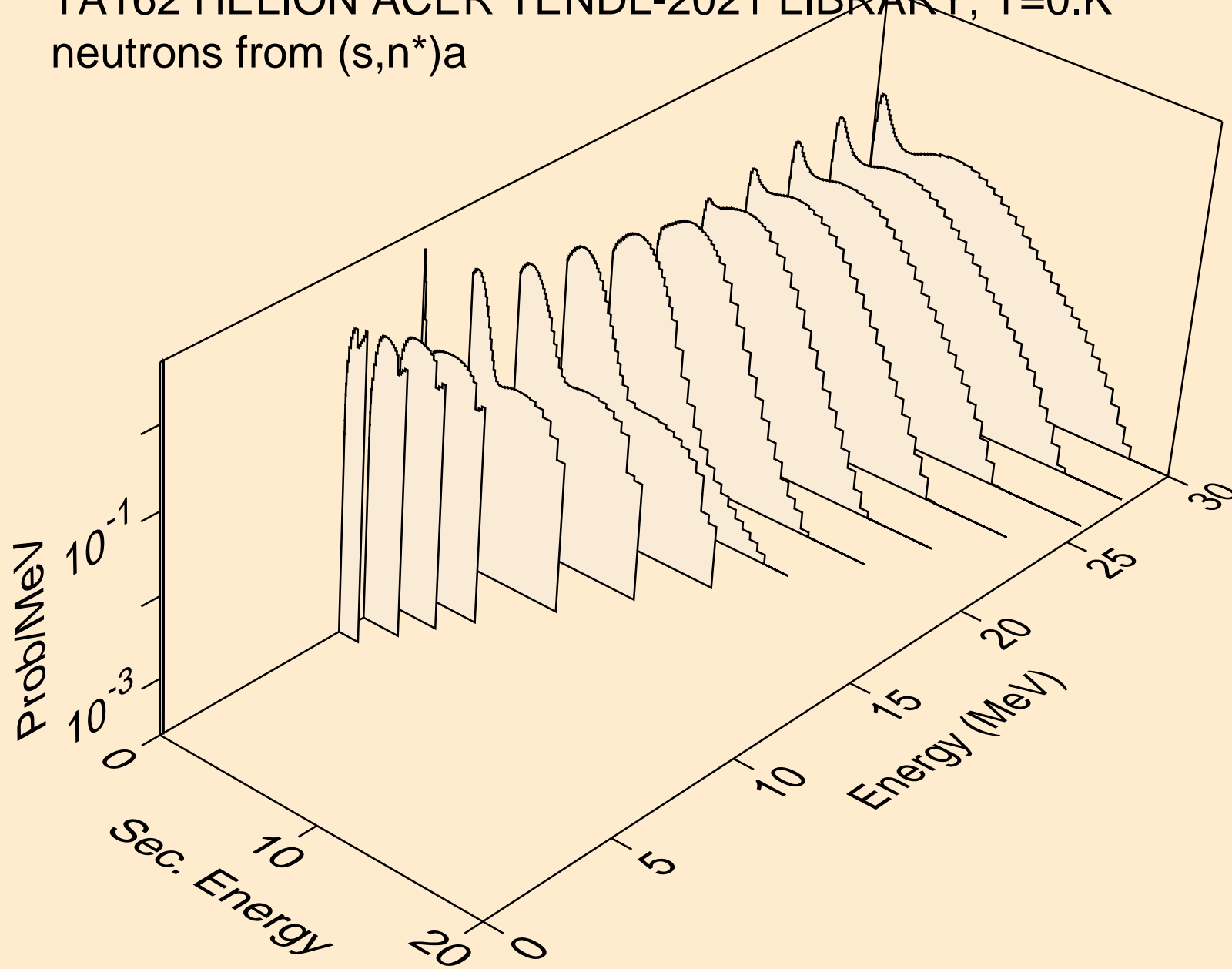

TA162 HELION ACER TENDL-2021 LIBRARY; T=0.K
neutrons from (s,2n)a

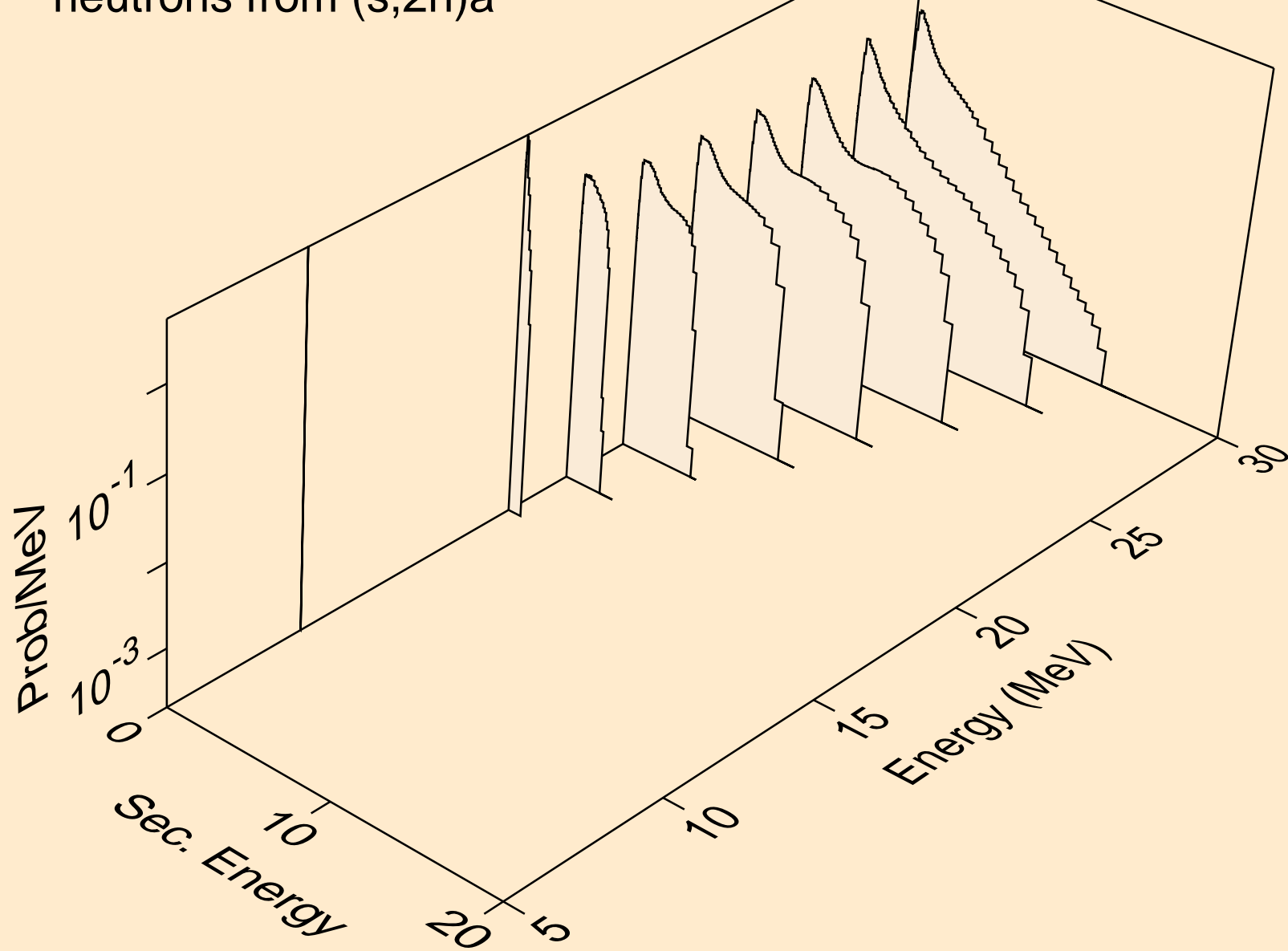

TA162 HELION ACER TENDL-2021 LIBRARY; T=0.K
neutrons from (s,n*)p

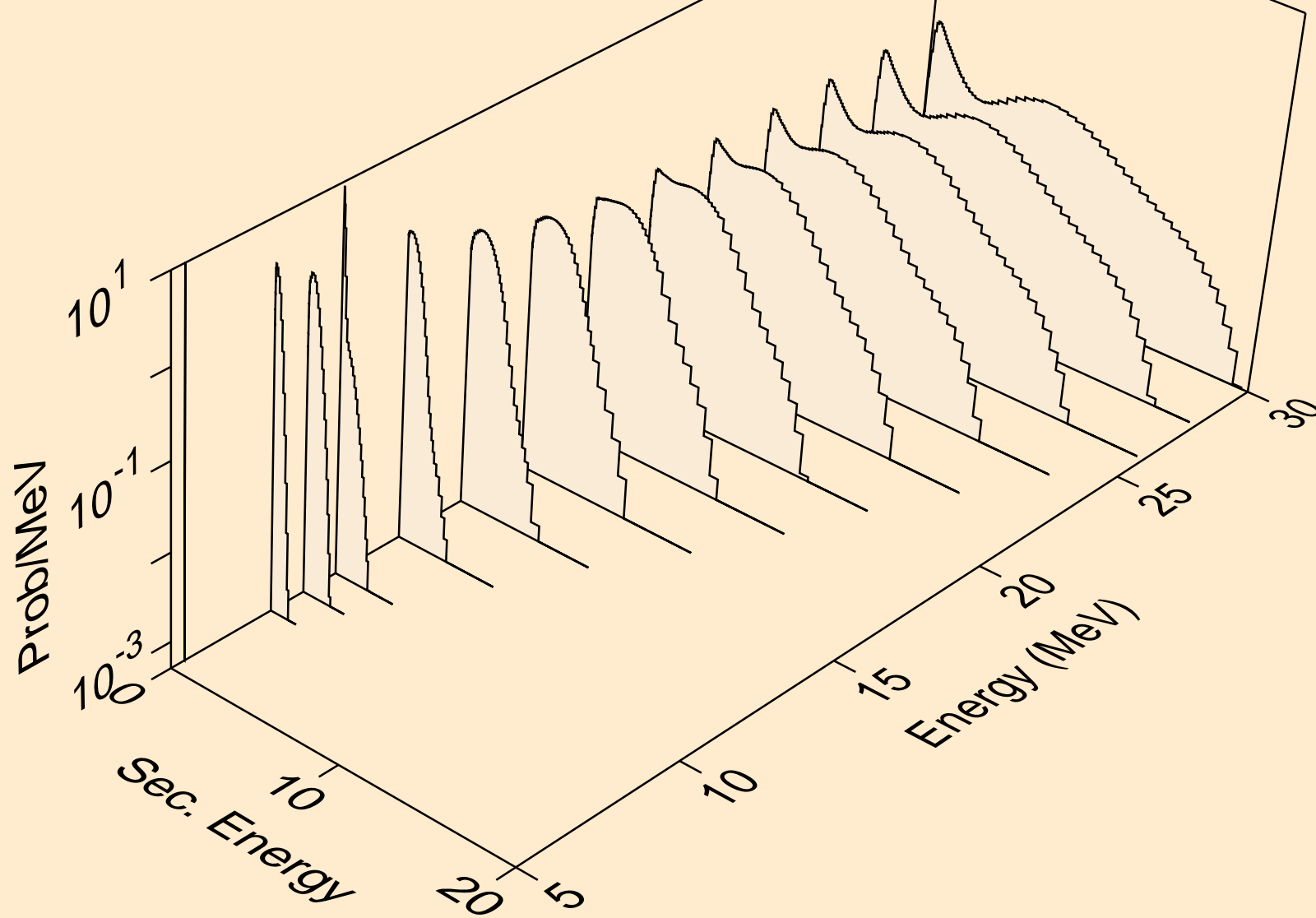

TA162 HELION ACER TENDL-2021 LIBRARY; T=0.K
neutrons from (s,n*)2a

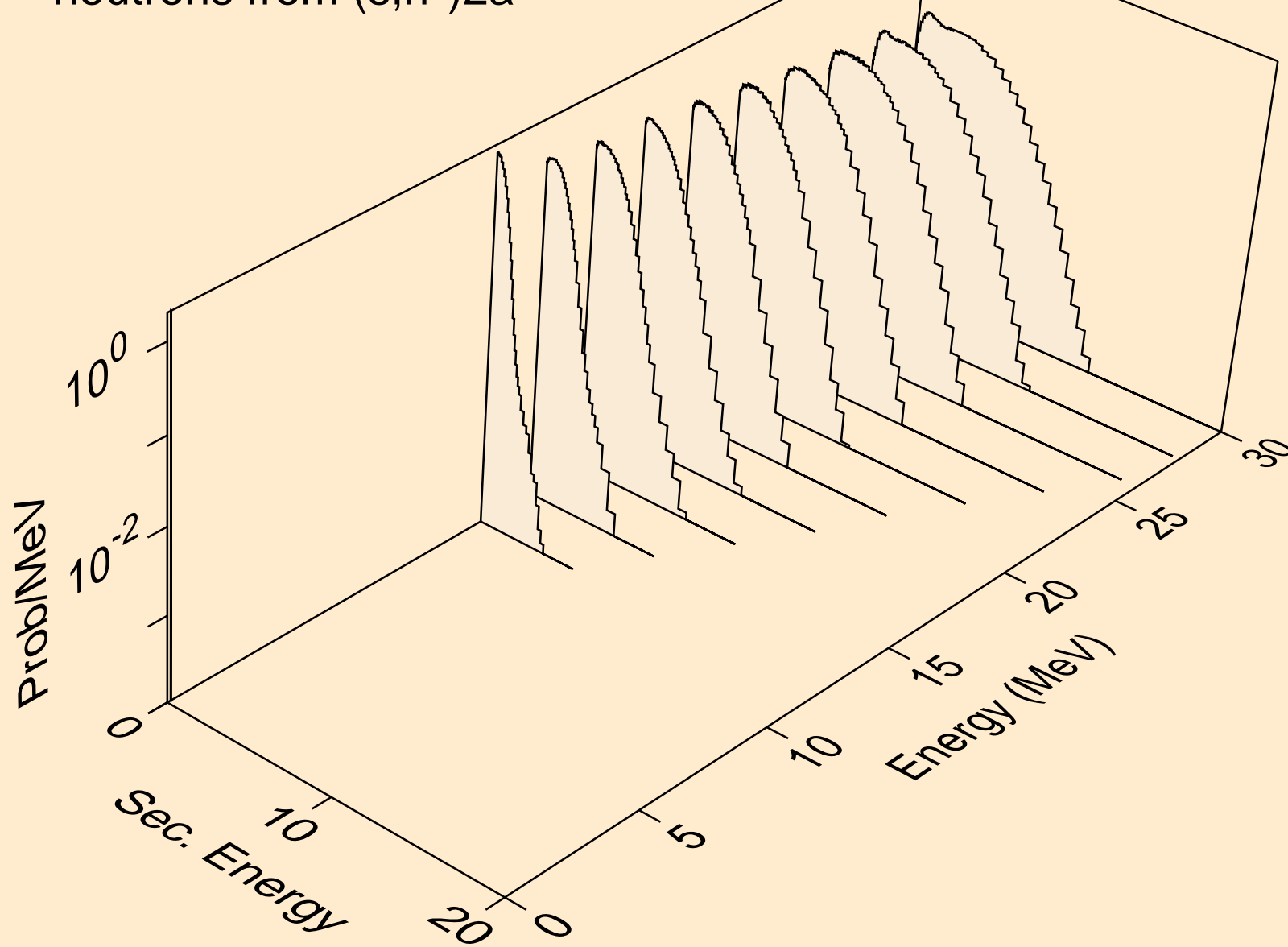

TA162 HELION ACER TENDL-2021 LIBRARY; T=0.K
neutrons from (s,2n)2a

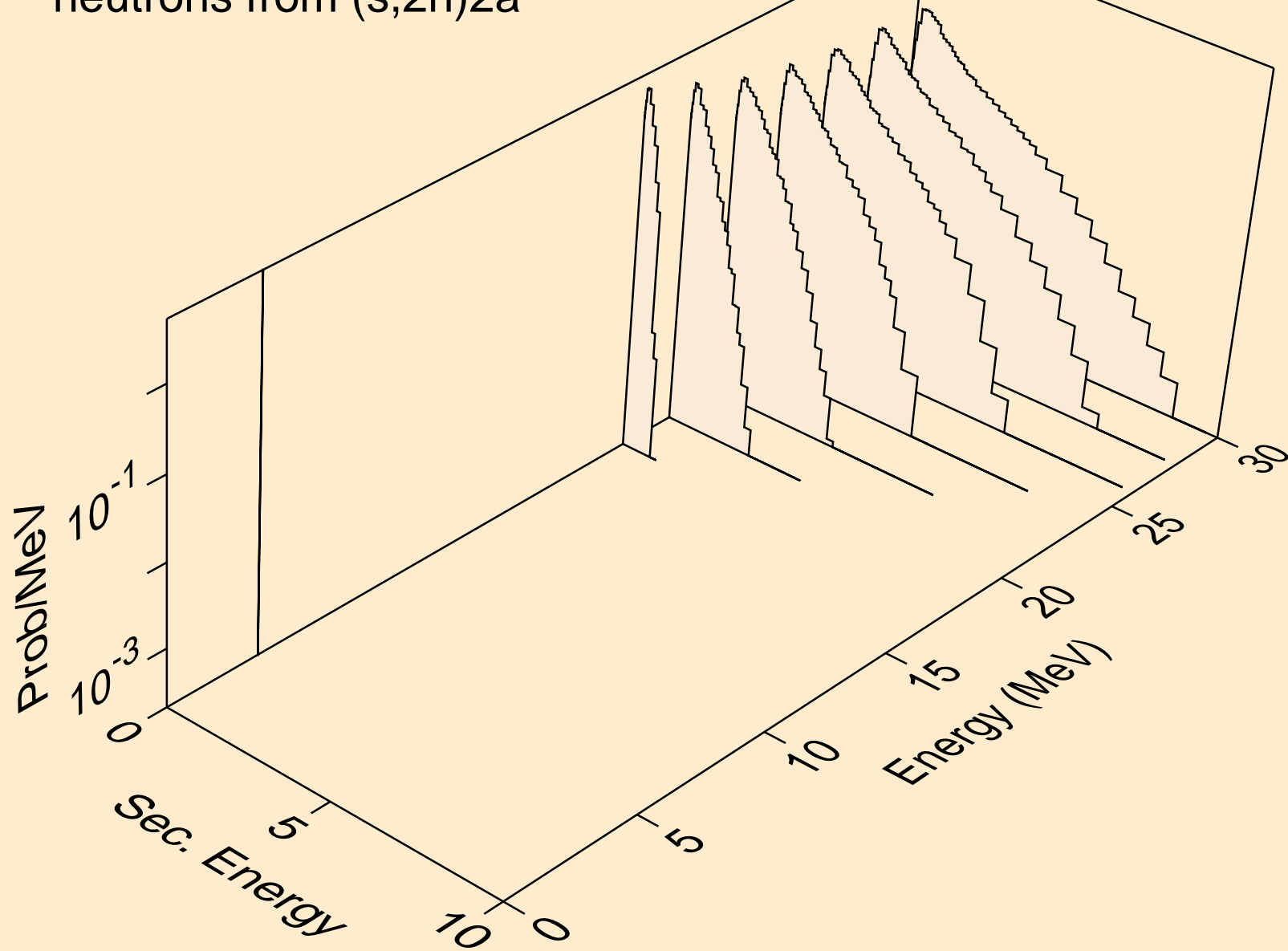

TA162 HELION ACER TENDL-2021 LIBRARY; T=0.K
neutrons from (s,n*)d

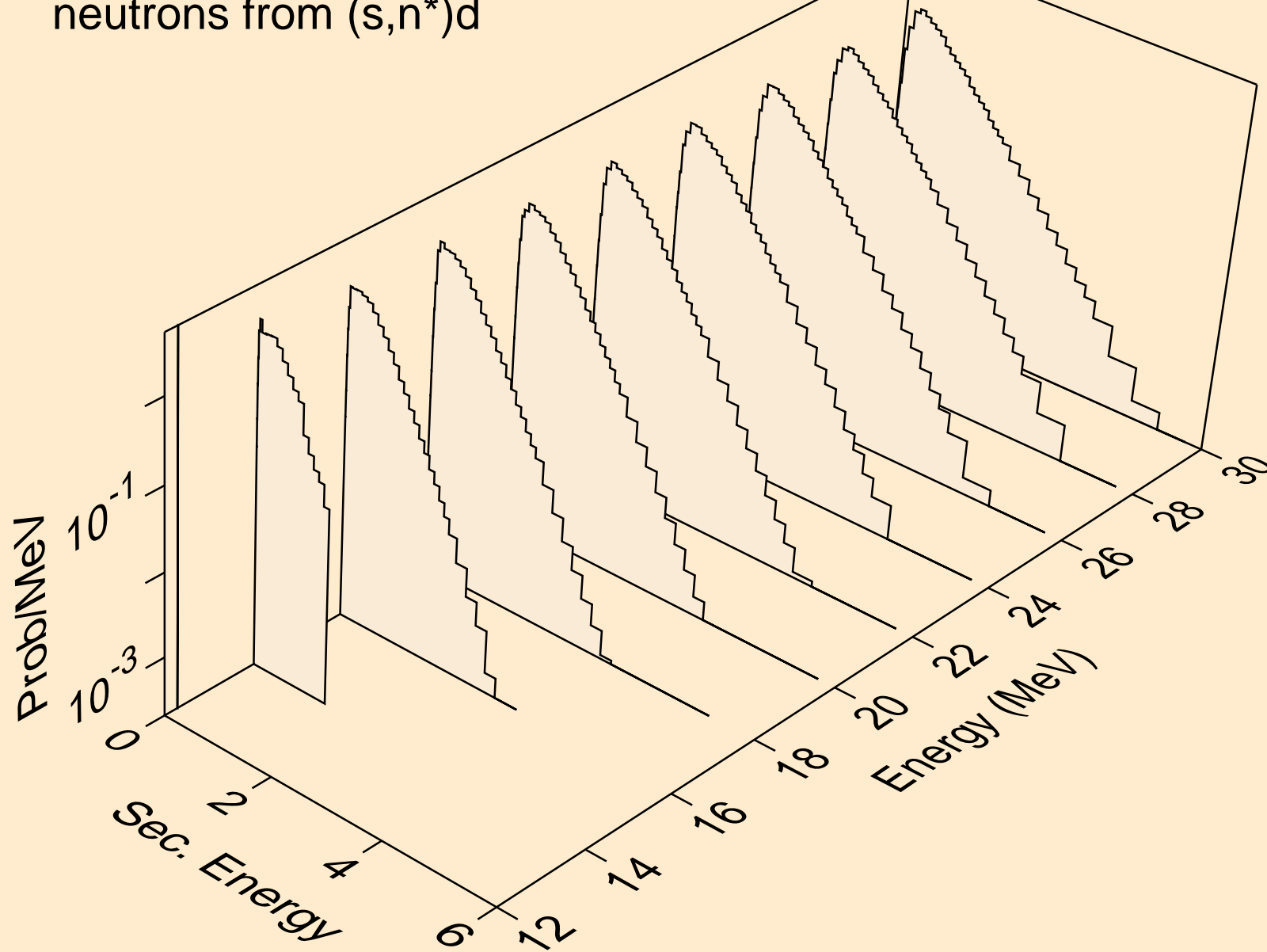

TA162 HELION ACER TENDL-2021 LIBRARY; T=0.K
neutrons from (s,n*)t

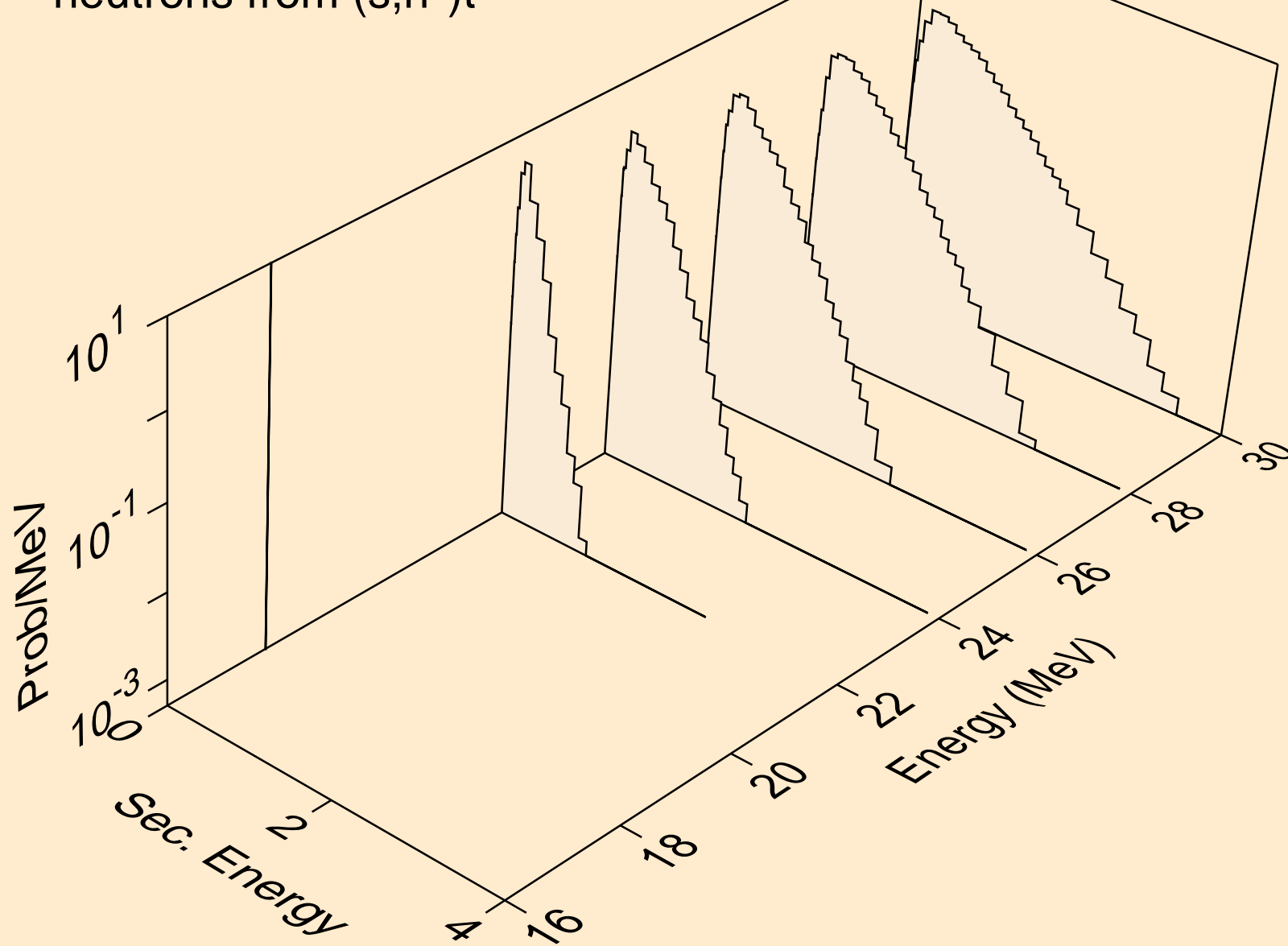

TA162 HELION ACER TENDL-2021 LIBRARY; T=0.K
neutrons from (s,n*)he3

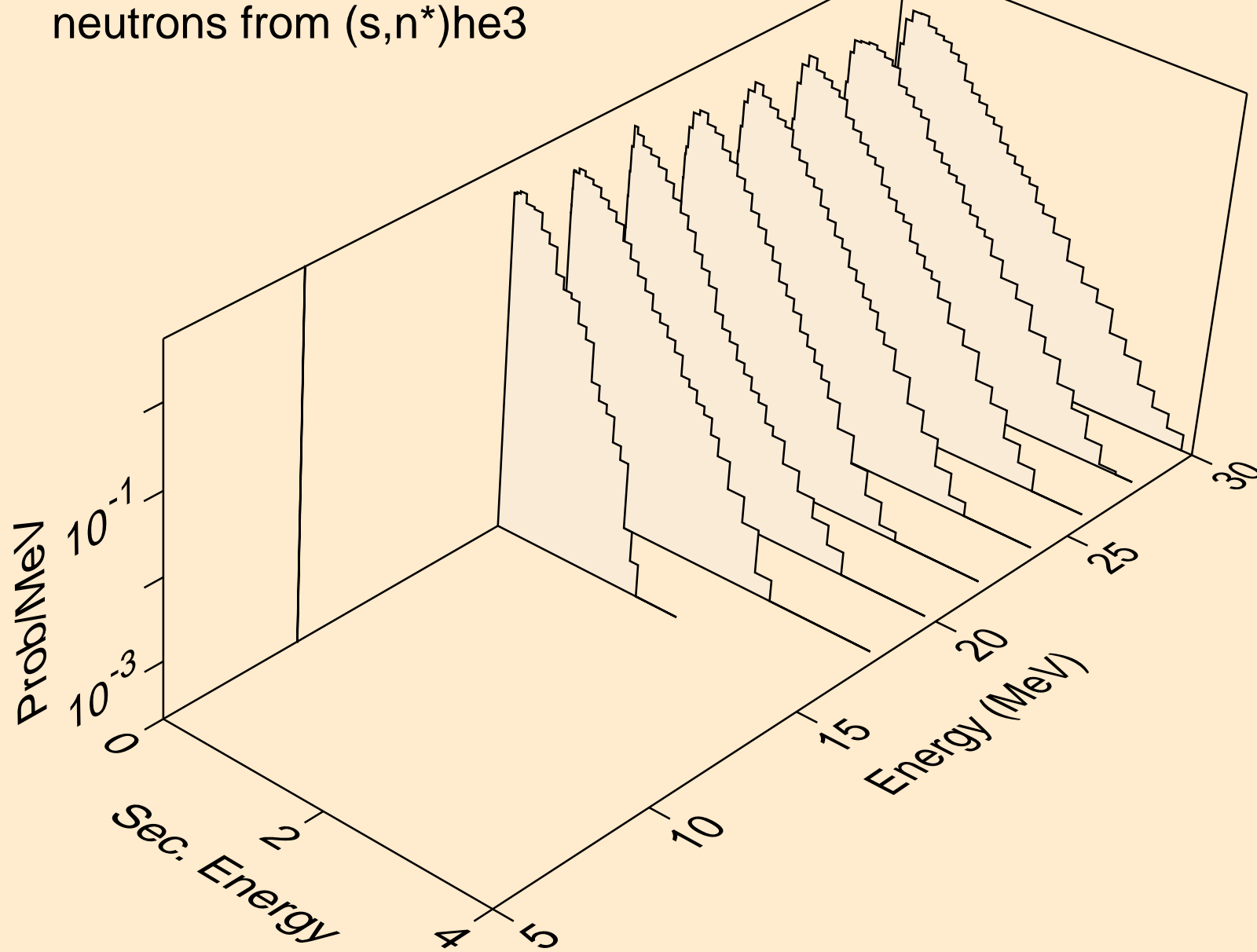

TA162 HELION ACER TENDL-2021 LIBRARY; T=0.K
neutrons from (s,2np)

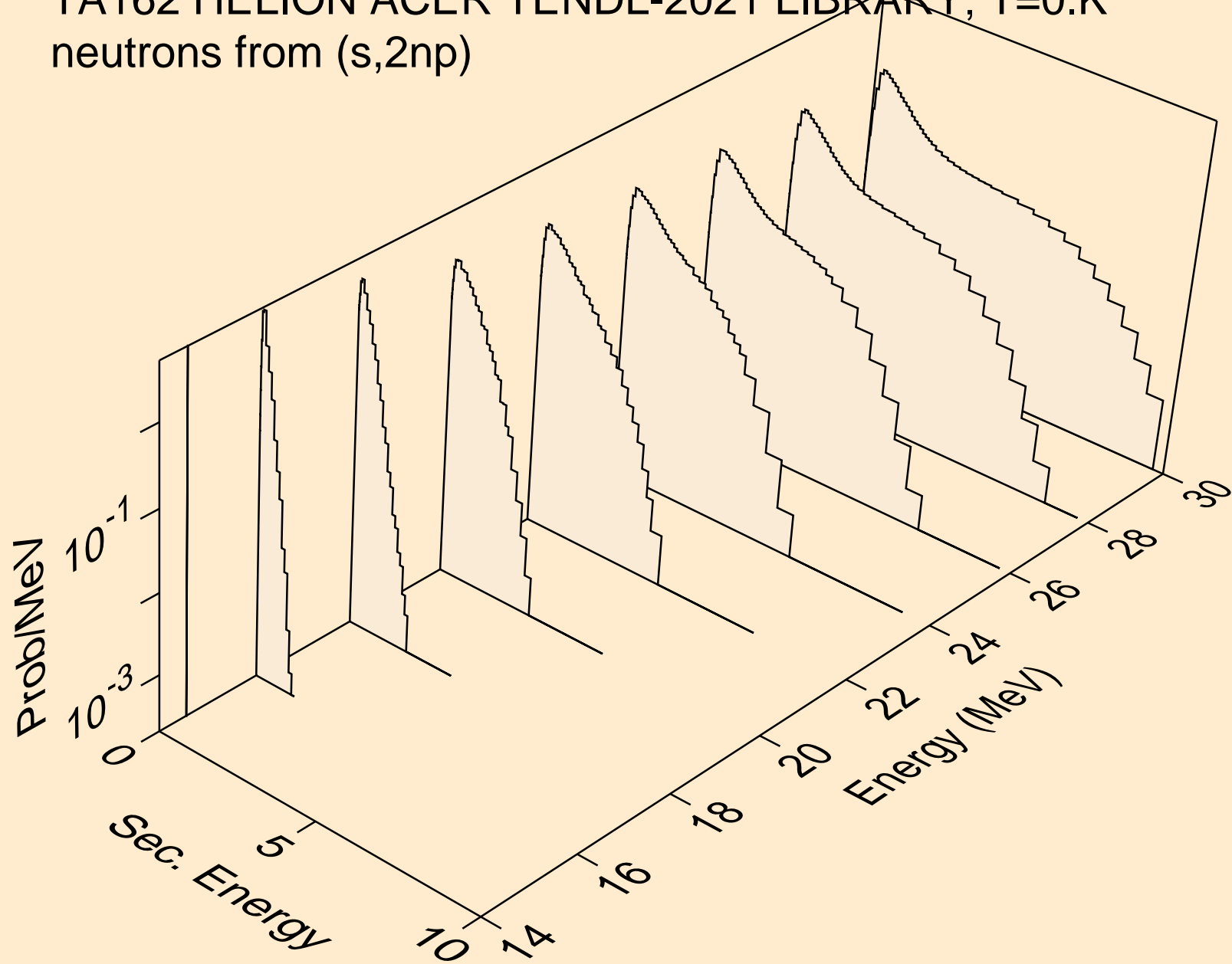

TA162 HELION ACER TENDL-2021 LIBRARY; T=0.K
neutrons from (s,2np)

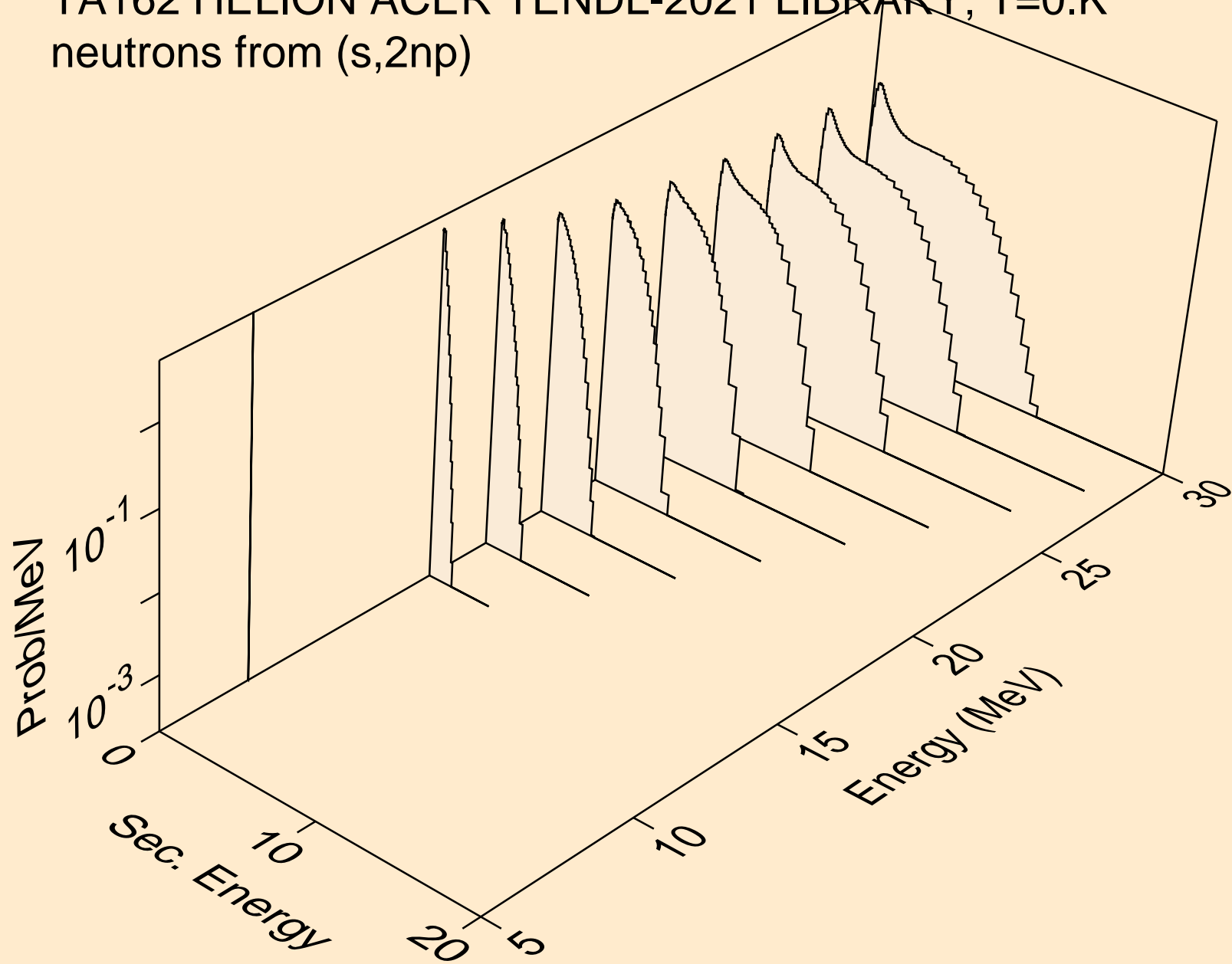

TA162 HELION ACER TENDL-2021 LIBRARY; T=0.K
neutrons from (s,npa)

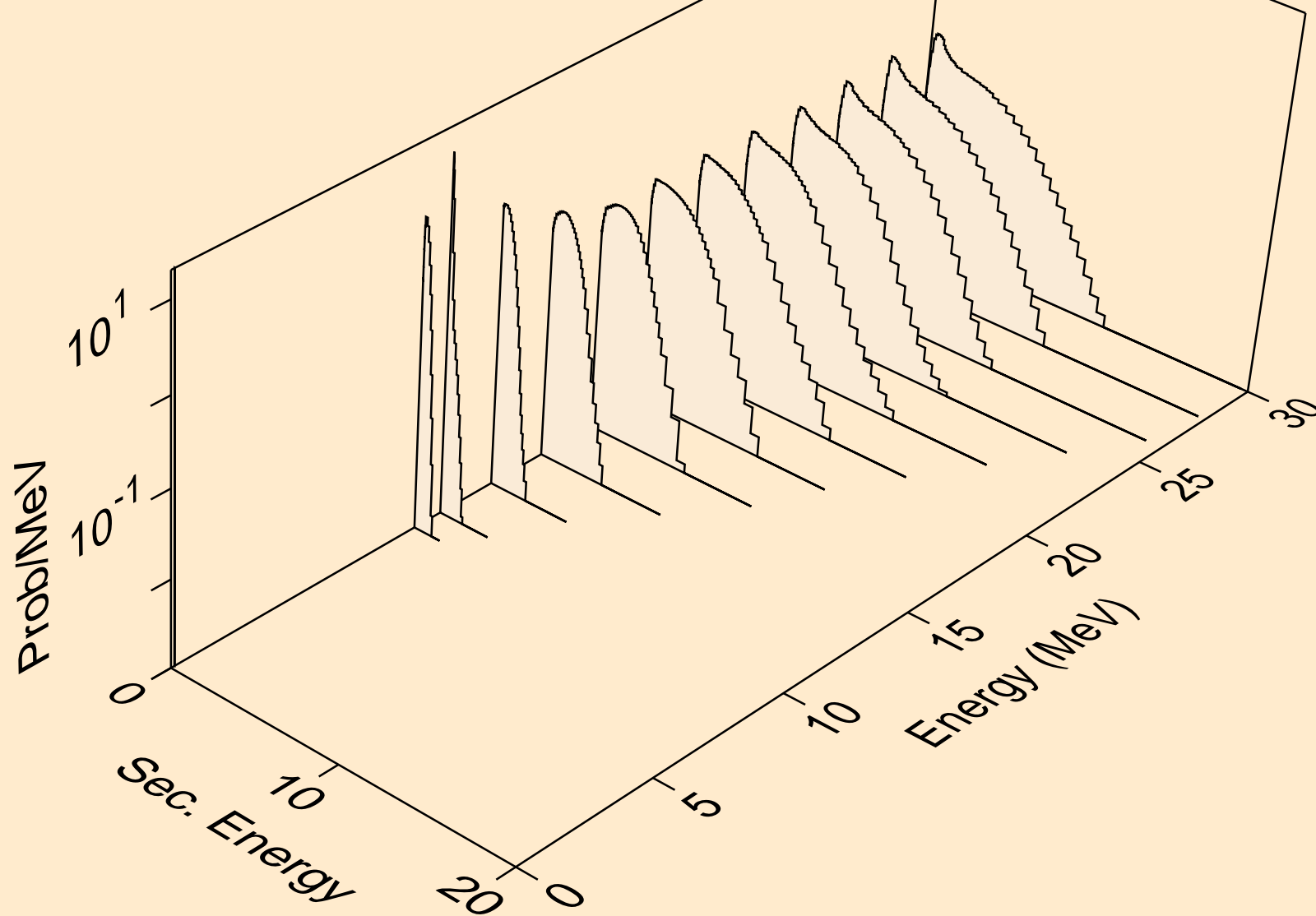

TA162 HELION ACER TENDL-2021 LIBRARY; T=0.K
protons from (s,x)

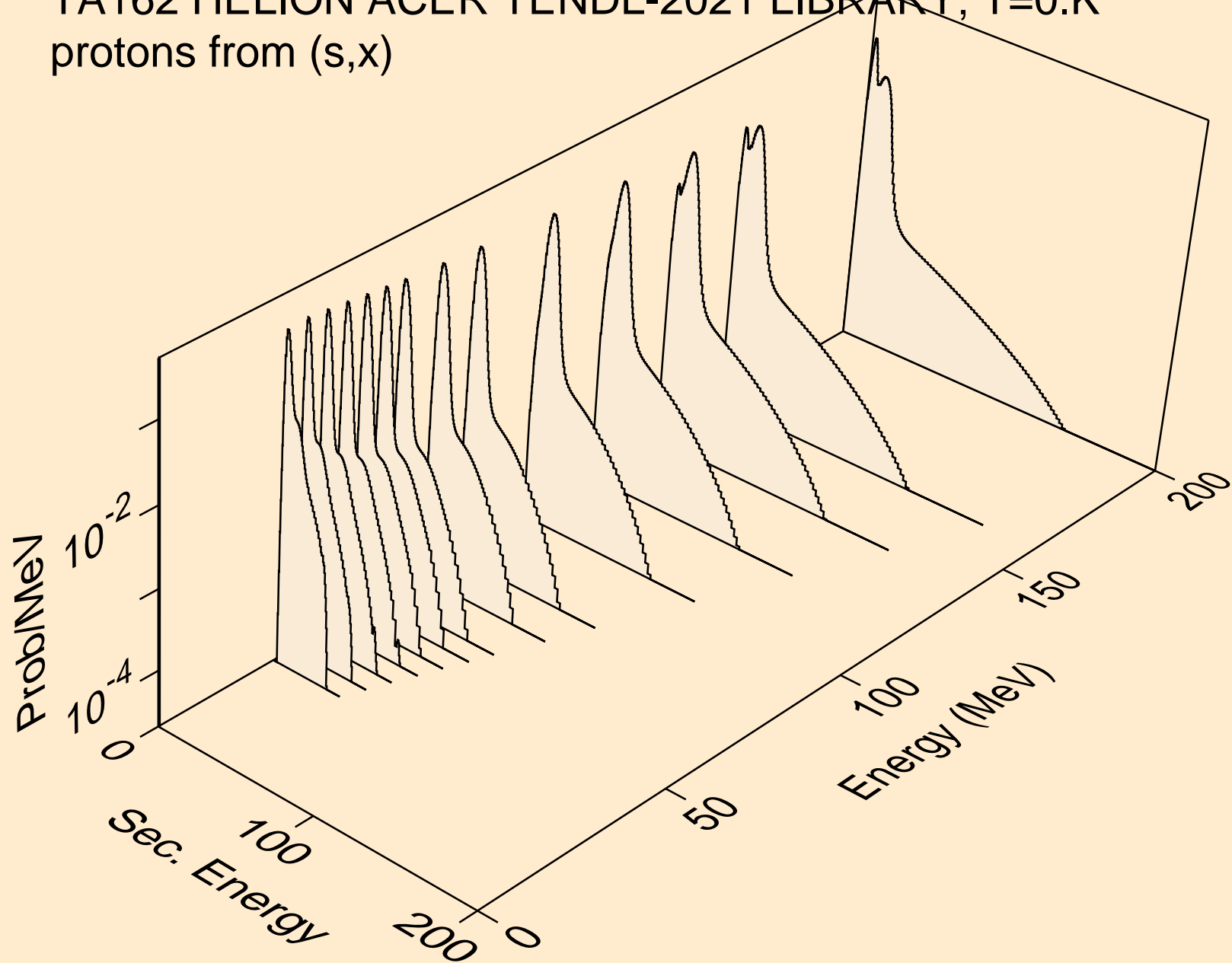

TA162 HELION ACER TENDL-2021 LIBRARY; T=0.K
protons from (s,n*)p

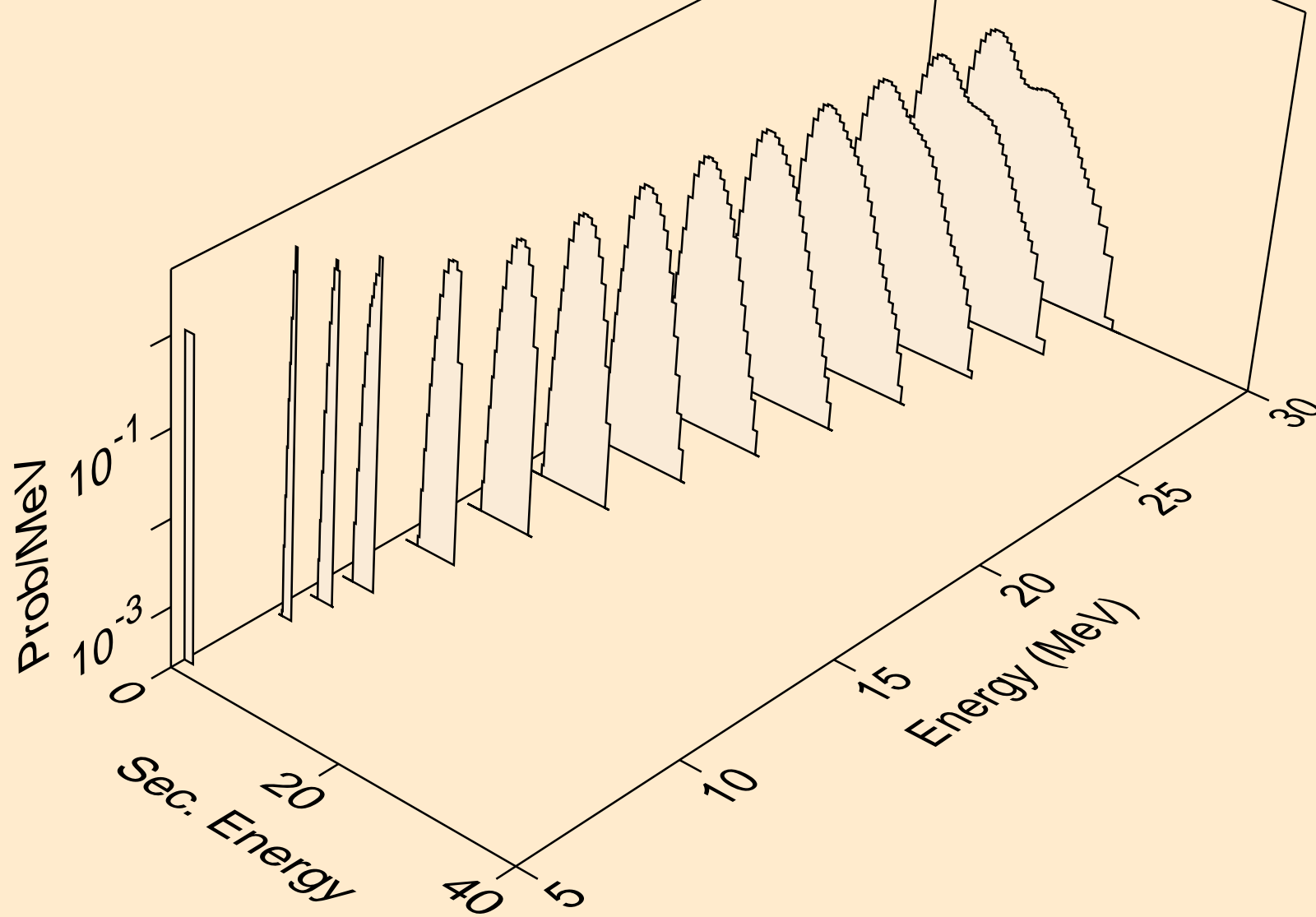

TA162 HELION ACER TENDL-2021 LIBRARY; T=0.K
protons from (s,2np)

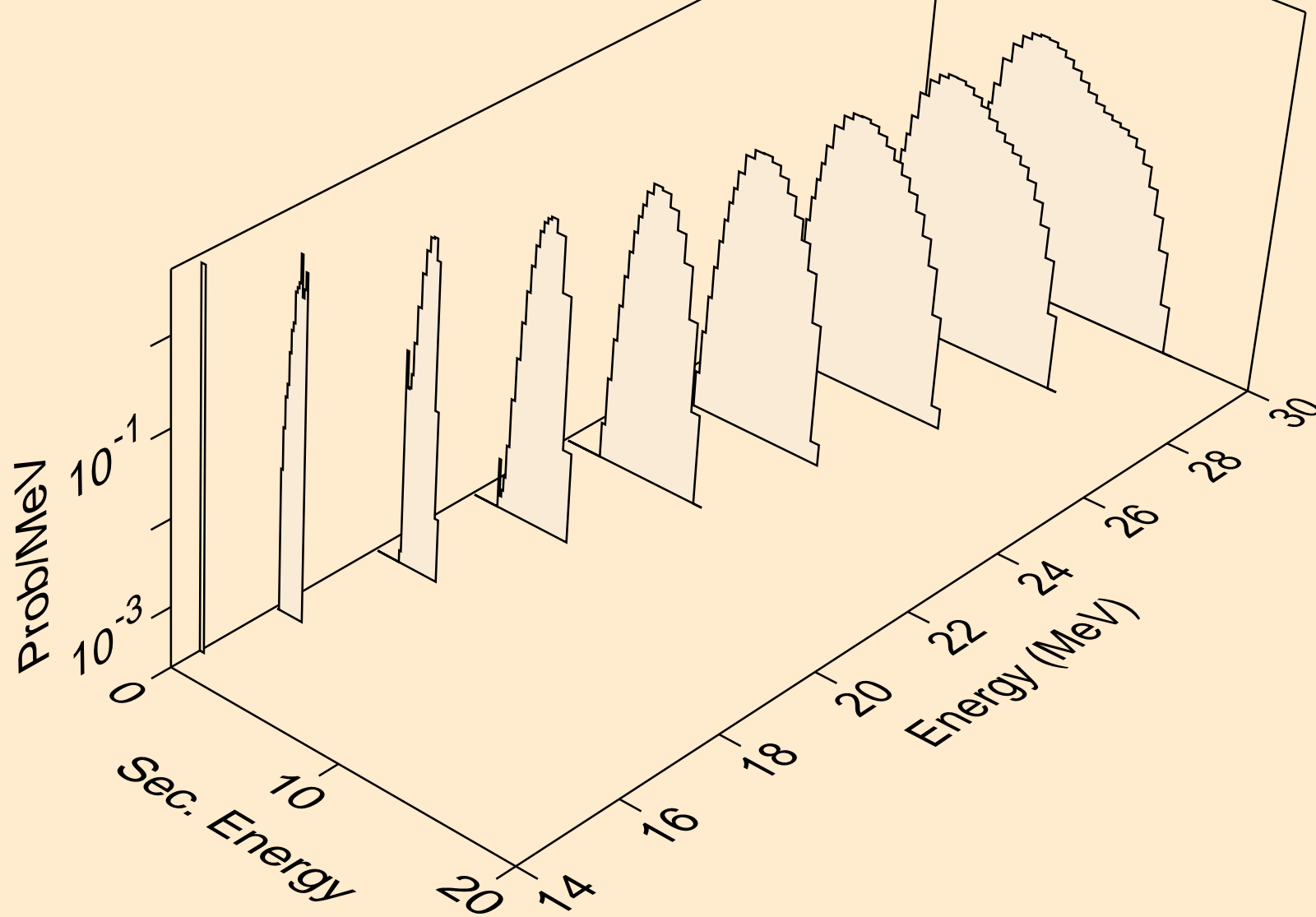

TA162 HELION ACER TENDL-2021 LIBRARY; T=0.K
protons from (s,2np)

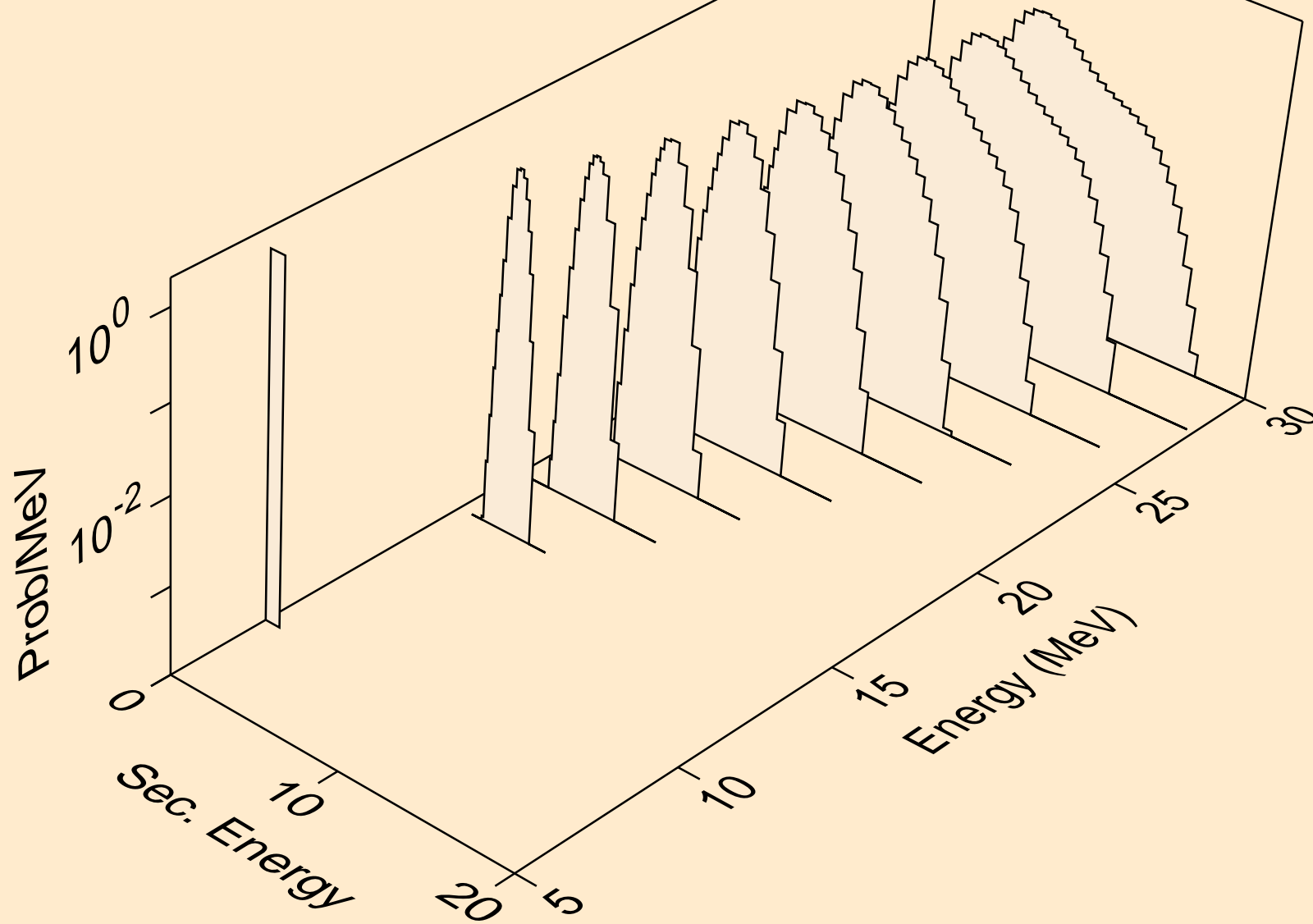

TA162 HELION ACER TENDL-2021 LIBRARY; T=0.K
protons from (s,npa)

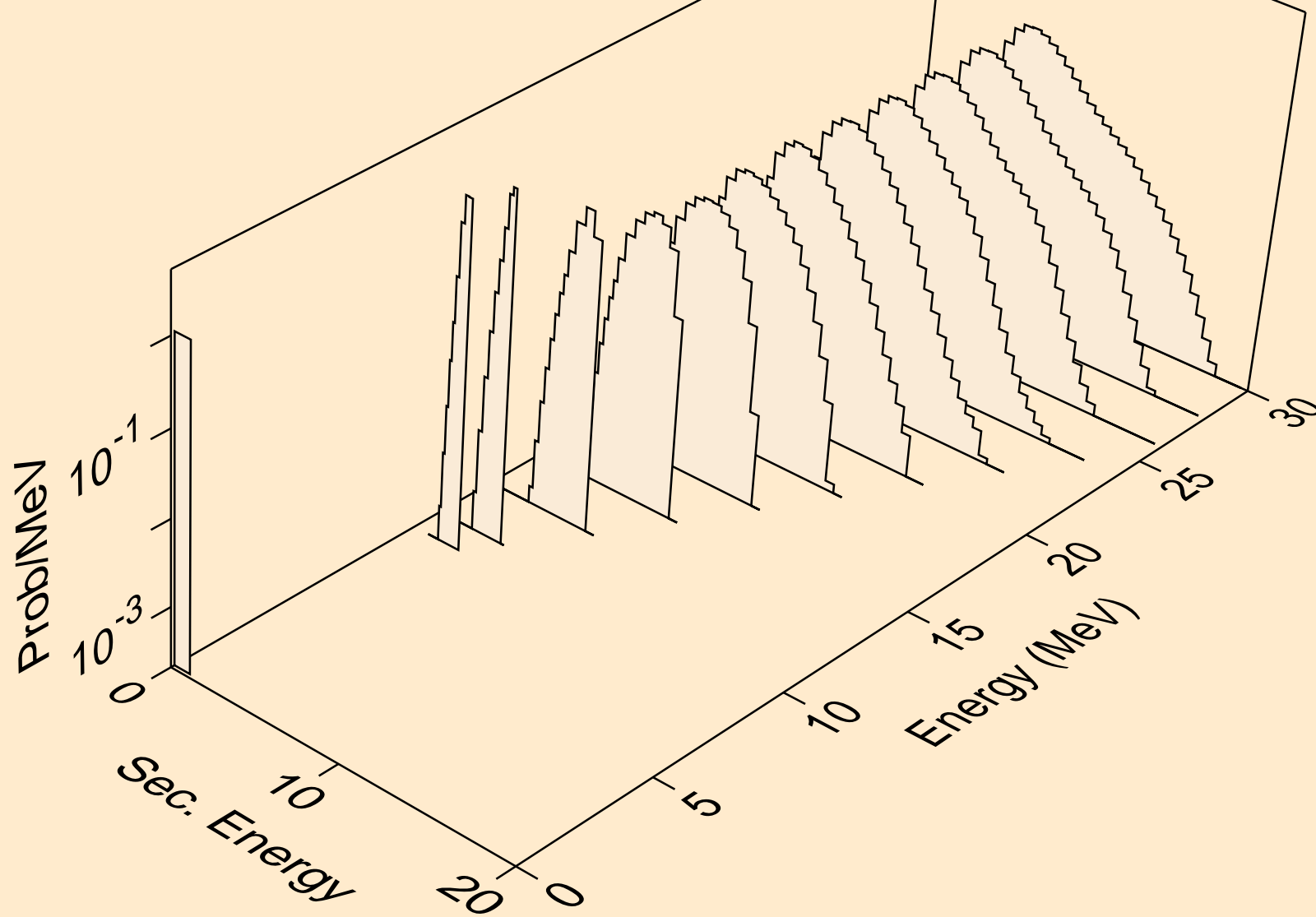

TA162 HELION ACER TENDL-2021 LIBRARY; T=0.K
protons from (s,p)

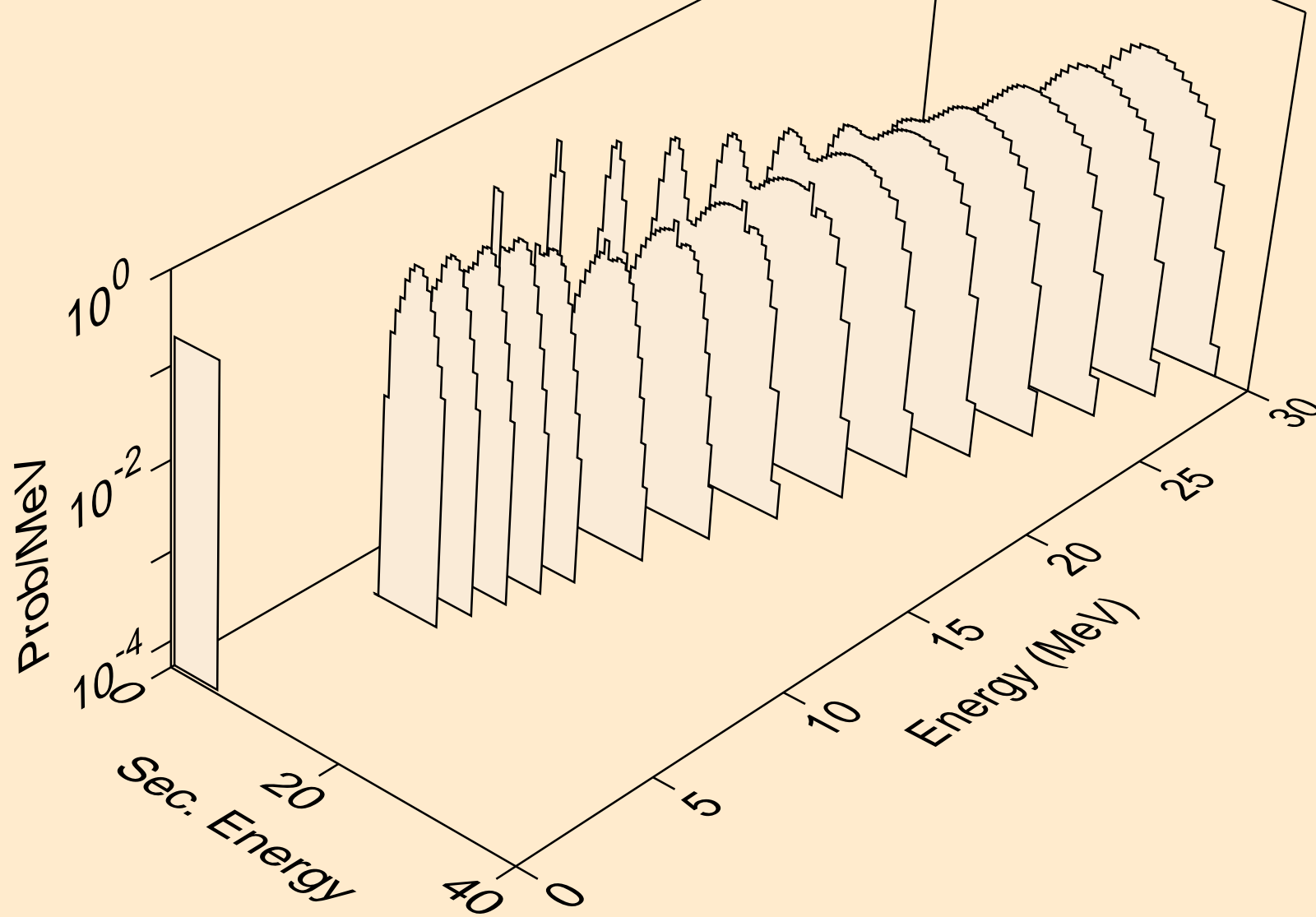

TA162 HELION ACER TENDL-2021 LIBRARY; T=0.K
protons from (s,2p)

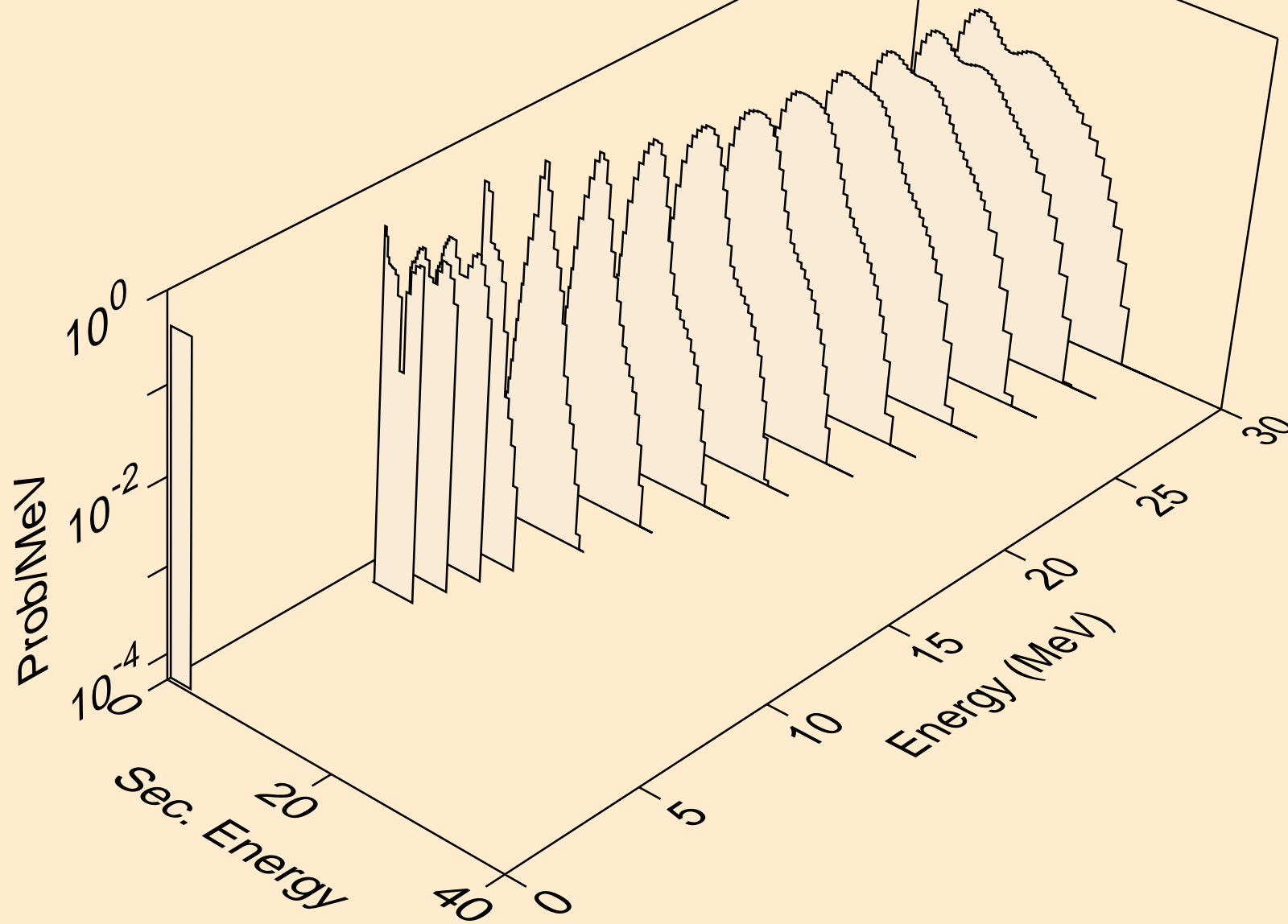

TA162 HELION ACER TENDL-2021 LIBRARY; T=0.K
protons from (s,pa)

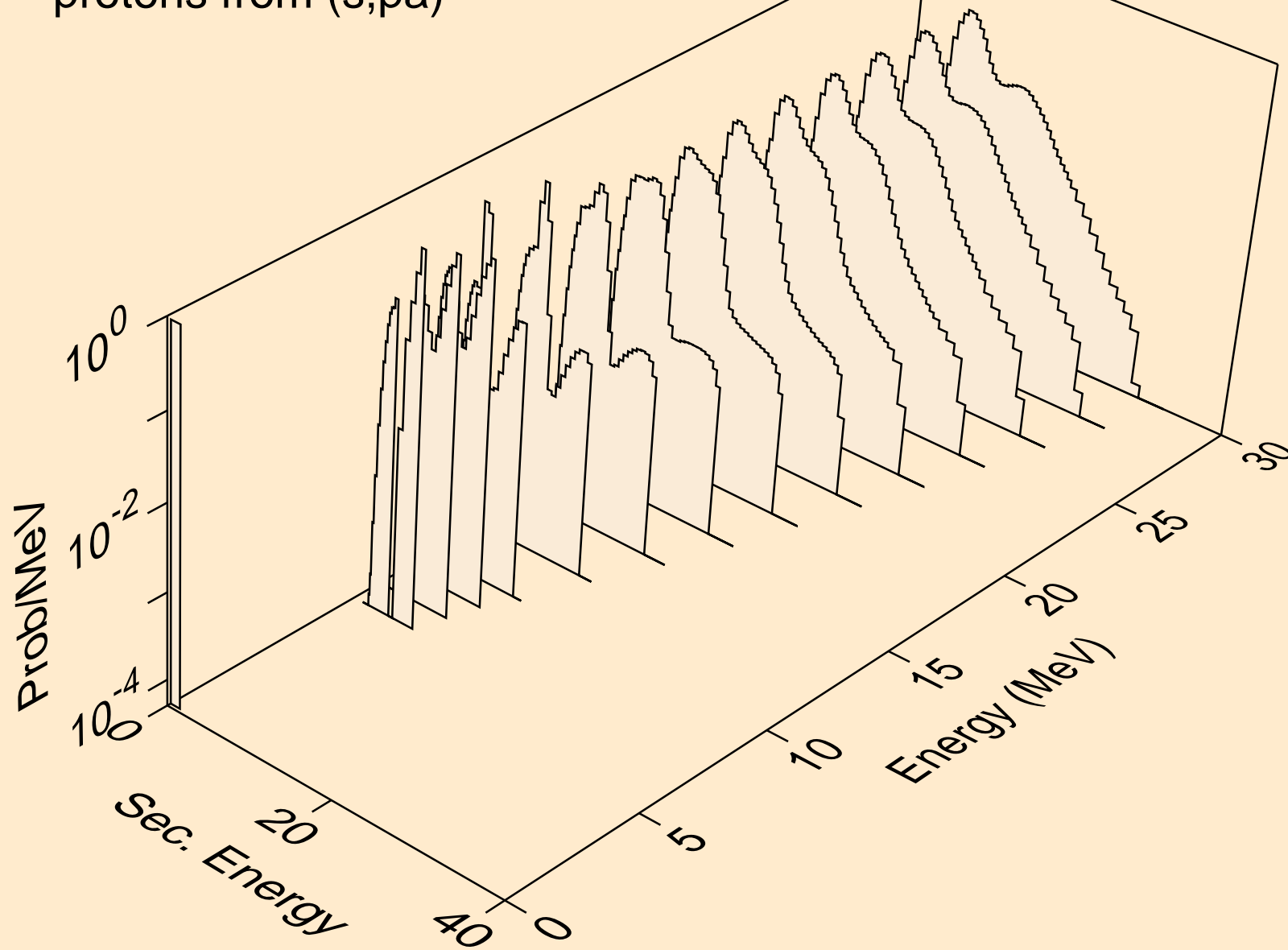

TA162 HELION ACER TENDL-2021 LIBRARY; T=0.K
protons from (s,pd)

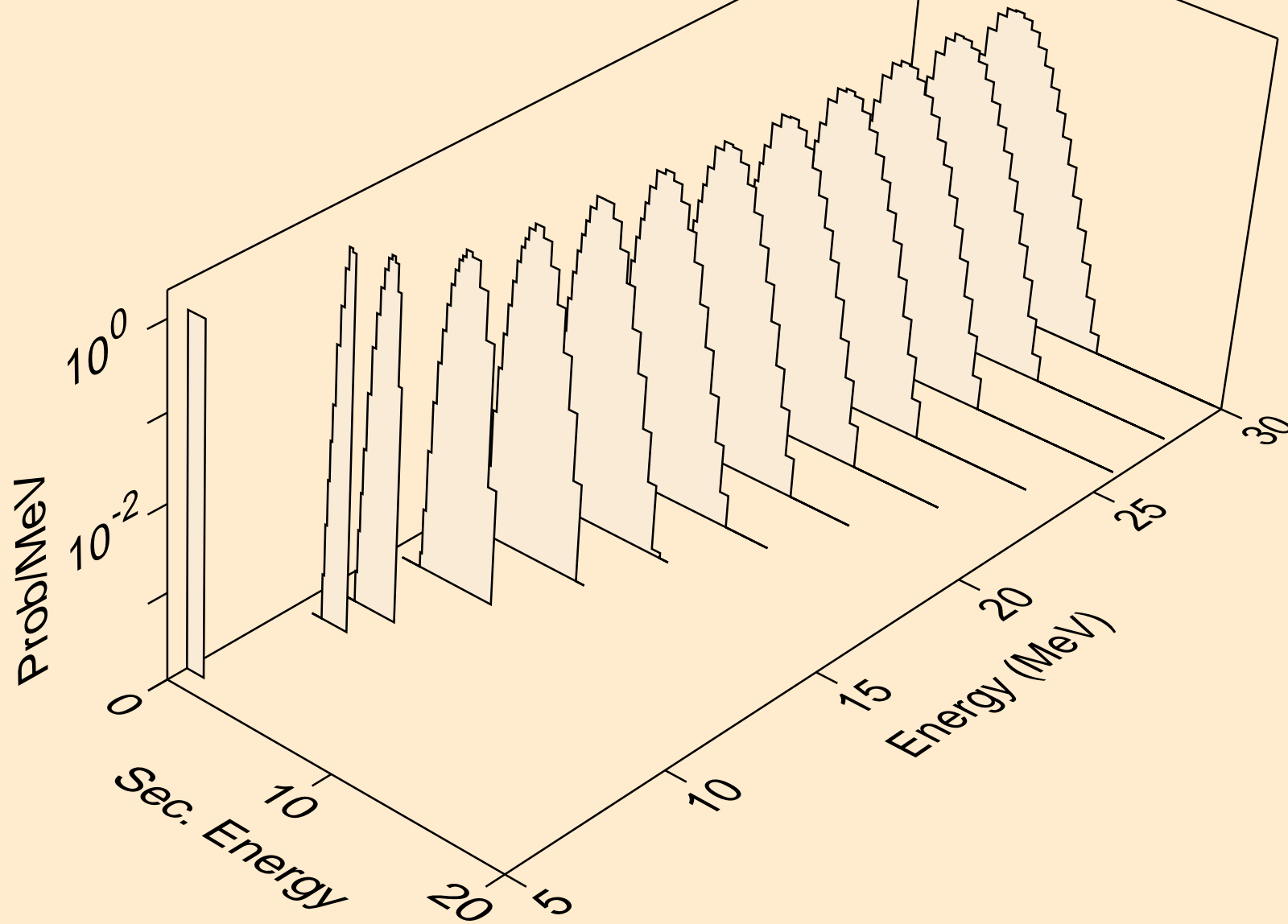

TA162 HELION ACER TENDL-2021 LIBRARY; T=0.K
protons from (s,pt)

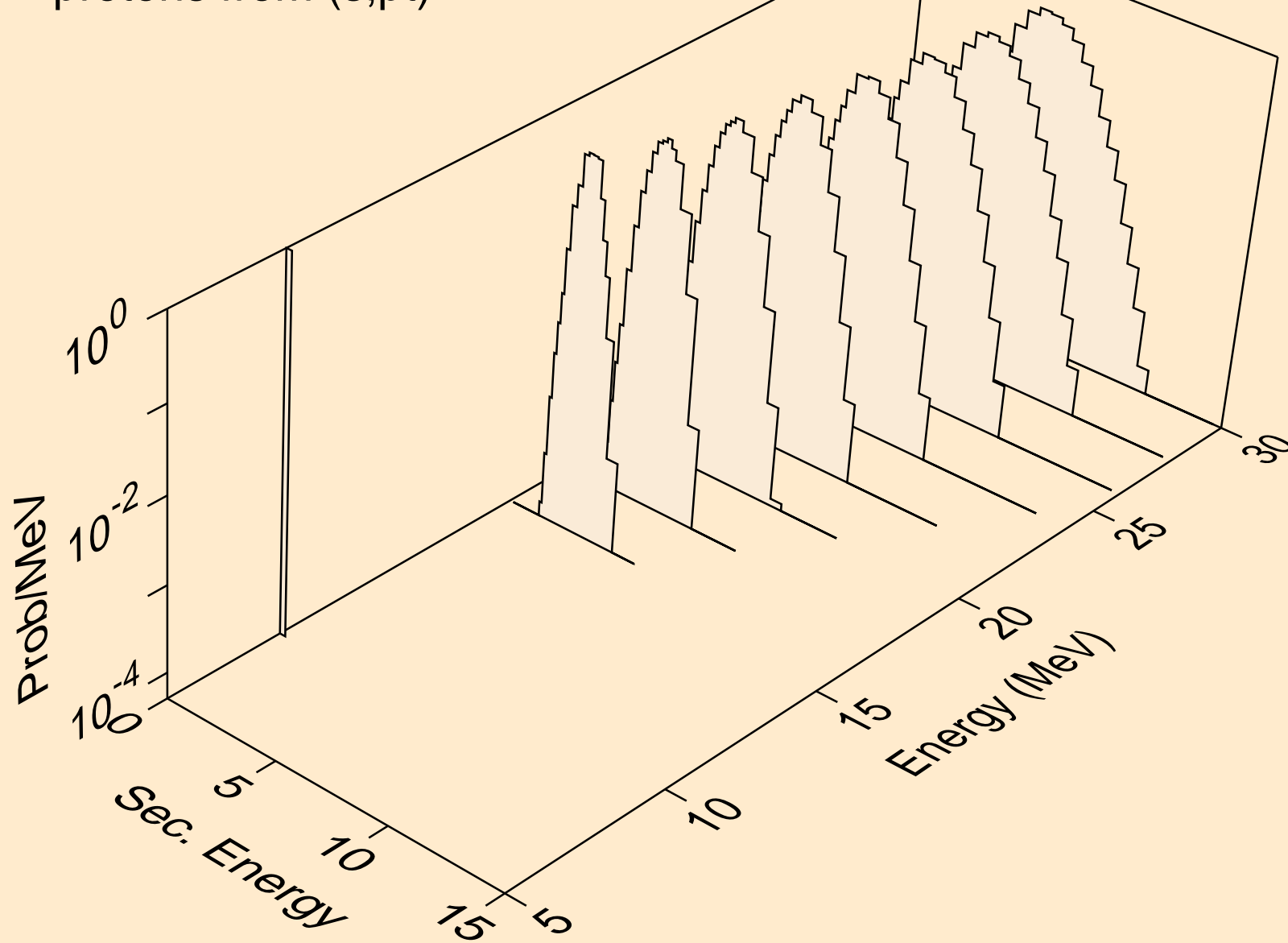

TA162 HELION ACER TENDL-2021 LIBRARY; T=0.K
deuterons from (s,x)

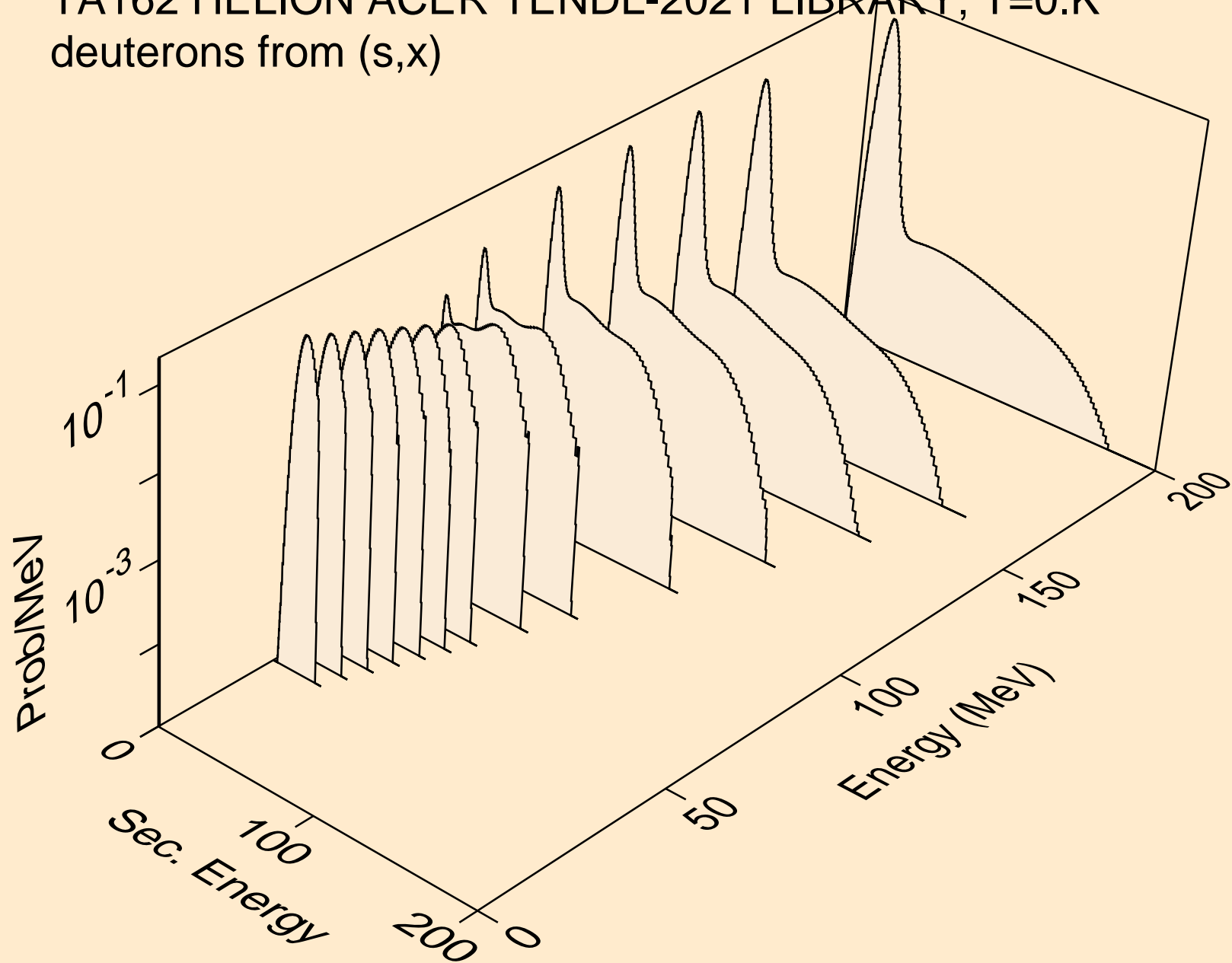

TA162 HELION ACER TENDL-2021 LIBRARY; T=0.K
deuterons from (s,2nd)

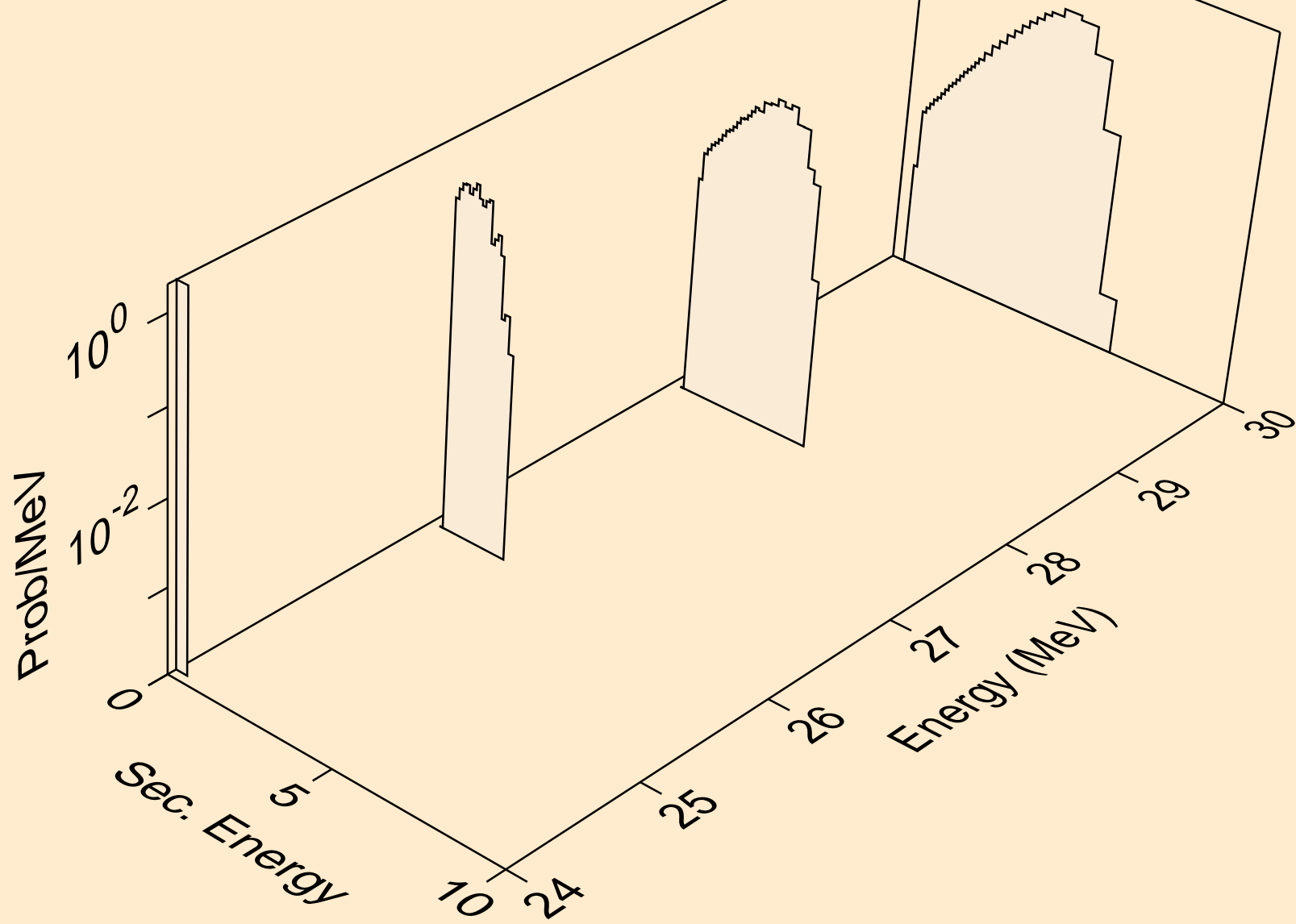

TA162 HELION ACER TENDL-2021 LIBRARY; T=0.K
deuterons from (s,n*)d

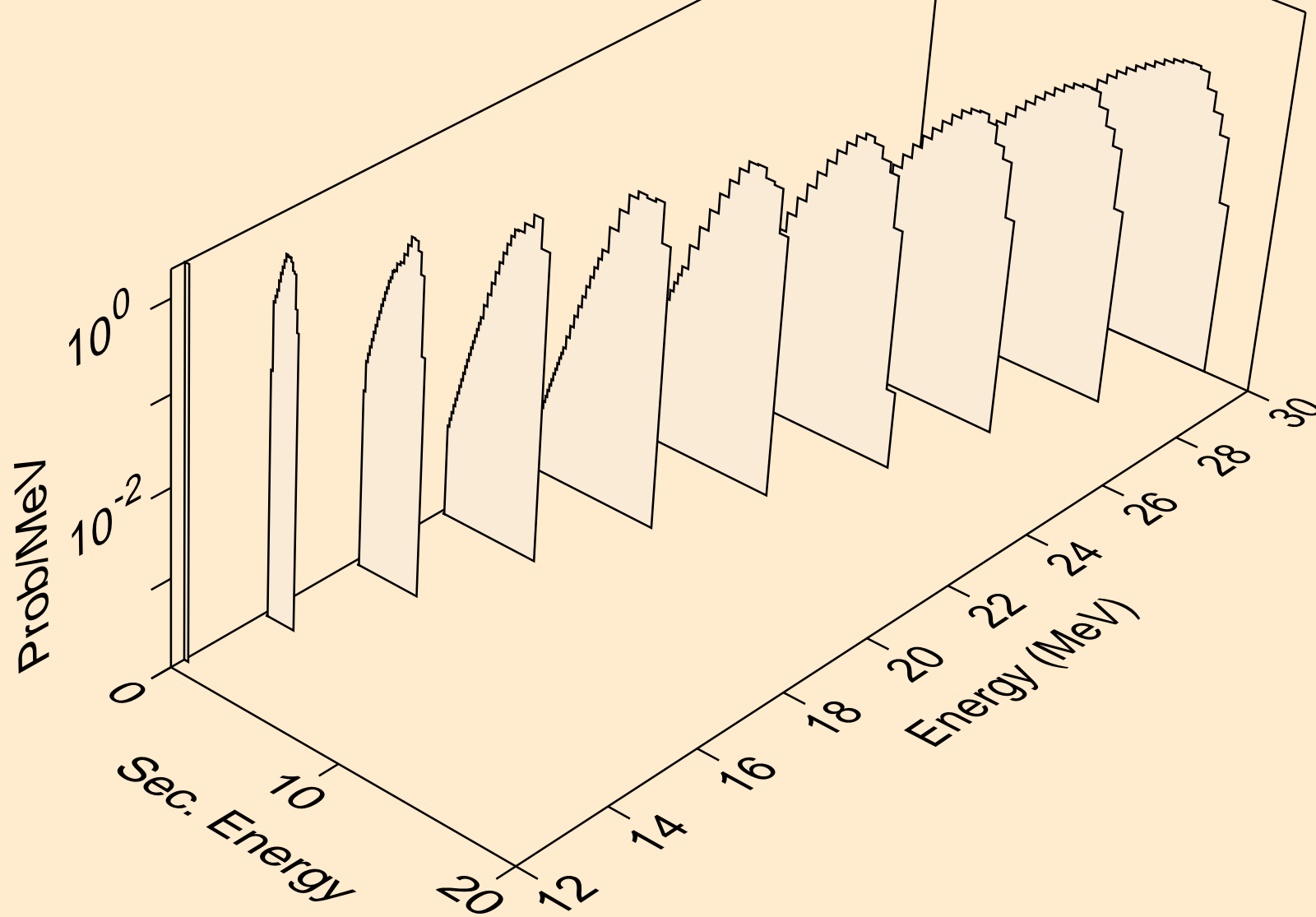

TA162 HELION ACER TENDL-2021 LIBRARY; T=0.K
deuterons from (s,d)

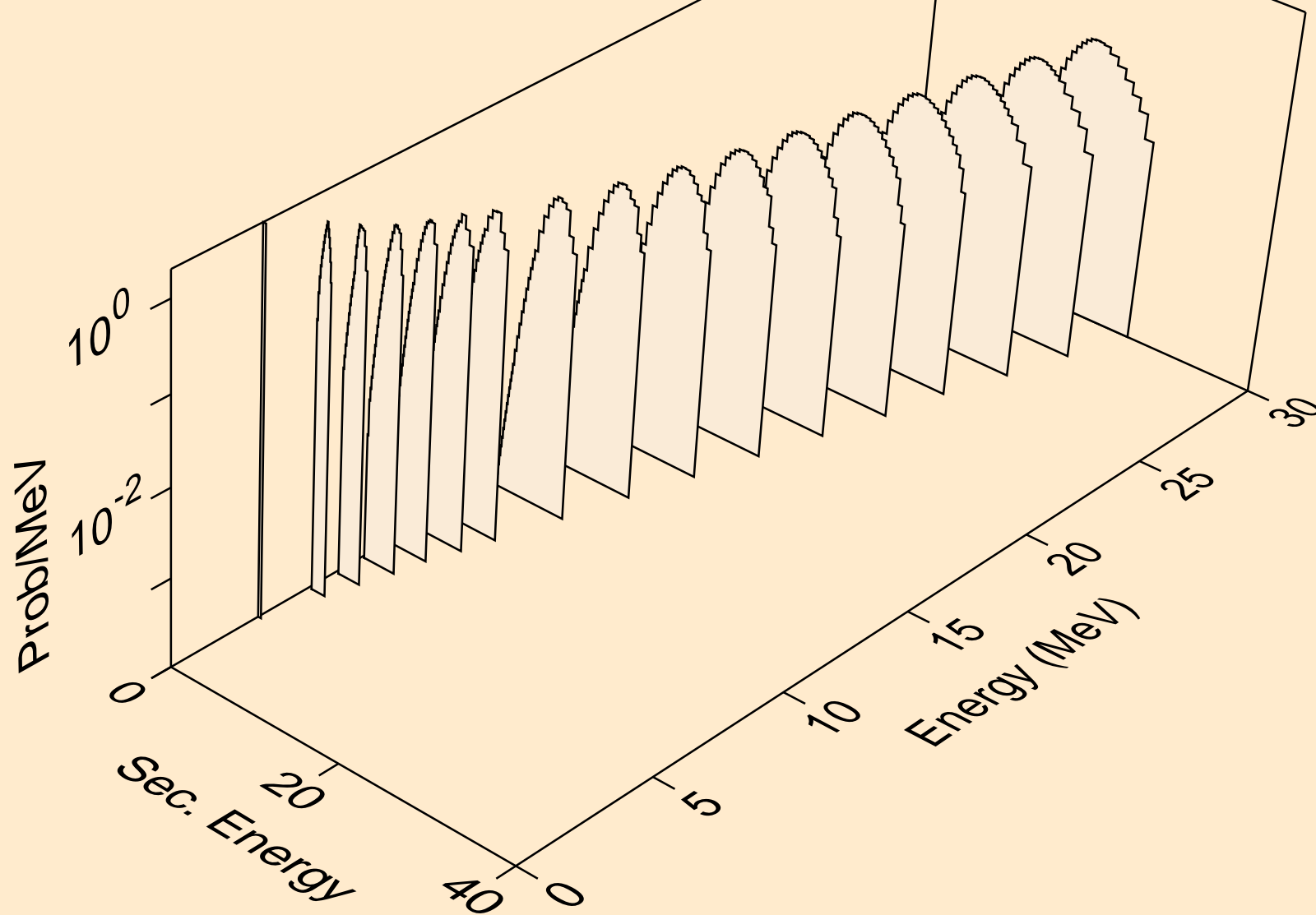

TA162 HELION ACER TENDL-2021 LIBRARY; T=0.K
deuterons from (s,d2a)

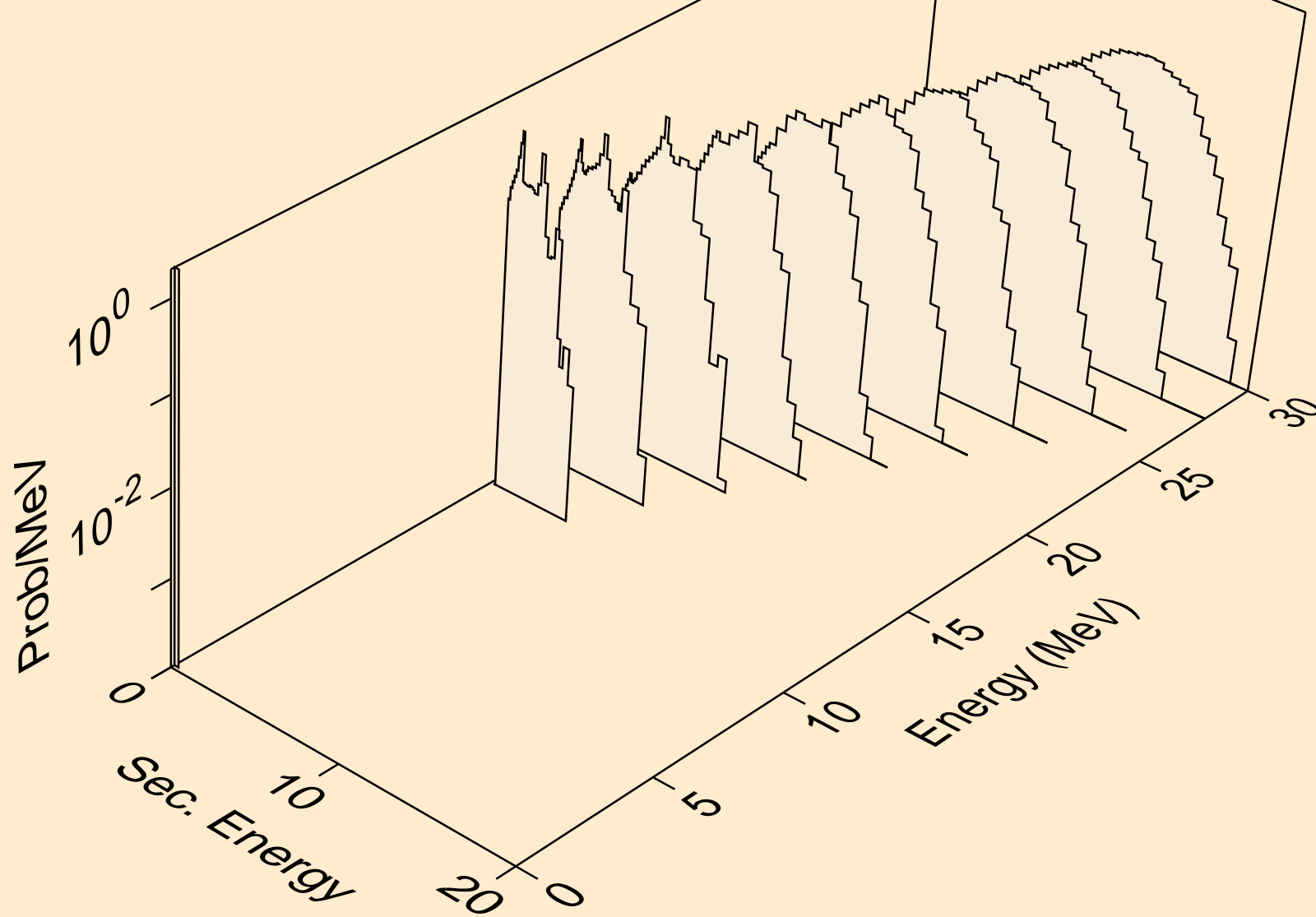

TA162 HELION ACER TENDL-2021 LIBRARY; T=0.K
deuterons from (s,pd)

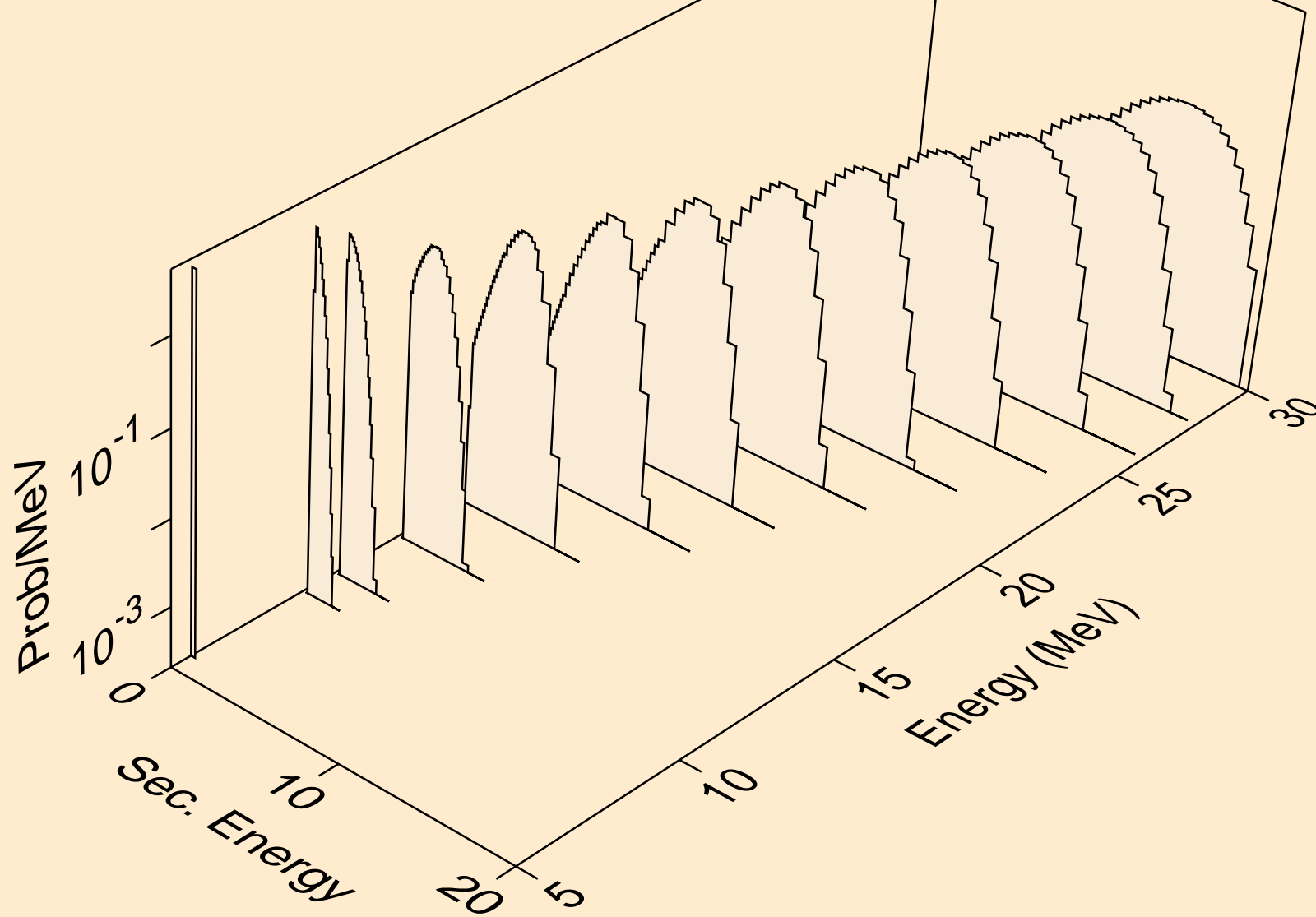

TA162 HELION ACER TENDL-2021 LIBRARY; T=0.K
deuterons from (s,da)

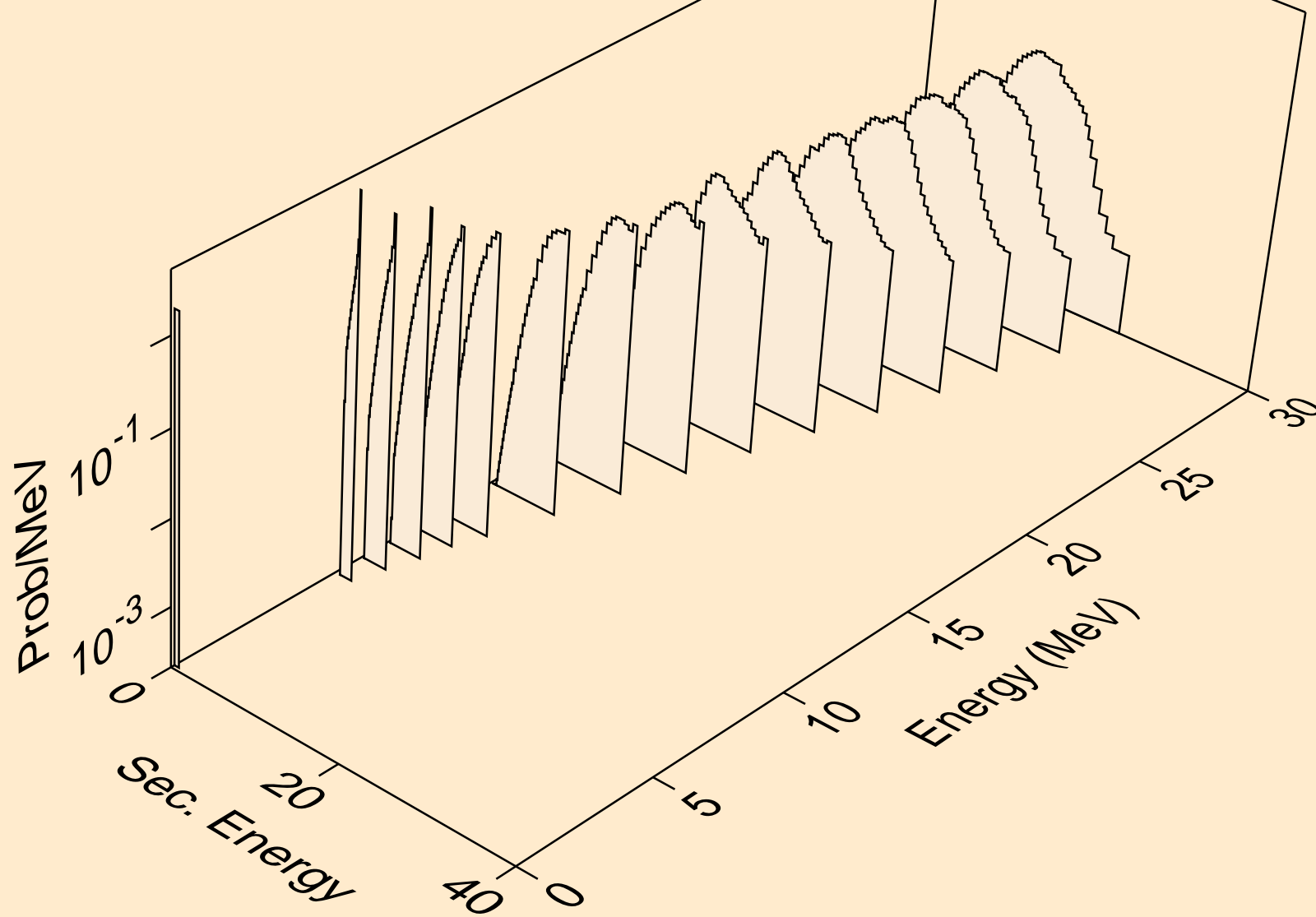

TA162 HELION ACER TENDL-2021 LIBRARY; T=0.K
tritons from (s,x)

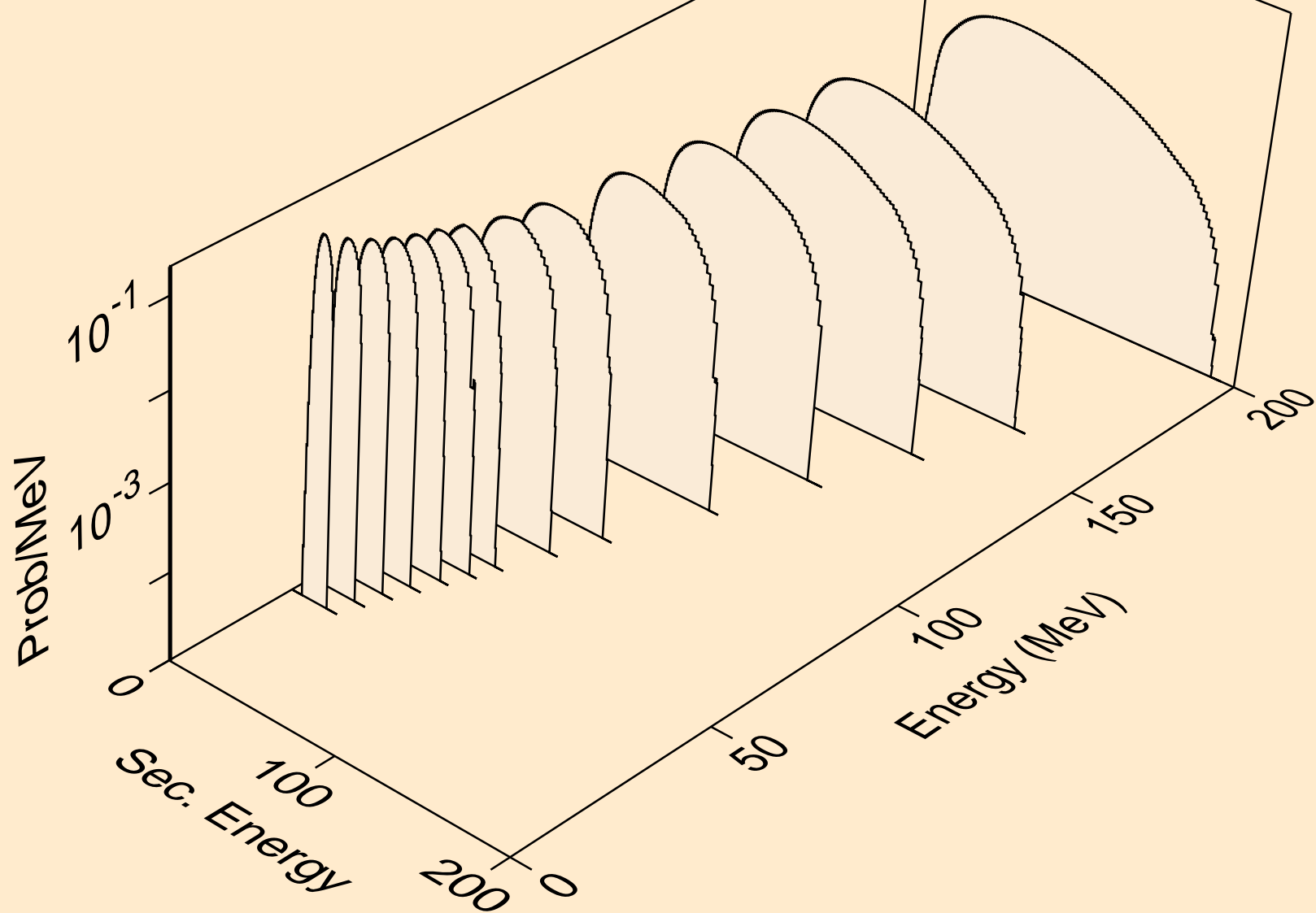

TA162 HELION ACER TENDL-2021 LIBRARY; T=0.K
tritons from (s,n*)t

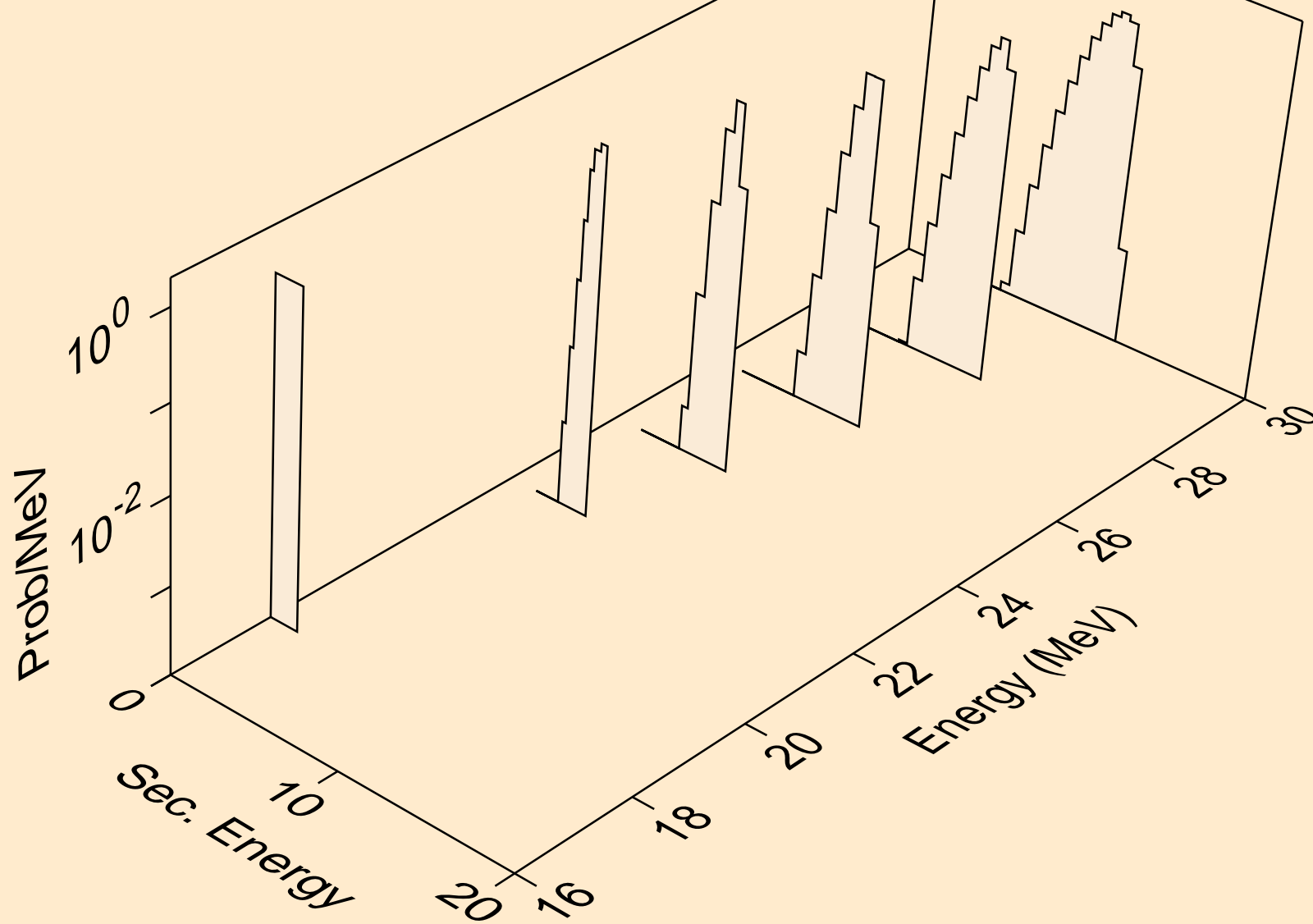

TA162 HELION ACER TENDL-2021 LIBRARY; T=0.K
tritons from (s,t)

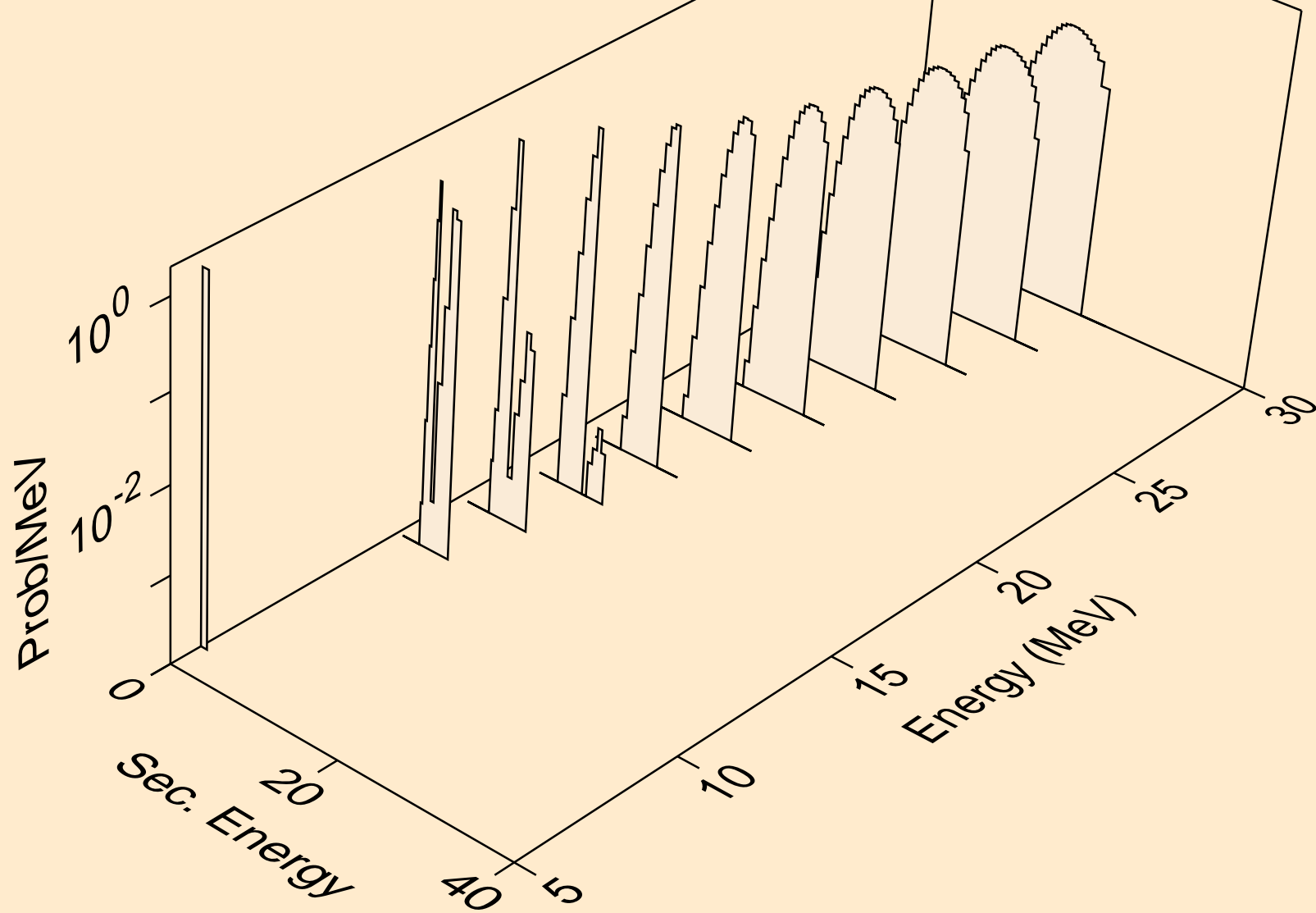

TA162 HELION ACER TENDL-2021 LIBRARY; T=0.K
tritons from (s,t2a)

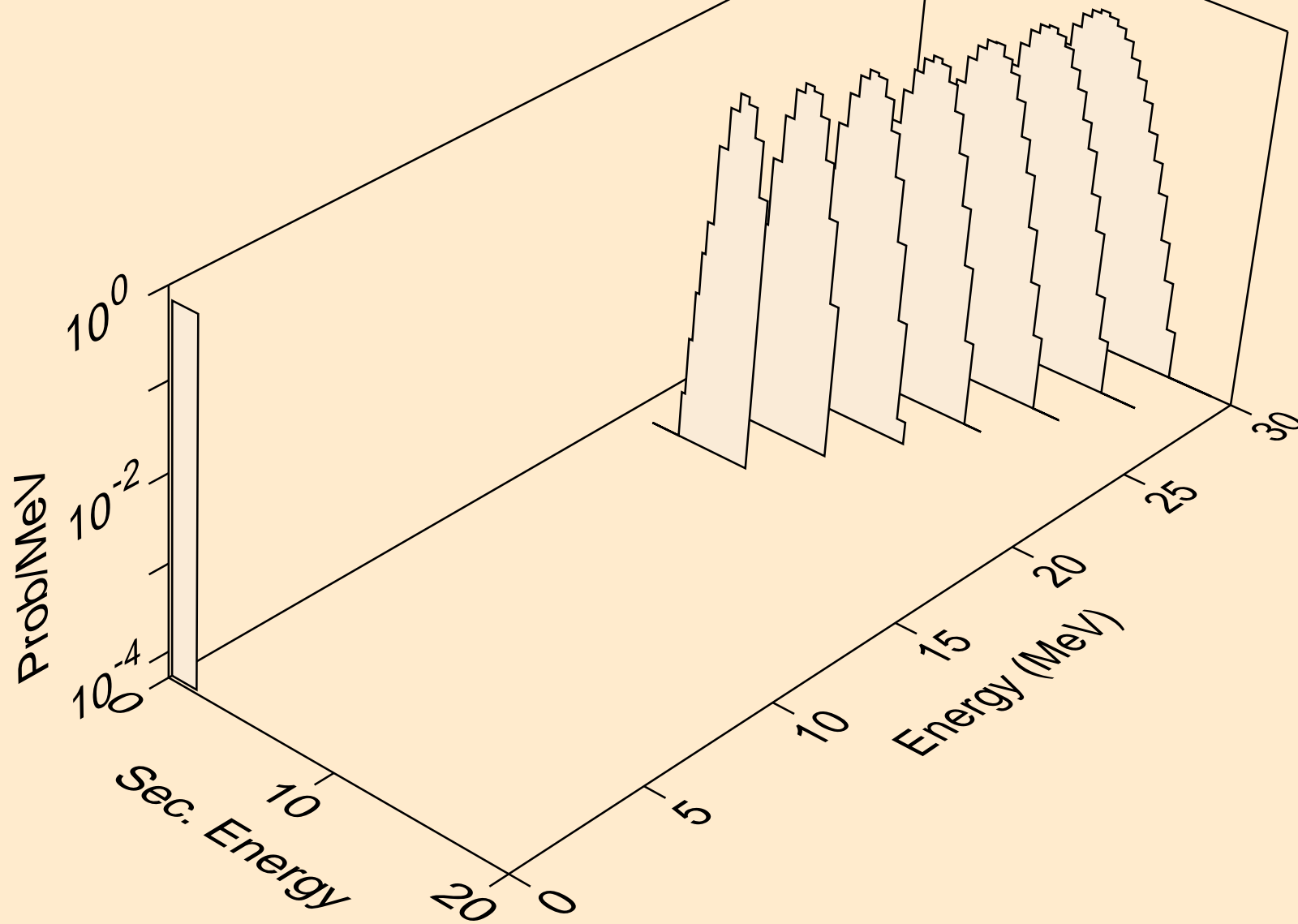

TA162 HELION ACER TENDL-2021 LIBRARY; T=0.K
tritons from (s,pt)

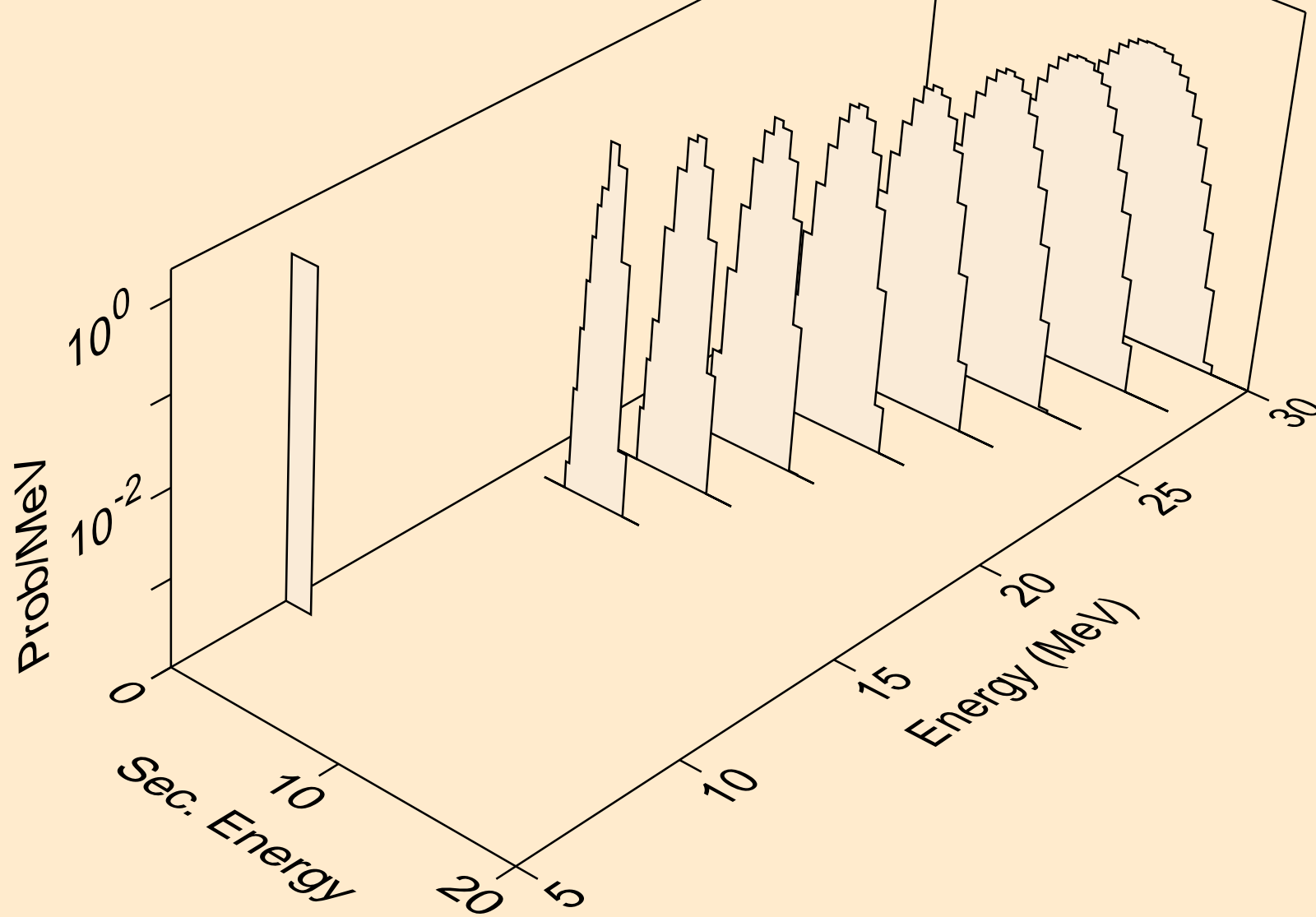

TA162 HELION ACER TENDL-2021 LIBRARY; T=0.K
alphas from (s,x)

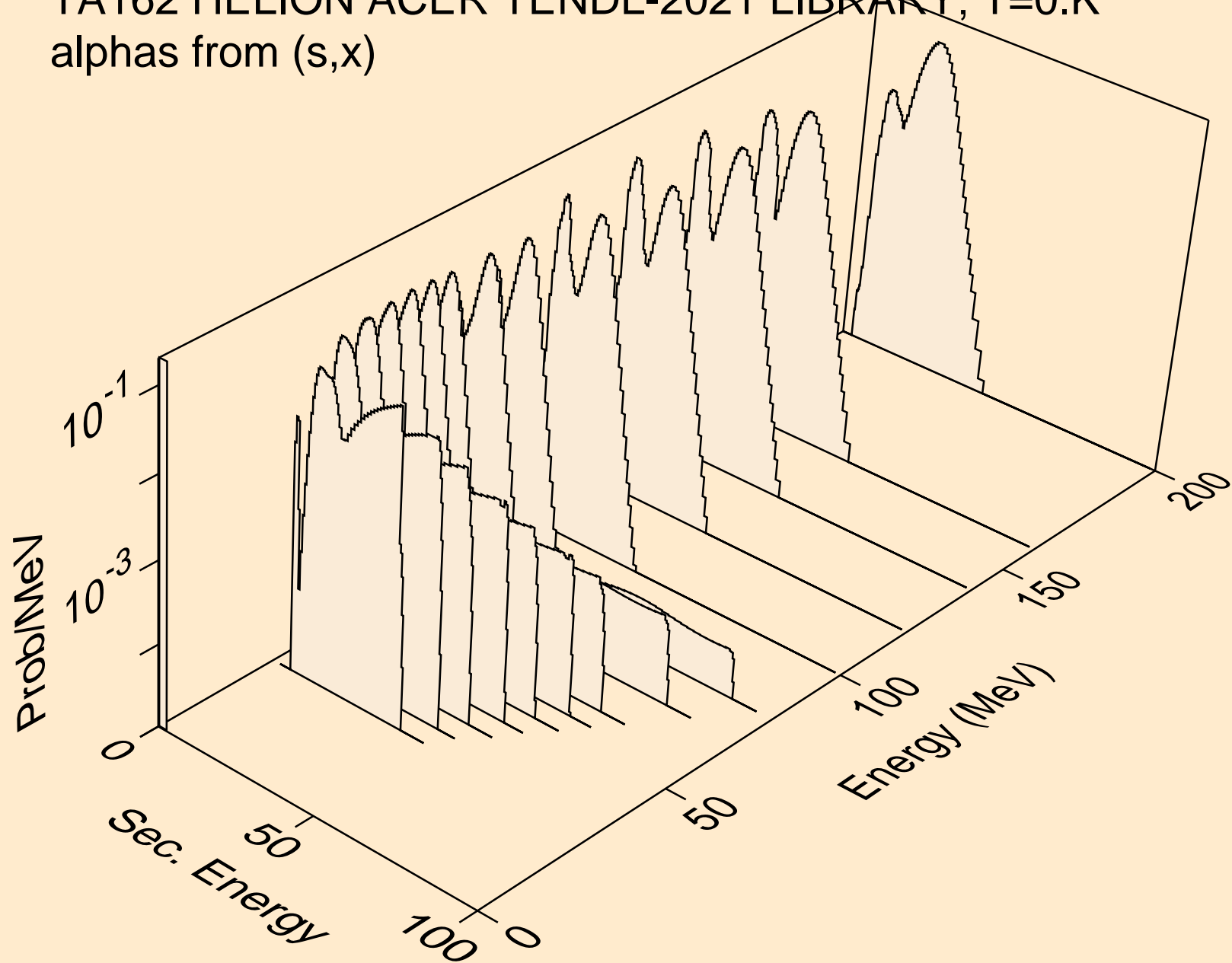

TA162 HELION ACER TENDL-2021 LIBRARY; T=0.K
alphas from (s,n*)a

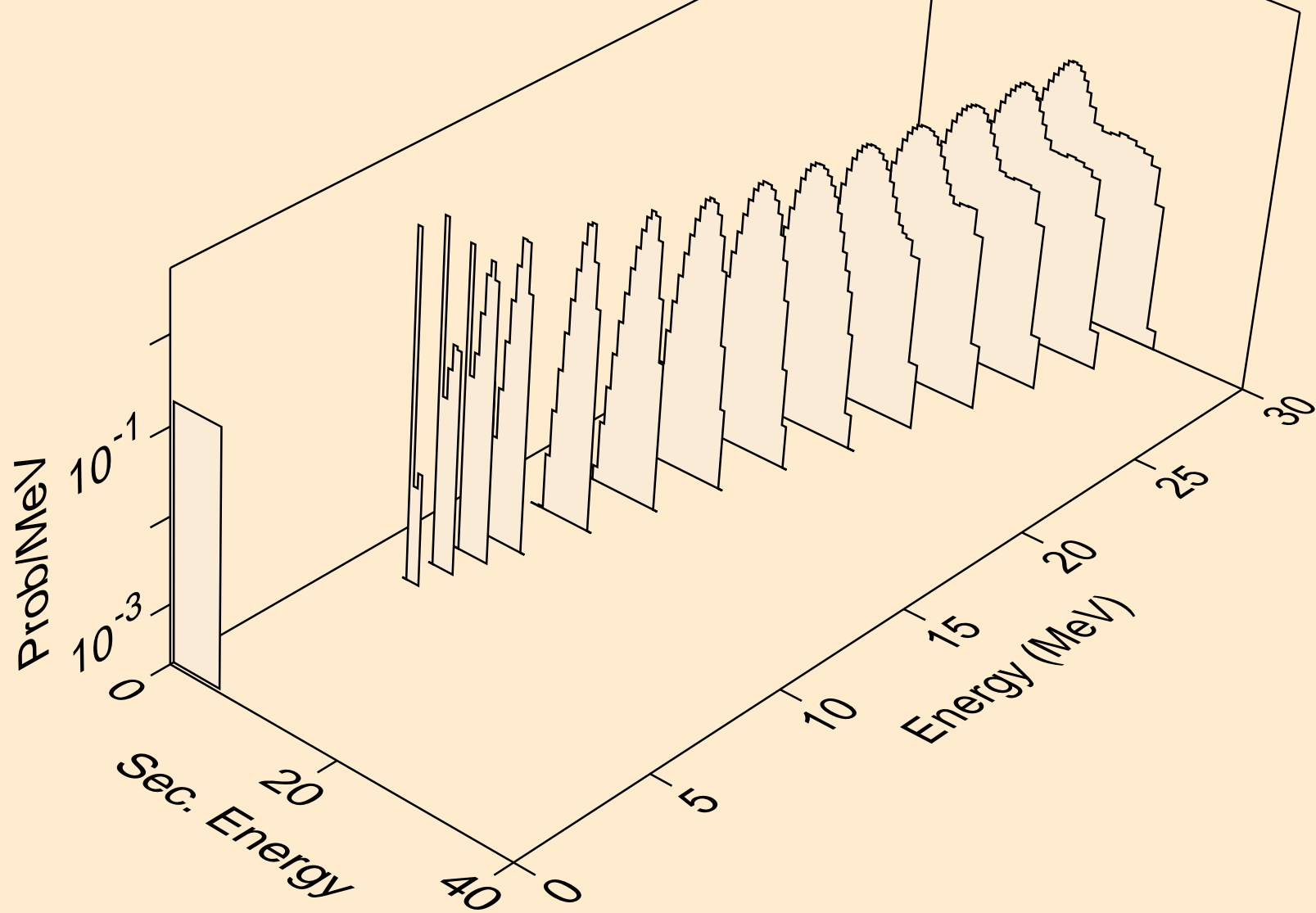

TA162 HELION ACER TENDL-2021 LIBRARY; T=0.K
alphas from (s,2n)a

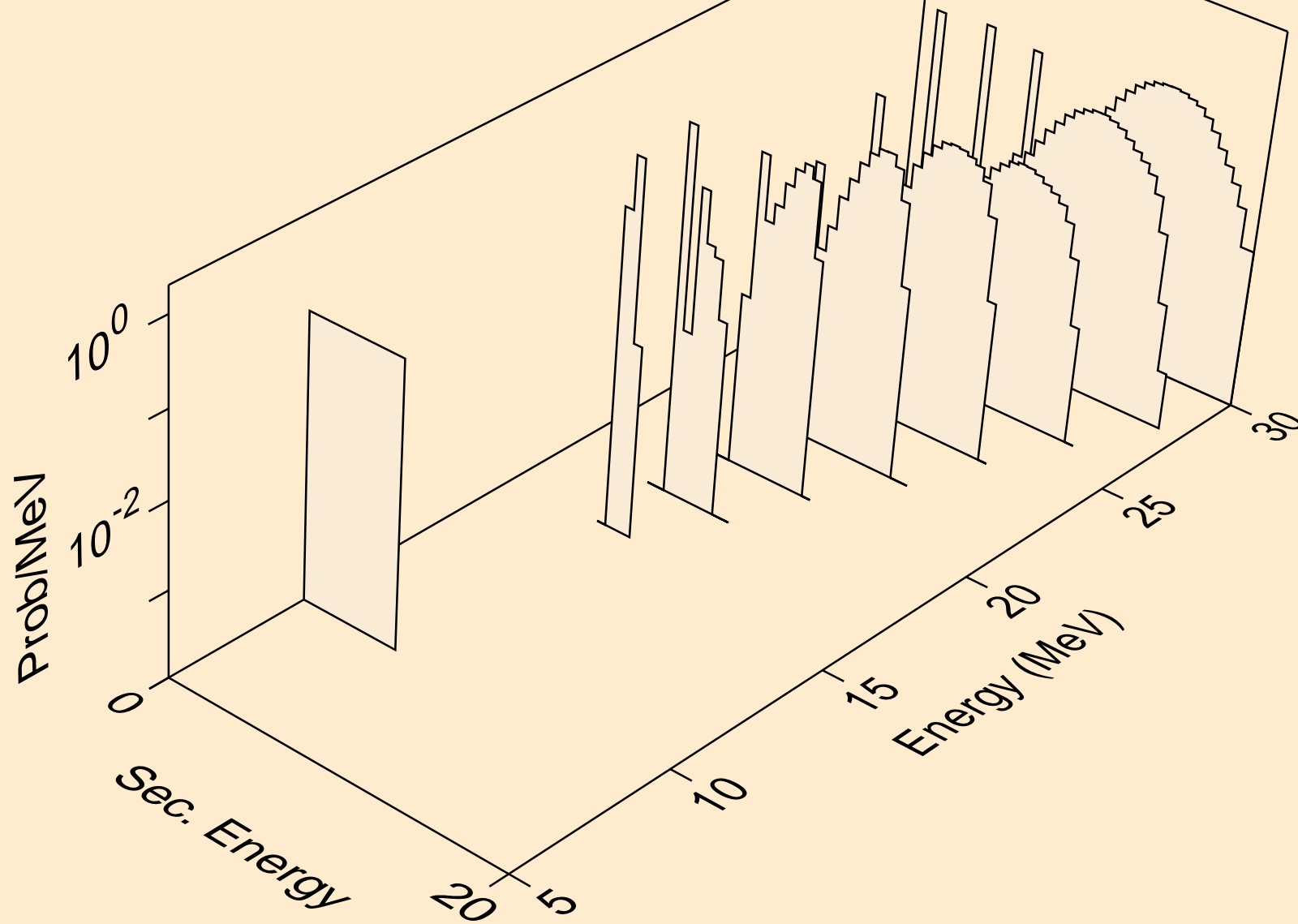

TA162 HELION ACER TENDL-2021 LIBRARY; T=0.K
alphas from (s,n*)2a

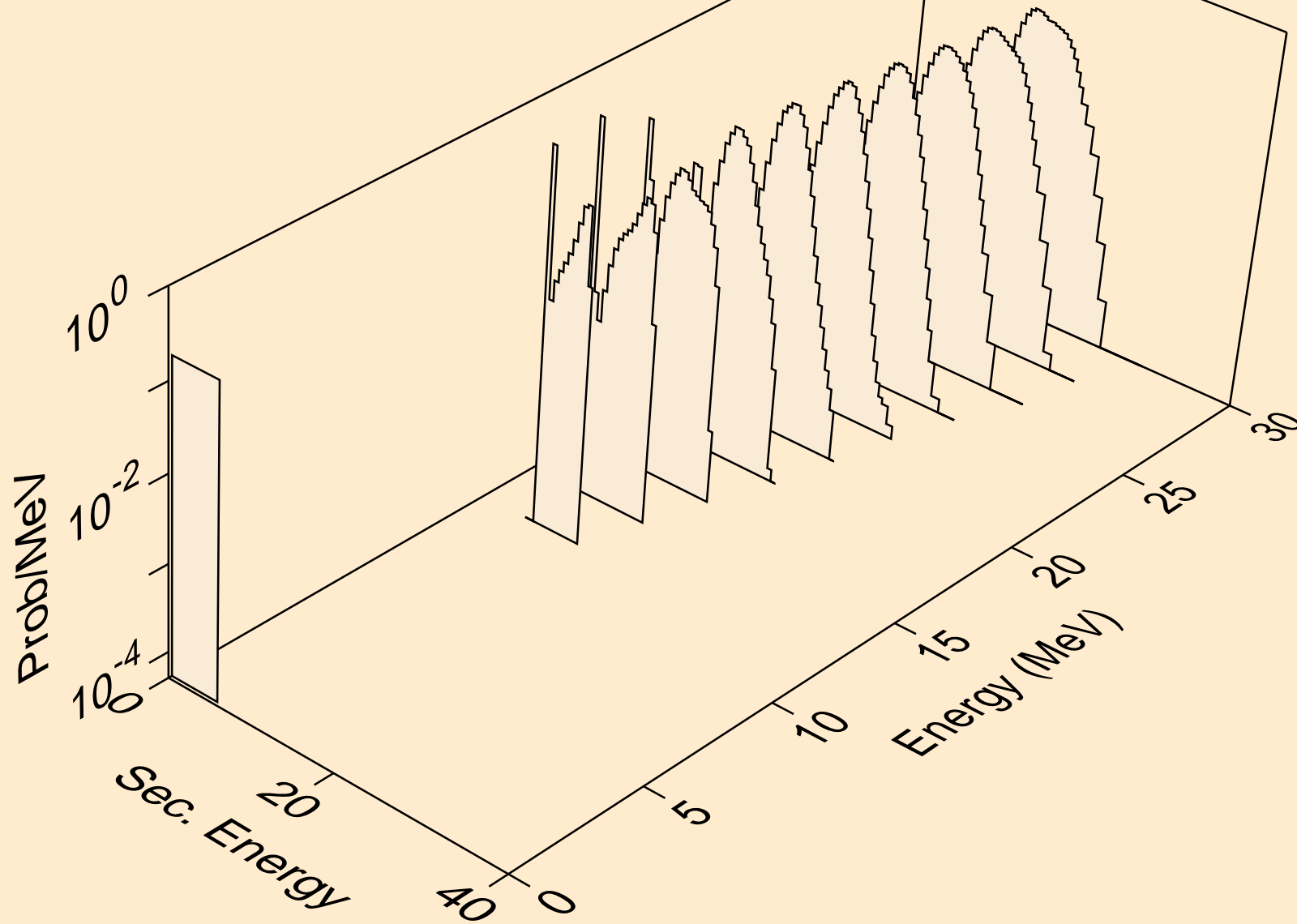

TA162 HELION ACER TENDL-2021 LIBRARY; T=0.K
alphas from (s,2n)2a

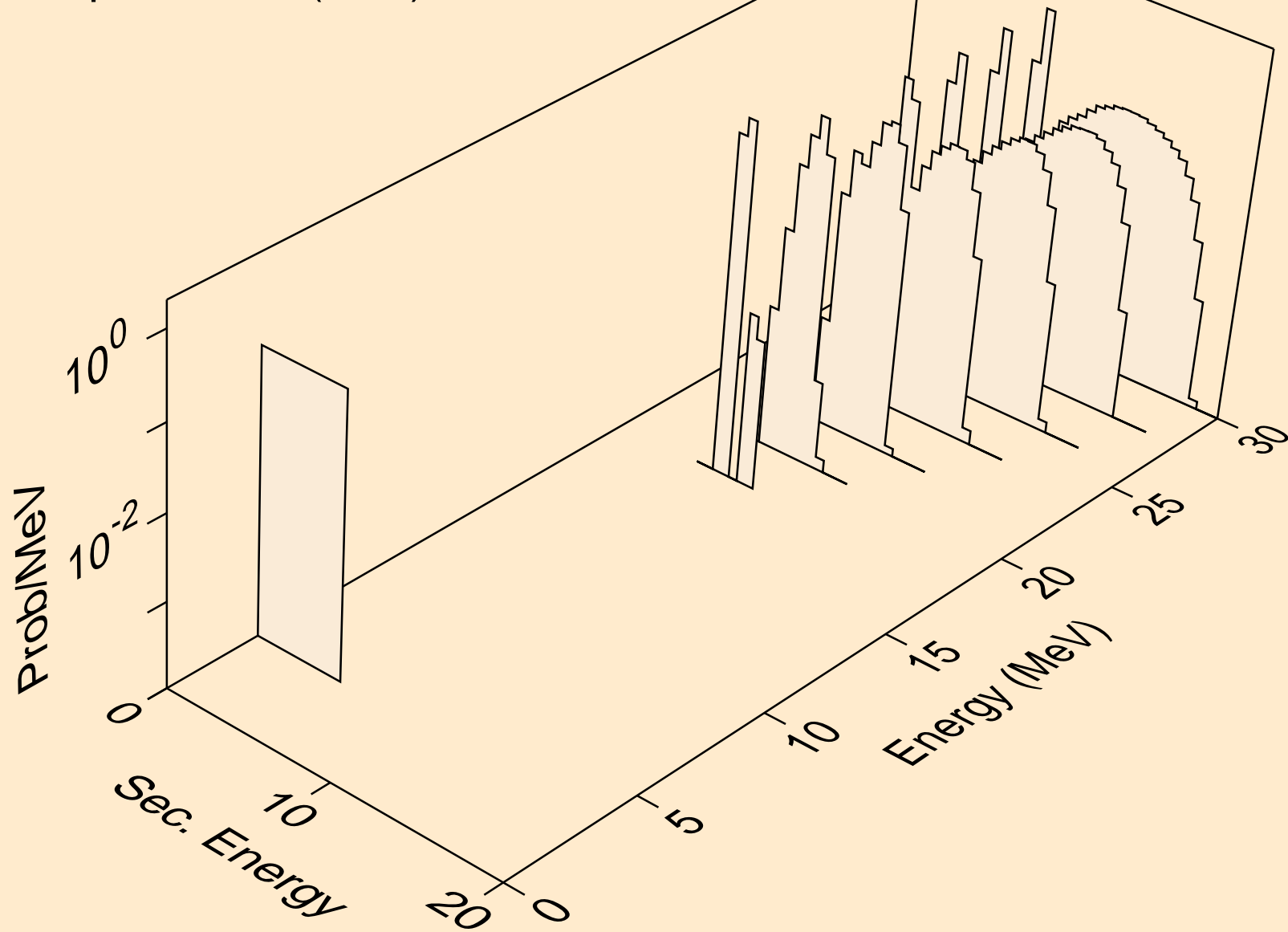

TA162 HELION ACER TENDL-2021 LIBRARY; T=0.K
alphas from (s,npa)

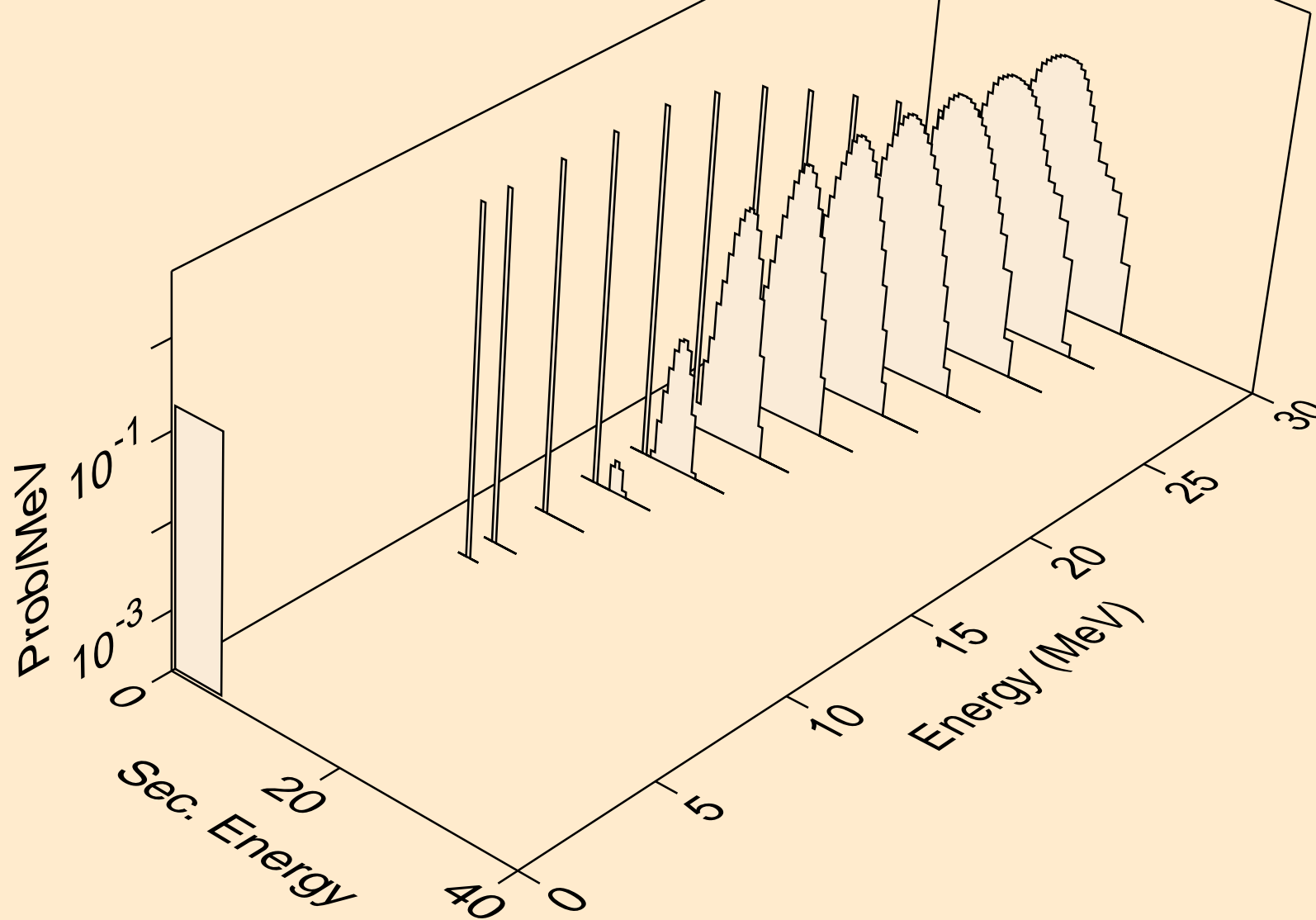

TA162 HELION ACER TENDL-2021 LIBRARY; T=0.K
alphas from (s,a)

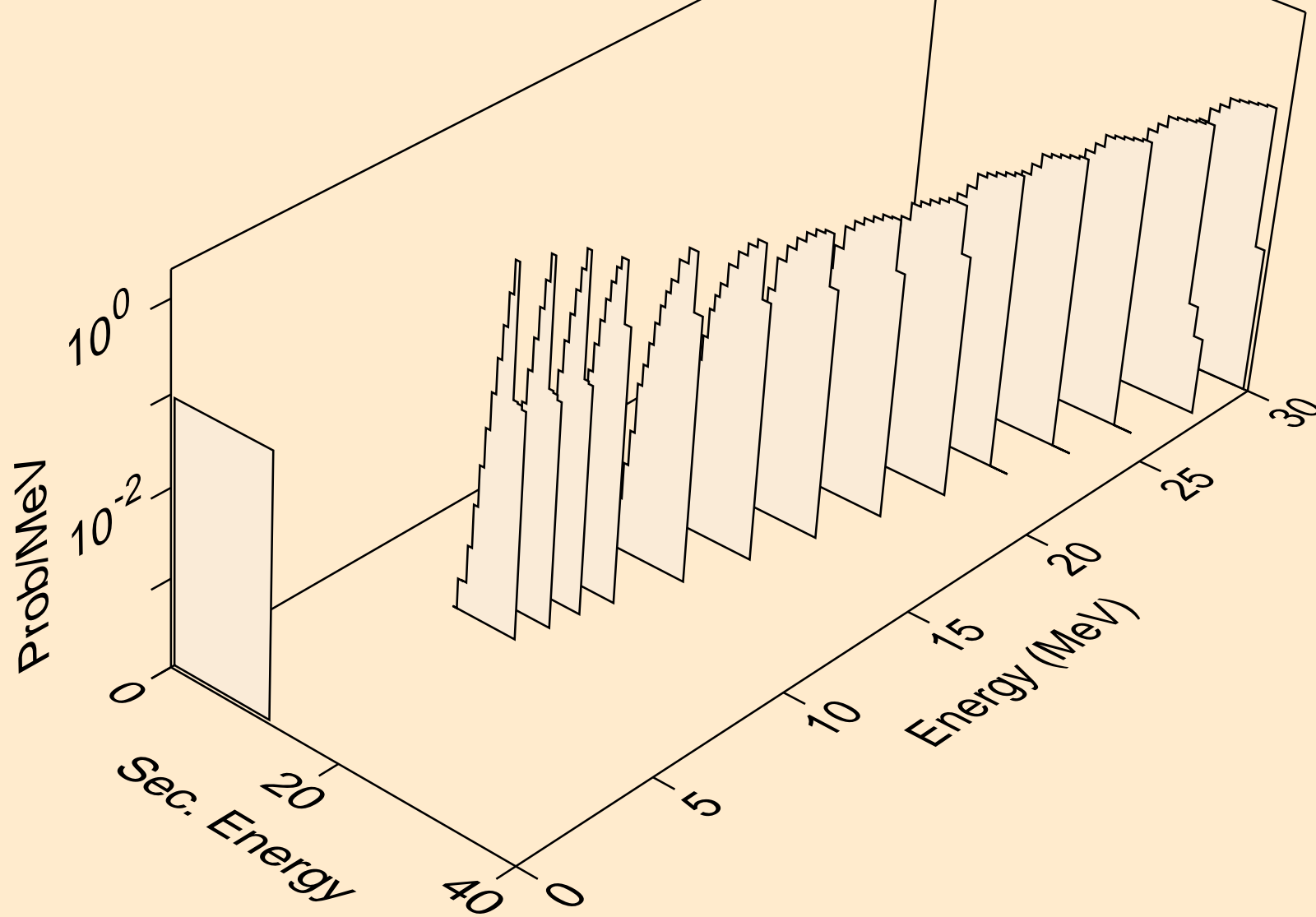

TA162 HELION ACER TENDL-2021 LIBRARY; T=0.K
alphas from (s,2a)

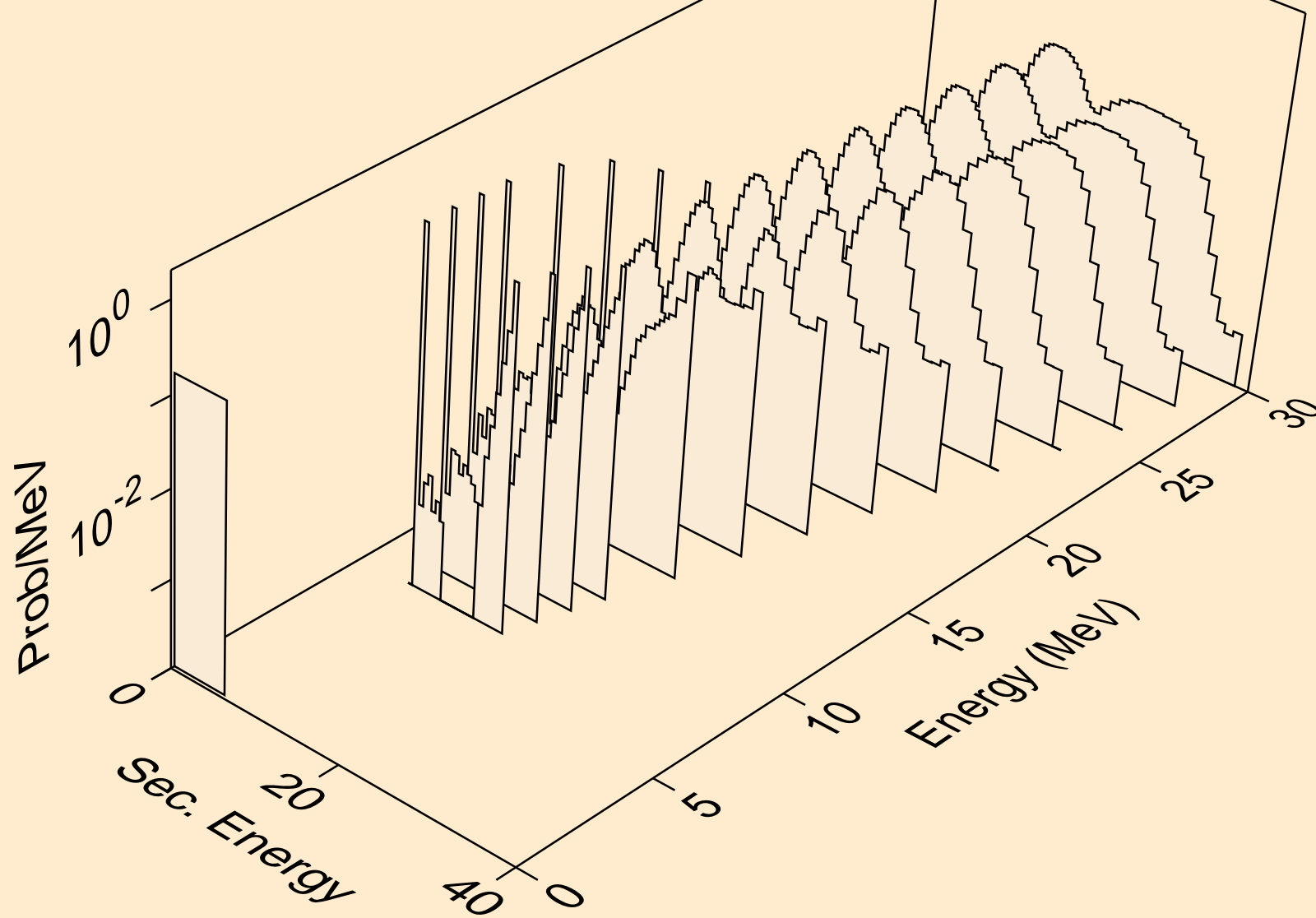

TA162 HELION ACER TENDL-2021 LIBRARY; T=0.K
alphas from (s,3a)

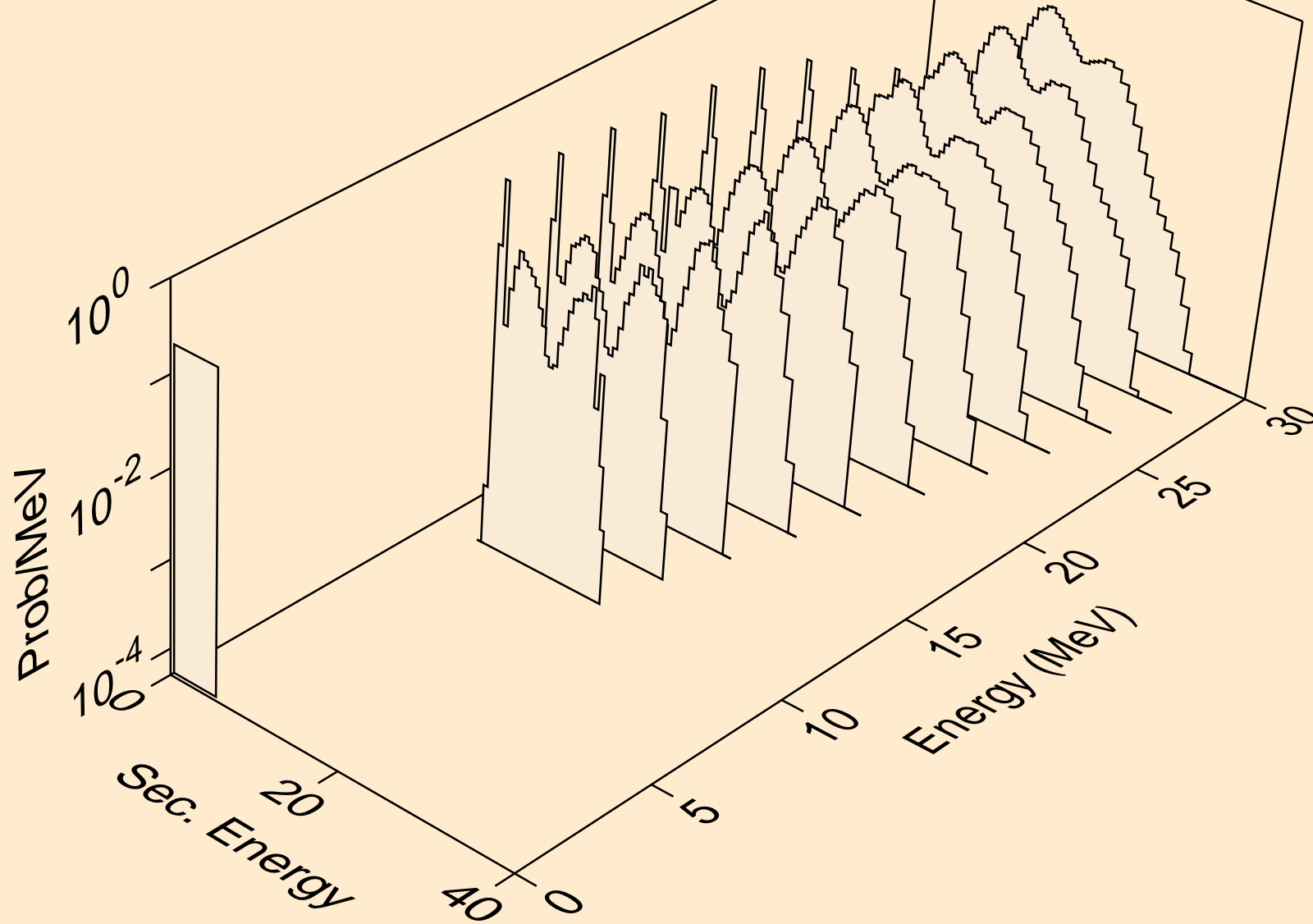

TA162 HELION ACER TENDL-2021 LIBRARY; T=0.K
alphas from (s,pa)

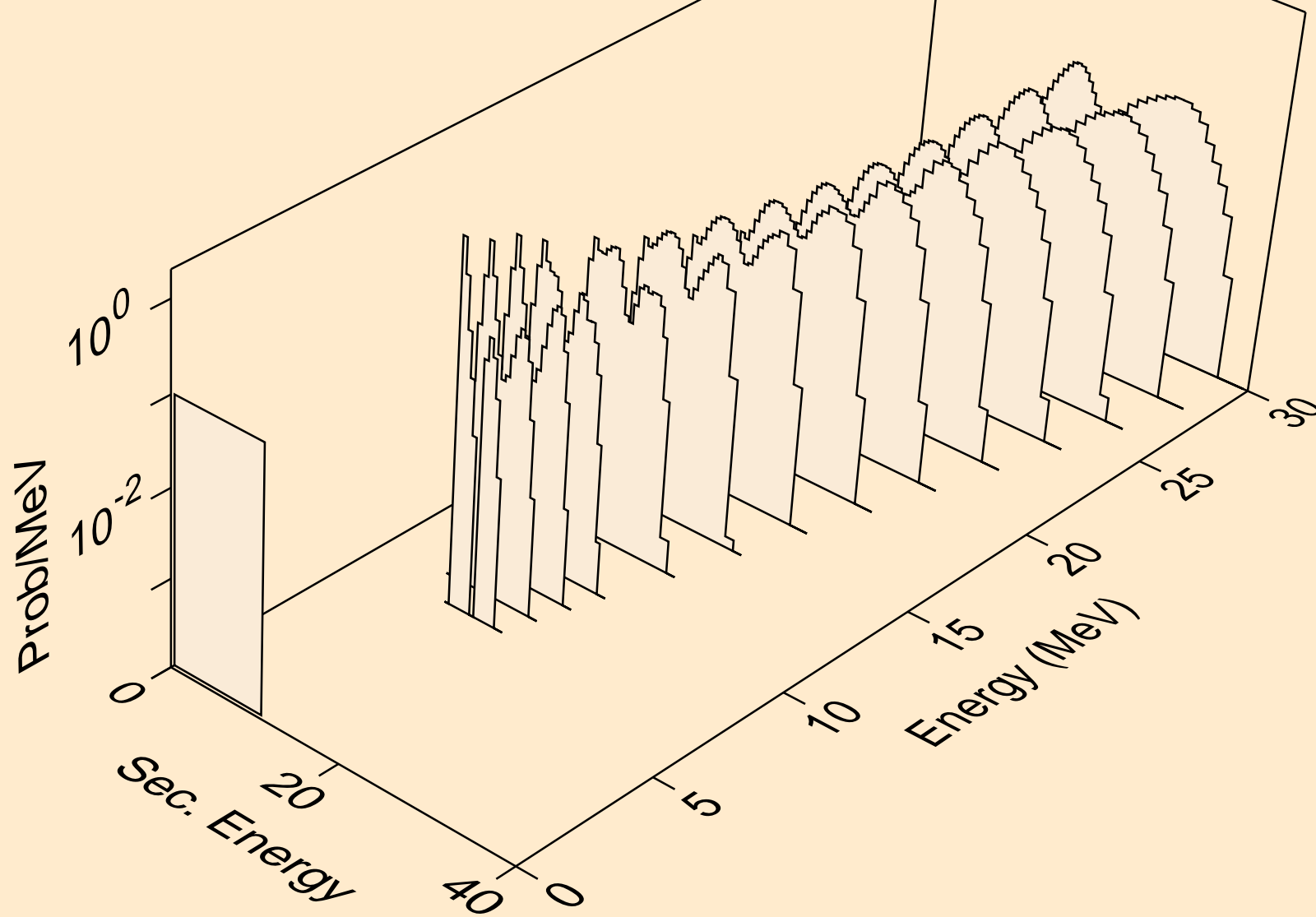

TA162 HELION ACER TENDL-2021 LIBRARY; T=0.K
alphas from (s,t2a)

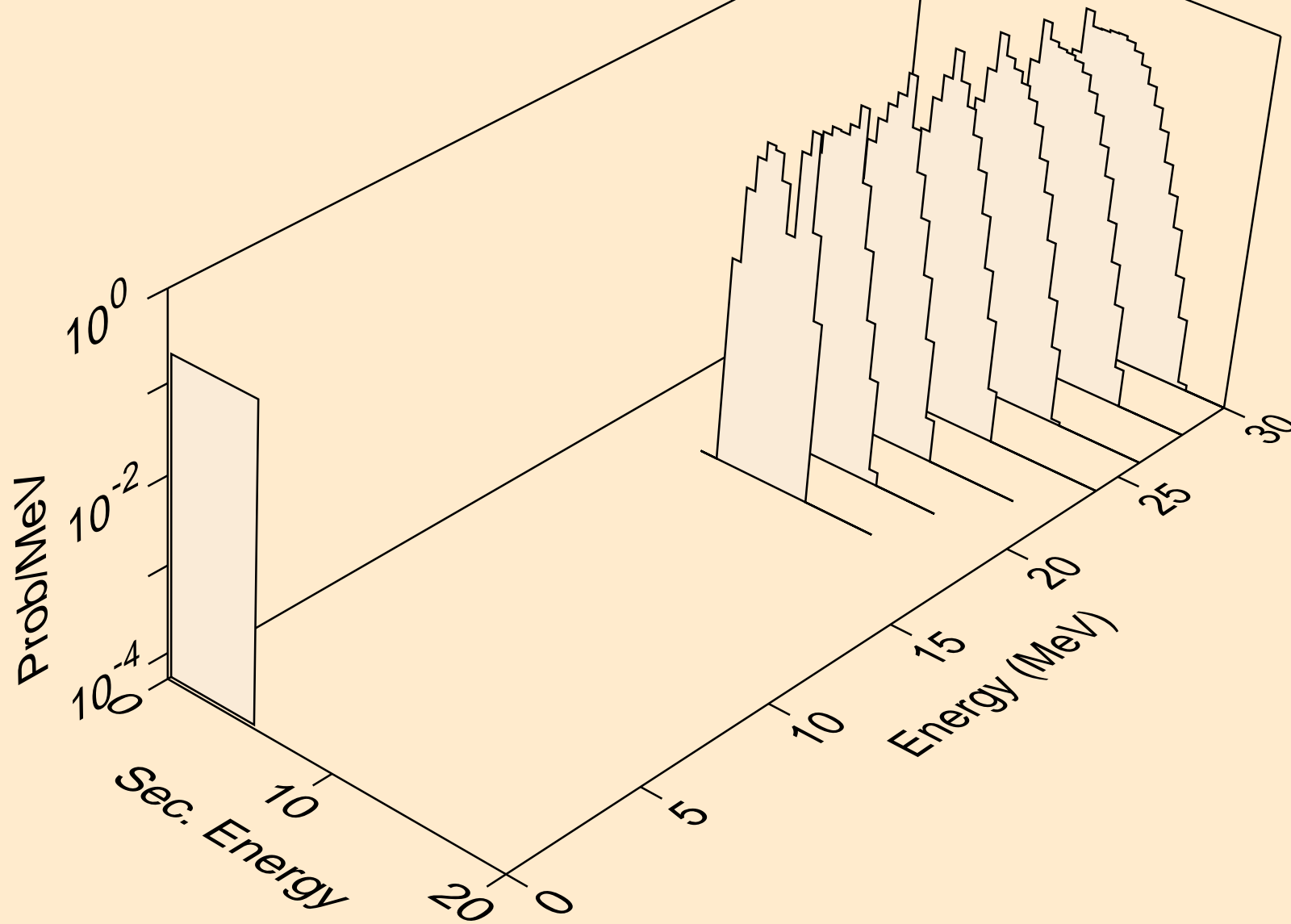

TA162 HELION ACER TENDL-2021 LIBRARY; T=0.K
alphas from (s,d2a)

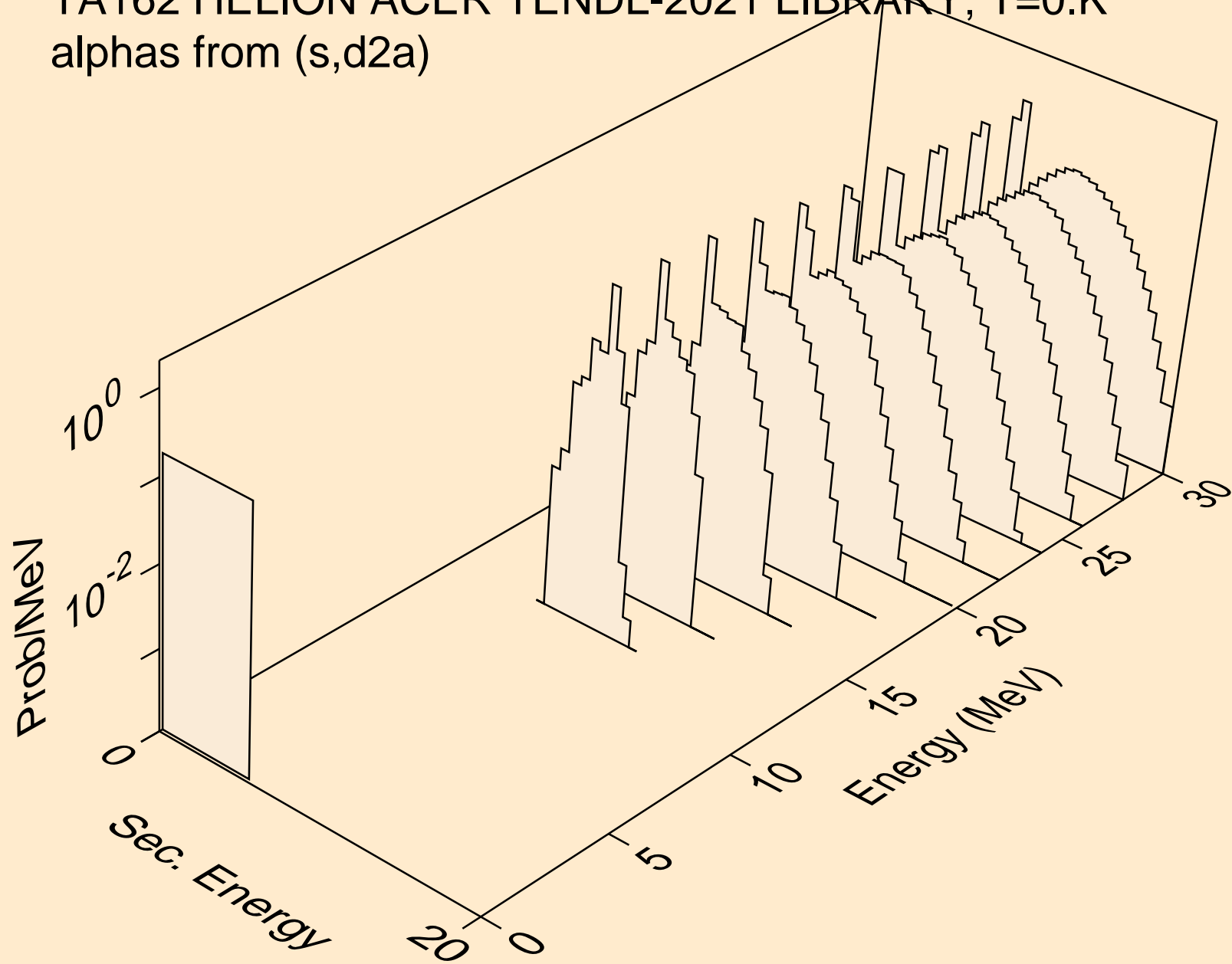

TA162 HELION ACER TENDL-2021 LIBRARY; T=0.K
alphas from (s,da)

