

TA187 HELION ACER TENDL-2021 LIBRARY; T=0.K  
Principal cross sections

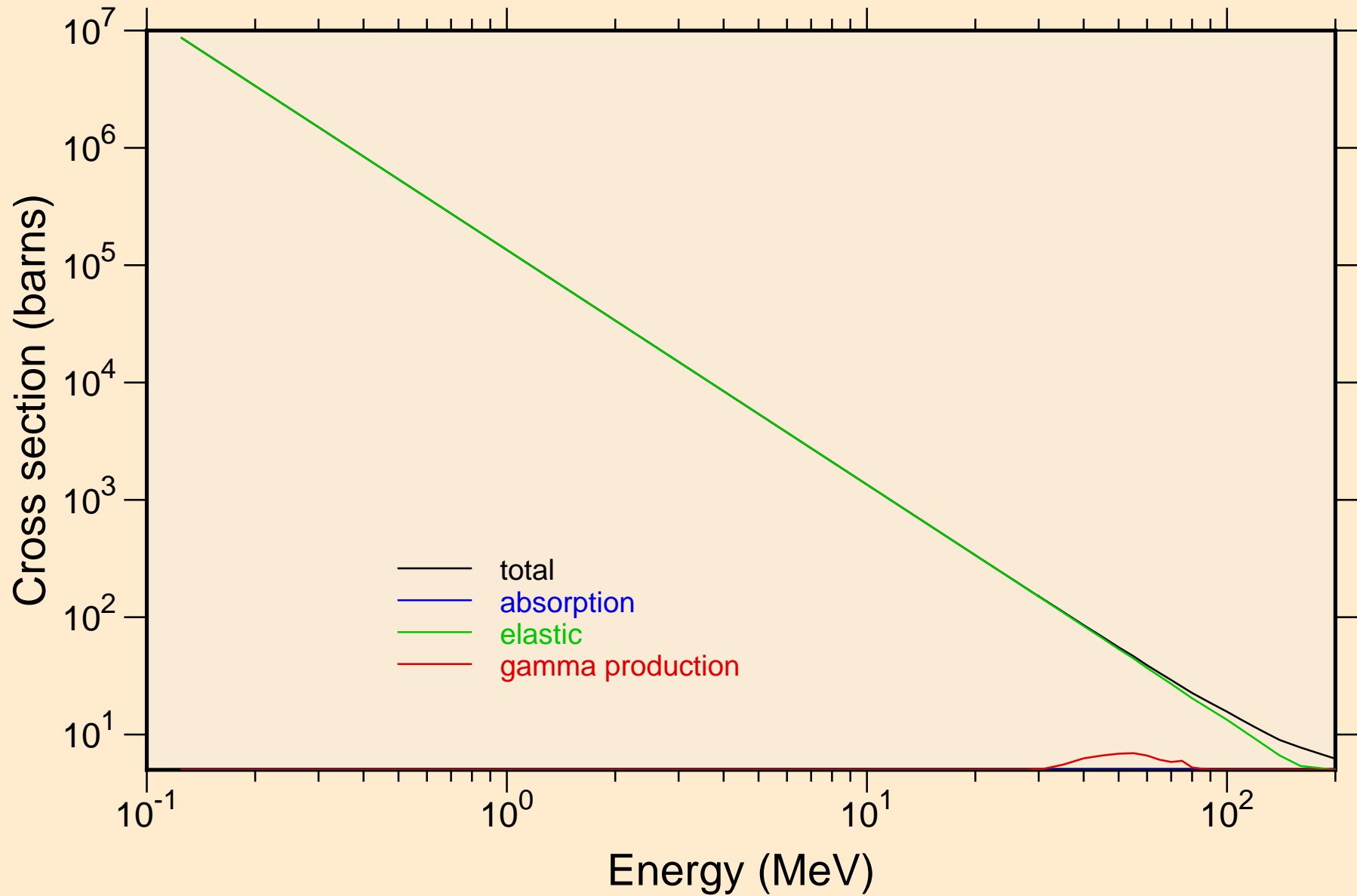

TA187 HELION ACER TENDL-2021 LIBRARY; T=0.K

Heating

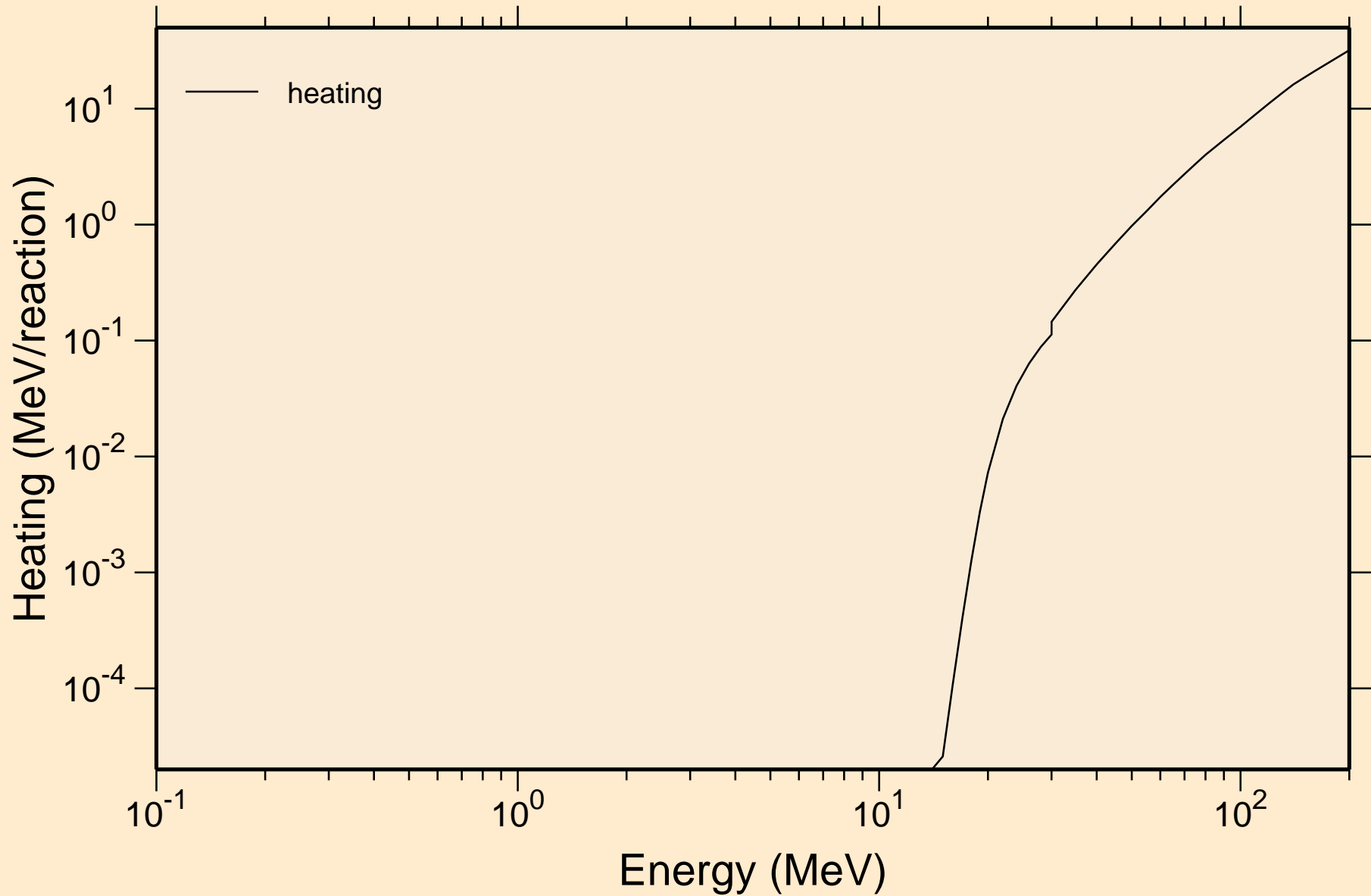

# TA187 HELION ACER TENDL-2021 LIBRARY; T=0.K

## Principal cross sections

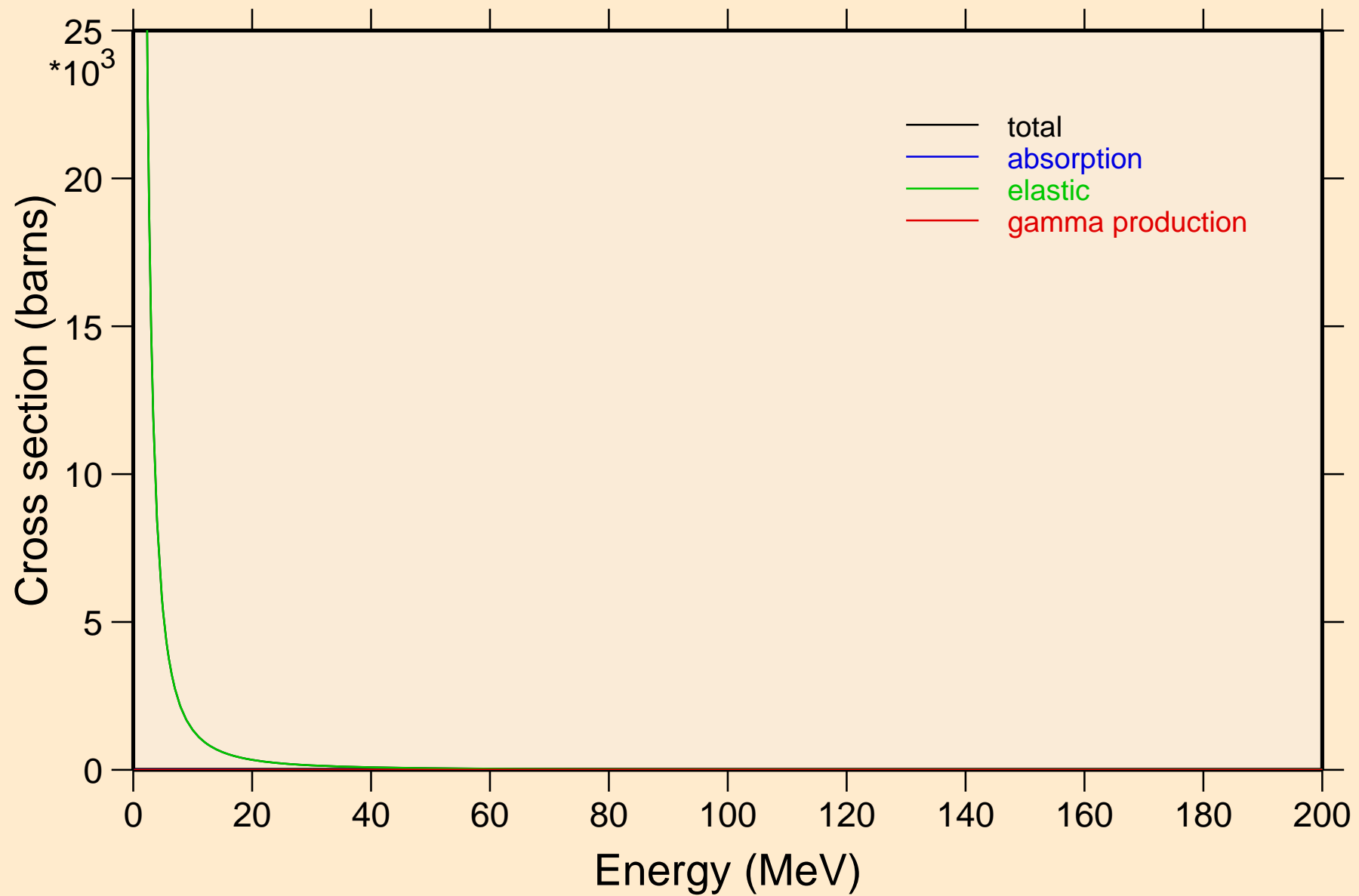

TA187 HELION ACER TENDL-2021 LIBRARY; T=0.K

Heating

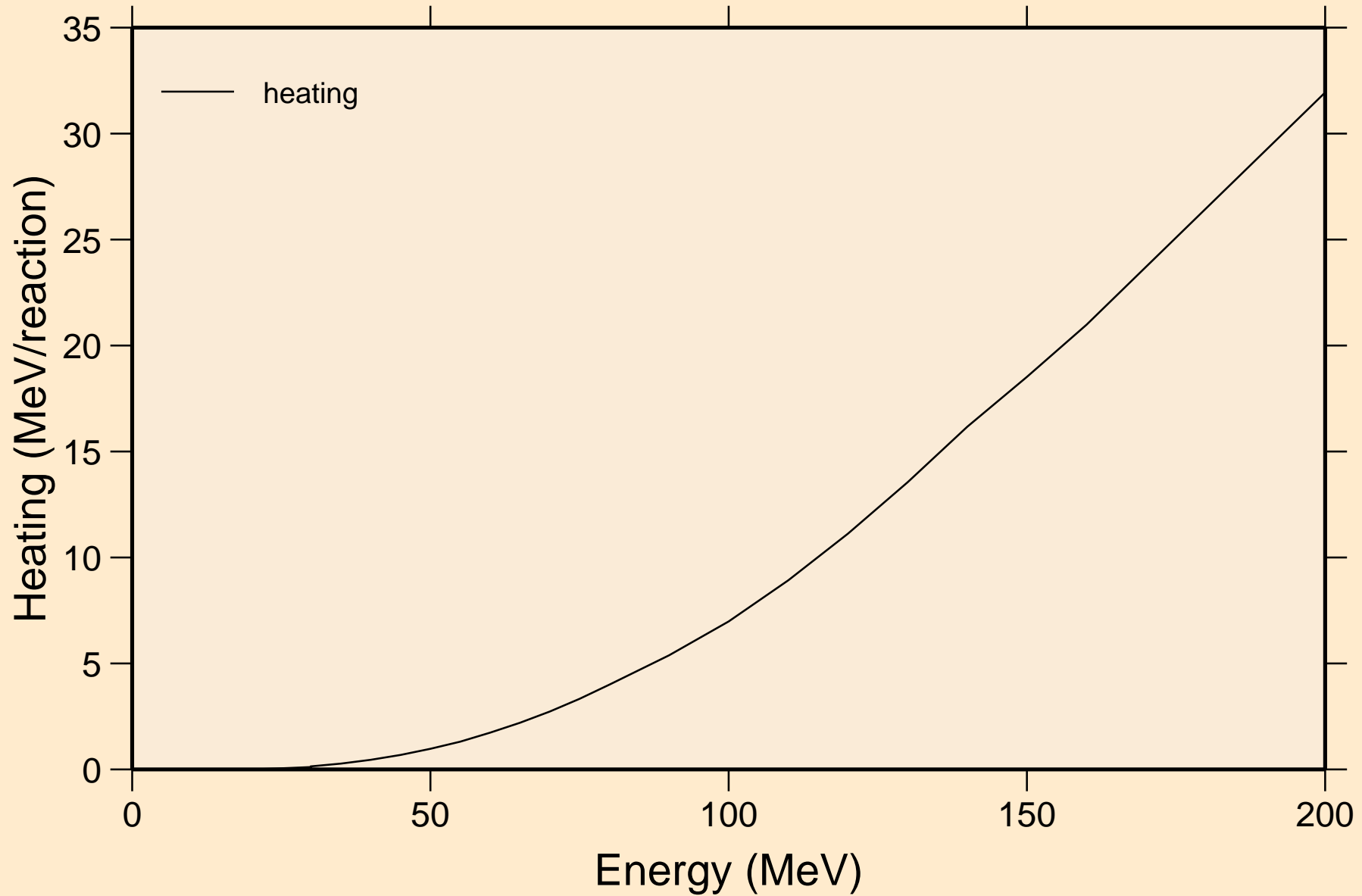

TA187 HELION ACER TENDL-2021 LIBRARY; T=0.K  
Threshold reactions

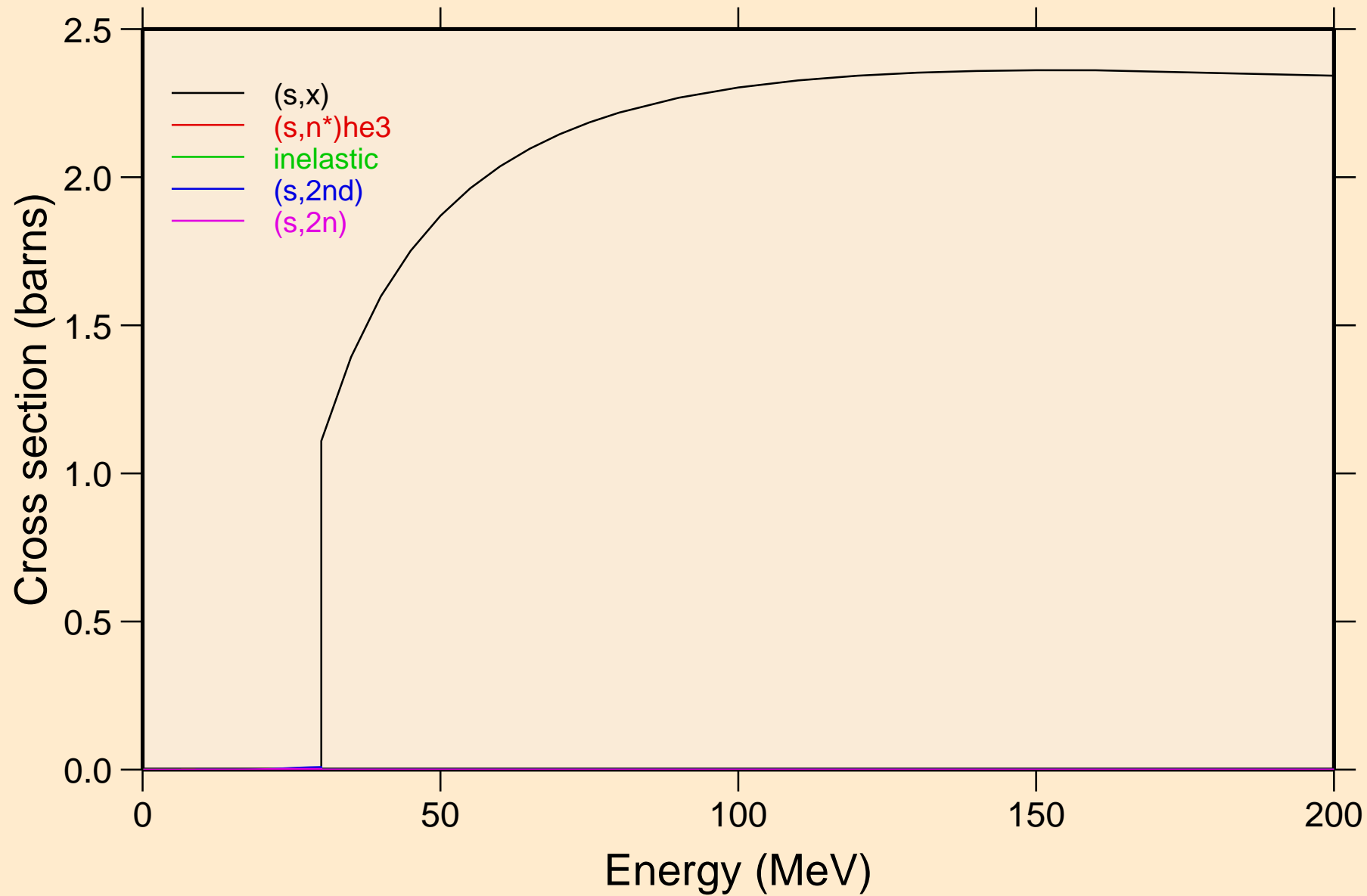

TA187 HELION ACER TENDL-2021 LIBRARY; T=0.K  
Threshold reactions

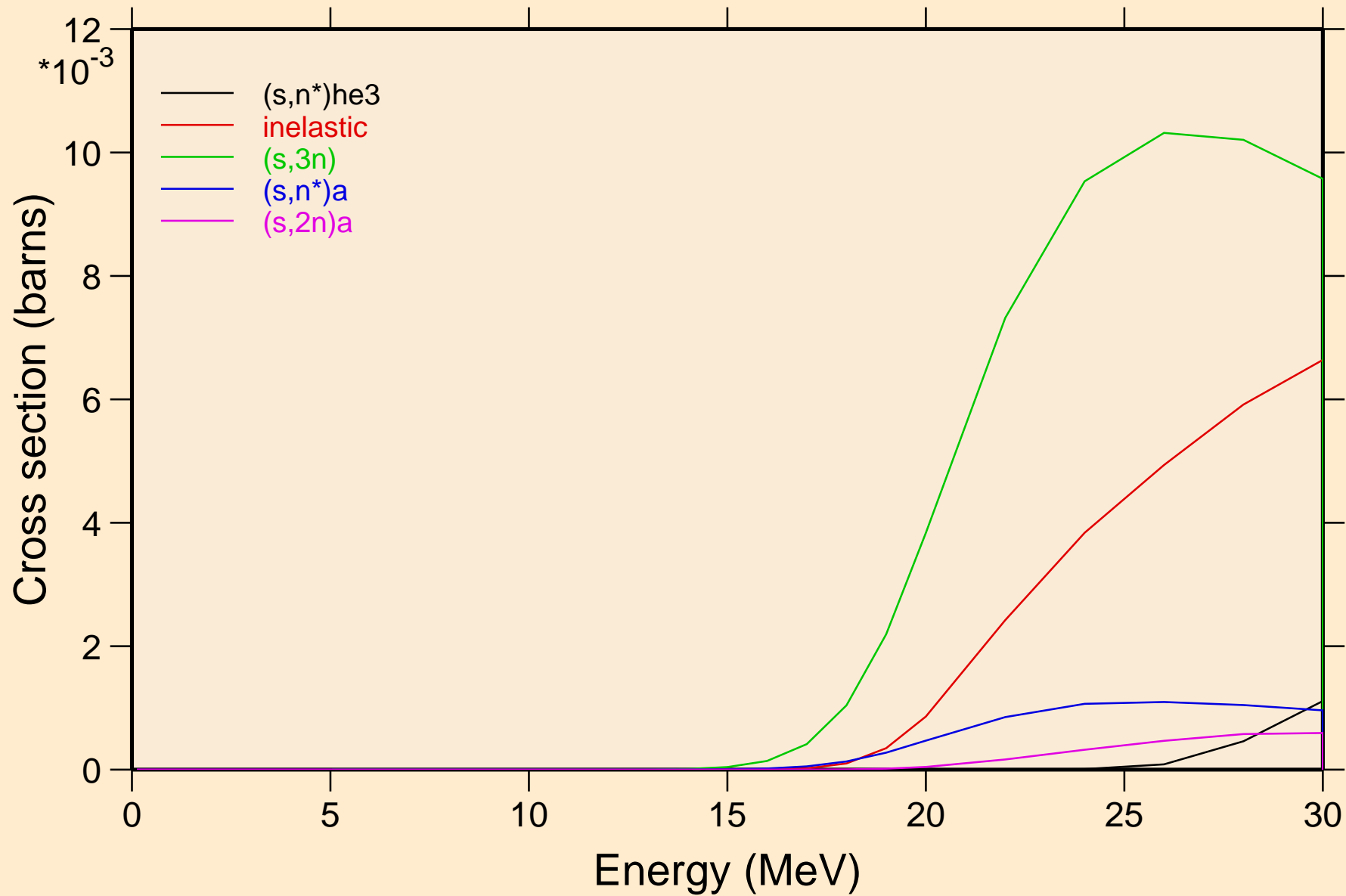

TA187 HELION ACER TENDL-2021 LIBRARY; T=0.K  
Threshold reactions

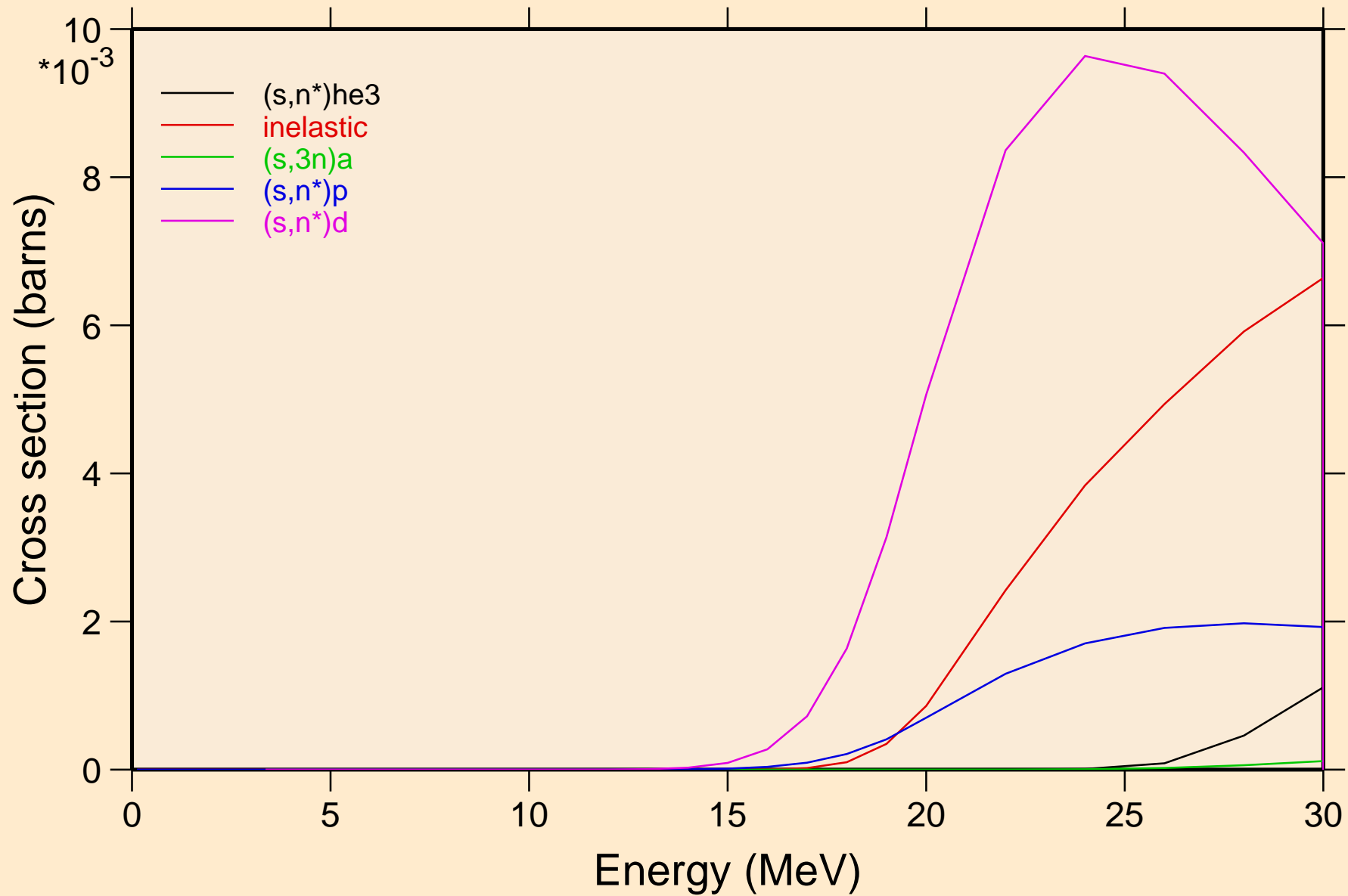

TA187 HELION ACER TENDL-2021 LIBRARY; T=0.K  
Threshold reactions

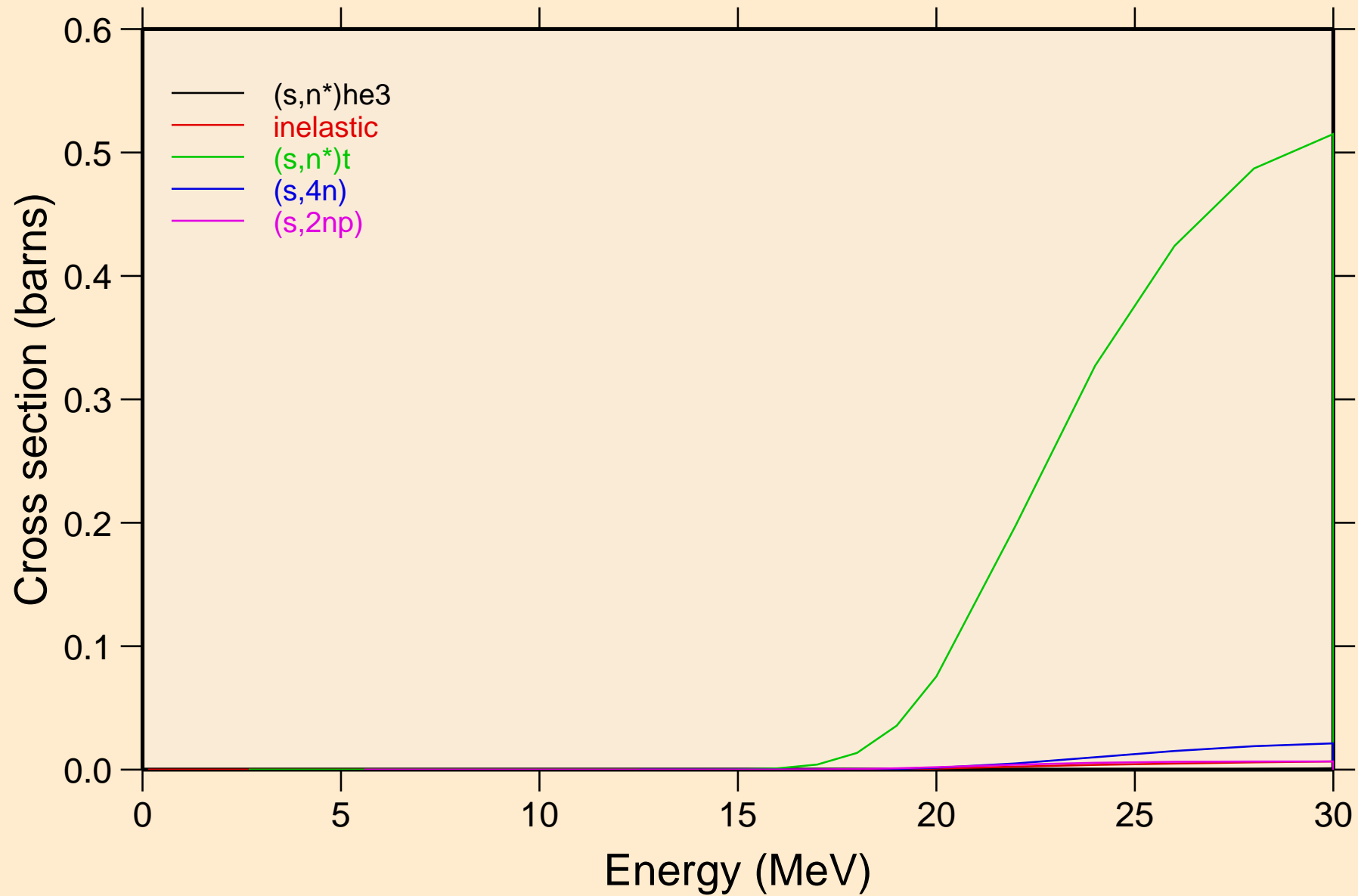



TA187 HELION ACER TENDL-2021 LIBRARY; T=0.K  
Threshold reactions

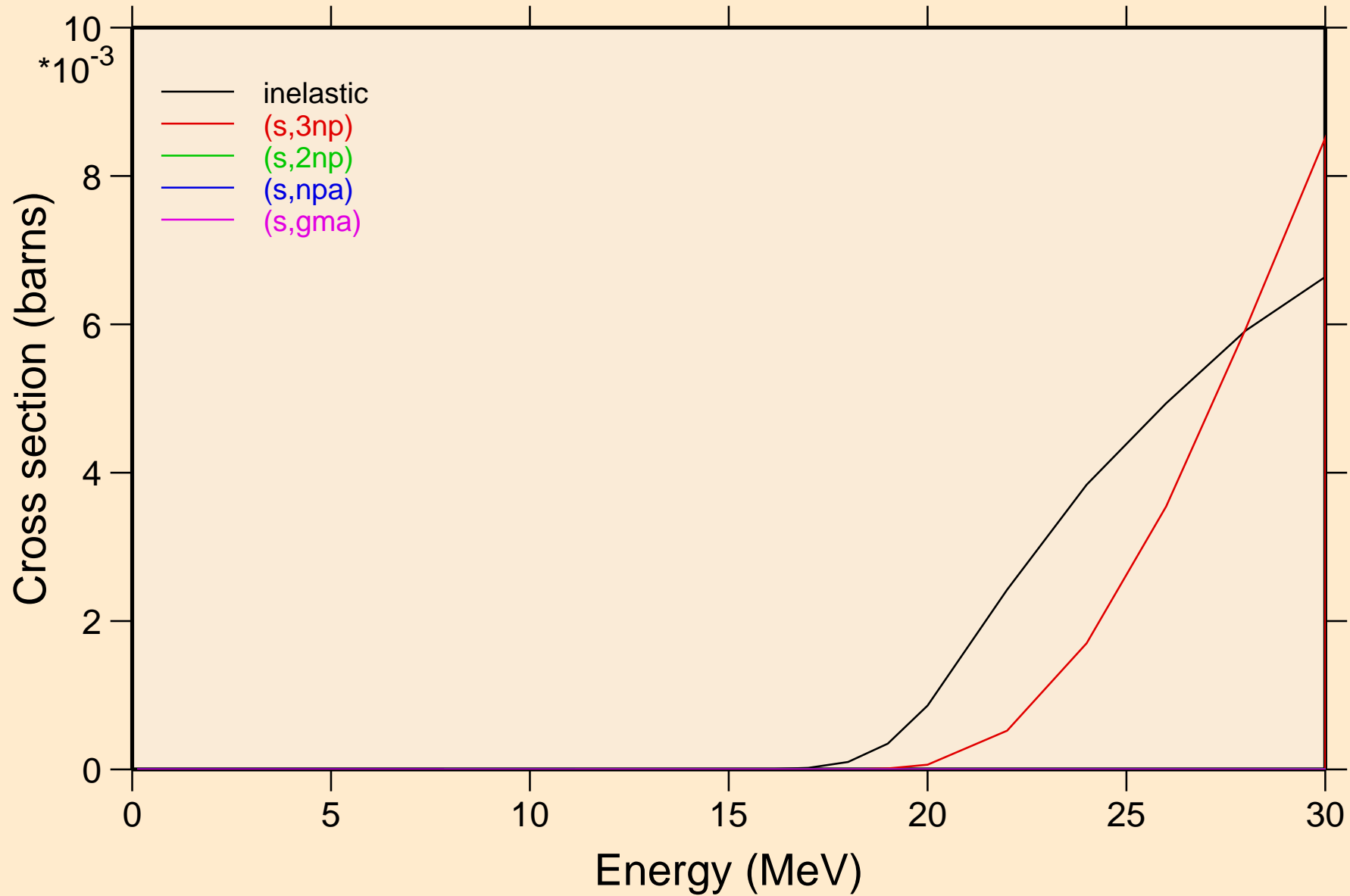

TA187 HELION ACER TENDL-2021 LIBRARY; T=0.K  
Threshold reactions

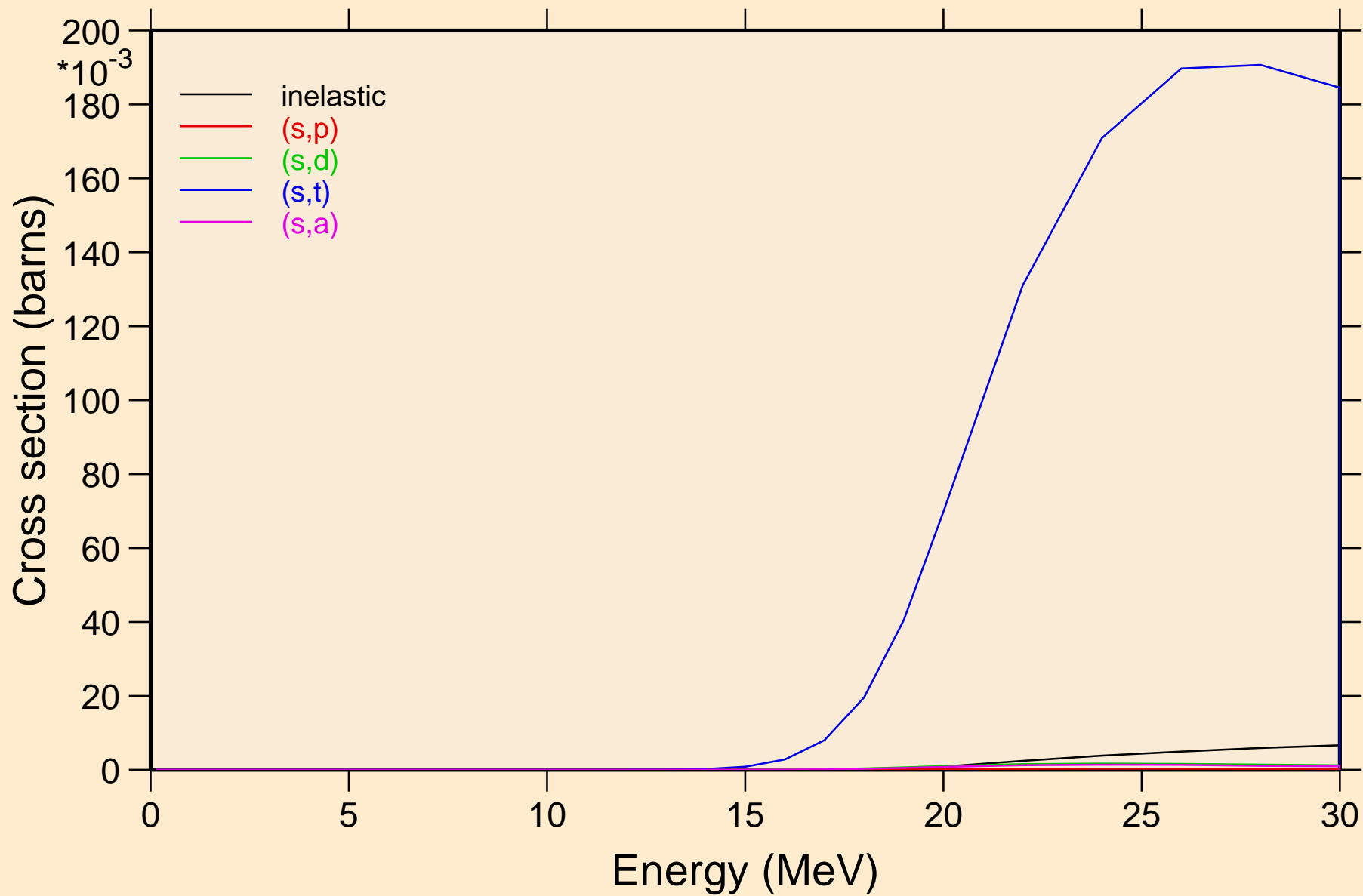

TA187 HELION ACER TENDL-2021 LIBRARY; T=0.K  
Threshold reactions

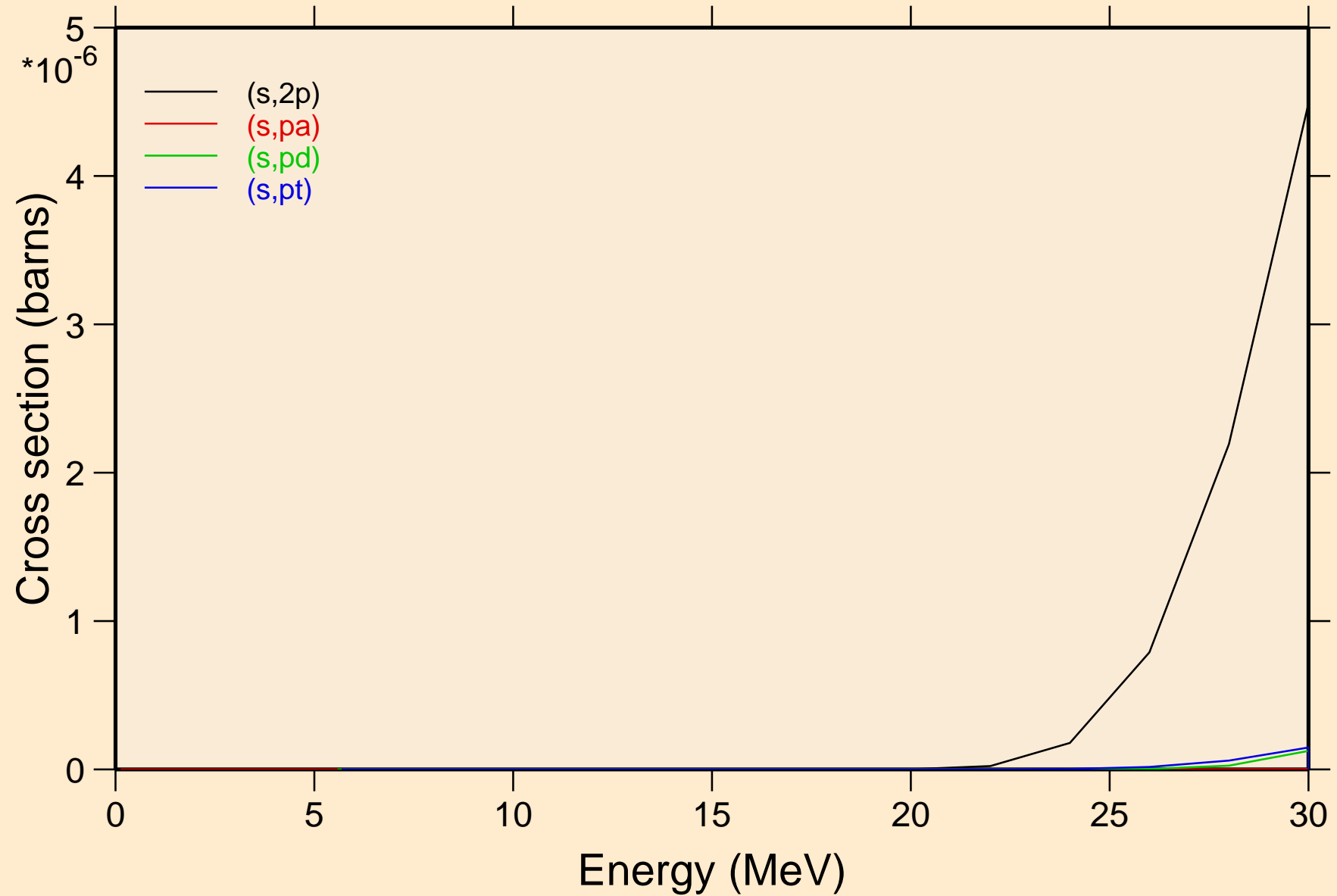

TA187 HELION ACER TENDL-2021 LIBRARY; T=0.K  
angular distribution for elastic

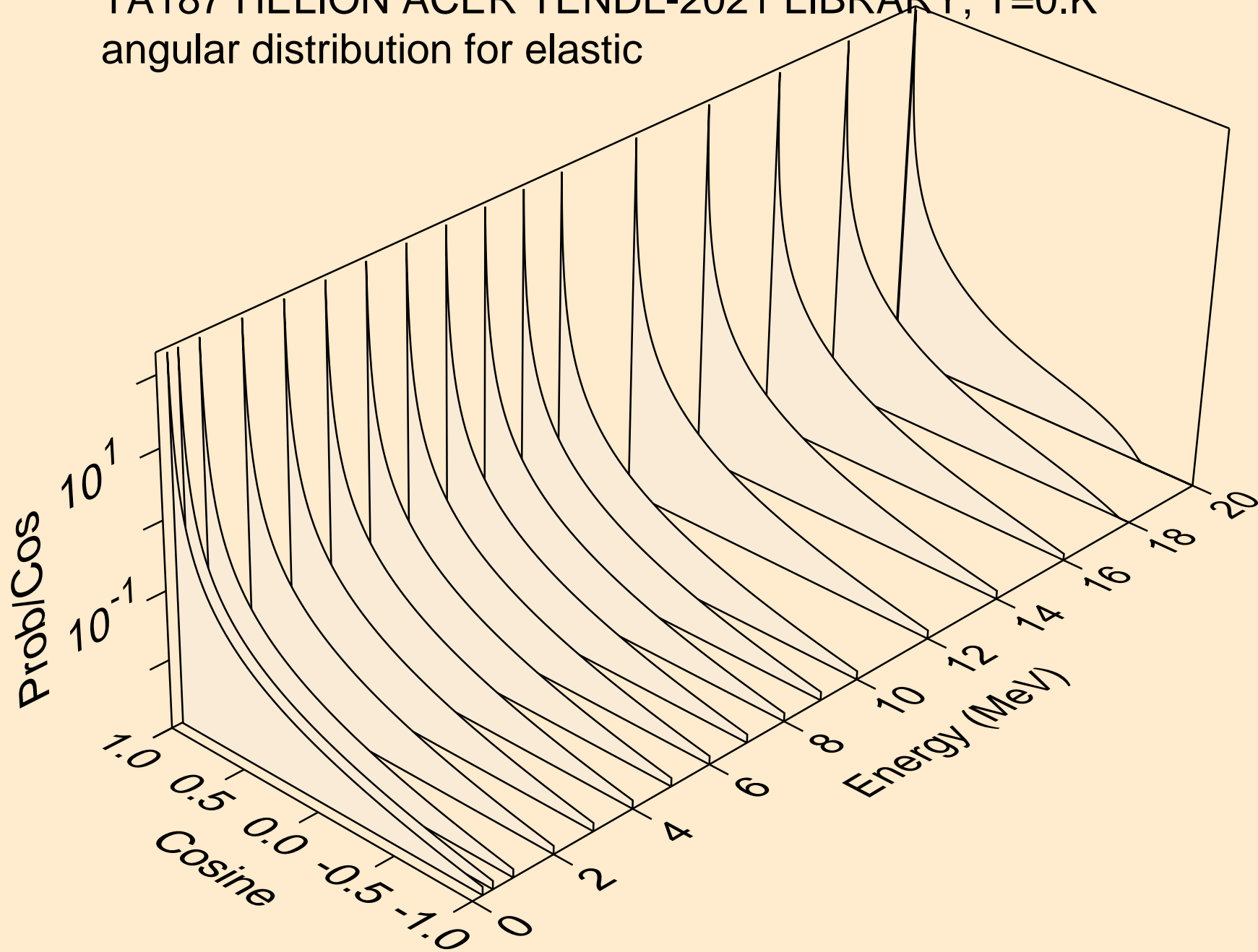

TA187 HELION ACER TENDL-2021 LIBRARY; T=0.K  
angular distribution for elastic

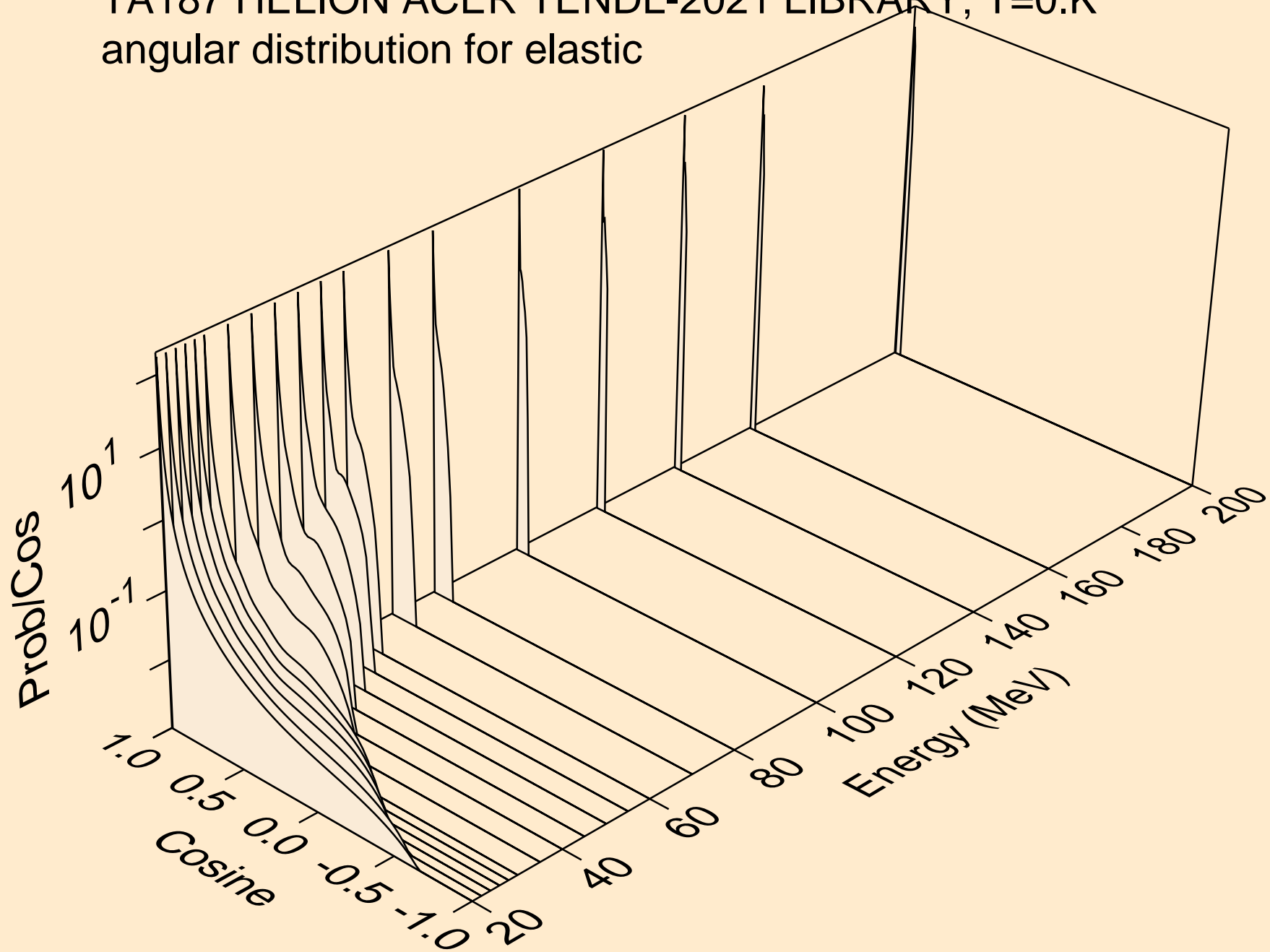

TA187 HELION ACER TENDL-2021 LIBRARY; T=0.K  
He-3 emission for (s,x)

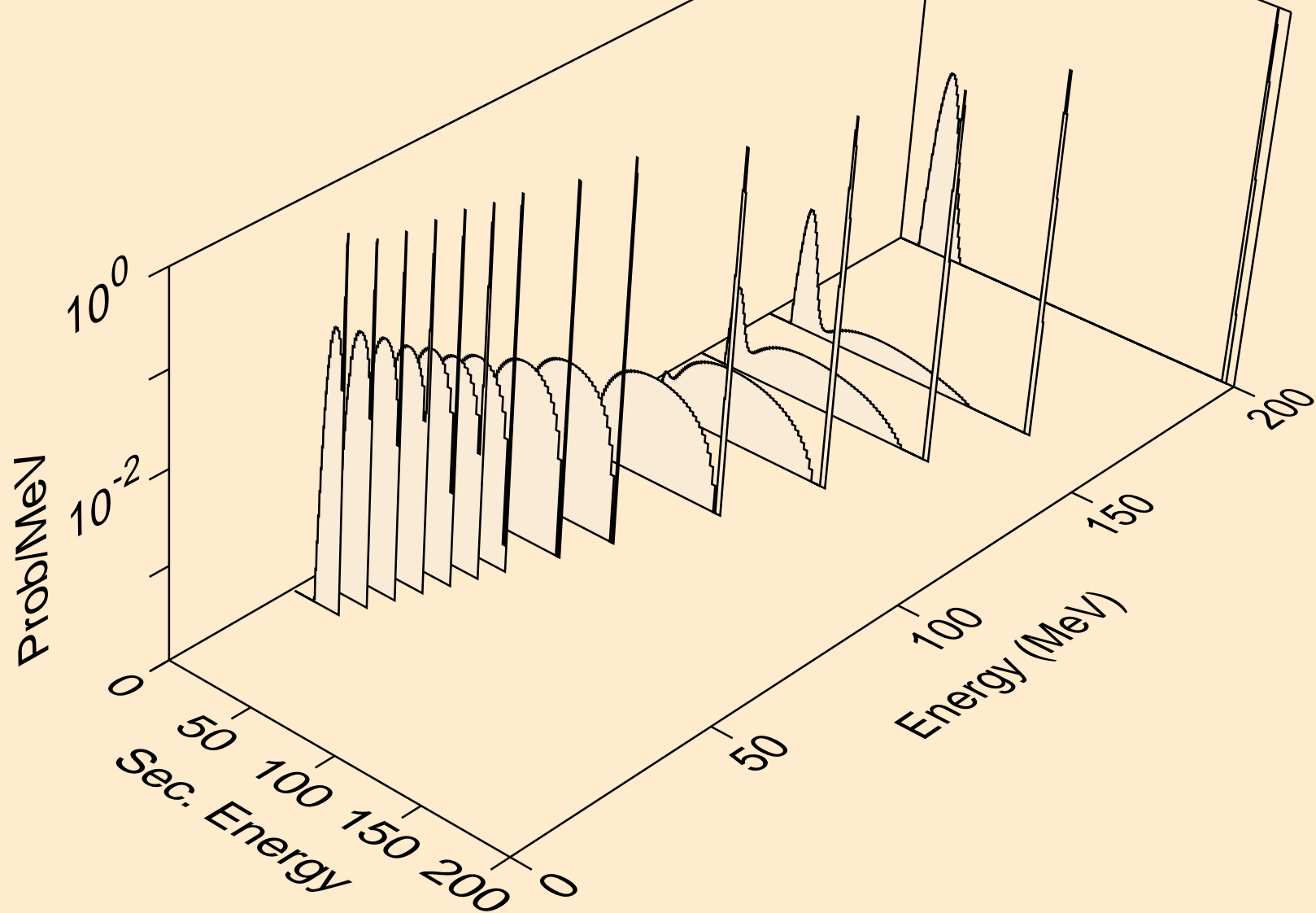

TA187 HELION ACER TENDL-2021 LIBRARY; T=0.K  
He-3 emission for (s,n\*)he3

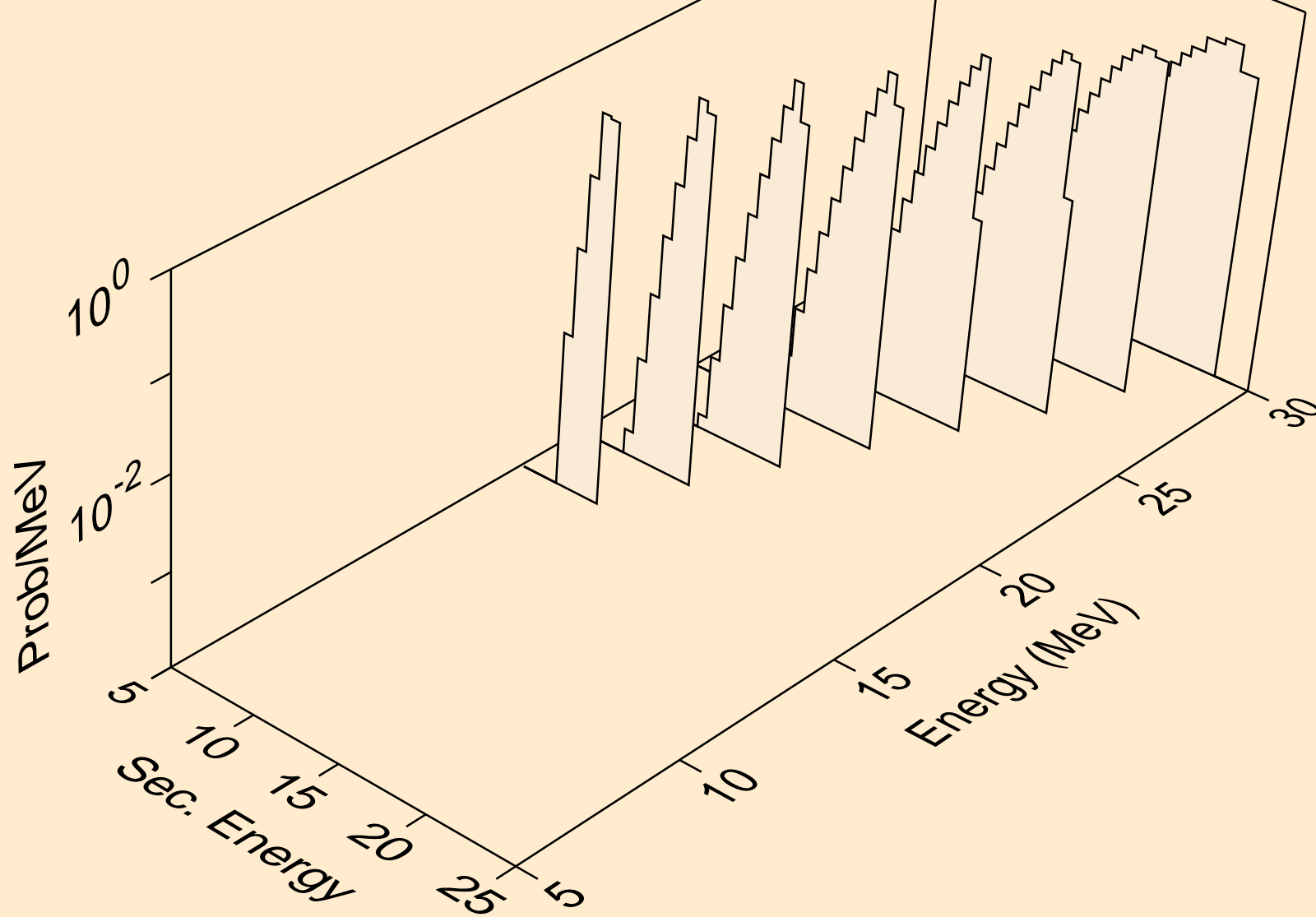

TA187 HELION ACER TENDL-2021 LIBRARY; T=0.K  
He-3 emission for inelastic

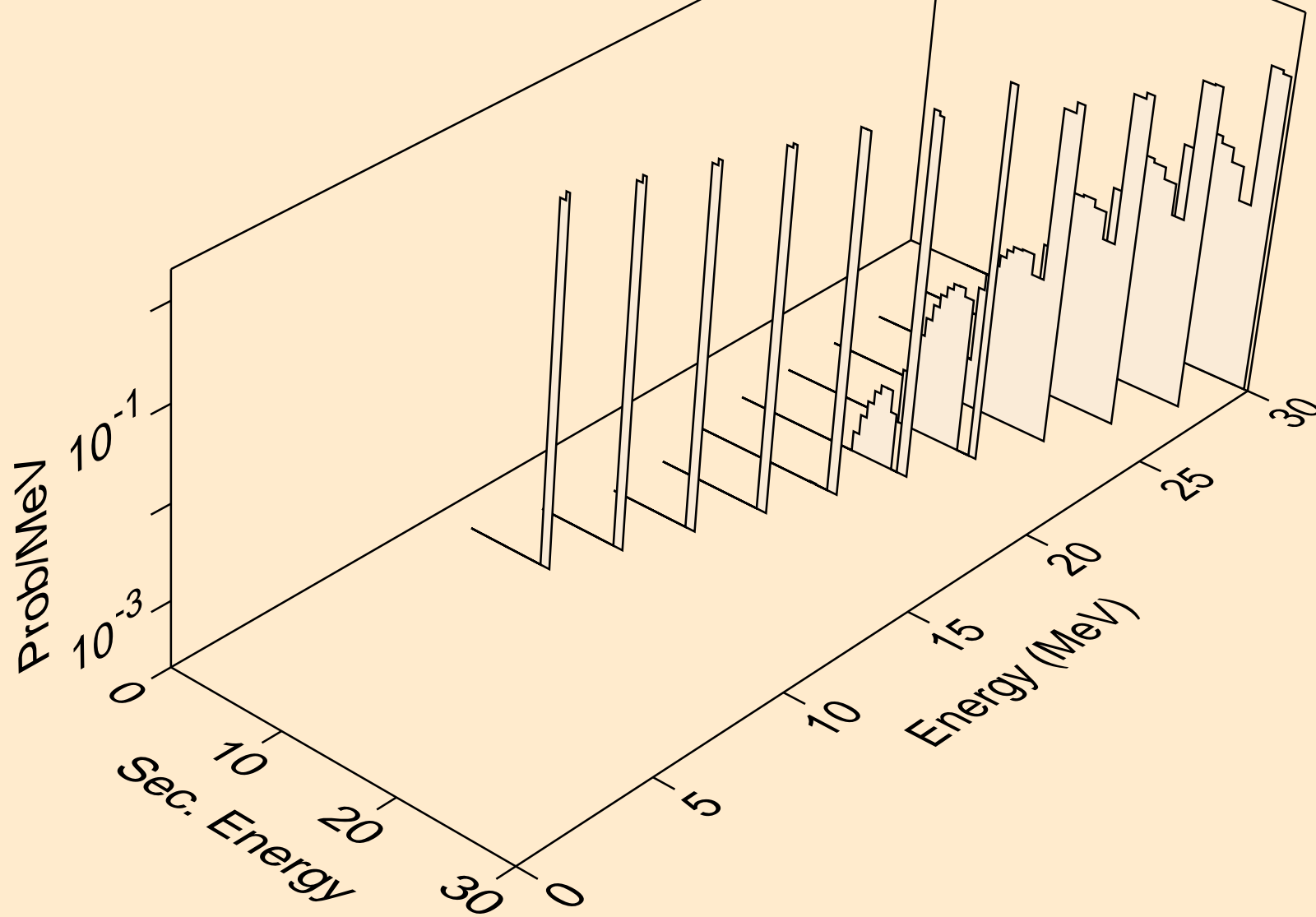



TA187 HELION ACER TENDL-2021 LIBRARY; T=0.K  
Photon emission for (z,n)

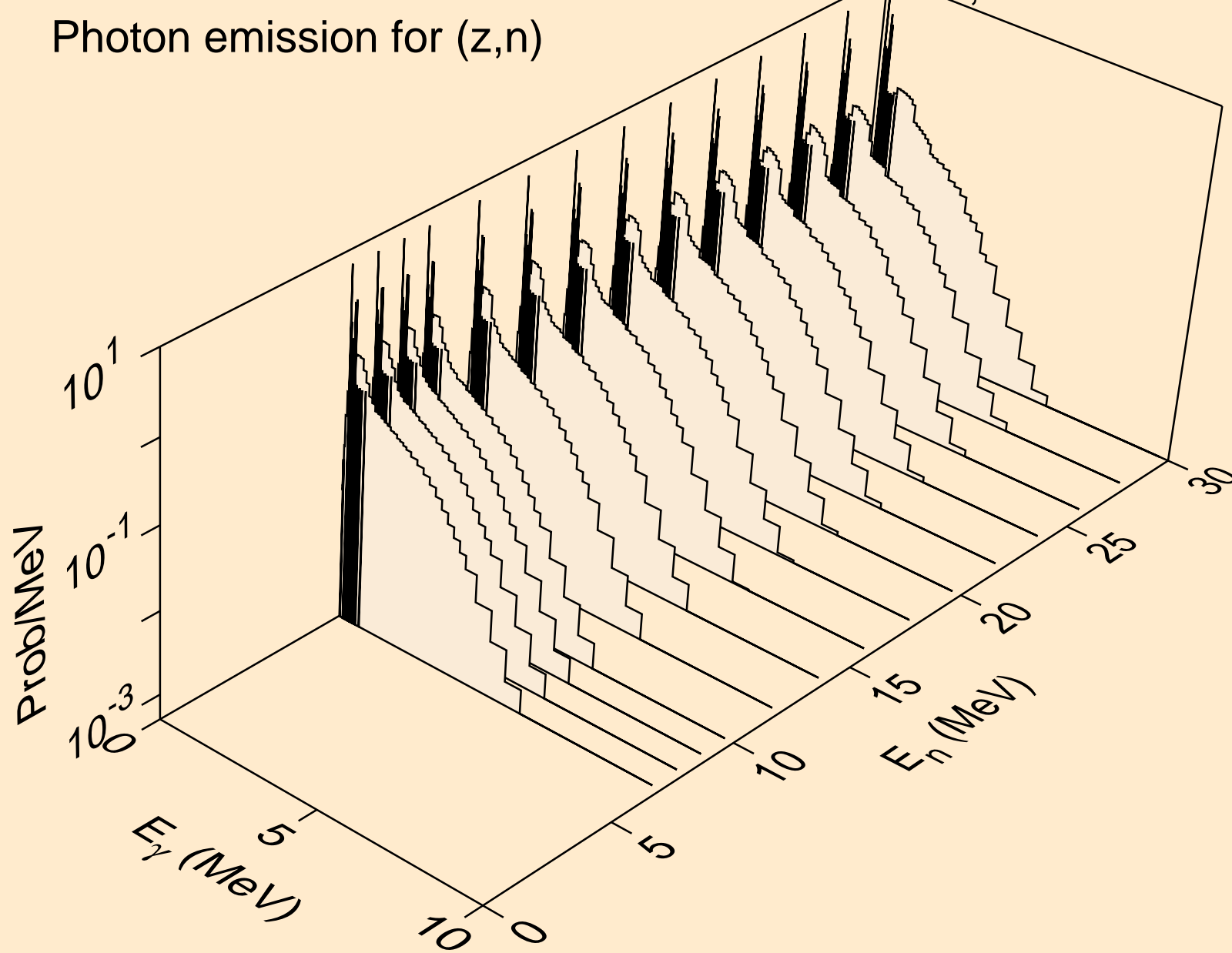

TA187 HELION ACER TENDL-2021 LIBRARY; T=0.K  
Photon emission for (n,x)

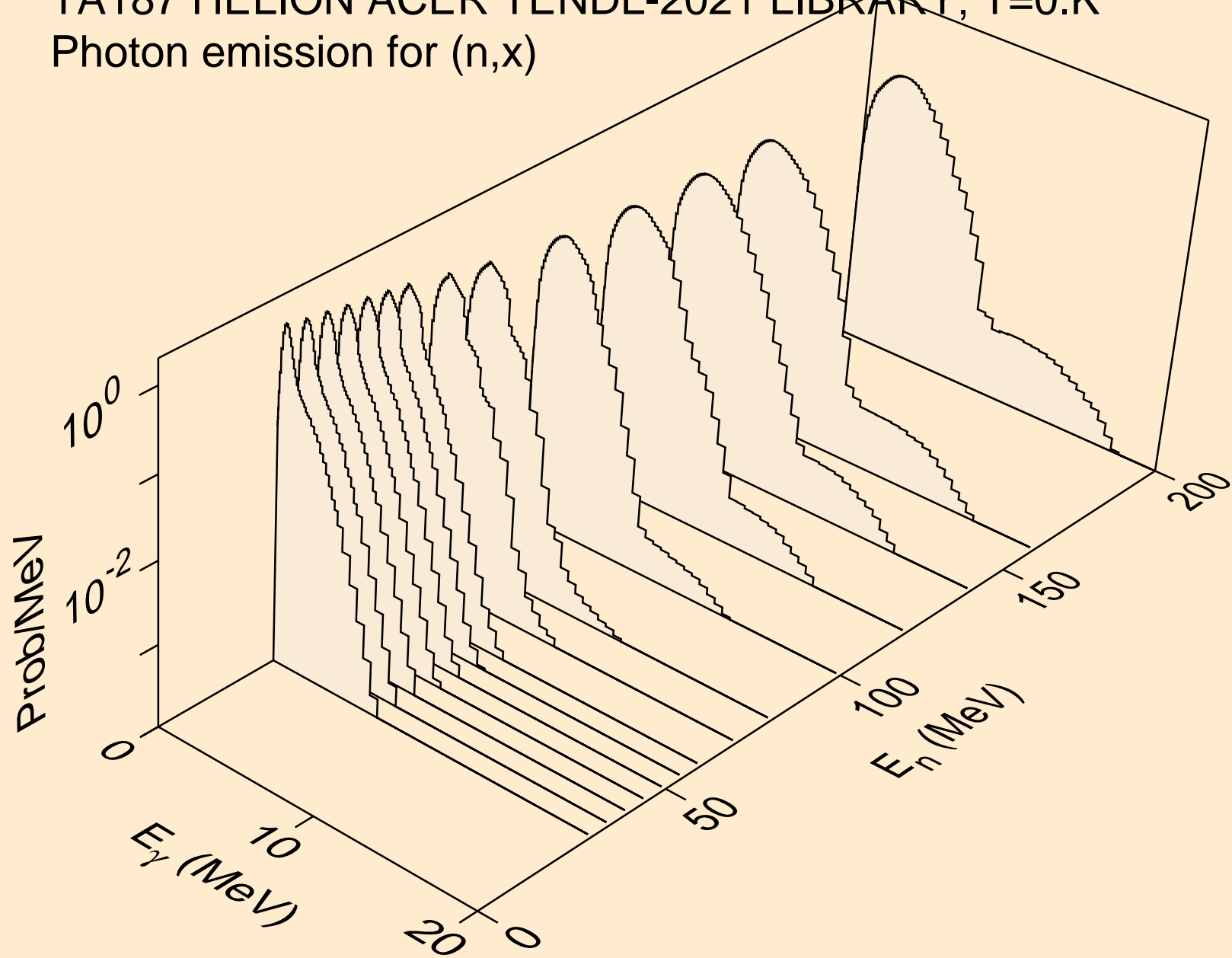

TA187 HELION ACER TENDL-2021 LIBRARY; T=0.K  
Photon emission for (n,2nd)

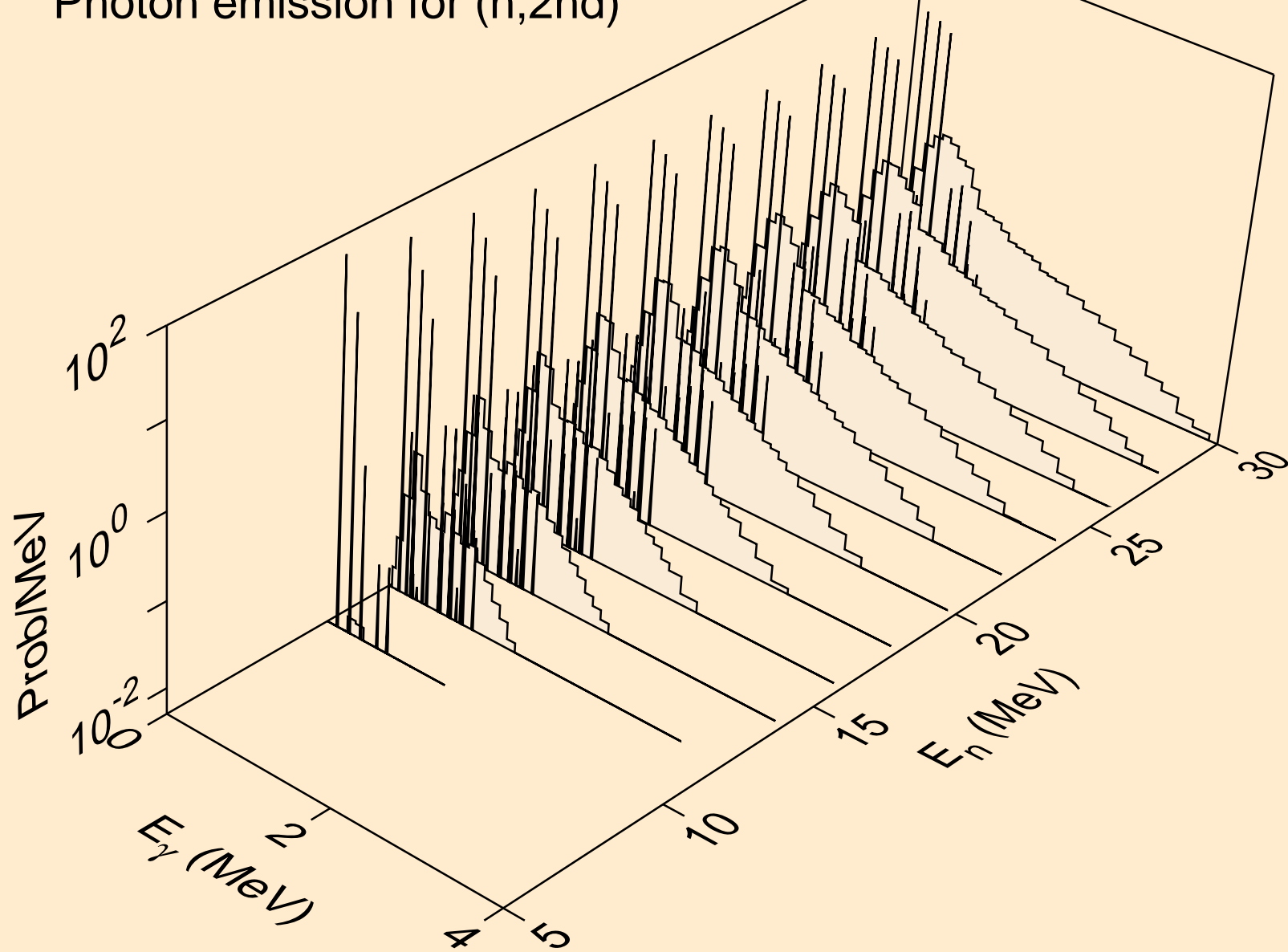

TA187 HELION ACER TENDL-2021 LIBRARY; T=0.K  
Photon emission for (n,2n)

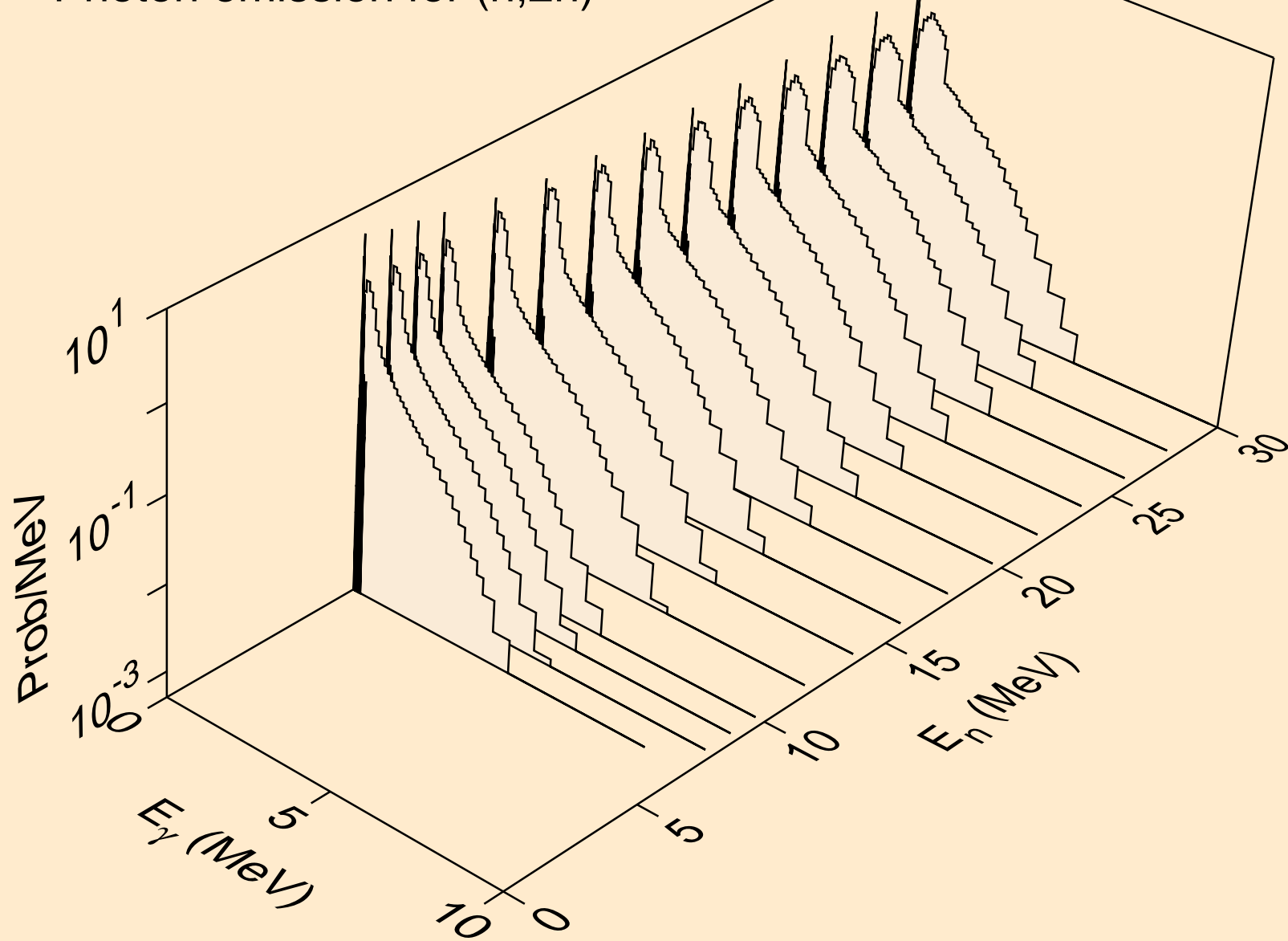

TA187 HELION ACER TENDL-2021 LIBRARY; T=0.K  
Photon emission for (n,3n)

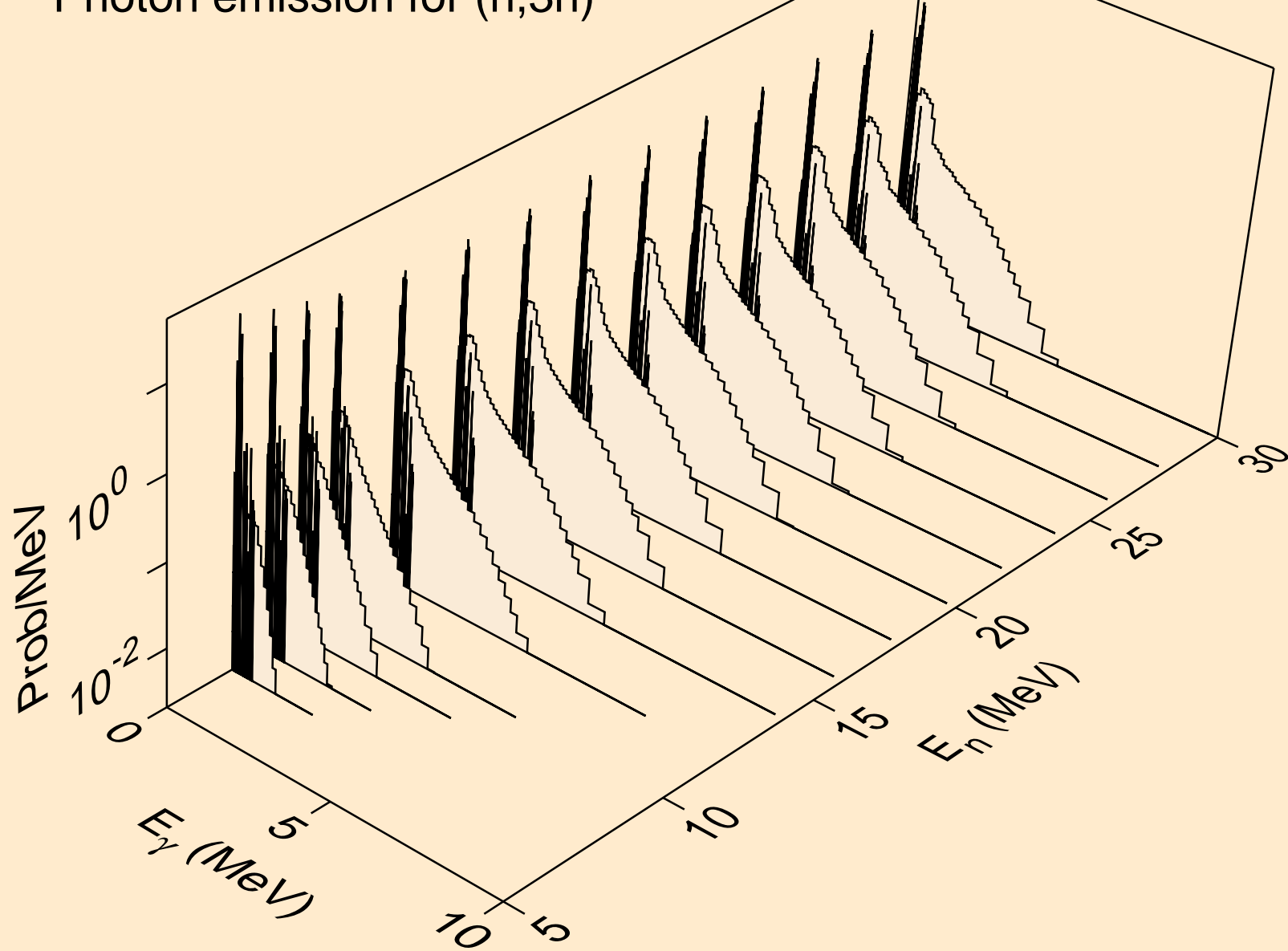

TA187 HELION ACER TENDL-2021 LIBRARY; T=0.K  
Photon emission for (n,n\*)a

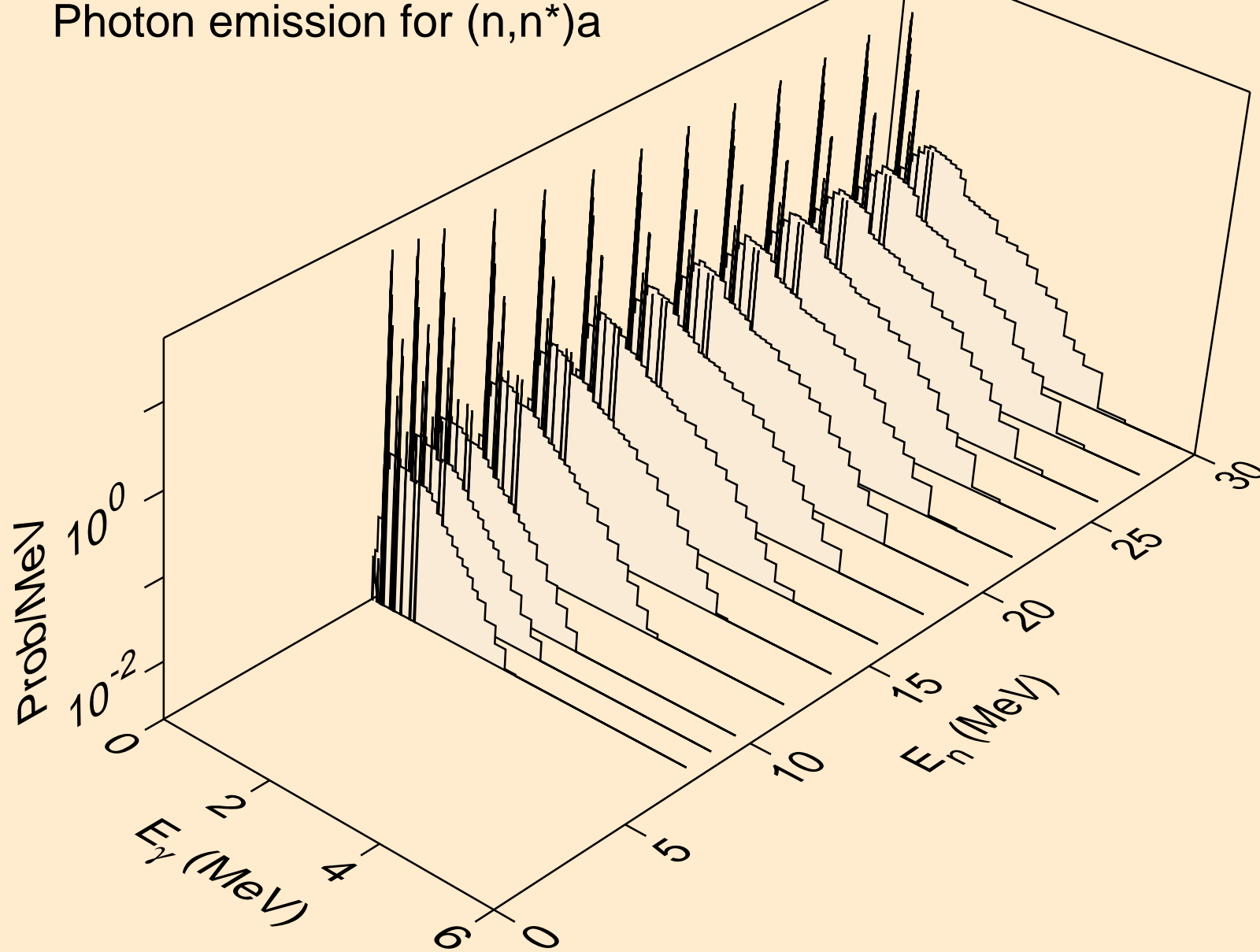

TA187 HELION ACER TENDL-2021 LIBRARY; T=0.K  
Photon emission for (n,2n)a

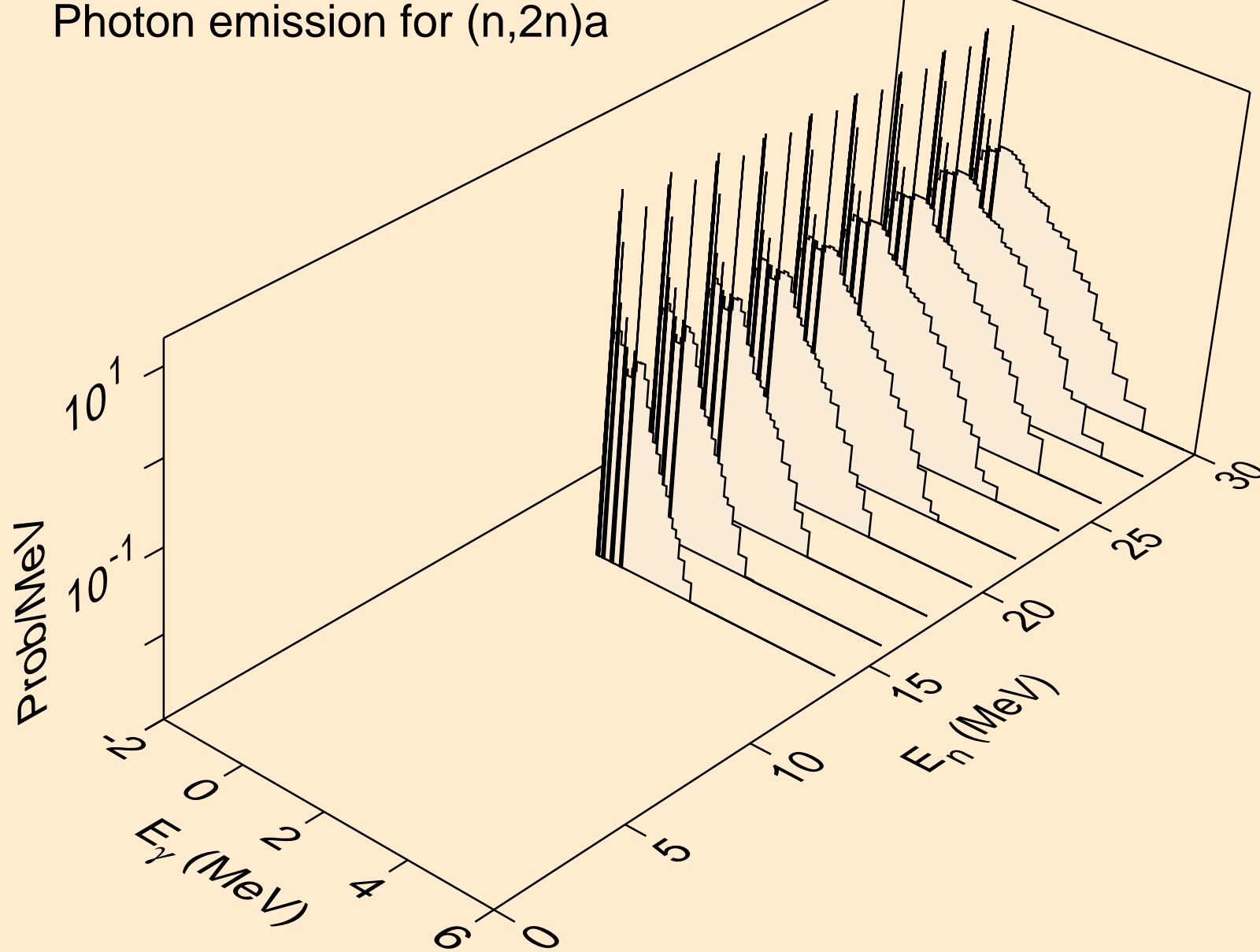

TA187 HELION ACER TENDL-2021 LIBRARY; T=0.K  
Photon emission for (n,3n)a

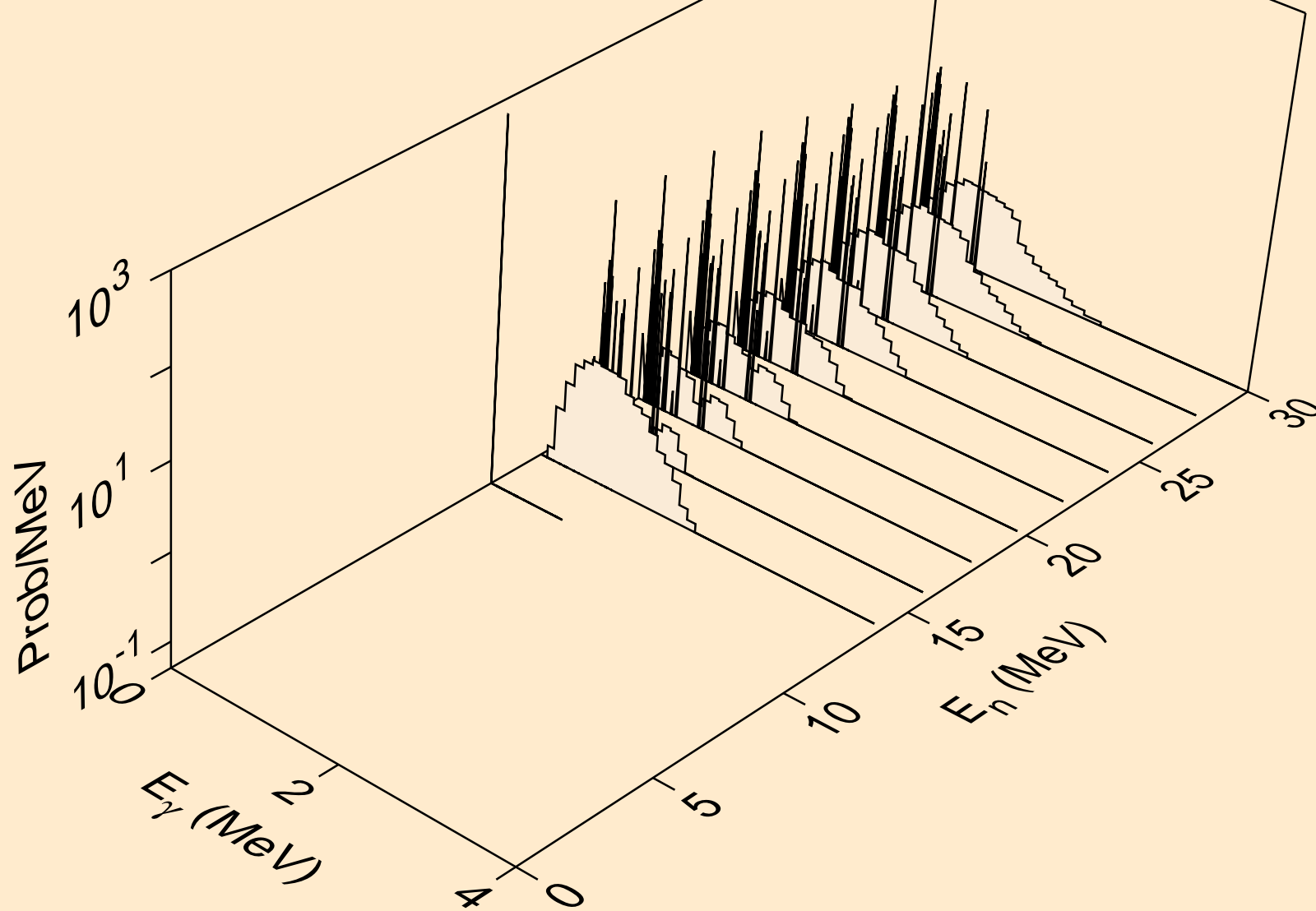



TA187 HELION ACER TENDL-2021 LIBRARY; T=0.K  
Photon emission for (n,n\*)p

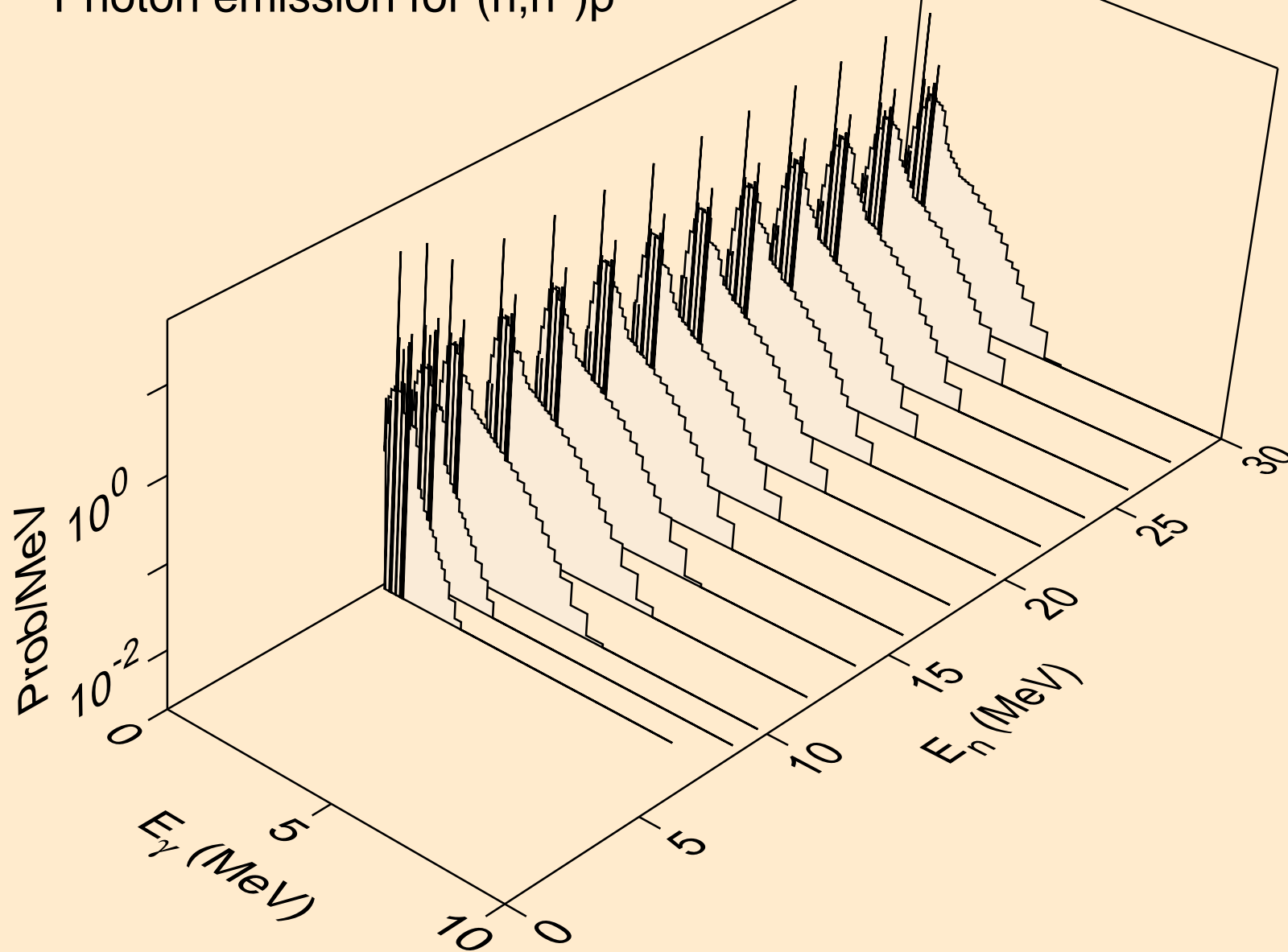

TA187 HELION ACER TENDL-2021 LIBRARY; T=0.K  
Photon emission for (n,n\*)d

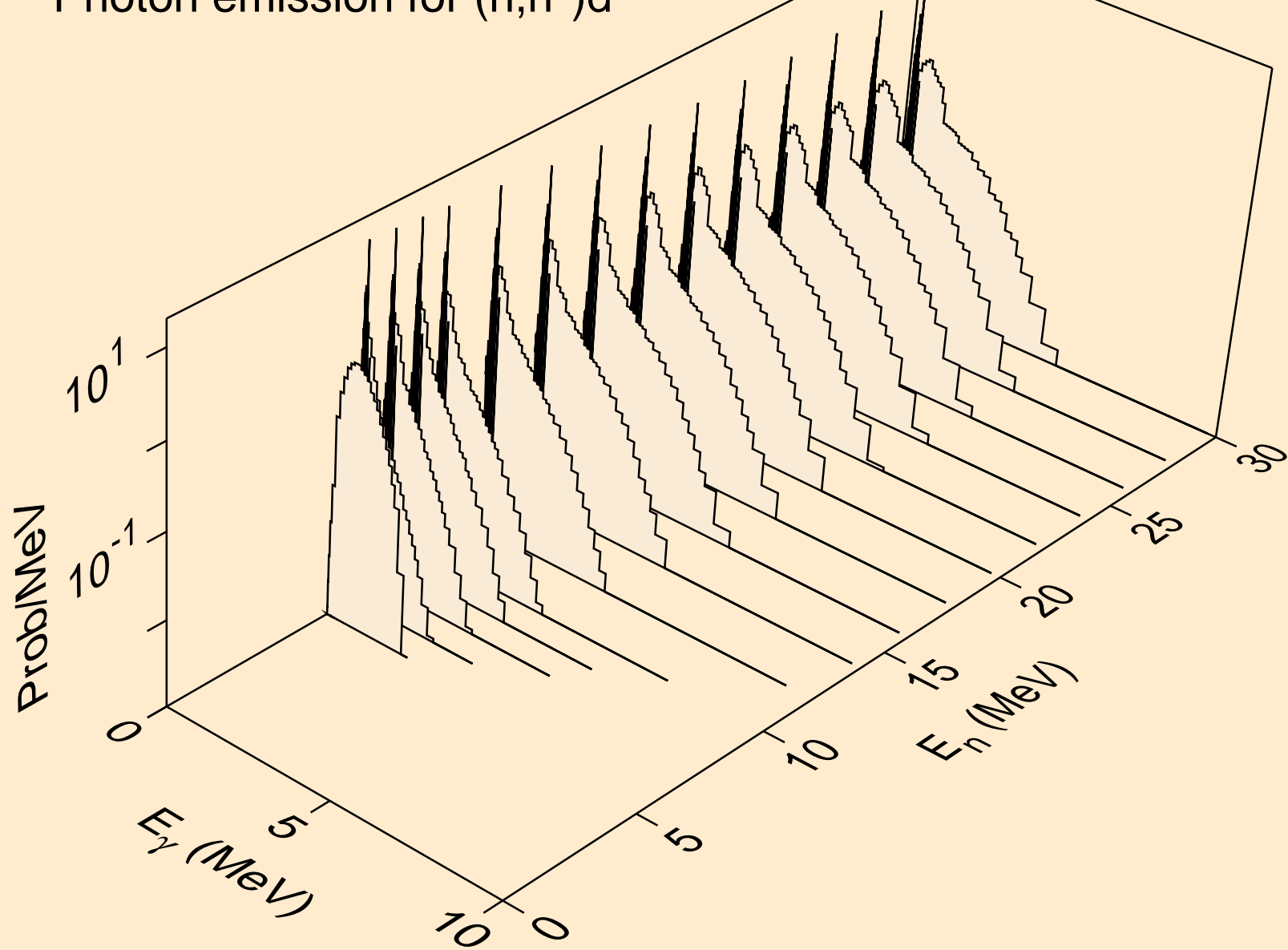

TA187 HELION ACER TENDL-2021 LIBRARY; T=0.K  
Photon emission for (n,n\*)t

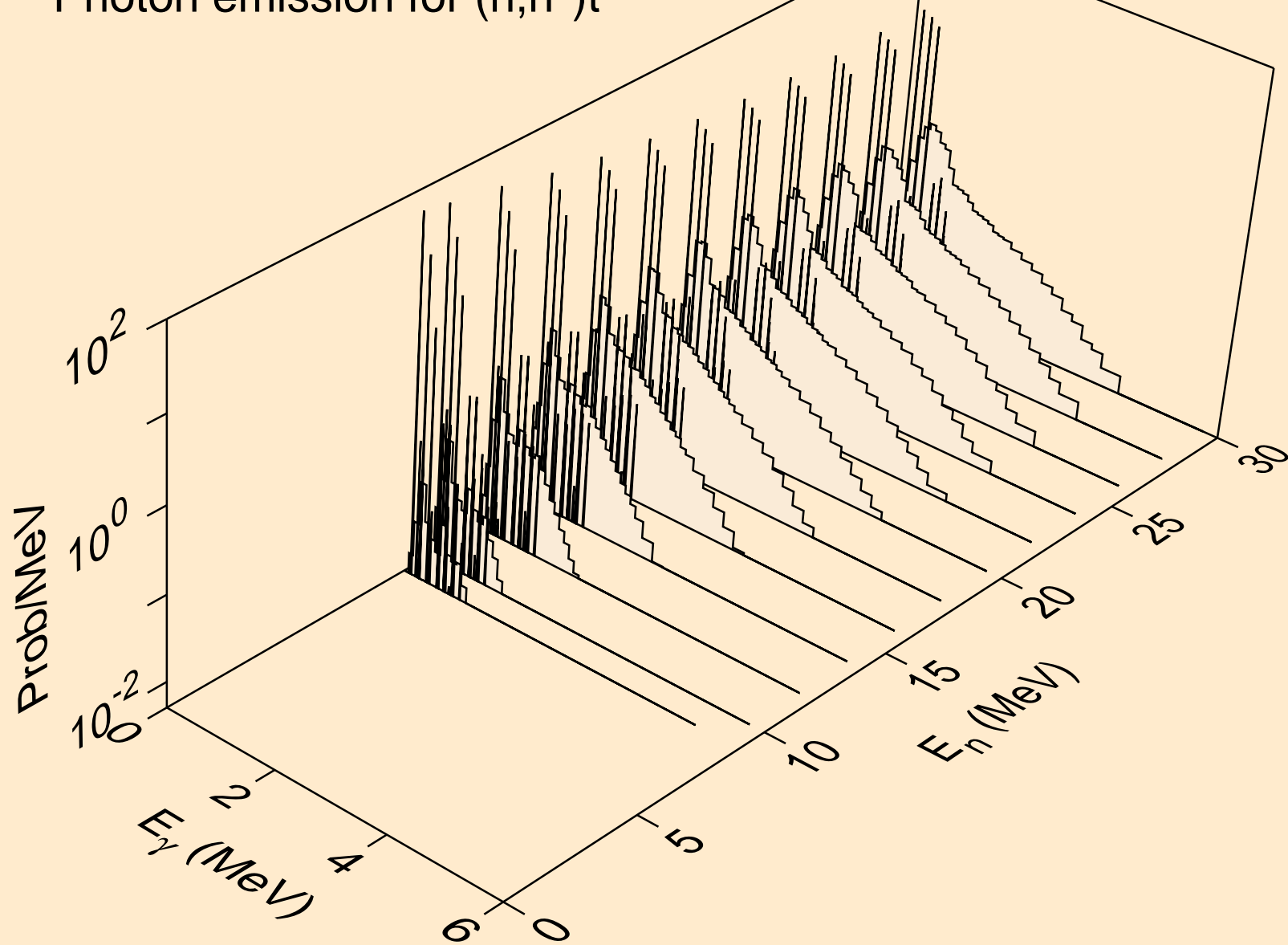

TA187 HELION ACER TENDL-2021 LIBRARY; T=0.K  
Photon emission for (n,n\*)he3

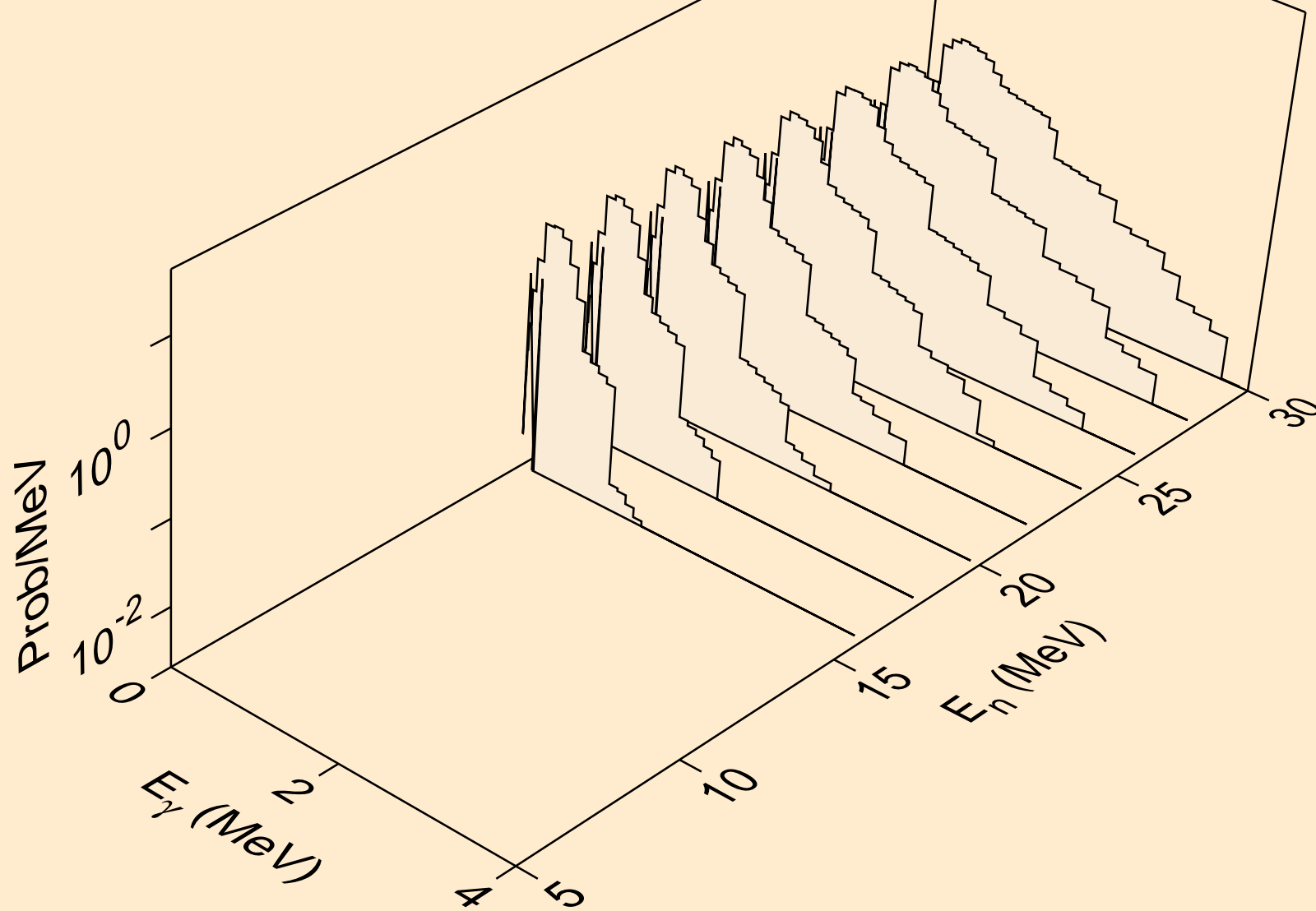

TA187 HELION ACER TENDL-2021 LIBRARY; T=0.K  
Photon emission for (n,4n)

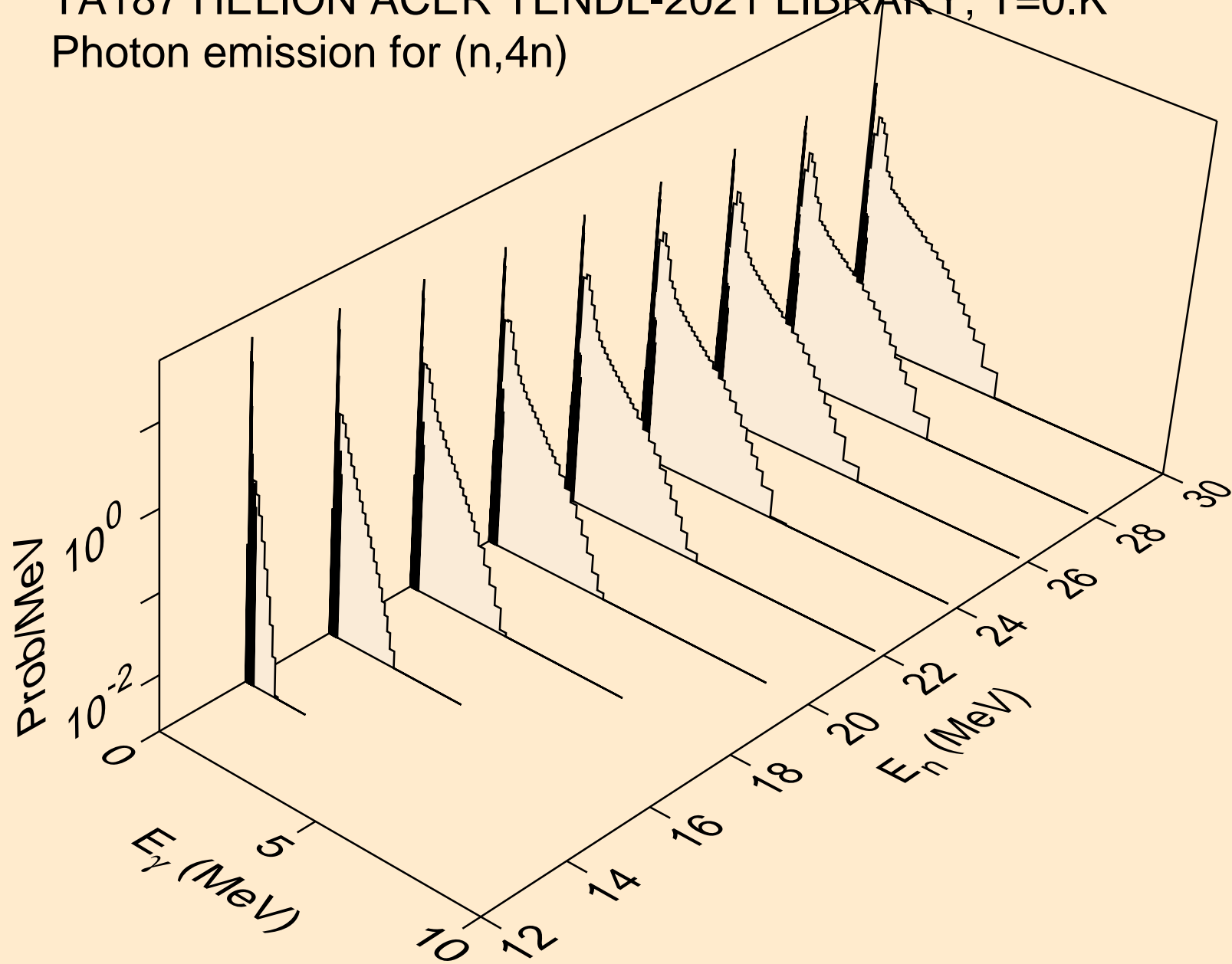

TA187 HELION ACER TENDL-2021 LIBRARY; T=0.K  
Photon emission for (n,2np)

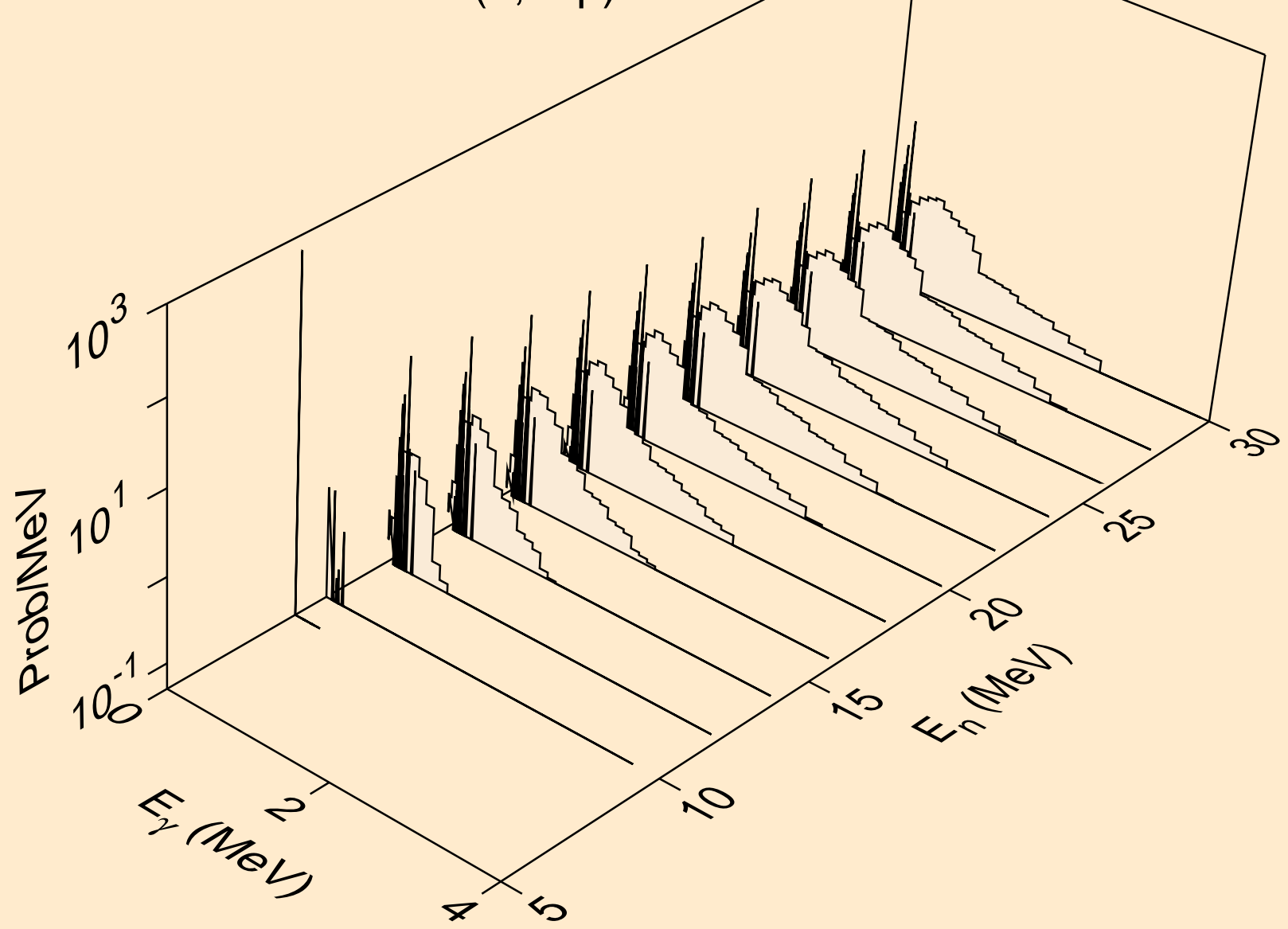

TA187 HELION ACER TENDL-2021 LIBRARY; T=0.K  
Photon emission for (n,3np)

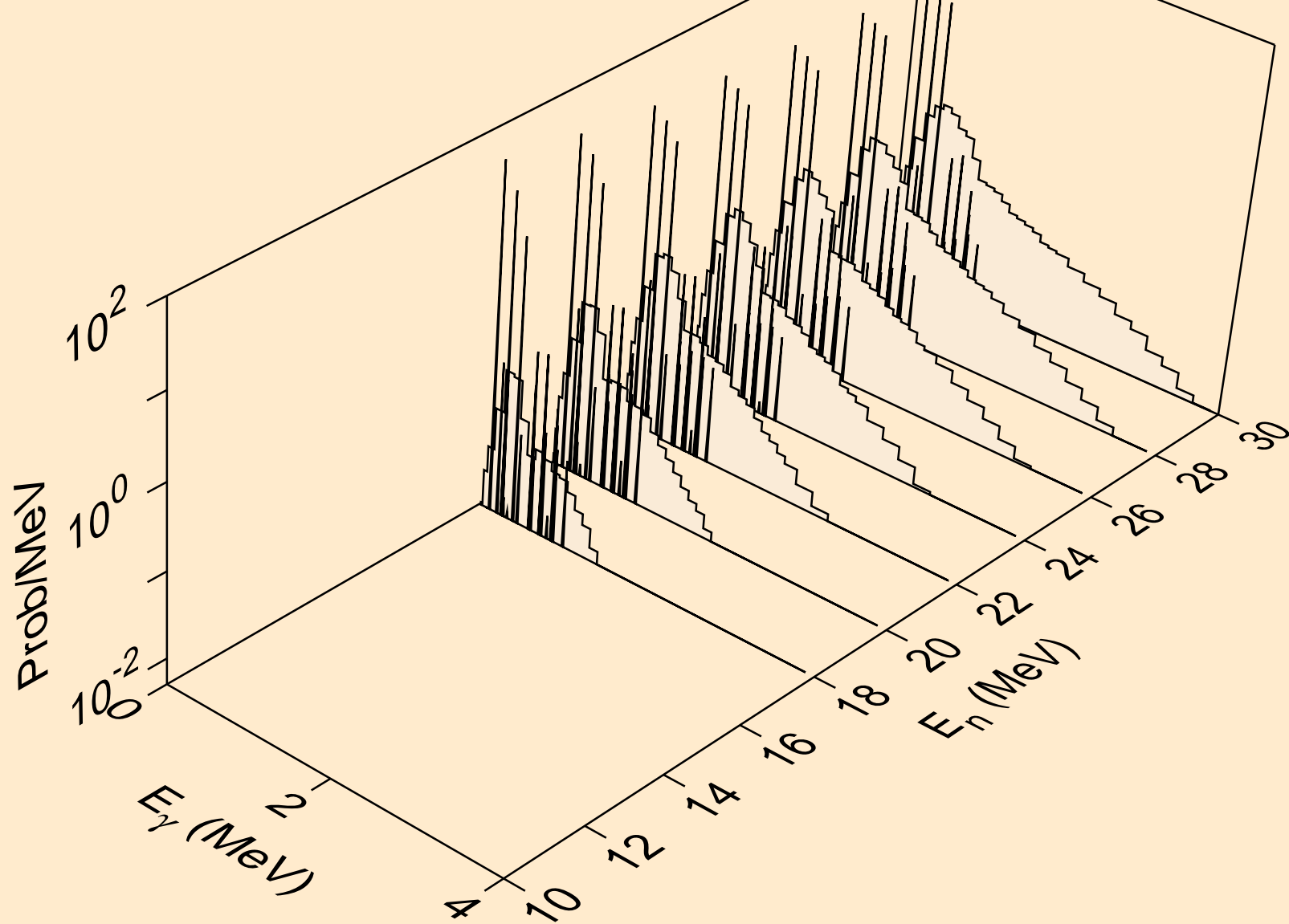

TA187 HELION ACER TENDL-2021 LIBRARY; T=0.K  
Photon emission for (n,2np)

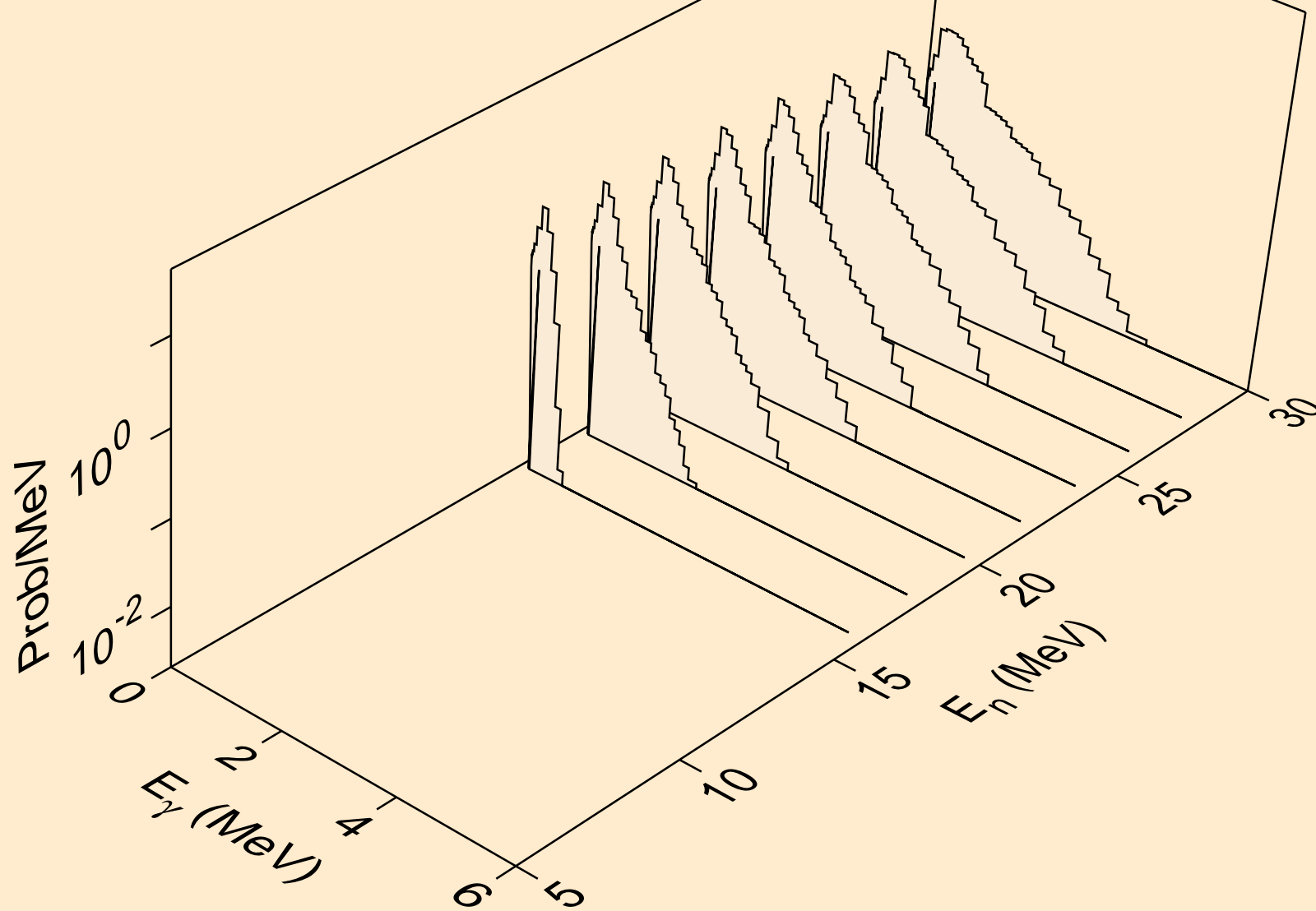



TA187 HELION ACER TENDL-2021 LIBRARY; T=0.K  
Photon emission for (n,npa)

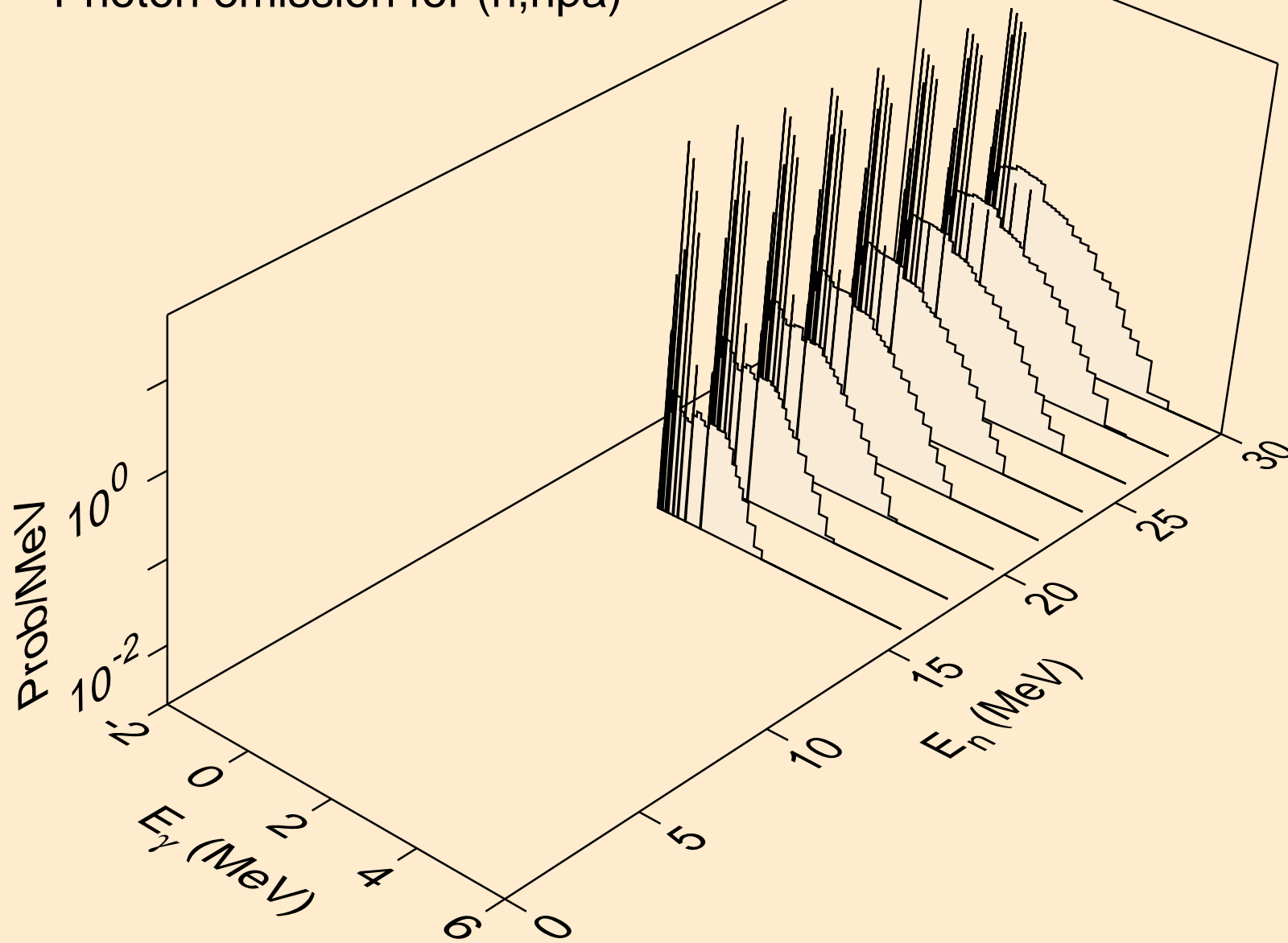

TA187 HELION ACER TENDL-2021 LIBRARY; T=0.K  
Photon emission for (n,gma)

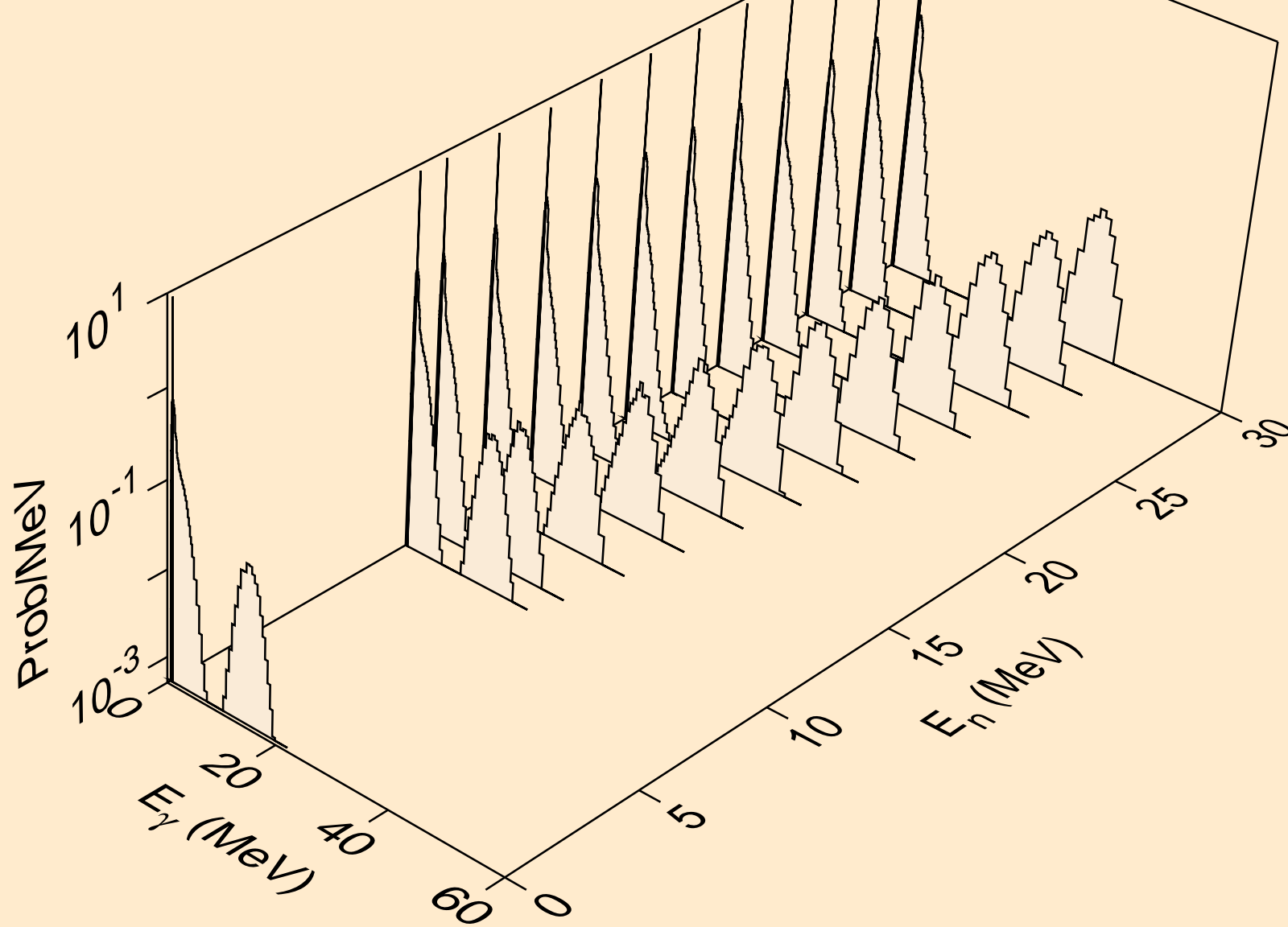

TA187 HELION ACER TENDL-2021 LIBRARY; T=0.K  
Photon emission for (n,p)

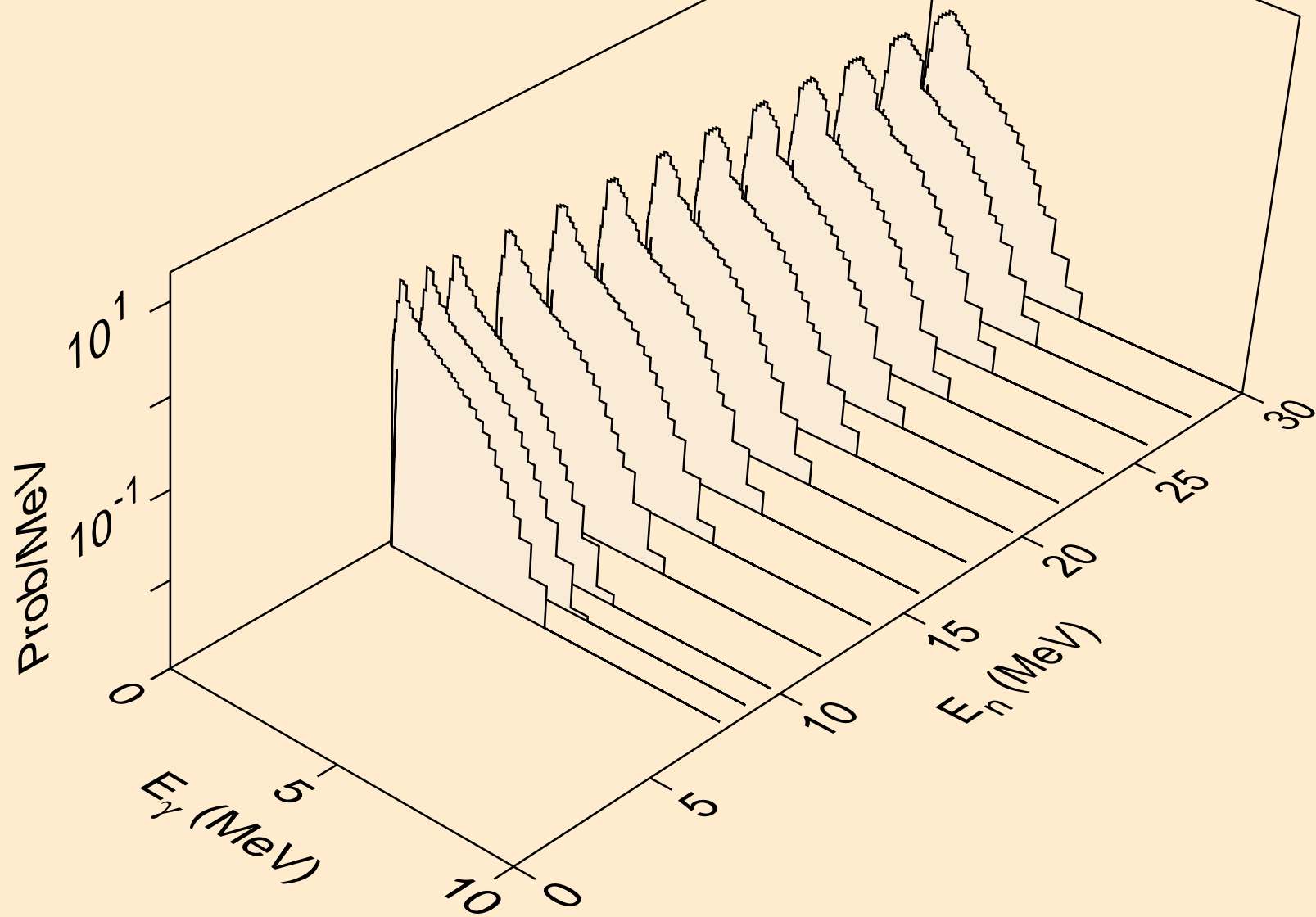

TA187 HELION ACER TENDL-2021 LIBRARY; T=0.K  
Photon emission for (n,d)

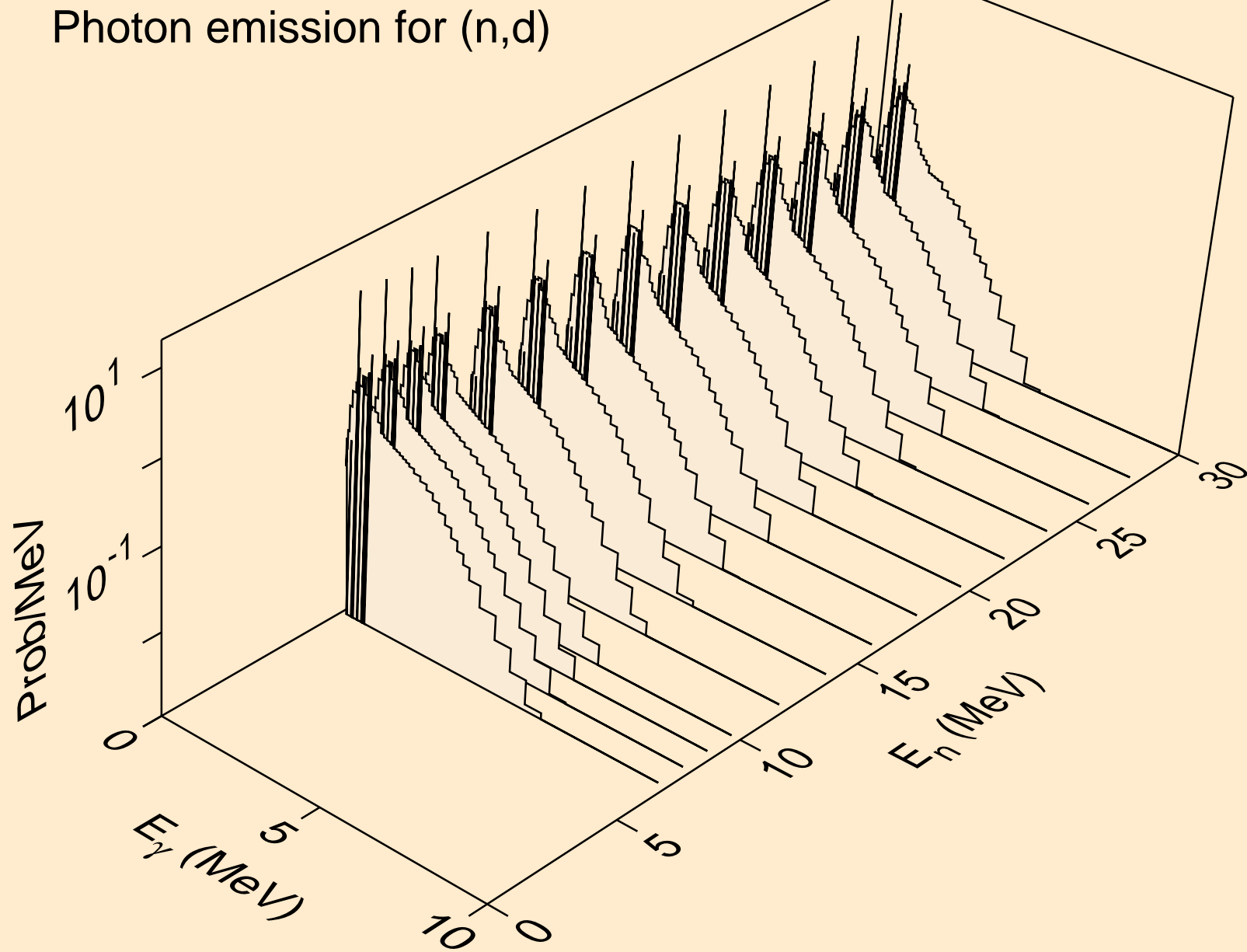

TA187 HELION ACER TENDL-2021 LIBRARY; T=0.K  
Photon emission for (n,t)

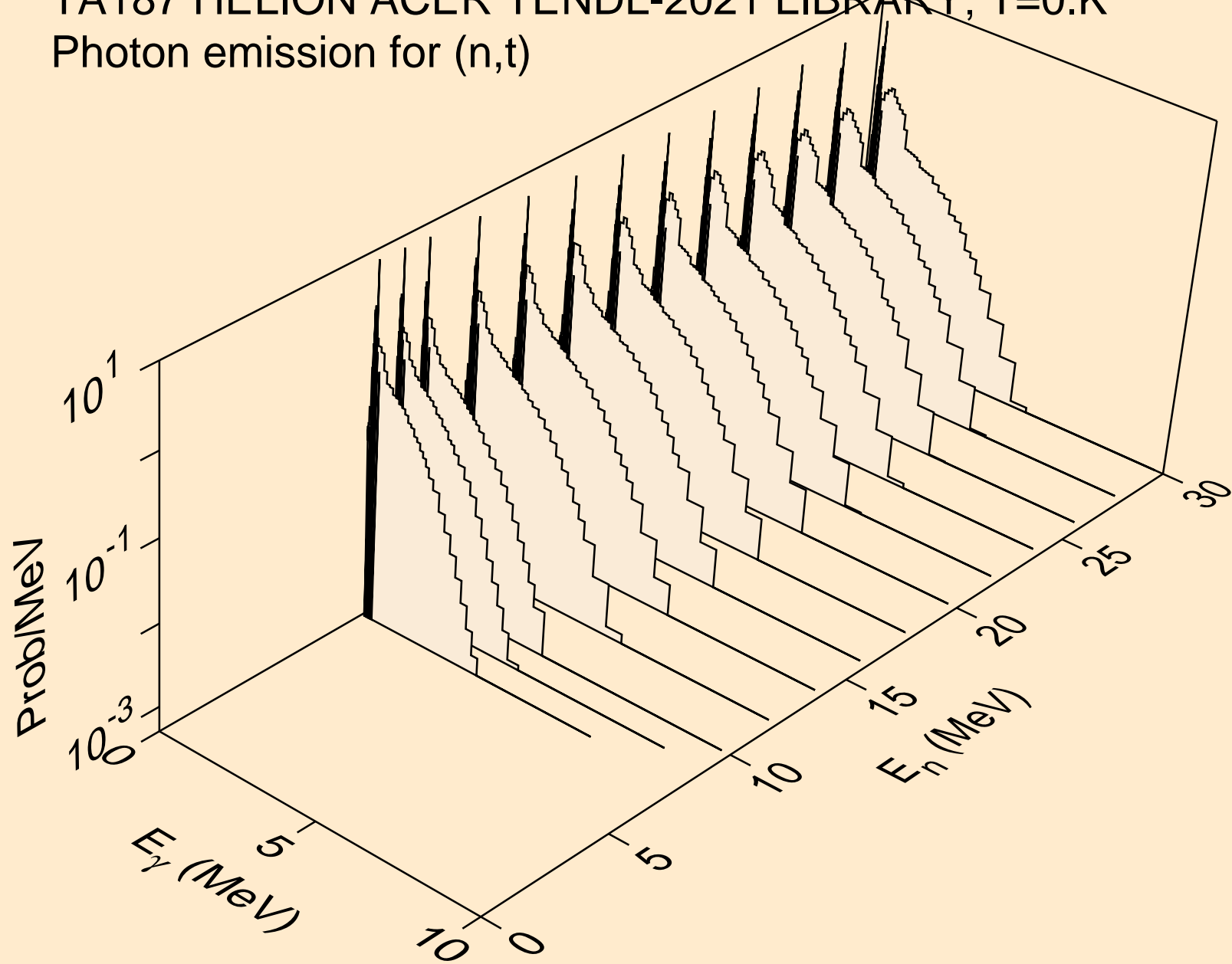

TA187 HELION ACER TENDL-2021 LIBRARY; T=0.K  
Photon emission for inelastic

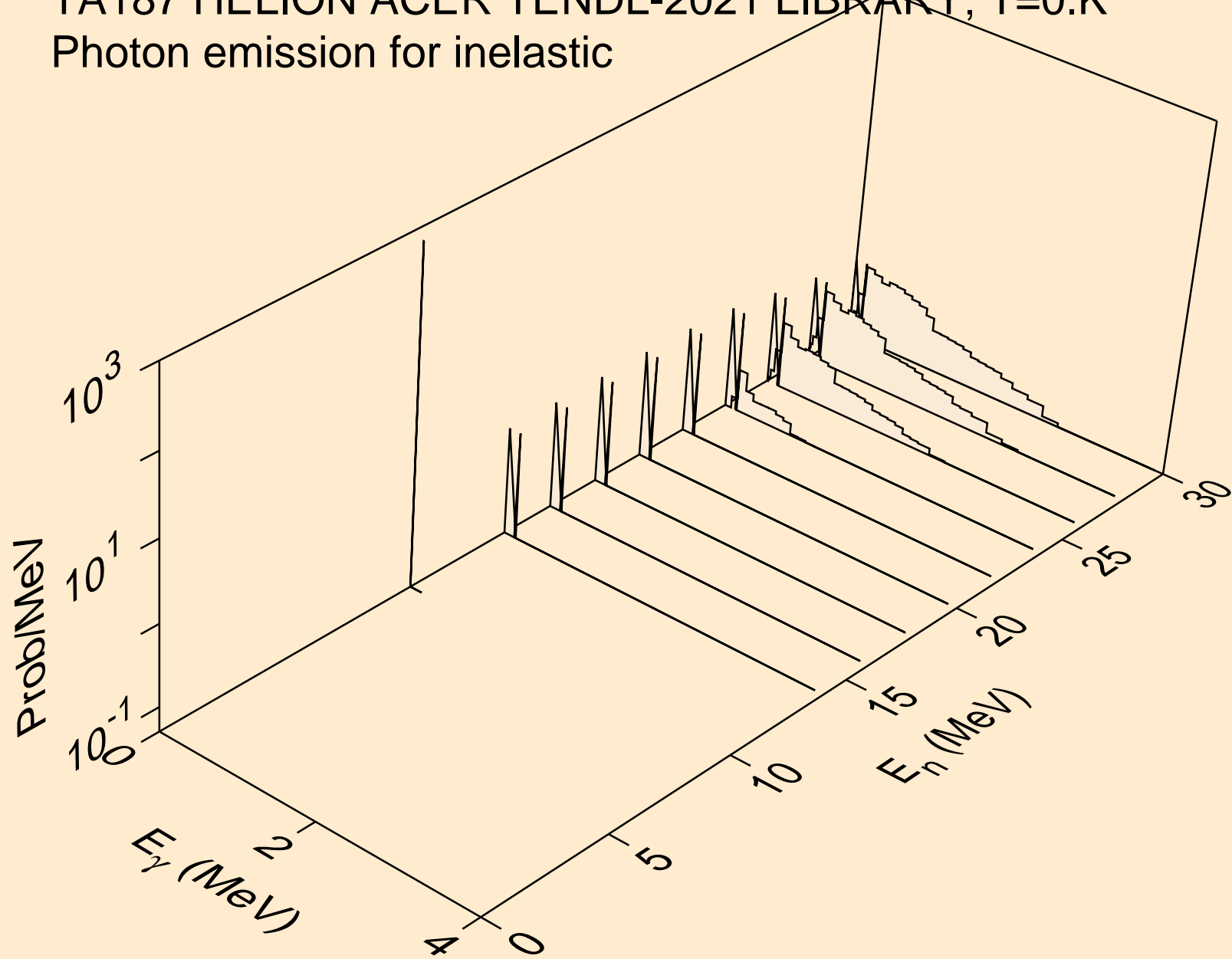

TA187 HELION ACER TENDL-2021 LIBRARY; T=0.K  
Photon emission for (n,a)

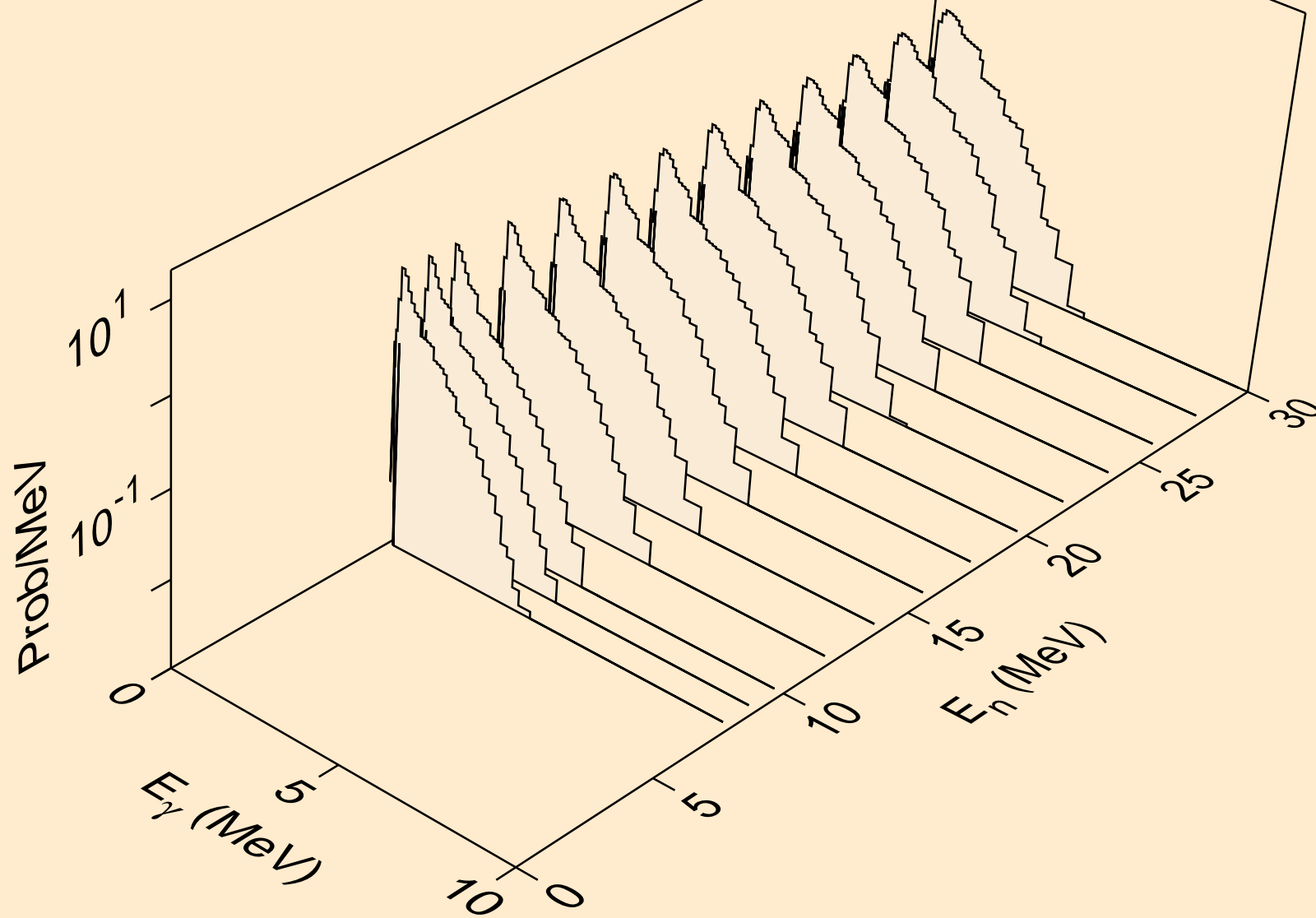

TA187 HELION ACER TENDL-2021 LIBRARY; T=0.K  
Photon emission for (n,2p)

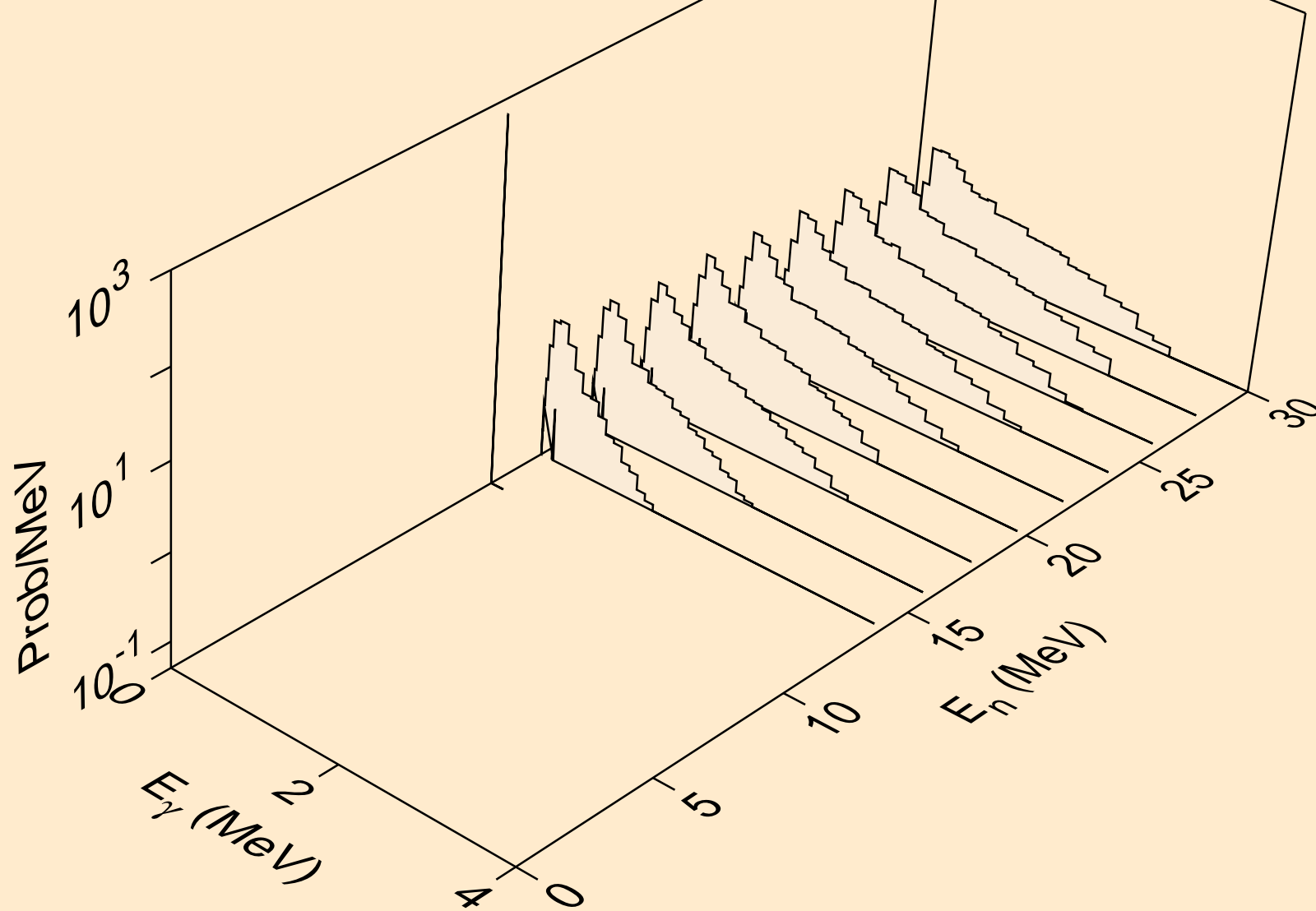



TA187 HELION ACER TENDL-2021 LIBRARY; T=0.K  
Photon emission for (n,pa)

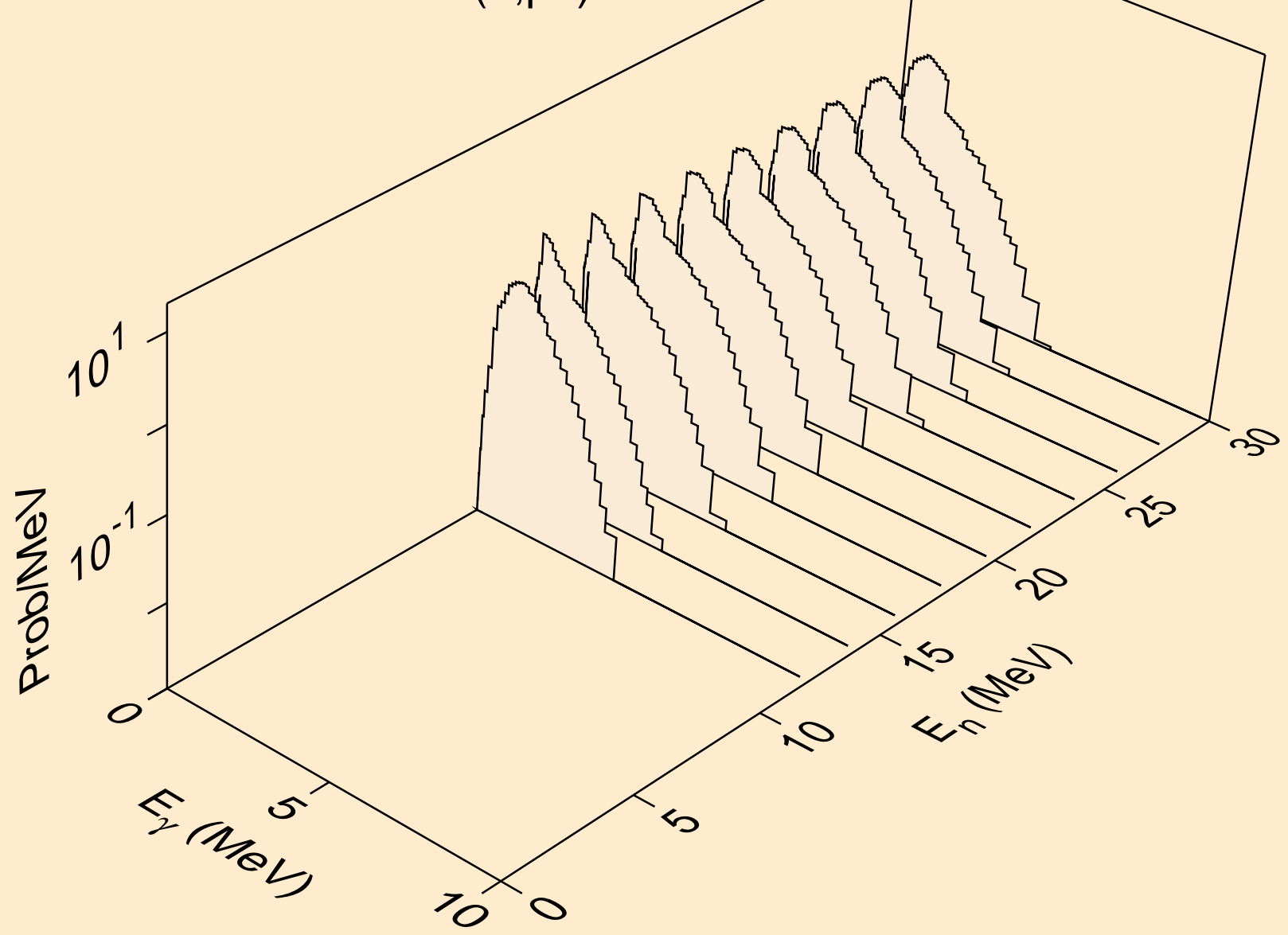

TA187 HELION ACER TENDL-2021 LIBRARY; T=0.K  
Photon emission for (n,pd)

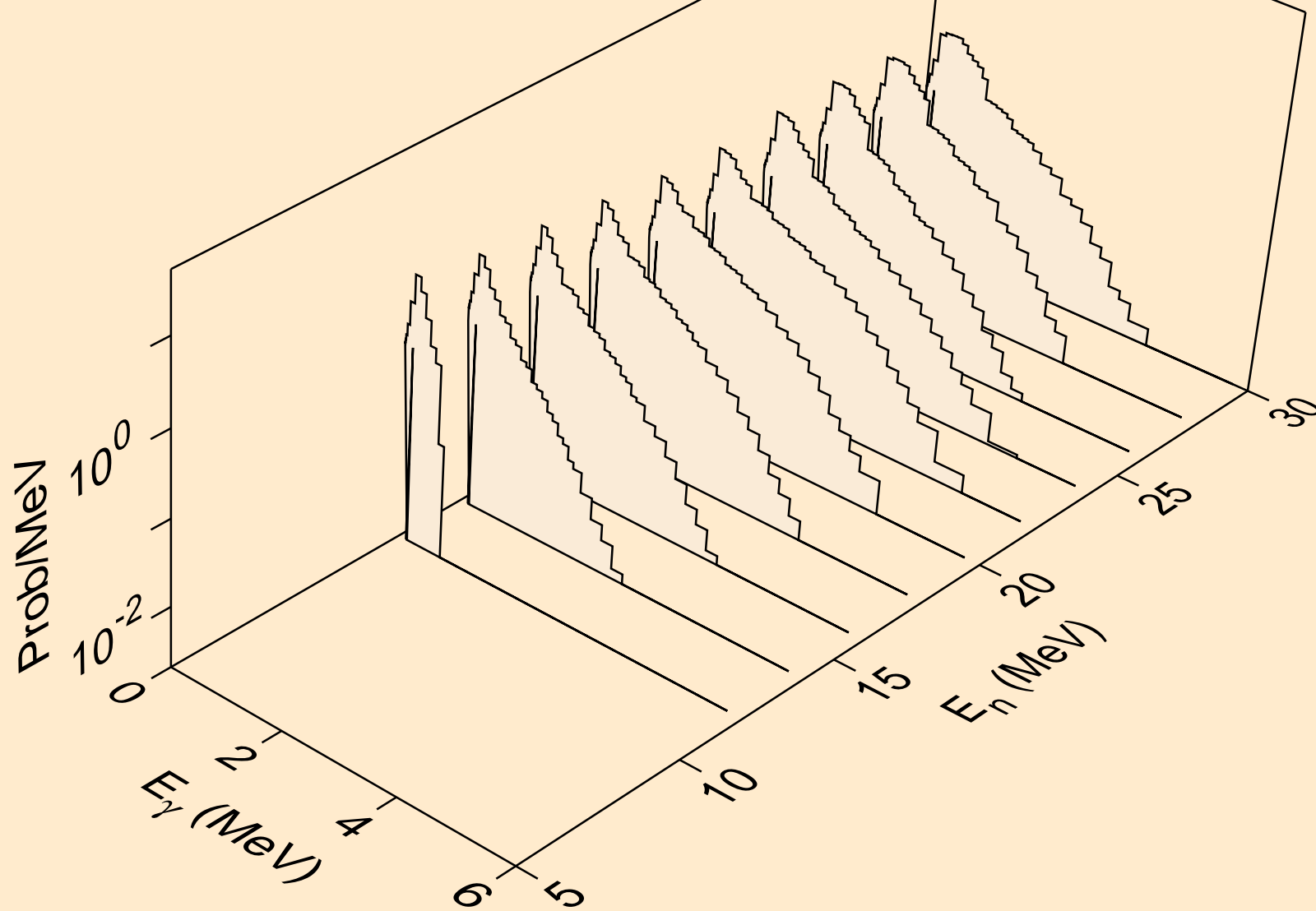

TA187 HELION ACER TENDL-2021 LIBRARY; T=0.K  
Photon emission for (n,pt)

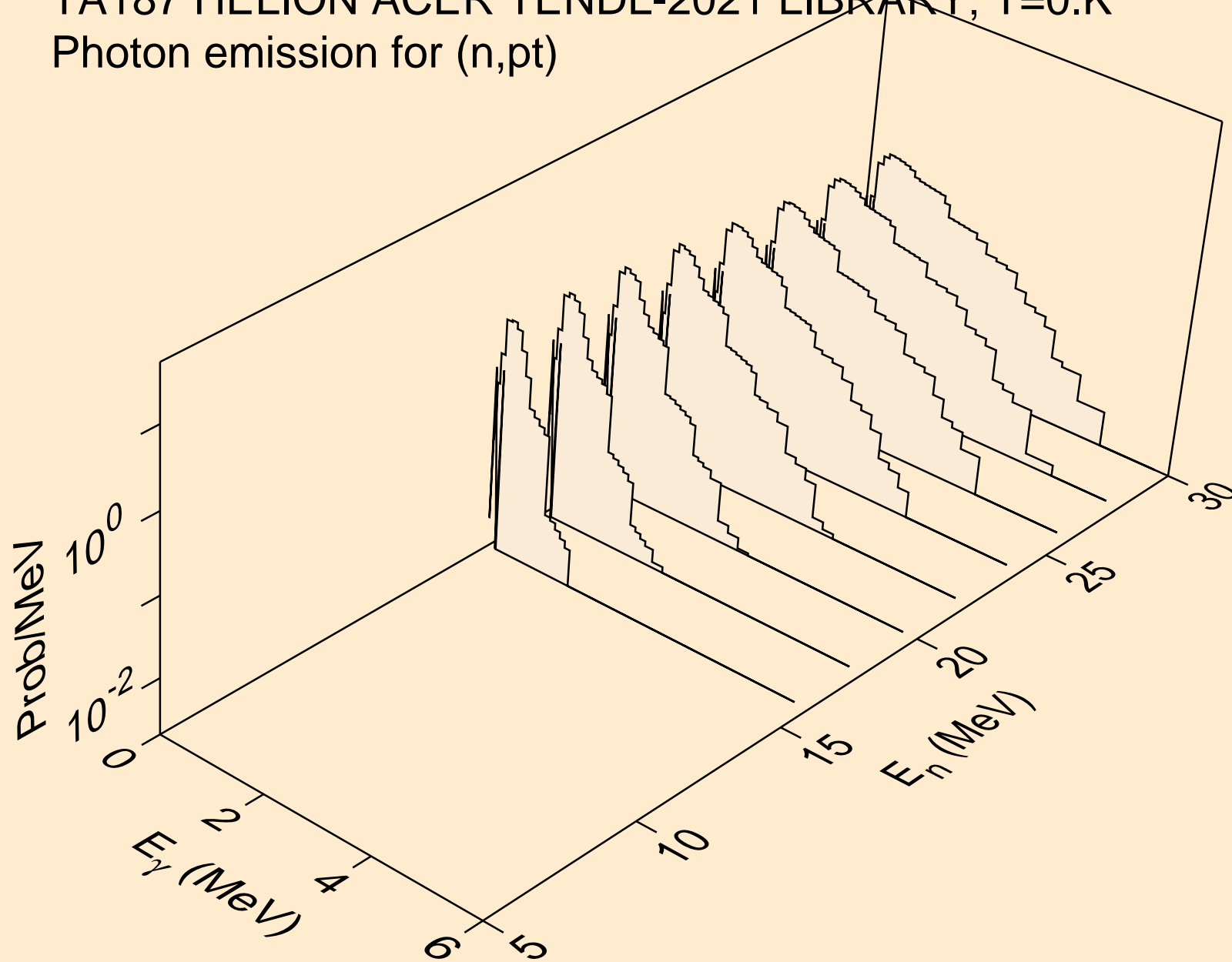

TA187 HELION ACER TENDL-2021 LIBRARY; T=0.K  
Particle heating contributions

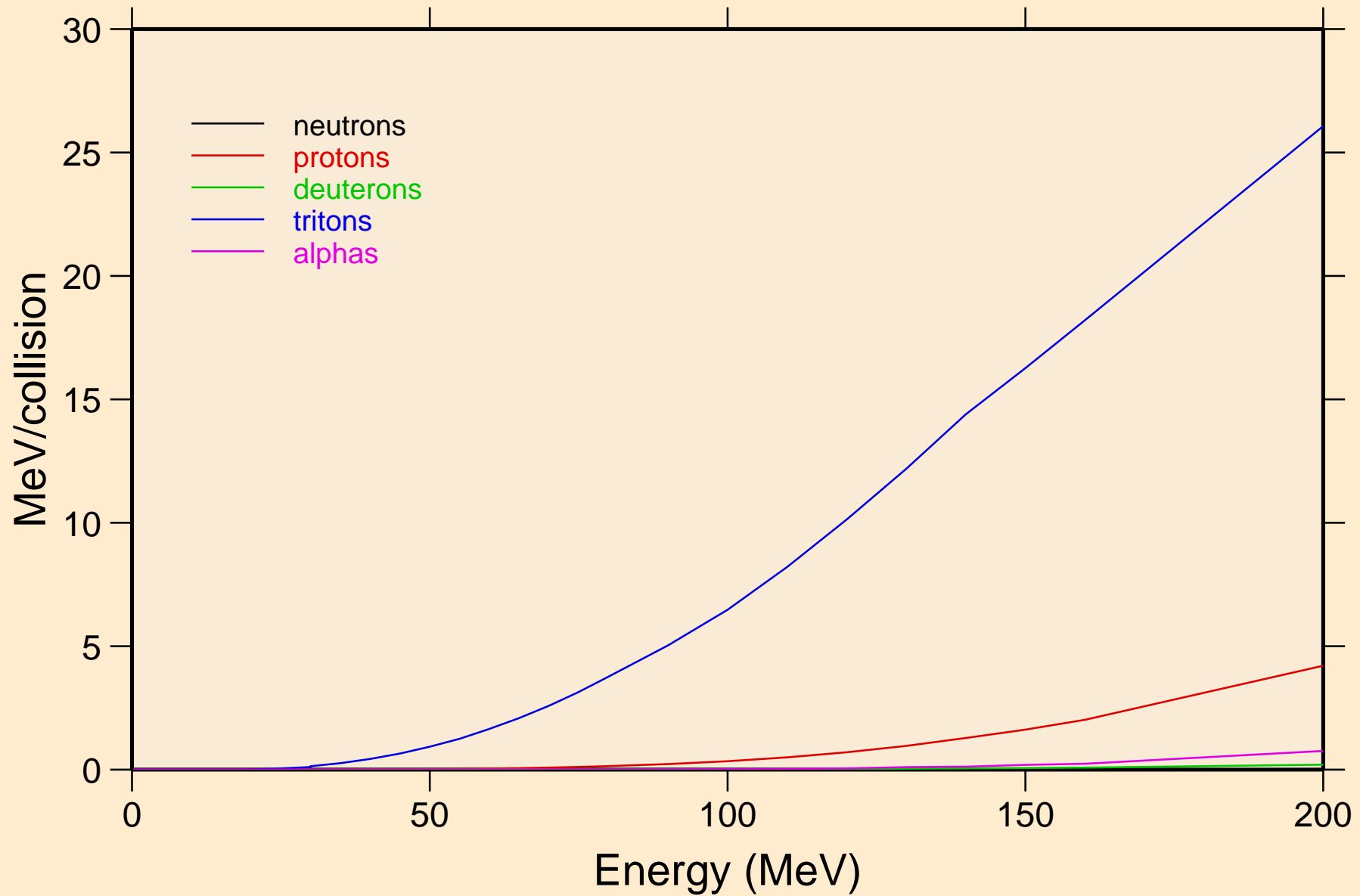

TA187 HELION ACER TENDL-2021 LIBRARY; T=0.K  
Recoil Heating

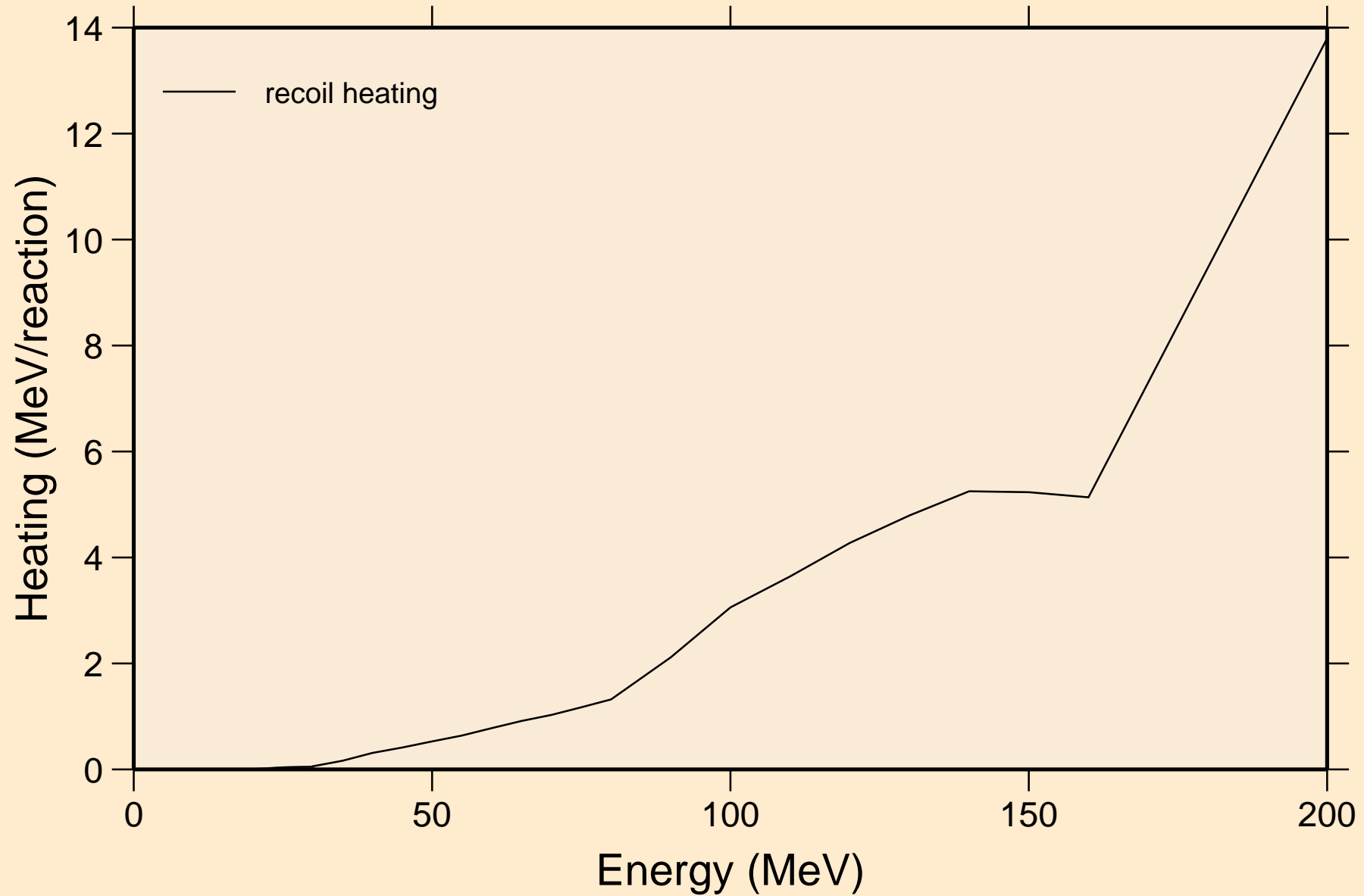

TA187 HELION ACER TENDL-2021 LIBRARY; T=0.K  
Particle production cross sections

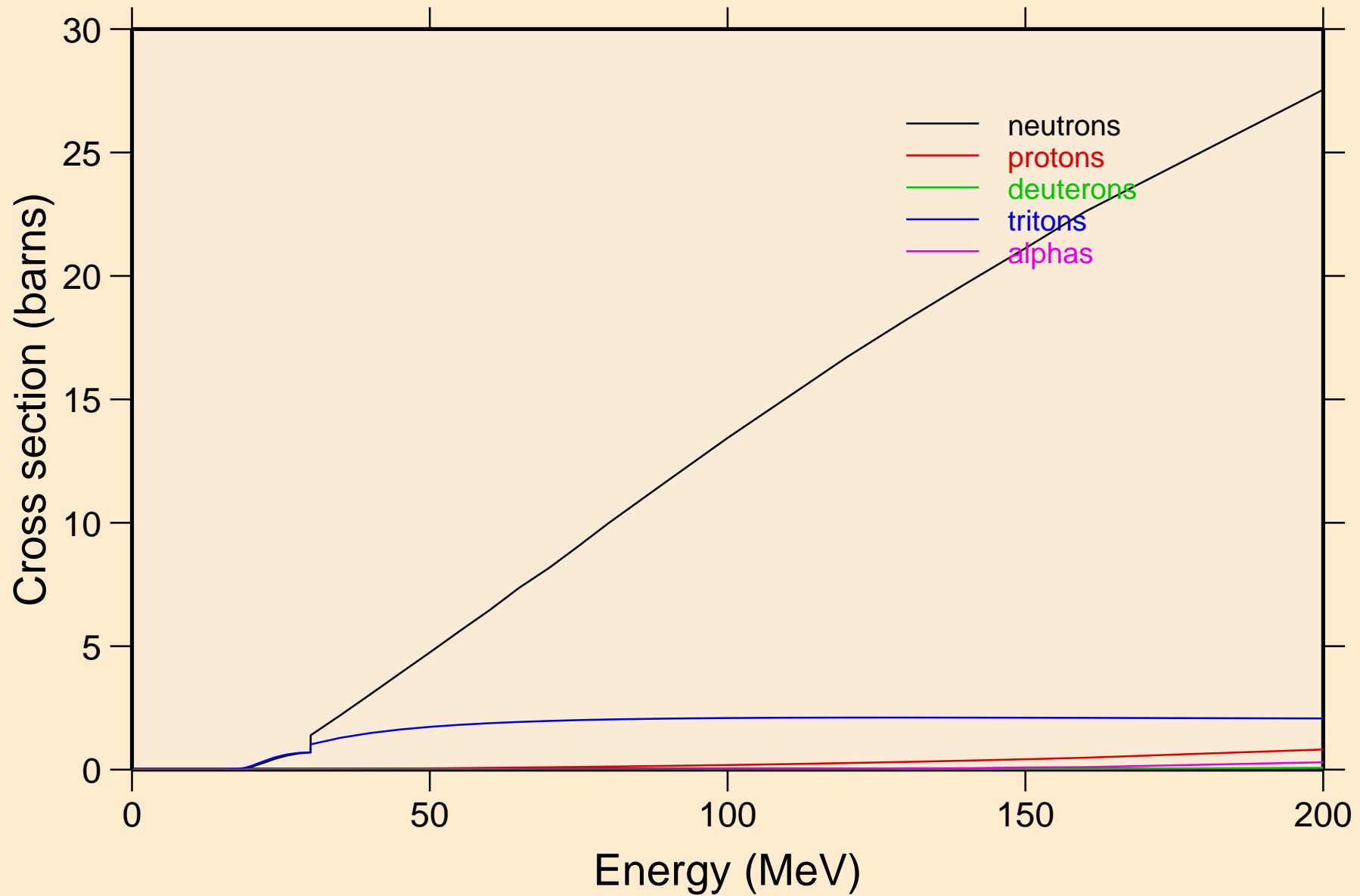

TA187 HELION ACER TENDL-2021 LIBRARY; T=0.K  
neutrons from (s,n)

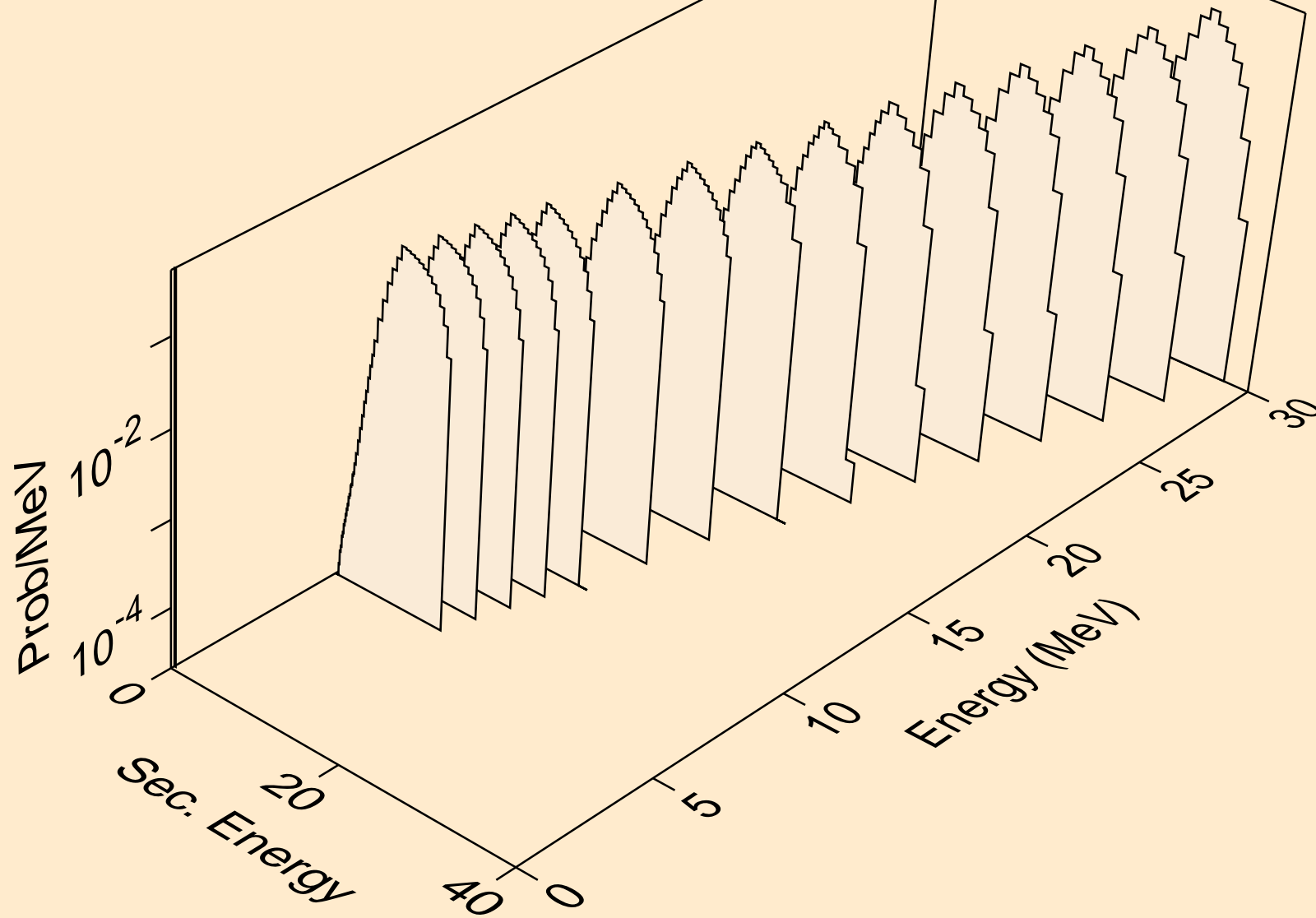

TA187 HELION ACER TENDL-2021 LIBRARY; T=0.K  
neutrons from (s,x)

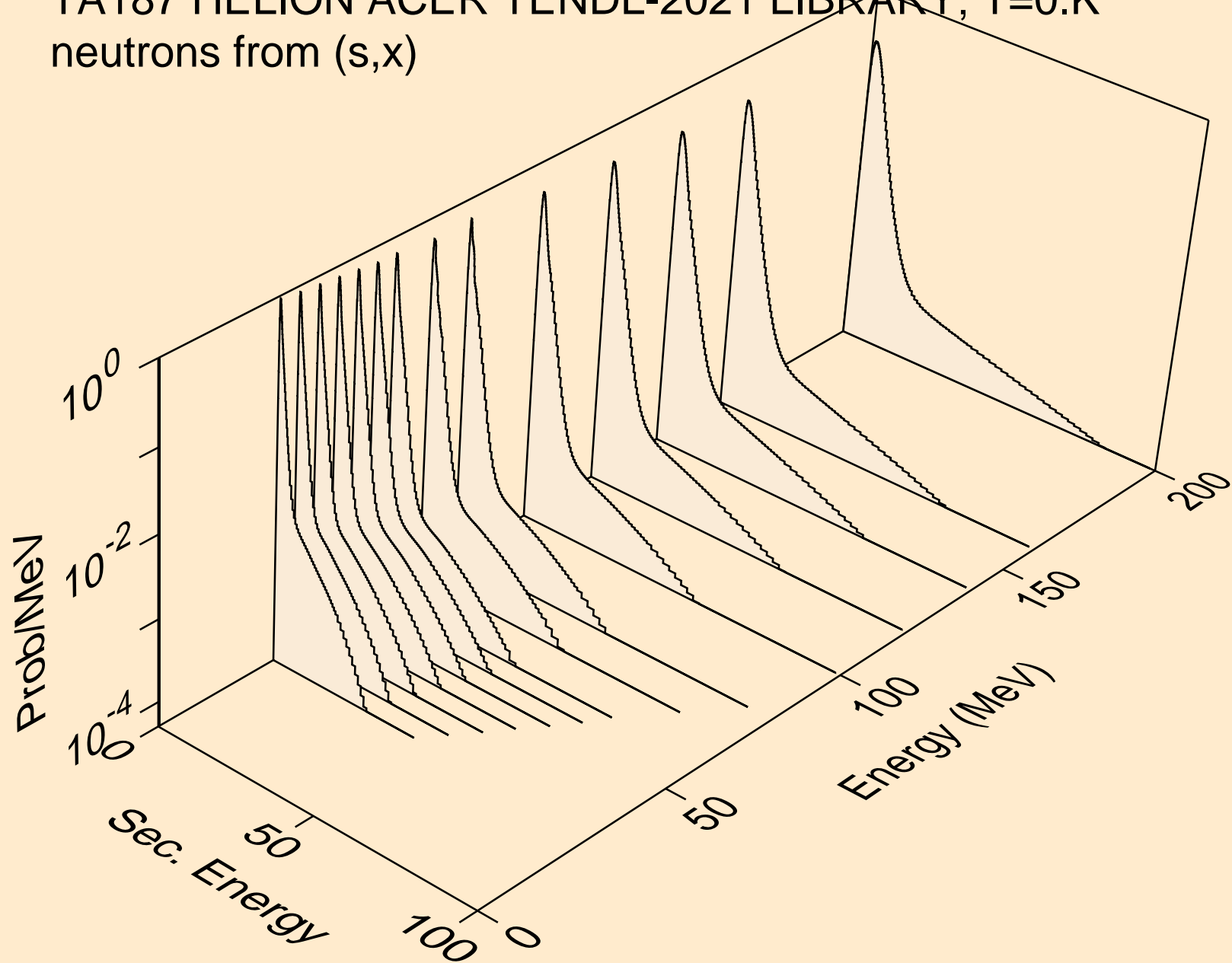



TA187 HELION ACER TENDL-2021 LIBRARY; T=0.K  
neutrons from (s,2nd)

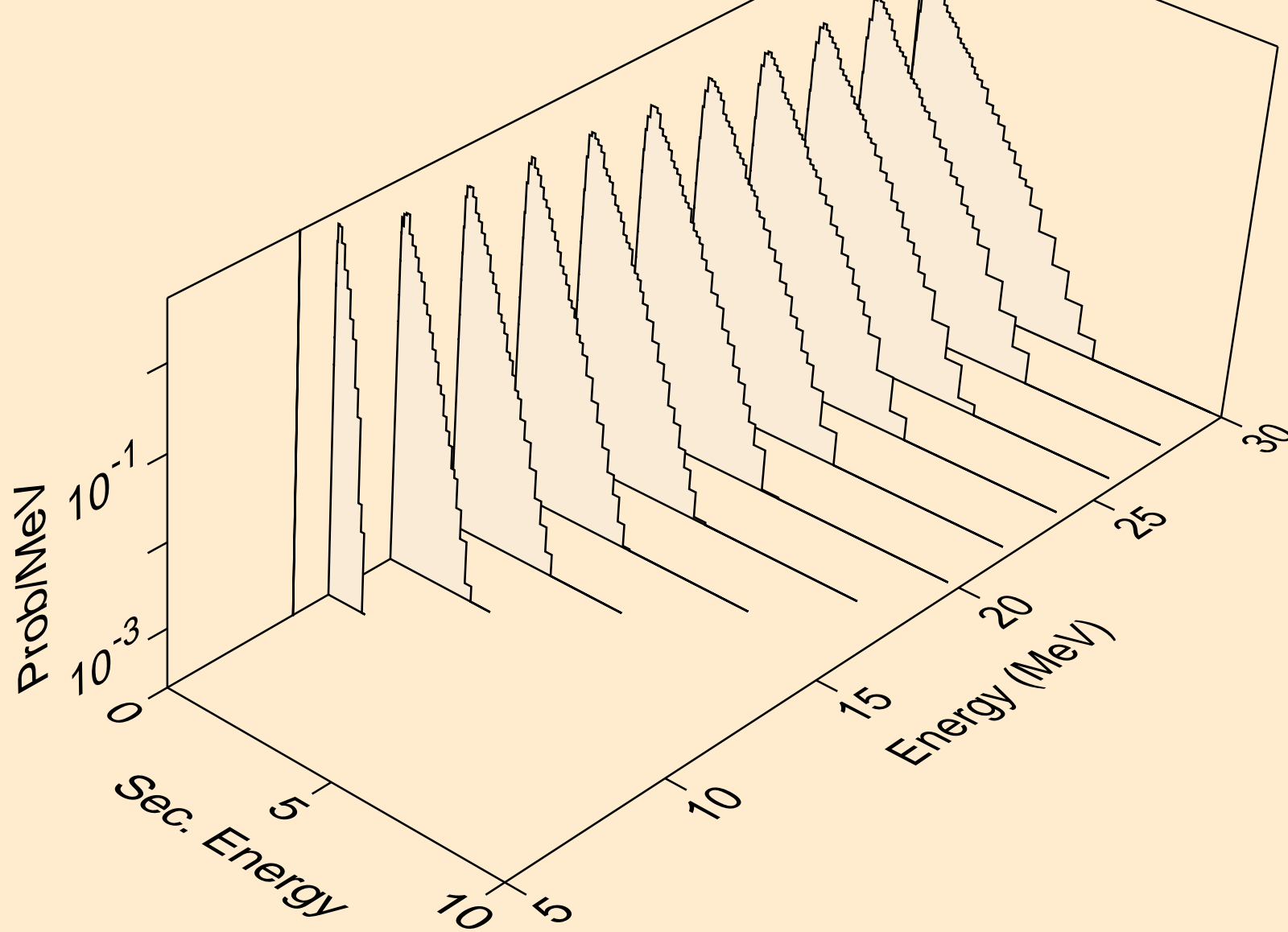

TA187 HELION ACER TENDL-2021 LIBRARY; T=0.K  
neutrons from (s,2n)

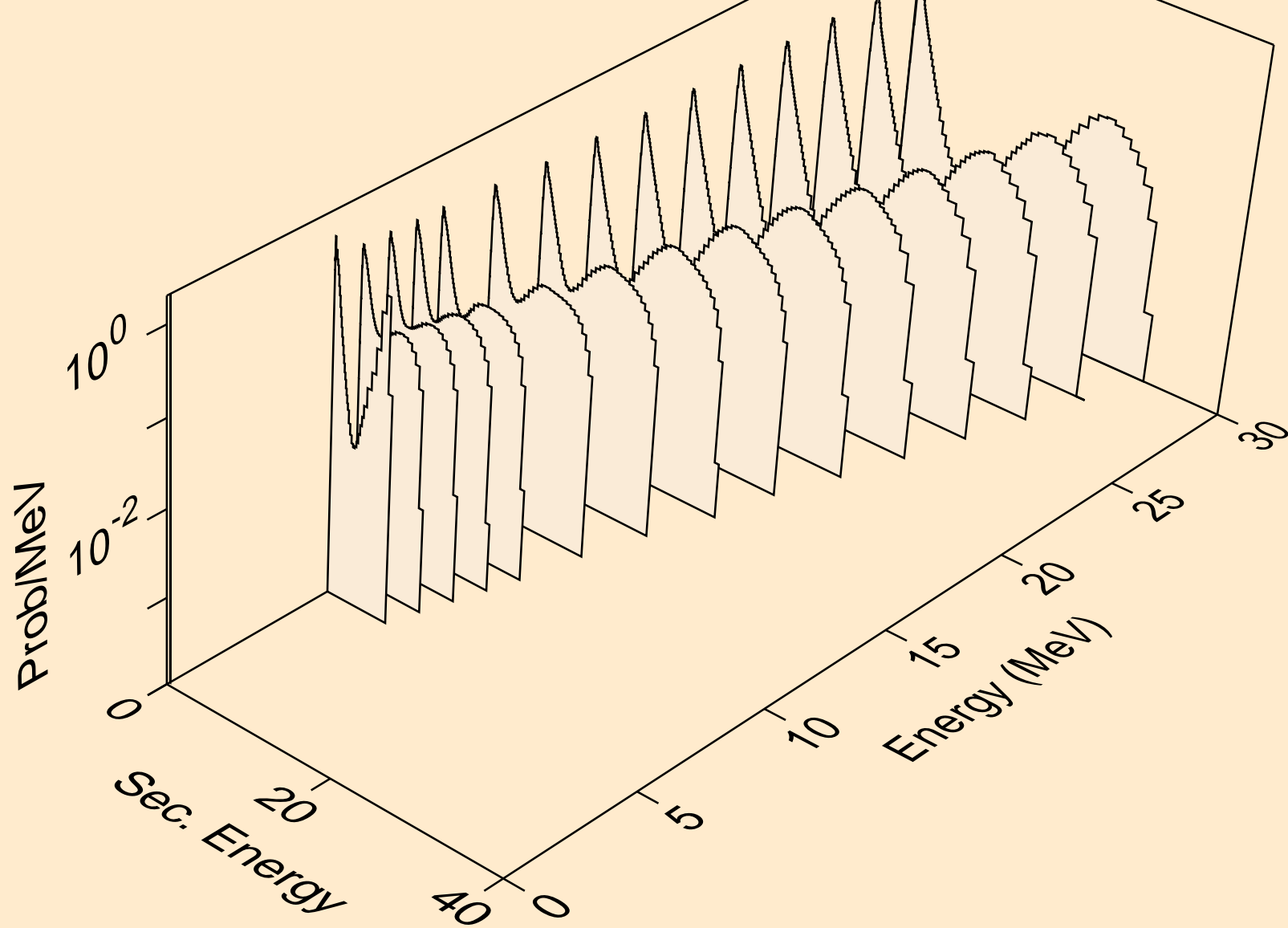

TA187 HELION ACER TENDL-2021 LIBRARY; T=0.K  
neutrons from (s,3n)

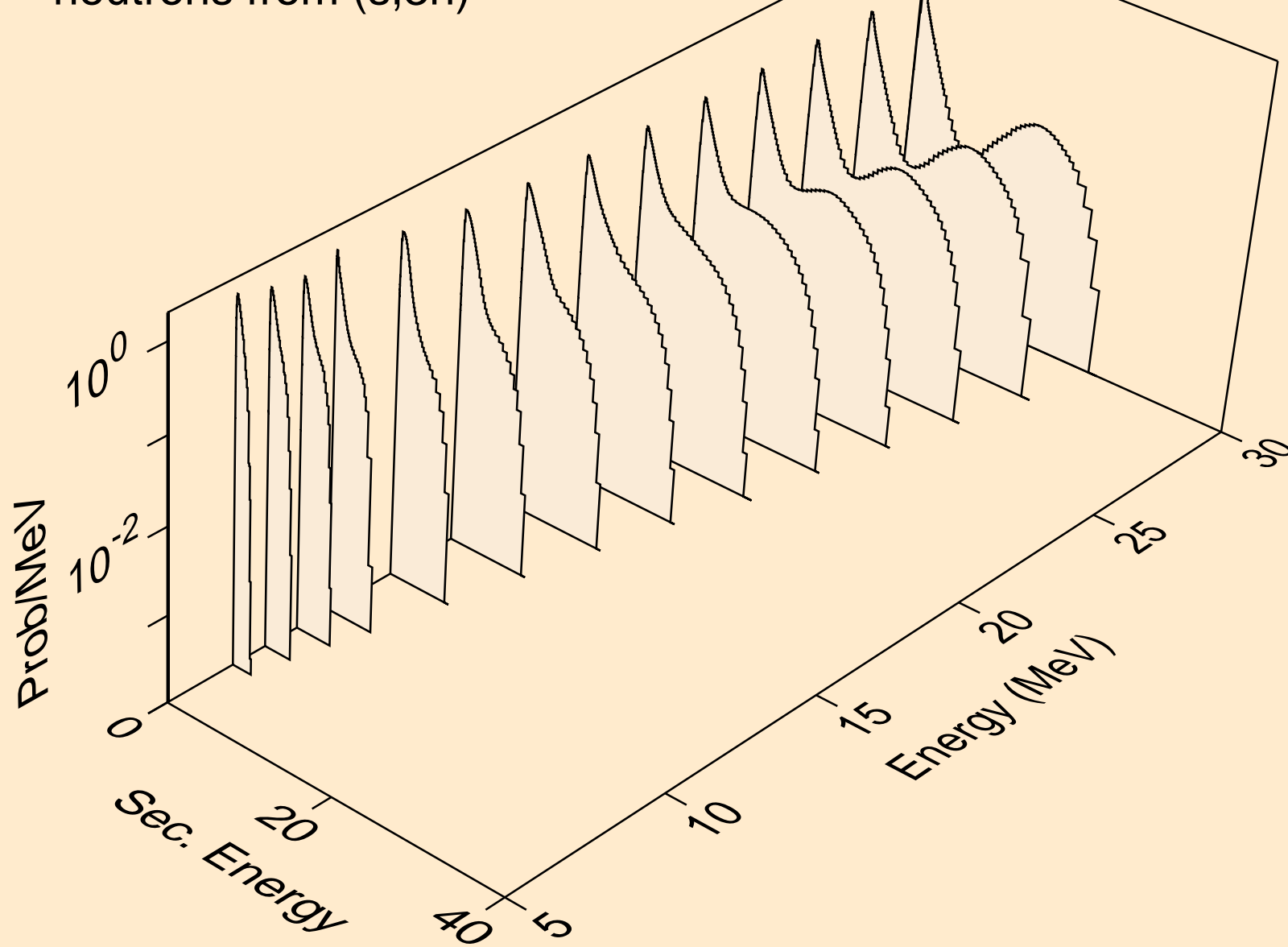

TA187 HELION ACER TENDL-2021 LIBRARY; T=0.K  
neutrons from (s,n\*)a

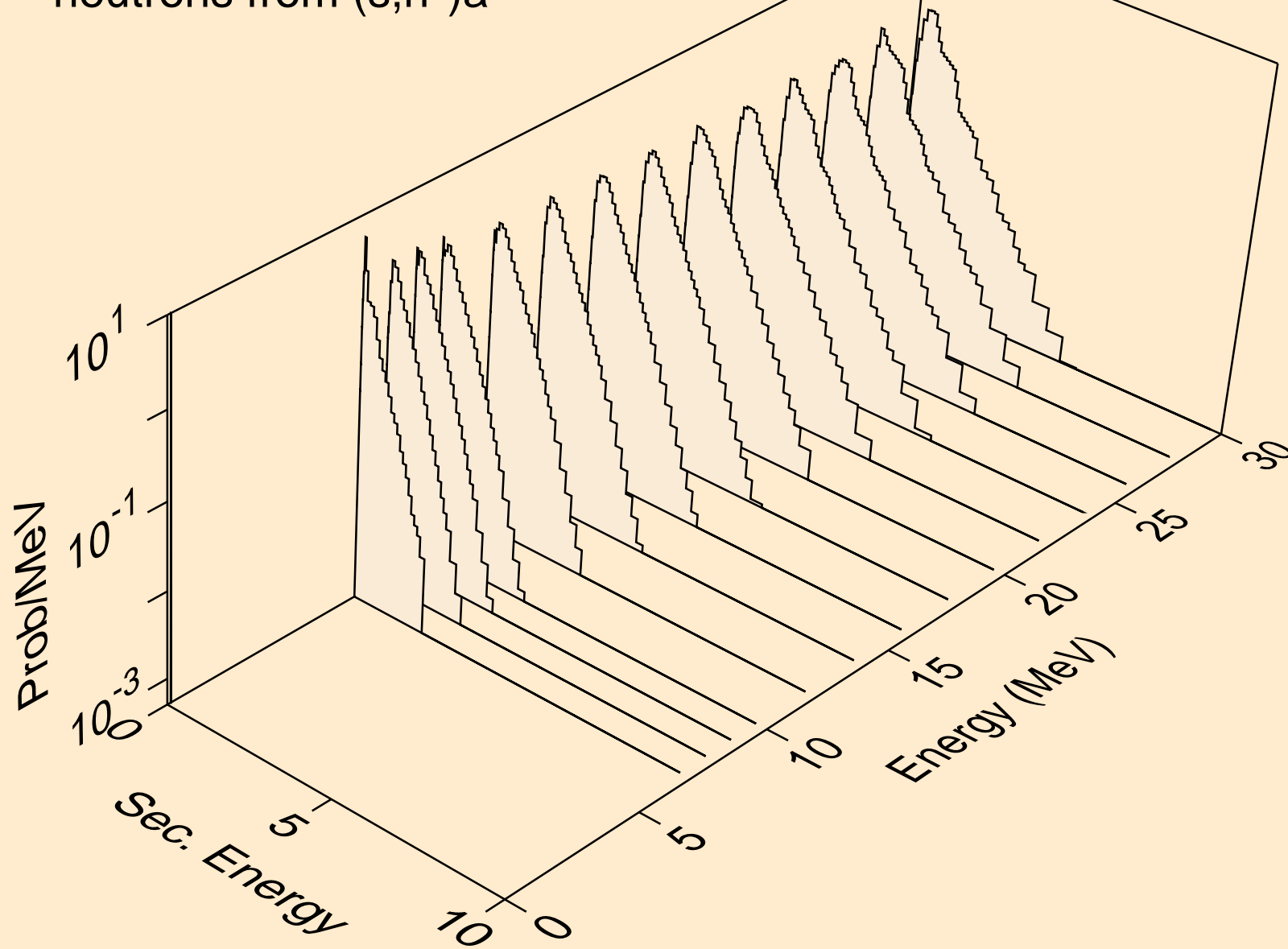

TA187 HELION ACER TENDL-2021 LIBRARY; T=0.K  
neutrons from (s,2n)a

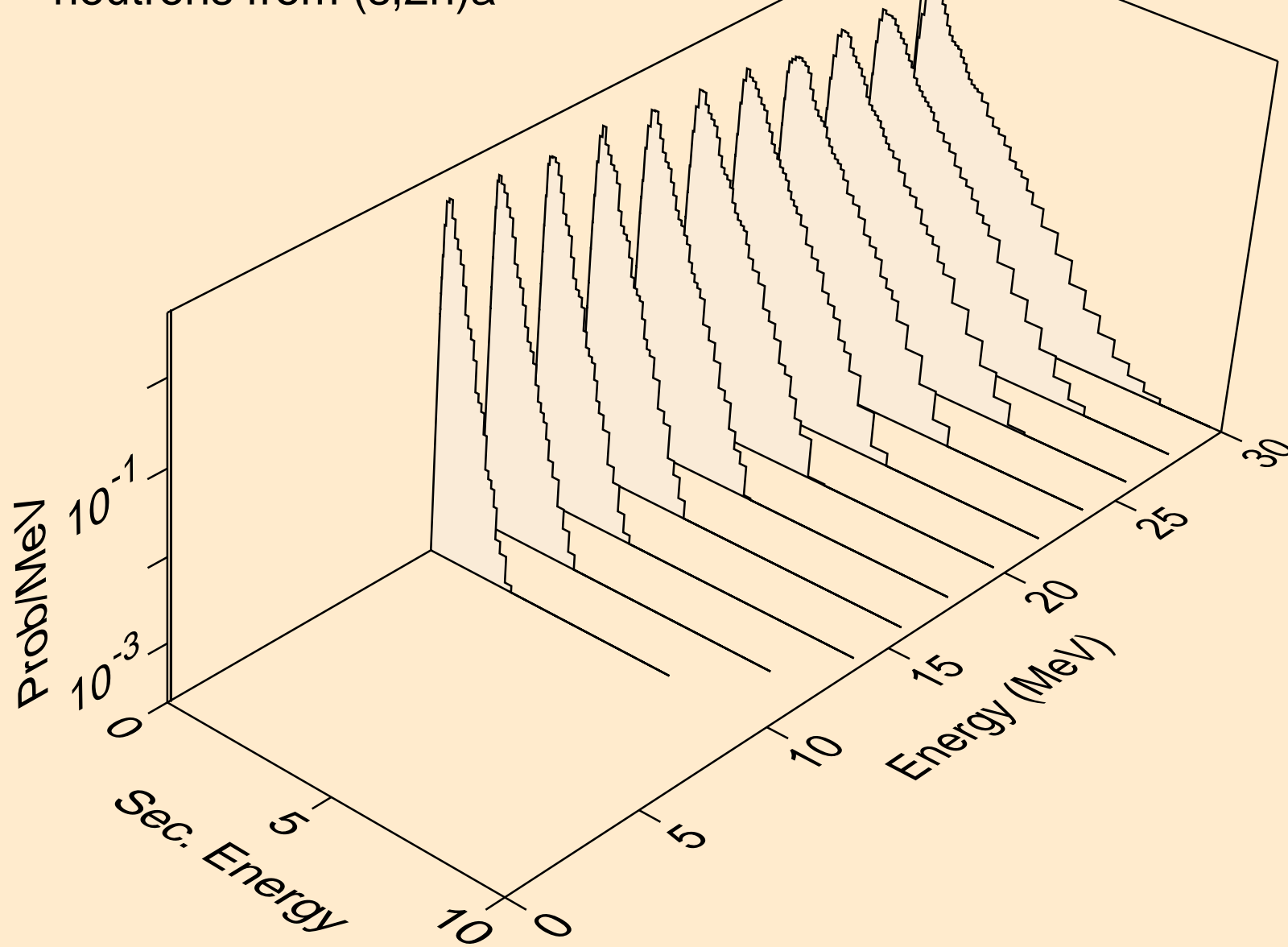

TA187 HELION ACER TENDL-2021 LIBRARY; T=0.K  
neutrons from (s,3n)a

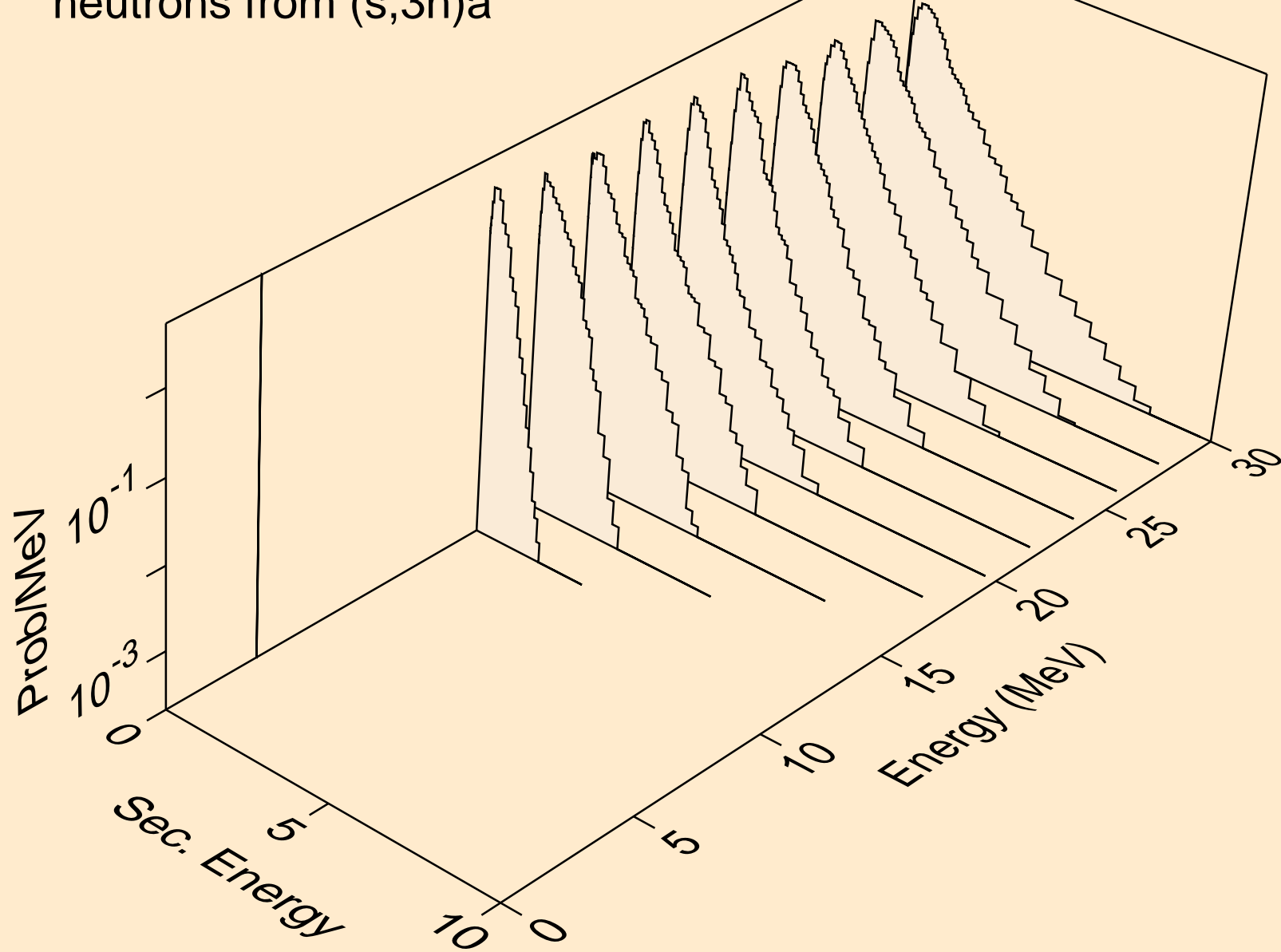

TA187 HELION ACER TENDL-2021 LIBRARY; T=0.K  
neutrons from (s,n\*)p

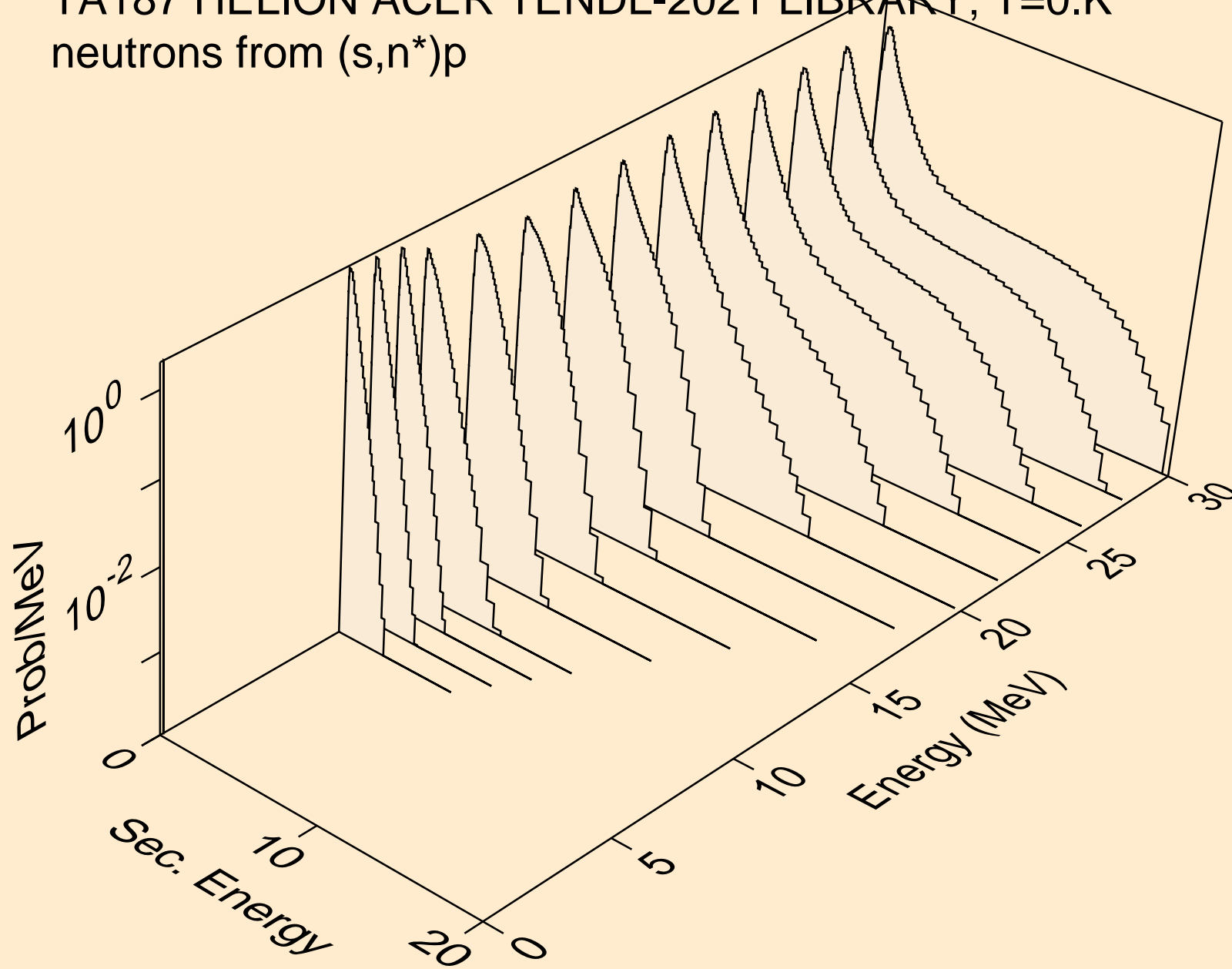

TA187 HELION ACER TENDL-2021 LIBRARY; T=0.K  
neutrons from (s,n\*)d

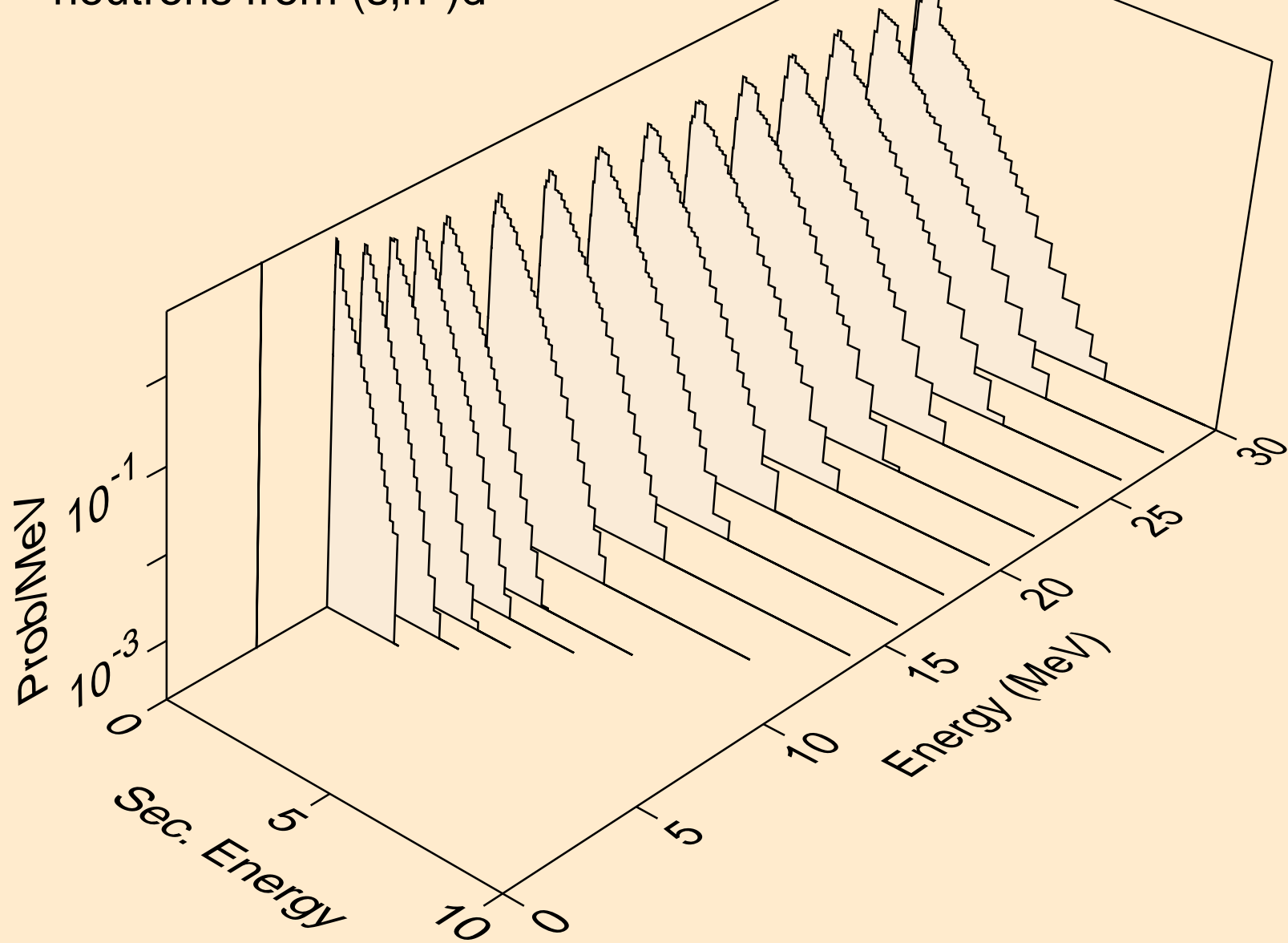



TA187 HELION ACER TENDL-2021 LIBRARY; T=0.K  
neutrons from (s,n\*)t

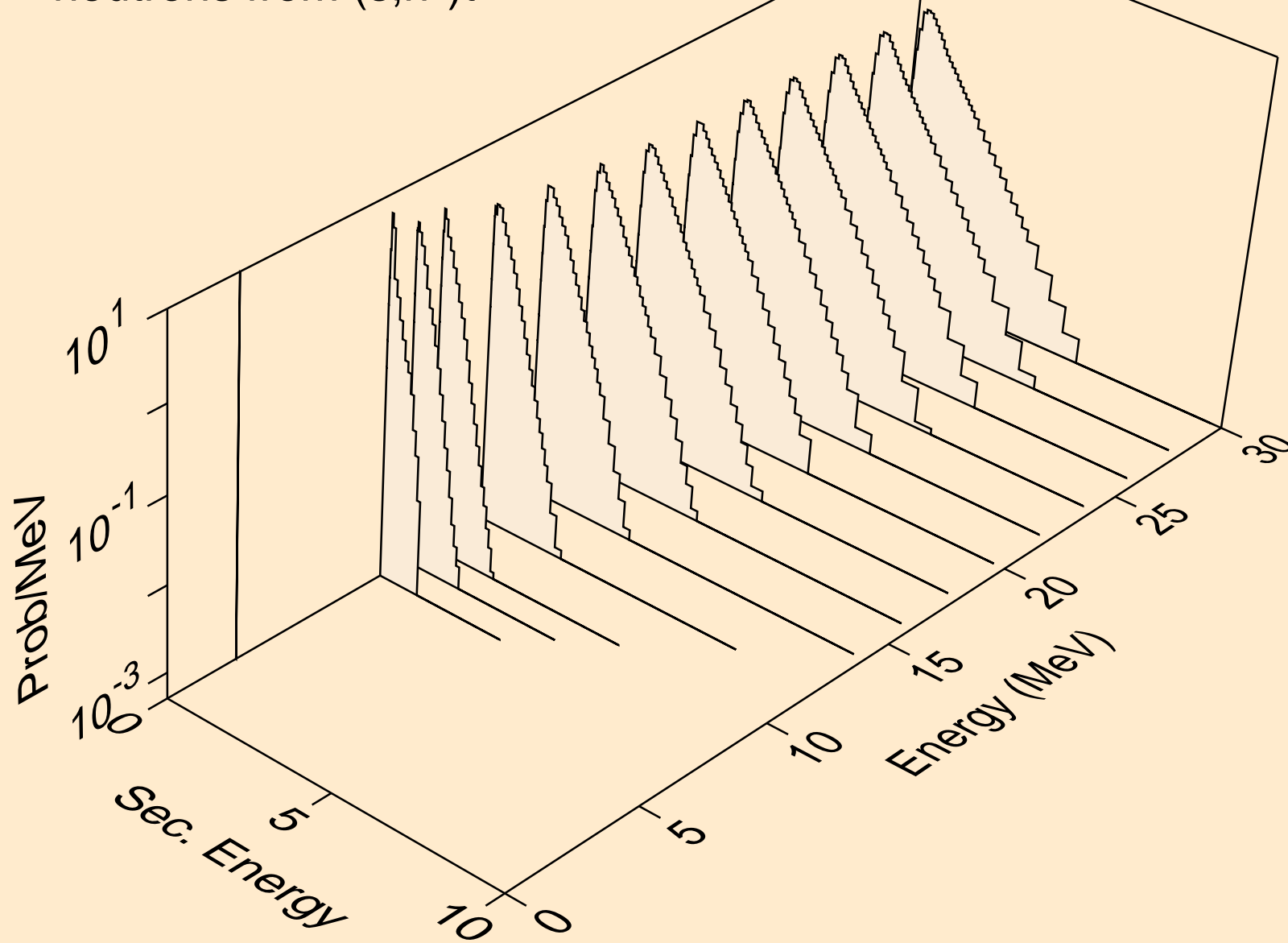

TA187 HELION ACER TENDL-2021 LIBRARY; T=0.K  
neutrons from (s,n\*)he3

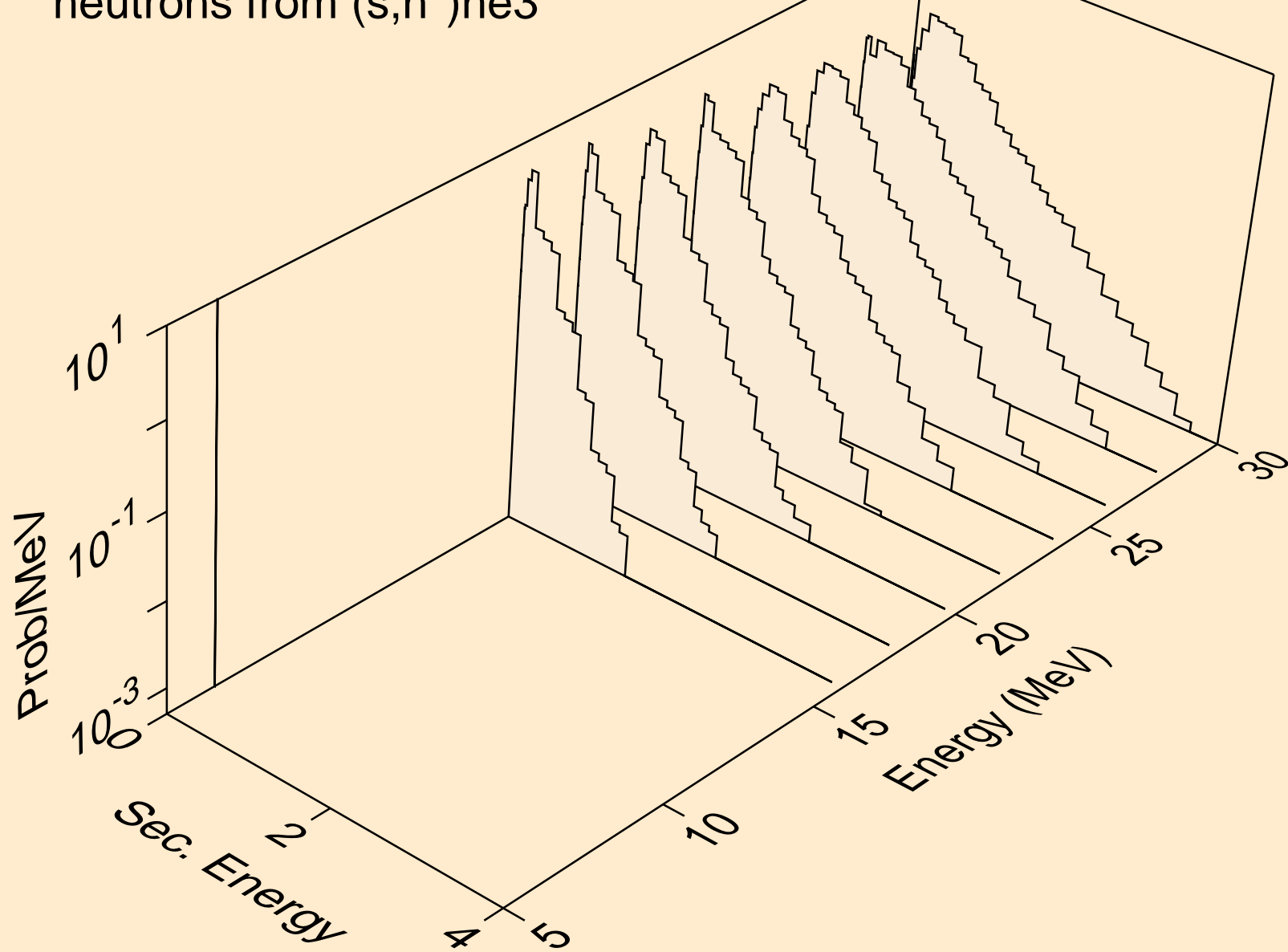

TA187 HELION ACER TENDL-2021 LIBRARY; T=0.K  
neutrons from (s,4n)

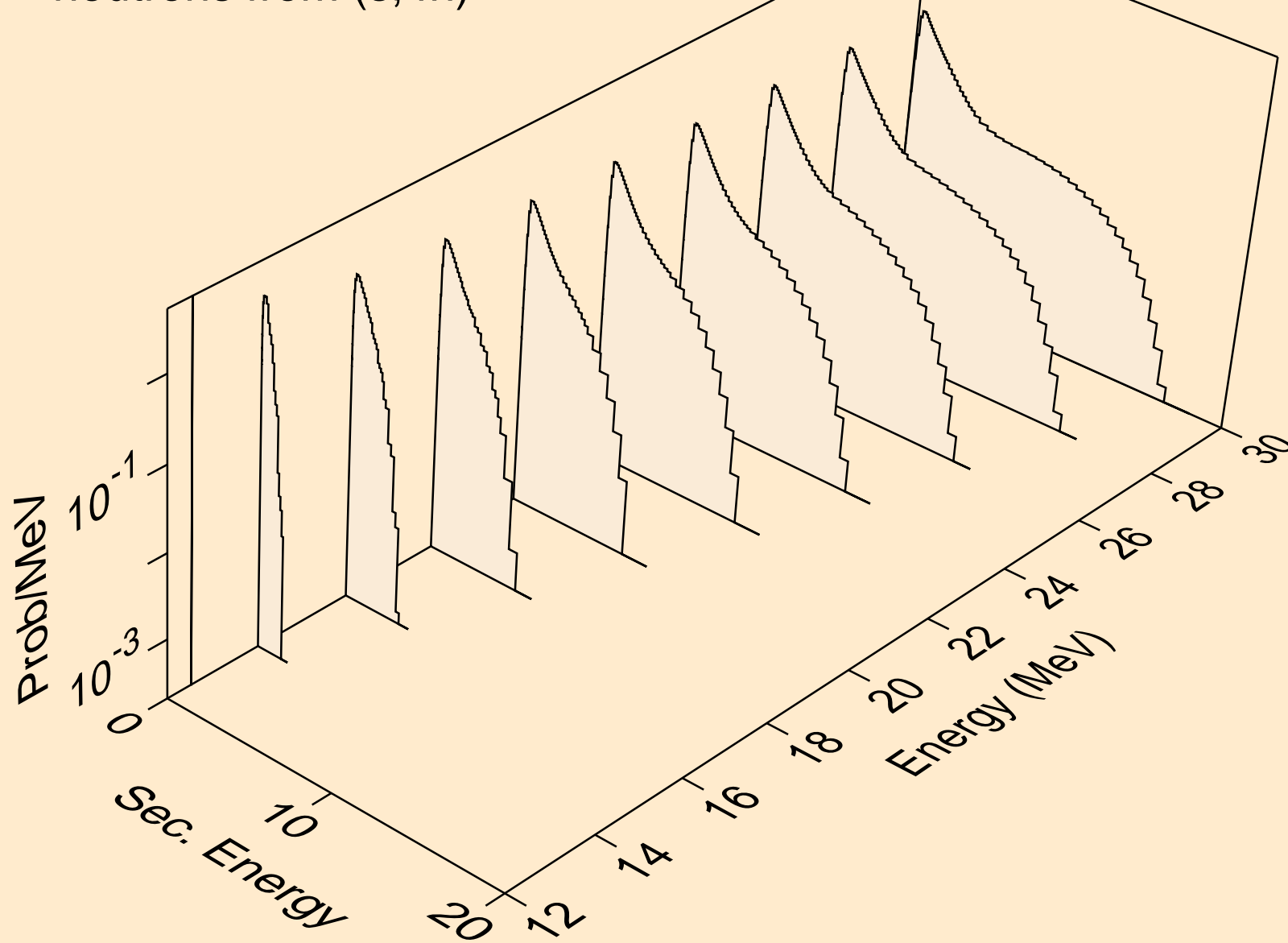

TA187 HELION ACER TENDL-2021 LIBRARY; T=0.K  
neutrons from (s,2np)

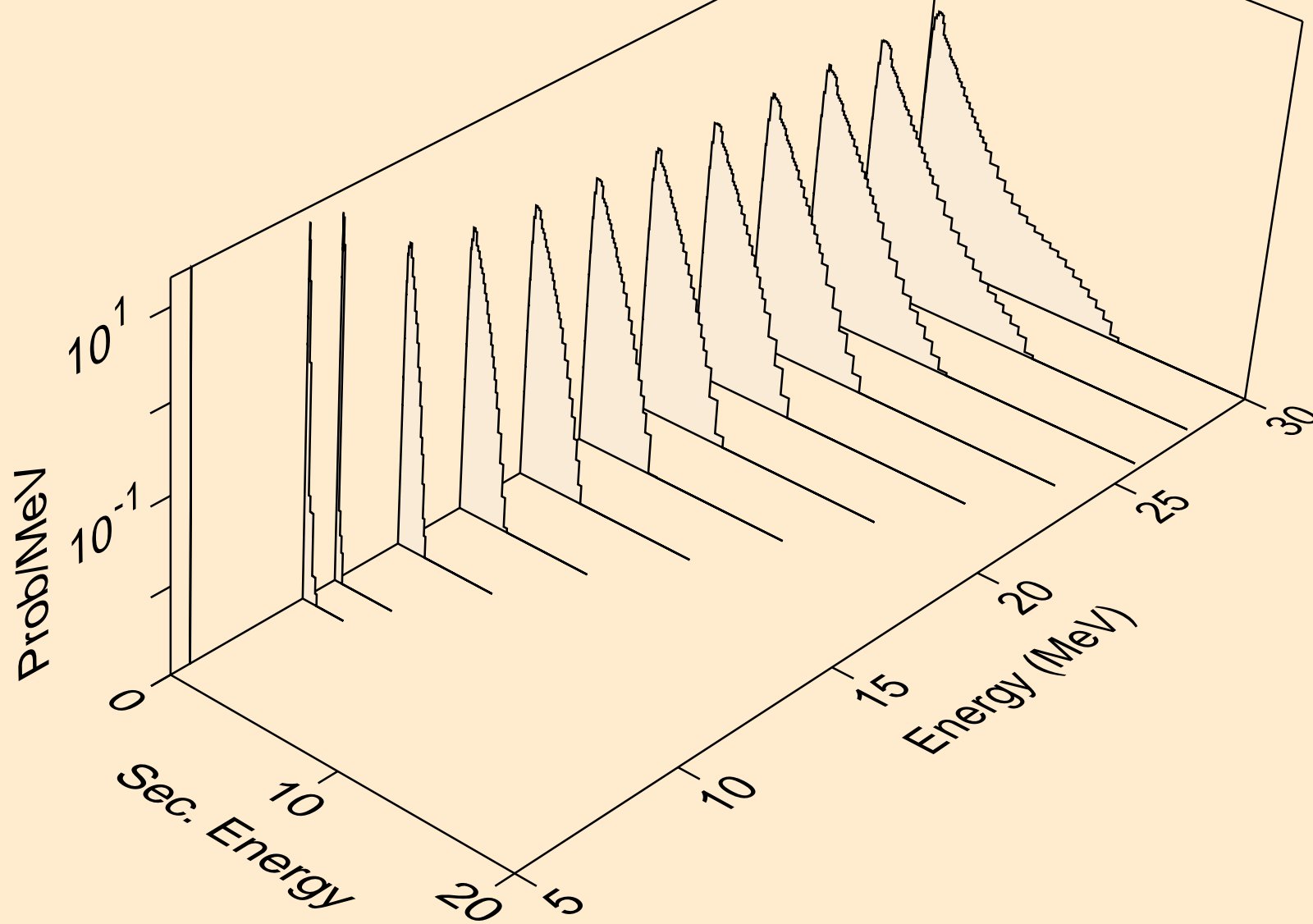

TA187 HELION ACER TENDL-2021 LIBRARY; T=0.K  
neutrons from (s,3np)

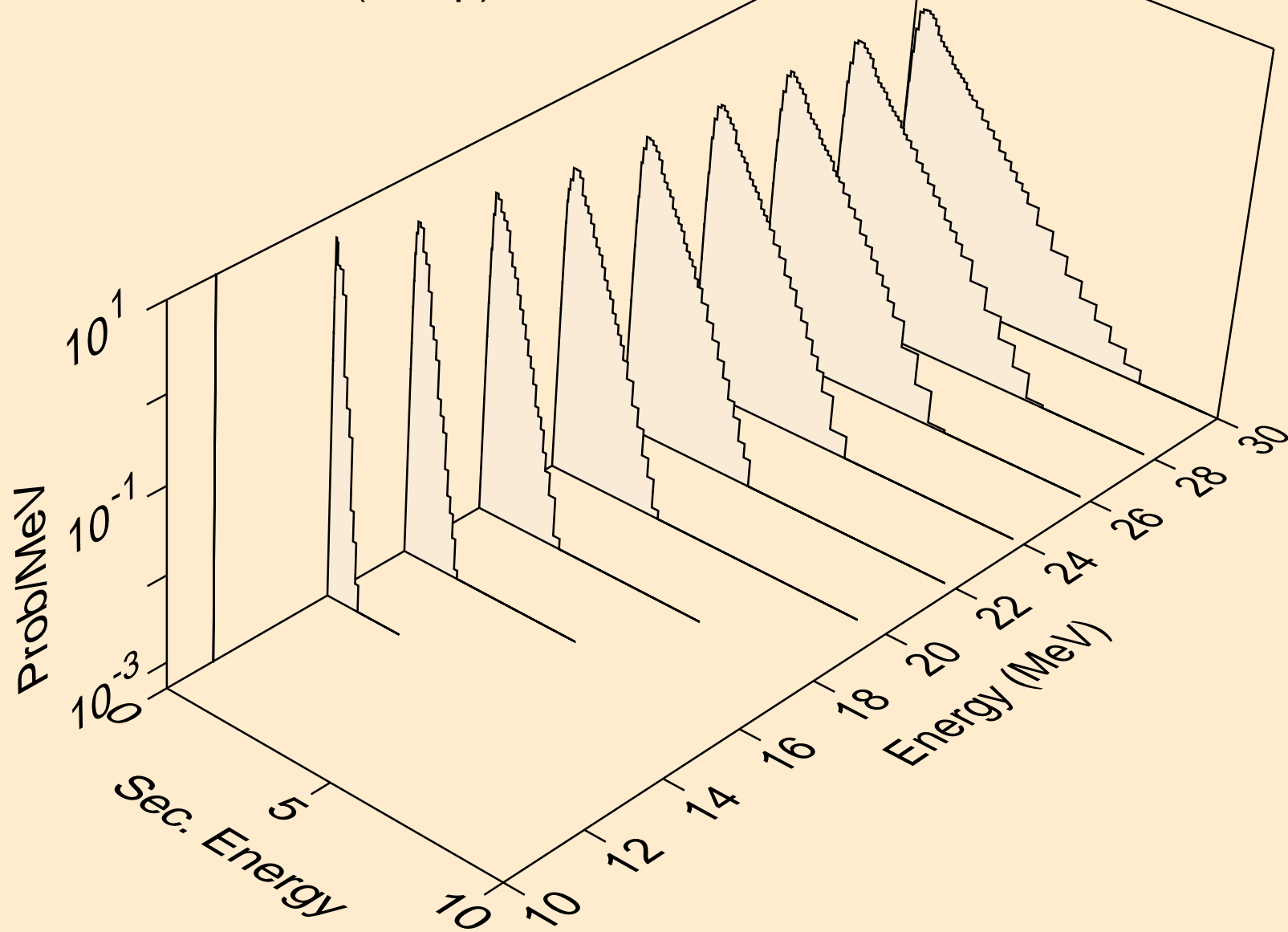

TA187 HELION ACER TENDL-2021 LIBRARY; T=0.K  
neutrons from (s,2np)

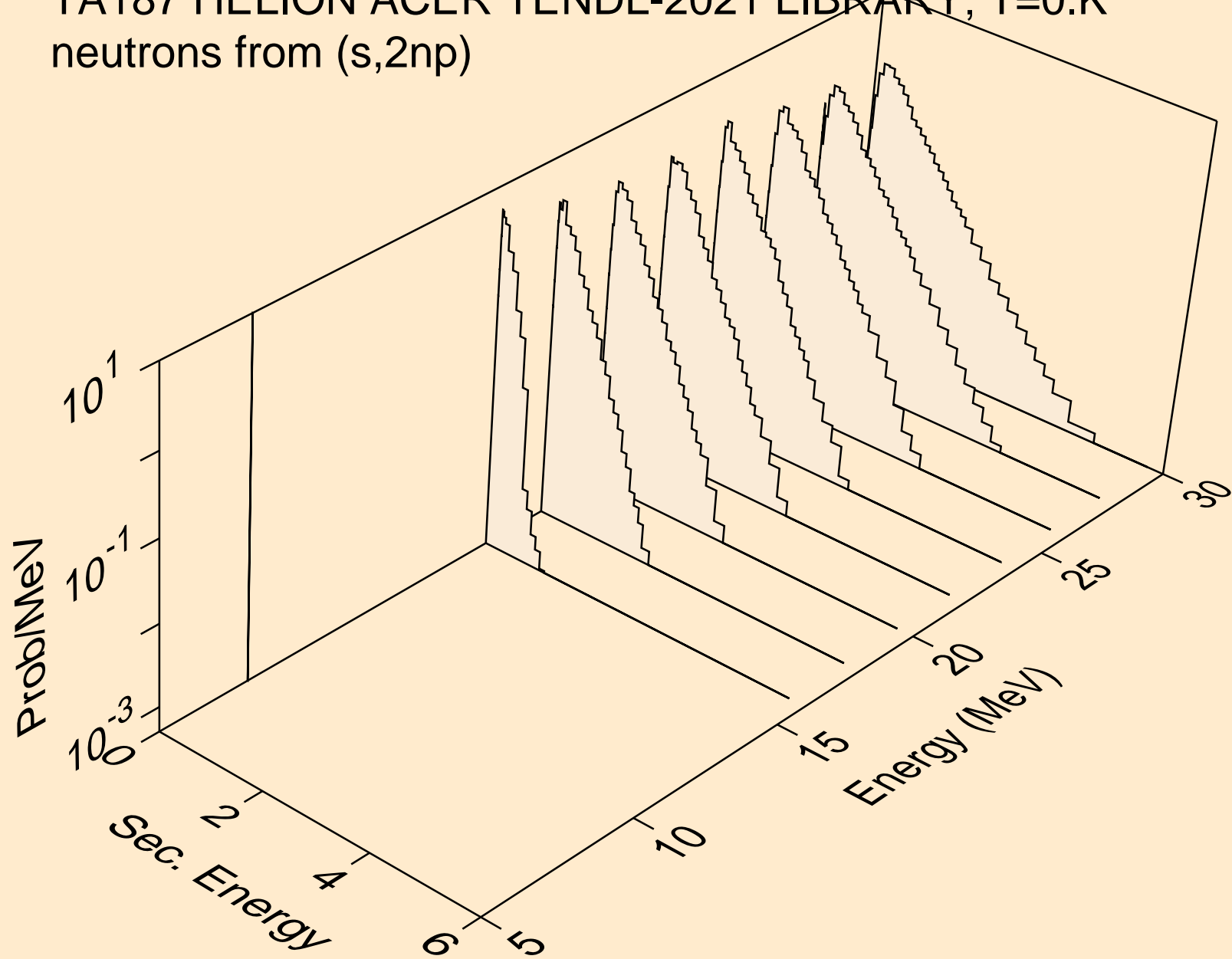

TA187 HELION ACER TENDL-2021 LIBRARY; T=0.K  
neutrons from (s,npa)

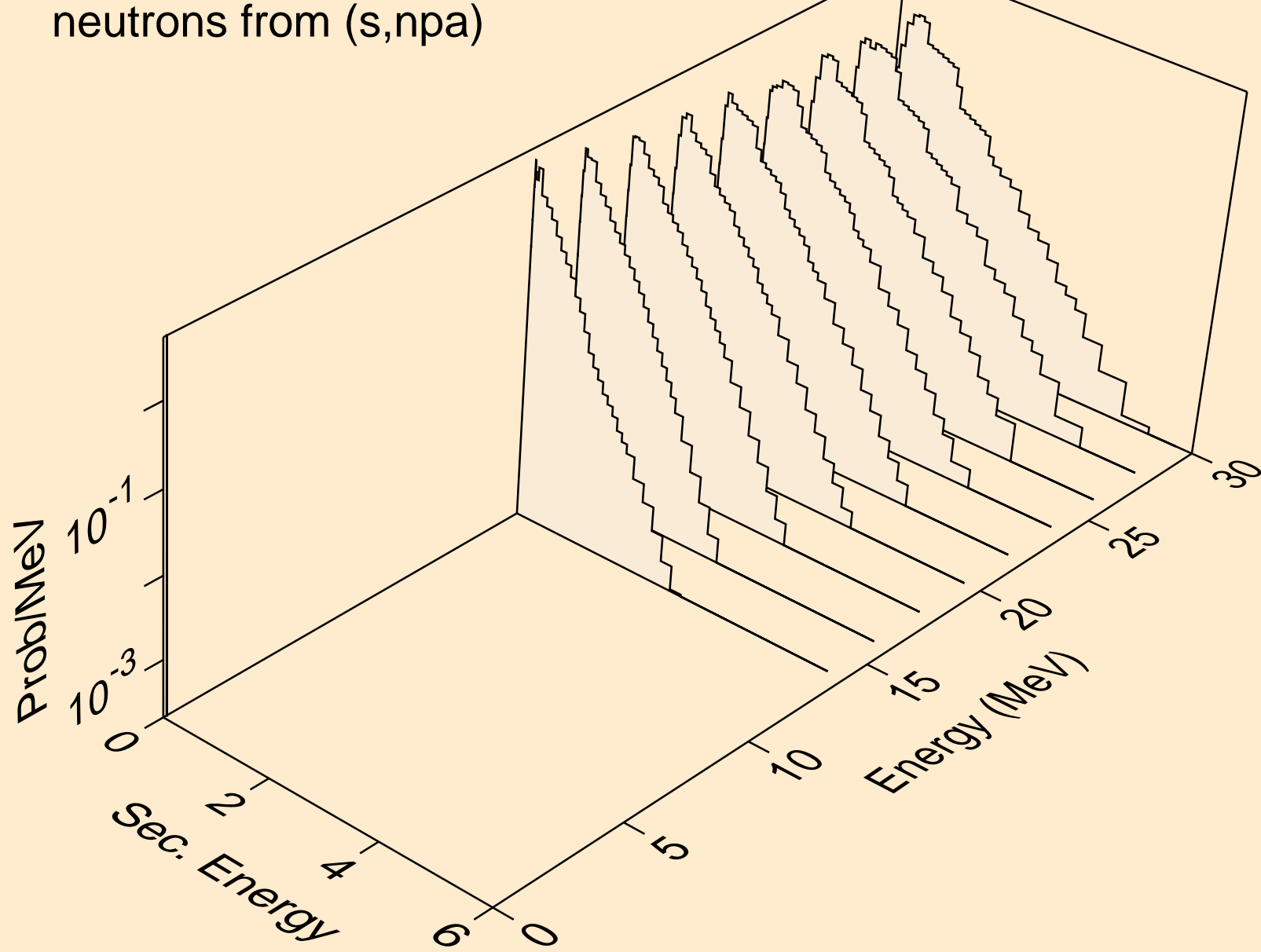

TA187 HELION ACER TENDL-2021 LIBRARY; T=0.K  
protons from (s,x)

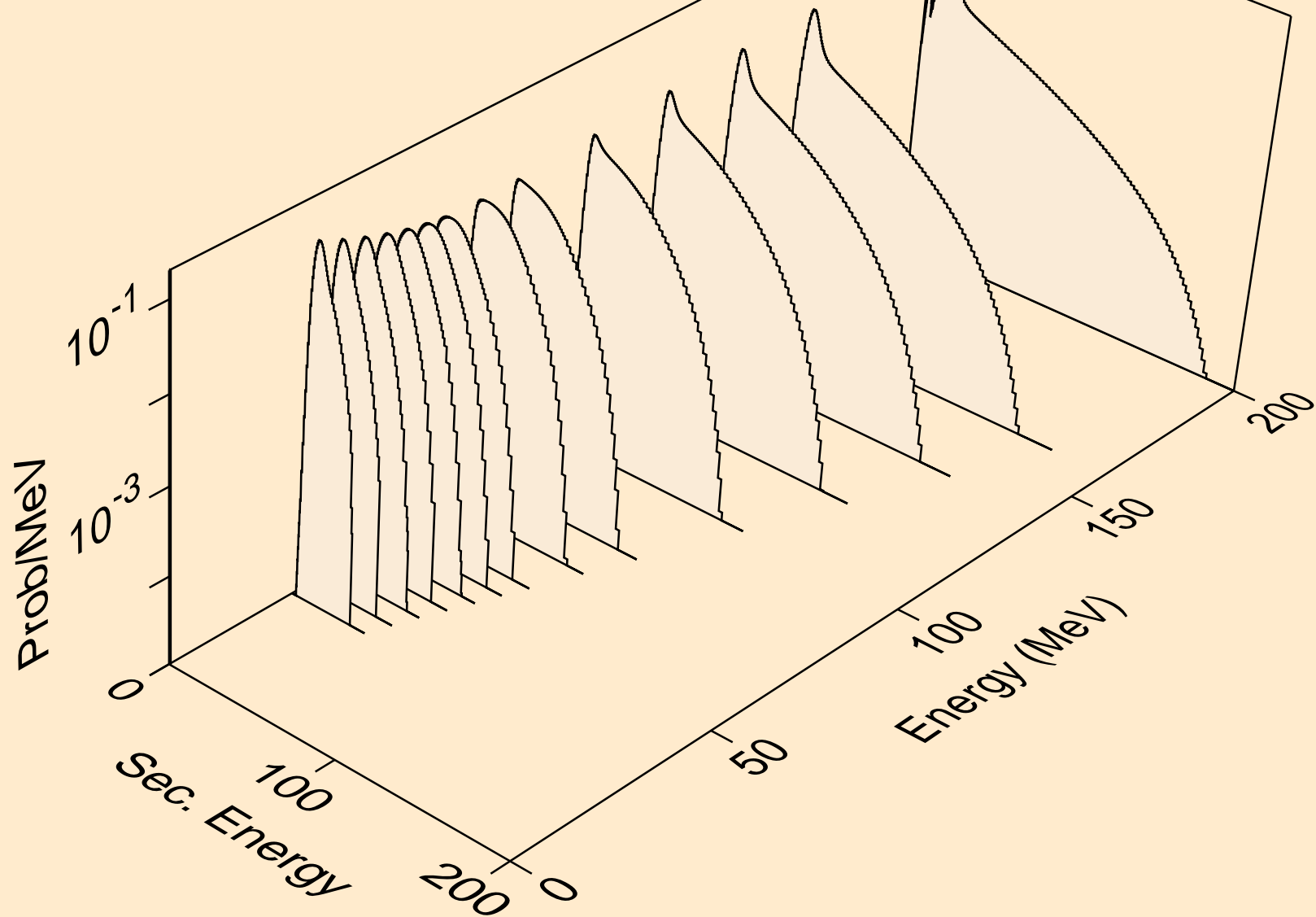



TA187 HELION ACER TENDL-2021 LIBRARY; T=0.K  
protons from (s,n\*)p

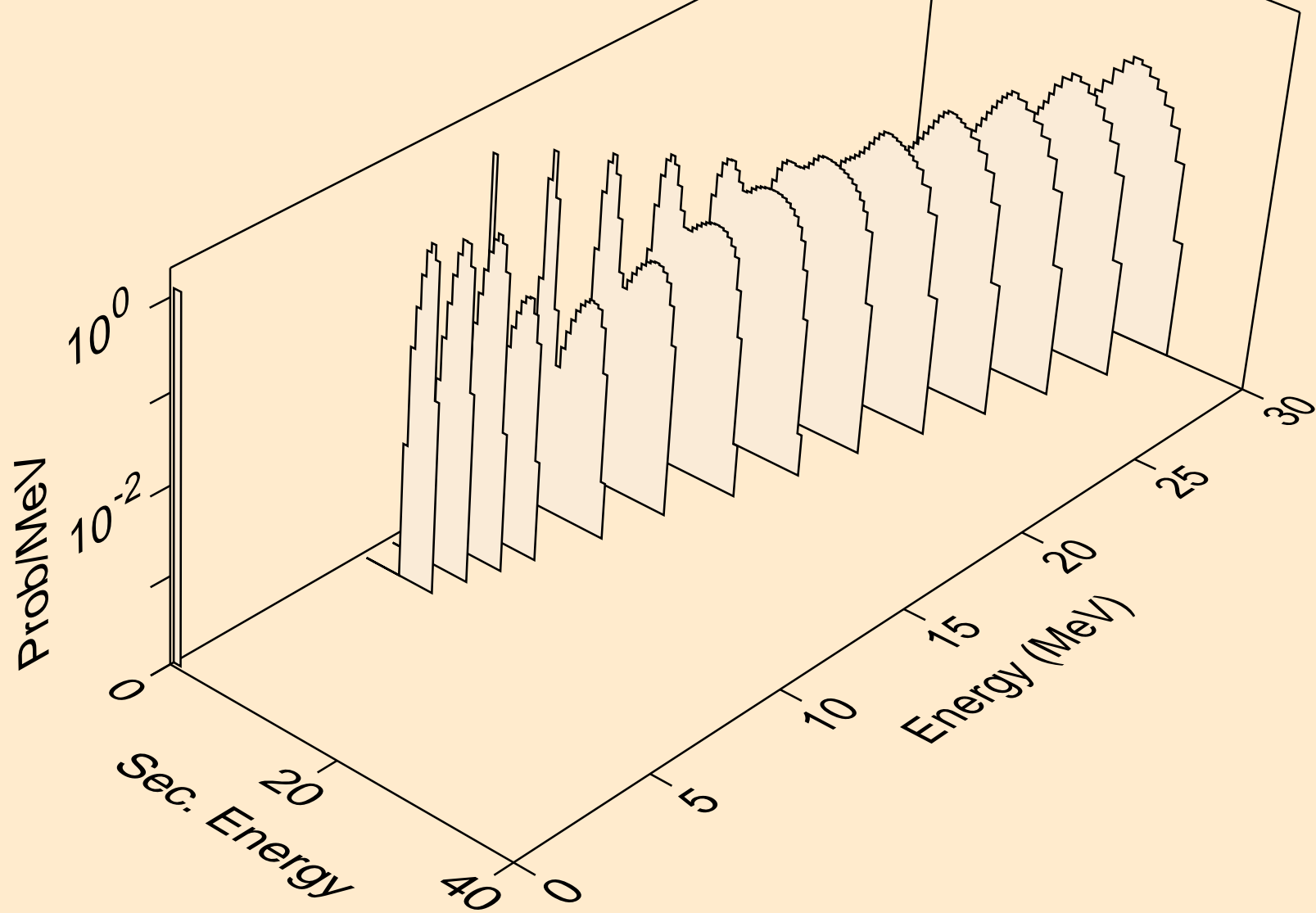

TA187 HELION ACER TENDL-2021 LIBRARY; T=0.K  
protons from (s,2np)

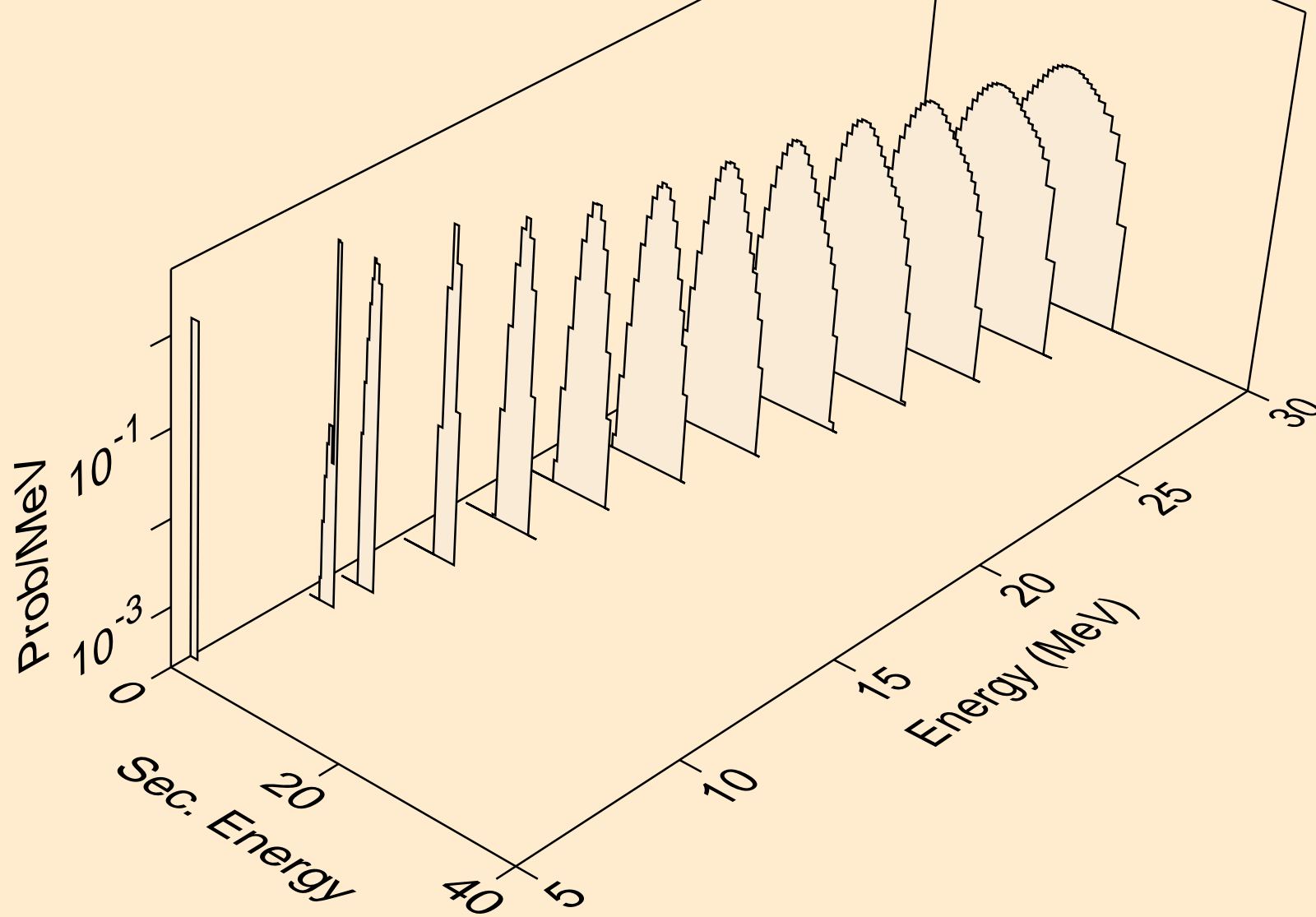

TA187 HELION ACER TENDL-2021 LIBRARY; T=0.K  
protons from (s,3np)

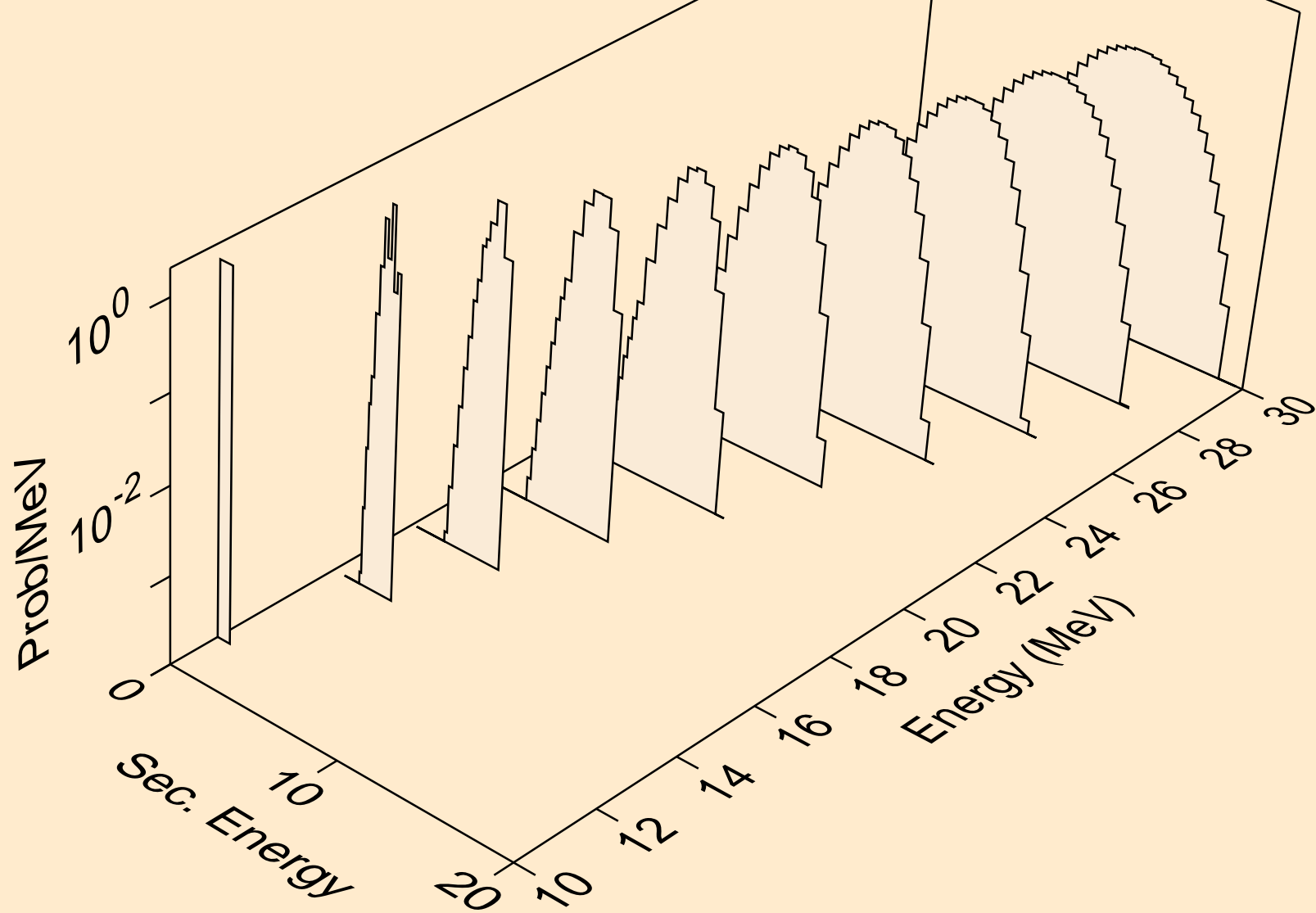

TA187 HELION ACER TENDL-2021 LIBRARY; T=0.K  
protons from (s,2np)

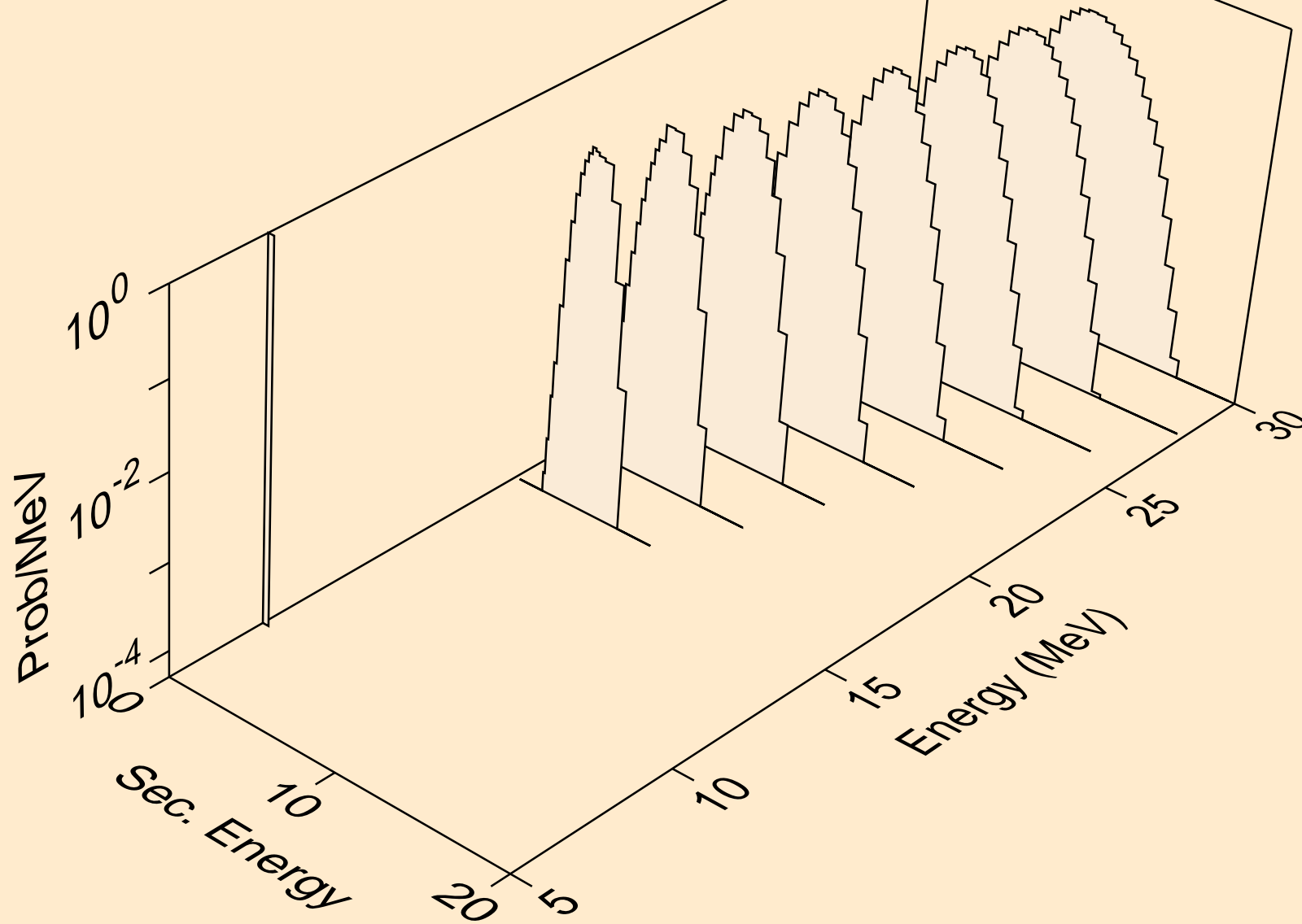

TA187 HELION ACER TENDL-2021 LIBRARY; T=0.K  
protons from (s,npa)

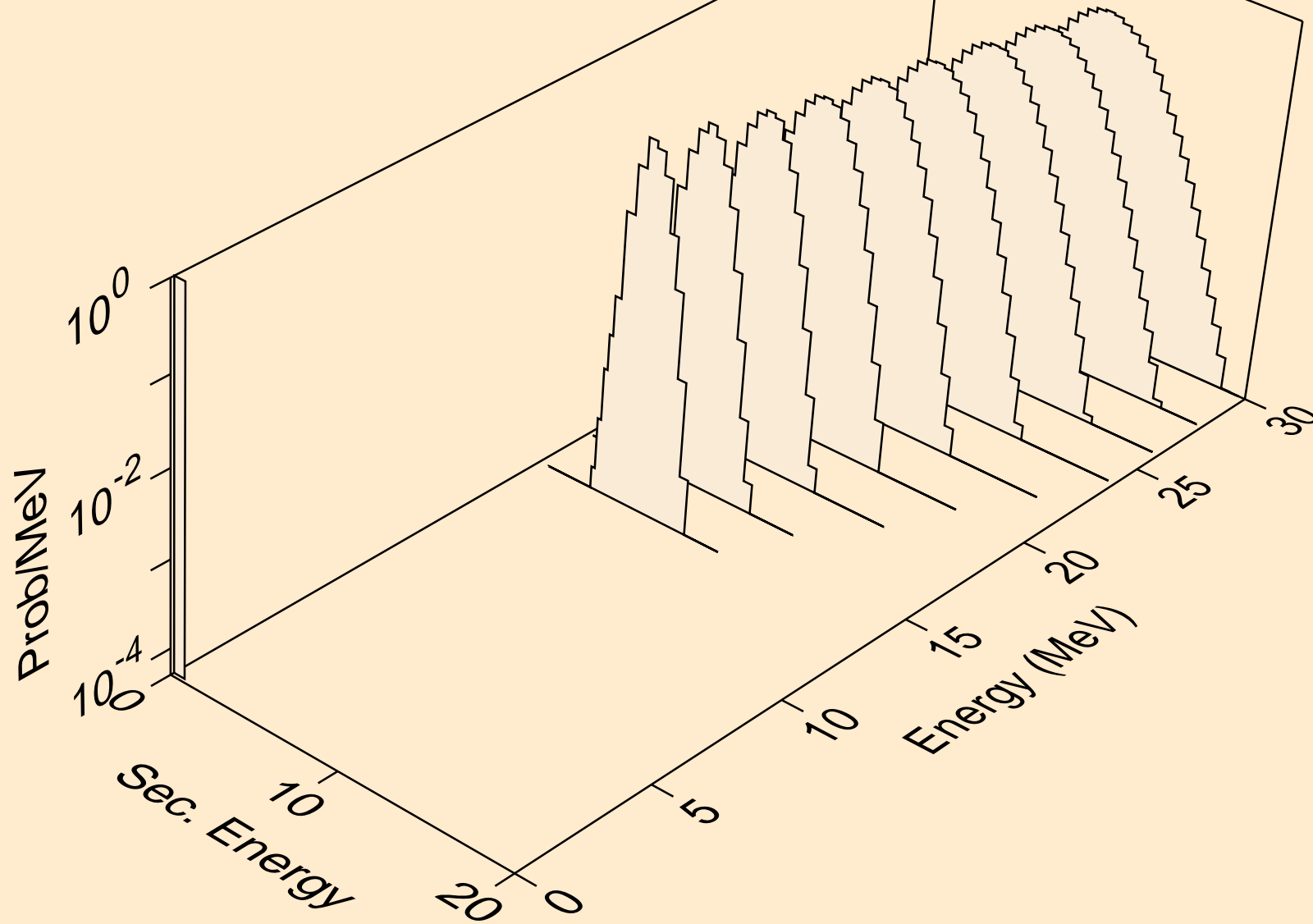

TA187 HELION ACER TENDL-2021 LIBRARY; T=0.K  
protons from (s,p)

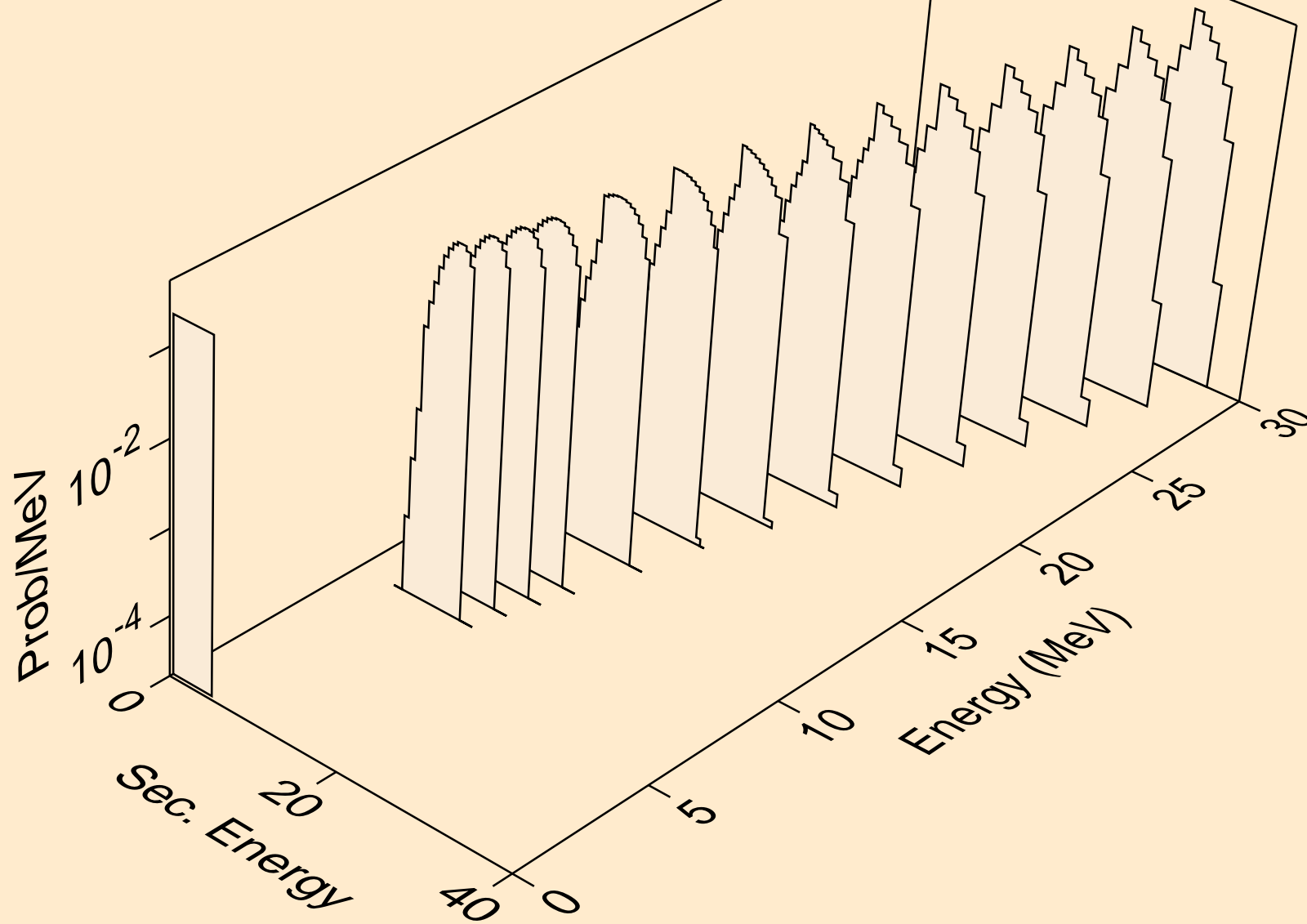

TA187 HELION ACER TENDL-2021 LIBRARY; T=0.K  
protons from (s,2p)

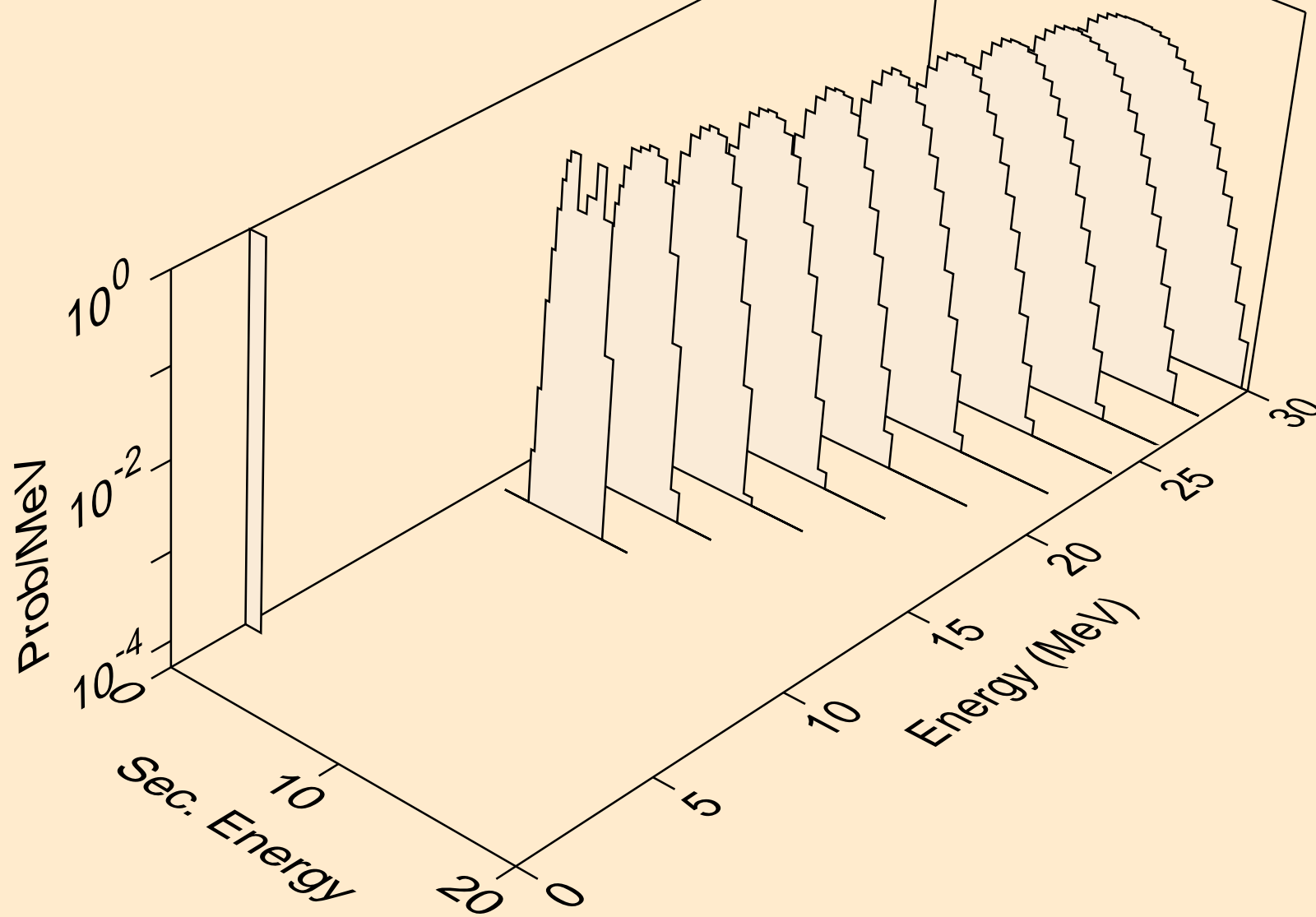

TA187 HELION ACER TENDL-2021 LIBRARY; T=0.K  
protons from (s,pa)

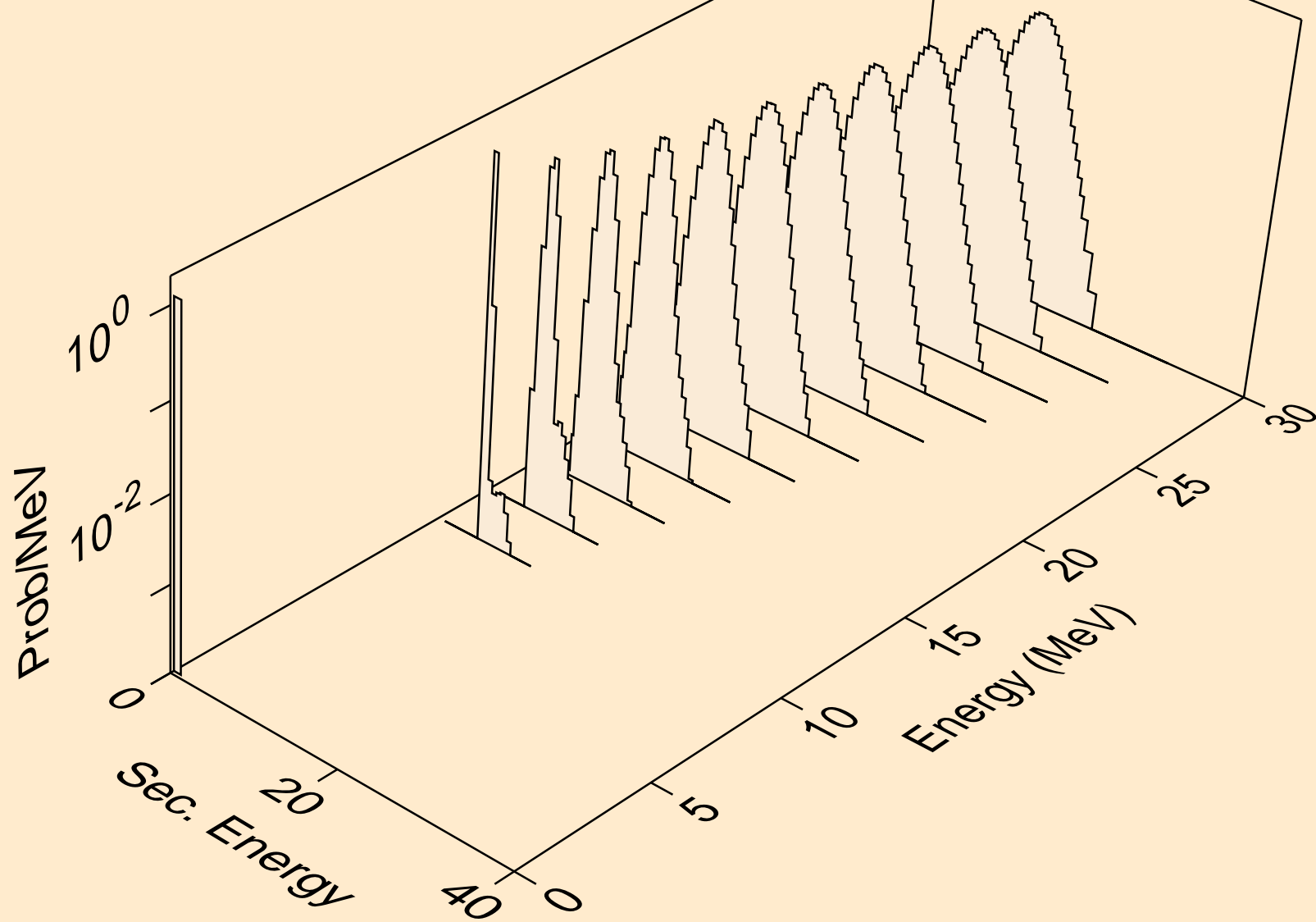



TA187 HELION ACER TENDL-2021 LIBRARY; T=0.K  
protons from (s,pd)

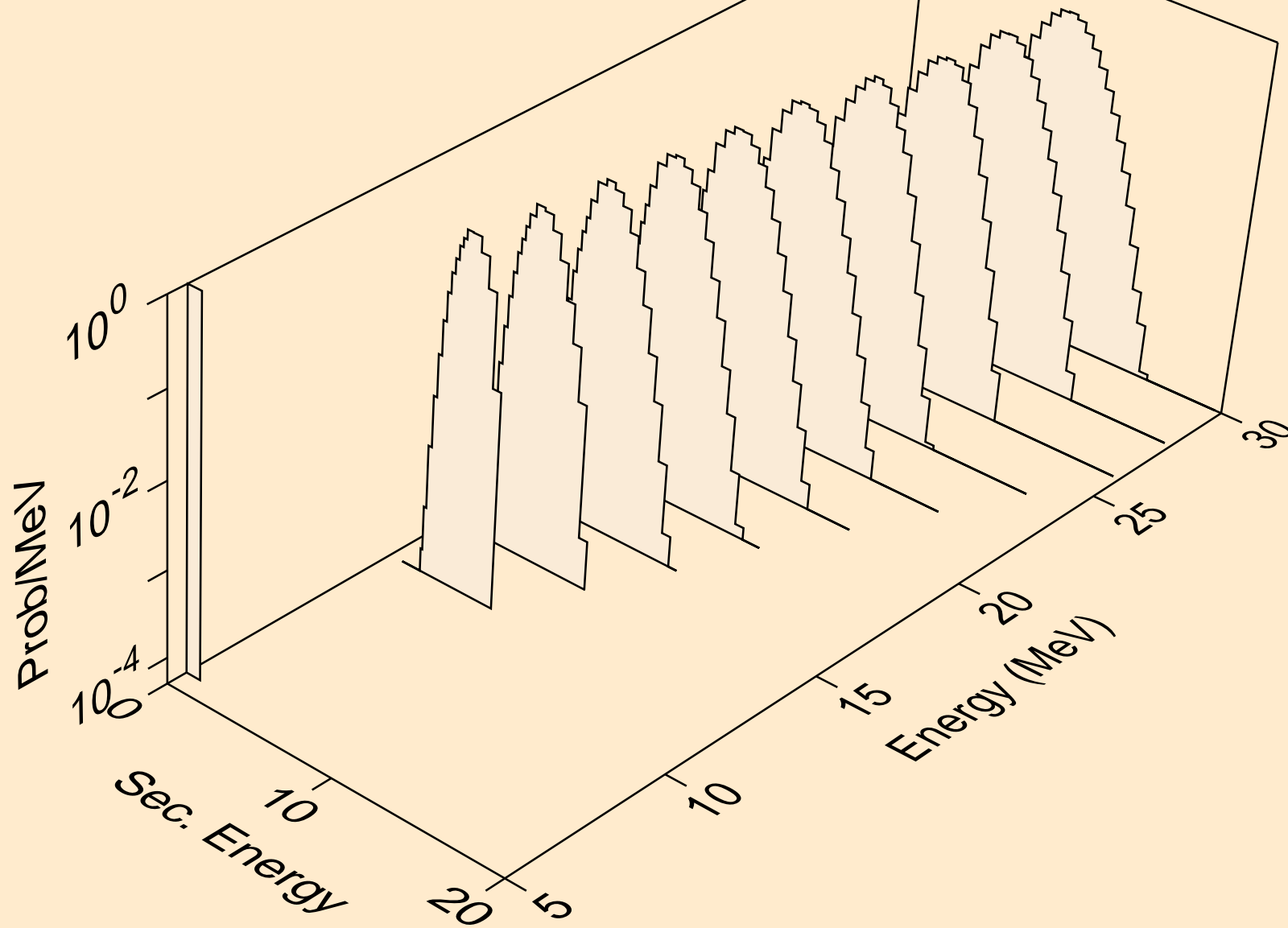

TA187 HELION ACER TENDL-2021 LIBRARY; T=0.K  
protons from (s,pt)

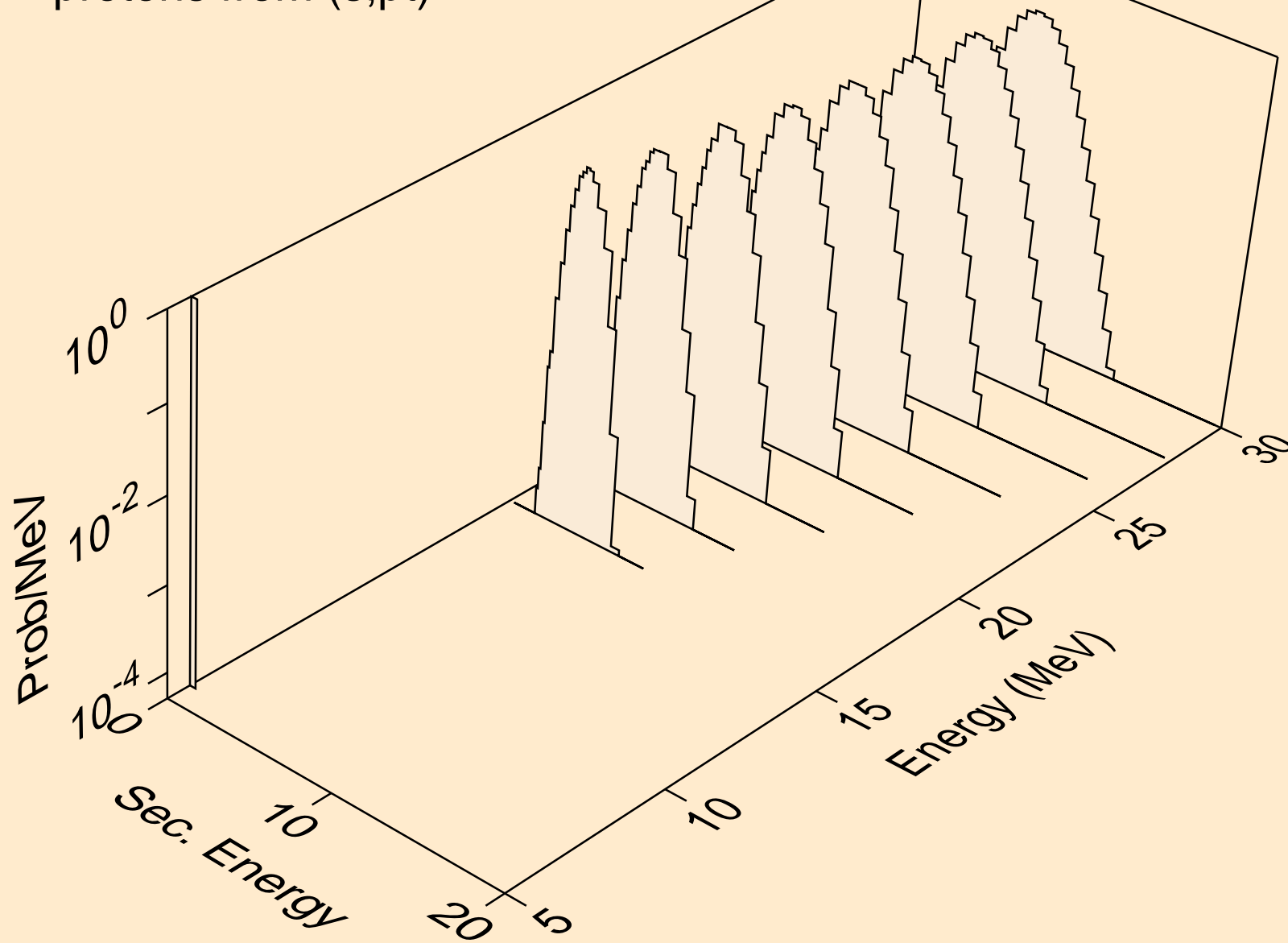

TA187 HELION ACER TENDL-2021 LIBRARY; T=0.K  
deuterons from (s,x)

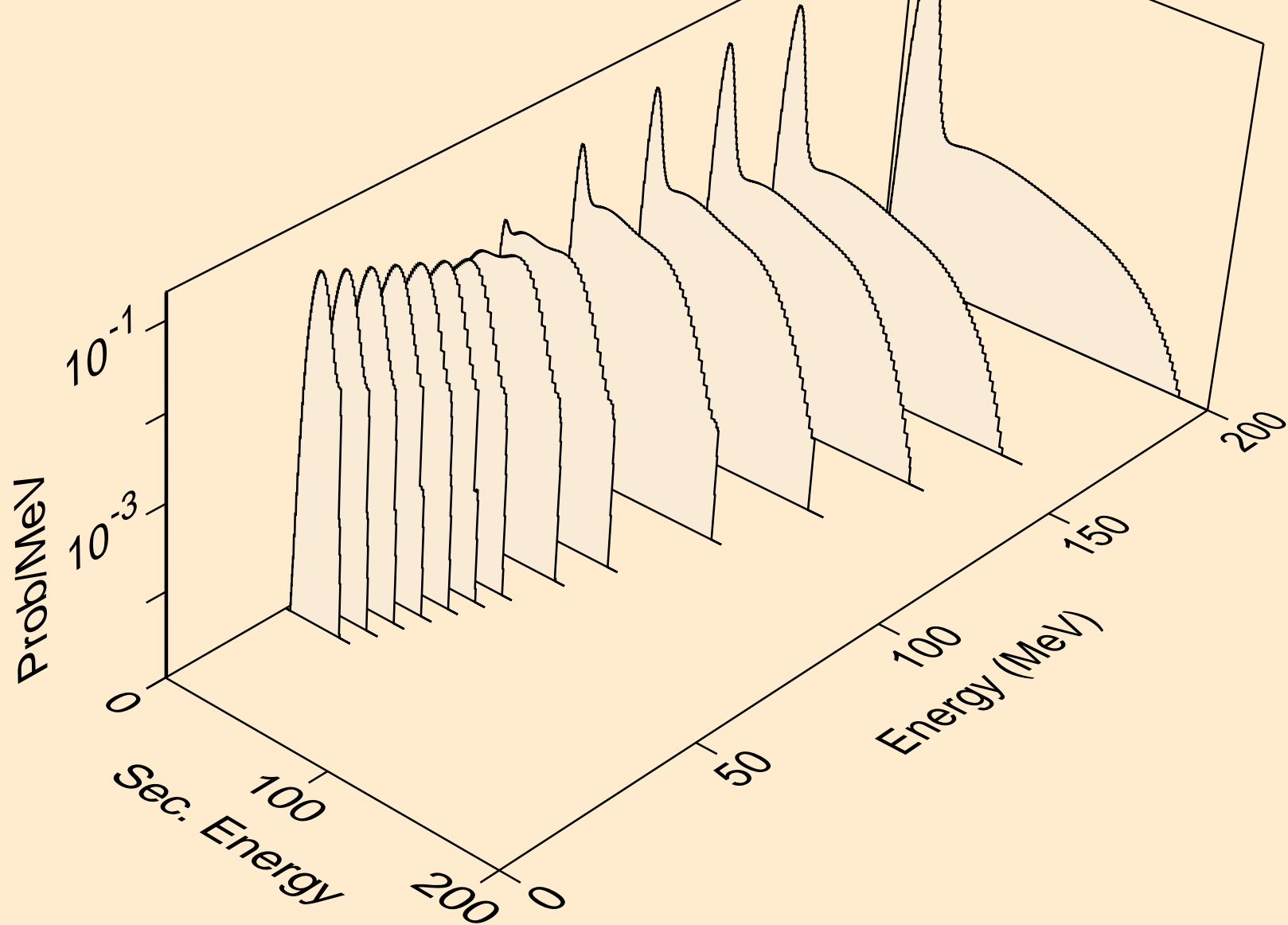

TA187 HELION ACER TENDL-2021 LIBRARY; T=0.K  
deuterons from (s,2nd)

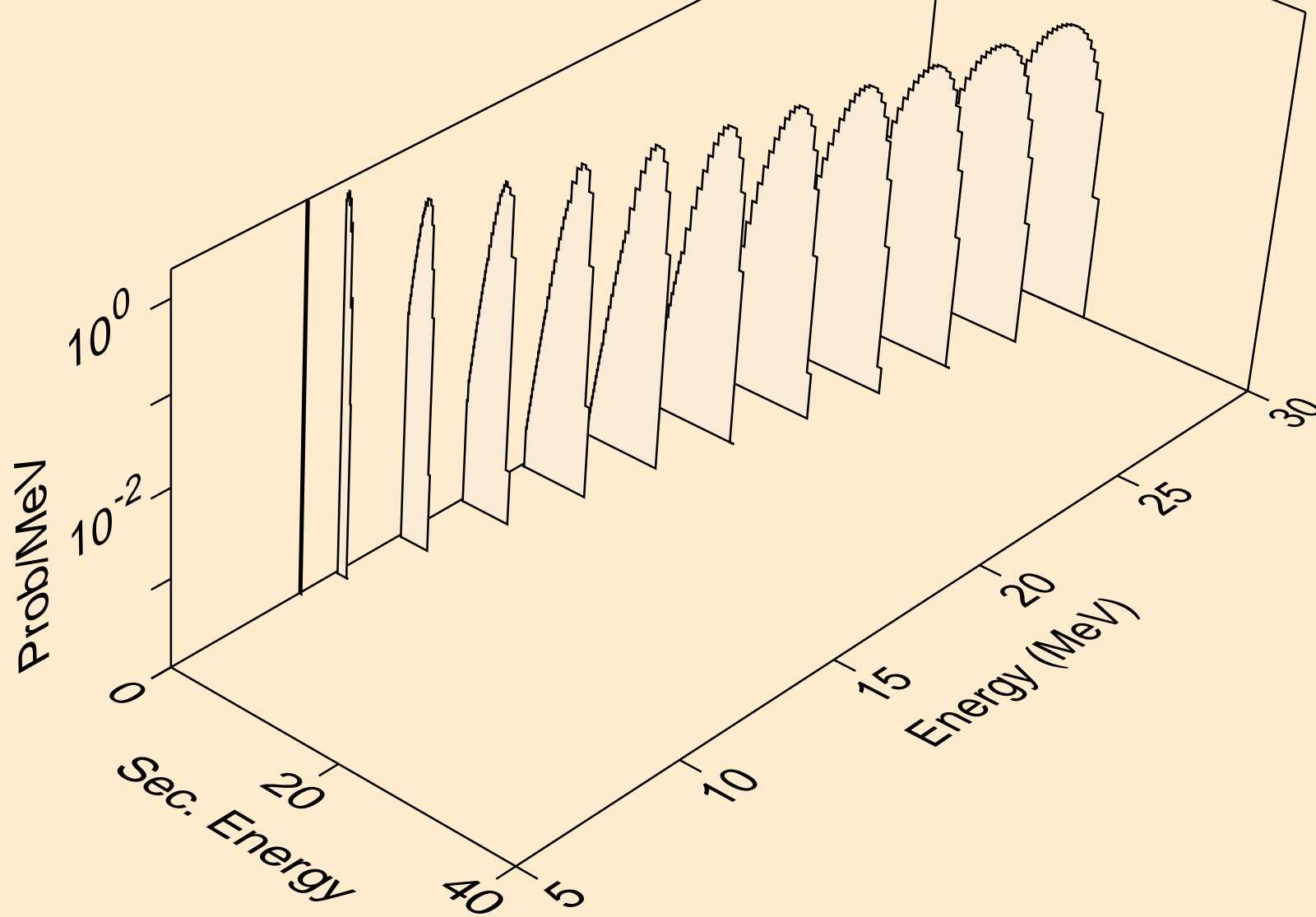

TA187 HELION ACER TENDL-2021 LIBRARY; T=0.K  
deuterons from (s,n\*)d

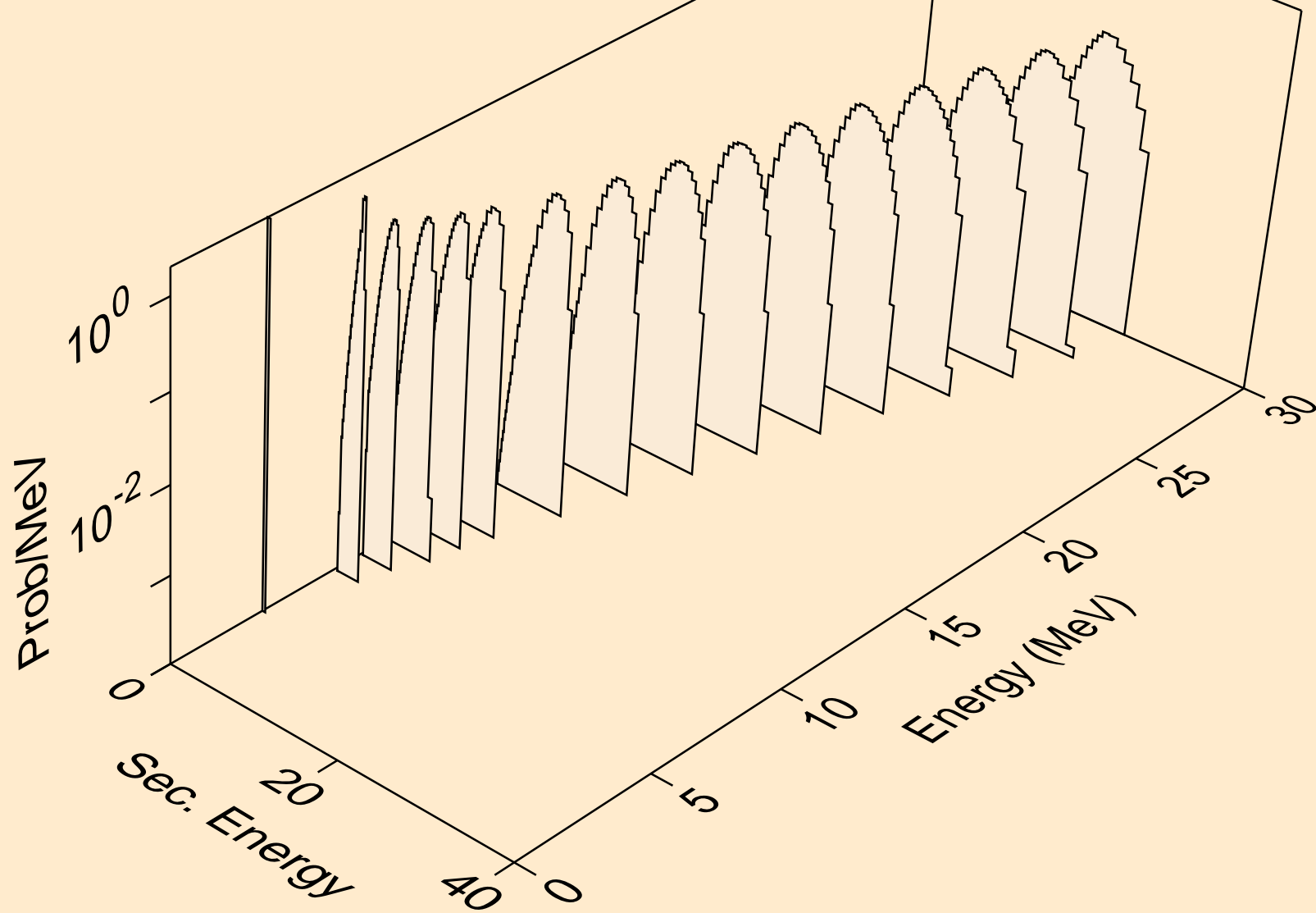

TA187 HELION ACER TENDL-2021 LIBRARY; T=0.K  
deuterons from (s,d)

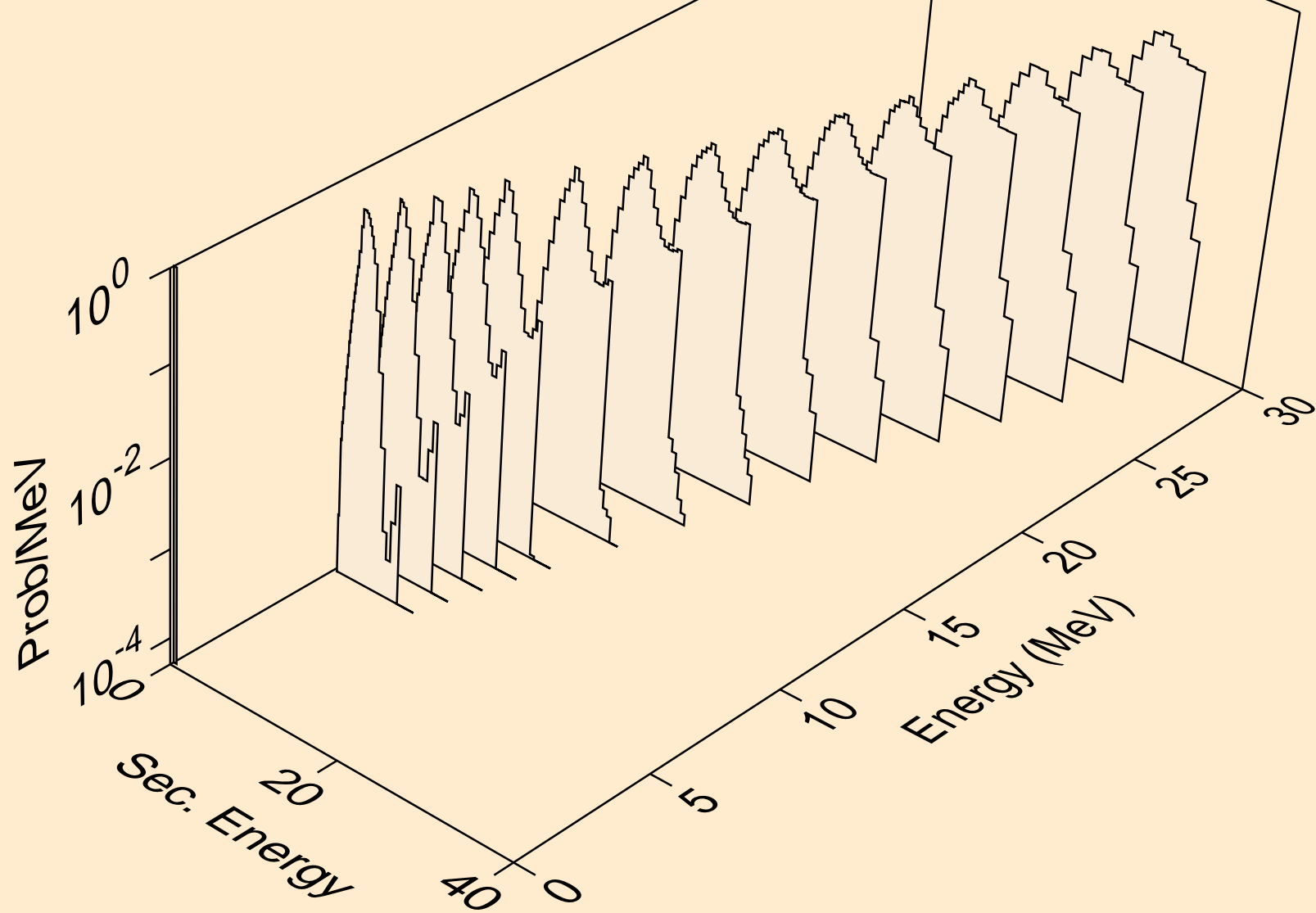

TA187 HELION ACER TENDL-2021 LIBRARY; T=0.K  
deuterons from (s,pd)

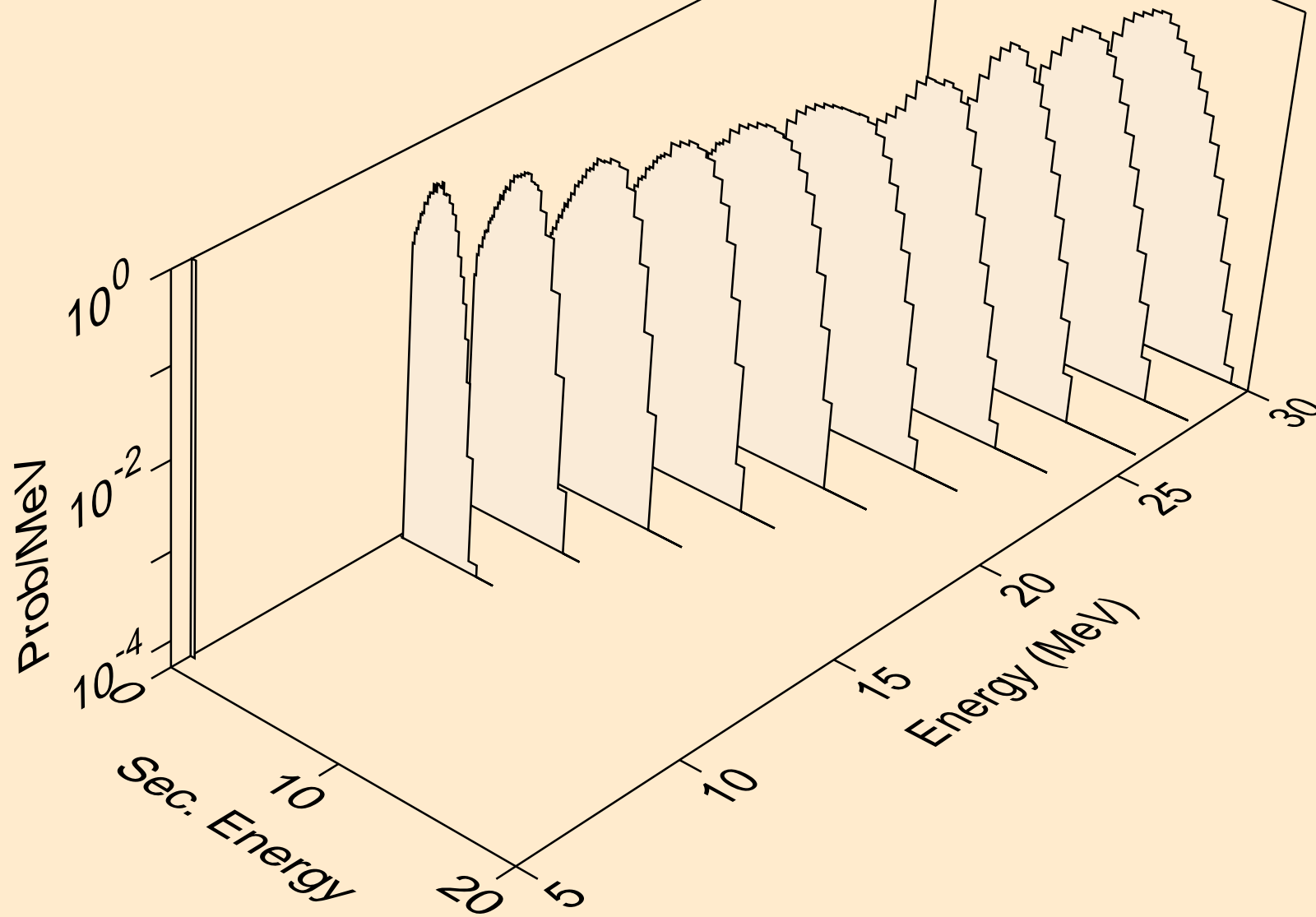

TA187 HELION ACER TENDL-2021 LIBRARY; T=0.K  
tritons from (s,x)

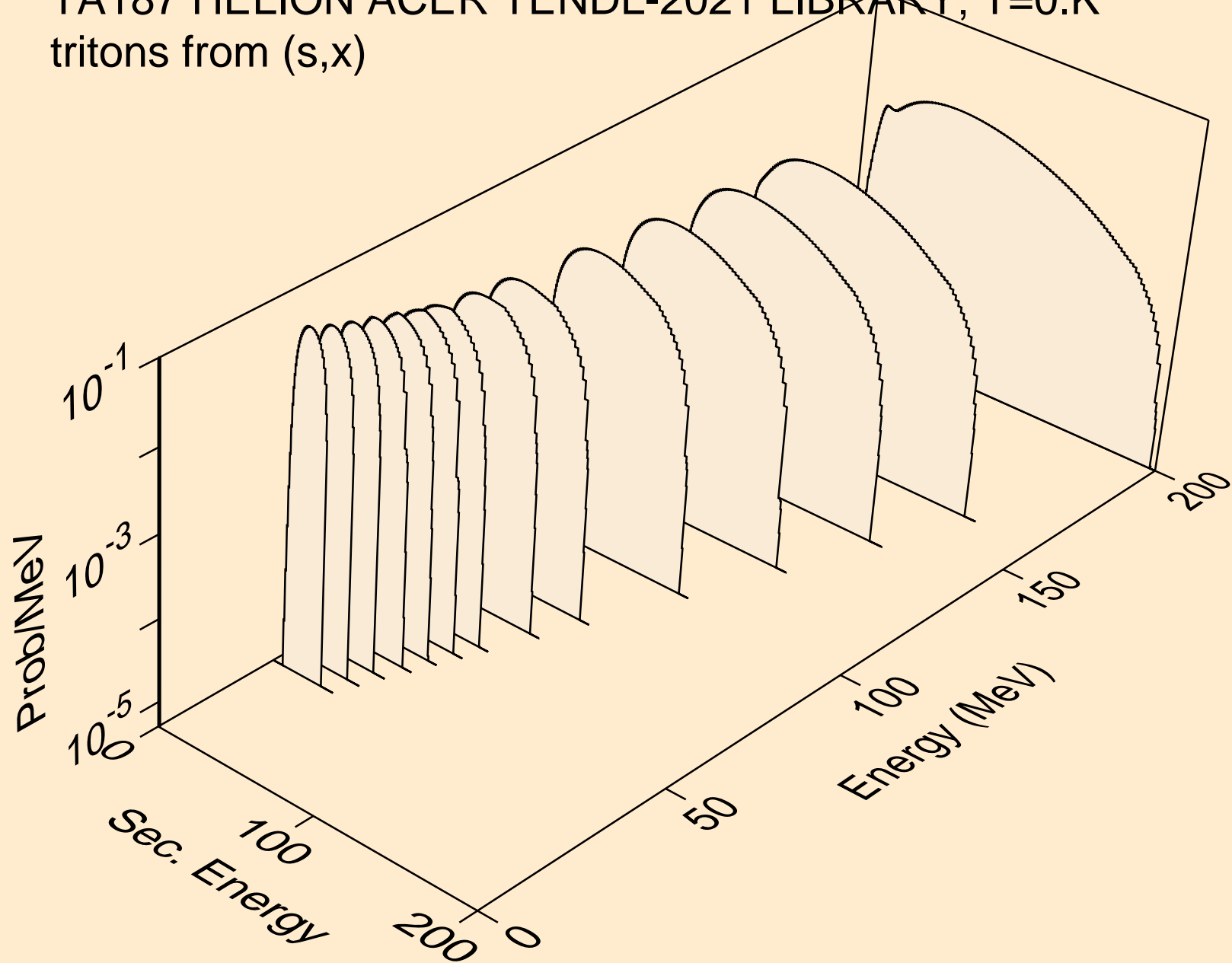



TA187 HELION ACER TENDL-2021 LIBRARY; T=0.K  
tritons from (s,n\*)t

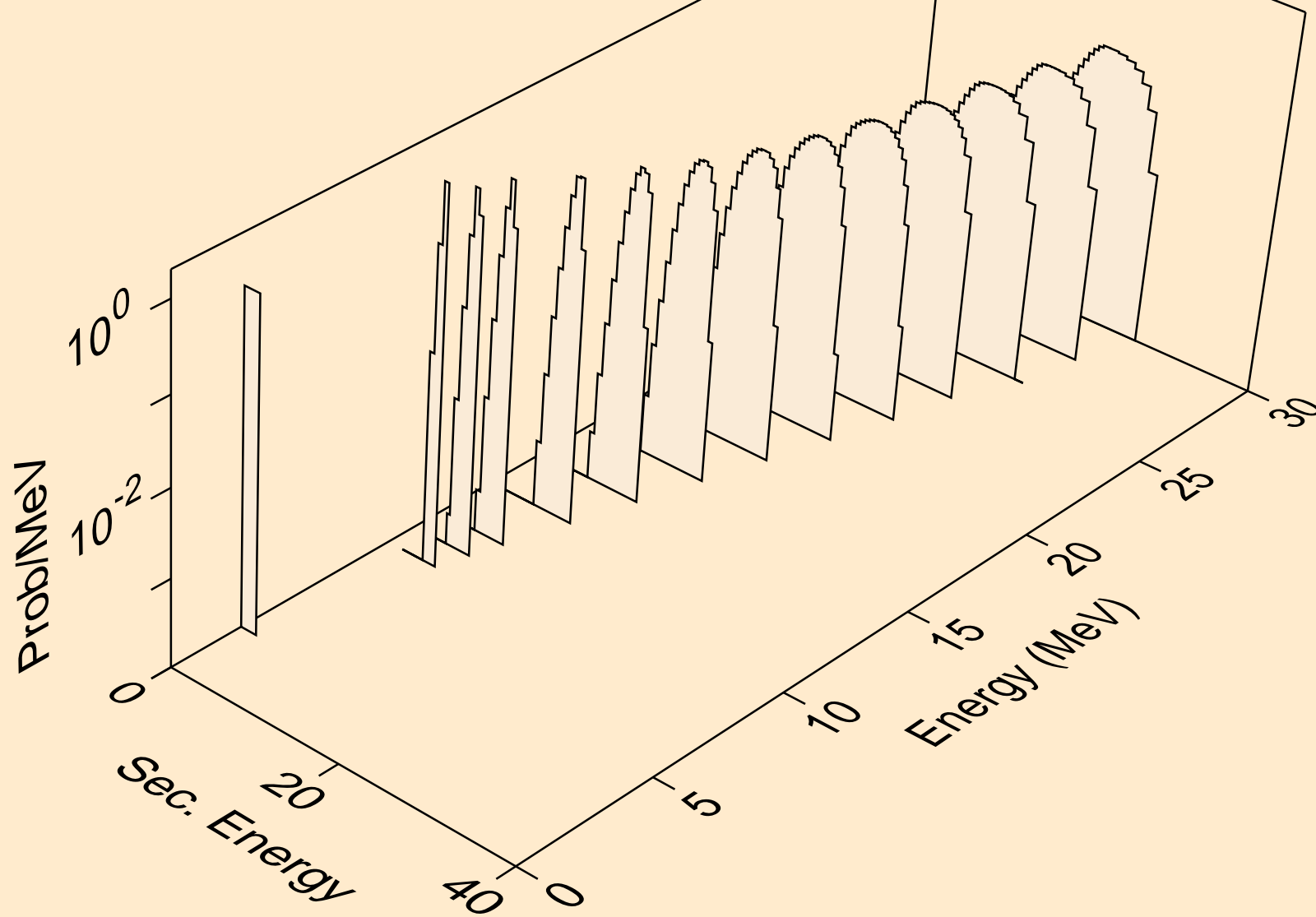

TA187 HELION ACER TENDL-2021 LIBRARY; T=0.K  
tritons from (s,t)

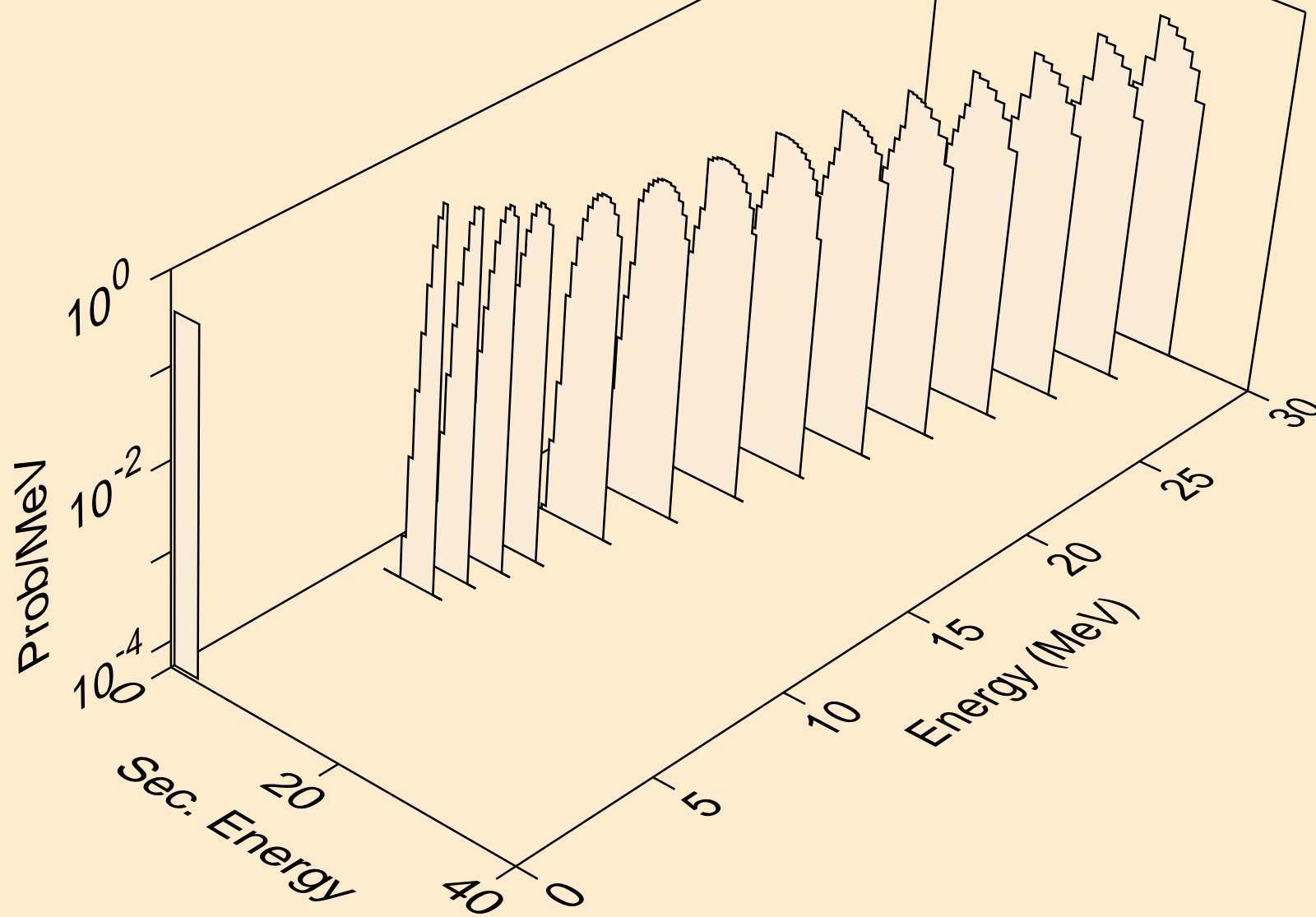

TA187 HELION ACER TENDL-2021 LIBRARY; T=0.K  
tritons from (s,pt)

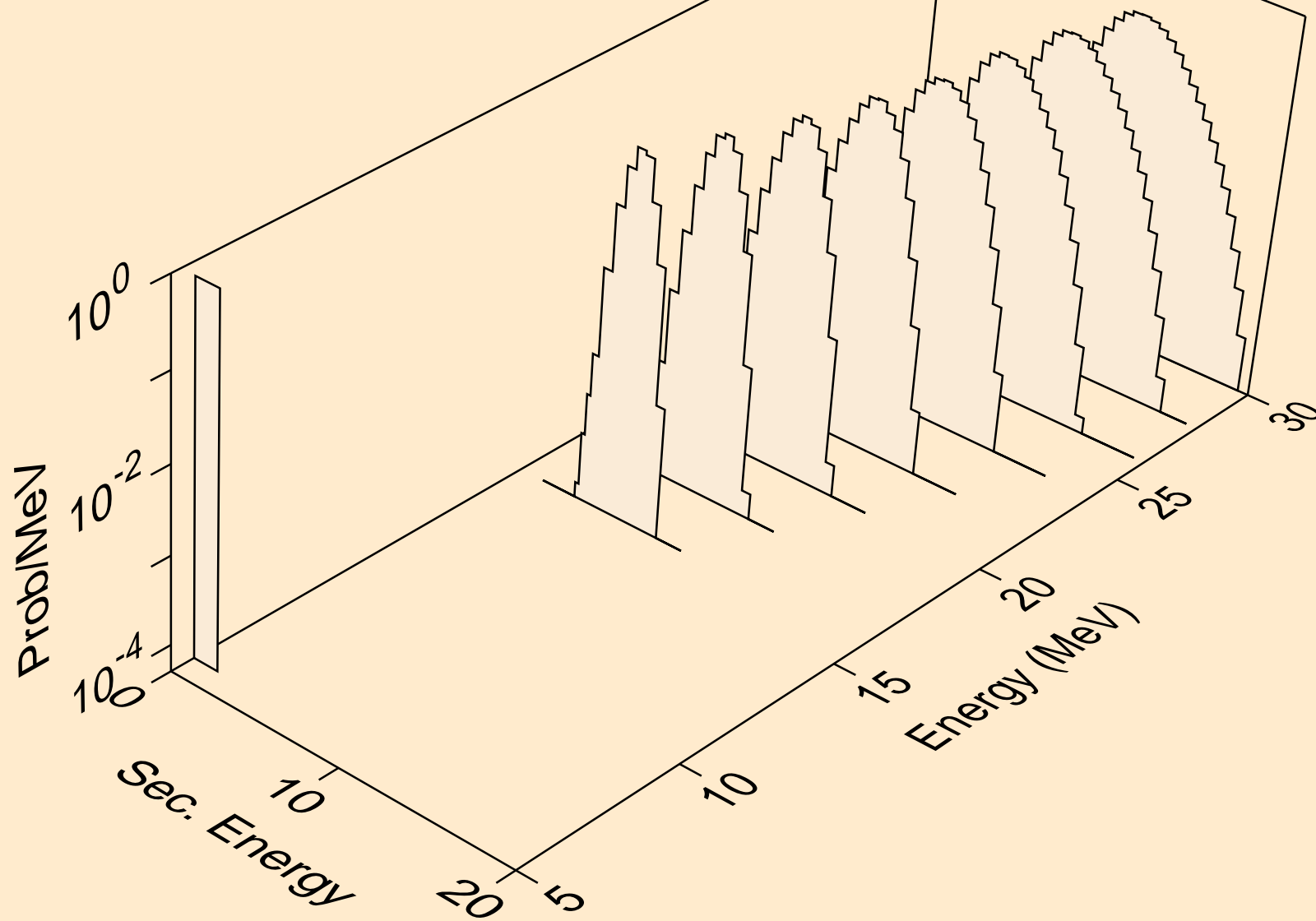

TA187 HELION ACER TENDL-2021 LIBRARY; T=0.K  
alphas from (s,x)

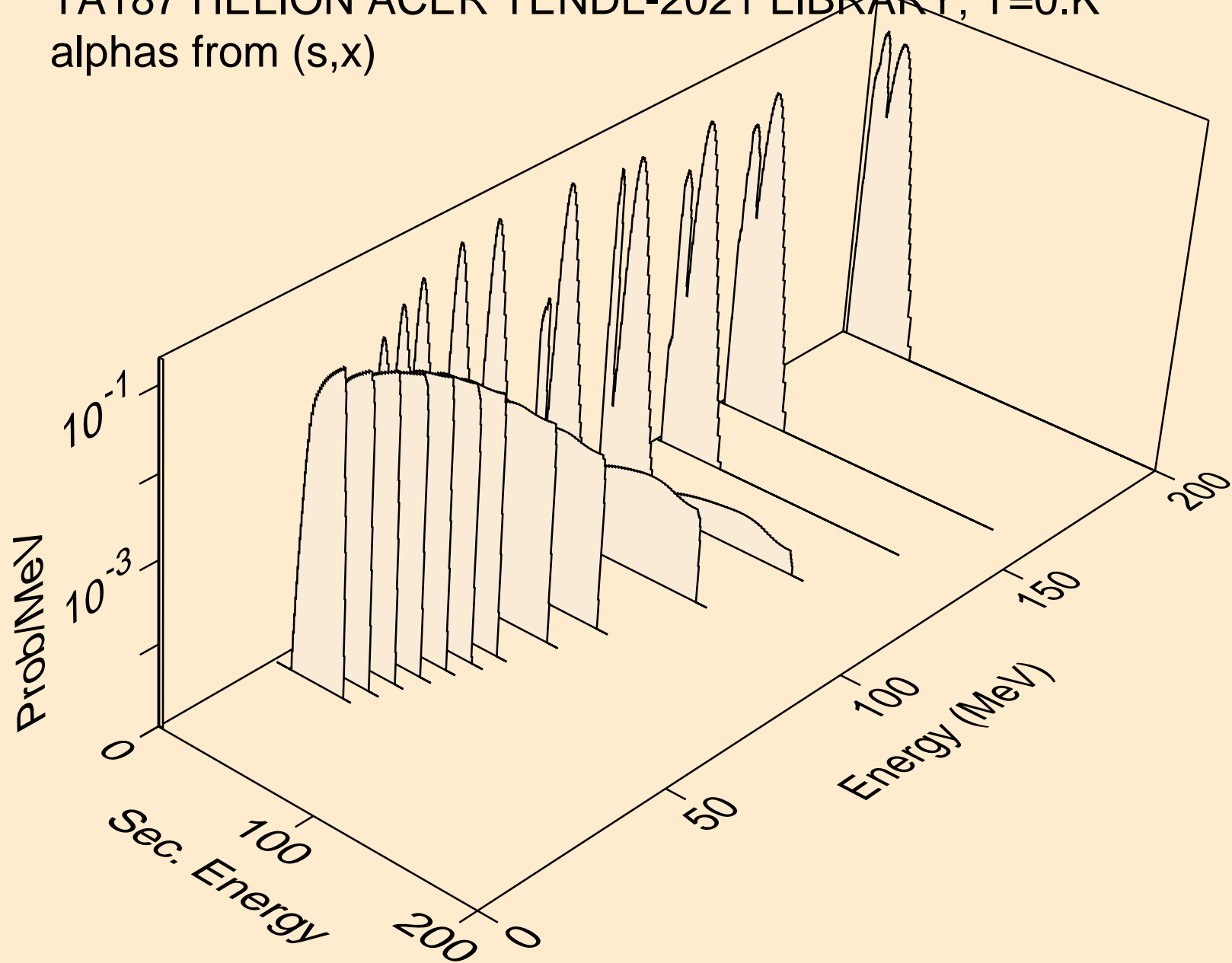

TA187 HELION ACER TENDL-2021 LIBRARY; T=0.K  
alphas from (s,n\*)a

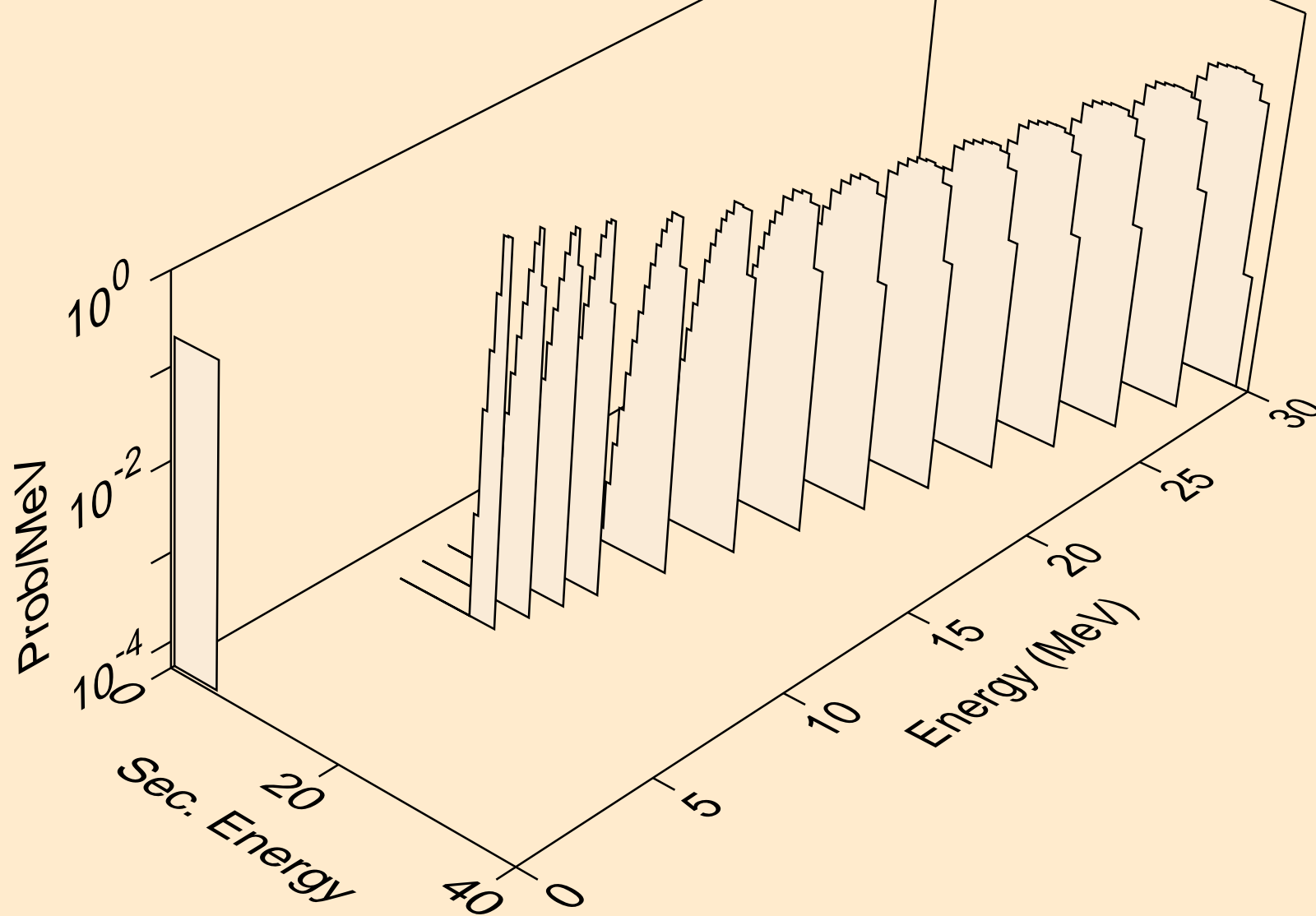

TA187 HELION ACER TENDL-2021 LIBRARY; T=0.K  
alphas from (s,2n)a

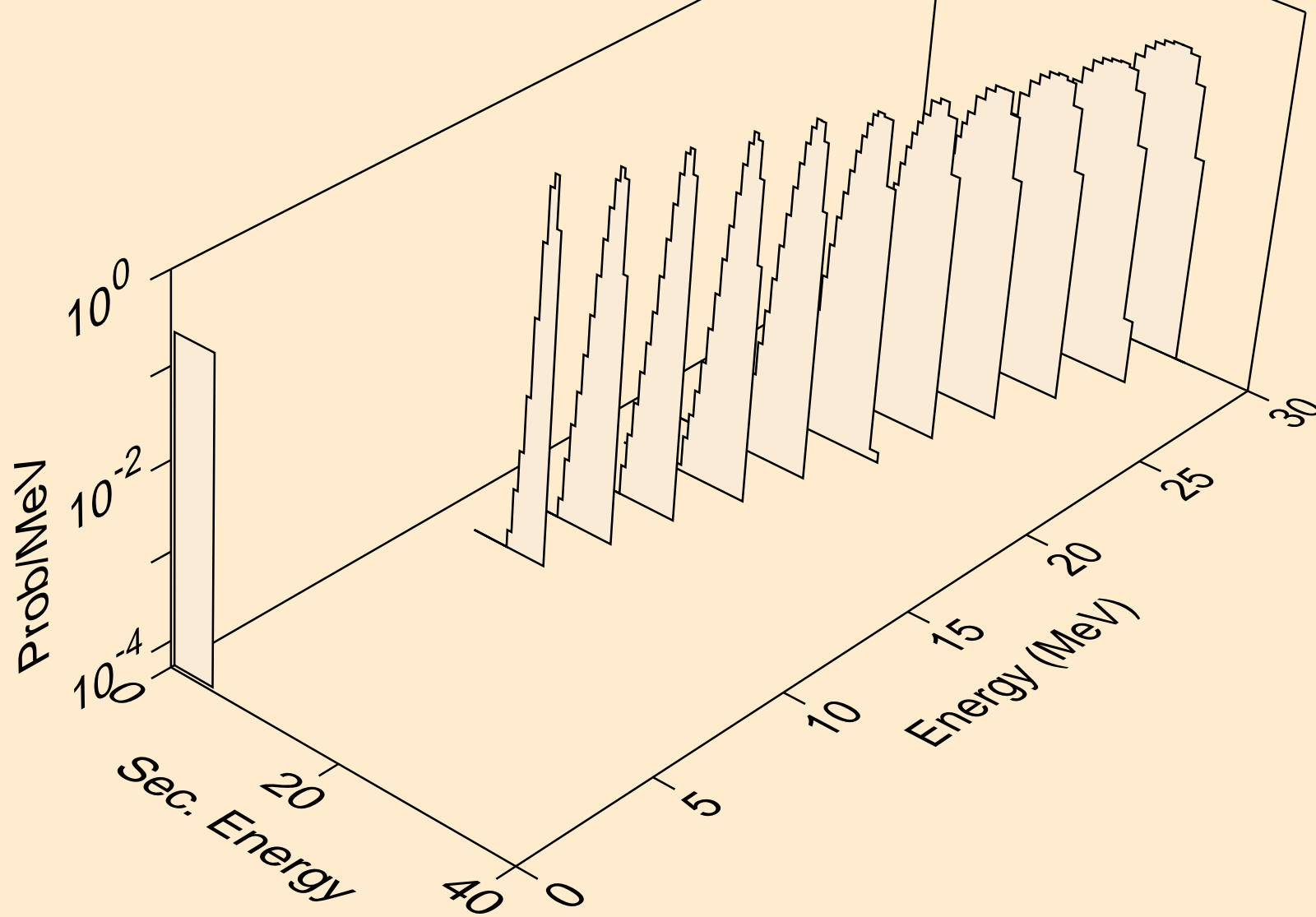

TA187 HELION ACER TENDL-2021 LIBRARY; T=0.K  
alphas from (s,3n)a

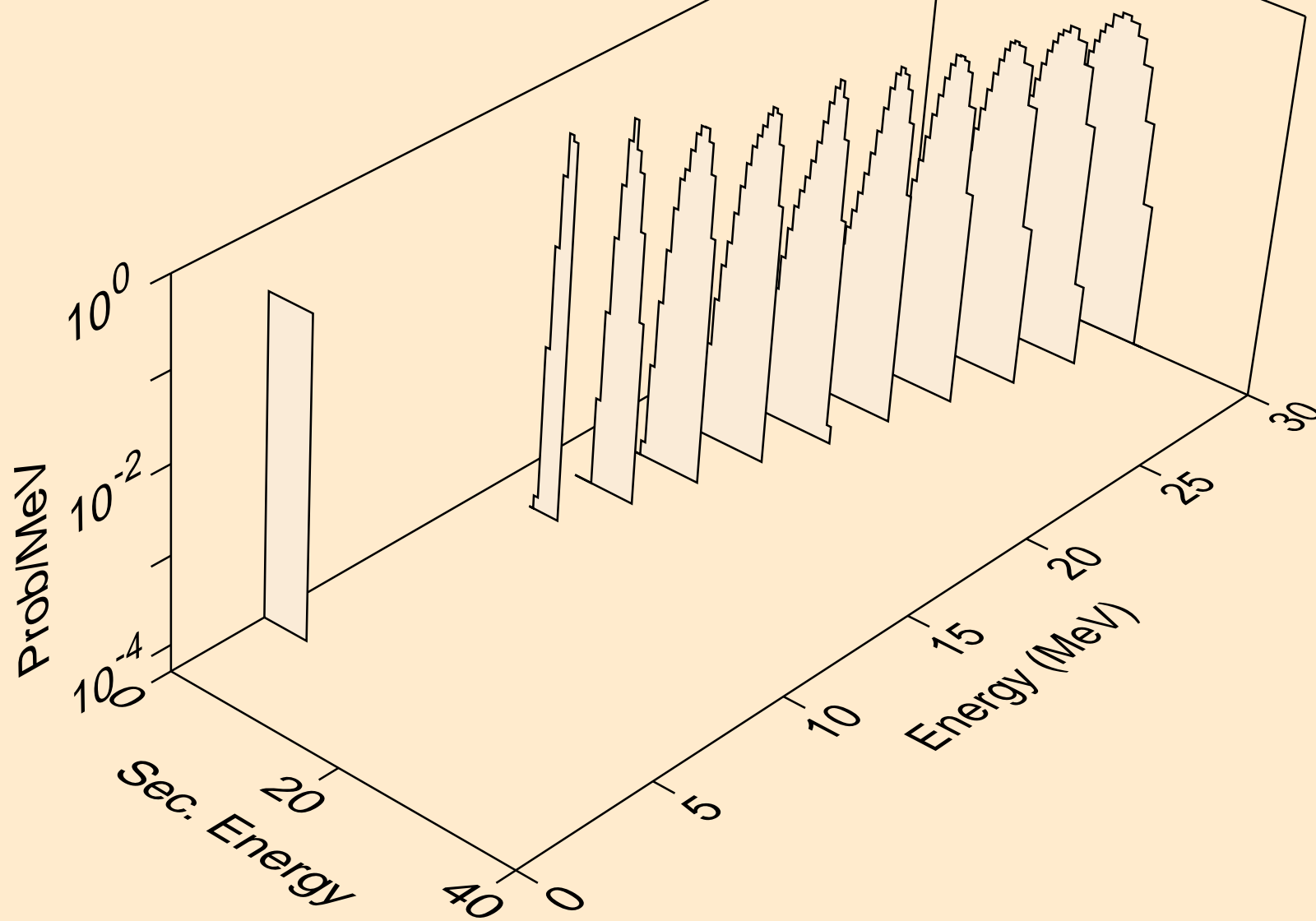

TA187 HELION ACER TENDL-2021 LIBRARY; T=0.K  
alphas from (s,npa)

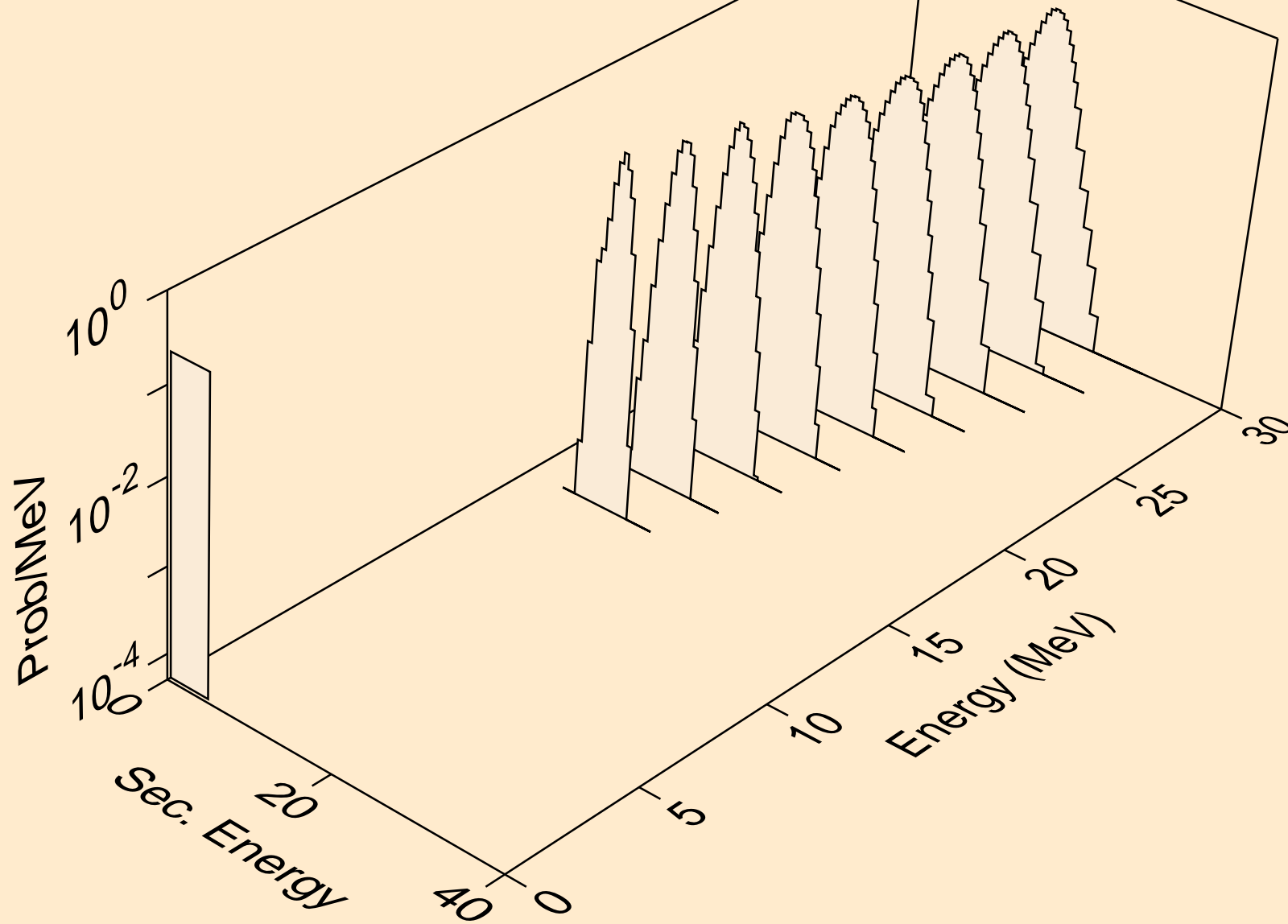



TA187 HELION ACER TENDL-2021 LIBRARY; T=0.K  
alphas from (s,a)

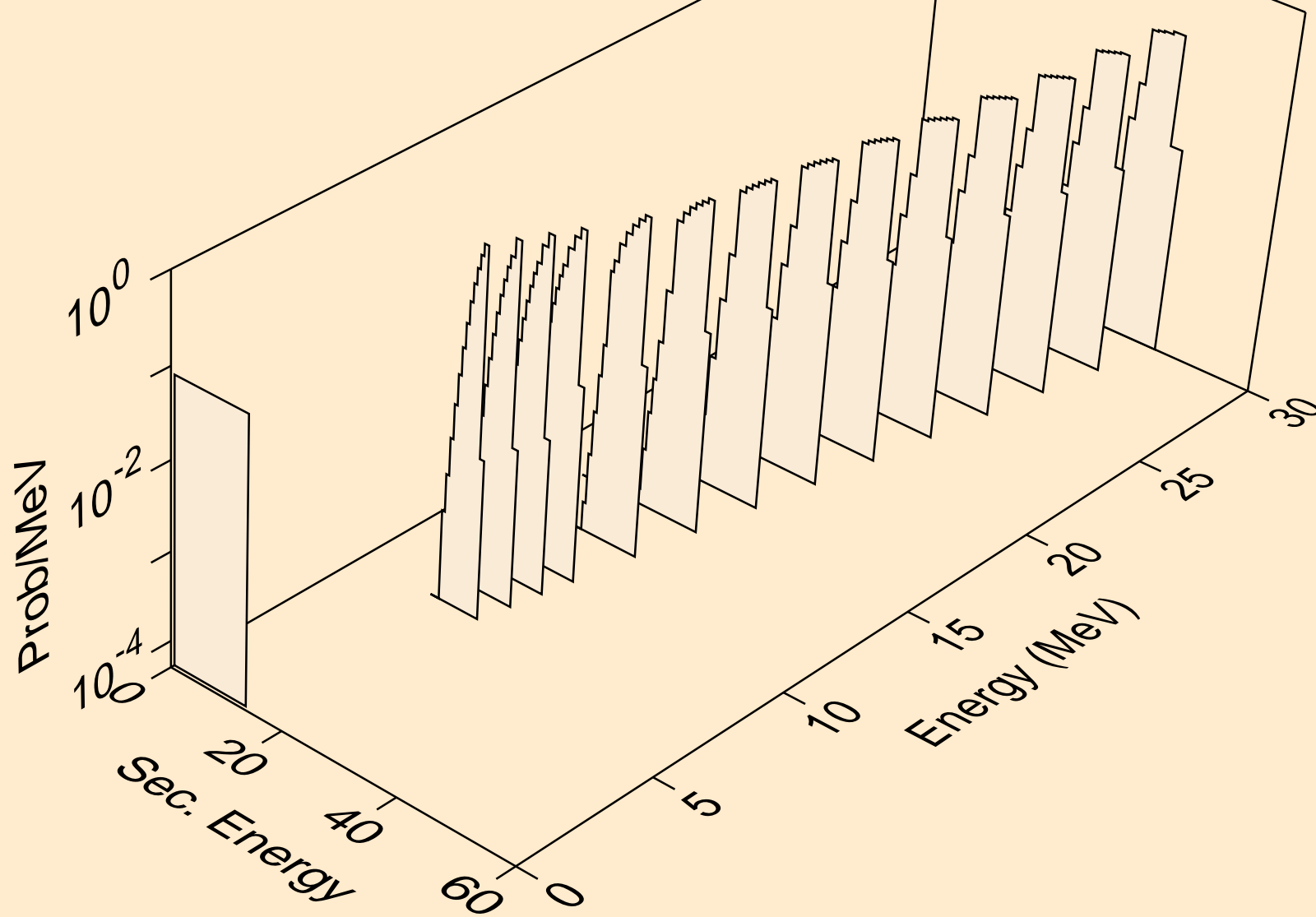

TA187 HELION ACER TENDL-2021 LIBRARY; T=0.K  
alphas from (s,pa)

