

TB144M HELION ACER TENDL-2021 LIBRARY; T=0.K  
Principal cross sections

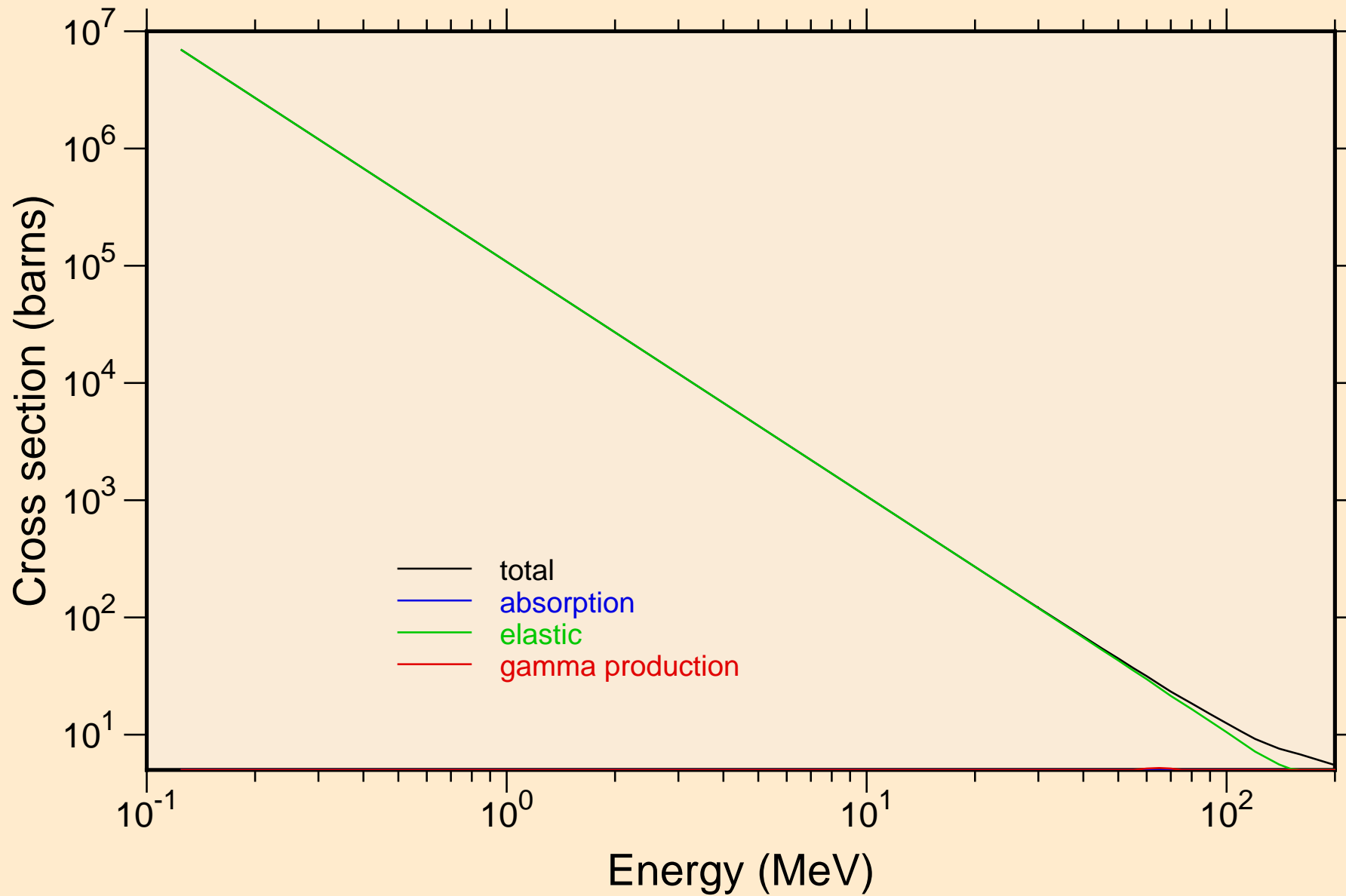

TB144M HELION ACER TENDL-2021 LIBRARY; T=0.K  
Heating

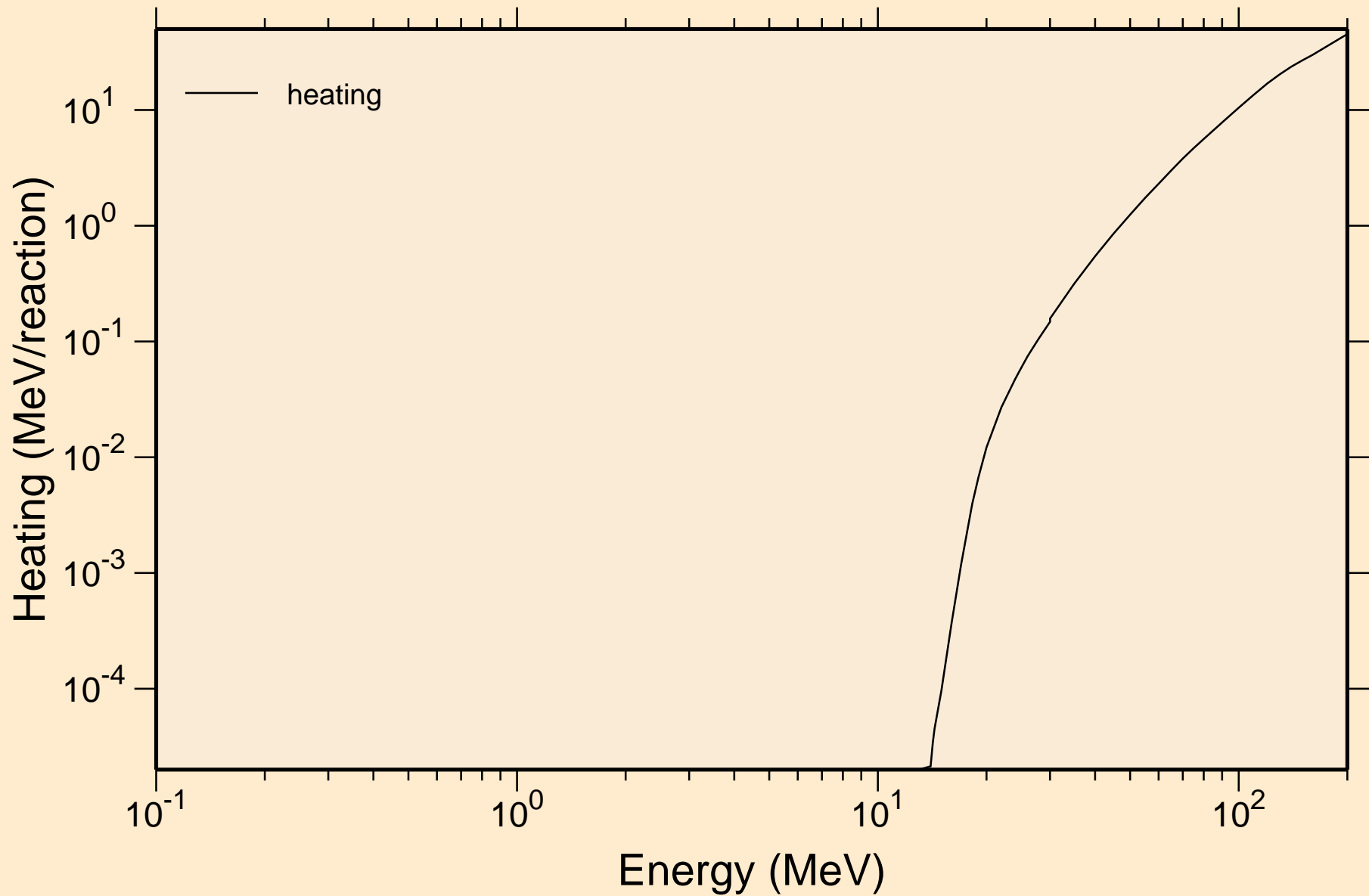

# TB144M HELION ACER TENDL-2021 LIBRARY; T=0.K

## Principal cross sections

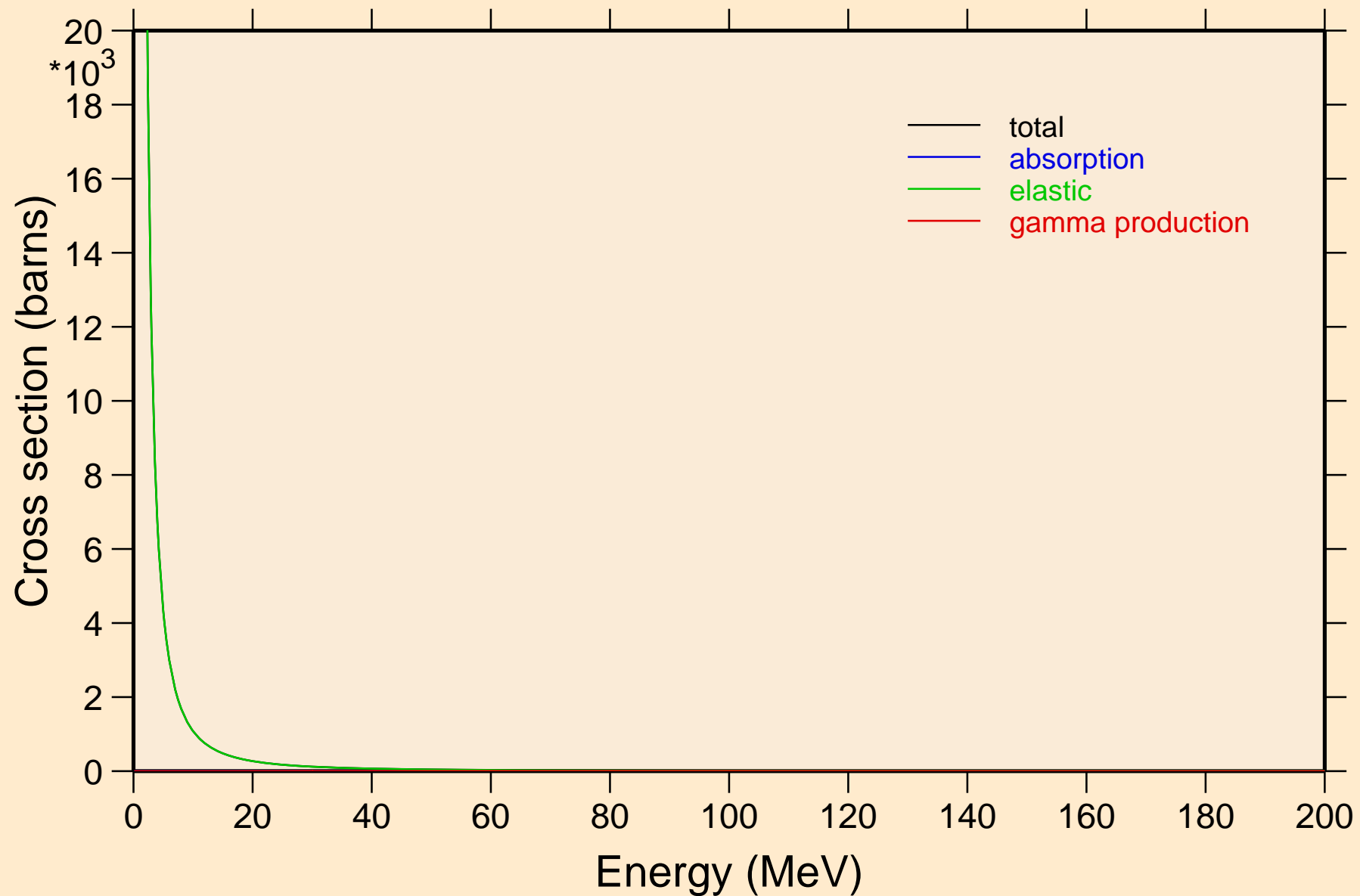

TB144M HELION ACER TENDL-2021 LIBRARY; T=0.K

Heating

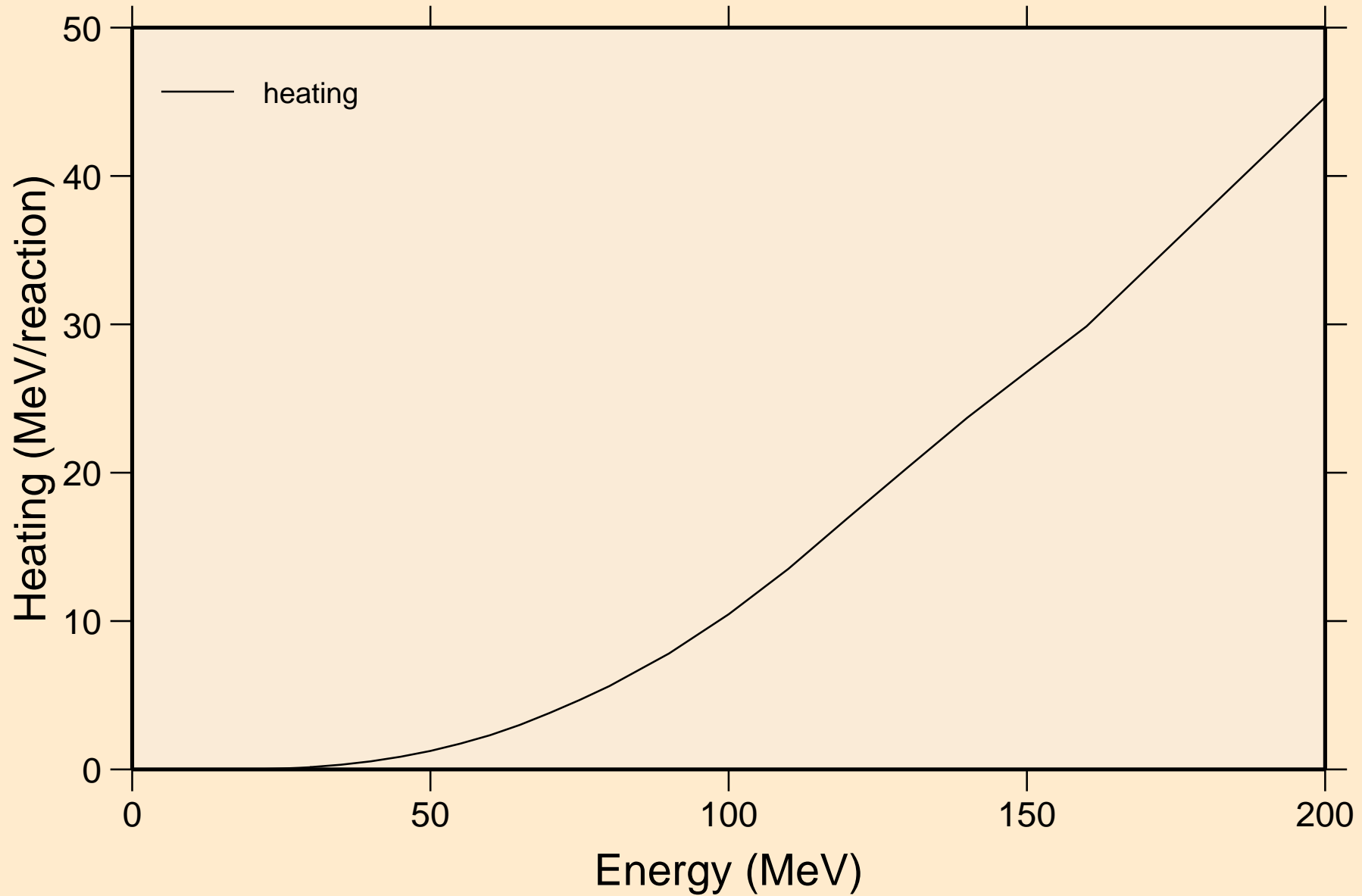

TB144M HELION ACER TENDL-2021 LIBRARY; T=0.K  
Threshold reactions

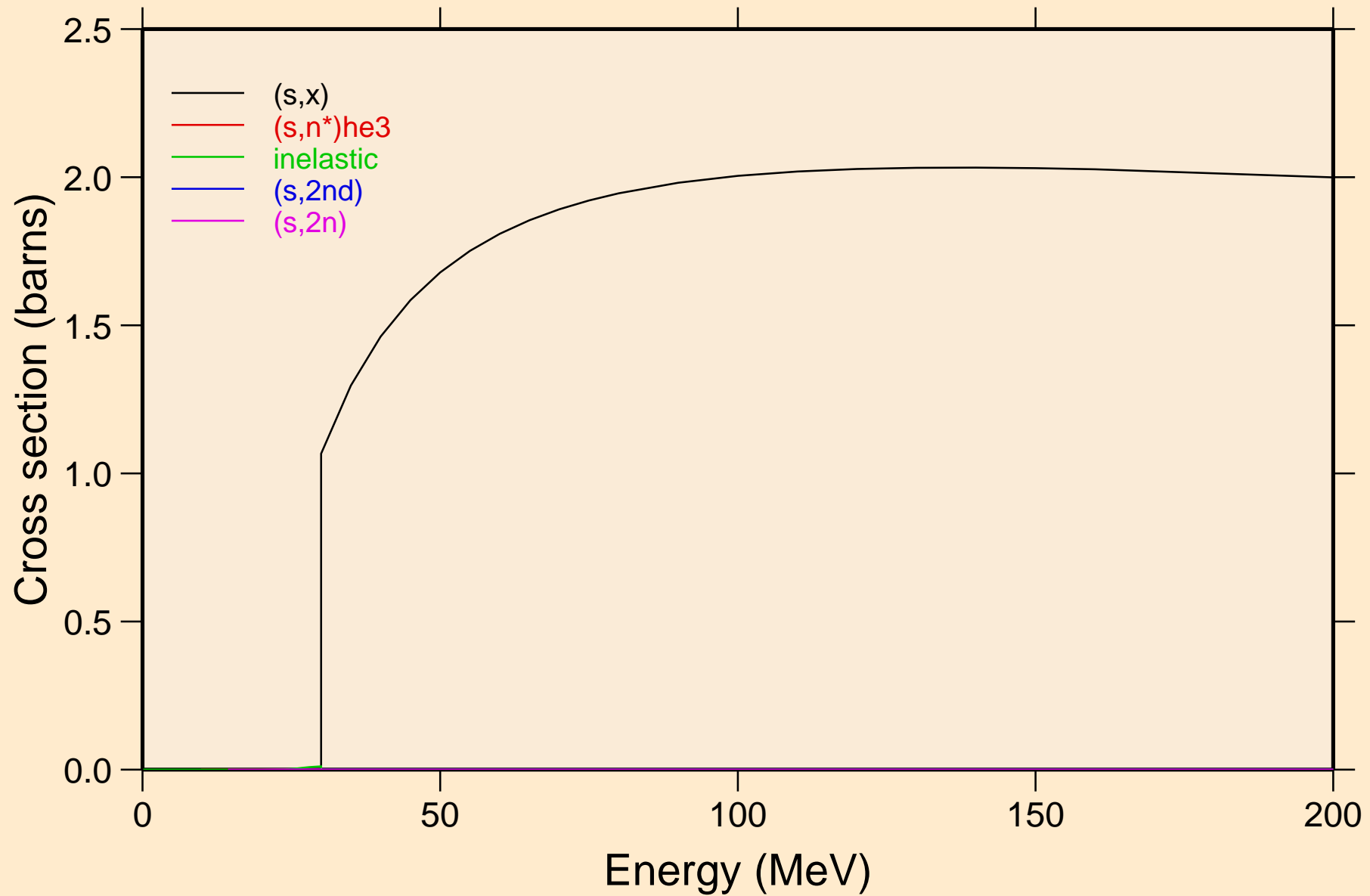

TB144M HELION ACER TENDL-2021 LIBRARY; T=0.K  
Threshold reactions

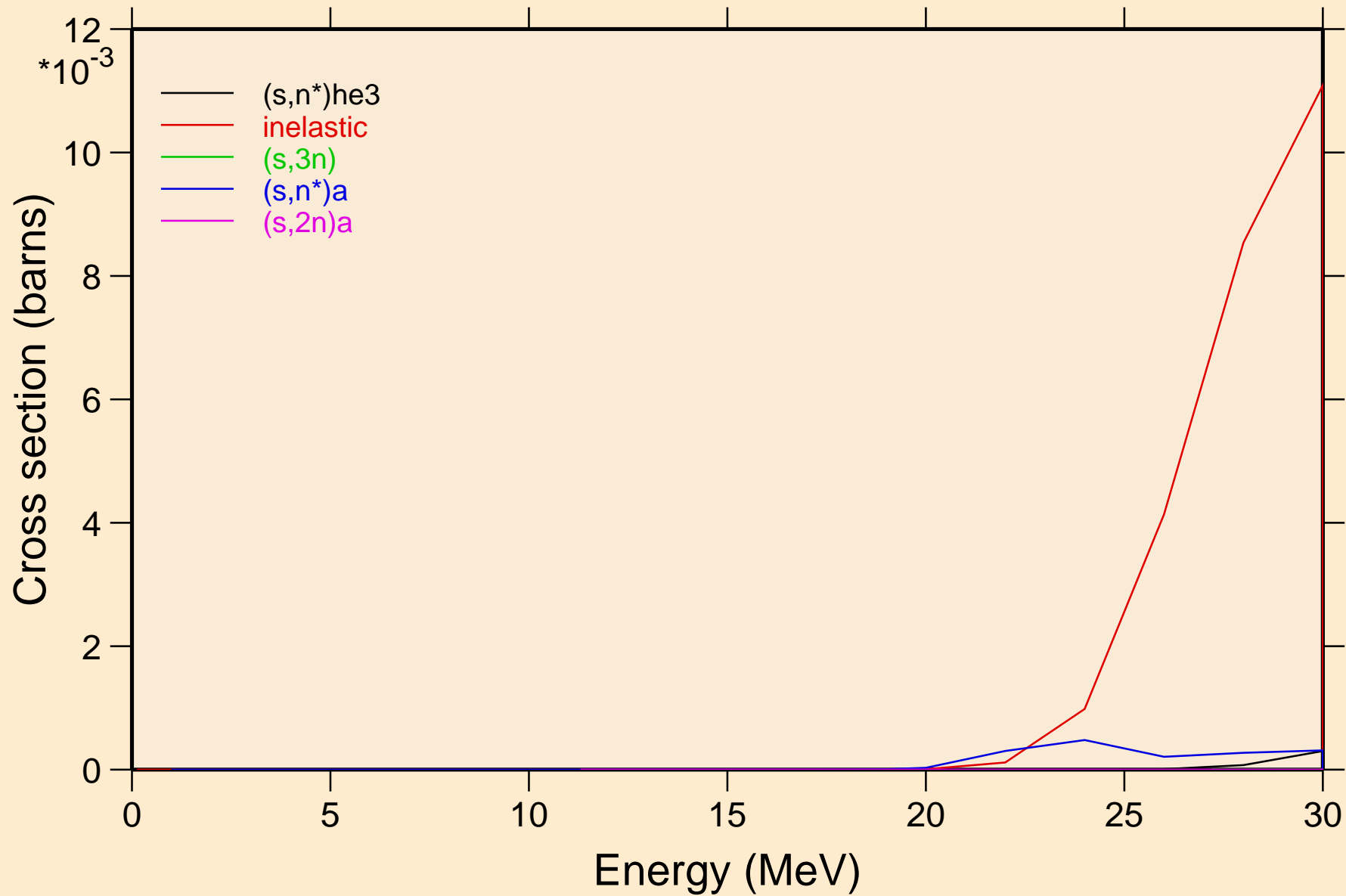

TB144M HELION ACER TENDL-2021 LIBRARY; T=0.K  
Threshold reactions

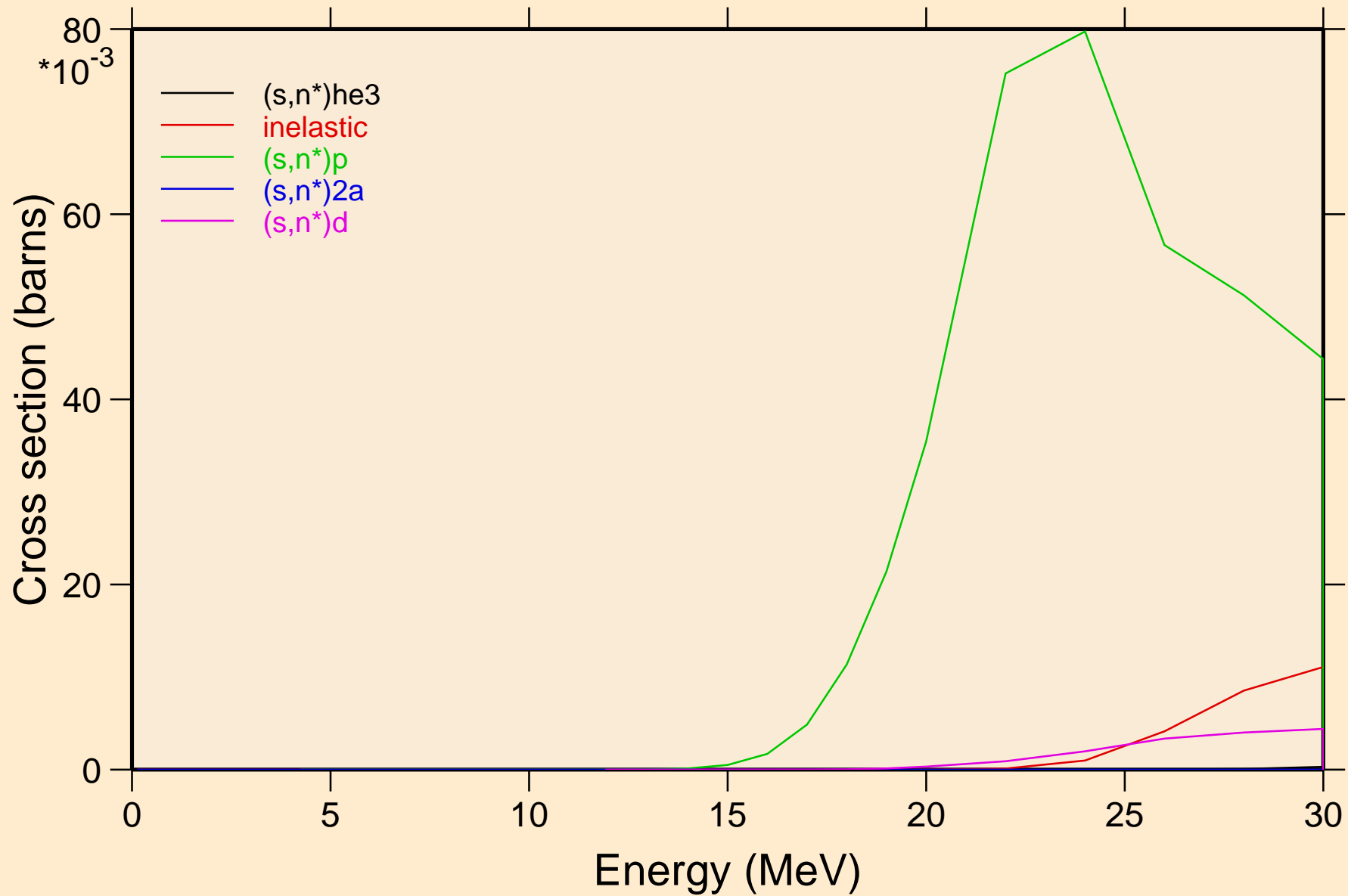

TB144M HELION ACER TENDL-2021 LIBRARY; T=0.K  
Threshold reactions

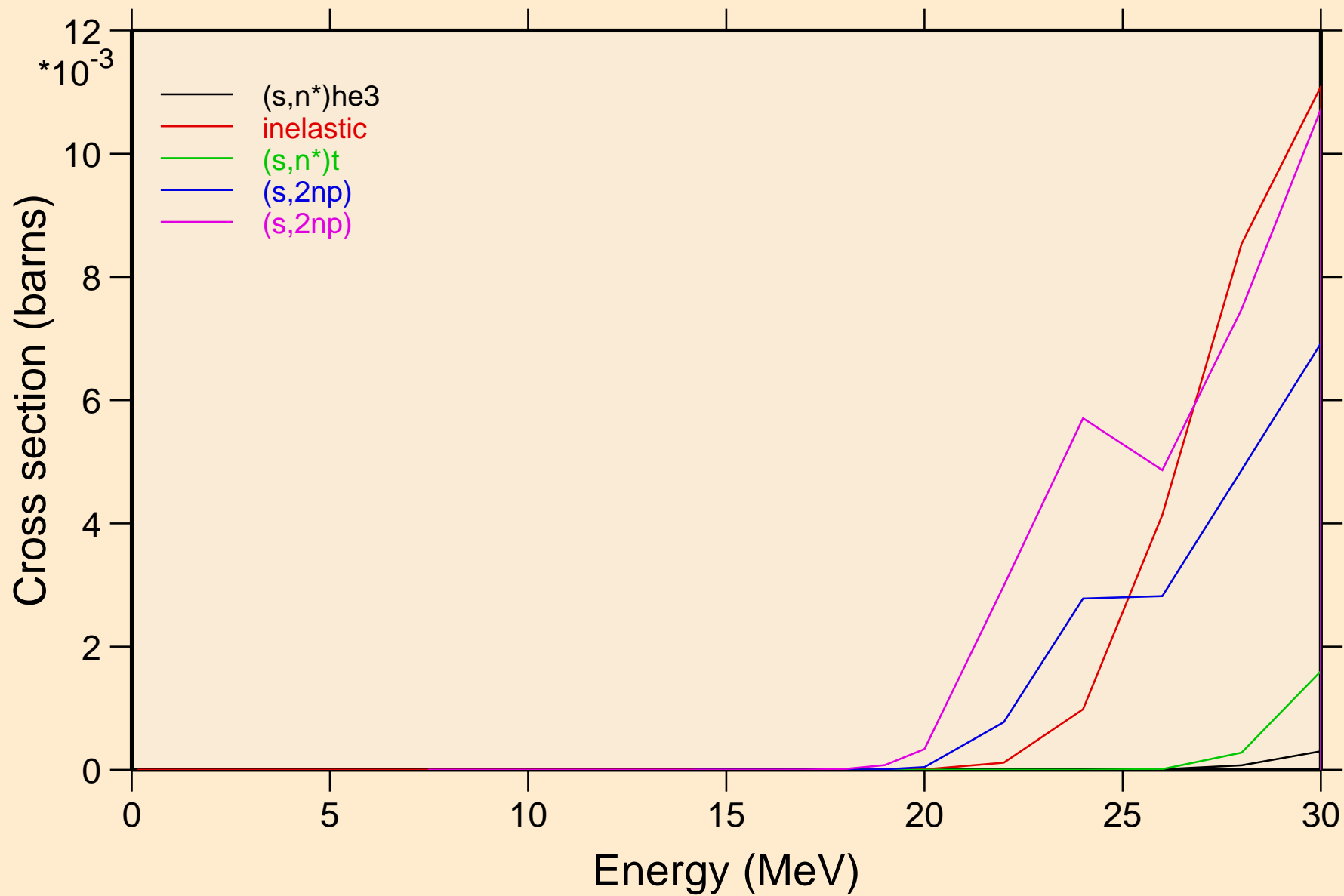



TB144M HELION ACER TENDL-2021 LIBRARY; T=0.K  
Threshold reactions

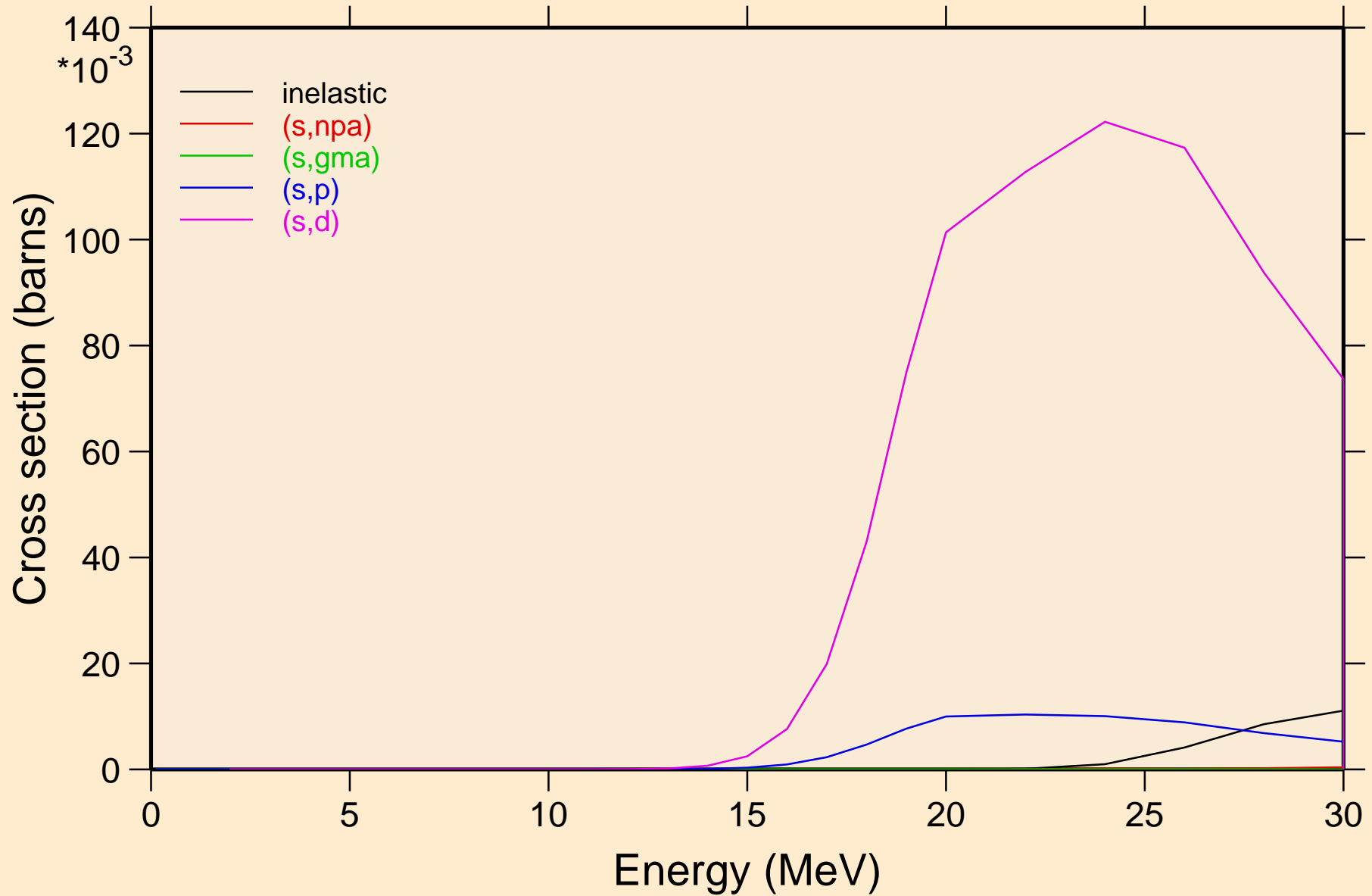

TB144M HELION ACER TENDL-2021 LIBRARY; T=0.K  
Threshold reactions

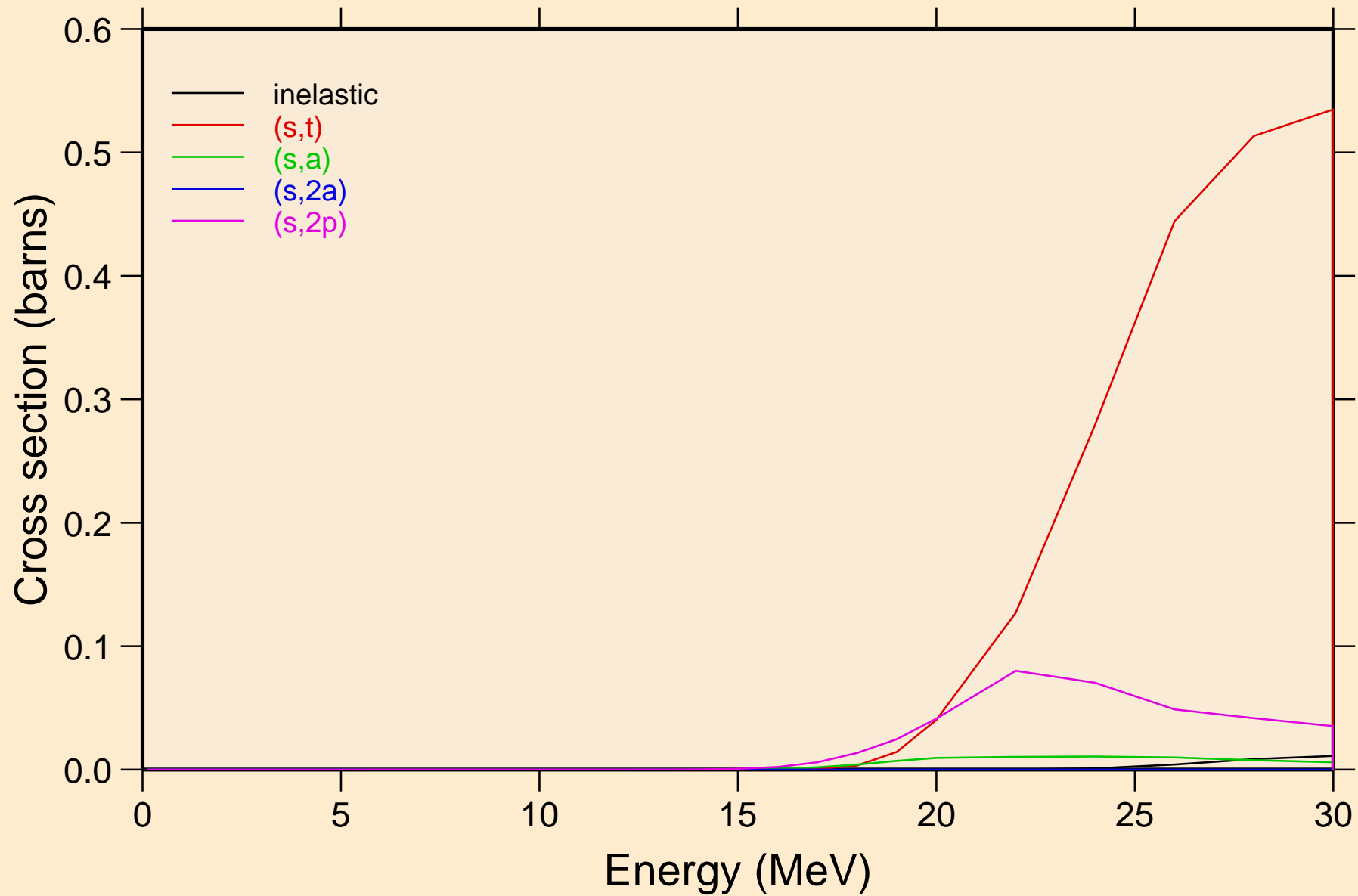

TB144M HELION ACER TENDL-2021 LIBRARY; T=0.K  
Threshold reactions

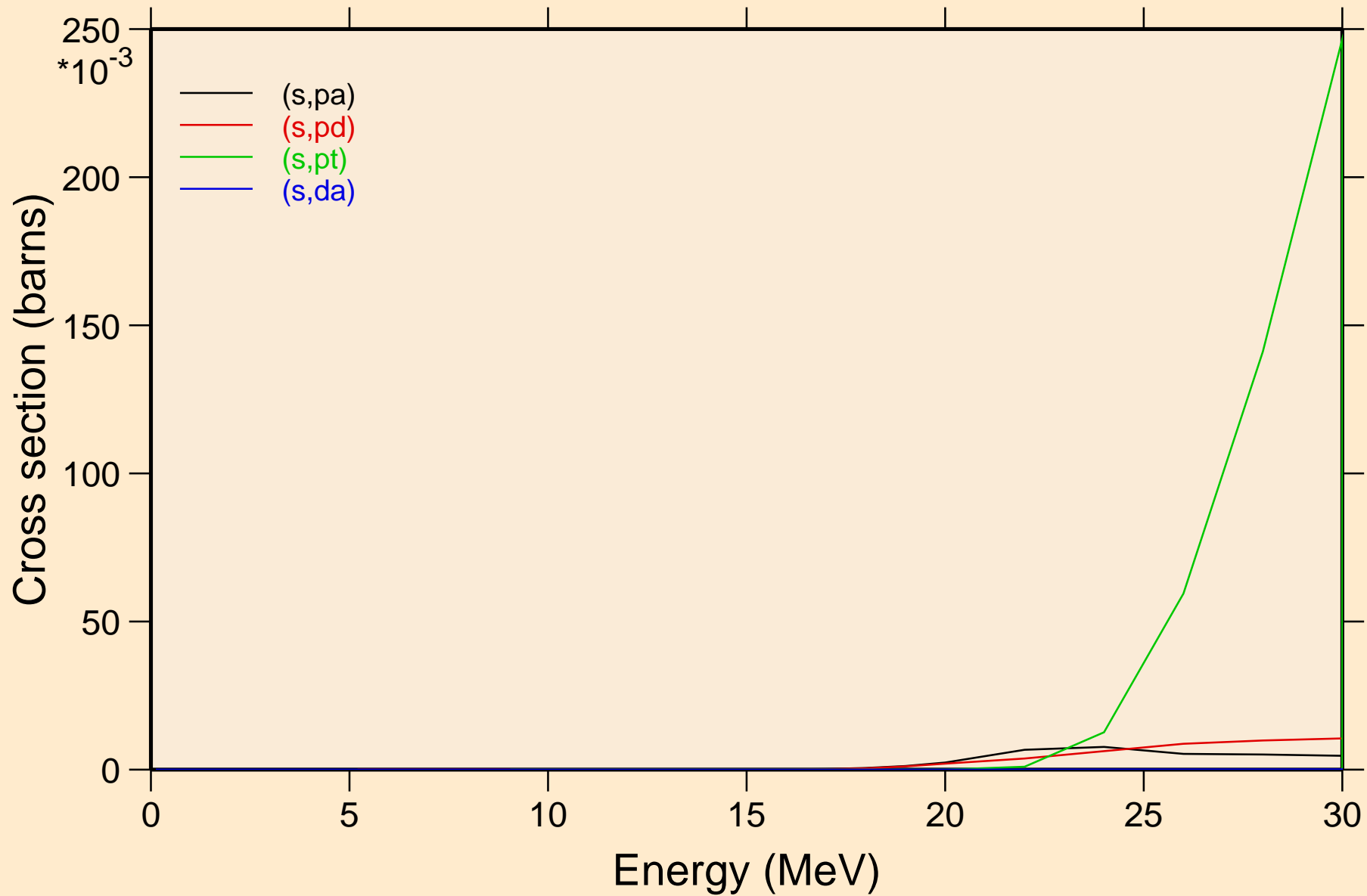

TB144M HELION ACER TENDL-2021 LIBRARY; T=0.K  
angular distribution for elastic

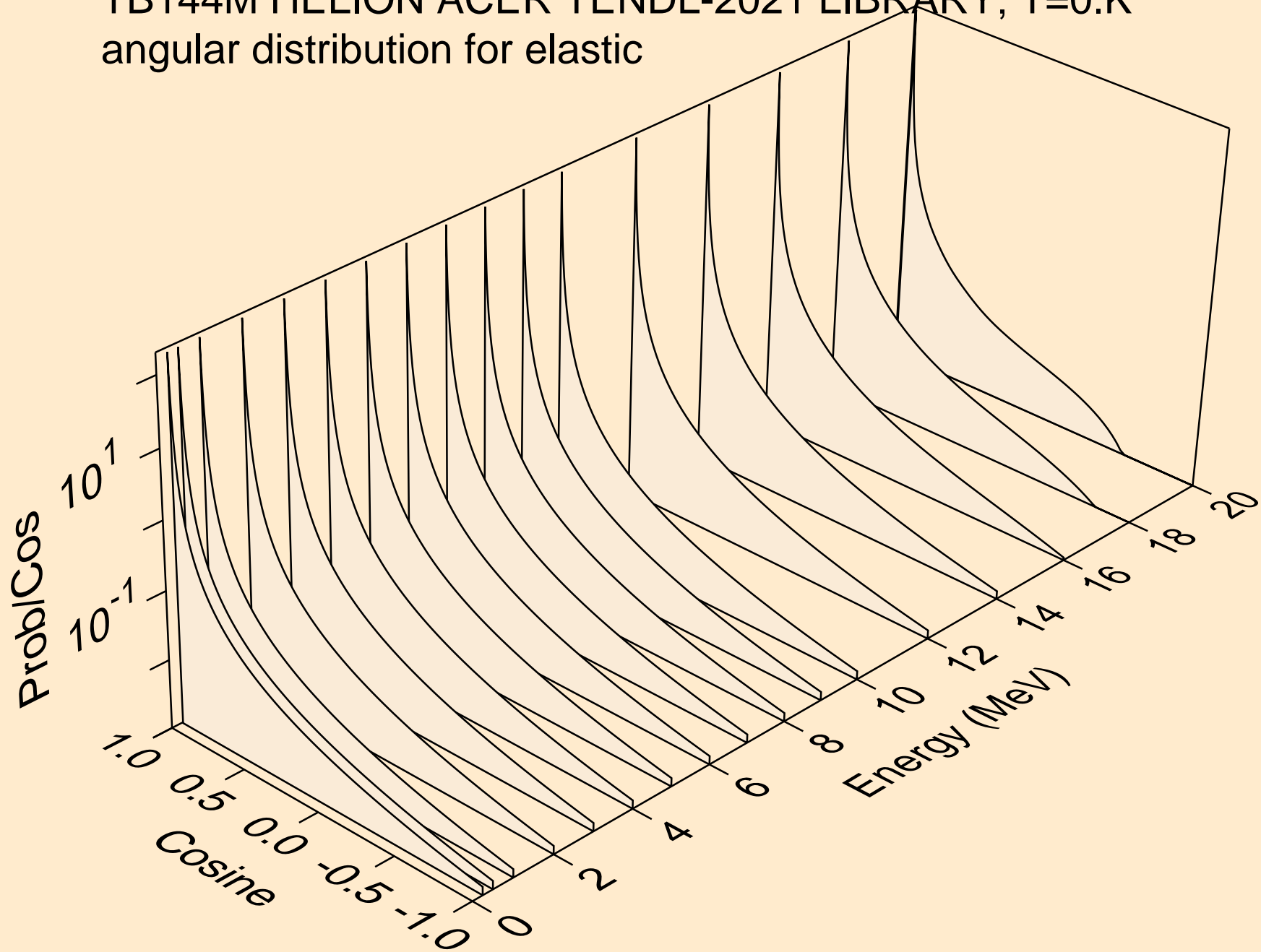

TB144M HELION ACER TENDL-2021 LIBRARY; T=0.K  
angular distribution for elastic

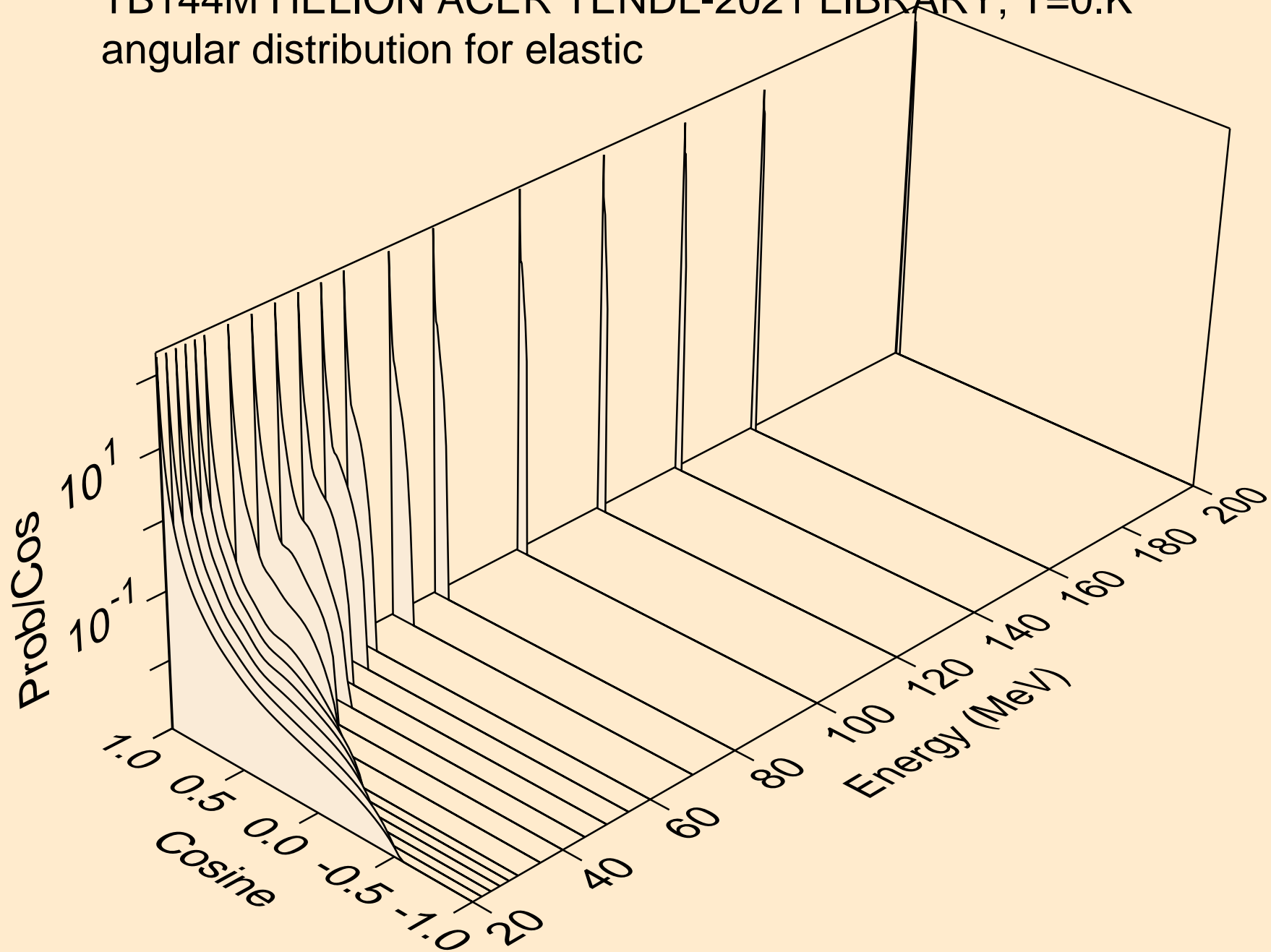

TB144M HELION ACER TENDL-2021 LIBRARY; T=0.K  
He-3 emission for (s,x)

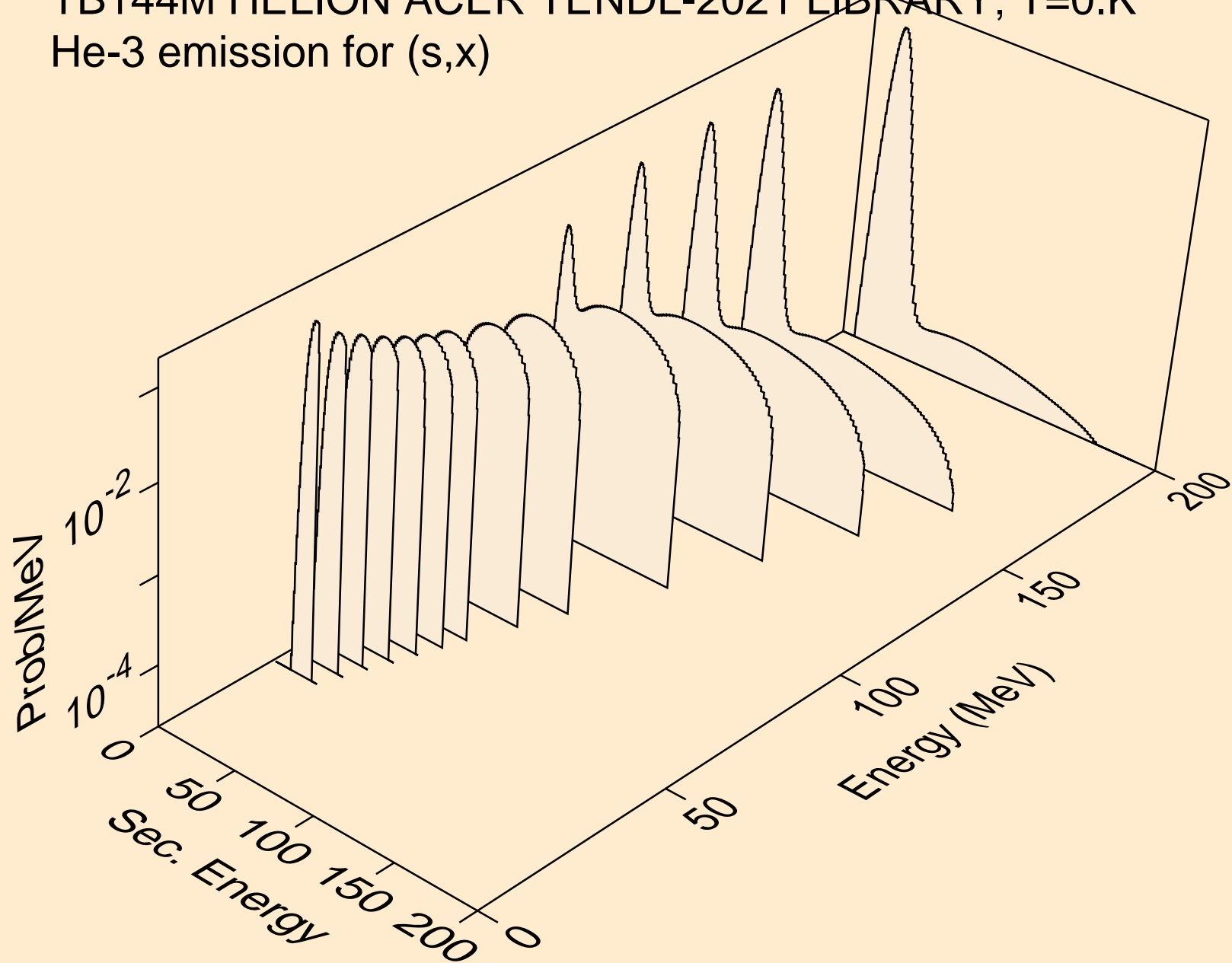

TB144M HELION ACER TENDL-2021 LIBRARY; T=0.K  
He-3 emission for (s,n\*)he3

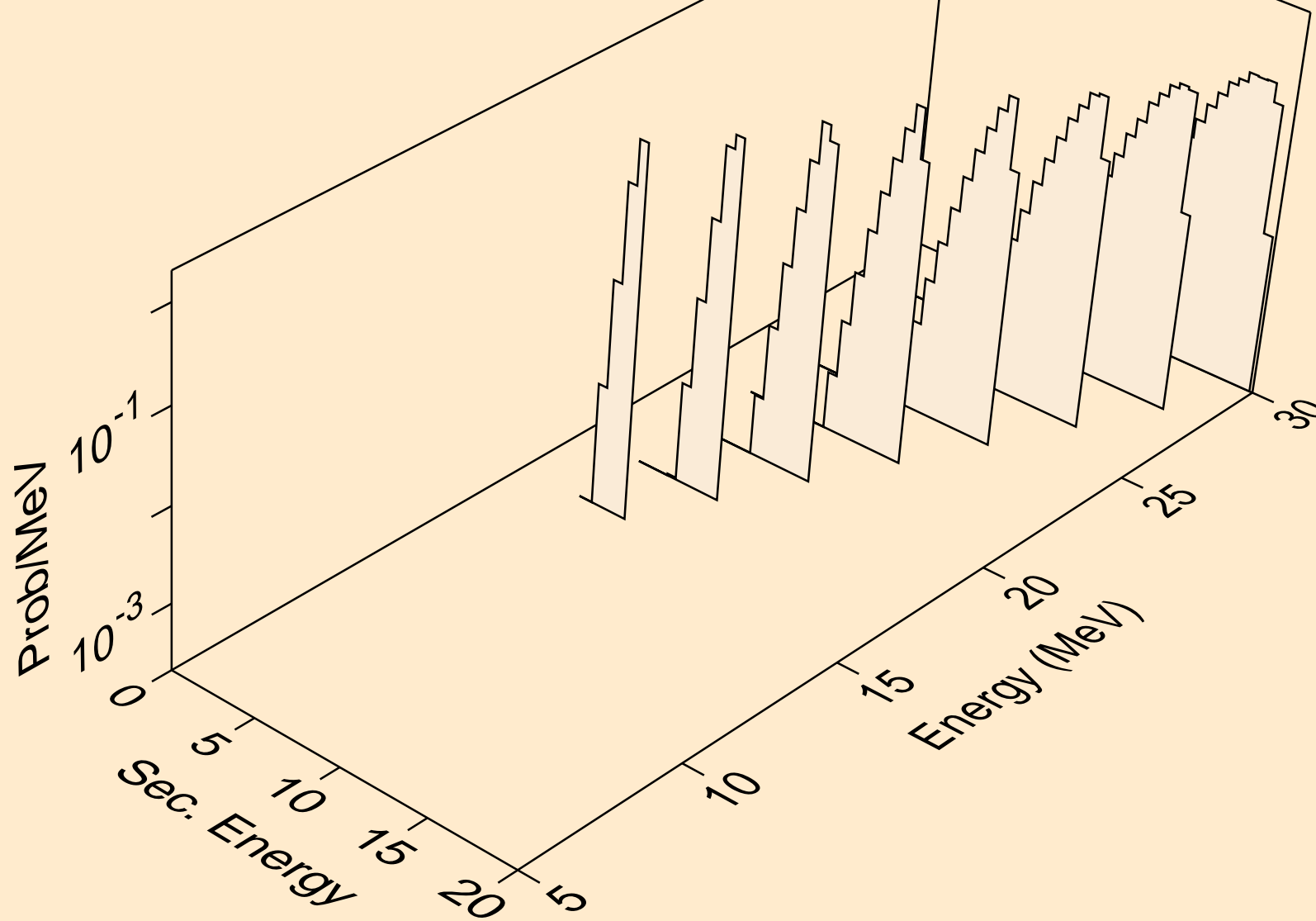

TB144M HELION ACER TENDL-2021 LIBRARY; T=0.K  
He-3 emission for inelastic

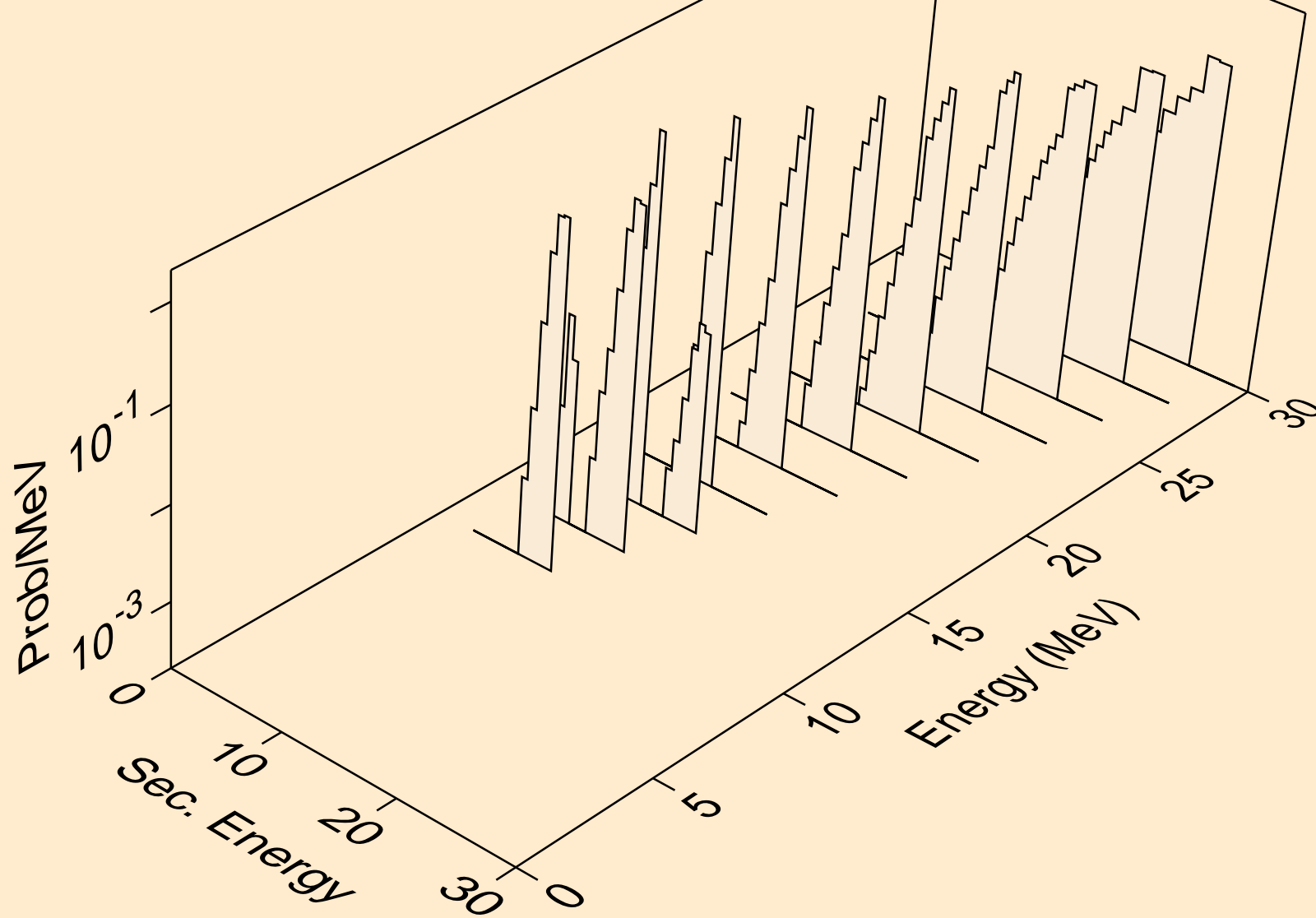



TB144M HELION ACER TENDL-2021 LIBRARY; T=0.K  
Photon emission for (z,n)

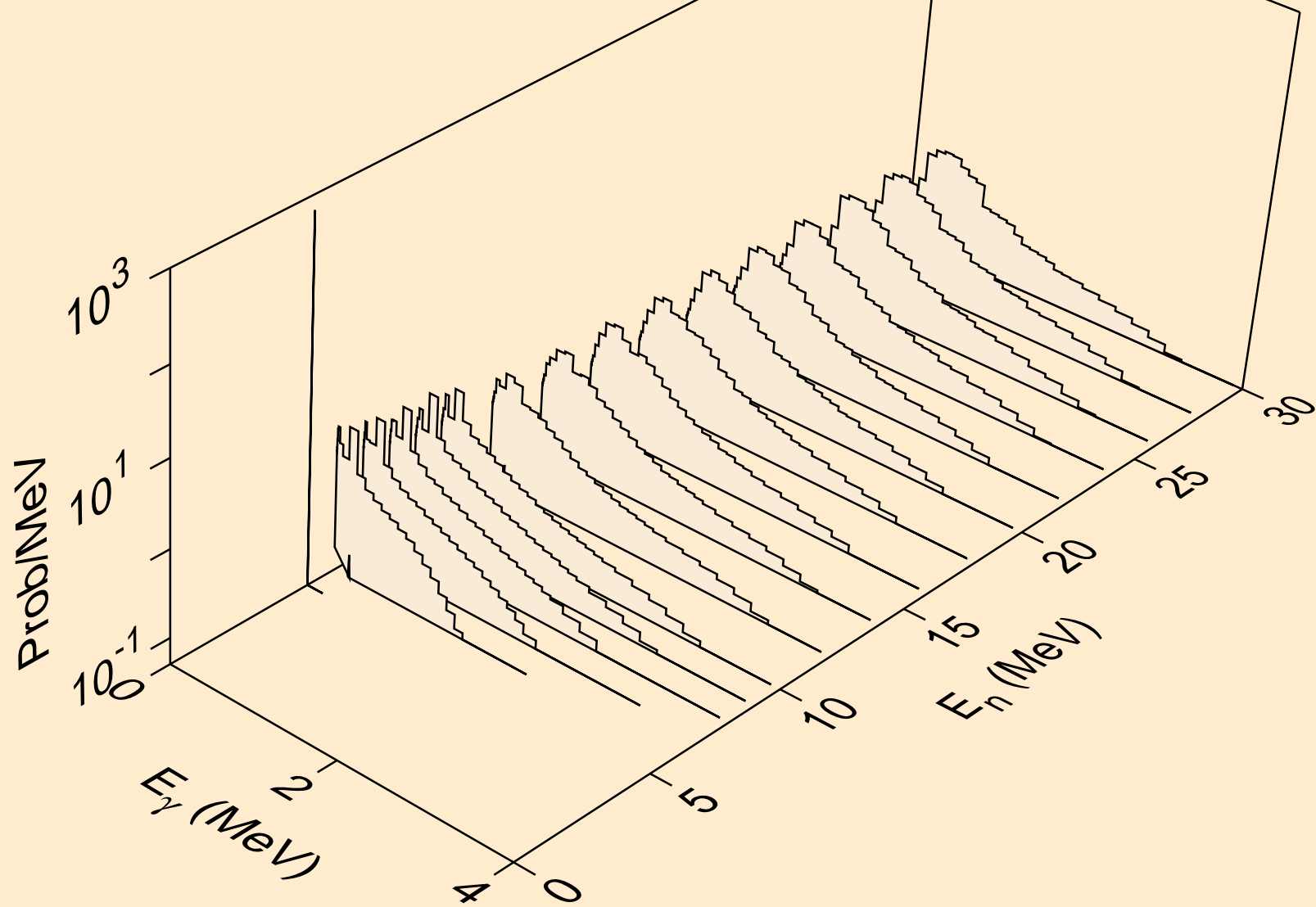

TB144M HELION ACER TENDL-2021 LIBRARY; T=0.K  
Photon emission for (n,x)

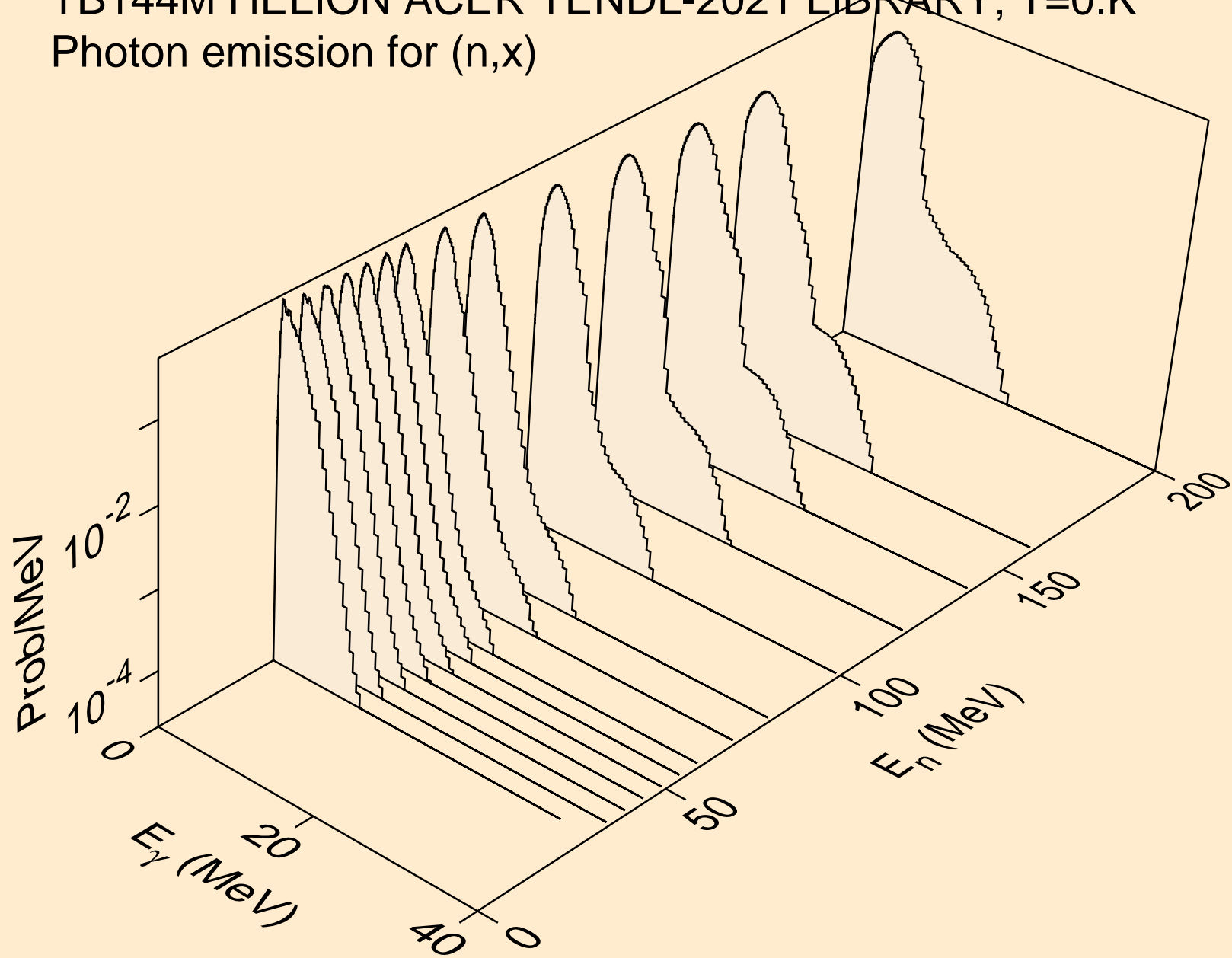

TB144M HELION ACER TENDL-2021 LIBRARY; T=0.K  
Photon emission for (n,2nd)

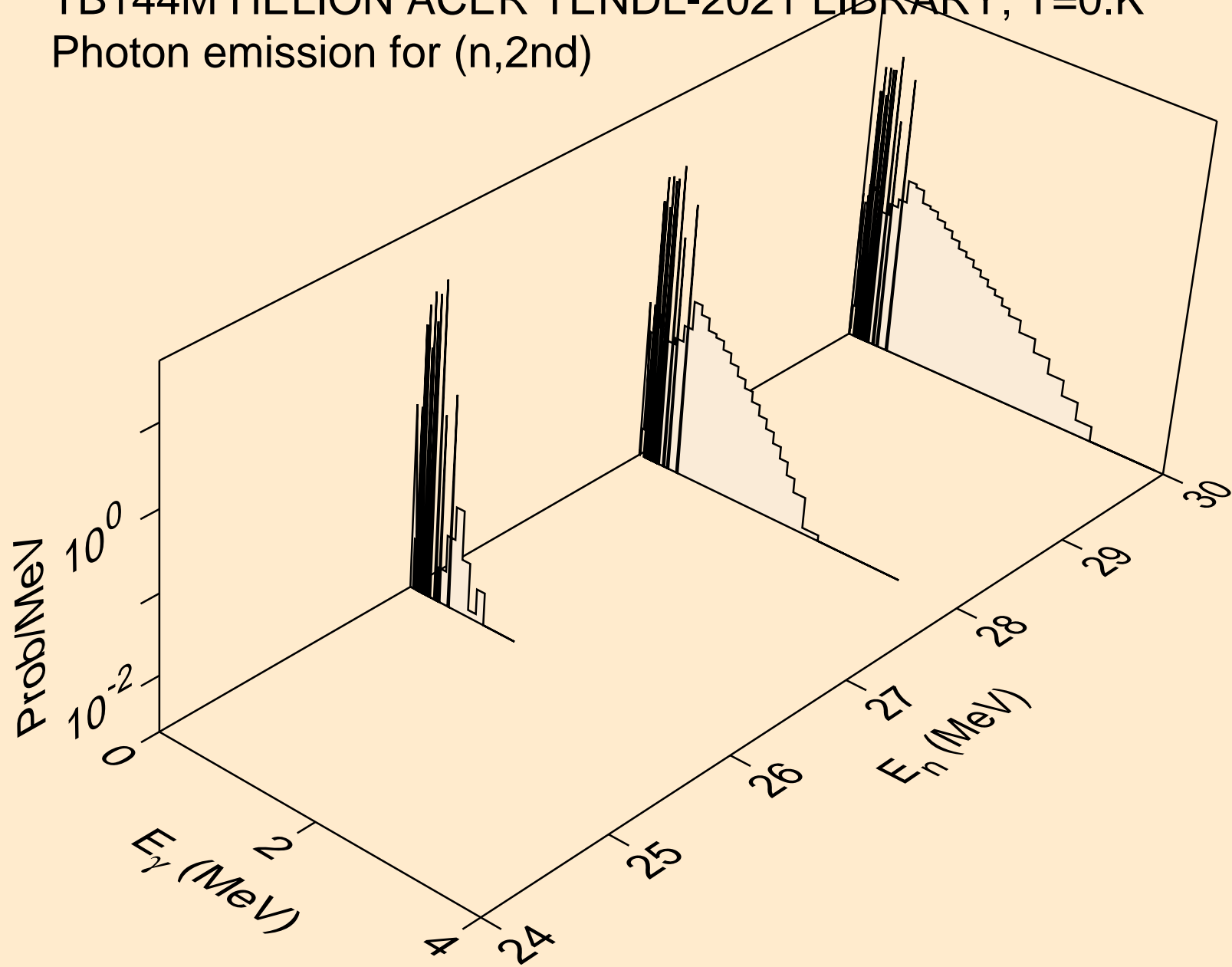

TB144M HELION ACER TENDL-2021 LIBRARY; T=0.K  
Photon emission for (n,2n)

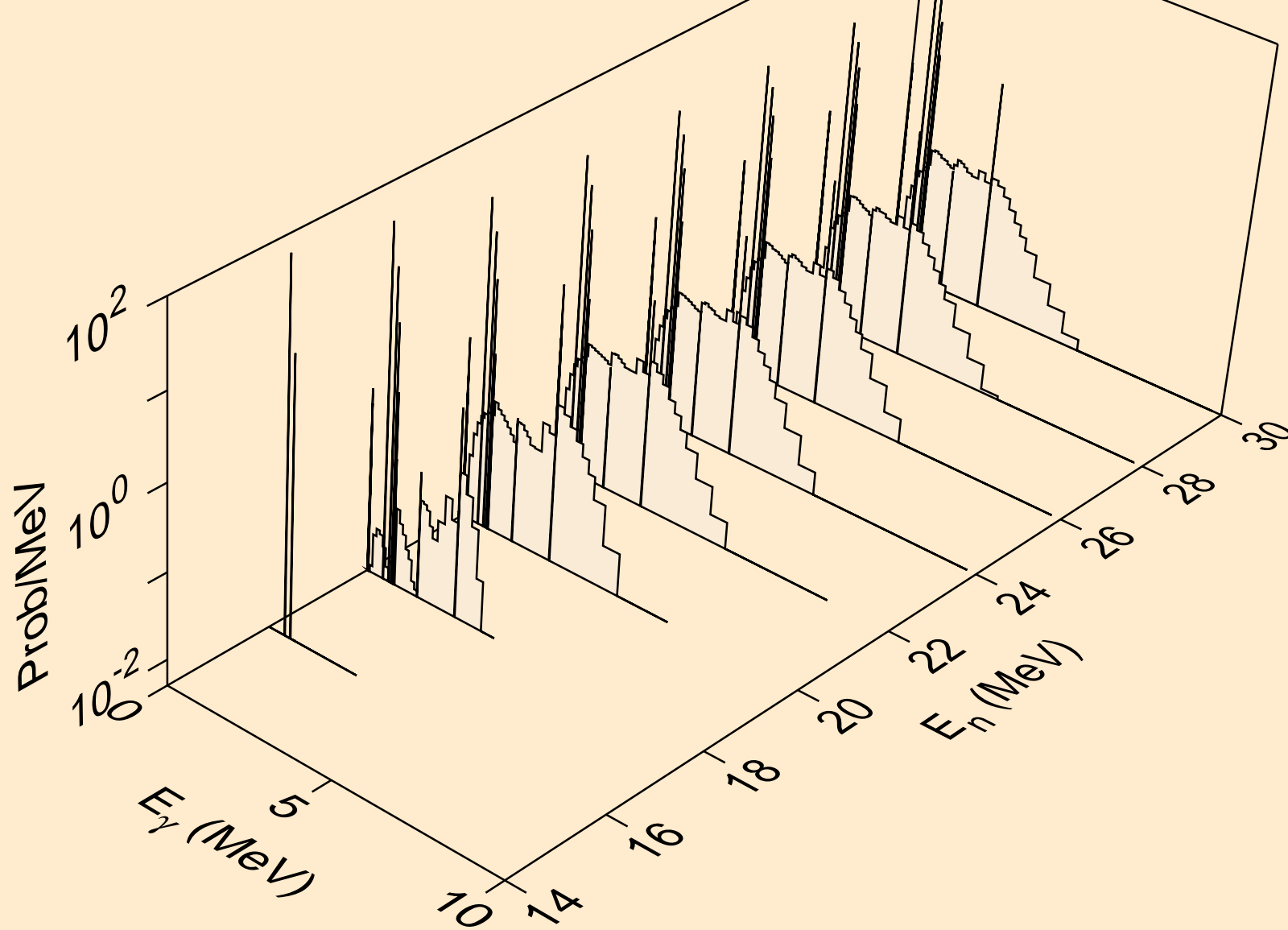

TB144M HELION ACER TENDL-2021 LIBRARY; T=0.K  
Photon emission for (n,3n)

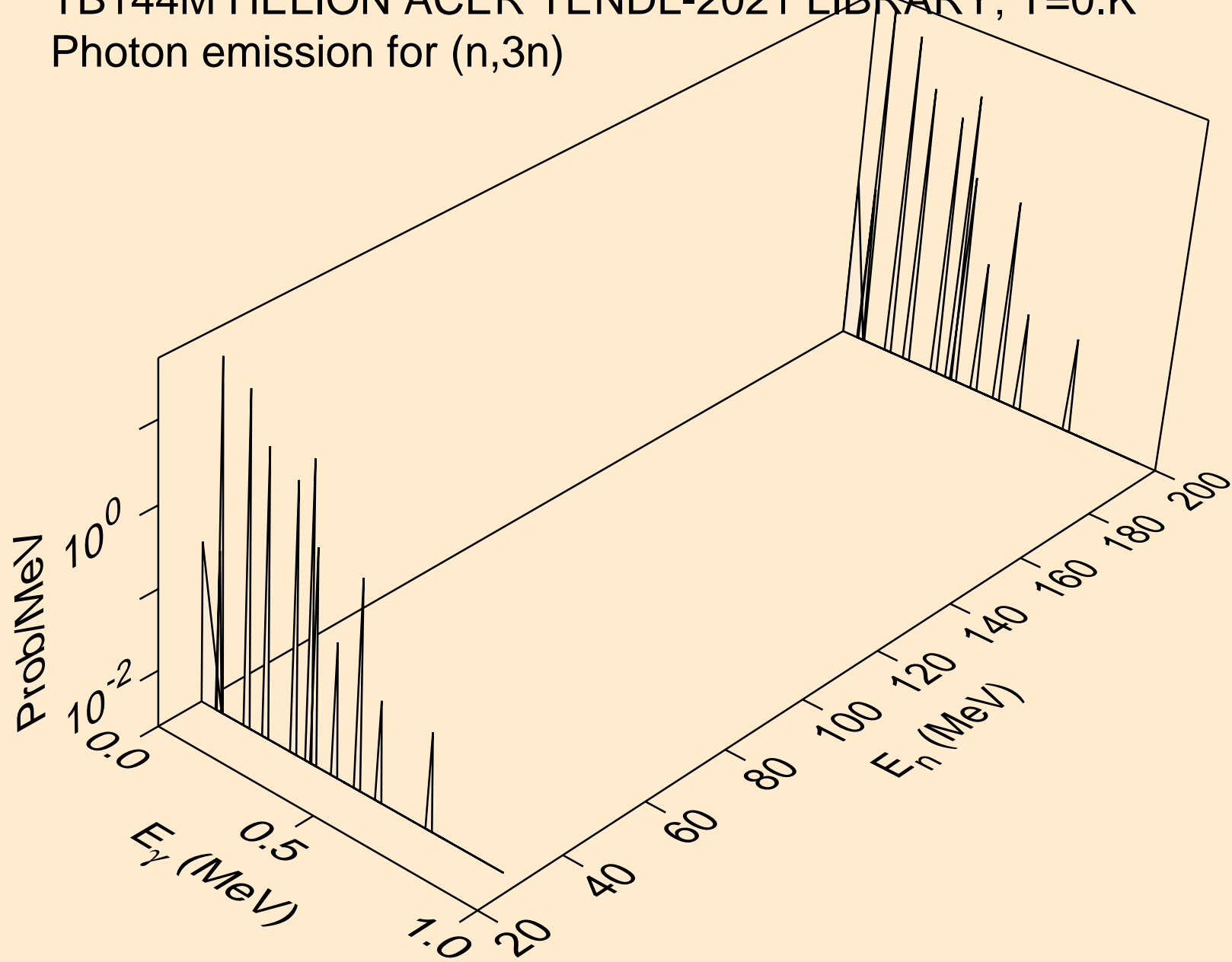

TB144M HELION ACER TENDL-2021 LIBRARY; T=0.K  
Photon emission for (n,n\*)a

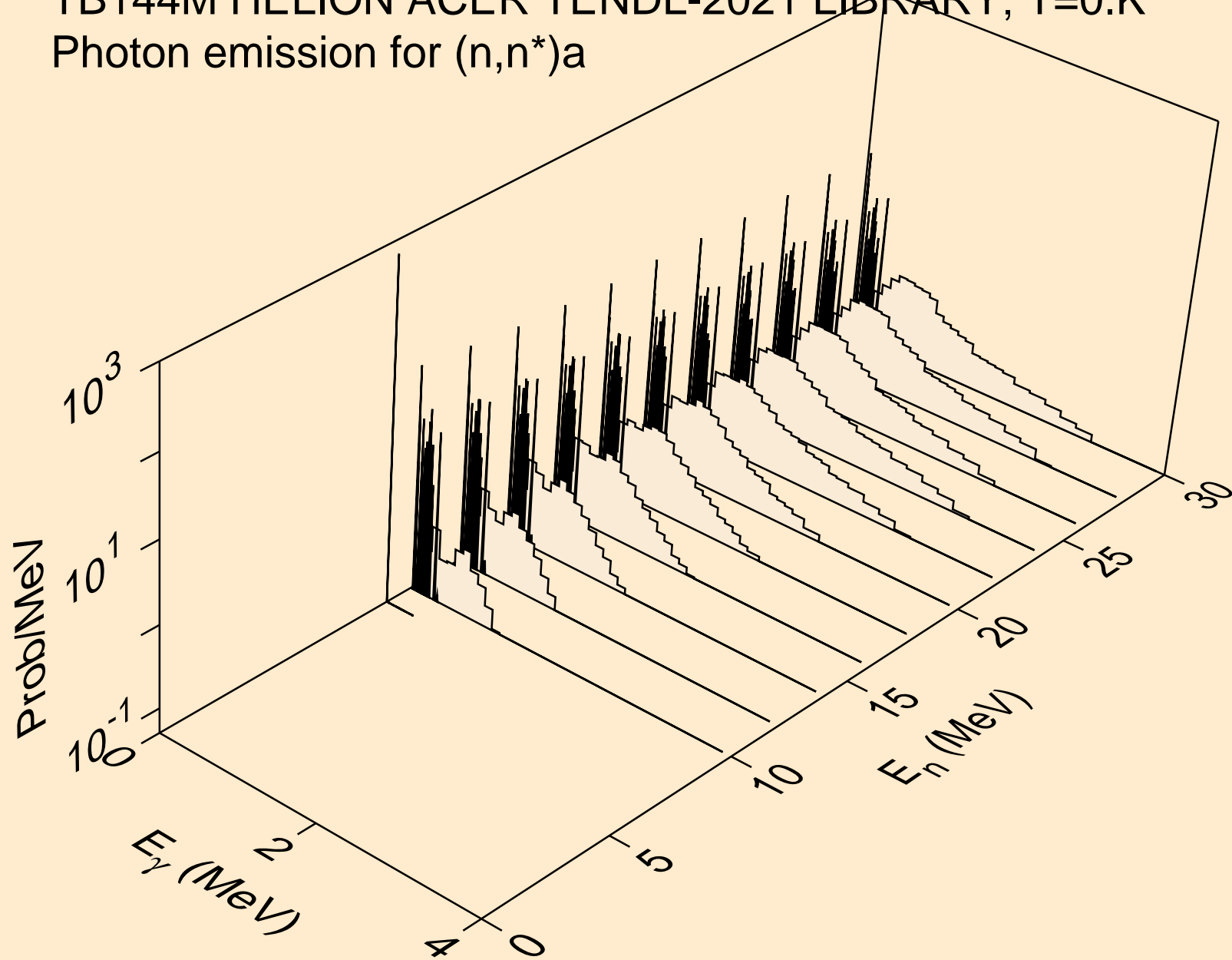

TB144M HELION ACER TENDL-2021 LIBRARY; T=0.K  
Photon emission for (n,2n)a

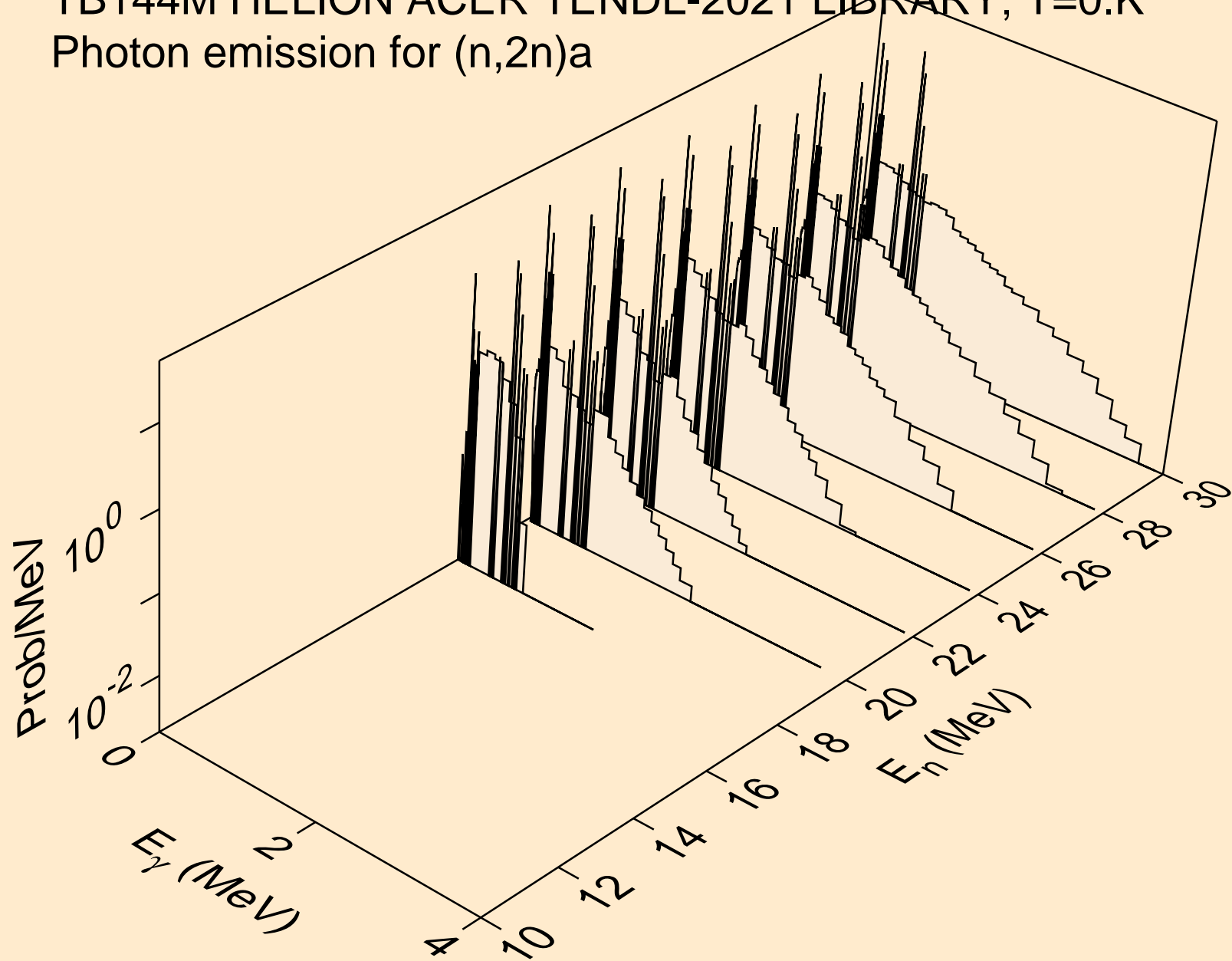

TB144M HELION ACER TENDL-2021 LIBRARY; T=0.K  
Photon emission for (n,n\*)p

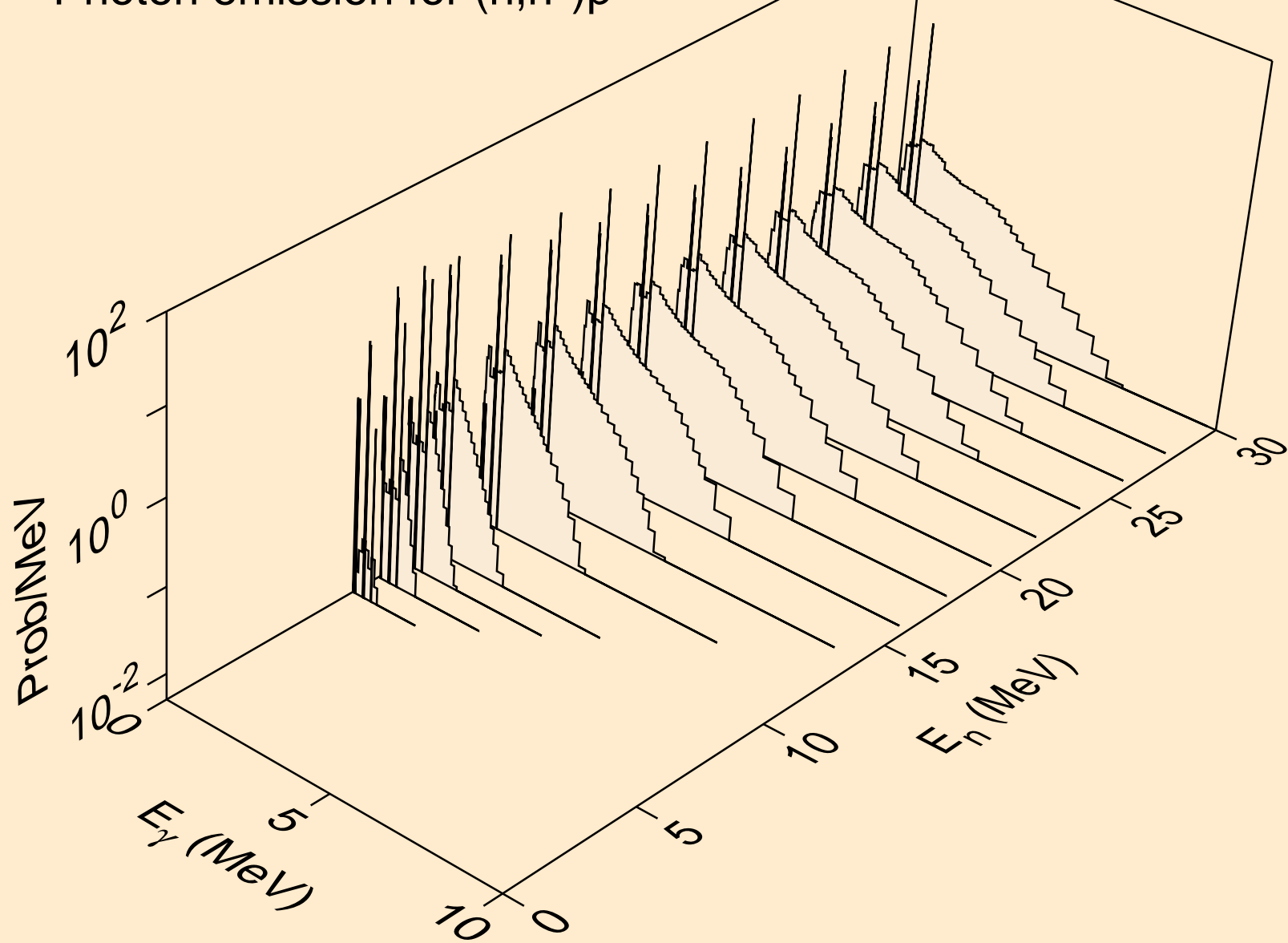



TB144M HELION ACER TENDL-2021 LIBRARY; T=0.K  
Photon emission for (n,n\*)2a

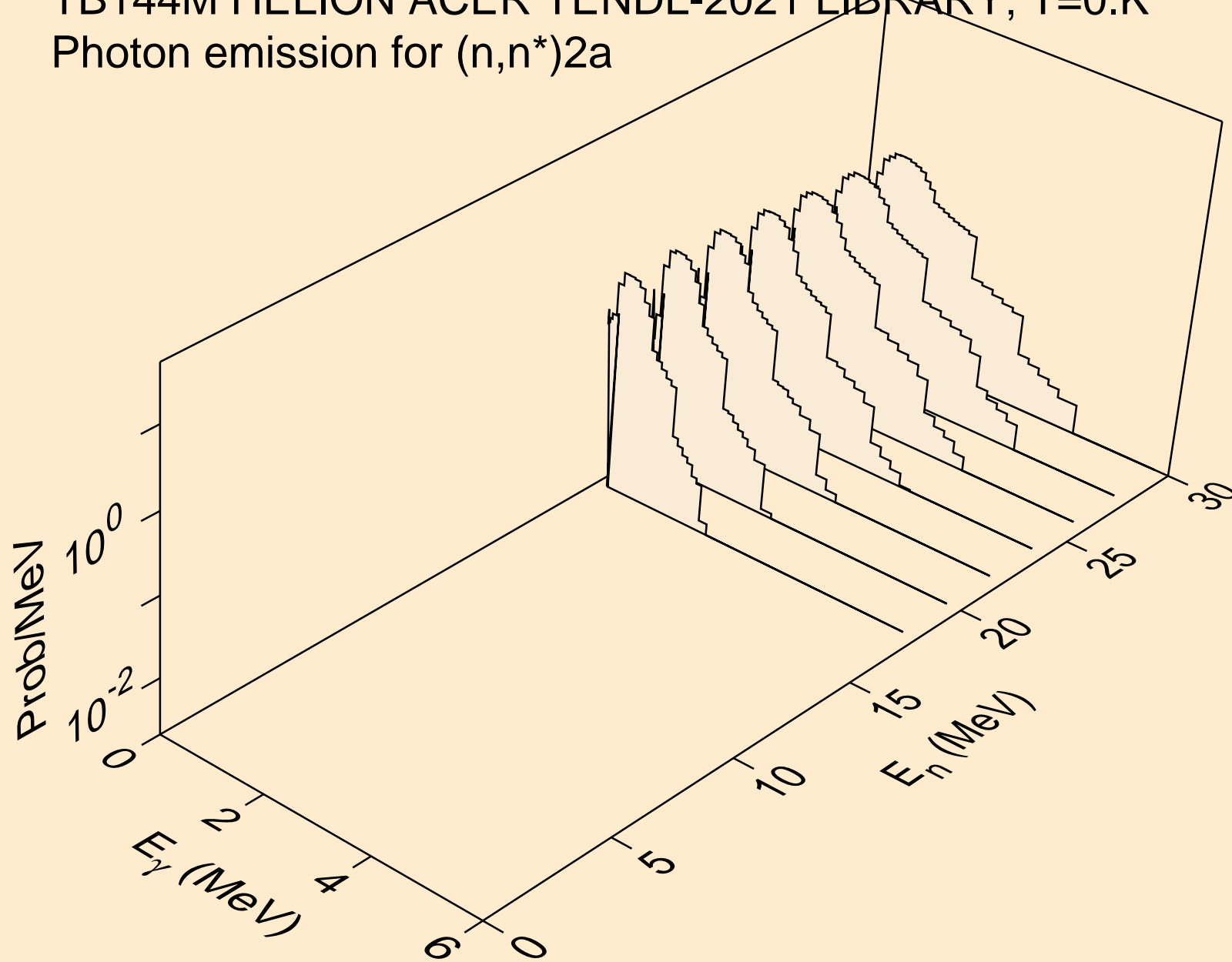

TB144M HELION ACER TENDL-2021 LIBRARY; T=0.K  
Photon emission for (n,n\*)d

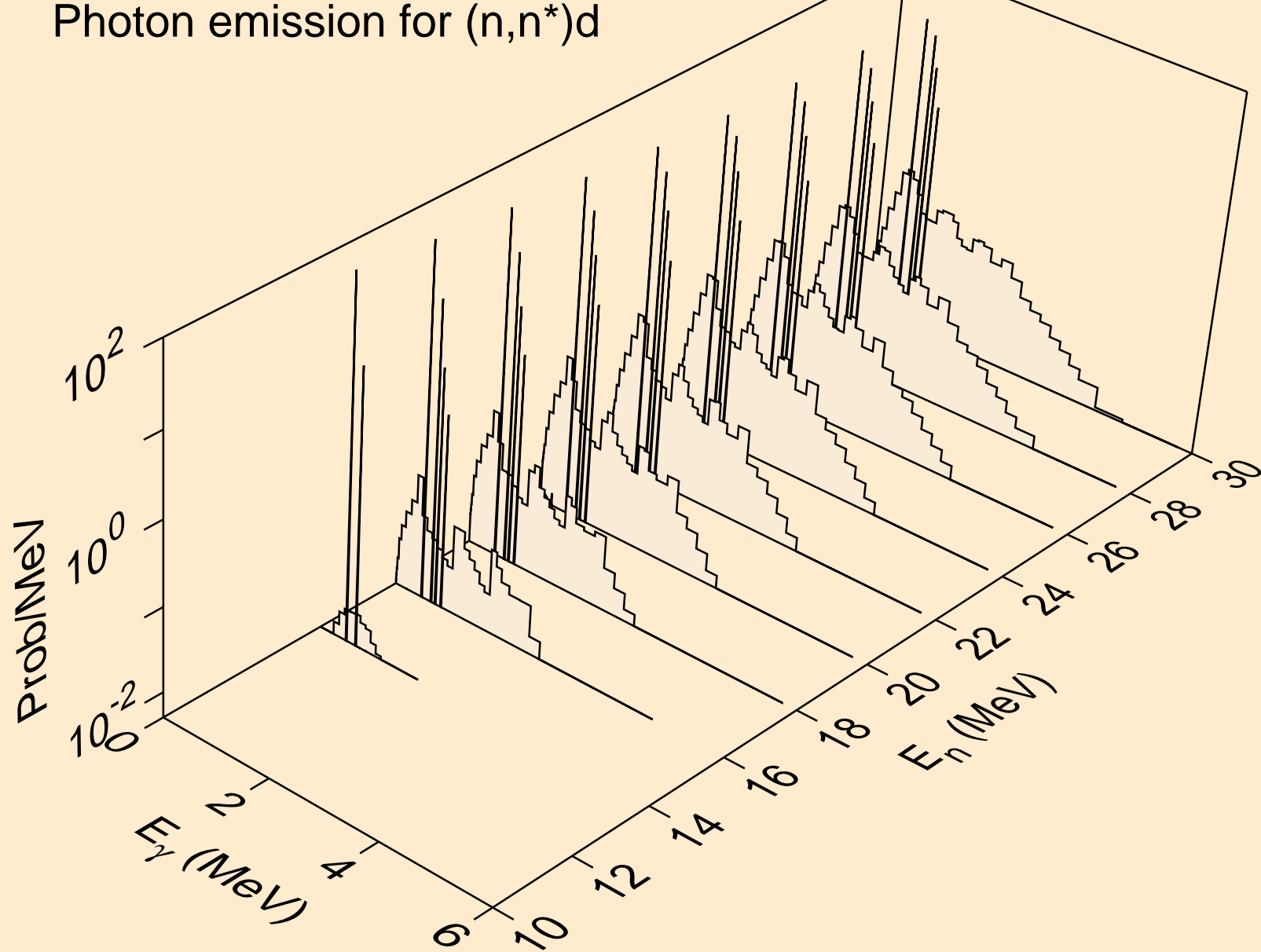

TB144M HELION ACER TENDL-2021 LIBRARY; T=0.K  
Photon emission for (n,n\*)t

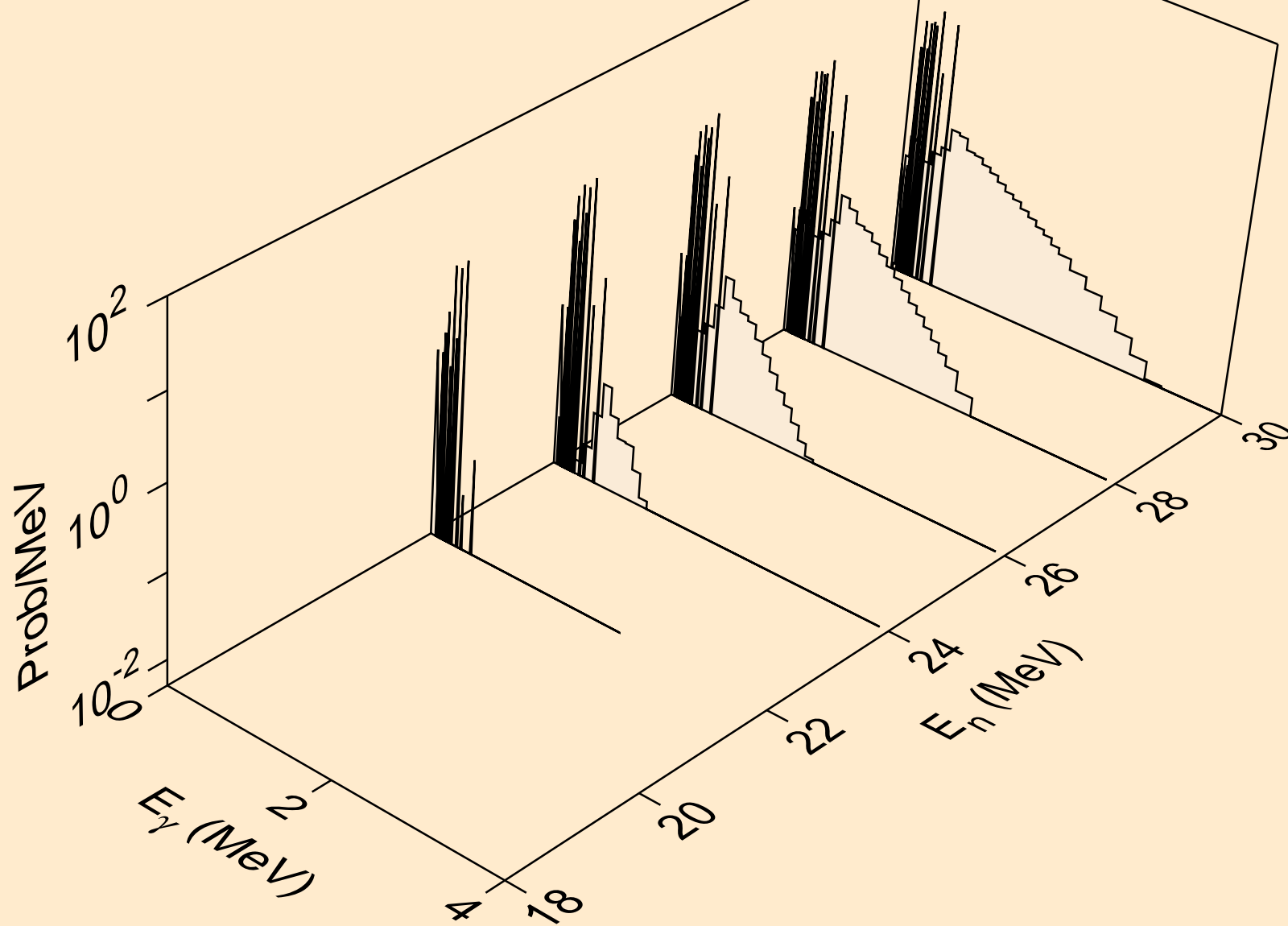

TB144M HELION ACER TENDL-2021 LIBRARY; T=0.K  
Photon emission for (n,n\*)he3

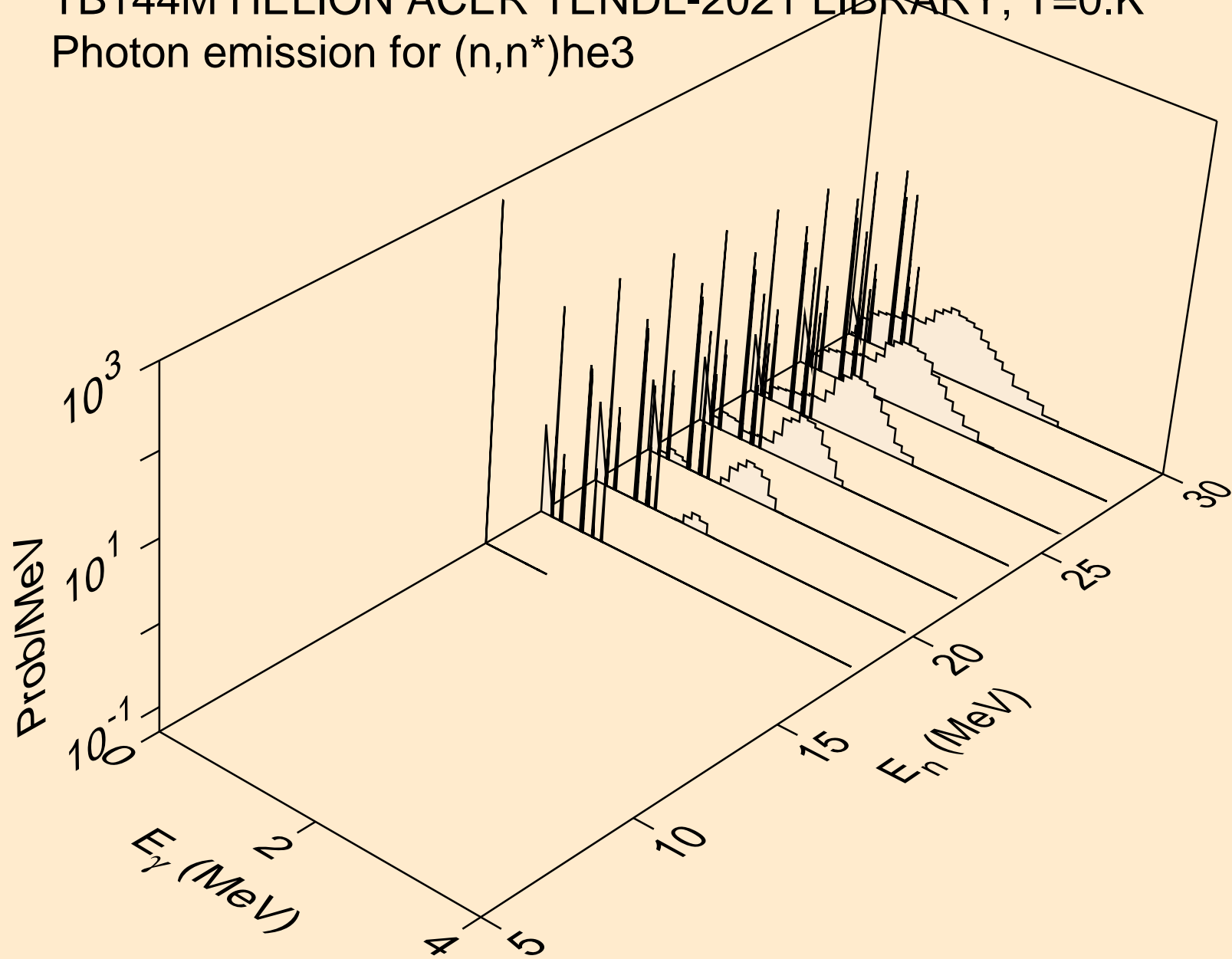

TB144M HELION ACER TENDL-2021 LIBRARY; T=0.K  
Photon emission for (n,2np)

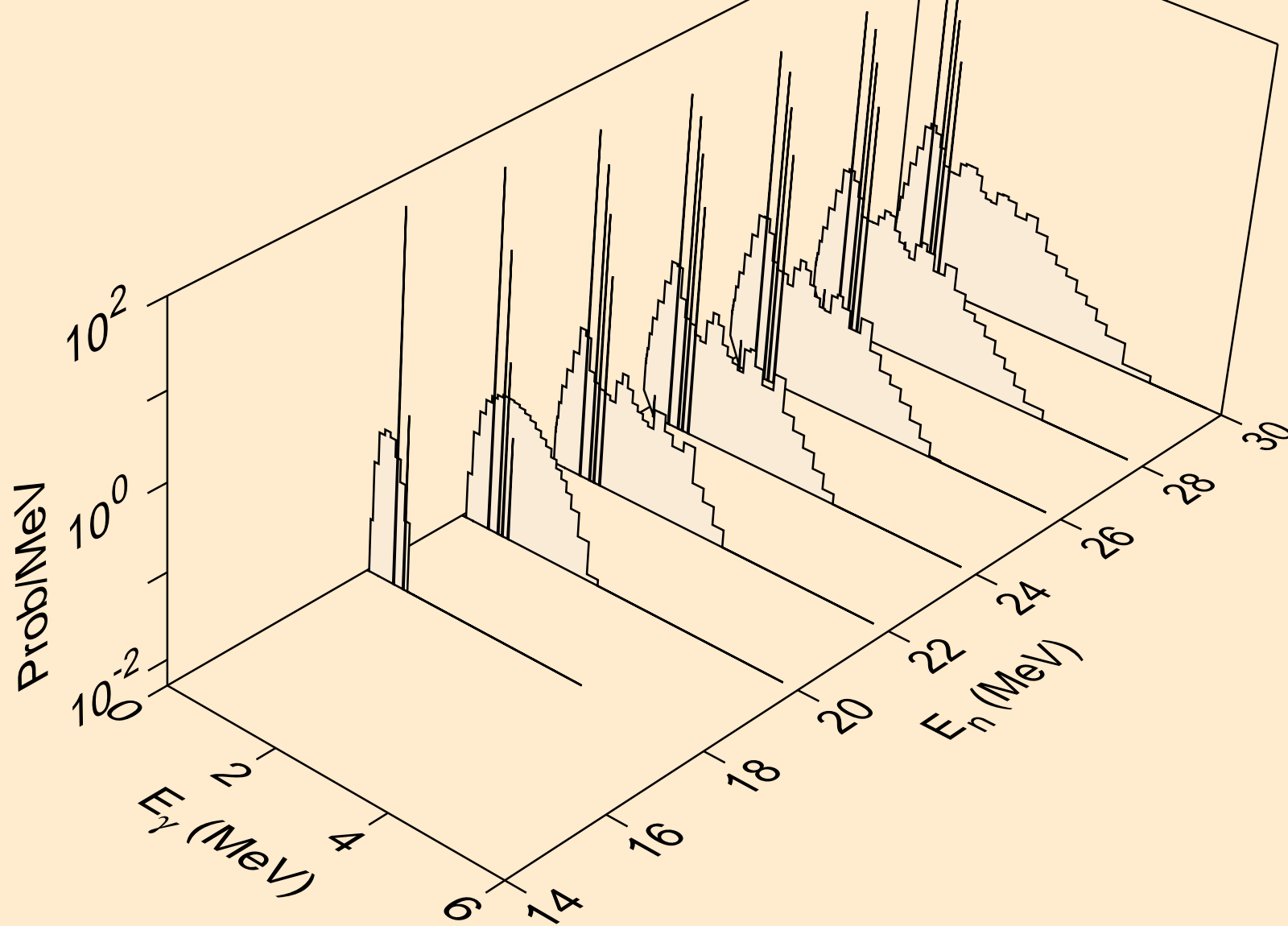

TB144M HELION ACER TENDL-2021 LIBRARY; T=0.K  
Photon emission for (n,2np)

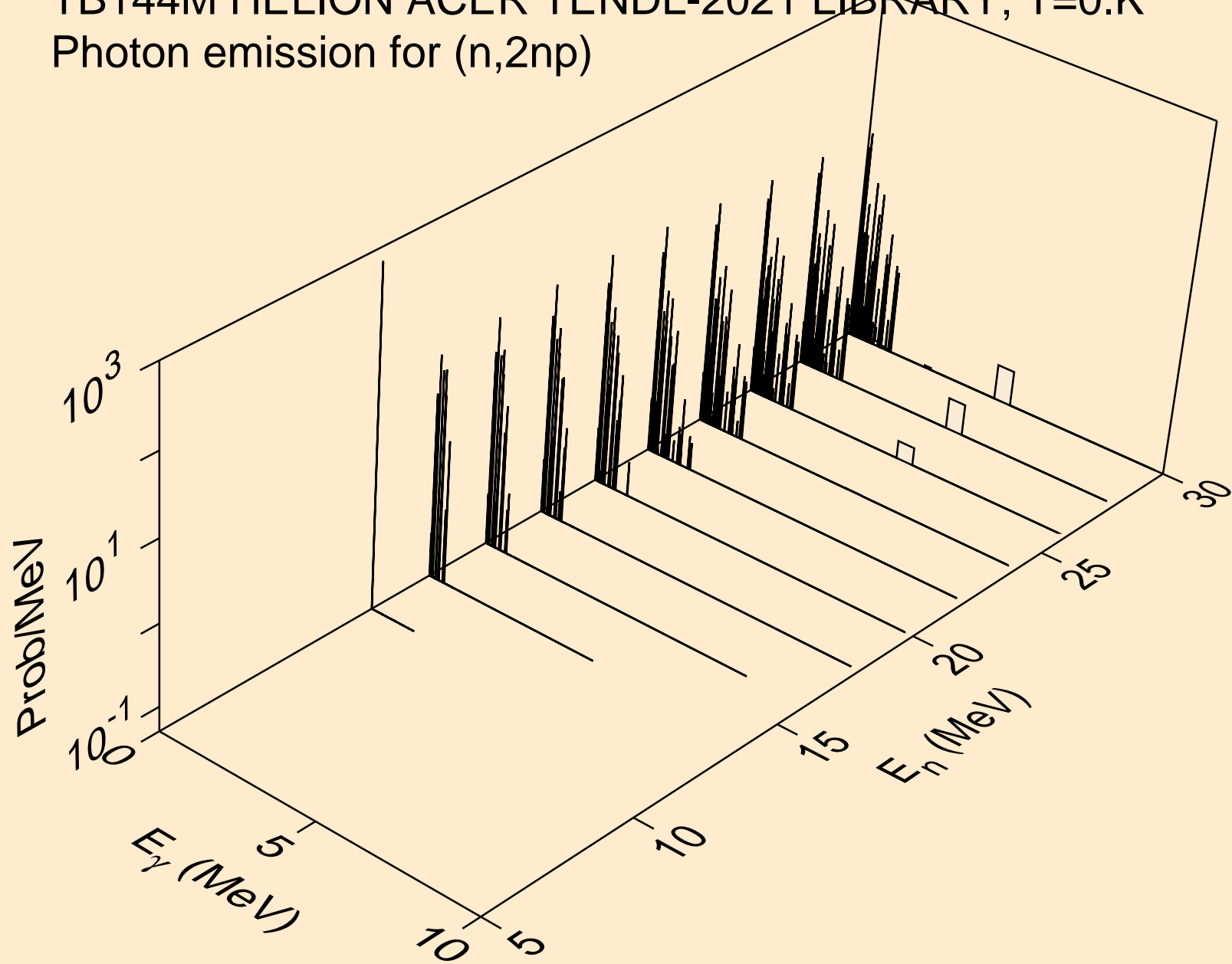

TB144M HELION ACER TENDL-2021 LIBRARY; T=0.K  
Photon emission for (n,npa)

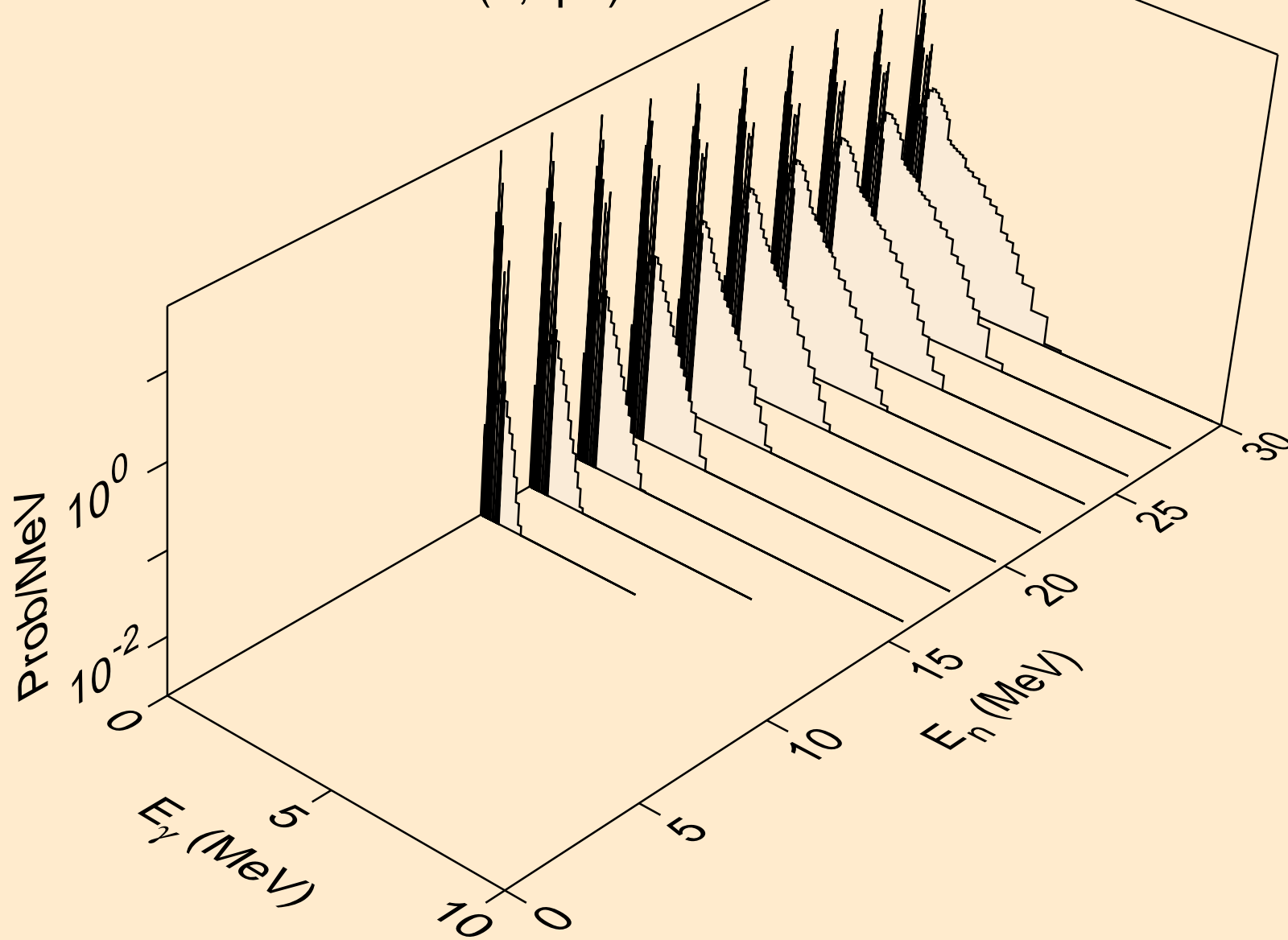

TB144M HELION ACER TENDL-2021 LIBRARY; T=0.K  
Photon emission for (n,gma)

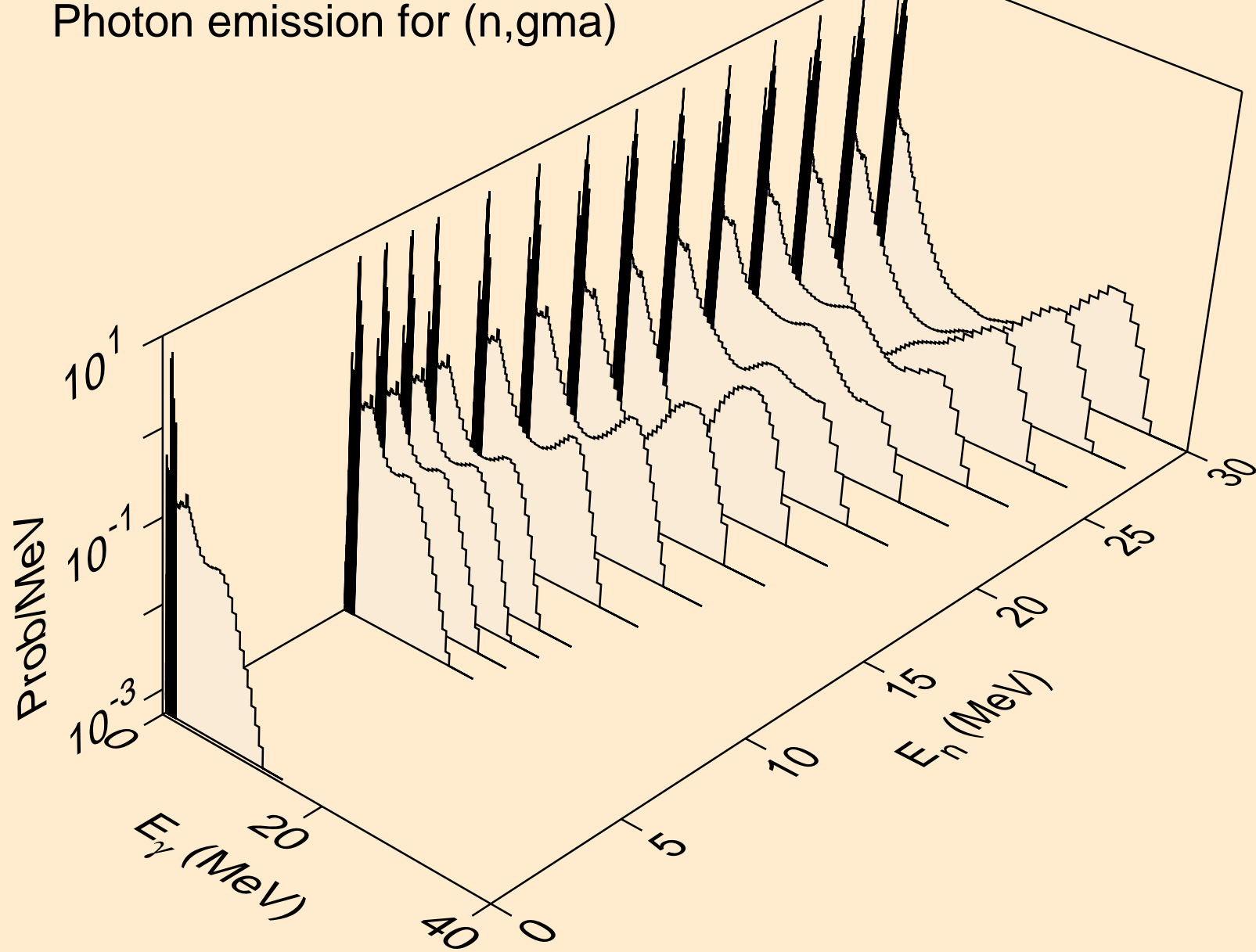



TB144M HELION ACER TENDL-2021 LIBRARY; T=0.K  
Photon emission for (n,p)

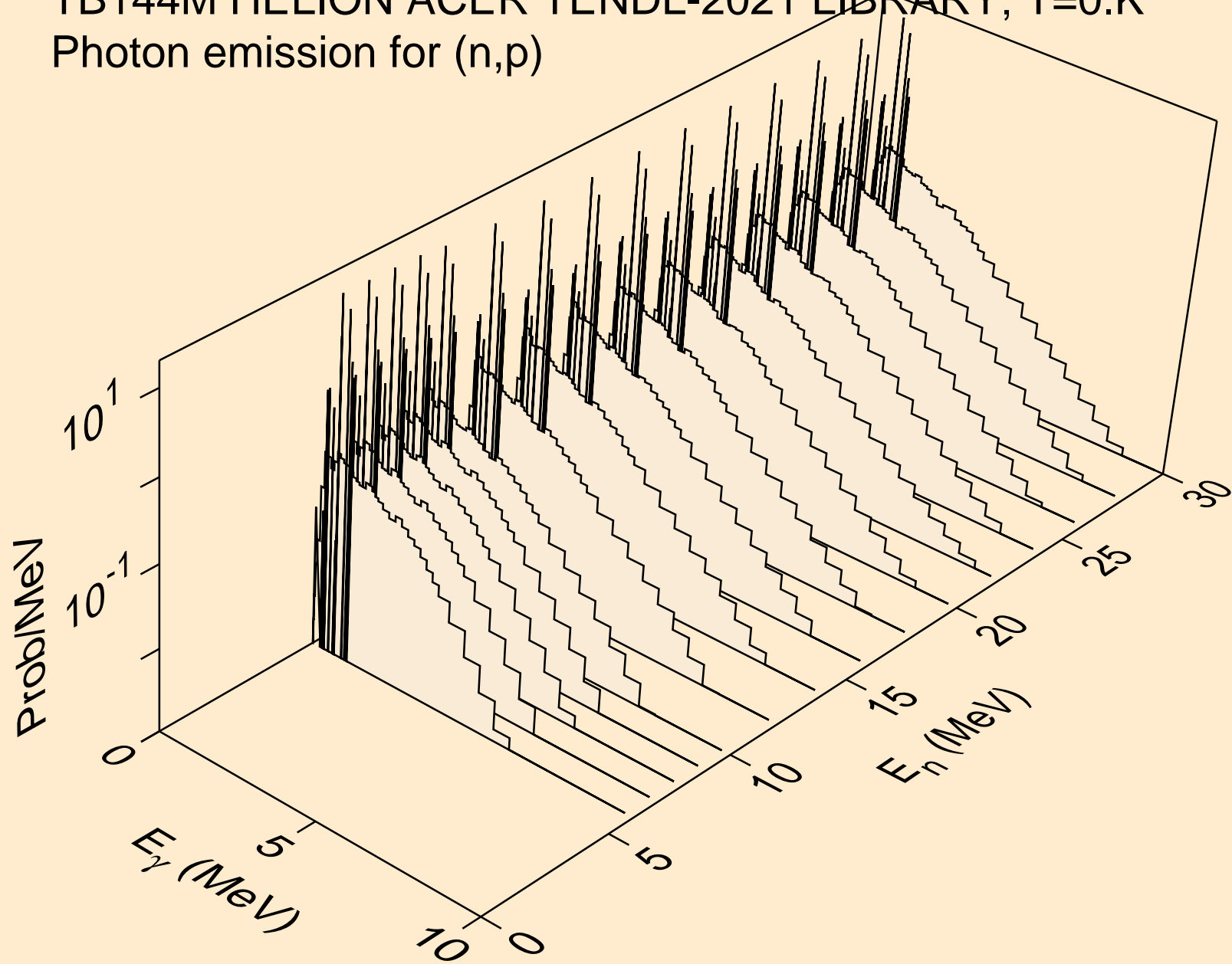

TB144M HELION ACER TENDL-2021 LIBRARY; T=0.K  
Photon emission for (n,d)

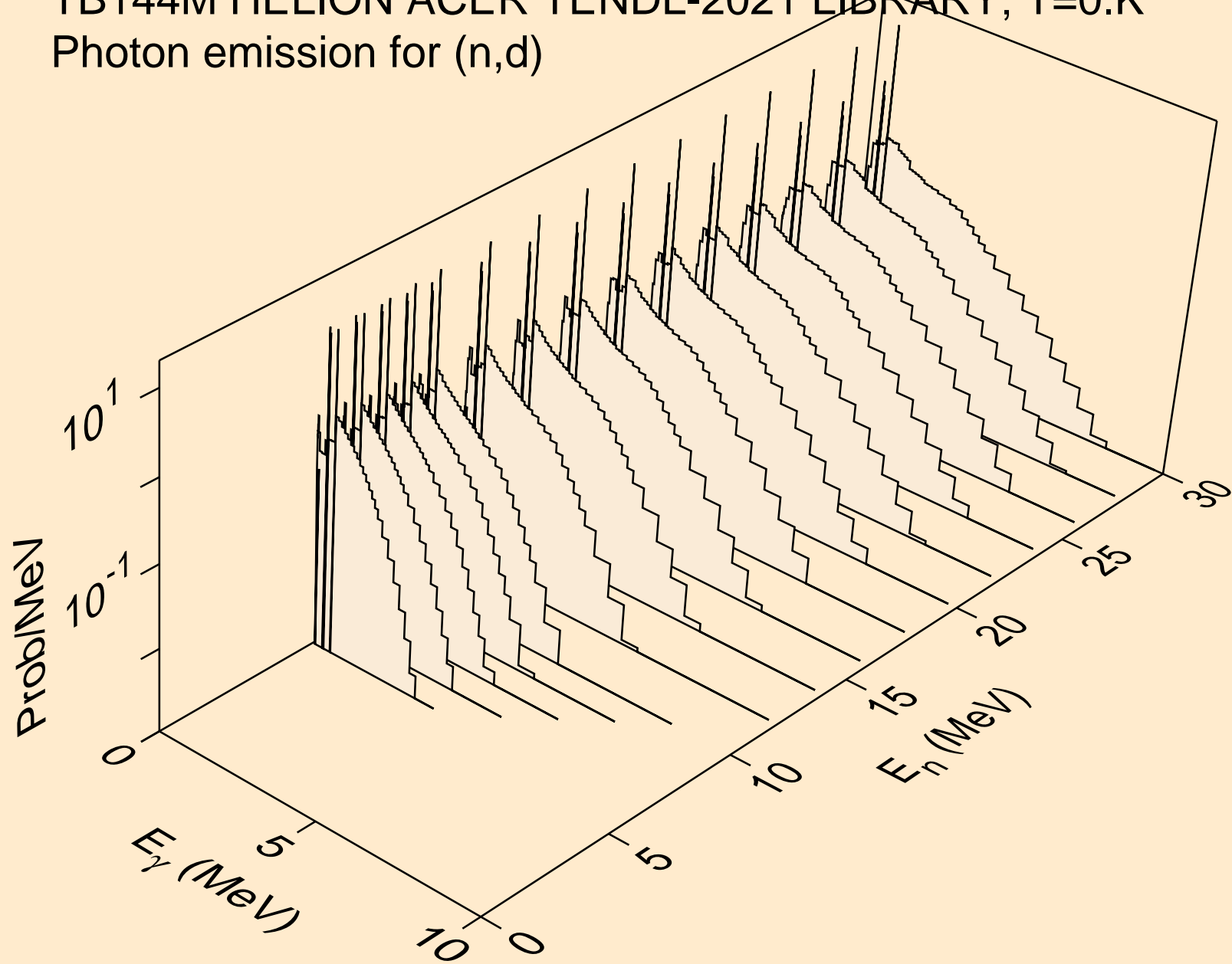

TB144M HELION ACER TENDL-2021 LIBRARY; T=0.K  
Photon emission for (n,t)

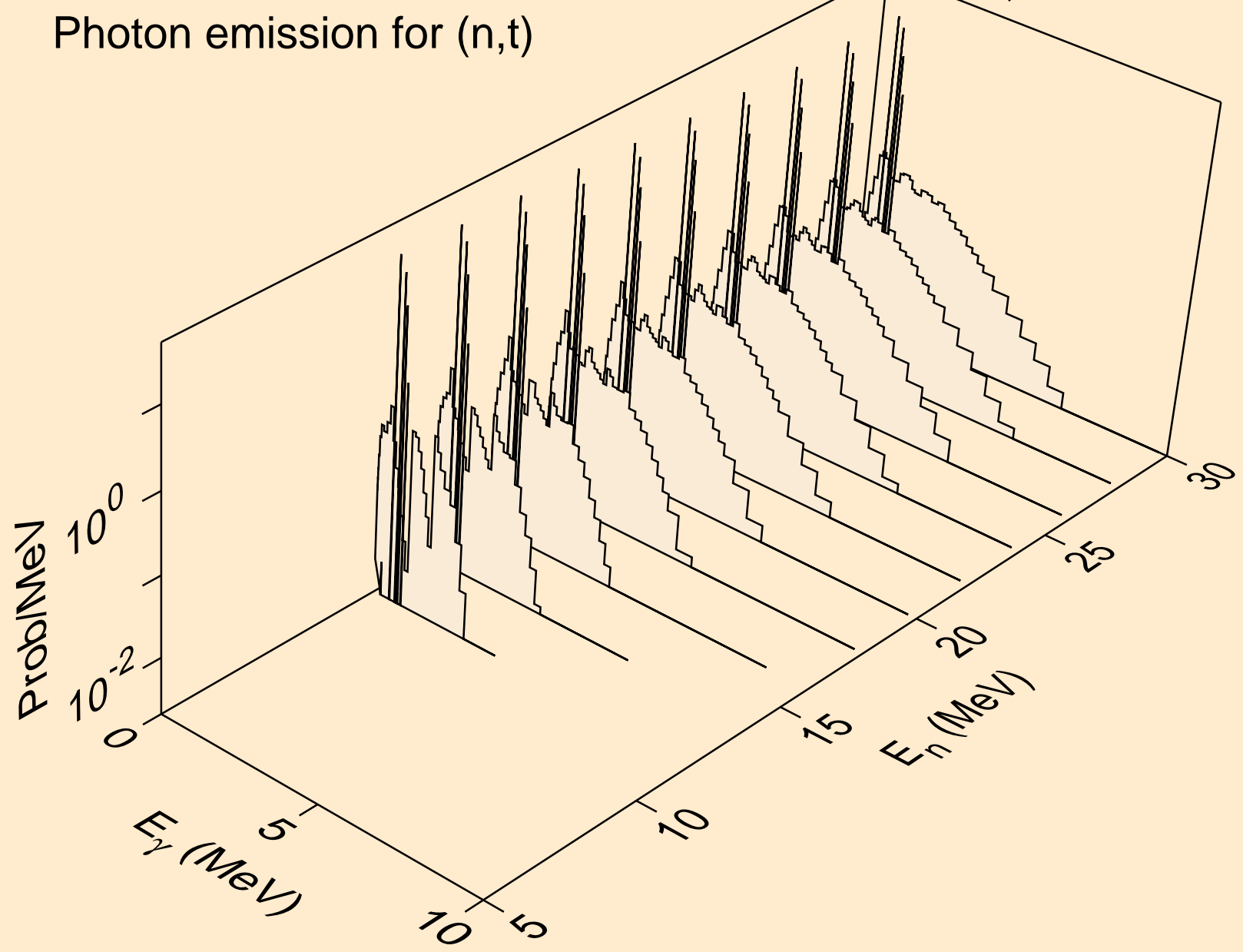

TB144M HELION ACER TENDL-2021 LIBRARY; T=0.K  
Photon emission for inelastic

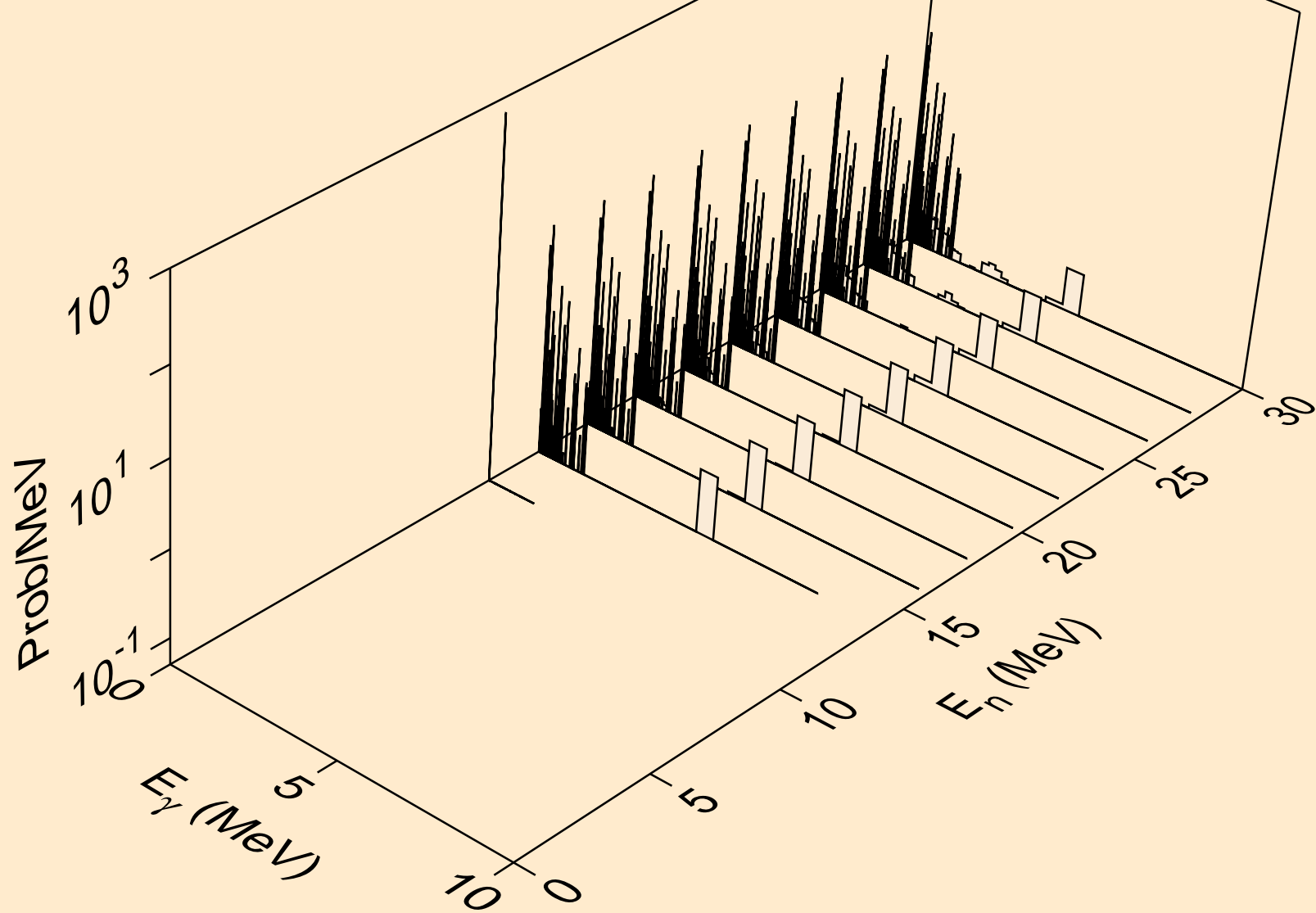

TB144M HELION ACER TENDL-2021 LIBRARY; T=0.K  
Photon emission for (n,a)

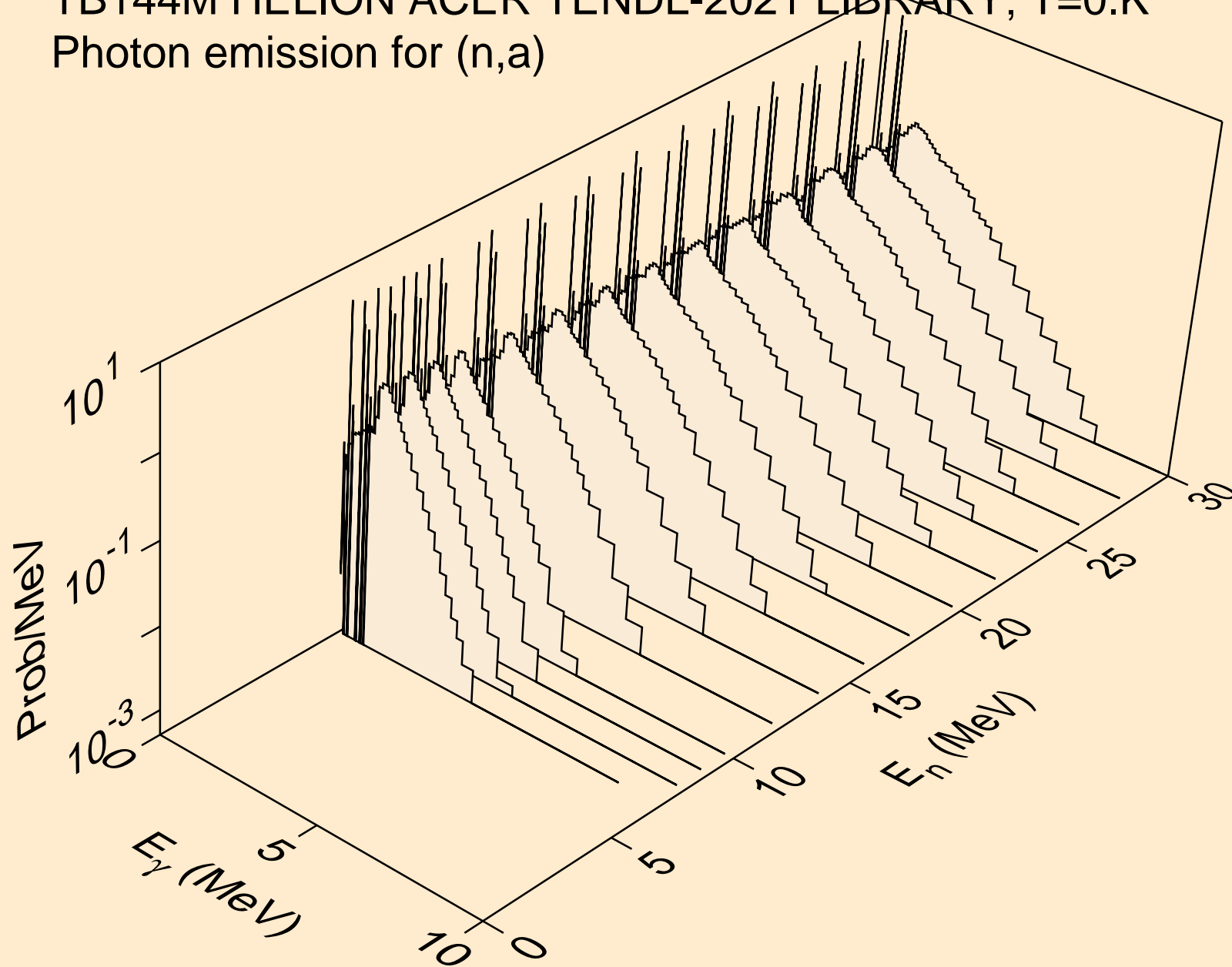

TB144M HELION ACER TENDL-2021 LIBRARY; T=0.K  
Photon emission for (n,2a)

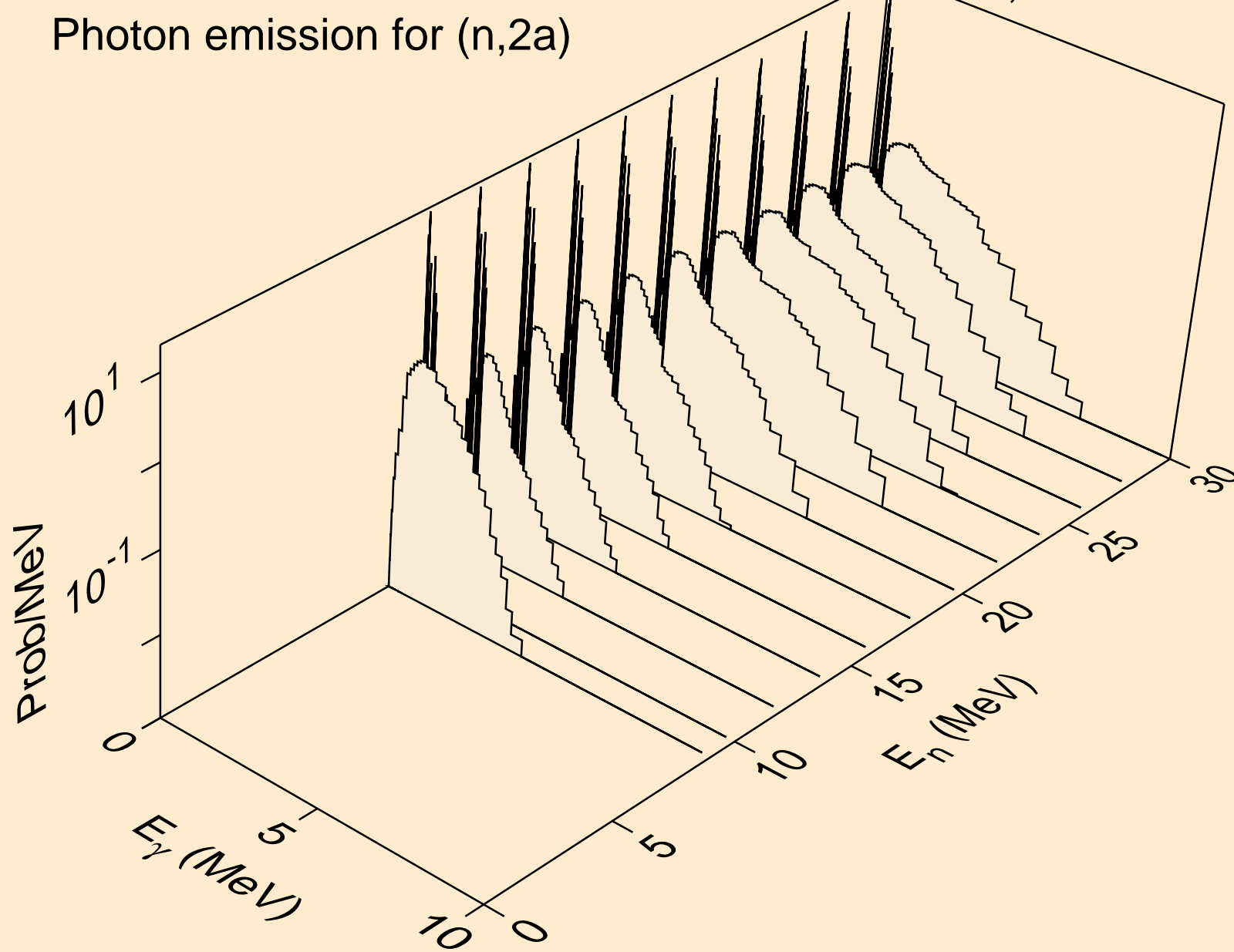

TB144M HELION ACER TENDL-2021 LIBRARY; T=0.K  
Photon emission for (n,2p)

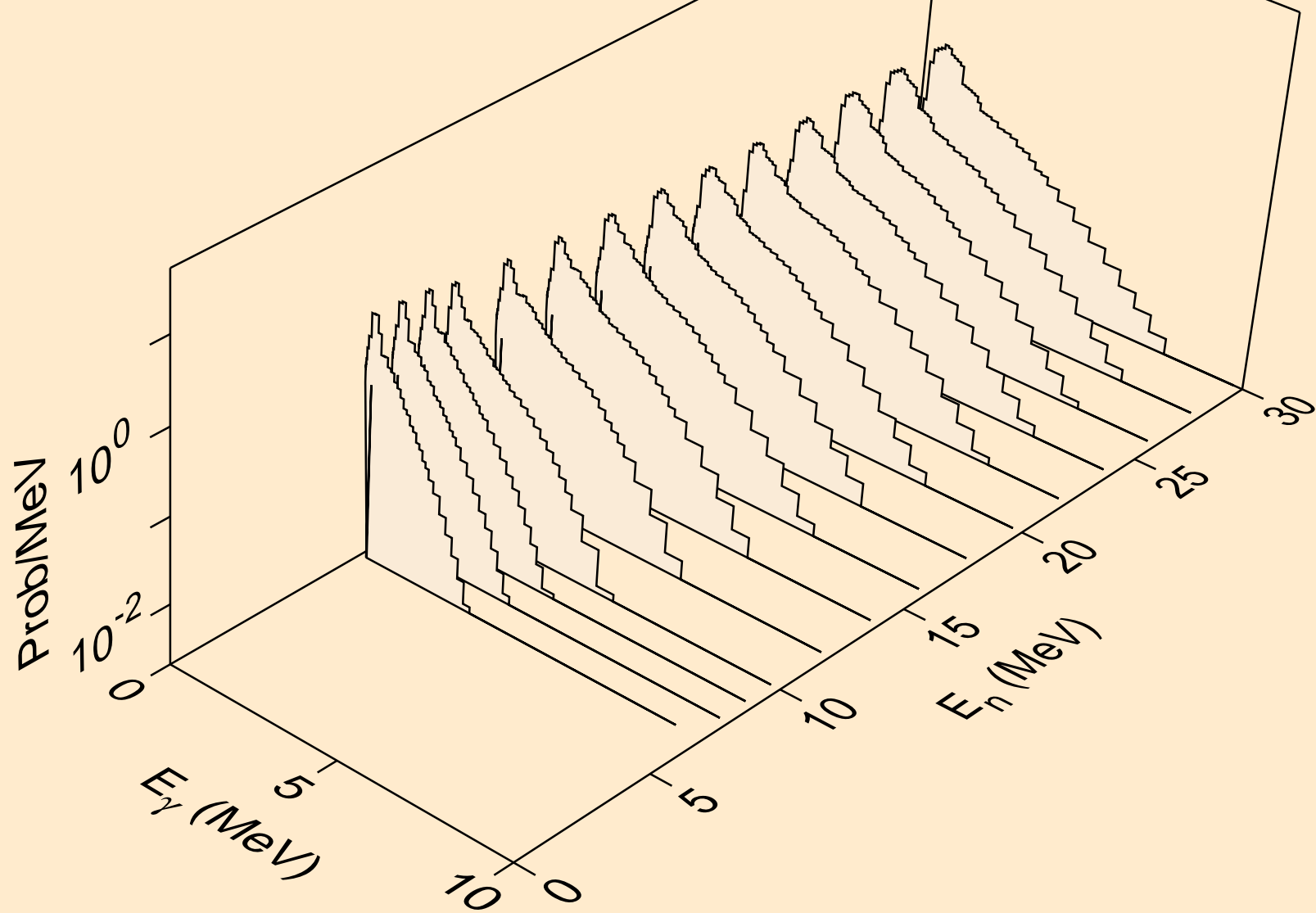

TB144M HELION ACER TENDL-2021 LIBRARY; T=0.K  
Photon emission for (n,pa)

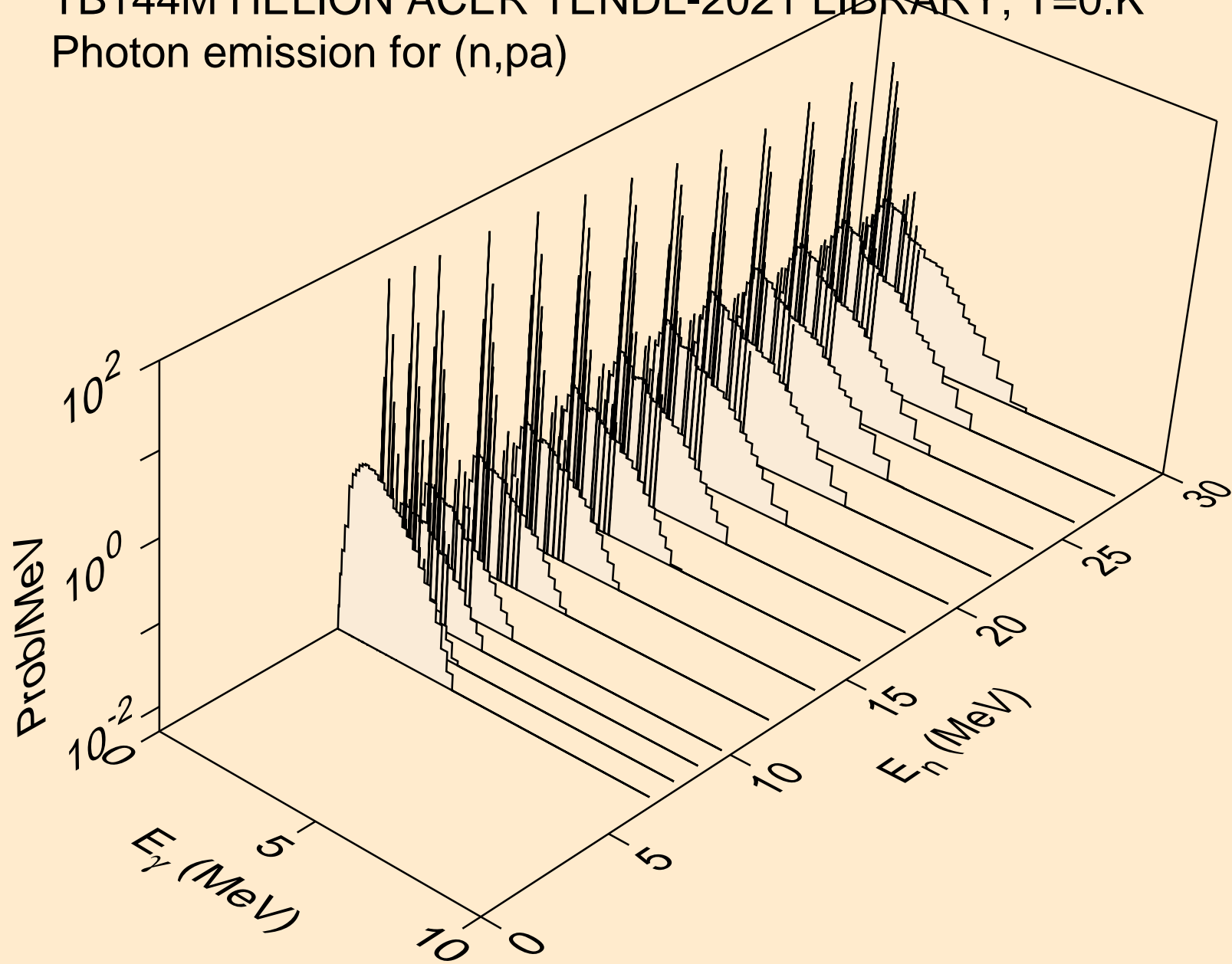



TB144M HELION ACER TENDL-2021 LIBRARY; T=0.K  
Photon emission for (n,pd)

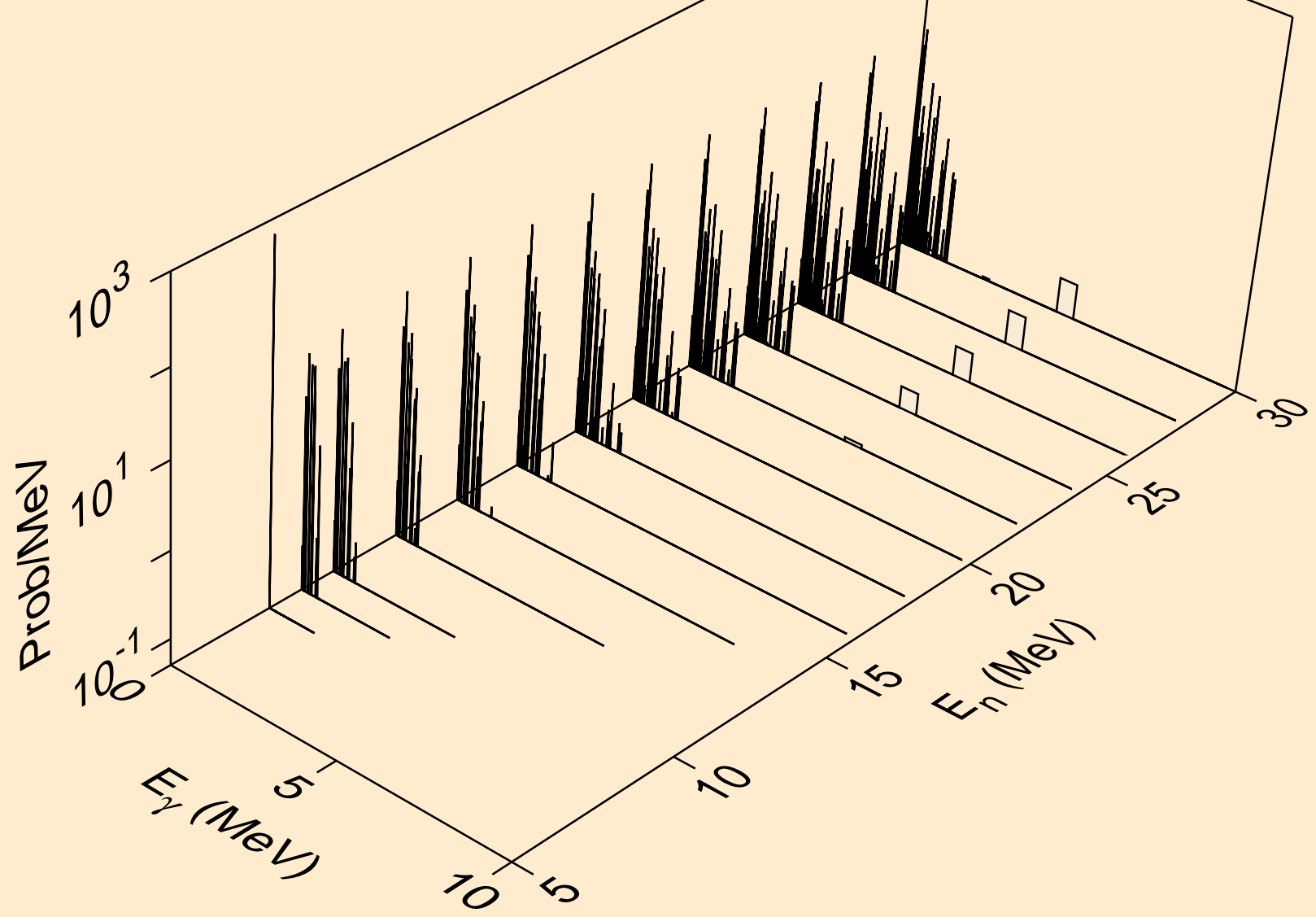

TB144M HELION ACER TENDL-2021 LIBRARY; T=0.K  
Photon emission for (n,pt)

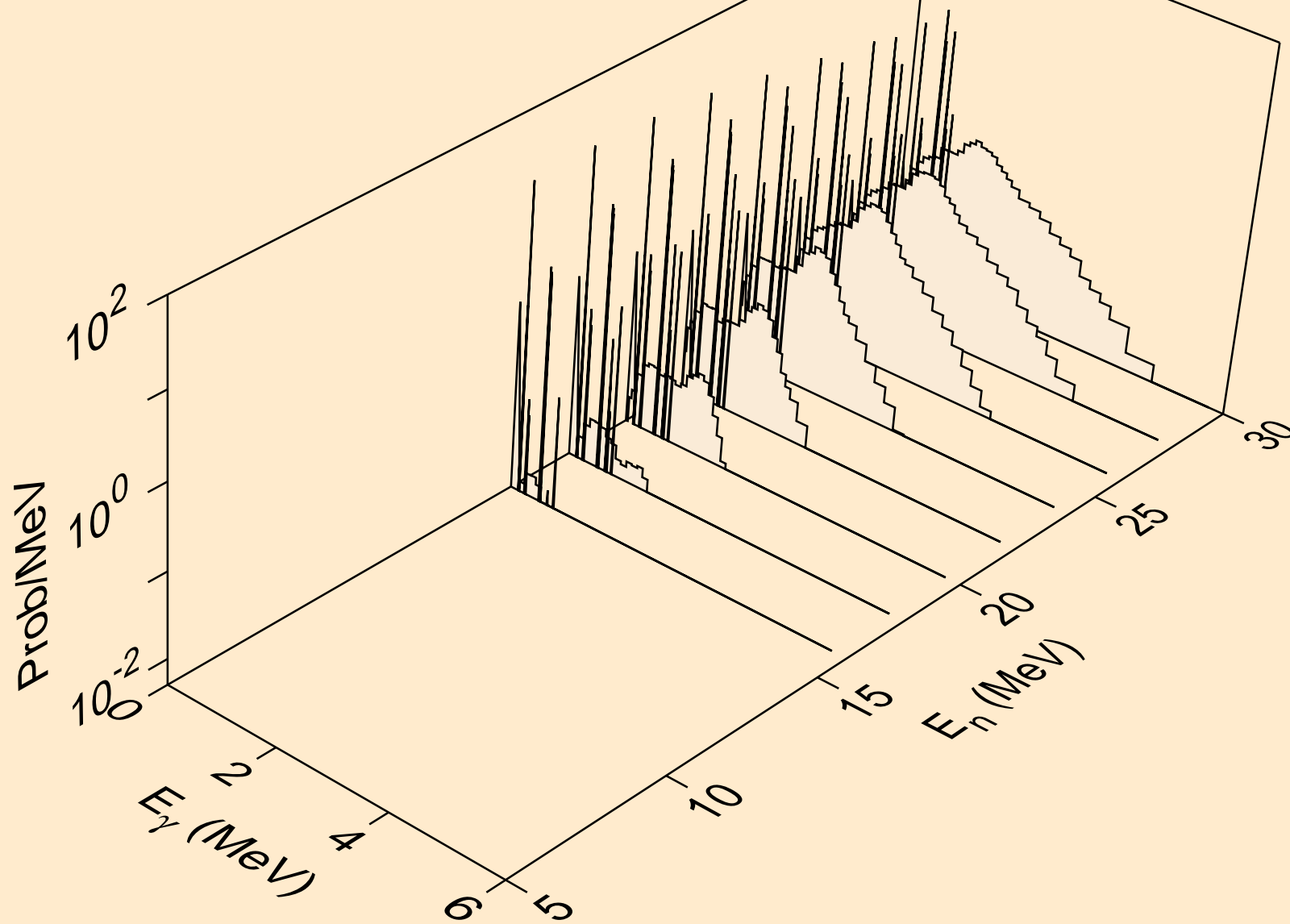

TB144M HELION ACER TENDL-2021 LIBRARY; T=0.K  
Photon emission for (n,da)

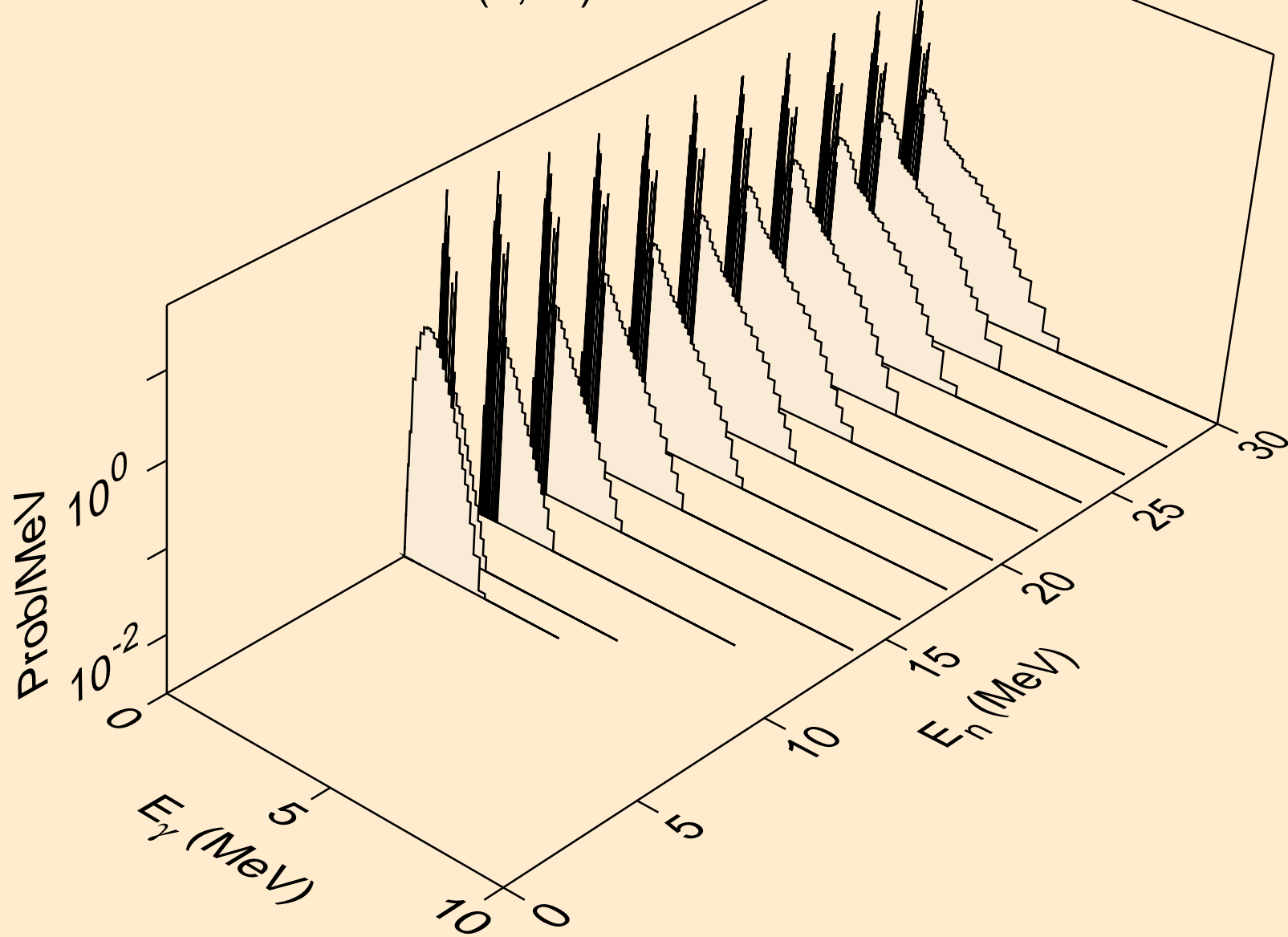

TB144M HELION ACER TENDL-2021 LIBRARY; T=0.K  
Particle heating contributions

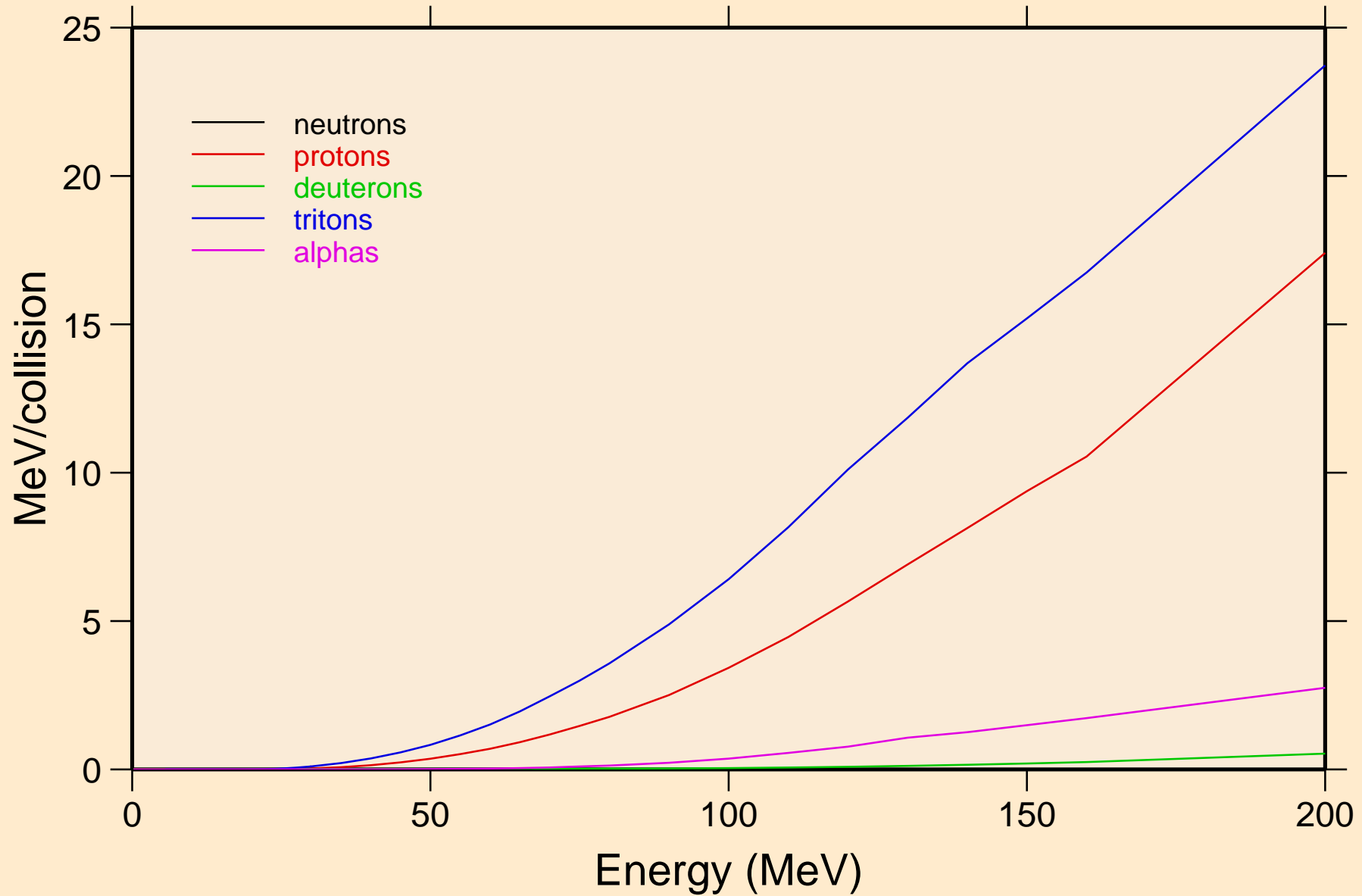

TB144M HELION ACER TENDL-2021 LIBRARY; T=0.K  
Recoil Heating

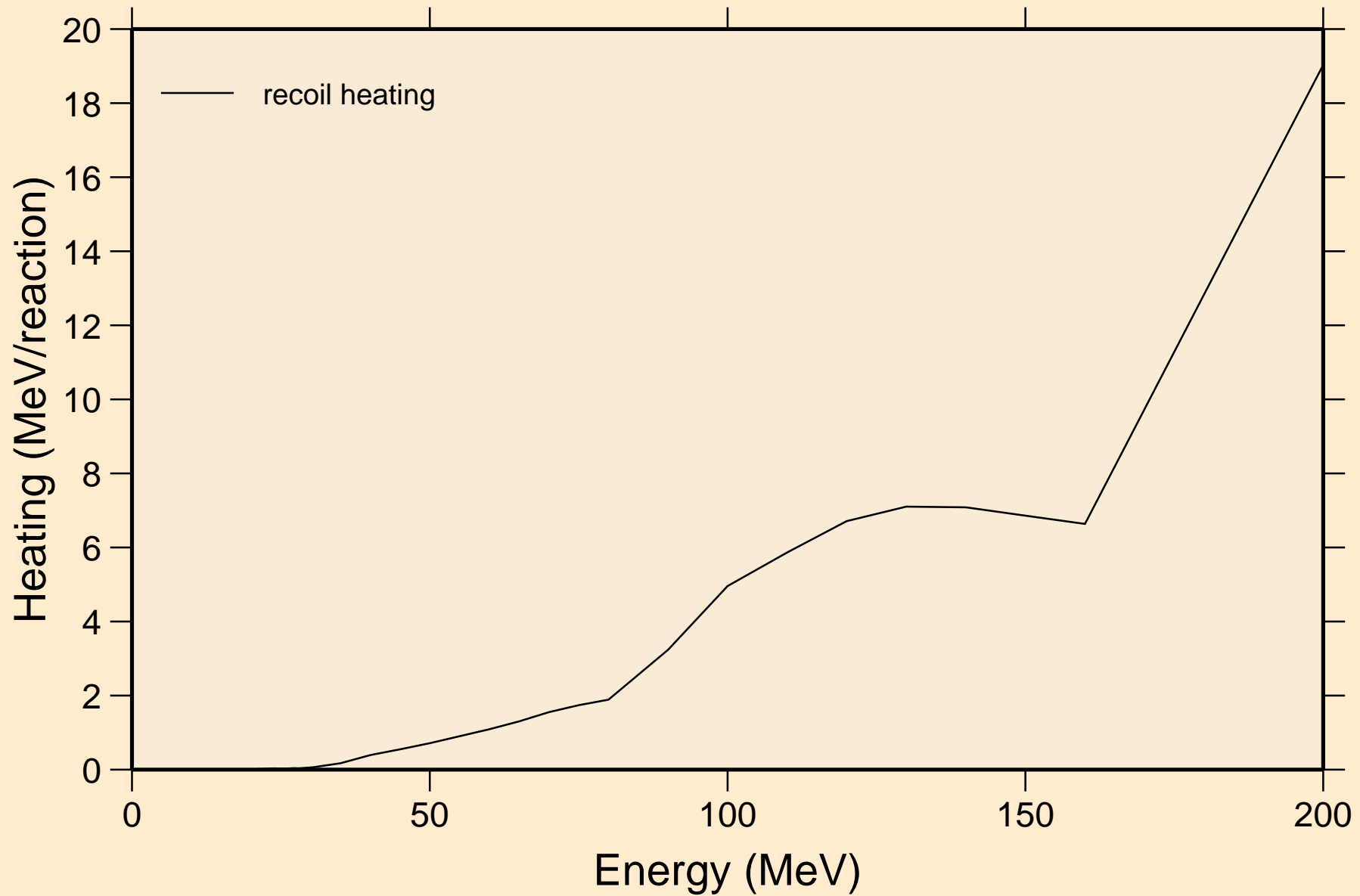

TB144M HELION ACER TENDL-2021 LIBRARY; T=0.K  
Particle production cross sections

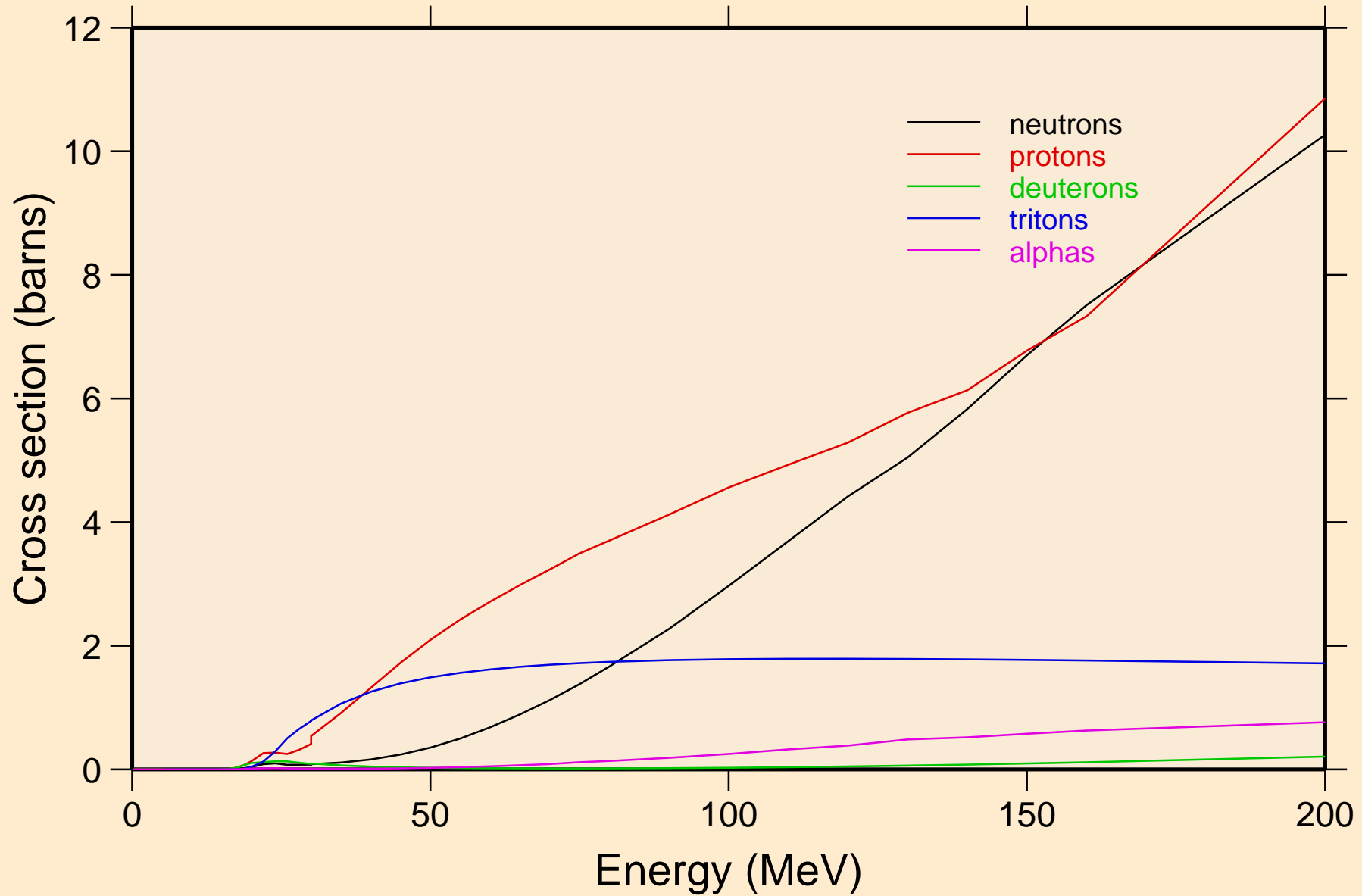

TB144M HELION ACER TENDL-2021 LIBRARY; T=0.K  
neutrons from (s,n)

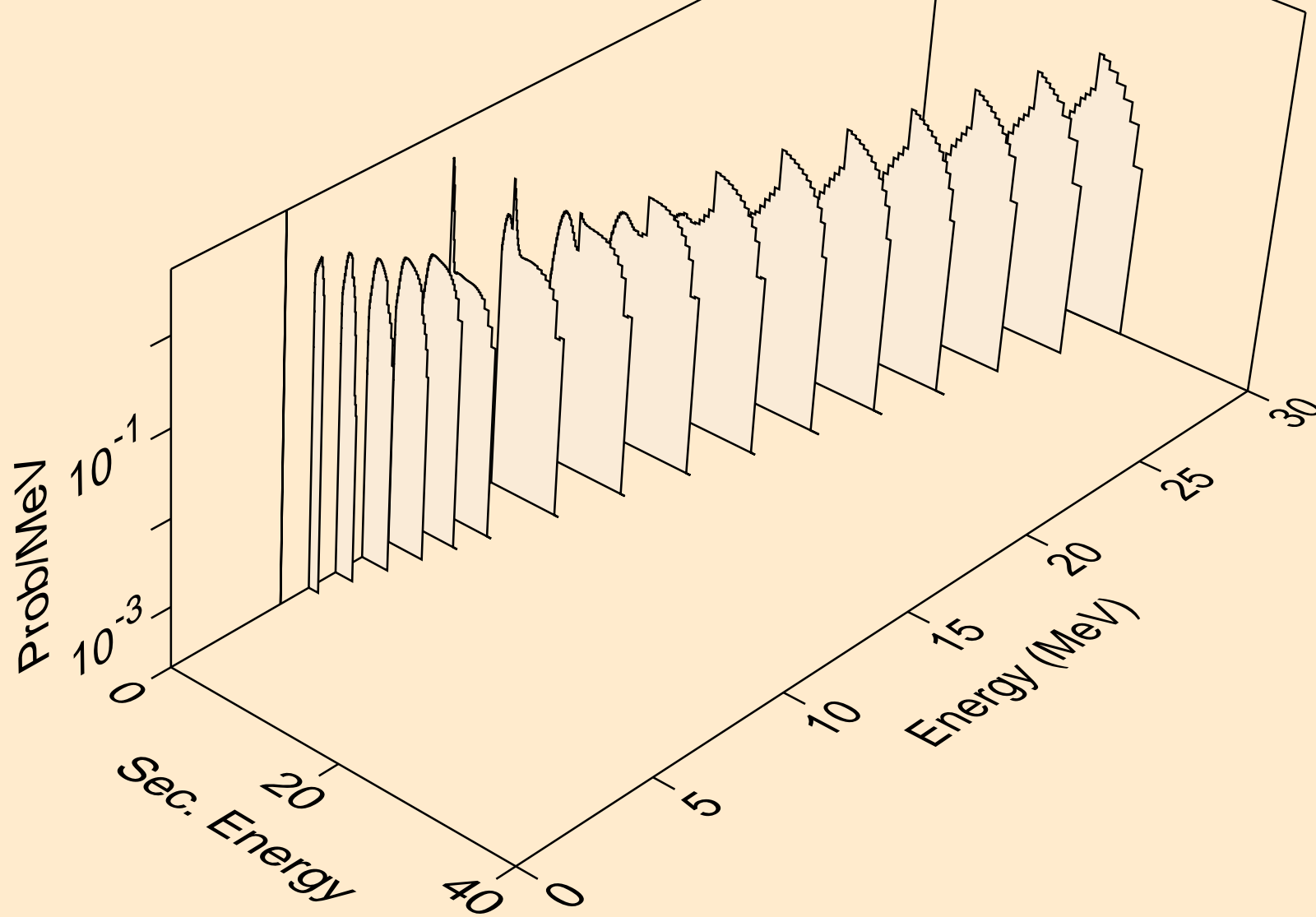

TB144M HELION ACER TENDL-2021 LIBRARY; T=0.K  
neutrons from (s,x)

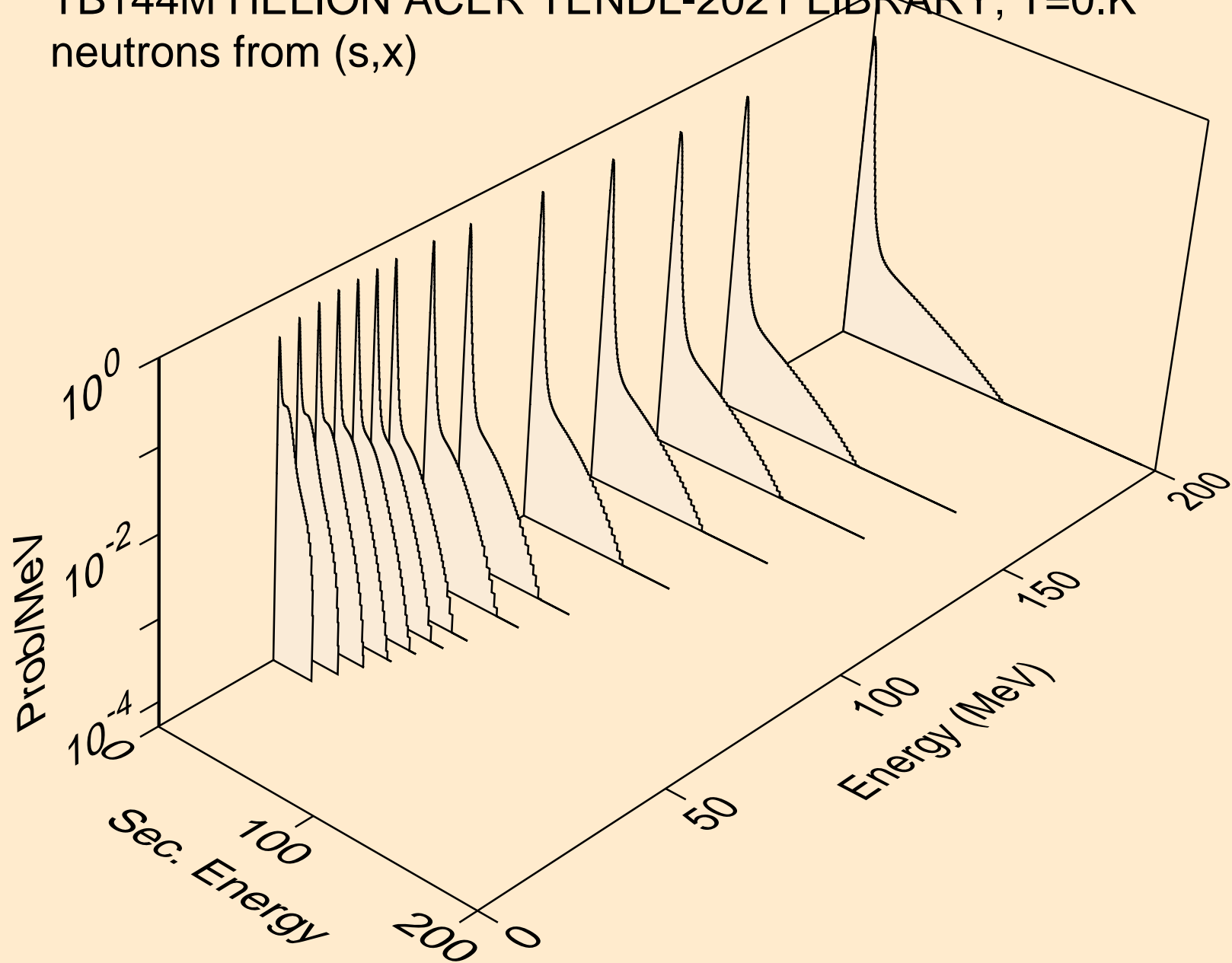



TB144M HELION ACER TENDL-2021 LIBRARY; T=0.K  
neutrons from (s,2nd)

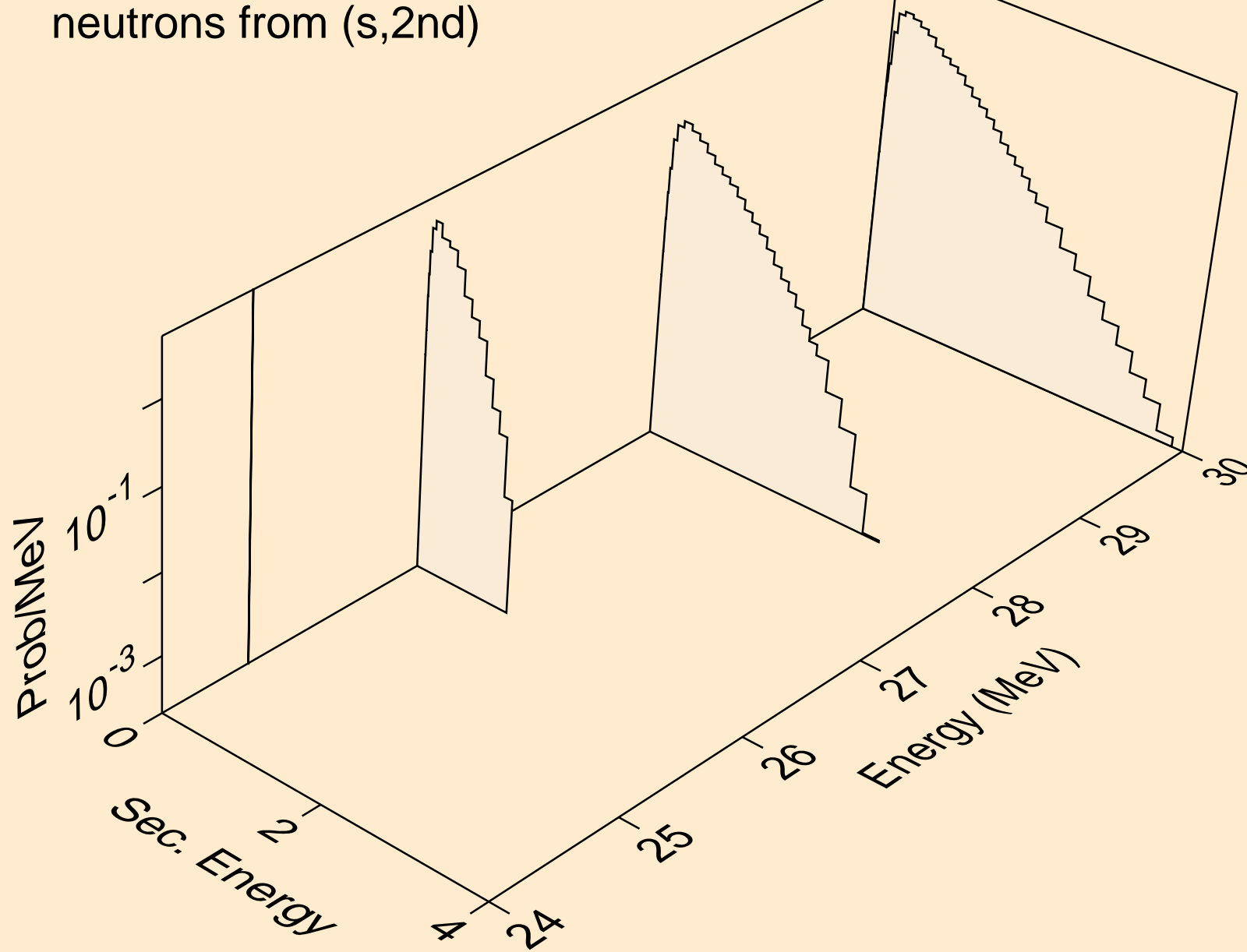

TB144M HELION ACER TENDL-2021 LIBRARY; T=0.K  
neutrons from (s,2n)

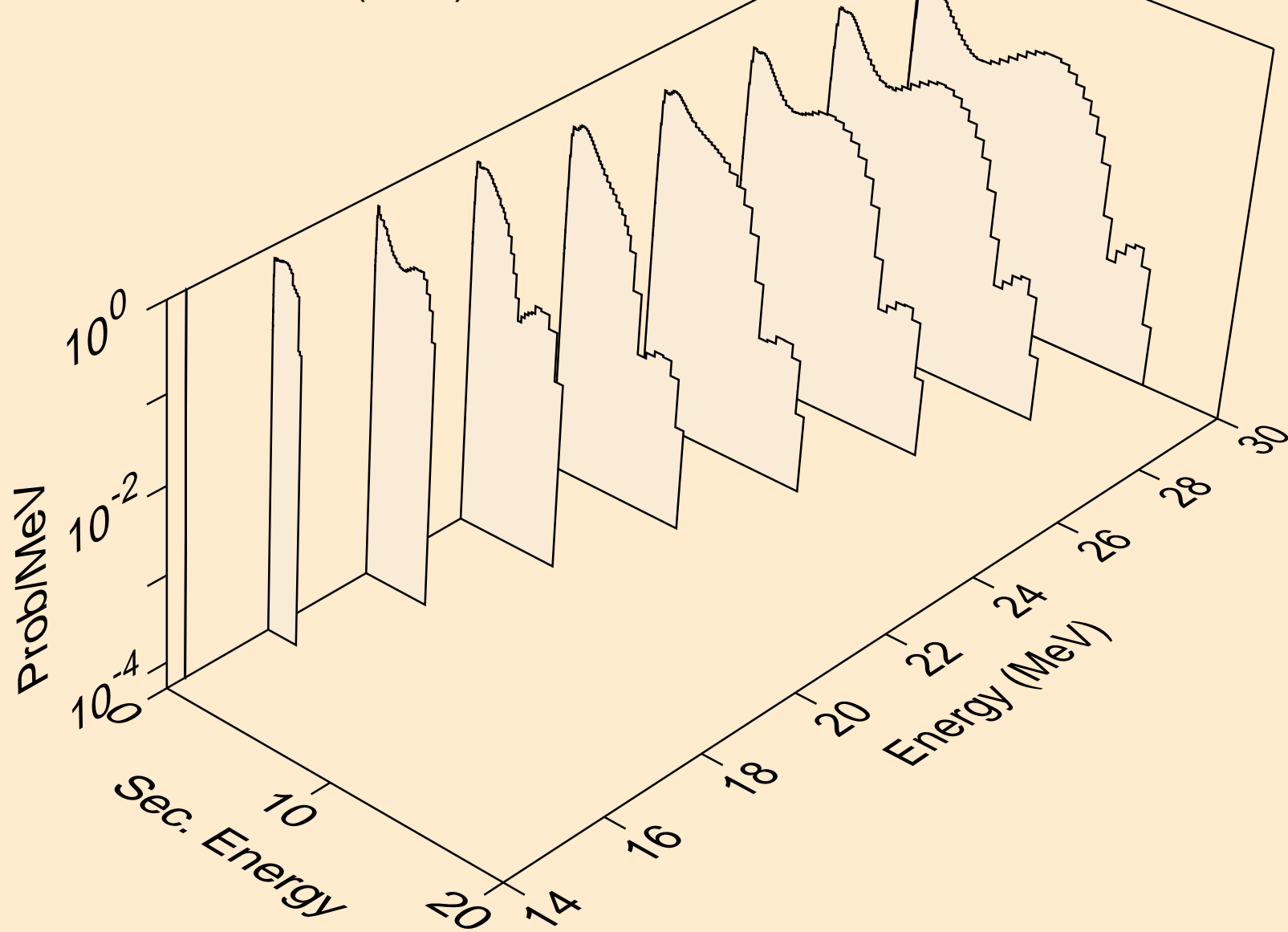

TB144M HELION ACER TENDL-2021 LIBRARY; T=0.K  
neutrons from (s,3n)

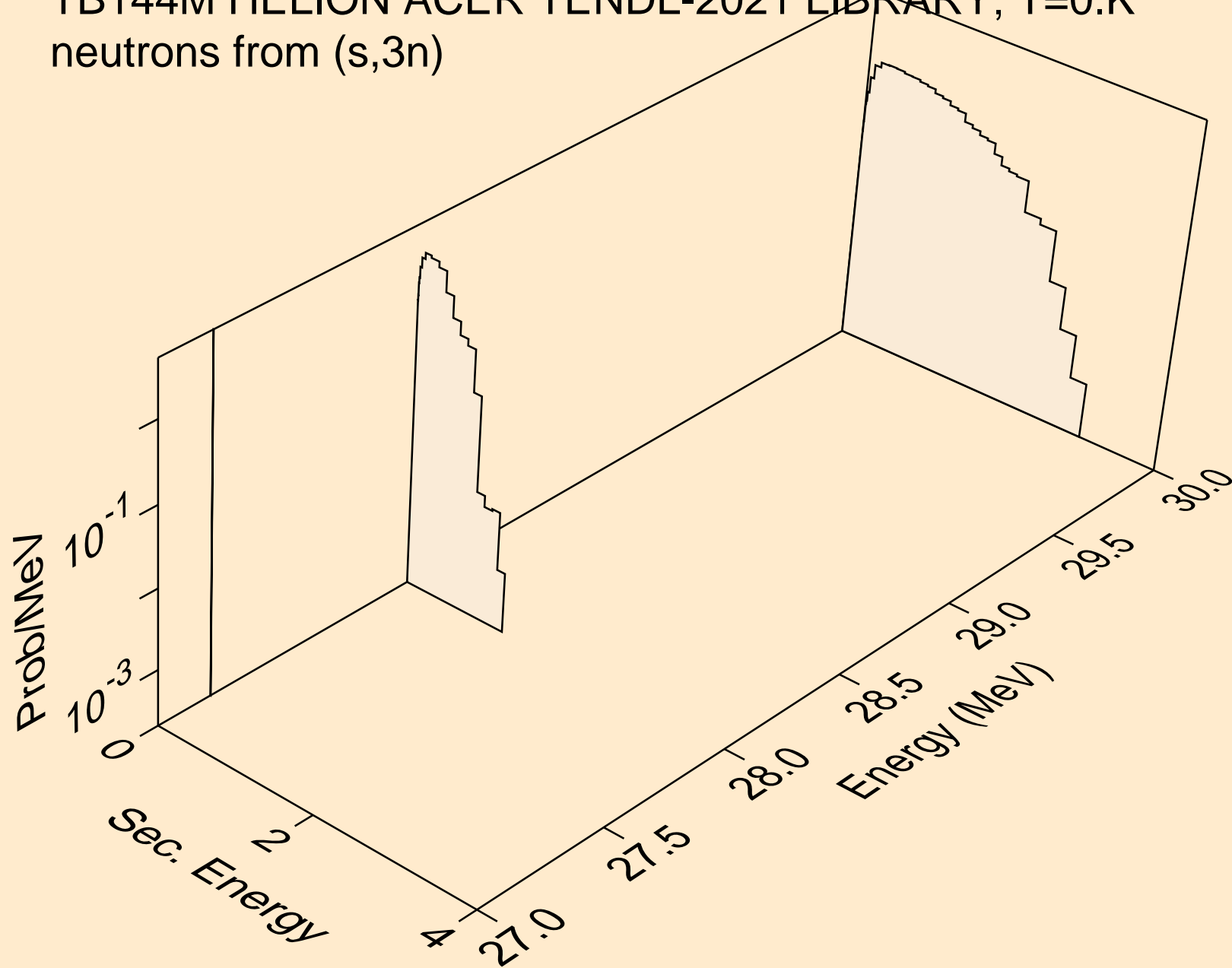

TB144M HELION ACER TENDL-2021 LIBRARY; T=0.K  
neutrons from (s,n\*)a

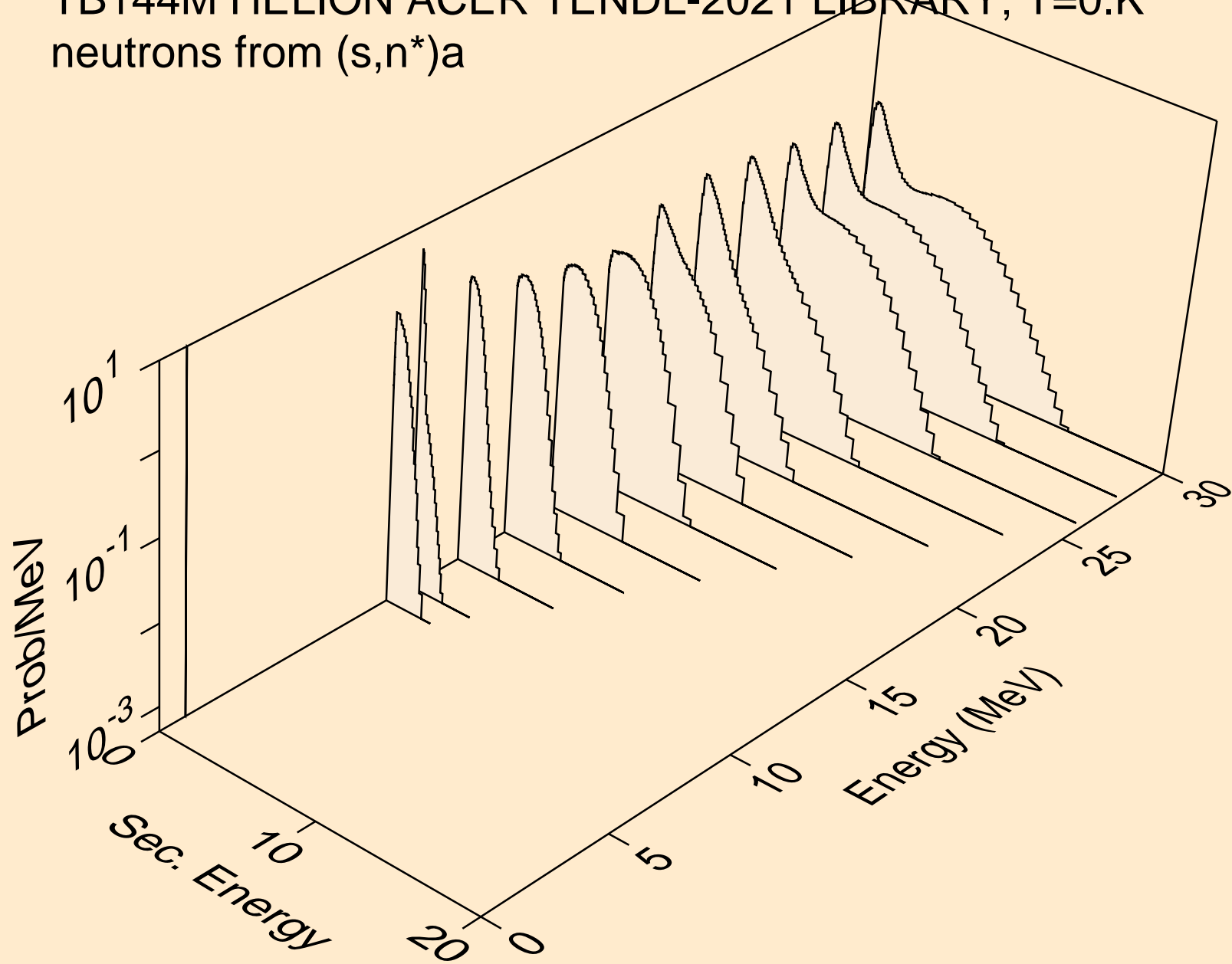

TB144M HELION ACER TENDL-2021 LIBRARY; T=0.K  
neutrons from (s,2n)a

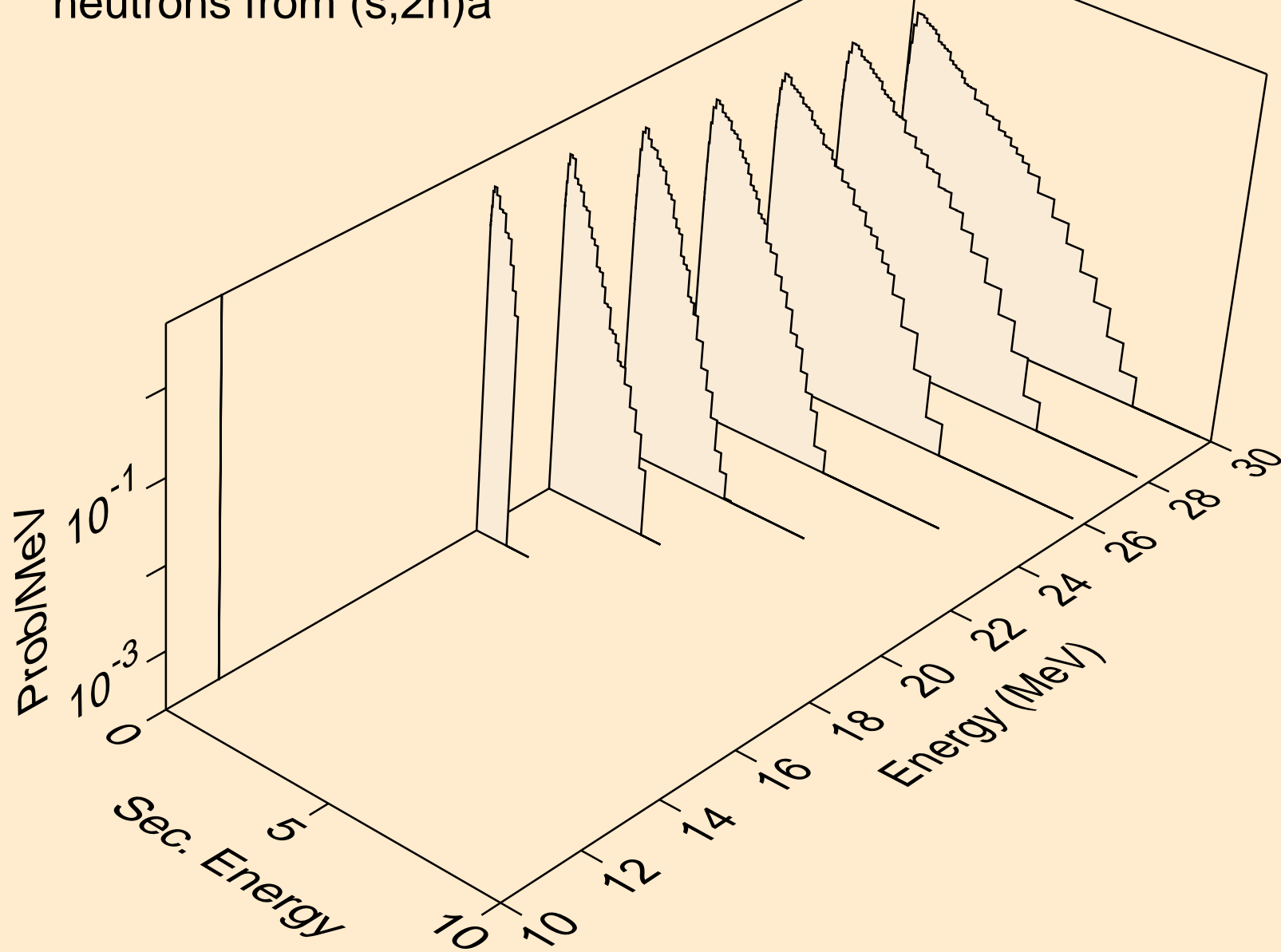

TB144M HELION ACER TENDL-2021 LIBRARY; T=0.K  
neutrons from (s,n\*)p

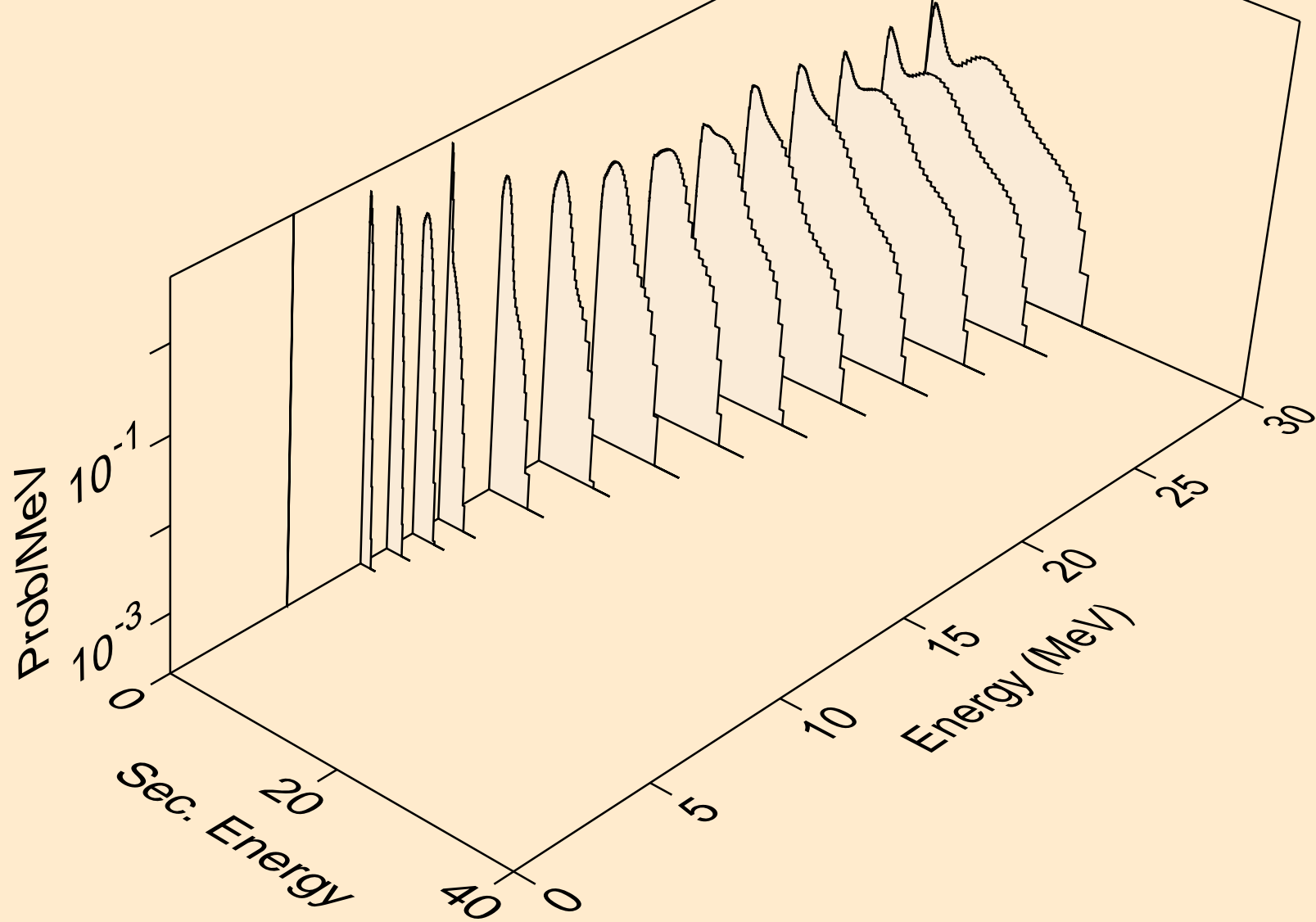

TB144M HELION ACER TENDL-2021 LIBRARY; T=0.K  
neutrons from (s,n\*)2a

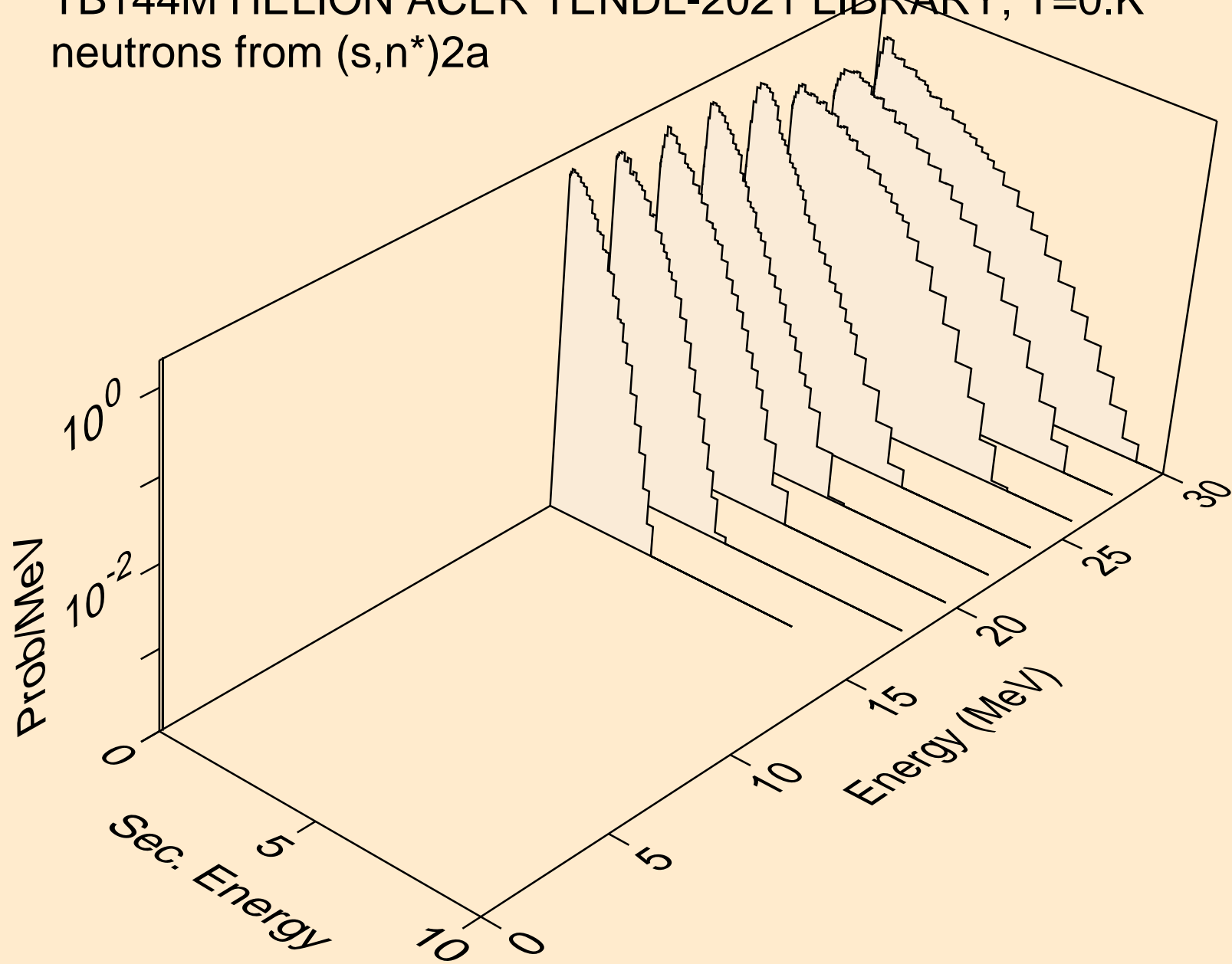

TB144M HELION ACER TENDL-2021 LIBRARY; T=0.K  
neutrons from (s,n\*)d

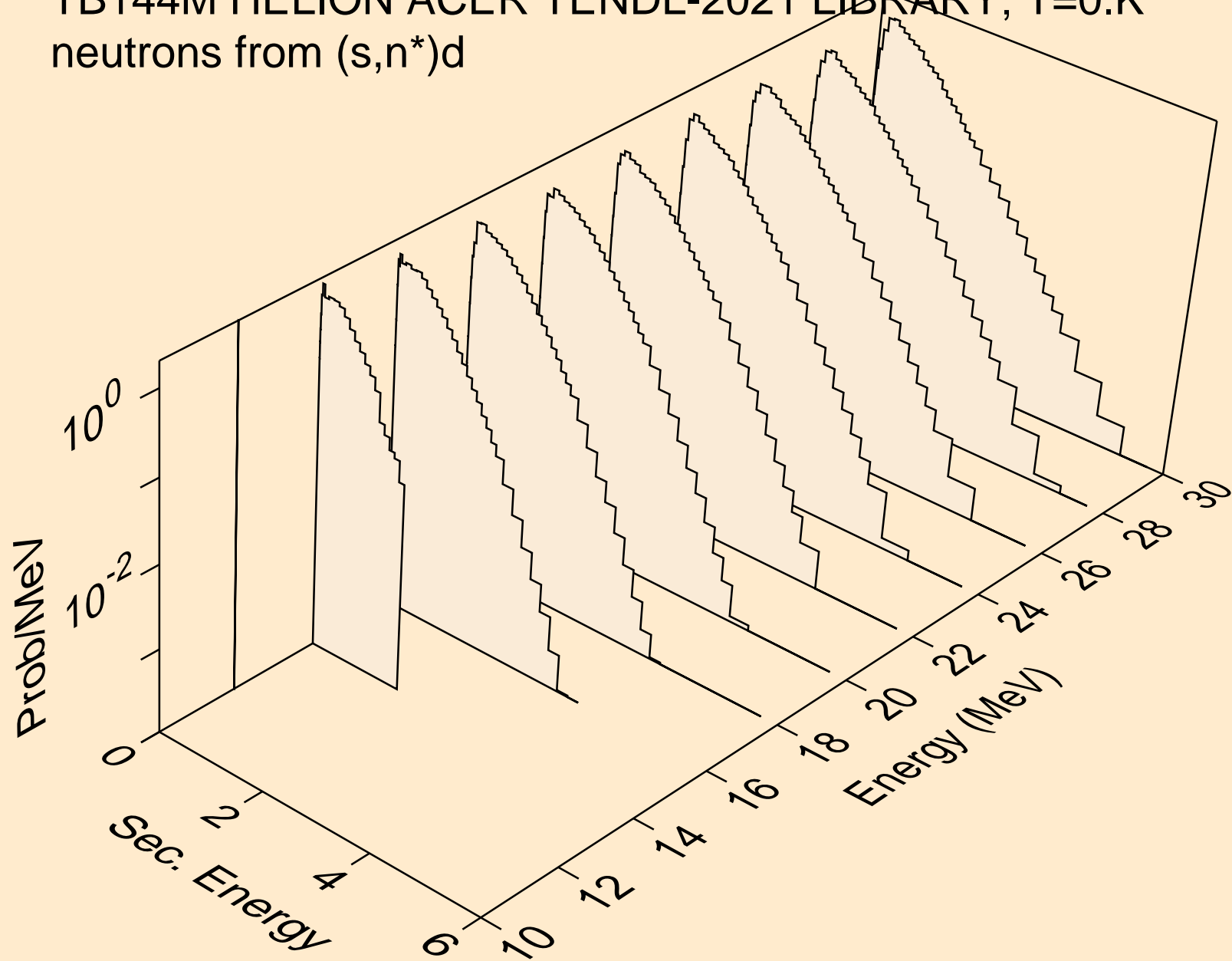



TB144M HELION ACER TENDL-2021 LIBRARY; T=0.K  
neutrons from (s,n\*)t

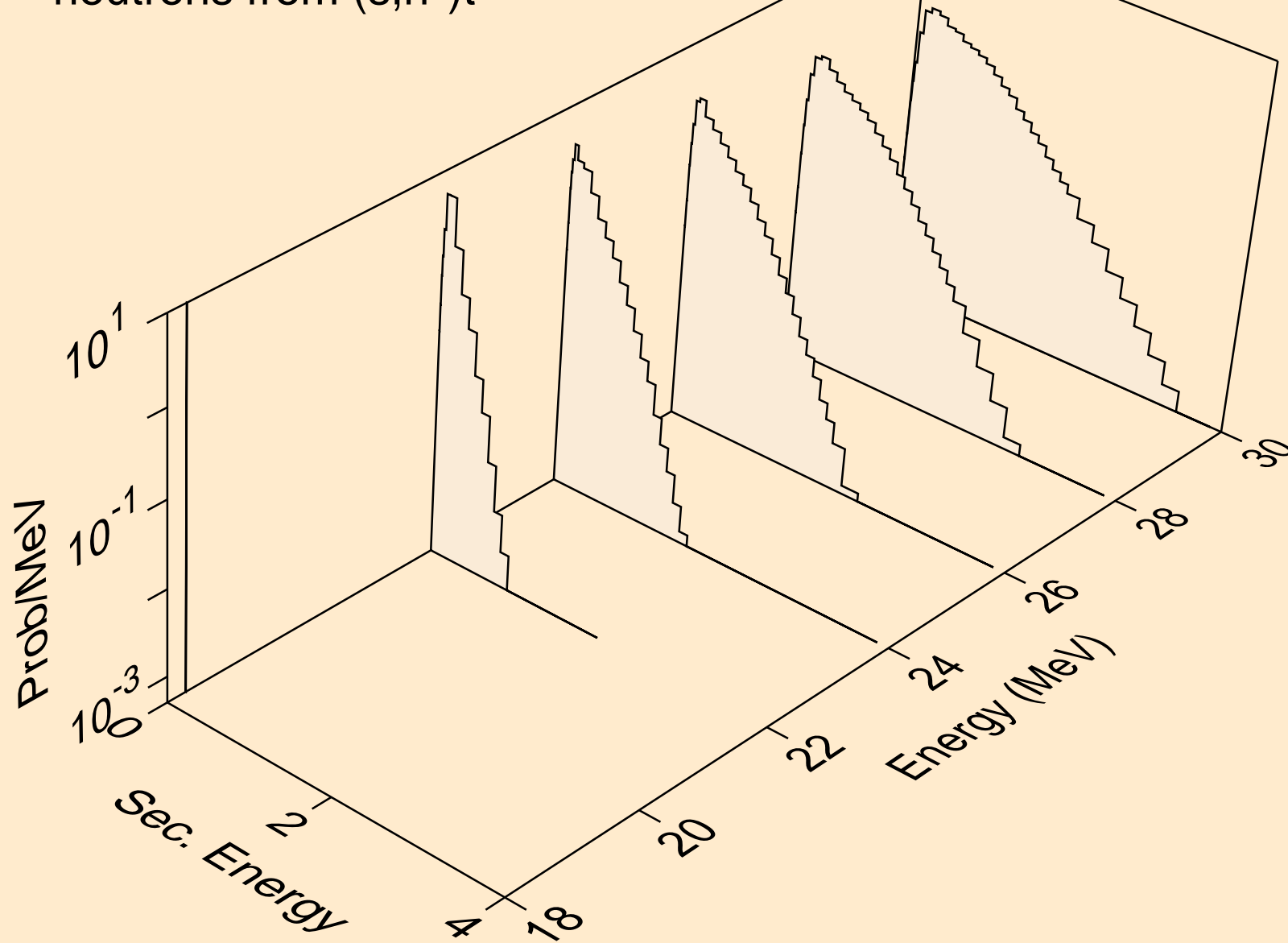

TB144M HELION ACER TENDL-2021 LIBRARY; T=0.K  
neutrons from (s,n\*)he3

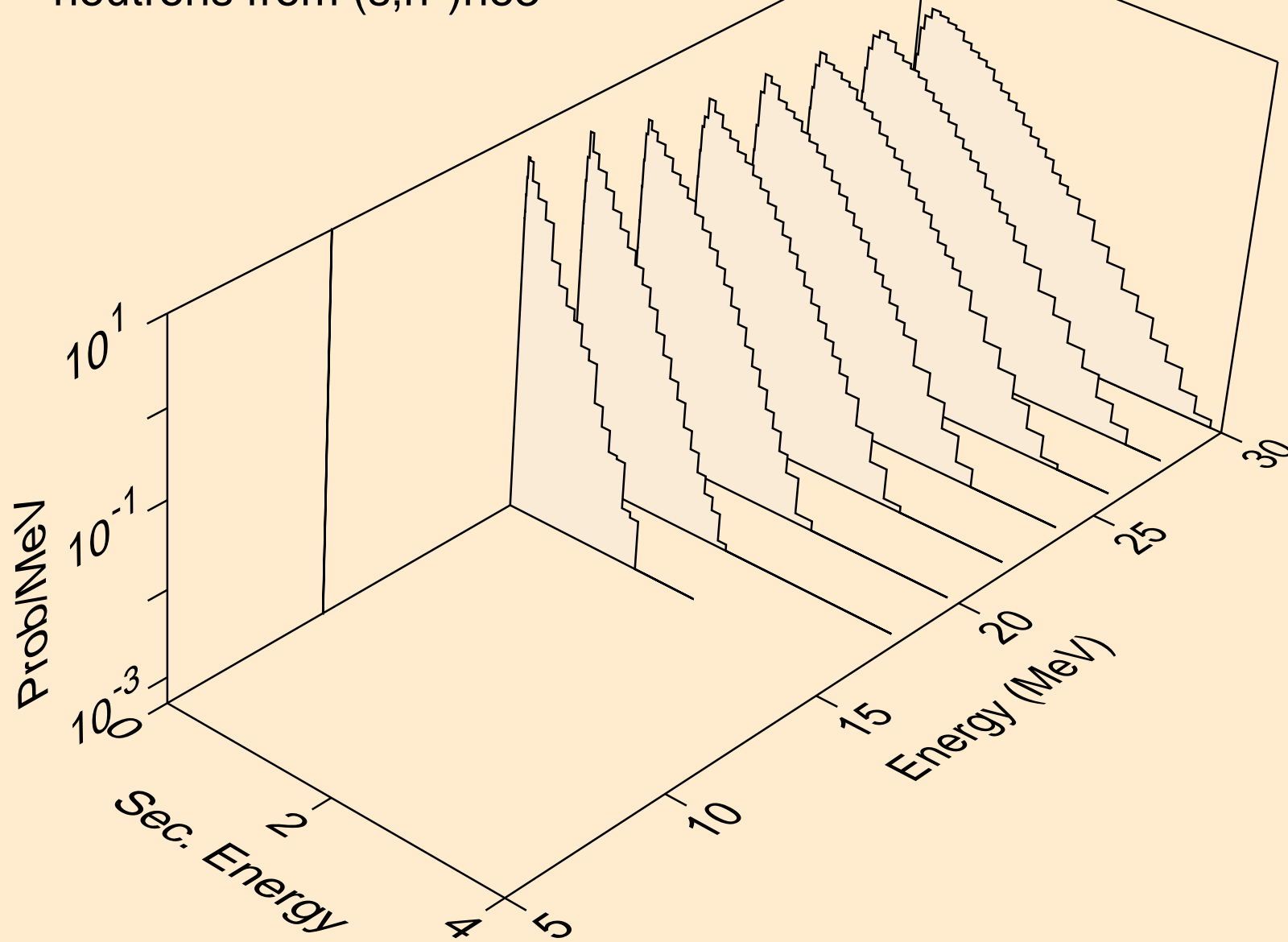

TB144M HELION ACER TENDL-2021 LIBRARY; T=0.K  
neutrons from (s,2np)

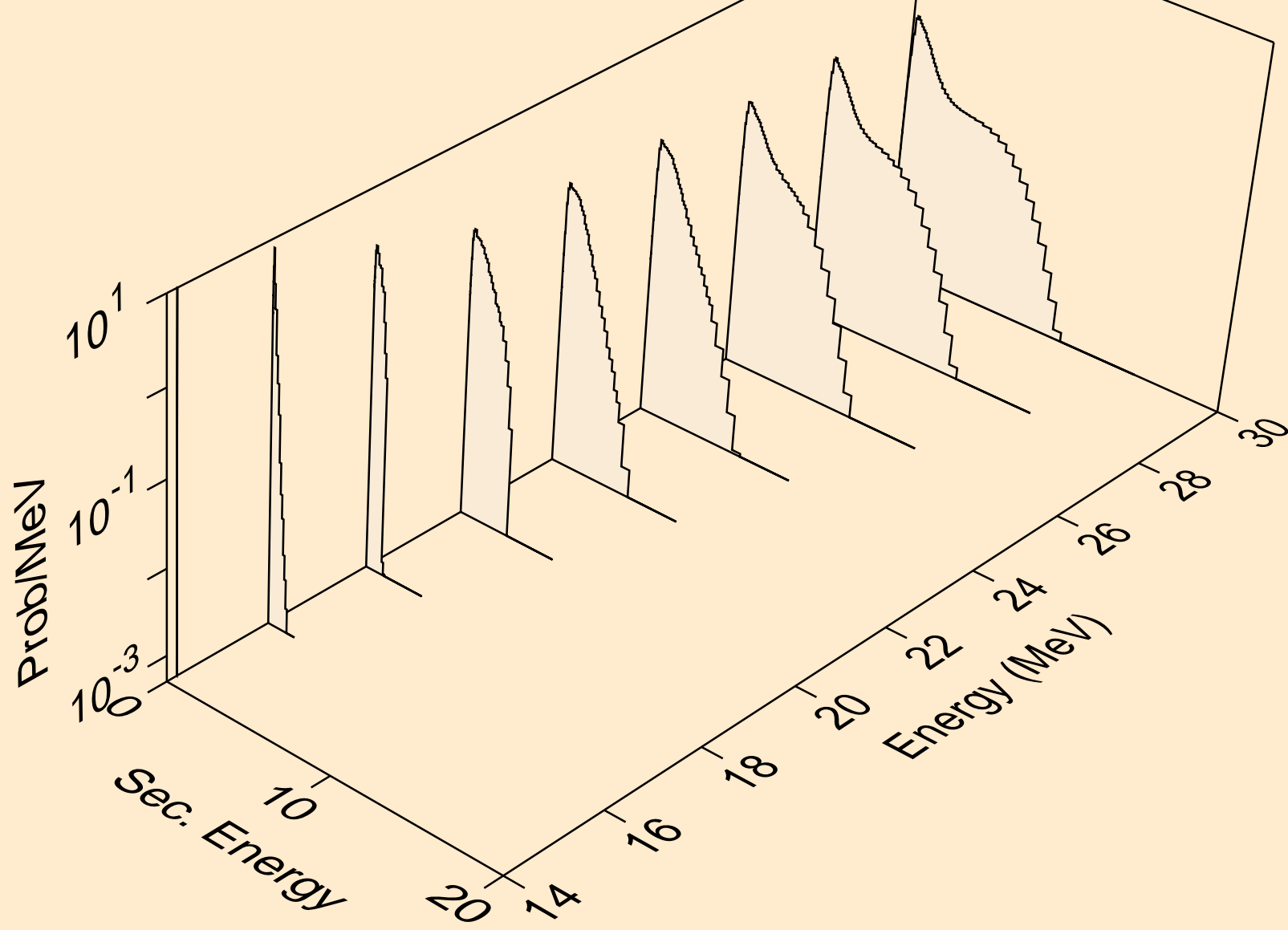

TB144M HELION ACER TENDL-2021 LIBRARY; T=0.K  
neutrons from (s,2np)

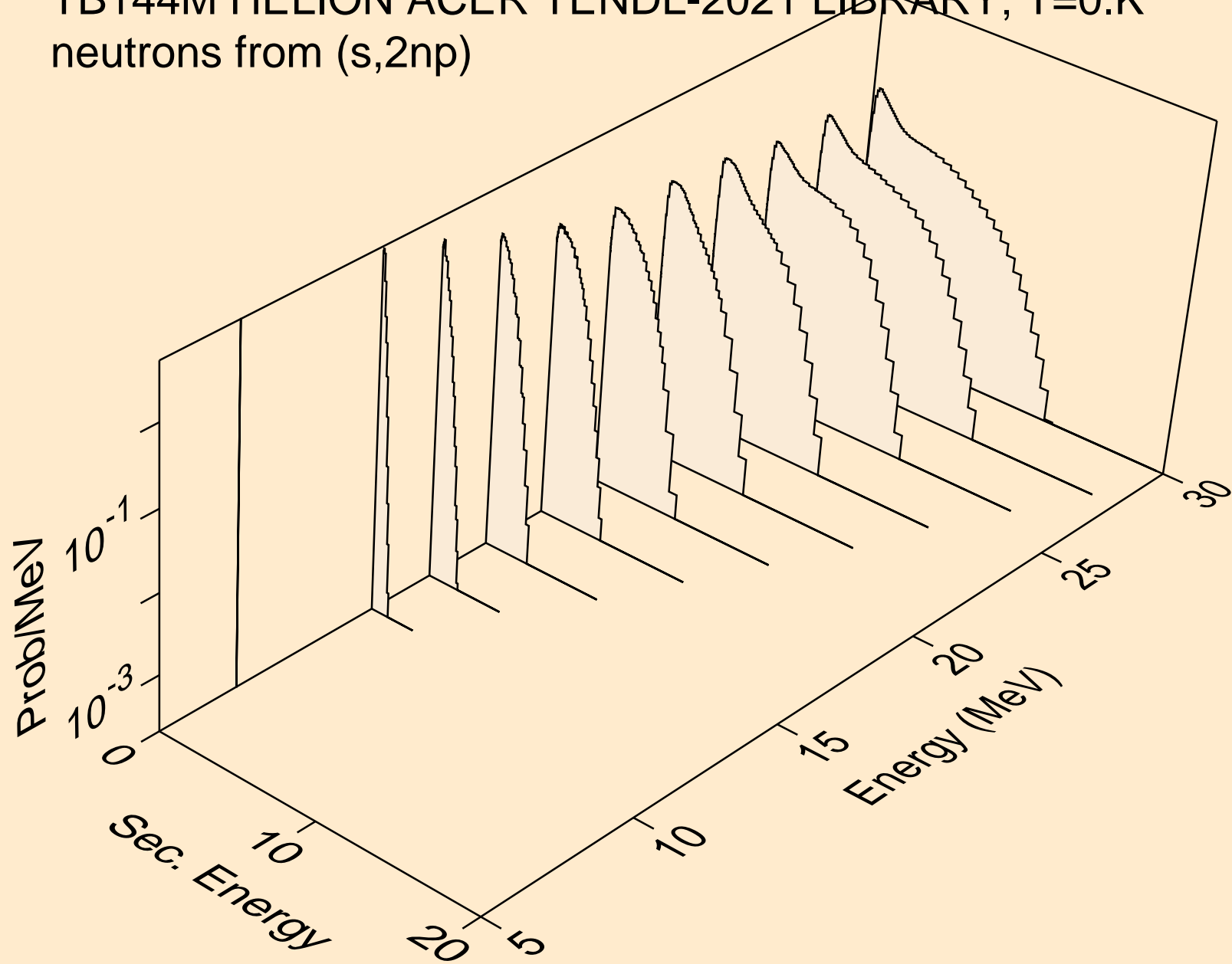

TB144M HELION ACER TENDL-2021 LIBRARY; T=0.K  
neutrons from (s,npa)

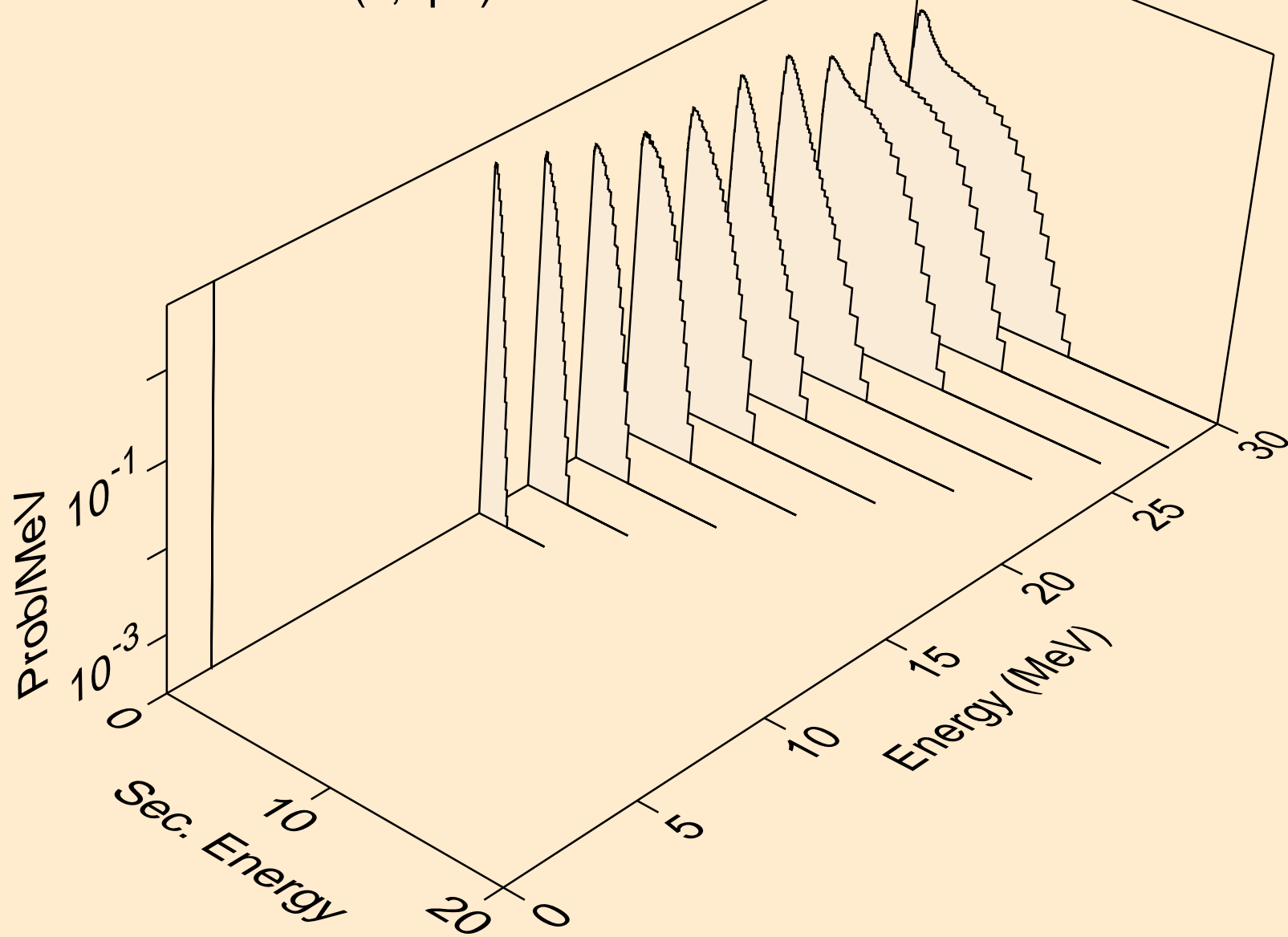

TB144M HELION ACER TENDL-2021 LIBRARY; T=0.K  
protons from (s,x)

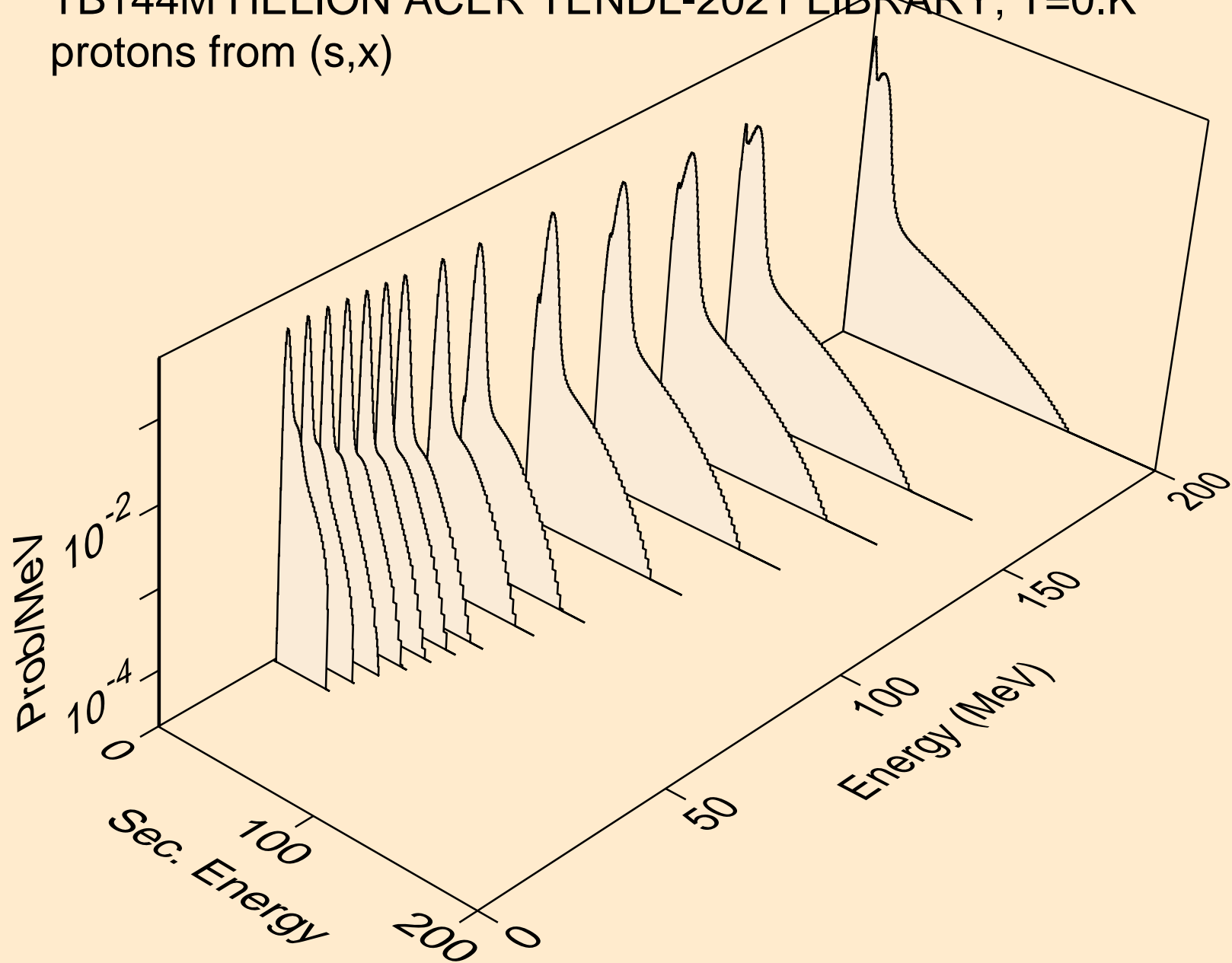

TB144M HELION ACER TENDL-2021 LIBRARY; T=0.K  
protons from (s,n\*)p

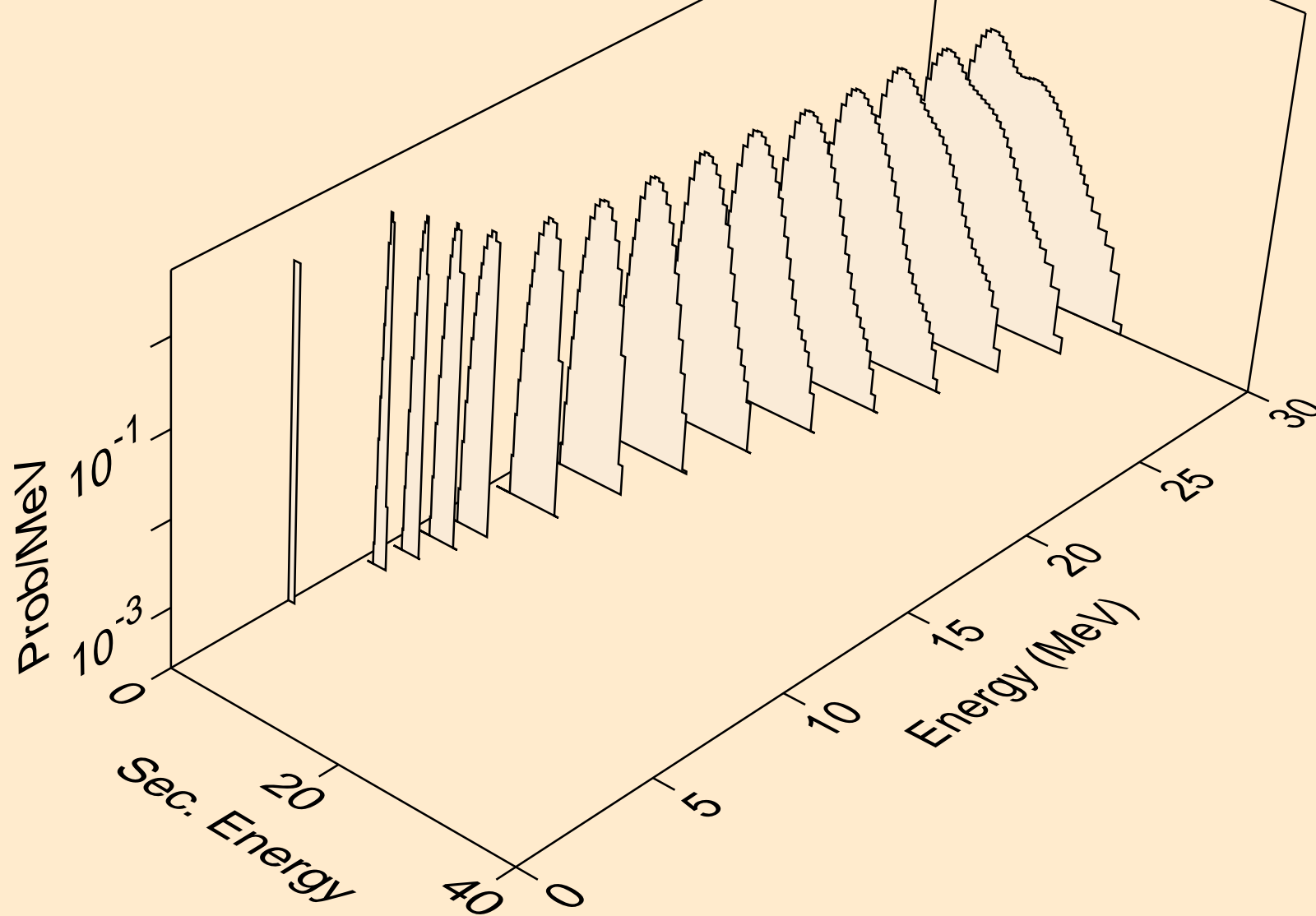

TB144M HELION ACER TENDL-2021 LIBRARY; T=0.K  
protons from (s,2np)

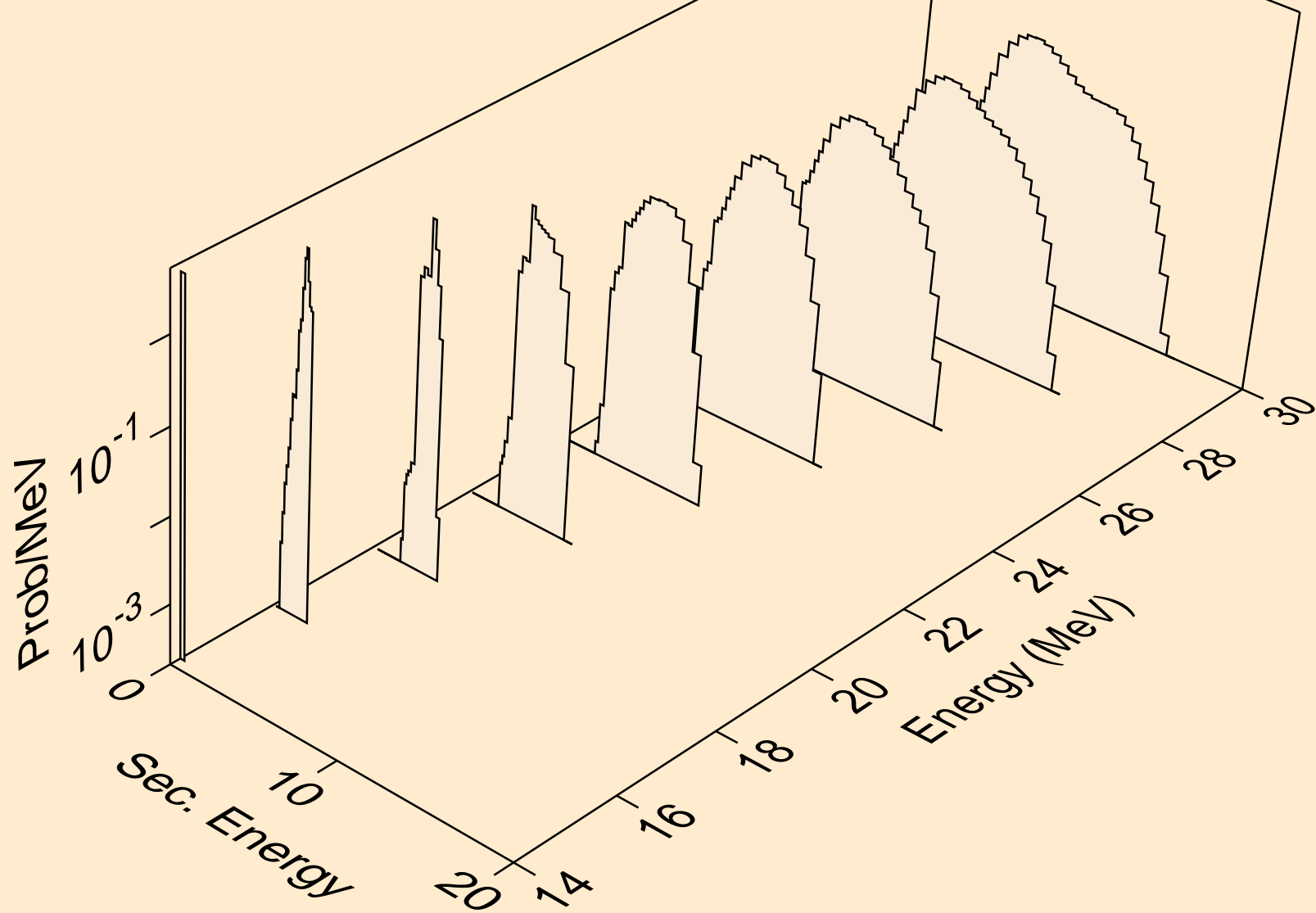



TB144M HELION ACER TENDL-2021 LIBRARY; T=0.K  
protons from (s,2np)

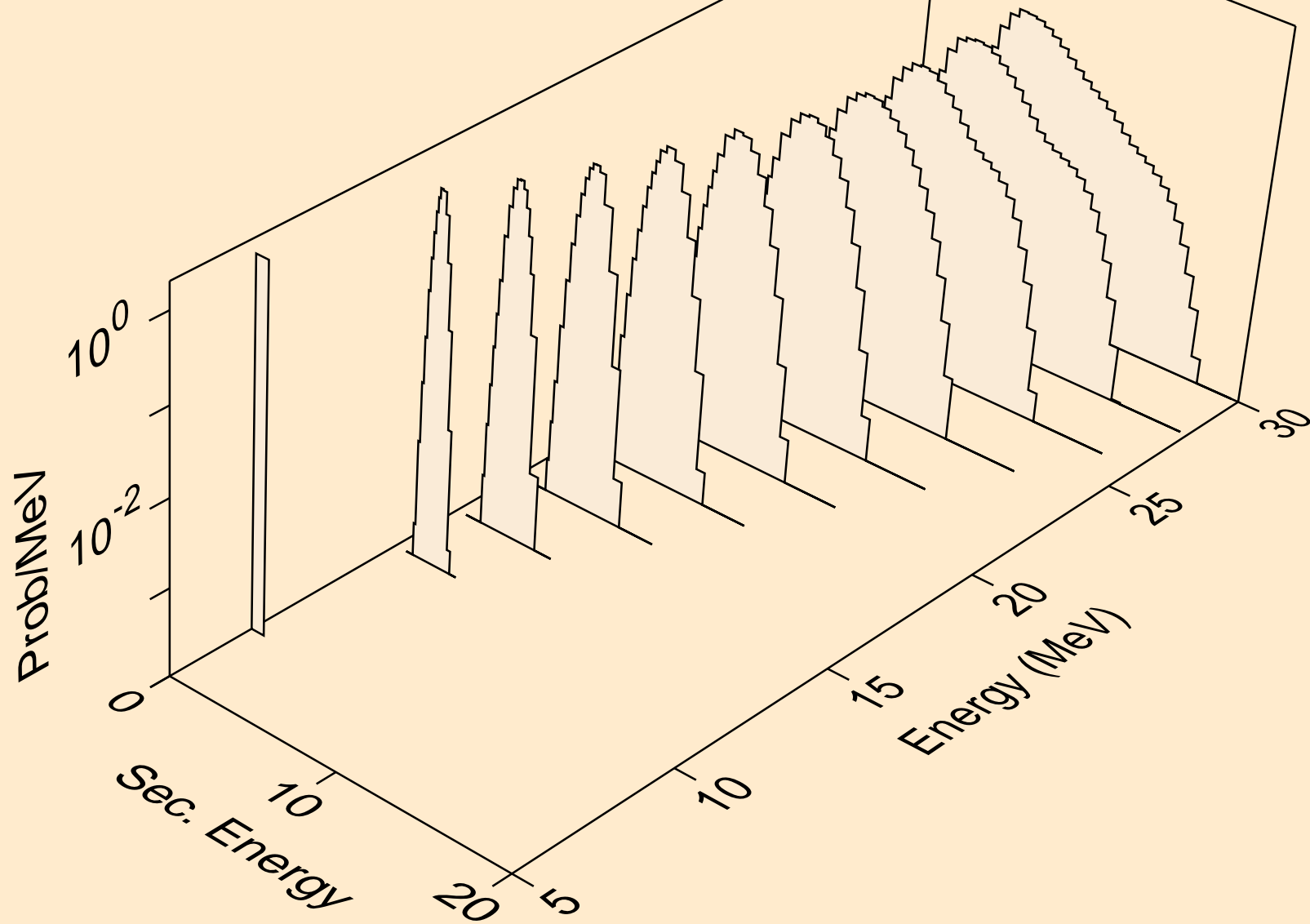

TB144M HELION ACER TENDL-2021 LIBRARY; T=0.K  
protons from (s,npa)

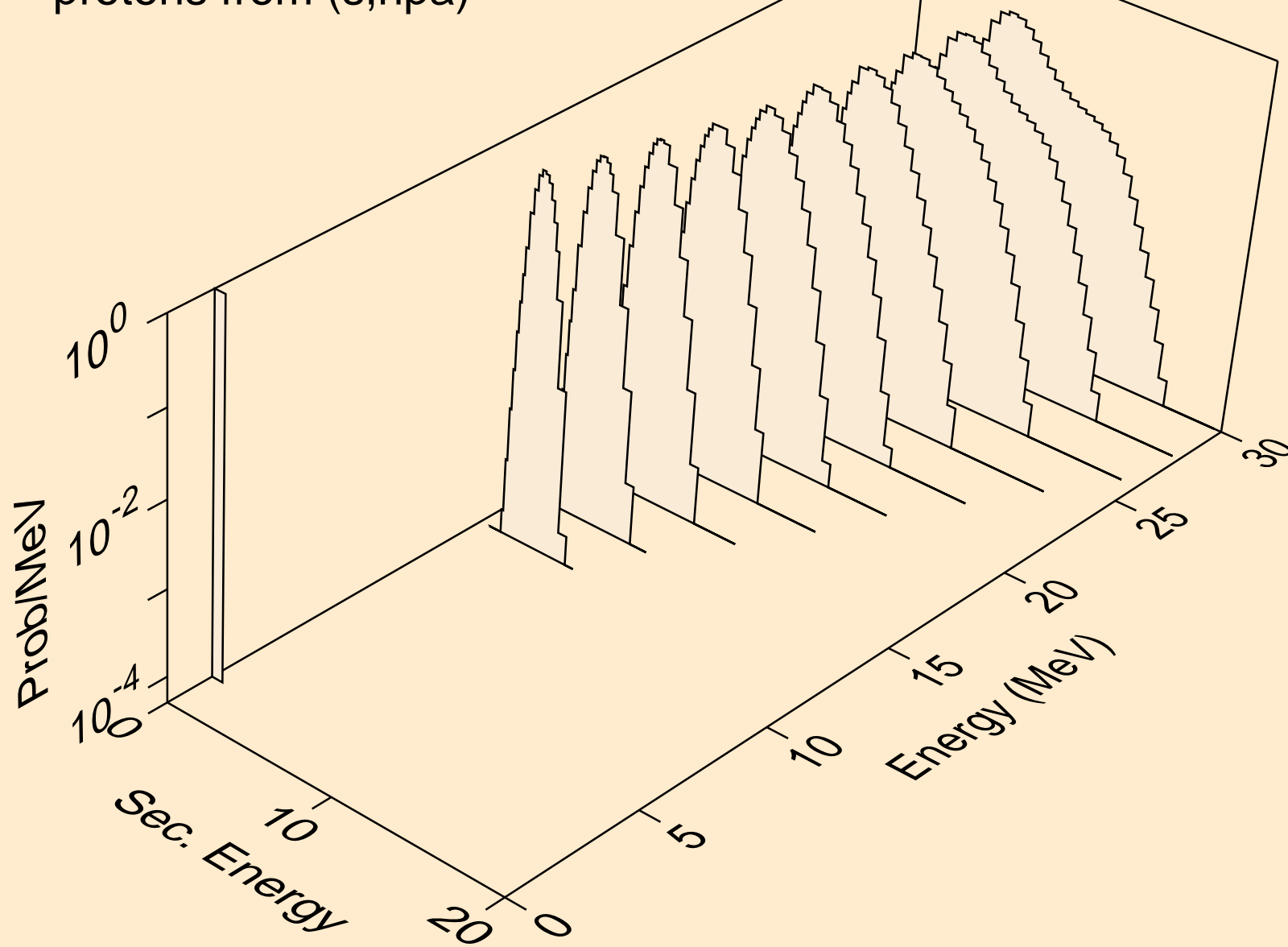

TB144M HELION ACER TENDL-2021 LIBRARY; T=0.K  
protons from (s,p)

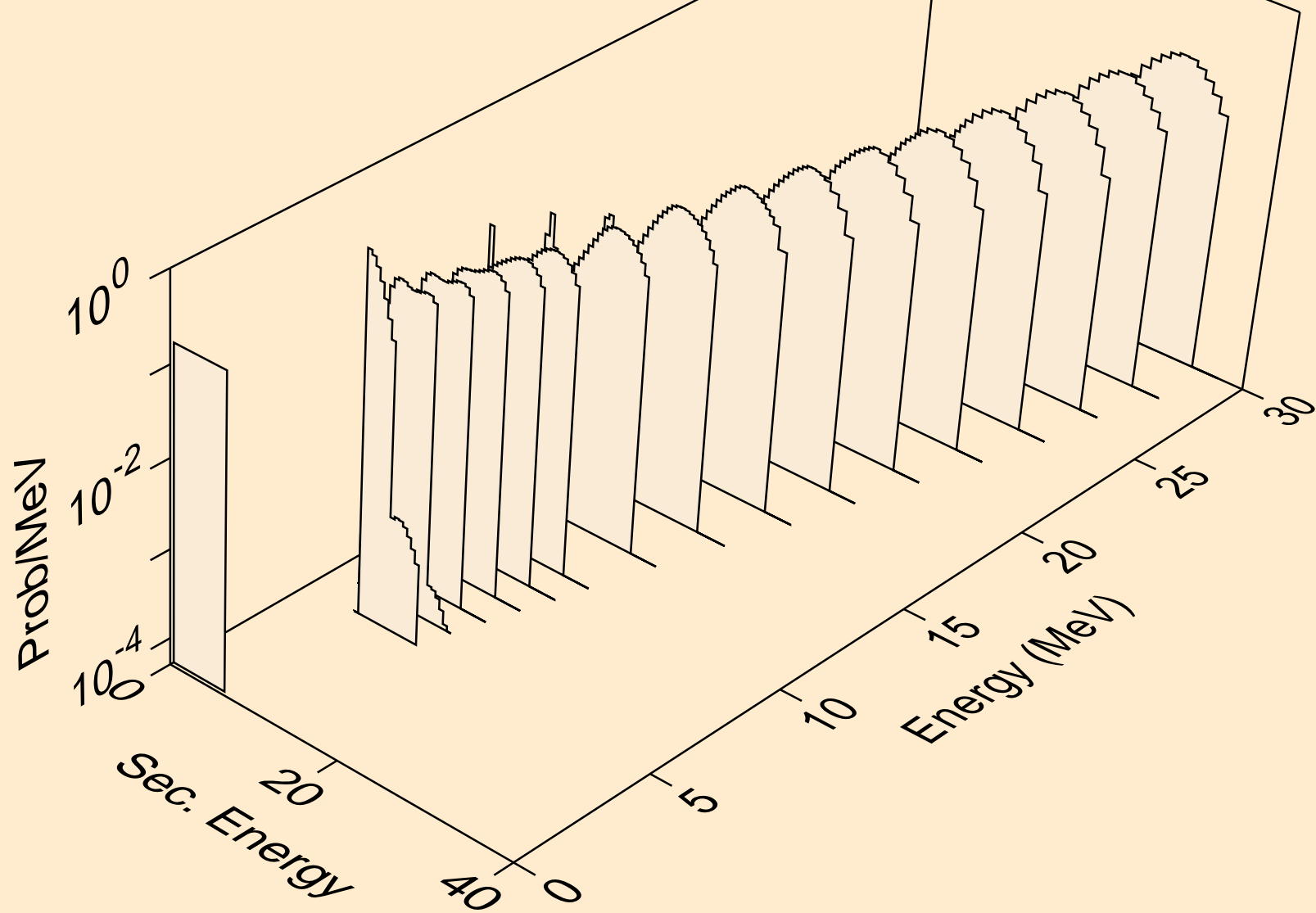

TB144M HELION ACER TENDL-2021 LIBRARY; T=0.K  
protons from (s,2p)

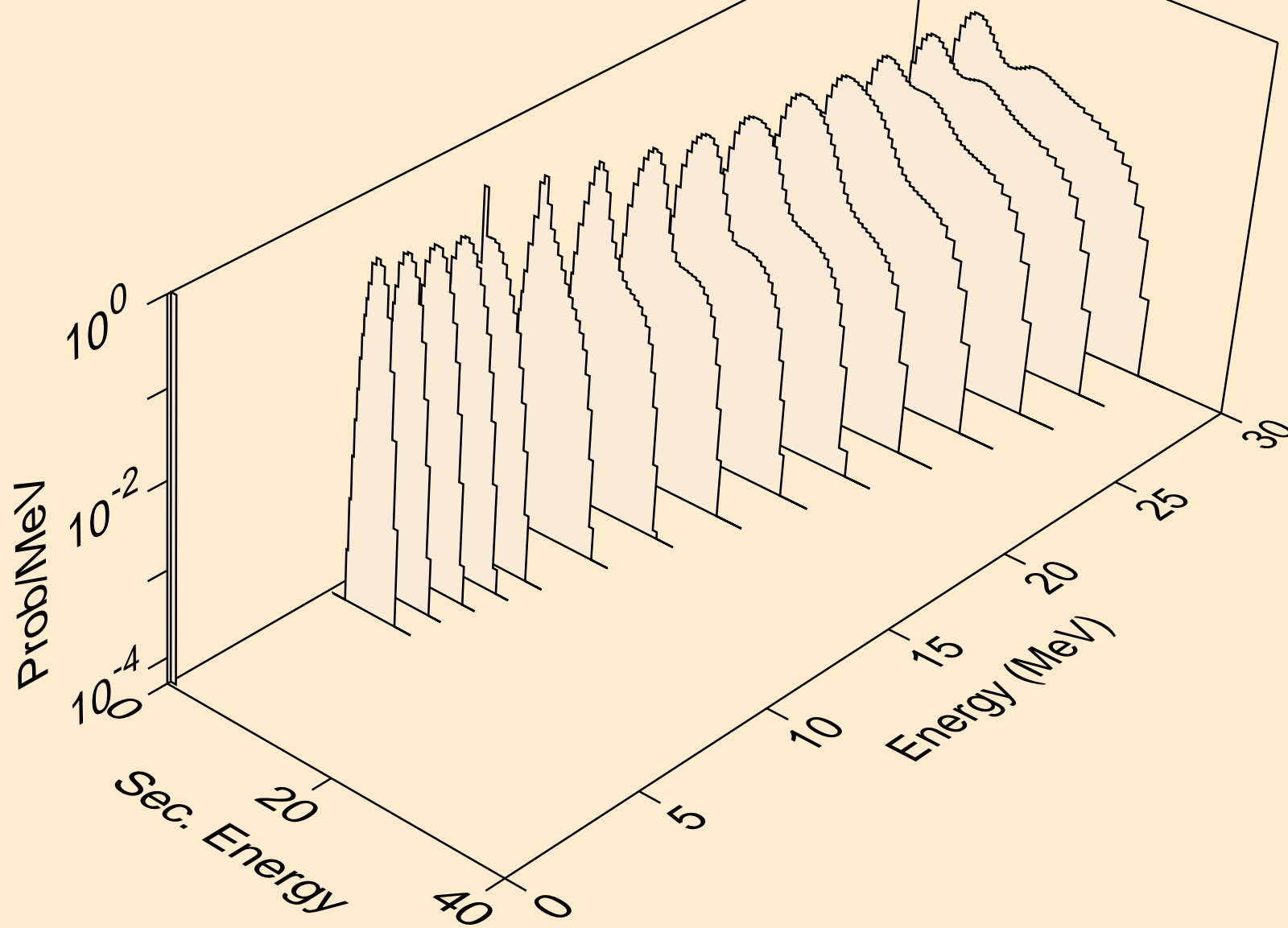

TB144M HELION ACER TENDL-2021 LIBRARY; T=0.K  
protons from (s,pa)

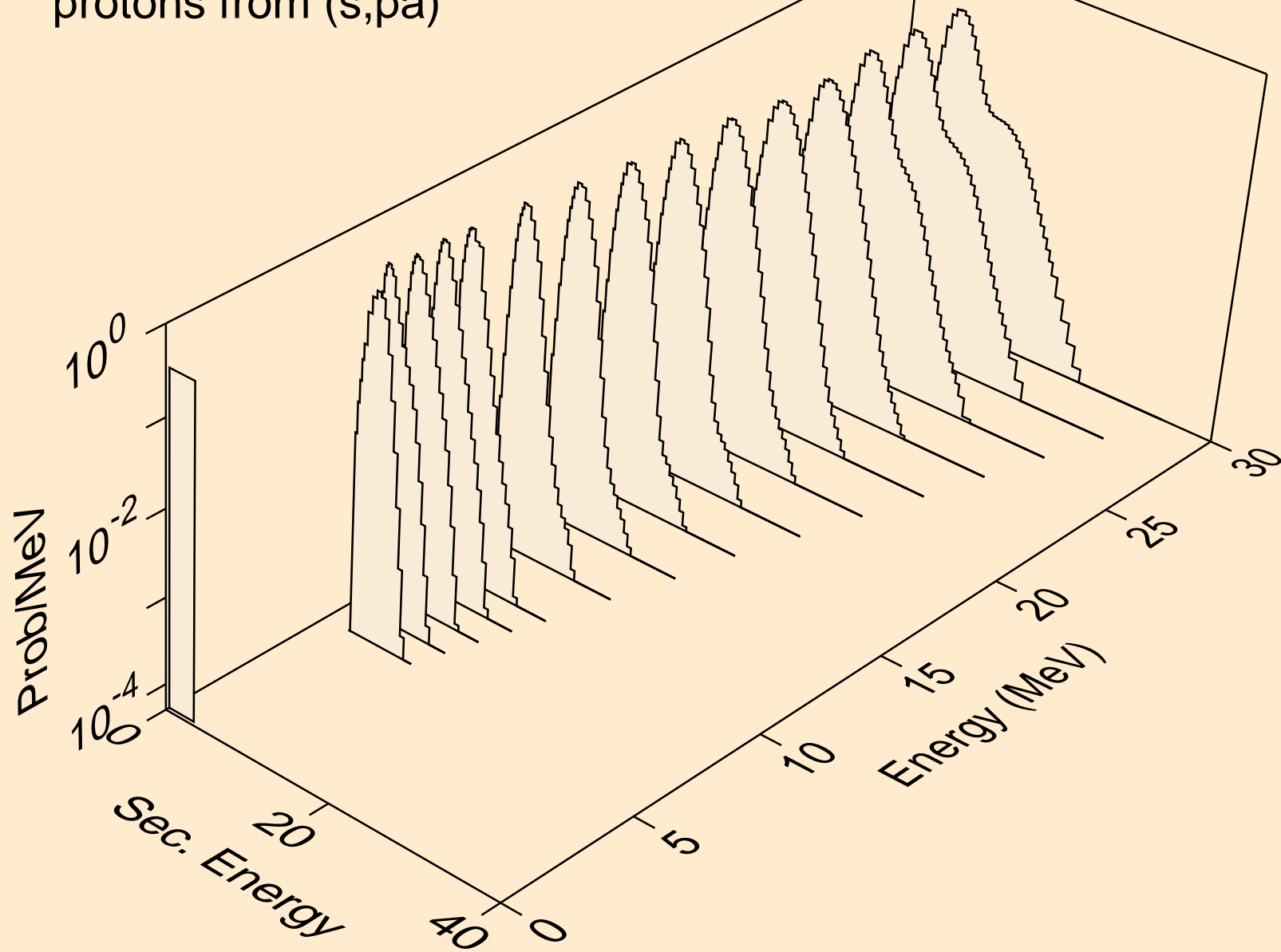

TB144M HELION ACER TENDL-2021 LIBRARY; T=0.K  
protons from (s,pd)

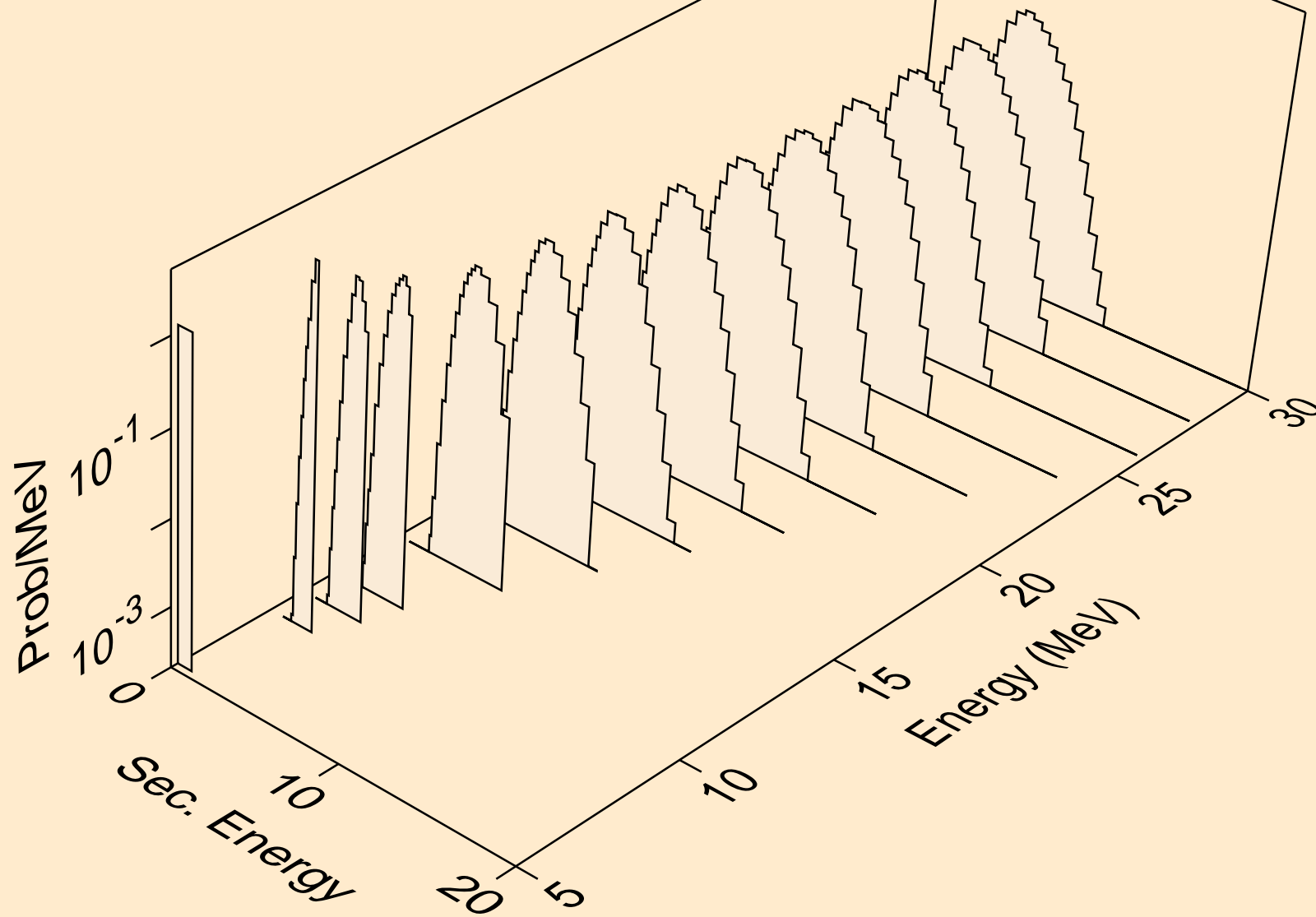

TB144M HELION ACER TENDL-2021 LIBRARY; T=0.K  
protons from (s,pt)

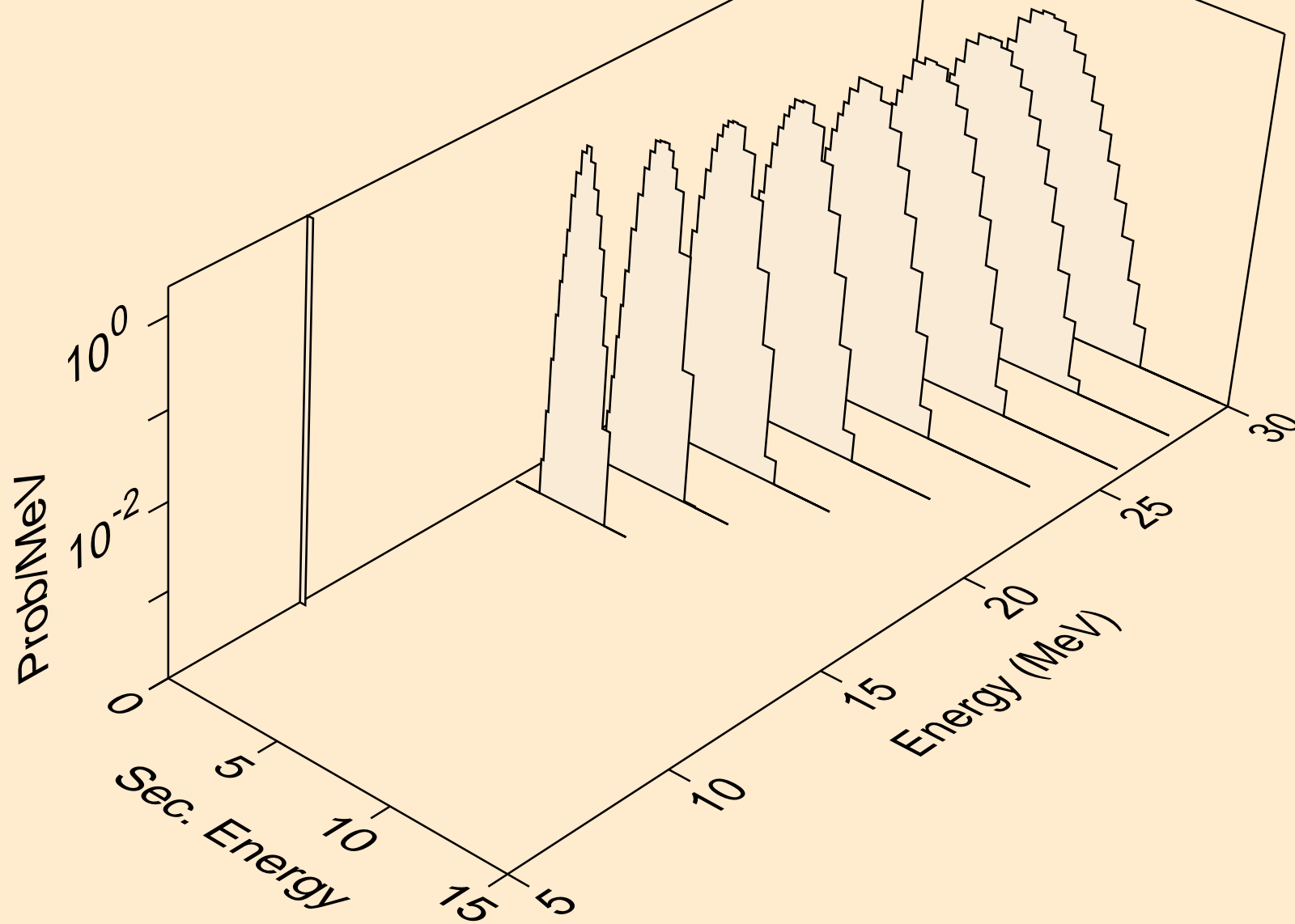

TB144M HELION ACER TENDL-2021 LIBRARY; T=0.K  
deuterons from (s,x)

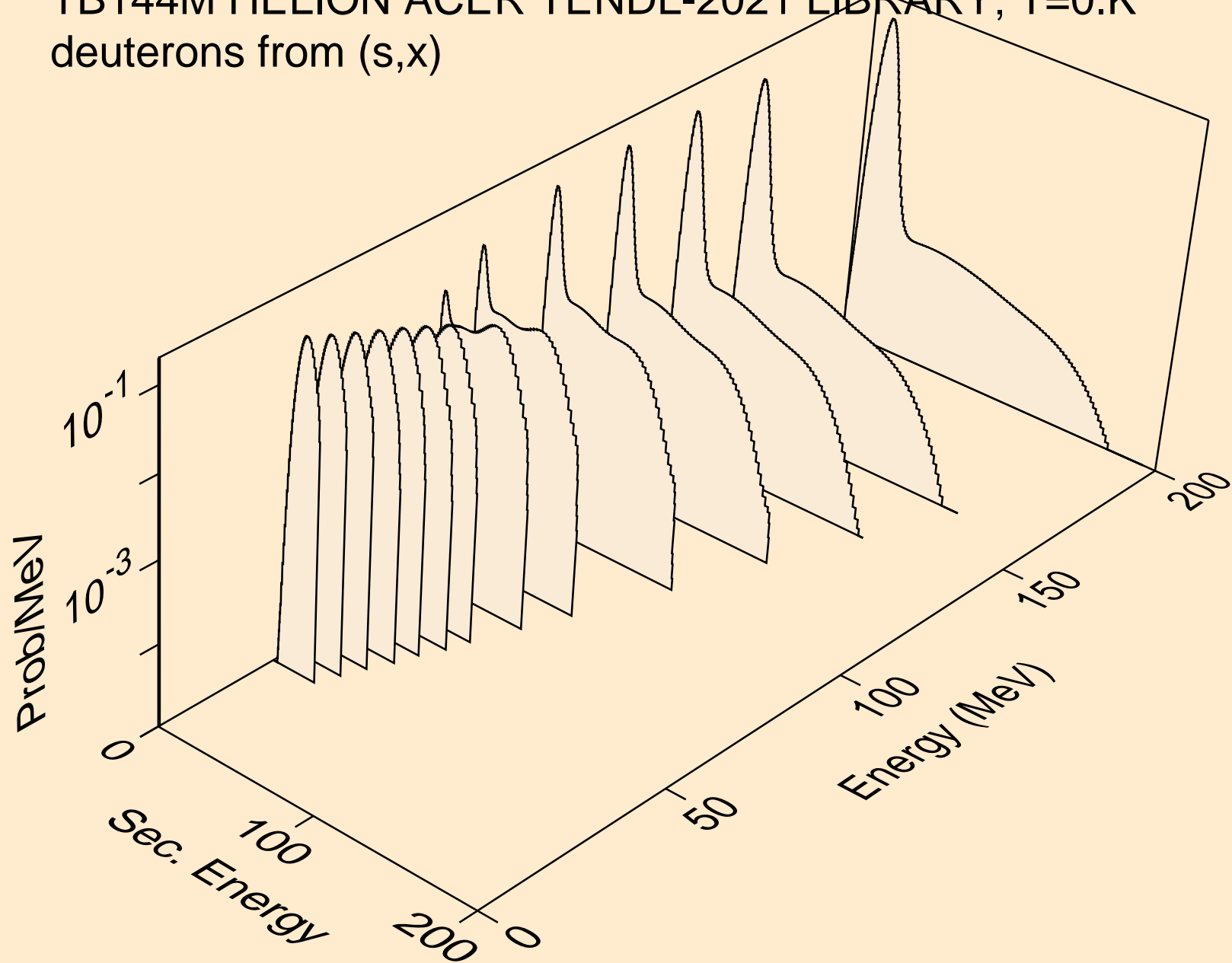



TB144M HELION ACER TENDL-2021 LIBRARY; T=0.K  
deuterons from (s,2nd)

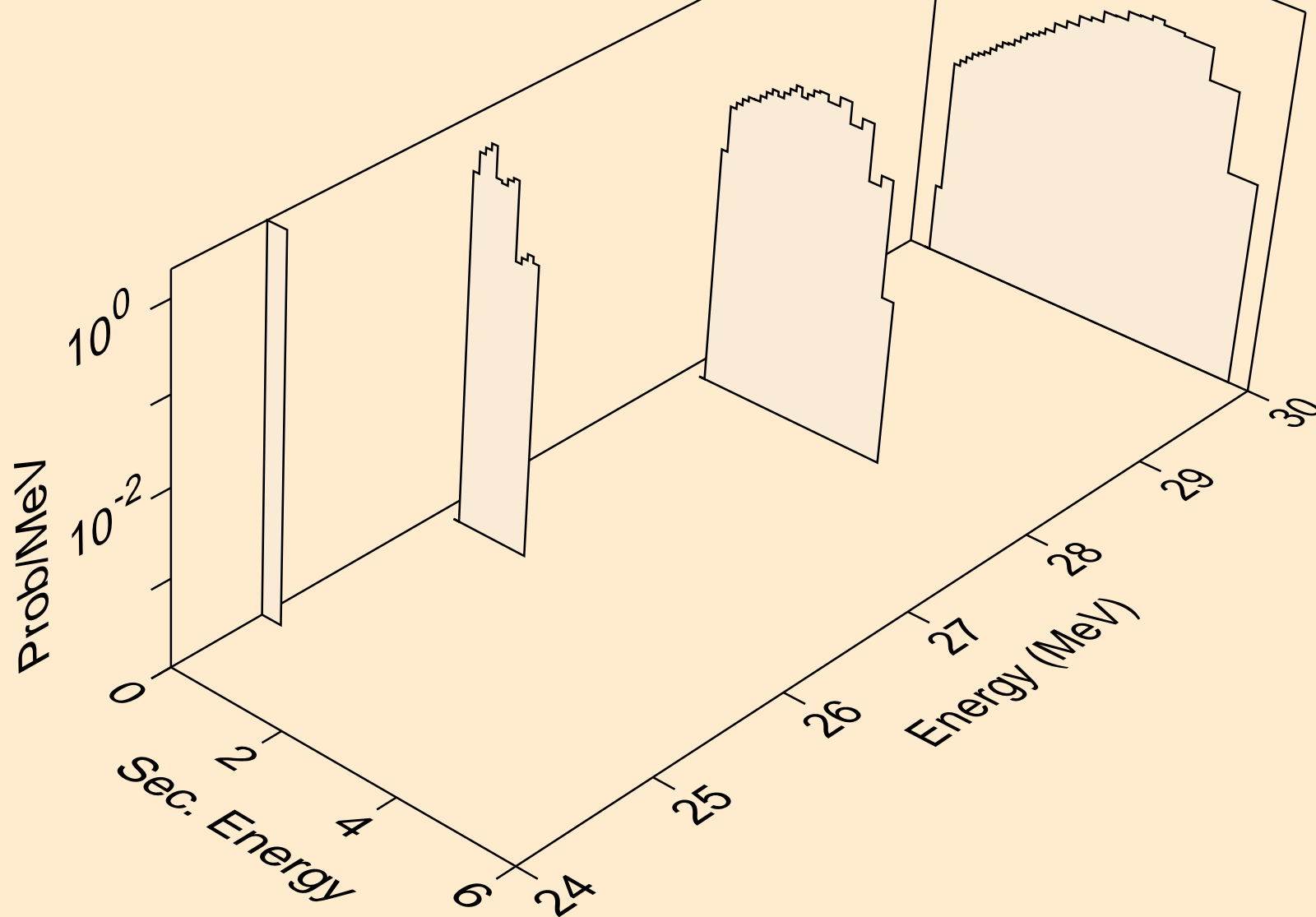

TB144M HELION ACER TENDL-2021 LIBRARY; T=0.K  
deuterons from (s,n\*)d

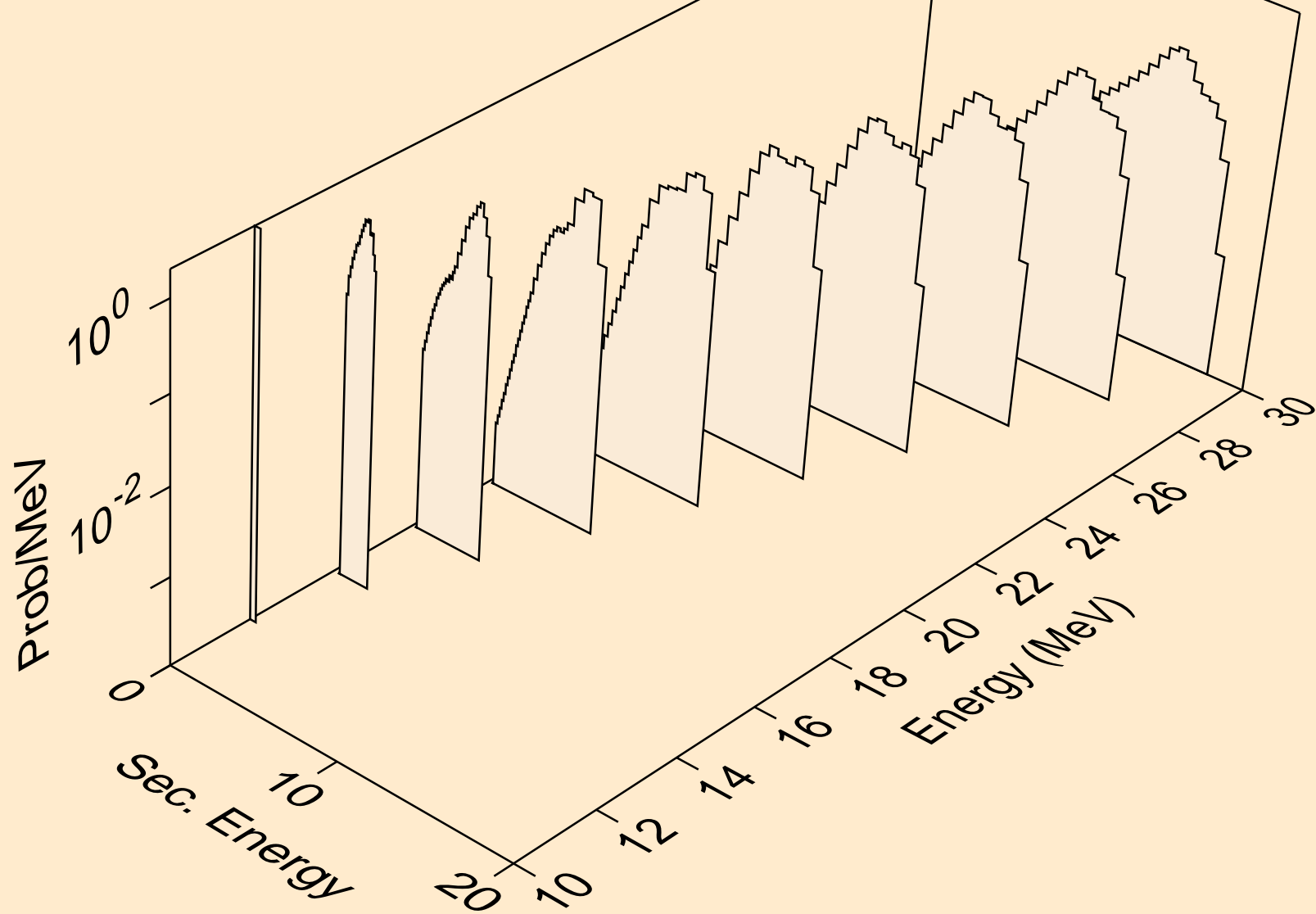

TB144M HELION ACER TENDL-2021 LIBRARY; T=0.K  
deuterons from (s,d)

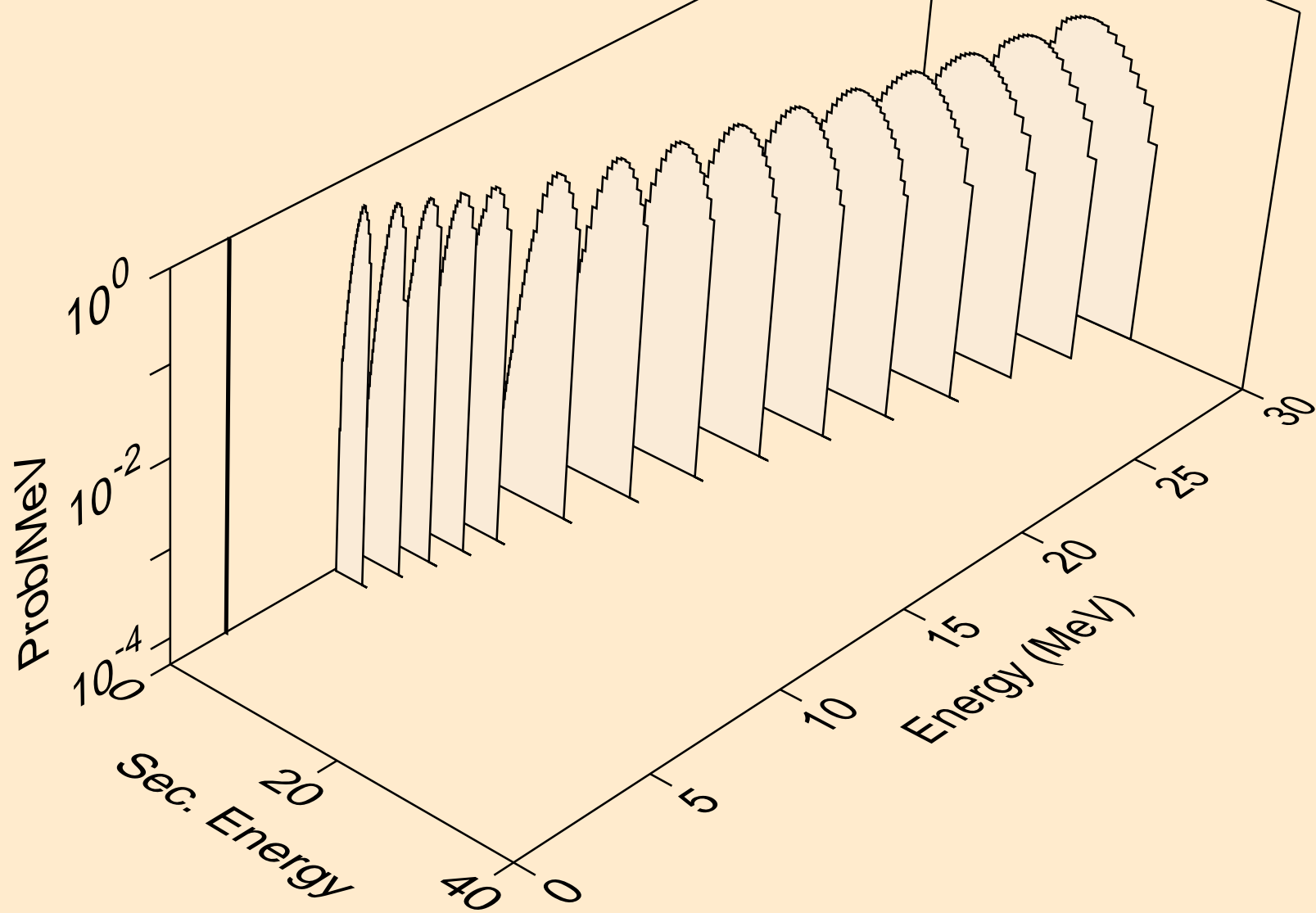

TB144M HELION ACER TENDL-2021 LIBRARY; T=0.K  
deuterons from (s,pd)

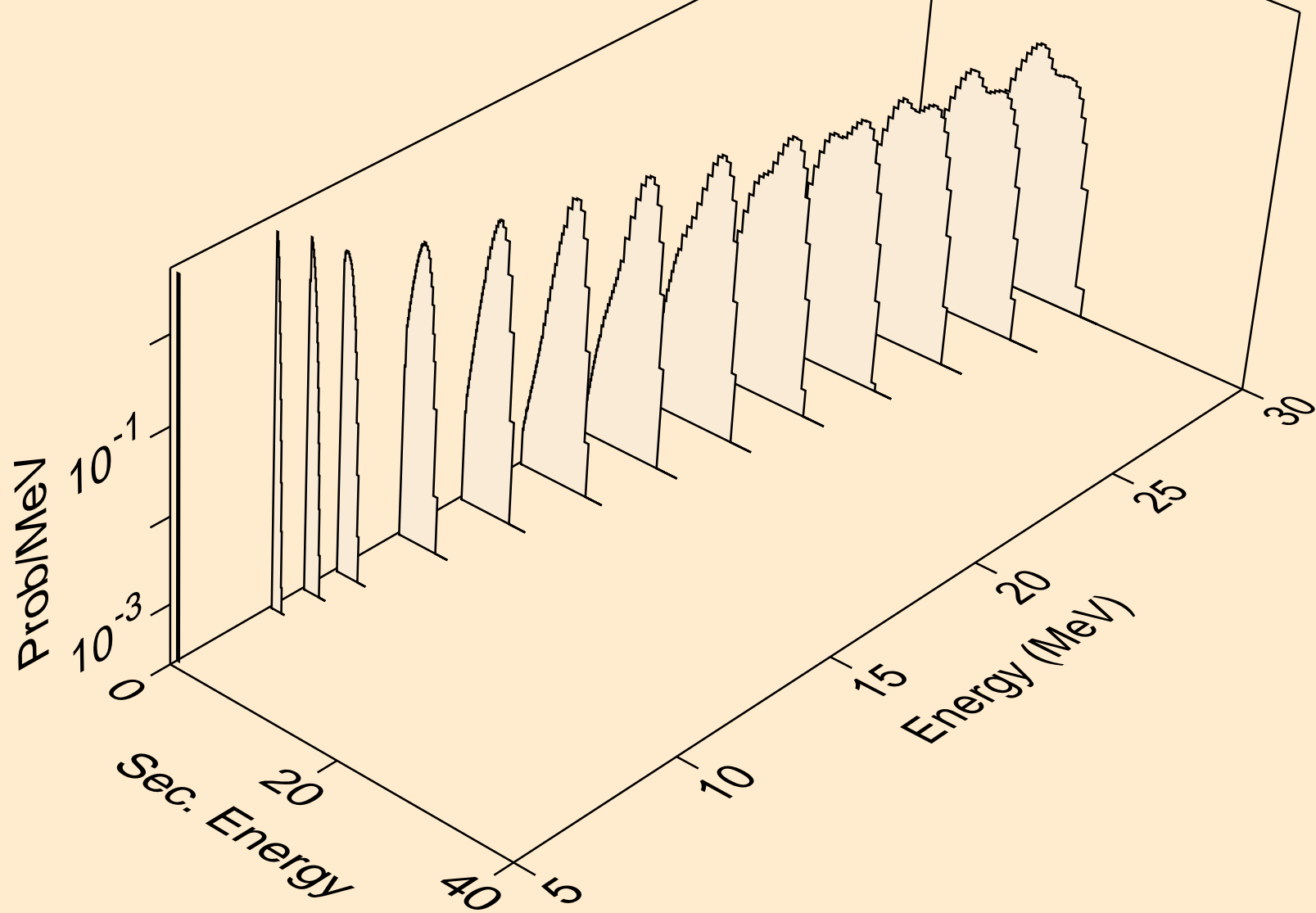

TB144M HELION ACER TENDL-2021 LIBRARY; T=0.K  
deuterons from (s,da)

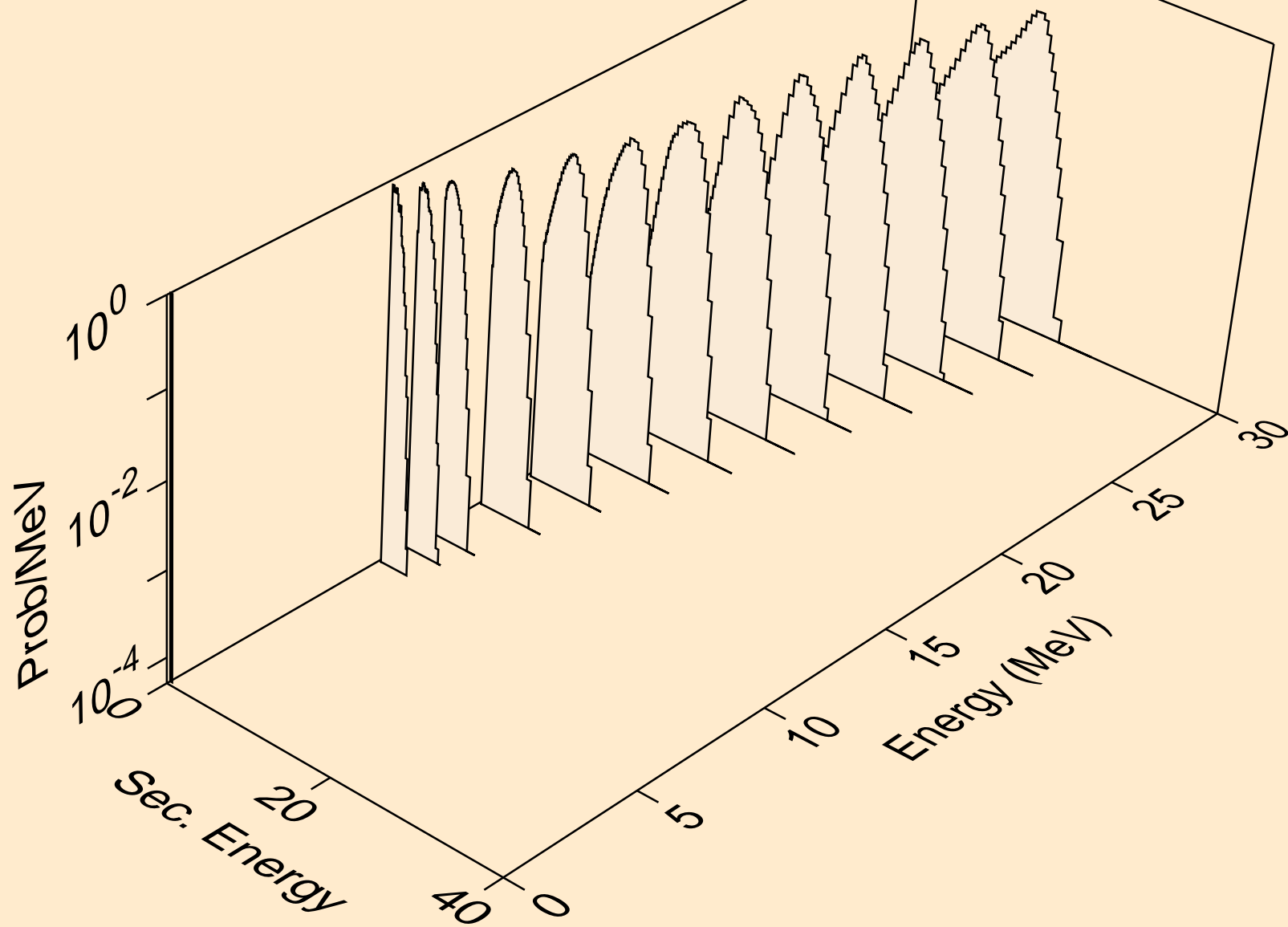

TB144M HELION ACER TENDL-2021 LIBRARY; T=0.K  
tritons from (s,x)

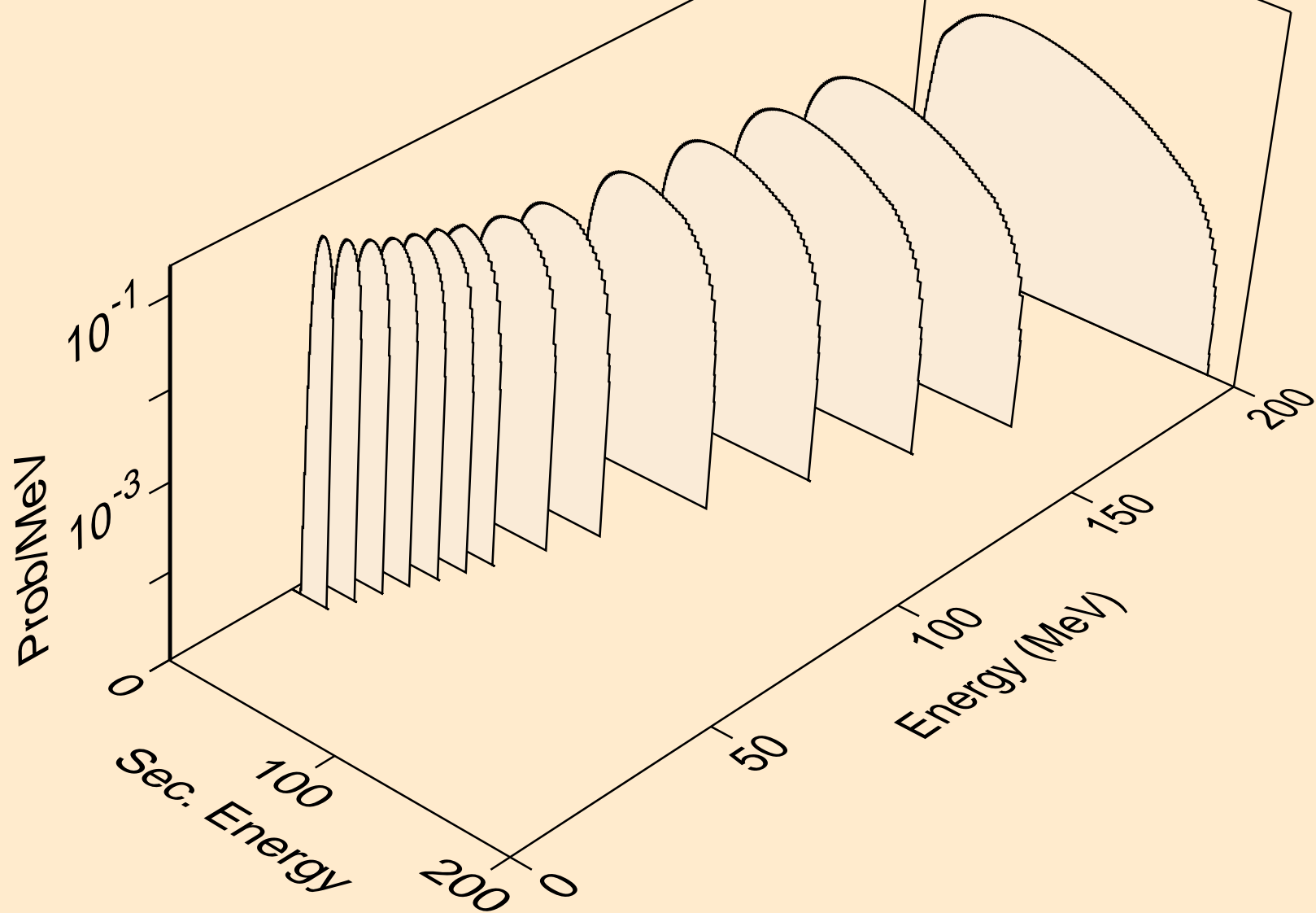

TB144M HELION ACER TENDL-2021 LIBRARY; T=0.K  
tritons from (s,n\*)t

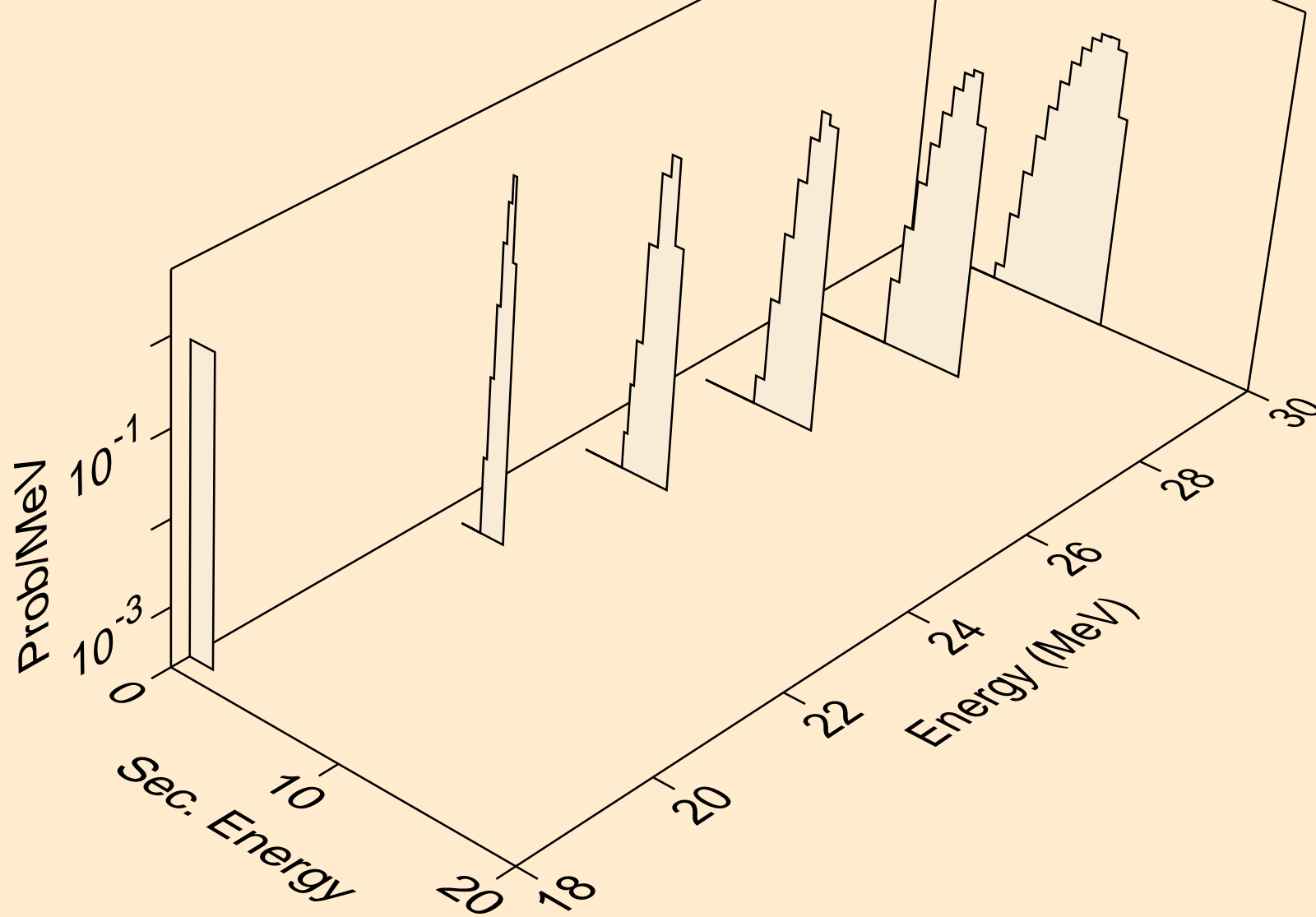

TB144M HELION ACER TENDL-2021 LIBRARY; T=0.K  
tritons from (s,t)

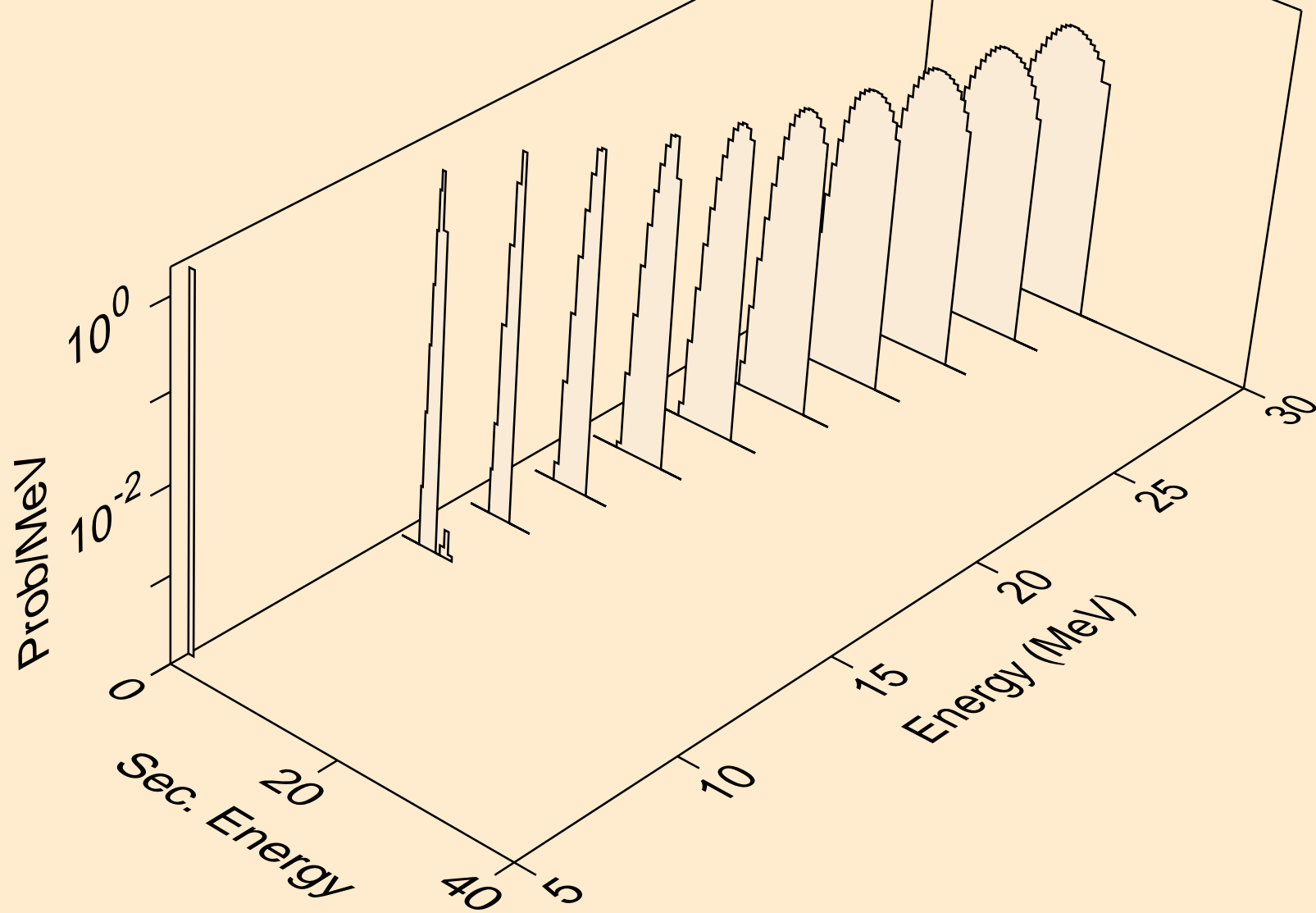



TB144M HELION ACER TENDL-2021 LIBRARY; T=0.K  
tritons from (s,pt)

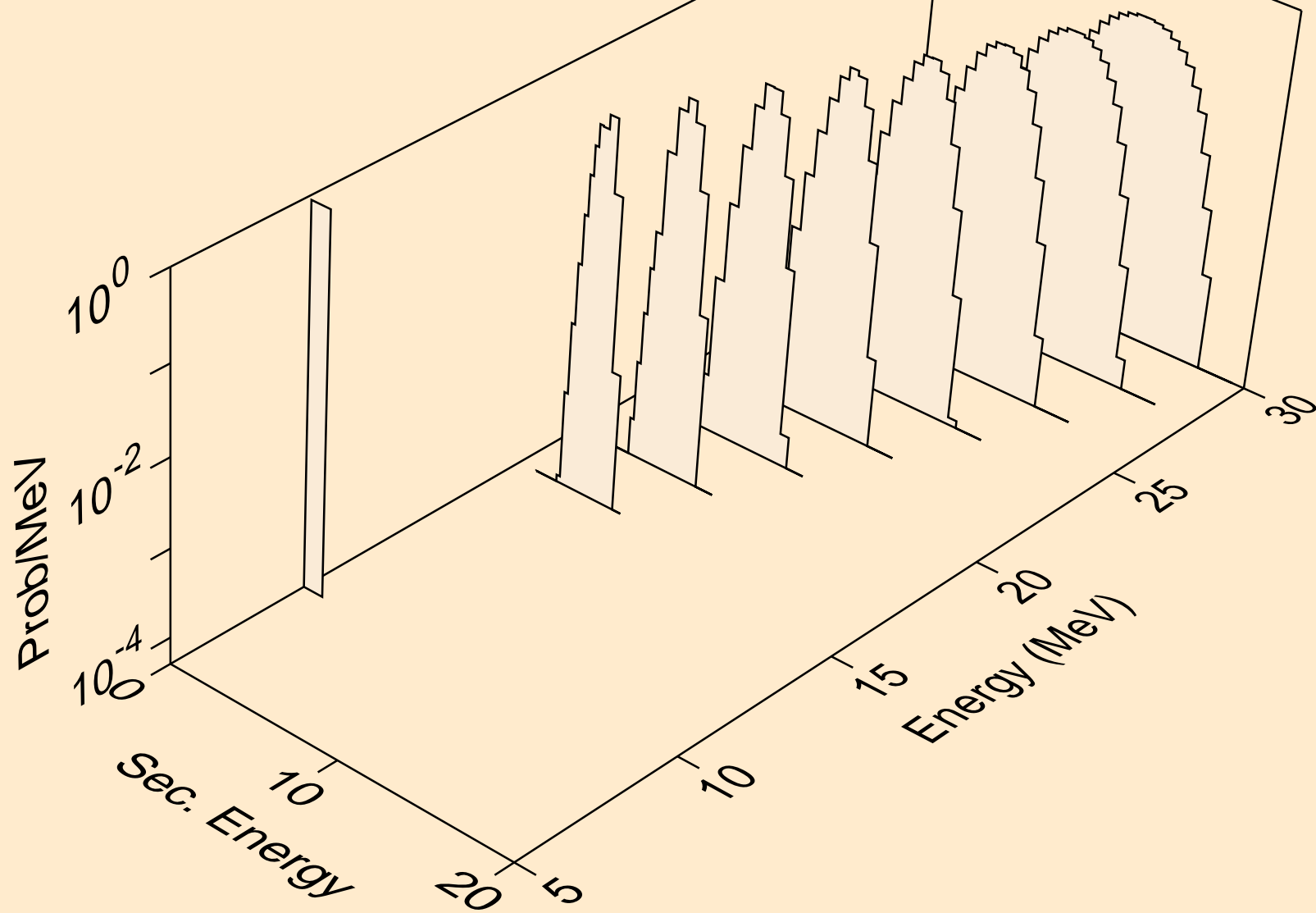

TB144M HELION ACER TENDL-2021 LIBRARY; T=0.K  
alphas from (s,x)

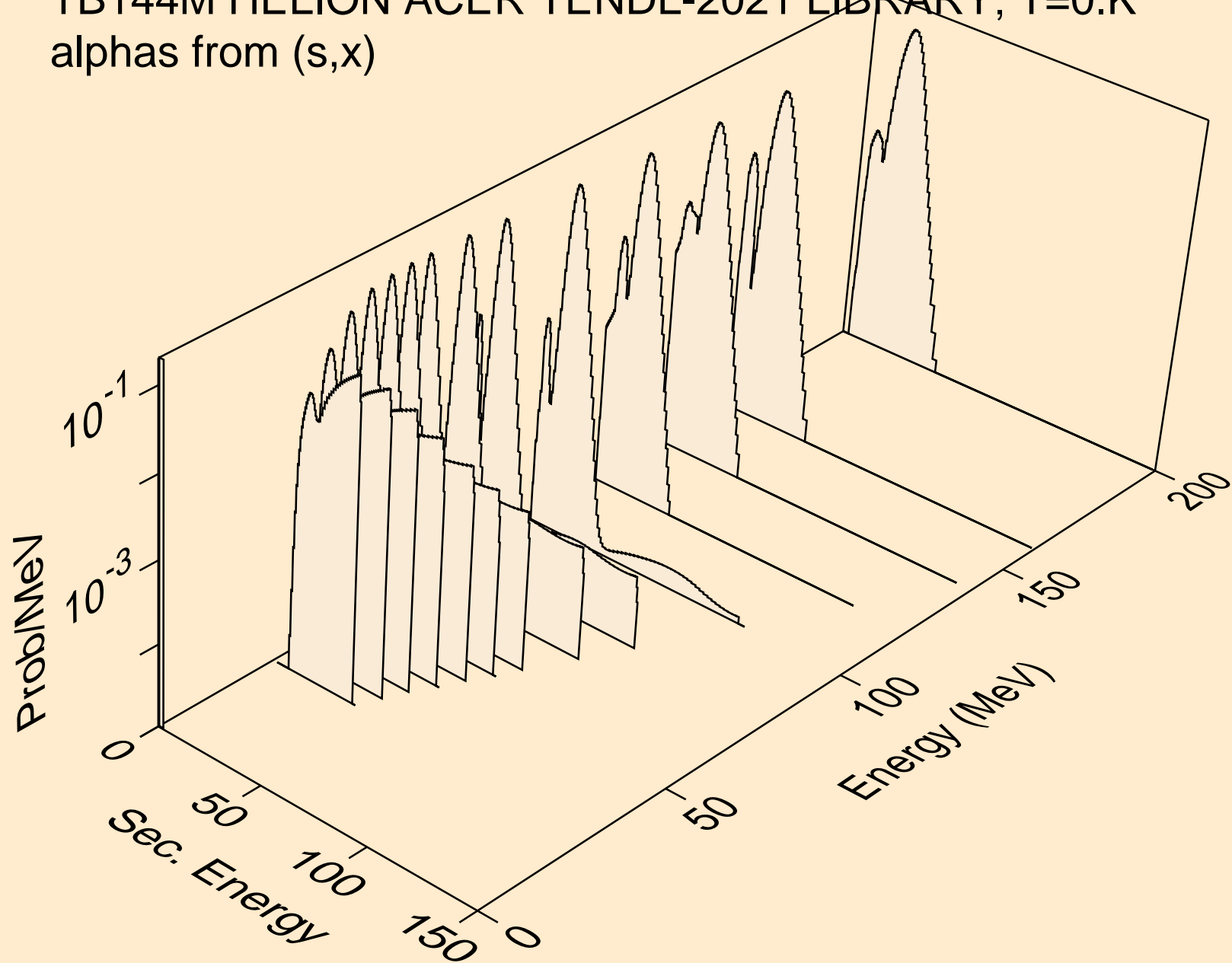

TB144M HELION ACER TENDL-2021 LIBRARY; T=0.K  
alphas from (s,n\*)a

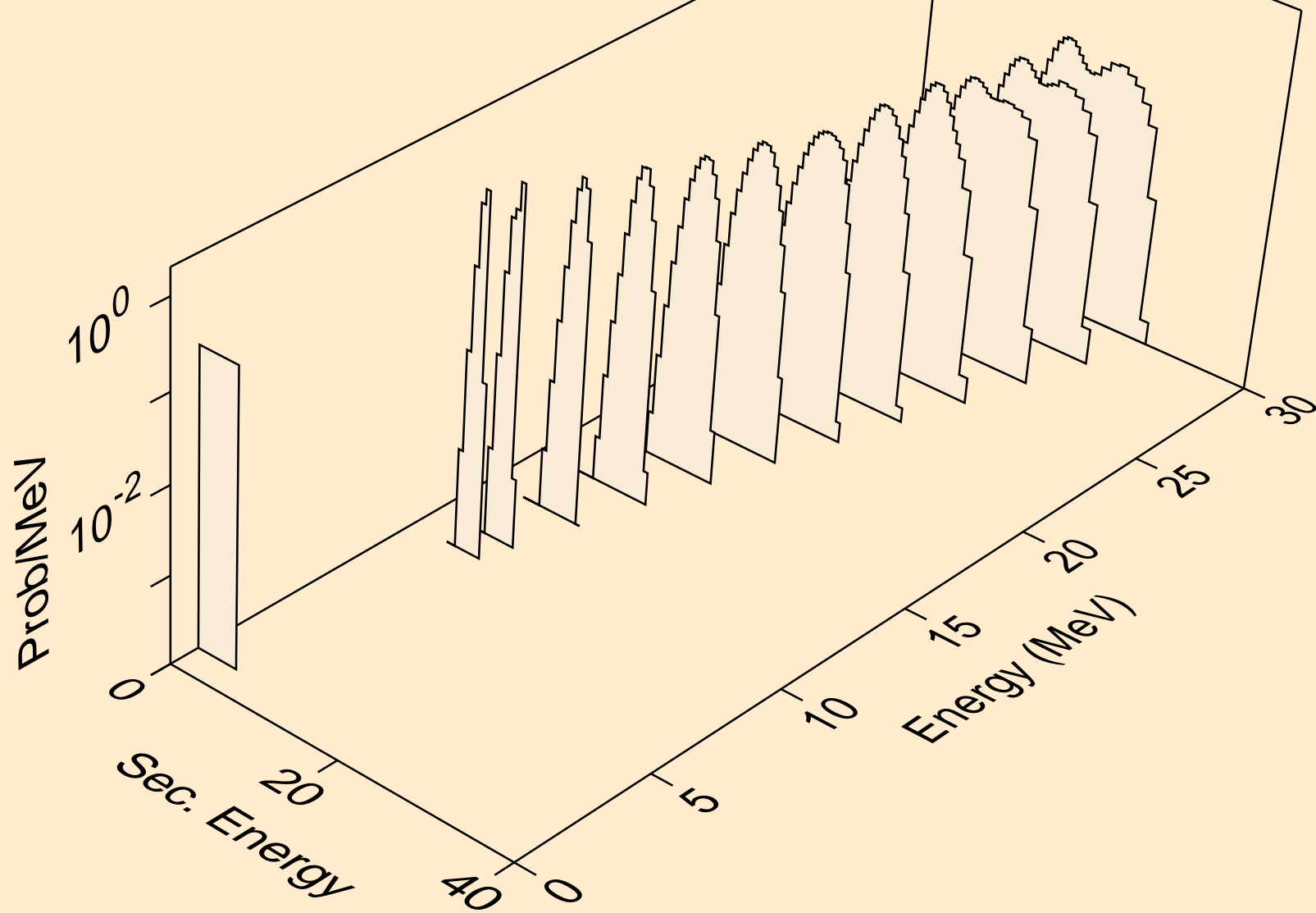

TB144M HELION ACER TENDL-2021 LIBRARY; T=0.K  
alphas from (s,2n)a

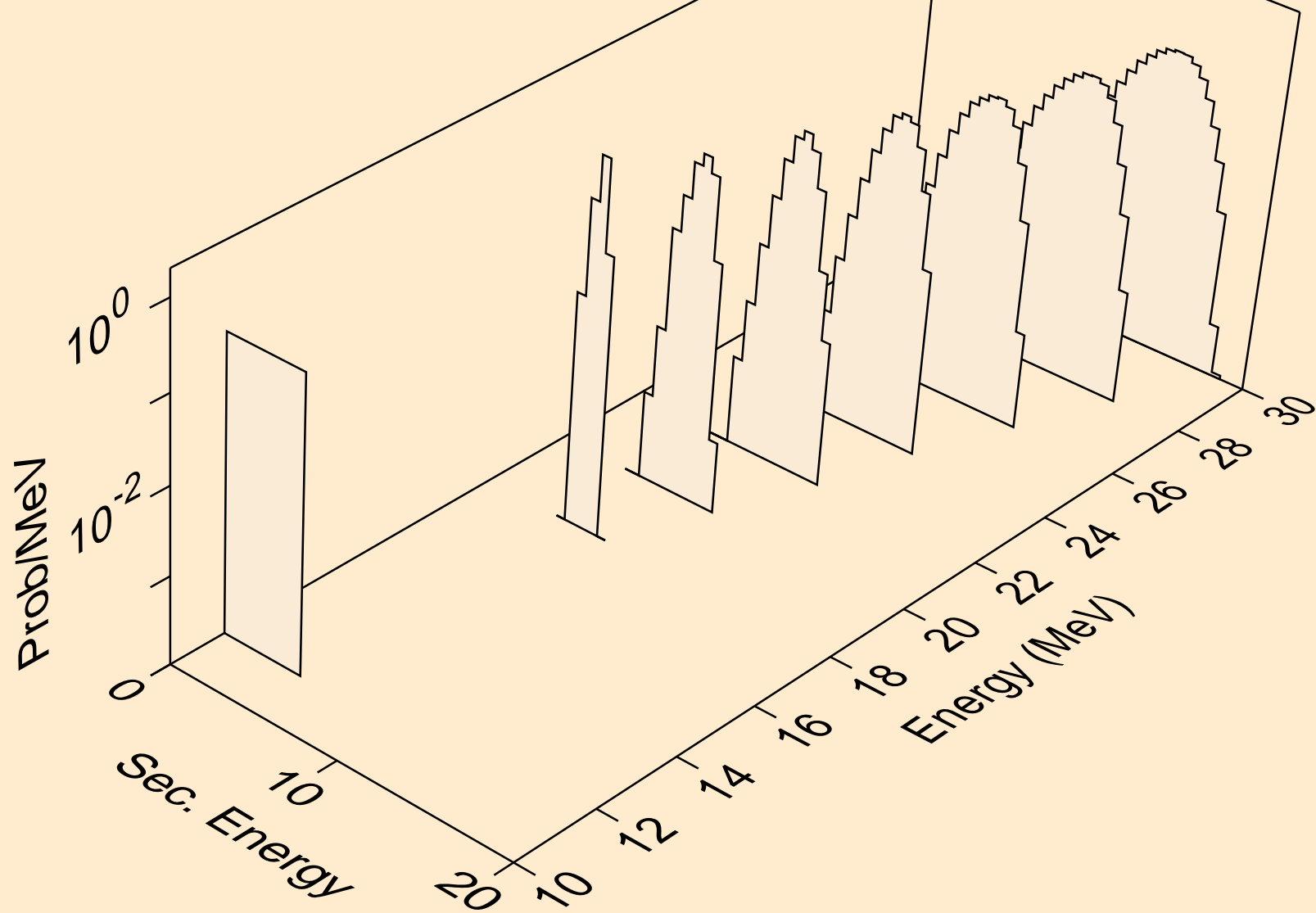

TB144M HELION ACER TENDL-2021 LIBRARY; T=0.K  
alphas from (s,n\*)2a

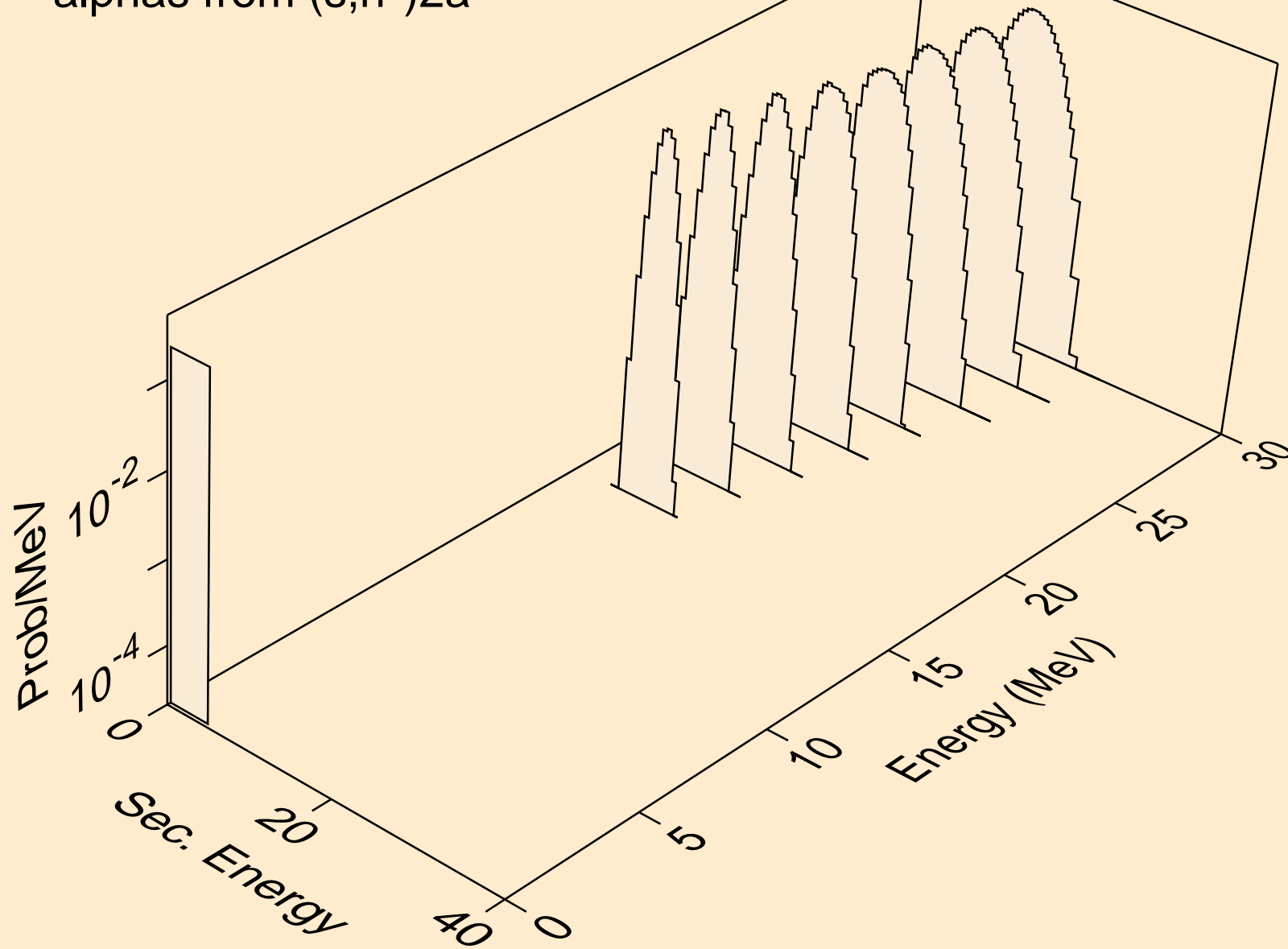

TB144M HELION ACER TENDL-2021 LIBRARY; T=0.K  
alphas from (s,npa)

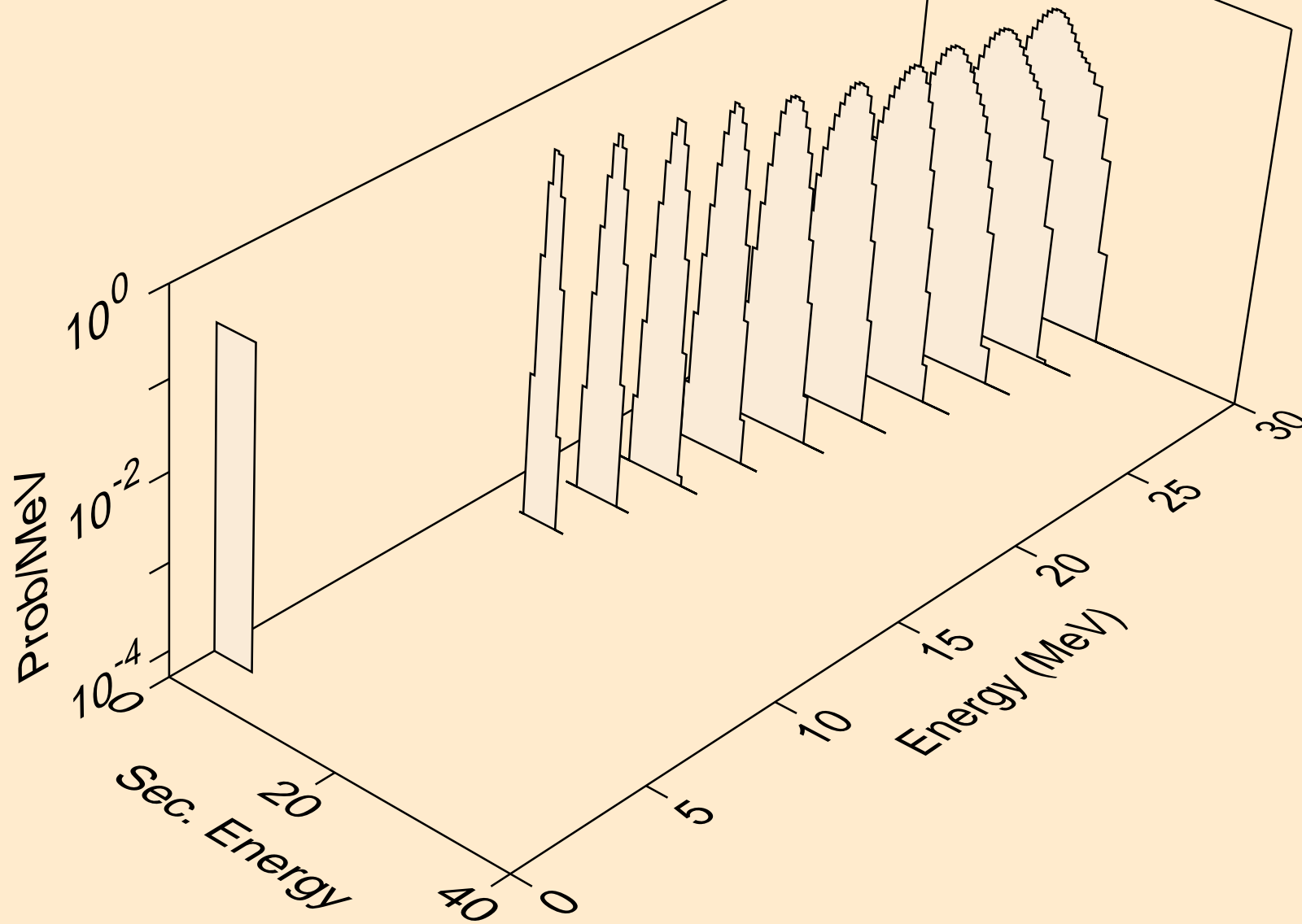

TB144M HELION ACER TENDL-2021 LIBRARY; T=0.K  
alphas from (s,a)

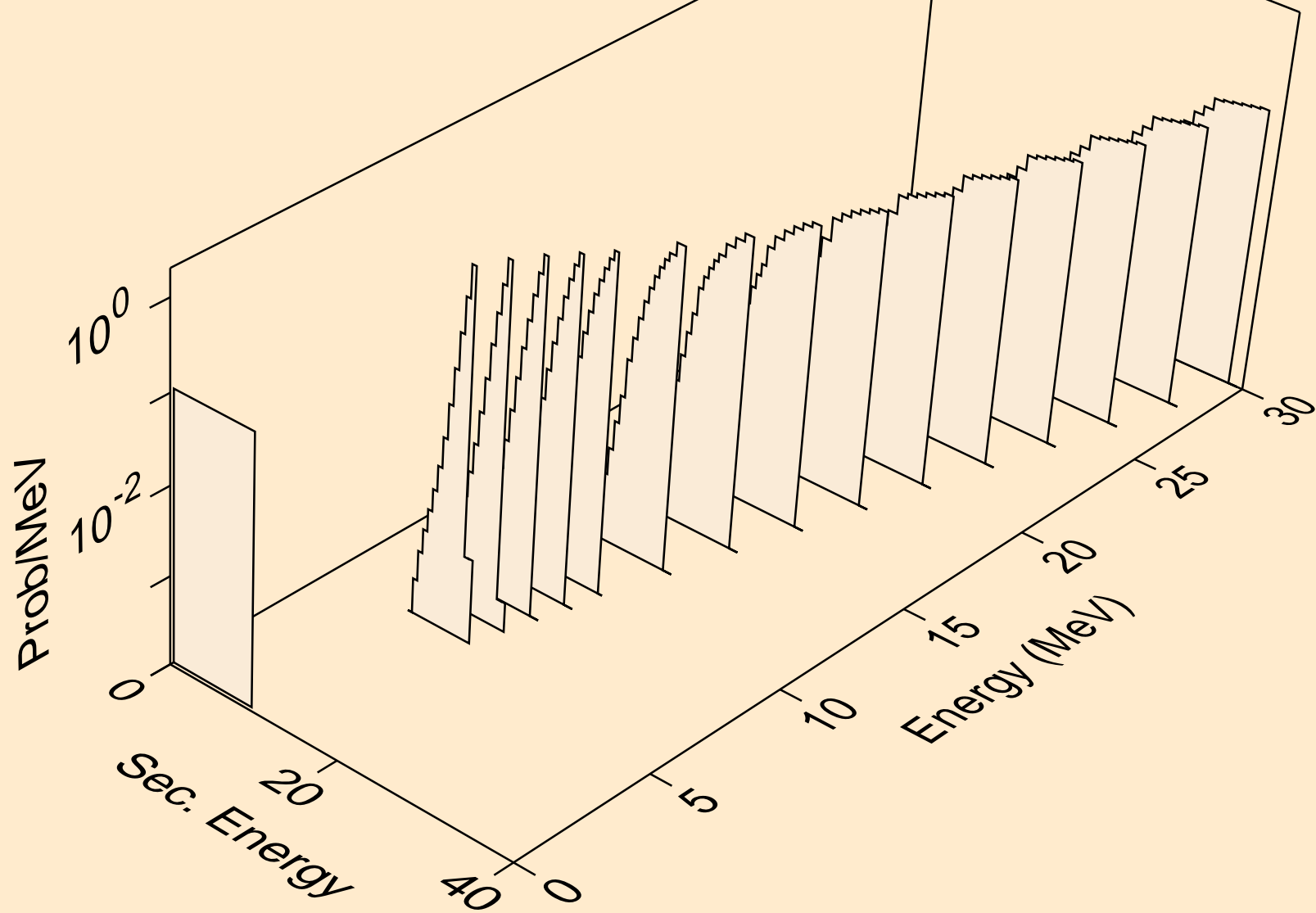

TB144M HELION ACER TENDL-2021 LIBRARY; T=0.K  
alphas from (s,2a)

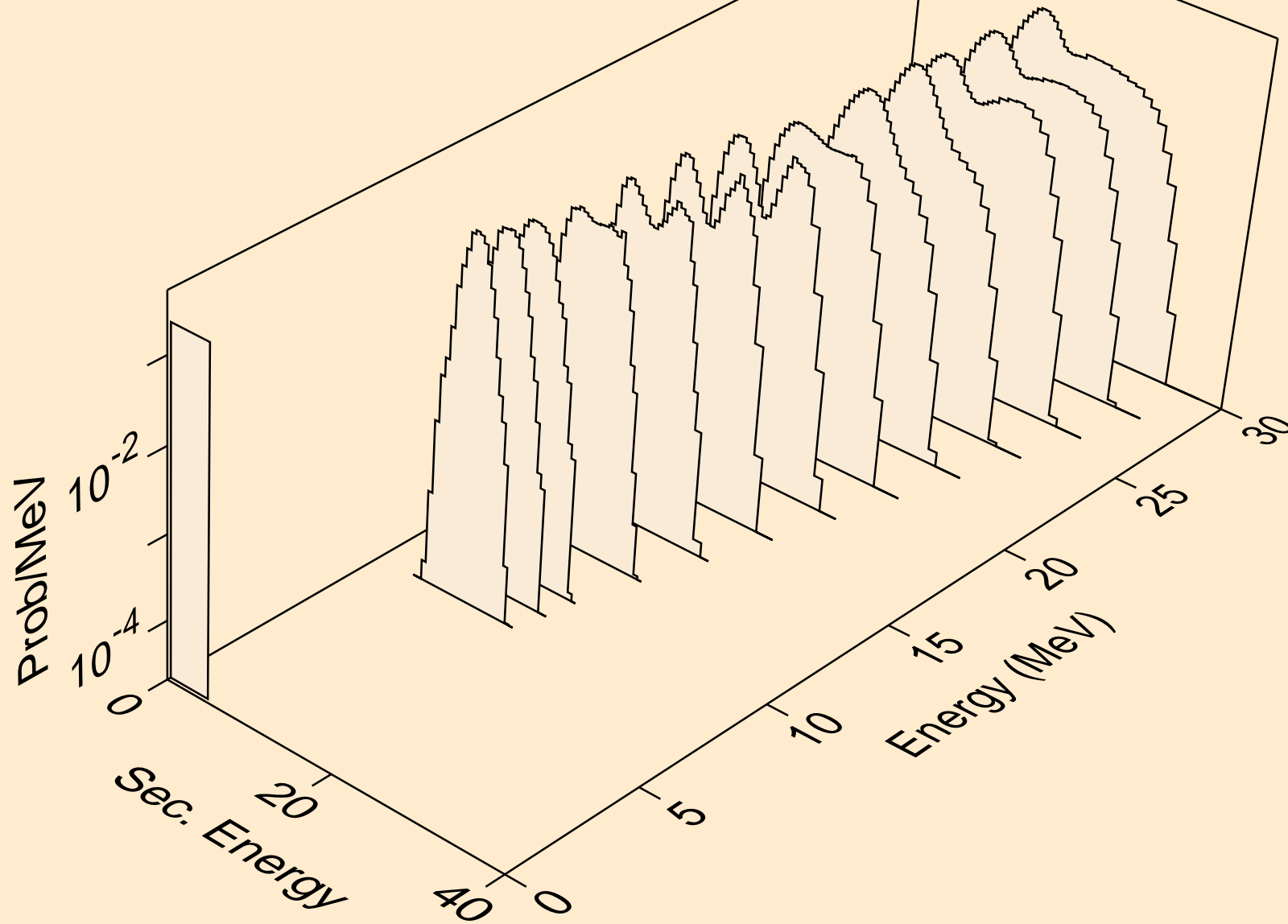



TB144M HELION ACER TENDL-2021 LIBRARY; T=0.K  
alphas from (s,pa)

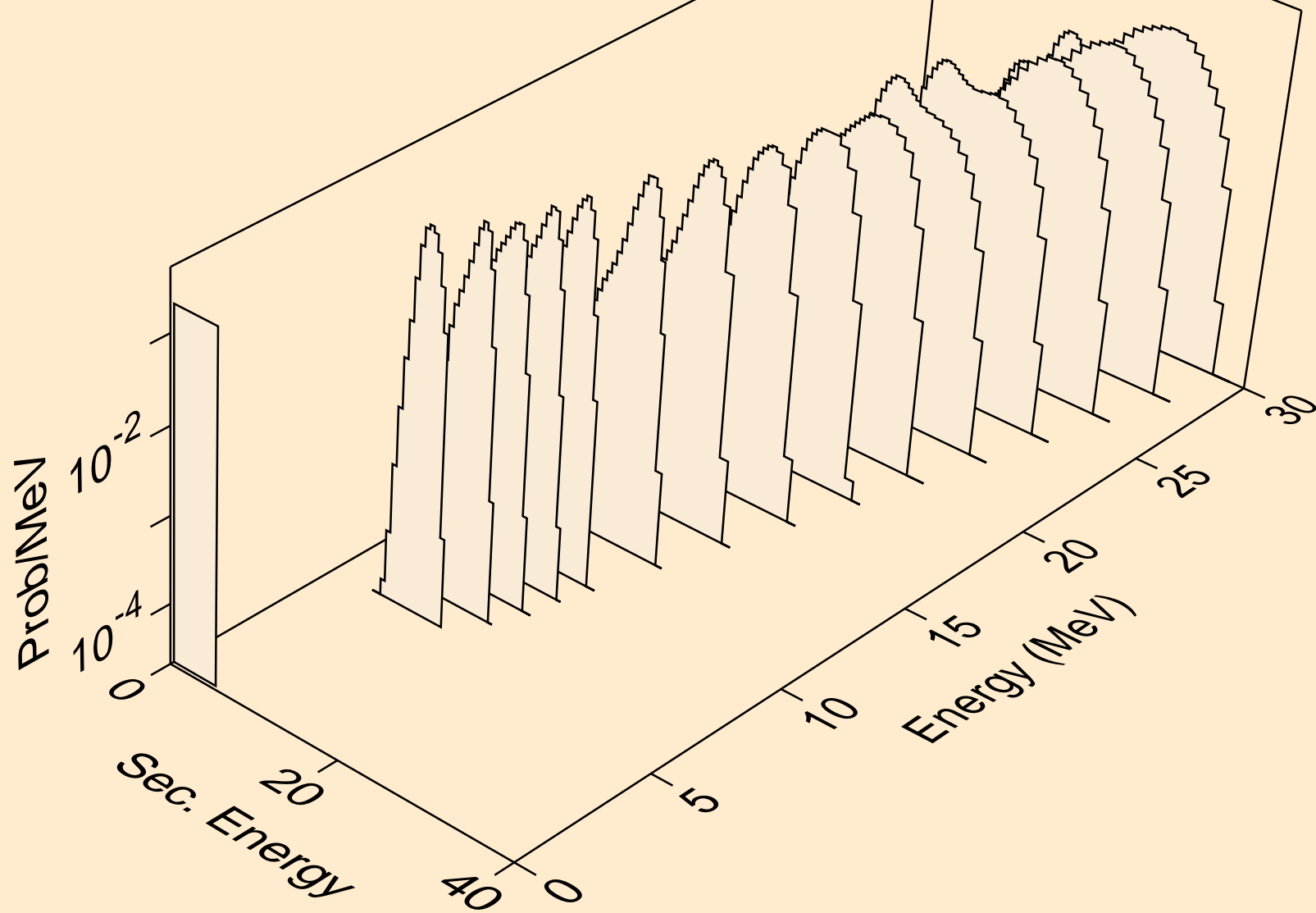

TB144M HELION ACER TENDL-2021 LIBRARY; T=0.K  
alphas from (s,da)

