

TB161 HELION ACER TENDL-2021 LIBRARY; T=0.K  
Principal cross sections

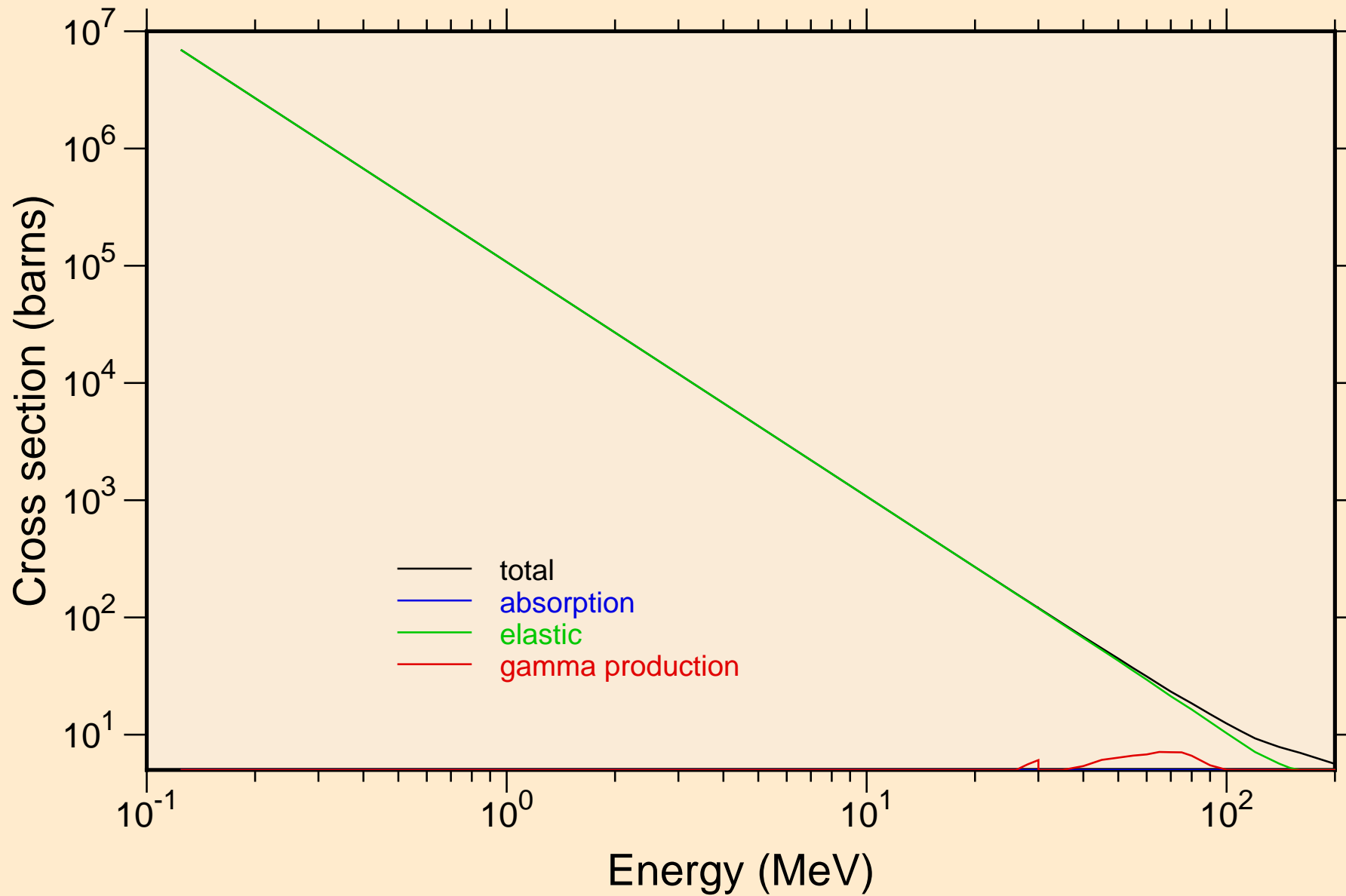

TB161 HELION ACER TENDL-2021 LIBRARY; T=0.K

Heating

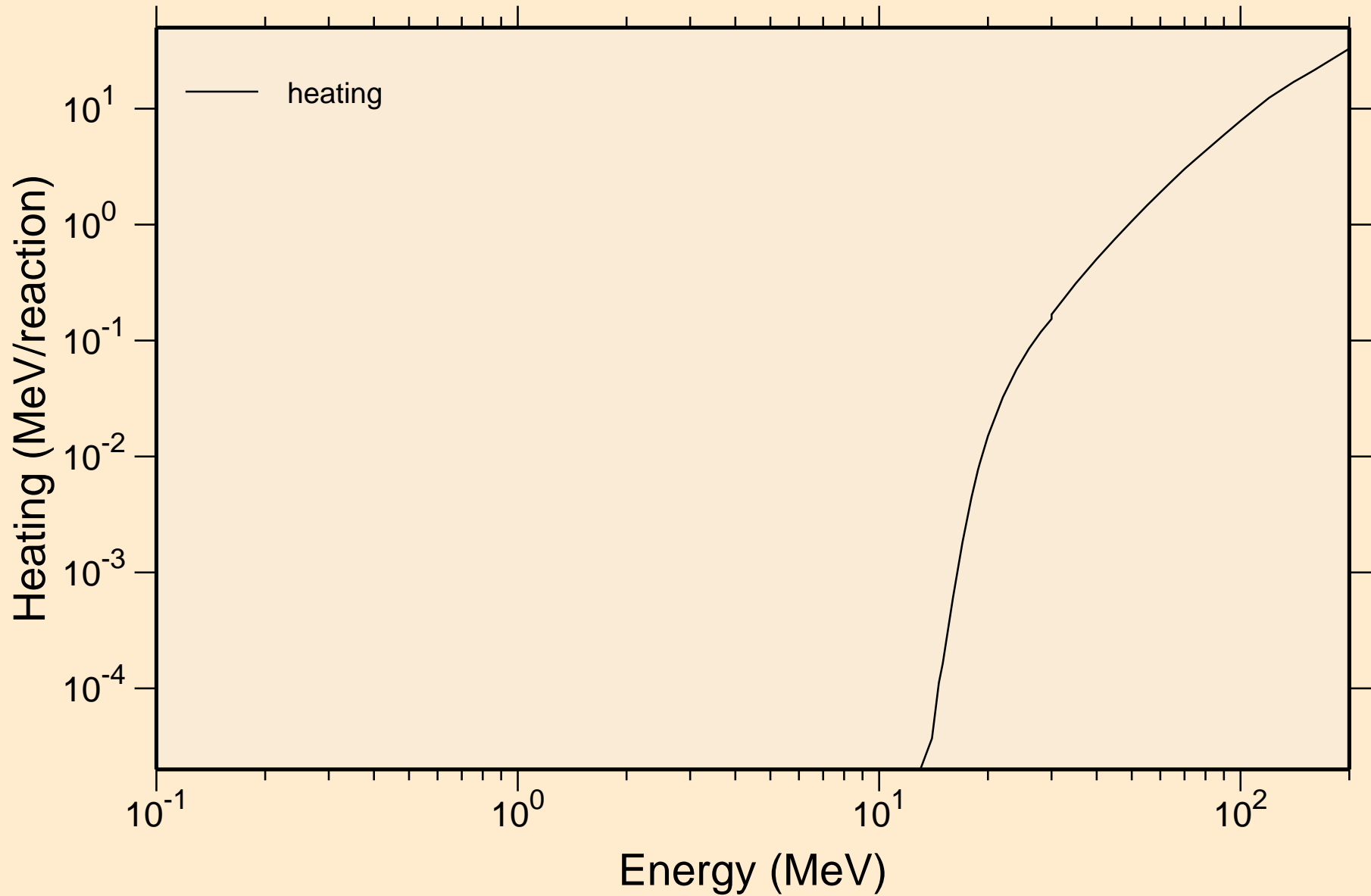

# TB161 HELION ACER TENDL-2021 LIBRARY; T=0.K

## Principal cross sections

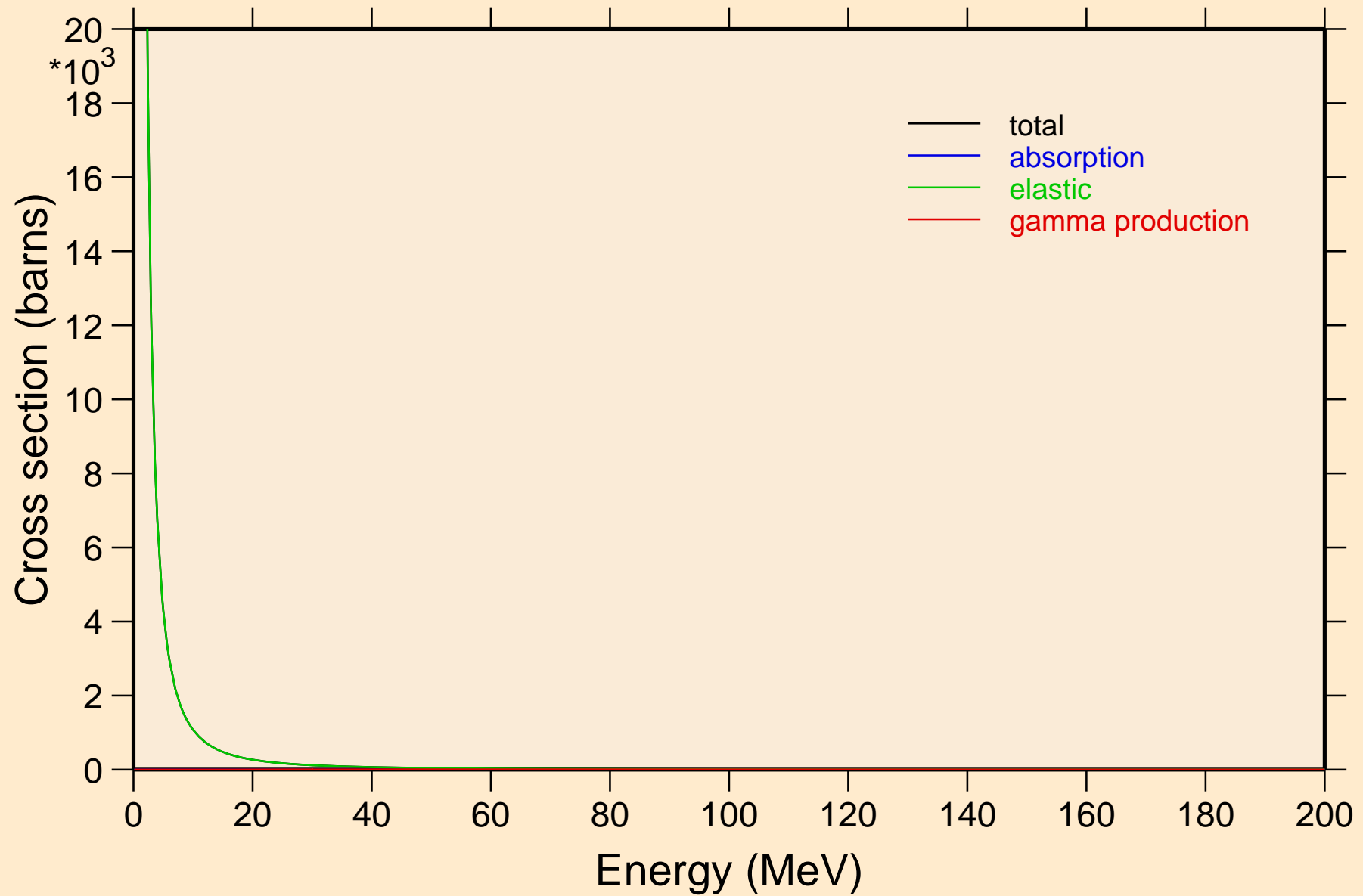

TB161 HELION ACER TENDL-2021 LIBRARY; T=0.K

Heating

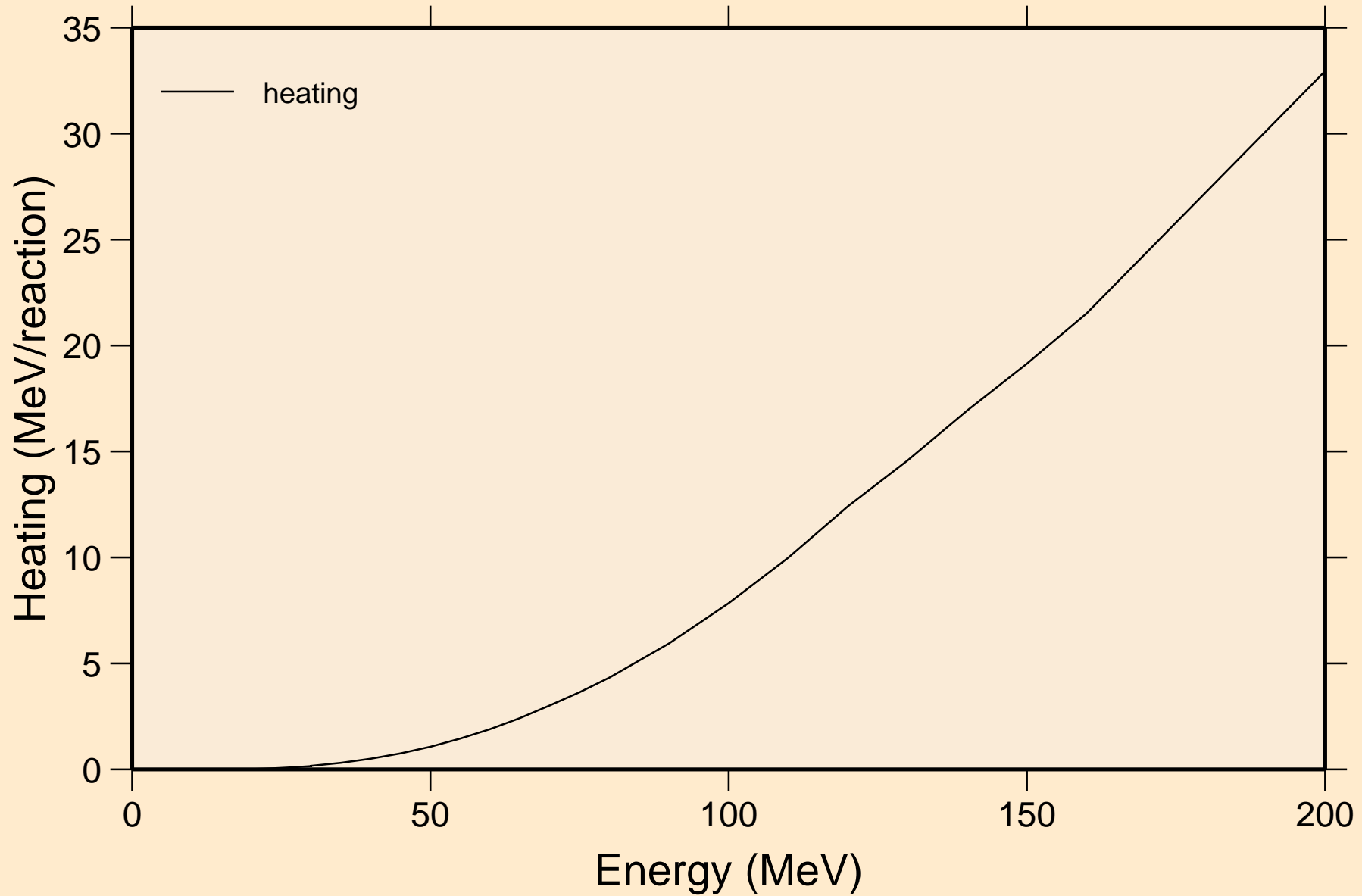

TB161 HELION ACER TENDL-2021 LIBRARY; T=0.K  
Threshold reactions

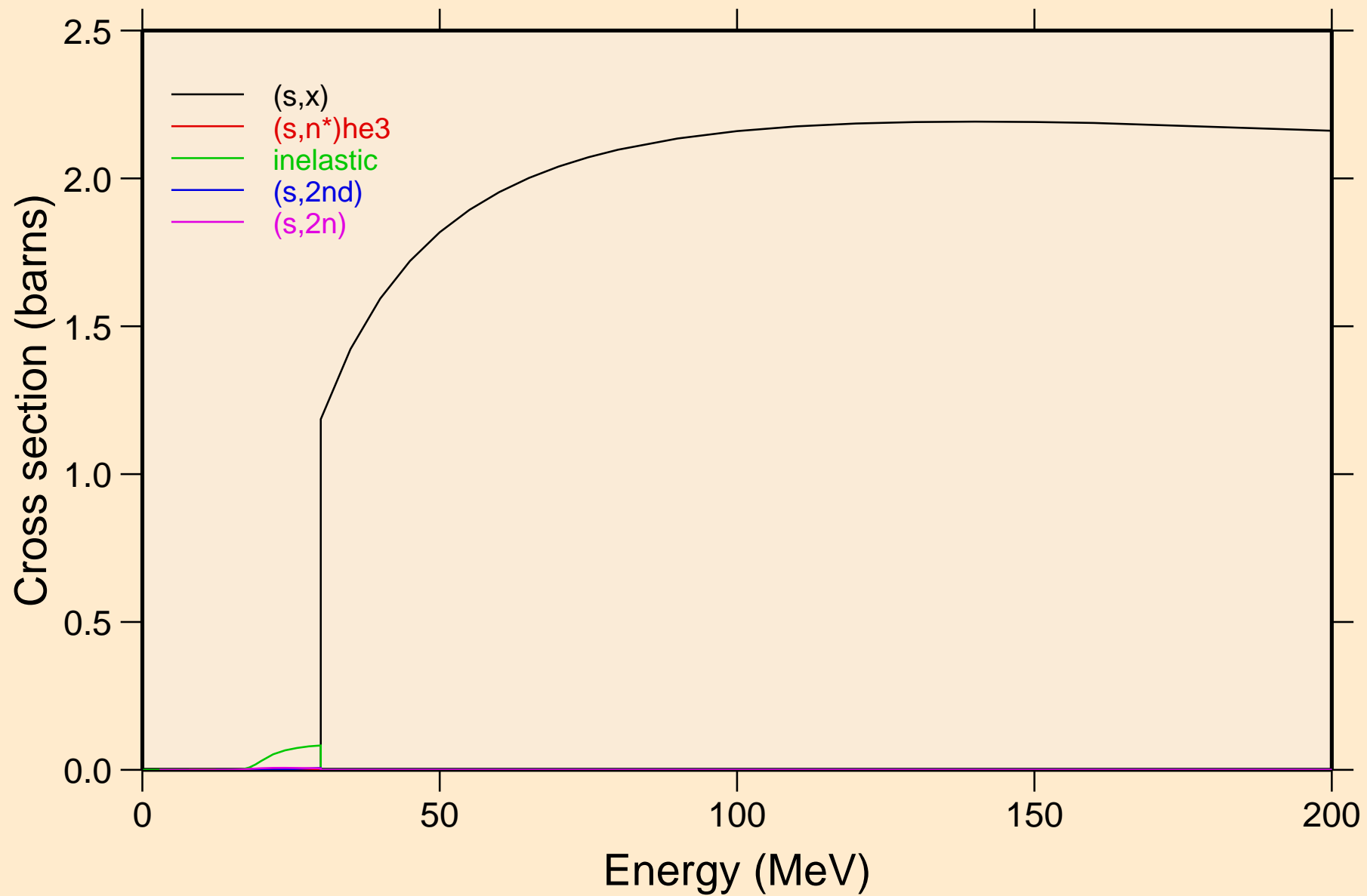

TB161 HELION ACER TENDL-2021 LIBRARY; T=0.K  
Threshold reactions

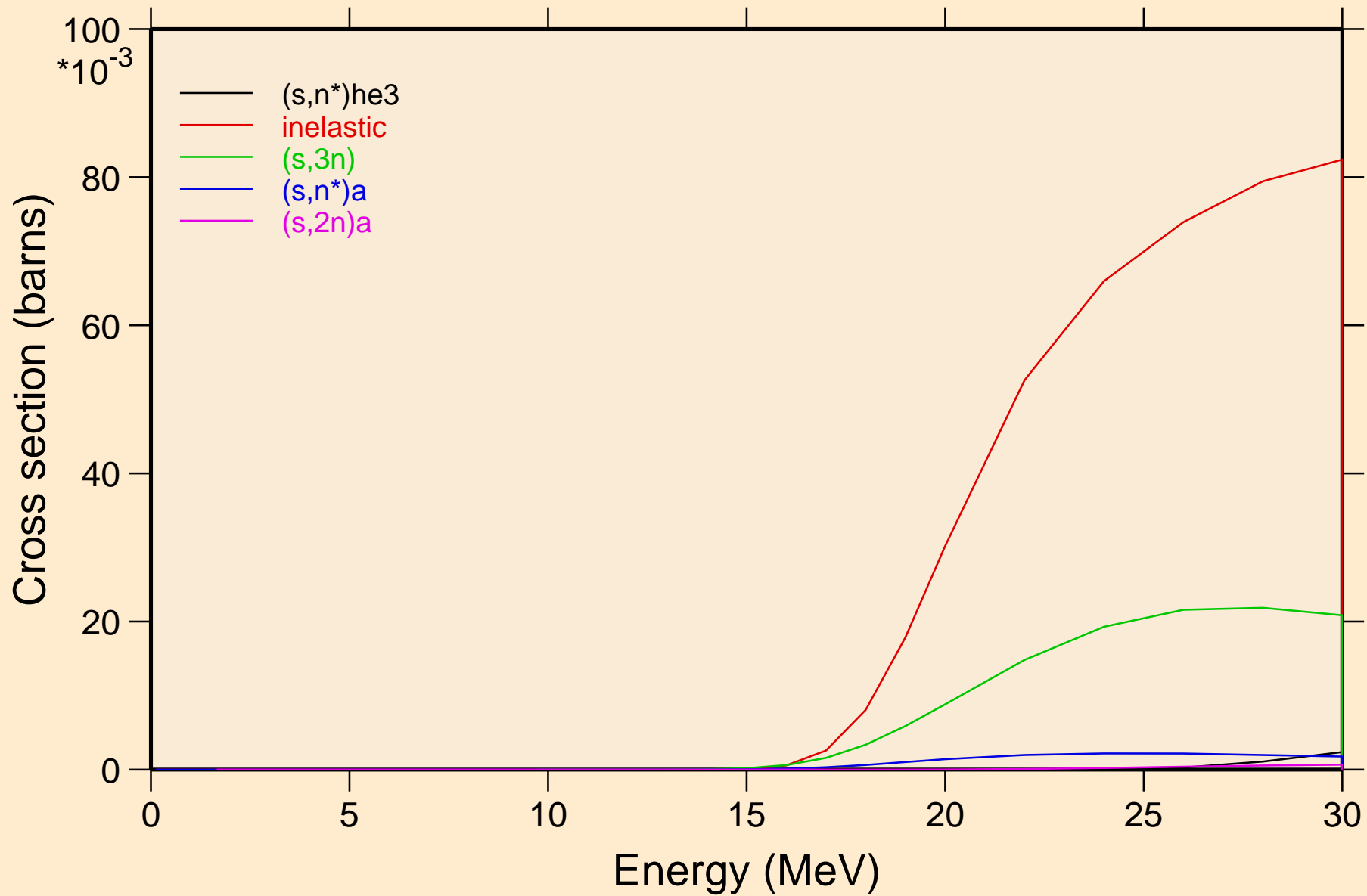

TB161 HELION ACER TENDL-2021 LIBRARY; T=0.K  
Threshold reactions

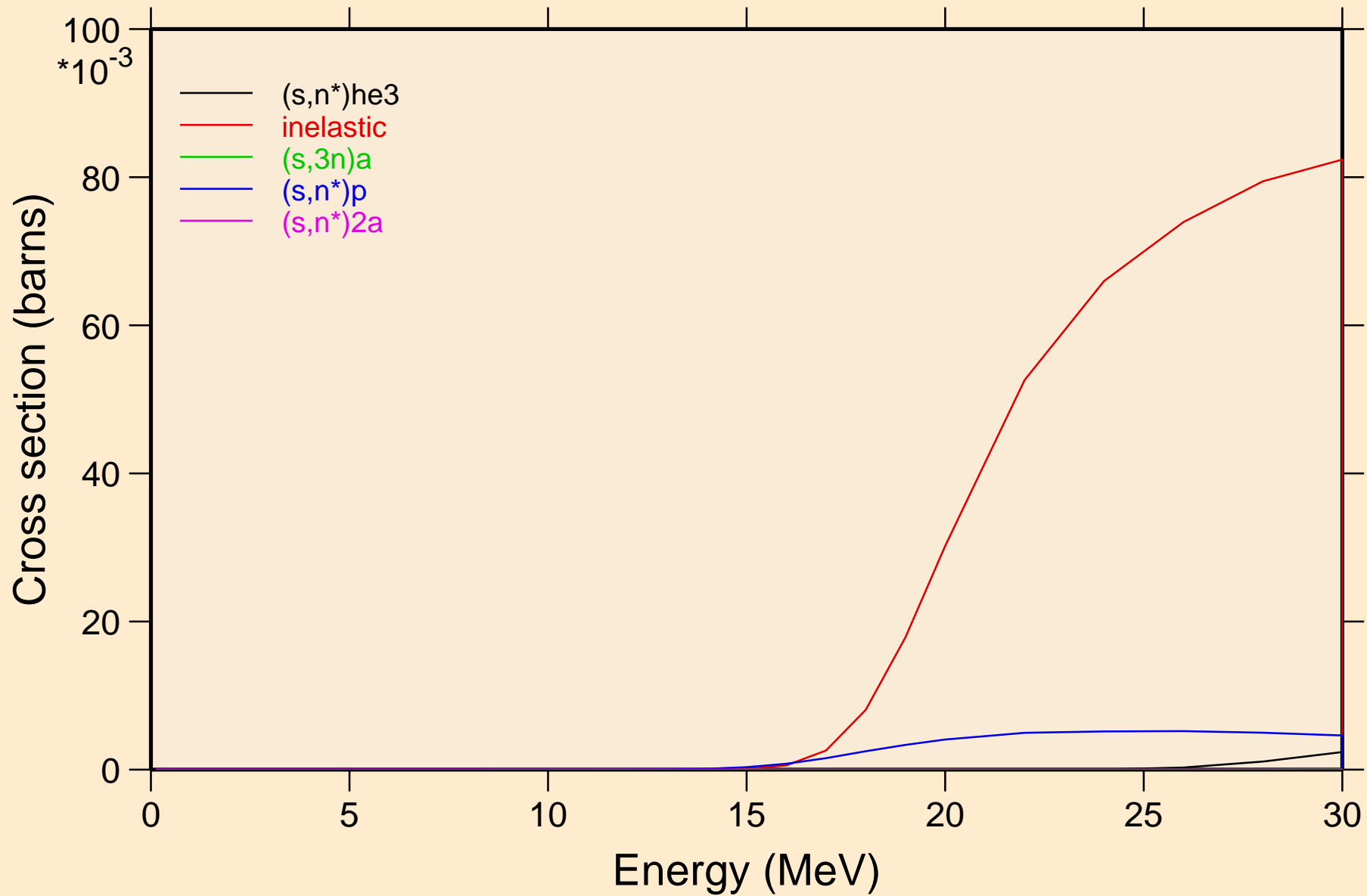

TB161 HELION ACER TENDL-2021 LIBRARY; T=0.K  
Threshold reactions

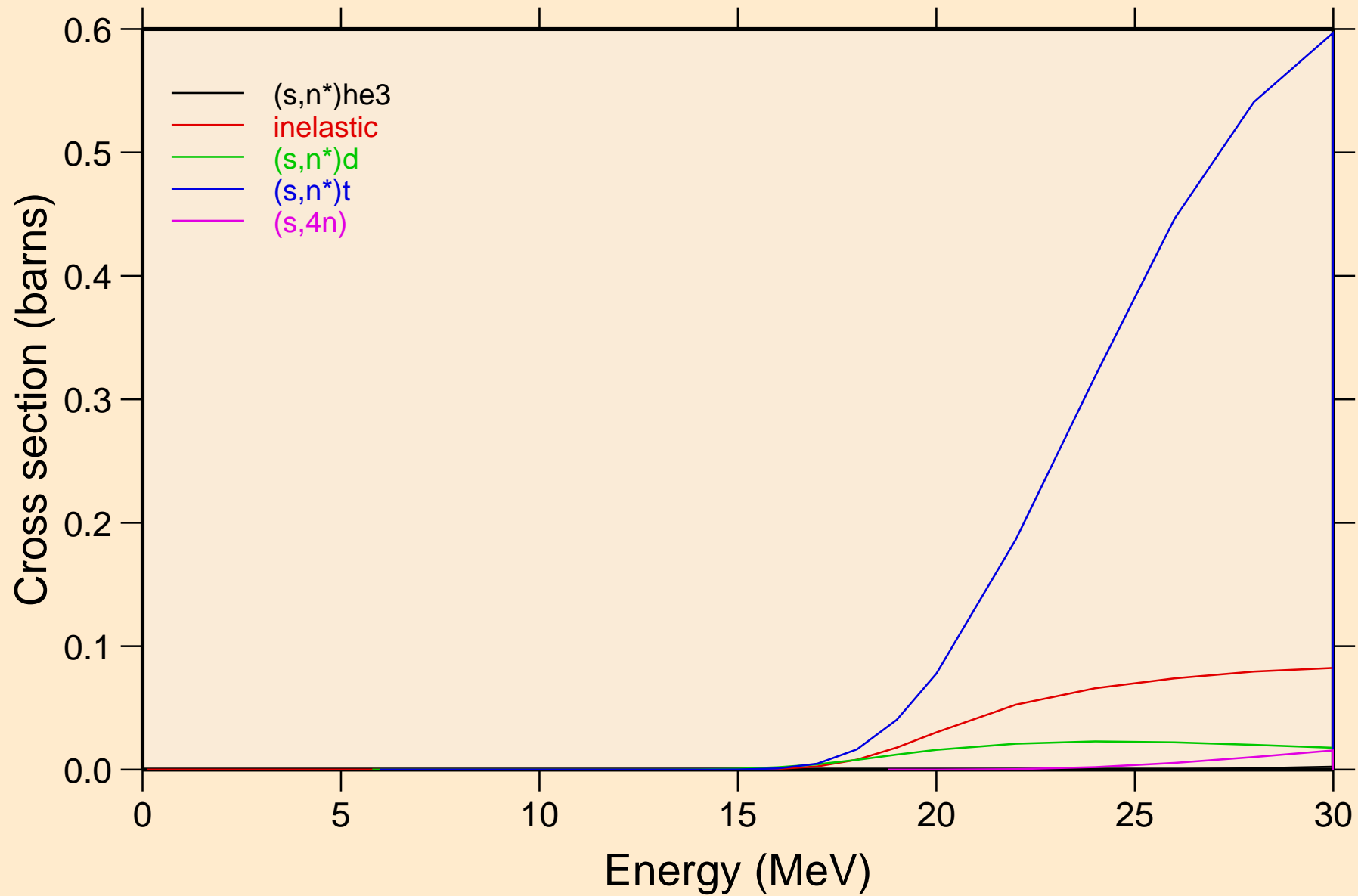



TB161 HELION ACER TENDL-2021 LIBRARY; T=0.K  
Threshold reactions

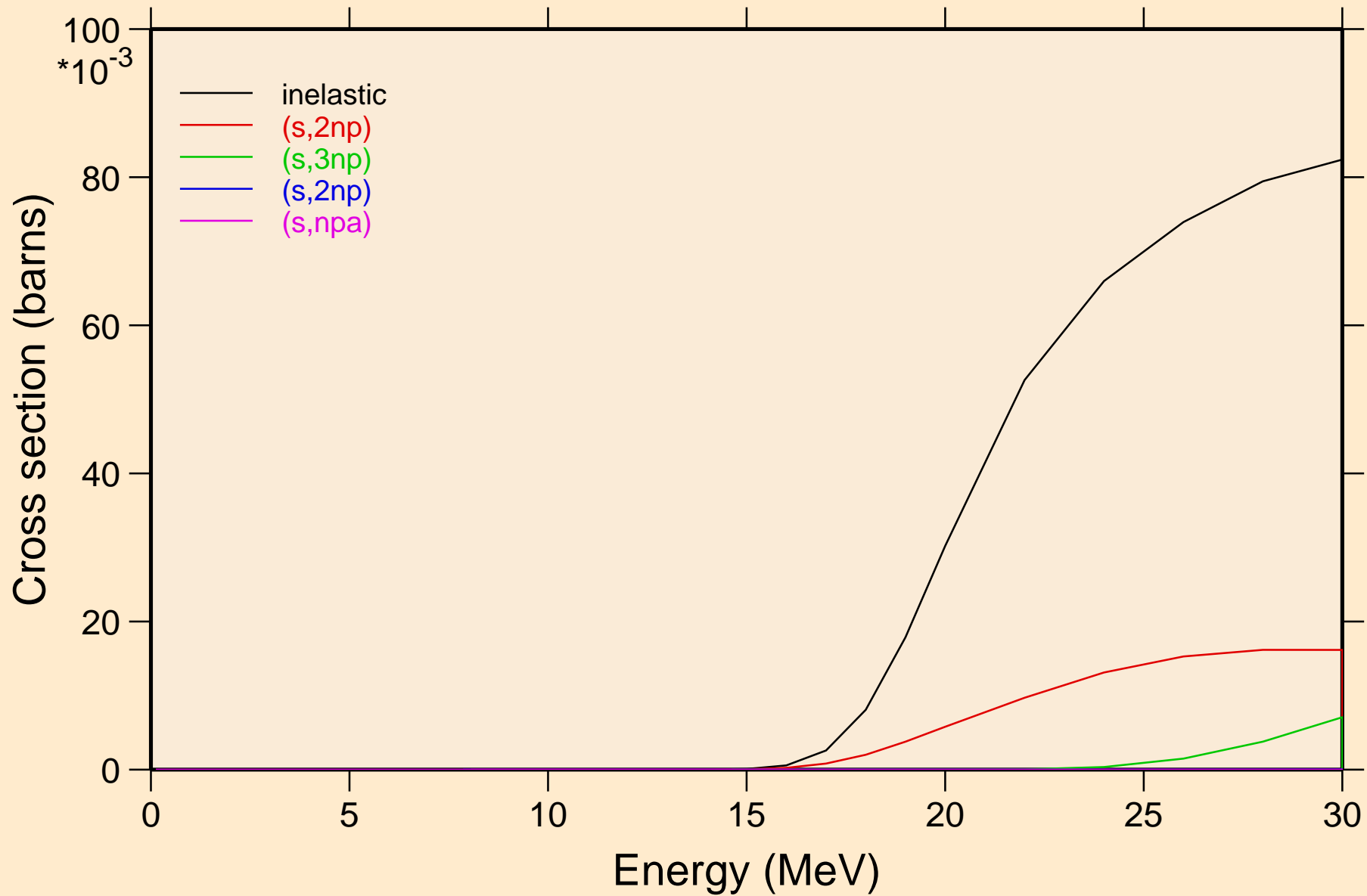

TB161 HELION ACER TENDL-2021 LIBRARY; T=0.K  
Threshold reactions

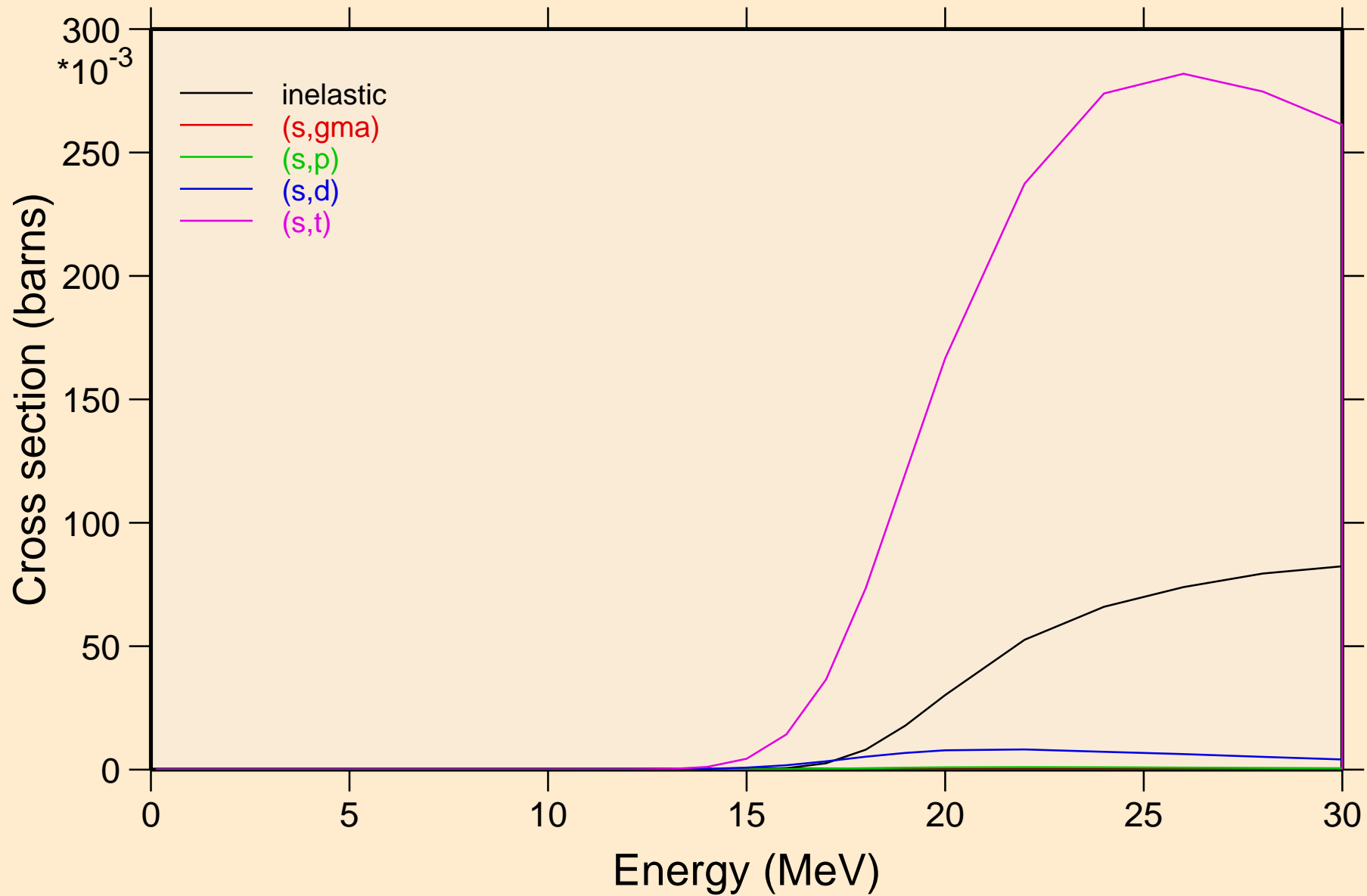

TB161 HELION ACER TENDL-2021 LIBRARY; T=0.K  
Threshold reactions

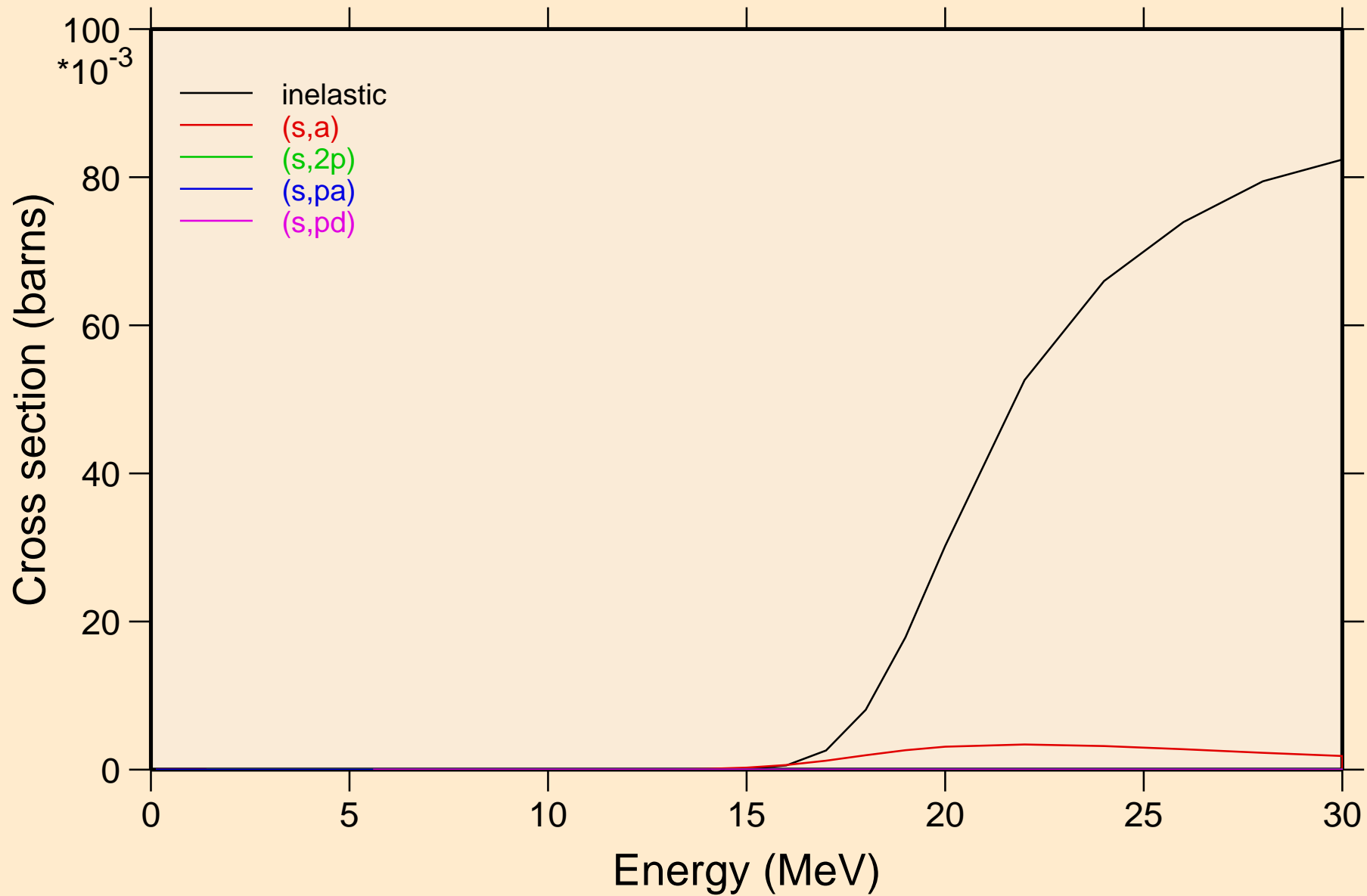

TB161 HELION ACER TENDL-2021 LIBRARY; T=0.K  
Threshold reactions

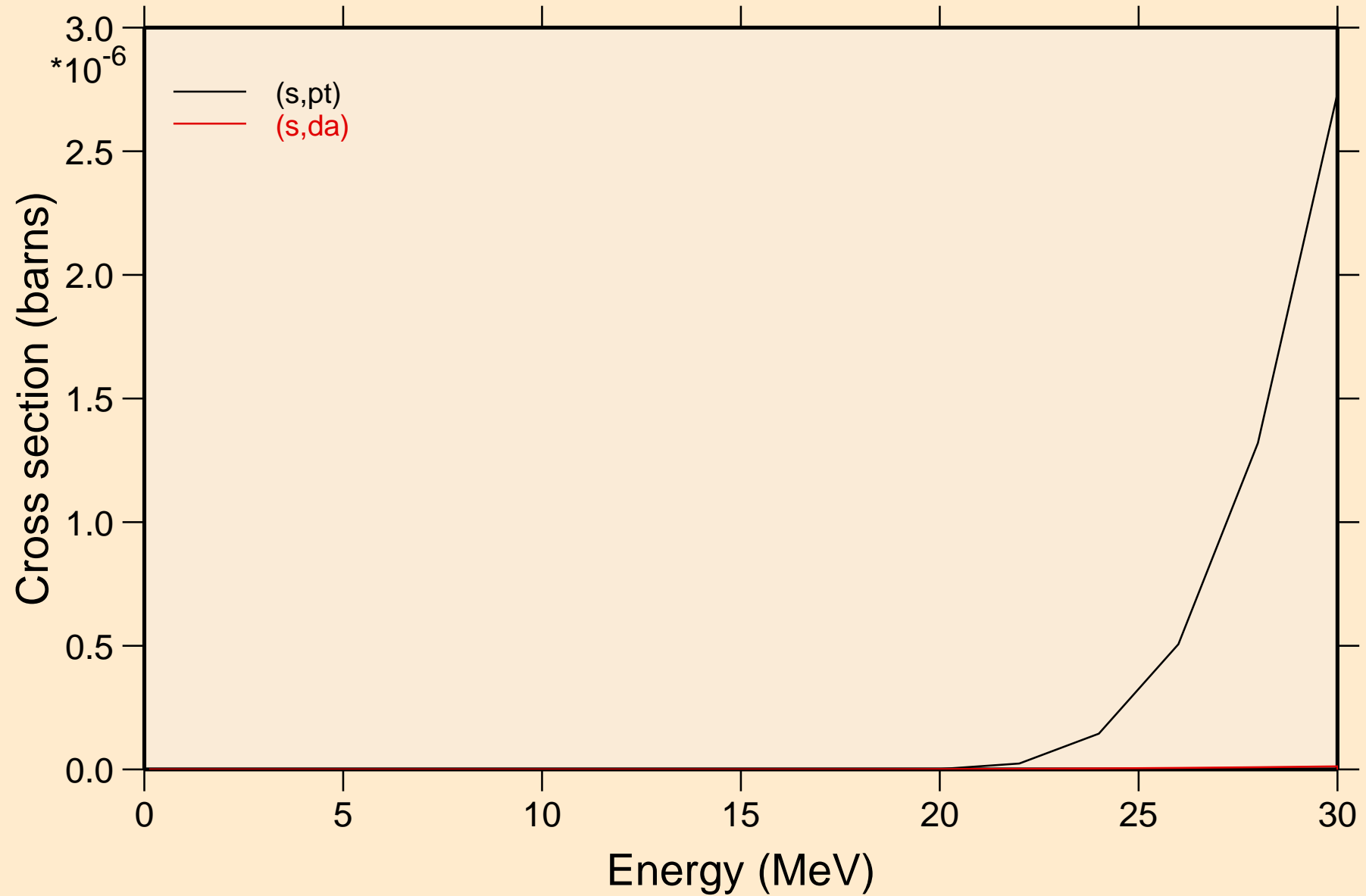

TB161 HELION ACER TENDL-2021 LIBRARY; T=0.K  
angular distribution for elastic

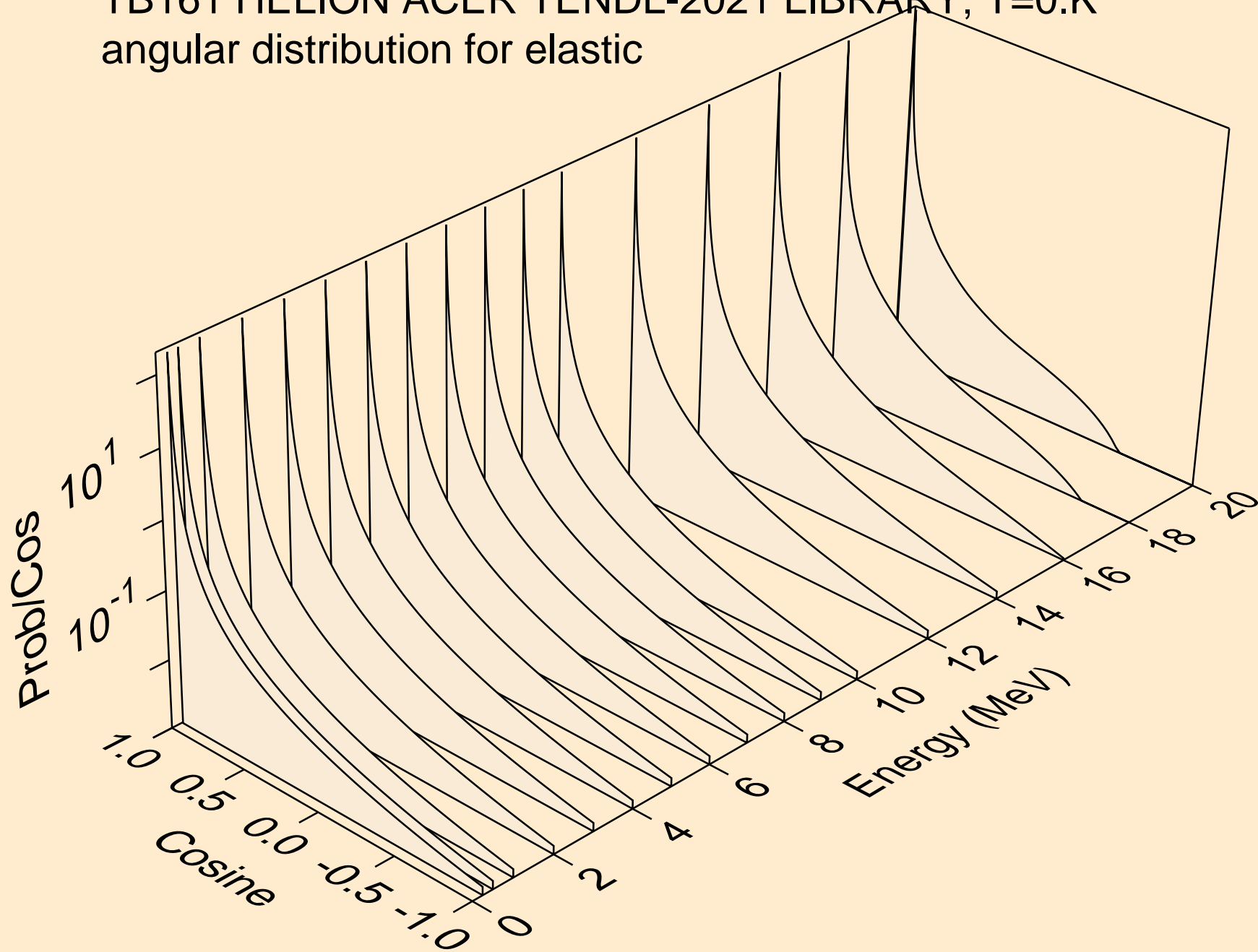

TB161 HELION ACER TENDL-2021 LIBRARY; T=0.K  
angular distribution for elastic

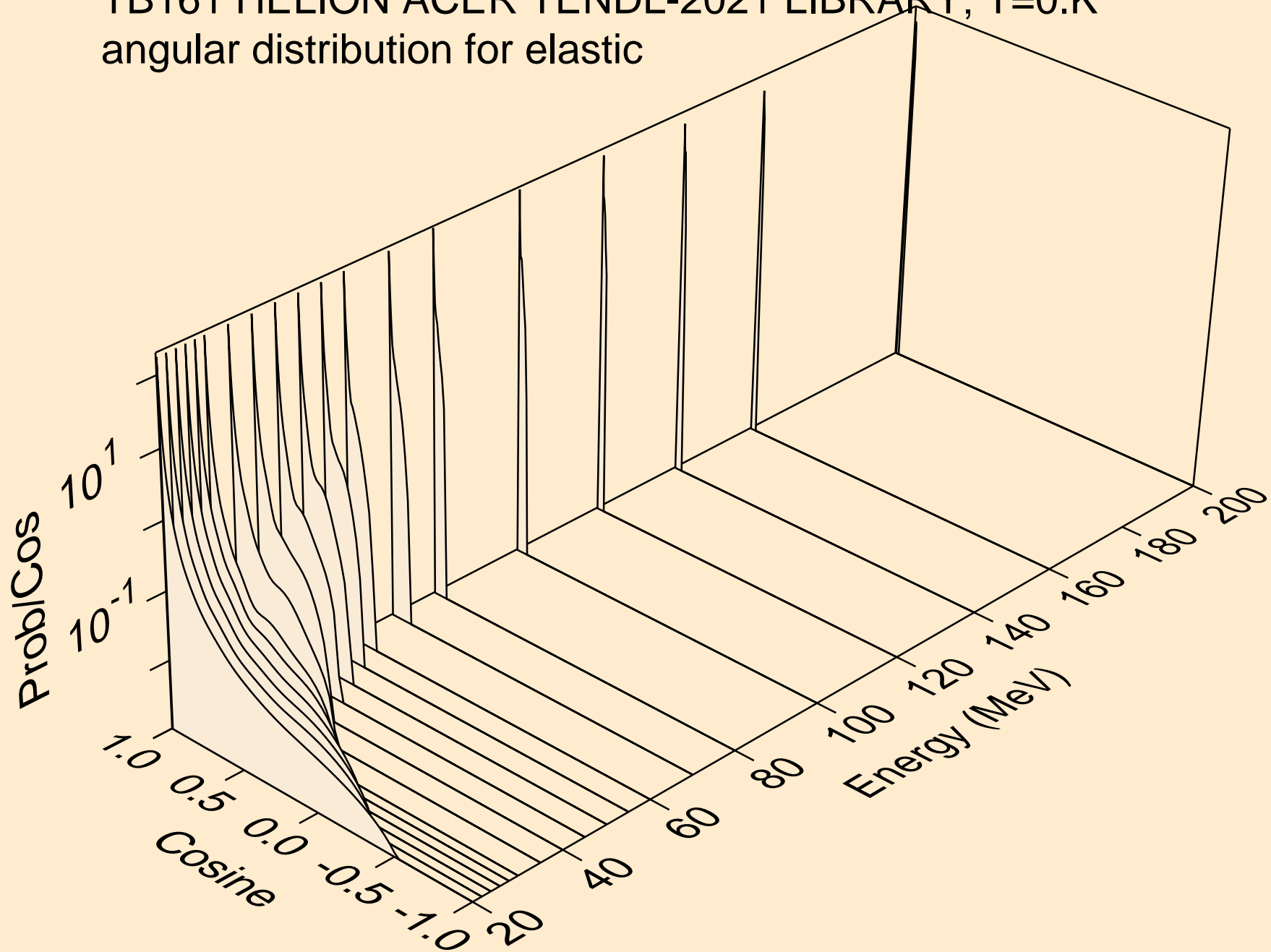

TB161 HELION ACER TENDL-2021 LIBRARY; T=0.K  
He-3 emission for (s,x)

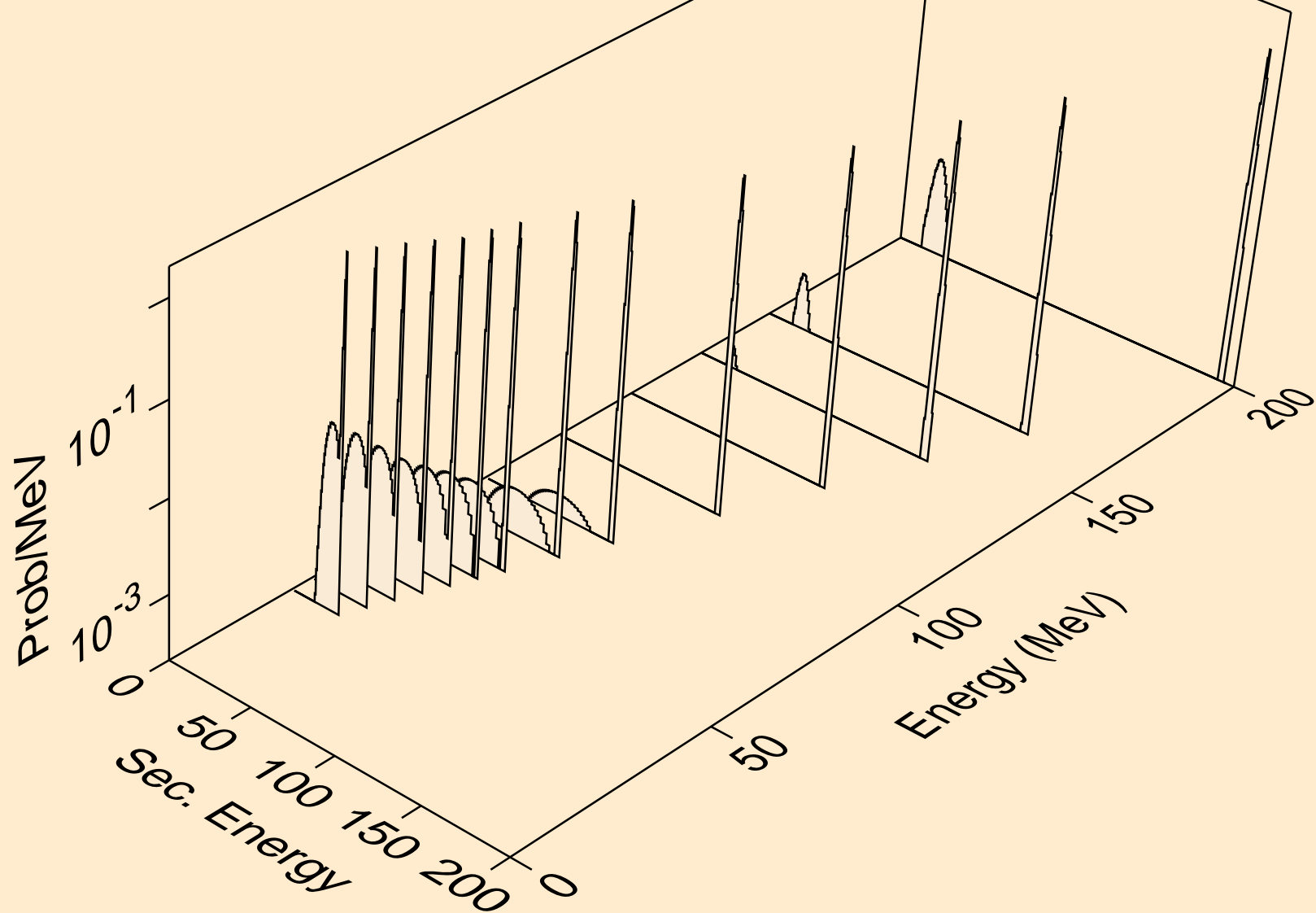

TB161 HELION ACER TENDL-2021 LIBRARY; T=0.K  
He-3 emission for (s,n\*)he3

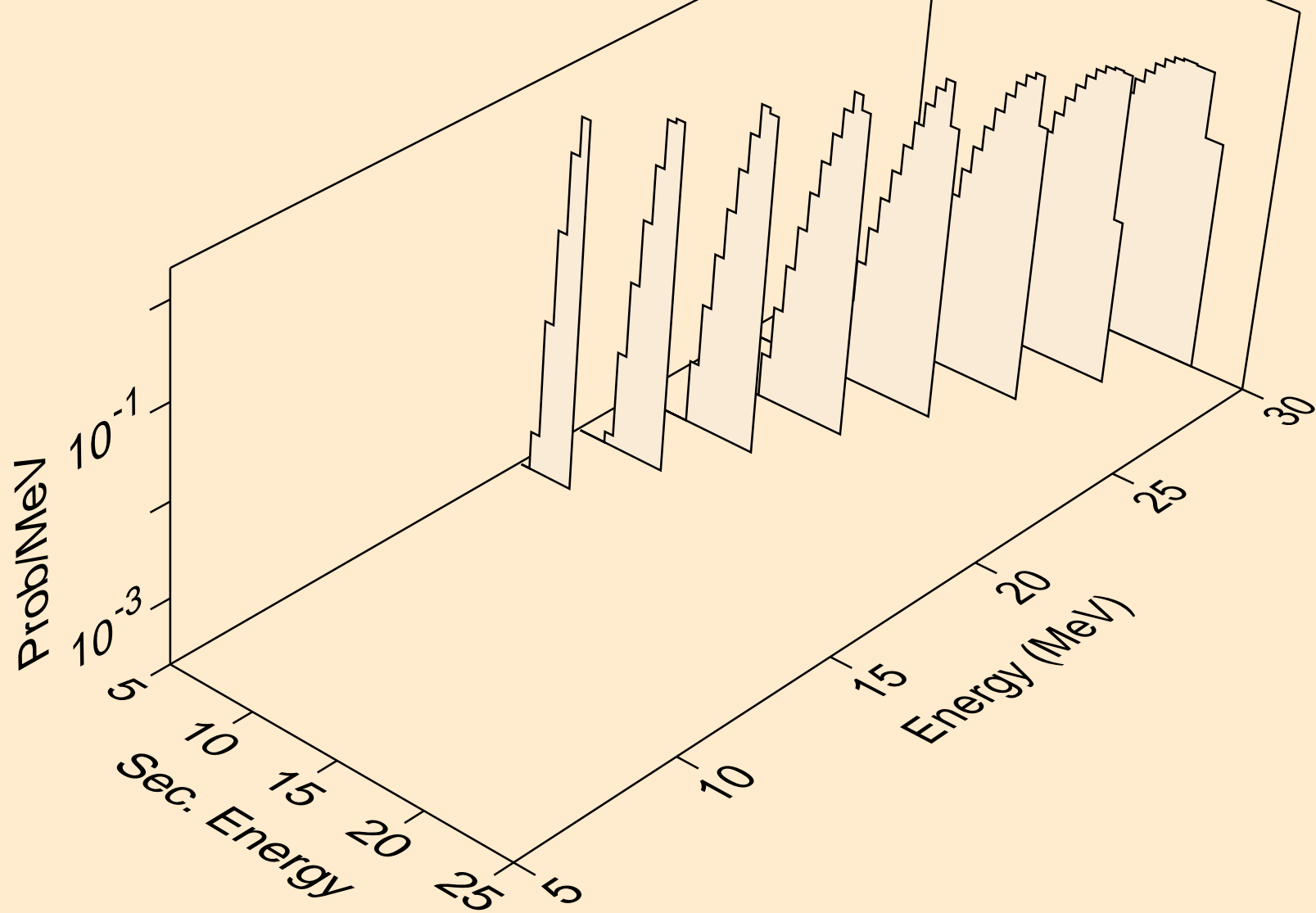



TB161 HELION ACER TENDL-2021 LIBRARY; T=0.K  
He-3 emission for inelastic

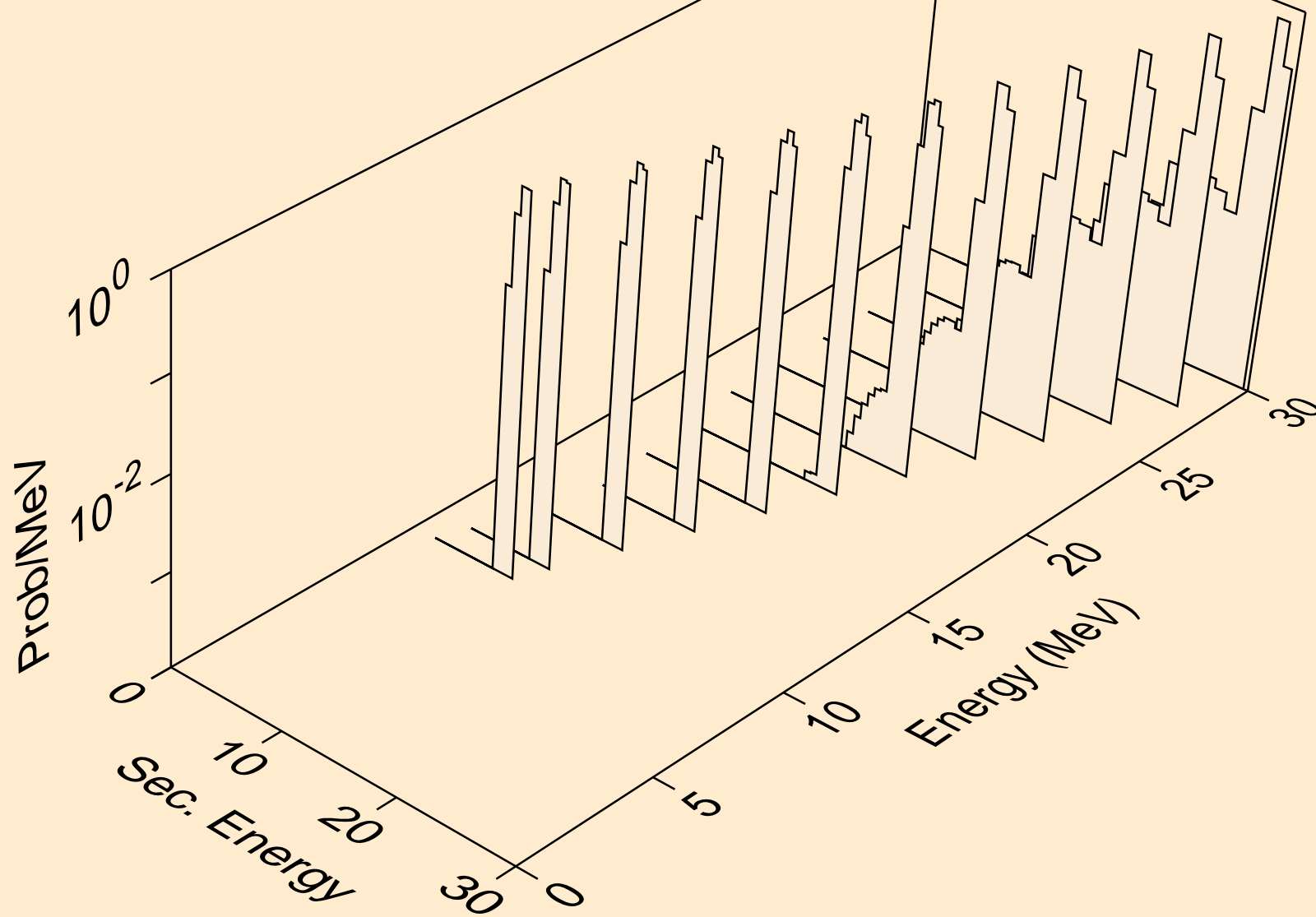

TB161 HELION ACER TENDL-2021 LIBRARY; T=0.K  
Photon emission for (z,n)

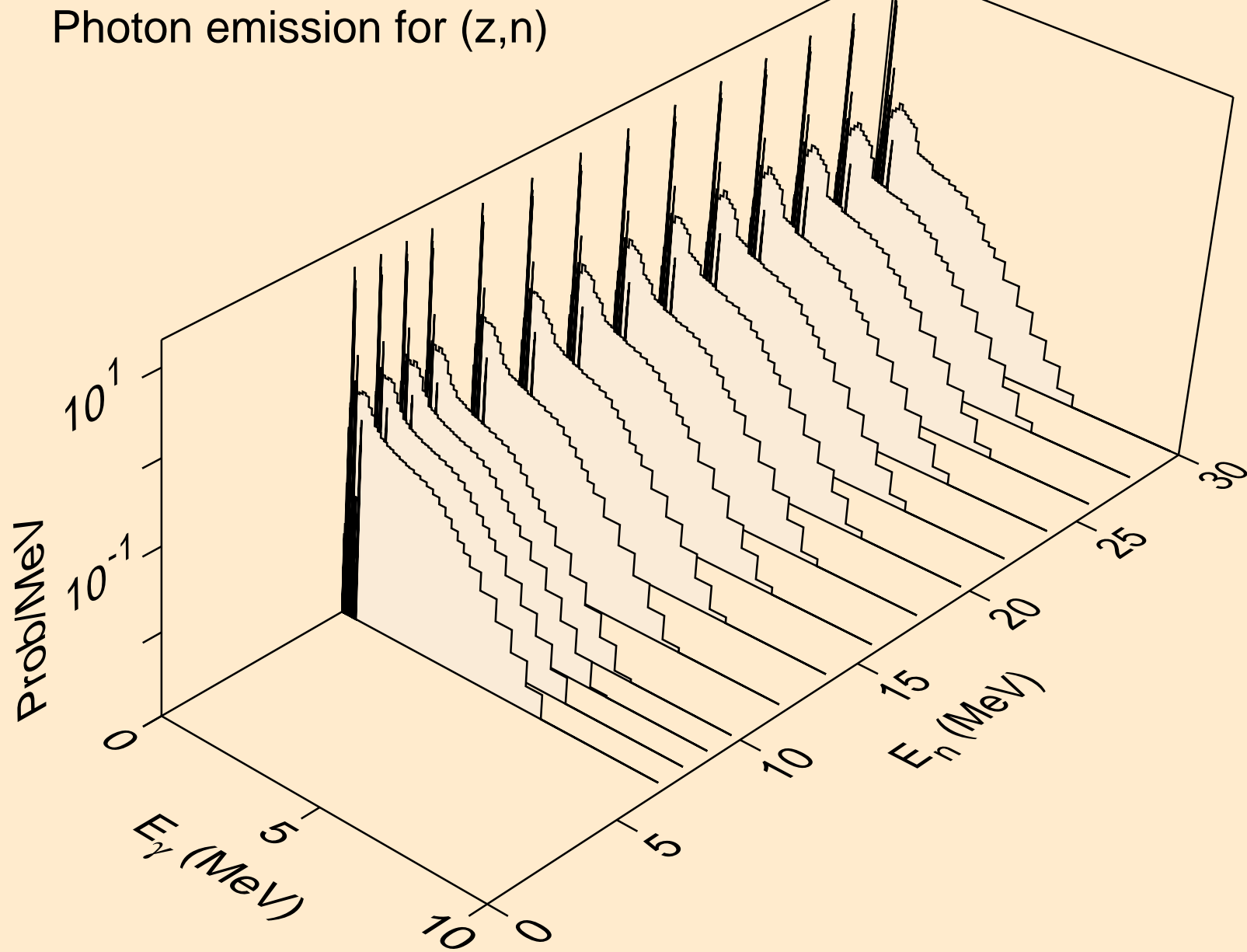

TB161 HELION ACER TENDL-2021 LIBRARY; T=0.K  
Photon emission for (n,x)

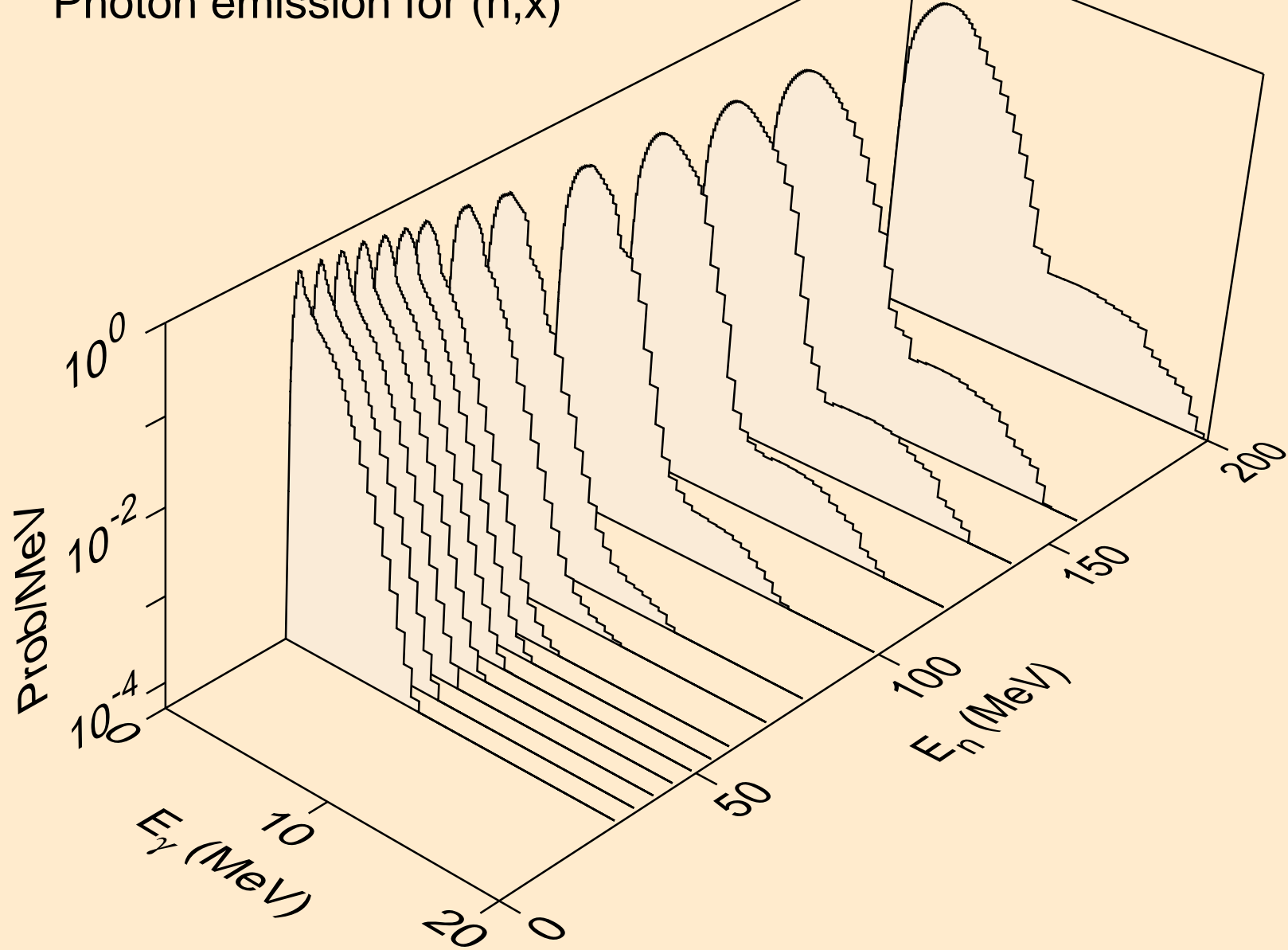

TB161 HELION ACER TENDL-2021 LIBRARY; T=0.K  
Photon emission for (n,2nd)

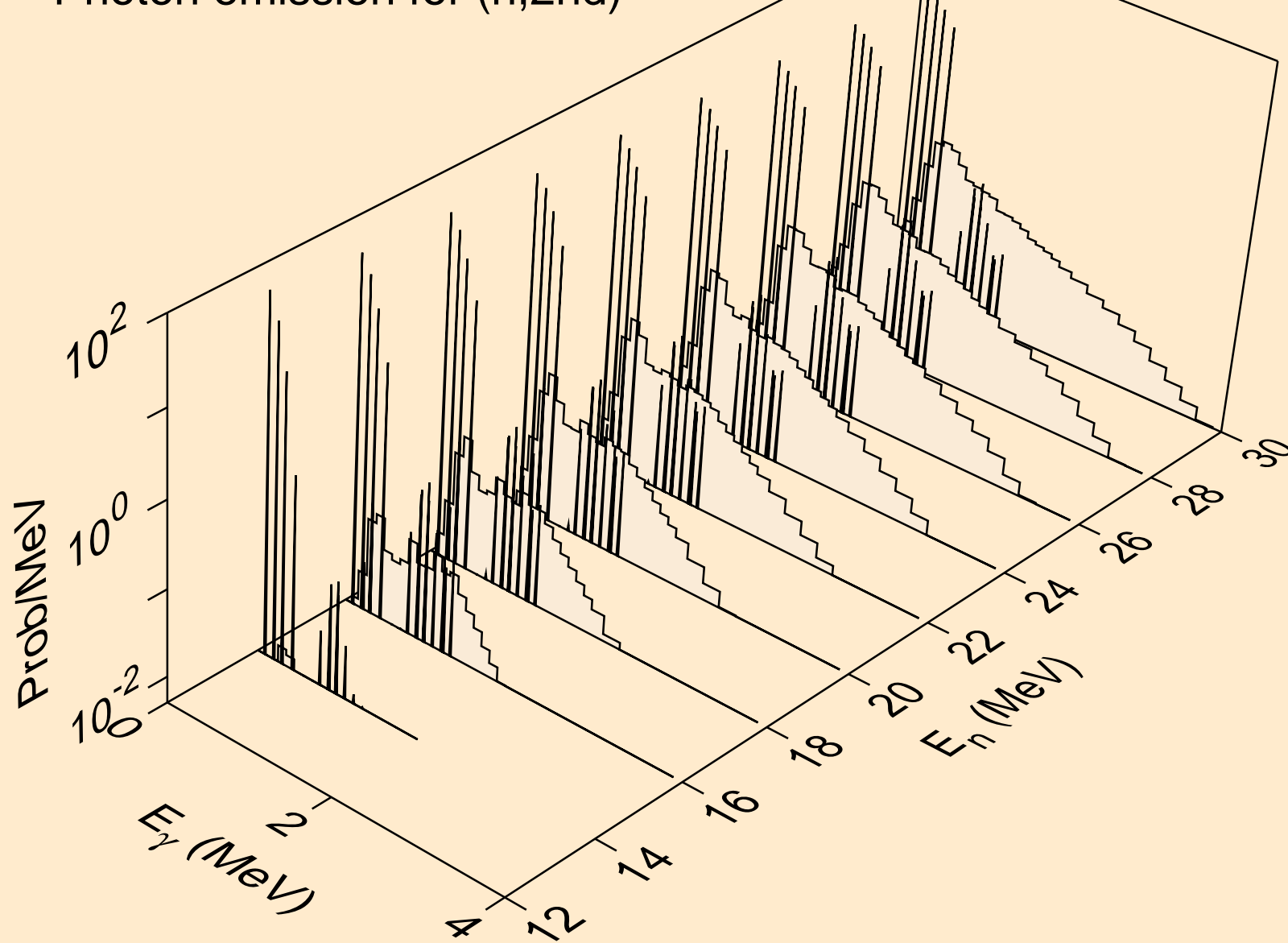

TB161 HELION ACER TENDL-2021 LIBRARY; T=0.K  
Photon emission for (n,2n)

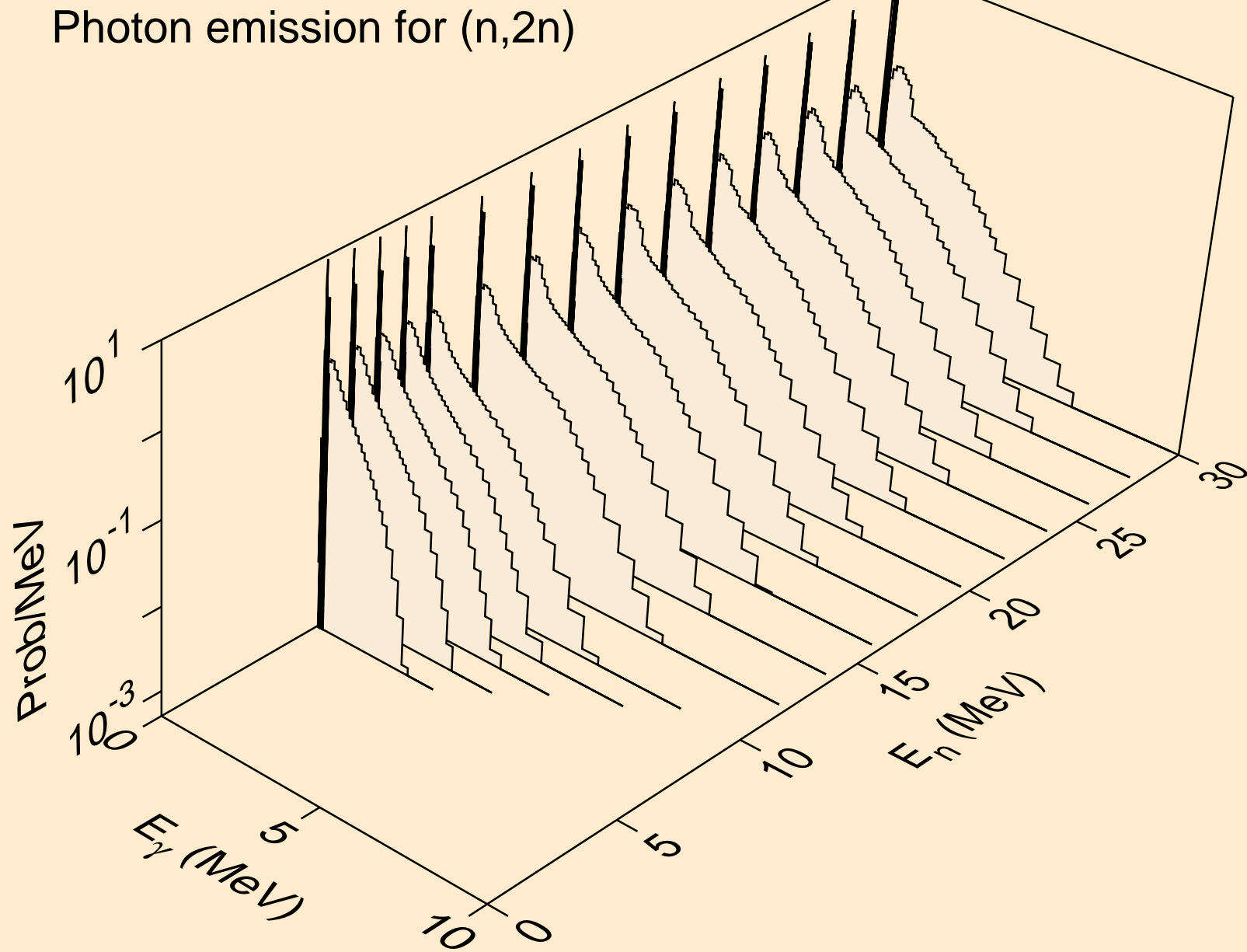

TB161 HELION ACER TENDL-2021 LIBRARY; T=0.K  
Photon emission for (n,3n)

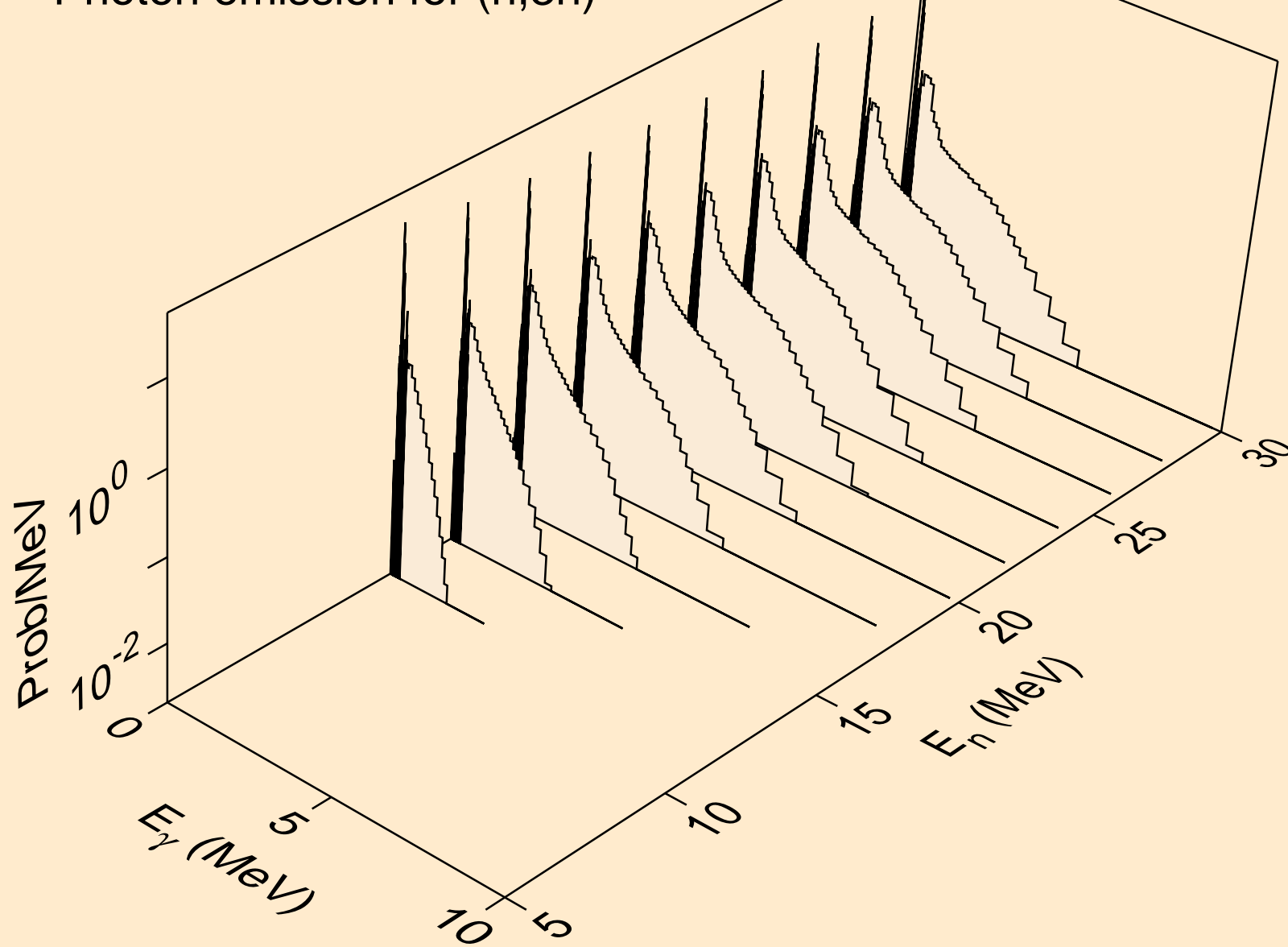

TB161 HELION ACER TENDL-2021 LIBRARY; T=0.K  
Photon emission for (n,n\*)a

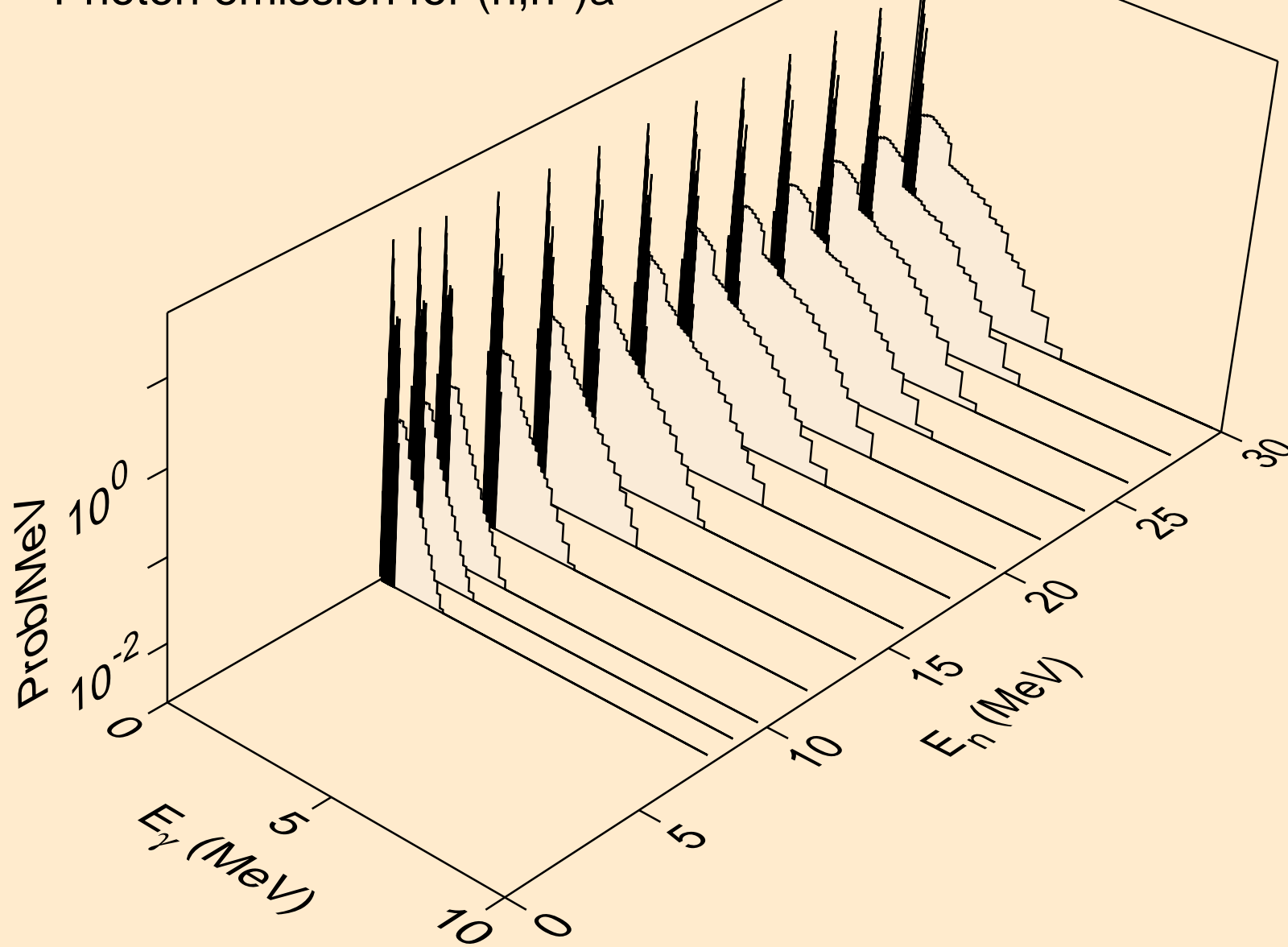

TB161 HELION ACER TENDL-2021 LIBRARY; T=0.K  
Photon emission for (n,2n)a

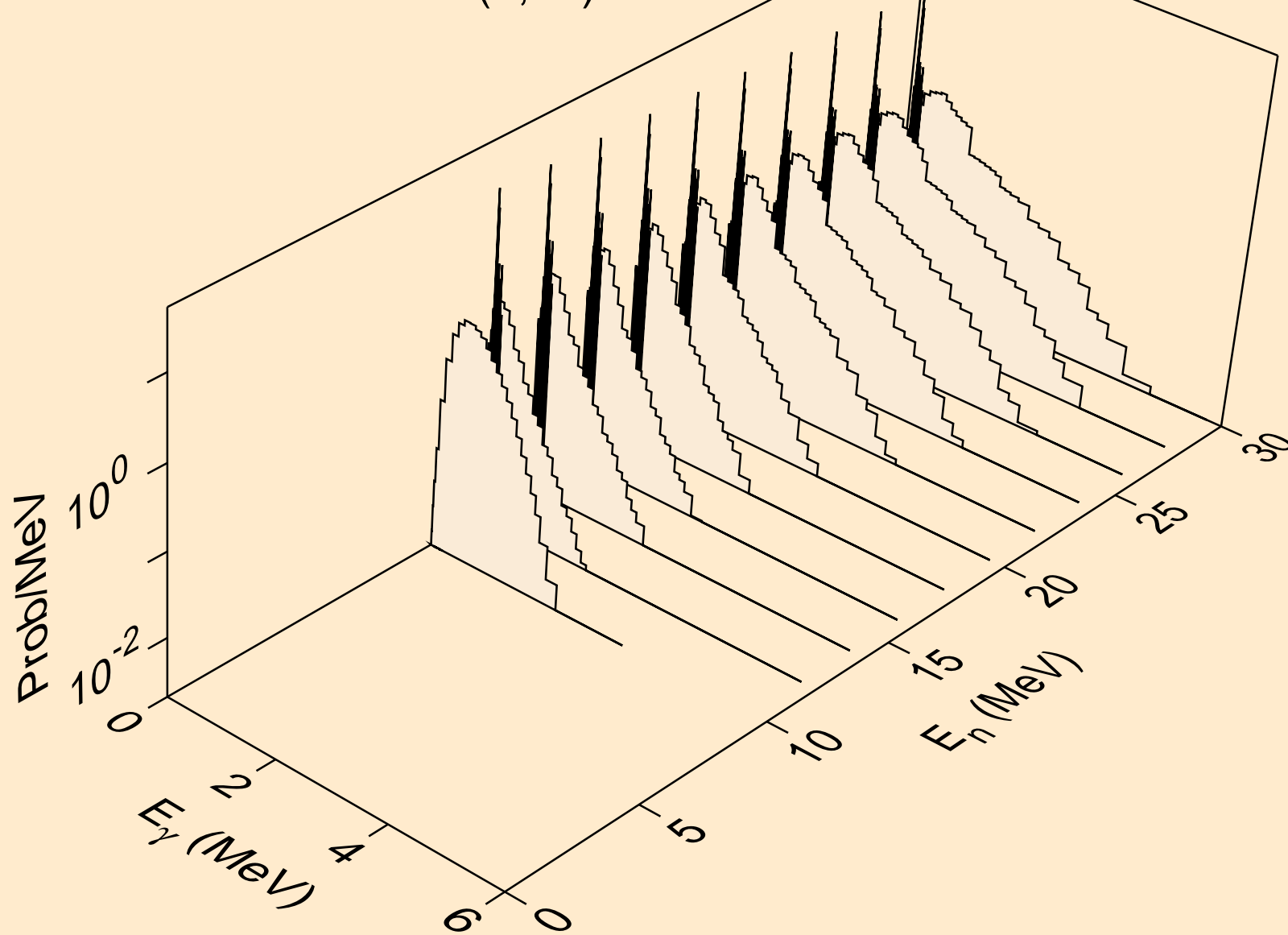



TB161 HELION ACER TENDL-2021 LIBRARY; T=0.K  
Photon emission for (n,3n)a

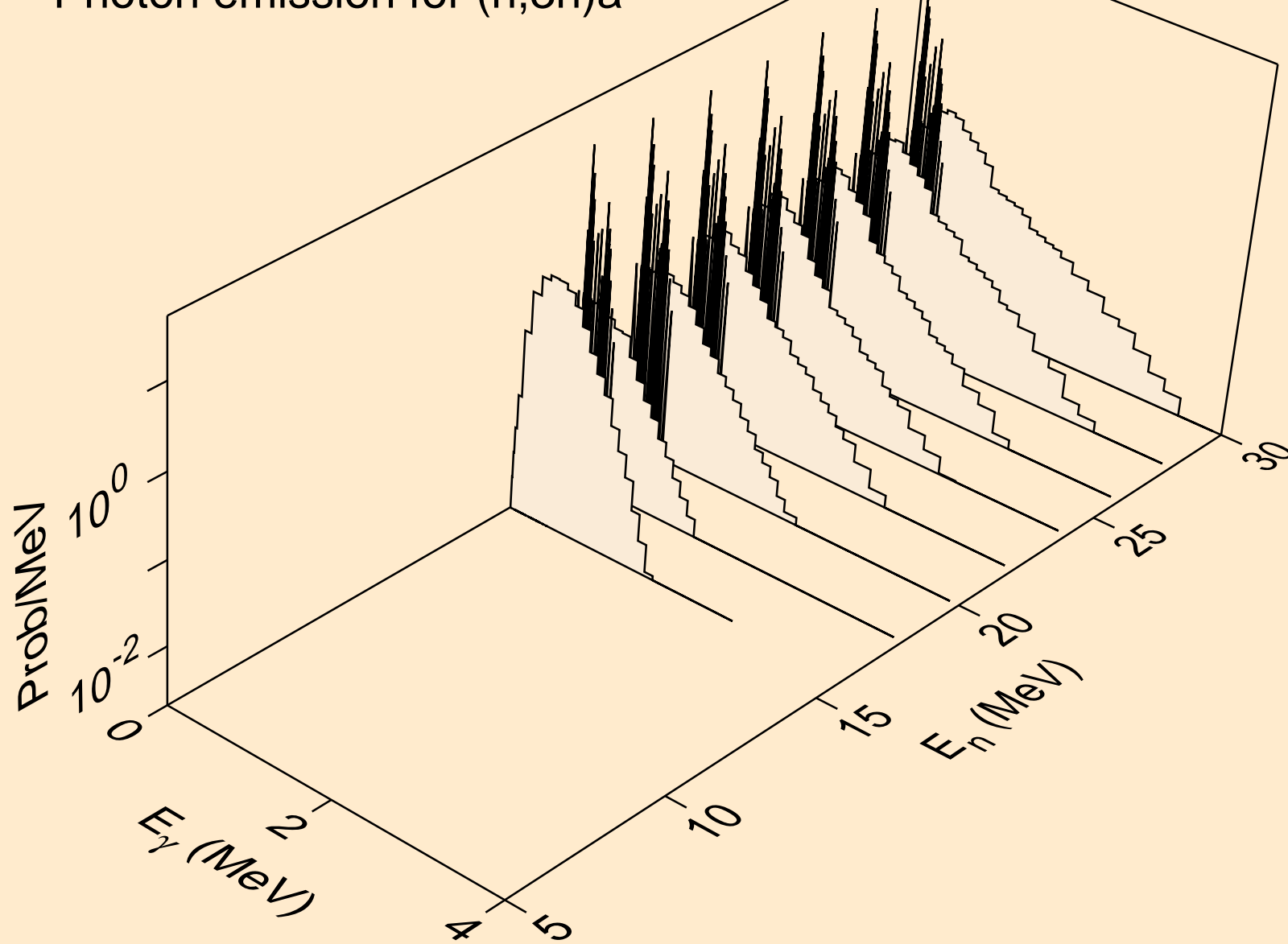

TB161 HELION ACER TENDL-2021 LIBRARY; T=0.K  
Photon emission for (n,n\*)p

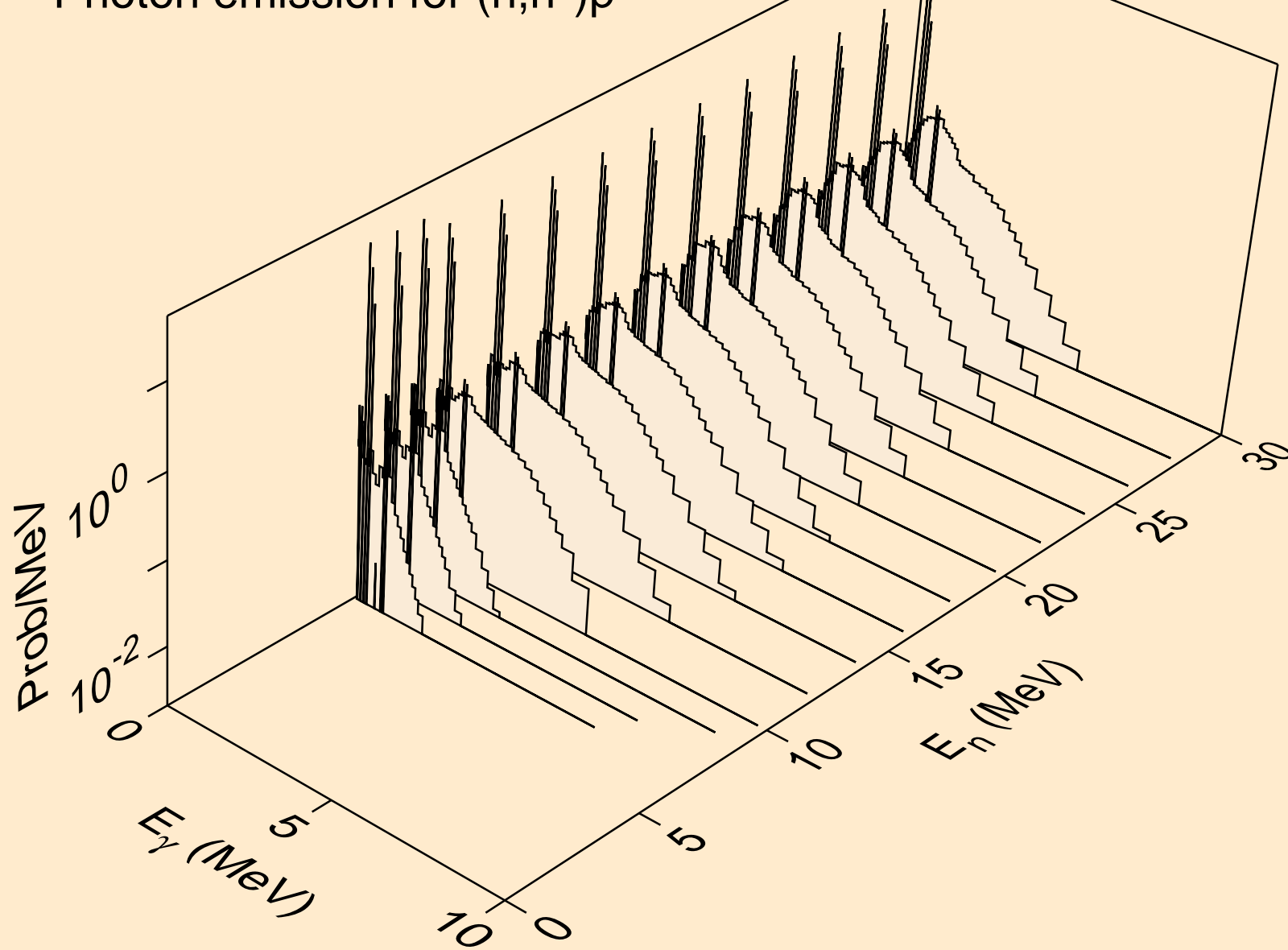

TB161 HELION ACER TENDL-2021 LIBRARY; T=0.K  
Photon emission for (n,n\*)2a

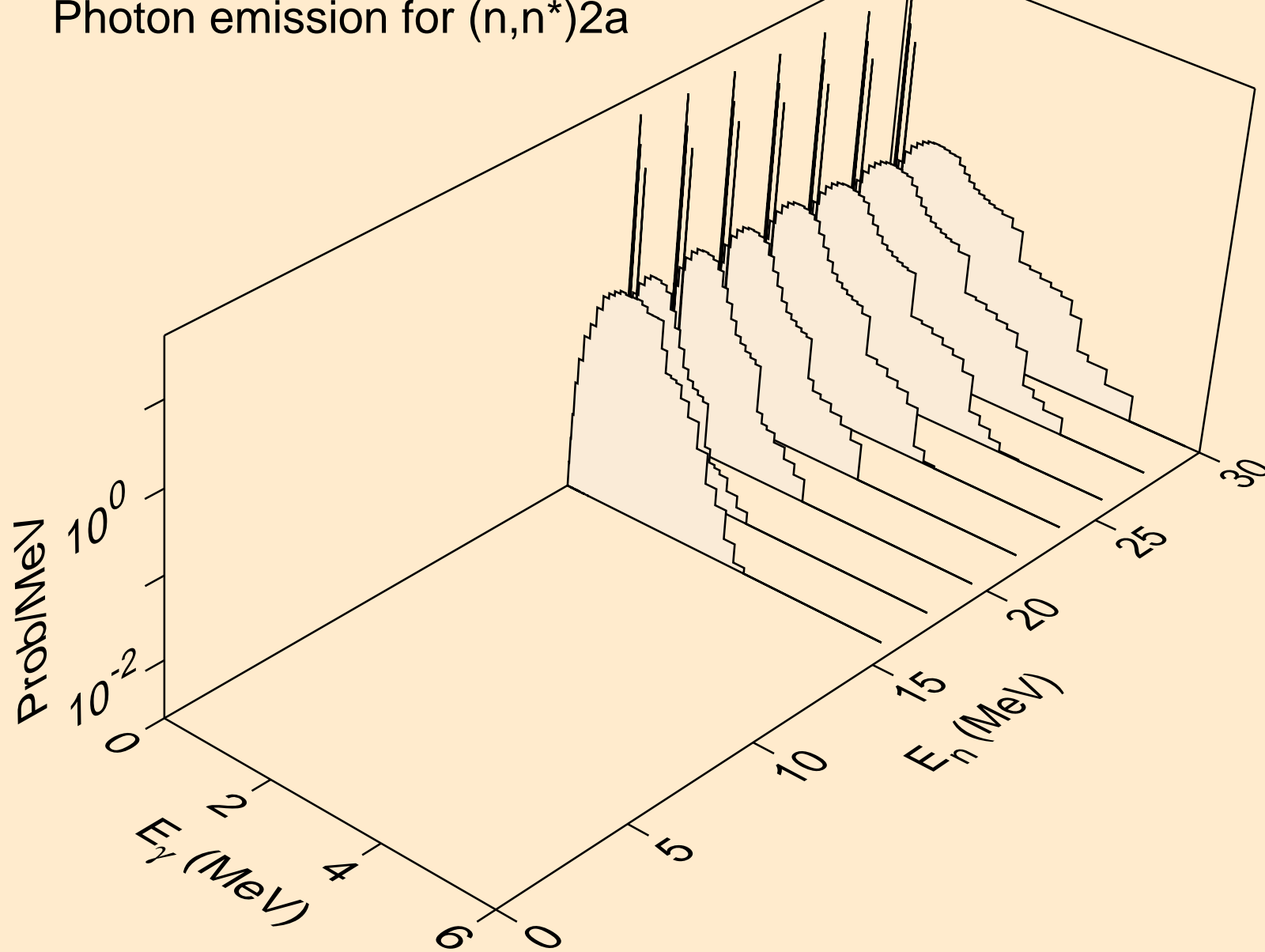

TB161 HELION ACER TENDL-2021 LIBRARY; T=0.K  
Photon emission for (n,n\*)d

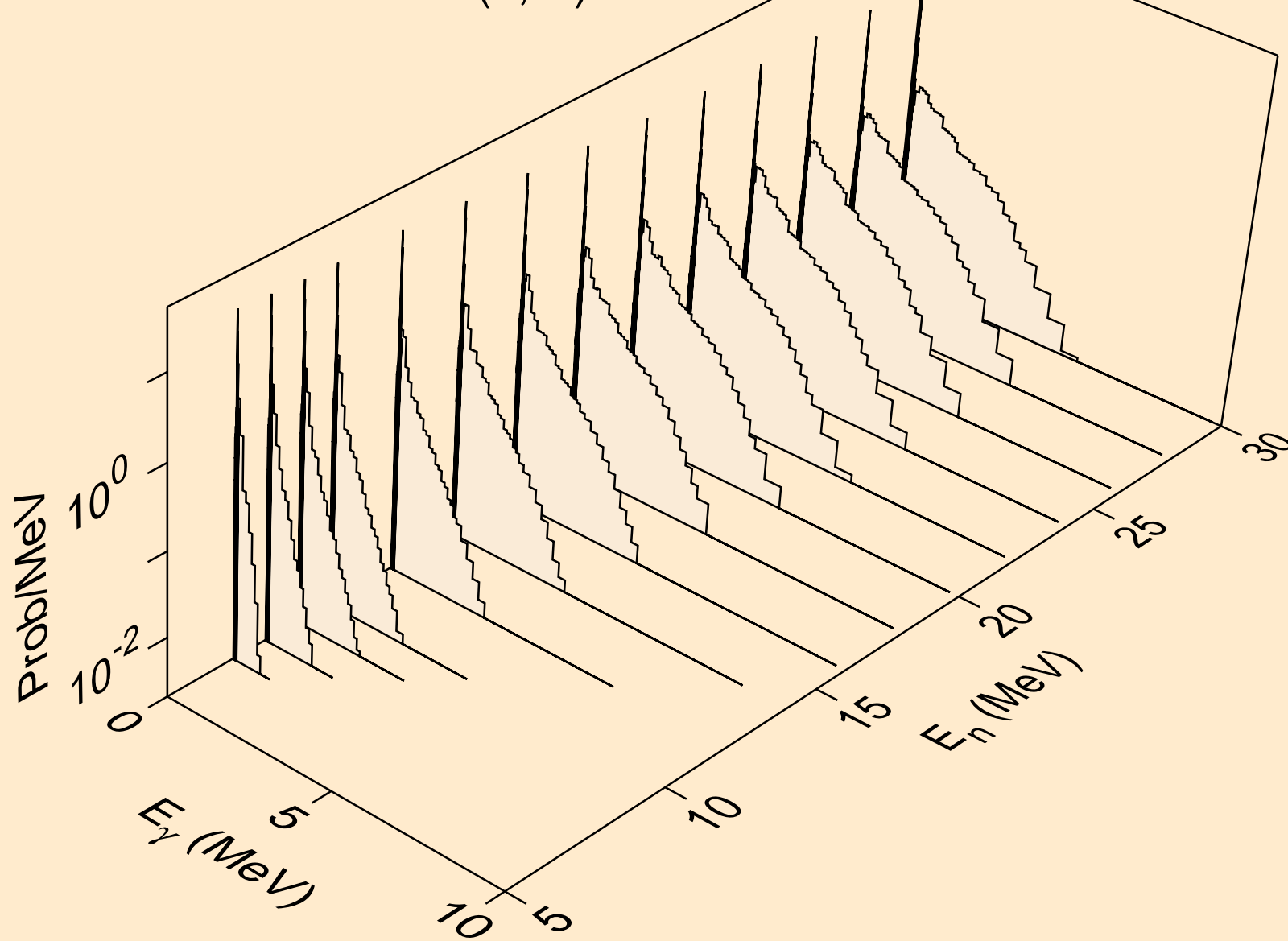

TB161 HELION ACER TENDL-2021 LIBRARY; T=0.K  
Photon emission for (n,n\*)t

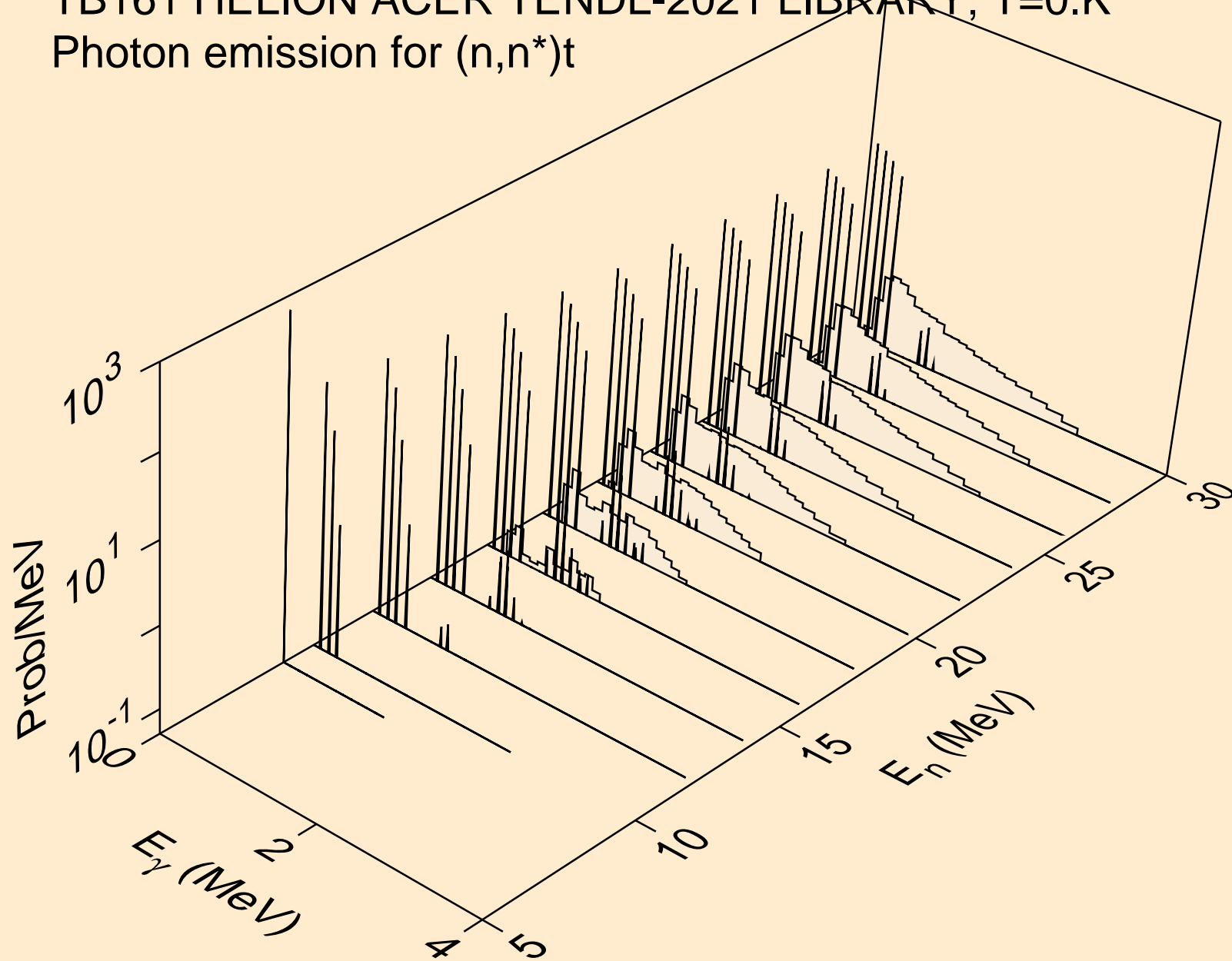

TB161 HELION ACER TENDL-2021 LIBRARY; T=0.K  
Photon emission for (n,n\*)he3

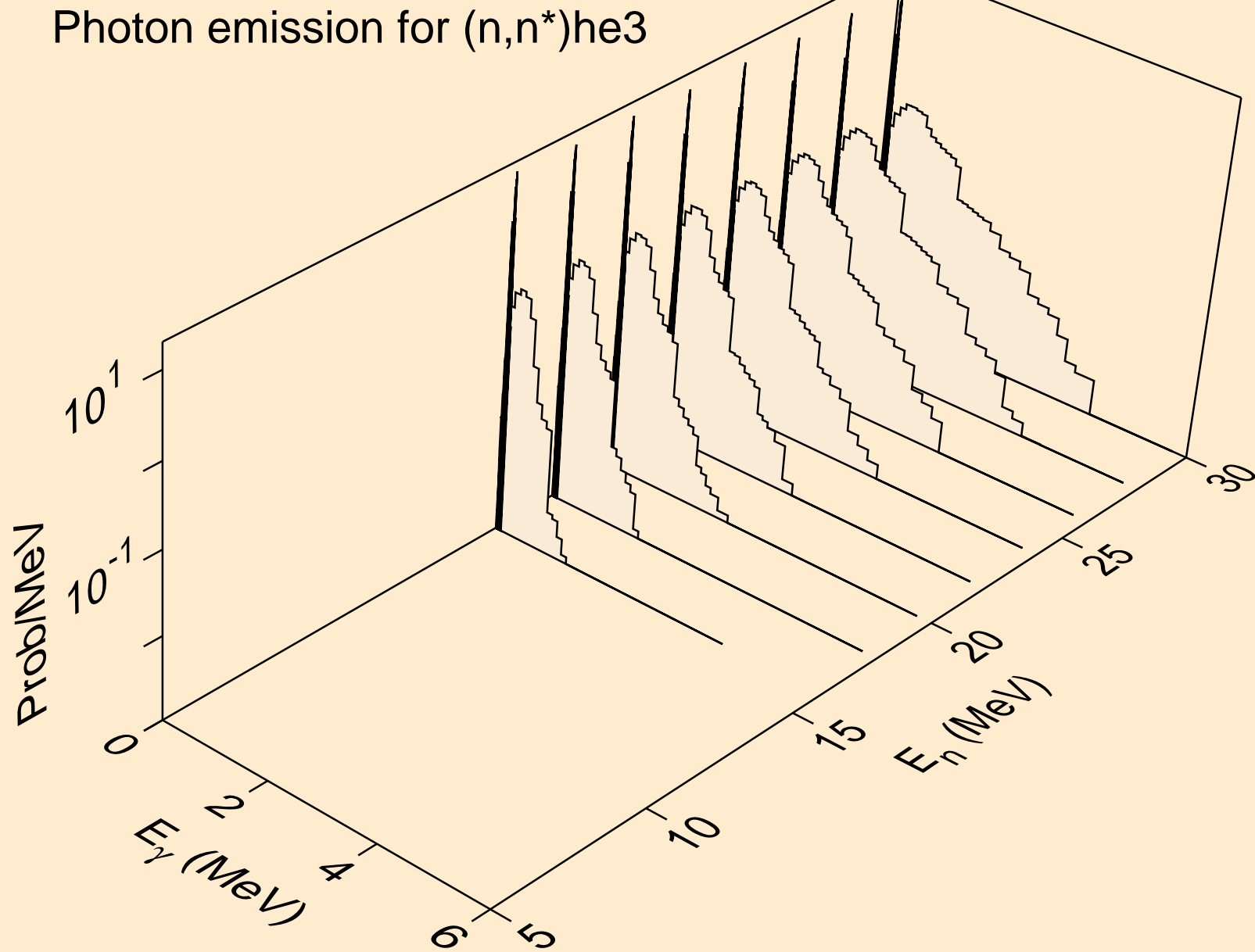

TB161 HELION ACER TENDL-2021 LIBRARY; T=0.K  
Photon emission for (n,4n)

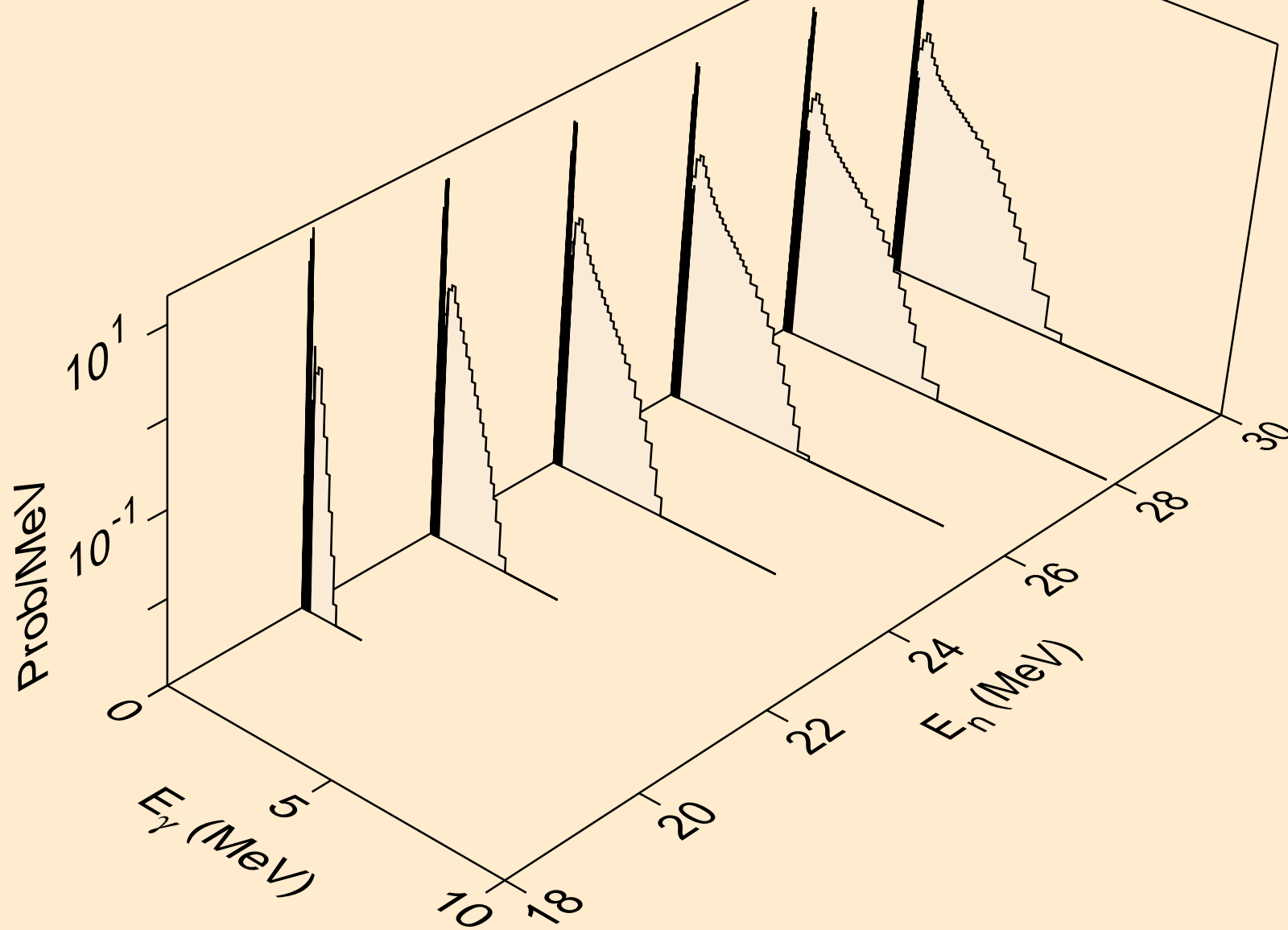

TB161 HELION ACER TENDL-2021 LIBRARY; T=0.K  
Photon emission for (n,2np)

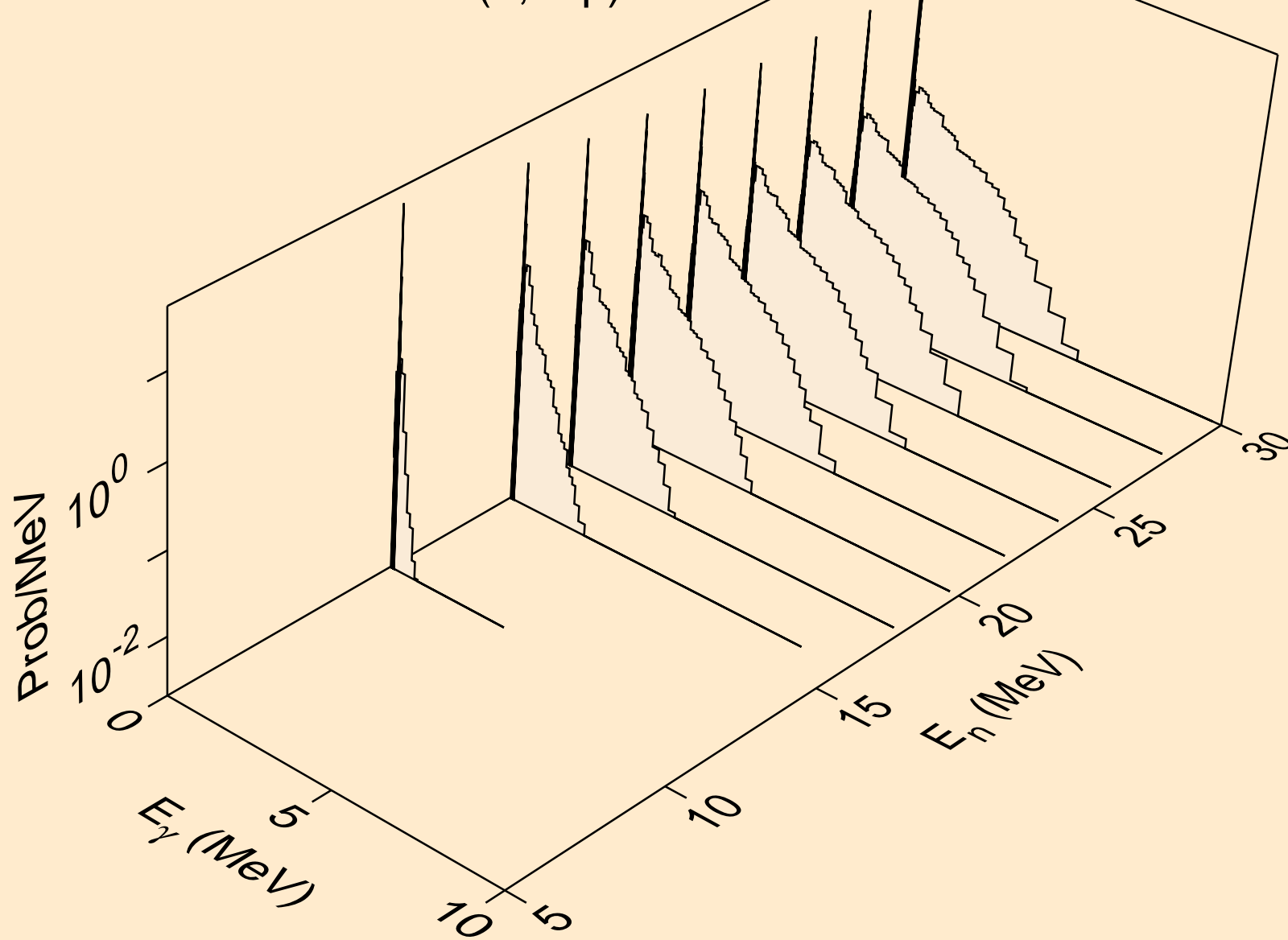



TB161 HELION ACER TENDL-2021 LIBRARY; T=0.K  
Photon emission for (n,3np)

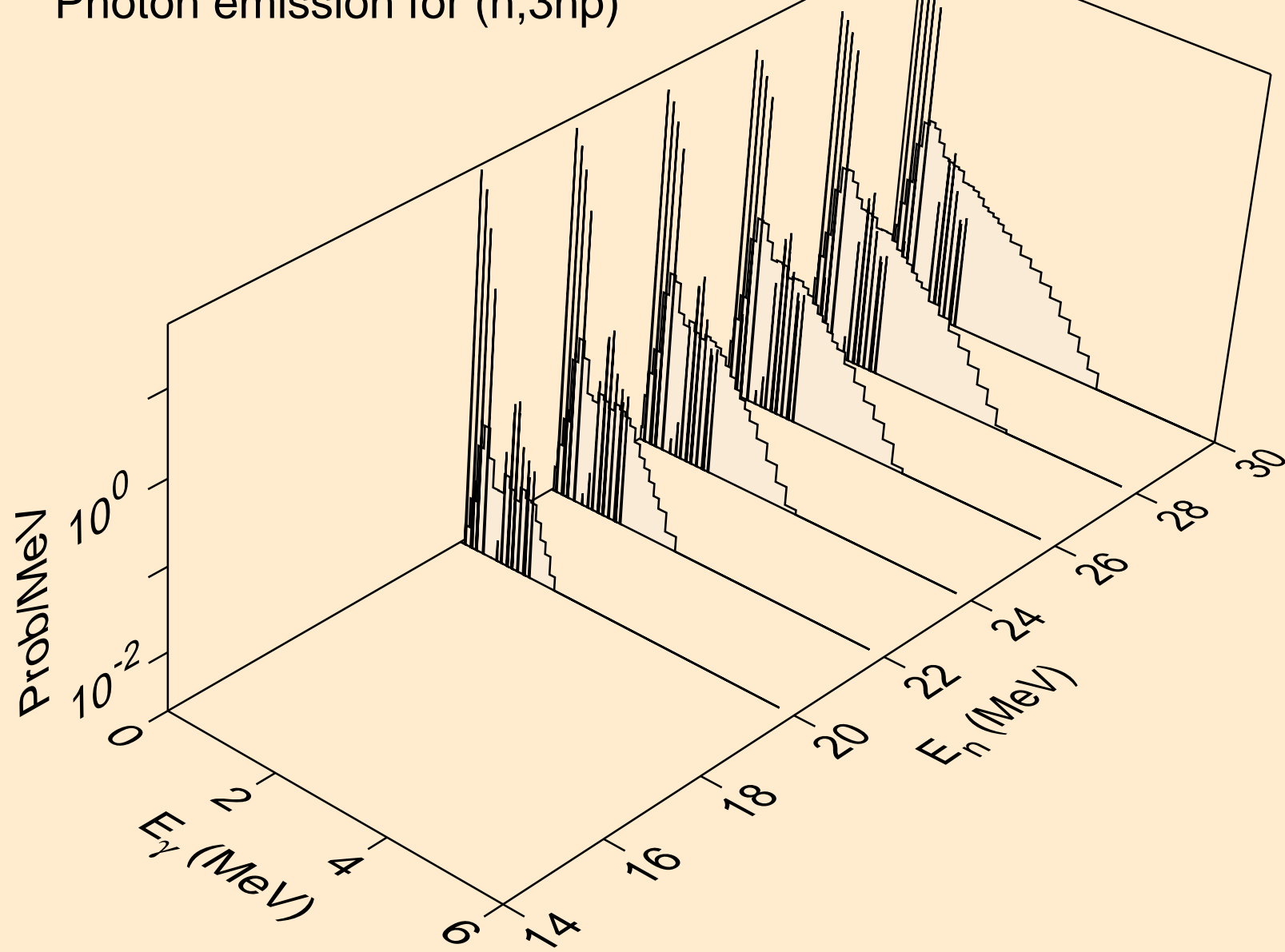

TB161 HELION ACER TENDL-2021 LIBRARY; T=0.K  
Photon emission for (n,2np)

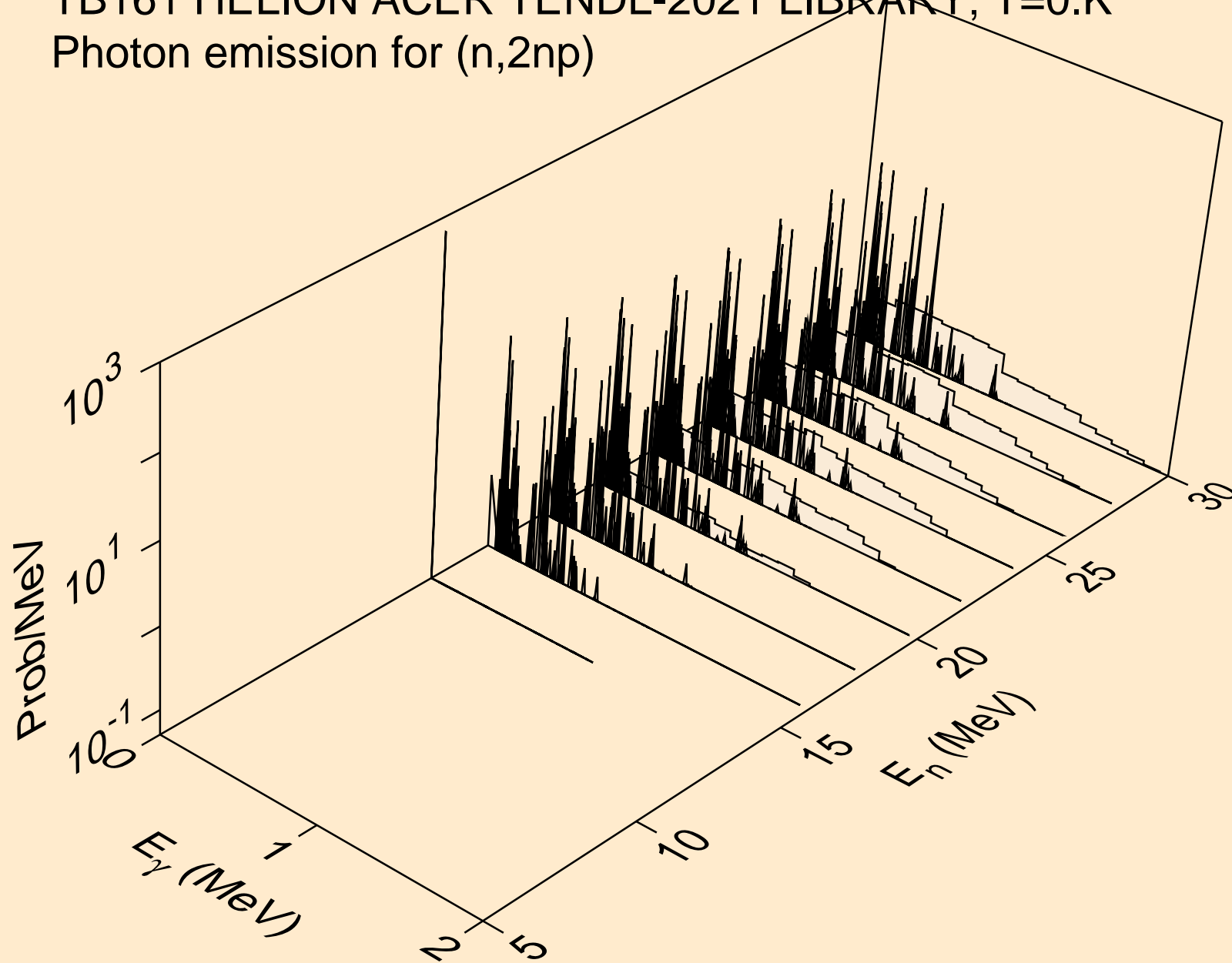

TB161 HELION ACER TENDL-2021 LIBRARY; T=0.K  
Photon emission for (n,npa)

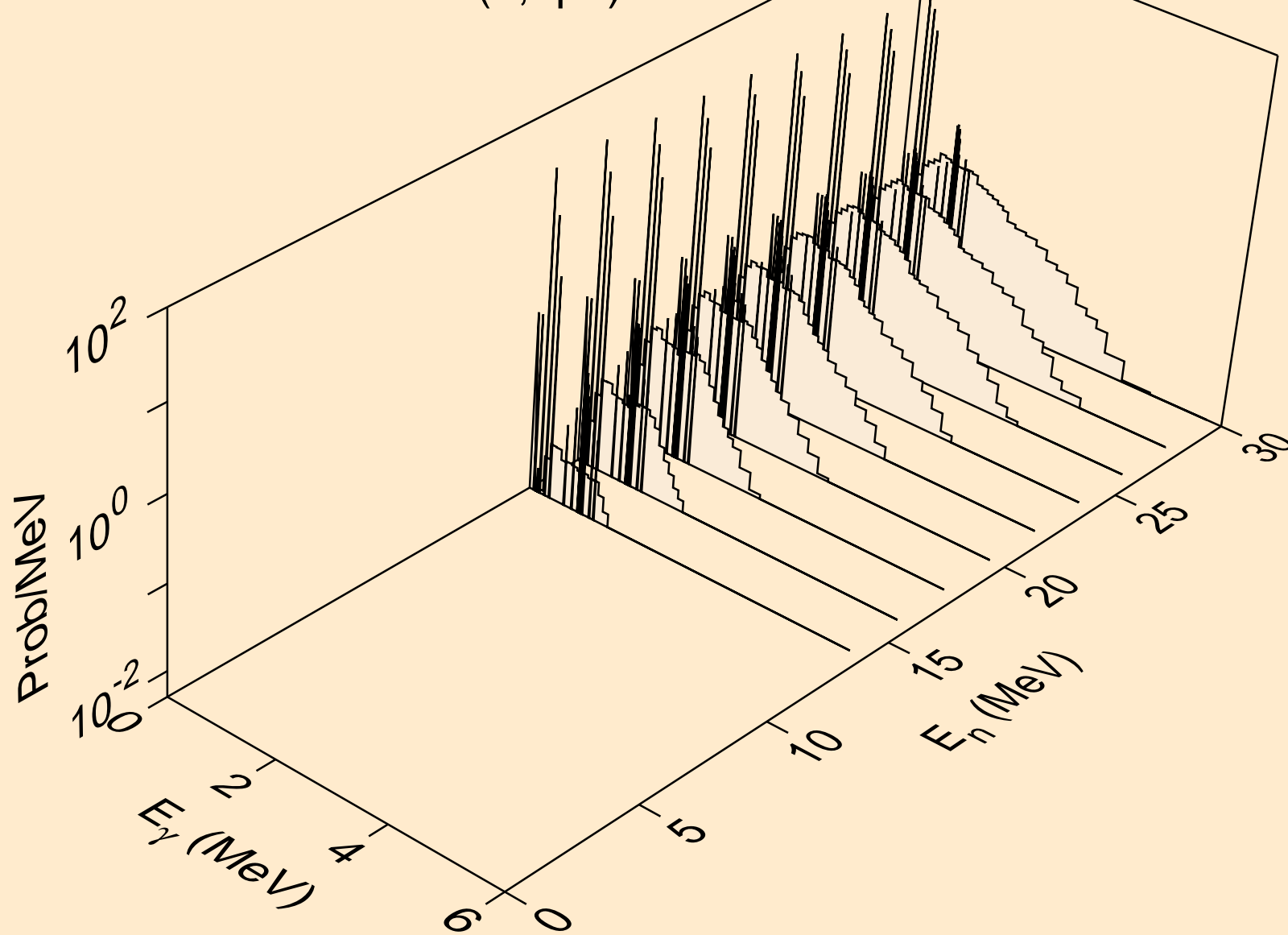

TB161 HELION ACER TENDL-2021 LIBRARY; T=0.K  
Photon emission for (n,gma)

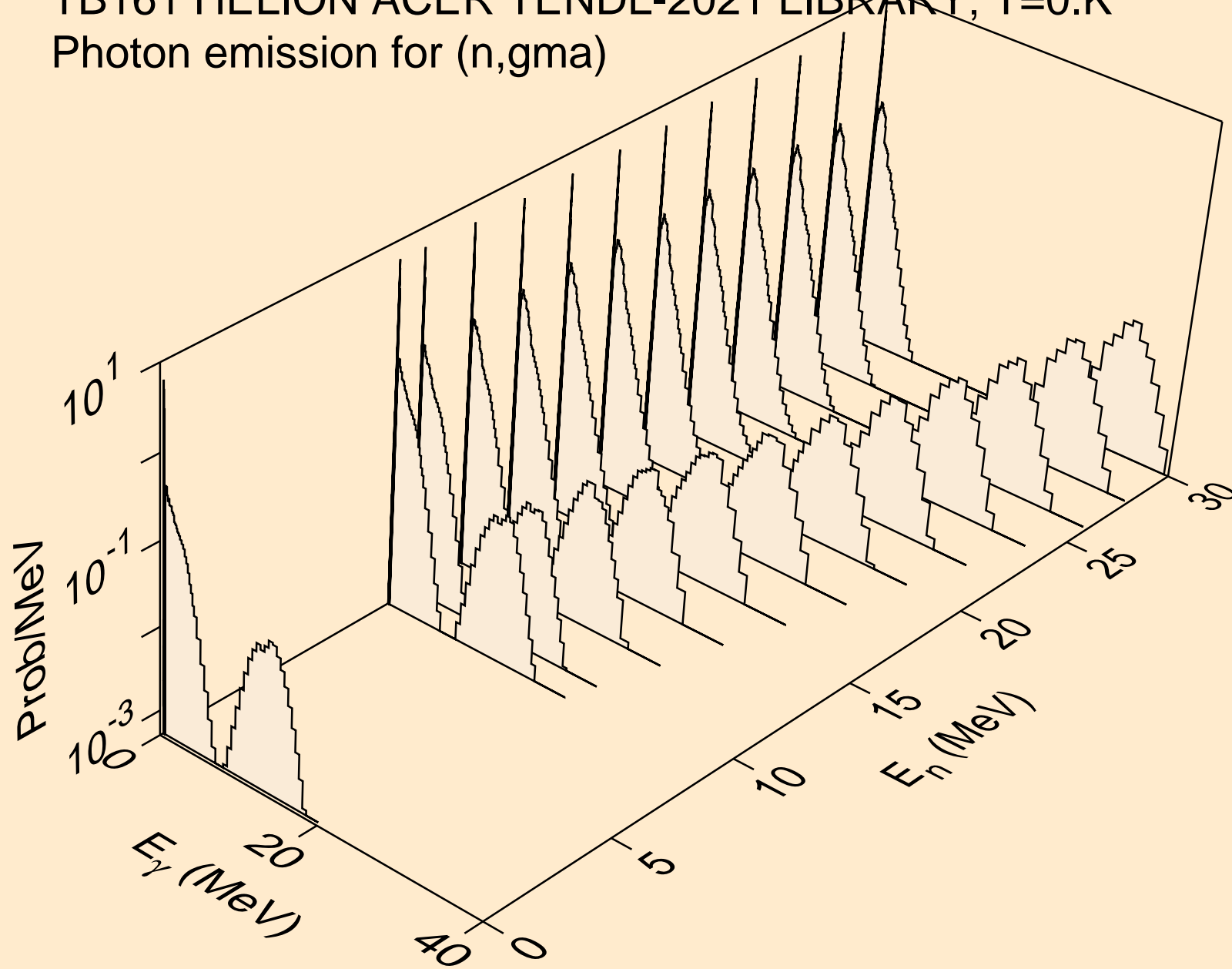

TB161 HELION ACER TENDL-2021 LIBRARY; T=0.K  
Photon emission for (n,p)

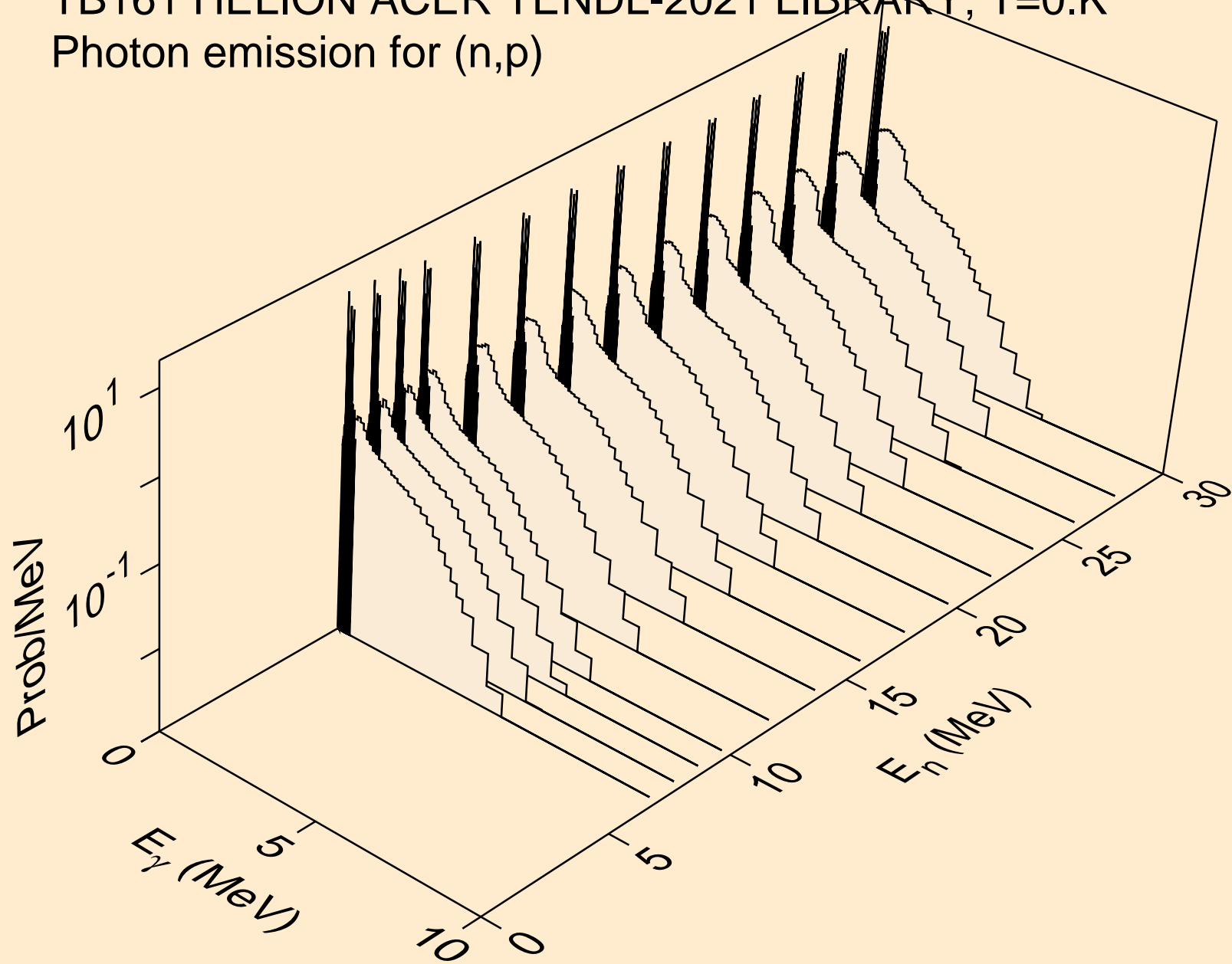

TB161 HELION ACER TENDL-2021 LIBRARY; T=0.K  
Photon emission for (n,d)

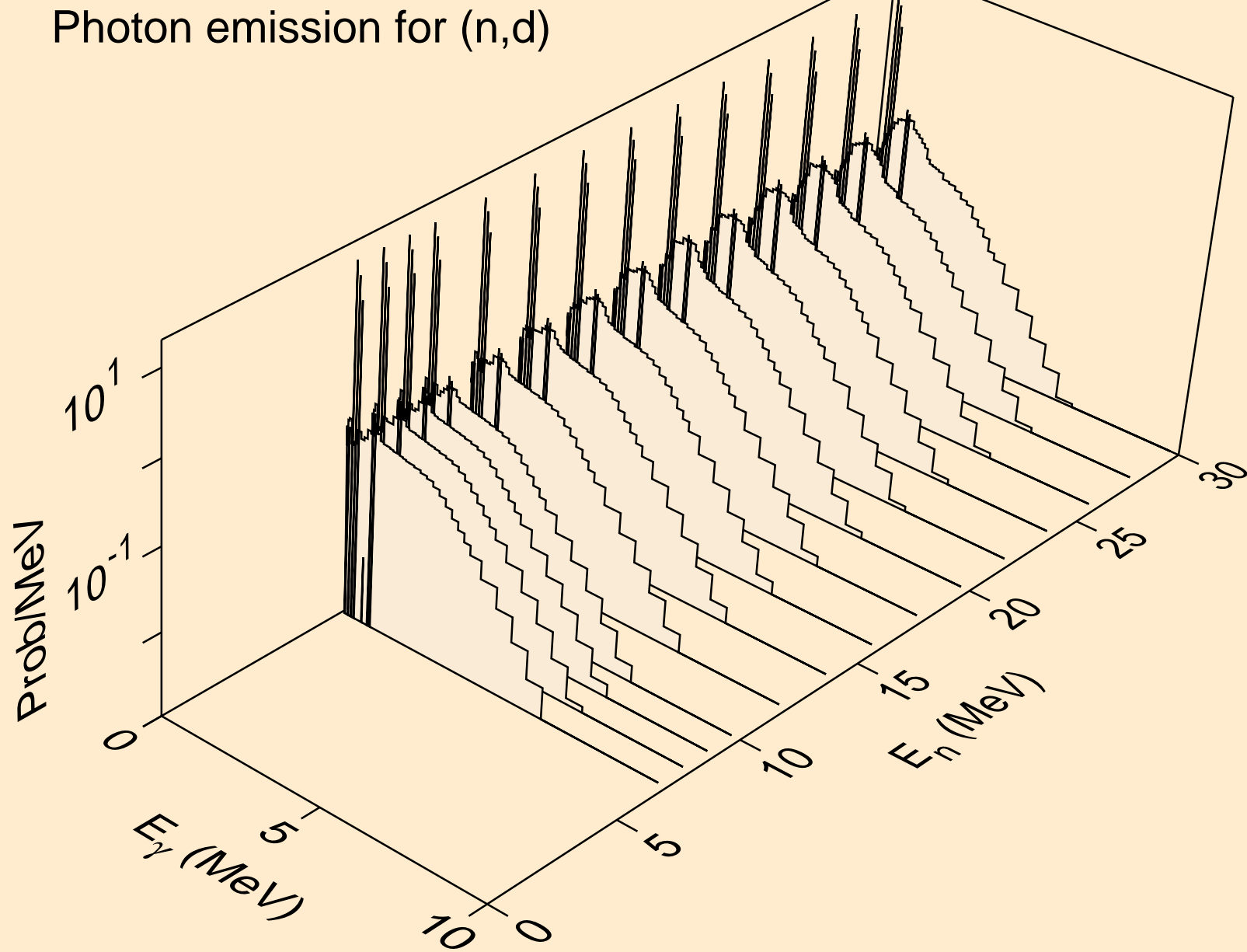

TB161 HELION ACER TENDL-2021 LIBRARY; T=0.K  
Photon emission for (n,t)

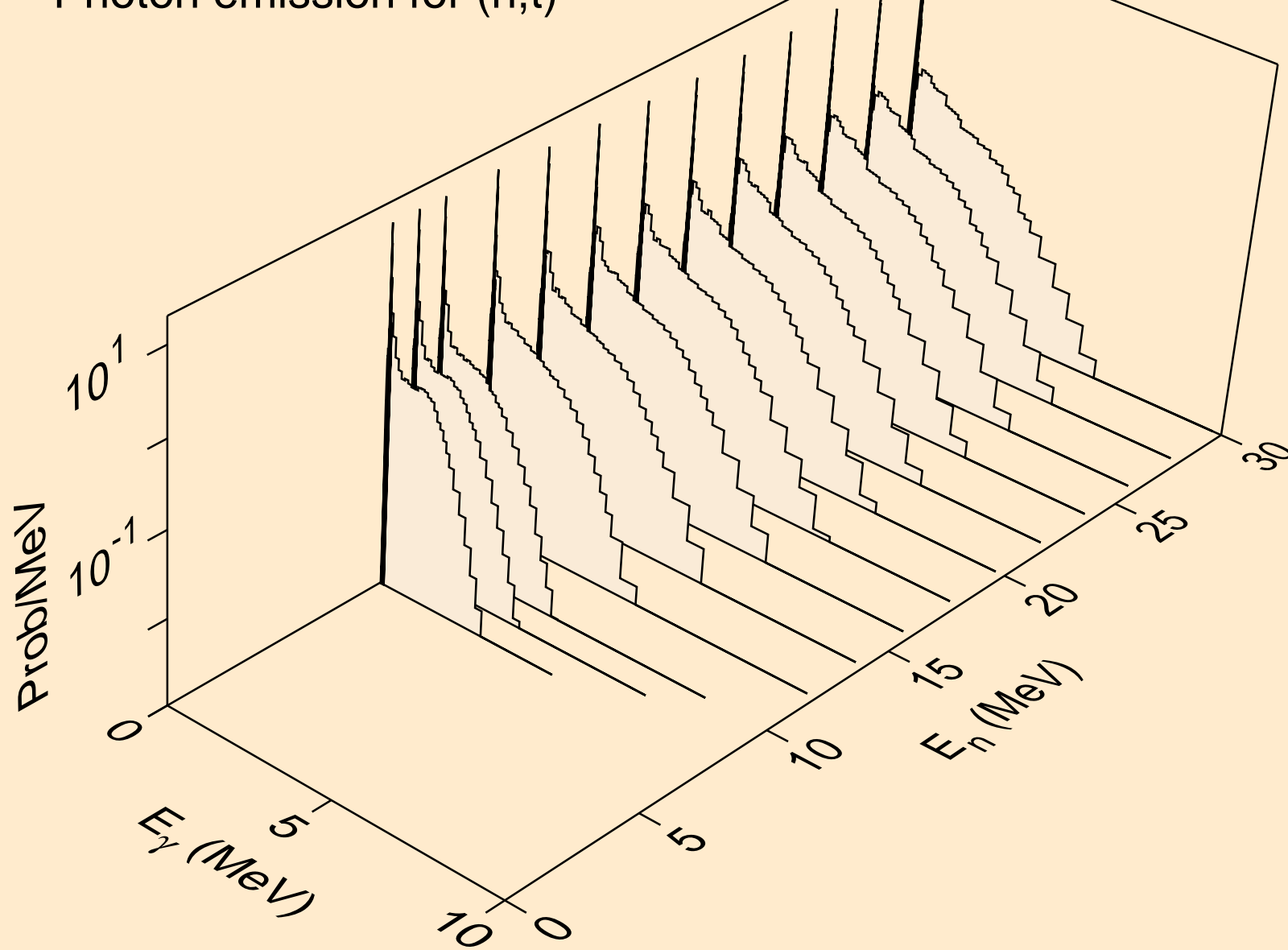

TB161 HELION ACER TENDL-2021 LIBRARY; T=0.K  
Photon emission for inelastic

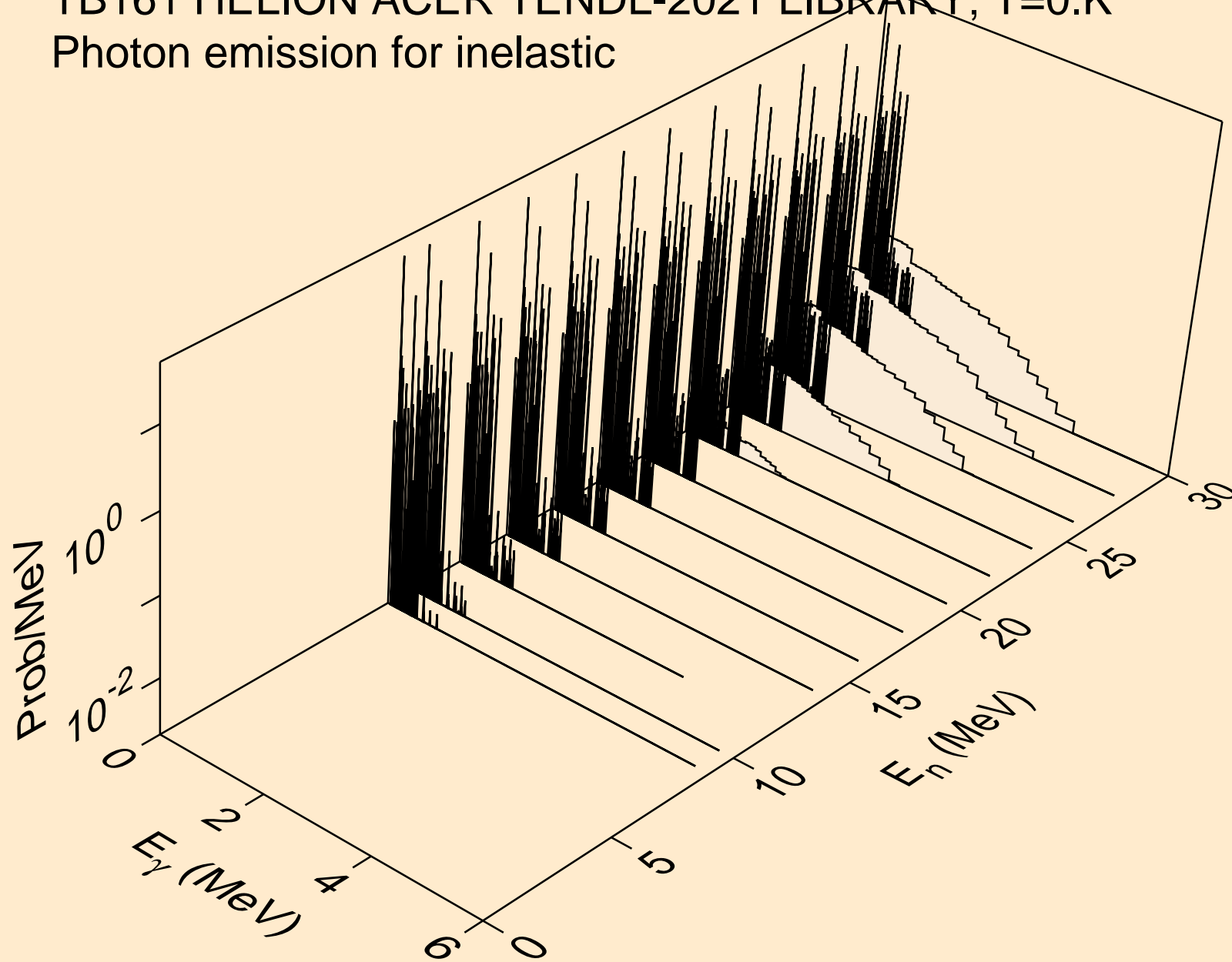



TB161 HELION ACER TENDL-2021 LIBRARY; T=0.K  
Photon emission for (n,a)

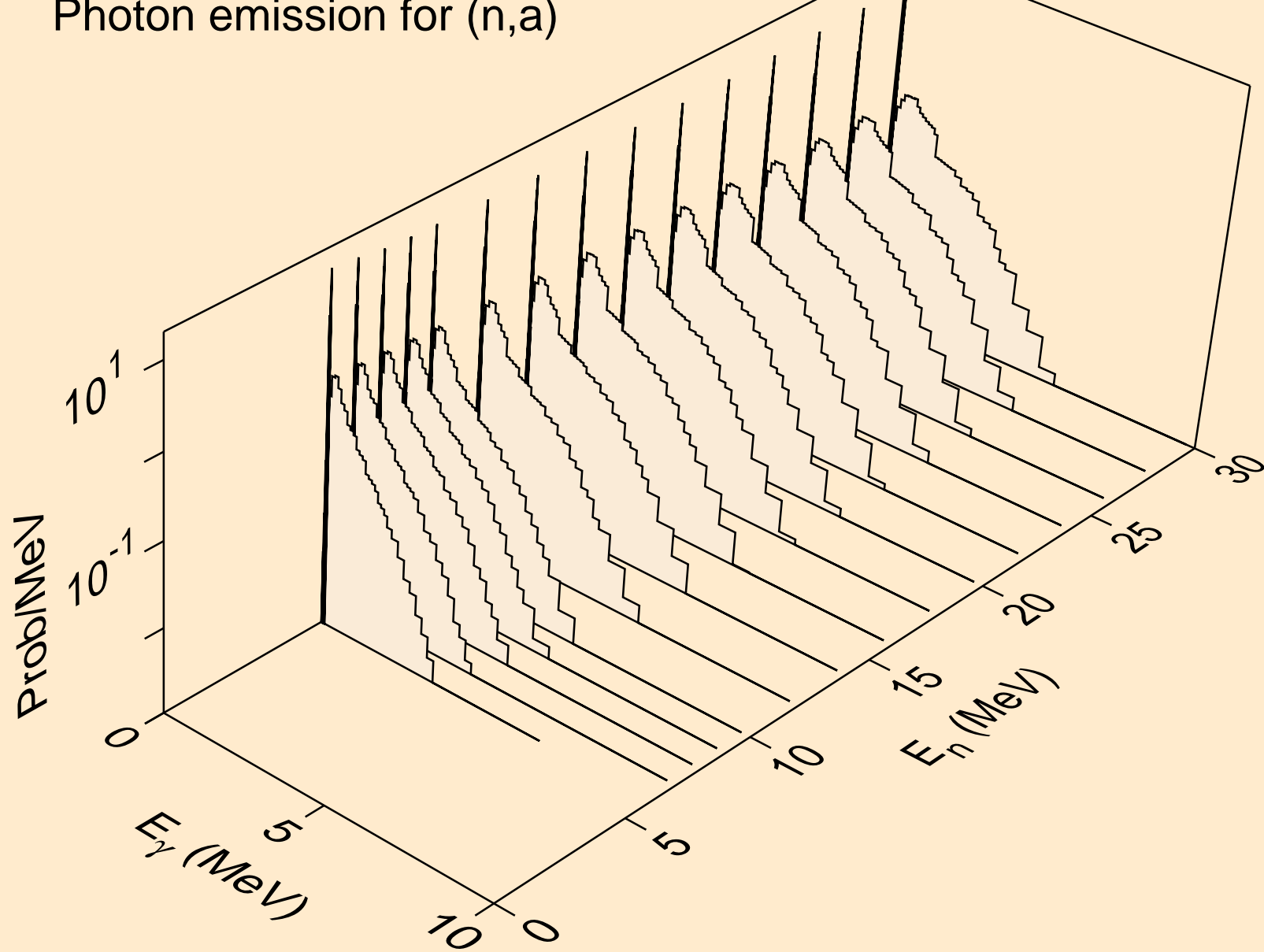

TB161 HELION ACER TENDL-2021 LIBRARY; T=0.K  
Photon emission for (n,2p)

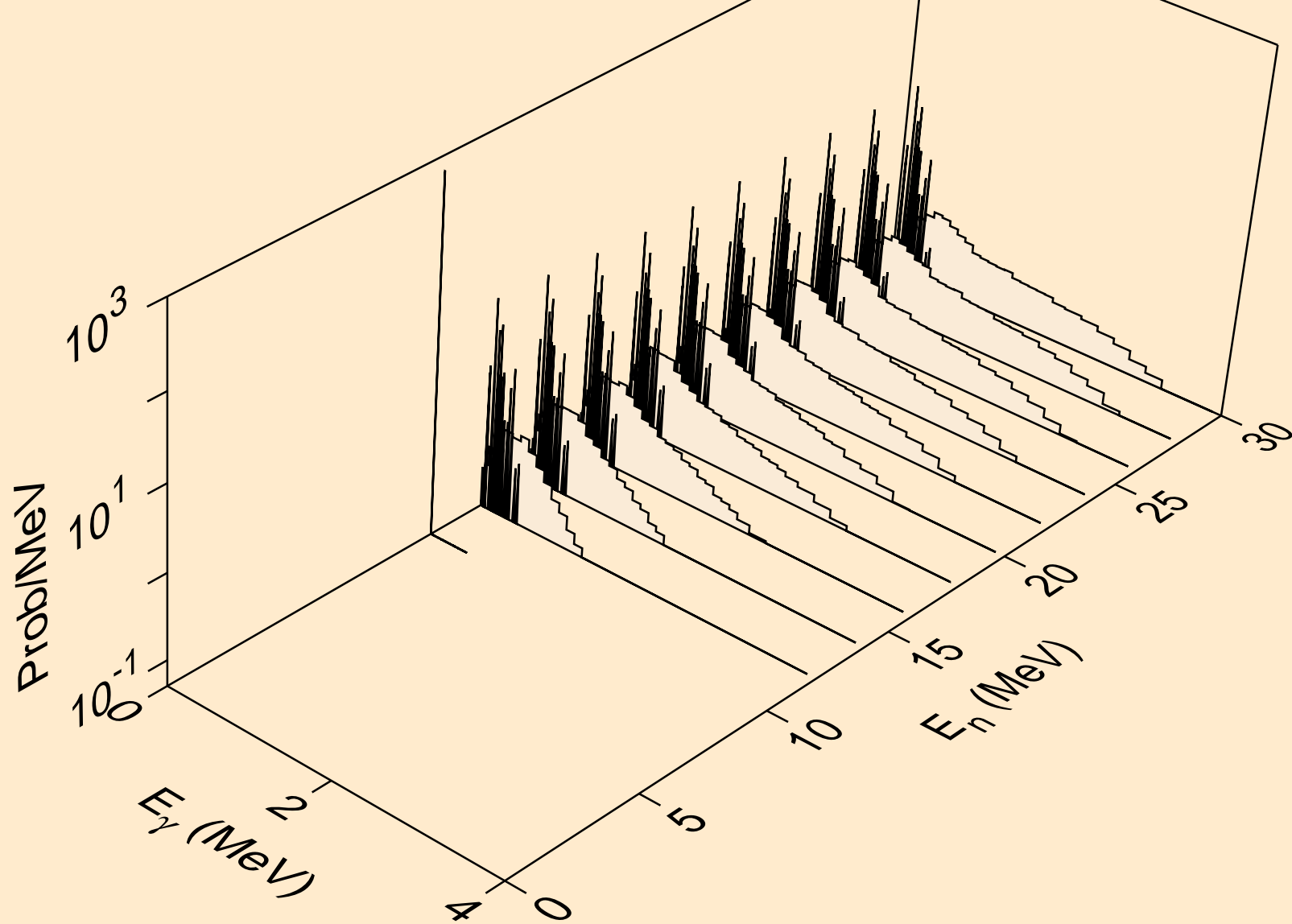

TB161 HELION ACER TENDL-2021 LIBRARY; T=0.K  
Photon emission for (n,pa)

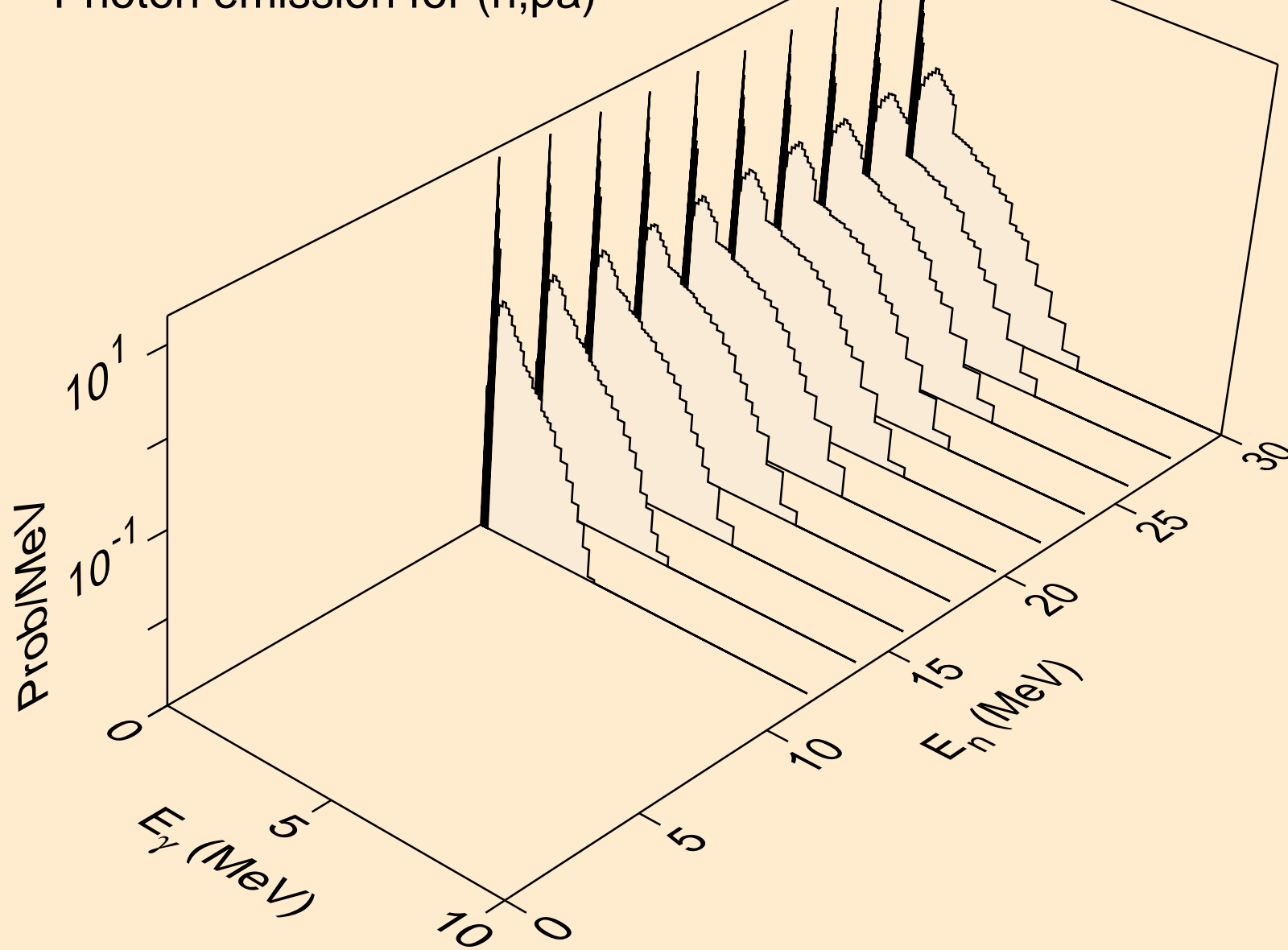

TB161 HELION ACER TENDL-2021 LIBRARY; T=0.K  
Photon emission for (n,pd)

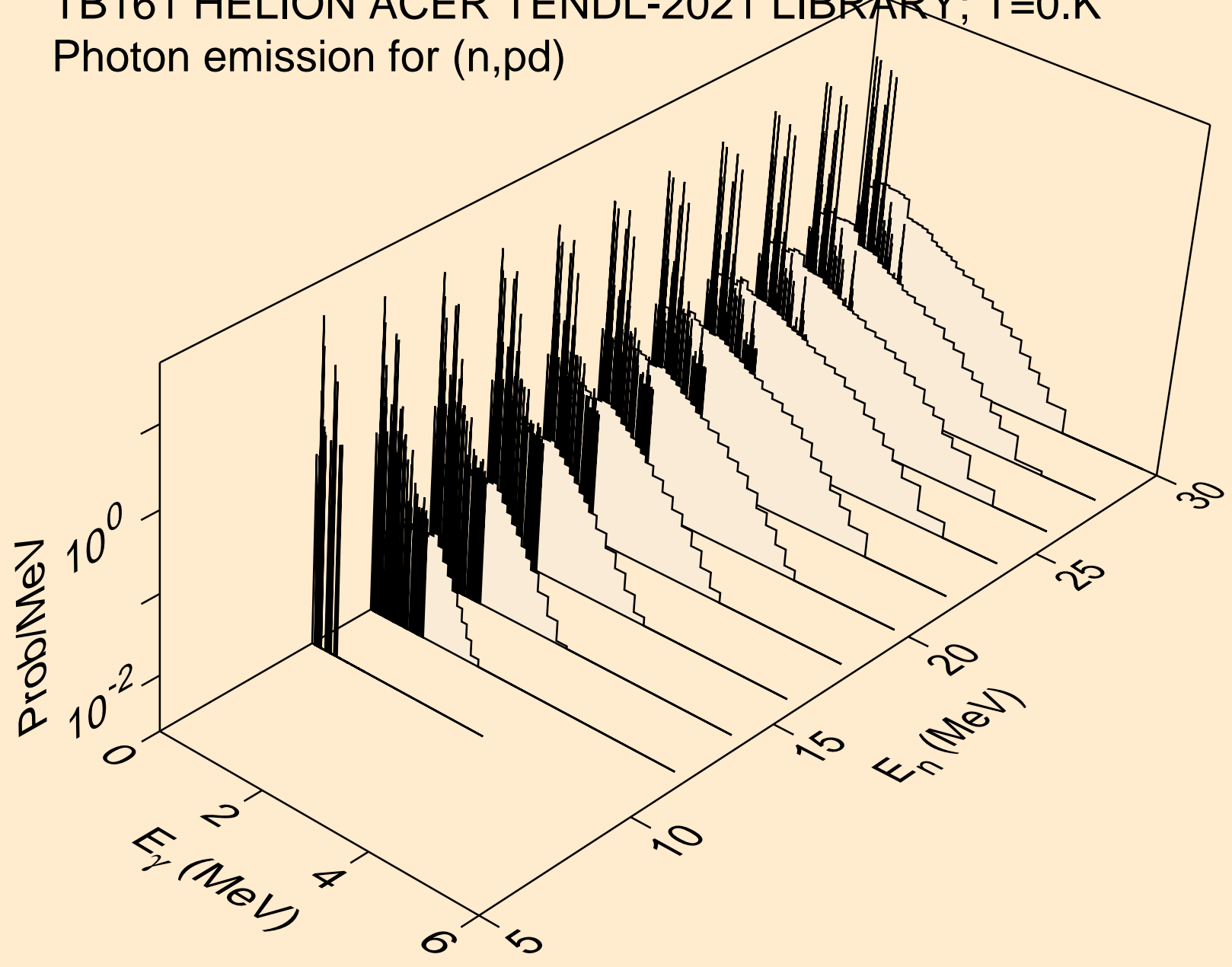

TB161 HELION ACER TENDL-2021 LIBRARY; T=0.K  
Photon emission for (n,pt)

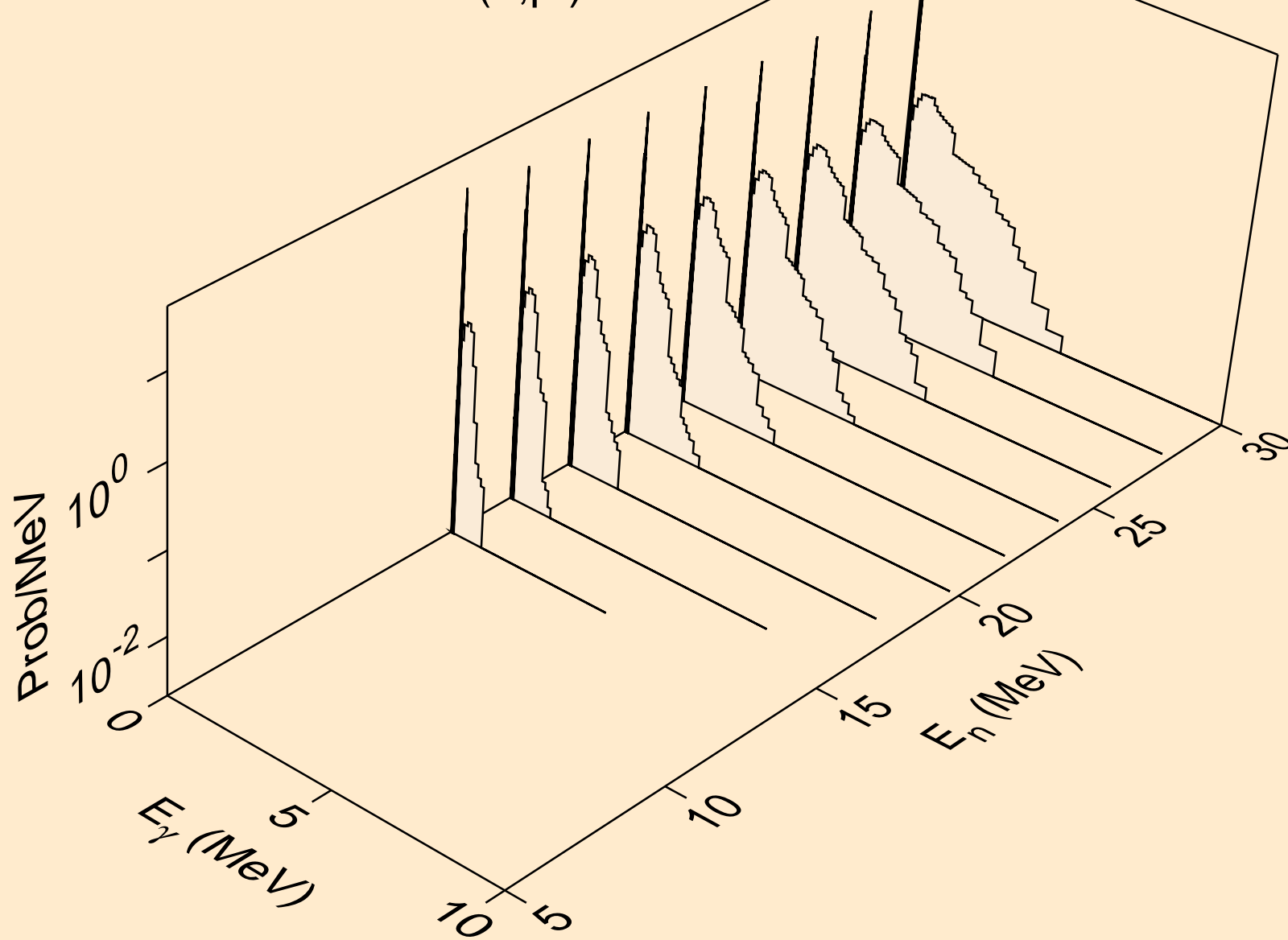

TB161 HELION ACER TENDL-2021 LIBRARY; T=0.K  
Photon emission for (n,da)

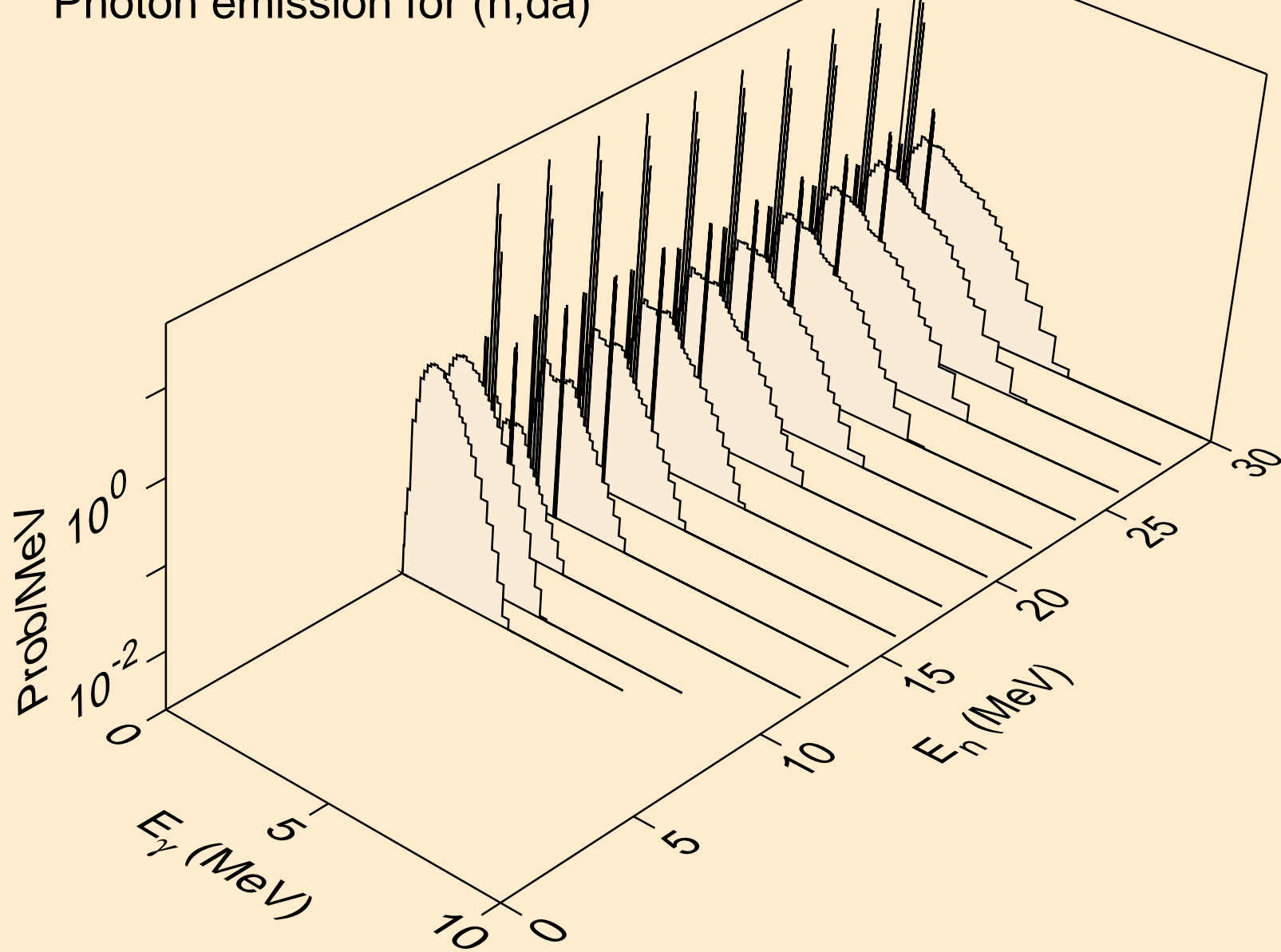

TB161 HELION ACER TENDL-2021 LIBRARY; T=0.K  
Particle heating contributions

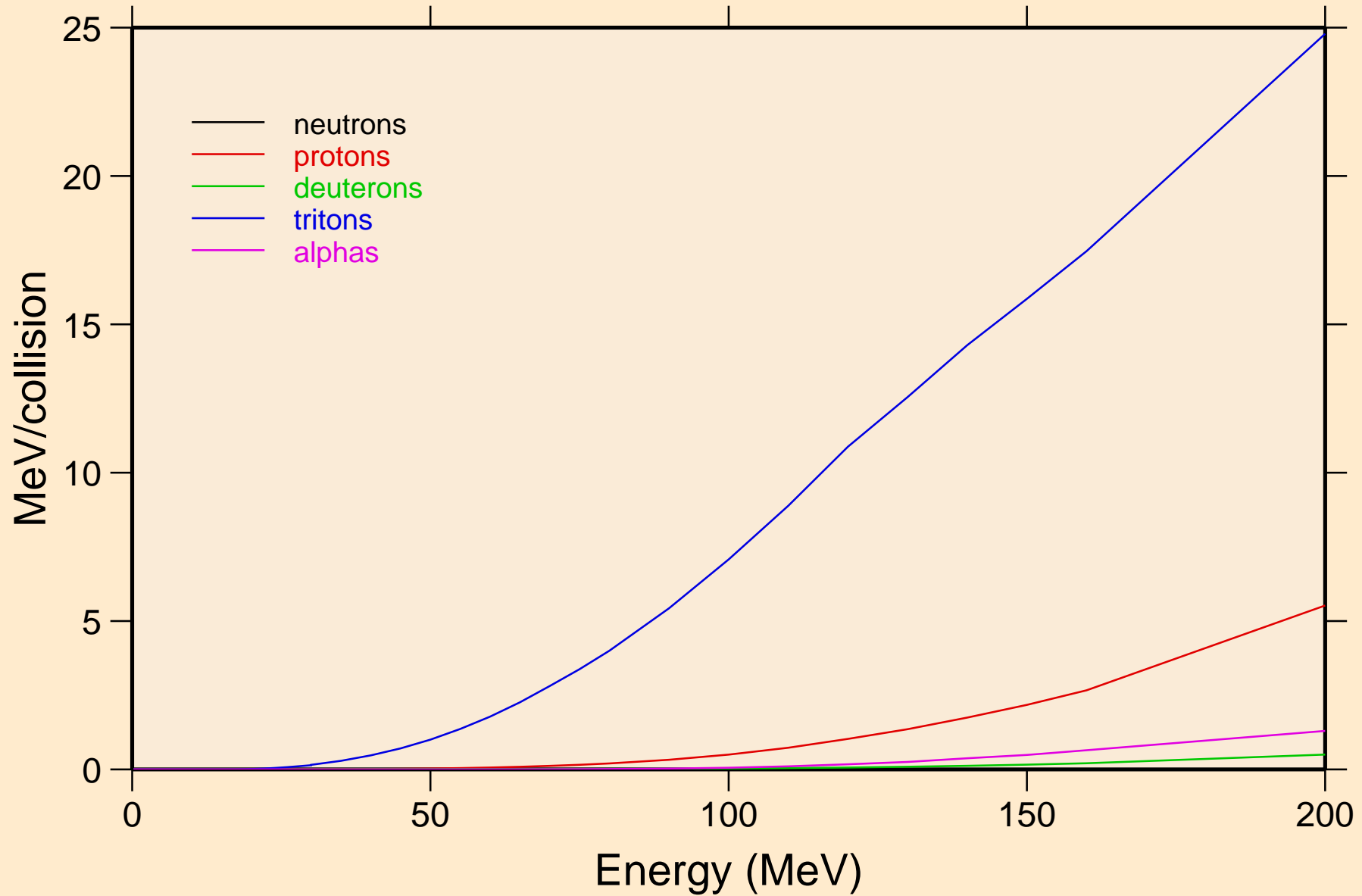

TB161 HELION ACER TENDL-2021 LIBRARY; T=0.K  
Recoil Heating

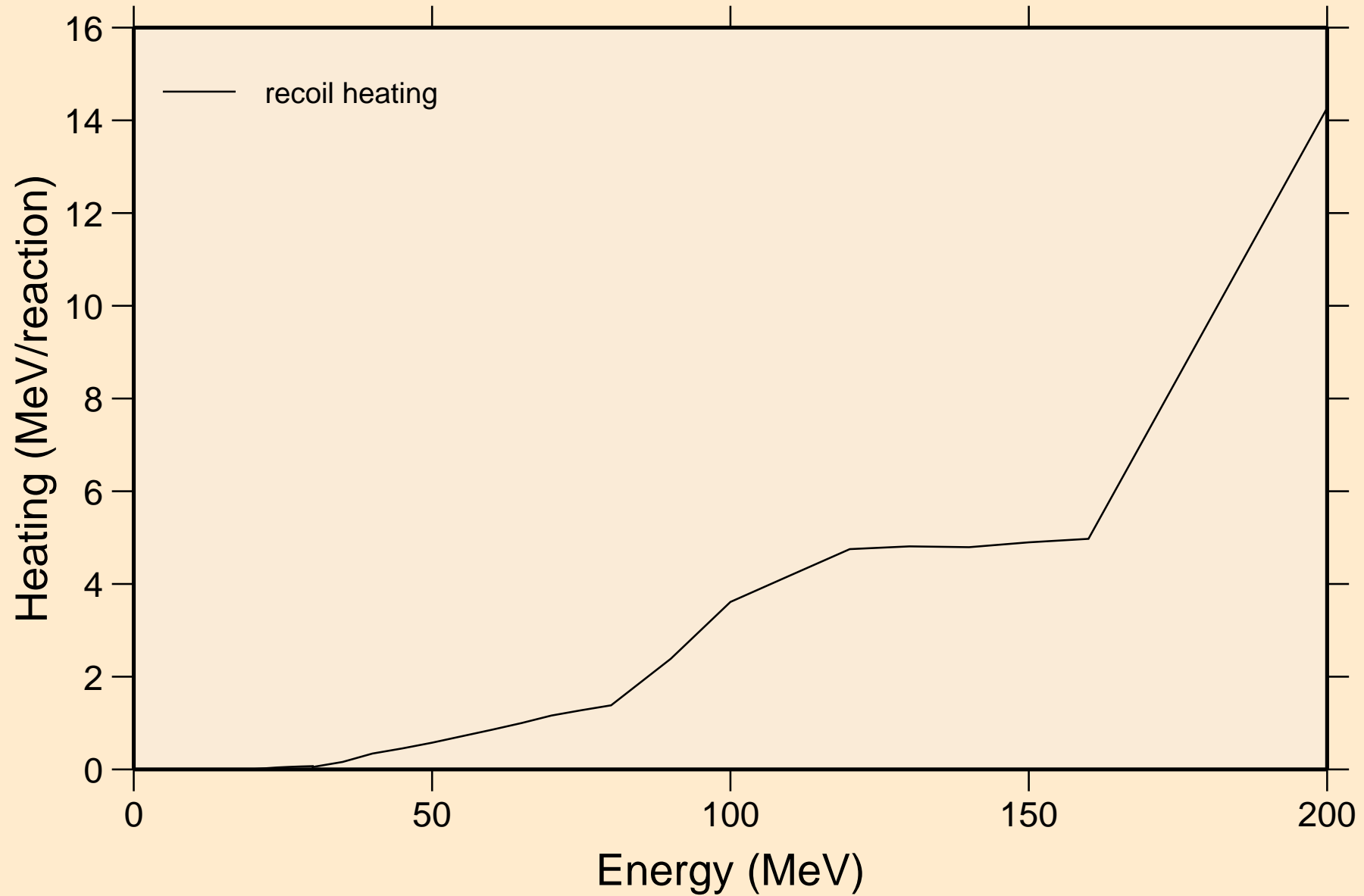



TB161 HELION ACER TENDL-2021 LIBRARY; T=0.K  
Particle production cross sections

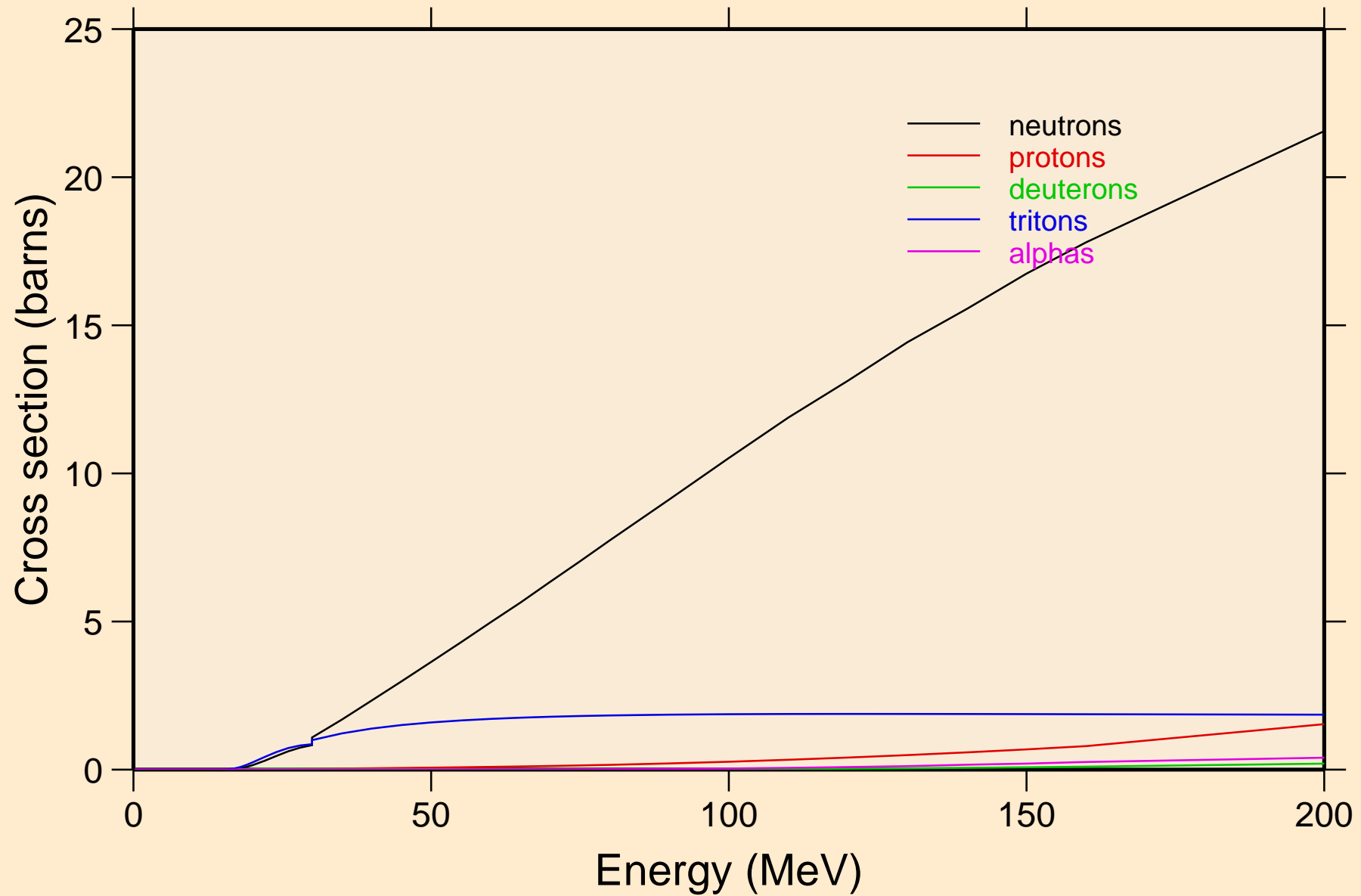

TB161 HELION ACER TENDL-2021 LIBRARY; T=0.K  
neutrons from (s,n)

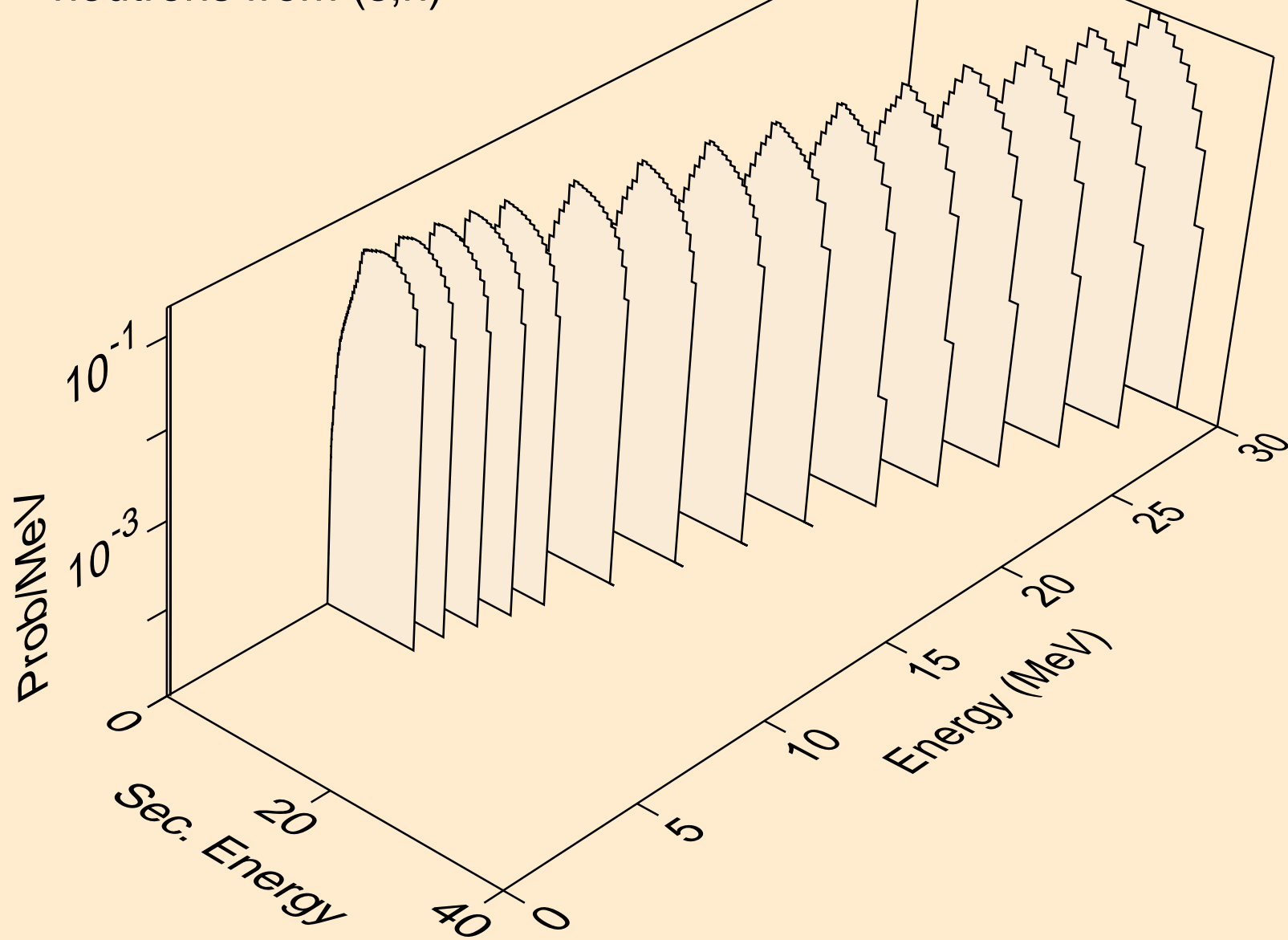

TB161 HELION ACER TENDL-2021 LIBRARY; T=0.K  
neutrons from (s,x)

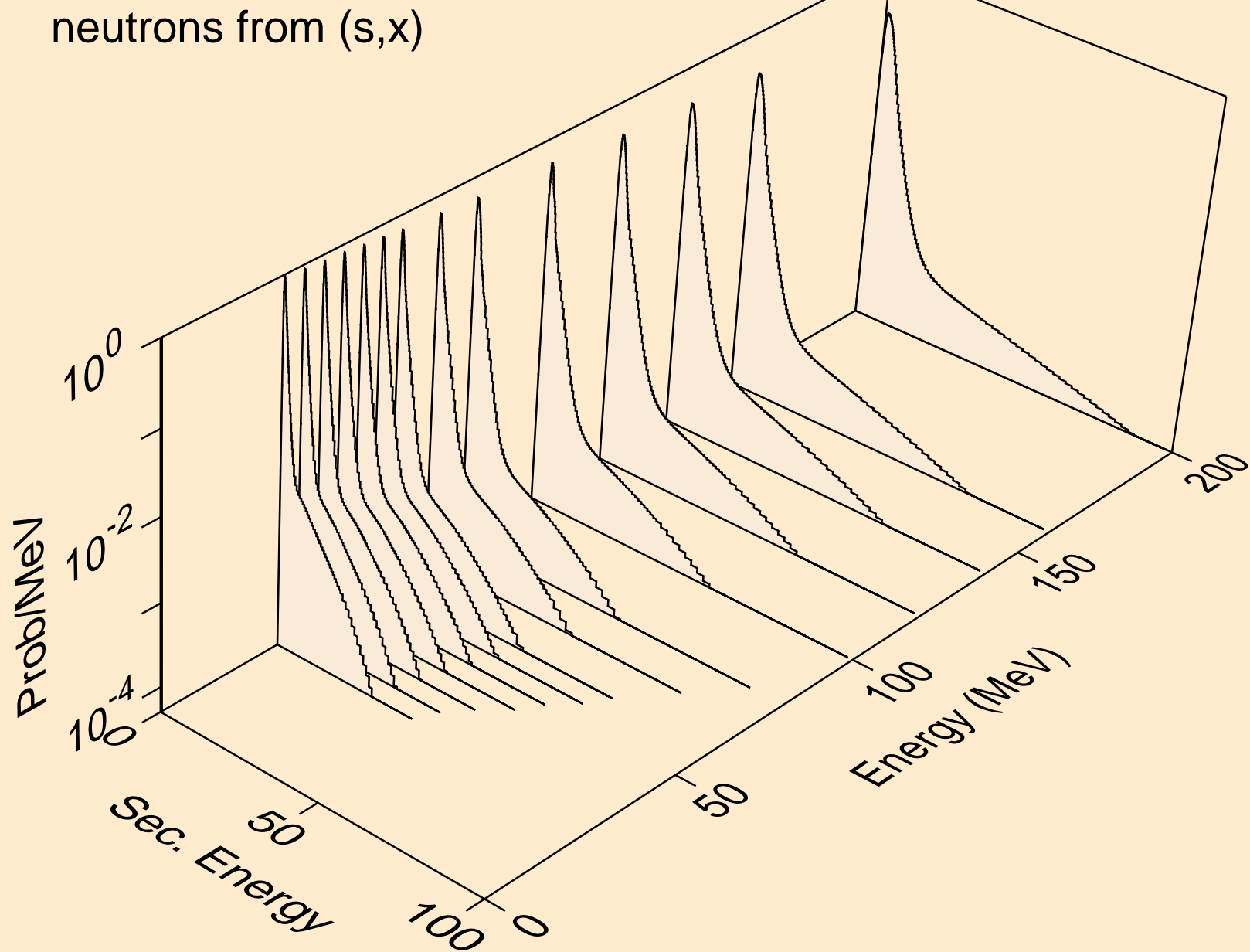

TB161 HELION ACER TENDL-2021 LIBRARY; T=0.K  
neutrons from (s,2nd)

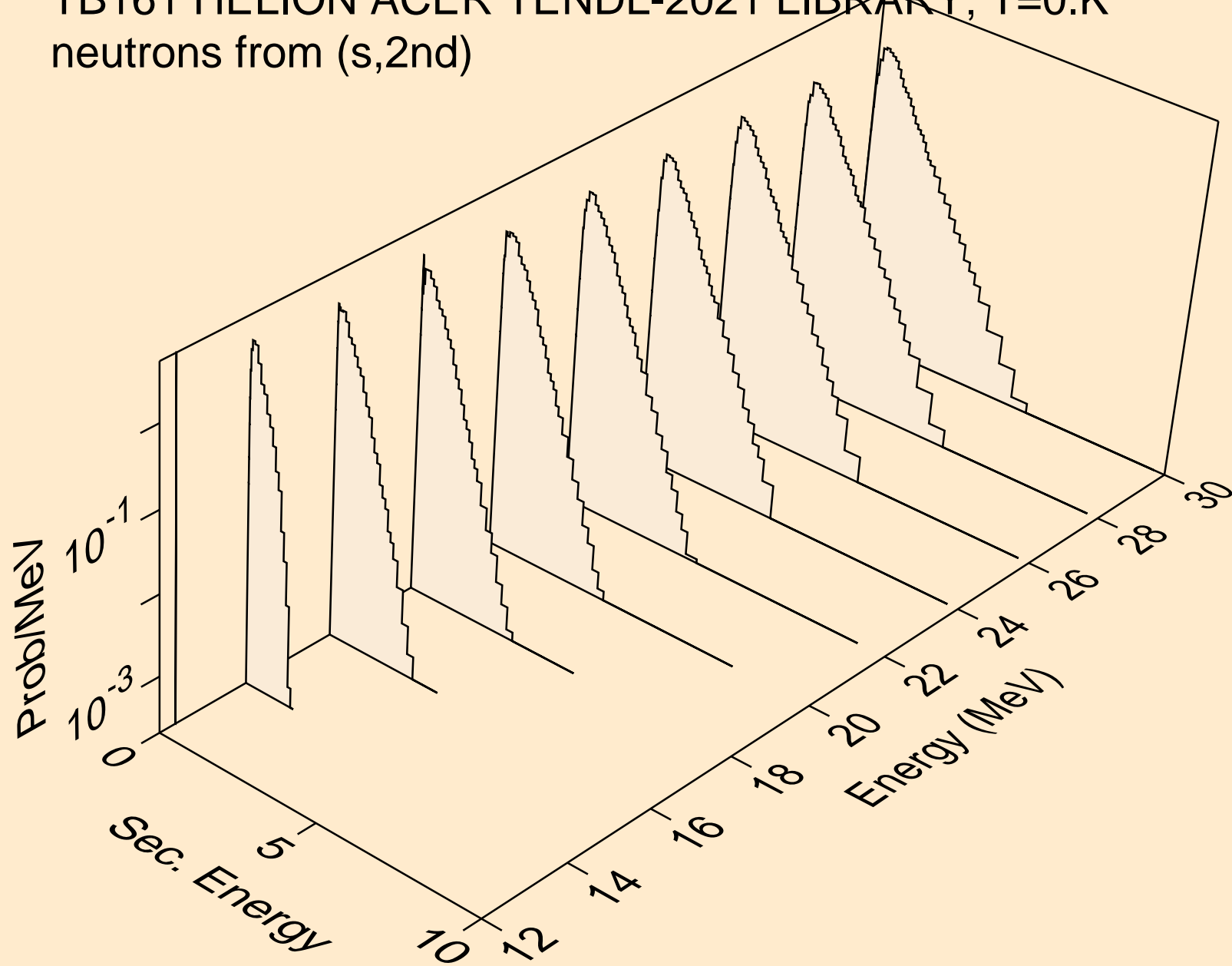

TB161 HELION ACER TENDL-2021 LIBRARY; T=0.K  
neutrons from (s,2n)

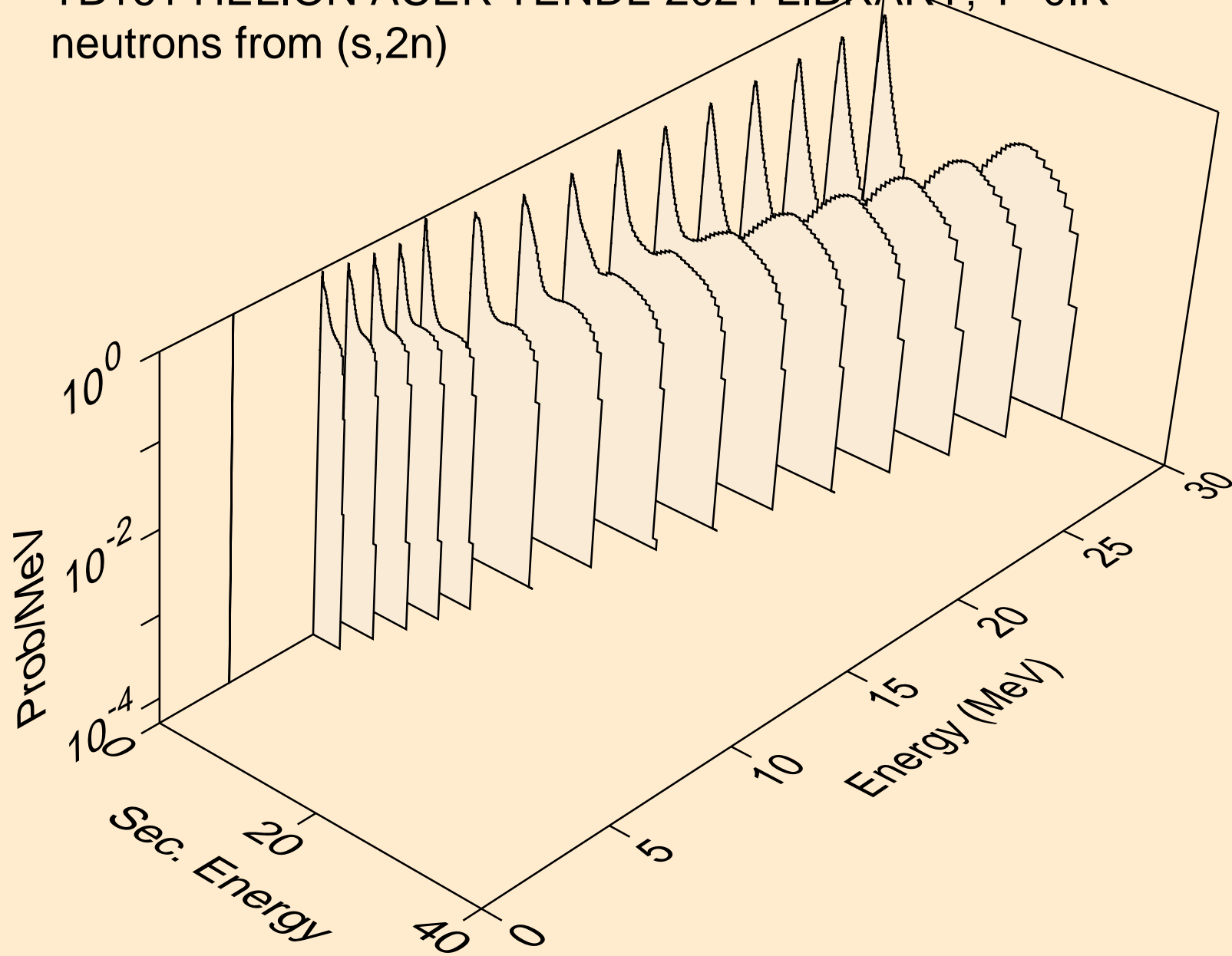

TB161 HELION ACER TENDL-2021 LIBRARY; T=0.K  
neutrons from (s,3n)

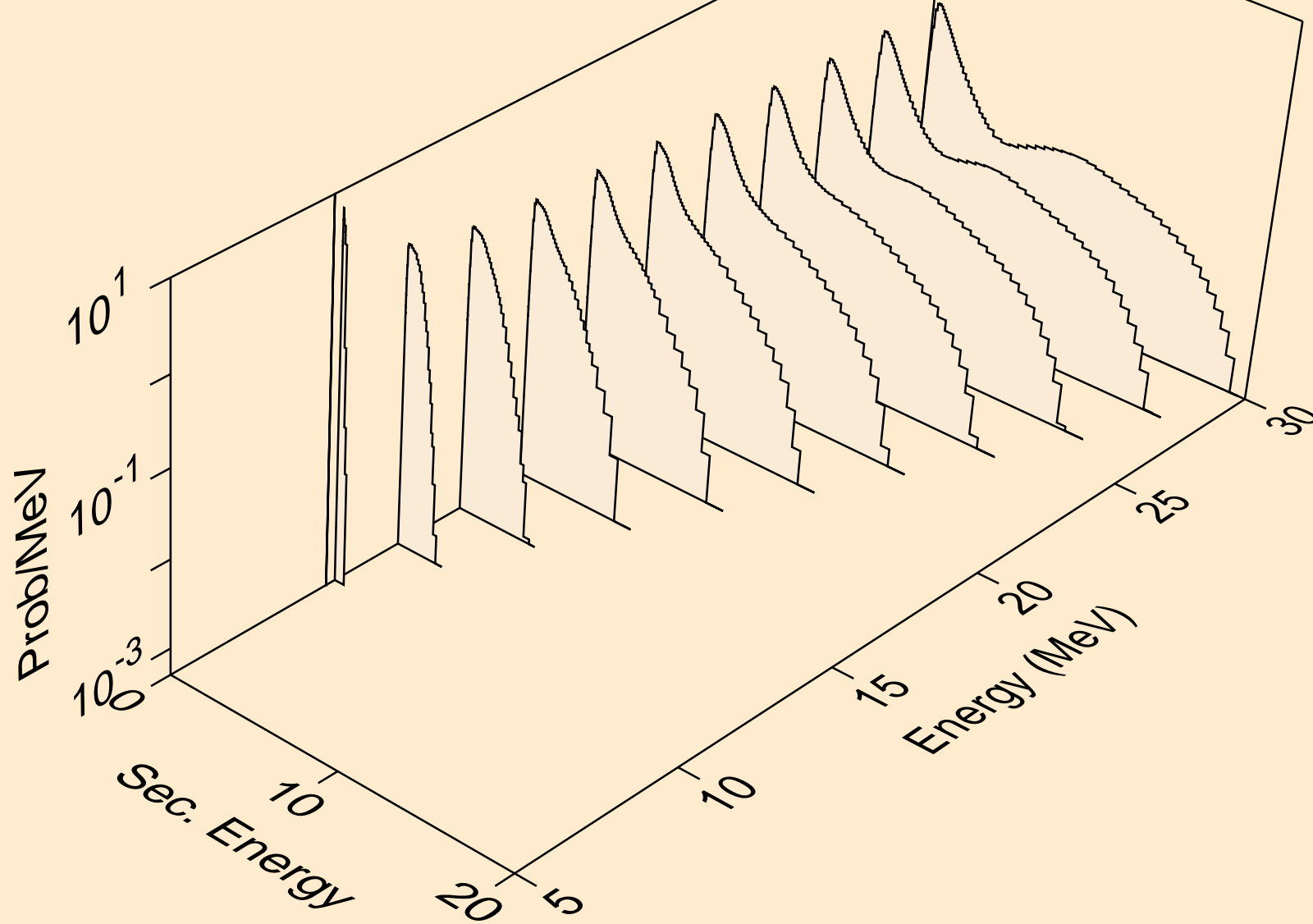

TB161 HELION ACER TENDL-2021 LIBRARY; T=0.K  
neutrons from (s,n\*)a

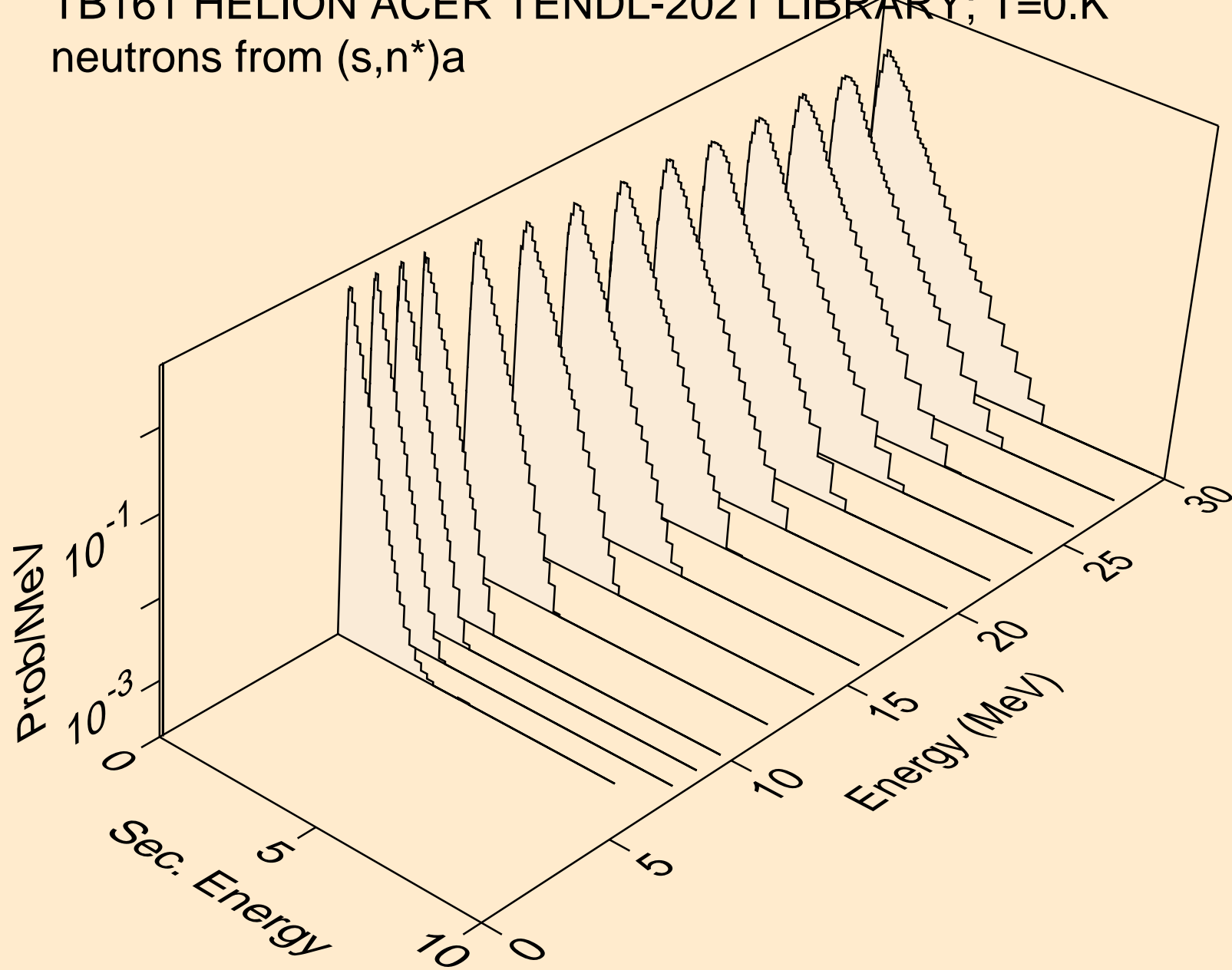

TB161 HELION ACER TENDL-2021 LIBRARY; T=0.K  
neutrons from (s,2n)a

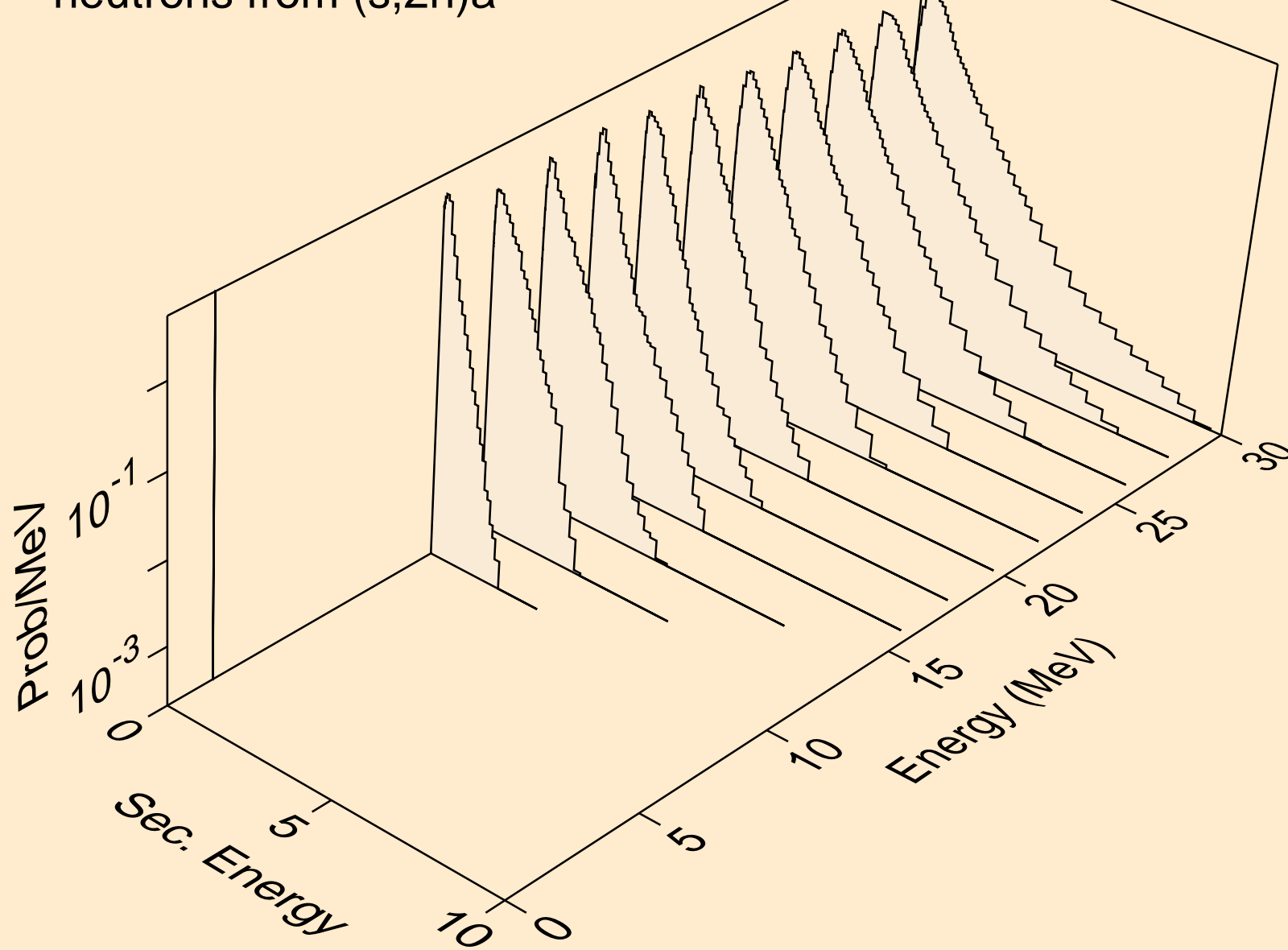



TB161 HELION ACER TENDL-2021 LIBRARY; T=0.K  
neutrons from (s,3n)a

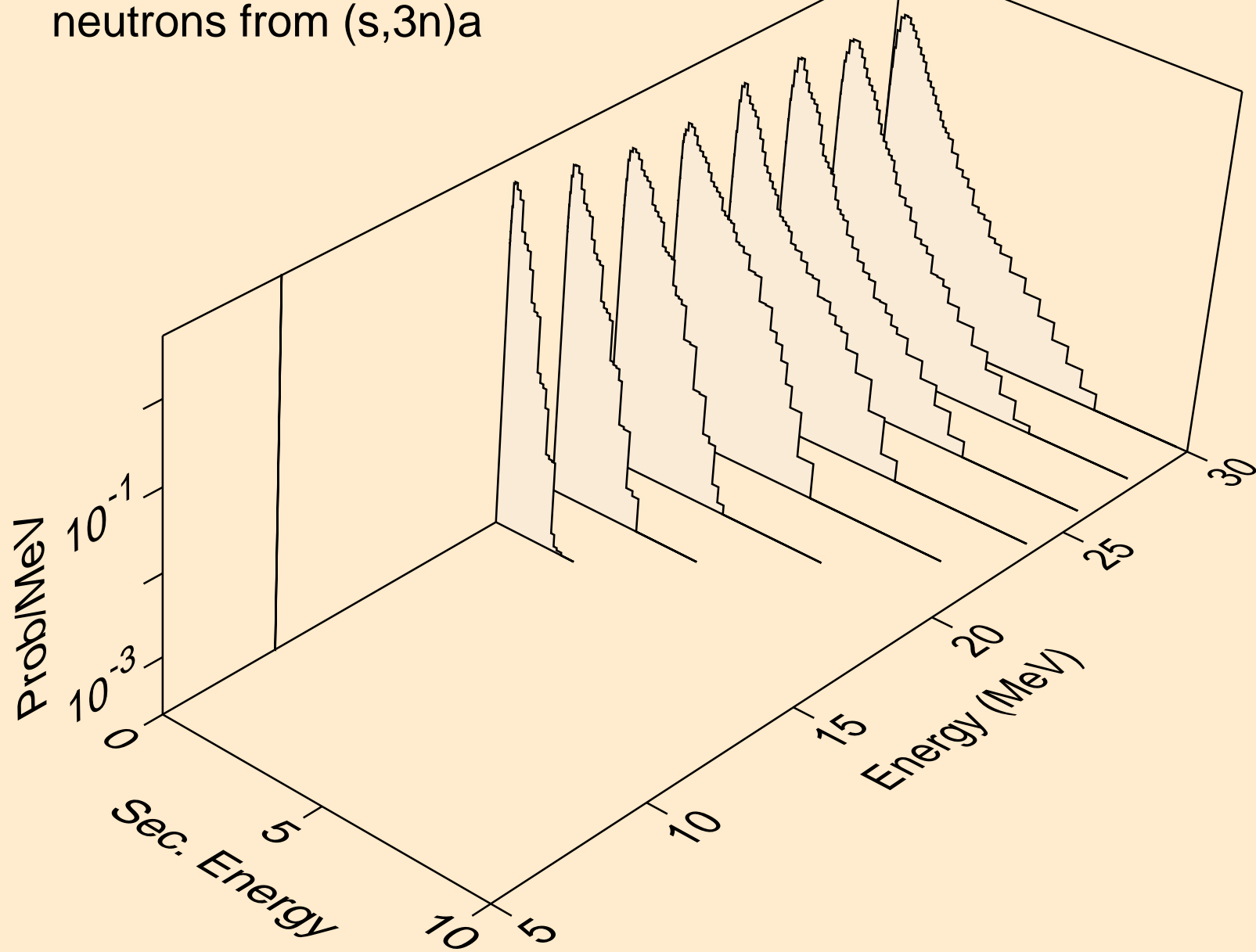

TB161 HELION ACER TENDL-2021 LIBRARY; T=0.K  
neutrons from (s,n\*)p

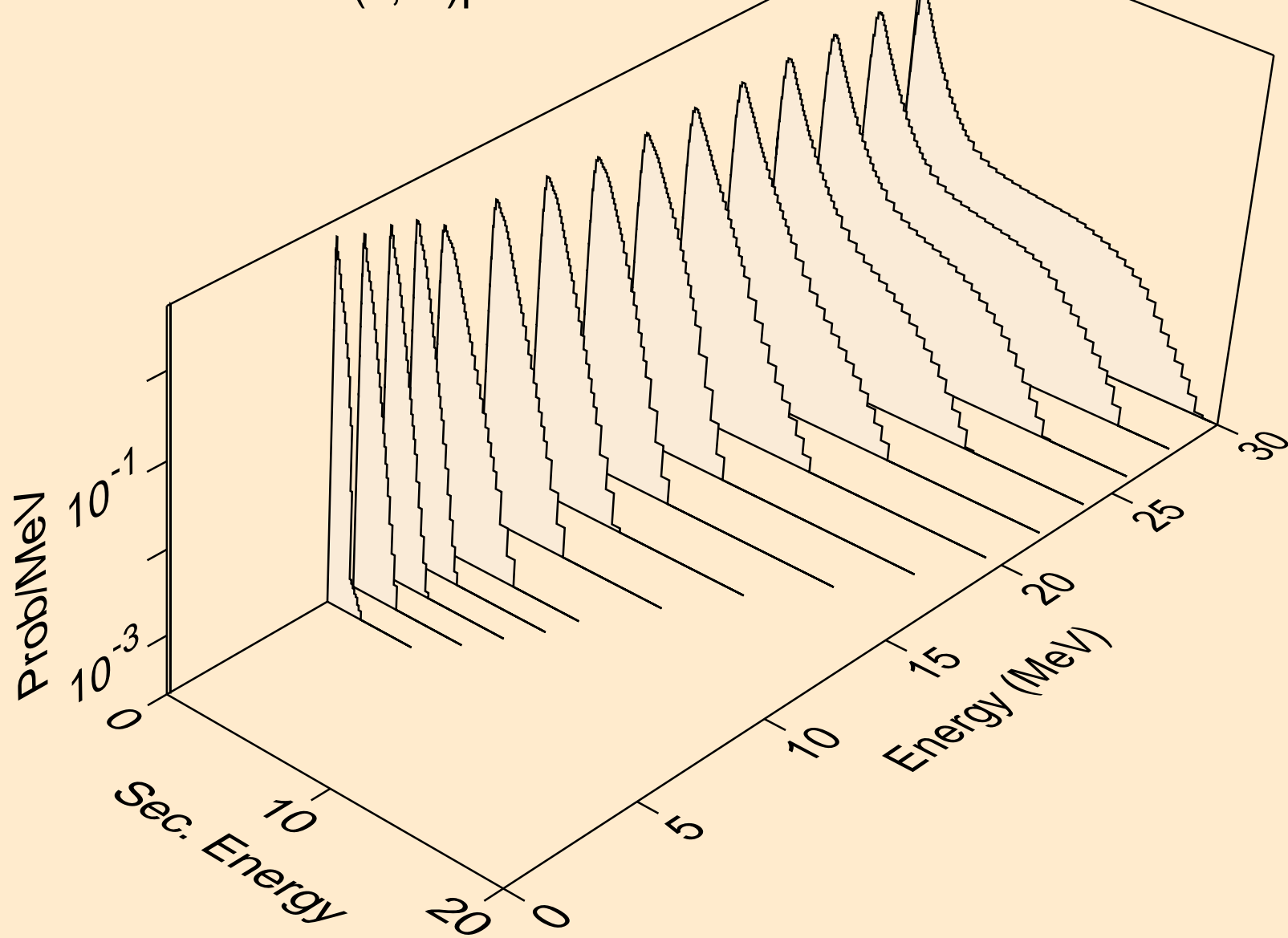

TB161 HELION ACER TENDL-2021 LIBRARY; T=0.K  
neutrons from (s,n\*)2a

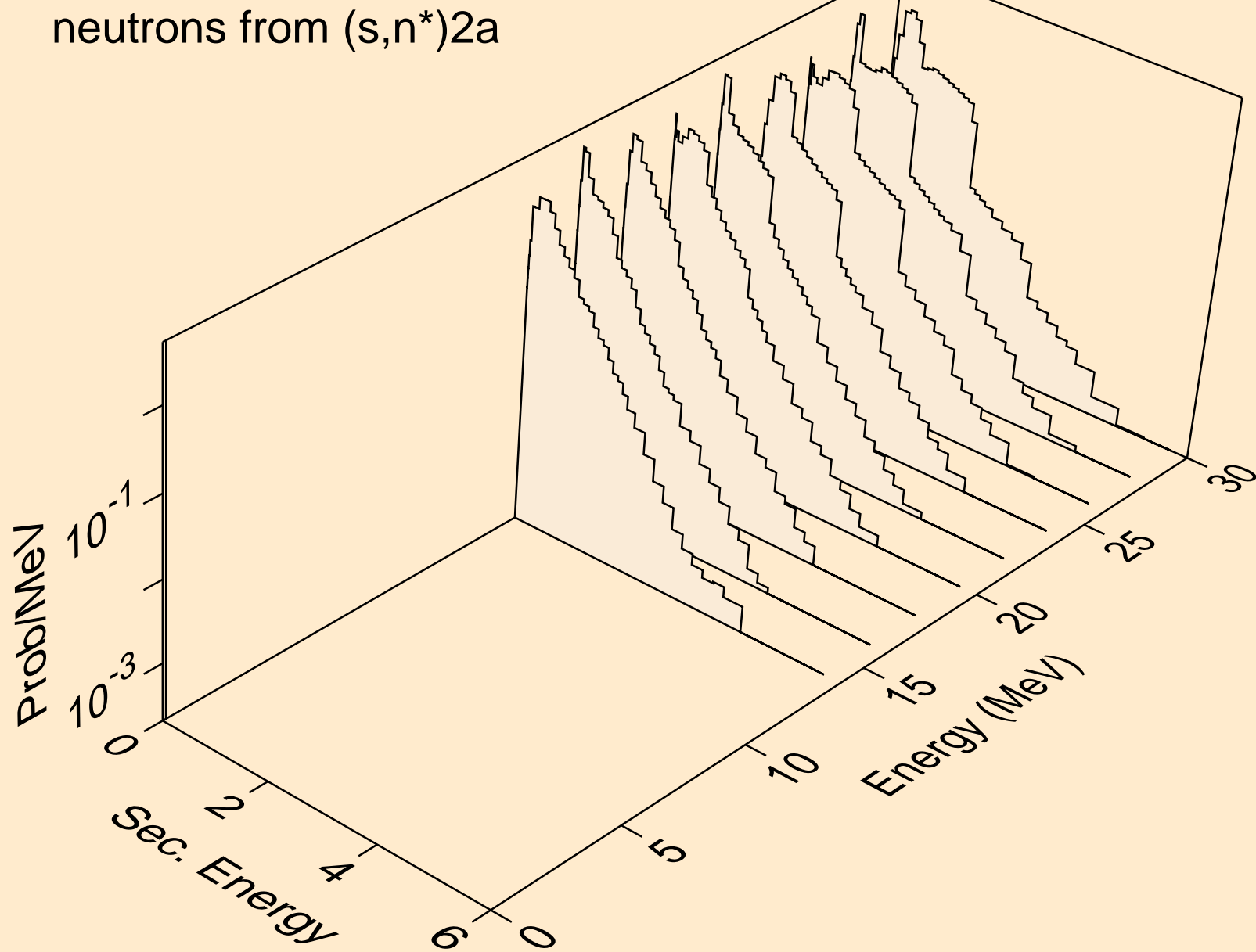

TB161 HELION ACER TENDL-2021 LIBRARY; T=0.K  
neutrons from (s,n\*)d

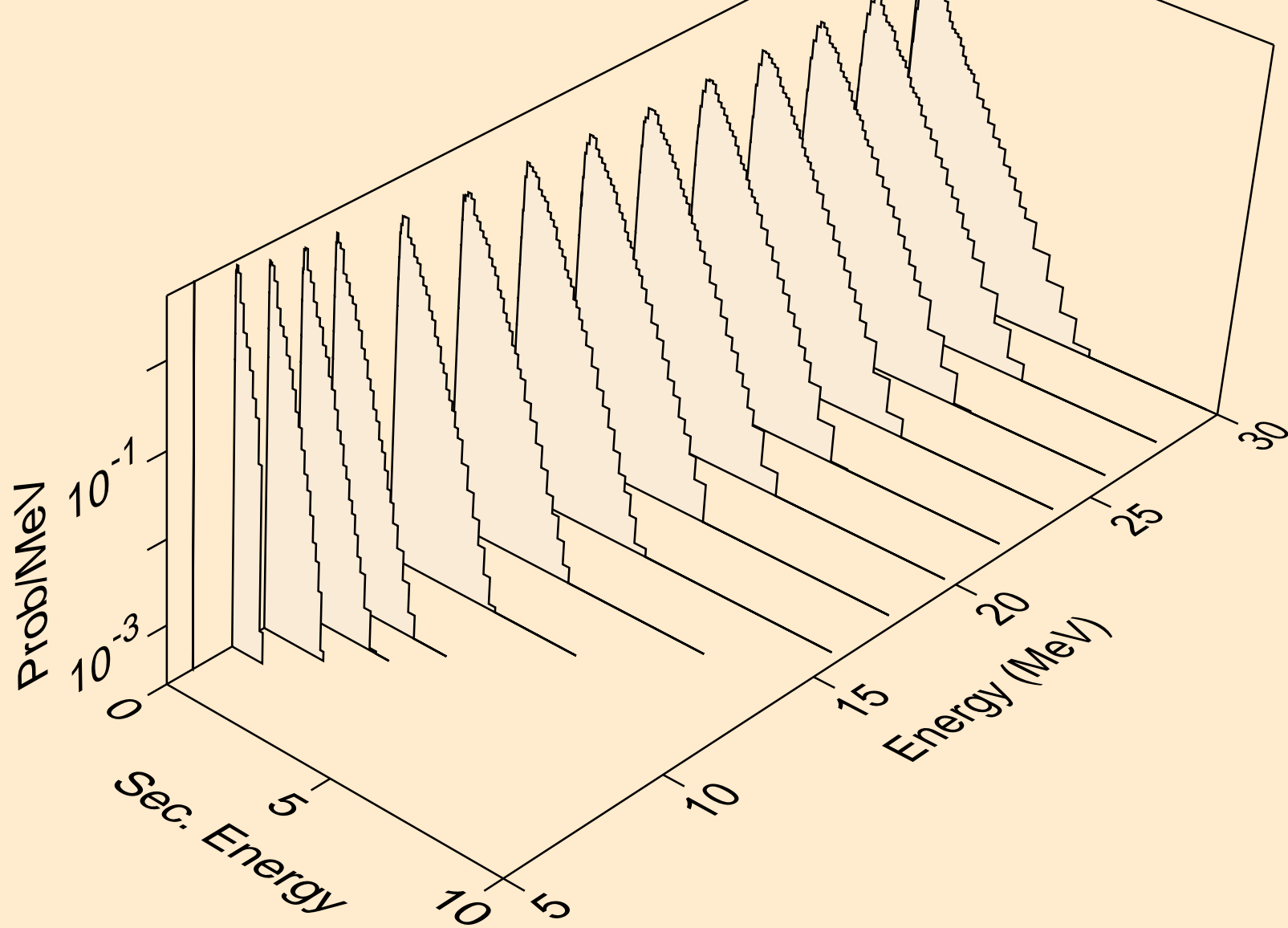

TB161 HELION ACER TENDL-2021 LIBRARY; T=0.K  
neutrons from (s,n\*)t

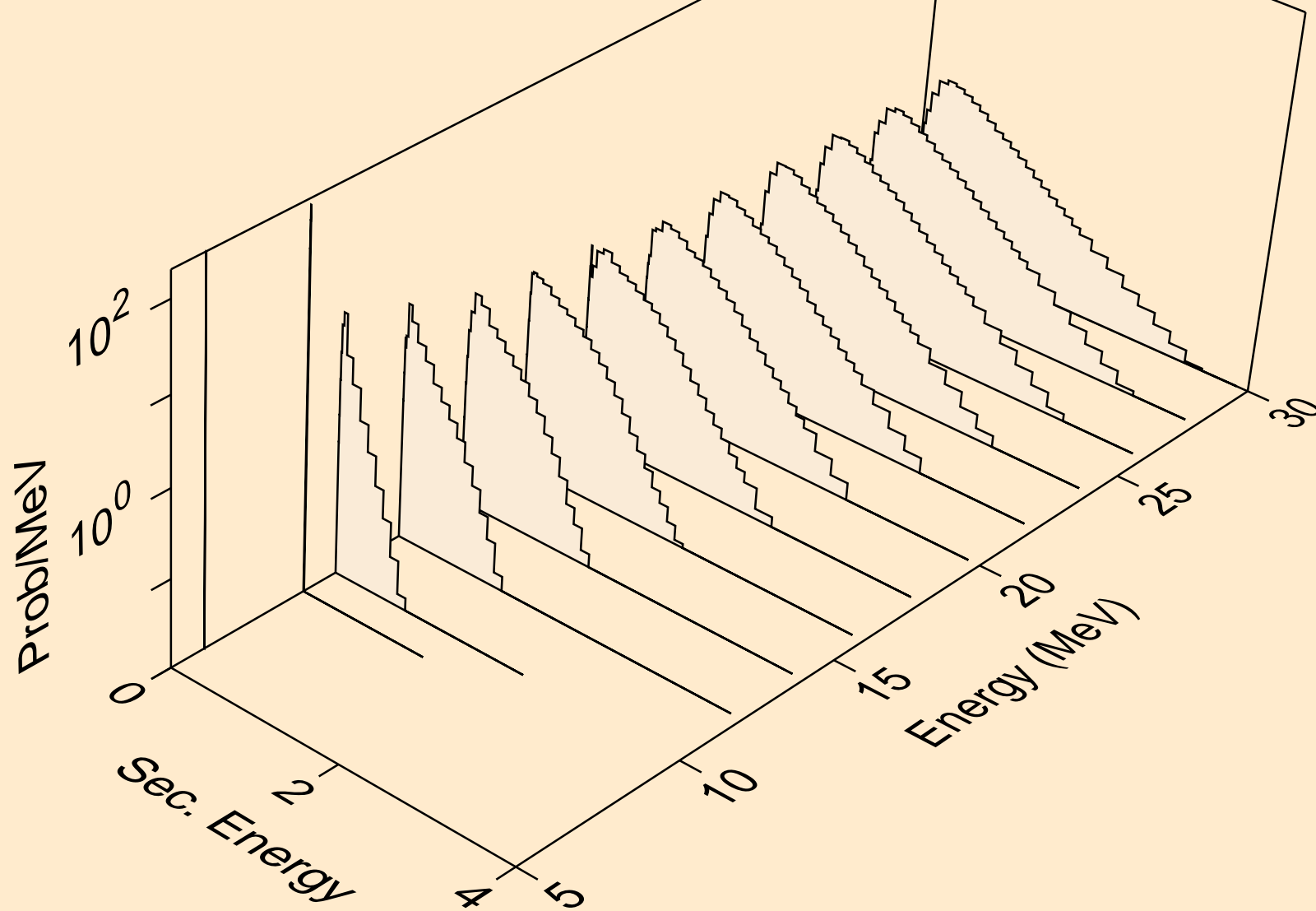

TB161 HELION ACER TENDL-2021 LIBRARY; T=0.K  
neutrons from (s,n\*)he3

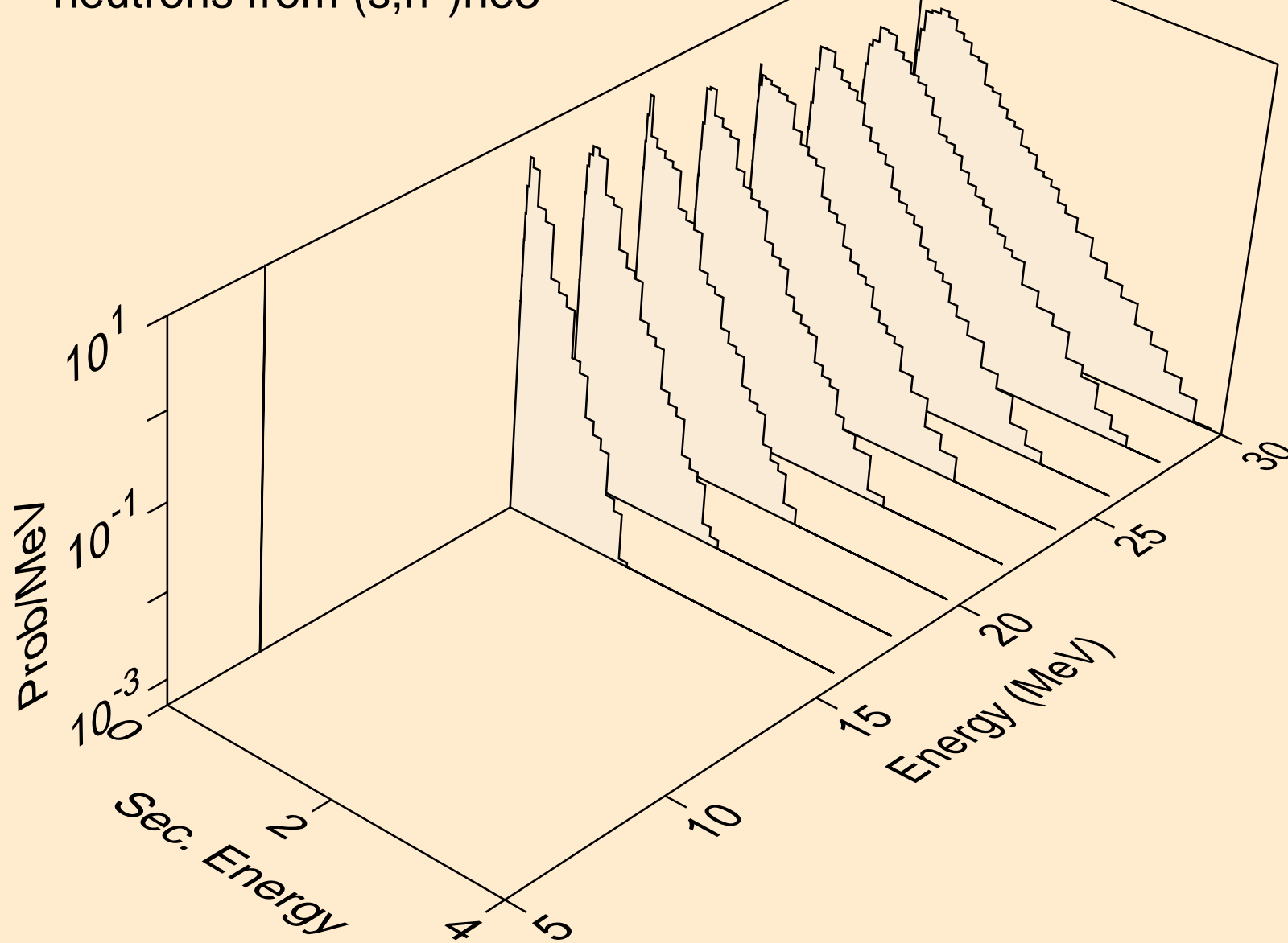

TB161 HELION ACER TENDL-2021 LIBRARY; T=0.K  
neutrons from (s,4n)

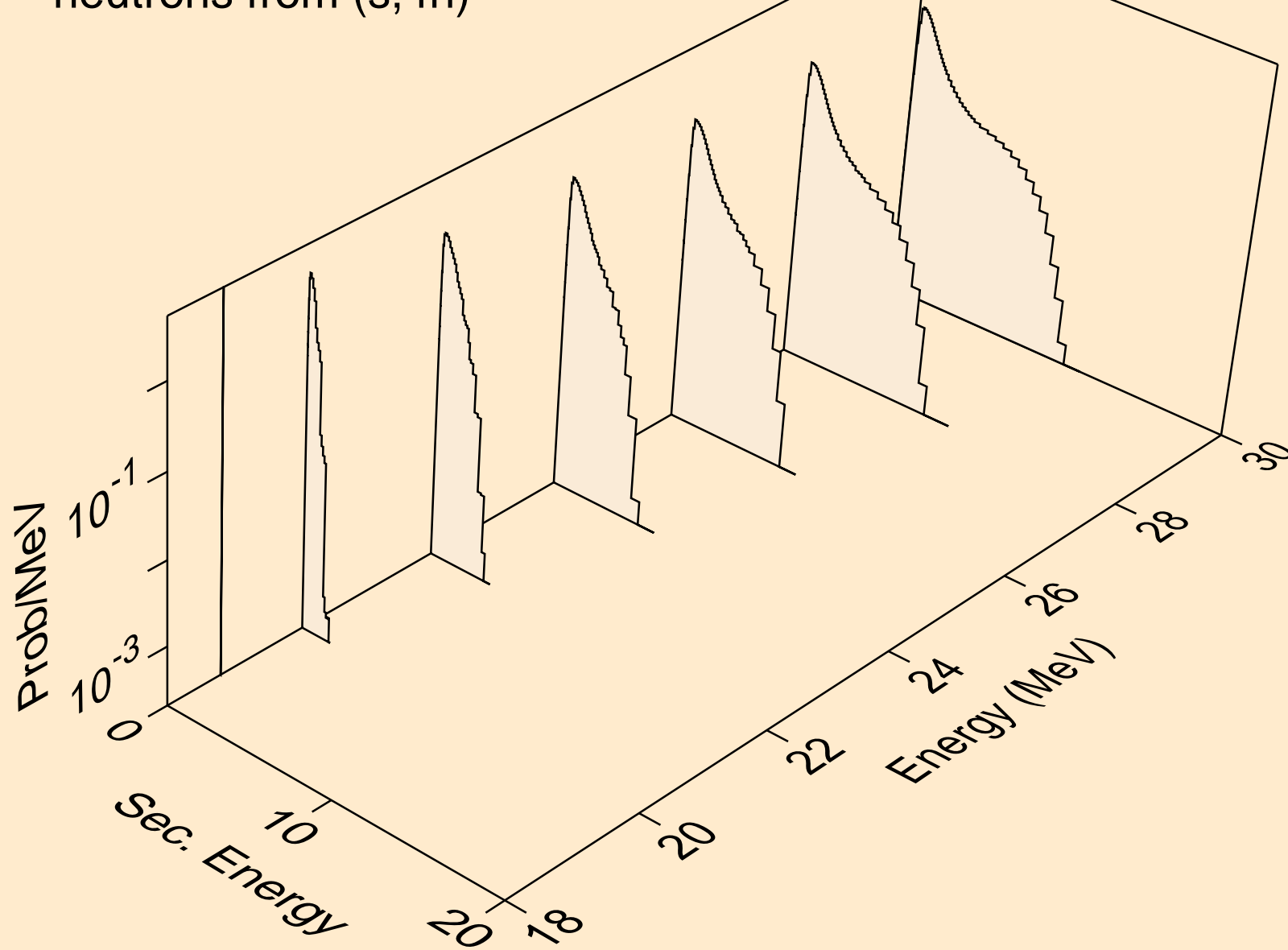

TB161 HELION ACER TENDL-2021 LIBRARY; T=0.K  
neutrons from (s,2np)

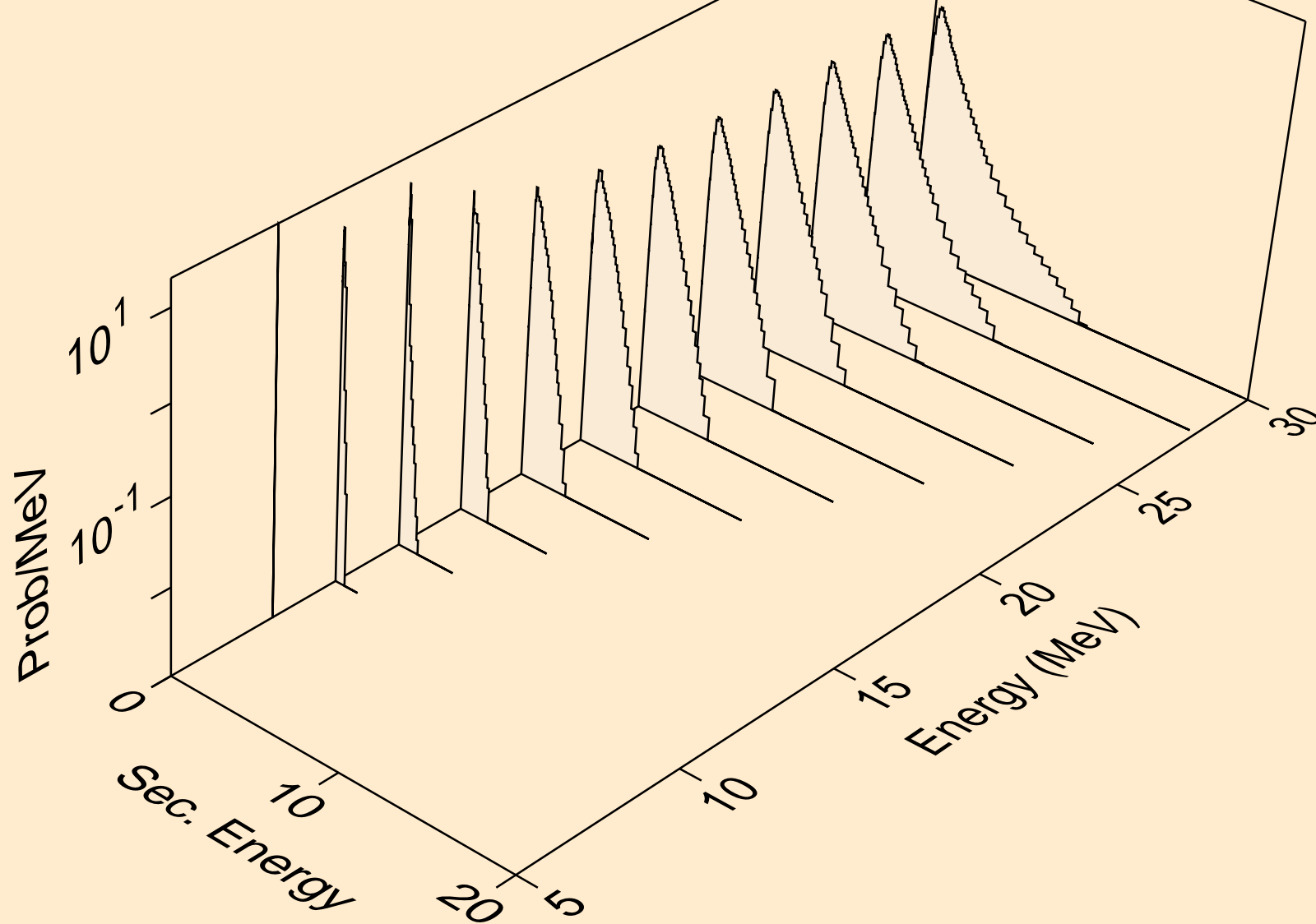



TB161 HELION ACER TENDL-2021 LIBRARY; T=0.K  
neutrons from (s,3np)

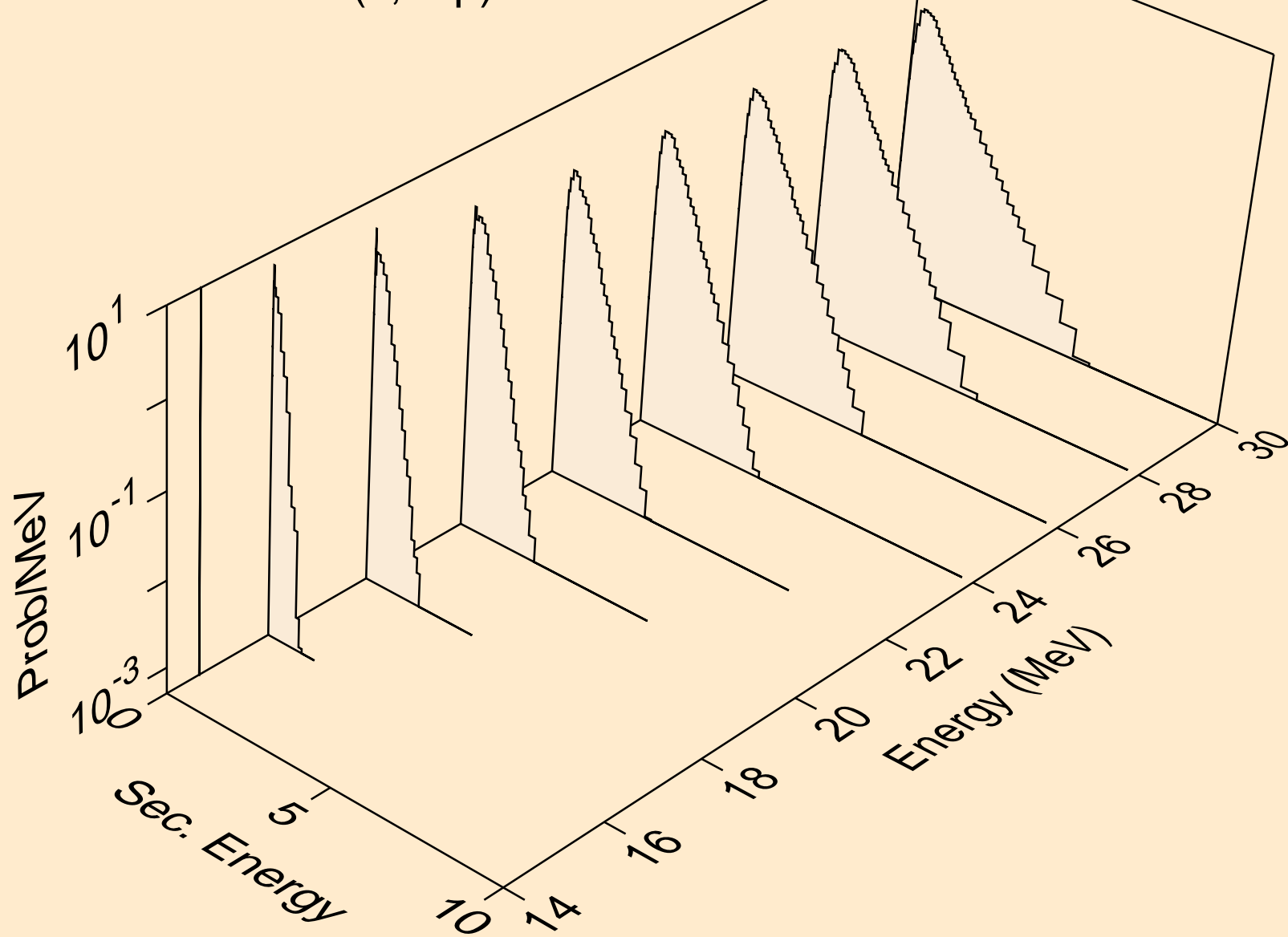

TB161 HELION ACER TENDL-2021 LIBRARY; T=0.K  
neutrons from (s,2np)

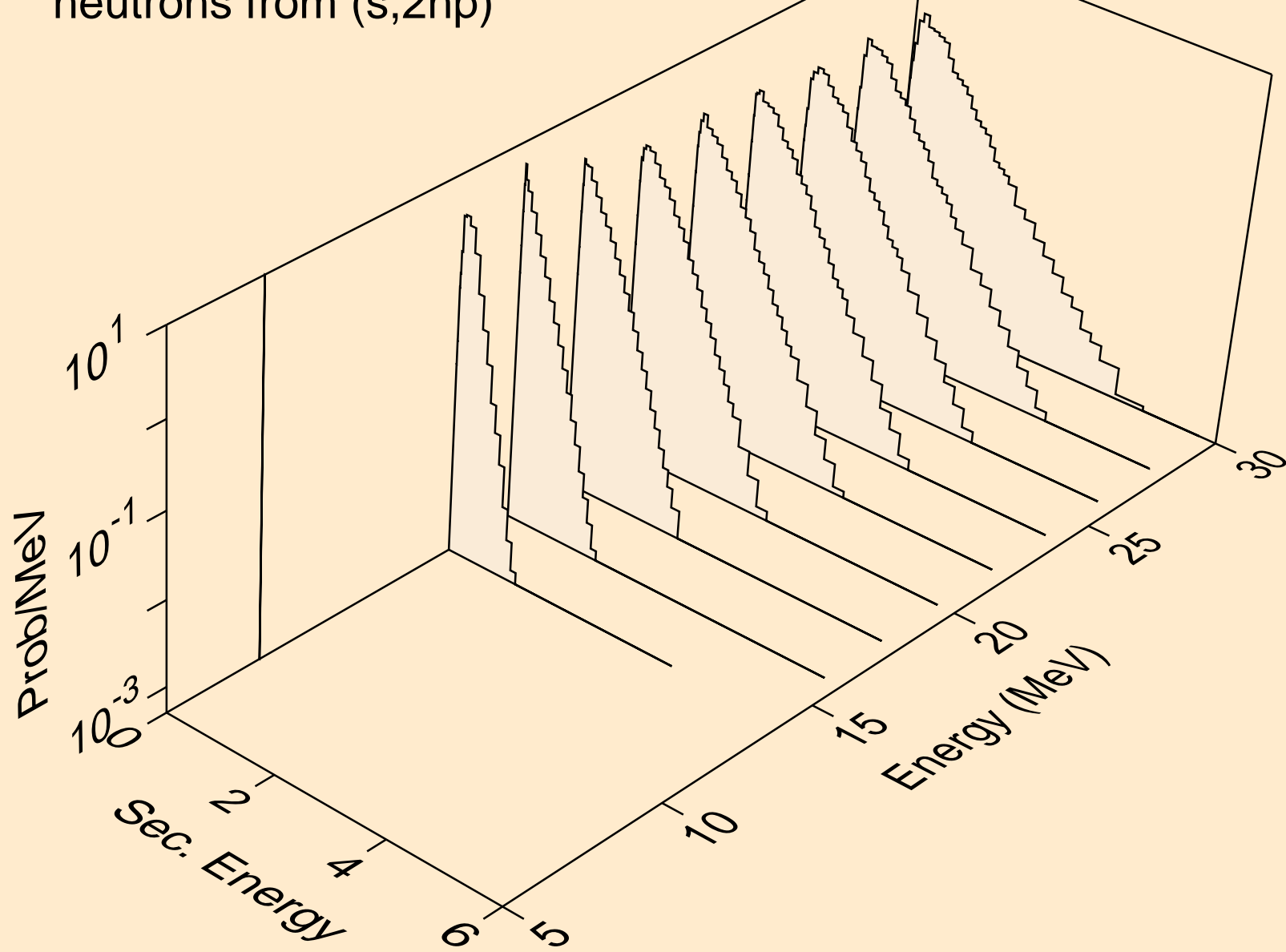

TB161 HELION ACER TENDL-2021 LIBRARY; T=0.K  
neutrons from (s,npa)

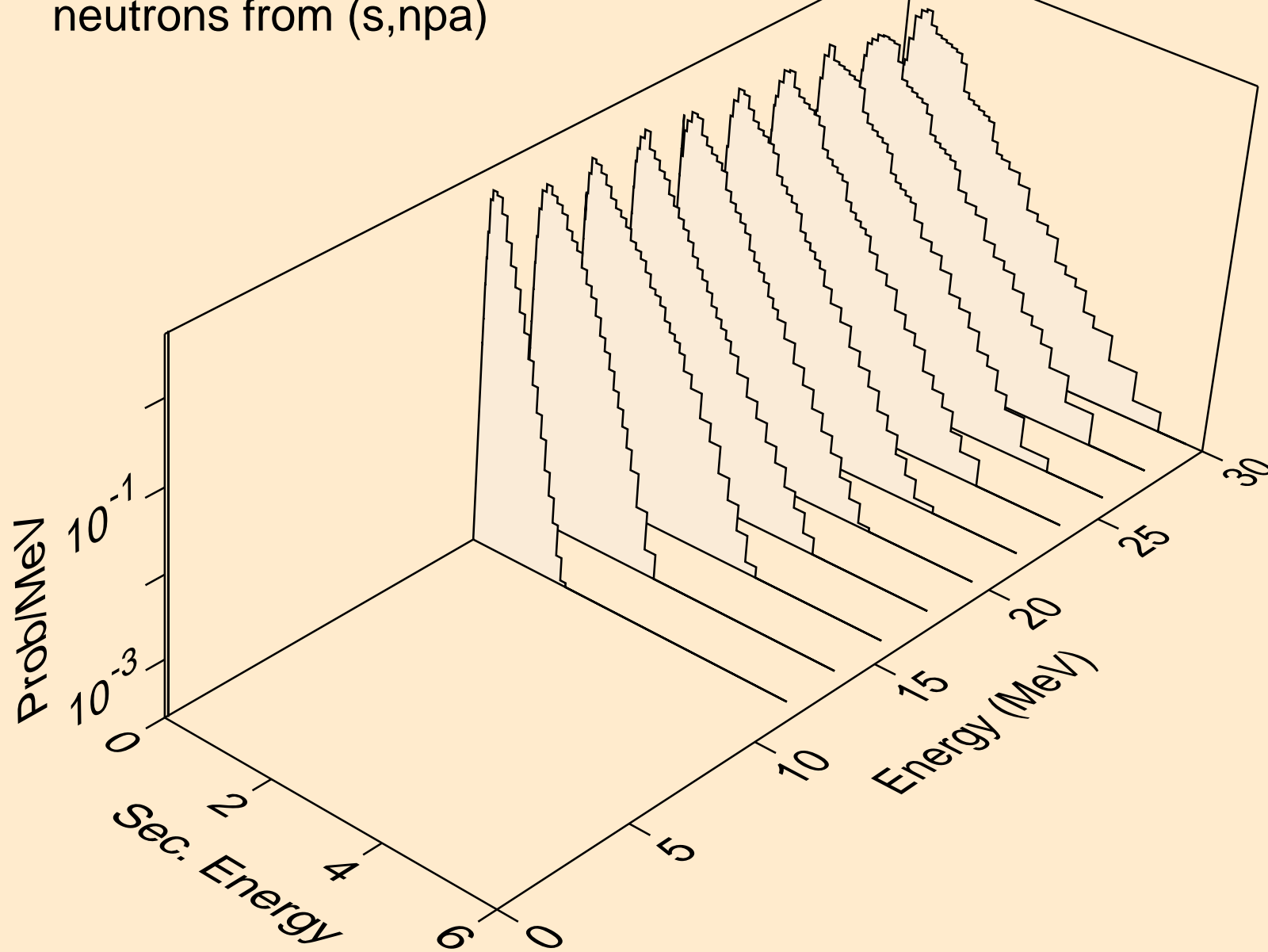

TB161 HELION ACER TENDL-2021 LIBRARY; T=0.K  
protons from (s,x)

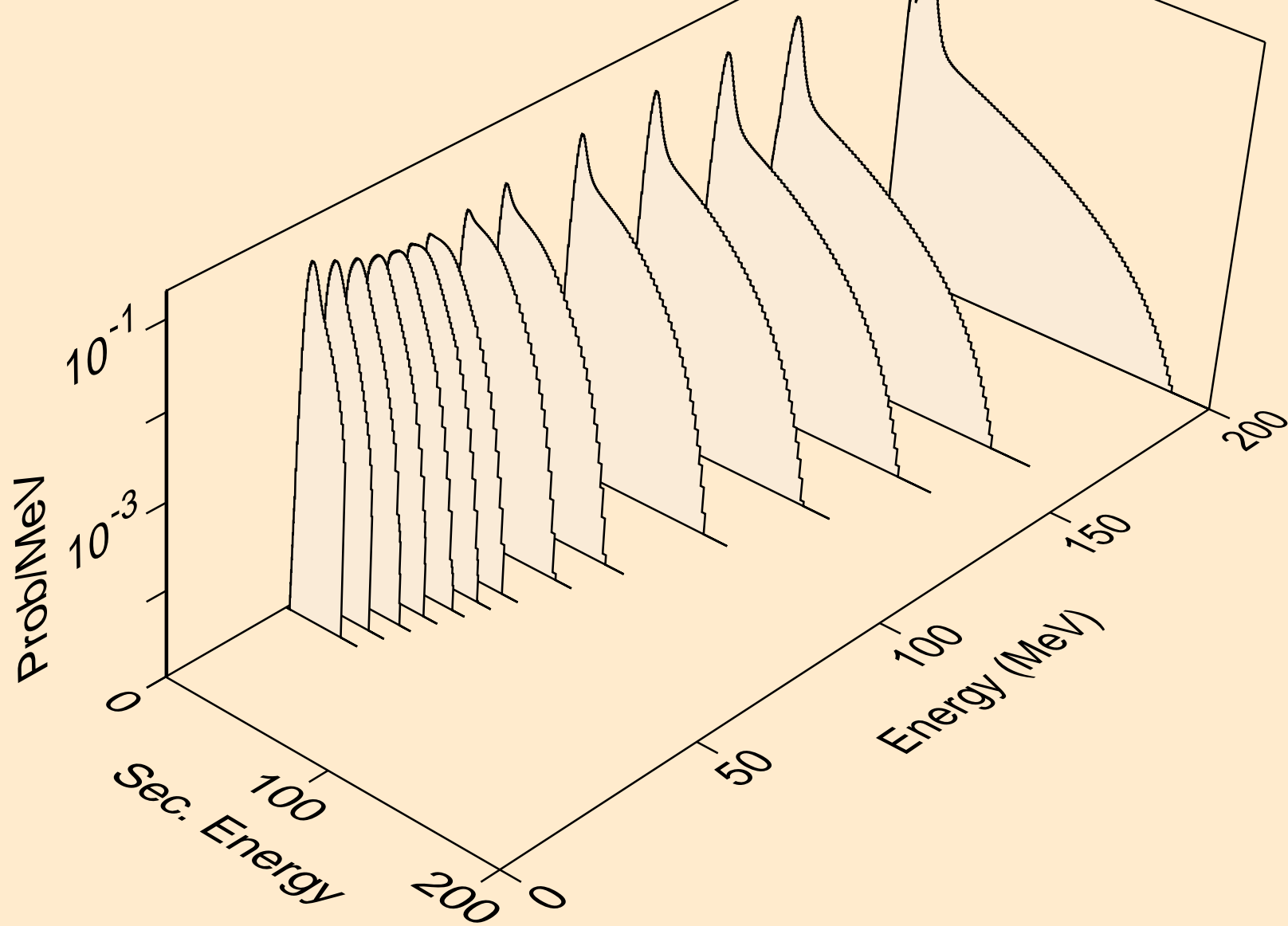

TB161 HELION ACER TENDL-2021 LIBRARY; T=0.K  
protons from (s,n\*)p

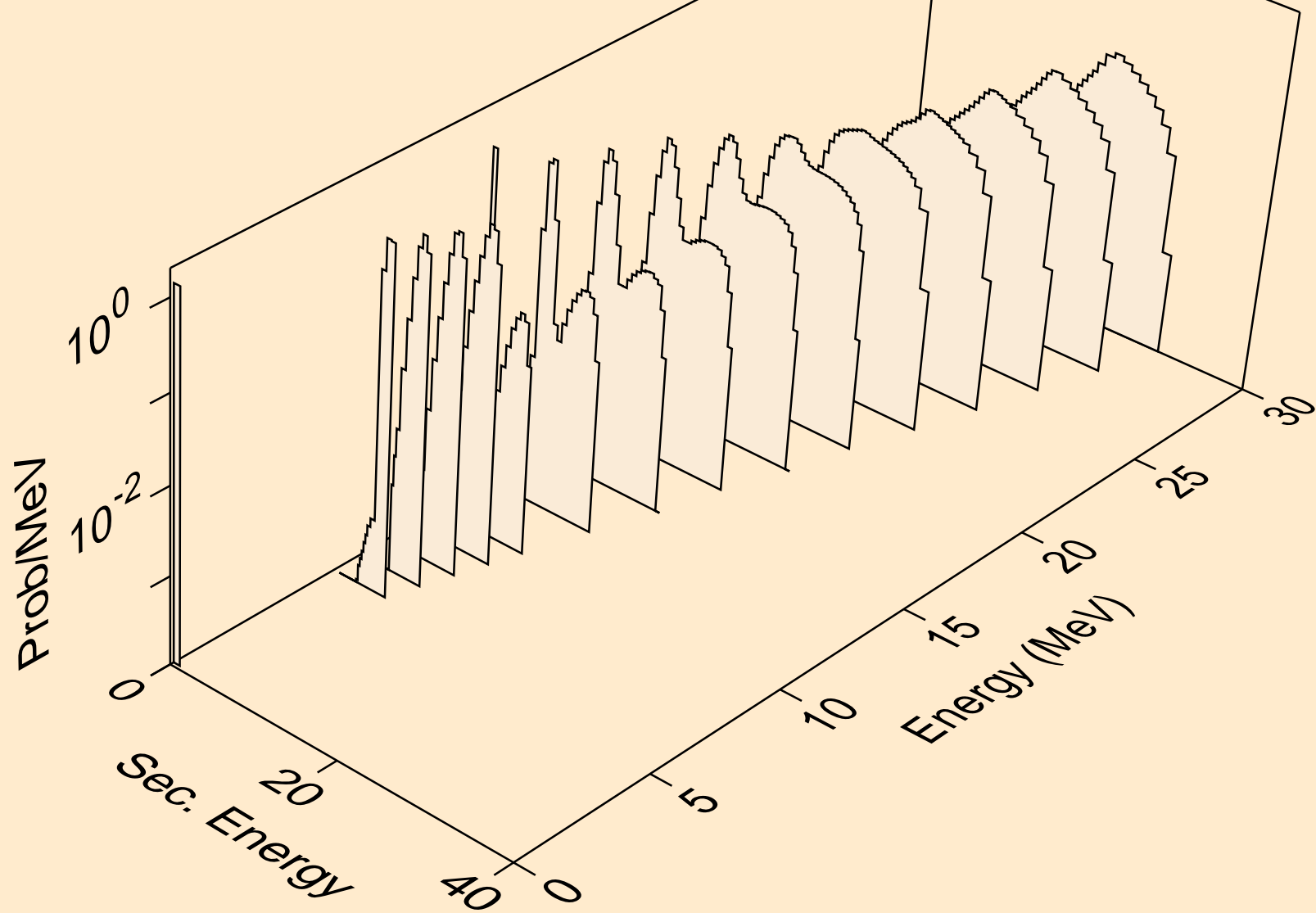

TB161 HELION ACER TENDL-2021 LIBRARY; T=0.K  
protons from (s,2np)

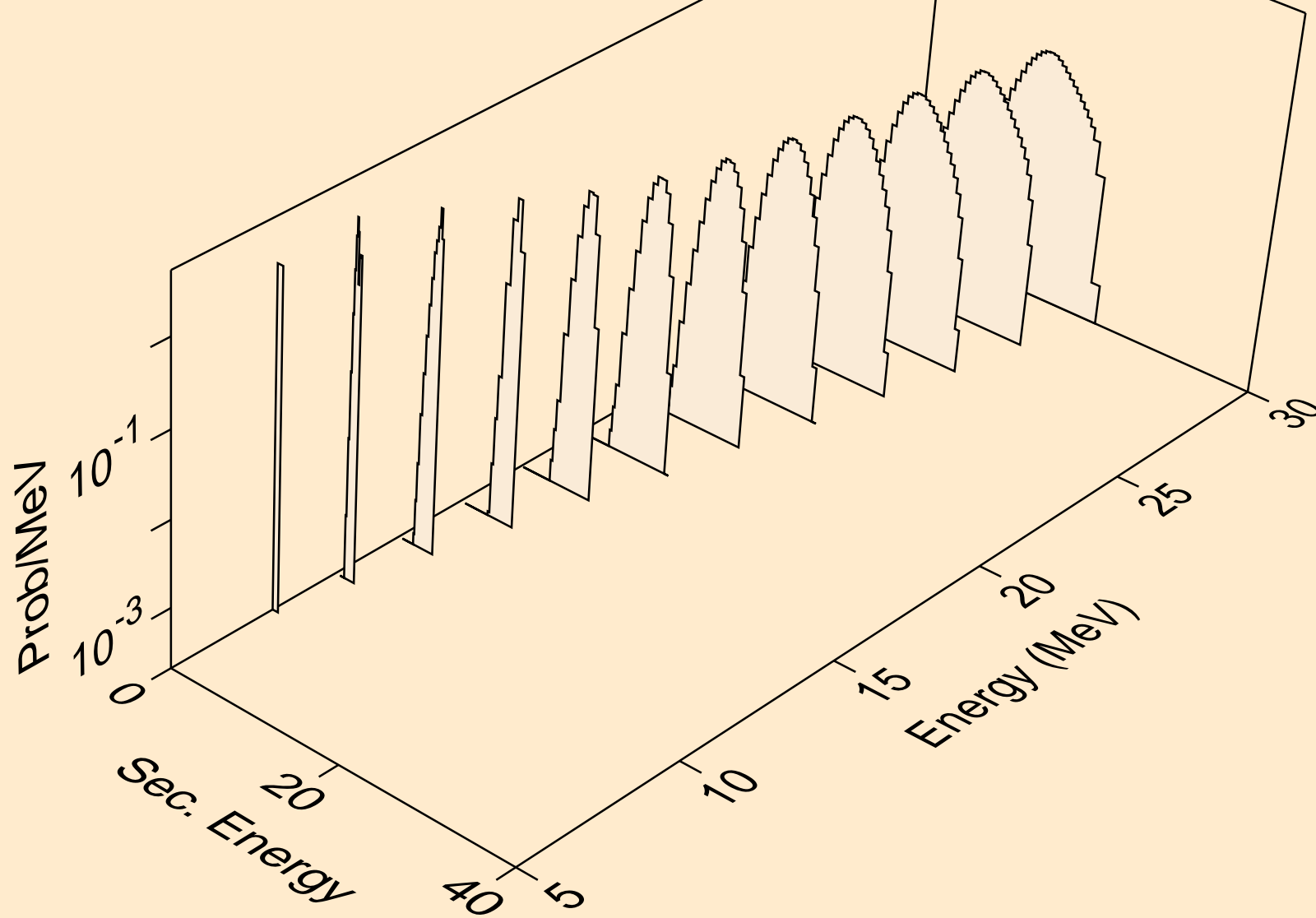

TB161 HELION ACER TENDL-2021 LIBRARY; T=0.K  
protons from (s,3np)

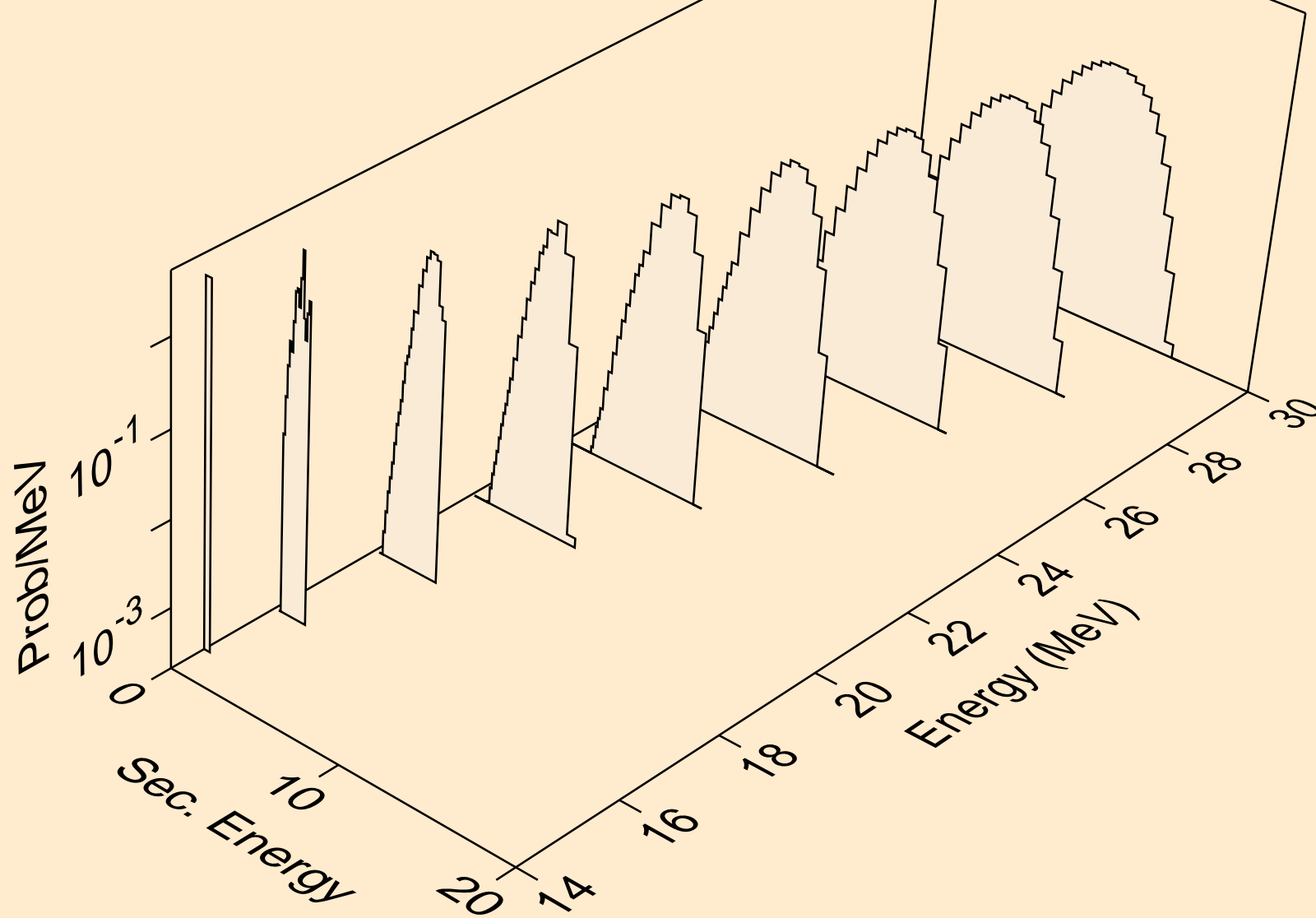

TB161 HELION ACER TENDL-2021 LIBRARY; T=0.K  
protons from (s,2np)

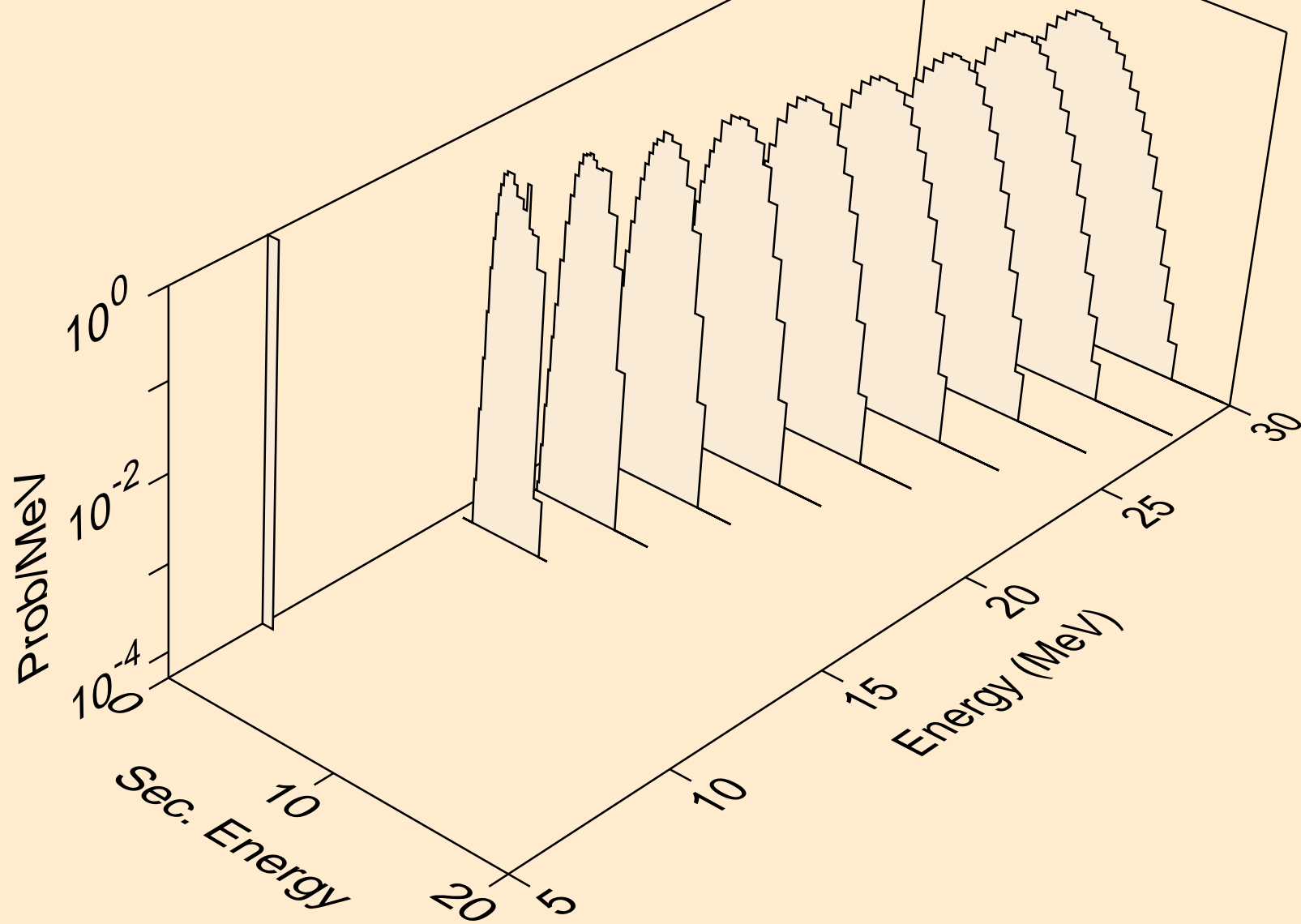



TB161 HELION ACER TENDL-2021 LIBRARY; T=0.K  
protons from (s,npa)

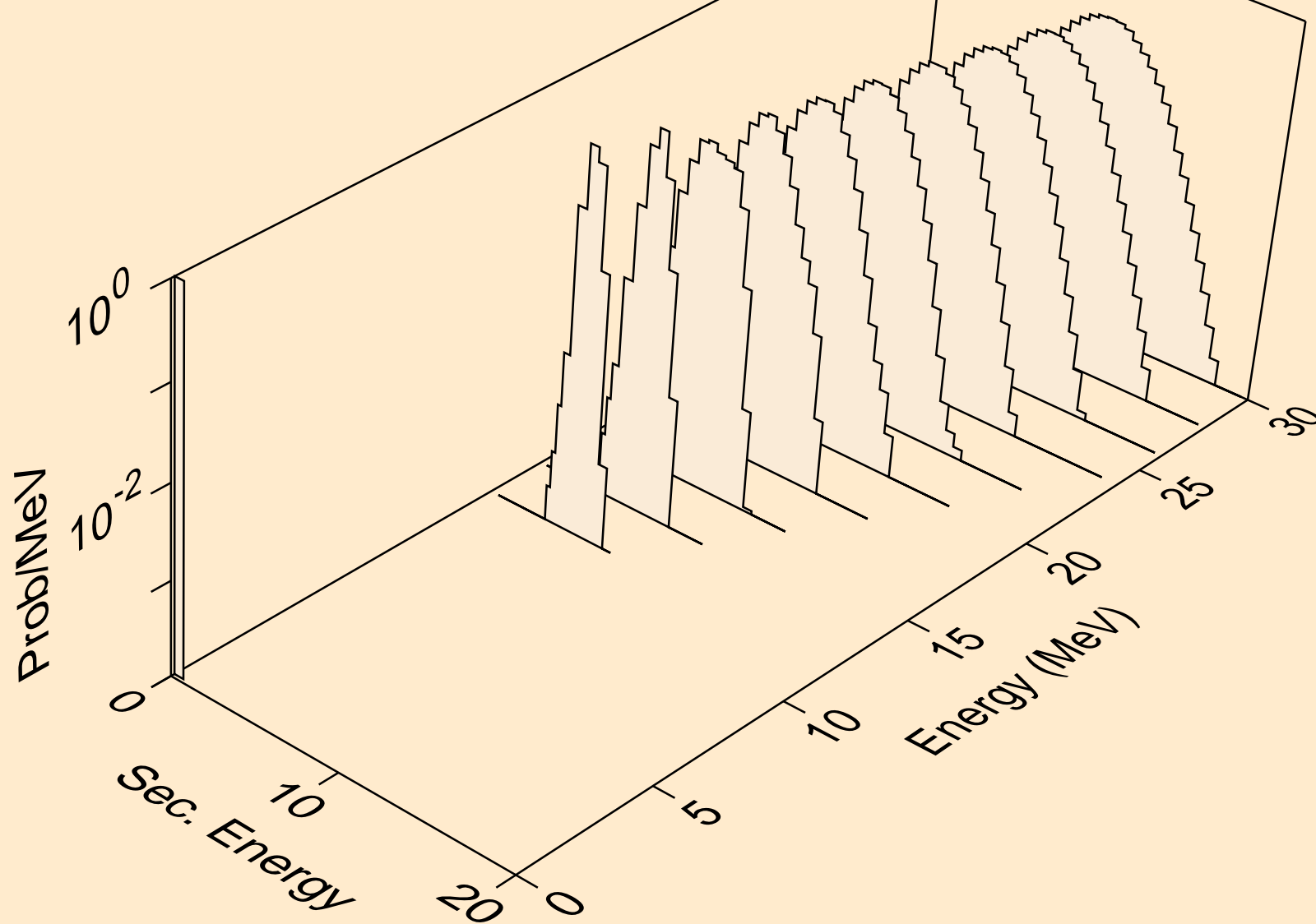

TB161 HELION ACER TENDL-2021 LIBRARY; T=0.K  
protons from (s,p)

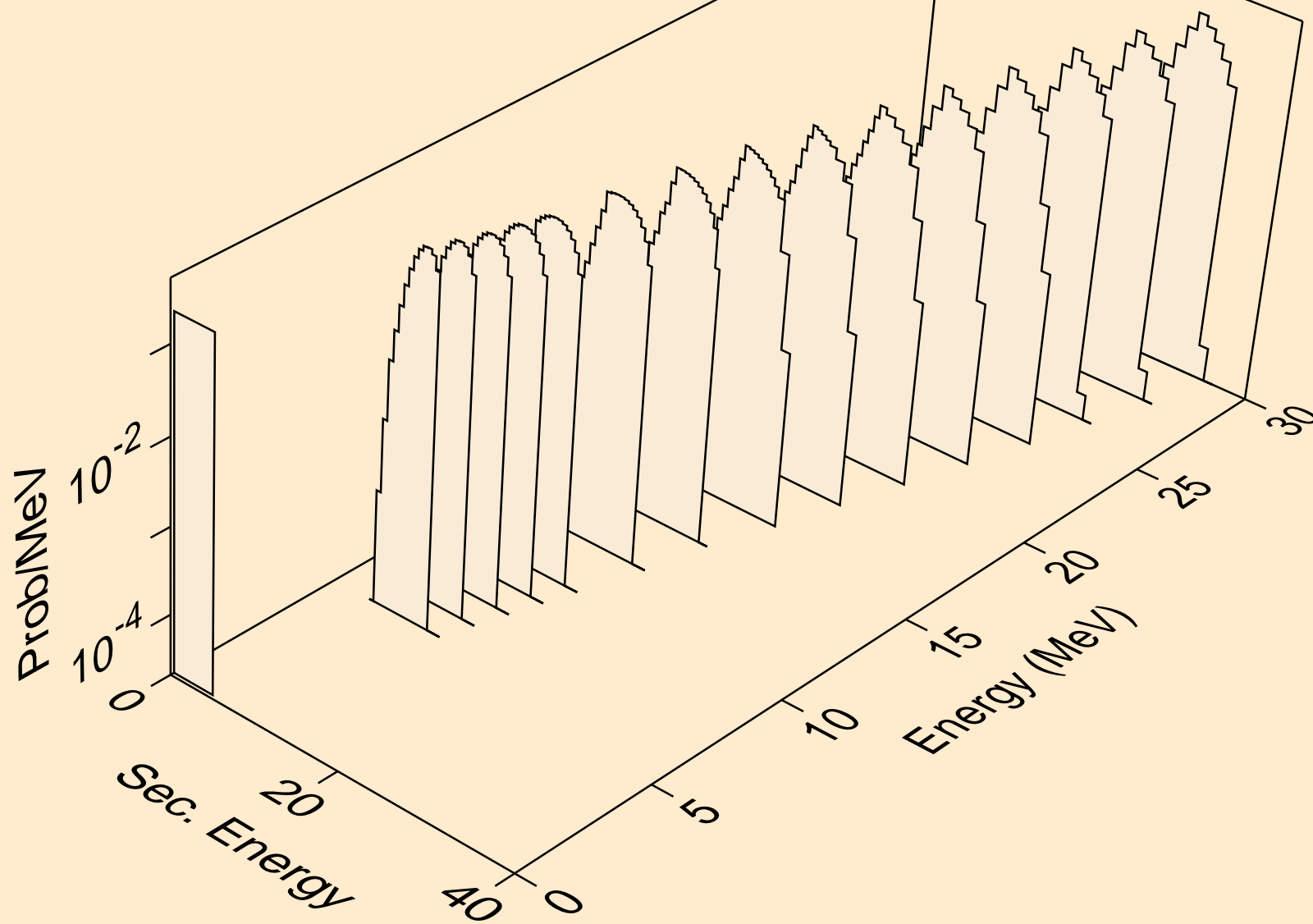

TB161 HELION ACER TENDL-2021 LIBRARY; T=0.K  
protons from (s,2p)

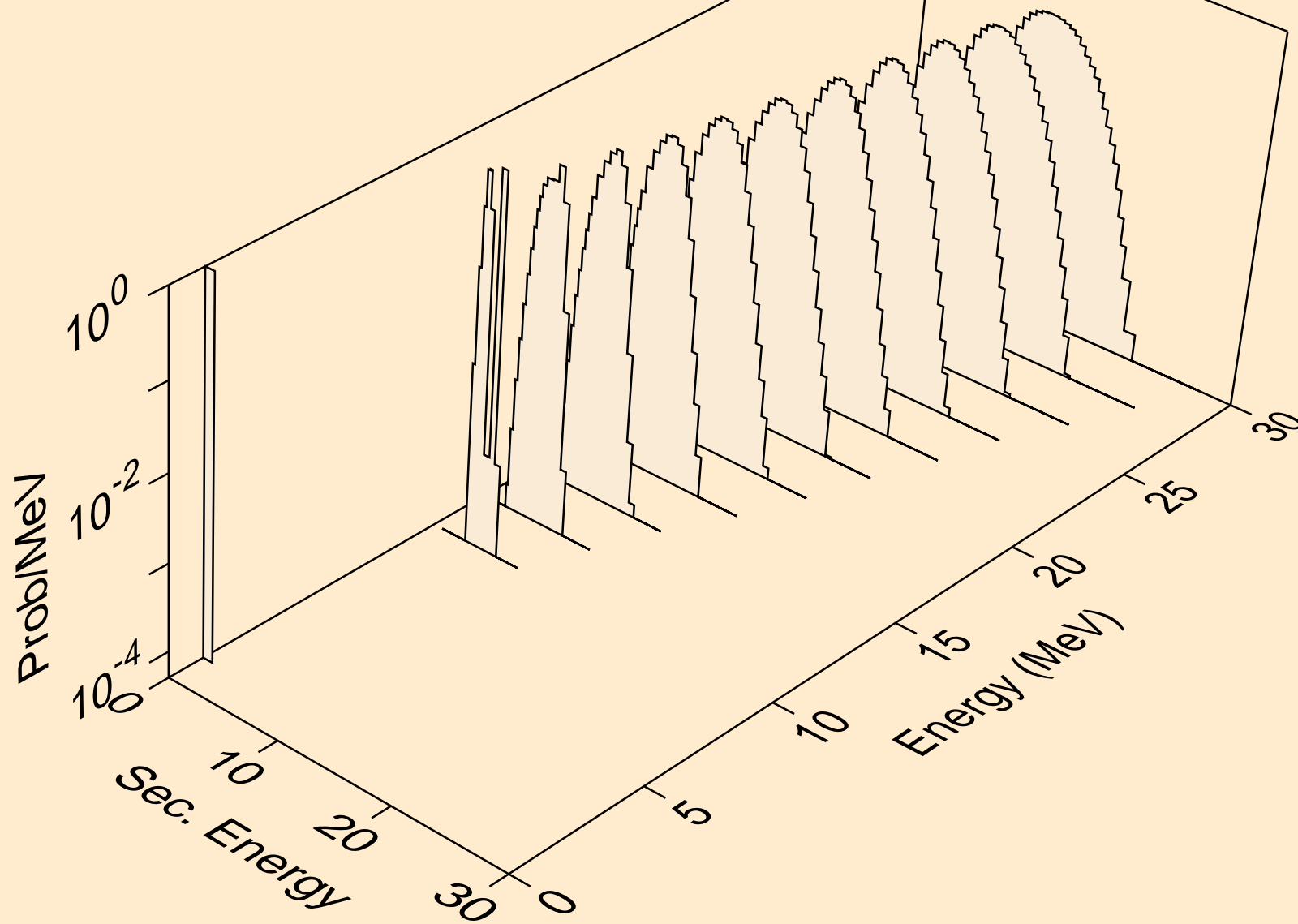

TB161 HELION ACER TENDL-2021 LIBRARY; T=0.K  
protons from (s,pa)

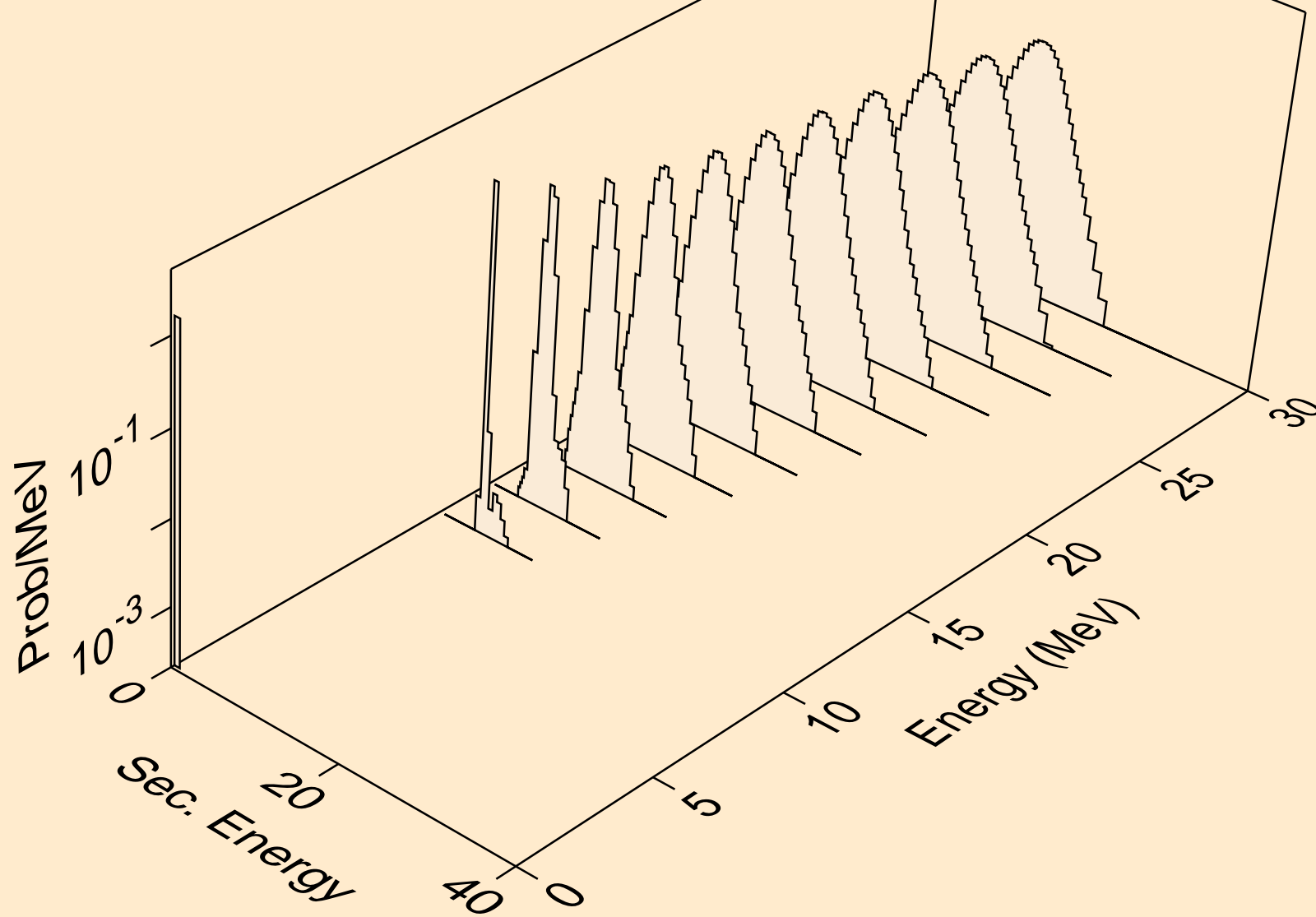

TB161 HELION ACER TENDL-2021 LIBRARY; T=0.K  
protons from (s,pd)

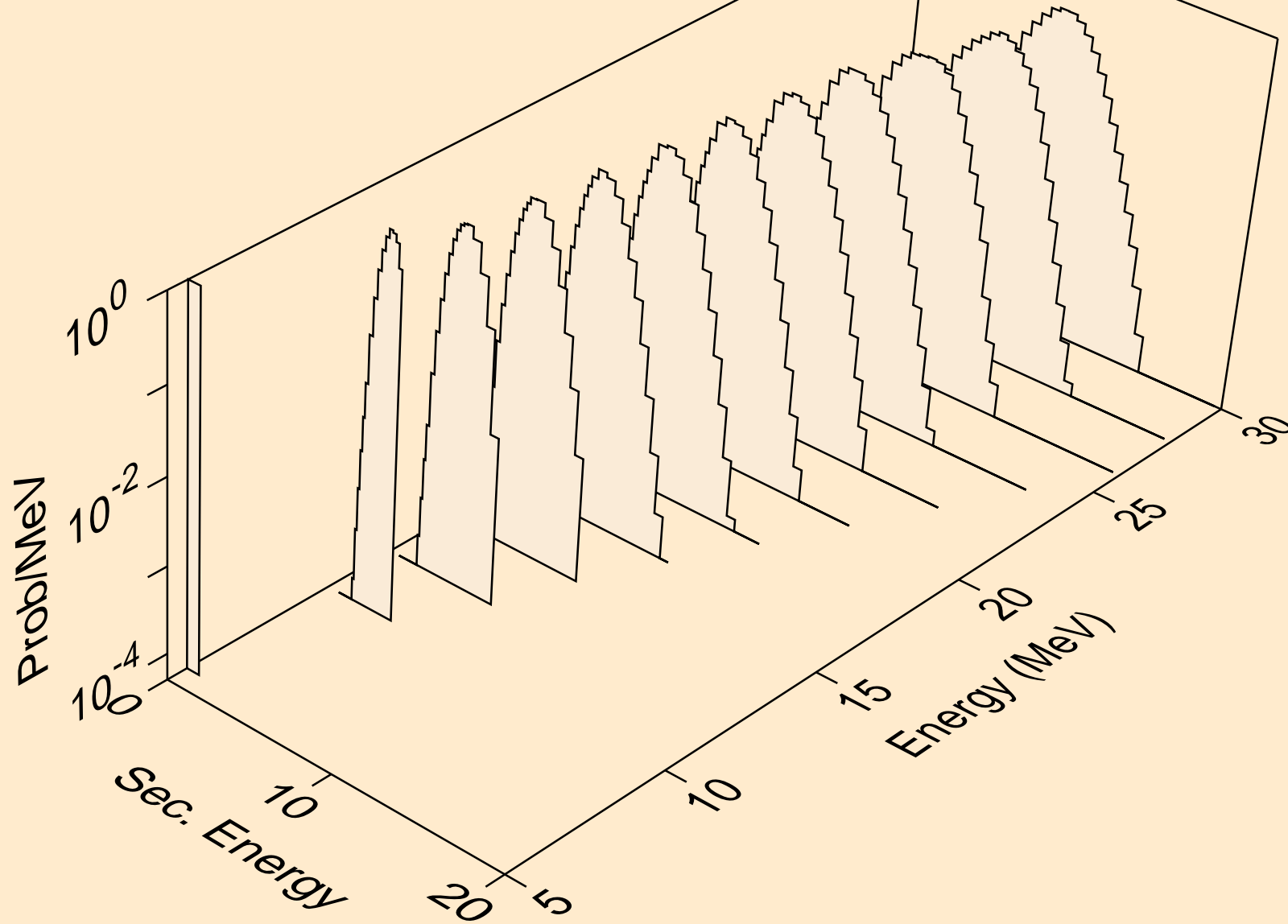

TB161 HELION ACER TENDL-2021 LIBRARY; T=0.K  
protons from (s,pt)

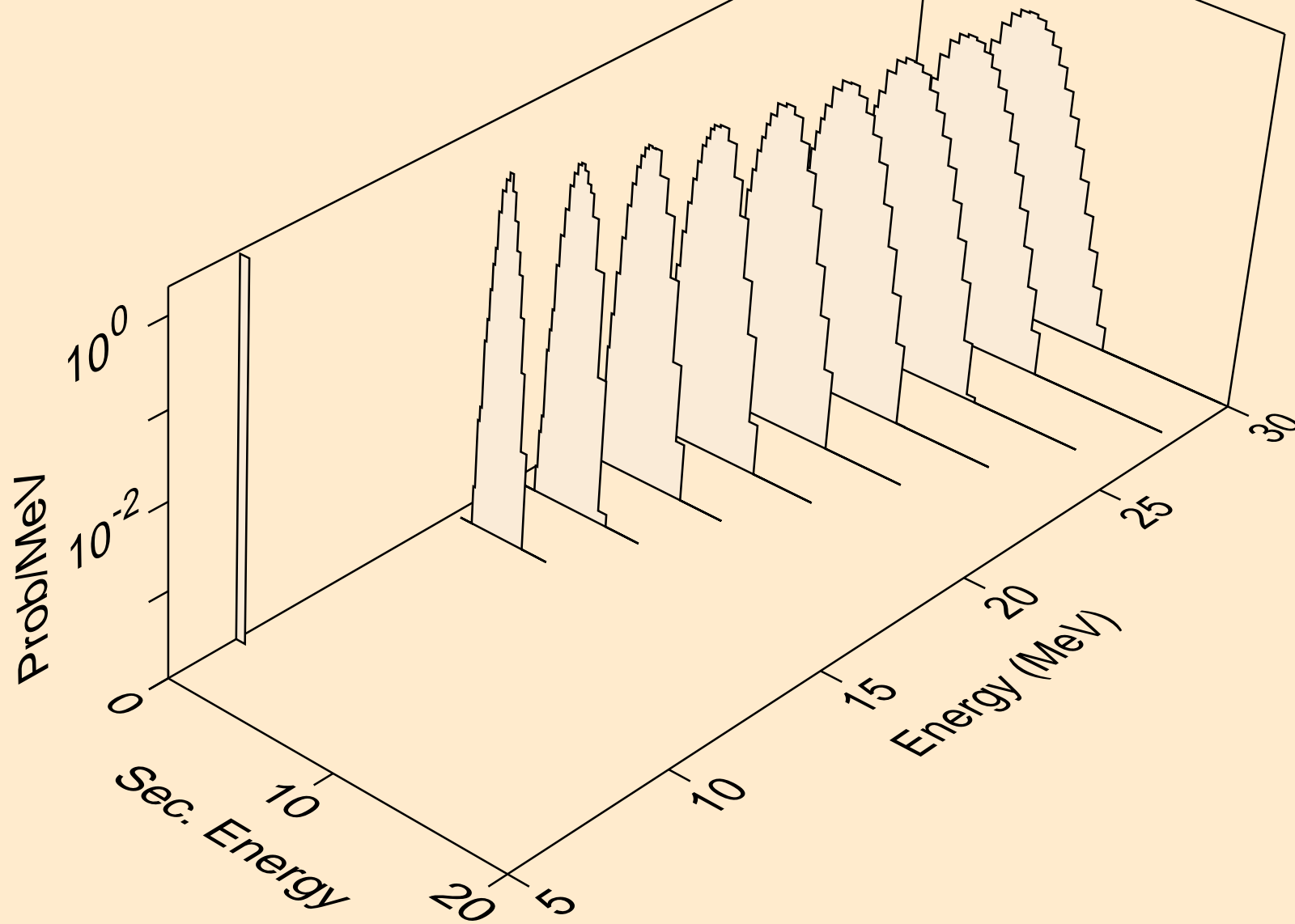

TB161 HELION ACER TENDL-2021 LIBRARY; T=0.K  
deuterons from (s,x)

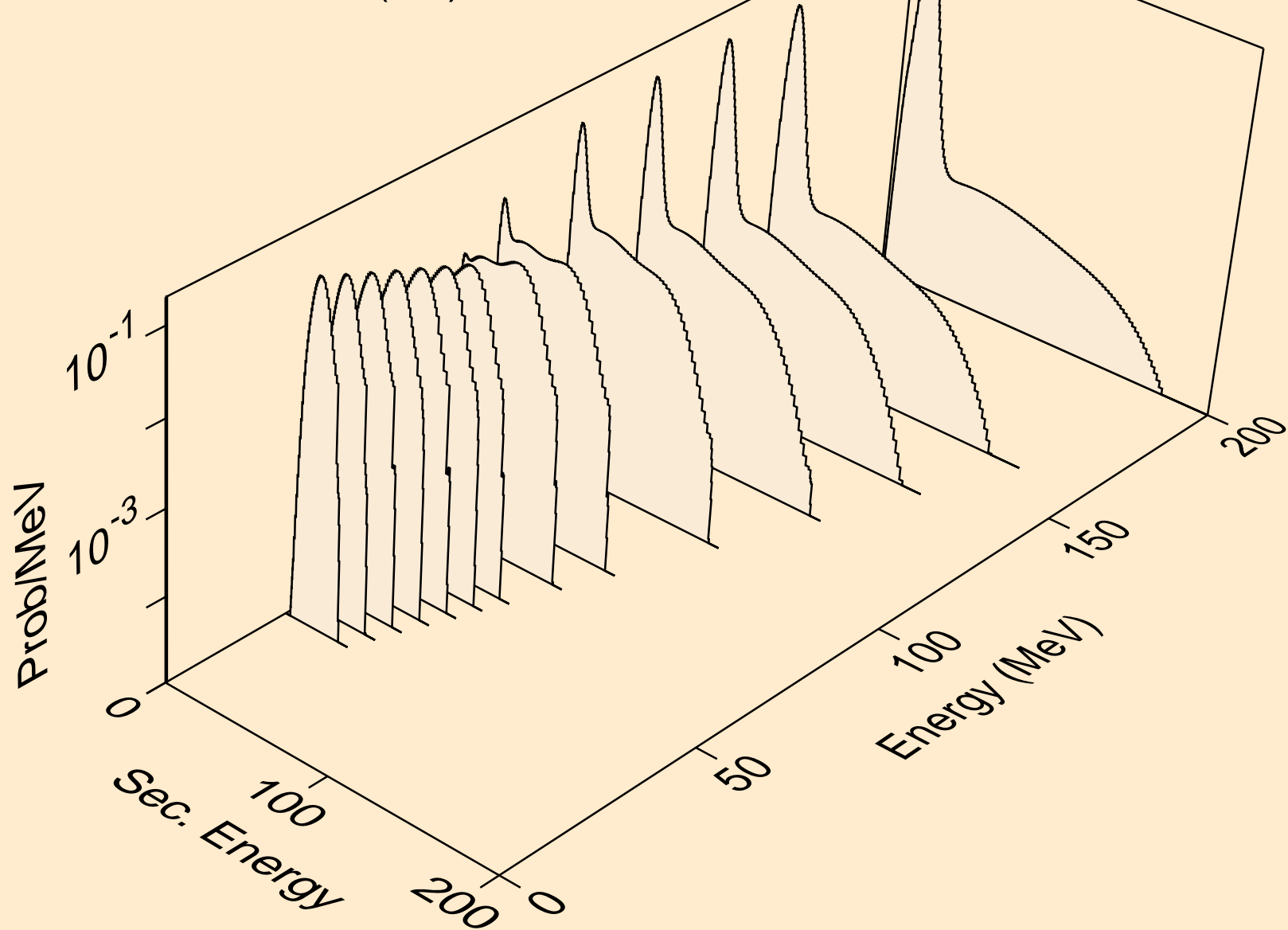

TB161 HELION ACER TENDL-2021 LIBRARY; T=0.K  
deuterons from (s,2nd)

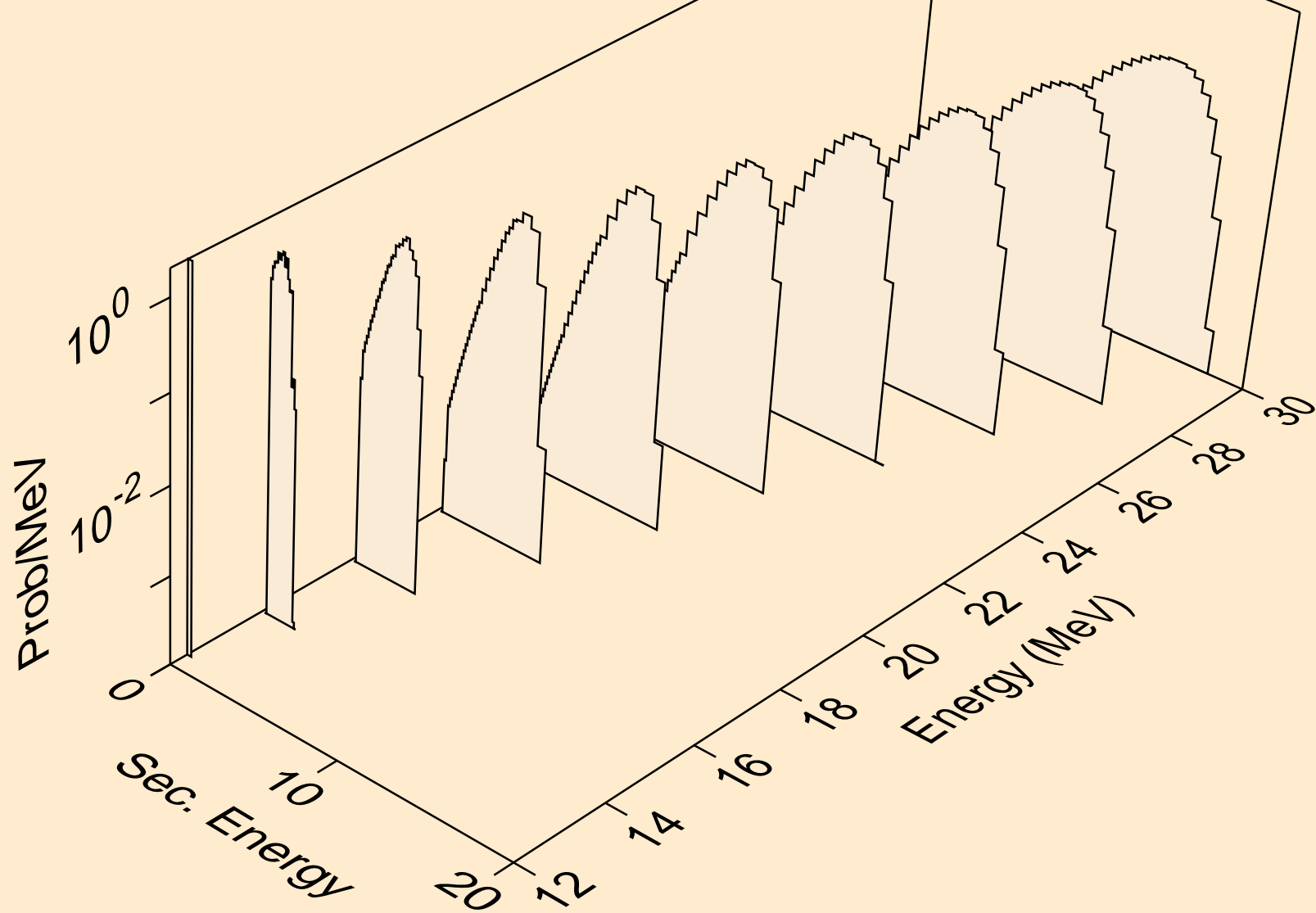



TB161 HELION ACER TENDL-2021 LIBRARY; T=0.K  
deuterons from (s,n\*)d

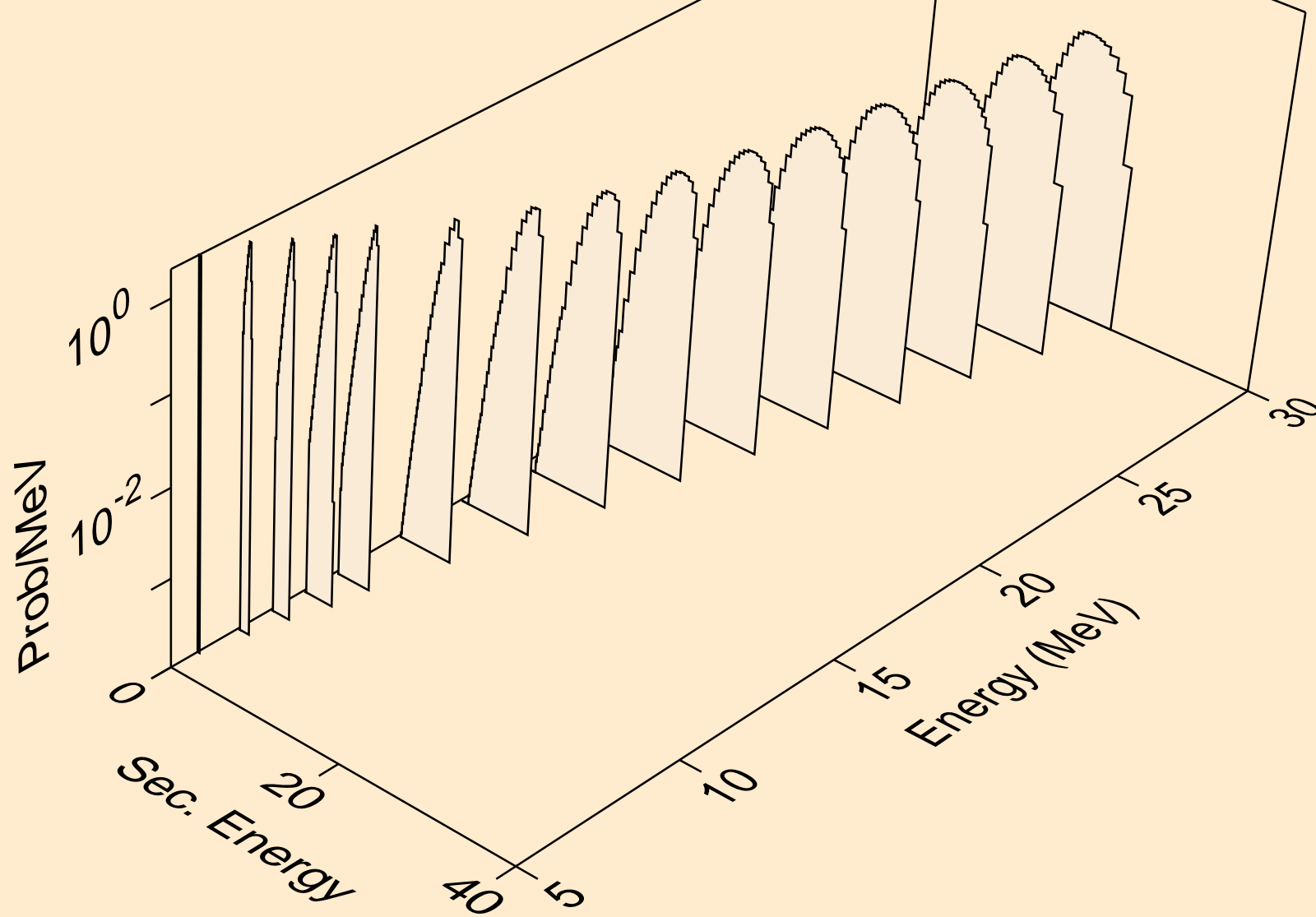

TB161 HELION ACER TENDL-2021 LIBRARY; T=0.K  
deuterons from (s,d)

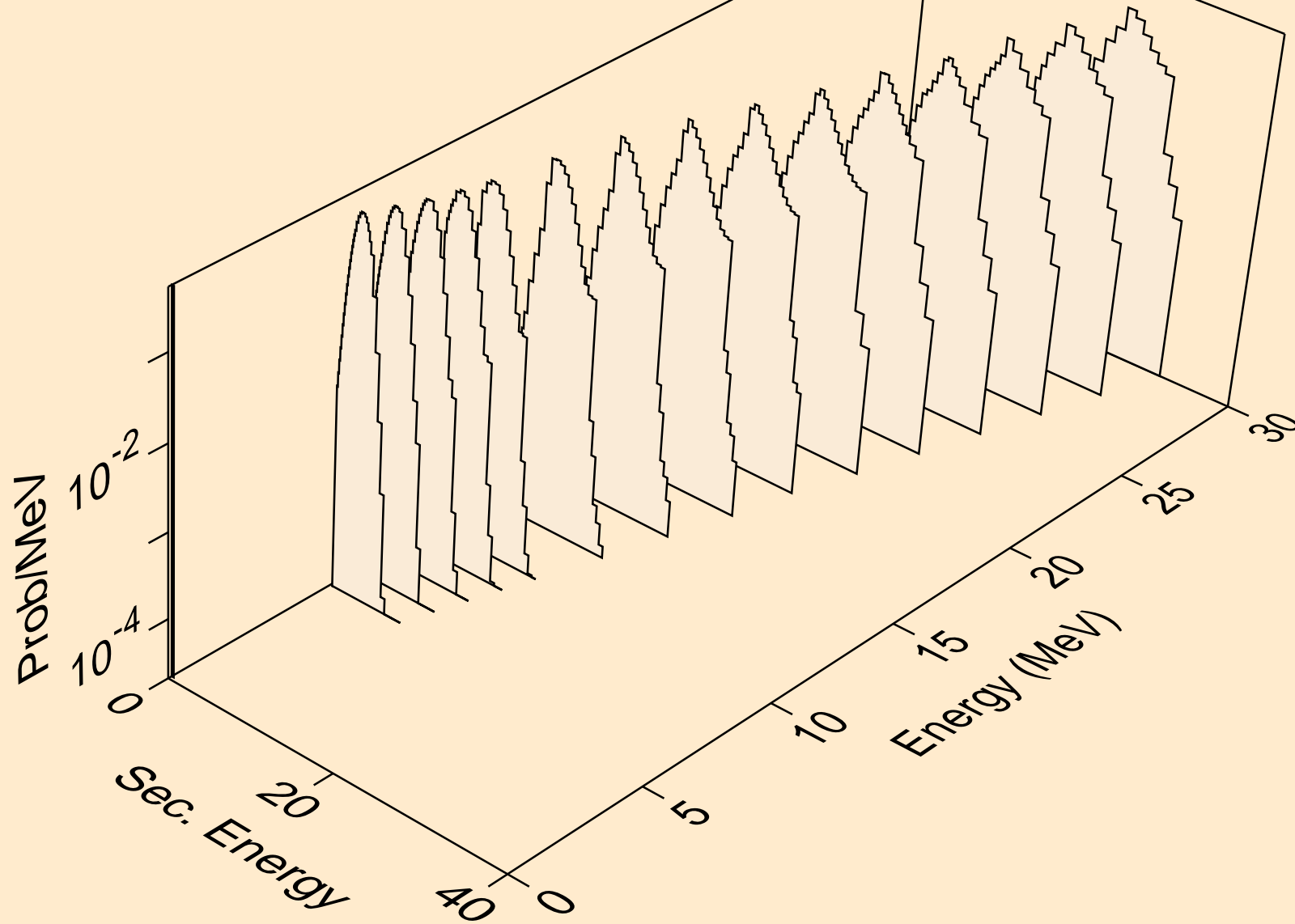

TB161 HELION ACER TENDL-2021 LIBRARY; T=0.K  
deuterons from (s,pd)

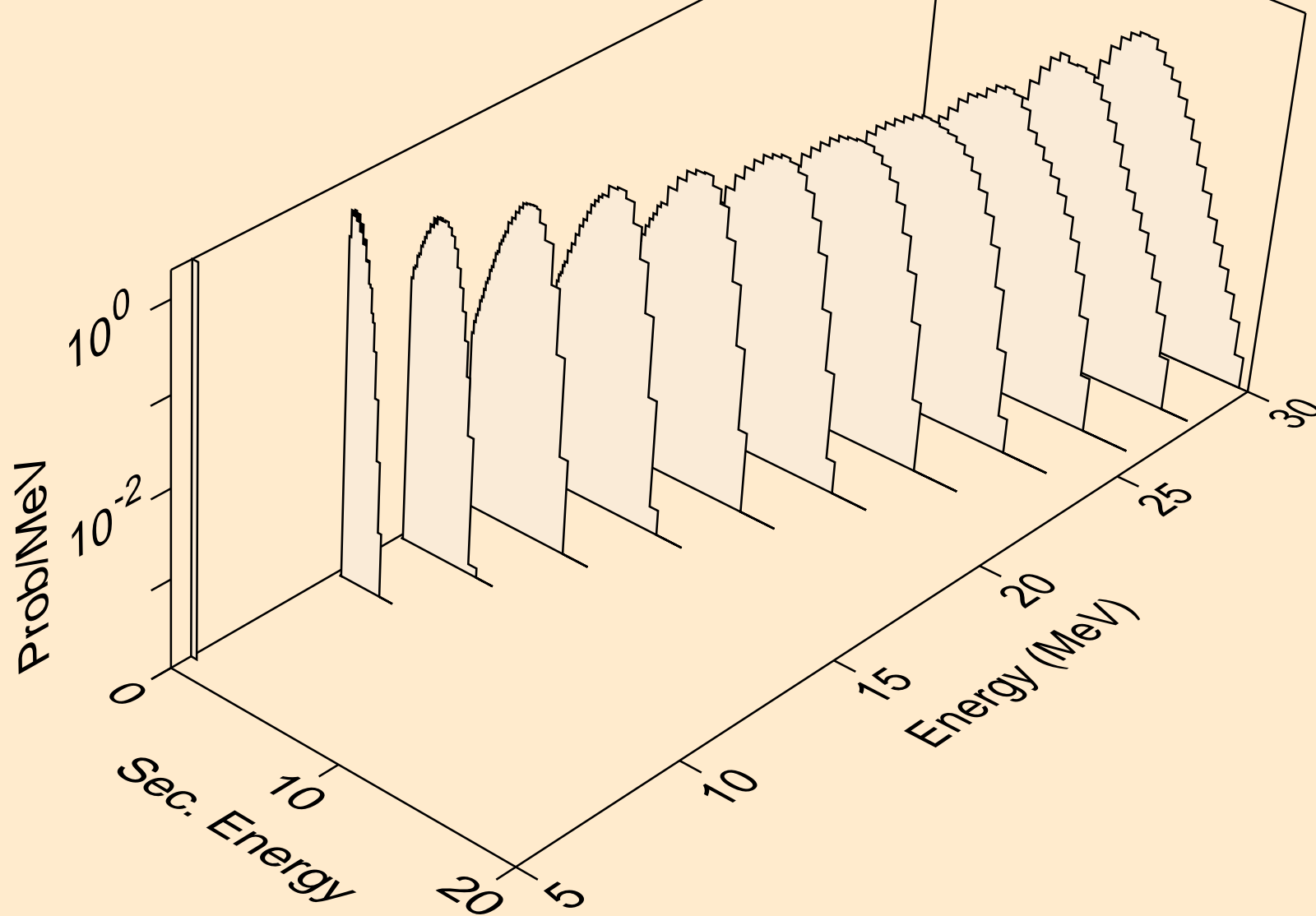

TB161 HELION ACER TENDL-2021 LIBRARY; T=0.K  
deuterons from (s,da)

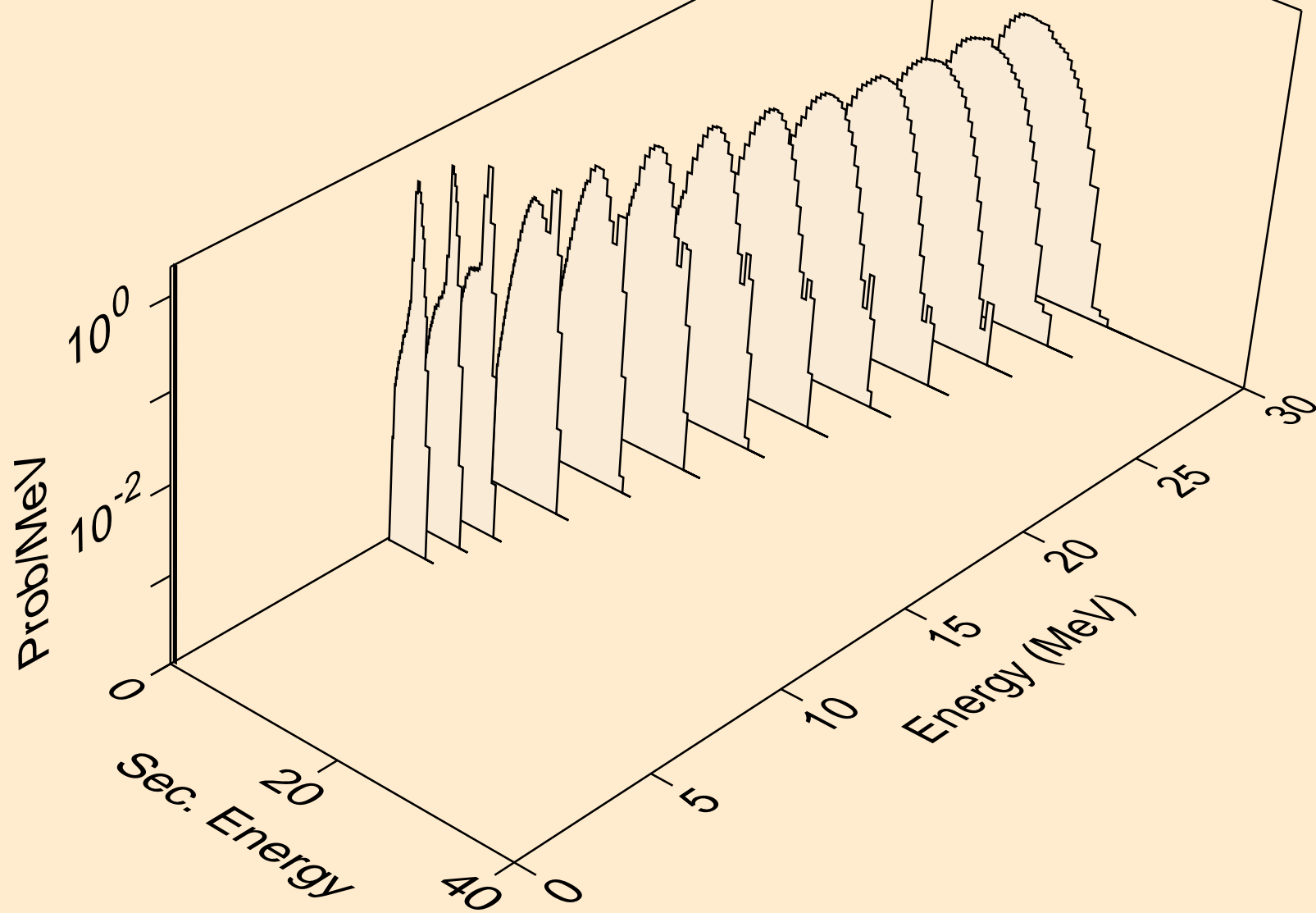

TB161 HELION ACER TENDL-2021 LIBRARY; T=0.K  
tritons from (s,x)

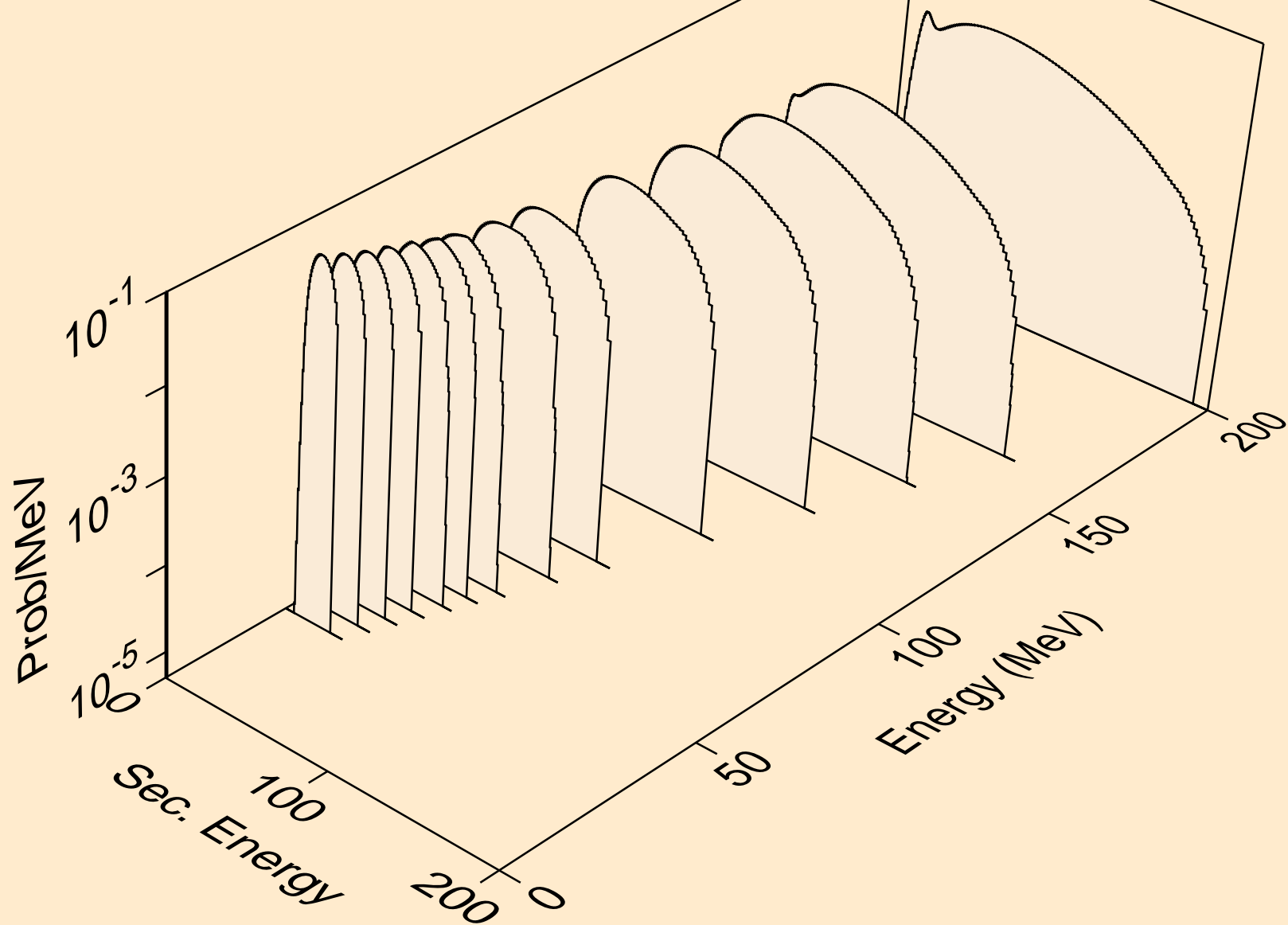

TB161 HELION ACER TENDL-2021 LIBRARY; T=0.K  
tritons from (s,n\*)t

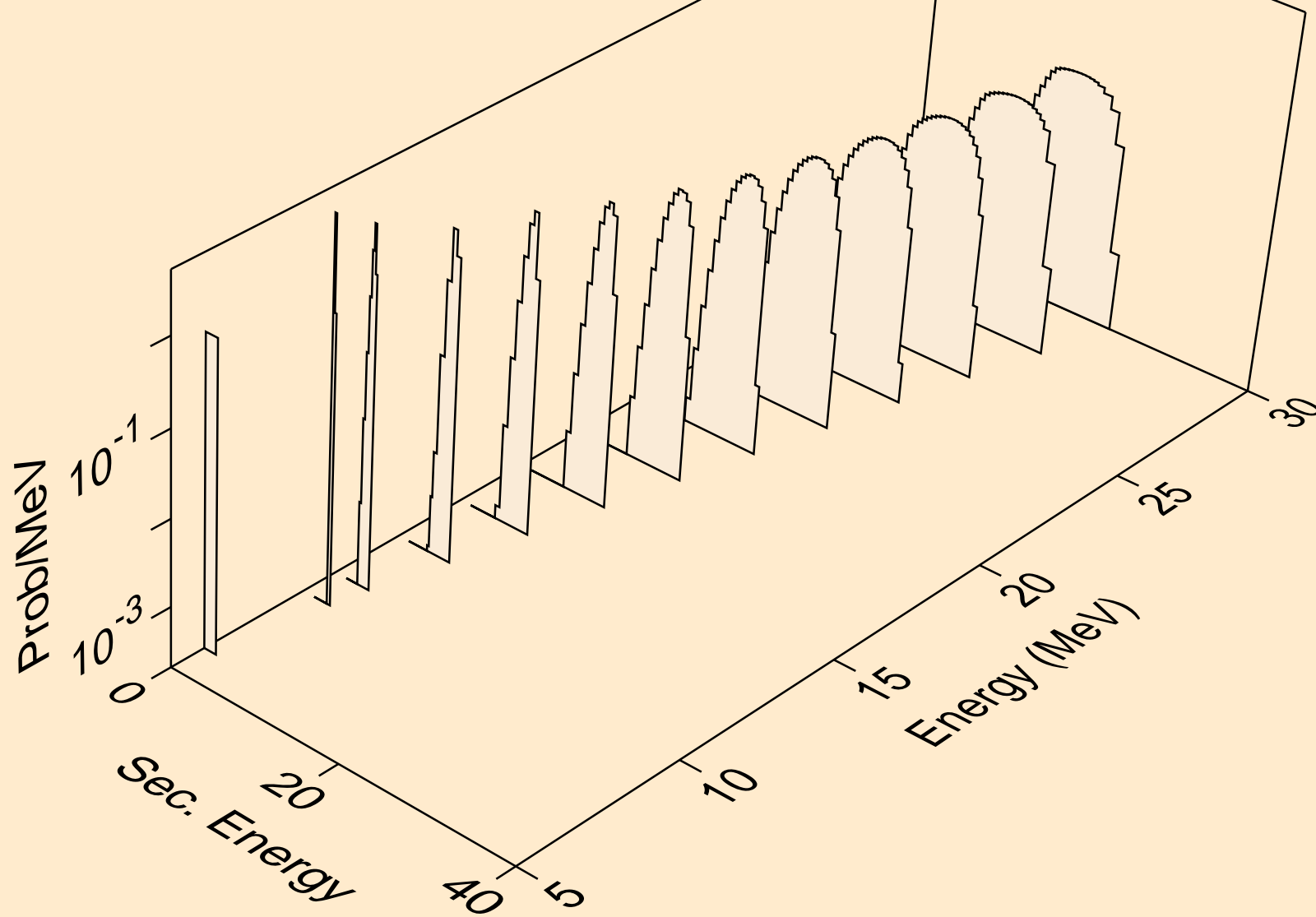

TB161 HELION ACER TENDL-2021 LIBRARY; T=0.K  
tritons from (s,t)

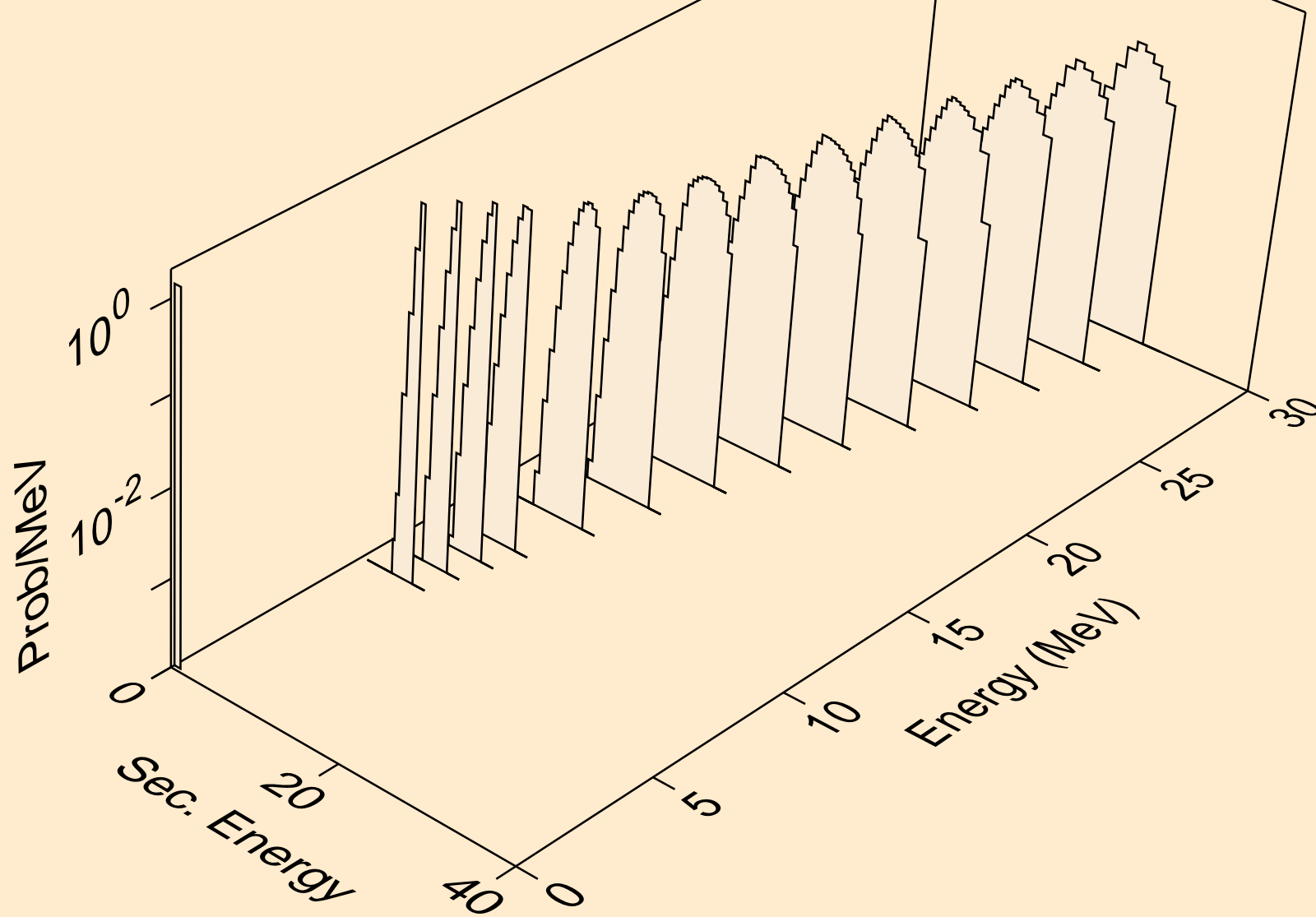

TB161 HELION ACER TENDL-2021 LIBRARY; T=0.K  
tritons from (s,pt)

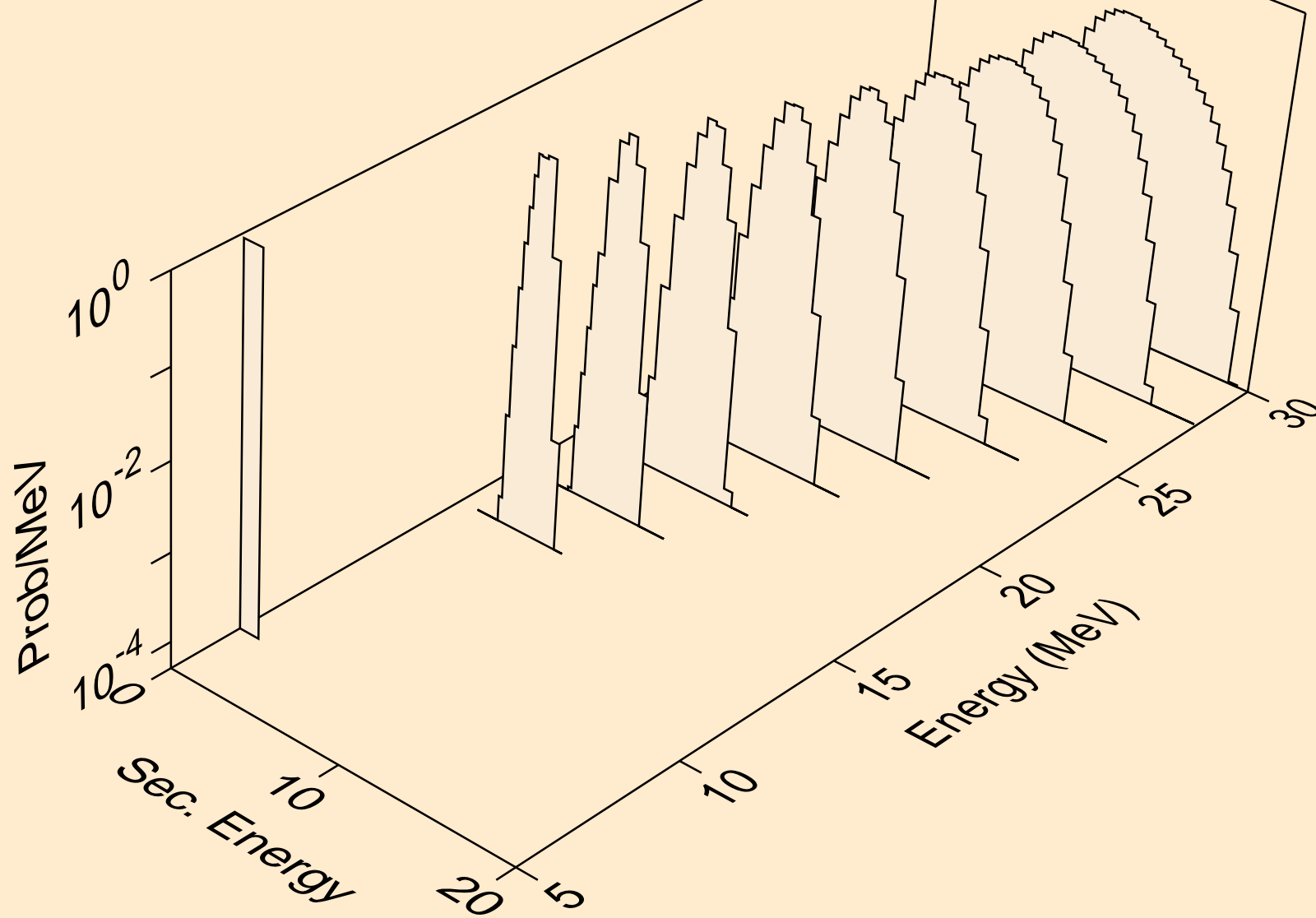



TB161 HELION ACER TENDL-2021 LIBRARY; T=0.K  
alphas from (s,x)

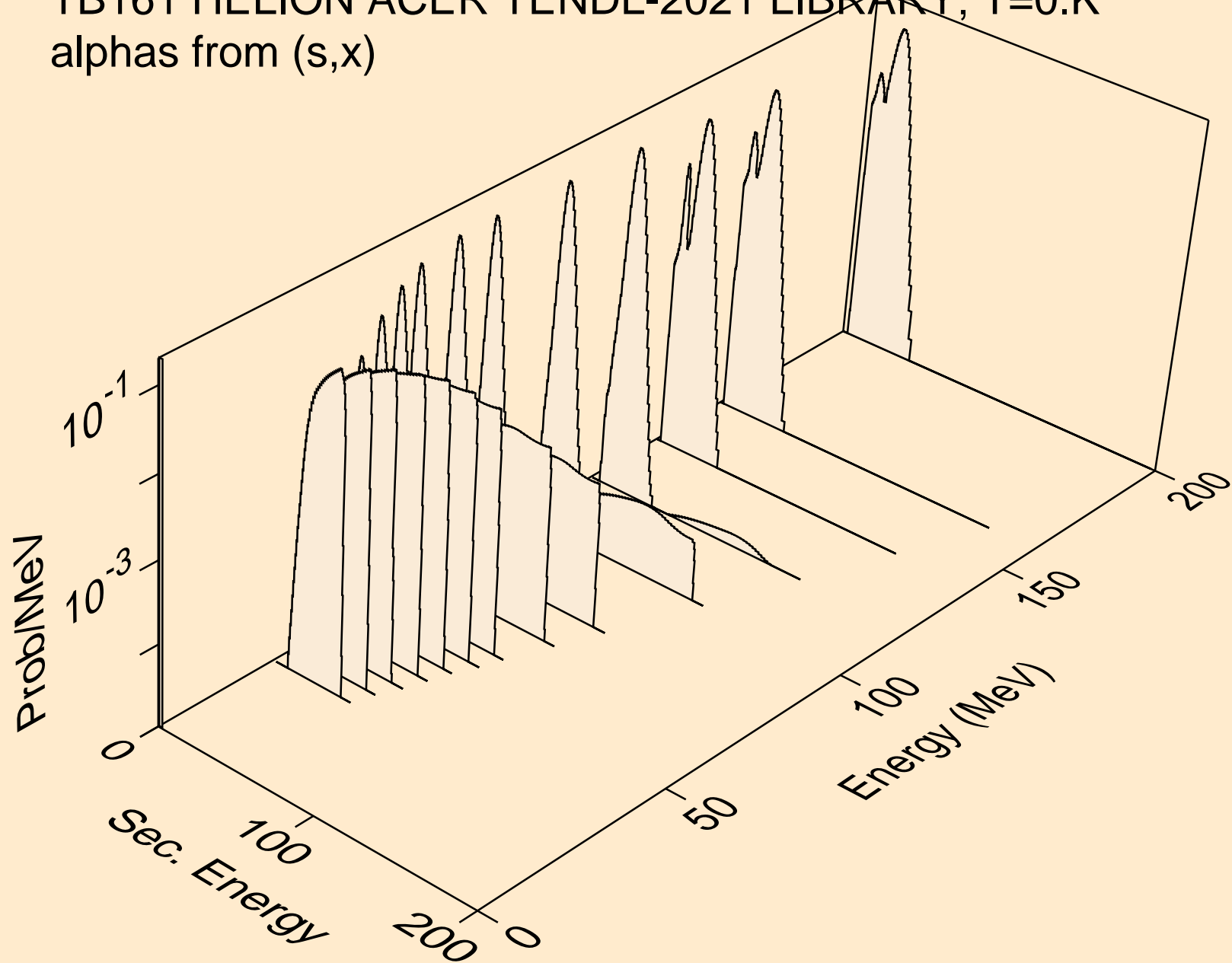

TB161 HELION ACER TENDL-2021 LIBRARY; T=0.K  
alphas from (s,n\*)a

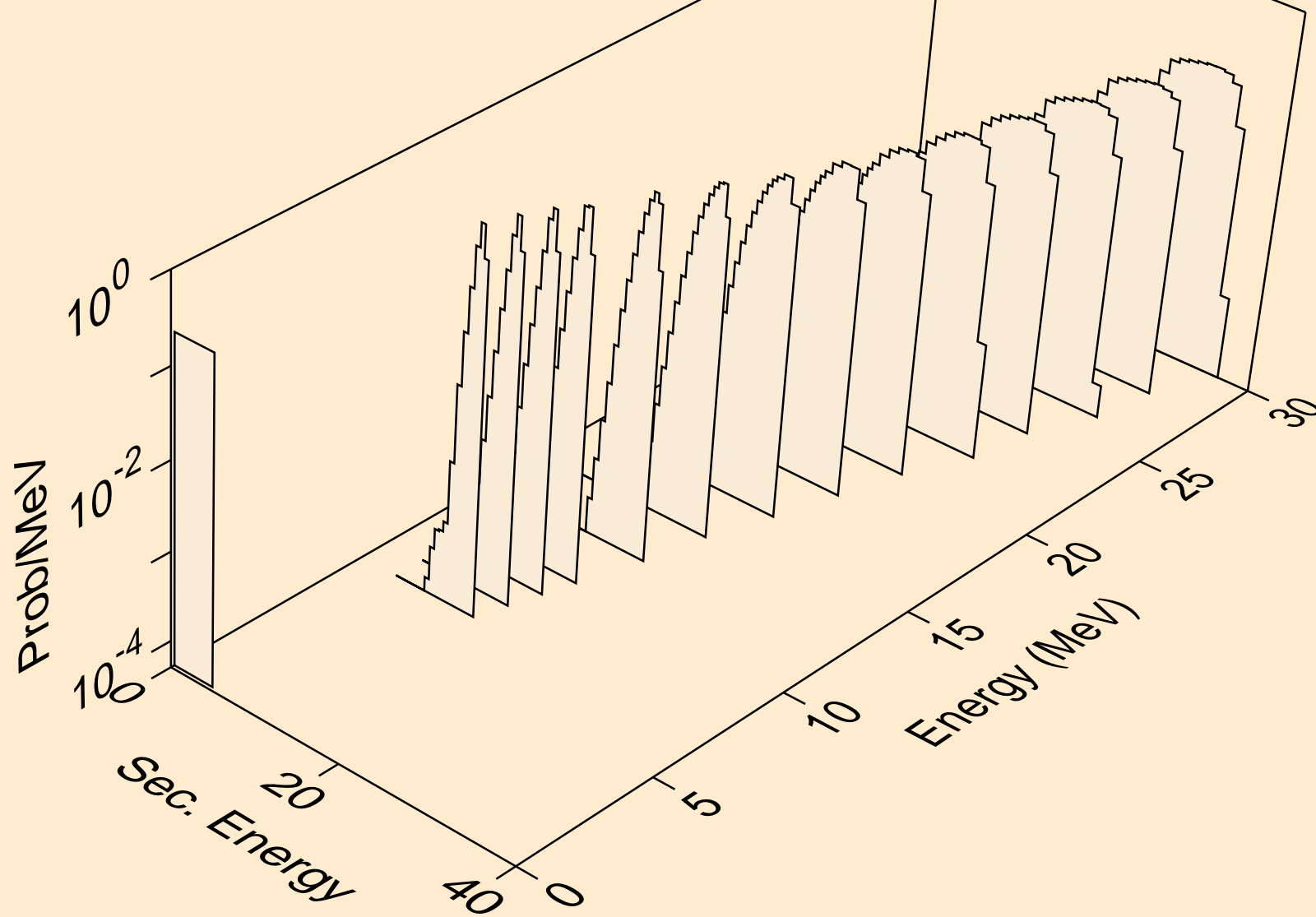

TB161 HELION ACER TENDL-2021 LIBRARY; T=0.K  
alphas from (s,2n)a

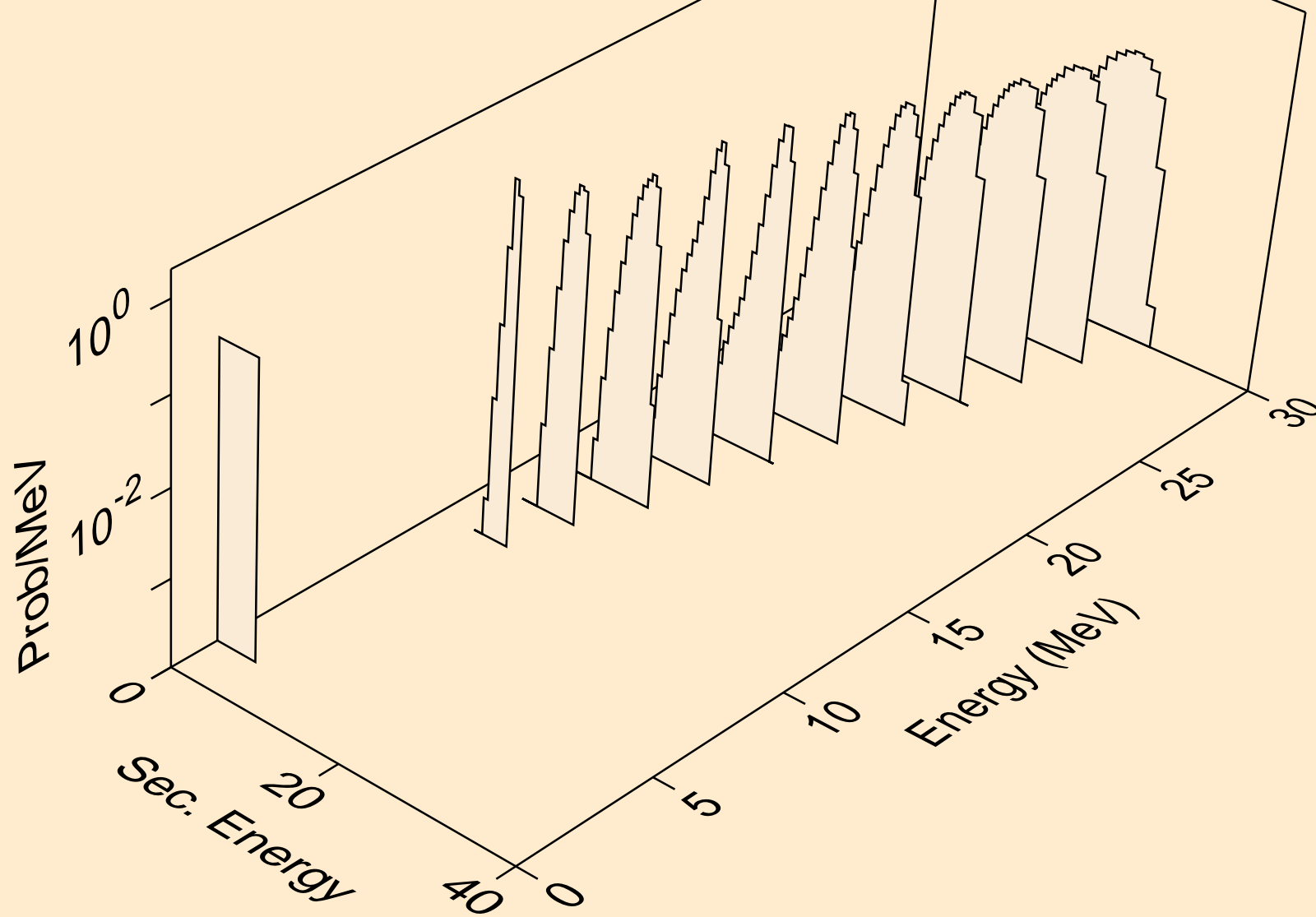

TB161 HELION ACER TENDL-2021 LIBRARY; T=0.K  
alphas from (s,3n)a

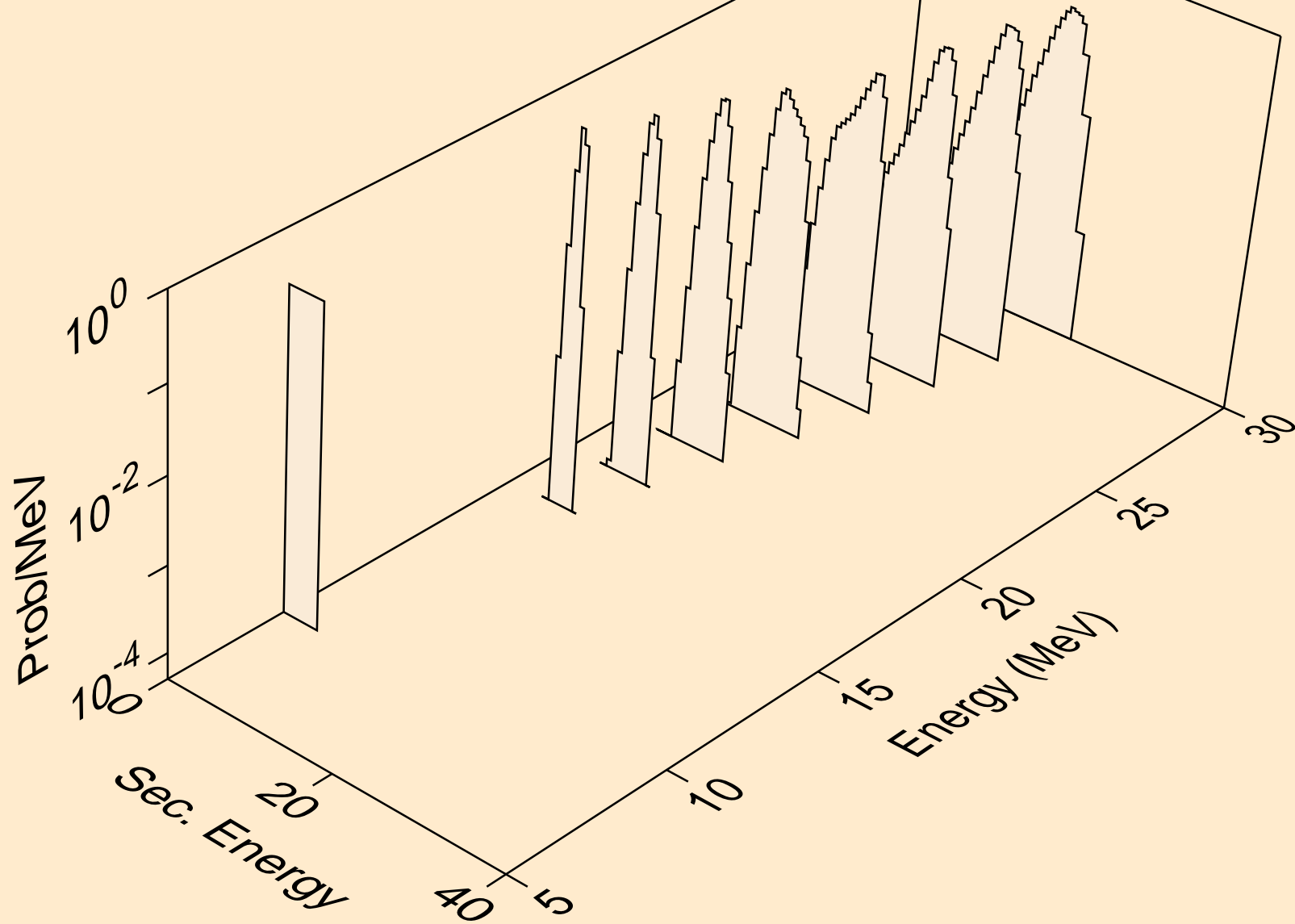

TB161 HELION ACER TENDL-2021 LIBRARY; T=0.K  
alphas from (s,n\*)2a

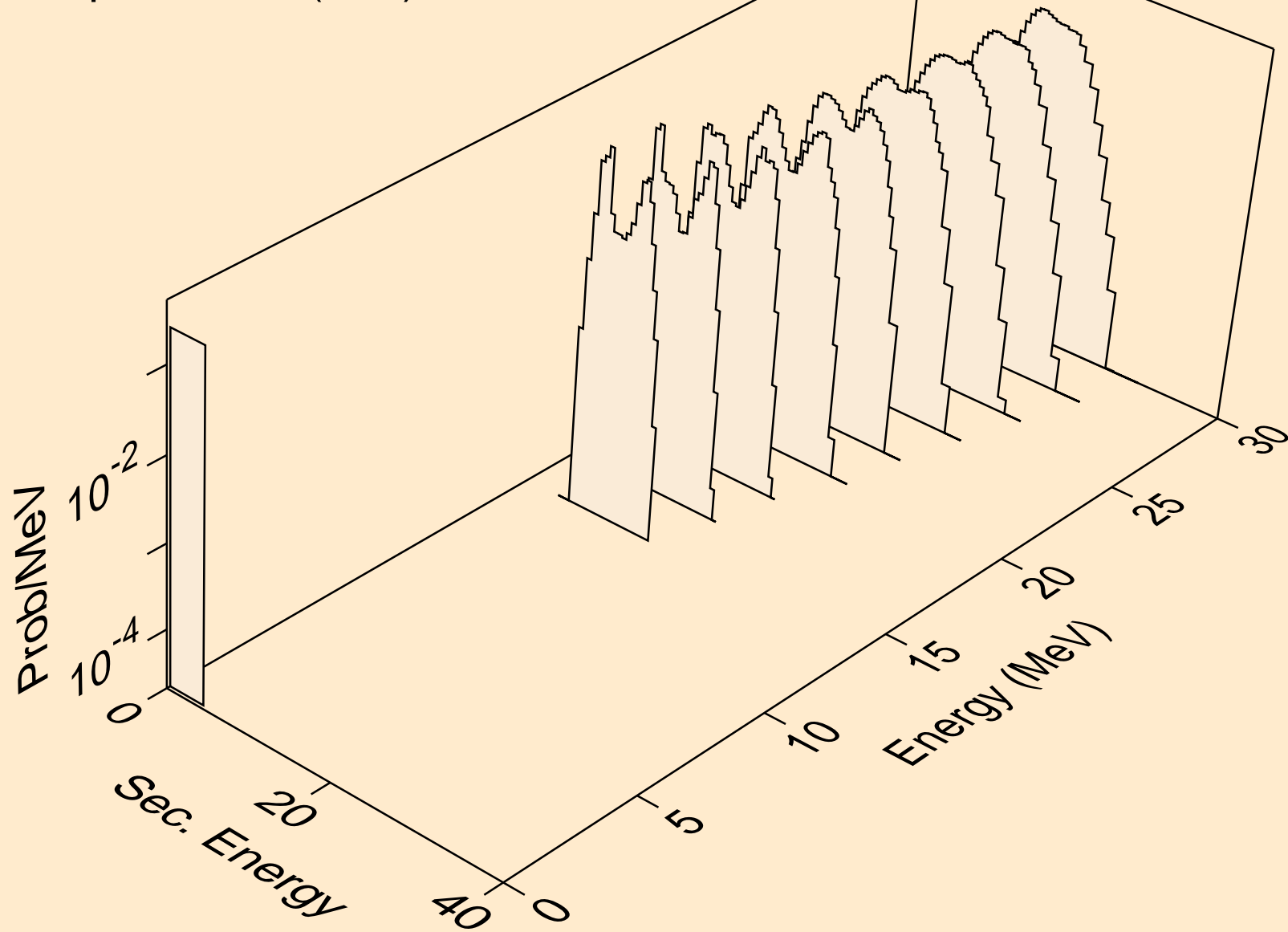

TB161 HELION ACER TENDL-2021 LIBRARY; T=0.K  
alphas from (s,npa)

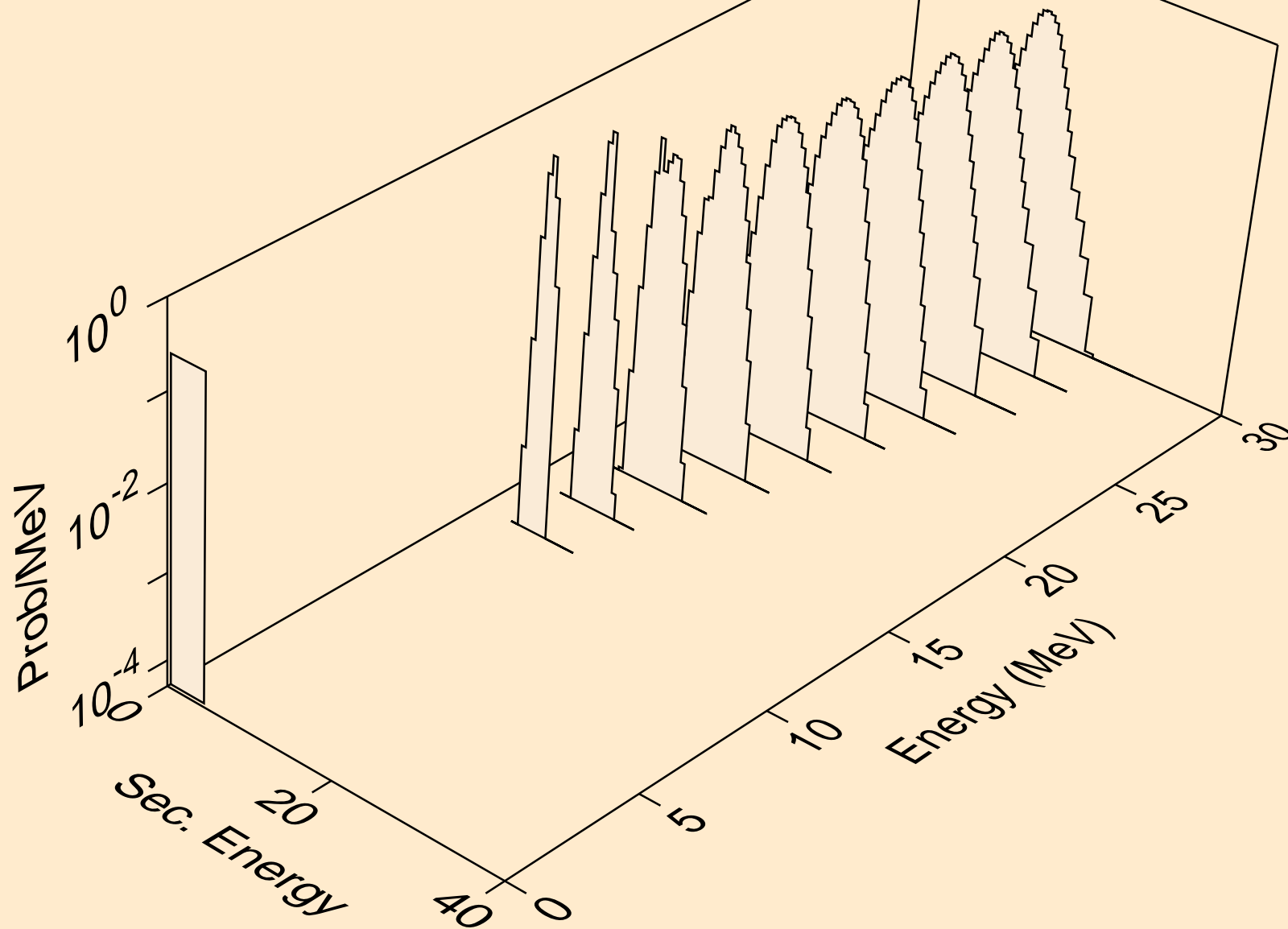

TB161 HELION ACER TENDL-2021 LIBRARY; T=0.K  
alphas from (s,a)

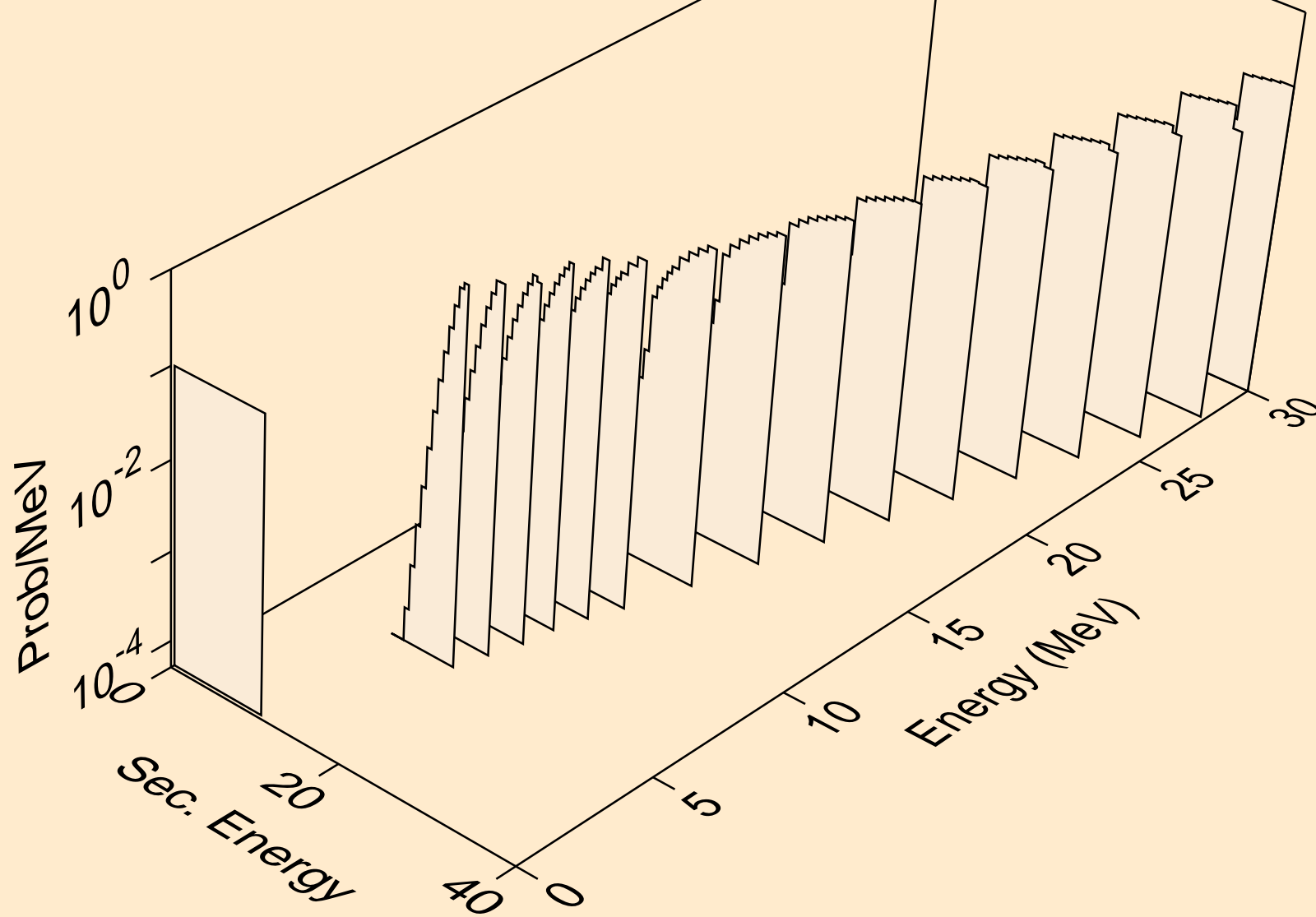

TB161 HELION ACER TENDL-2021 LIBRARY; T=0.K  
alphas from (s,pa)

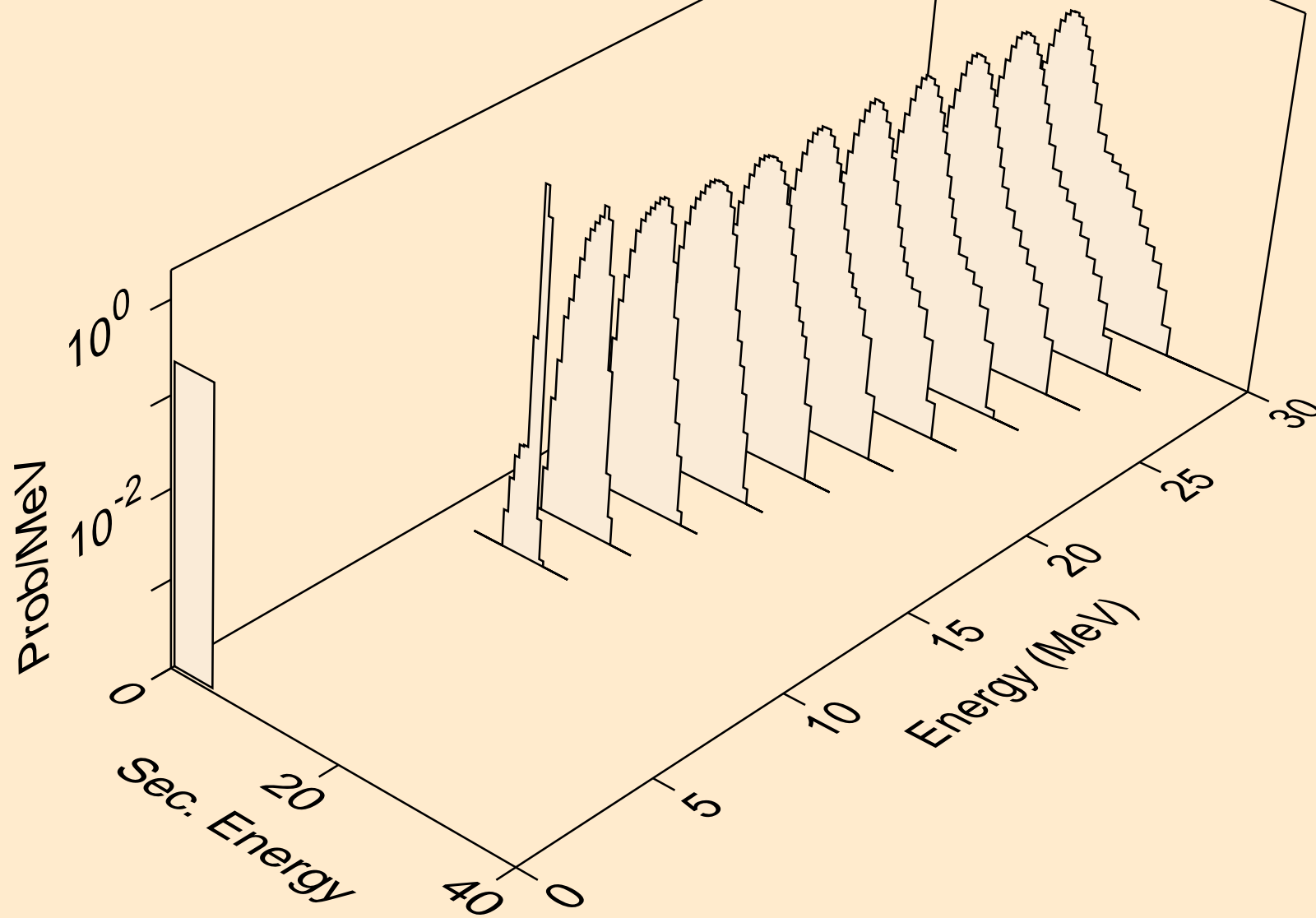



TB161 HELION ACER TENDL-2021 LIBRARY; T=0.K  
alphas from (s,da)

