

TC104 HELION ACER TENDL-2021 LIBRARY; T=0.K  
Principal cross sections

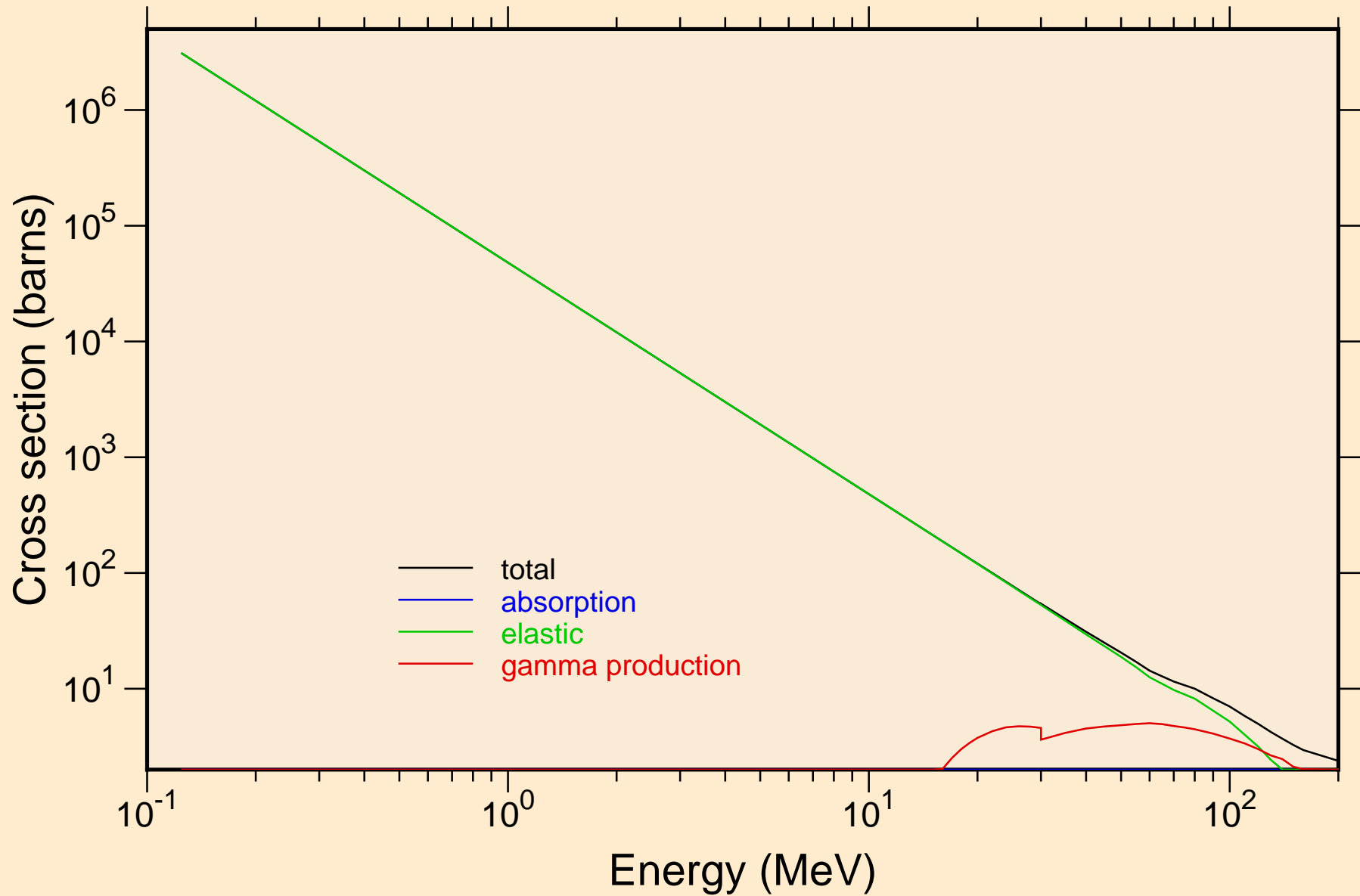

TC104 HELION ACER TENDL-2021 LIBRARY; T=0.K

Heating

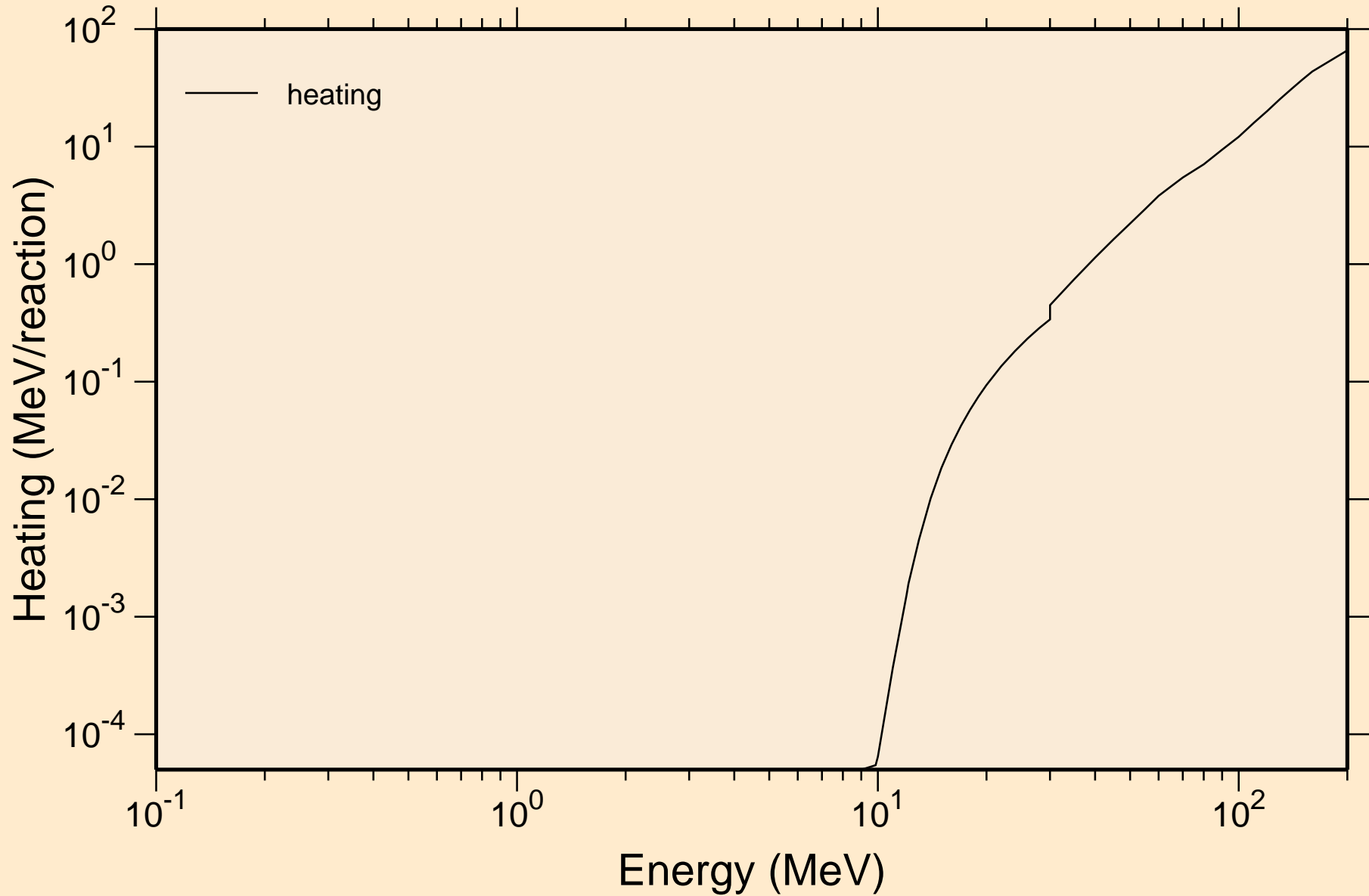

# TC104 HELION ACER TENDL-2021 LIBRARY; T=0.K

## Principal cross sections

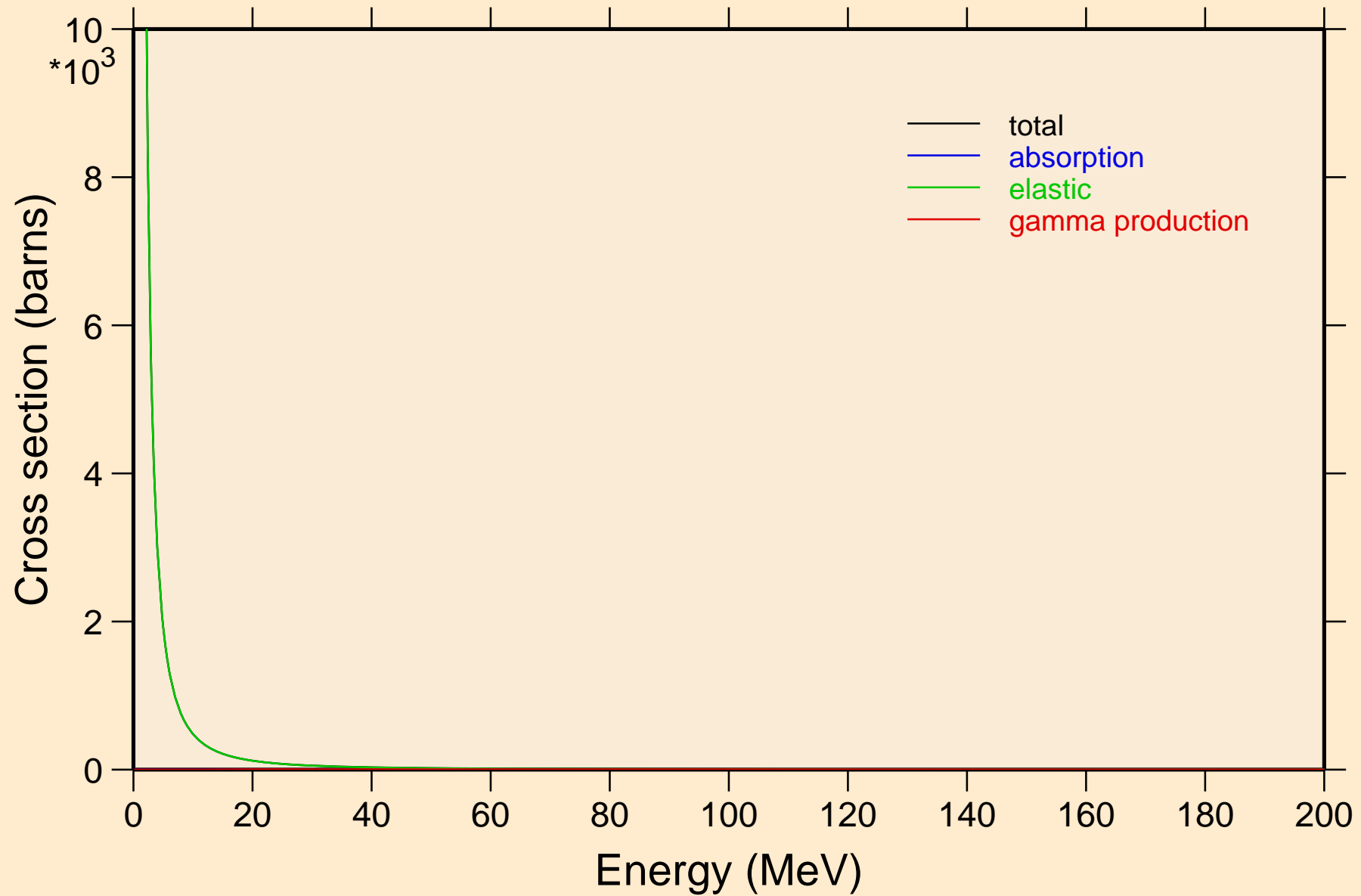

TC104 HELION ACER TENDL-2021 LIBRARY; T=0.K

Heating

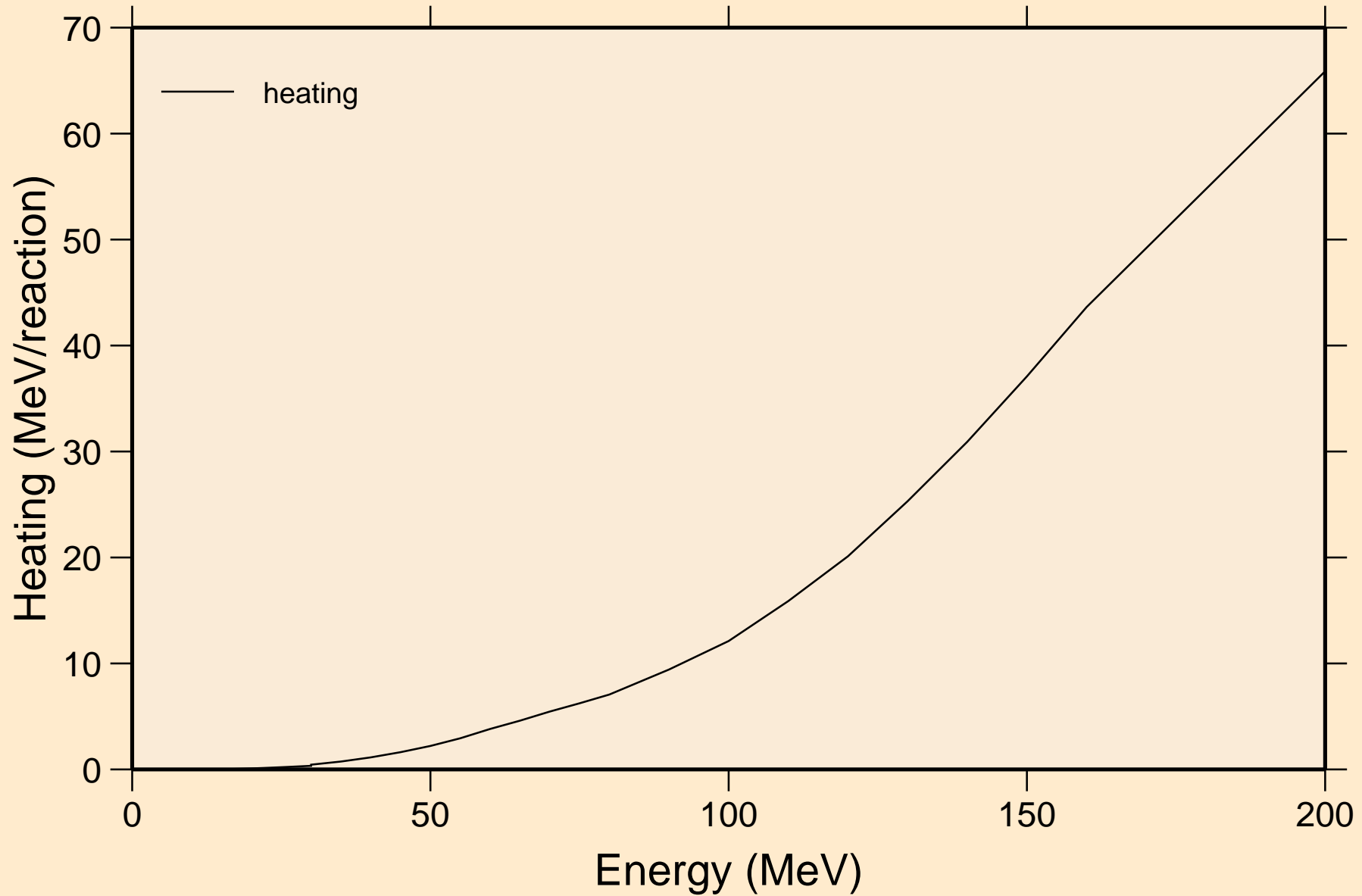

TC104 HELION ACER TENDL-2021 LIBRARY; T=0.K  
Threshold reactions

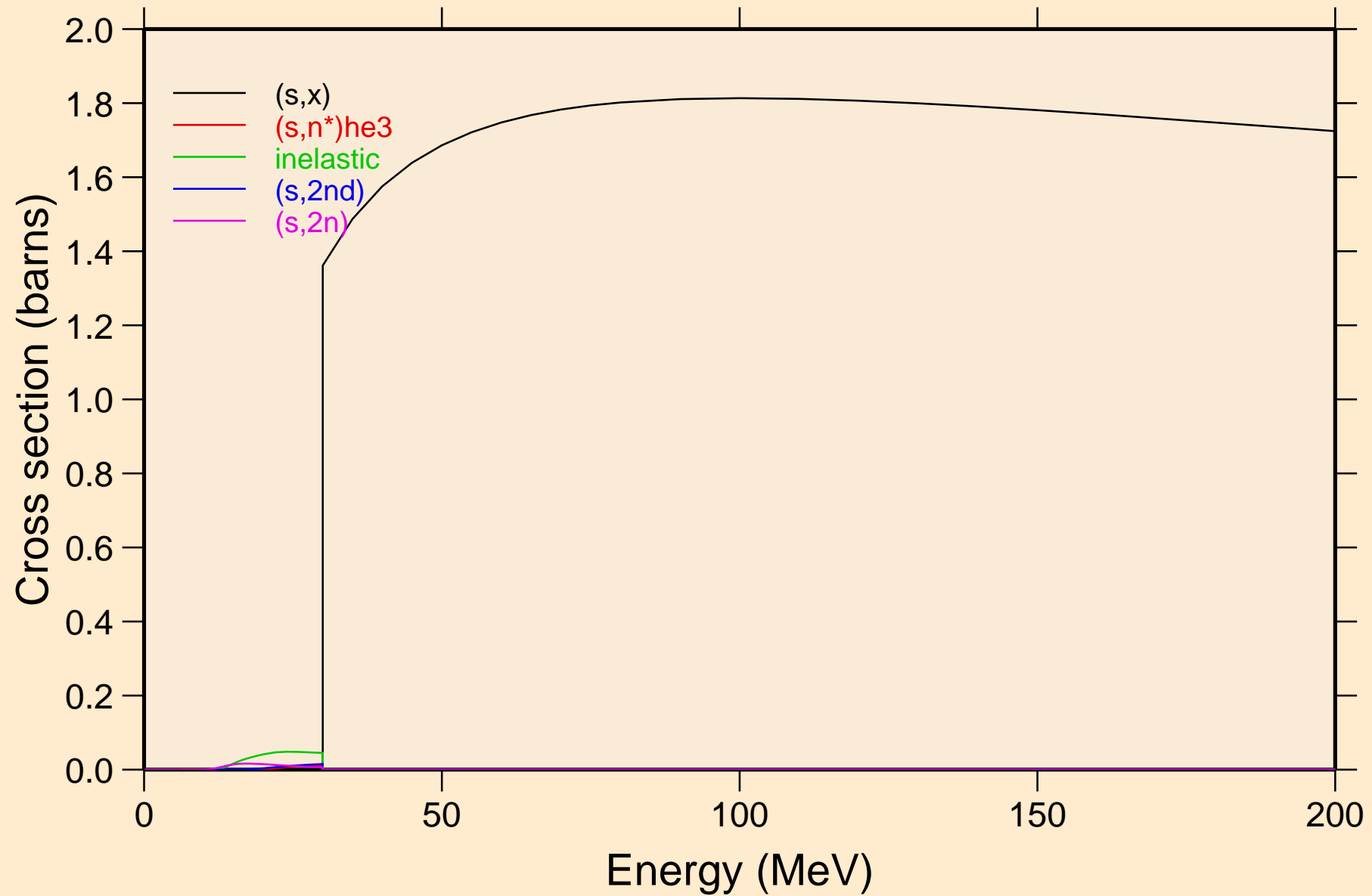

TC104 HELION ACER TENDL-2021 LIBRARY; T=0.K  
Threshold reactions

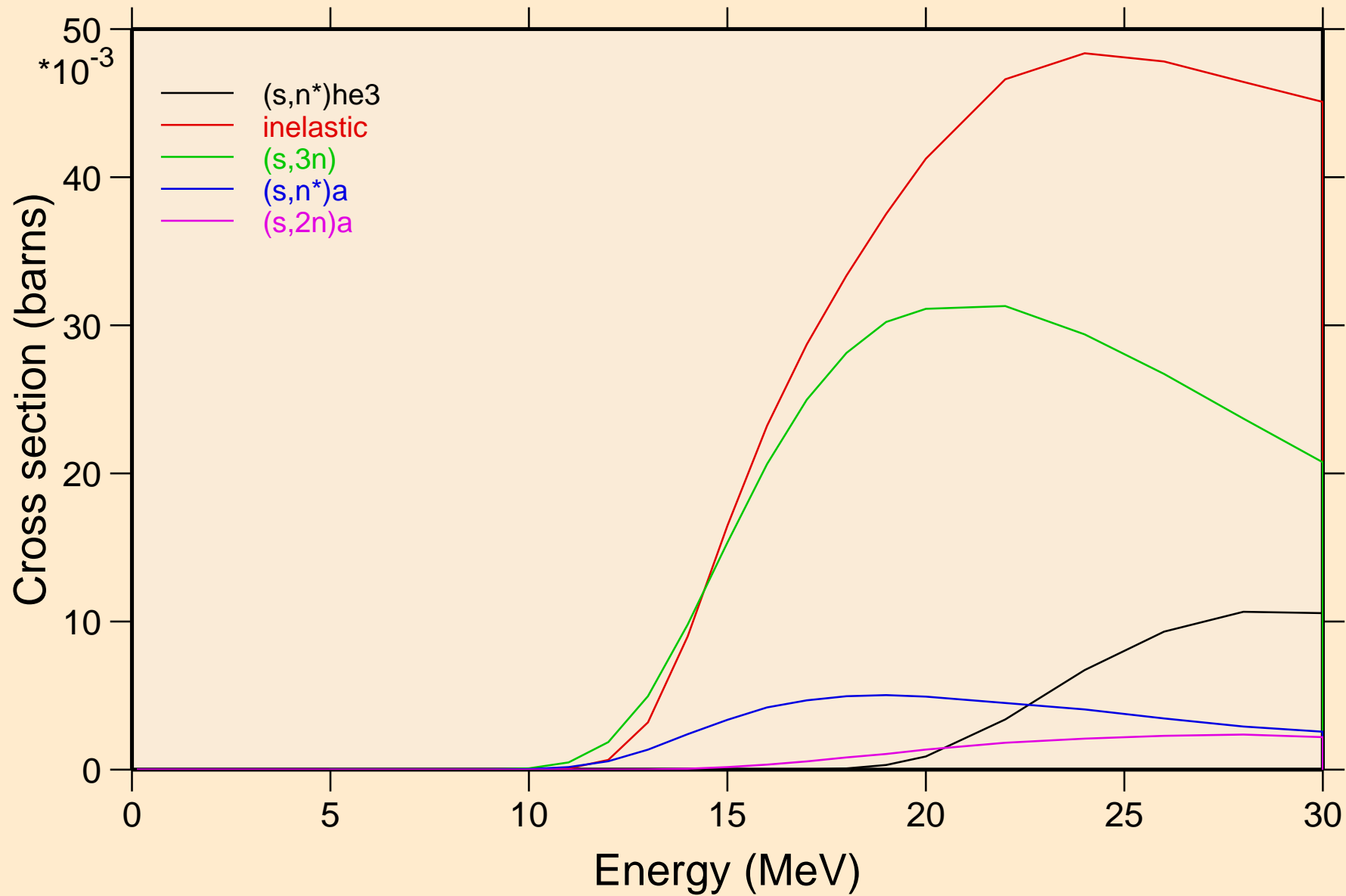

TC104 HELION ACER TENDL-2021 LIBRARY; T=0.K  
Threshold reactions

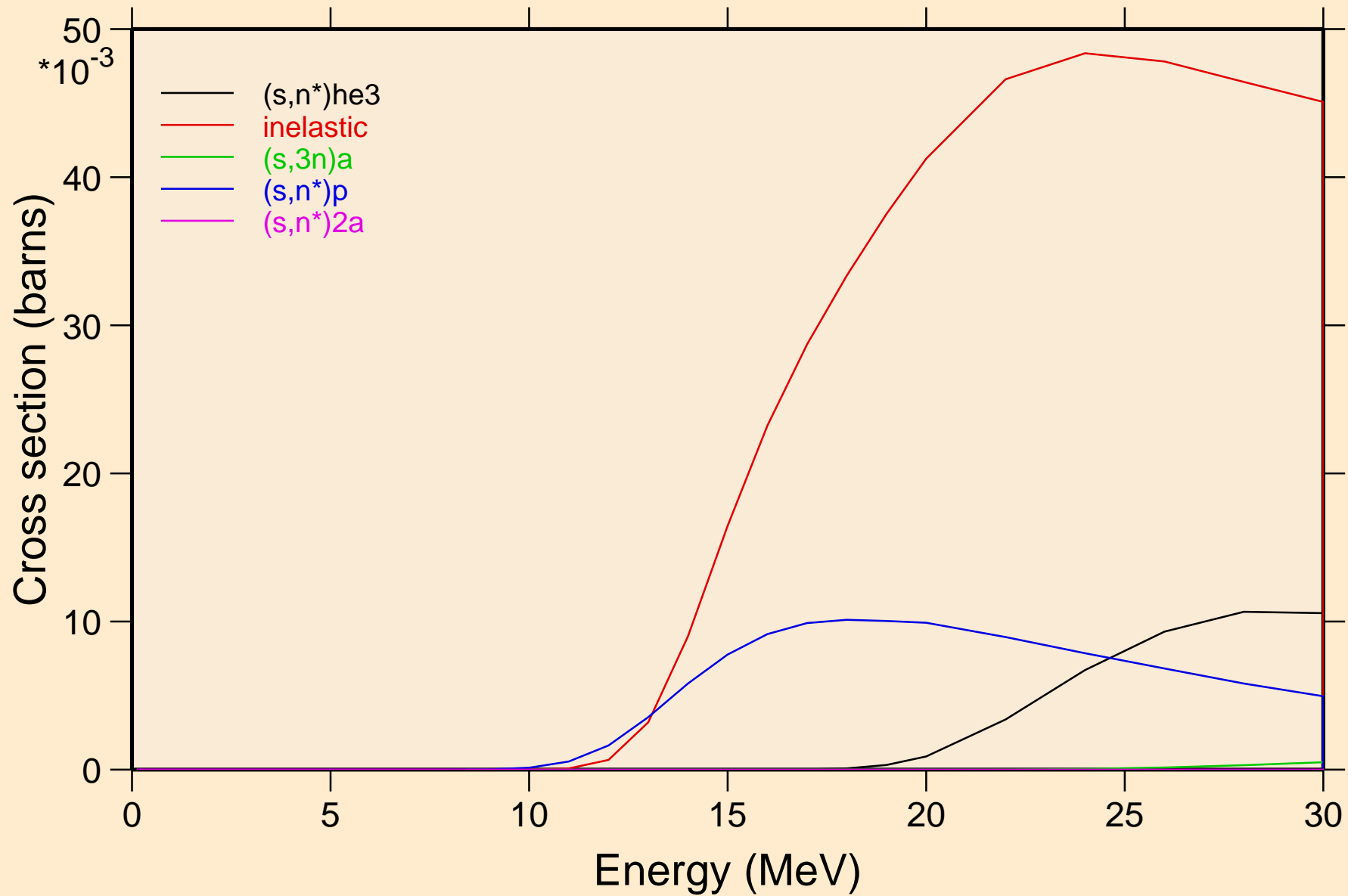

TC104 HELION ACER TENDL-2021 LIBRARY; T=0.K  
Threshold reactions

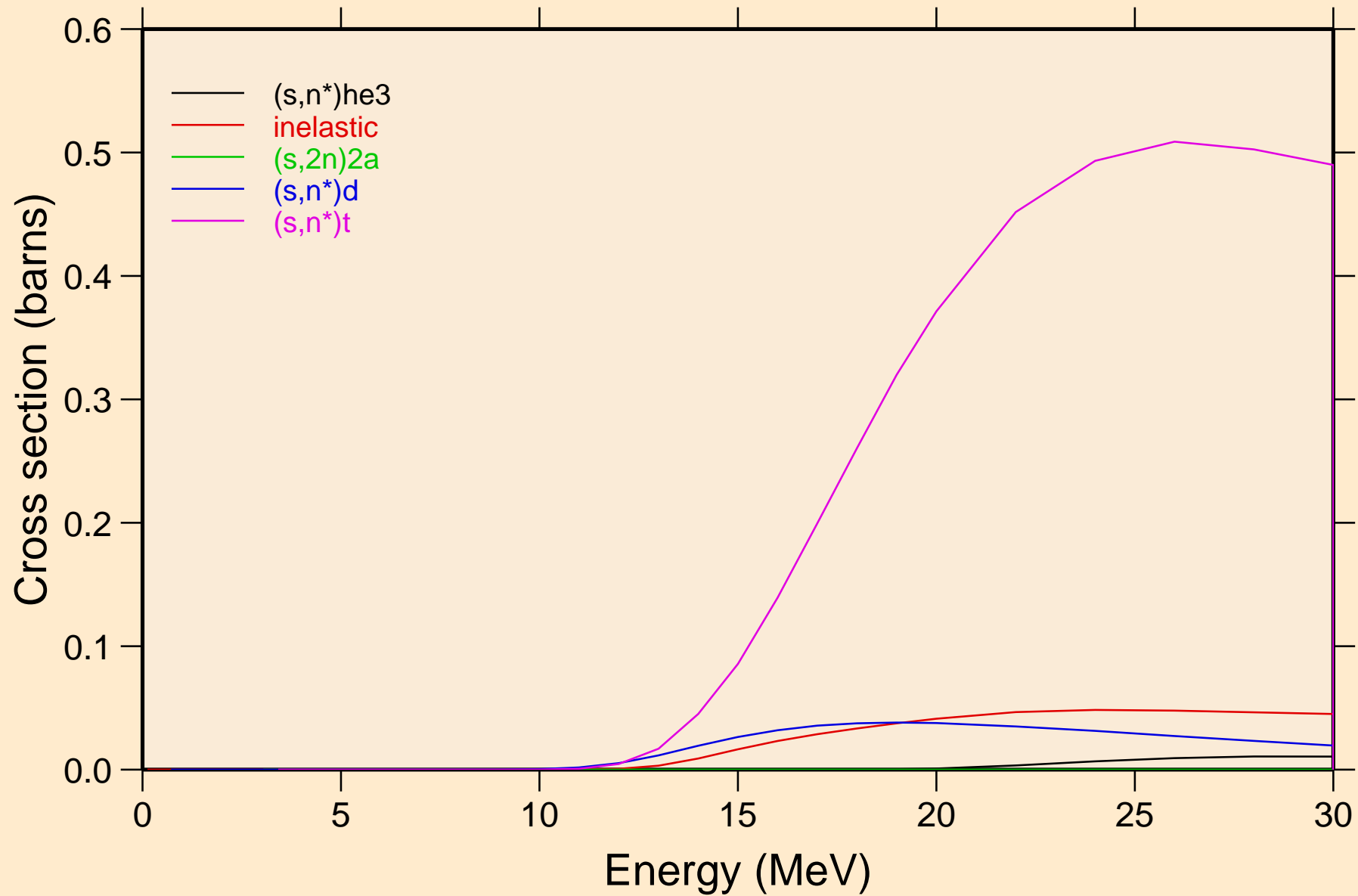



TC104 HELION ACER TENDL-2021 LIBRARY; T=0.K  
Threshold reactions

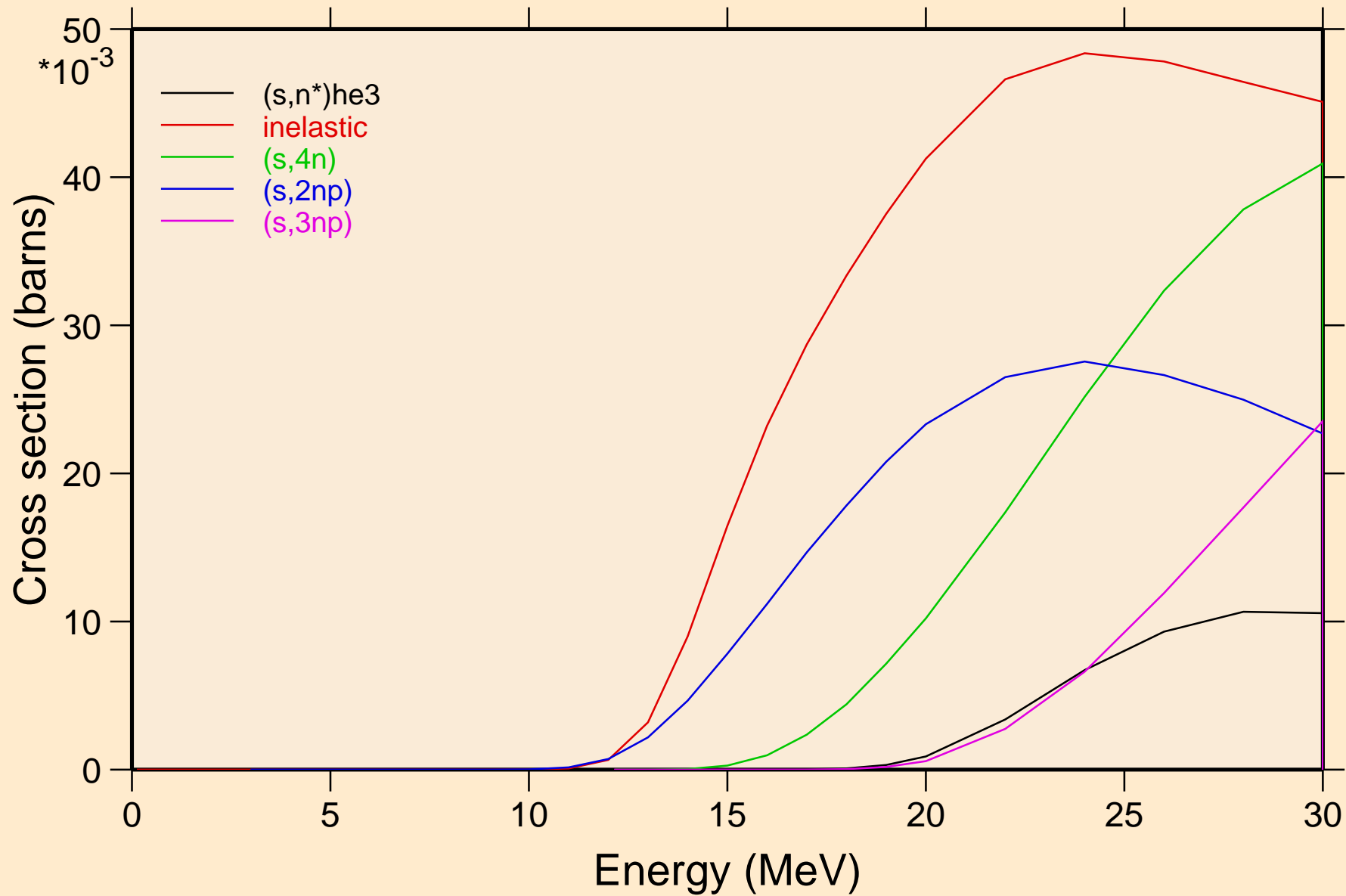

TC104 HELION ACER TENDL-2021 LIBRARY; T=0.K  
Threshold reactions

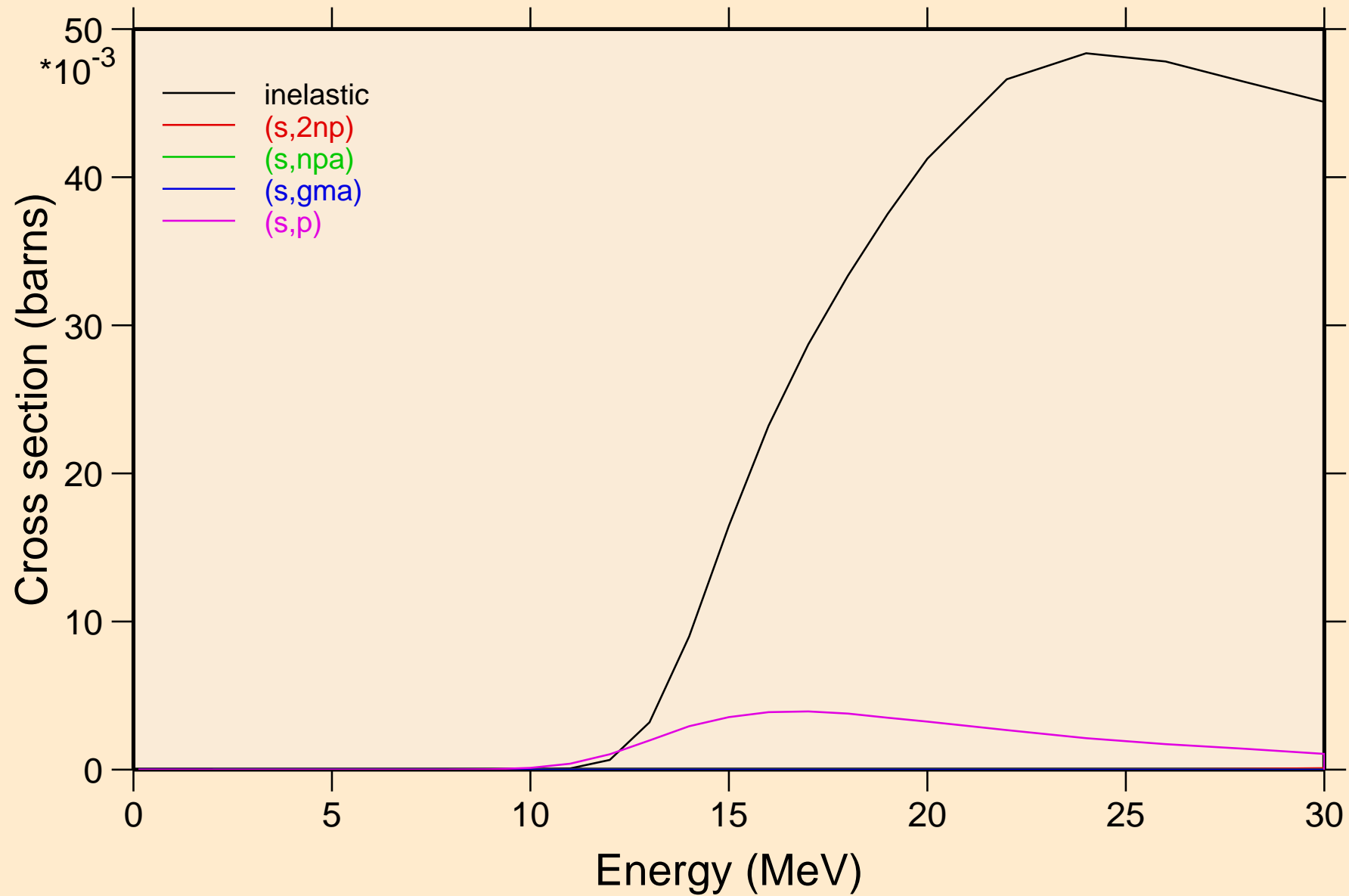

TC104 HELION ACER TENDL-2021 LIBRARY; T=0.K  
Threshold reactions

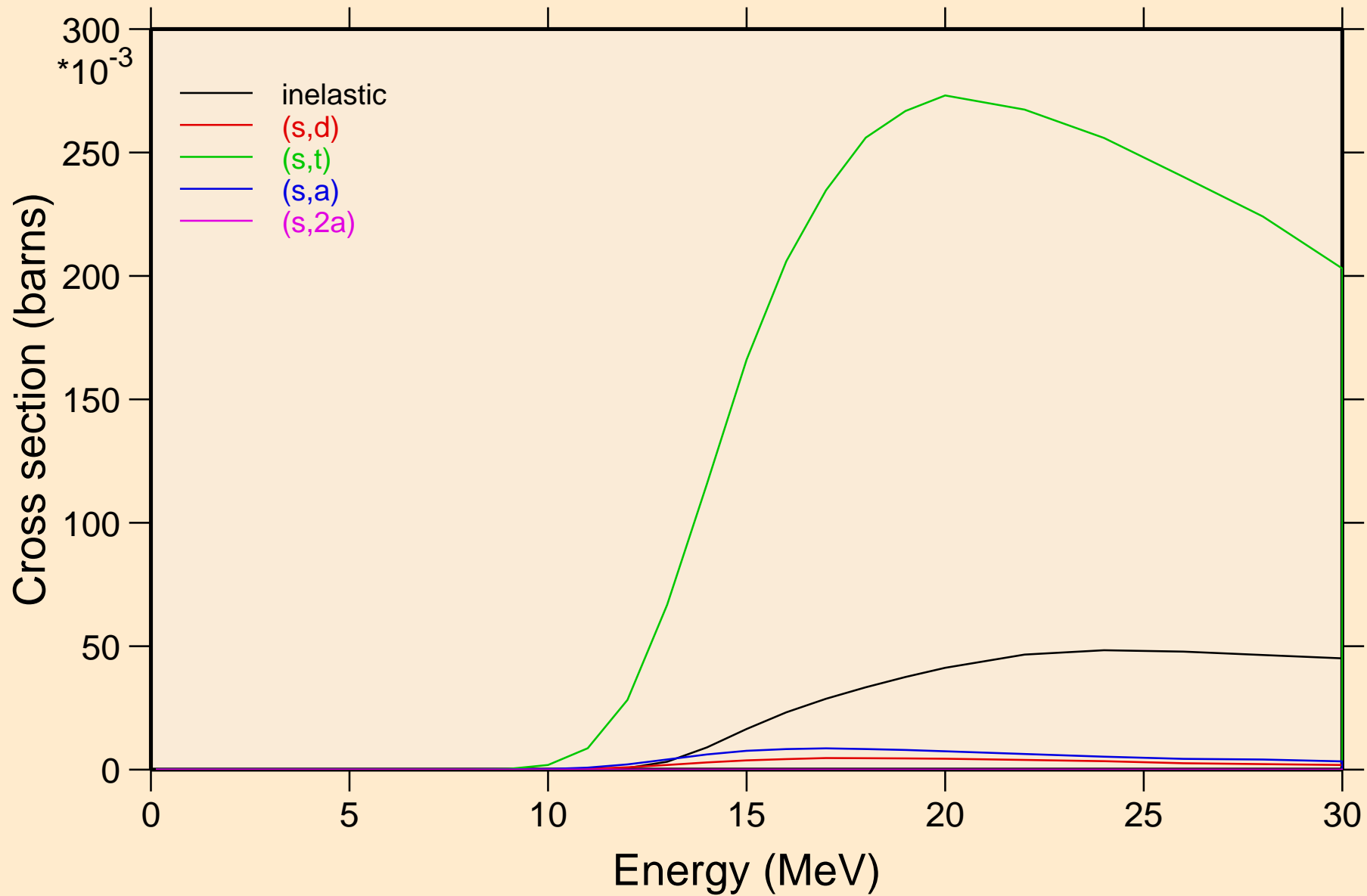

TC104 HELION ACER TENDL-2021 LIBRARY; T=0.K  
Threshold reactions

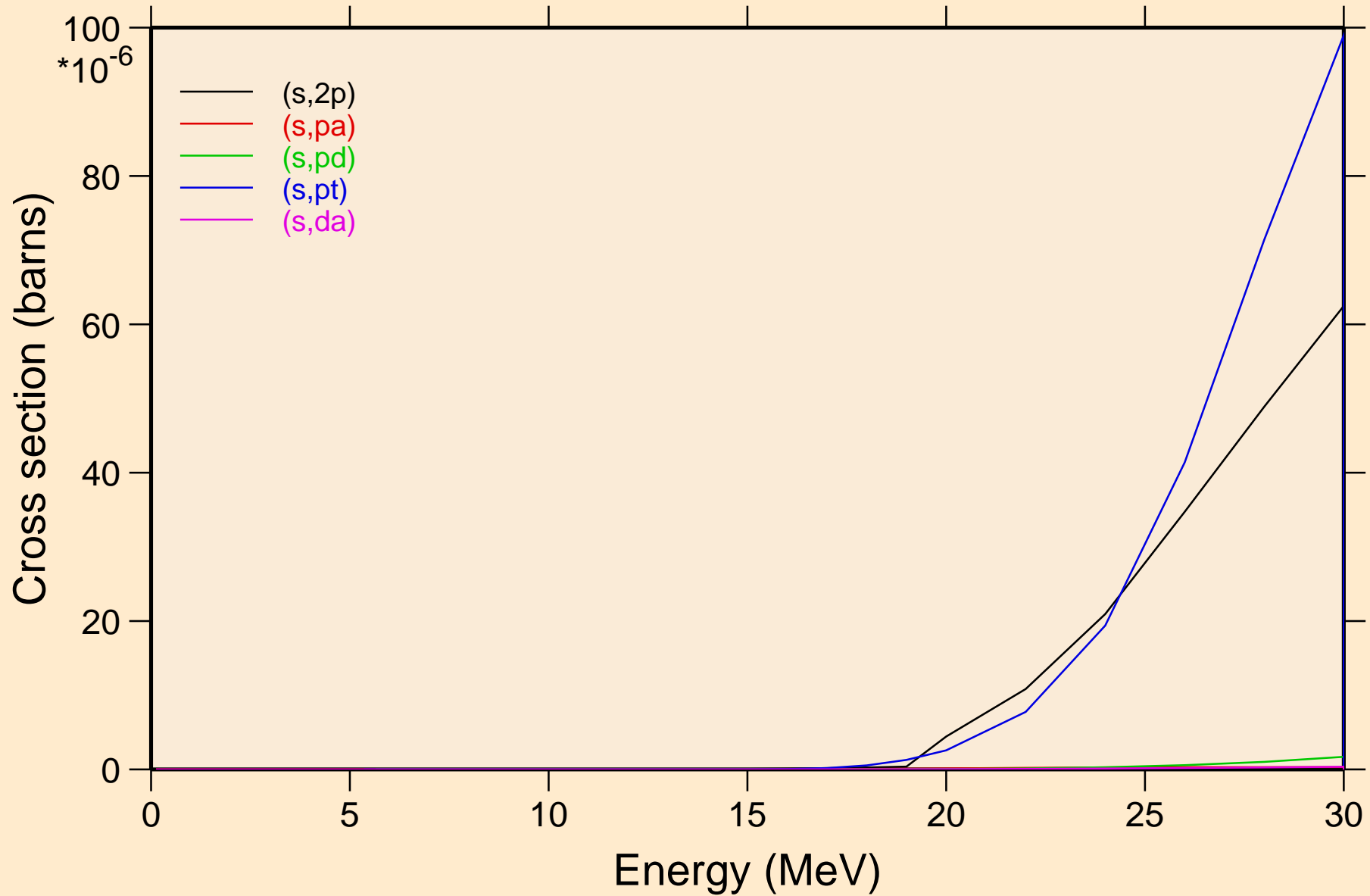

TC104 HELION ACER TENDL-2021 LIBRARY; T=0.K  
angular distribution for elastic

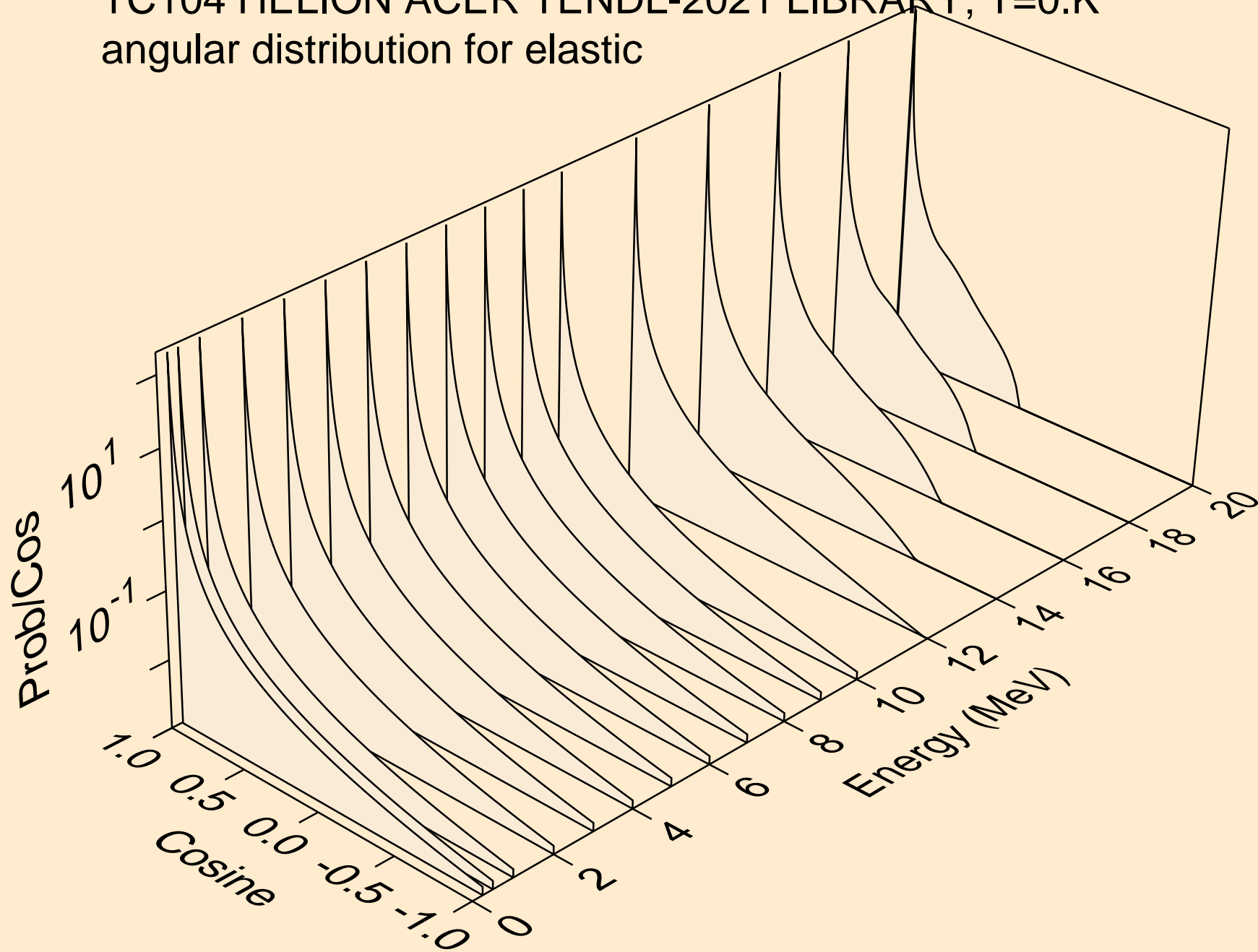

TC104 HELION ACER TENDL-2021 LIBRARY; T=0.K  
angular distribution for elastic

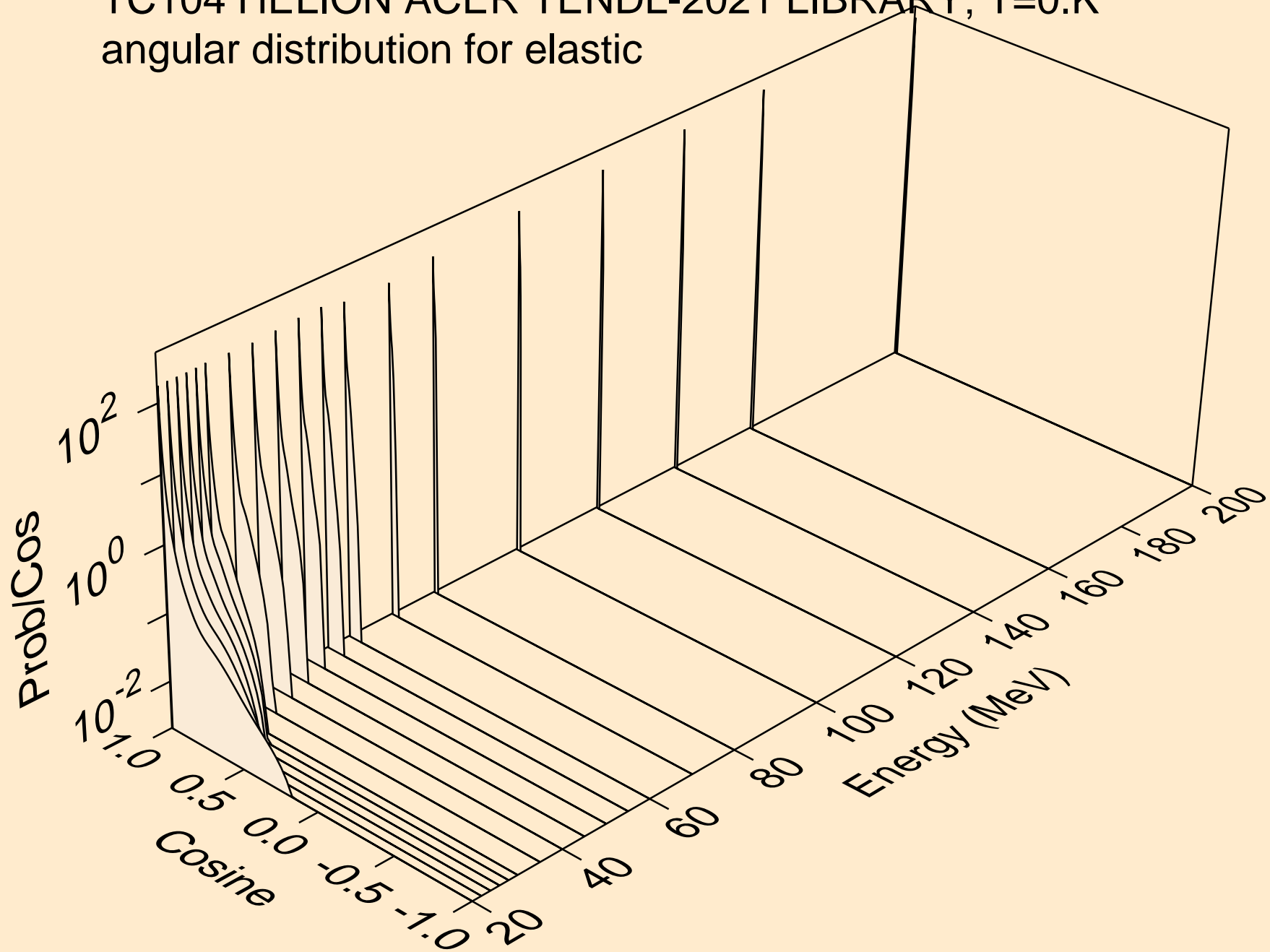

TC104 HELION ACER TENDL-2021 LIBRARY; T=0.K  
He-3 emission for (s,x)

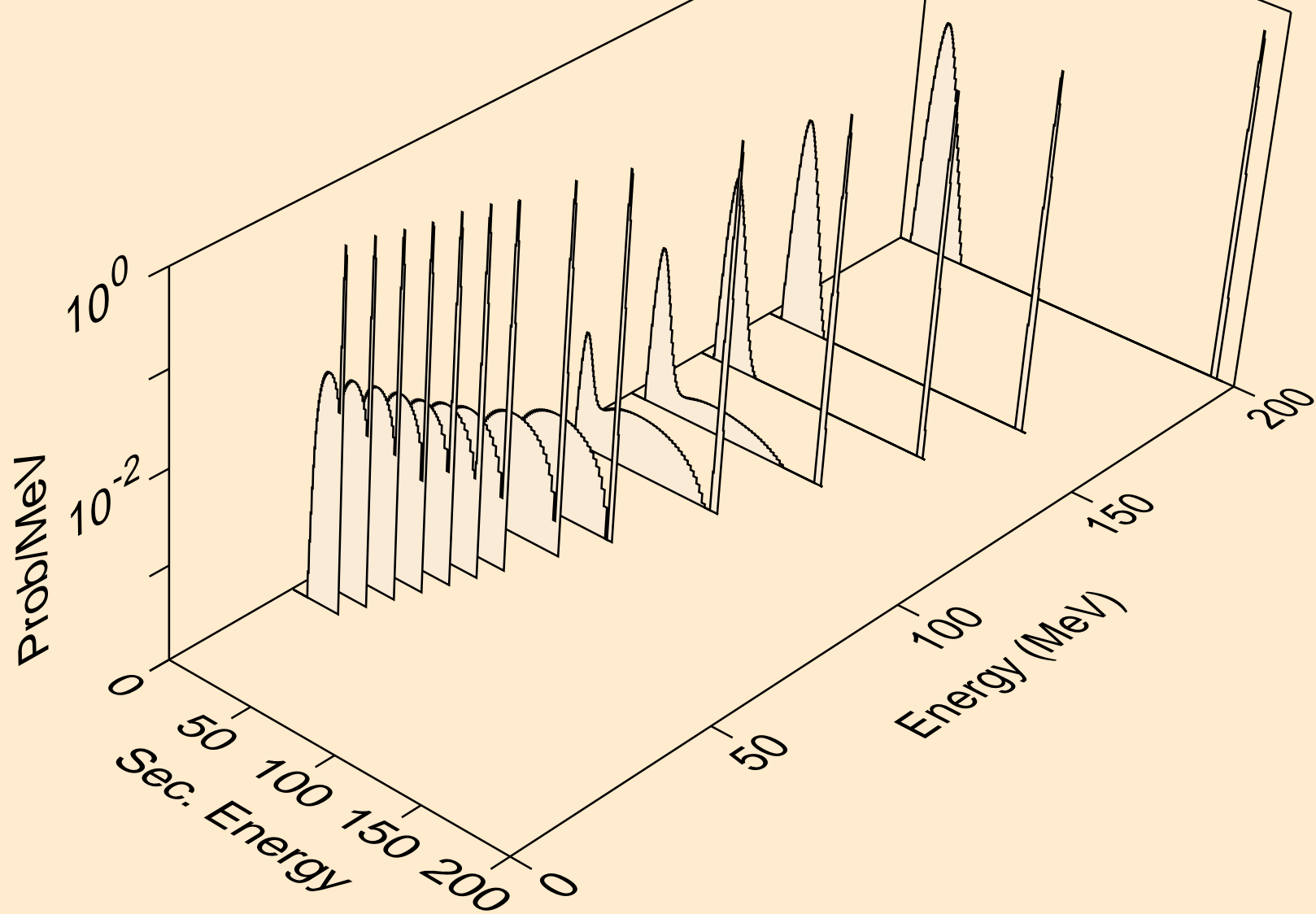

TC104 HELION ACER TENDL-2021 LIBRARY; T=0.K  
He-3 emission for (s,n\*)he3

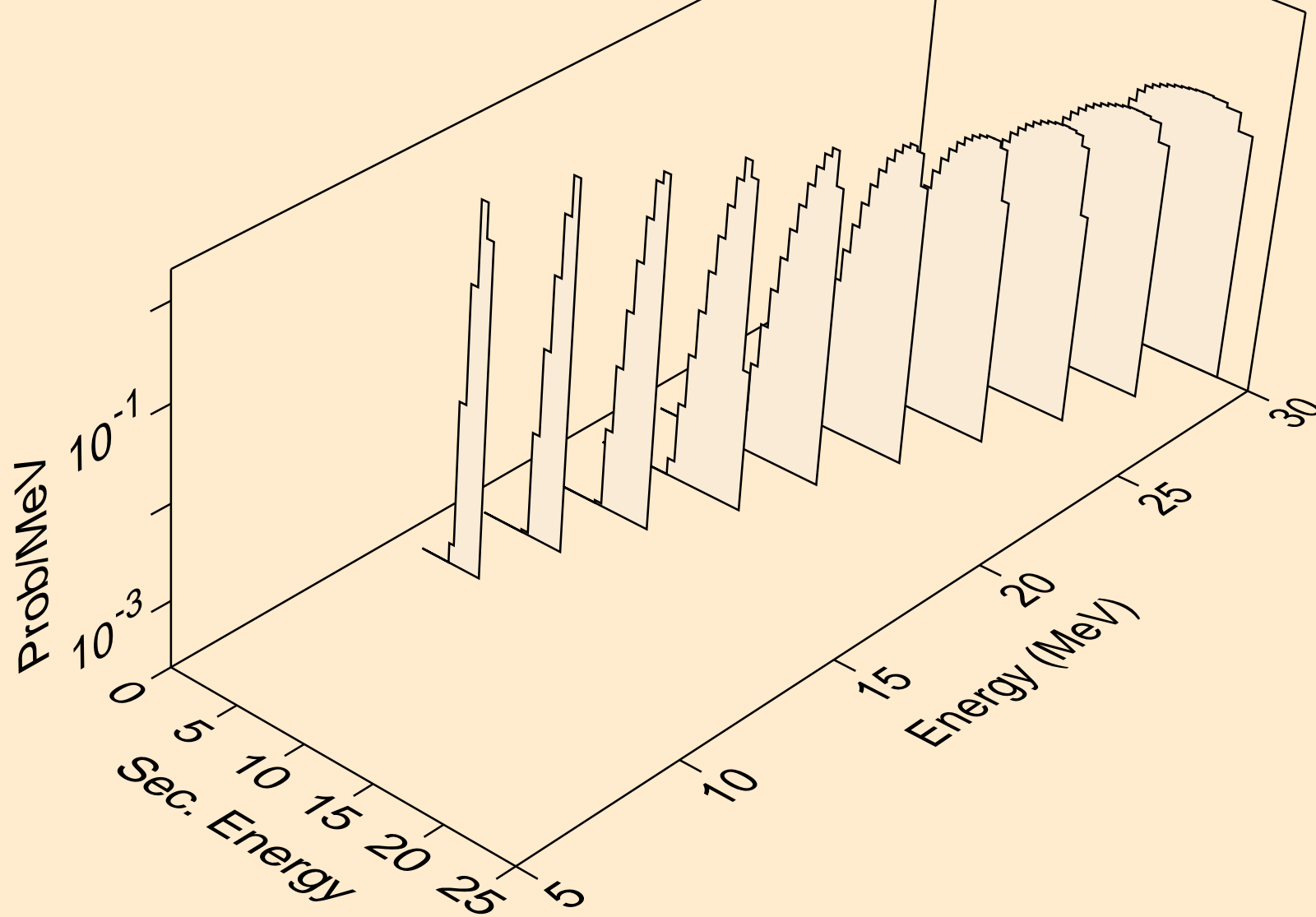



TC104 HELION ACER TENDL-2021 LIBRARY; T=0.K  
He-3 emission for inelastic

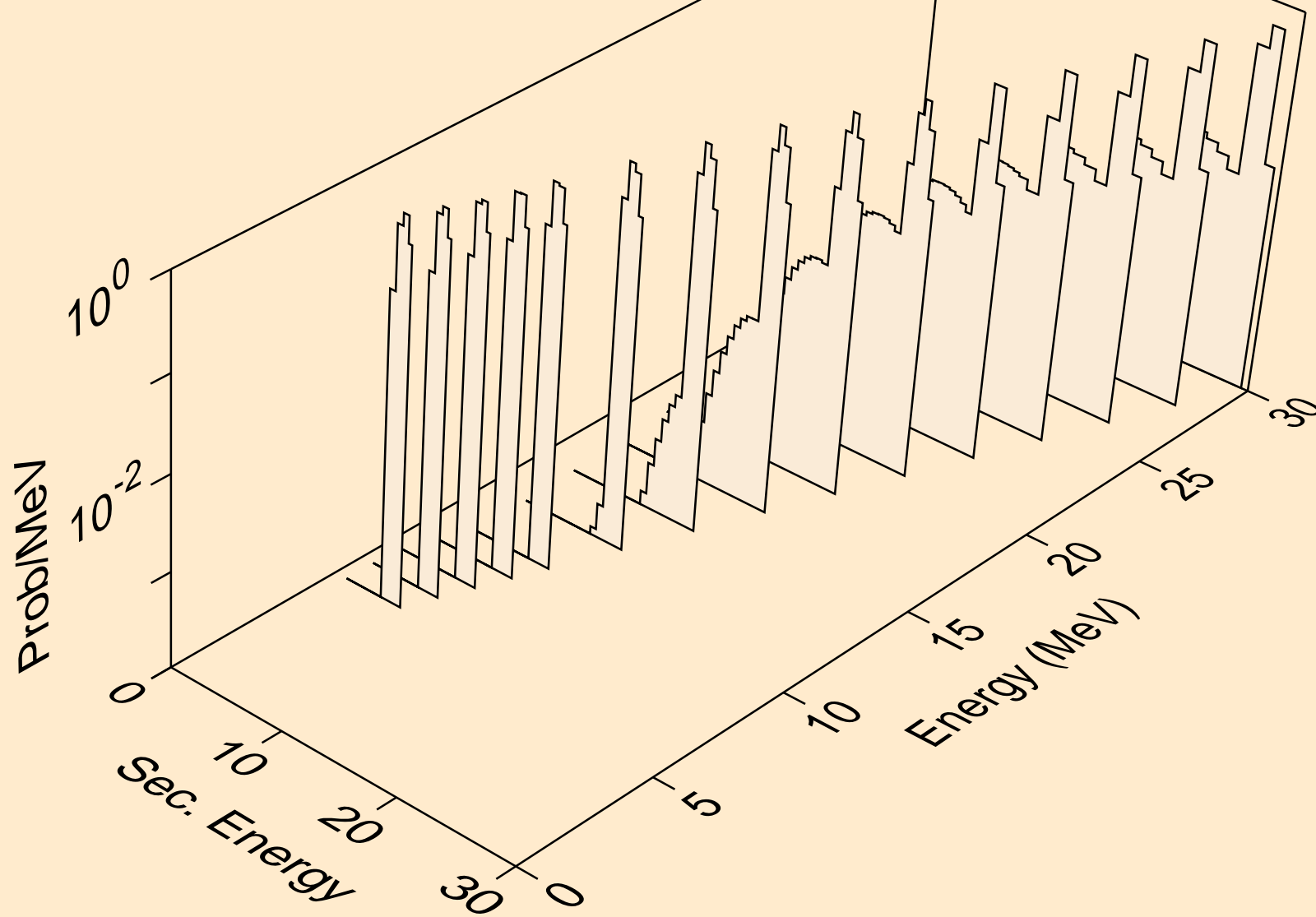

TC104 HELION ACER TENDL-2021 LIBRARY; T=0.K  
Photon emission for (z,n)

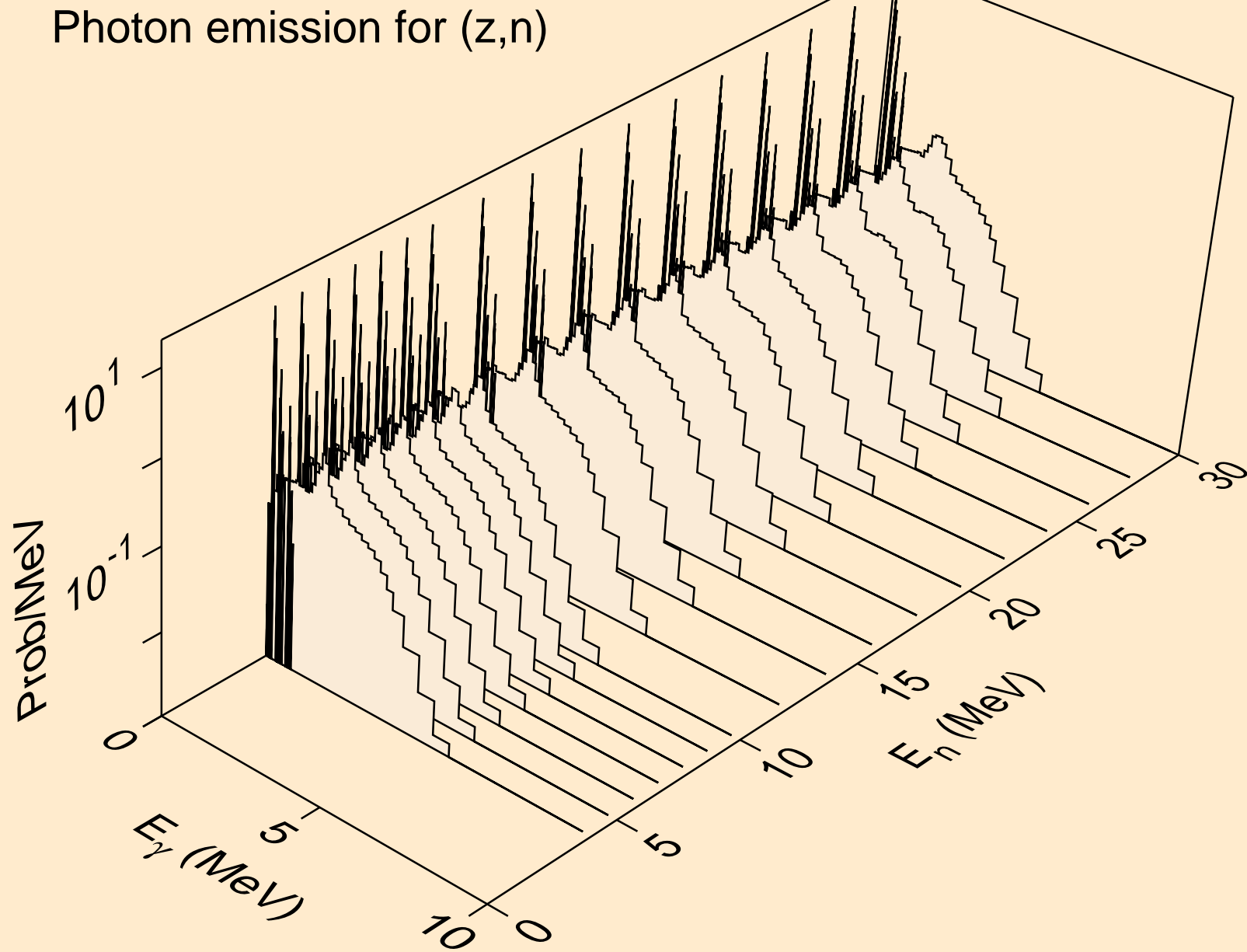

TC104 HELION ACER TENDL-2021 LIBRARY; T=0.K  
Photon emission for (n,x)

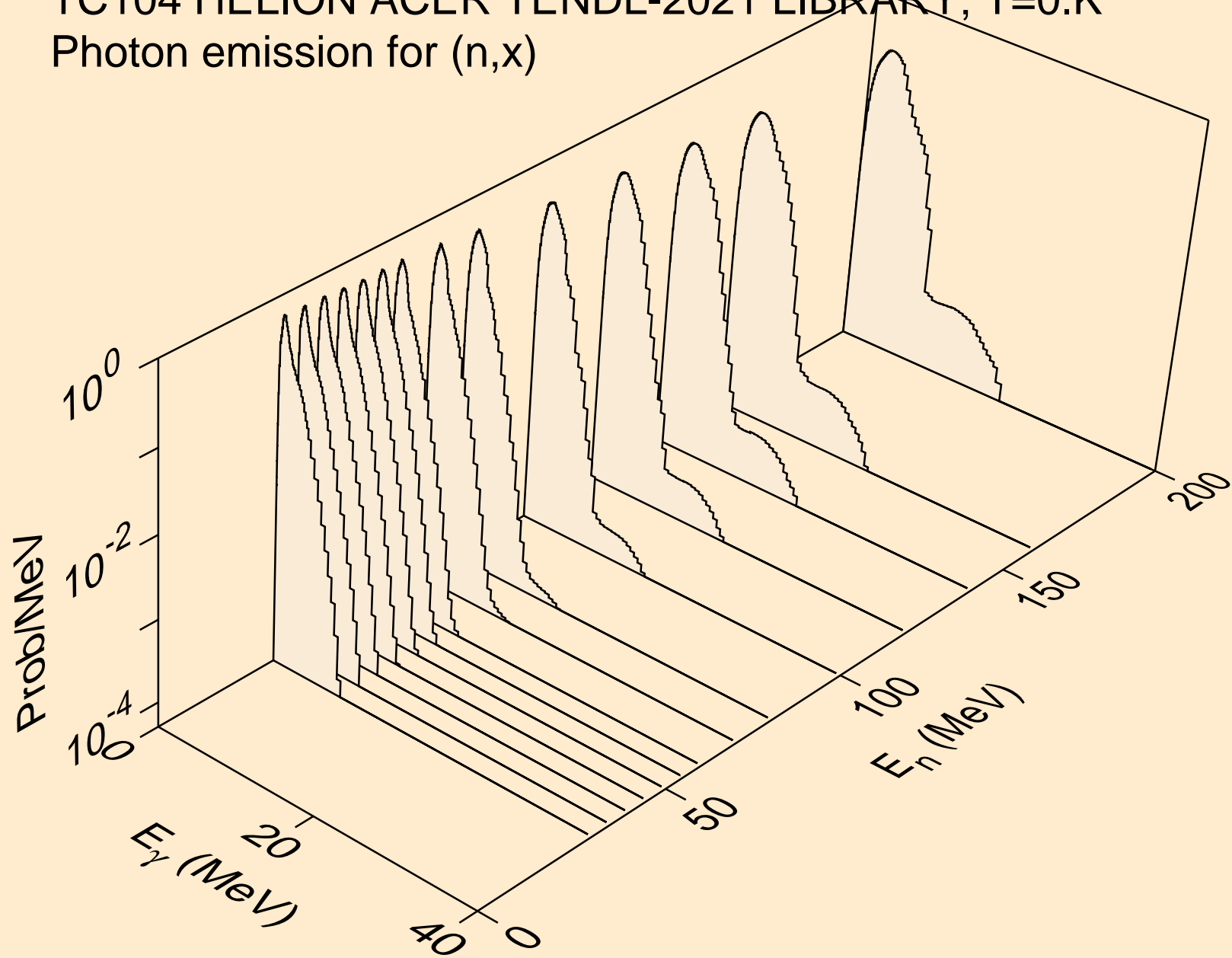

TC104 HELION ACER TENDL-2021 LIBRARY; T=0.K  
Photon emission for (n,2nd)

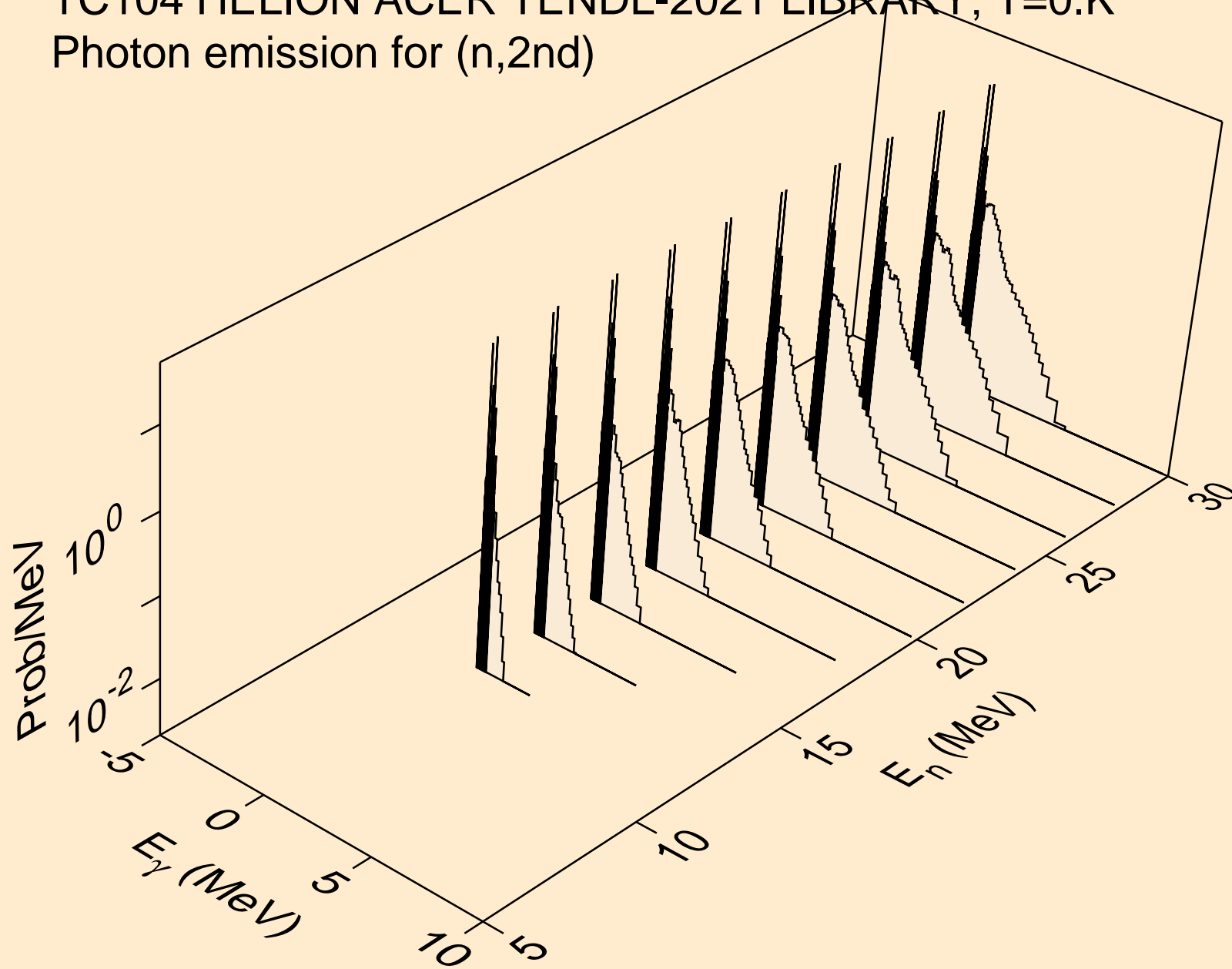

TC104 HELION ACER TENDL-2021 LIBRARY; T=0.K  
Photon emission for (n,2n)

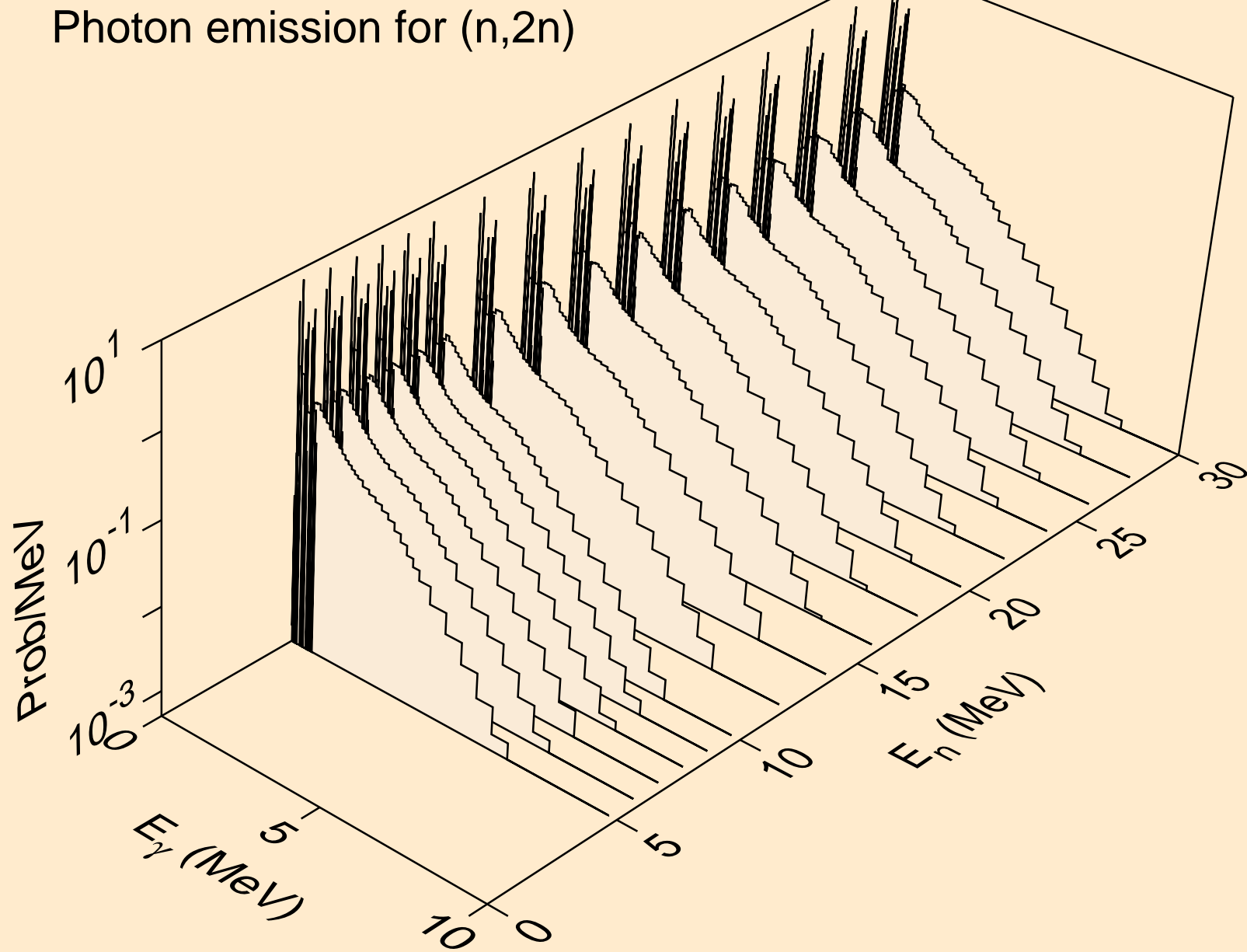

TC104 HELION ACER TENDL-2021 LIBRARY; T=0.K  
Photon emission for (n,3n)

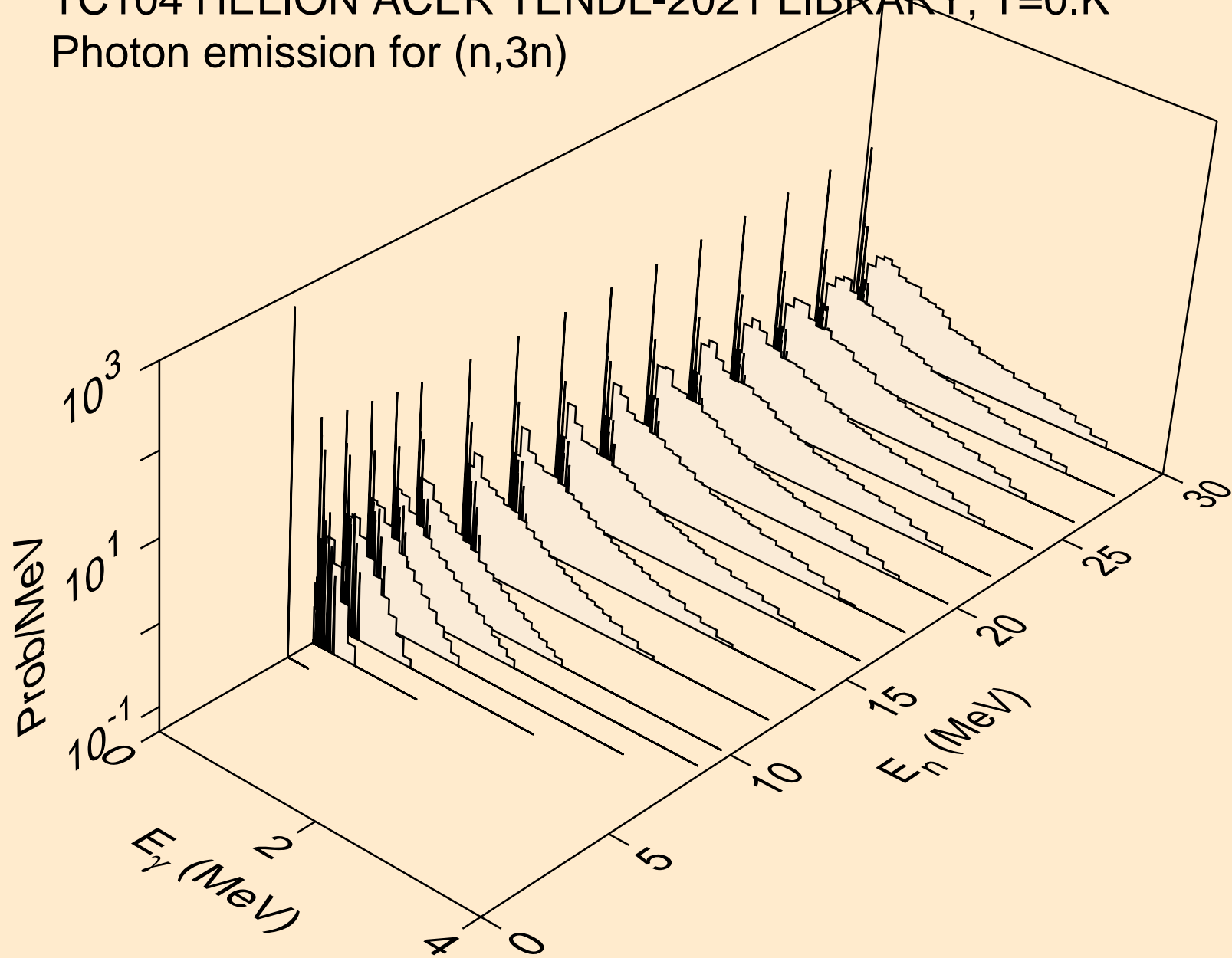

TC104 HELION ACER TENDL-2021 LIBRARY; T=0.K  
Photon emission for (n,n\*)a

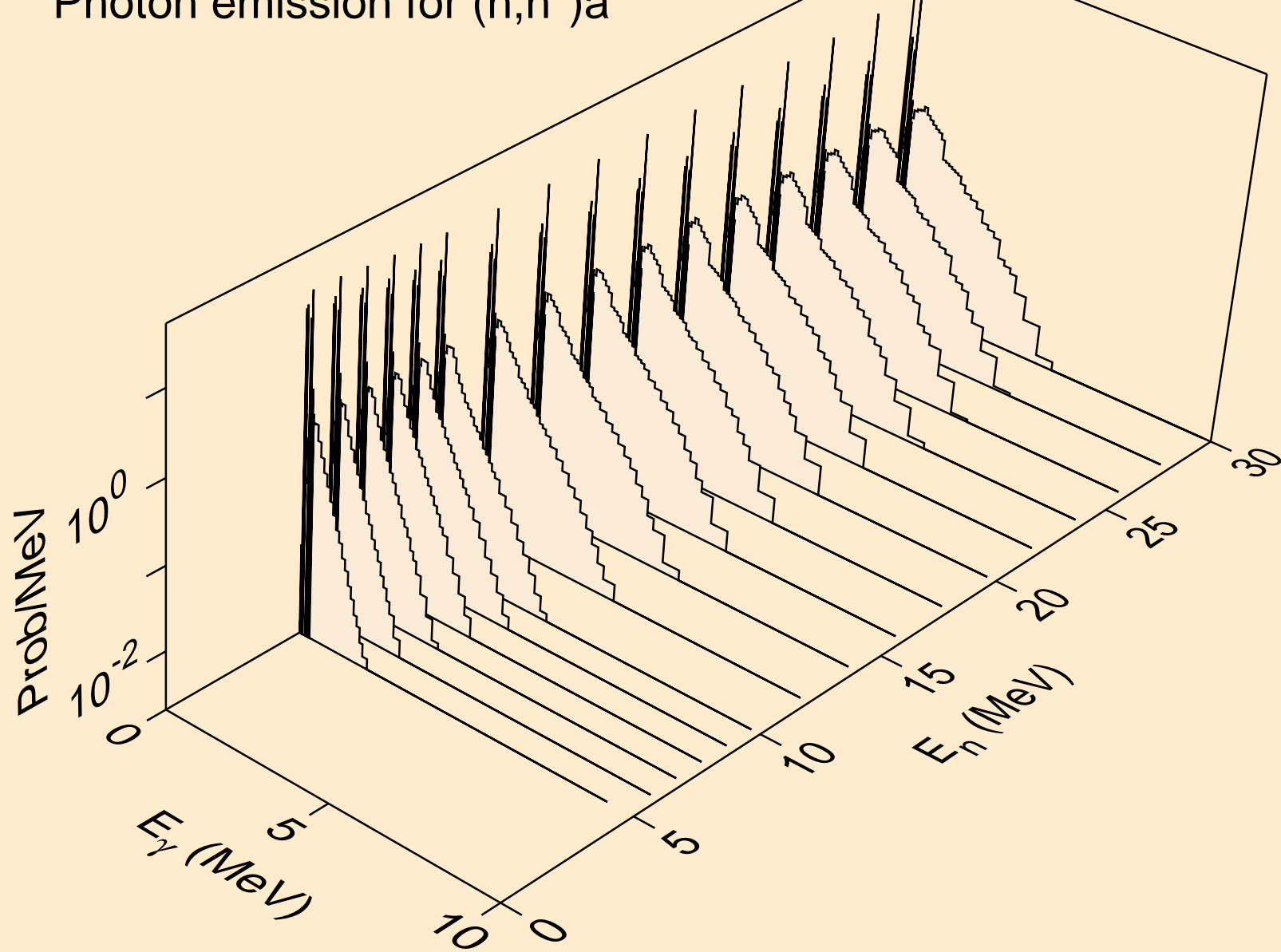

TC104 HELION ACER TENDL-2021 LIBRARY; T=0.K  
Photon emission for (n,2n)a

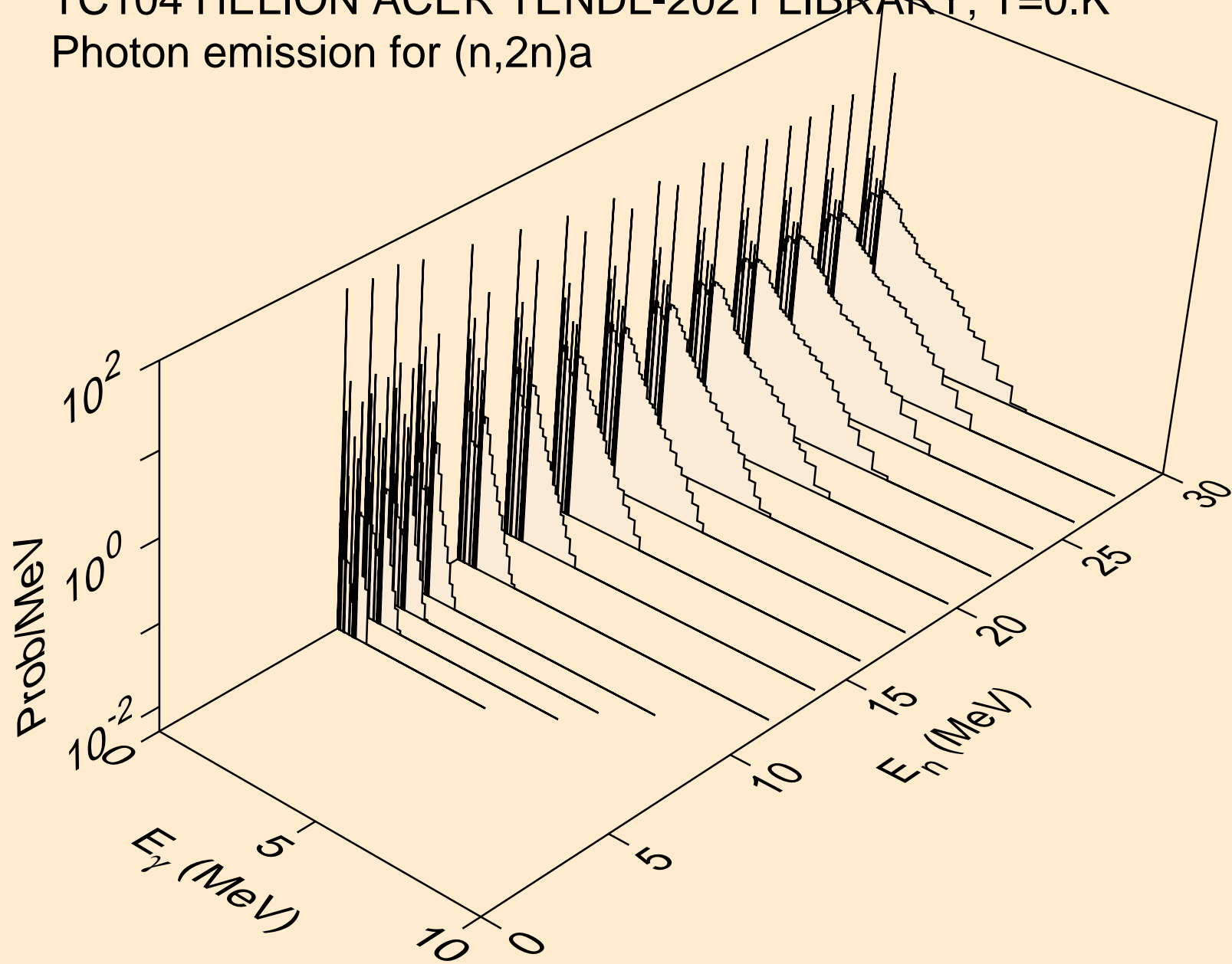



TC104 HELION ACER TENDL-2021 LIBRARY; T=0.K  
Photon emission for (n,3n)a

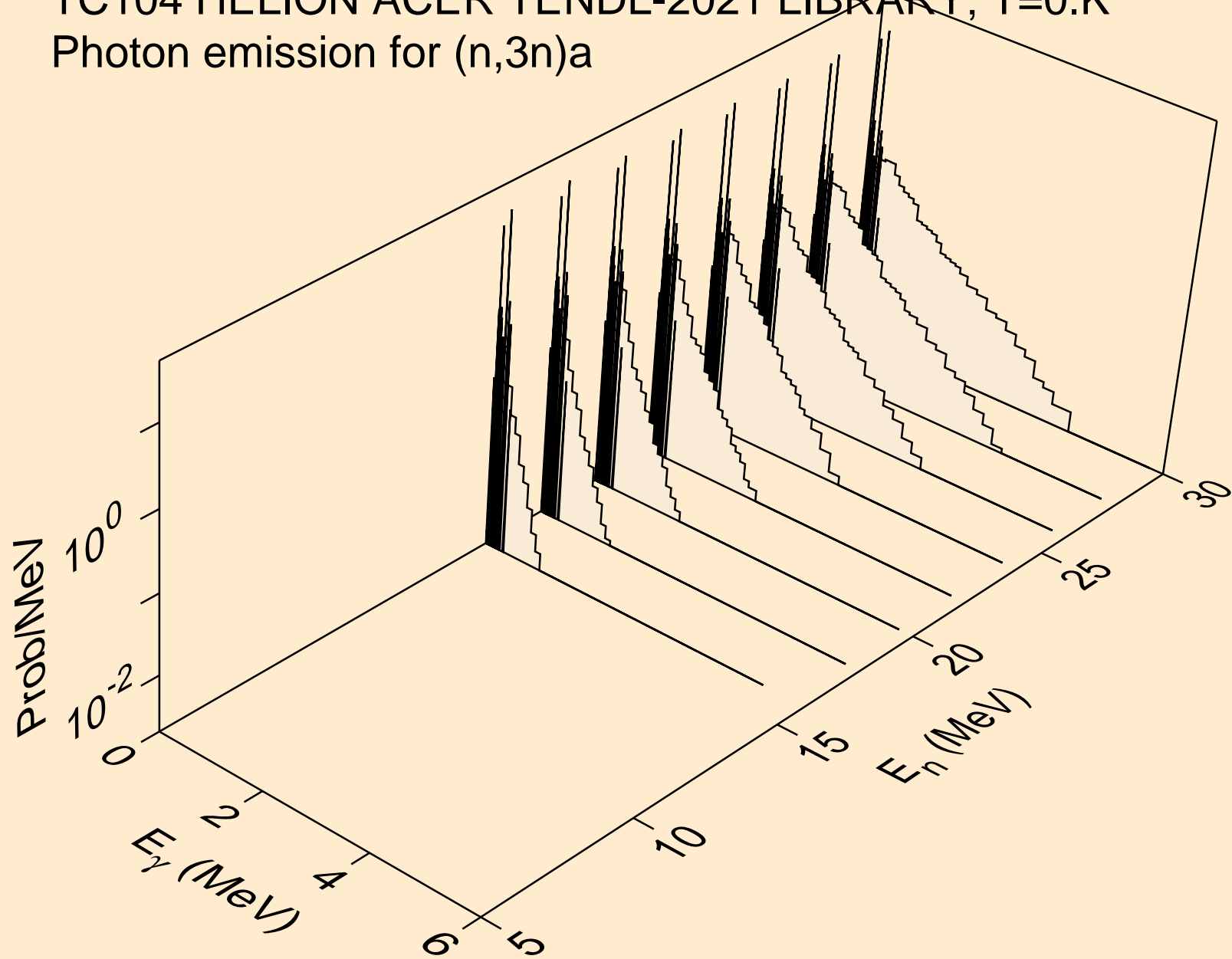

TC104 HELION ACER TENDL-2021 LIBRARY; T=0.K  
Photon emission for (n,n\*)p

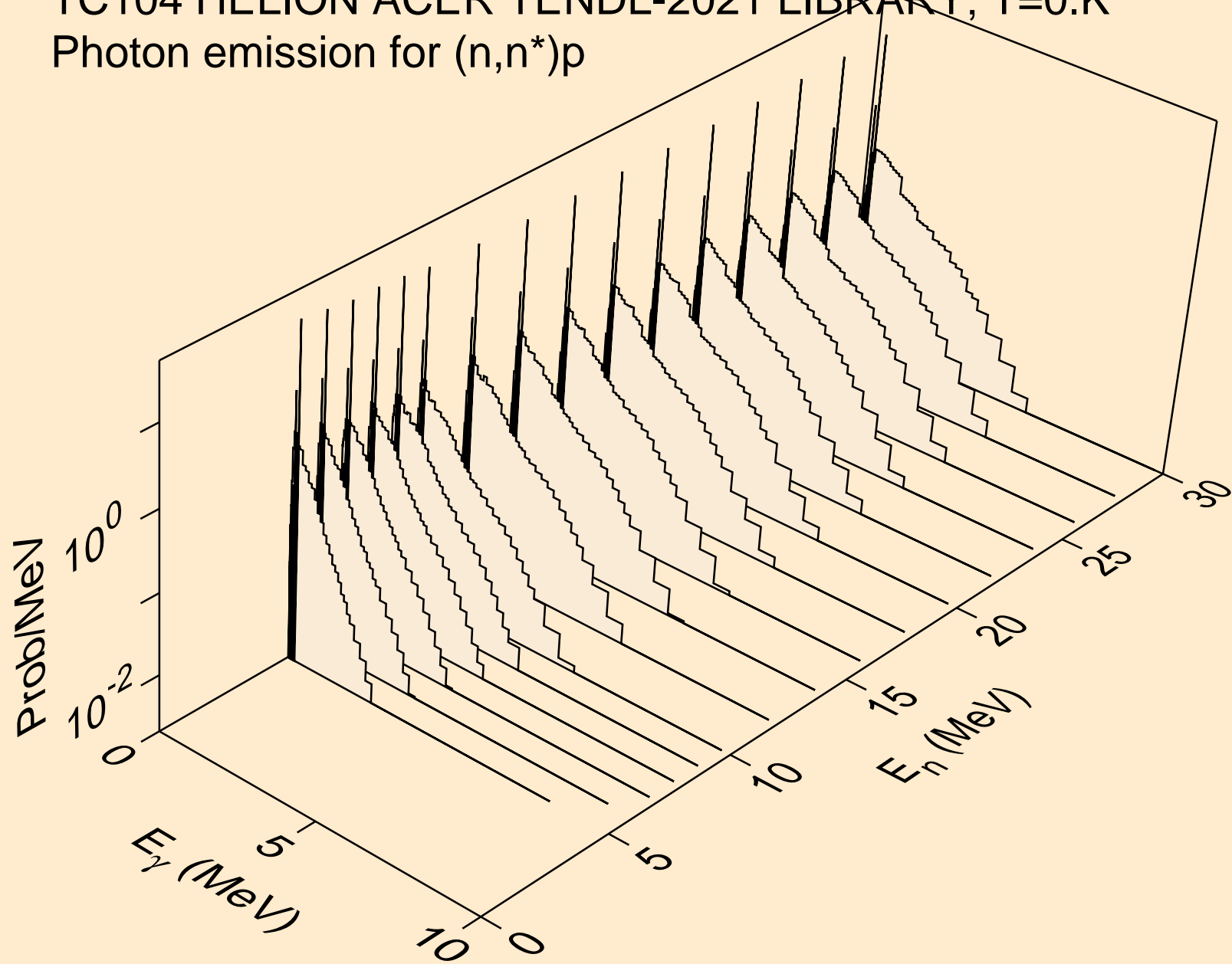

TC104 HELION ACER TENDL-2021 LIBRARY; T=0.K  
Photon emission for (n,n\*)2a

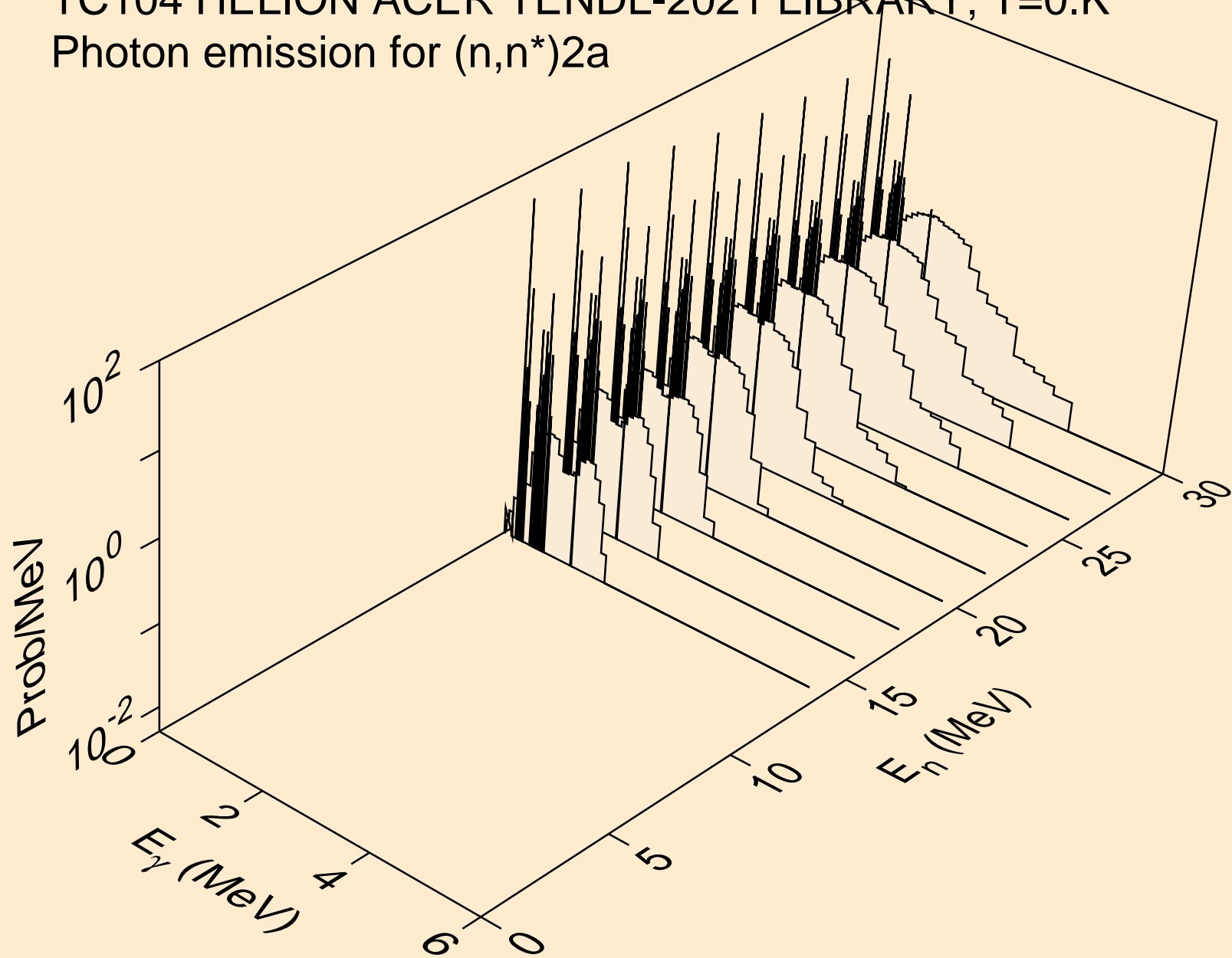

TC104 HELION ACER TENDL-2021 LIBRARY; T=0.K  
Photon emission for (n,2n)2a

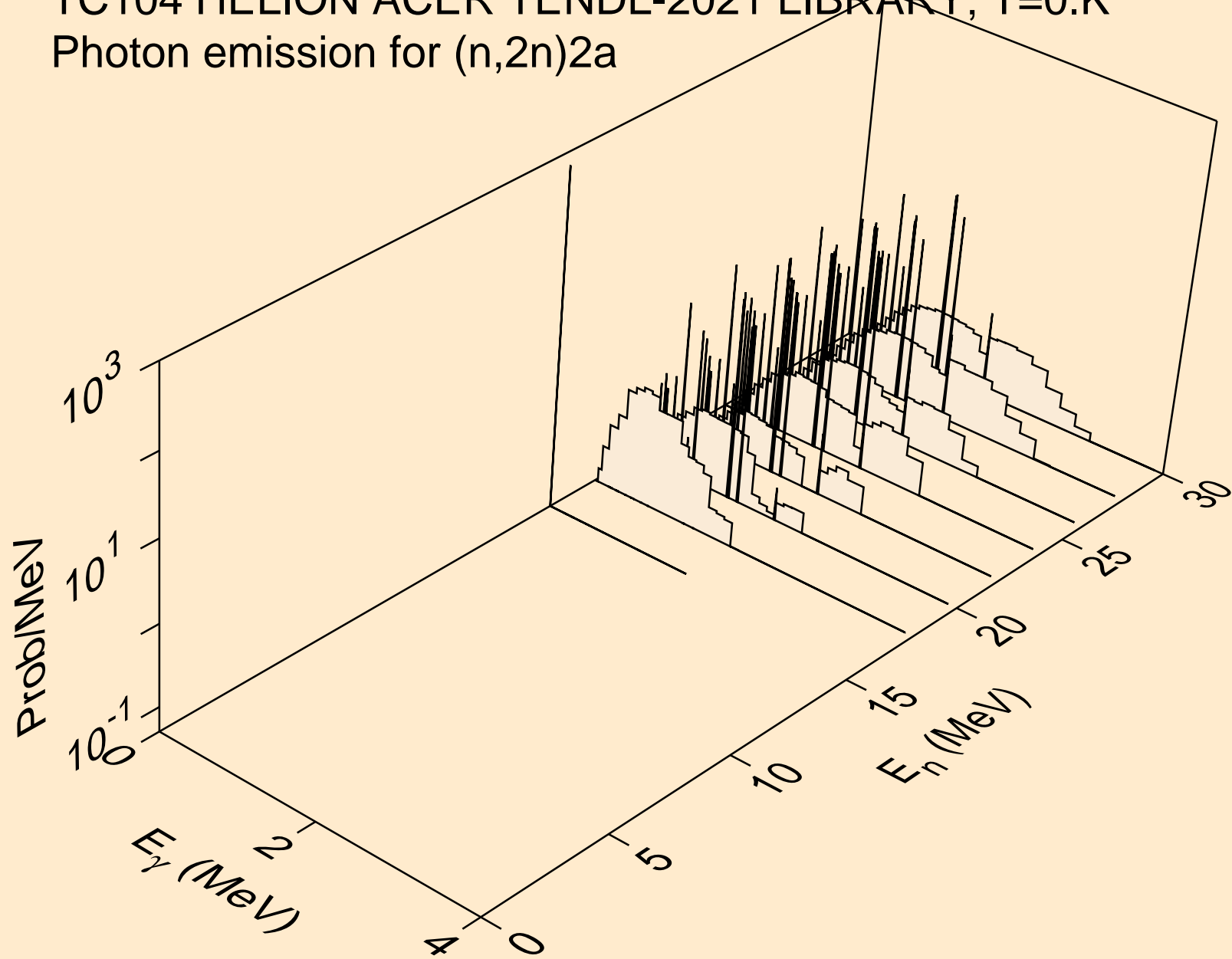

TC104 HELION ACER TENDL-2021 LIBRARY; T=0.K  
Photon emission for (n,n\*)d

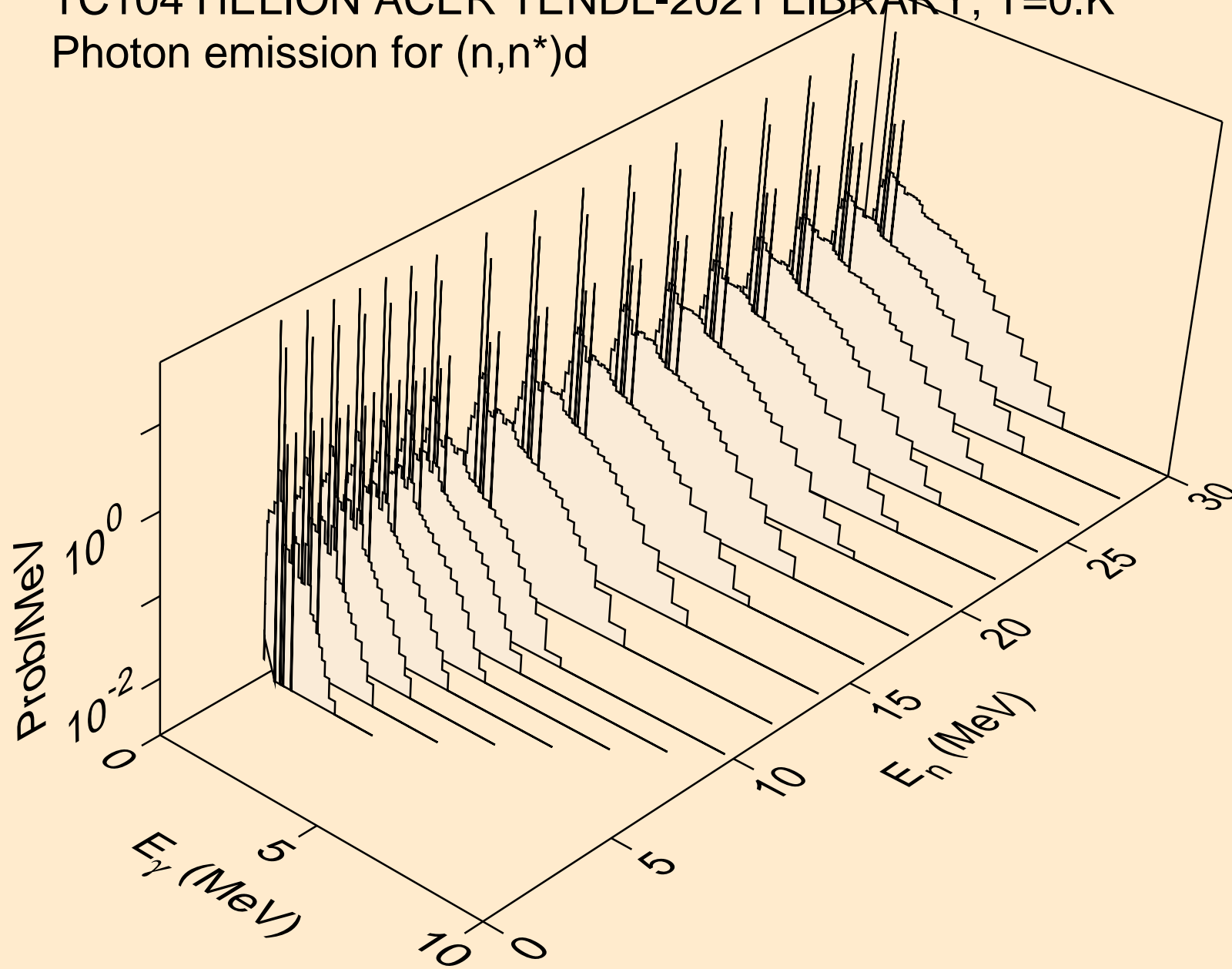

TC104 HELION ACER TENDL-2021 LIBRARY; T=0.K  
Photon emission for (n,n\*)t

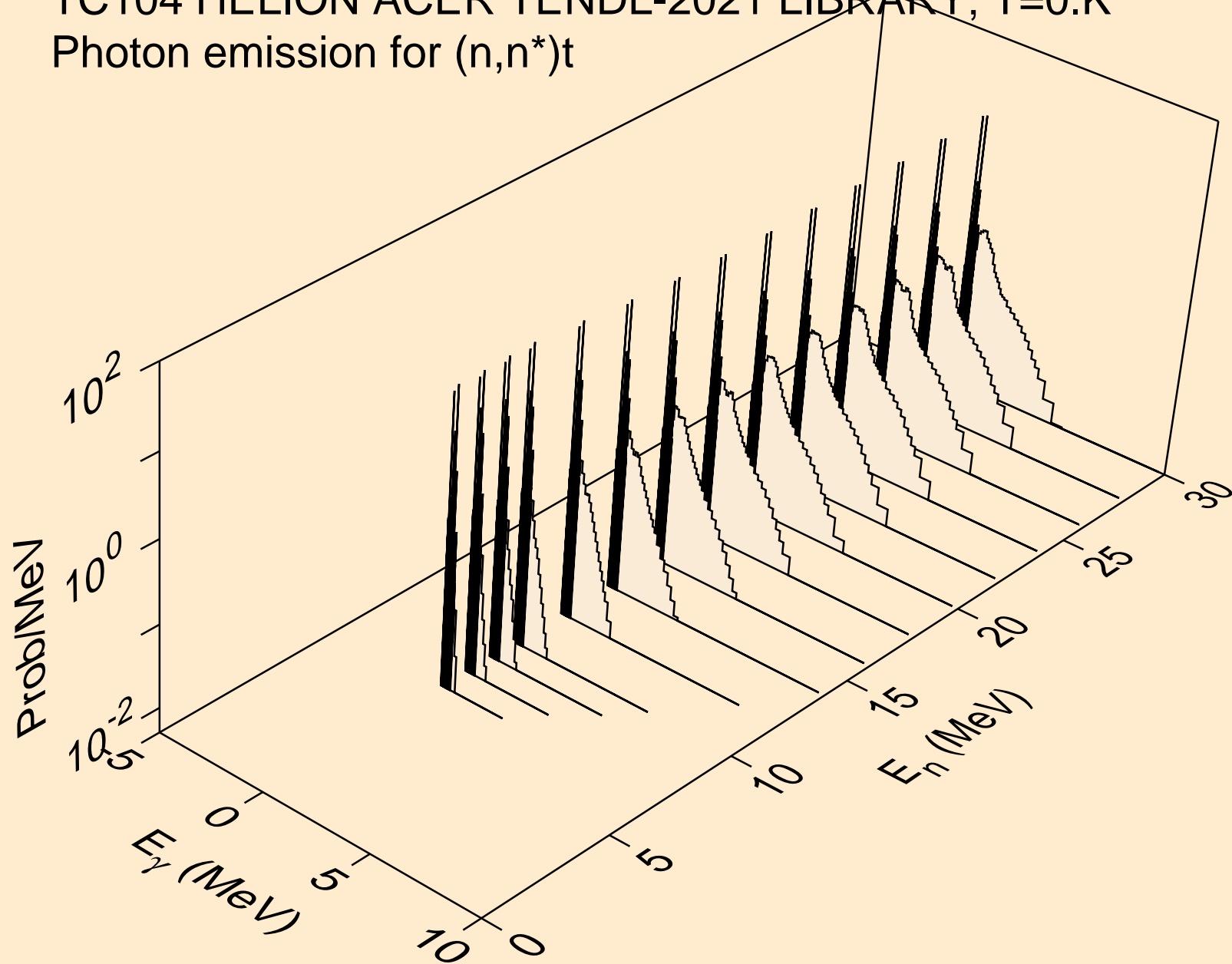

TC104 HELION ACER TENDL-2021 LIBRARY; T=0.K  
Photon emission for (n,n\*)he3

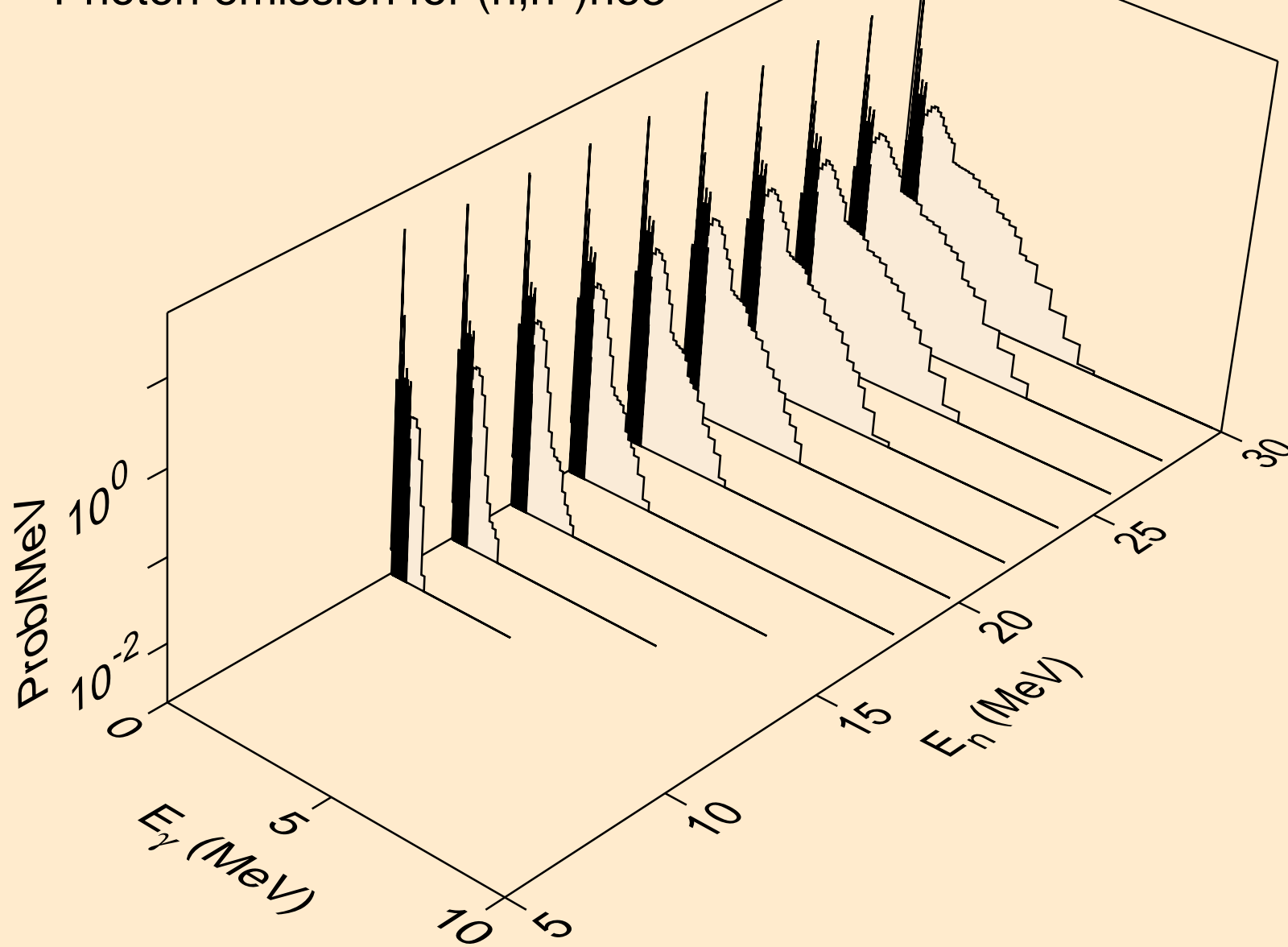

TC104 HELION ACER TENDL-2021 LIBRARY; T=0.K  
Photon emission for (n,4n)

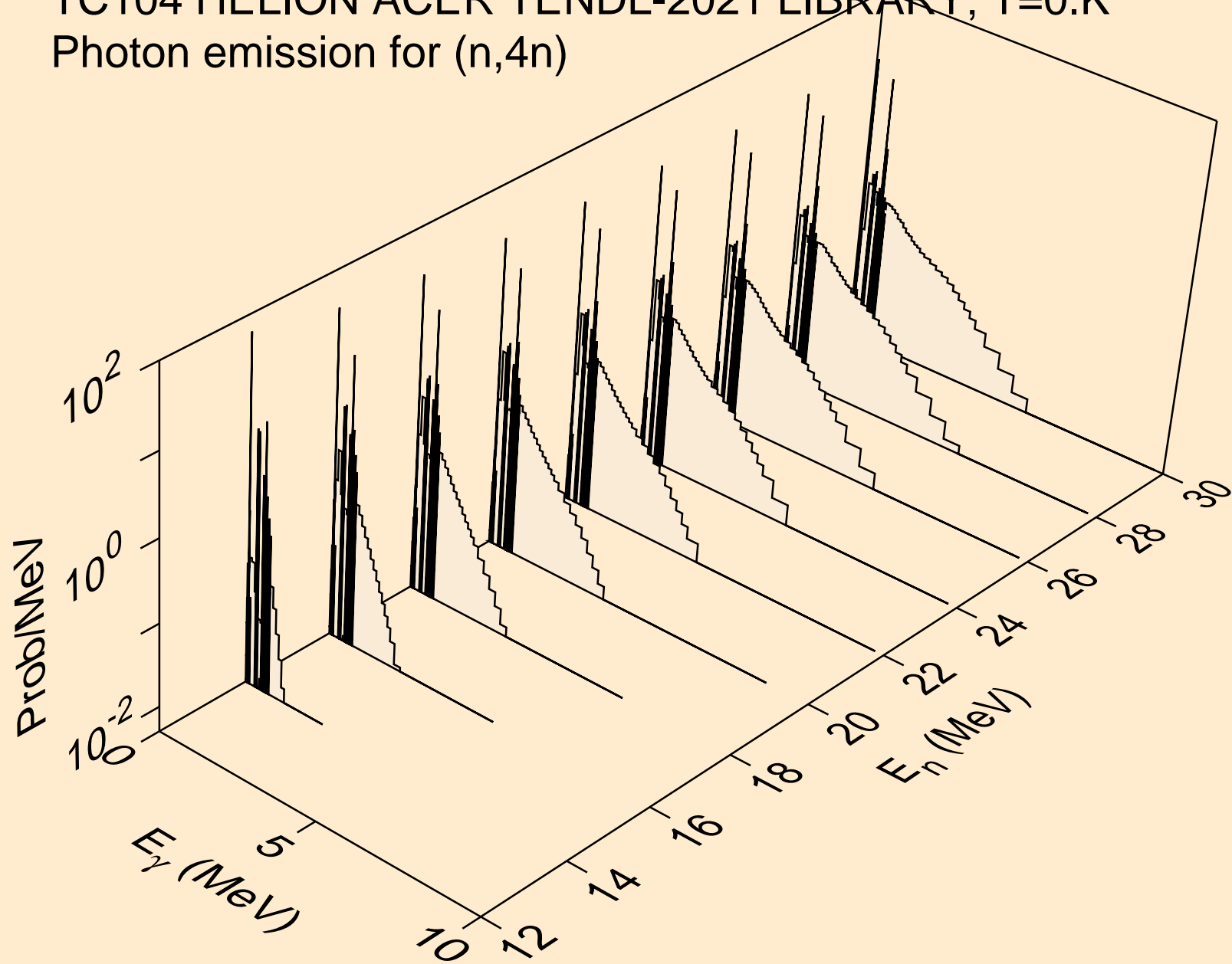



TC104 HELION ACER TENDL-2021 LIBRARY; T=0.K  
Photon emission for (n,2np)

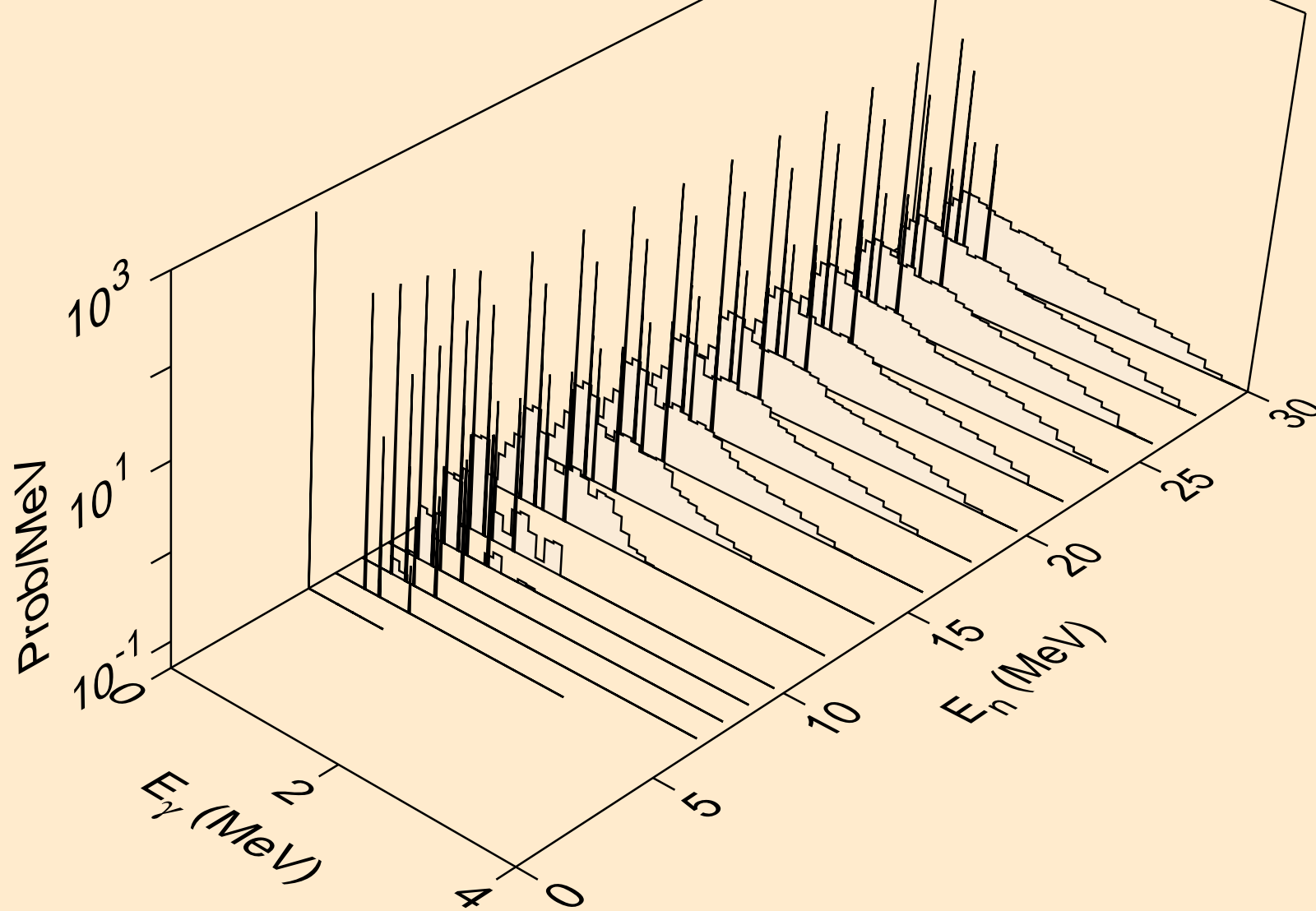

TC104 HELION ACER TENDL-2021 LIBRARY; T=0.K  
Photon emission for (n,3np)

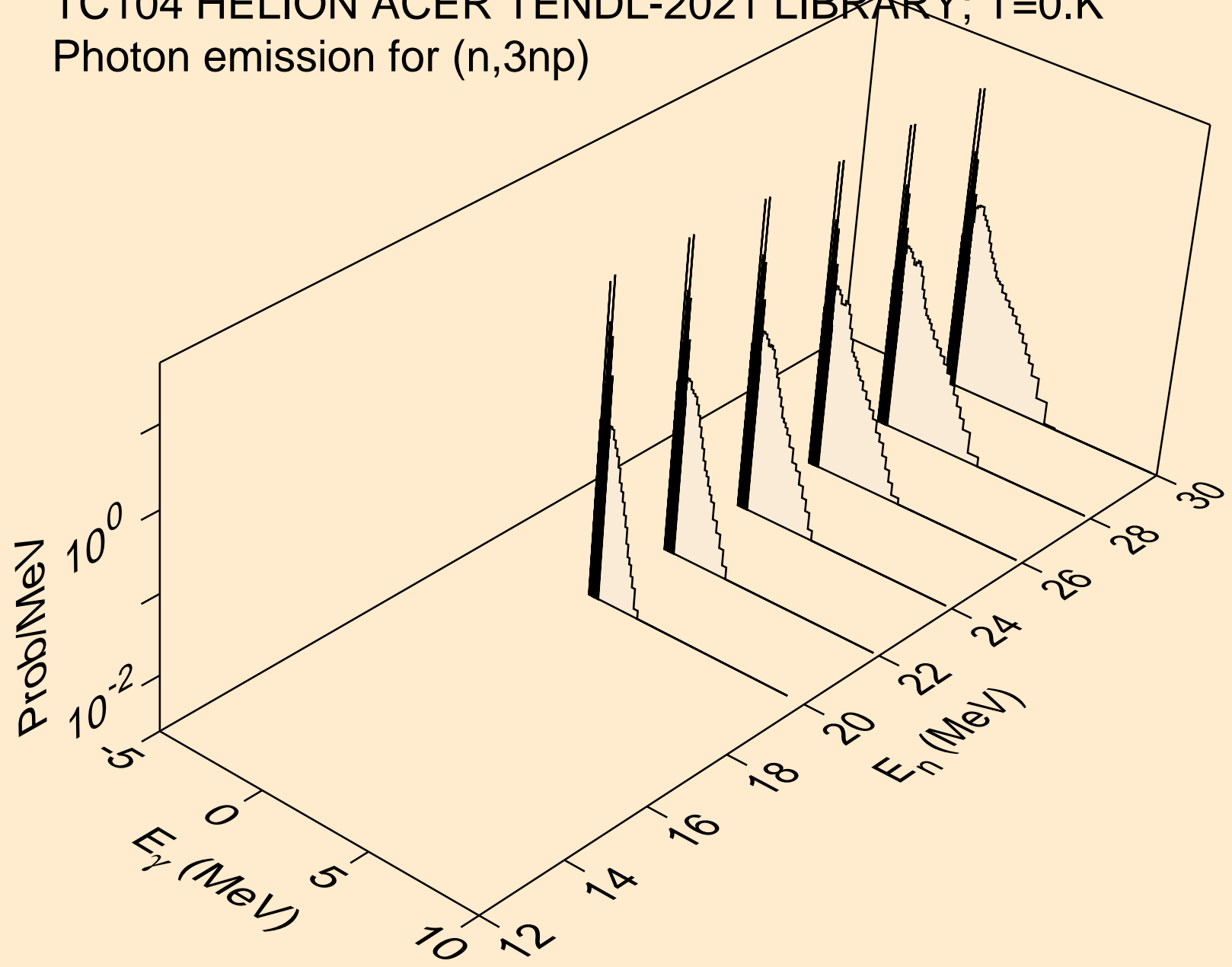

TC104 HELION ACER TENDL-2021 LIBRARY; T=0.K  
Photon emission for (n,2np)

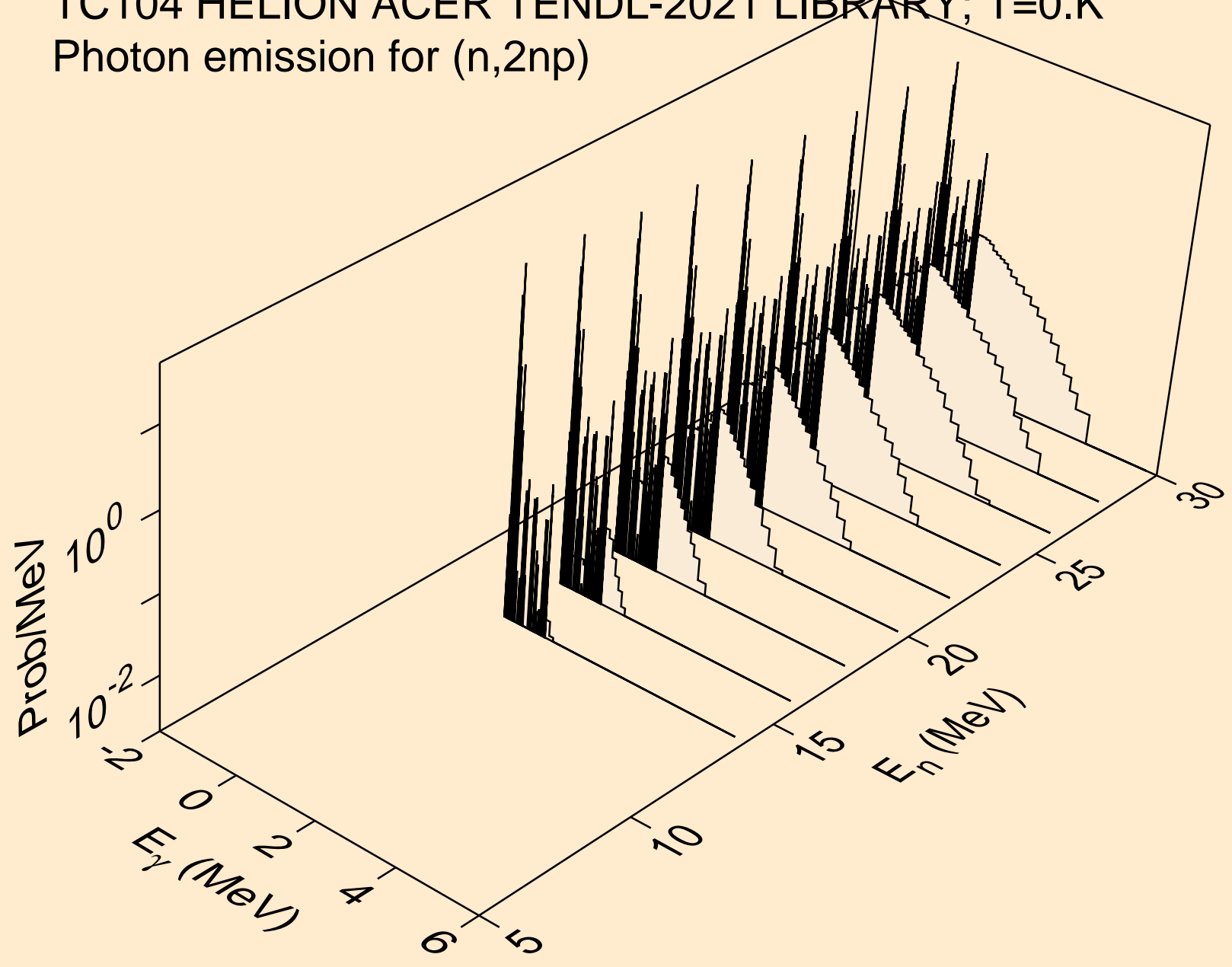

TC104 HELION ACER TENDL-2021 LIBRARY; T=0.K  
Photon emission for (n,npa)

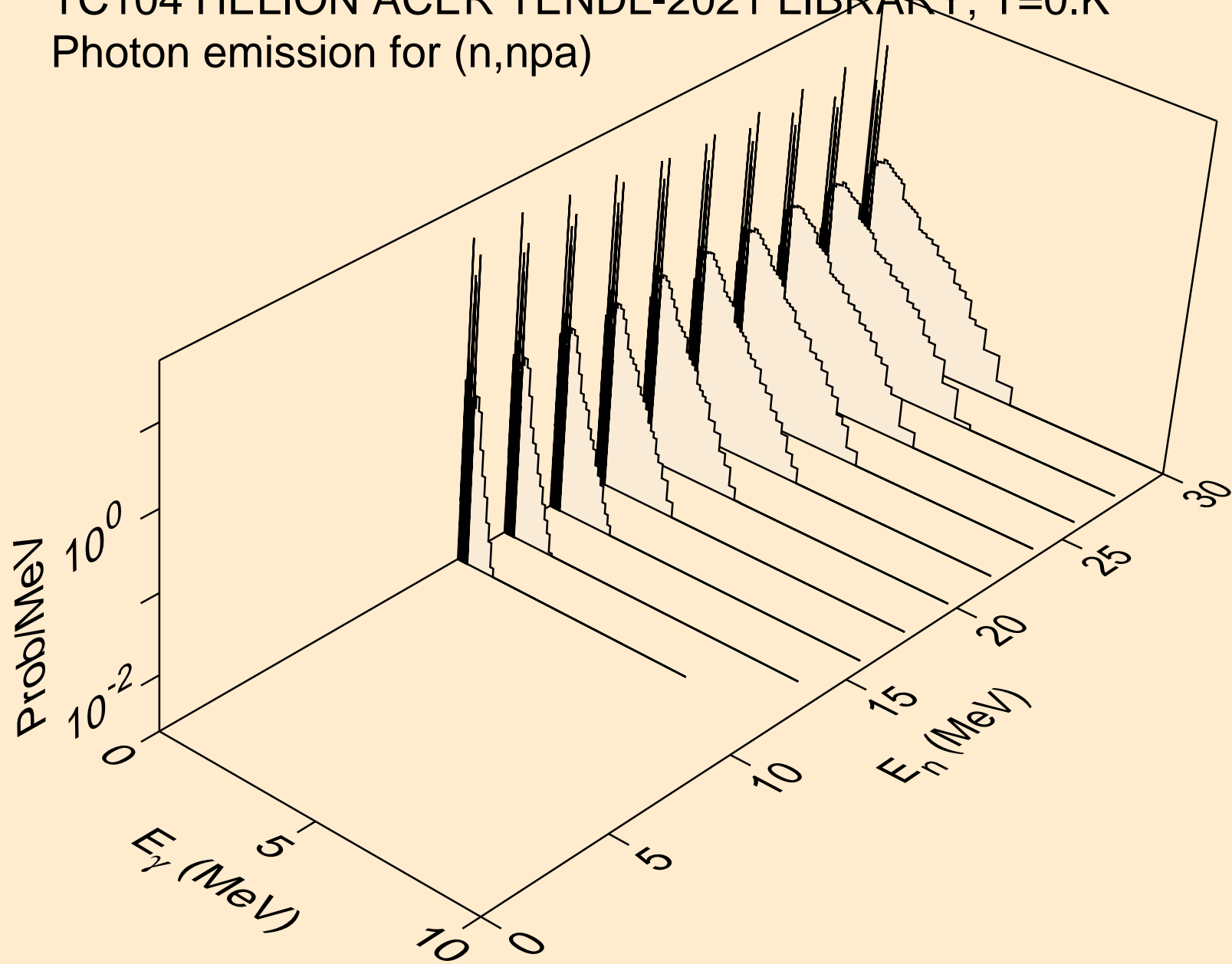

TC104 HELION ACER TENDL-2021 LIBRARY; T=0.K  
Photon emission for (n,gma)

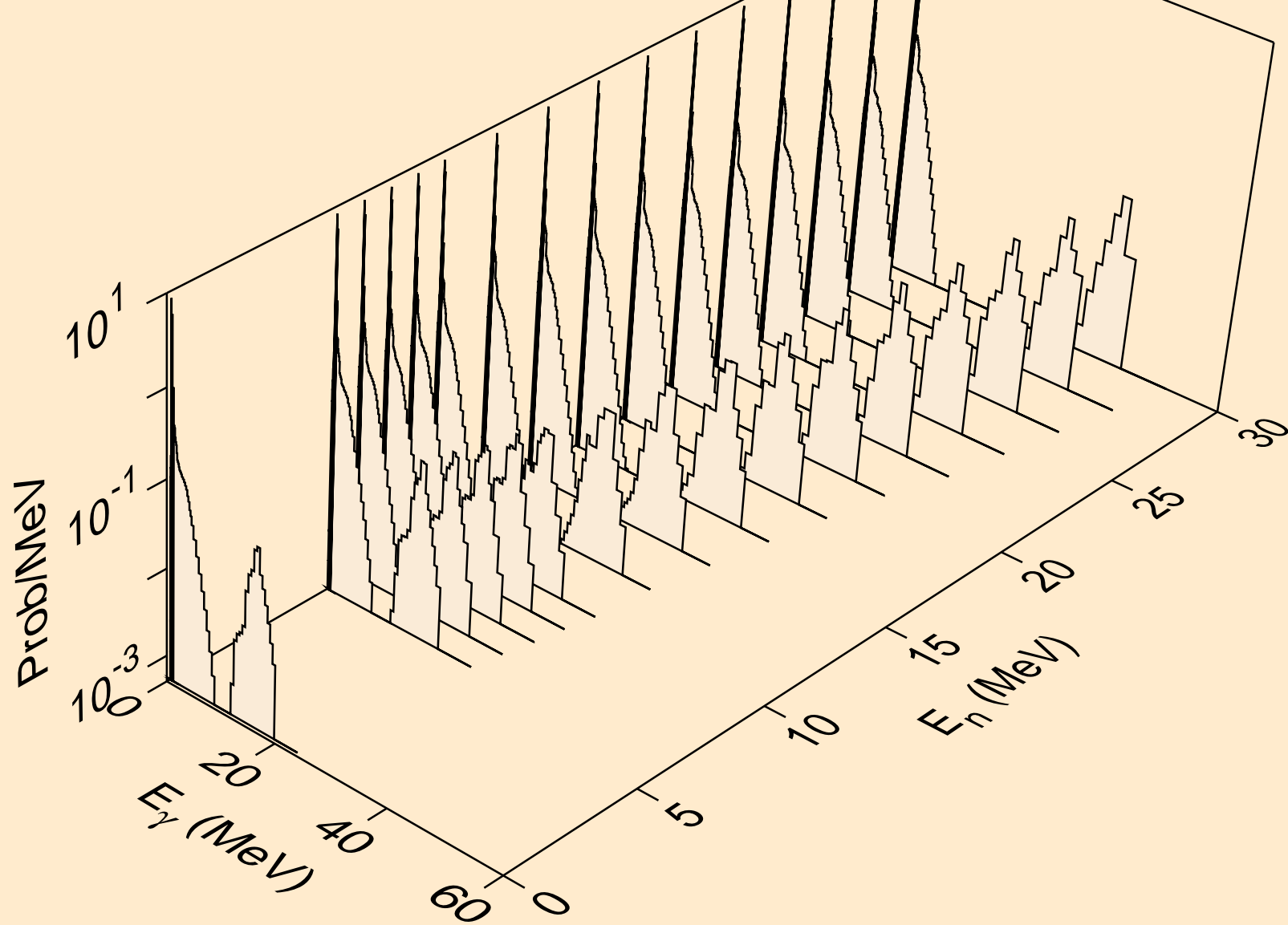

TC104 HELION ACER TENDL-2021 LIBRARY; T=0.K  
Photon emission for (n,p)

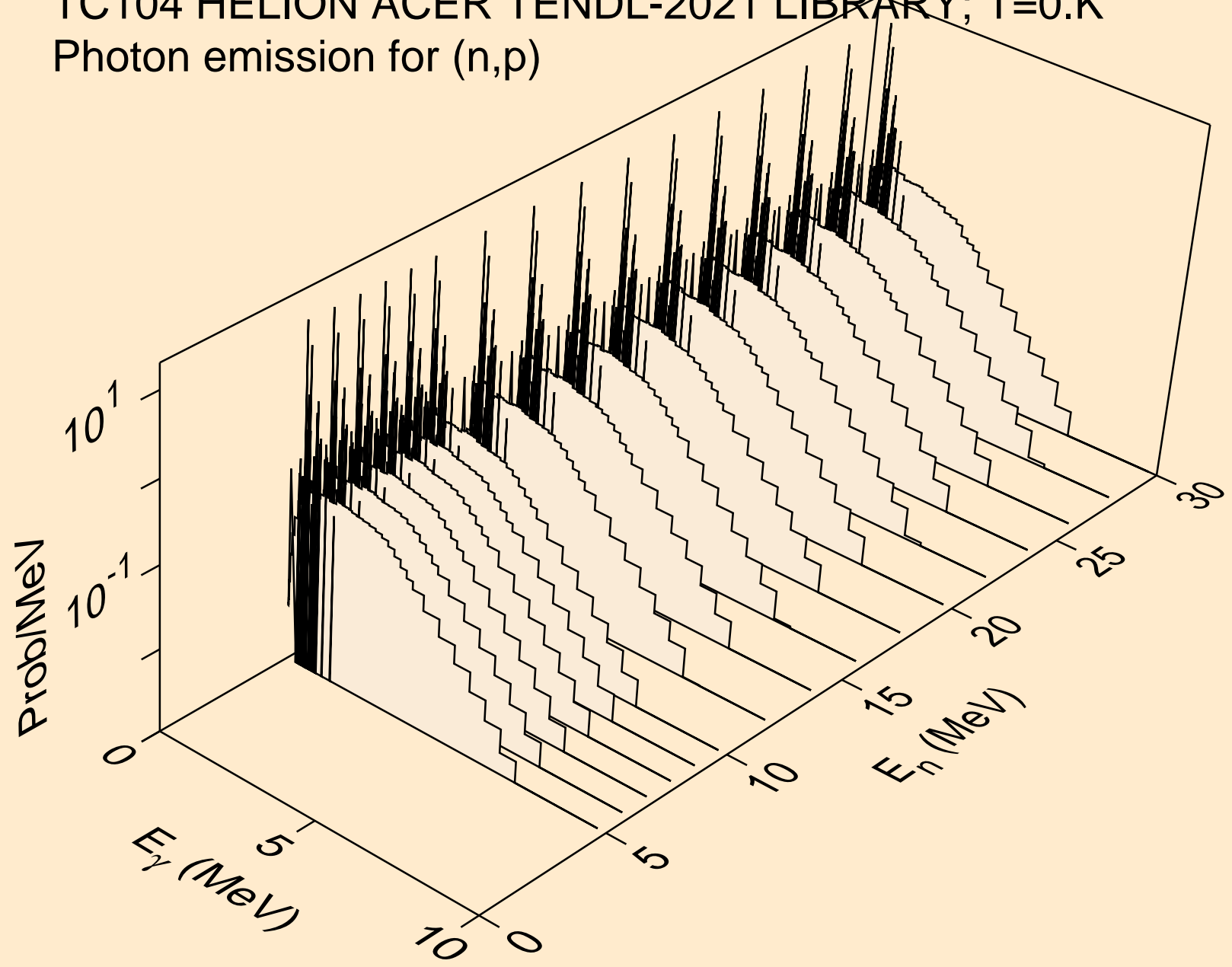

TC104 HELION ACER TENDL-2021 LIBRARY; T=0.K  
Photon emission for (n,d)

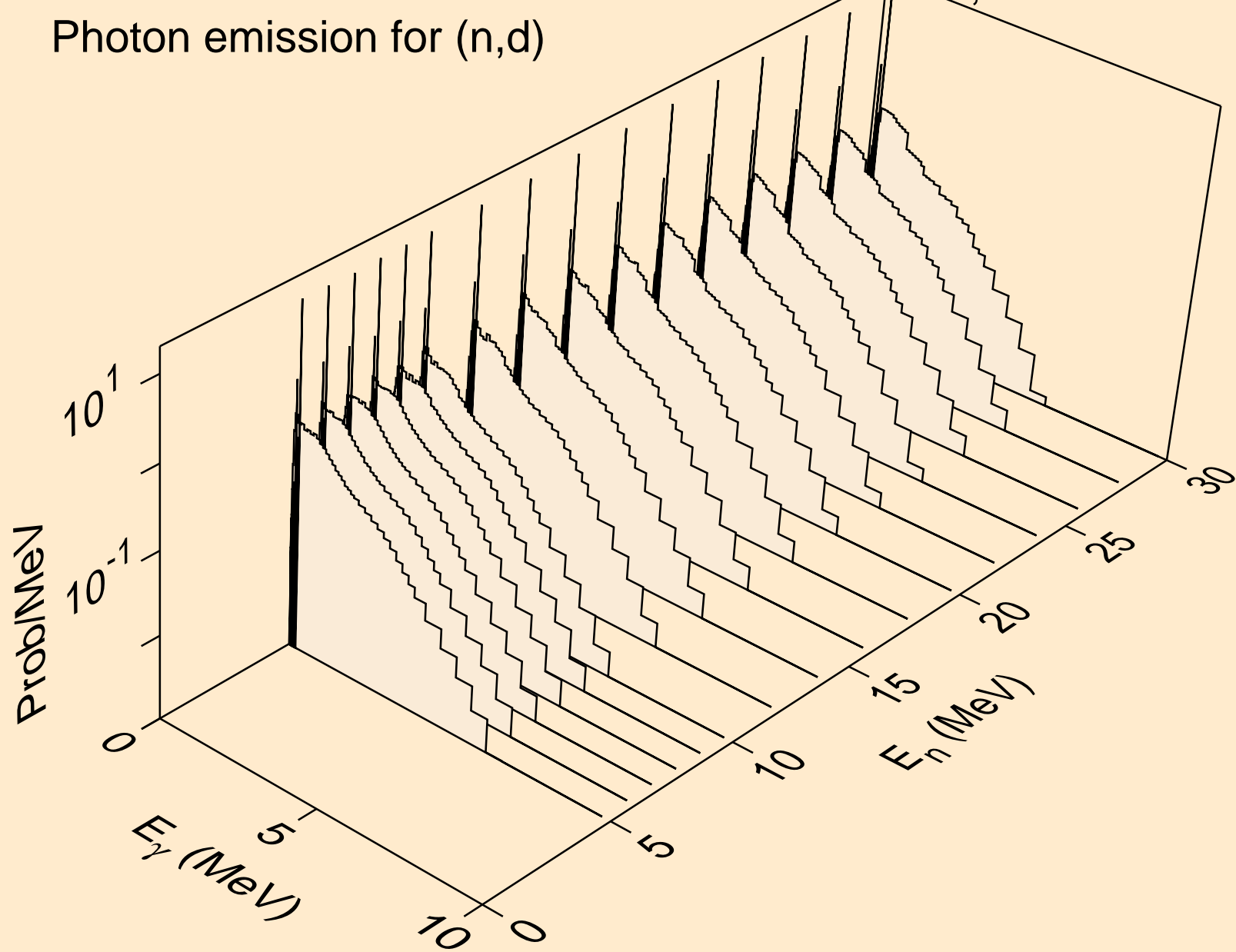

TC104 HELION ACER TENDL-2021 LIBRARY; T=0.K  
Photon emission for (n,t)

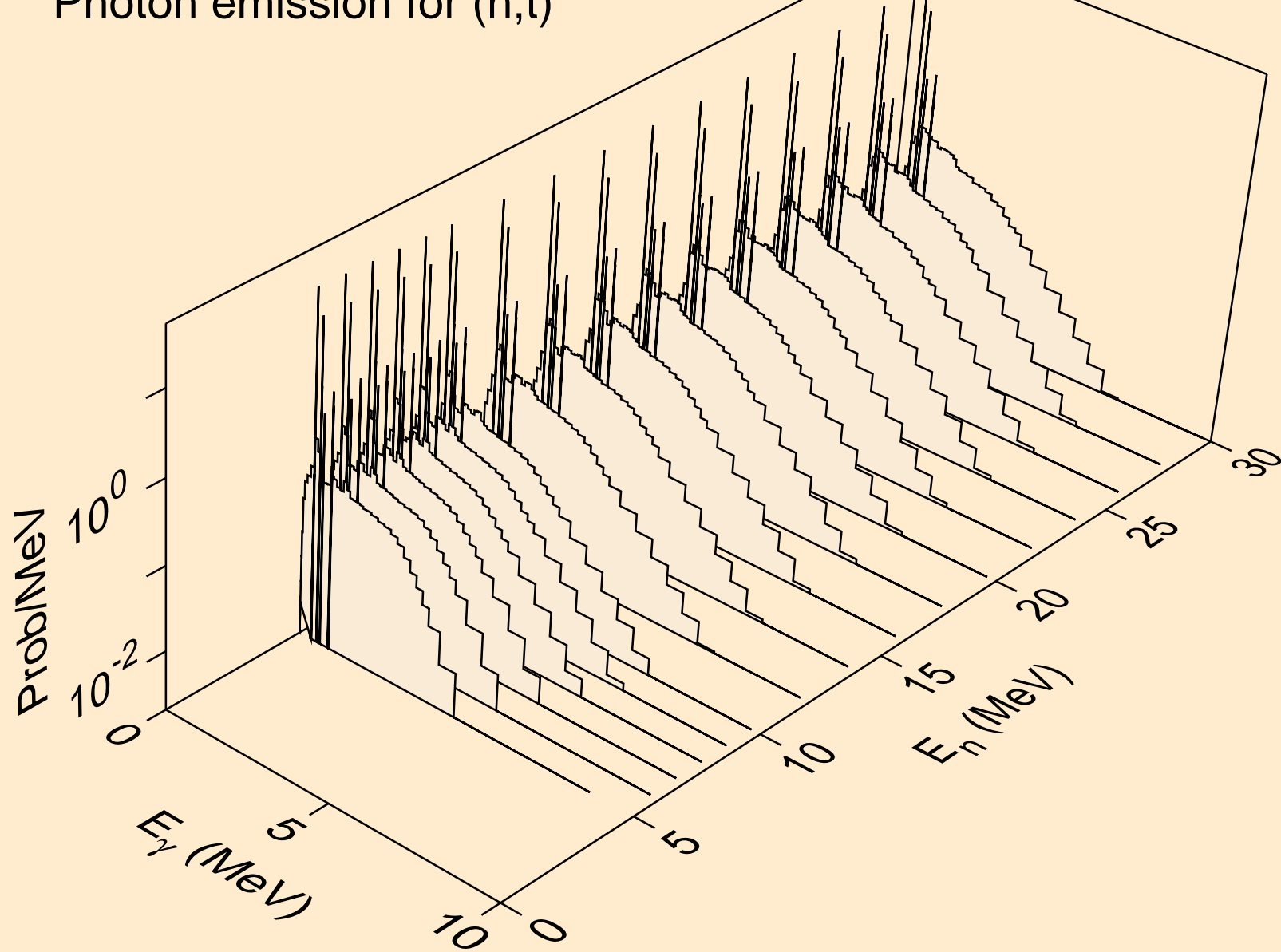



TC104 HELION ACER TENDL-2021 LIBRARY; T=0.K  
Photon emission for inelastic

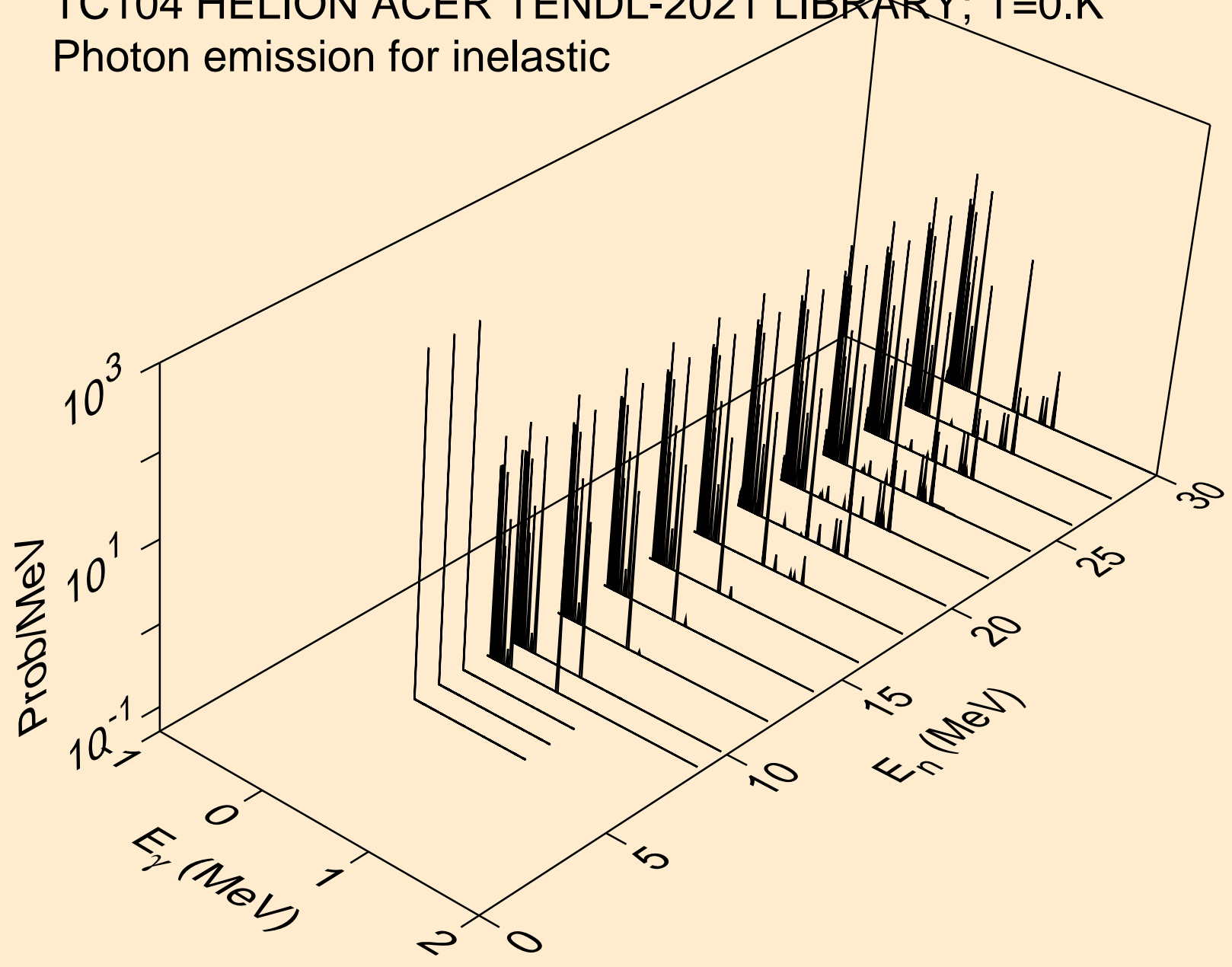

TC104 HELION ACER TENDL-2021 LIBRARY; T=0.K  
Photon emission for (n,a)

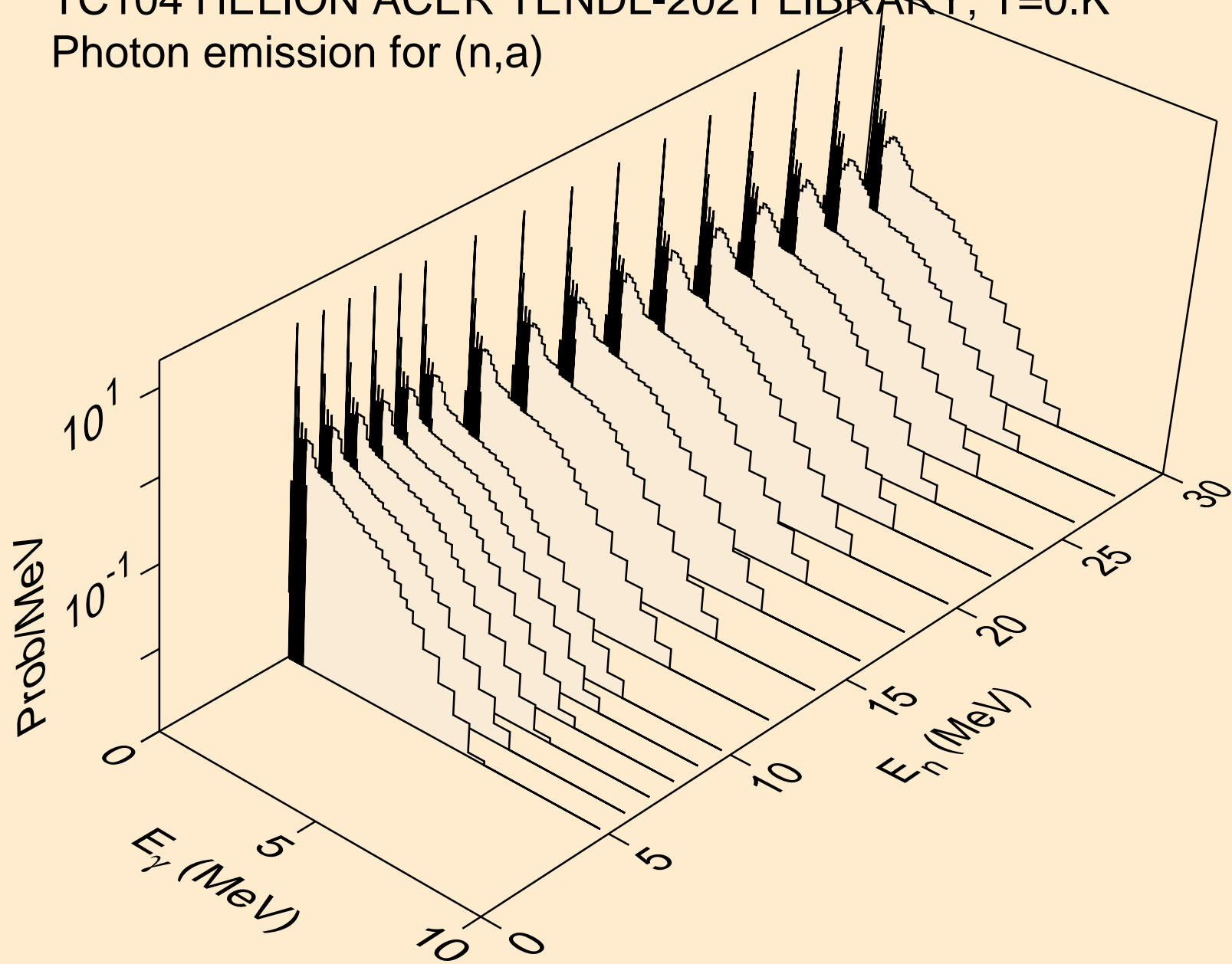

TC104 HELION ACER TENDL-2021 LIBRARY; T=0.K  
Photon emission for (n,2a)

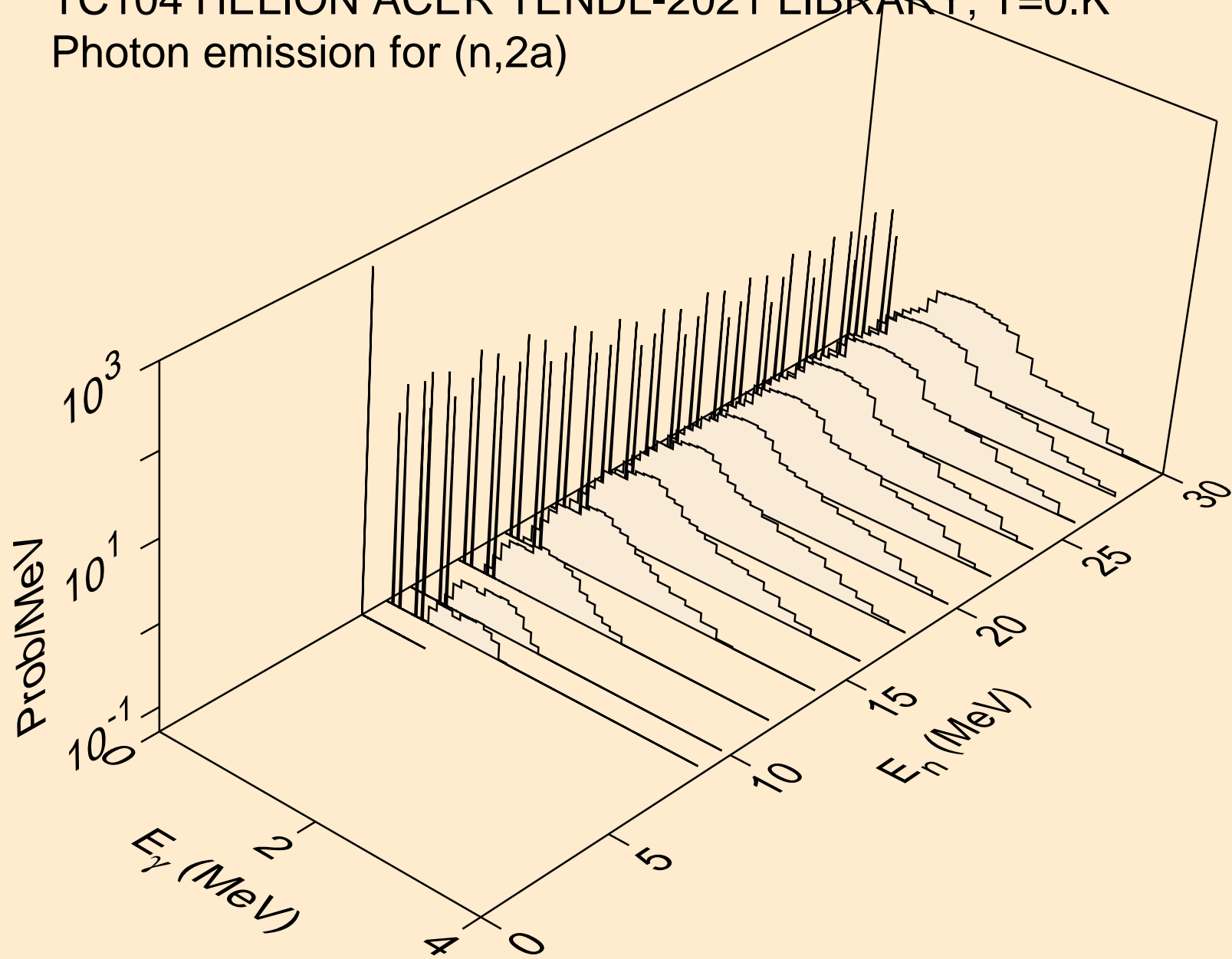

TC104 HELION ACER TENDL-2021 LIBRARY; T=0.K  
Photon emission for (n,2p)

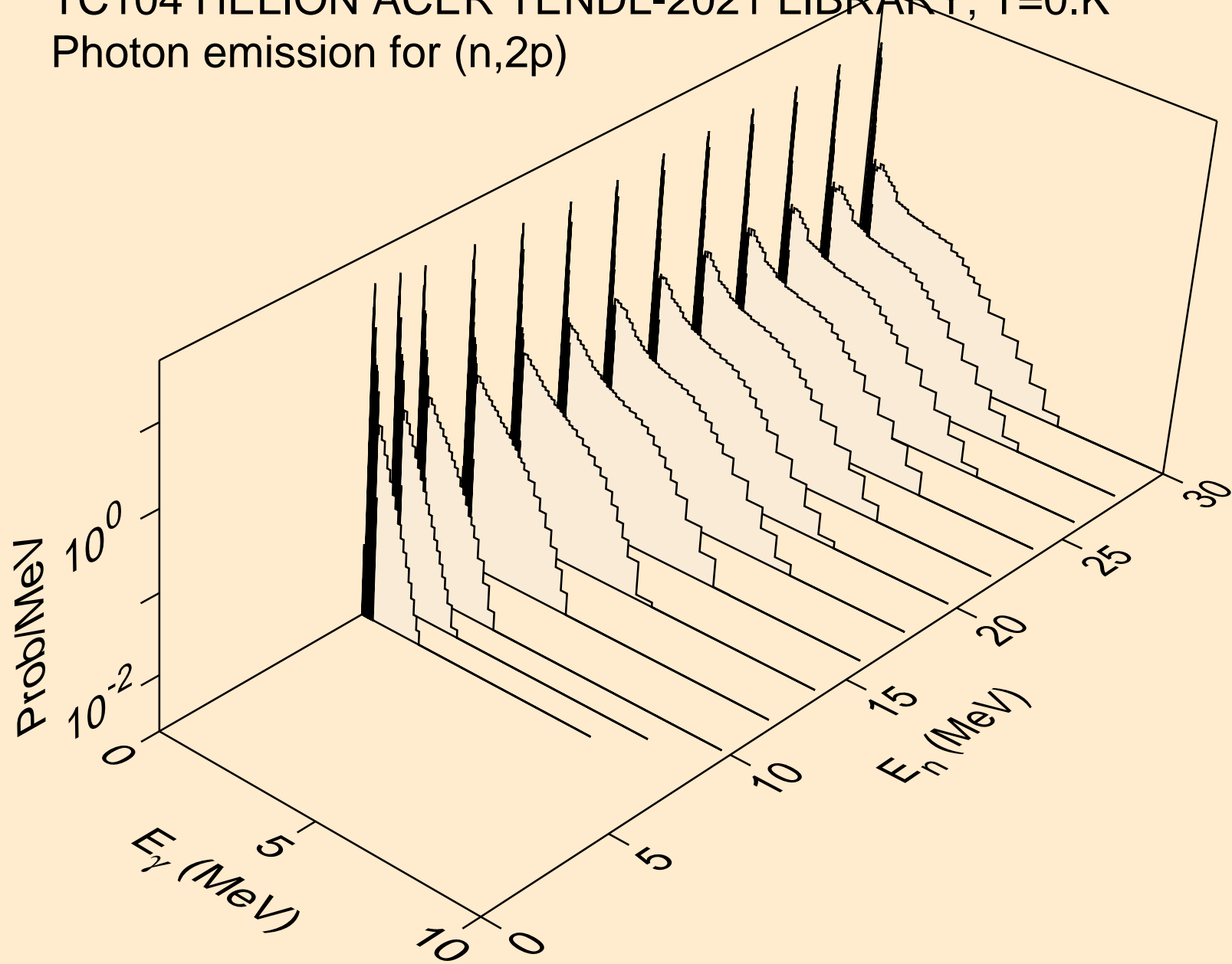

TC104 HELION ACER TENDL-2021 LIBRARY; T=0.K  
Photon emission for (n,pa)

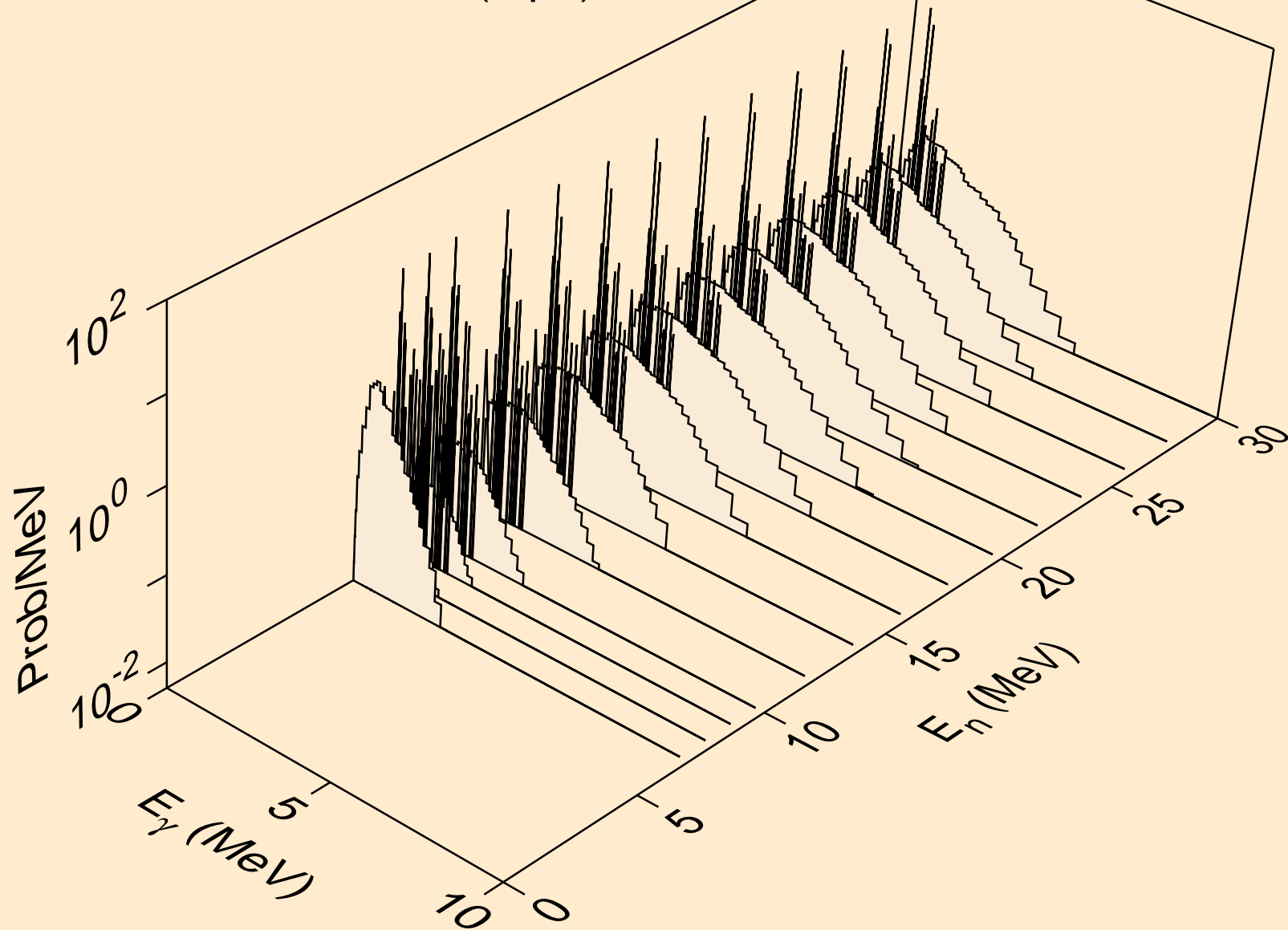

TC104 HELION ACER TENDL-2021 LIBRARY; T=0.K  
Photon emission for (n,pd)

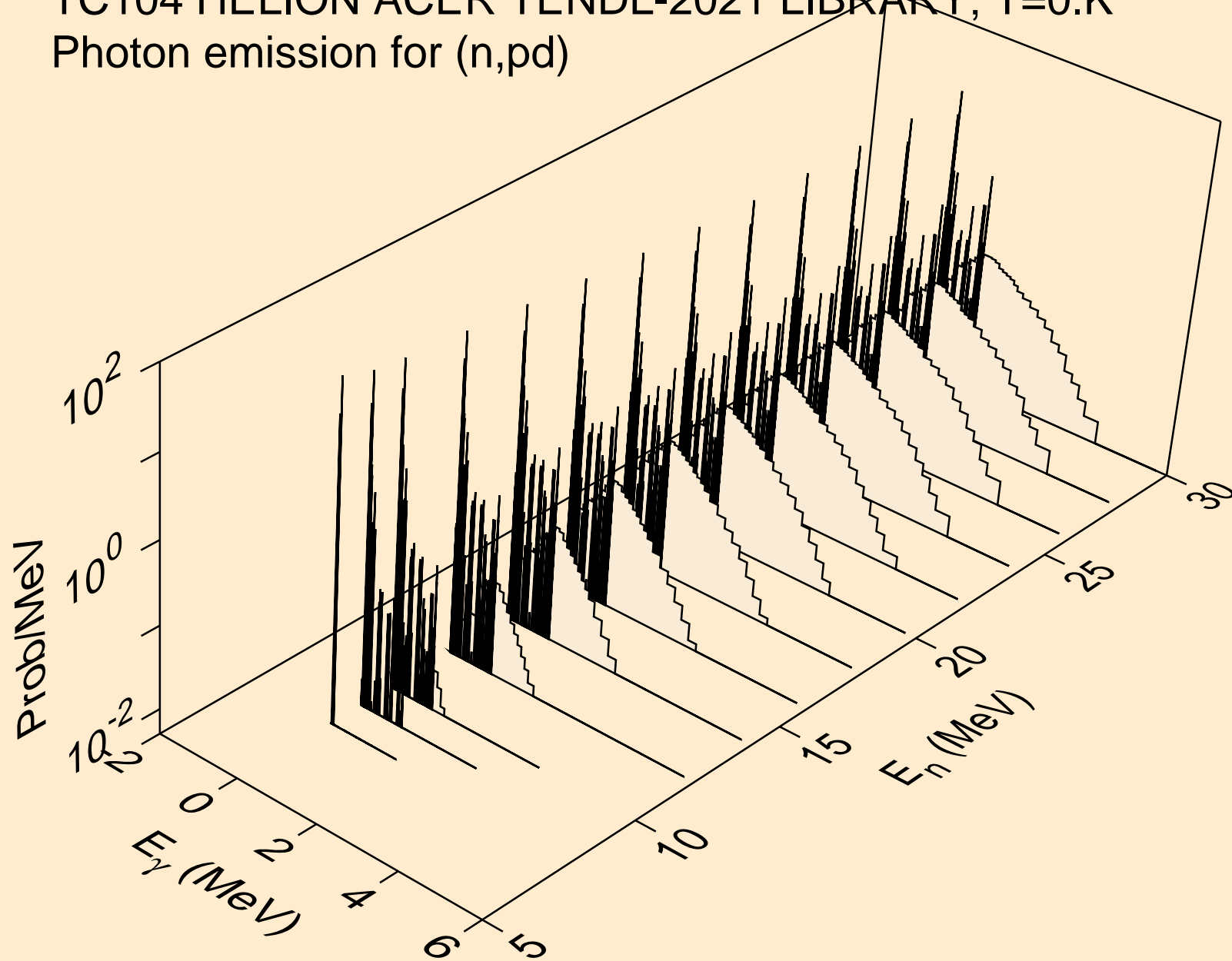

TC104 HELION ACER TENDL-2021 LIBRARY; T=0.K

Photon emission for (n,pt)

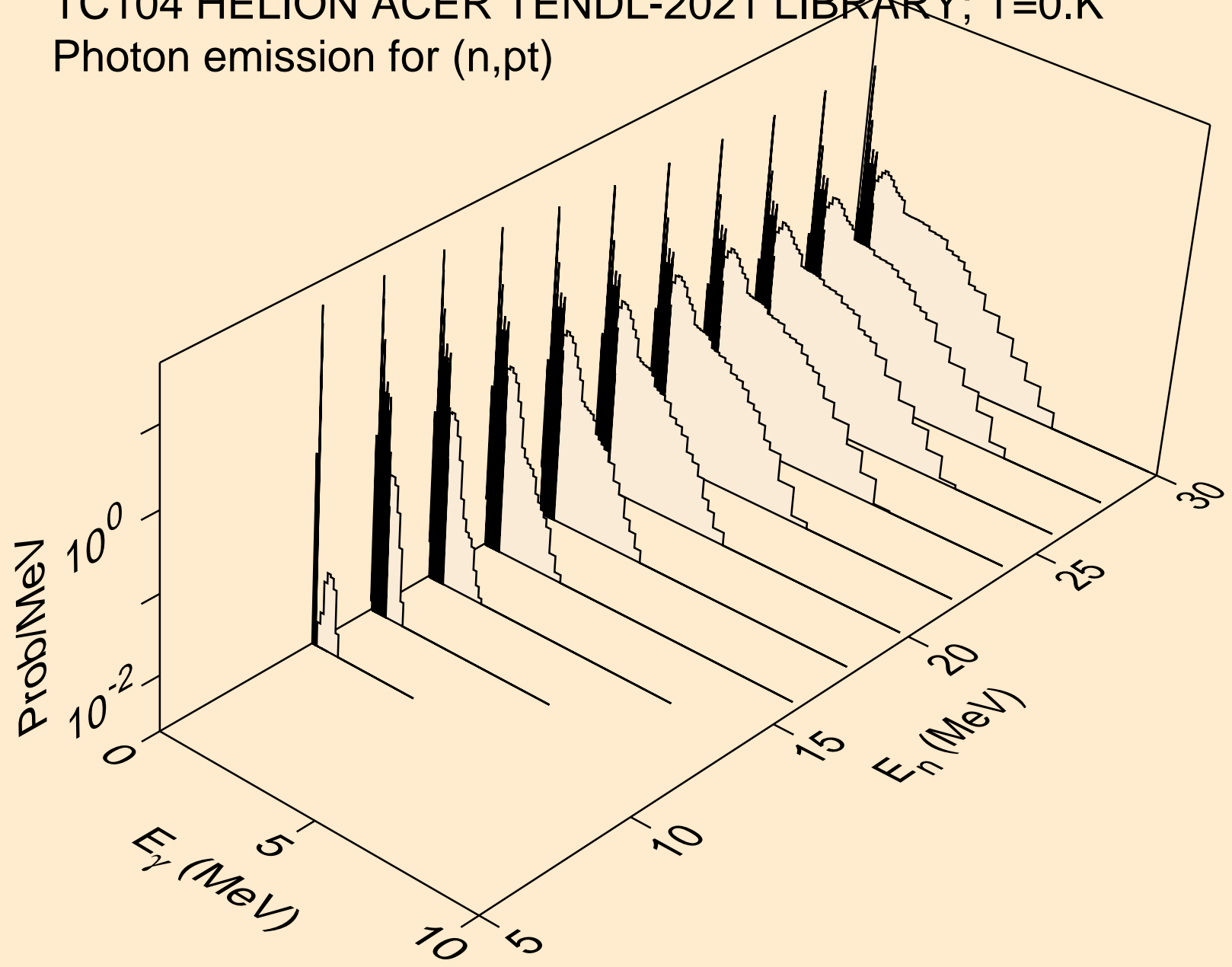

TC104 HELION ACER TENDL-2021 LIBRARY; T=0.K  
Photon emission for (n,da)

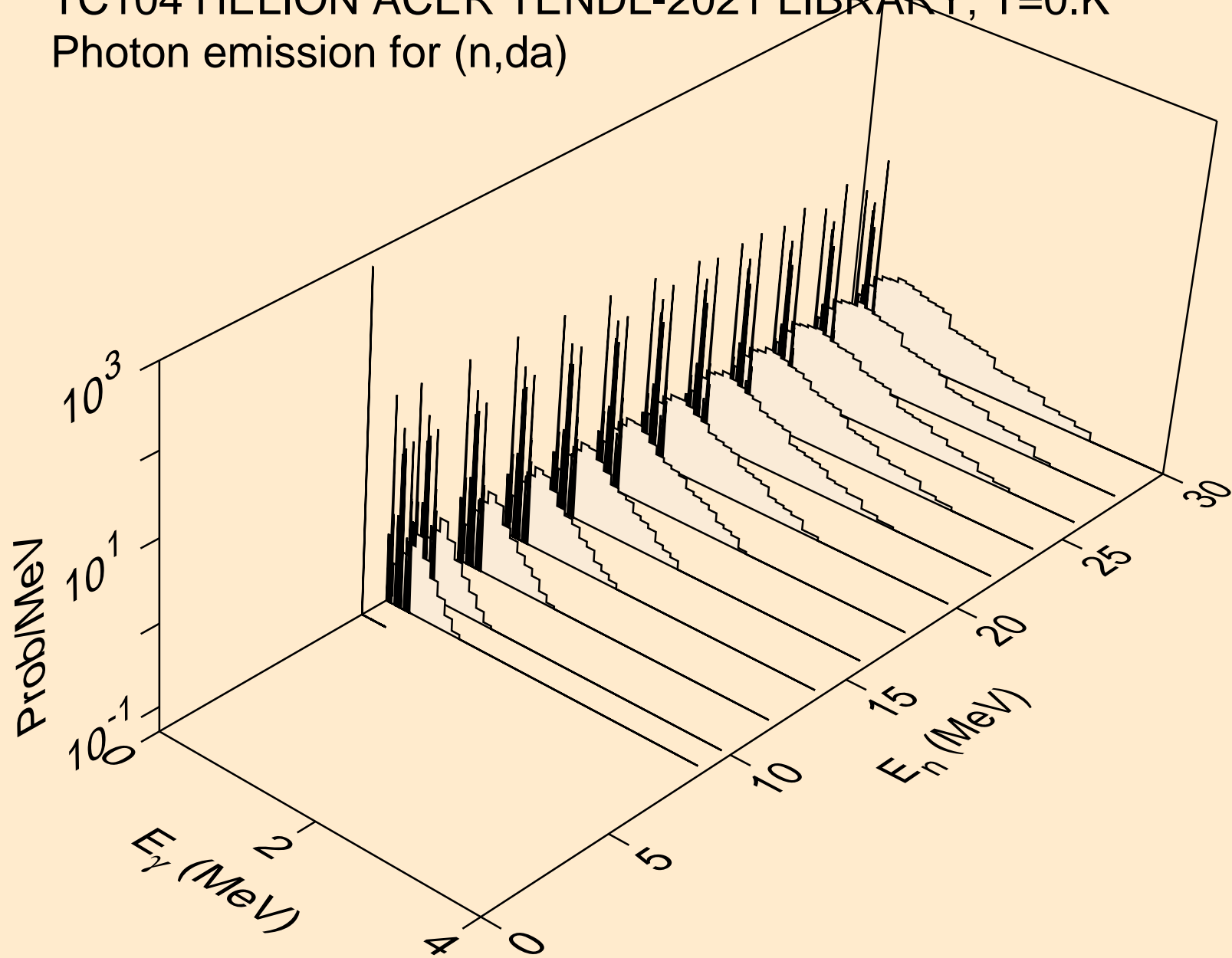



TC104 HELION ACER TENDL-2021 LIBRARY; T=0.K  
Particle heating contributions

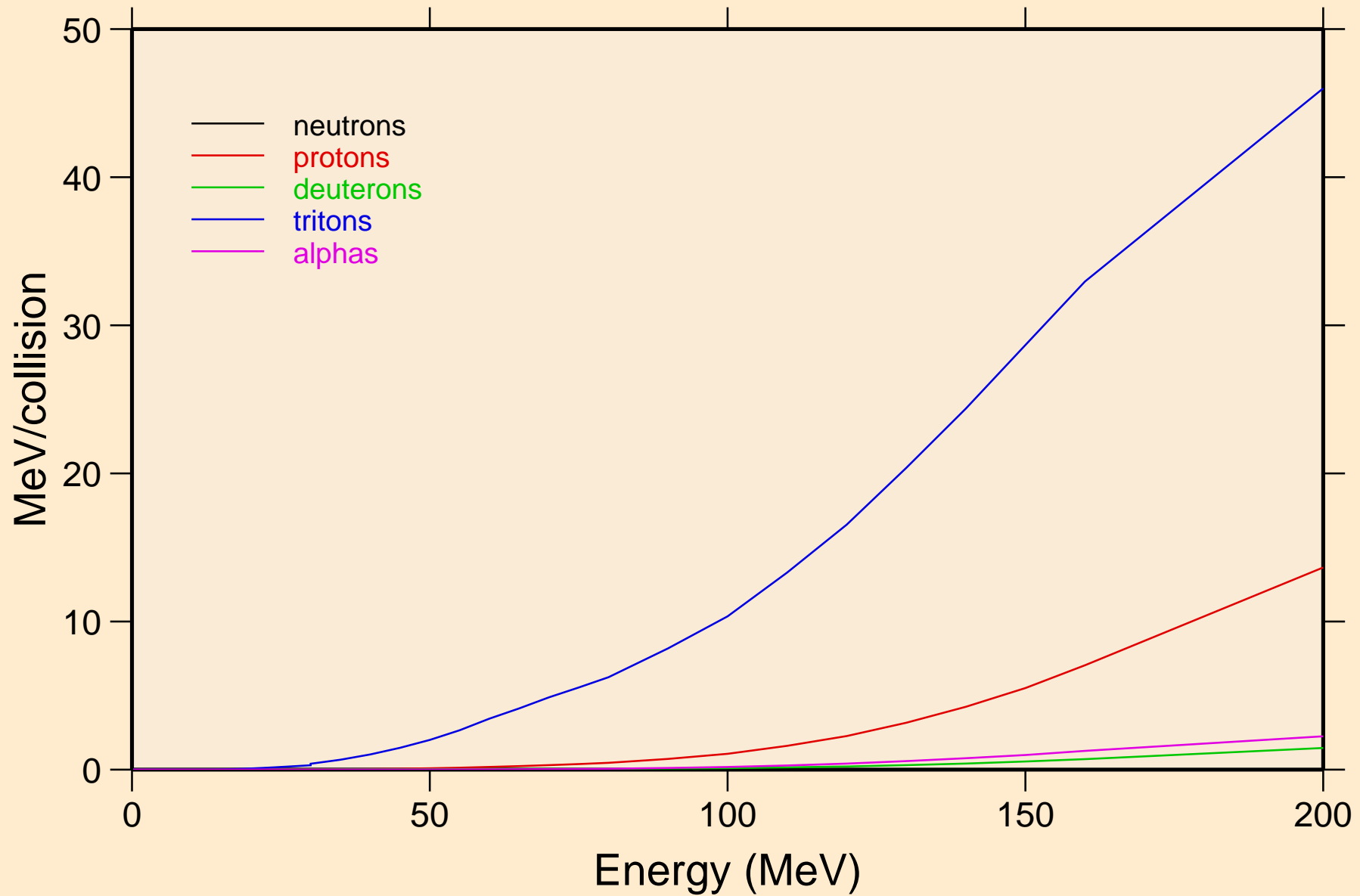

TC104 HELION ACER TENDL-2021 LIBRARY; T=0.K  
Recoil Heating

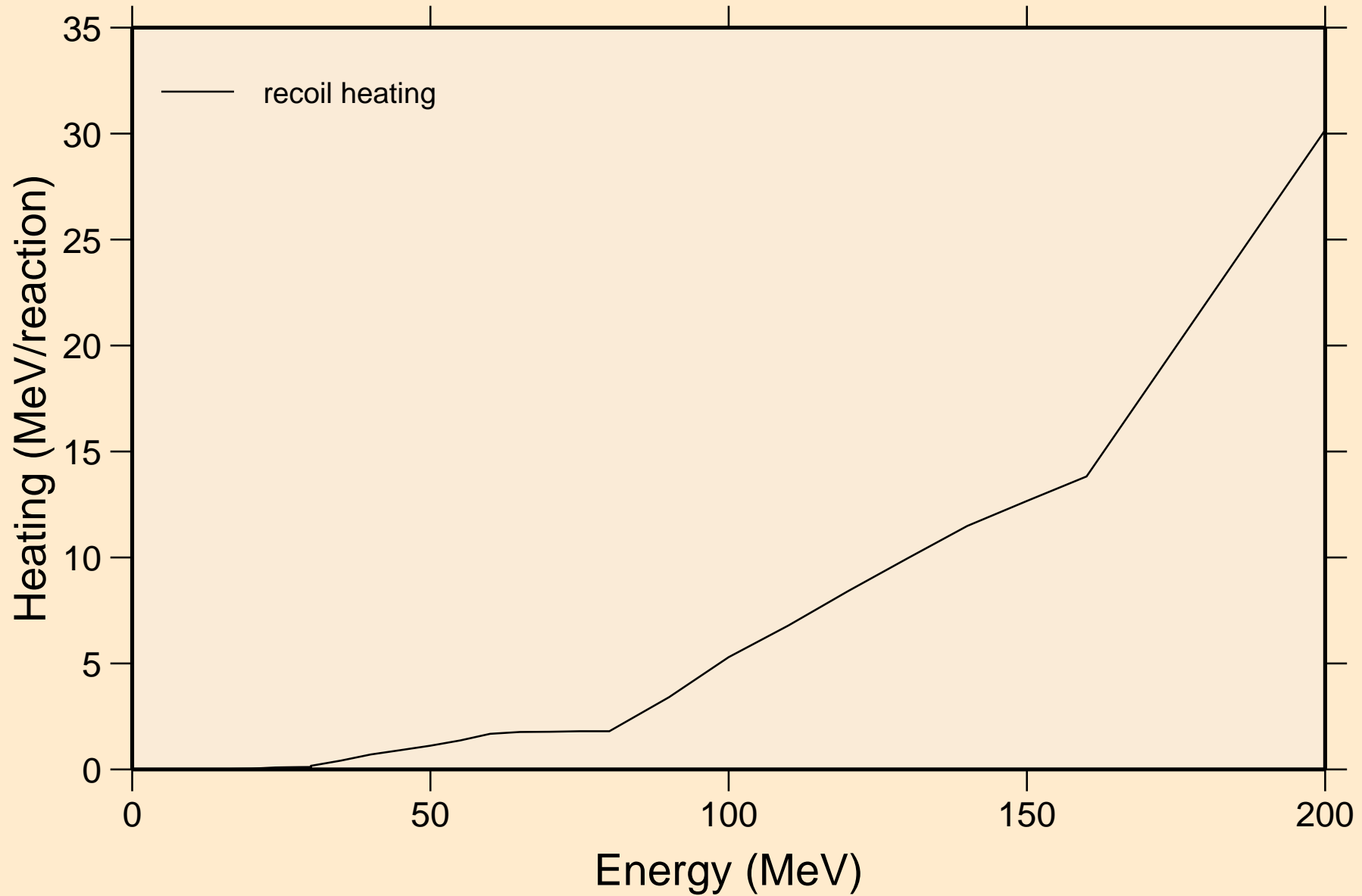

TC104 HELION ACER TENDL-2021 LIBRARY; T=0.K  
Particle production cross sections

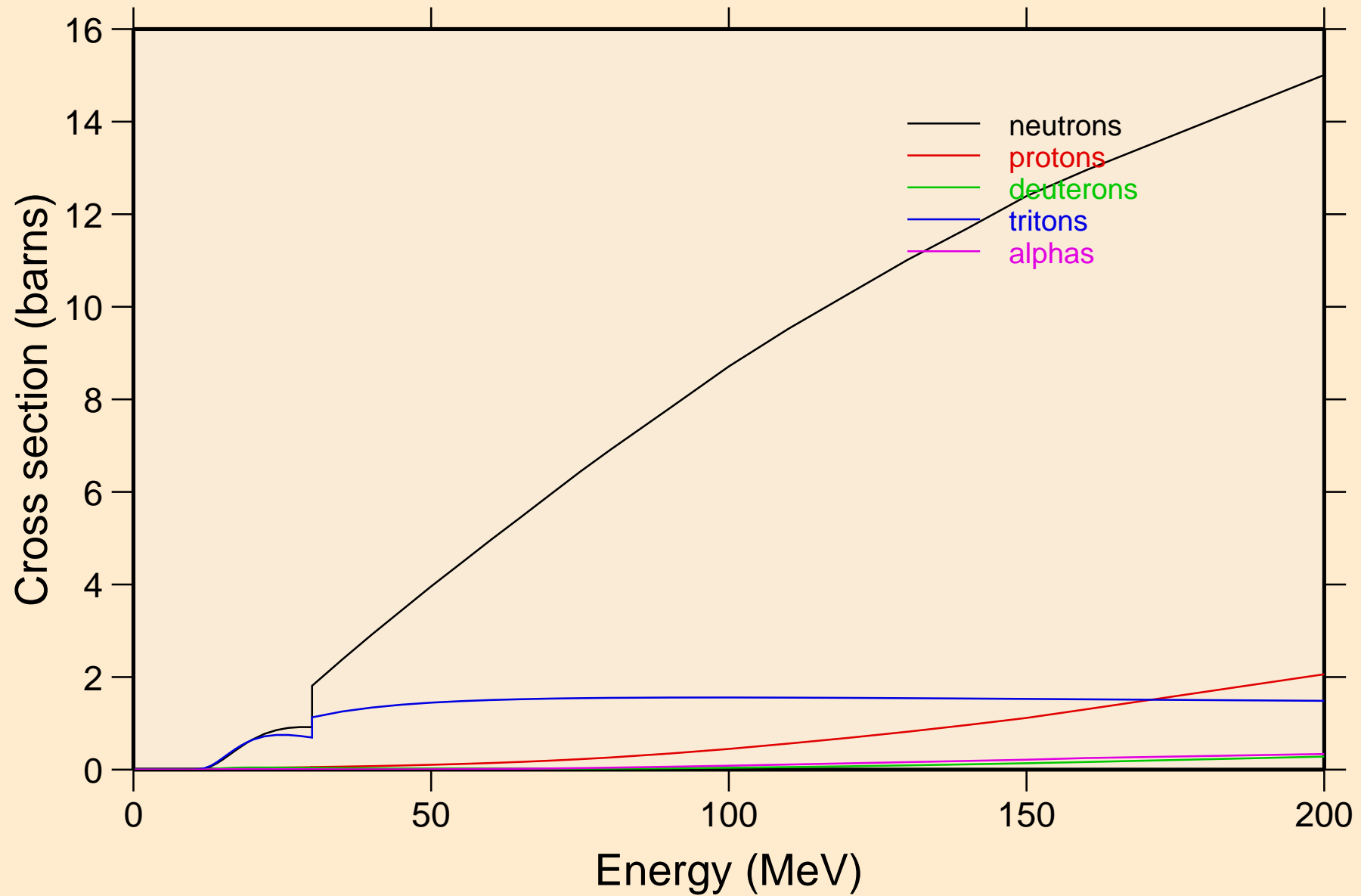

TC104 HELION ACER TENDL-2021 LIBRARY; T=0.K  
neutrons from (s,n)

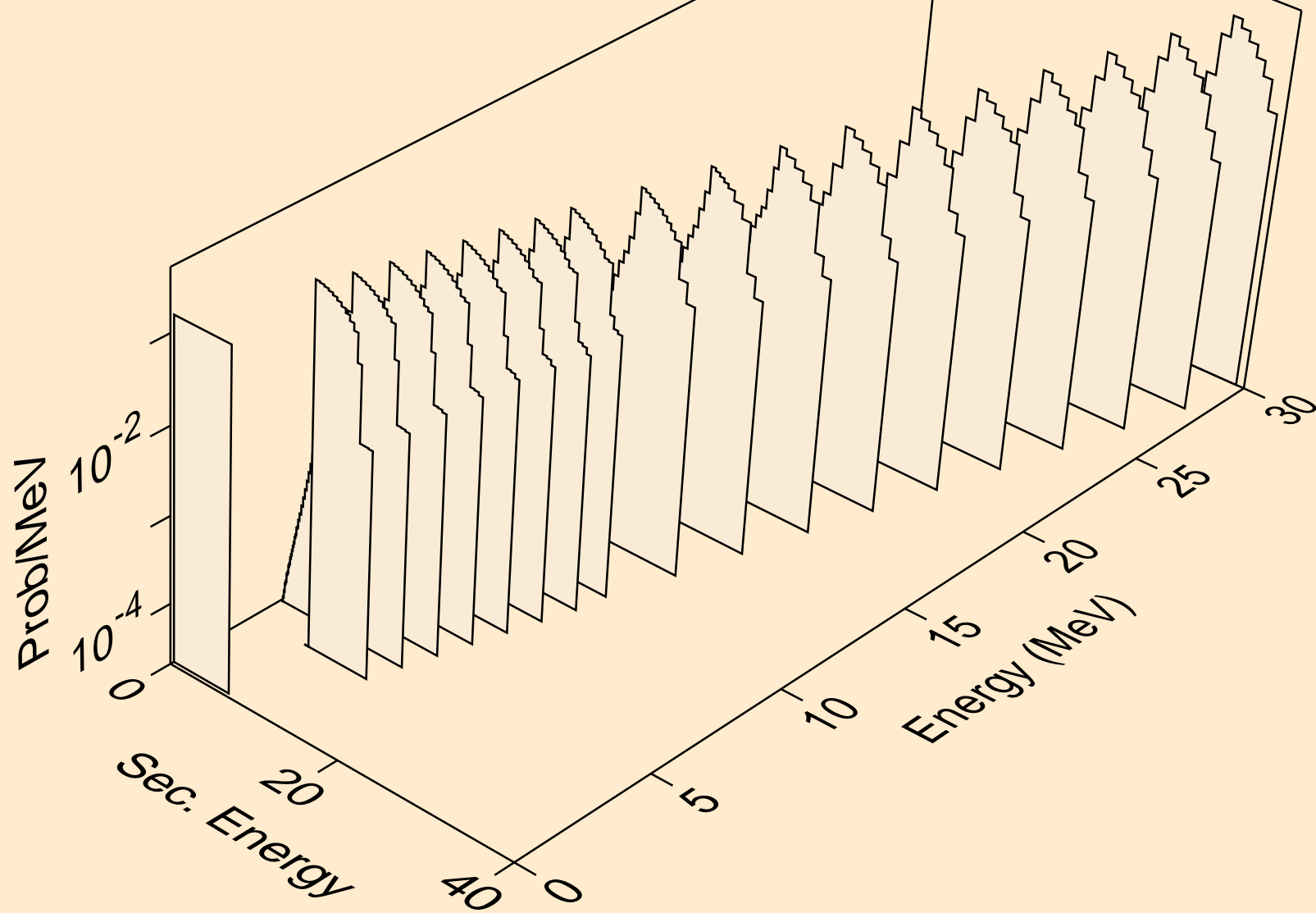

TC104 HELION ACER TENDL-2021 LIBRARY; T=0.K  
neutrons from (s,x)

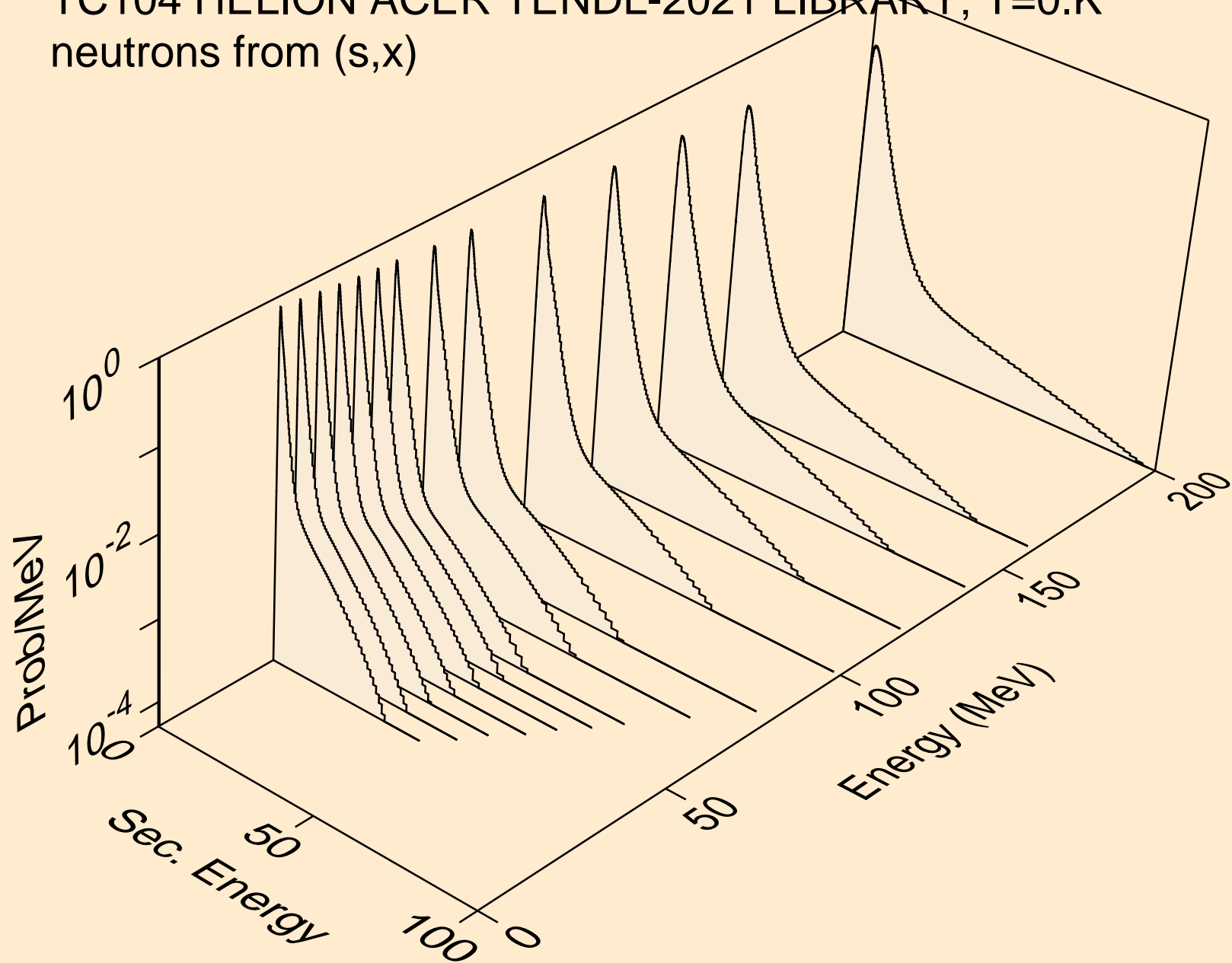

TC104 HELION ACER TENDL-2021 LIBRARY; T=0.K  
neutrons from (s,2nd)

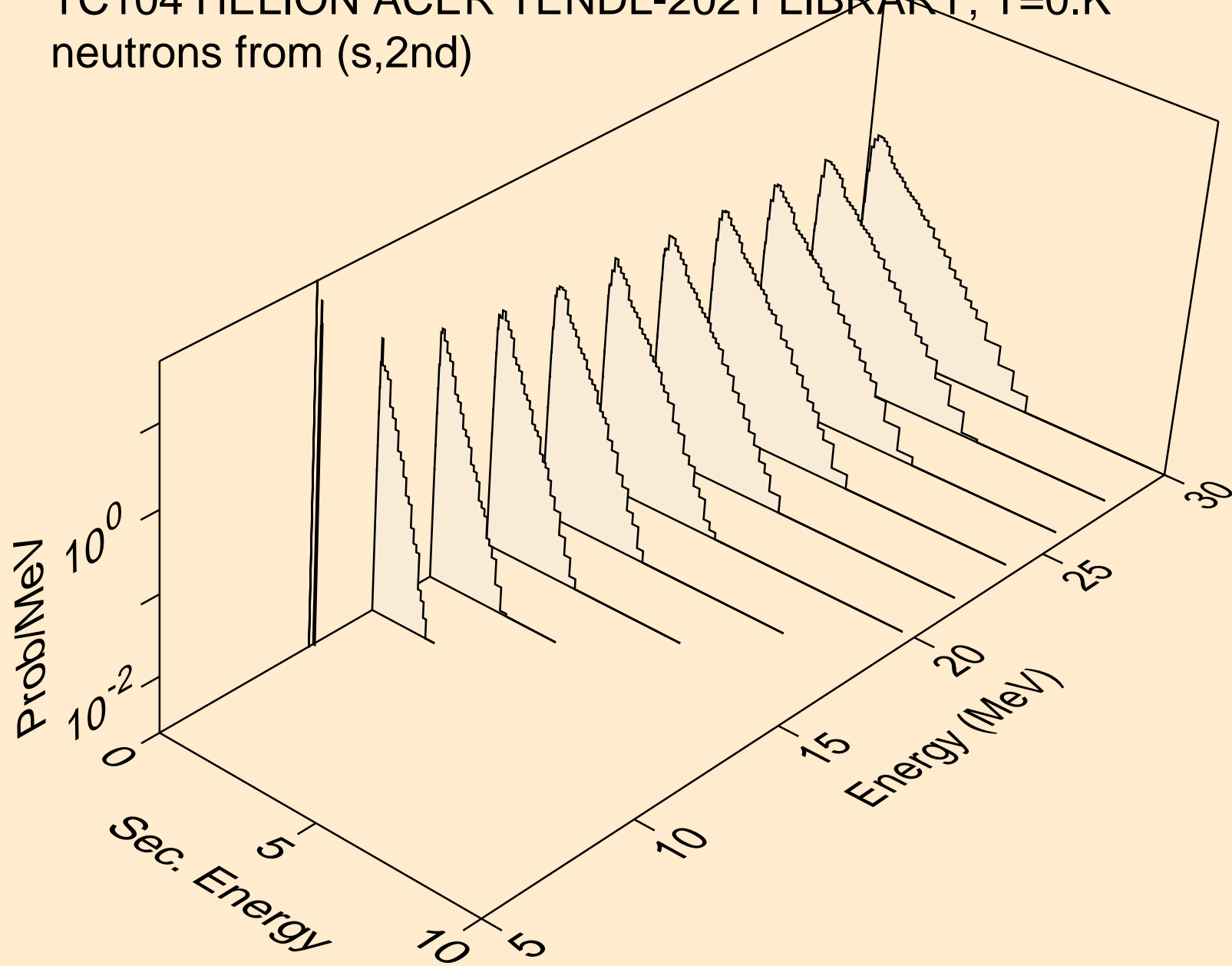

TC104 HELION ACER TENDL-2021 LIBRARY; T=0.K  
neutrons from (s,2n)

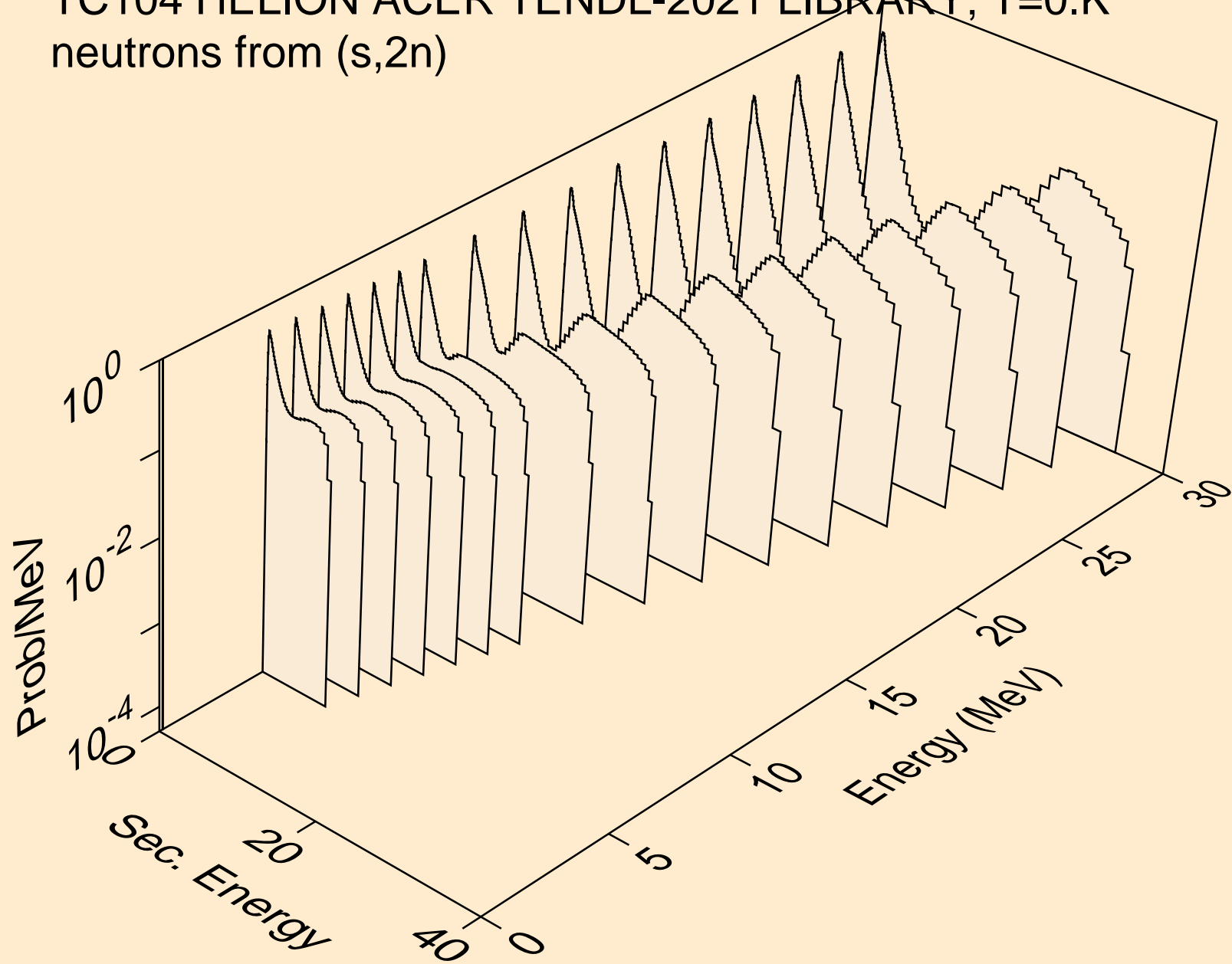

TC104 HELION ACER TENDL-2021 LIBRARY; T=0.K  
neutrons from (s,3n)

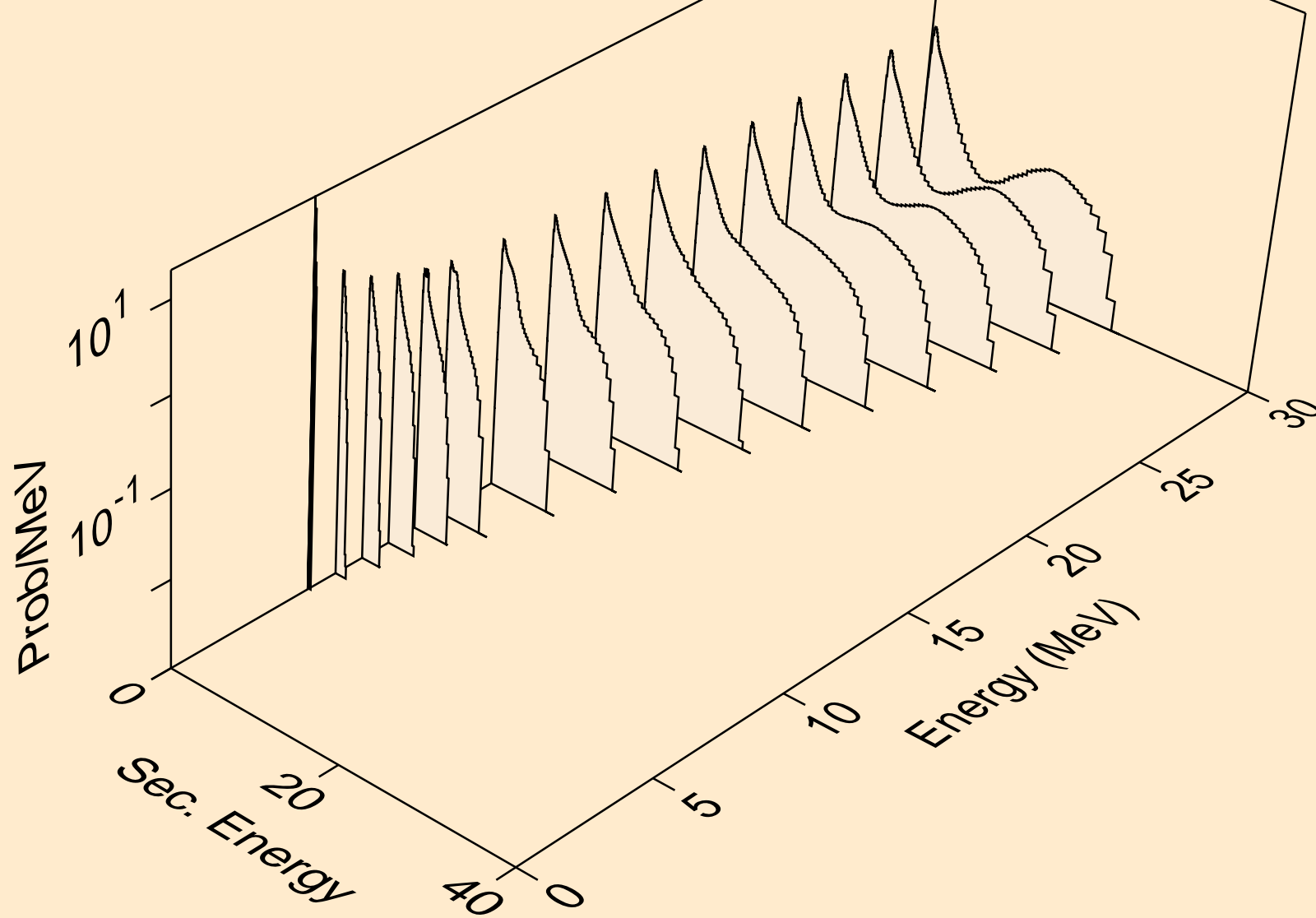



TC104 HELION ACER TENDL-2021 LIBRARY; T=0.K  
neutrons from (s,n\*)a

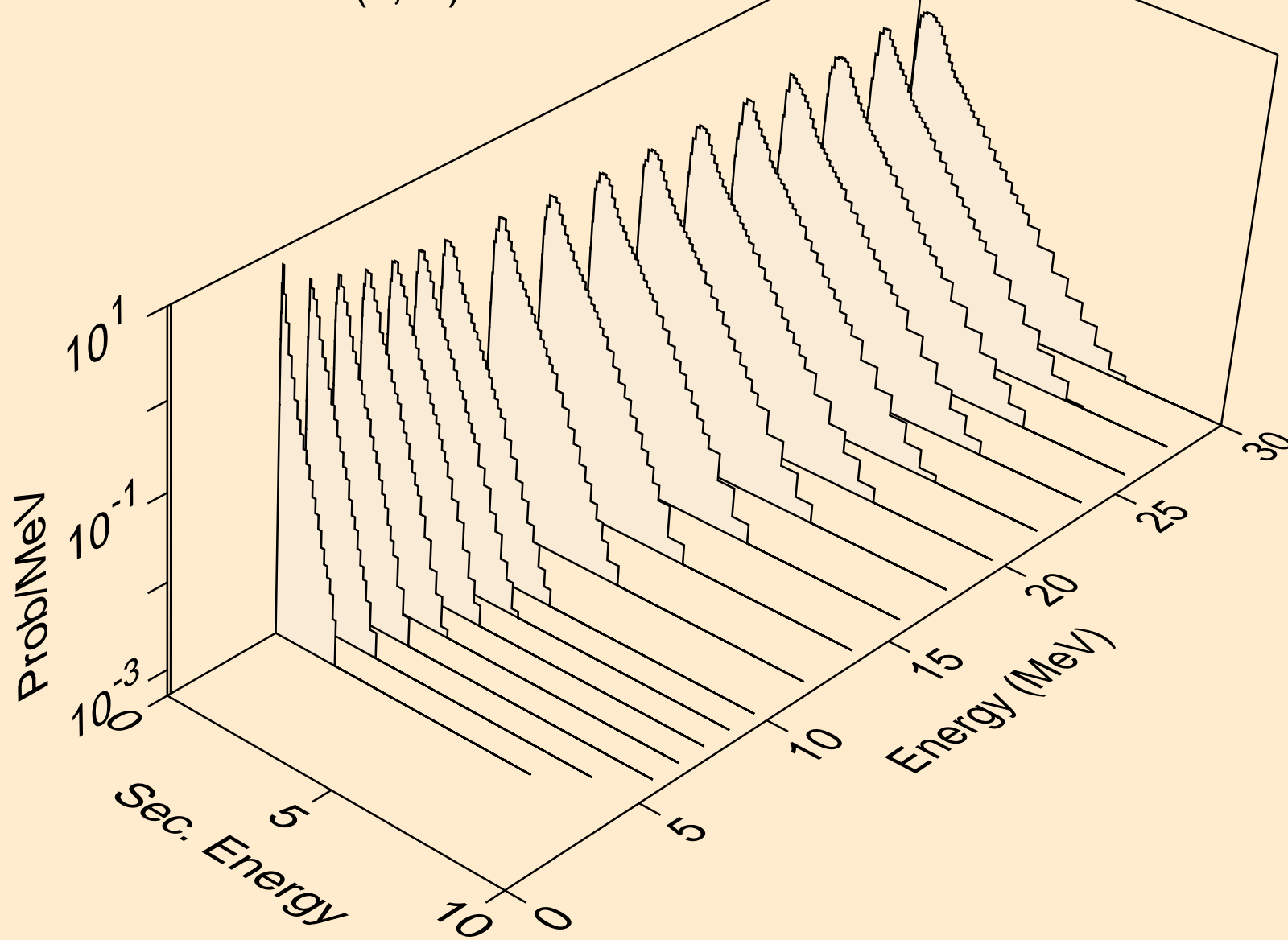

TC104 HELION ACER TENDL-2021 LIBRARY; T=0.K  
neutrons from (s,2n)a

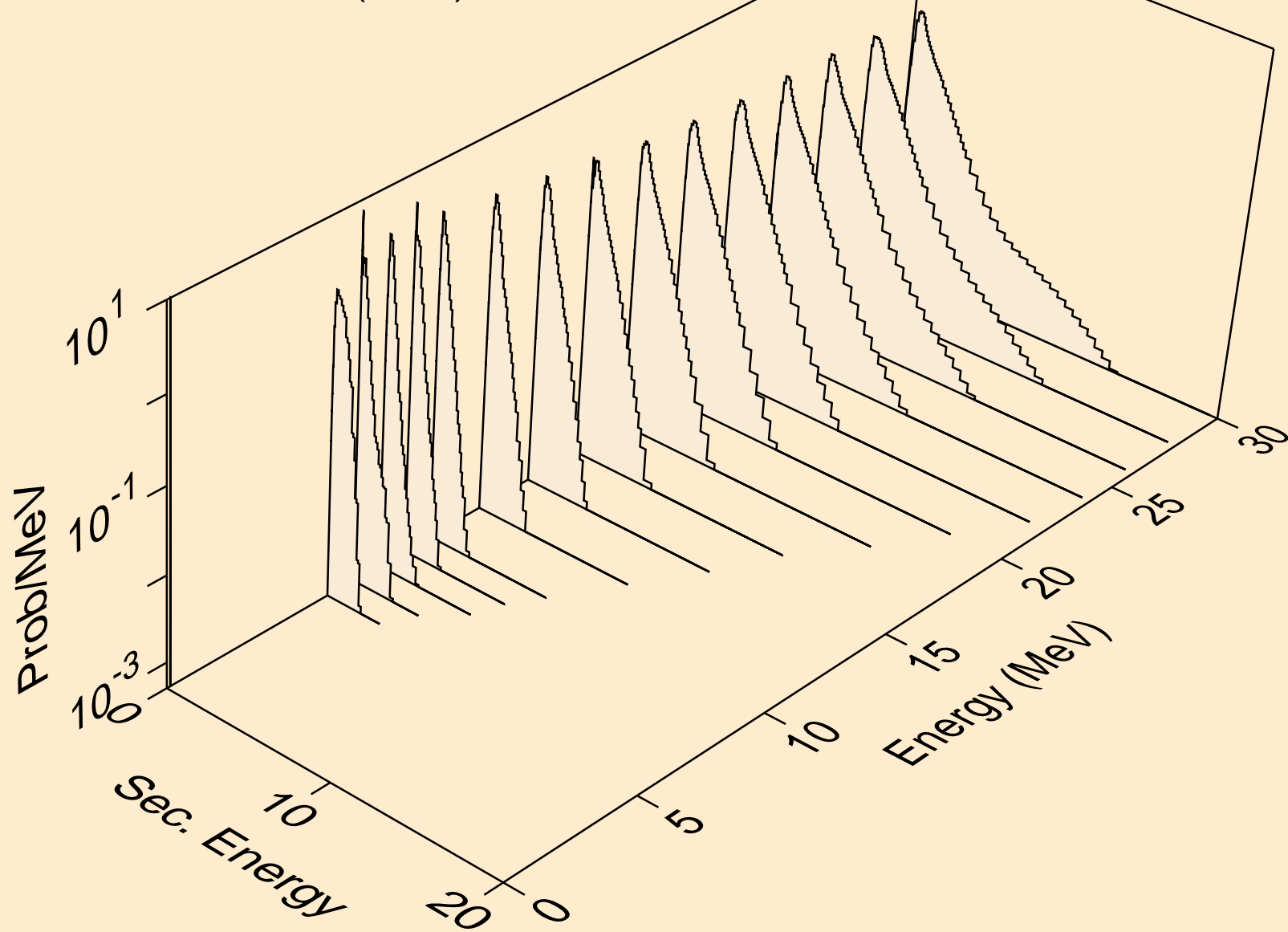

TC104 HELION ACER TENDL-2021 LIBRARY; T=0.K  
neutrons from (s,3n)a

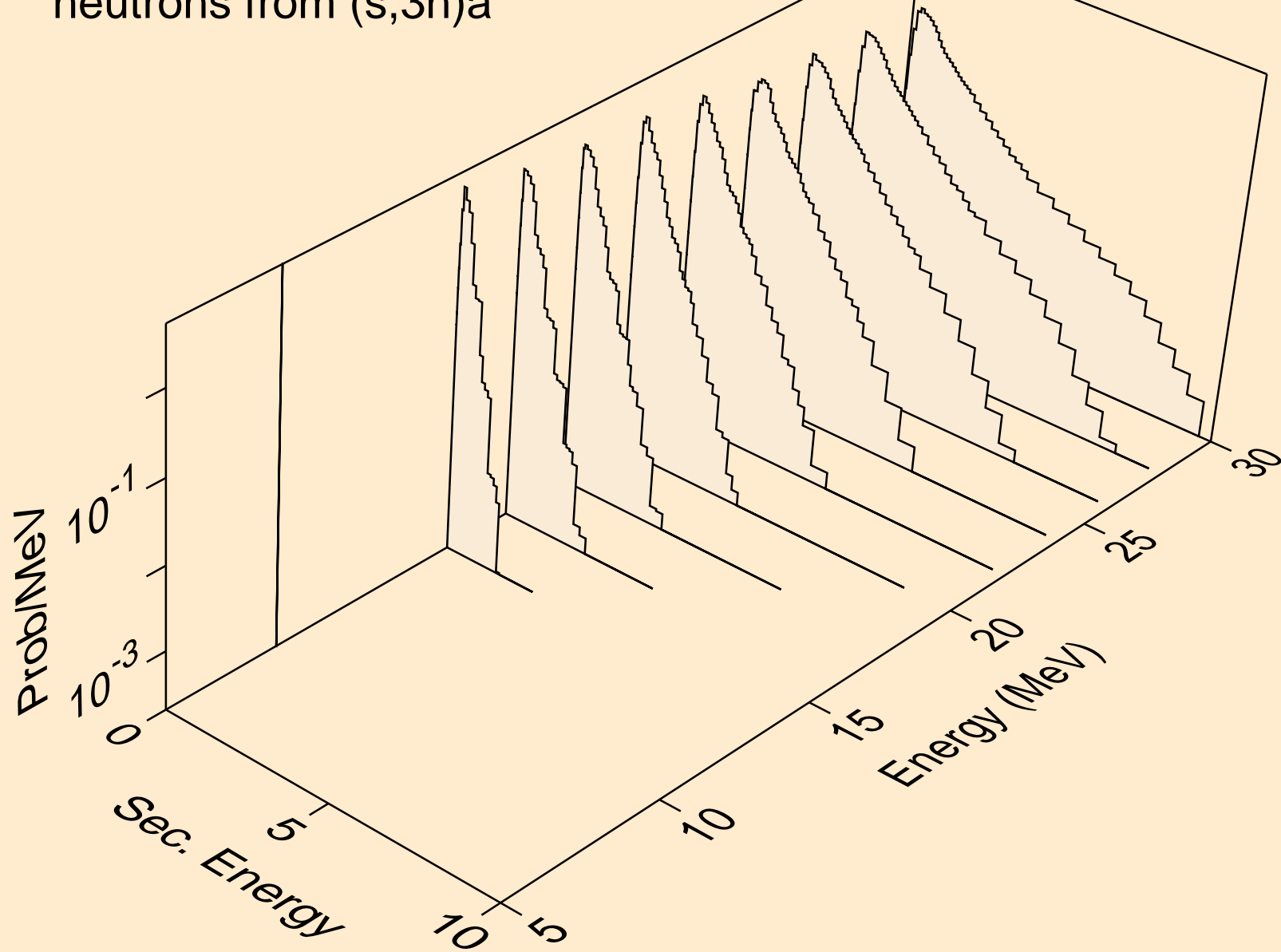

TC104 HELION ACER TENDL-2021 LIBRARY; T=0.K  
neutrons from (s,n\*)p

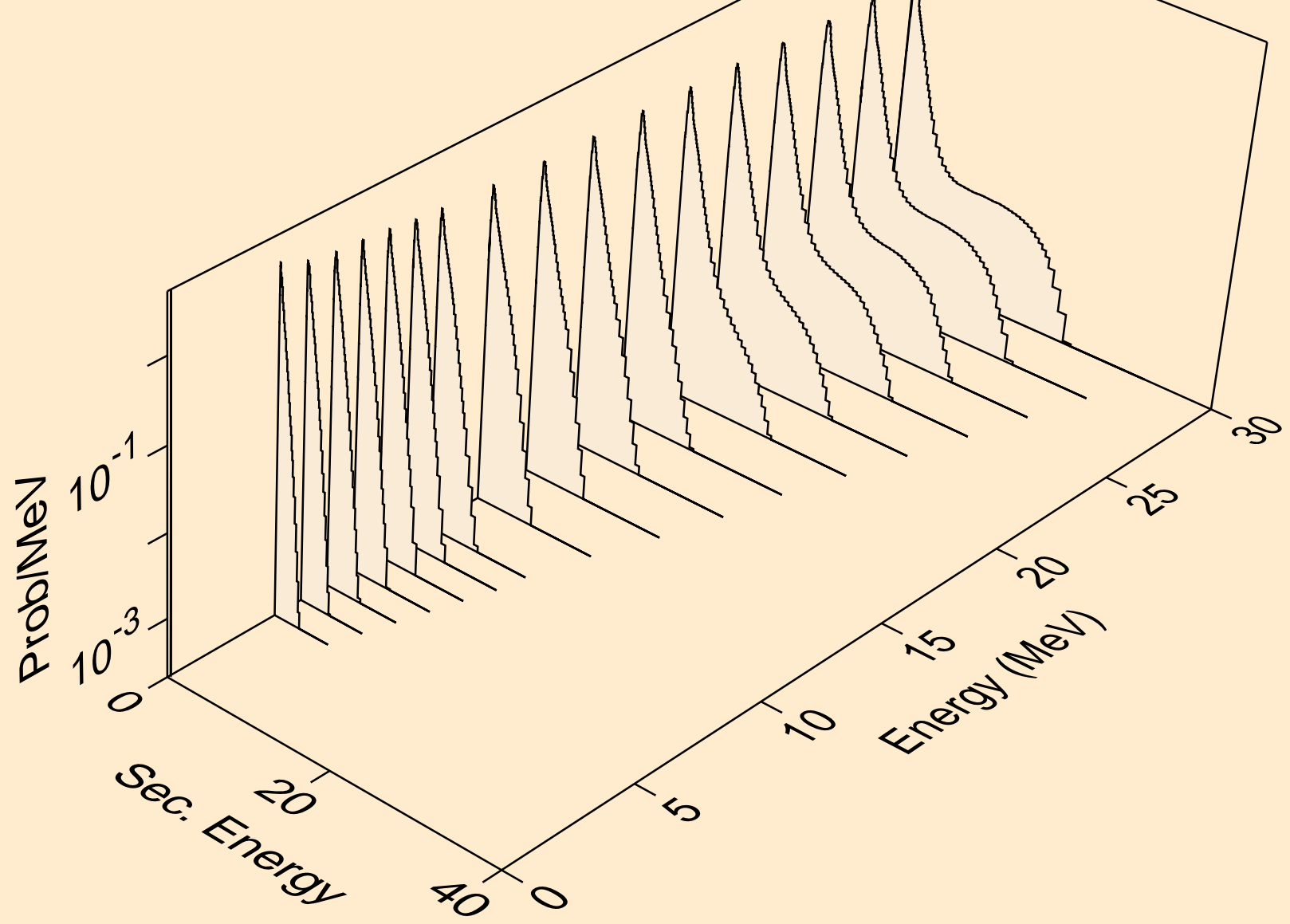

TC104 HELION ACER TENDL-2021 LIBRARY; T=0.K  
neutrons from (s,n\*)2a

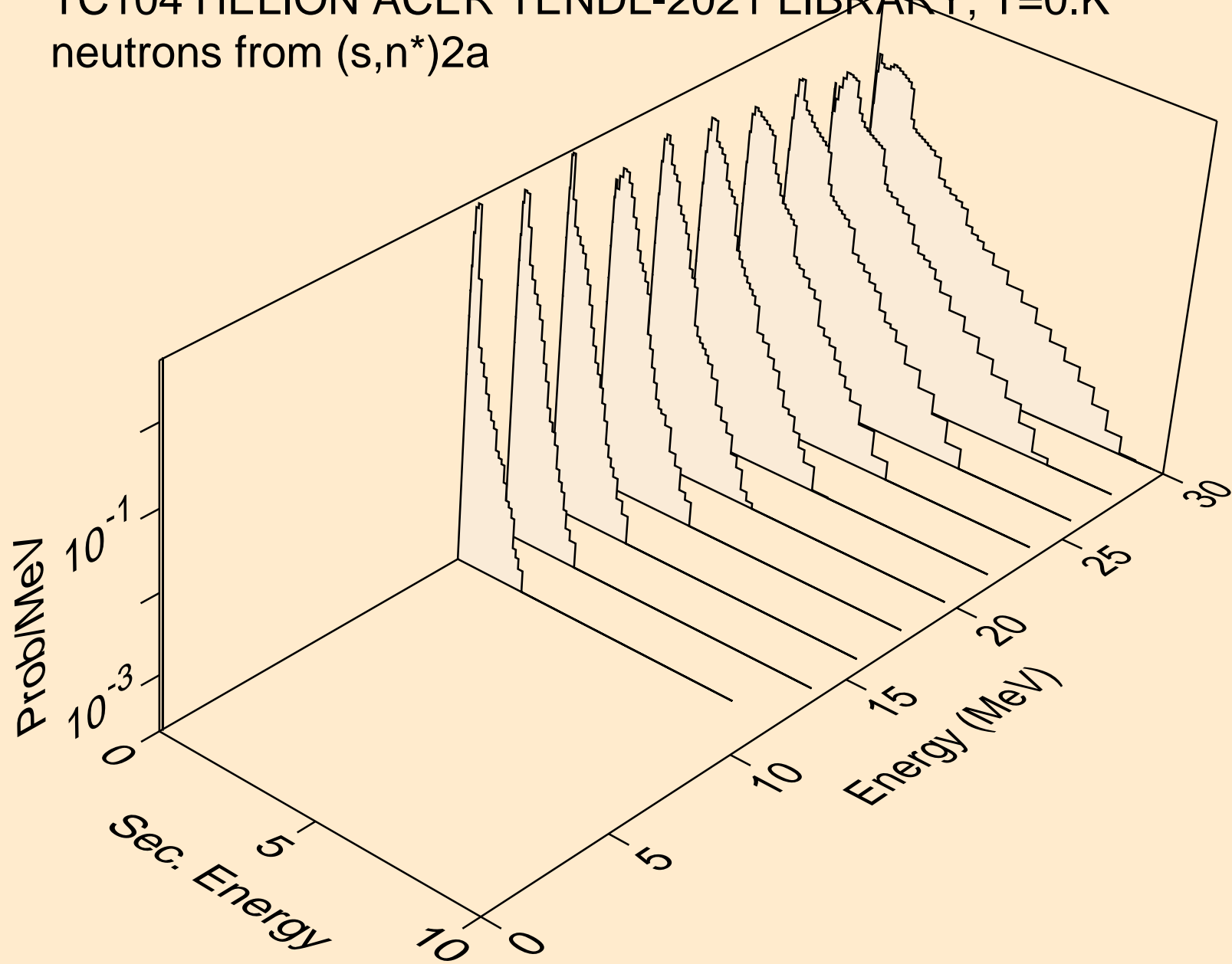

TC104 HELION ACER TENDL-2021 LIBRARY; T=0.K  
neutrons from (s,2n)2a

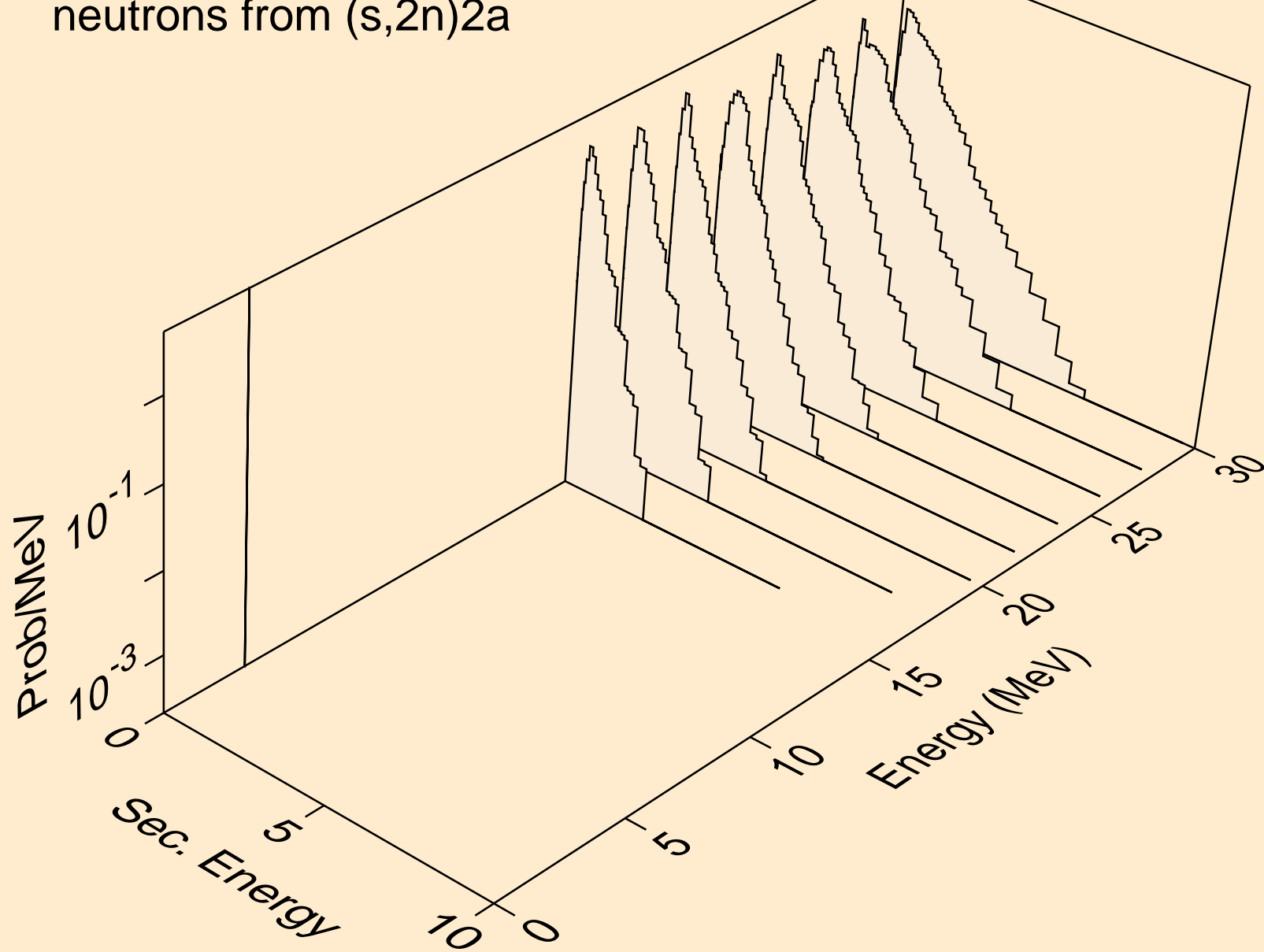

TC104 HELION ACER TENDL-2021 LIBRARY; T=0.K  
neutrons from (s,n\*)d

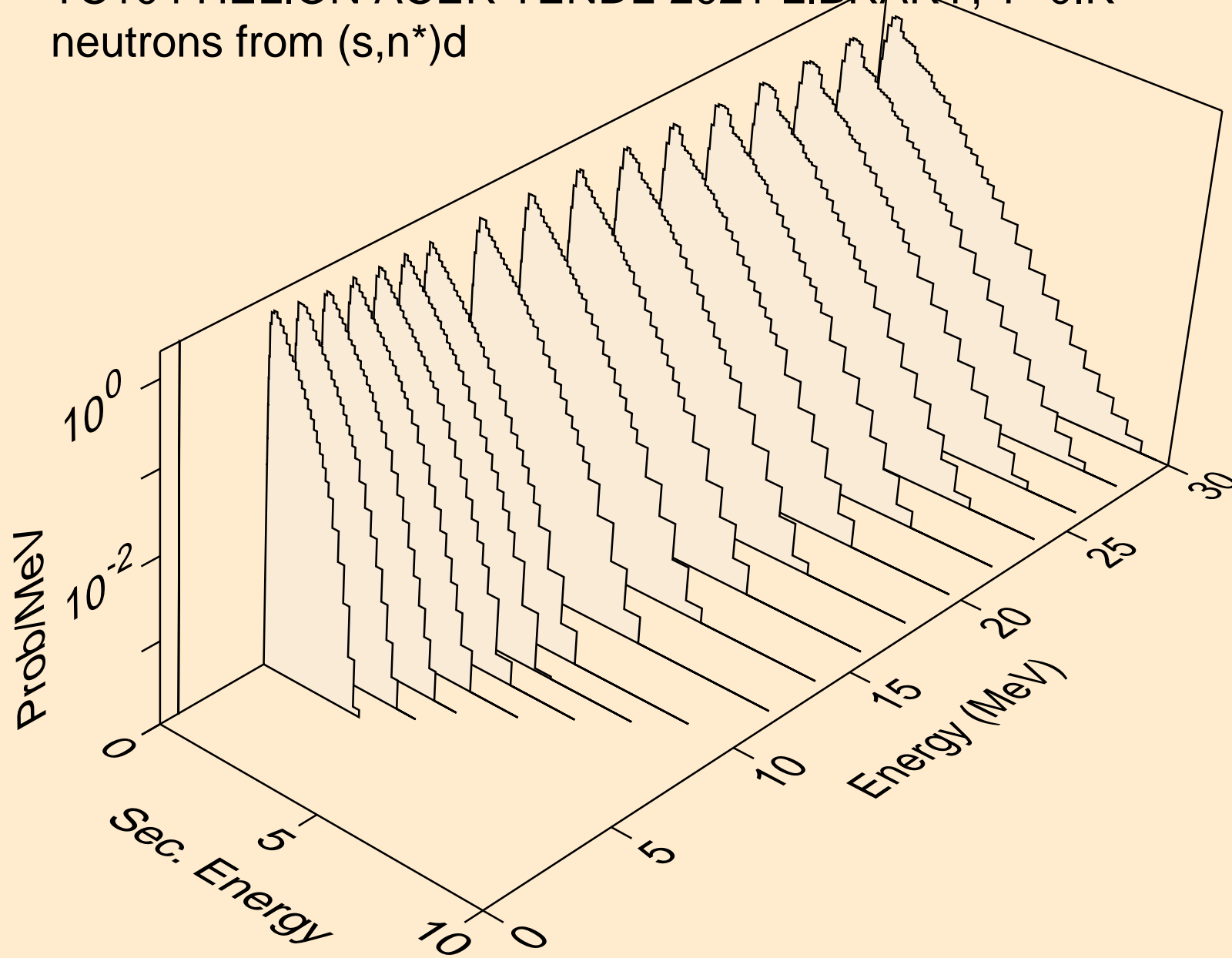

TC104 HELION ACER TENDL-2021 LIBRARY; T=0.K  
neutrons from (s,n\*)t

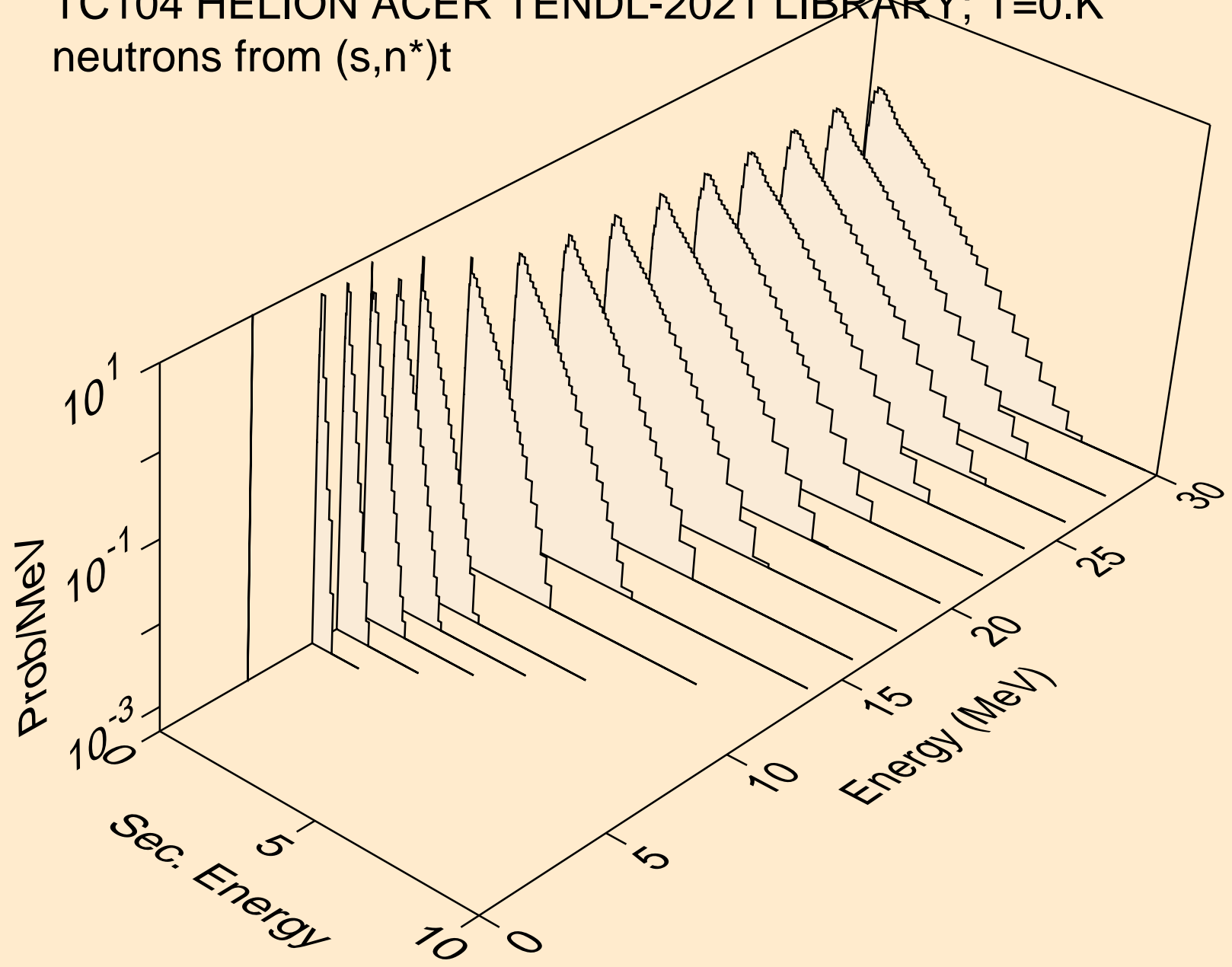



TC104 HELION ACER TENDL-2021 LIBRARY; T=0.K  
neutrons from (s,n\*)he3

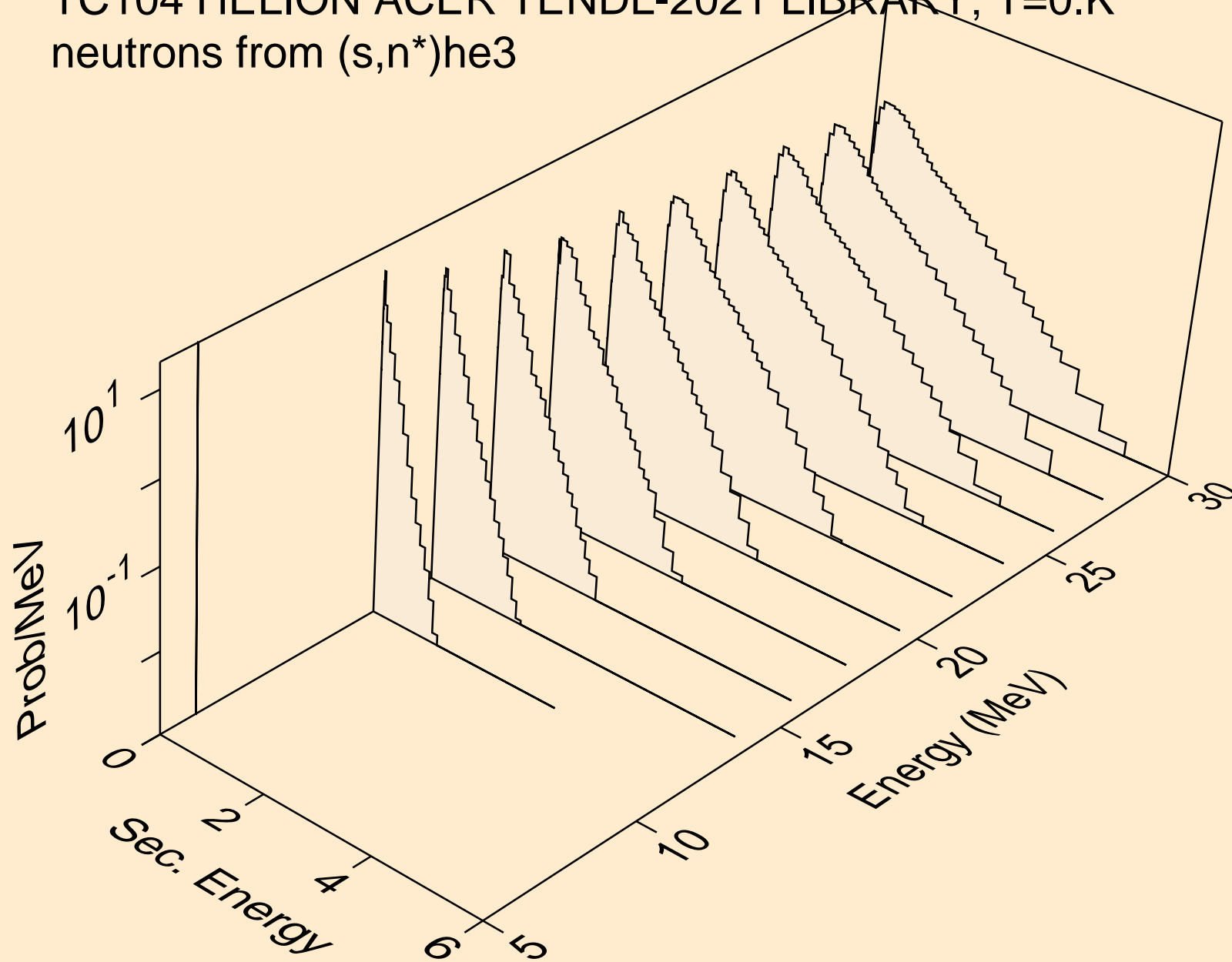

TC104 HELION ACER TENDL-2021 LIBRARY; T=0.K  
neutrons from (s,4n)

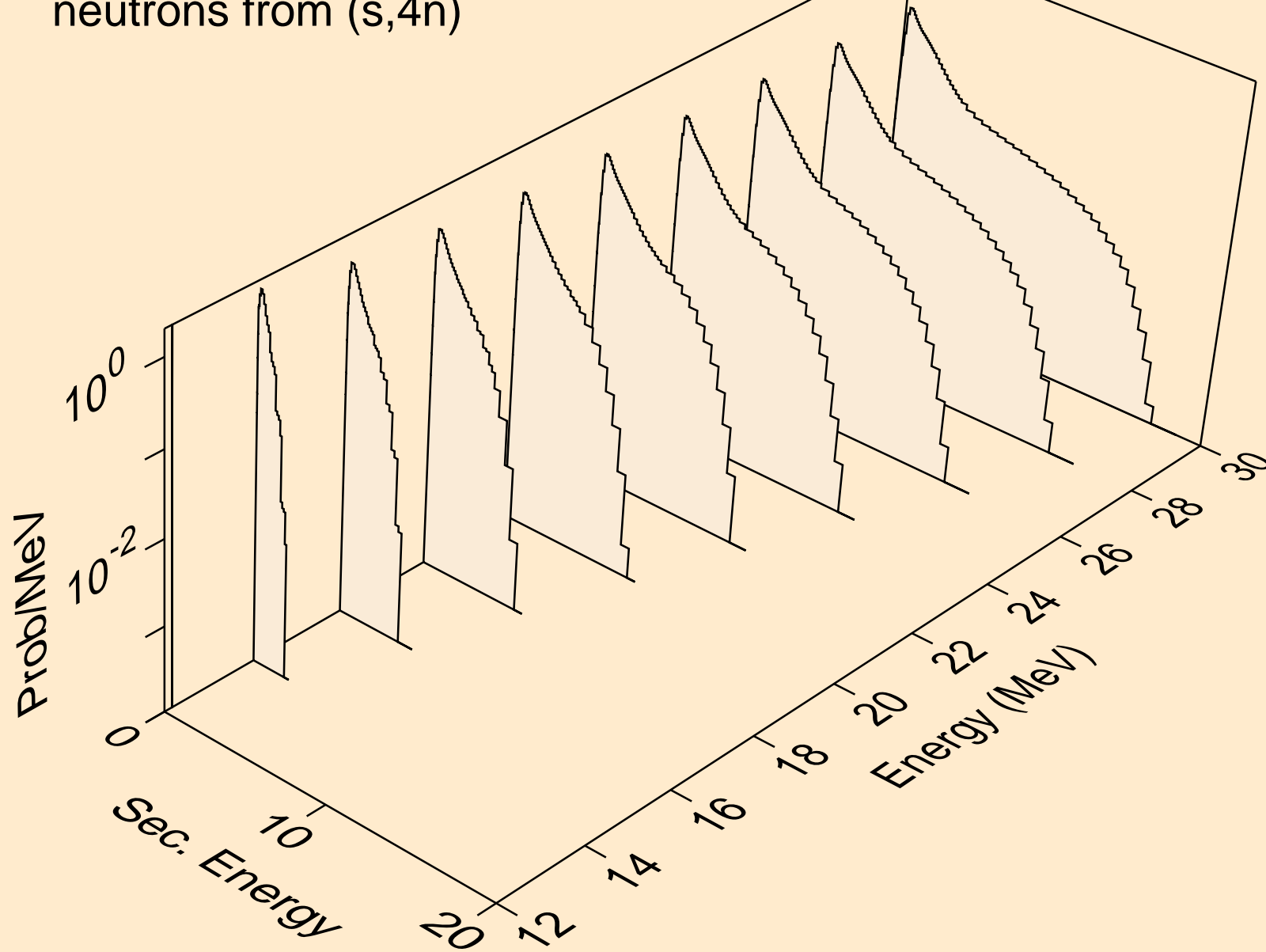

TC104 HELION ACER TENDL-2021 LIBRARY; T=0.K  
neutrons from (s,2np)

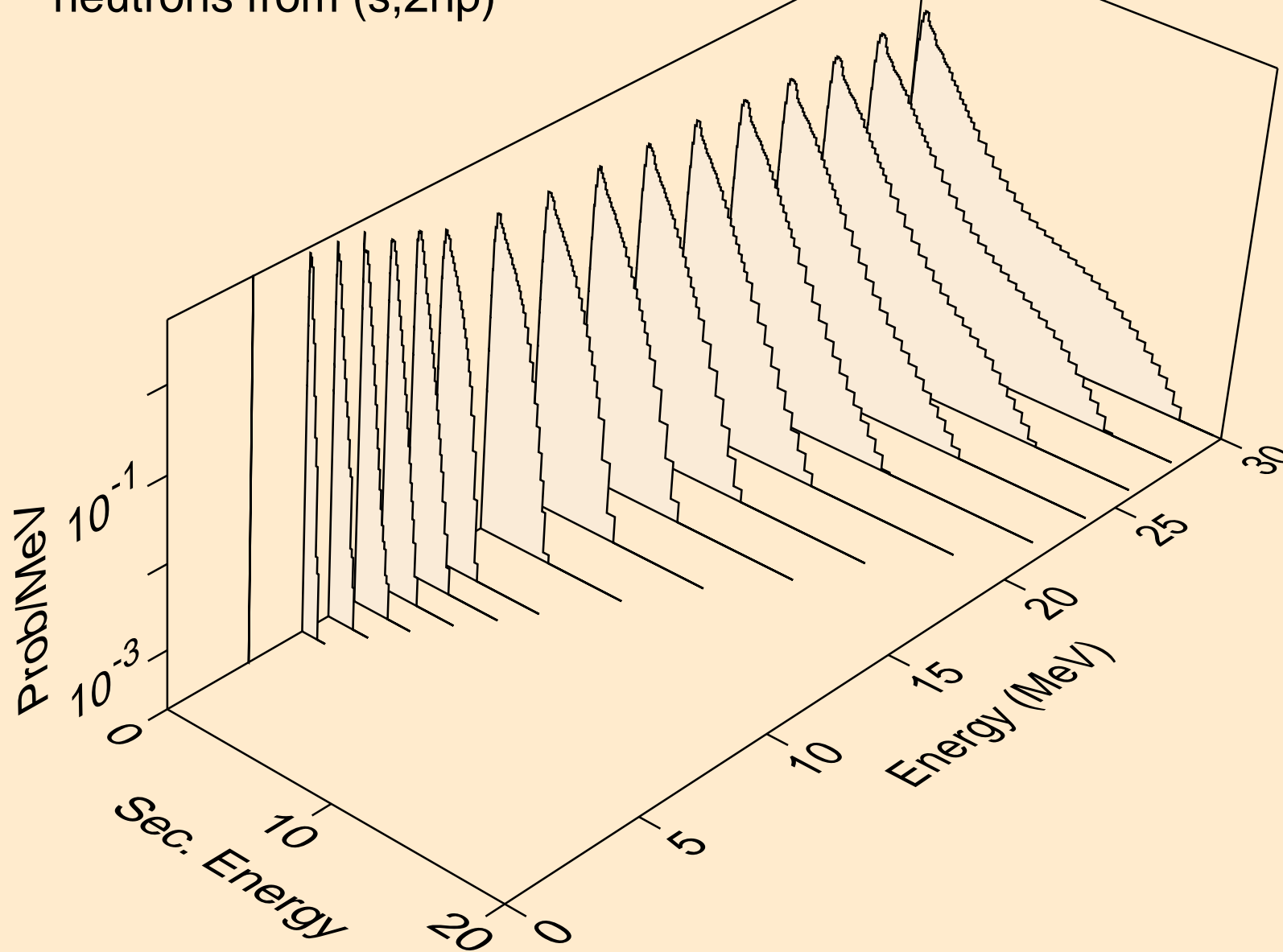

TC104 HELION ACER TENDL-2021 LIBRARY; T=0.K  
neutrons from (s,3np)

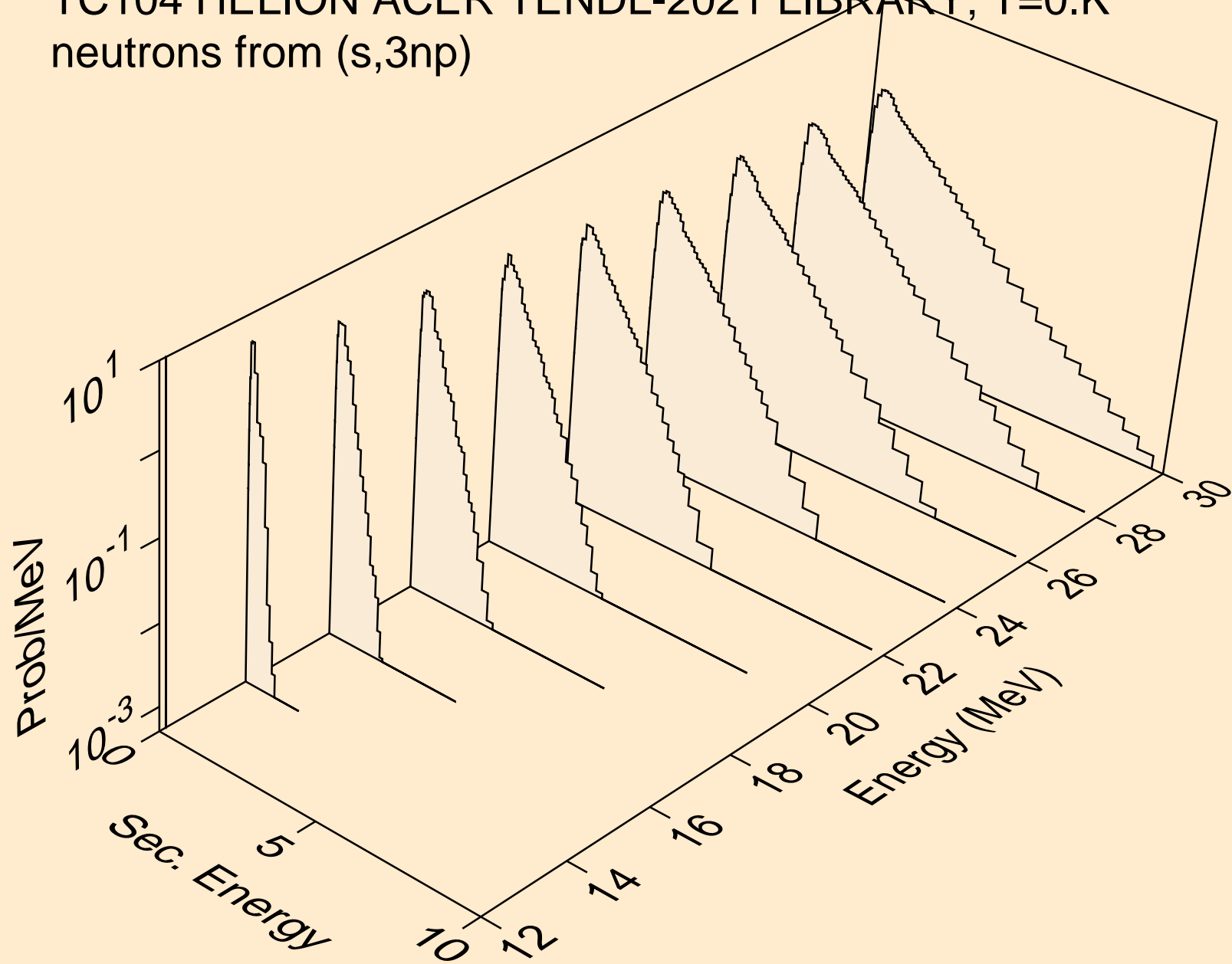

TC104 HELION ACER TENDL-2021 LIBRARY; T=0.K  
neutrons from (s,2np)

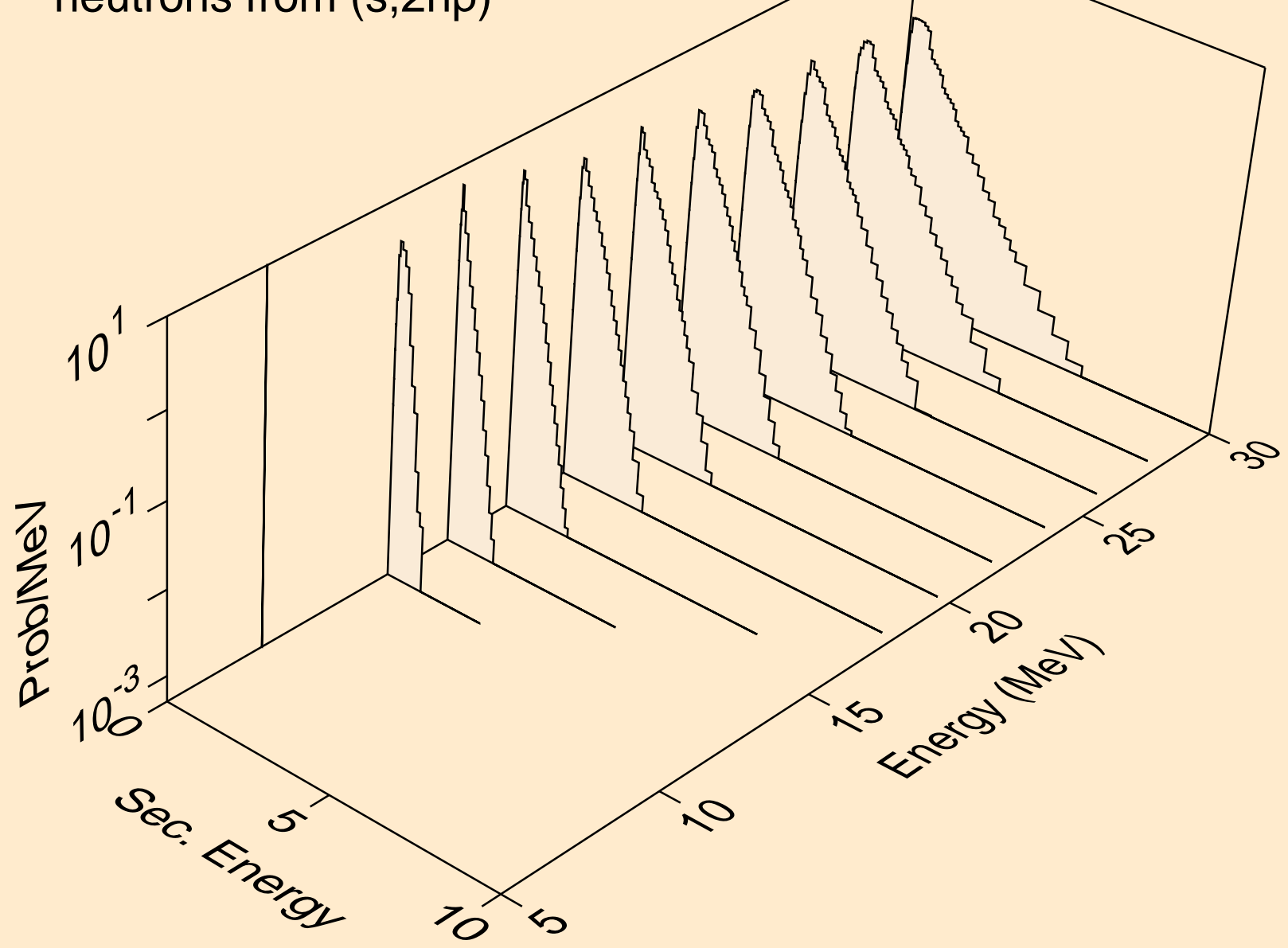

TC104 HELION ACER TENDL-2021 LIBRARY; T=0.K  
neutrons from (s,npa)

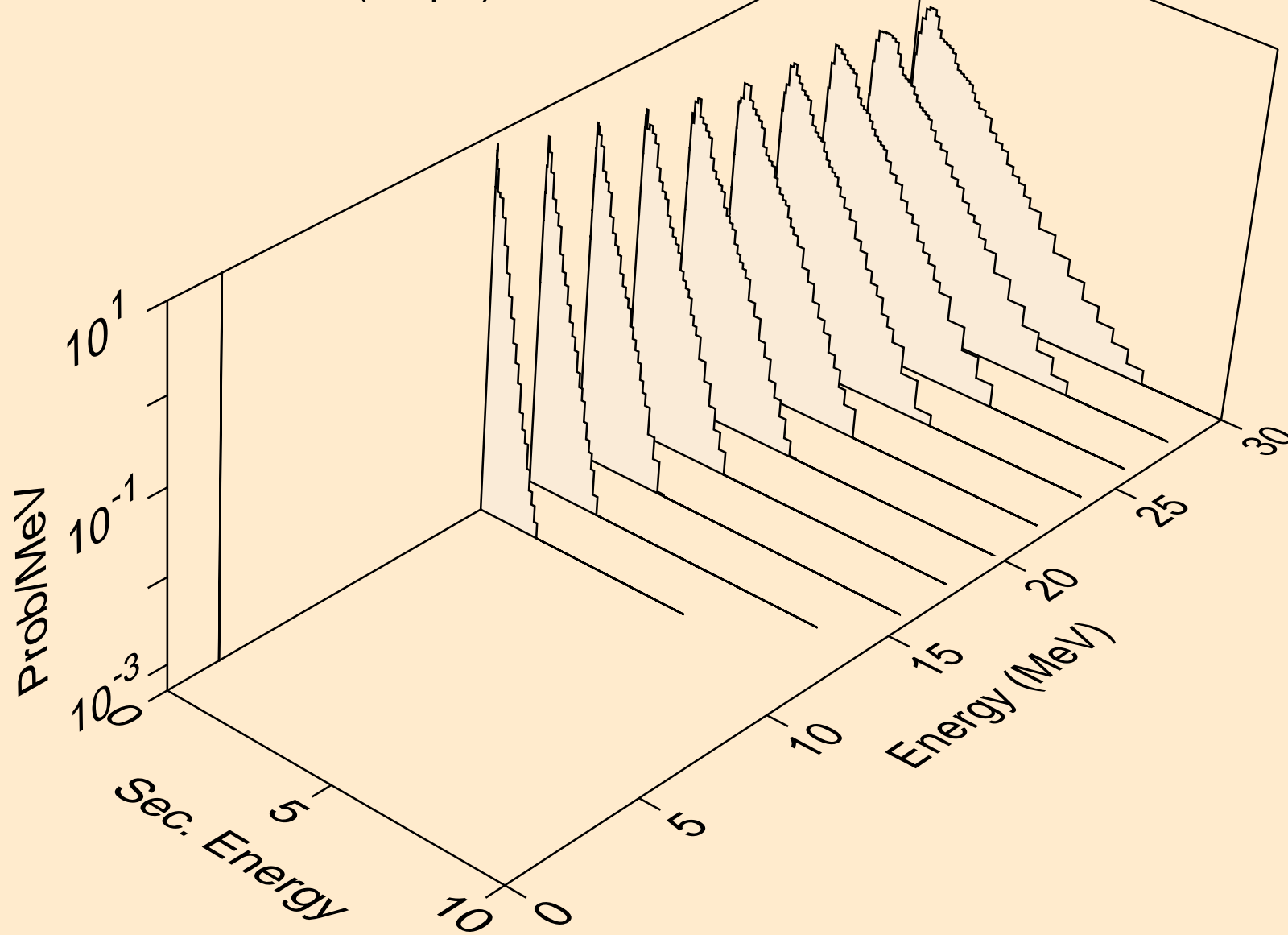

TC104 HELION ACER TENDL-2021 LIBRARY; T=0.K  
protons from (s,x)

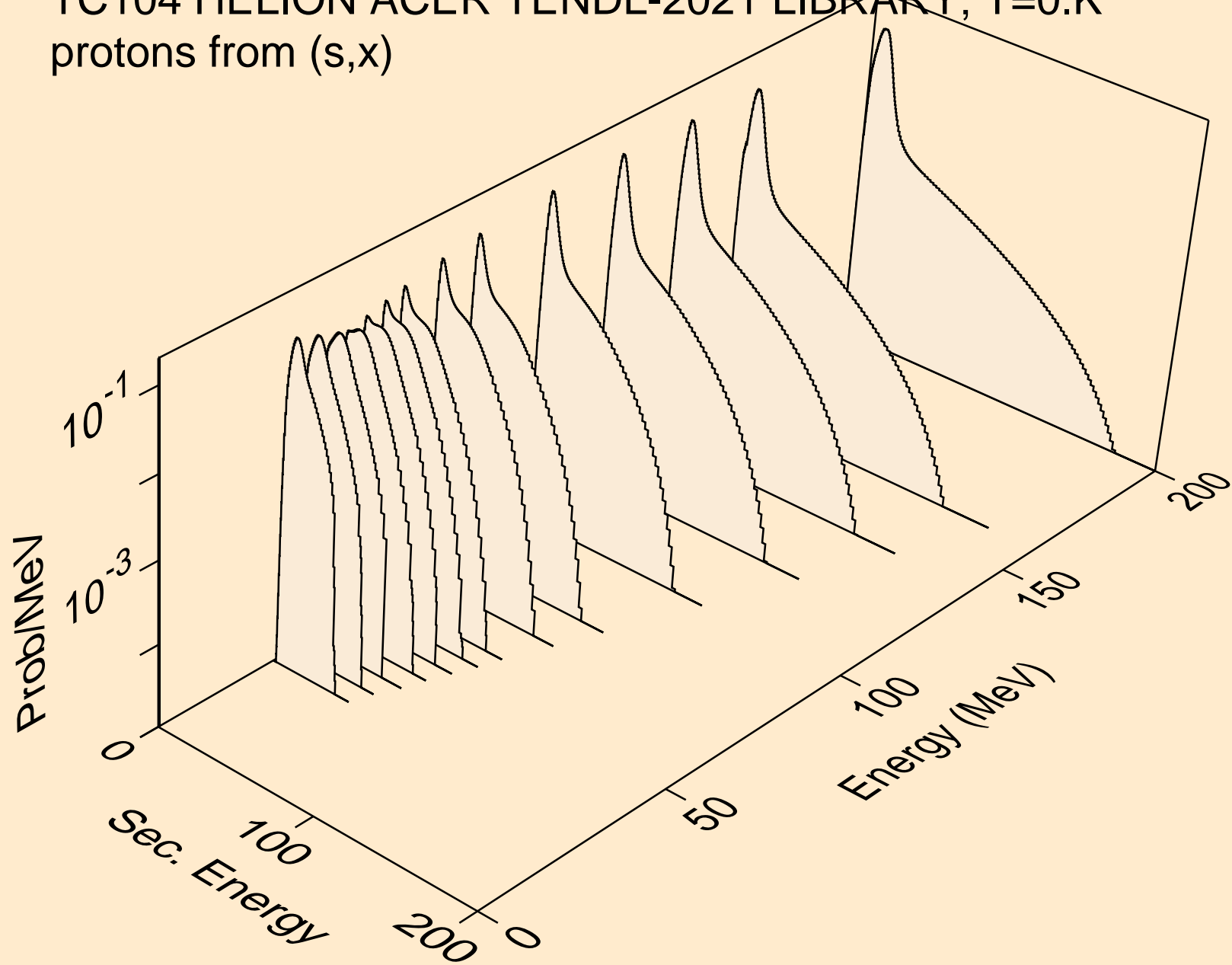

TC104 HELION ACER TENDL-2021 LIBRARY; T=0.K  
protons from (s,n\*)p

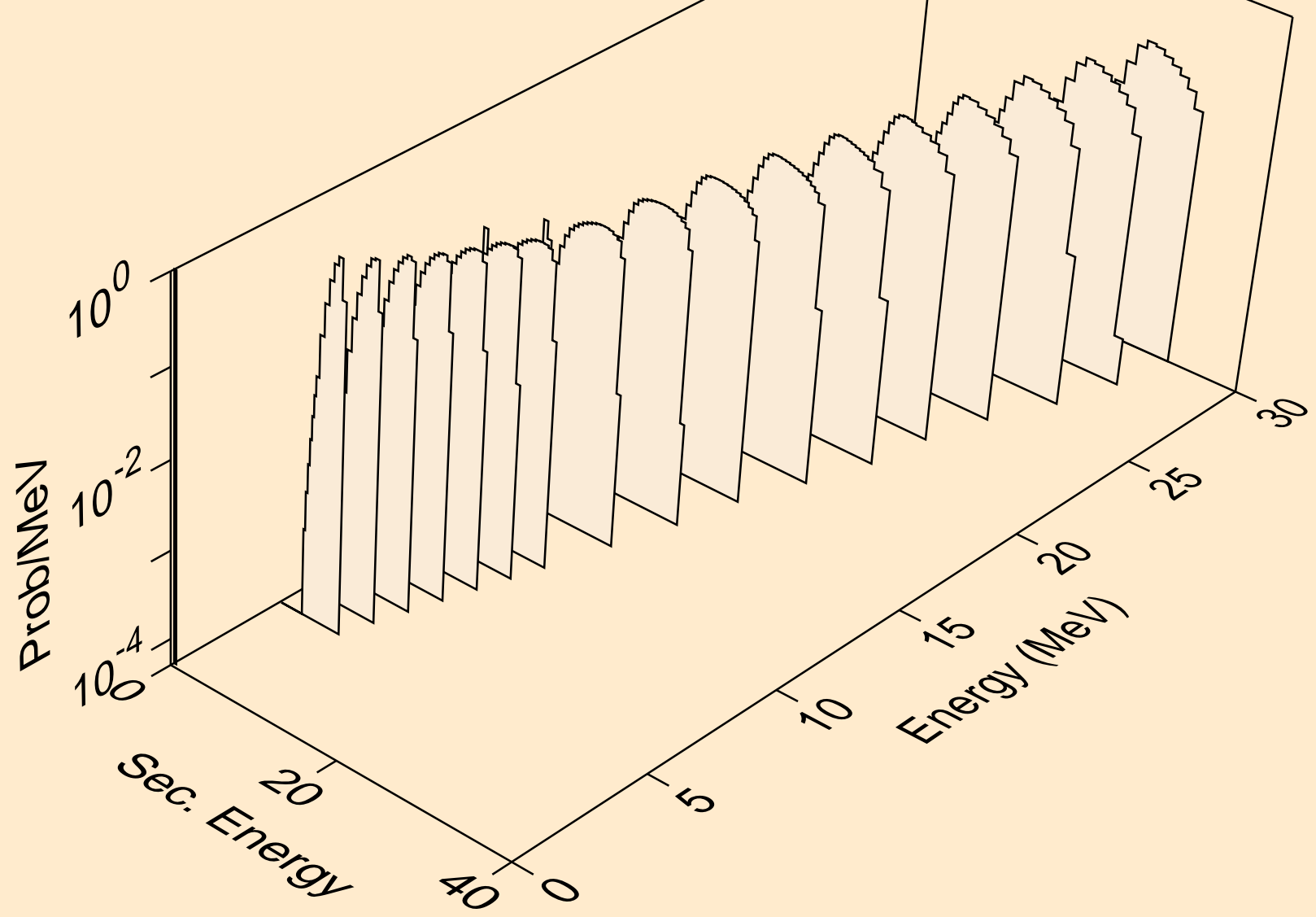



TC104 HELION ACER TENDL-2021 LIBRARY; T=0.K  
protons from (s,2np)

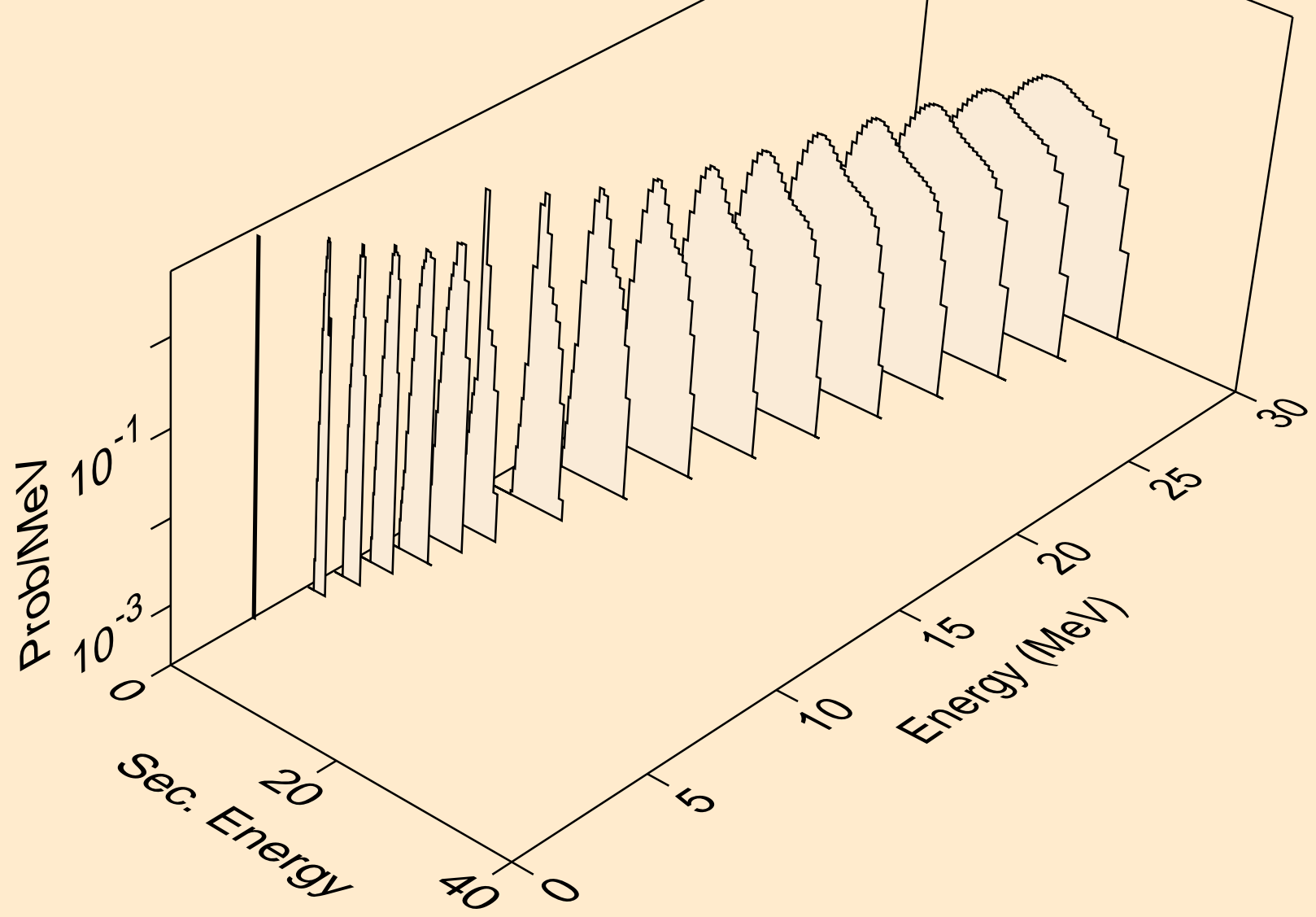

TC104 HELION ACER TENDL-2021 LIBRARY; T=0.K  
protons from (s,3np)

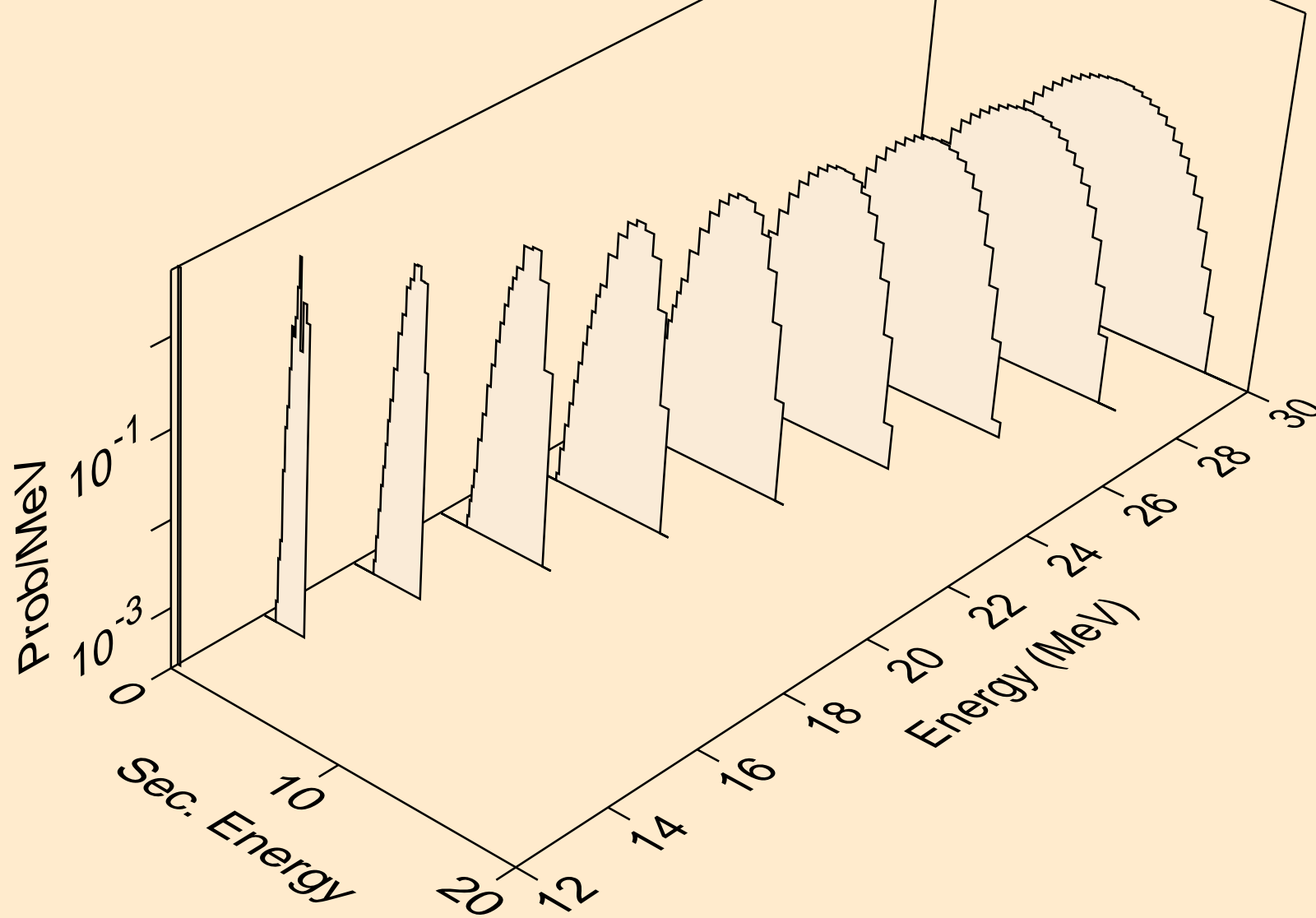

TC104 HELION ACER TENDL-2021 LIBRARY; T=0.K  
protons from (s,2np)

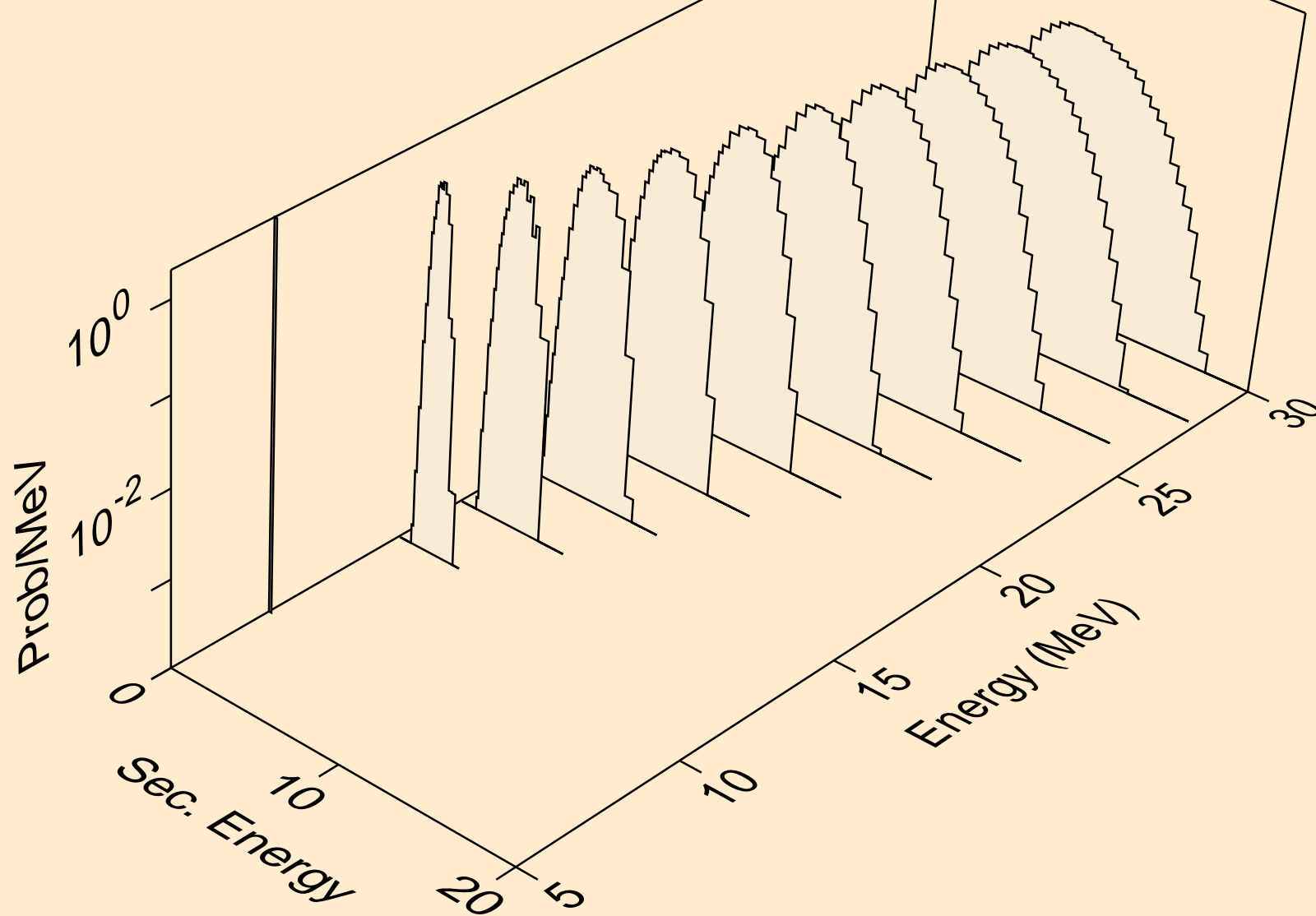

TC104 HELION ACER TENDL-2021 LIBRARY; T=0.K  
protons from (s,npa)

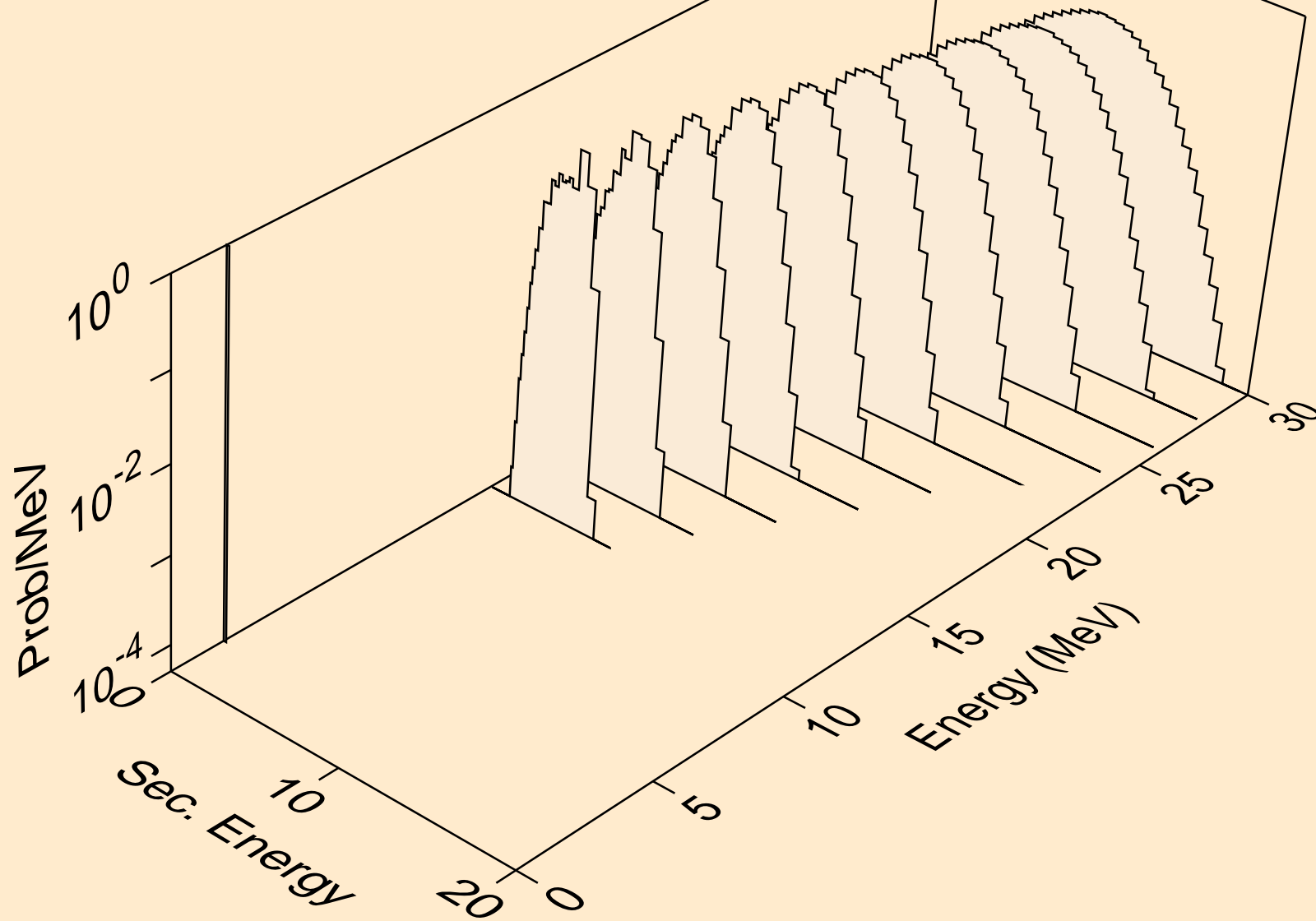

TC104 HELION ACER TENDL-2021 LIBRARY; T=0.K  
protons from (s,p)

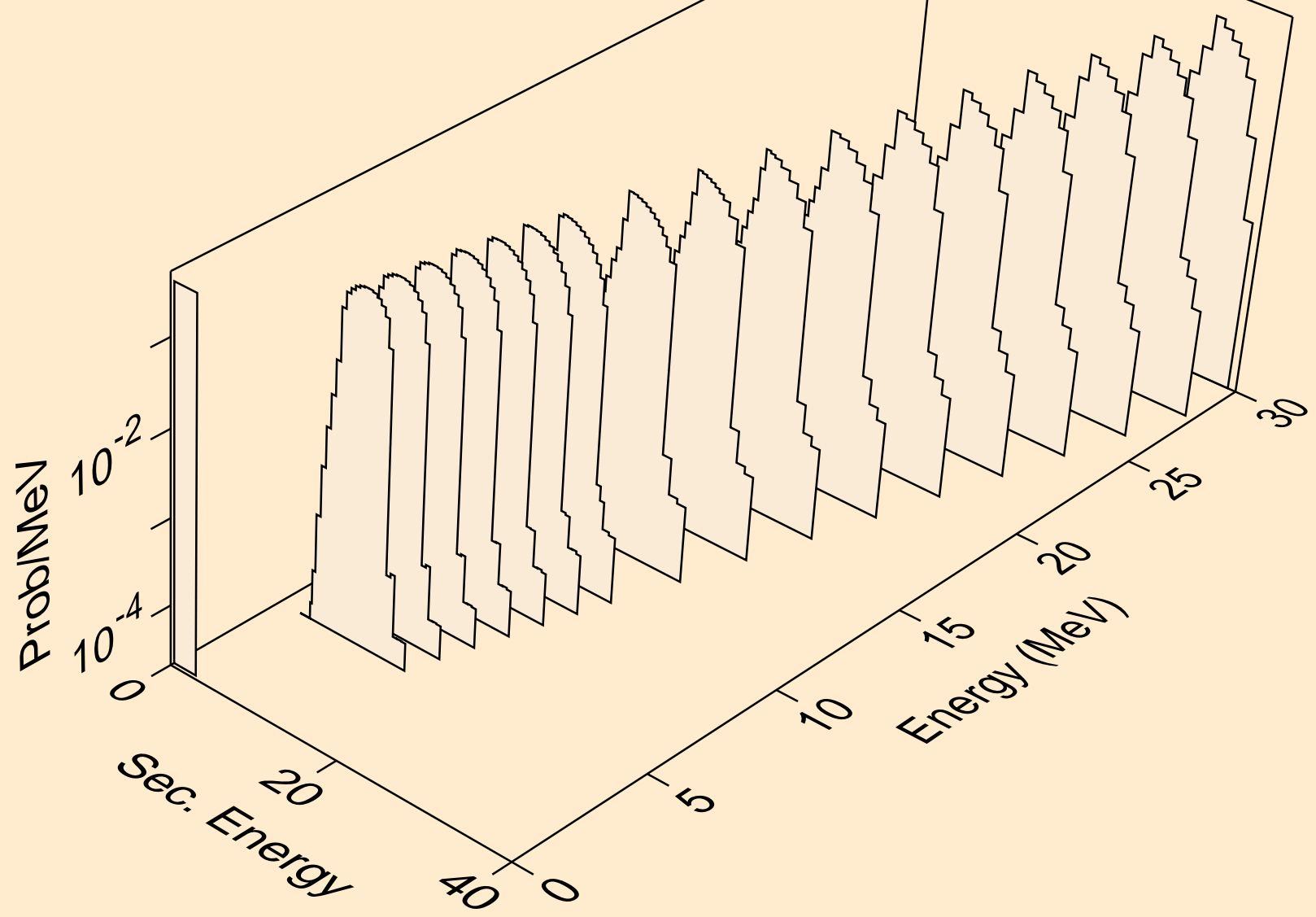

TC104 HELION ACER TENDL-2021 LIBRARY; T=0.K  
protons from (s,2p)

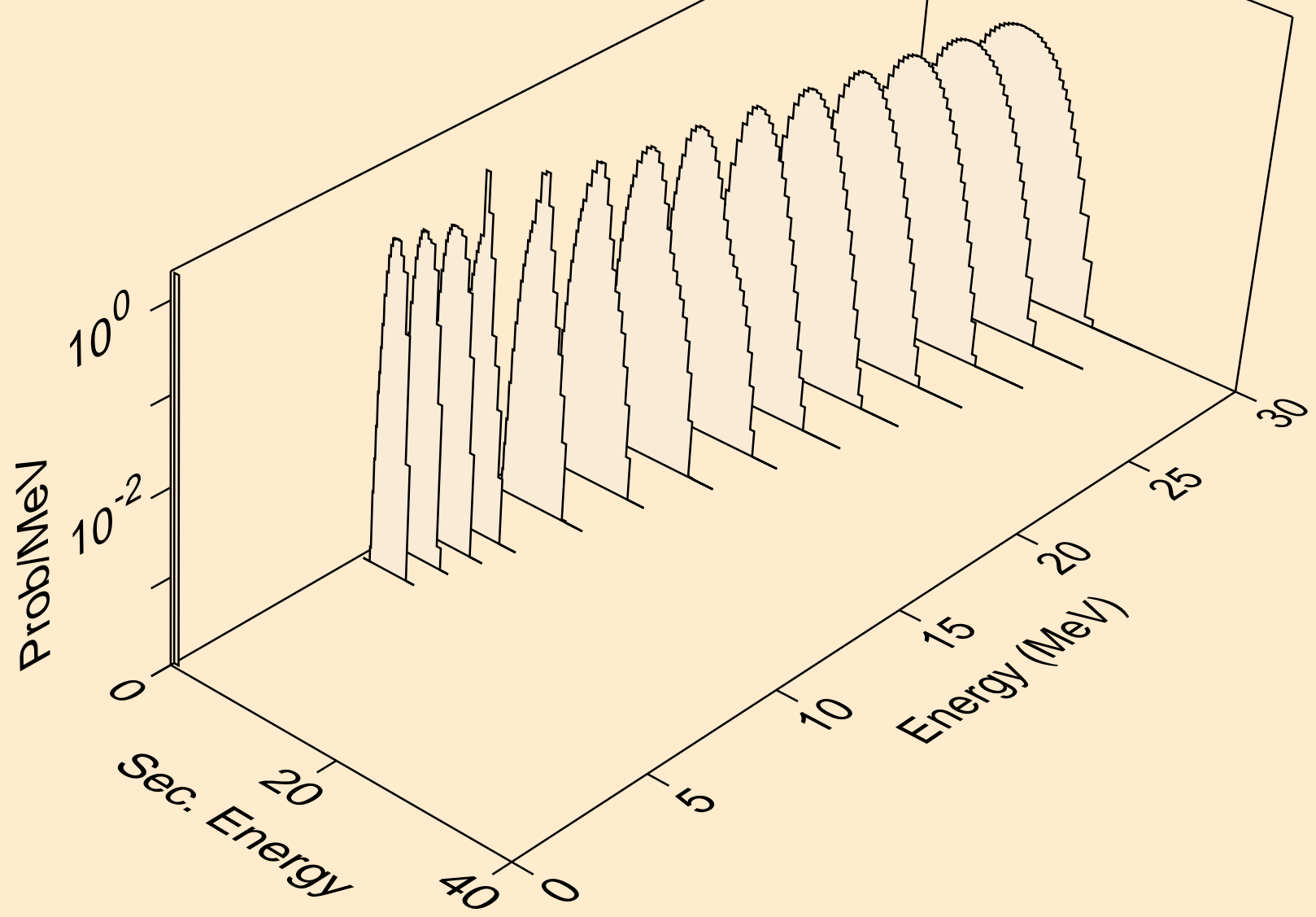

TC104 HELION ACER TENDL-2021 LIBRARY; T=0.K  
protons from (s,pa)

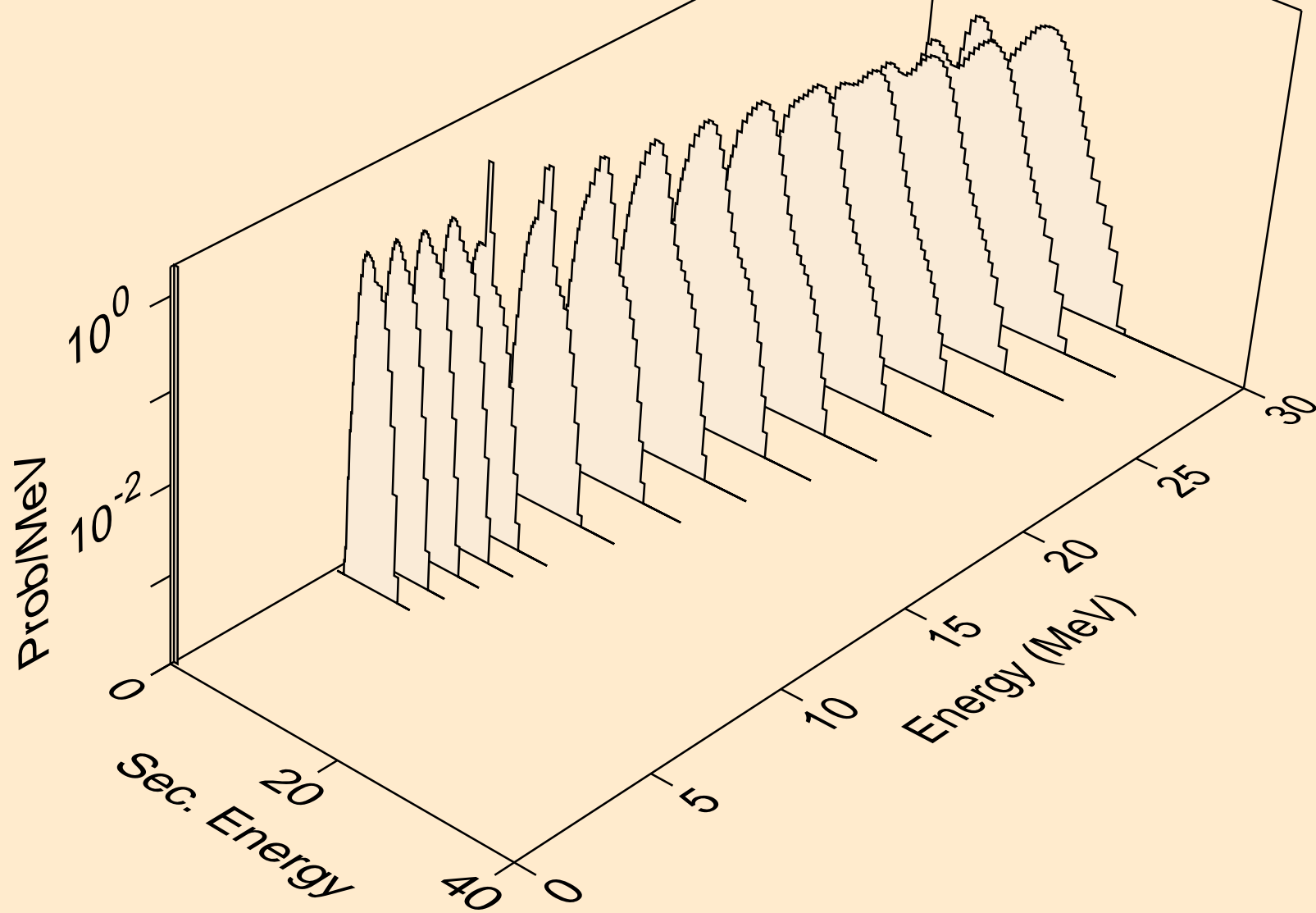

TC104 HELION ACER TENDL-2021 LIBRARY; T=0.K  
protons from (s,pd)

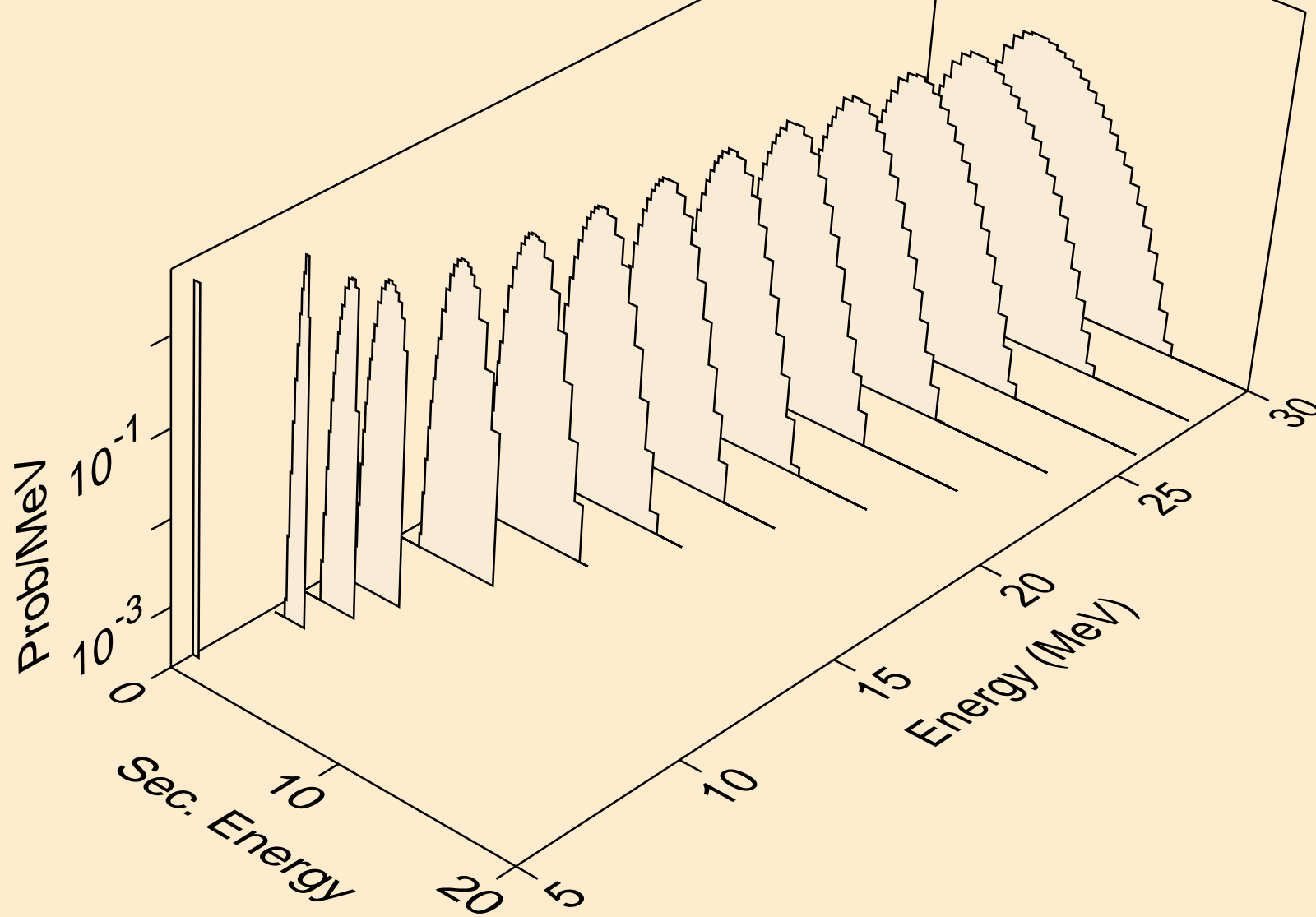



TC104 HELION ACER TENDL-2021 LIBRARY; T=0.K  
protons from (s,pt)

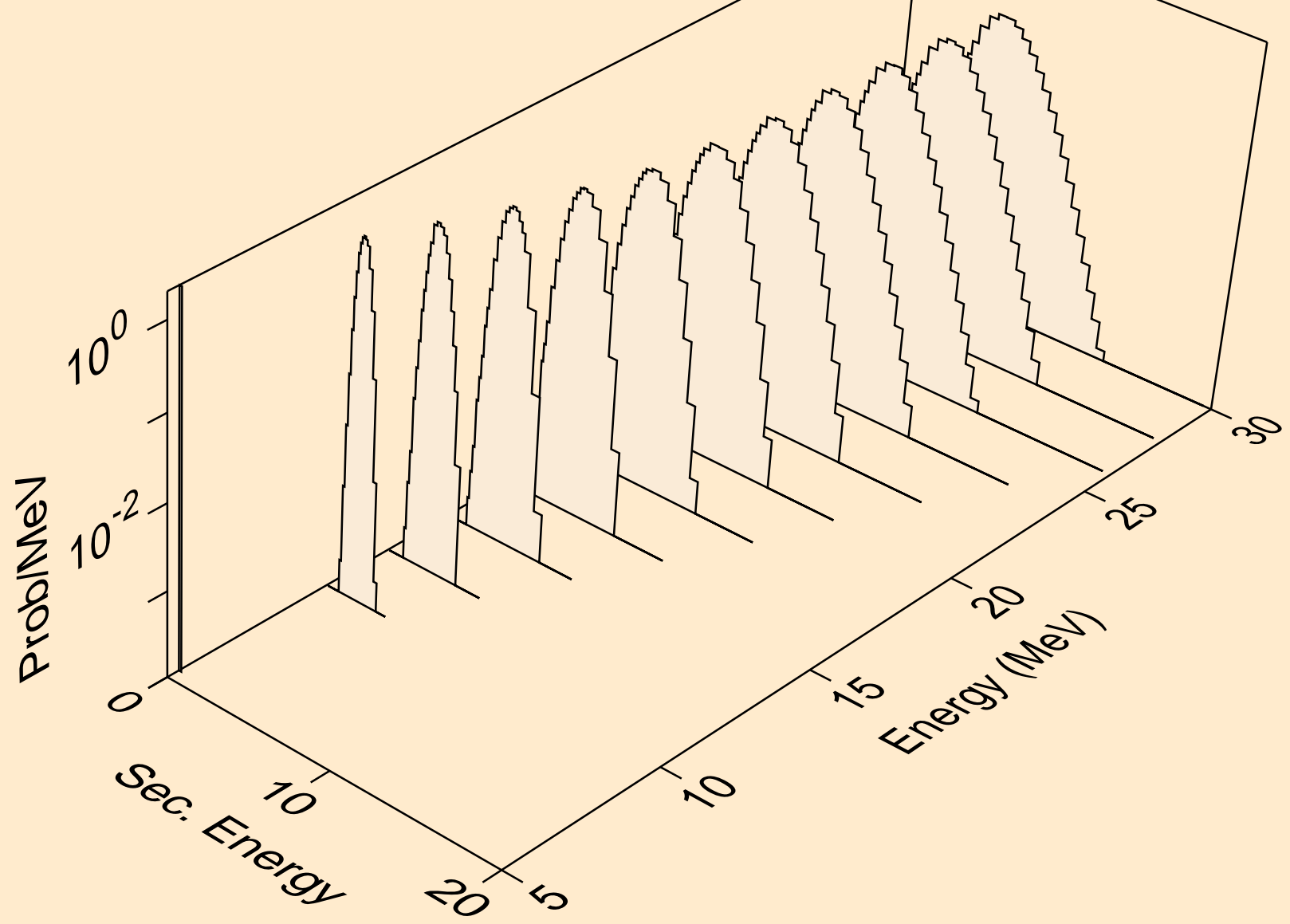

TC104 HELION ACER TENDL-2021 LIBRARY; T=0.K  
deuterons from (s,x)

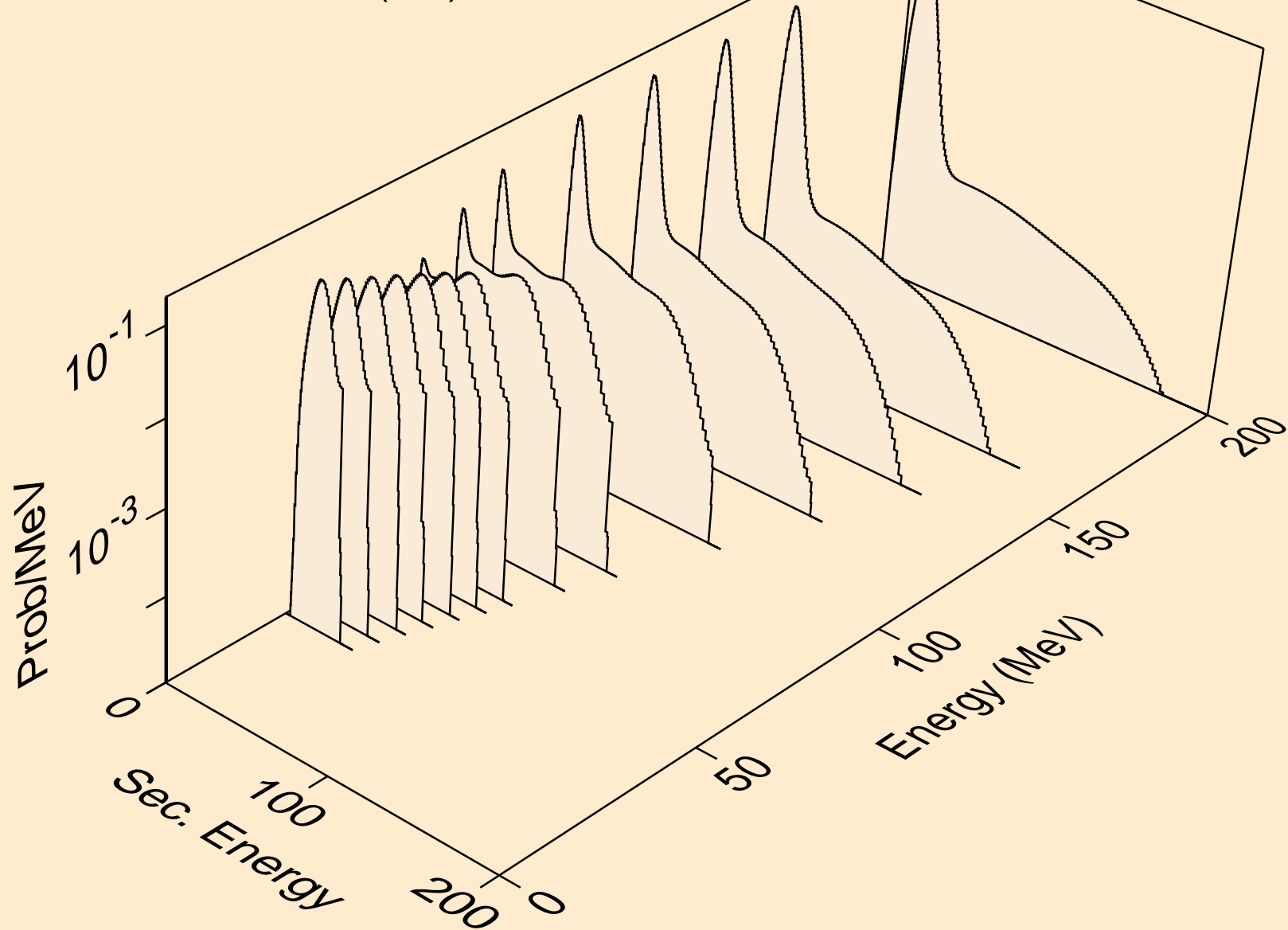

TC104 HELION ACER TENDL-2021 LIBRARY; T=0.K  
deuterons from (s,2nd)

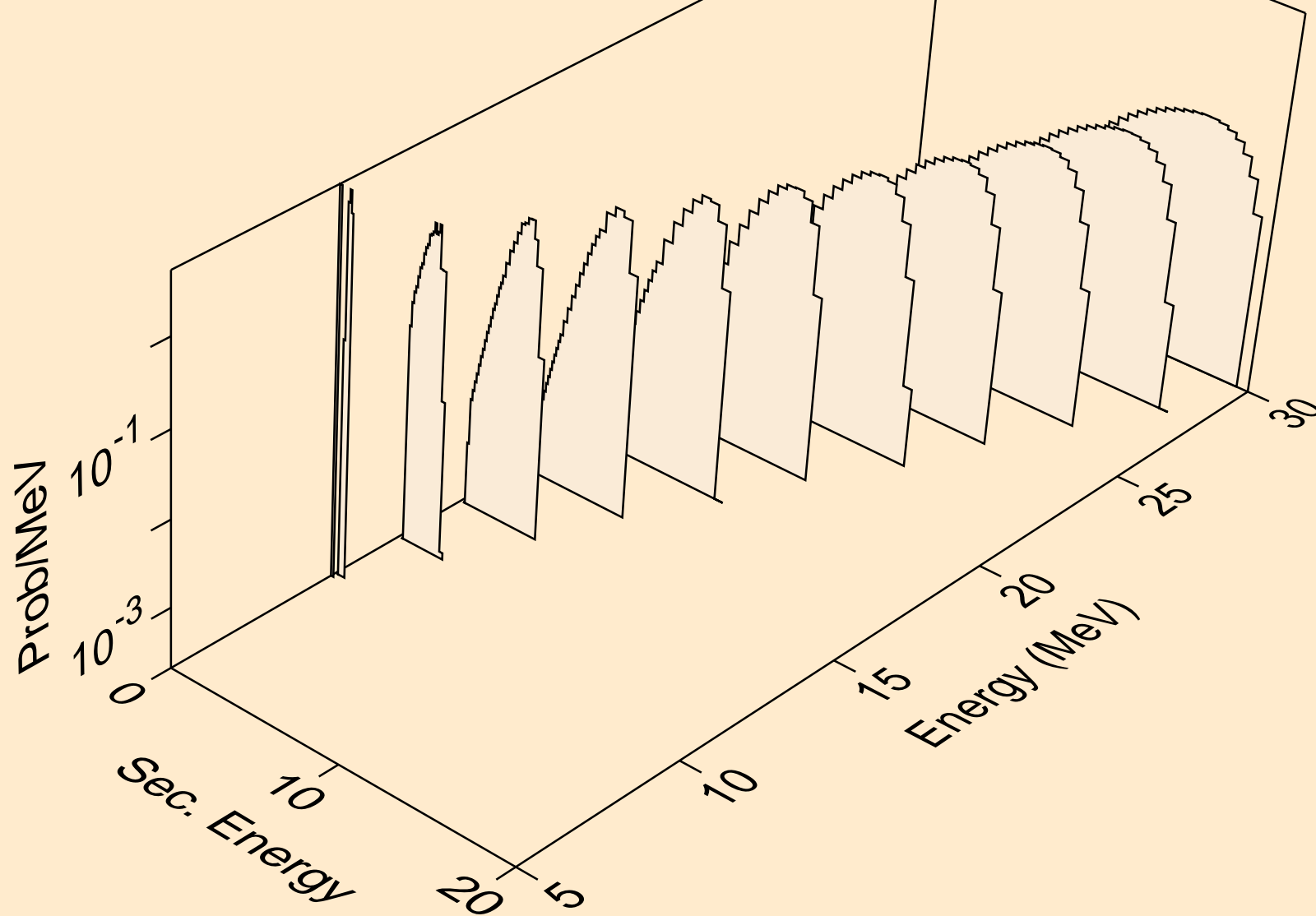

TC104 HELION ACER TENDL-2021 LIBRARY; T=0.K  
deuterons from (s,n\*)d

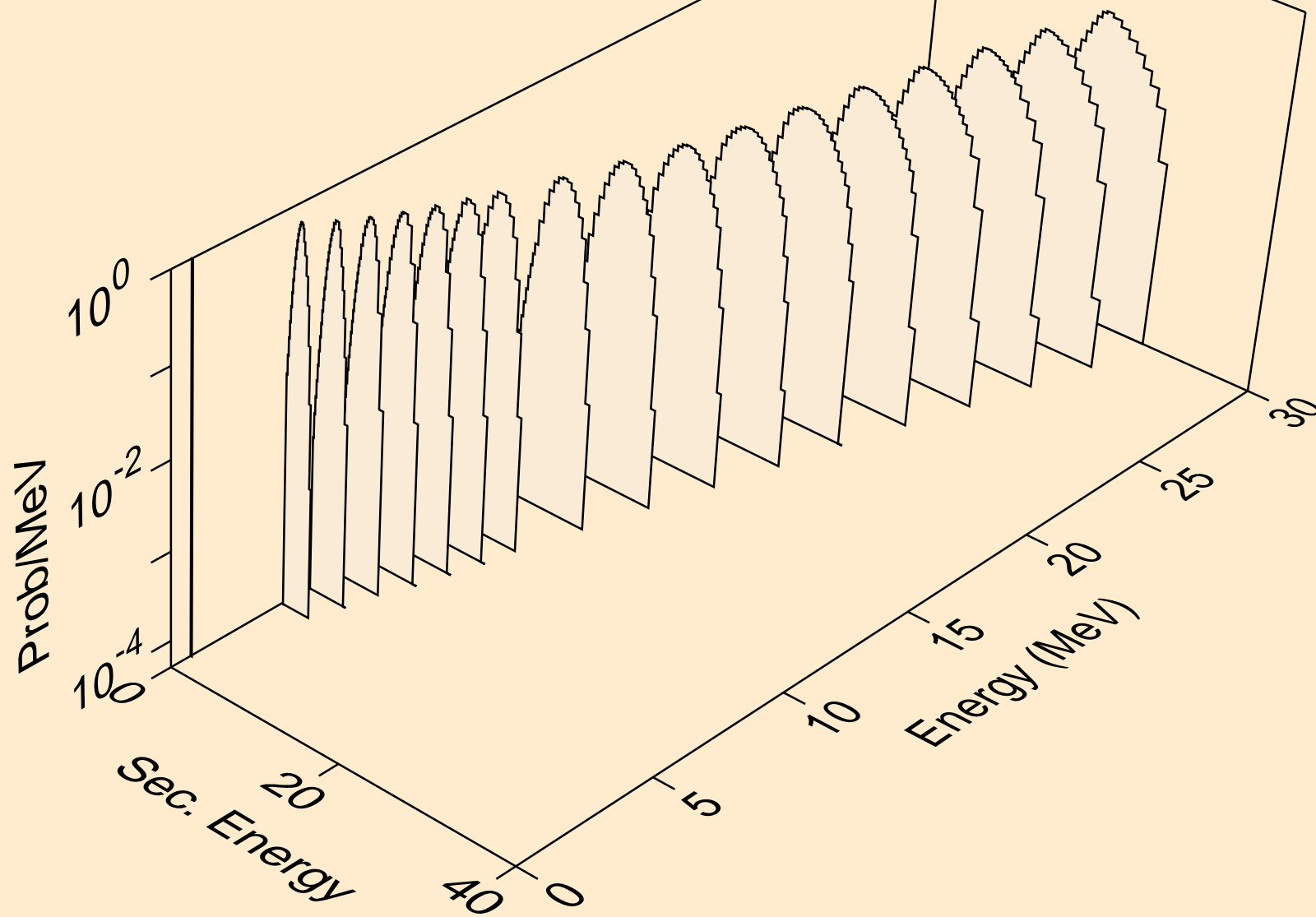

TC104 HELION ACER TENDL-2021 LIBRARY; T=0.K  
deuterons from (s,d)

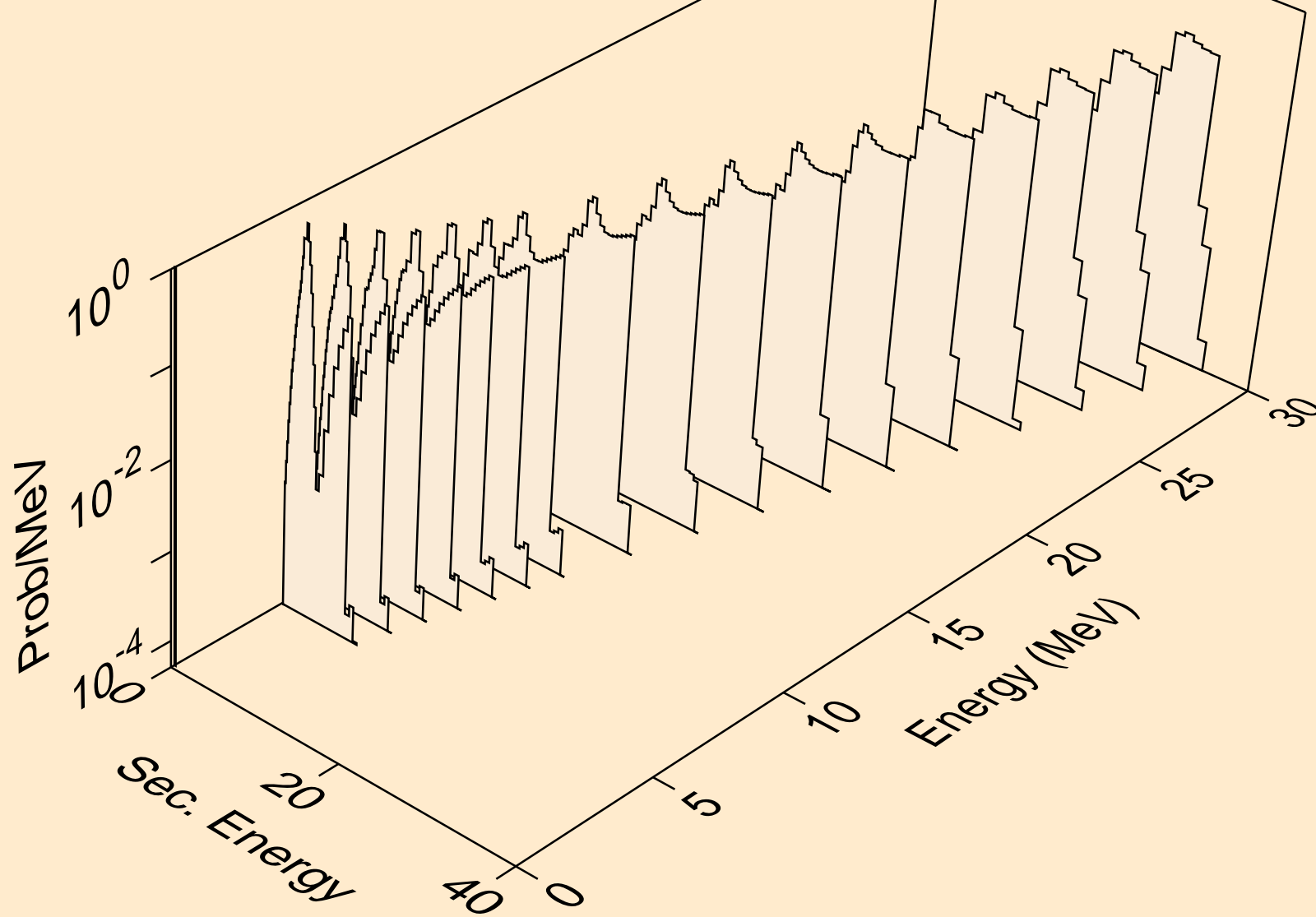

TC104 HELION ACER TENDL-2021 LIBRARY; T=0.K  
deuterons from (s,pd)

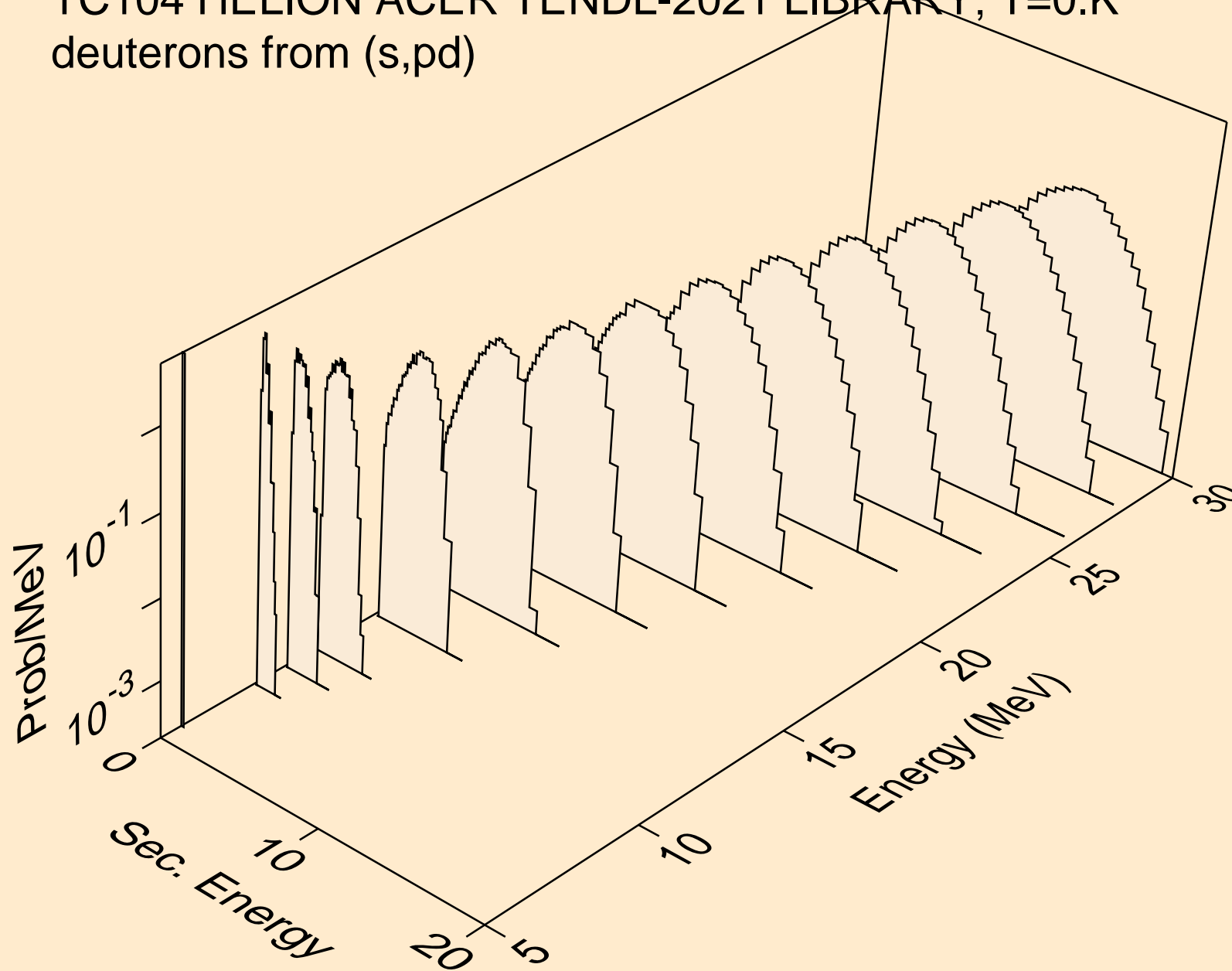

TC104 HELION ACER TENDL-2021 LIBRARY; T=0.K  
deuterons from (s,da)

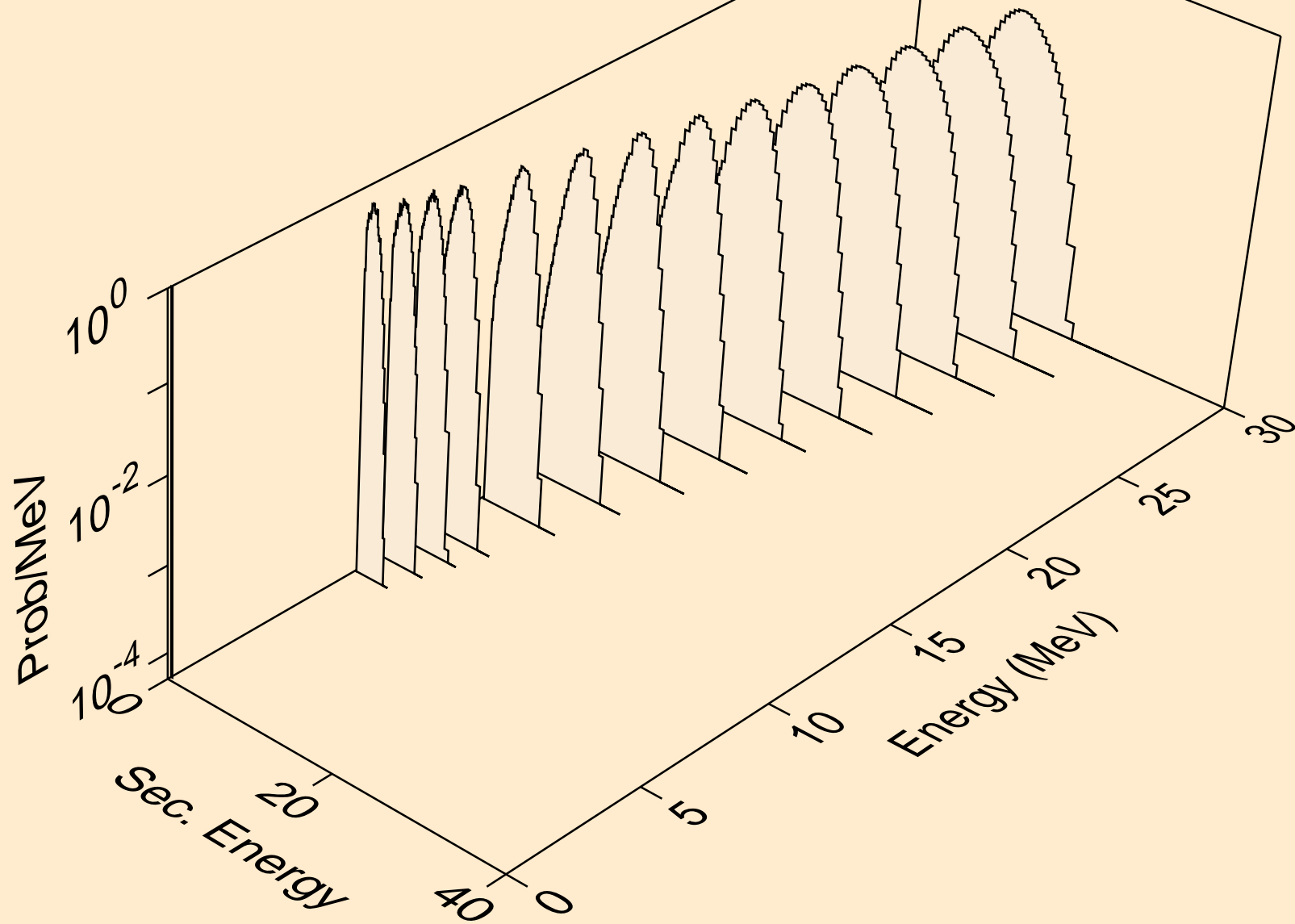

TC104 HELION ACER TENDL-2021 LIBRARY; T=0.K  
tritons from (s,x)

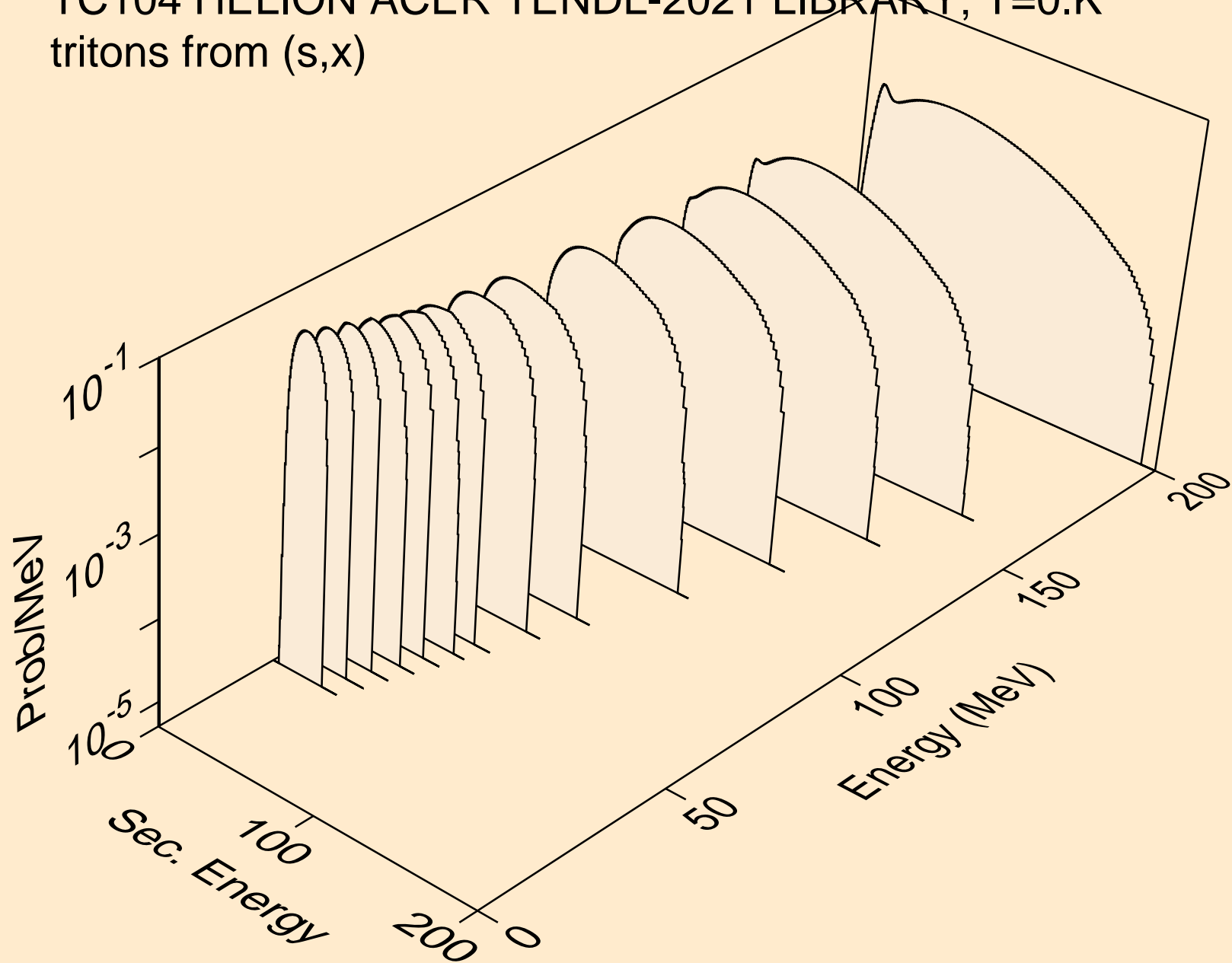



TC104 HELION ACER TENDL-2021 LIBRARY; T=0.K  
tritons from (s,n\*)t

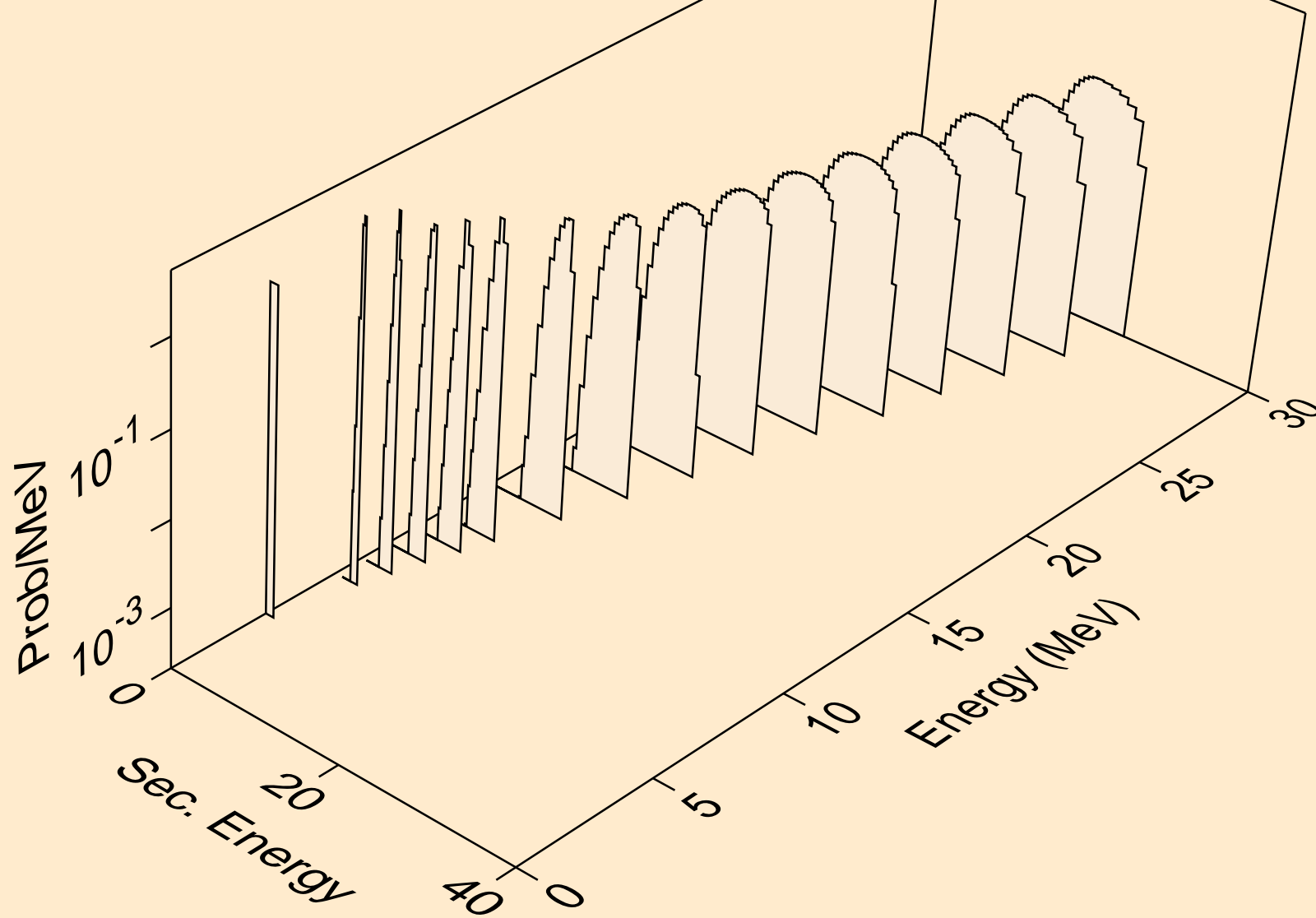

TC104 HELION ACER TENDL-2021 LIBRARY; T=0.K  
tritons from (s,t)

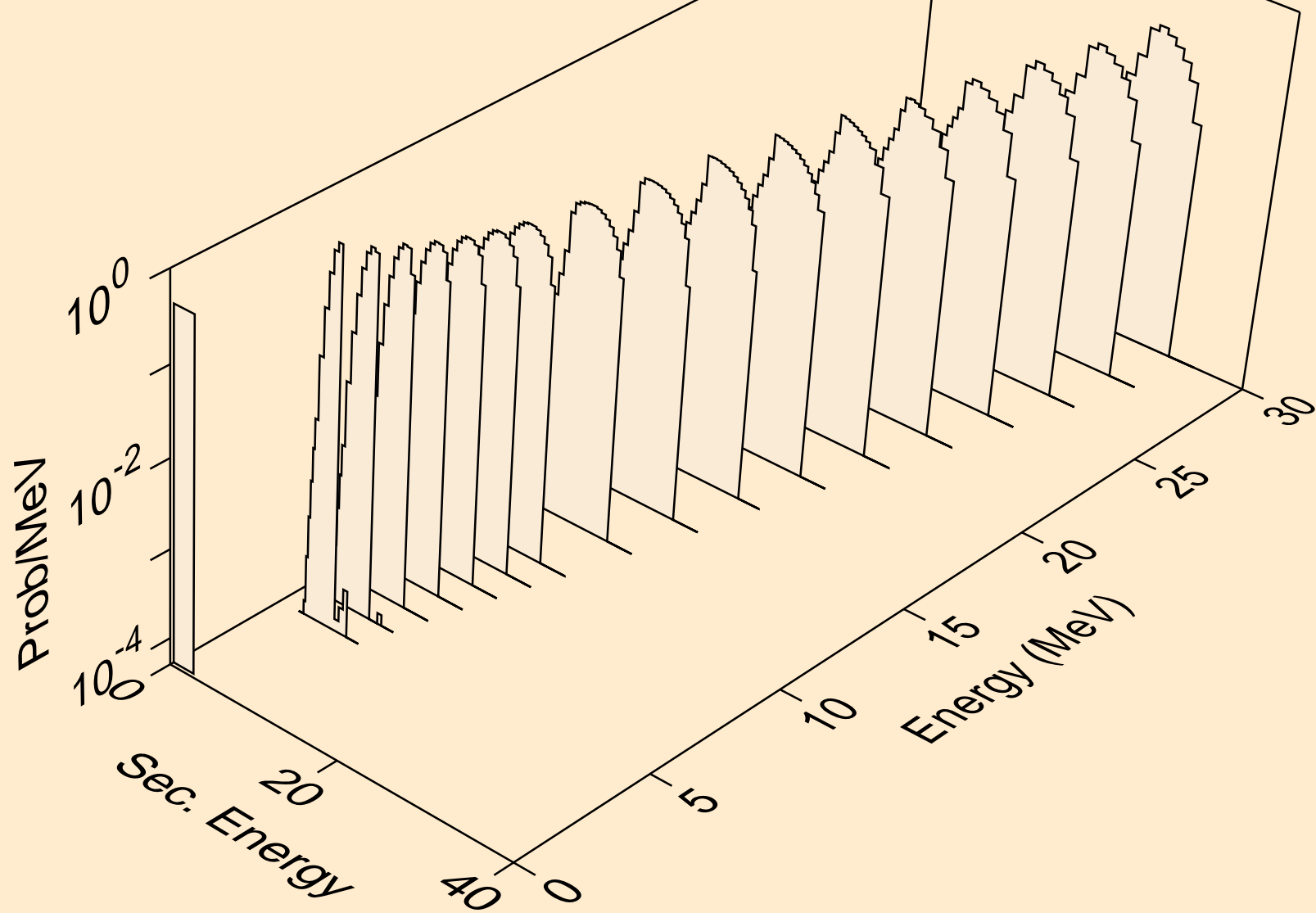

TC104 HELION ACER TENDL-2021 LIBRARY; T=0.K  
tritons from (s,pt)

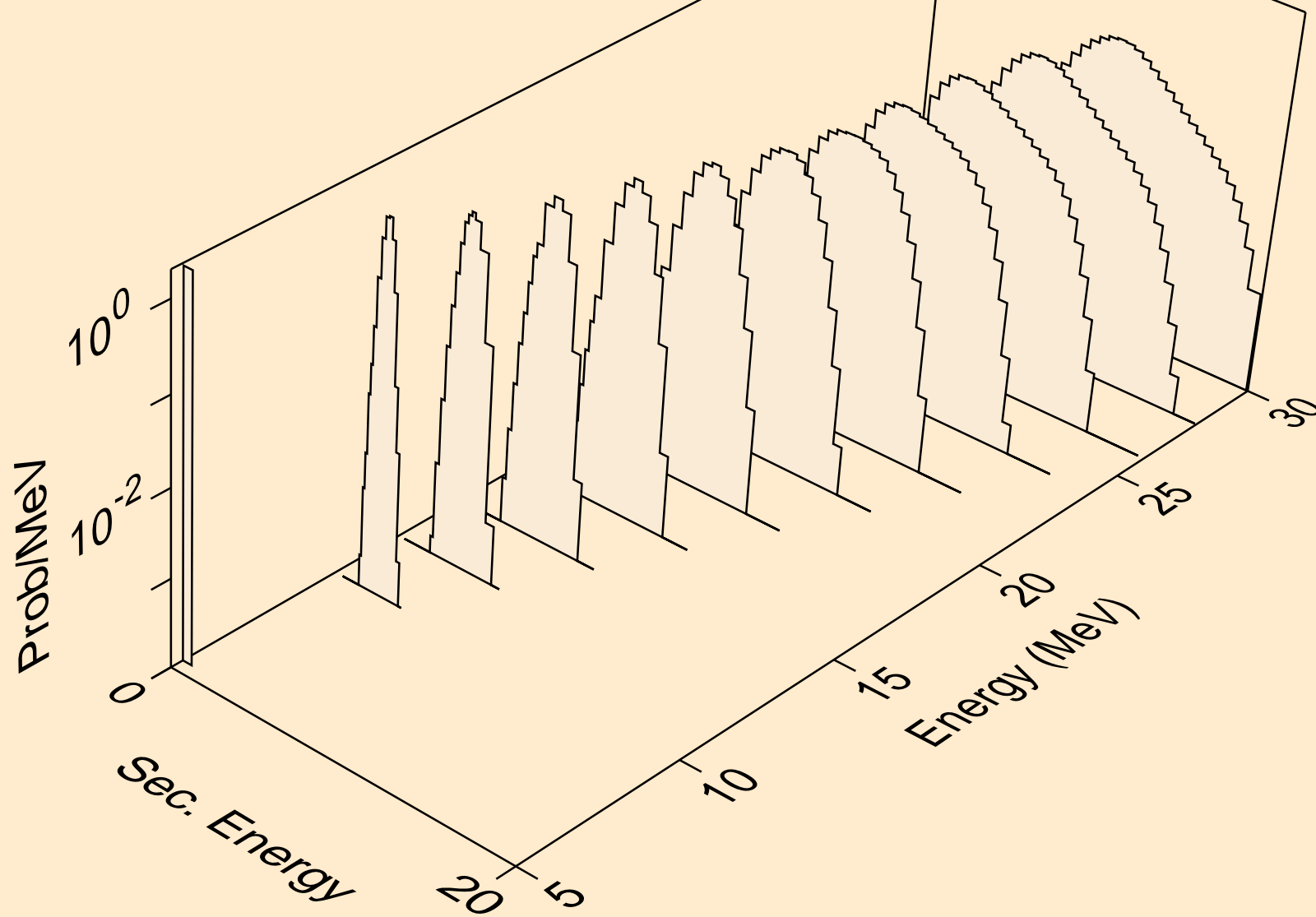

TC104 HELION ACER TENDL-2021 LIBRARY; T=0.K  
alphas from (s,x)

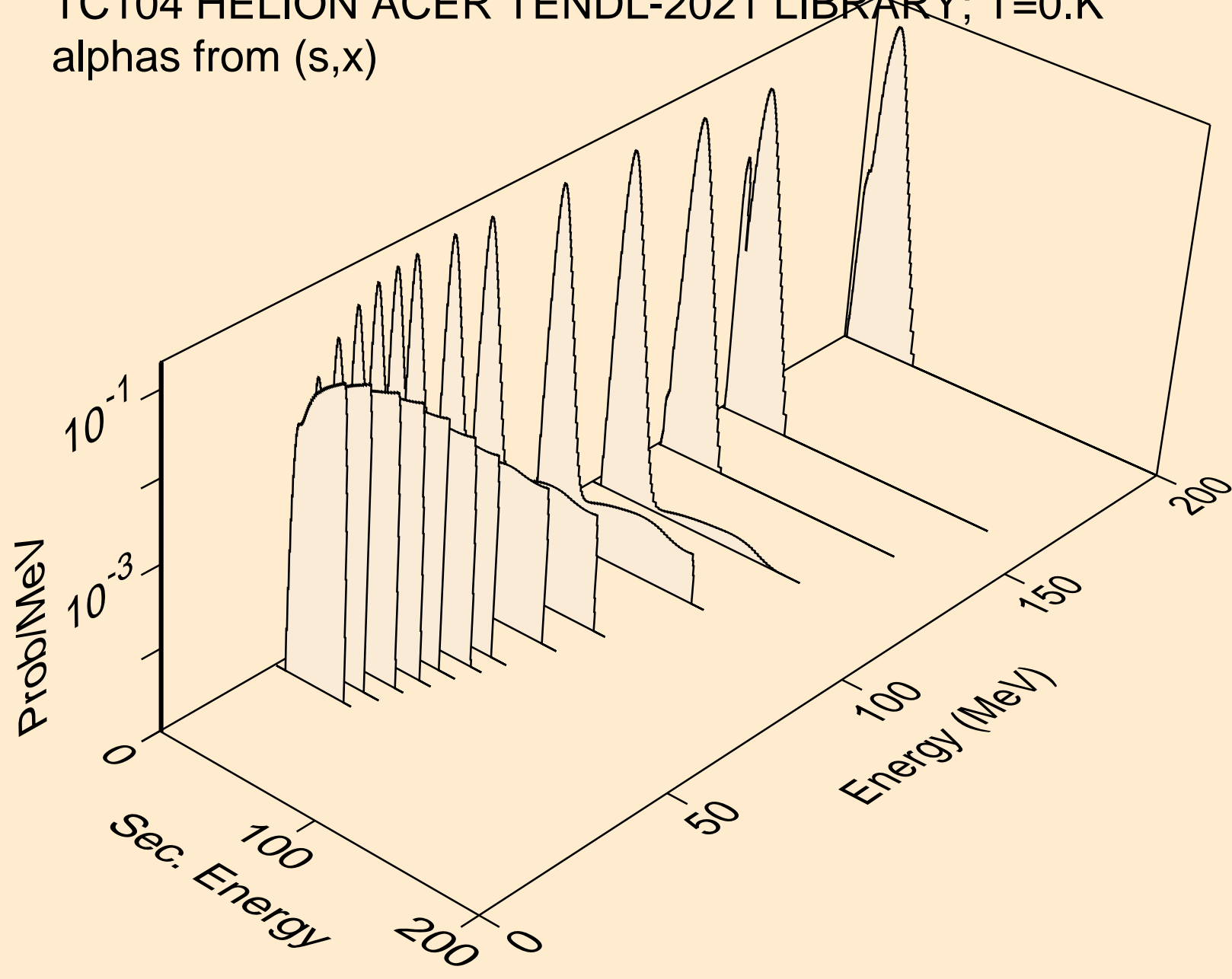

TC104 HELION ACER TENDL-2021 LIBRARY; T=0.K  
alphas from (s,n\*)a

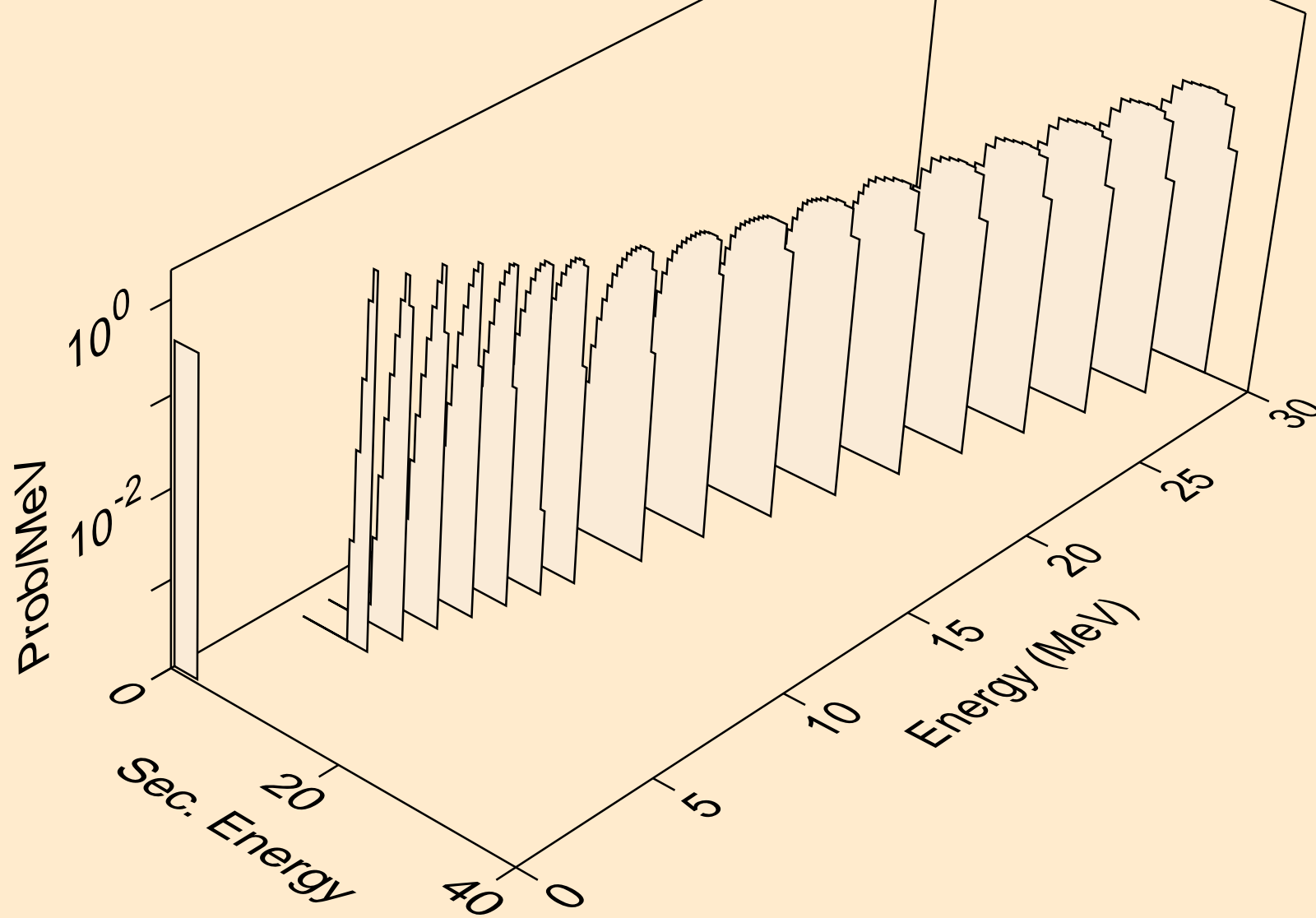

TC104 HELION ACER TENDL-2021 LIBRARY; T=0.K  
alphas from (s,2n)a

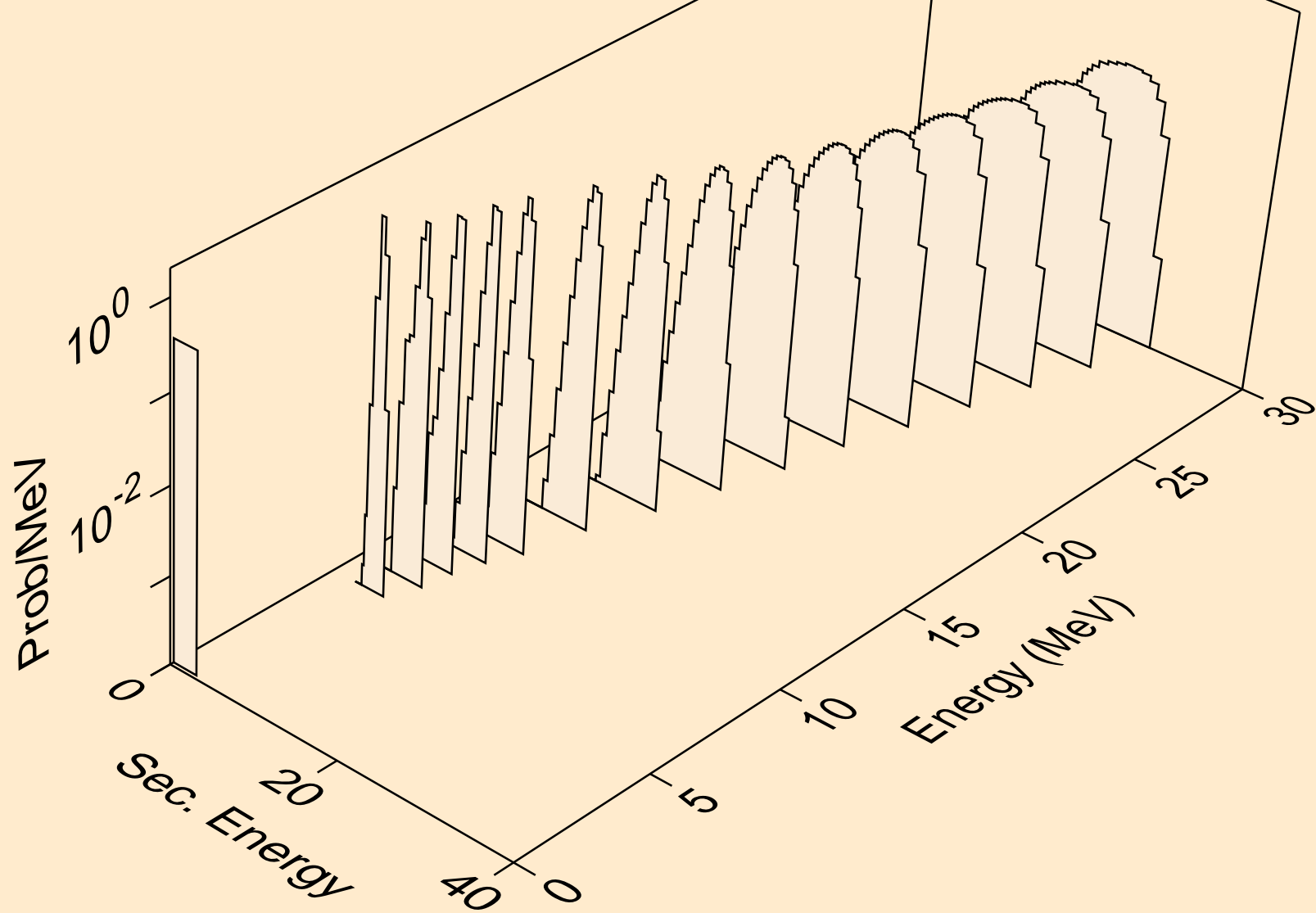

TC104 HELION ACER TENDL-2021 LIBRARY; T=0.K  
alphas from (s,3n)a

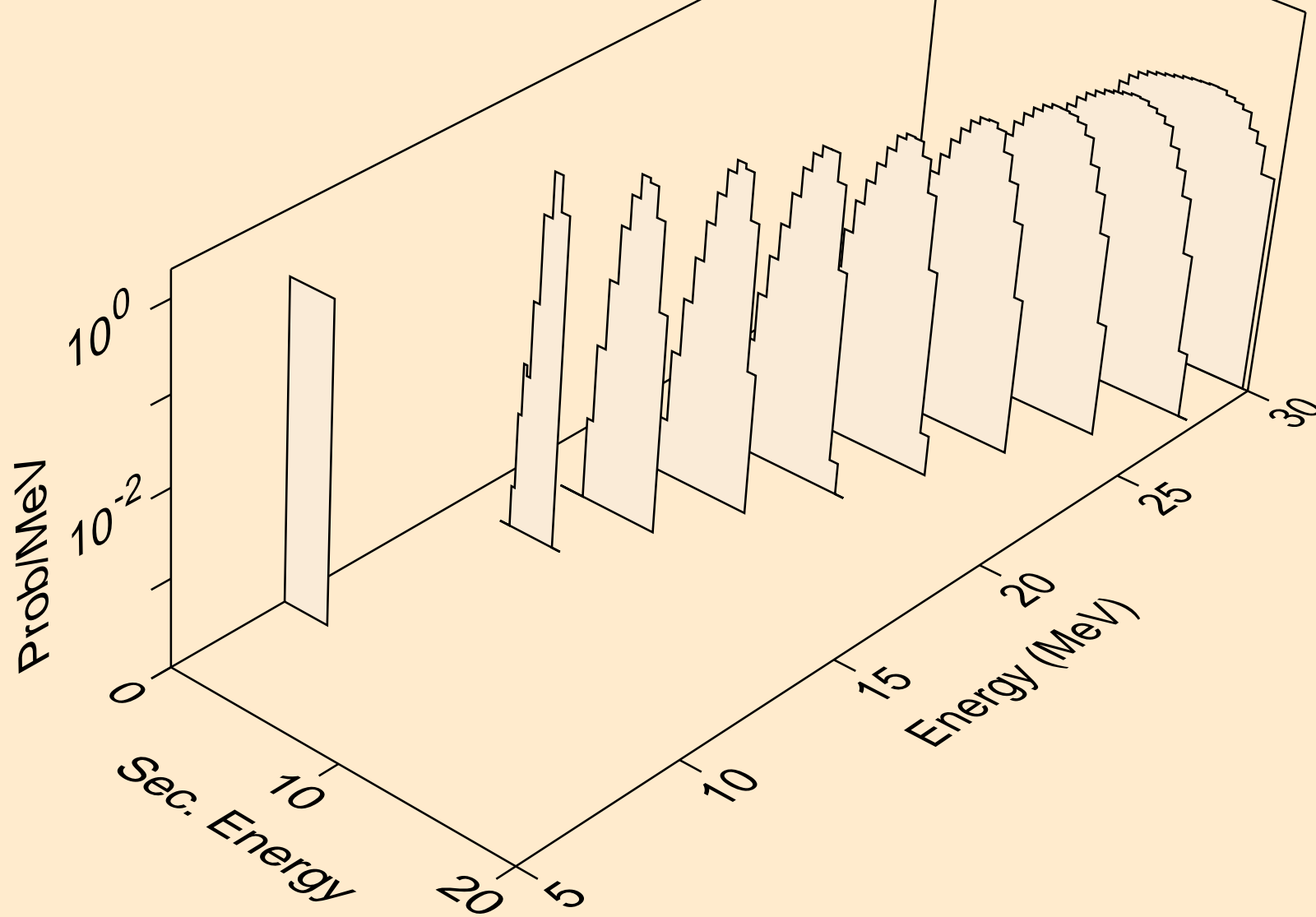

TC104 HELION ACER TENDL-2021 LIBRARY; T=0.K  
alphas from (s,n\*)2a

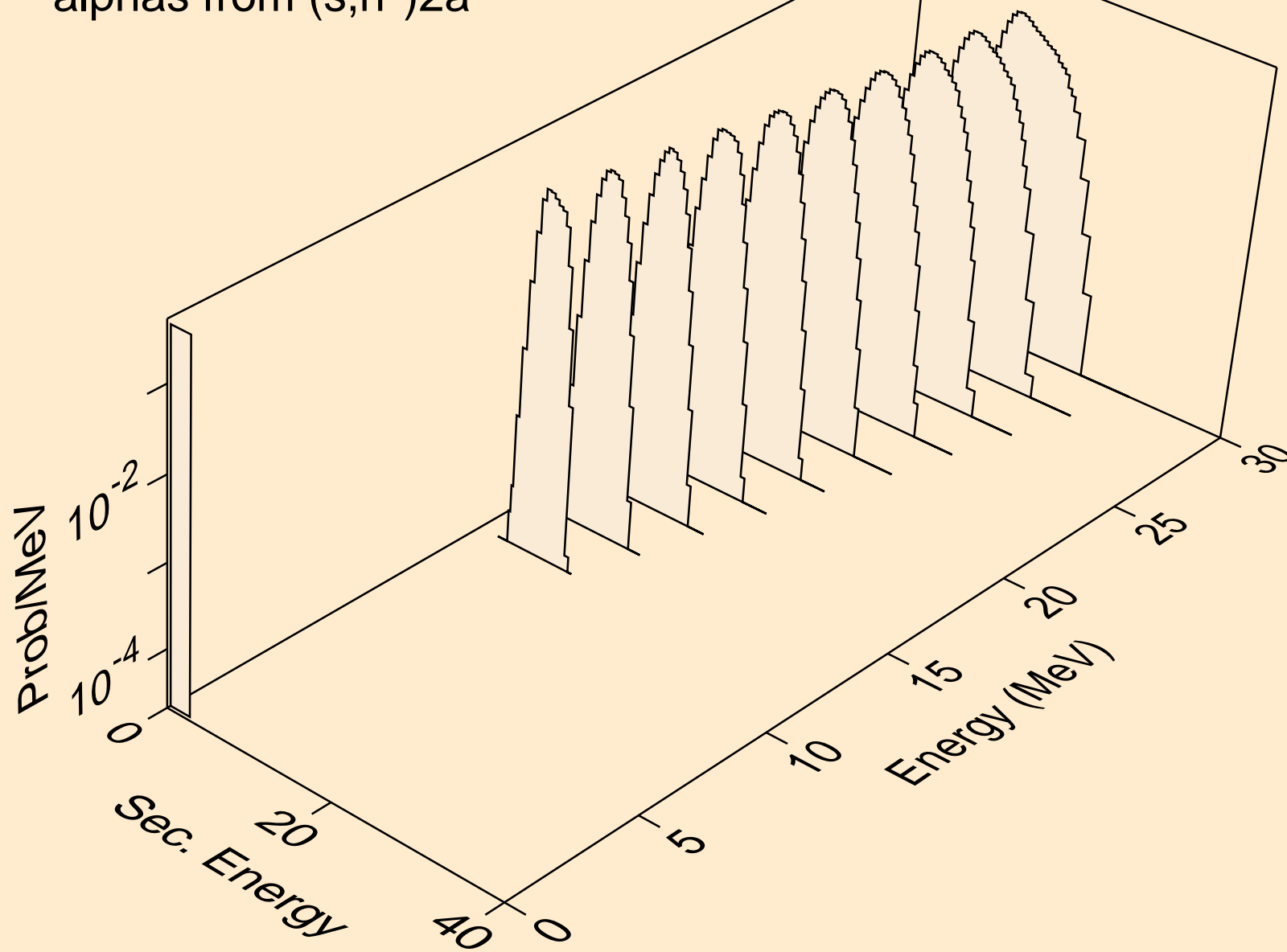



TC104 HELION ACER TENDL-2021 LIBRARY; T=0.K  
alphas from (s,2n)2a

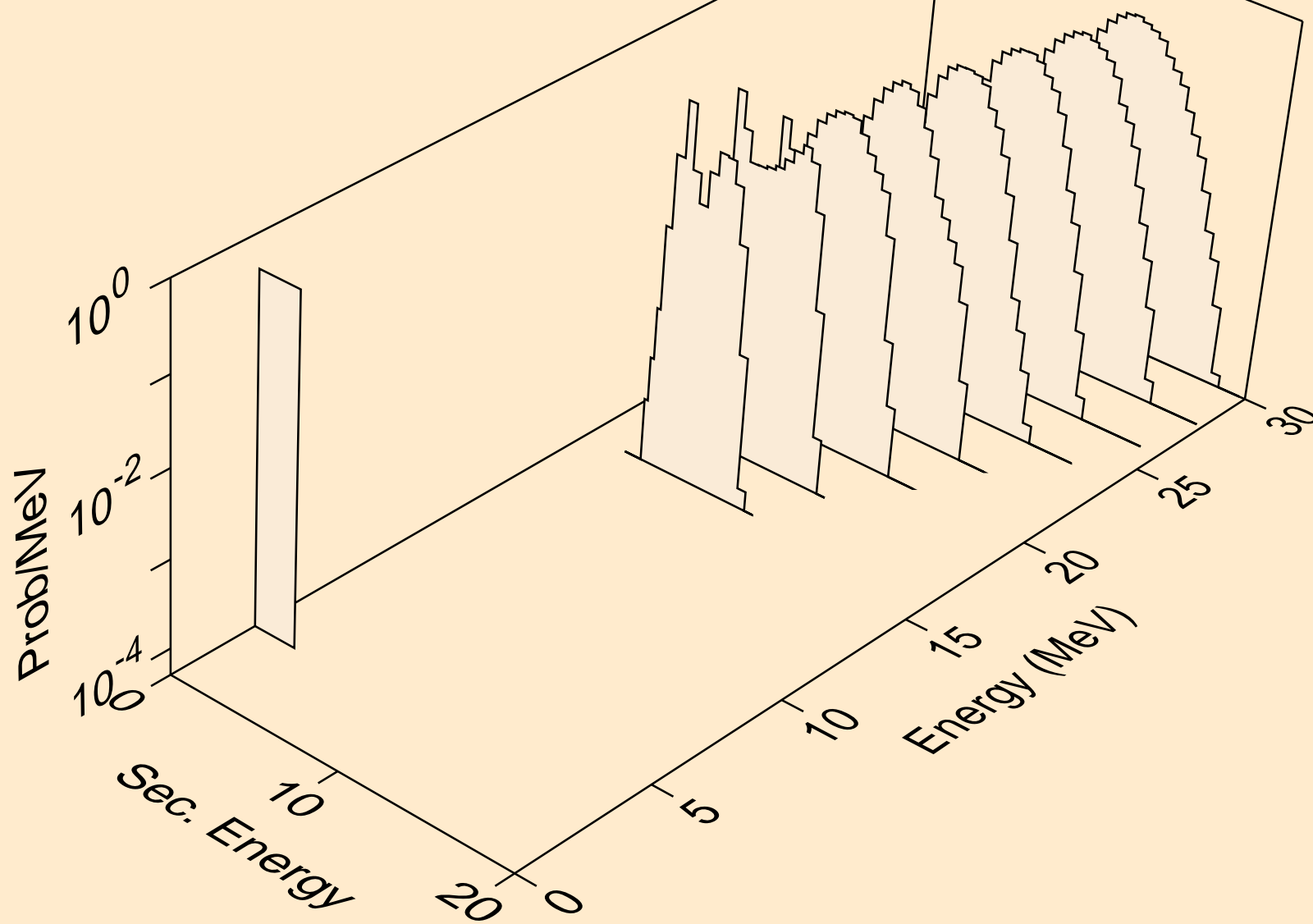

TC104 HELION ACER TENDL-2021 LIBRARY; T=0.K  
alphas from (s,npa)

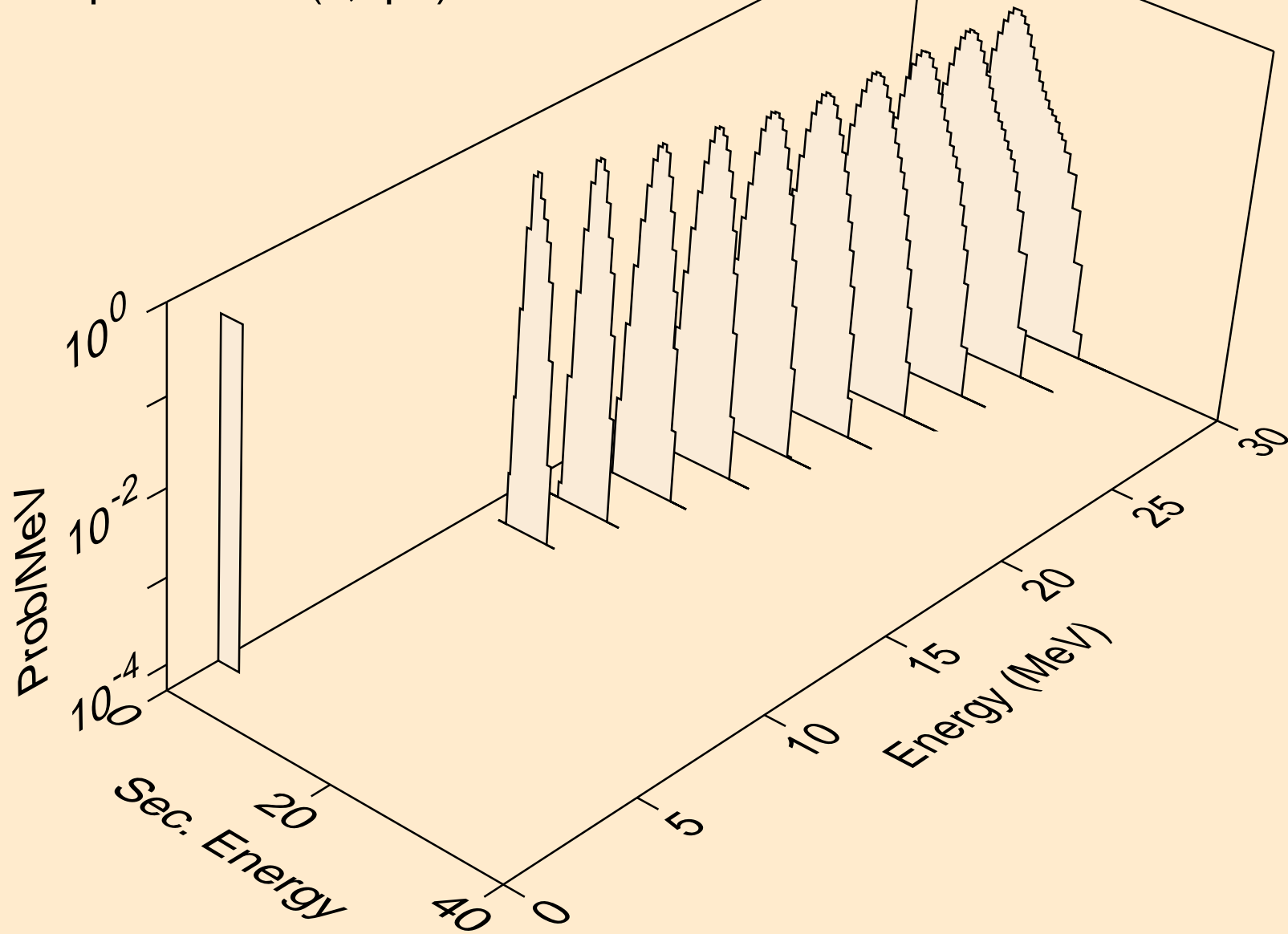

TC104 HELION ACER TENDL-2021 LIBRARY; T=0.K  
alphas from (s,a)

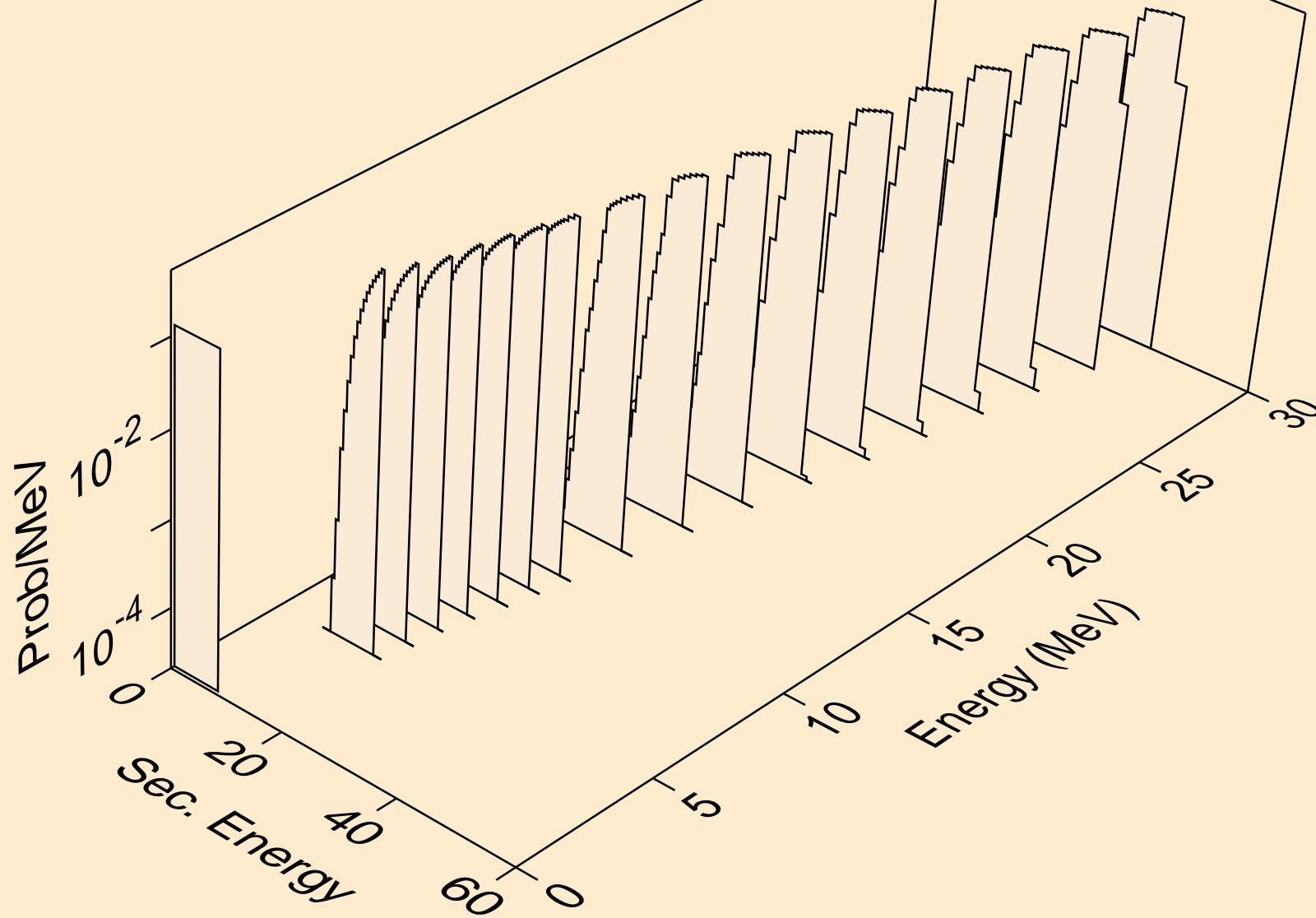

TC104 HELION ACER TENDL-2021 LIBRARY; T=0.K  
alphas from (s,2a)

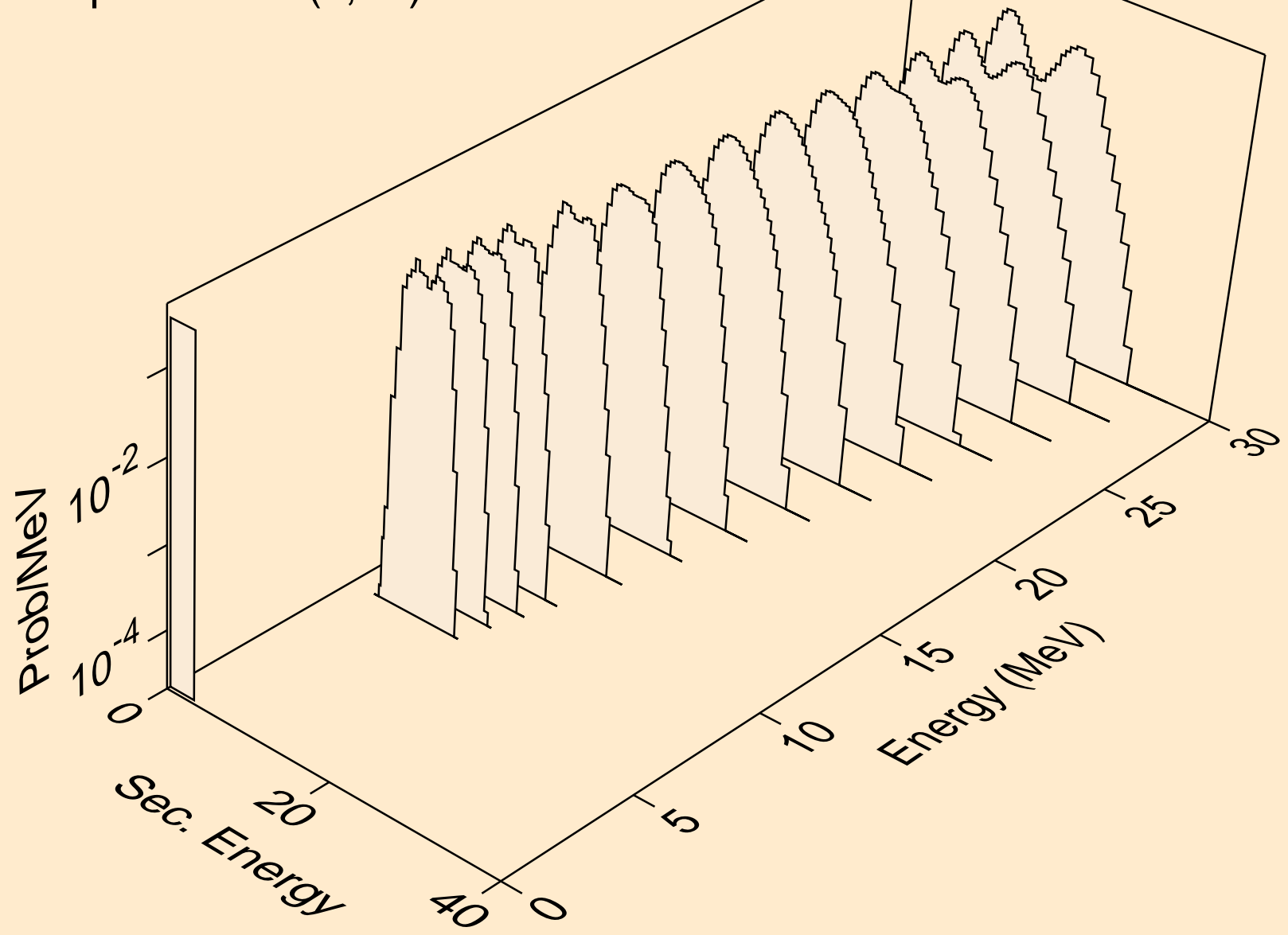

TC104 HELION ACER TENDL-2021 LIBRARY; T=0.K  
alphas from (s,pa)

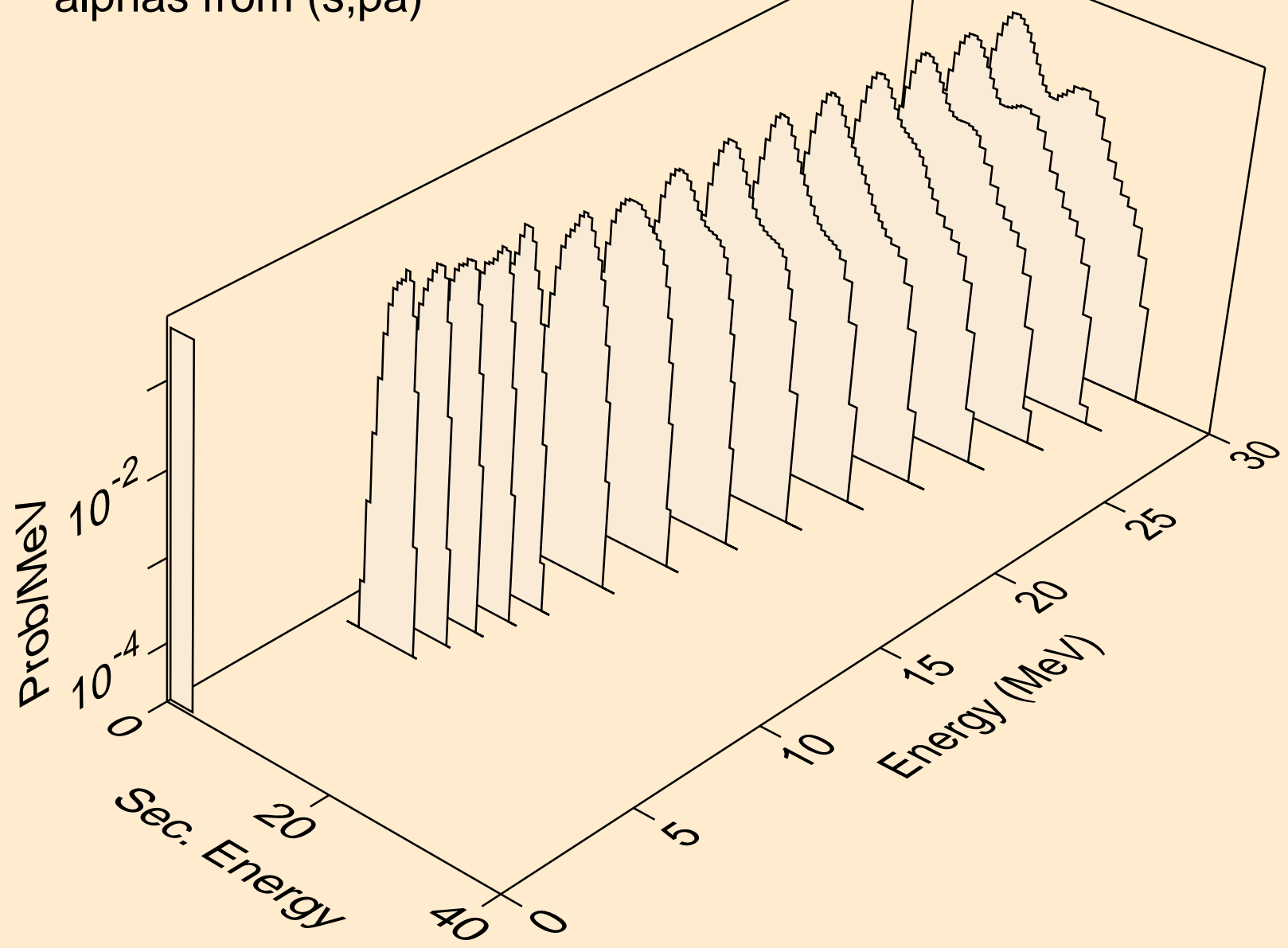

TC104 HELION ACER TENDL-2021 LIBRARY; T=0.K  
alphas from (s,da)

