

TL196 HELION ACER TENDL-2021 LIBRARY; T=0.K  
Principal cross sections

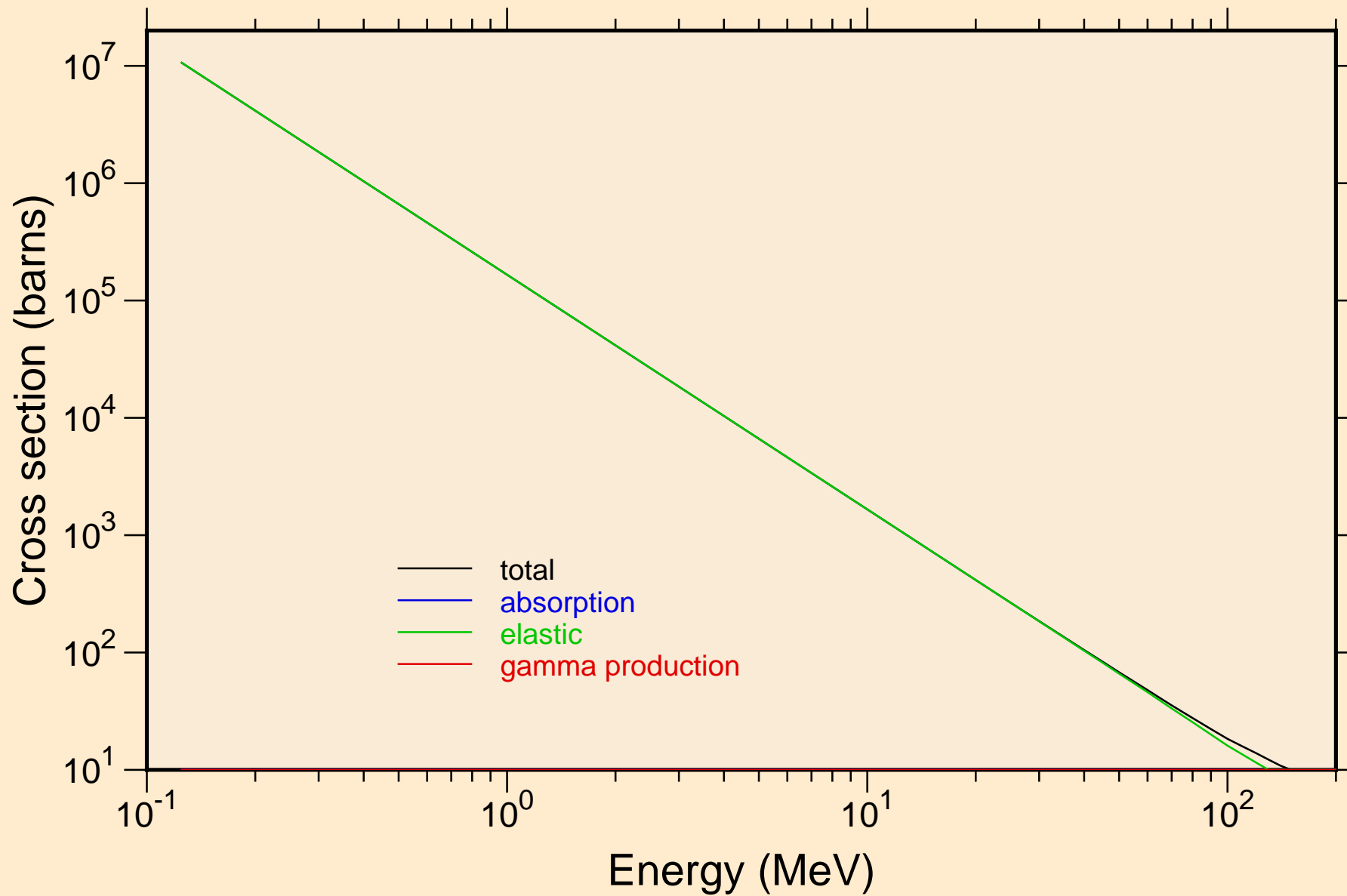

TL196 HELION ACER TENDL-2021 LIBRARY; T=0.K

Heating

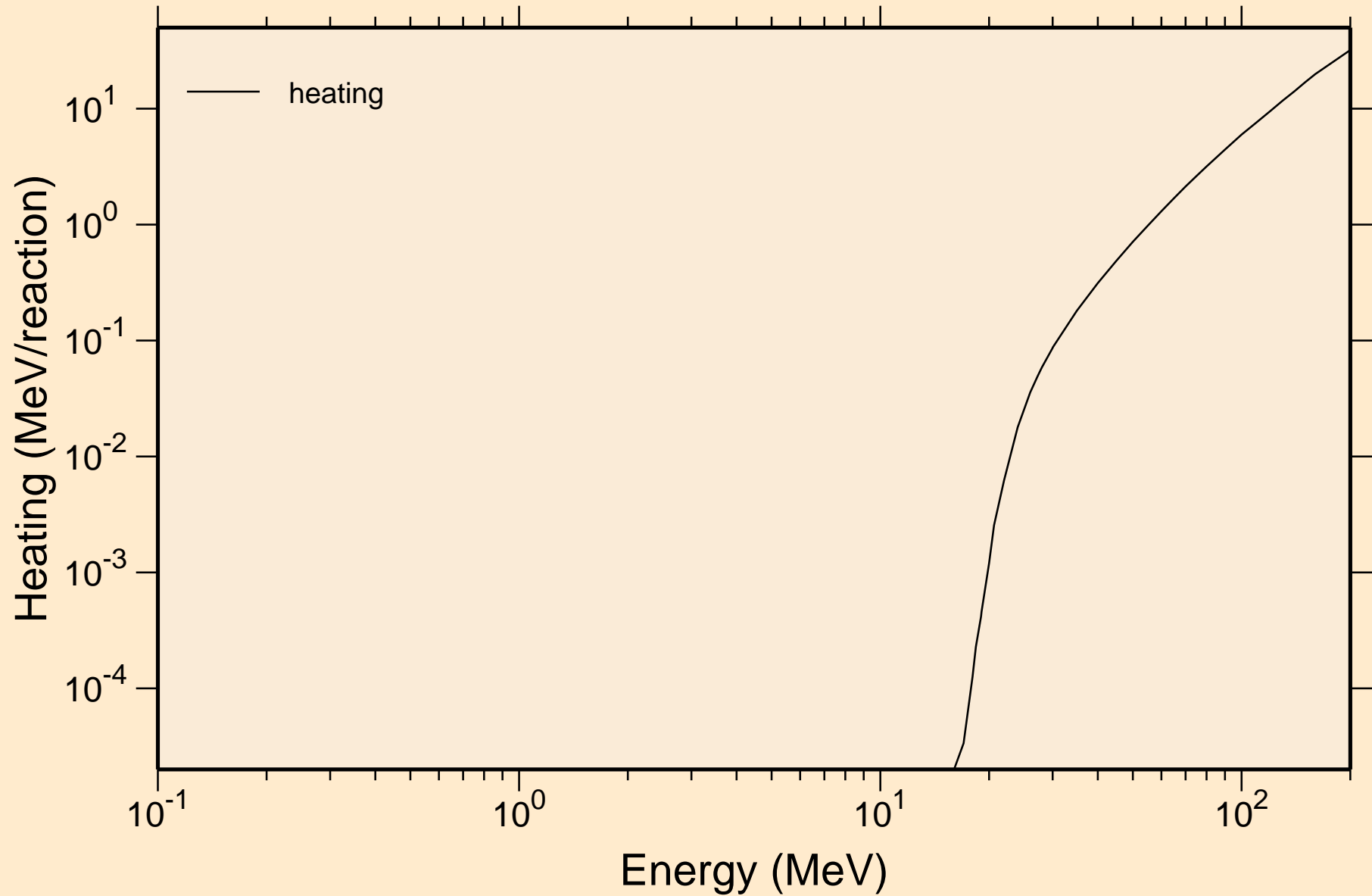

# TL196 HELION ACER TENDL-2021 LIBRARY; T=0.K

## Principal cross sections

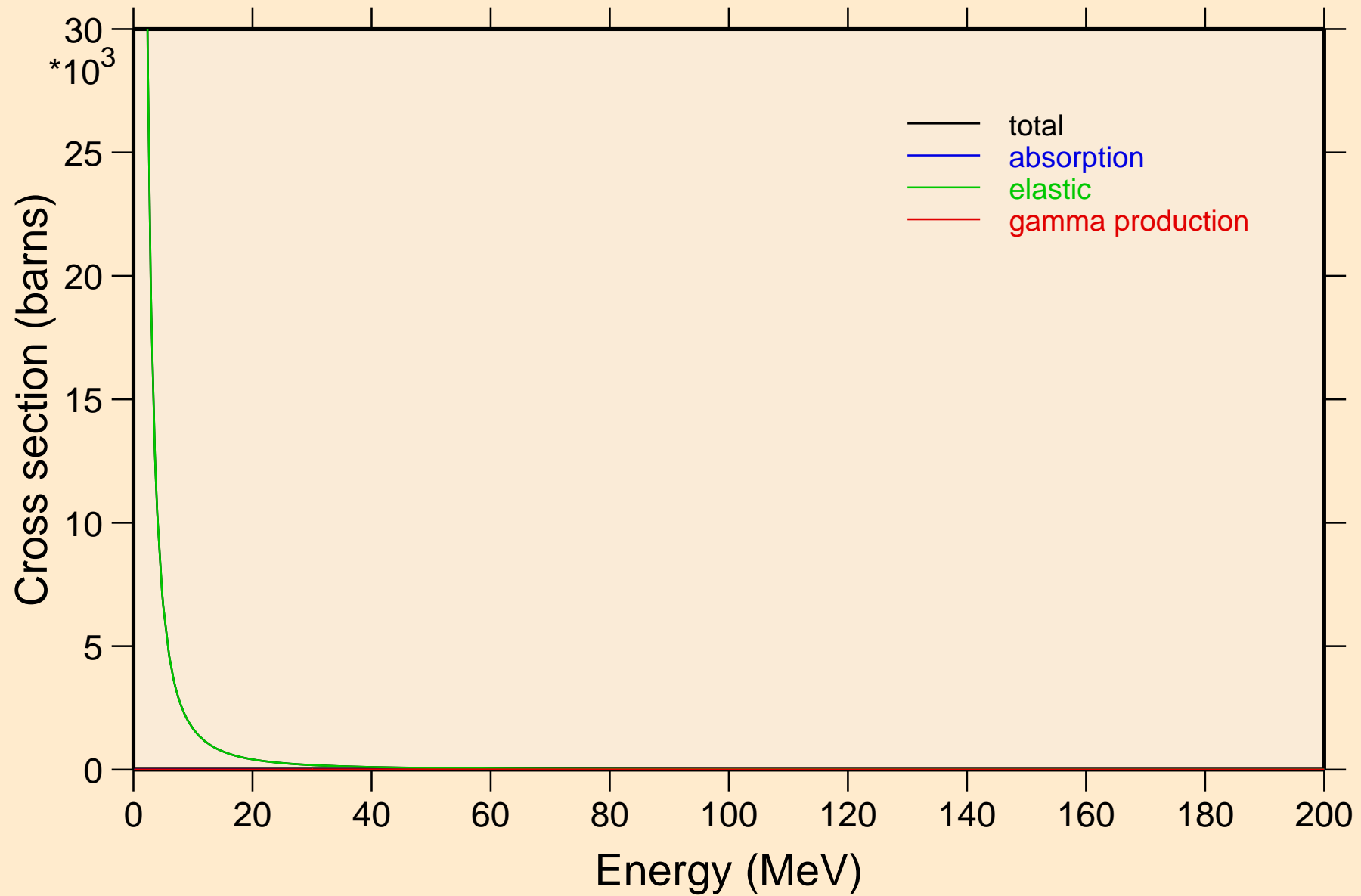

TL196 HELION ACER TENDL-2021 LIBRARY; T=0.K

Heating

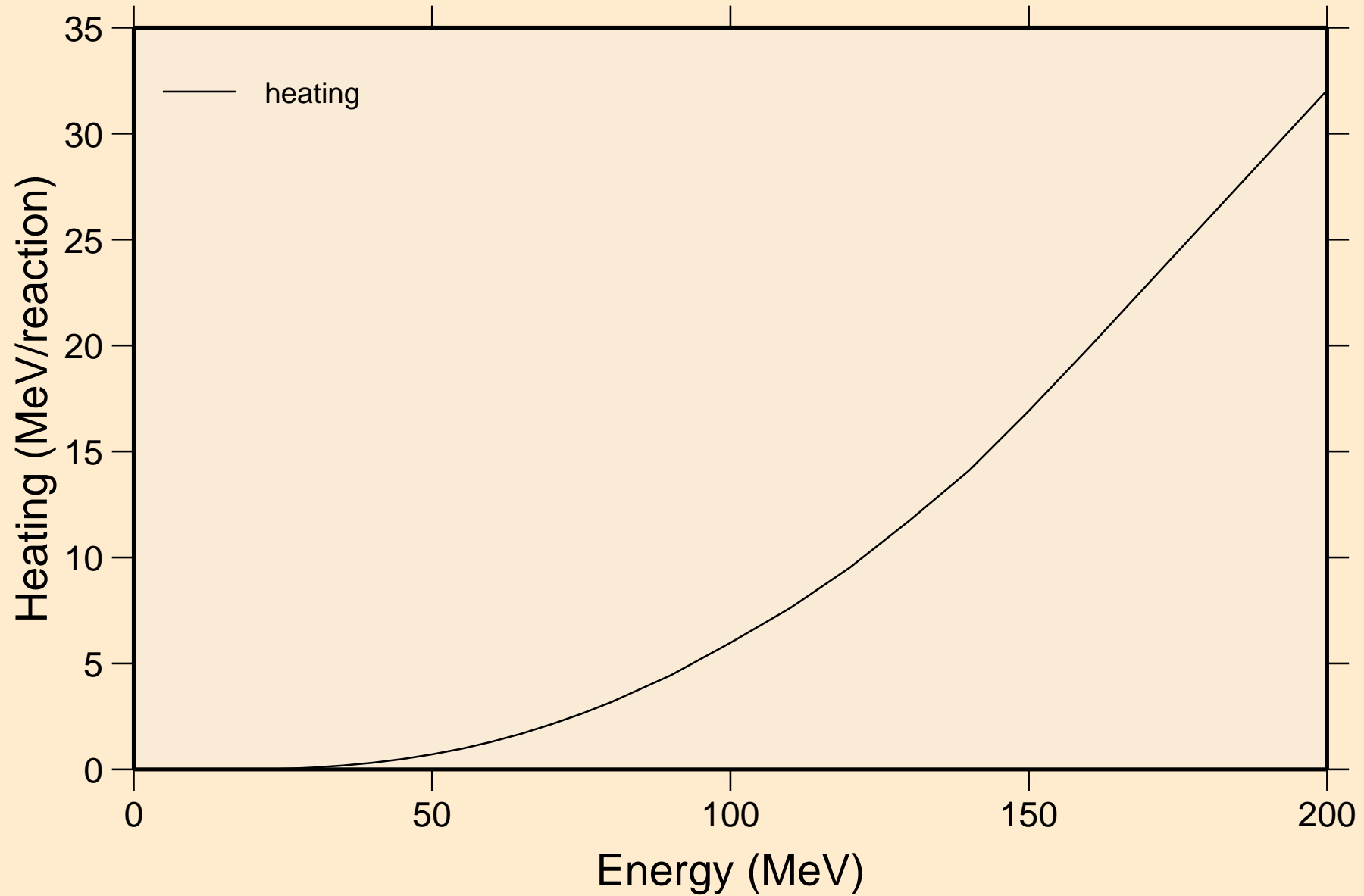

TL196 HELION ACER TENDL-2021 LIBRARY; T=0.K  
Threshold reactions

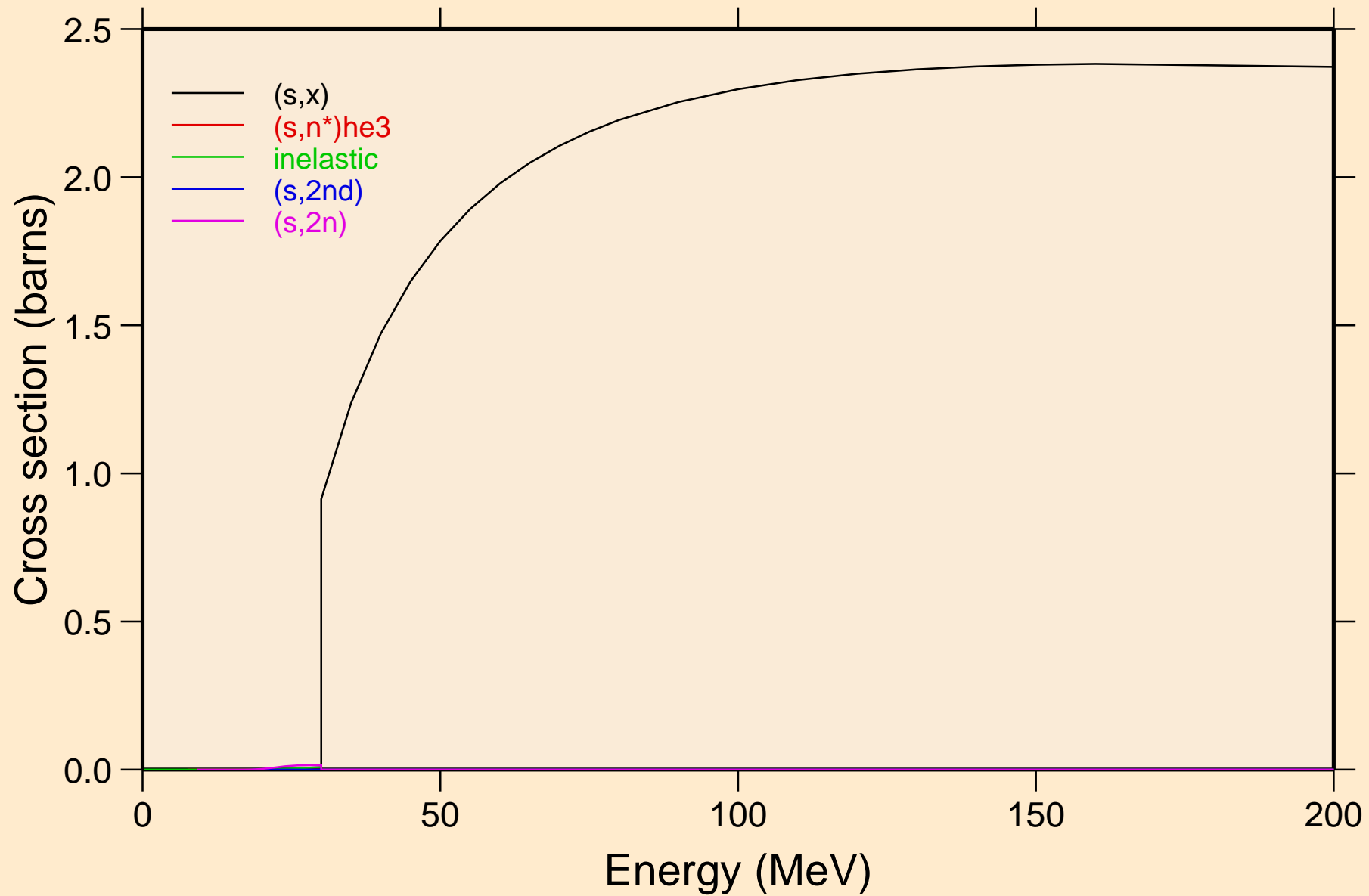

TL196 HELION ACER TENDL-2021 LIBRARY; T=0.K  
Threshold reactions

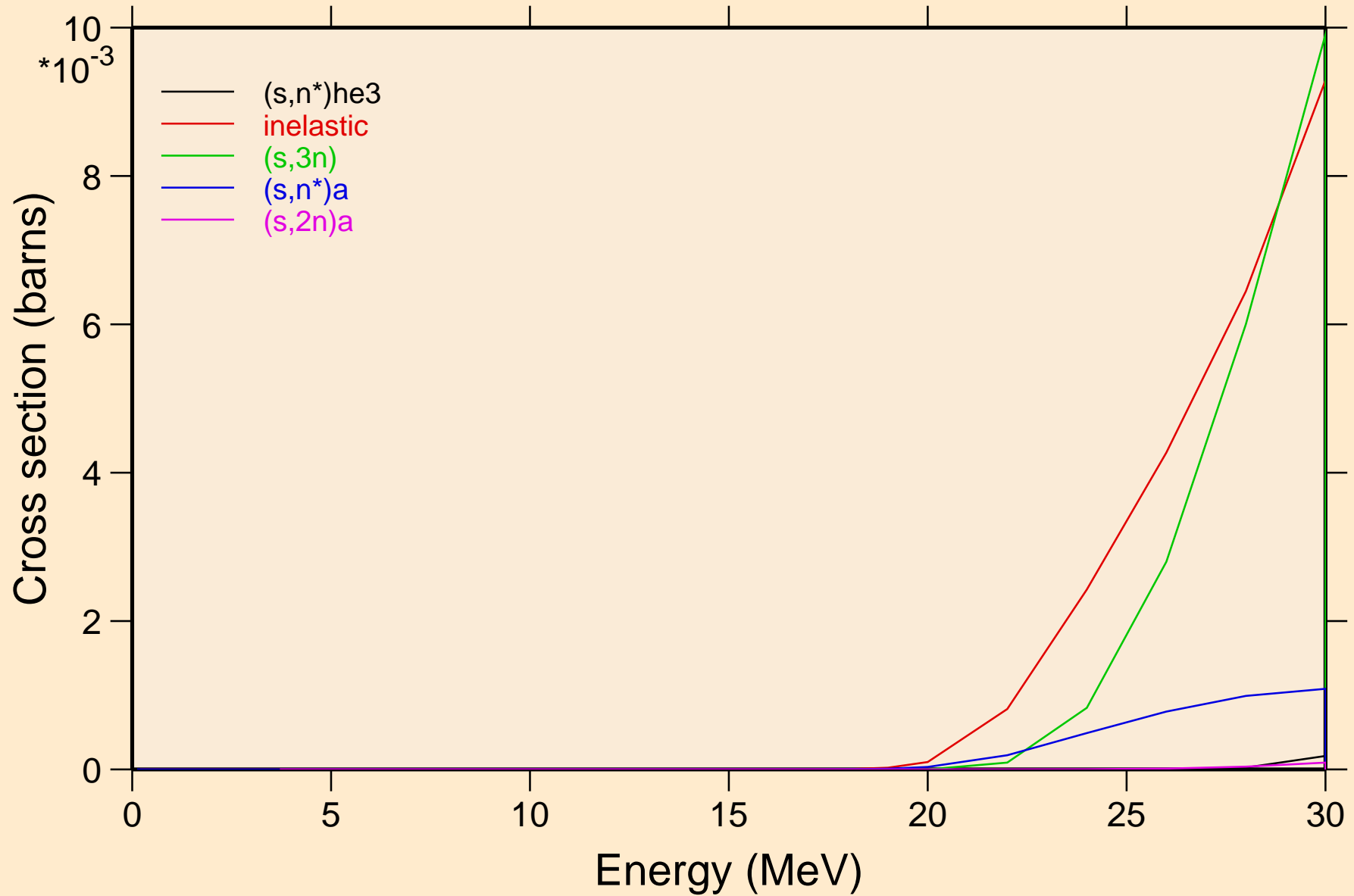

TL196 HELION ACER TENDL-2021 LIBRARY; T=0.K  
Threshold reactions

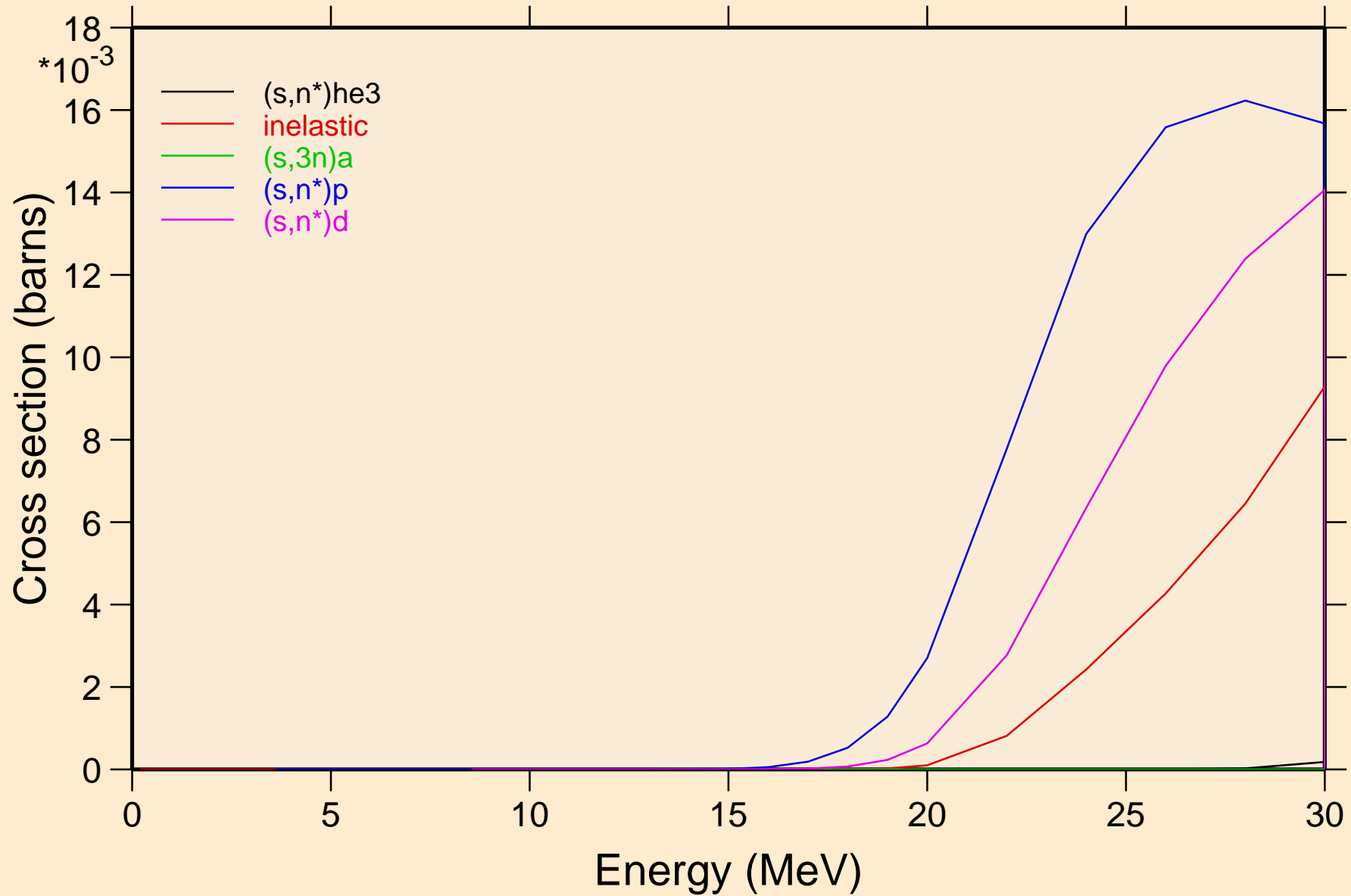

TL196 HELION ACER TENDL-2021 LIBRARY; T=0.K  
Threshold reactions

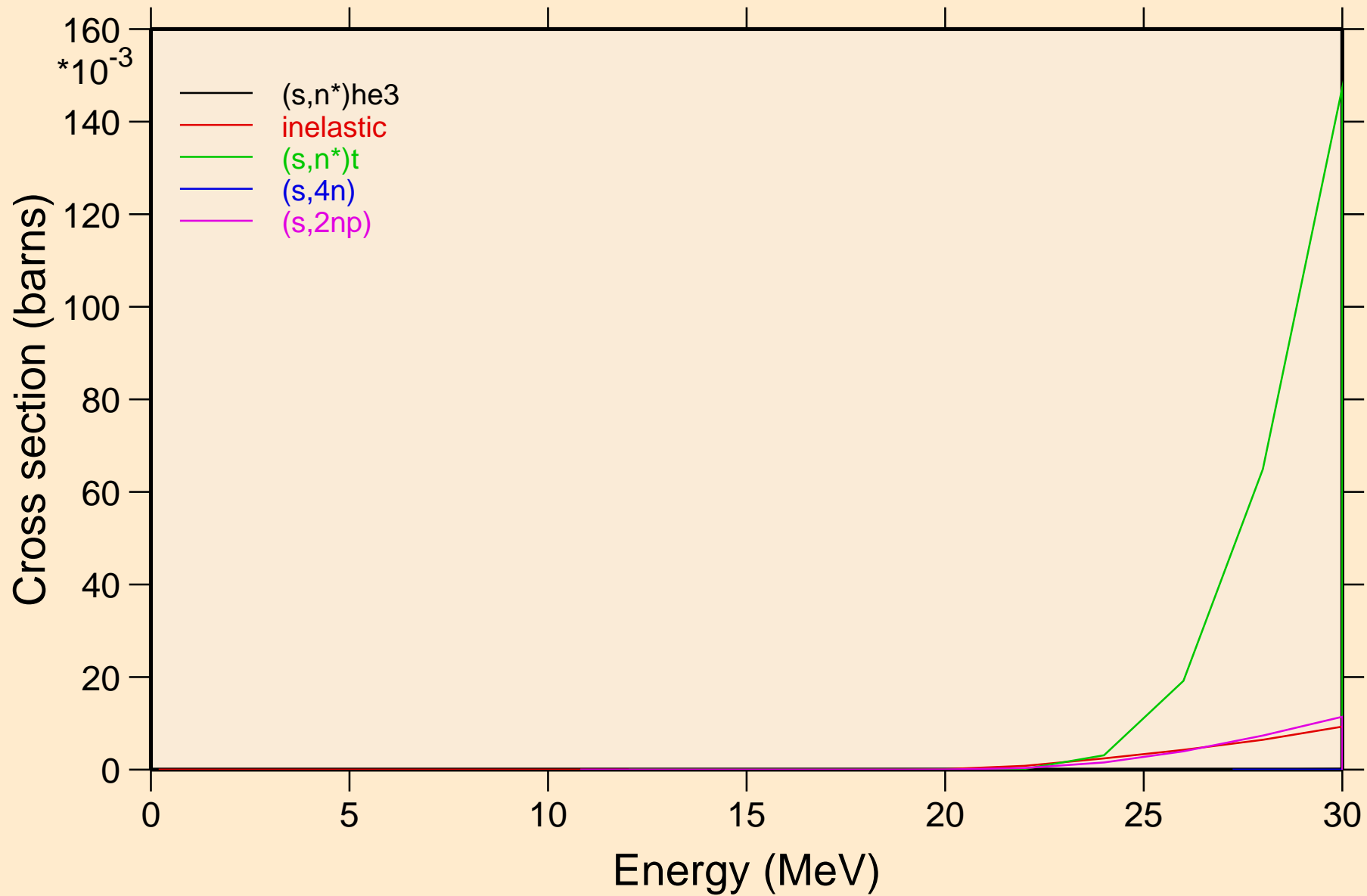



TL196 HELION ACER TENDL-2021 LIBRARY; T=0.K  
Threshold reactions

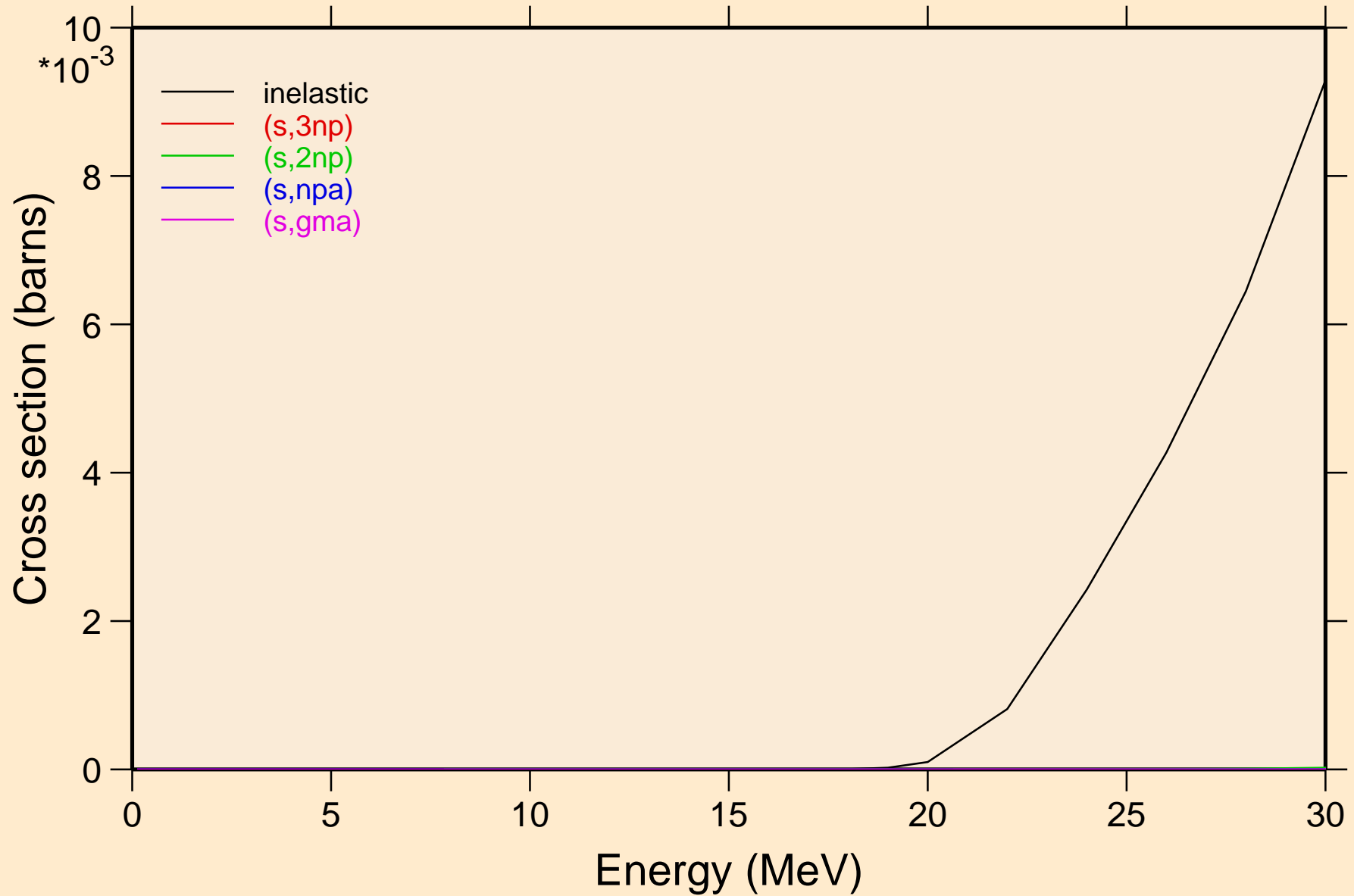

TL196 HELION ACER TENDL-2021 LIBRARY; T=0.K  
Threshold reactions

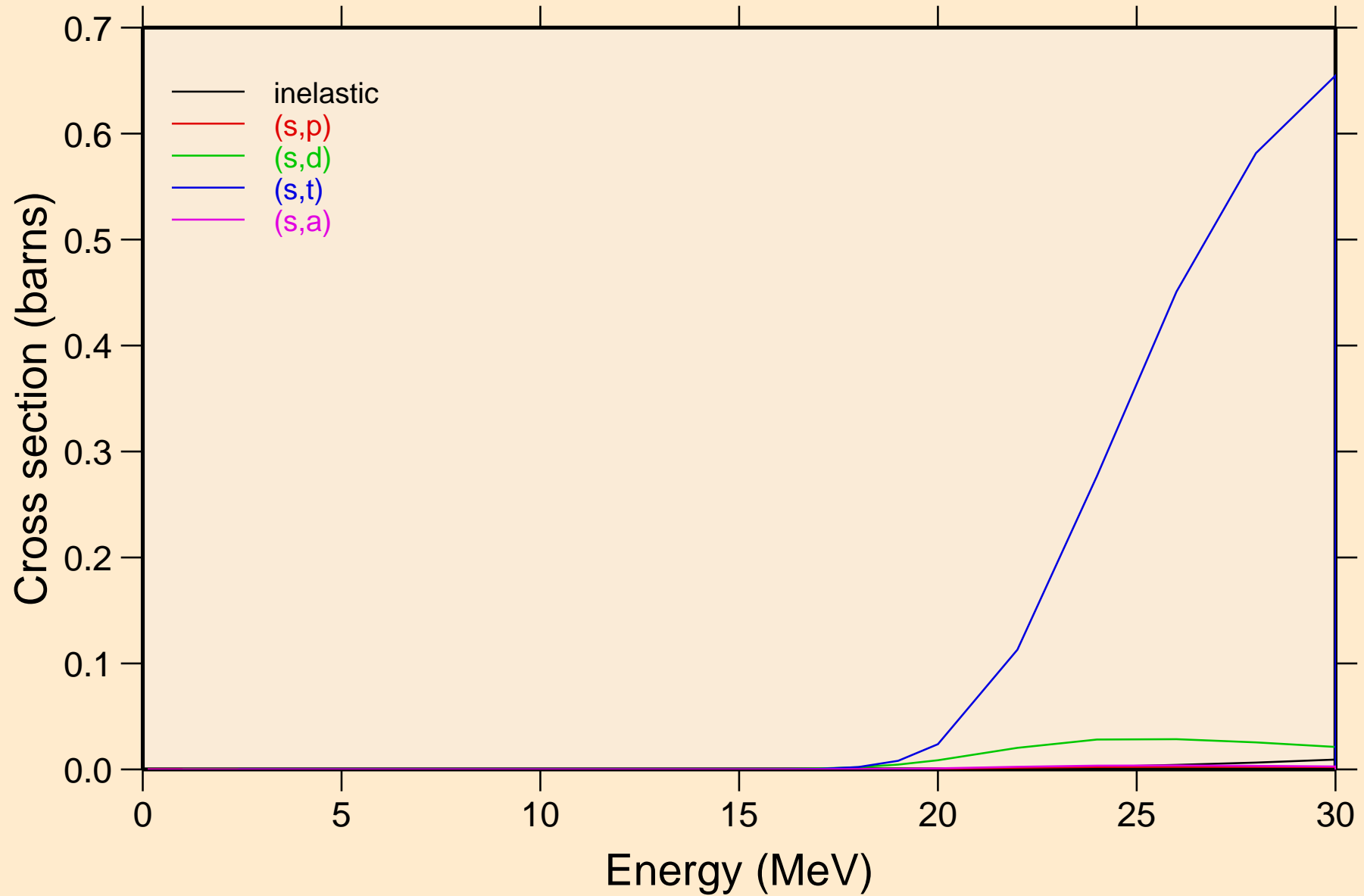

TL196 HELION ACER TENDL-2021 LIBRARY; T=0.K  
Threshold reactions

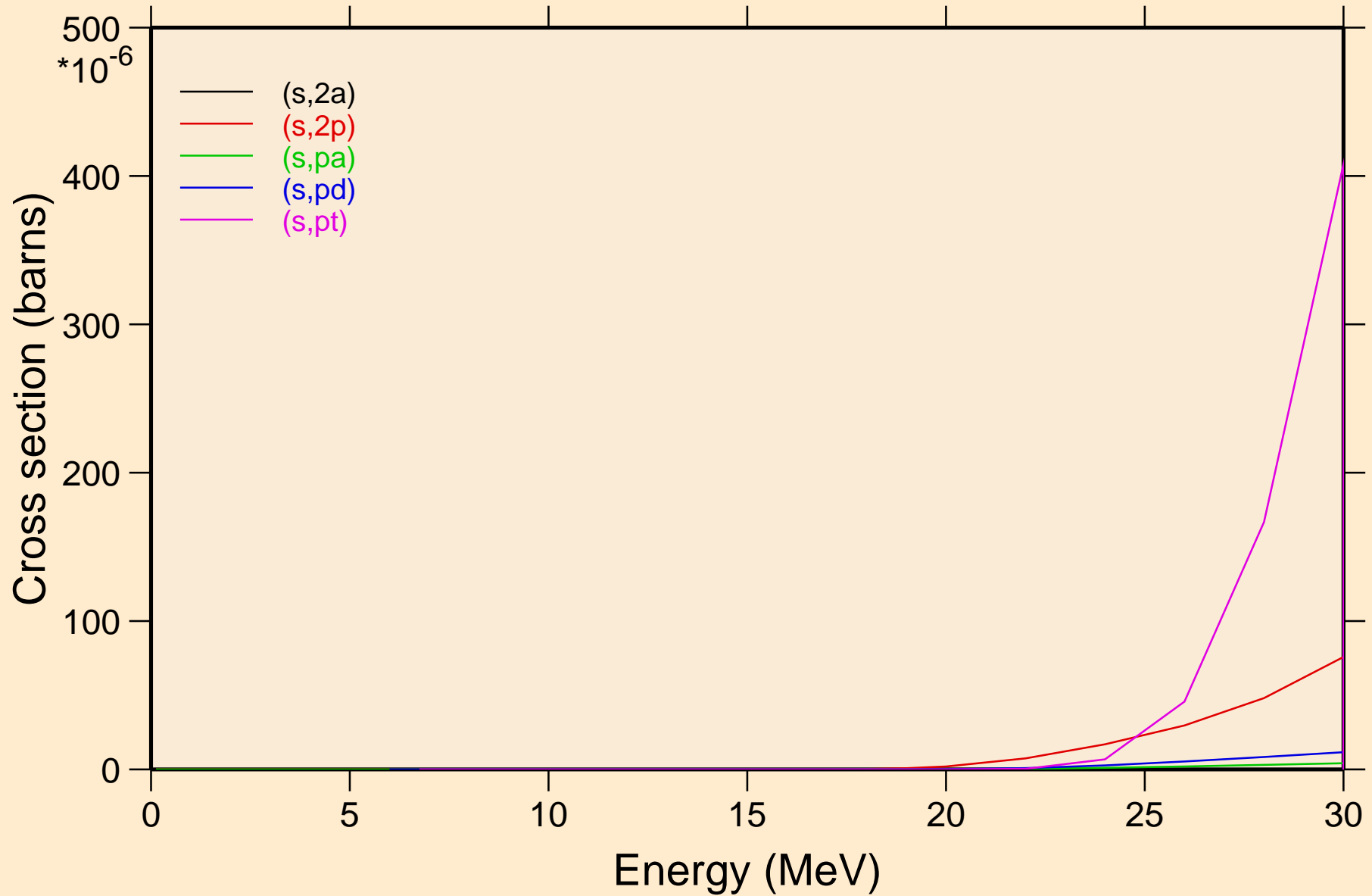

TL196 HELION ACER TENDL-2021 LIBRARY; T=0.K  
Threshold reactions

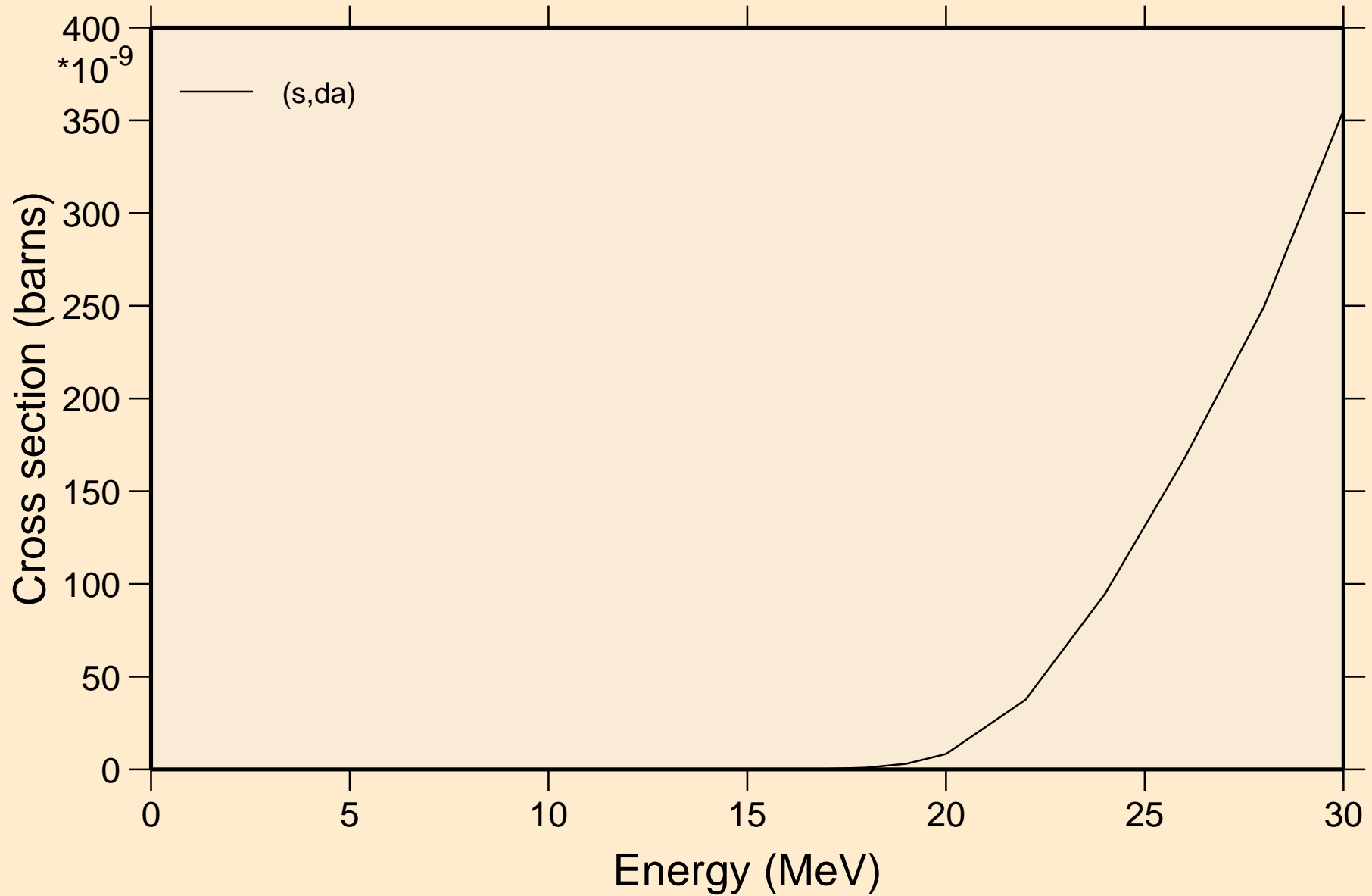

TL196 HELION ACER TENDL-2021 LIBRARY; T=0.K  
angular distribution for elastic

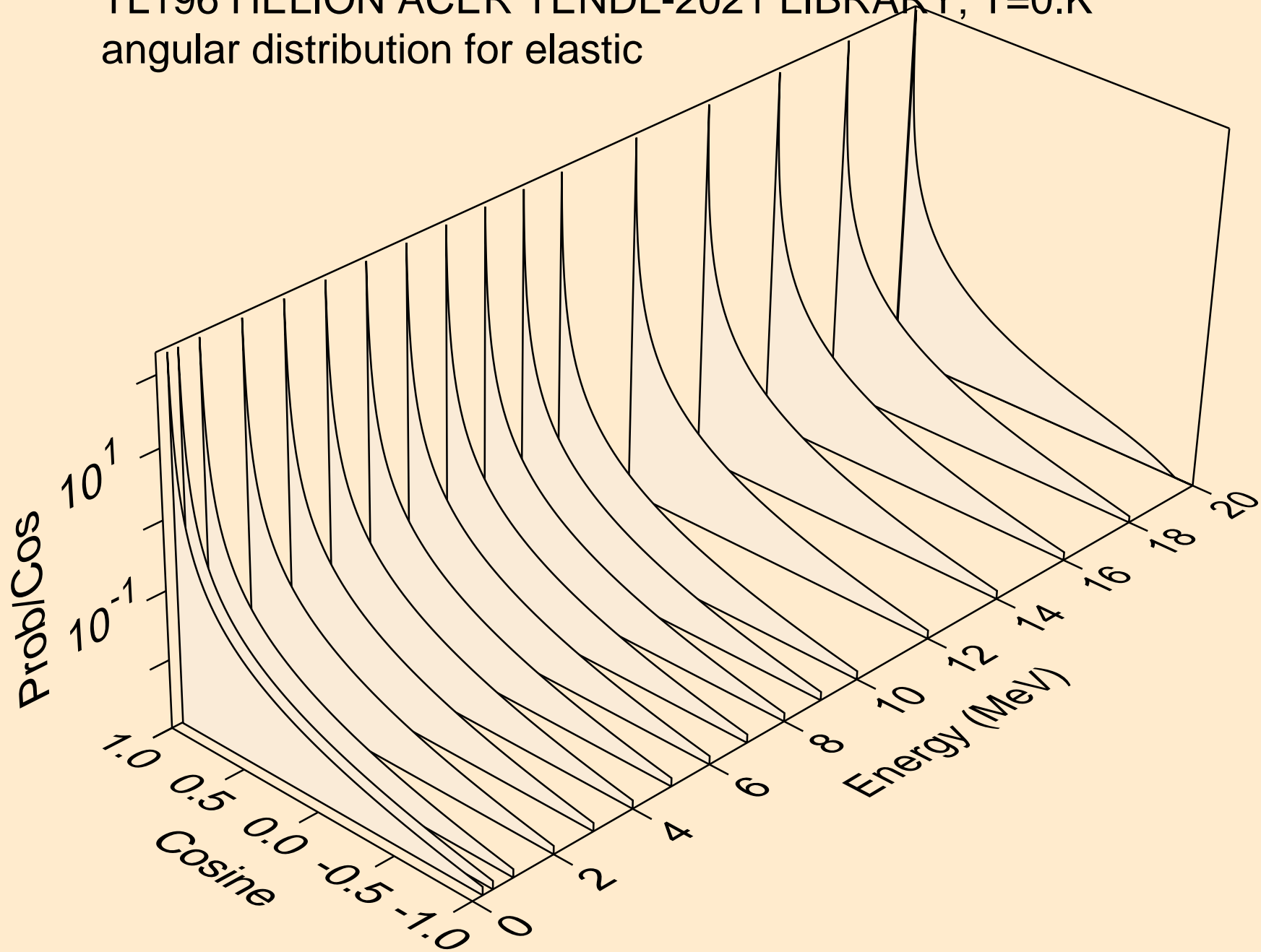

TL196 HELION ACER TENDL-2021 LIBRARY; T=0.K  
angular distribution for elastic

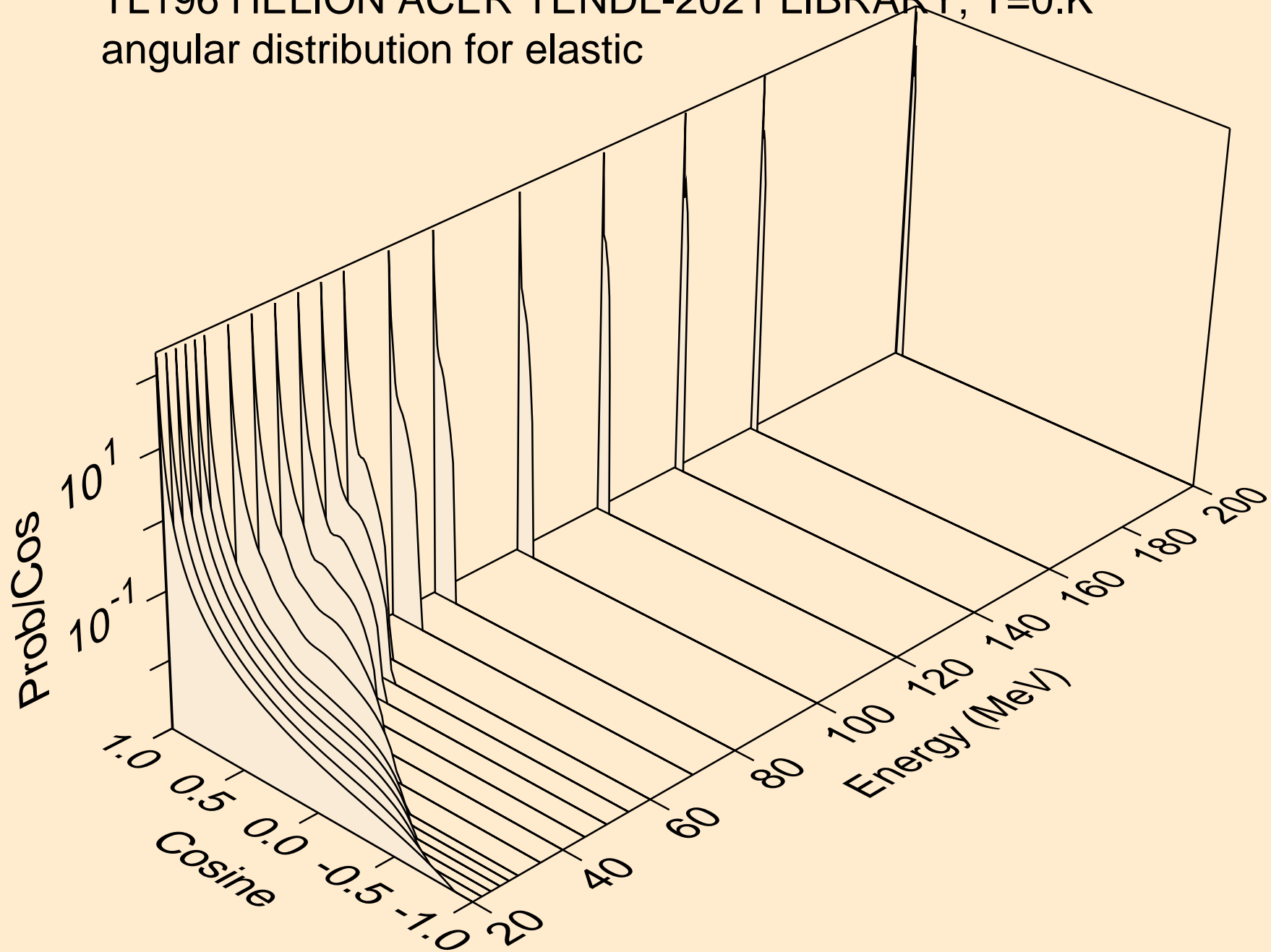

TL196 HELION ACER TENDL-2021 LIBRARY; T=0.K  
He-3 emission for (s,x)

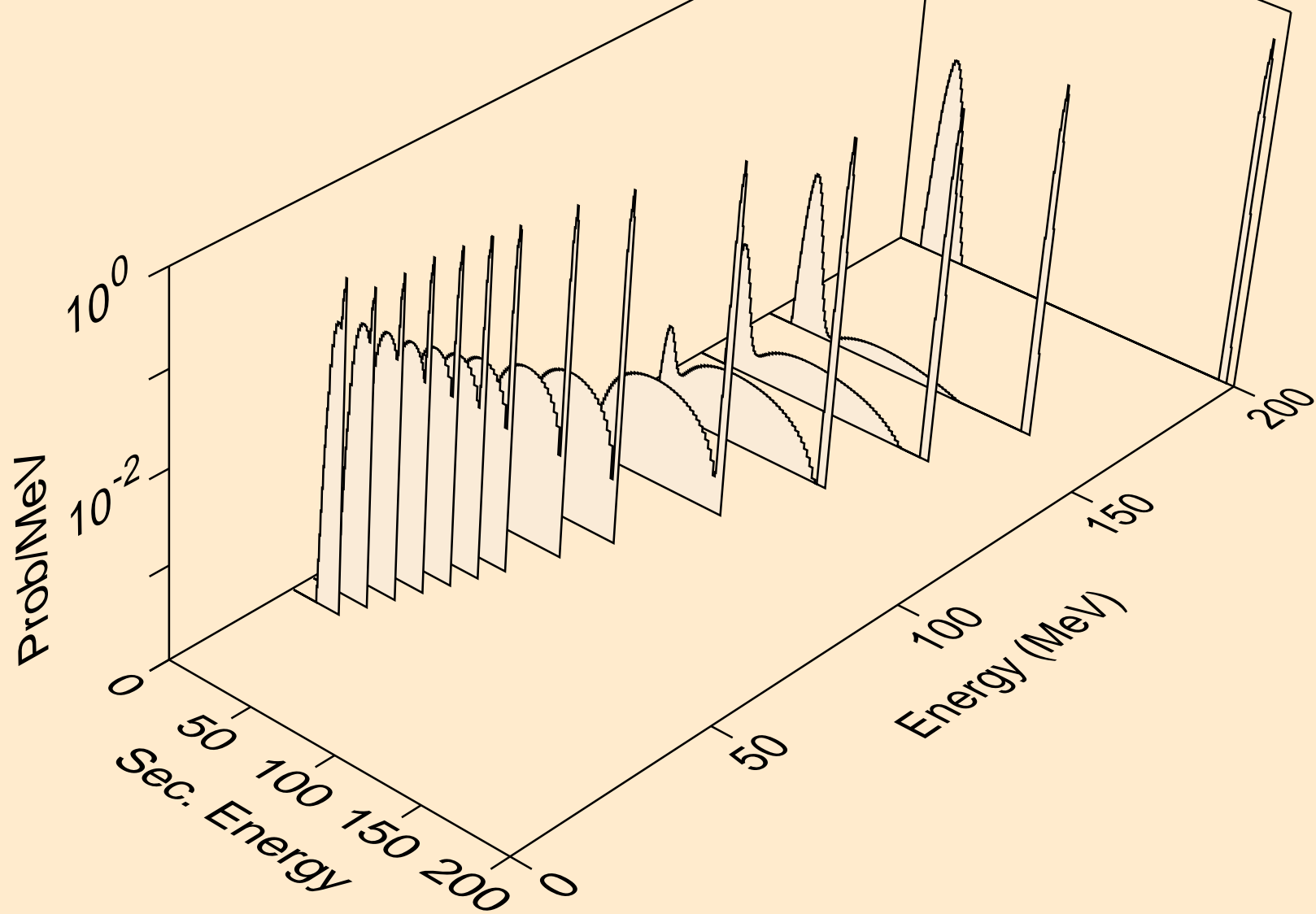

TL196 HELION ACER TENDL-2021 LIBRARY; T=0.K  
He-3 emission for (s,n\*)he3

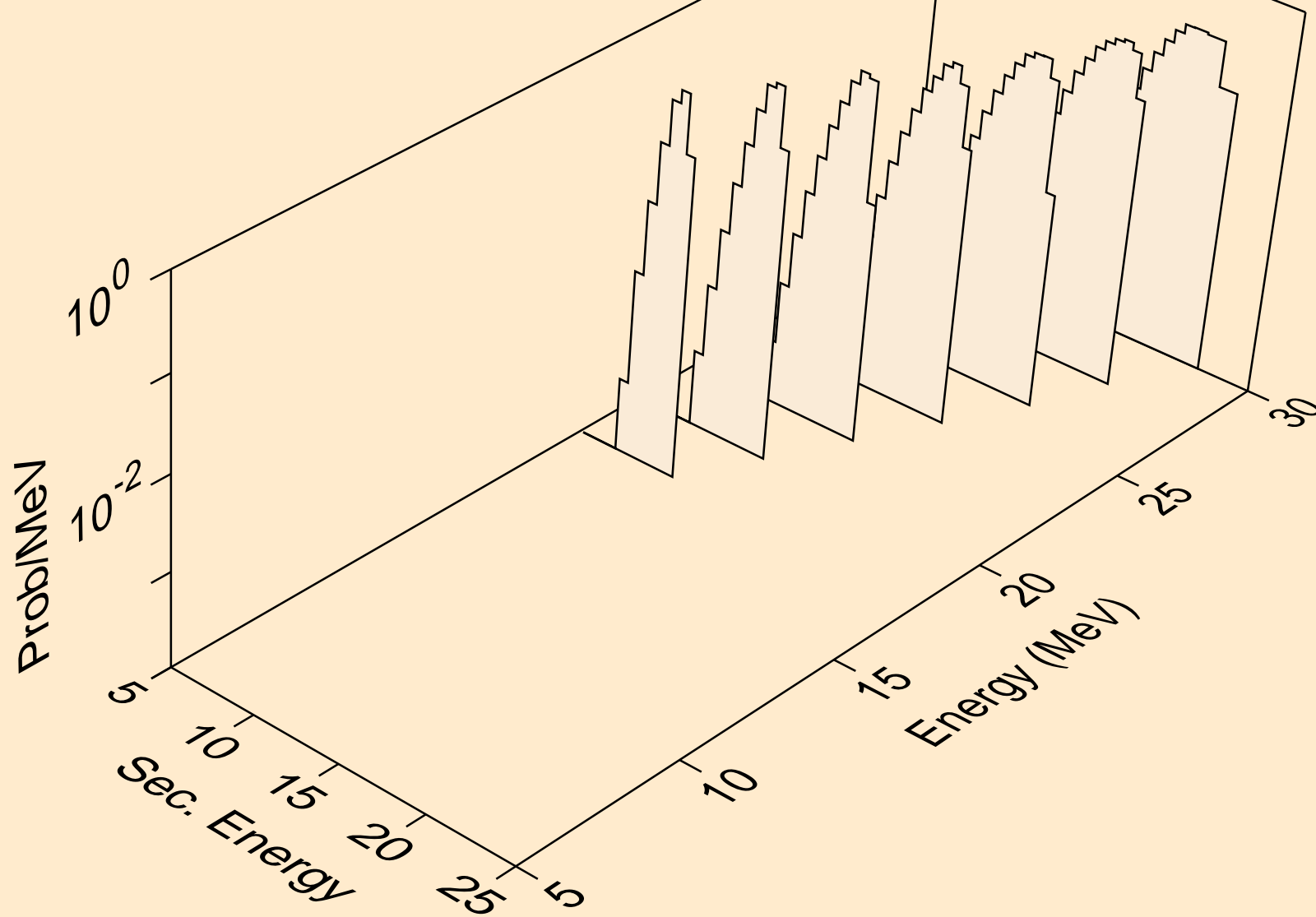



TL196 HELION ACER TENDL-2021 LIBRARY; T=0.K  
He-3 emission for inelastic

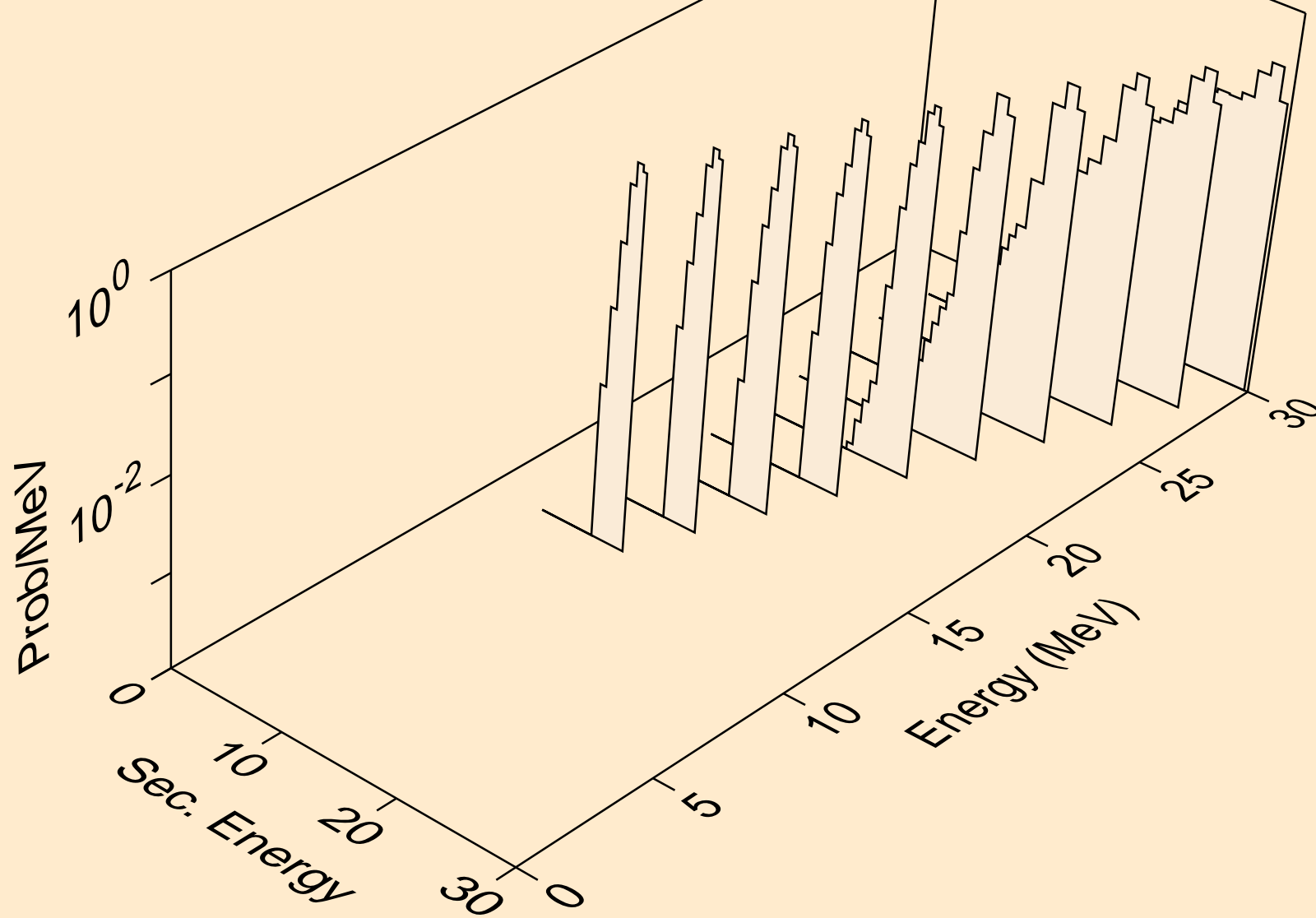

TL196 HELION ACER TENDL-2021 LIBRARY; T=0.K  
Photon emission for (z,n)

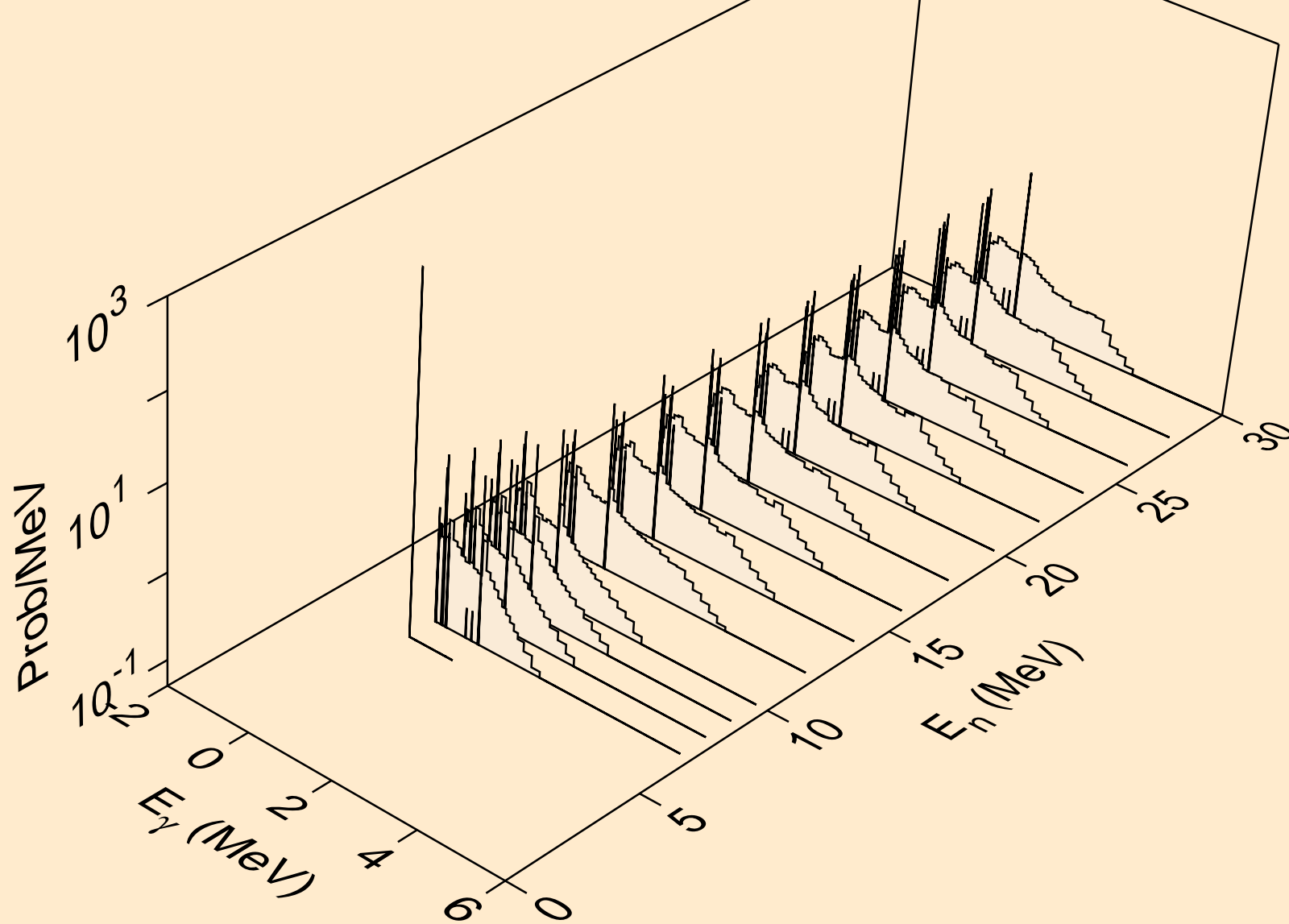

TL196 HELION ACER TENDL-2021 LIBRARY; T=0.K  
Photon emission for (n,x)

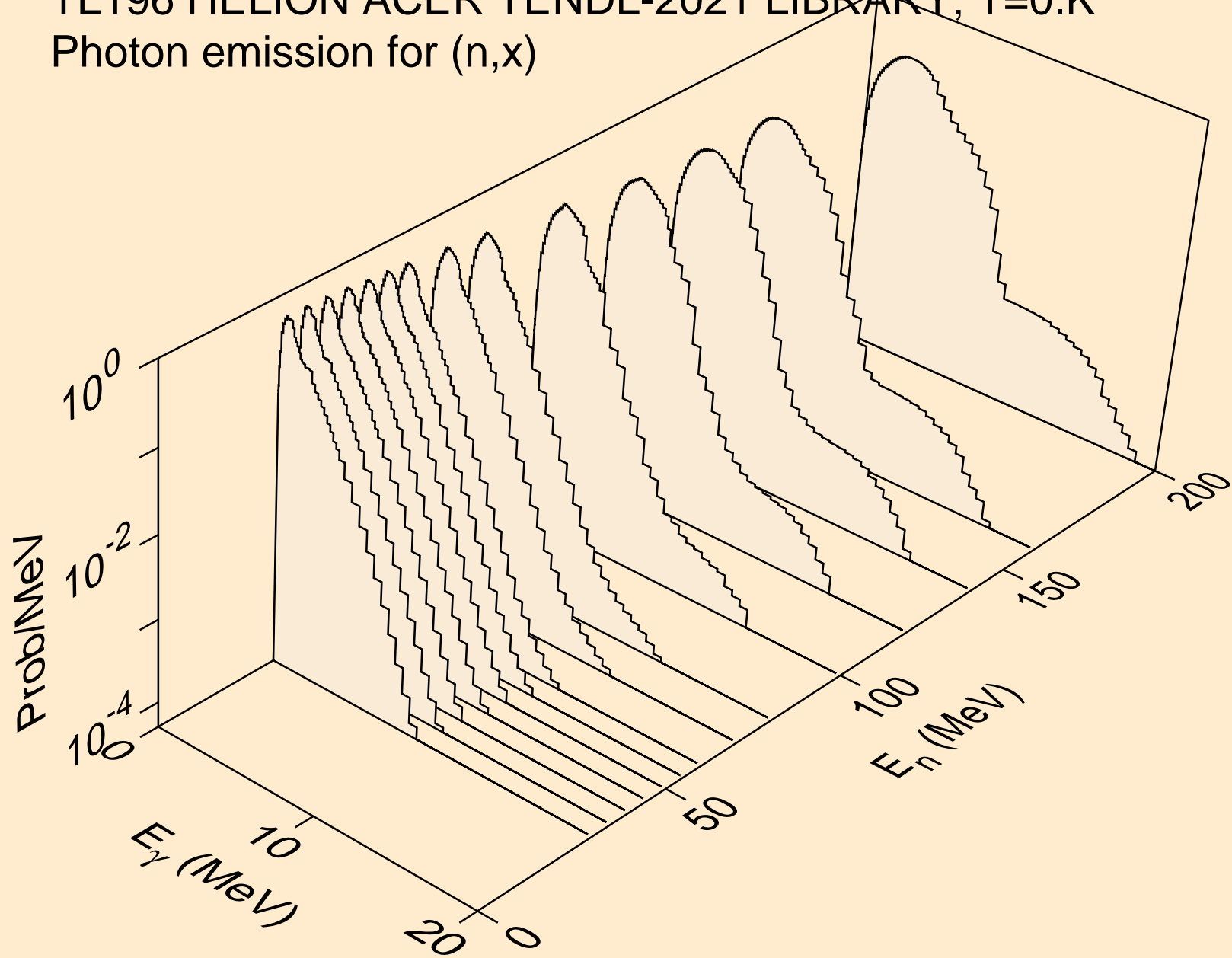

TL196 HELION ACER TENDL-2021 LIBRARY; T=0.K  
Photon emission for (n,2nd)

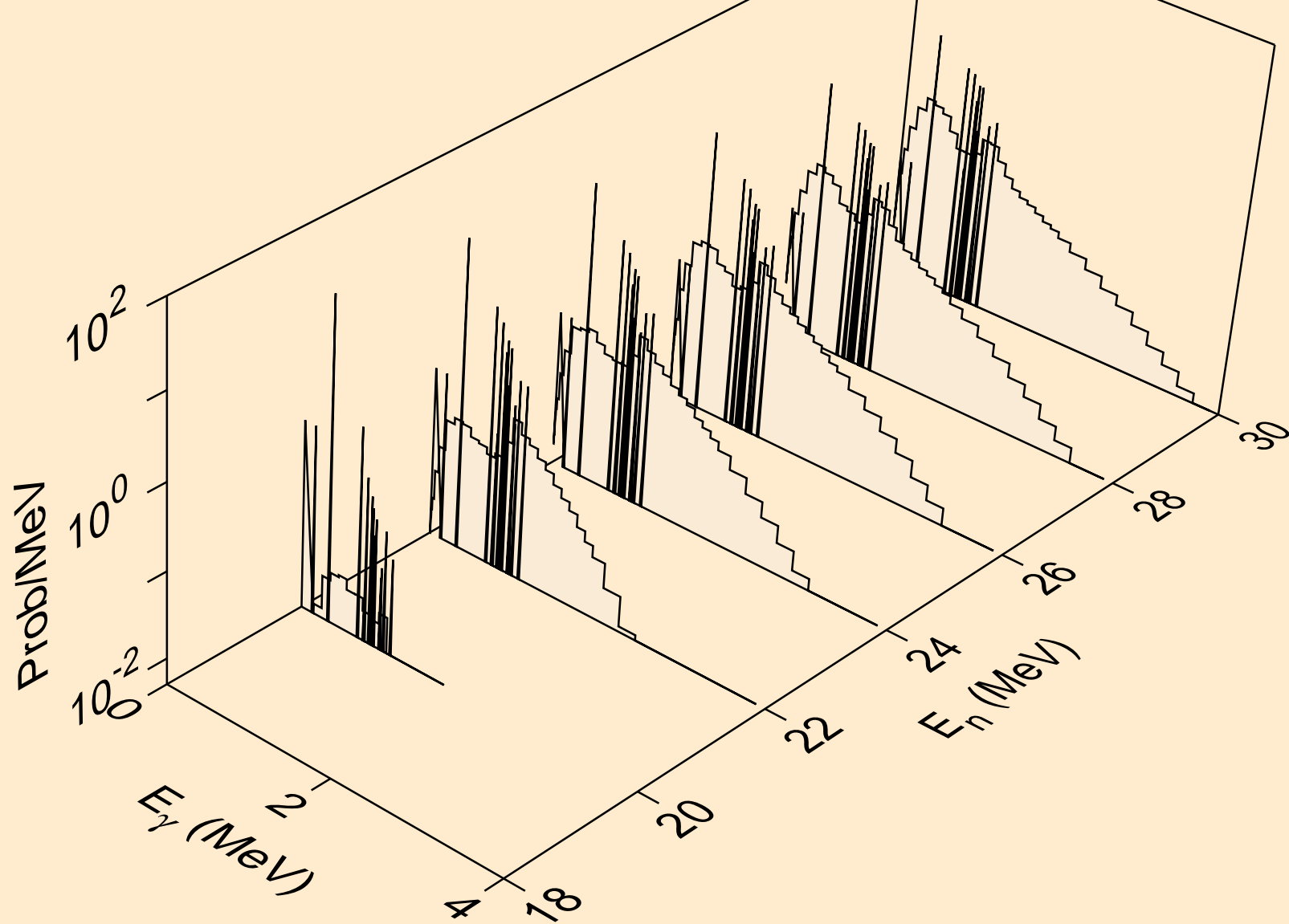

TL196 HELION ACER TENDL-2021 LIBRARY; T=0.K  
Photon emission for (n,2n)

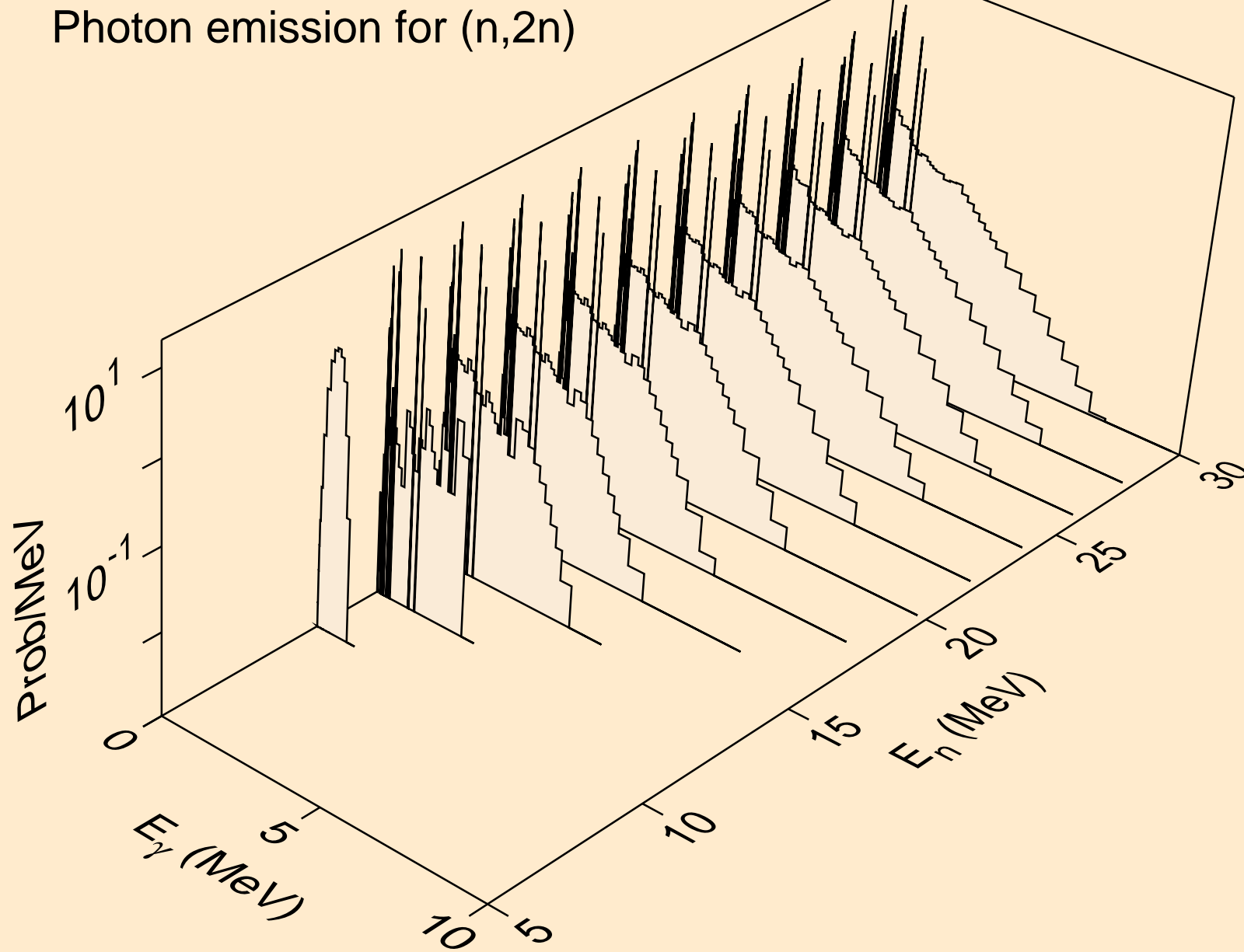

TL196 HELION ACER TENDL-2021 LIBRARY; T=0.K  
Photon emission for (n,3n)

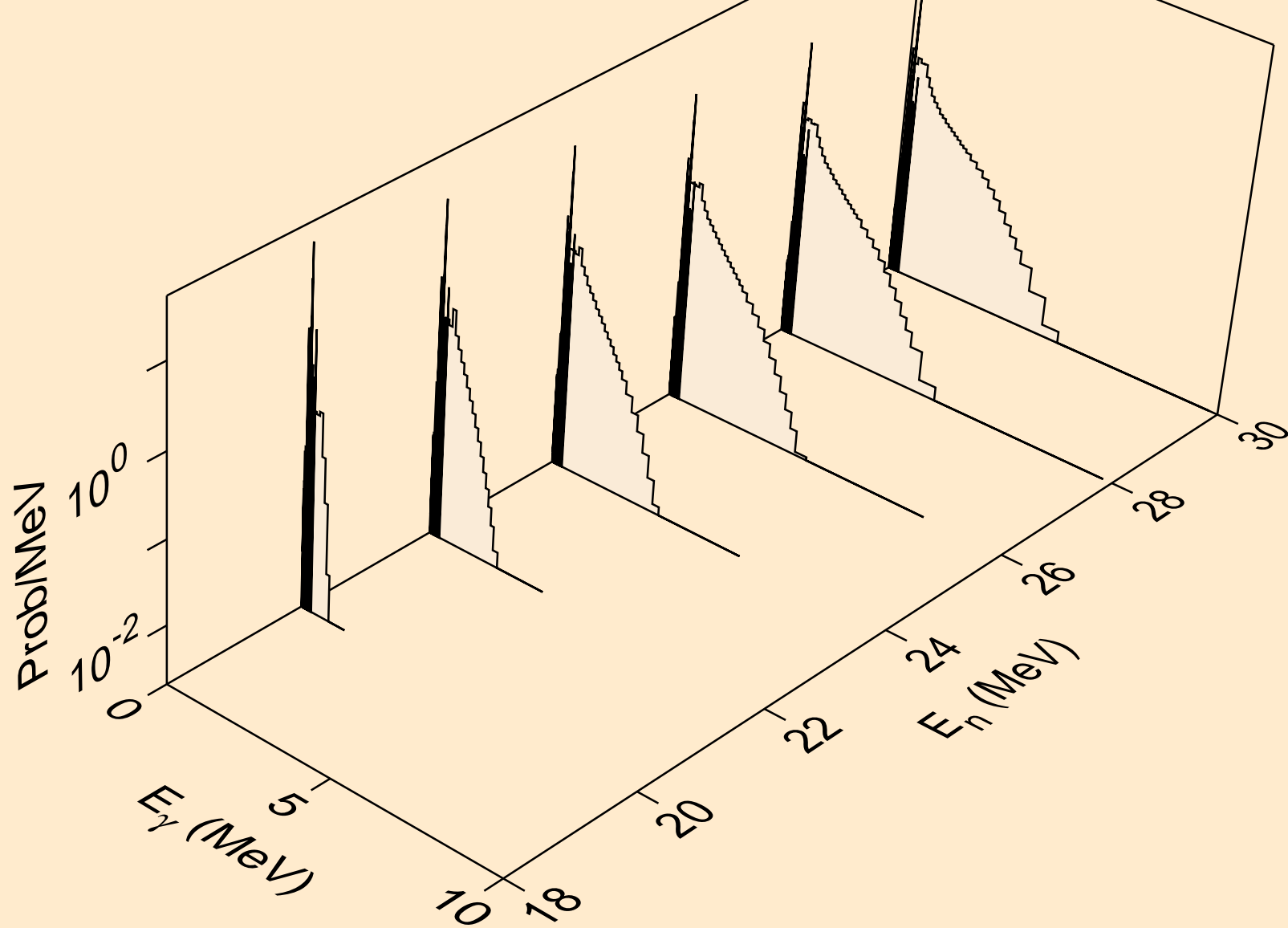

TL196 HELION ACER TENDL-2021 LIBRARY; T=0.K  
Photon emission for (n,n\*)a

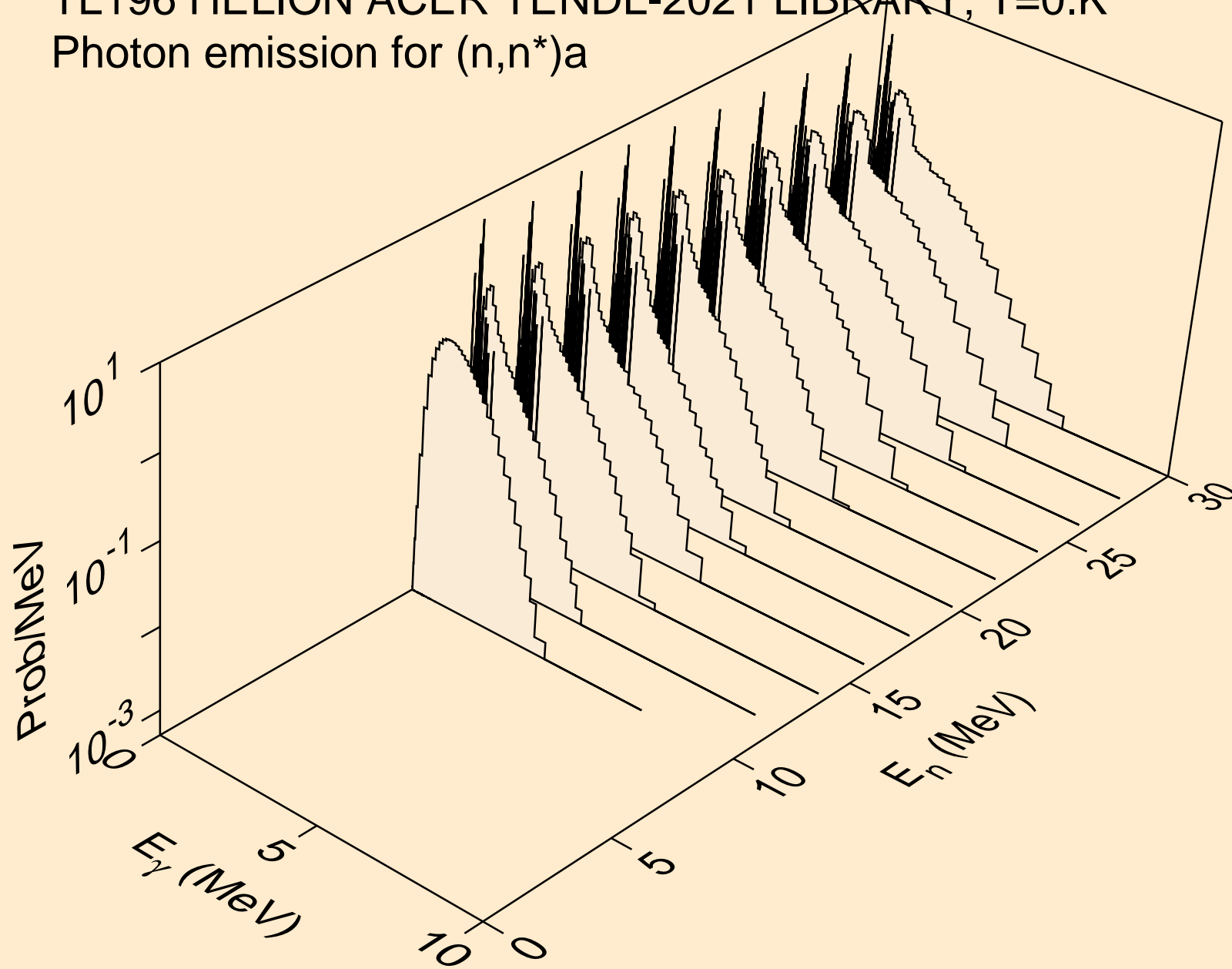

TL196 HELION ACER TENDL-2021 LIBRARY; T=0.K  
Photon emission for (n,2n)a

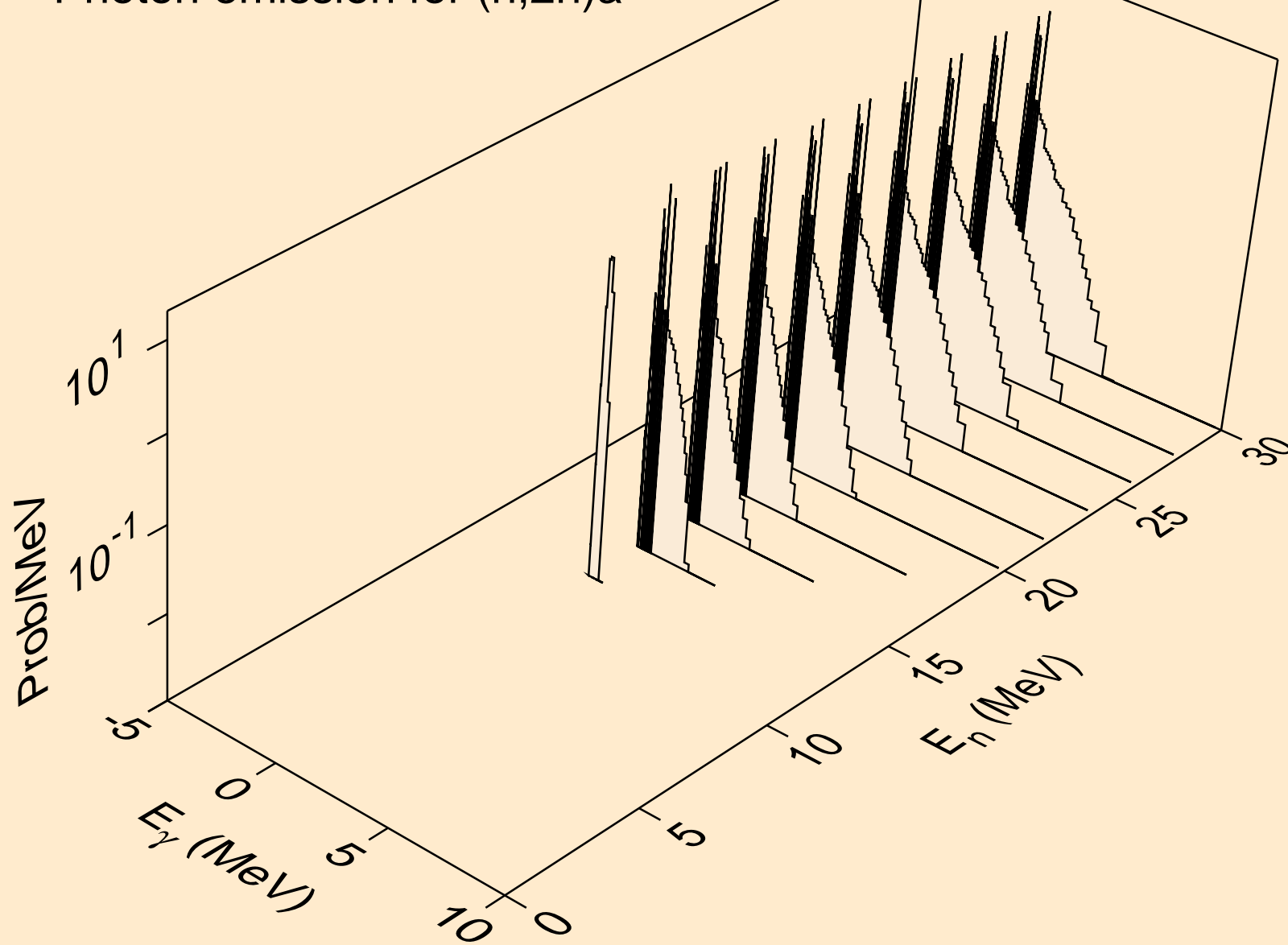



TL196 HELION ACER TENDL-2021 LIBRARY; T=0.K  
Photon emission for (n,3n)a

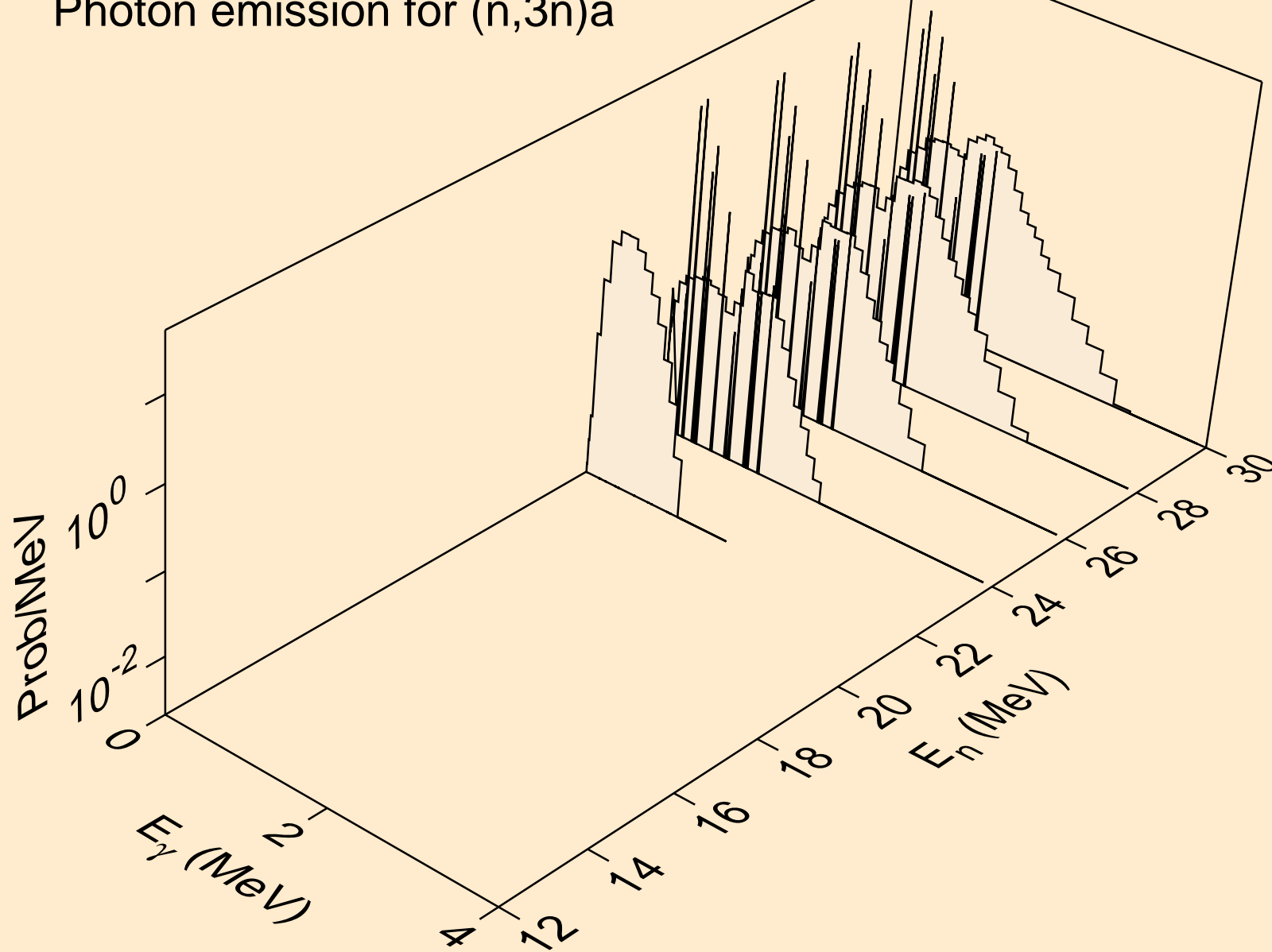

TL196 HELION ACER TENDL-2021 LIBRARY; T=0.K  
Photon emission for (n,n\*)p

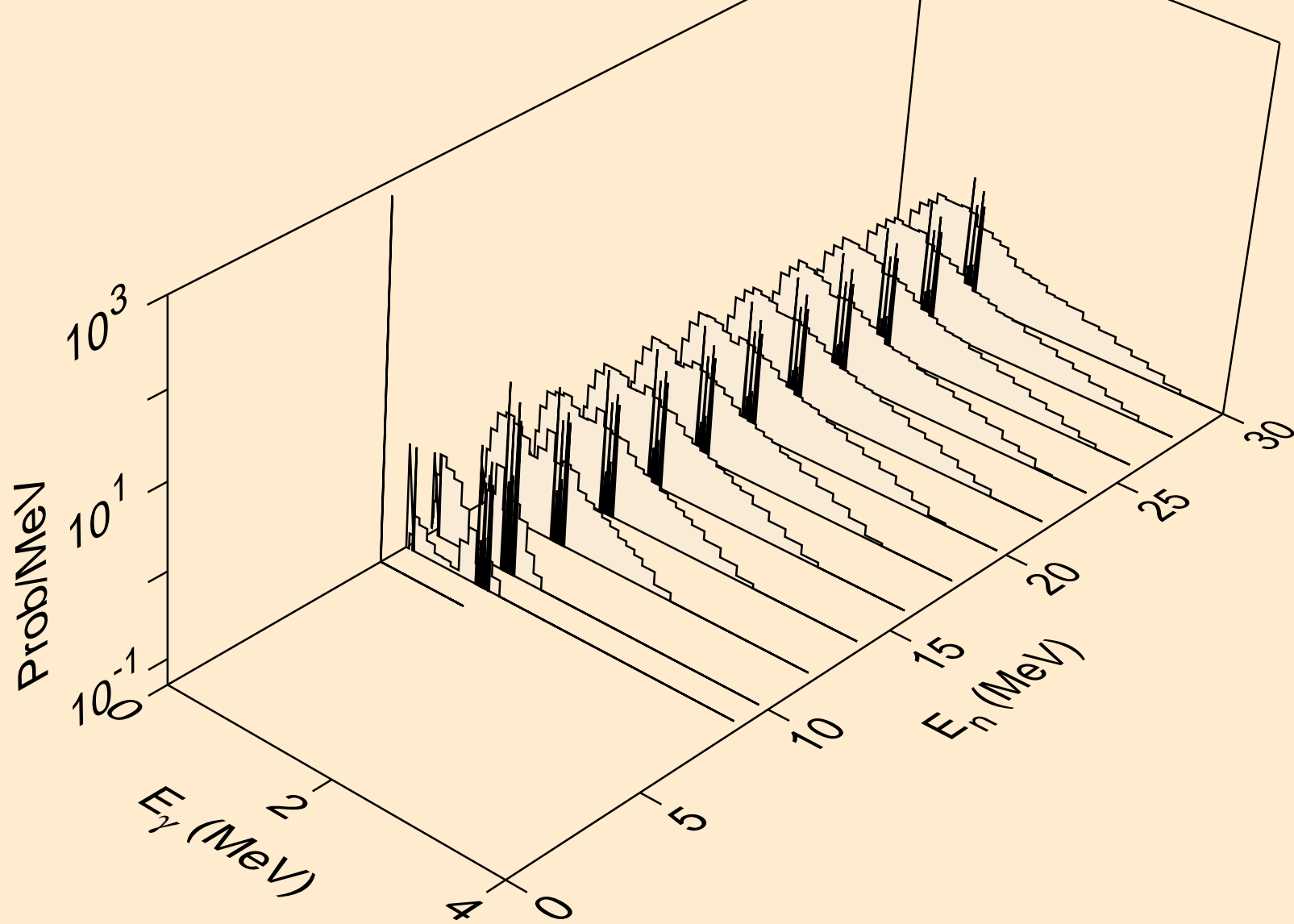

TL196 HELION ACER TENDL-2021 LIBRARY; T=0.K  
Photon emission for (n,n\*)d

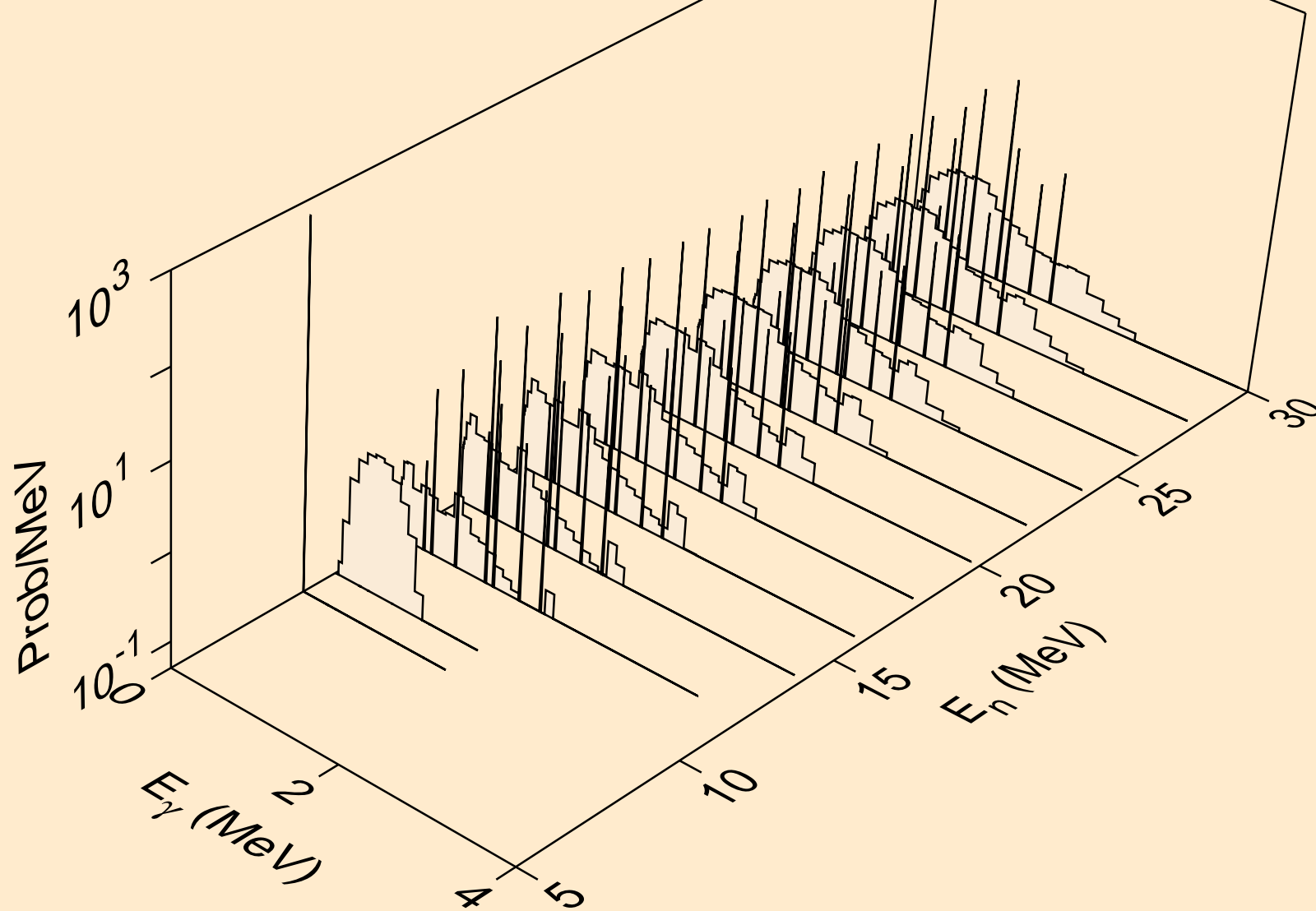

TL196 HELION ACER TENDL-2021 LIBRARY; T=0.K  
Photon emission for (n,n\*)t

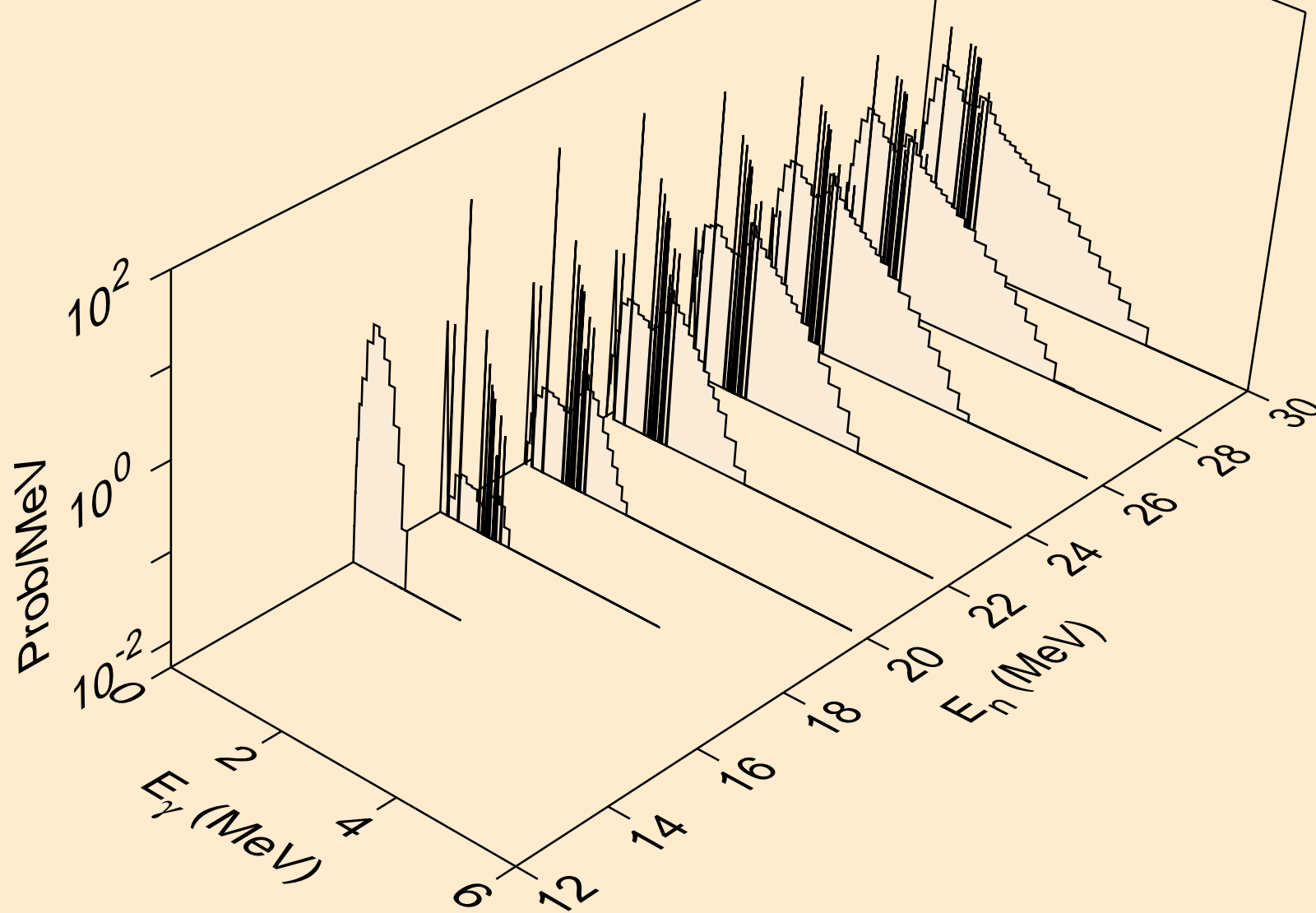

TL196 HELION ACER TENDL-2021 LIBRARY; T=0.K  
Photon emission for (n,n\*)he3

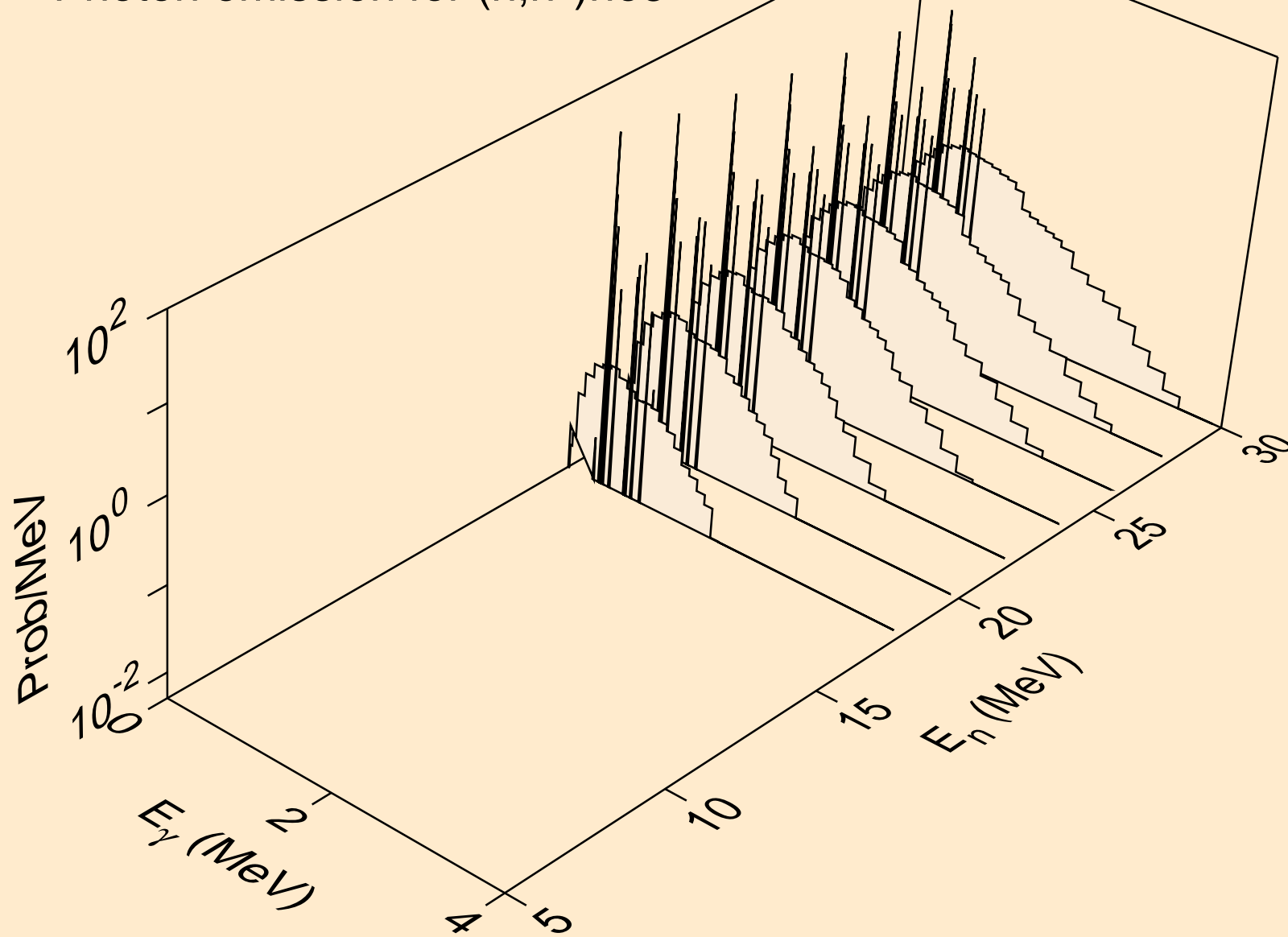

TL196 HELION ACER TENDL-2021 LIBRARY; T=0.K  
Photon emission for (n,4n)

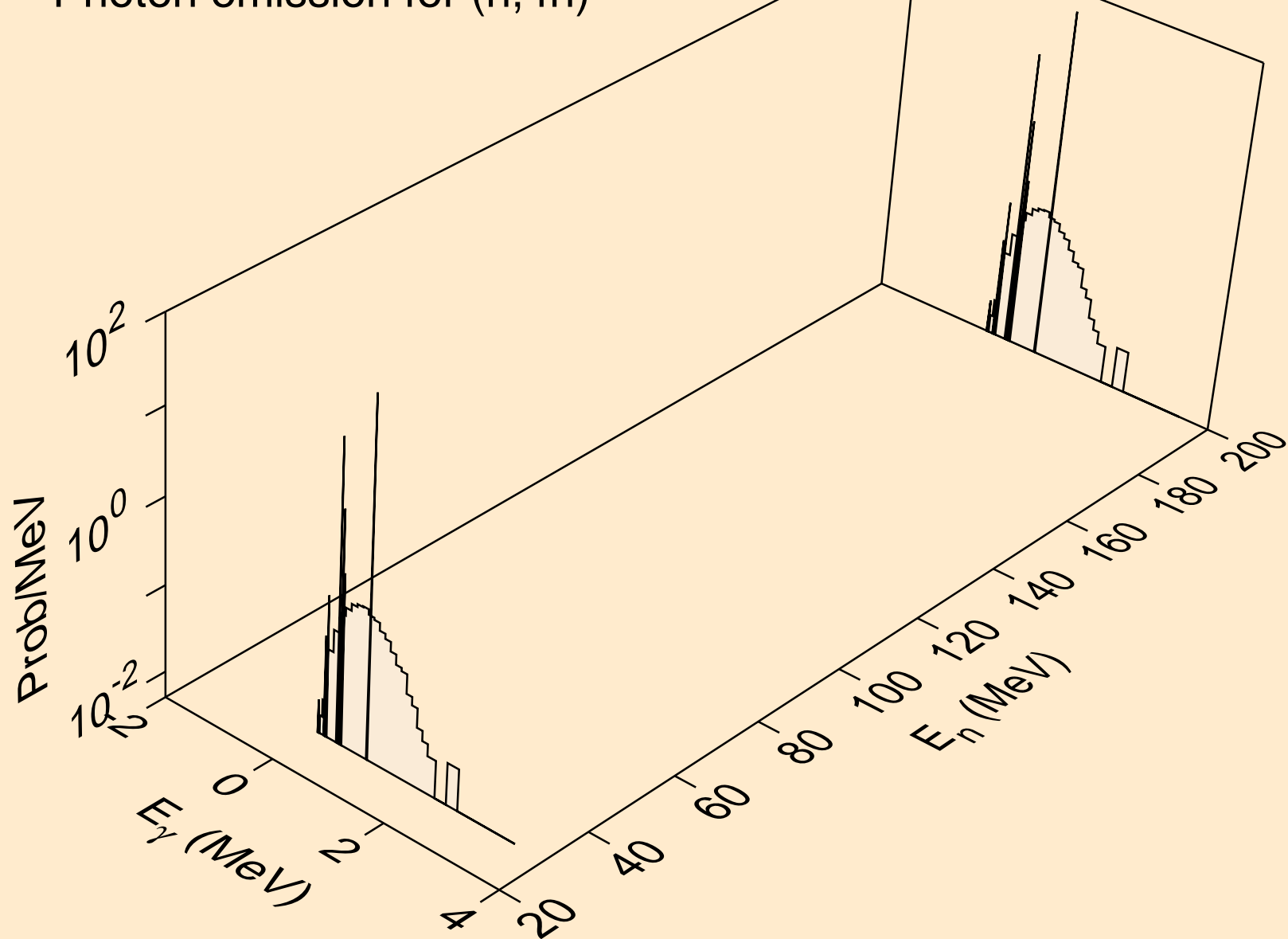

TL196 HELION ACER TENDL-2021 LIBRARY; T=0.K  
Photon emission for (n,2np)

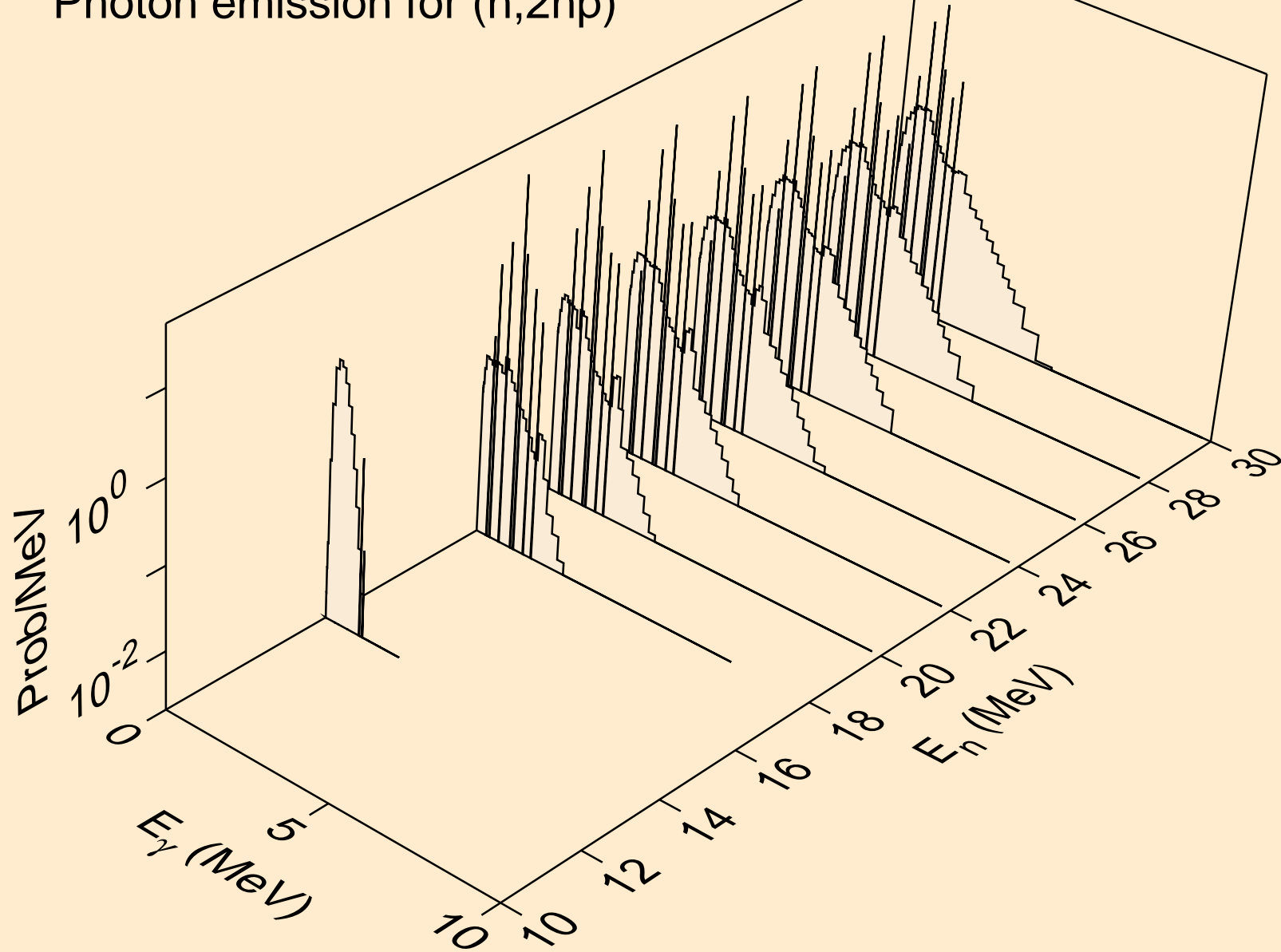

TL196 HELION ACER TENDL-2021 LIBRARY; T=0.K  
Photon emission for (n,3np)

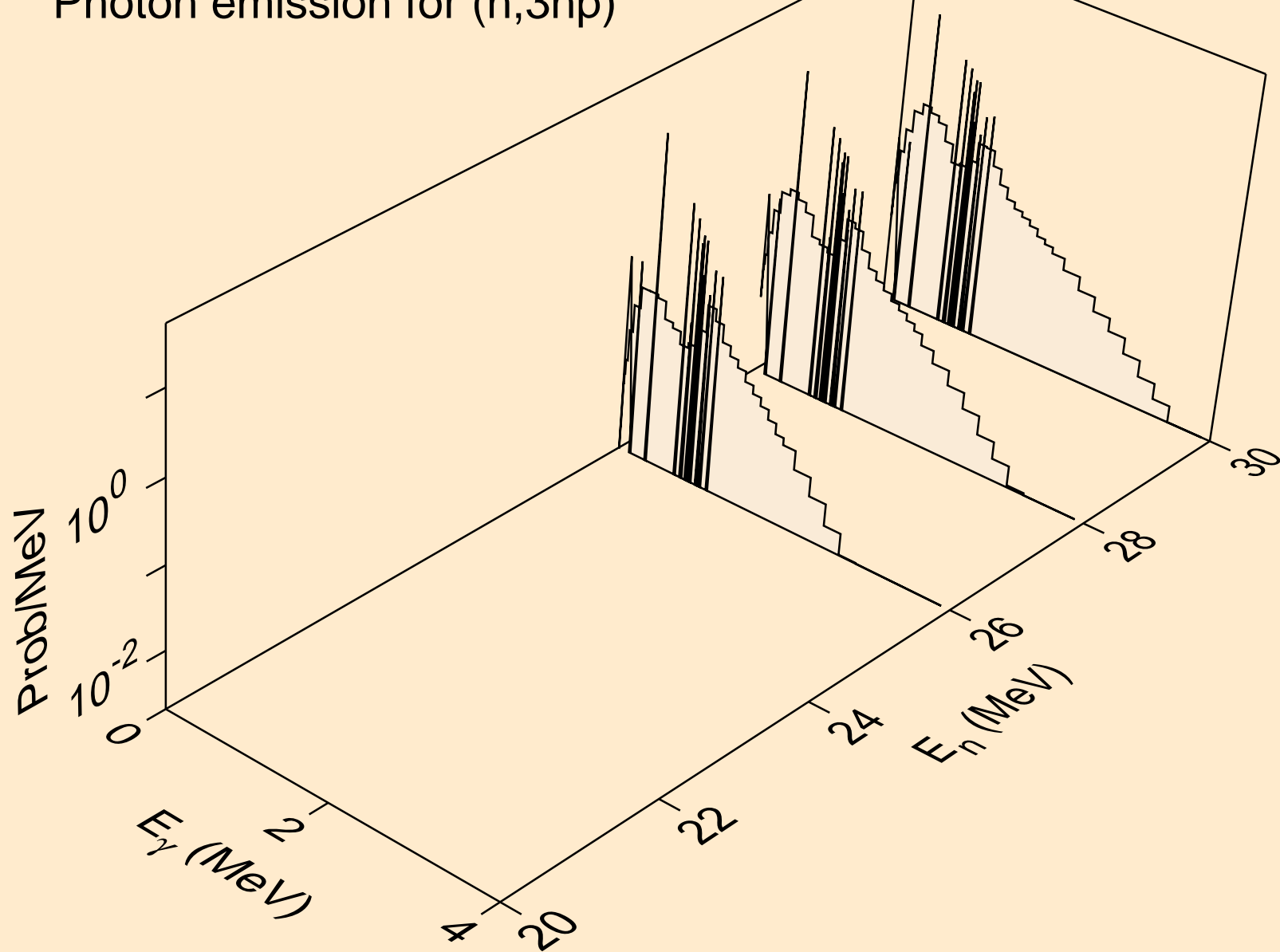



TL196 HELION ACER TENDL-2021 LIBRARY; T=0.K  
Photon emission for (n,2np)

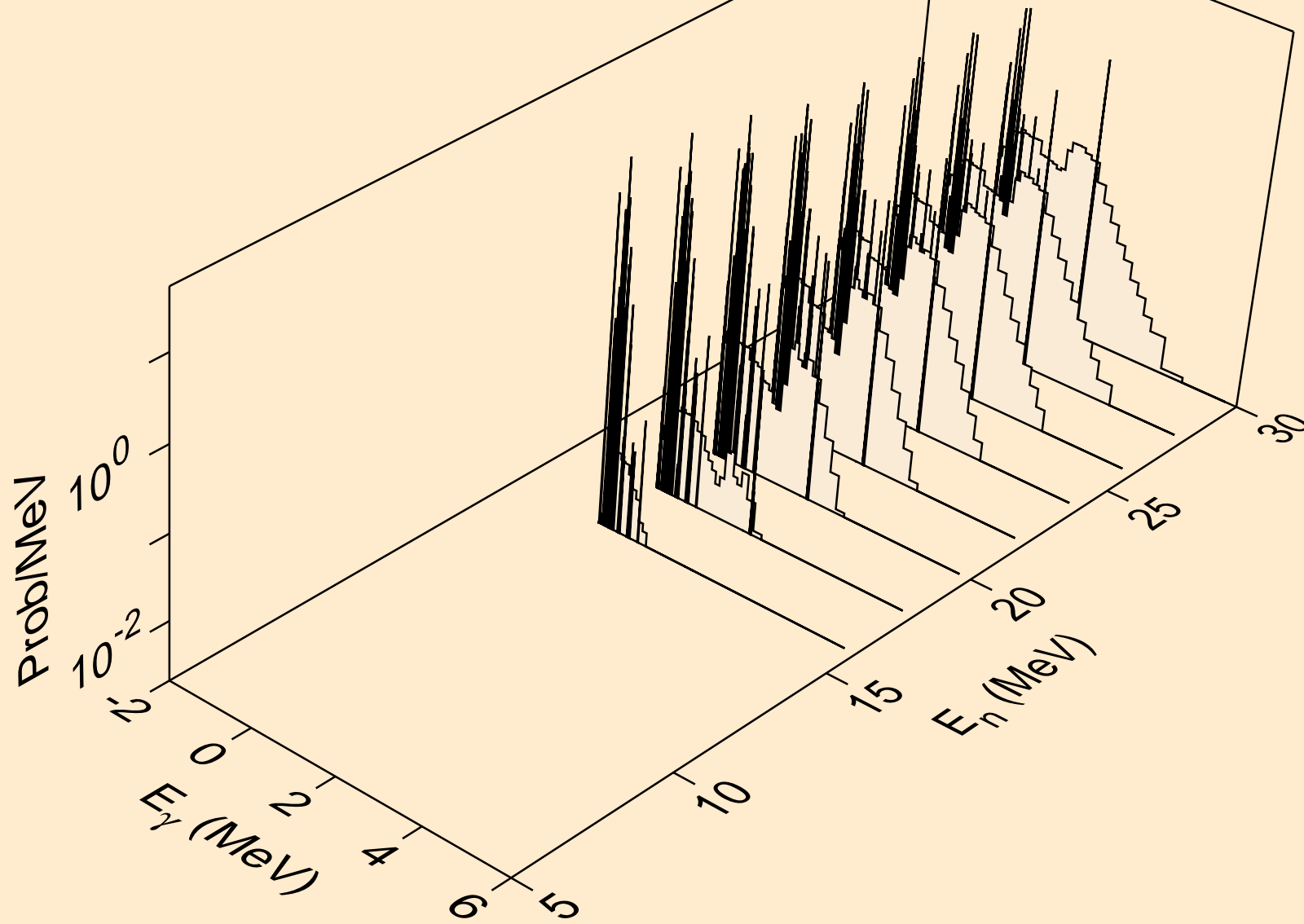

TL196 HELION ACER TENDL-2021 LIBRARY; T=0.K  
Photon emission for (n,npa)

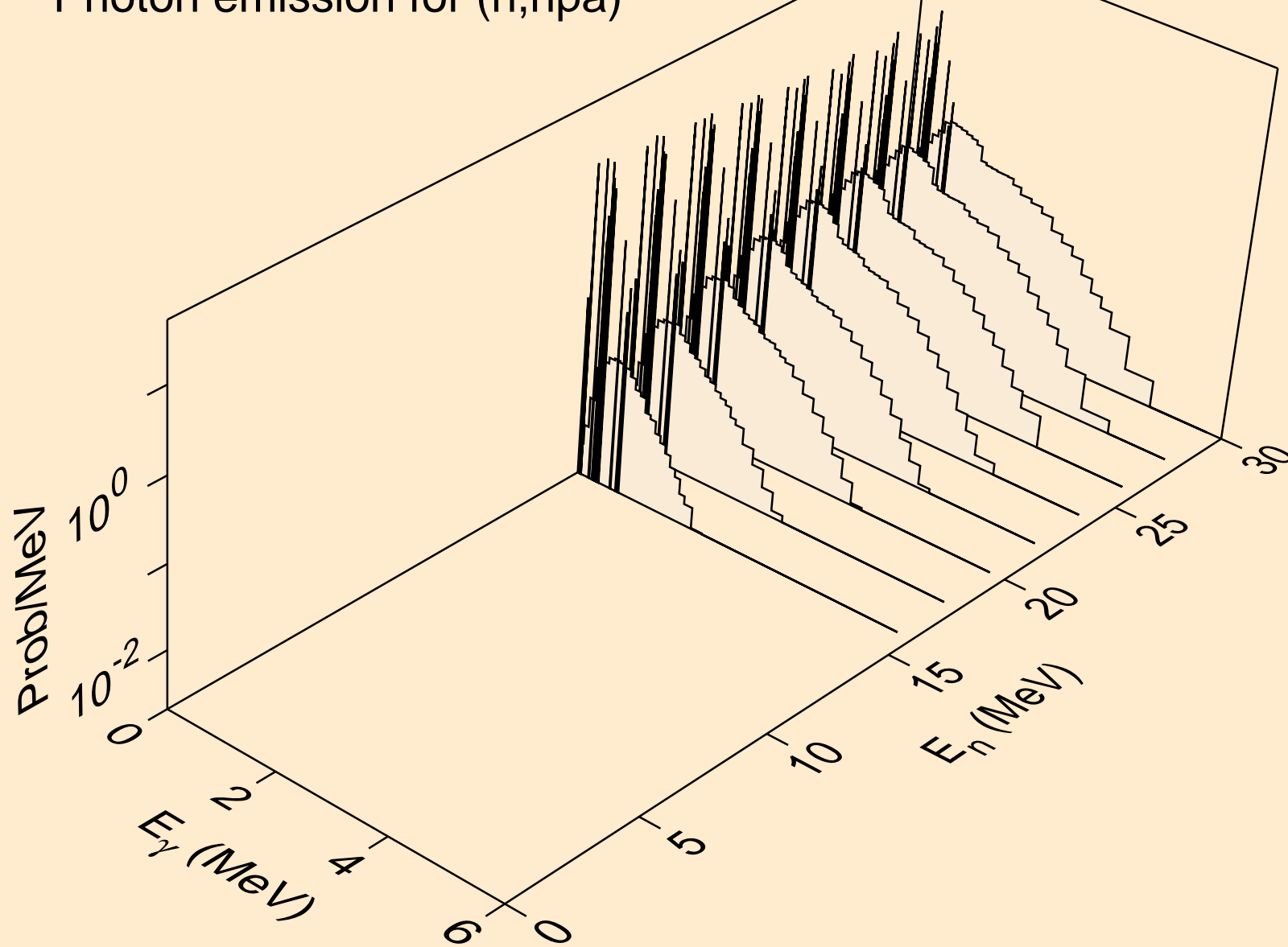

TL196 HELION ACER TENDL-2021 LIBRARY; T=0.K  
Photon emission for (n,gma)

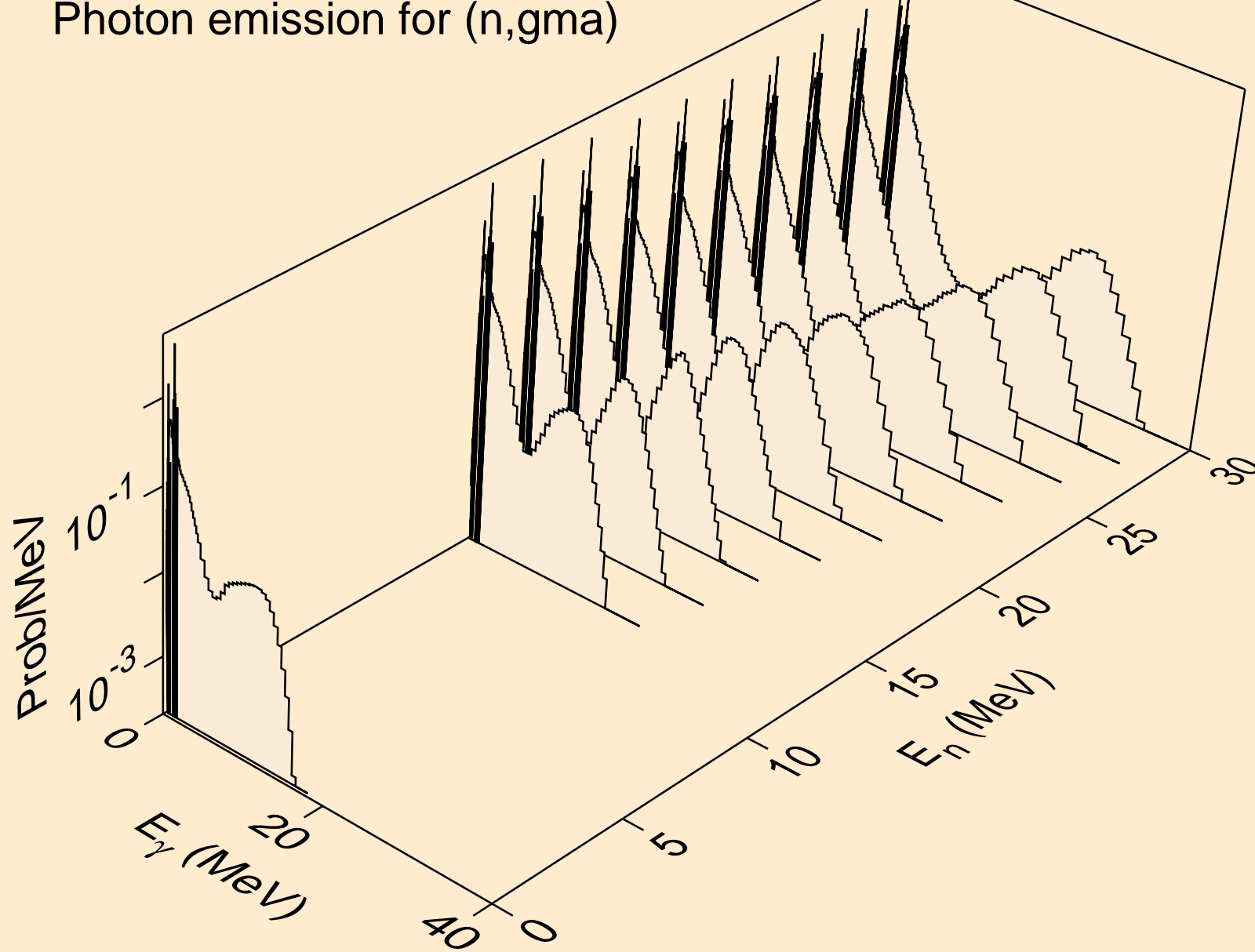

TL196 HELION ACER TENDL-2021 LIBRARY; T=0.K  
Photon emission for (n,p)

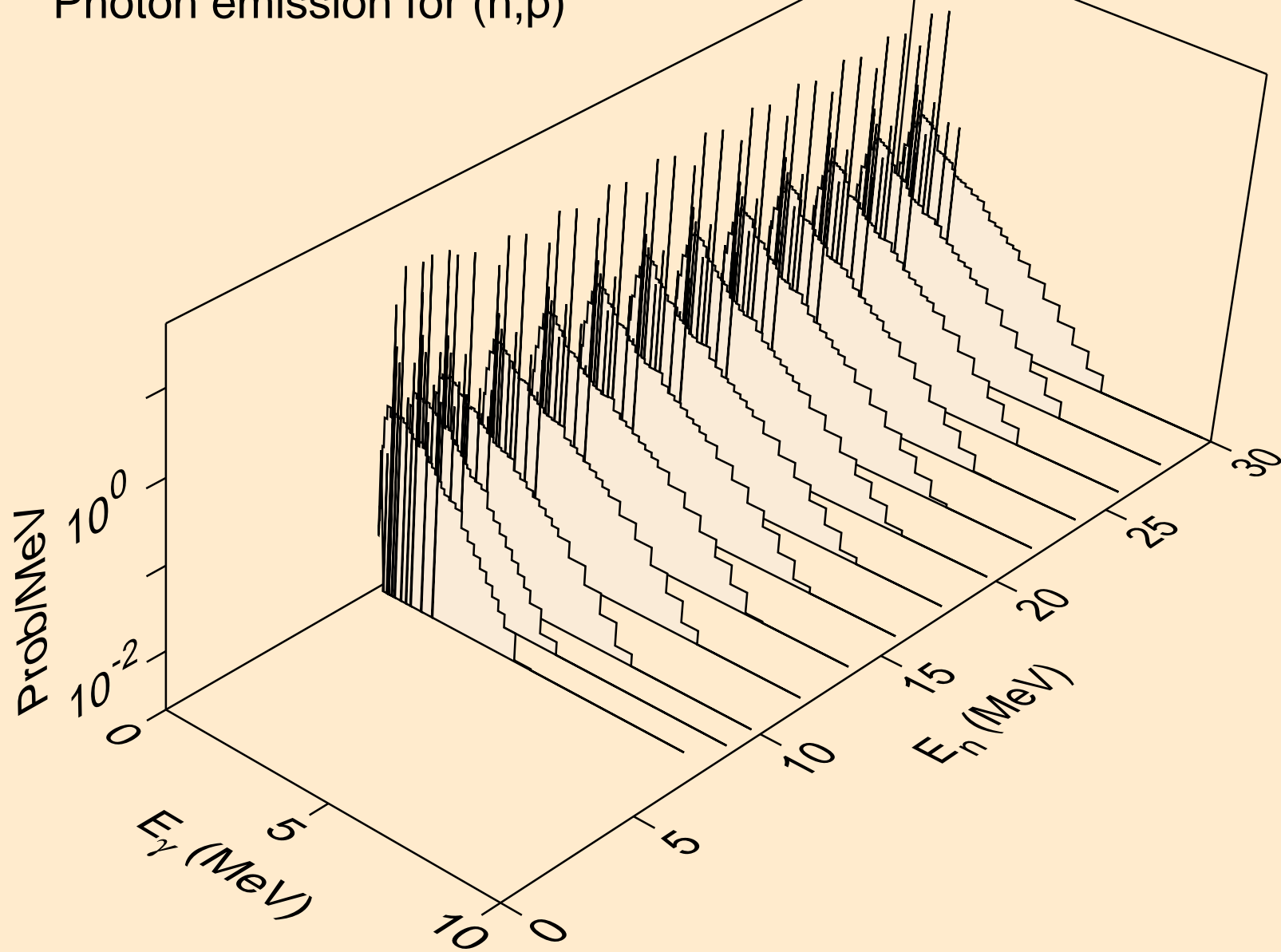

TL196 HELION ACER TENDL-2021 LIBRARY; T=0.K  
Photon emission for (n,d)

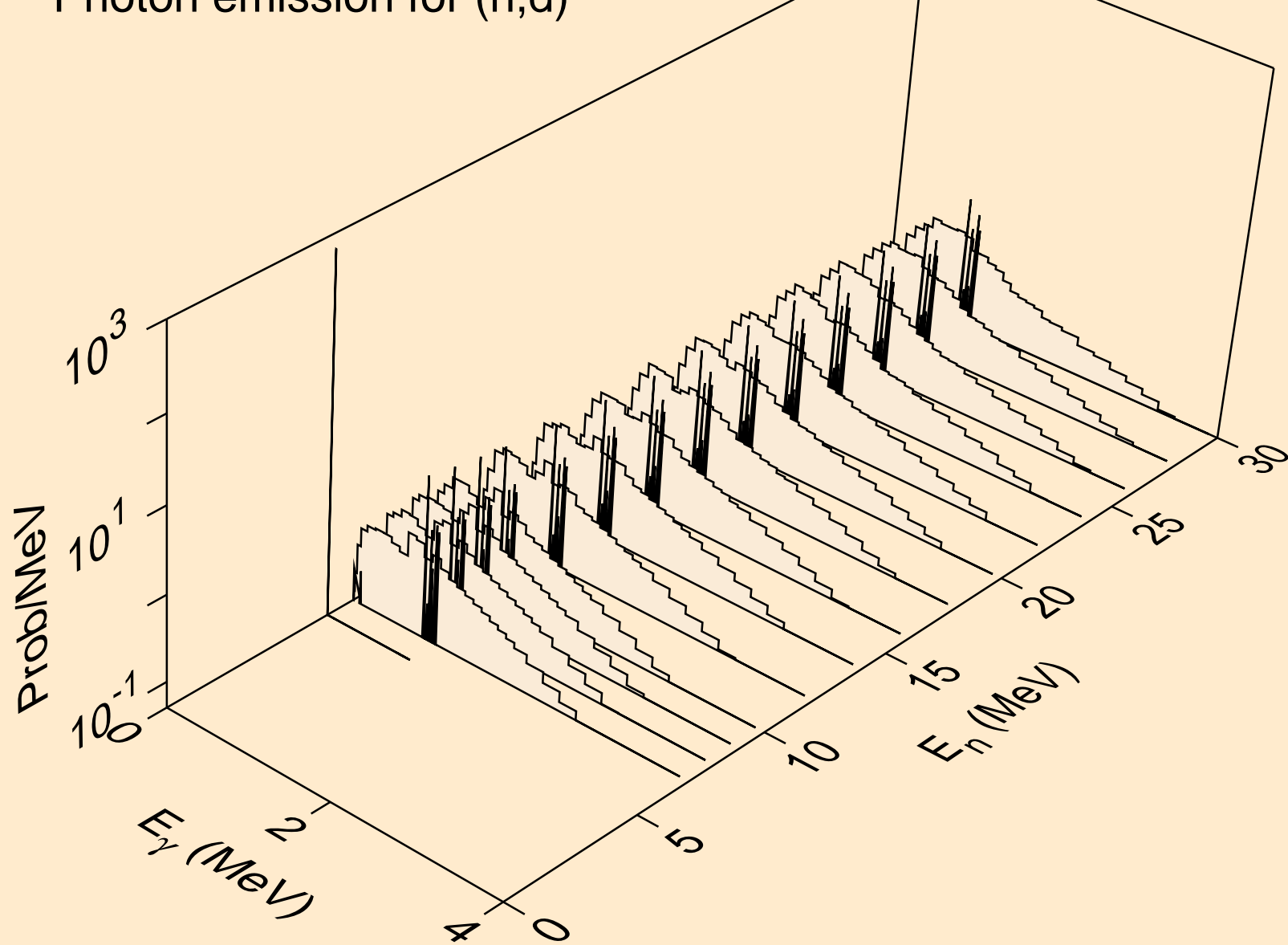

TL196 HELION ACER TENDL-2021 LIBRARY; T=0.K  
Photon emission for (n,t)

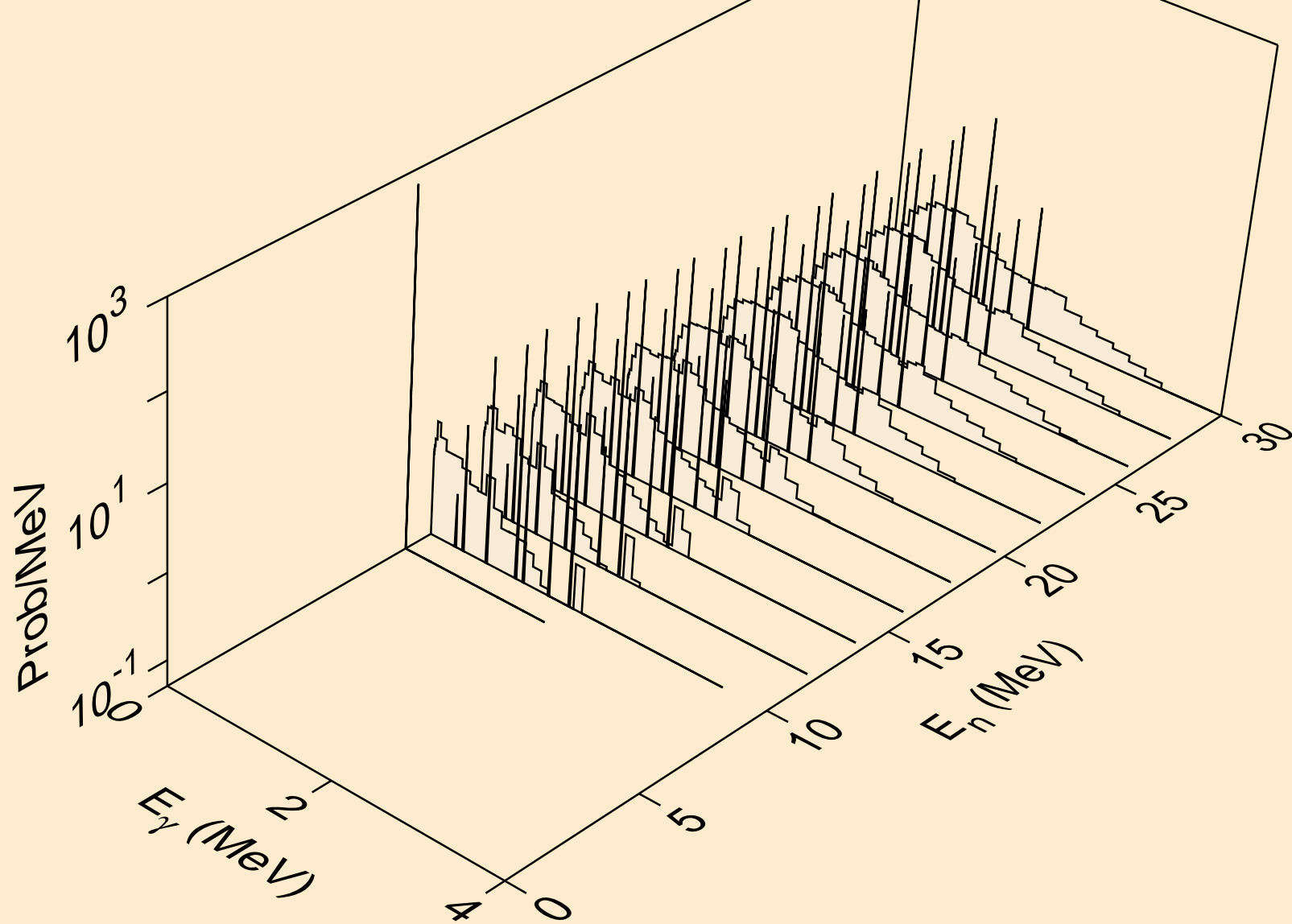

TL196 HELION ACER TENDL-2021 LIBRARY; T=0.K  
Photon emission for inelastic

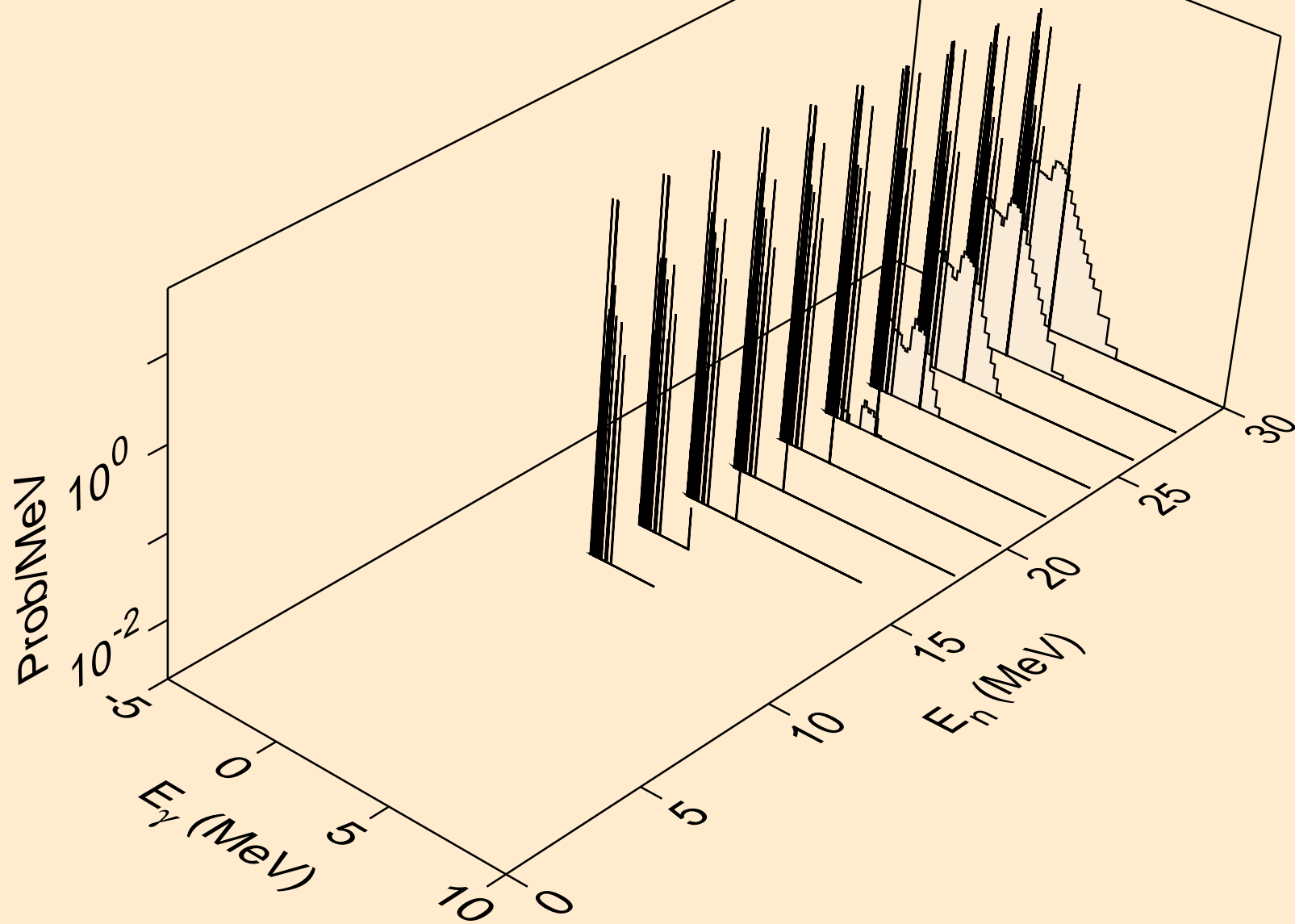

TL196 HELION ACER TENDL-2021 LIBRARY; T=0.K  
Photon emission for (n,a)

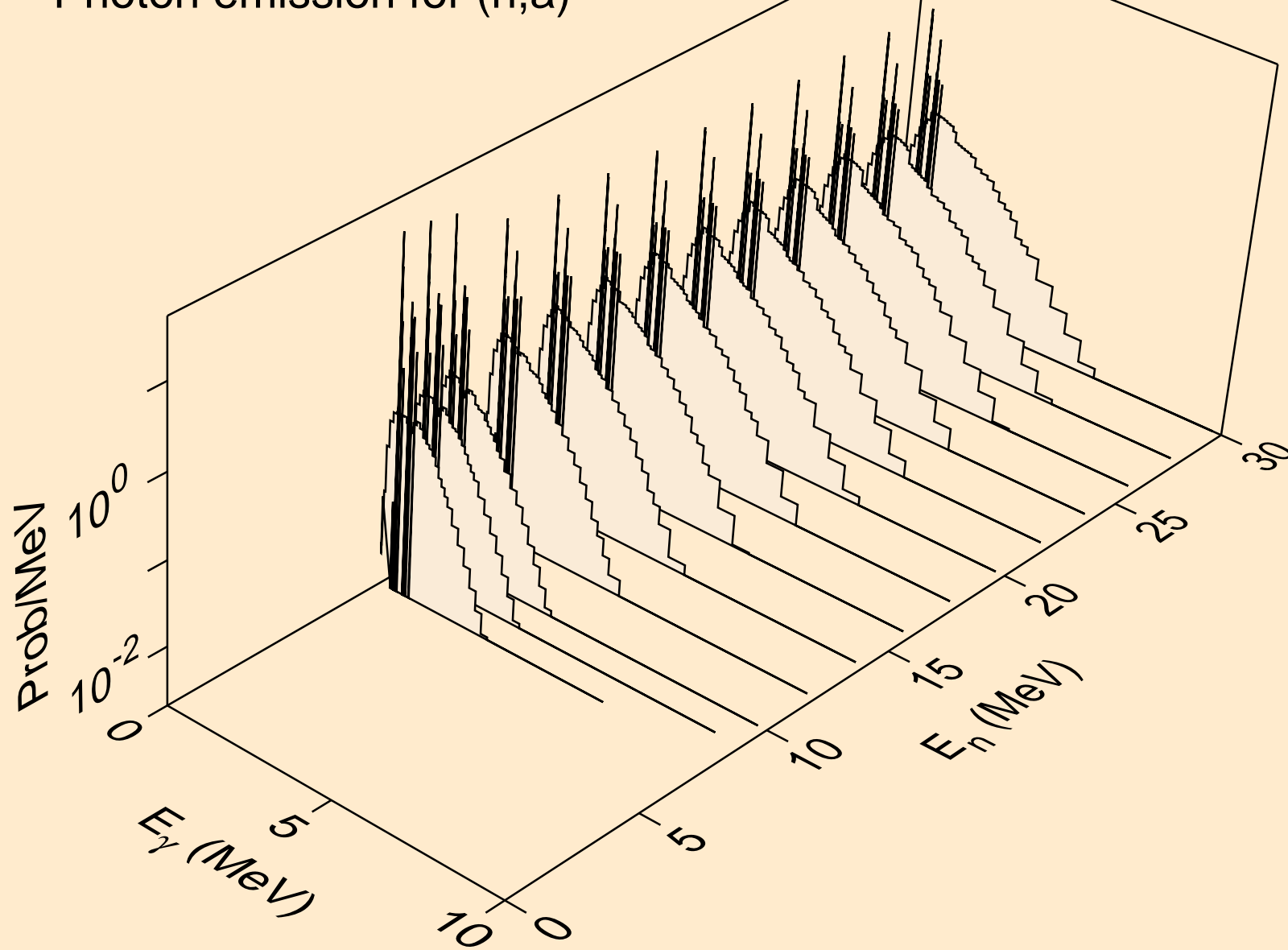



TL196 HELION ACER TENDL-2021 LIBRARY; T=0.K  
Photon emission for (n,2a)

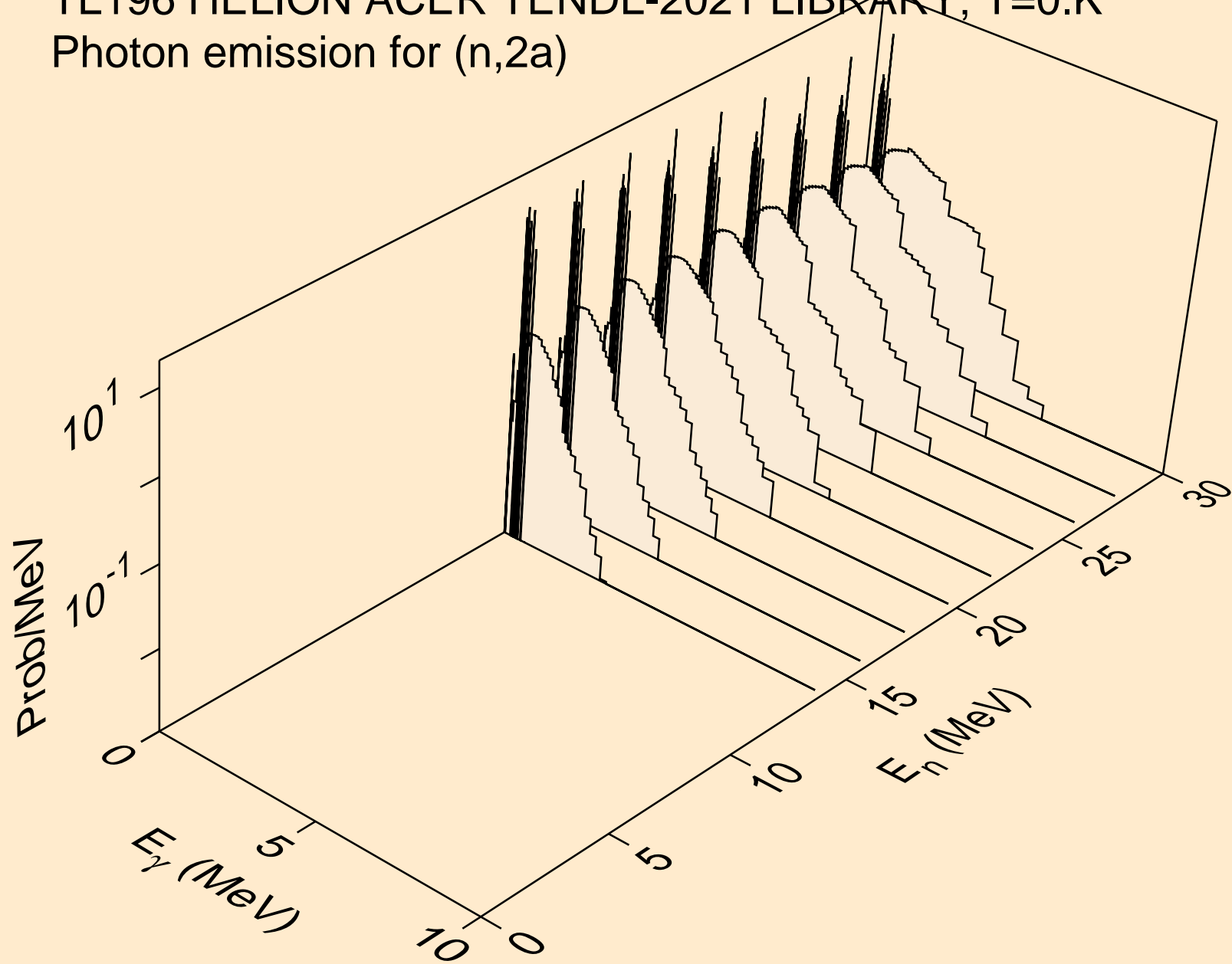

TL196 HELION ACER TENDL-2021 LIBRARY; T=0.K  
Photon emission for (n,2p)

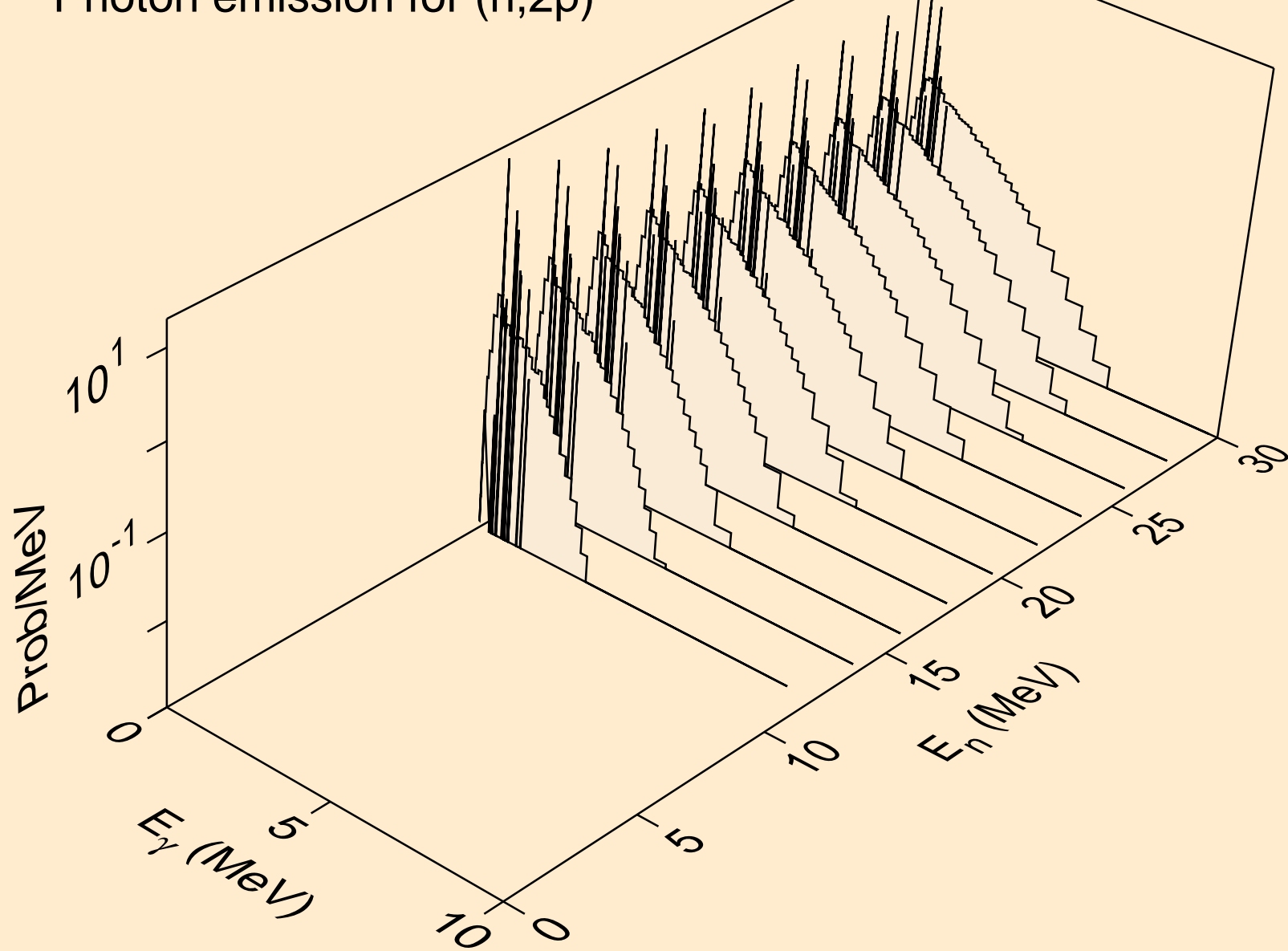

TL196 HELION ACER TENDL-2021 LIBRARY; T=0.K  
Photon emission for (n,p $\alpha$ )

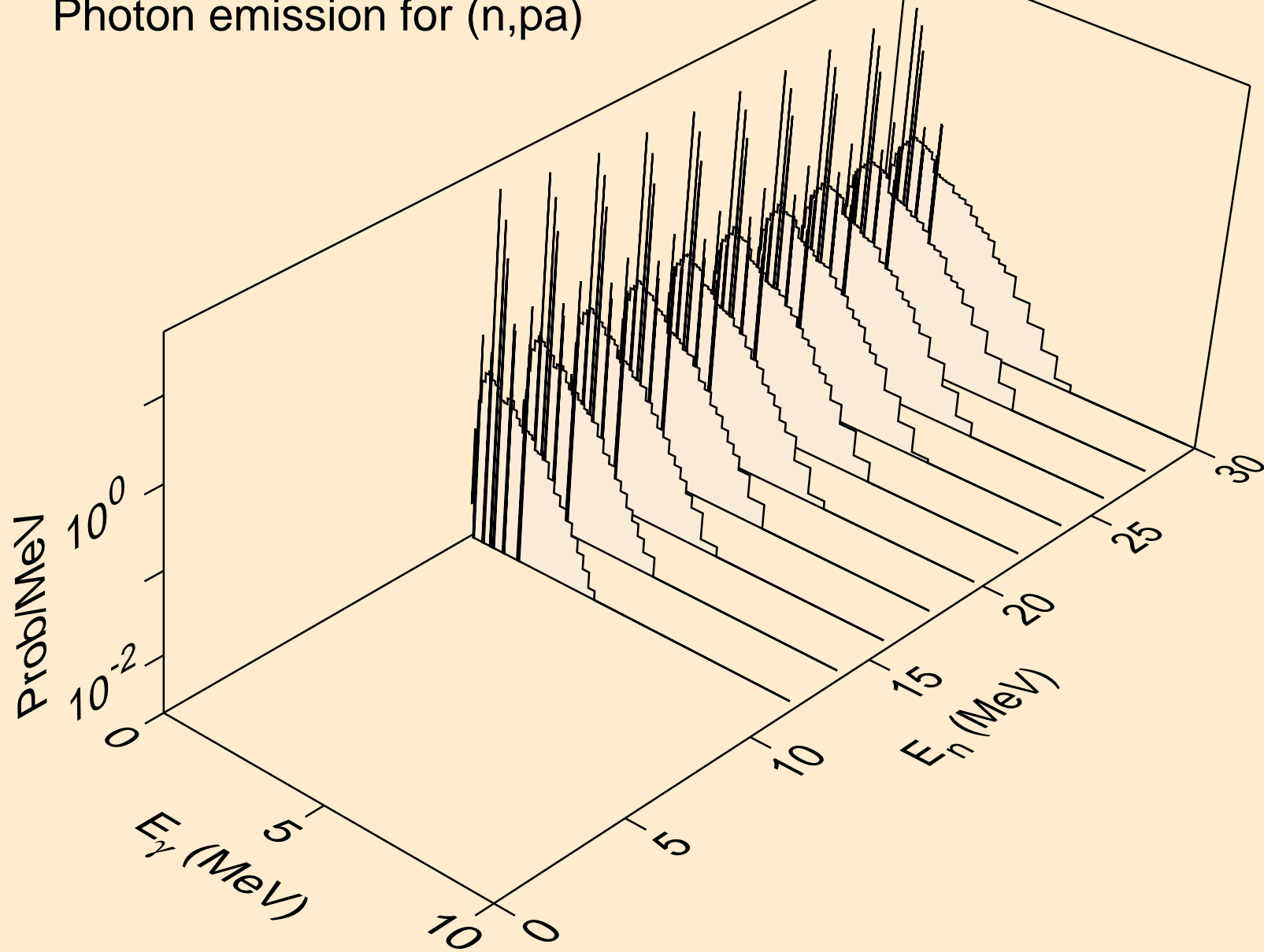

TL196 HELION ACER TENDL-2021 LIBRARY; T=0.K  
Photon emission for (n,pd)

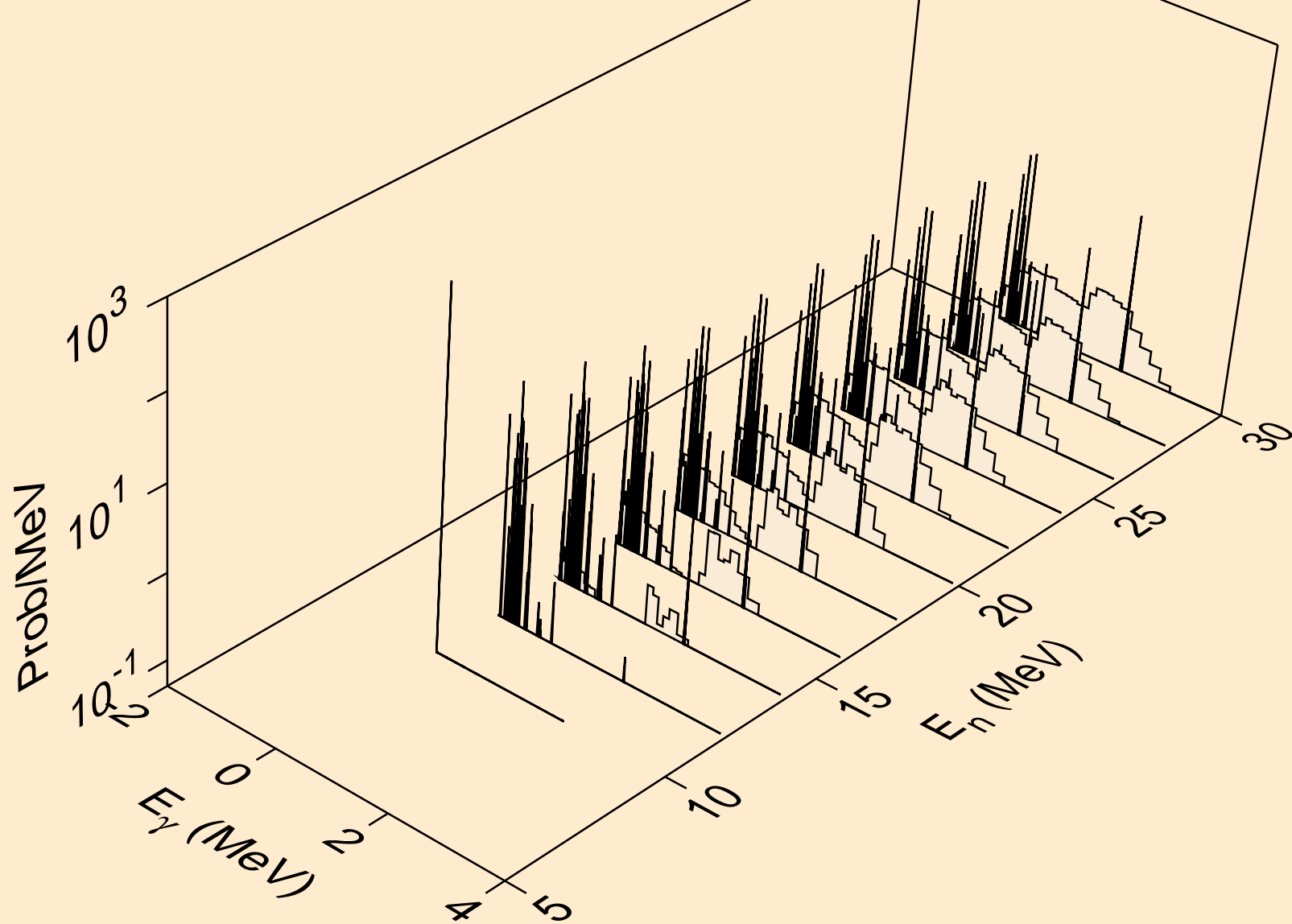

TL196 HELION ACER TENDL-2021 LIBRARY; T=0.K  
Photon emission for (n,pt)

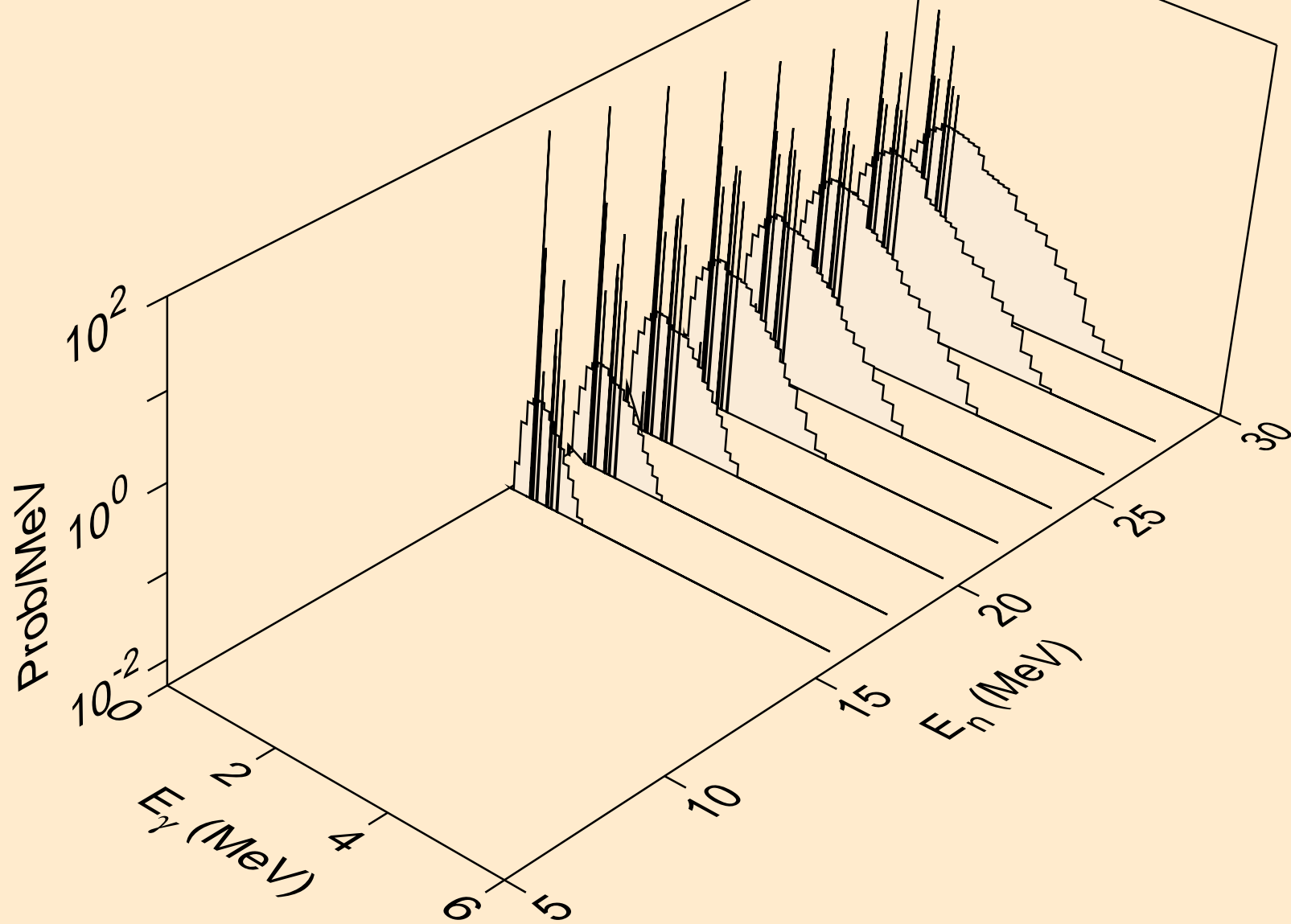

TL196 HELION ACER TENDL-2021 LIBRARY; T=0.K  
Photon emission for (n,da)

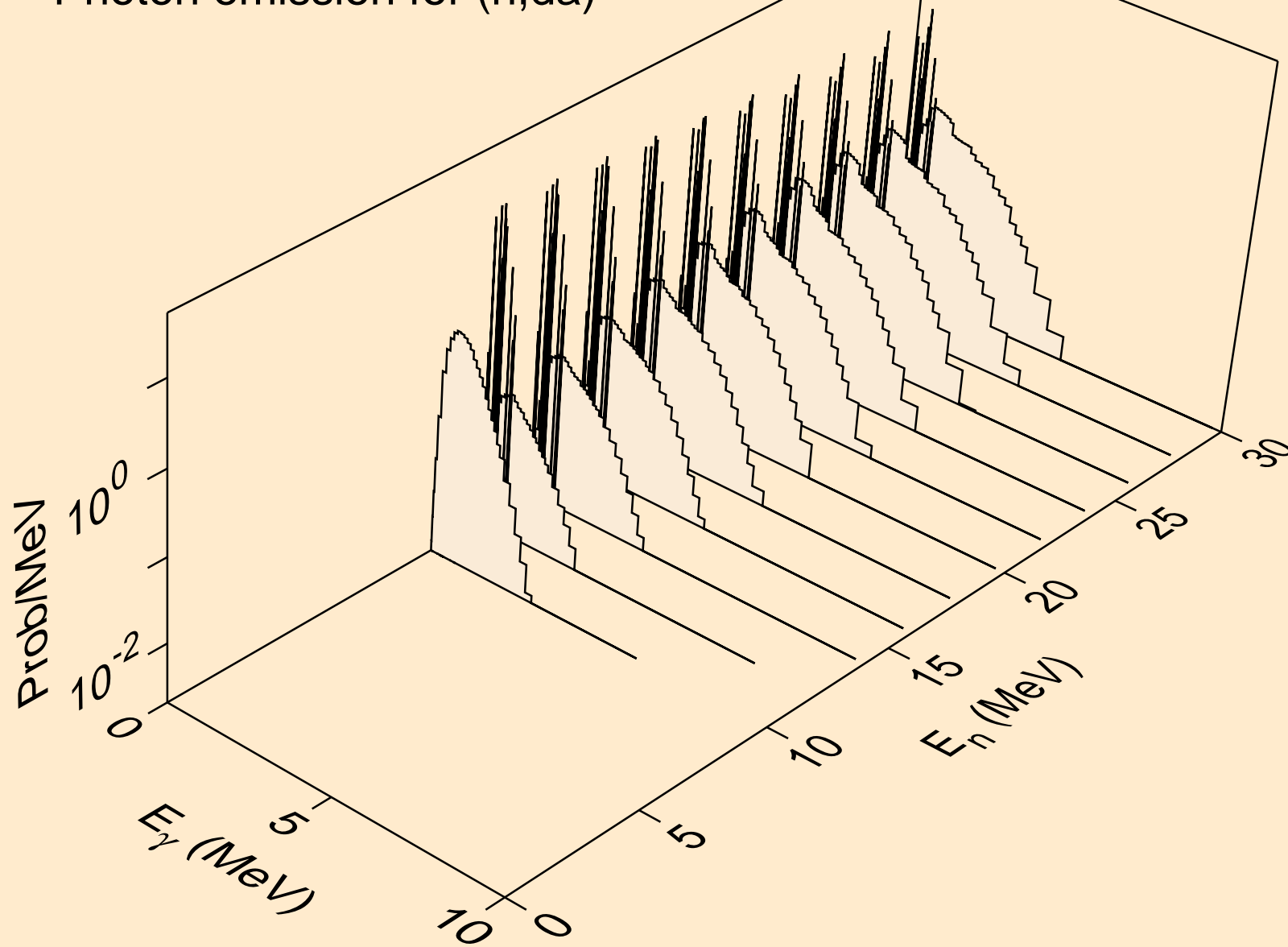

TL196 HELION ACER TENDL-2021 LIBRARY; T=0.K  
Particle heating contributions

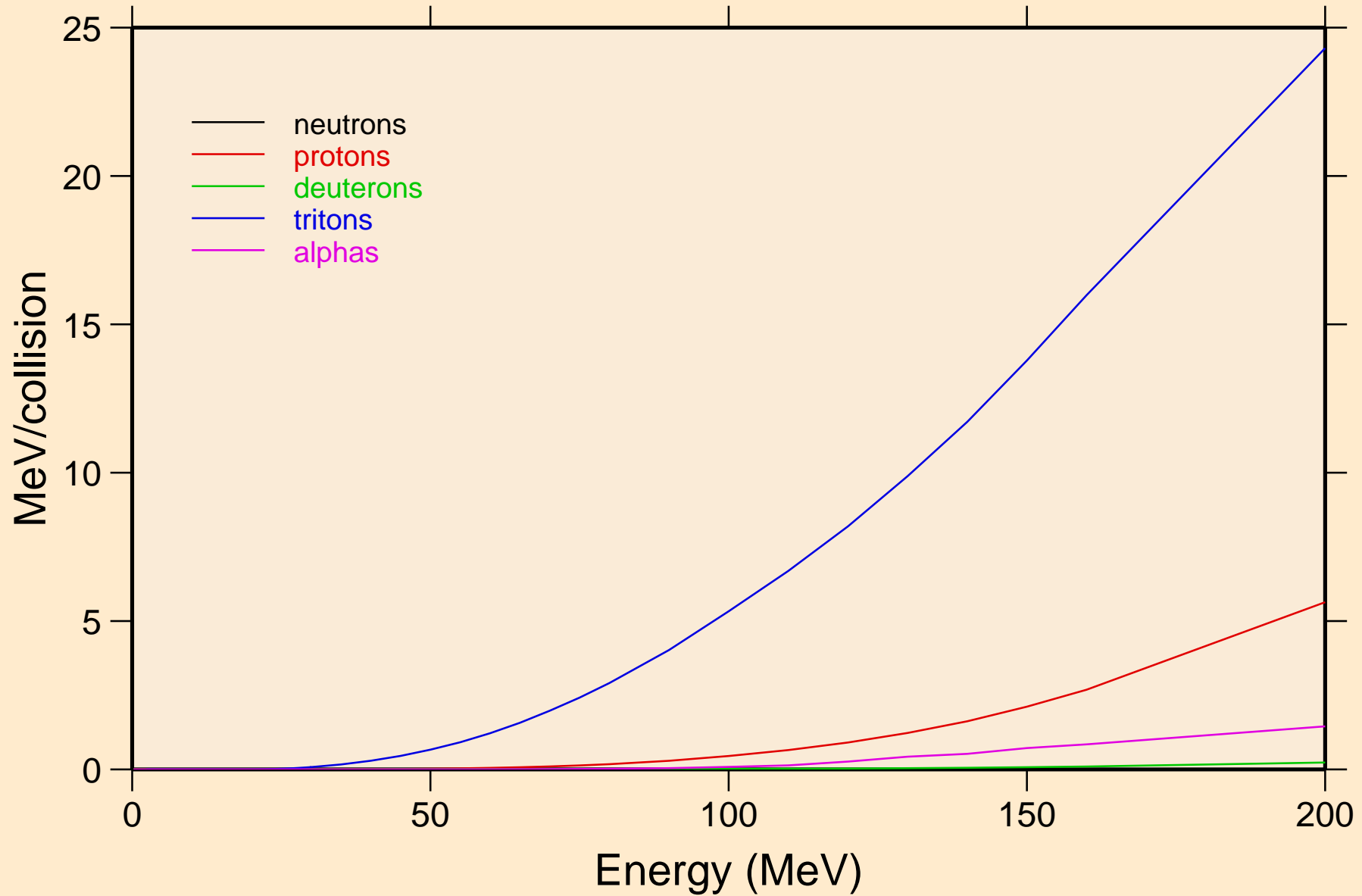

TL196 HELION ACER TENDL-2021 LIBRARY; T=0.K

Recoil Heating

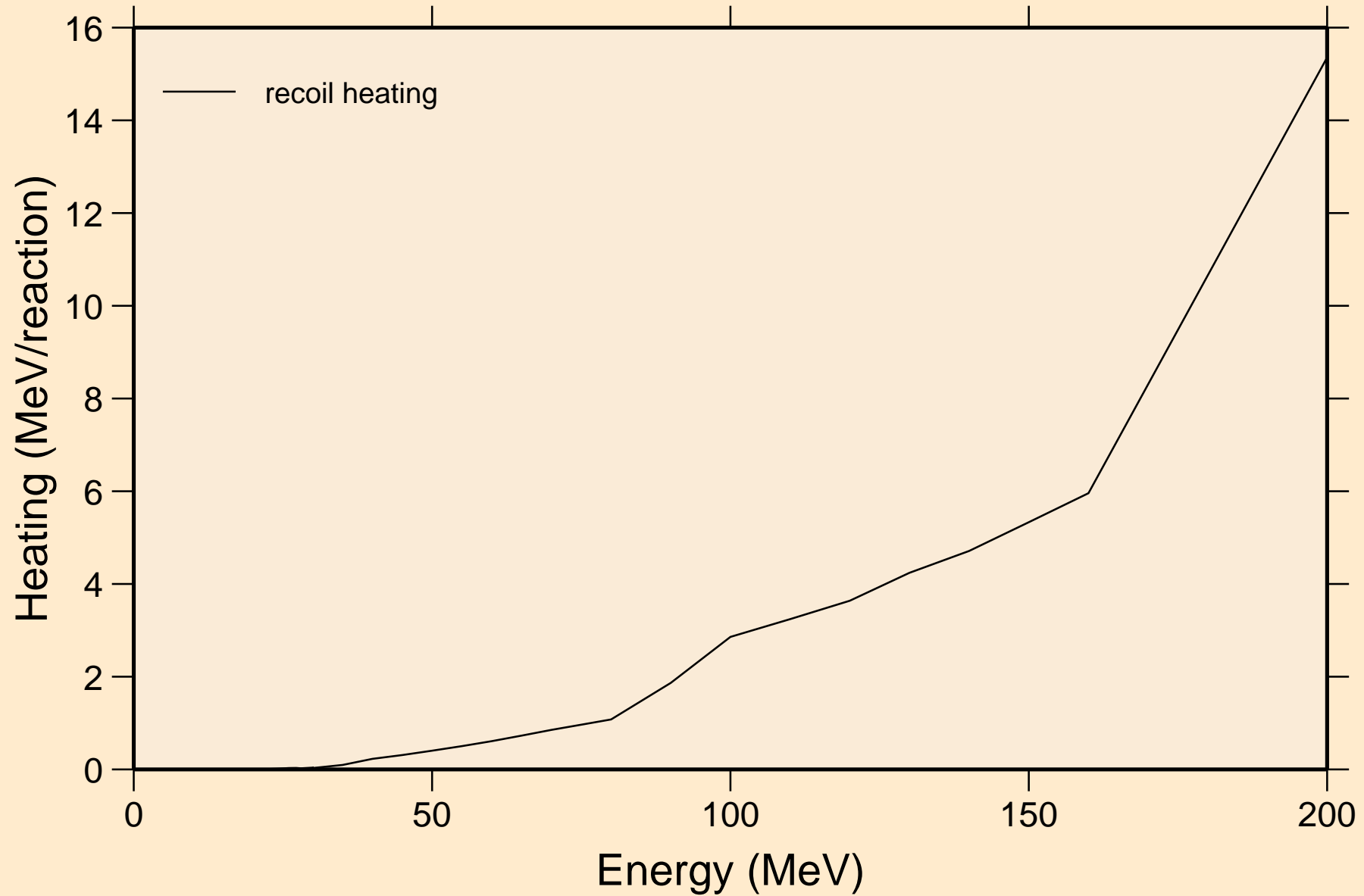



TL196 HELION ACER TENDL-2021 LIBRARY; T=0.K  
Particle production cross sections

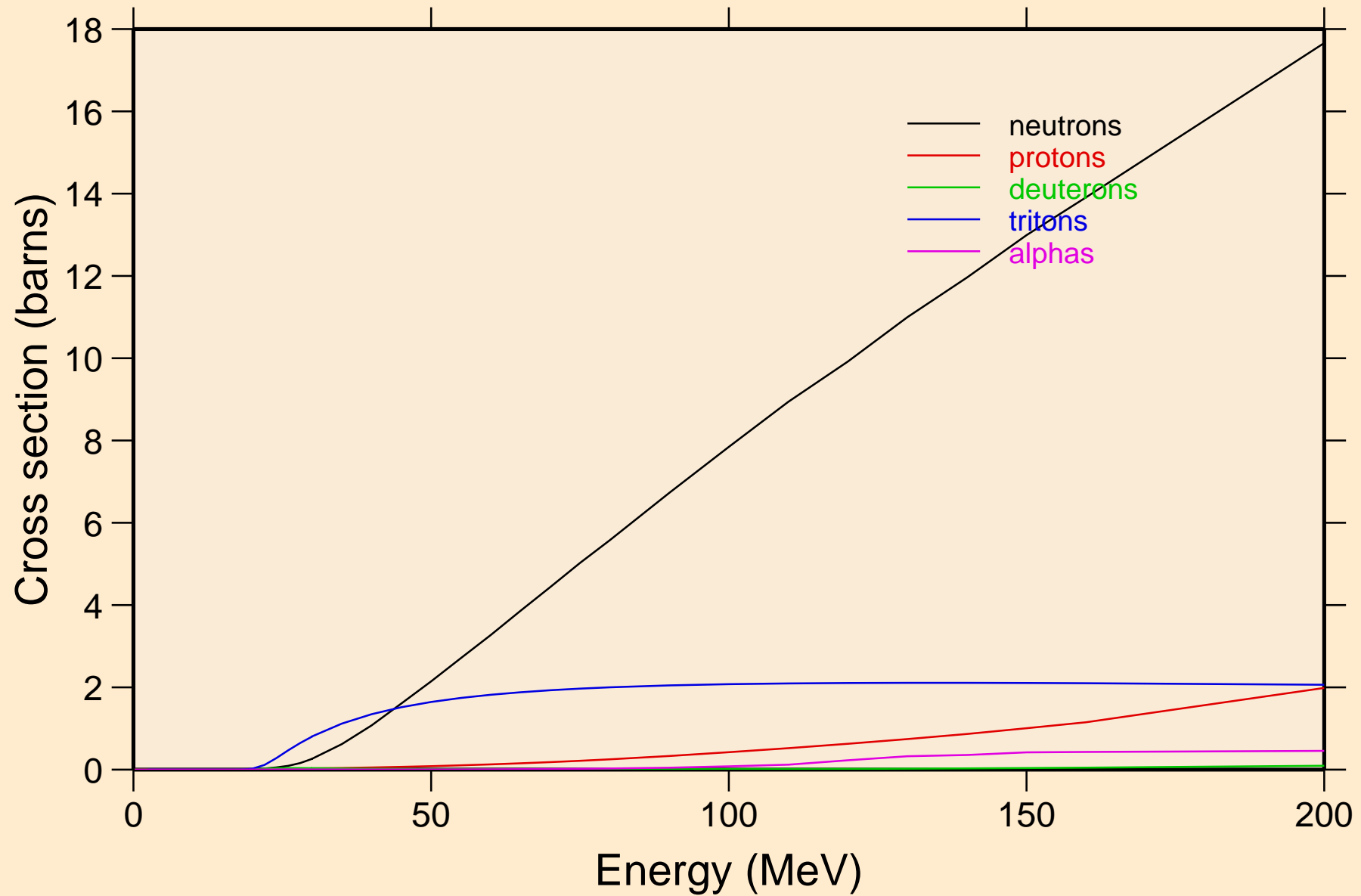

TL196 HELION ACER TENDL-2021 LIBRARY; T=0.K  
neutrons from (s,n)

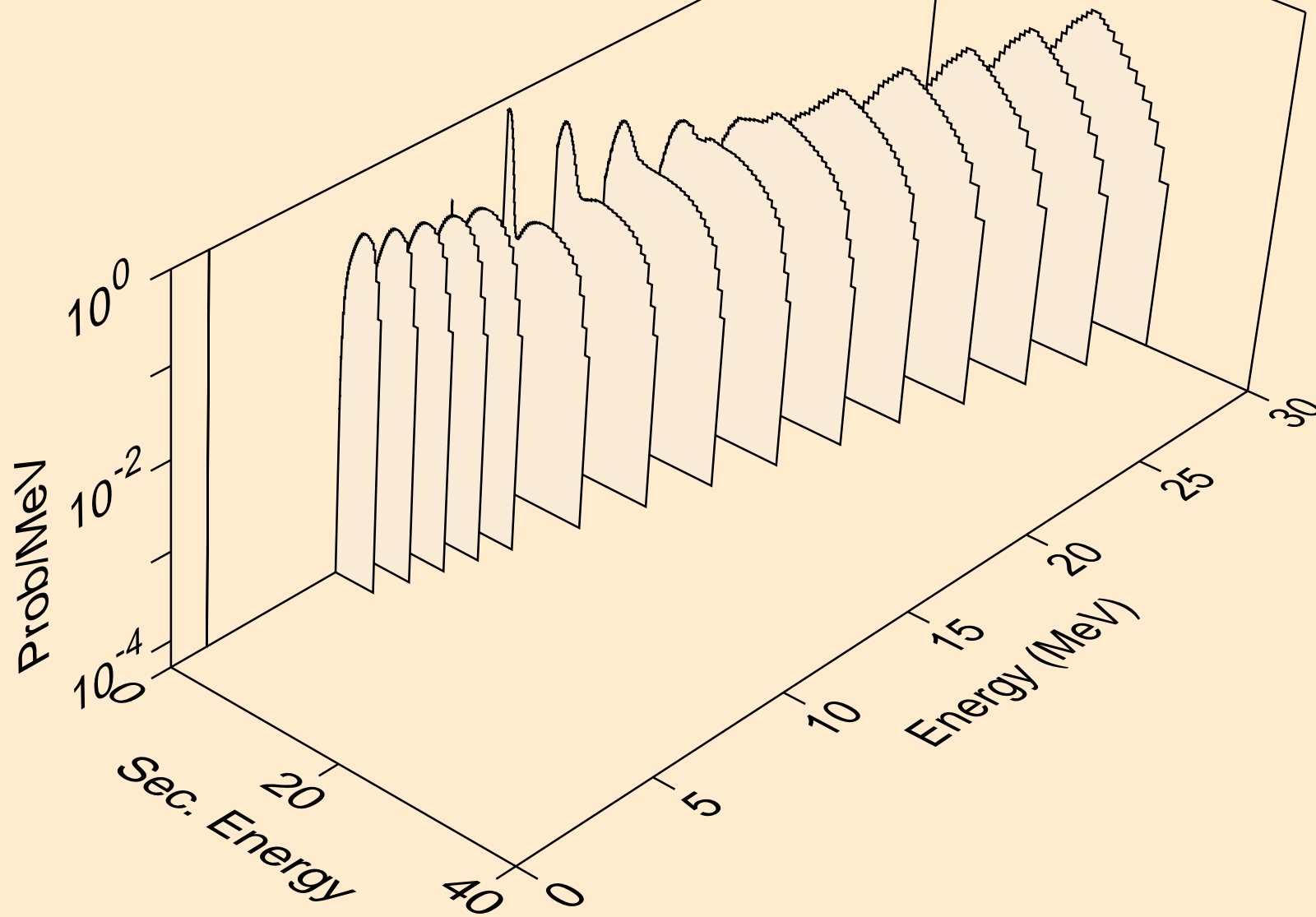

TL196 HELION ACER TENDL-2021 LIBRARY; T=0.K  
neutrons from (s,x)

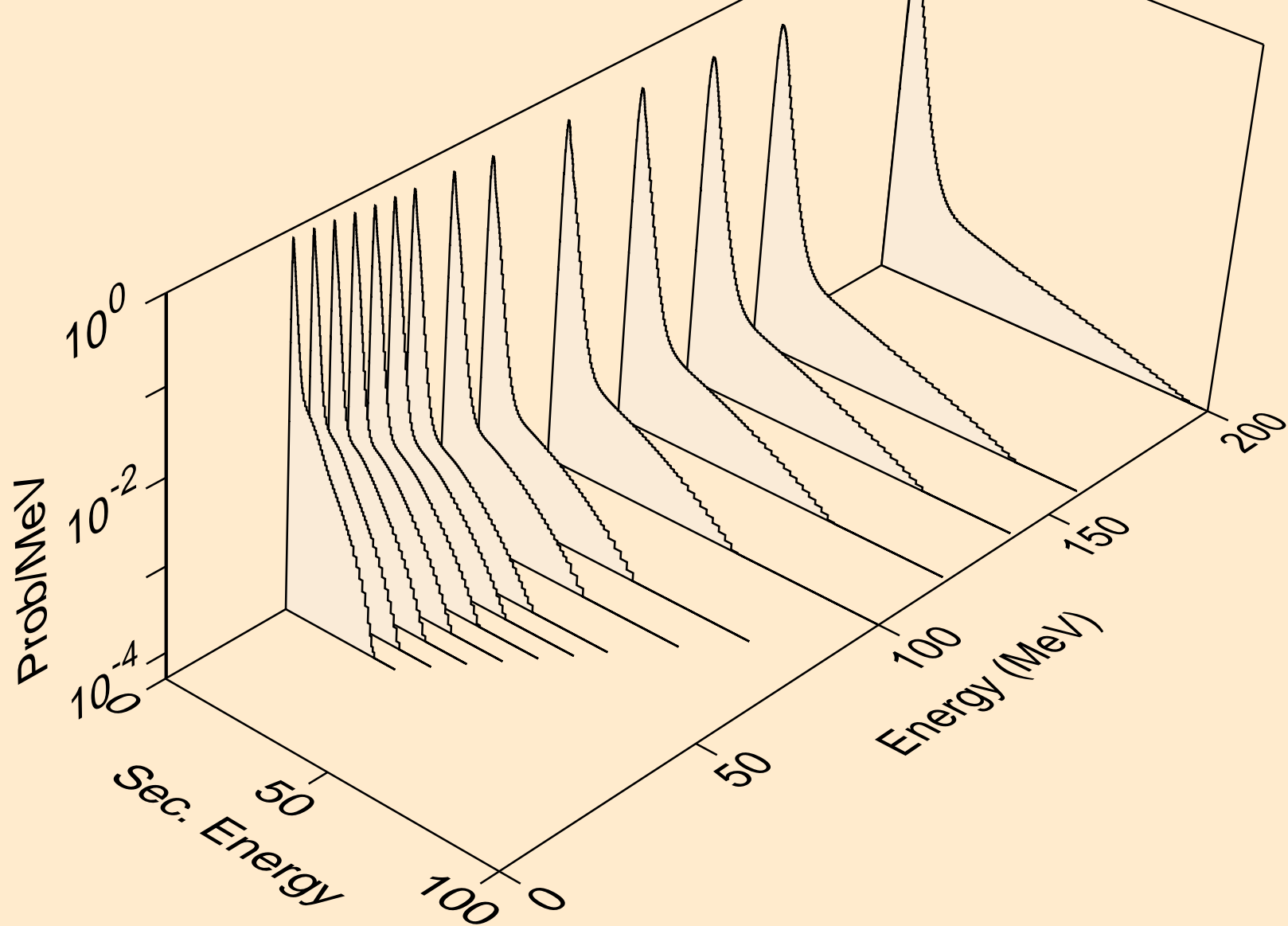

TL196 HELION ACER TENDL-2021 LIBRARY; T=0.K  
neutrons from (s,2nd)

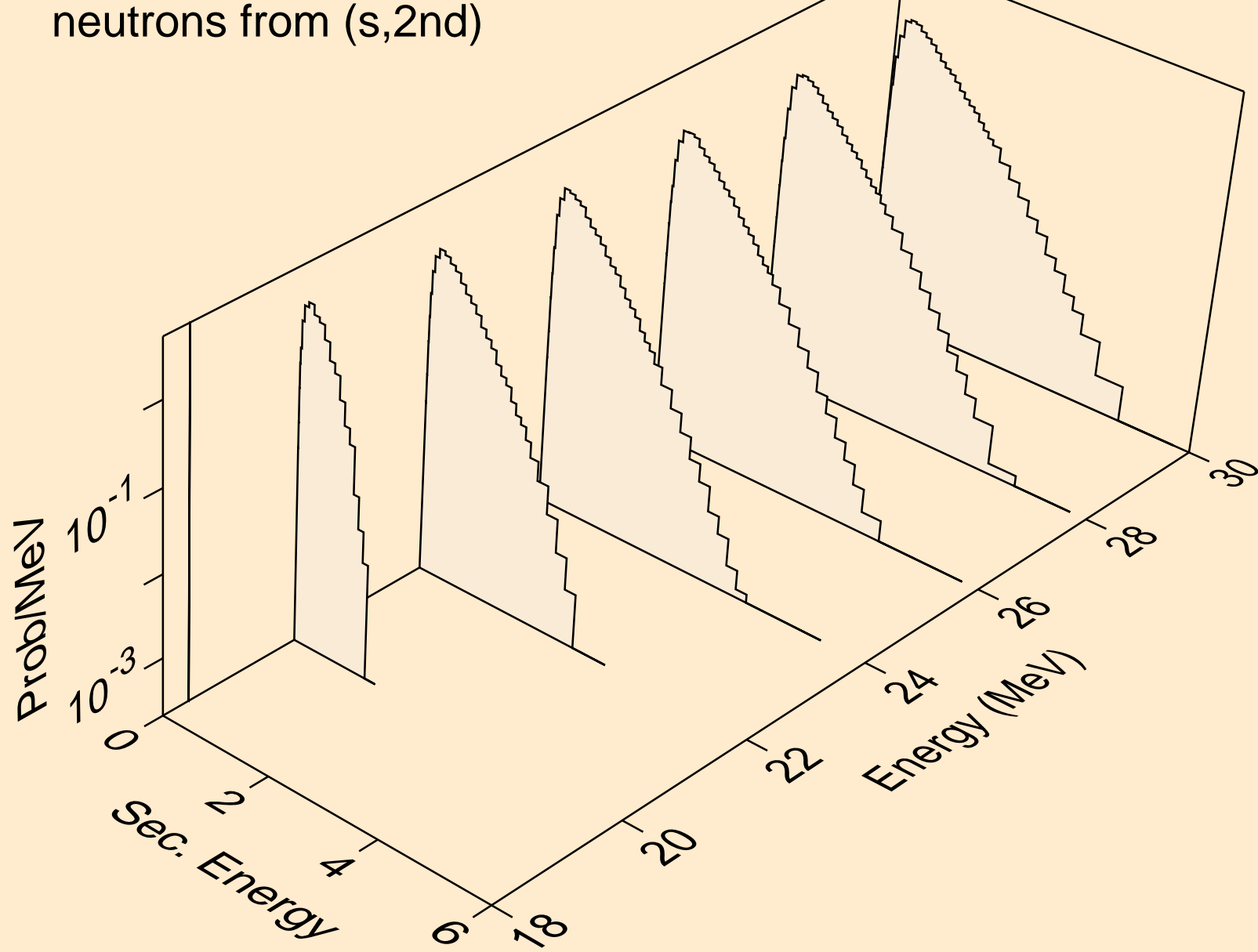

TL196 HELION ACER TENDL-2021 LIBRARY; T=0.K  
neutrons from (s,2n)

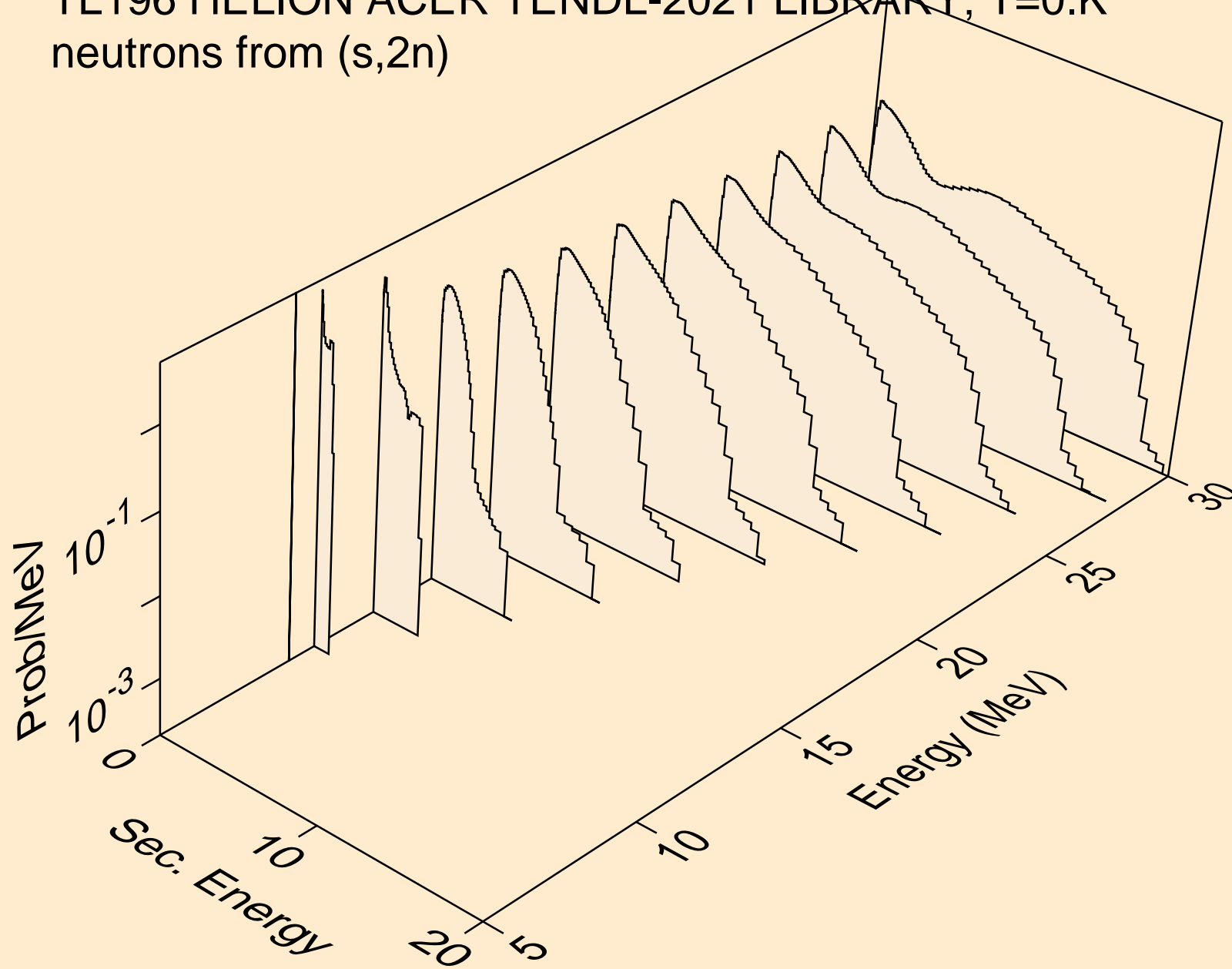

TL196 HELION ACER TENDL-2021 LIBRARY; T=0.K  
neutrons from (s,3n)

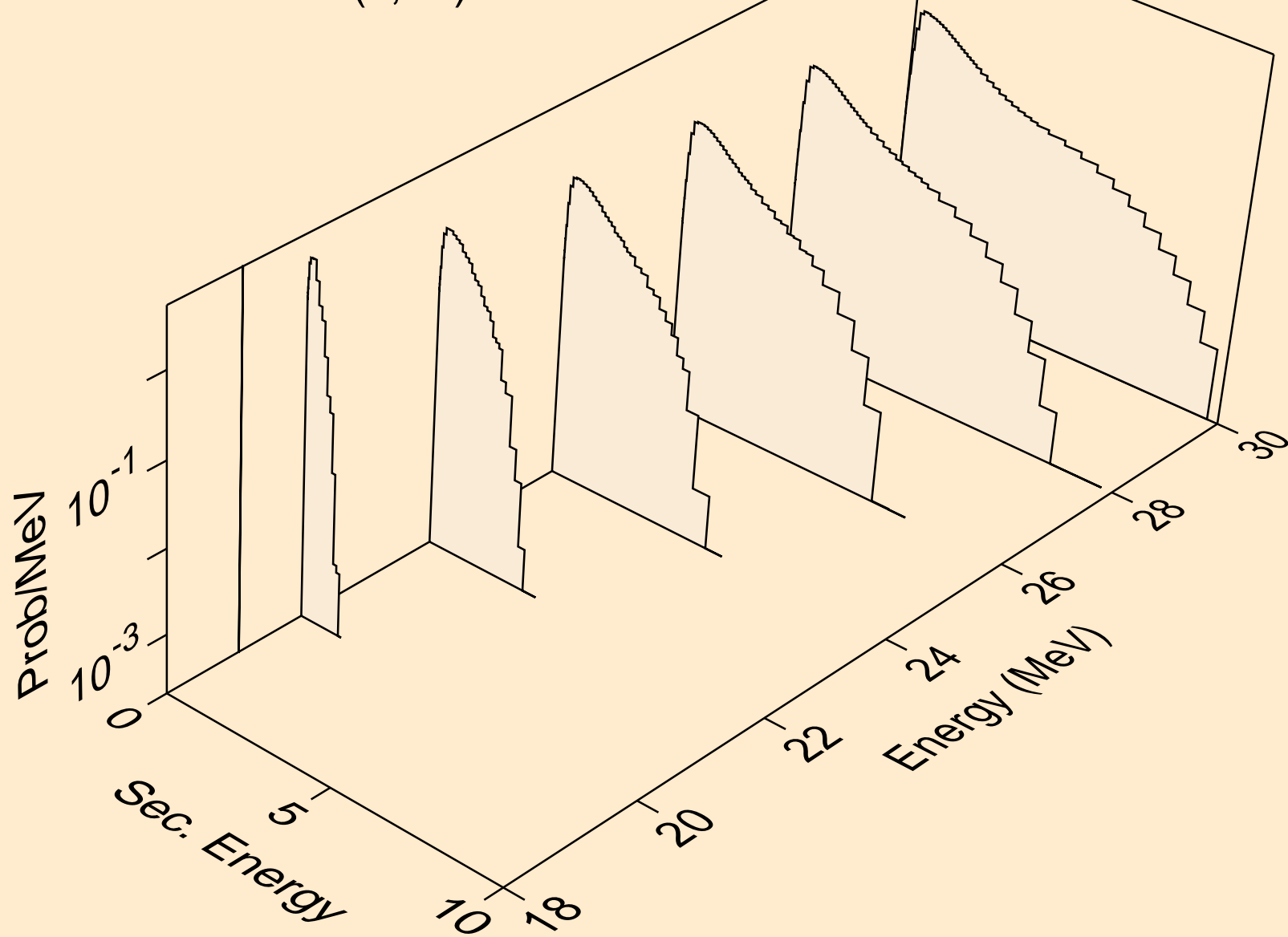

TL196 HELION ACER TENDL-2021 LIBRARY; T=0.K  
neutrons from (s,n\*)a

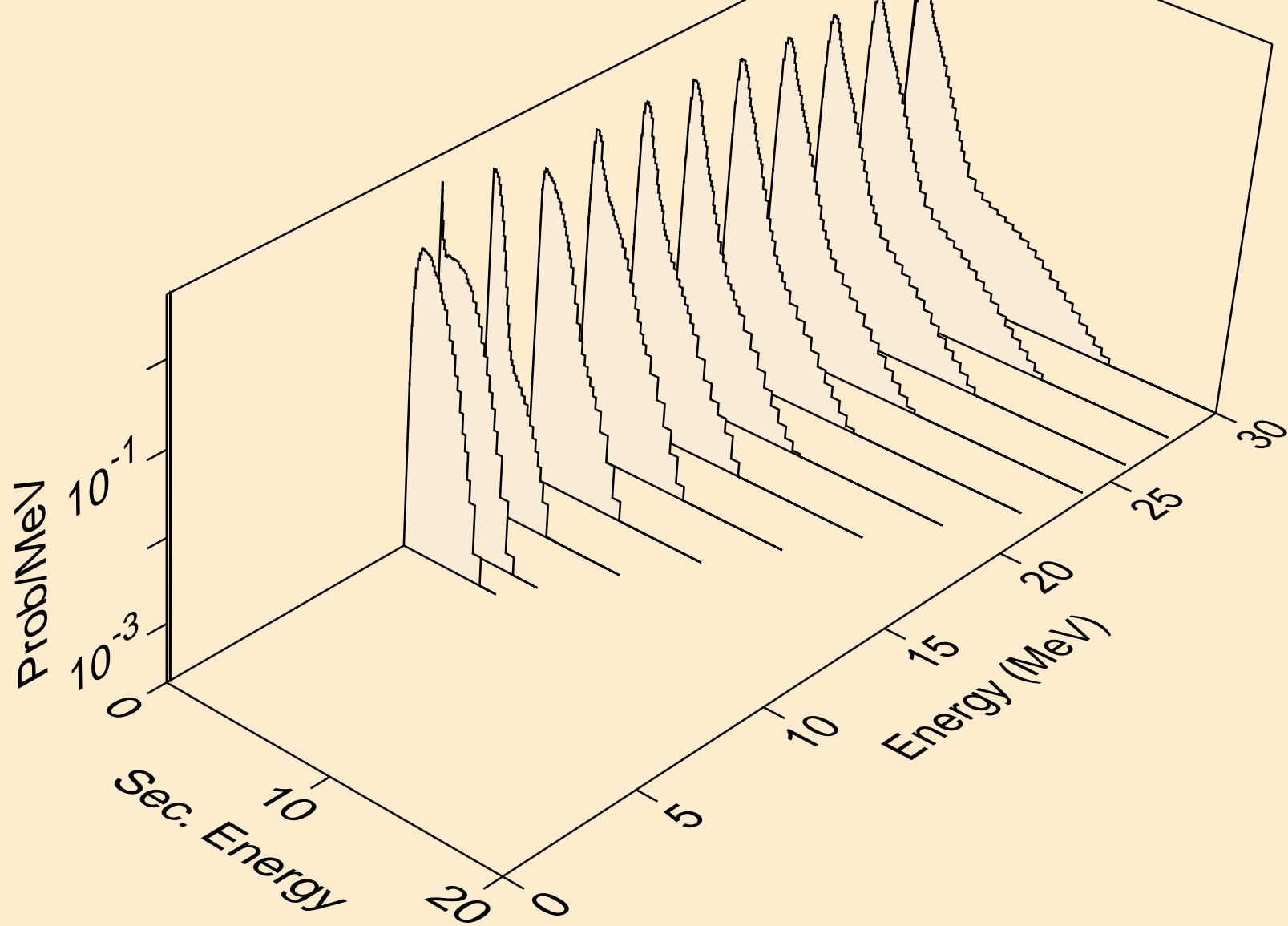

TL196 HELION ACER TENDL-2021 LIBRARY; T=0.K  
neutrons from (s,2n)a

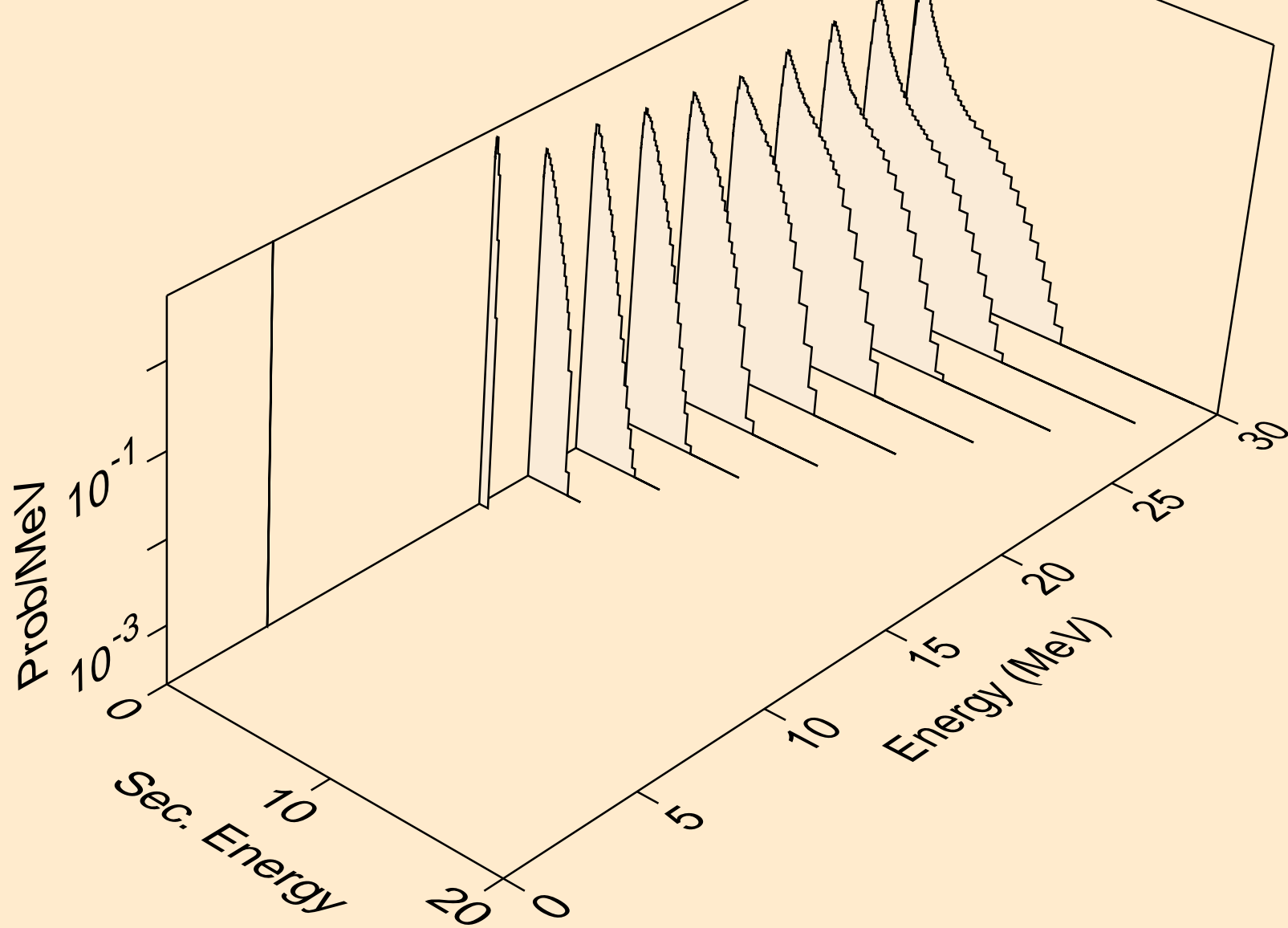



TL196 HELION ACER TENDL-2021 LIBRARY; T=0.K  
neutrons from (s,3n)a

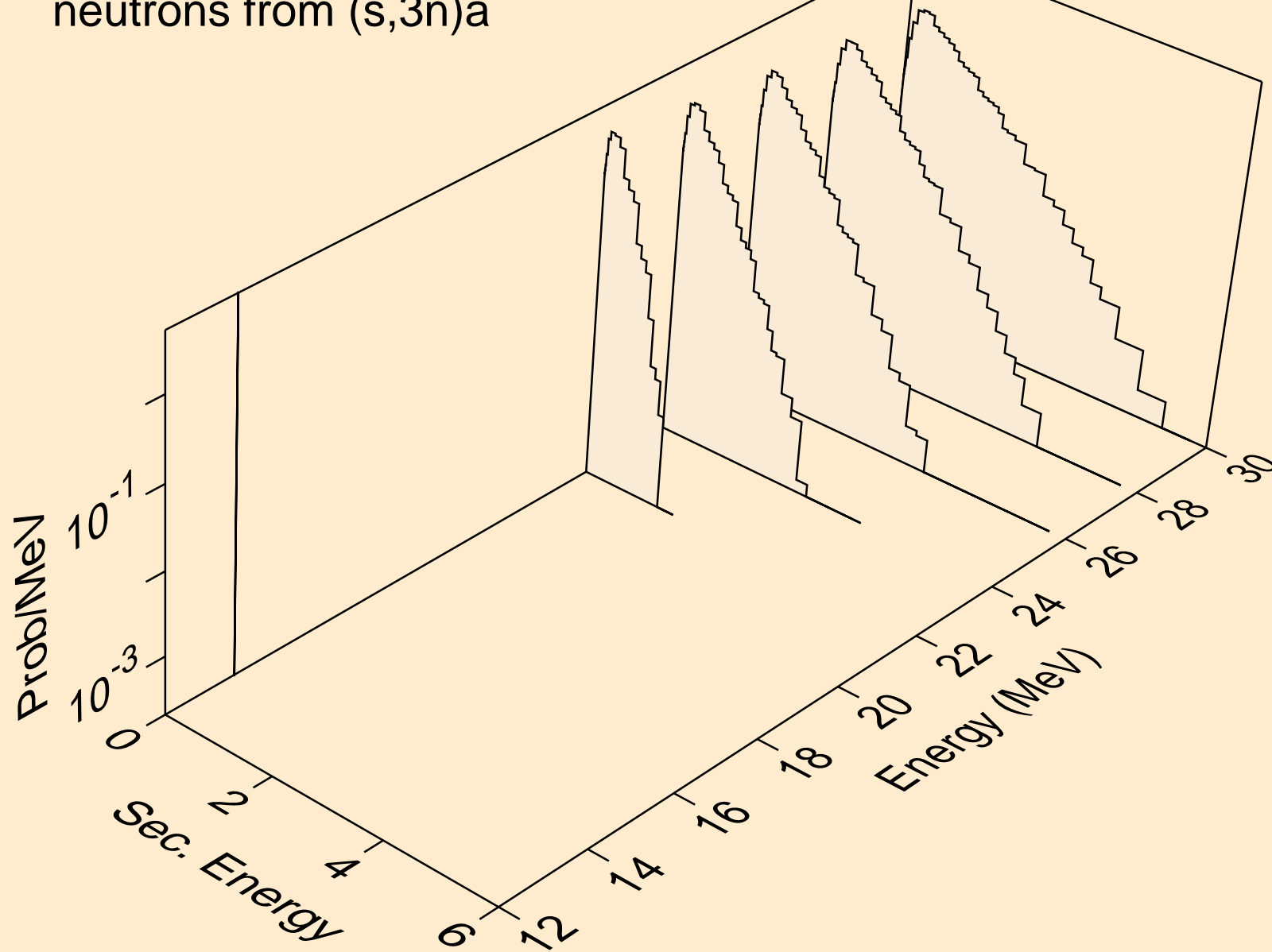

TL196 HELION ACER TENDL-2021 LIBRARY; T=0.K  
neutrons from (s,n\*)p

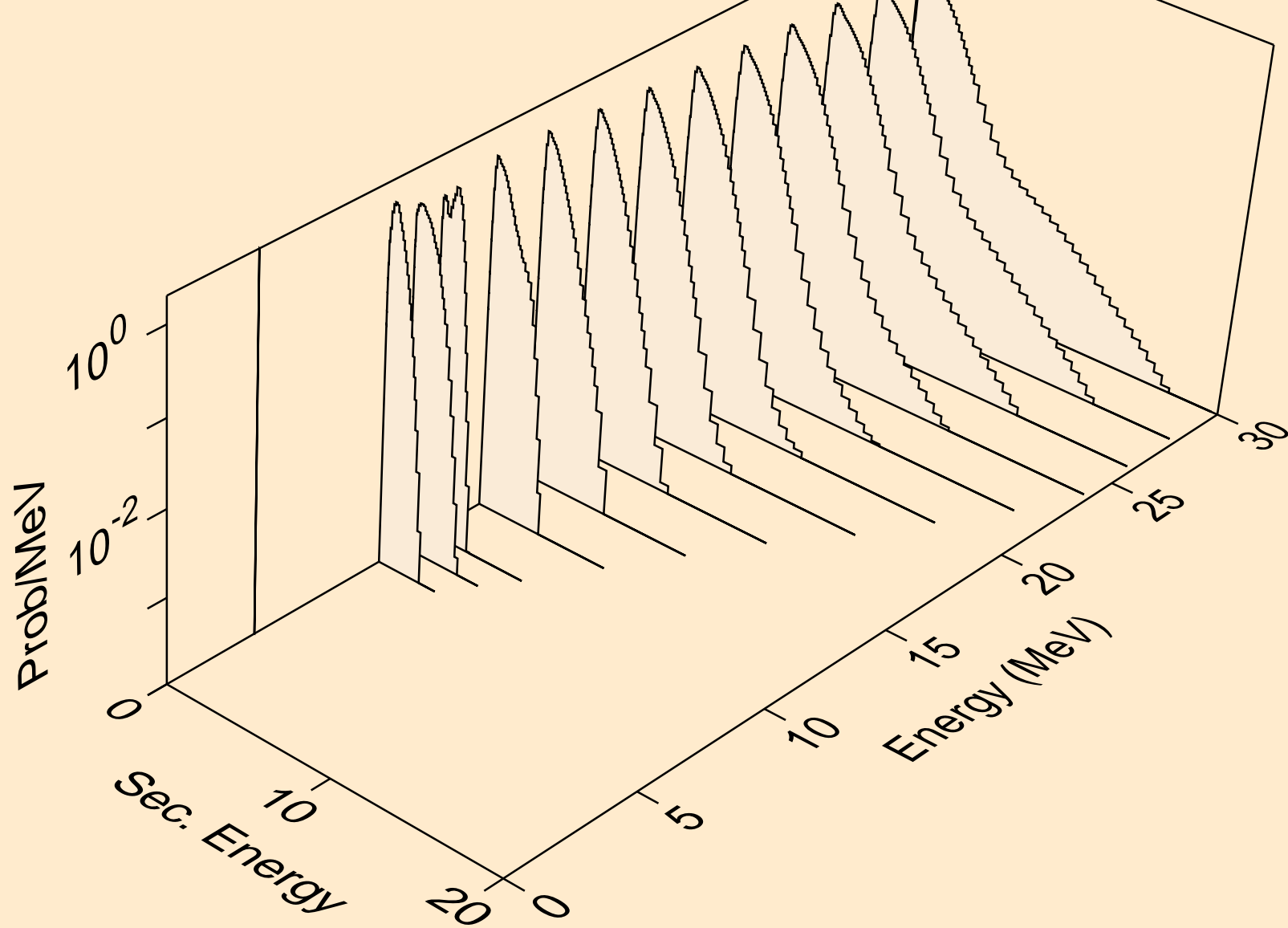

TL196 HELION ACER TENDL-2021 LIBRARY; T=0.K  
neutrons from (s,n\*)d

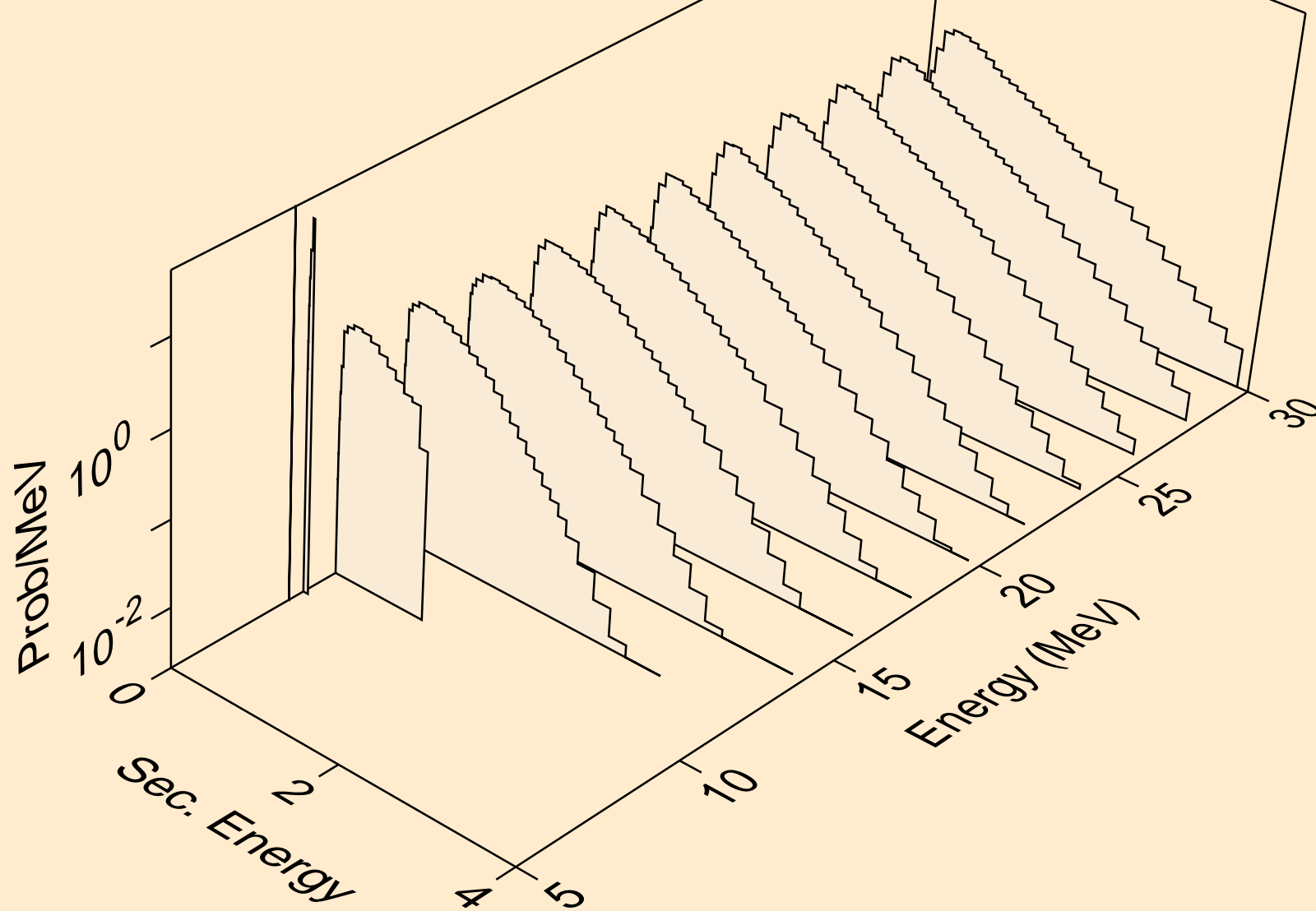

TL196 HELION ACER TENDL-2021 LIBRARY; T=0.K  
neutrons from (s,n\*)t

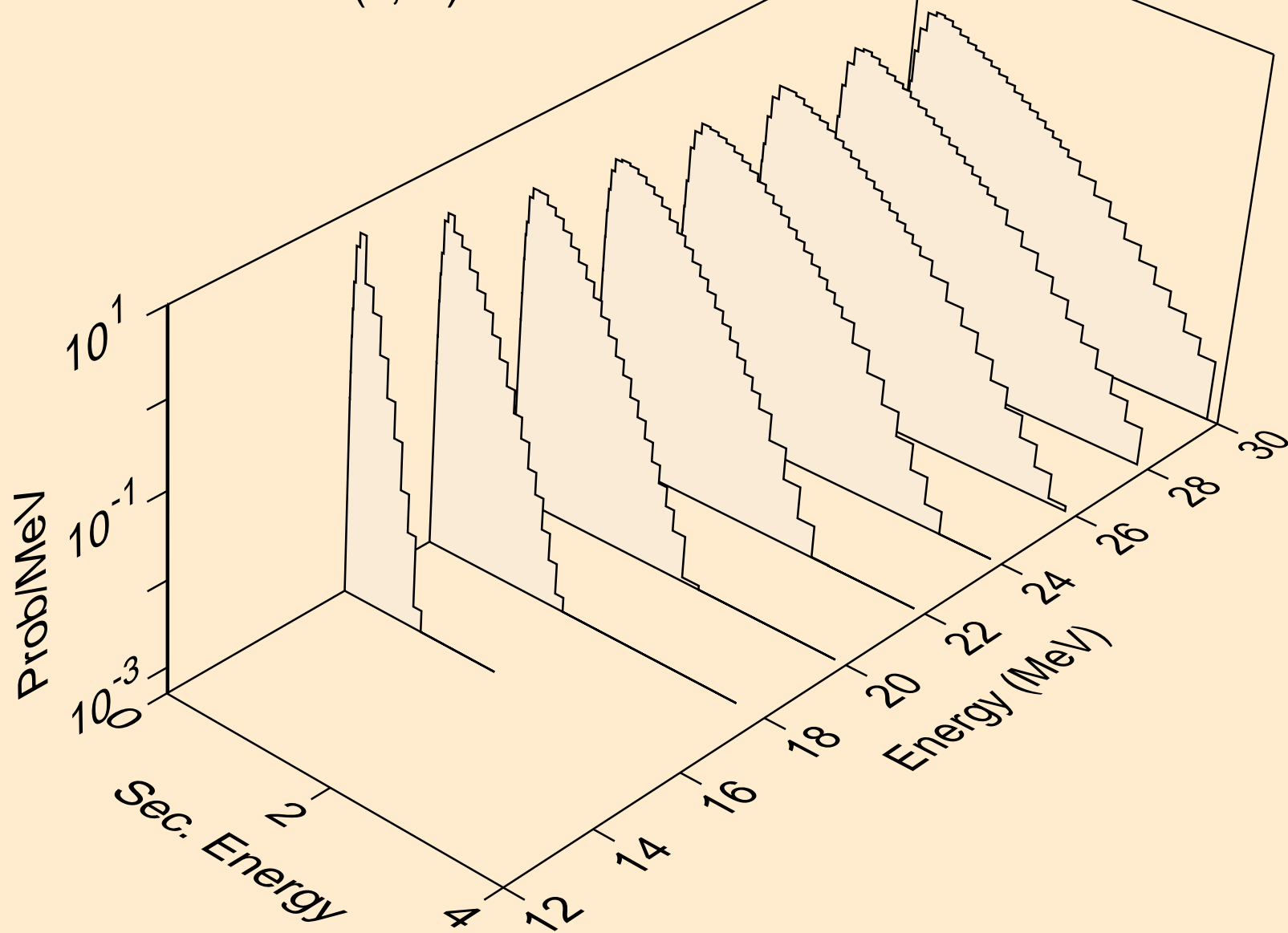

TL196 HELION ACER TENDL-2021 LIBRARY; T=0.K  
neutrons from (s,n\*)he3

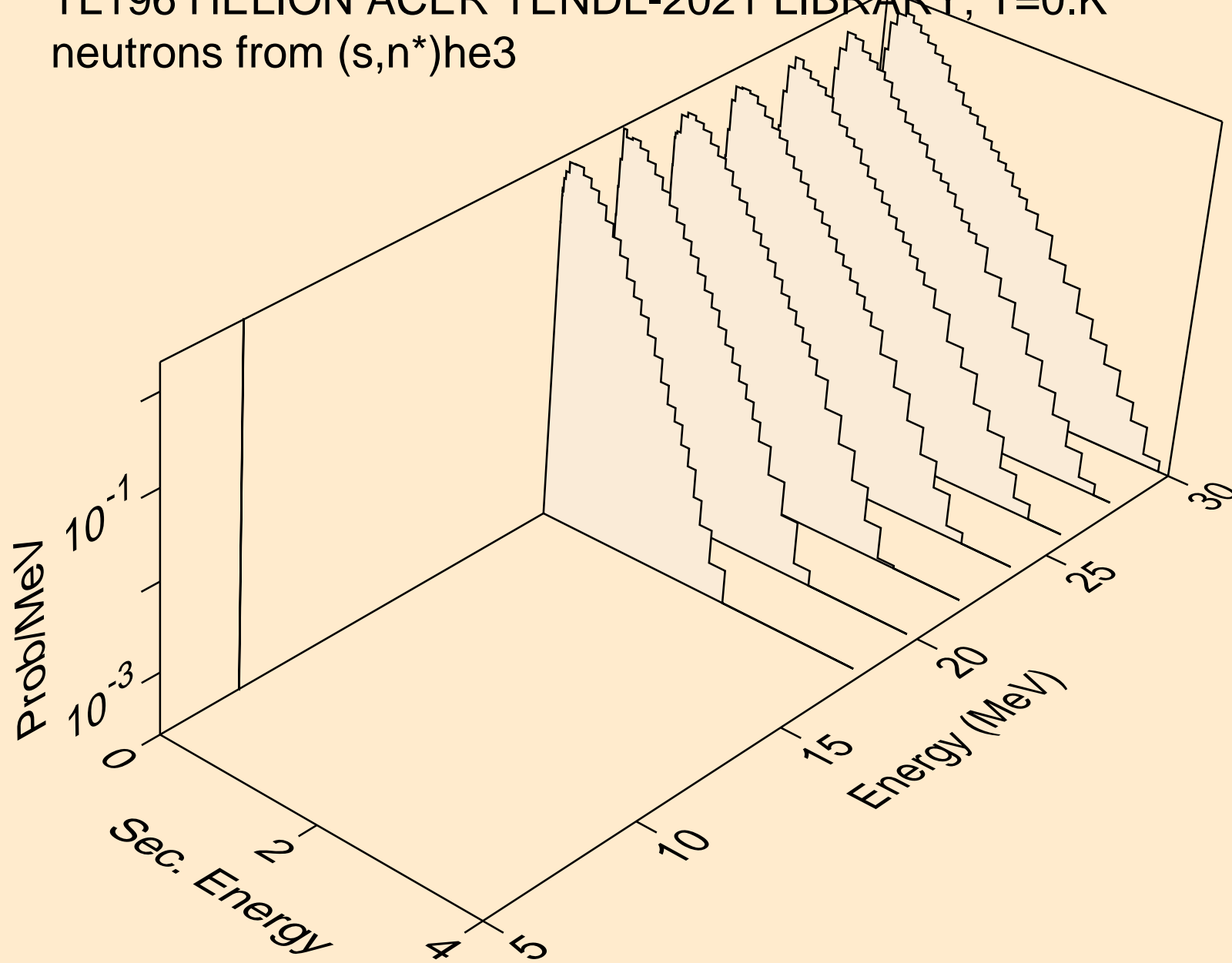

TL196 HELION ACER TENDL-2021 LIBRARY; T=0.K  
neutrons from (s,4n)

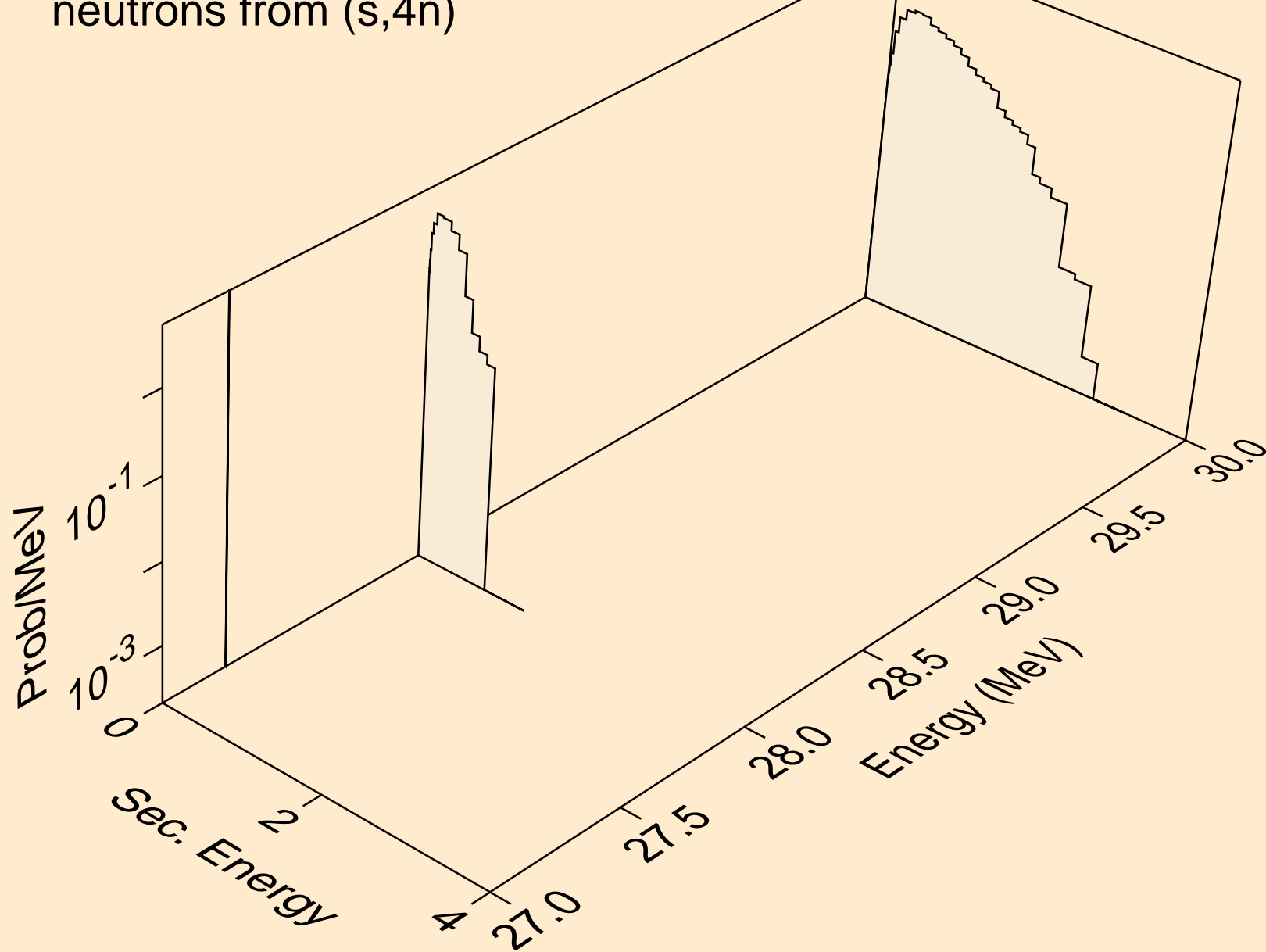

TL196 HELION ACER TENDL-2021 LIBRARY; T=0.K  
neutrons from (s,2np)

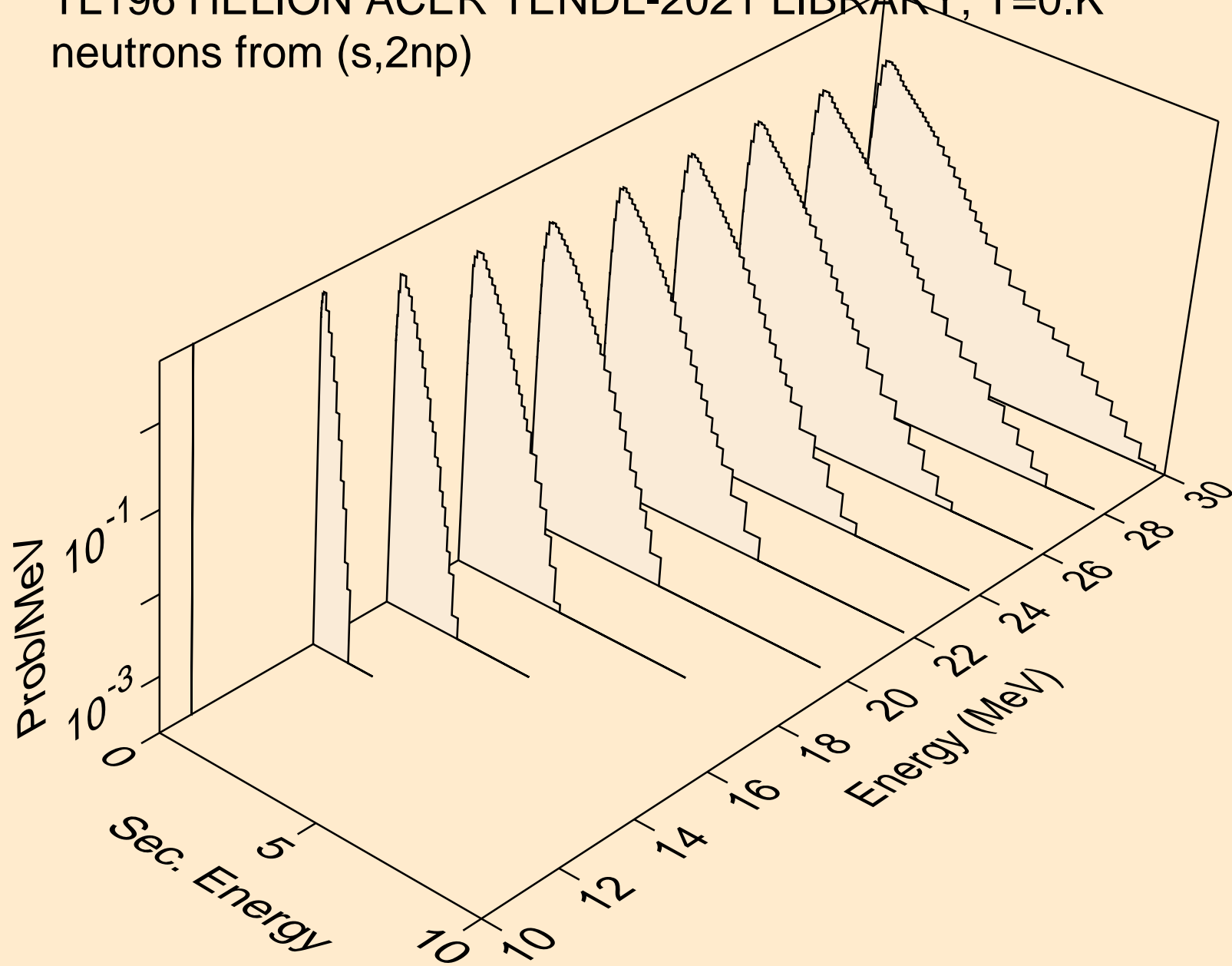

TL196 HELION ACER TENDL-2021 LIBRARY; T=0.K  
neutrons from (s,3np)

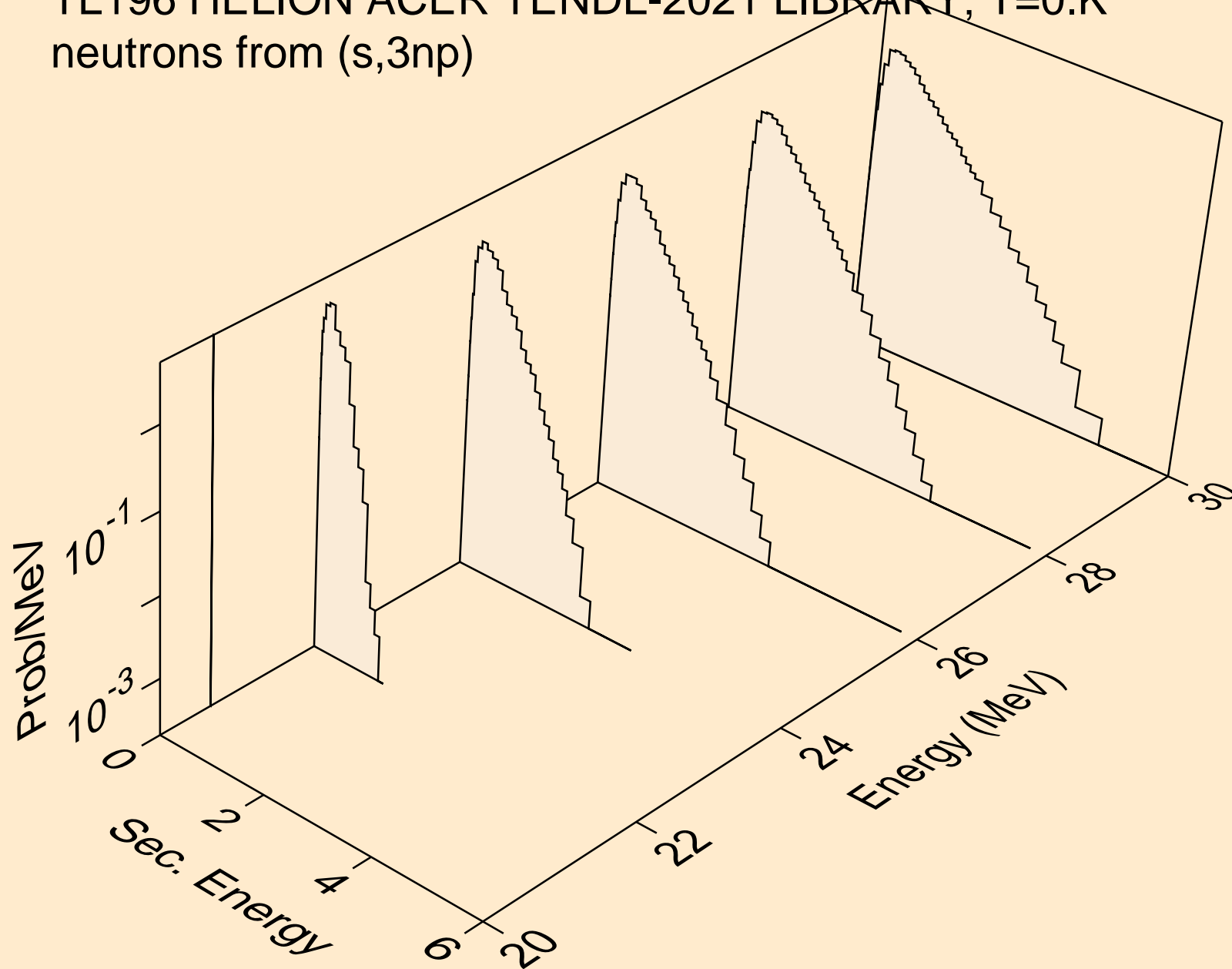



TL196 HELION ACER TENDL-2021 LIBRARY; T=0.K  
neutrons from (s,2np)

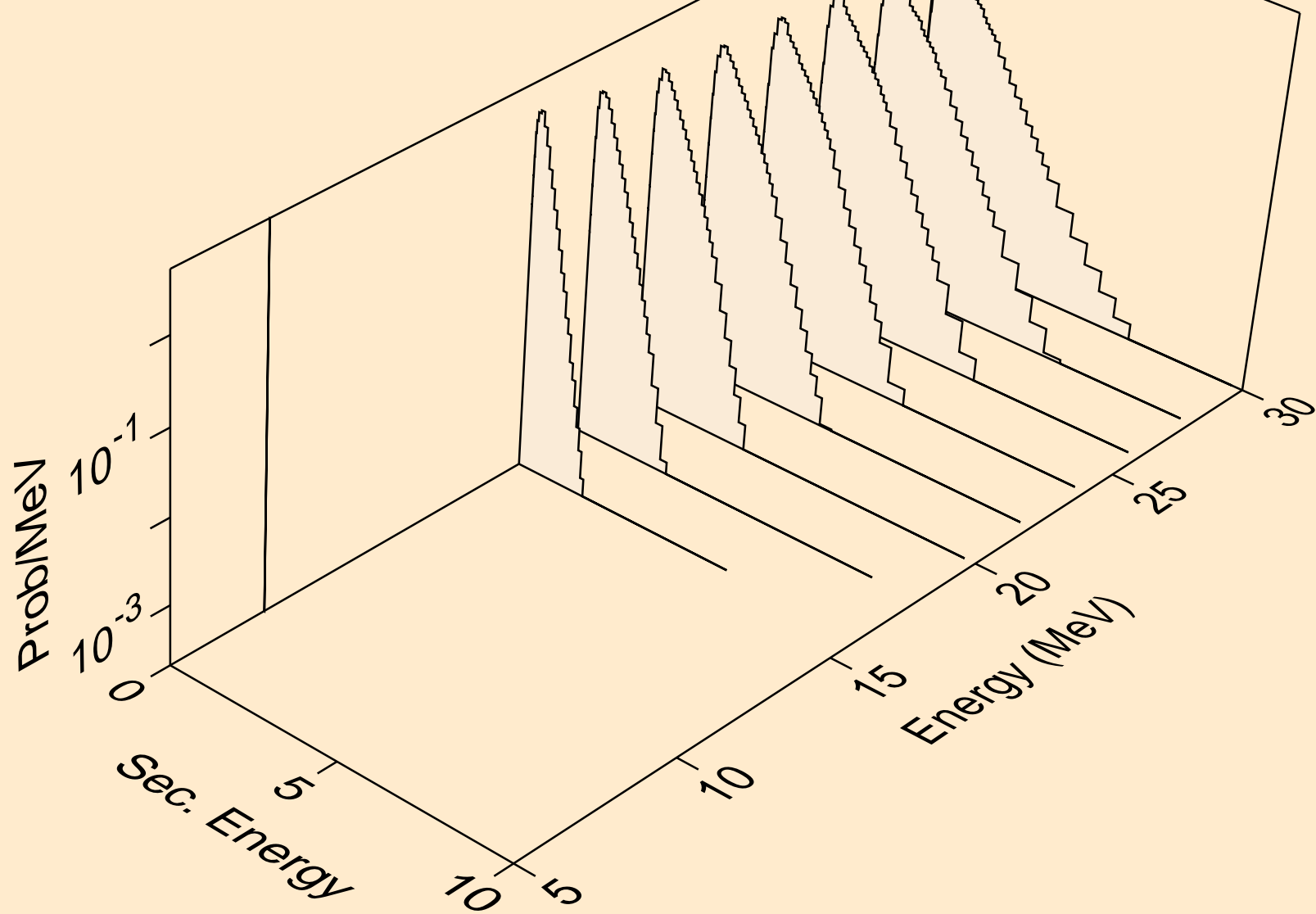

TL196 HELION ACER TENDL-2021 LIBRARY; T=0.K  
neutrons from (s,npa)

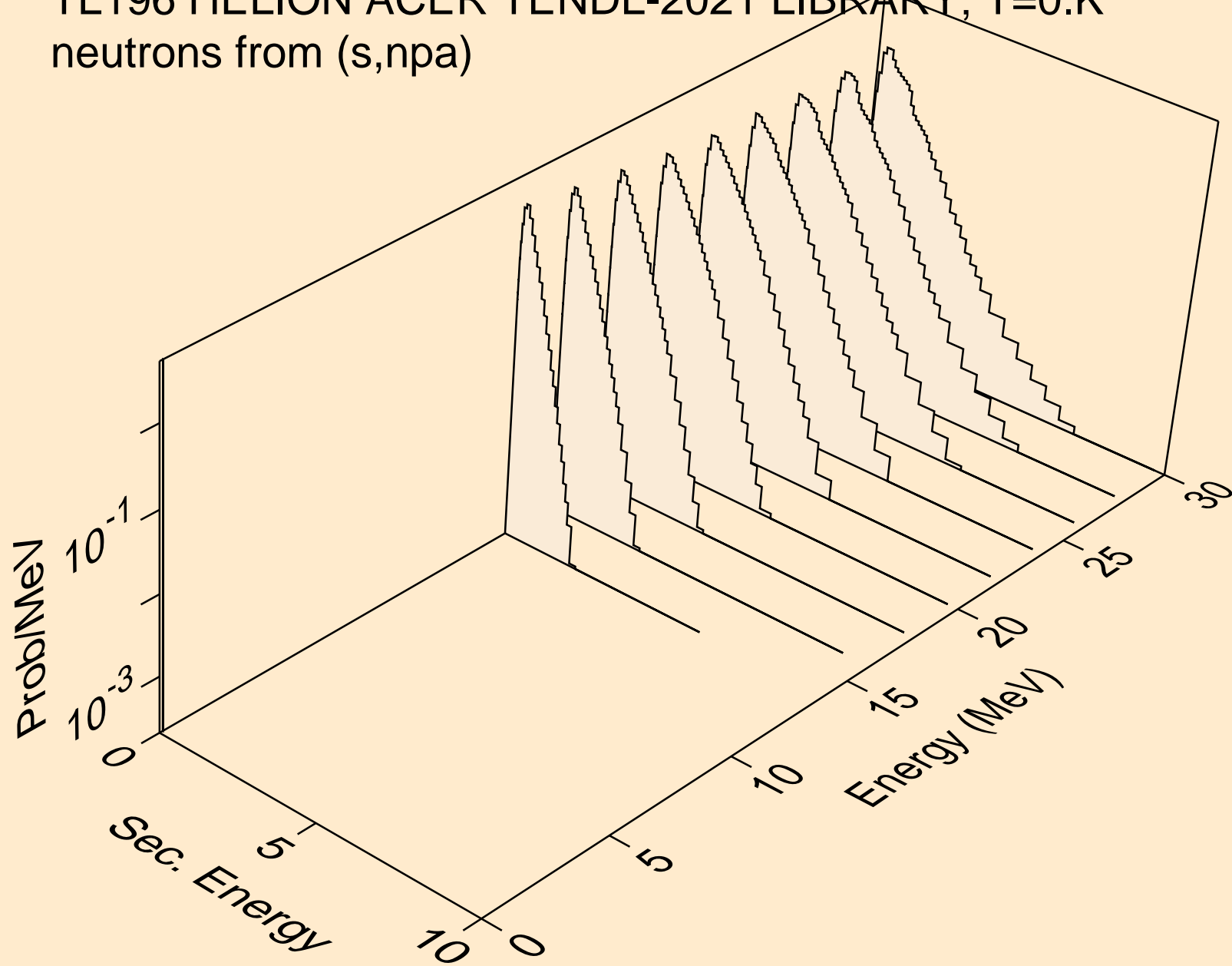

TL196 HELION ACER TENDL-2021 LIBRARY; T=0.K  
protons from (s,x)

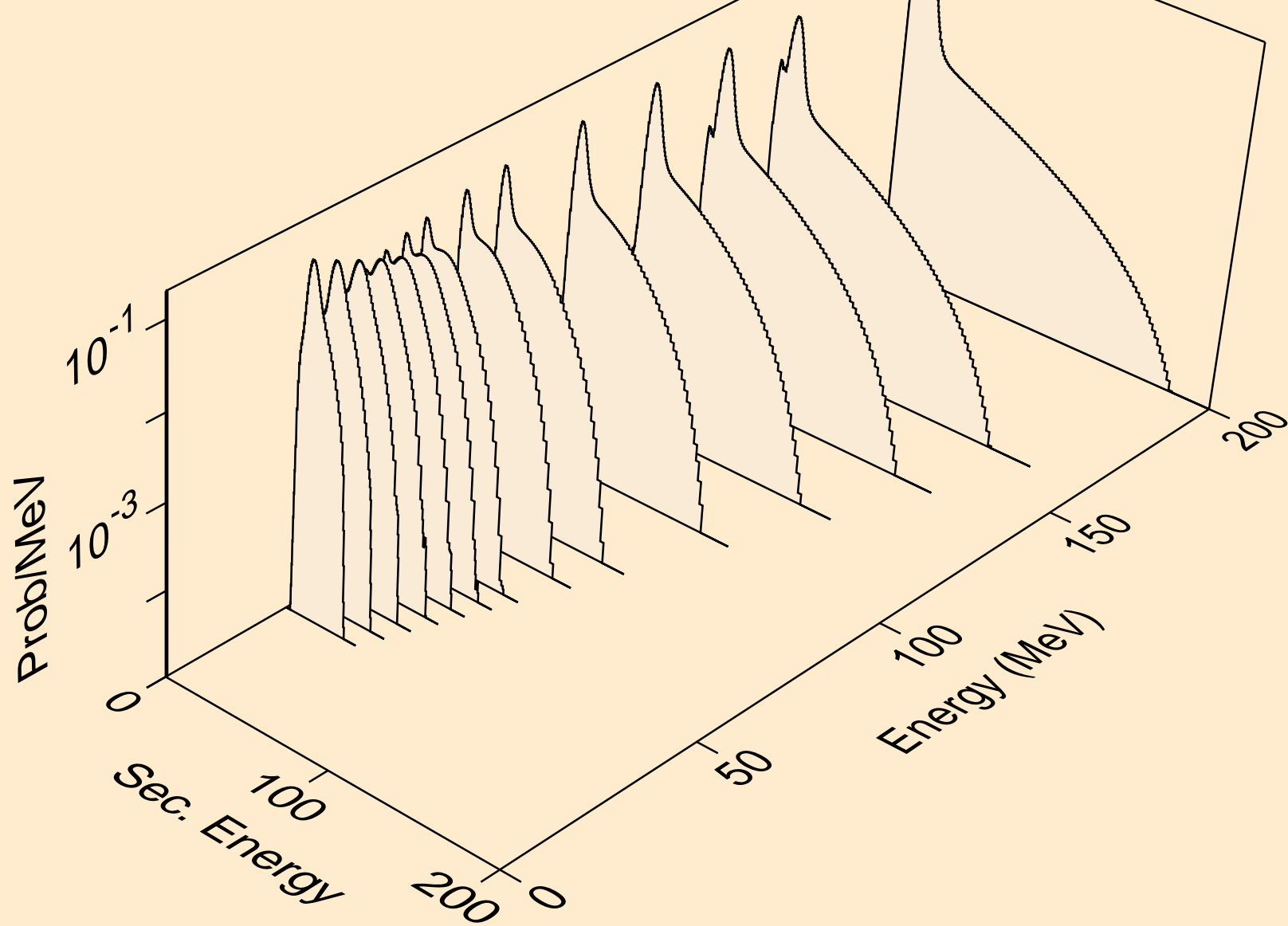

TL196 HELION ACER TENDL-2021 LIBRARY; T=0.K  
protons from (s,n\*)p

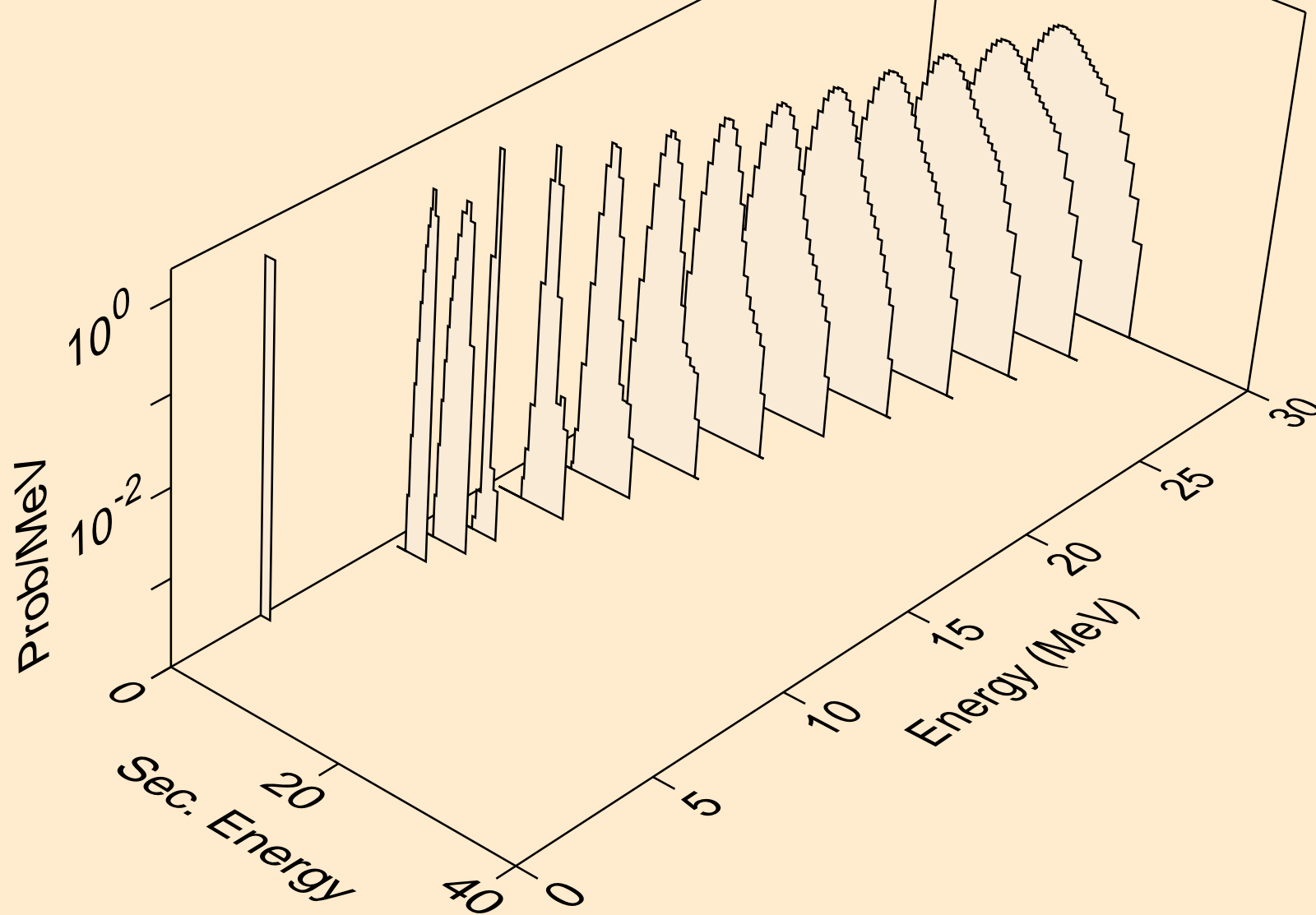

TL196 HELION ACER TENDL-2021 LIBRARY; T=0.K  
protons from (s,2np)

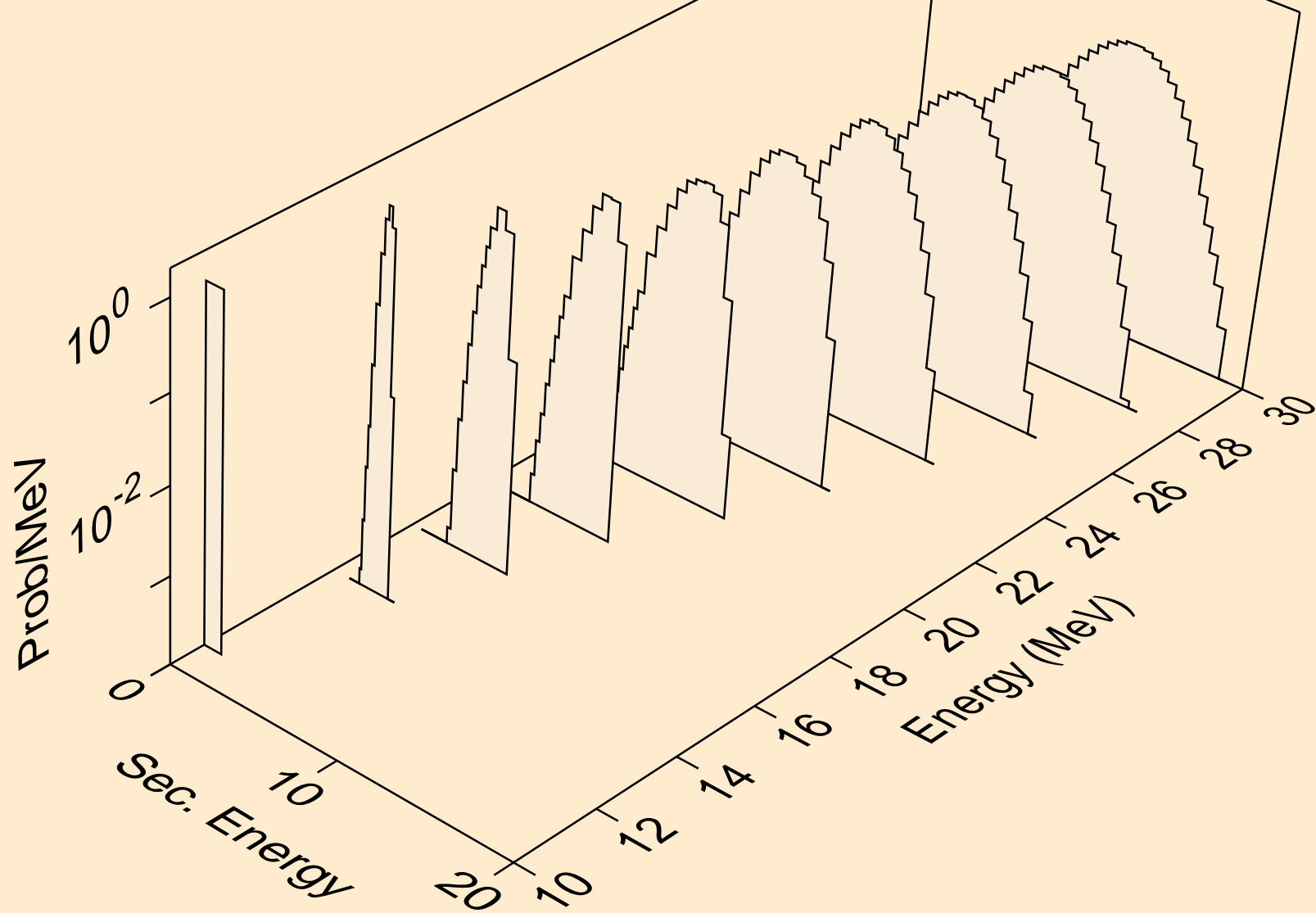

TL196 HELION ACER TENDL-2021 LIBRARY; T=0.K  
protons from (s,3np)

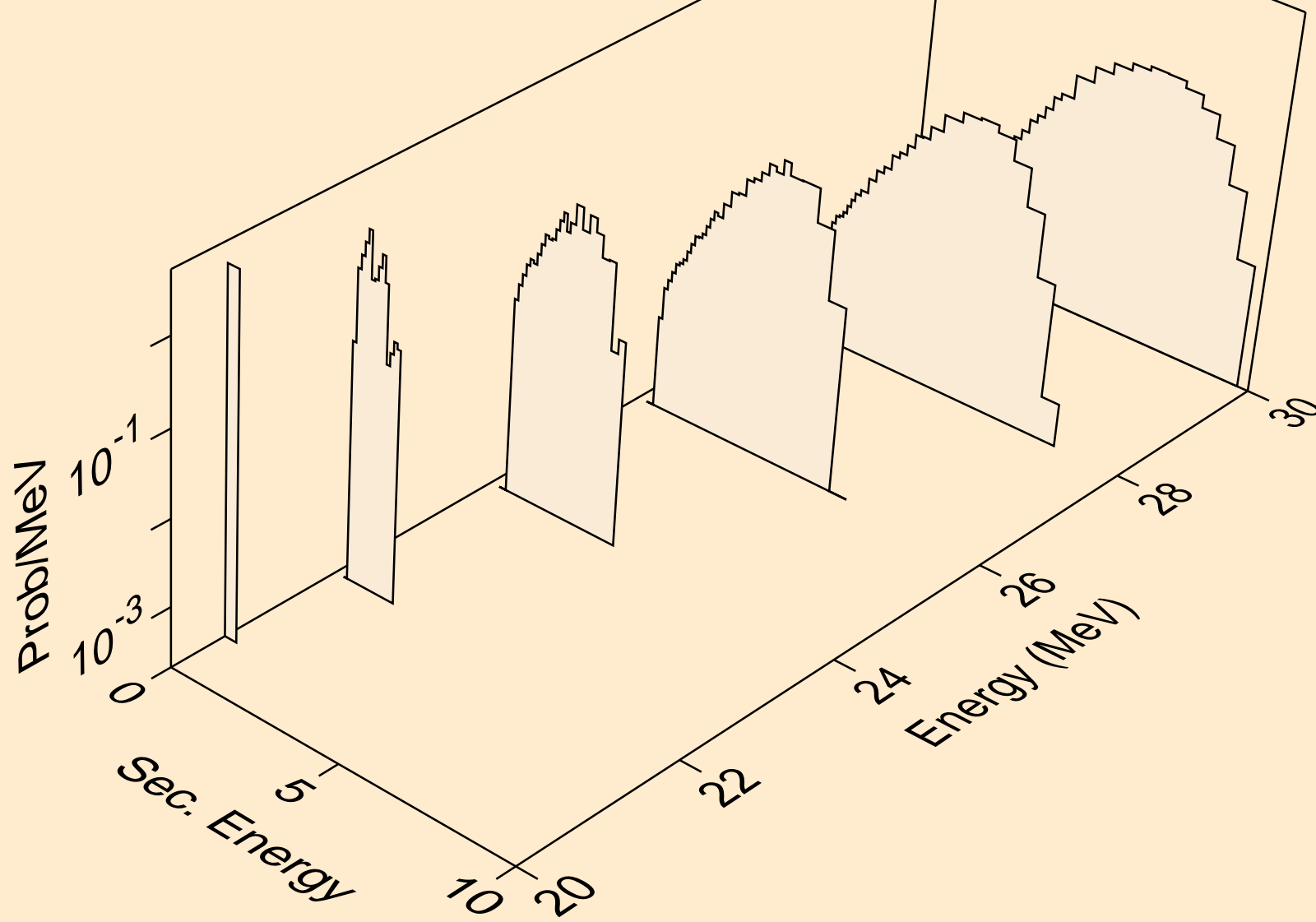

TL196 HELION ACER TENDL-2021 LIBRARY; T=0.K  
protons from (s,2np)

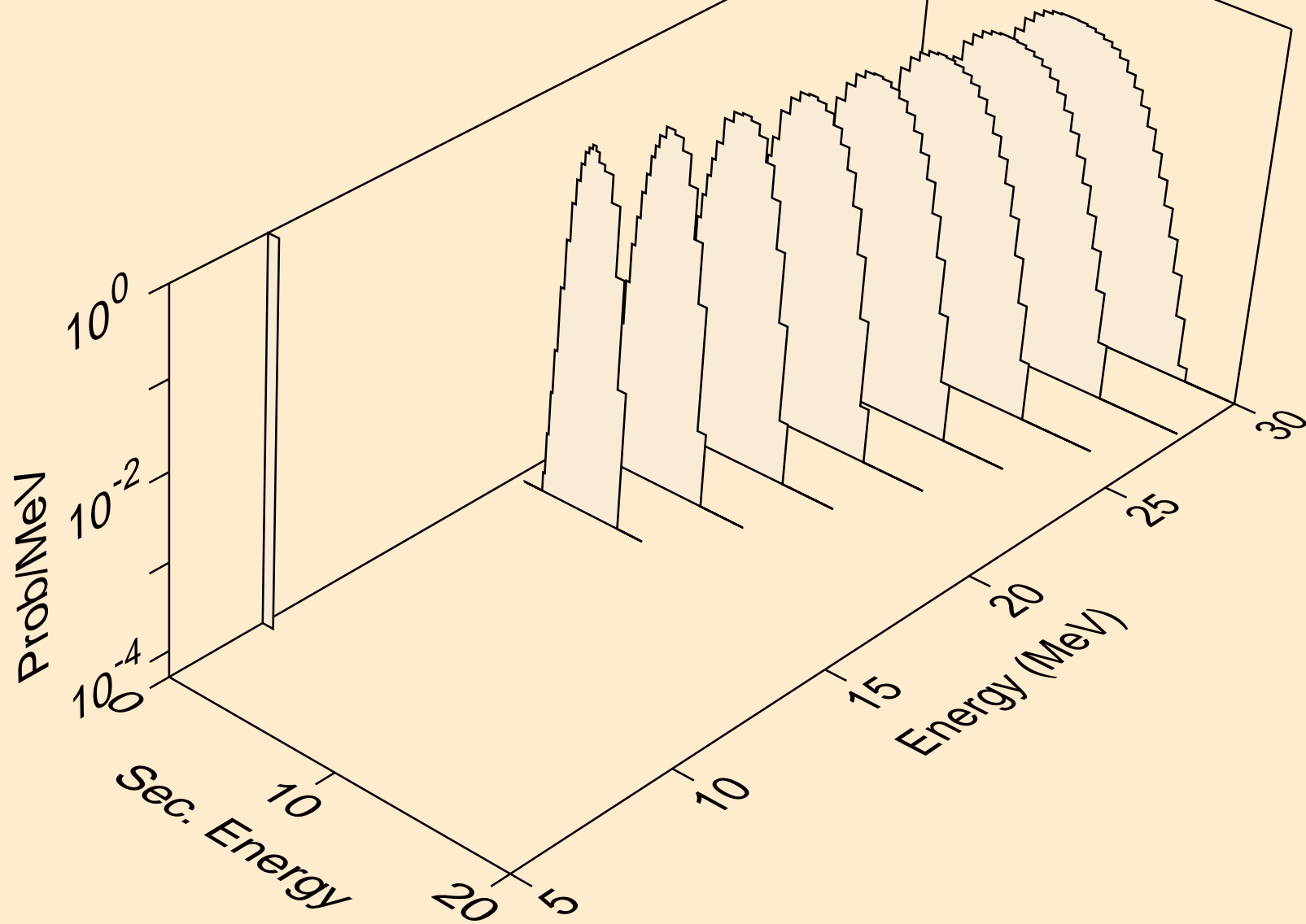

TL196 HELION ACER TENDL-2021 LIBRARY; T=0.K  
protons from (s,npa)

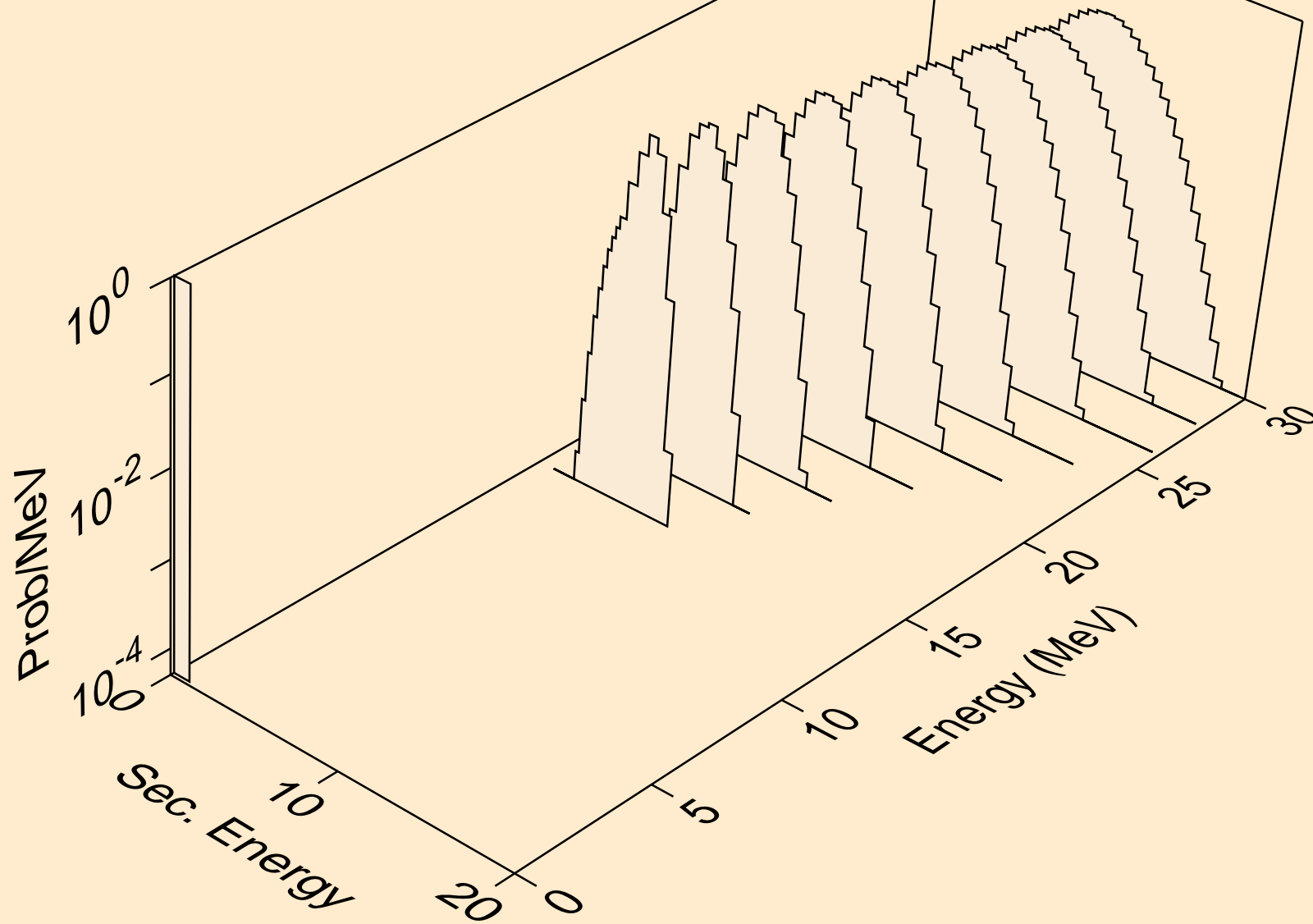



TL196 HELION ACER TENDL-2021 LIBRARY; T=0.K  
protons from (s,p)

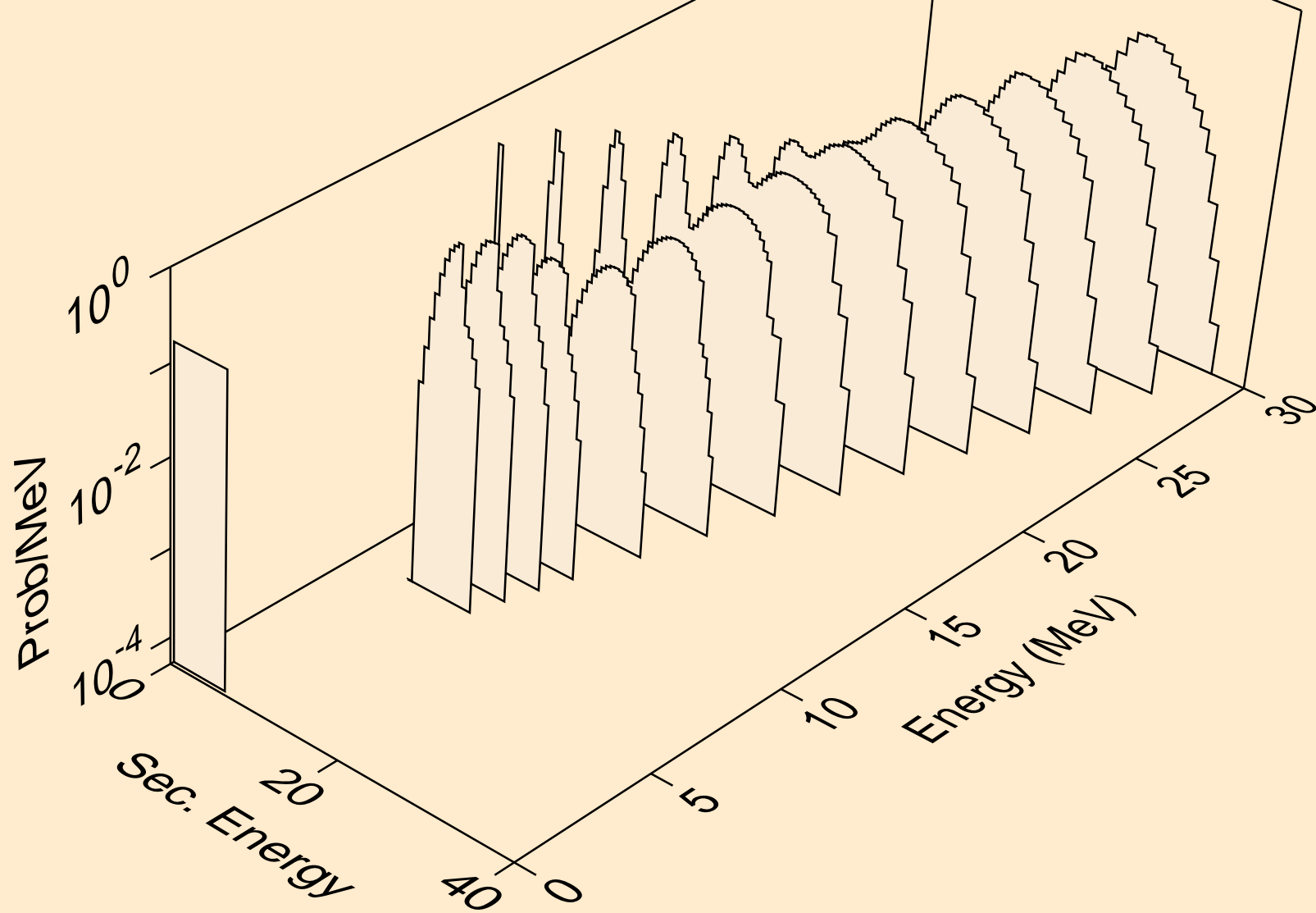

TL196 HELION ACER TENDL-2021 LIBRARY; T=0.K  
protons from (s,2p)

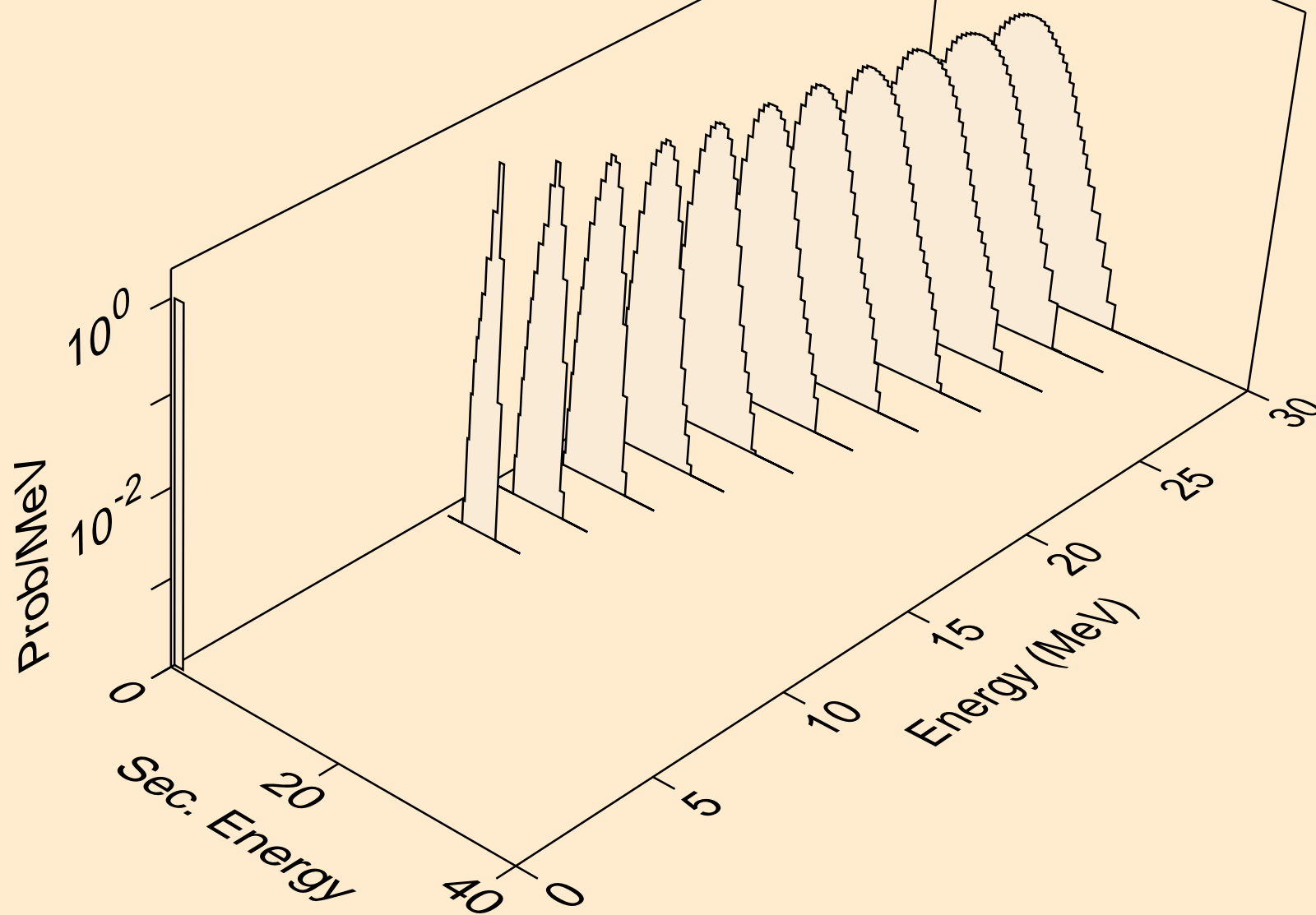

TL196 HELION ACER TENDL-2021 LIBRARY; T=0.K  
protons from (s,pa)

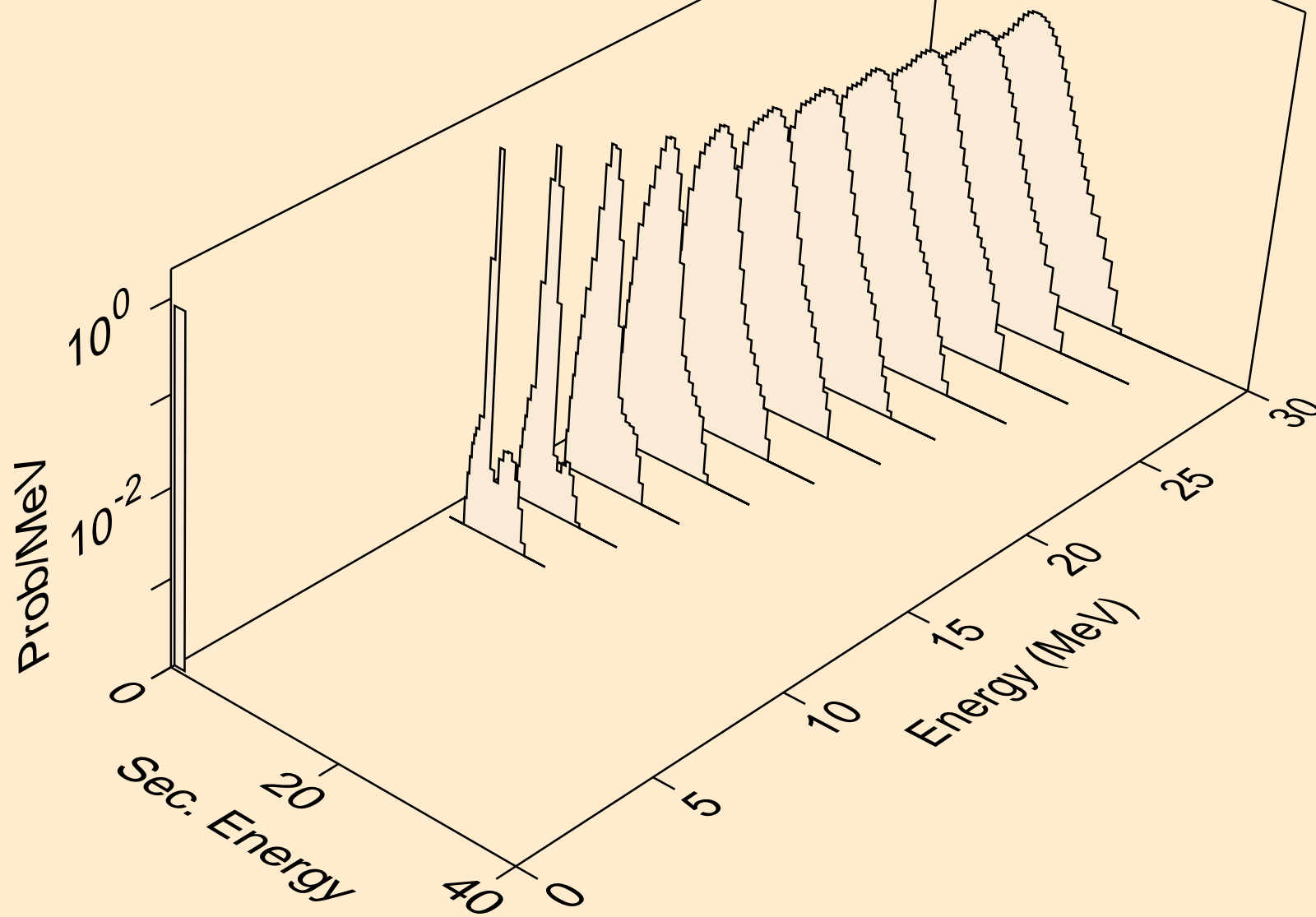

TL196 HELION ACER TENDL-2021 LIBRARY; T=0.K  
protons from (s,pd)

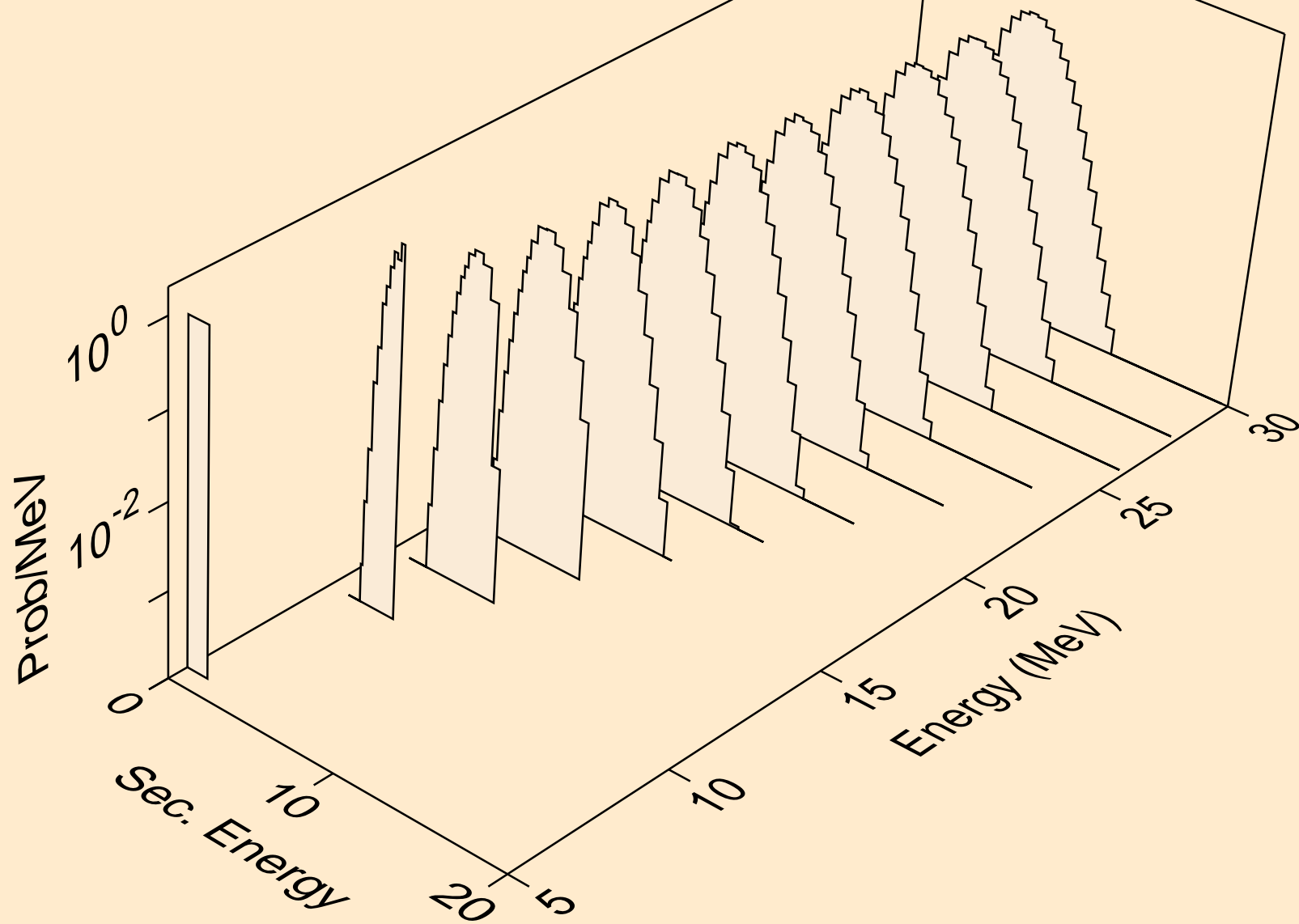

TL196 HELION ACER TENDL-2021 LIBRARY; T=0.K  
protons from (s,pt)

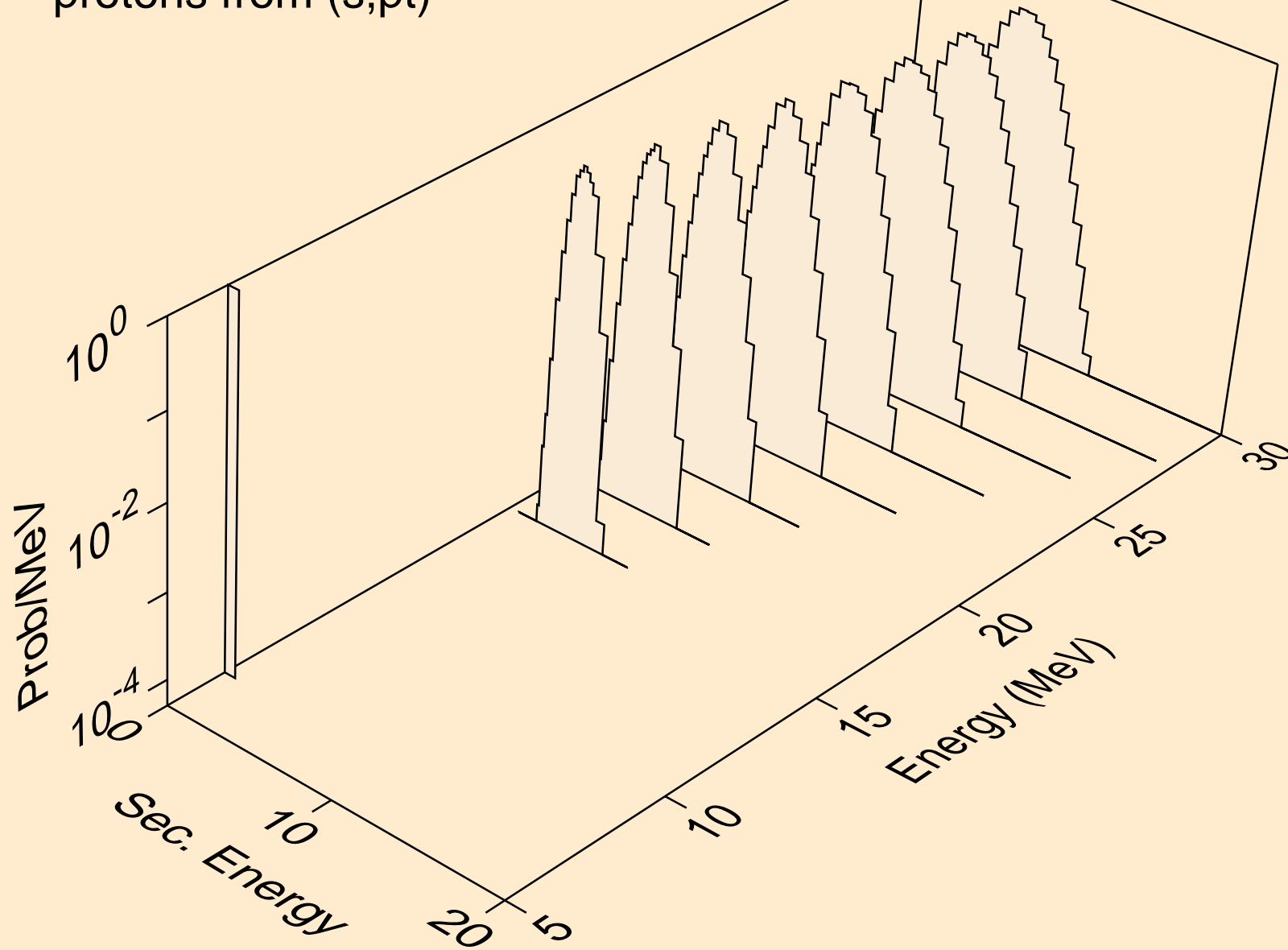

TL196 HELION ACER TENDL-2021 LIBRARY; T=0.K  
deuterons from (s,x)

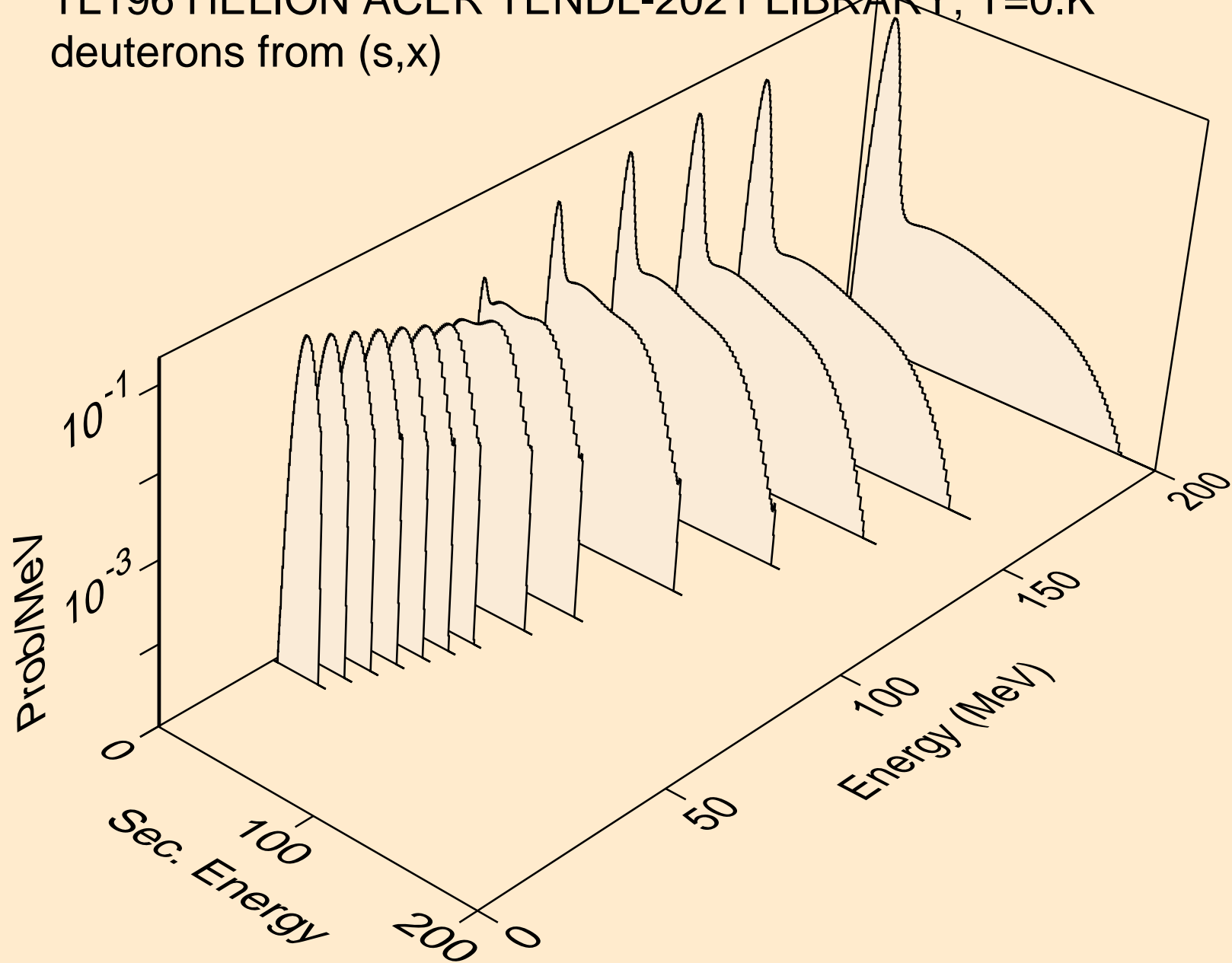

TL196 HELION ACER TENDL-2021 LIBRARY; T=0.K  
deuterons from (s,2nd)

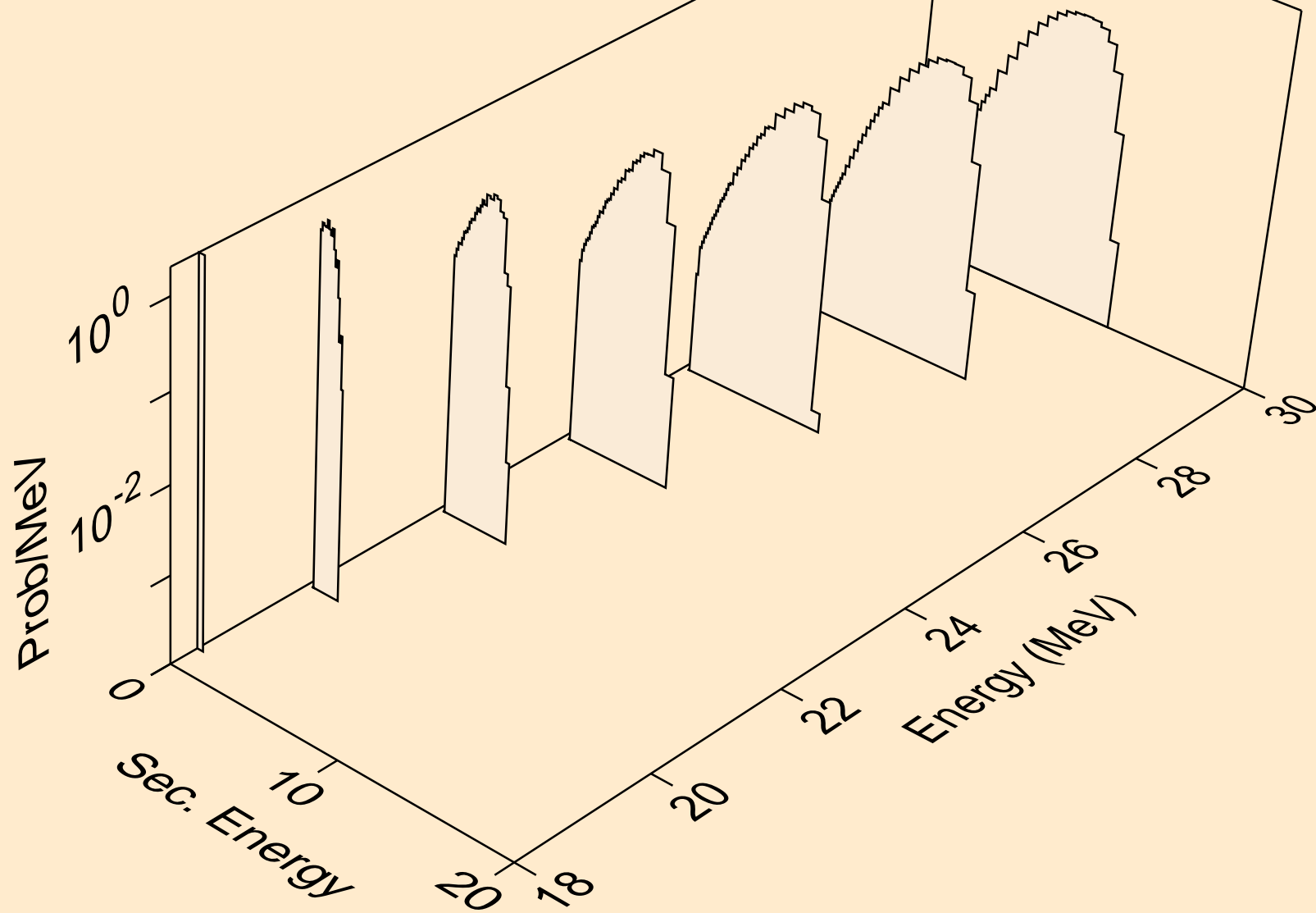

TL196 HELION ACER TENDL-2021 LIBRARY; T=0.K  
deuterons from (s,n\*)d

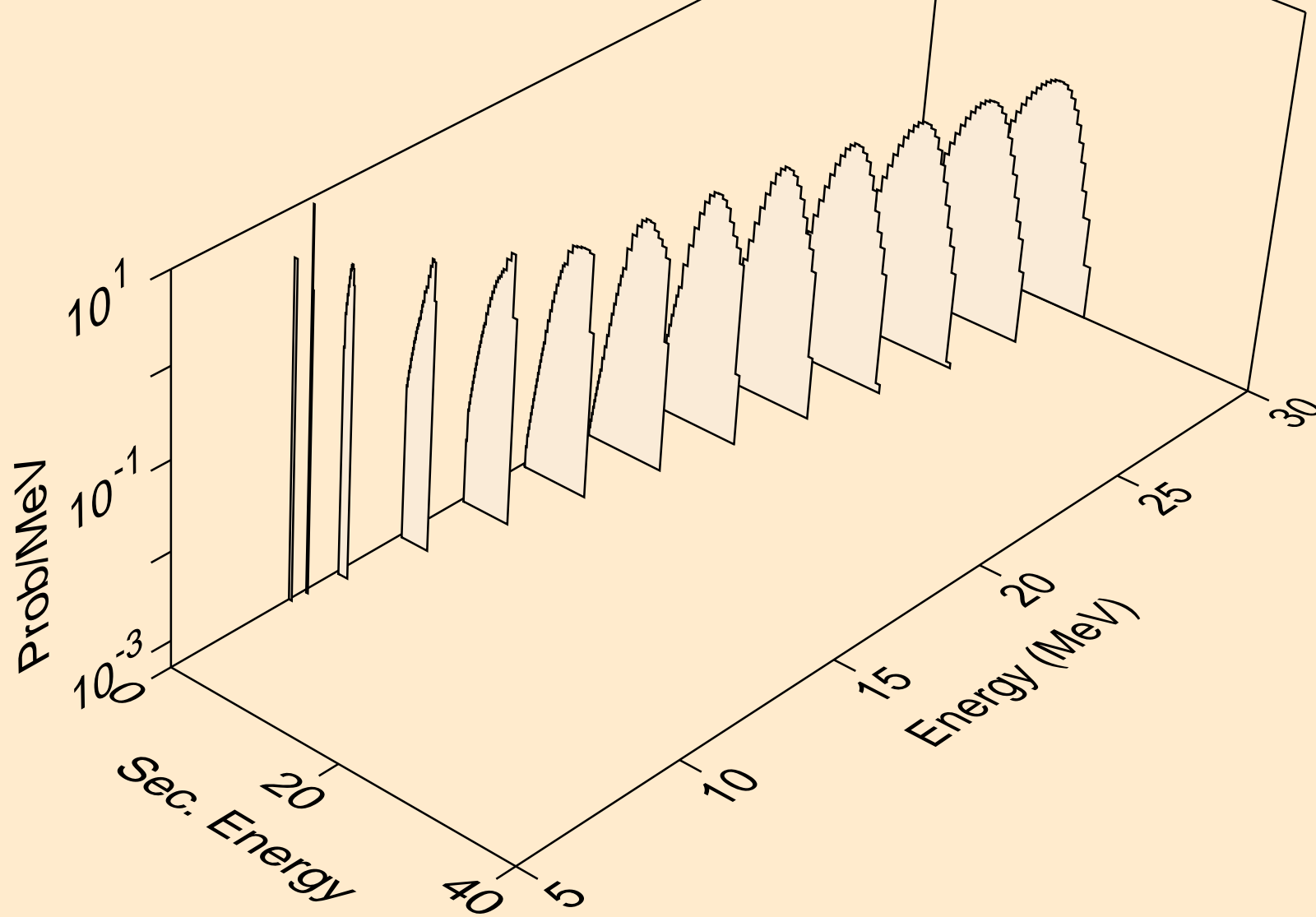



TL196 HELION ACER TENDL-2021 LIBRARY; T=0.K  
deuterons from (s,d)

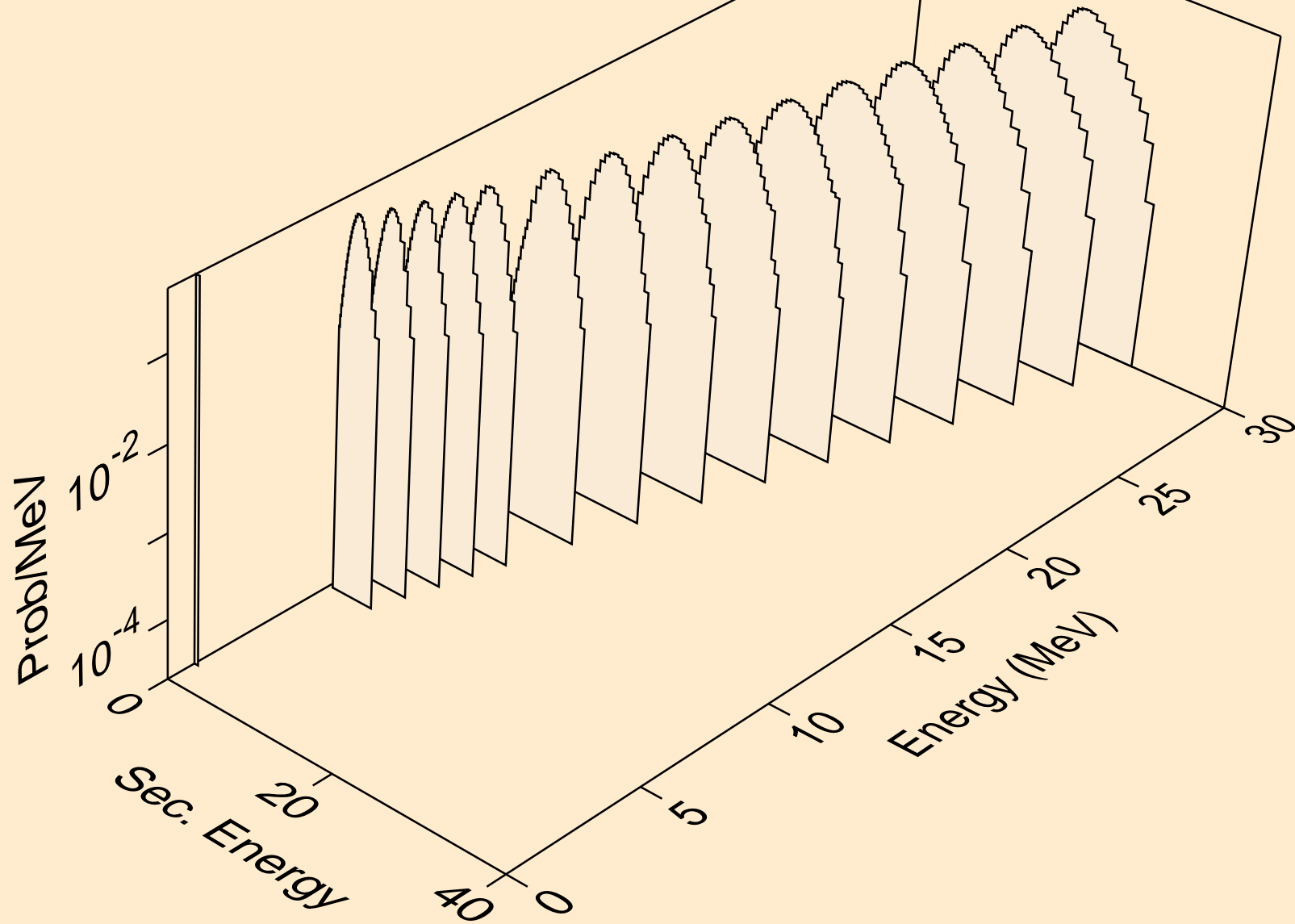

TL196 HELION ACER TENDL-2021 LIBRARY; T=0.K  
deuterons from (s,pd)

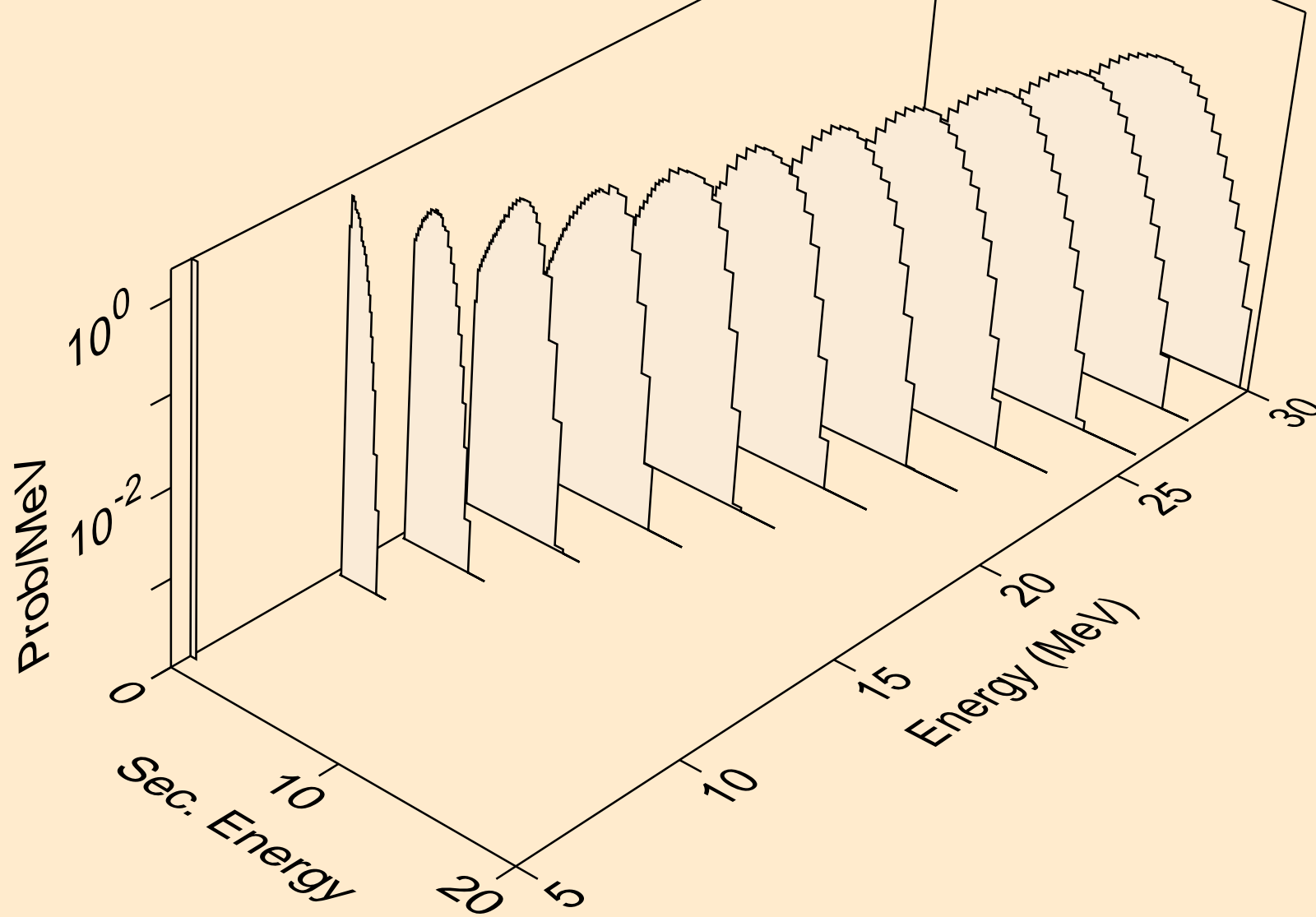

TL196 HELION ACER TENDL-2021 LIBRARY; T=0.K  
deuterons from (s,da)

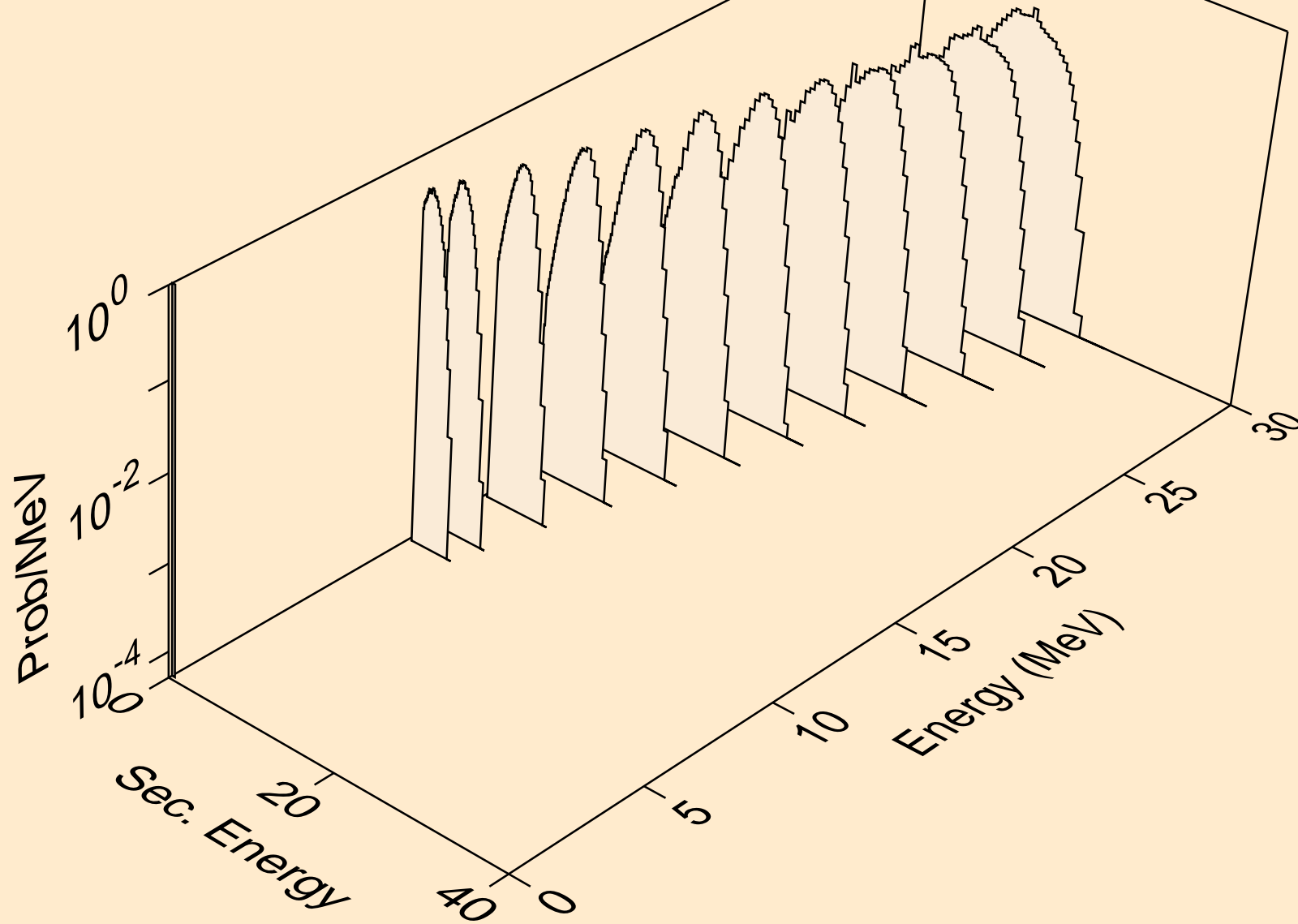

TL196 HELION ACER TENDL-2021 LIBRARY; T=0.K  
tritons from (s,x)

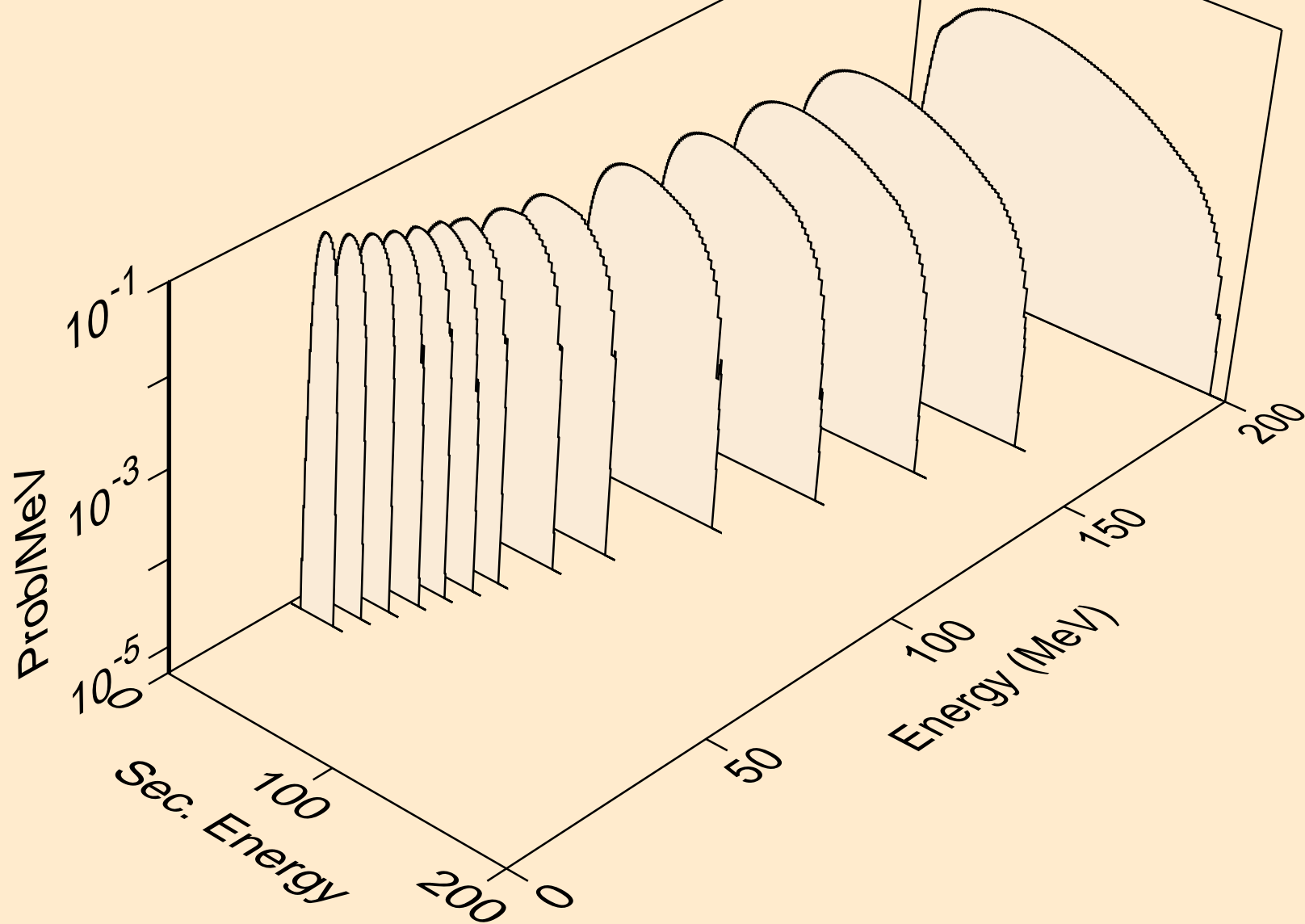

TL196 HELION ACER TENDL-2021 LIBRARY; T=0.K  
tritons from (s,n\*)t

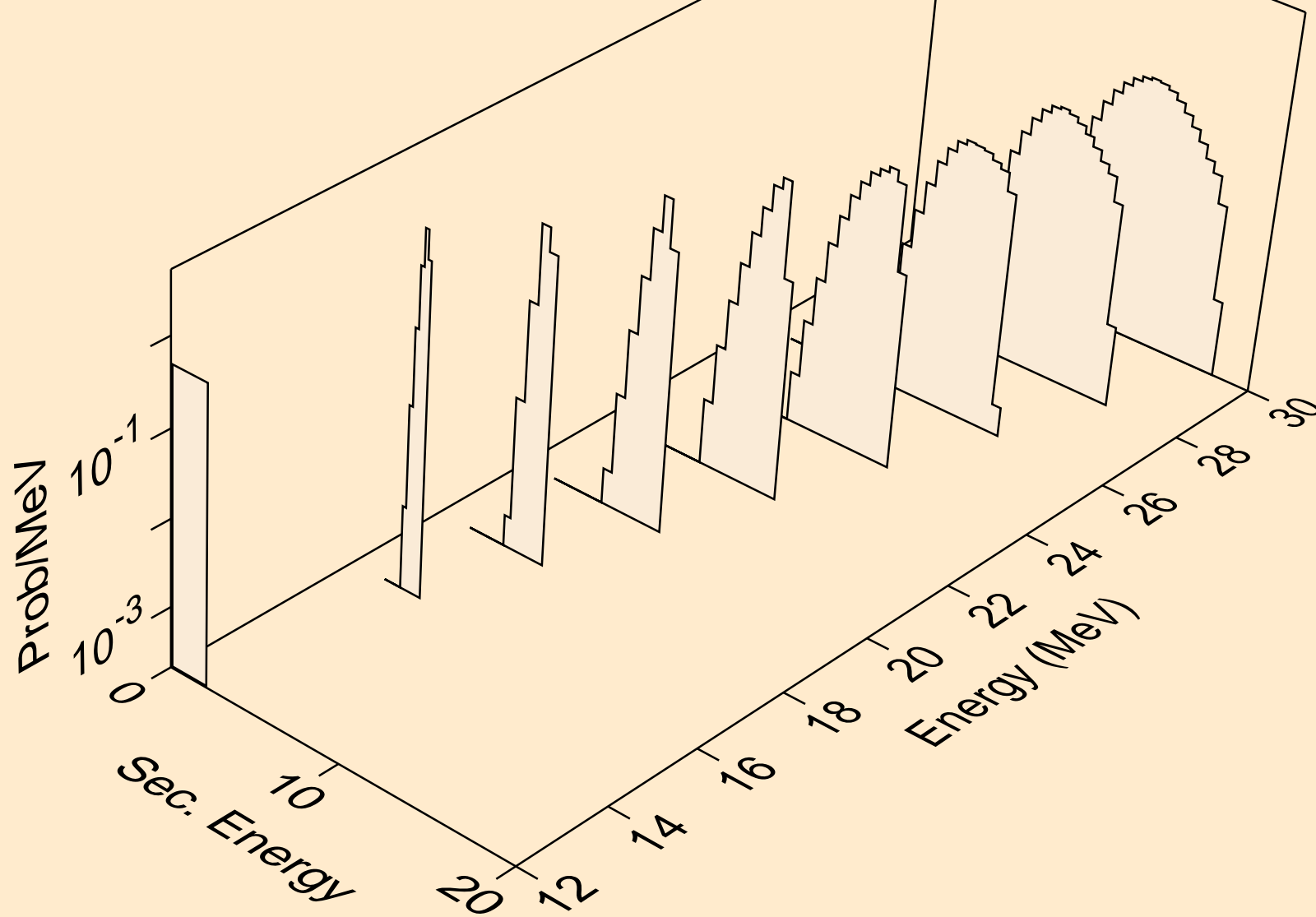

TL196 HELION ACER TENDL-2021 LIBRARY; T=0.K  
tritons from (s,t)

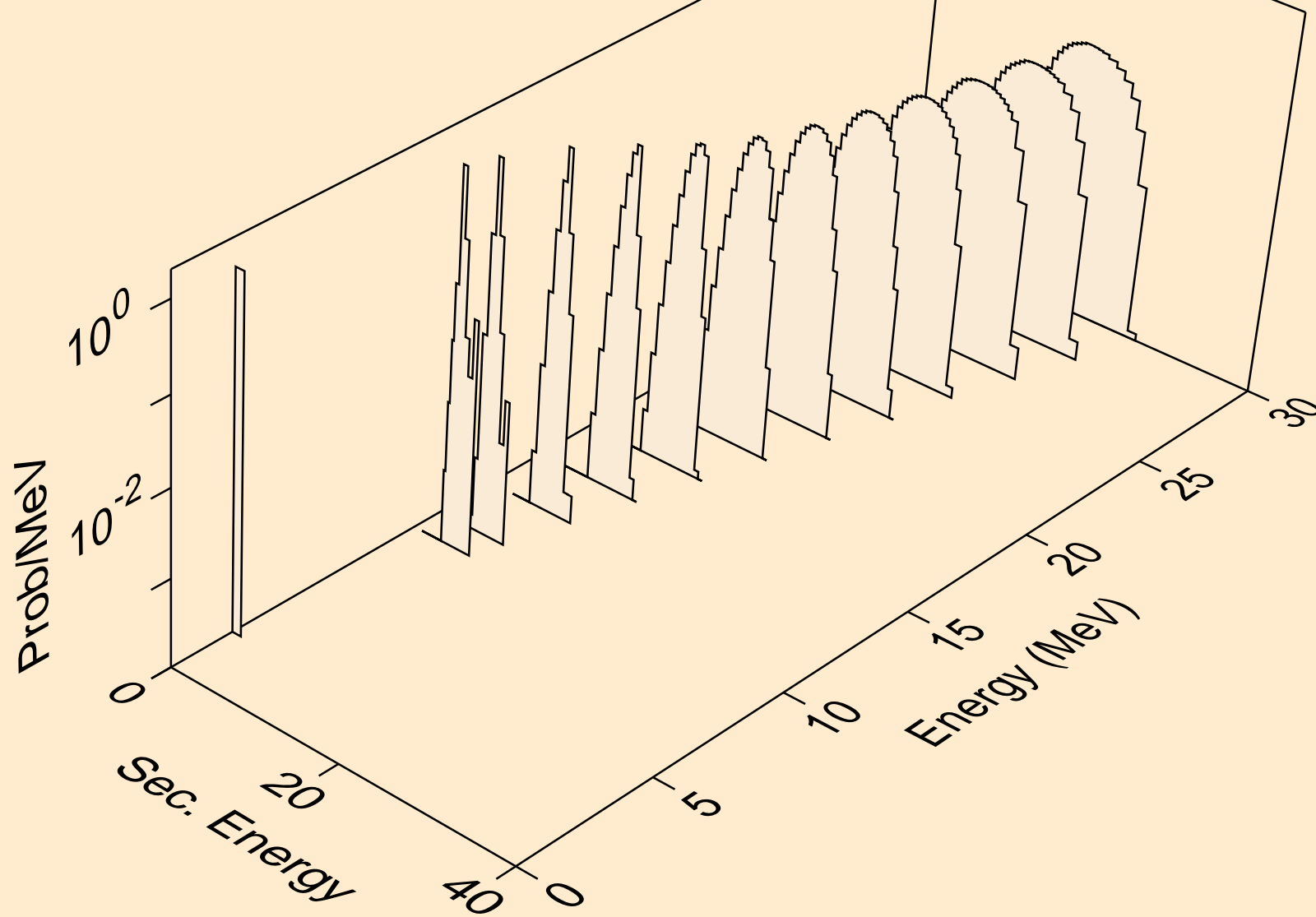

TL196 HELION ACER TENDL-2021 LIBRARY; T=0.K  
tritons from (s,pt)

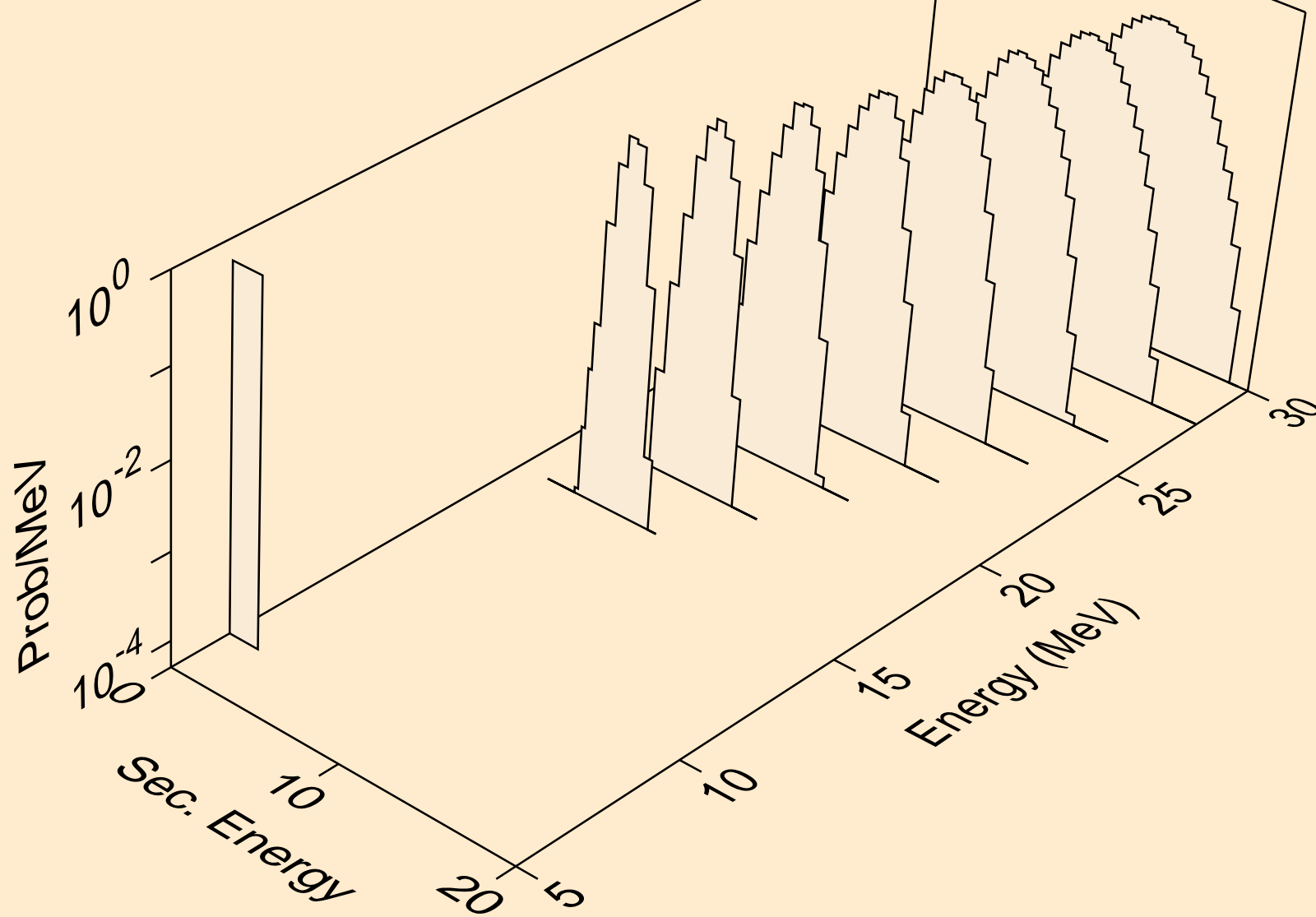

TL196 HELION ACER TENDL-2021 LIBRARY; T=0.K  
alphas from (s,x)

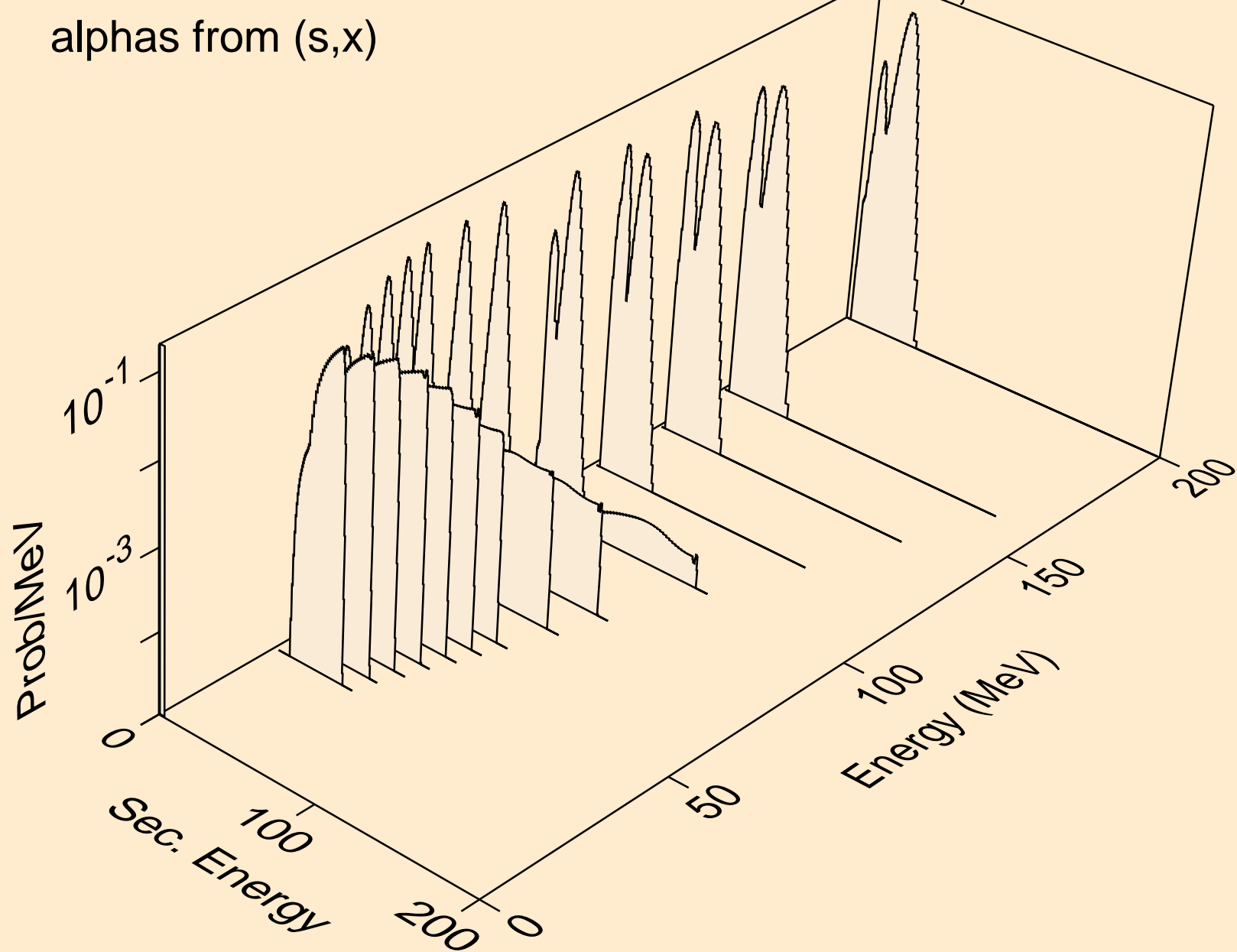



TL196 HELION ACER TENDL-2021 LIBRARY; T=0.K  
alphas from (s,n\*)a

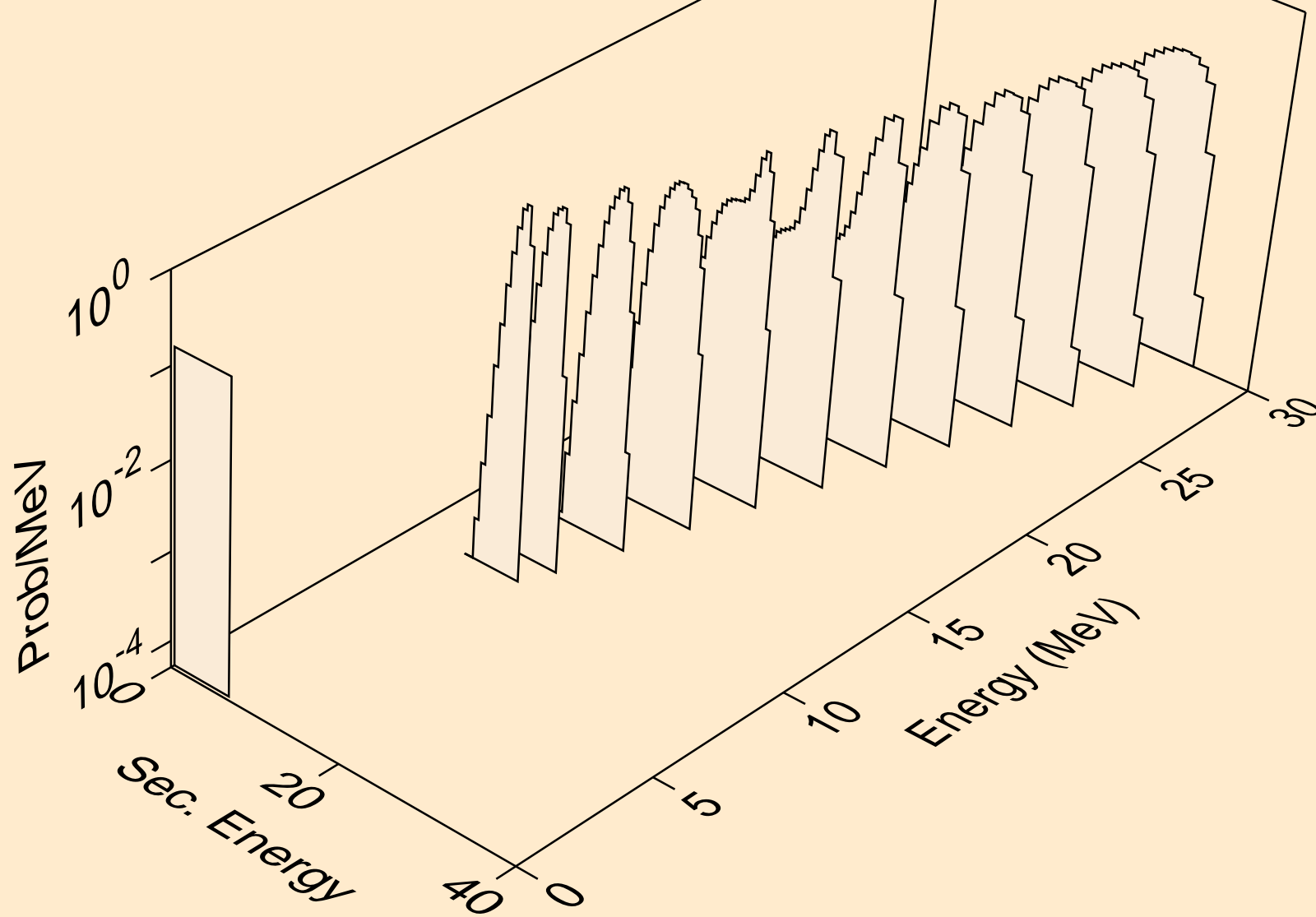

TL196 HELION ACER TENDL-2021 LIBRARY; T=0.K  
alphas from (s,2n)a

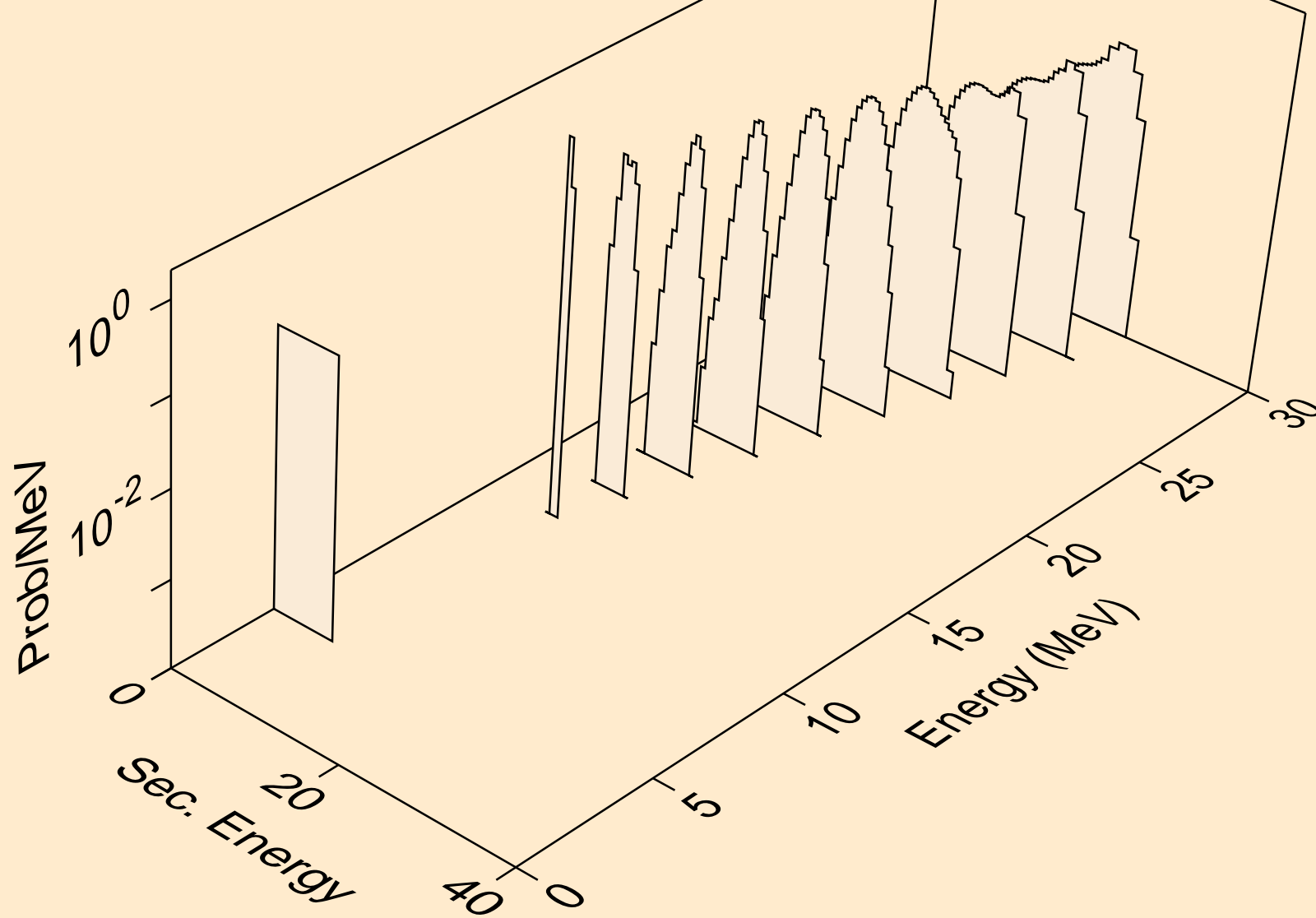

TL196 HELION ACER TENDL-2021 LIBRARY; T=0.K  
alphas from (s,3n)a

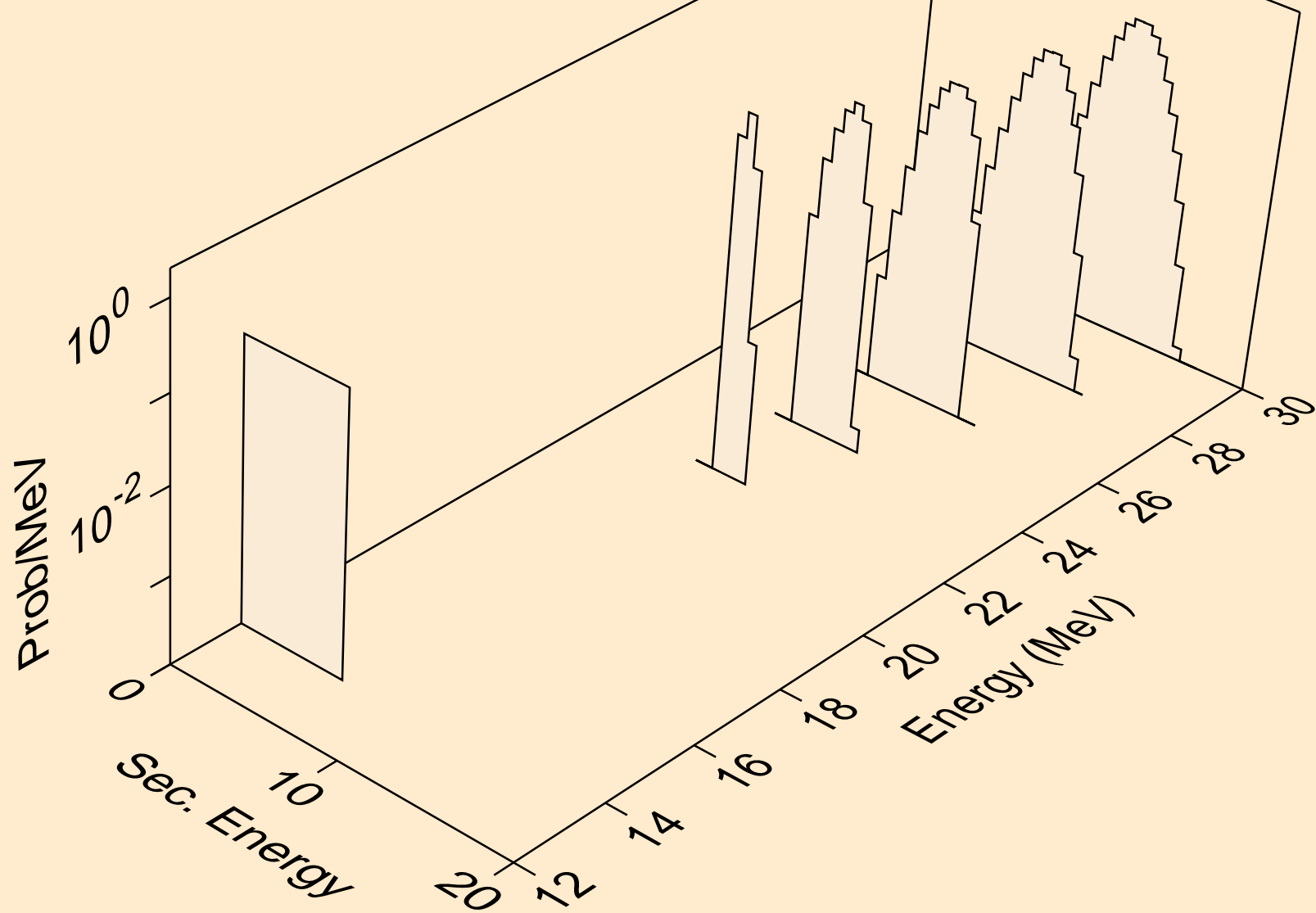

TL196 HELION ACER TENDL-2021 LIBRARY; T=0.K  
alphas from (s,npa)

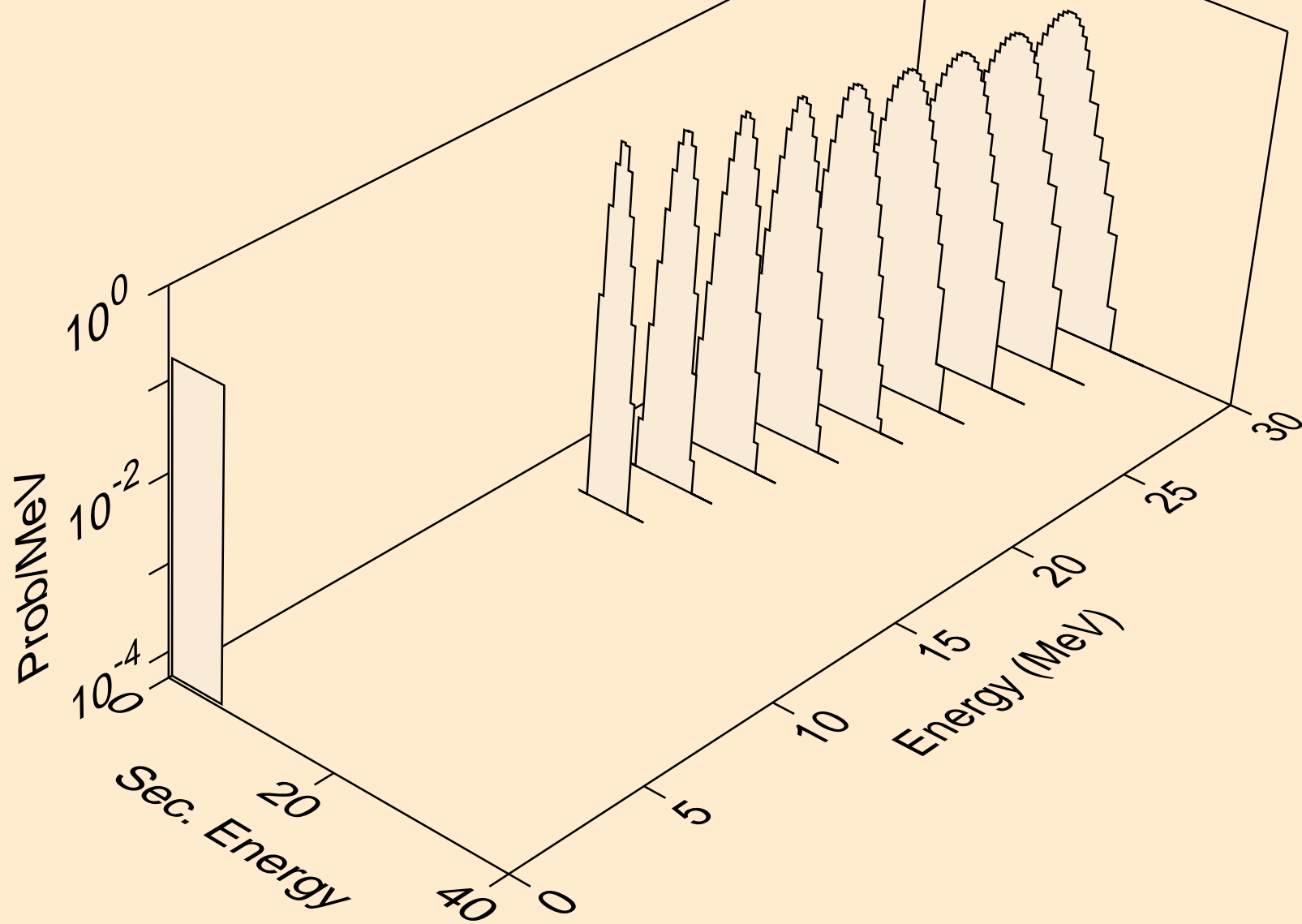

TL196 HELION ACER TENDL-2021 LIBRARY; T=0.K  
alphas from (s,a)

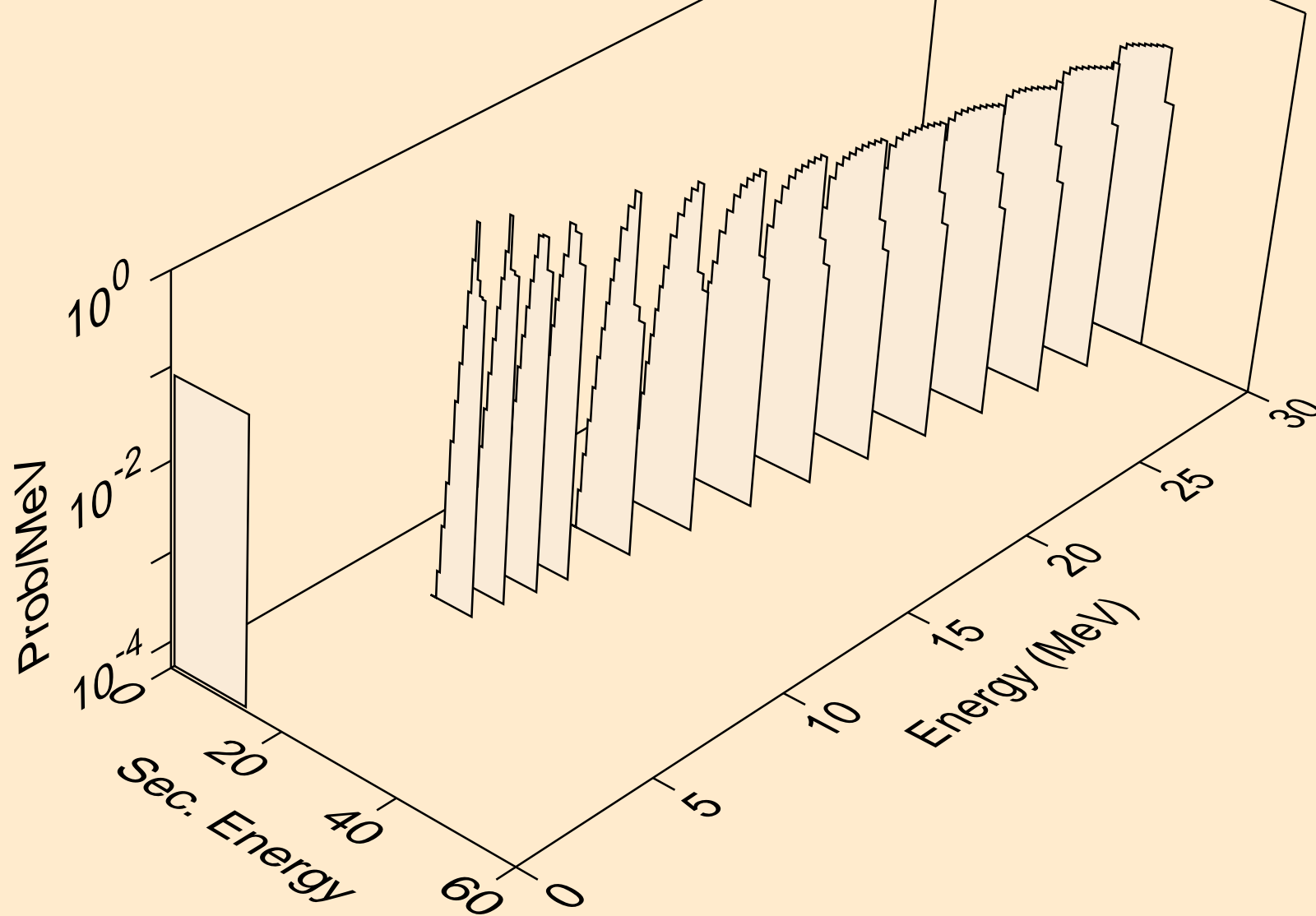

TL196 HELION ACER TENDL-2021 LIBRARY; T=0.K  
alphas from (s,2a)

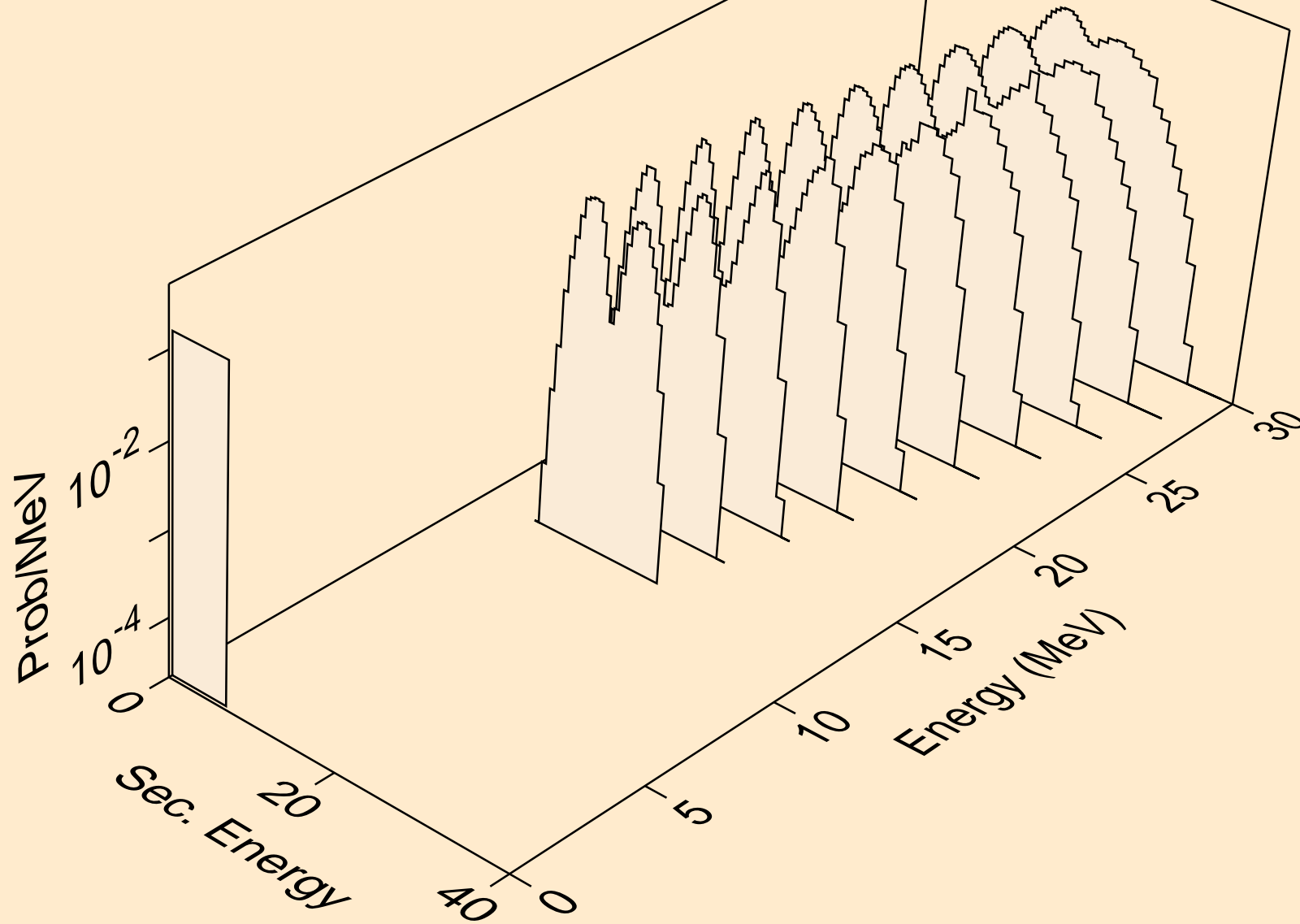

TL196 HELION ACER TENDL-2021 LIBRARY; T=0.K  
alphas from (s,pa)

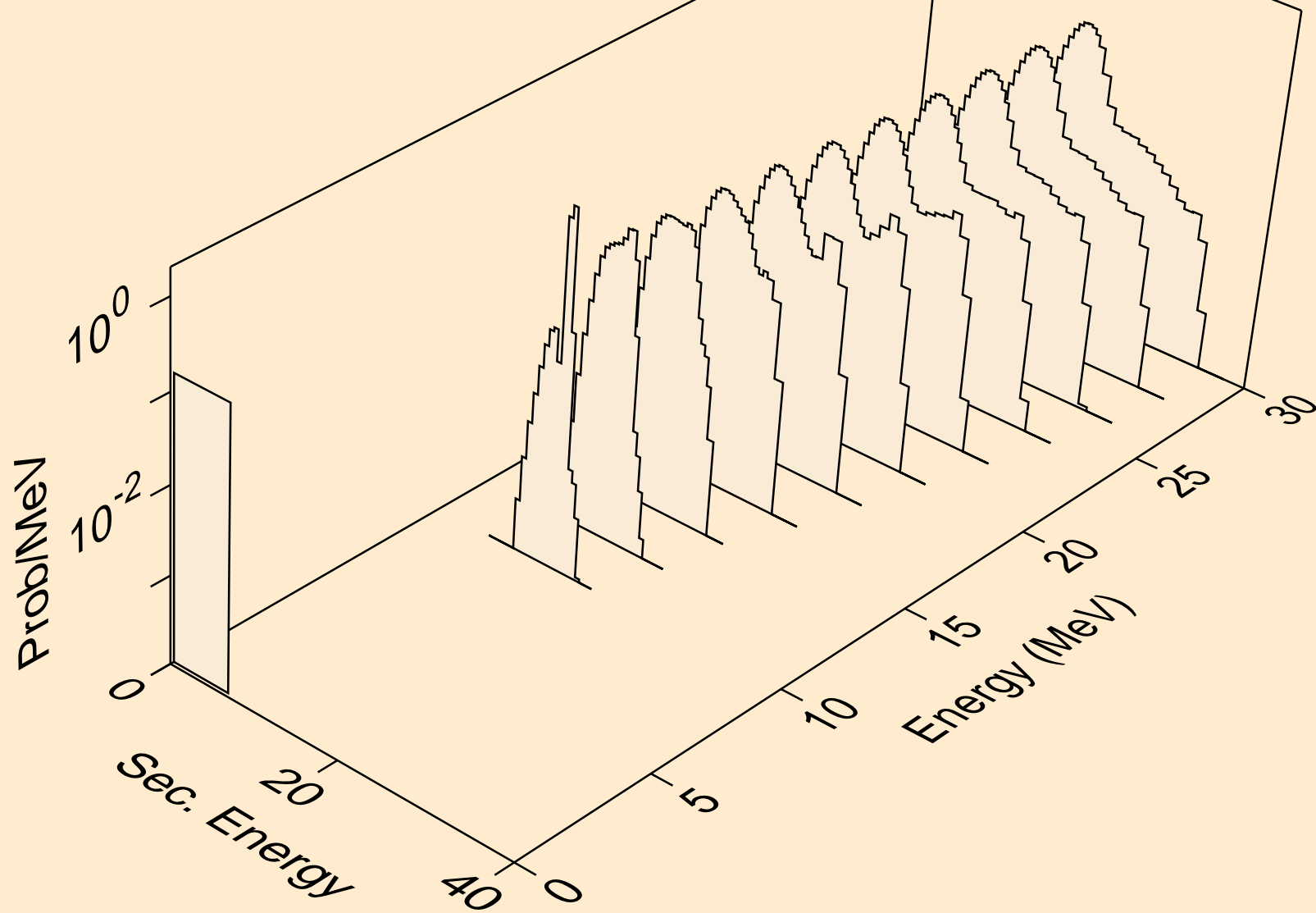

TL196 HELION ACER TENDL-2021 LIBRARY; T=0.K  
alphas from (s,da)

