

# TM157 HELION ACER TENDL-2021 LIBRARY; T=0.K

## Principal cross sections

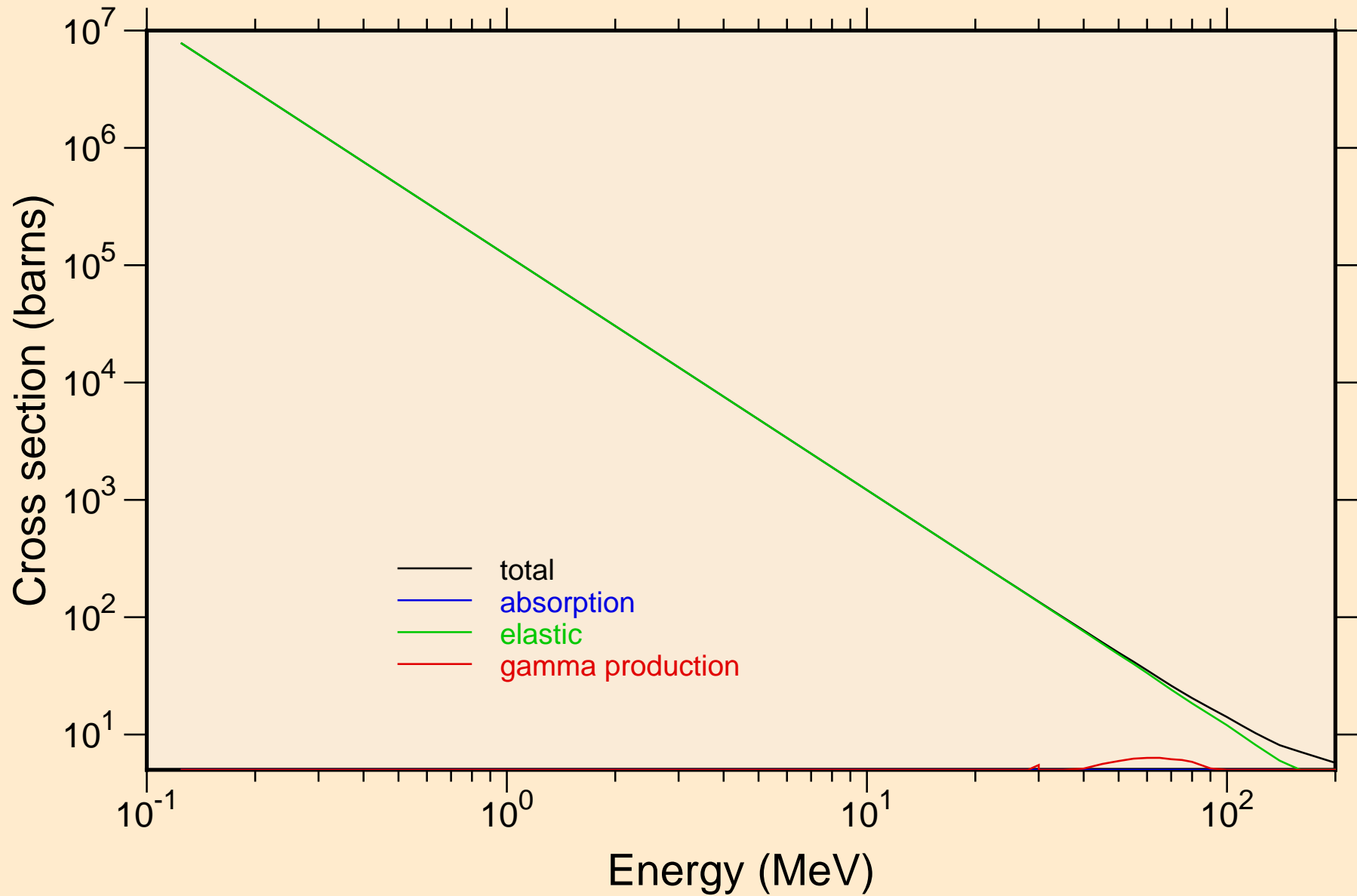

TM157 HELION ACER TENDL-2021 LIBRARY; T=0.K

Heating

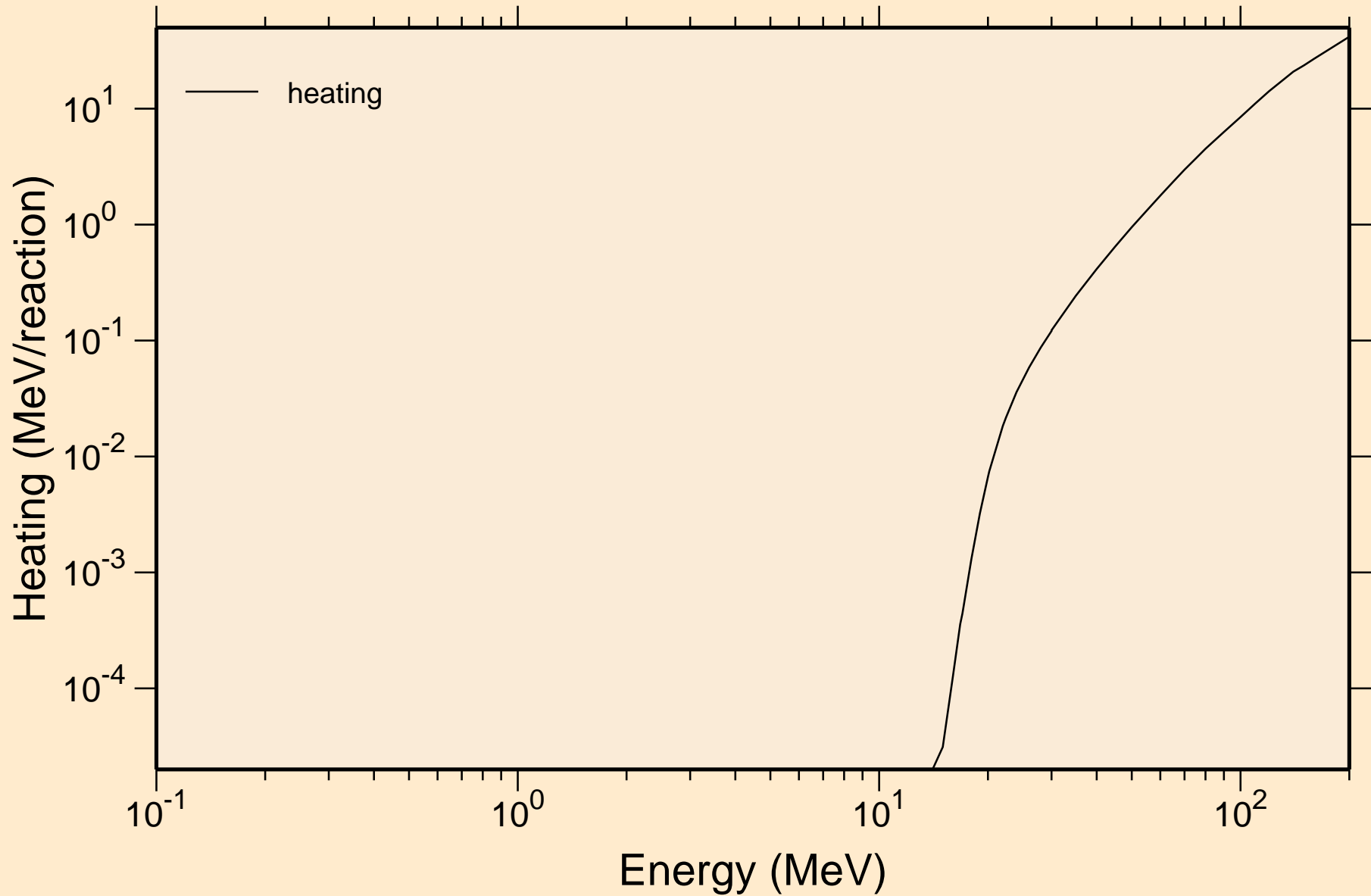

# TM157 HELION ACER TENDL-2021 LIBRARY; T=0.K

## Principal cross sections

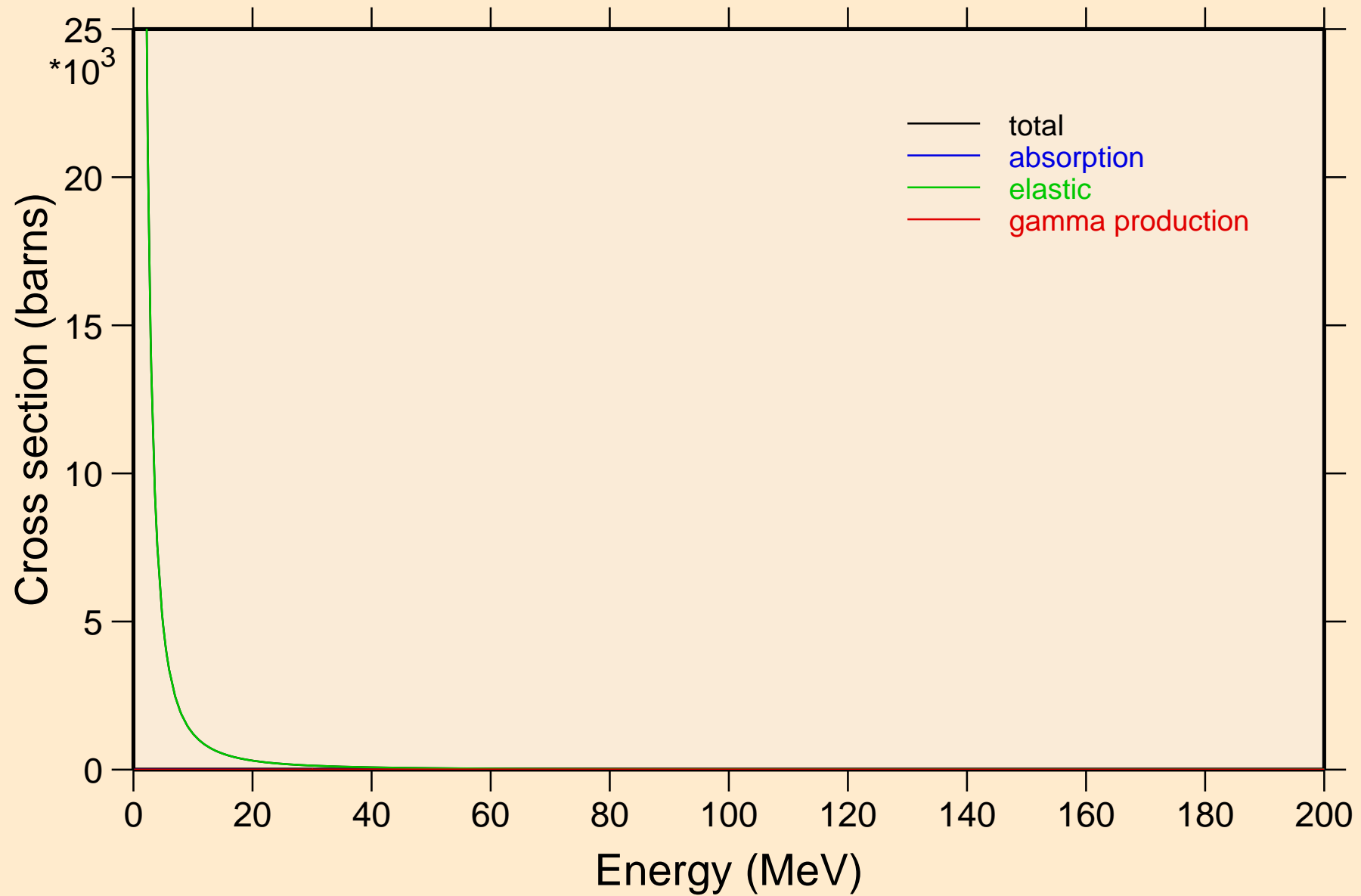

TM157 HELION ACER TENDL-2021 LIBRARY; T=0.K

Heating

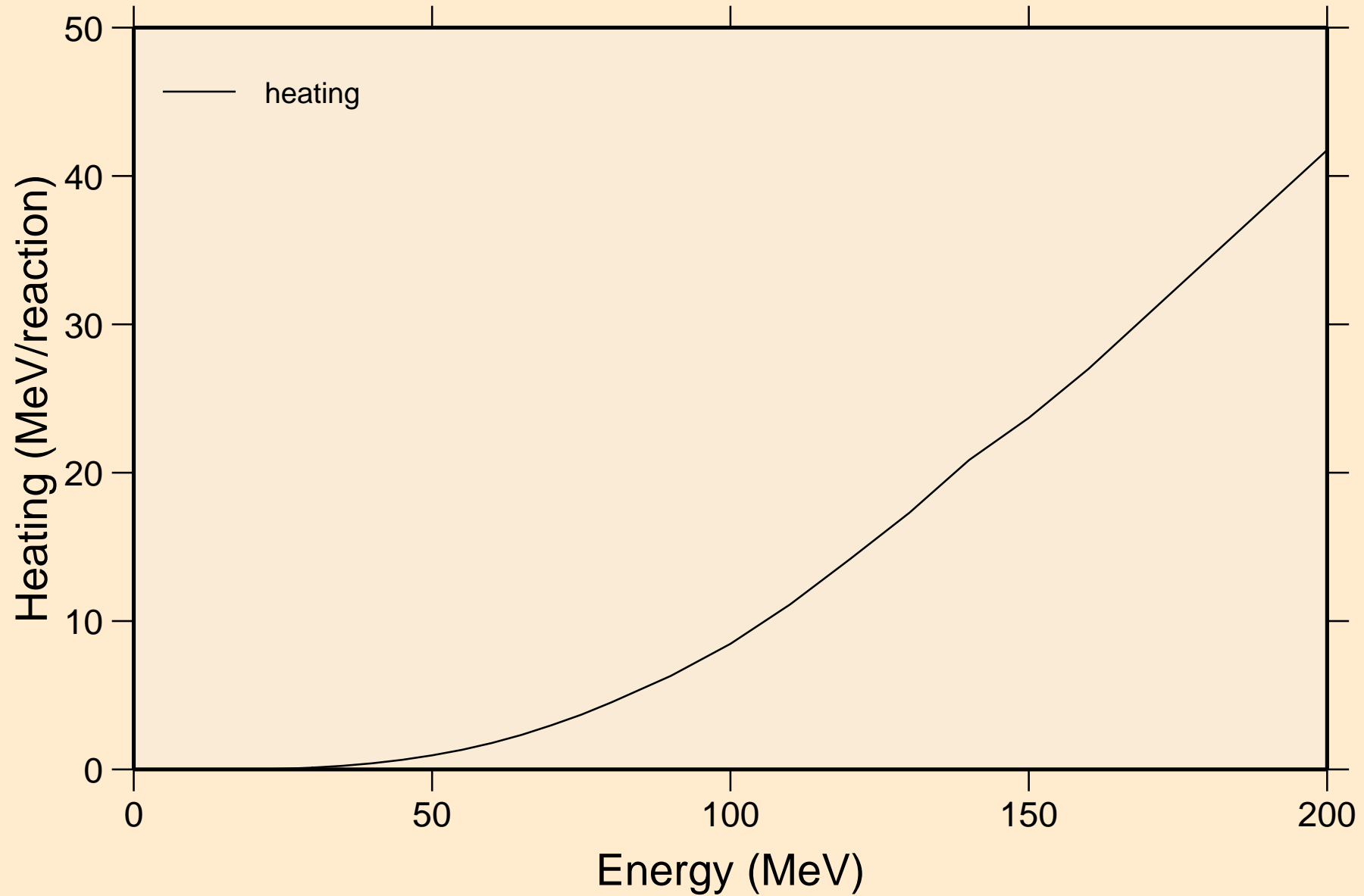

TM157 HELION ACER TENDL-2021 LIBRARY; T=0.K  
Threshold reactions

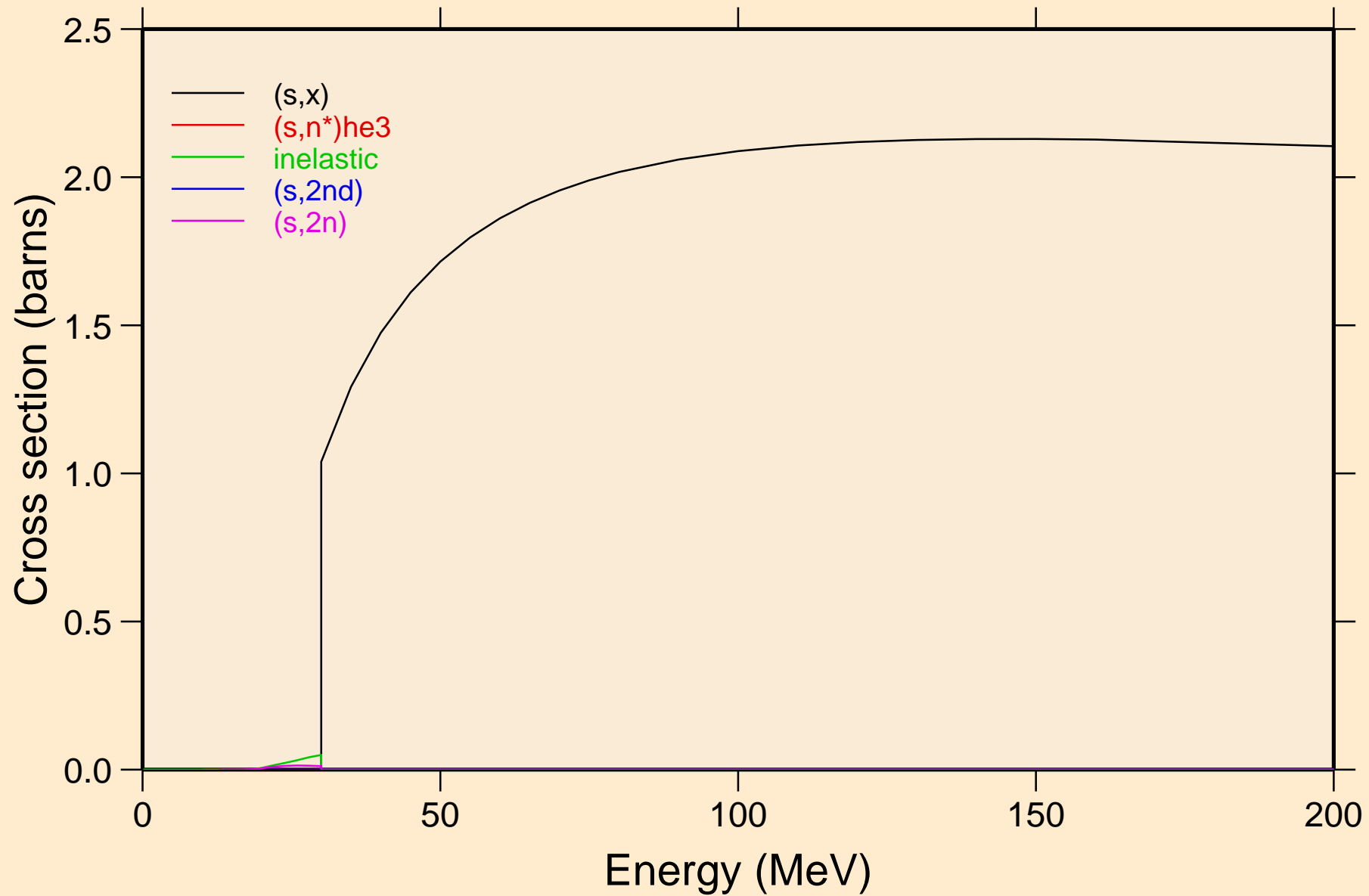

TM157 HELION ACER TENDL-2021 LIBRARY; T=0.K  
Threshold reactions

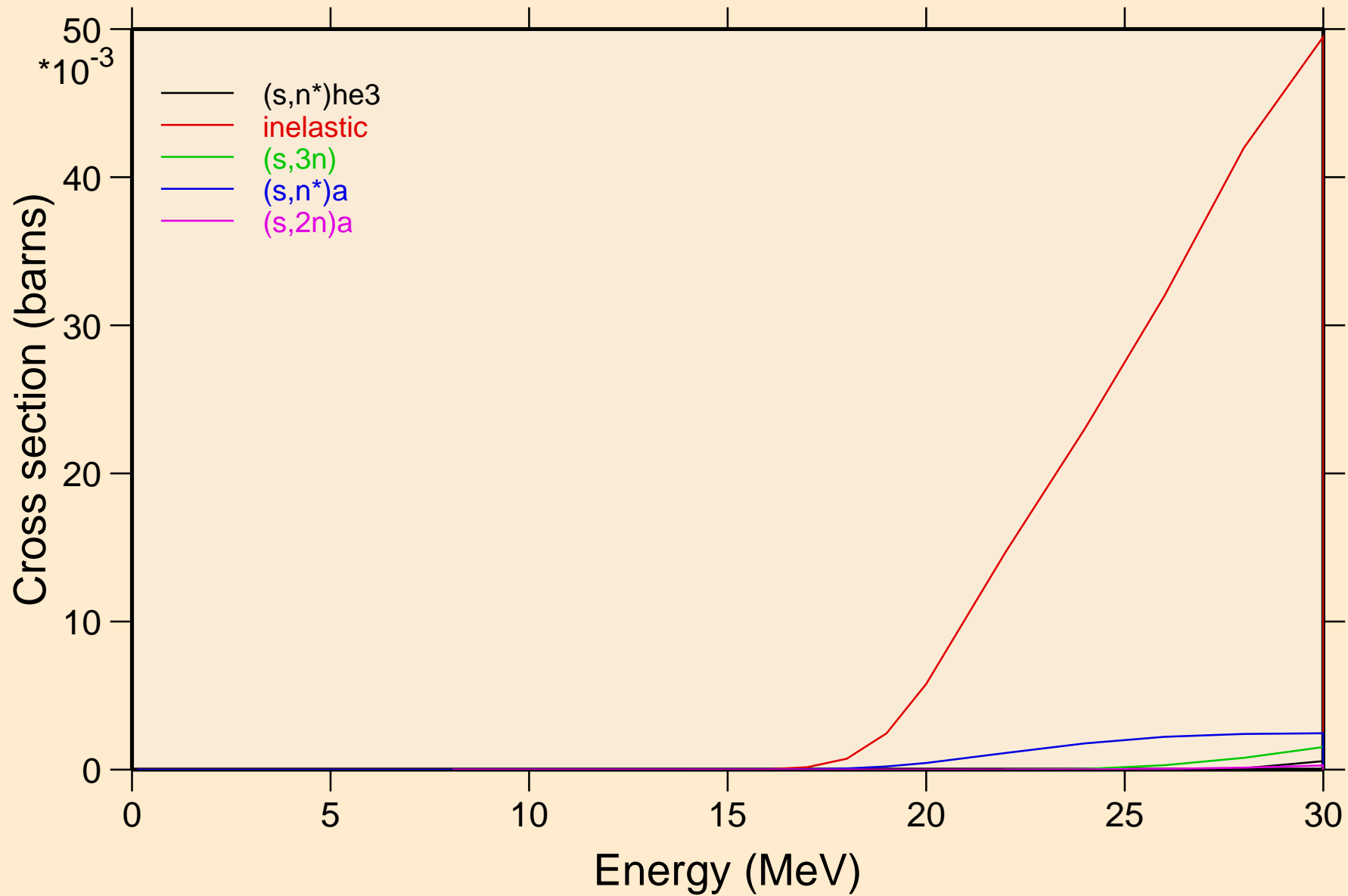

TM157 HELION ACER TENDL-2021 LIBRARY; T=0.K  
Threshold reactions

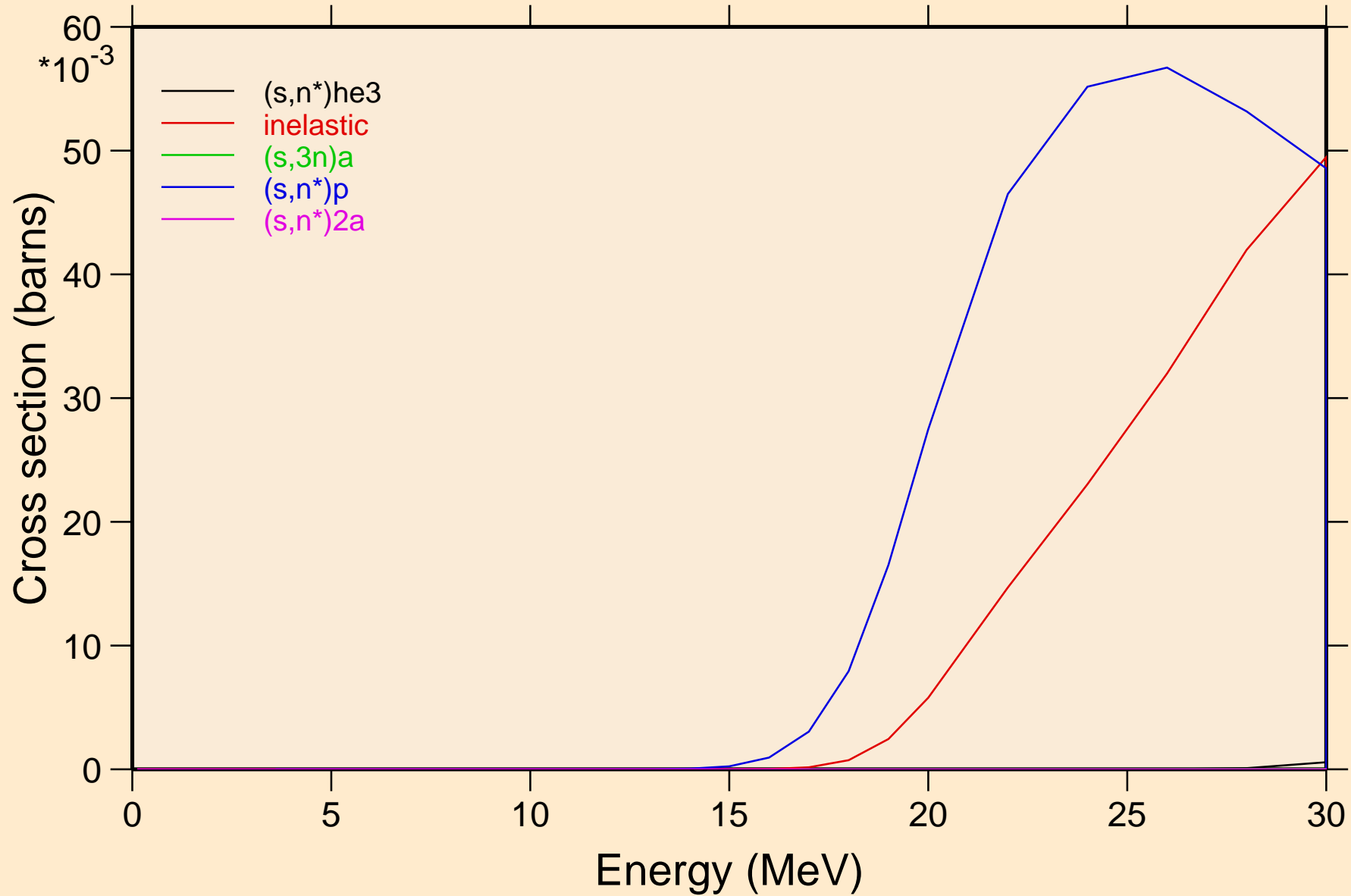

TM157 HELION ACER TENDL-2021 LIBRARY; T=0.K  
Threshold reactions

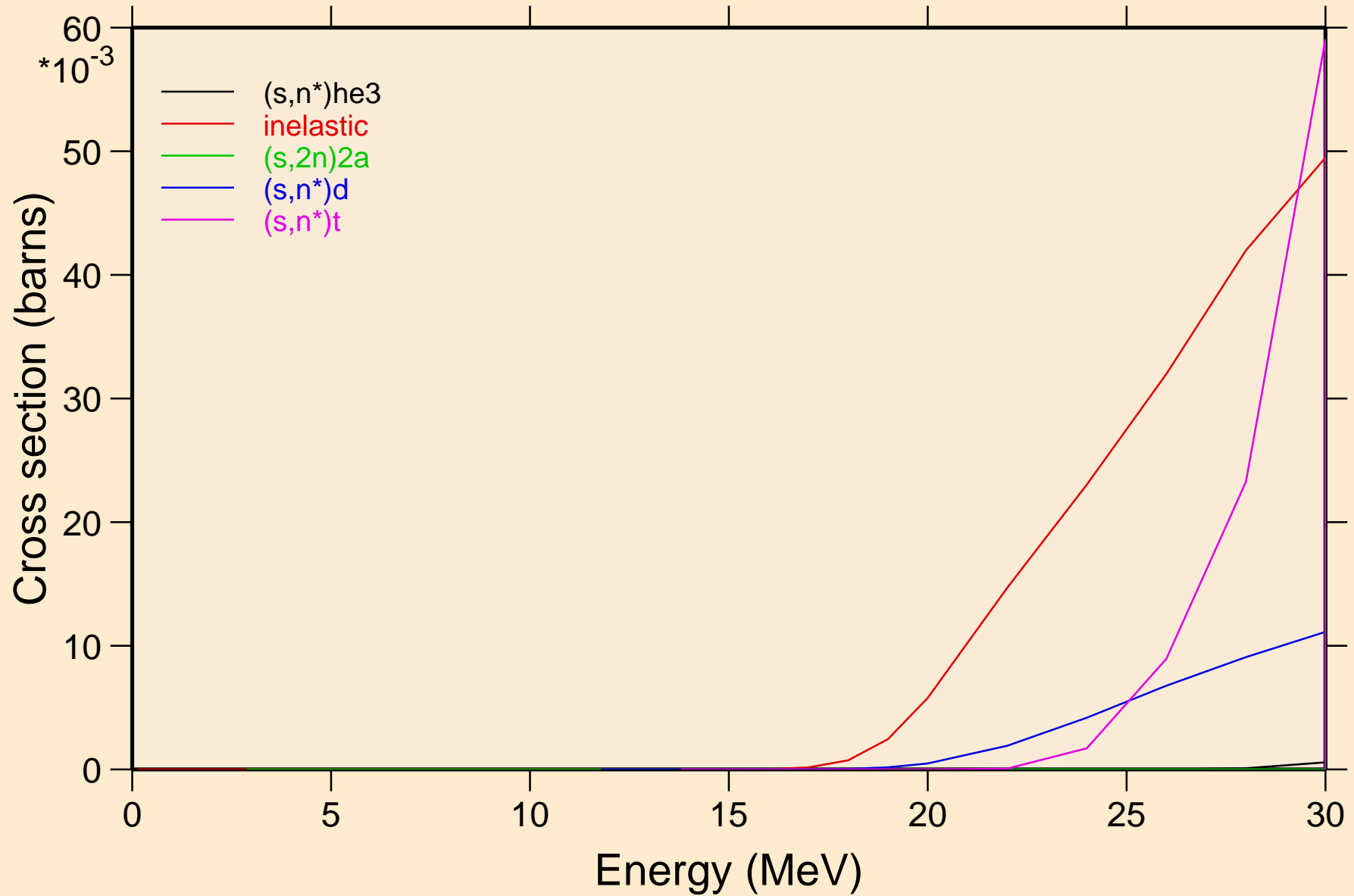



TM157 HELION ACER TENDL-2021 LIBRARY; T=0.K  
Threshold reactions

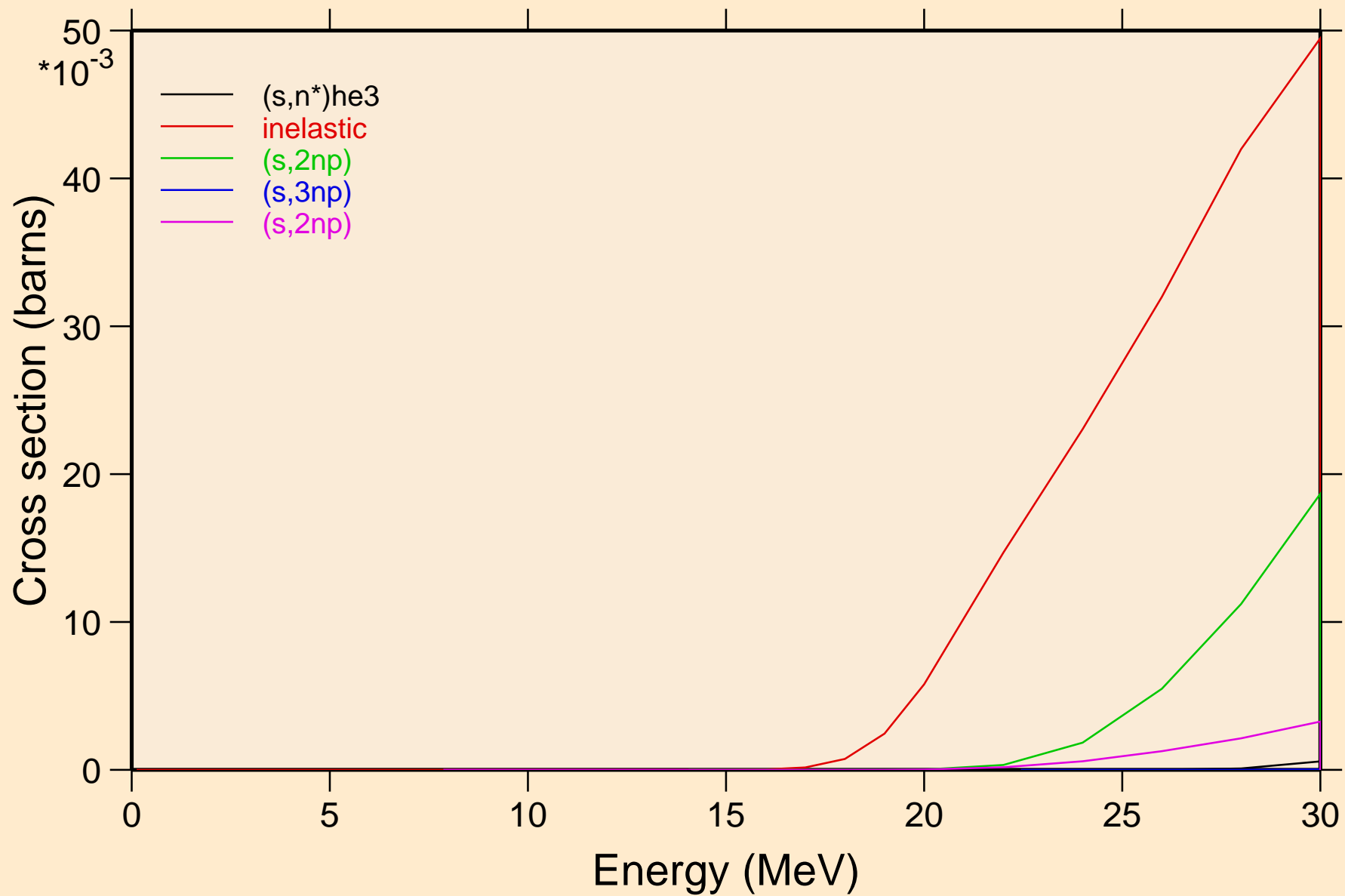

TM157 HELION ACER TENDL-2021 LIBRARY; T=0.K  
Threshold reactions

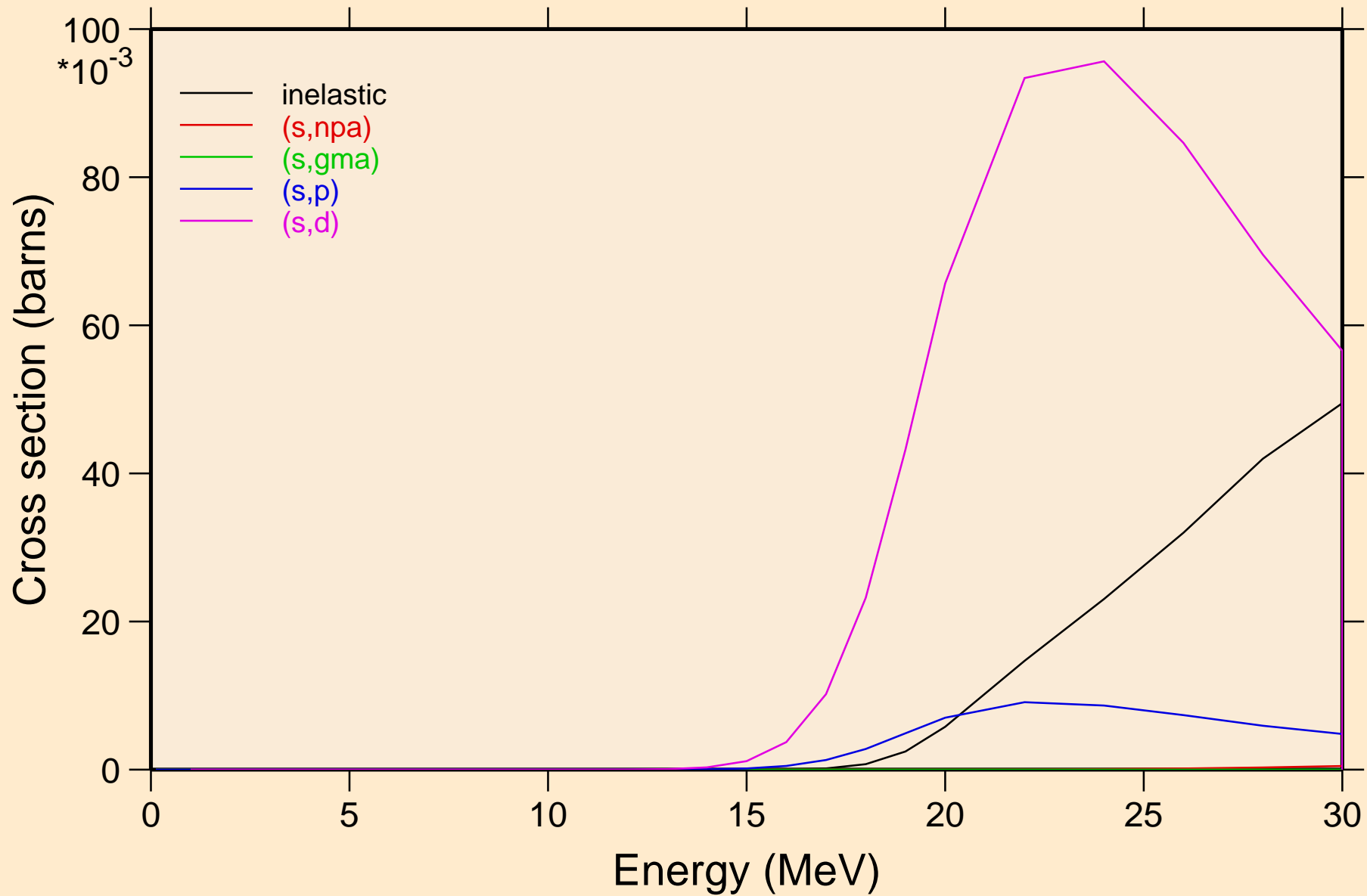

TM157 HELION ACER TENDL-2021 LIBRARY; T=0.K  
Threshold reactions

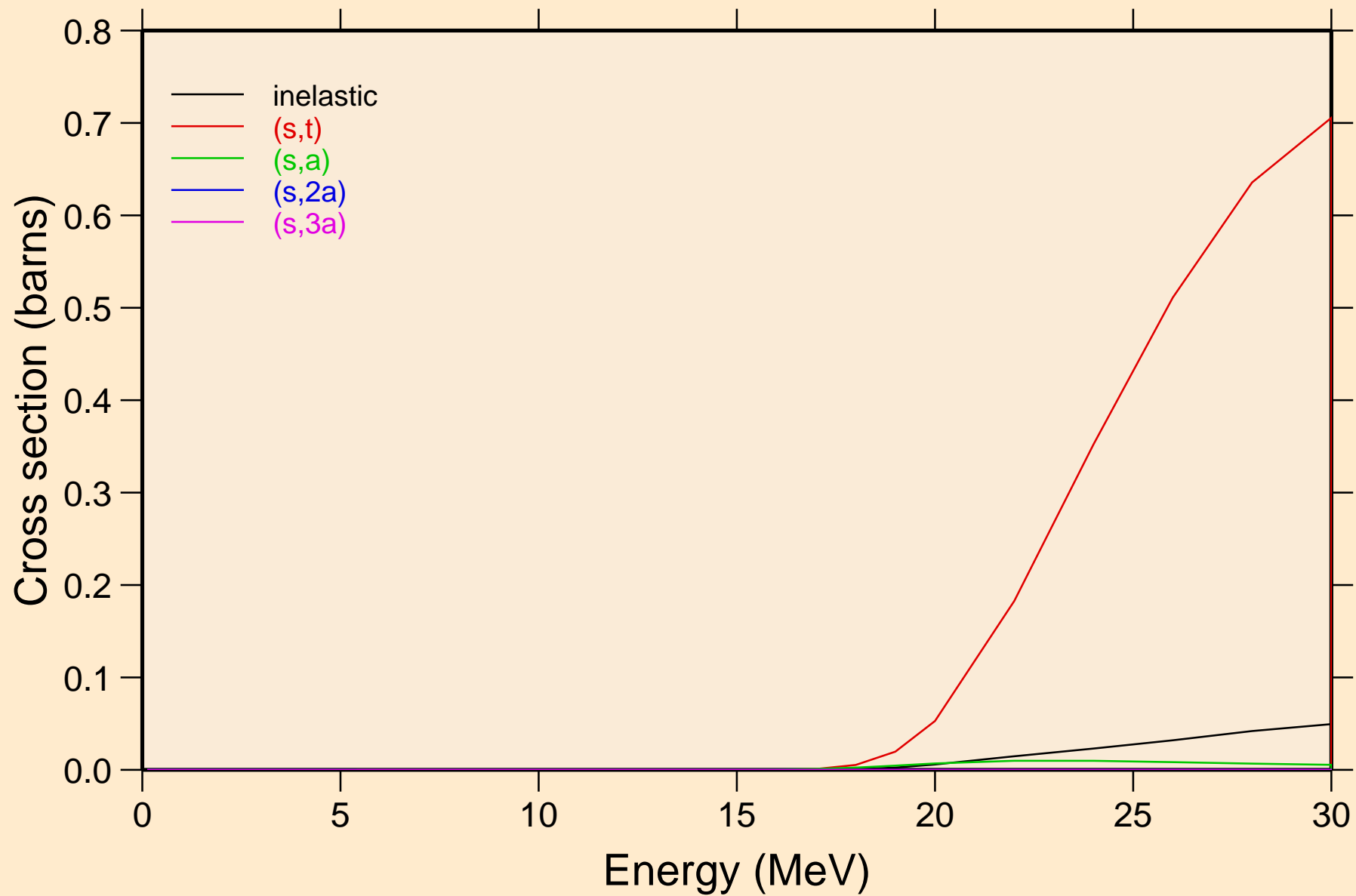

TM157 HELION ACER TENDL-2021 LIBRARY; T=0.K  
Threshold reactions

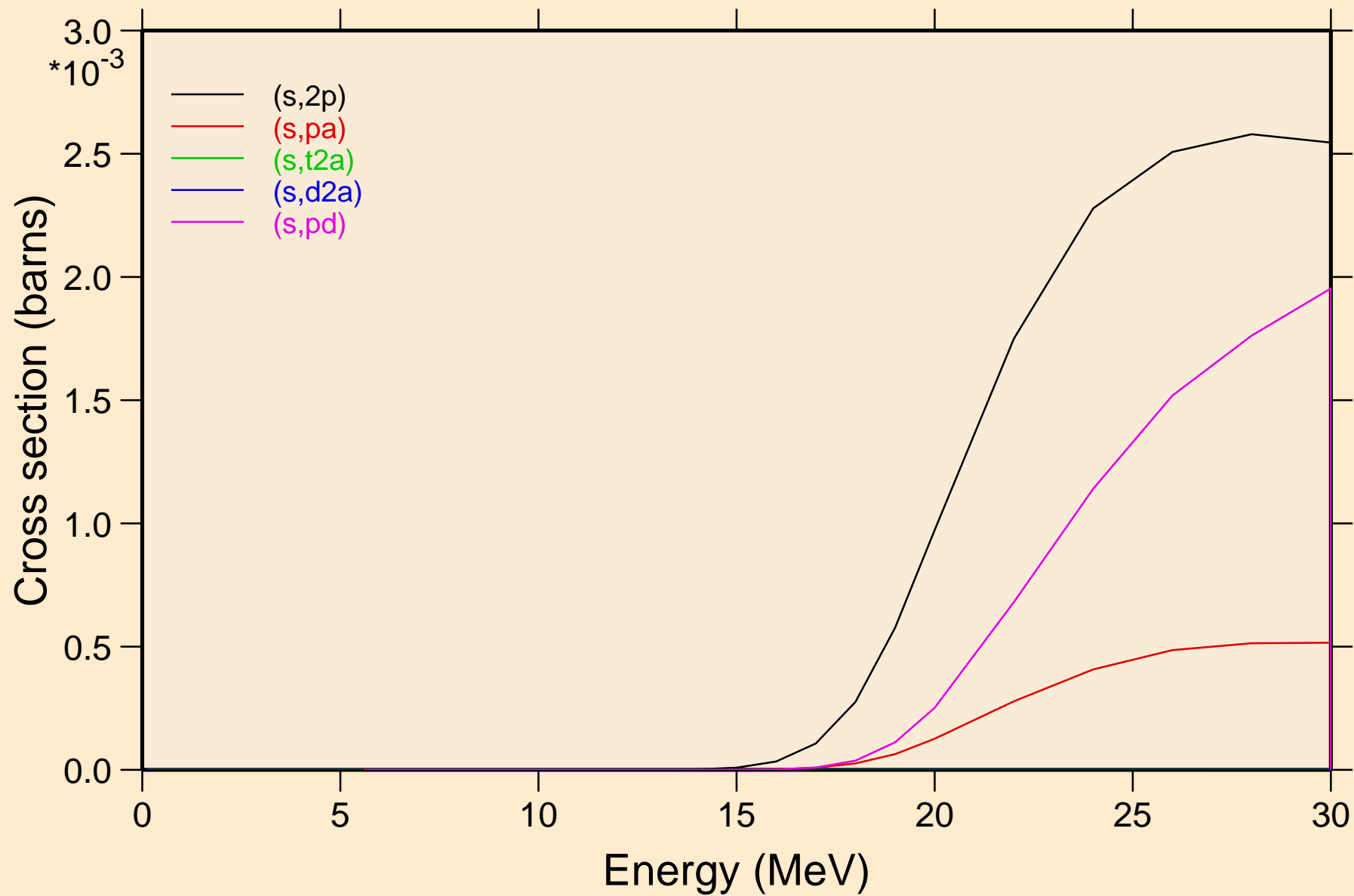

TM157 HELION ACER TENDL-2021 LIBRARY; T=0.K  
Threshold reactions

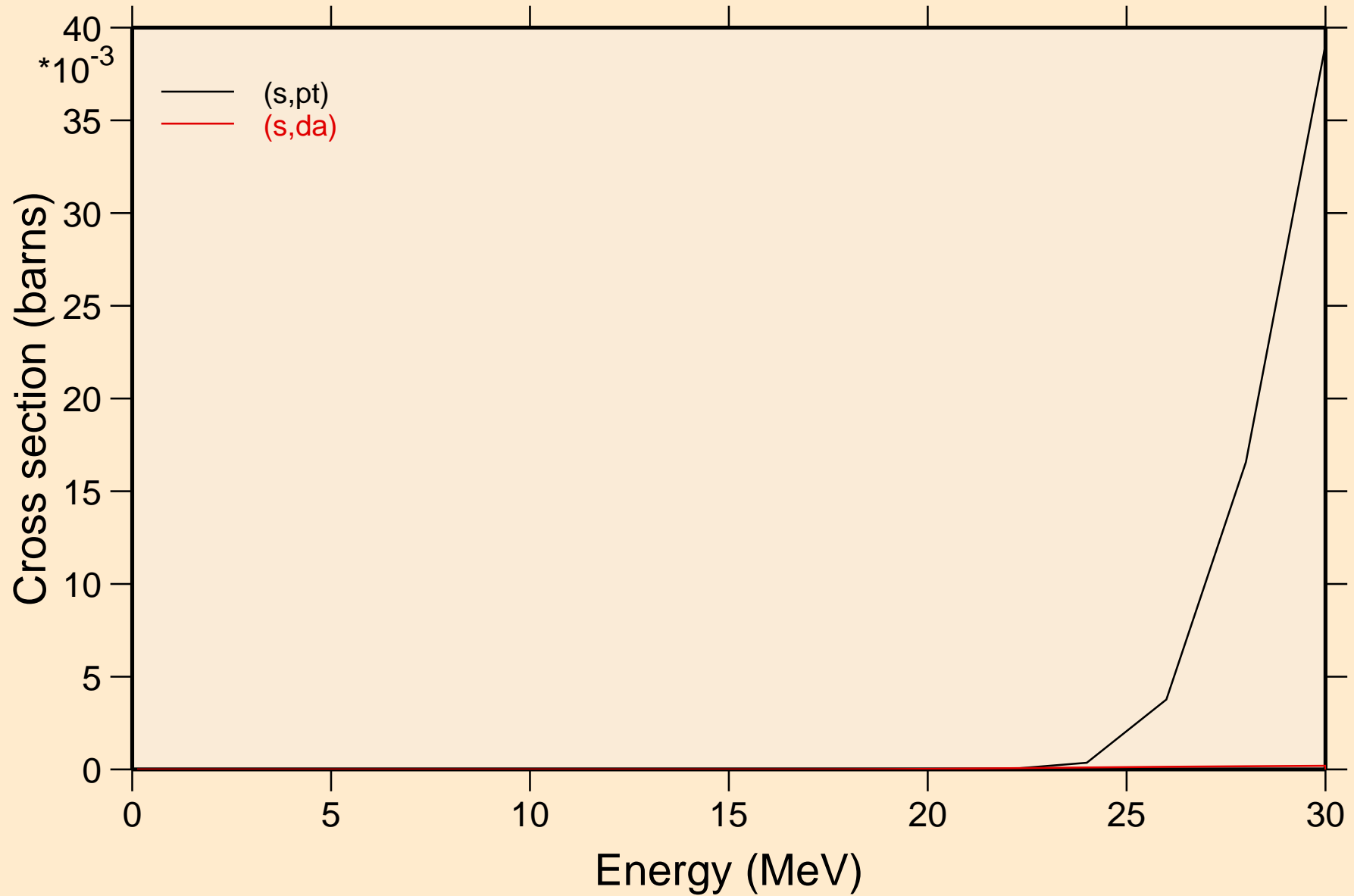

TM157 HELION ACER TENDL-2021 LIBRARY; T=0.K  
angular distribution for elastic

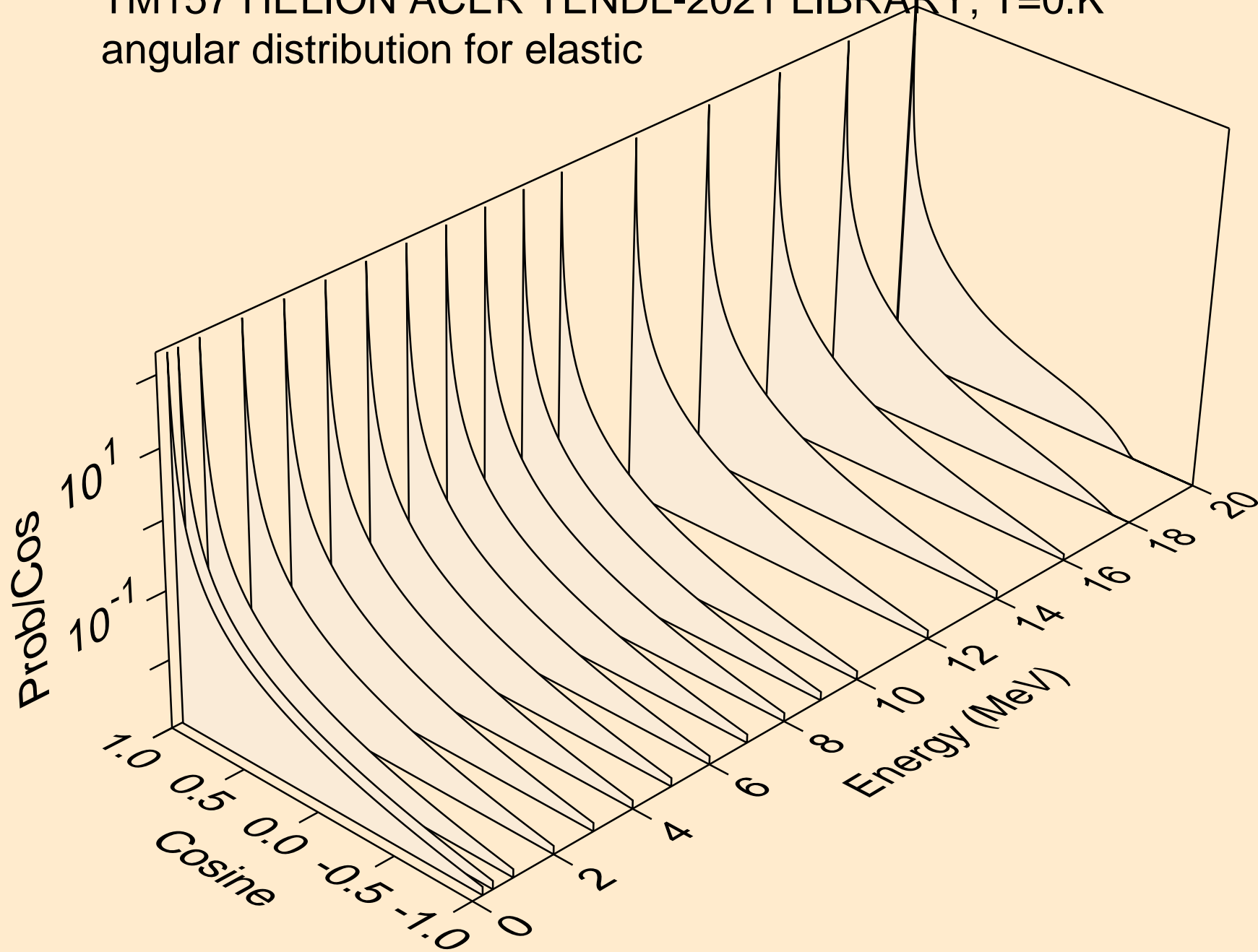

TM157 HELION ACER TENDL-2021 LIBRARY; T=0.K  
angular distribution for elastic

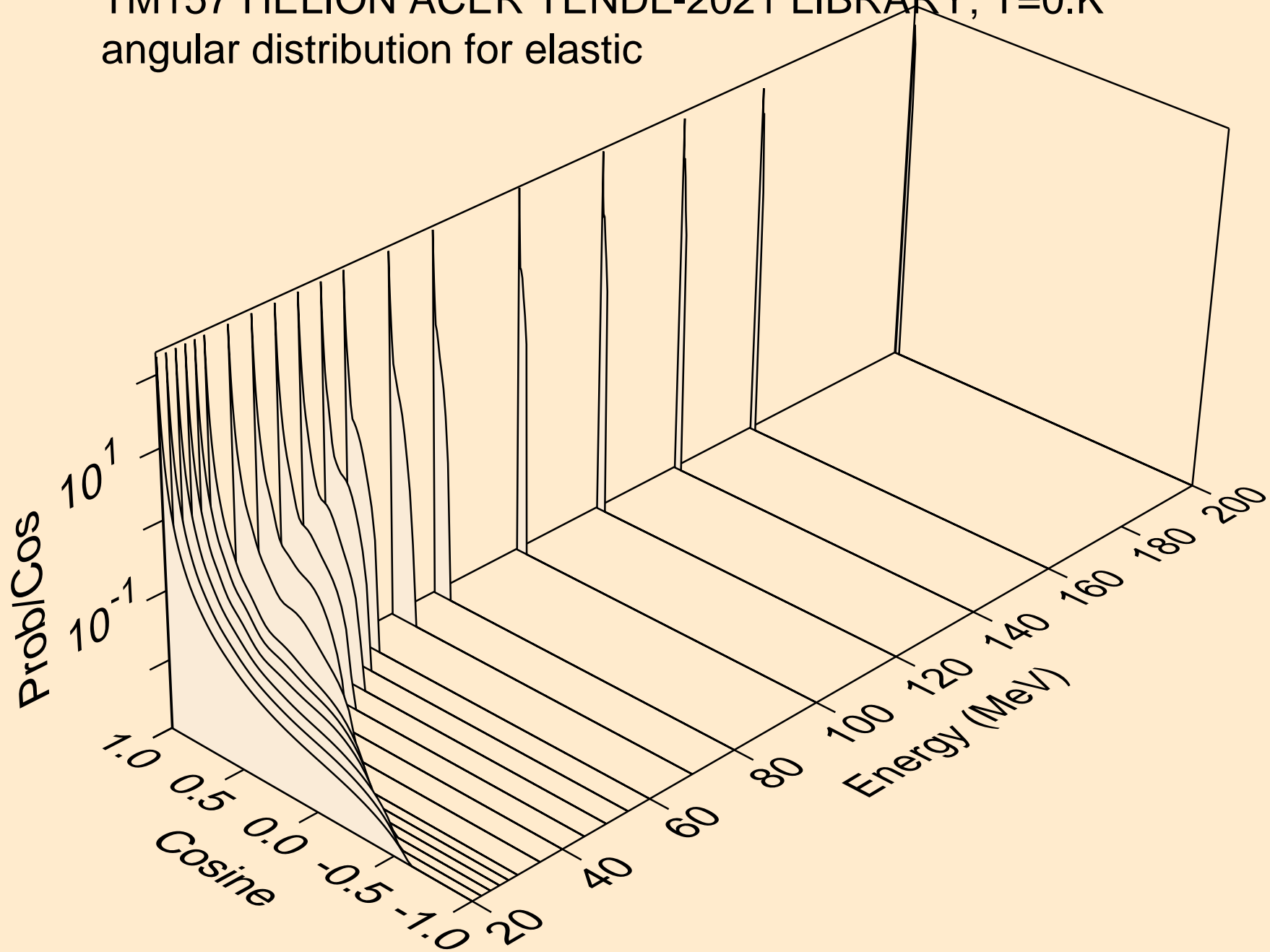

TM157 HELION ACER TENDL-2021 LIBRARY; T=0.K  
He-3 emission for (s,x)

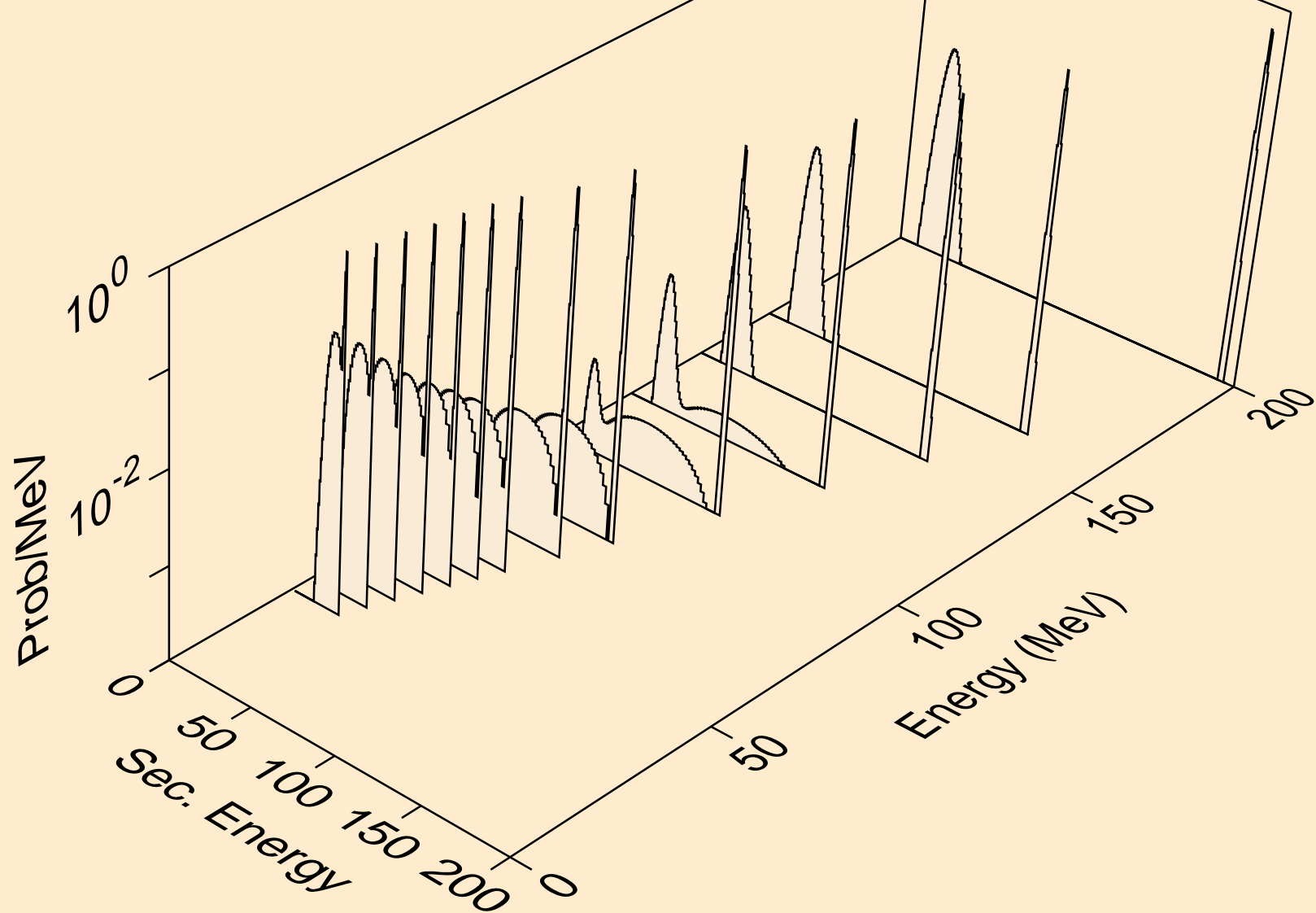



TM157 HELION ACER TENDL-2021 LIBRARY; T=0.K  
He-3 emission for (s,n\*)he3

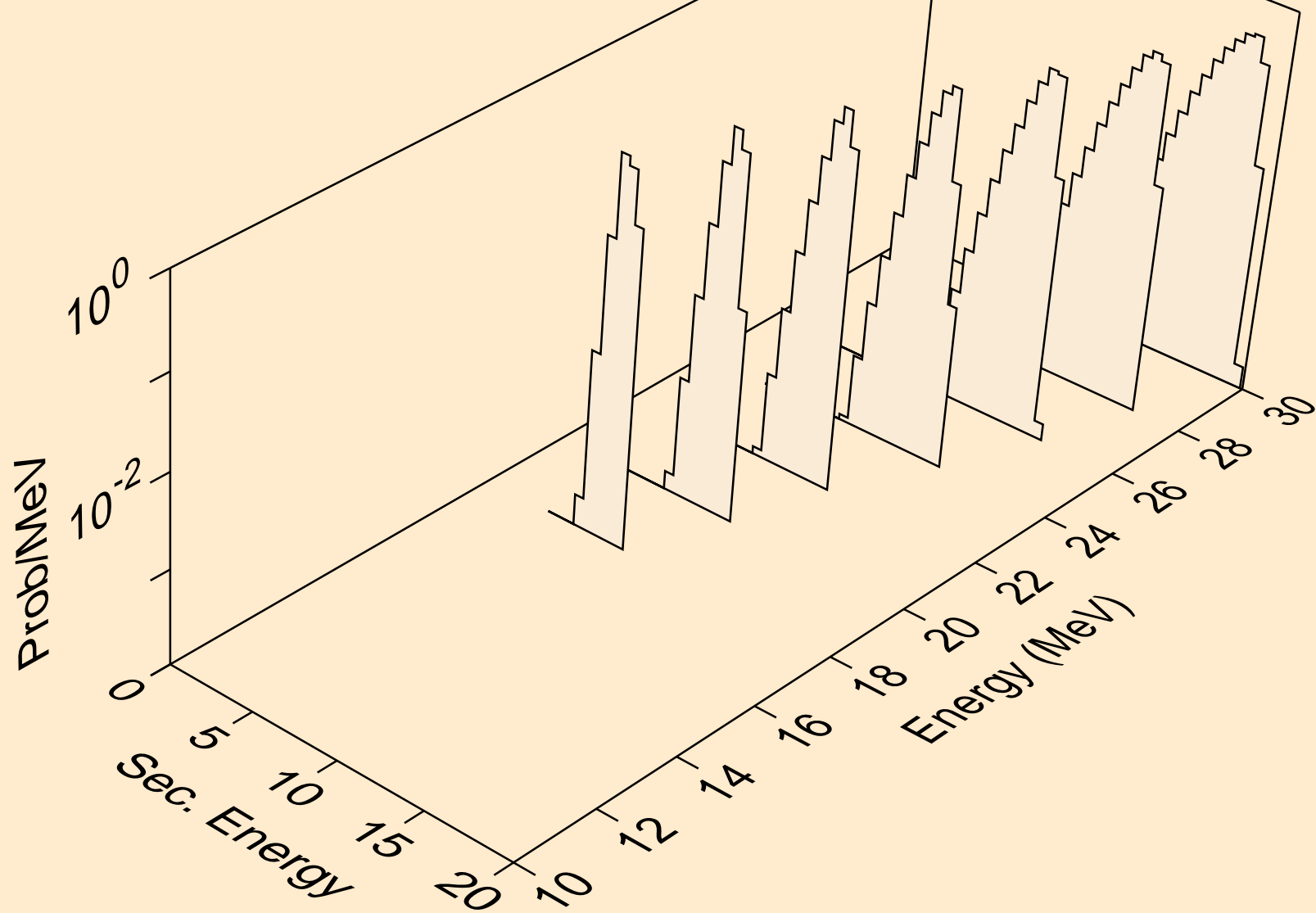

TM157 HELION ACER TENDL-2021 LIBRARY; T=0.K  
He-3 emission for inelastic

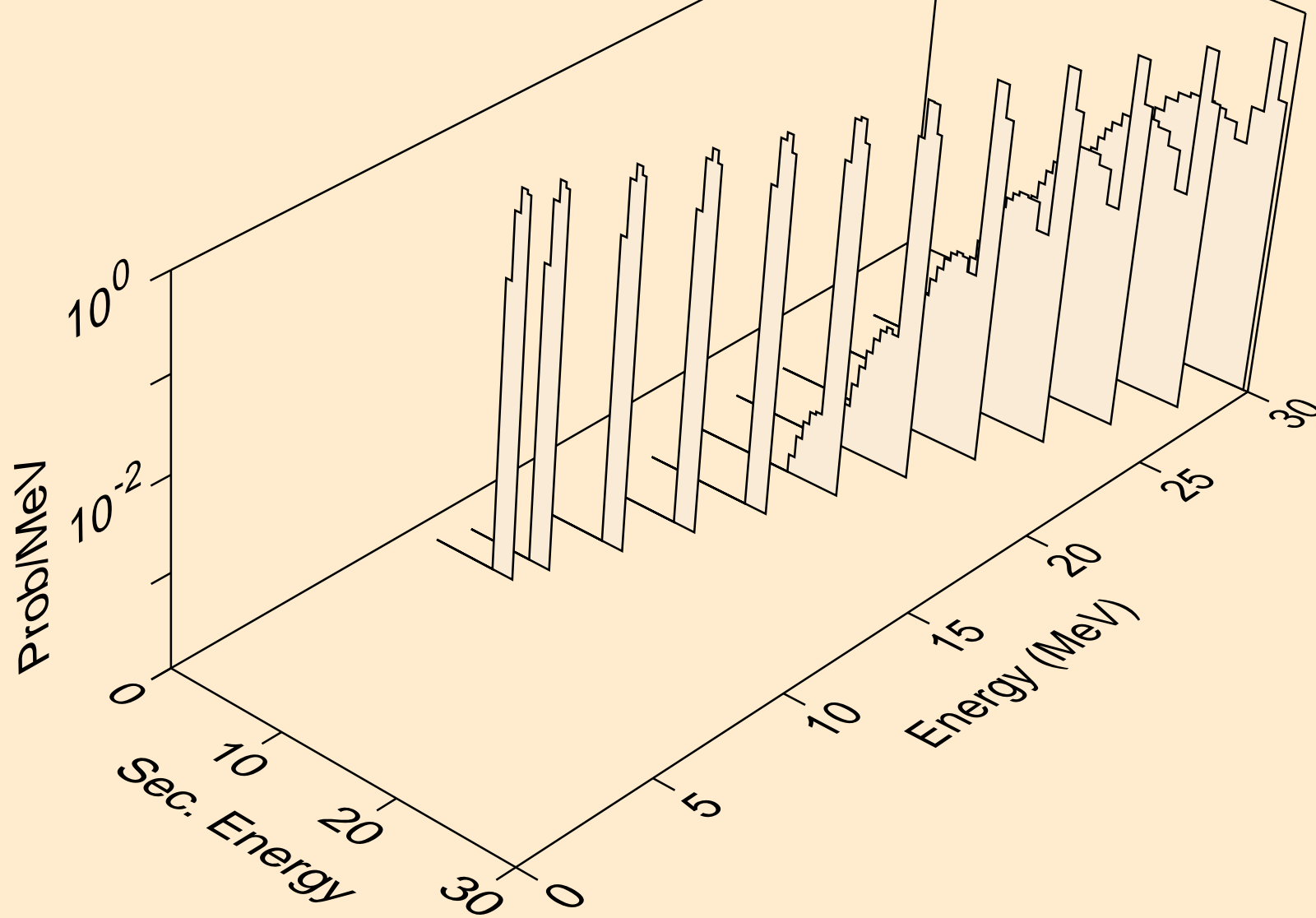

TM157 HELION ACER TENDL-2021 LIBRARY; T=0.K  
Photon emission for (z,n)

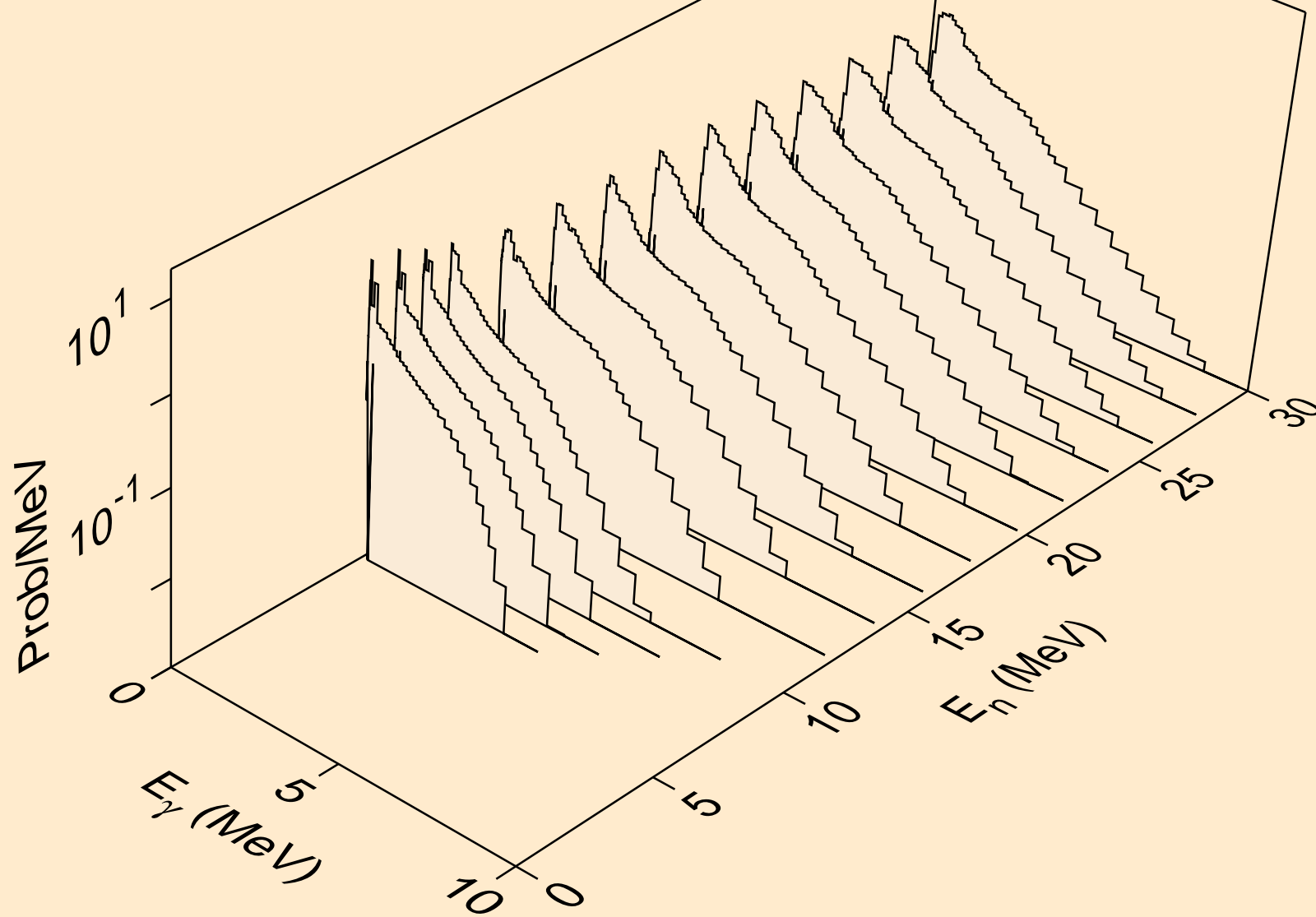

TM157 HELION ACER TENDL-2021 LIBRARY; T=0.K  
Photon emission for (n,x)

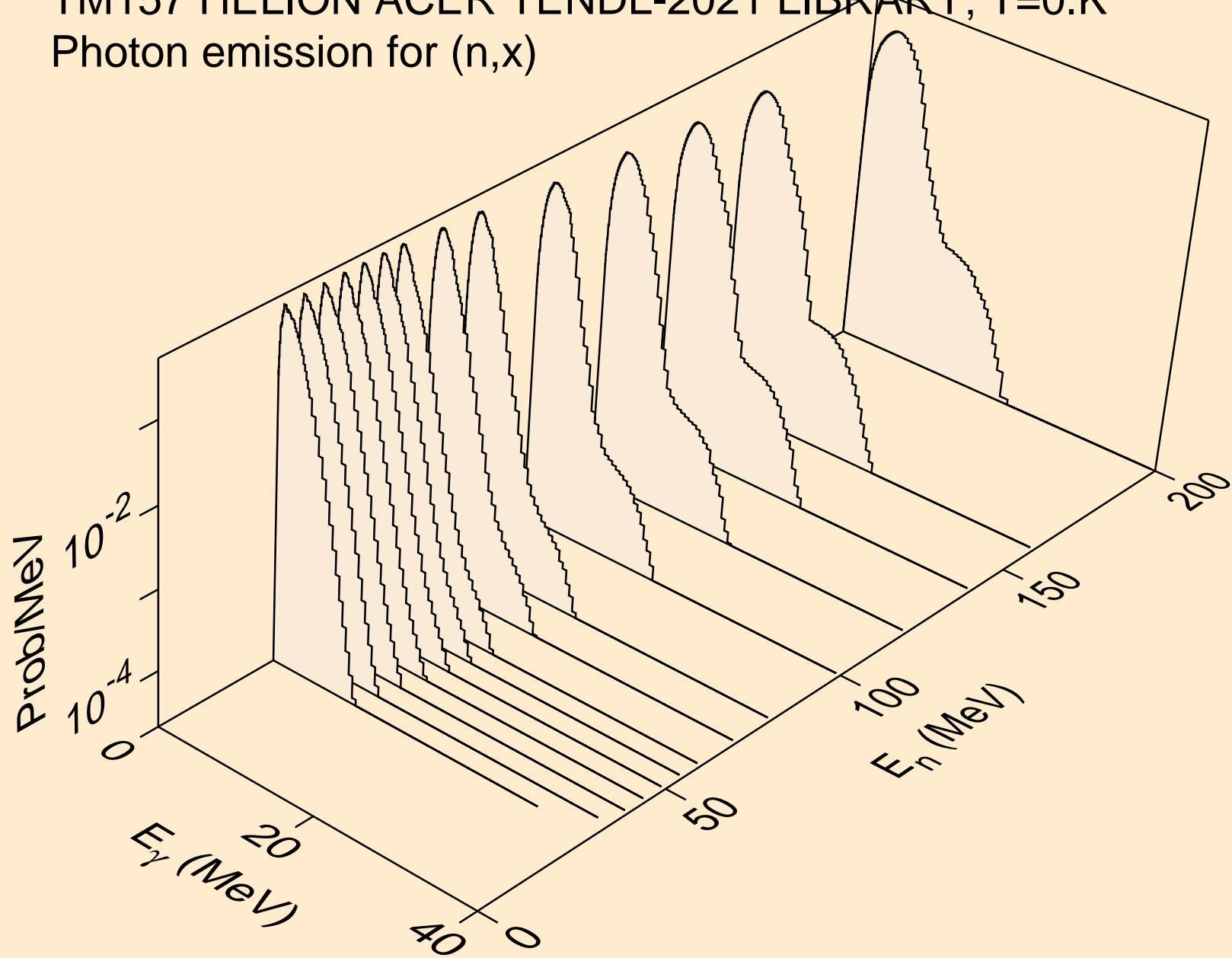

TM157 HELION ACER TENDL-2021 LIBRARY; T=0.K  
Photon emission for (n,2nd)

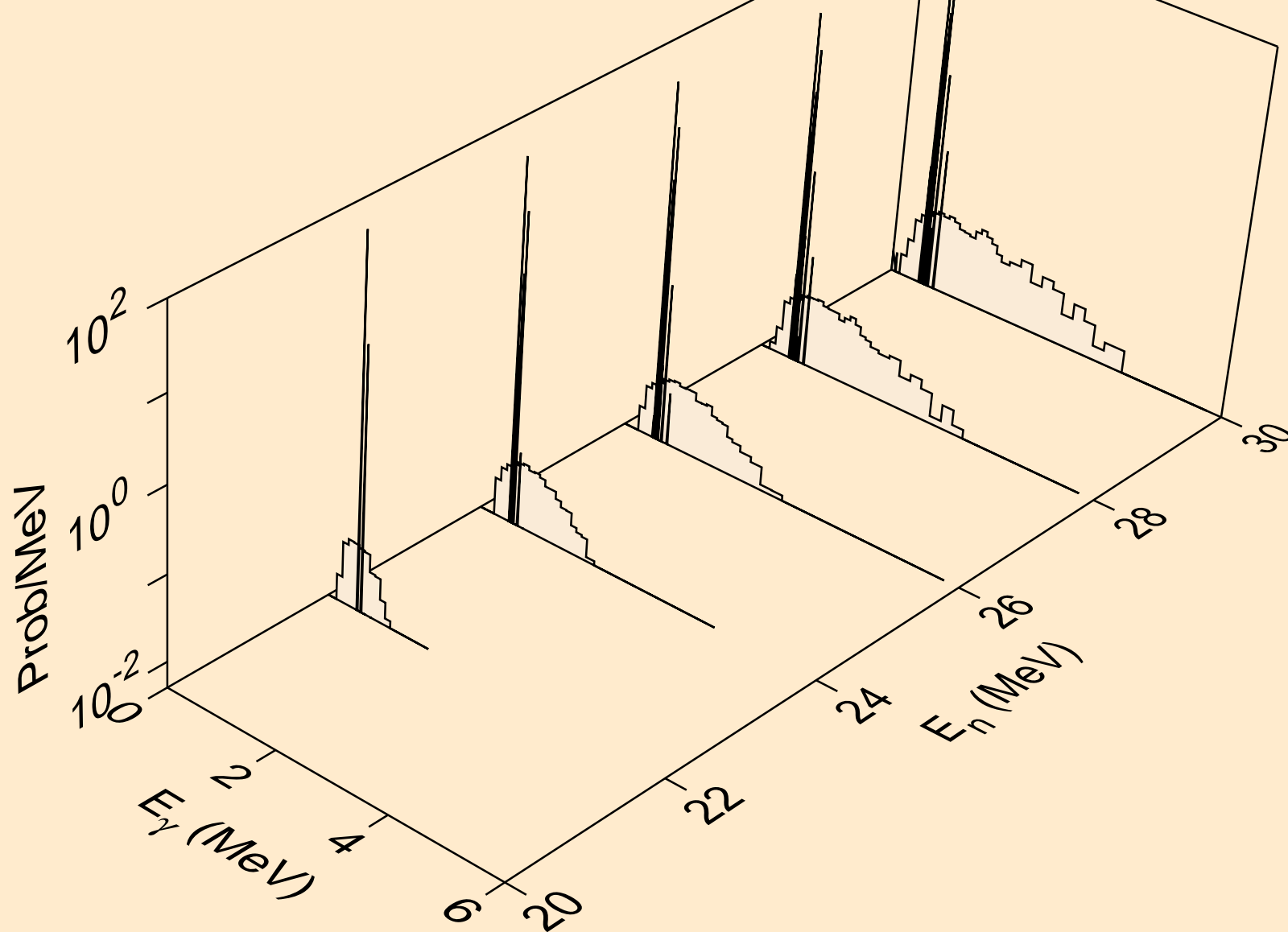

TM157 HELION ACER TENDL-2021 LIBRARY; T=0.K  
Photon emission for (n,2n)

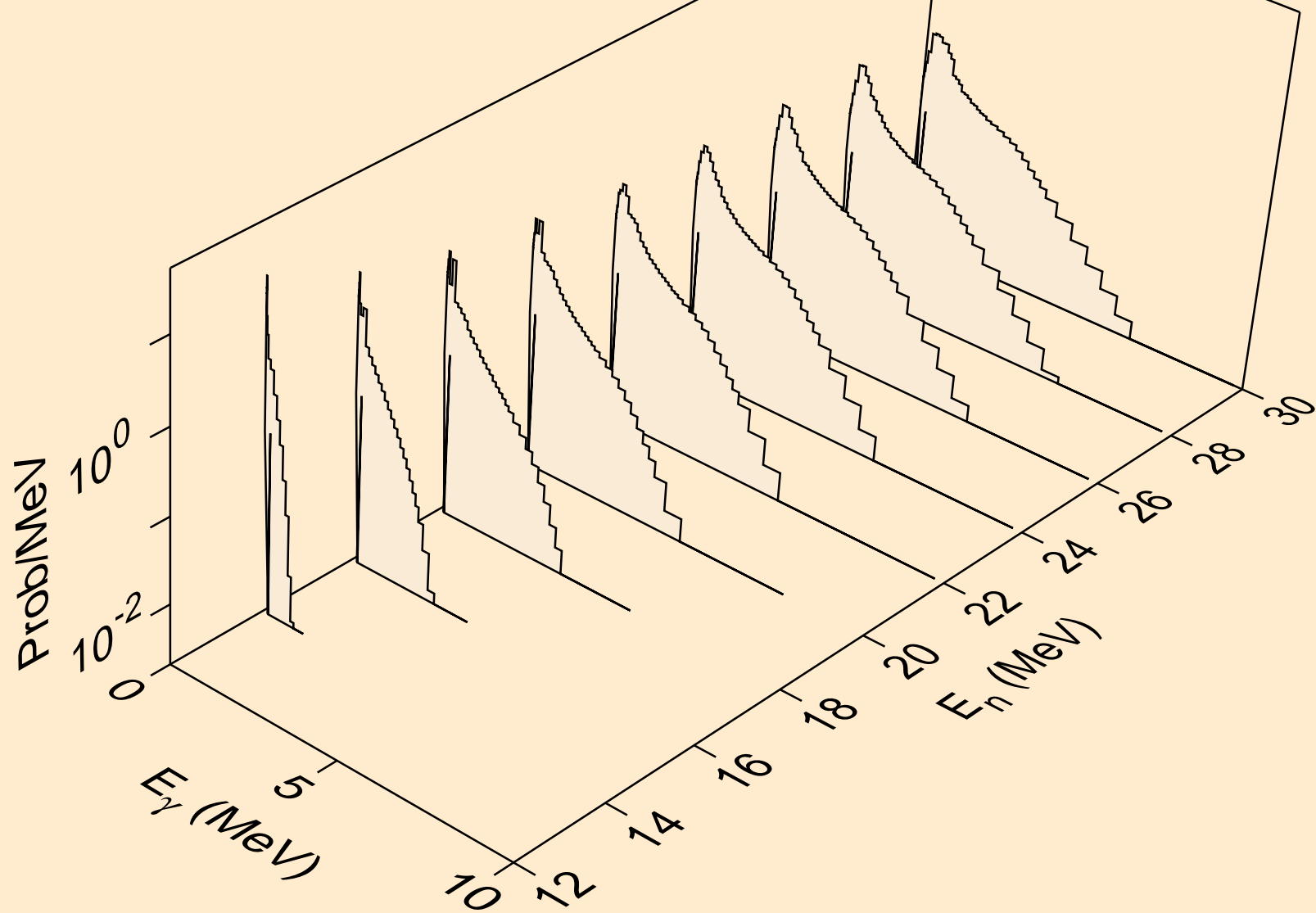

TM157 HELION ACER TENDL-2021 LIBRARY; T=0.K  
Photon emission for (n,3n)

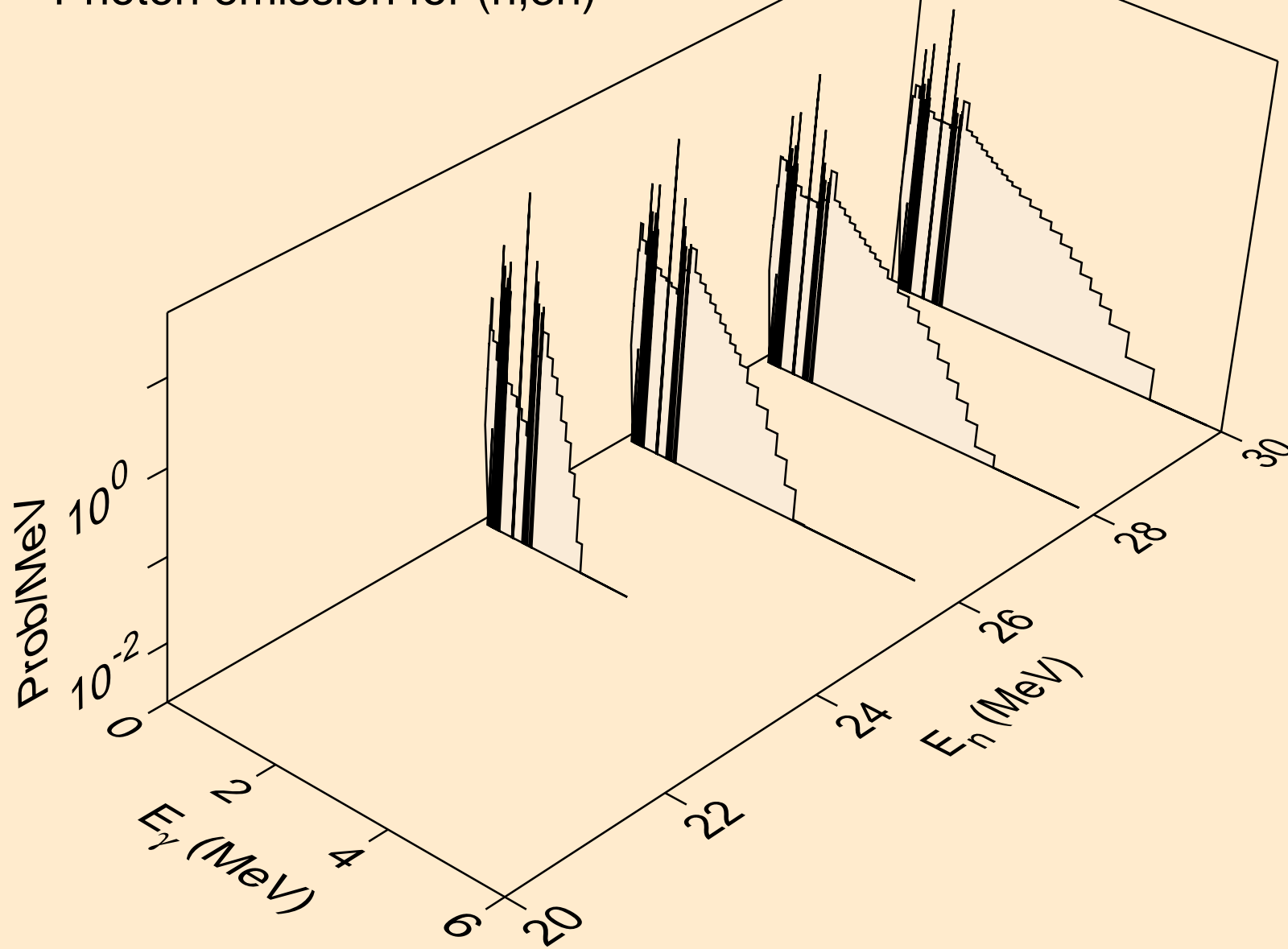

TM157 HELION ACER TENDL-2021 LIBRARY; T=0.K  
Photon emission for (n,n\*)a

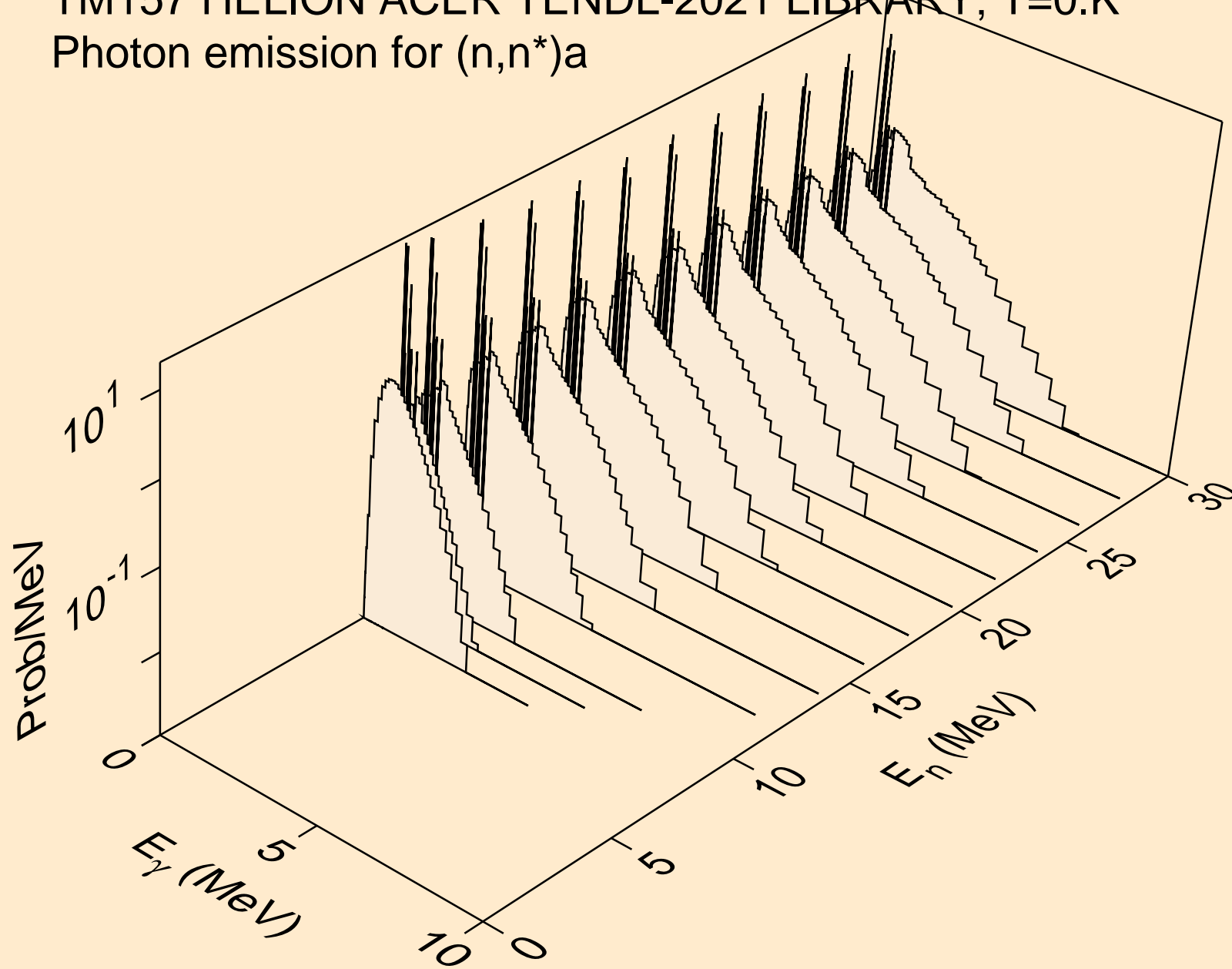



TM157 HELION ACER TENDL-2021 LIBRARY; T=0.K  
Photon emission for (n,2n)a

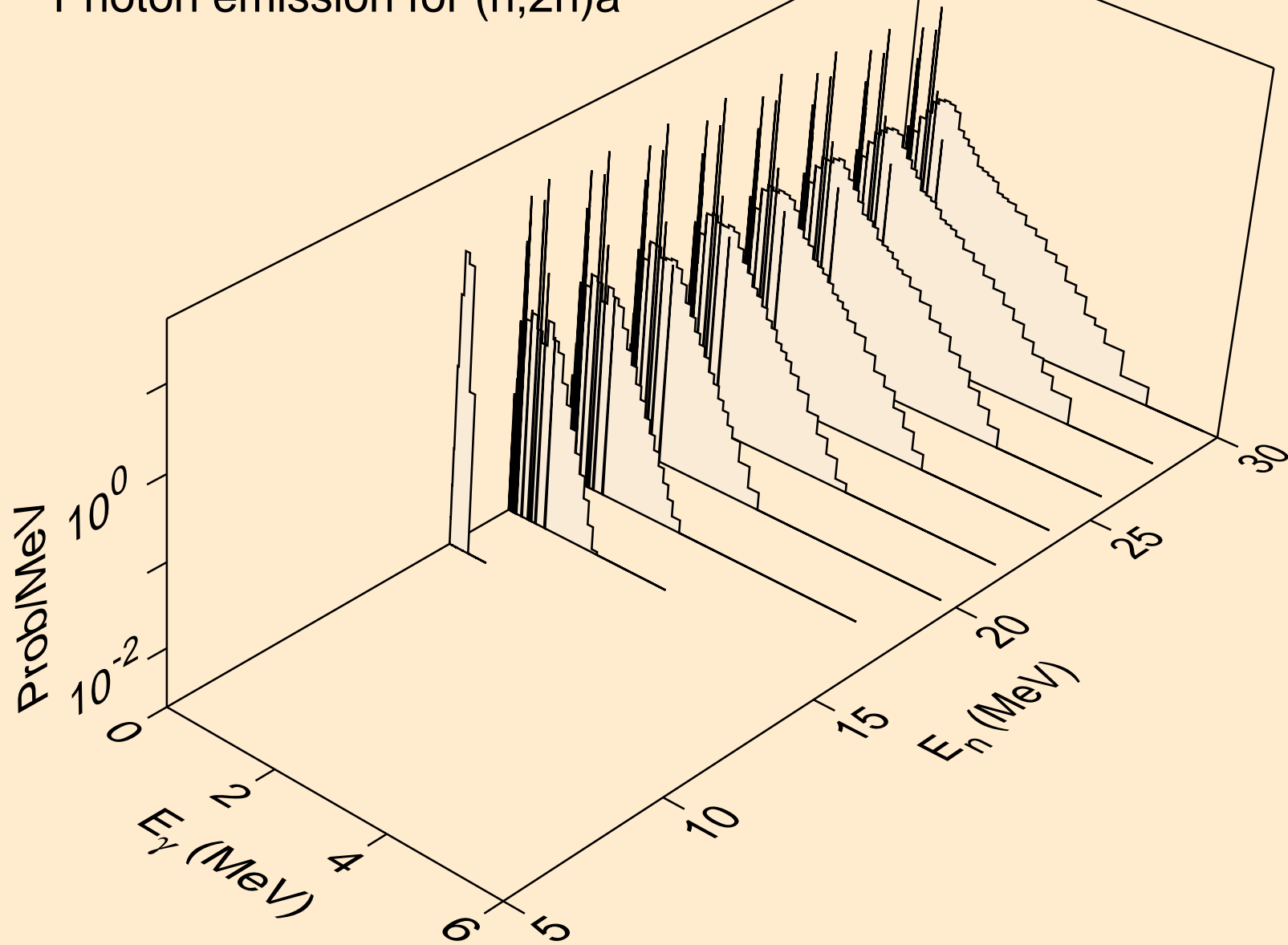

TM157 HELION ACER TENDL-2021 LIBRARY; T=0.K  
Photon emission for (n,3n)a

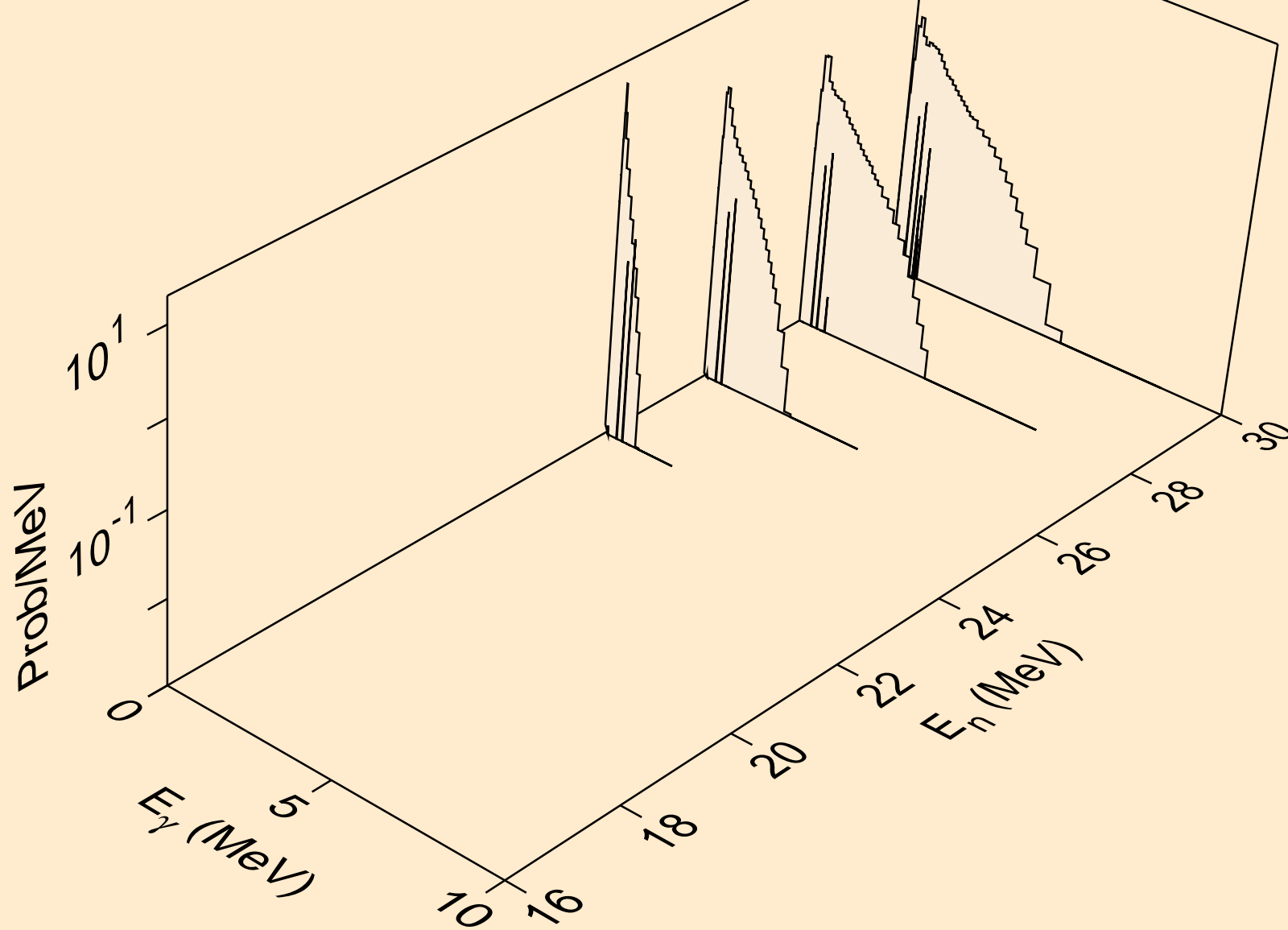

TM157 HELION ACER TENDL-2021 LIBRARY; T=0.K  
Photon emission for (n,n\*)p

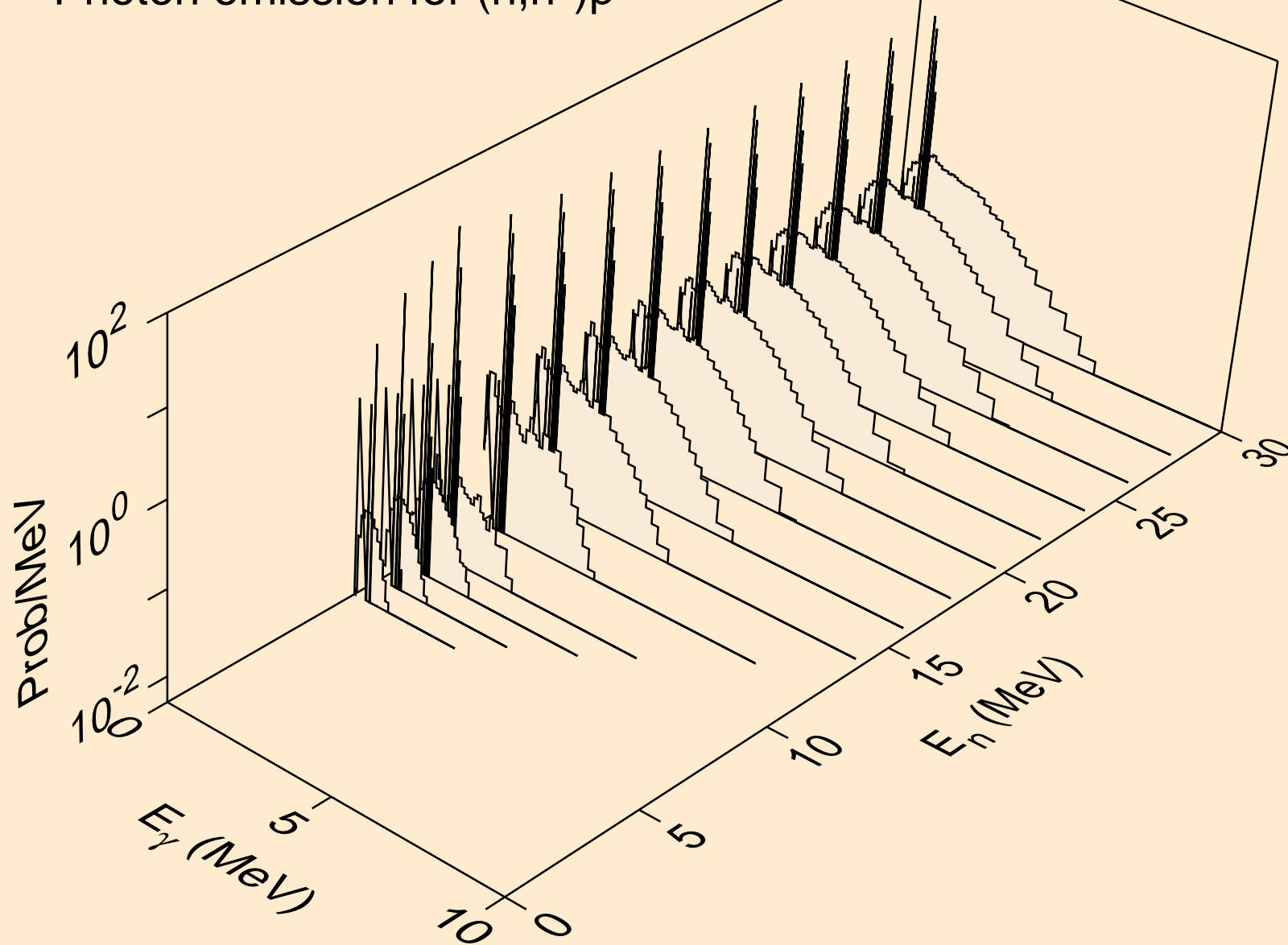

TM157 HELION ACER TENDL-2021 LIBRARY; T=0.K  
Photon emission for (n,n\*)2a

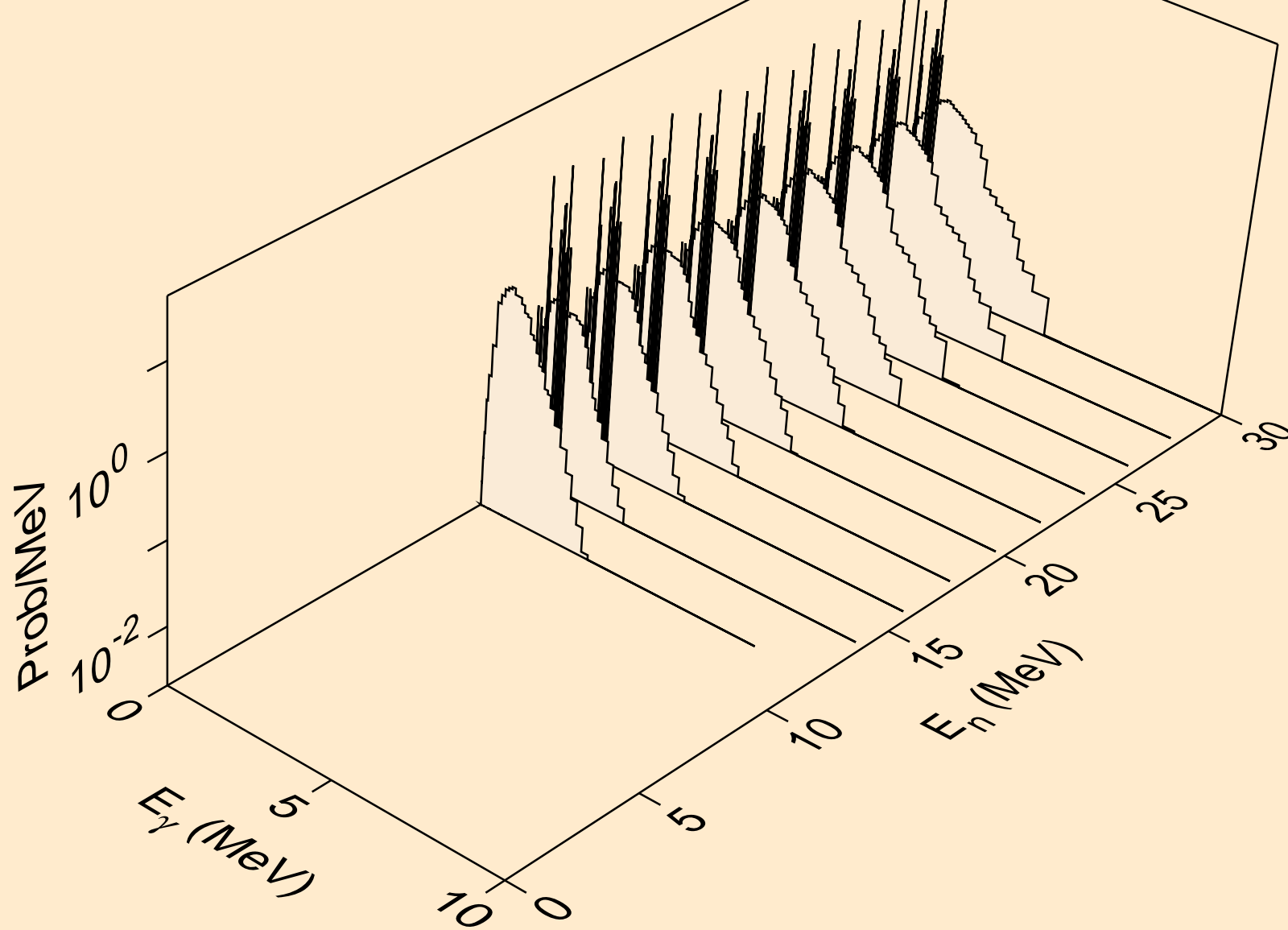

TM157 HELION ACER TENDL-2021 LIBRARY; T=0.K  
Photon emission for (n,2n)2a

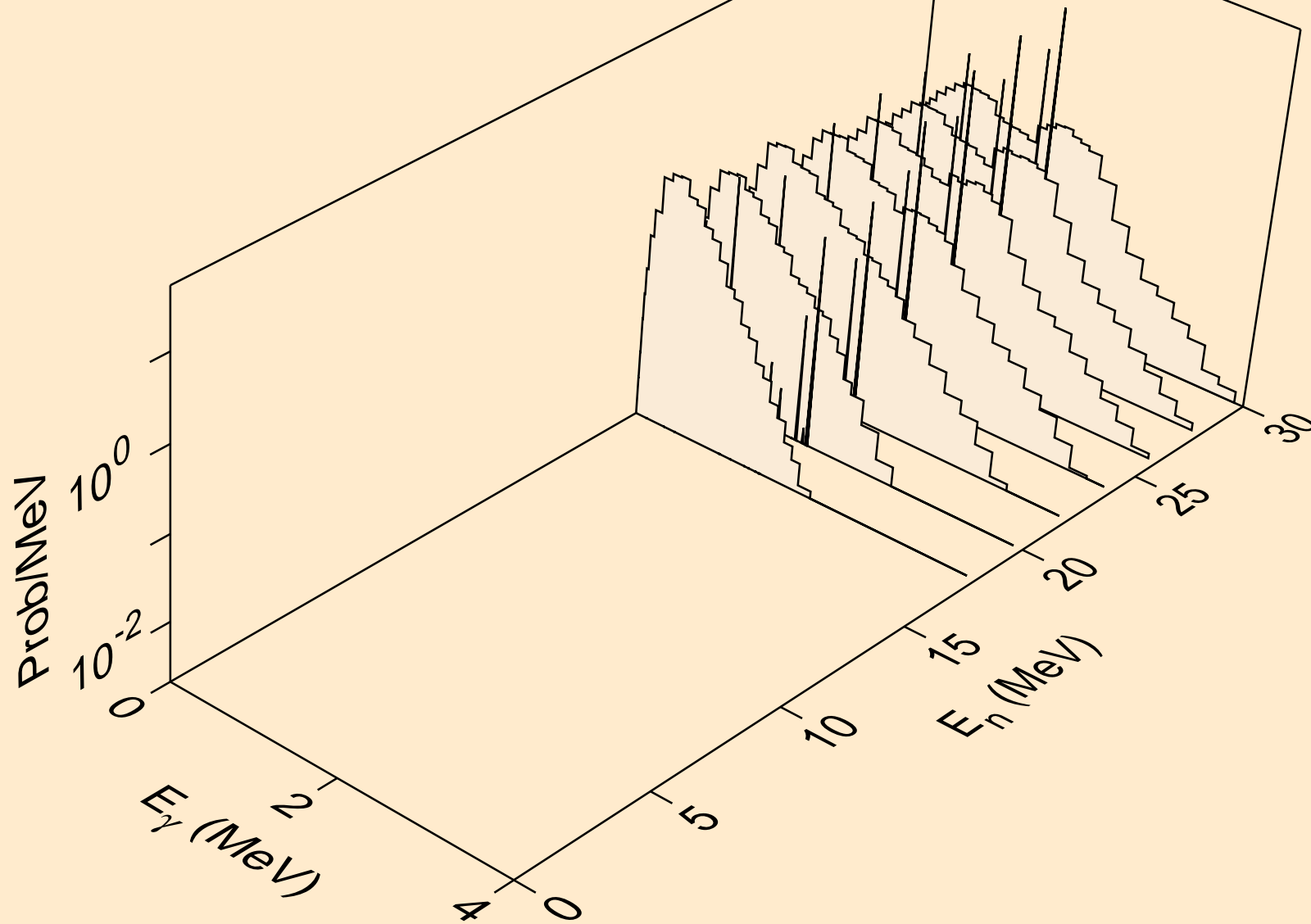

TM157 HELION ACER TENDL-2021 LIBRARY; T=0.K  
Photon emission for (n,n\*)d

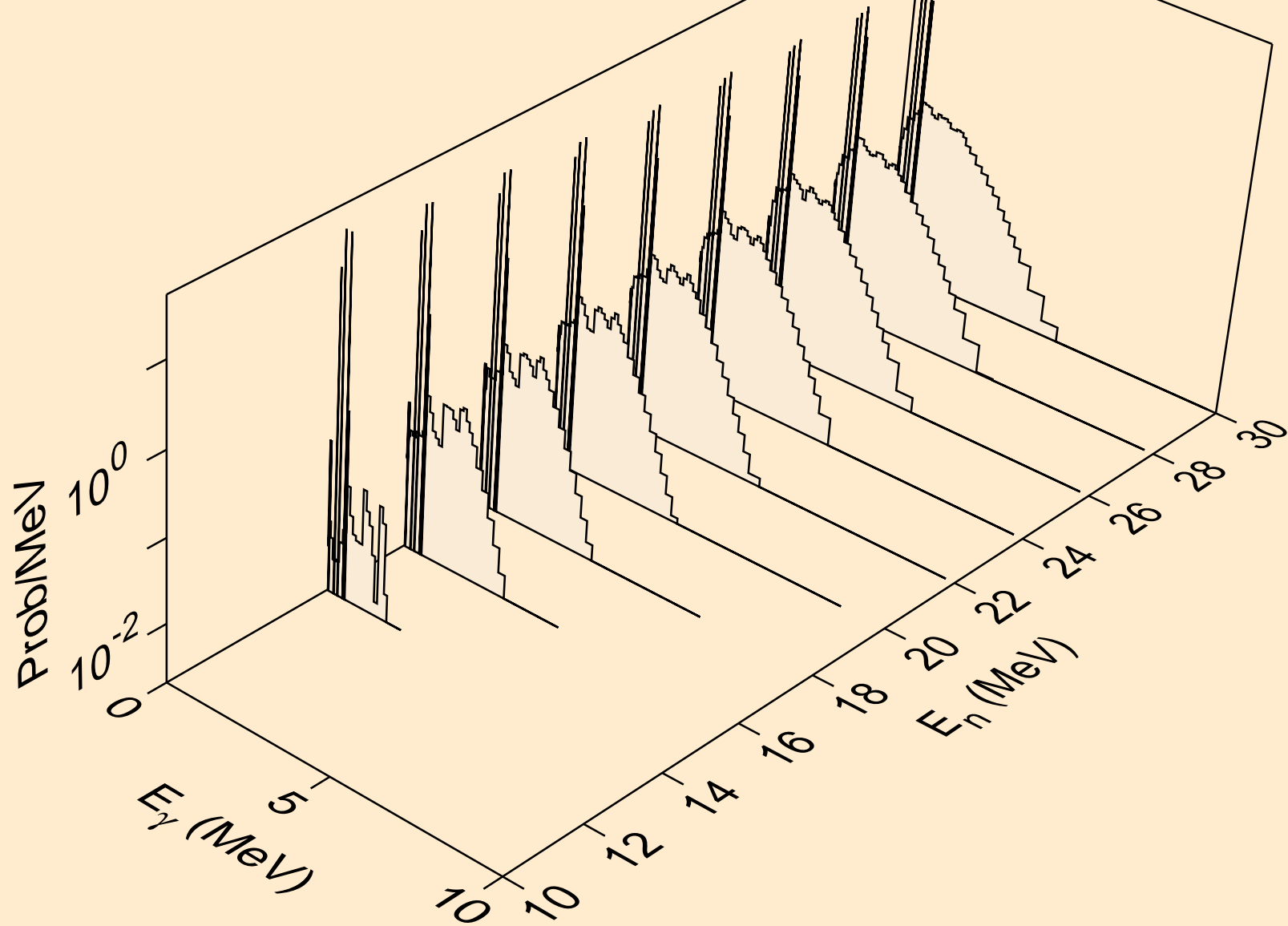

TM157 HELION ACER TENDL-2021 LIBRARY; T=0.K  
Photon emission for (n,n\*)t

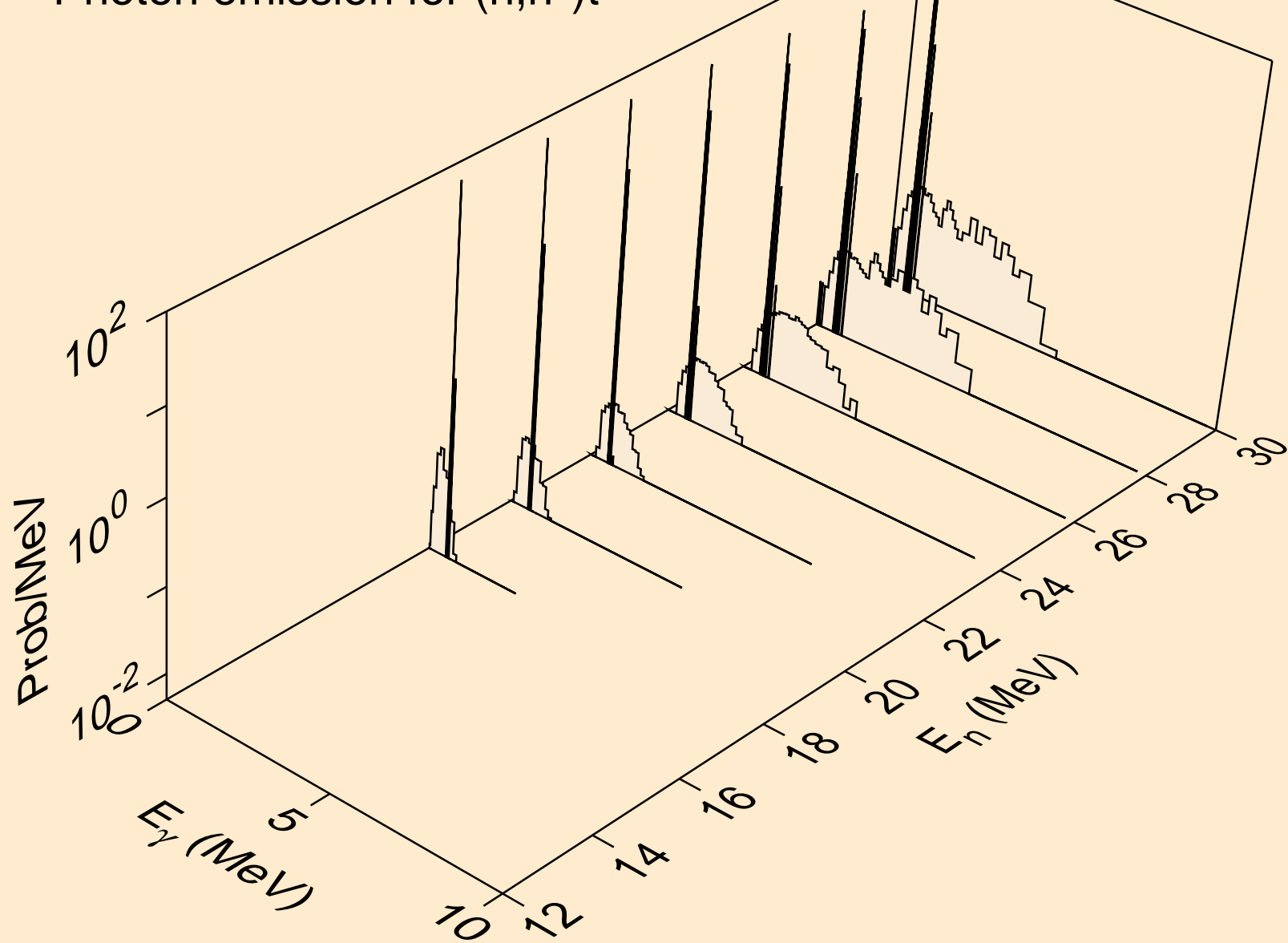

TM157 HELION ACER TENDL-2021 LIBRARY; T=0.K  
Photon emission for (n,n\*)he3

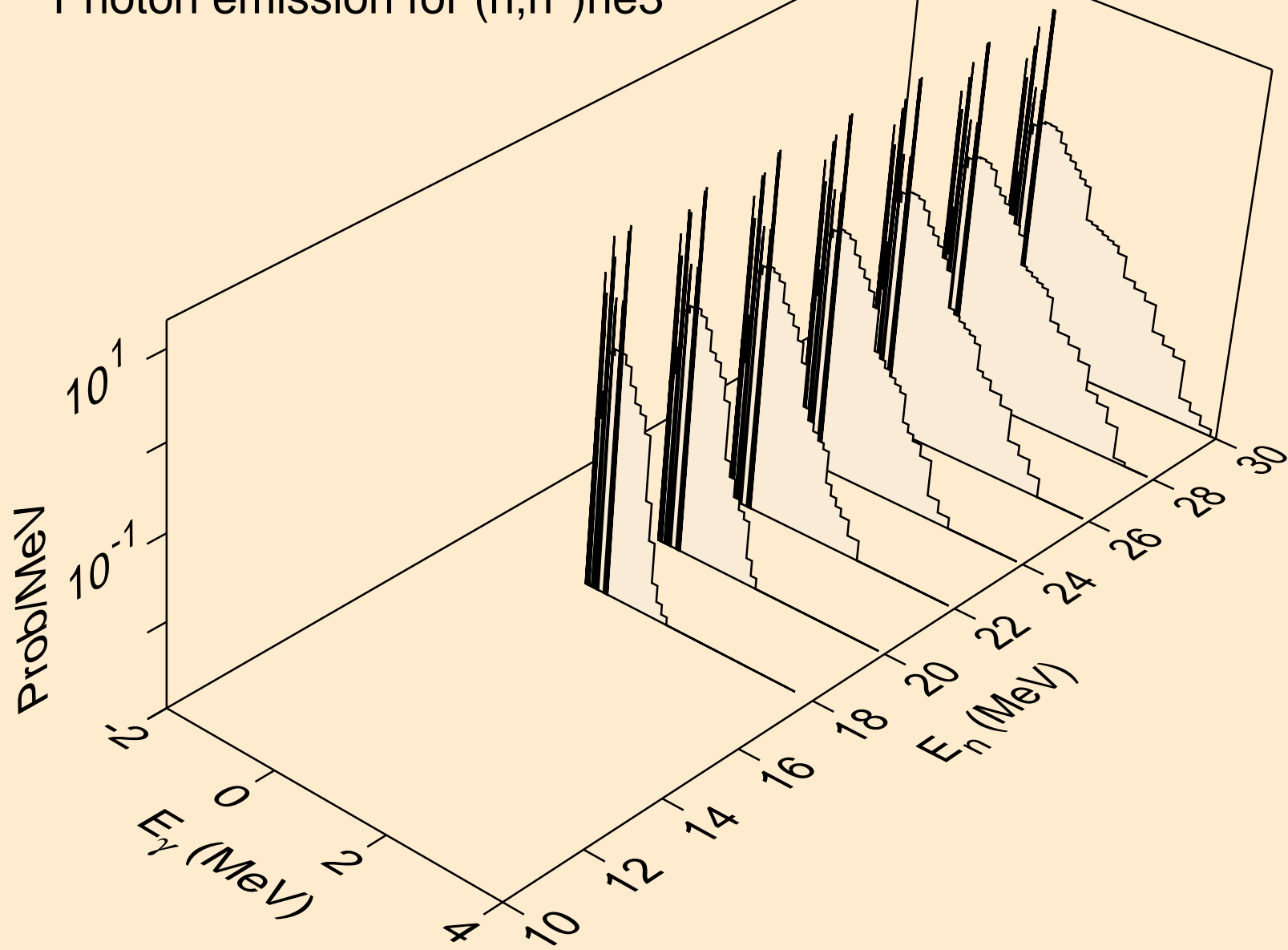



TM157 HELION ACER TENDL-2021 LIBRARY; T=0.K  
Photon emission for (n,2np)

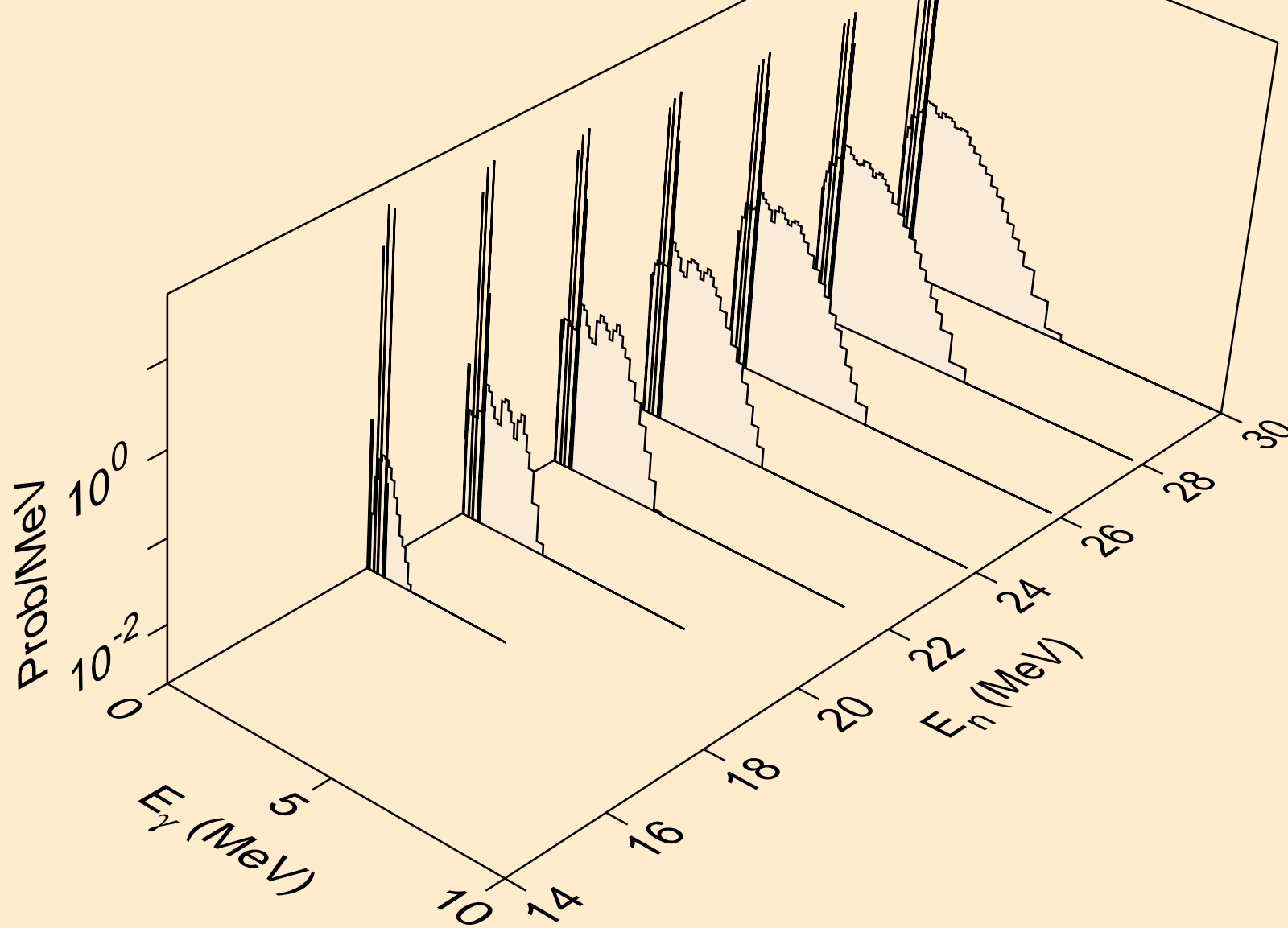

TM157 HELION ACER TENDL-2021 LIBRARY; T=0.K  
Photon emission for (n,3np)

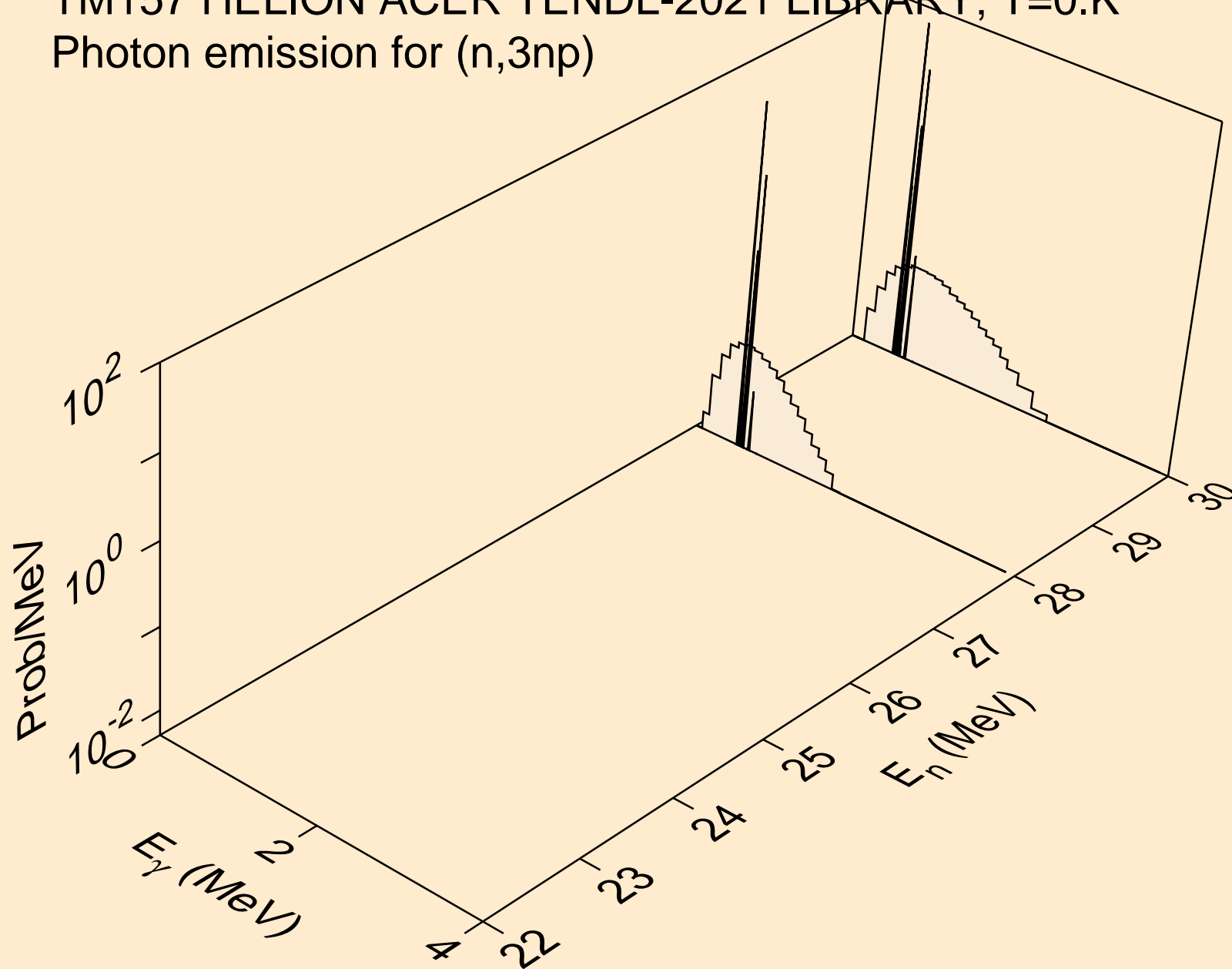

TM157 HELION ACER TENDL-2021 LIBRARY; T=0.K  
Photon emission for (n,2np)

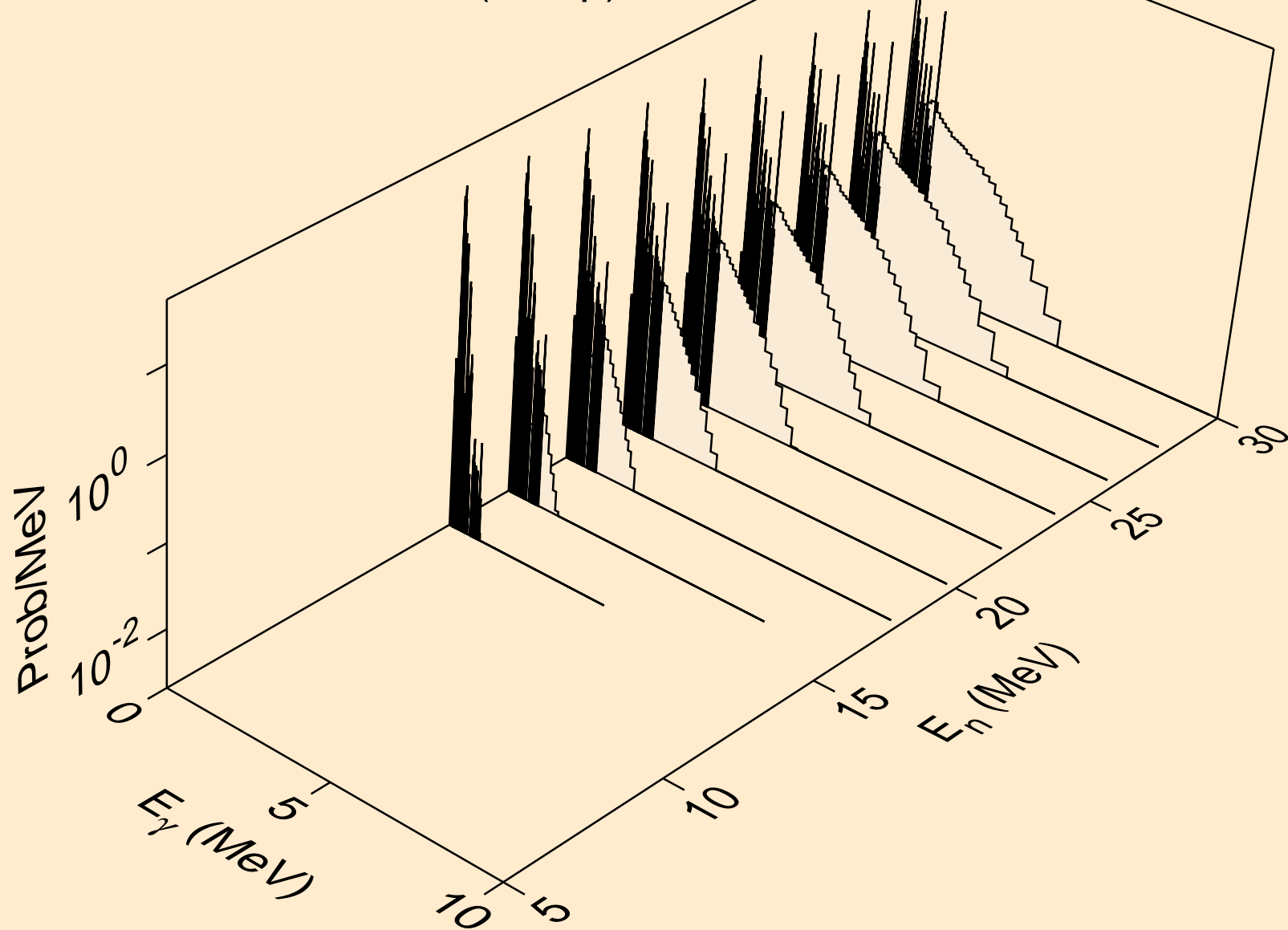

TM157 HELION ACER TENDL-2021 LIBRARY; T=0.K  
Photon emission for (n,npa)

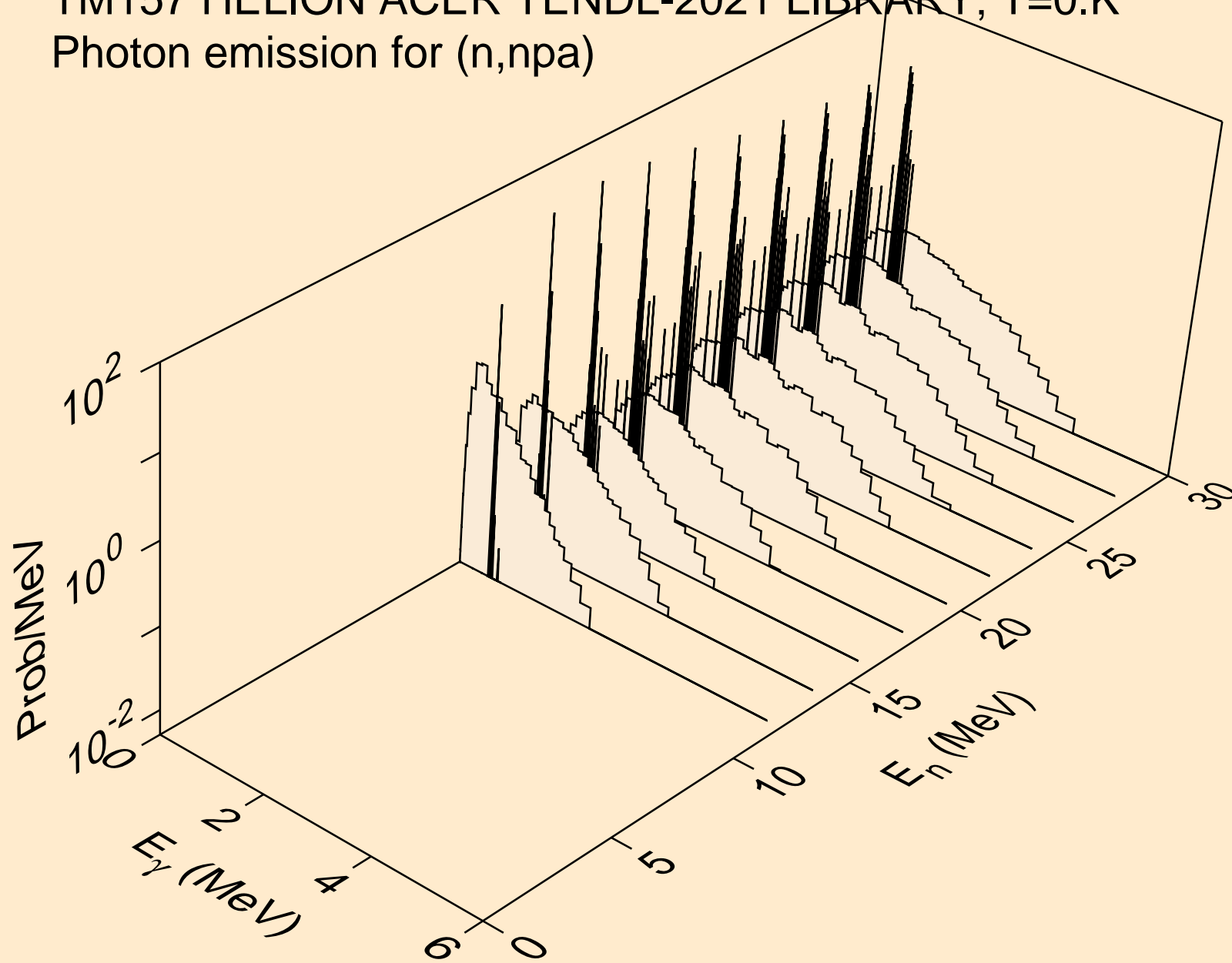

TM157 HELION ACER TENDL-2021 LIBRARY; T=0.K  
Photon emission for (n,gma)

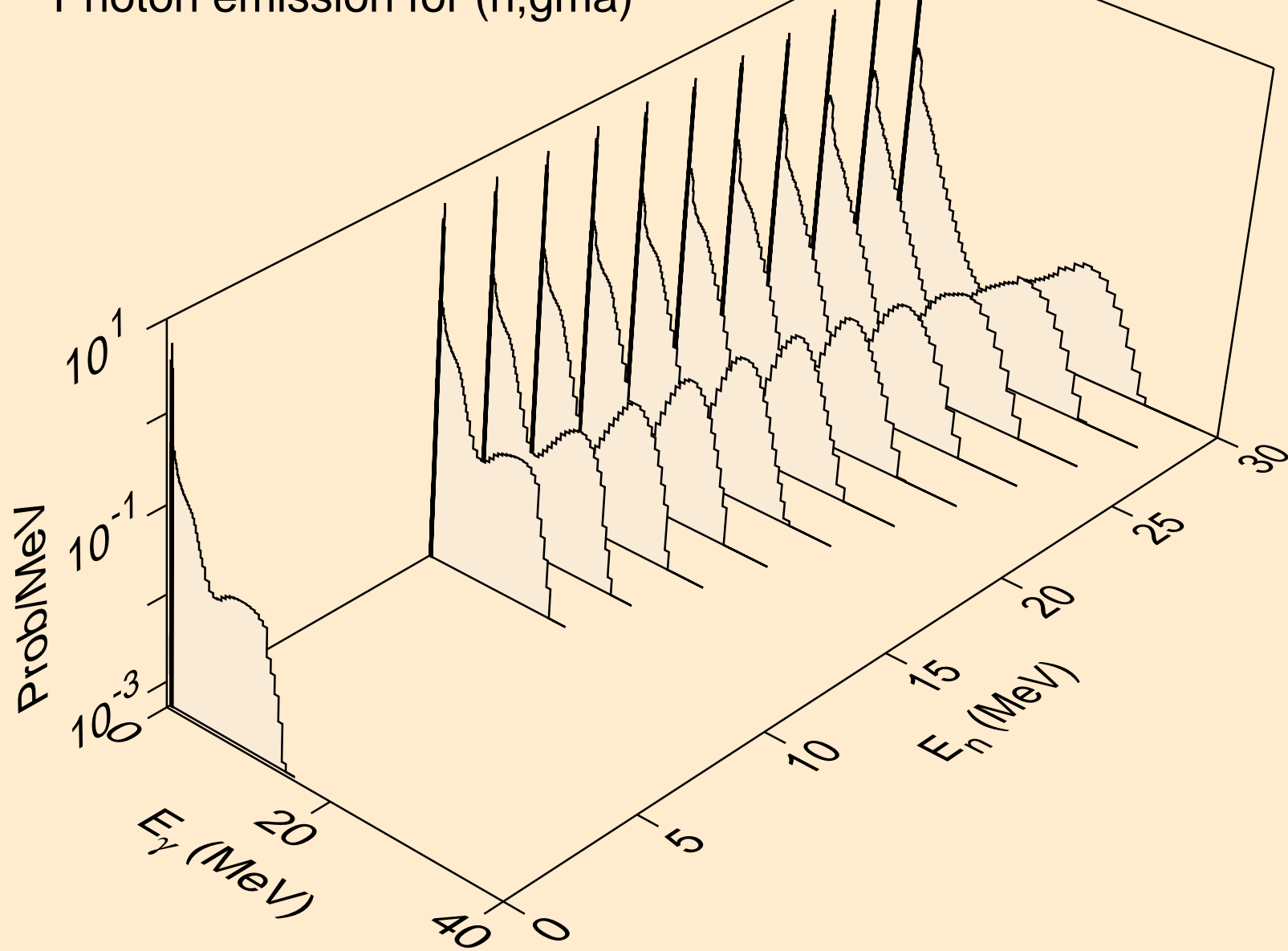

TM157 HELION ACER TENDL-2021 LIBRARY; T=0.K  
Photon emission for (n,p)

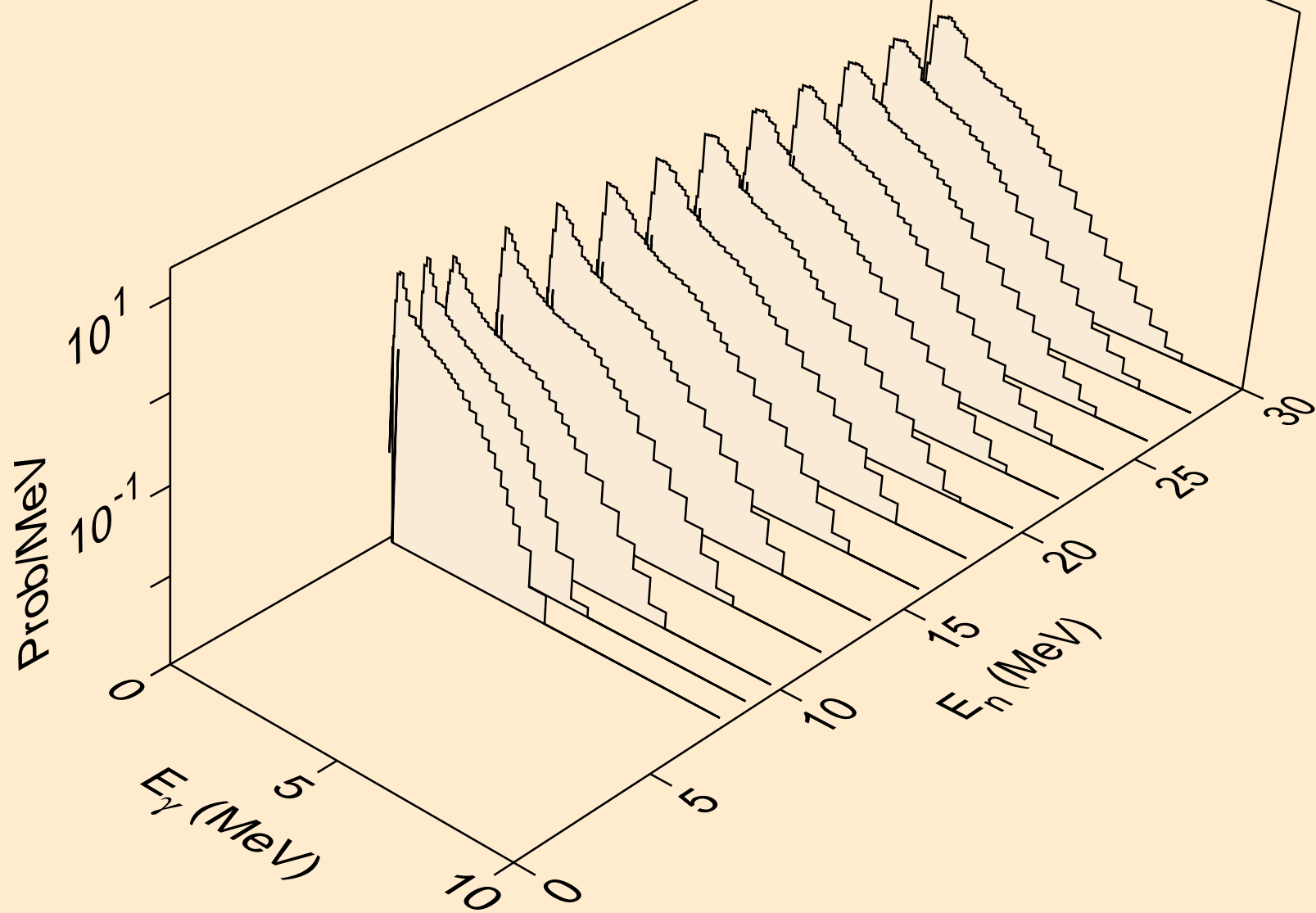

TM157 HELION ACER TENDL-2021 LIBRARY; T=0.K  
Photon emission for (n,d)

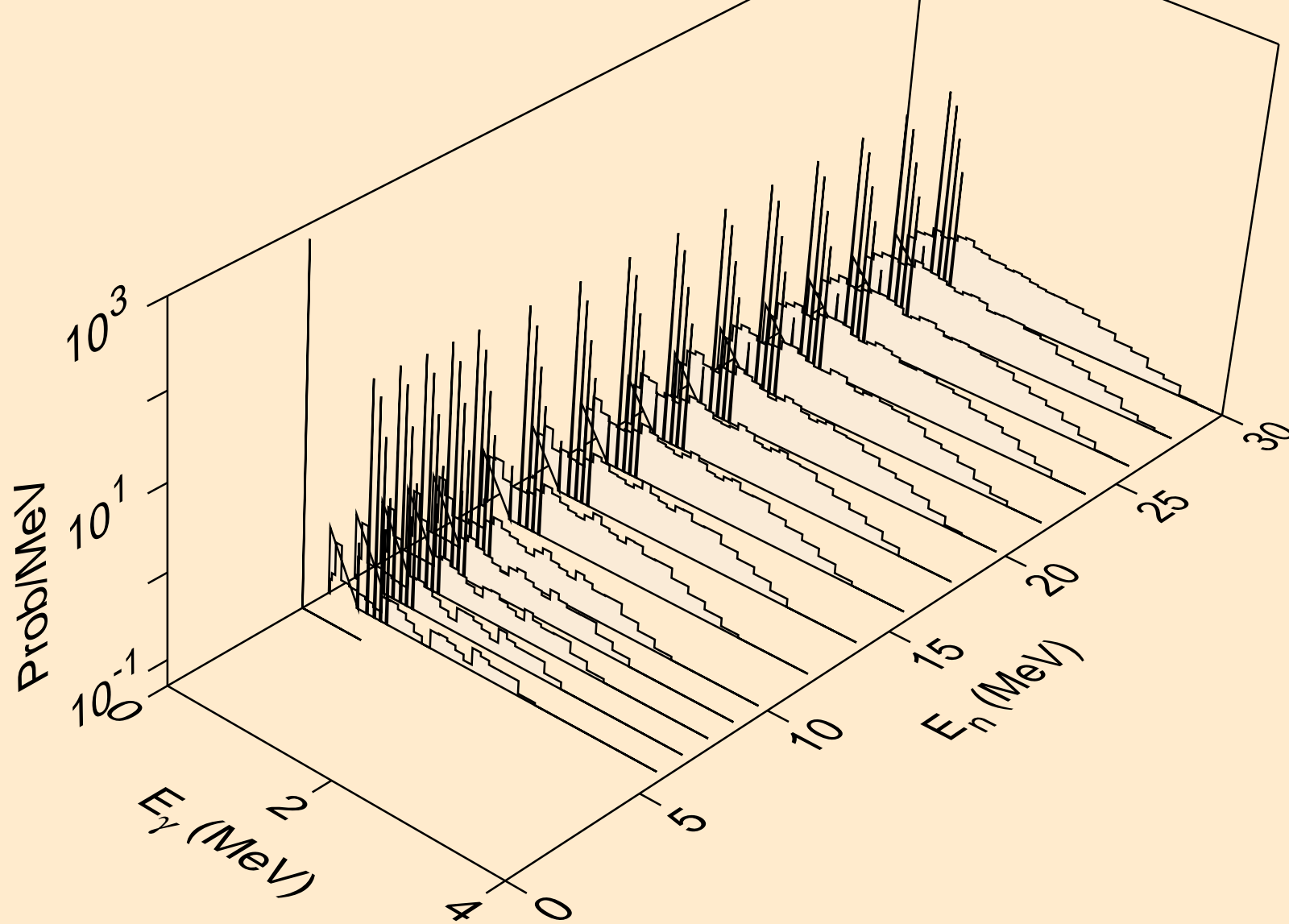

TM157 HELION ACER TENDL-2021 LIBRARY; T=0.K  
Photon emission for (n,t)

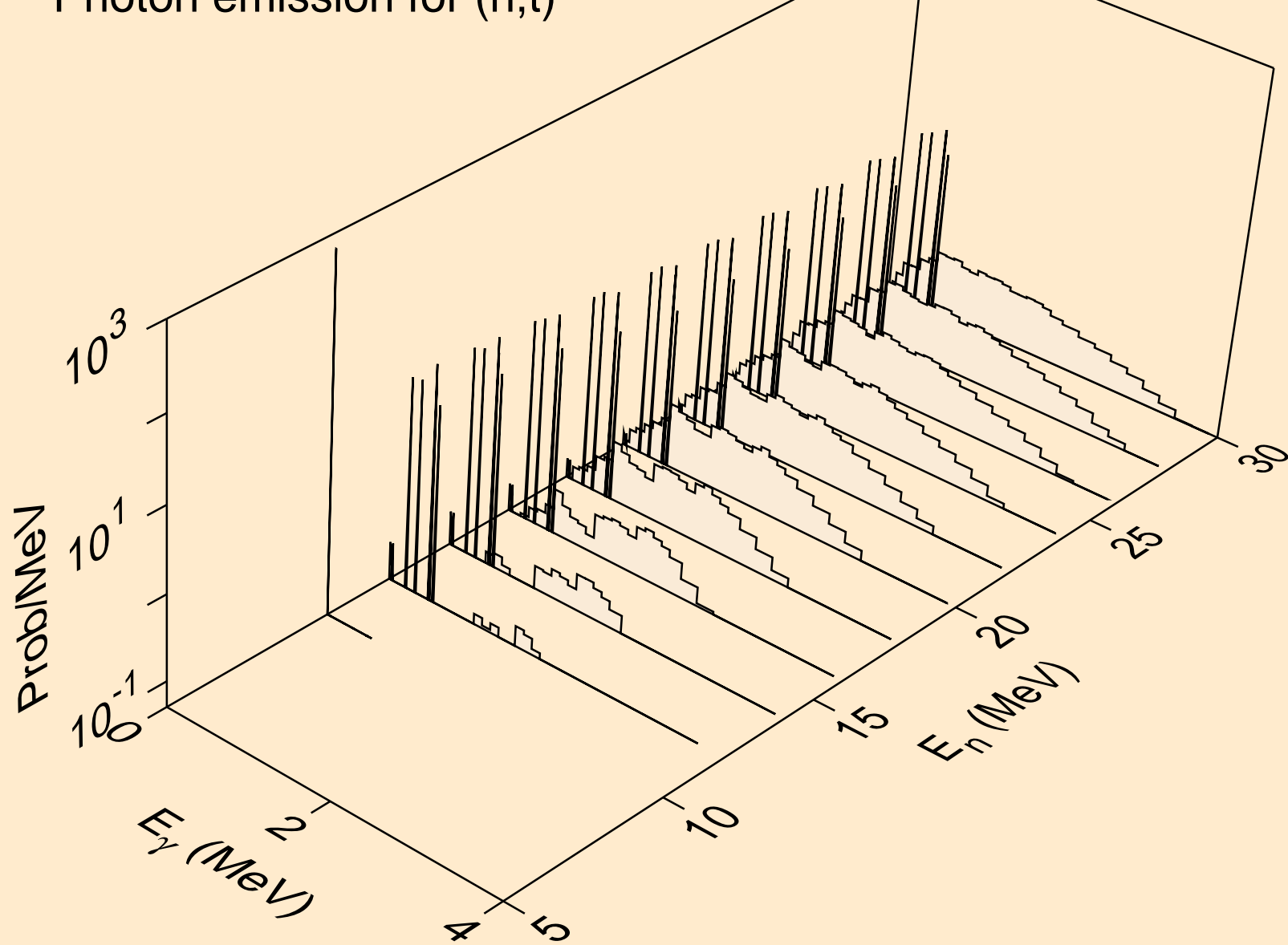



TM157 HELION ACER TENDL-2021 LIBRARY; T=0.K  
Photon emission for inelastic

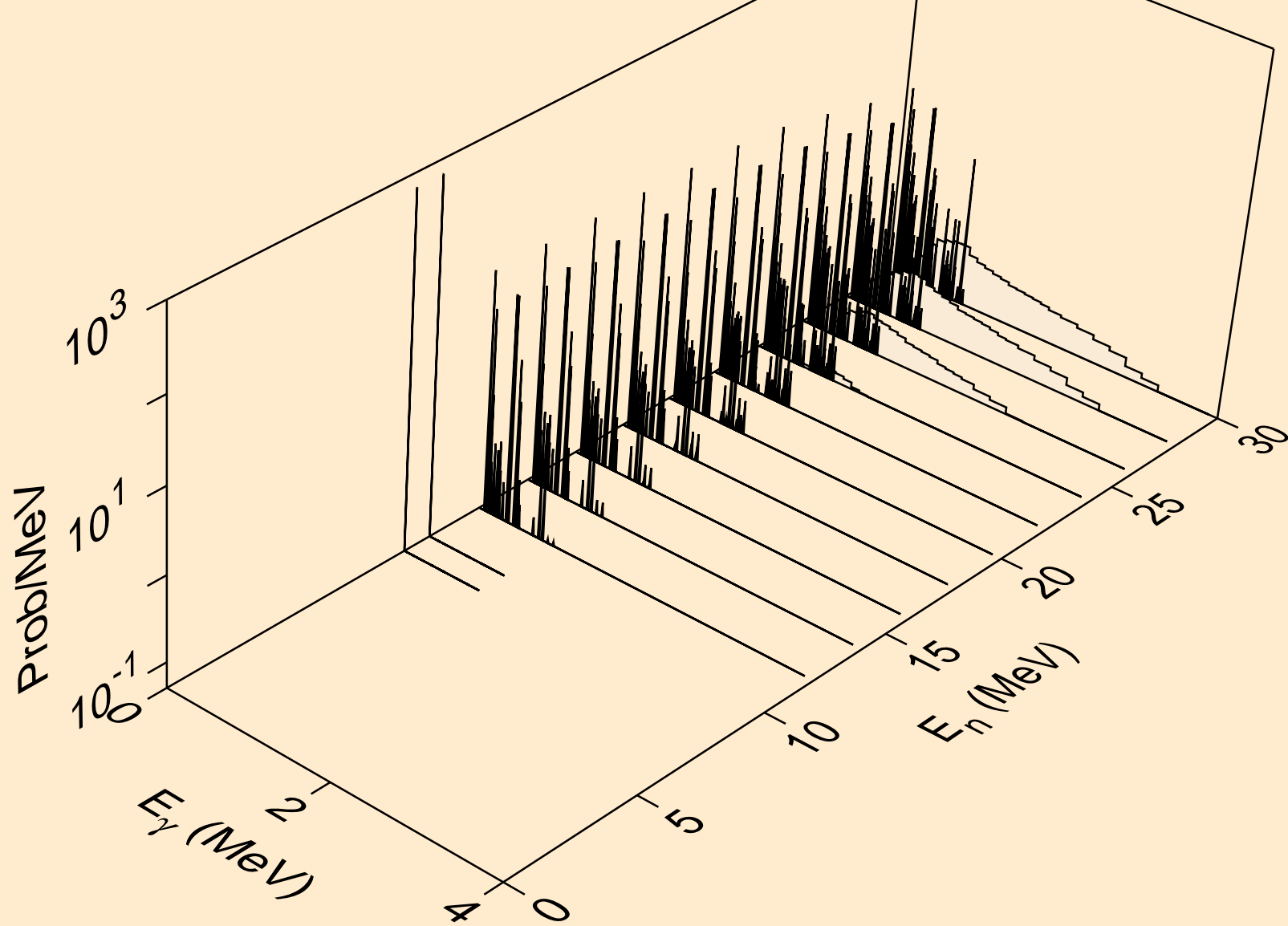

TM157 HELION ACER TENDL-2021 LIBRARY; T=0.K  
Photon emission for (n,a)

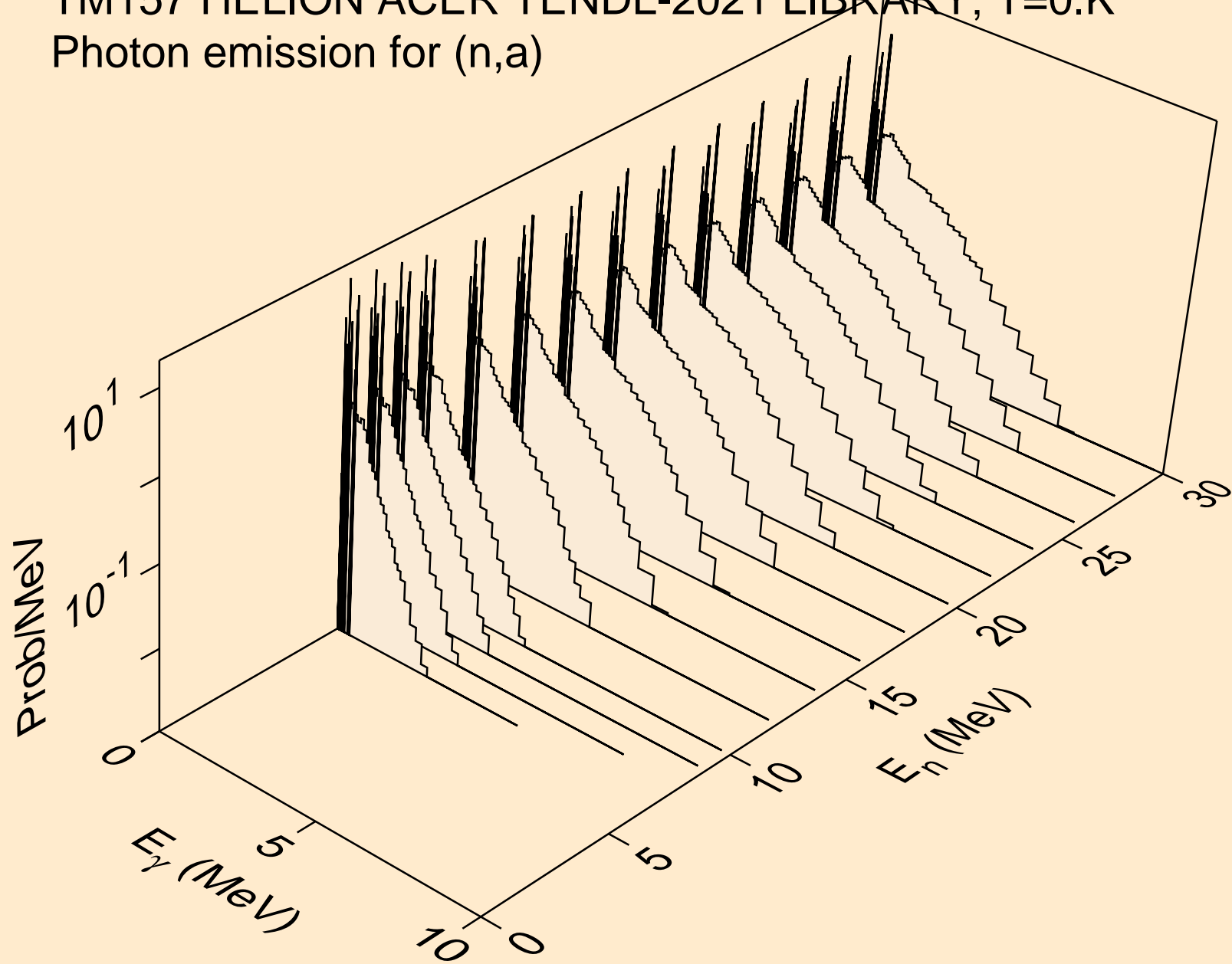

TM157 HELION ACER TENDL-2021 LIBRARY; T=0.K  
Photon emission for (n,2a)

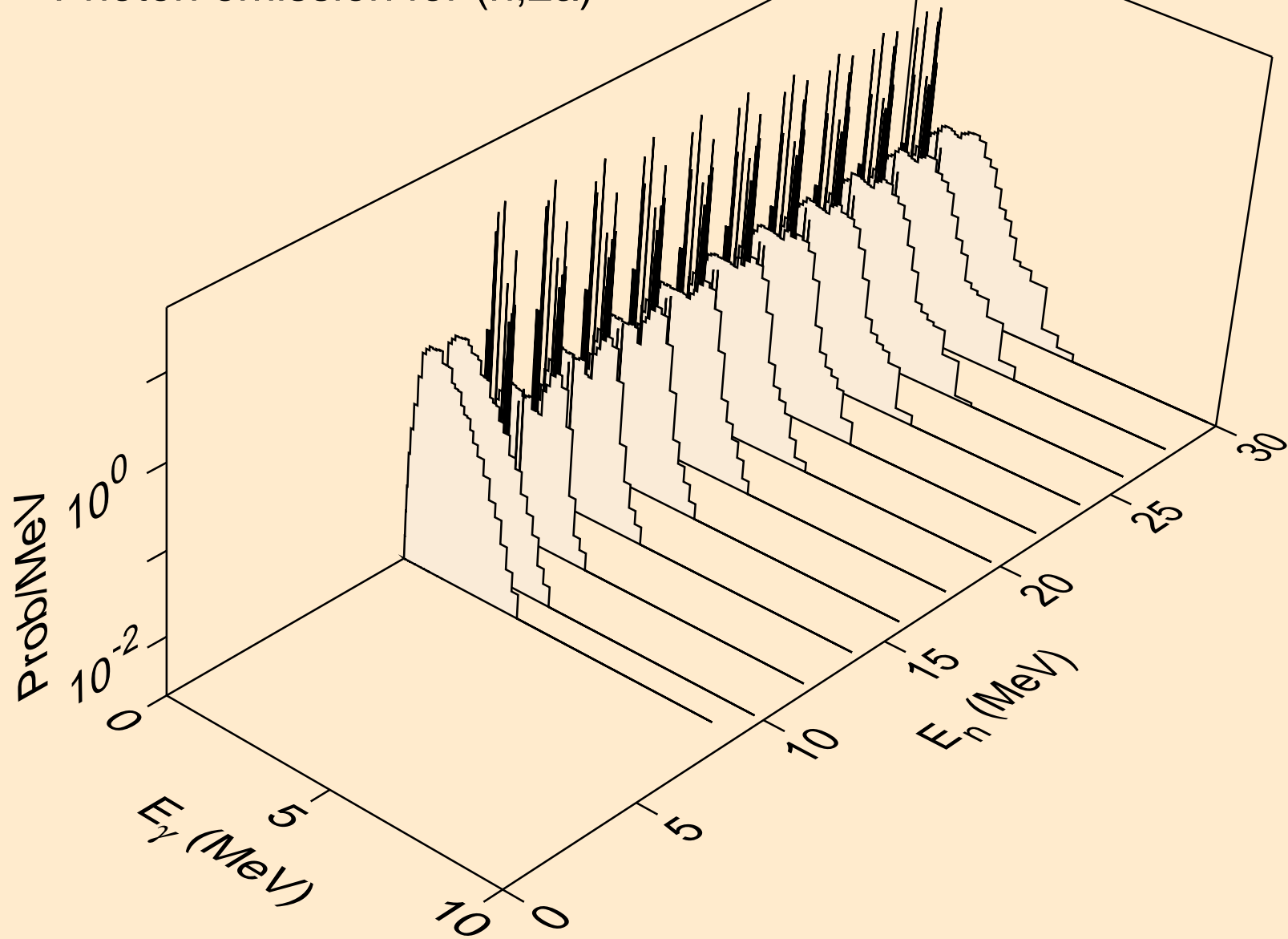

TM157 HELION ACER TENDL-2021 LIBRARY; T=0.K  
Photon emission for (n,3a)

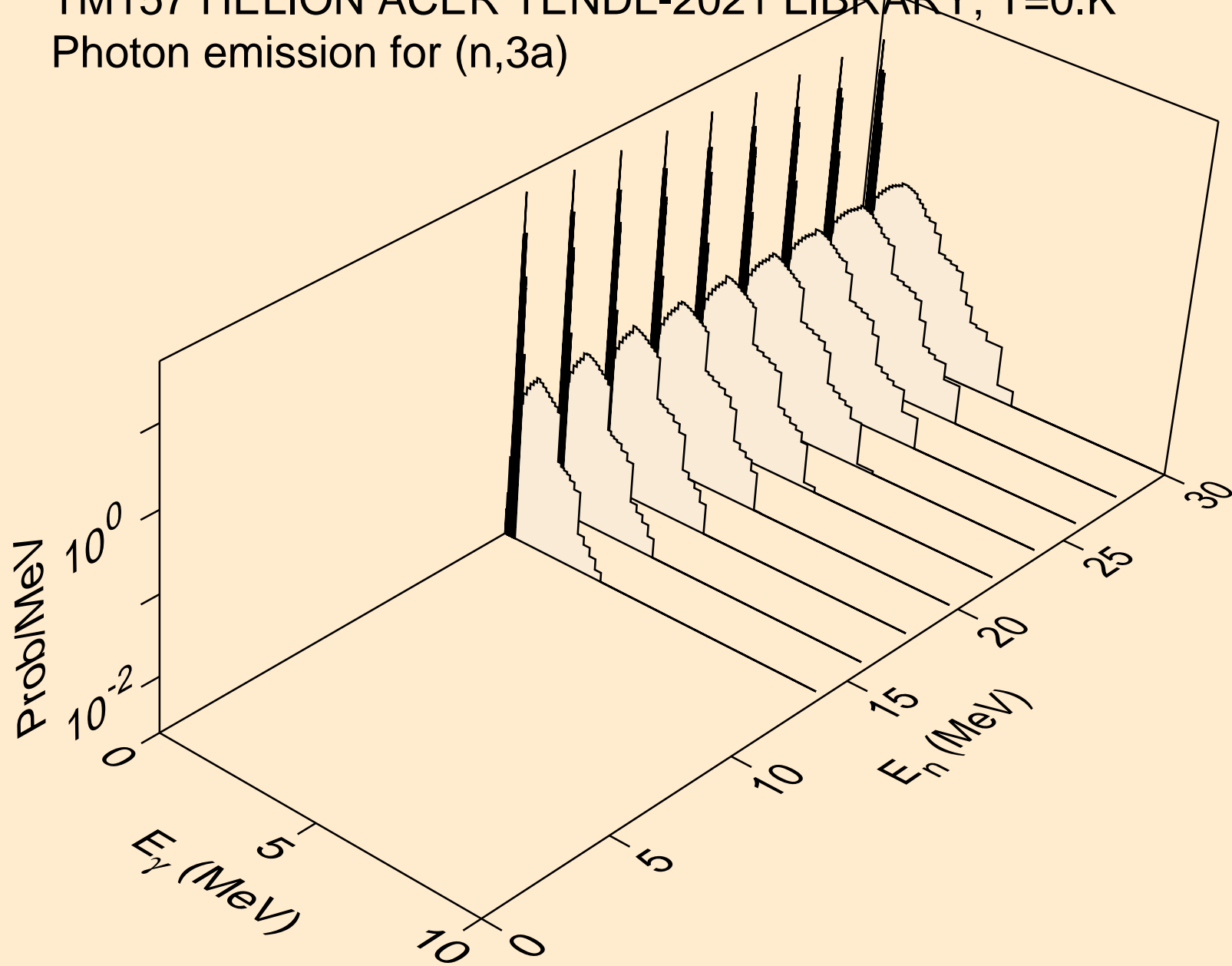

TM157 HELION ACER TENDL-2021 LIBRARY; T=0.K  
Photon emission for (n,2p)

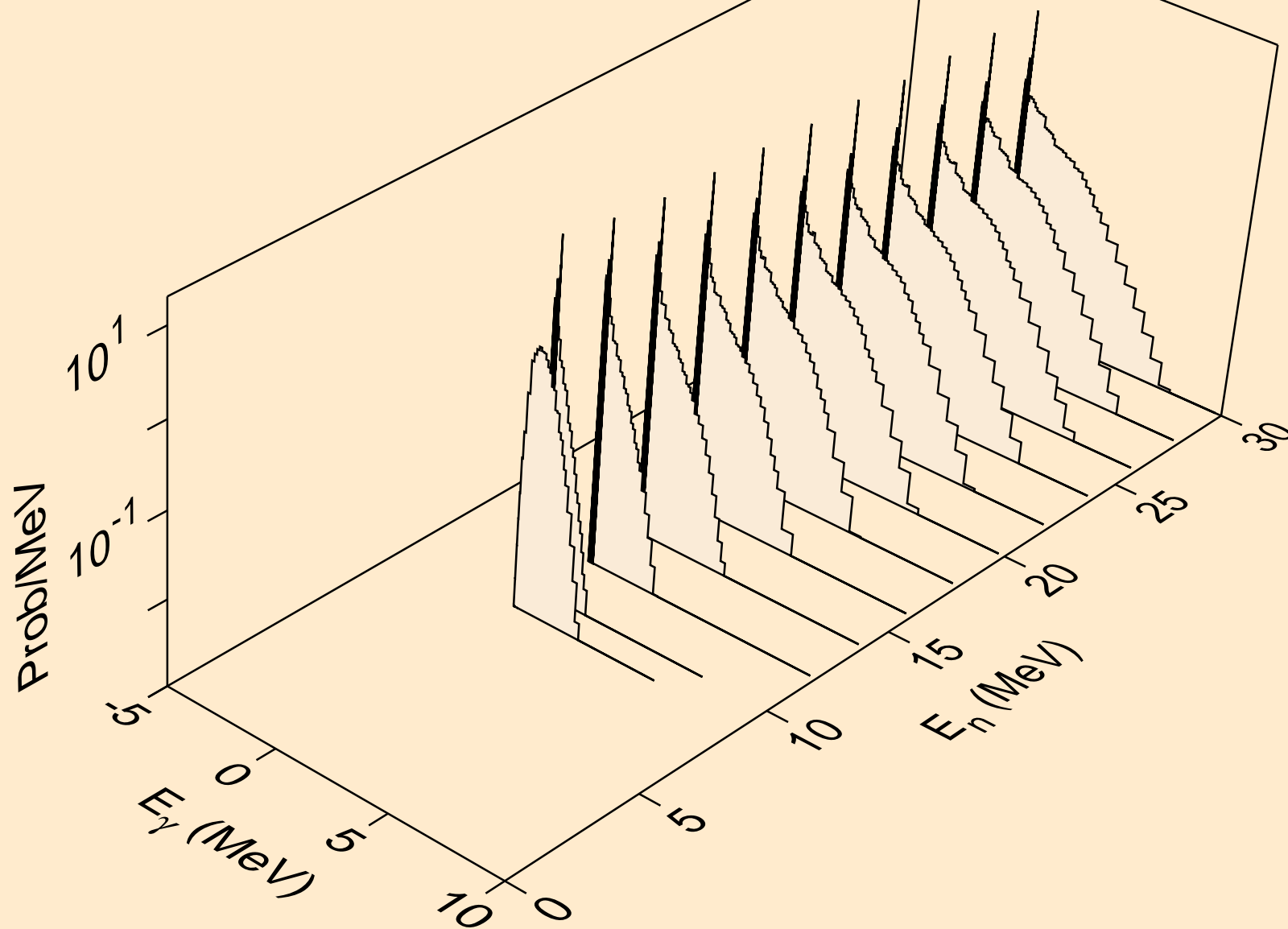

TM157 HELION ACER TENDL-2021 LIBRARY; T=0.K  
Photon emission for (n,pa)

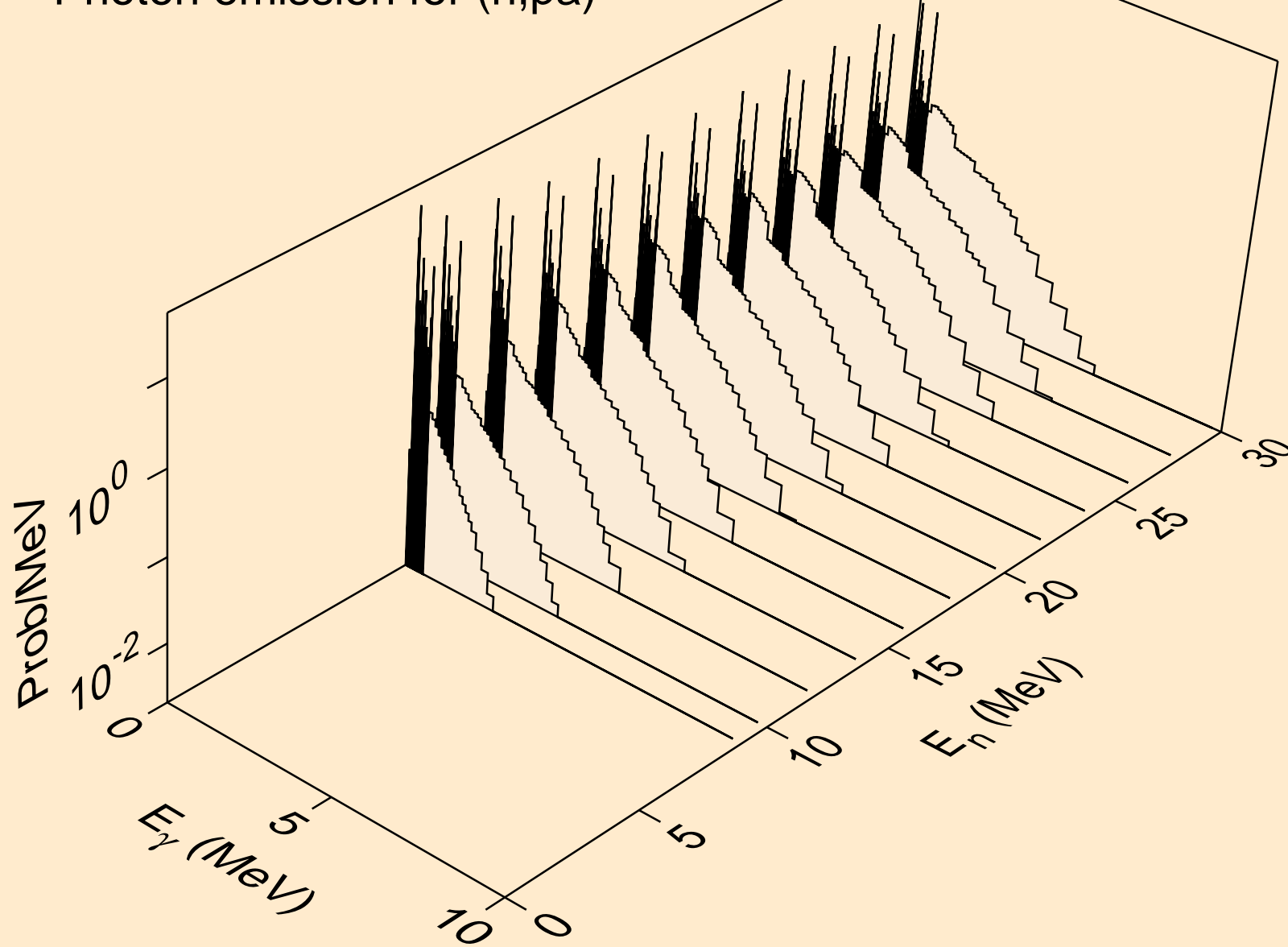

TM157 HELION ACER TENDL-2021 LIBRARY; T=0.K  
Photon emission for (n,t2a)

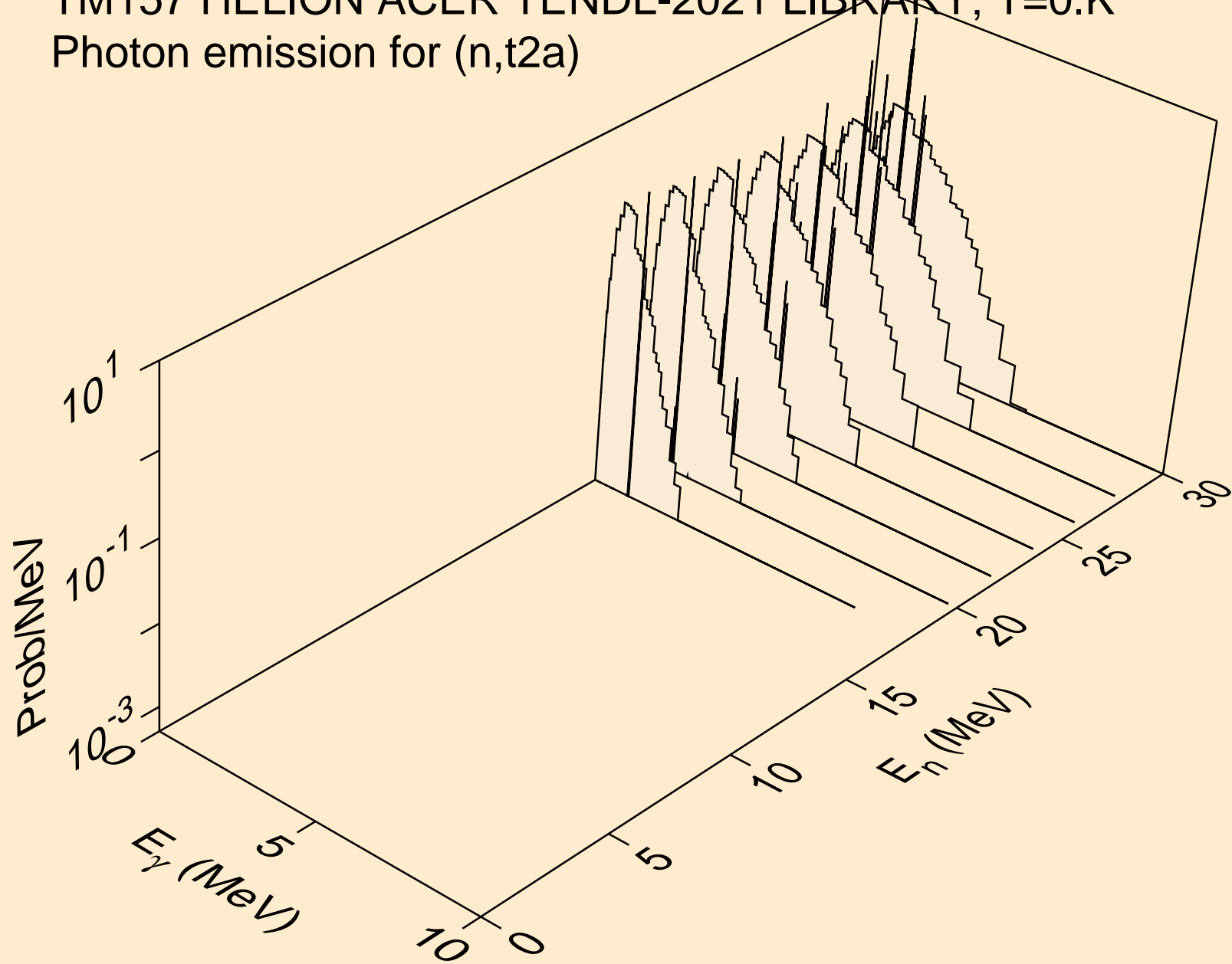

TM157 HELION ACER TENDL-2021 LIBRARY; T=0.K  
Photon emission for (n,d2a)

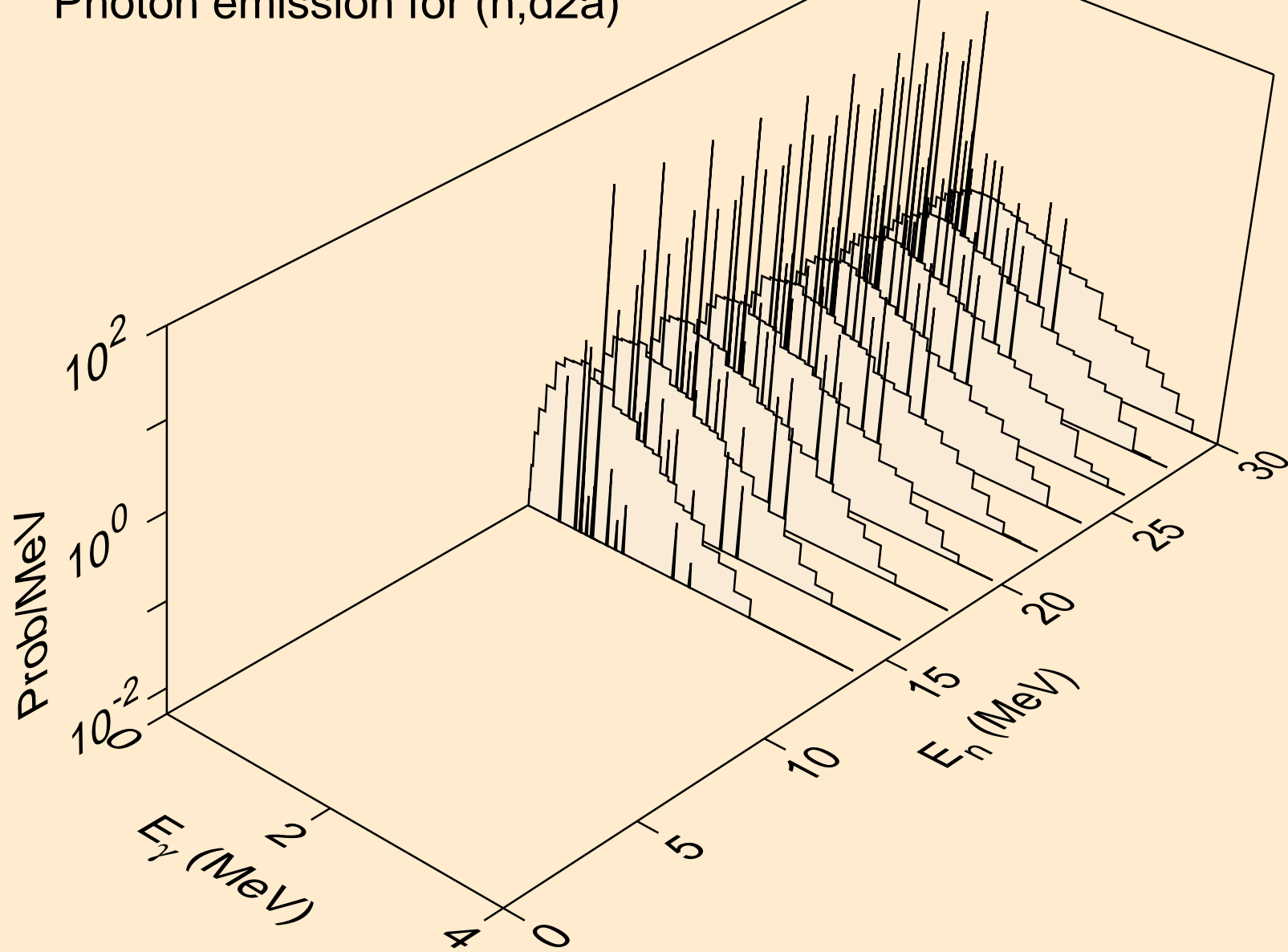



TM157 HELION ACER TENDL-2021 LIBRARY; T=0.K  
Photon emission for (n,pd)

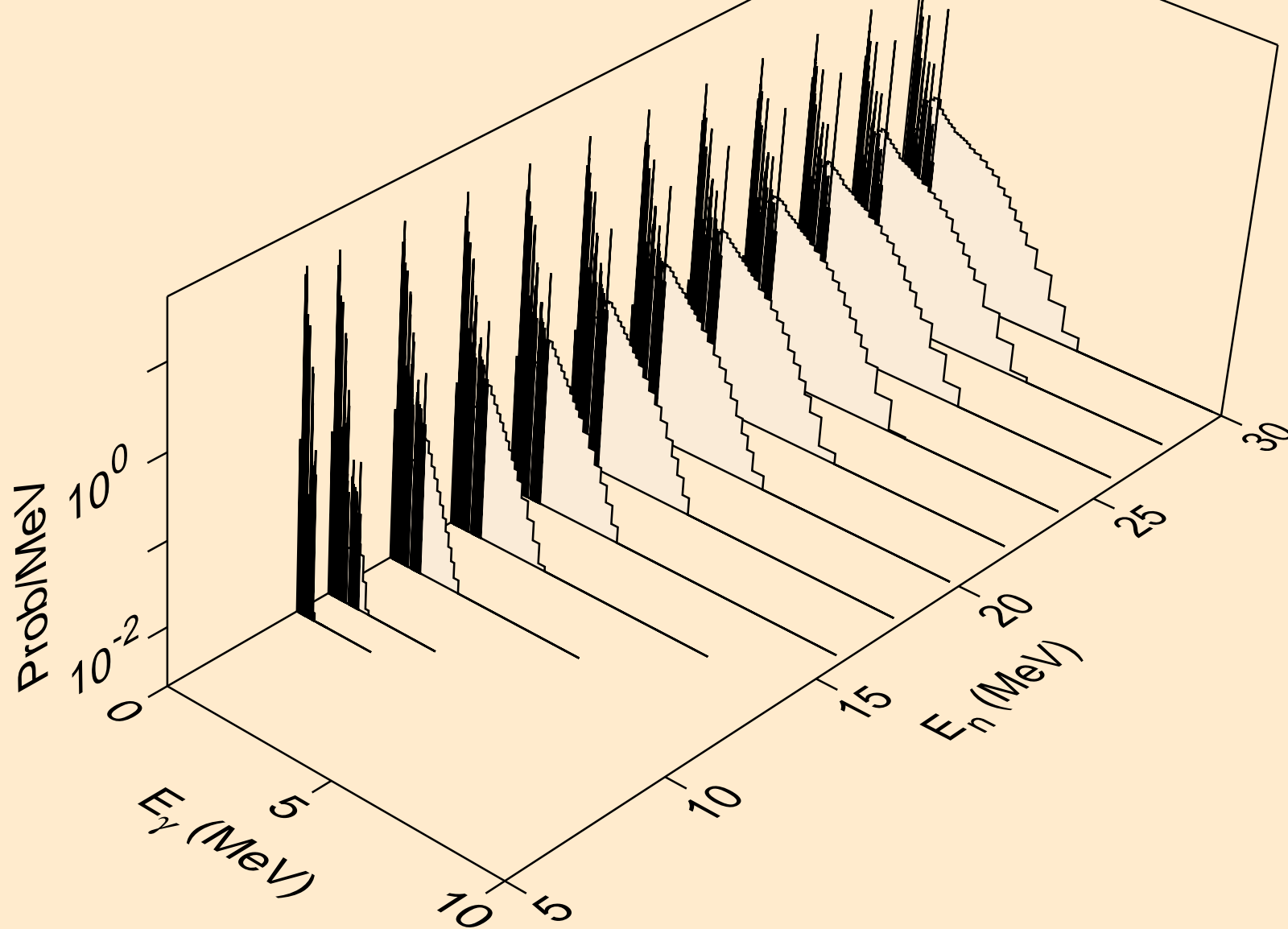

TM157 HELION ACER TENDL-2021 LIBRARY; T=0.K  
Photon emission for (n,pt)

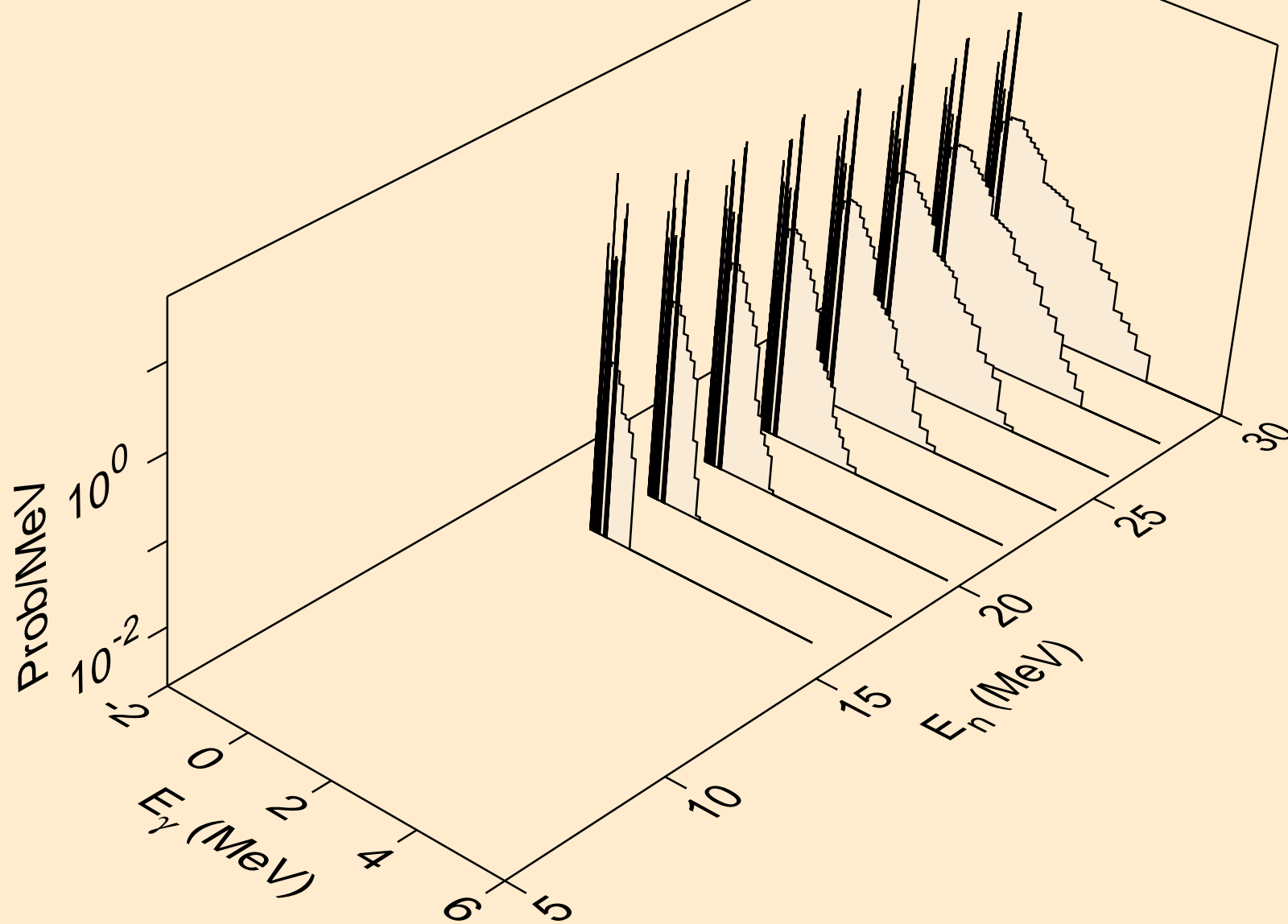

TM157 HELION ACER TENDL-2021 LIBRARY; T=0.K  
Photon emission for (n,da)

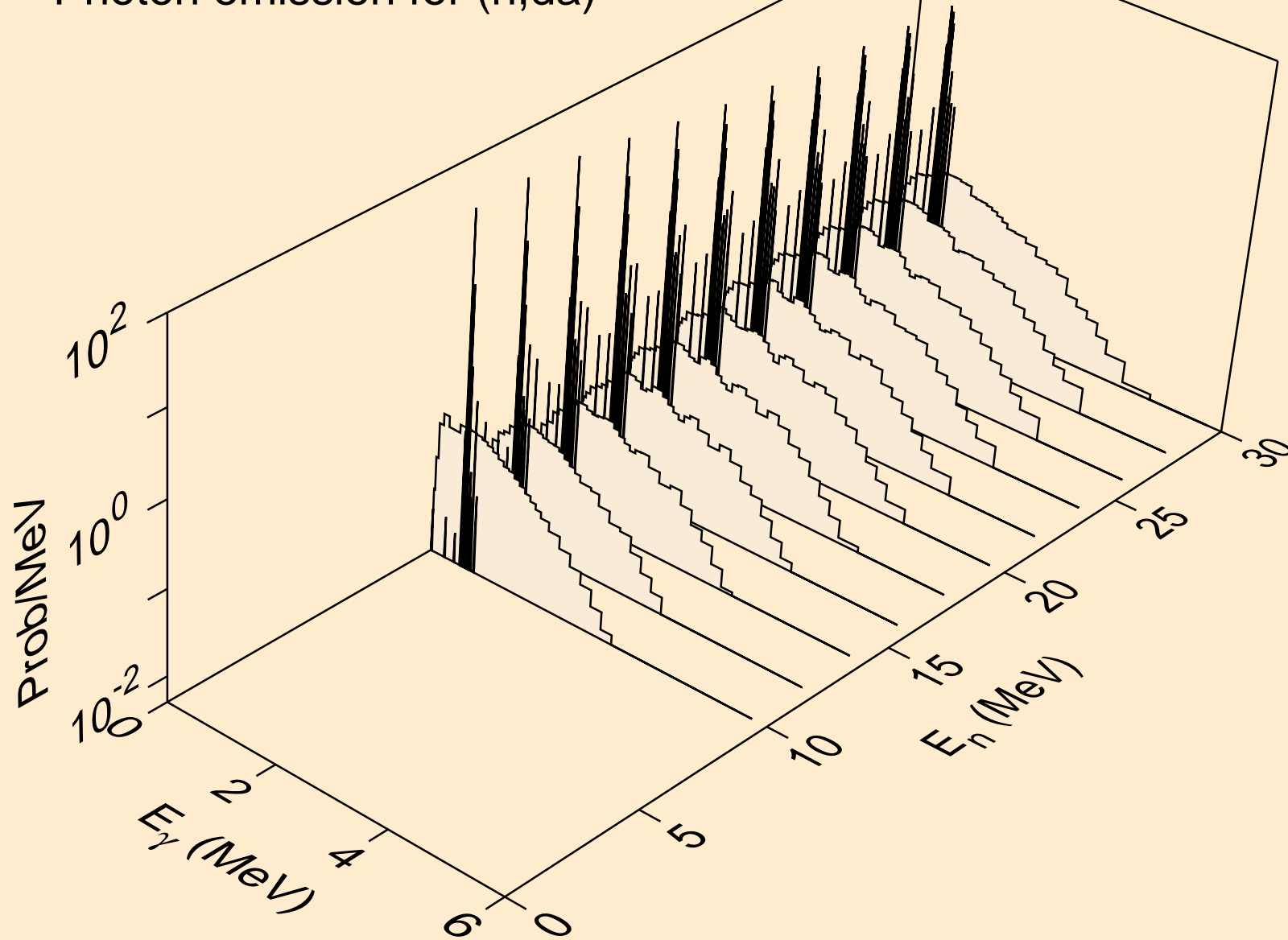

# TM157 HELION ACER TENDL-2021 LIBRARY; T=0.K

## Particle heating contributions

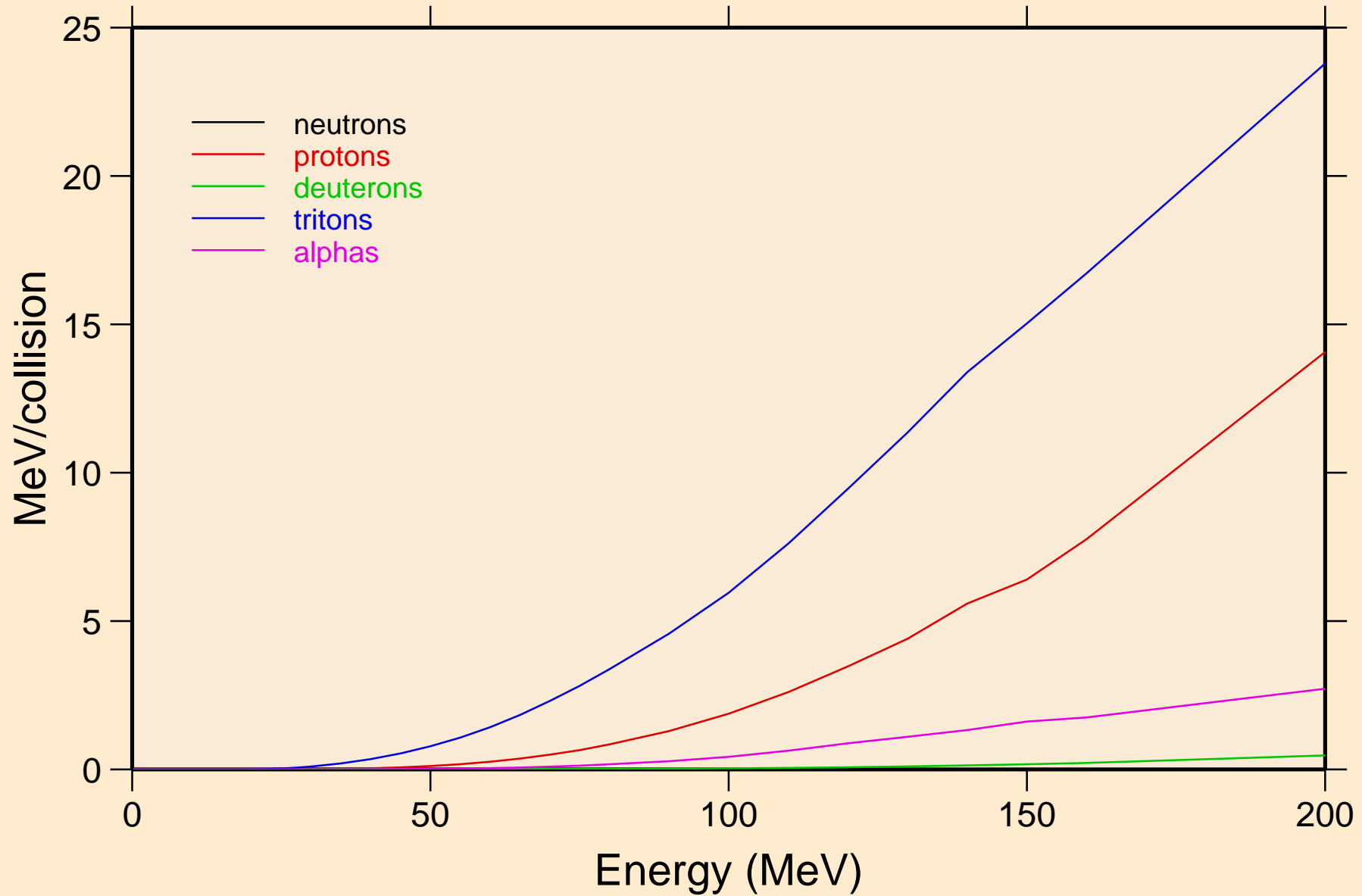

TM157 HELION ACER TENDL-2021 LIBRARY; T=0.K  
Recoil Heating

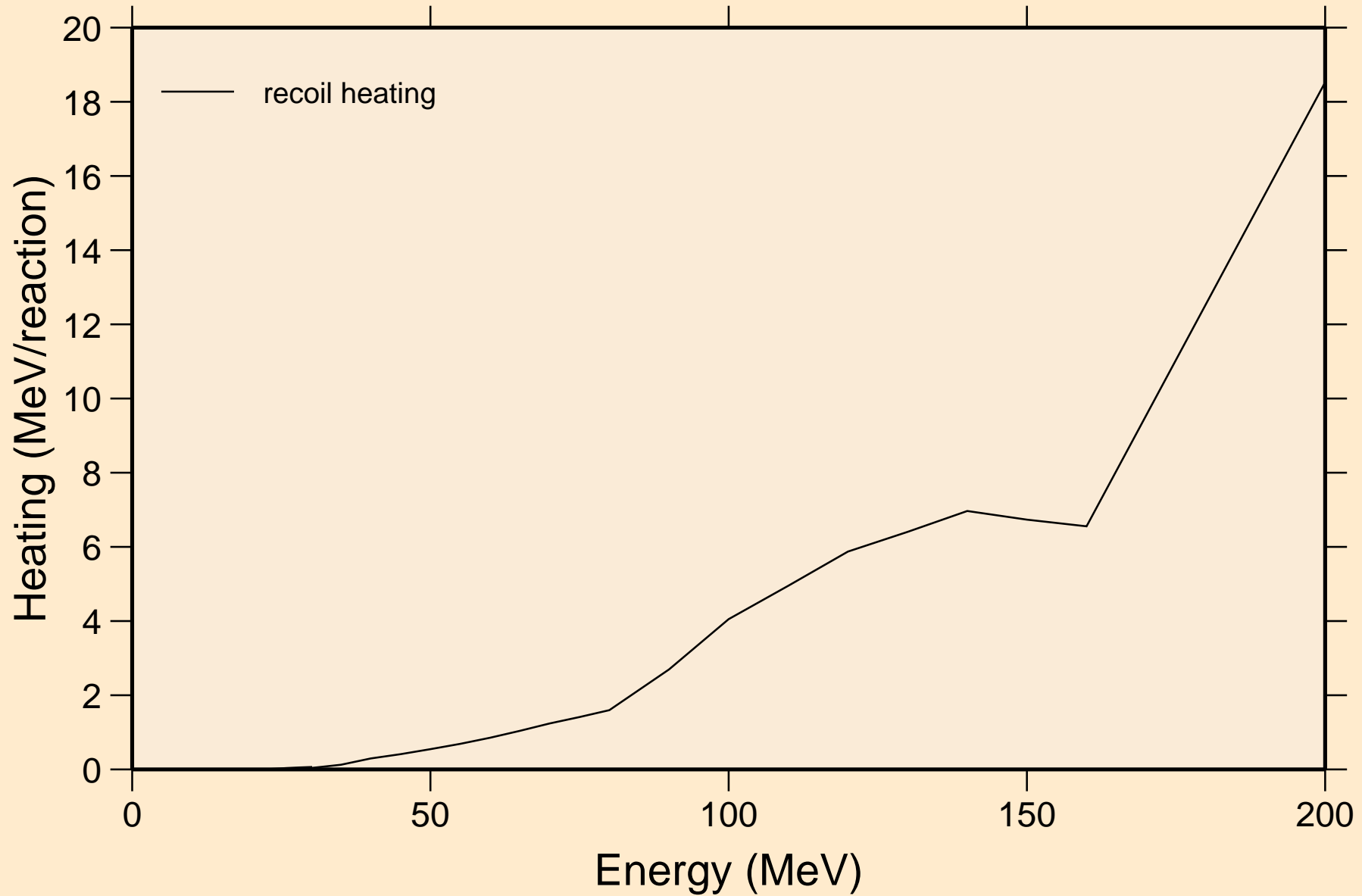

TM157 HELION ACER TENDL-2021 LIBRARY; T=0.K  
Particle production cross sections

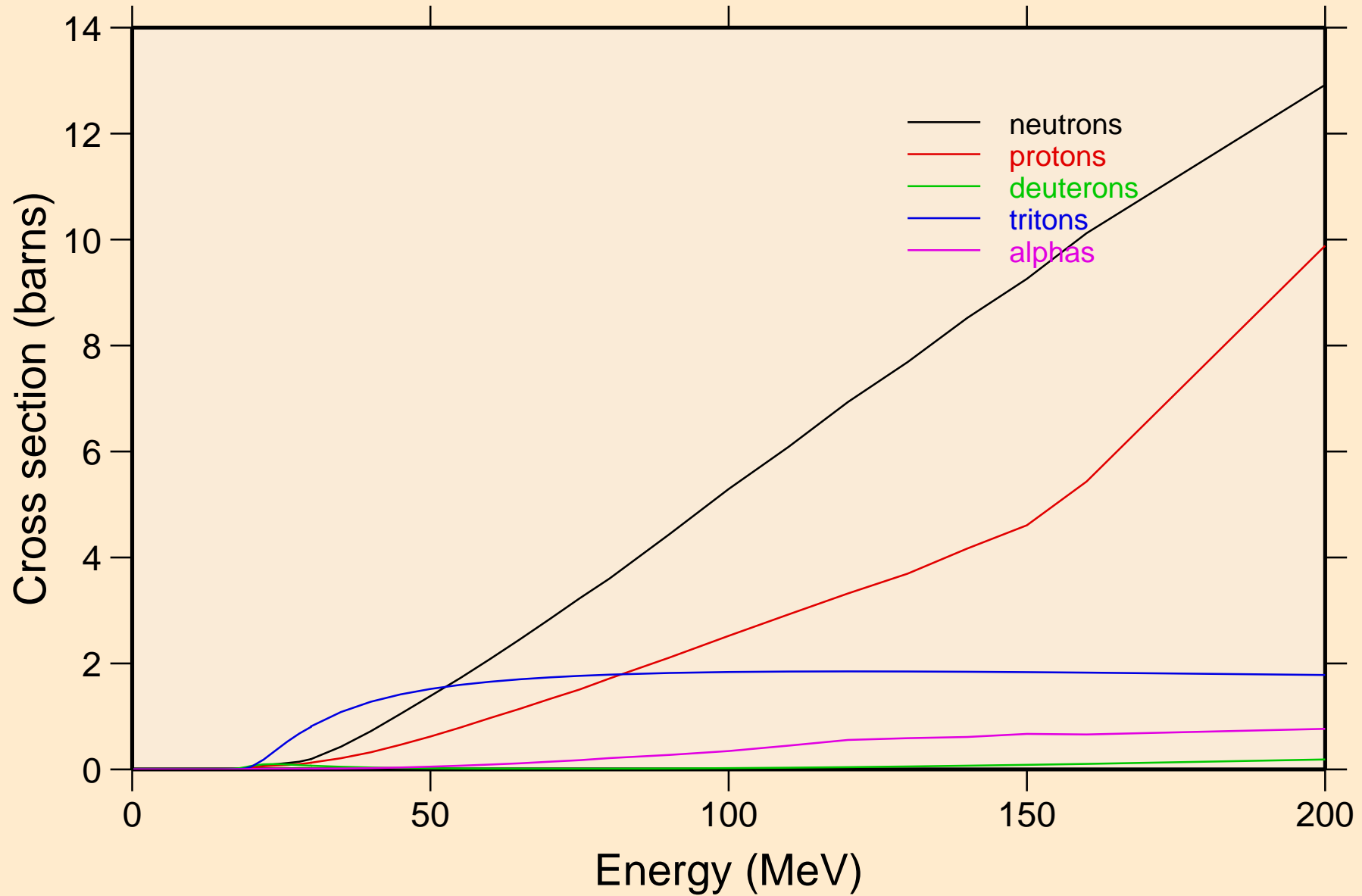

TM157 HELION ACER TENDL-2021 LIBRARY; T=0.K  
neutrons from (s,n)

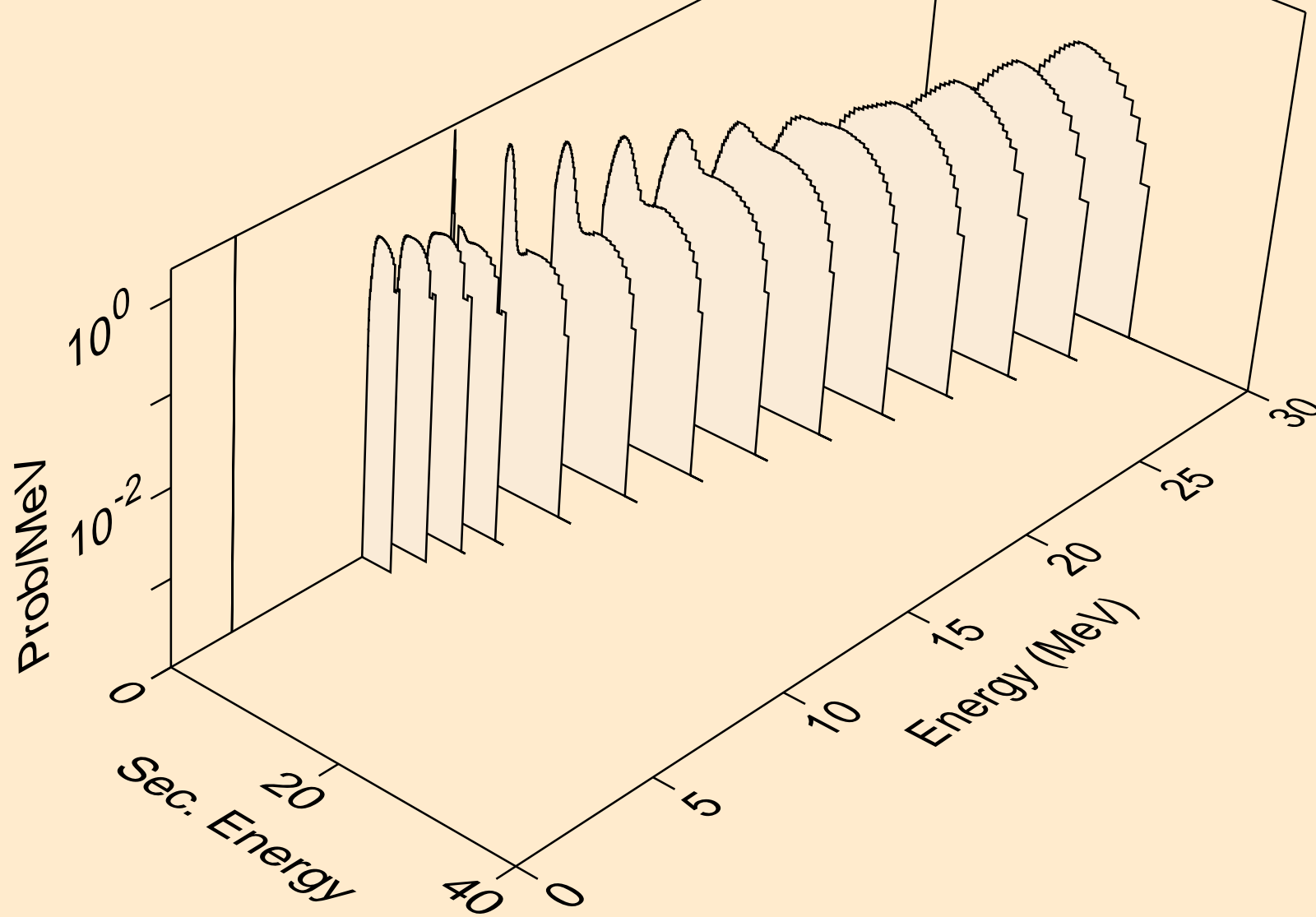

TM157 HELION ACER TENDL-2021 LIBRARY; T=0.K  
neutrons from (s,x)

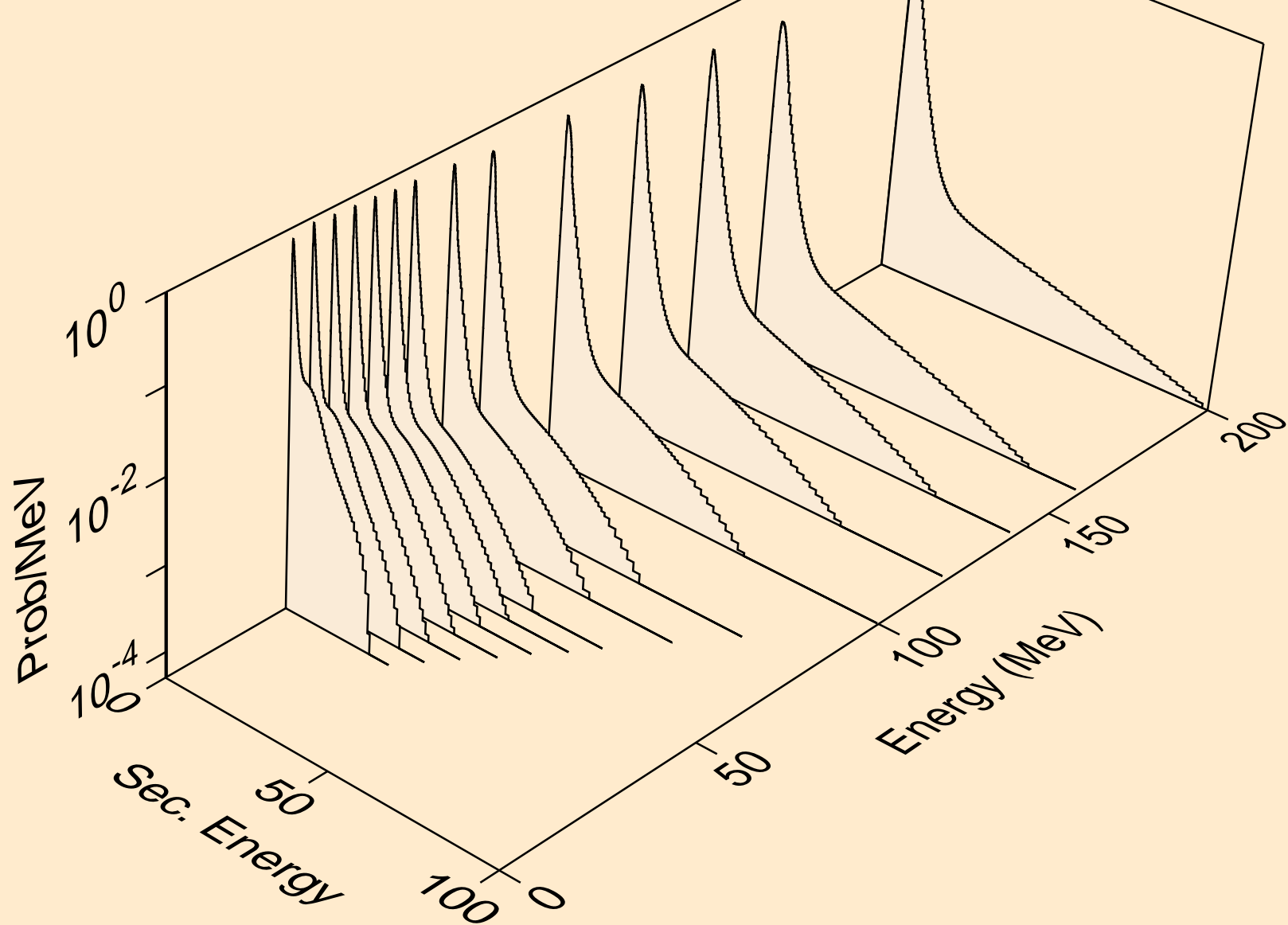



TM157 HELION ACER TENDL-2021 LIBRARY; T=0.K  
neutrons from (s,2nd)

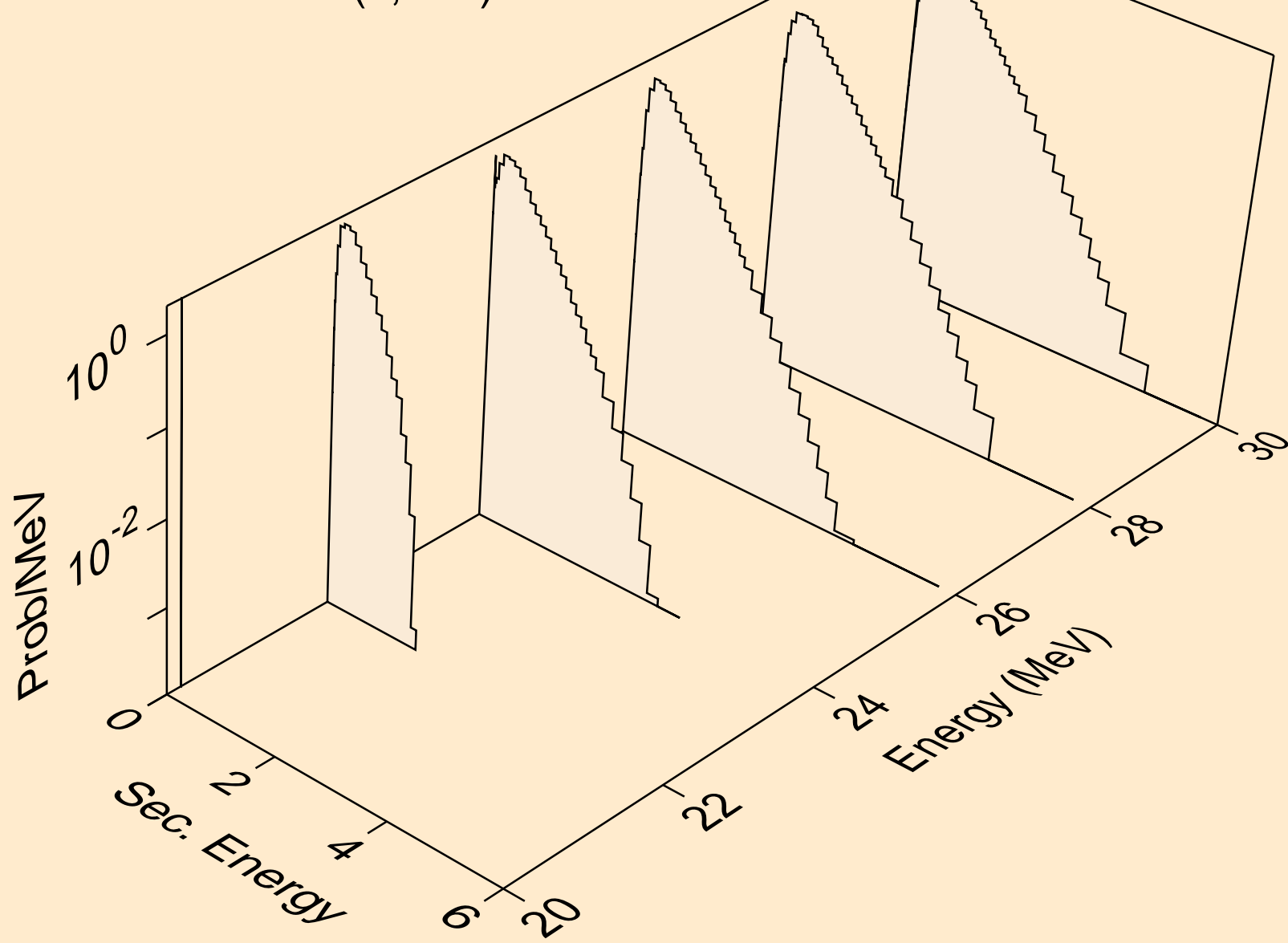

TM157 HELION ACER TENDL-2021 LIBRARY; T=0.K  
neutrons from (s,2n)

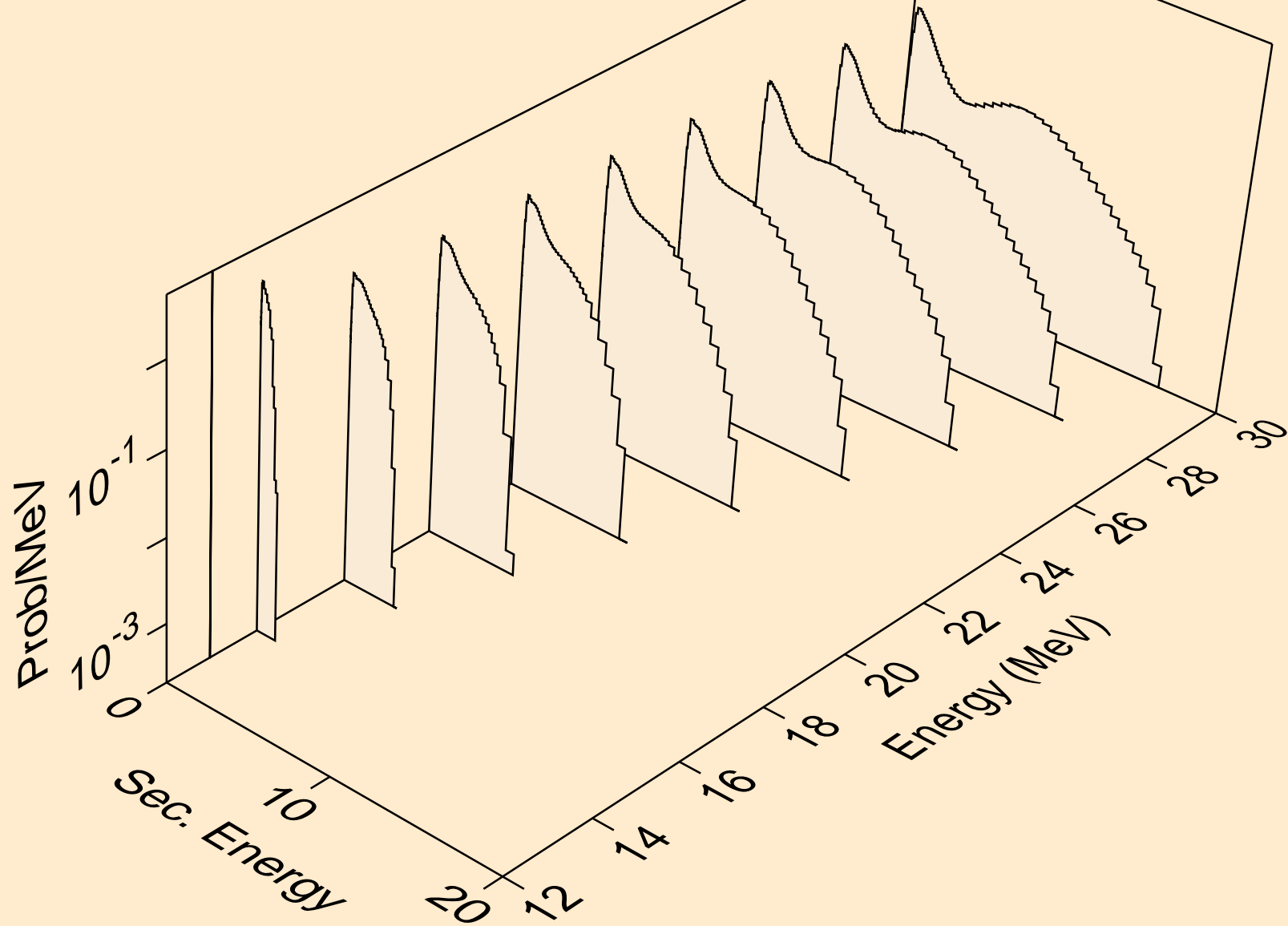

TM157 HELION ACER TENDL-2021 LIBRARY; T=0.K  
neutrons from (s,3n)

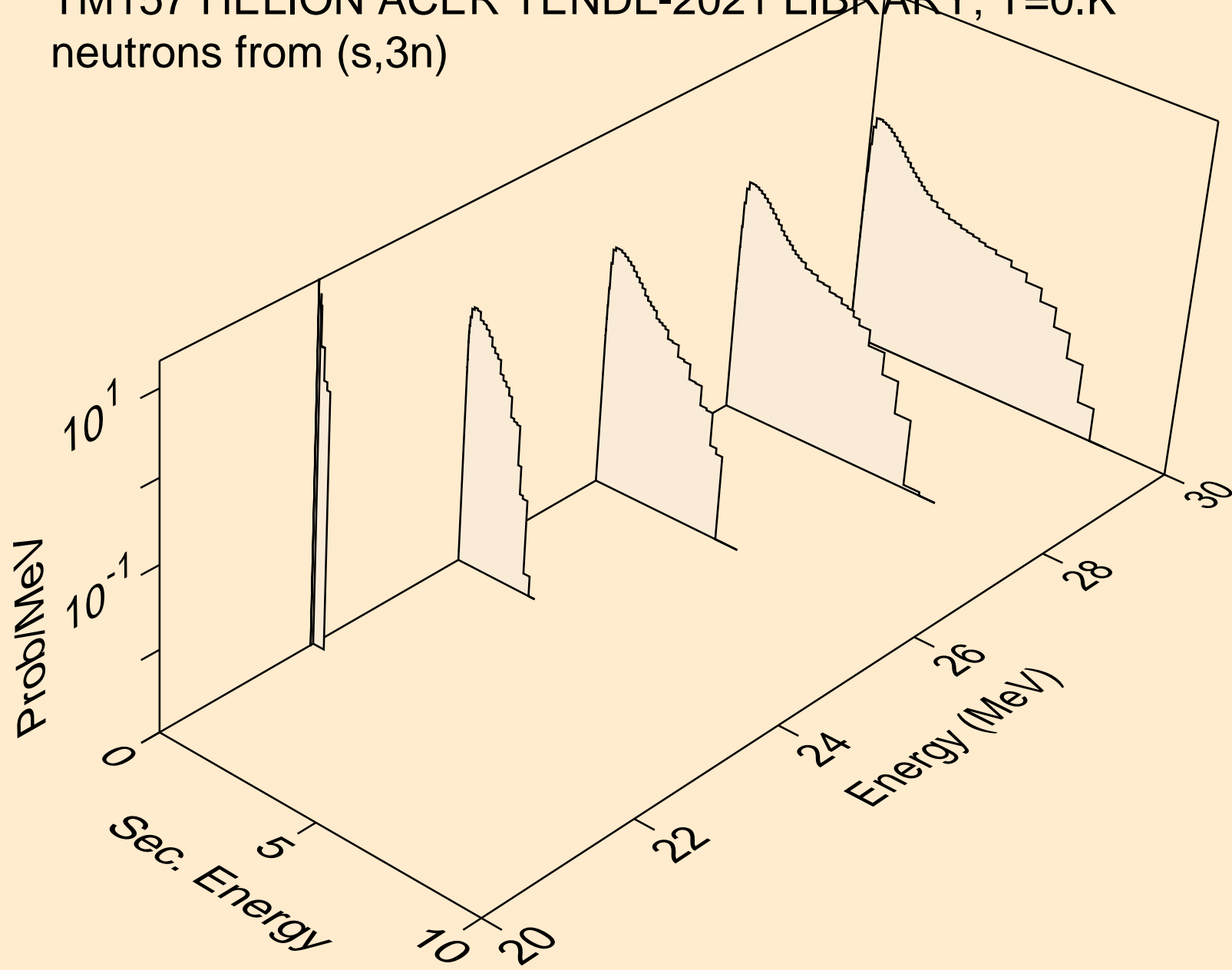

TM157 HELION ACER TENDL-2021 LIBRARY; T=0.K  
neutrons from (s,n\*)a

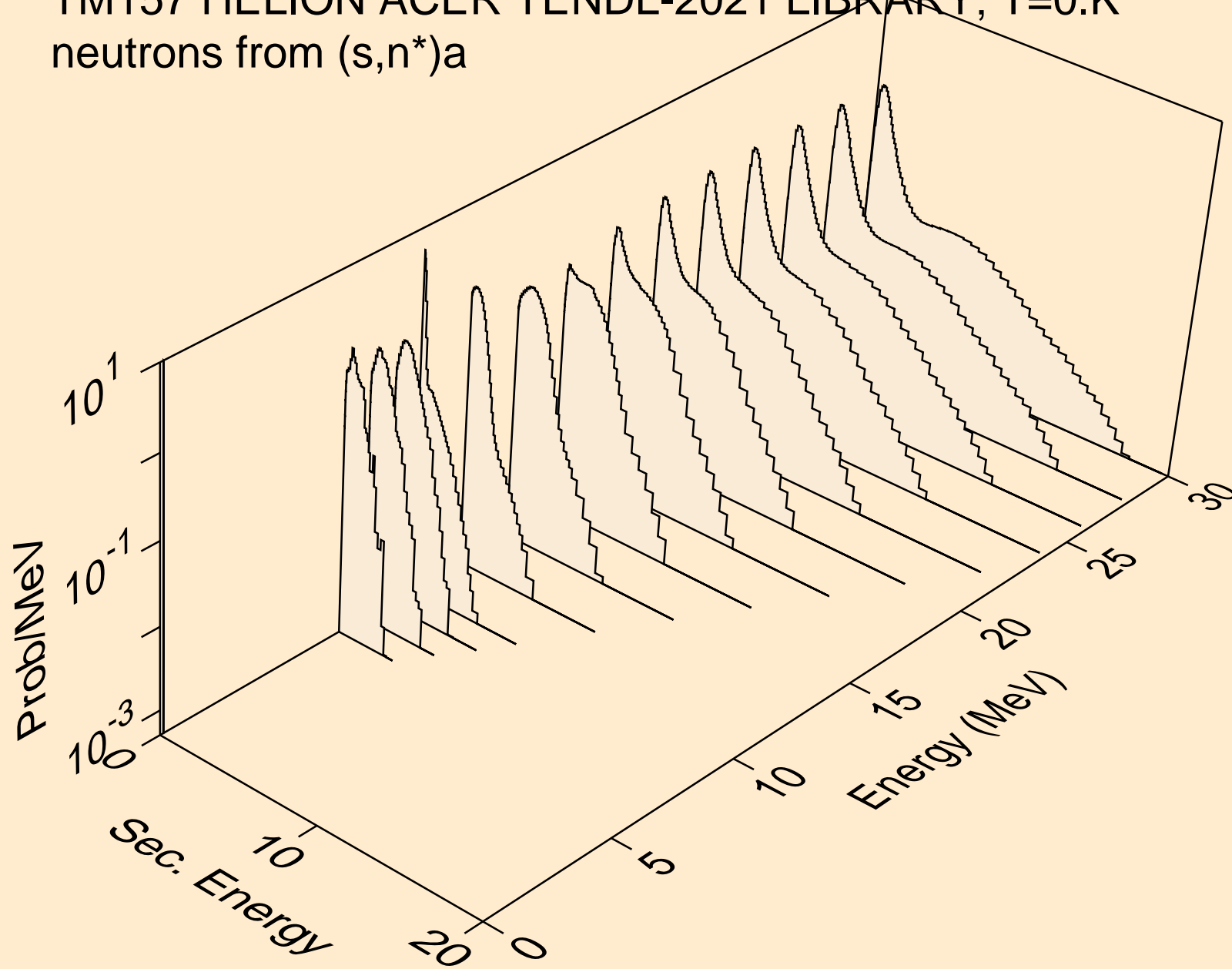

TM157 HELION ACER TENDL-2021 LIBRARY; T=0.K  
neutrons from (s,2n)a

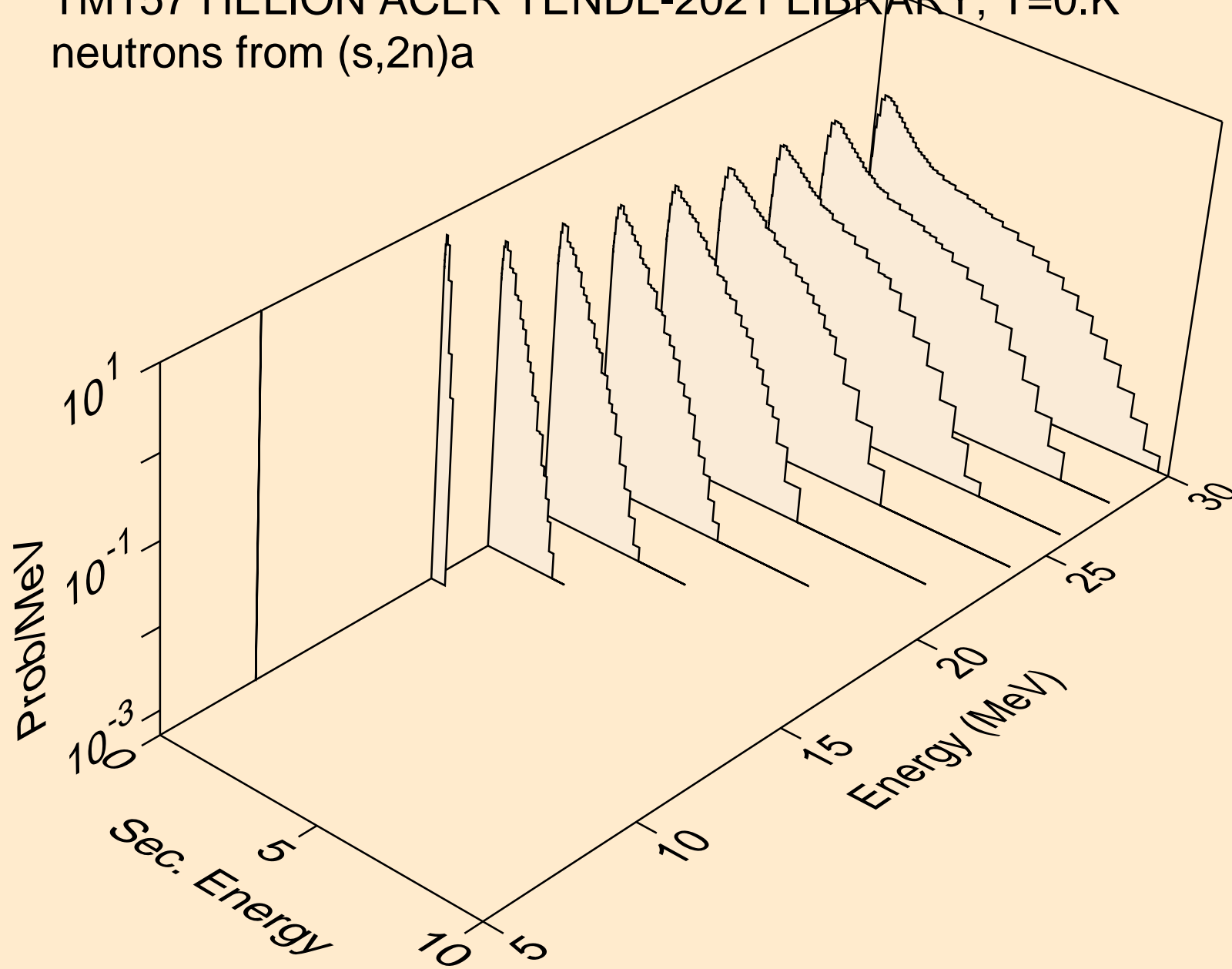

TM157 HELION ACER TENDL-2021 LIBRARY; T=0.K  
neutrons from (s,3n)a

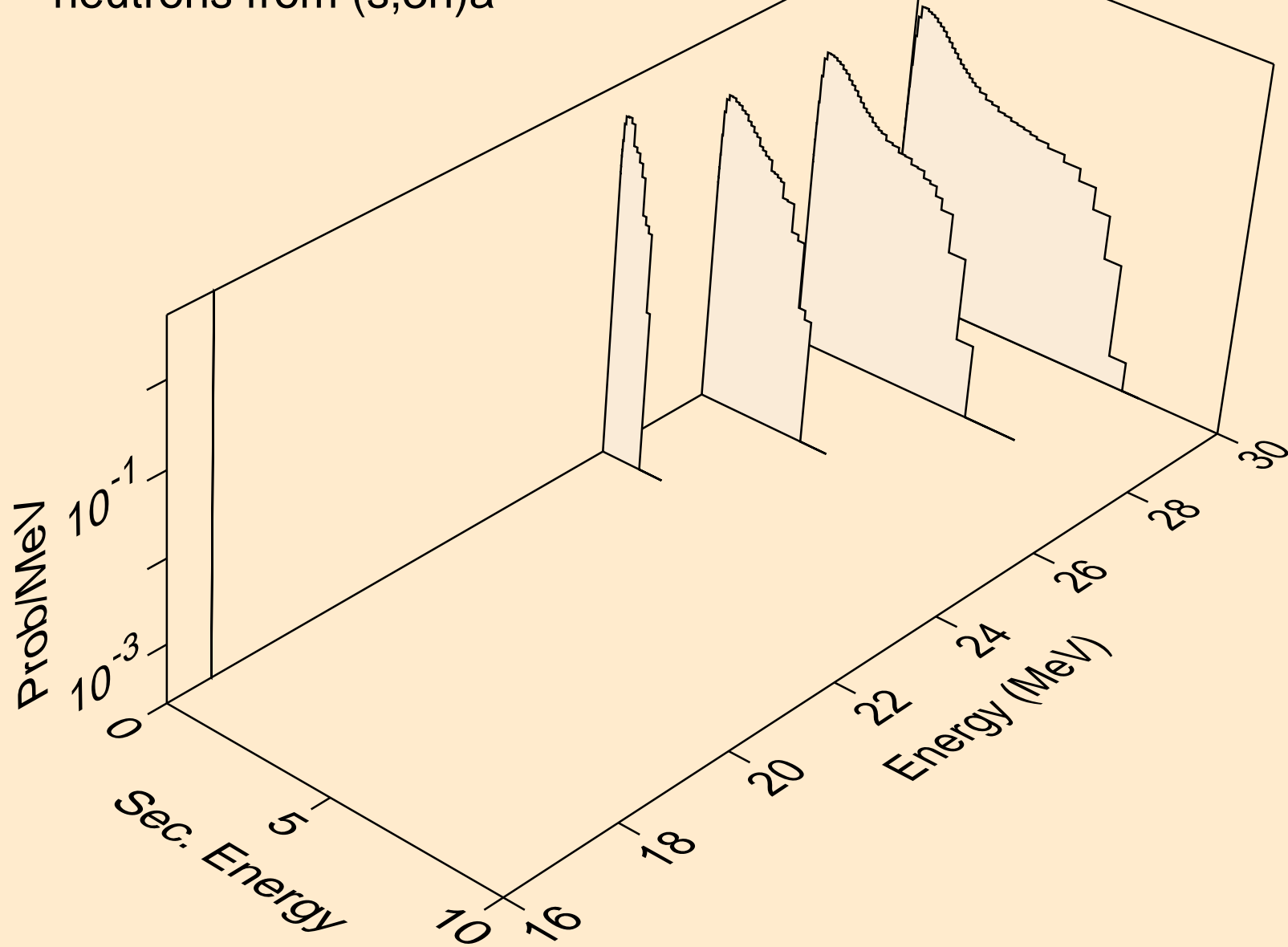

TM157 HELION ACER TENDL-2021 LIBRARY; T=0.K  
neutrons from (s,n\*)p

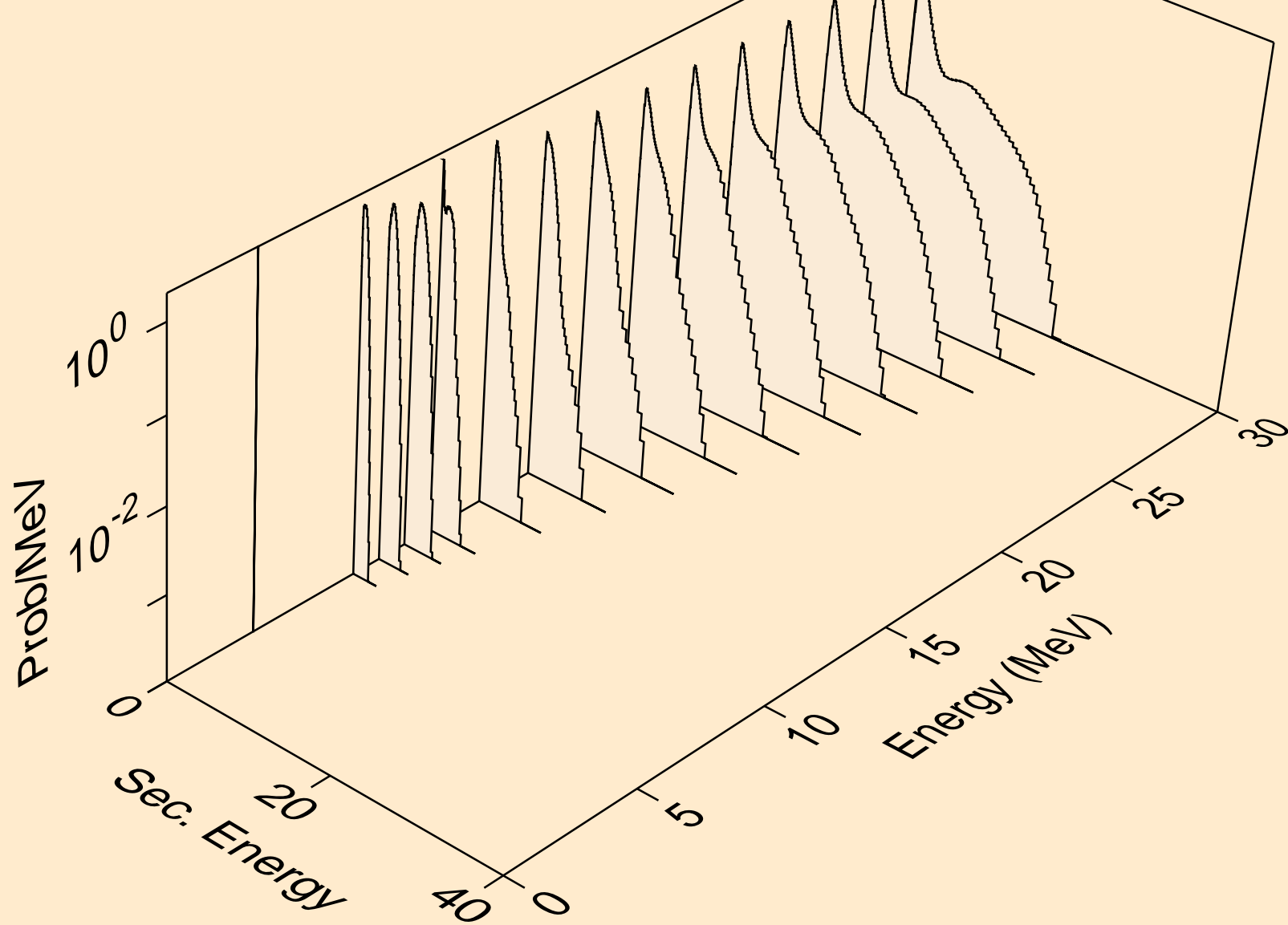

TM157 HELION ACER TENDL-2021 LIBRARY; T=0.K  
neutrons from (s,n\*)2a

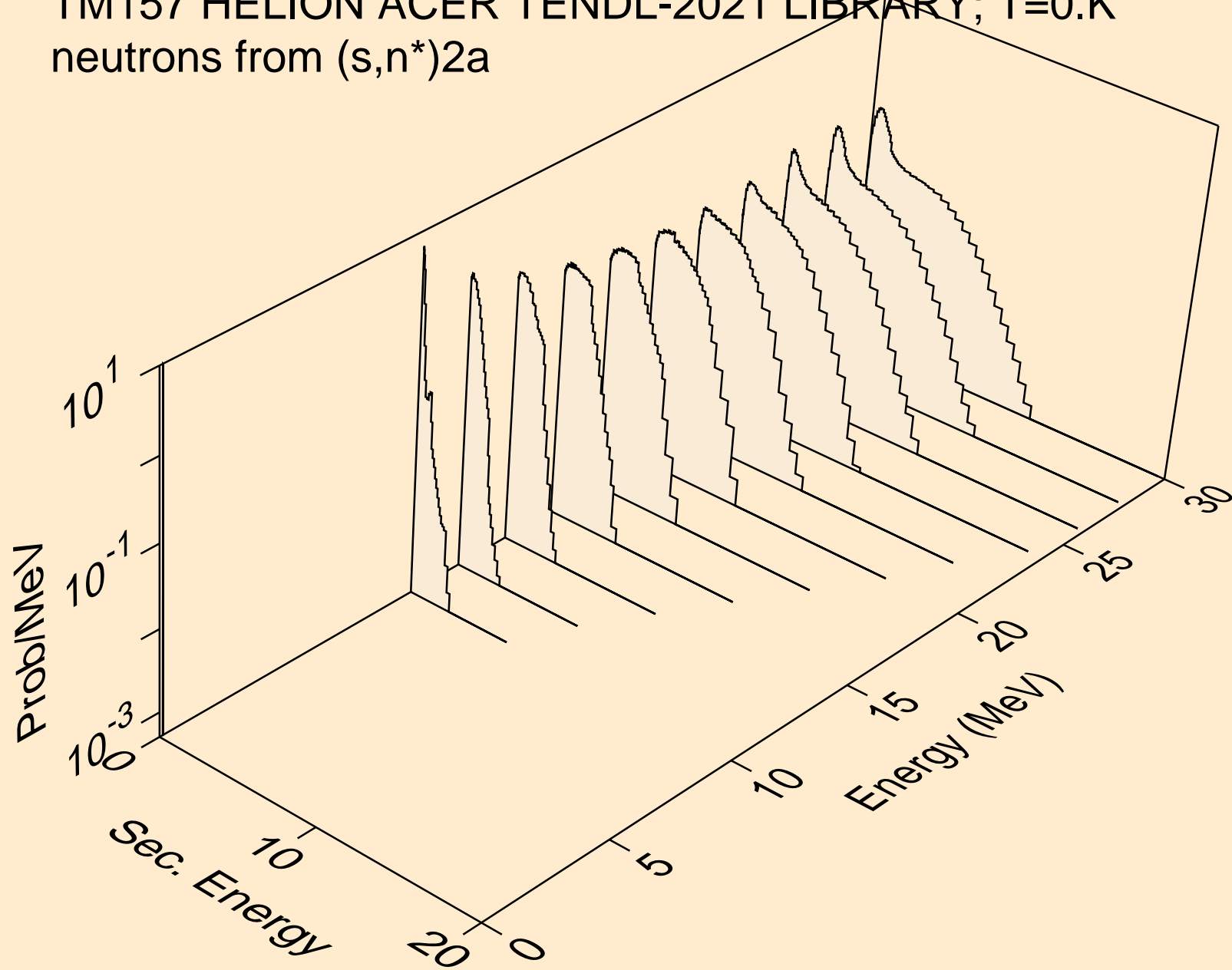



TM157 HELION ACER TENDL-2021 LIBRARY; T=0.K  
neutrons from (s,2n)2a

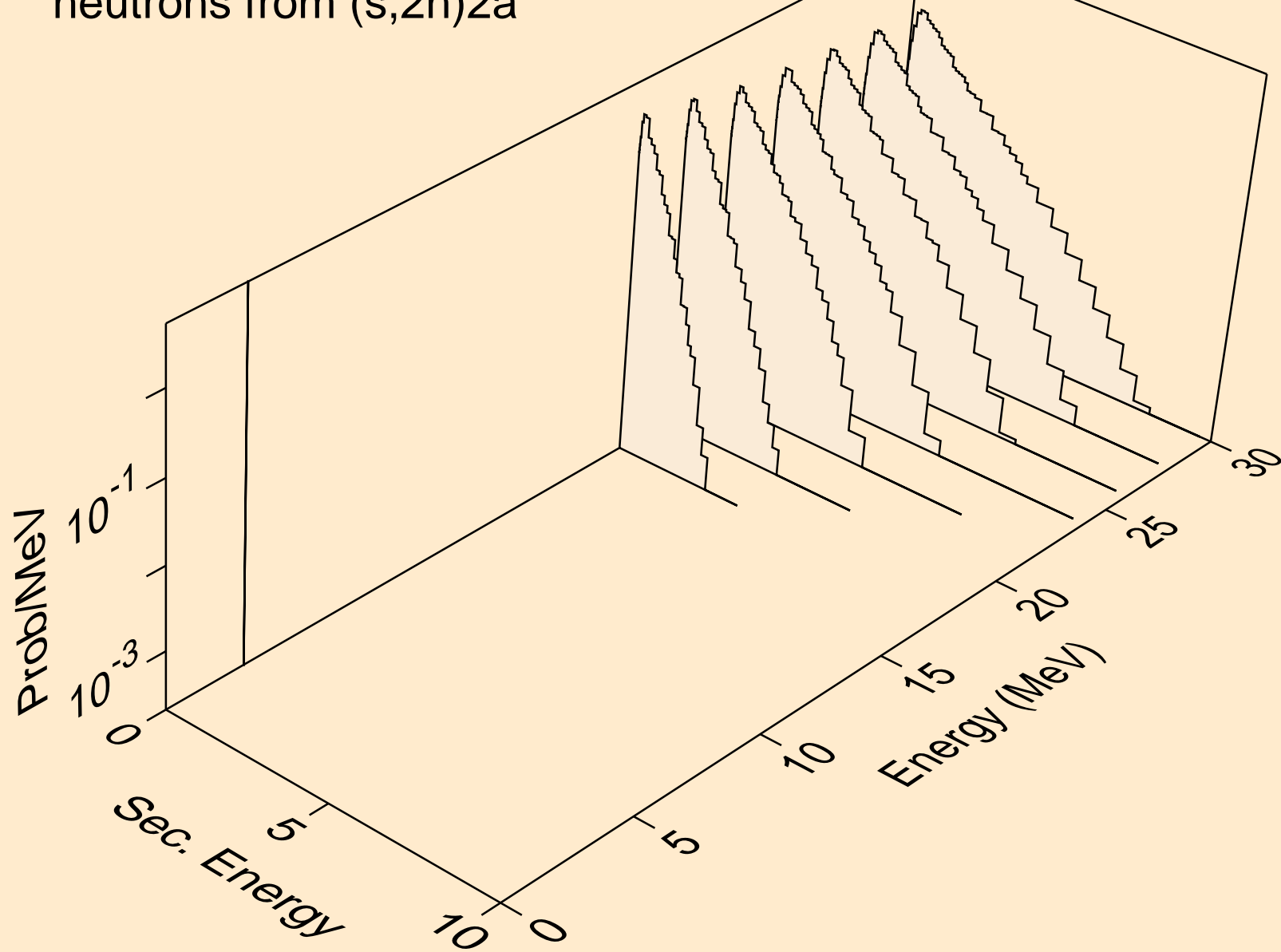

TM157 HELION ACER TENDL-2021 LIBRARY; T=0.K  
neutrons from (s,n\*)d

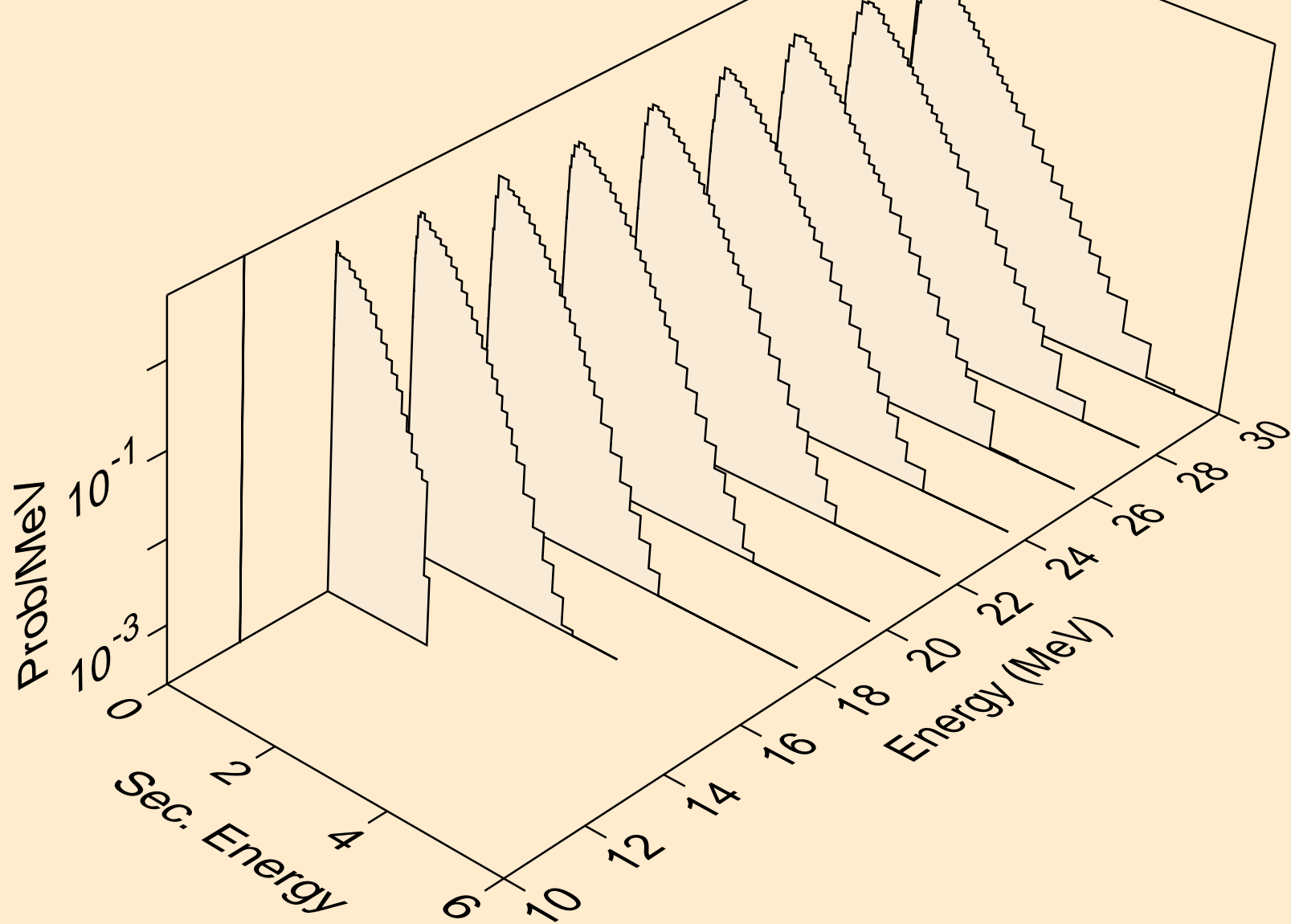

TM157 HELION ACER TENDL-2021 LIBRARY; T=0.K  
neutrons from (s,n\*)t

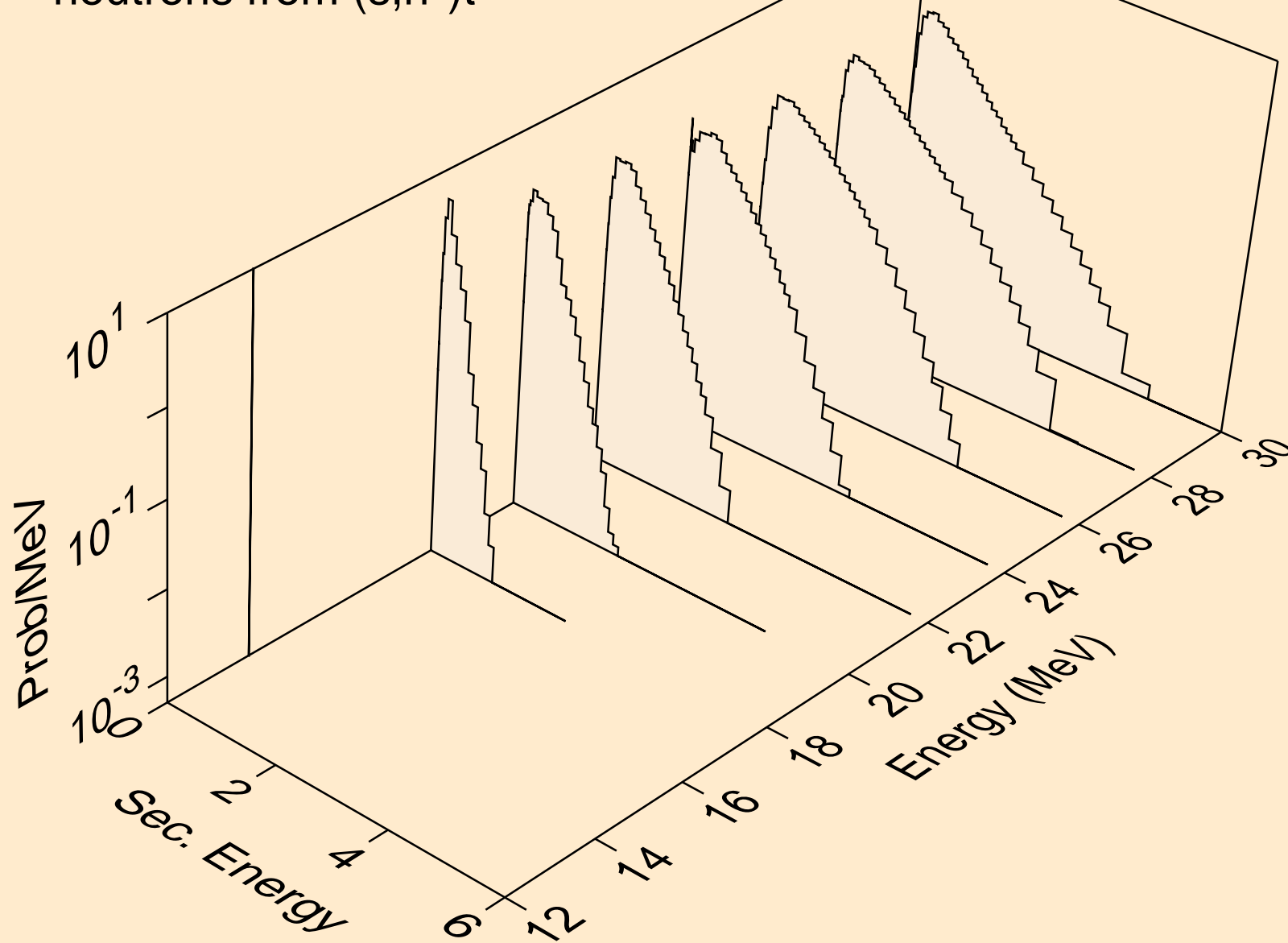

TM157 HELION ACER TENDL-2021 LIBRARY; T=0.K  
neutrons from (s,n\*)he3

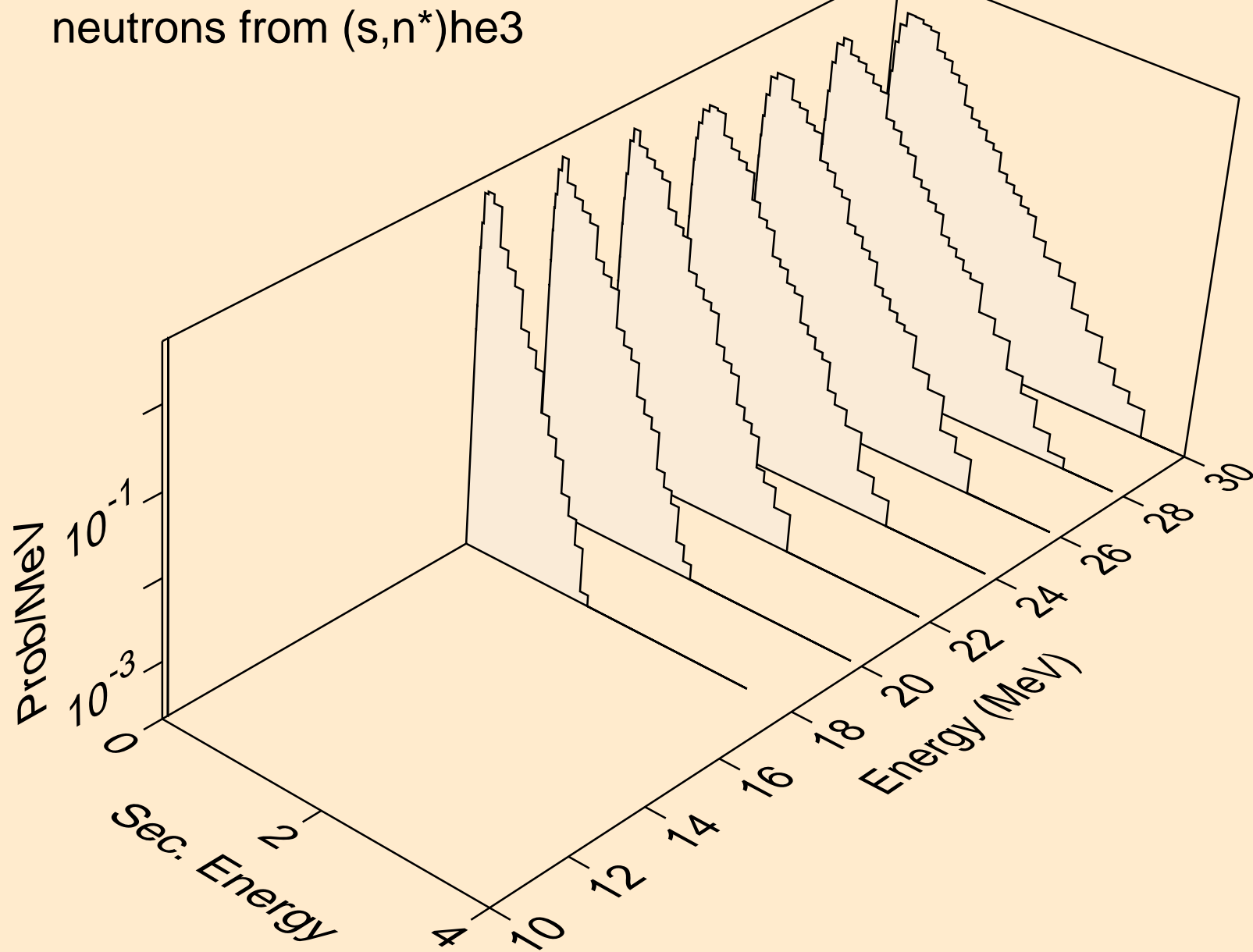

TM157 HELION ACER TENDL-2021 LIBRARY; T=0.K  
neutrons from (s,2np)

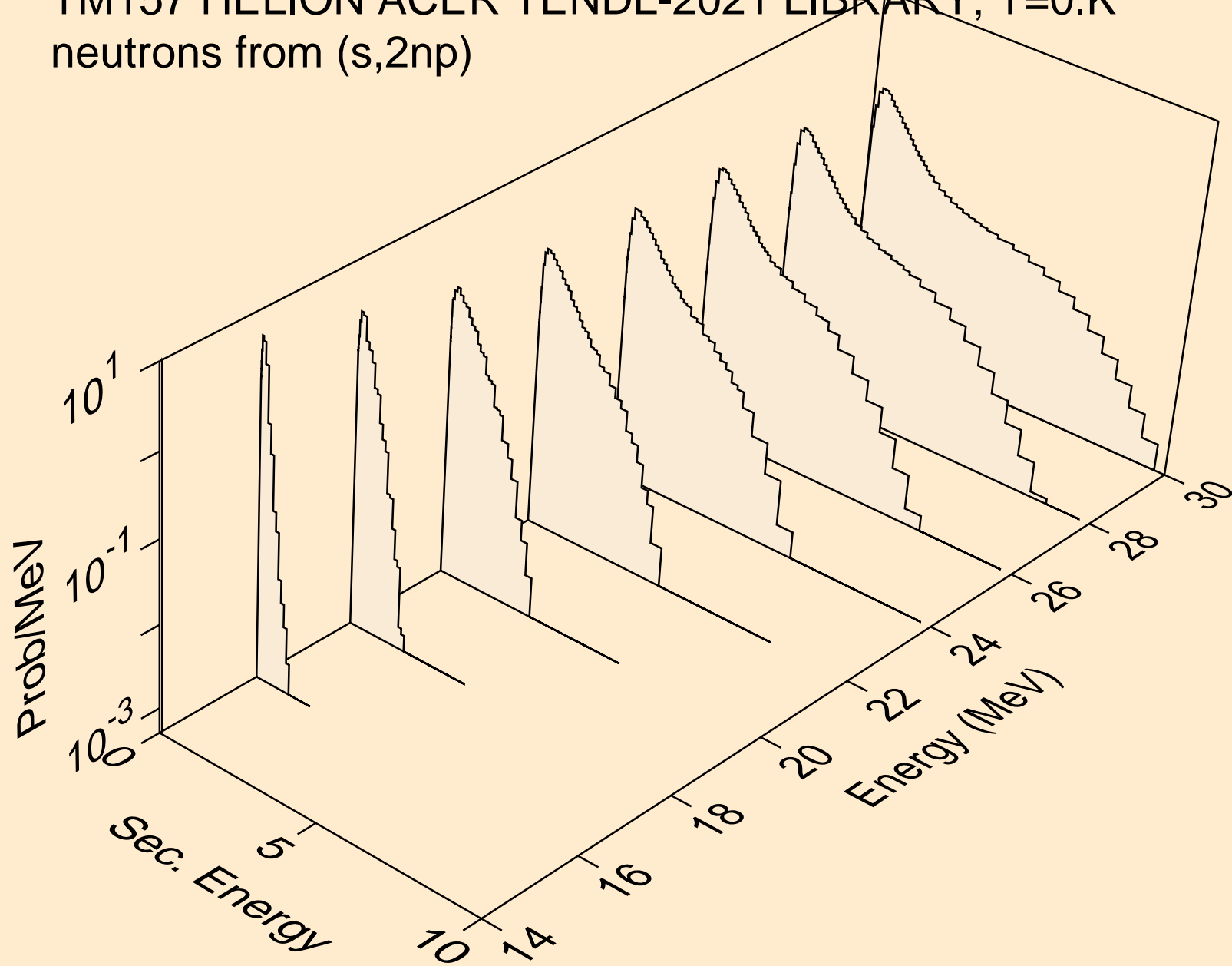

TM157 HELION ACER TENDL-2021 LIBRARY; T=0.K  
neutrons from (s,3np)

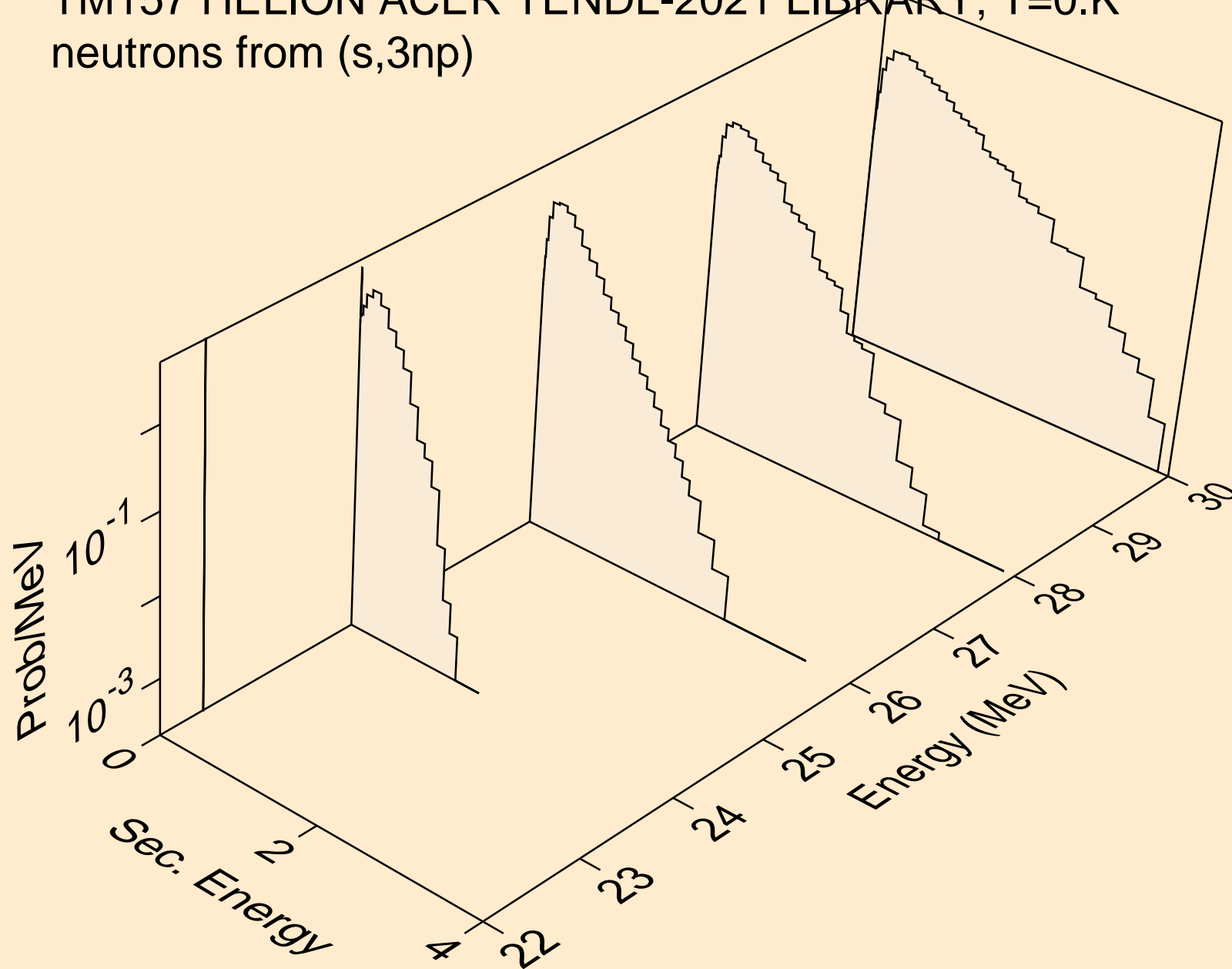

TM157 HELION ACER TENDL-2021 LIBRARY; T=0.K  
neutrons from (s,2np)

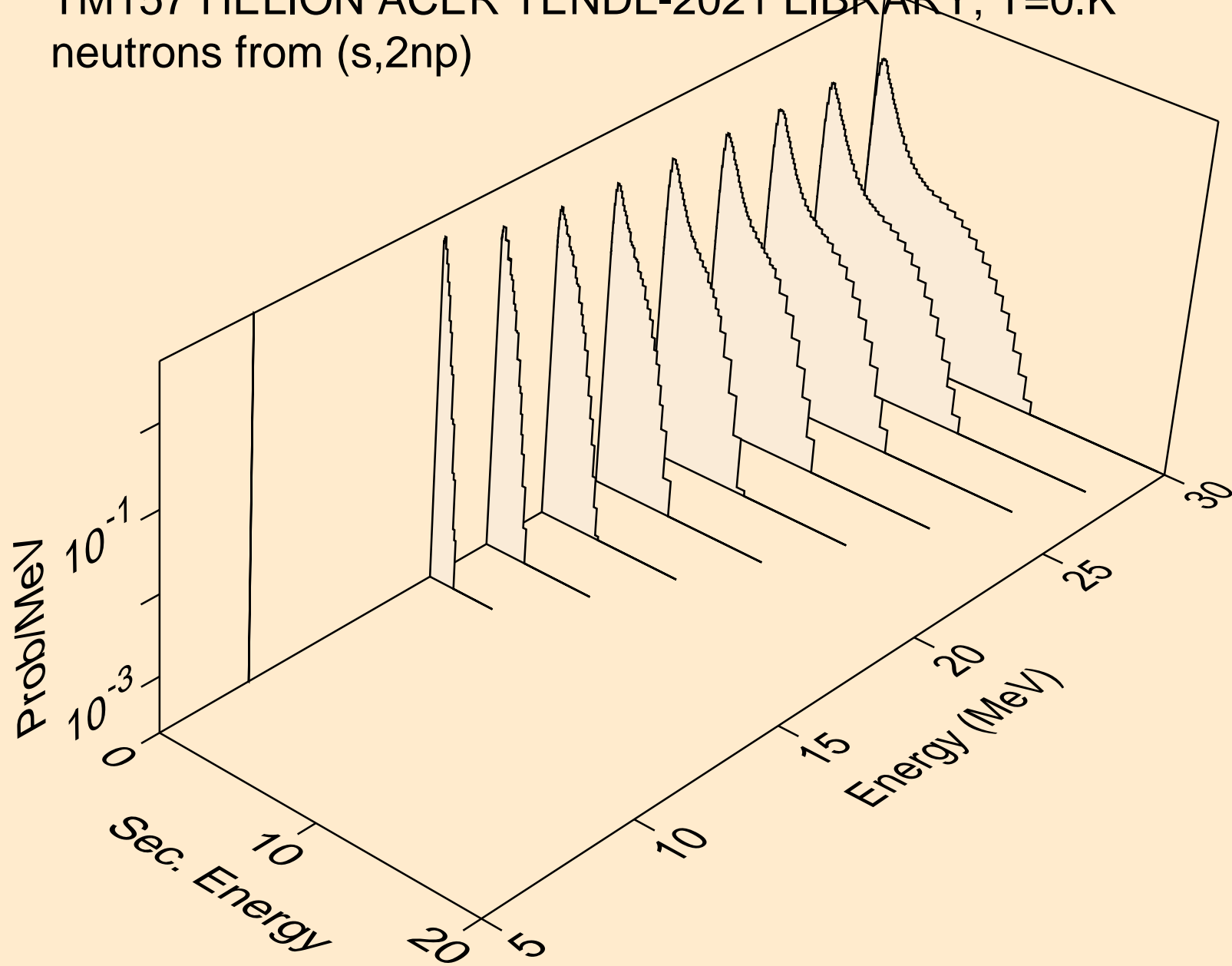

TM157 HELION ACER TENDL-2021 LIBRARY; T=0.K  
neutrons from (s,npa)

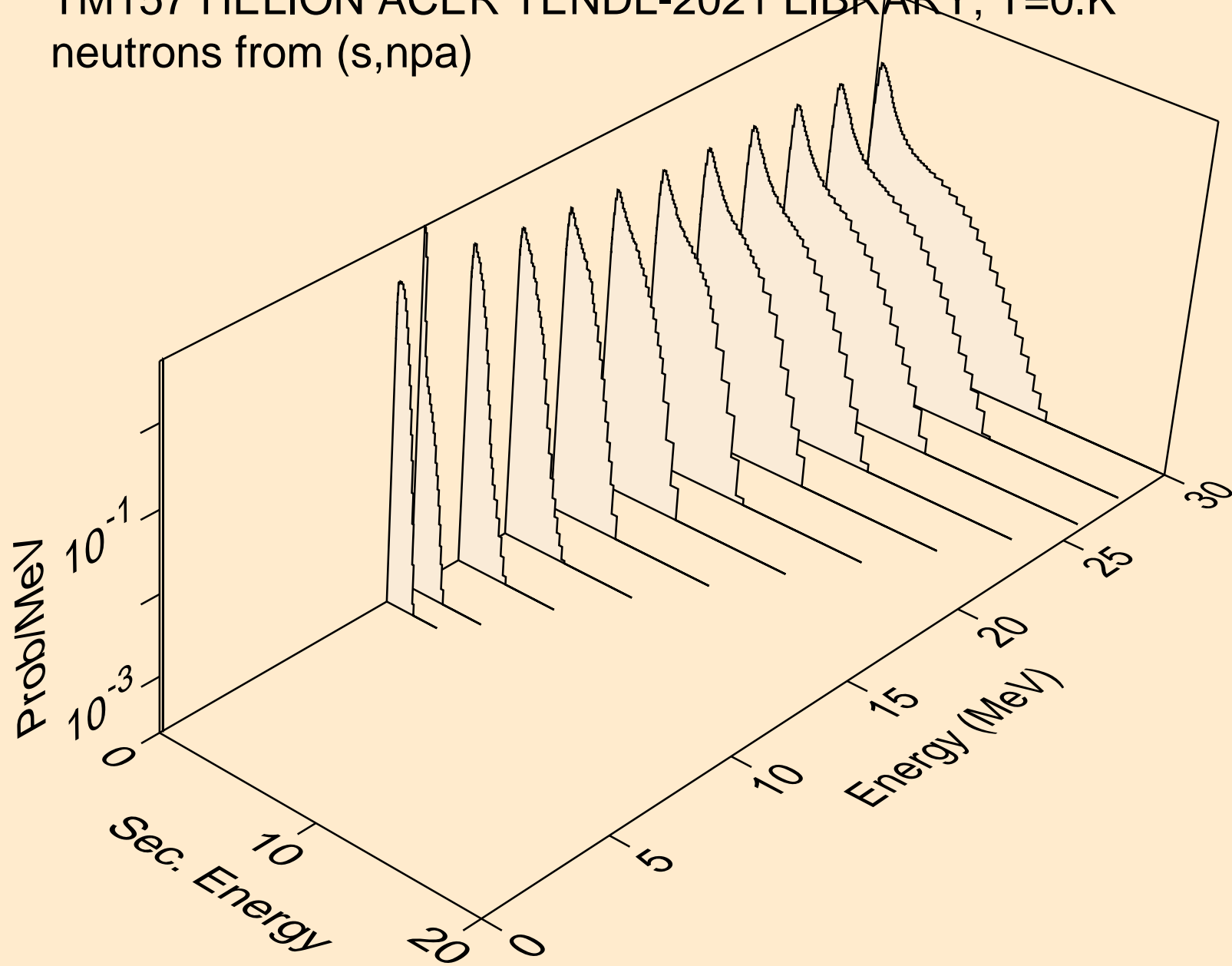



TM157 HELION ACER TENDL-2021 LIBRARY; T=0.K  
protons from (s,x)

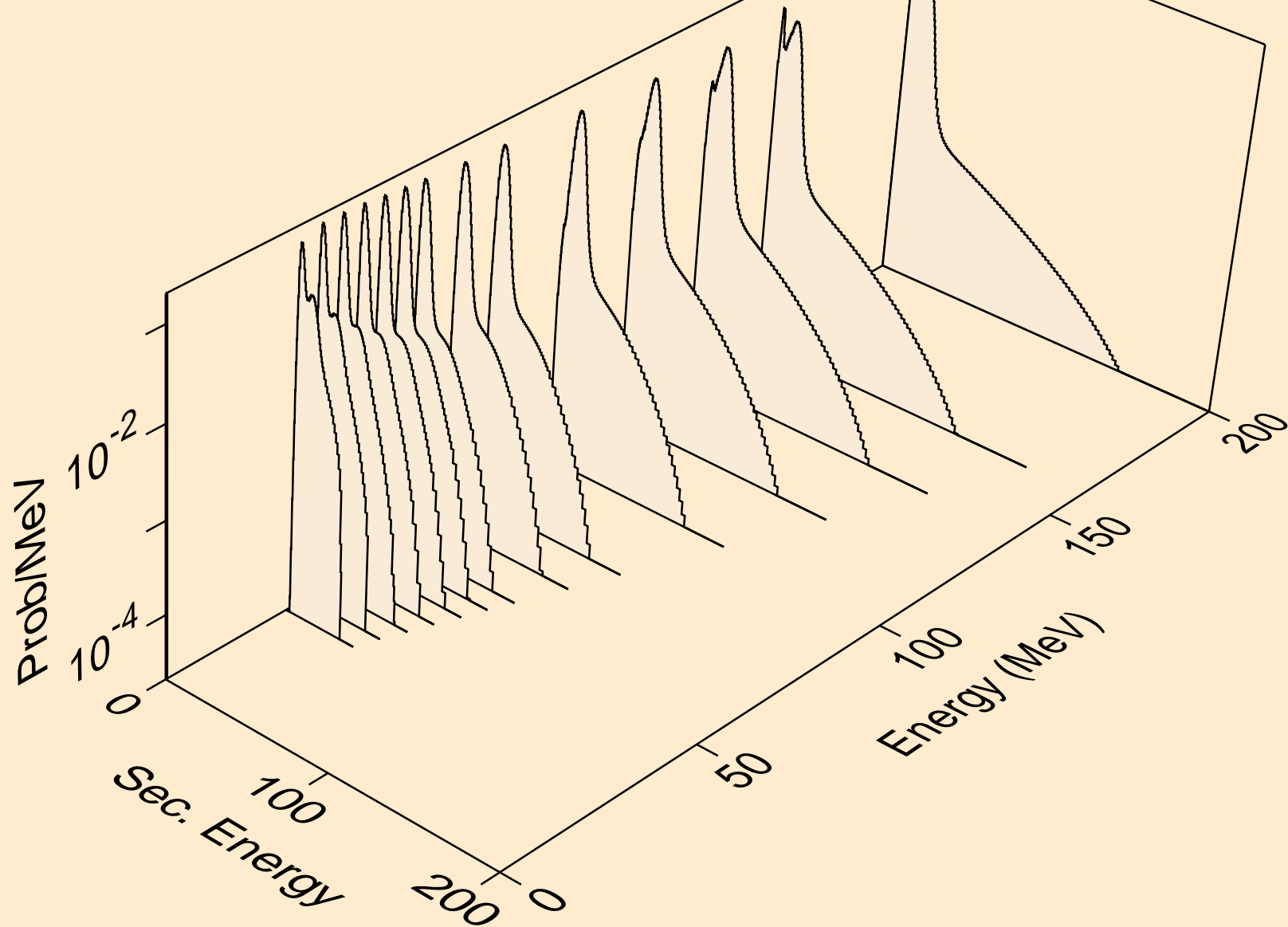

TM157 HELION ACER TENDL-2021 LIBRARY; T=0.K  
protons from (s,n\*)p

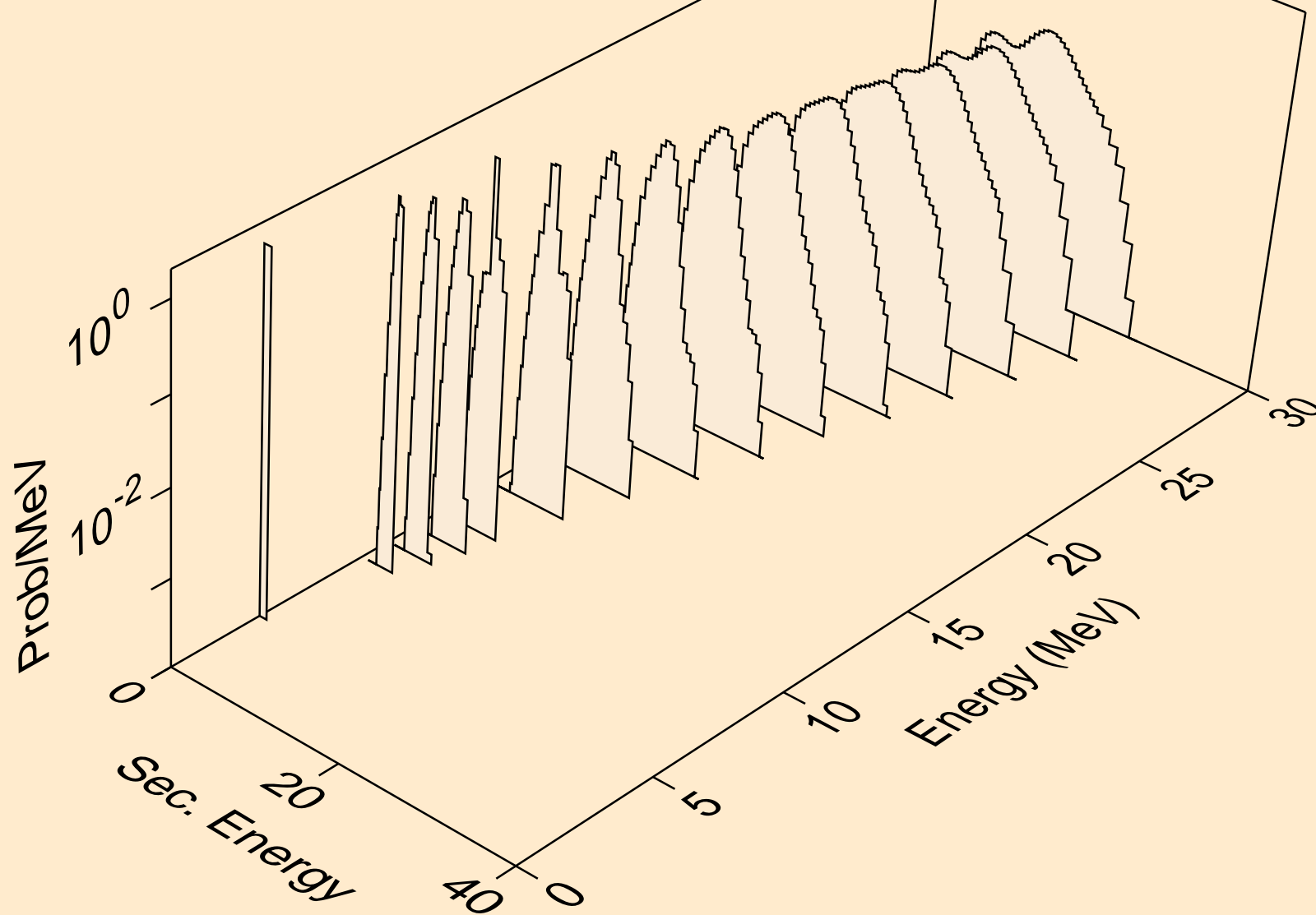

TM157 HELION ACER TENDL-2021 LIBRARY; T=0.K  
protons from (s,2np)

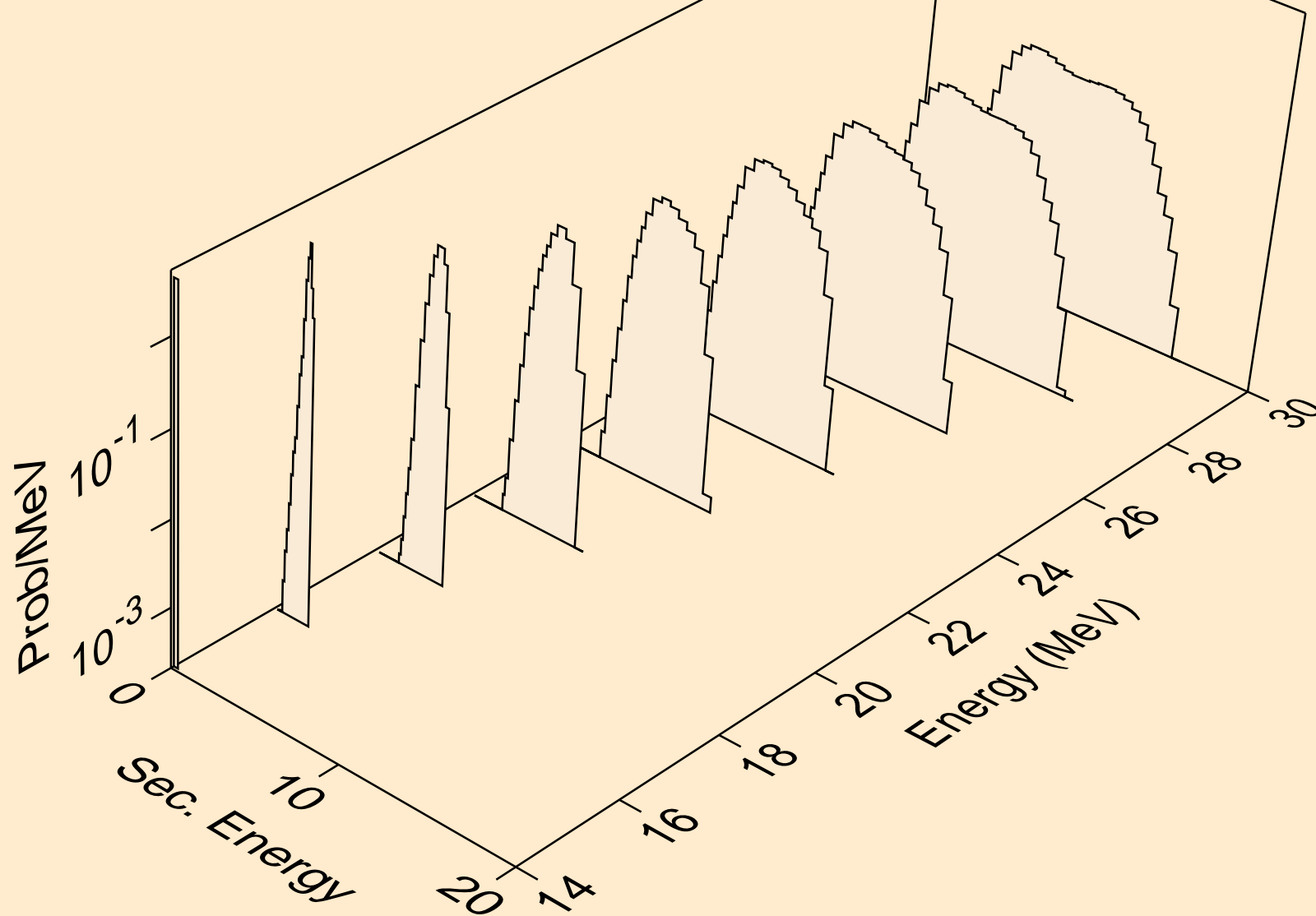

TM157 HELION ACER TENDL-2021 LIBRARY; T=0.K  
protons from (s,3np)

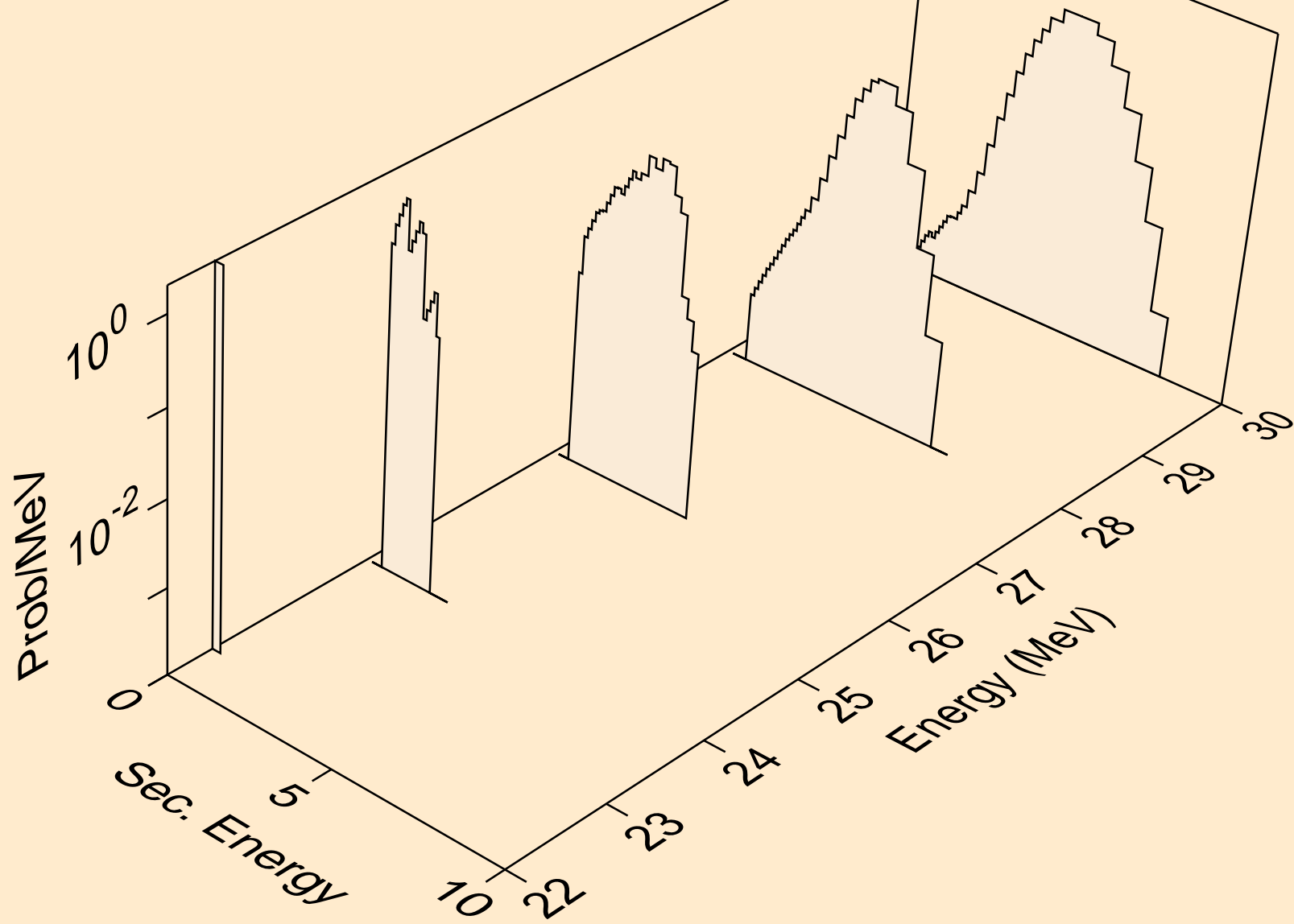

TM157 HELION ACER TENDL-2021 LIBRARY; T=0.K  
protons from (s,2np)

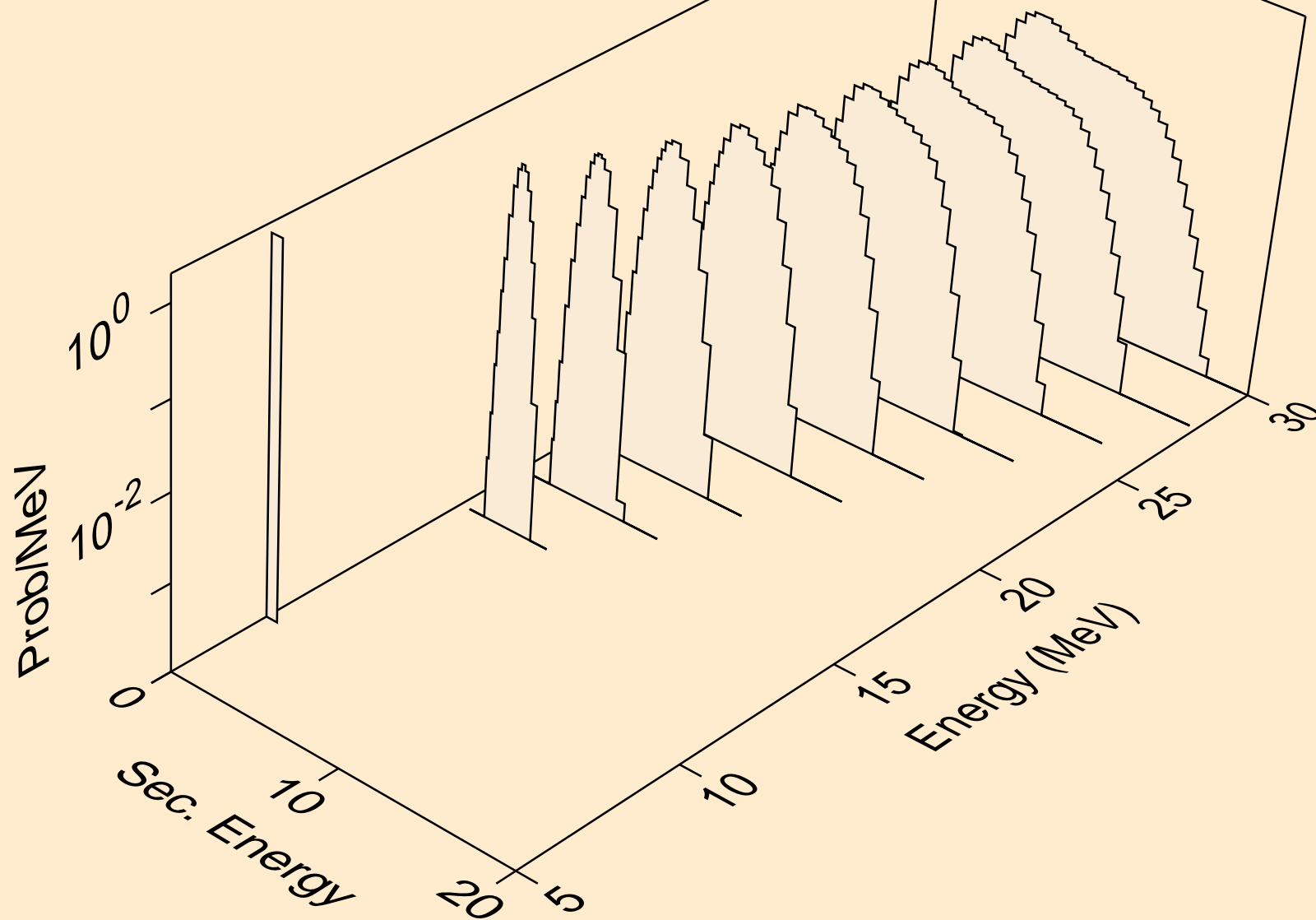

TM157 HELION ACER TENDL-2021 LIBRARY; T=0.K  
protons from (s,npa)

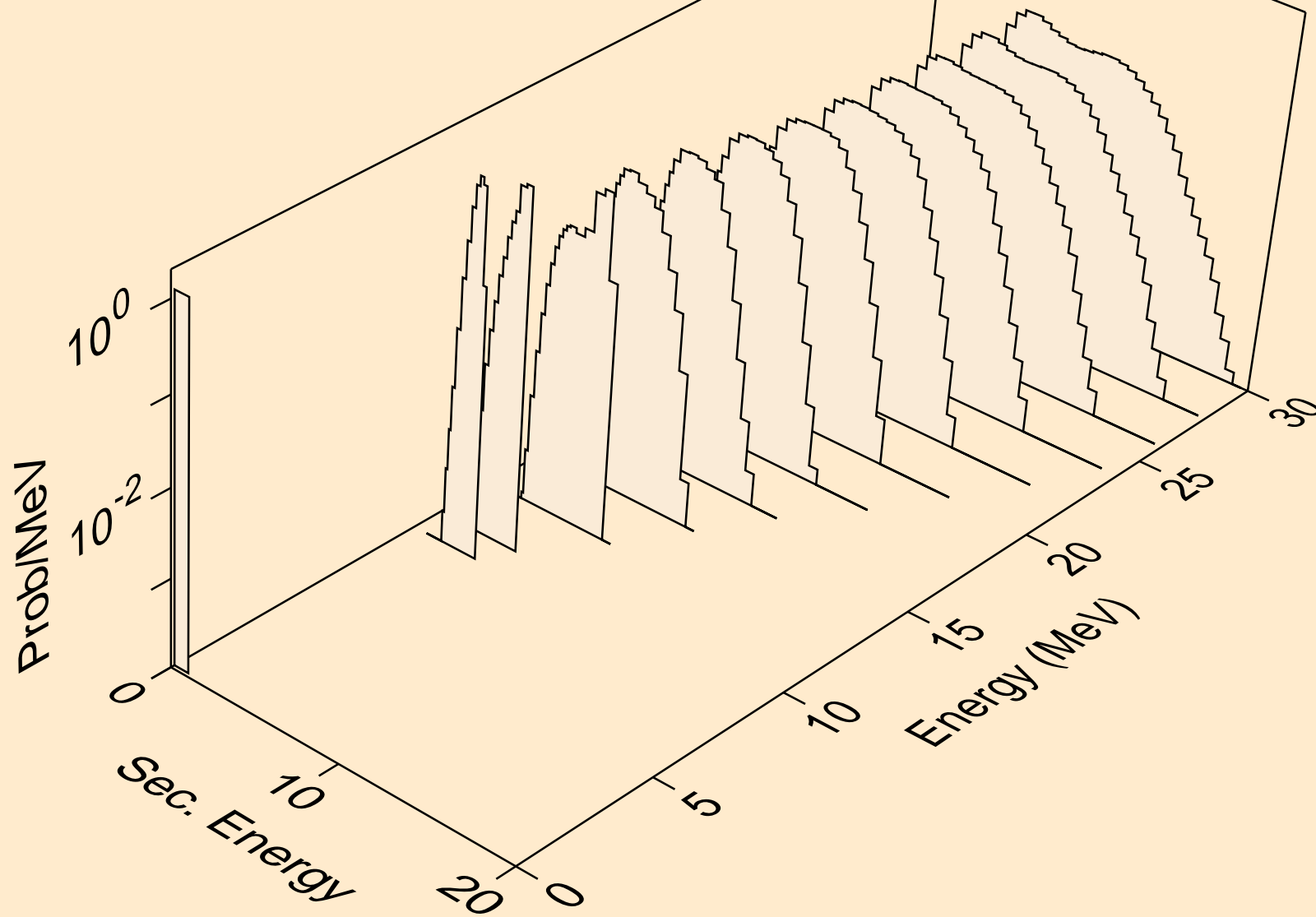

TM157 HELION ACER TENDL-2021 LIBRARY; T=0.K  
protons from (s,p)

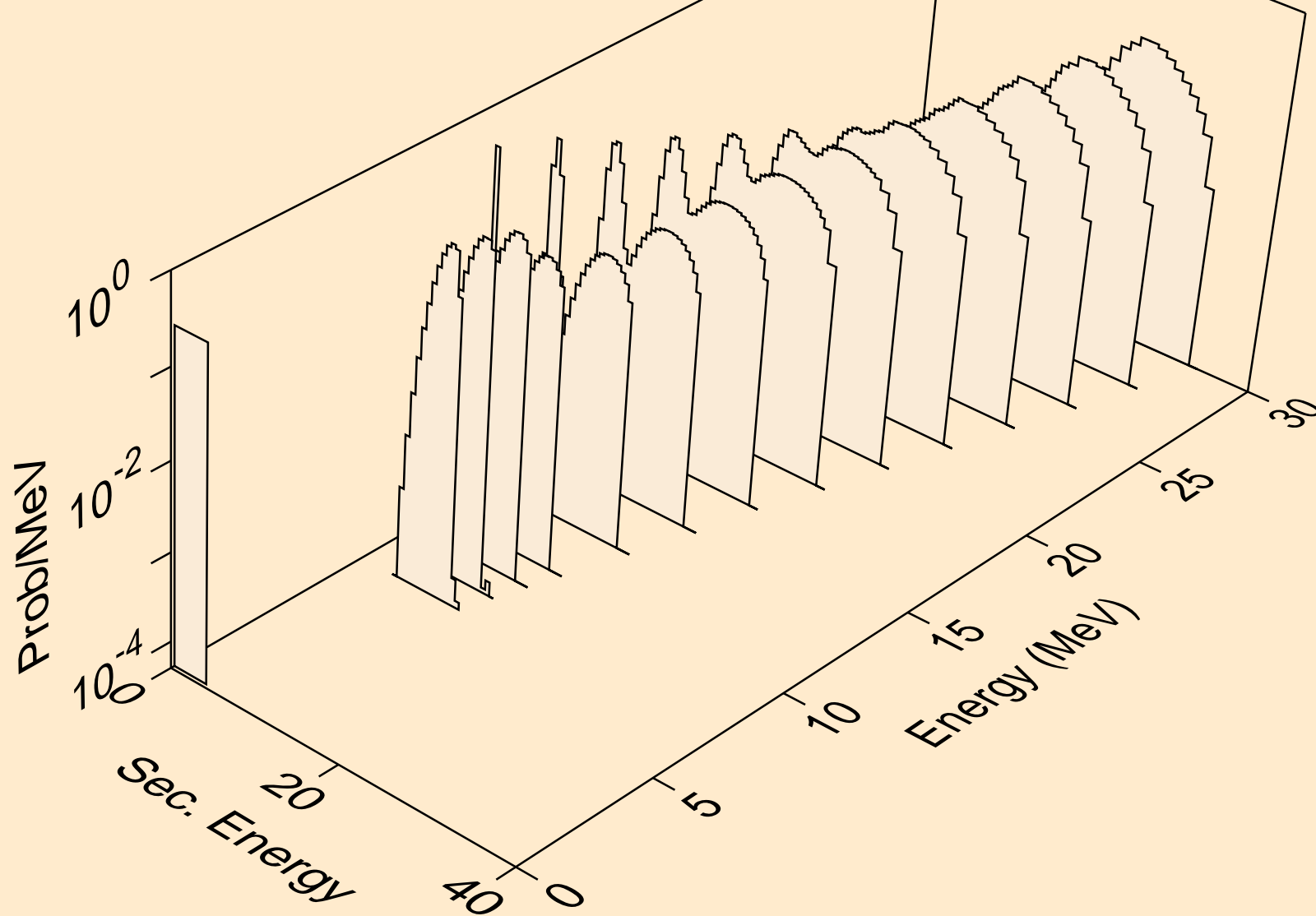

TM157 HELION ACER TENDL-2021 LIBRARY; T=0.K  
protons from (s,2p)

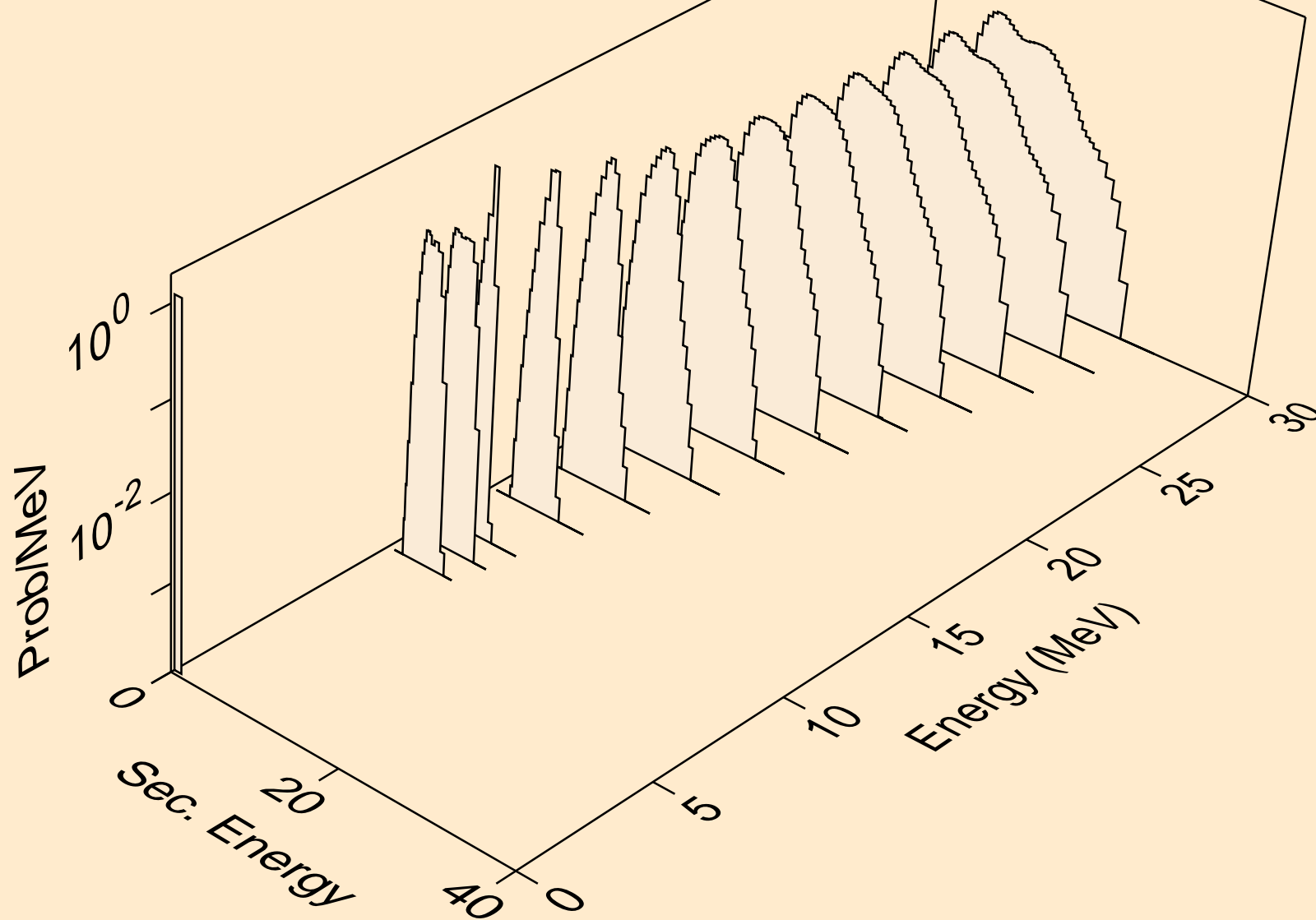



TM157 HELION ACER TENDL-2021 LIBRARY; T=0.K  
protons from (s,pa)

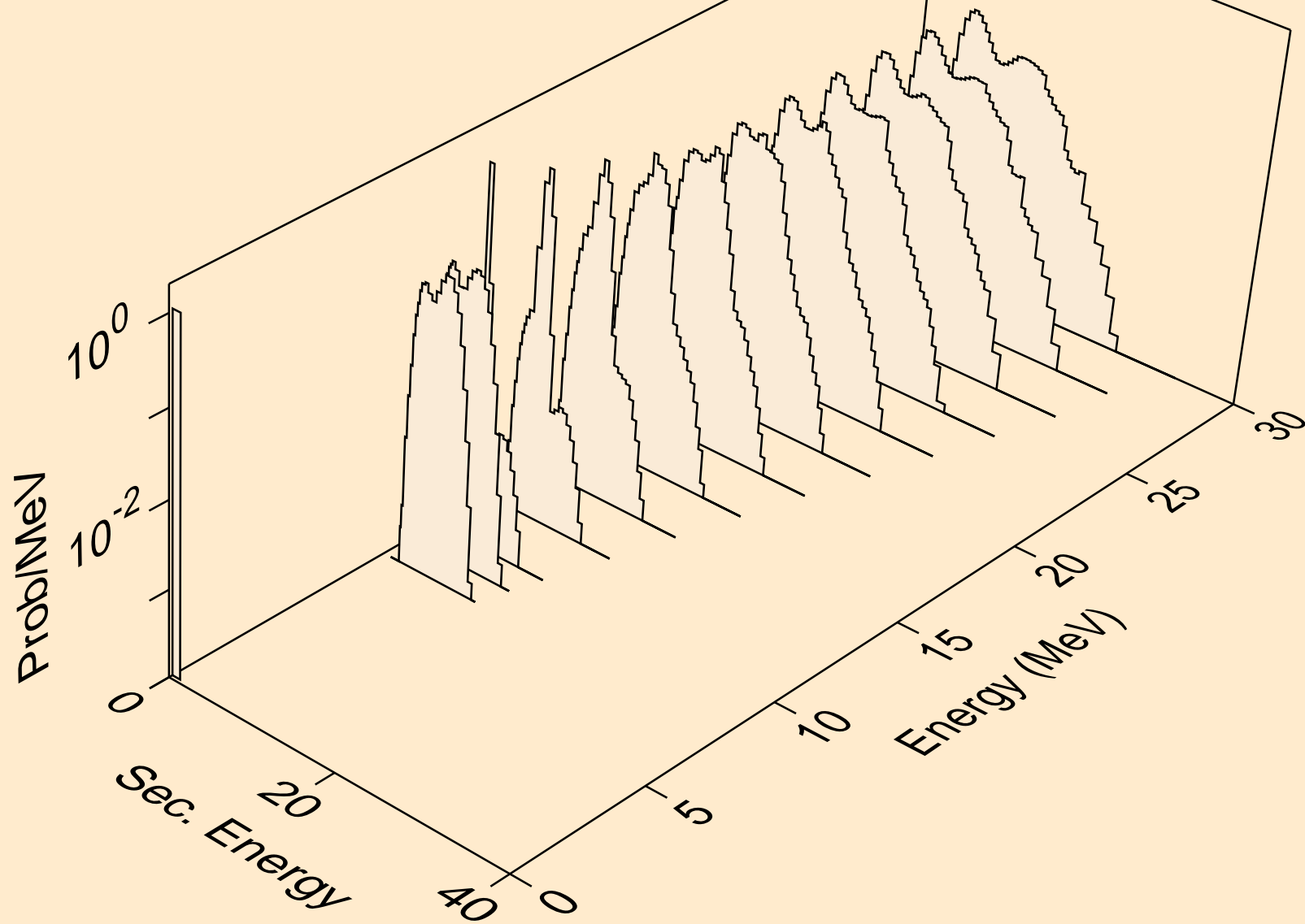

TM157 HELION ACER TENDL-2021 LIBRARY; T=0.K  
protons from (s,pd)

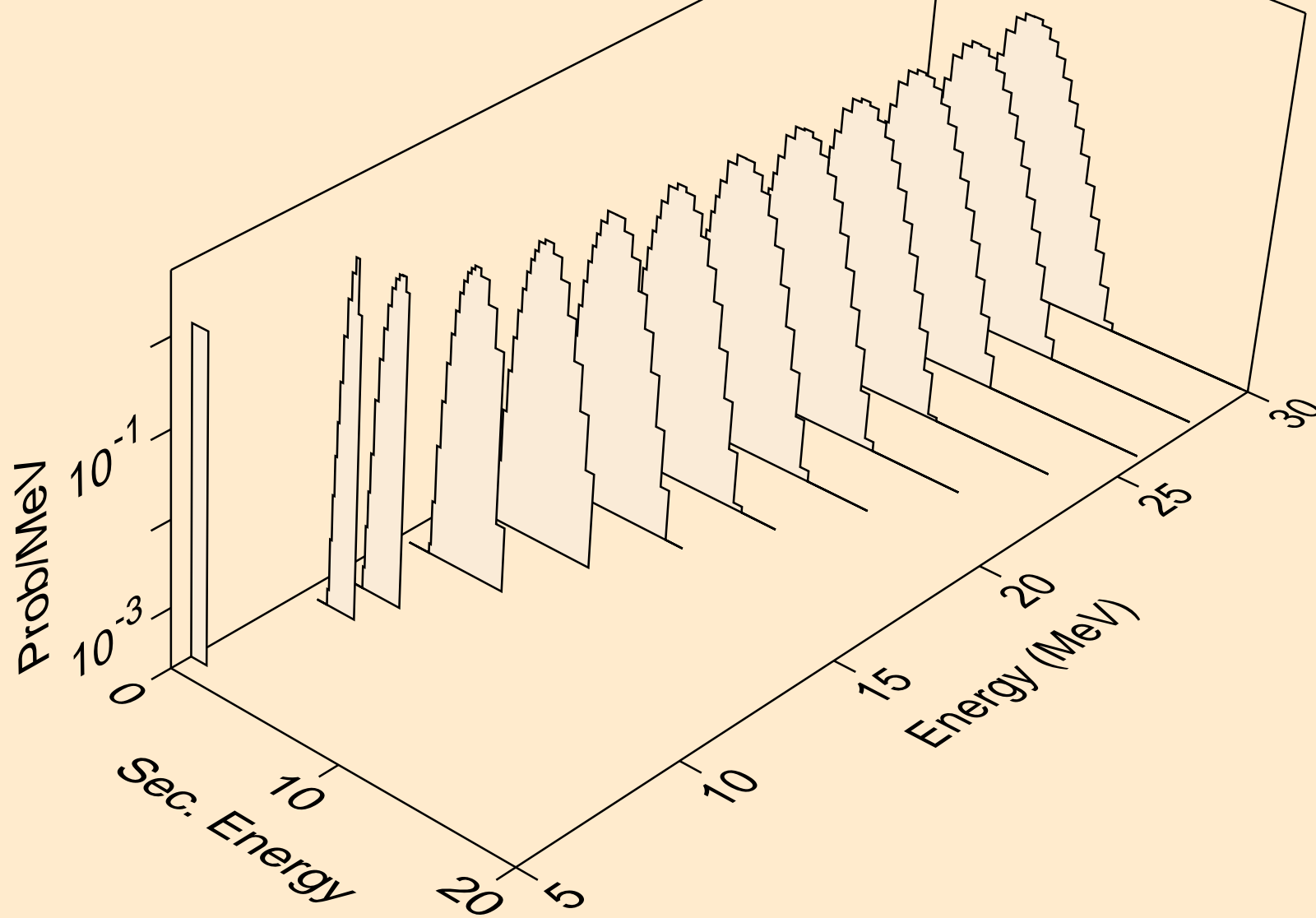

TM157 HELION ACER TENDL-2021 LIBRARY; T=0.K  
protons from (s,pt)

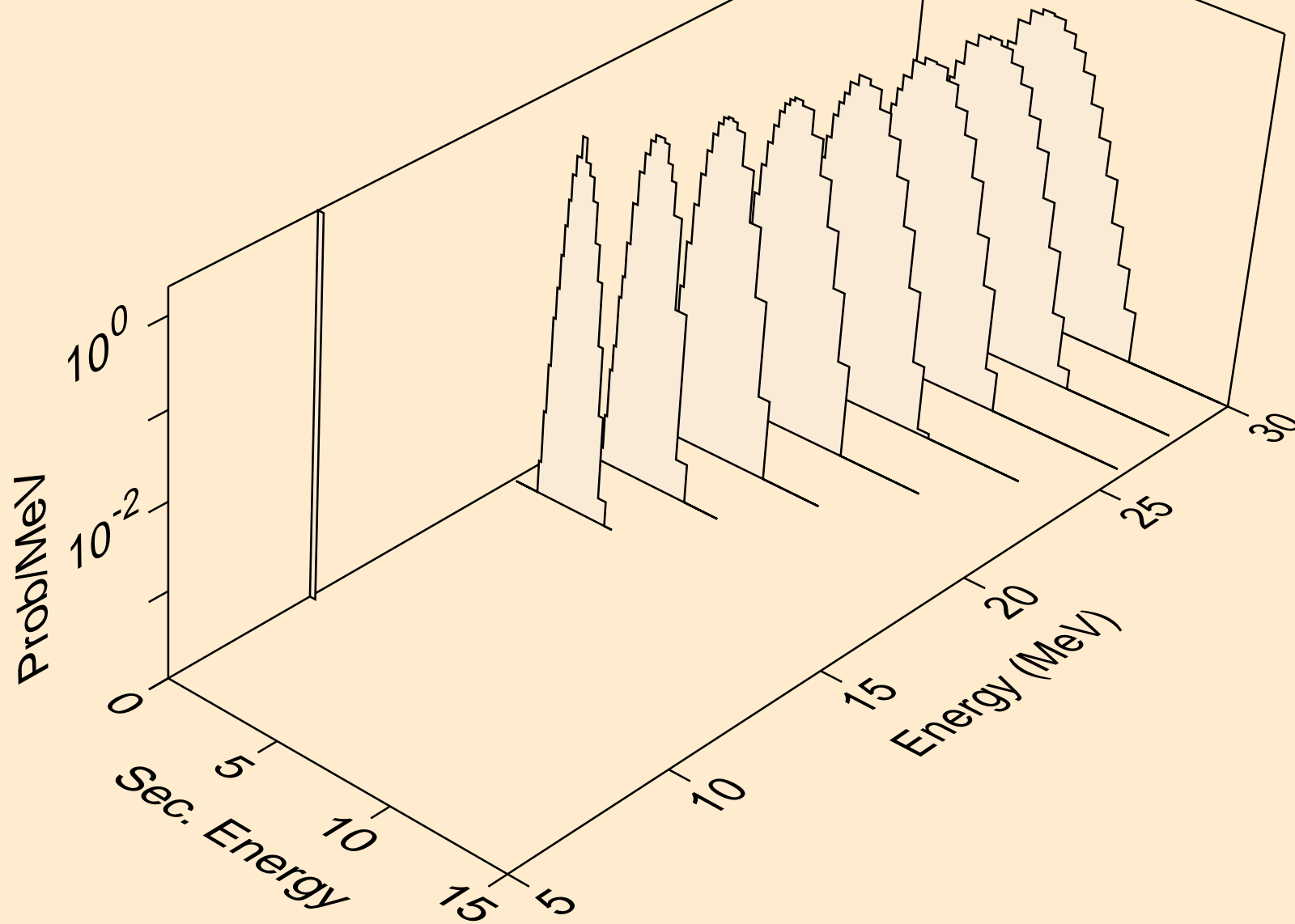

TM157 HELION ACER TENDL-2021 LIBRARY; T=0.K  
deuterons from (s,x)

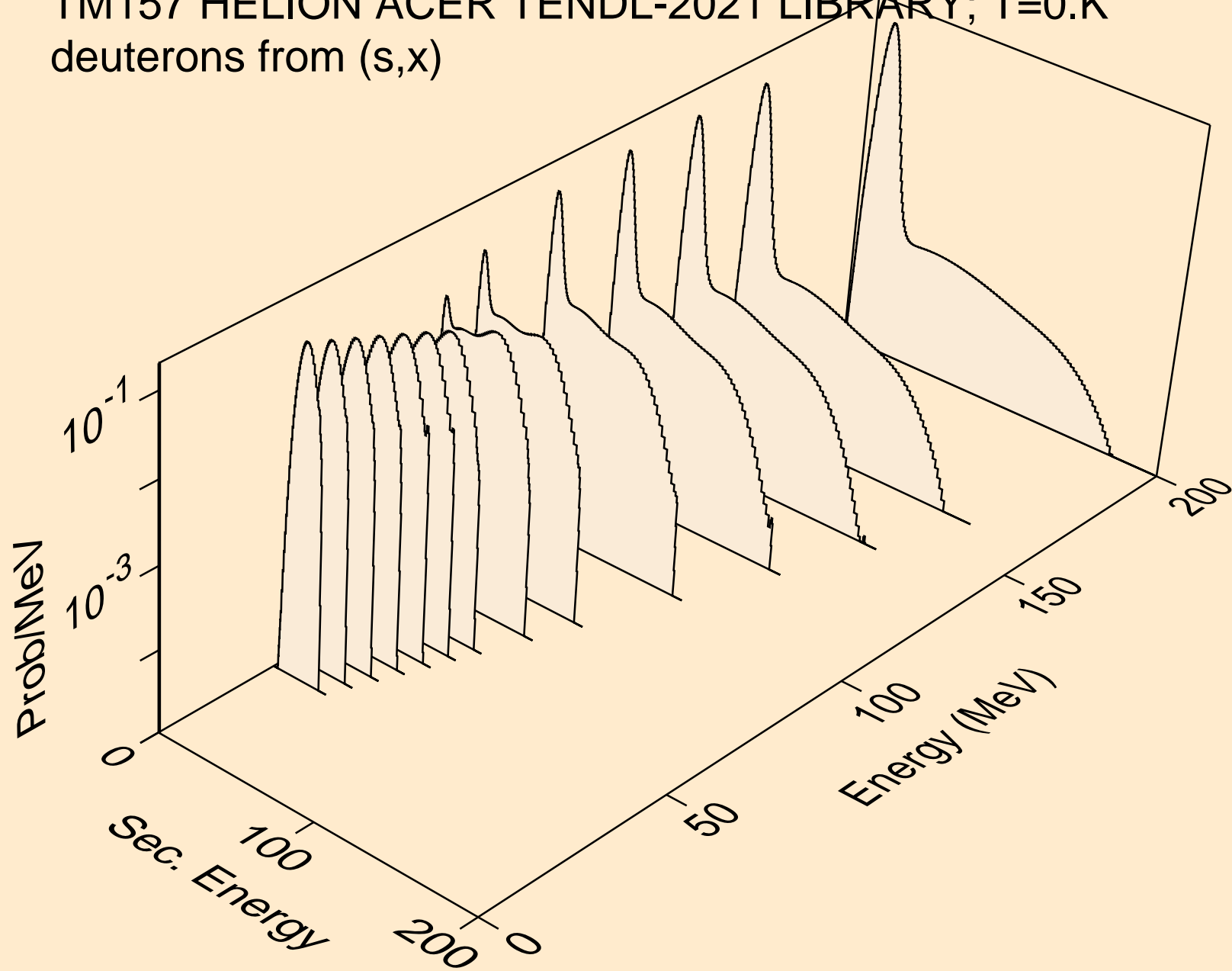

TM157 HELION ACER TENDL-2021 LIBRARY; T=0.K  
deuterons from (s,2nd)

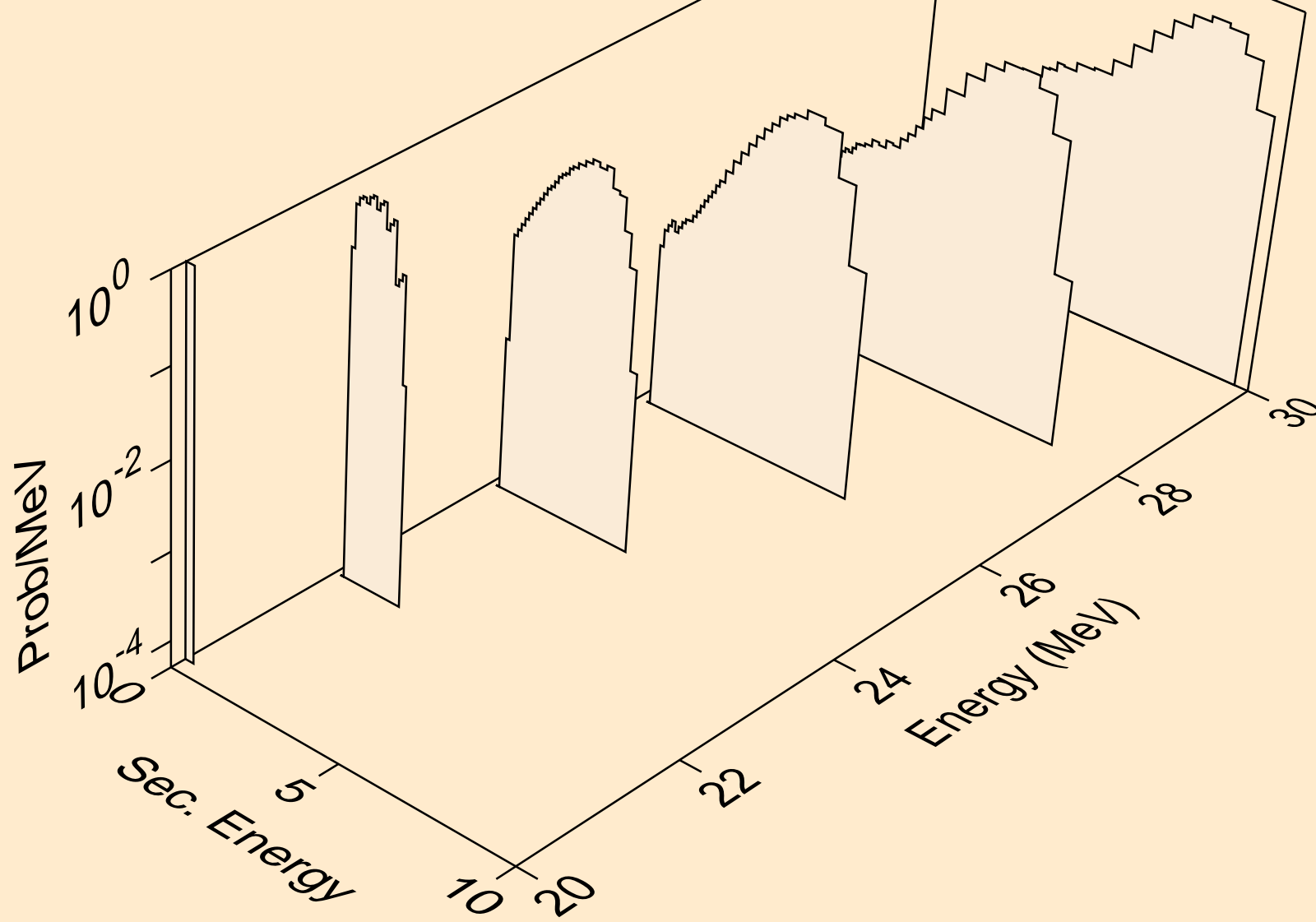

TM157 HELION ACER TENDL-2021 LIBRARY; T=0.K  
deuterons from (s,n\*)d

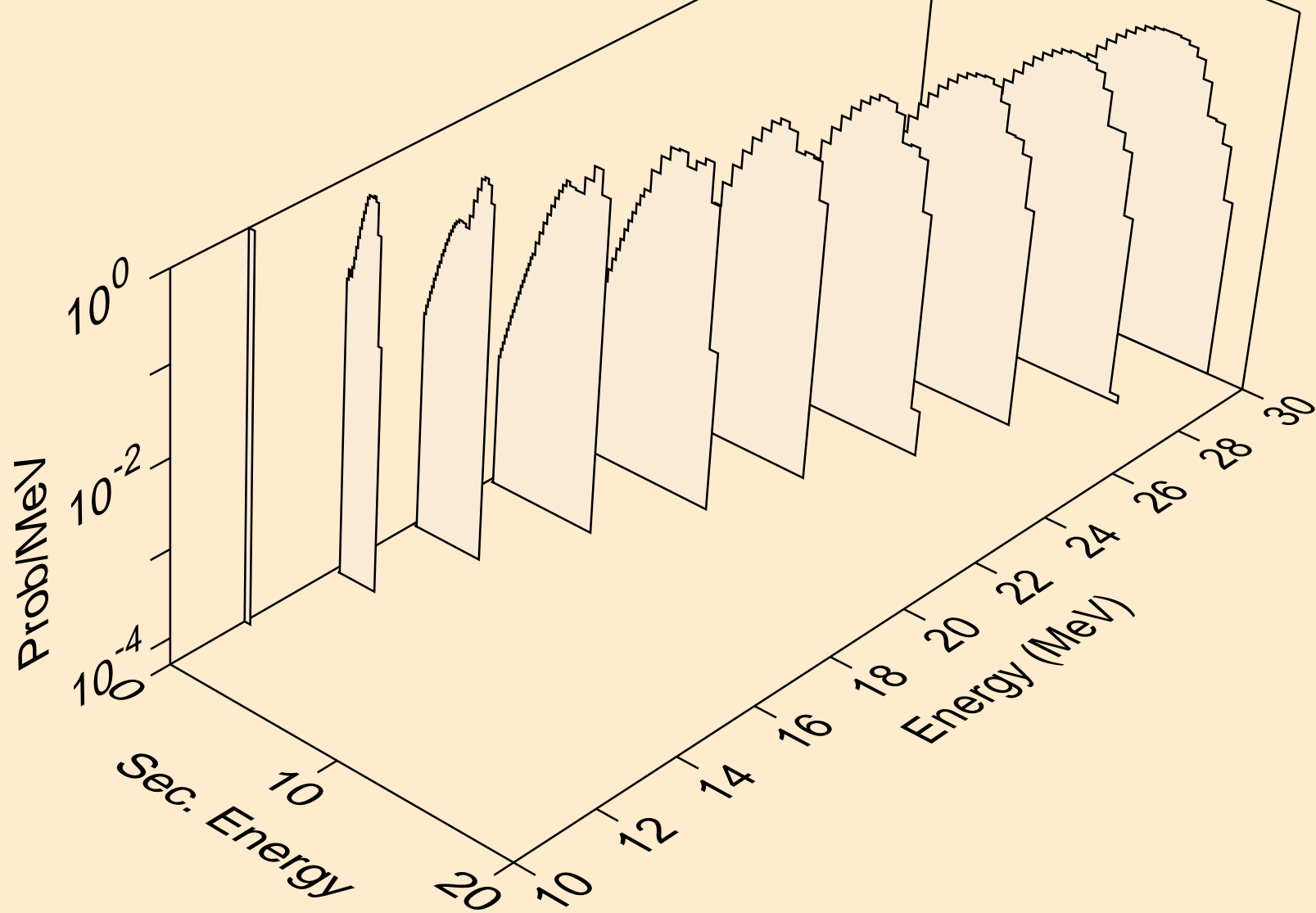

TM157 HELION ACER TENDL-2021 LIBRARY; T=0.K  
deuterons from (s,d)

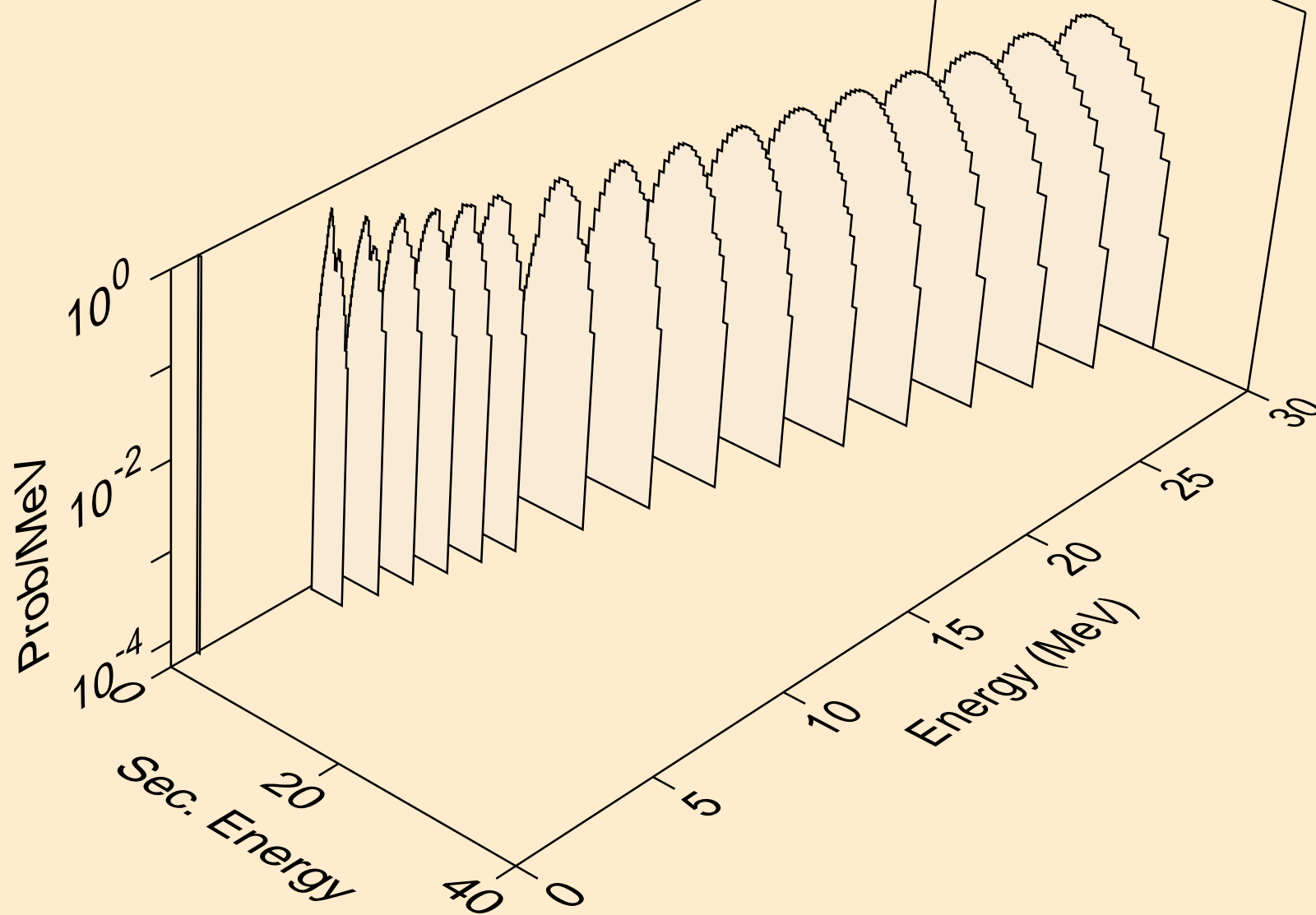

TM157 HELION ACER TENDL-2021 LIBRARY; T=0.K  
deuterons from (s,d2a)

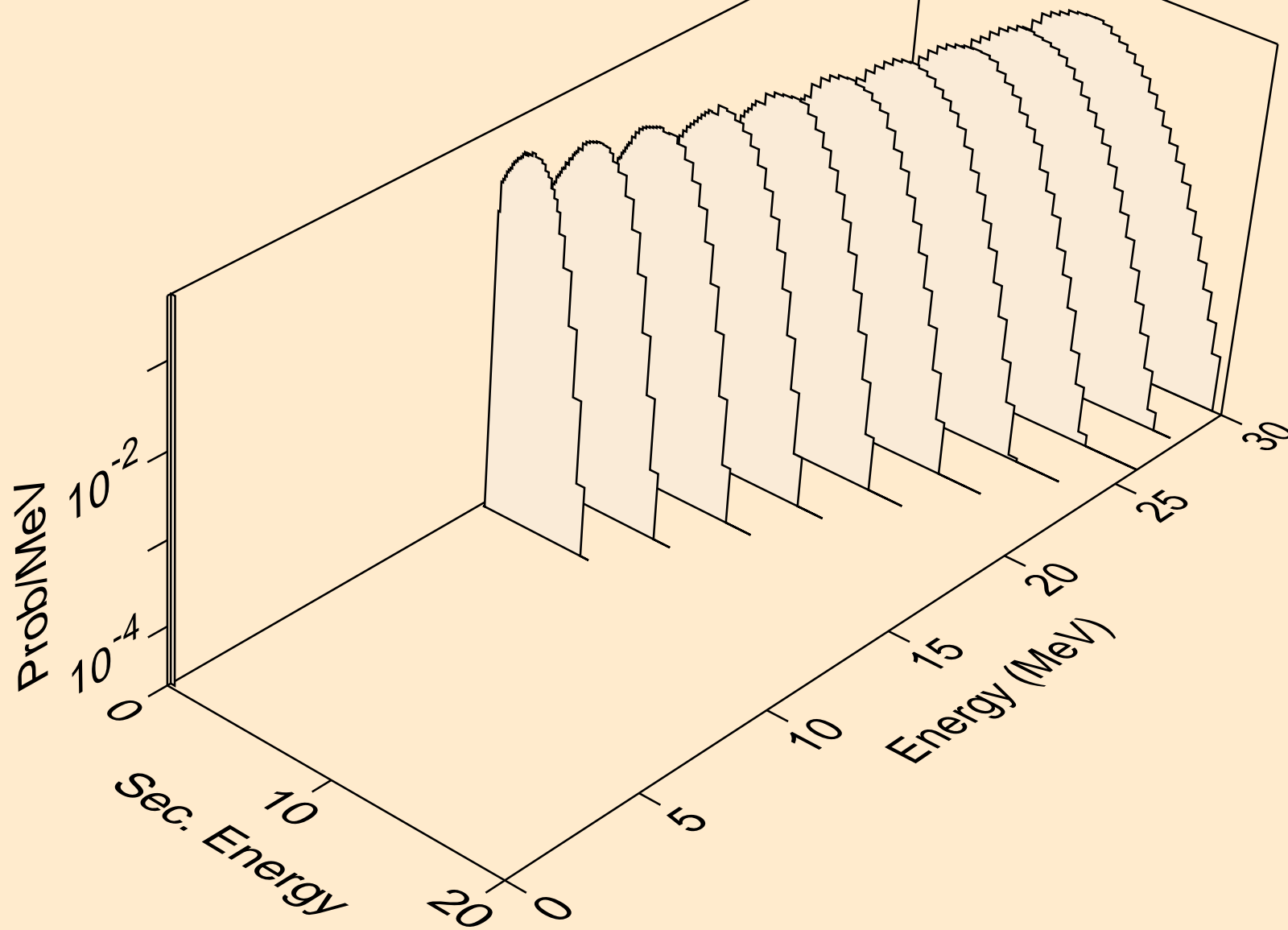



TM157 HELION ACER TENDL-2021 LIBRARY; T=0.K  
deuterons from (s,pd)

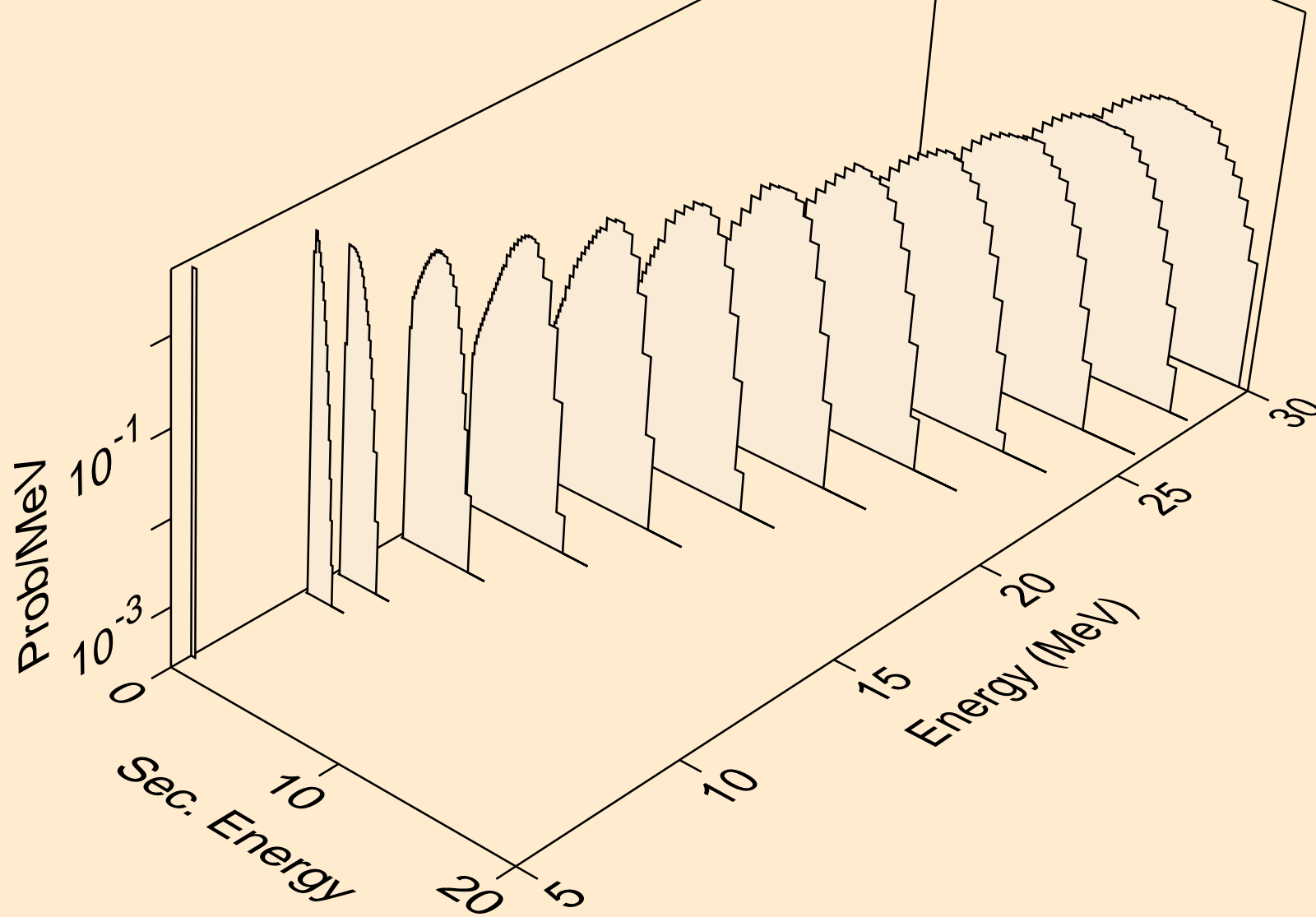

TM157 HELION ACER TENDL-2021 LIBRARY; T=0.K  
deuterons from (s,da)

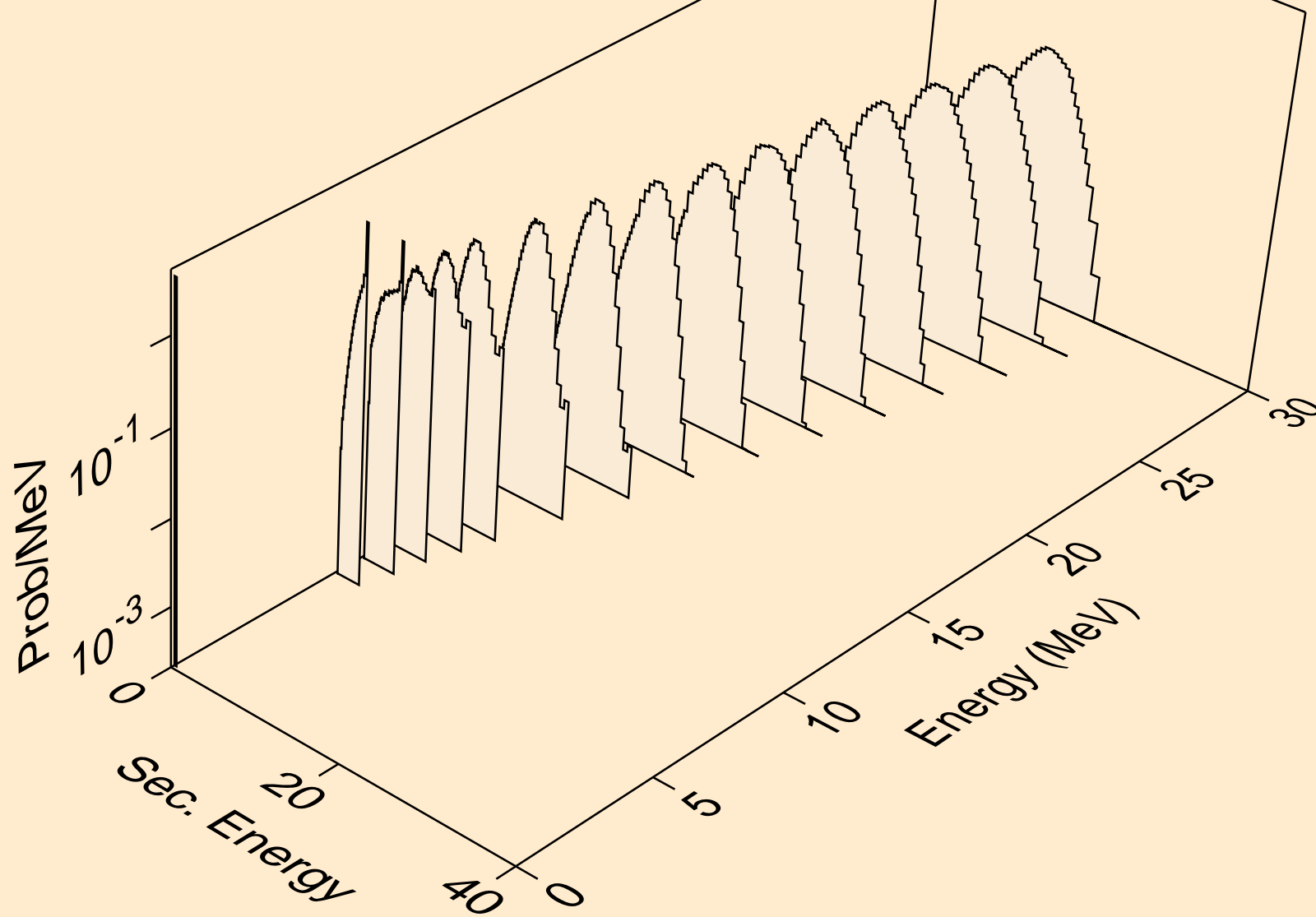

TM157 HELION ACER TENDL-2021 LIBRARY; T=0.K  
tritons from (s,x)

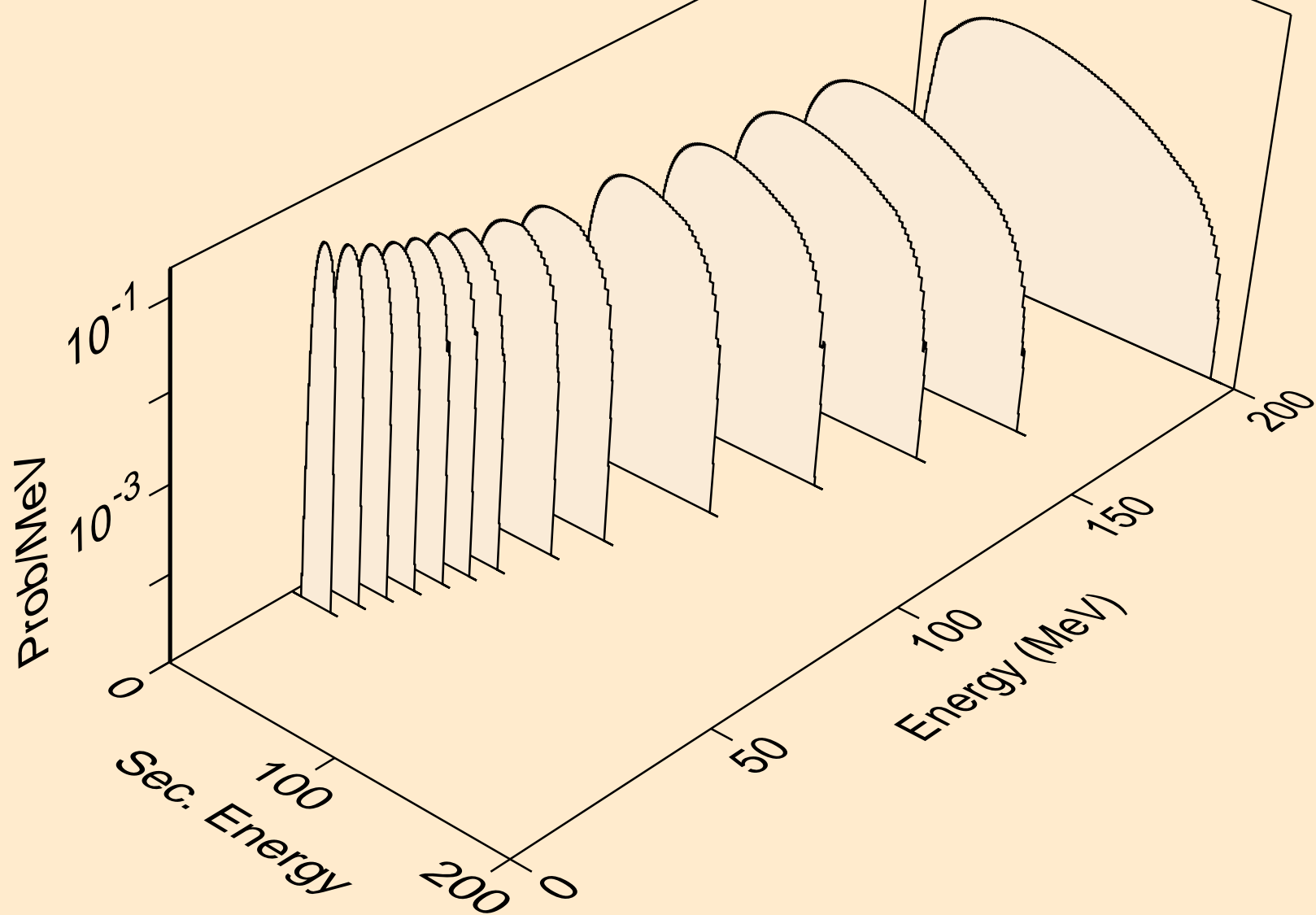

TM157 HELION ACER TENDL-2021 LIBRARY; T=0.K  
tritons from (s,n\*)t

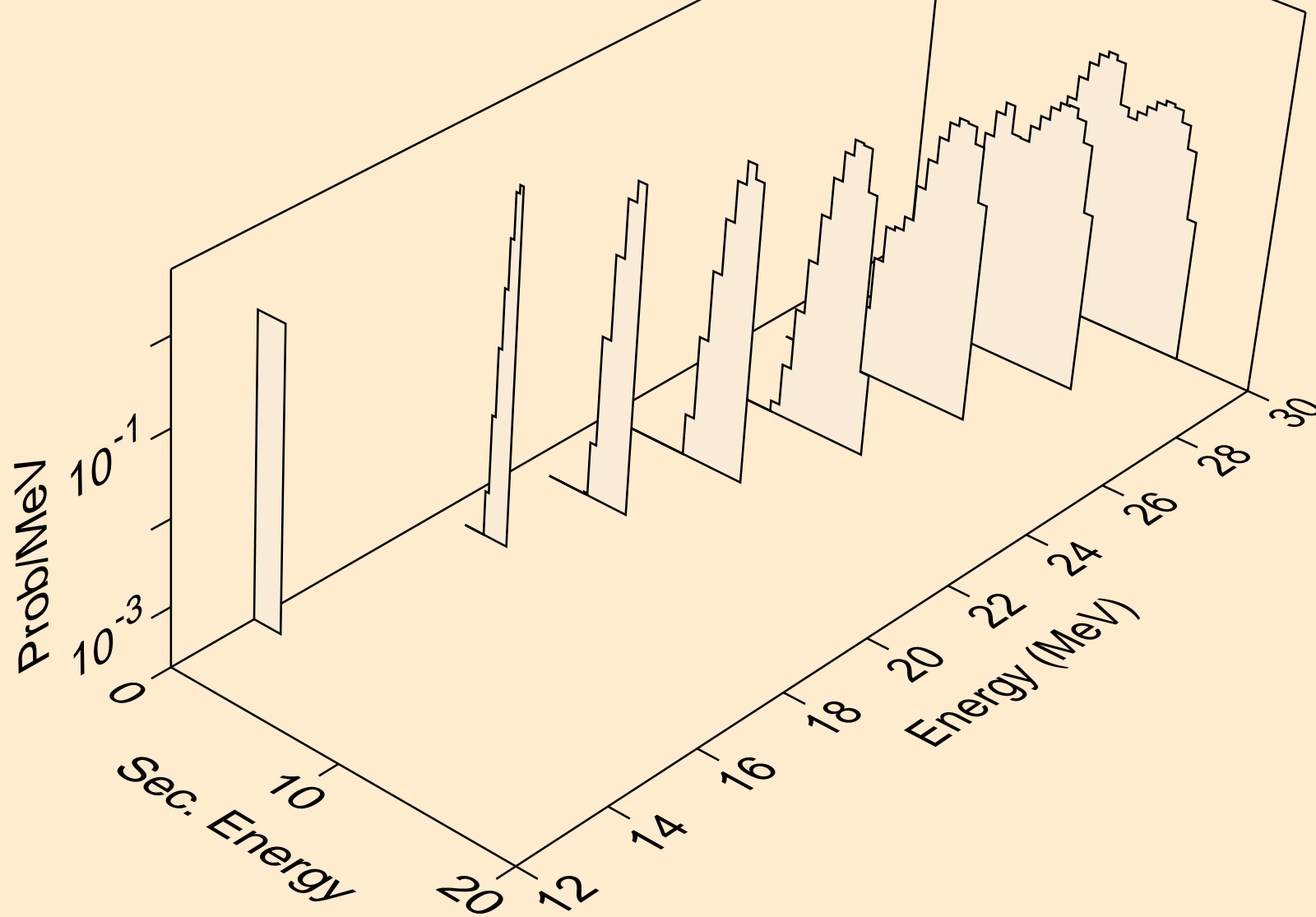

TM157 HELION ACER TENDL-2021 LIBRARY; T=0.K  
tritons from (s,t)

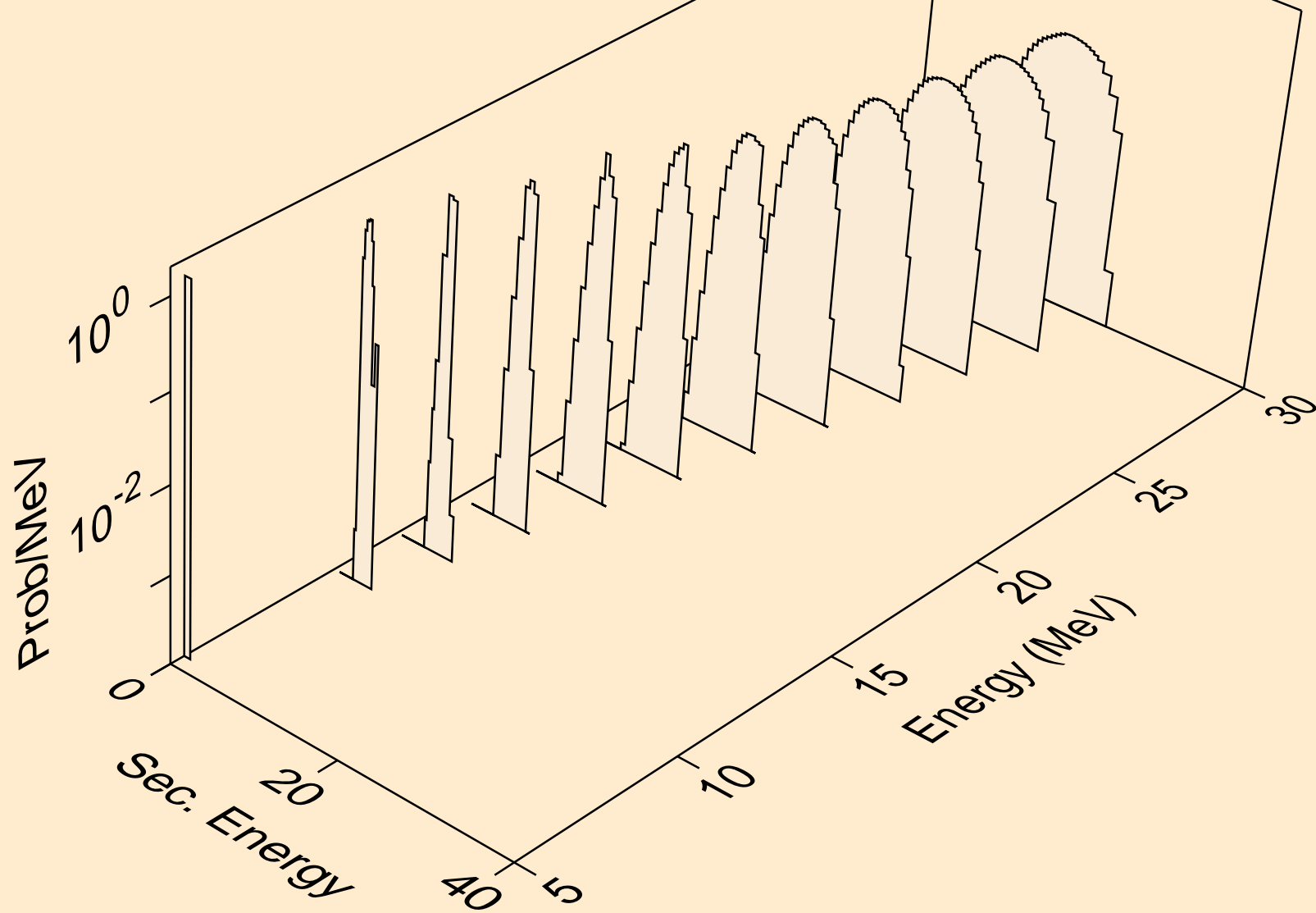

TM157 HELION ACER TENDL-2021 LIBRARY; T=0.K  
tritons from (s,t2a)

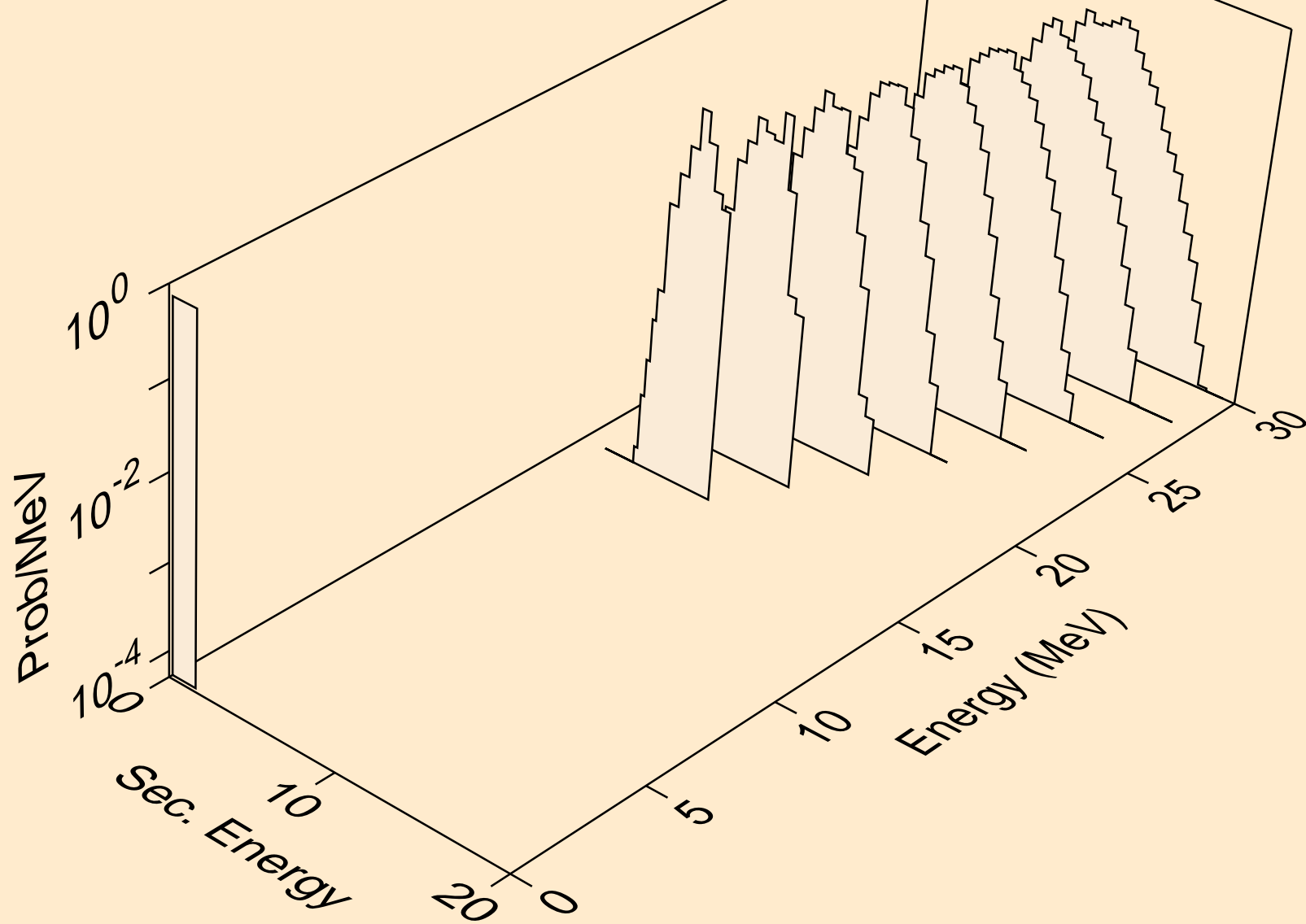

TM157 HELION ACER TENDL-2021 LIBRARY; T=0.K  
tritons from (s,pt)

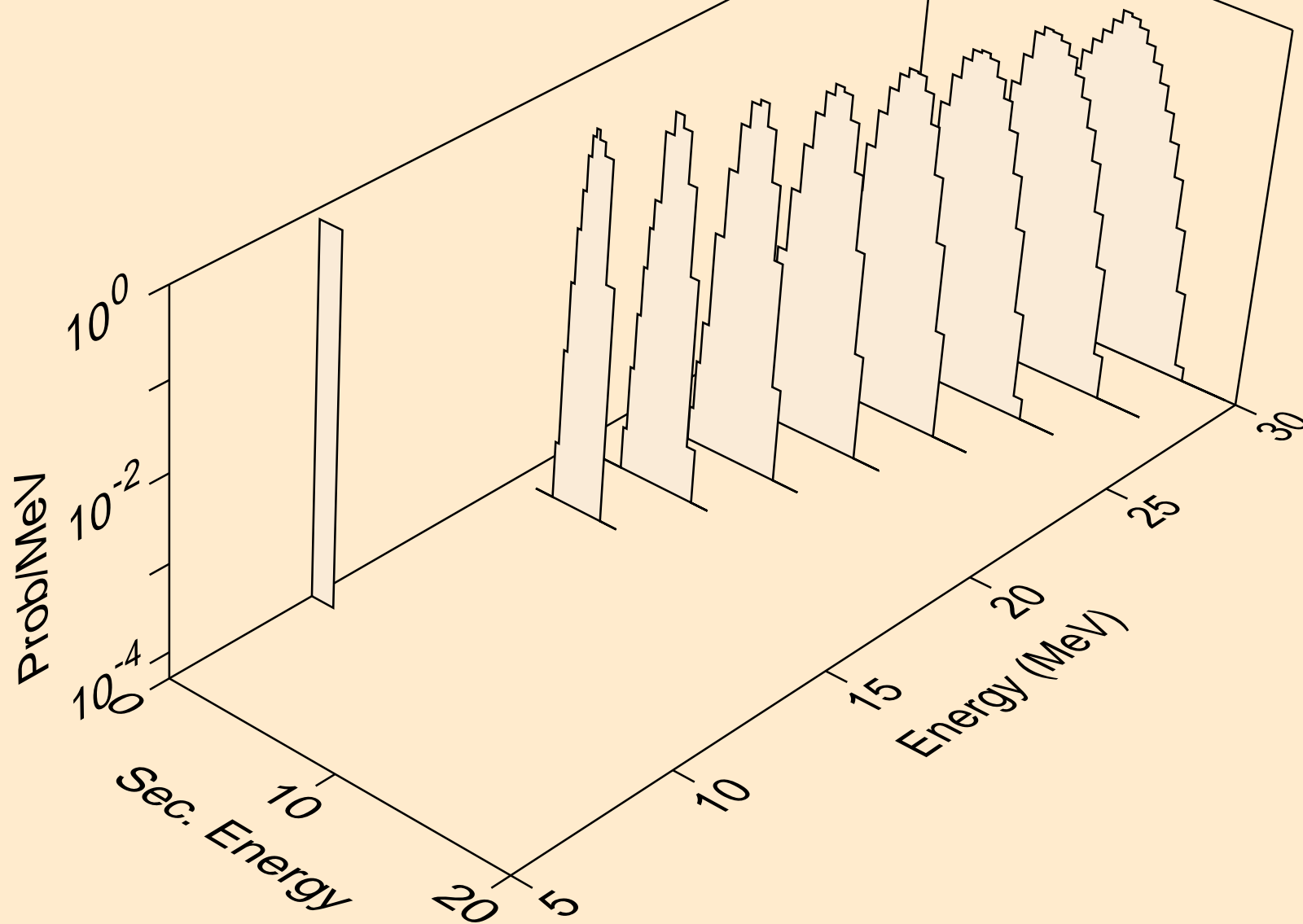

TM157 HELION ACER TENDL-2021 LIBRARY; T=0.K  
alphas from (s,x)

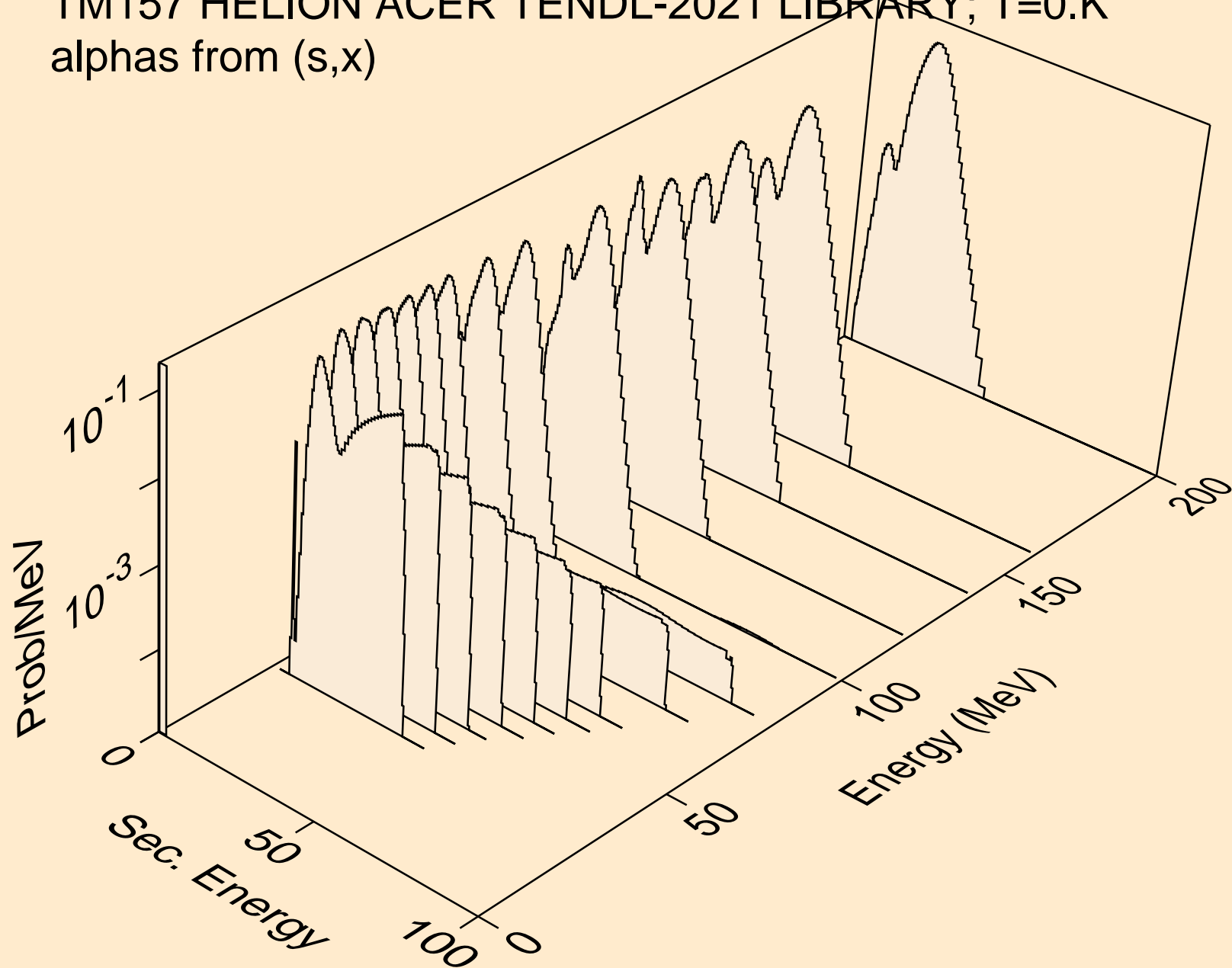



TM157 HELION ACER TENDL-2021 LIBRARY; T=0.K  
alphas from (s,n\*)a

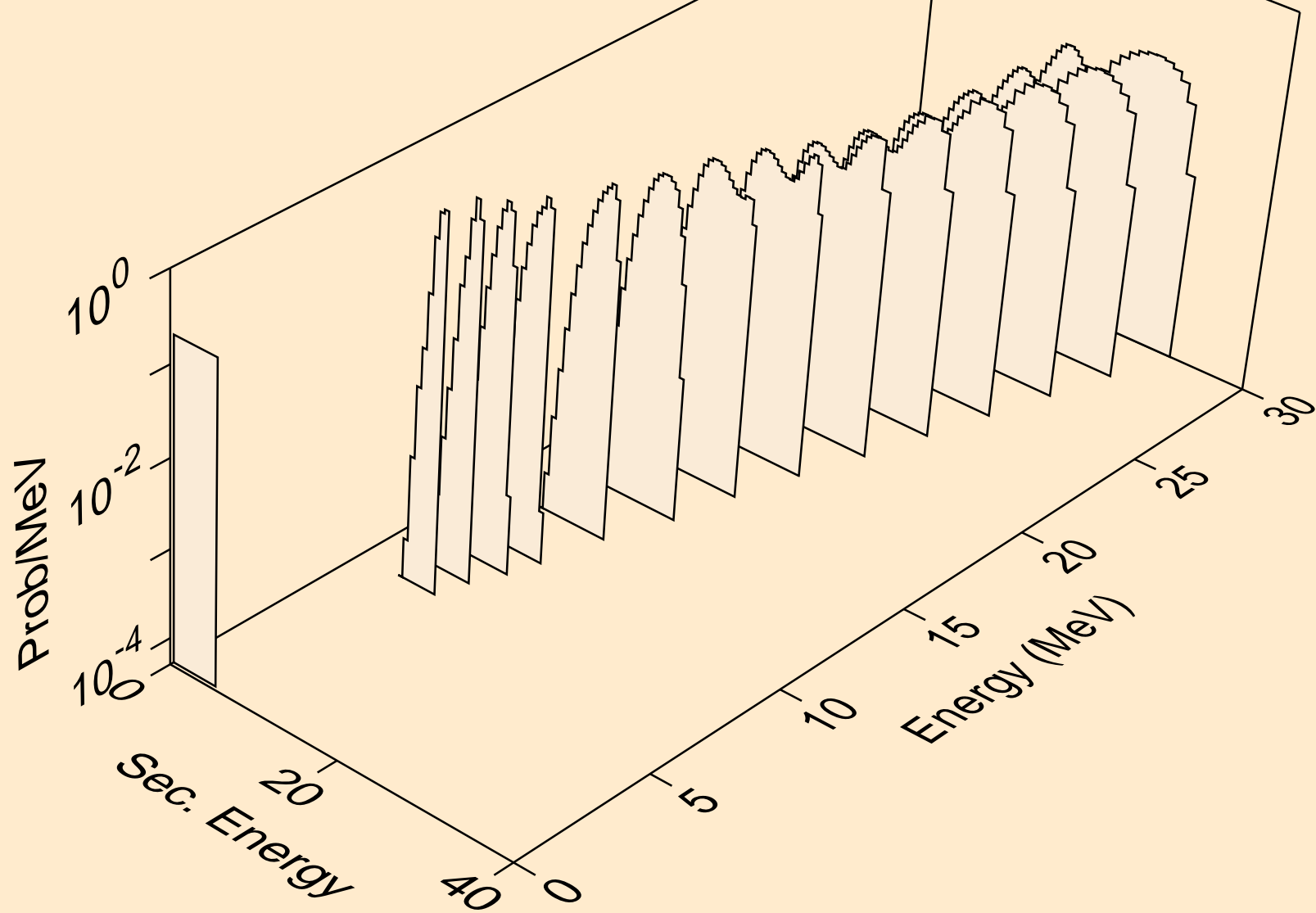

TM157 HELION ACER TENDL-2021 LIBRARY; T=0.K  
alphas from (s,2n)a

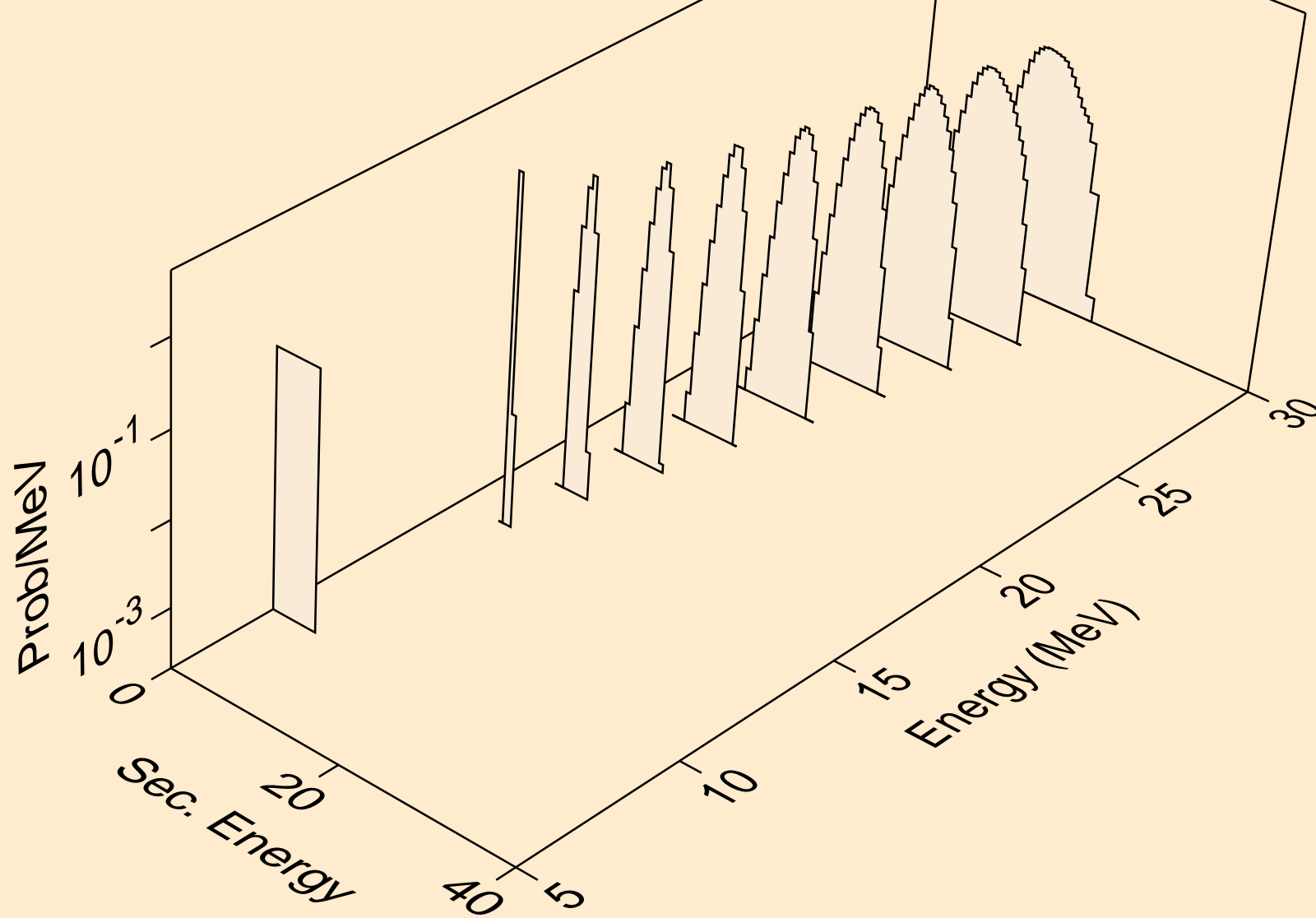

TM157 HELION ACER TENDL-2021 LIBRARY; T=0.K  
alphas from (s,3n)a

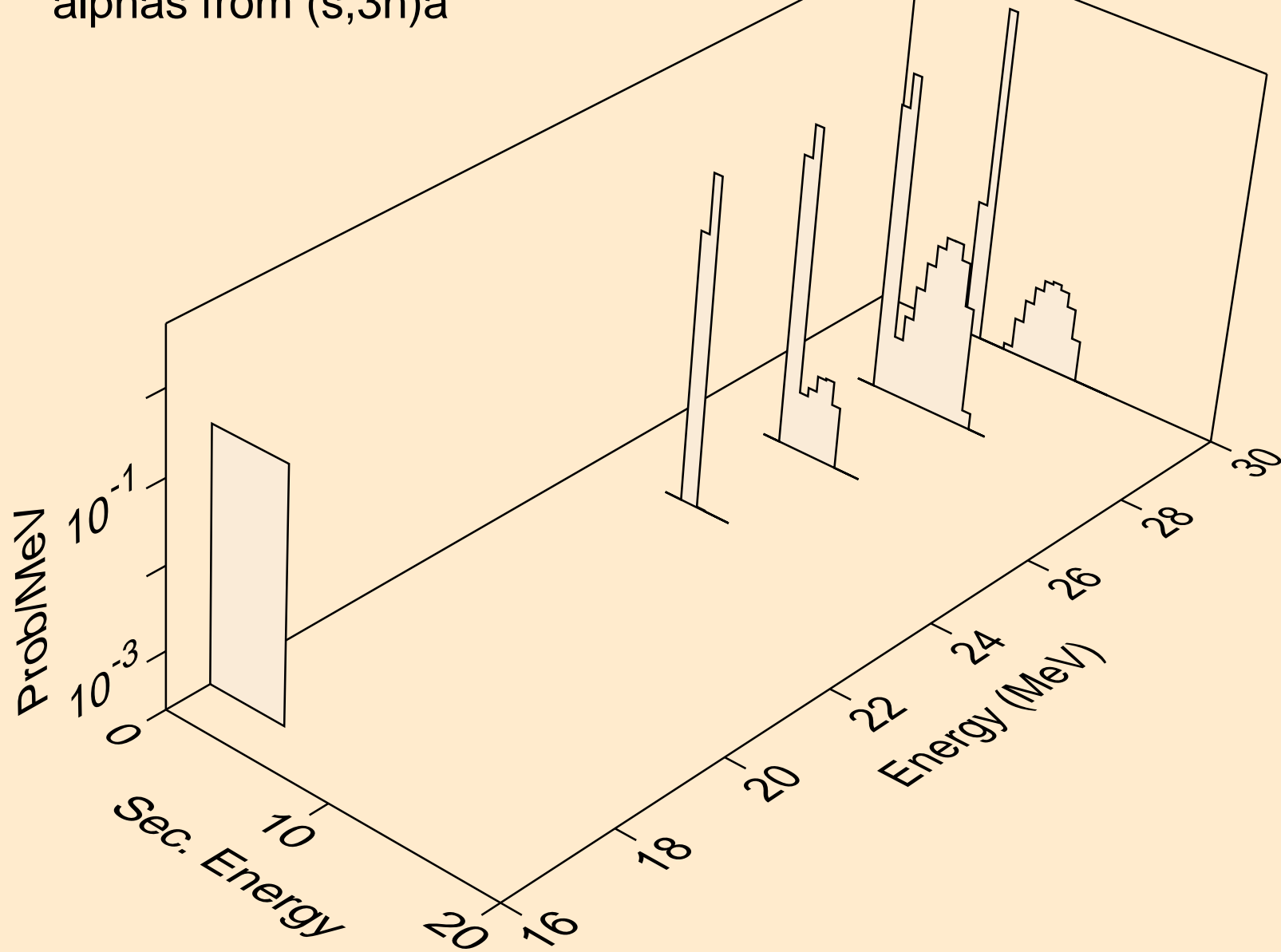

TM157 HELION ACER TENDL-2021 LIBRARY; T=0.K  
alphas from (s,n\*)2a

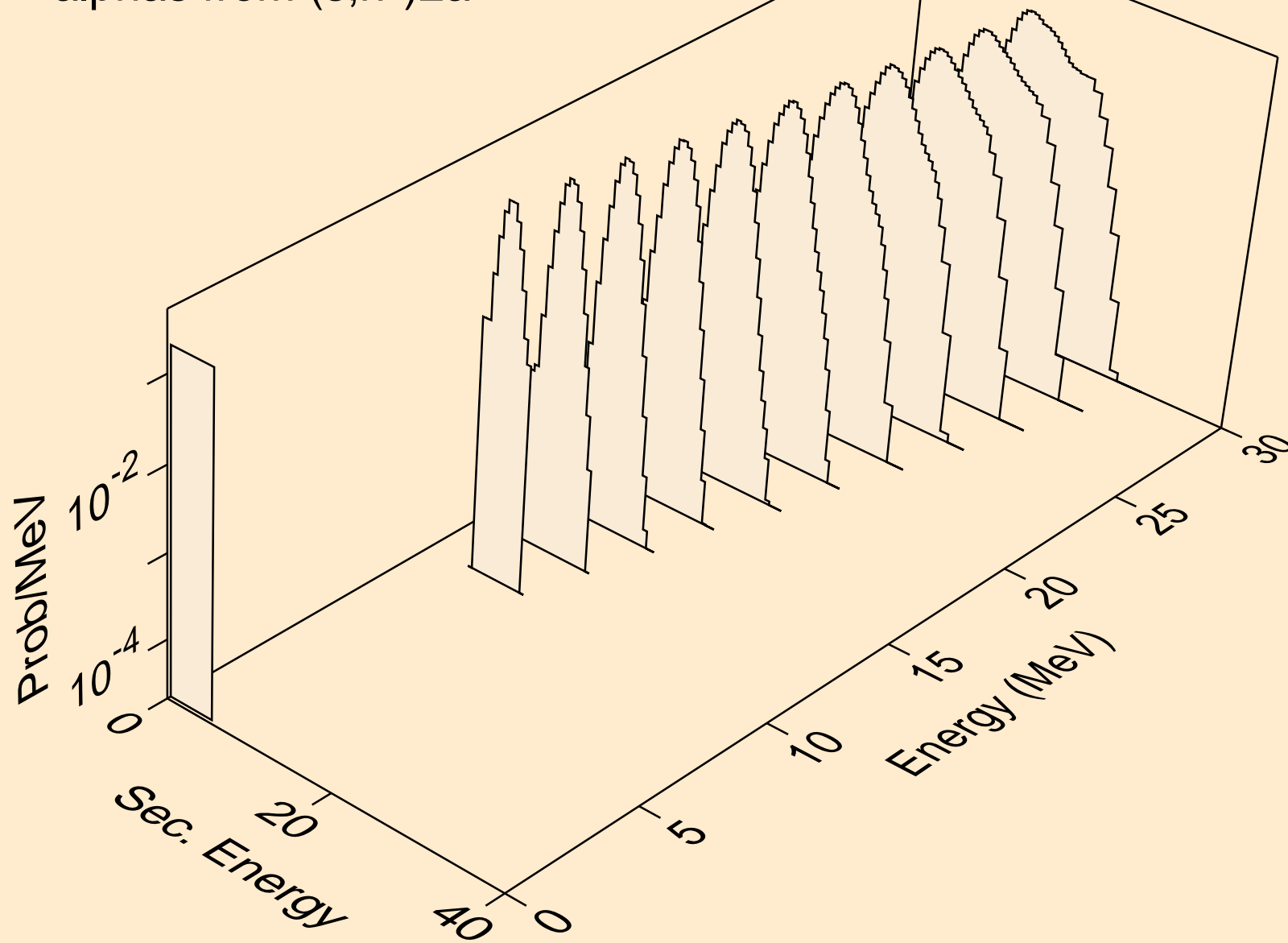

TM157 HELION ACER TENDL-2021 LIBRARY; T=0.K  
alphas from (s,2n)2a

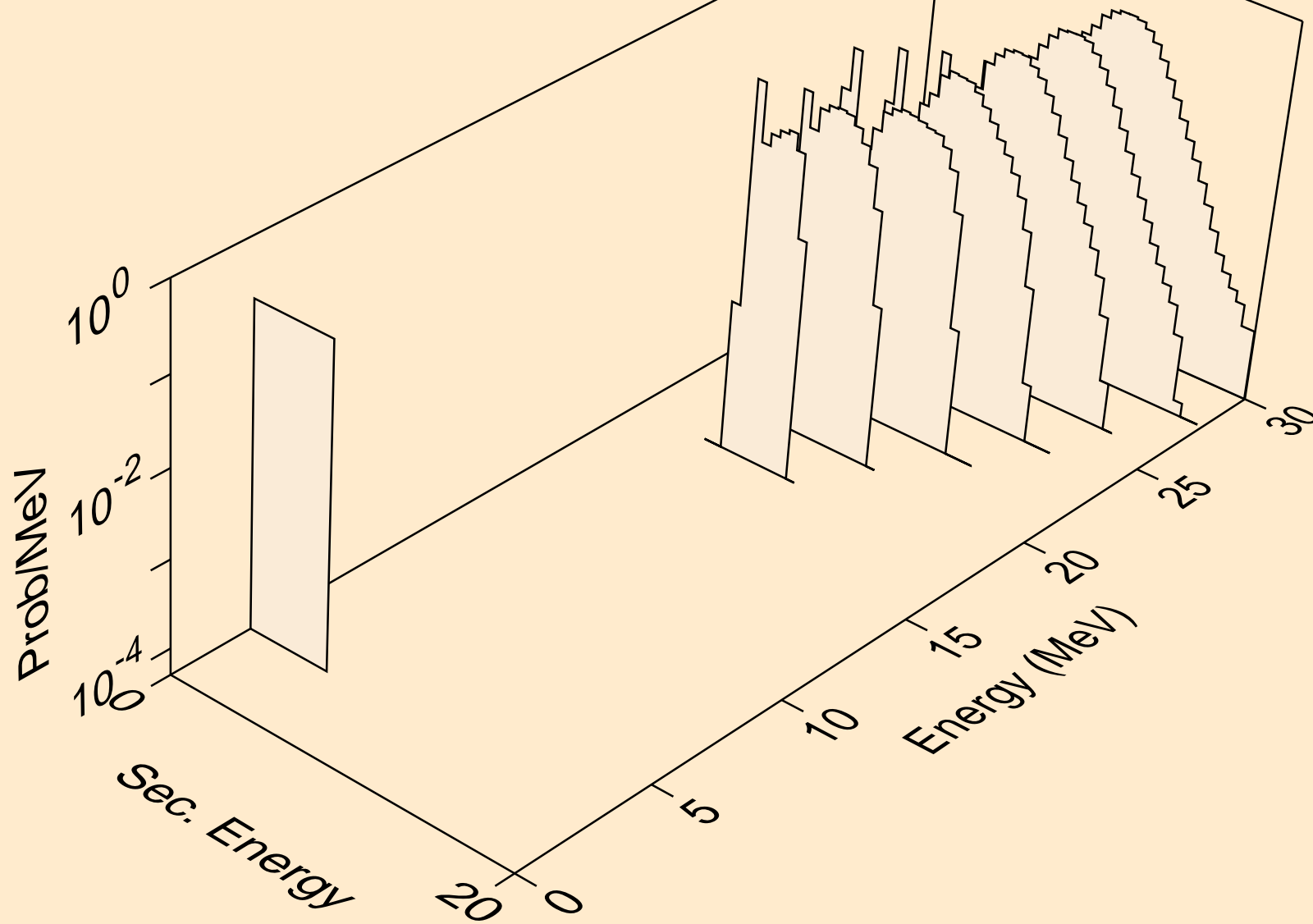

TM157 HELION ACER TENDL-2021 LIBRARY; T=0.K  
alphas from (s,npa)

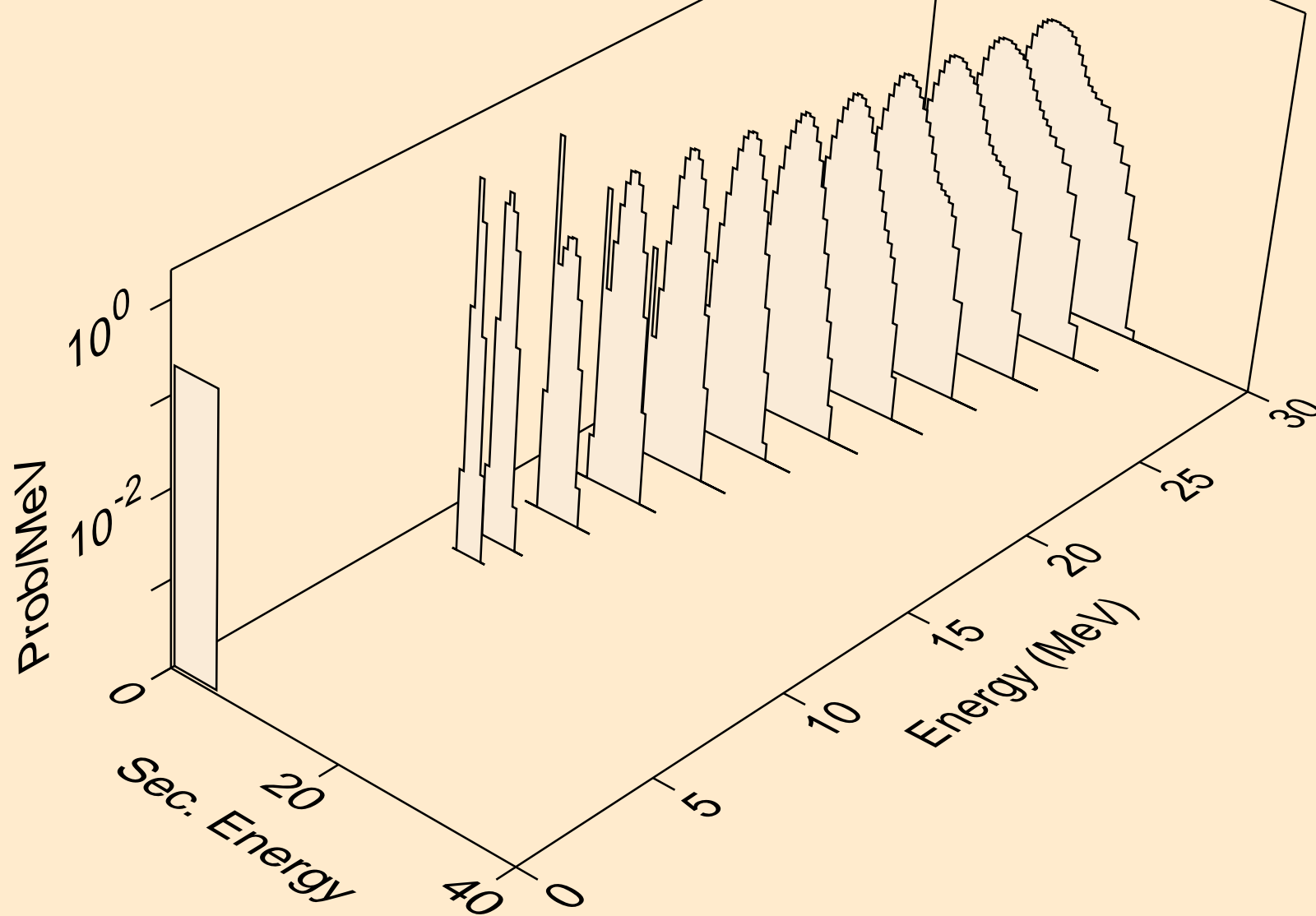

TM157 HELION ACER TENDL-2021 LIBRARY; T=0.K  
alphas from (s,a)

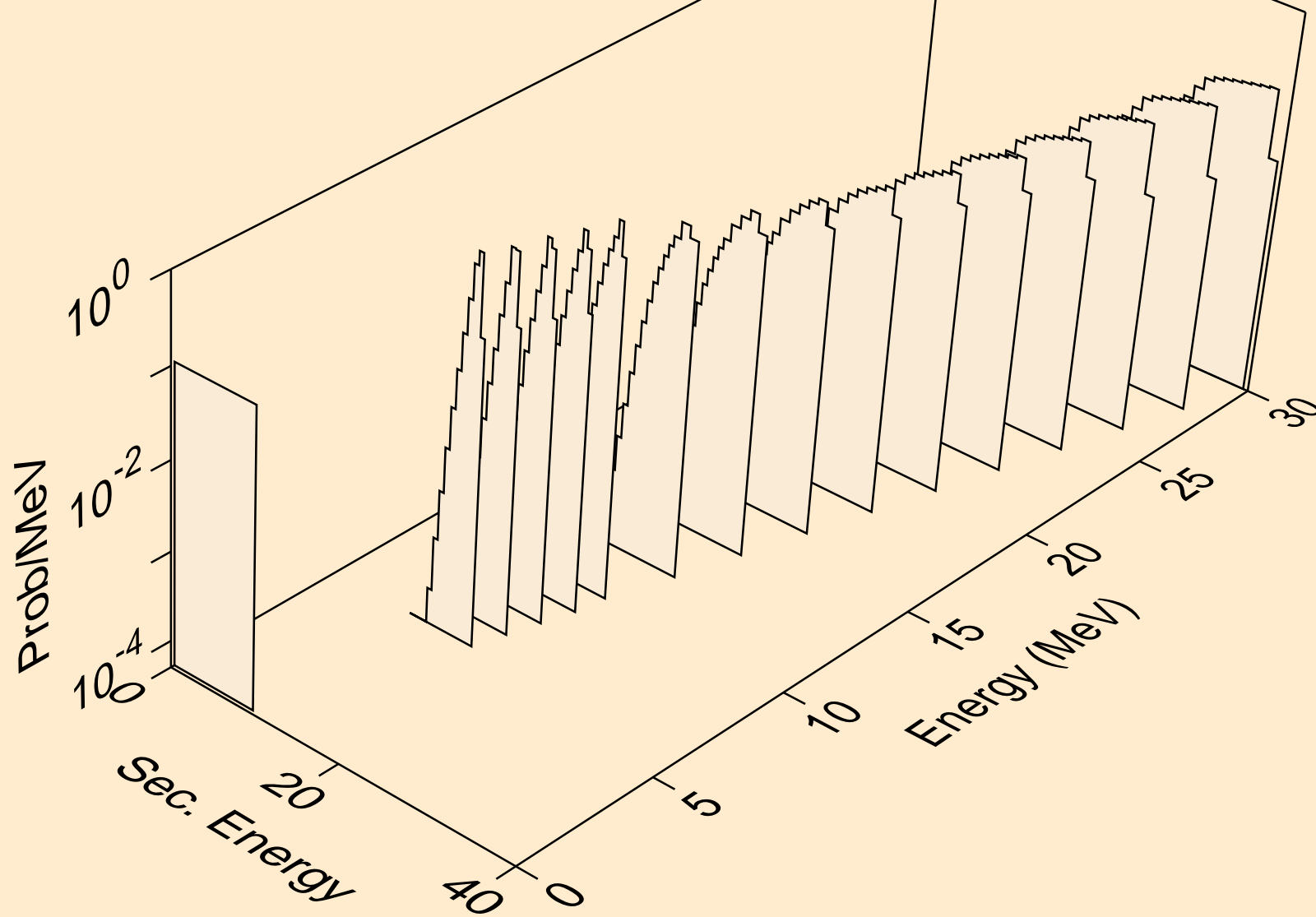

TM157 HELION ACER TENDL-2021 LIBRARY; T=0.K  
alphas from (s,2a)

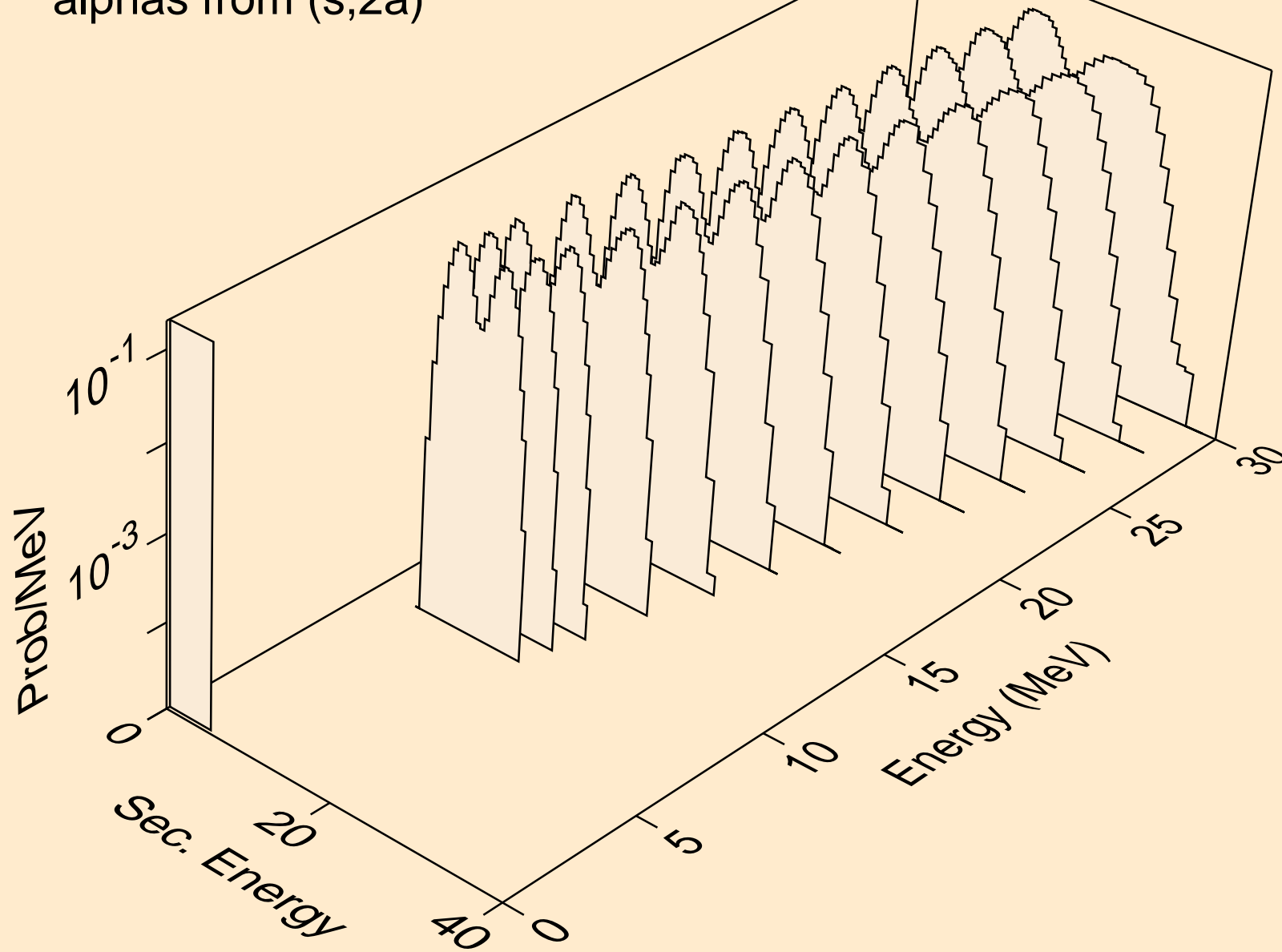



TM157 HELION ACER TENDL-2021 LIBRARY; T=0.K  
alphas from (s,3a)

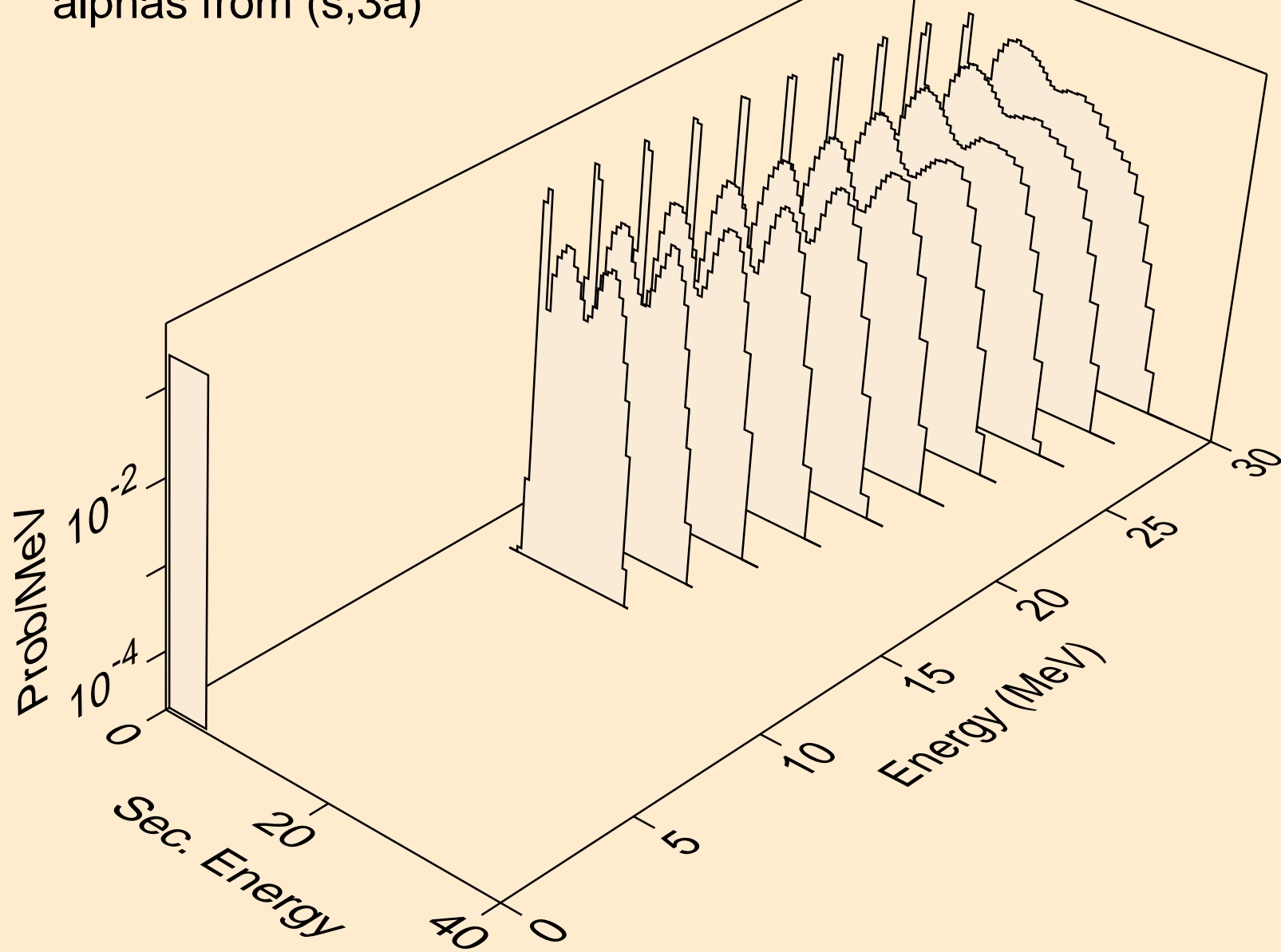

TM157 HELION ACER TENDL-2021 LIBRARY; T=0.K  
alphas from (s,pa)

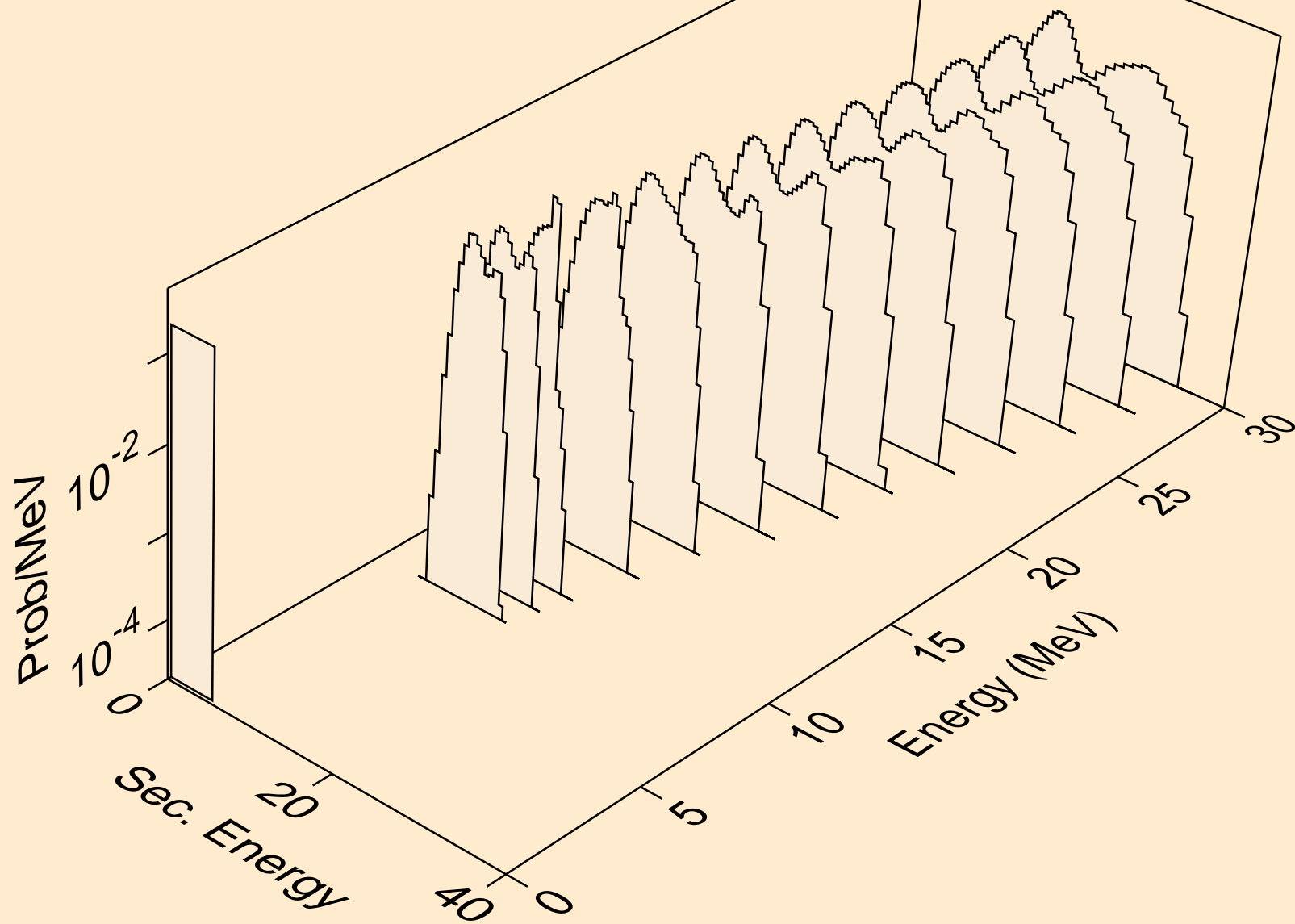

TM157 HELION ACER TENDL-2021 LIBRARY; T=0.K  
alphas from (s,t2a)

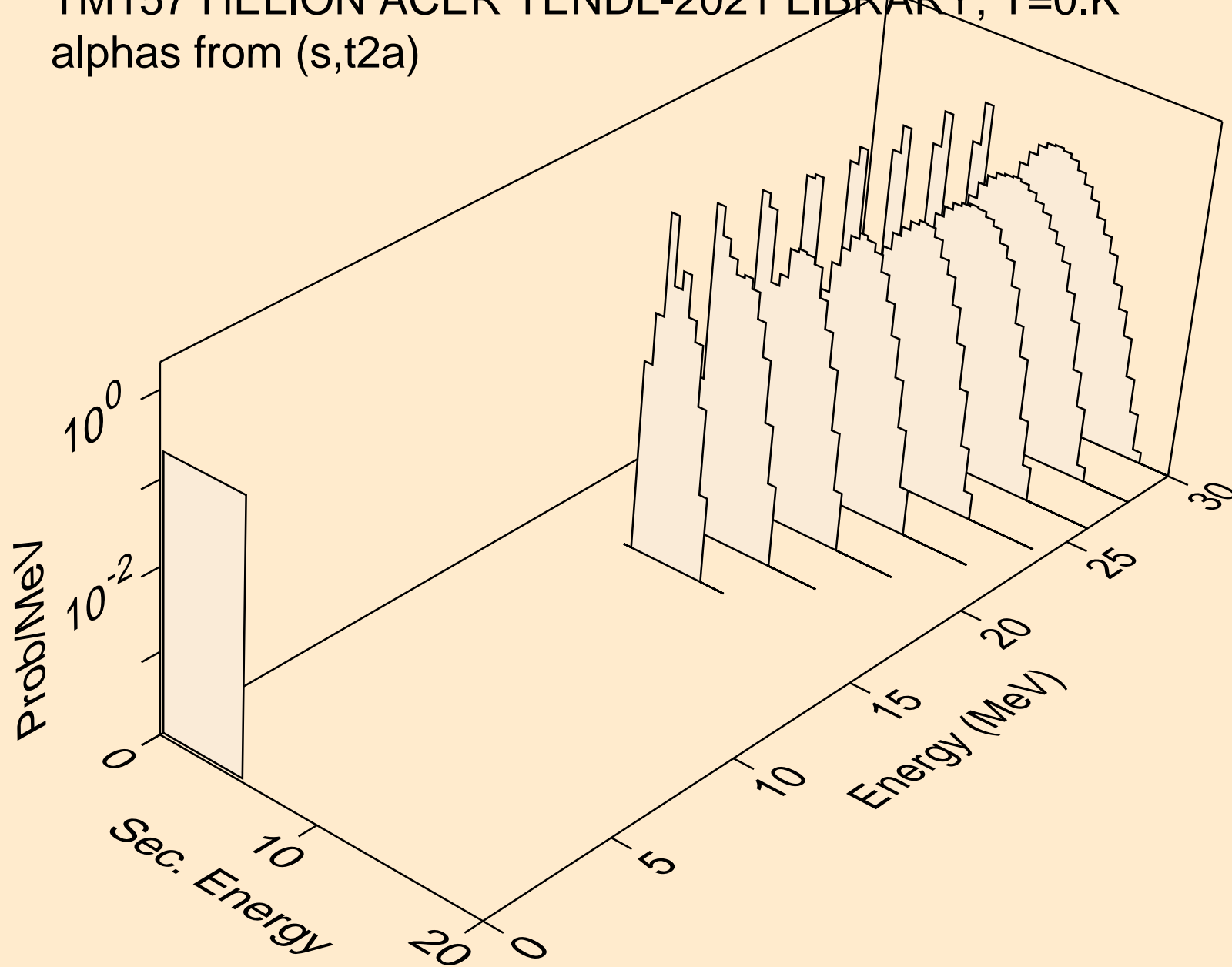

TM157 HELION ACER TENDL-2021 LIBRARY; T=0.K  
alphas from (s,d2a)

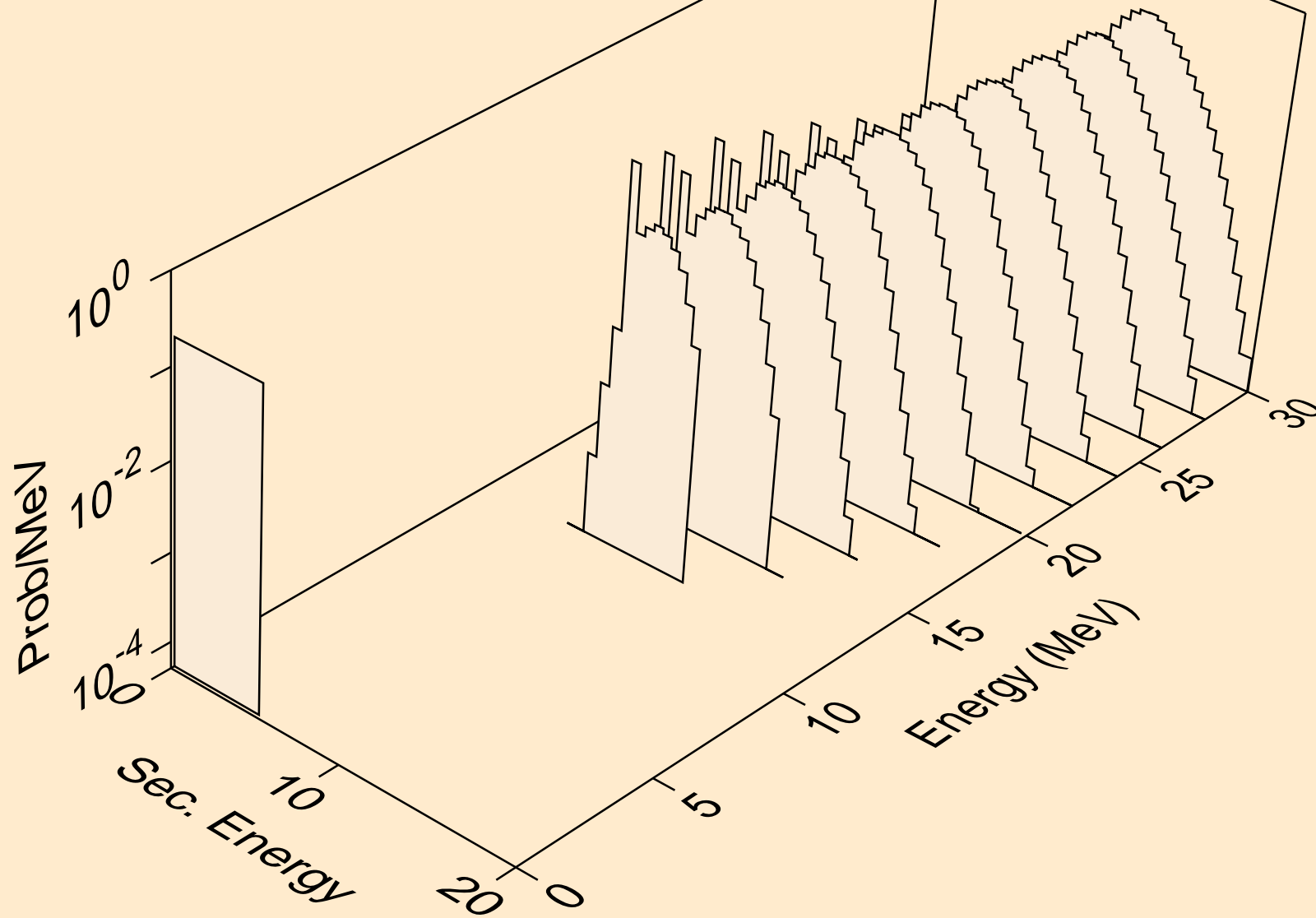

TM157 HELION ACER TENDL-2021 LIBRARY; T=0.K  
alphas from (s,da)

