

U241 HELION ACER TENDL-2021 LIBRARY; T=0.K  
Principal cross sections

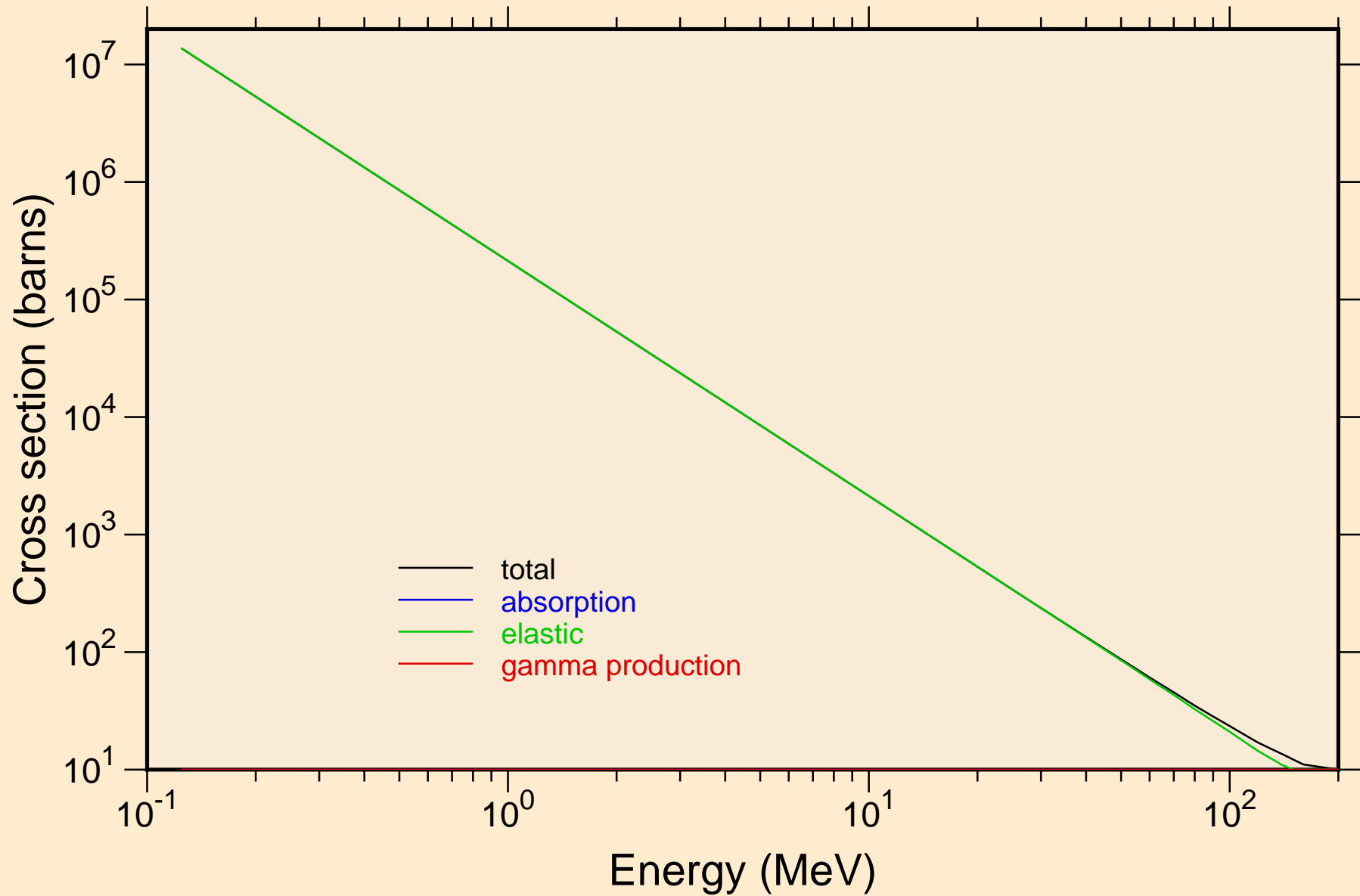

U241 HELION ACER TENDL-2021 LIBRARY; T=0.K  
Heating

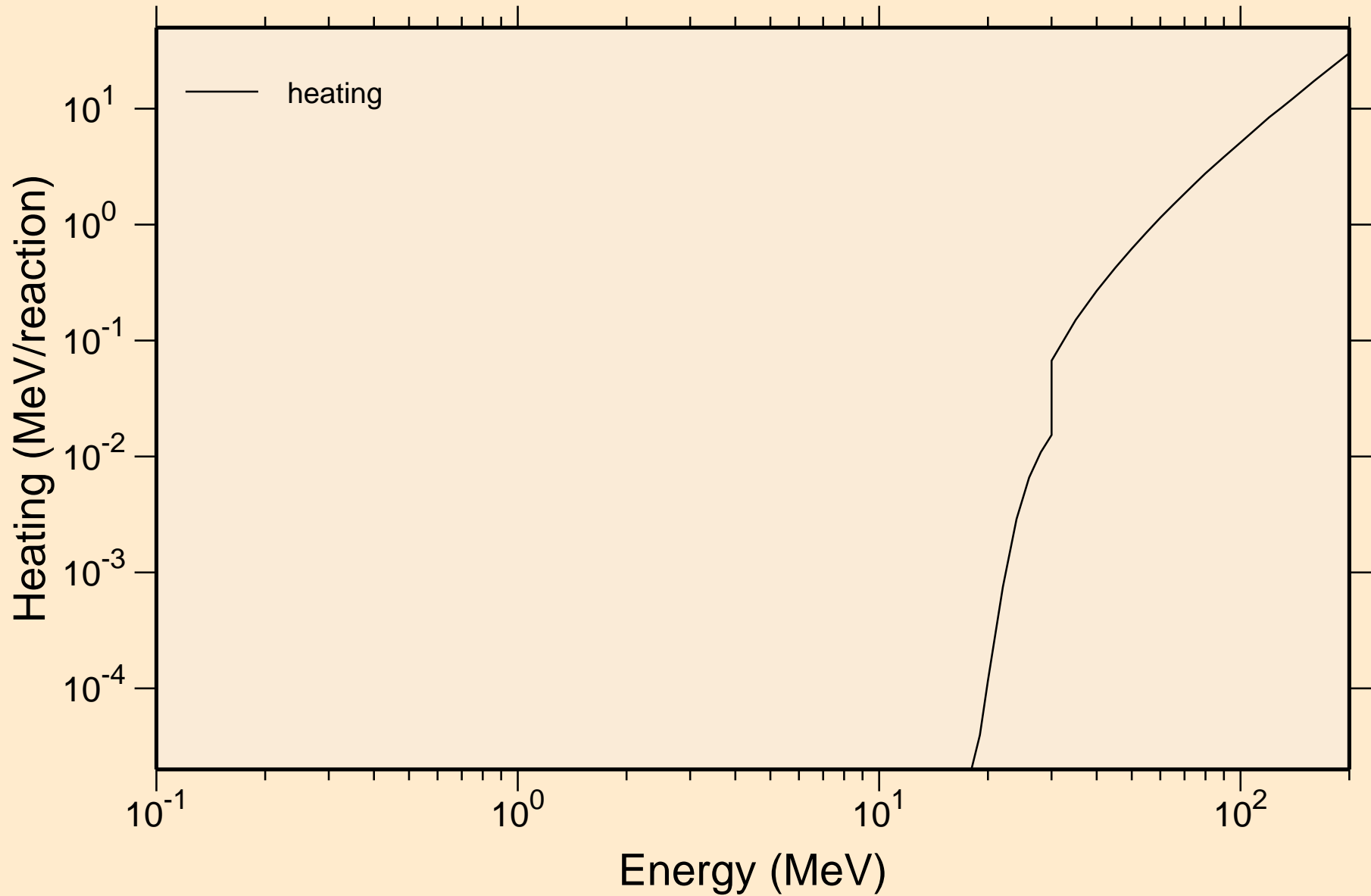

# U241 HELION ACER TENDL-2021 LIBRARY; T=0.K

## Principal cross sections

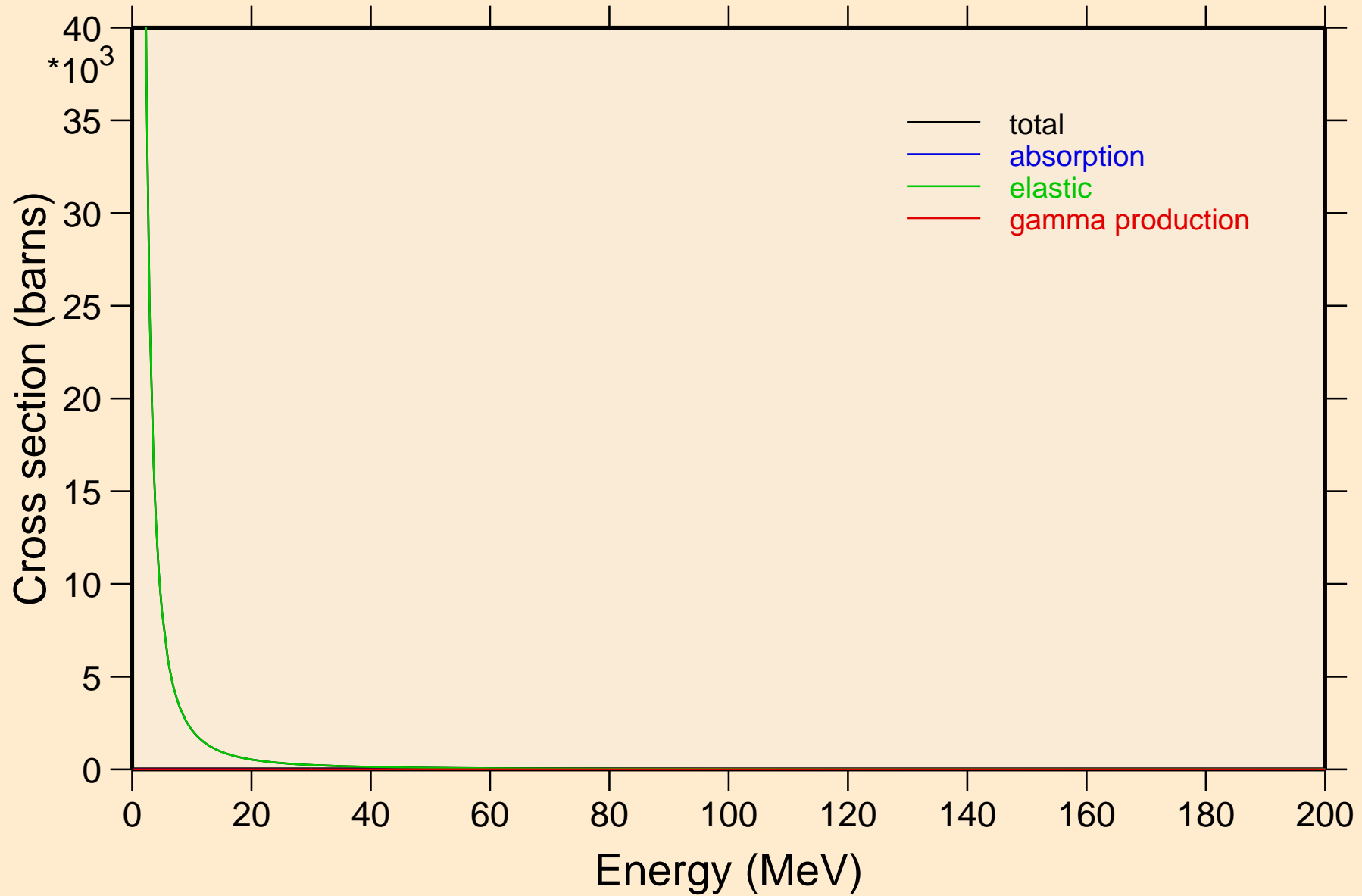

U241 HELION ACER TENDL-2021 LIBRARY; T=0.K

Heating

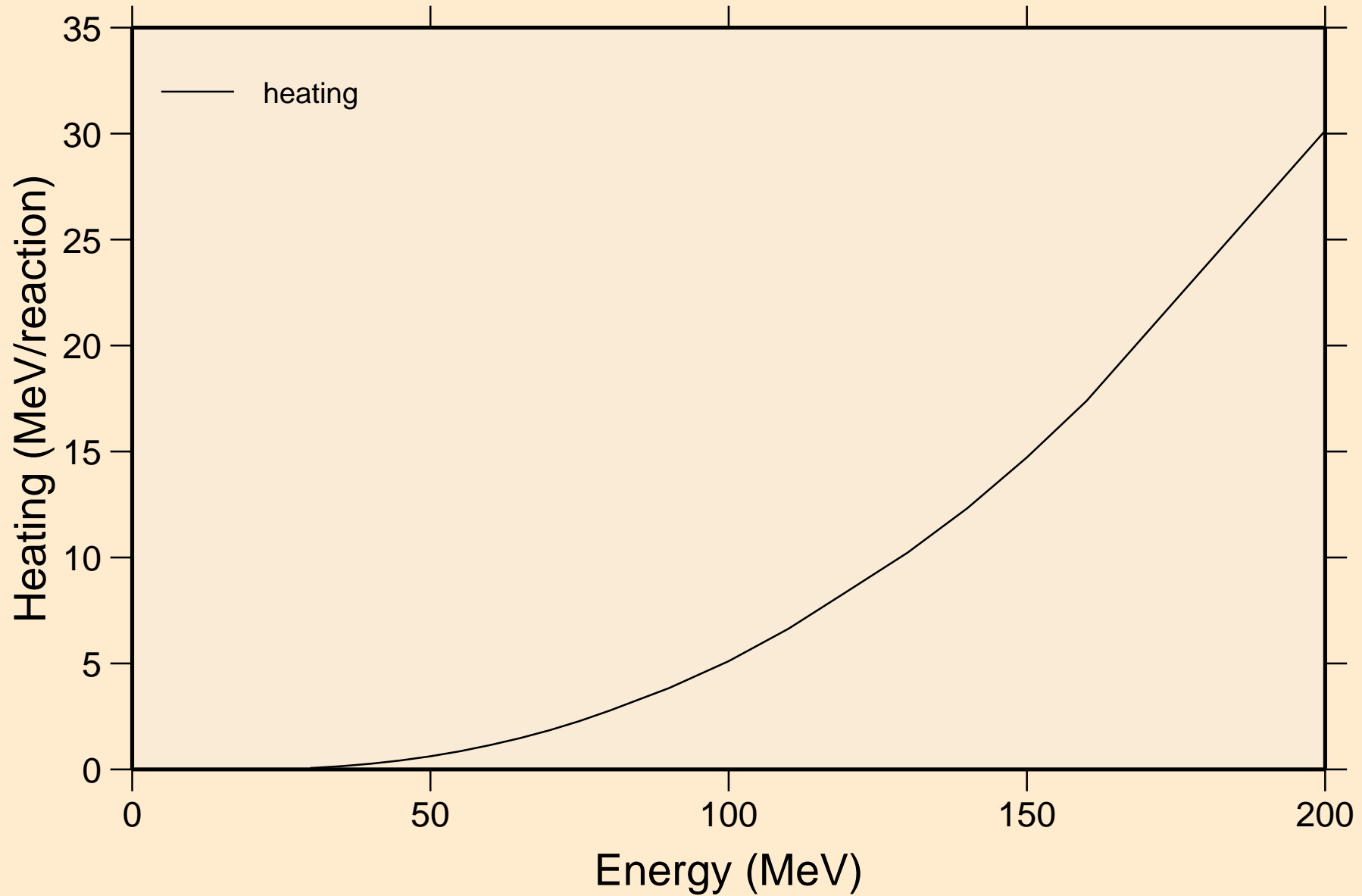

U241 HELION ACER TENDL-2021 LIBRARY; T=0.K  
Threshold reactions

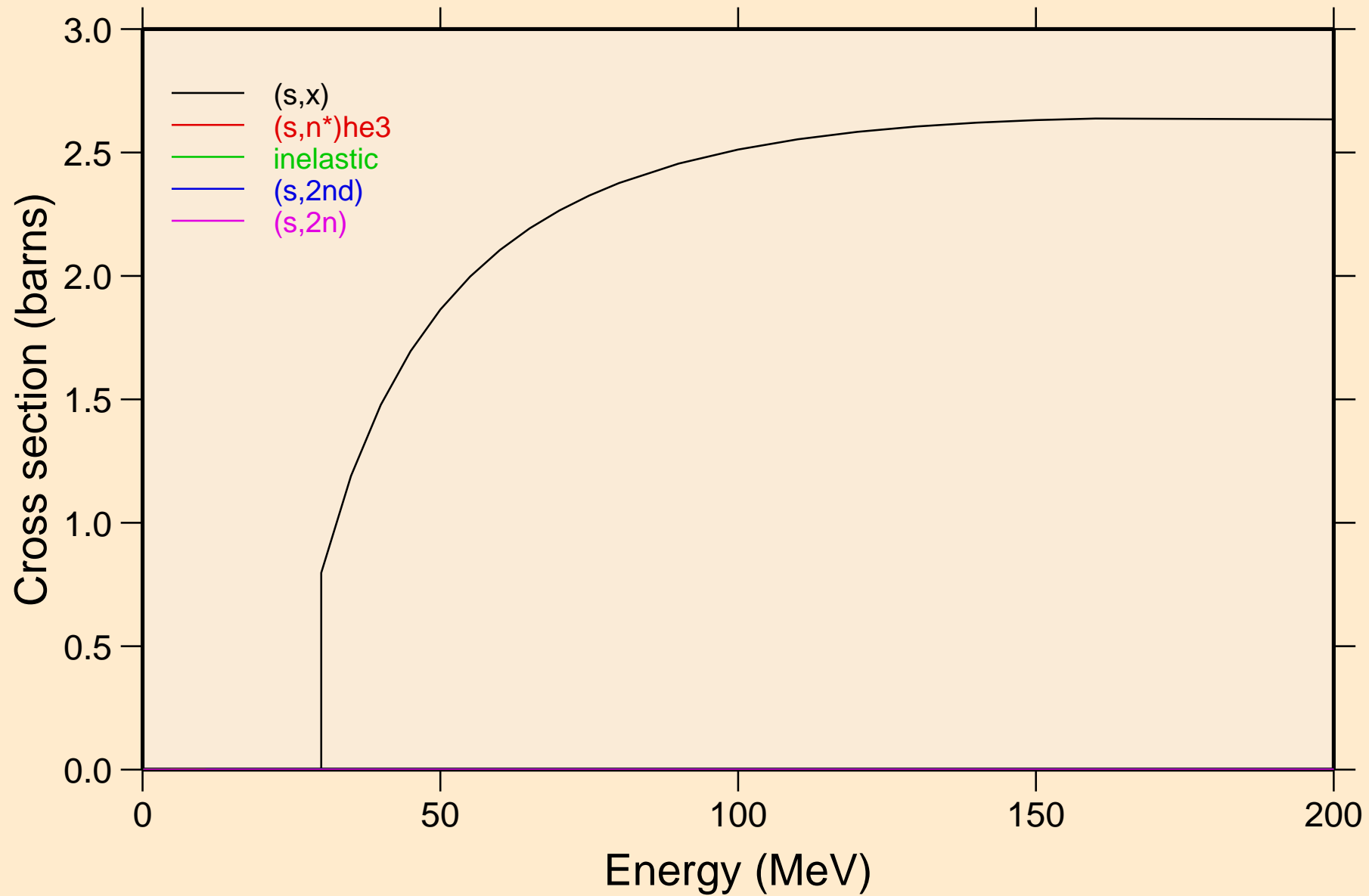

U241 HELION ACER TENDL-2021 LIBRARY; T=0.K  
Threshold reactions

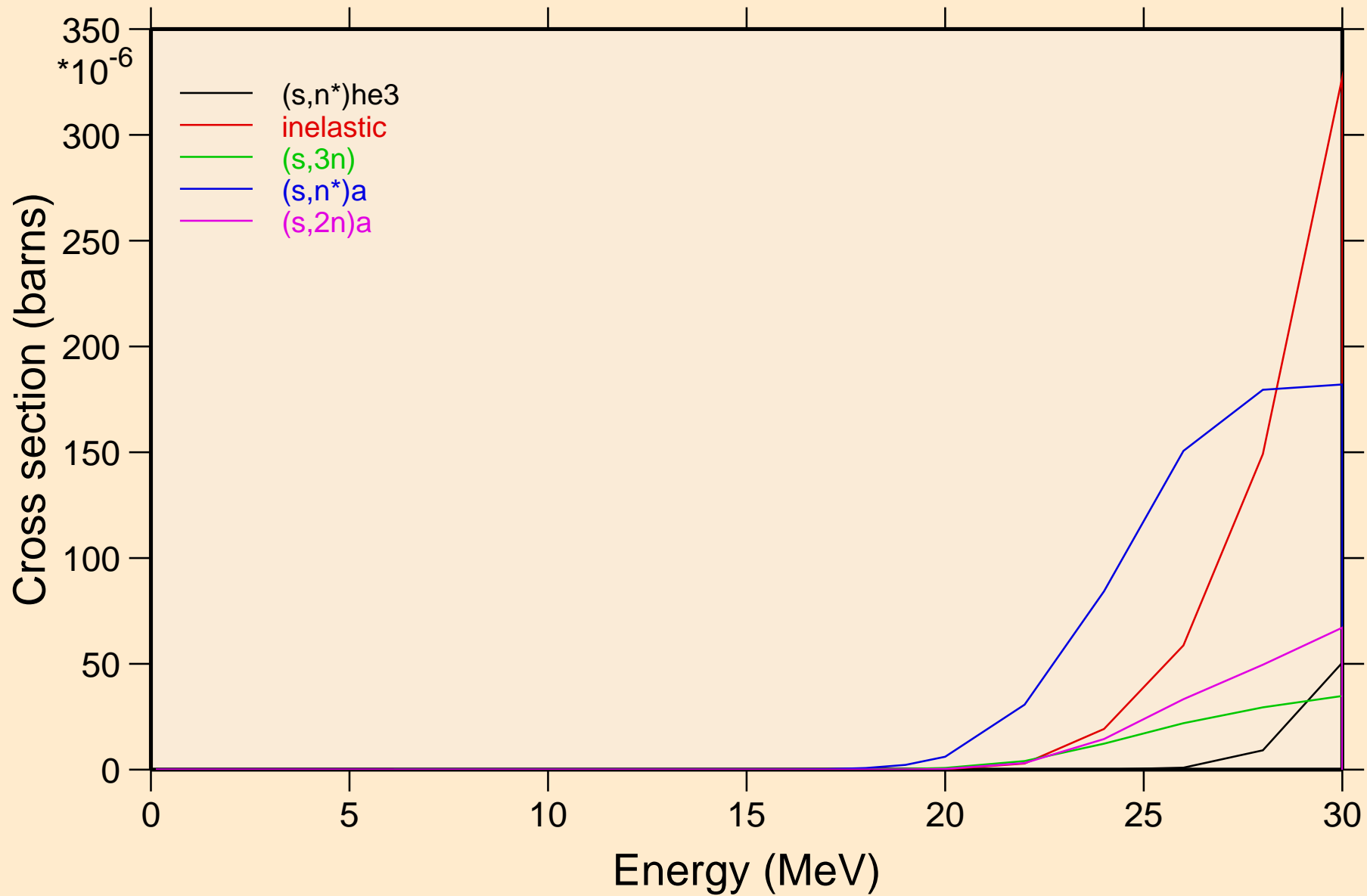

# U241 HELION ACER TENDL-2021 LIBRARY; T=0.K

## Threshold reactions

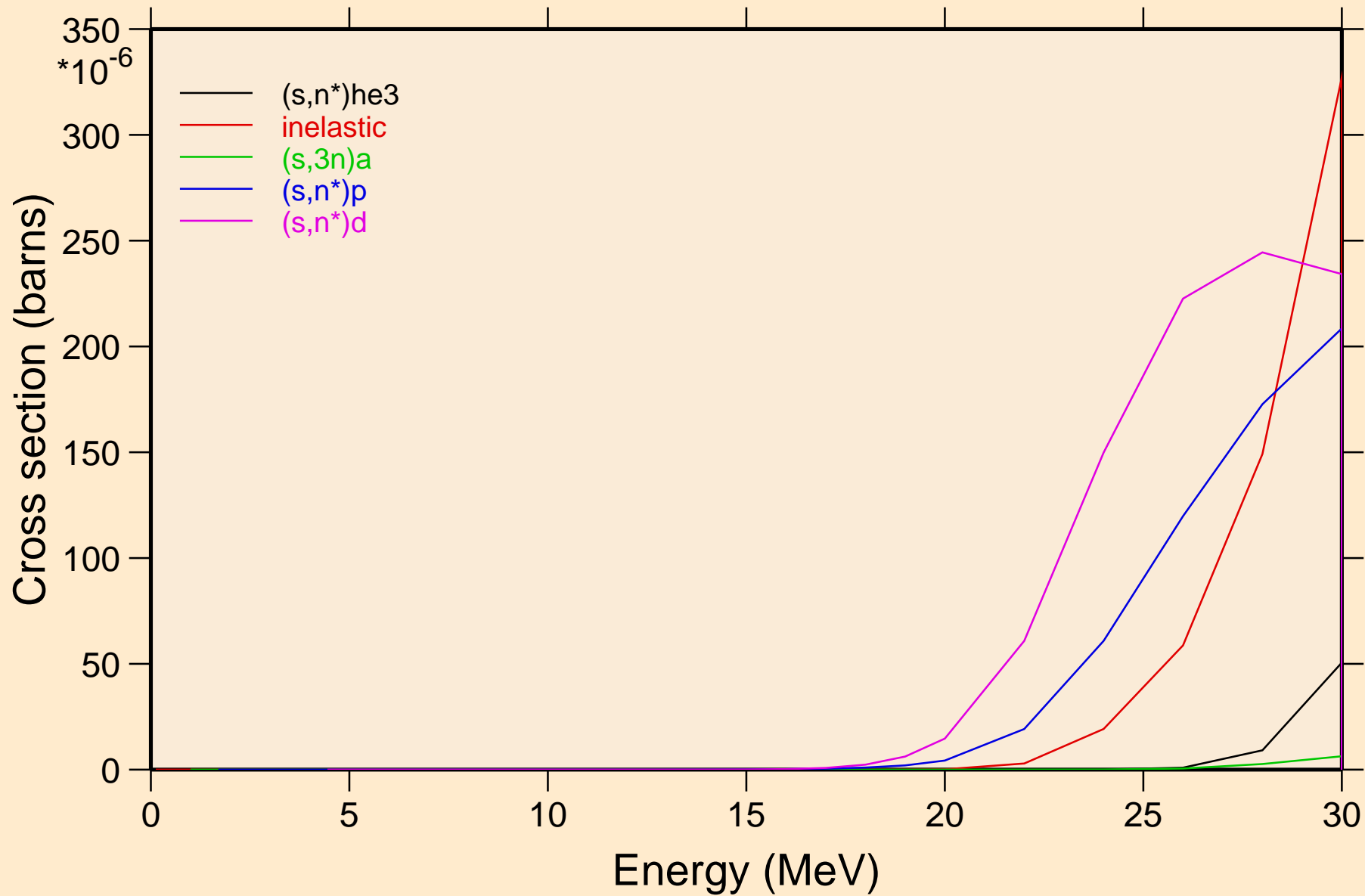

U241 HELION ACER TENDL-2021 LIBRARY; T=0.K  
Threshold reactions

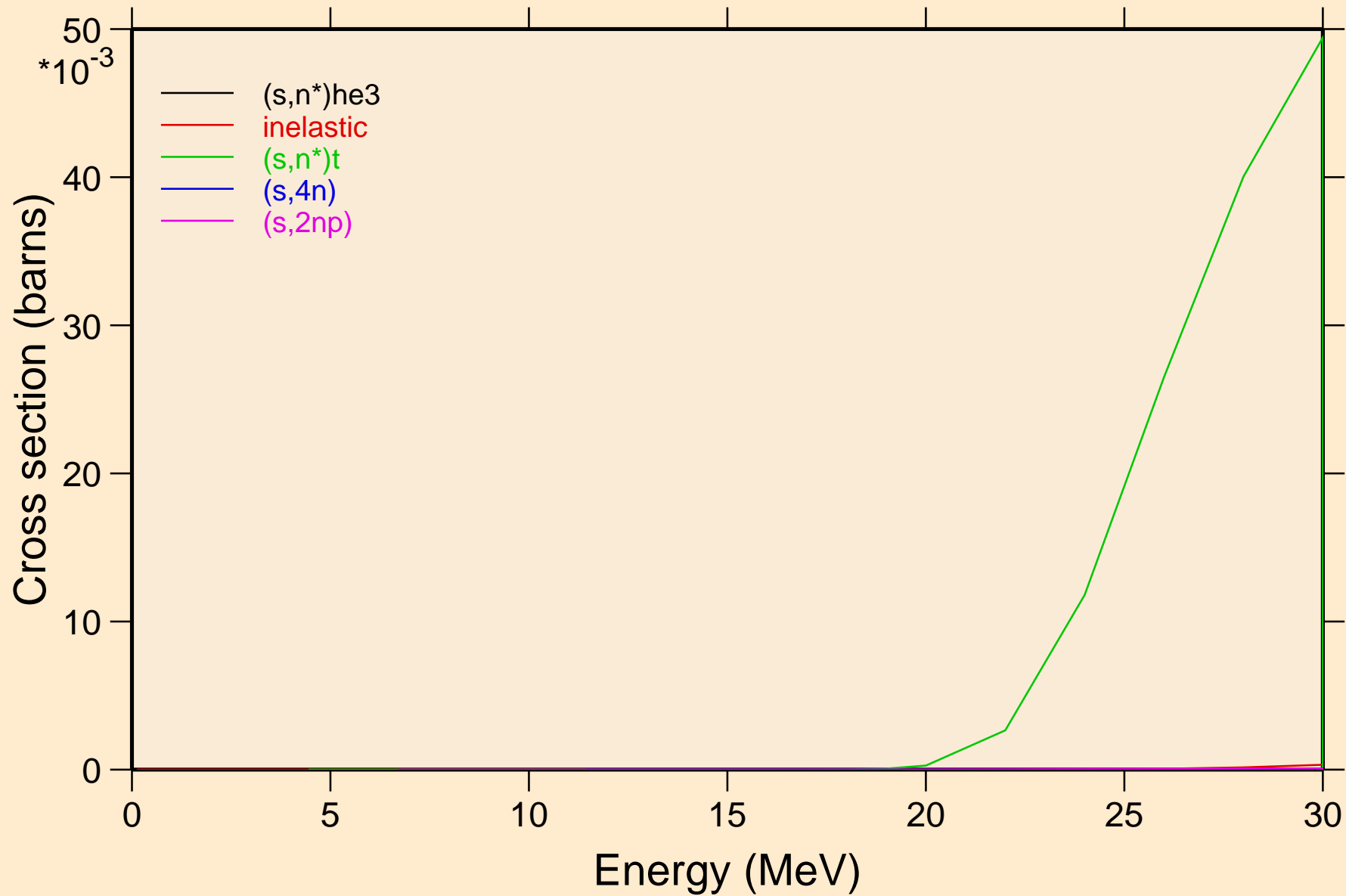



U241 HELION ACER TENDL-2021 LIBRARY; T=0.K  
Threshold reactions

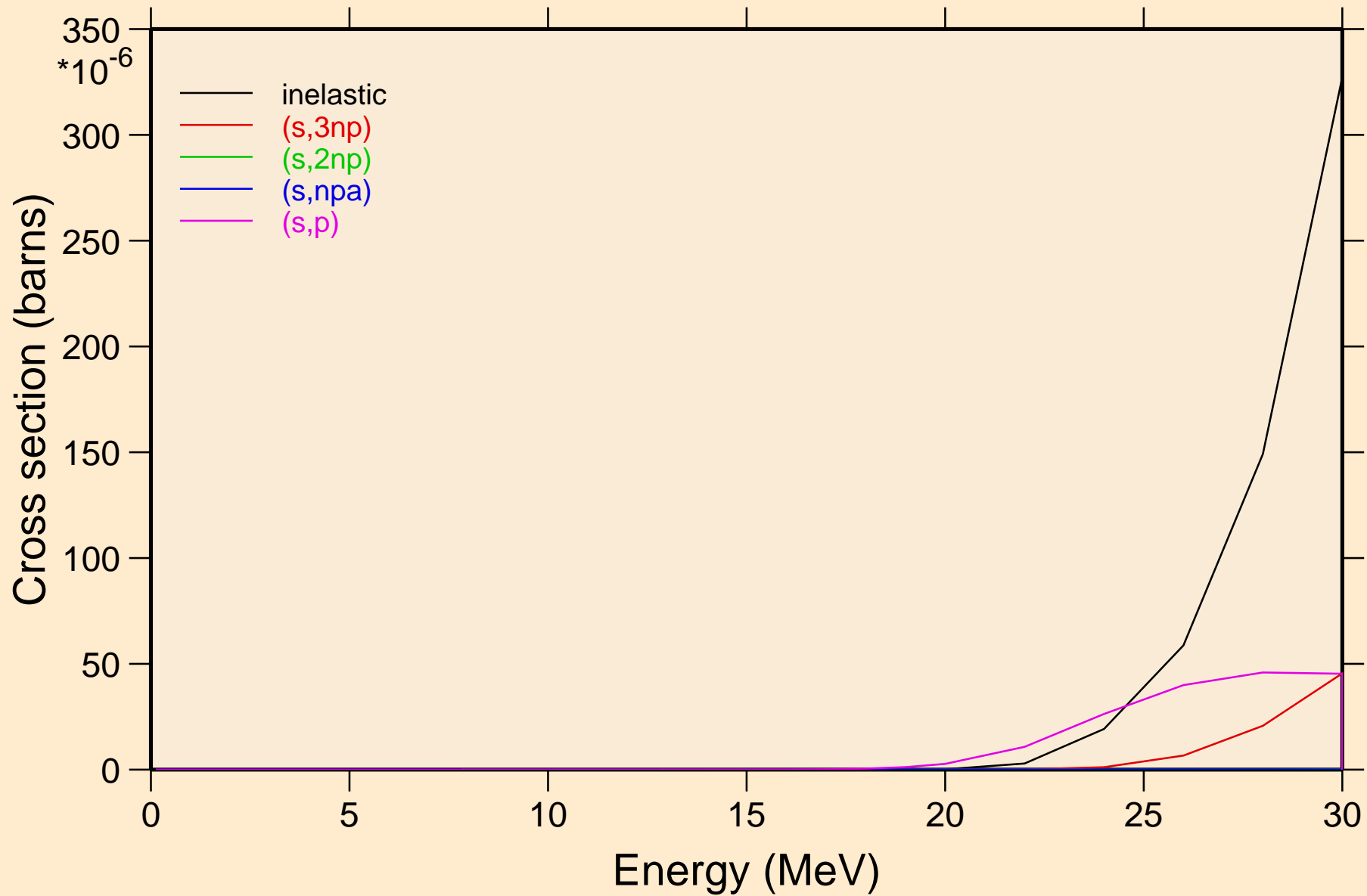

U241 HELION ACER TENDL-2021 LIBRARY; T=0.K  
Threshold reactions

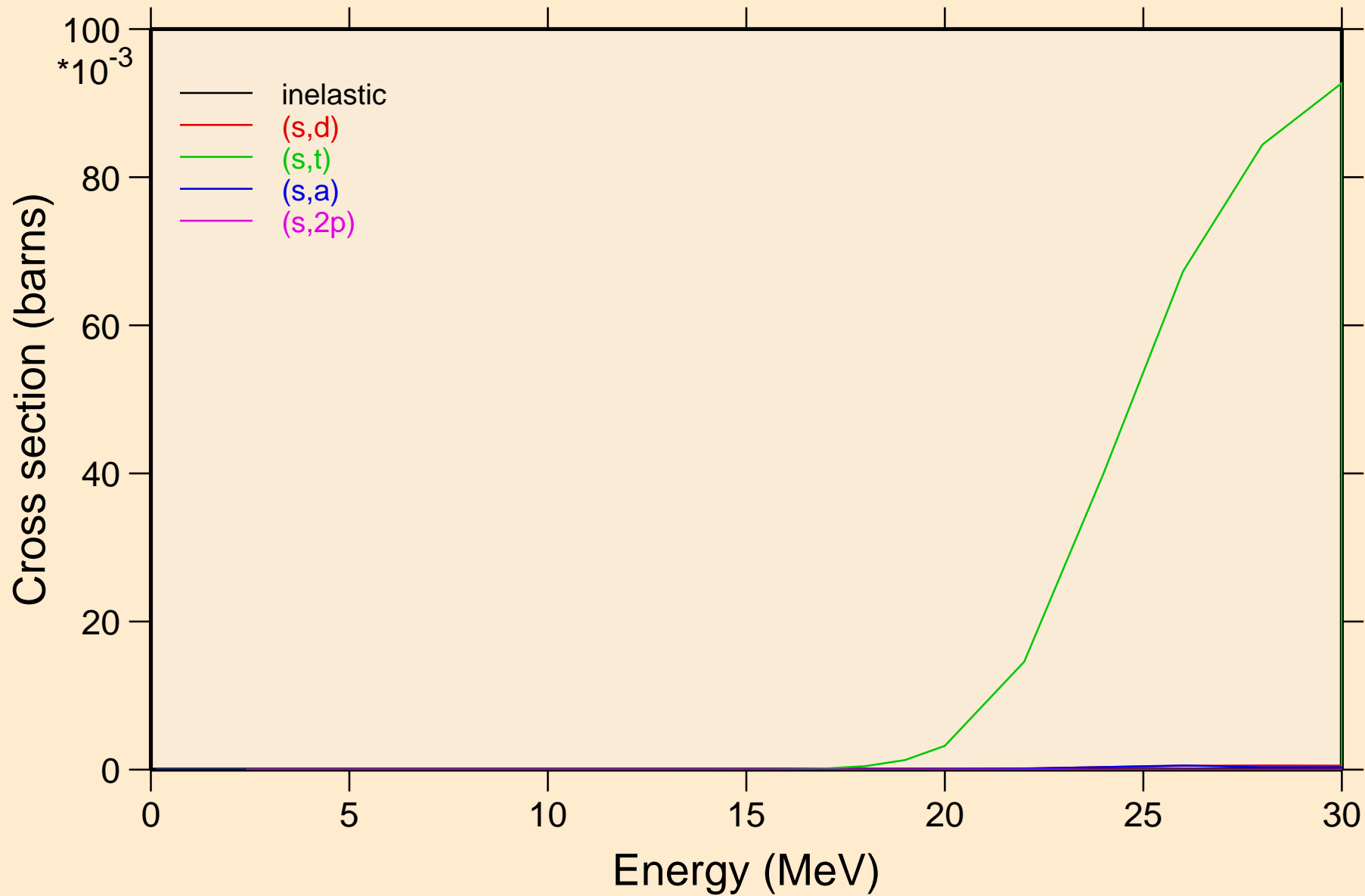

U241 HELION ACER TENDL-2021 LIBRARY; T=0.K  
Threshold reactions

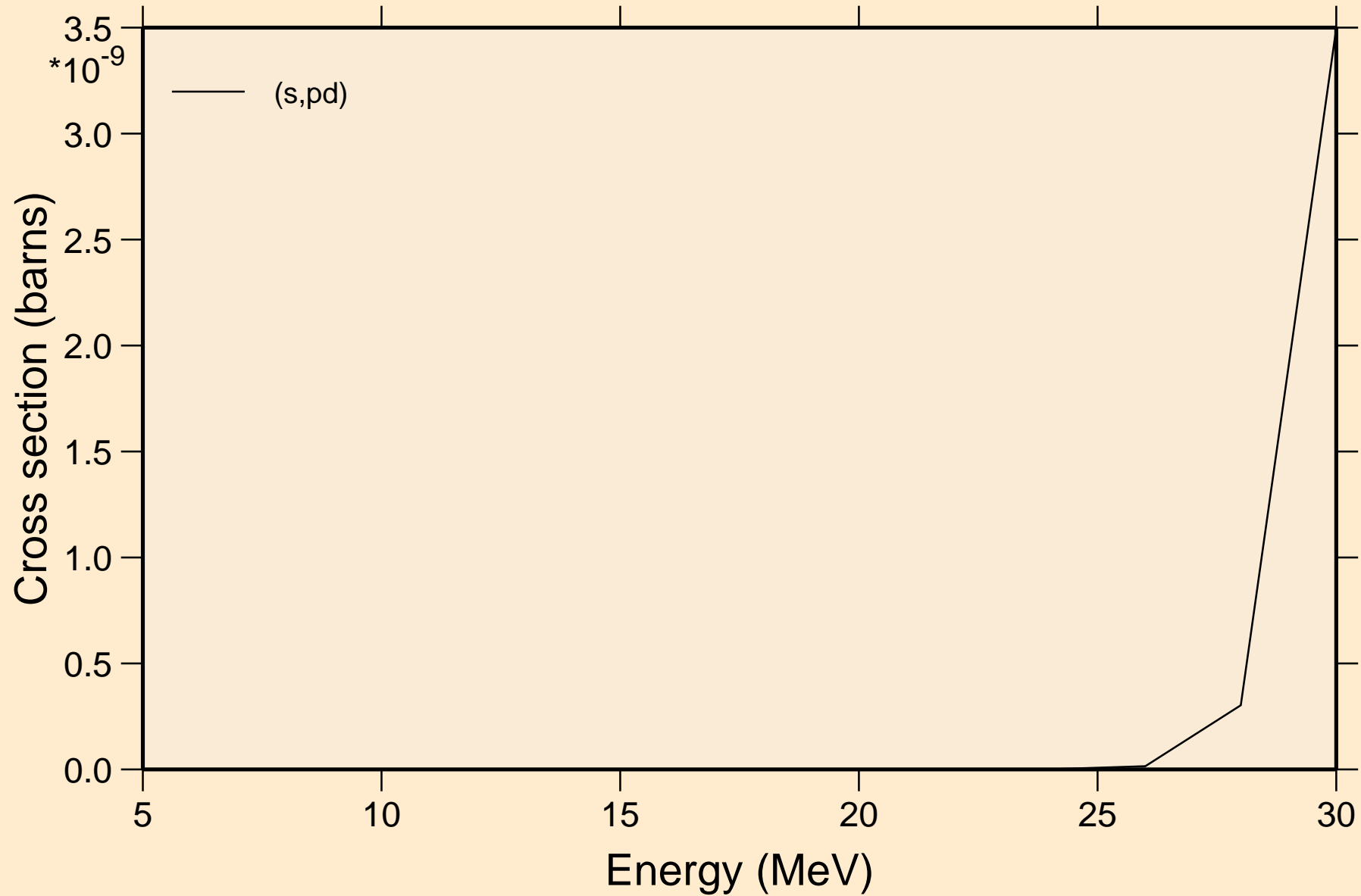

U241 HELION ACER TENDL-2021 LIBRARY; T=0.K  
angular distribution for elastic

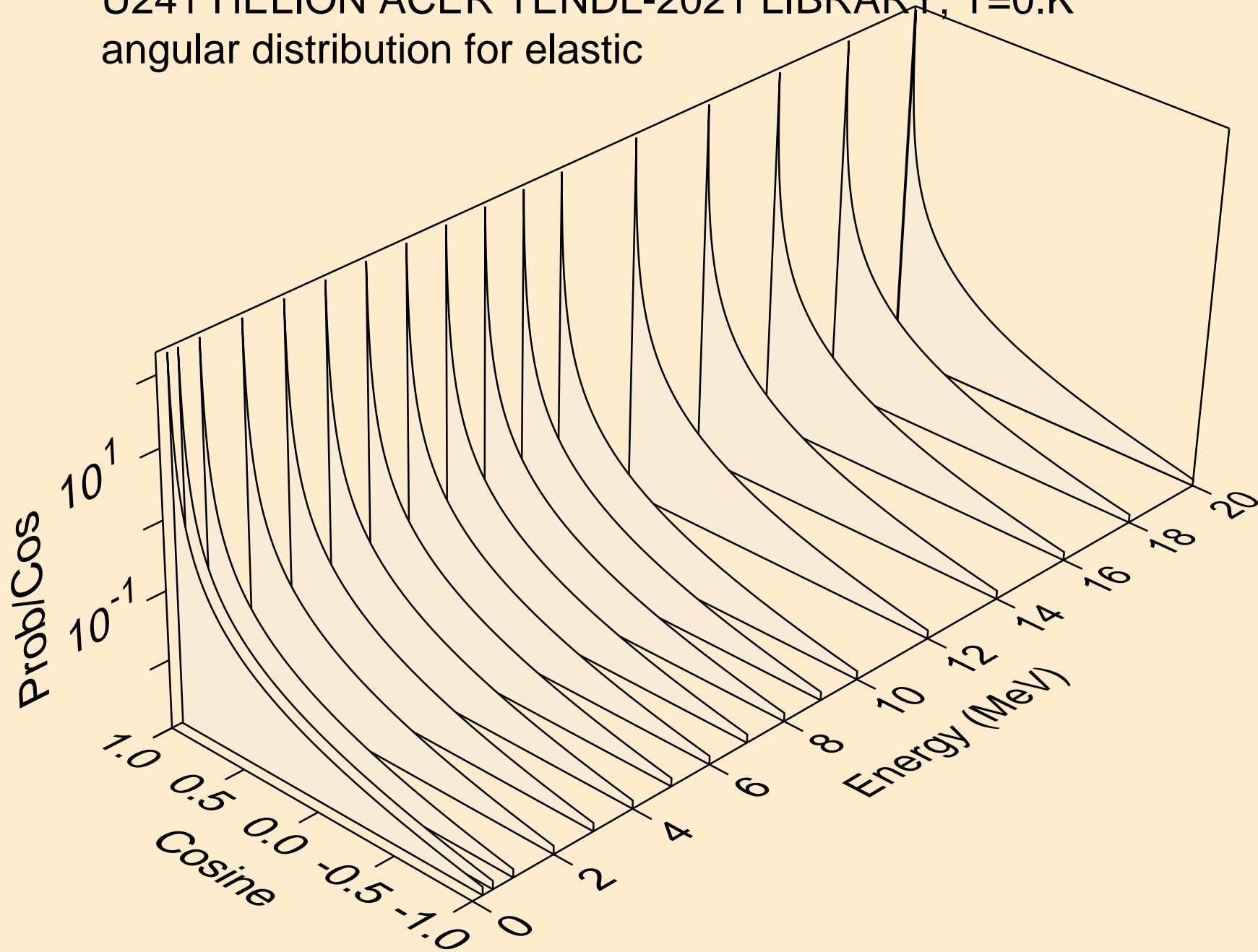

U241 HELION ACER TENDL-2021 LIBRARY; T=0.K  
angular distribution for elastic

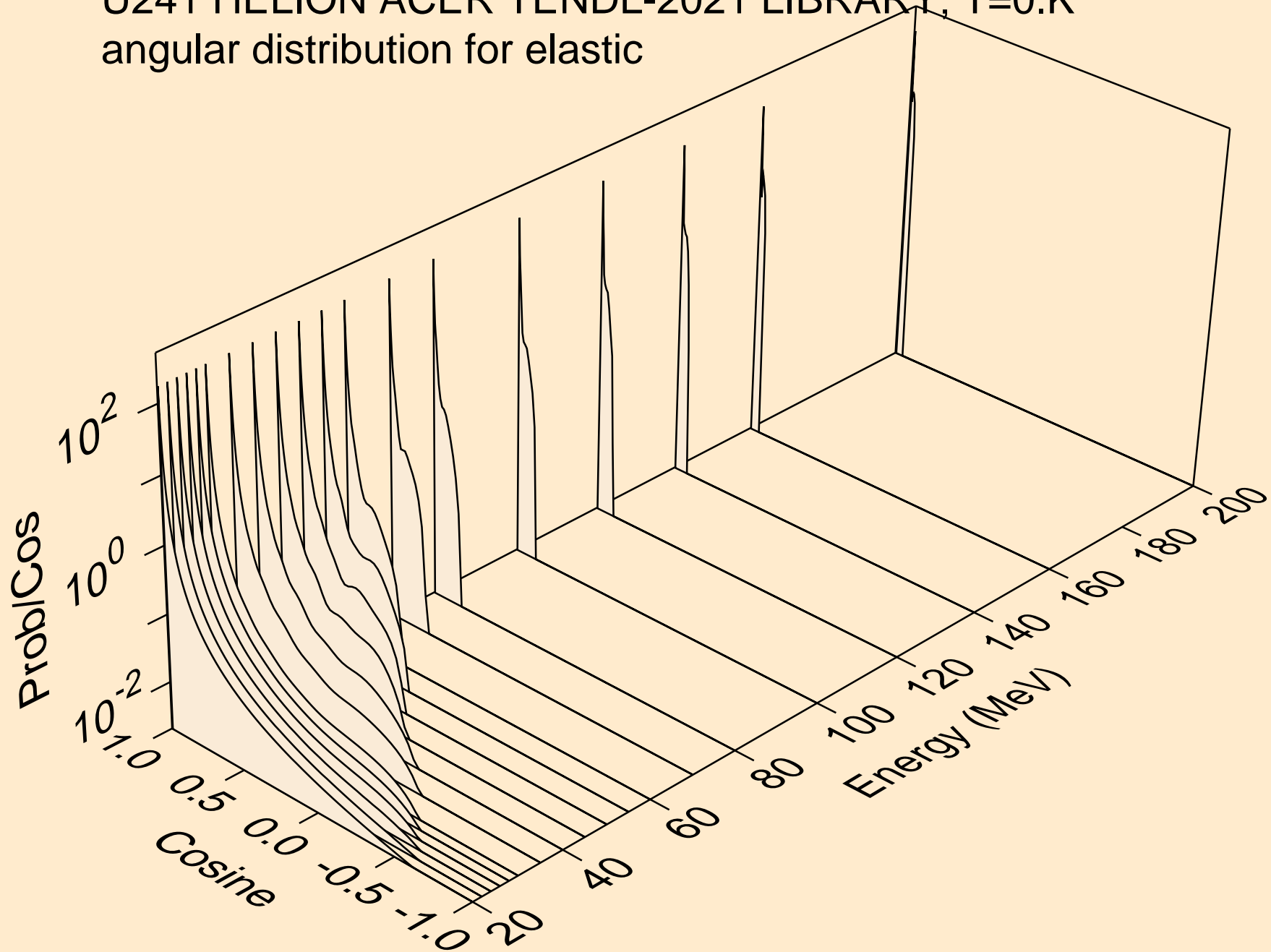

U241 HELION ACER TENDL-2021 LIBRARY; T=0.K  
He-3 emission for (s,x)

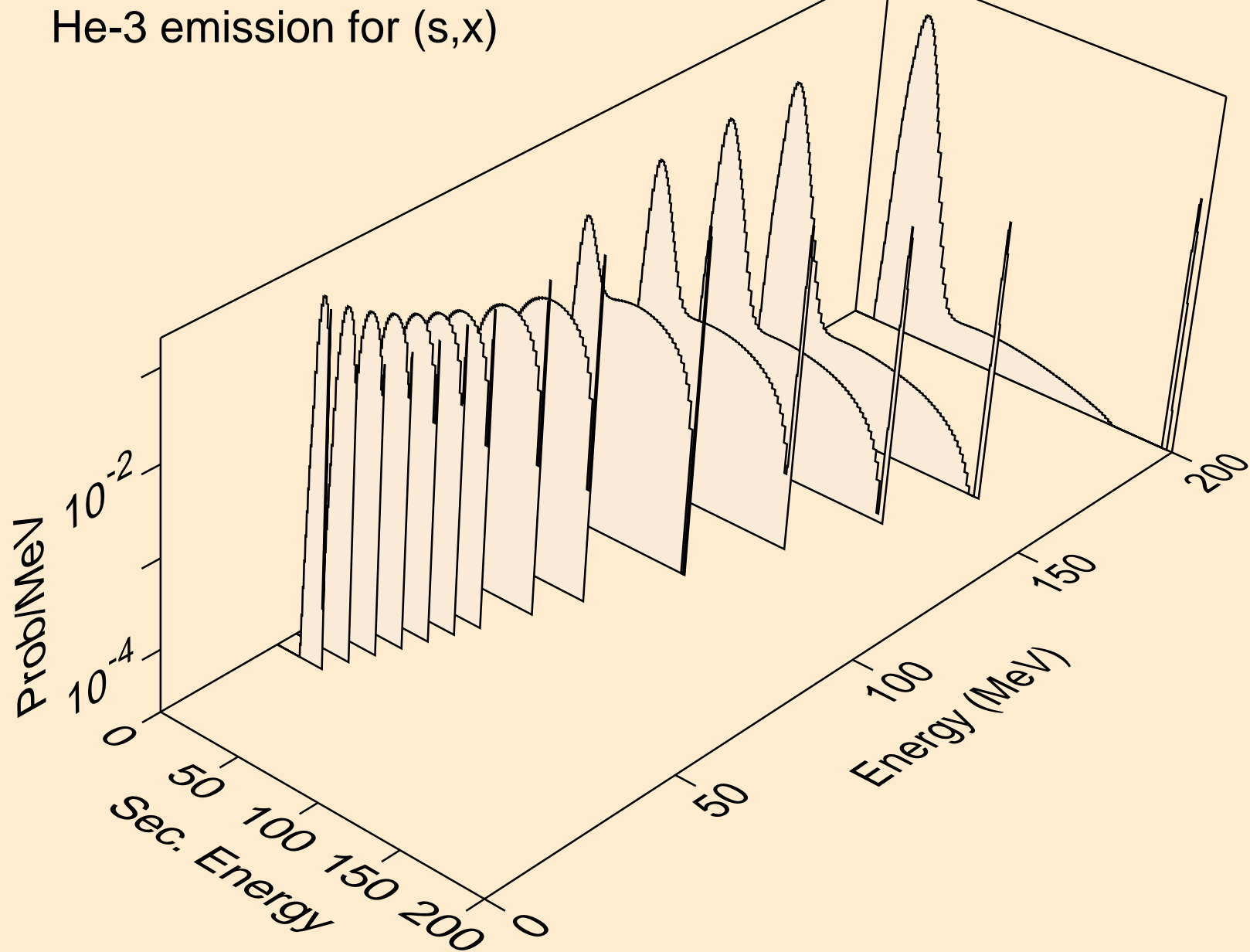

U241 HELION ACER TENDL-2021 LIBRARY; T=0.K  
He-3 emission for (s,n\*)he3

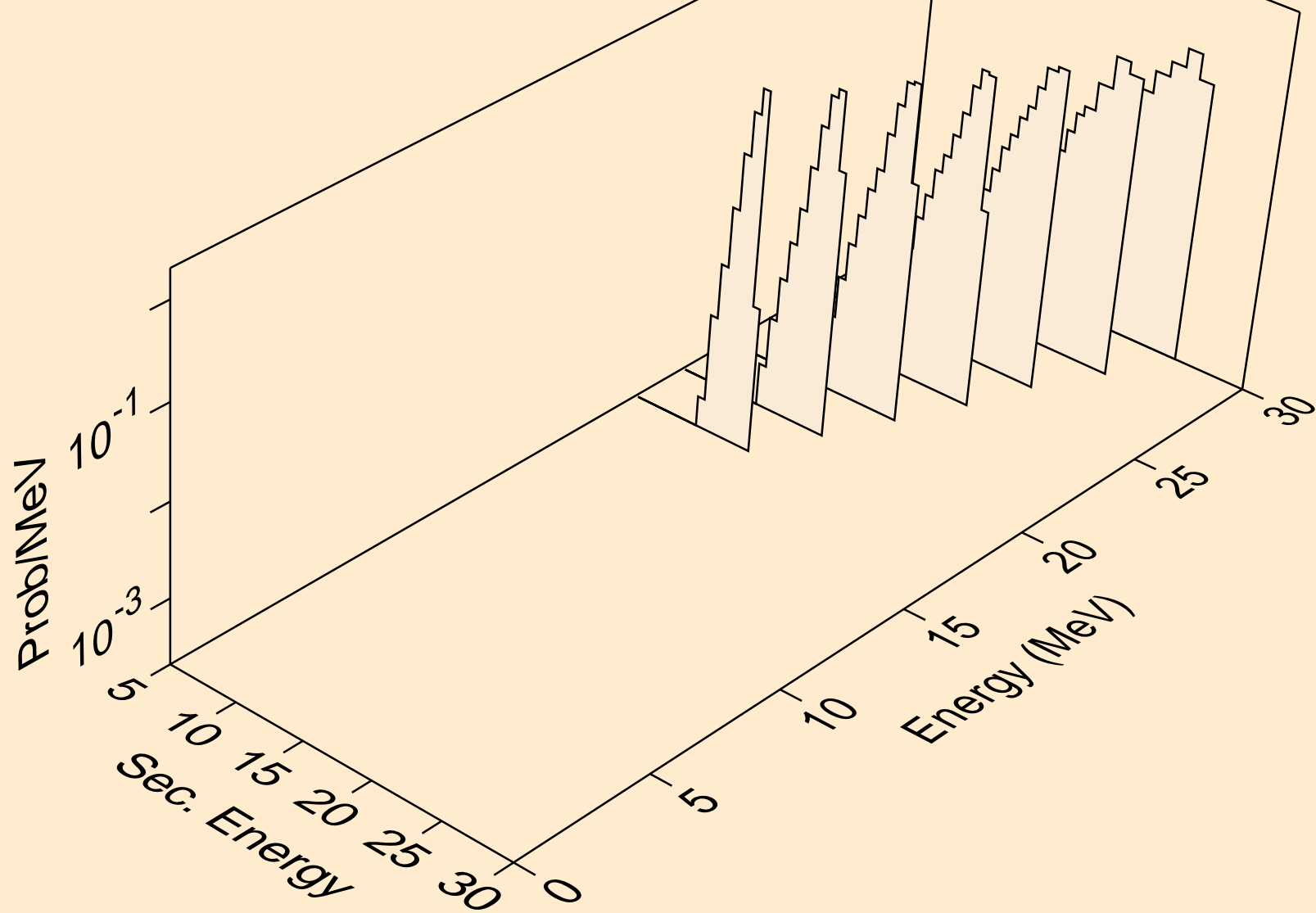

U241 HELION ACER TENDL-2021 LIBRARY; T=0.K  
He-3 emission for inelastic

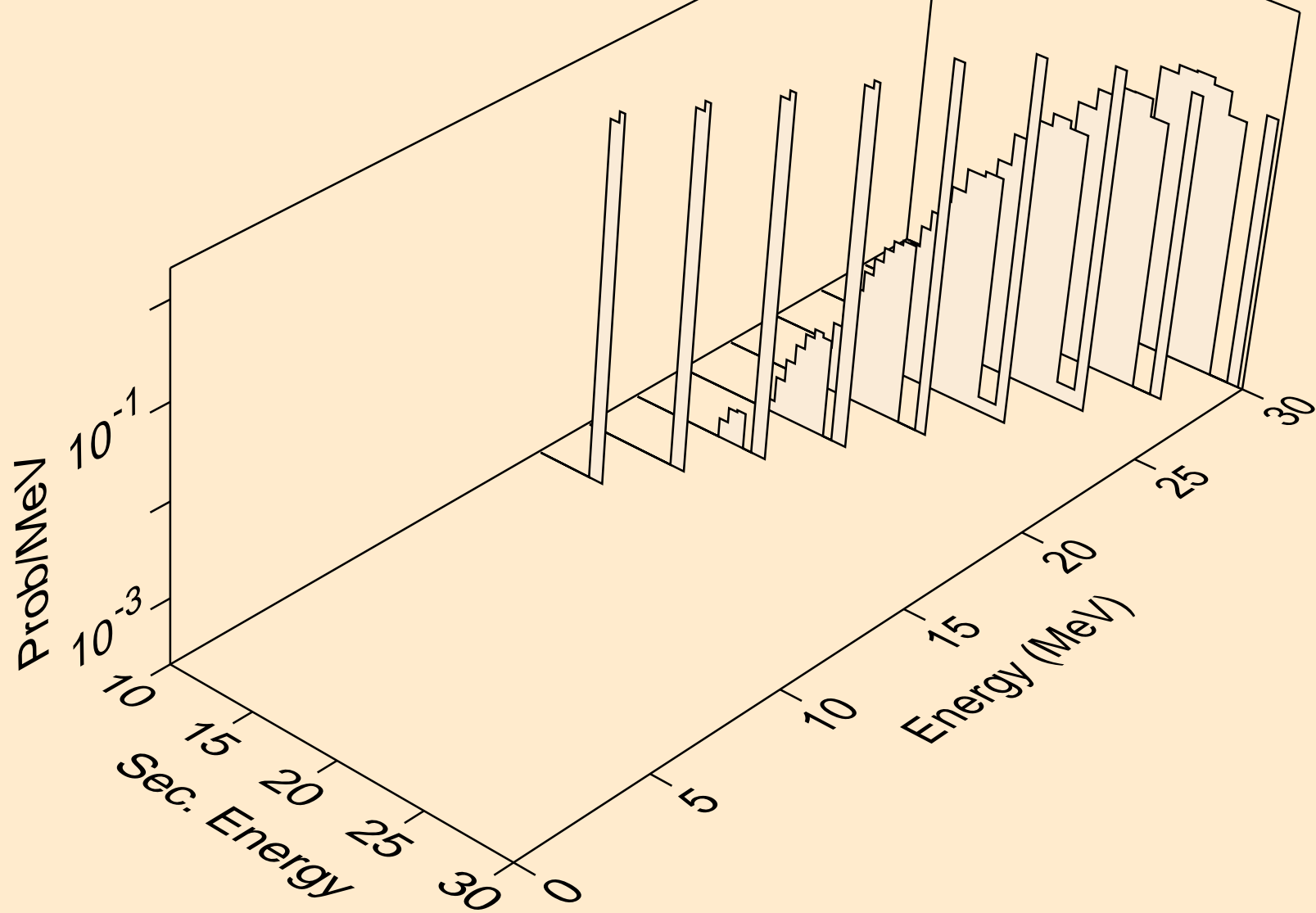



U241 HELION ACER TENDL-2021 LIBRARY; T=0.K  
Photon emission for (z,n)

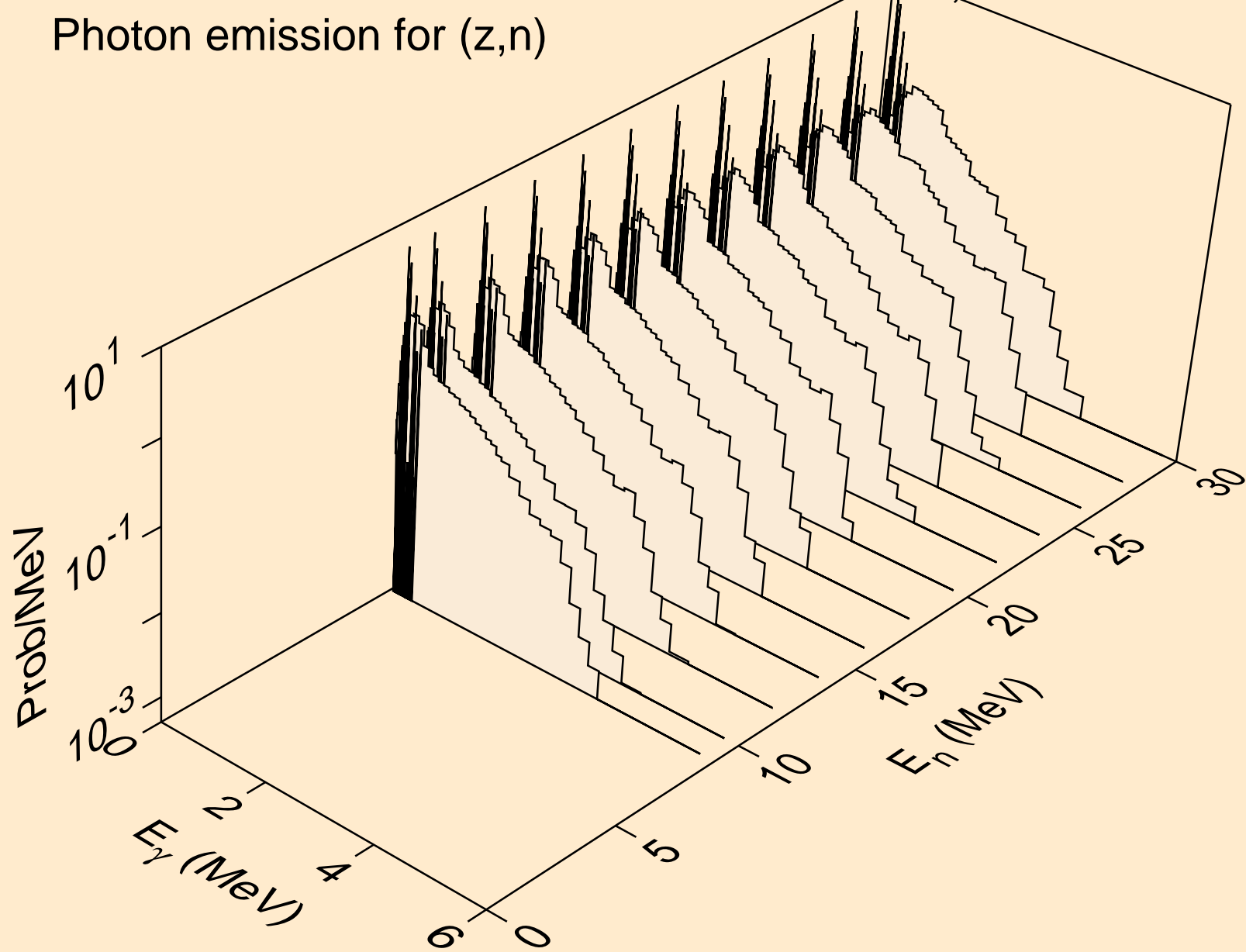

U241 HELION ACER TENDL-2021 LIBRARY; T=0.K  
Photon emission for (n,x)

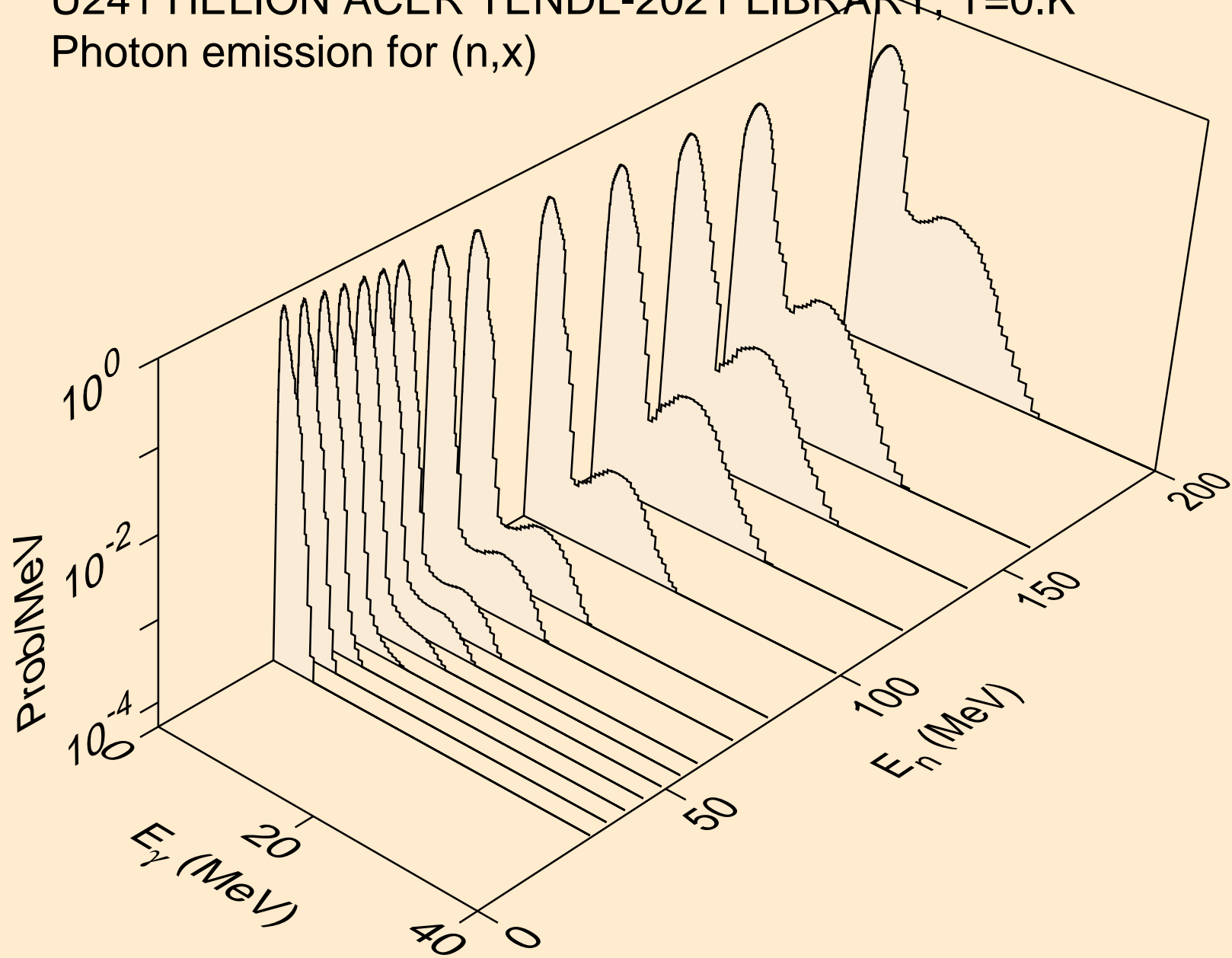

U241 HELION ACER TENDL-2021 LIBRARY; T=0.K  
Photon emission for (n,2nd)

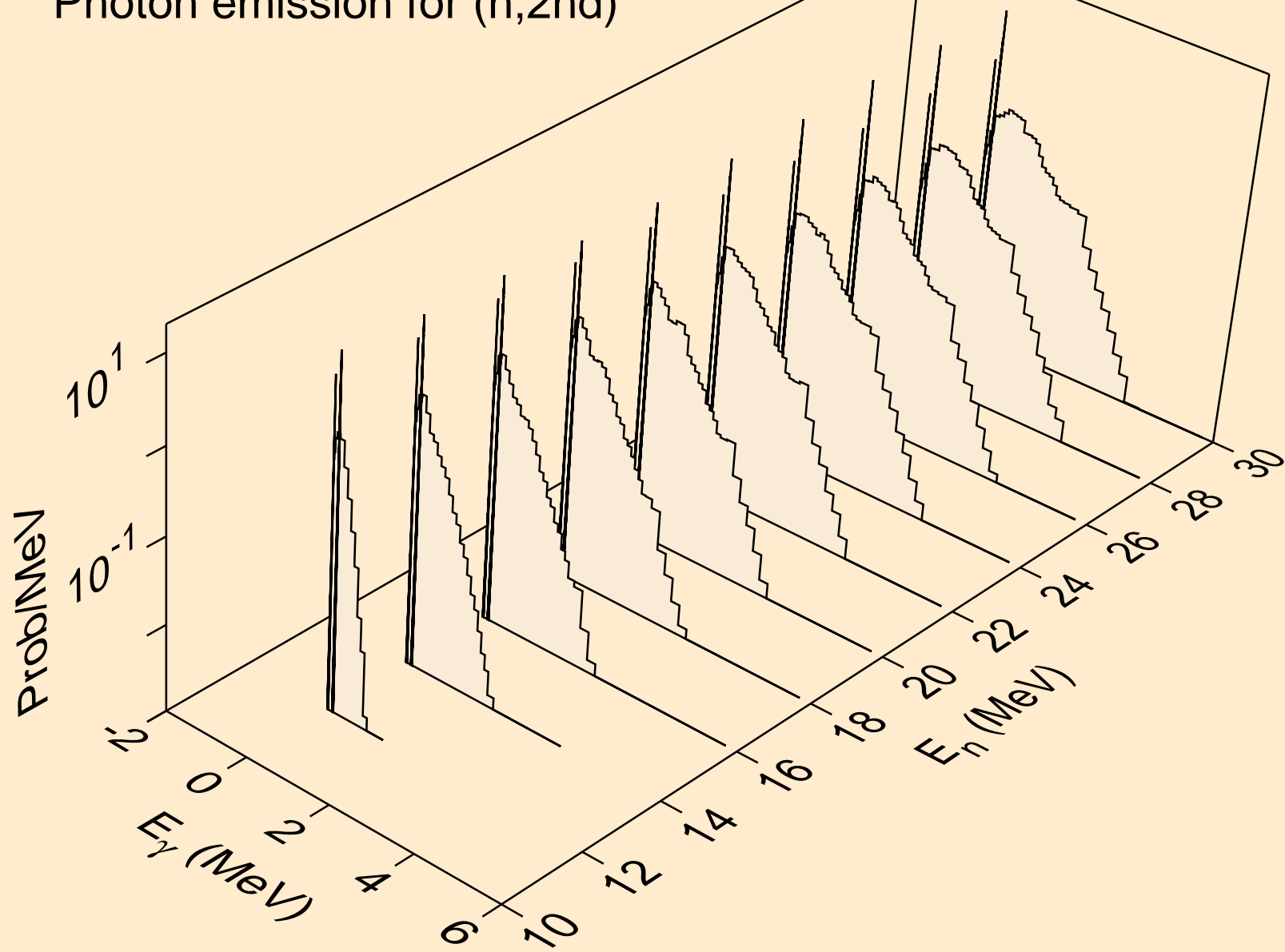

U241 HELION ACER TENDL-2021 LIBRARY; T=0.K  
Photon emission for (n,2n)

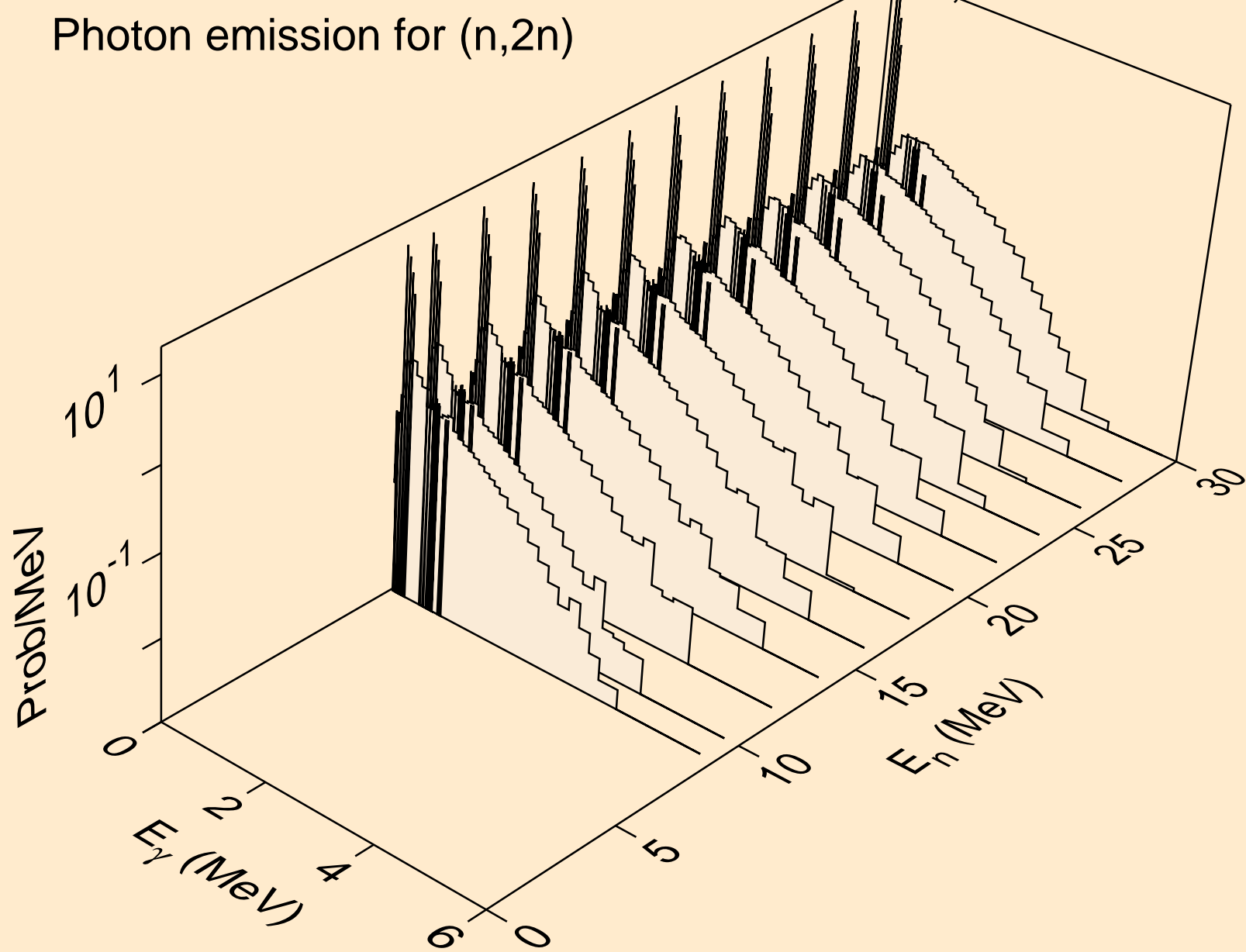

U241 HELION ACER TENDL-2021 LIBRARY; T=0.K  
Photon emission for (n,3n)

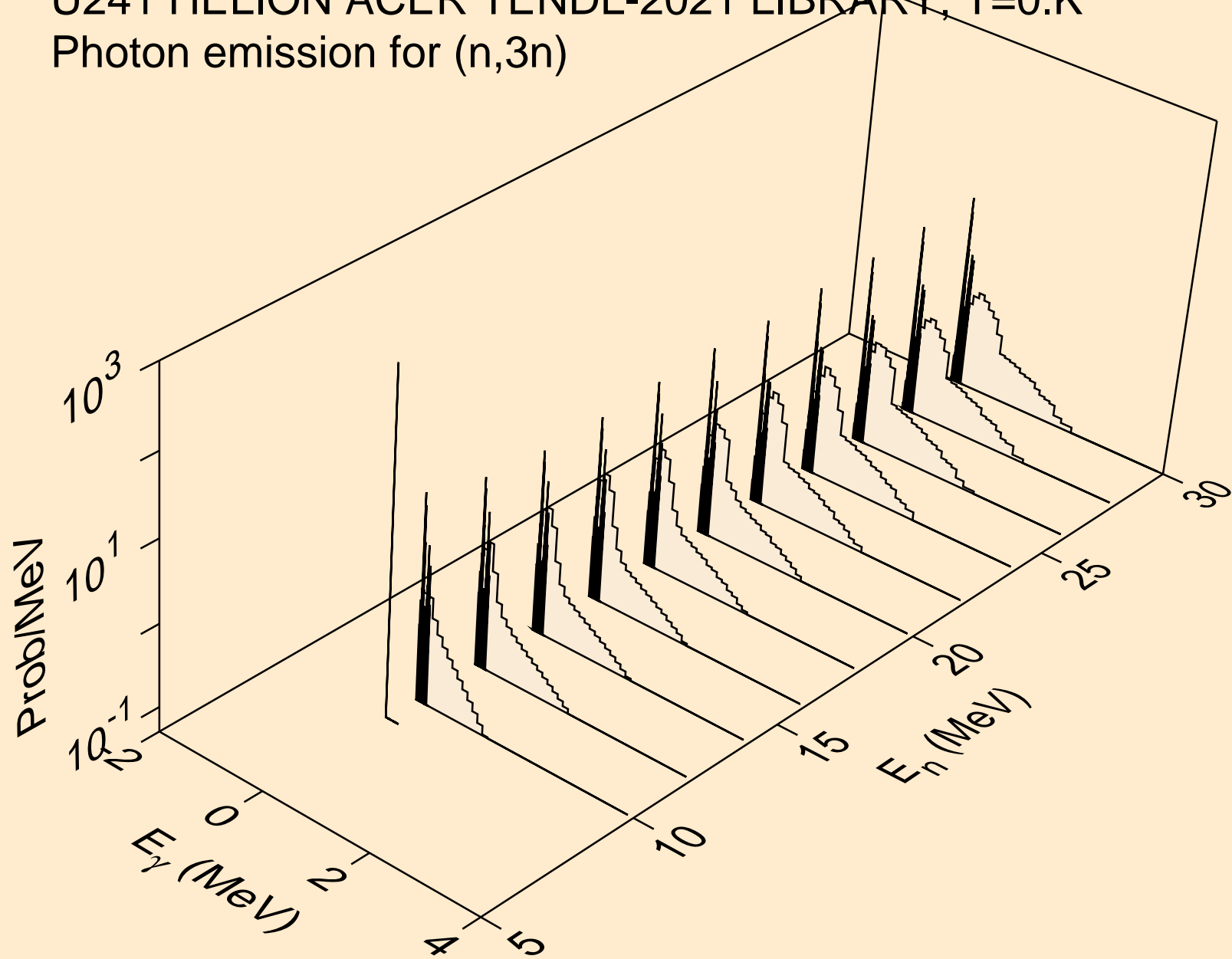

U241 HELION ACER TENDL-2021 LIBRARY; T=0.K  
Photon emission for (n,n\*)a

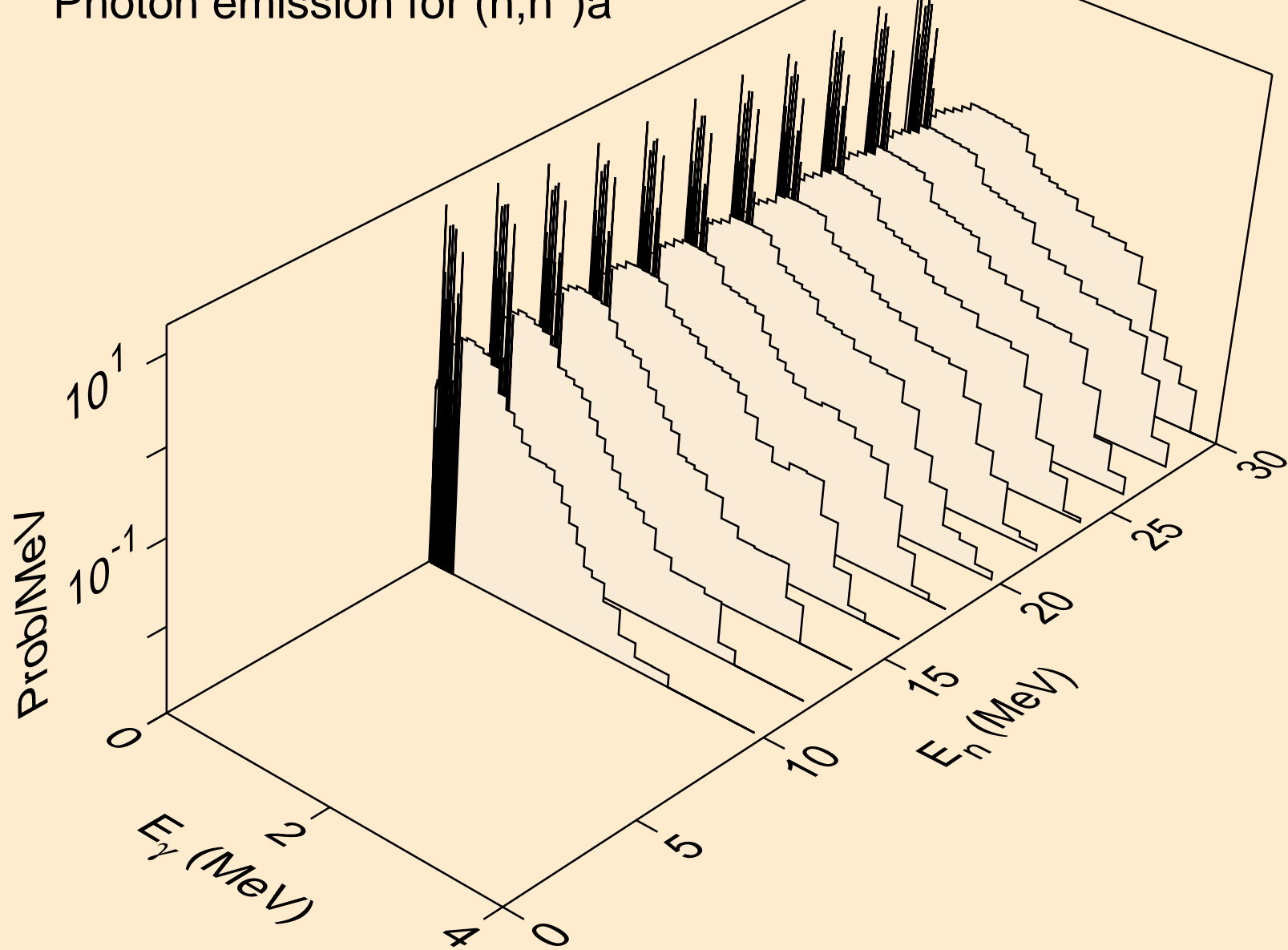

U241 HELION ACER TENDL-2021 LIBRARY; T=0.K  
Photon emission for (n,2n)a

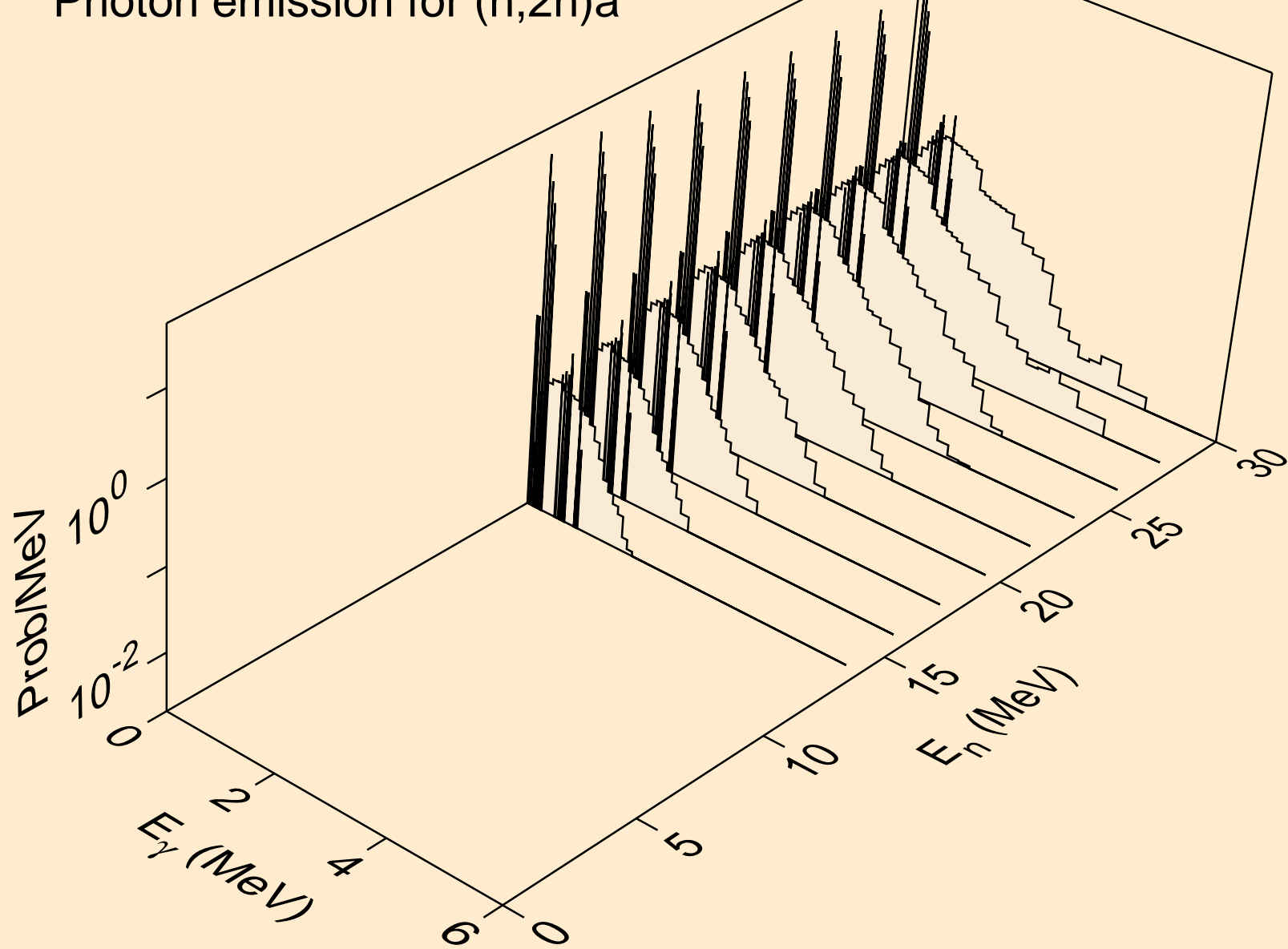

U241 HELION ACER TENDL-2021 LIBRARY; T=0.K  
Photon emission for (n,3n)a

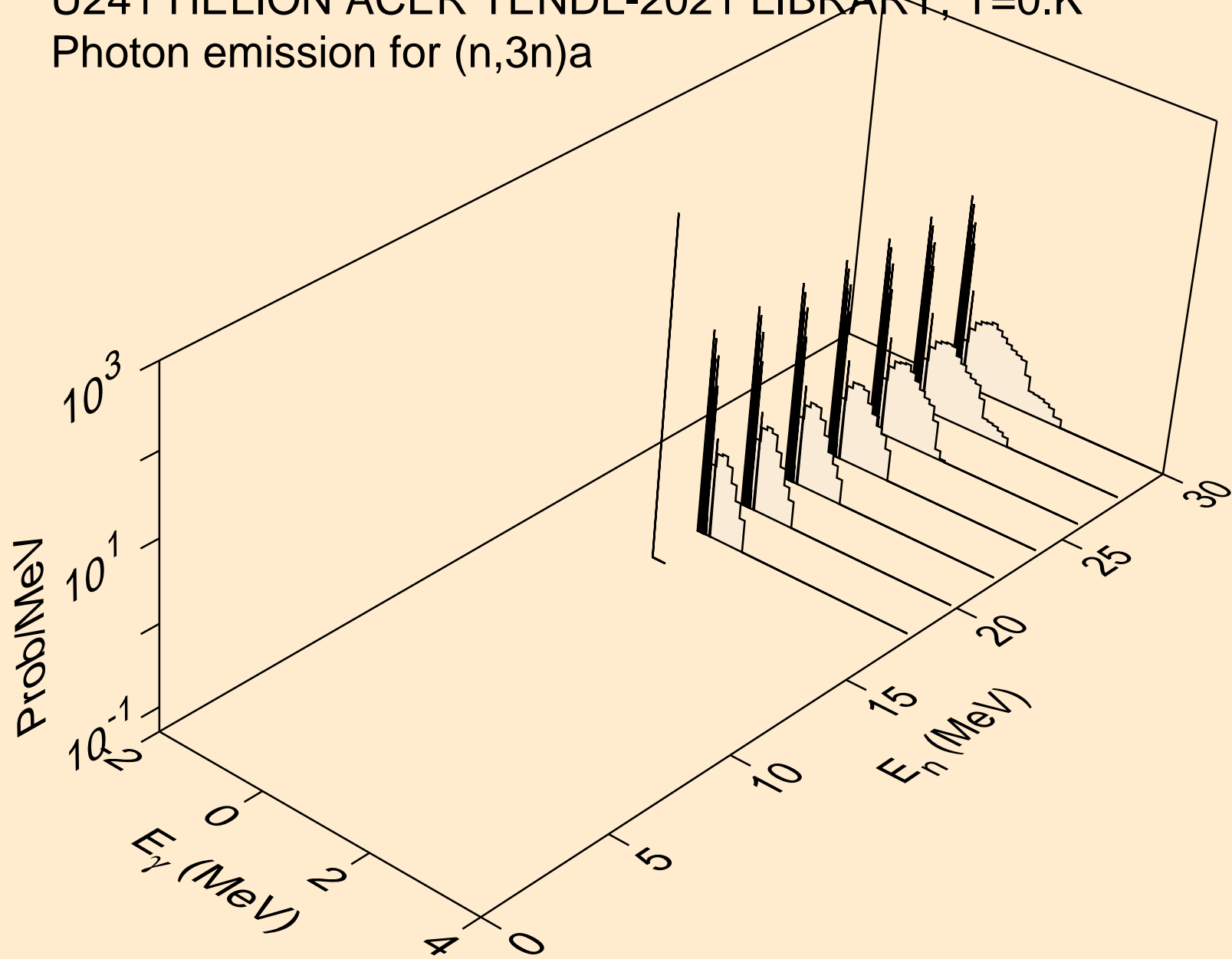



U241 HELION ACER TENDL-2021 LIBRARY; T=0.K  
Photon emission for (n,n\*)p

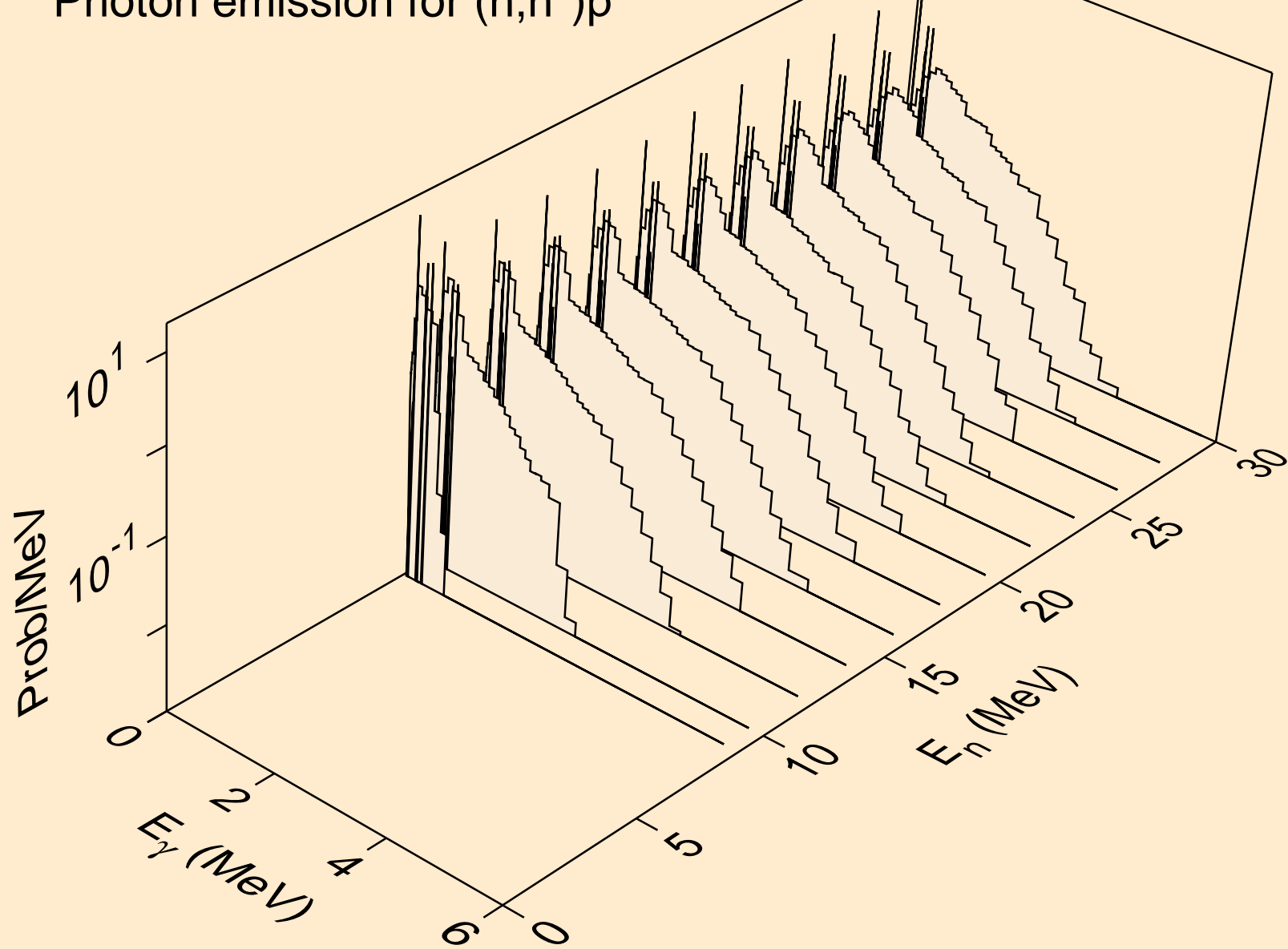

U241 HELION ACER TENDL-2021 LIBRARY; T=0.K  
Photon emission for (n,n\*)d

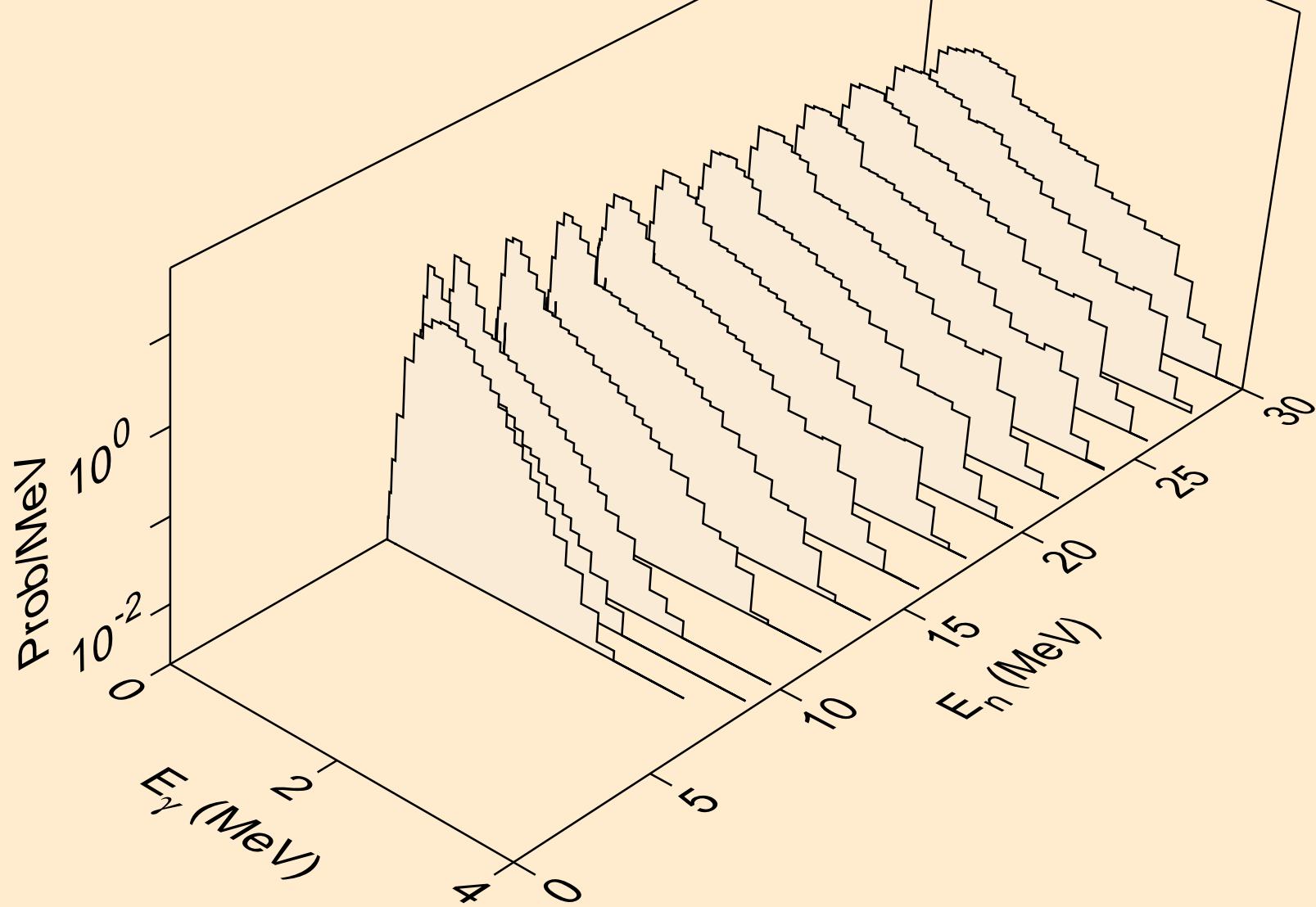

U241 HELION ACER TENDL-2021 LIBRARY; T=0.K  
Photon emission for (n,n\*)t

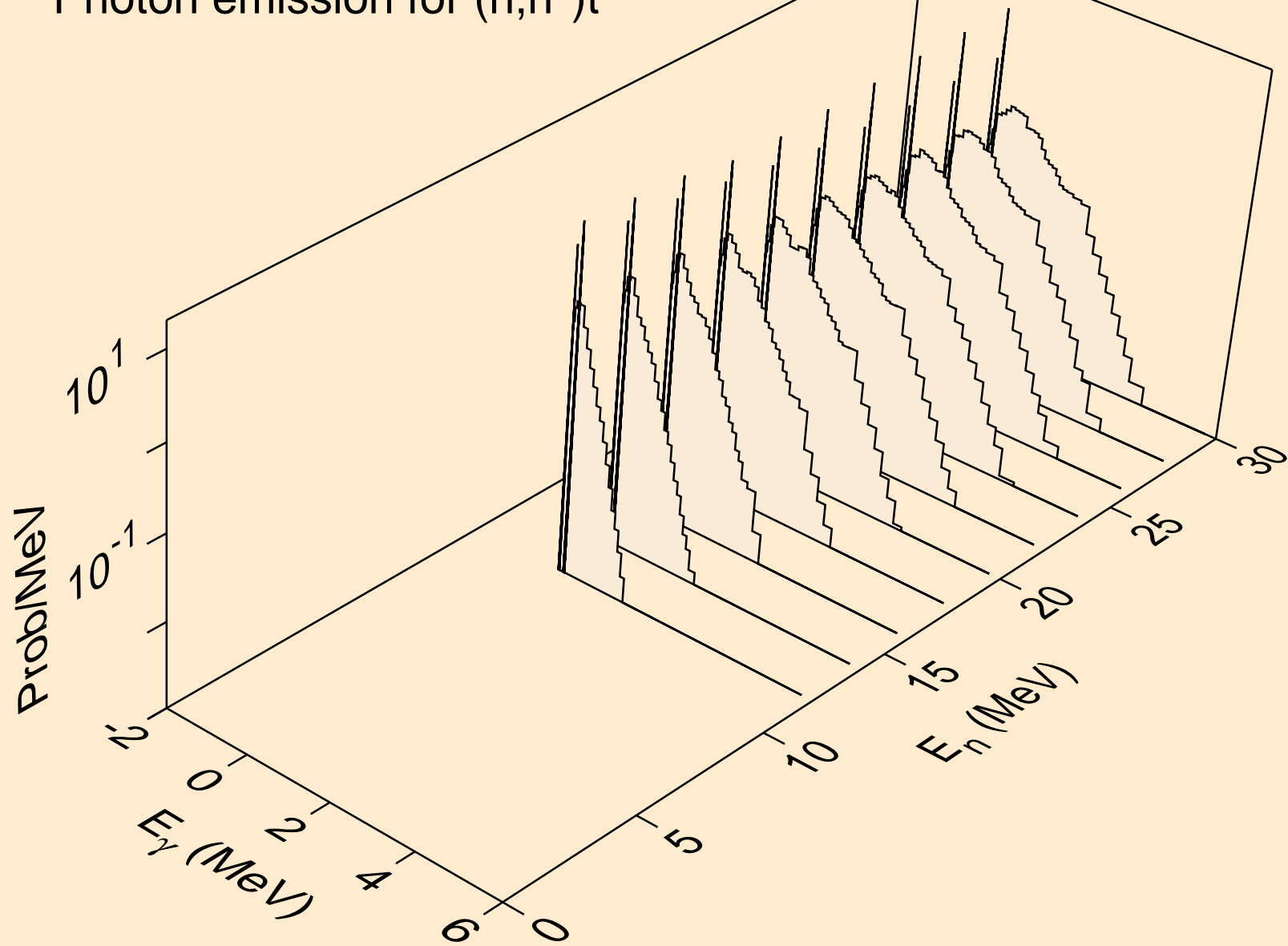

U241 HELION ACER TENDL-2021 LIBRARY; T=0.K  
Photon emission for (n,n\*)he3

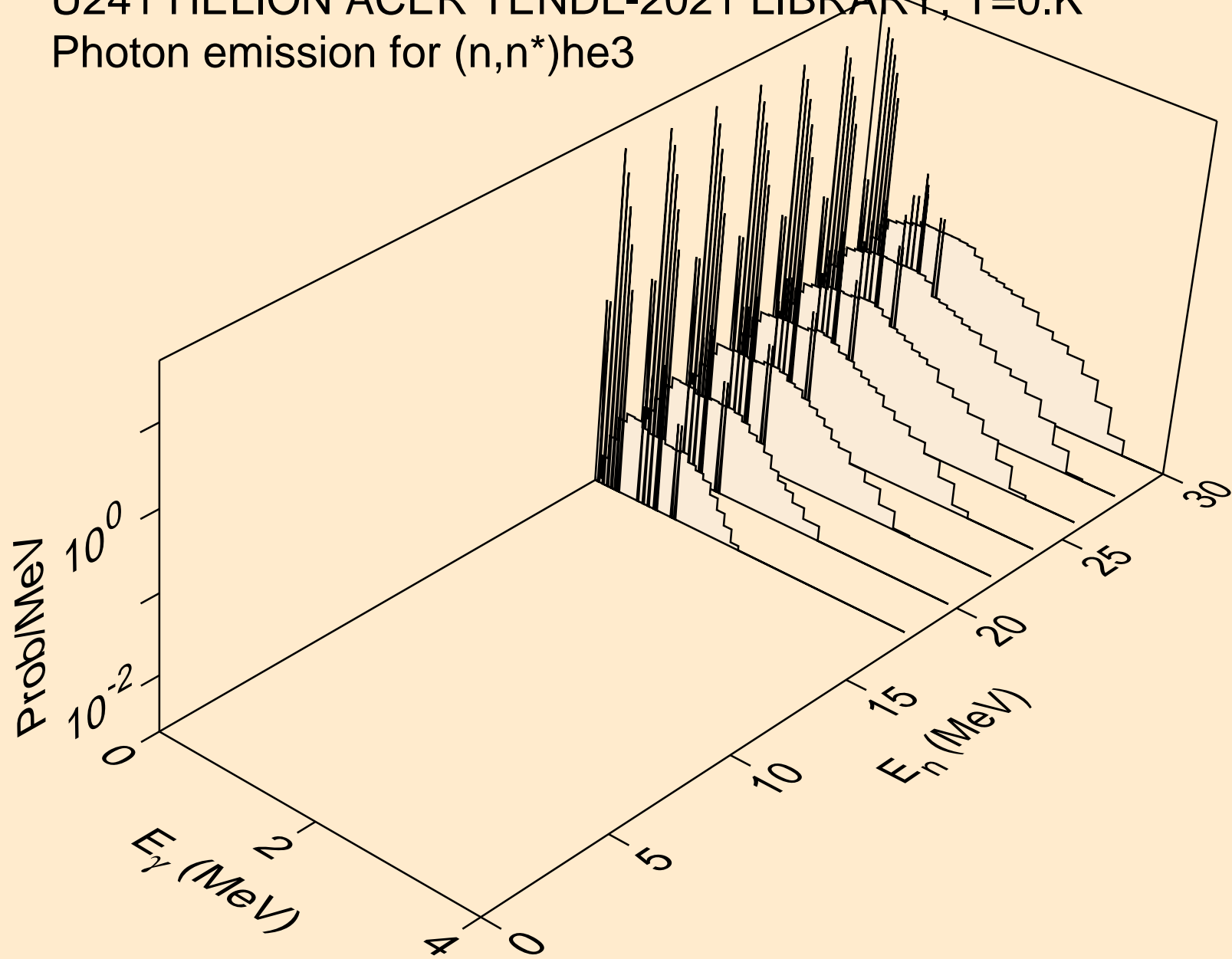

U241 HELION ACER TENDL-2021 LIBRARY; T=0.K  
Photon emission for (n,4n)

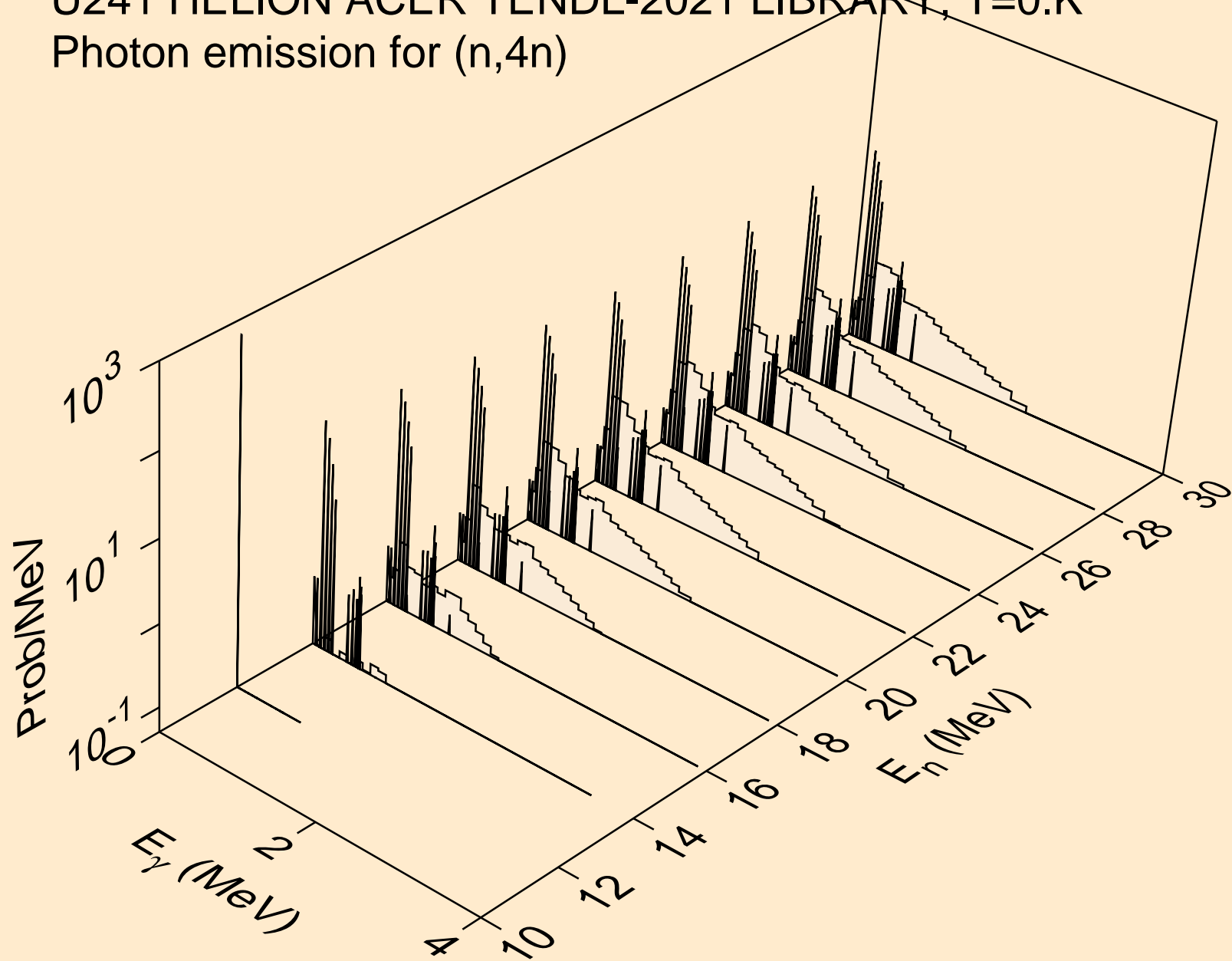

U241 HELION ACER TENDL-2021 LIBRARY; T=0.K  
Photon emission for (n,2np)

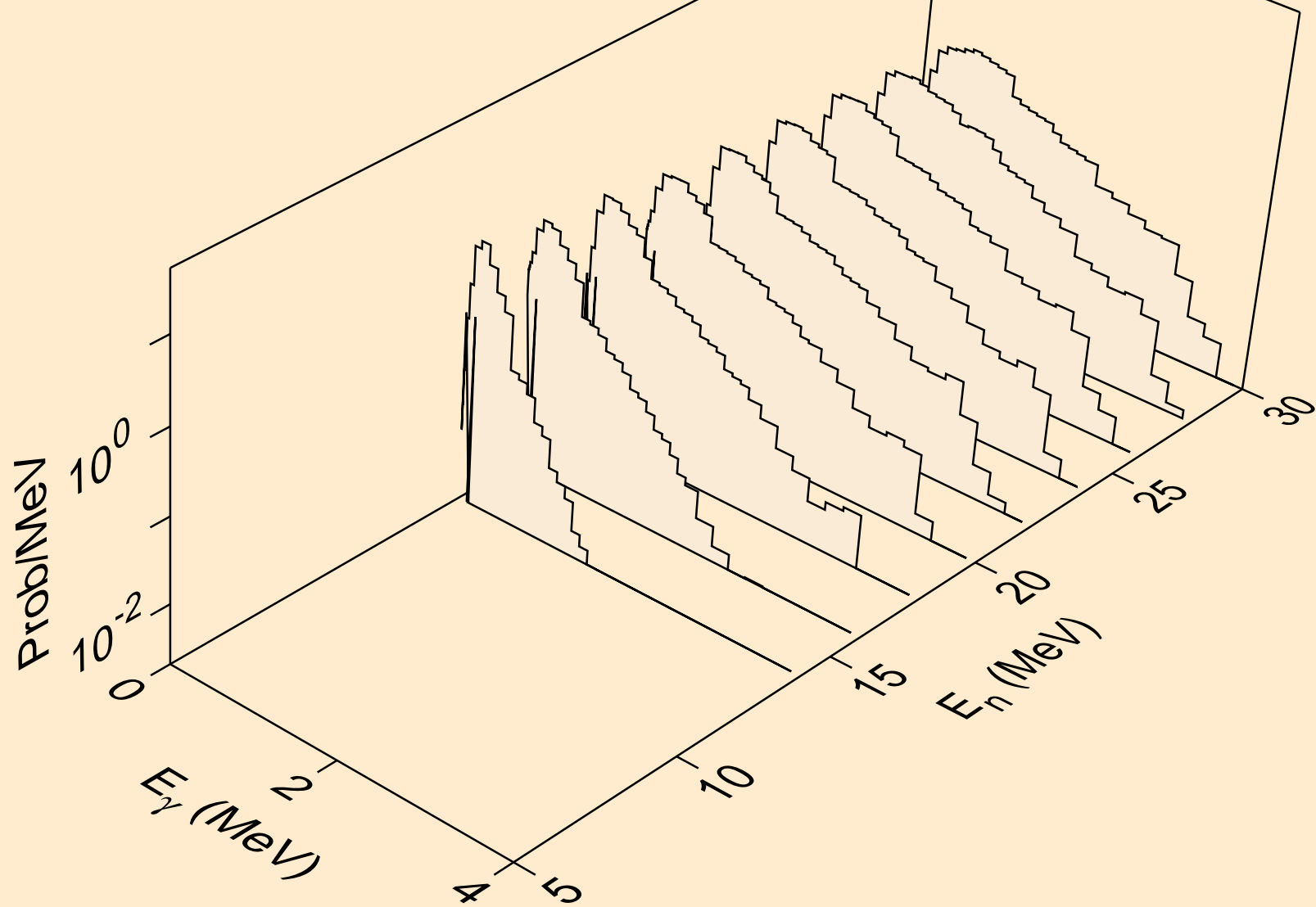

U241 HELION ACER TENDL-2021 LIBRARY; T=0.K  
Photon emission for (n,3np)

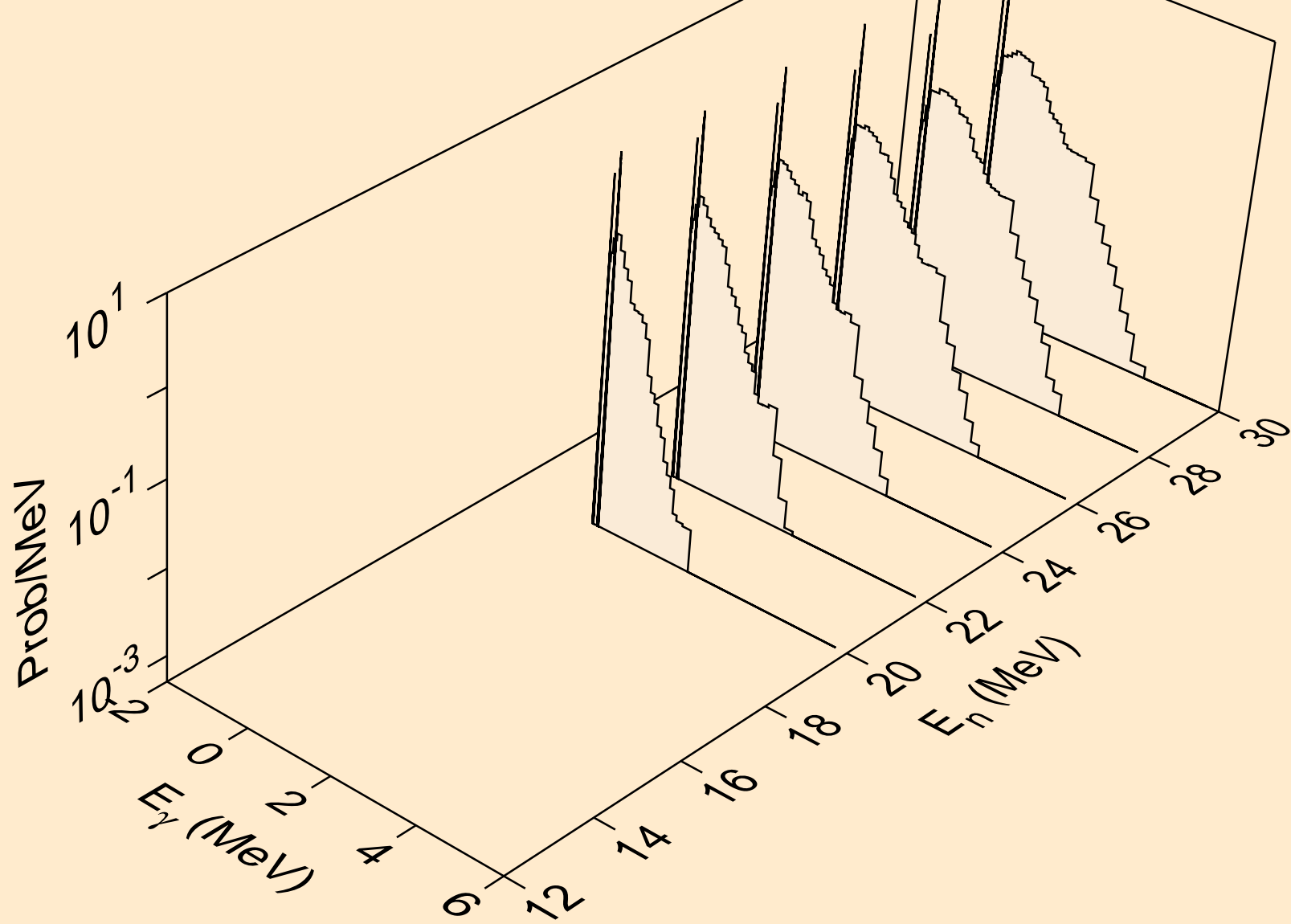

U241 HELION ACER TENDL-2021 LIBRARY; T=0.K  
Photon emission for (n,2np)

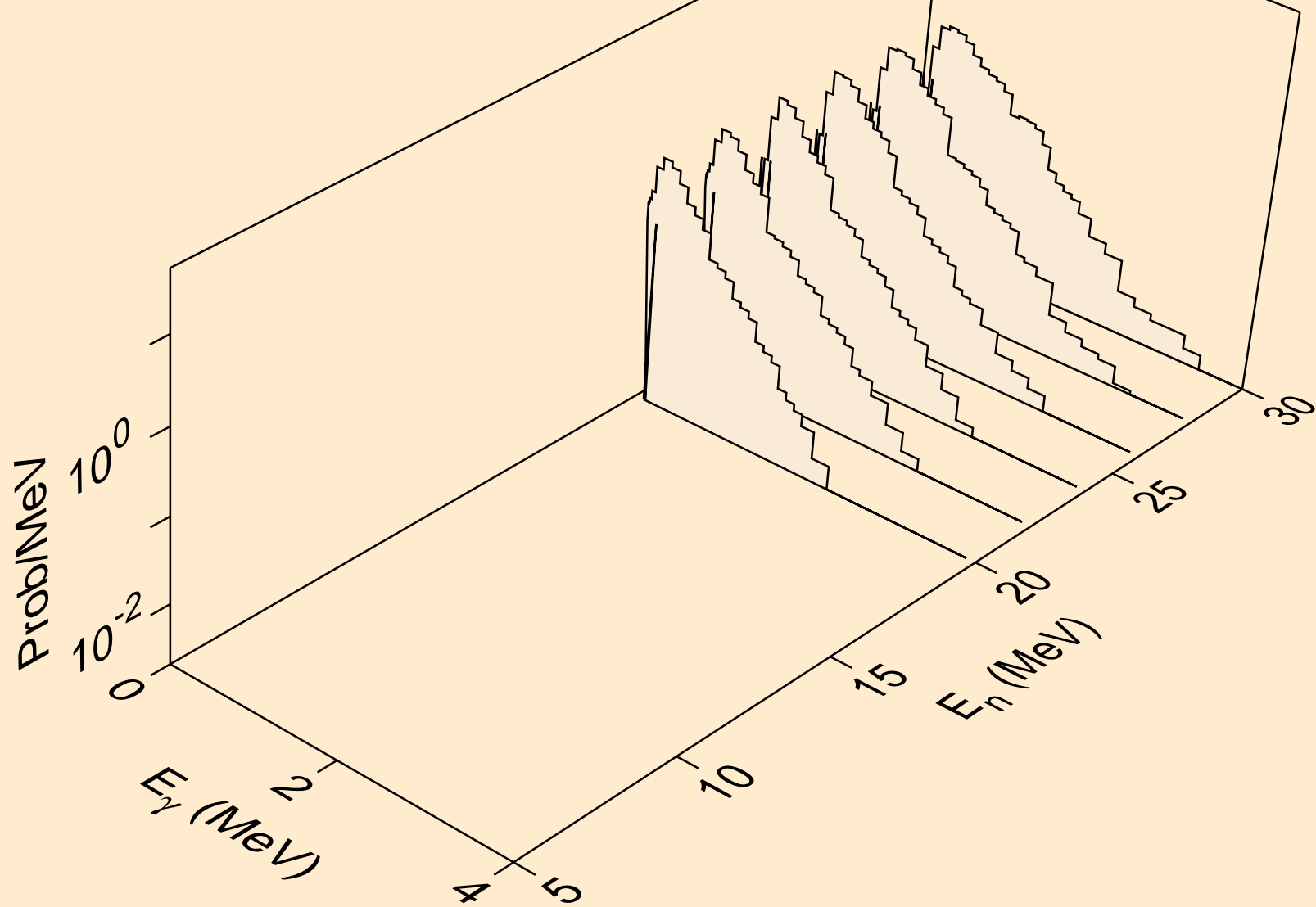



U241 HELION ACER TENDL-2021 LIBRARY; T=0.K  
Photon emission for (n,npa)

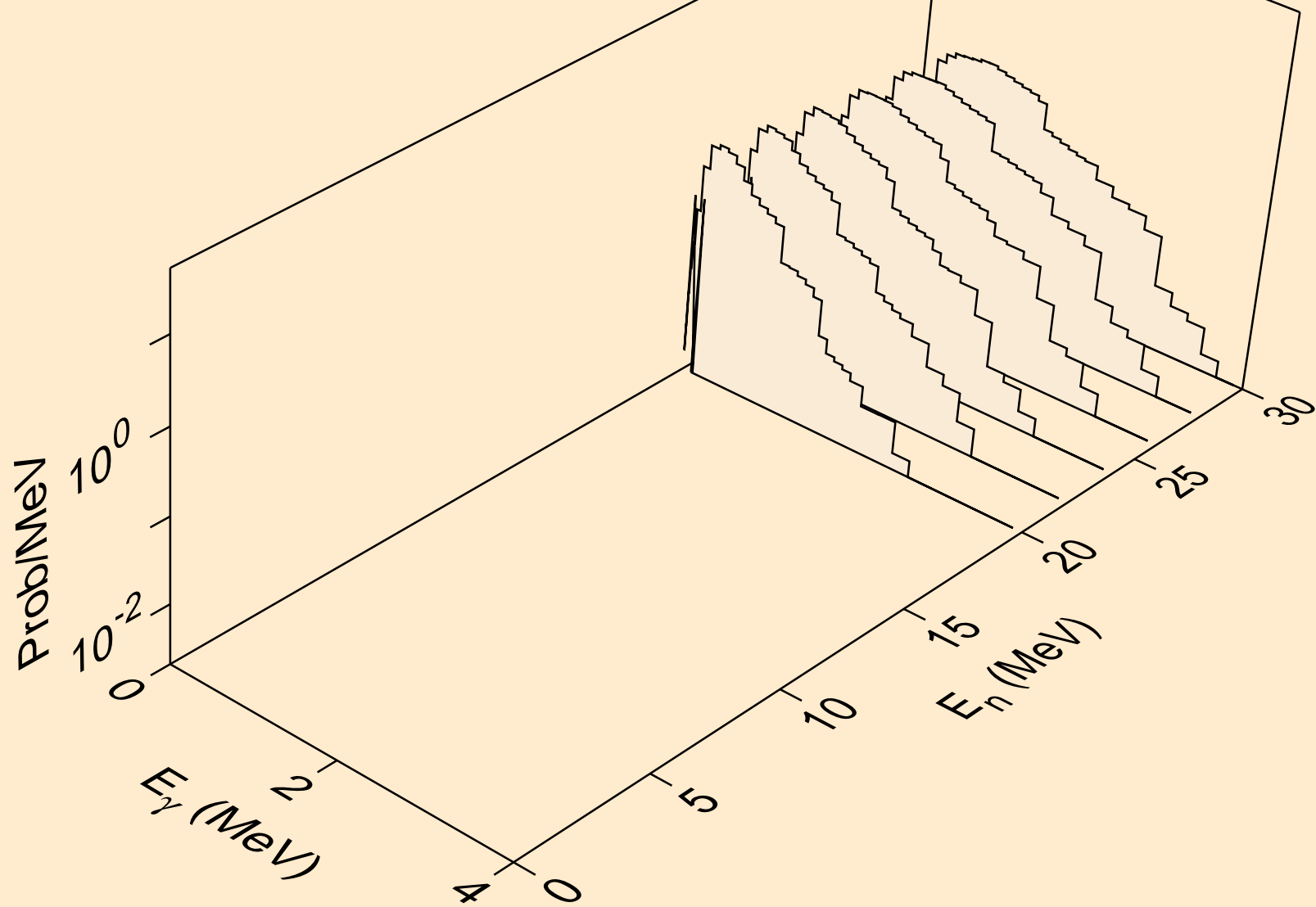

U241 HELION ACER TENDL-2021 LIBRARY; T=0.K  
Photon emission for (n,p)

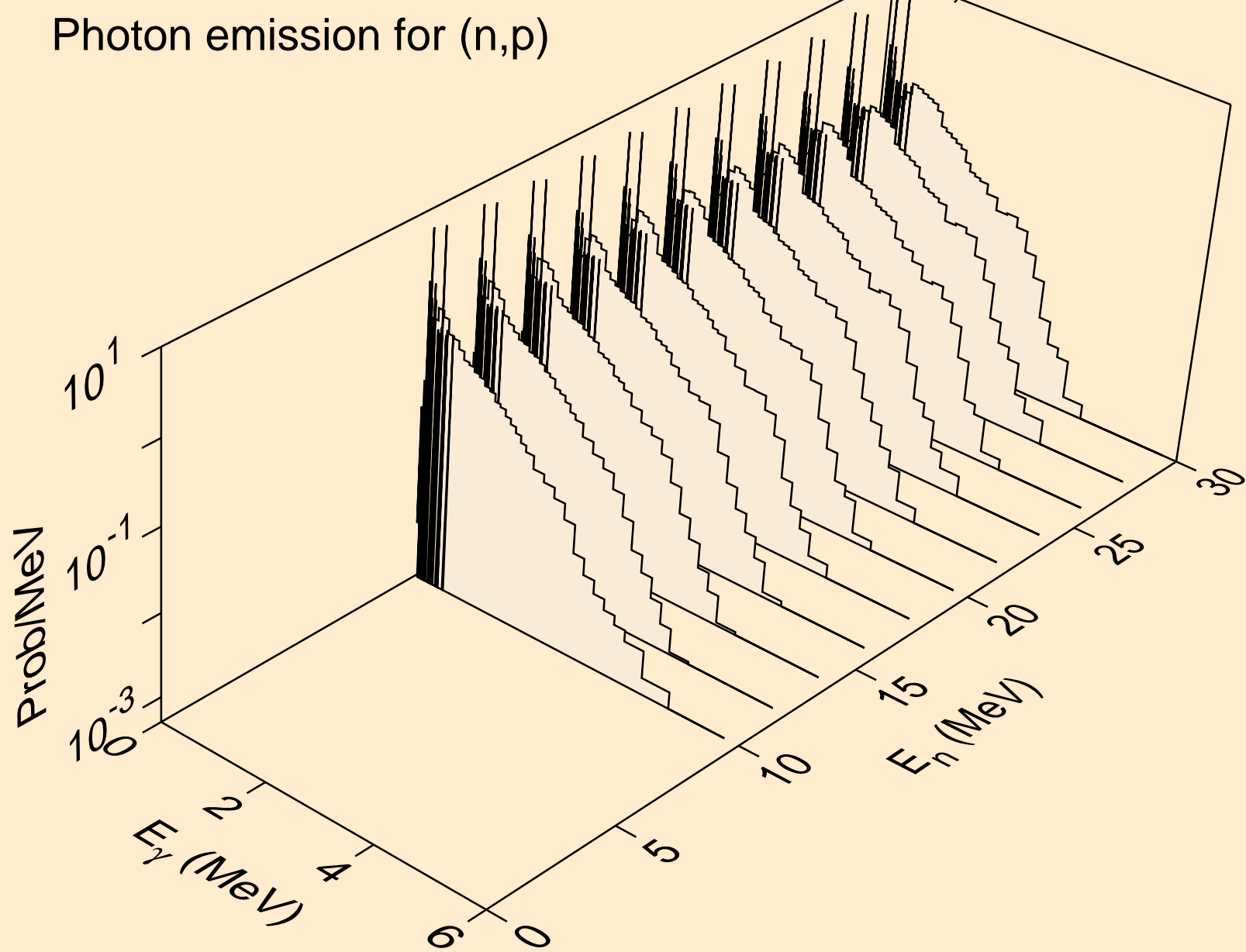

U241 HELION ACER TENDL-2021 LIBRARY; T=0.K  
Photon emission for (n,d)

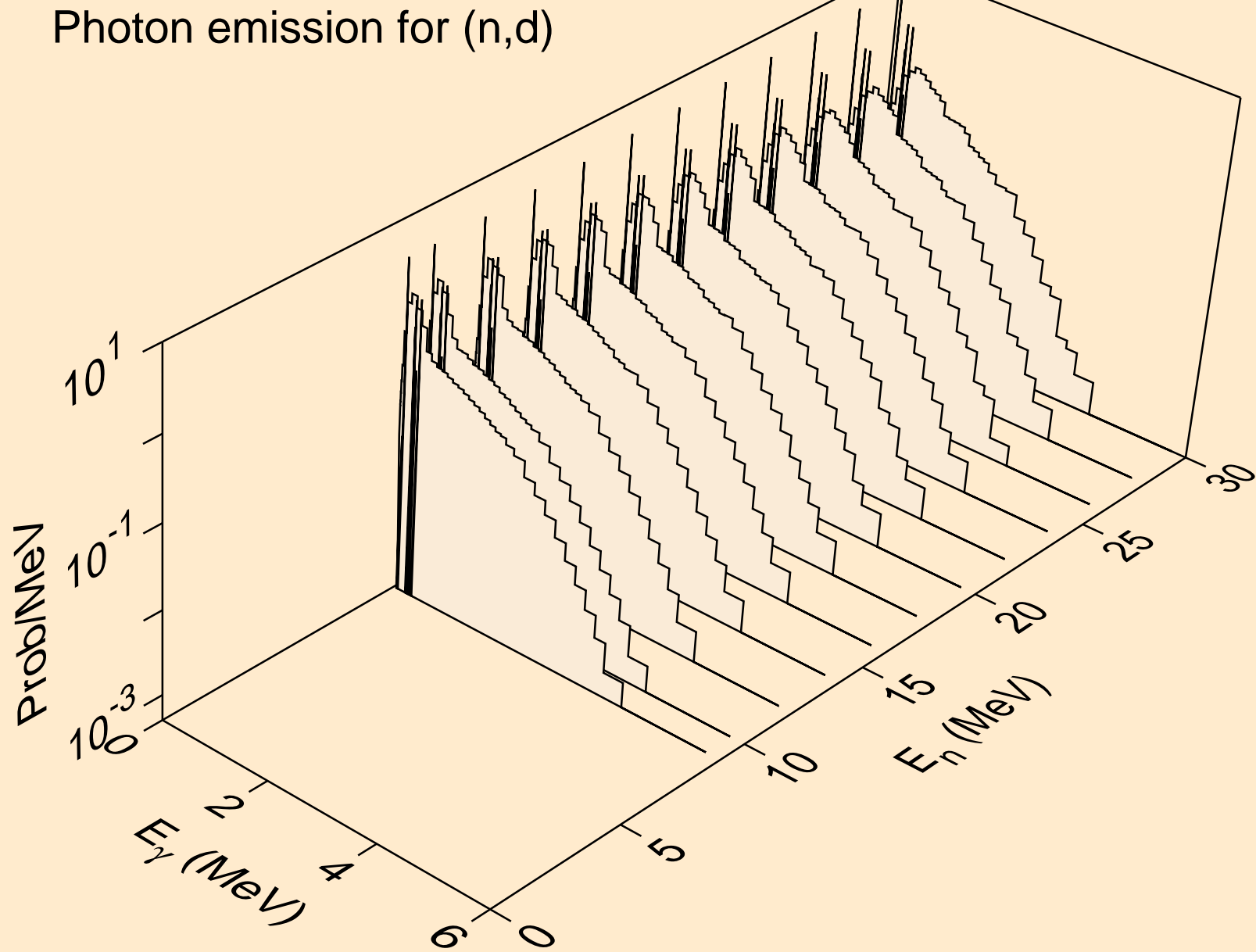

U241 HELION ACER TENDL-2021 LIBRARY; T=0.K  
Photon emission for (n,t)

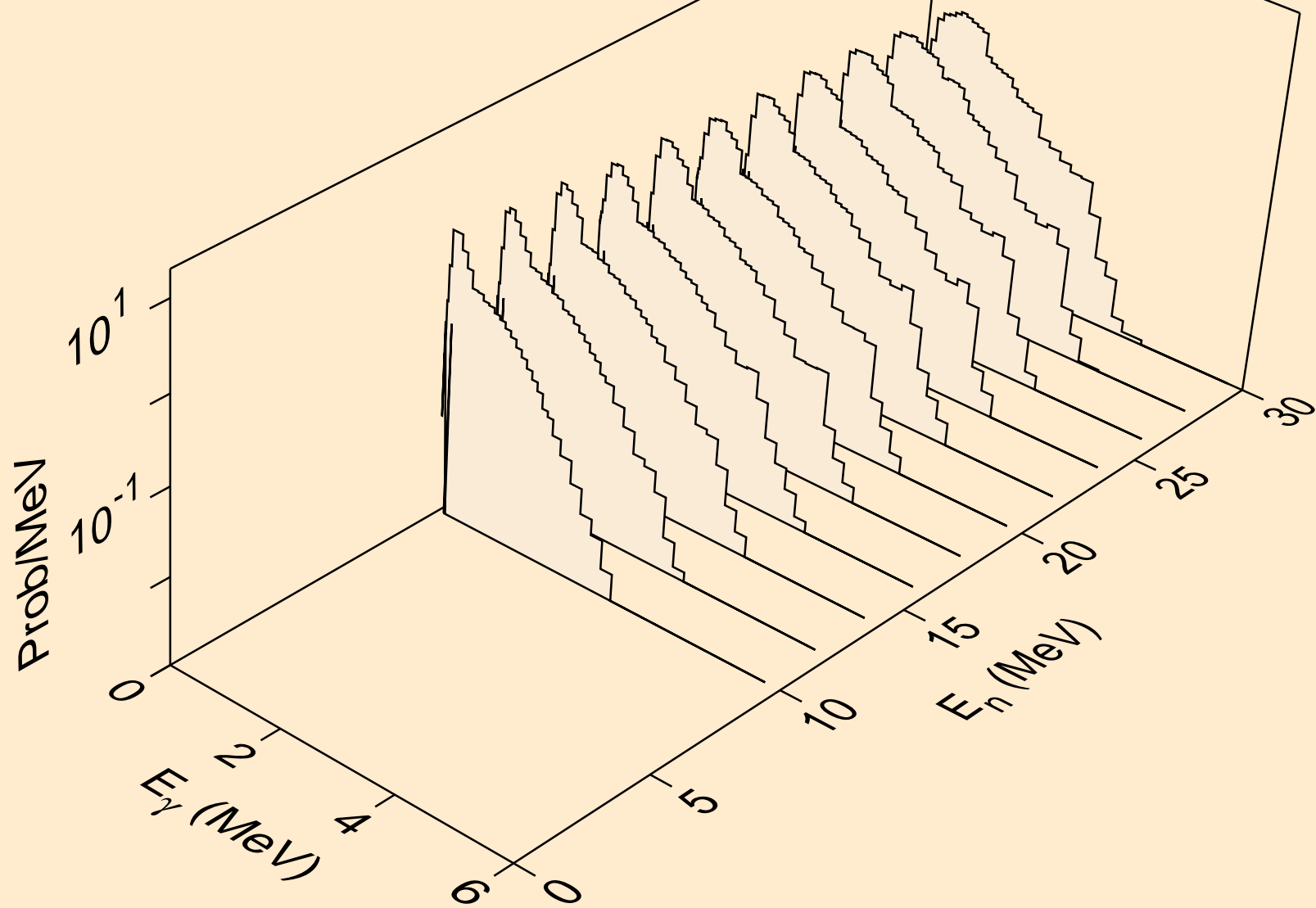

U241 HELION ACER TENDL-2021 LIBRARY; T=0.K  
Photon emission for inelastic

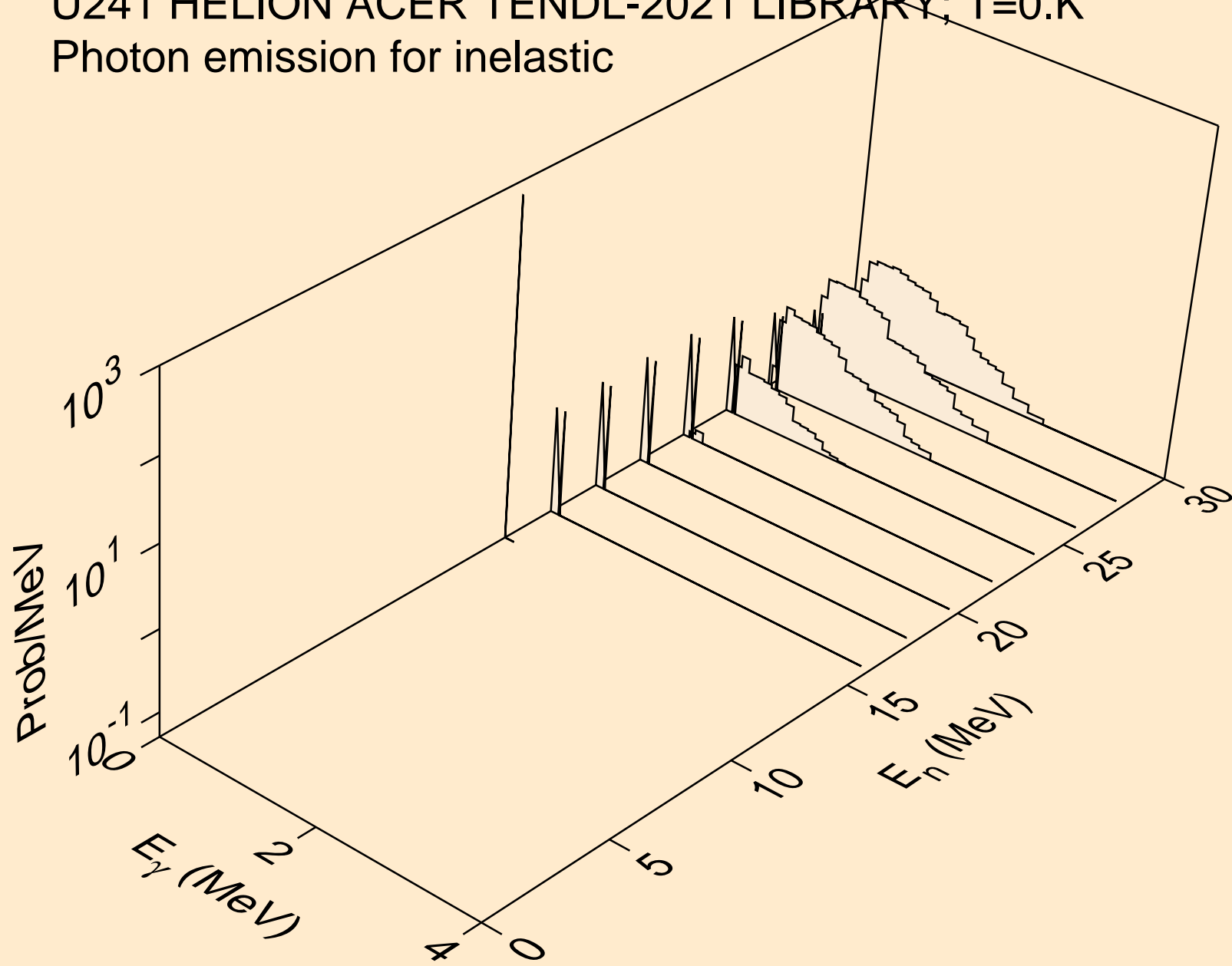

U241 HELION ACER TENDL-2021 LIBRARY; T=0.K  
Photon emission for (n,a)

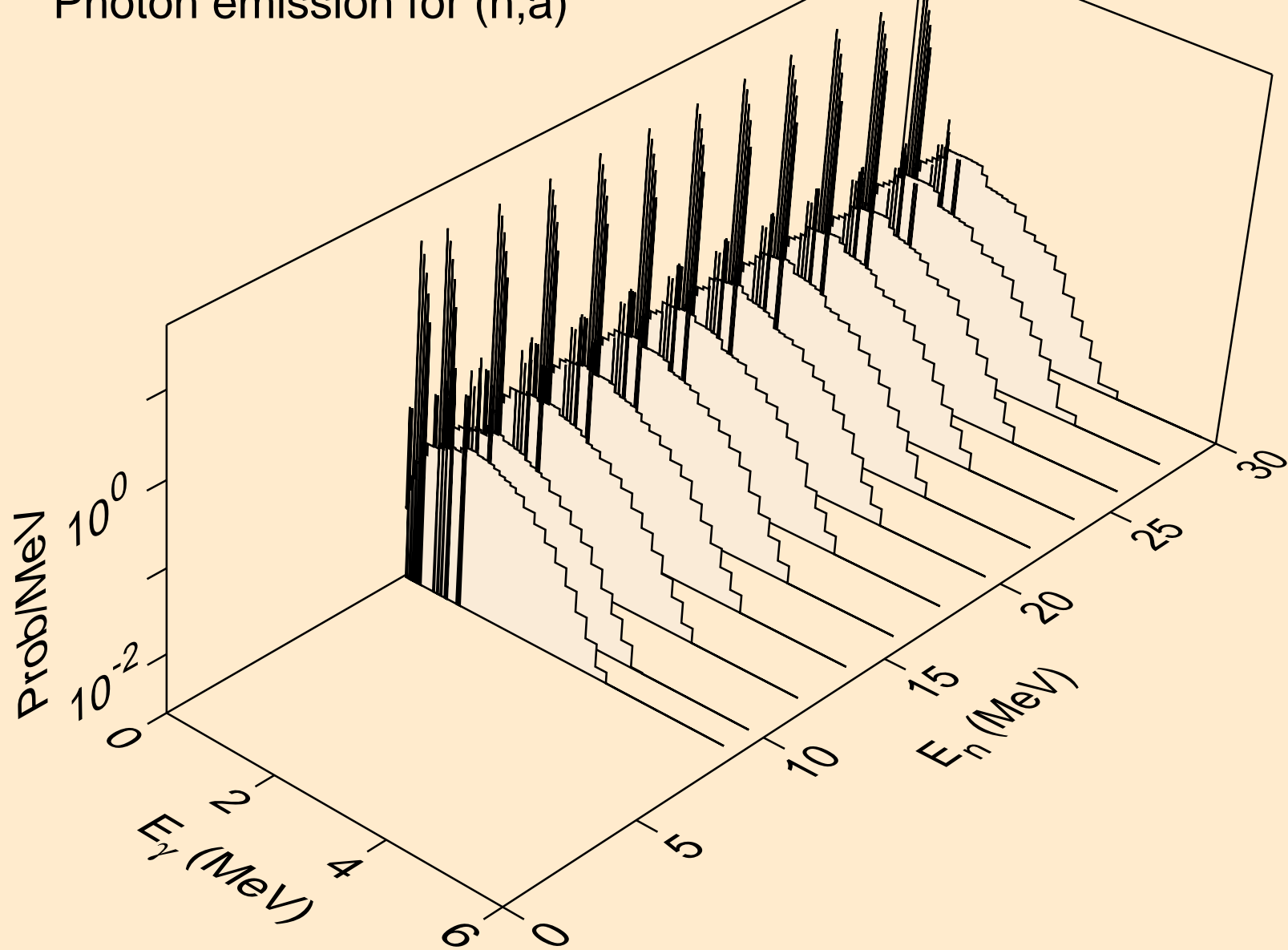

U241 HELION ACER TENDL-2021 LIBRARY; T=0.K  
Photon emission for (n,2p)

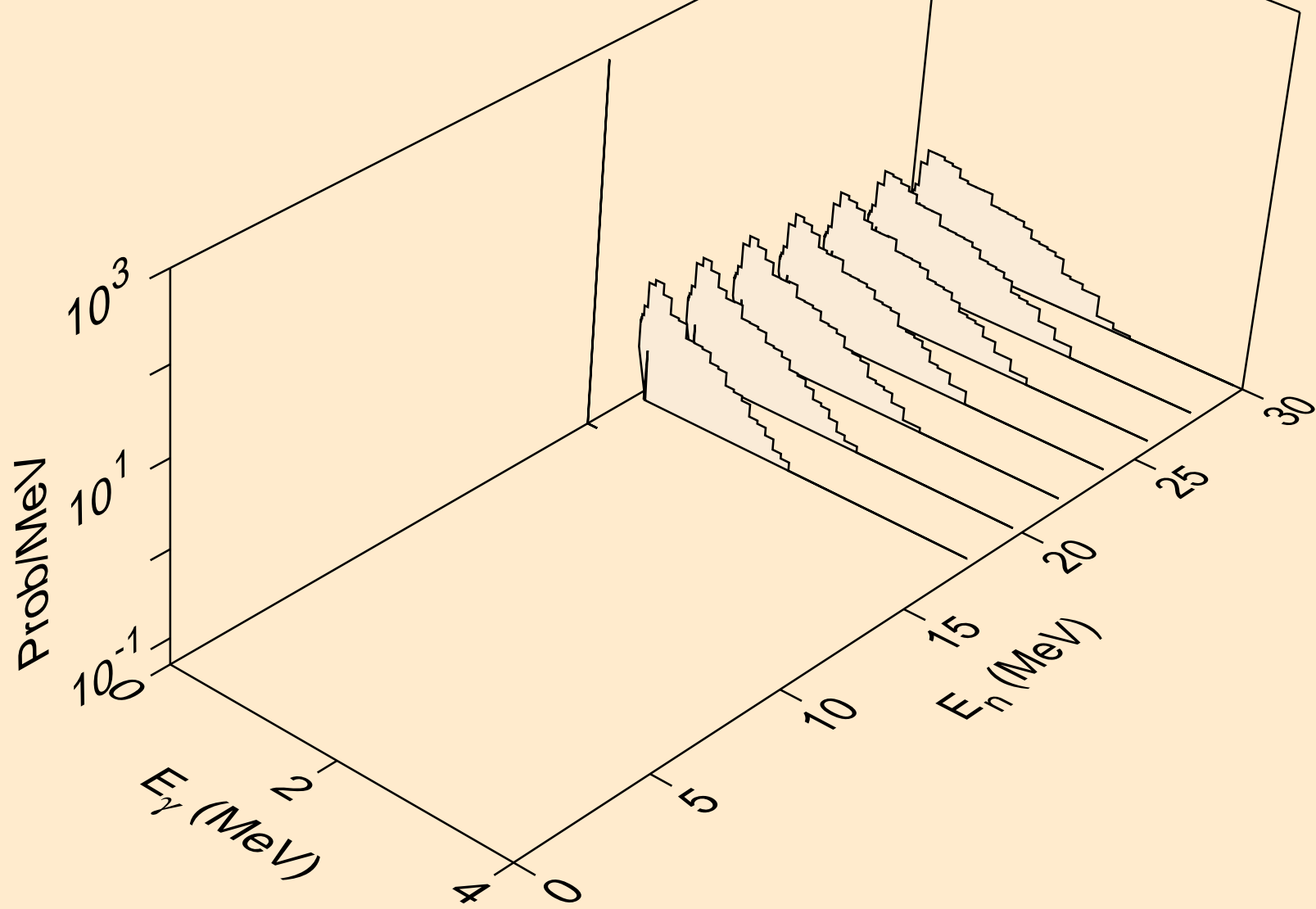

U241 HELION ACER TENDL-2021 LIBRARY; T=0.K  
Photon emission for (n,pd)

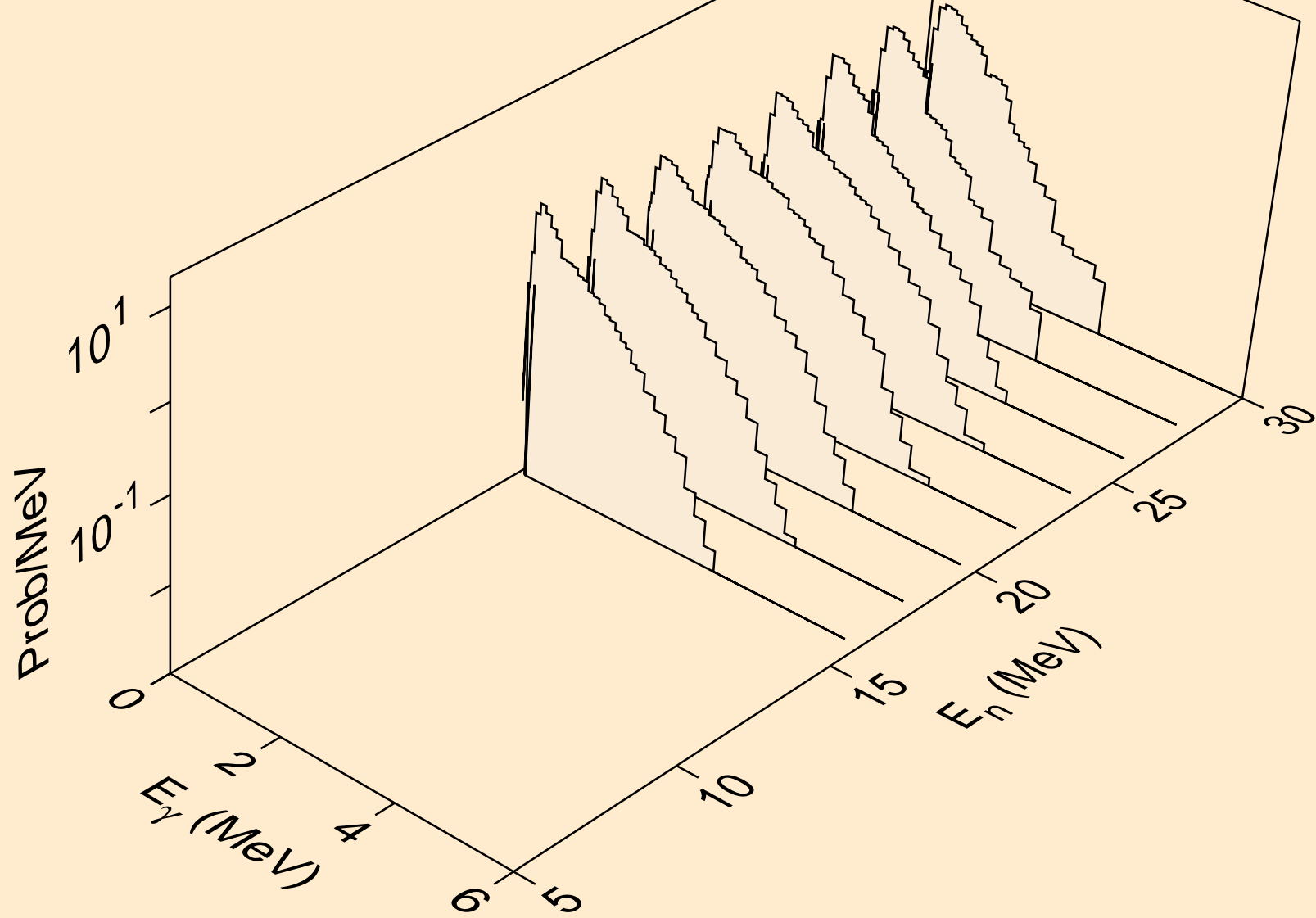



# U241 HELION ACER TENDL-2021 LIBRARY; T=0.K

## Particle heating contributions

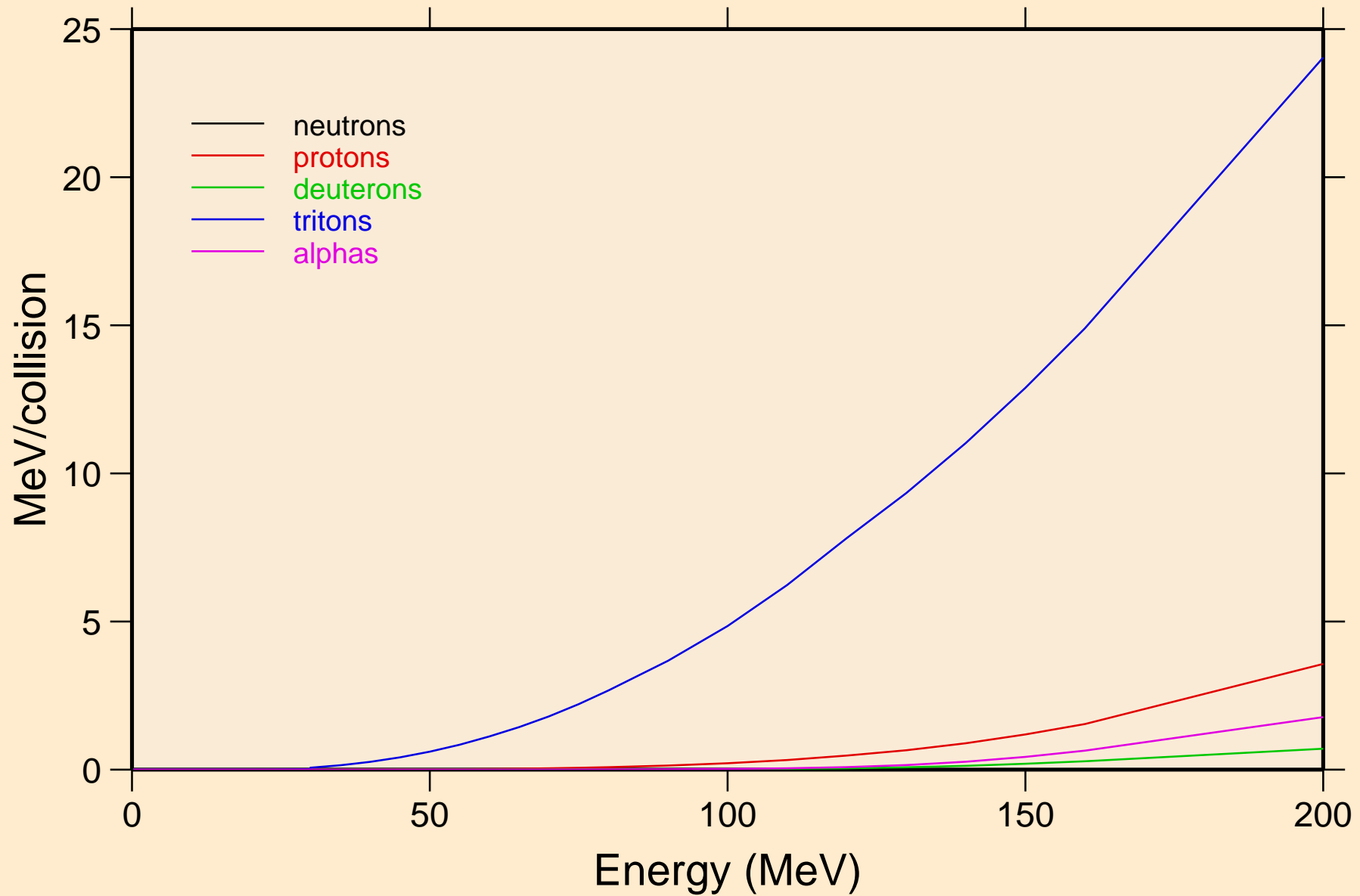

U241 HELION ACER TENDL-2021 LIBRARY; T=0.K  
Recoil Heating

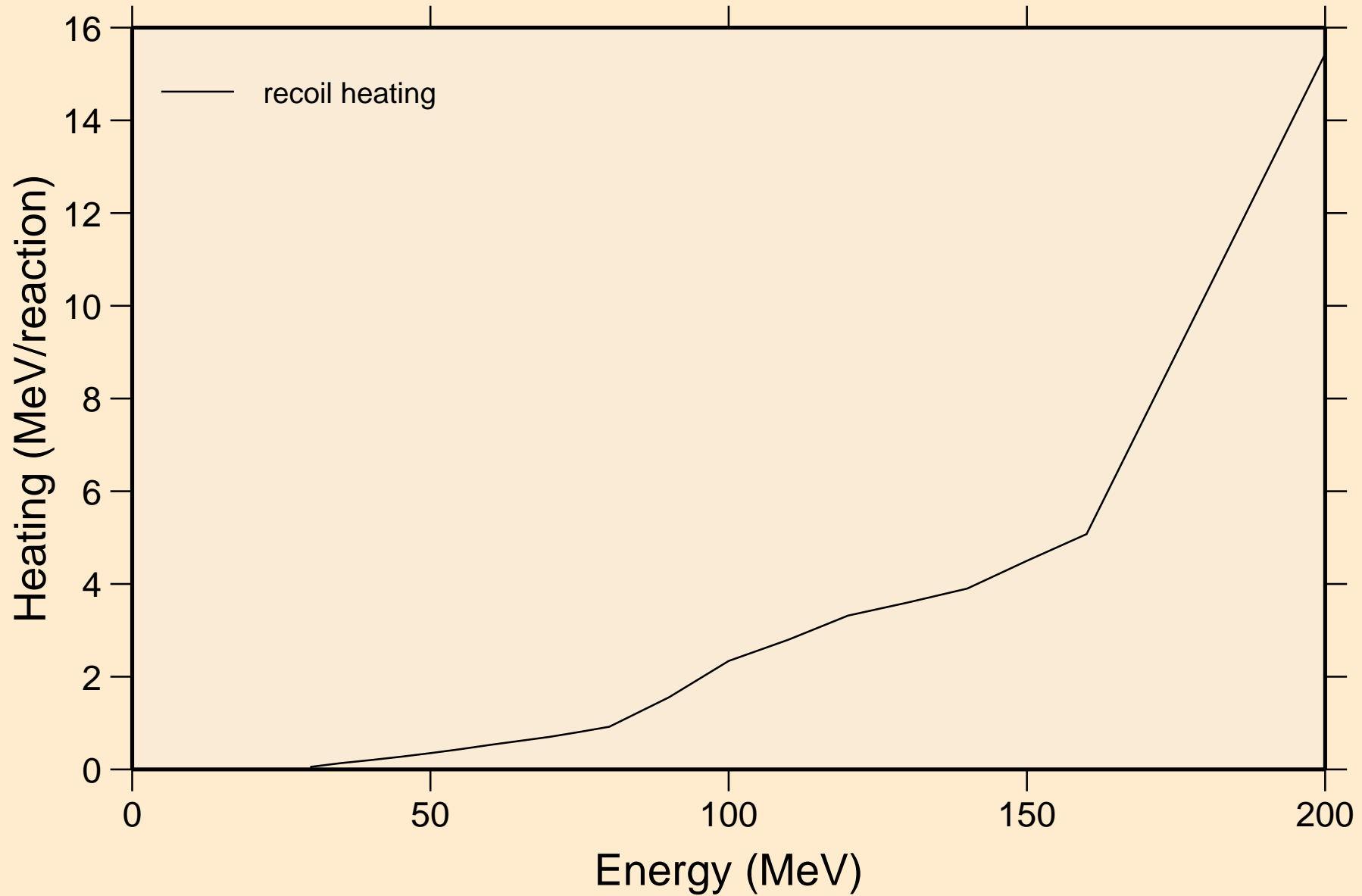

U241 HELION ACER TENDL-2021 LIBRARY; T=0.K  
Particle production cross sections

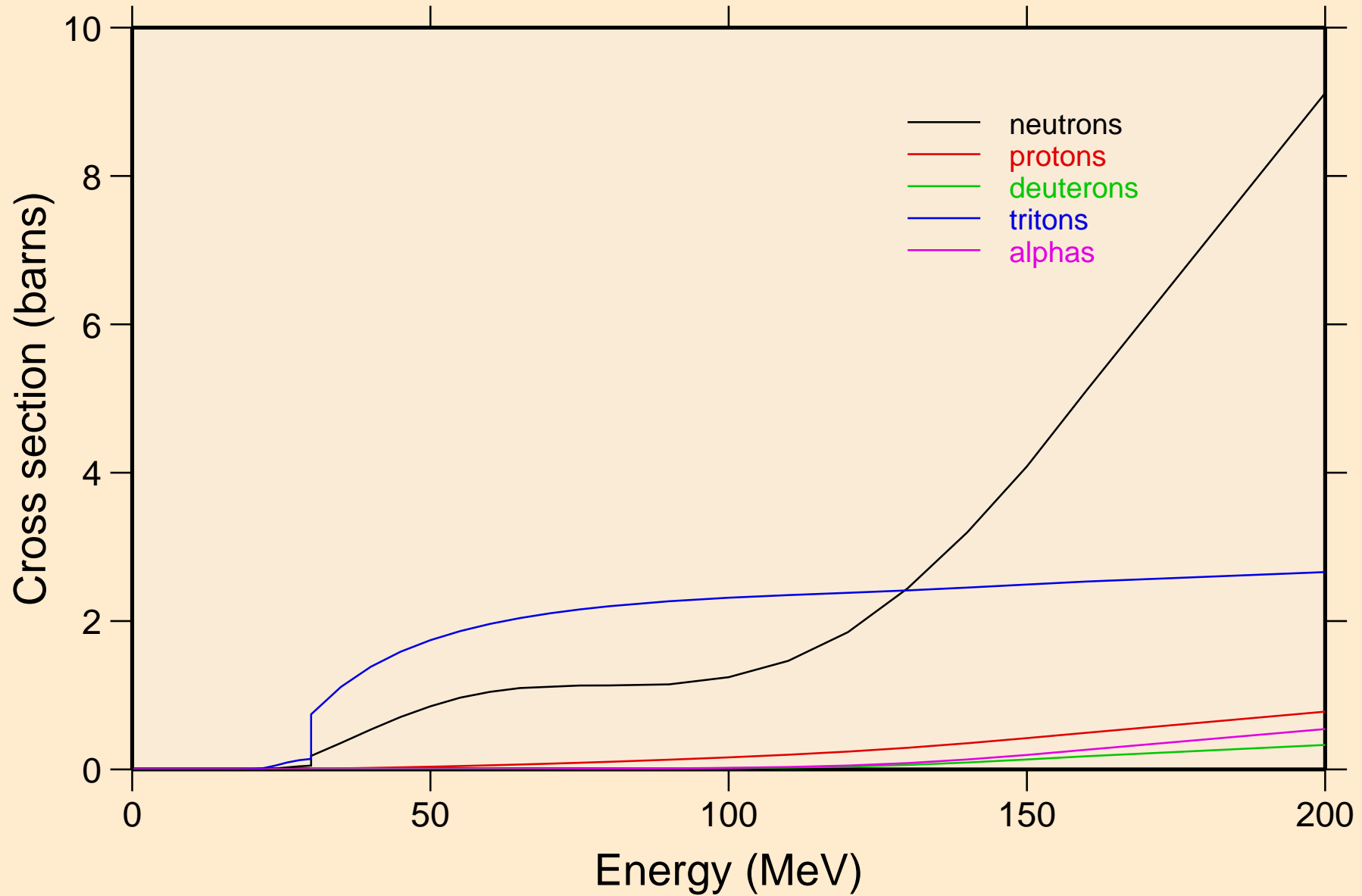

U241 HELION ACER TENDL-2021 LIBRARY; T=0.K  
neutrons from (s,n)

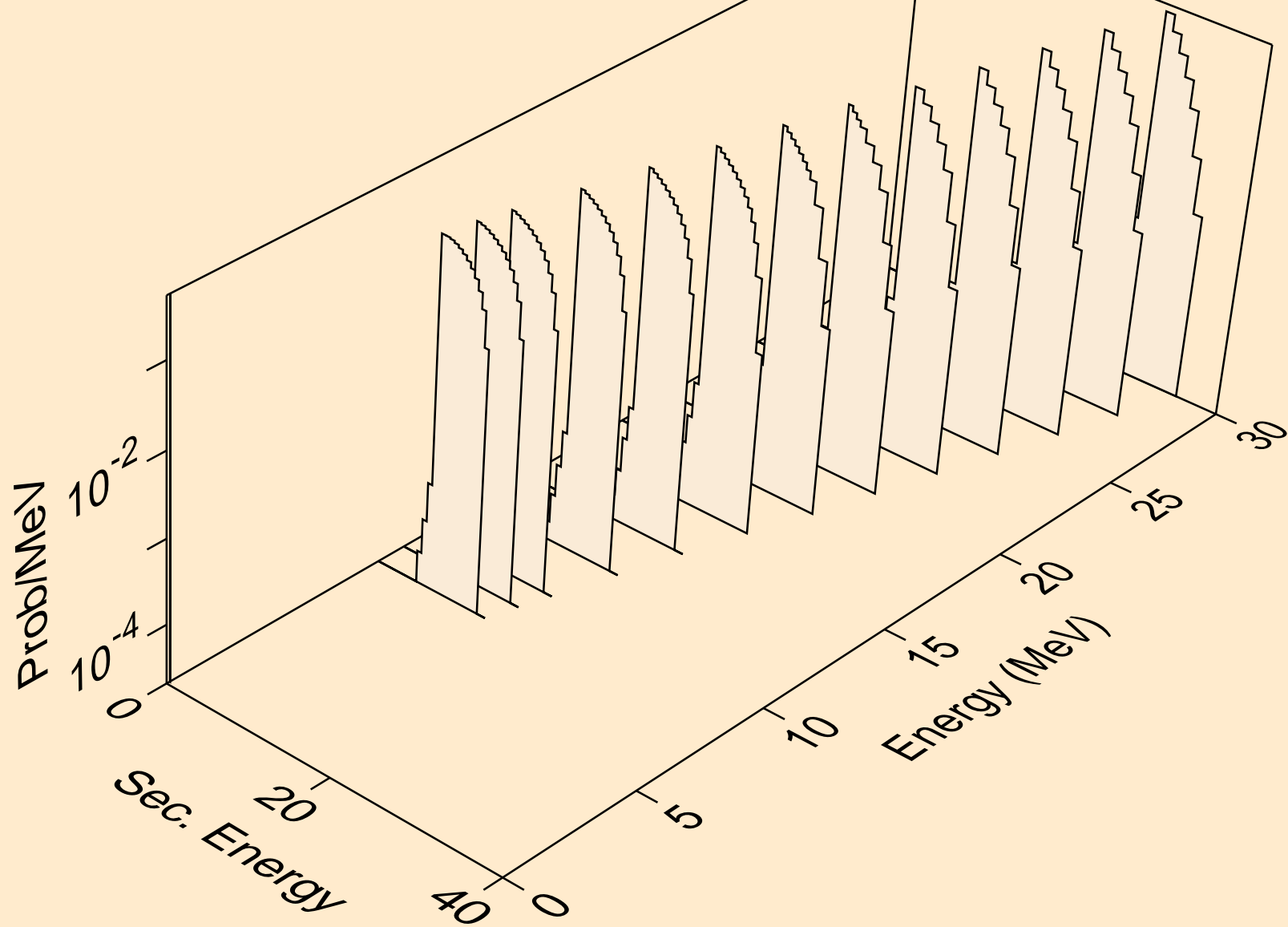

U241 HELION ACER TENDL-2021 LIBRARY; T=0.K  
neutrons from (s,x)

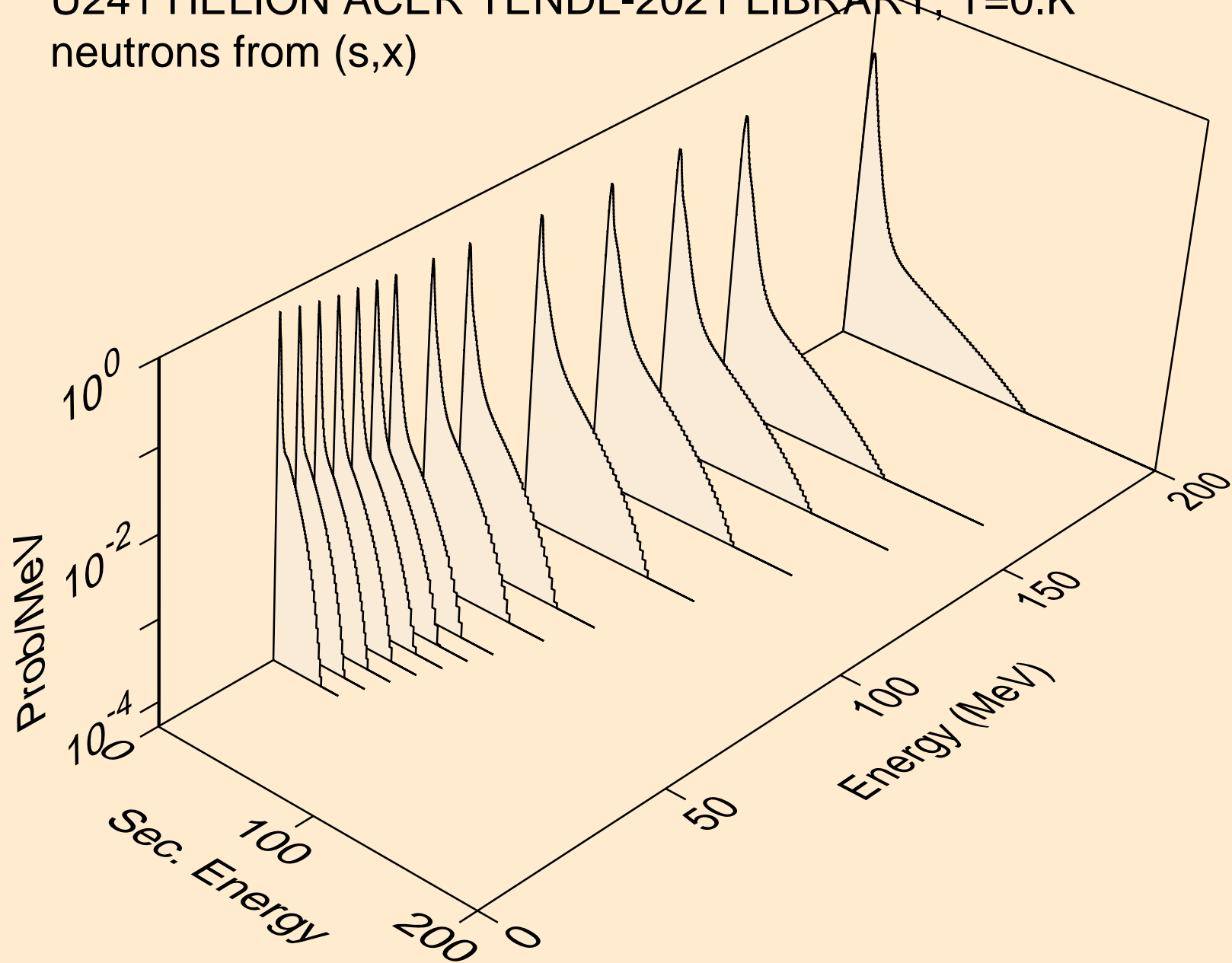

U241 HELION ACER TENDL-2021 LIBRARY; T=0.K  
neutrons from (s,2nd)

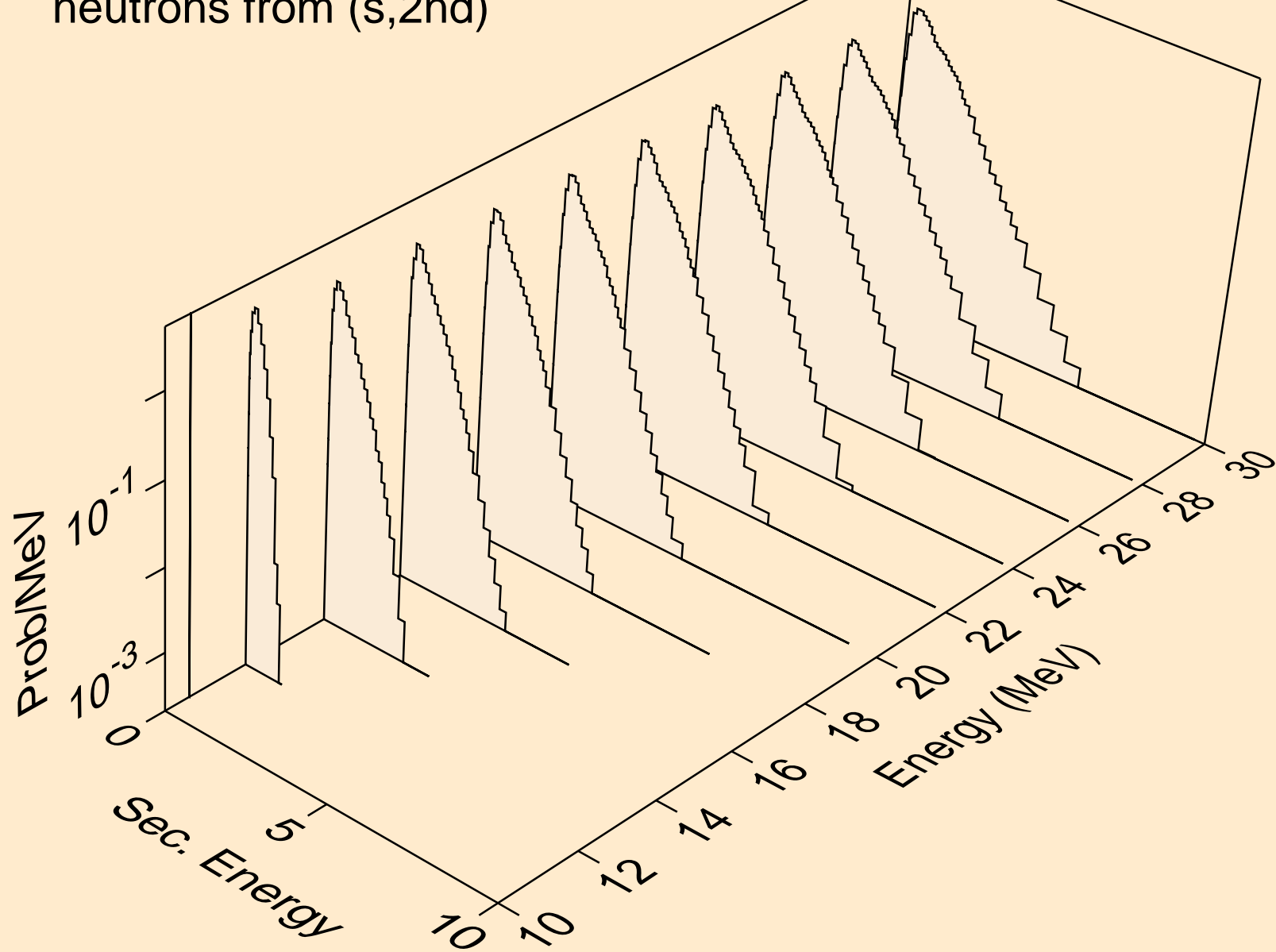

U241 HELION ACER TENDL-2021 LIBRARY; T=0.K  
neutrons from (s,2n)

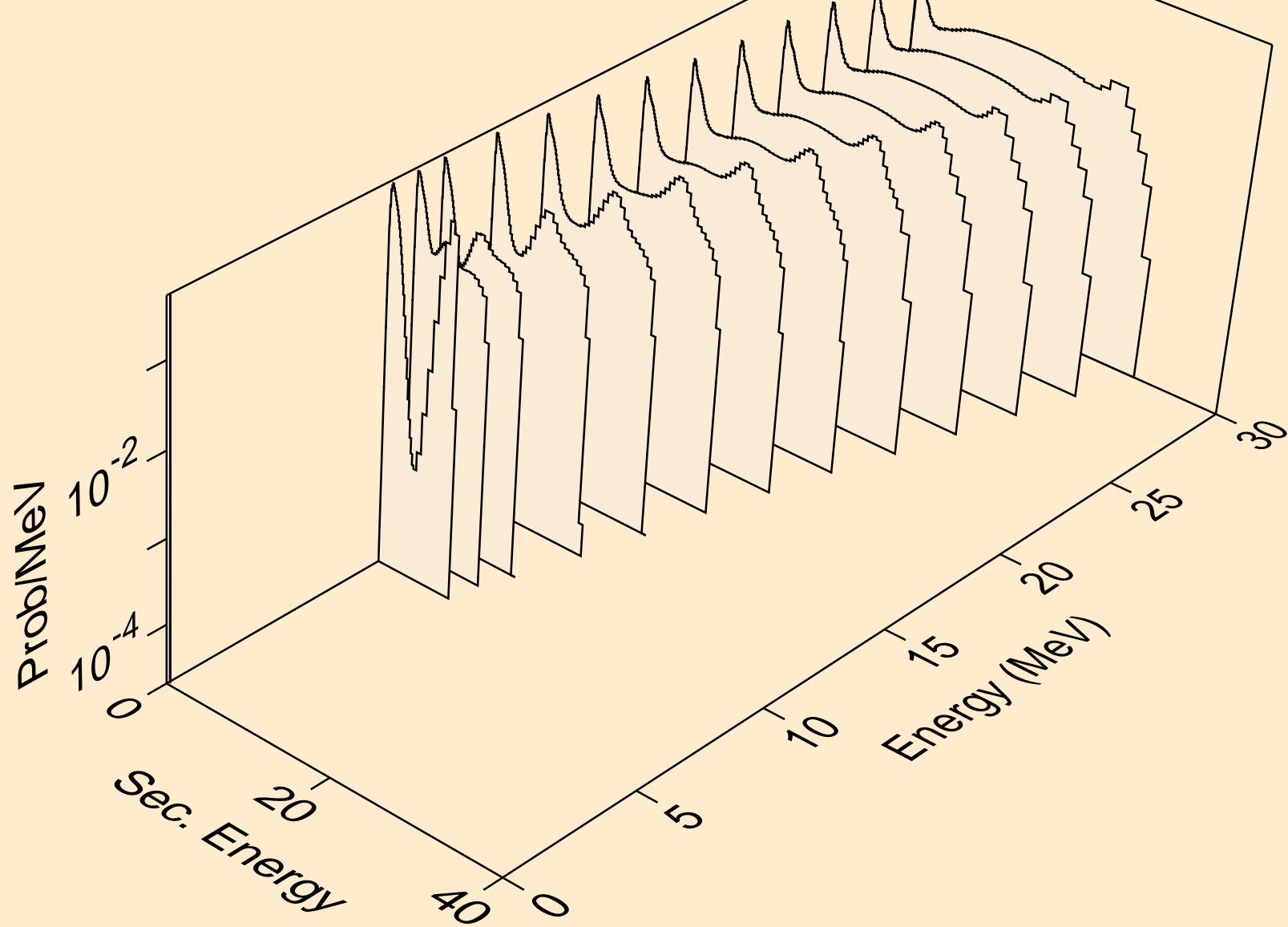

U241 HELION ACER TENDL-2021 LIBRARY; T=0.K  
neutrons from (s,3n)

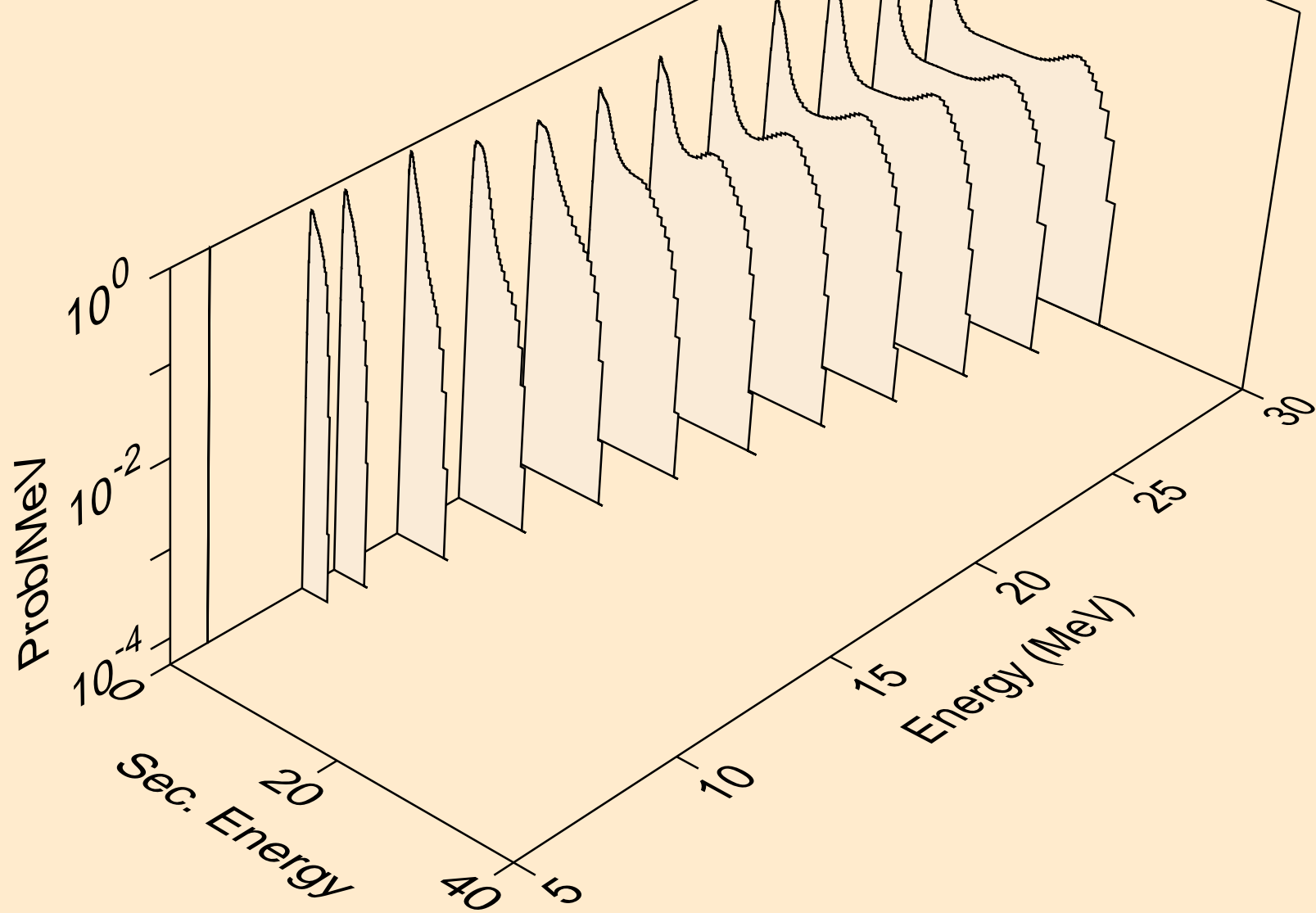



U241 HELION ACER TENDL-2021 LIBRARY; T=0.K  
neutrons from (s,n\*)a

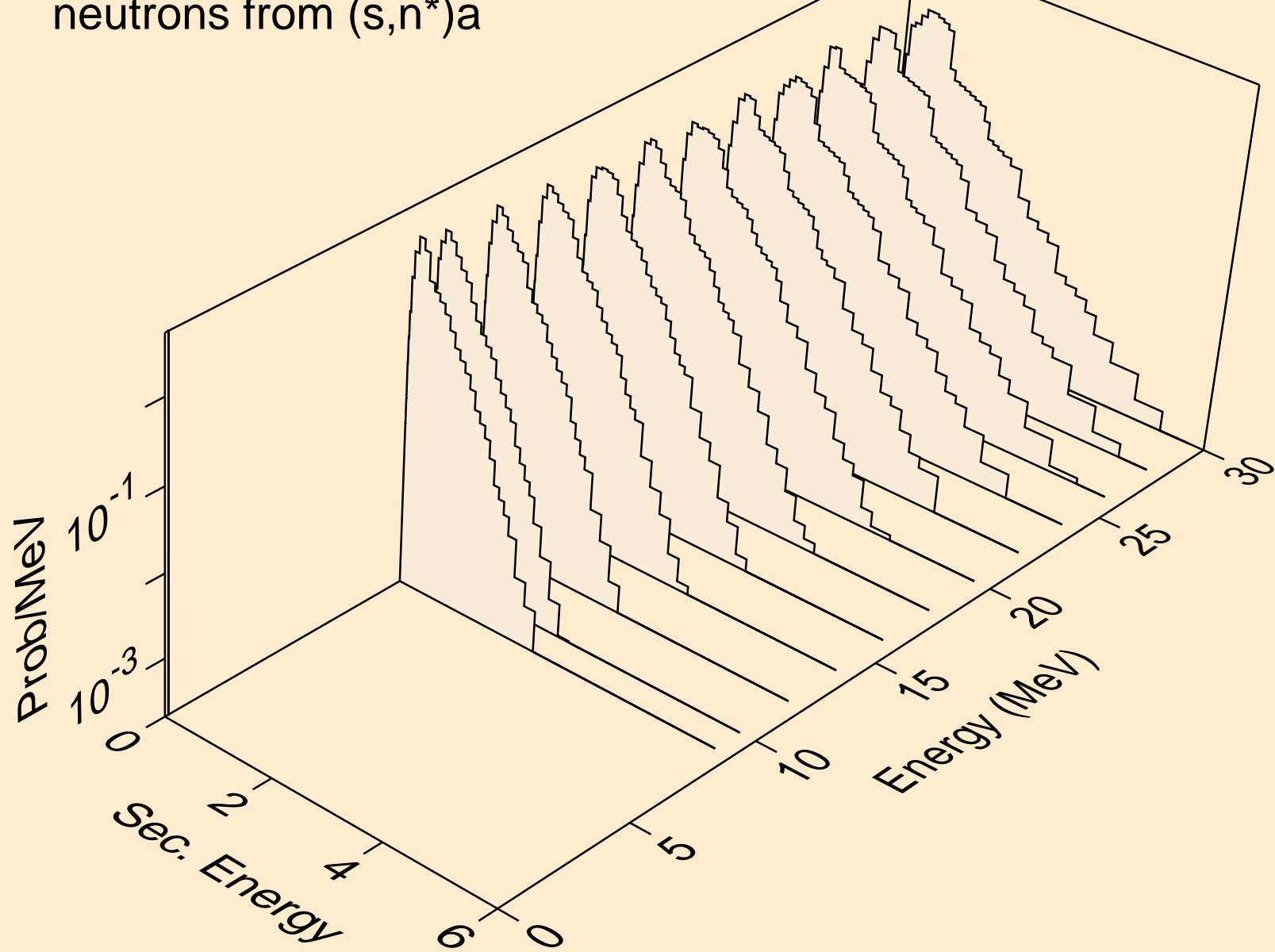

U241 HELION ACER TENDL-2021 LIBRARY; T=0.K  
neutrons from (s,2n)a

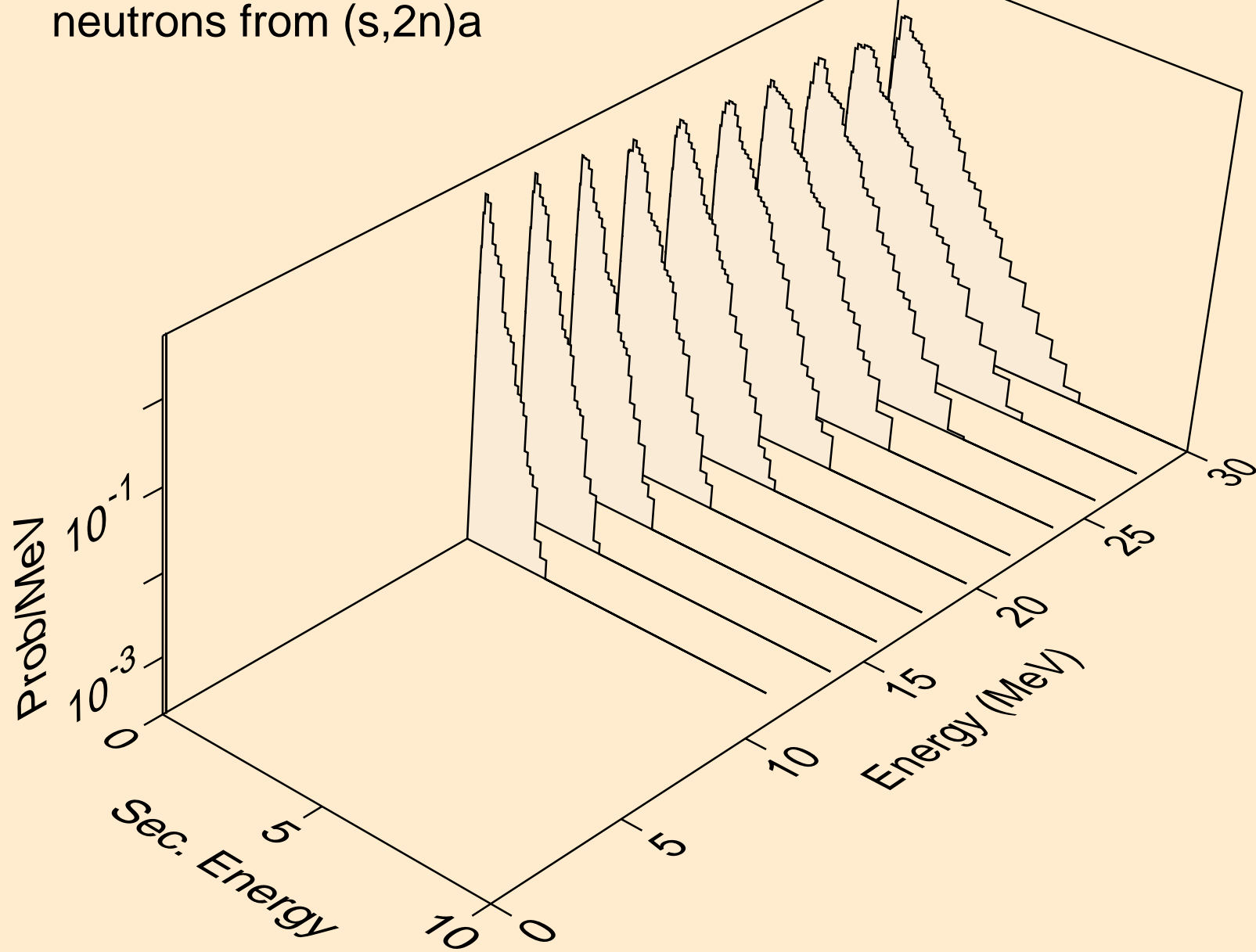

U241 HELION ACER TENDL-2021 LIBRARY; T=0.K  
neutrons from (s,3n)a

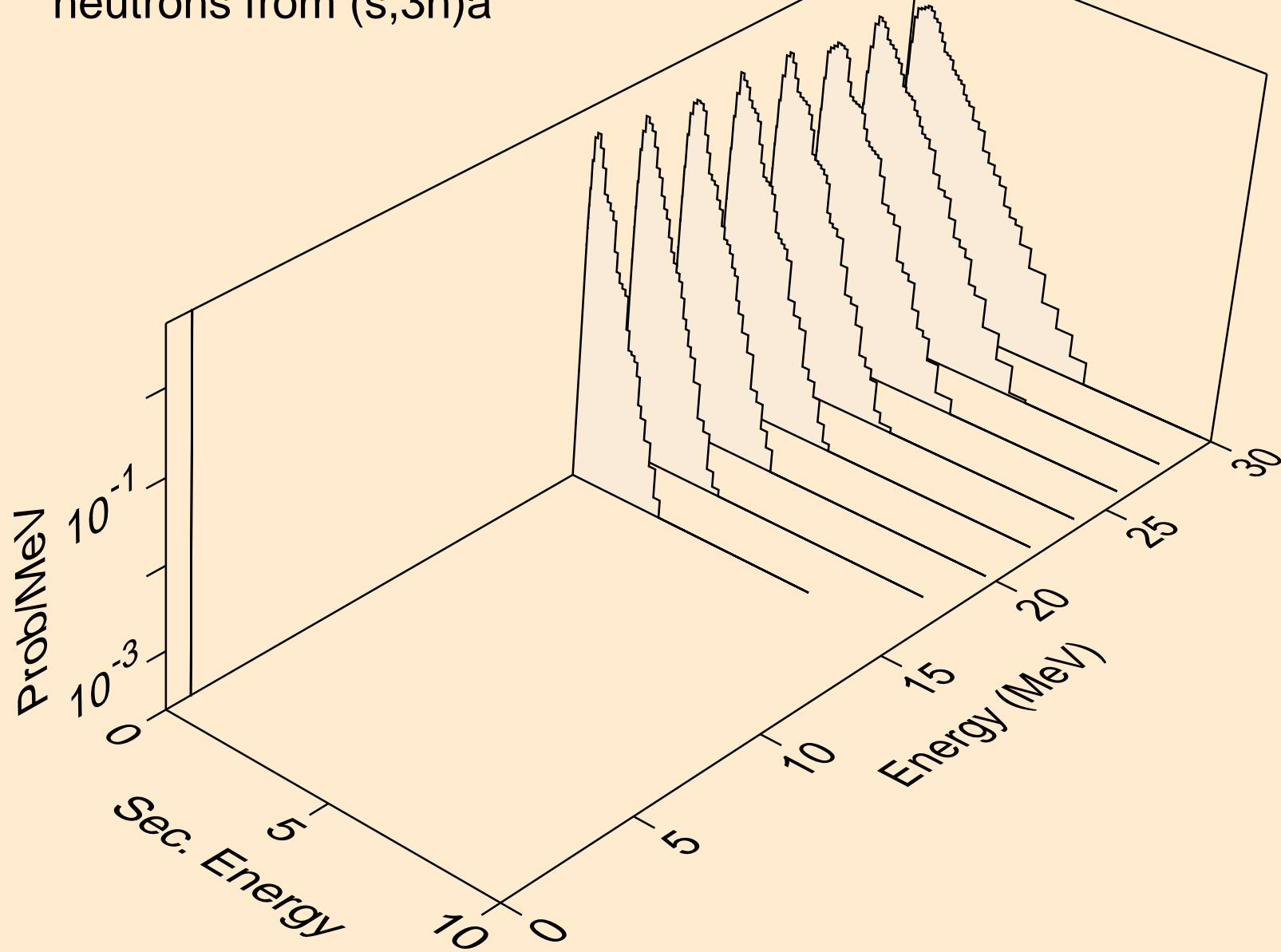

U241 HELION ACER TENDL-2021 LIBRARY; T=0.K  
neutrons from (s,n\*)p

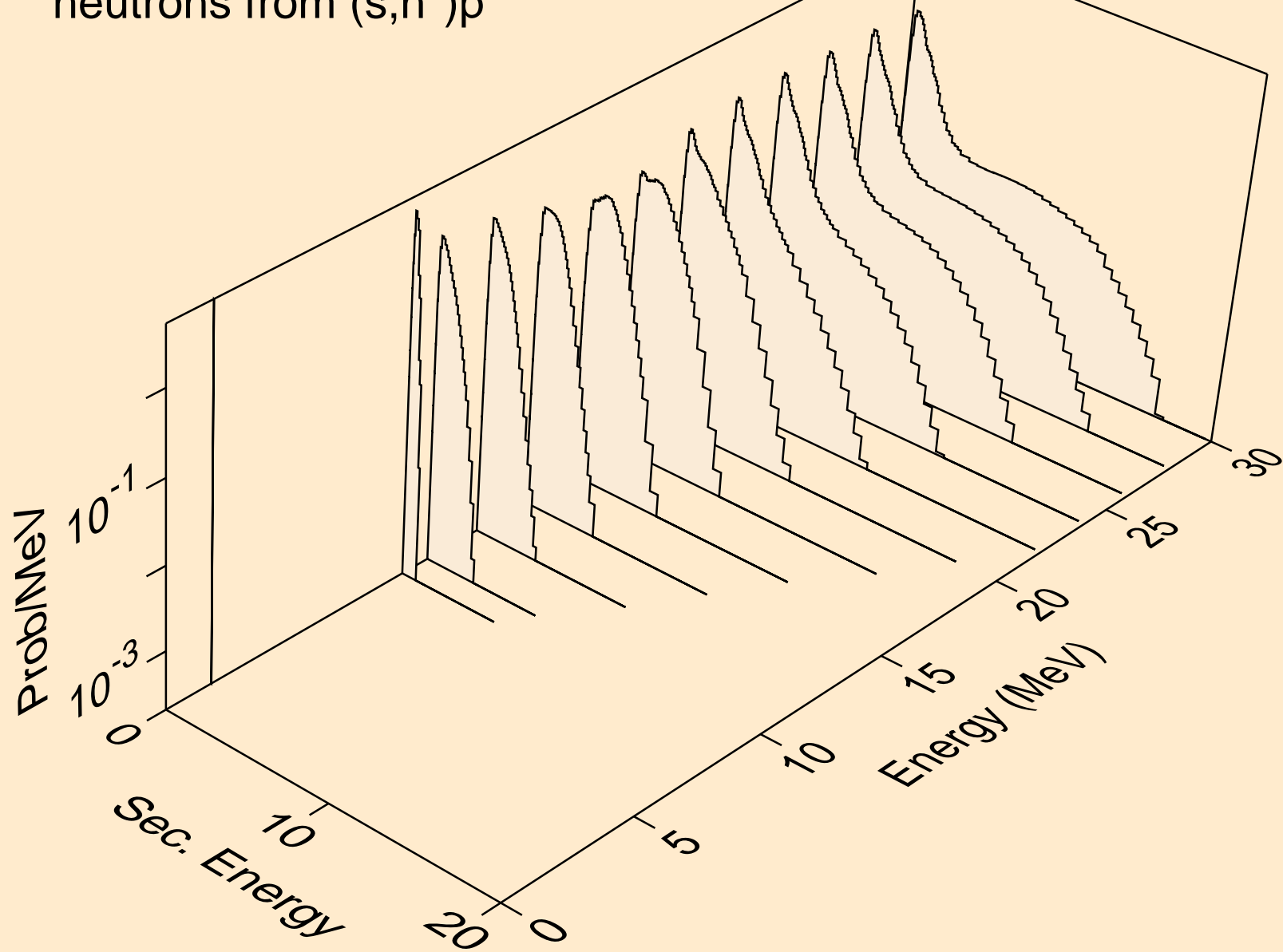

U241 HELION ACER TENDL-2021 LIBRARY; T=0.K  
neutrons from (s,n\*)d

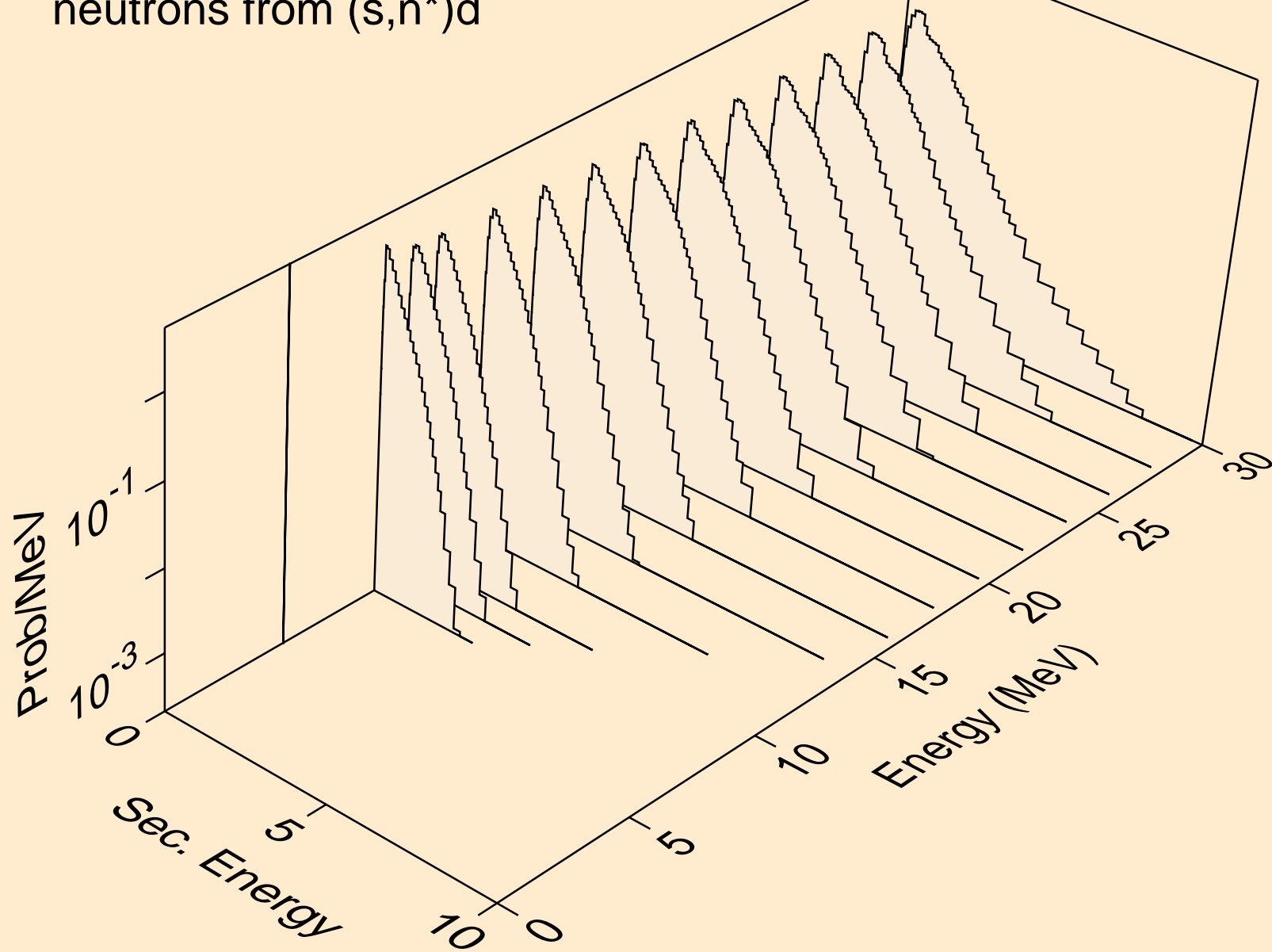

U241 HELION ACER TENDL-2021 LIBRARY; T=0.K  
neutrons from (s,n\*)t

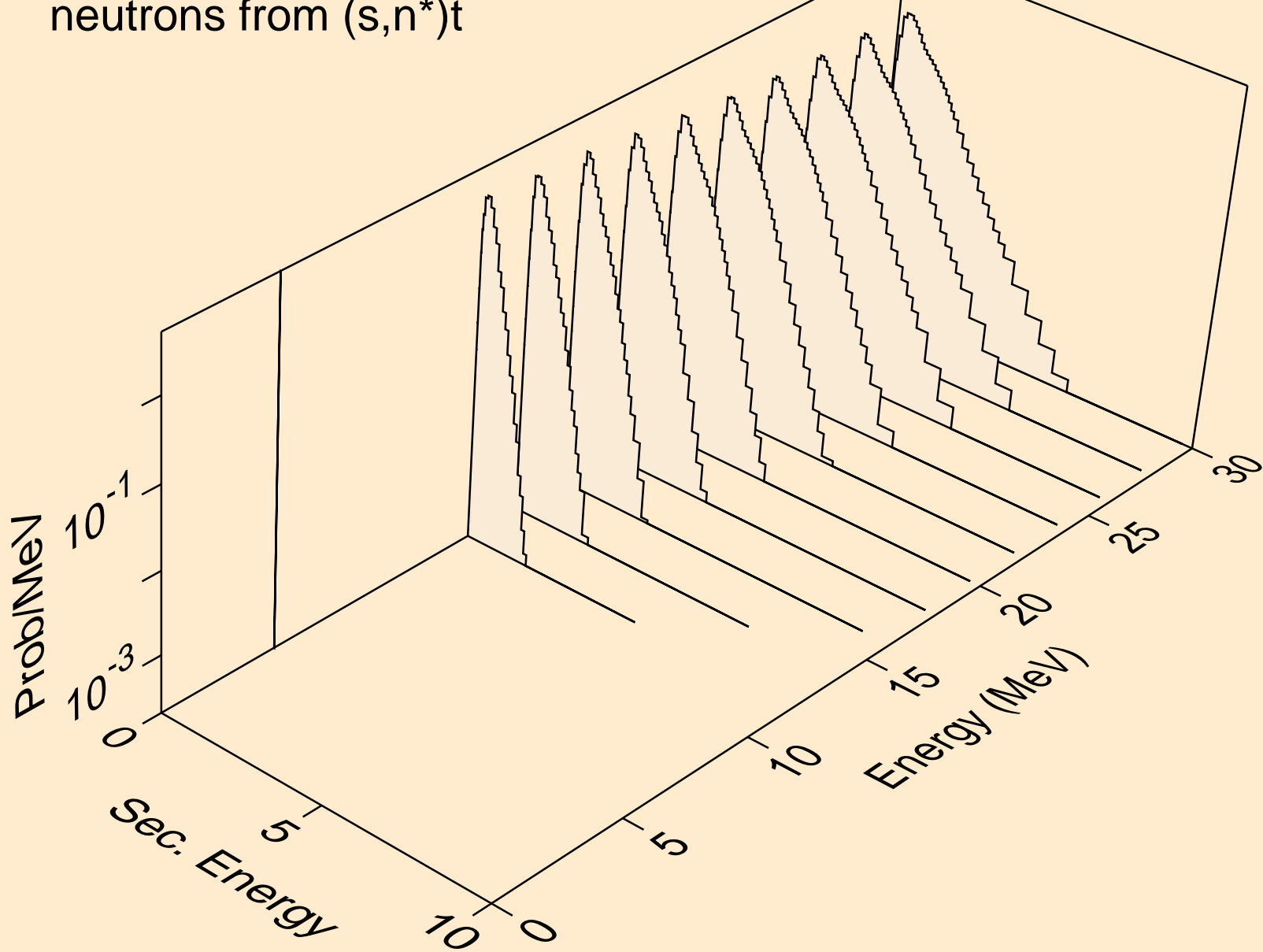

U241 HELION ACER TENDL-2021 LIBRARY; T=0.K  
neutrons from (s,n\*)he3

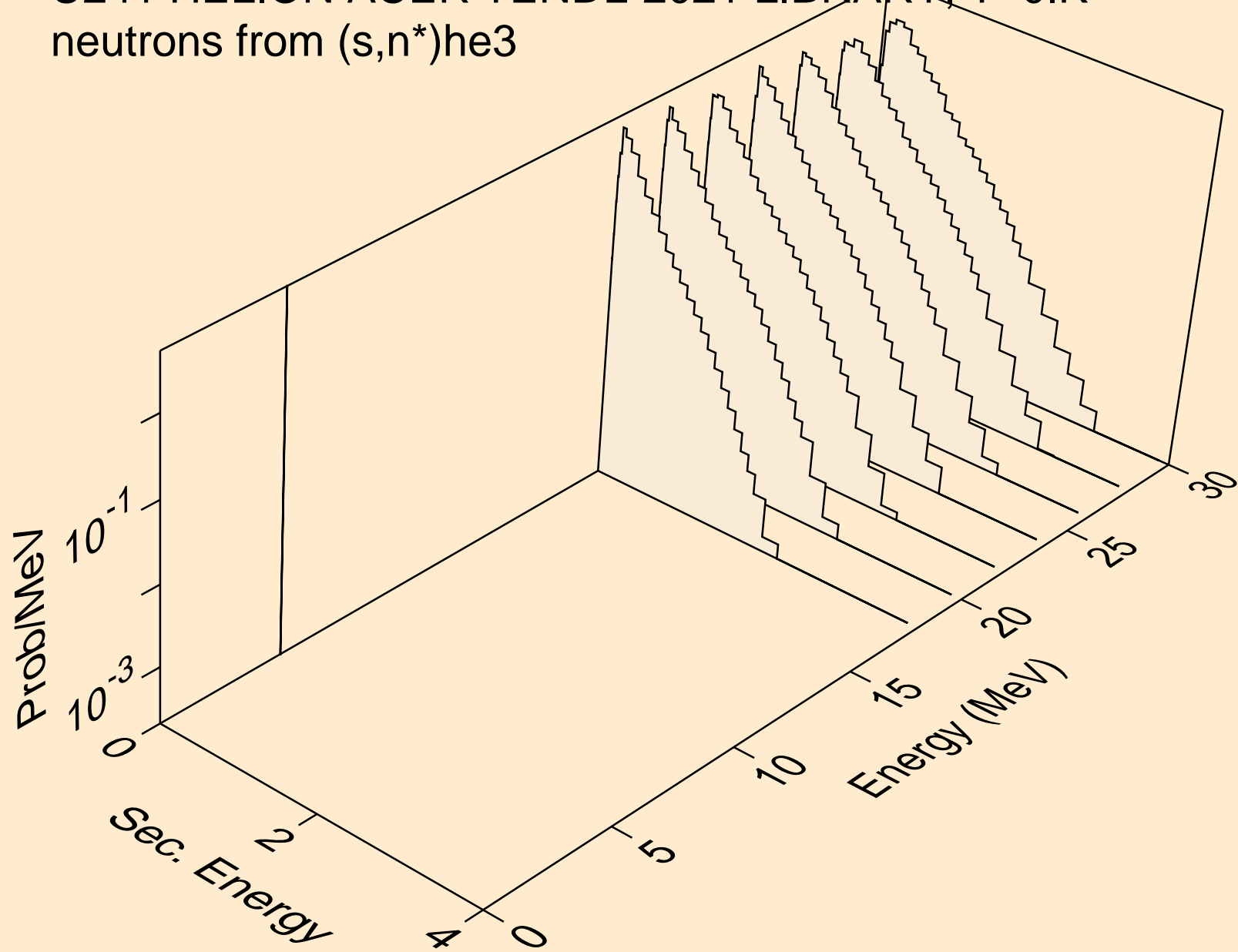

U241 HELION ACER TENDL-2021 LIBRARY; T=0.K  
neutrons from (s,4n)

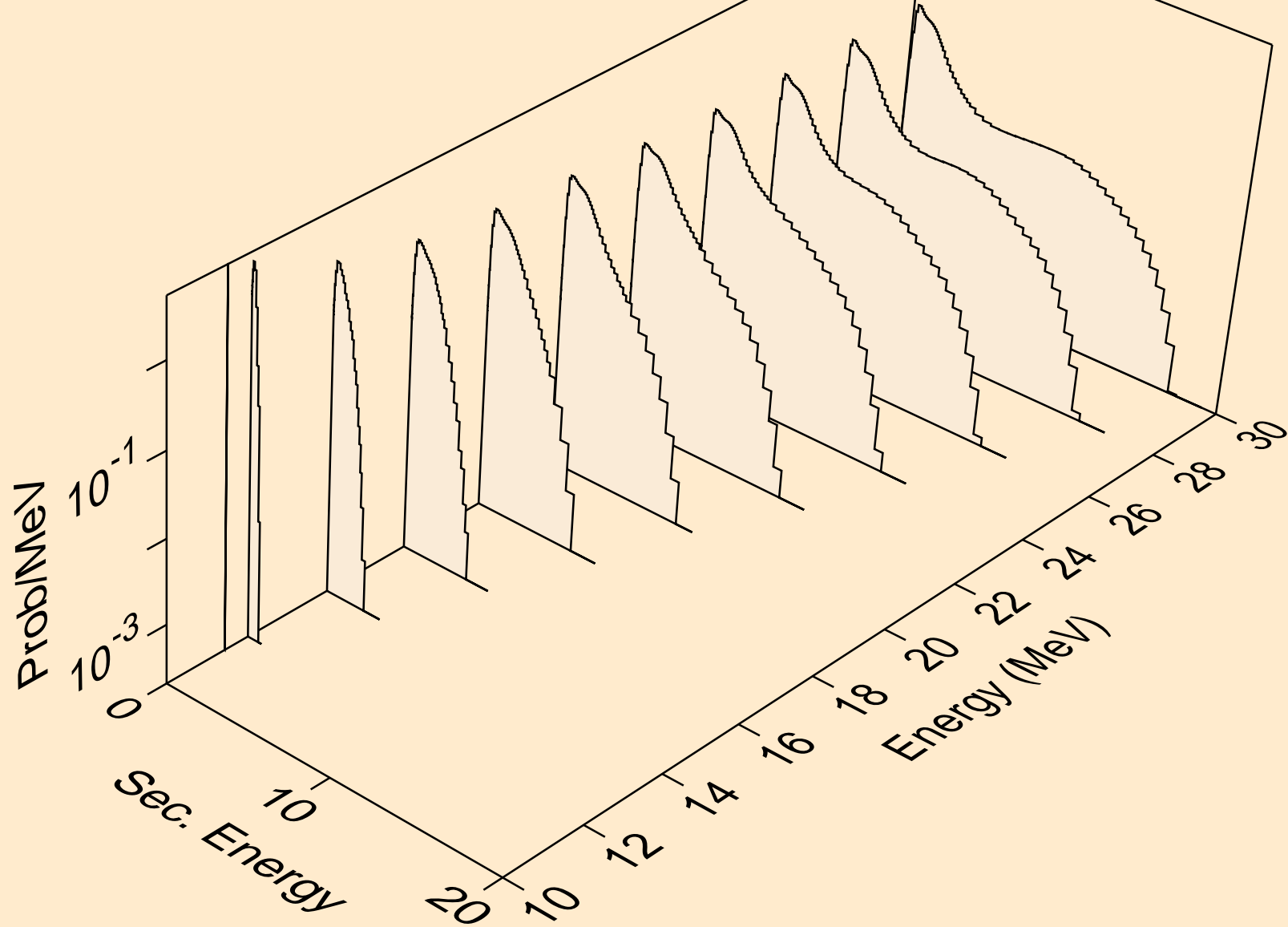



U241 HELION ACER TENDL-2021 LIBRARY; T=0.K  
neutrons from (s,2np)

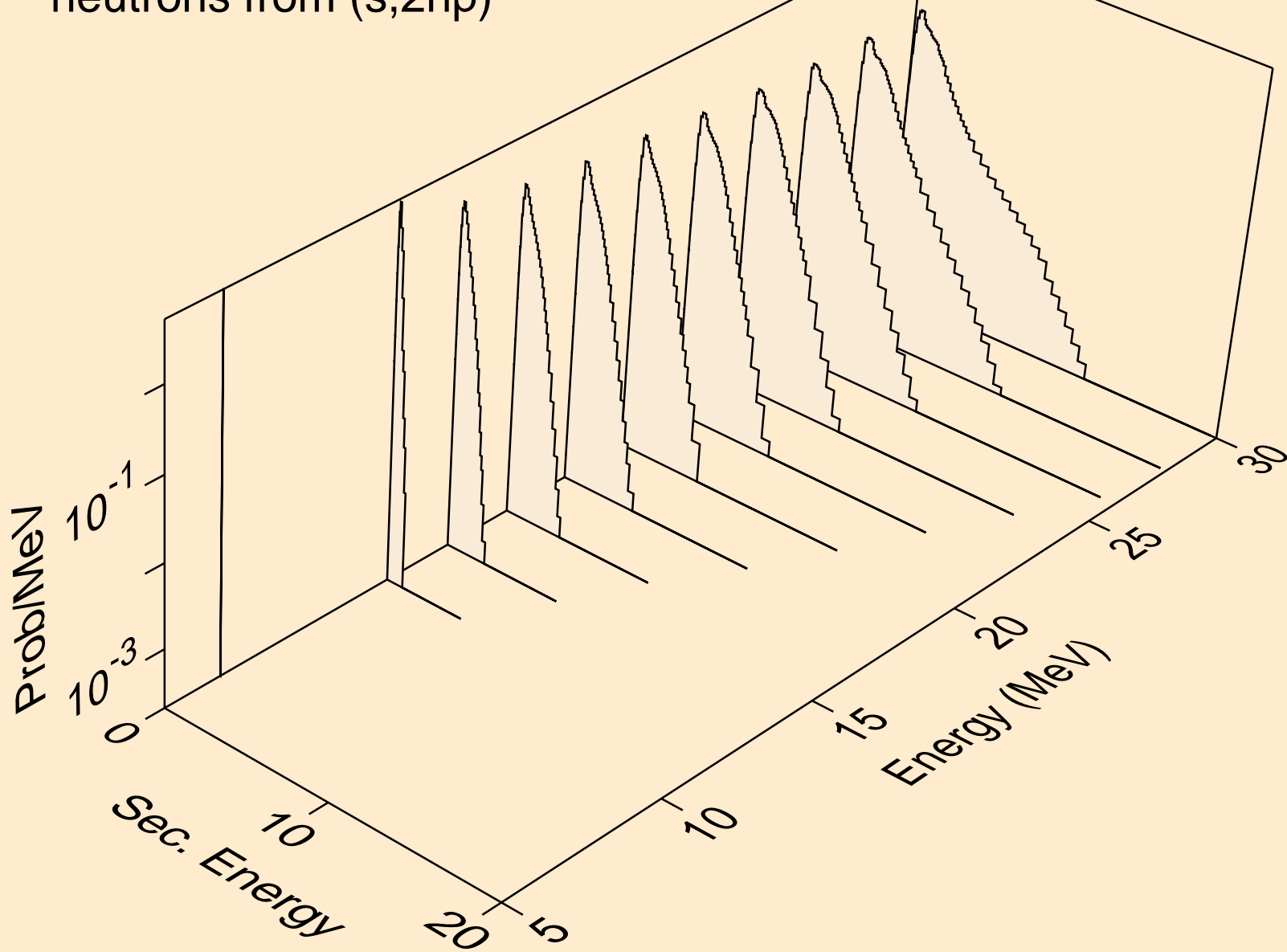

U241 HELION ACER TENDL-2021 LIBRARY; T=0.K  
neutrons from (s,3np)

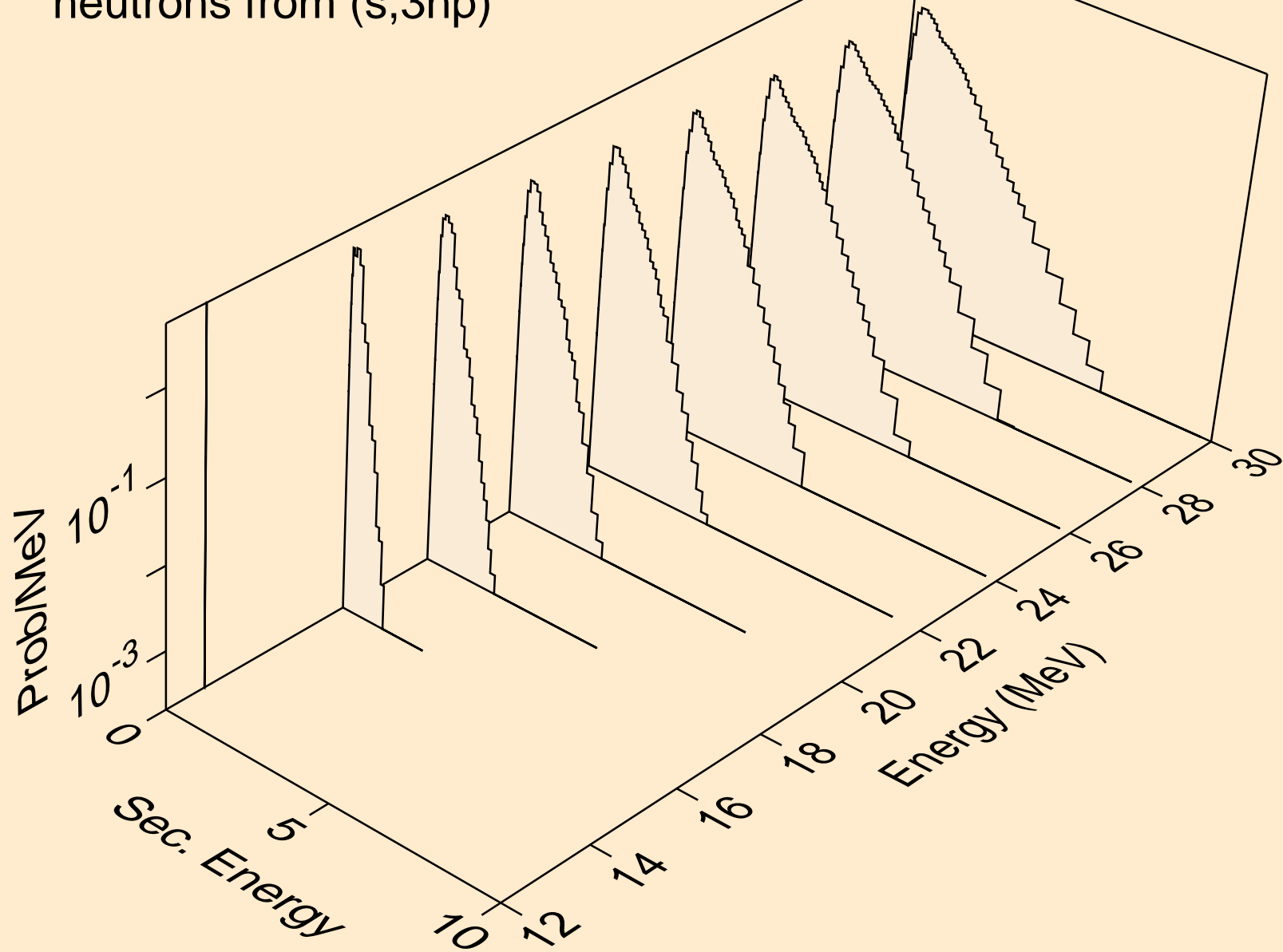

U241 HELION ACER TENDL-2021 LIBRARY; T=0.K  
neutrons from (s,2np)

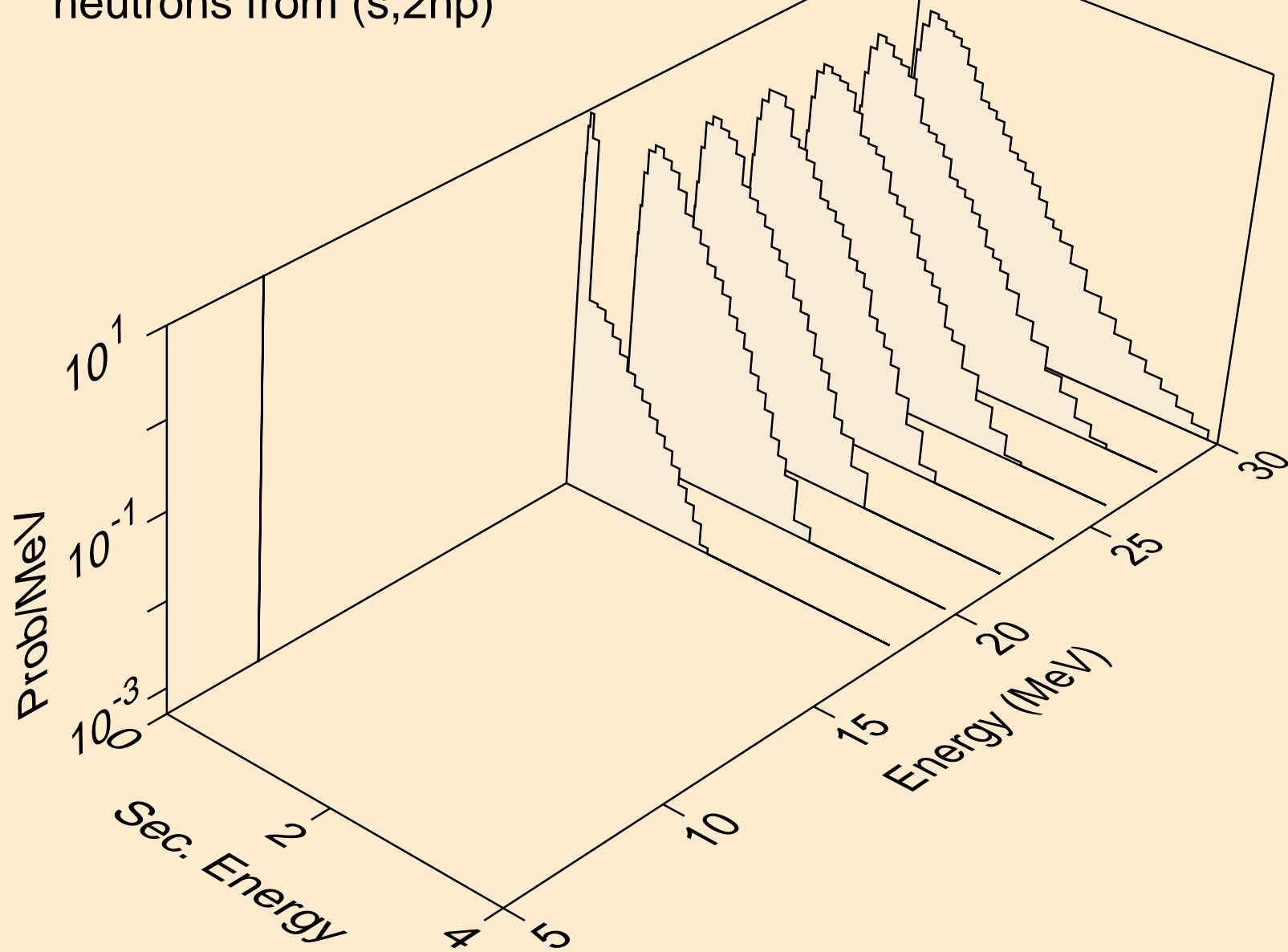

U241 HELION ACER TENDL-2021 LIBRARY; T=0.K  
neutrons from (s,npa)

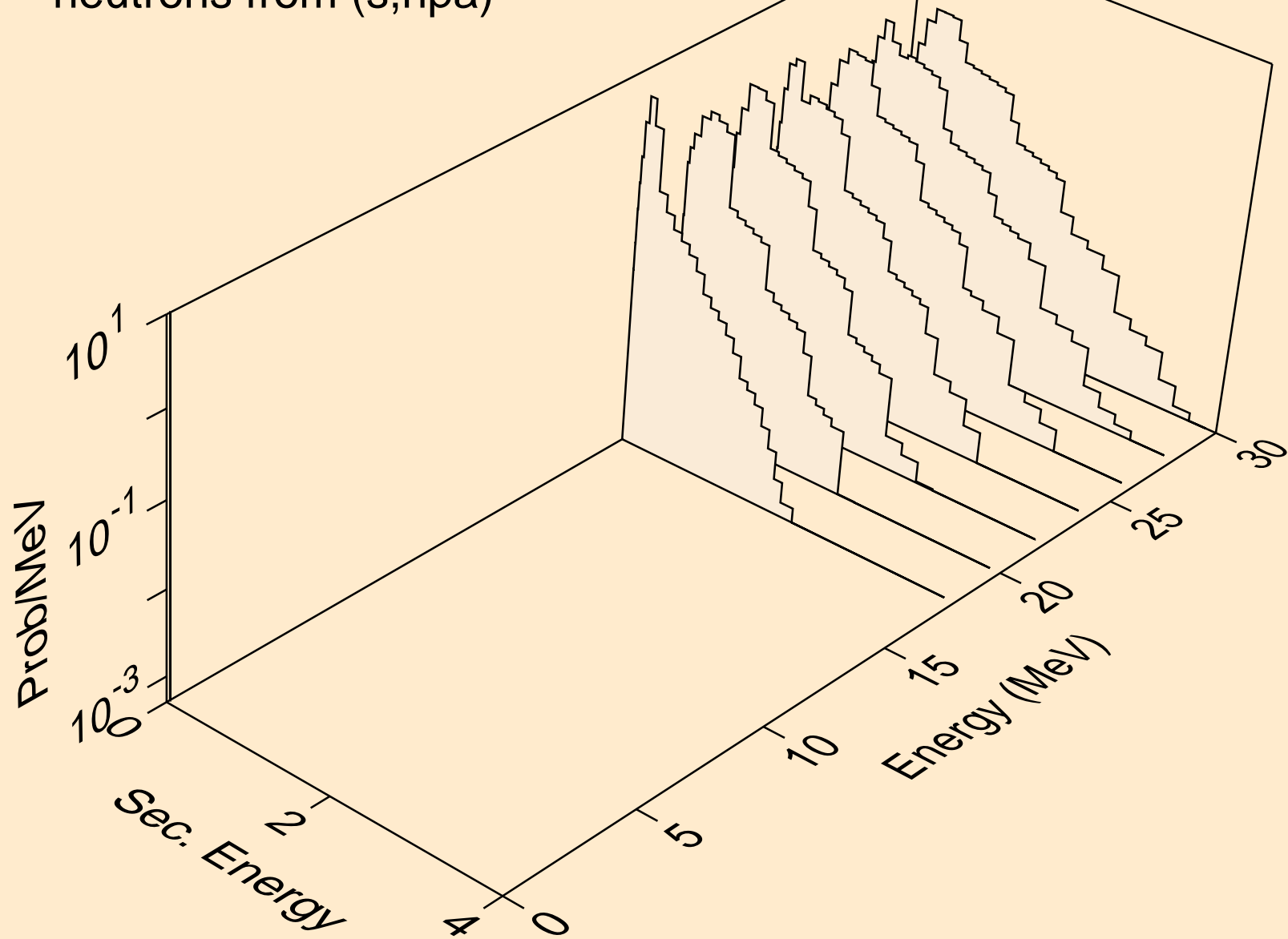

U241 HELION ACER TENDL-2021 LIBRARY; T=0.K  
protons from (s,x)

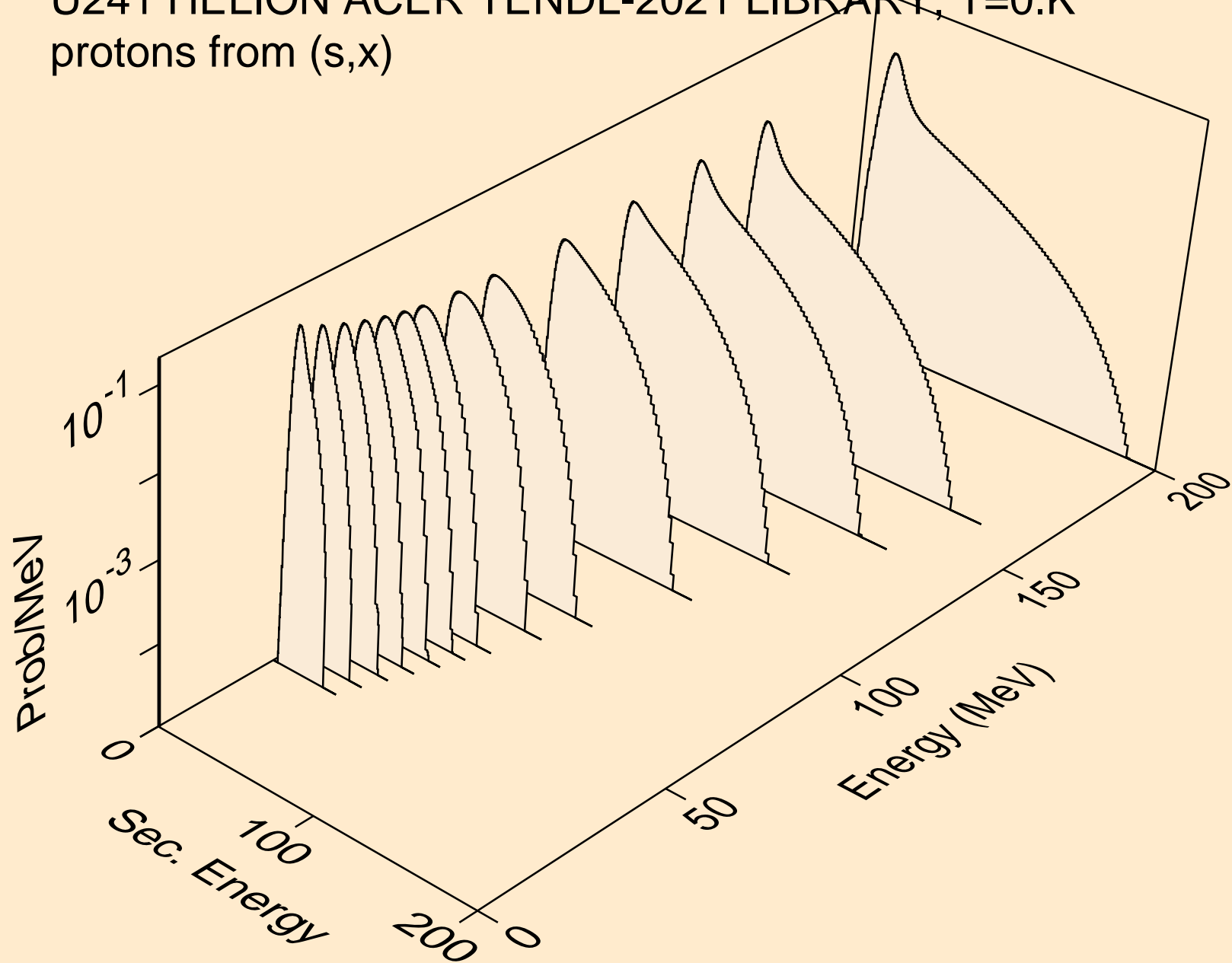

U241 HELION ACER TENDL-2021 LIBRARY; T=0.K  
protons from (s,n\*)p

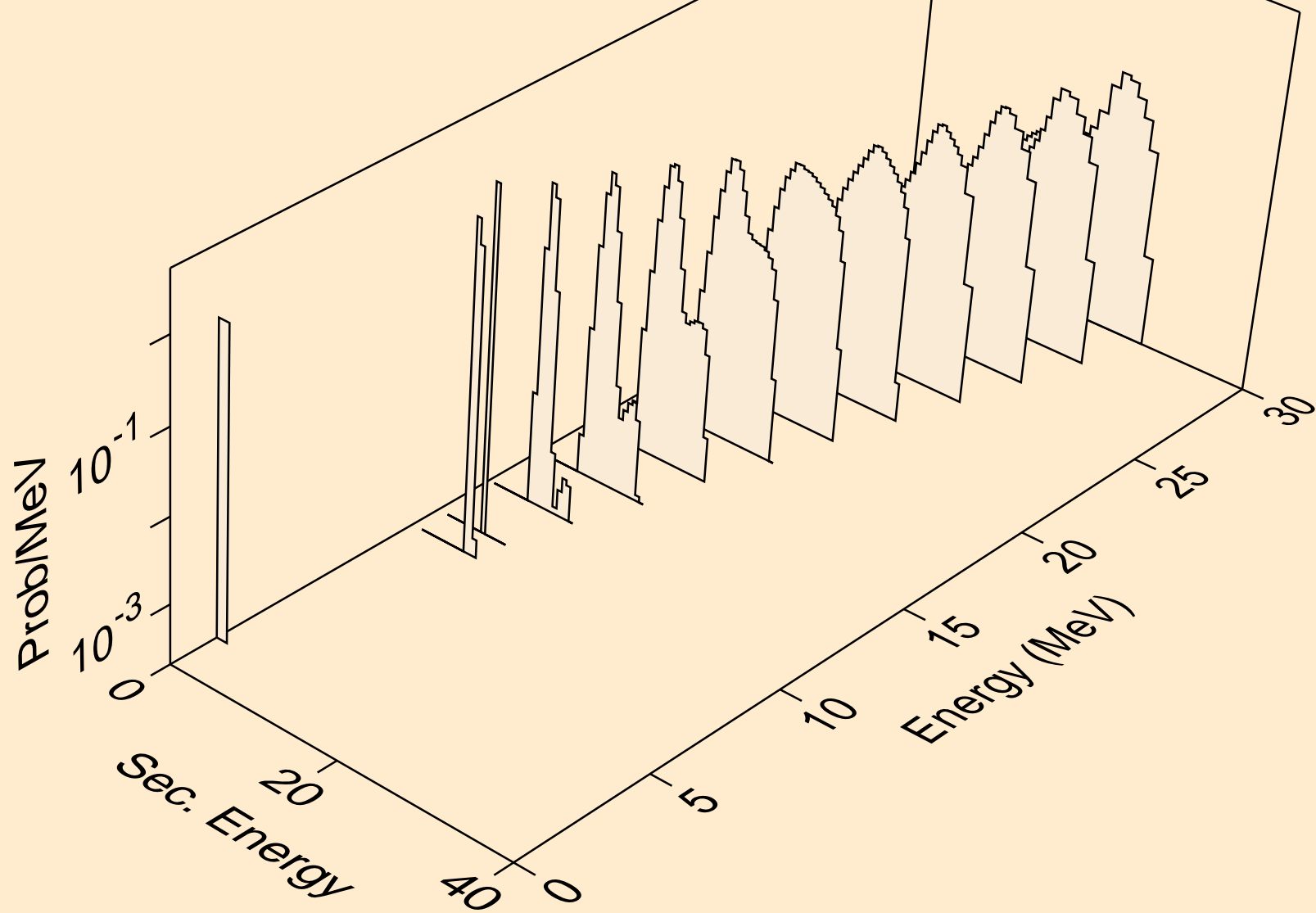

U241 HELION ACER TENDL-2021 LIBRARY; T=0.K  
protons from (s,2np)

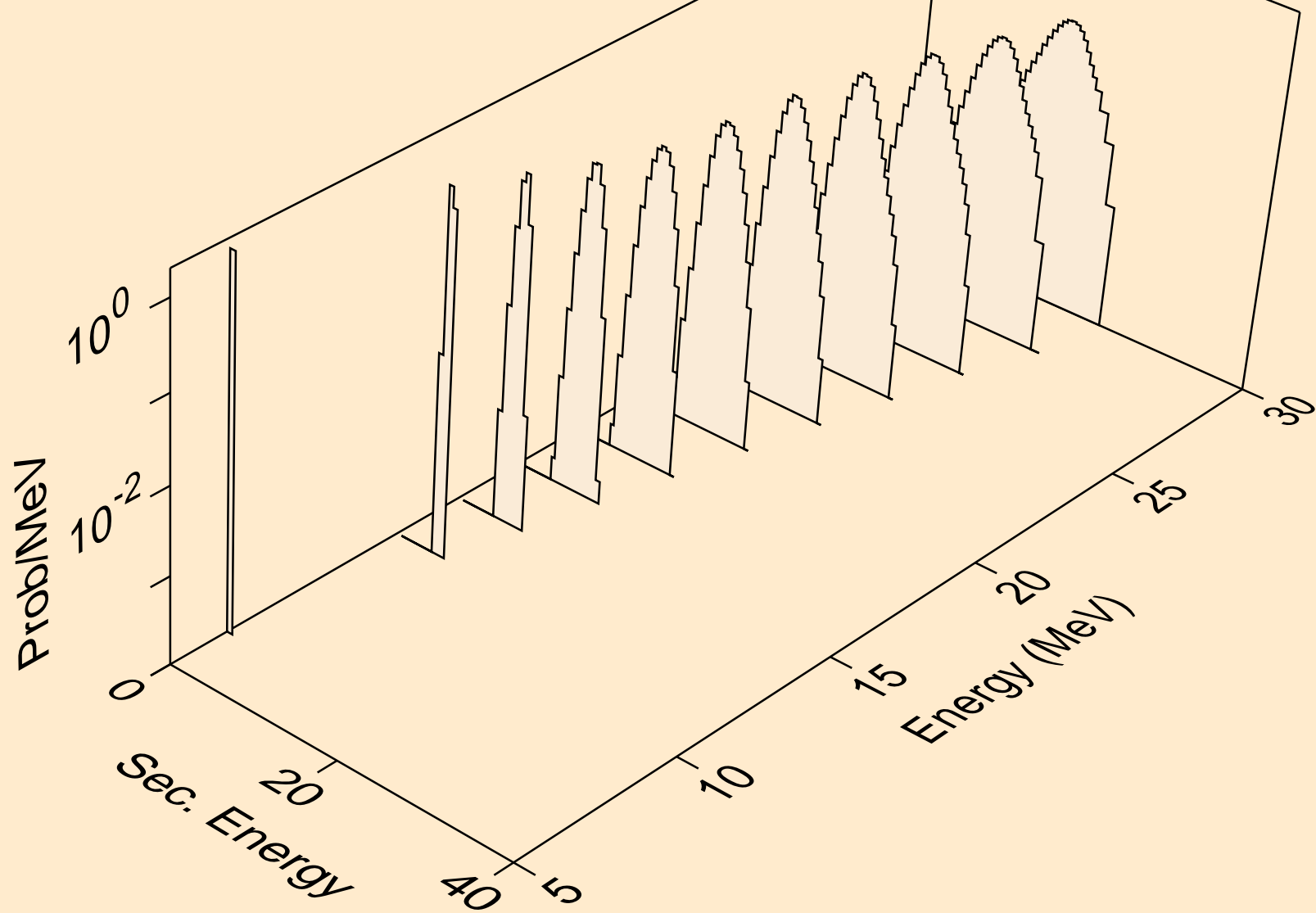

U241 HELION ACER TENDL-2021 LIBRARY; T=0.K  
protons from (s,3np)

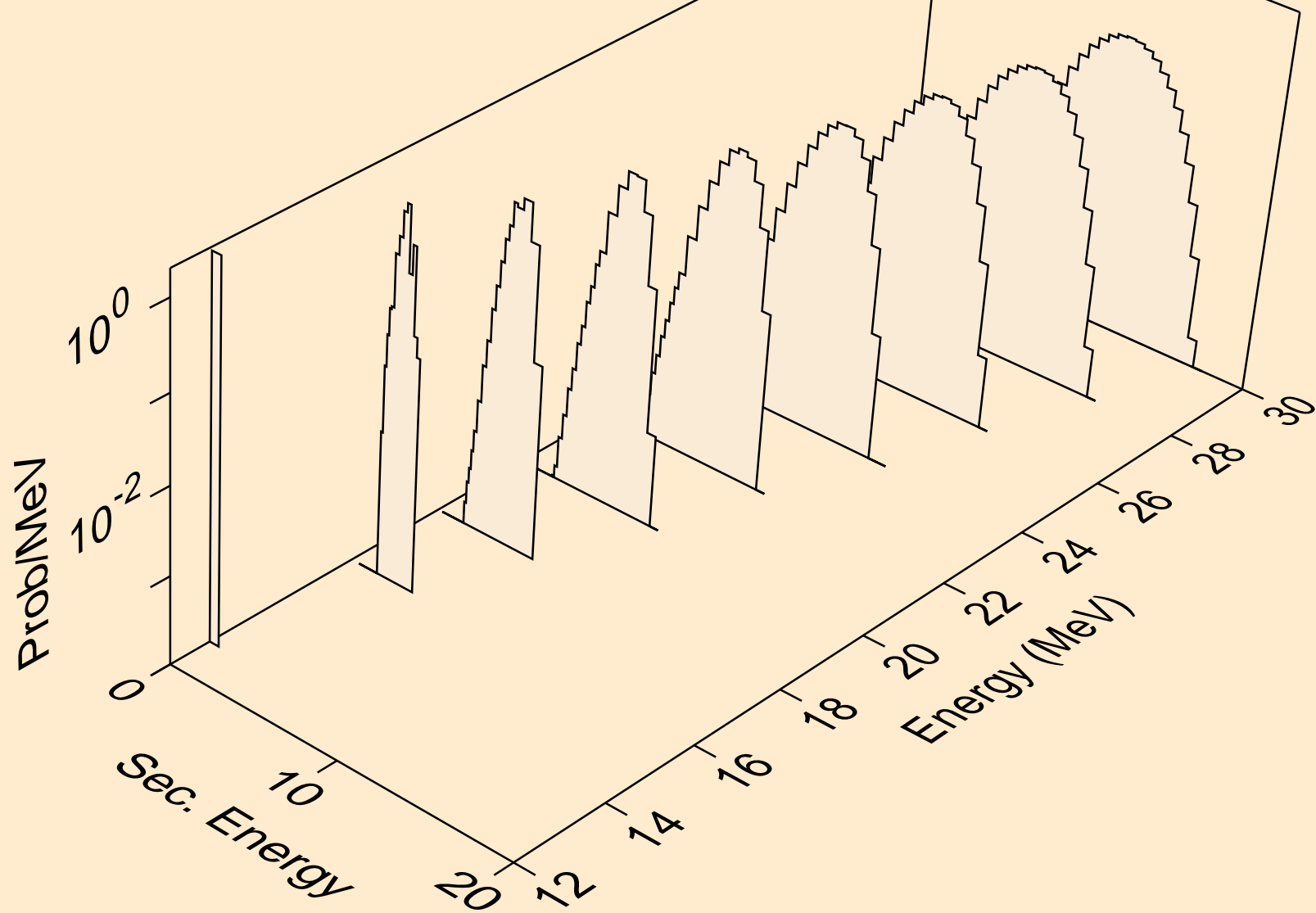



U241 HELION ACER TENDL-2021 LIBRARY; T=0.K  
protons from (s,2np)

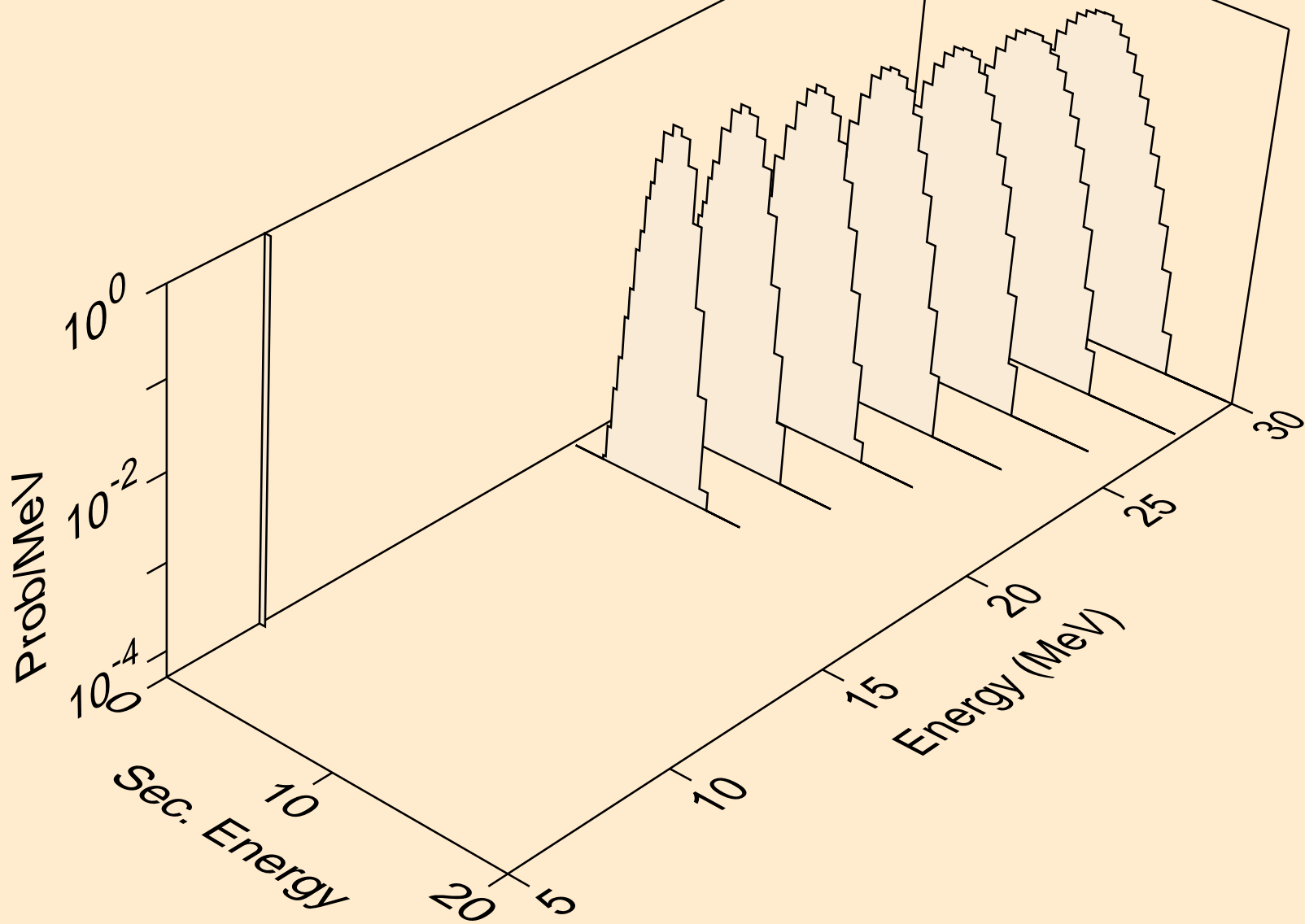

U241 HELION ACER TENDL-2021 LIBRARY; T=0.K  
protons from (s,npa)

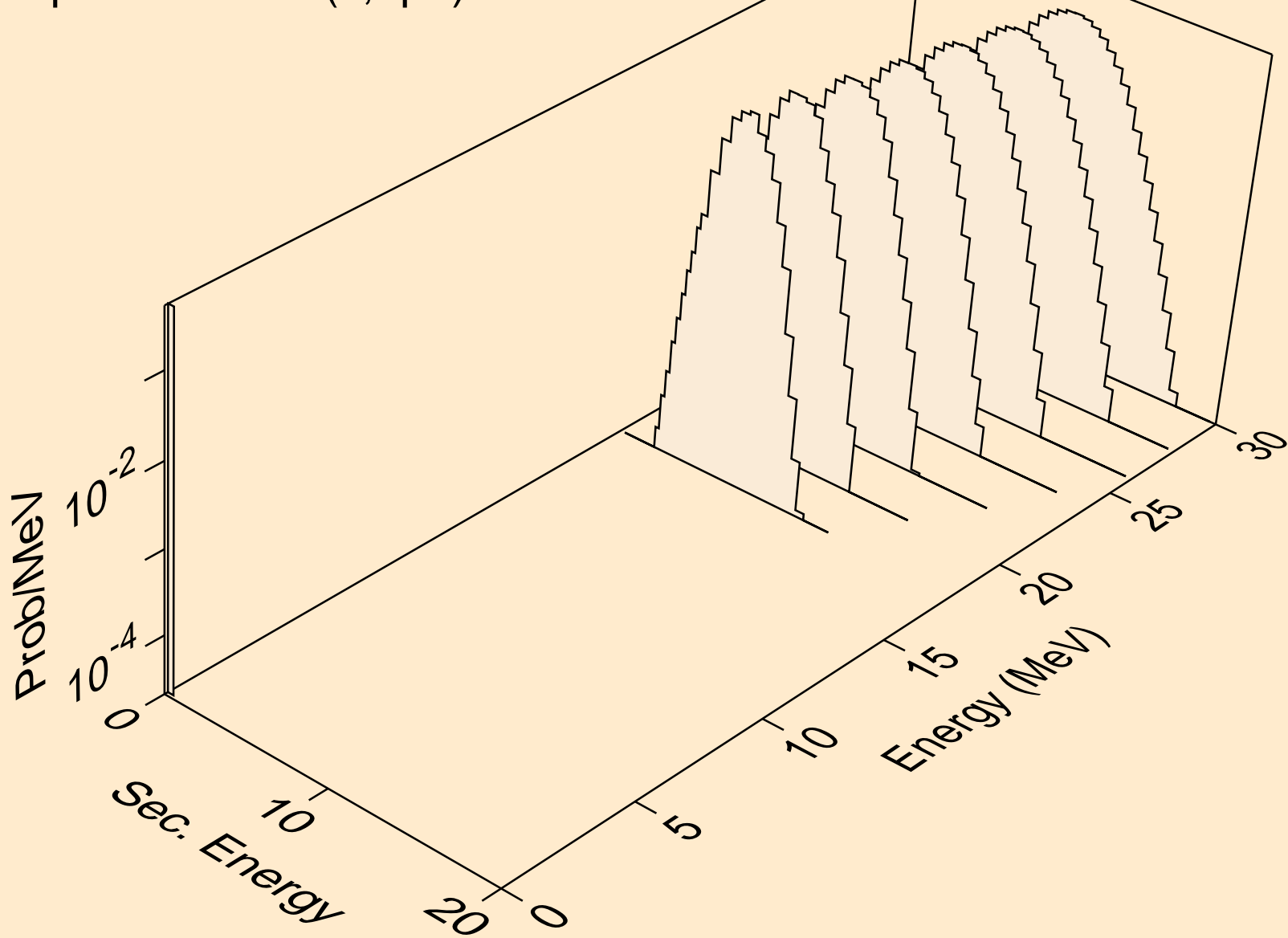

U241 HELION ACER TENDL-2021 LIBRARY; T=0.K  
protons from (s,p)

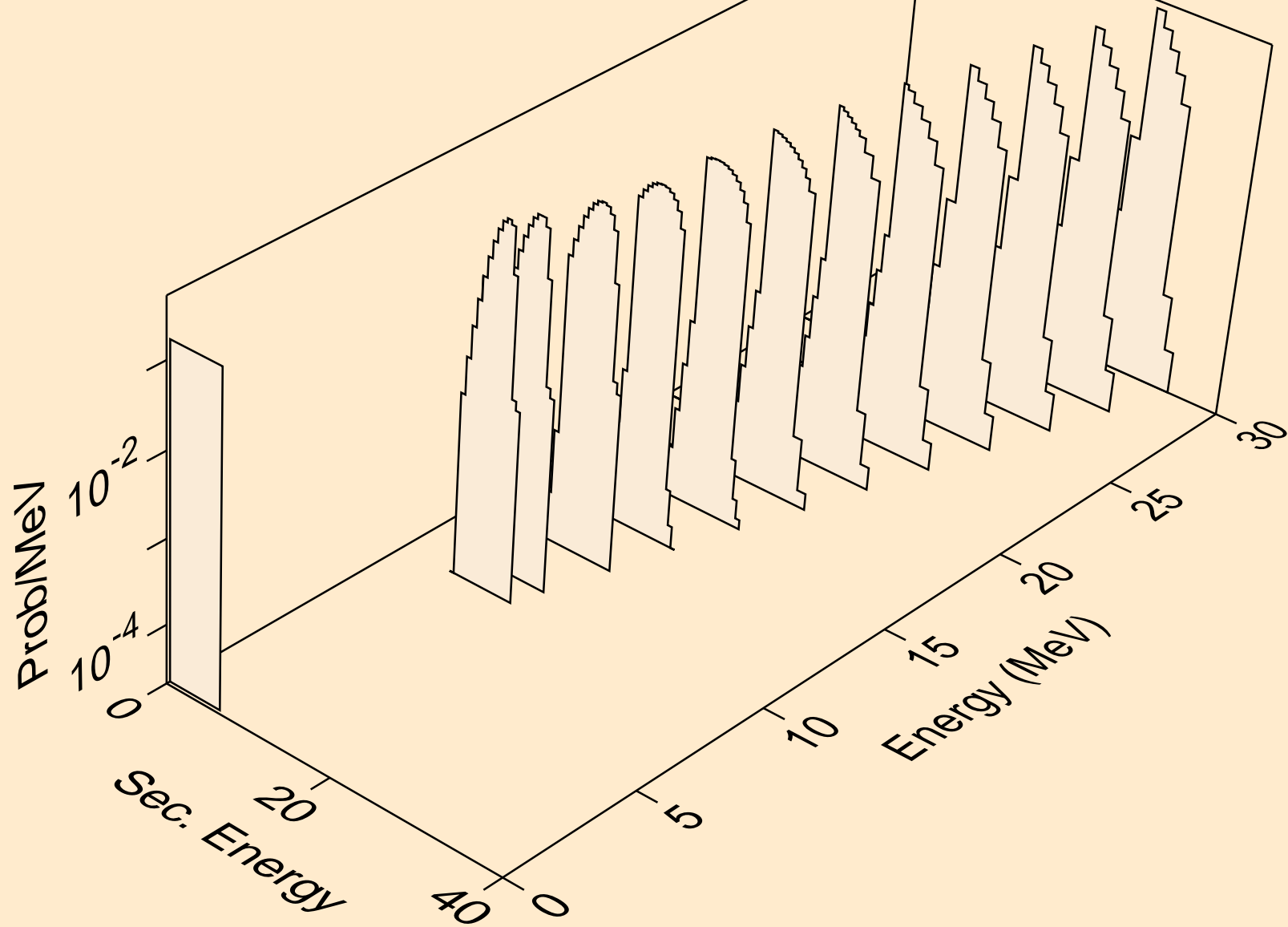

U241 HELION ACER TENDL-2021 LIBRARY; T=0.K  
protons from (s,2p)

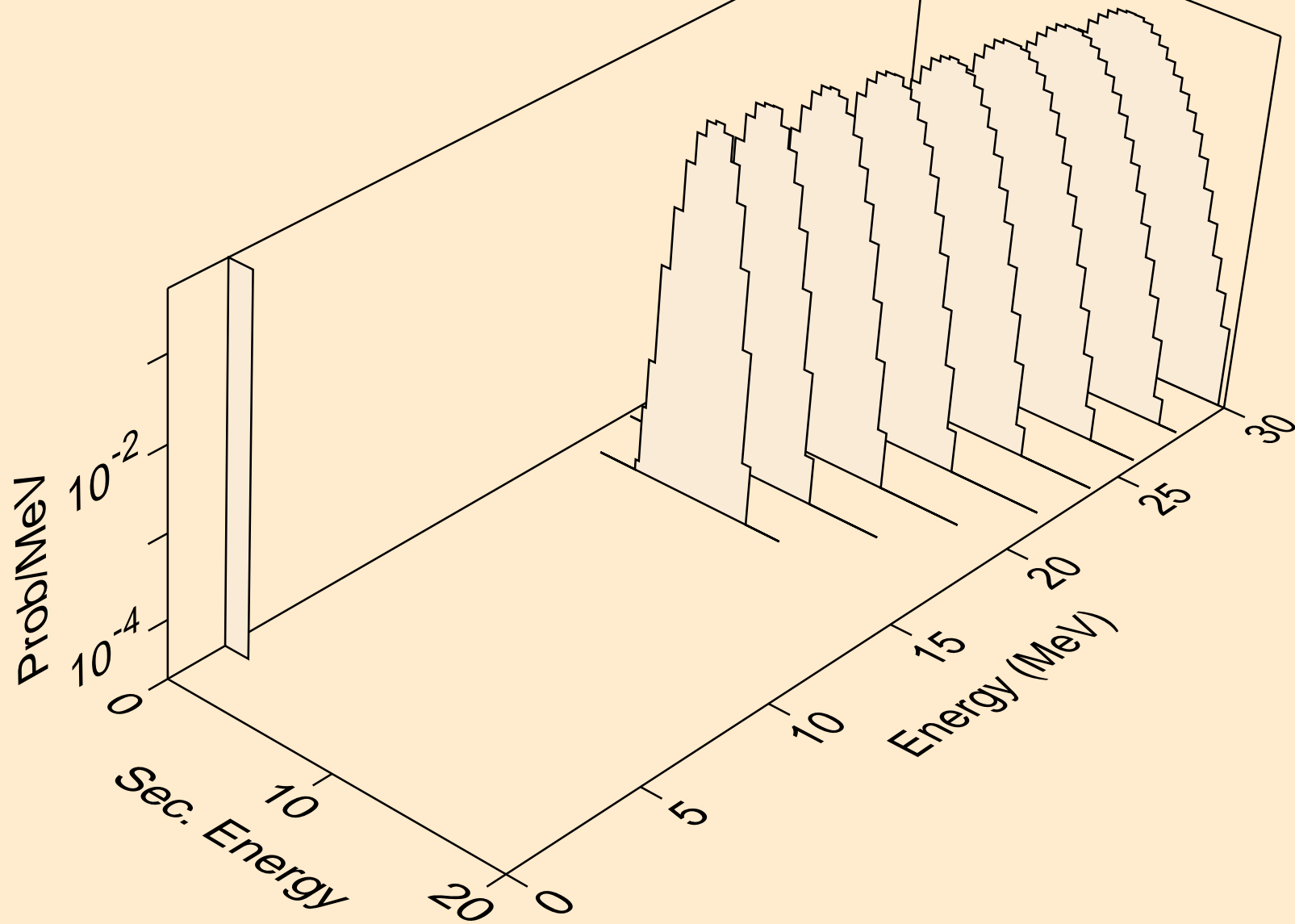

U241 HELION ACER TENDL-2021 LIBRARY; T=0.K  
protons from (s,pd)

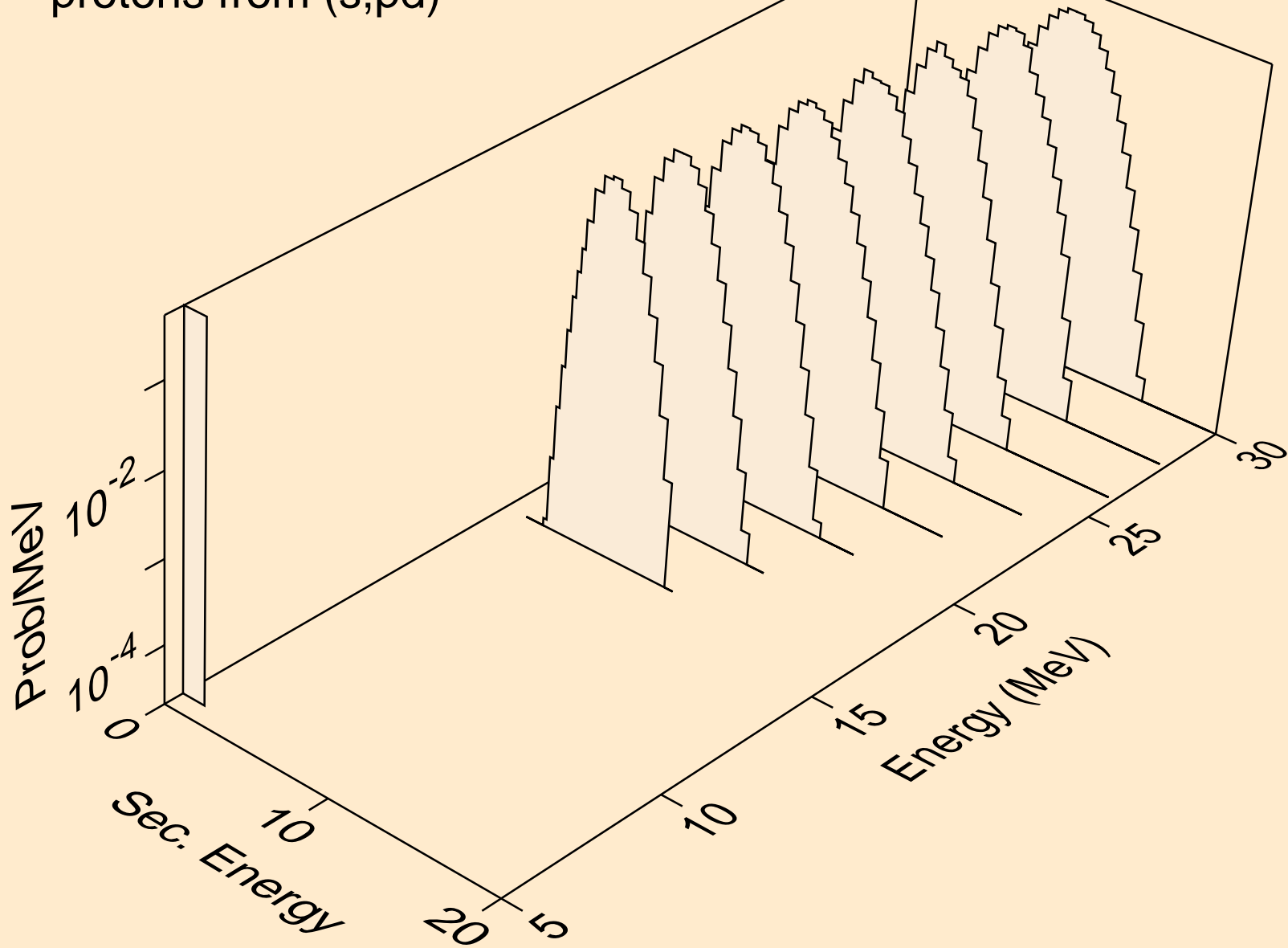

U241 HELION ACER TENDL-2021 LIBRARY; T=0.K  
deuterons from (s,x)

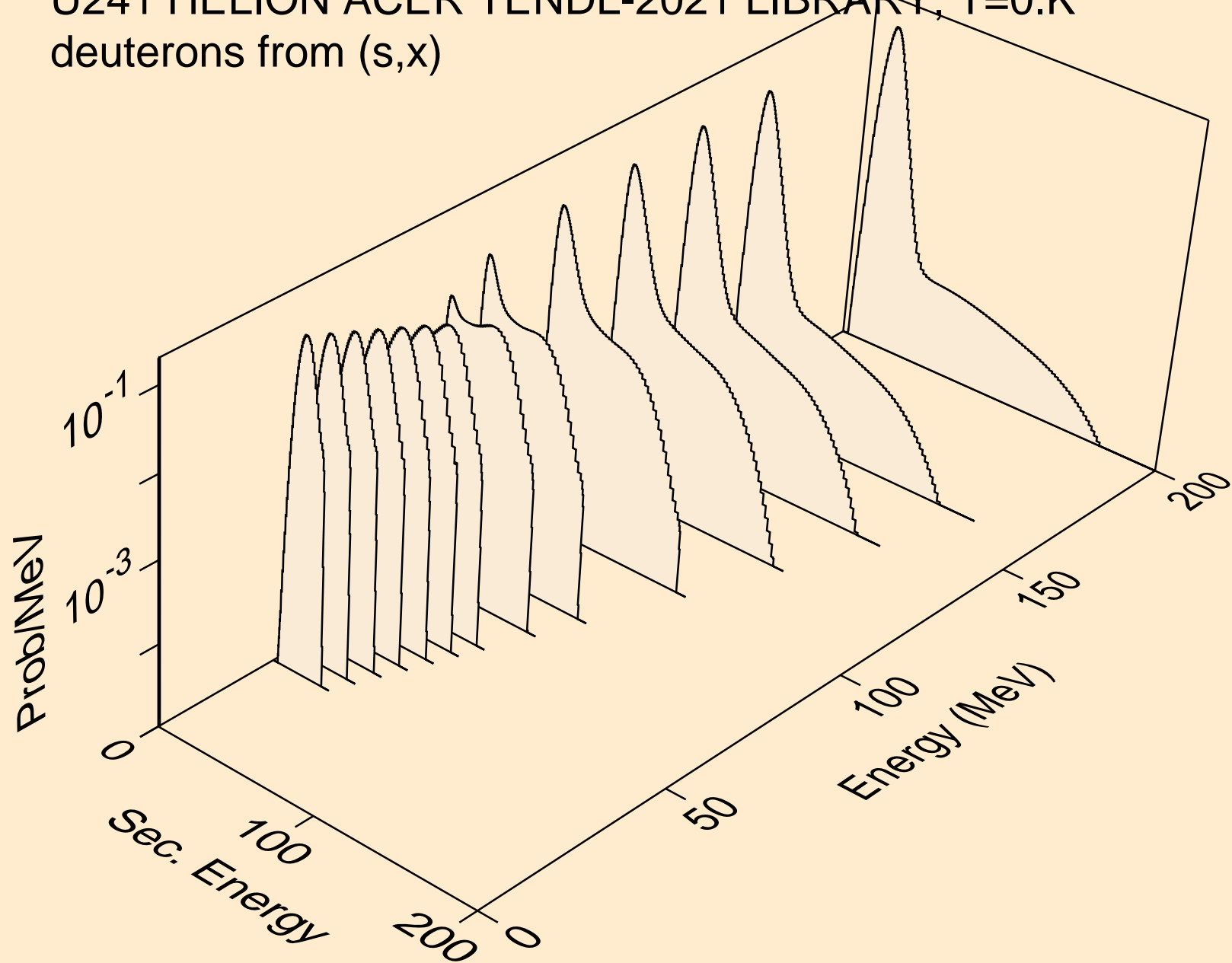

U241 HELION ACER TENDL-2021 LIBRARY; T=0.K  
deuterons from (s,2nd)

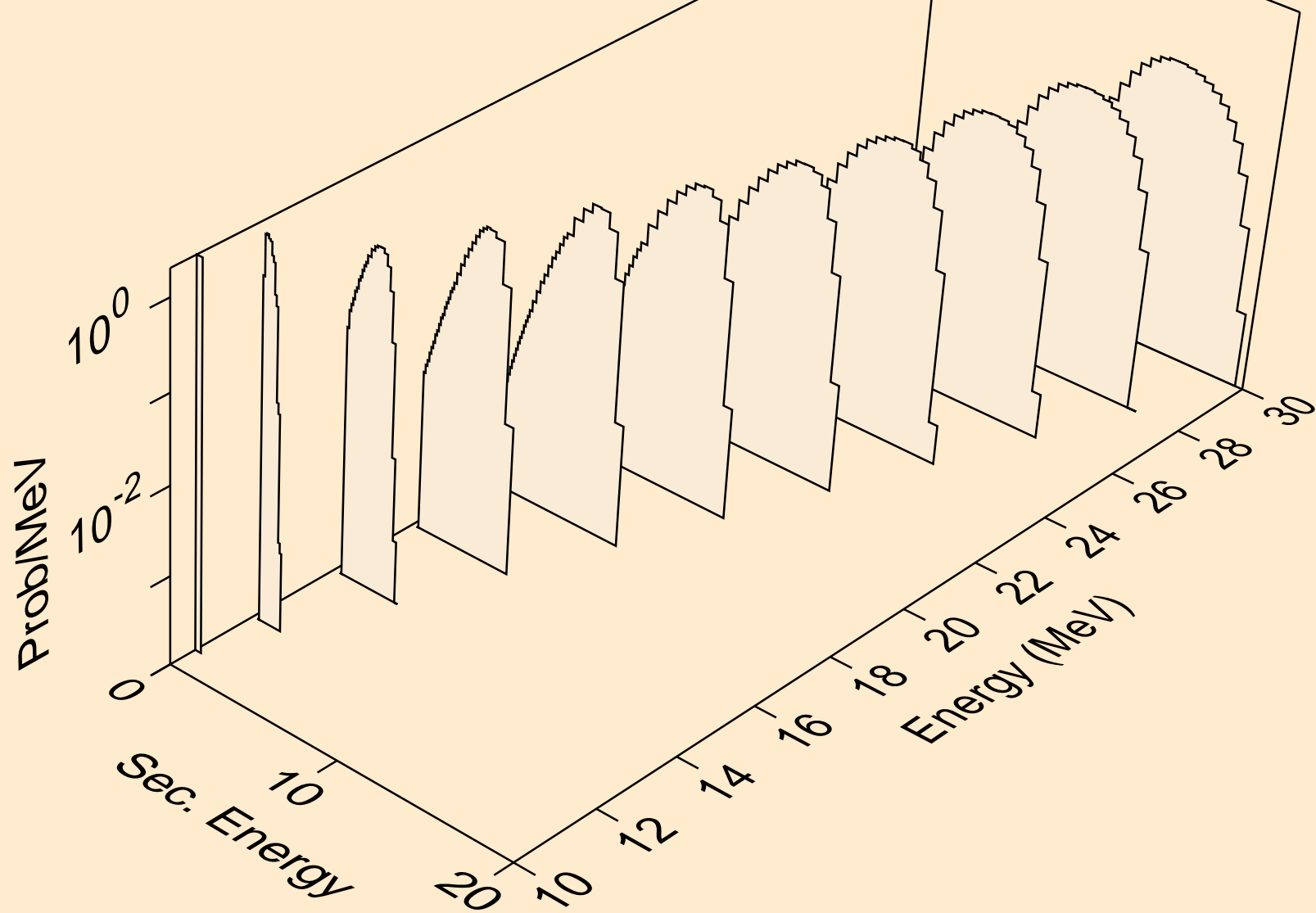

U241 HELION ACER TENDL-2021 LIBRARY; T=0.K  
deuterons from (s,n\*)d

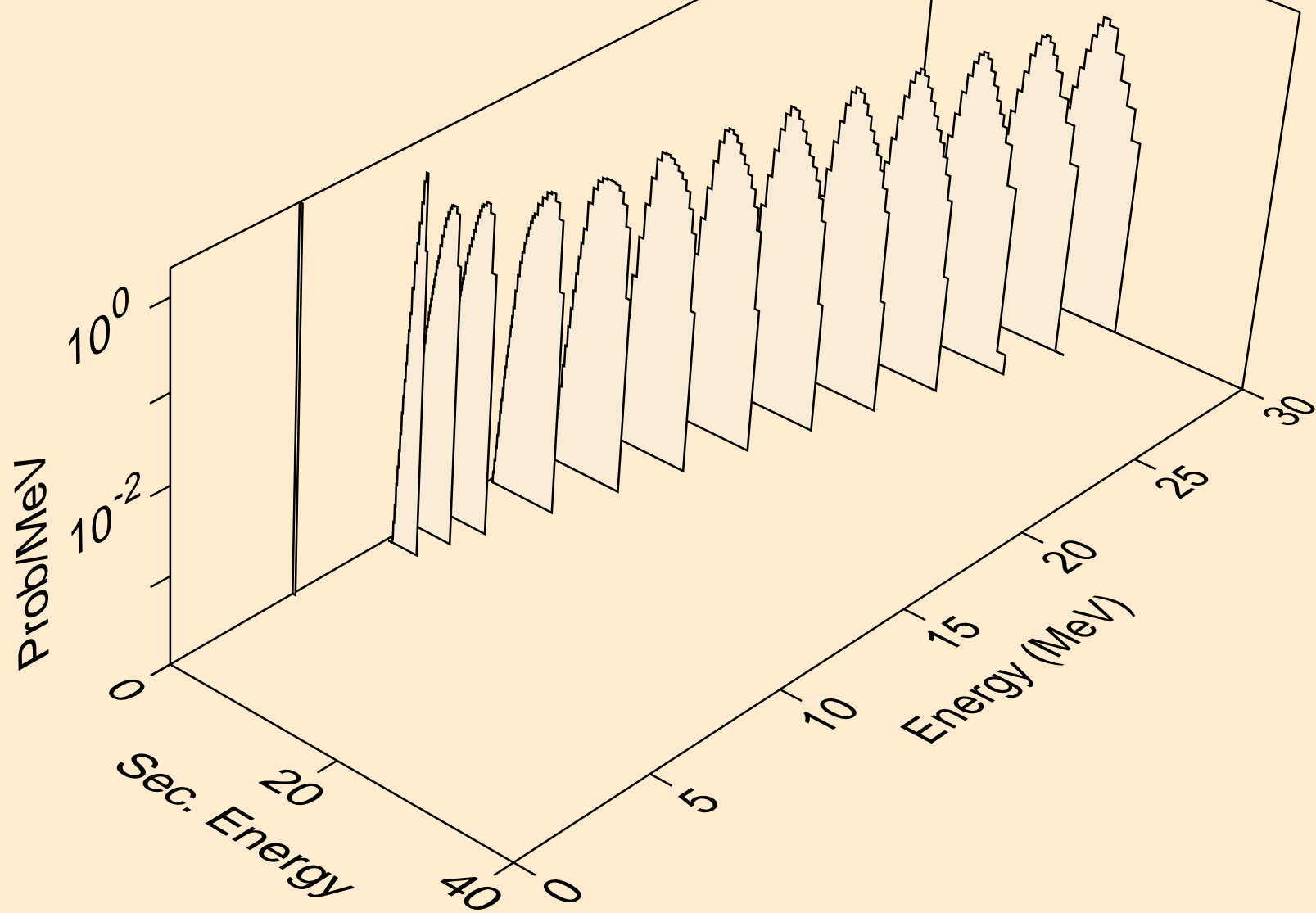



U241 HELION ACER TENDL-2021 LIBRARY; T=0.K  
deuterons from (s,d)

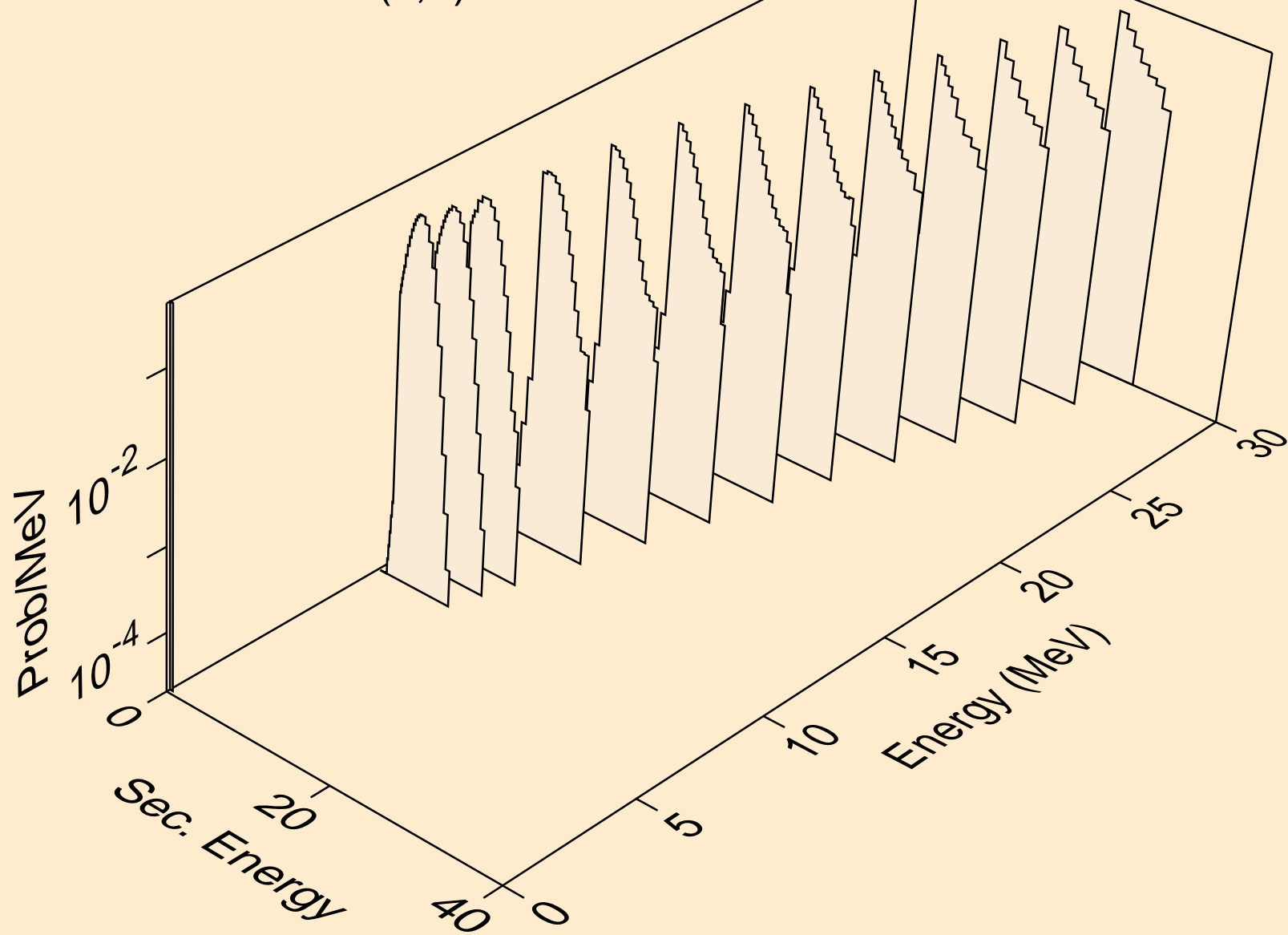

U241 HELION ACER TENDL-2021 LIBRARY; T=0.K  
deuterons from (s,pd)

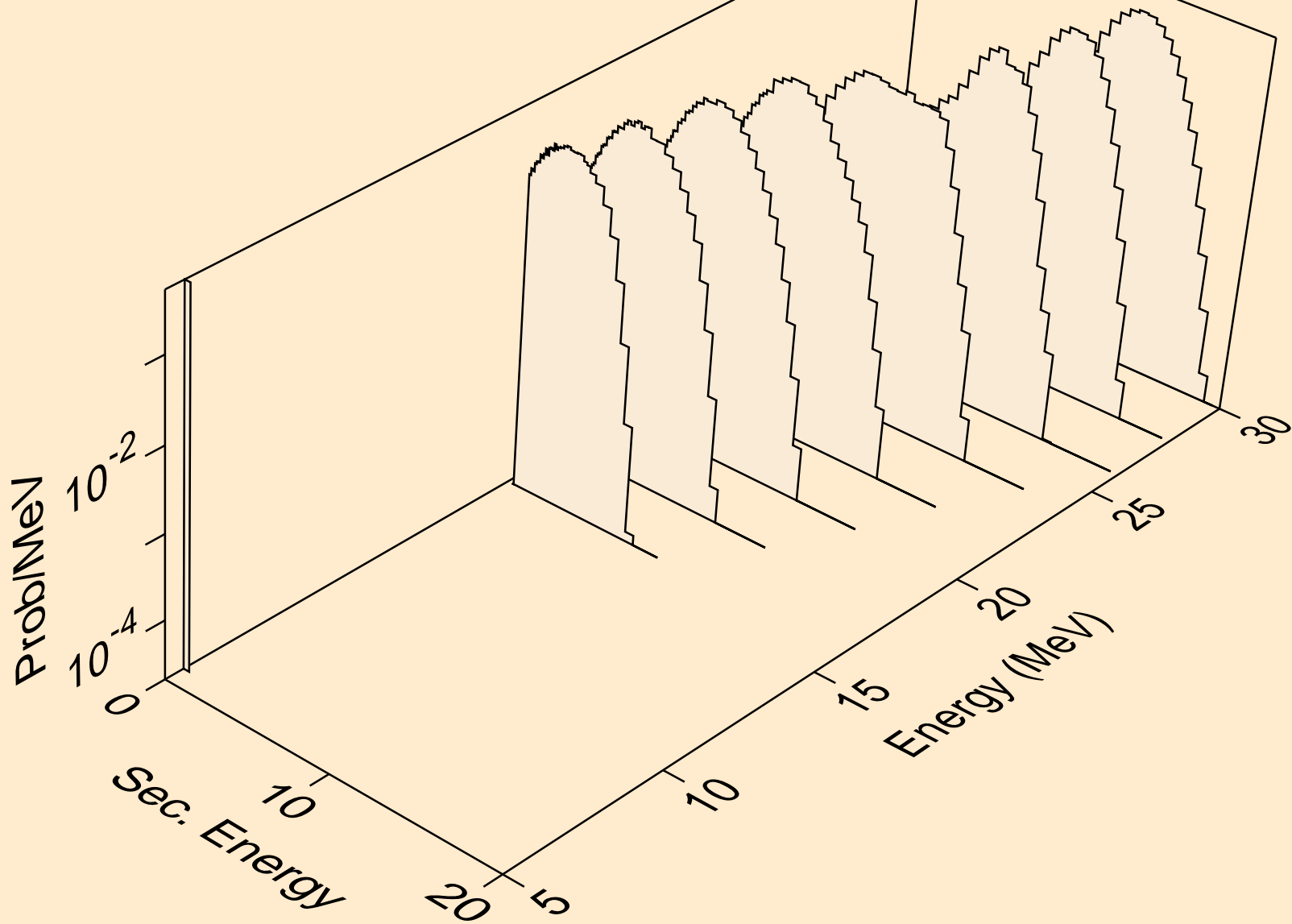

U241 HELION ACER TENDL-2021 LIBRARY; T=0.K  
tritons from (s,x)

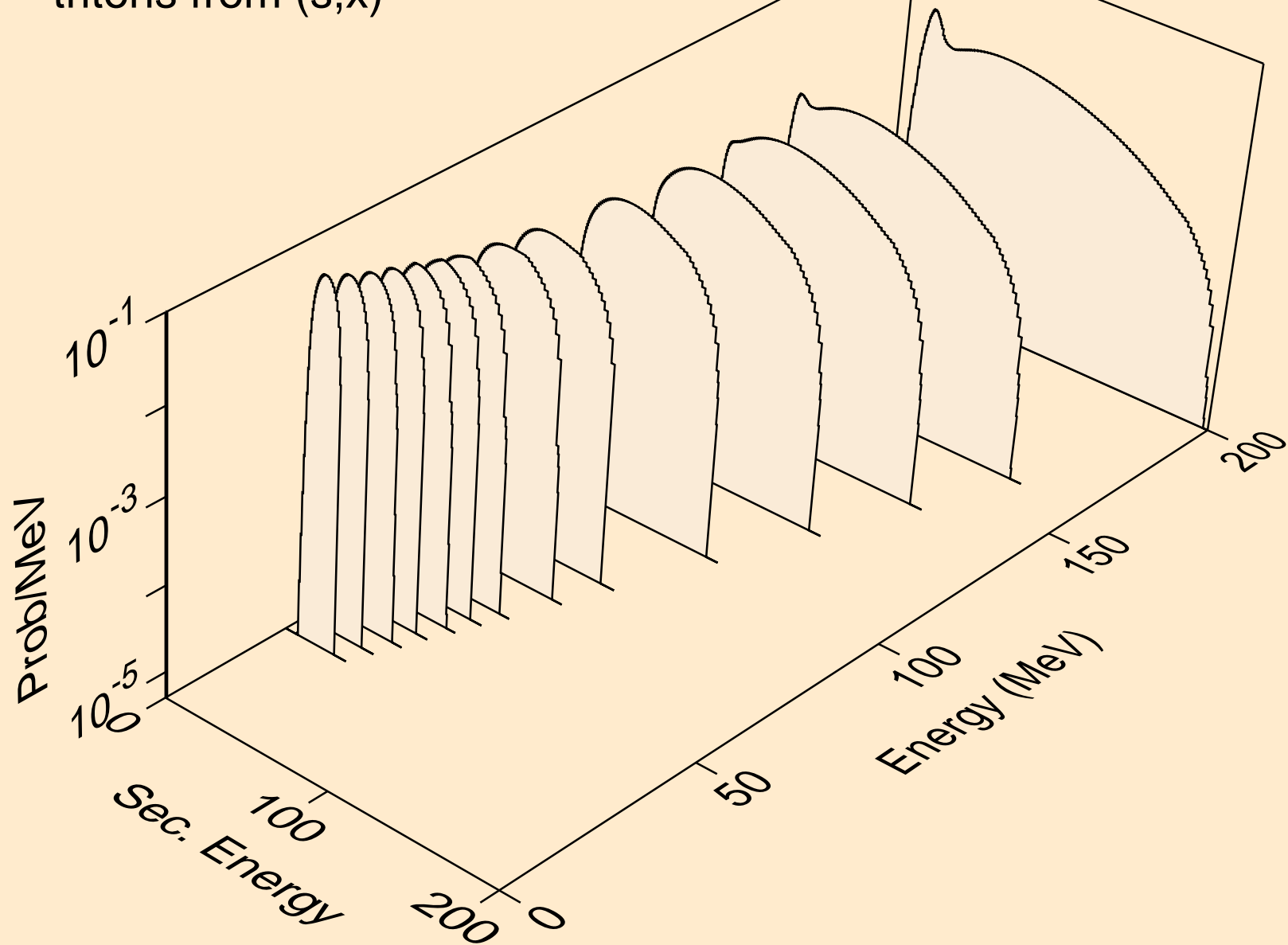

U241 HELION ACER TENDL-2021 LIBRARY; T=0.K  
tritons from (s,n\*)t

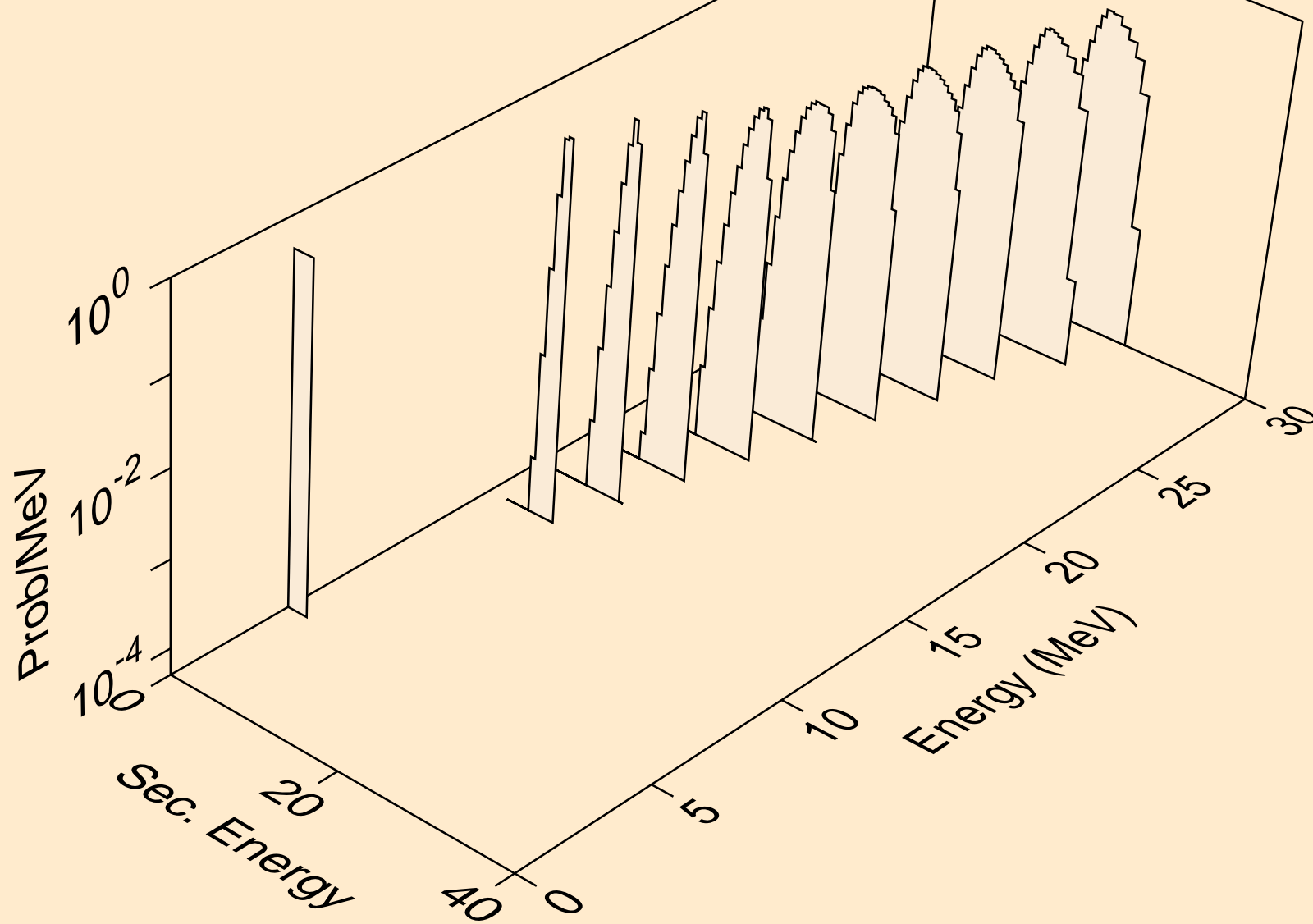

U241 HELION ACER TENDL-2021 LIBRARY; T=0.K  
tritons from (s,t)

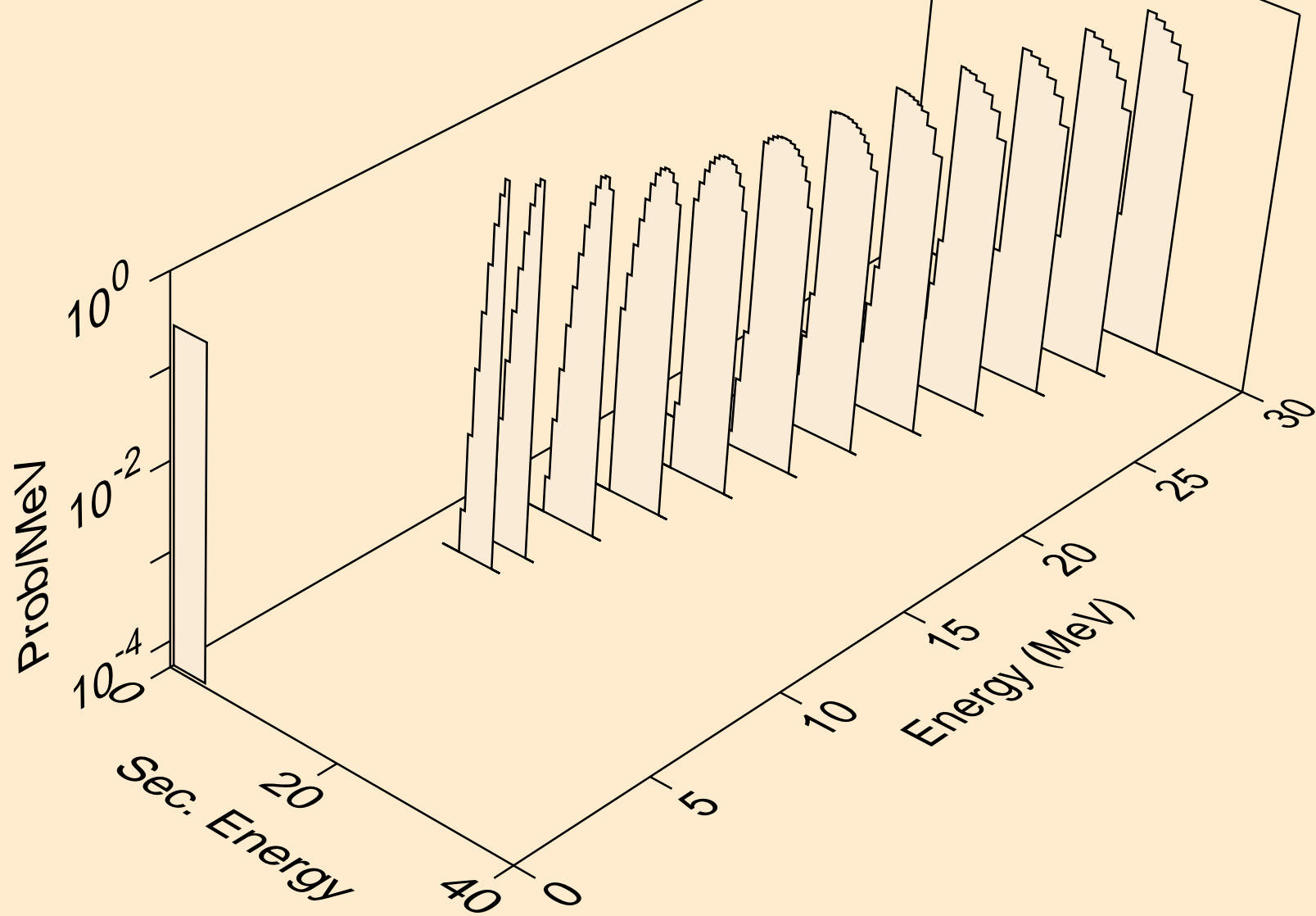

U241 HELION ACER TENDL-2021 LIBRARY; T=0.K  
alphas from (s,x)

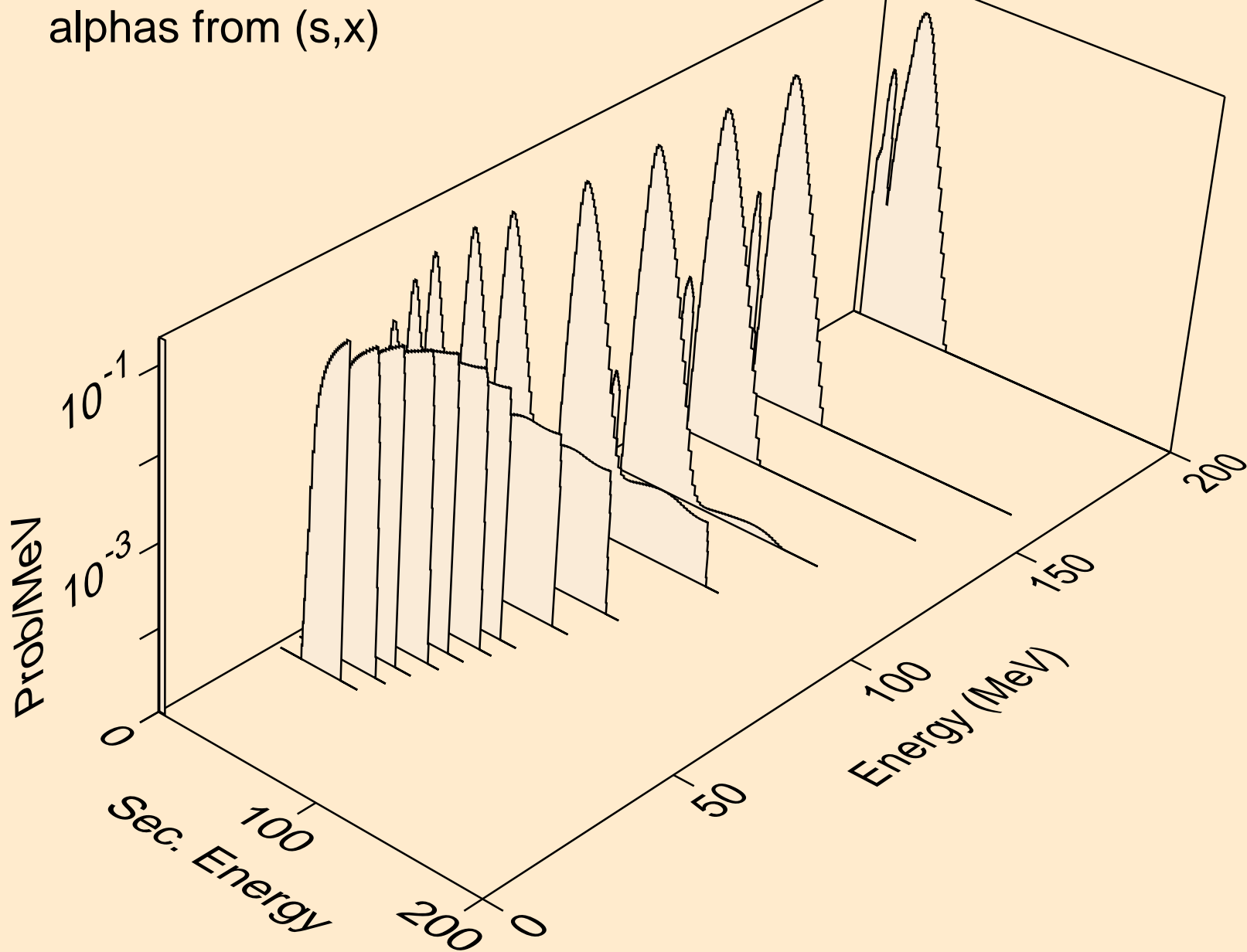

U241 HELION ACER TENDL-2021 LIBRARY; T=0.K  
alphas from (s,n\*)a

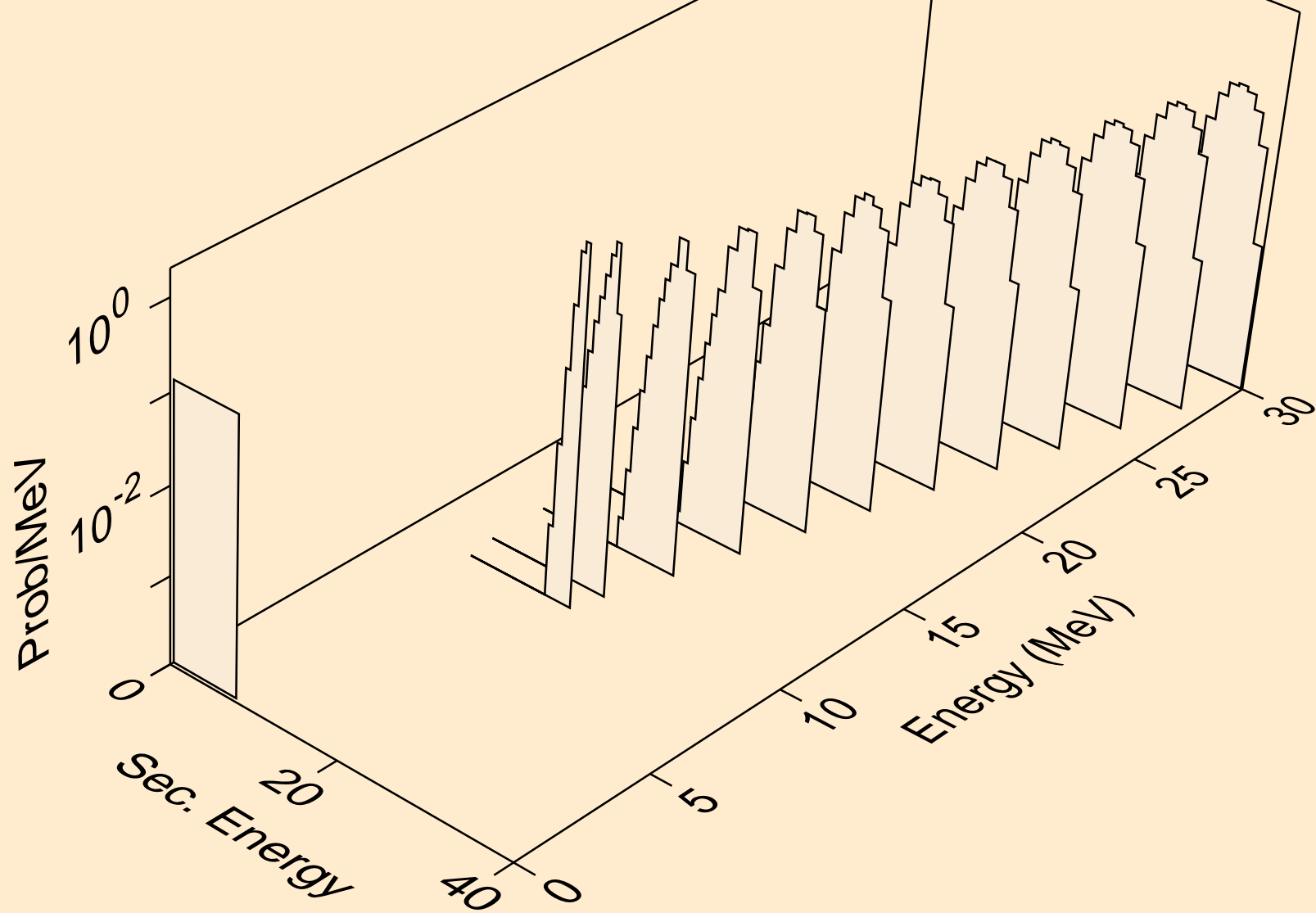

U241 HELION ACER TENDL-2021 LIBRARY; T=0.K  
alphas from (s,2n)a

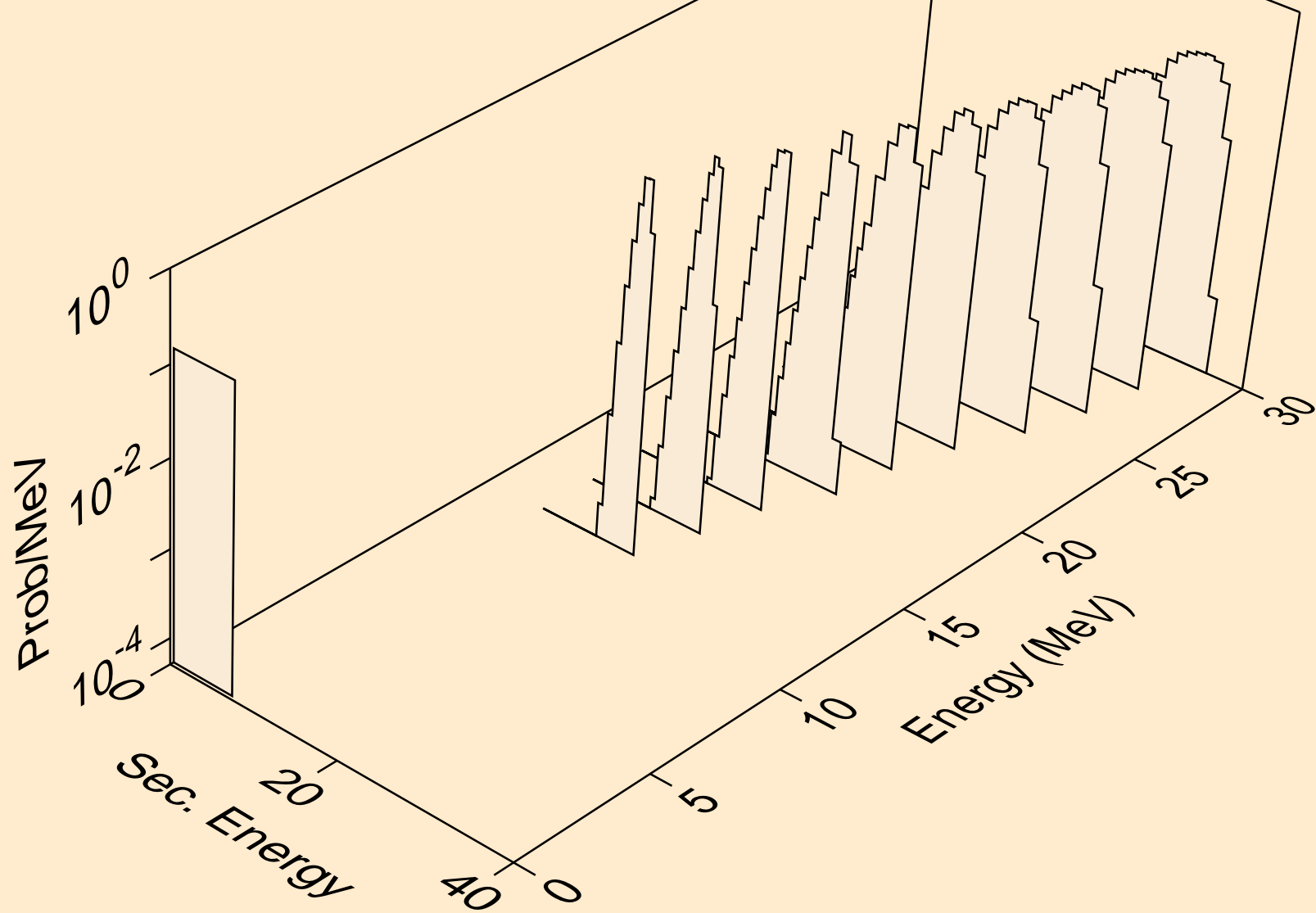



U241 HELION ACER TENDL-2021 LIBRARY; T=0.K  
alphas from (s,3n)a

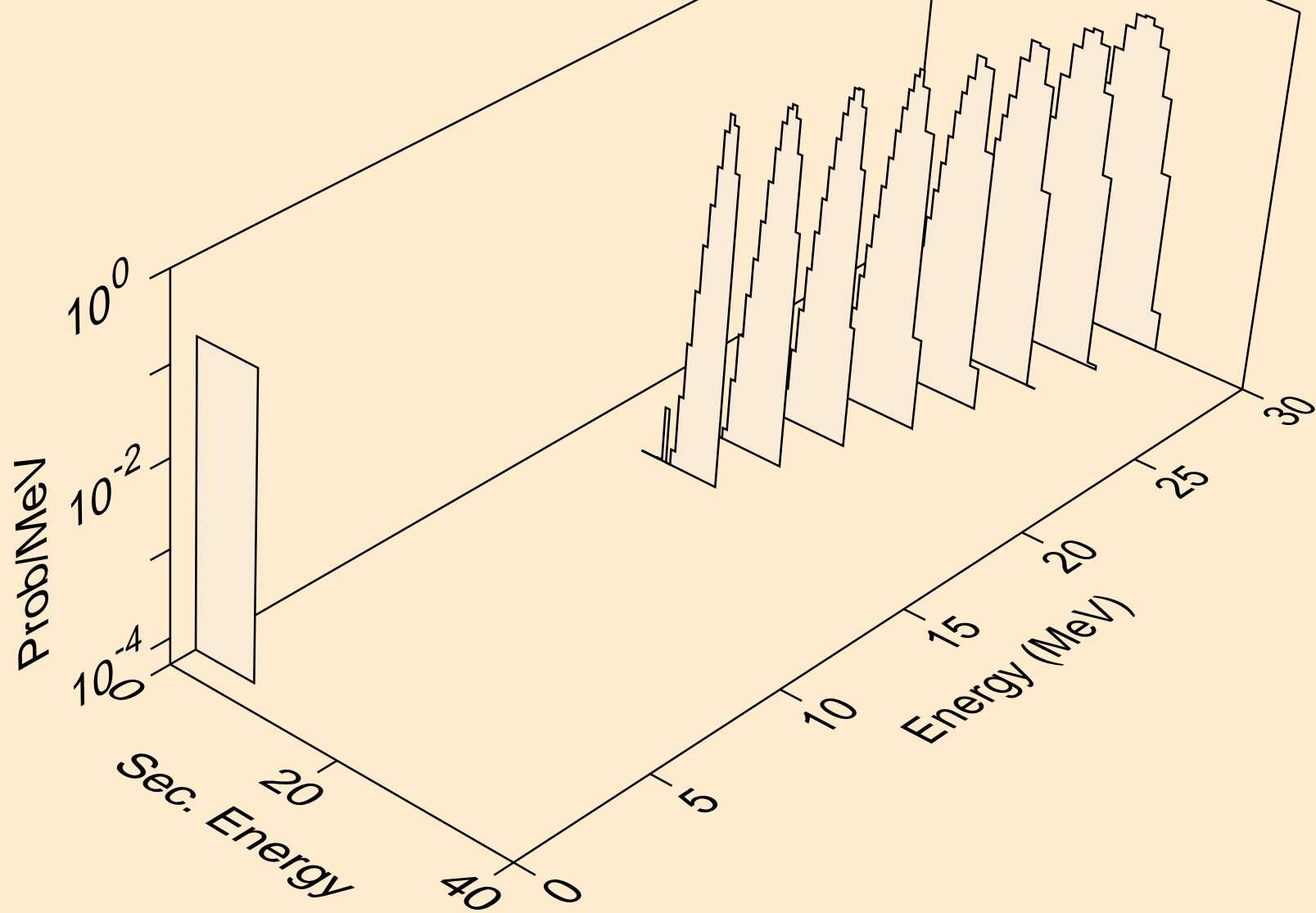

U241 HELION ACER TENDL-2021 LIBRARY; T=0.K  
alphas from (s,npa)

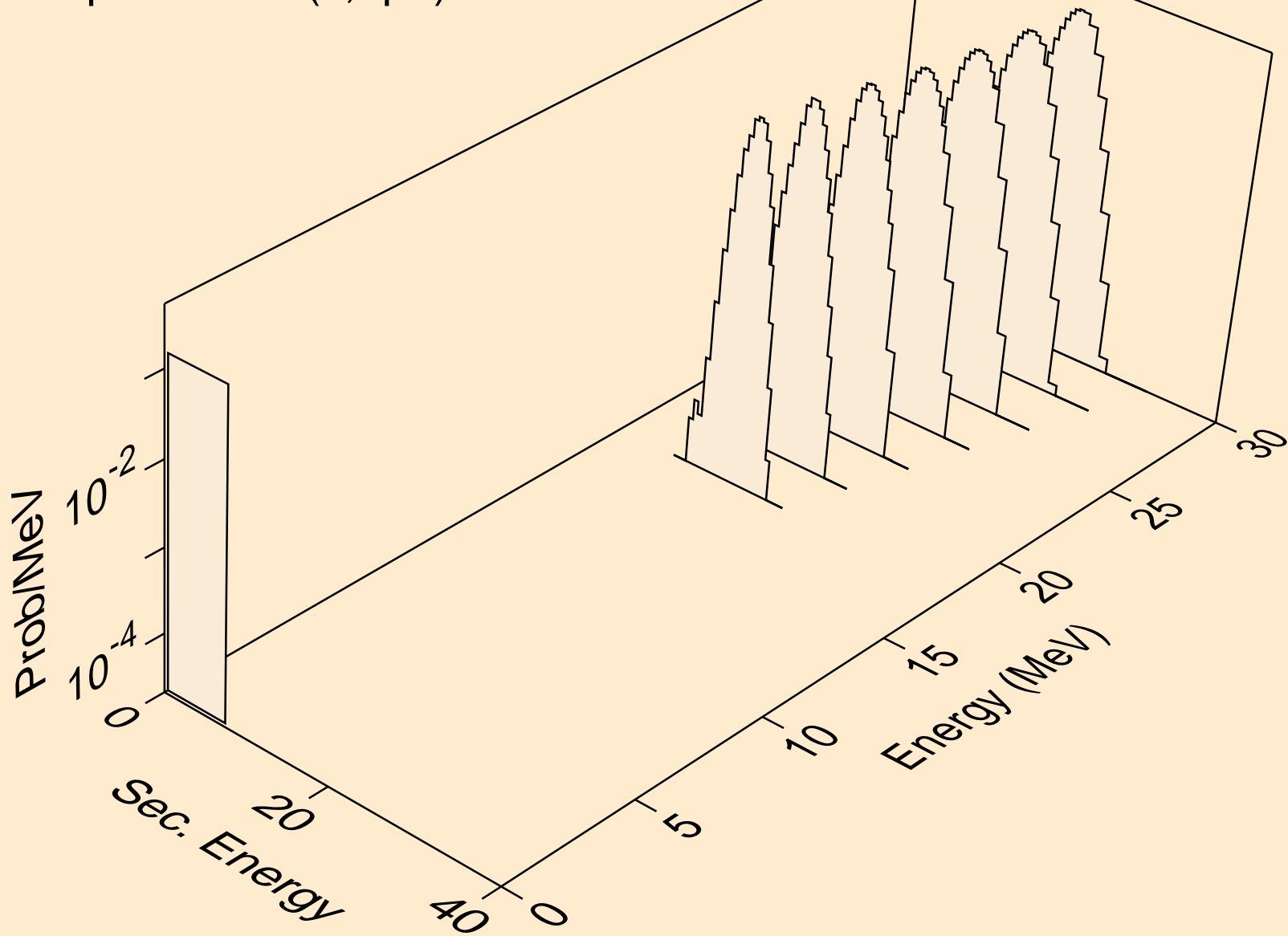

U241 HELION ACER TENDL-2021 LIBRARY; T=0.K  
alphas from (s,a)

