

# W177 HELION ACER TENDL-2021 LIBRARY; T=0.K

## Principal cross sections

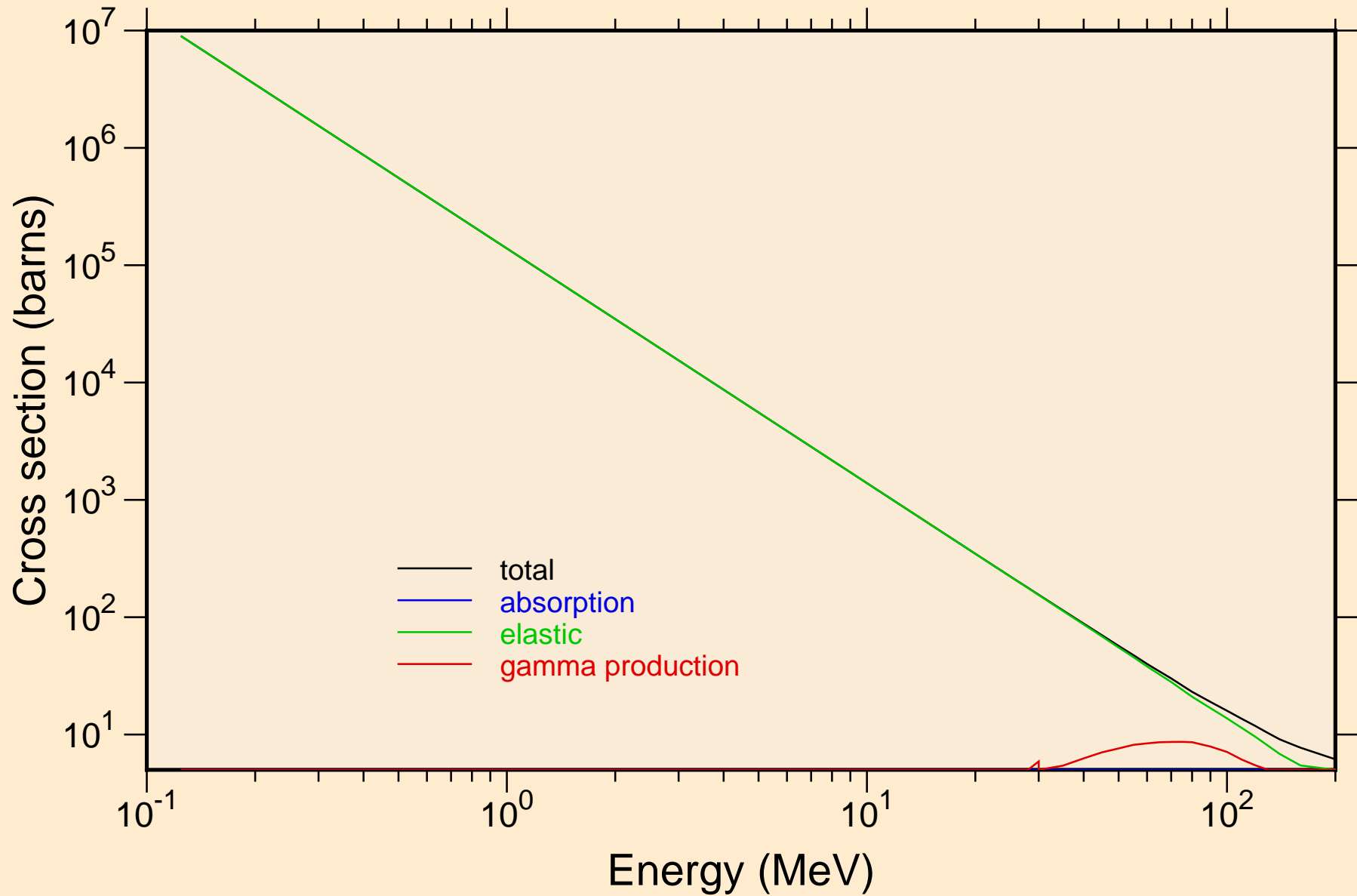

W177 HELION ACER TENDL-2021 LIBRARY; T=0.K

Heating

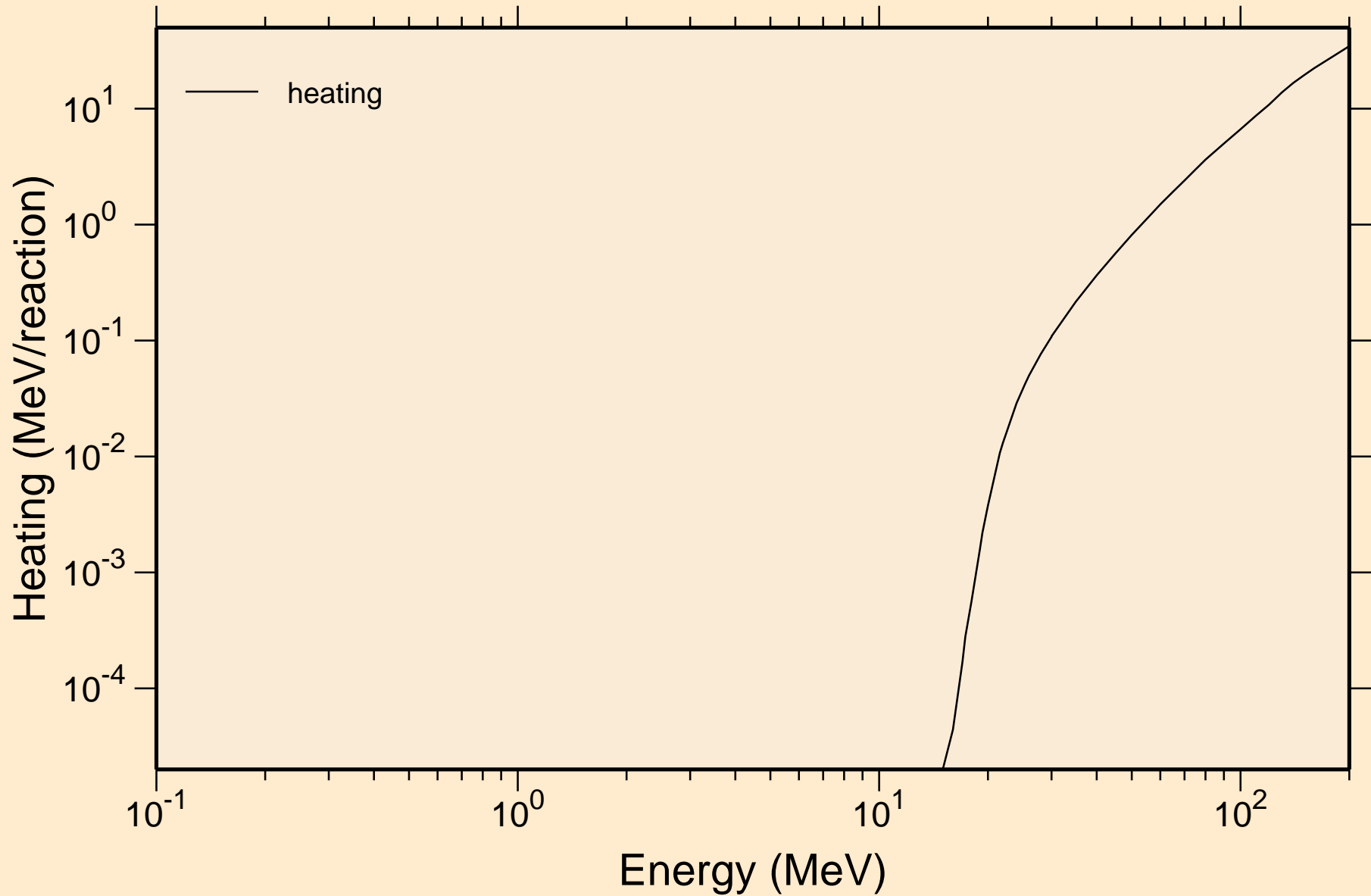

# W177 HELION ACER TENDL-2021 LIBRARY; T=0.K

## Principal cross sections

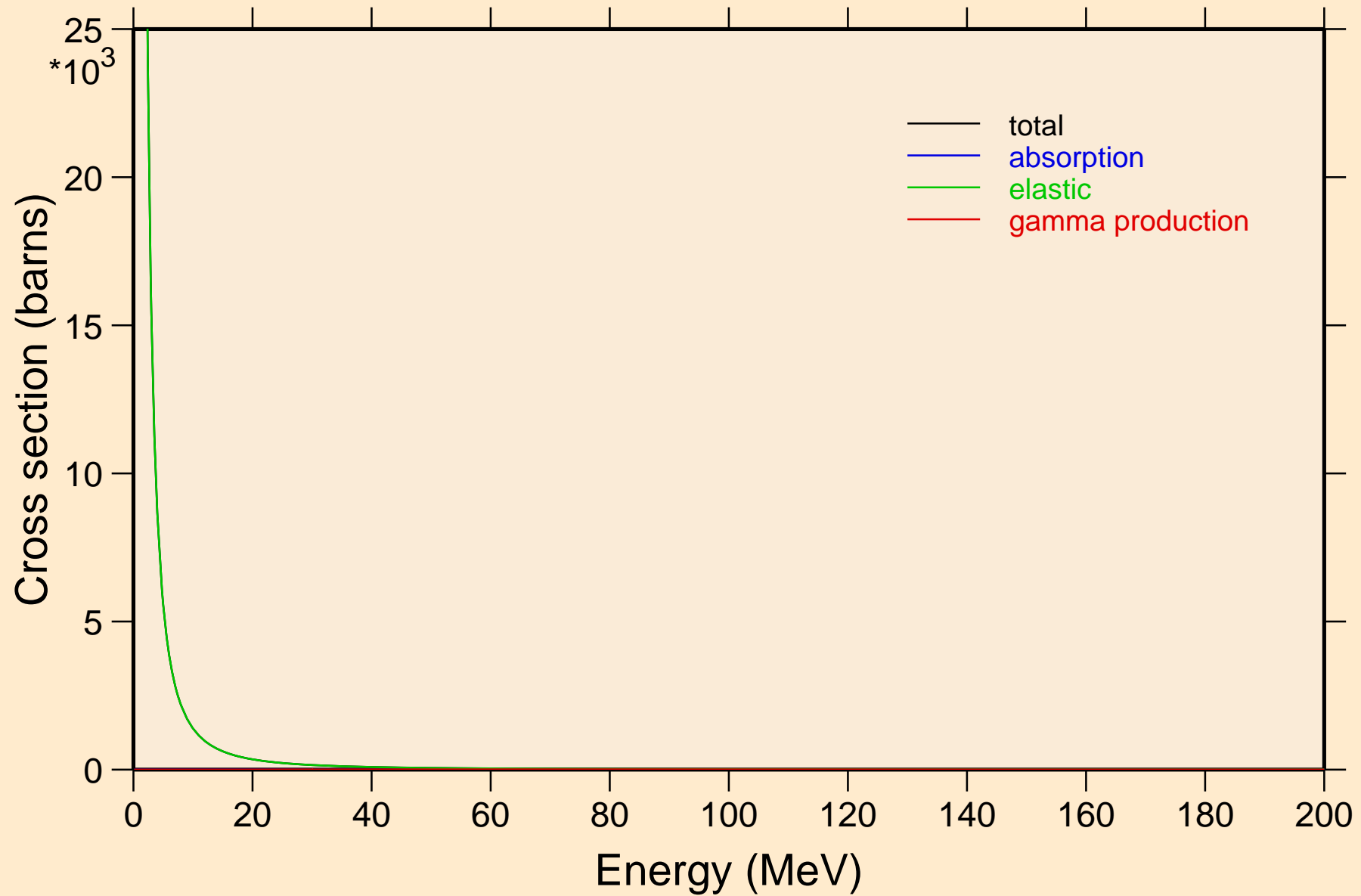

W177 HELION ACER TENDL-2021 LIBRARY; T=0.K

Heating

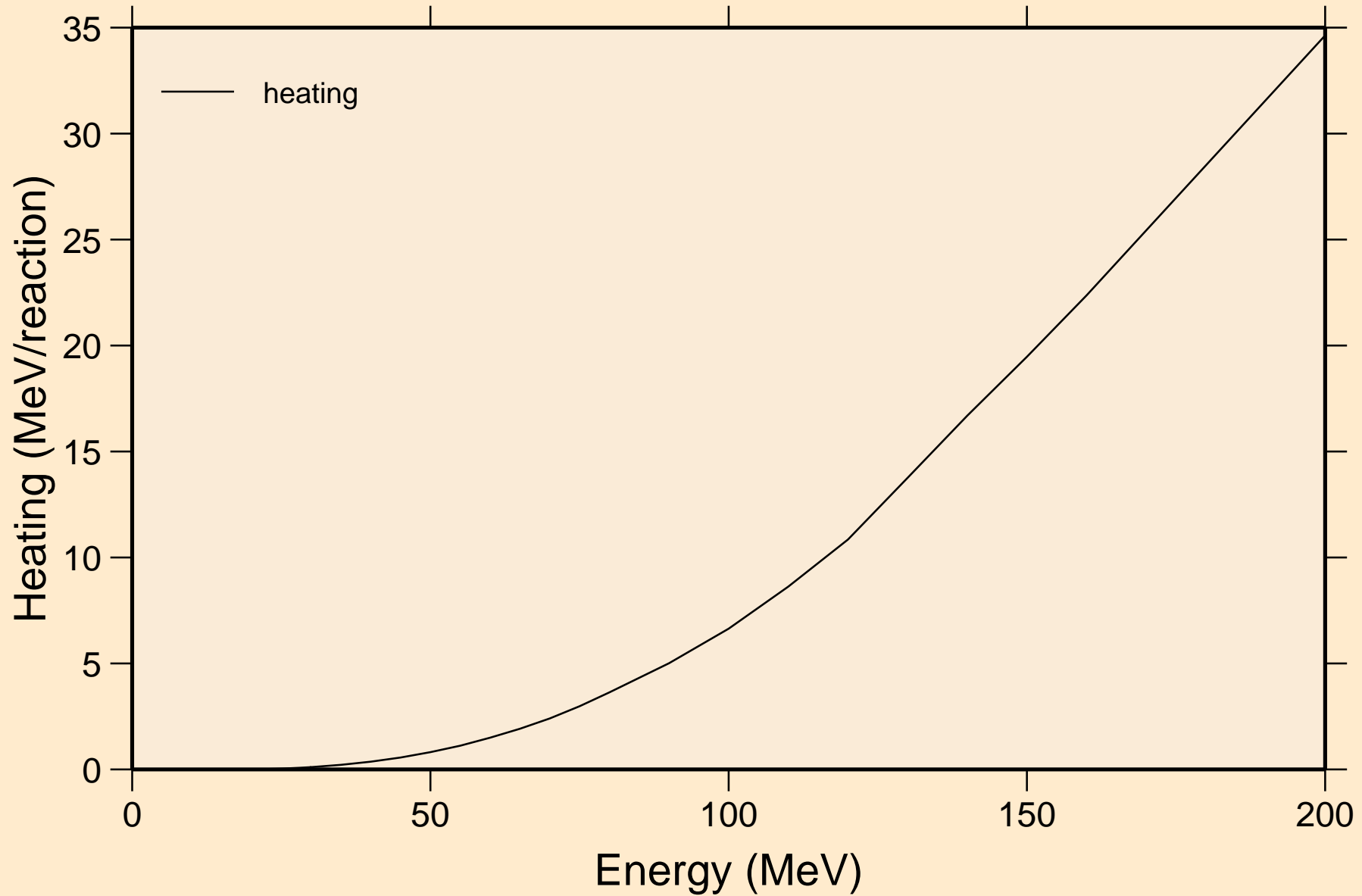

W177 HELION ACER TENDL-2021 LIBRARY; T=0.K  
Threshold reactions

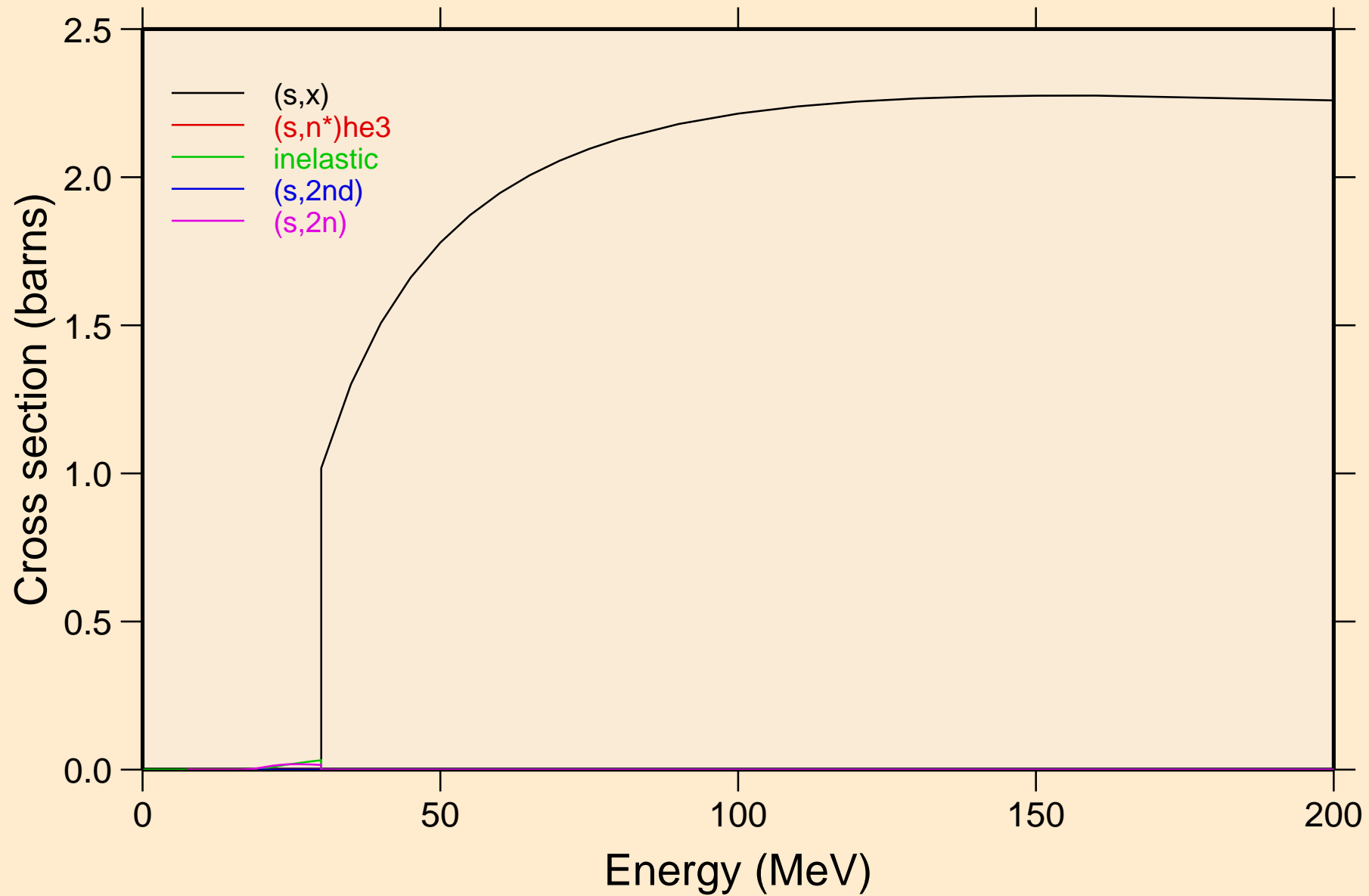

W177 HELION ACER TENDL-2021 LIBRARY; T=0.K  
Threshold reactions

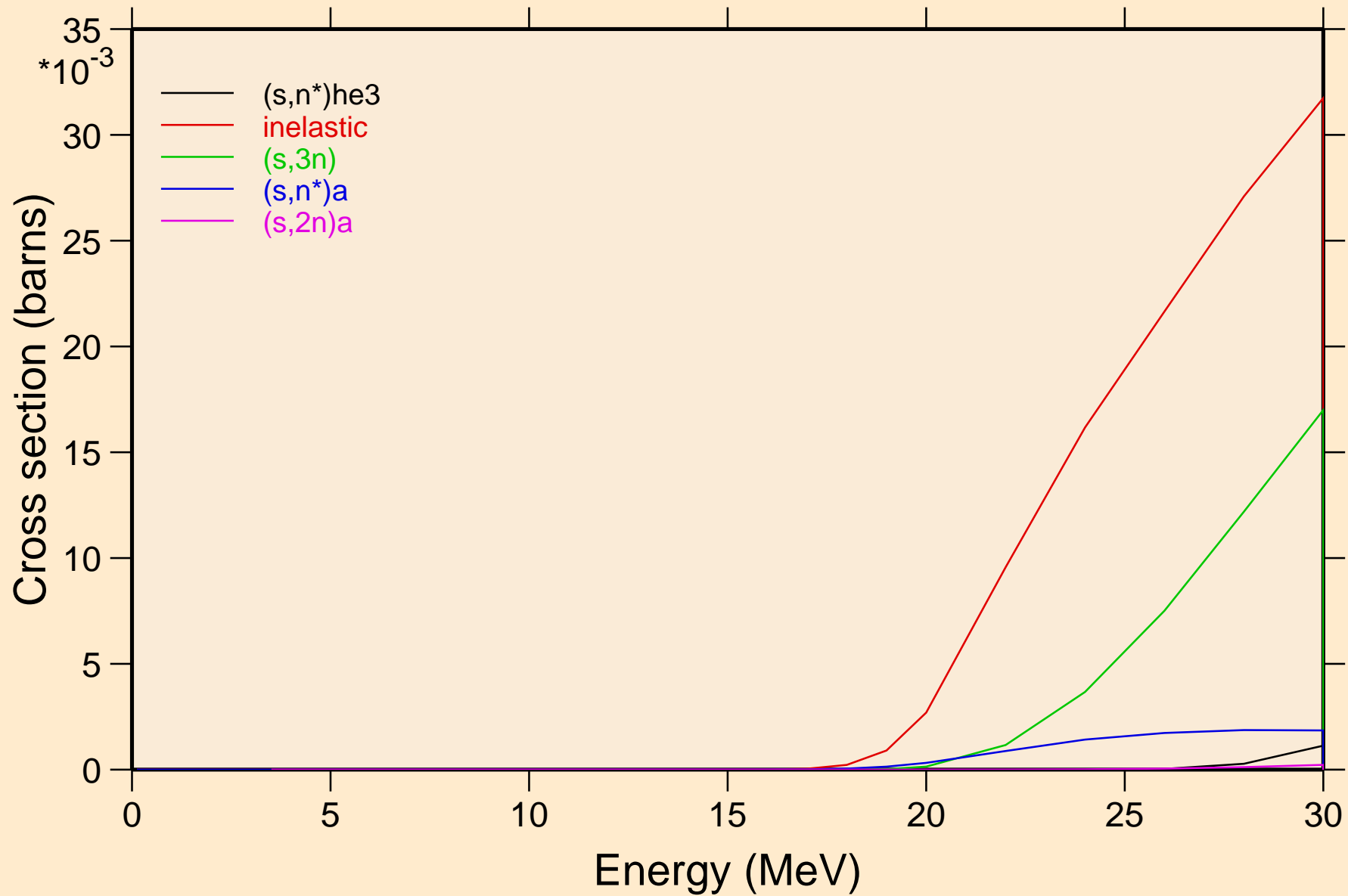

W177 HELION ACER TENDL-2021 LIBRARY; T=0.K  
Threshold reactions

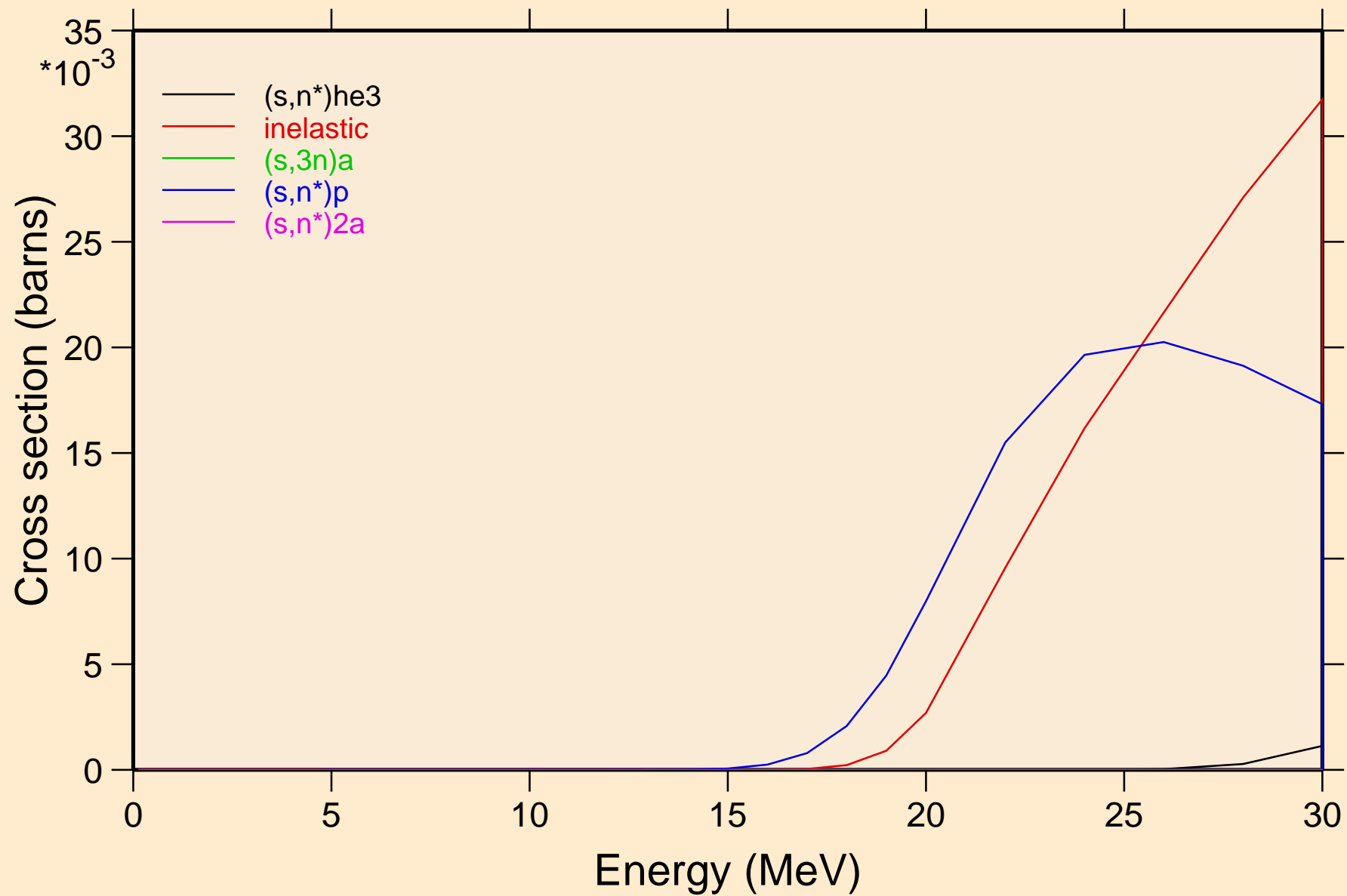

W177 HELION ACER TENDL-2021 LIBRARY; T=0.K  
Threshold reactions

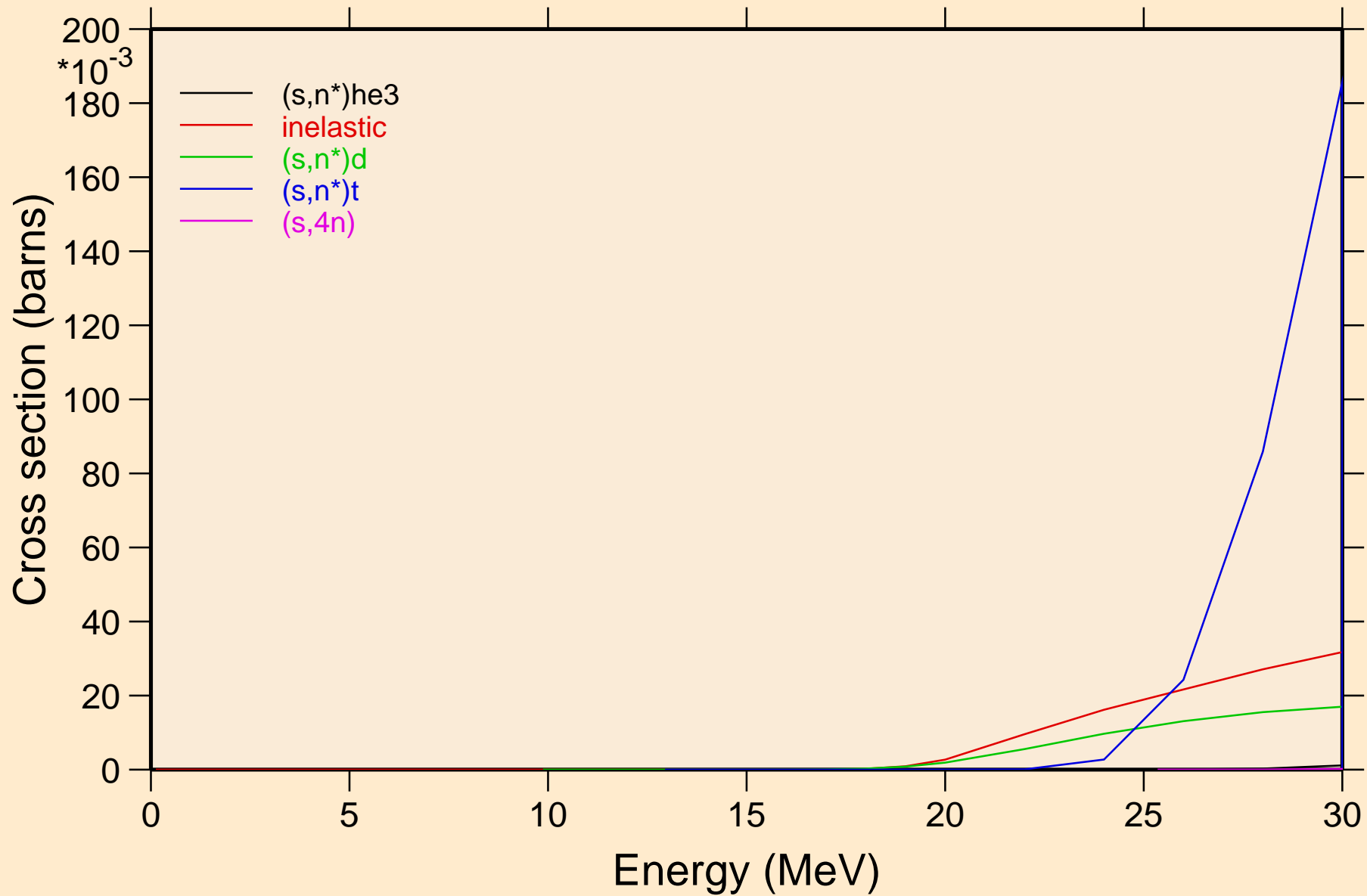



W177 HELION ACER TENDL-2021 LIBRARY; T=0.K  
Threshold reactions

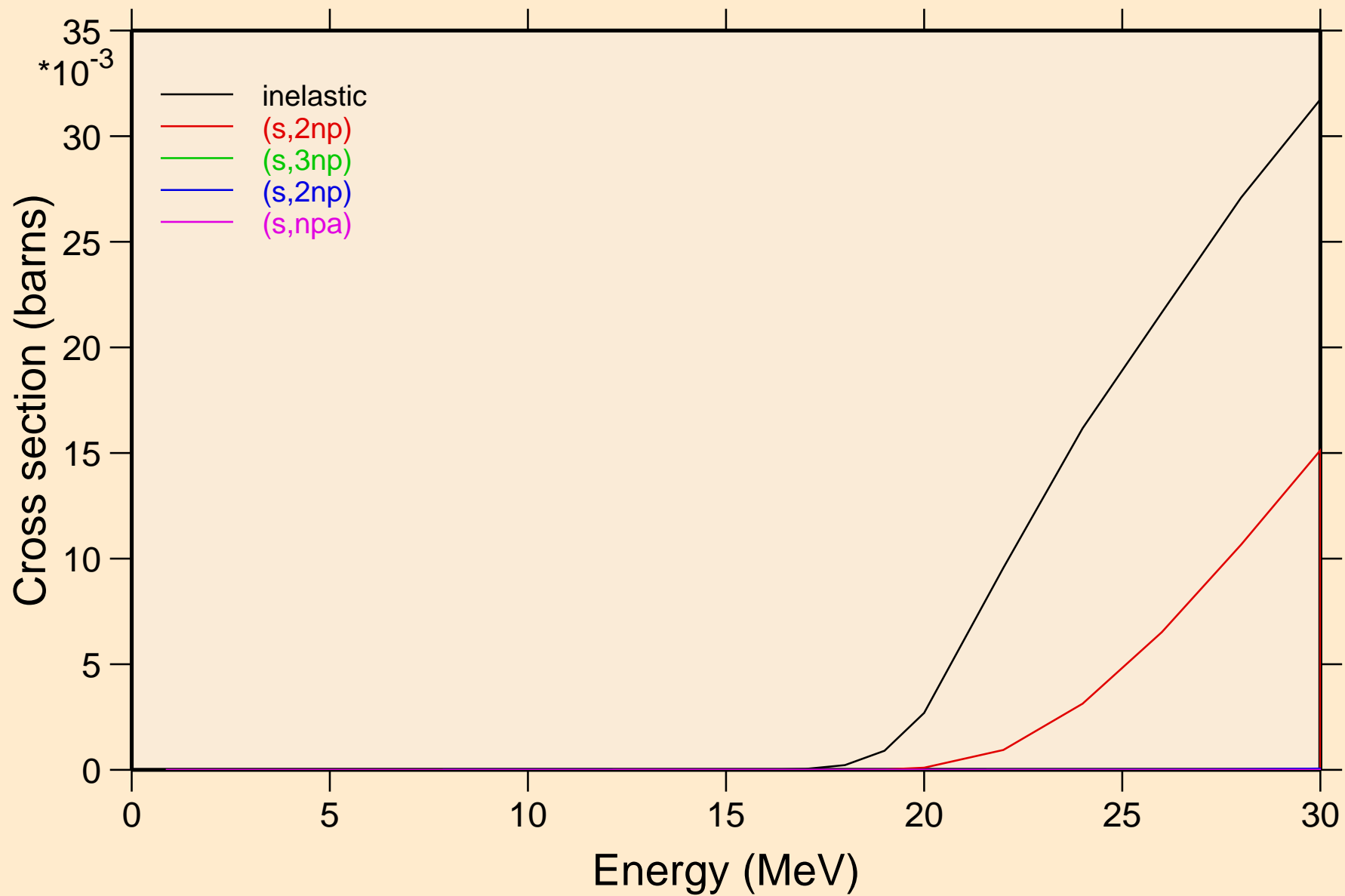

W177 HELION ACER TENDL-2021 LIBRARY; T=0.K  
Threshold reactions

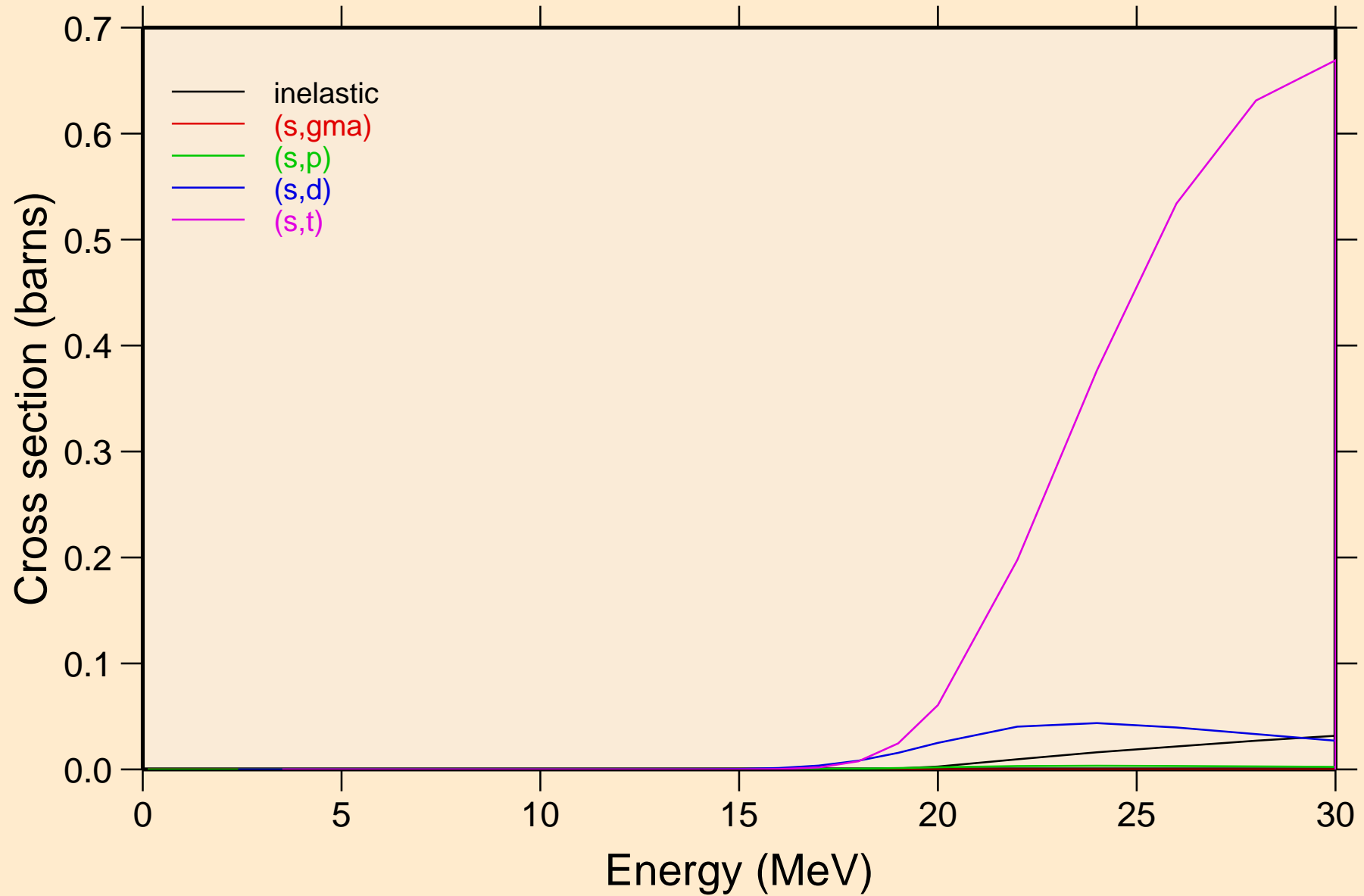

W177 HELION ACER TENDL-2021 LIBRARY; T=0.K  
Threshold reactions

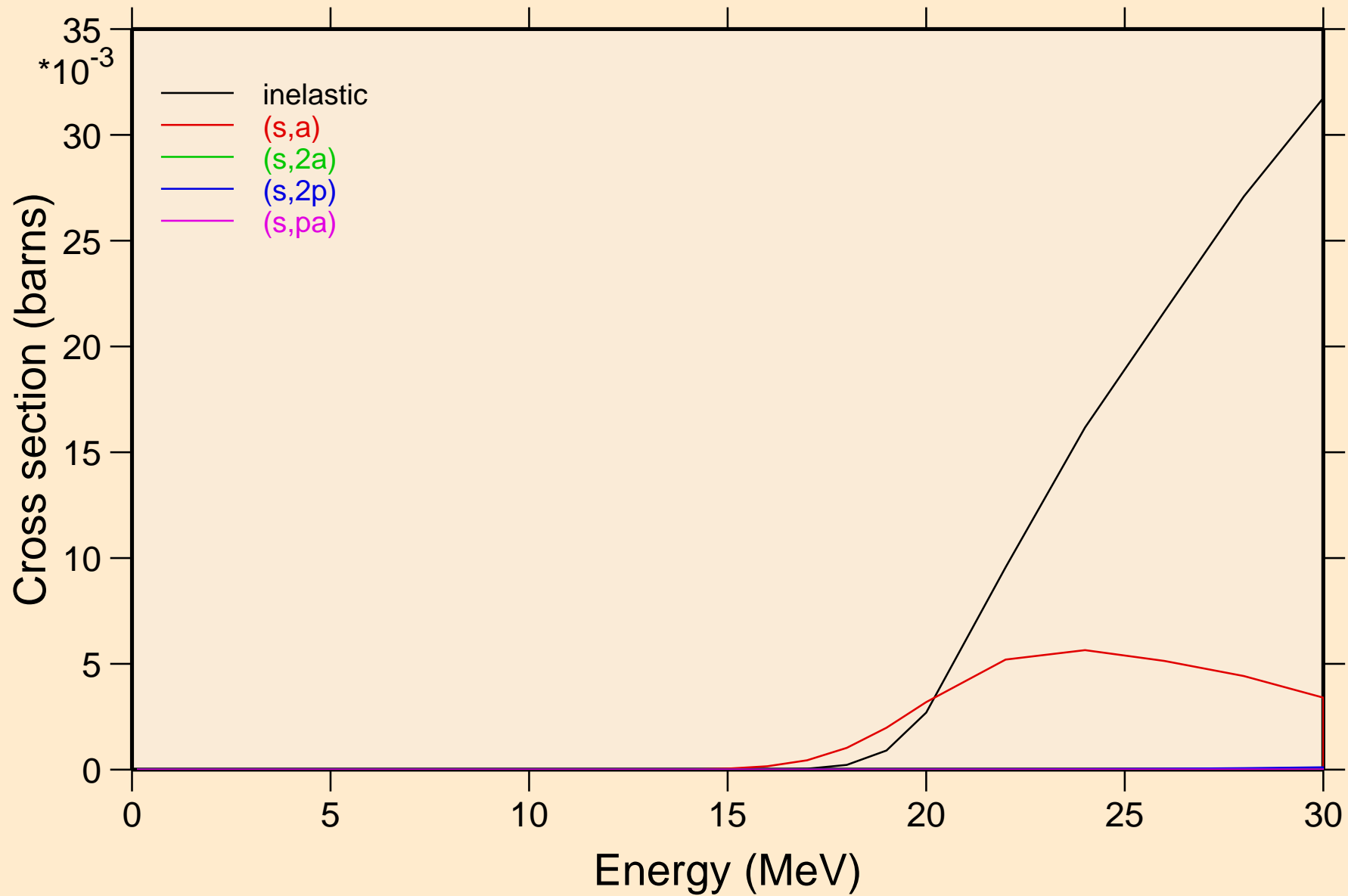

W177 HELION ACER TENDL-2021 LIBRARY; T=0.K  
Threshold reactions

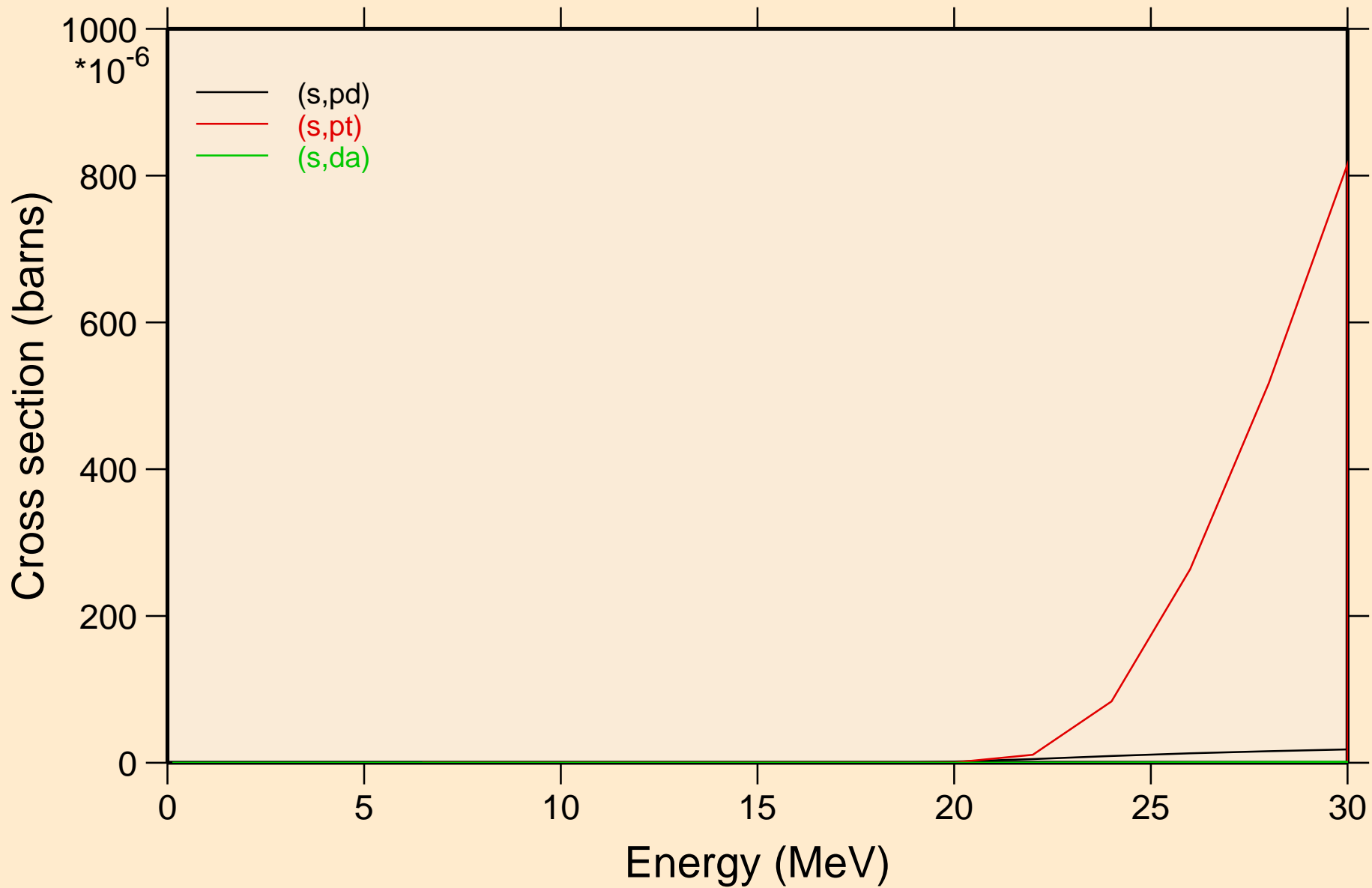

W177 HELION ACER TENDL-2021 LIBRARY; T=0.K  
angular distribution for elastic

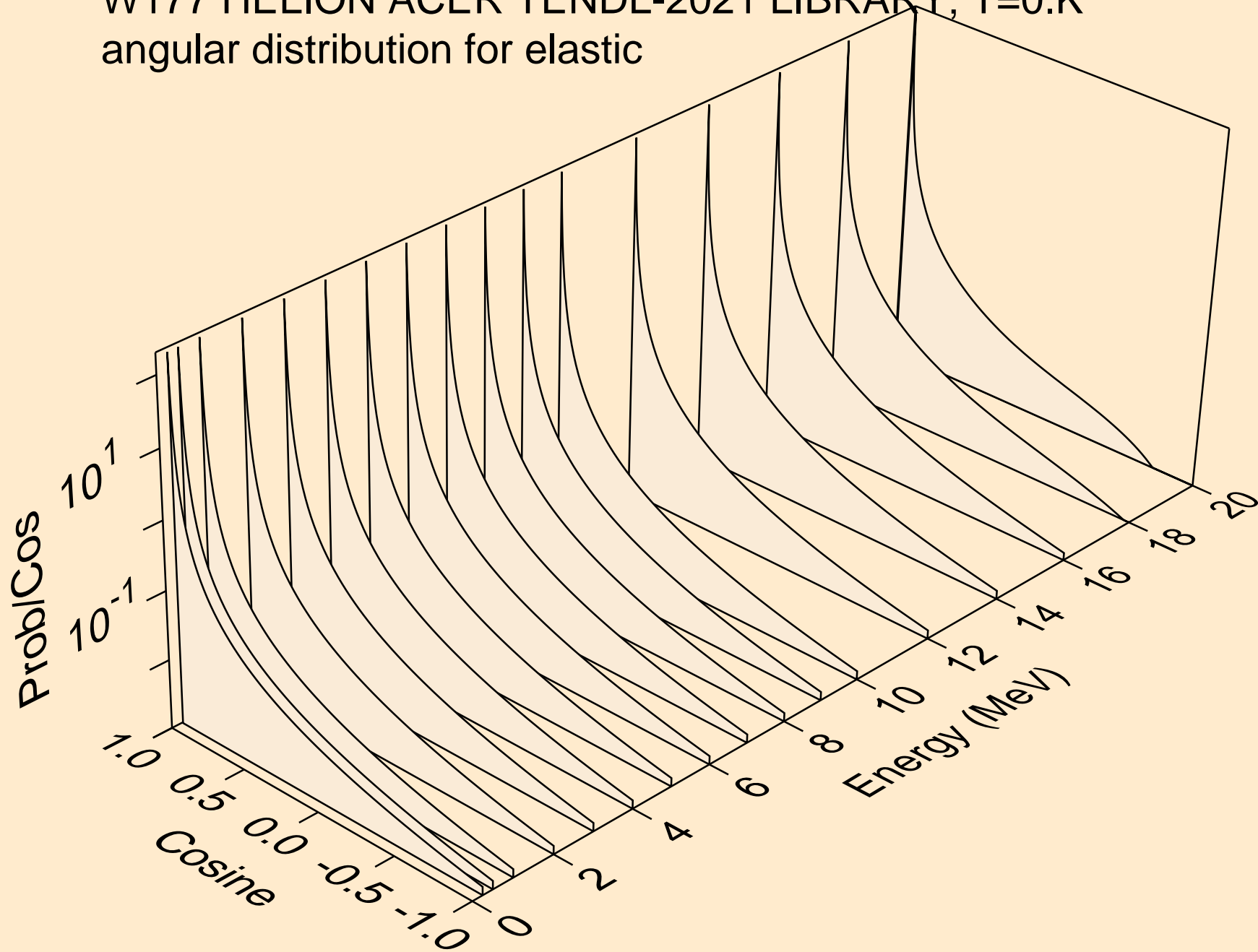

W177 HELION ACER TENDL-2021 LIBRARY; T=0.K  
angular distribution for elastic

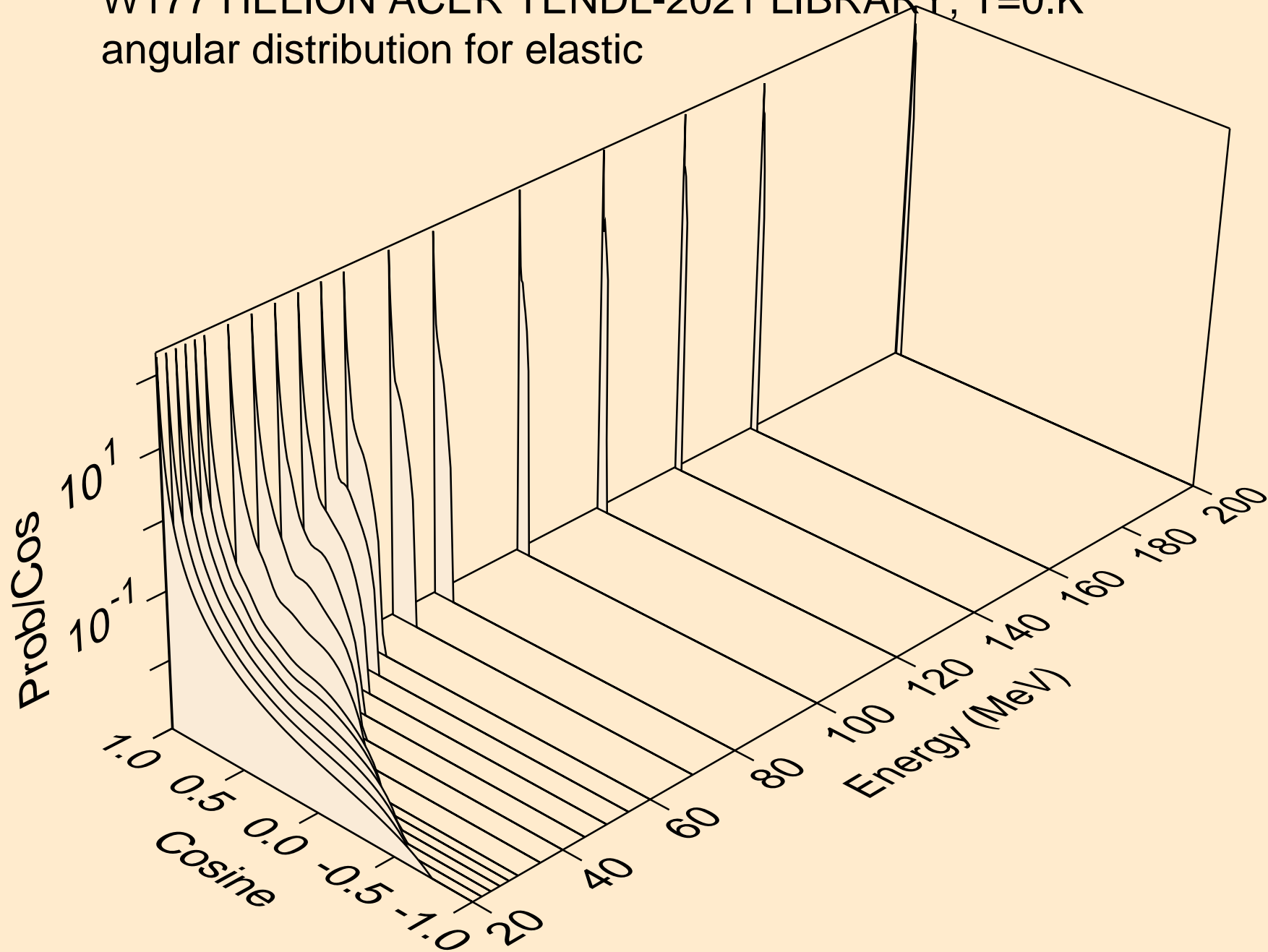

W177 HELION ACER TENDL-2021 LIBRARY; T=0.K  
He-3 emission for (s,x)

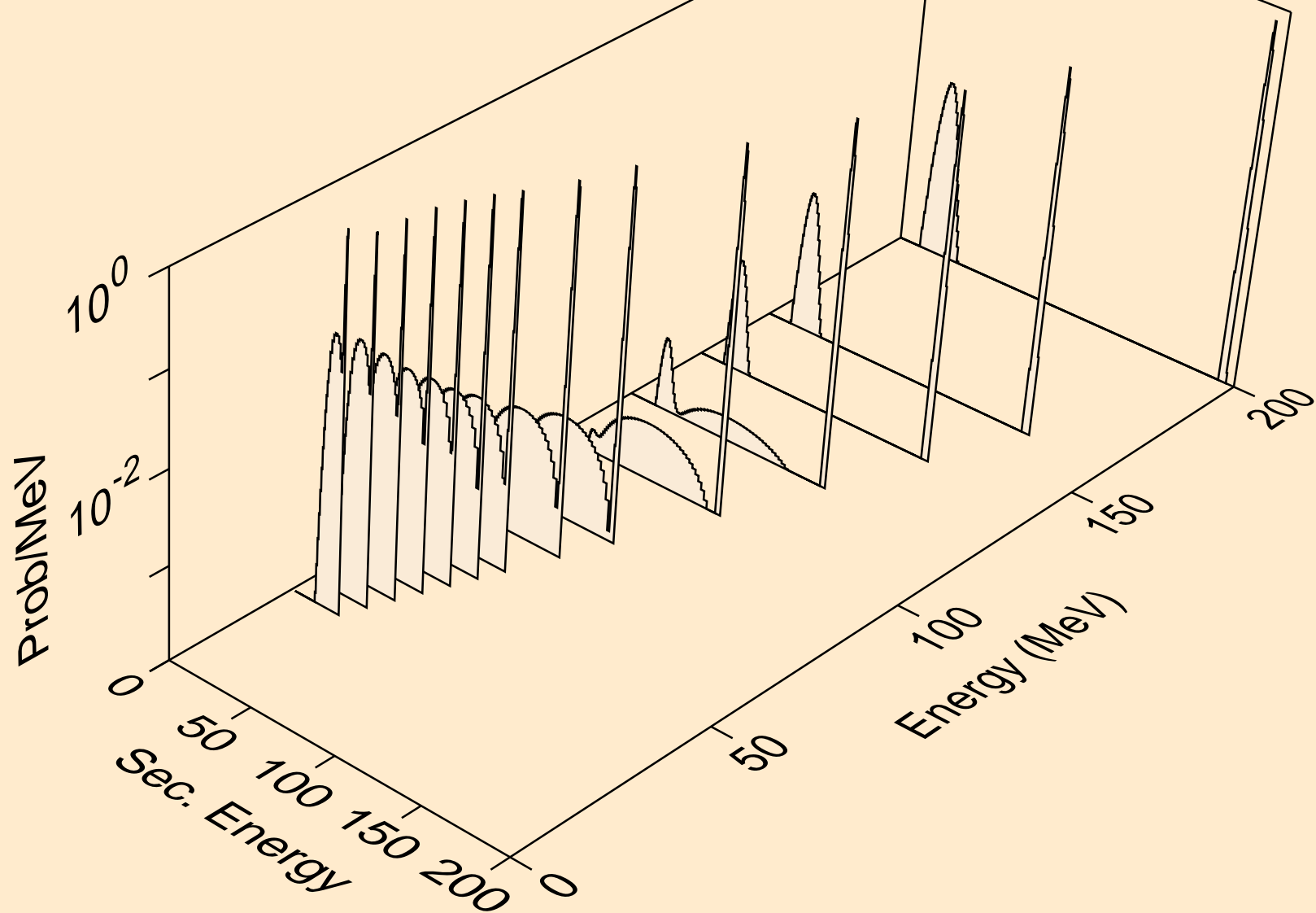

W177 HELION ACER TENDL-2021 LIBRARY; T=0.K  
He-3 emission for (s,n\*)he3

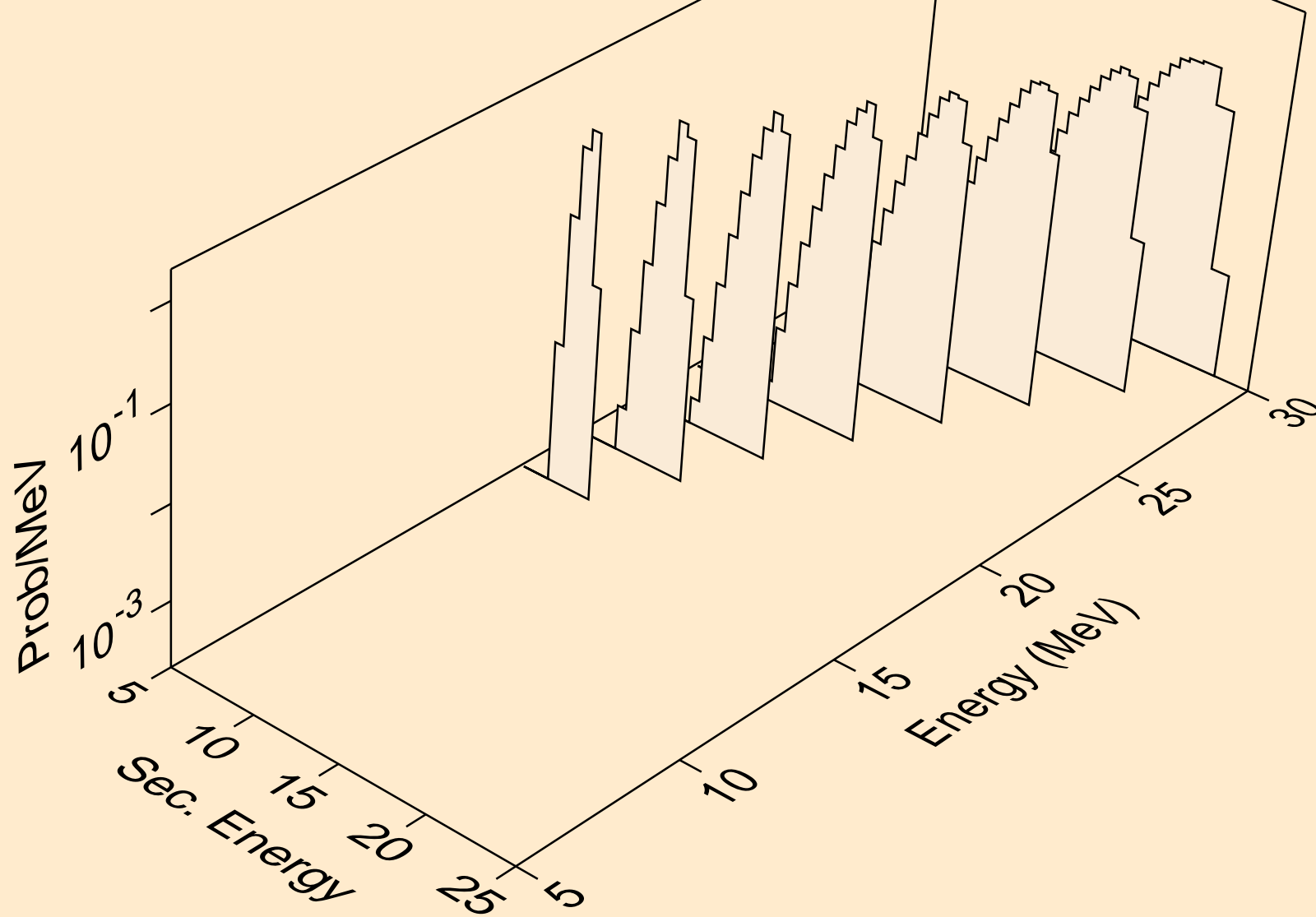



W177 HELION ACER TENDL-2021 LIBRARY; T=0.K  
He-3 emission for inelastic

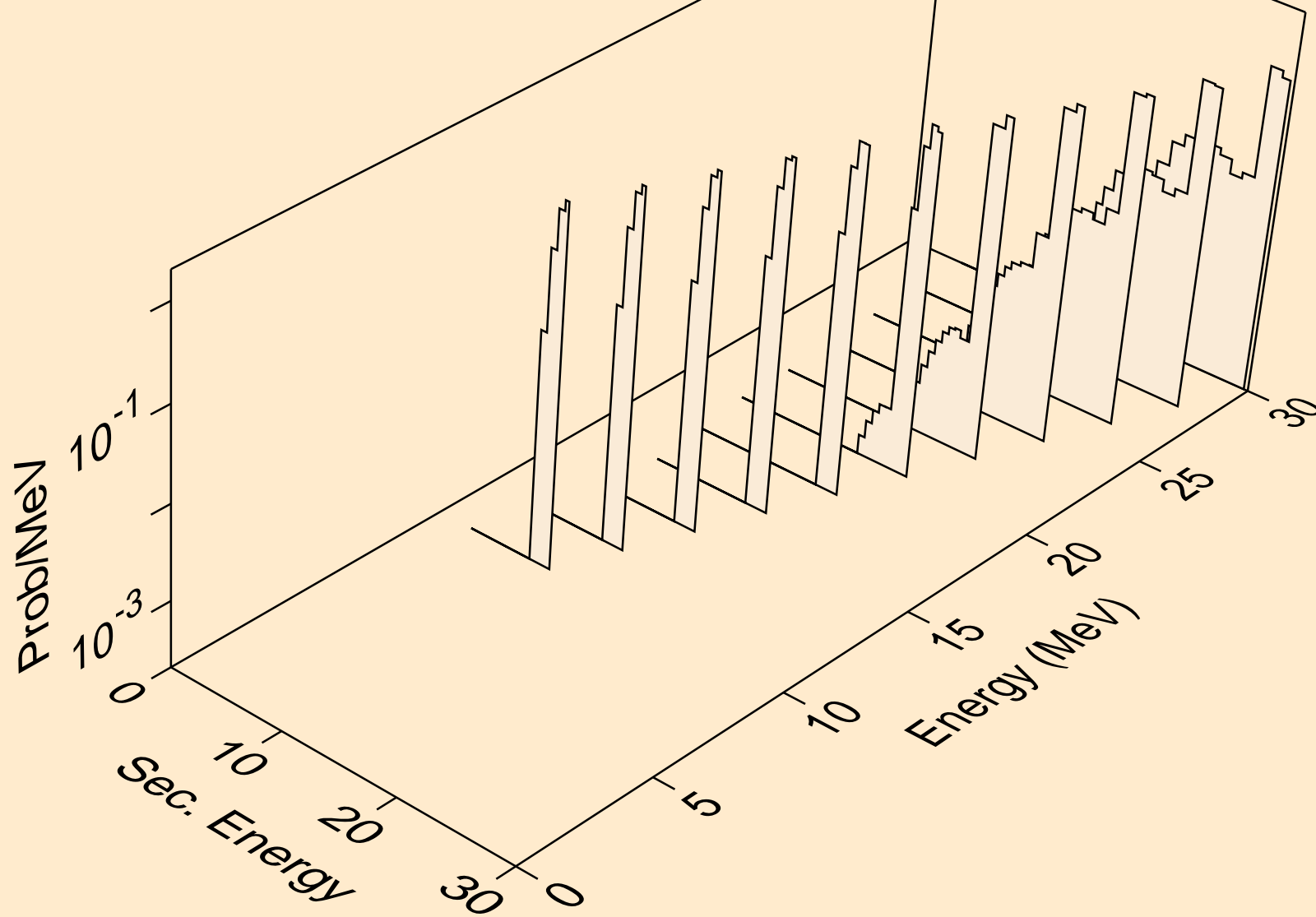

W177 HELION ACER TENDL-2021 LIBRARY; T=0.K  
Photon emission for (z,n)

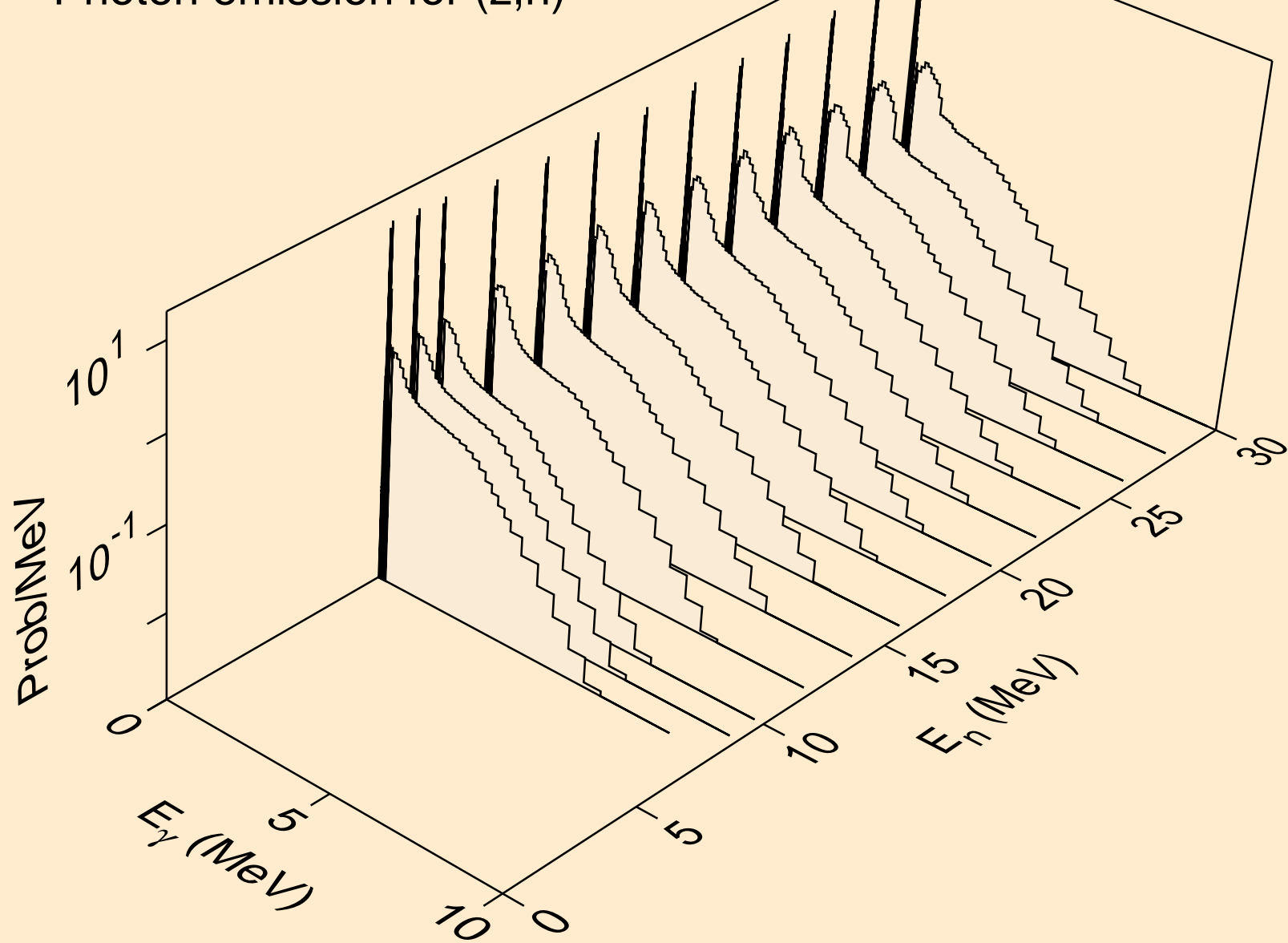

W177 HELION ACER TENDL-2021 LIBRARY; T=0.K  
Photon emission for (n,x)

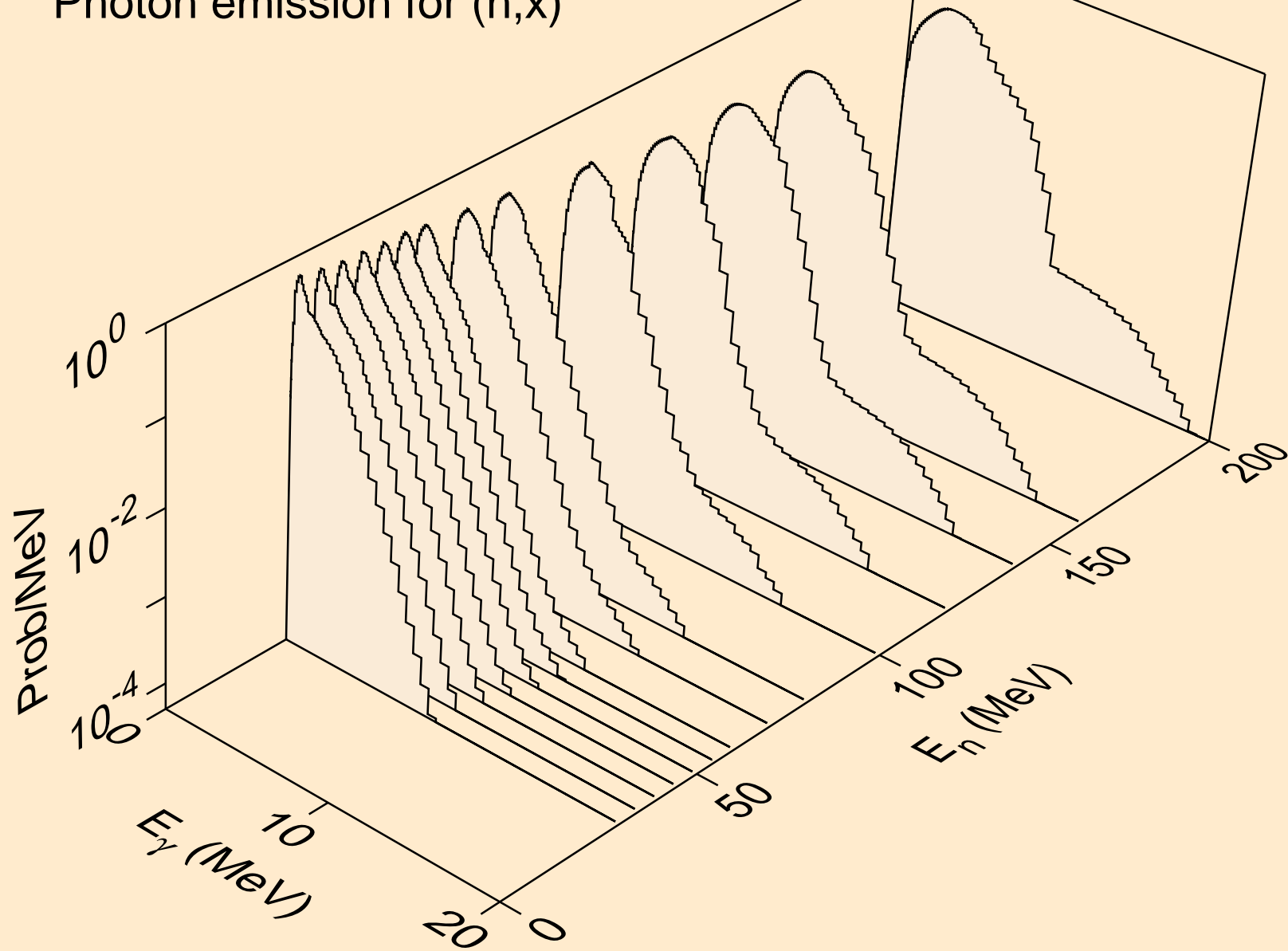

W177 HELION ACER TENDL-2021 LIBRARY; T=0.K  
Photon emission for (n,2nd)

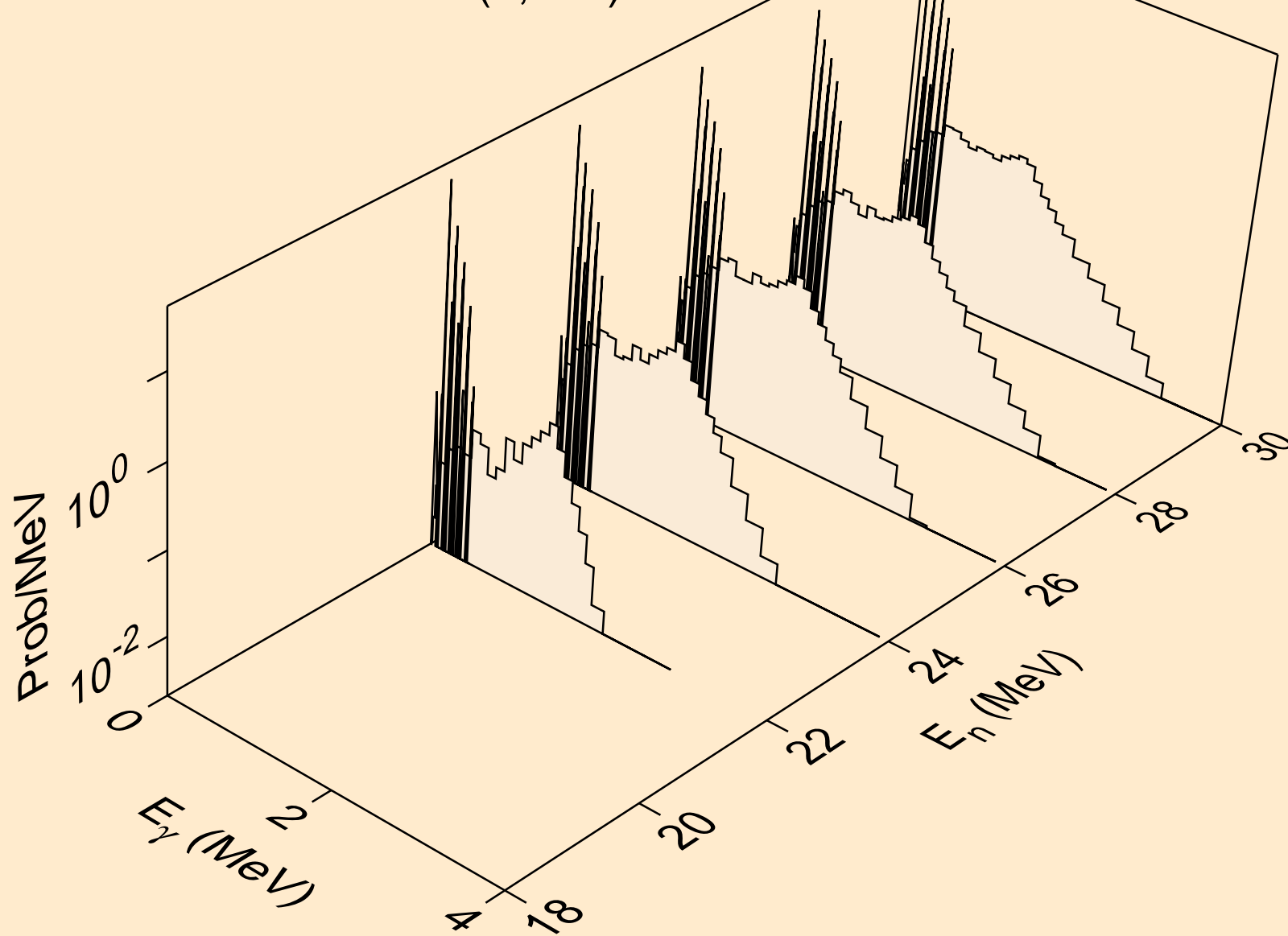

W177 HELION ACER TENDL-2021 LIBRARY; T=0.K  
Photon emission for (n,2n)

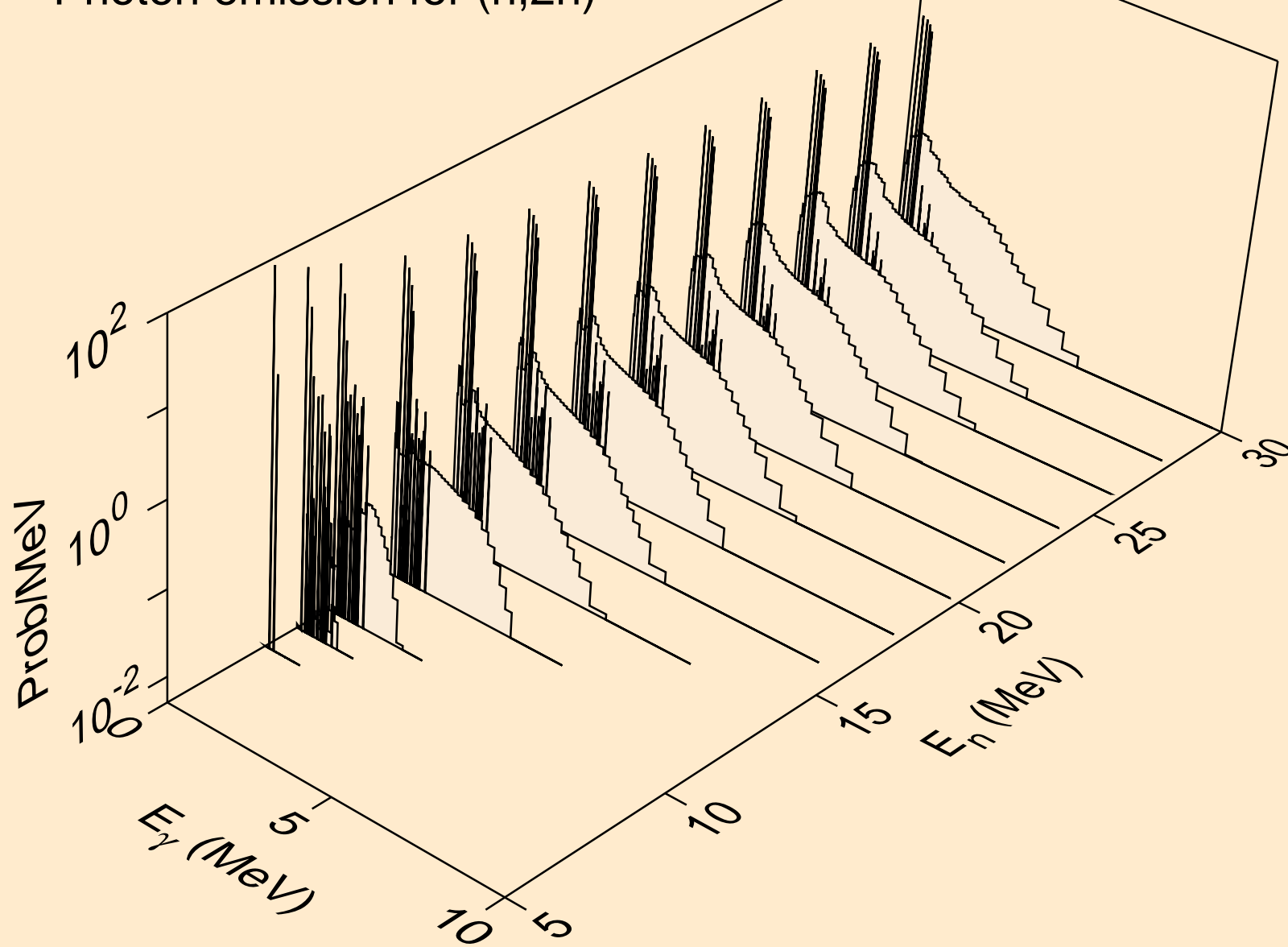

W177 HELION ACER TENDL-2021 LIBRARY; T=0.K  
Photon emission for (n,3n)

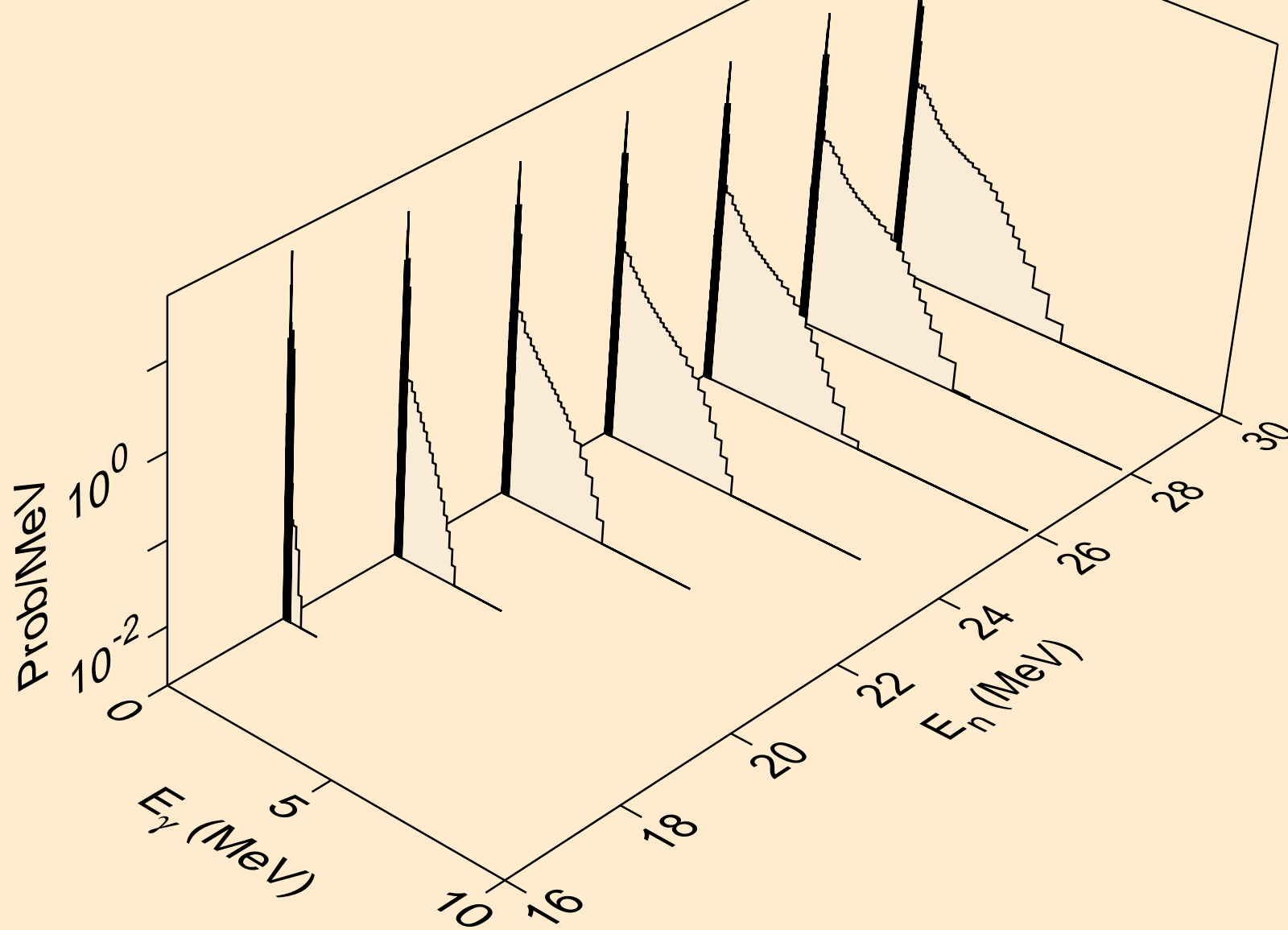

W177 HELION ACER TENDL-2021 LIBRARY; T=0.K  
Photon emission for (n,n\*)a

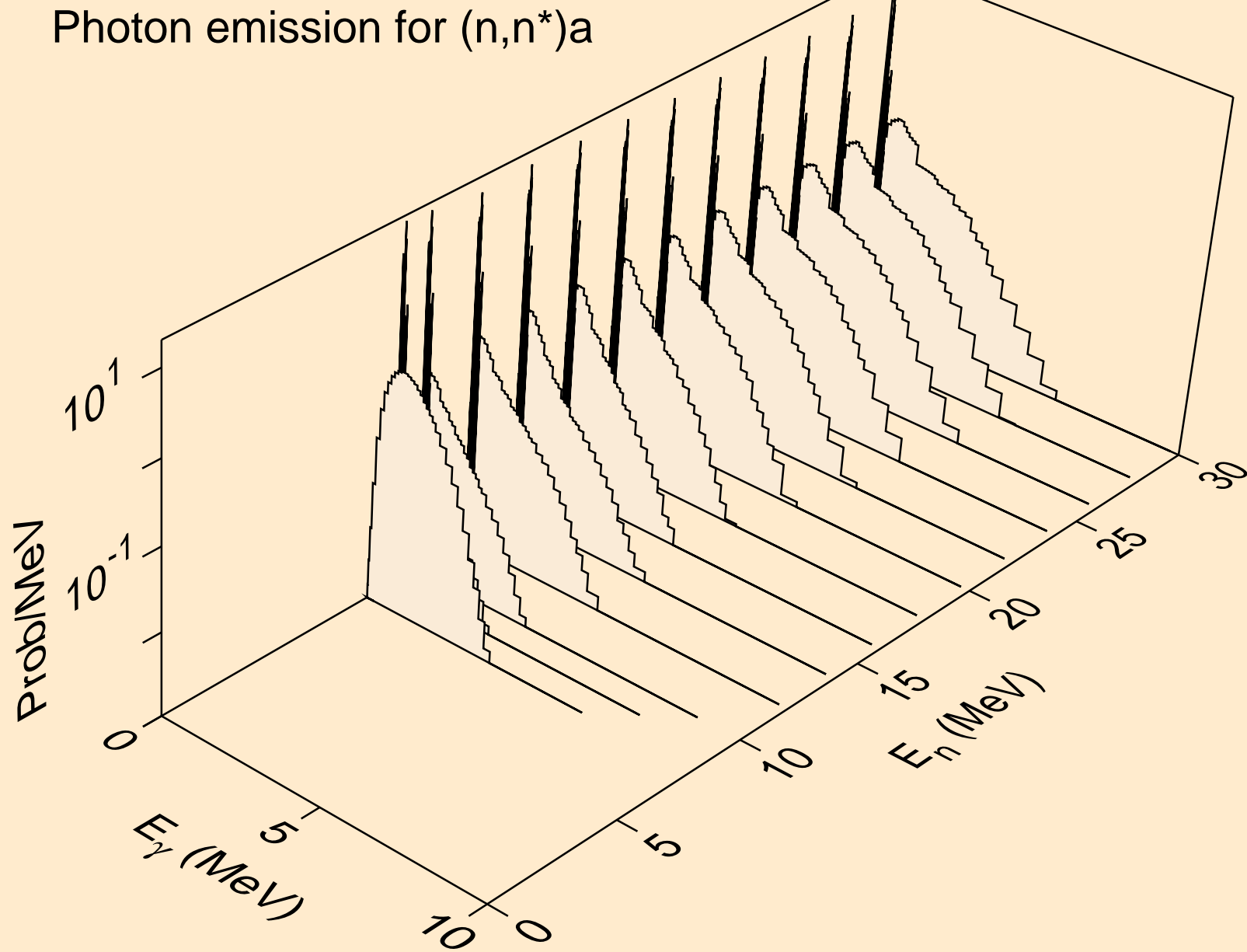

W177 HELION ACER TENDL-2021 LIBRARY; T=0.K  
Photon emission for (n,2n)a

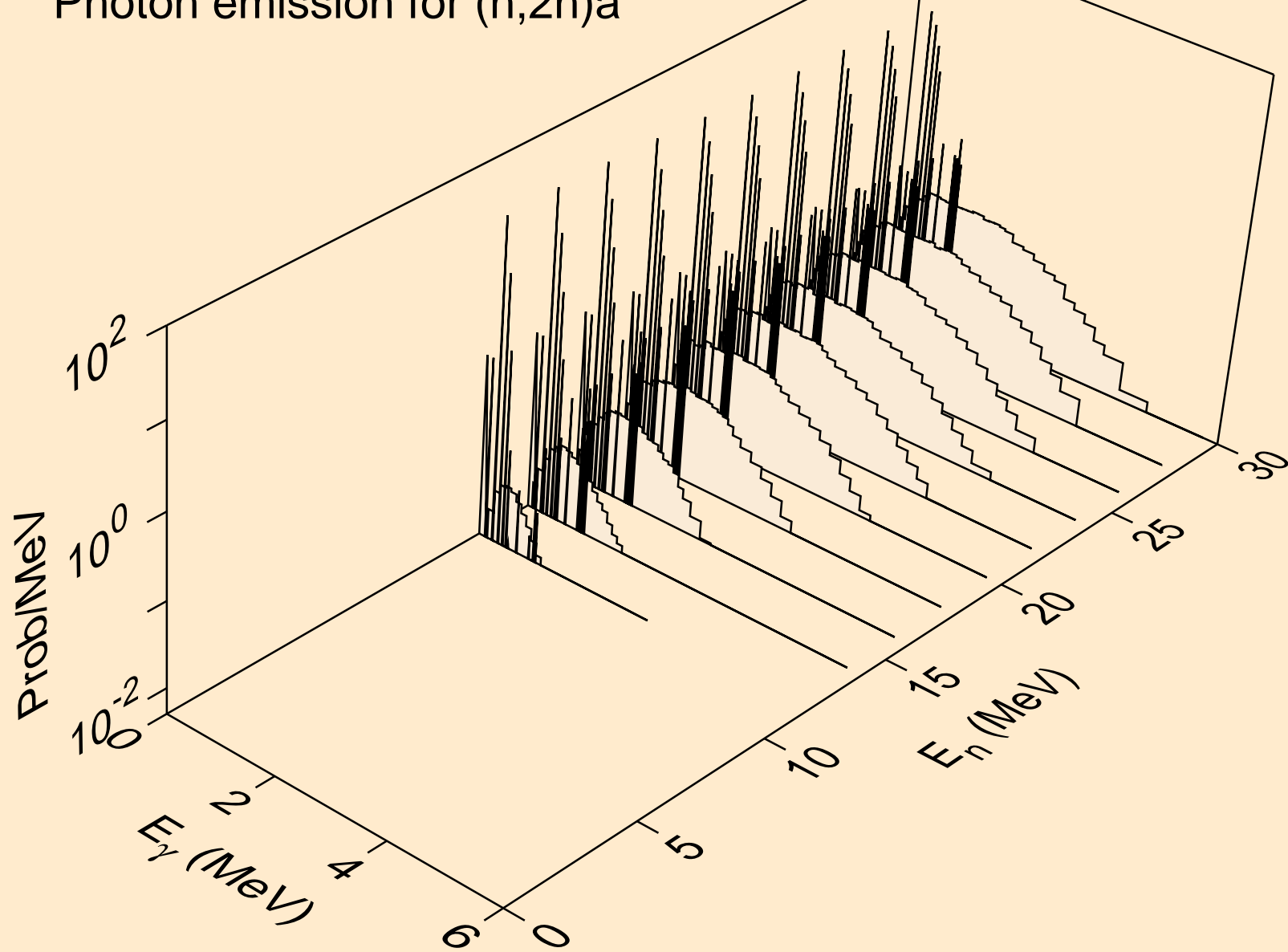



W177 HELION ACER TENDL-2021 LIBRARY; T=0.K  
Photon emission for (n,3n)a

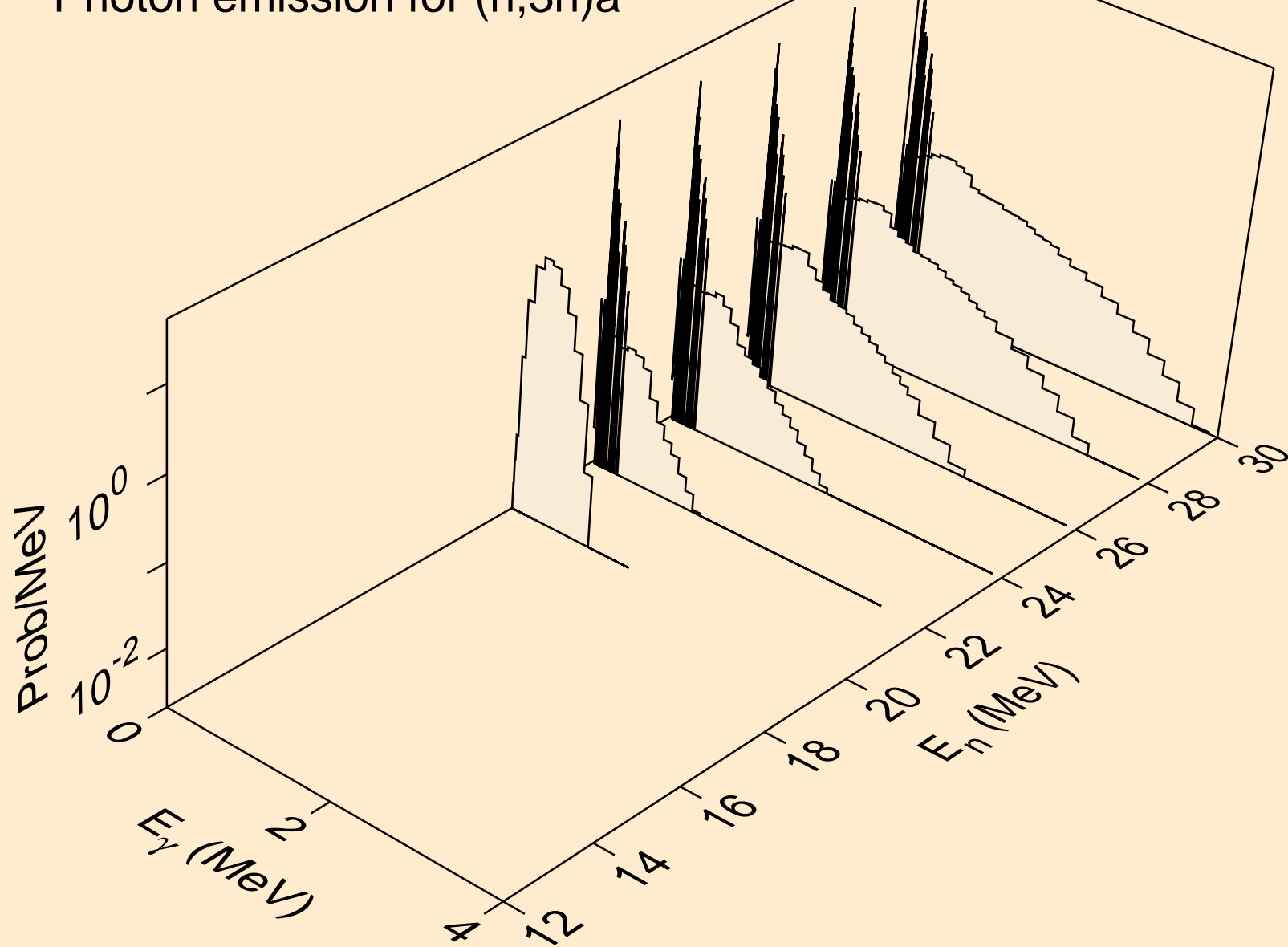

W177 HELION ACER TENDL-2021 LIBRARY; T=0.K  
Photon emission for (n,n\*)p

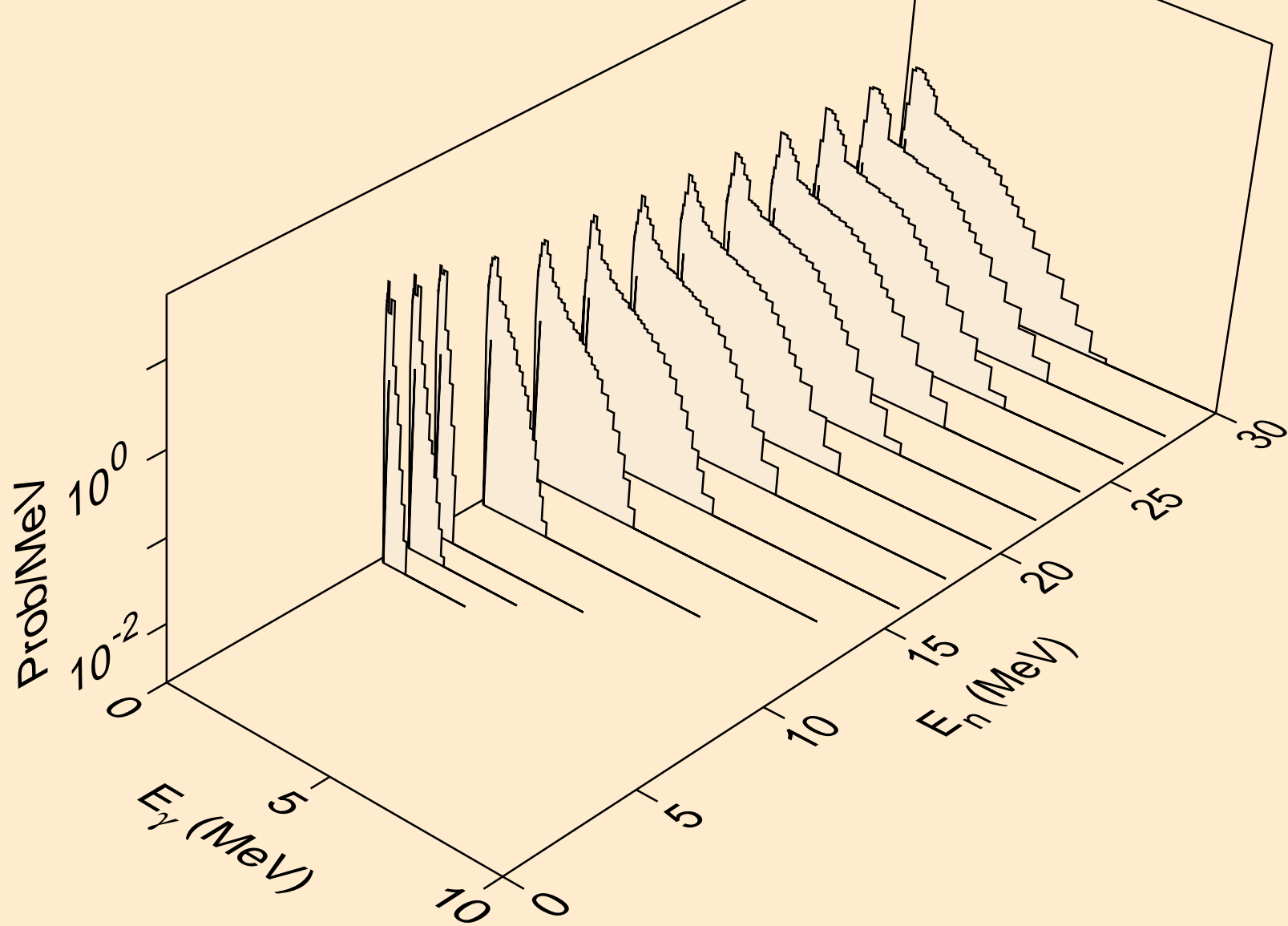

W177 HELION ACER TENDL-2021 LIBRARY; T=0.K  
Photon emission for (n,n\*)2a

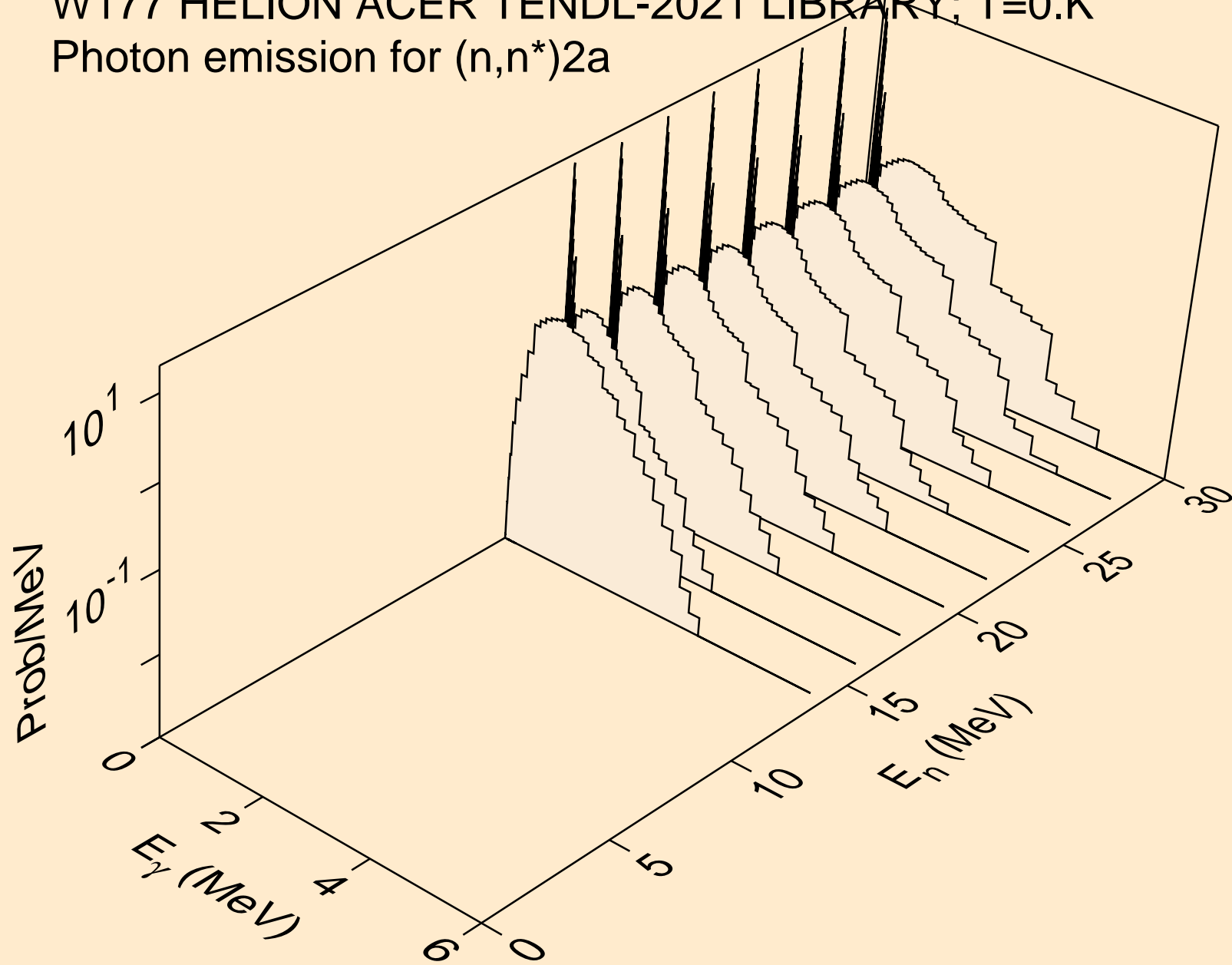

W177 HELION ACER TENDL-2021 LIBRARY; T=0.K  
Photon emission for (n,n\*)d

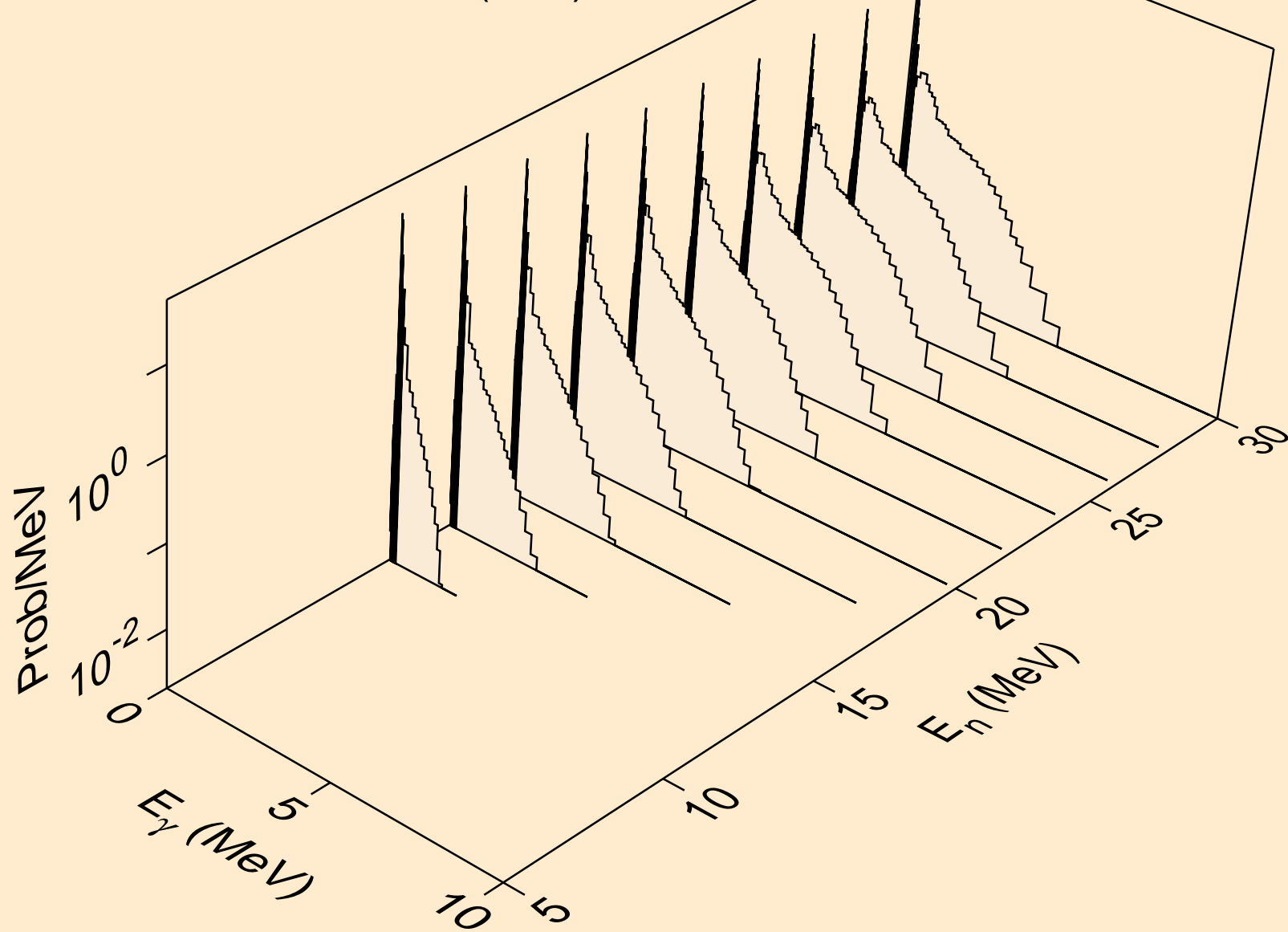

W177 HELION ACER TENDL-2021 LIBRARY; T=0.K  
Photon emission for (n,n\*)t

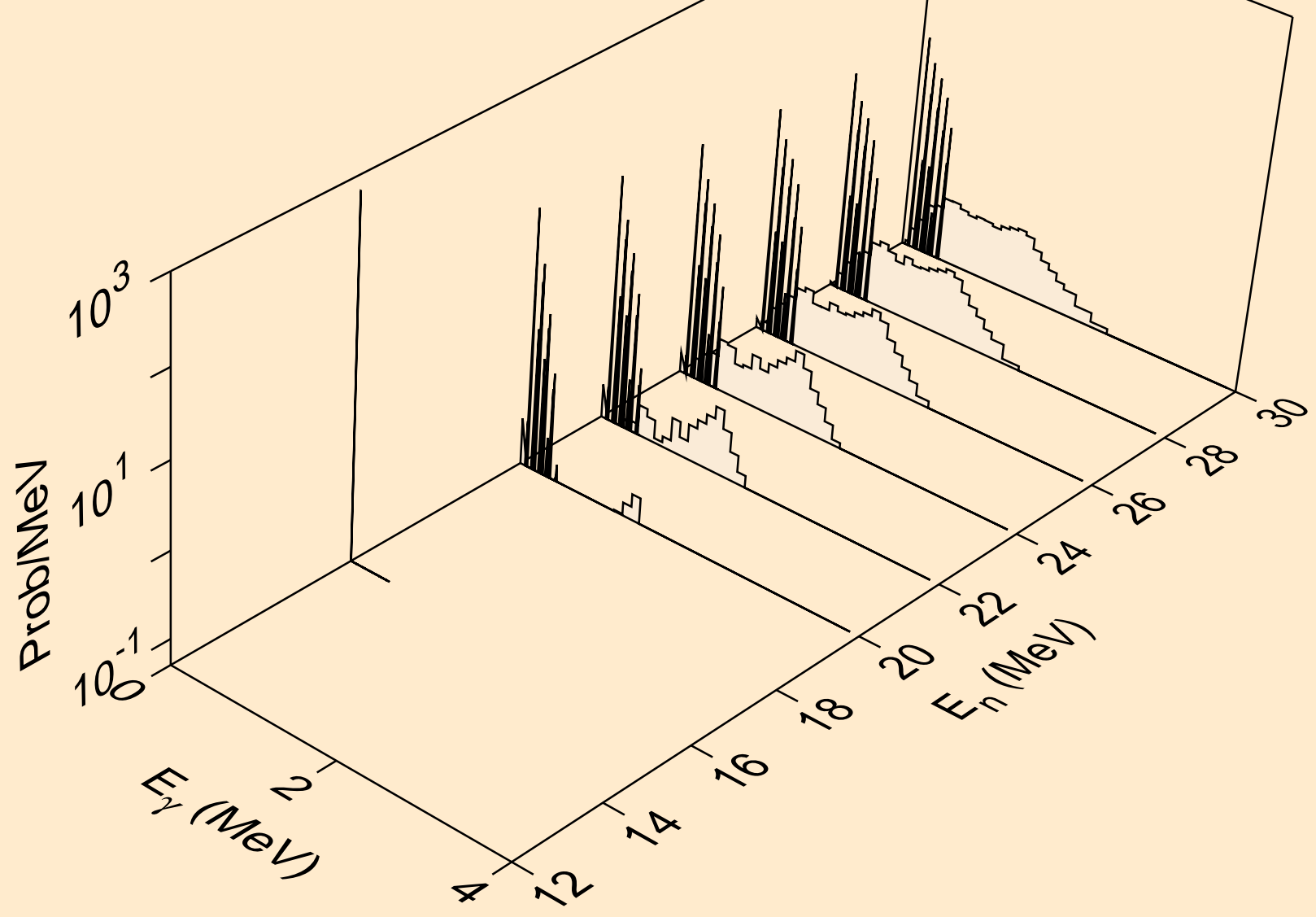

W177 HELION ACER TENDL-2021 LIBRARY; T=0.K  
Photon emission for (n,n\*)he3

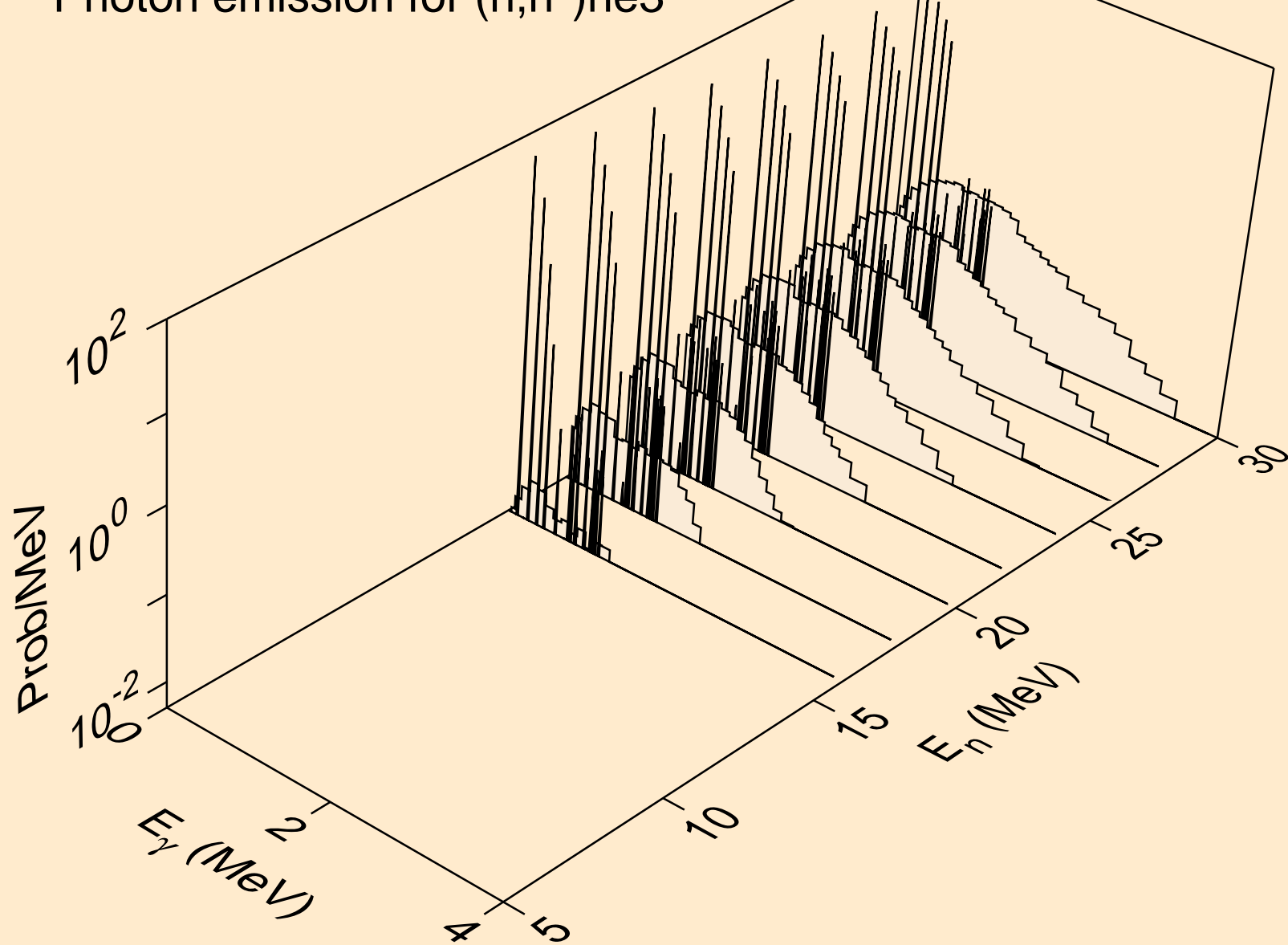

W177 HELION ACER TENDL-2021 LIBRARY; T=0.K  
Photon emission for (n,4n)

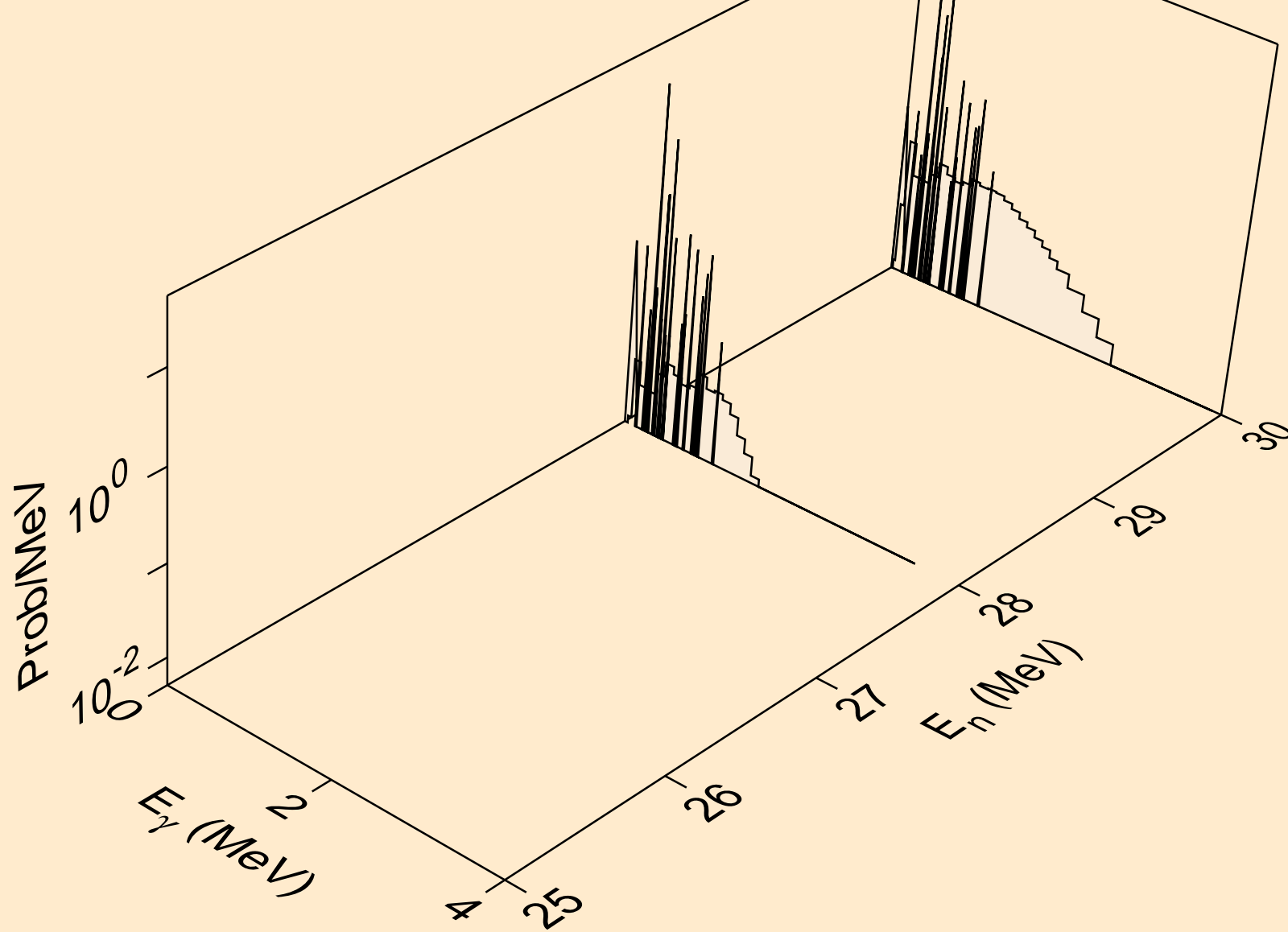

W177 HELION ACER TENDL-2021 LIBRARY; T=0.K  
Photon emission for (n,2np)

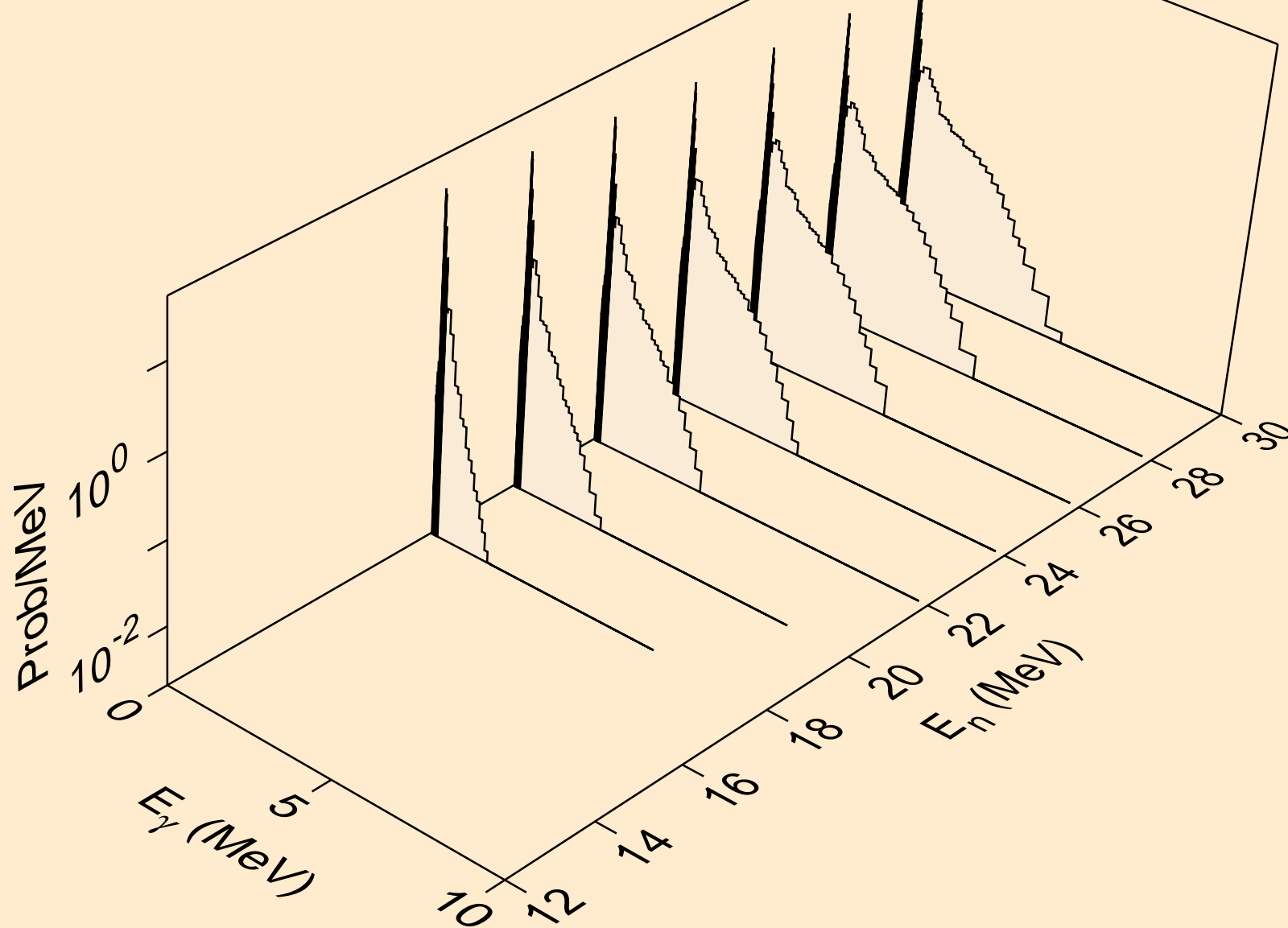



W177 HELION ACER TENDL-2021 LIBRARY; T=0.K  
Photon emission for (n,3np)

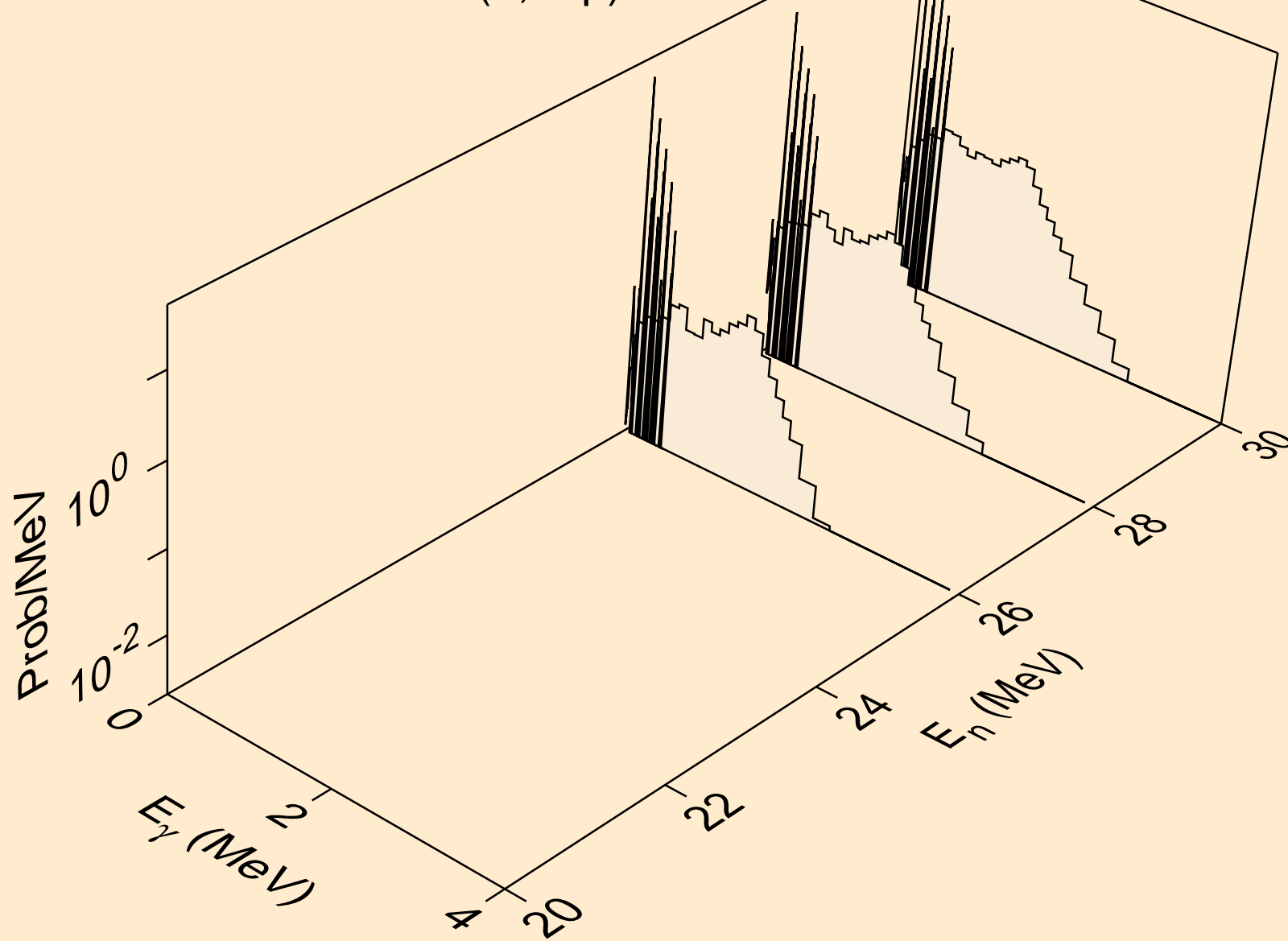

W177 HELION ACER TENDL-2021 LIBRARY; T=0.K  
Photon emission for (n,2np)

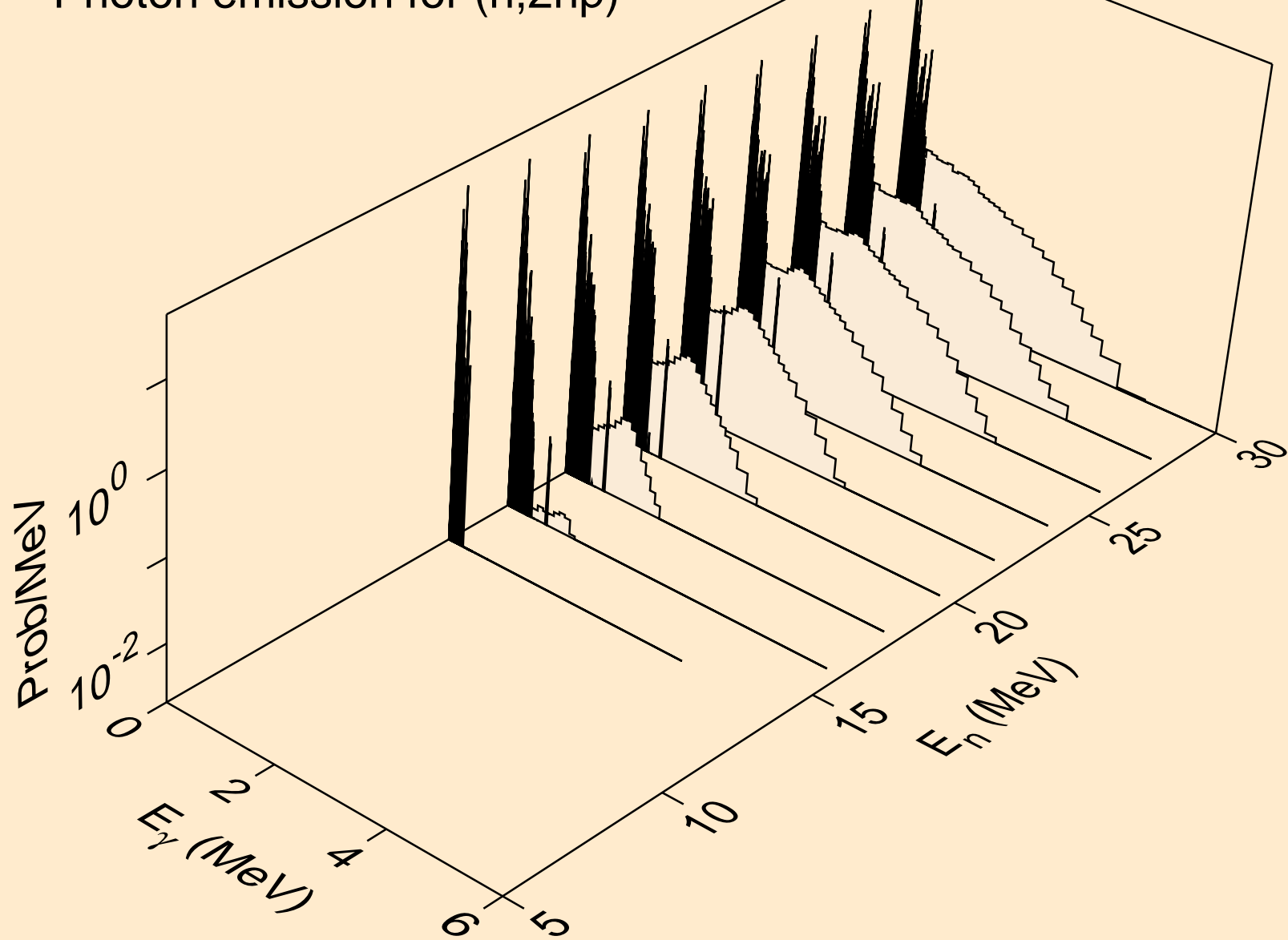

W177 HELION ACER TENDL-2021 LIBRARY; T=0.K  
Photon emission for (n,npa)

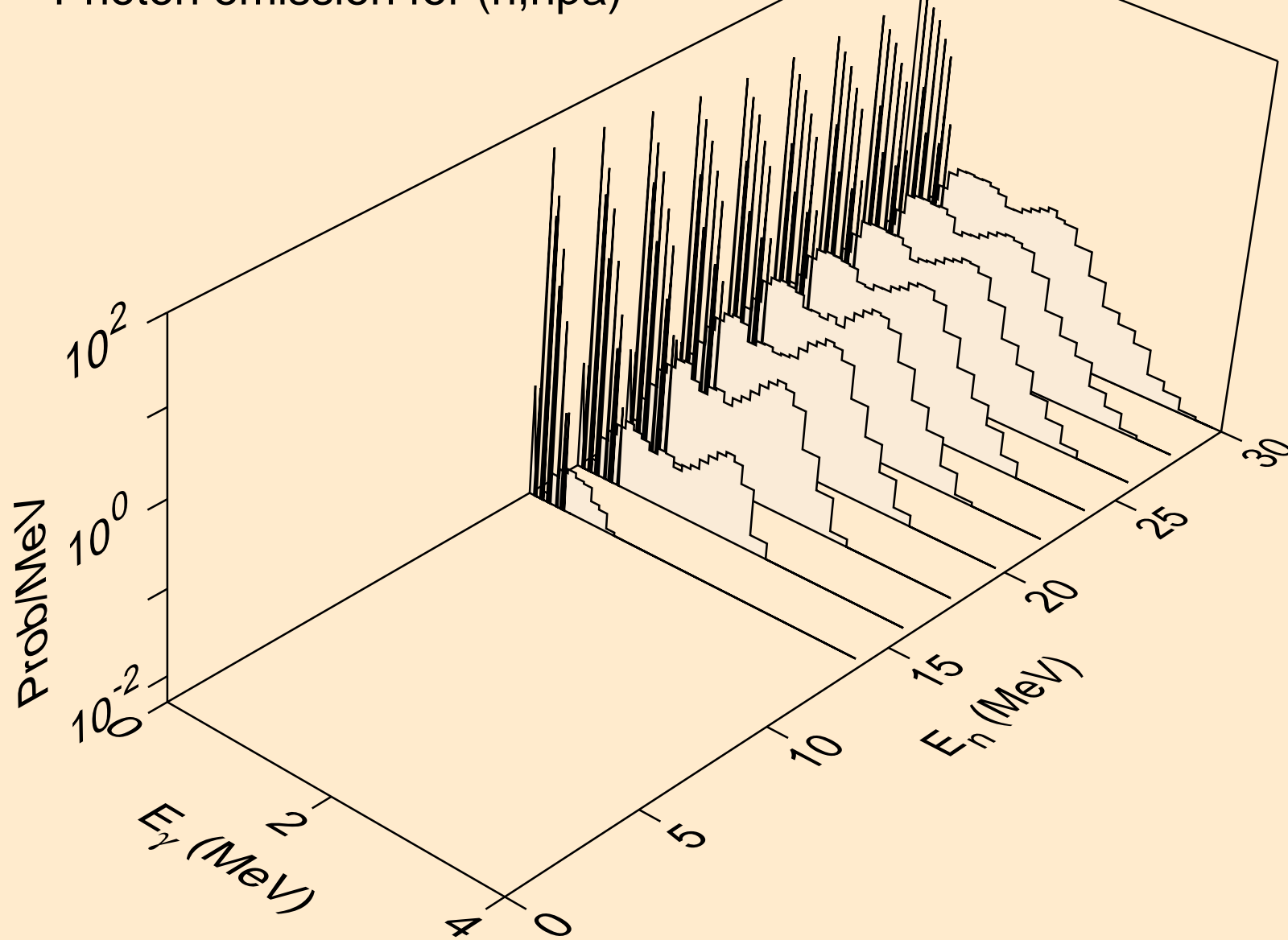

W177 HELION ACER TENDL-2021 LIBRARY; T=0.K  
Photon emission for (n,gma)

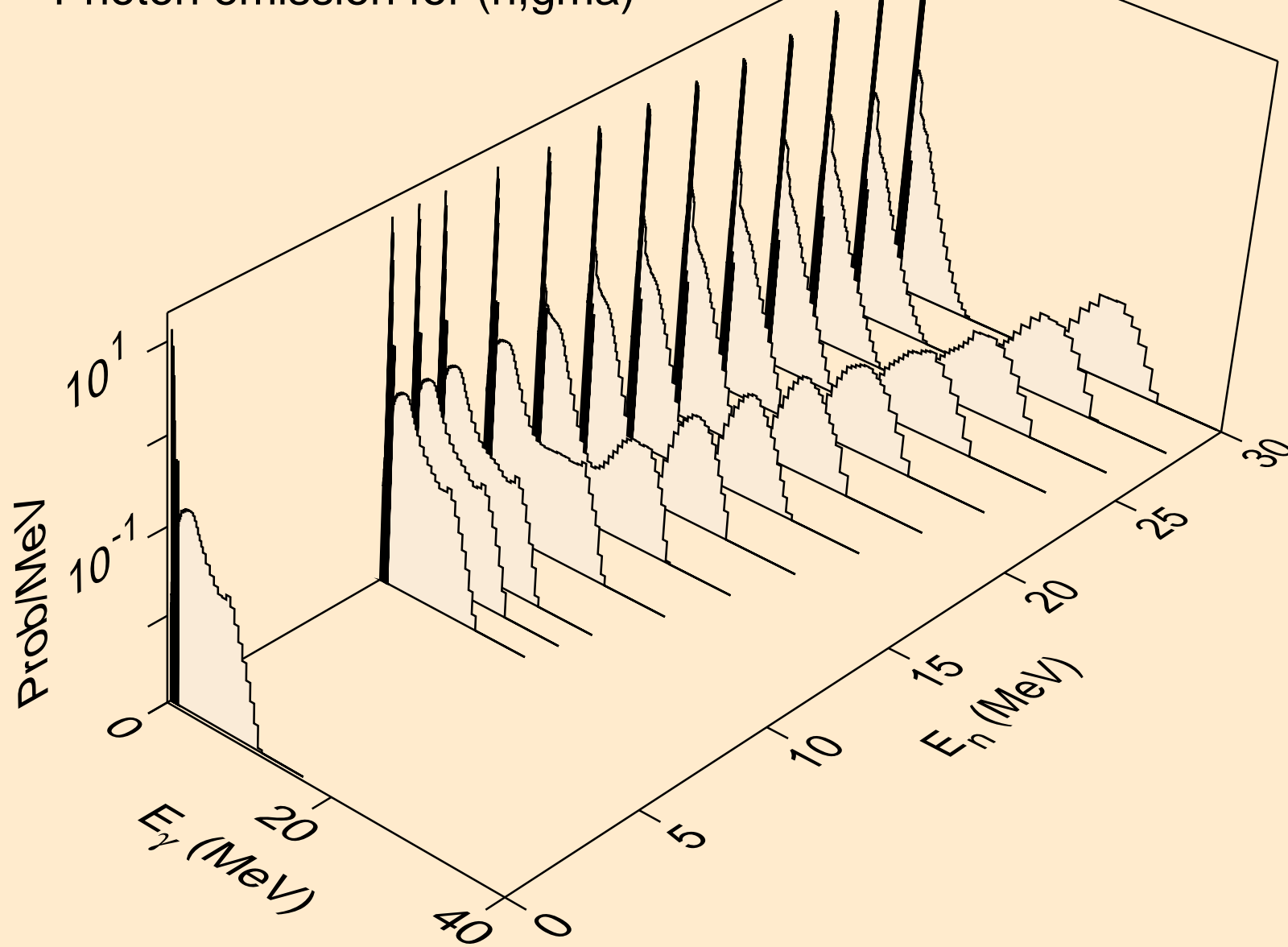

W177 HELION ACER TENDL-2021 LIBRARY; T=0.K  
Photon emission for (n,p)

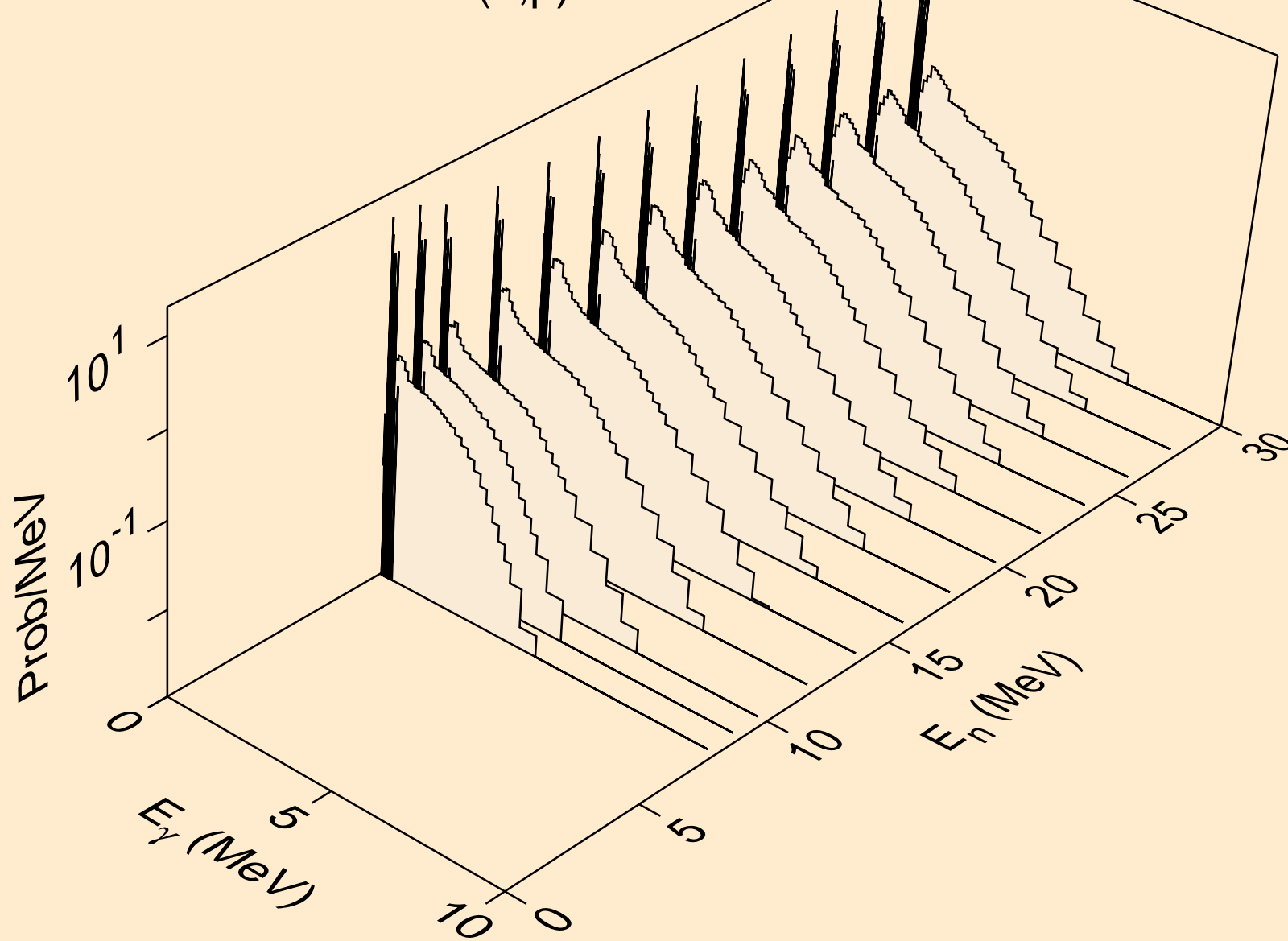

W177 HELION ACER TENDL-2021 LIBRARY; T=0.K  
Photon emission for (n,d)

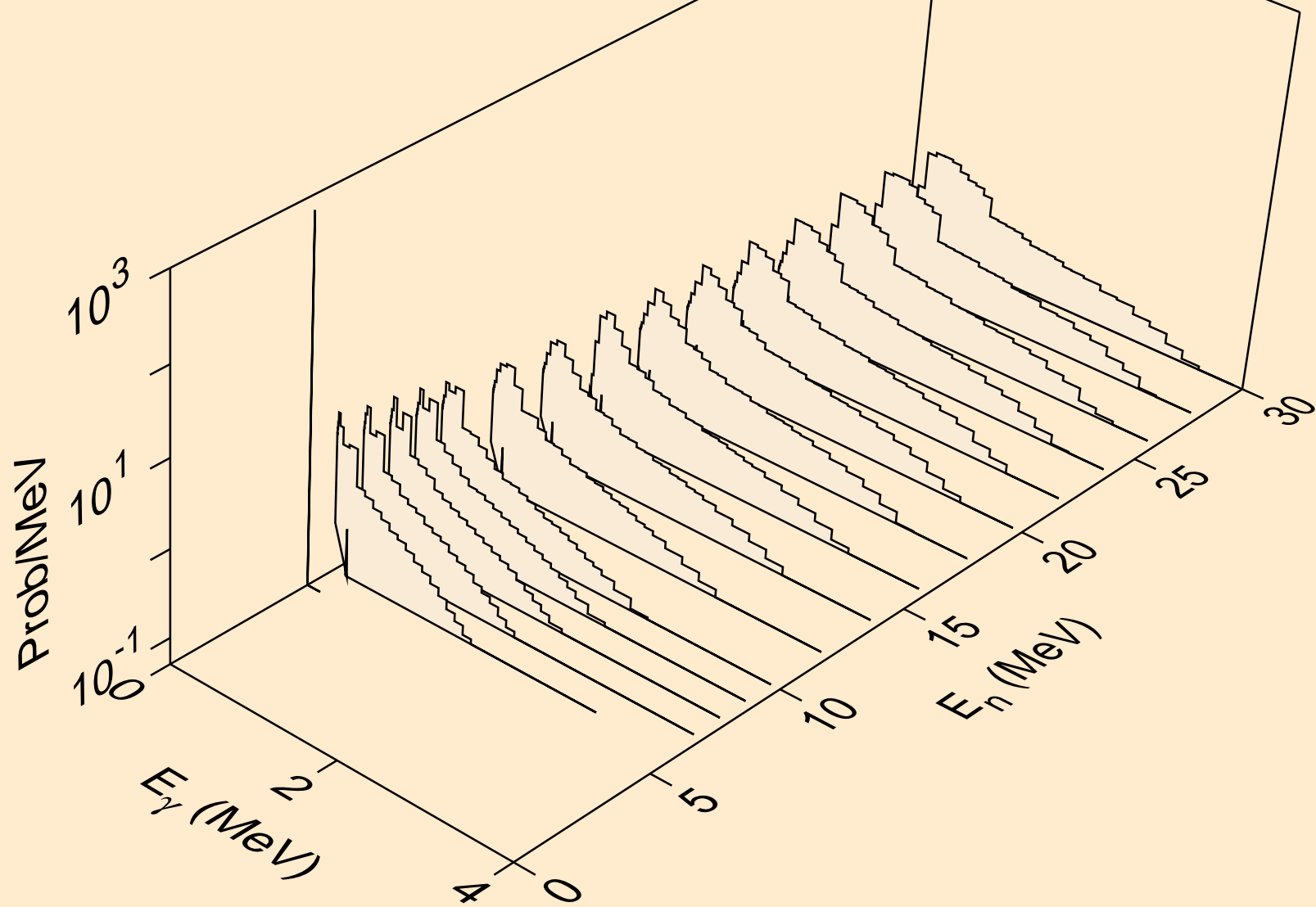

W177 HELION ACER TENDL-2021 LIBRARY; T=0.K  
Photon emission for (n,t)

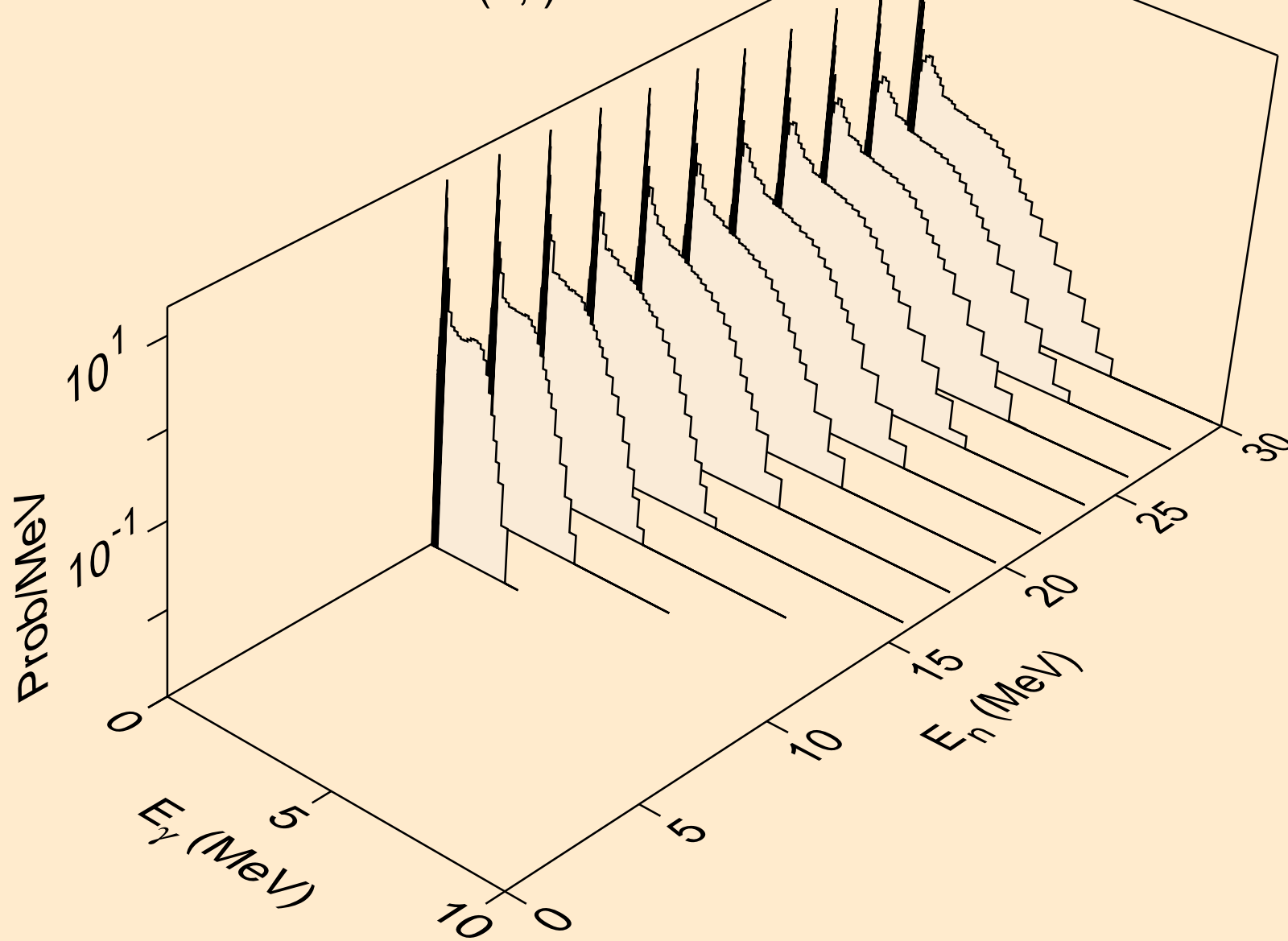

W177 HELION ACER TENDL-2021 LIBRARY; T=0.K  
Photon emission for inelastic

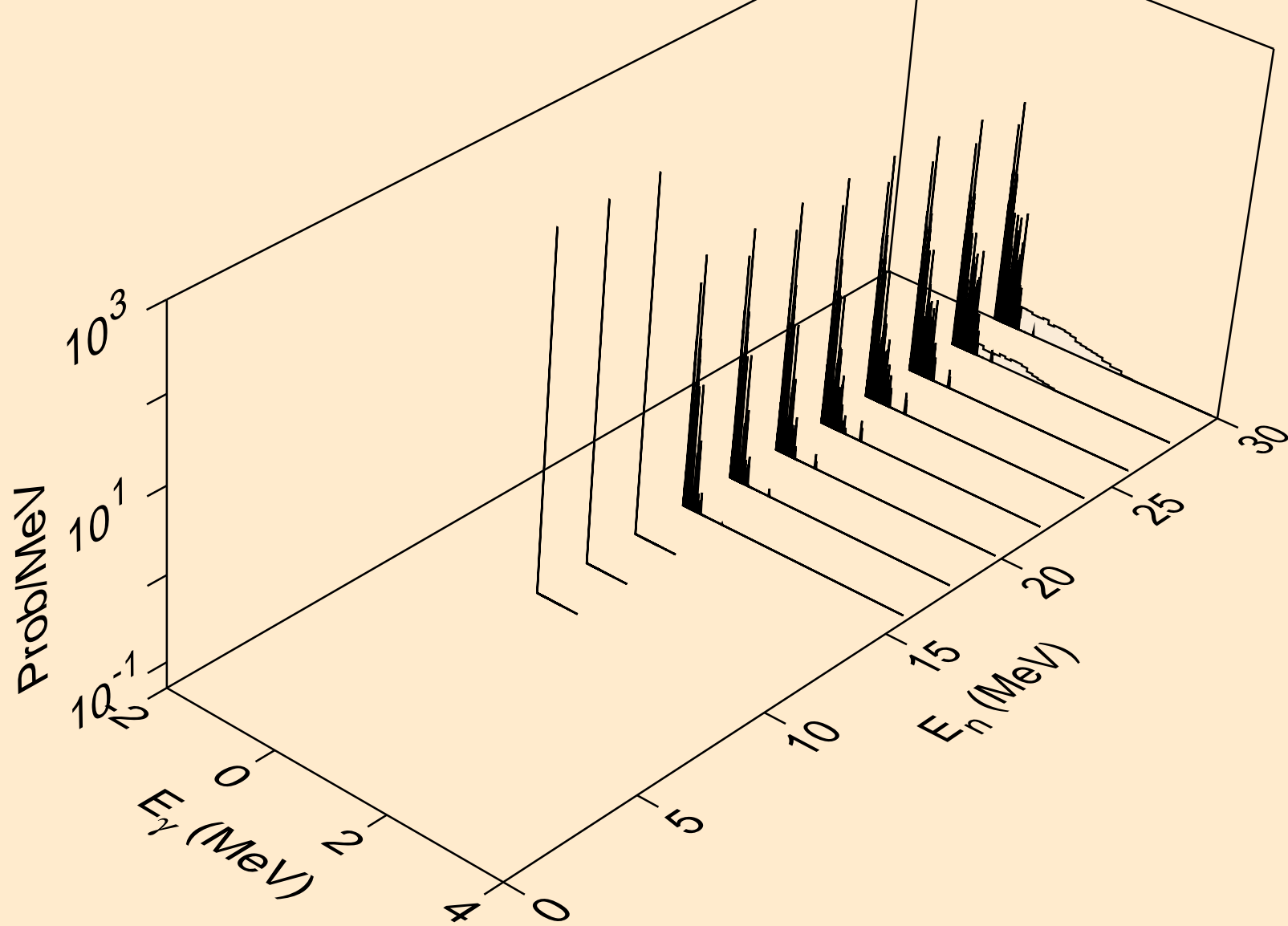



W177 HELION ACER TENDL-2021 LIBRARY; T=0.K  
Photon emission for (n,a)

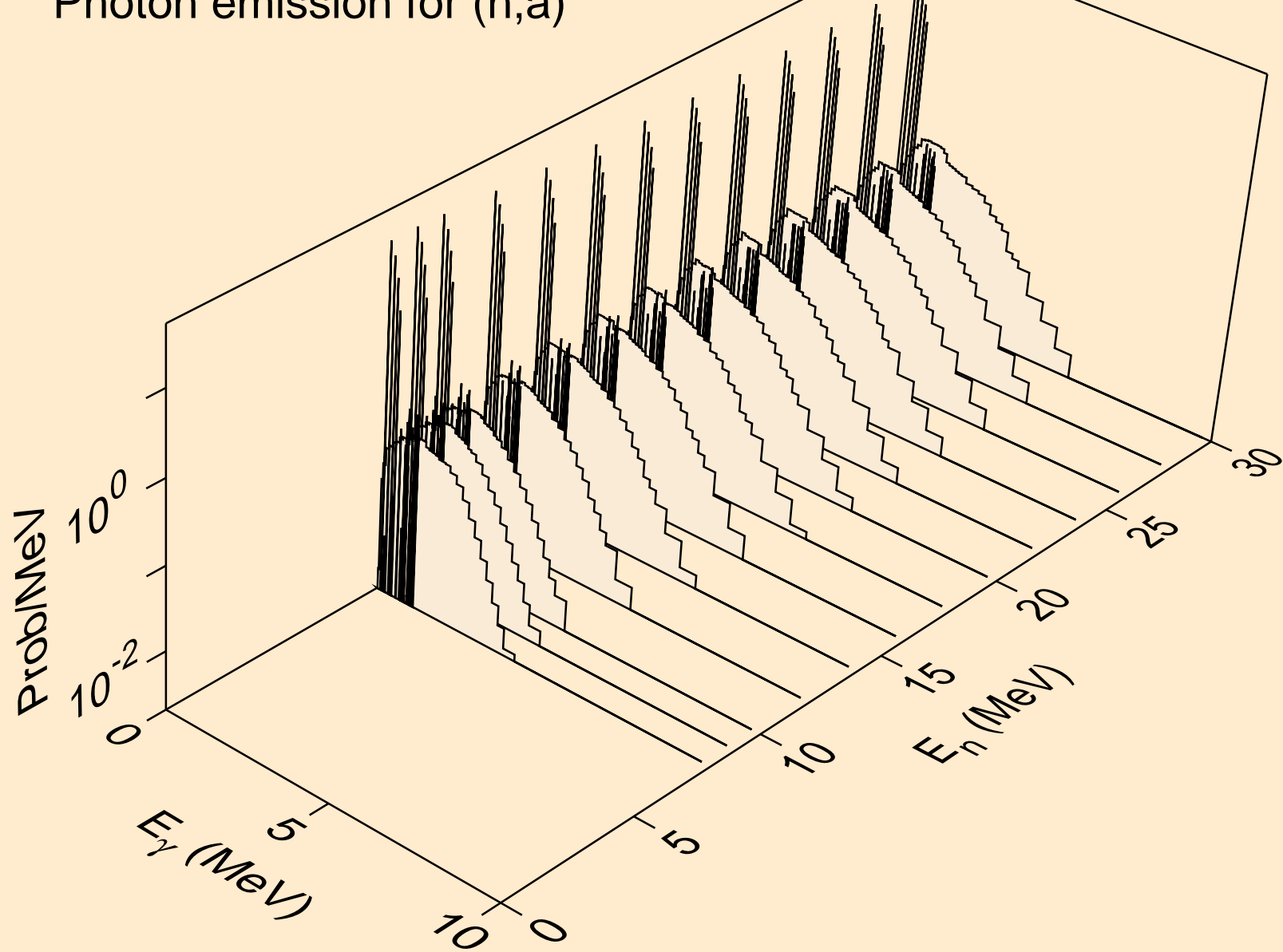

W177 HELION ACER TENDL-2021 LIBRARY; T=0.K  
Photon emission for (n,2a)

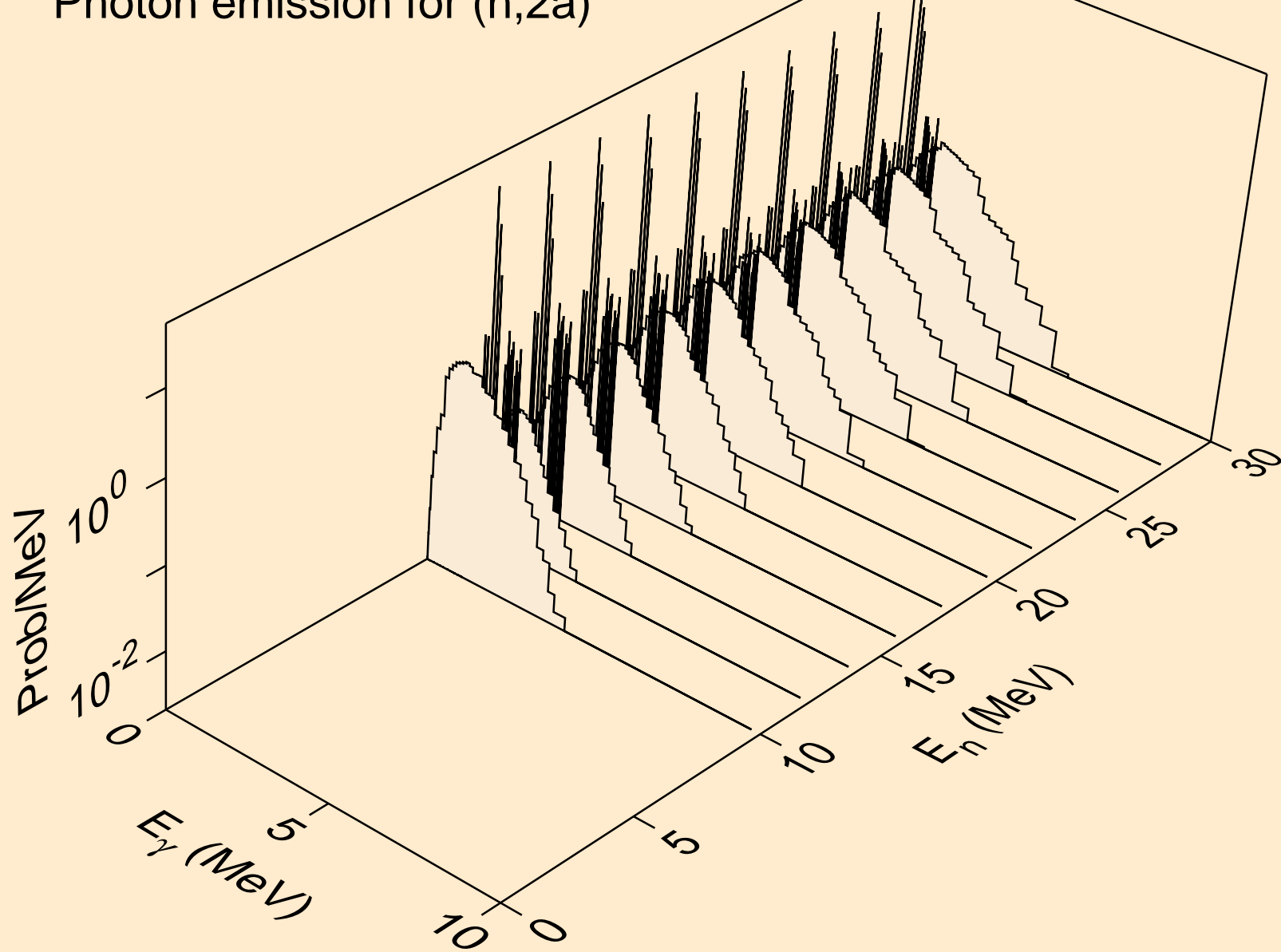

W177 HELION ACER TENDL-2021 LIBRARY; T=0.K  
Photon emission for (n,2p)

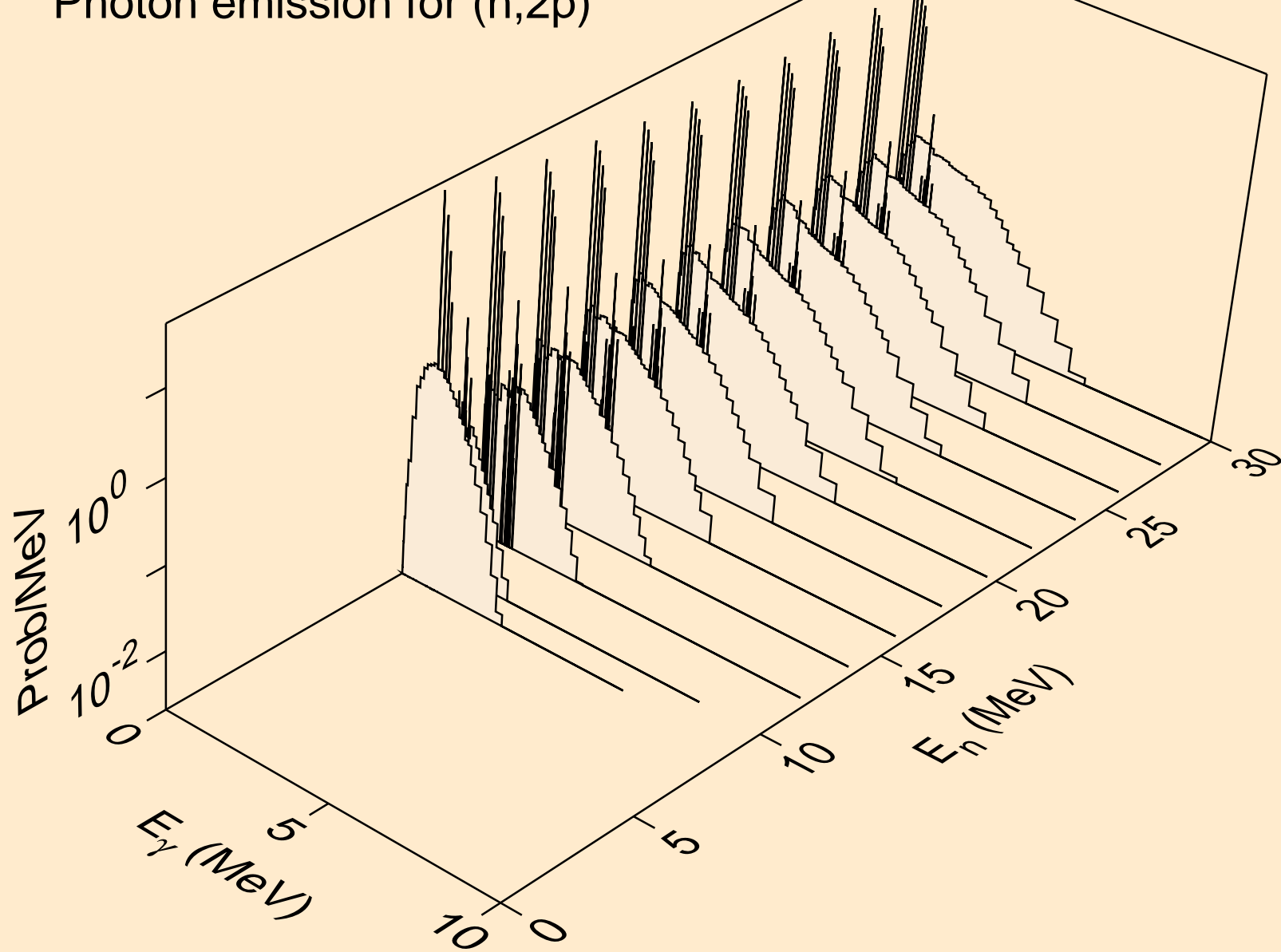

W177 HELION ACER TENDL-2021 LIBRARY; T=0.K  
Photon emission for (n,pa)

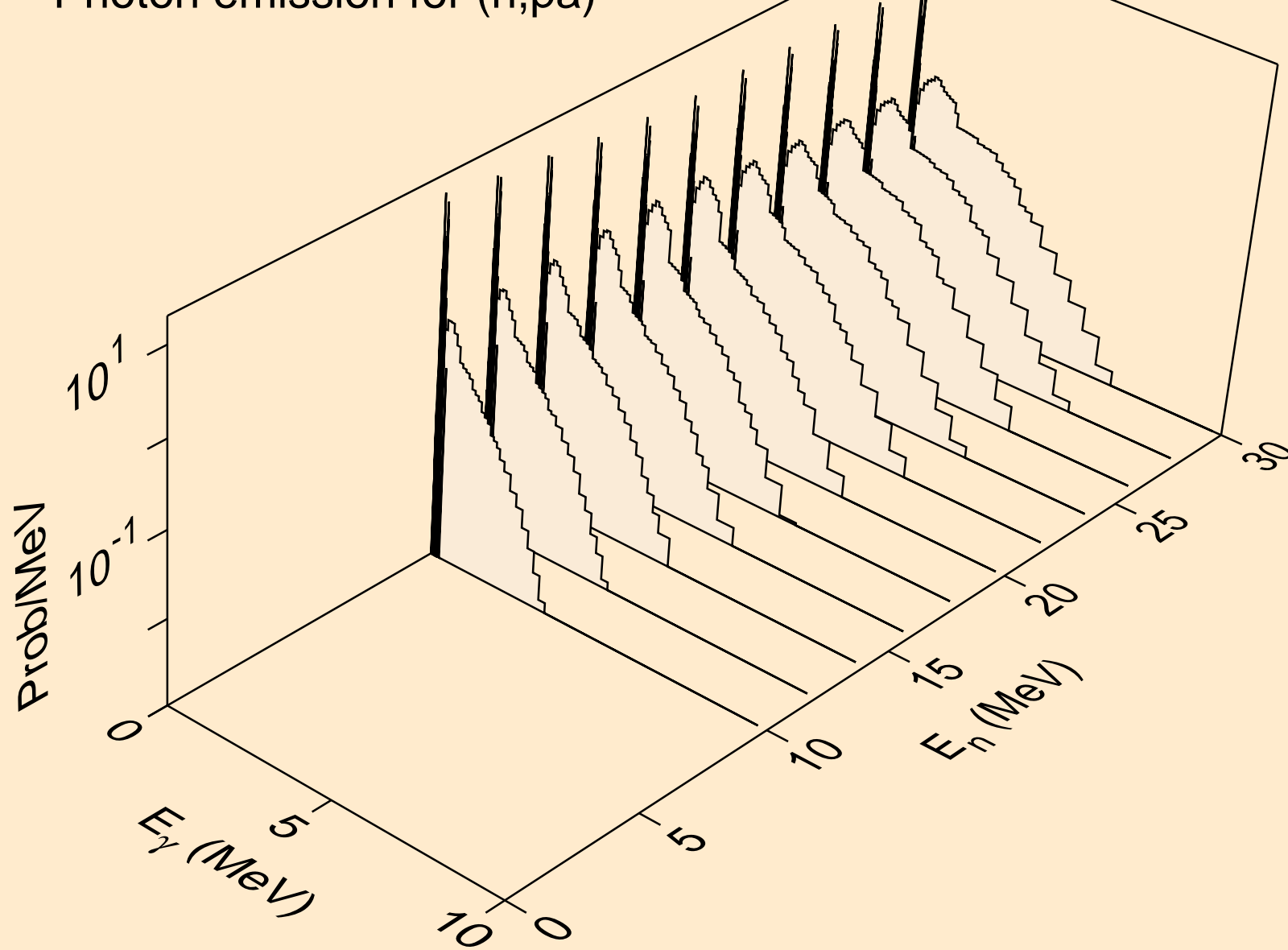

W177 HELION ACER TENDL-2021 LIBRARY; T=0.K  
Photon emission for (n,pd)

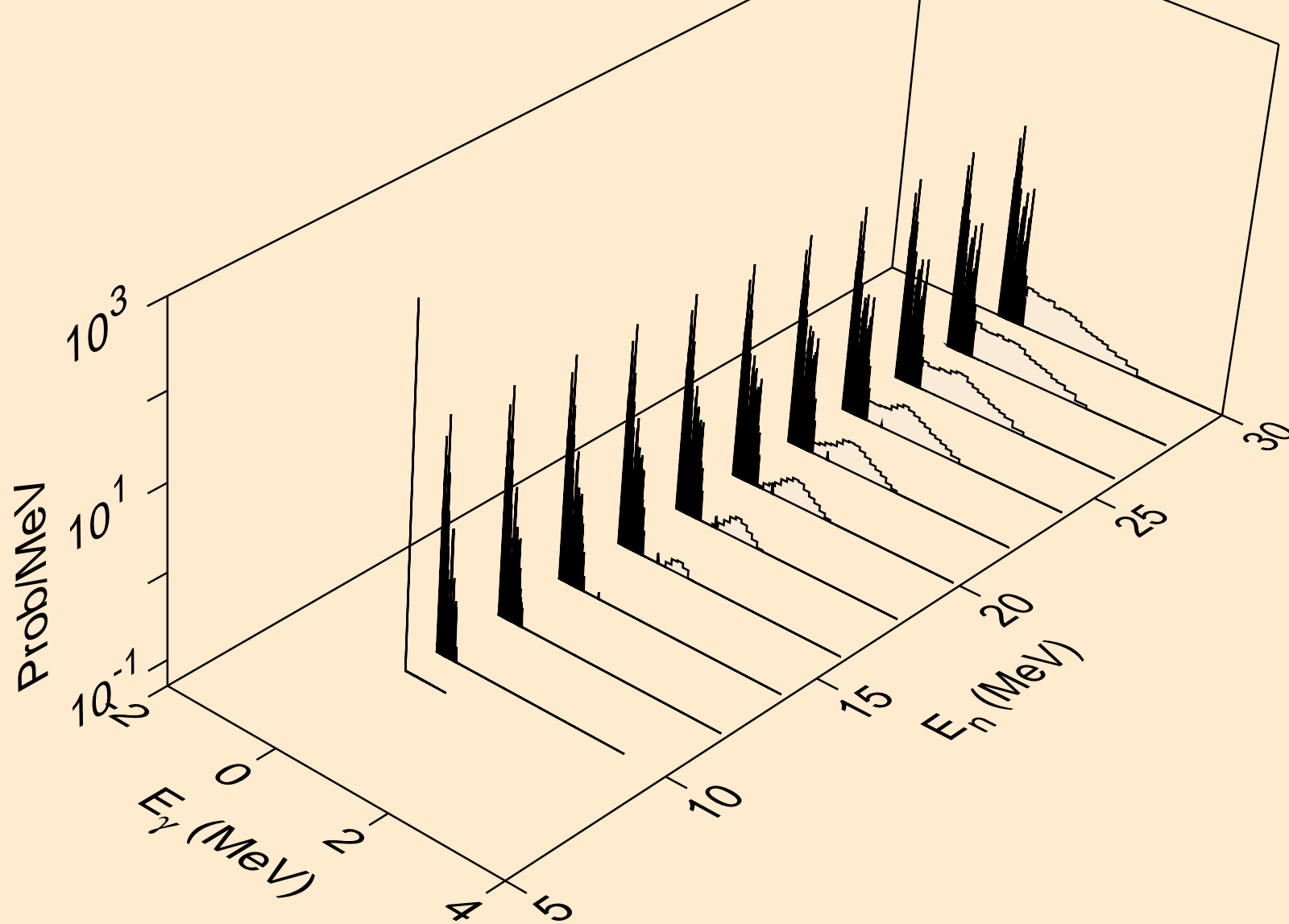

W177 HELION ACER TENDL-2021 LIBRARY; T=0.K  
Photon emission for (n,pt)

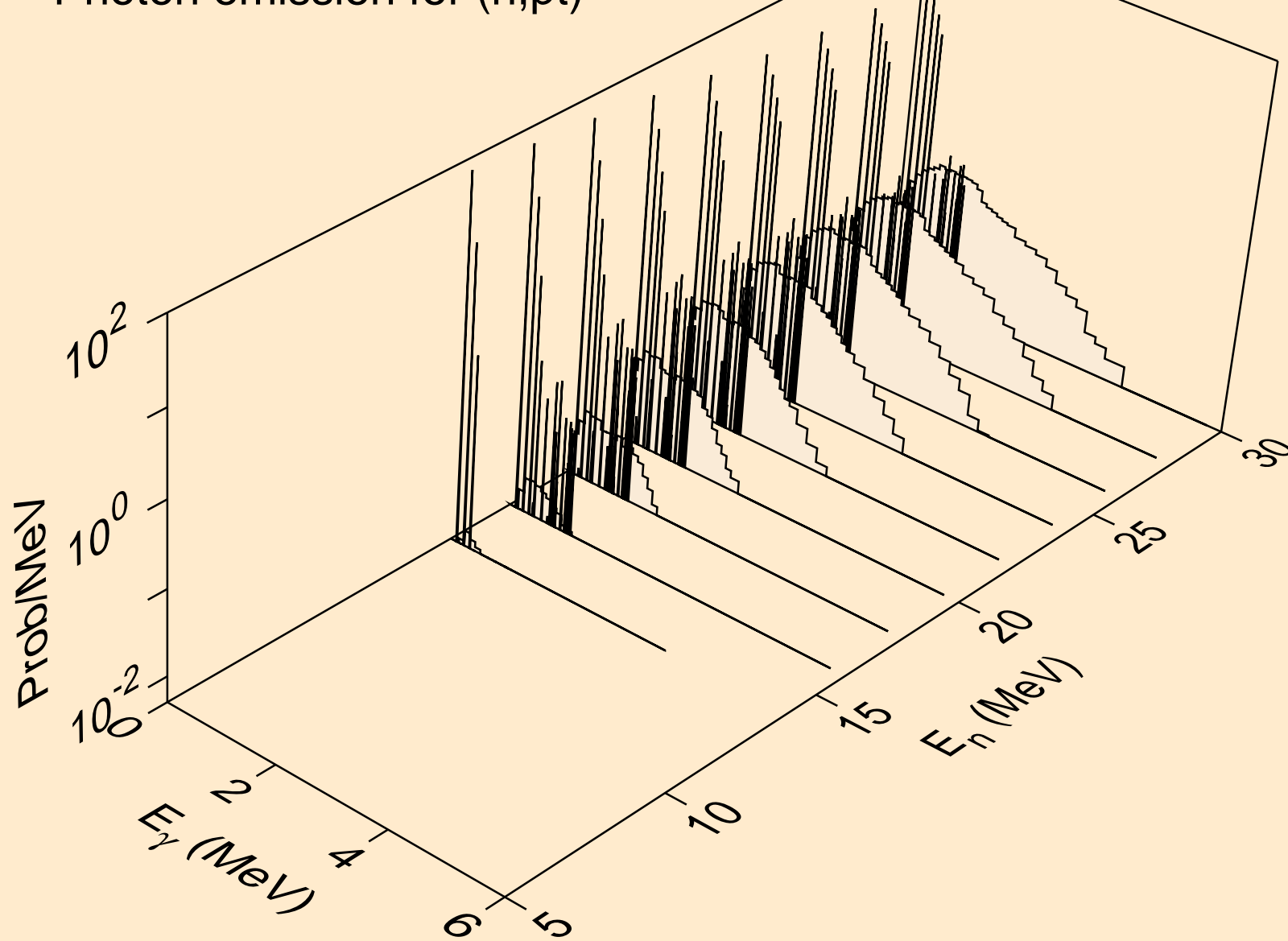

W177 HELION ACER TENDL-2021 LIBRARY; T=0.K  
Photon emission for (n,da)

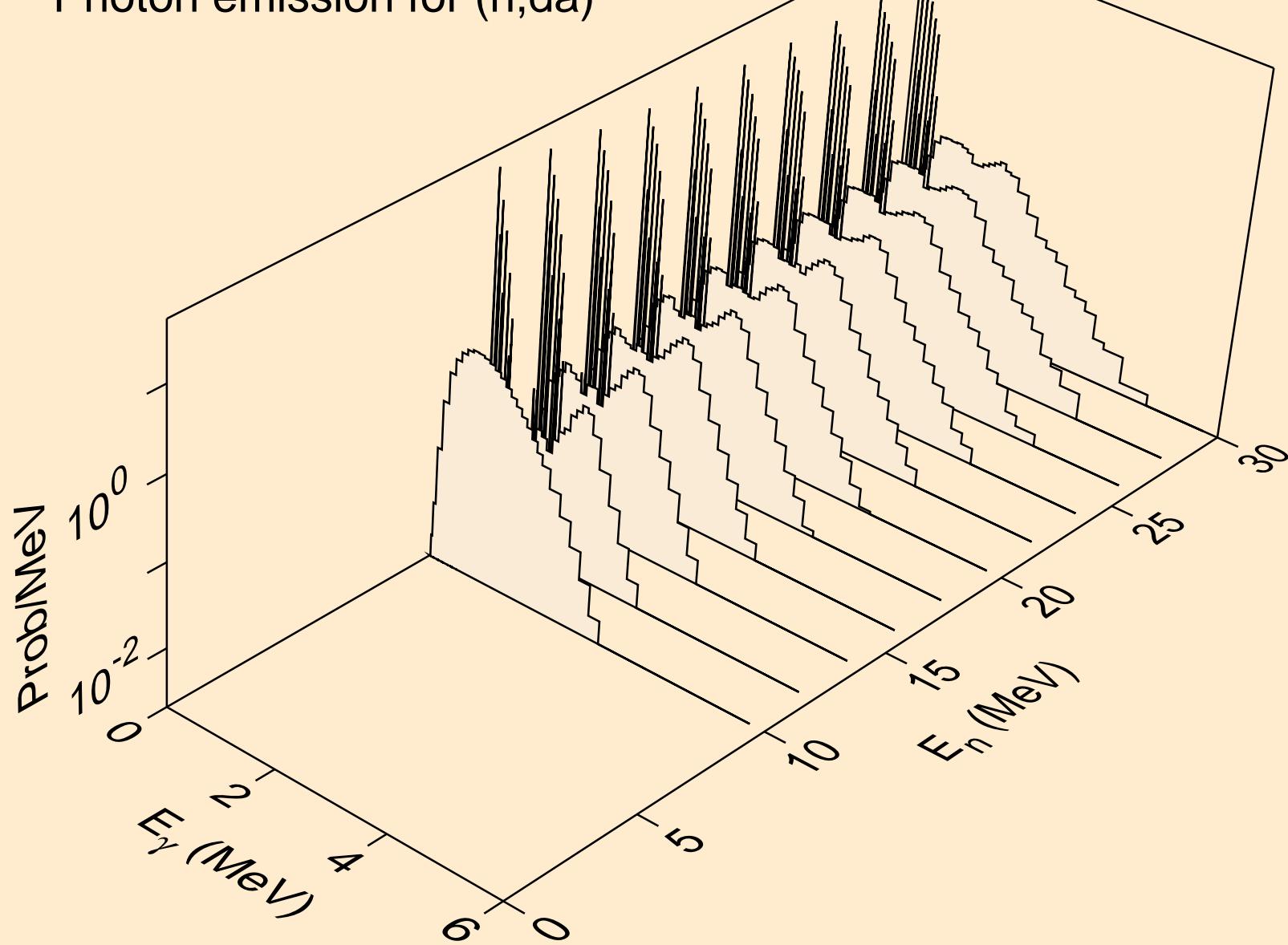

W177 HELION ACER TENDL-2021 LIBRARY; T=0.K  
Particle heating contributions

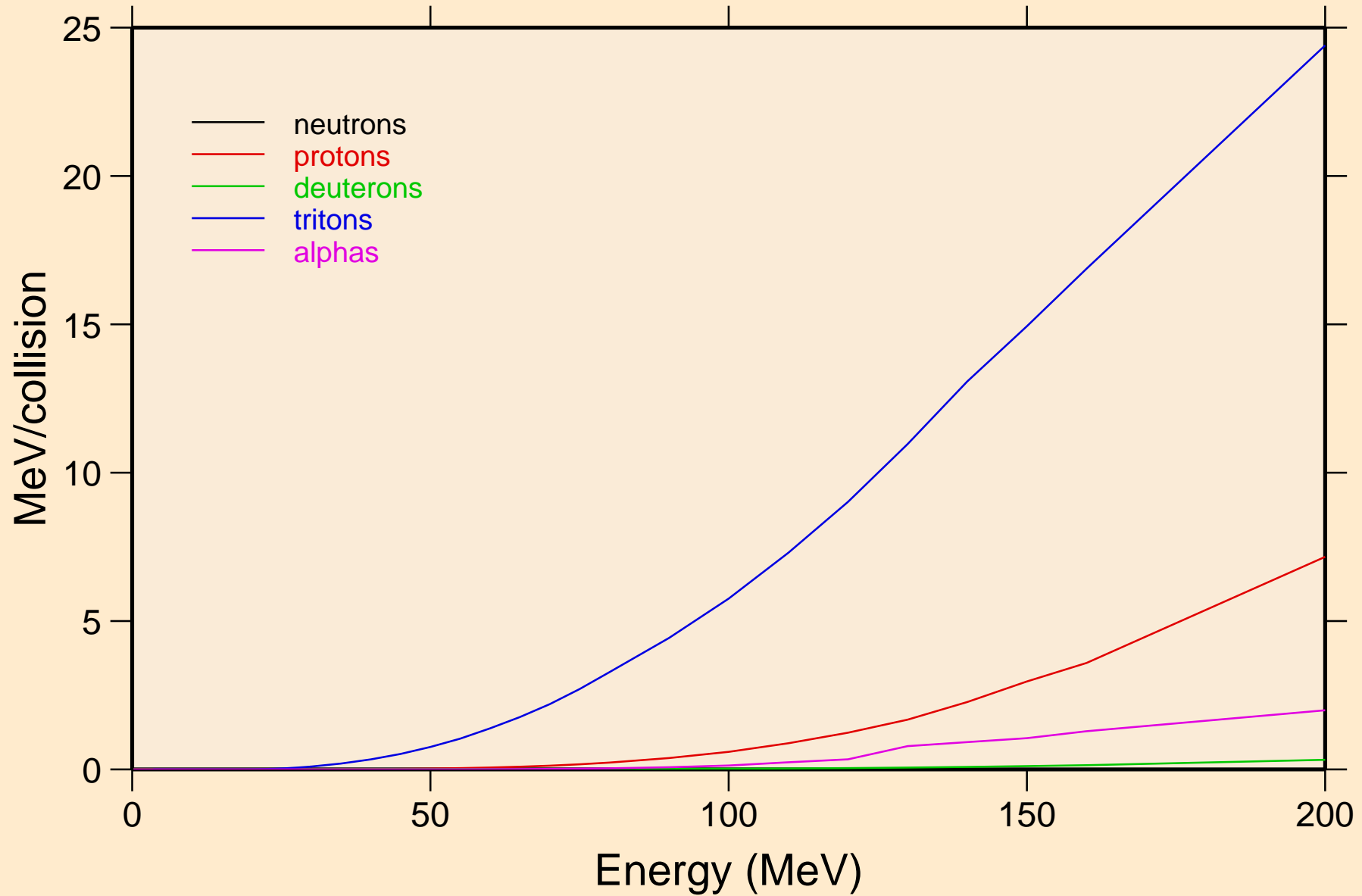



W177 HELION ACER TENDL-2021 LIBRARY; T=0.K  
Recoil Heating

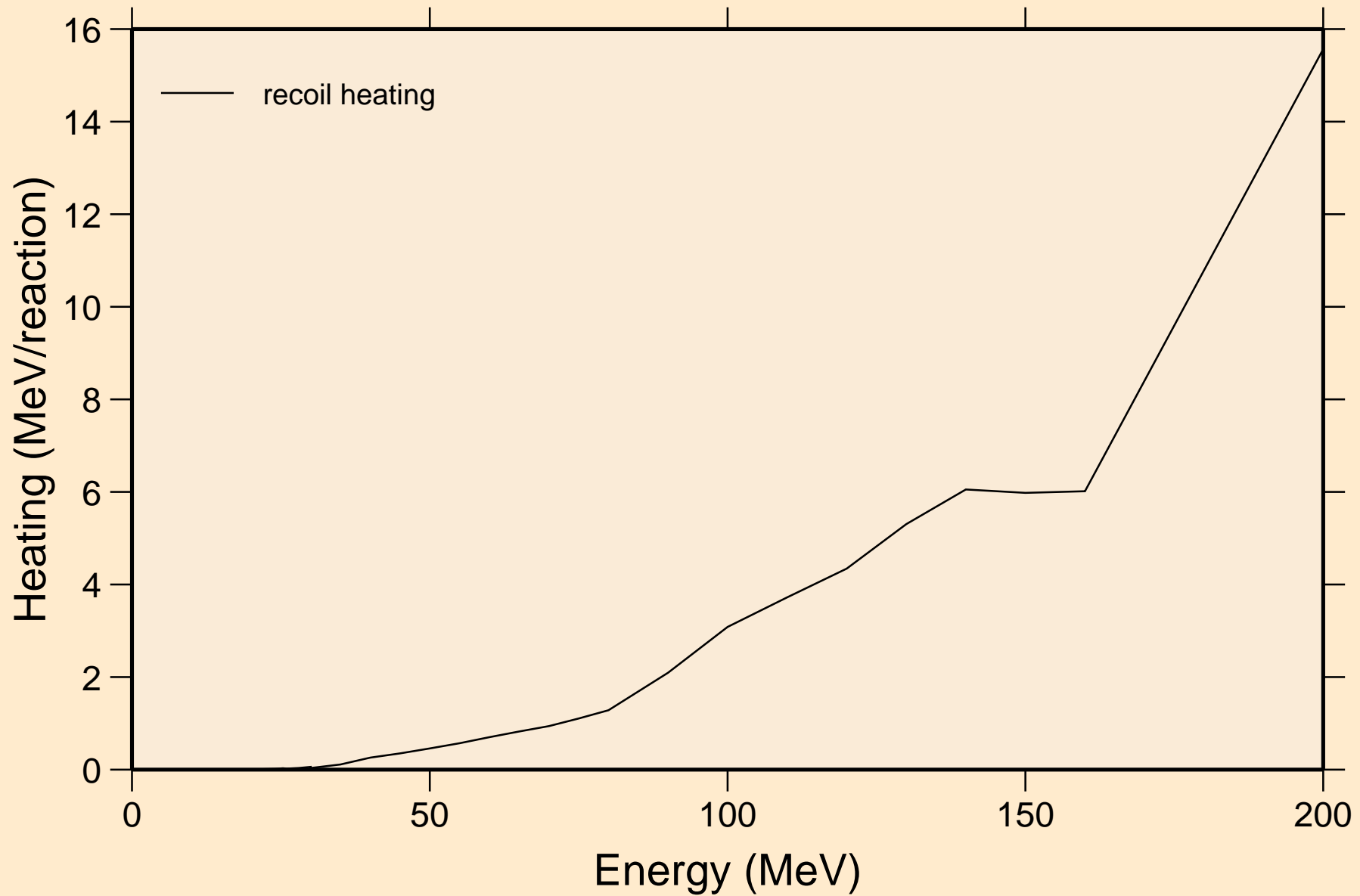

W177 HELION ACER TENDL-2021 LIBRARY; T=0.K  
Particle production cross sections

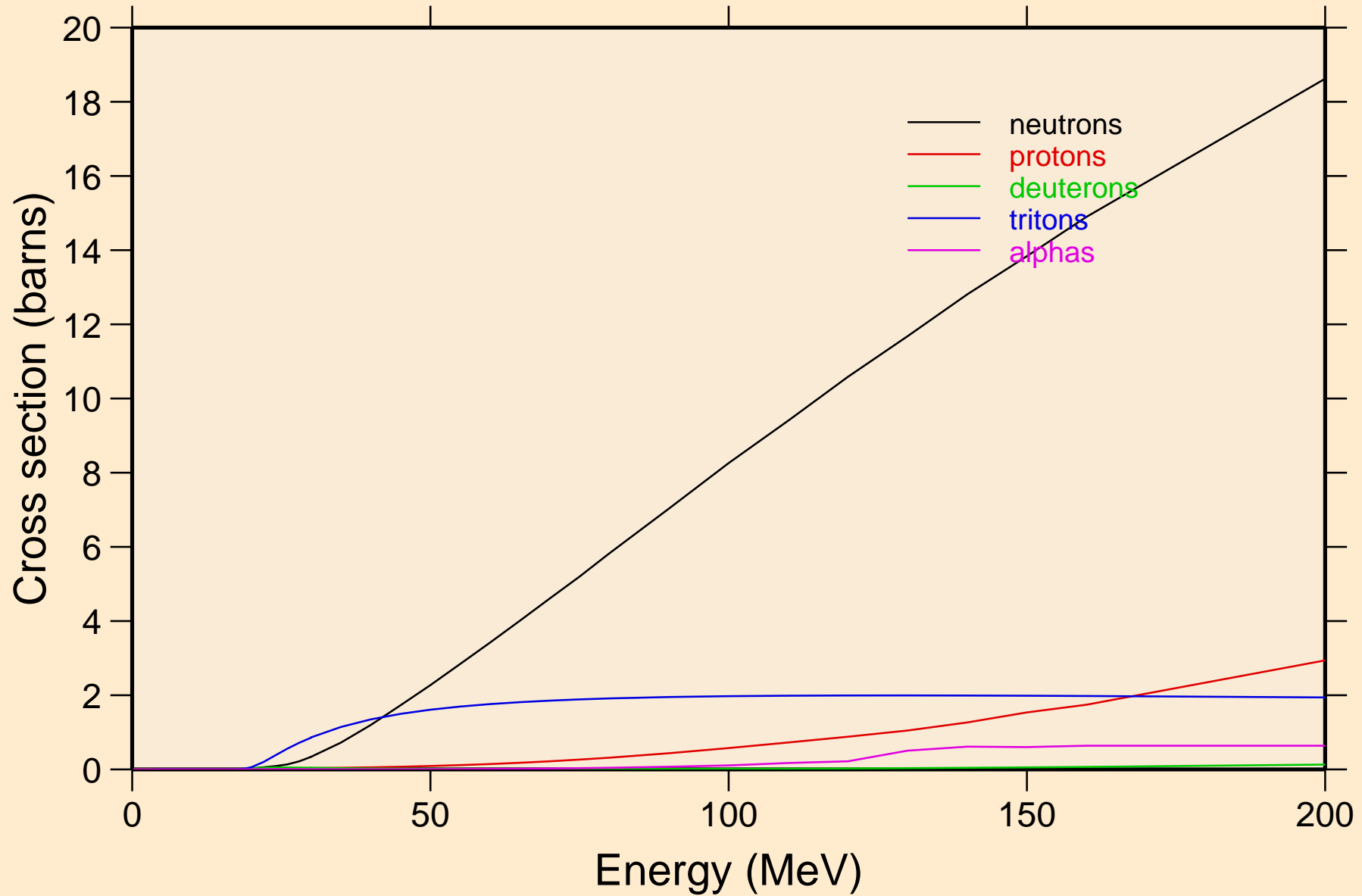

W177 HELION ACER TENDL-2021 LIBRARY; T=0.K  
neutrons from (s,n)

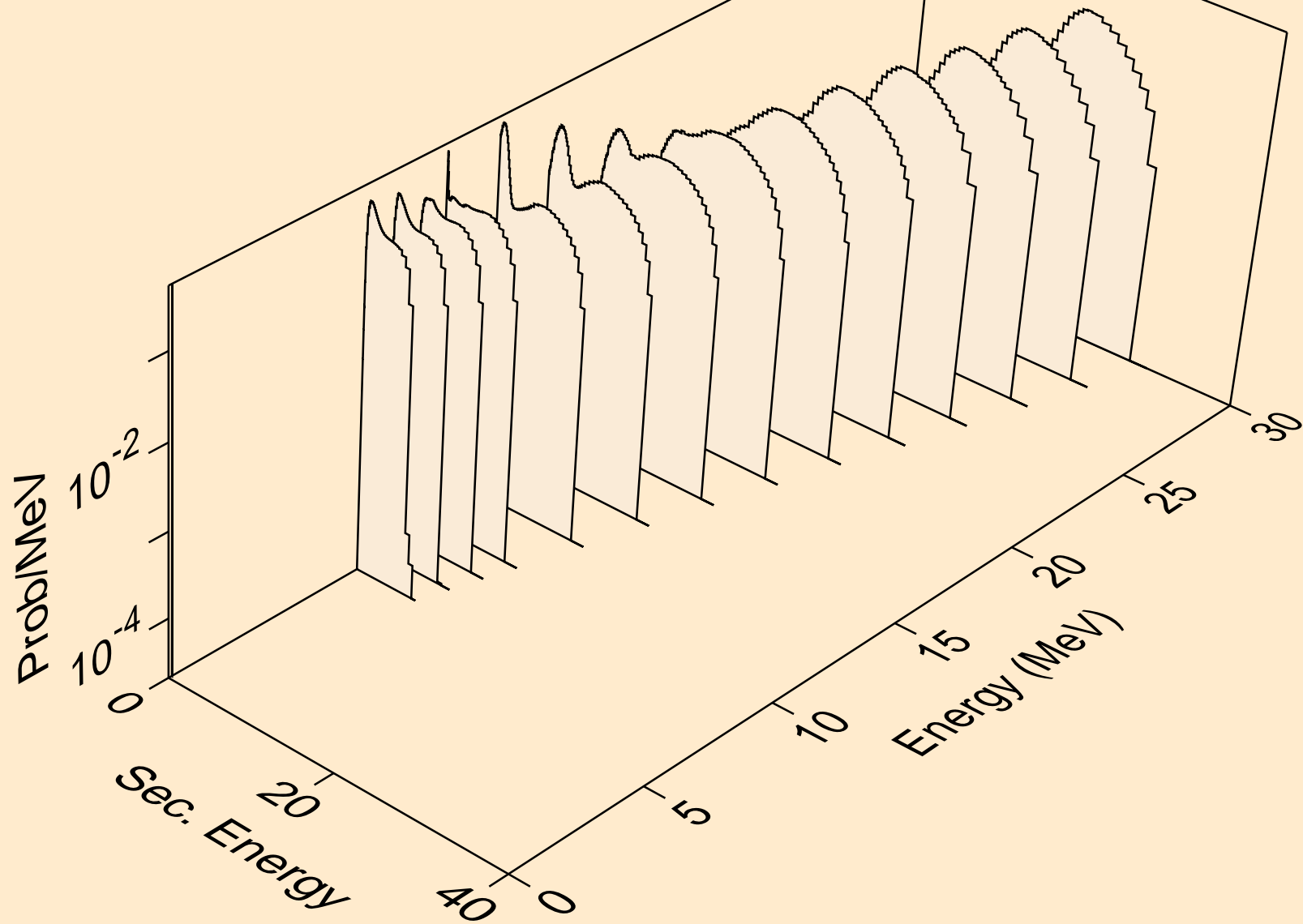

W177 HELION ACER TENDL-2021 LIBRARY; T=0.K  
neutrons from (s,x)

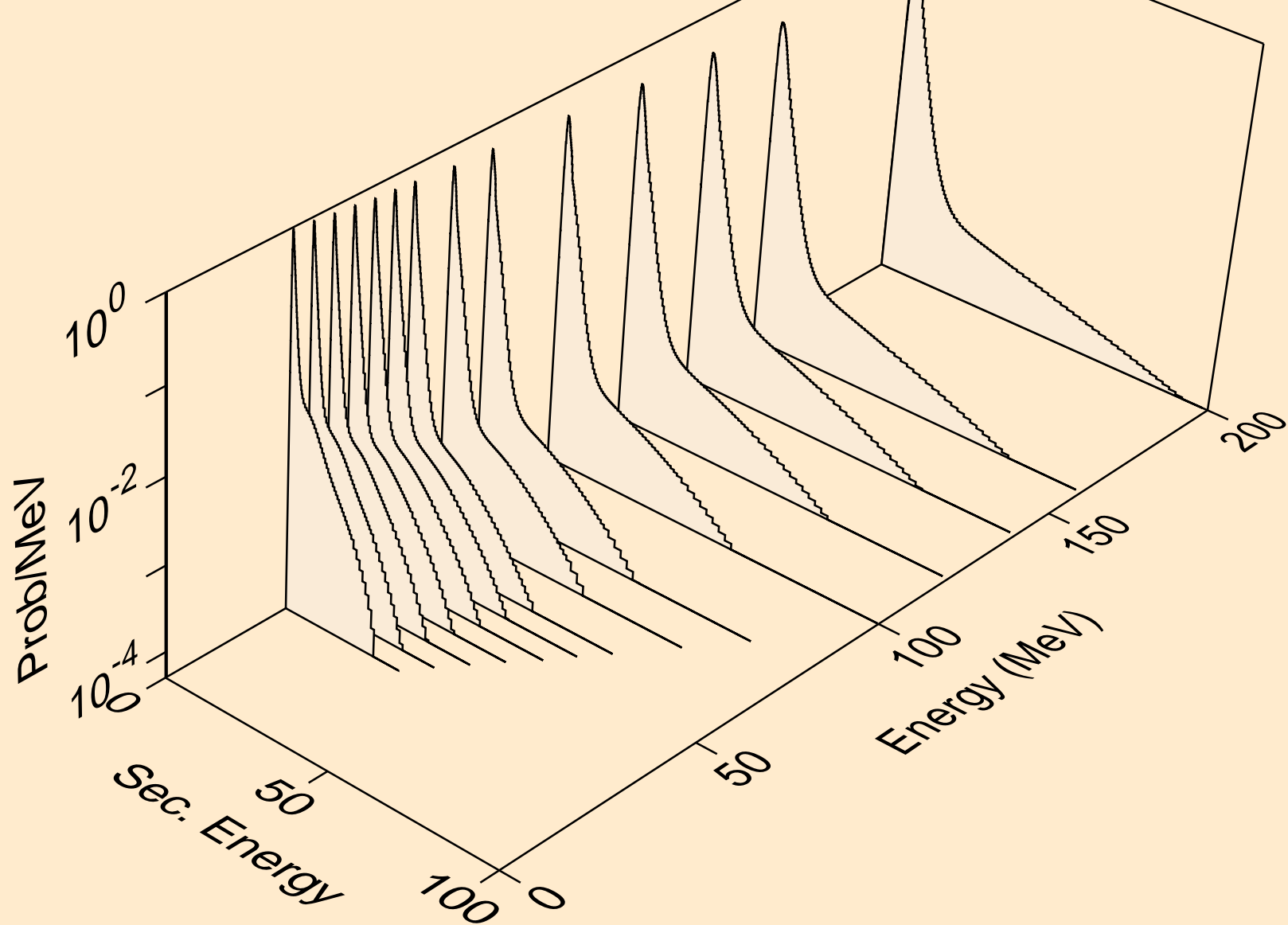

W177 HELION ACER TENDL-2021 LIBRARY; T=0.K  
neutrons from (s,2nd)

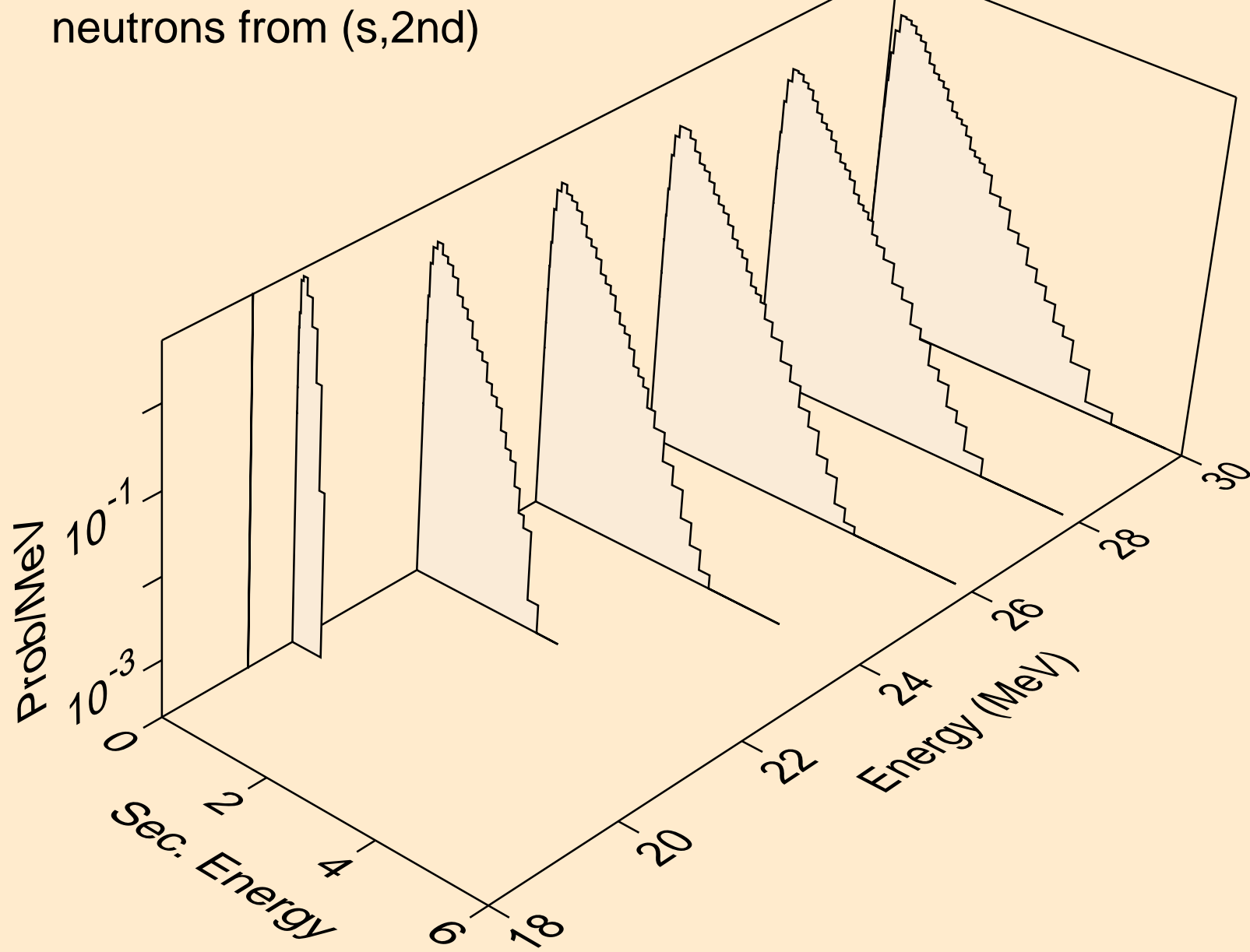

W177 HELION ACER TENDL-2021 LIBRARY; T=0.K  
neutrons from (s,2n)

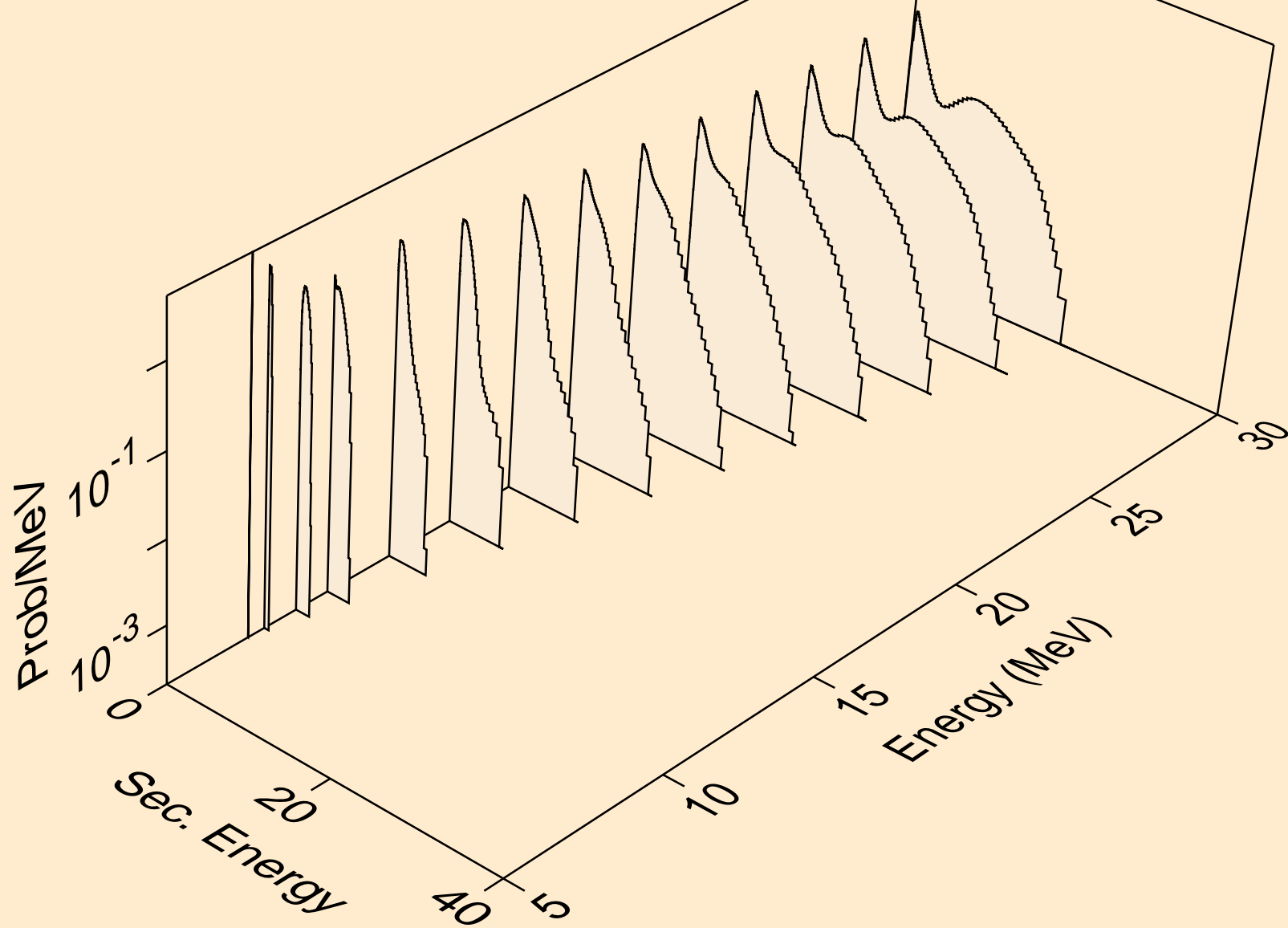

W177 HELION ACER TENDL-2021 LIBRARY; T=0.K  
neutrons from (s,3n)

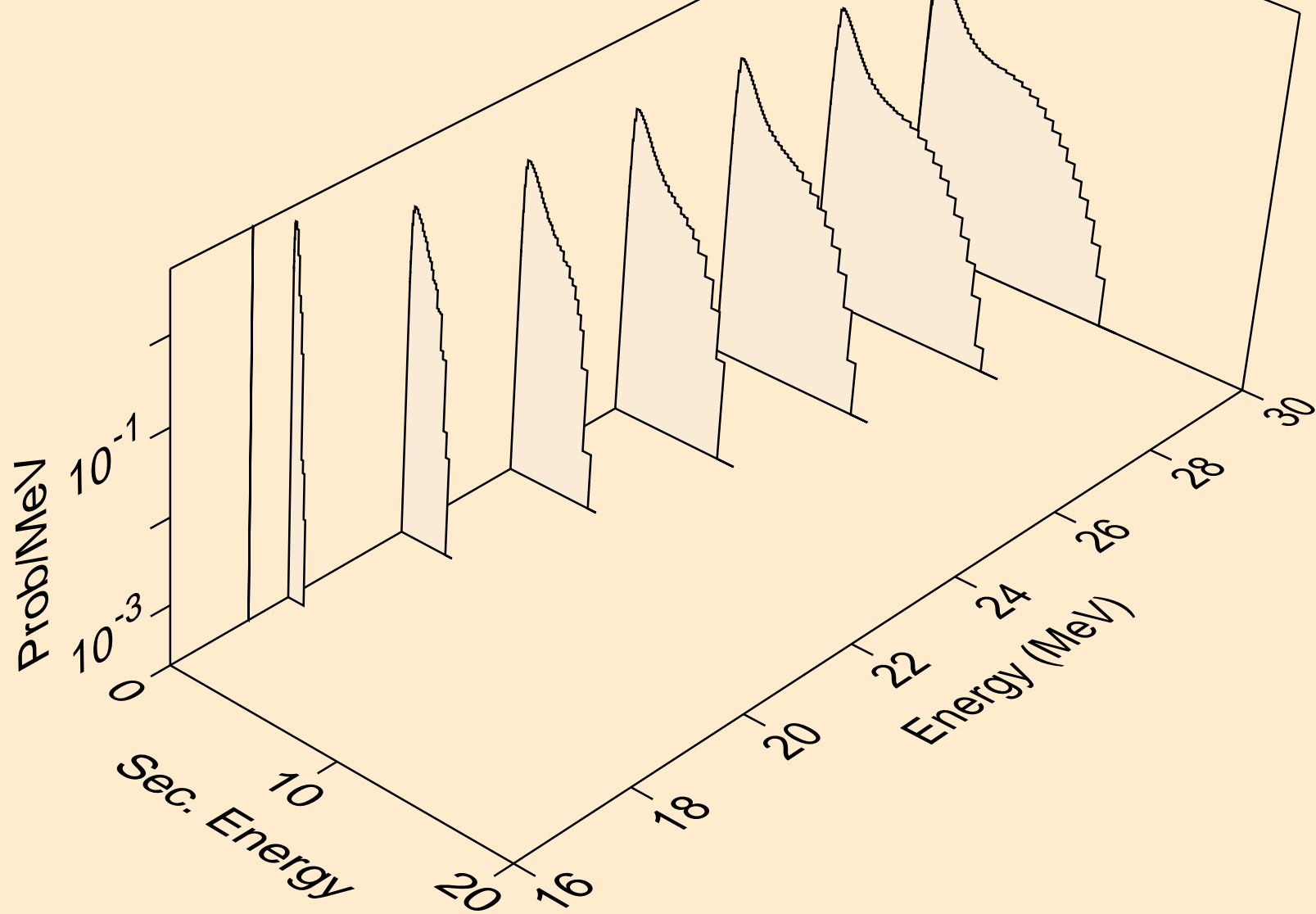

W177 HELION ACER TENDL-2021 LIBRARY; T=0.K  
neutrons from (s,n\*)a

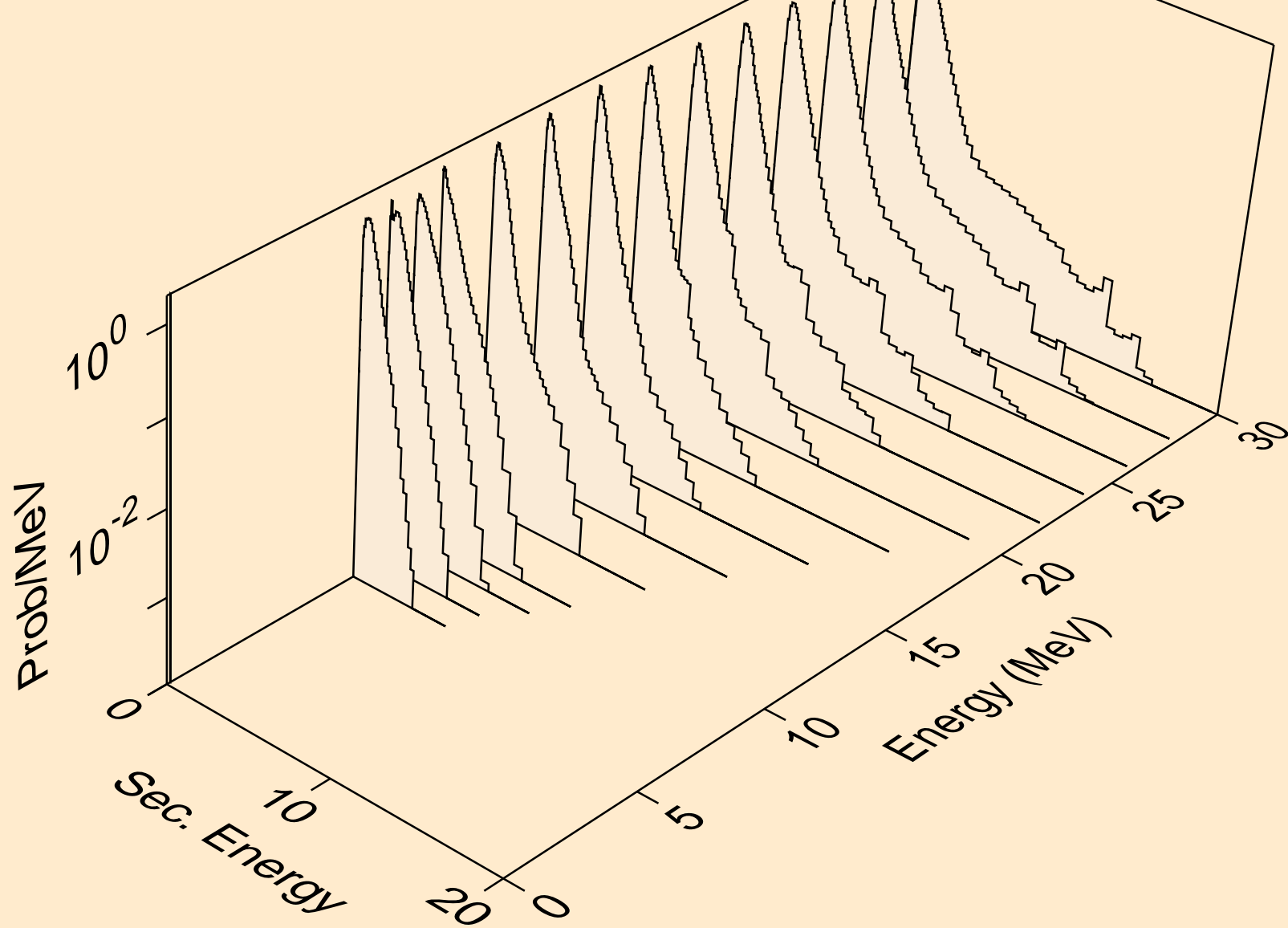



W177 HELION ACER TENDL-2021 LIBRARY; T=0.K  
neutrons from (s,2n)a

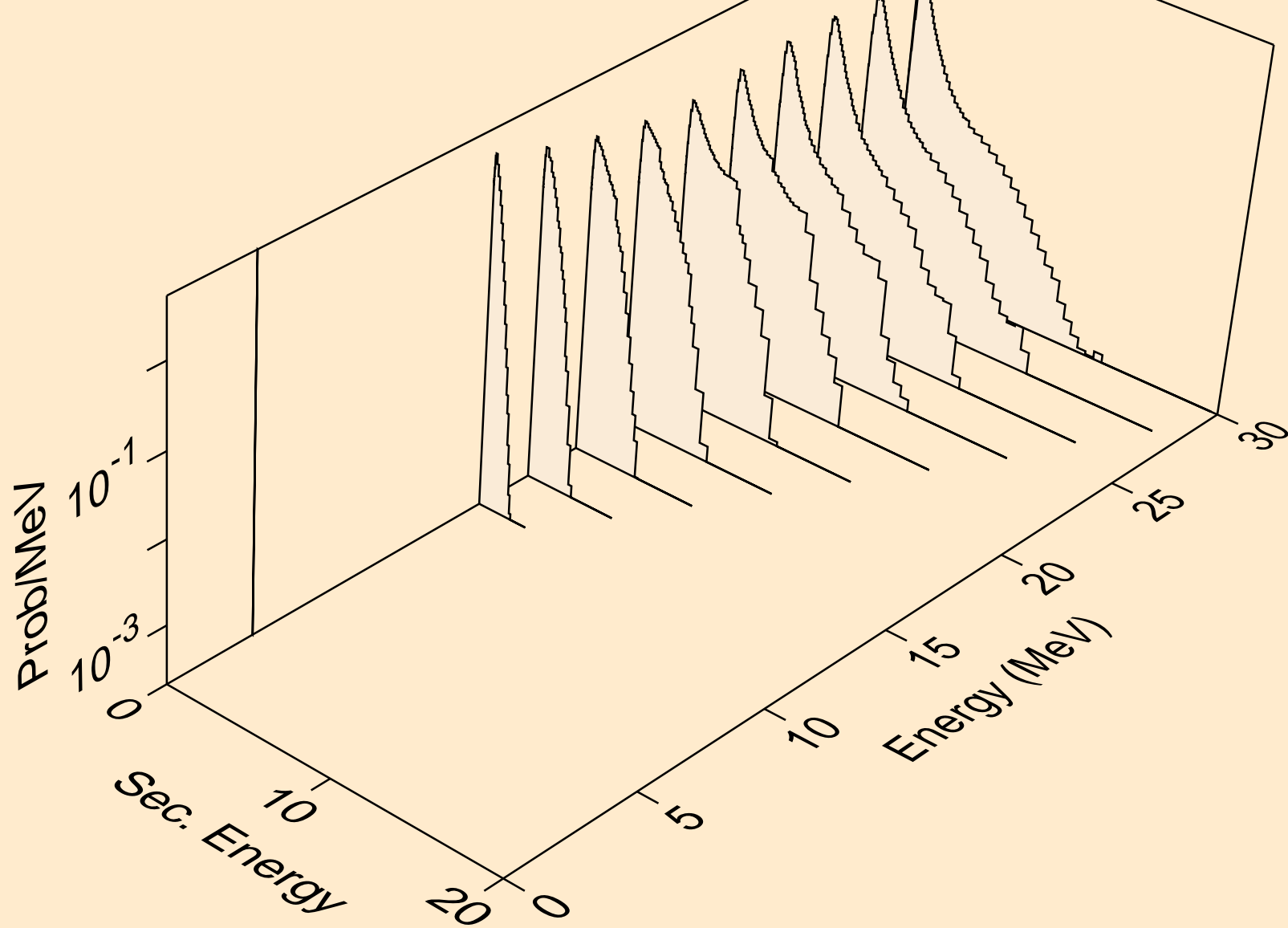

W177 HELION ACER TENDL-2021 LIBRARY; T=0.K  
neutrons from (s,3n)a

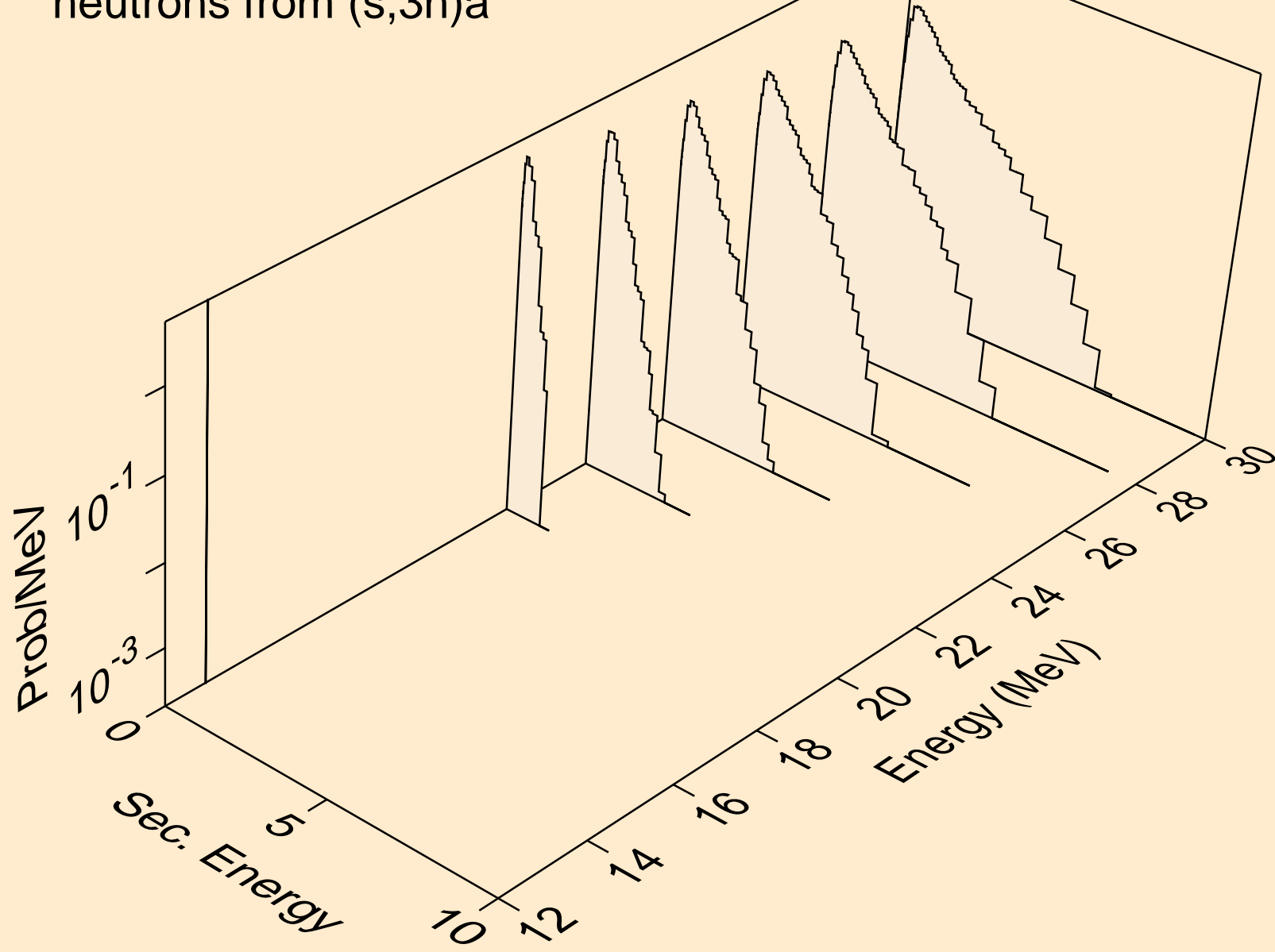

W177 HELION ACER TENDL-2021 LIBRARY; T=0.K  
neutrons from (s,n\*)p

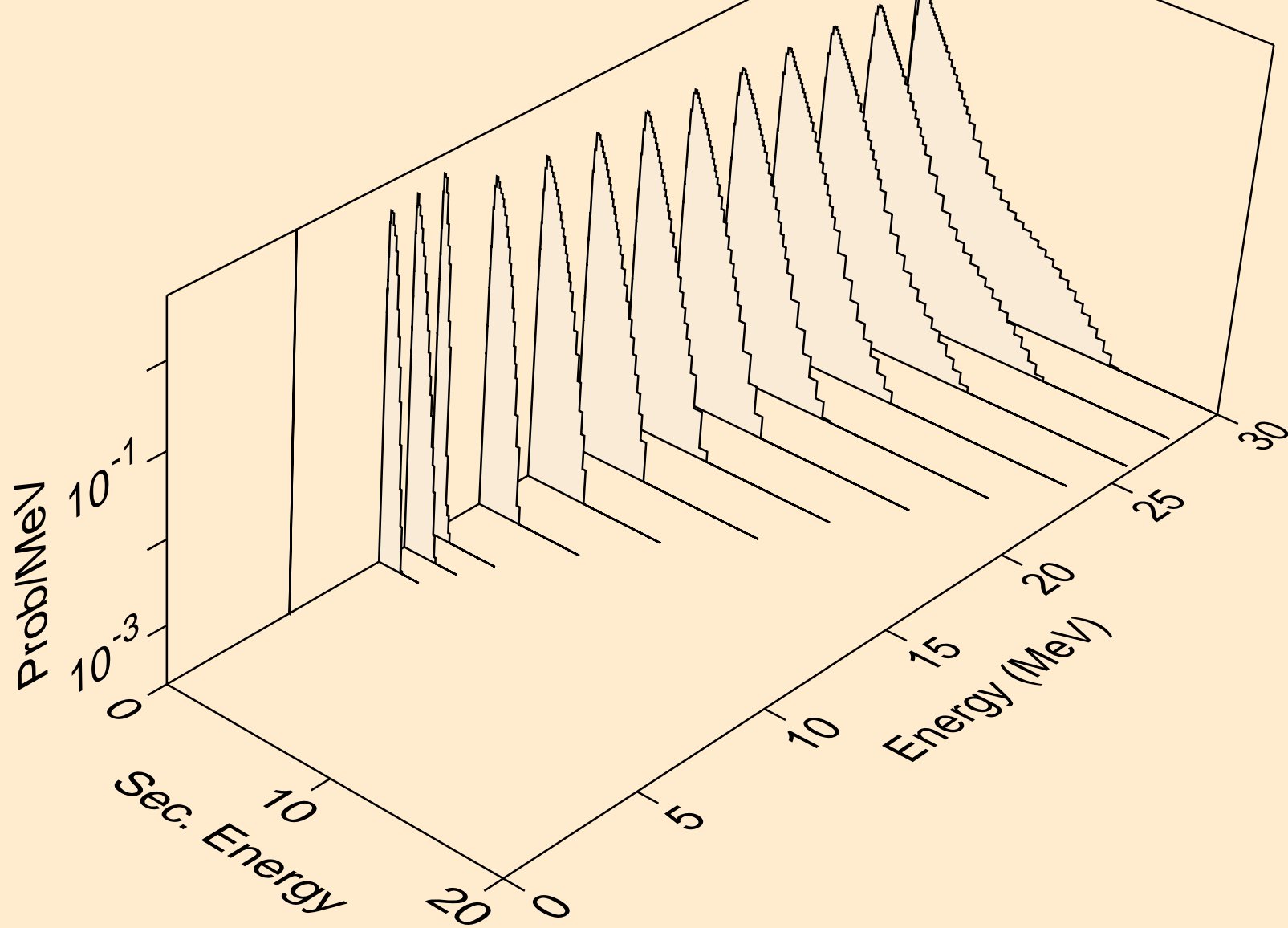

W177 HELION ACER TENDL-2021 LIBRARY; T=0.K  
neutrons from (s,n\*)2a

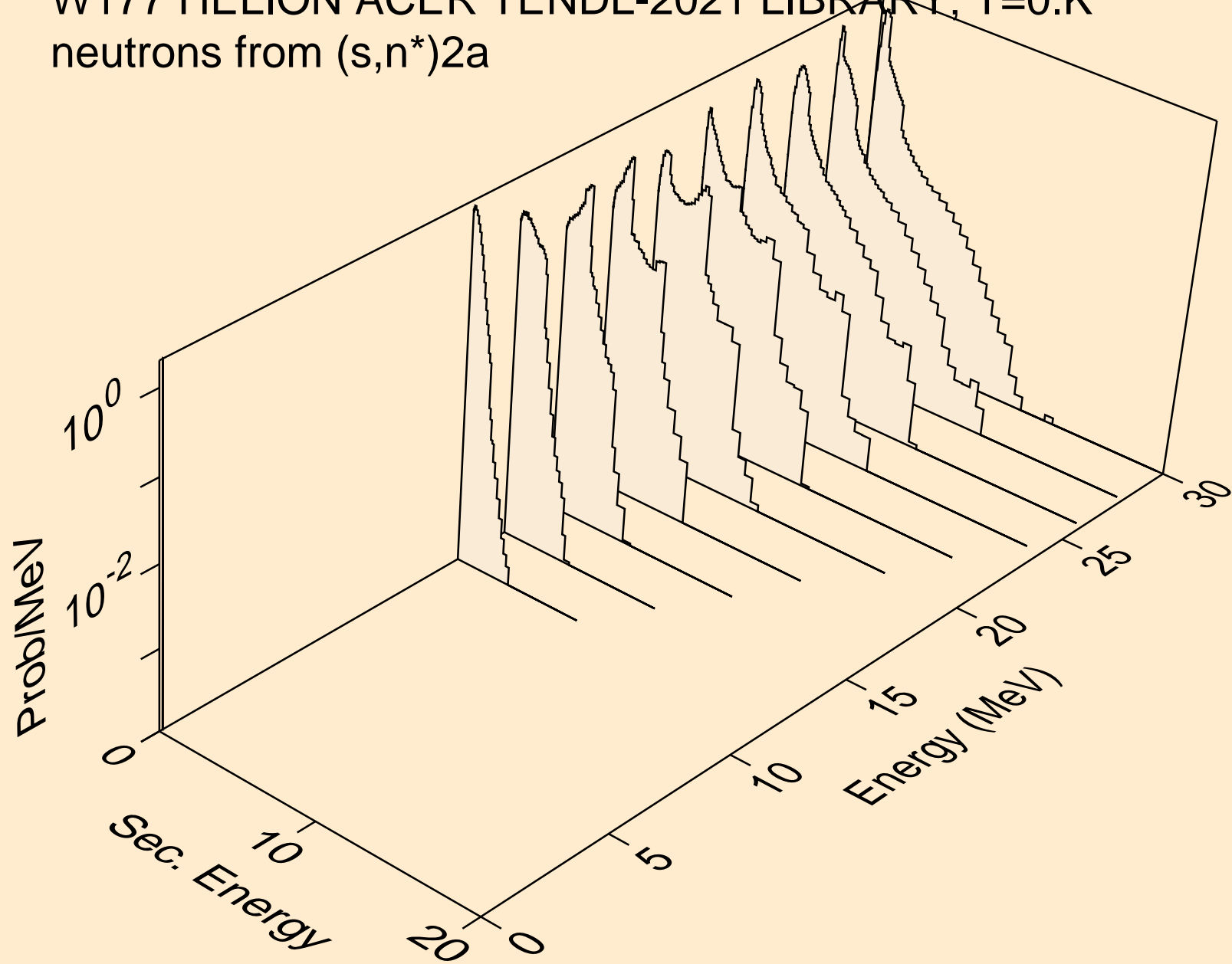

W177 HELION ACER TENDL-2021 LIBRARY; T=0.K  
neutrons from (s,n\*)d

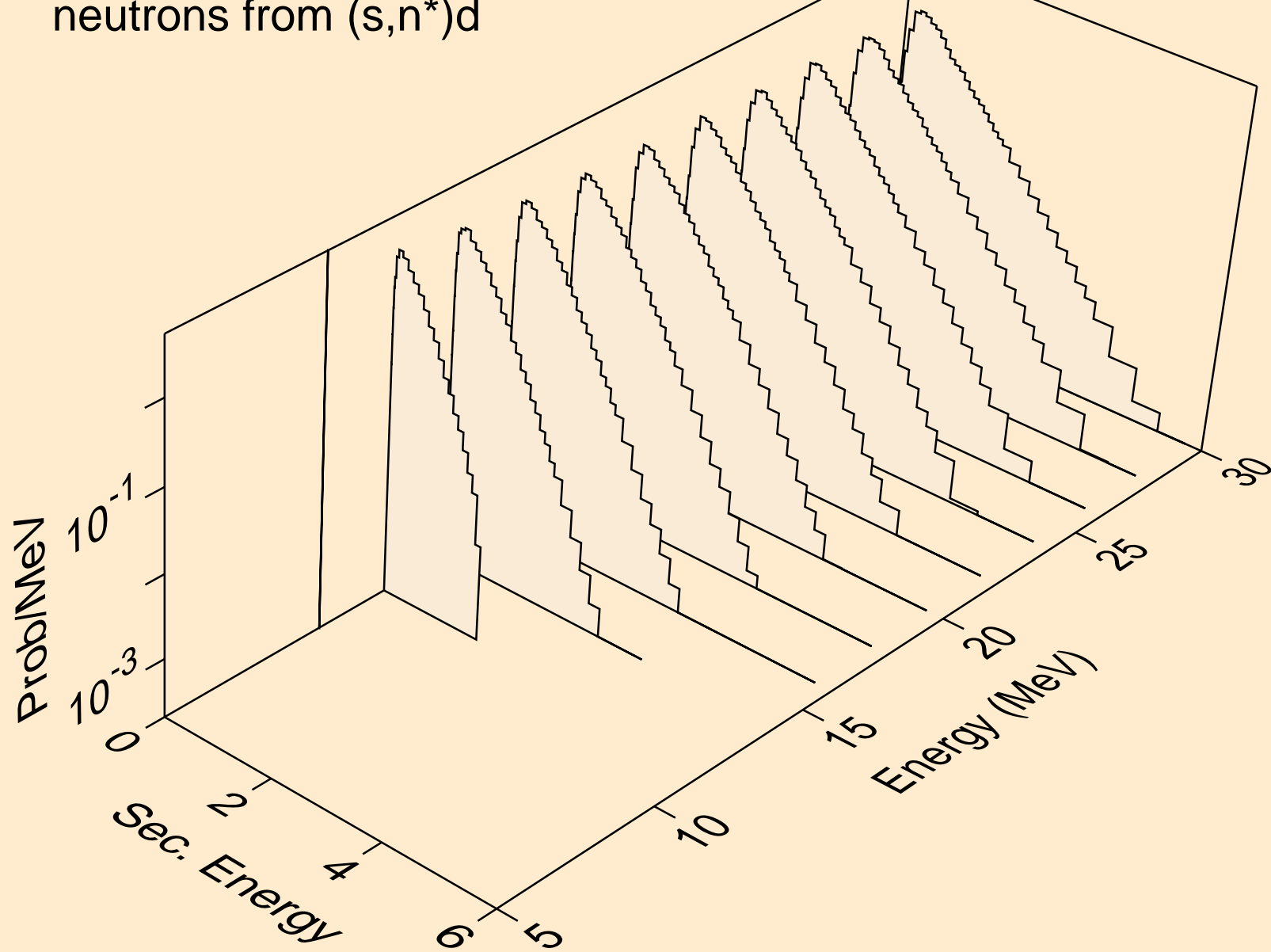

W177 HELION ACER TENDL-2021 LIBRARY; T=0.K  
neutrons from (s,n\*)t

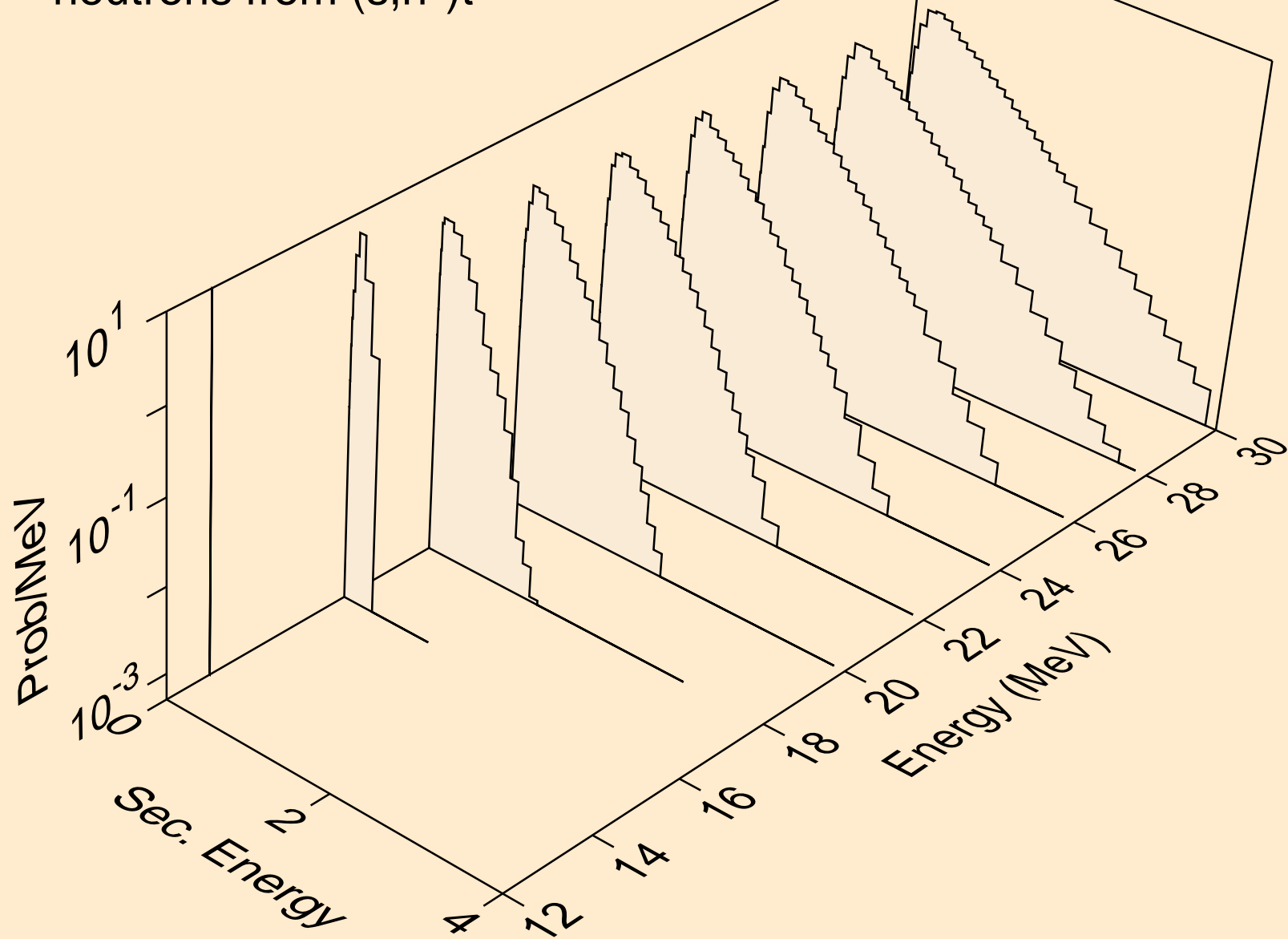

W177 HELION ACER TENDL-2021 LIBRARY; T=0.K  
neutrons from (s,n\*)he3

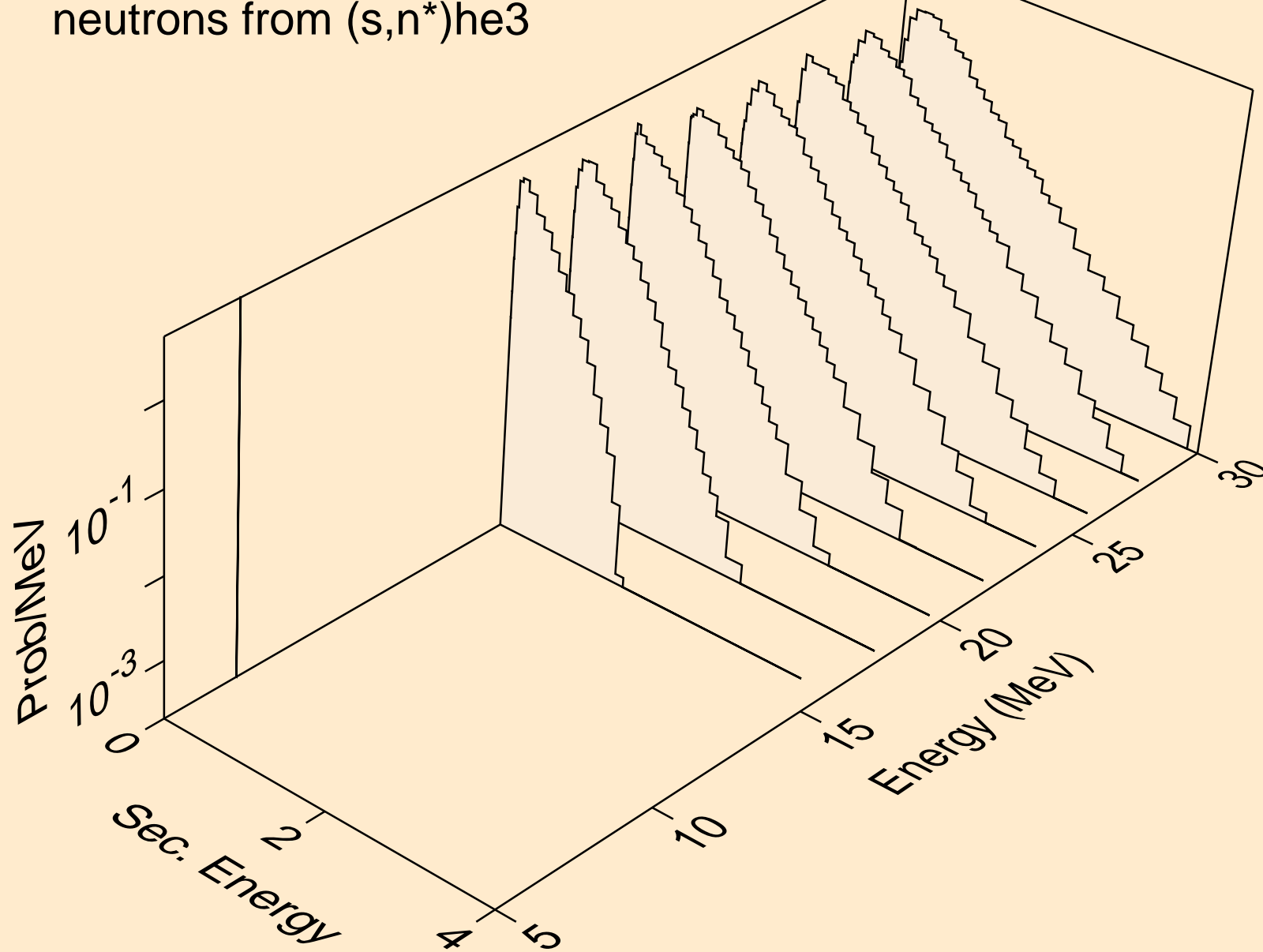

W177 HELION ACER TENDL-2021 LIBRARY; T=0.K  
neutrons from (s,4n)

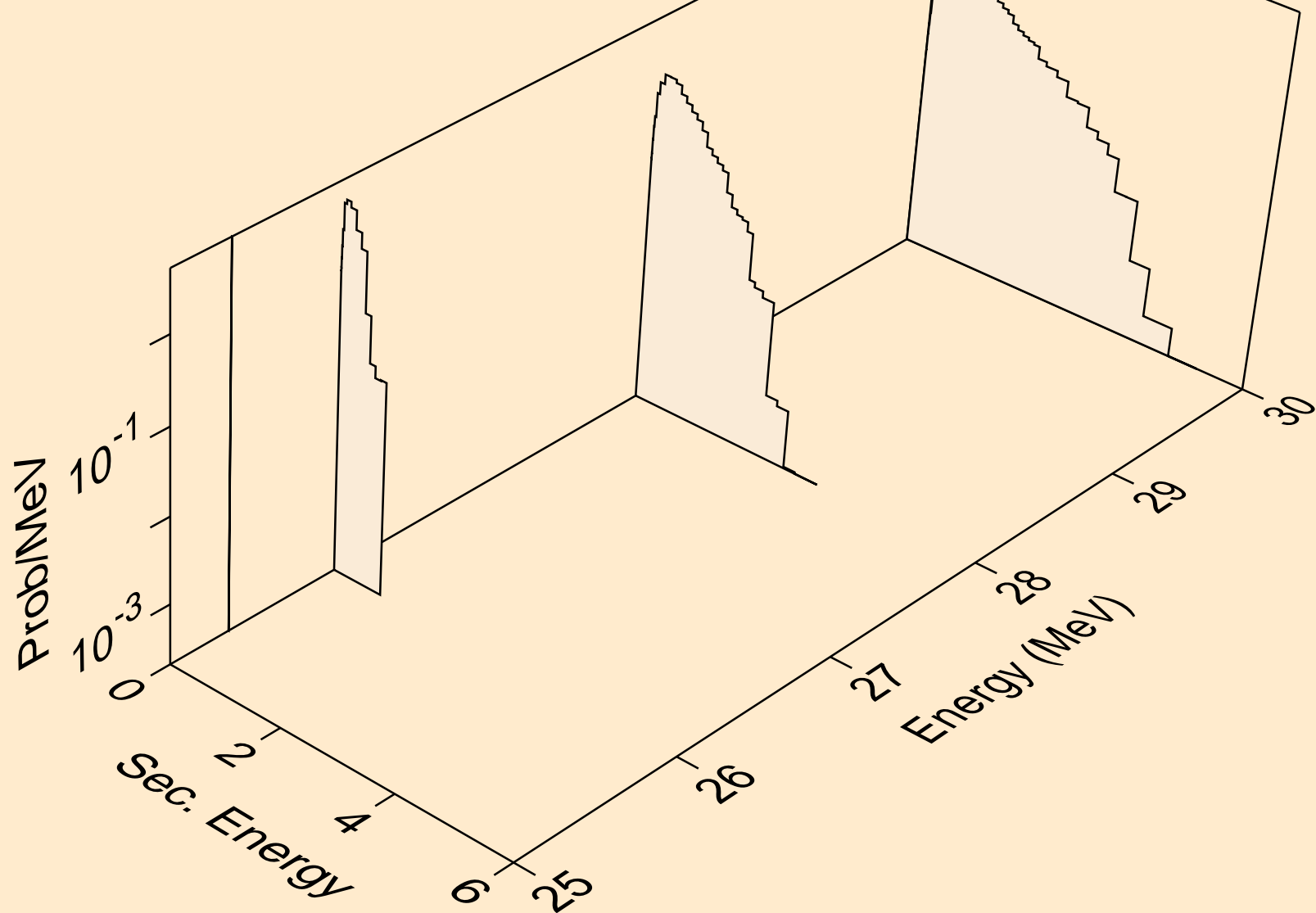



W177 HELION ACER TENDL-2021 LIBRARY; T=0.K  
neutrons from (s,2np)

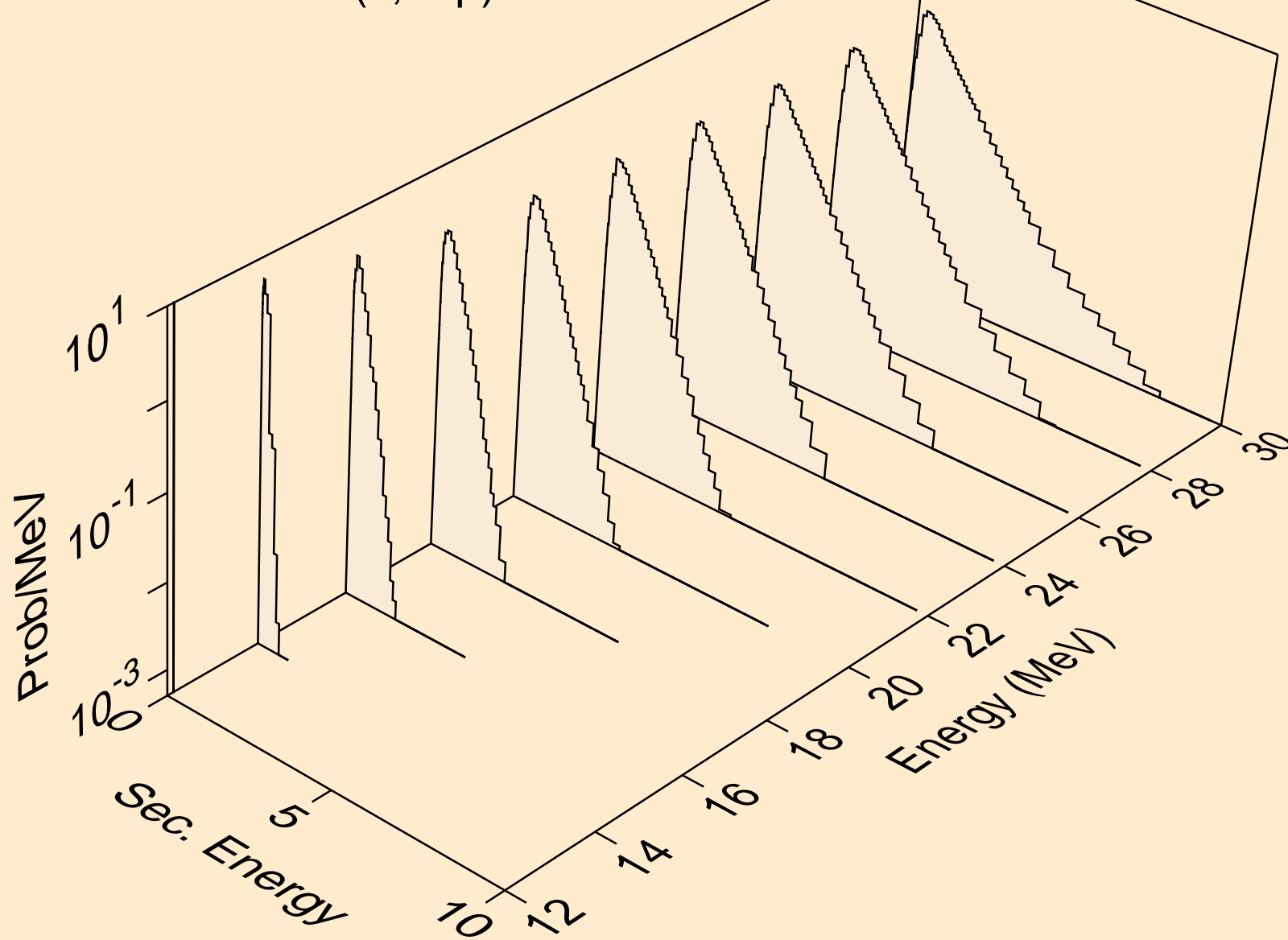

W177 HELION ACER TENDL-2021 LIBRARY; T=0.K  
neutrons from (s,3np)

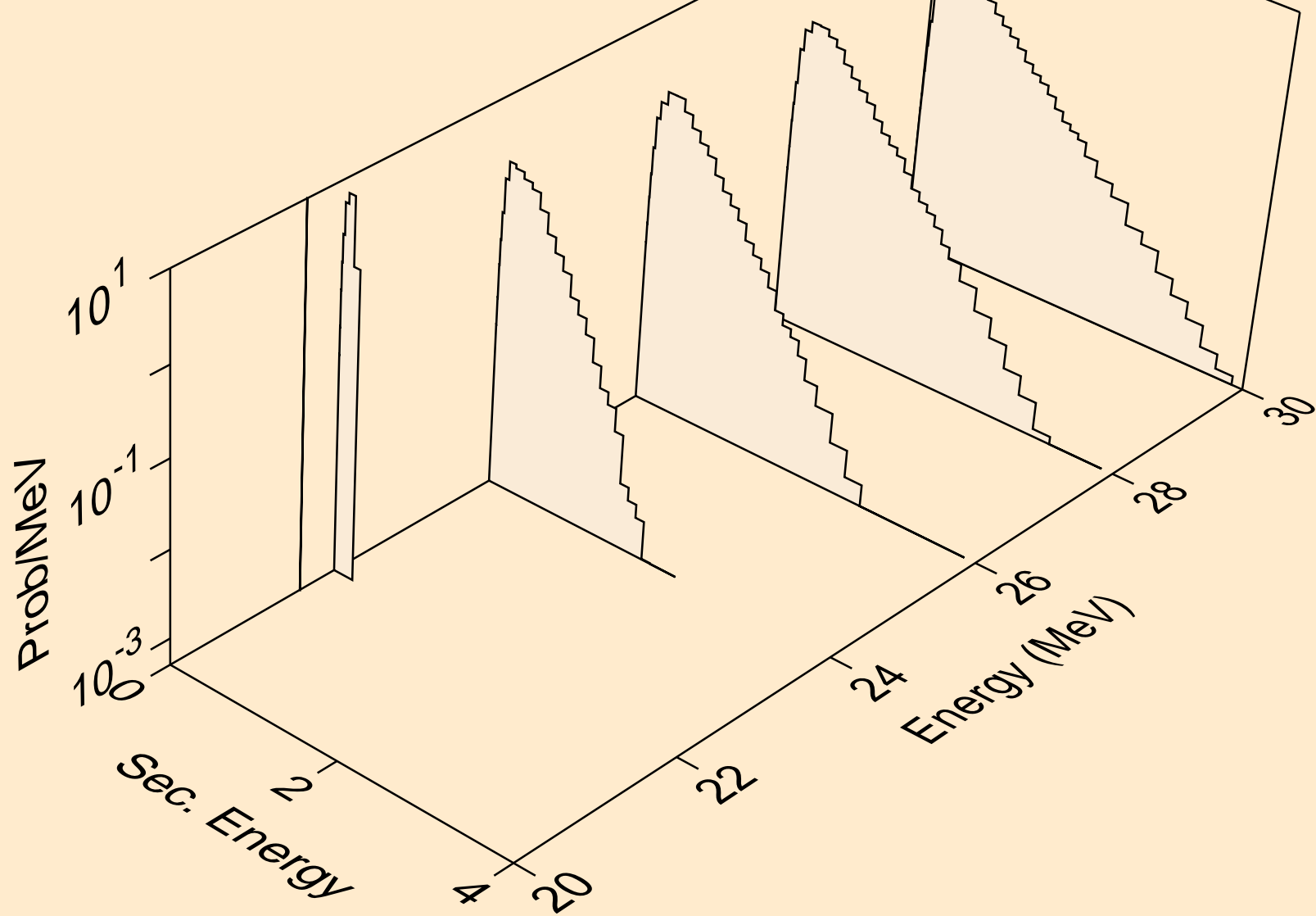

W177 HELION ACER TENDL-2021 LIBRARY; T=0.K  
neutrons from (s,2np)

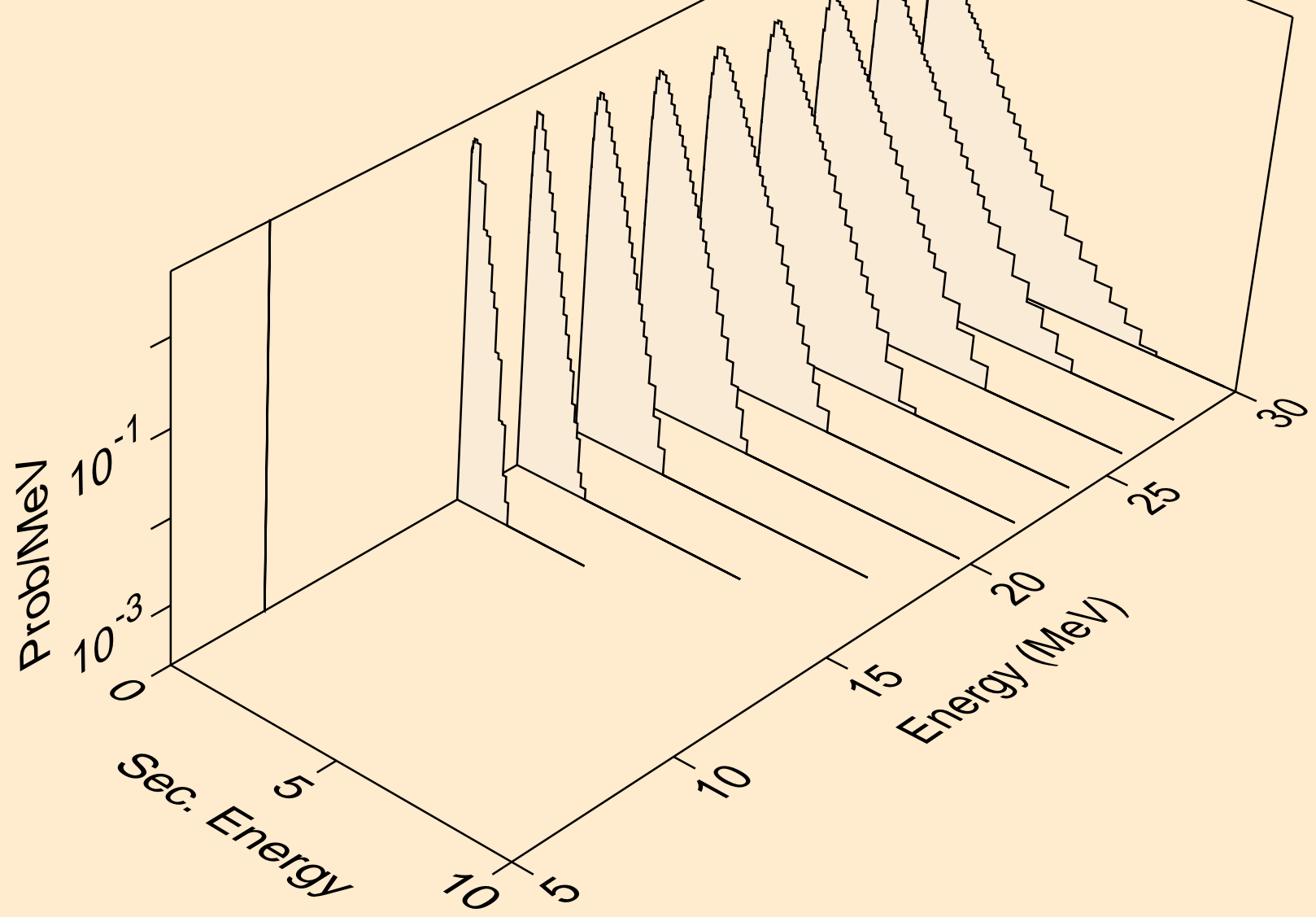

W177 HELION ACER TENDL-2021 LIBRARY; T=0.K  
neutrons from (s,npa)

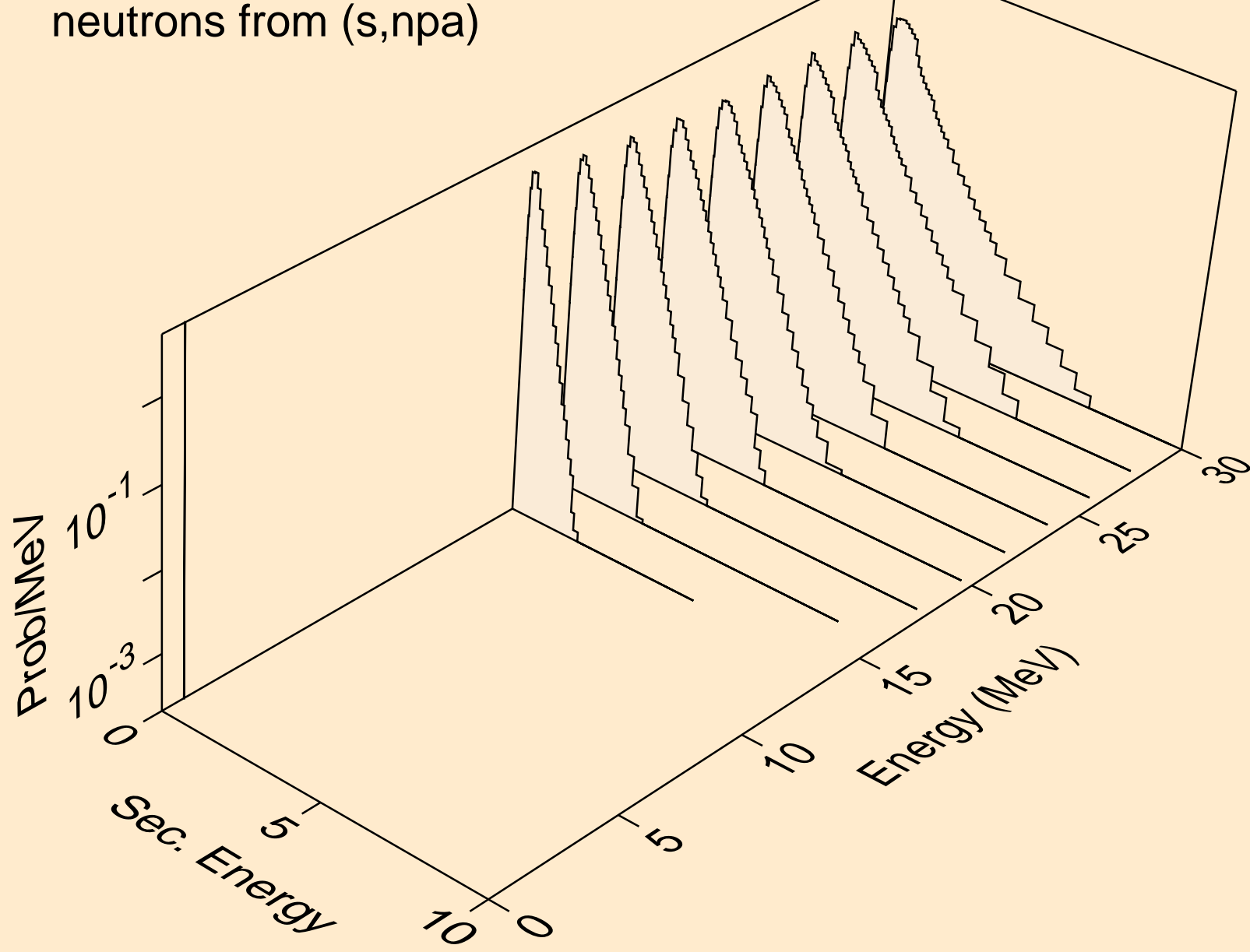

W177 HELION ACER TENDL-2021 LIBRARY; T=0.K  
protons from (s,x)

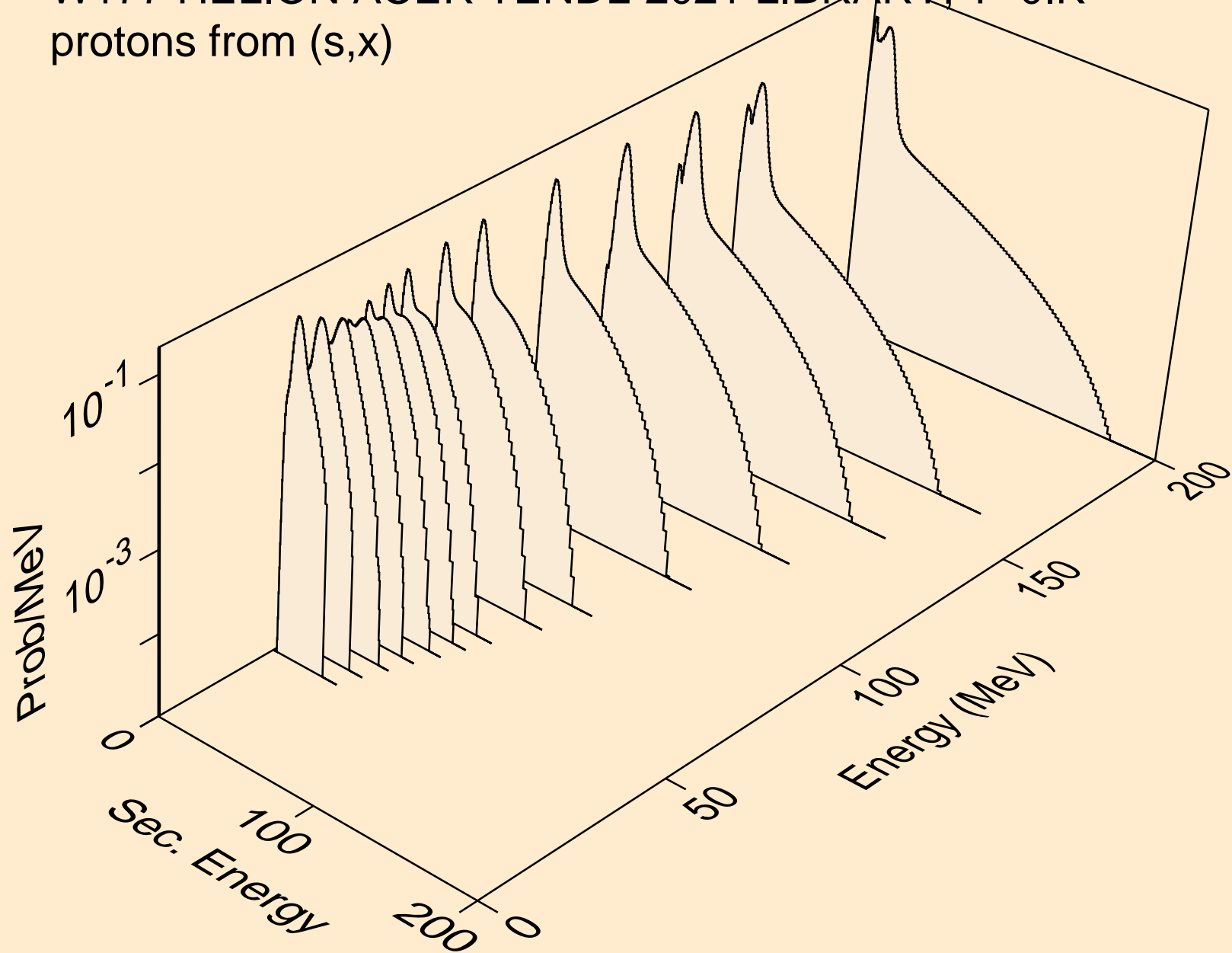

W177 HELION ACER TENDL-2021 LIBRARY; T=0.K  
protons from (s,n\*)p

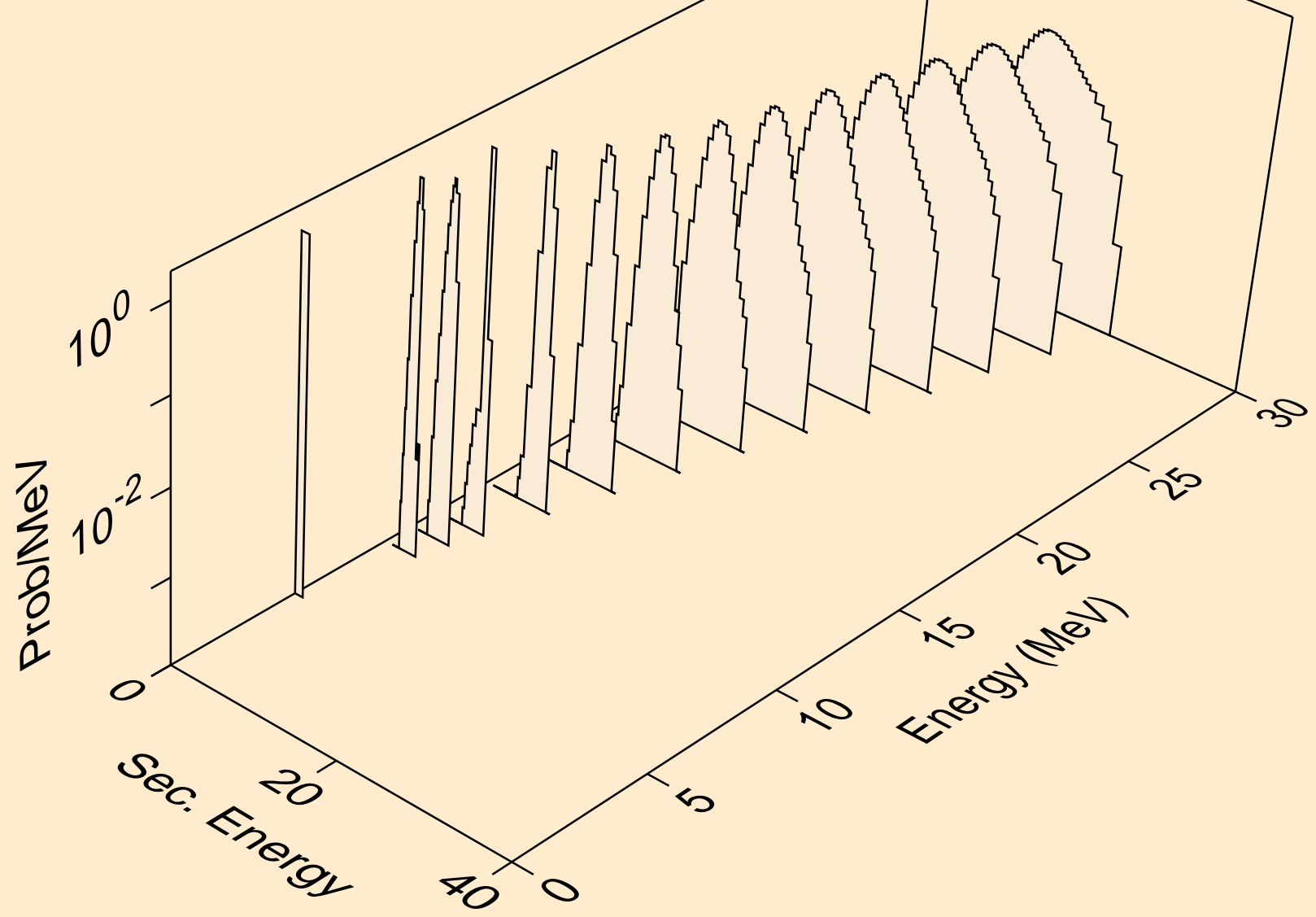

W177 HELION ACER TENDL-2021 LIBRARY; T=0.K  
protons from (s,2np)

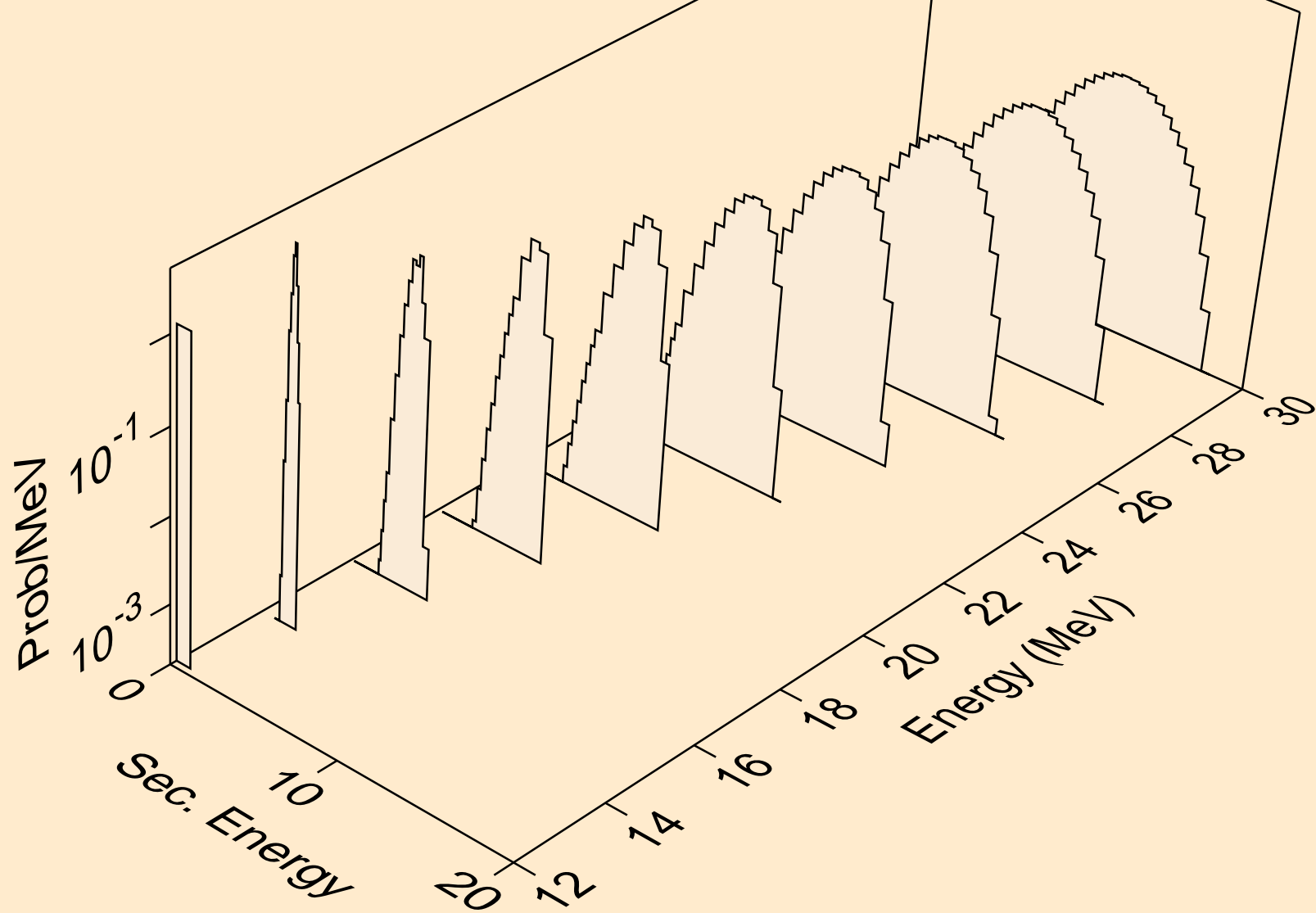

W177 HELION ACER TENDL-2021 LIBRARY; T=0.K  
protons from (s,3np)

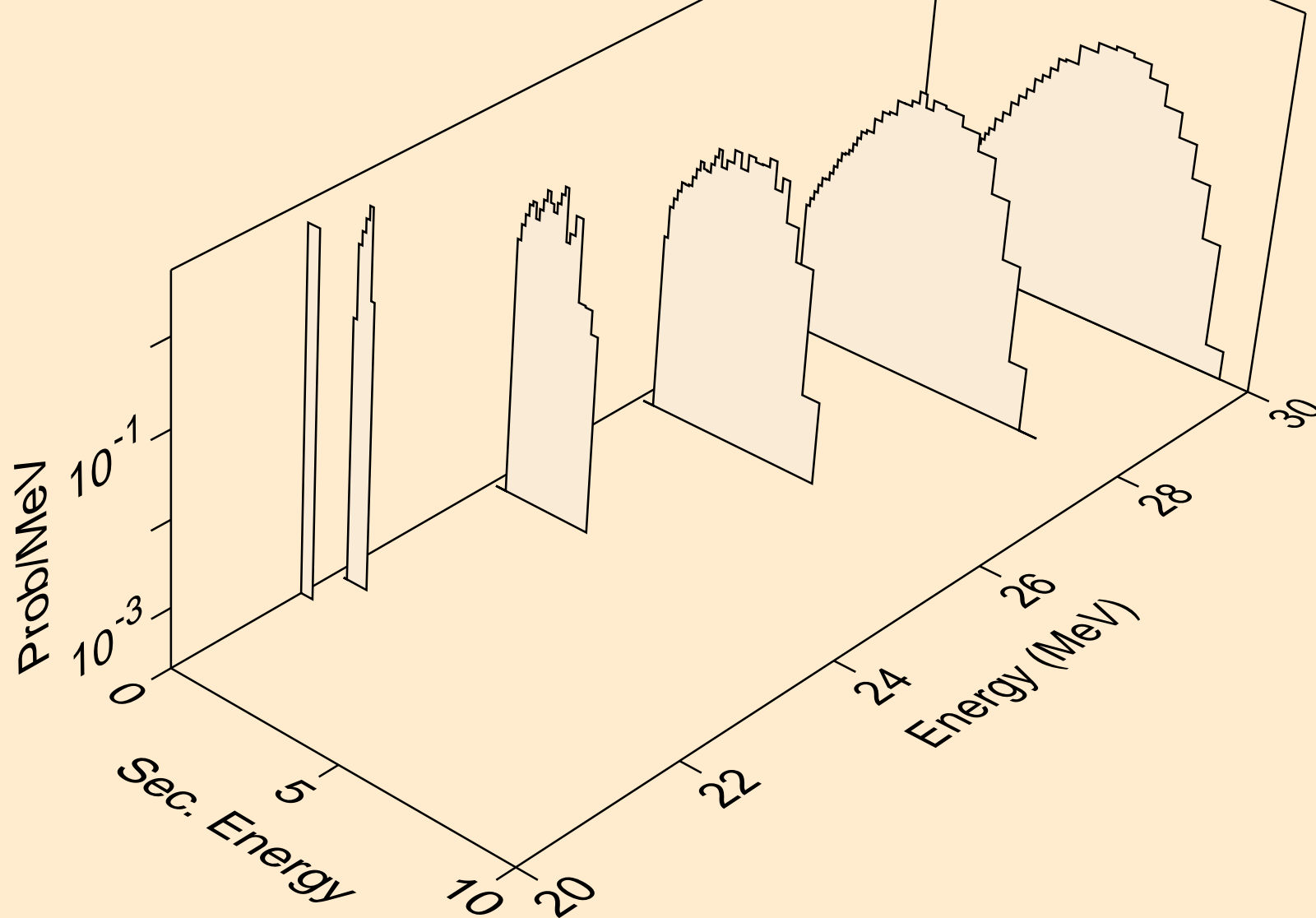



W177 HELION ACER TENDL-2021 LIBRARY; T=0.K  
protons from (s,2np)

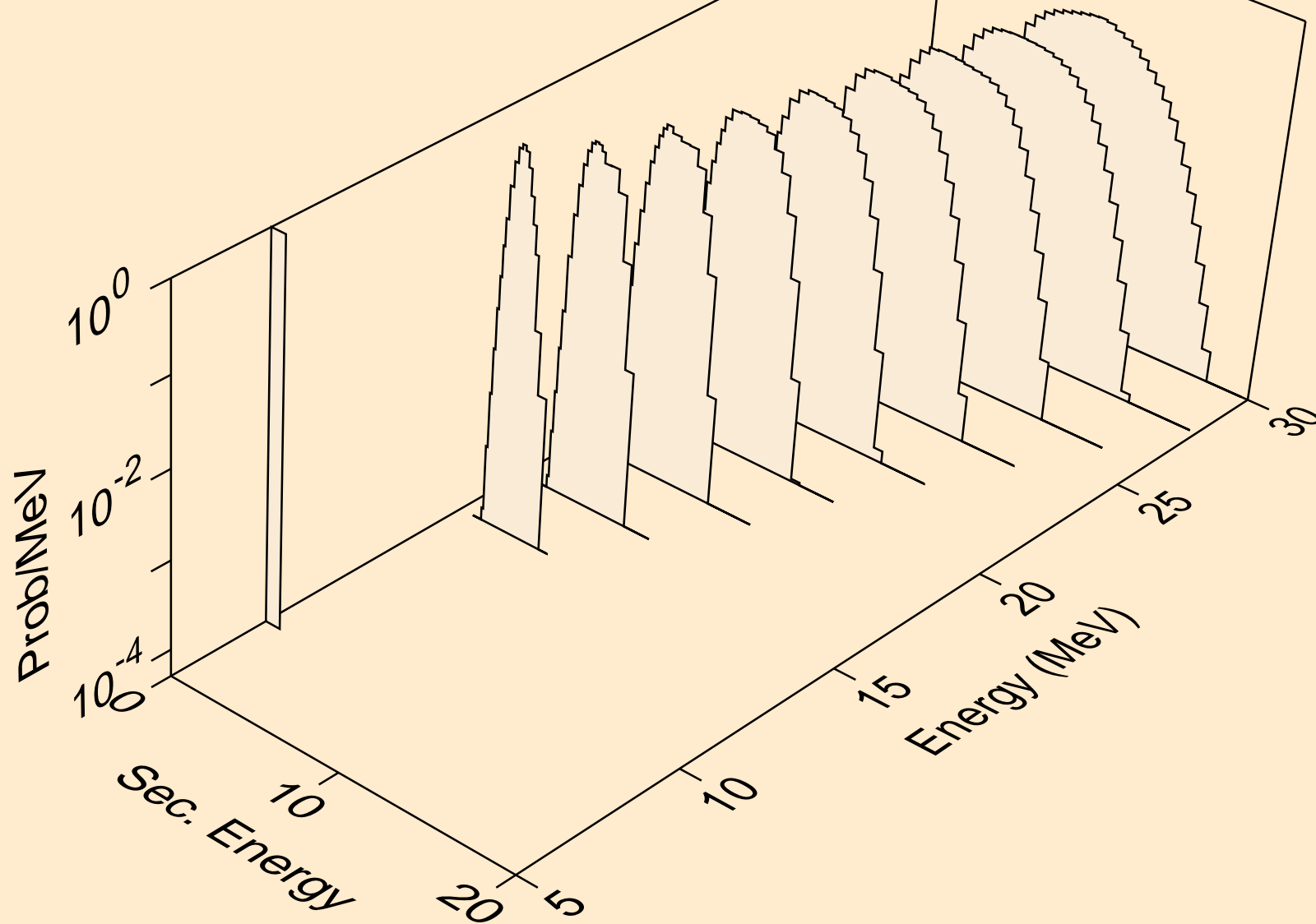

W177 HELION ACER TENDL-2021 LIBRARY; T=0.K  
protons from (s,npa)

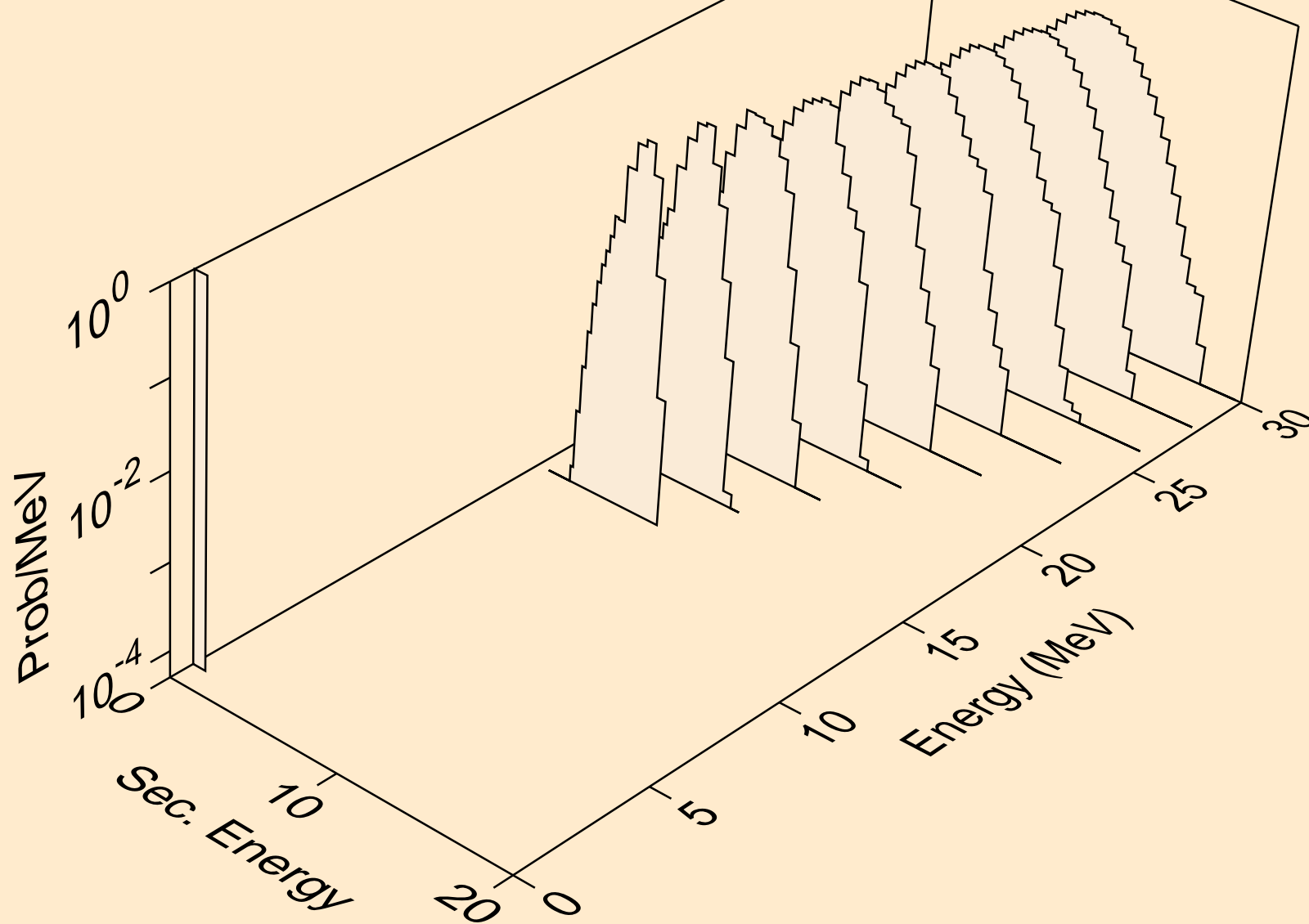

W177 HELION ACER TENDL-2021 LIBRARY; T=0.K  
protons from (s,p)

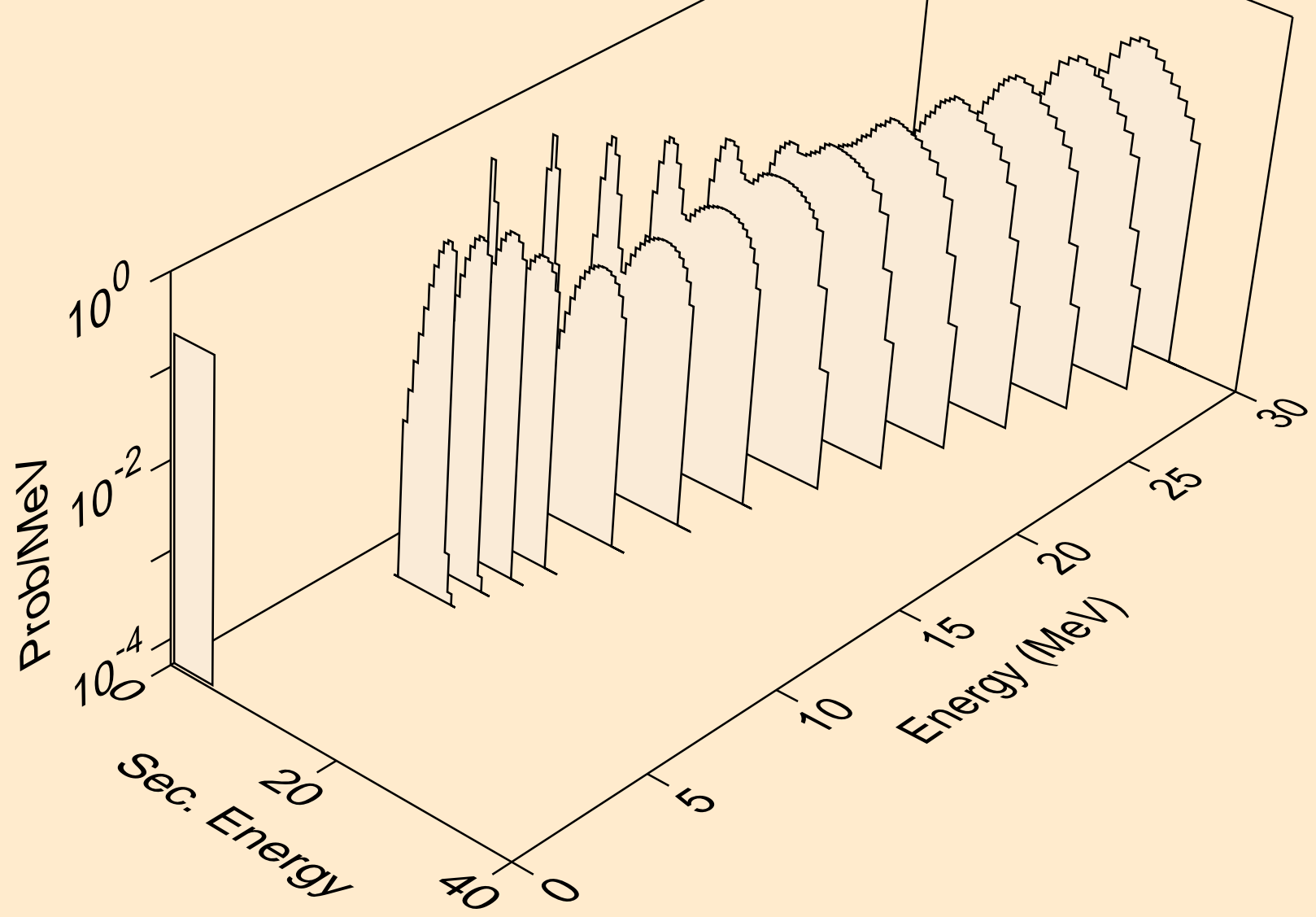

W177 HELION ACER TENDL-2021 LIBRARY; T=0.K  
protons from (s,2p)

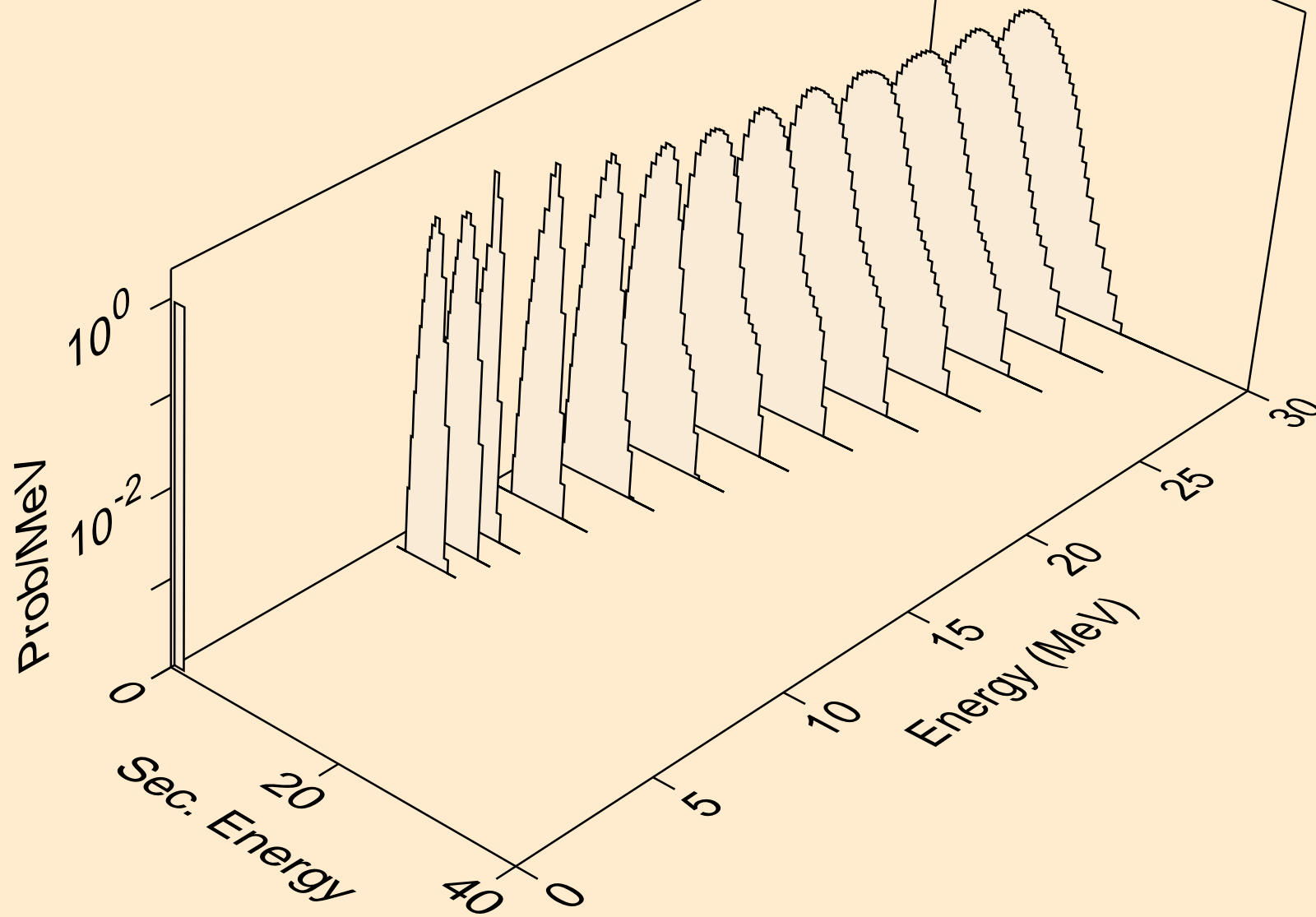

W177 HELION ACER TENDL-2021 LIBRARY; T=0.K  
protons from (s,pa)

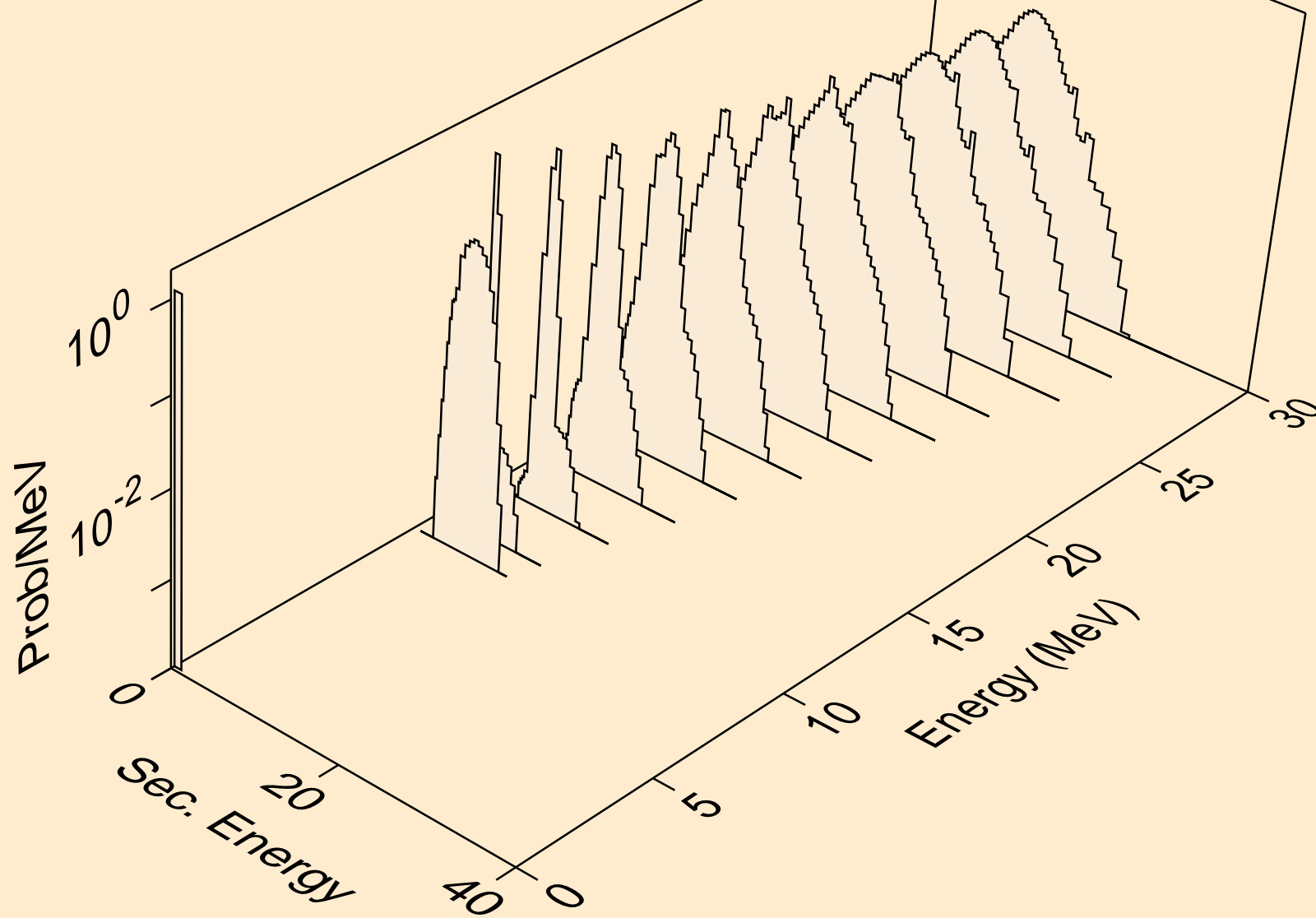

W177 HELION ACER TENDL-2021 LIBRARY; T=0.K  
protons from (s,pd)

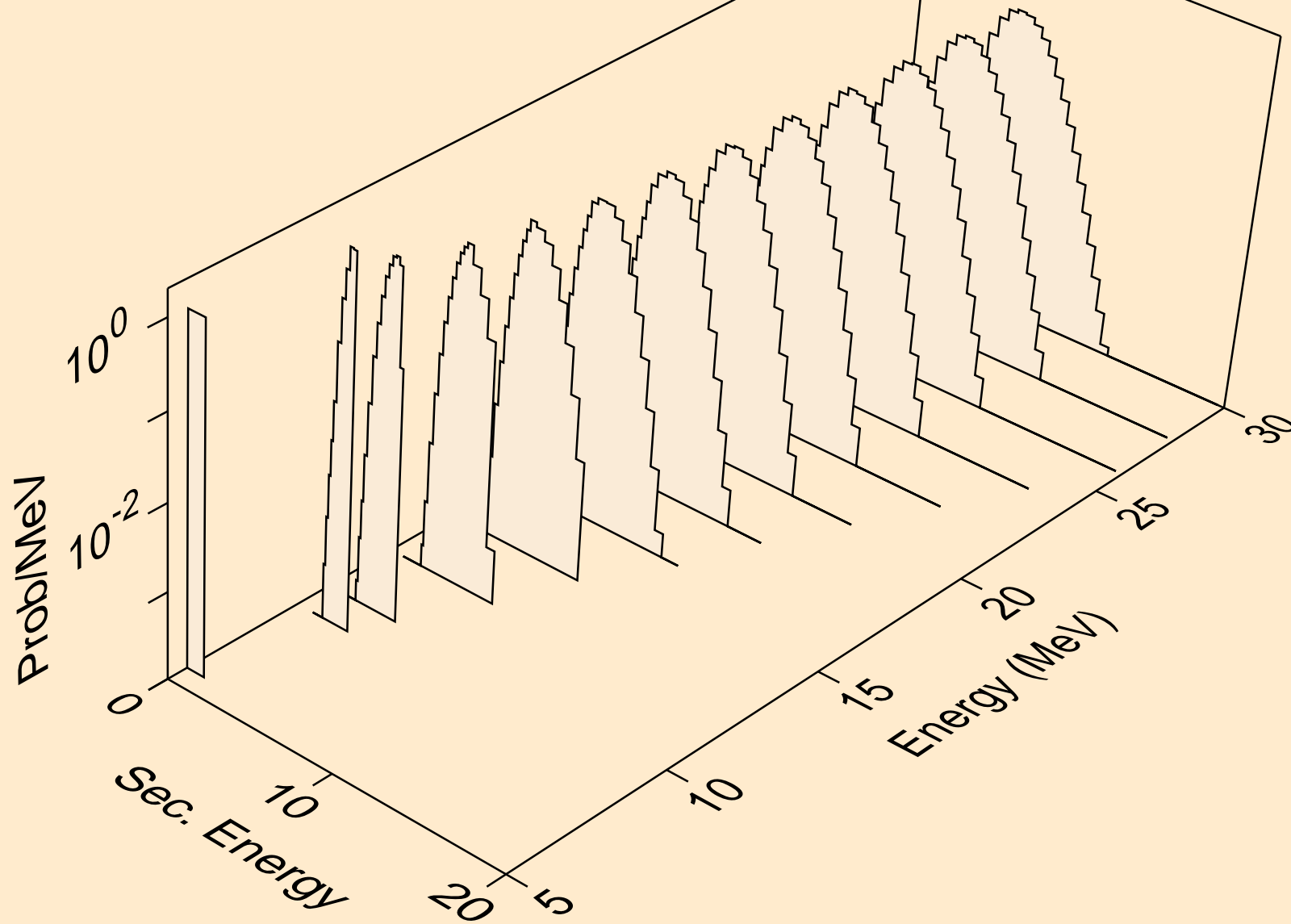

W177 HELION ACER TENDL-2021 LIBRARY; T=0.K  
protons from (s,pt)

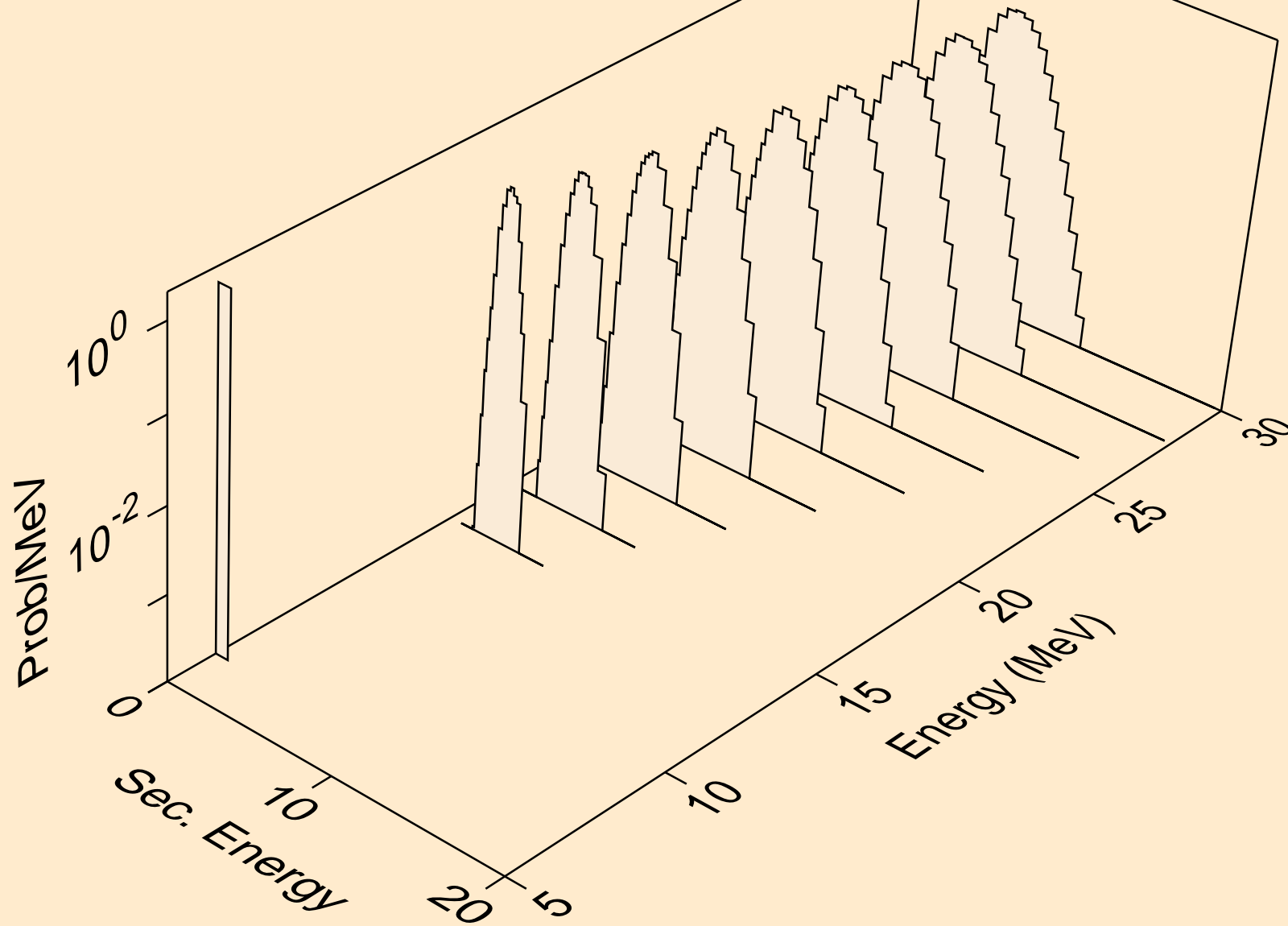

W177 HELION ACER TENDL-2021 LIBRARY; T=0.K  
deuterons from (s,x)

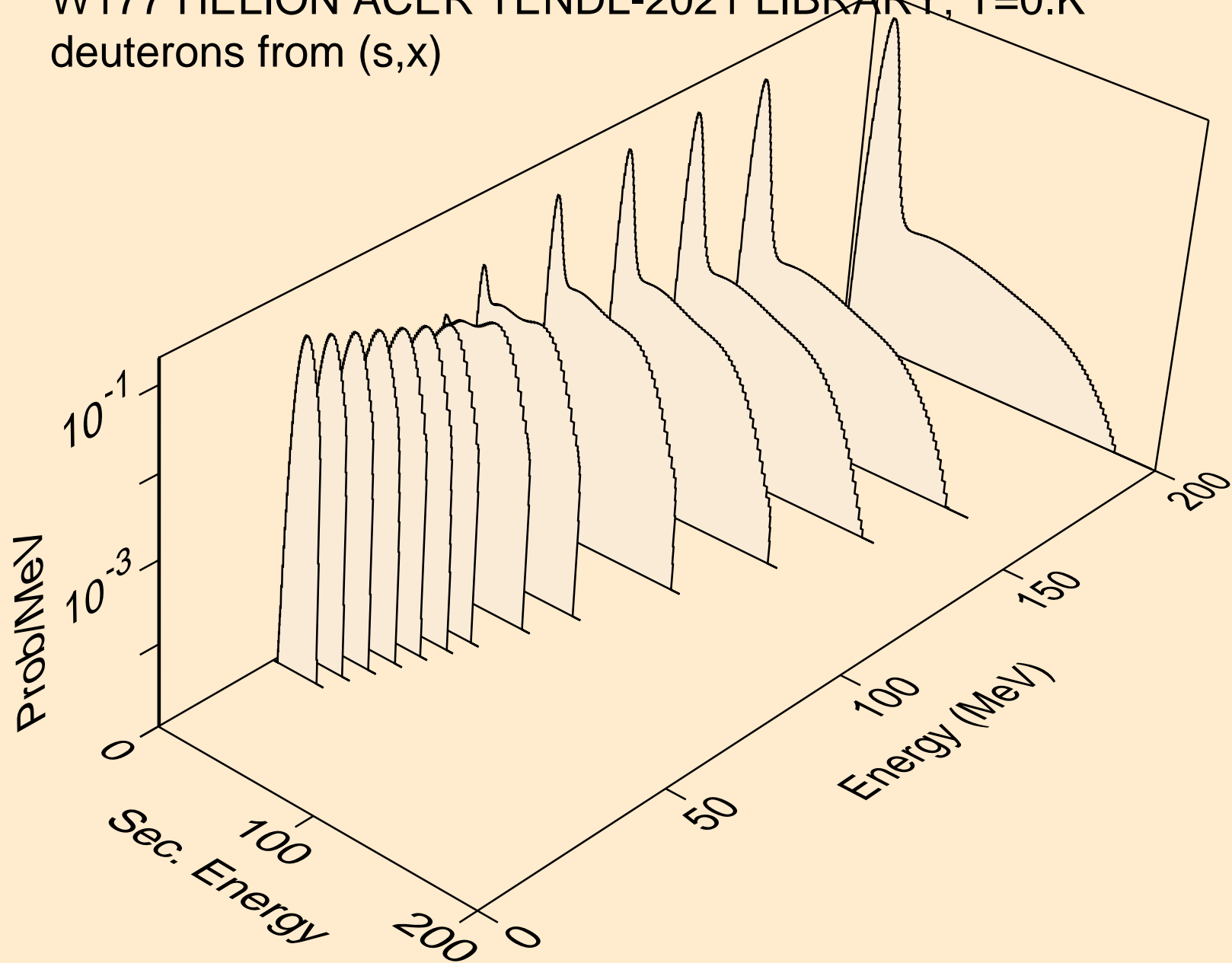



W177 HELION ACER TENDL-2021 LIBRARY; T=0.K  
deuterons from (s,2nd)

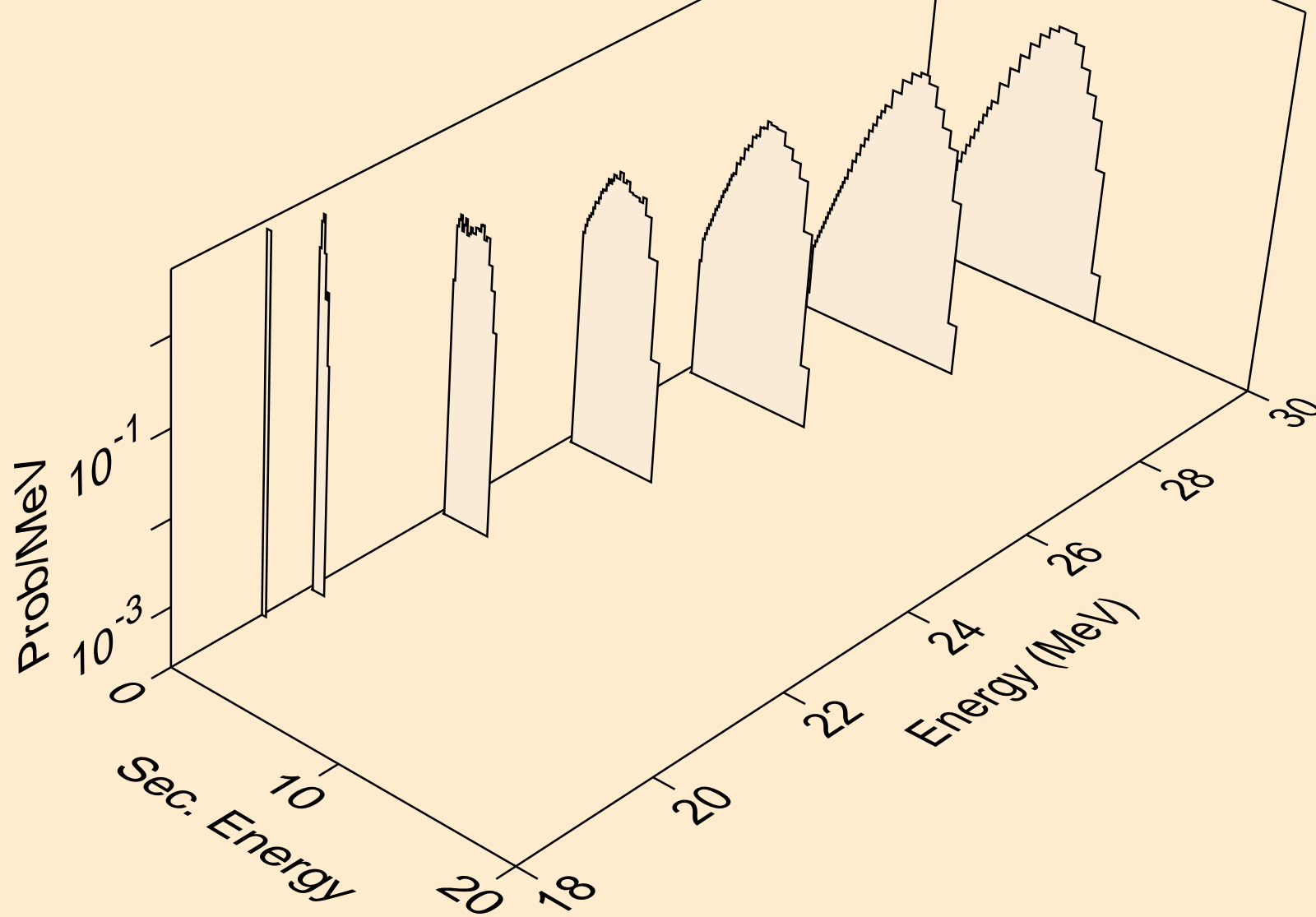

W177 HELION ACER TENDL-2021 LIBRARY; T=0.K  
deuterons from (s,n\*)d

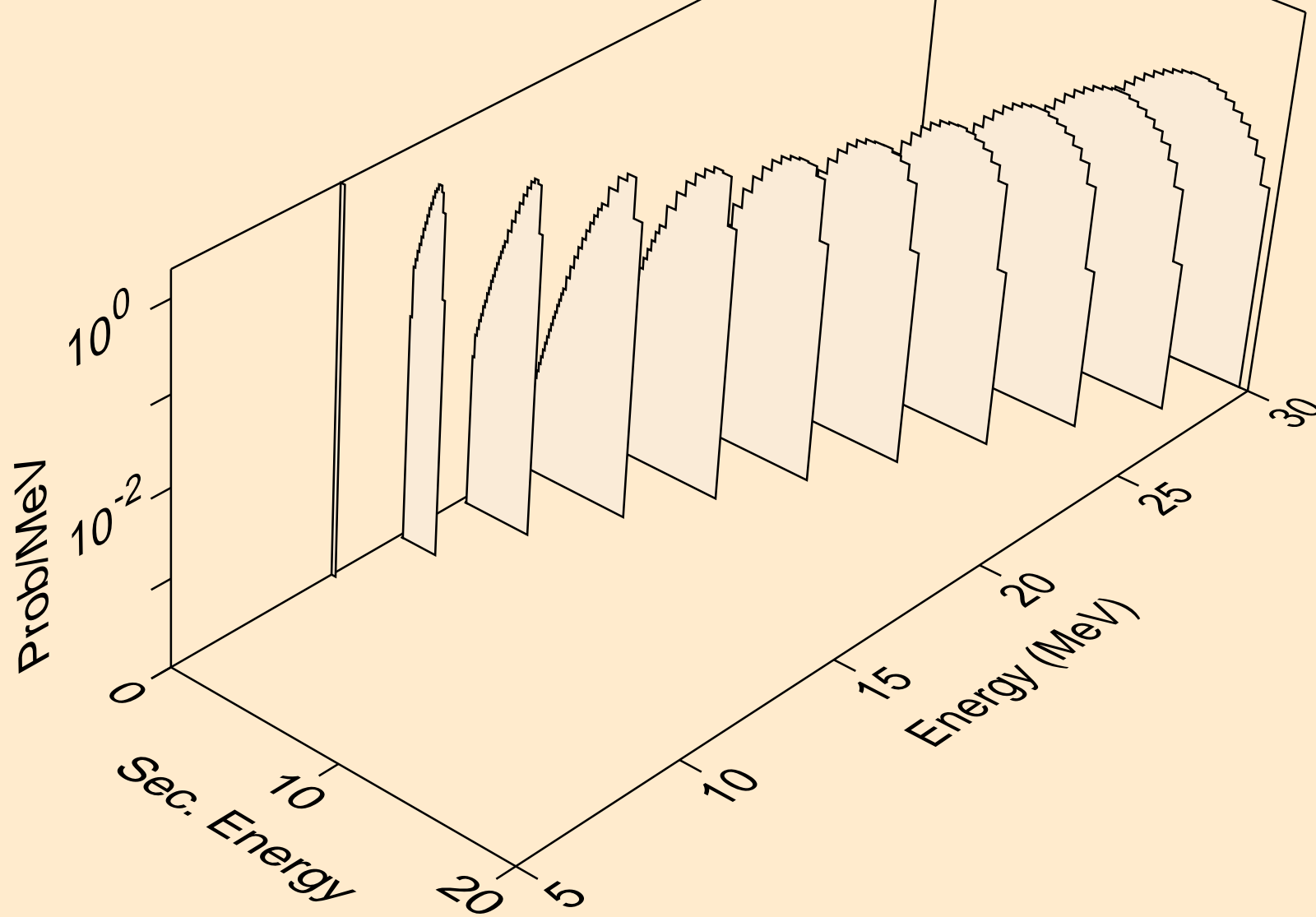

W177 HELION ACER TENDL-2021 LIBRARY; T=0.K  
deuterons from (s,d)

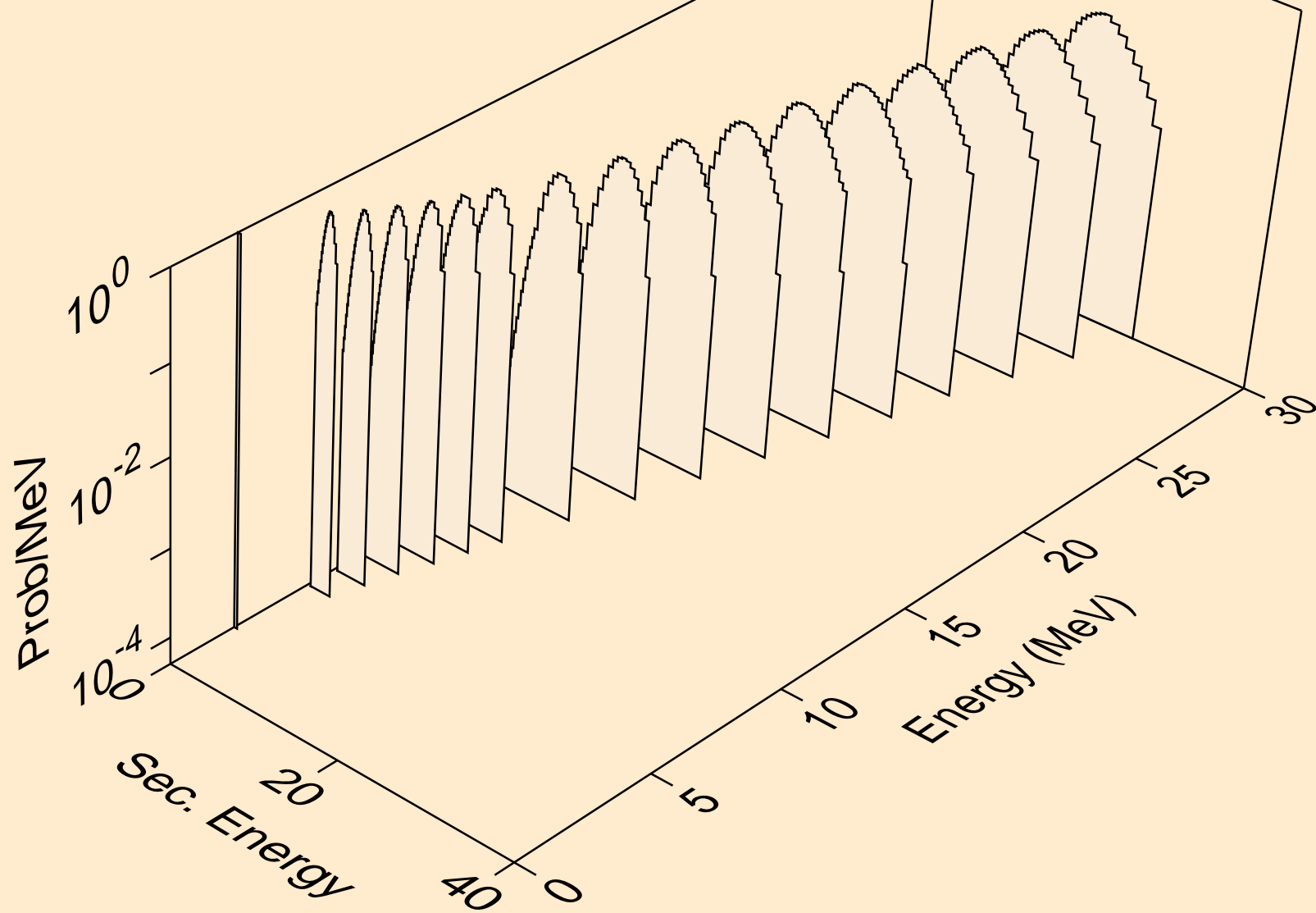

W177 HELION ACER TENDL-2021 LIBRARY; T=0.K  
deuterons from (s,pd)

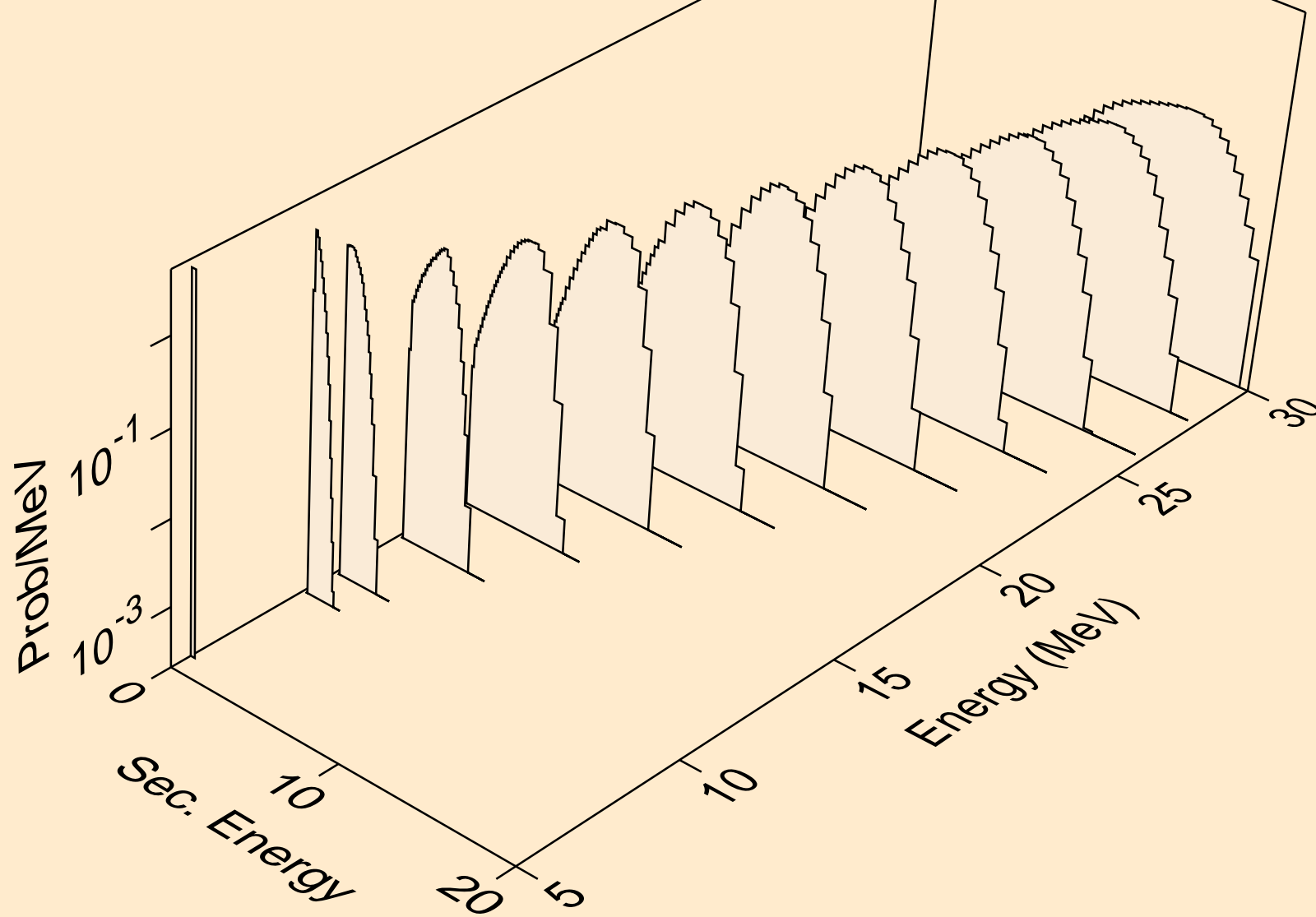

W177 HELION ACER TENDL-2021 LIBRARY; T=0.K  
deuterons from (s,da)

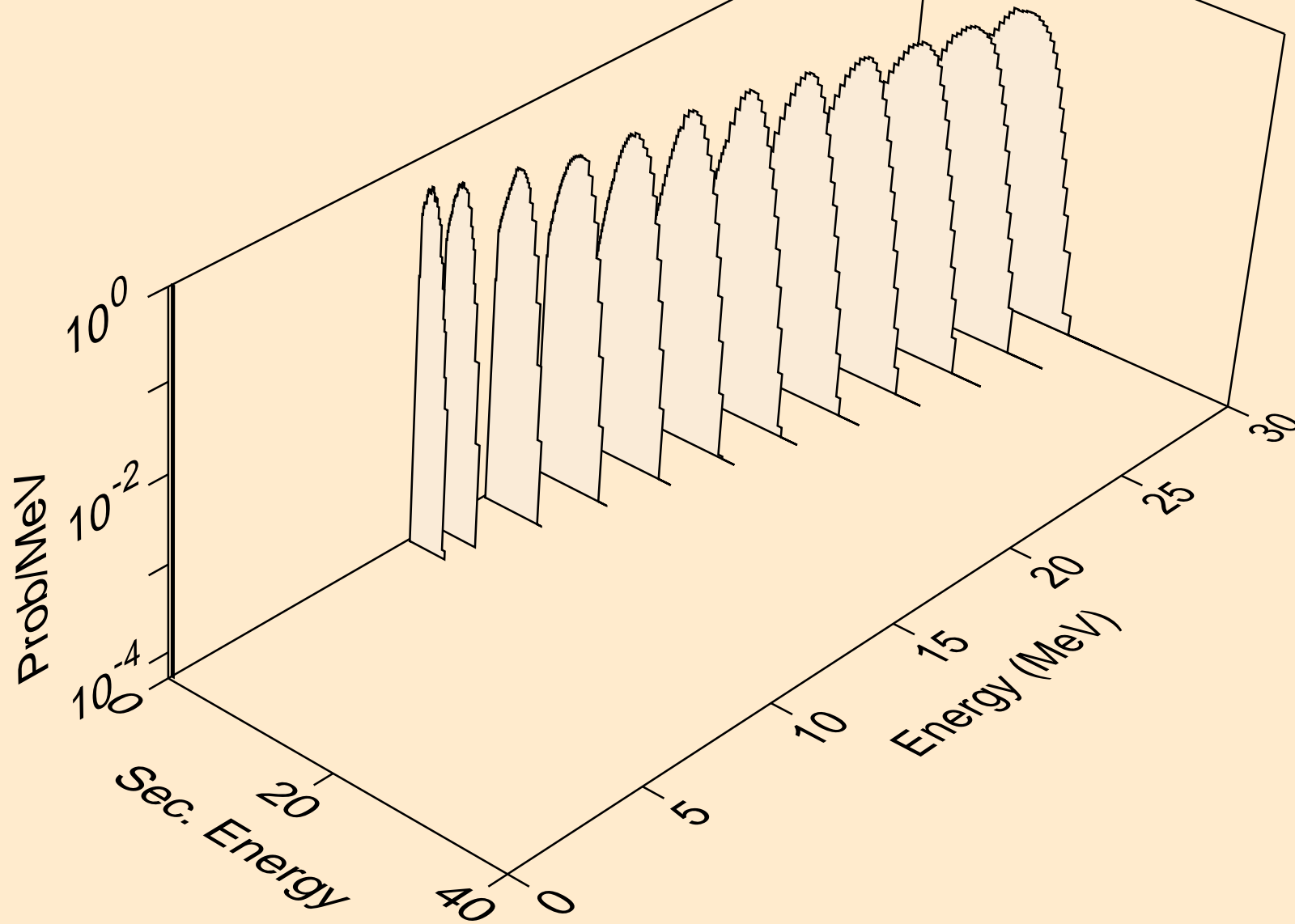

W177 HELION ACER TENDL-2021 LIBRARY; T=0.K  
tritons from (s,x)

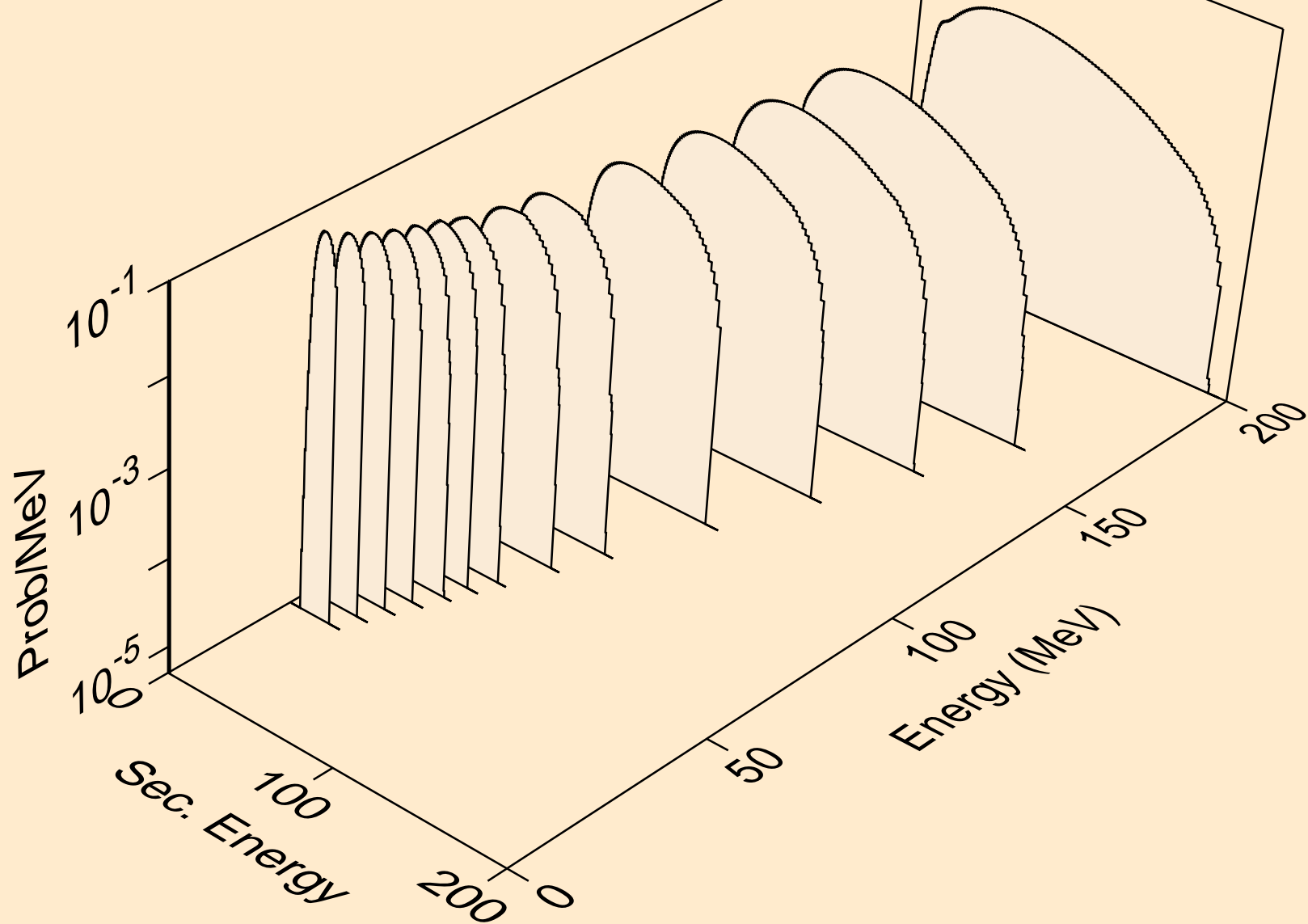

W177 HELION ACER TENDL-2021 LIBRARY; T=0.K  
tritons from (s,n\*)t

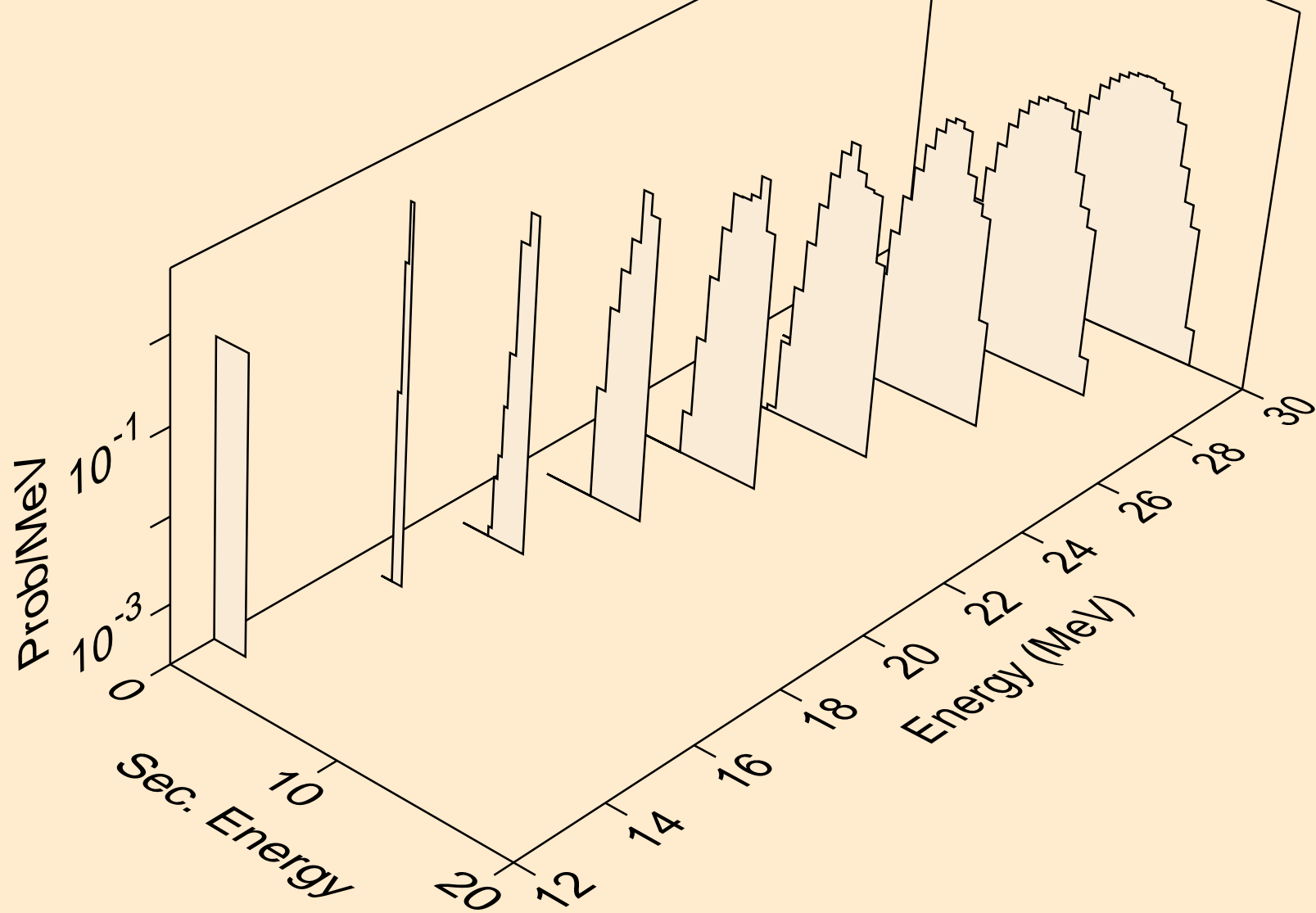

W177 HELION ACER TENDL-2021 LIBRARY; T=0.K  
tritons from (s,t)

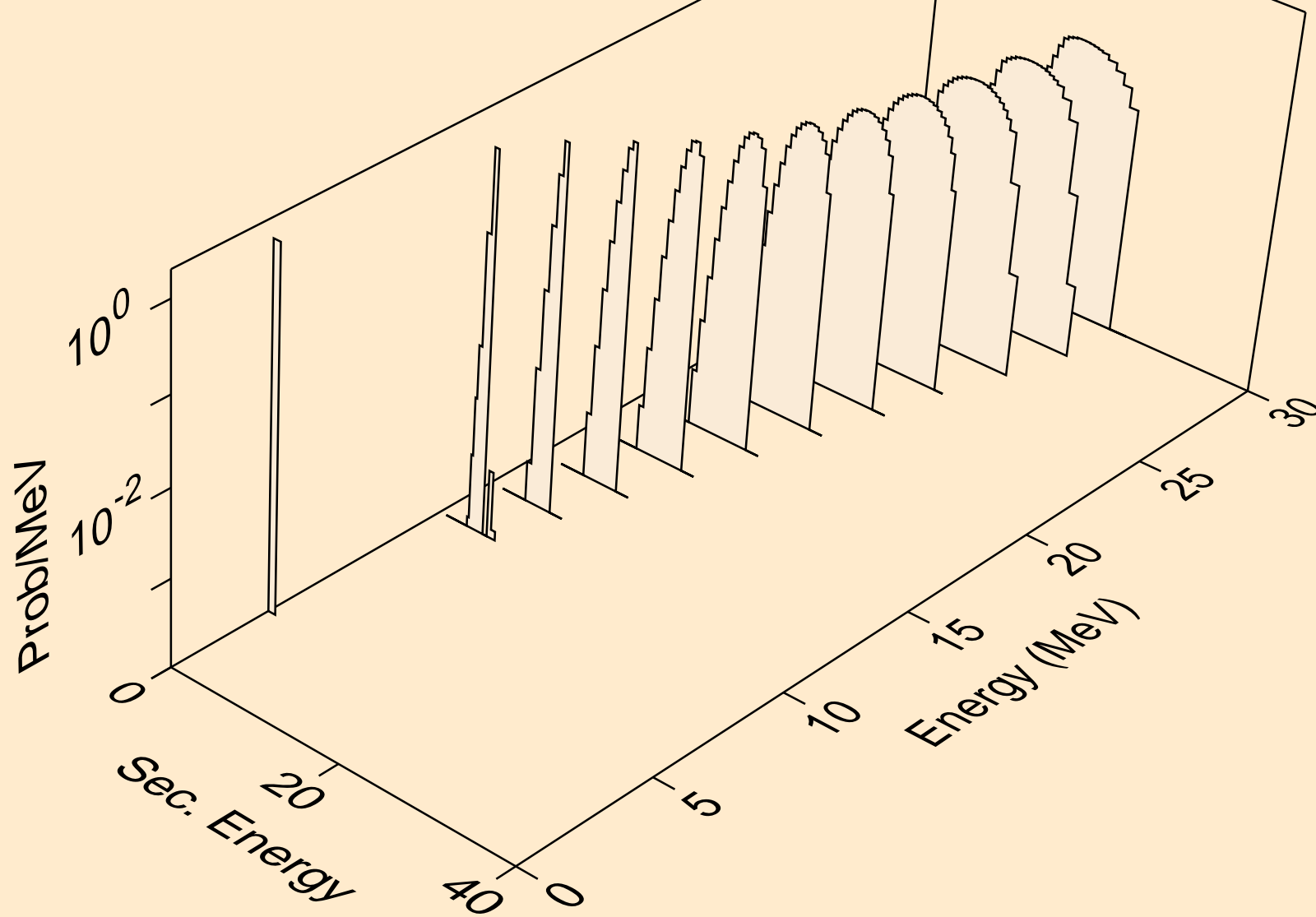



W177 HELION ACER TENDL-2021 LIBRARY; T=0.K  
tritons from (s,pt)

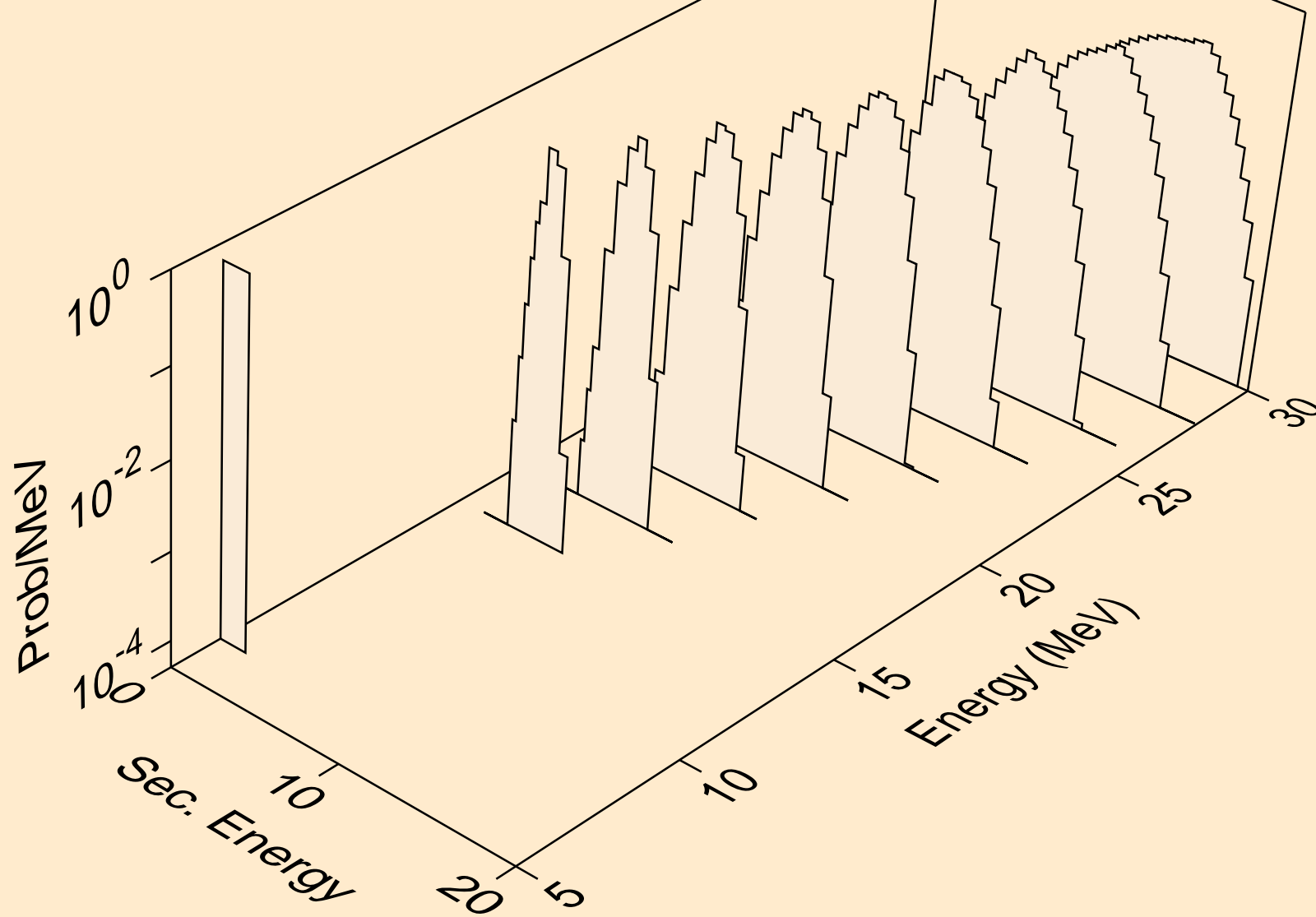

W177 HELION ACER TENDL-2021 LIBRARY; T=0.K  
alphas from (s,x)

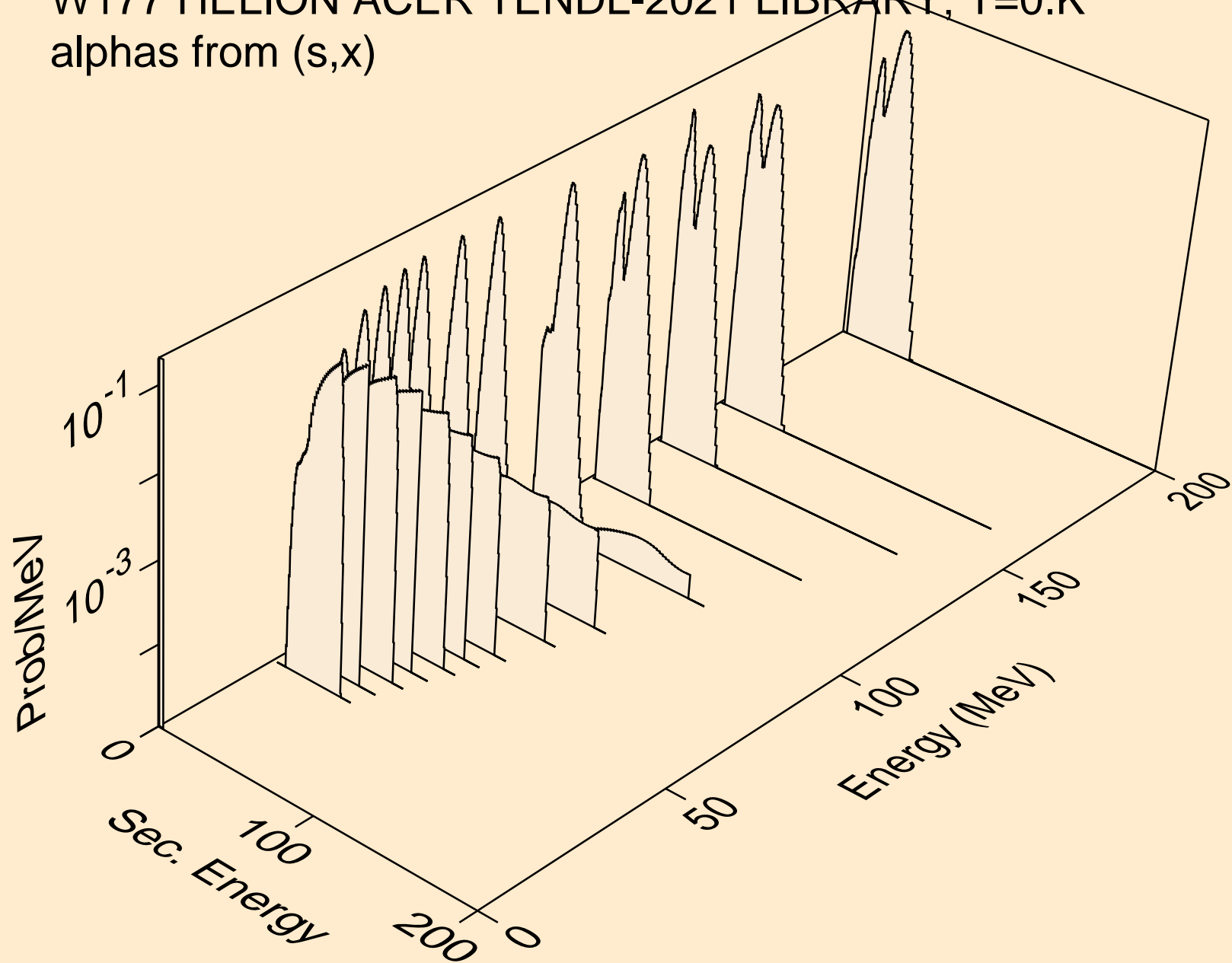

W177 HELION ACER TENDL-2021 LIBRARY; T=0.K  
alphas from (s,n\*)a

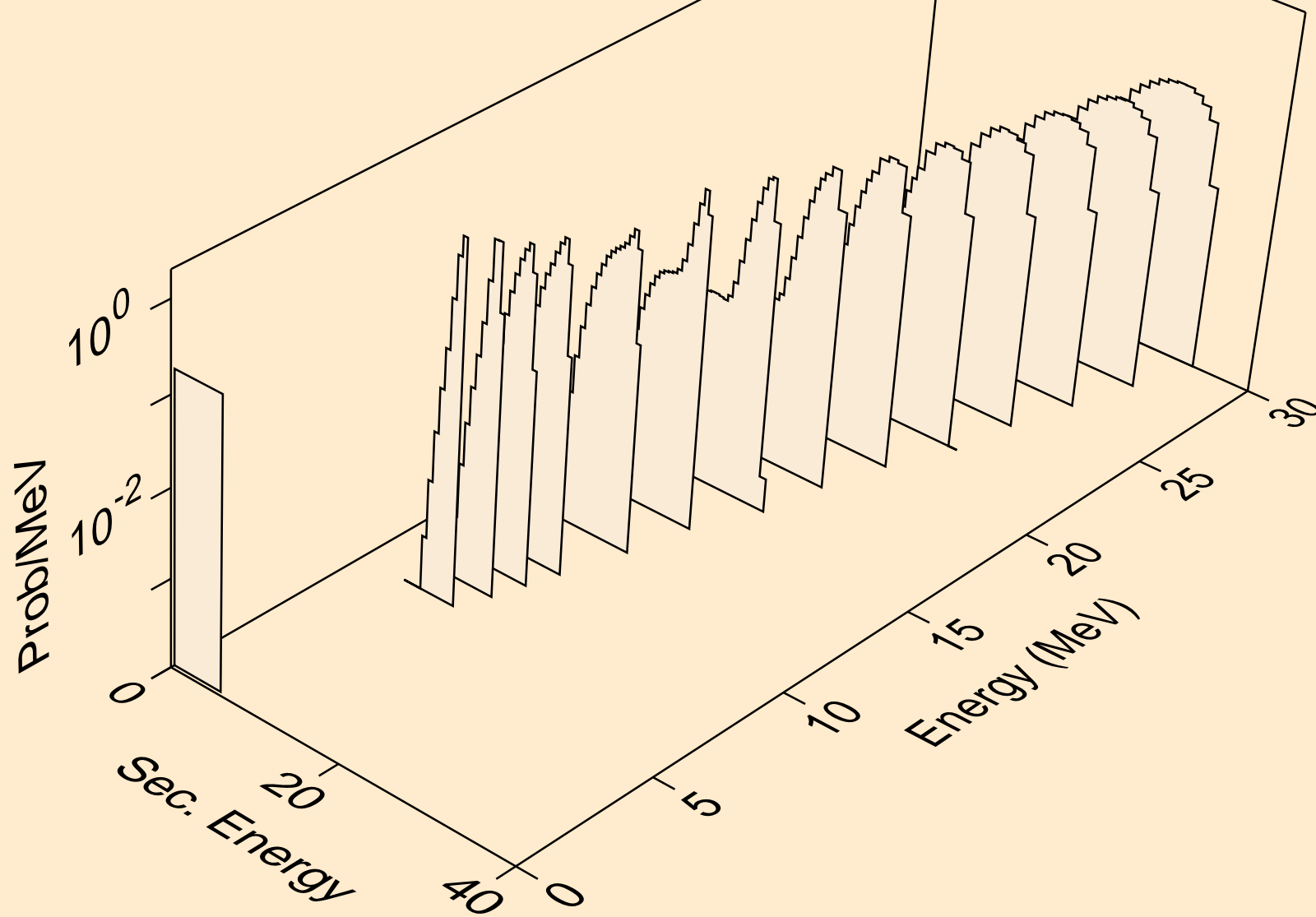

W177 HELION ACER TENDL-2021 LIBRARY; T=0.K  
alphas from (s,2n)a

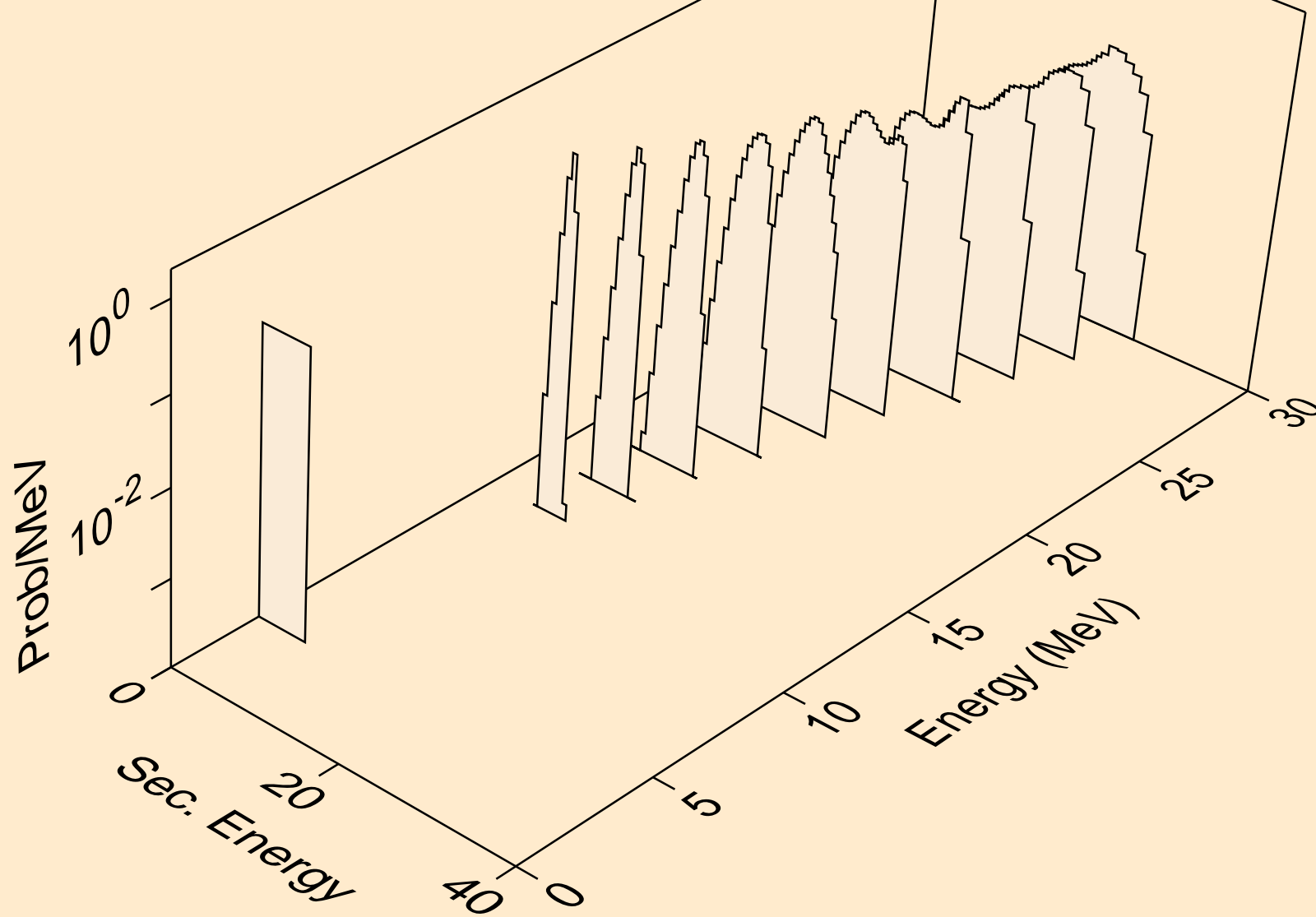

W177 HELION ACER TENDL-2021 LIBRARY; T=0.K  
alphas from (s,3n)a

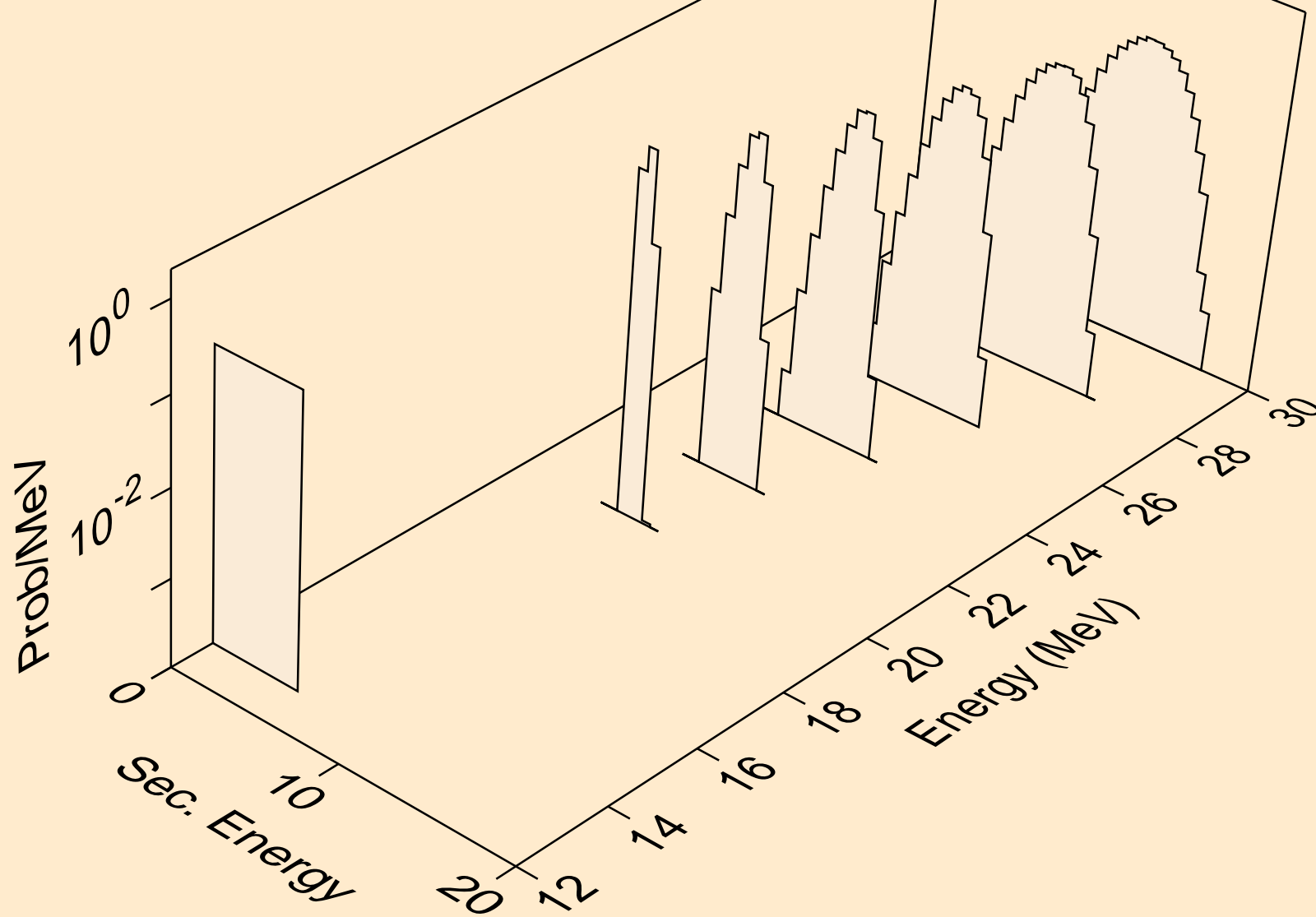

W177 HELION ACER TENDL-2021 LIBRARY; T=0.K  
alphas from (s,n\*)2a

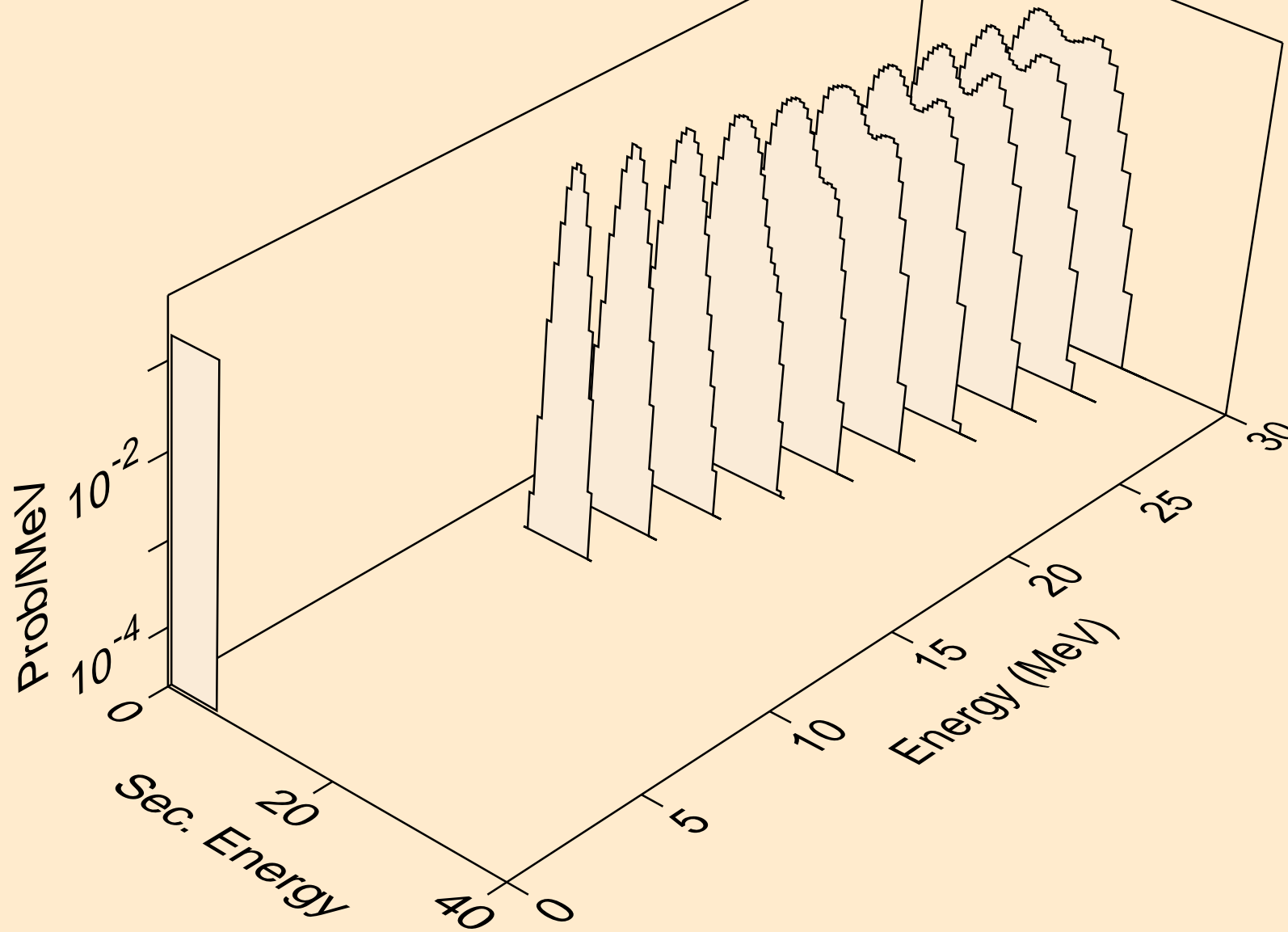

W177 HELION ACER TENDL-2021 LIBRARY; T=0.K  
alphas from (s,npa)

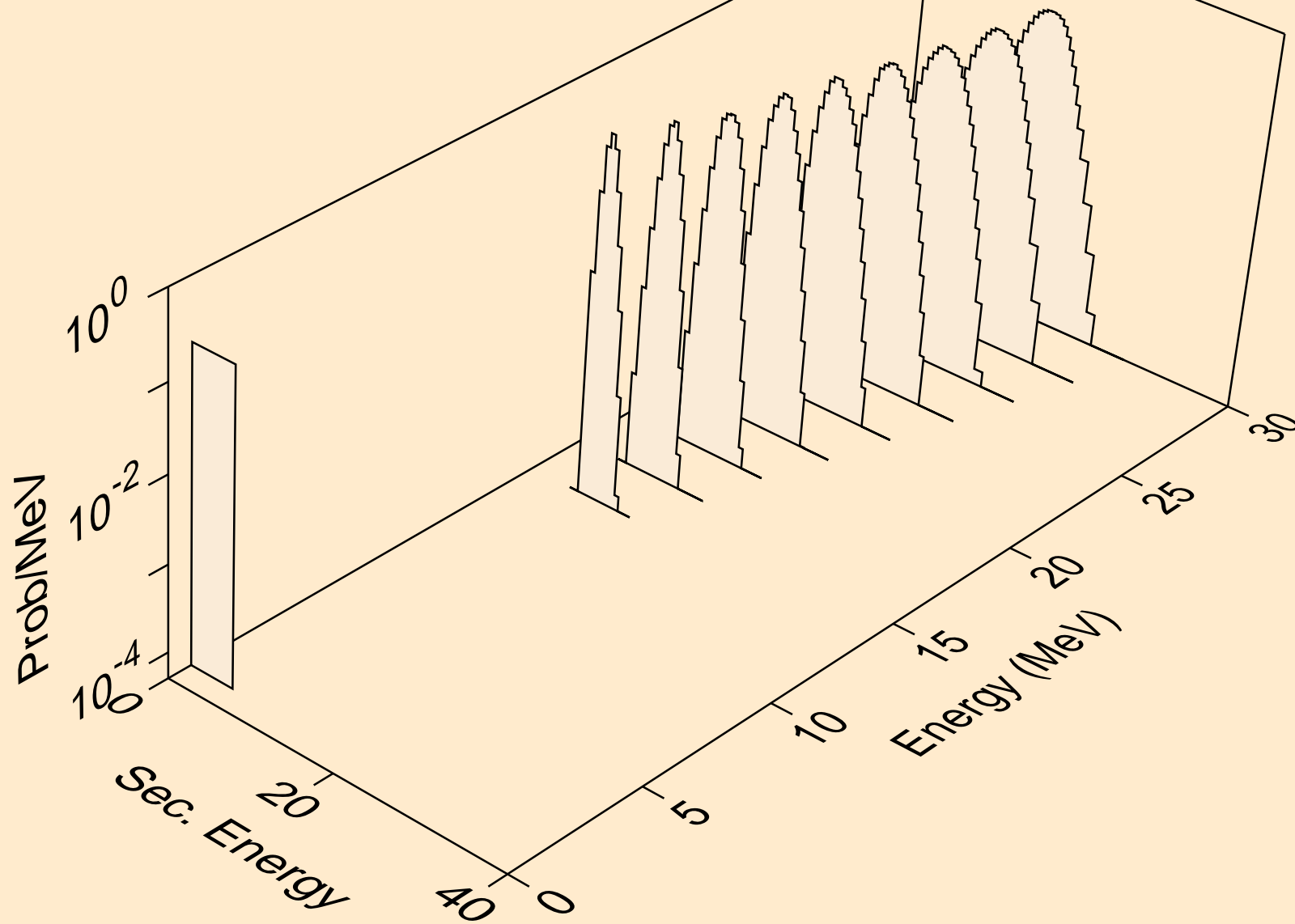

W177 HELION ACER TENDL-2021 LIBRARY; T=0.K  
alphas from (s,a)

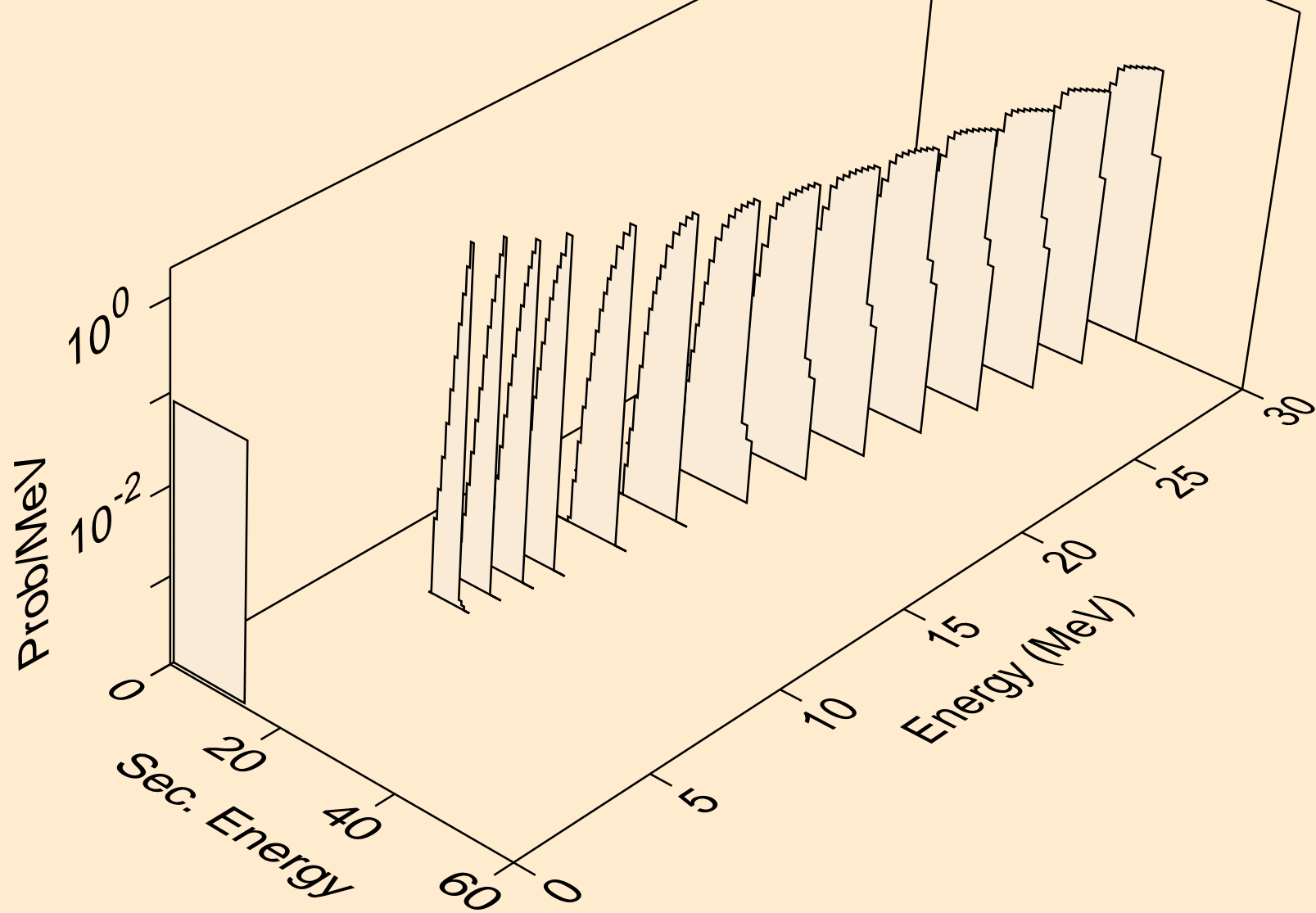



W177 HELION ACER TENDL-2021 LIBRARY; T=0.K  
alphas from (s,2a)

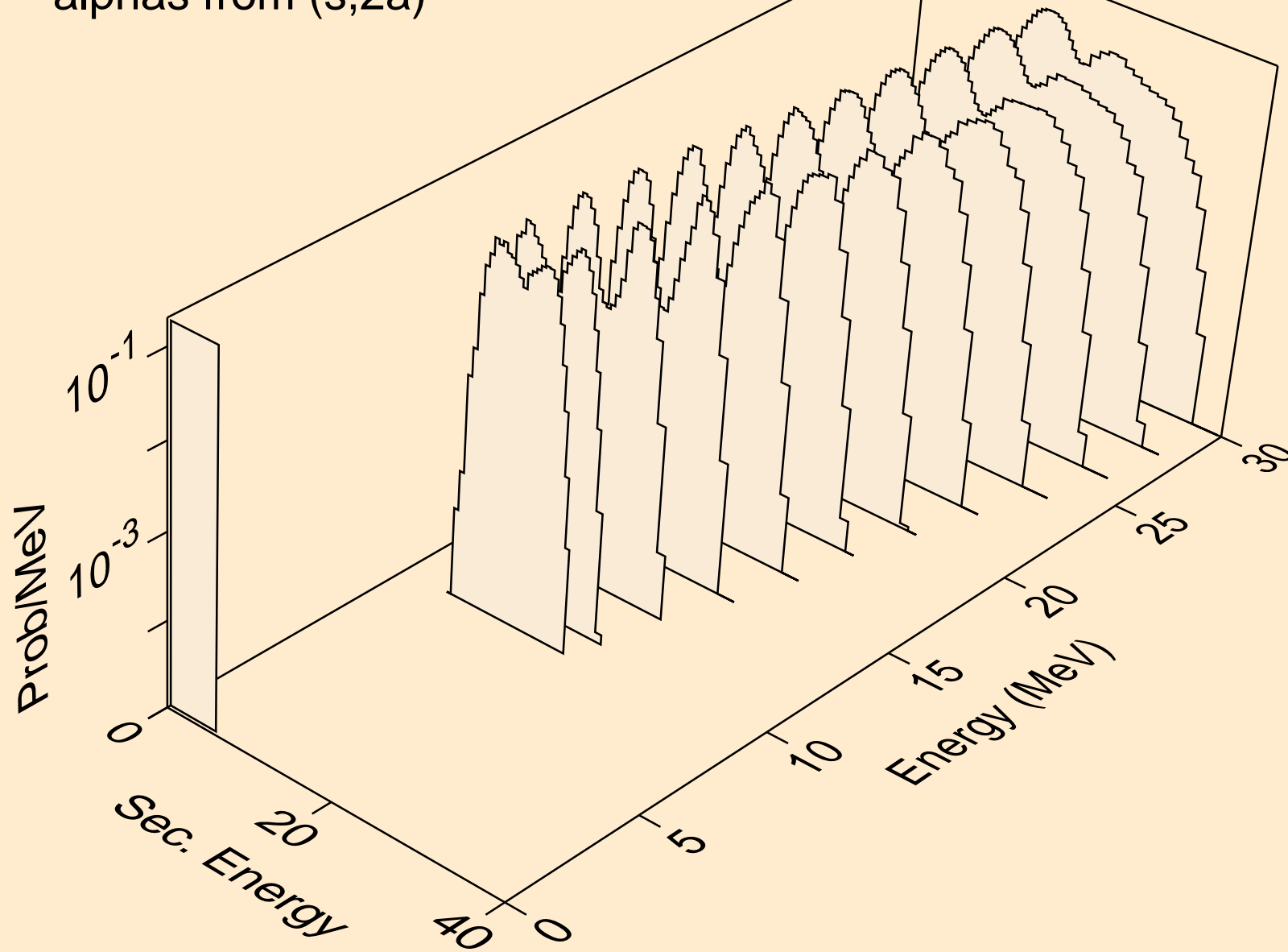

W177 HELION ACER TENDL-2021 LIBRARY; T=0.K  
alphas from (s,pa)

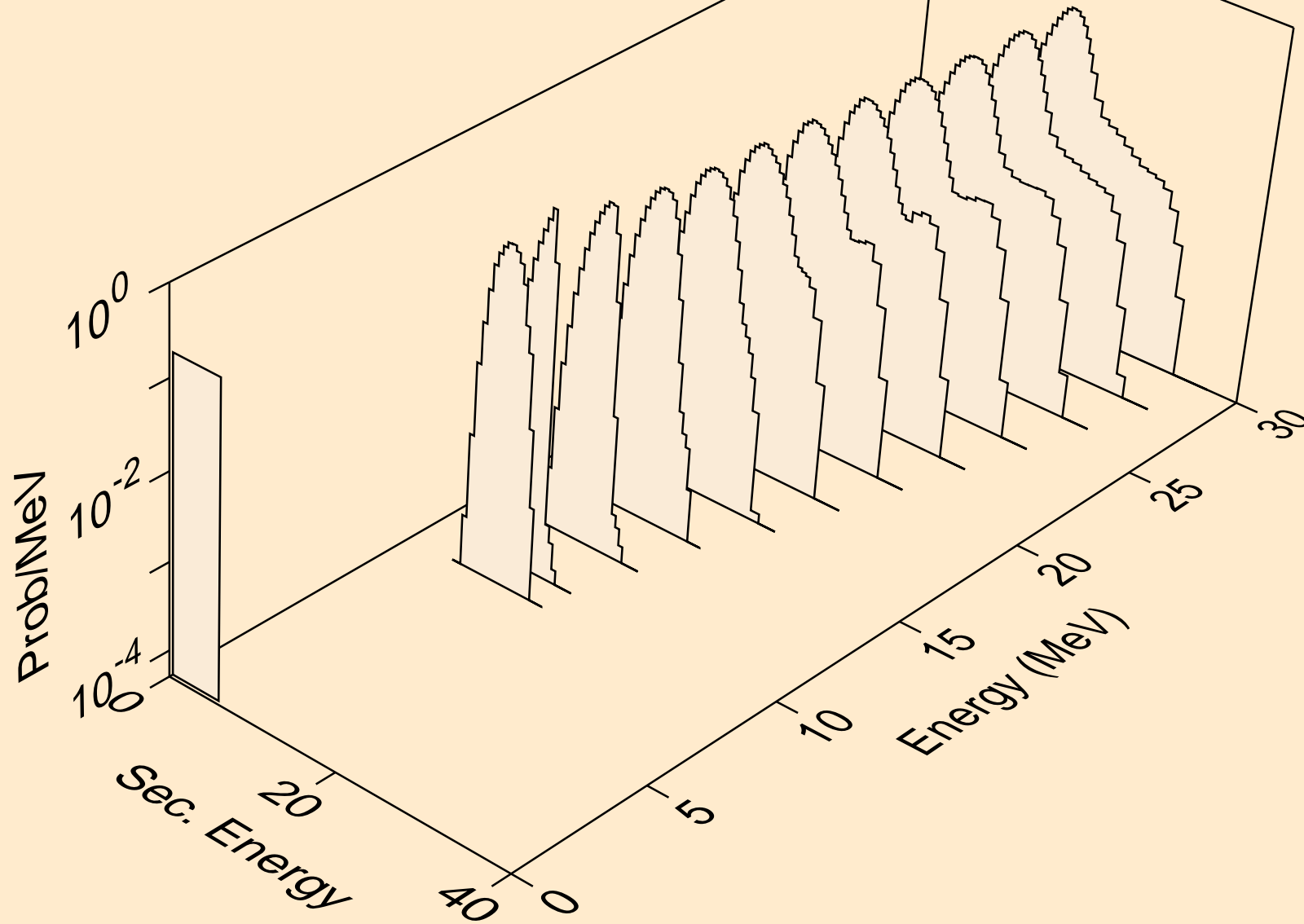

W177 HELION ACER TENDL-2021 LIBRARY; T=0.K  
alphas from (s,da)

