

YB181 HELION ACER TENDL-2021 LIBRARY; T=0.K  
Principal cross sections

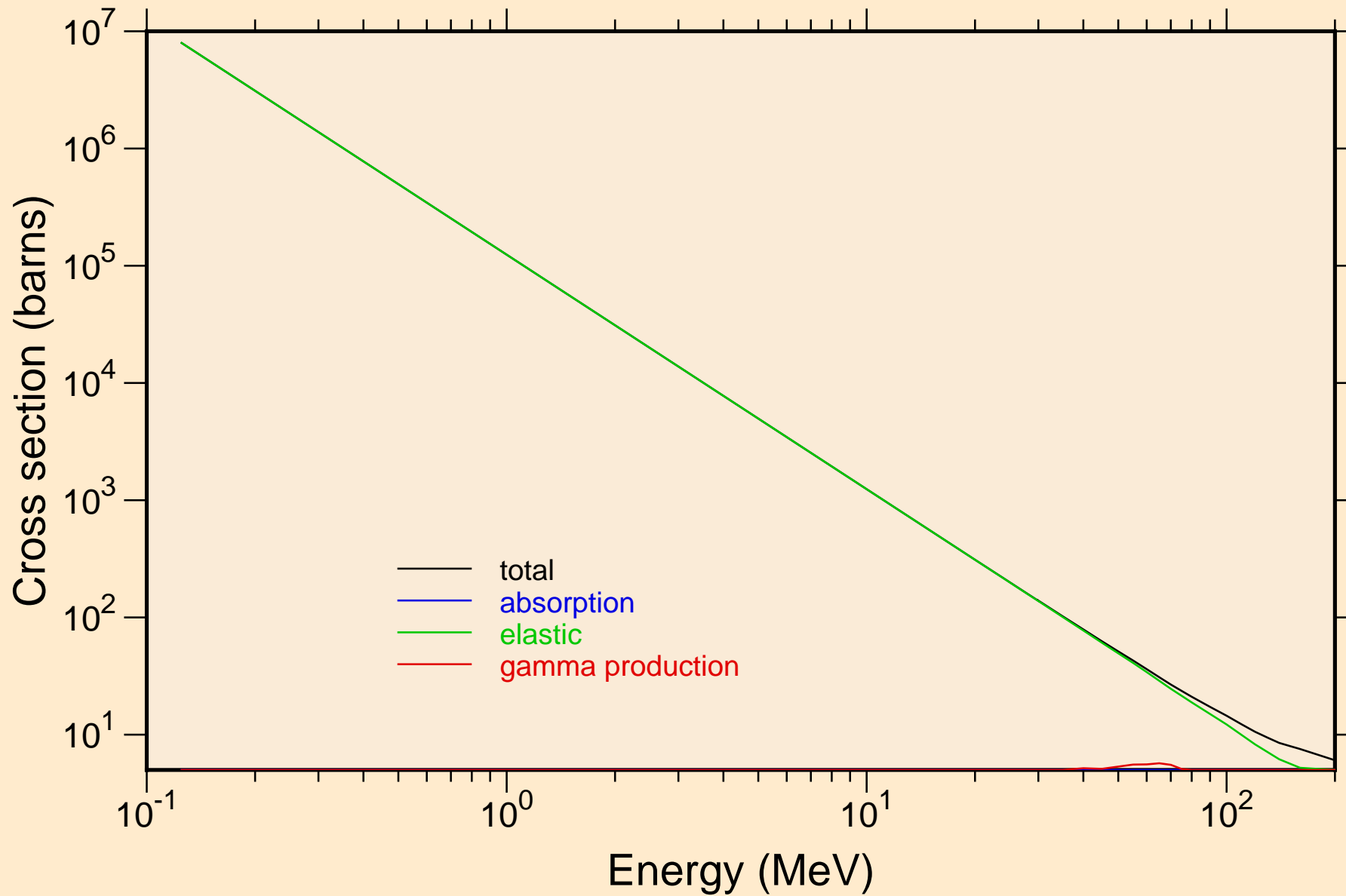

YB181 HELION ACER TENDL-2021 LIBRARY; T=0.K

Heating

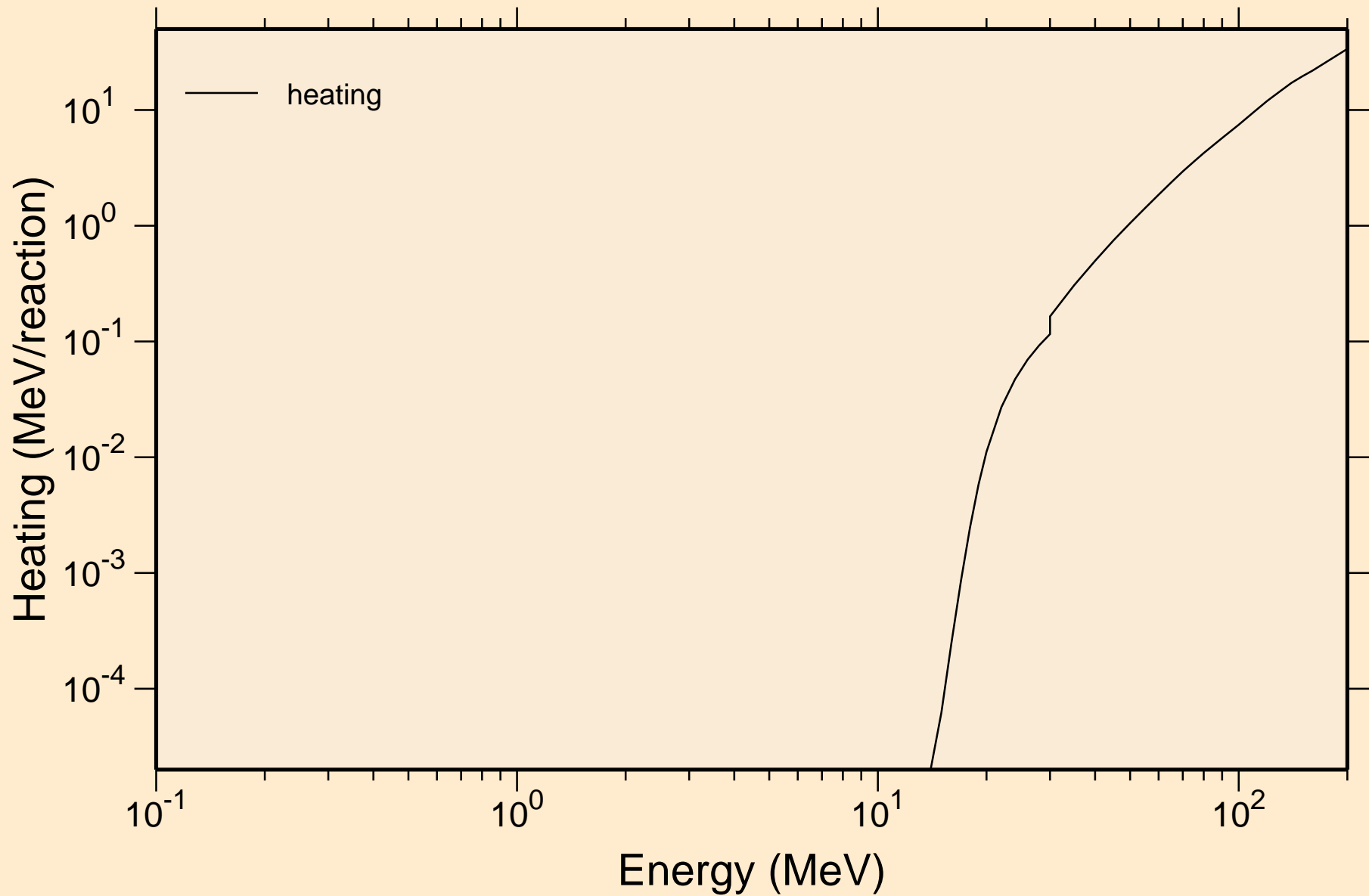

# YB181 HELION ACER TENDL-2021 LIBRARY; T=0.K

## Principal cross sections

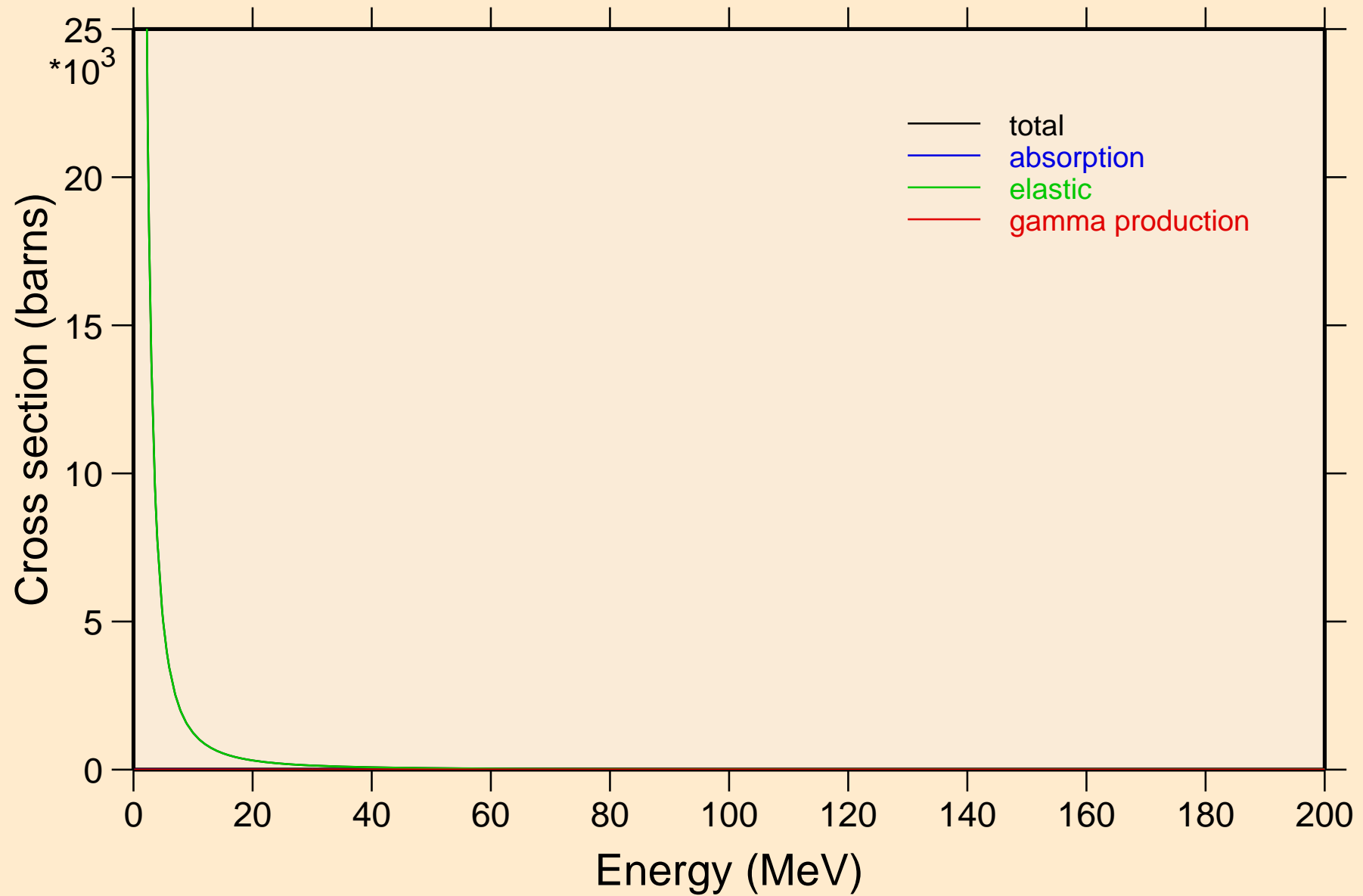

YB181 HELION ACER TENDL-2021 LIBRARY; T=0.K

Heating

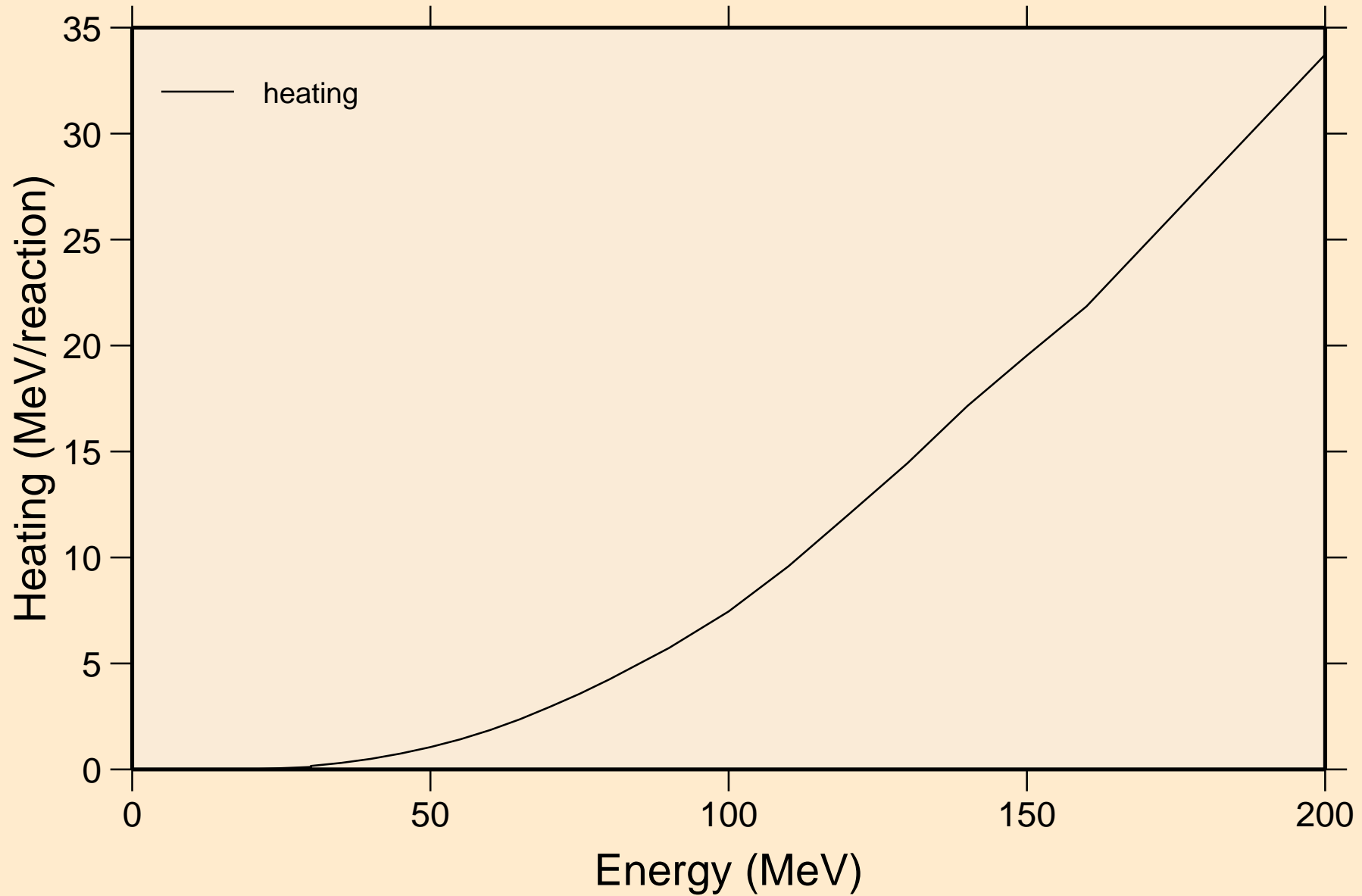

YB181 HELION ACER TENDL-2021 LIBRARY; T=0.K  
Threshold reactions

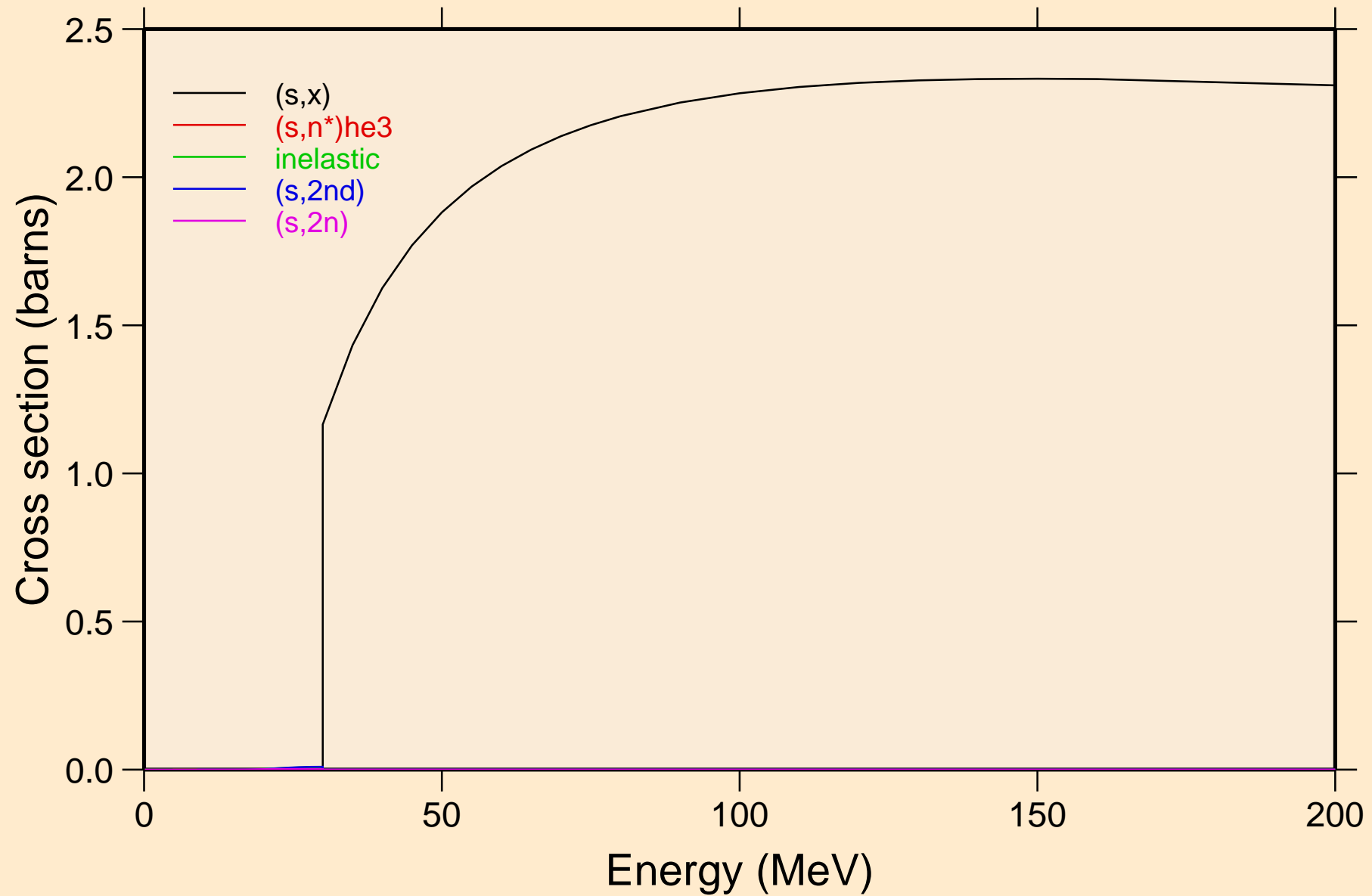

YB181 HELION ACER TENDL-2021 LIBRARY; T=0.K  
Threshold reactions

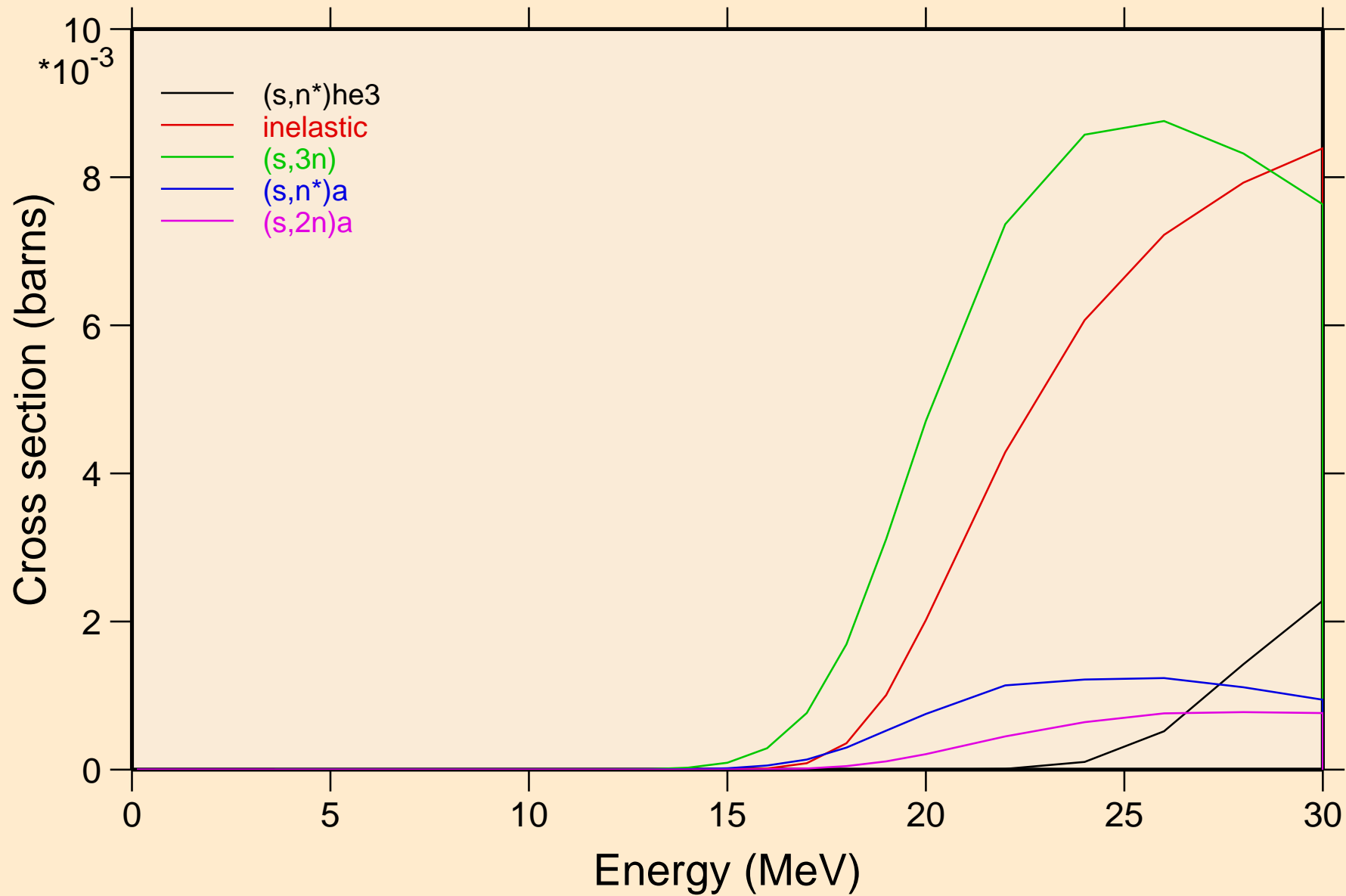

YB181 HELION ACER TENDL-2021 LIBRARY; T=0.K  
Threshold reactions

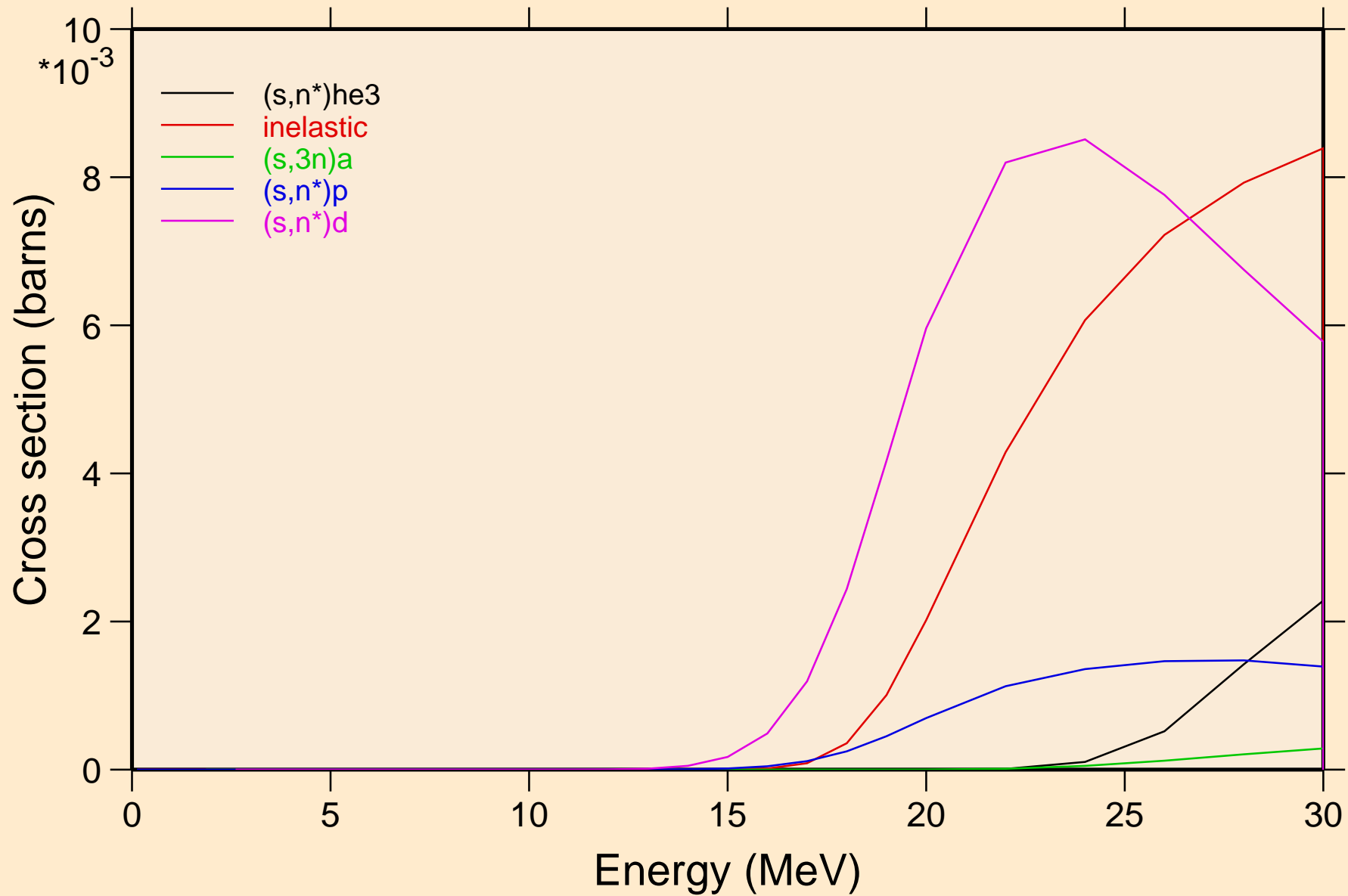

YB181 HELION ACER TENDL-2021 LIBRARY; T=0.K  
Threshold reactions

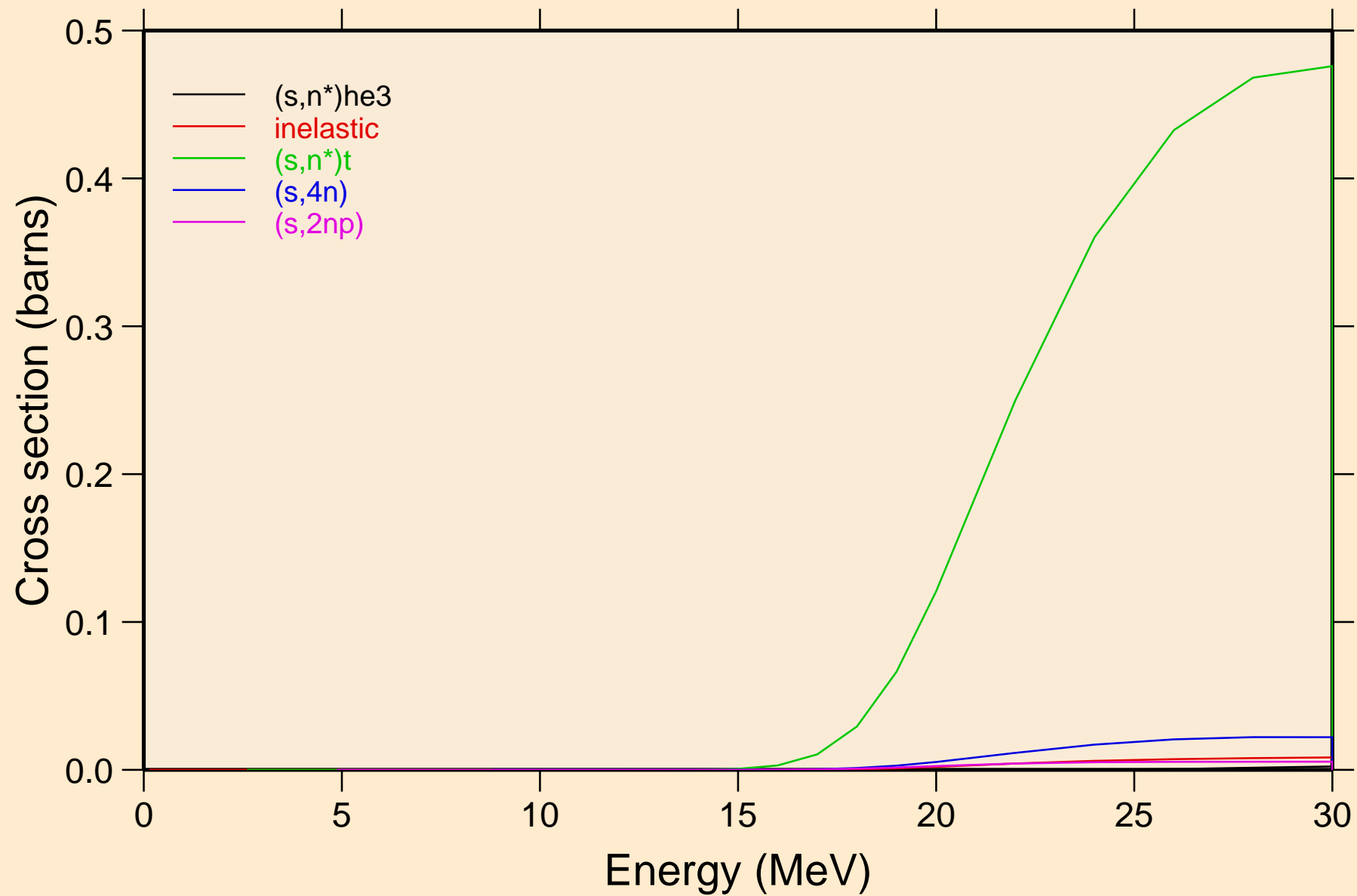



YB181 HELION ACER TENDL-2021 LIBRARY; T=0.K  
Threshold reactions

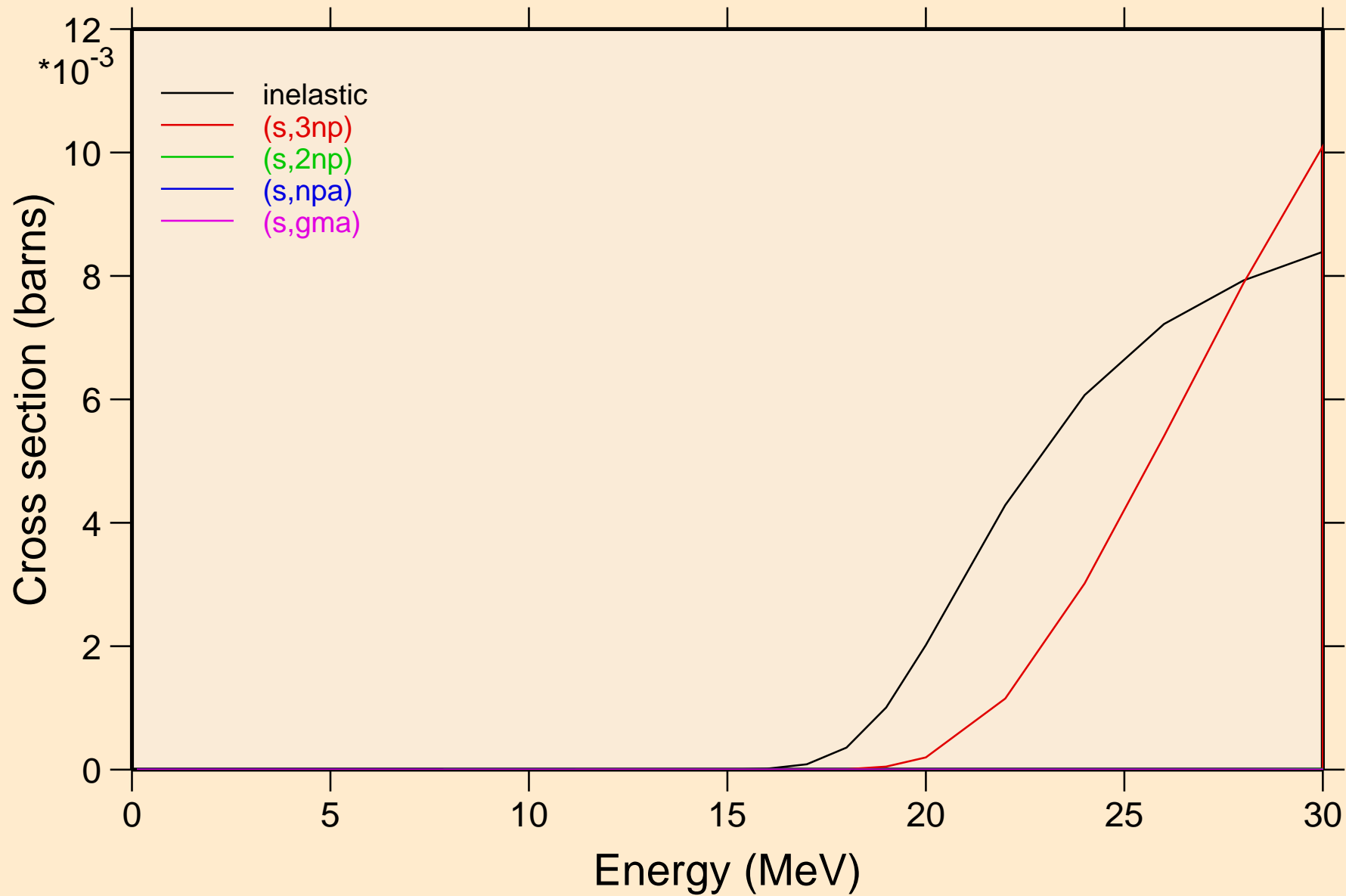

YB181 HELION ACER TENDL-2021 LIBRARY; T=0.K  
Threshold reactions

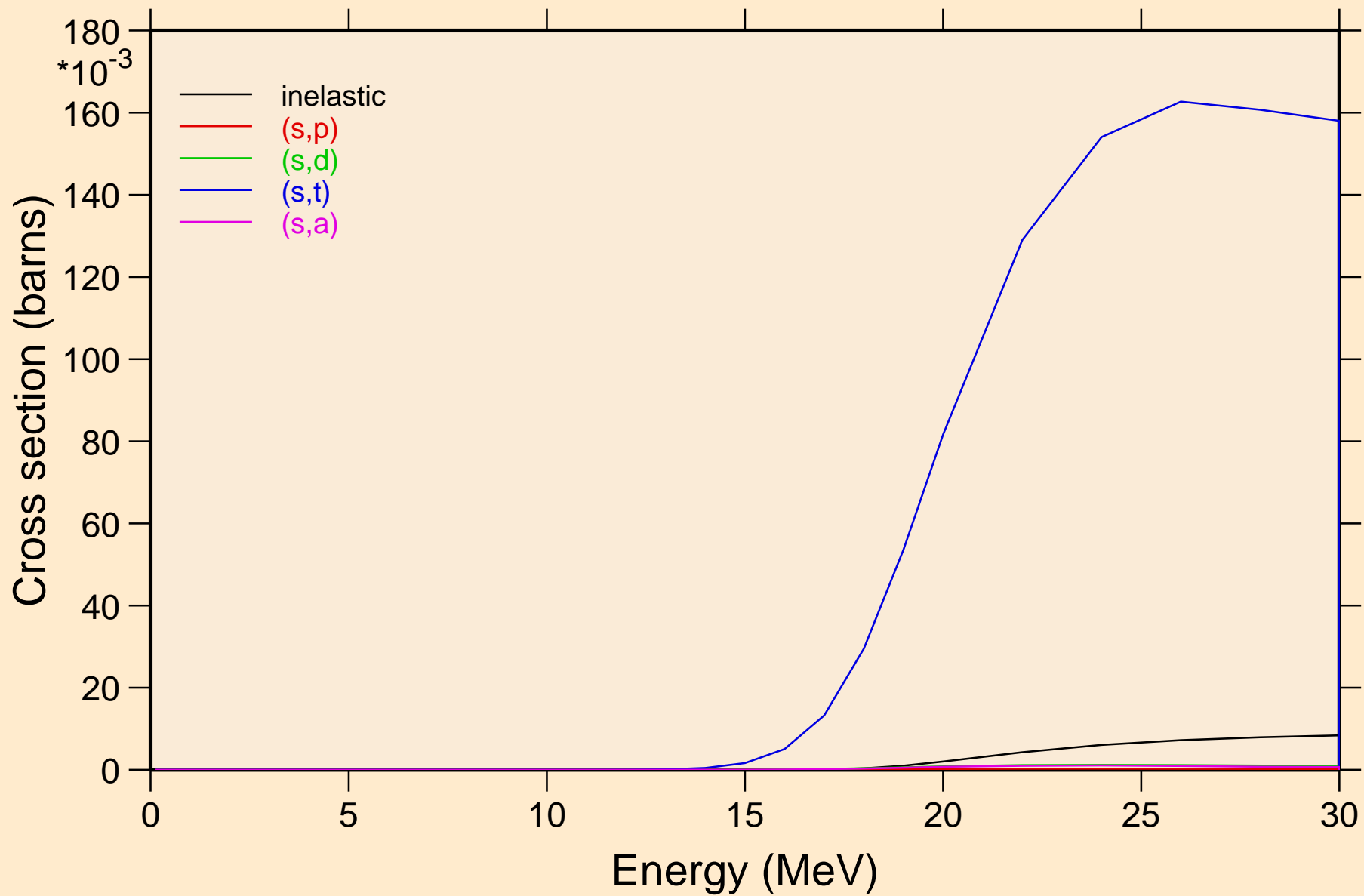

YB181 HELION ACER TENDL-2021 LIBRARY; T=0.K  
Threshold reactions

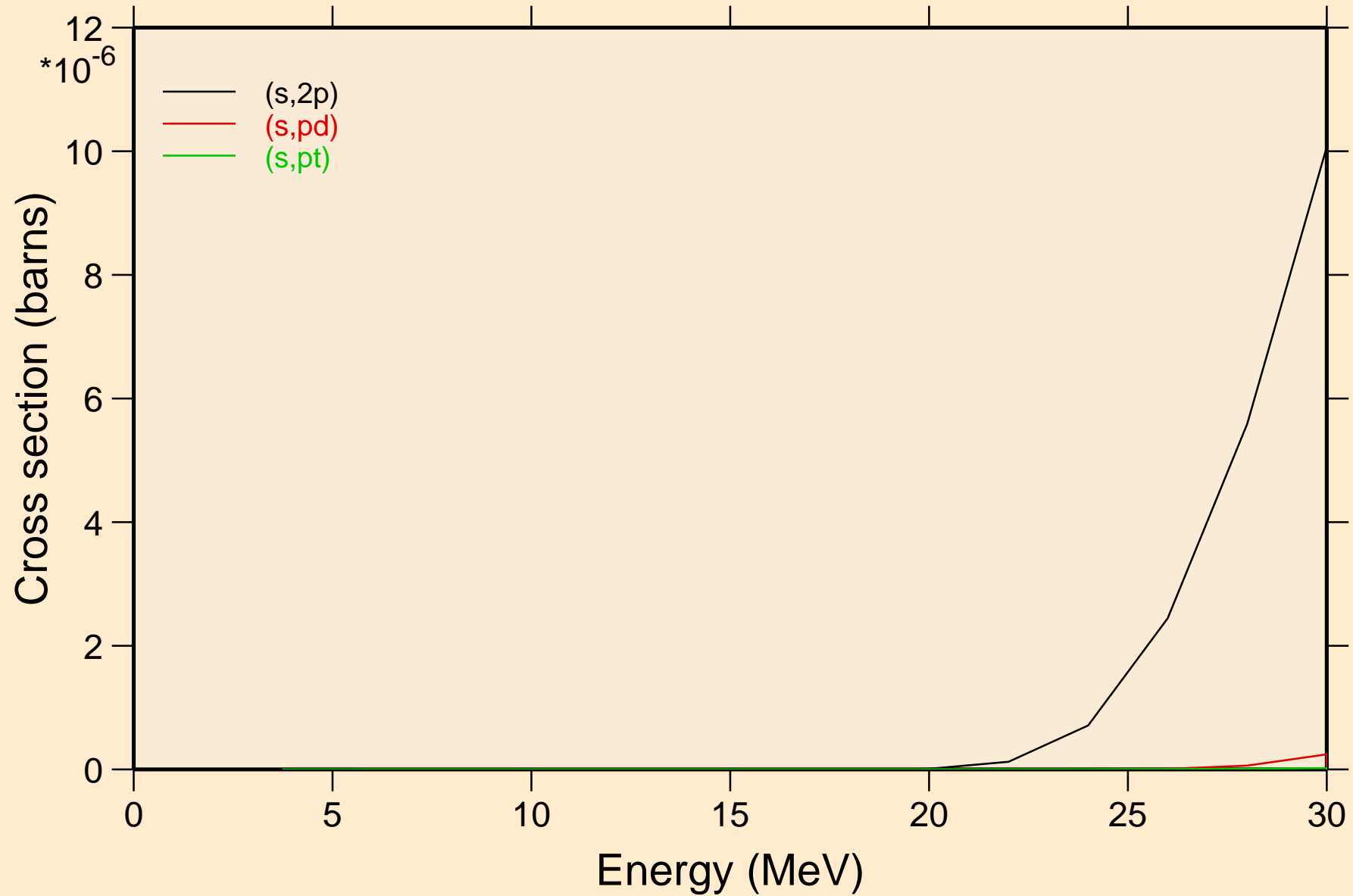

YB181 HELION ACER TENDL-2021 LIBRARY; T=0.K  
angular distribution for elastic

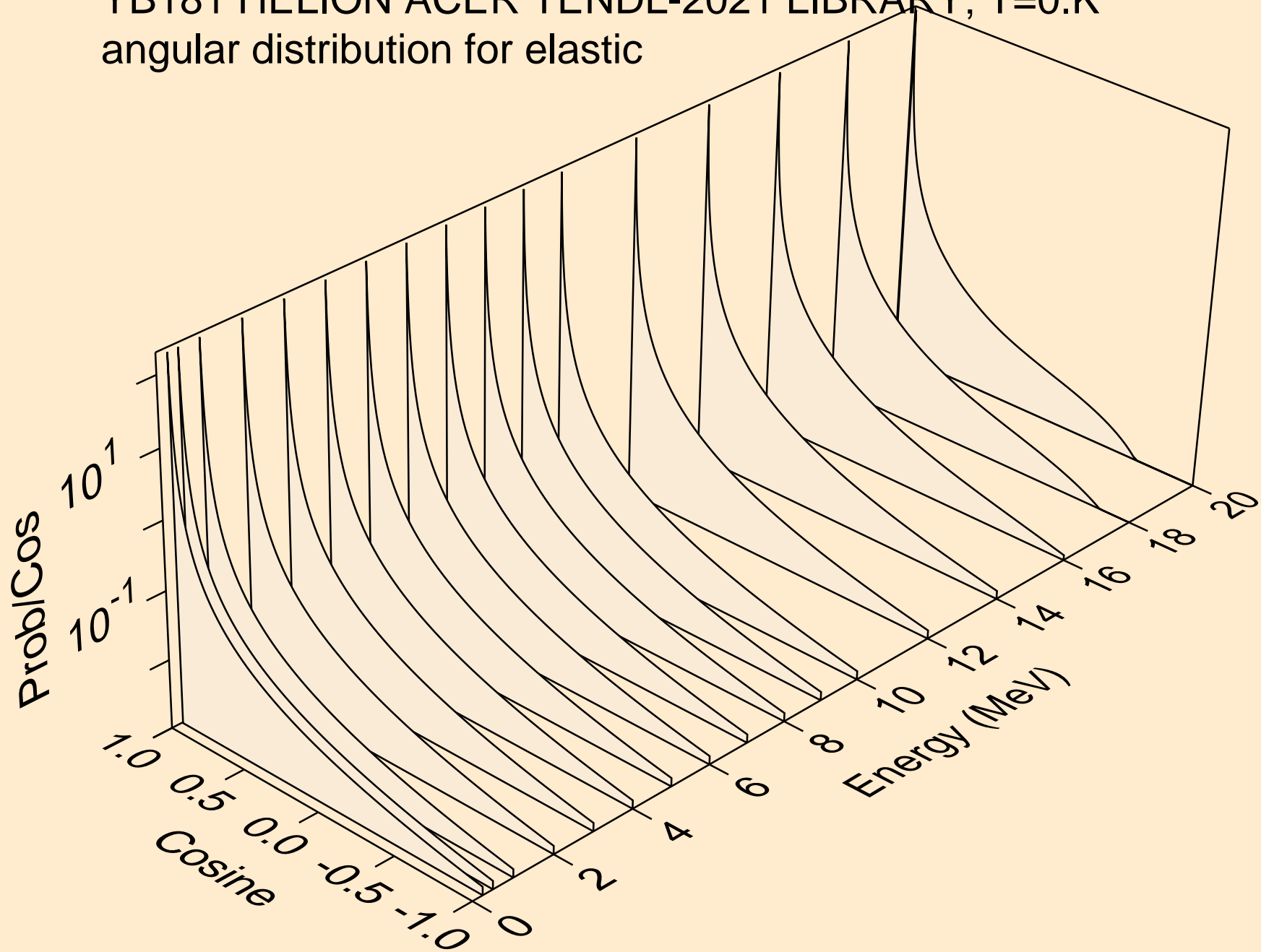

YB181 HELION ACER TENDL-2021 LIBRARY; T=0.K  
angular distribution for elastic

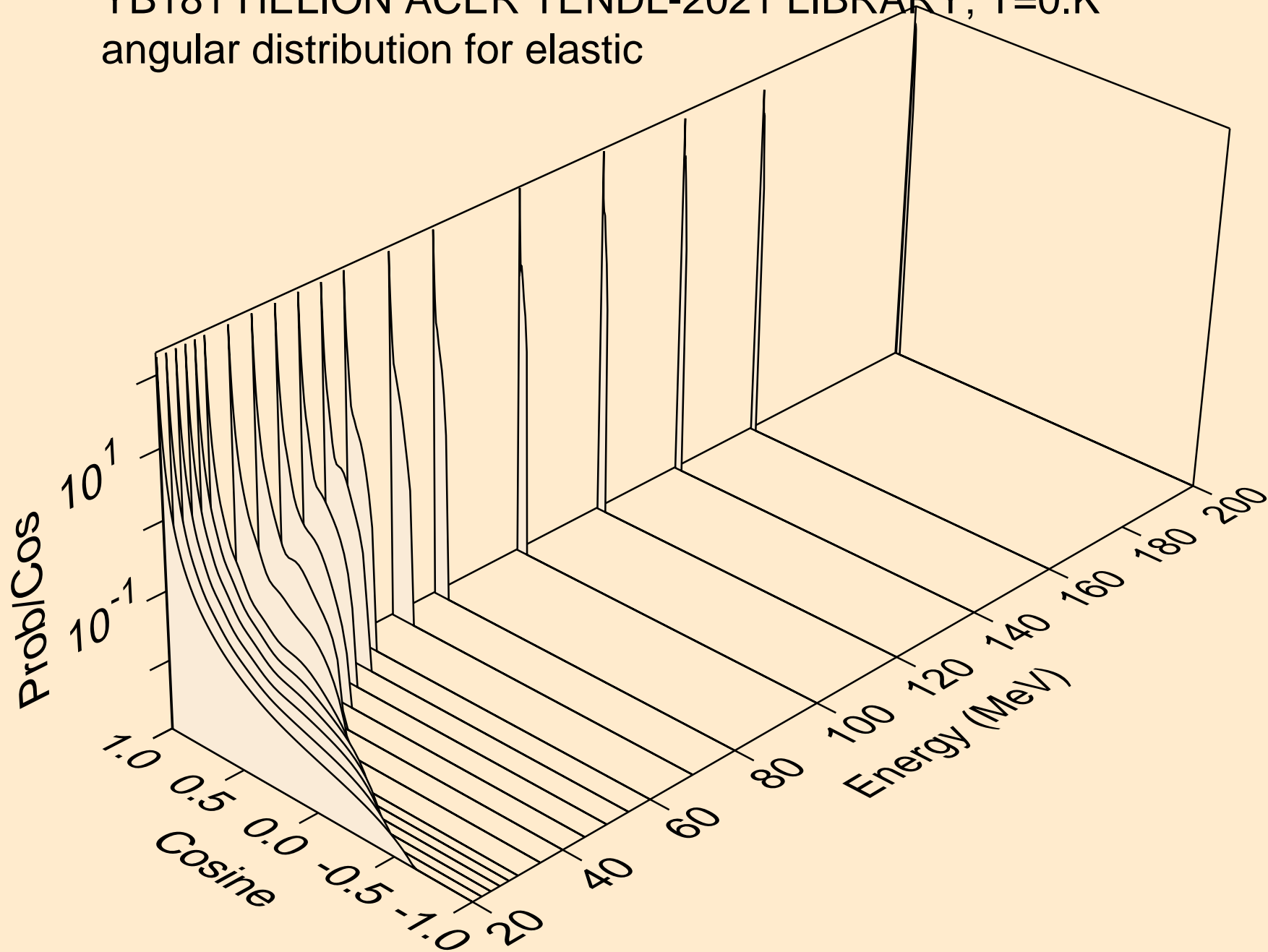

YB181 HELION ACER TENDL-2021 LIBRARY; T=0.K  
He-3 emission for (s,x)

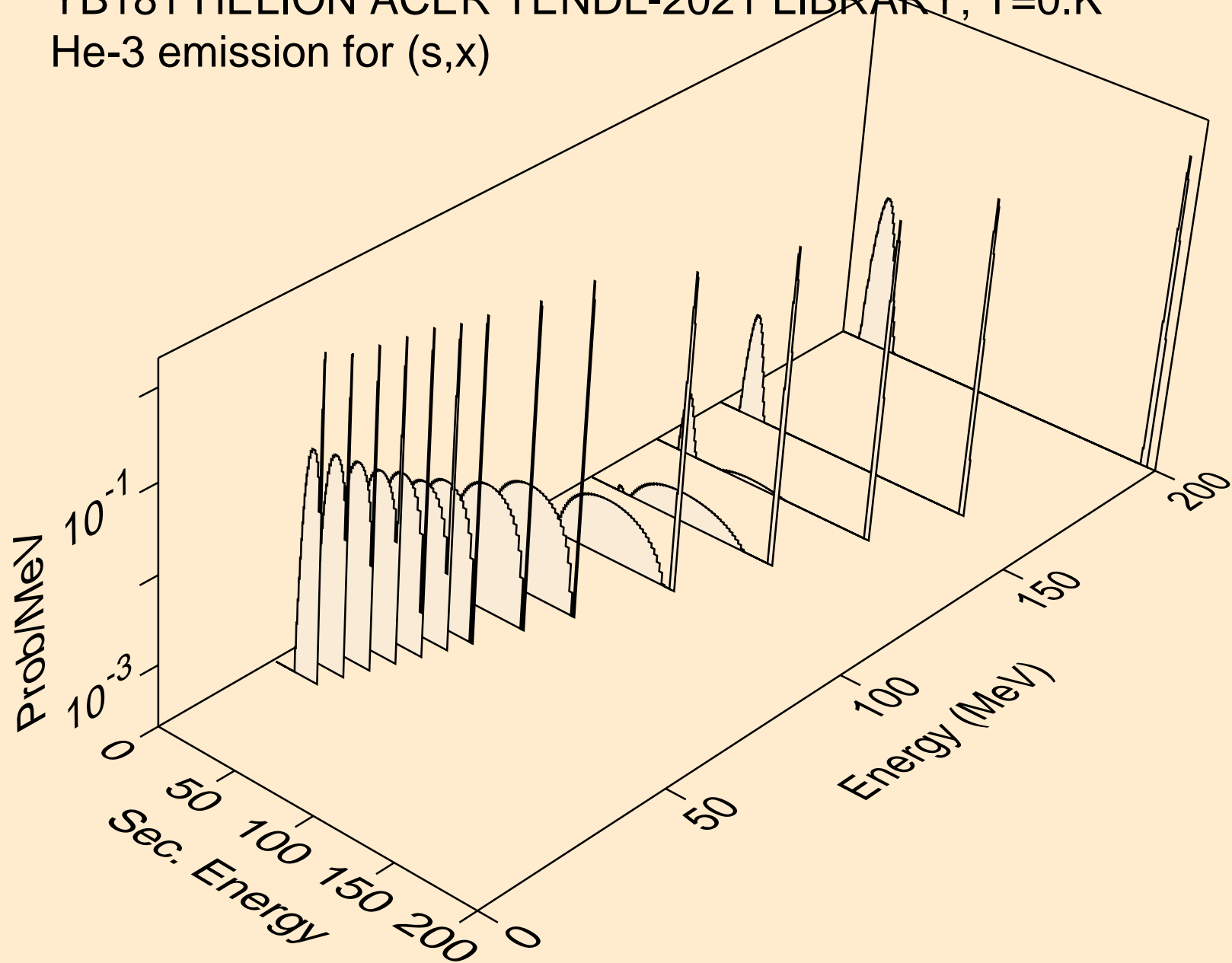

YB181 HELION ACER TENDL-2021 LIBRARY; T=0.K  
He-3 emission for (s,n\*)he3

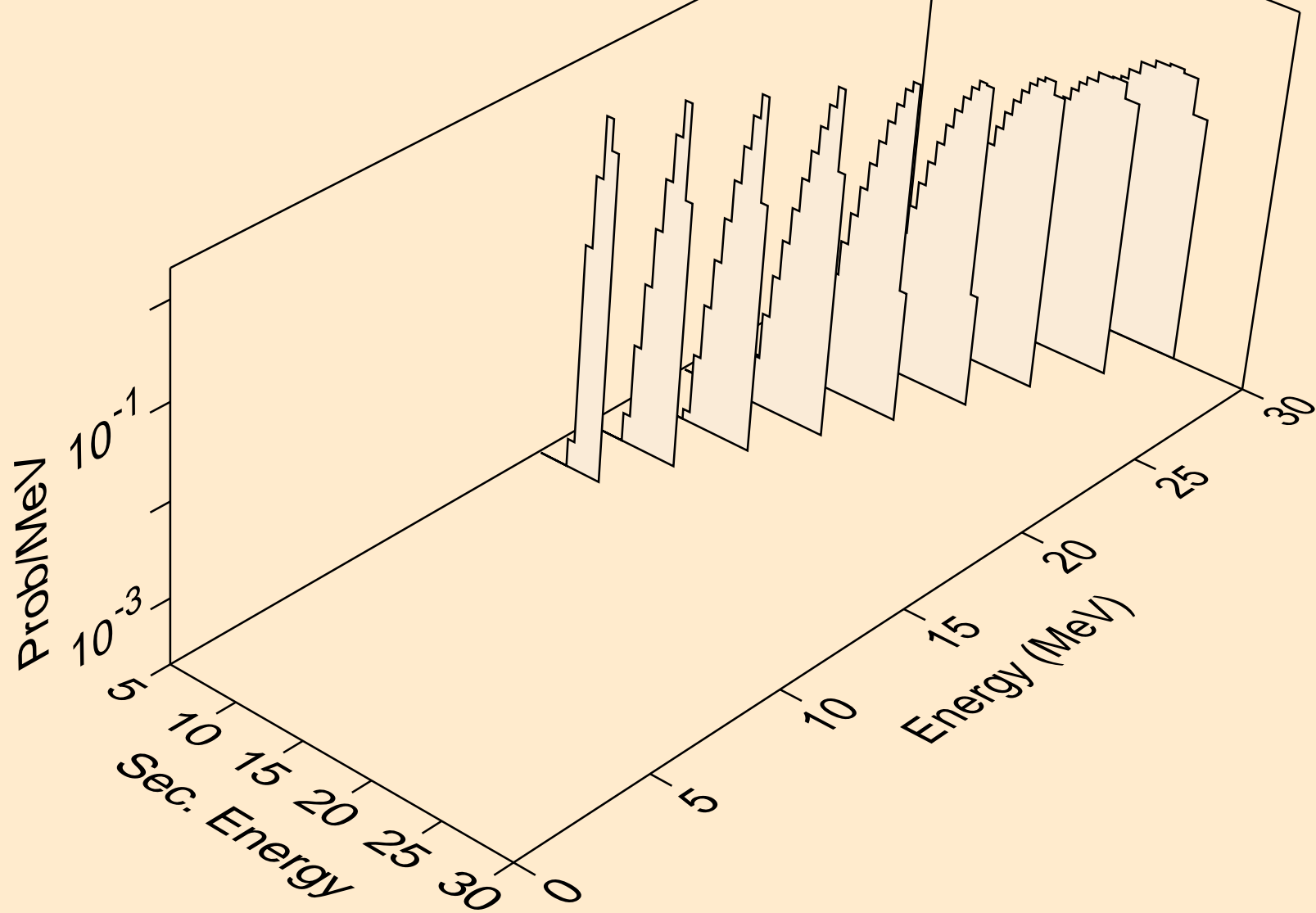

YB181 HELION ACER TENDL-2021 LIBRARY; T=0.K  
He-3 emission for inelastic

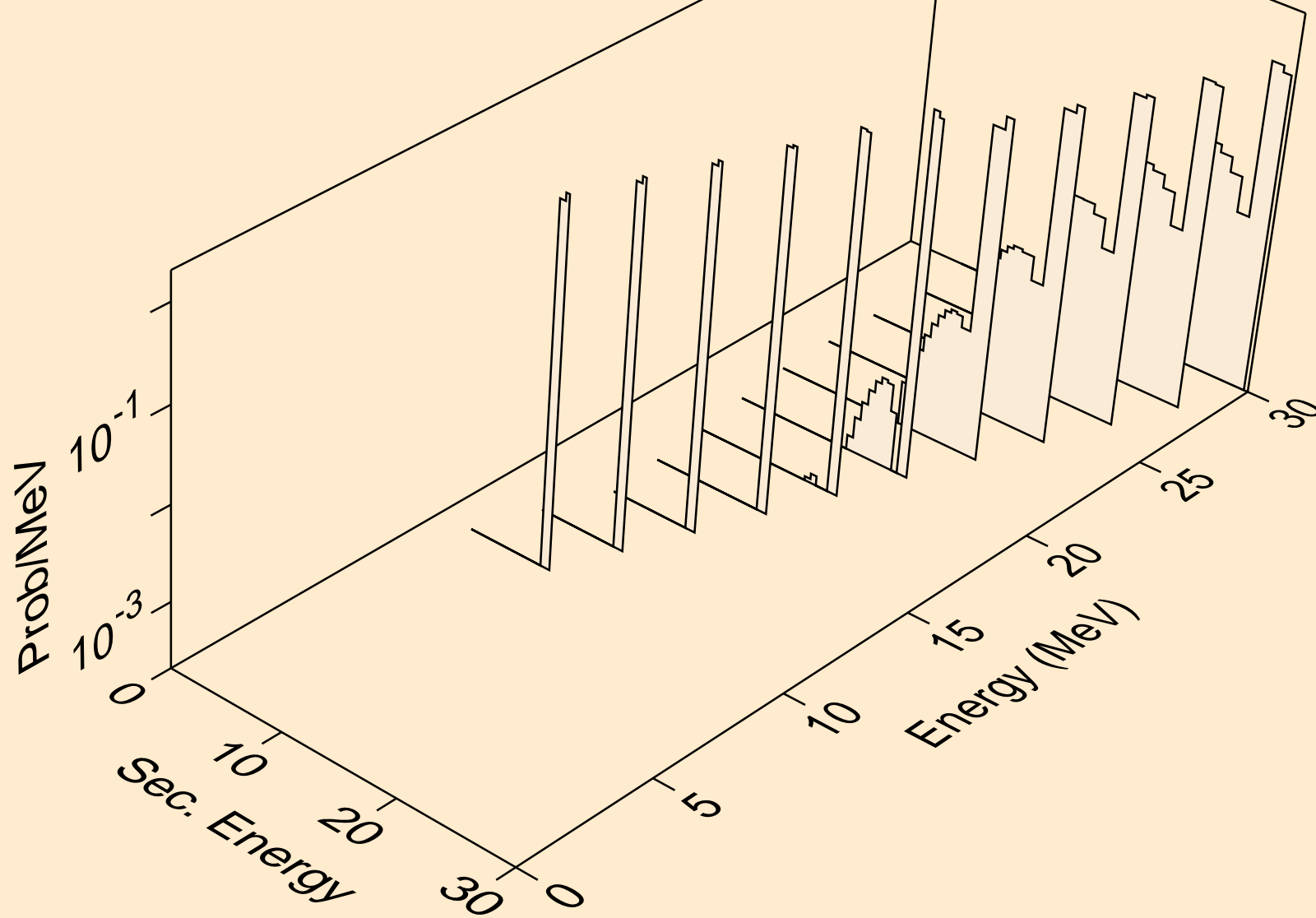



YB181 HELION ACER TENDL-2021 LIBRARY; T=0.K  
Photon emission for (z,n)

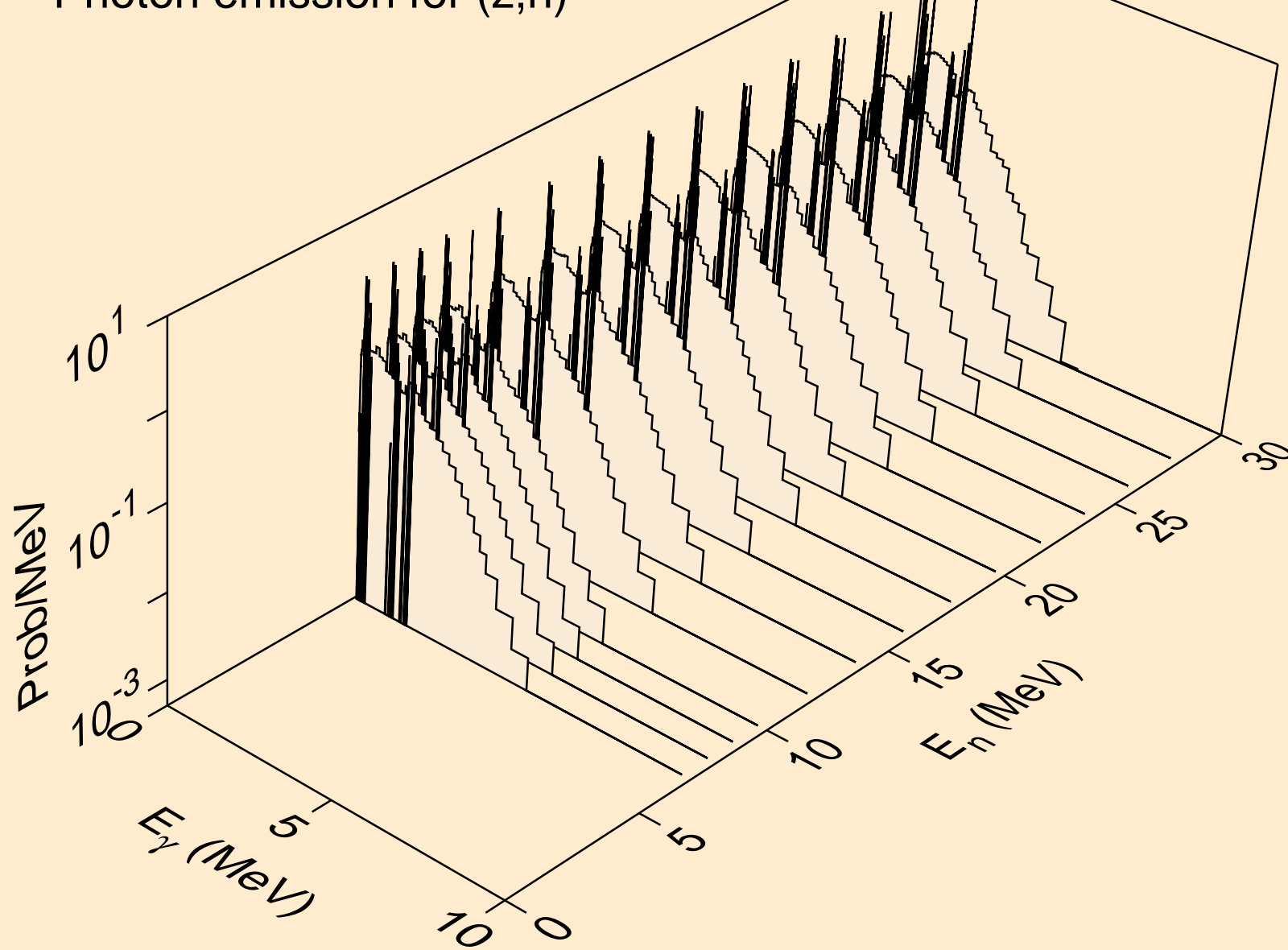

YB181 HELION ACER TENDL-2021 LIBRARY; T=0.K  
Photon emission for (n,x)

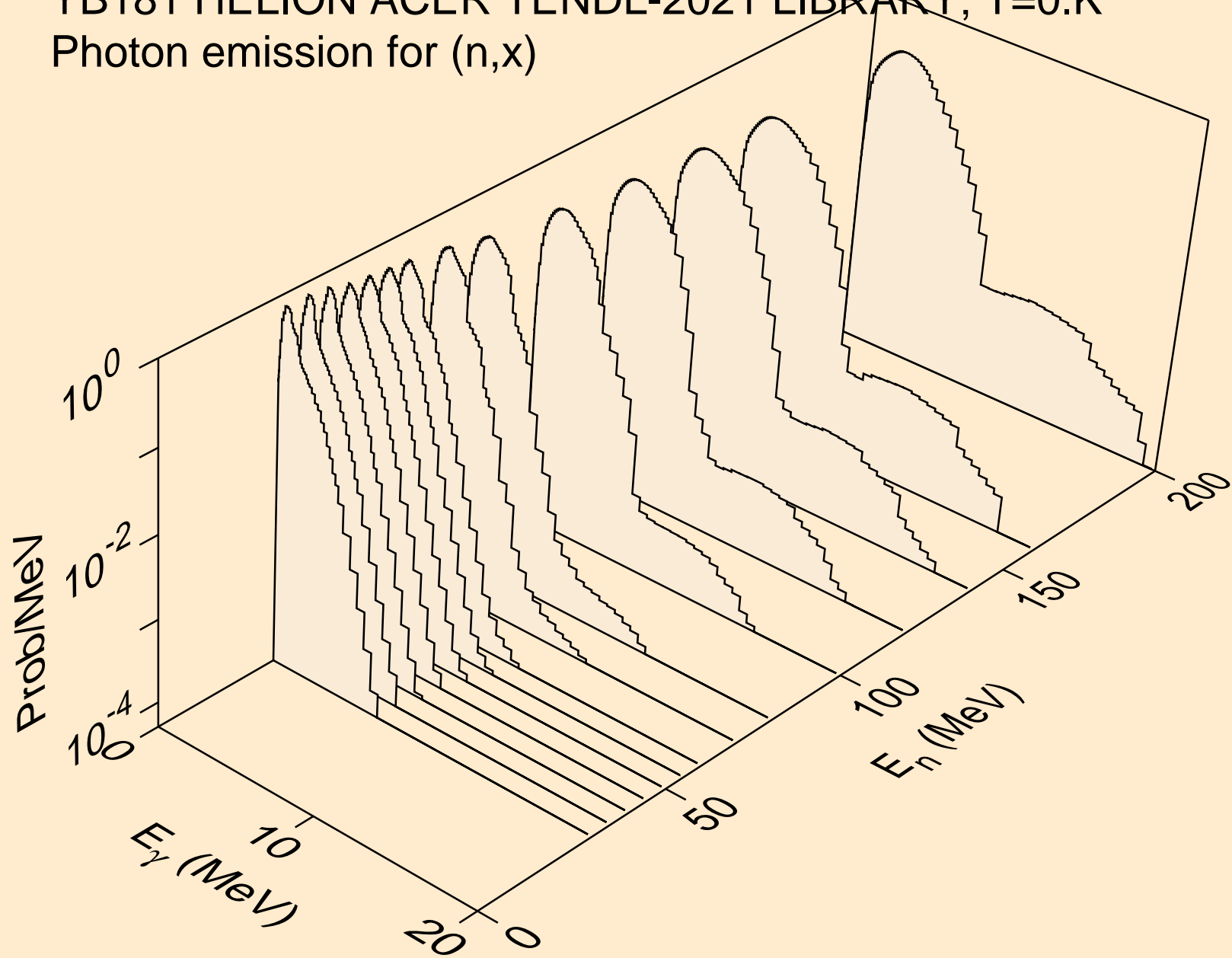

YB181 HELION ACER TENDL-2021 LIBRARY; T=0.K  
Photon emission for (n,2nd)

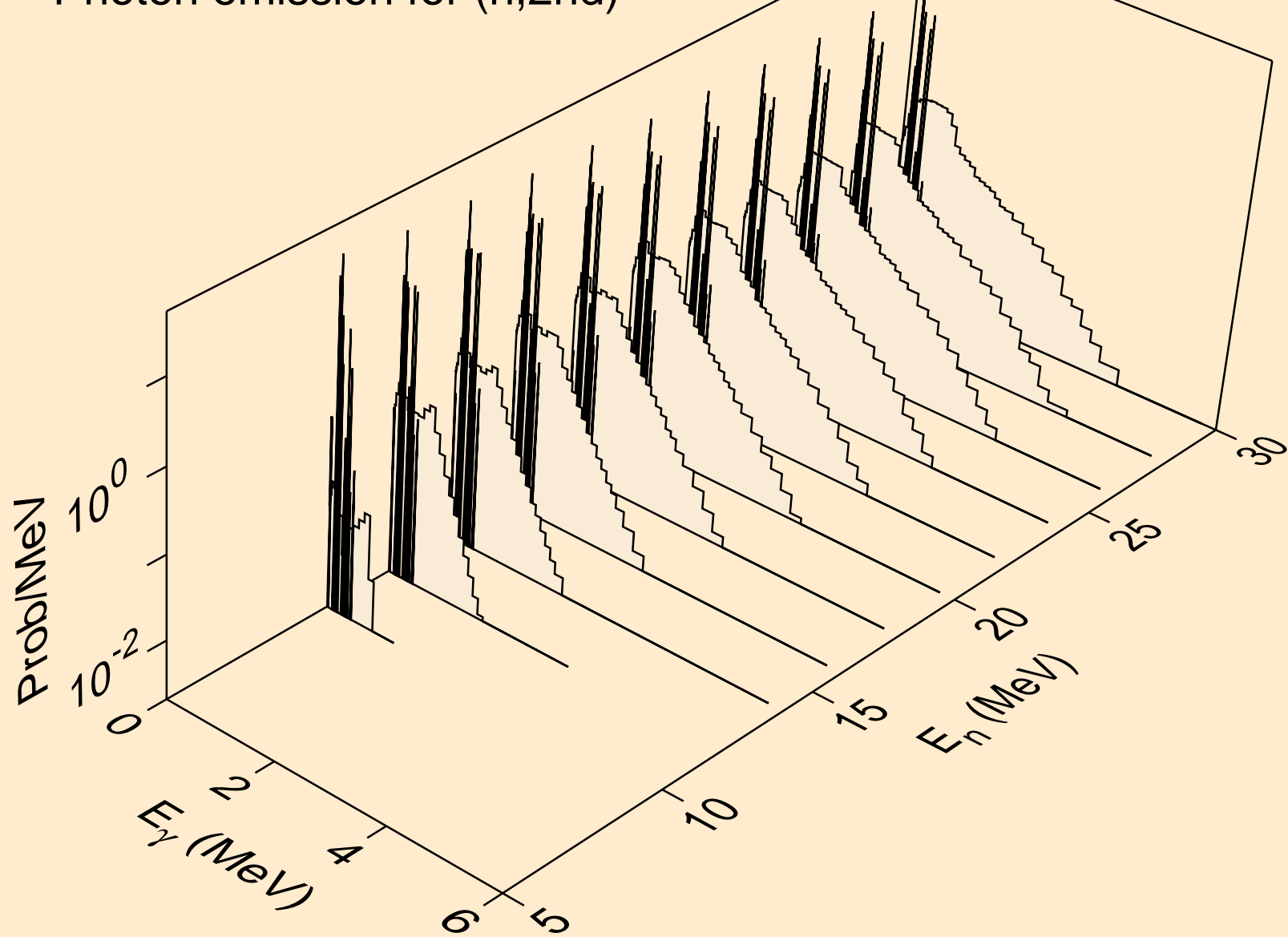

YB181 HELION ACER TENDL-2021 LIBRARY; T=0.K  
Photon emission for (n,2n)

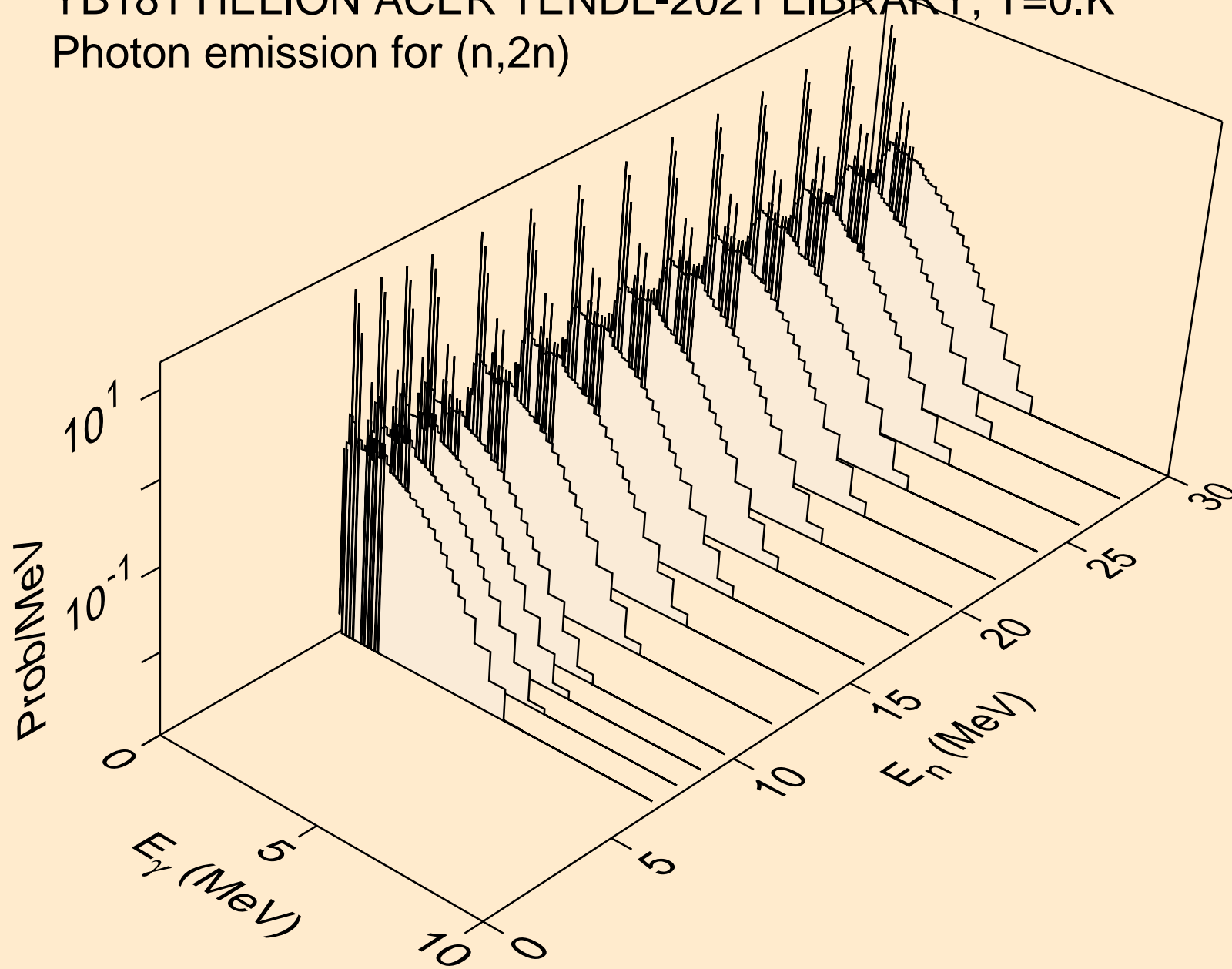

YB181 HELION ACER TENDL-2021 LIBRARY; T=0.K  
Photon emission for (n,3n)

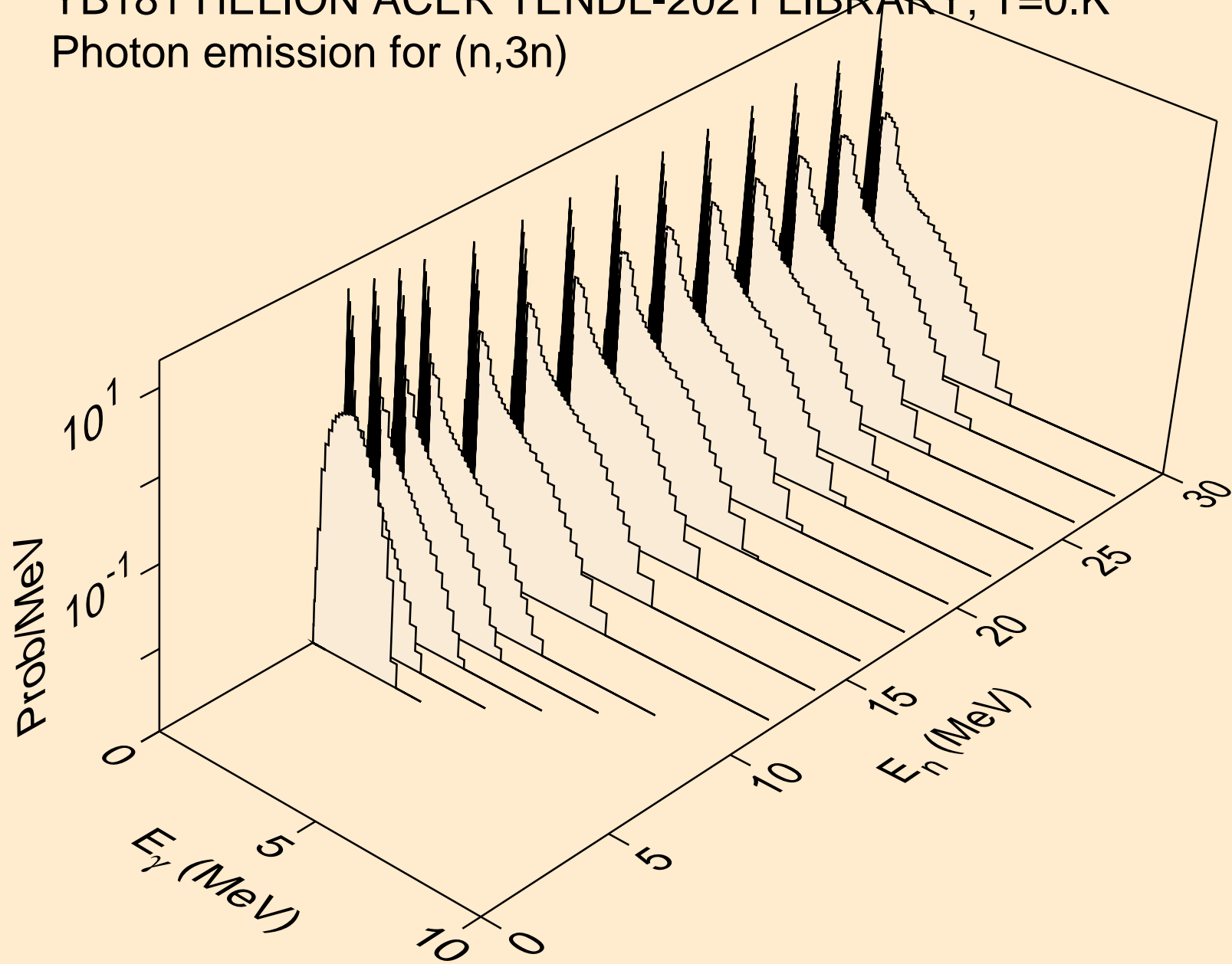

YB181 HELION ACER TENDL-2021 LIBRARY; T=0.K  
Photon emission for (n,n\*)a

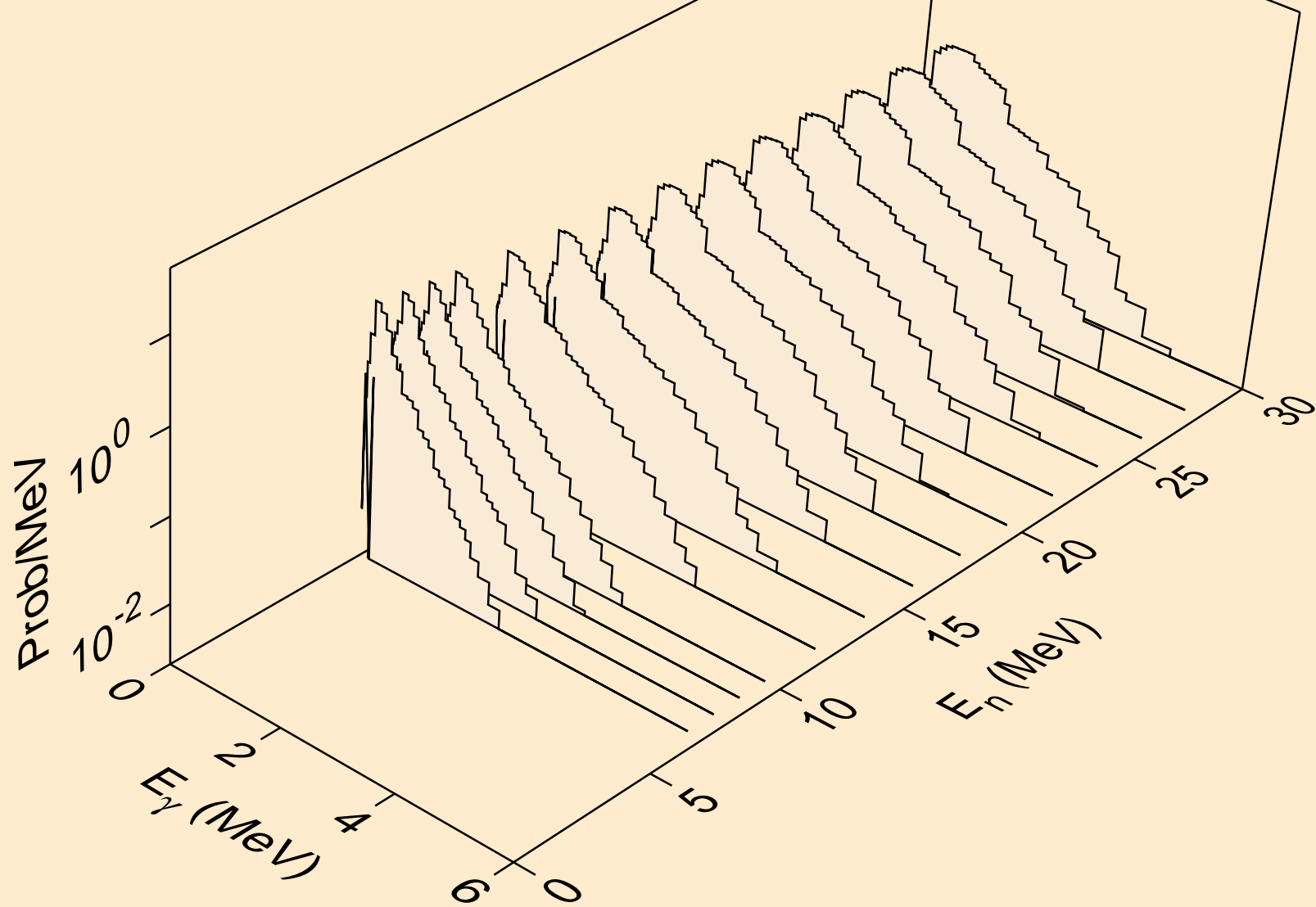

YB181 HELION ACER TENDL-2021 LIBRARY; T=0.K  
Photon emission for (n,2n) $\alpha$

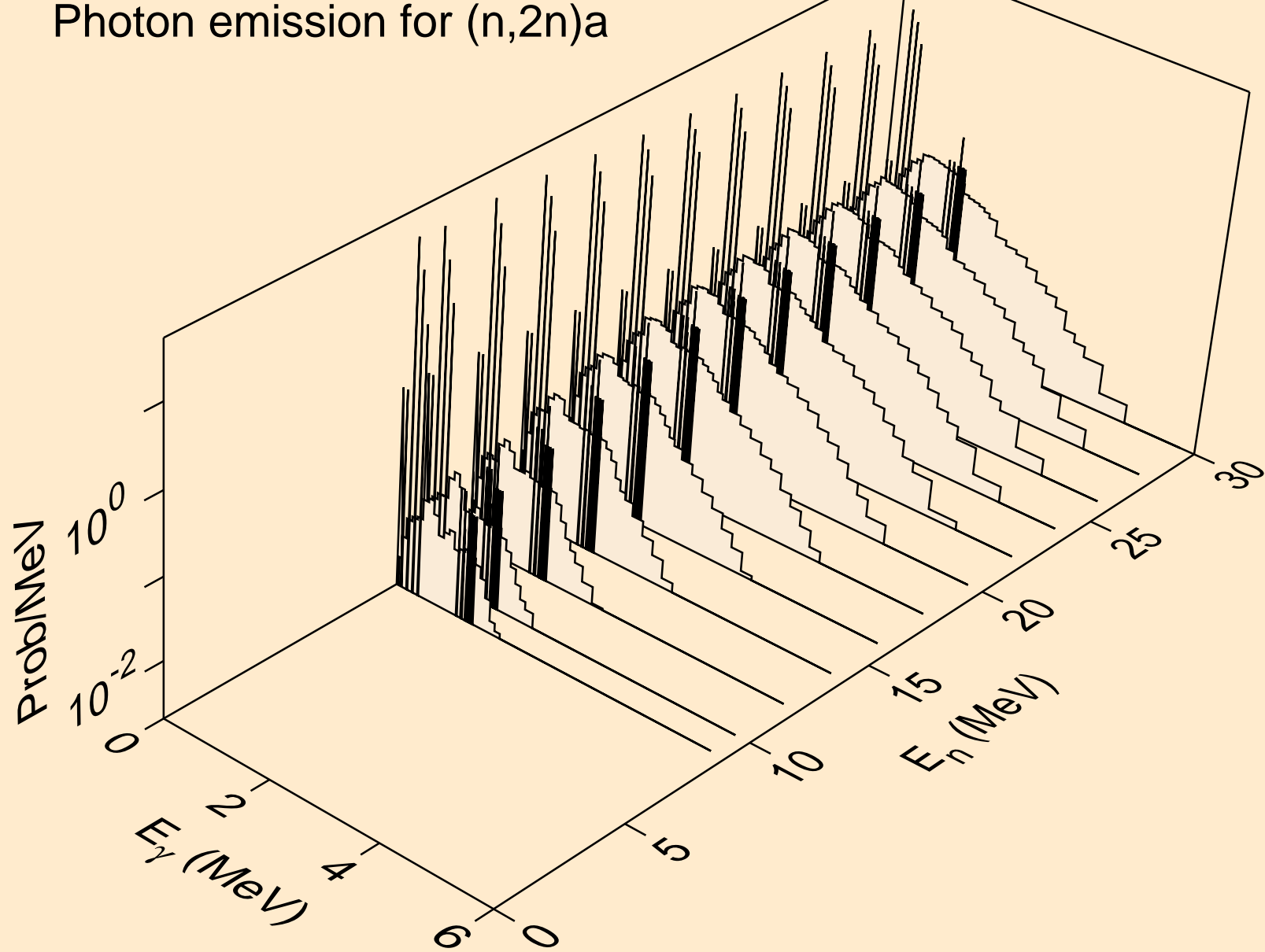

YB181 HELION ACER TENDL-2021 LIBRARY; T=0.K  
Photon emission for (n,3n)a

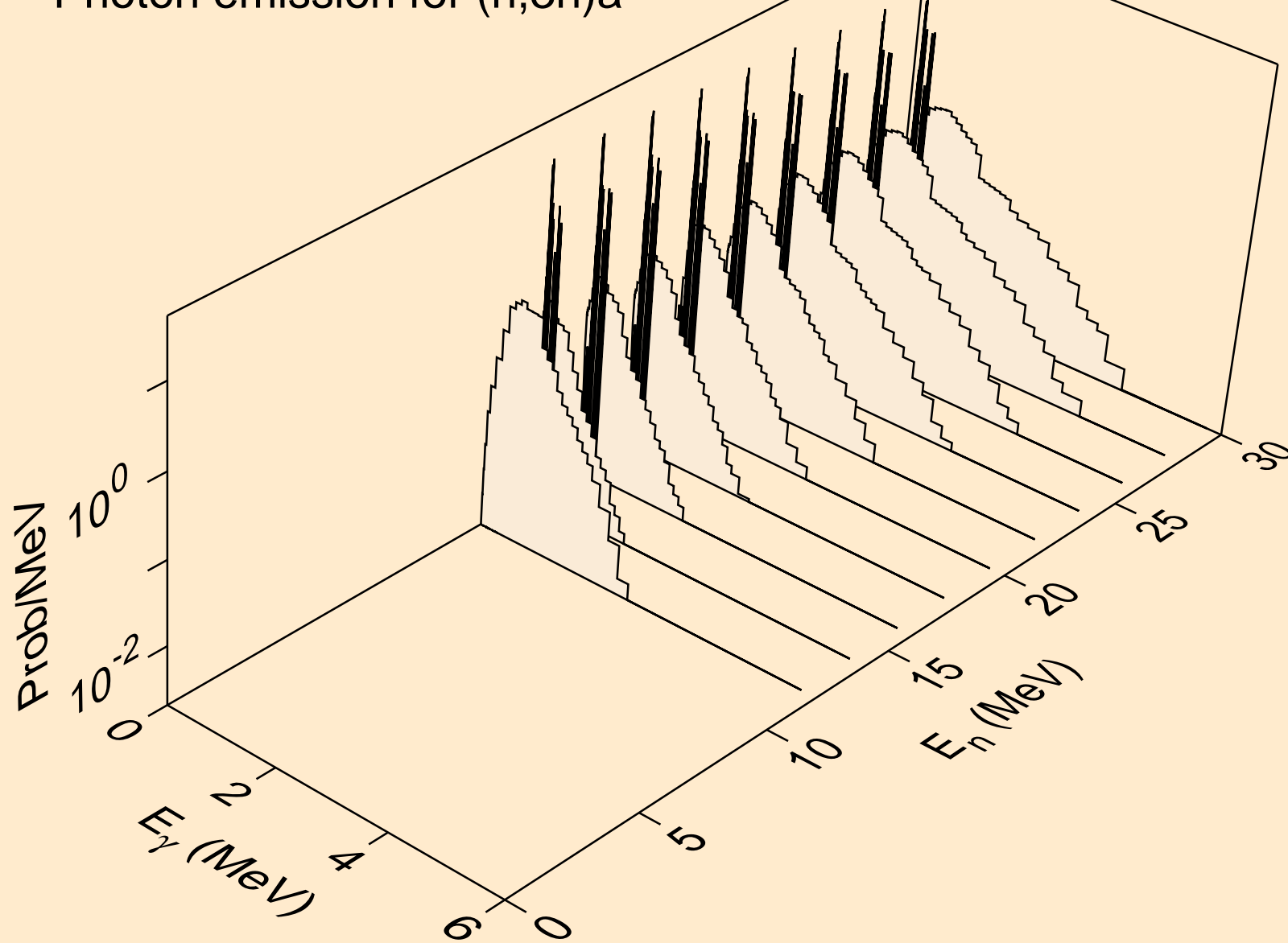



YB181 HELION ACER TENDL-2021 LIBRARY; T=0.K  
Photon emission for (n,n\*)p

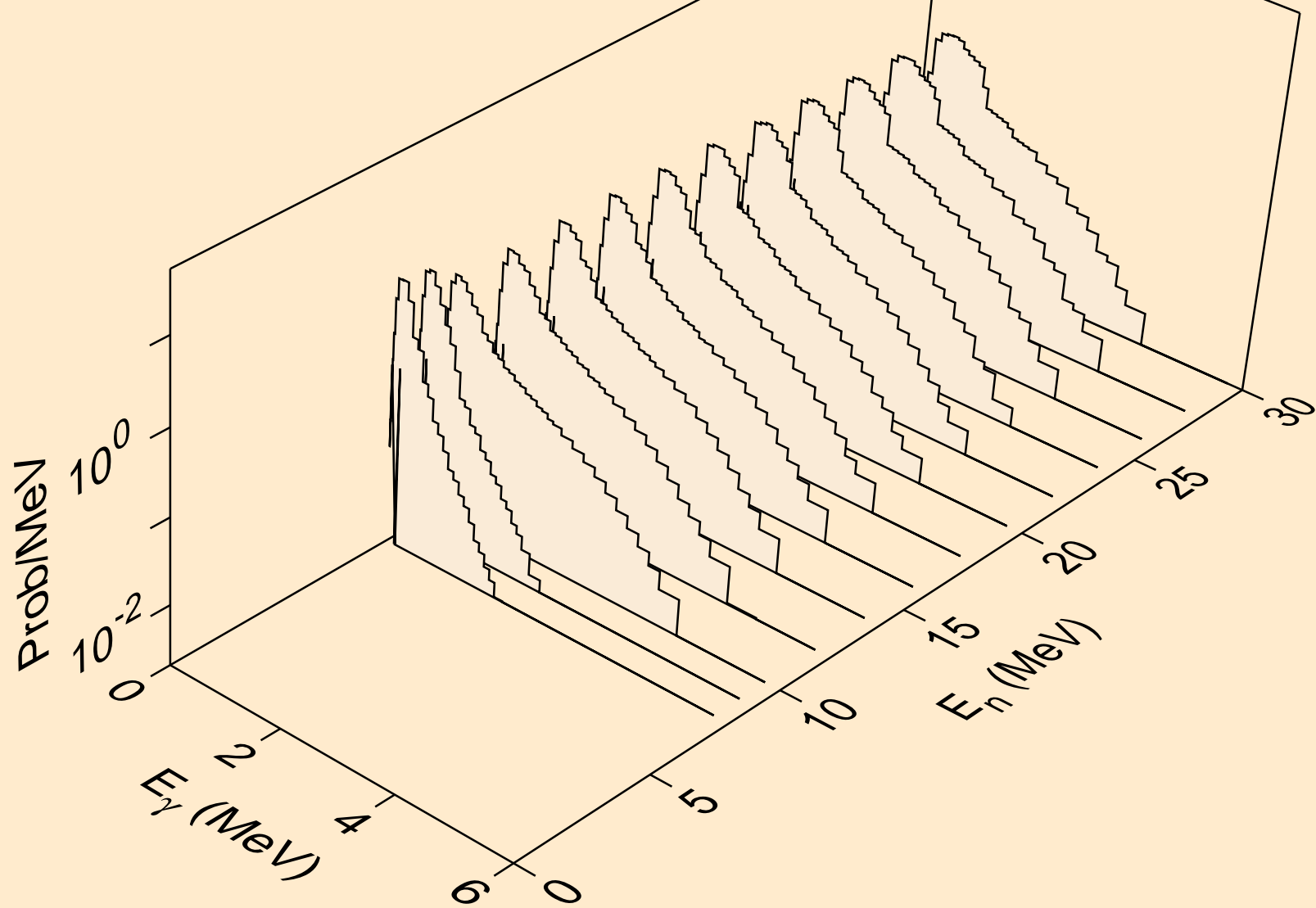

YB181 HELION ACER TENDL-2021 LIBRARY; T=0.K  
Photon emission for (n,n\*)d

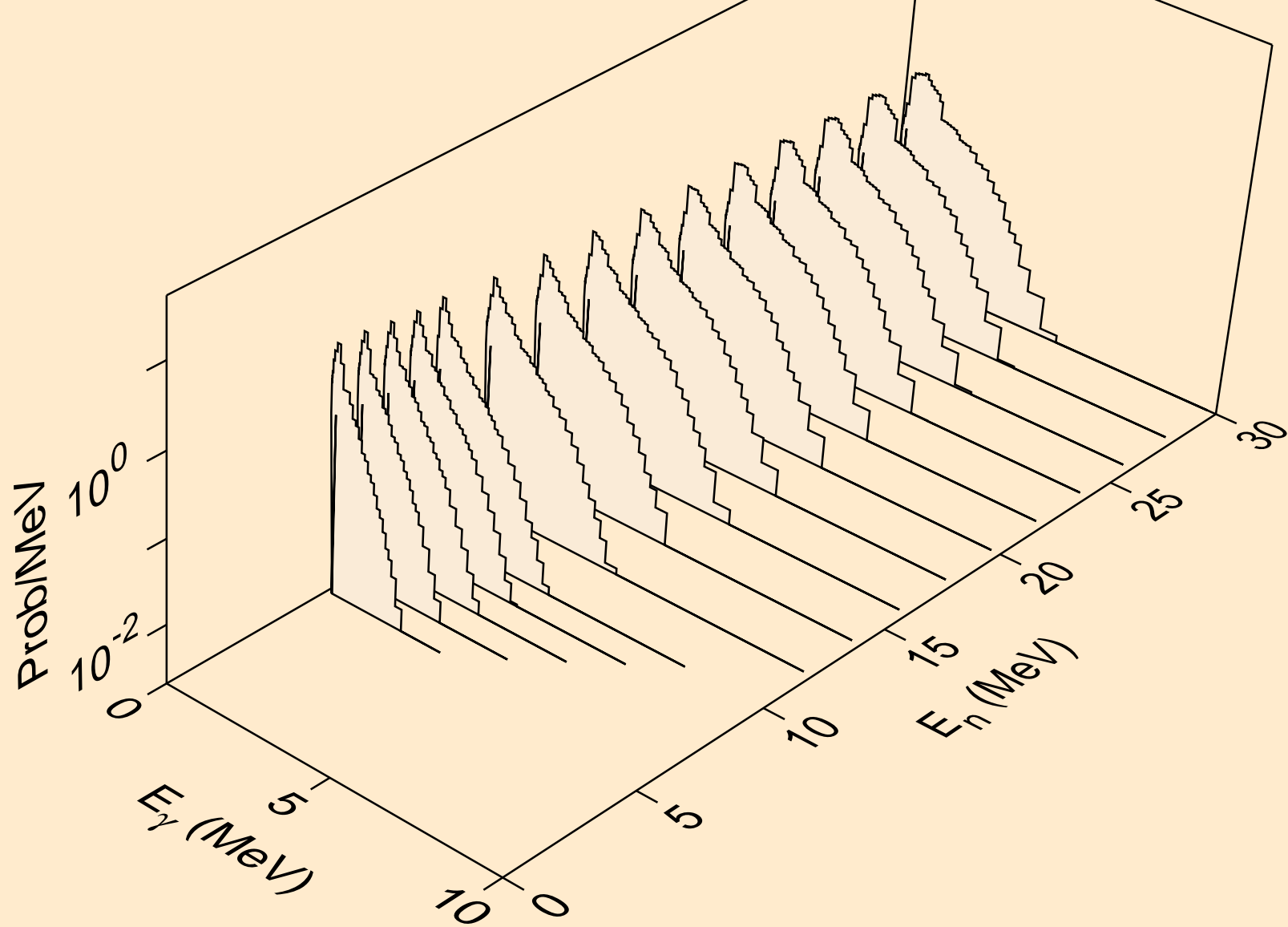

YB181 HELION ACER TENDL-2021 LIBRARY; T=0.K  
Photon emission for (n,n\*)t

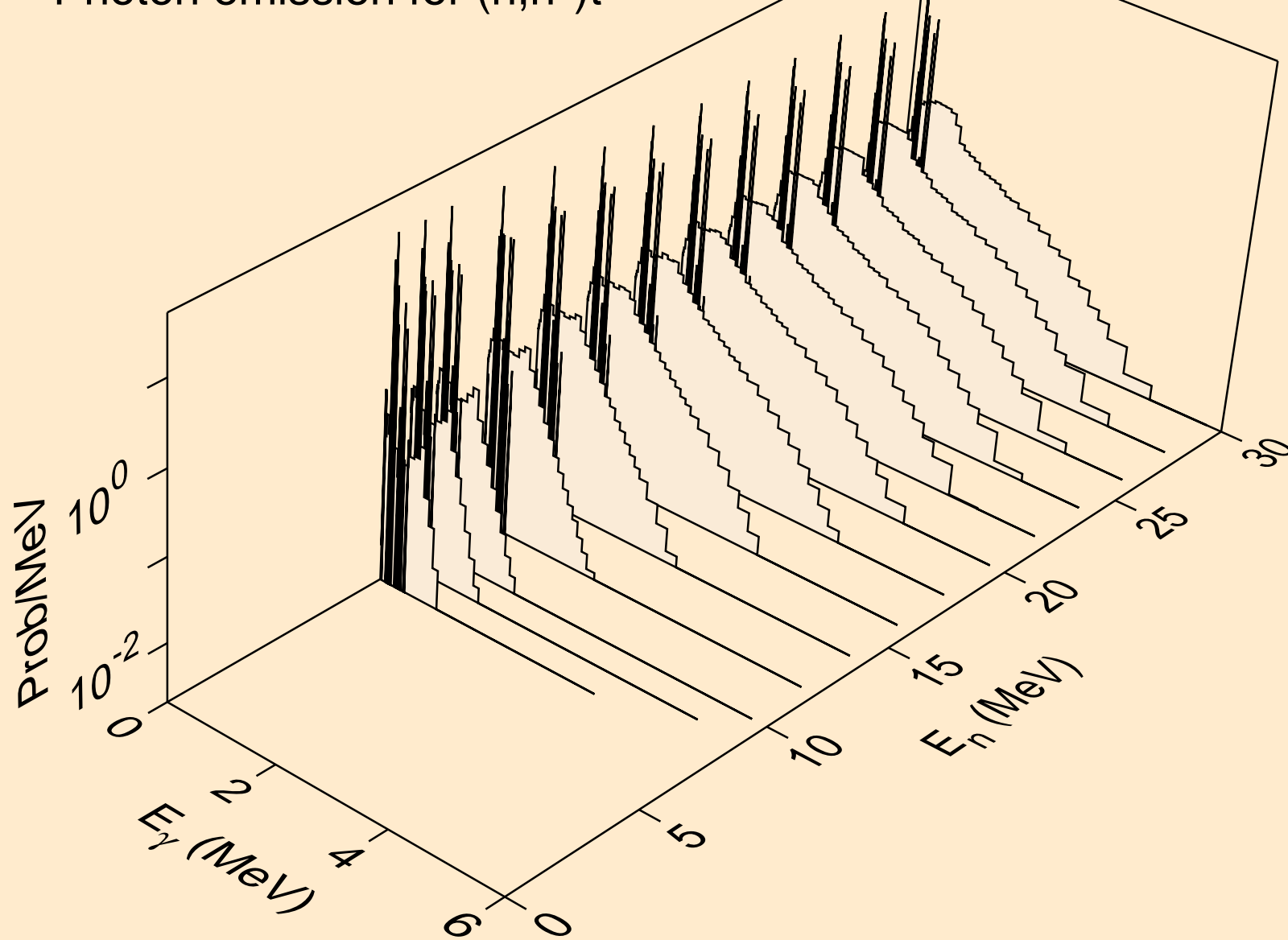

YB181 HELION ACER TENDL-2021 LIBRARY; T=0.K  
Photon emission for (n,n\*)he3

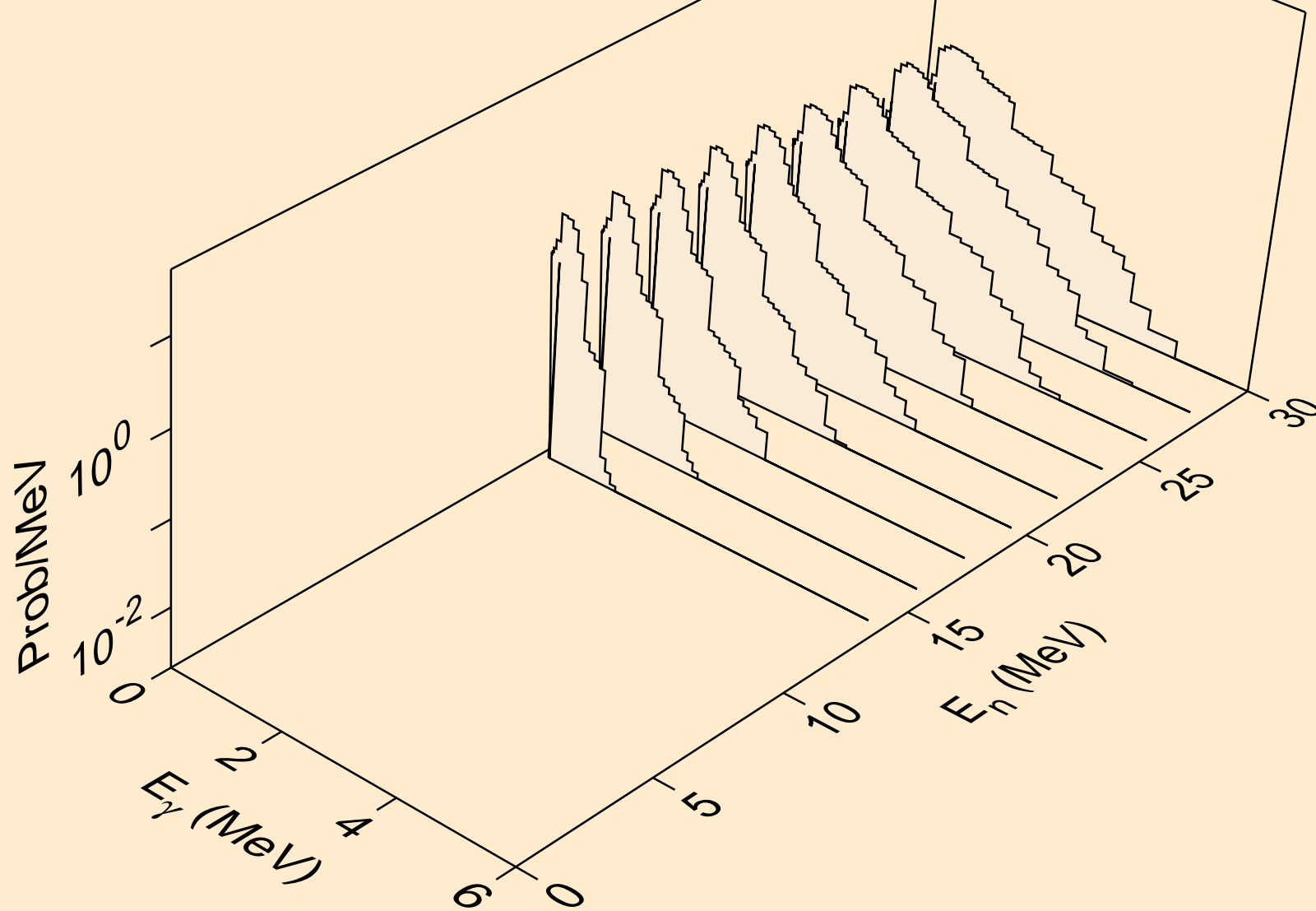

YB181 HELION ACER TENDL-2021 LIBRARY; T=0.K  
Photon emission for (n,4n)

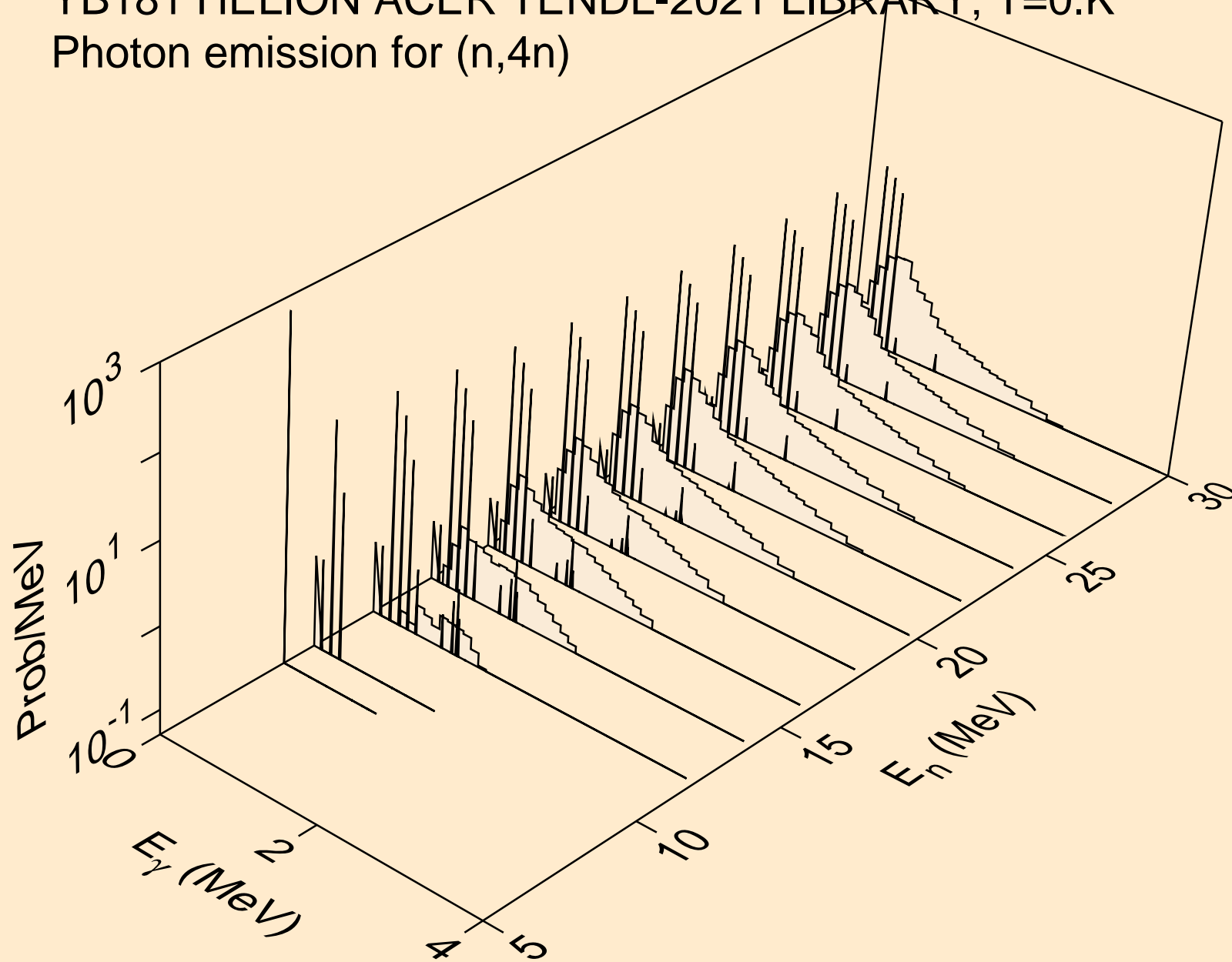

YB181 HELION ACER TENDL-2021 LIBRARY; T=0.K  
Photon emission for (n,2np)

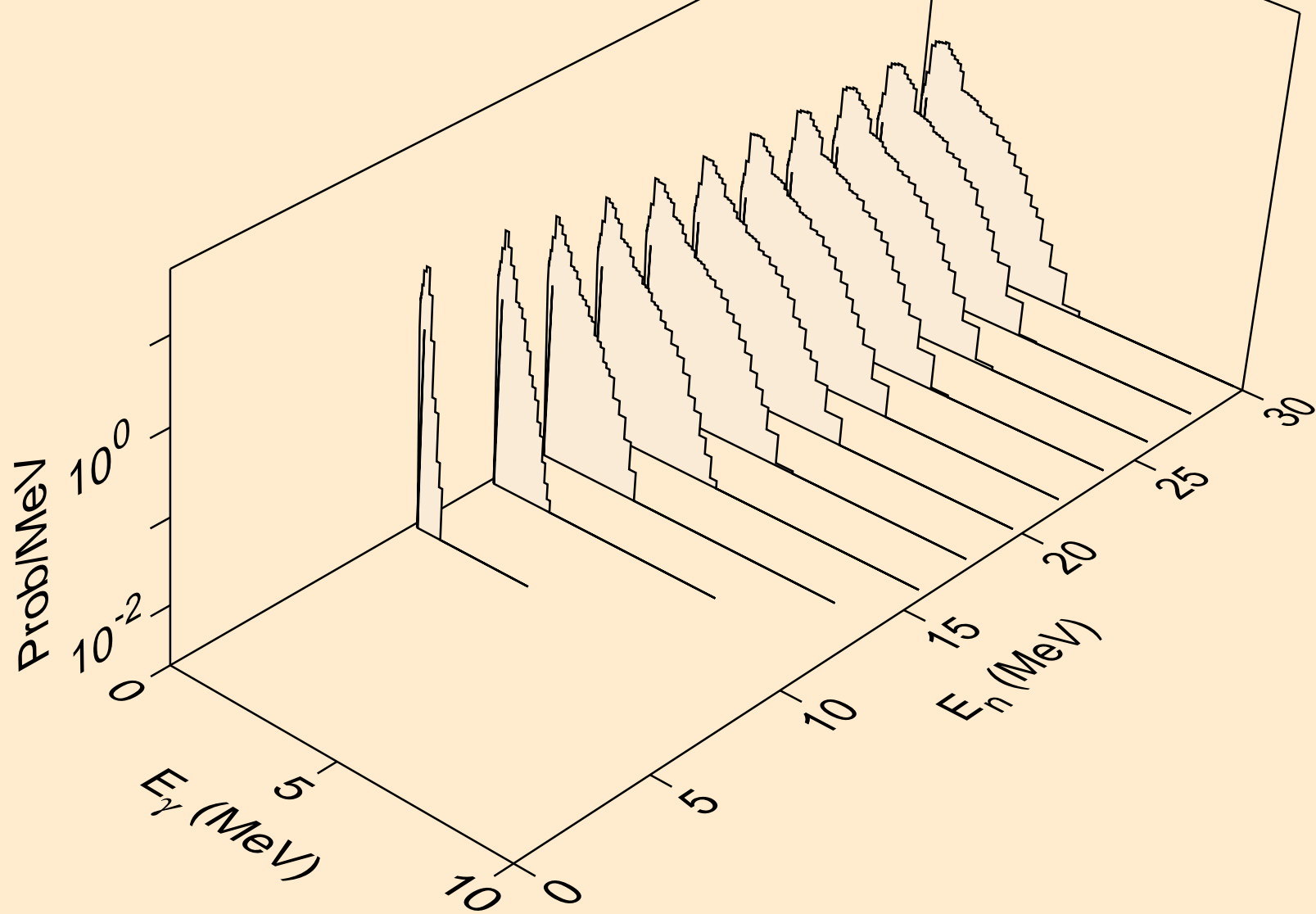

YB181 HELION ACER TENDL-2021 LIBRARY; T=0.K  
Photon emission for (n,3np)

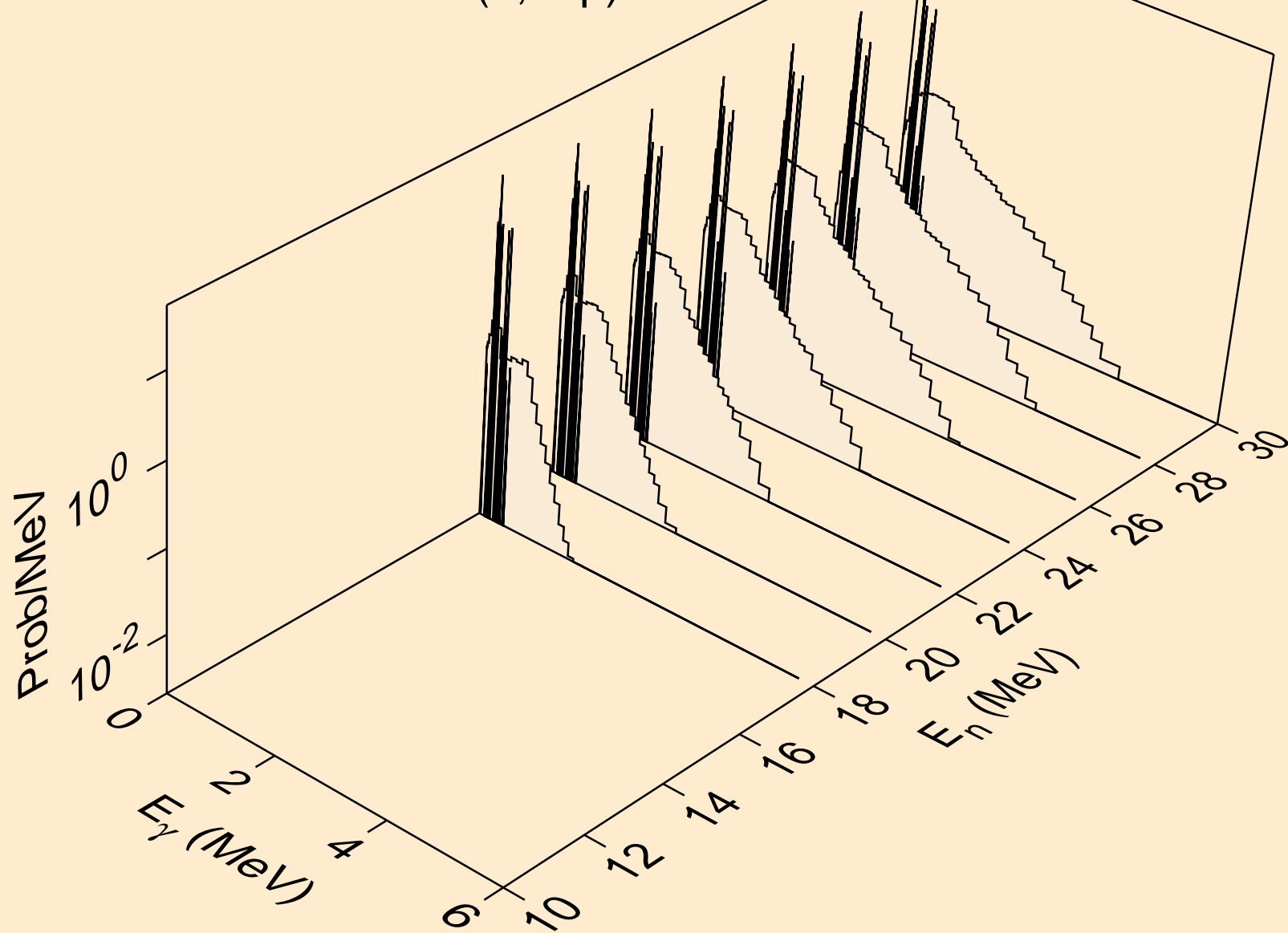

YB181 HELION ACER TENDL-2021 LIBRARY; T=0.K  
Photon emission for (n,2np)

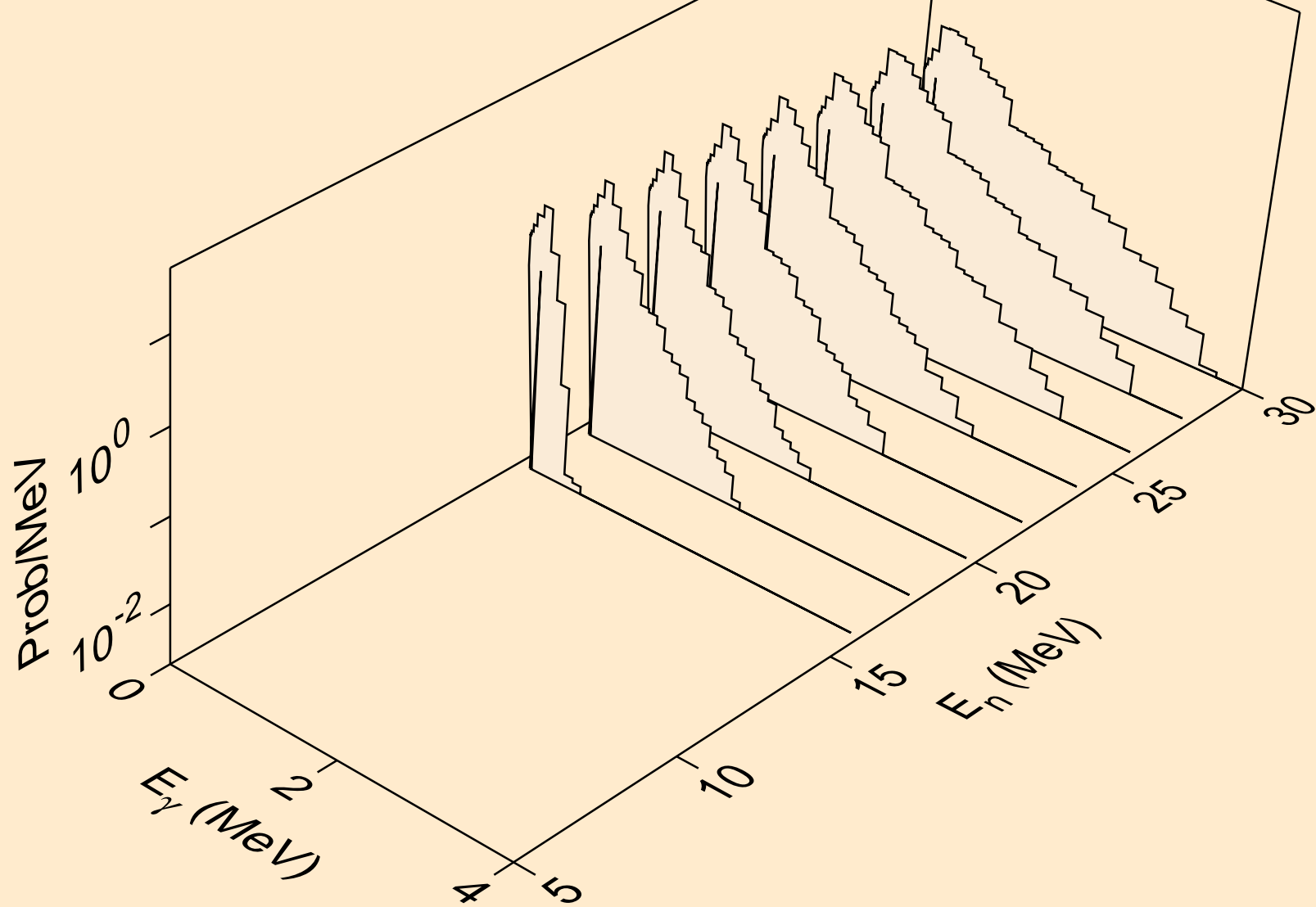



YB181 HELION ACER TENDL-2021 LIBRARY; T=0.K  
Photon emission for (n,npa)

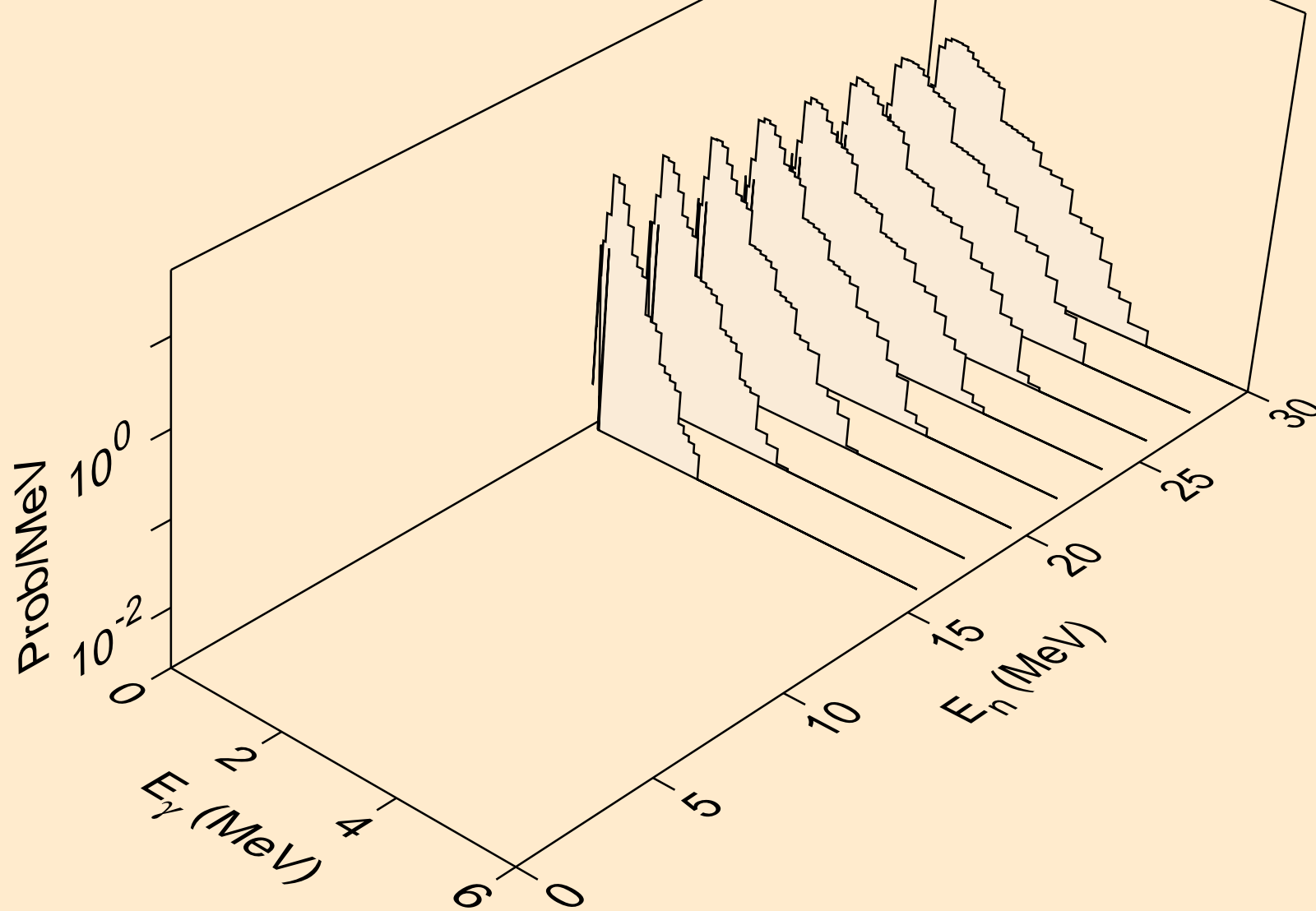

YB181 HELION ACER TENDL-2021 LIBRARY; T=0.K  
Photon emission for (n,gma)

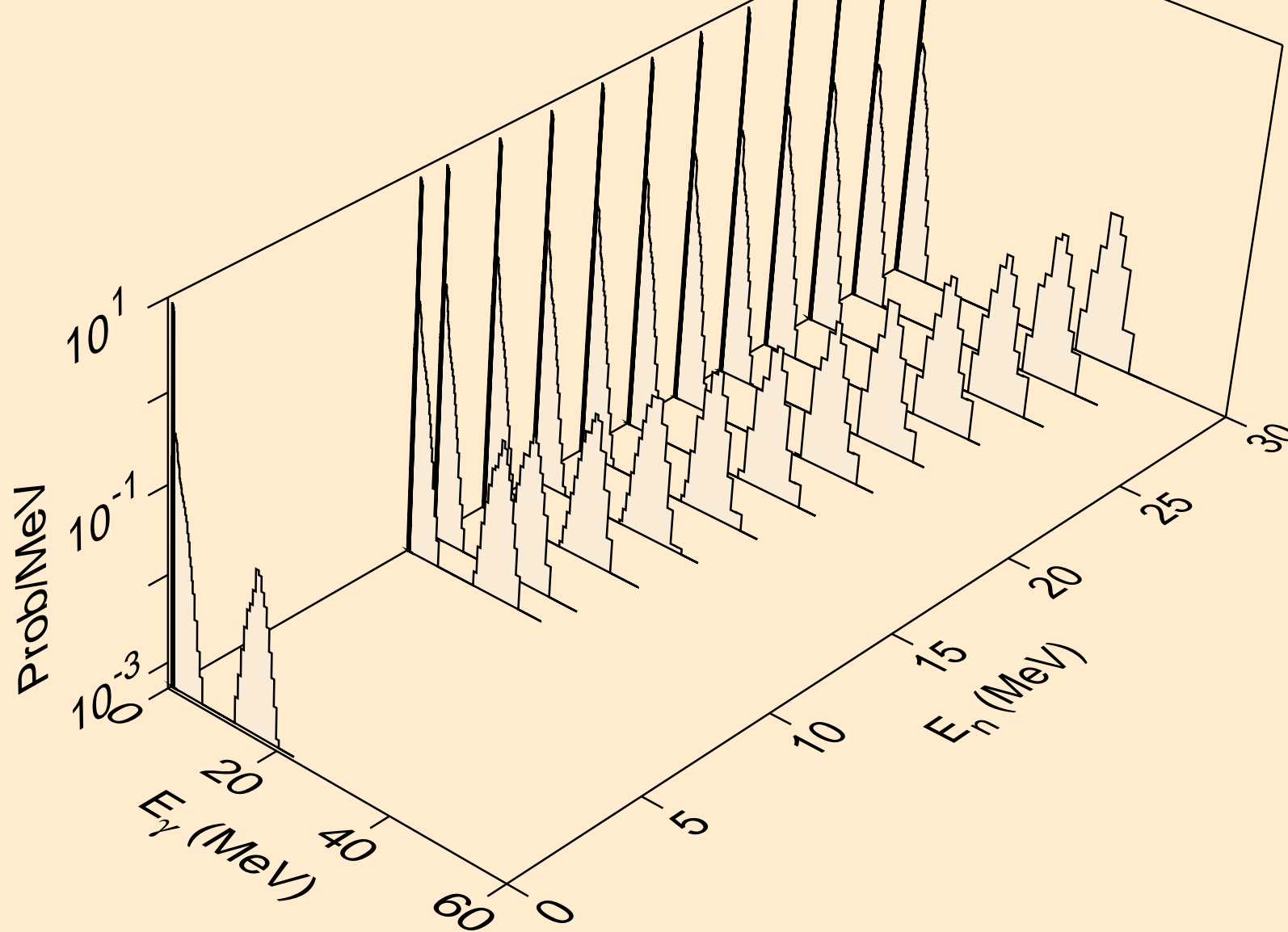

YB181 HELION ACER TENDL-2021 LIBRARY; T=0.K  
Photon emission for (n,p)

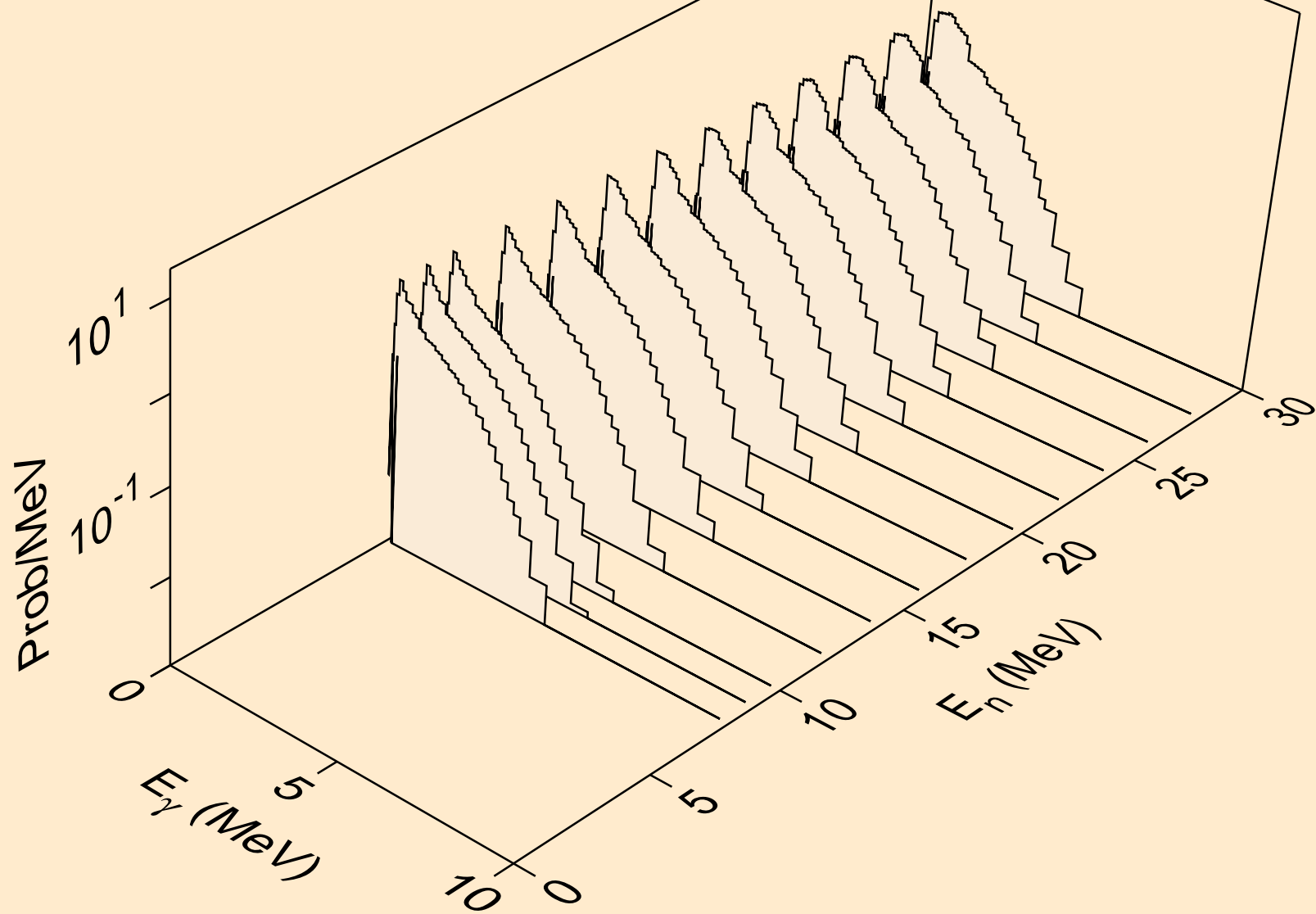

YB181 HELION ACER TENDL-2021 LIBRARY; T=0.K  
Photon emission for (n,d)

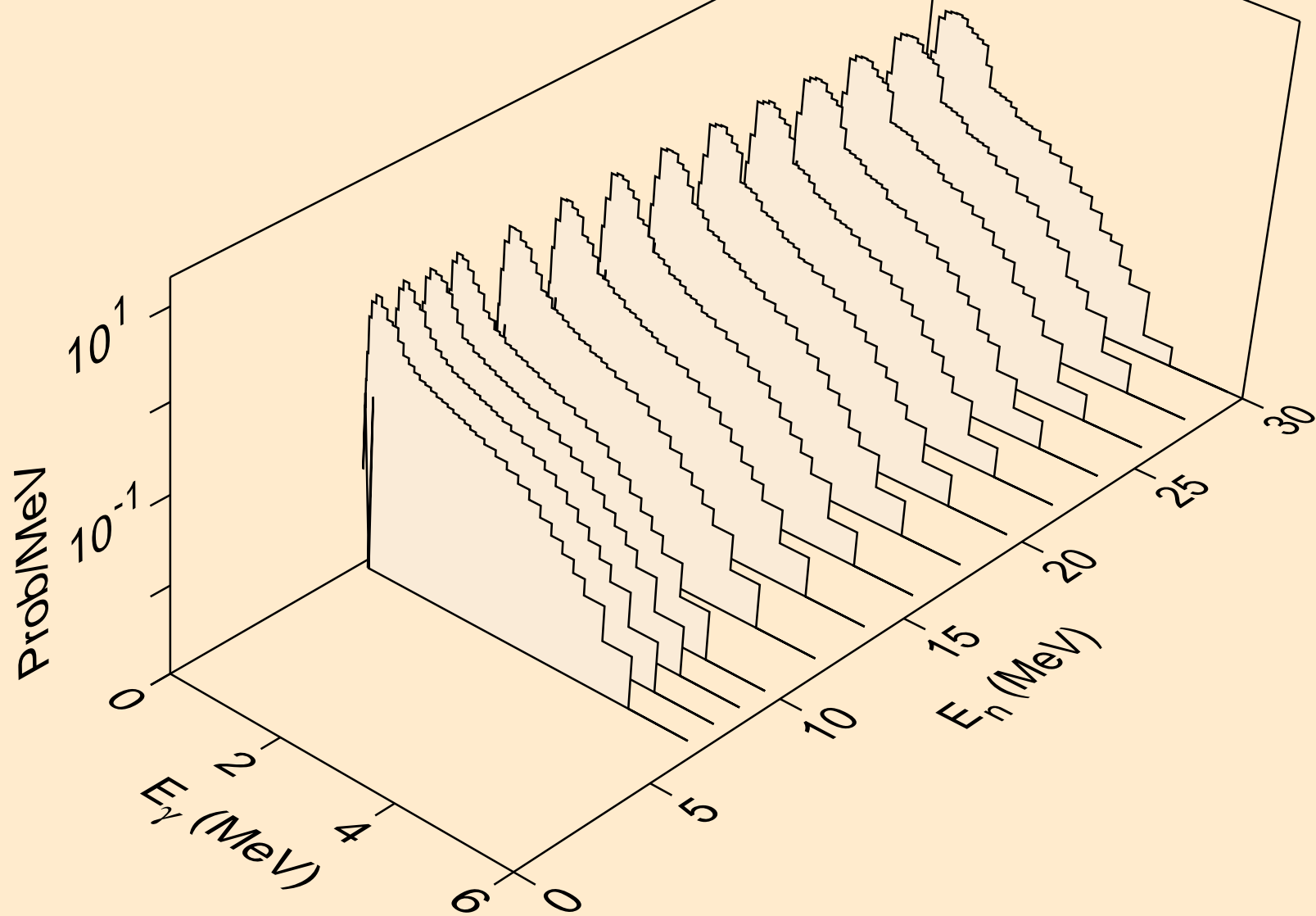

YB181 HELION ACER TENDL-2021 LIBRARY; T=0.K  
Photon emission for (n,t)

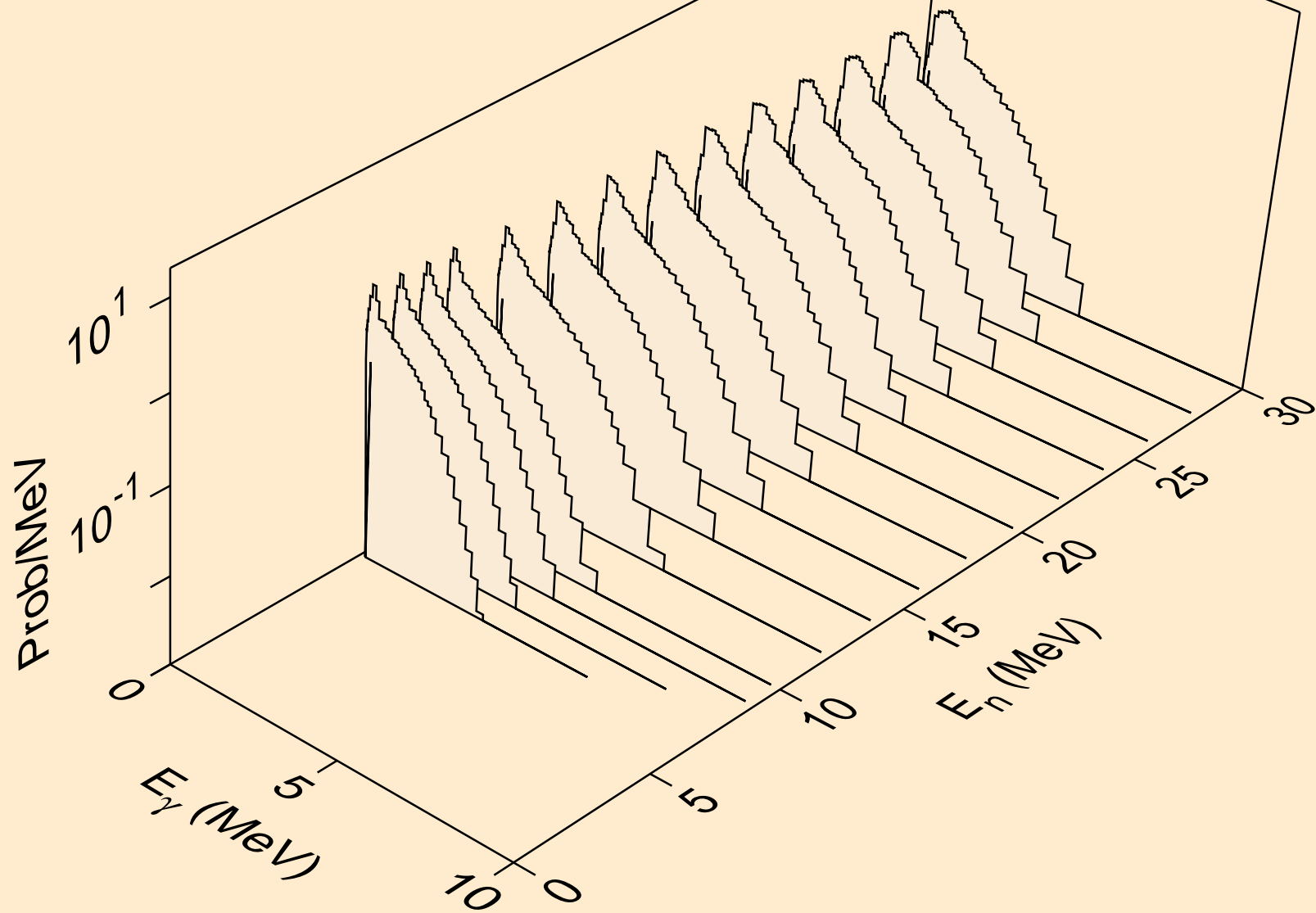

YB181 HELION ACER TENDL-2021 LIBRARY; T=0.K  
Photon emission for inelastic

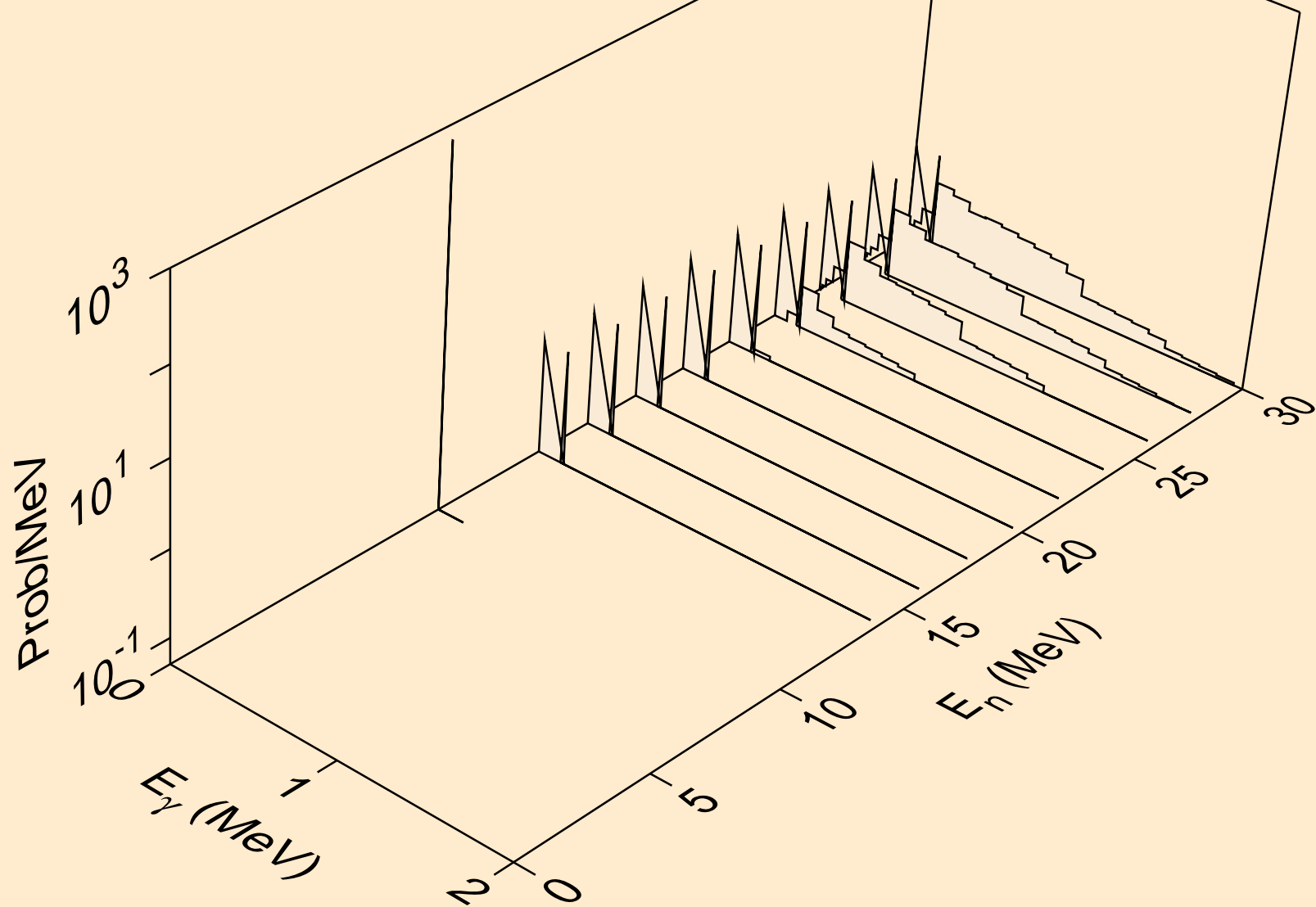

YB181 HELION ACER TENDL-2021 LIBRARY; T=0.K  
Photon emission for (n,a)

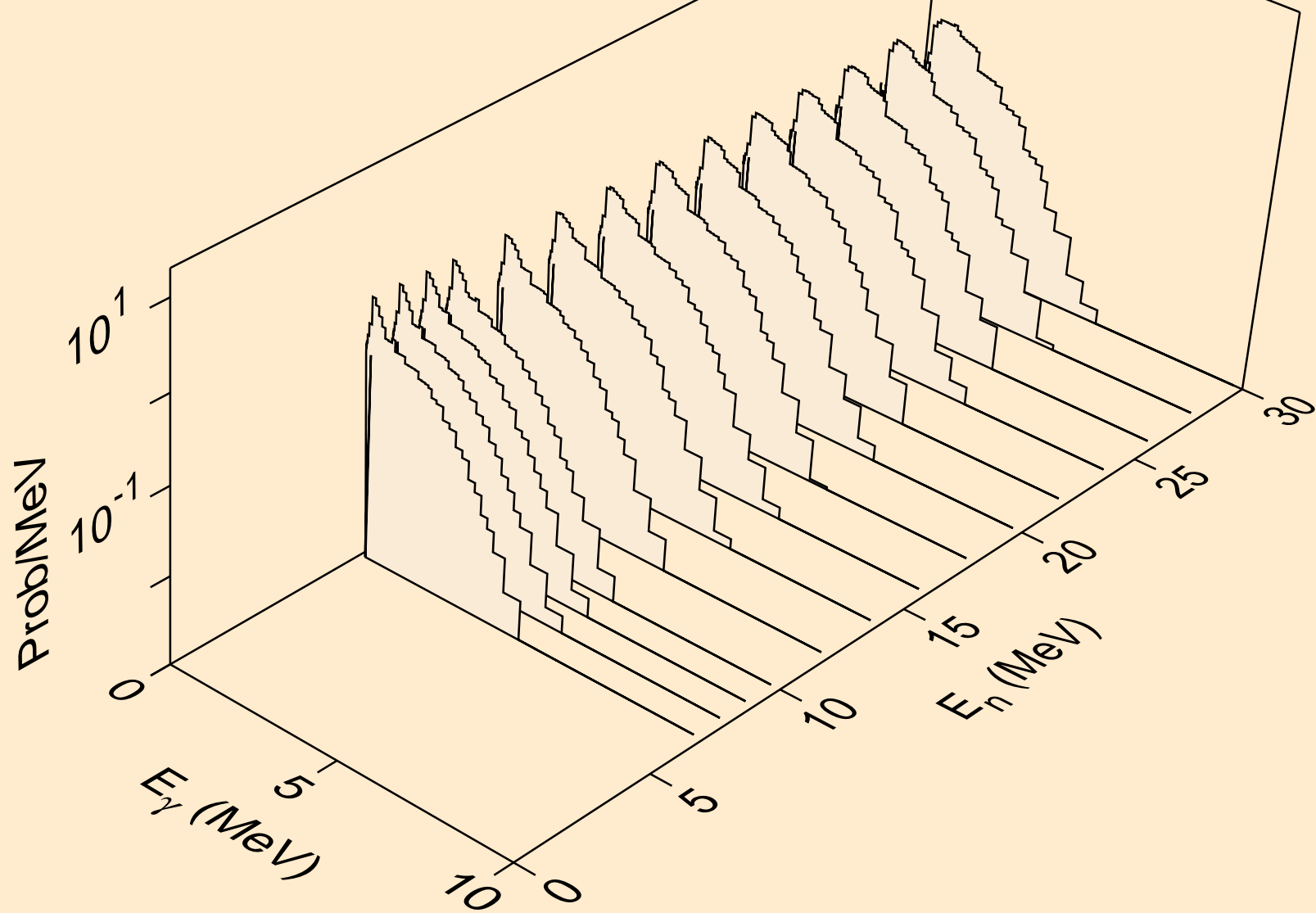

YB181 HELION ACER TENDL-2021 LIBRARY; T=0.K  
Photon emission for (n,2p)

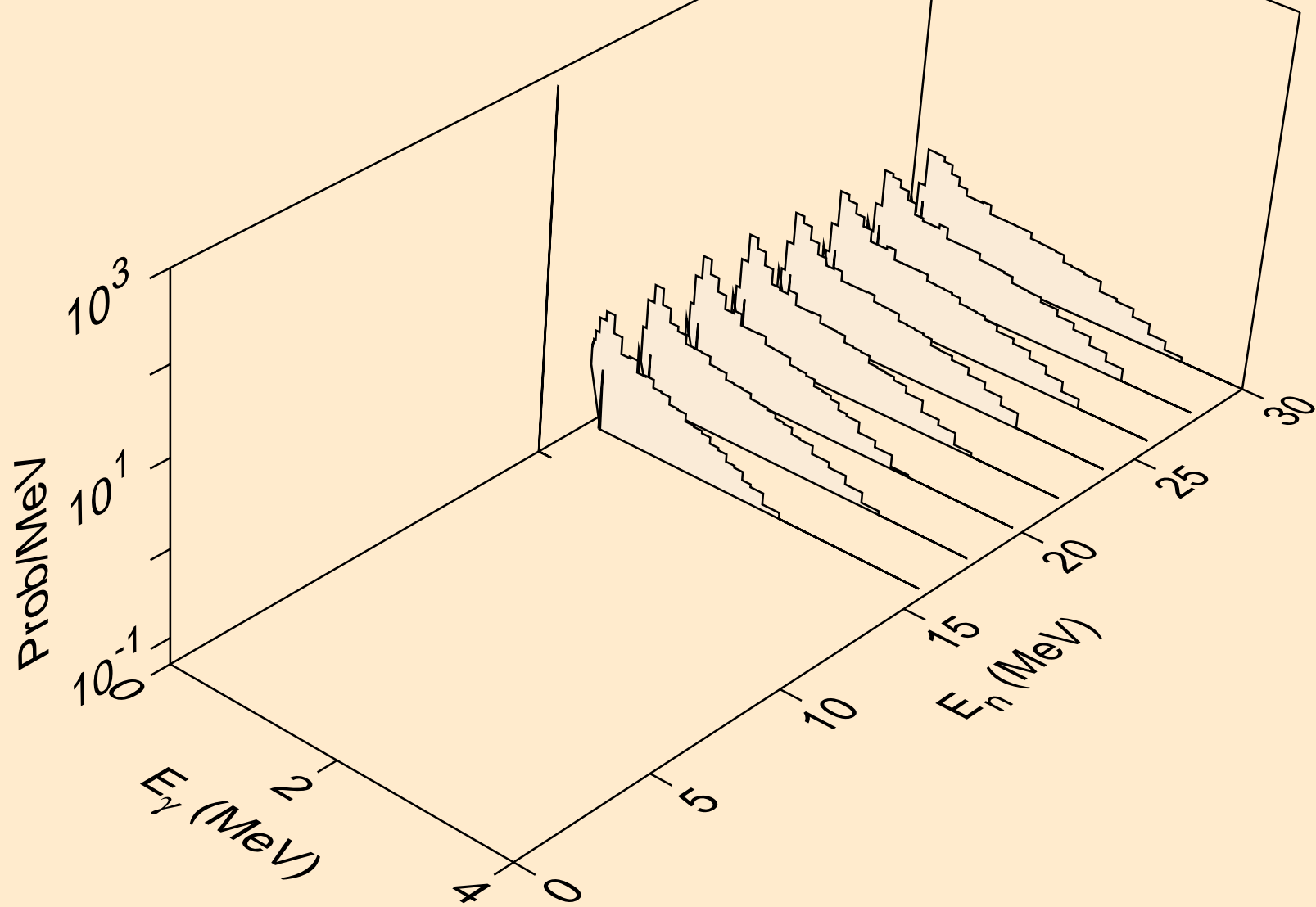



YB181 HELION ACER TENDL-2021 LIBRARY; T=0.K  
Photon emission for (n,pd)

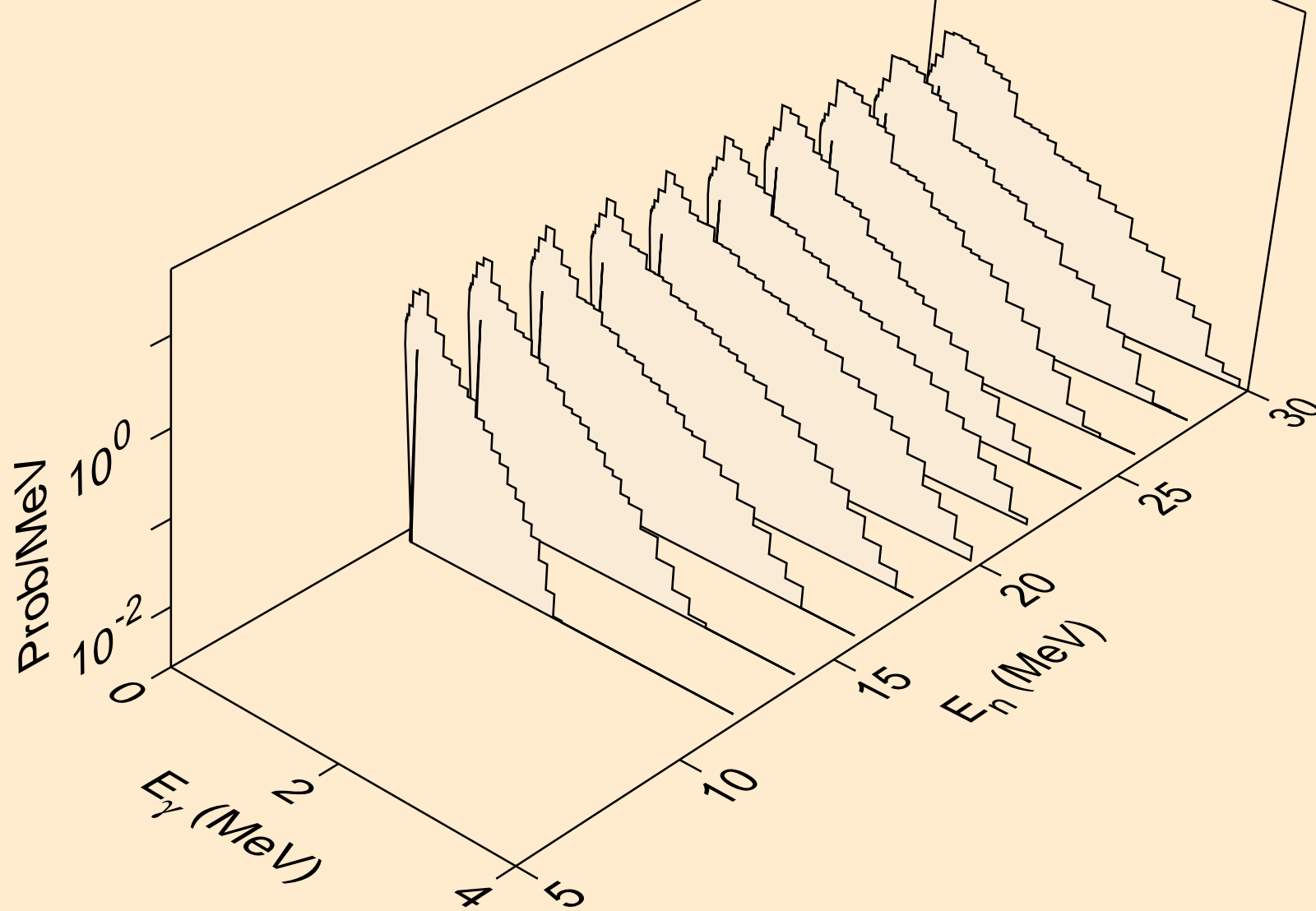

YB181 HELION ACER TENDL-2021 LIBRARY; T=0.K  
Photon emission for (n,pt)

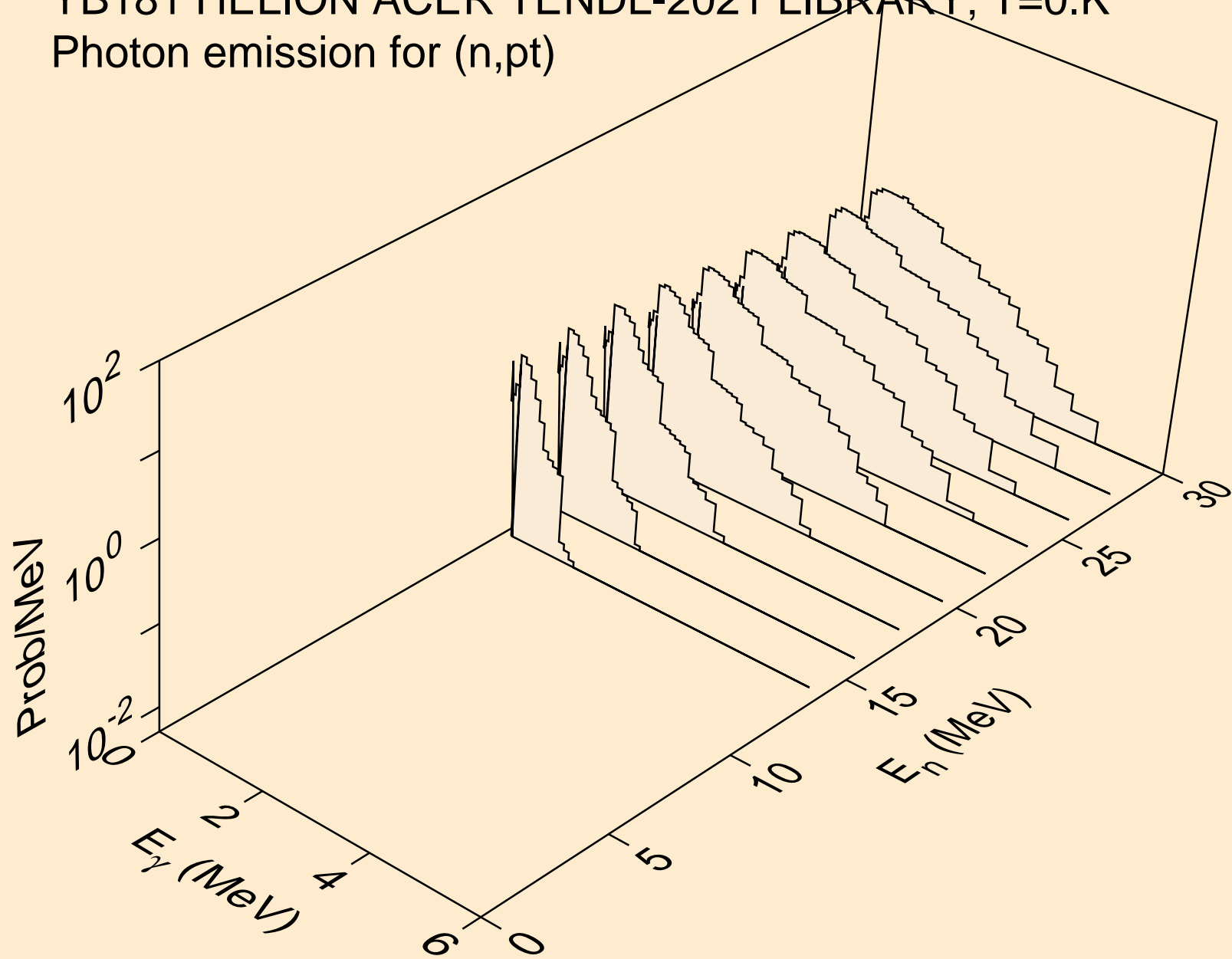

YB181 HELION ACER TENDL-2021 LIBRARY; T=0.K  
Particle heating contributions

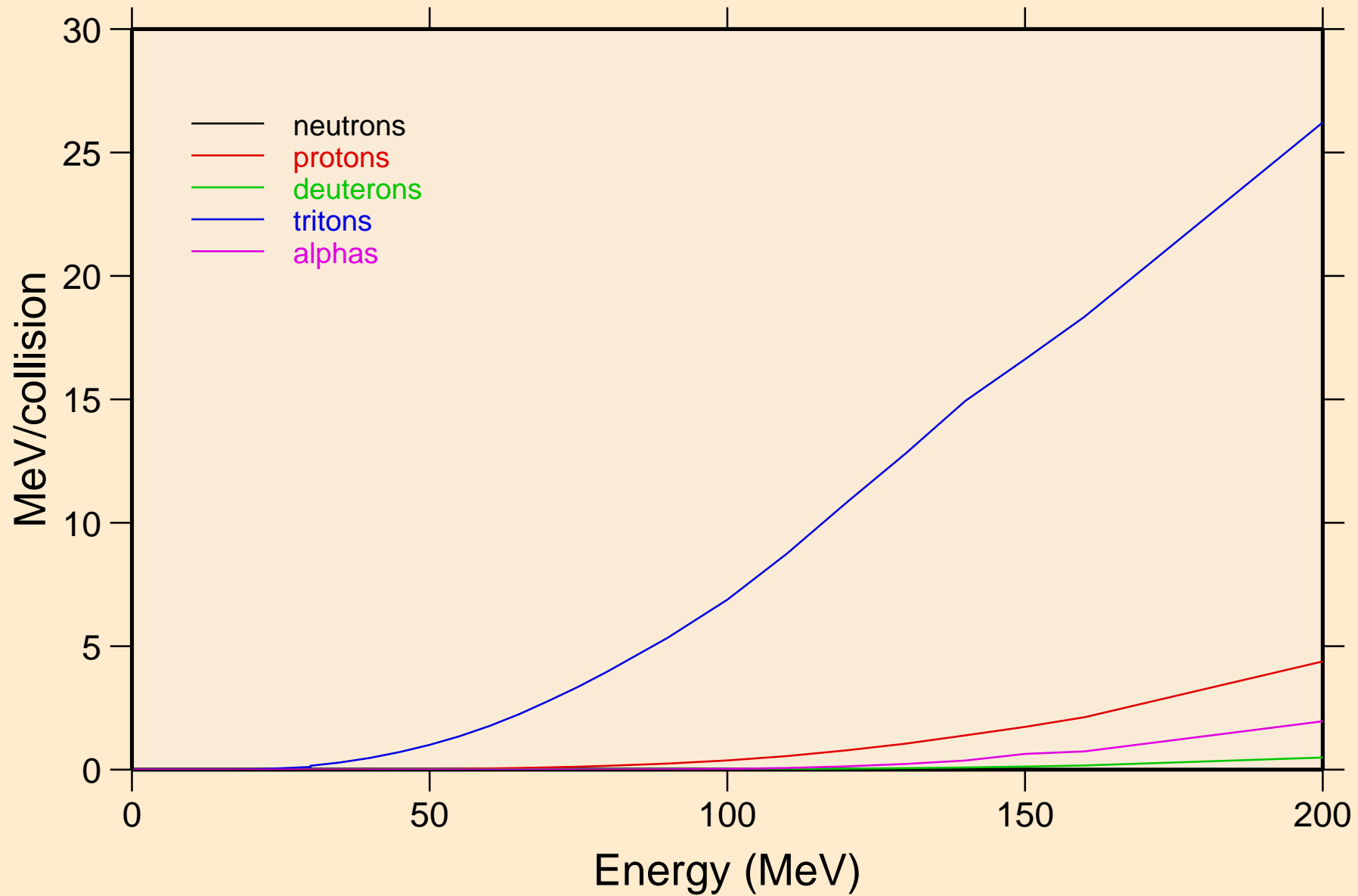

YB181 HELION ACER TENDL-2021 LIBRARY; T=0.K  
Recoil Heating

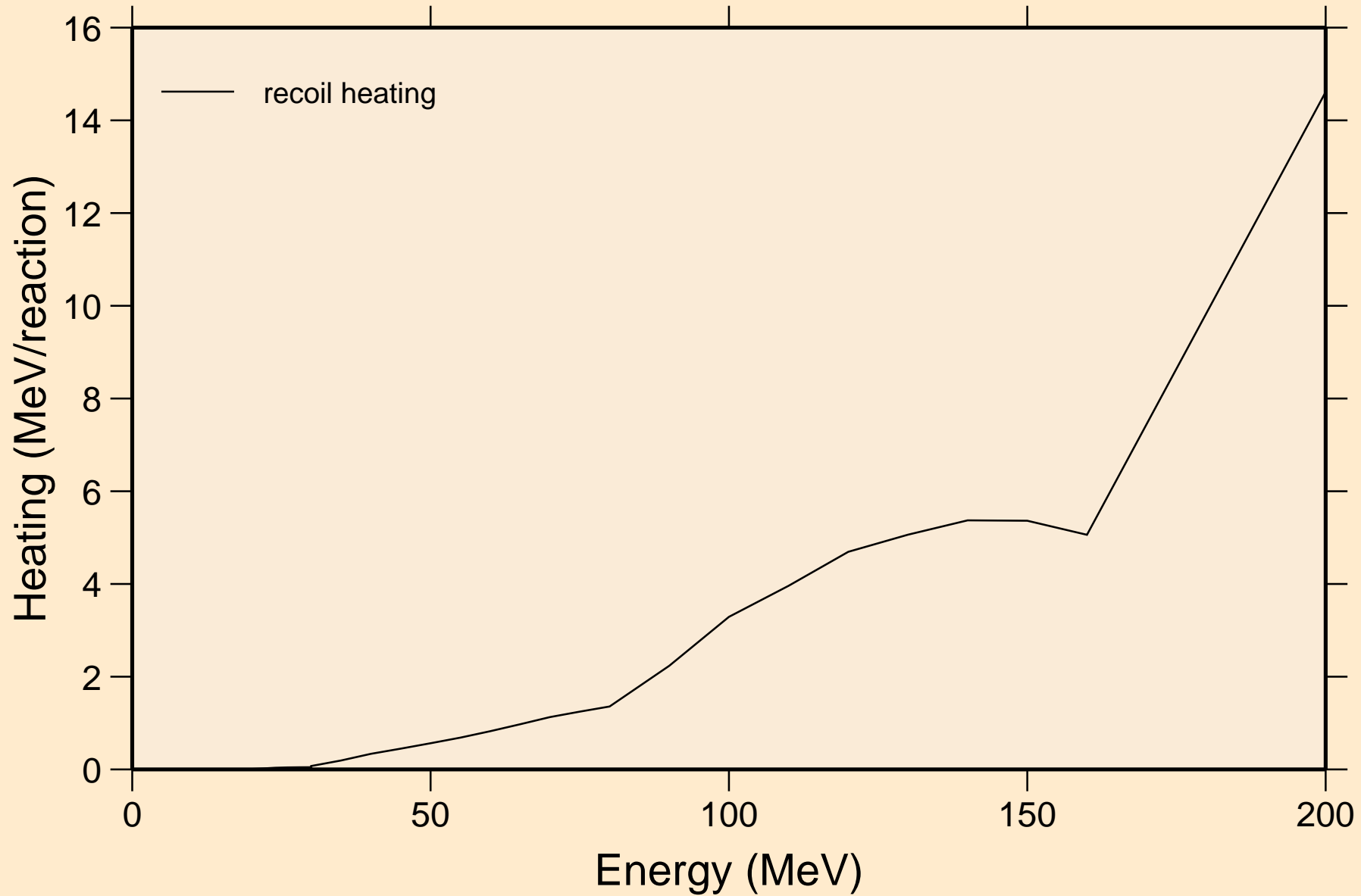

YB181 HELION ACER TENDL-2021 LIBRARY; T=0.K  
Particle production cross sections

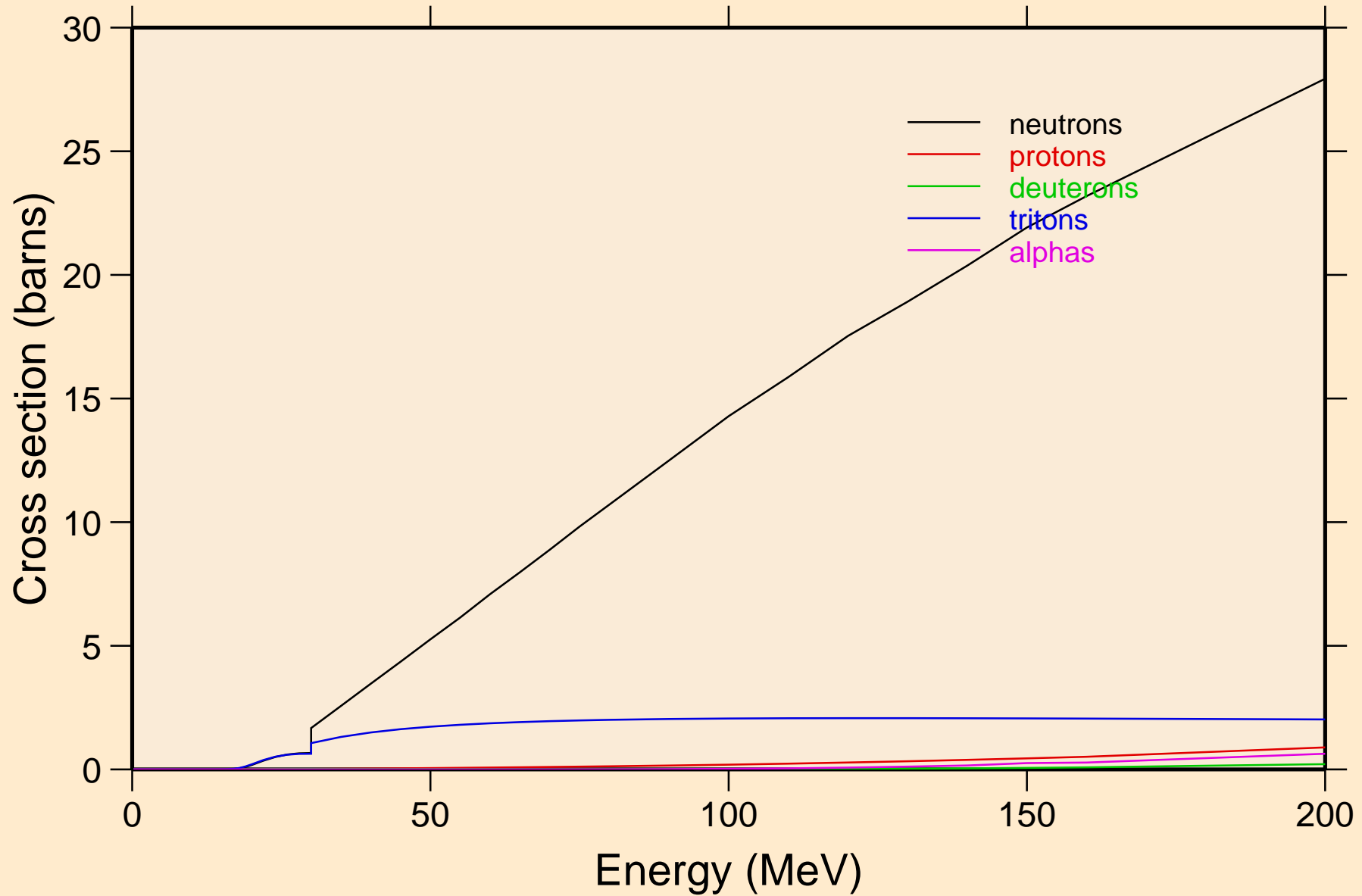

YB181 HELION ACER TENDL-2021 LIBRARY; T=0.K  
neutrons from (s,n)

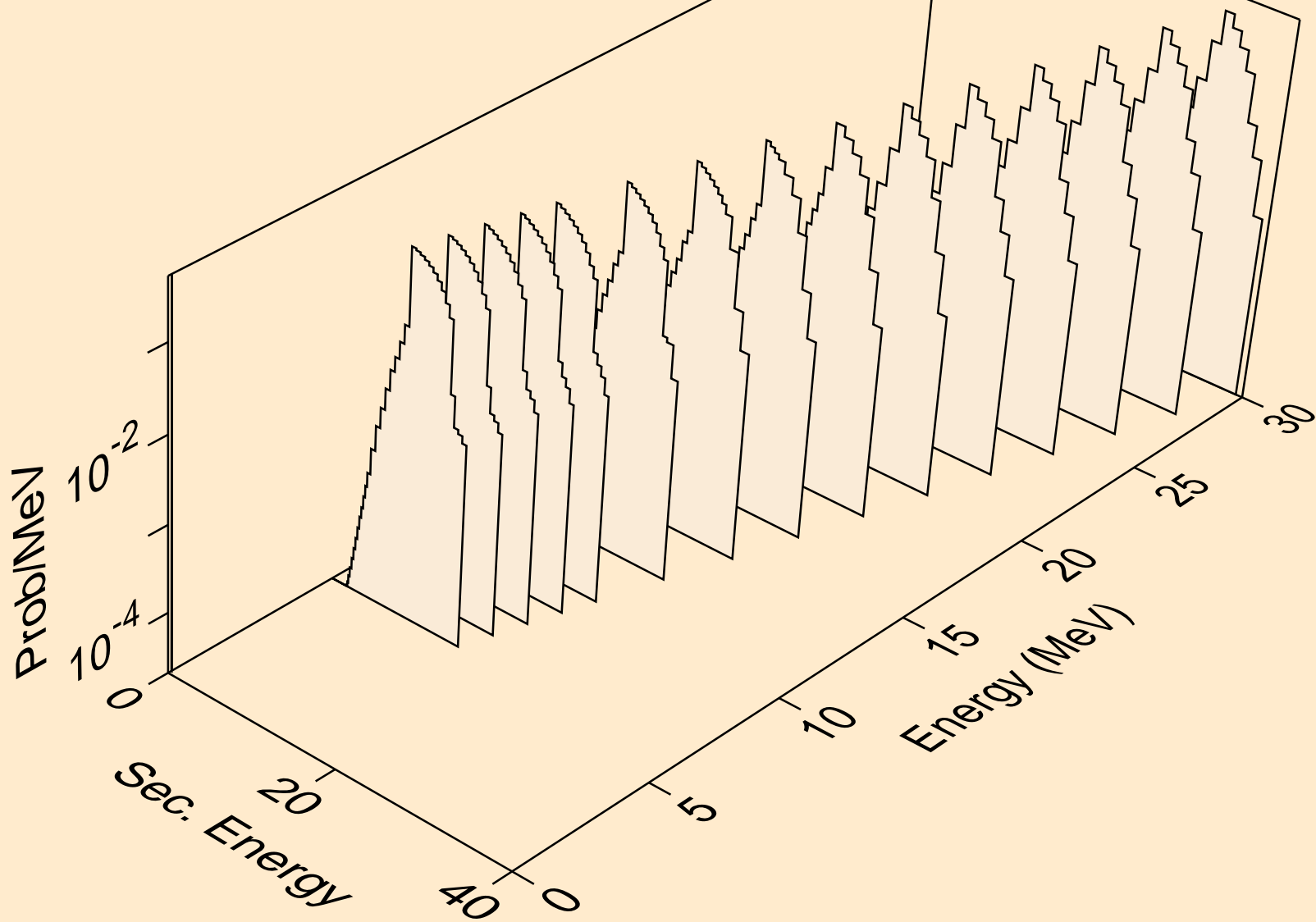

YB181 HELION ACER TENDL-2021 LIBRARY; T=0.K  
neutrons from (s,x)

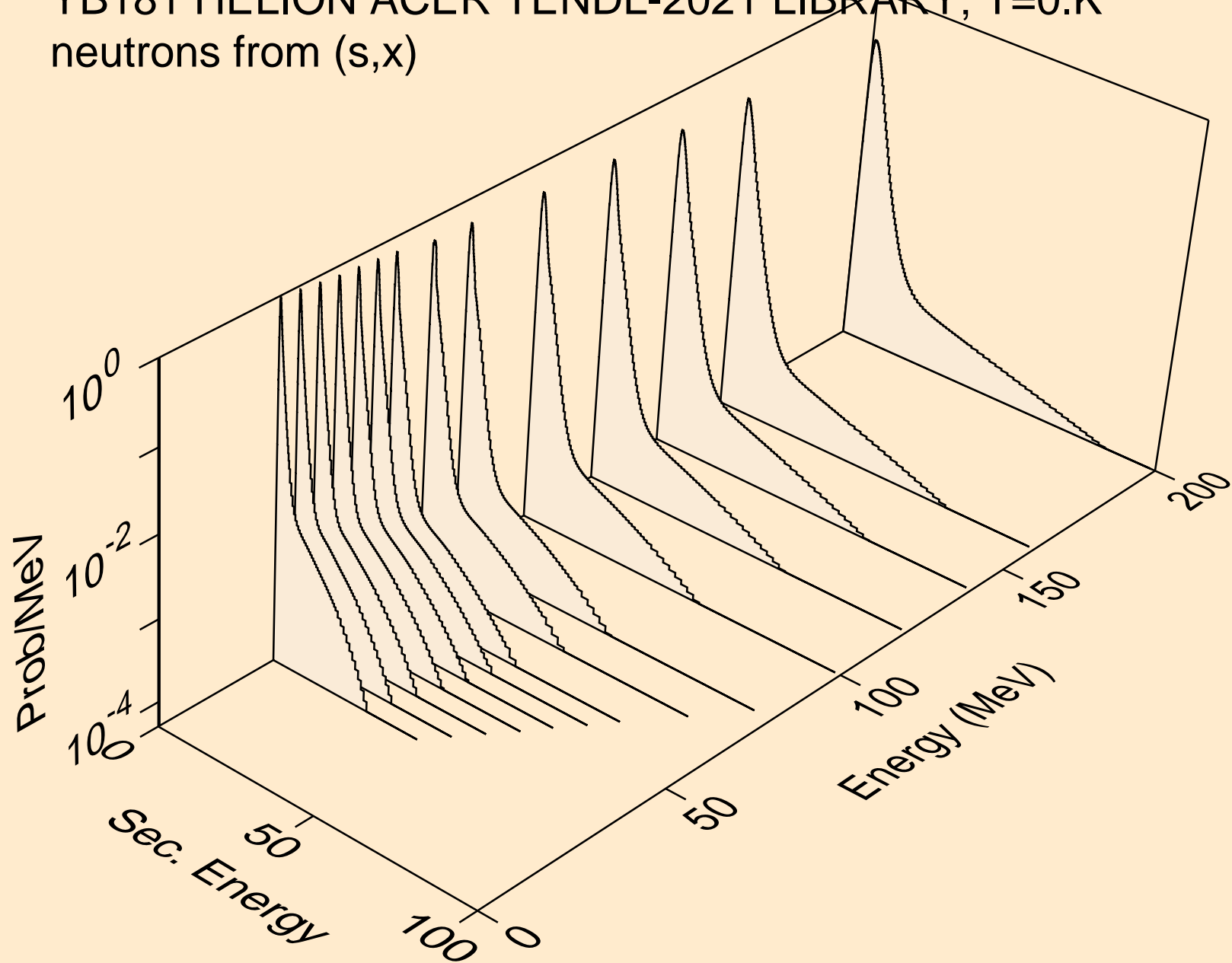

YB181 HELION ACER TENDL-2021 LIBRARY; T=0.K  
neutrons from (s,2nd)

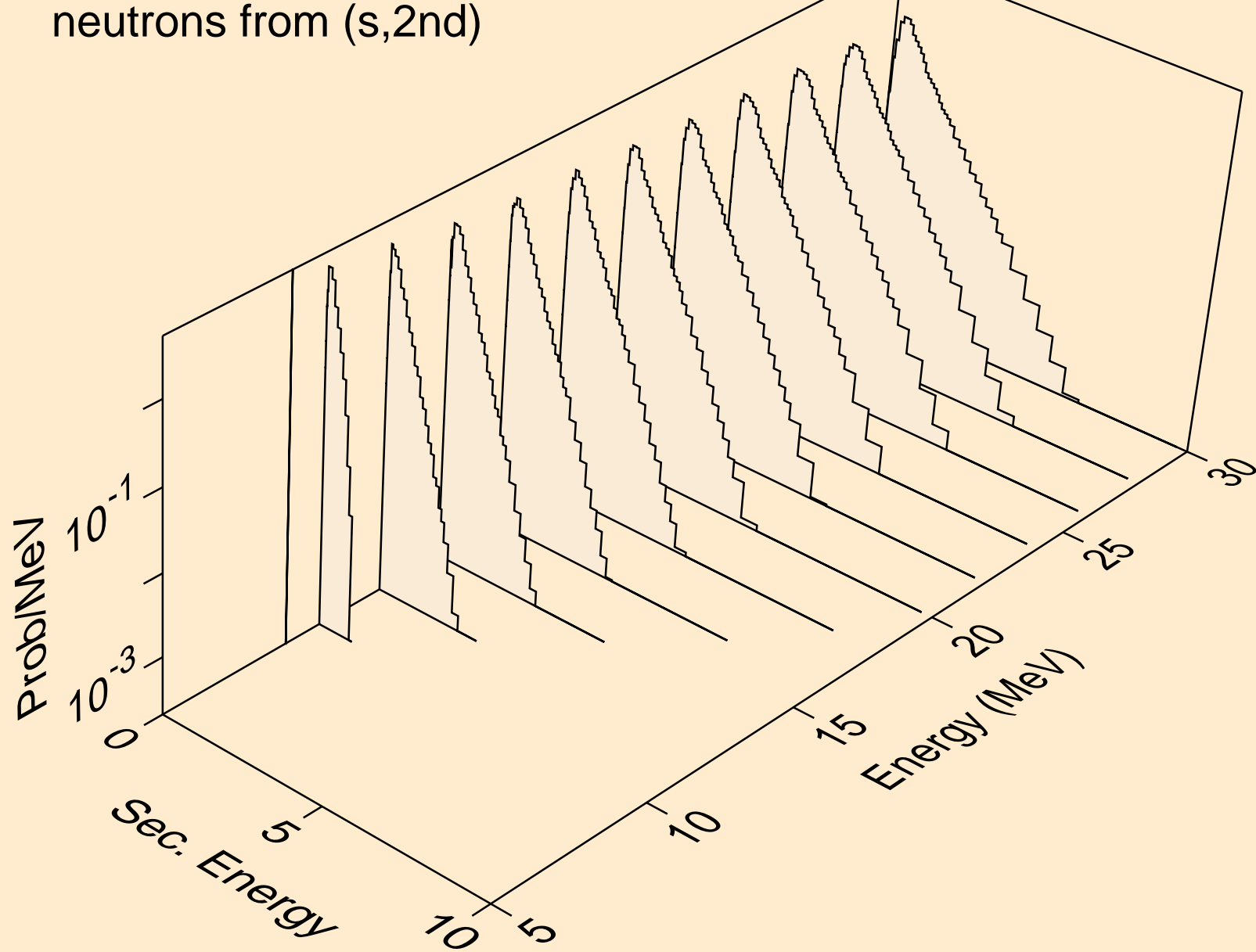



YB181 HELION ACER TENDL-2021 LIBRARY; T=0.K  
neutrons from (s,2n)

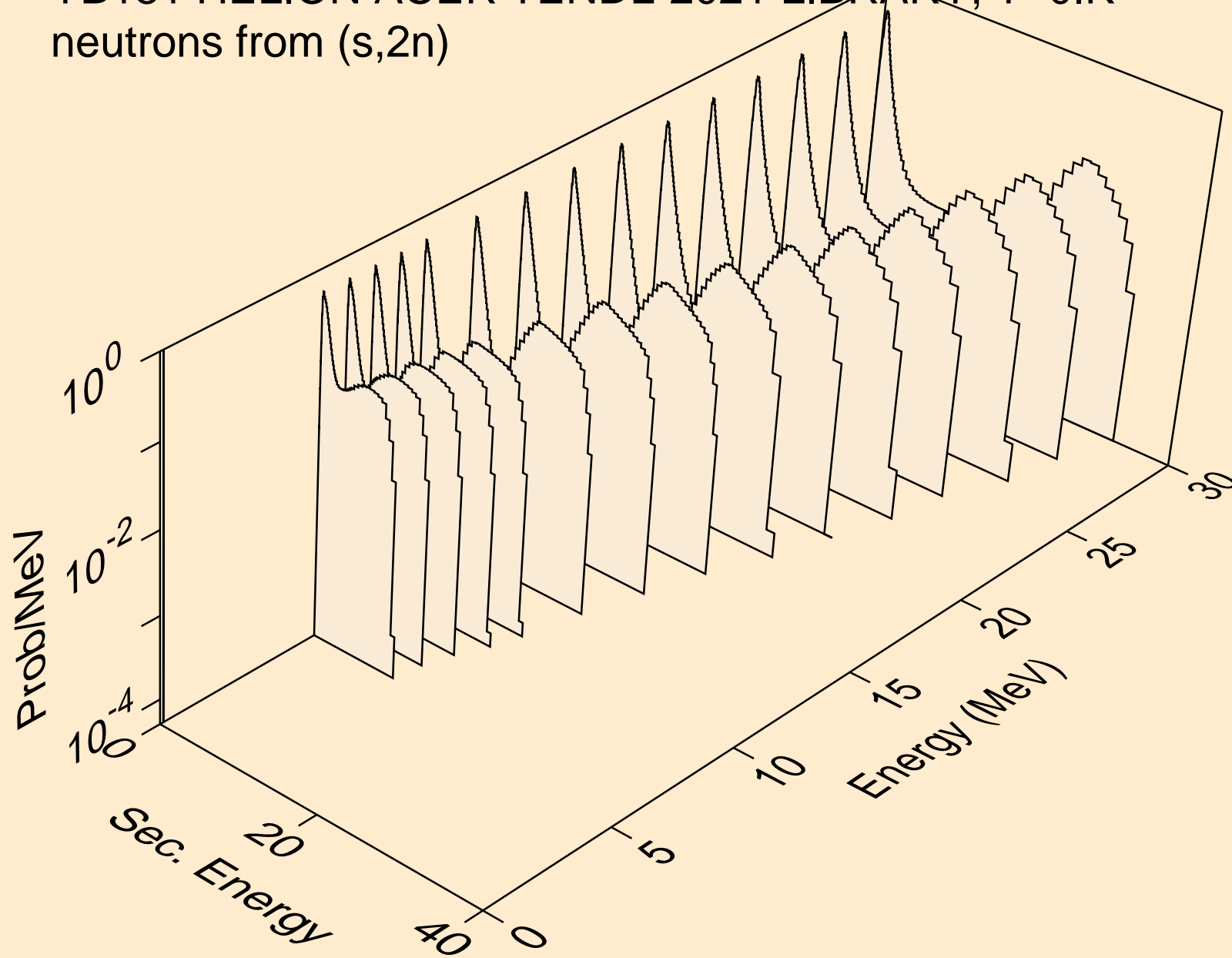

YB181 HELION ACER TENDL-2021 LIBRARY; T=0.K  
neutrons from (s,3n)

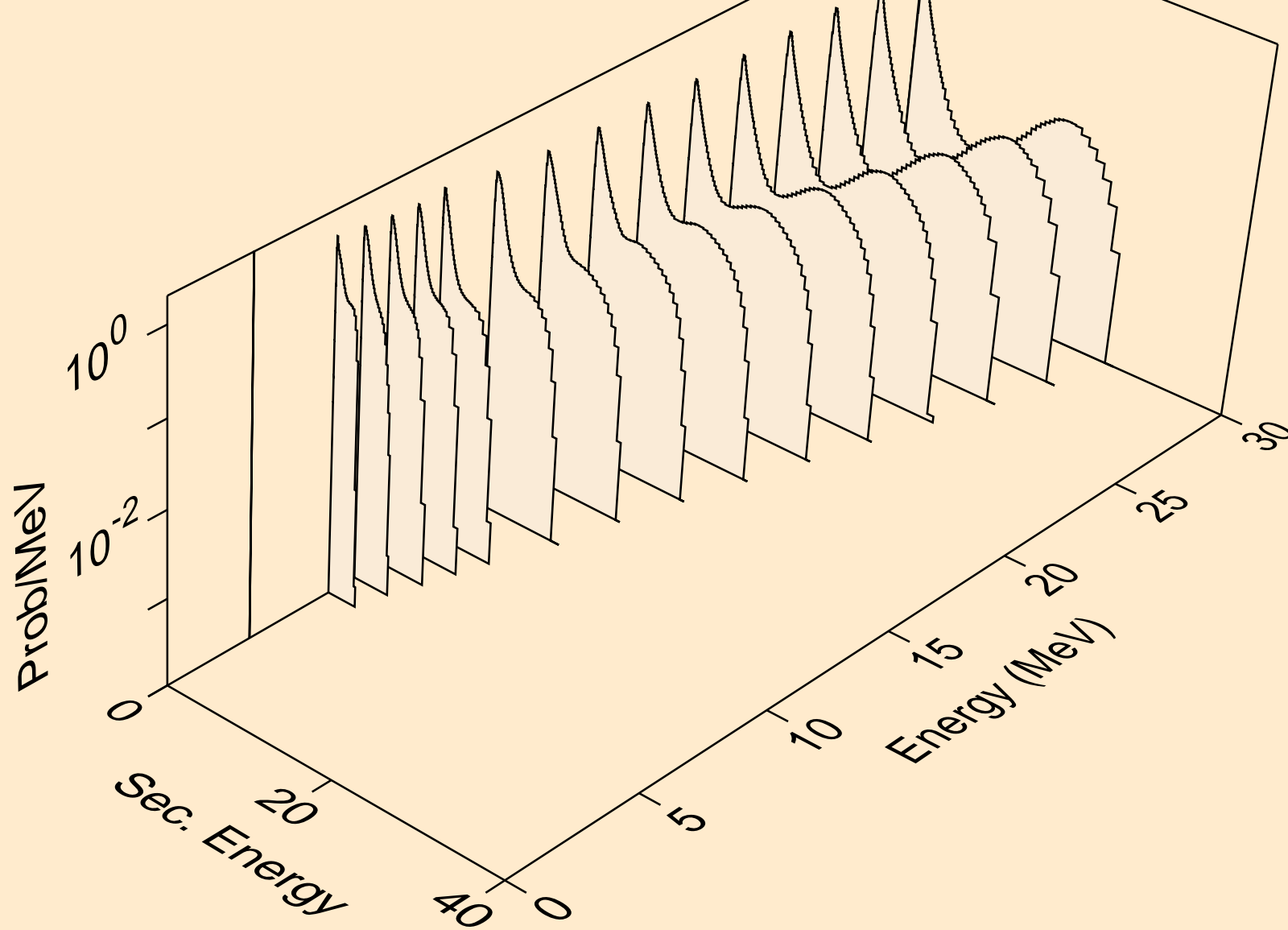

YB181 HELION ACER TENDL-2021 LIBRARY; T=0.K  
neutrons from (s,n\*)a

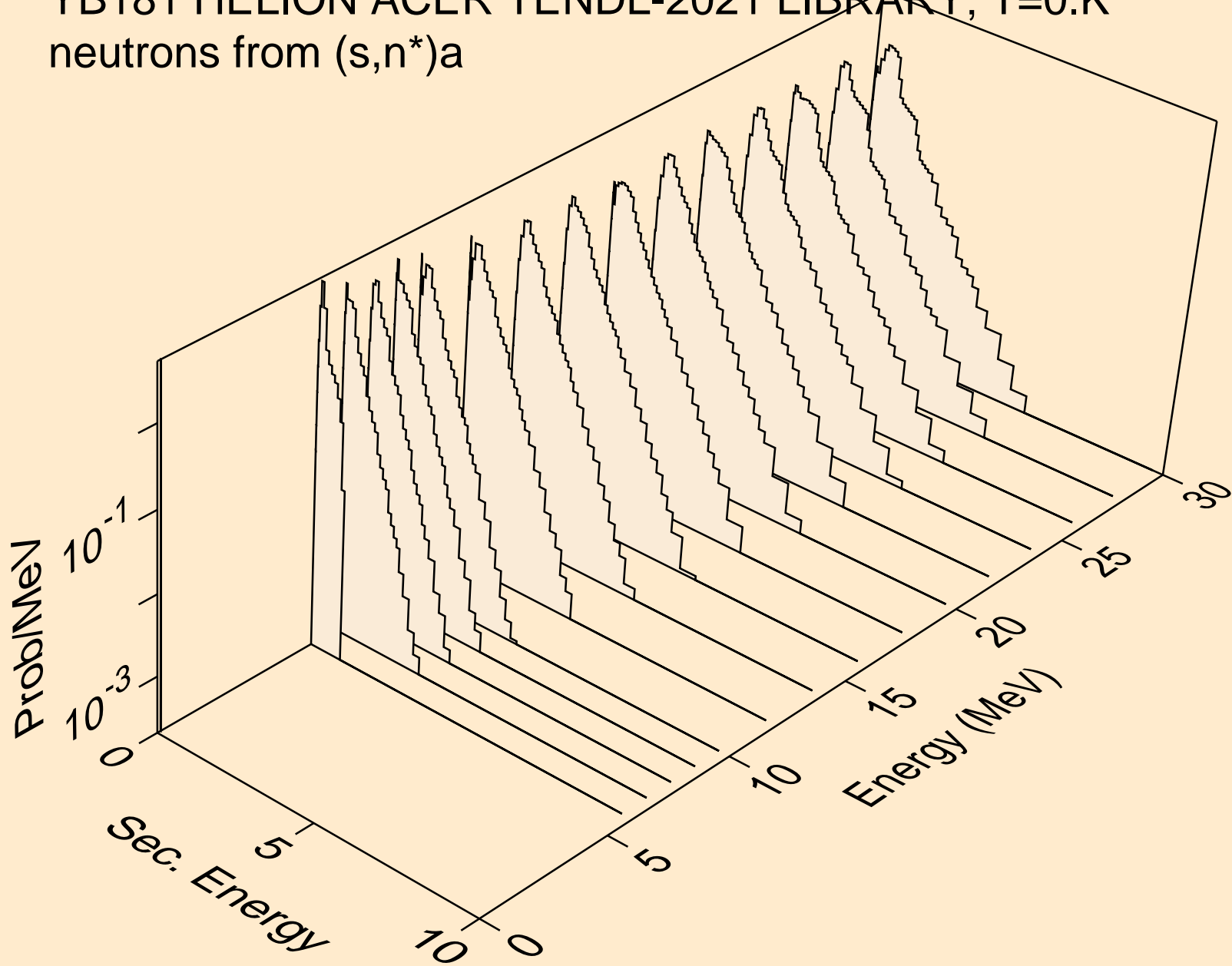

YB181 HELION ACER TENDL-2021 LIBRARY; T=0.K  
neutrons from (s,2n)a

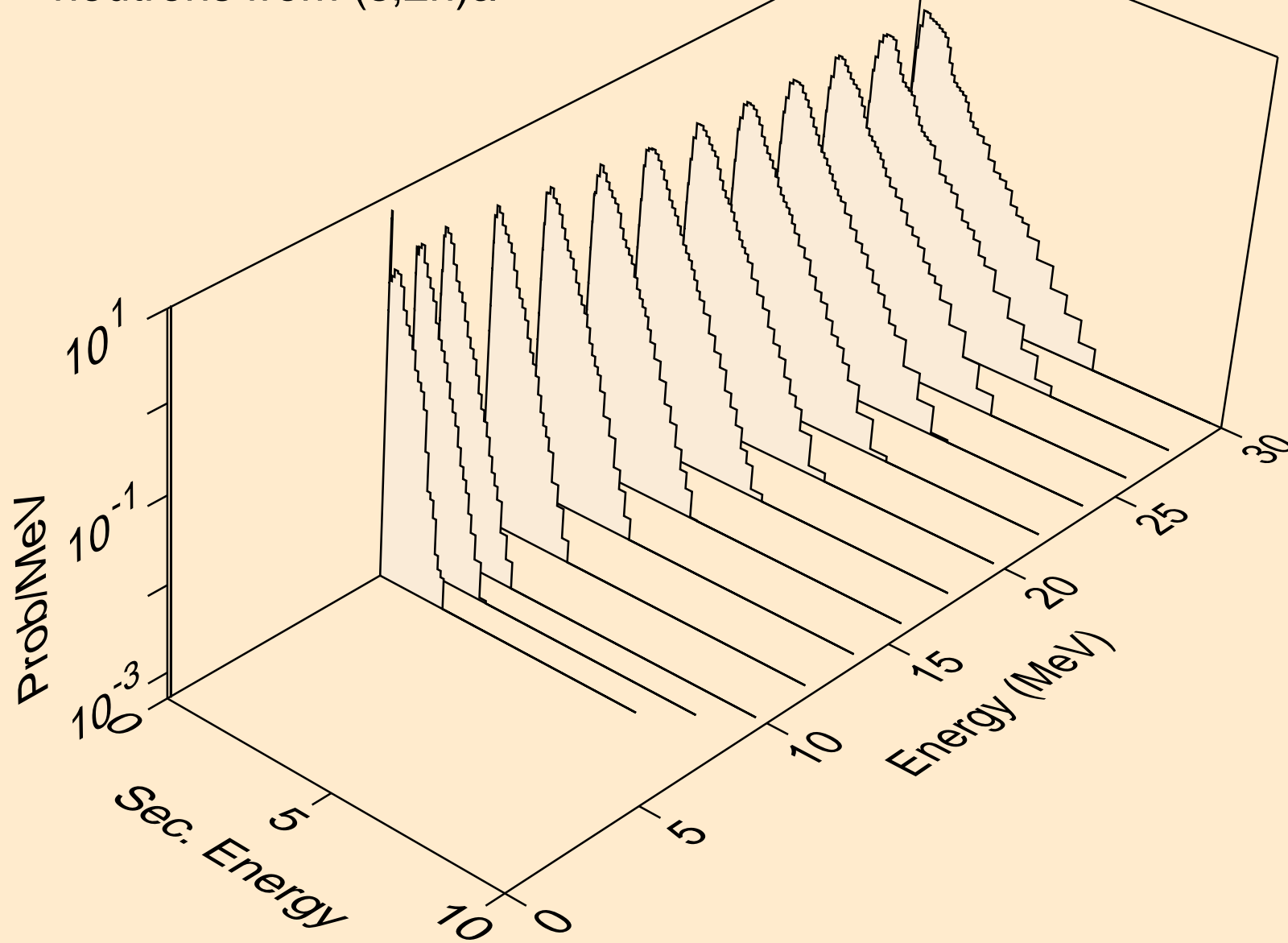

YB181 HELION ACER TENDL-2021 LIBRARY; T=0.K  
neutrons from (s,3n)a

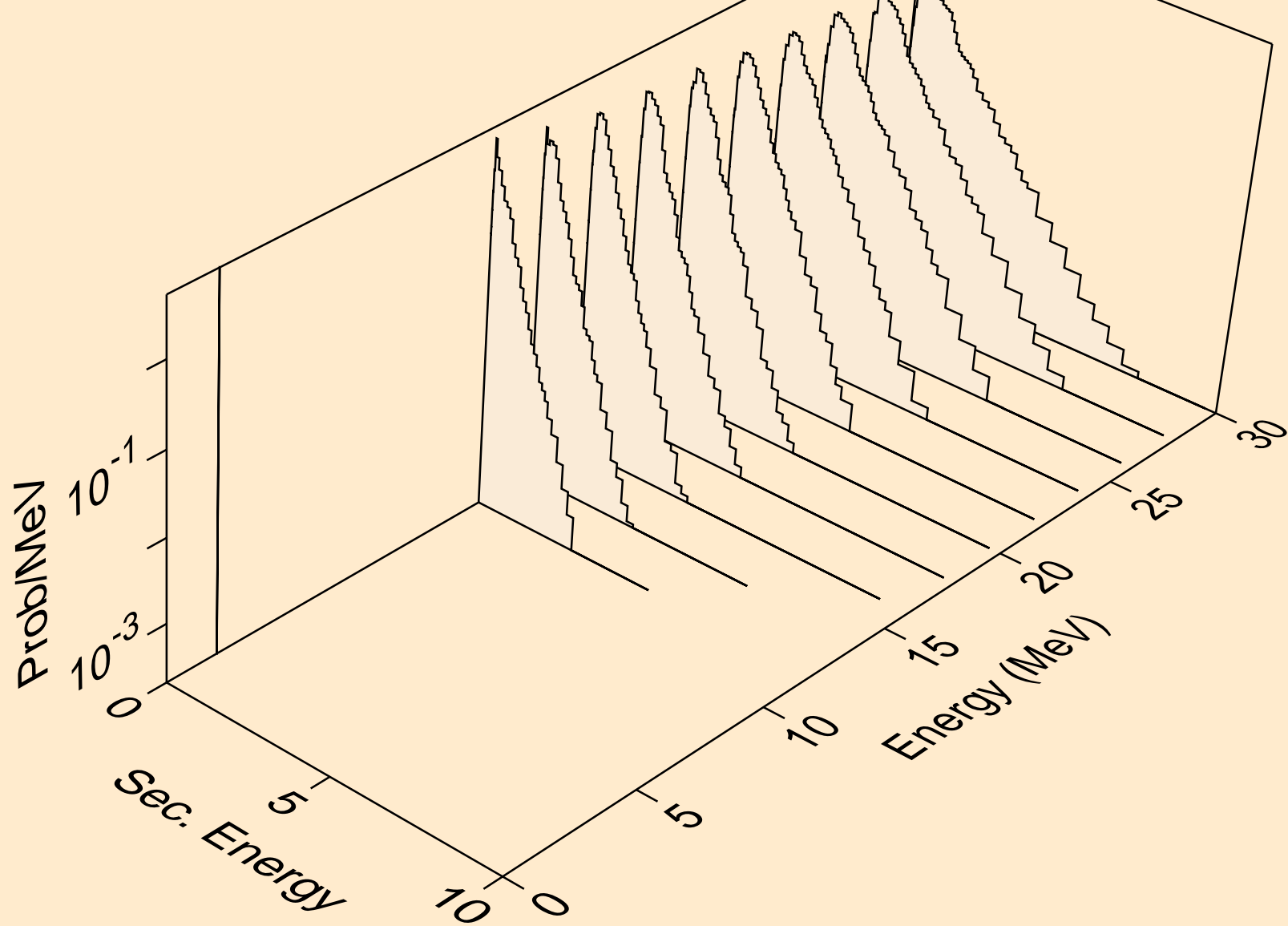

YB181 HELION ACER TENDL-2021 LIBRARY; T=0.K  
neutrons from (s,n\*)p

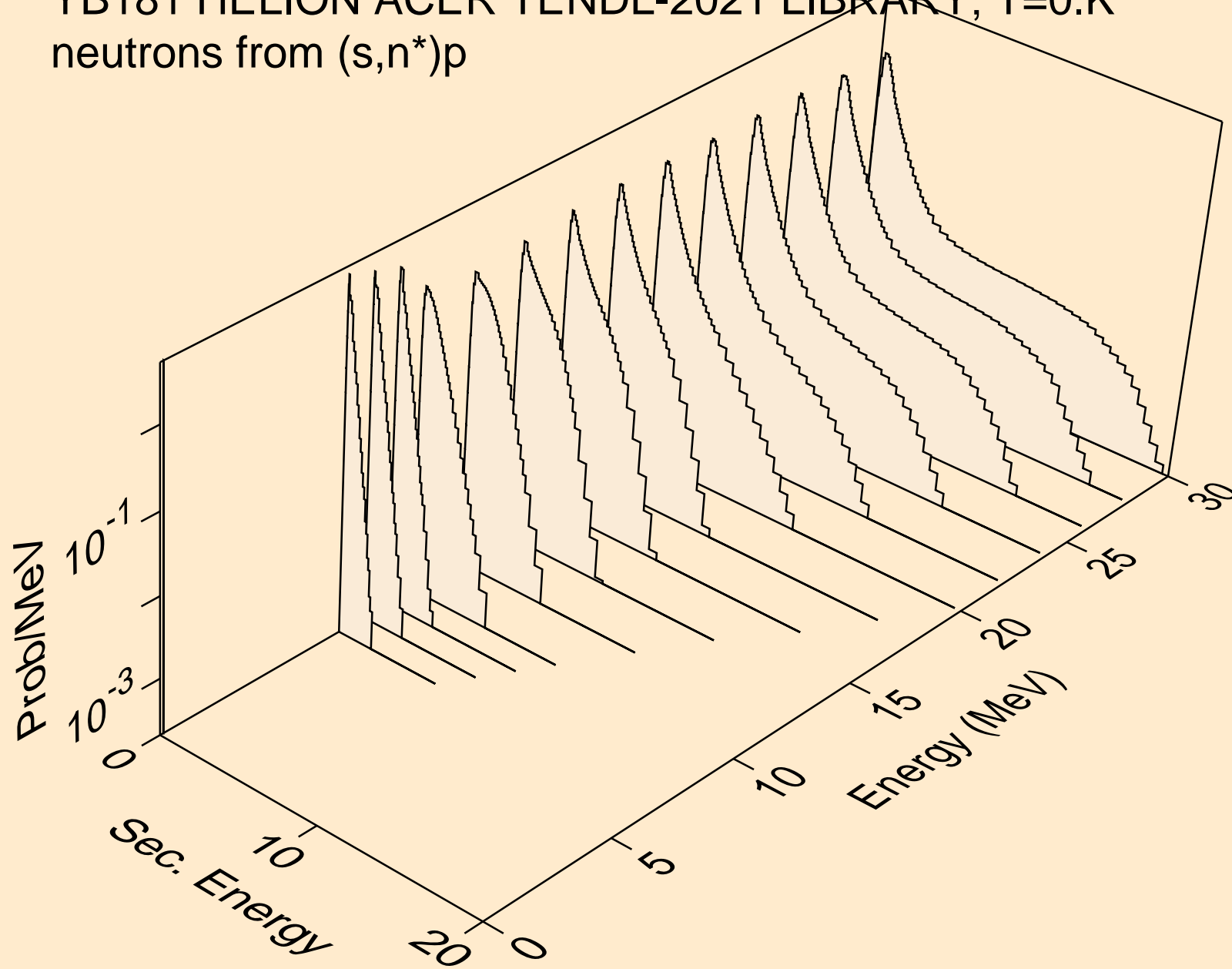

YB181 HELION ACER TENDL-2021 LIBRARY; T=0.K  
neutrons from (s,n\*)d

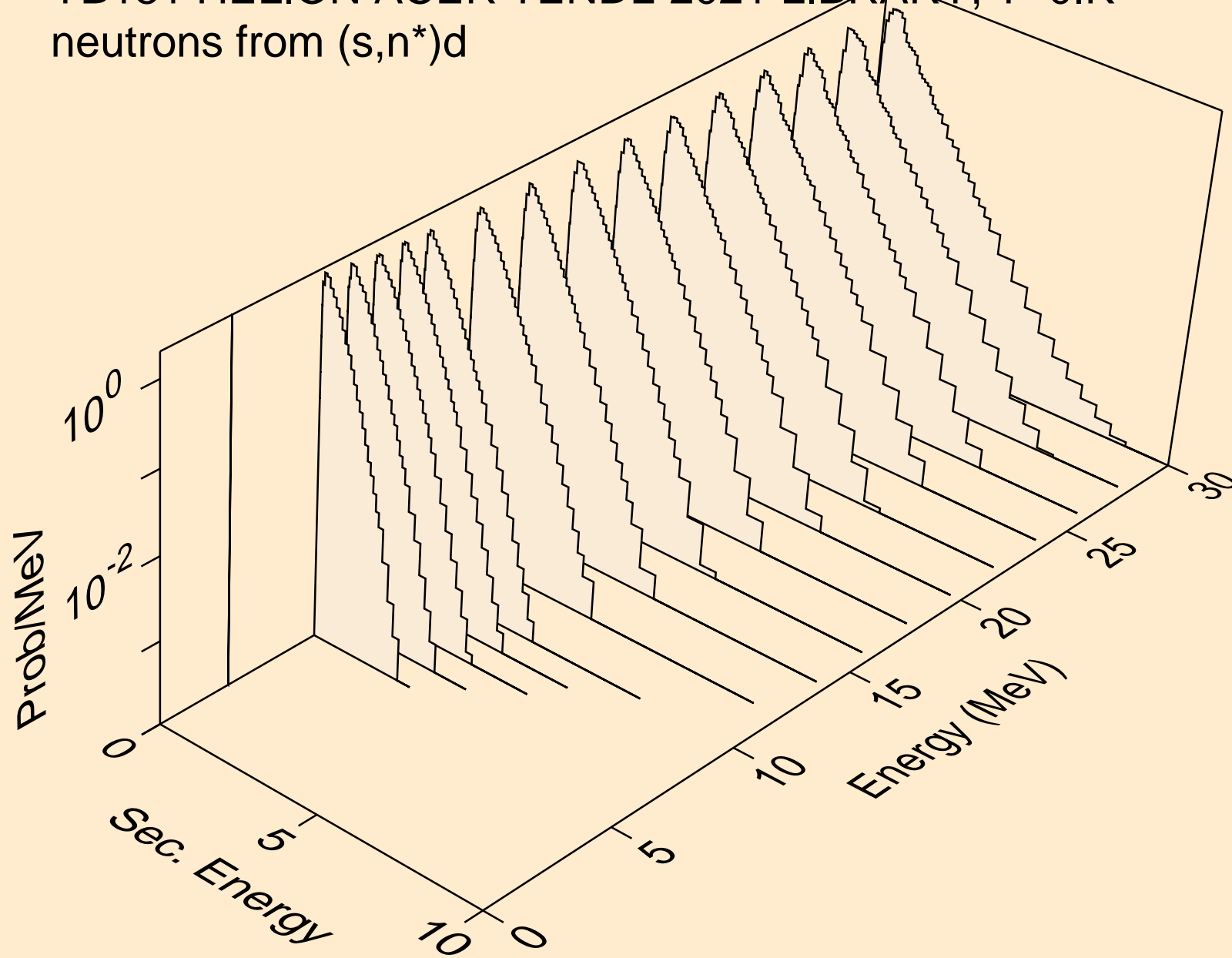

YB181 HELION ACER TENDL-2021 LIBRARY; T=0.K  
neutrons from (s,n\*)t

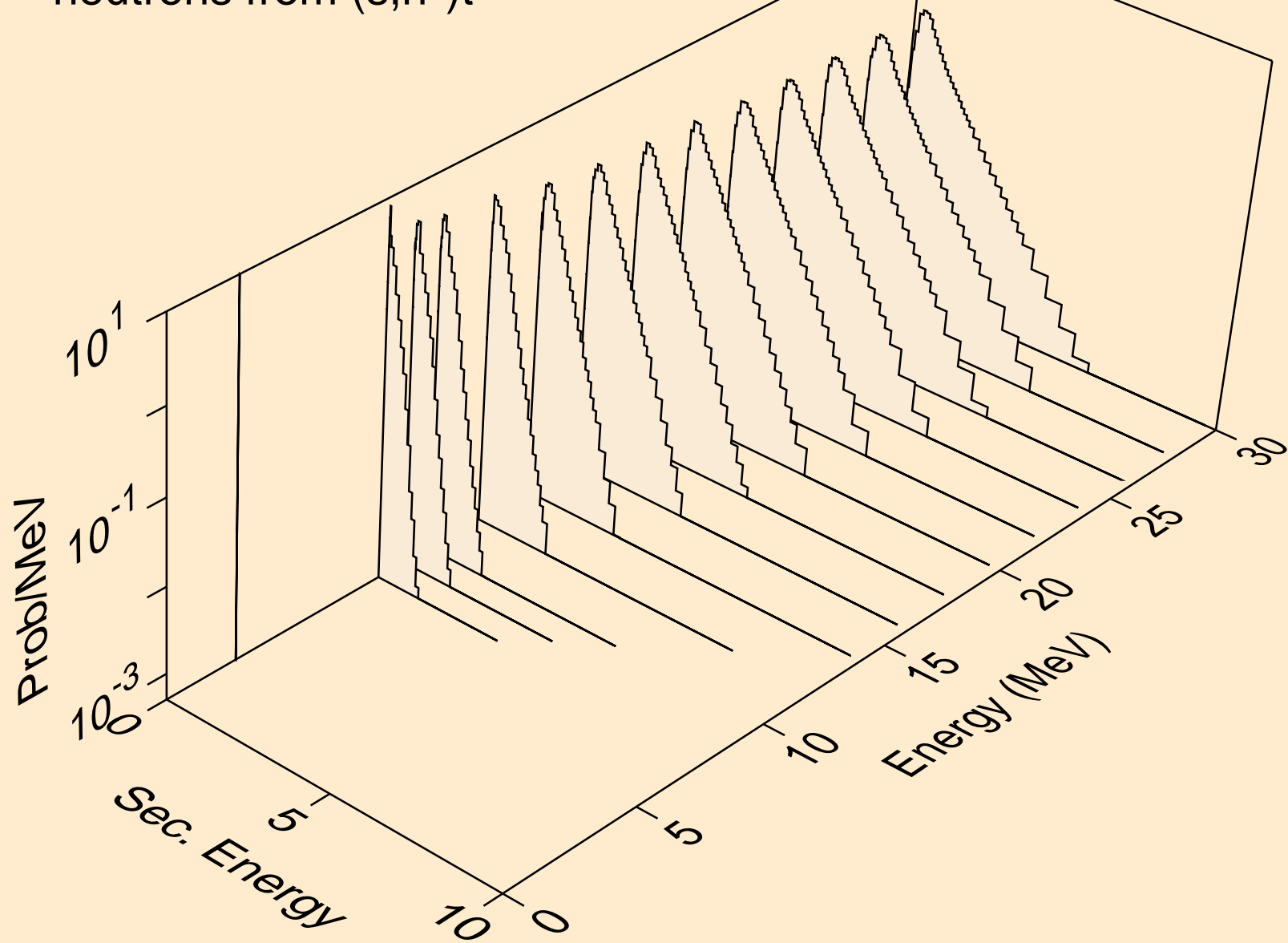



YB181 HELION ACER TENDL-2021 LIBRARY; T=0.K  
neutrons from (s,n\*)he3

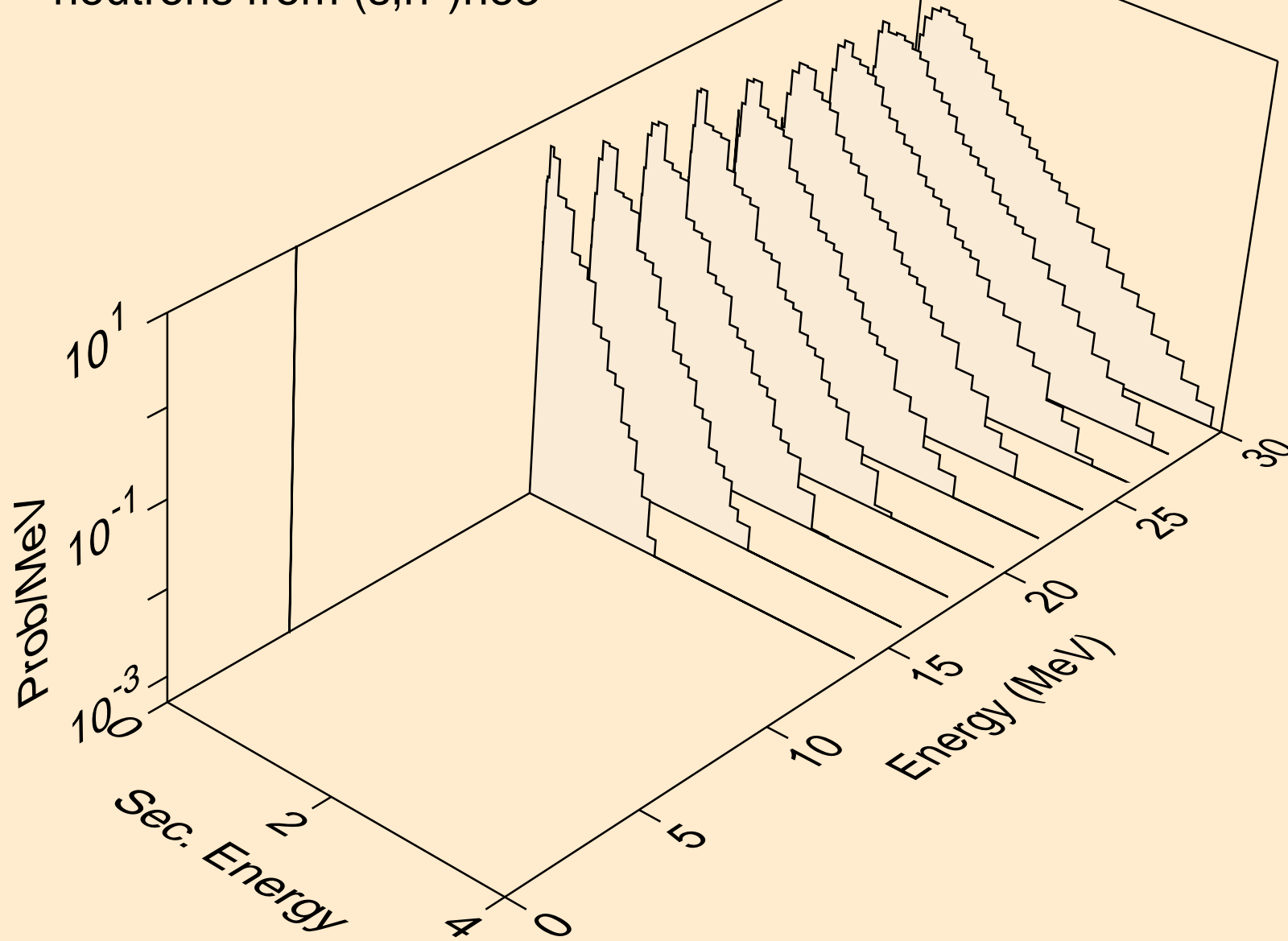

YB181 HELION ACER TENDL-2021 LIBRARY; T=0.K  
neutrons from (s,4n)

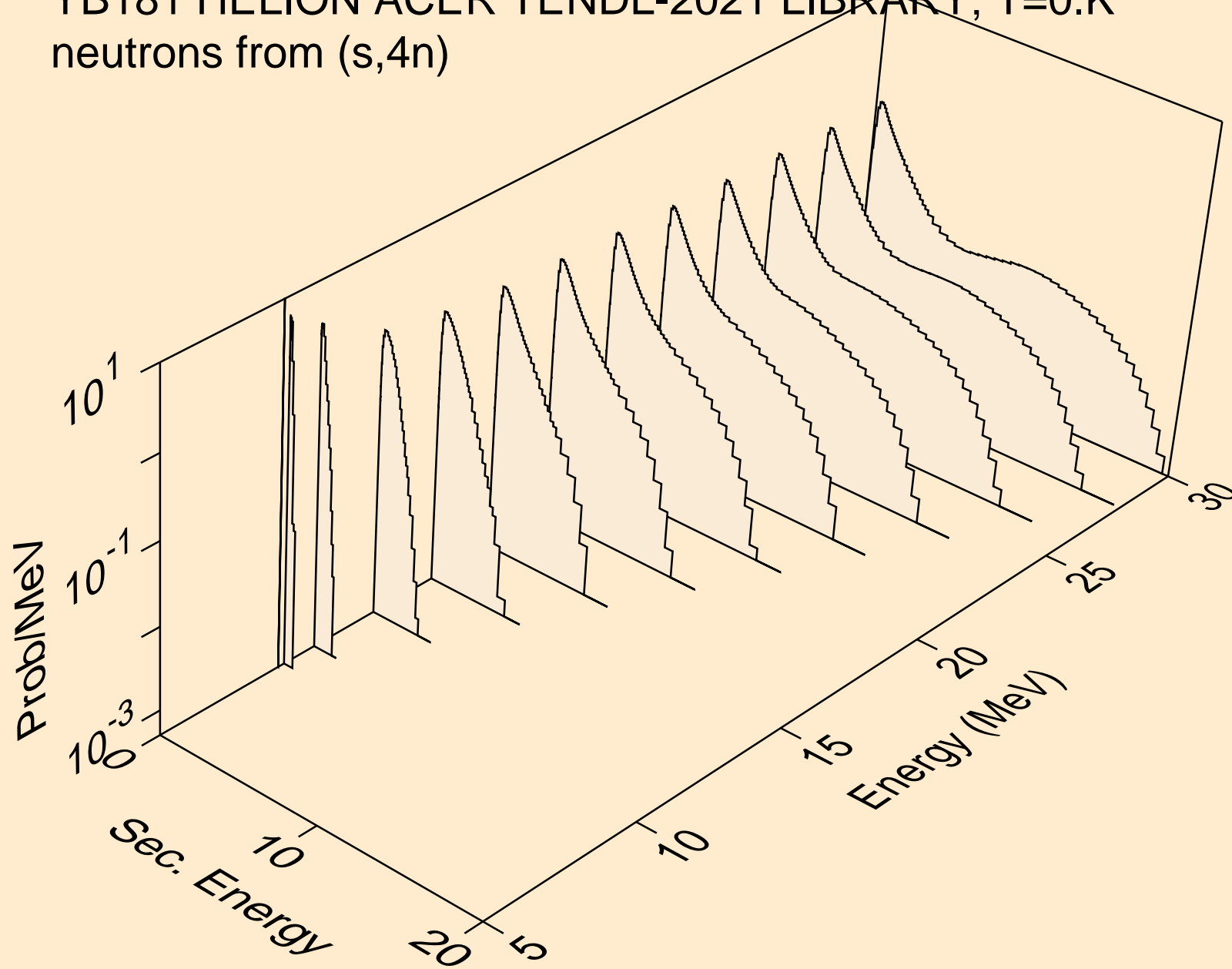

YB181 HELION ACER TENDL-2021 LIBRARY; T=0.K  
neutrons from (s,2np)

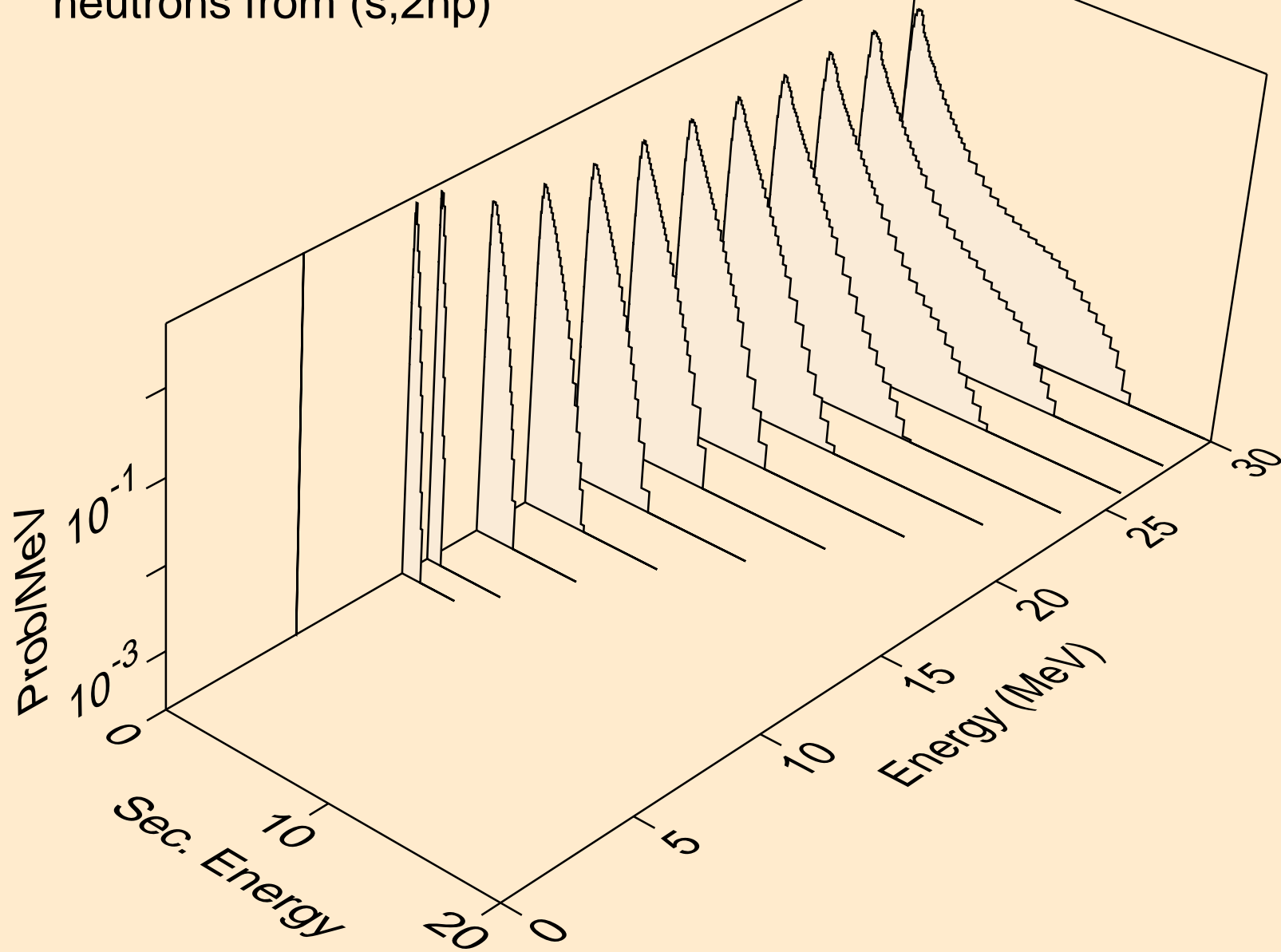

YB181 HELION ACER TENDL-2021 LIBRARY; T=0.K  
neutrons from (s,3np)

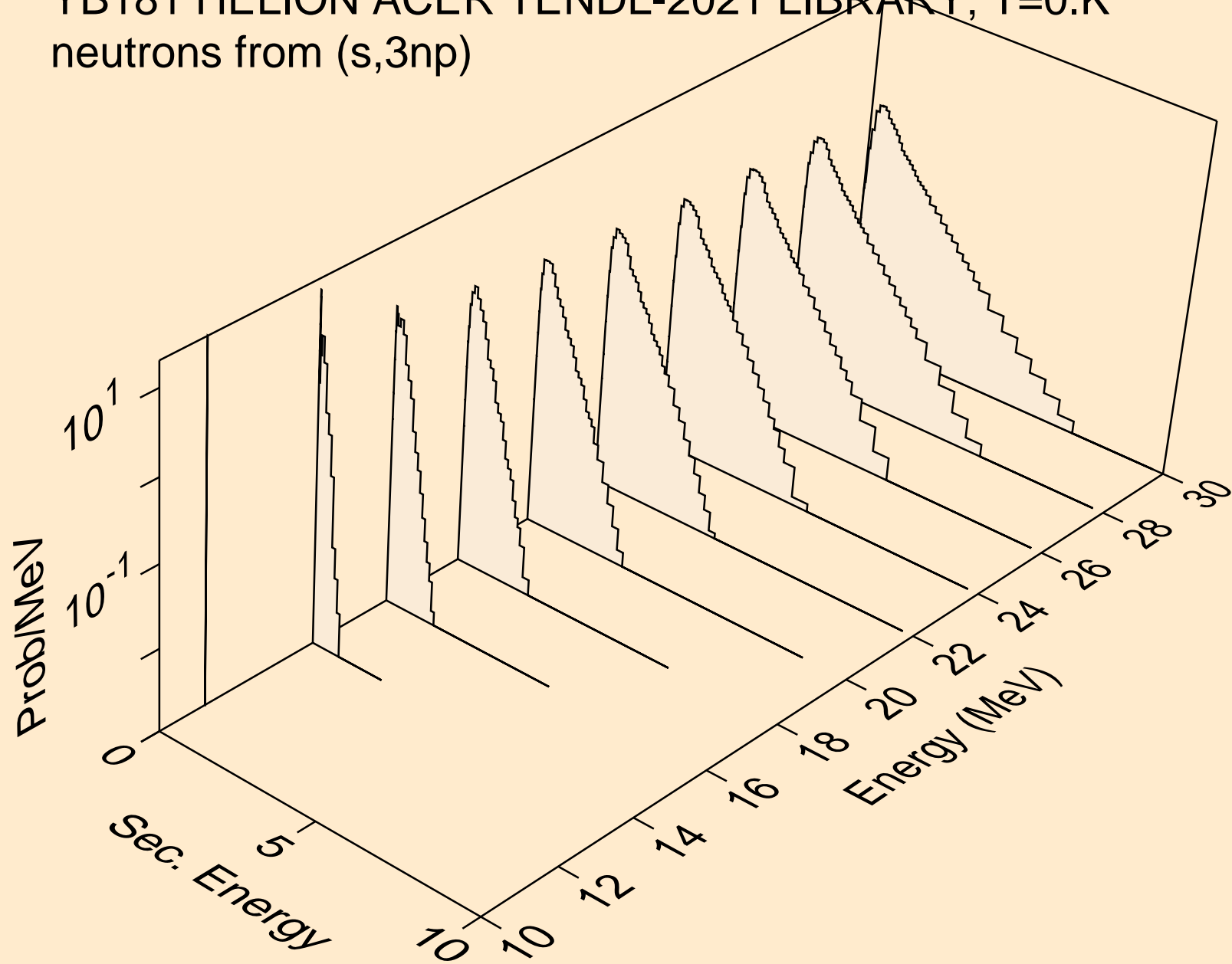

YB181 HELION ACER TENDL-2021 LIBRARY; T=0.K  
neutrons from (s,2np)

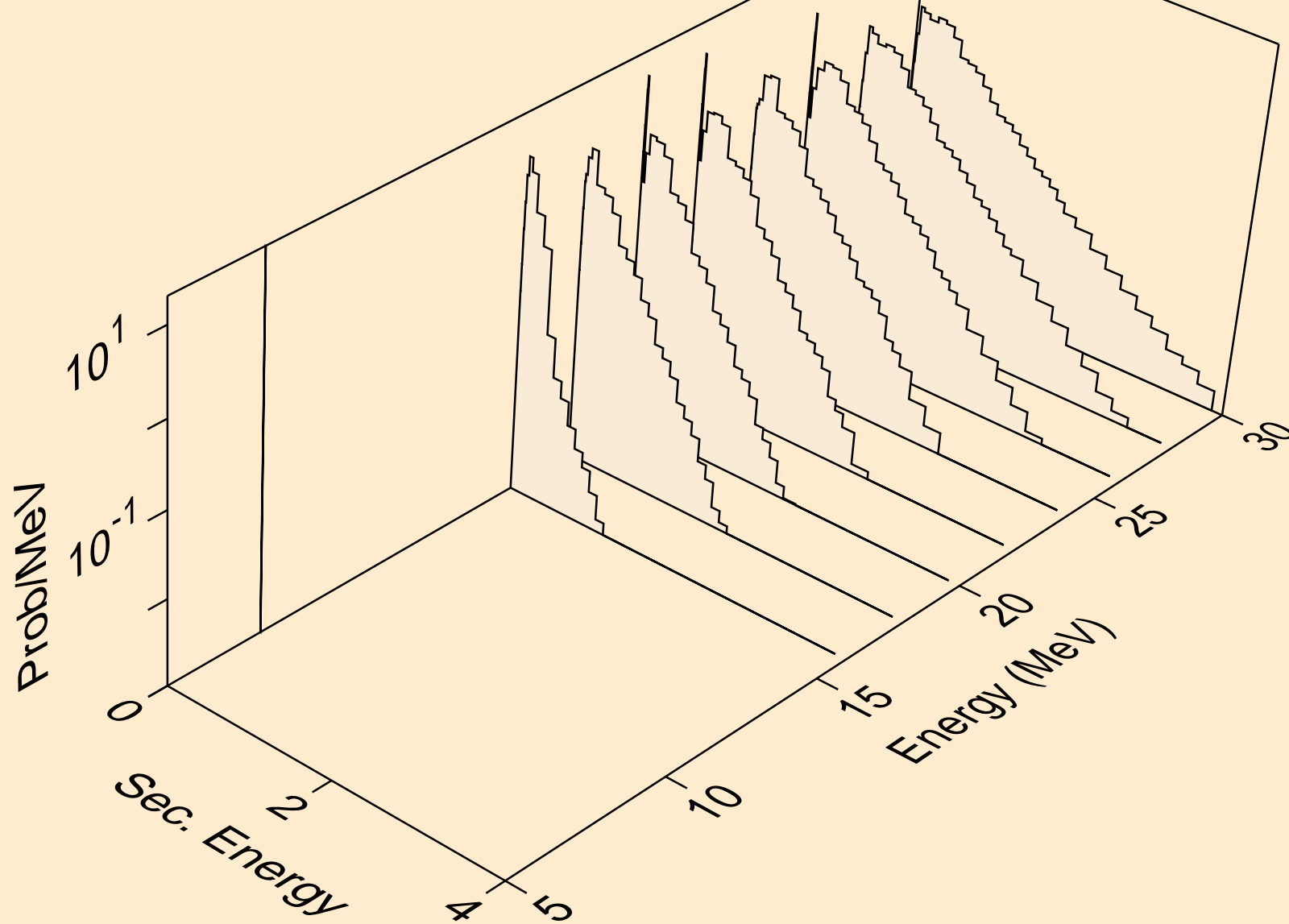

YB181 HELION ACER TENDL-2021 LIBRARY; T=0.K  
neutrons from (s,npa)

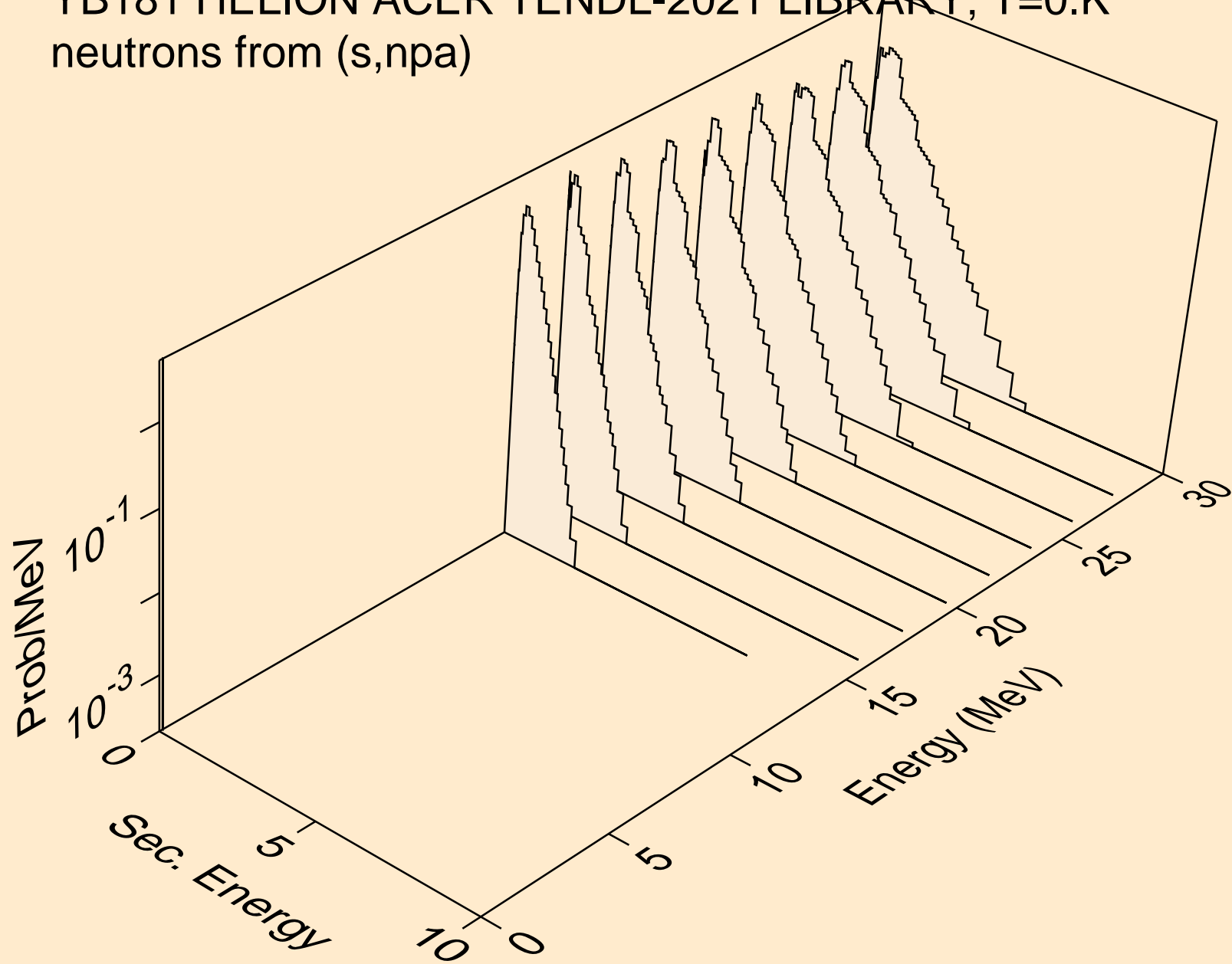

YB181 HELION ACER TENDL-2021 LIBRARY; T=0.K  
protons from (s,x)

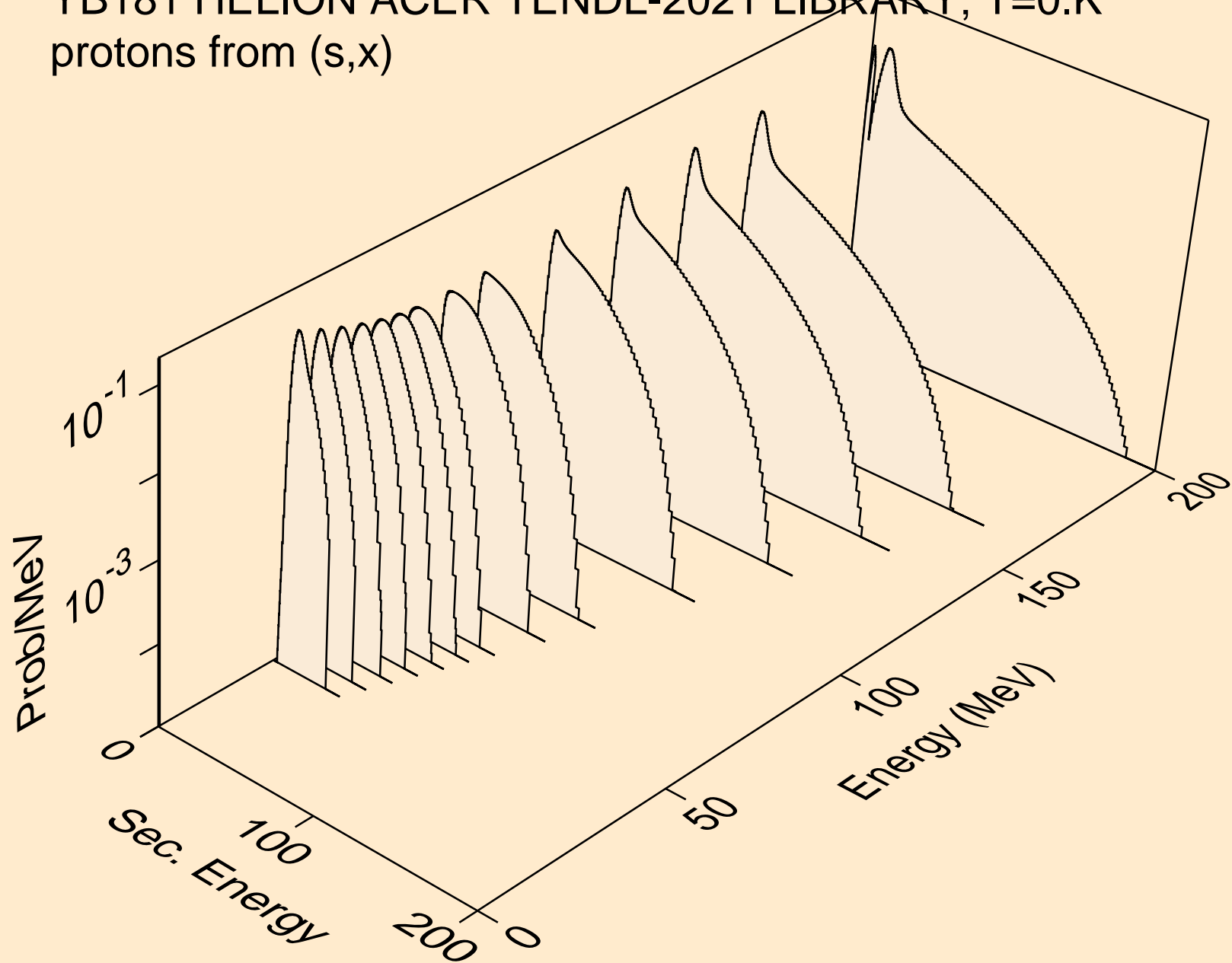

YB181 HELION ACER TENDL-2021 LIBRARY; T=0.K  
protons from (s,n\*)p

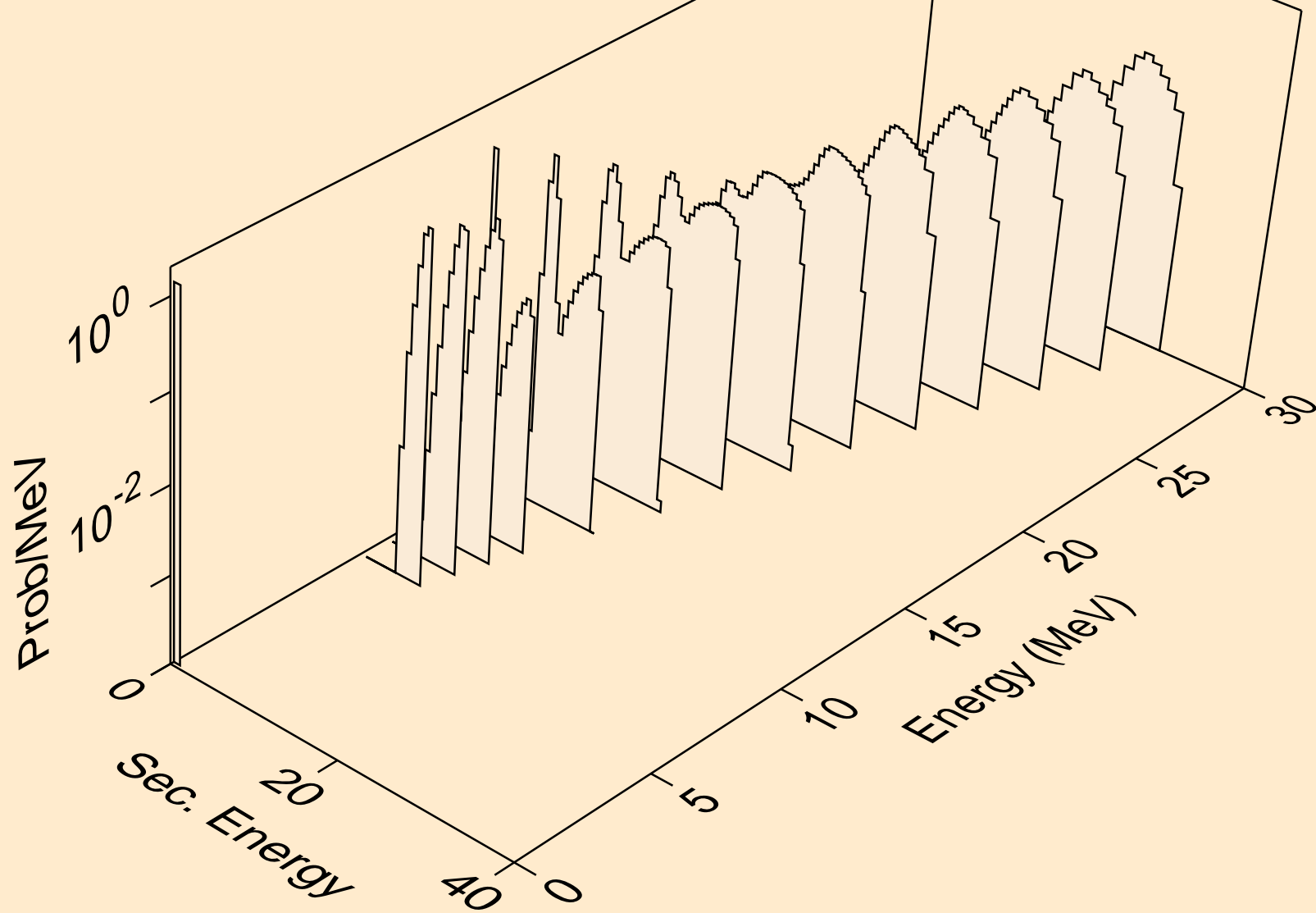



YB181 HELION ACER TENDL-2021 LIBRARY; T=0.K  
protons from (s,2np)

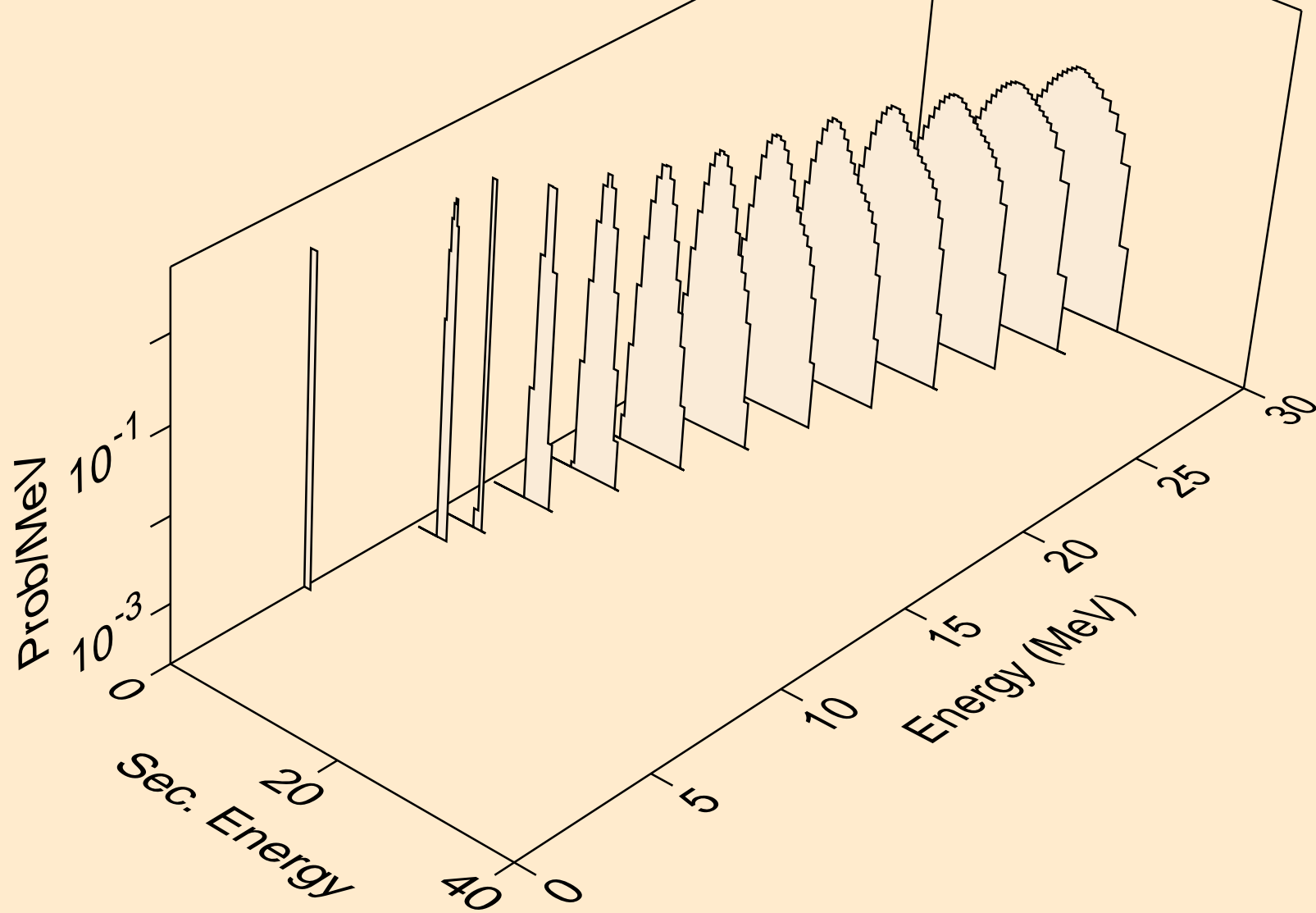

YB181 HELION ACER TENDL-2021 LIBRARY; T=0.K  
protons from (s,3np)

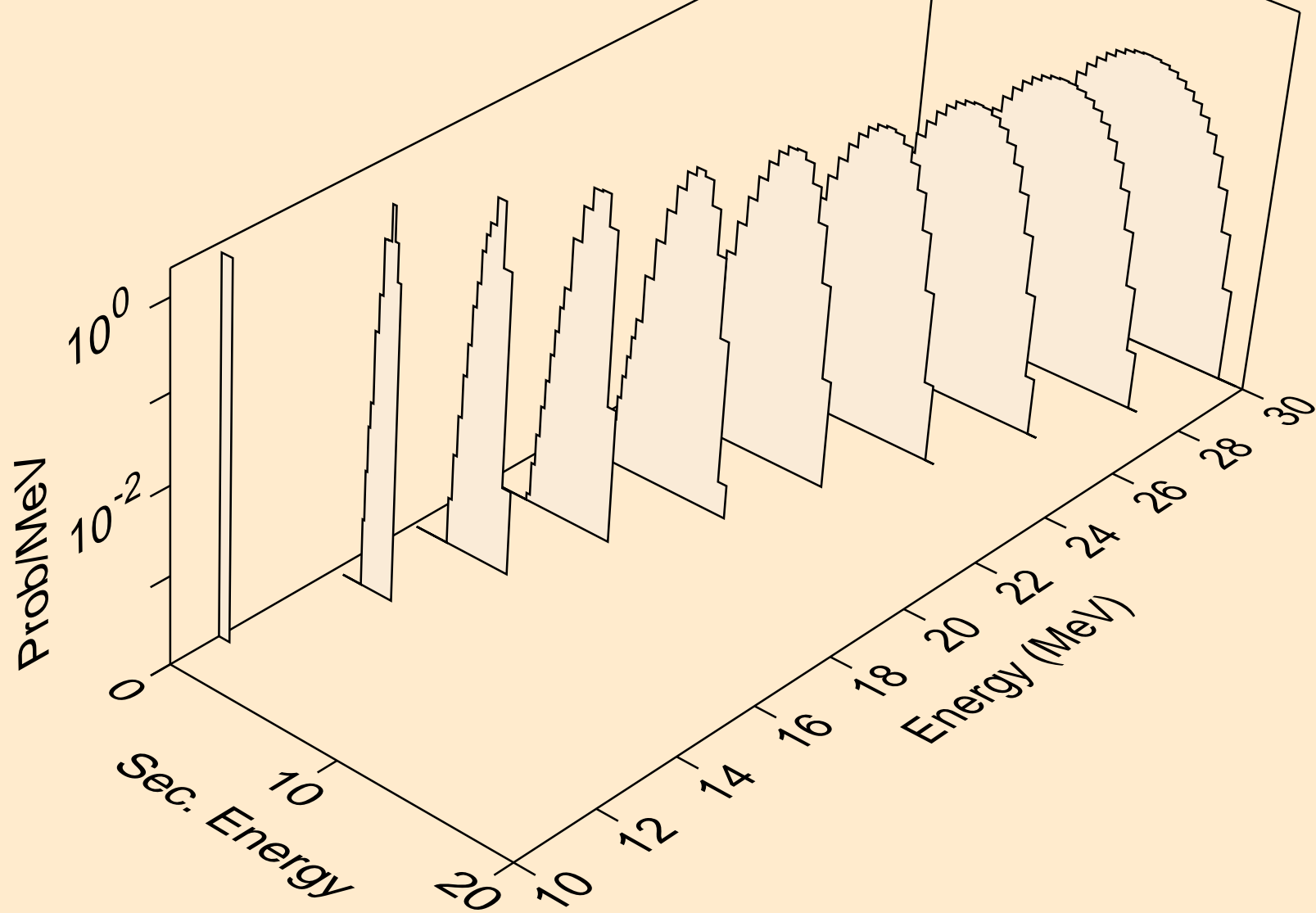

YB181 HELION ACER TENDL-2021 LIBRARY; T=0.K  
protons from (s,2np)

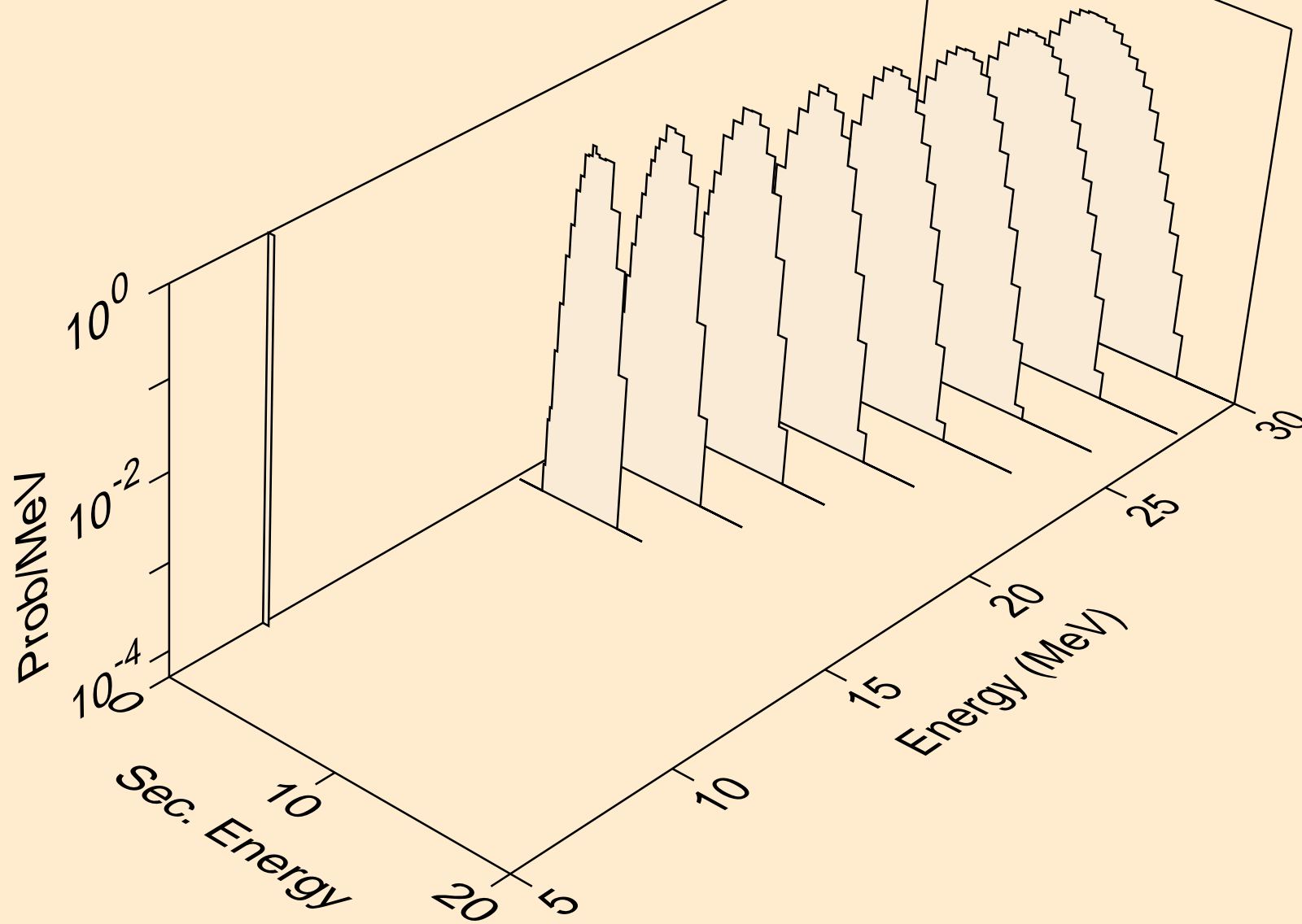

YB181 HELION ACER TENDL-2021 LIBRARY; T=0.K  
protons from (s,npa)

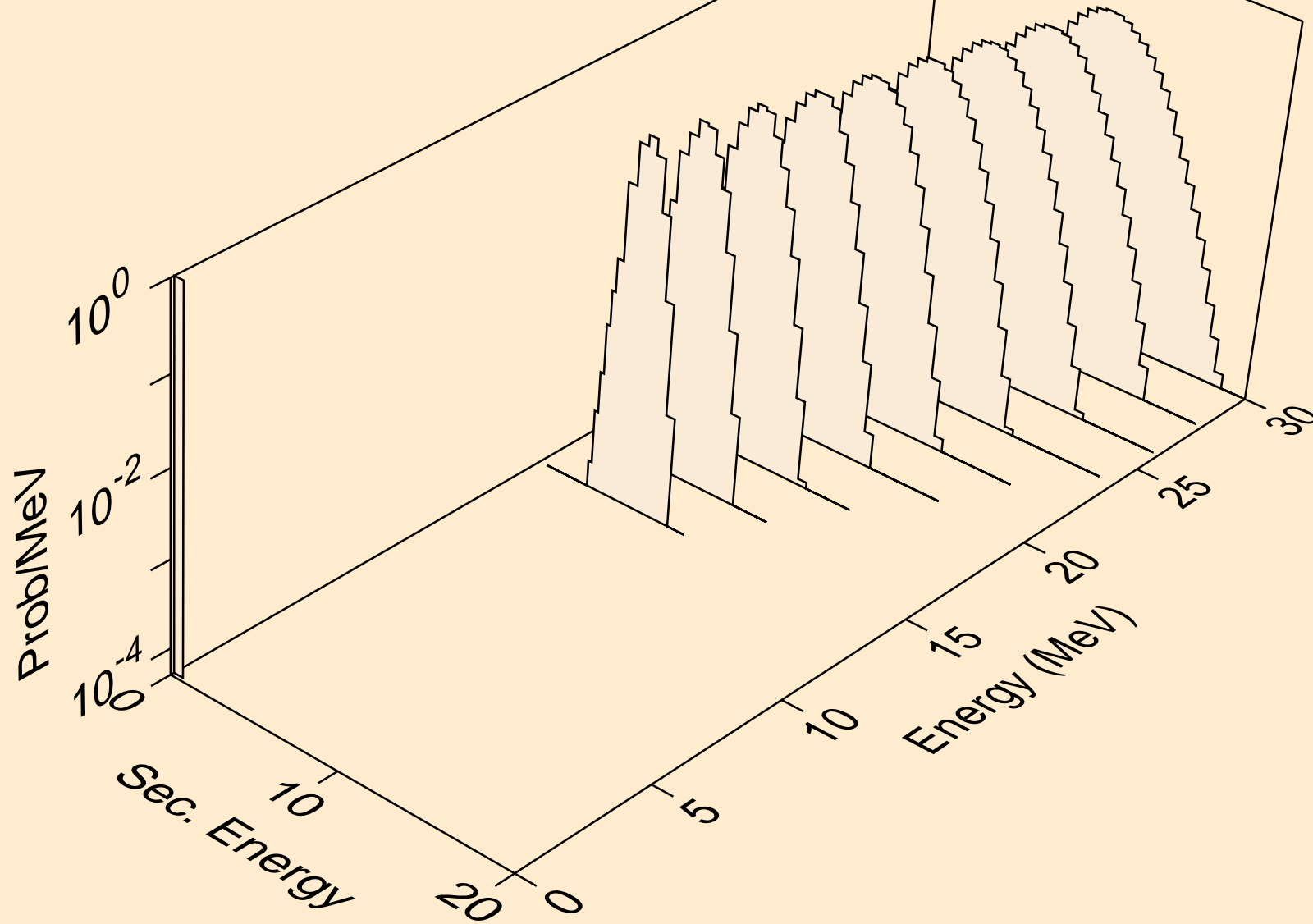

YB181 HELION ACER TENDL-2021 LIBRARY; T=0.K  
protons from (s,p)

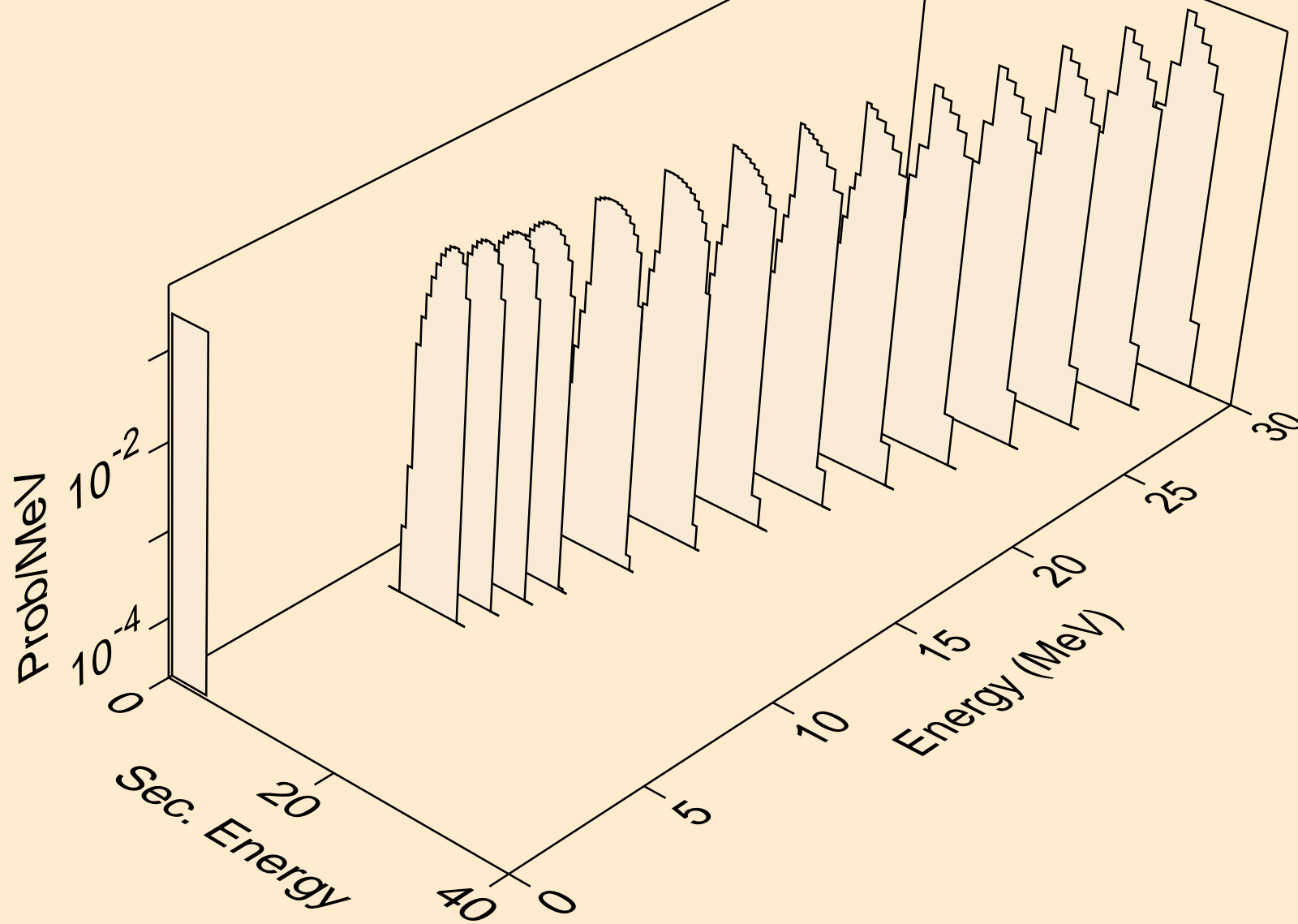

YB181 HELION ACER TENDL-2021 LIBRARY; T=0.K  
protons from (s,2p)

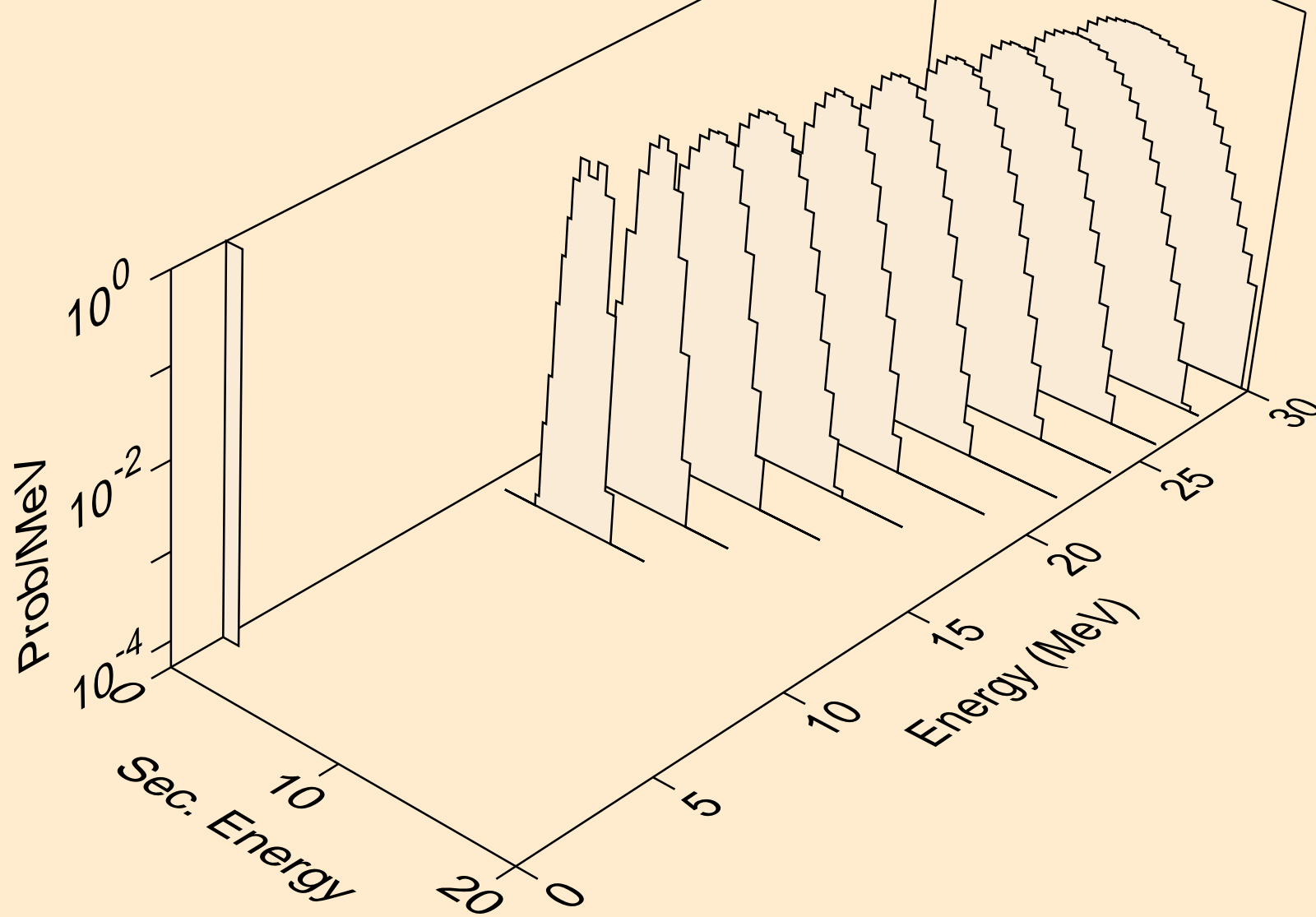

YB181 HELION ACER TENDL-2021 LIBRARY; T=0.K  
protons from (s,pd)

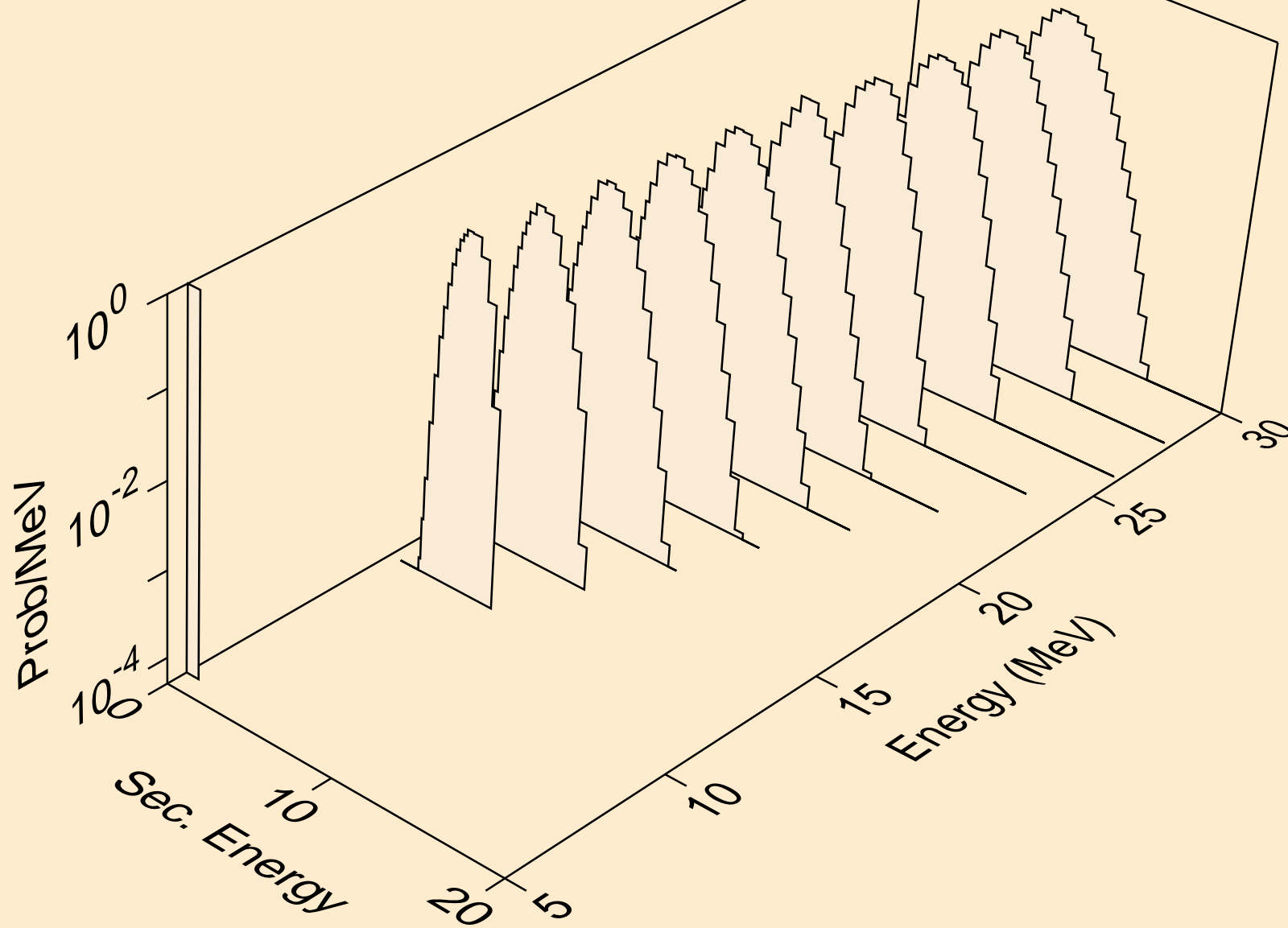

YB181 HELION ACER TENDL-2021 LIBRARY; T=0.K  
protons from (s,pt)

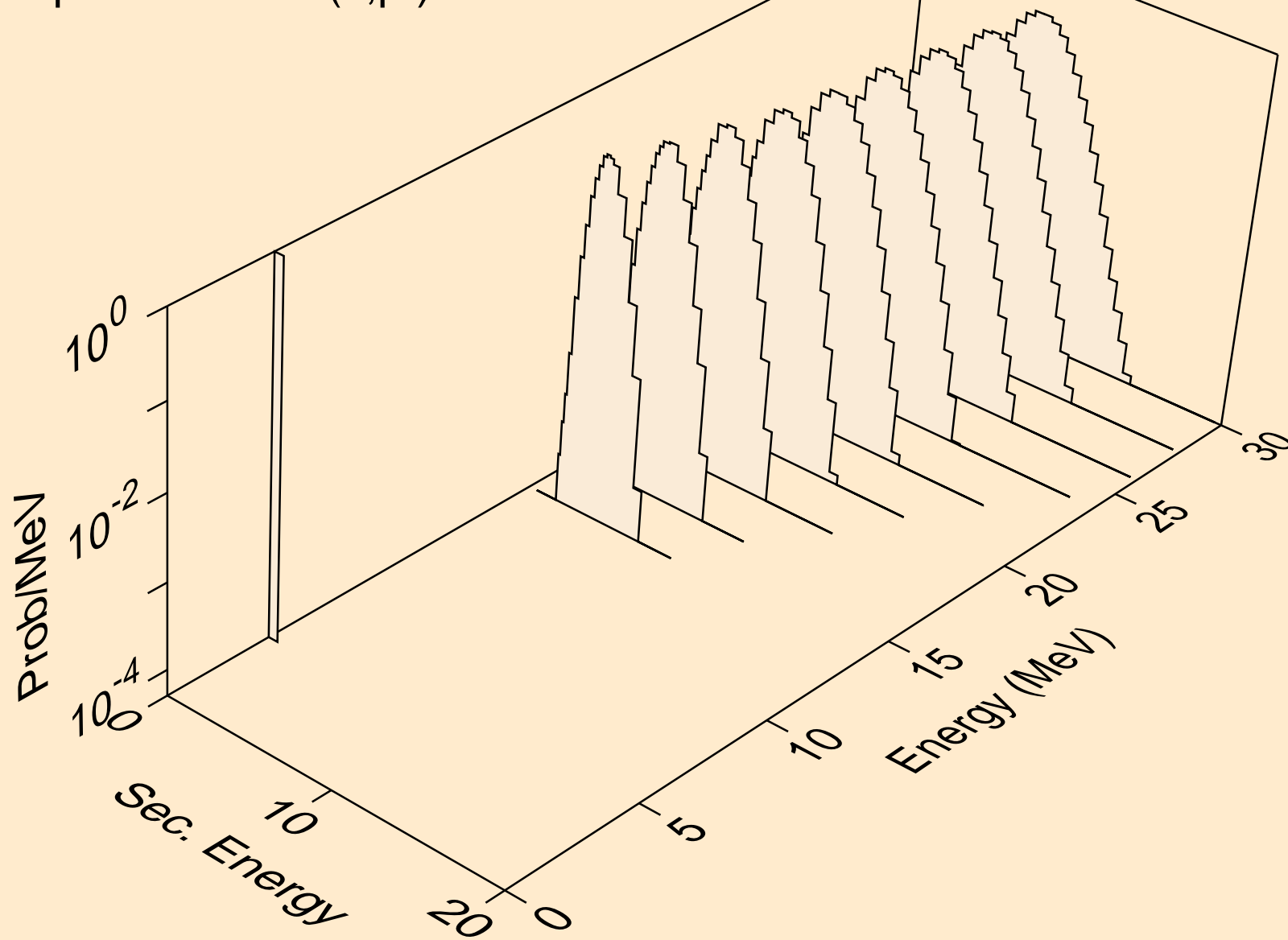



YB181 HELION ACER TENDL-2021 LIBRARY; T=0.K  
deuterons from (s,x)

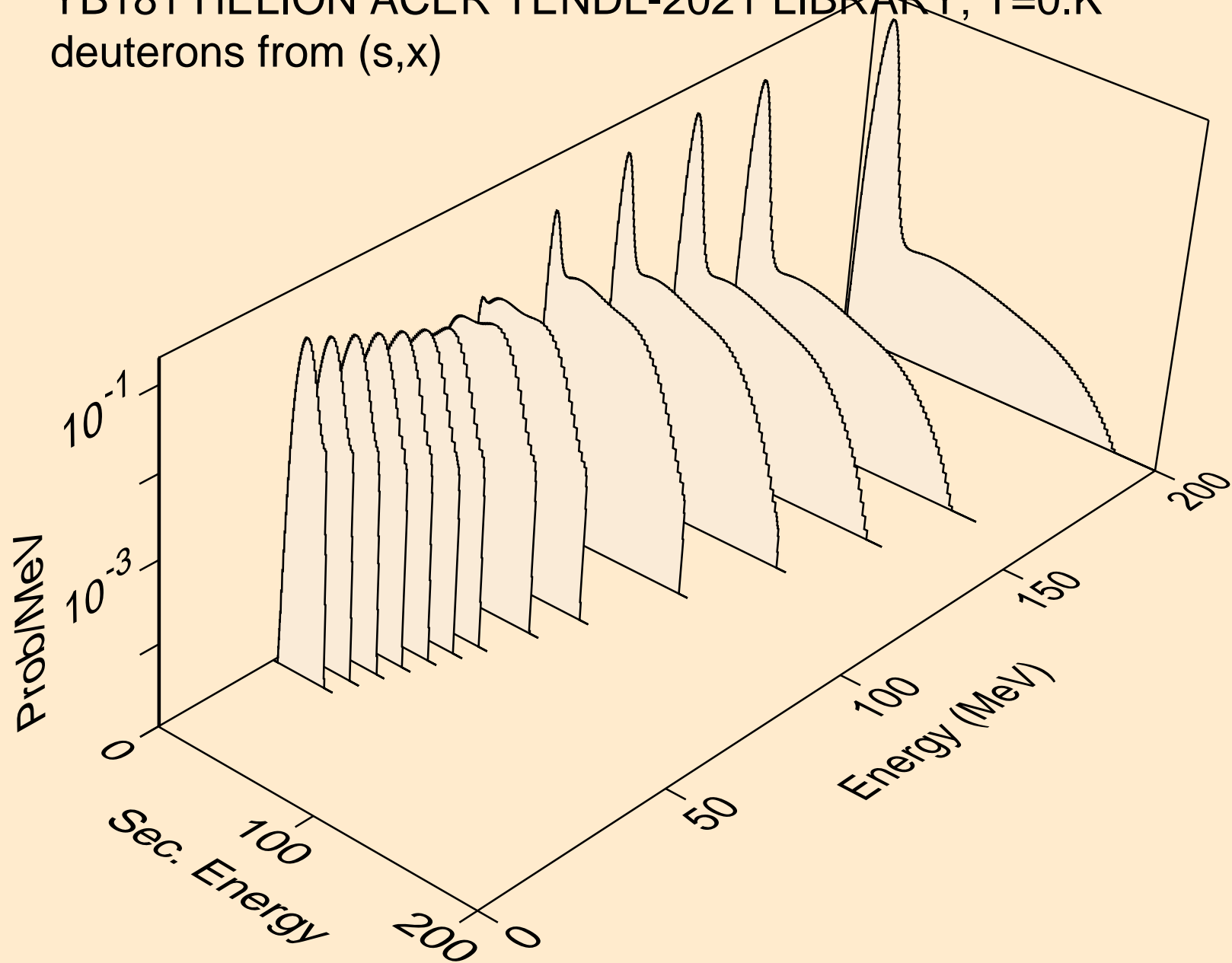

YB181 HELION ACER TENDL-2021 LIBRARY; T=0.K  
deuterons from (s,2nd)

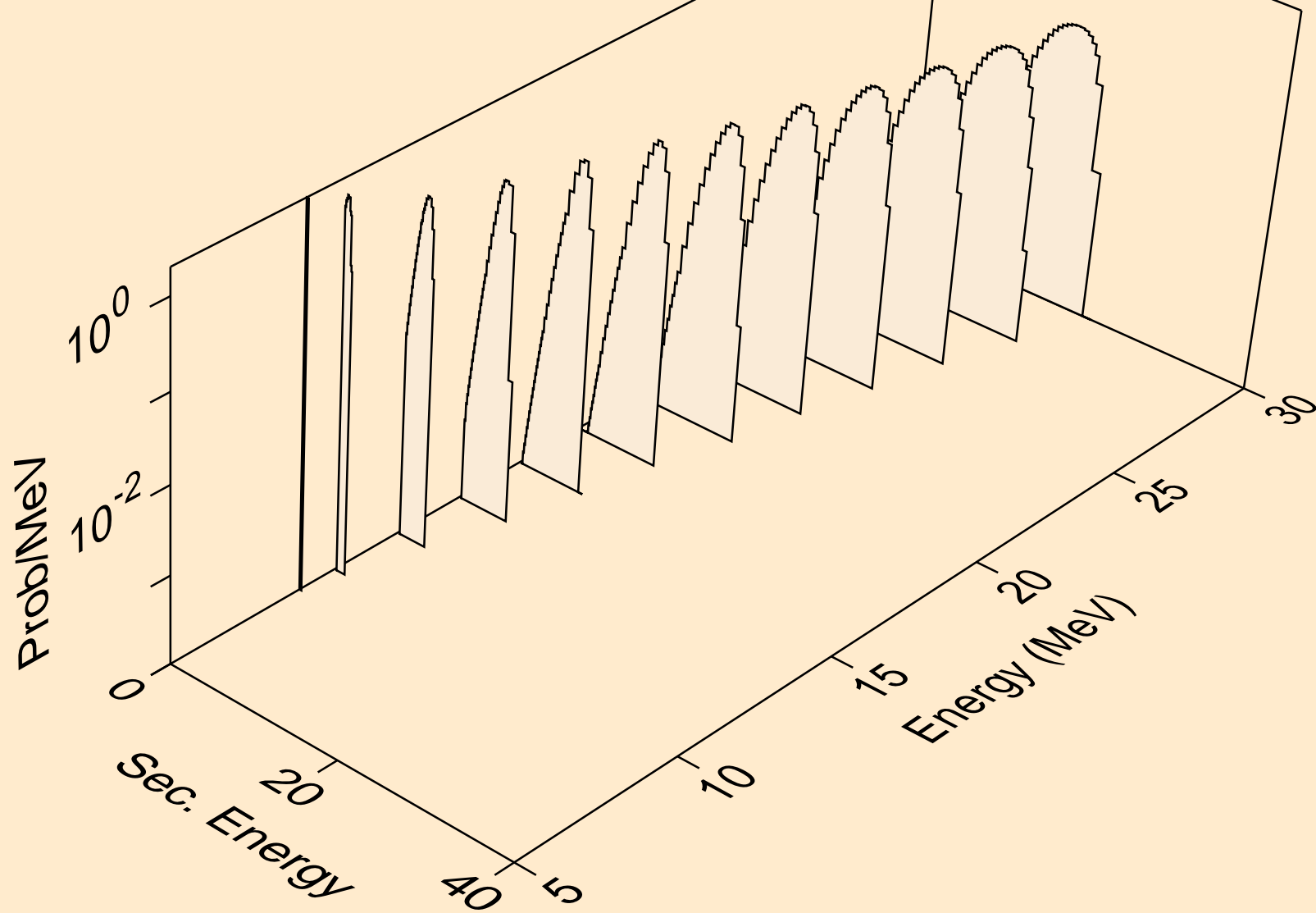

YB181 HELION ACER TENDL-2021 LIBRARY; T=0.K  
deuterons from (s,n\*)d

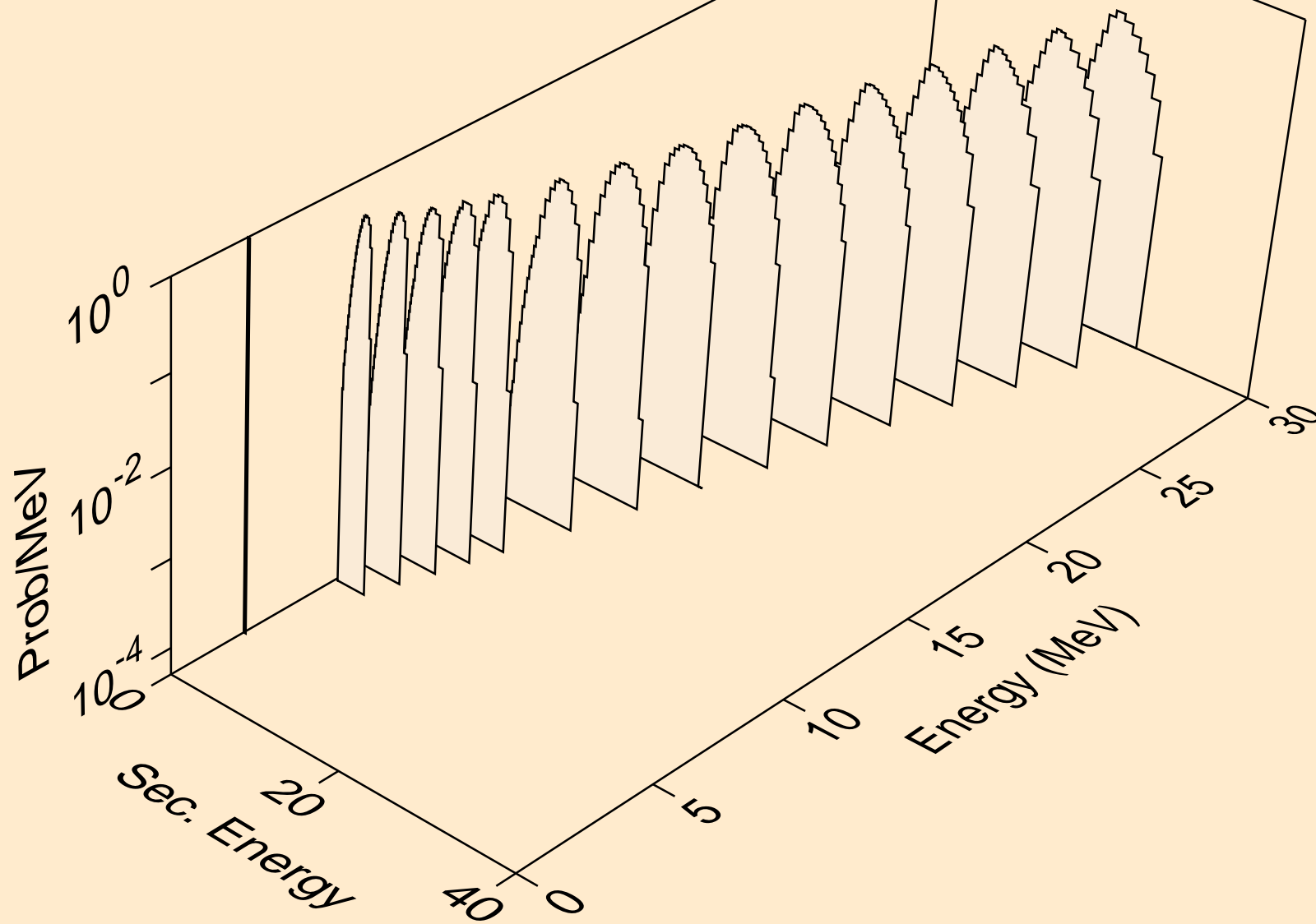

YB181 HELION ACER TENDL-2021 LIBRARY; T=0.K  
deuterons from (s,d)

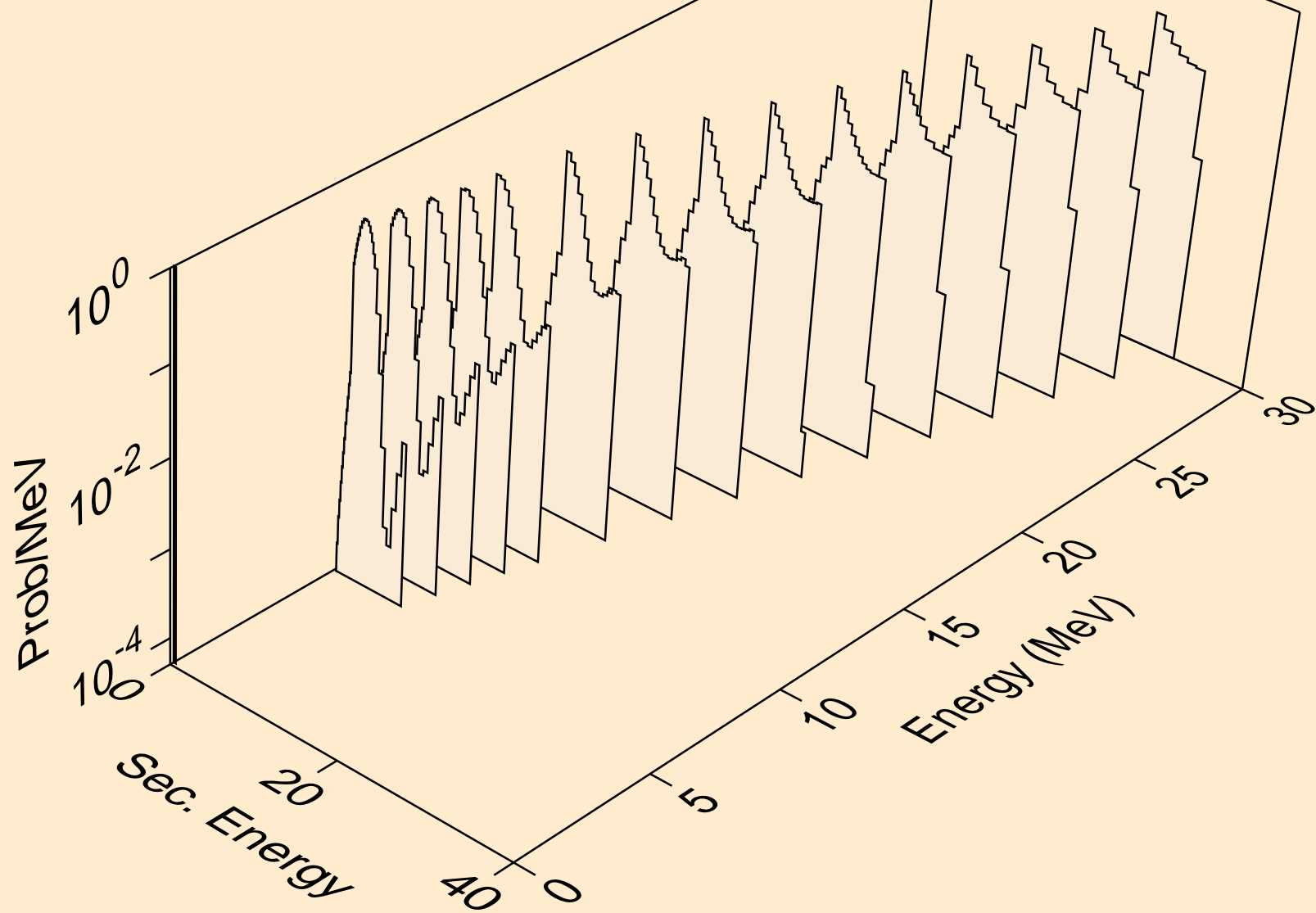

YB181 HELION ACER TENDL-2021 LIBRARY; T=0.K  
deuterons from (s,pd)

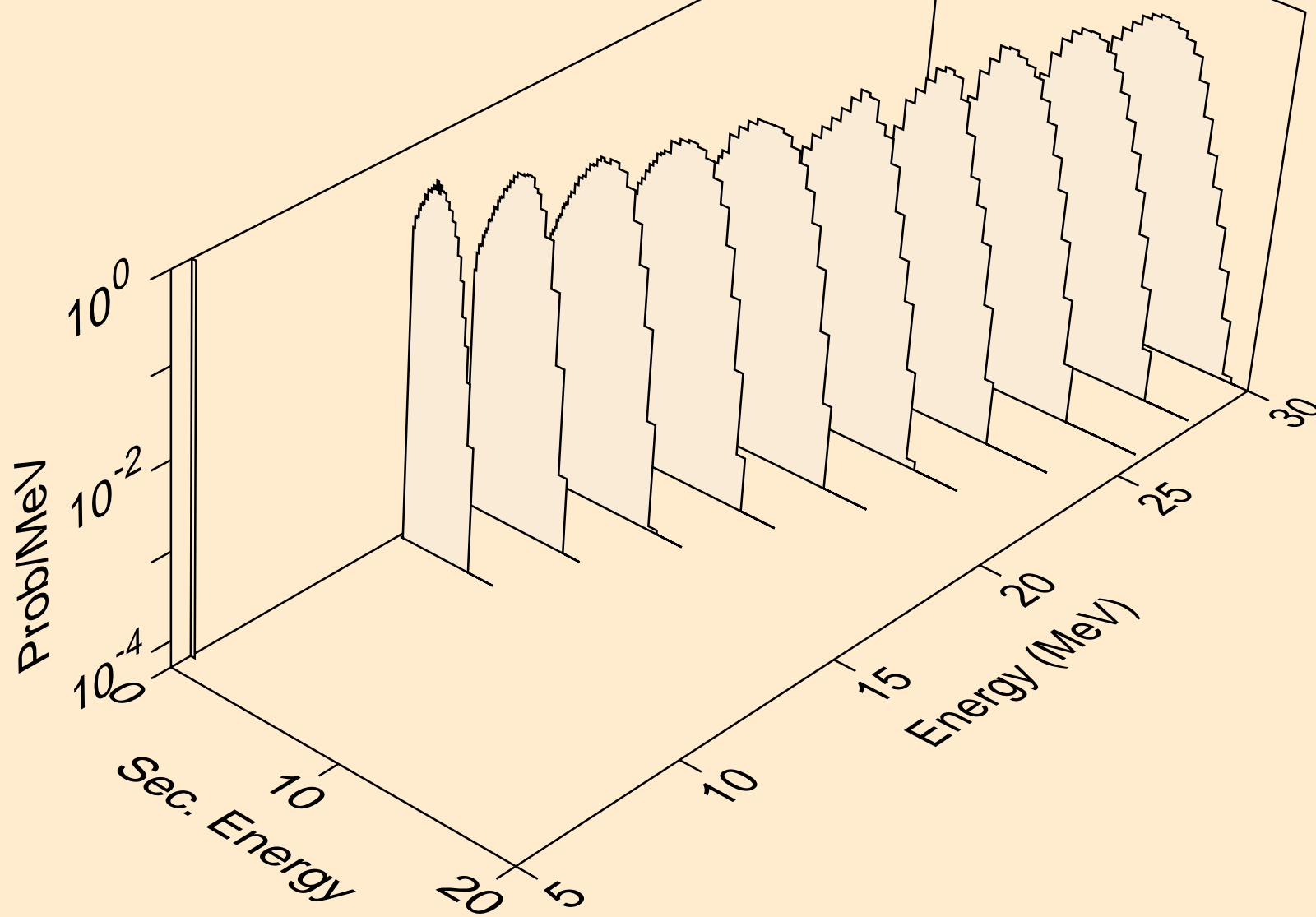

YB181 HELION ACER TENDL-2021 LIBRARY; T=0.K  
tritons from (s,x)

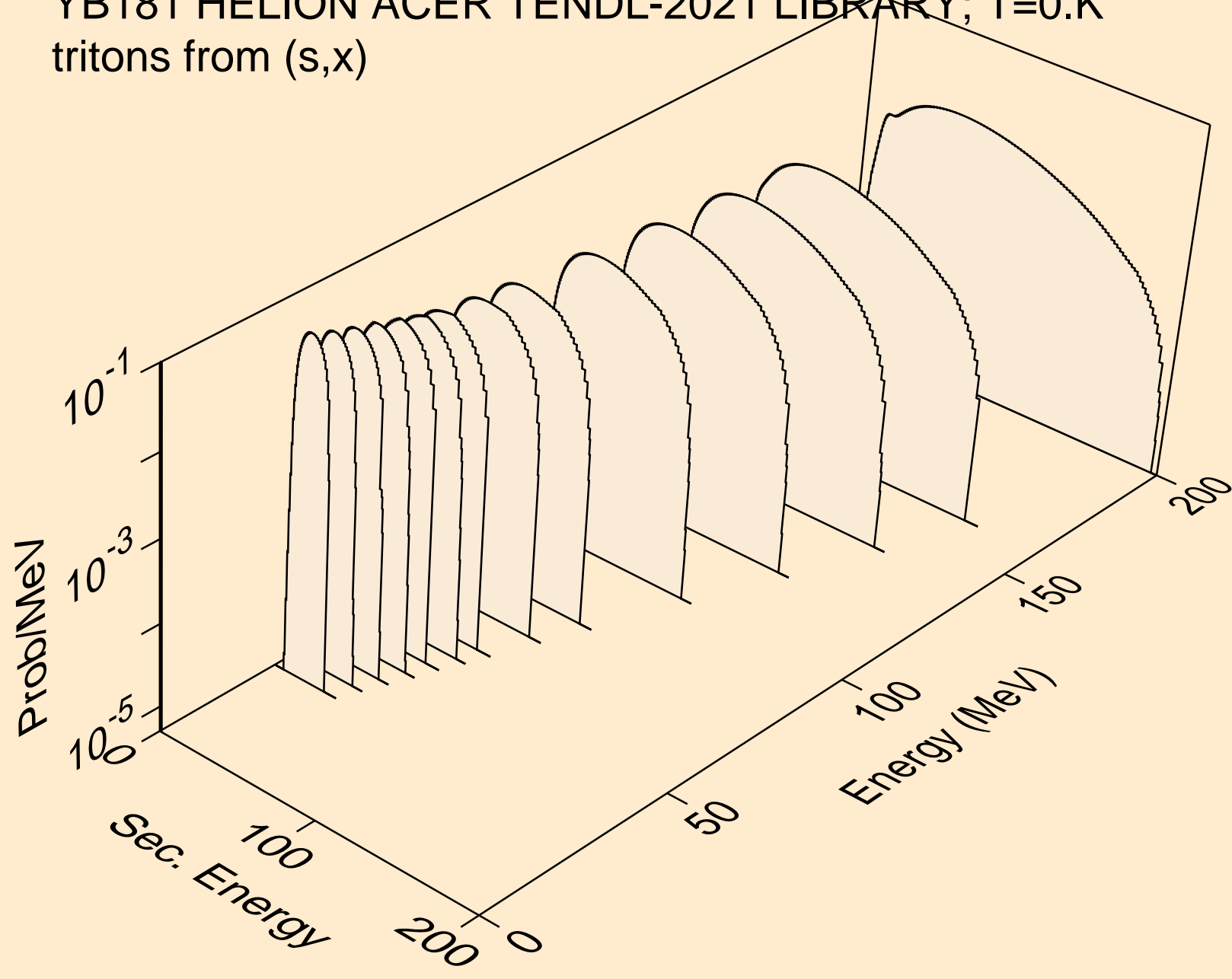

YB181 HELION ACER TENDL-2021 LIBRARY; T=0.K  
tritons from (s,n\*)t

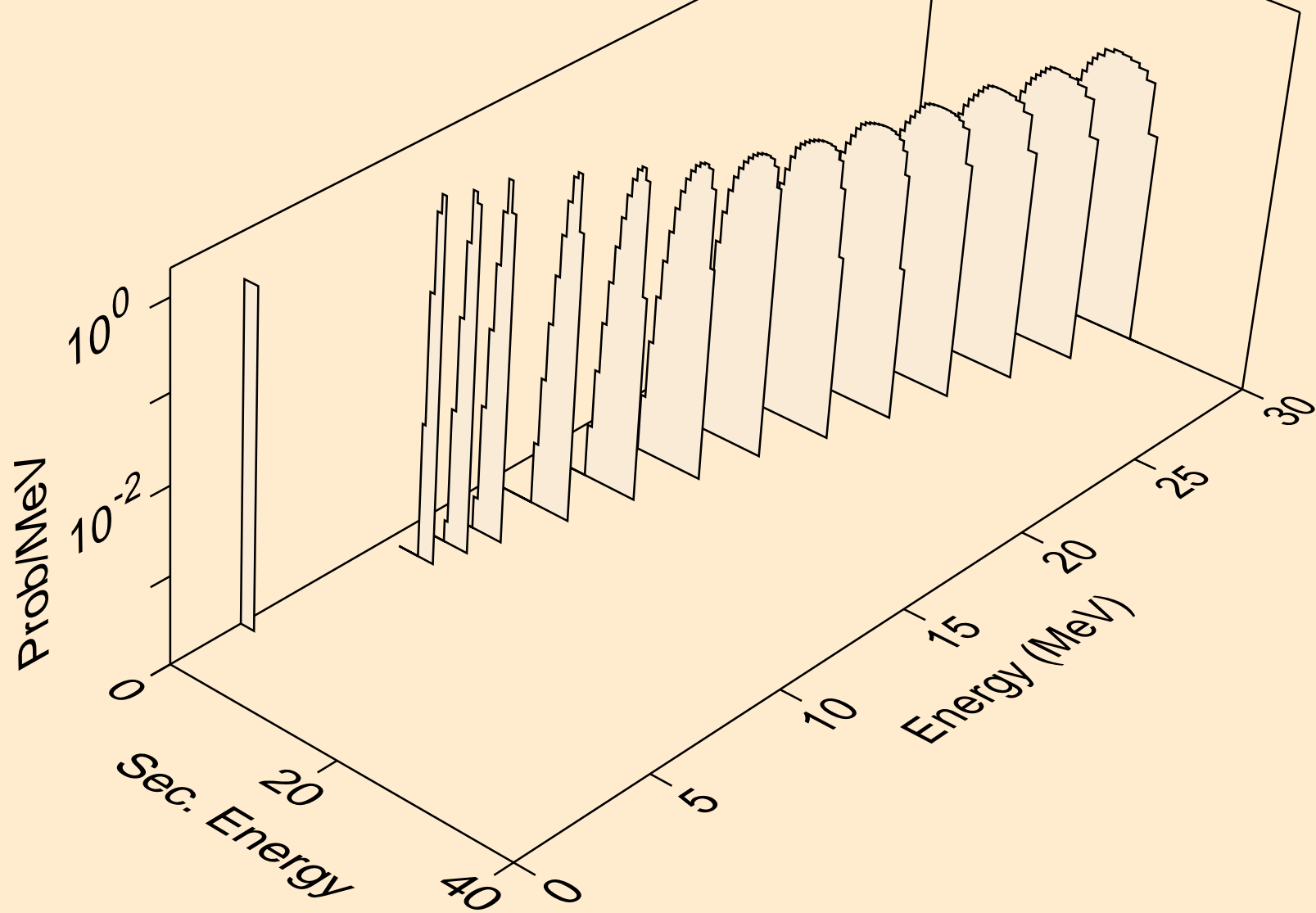

YB181 HELION ACER TENDL-2021 LIBRARY; T=0.K  
tritons from (s,t)

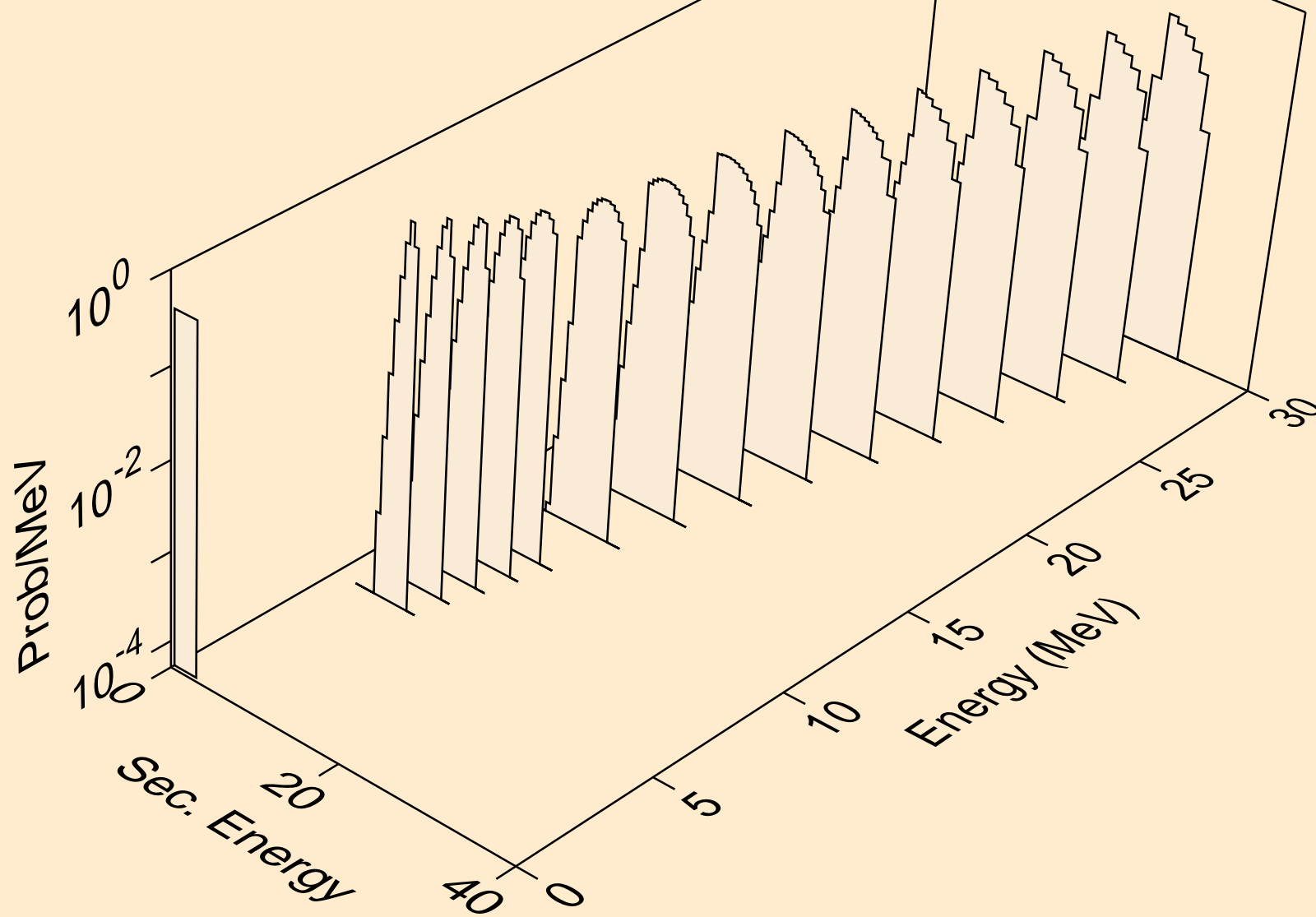



YB181 HELION ACER TENDL-2021 LIBRARY; T=0.K  
tritons from (s,pt)

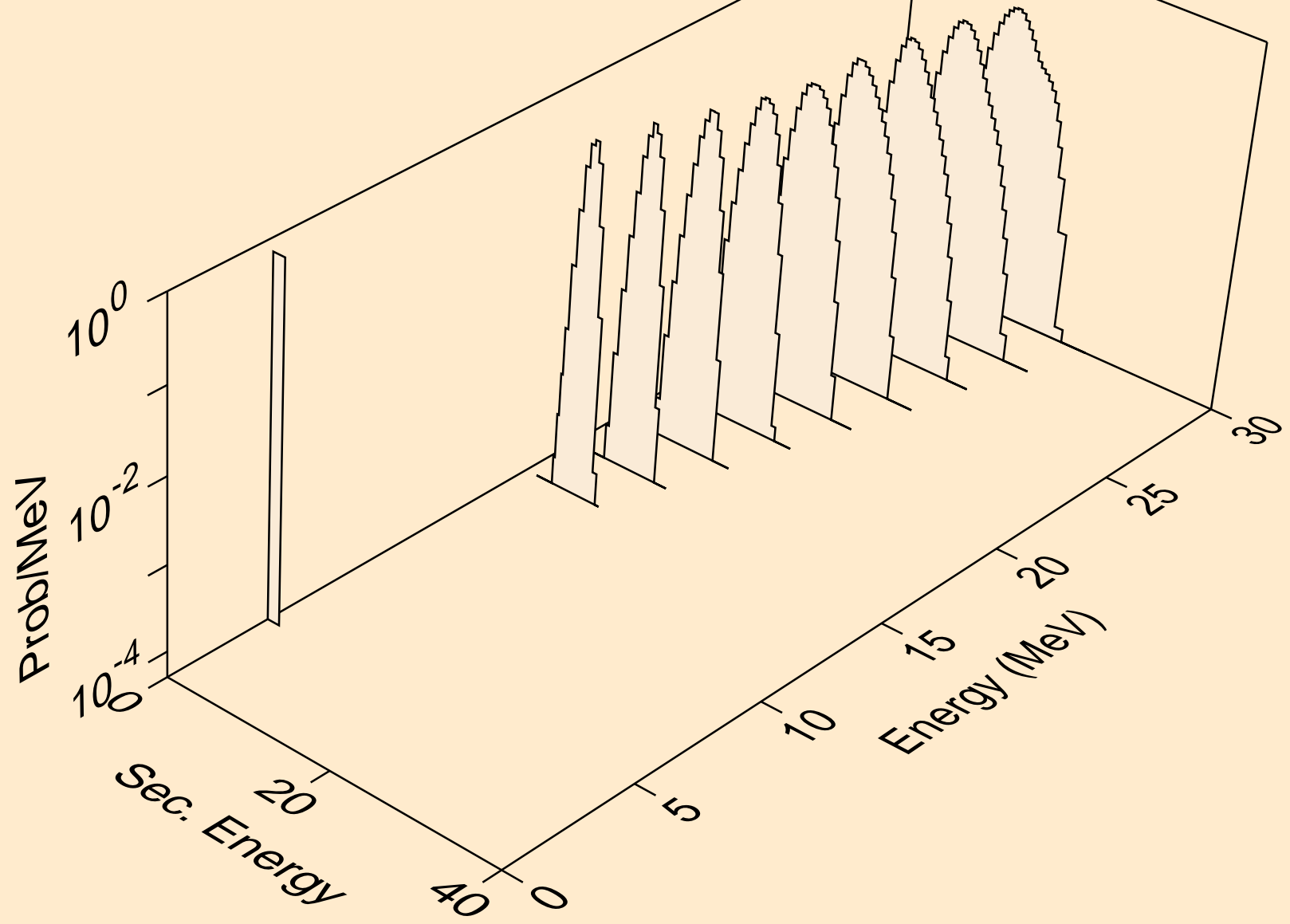

YB181 HELION ACER TENDL-2021 LIBRARY; T=0.K  
alphas from (s,x)

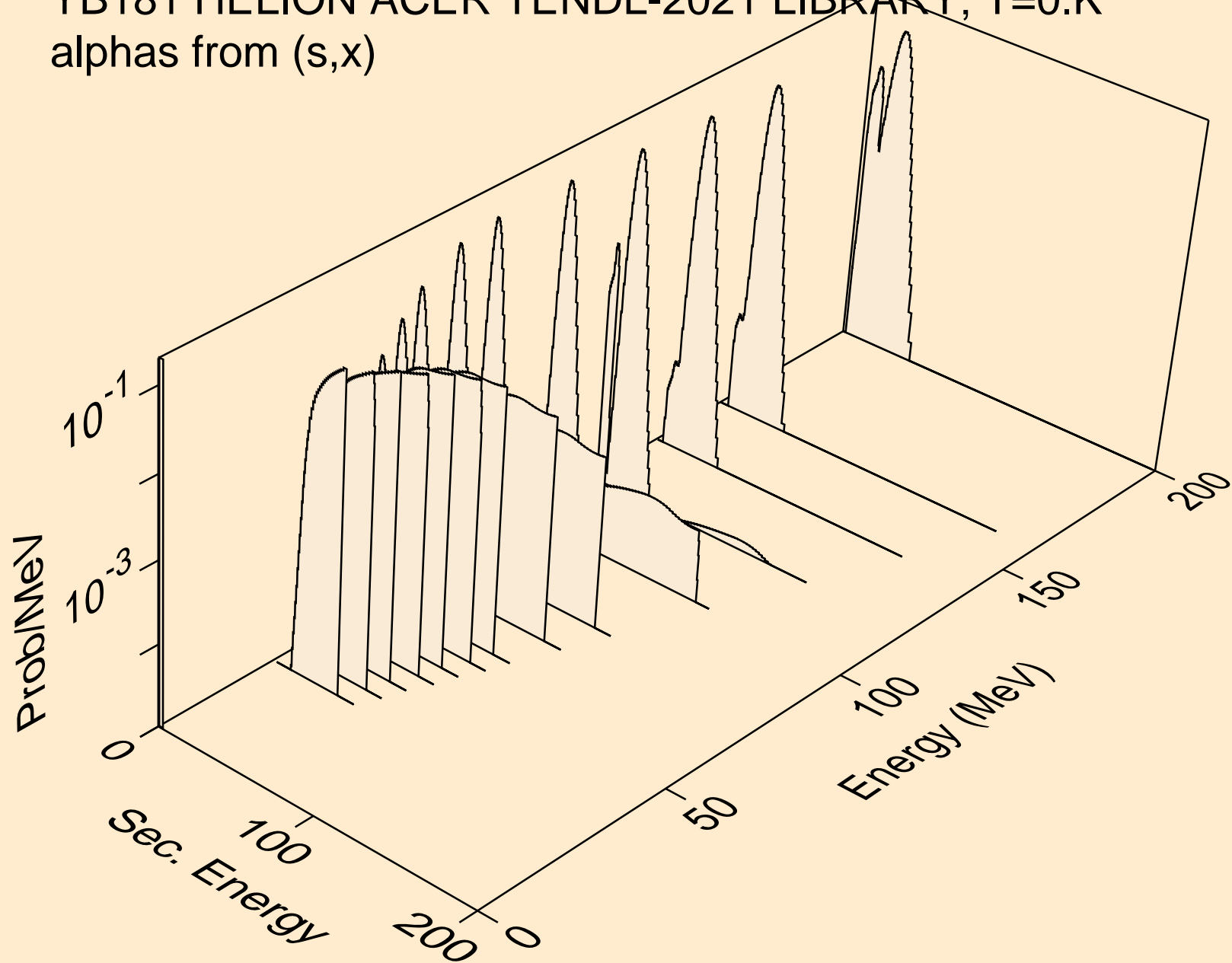

YB181 HELION ACER TENDL-2021 LIBRARY; T=0.K  
alphas from (s,n\*)a

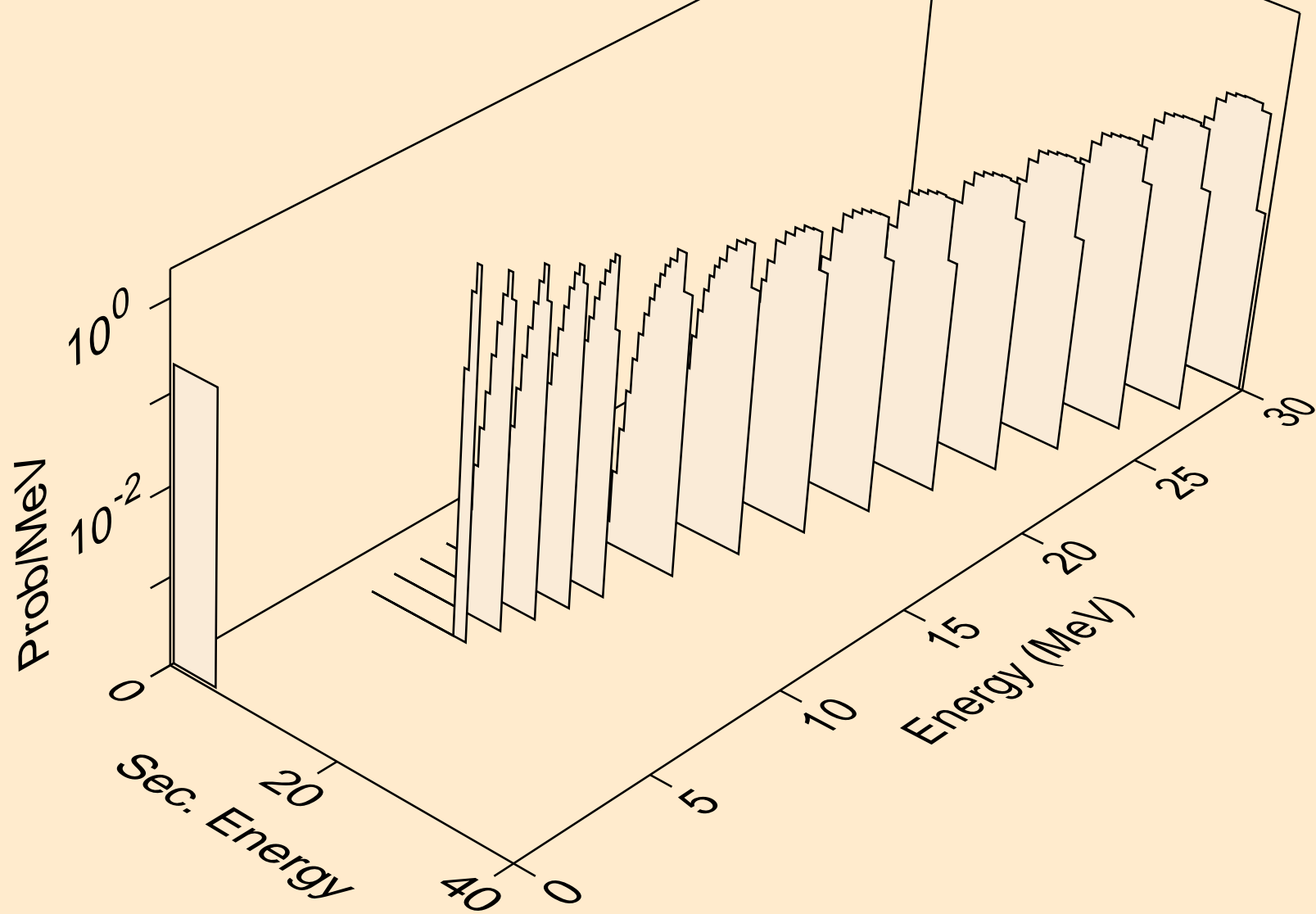

YB181 HELION ACER TENDL-2021 LIBRARY; T=0.K  
alphas from (s,2n)a

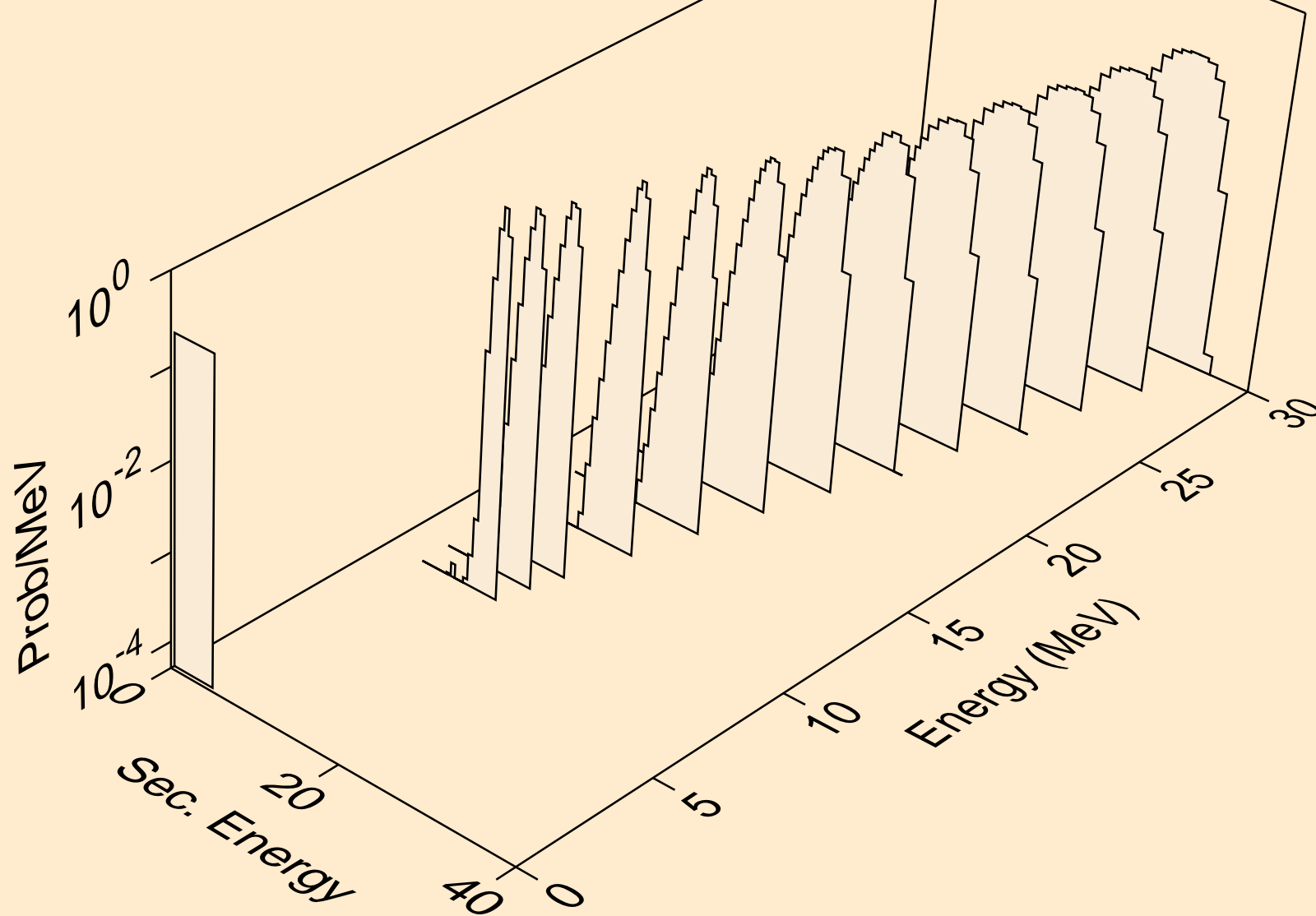

YB181 HELION ACER TENDL-2021 LIBRARY; T=0.K  
alphas from (s,3n)a

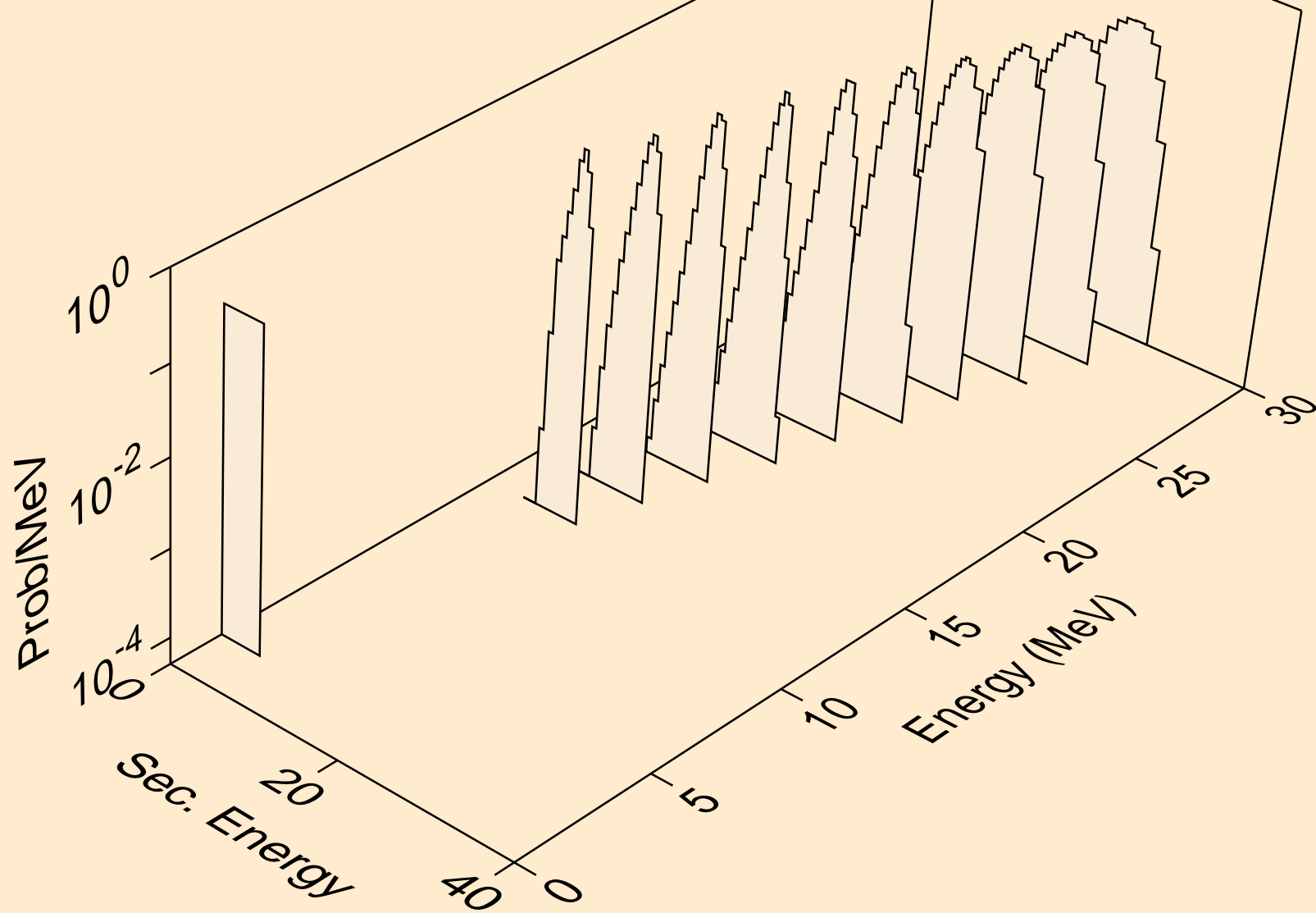

YB181 HELION ACER TENDL-2021 LIBRARY; T=0.K  
alphas from (s,npa)

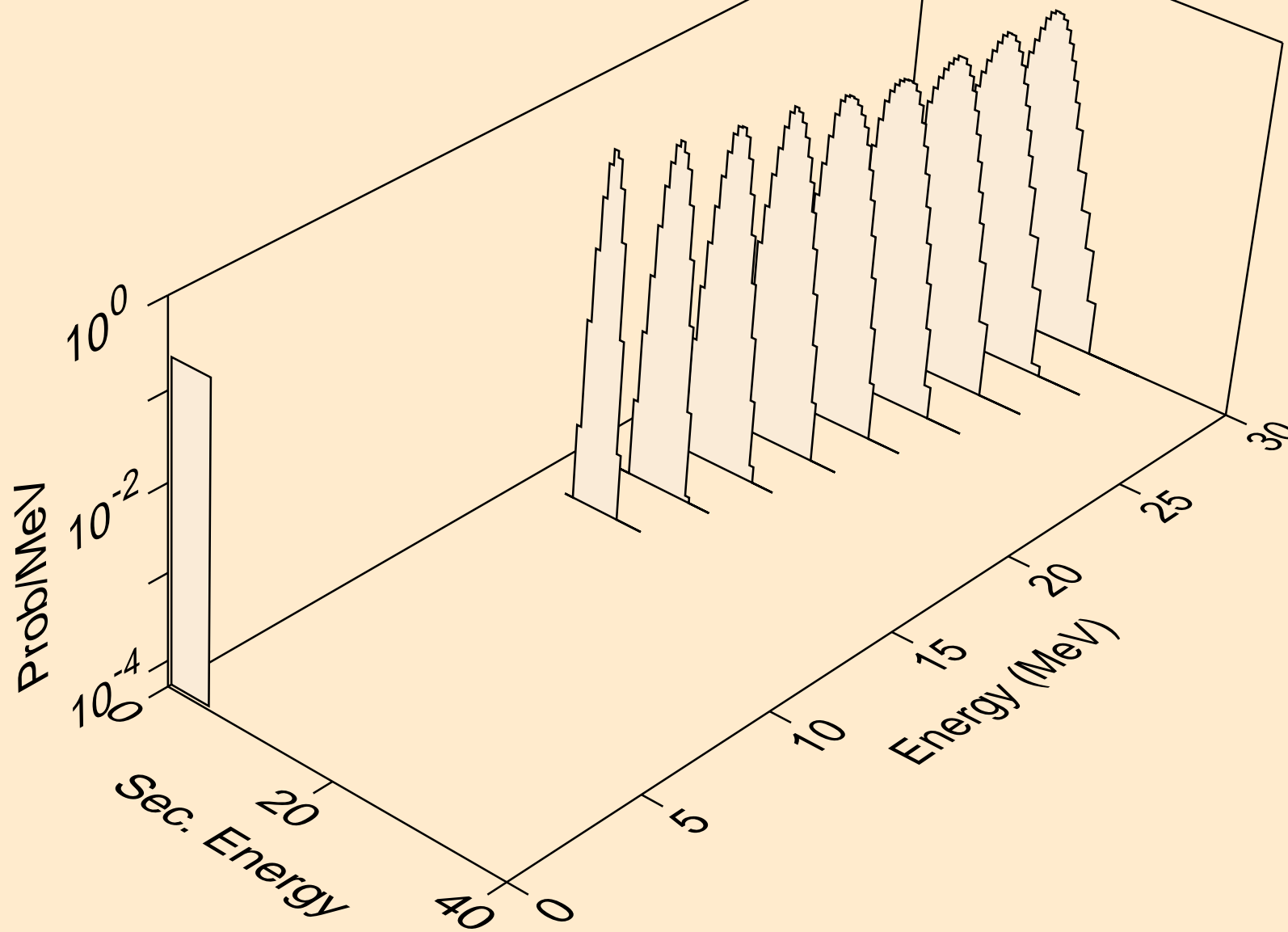

YB181 HELION ACER TENDL-2021 LIBRARY; T=0.K  
alphas from (s,a)

