

ZR102 HELION ACER TENDL-2021 LIBRARY; T=0.K  
Principal cross sections

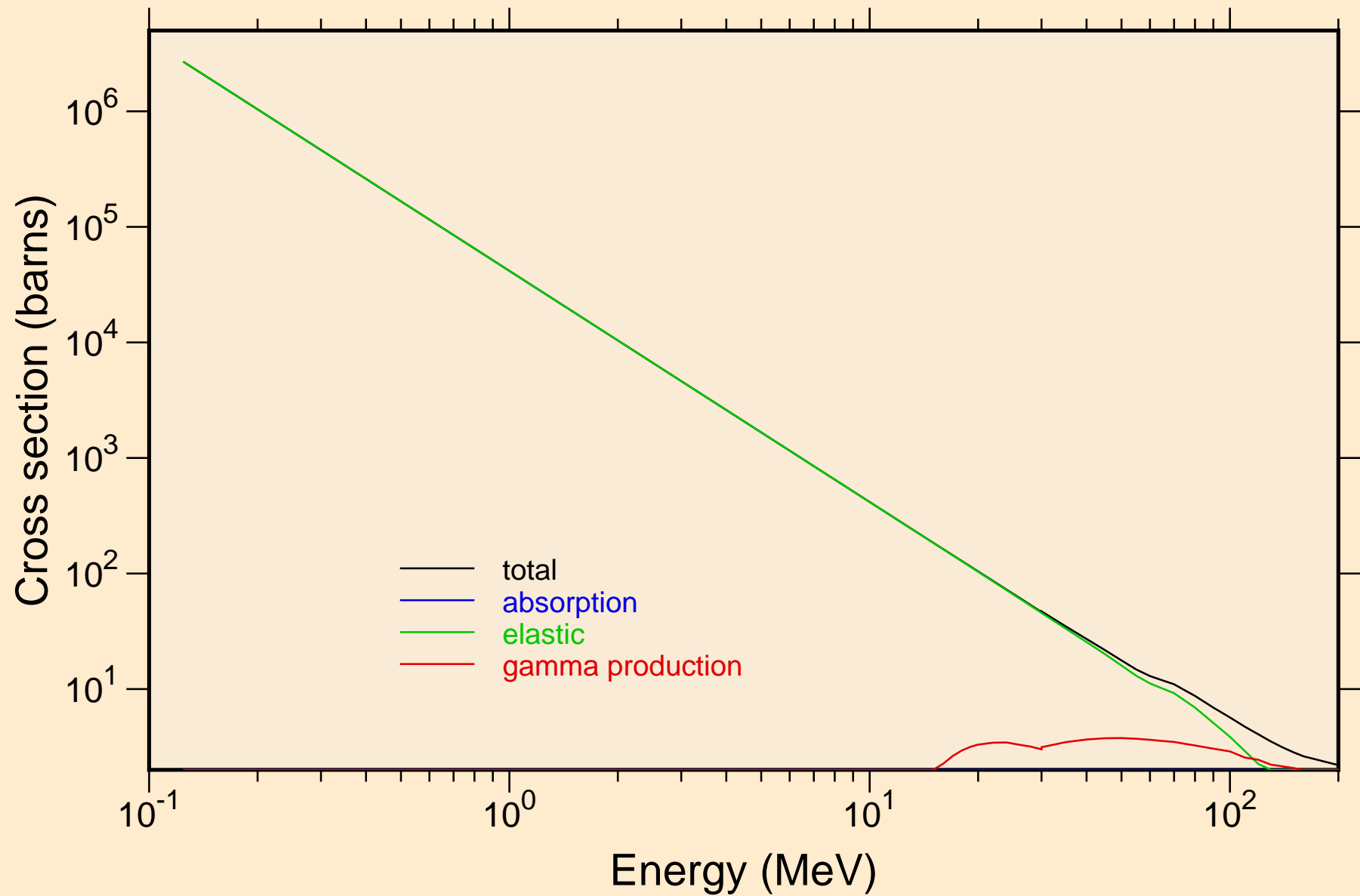

ZR102 HELION ACER TENDL-2021 LIBRARY; T=0.K

Heating

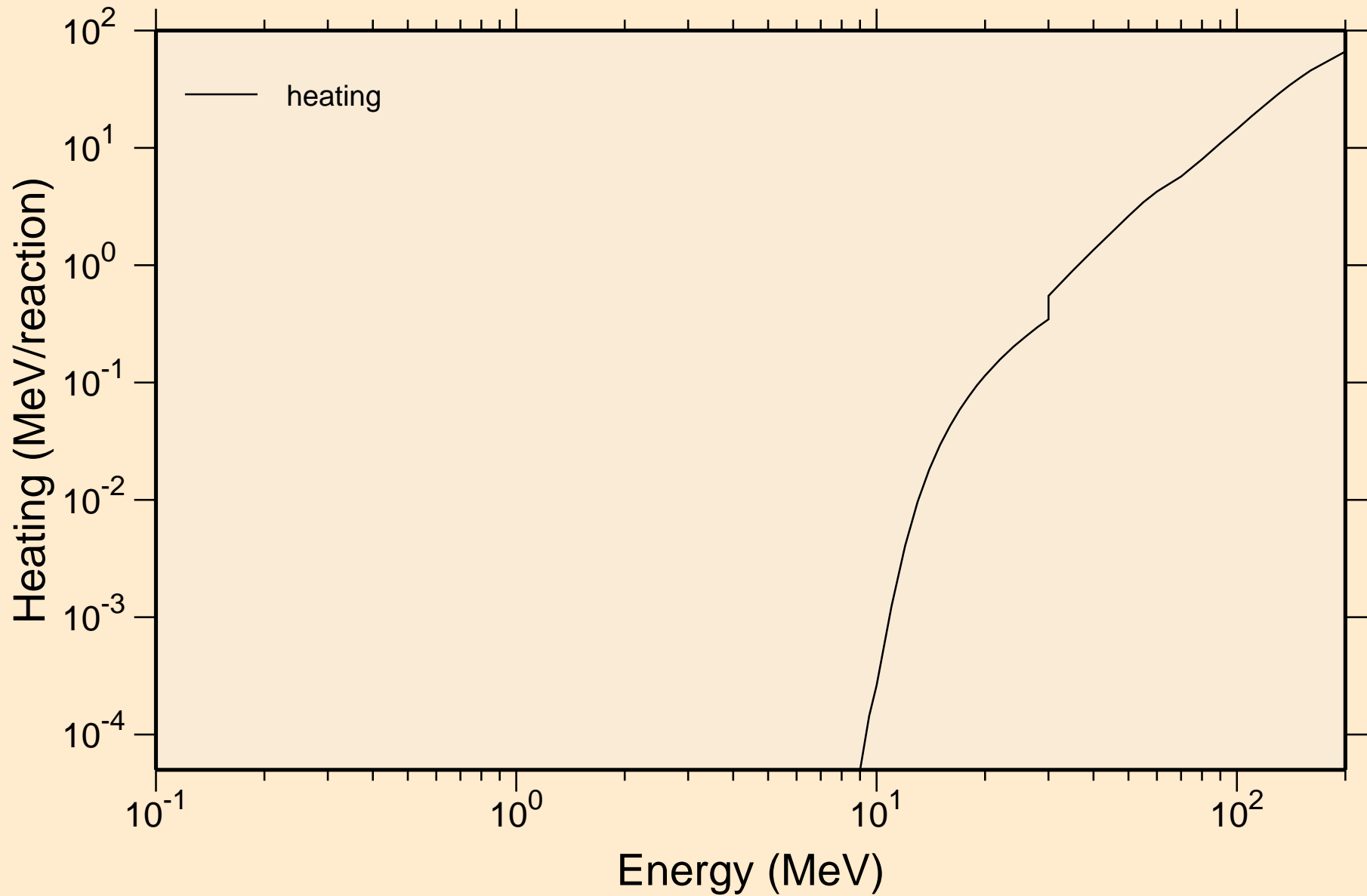

# ZR102 HELION ACER TENDL-2021 LIBRARY; T=0.K

## Principal cross sections

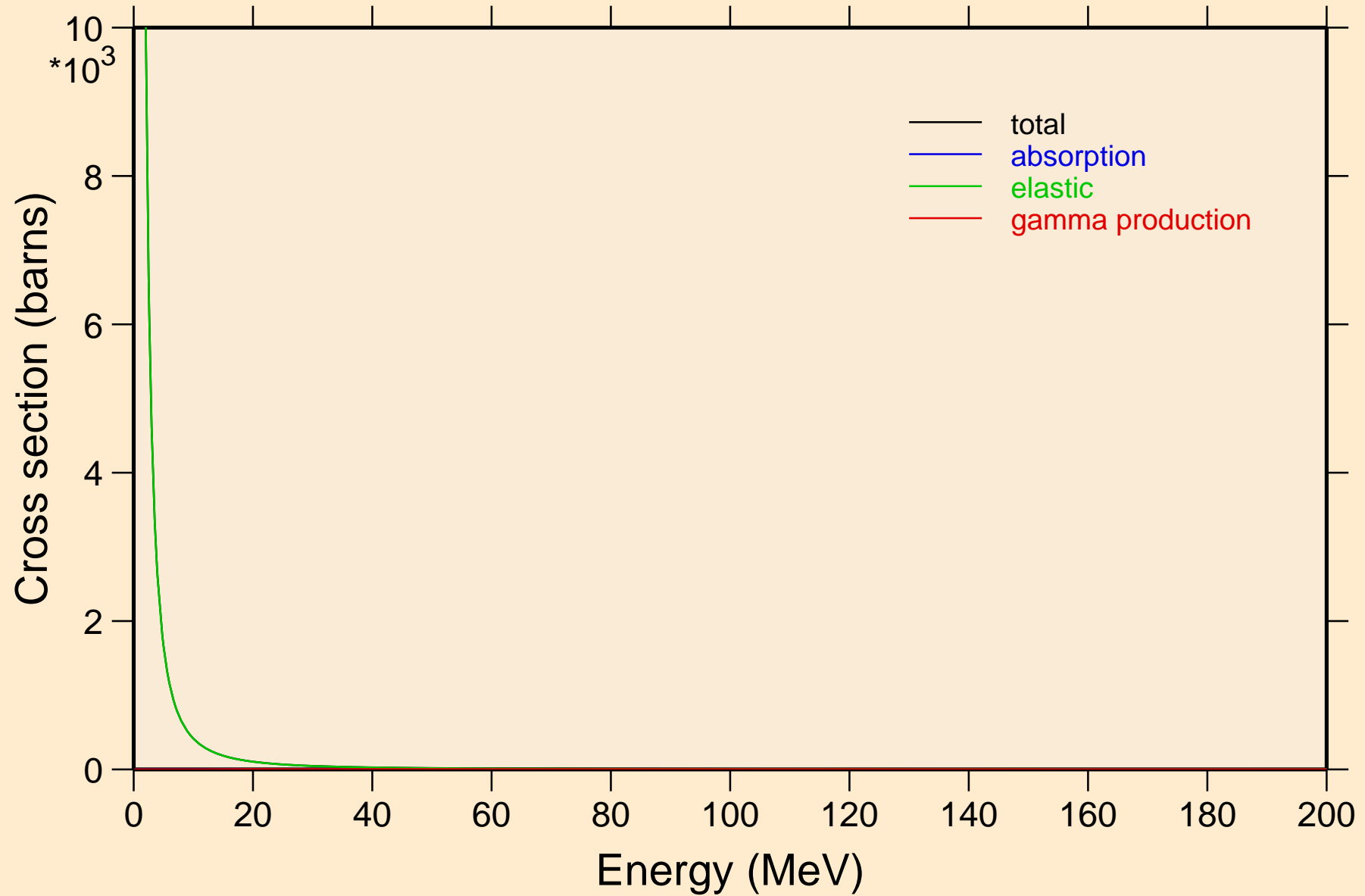

ZR102 HELION ACER TENDL-2021 LIBRARY; T=0.K

Heating

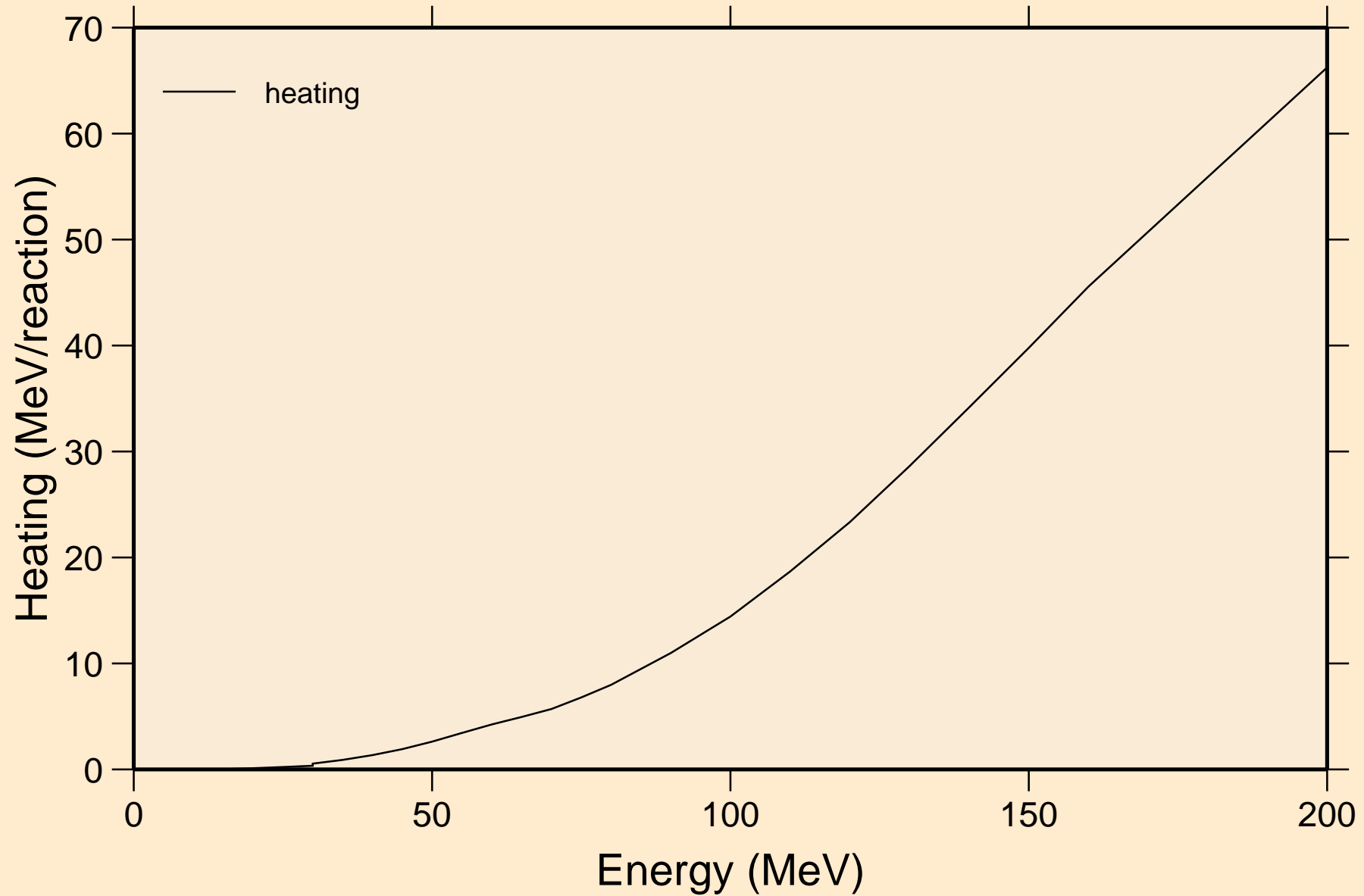

ZR102 HELION ACER TENDL-2021 LIBRARY; T=0.K  
Threshold reactions

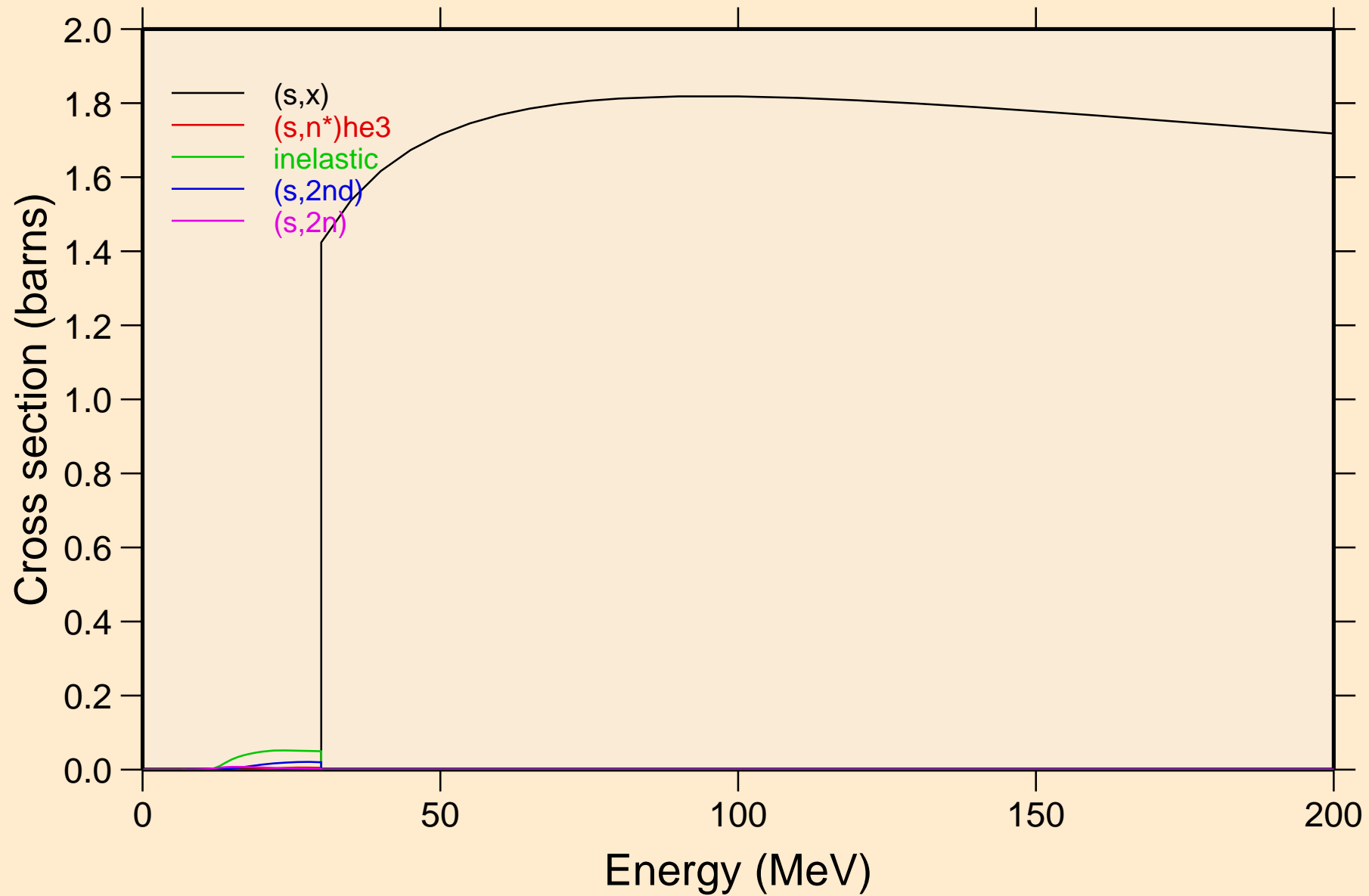

ZR102 HELION ACER TENDL-2021 LIBRARY; T=0.K  
Threshold reactions

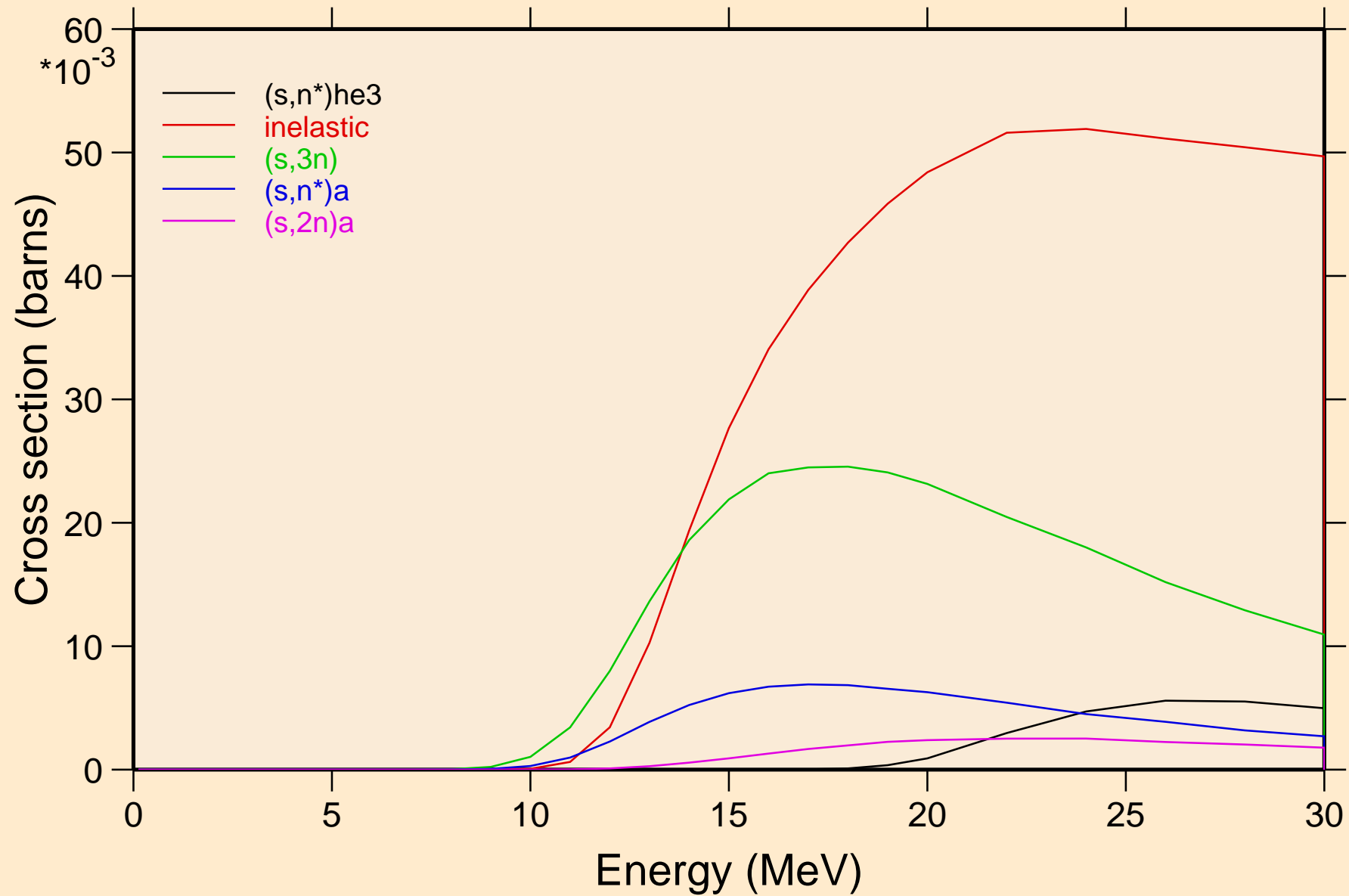

ZR102 HELION ACER TENDL-2021 LIBRARY; T=0.K  
Threshold reactions

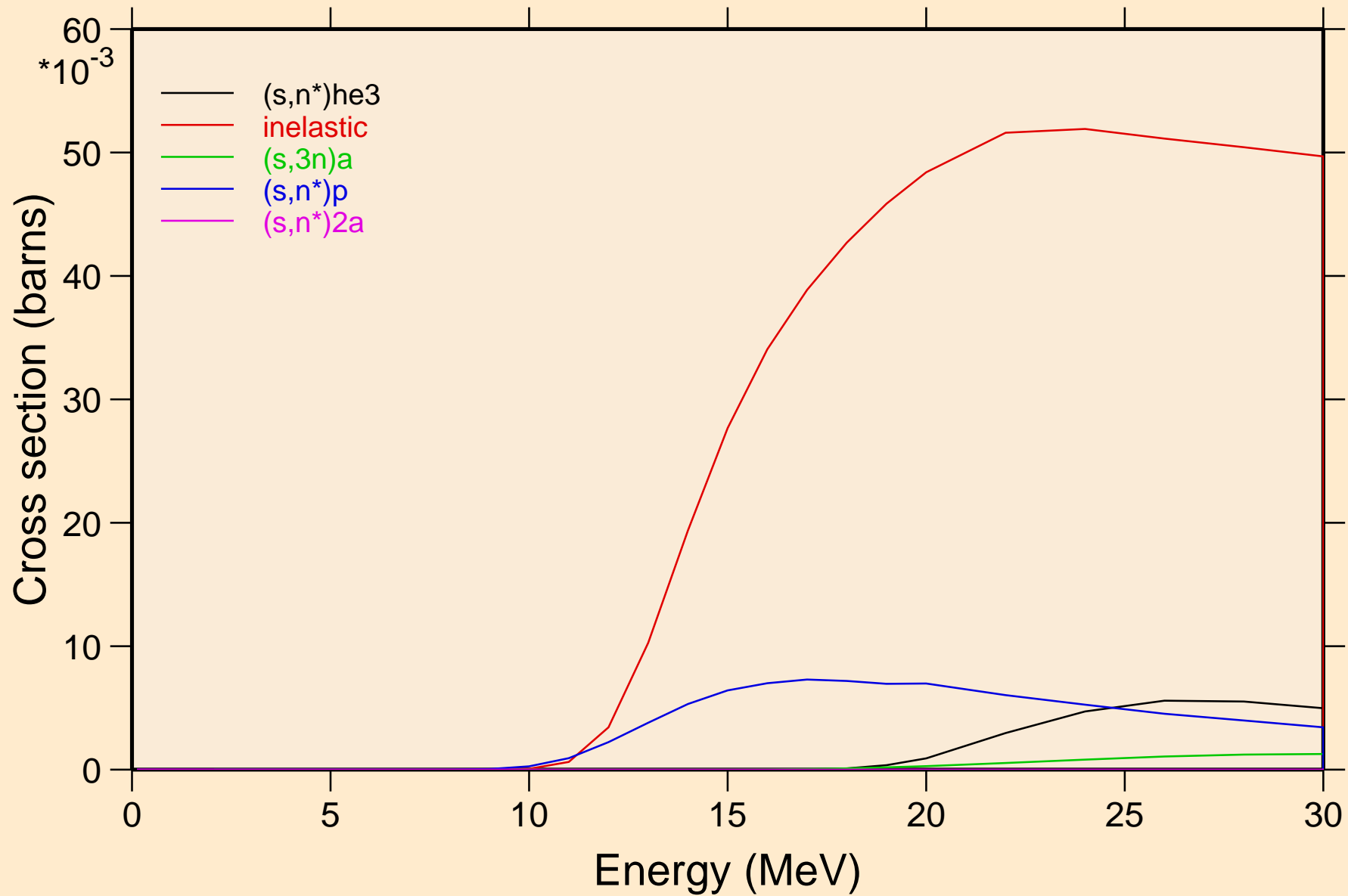

ZR102 HELION ACER TENDL-2021 LIBRARY; T=0.K  
Threshold reactions

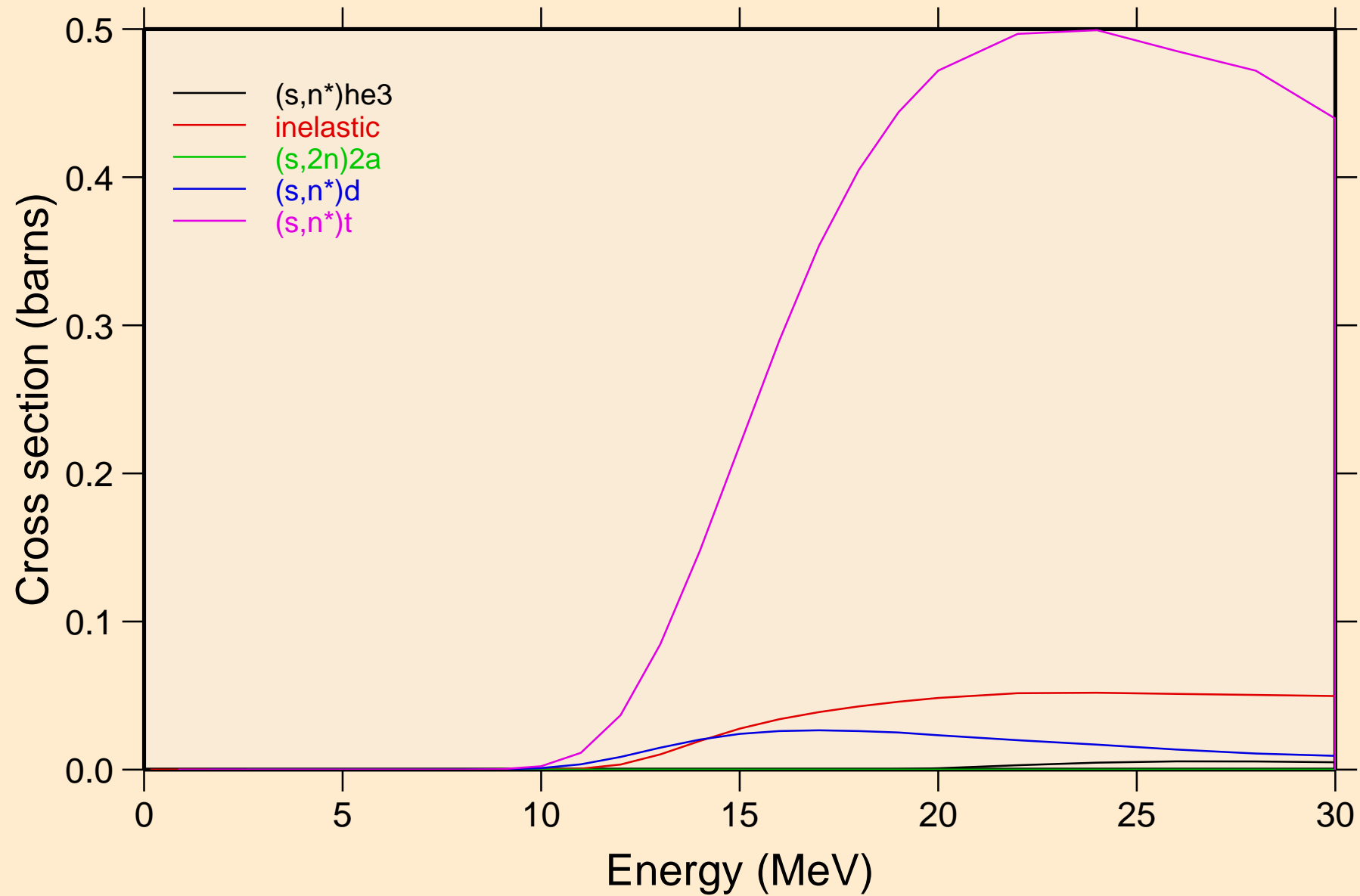



ZR102 HELION ACER TENDL-2021 LIBRARY; T=0.K  
Threshold reactions

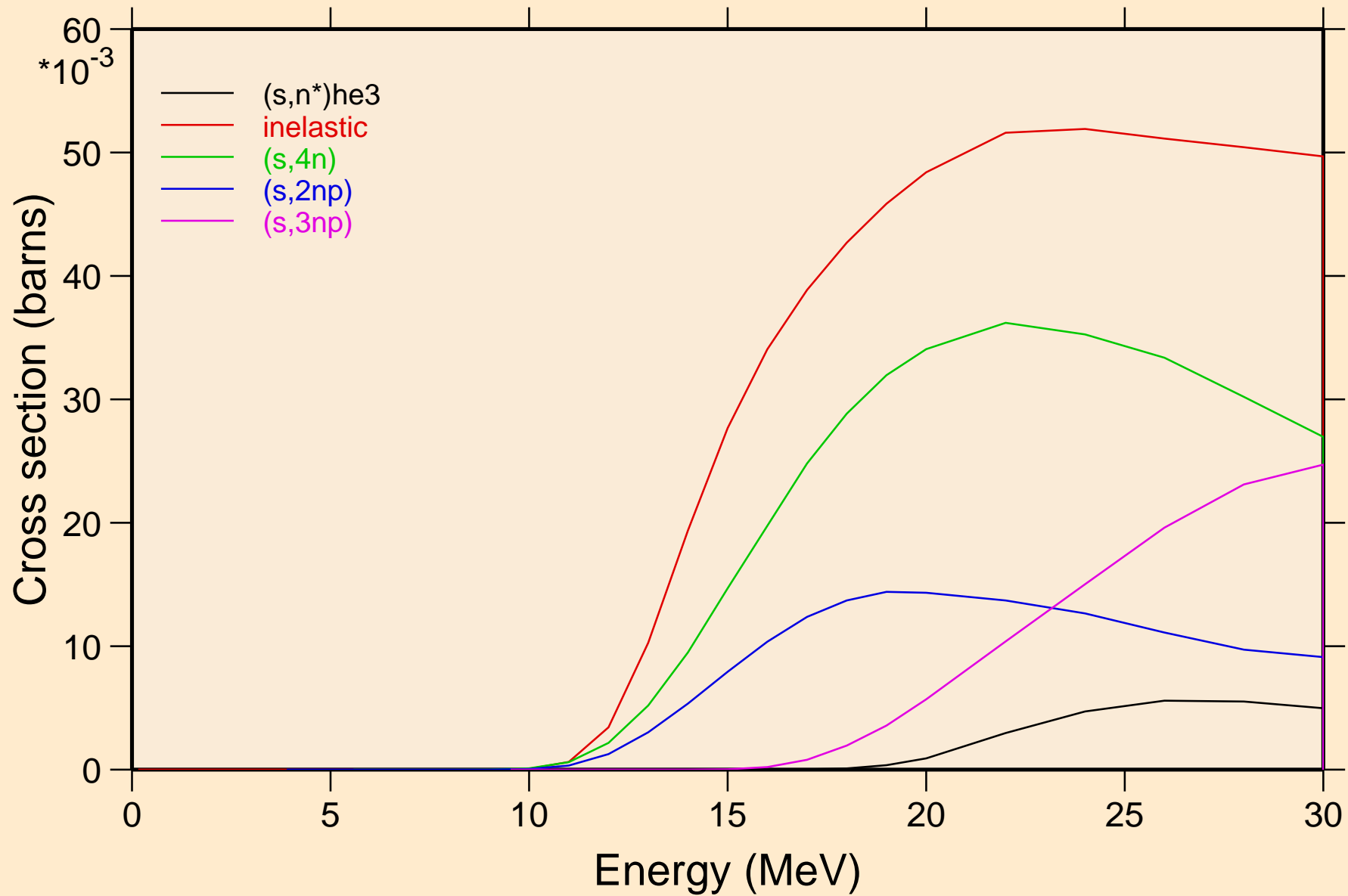

ZR102 HELION ACER TENDL-2021 LIBRARY; T=0.K  
Threshold reactions

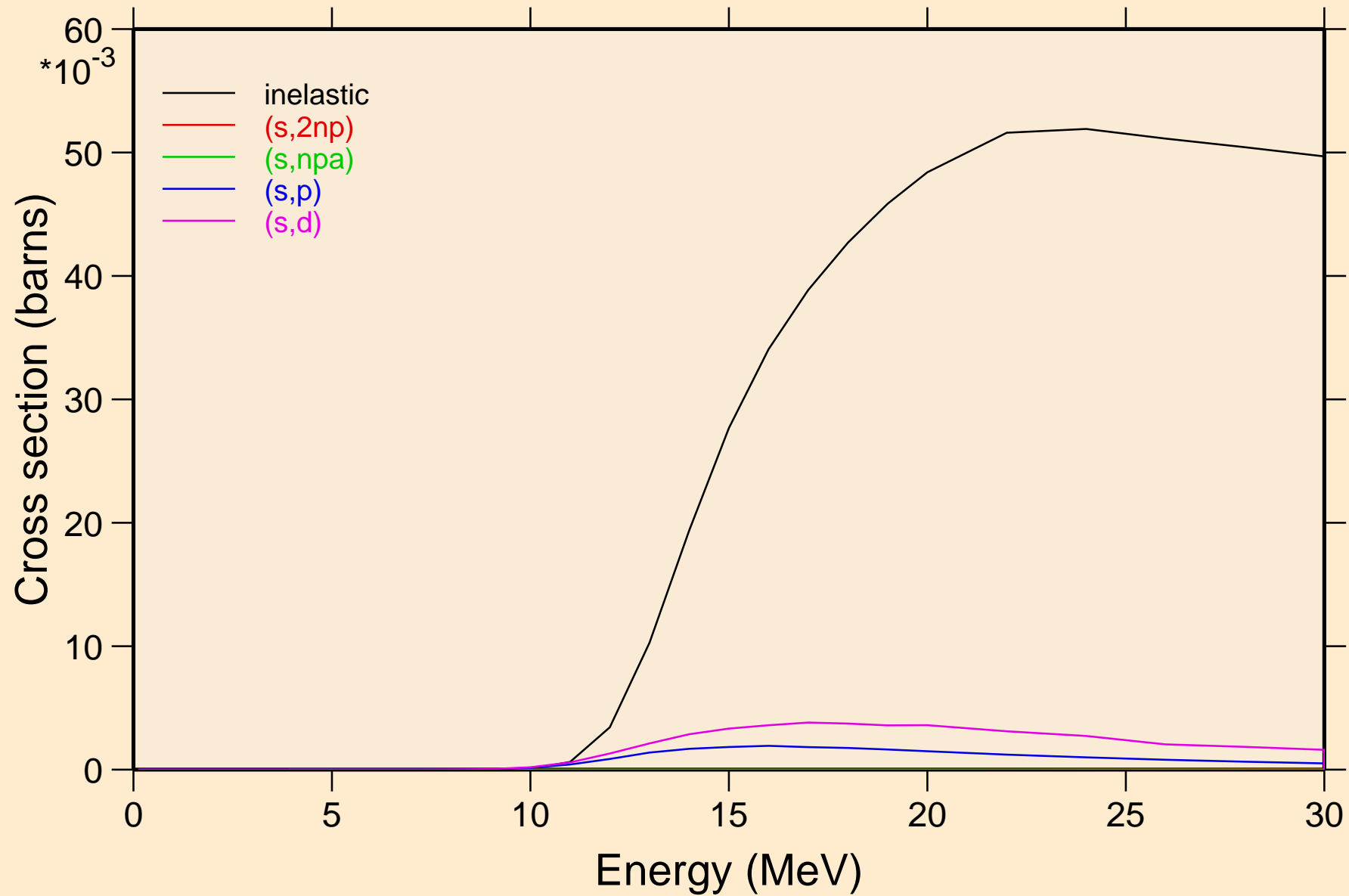

ZR102 HELION ACER TENDL-2021 LIBRARY; T=0.K  
Threshold reactions

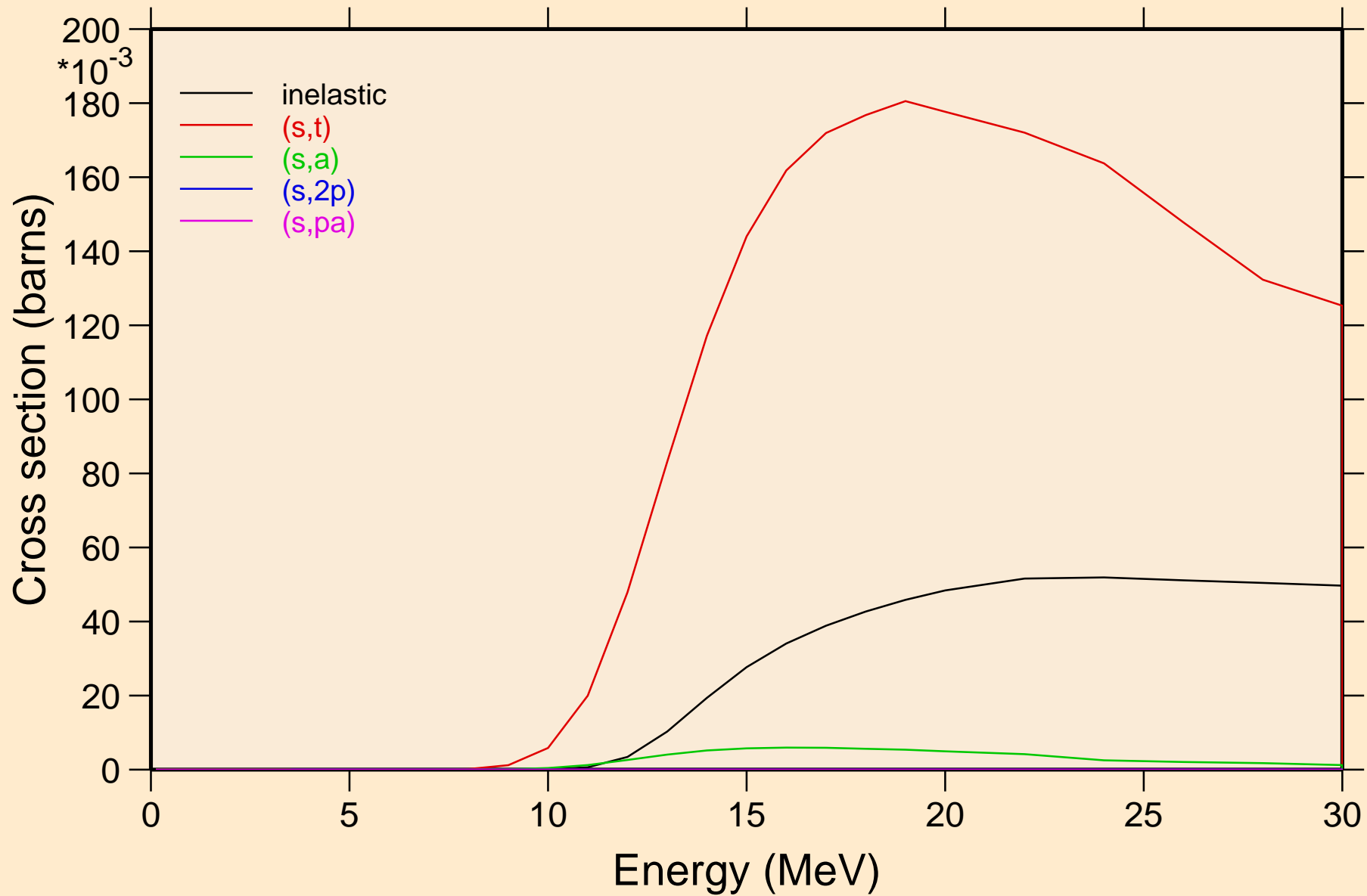

ZR102 HELION ACER TENDL-2021 LIBRARY; T=0.K  
Threshold reactions

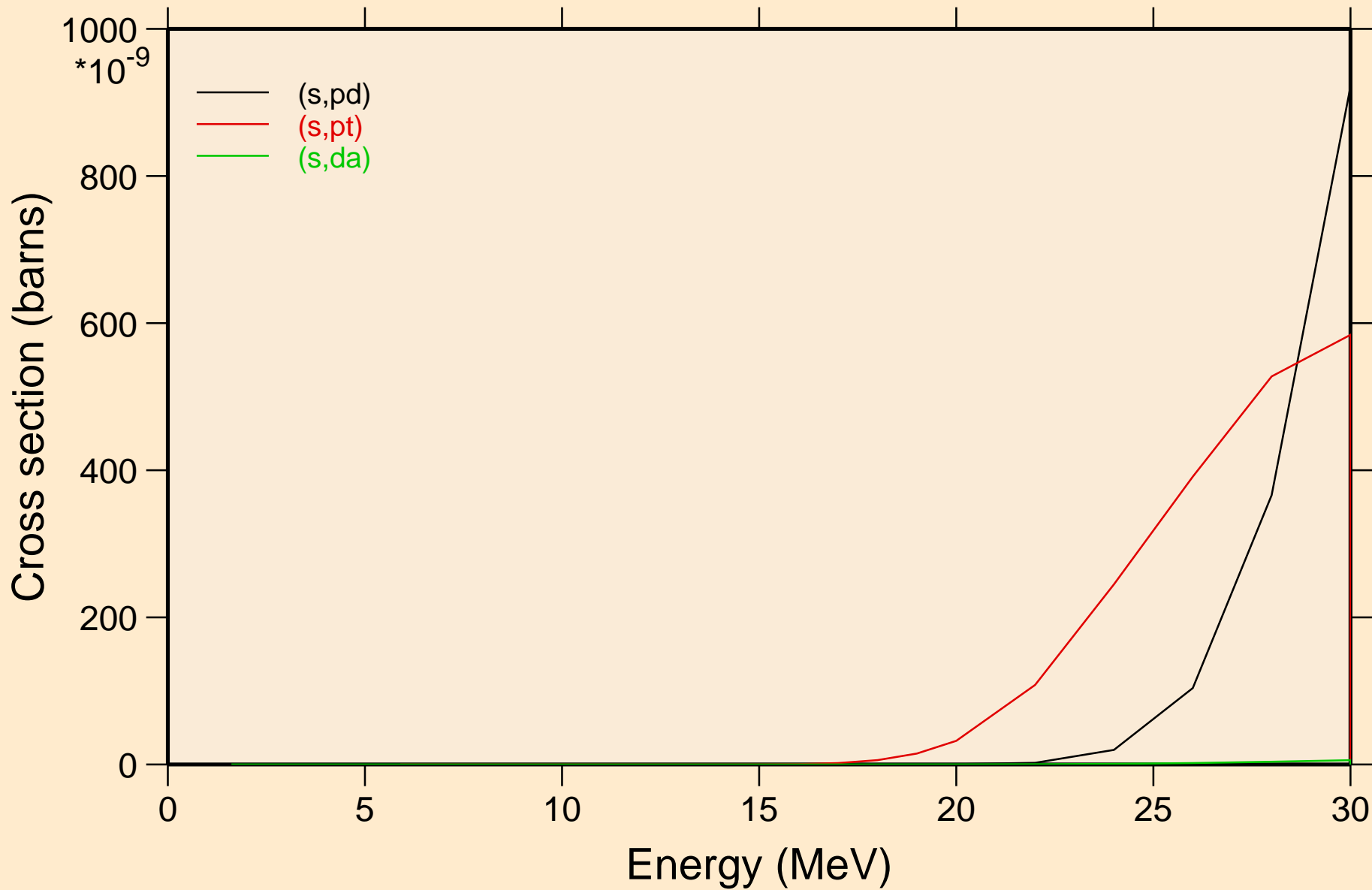

ZR102 HELION ACER TENDL-2021 LIBRARY; T=0.K  
angular distribution for elastic

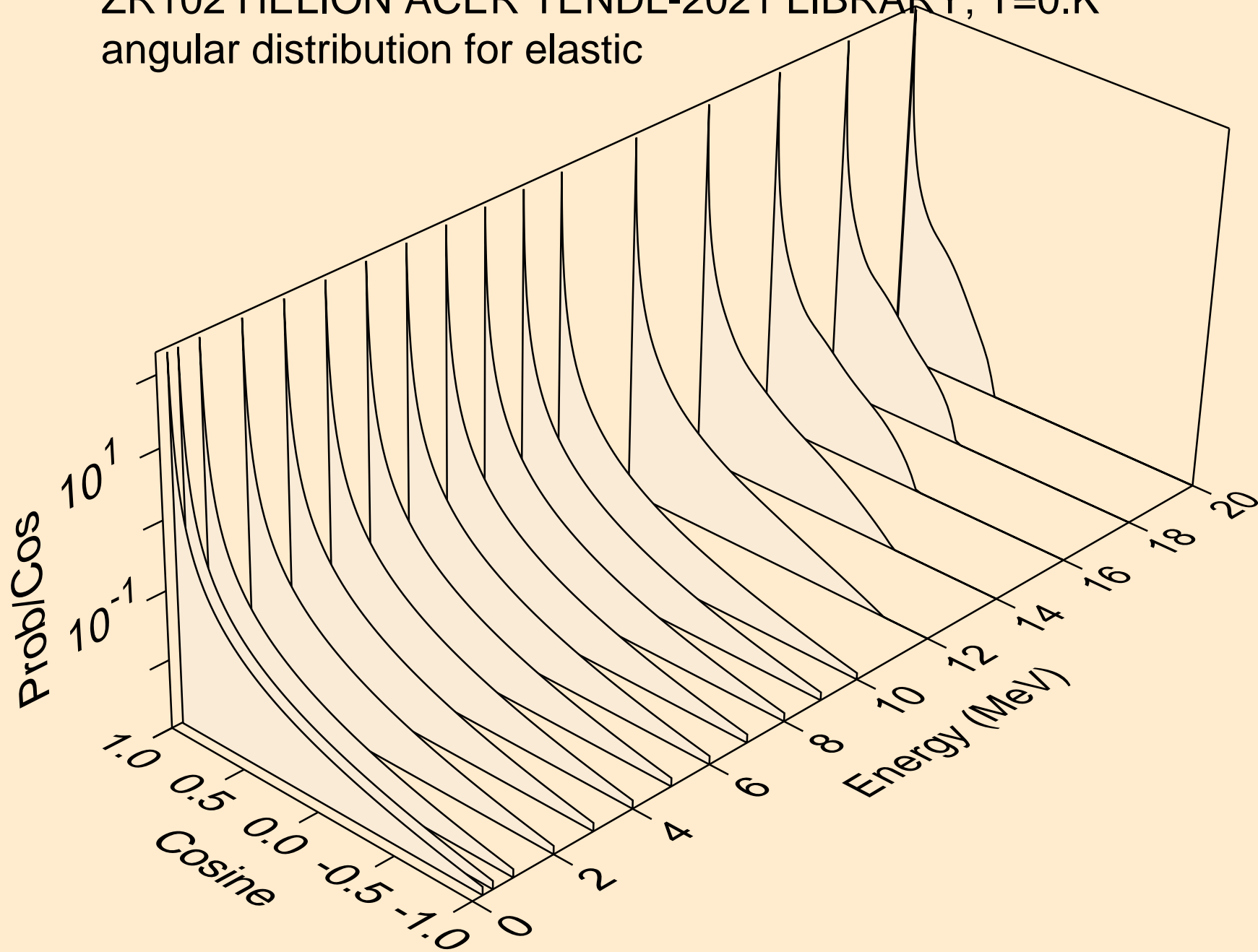

ZR102 HELION ACER TENDL-2021 LIBRARY; T=0.K  
angular distribution for elastic

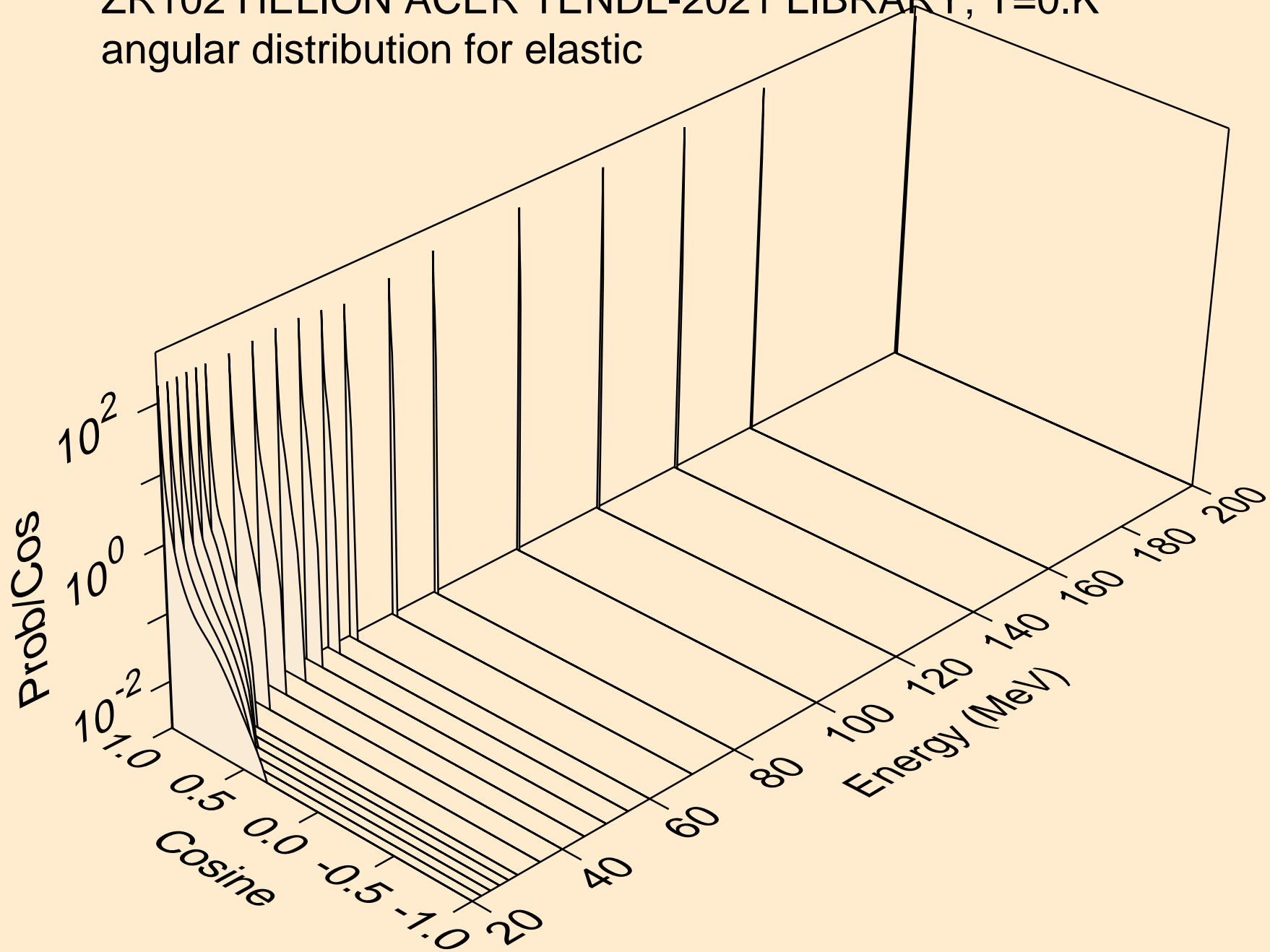

ZR102 HELION ACER TENDL-2021 LIBRARY; T=0.K  
He-3 emission for (s,x)

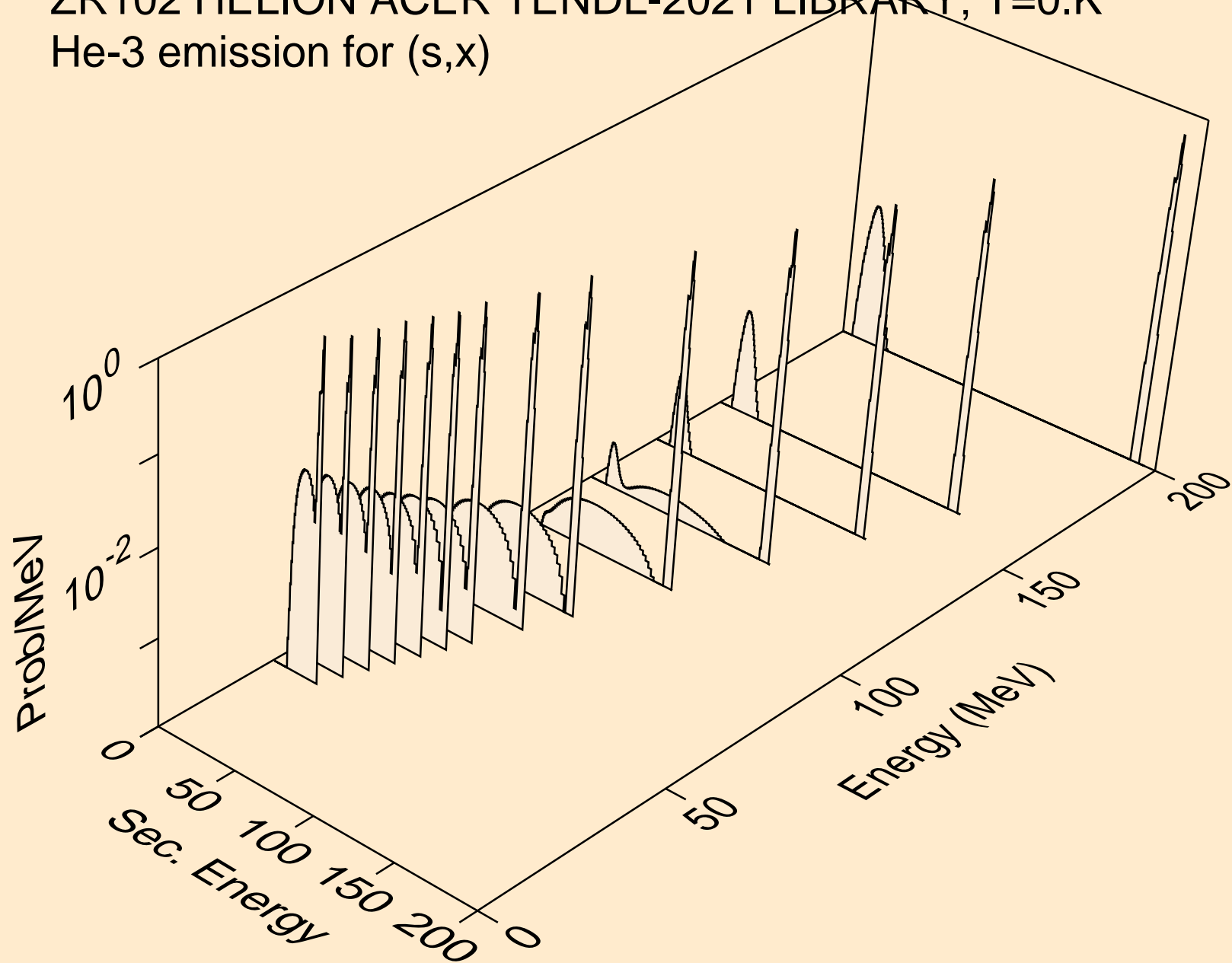

ZR102 HELION ACER TENDL-2021 LIBRARY; T=0.K  
He-3 emission for (s,n\*)he3

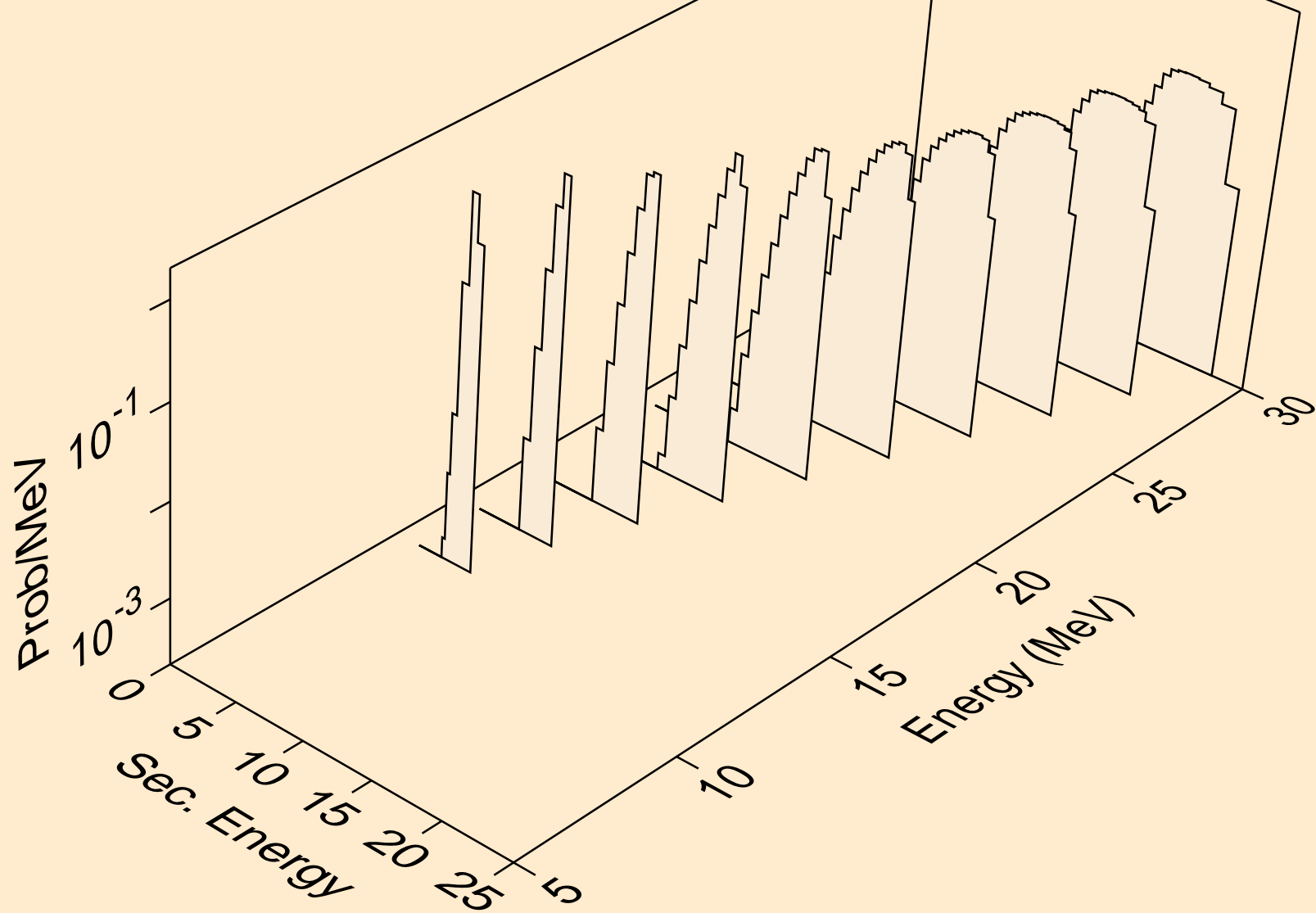



ZR102 HELION ACER TENDL-2021 LIBRARY; T=0.K  
He-3 emission for inelastic

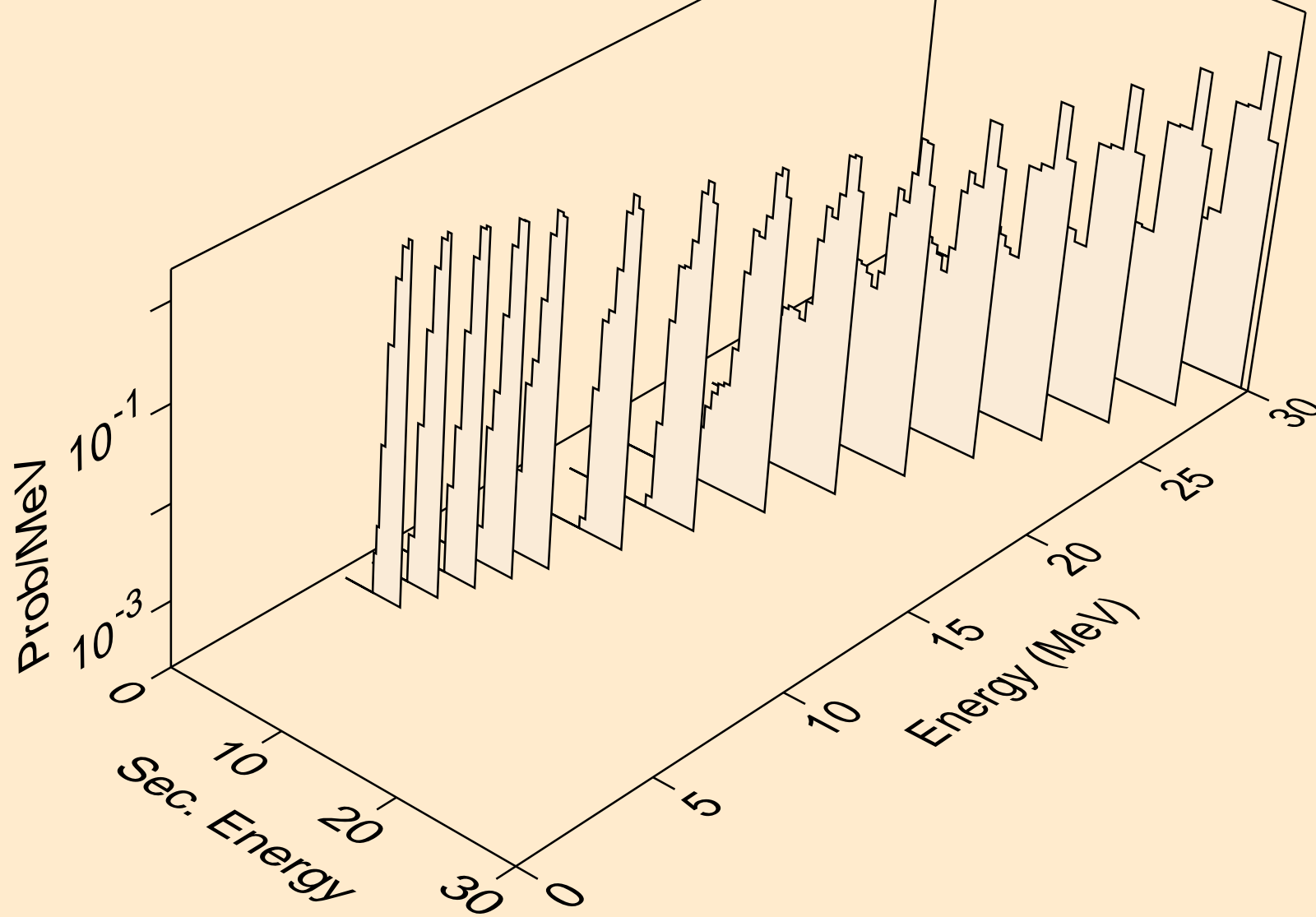

ZR102 HELION ACER TENDL-2021 LIBRARY; T=0.K  
Photon emission for (z,n)

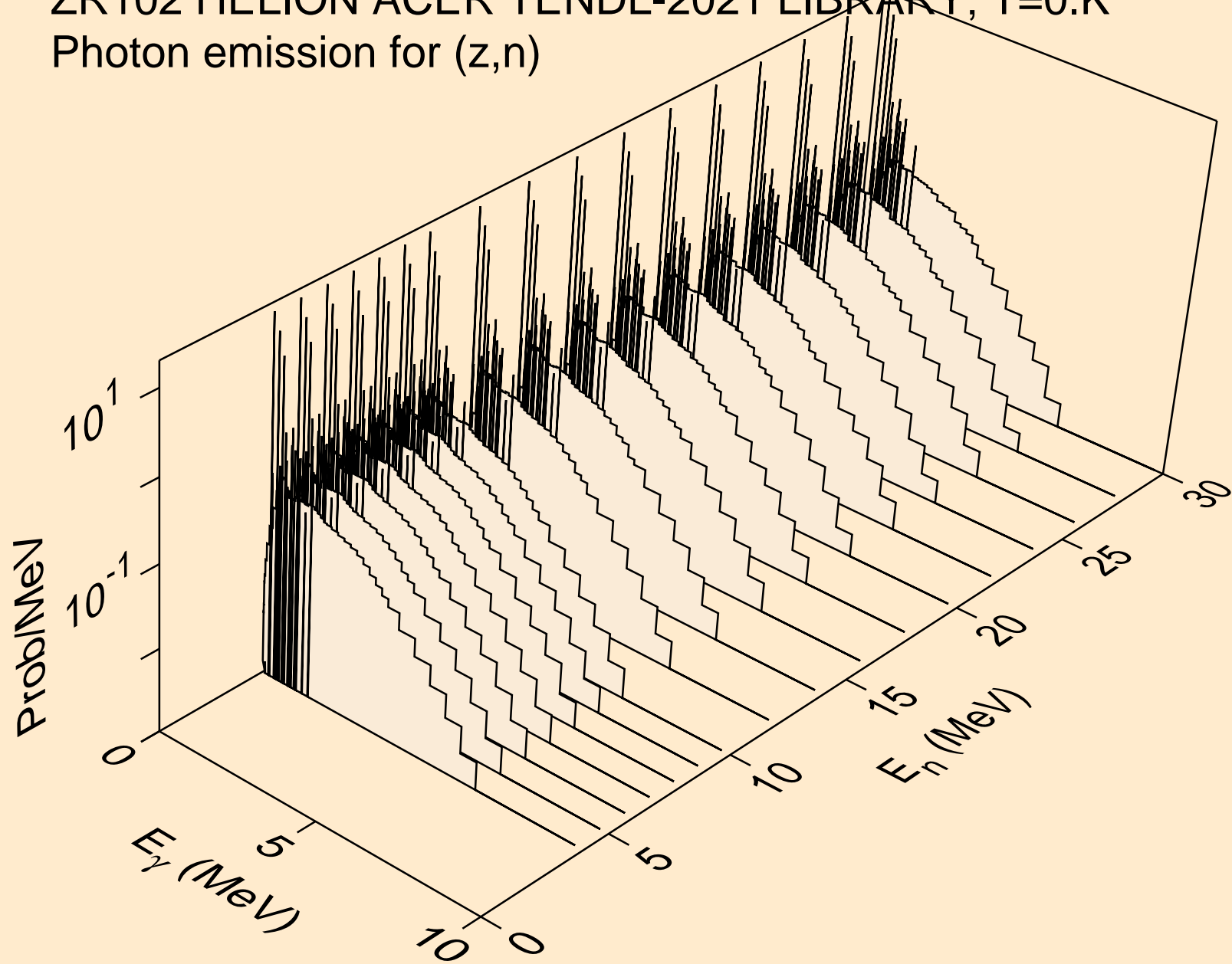

ZR102 HELION ACER TENDL-2021 LIBRARY; T=0.K  
Photon emission for (n,x)

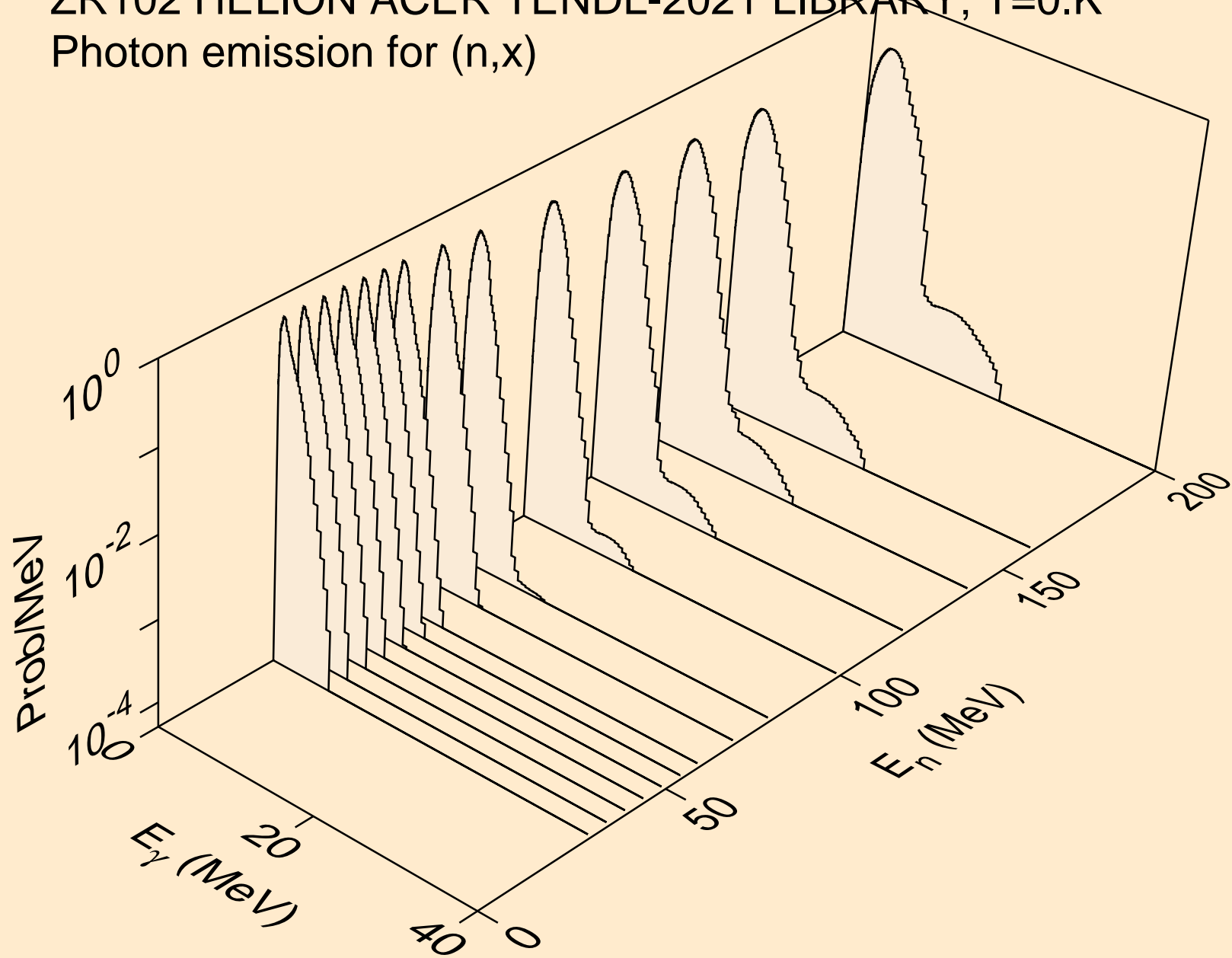

ZR102 HELION ACER TENDL-2021 LIBRARY; T=0.K  
Photon emission for (n,2nd)

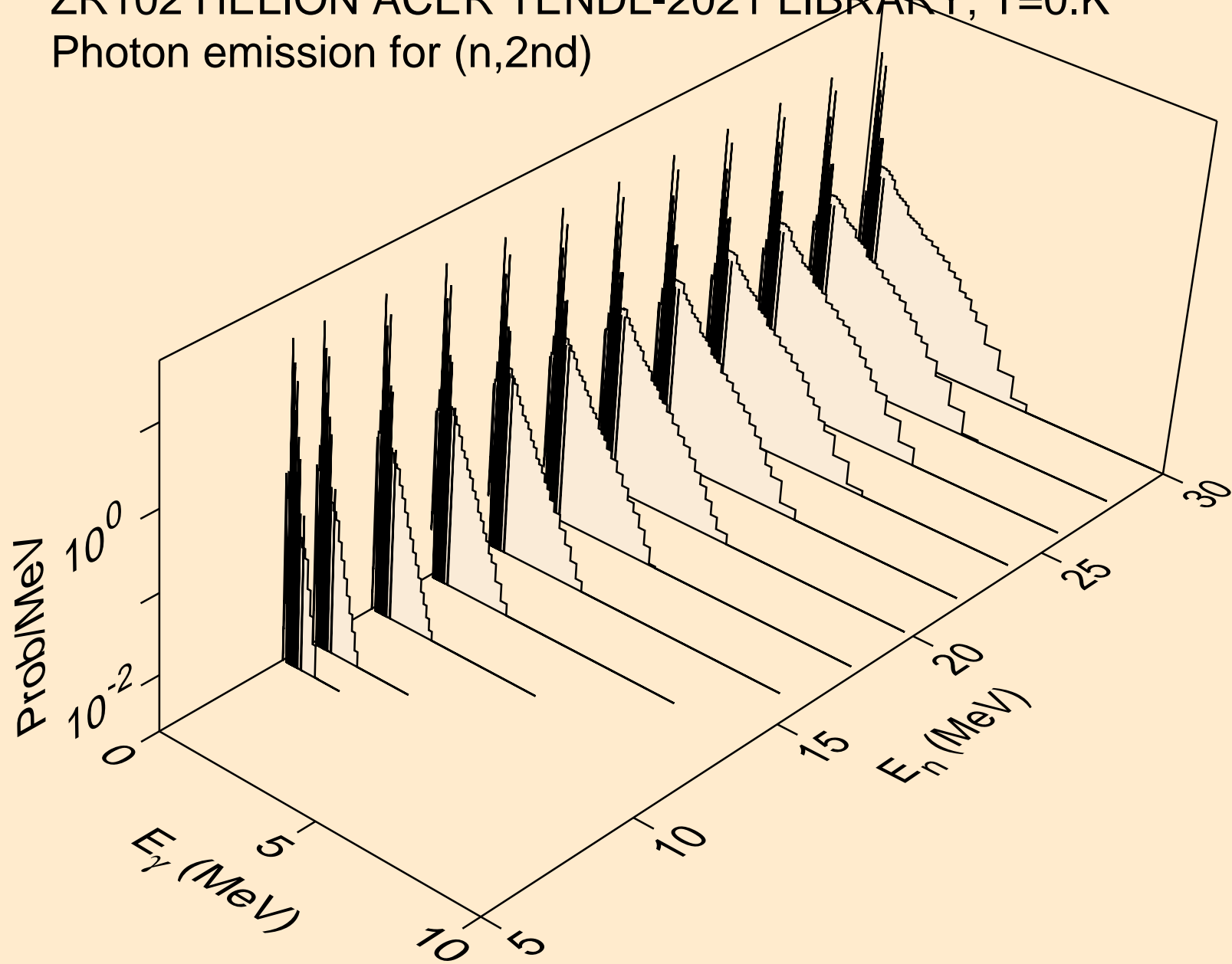

ZR102 HELION ACER TENDL-2021 LIBRARY; T=0.K  
Photon emission for (n,2n)

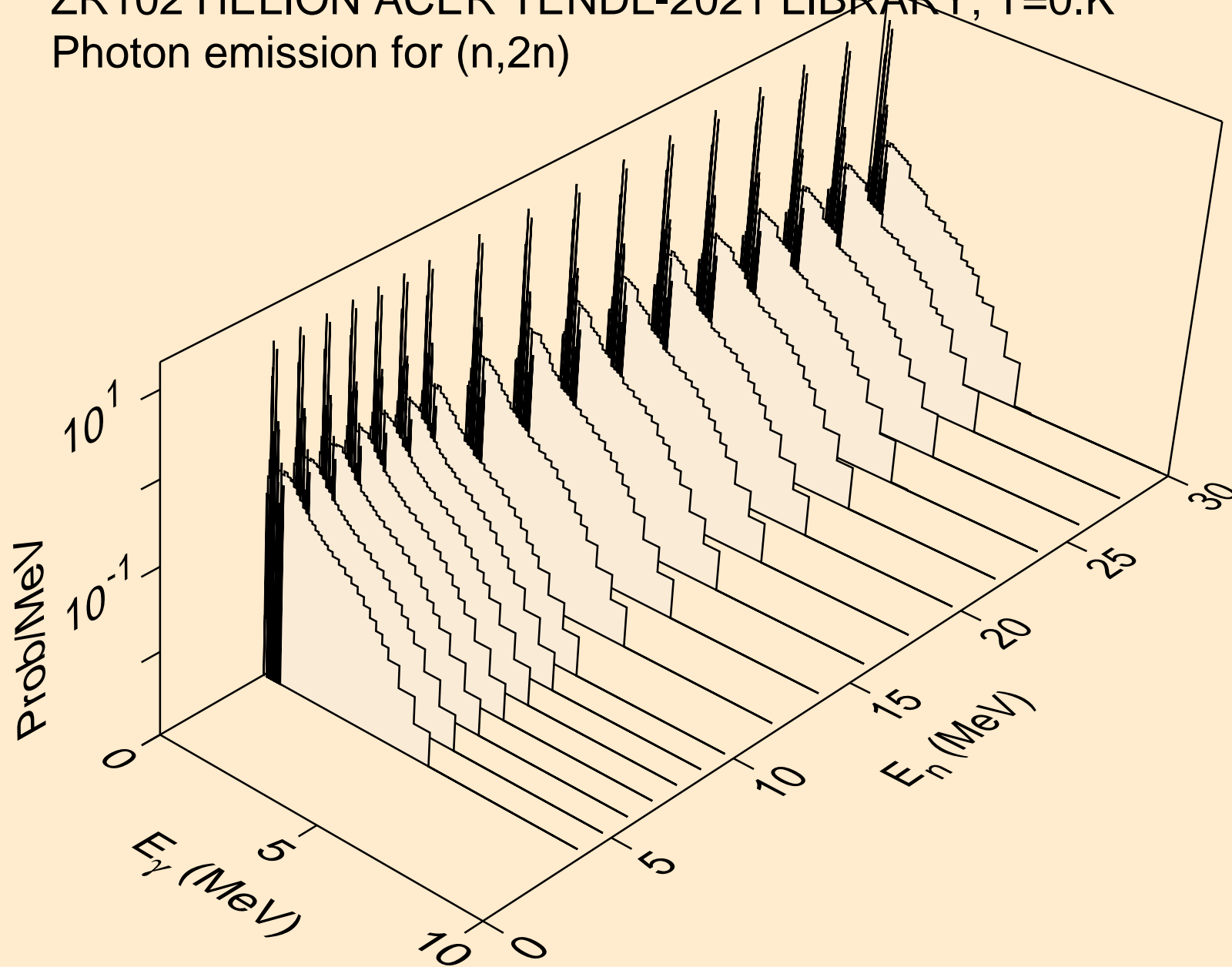

ZR102 HELION ACER TENDL-2021 LIBRARY; T=0.K  
Photon emission for (n,3n)

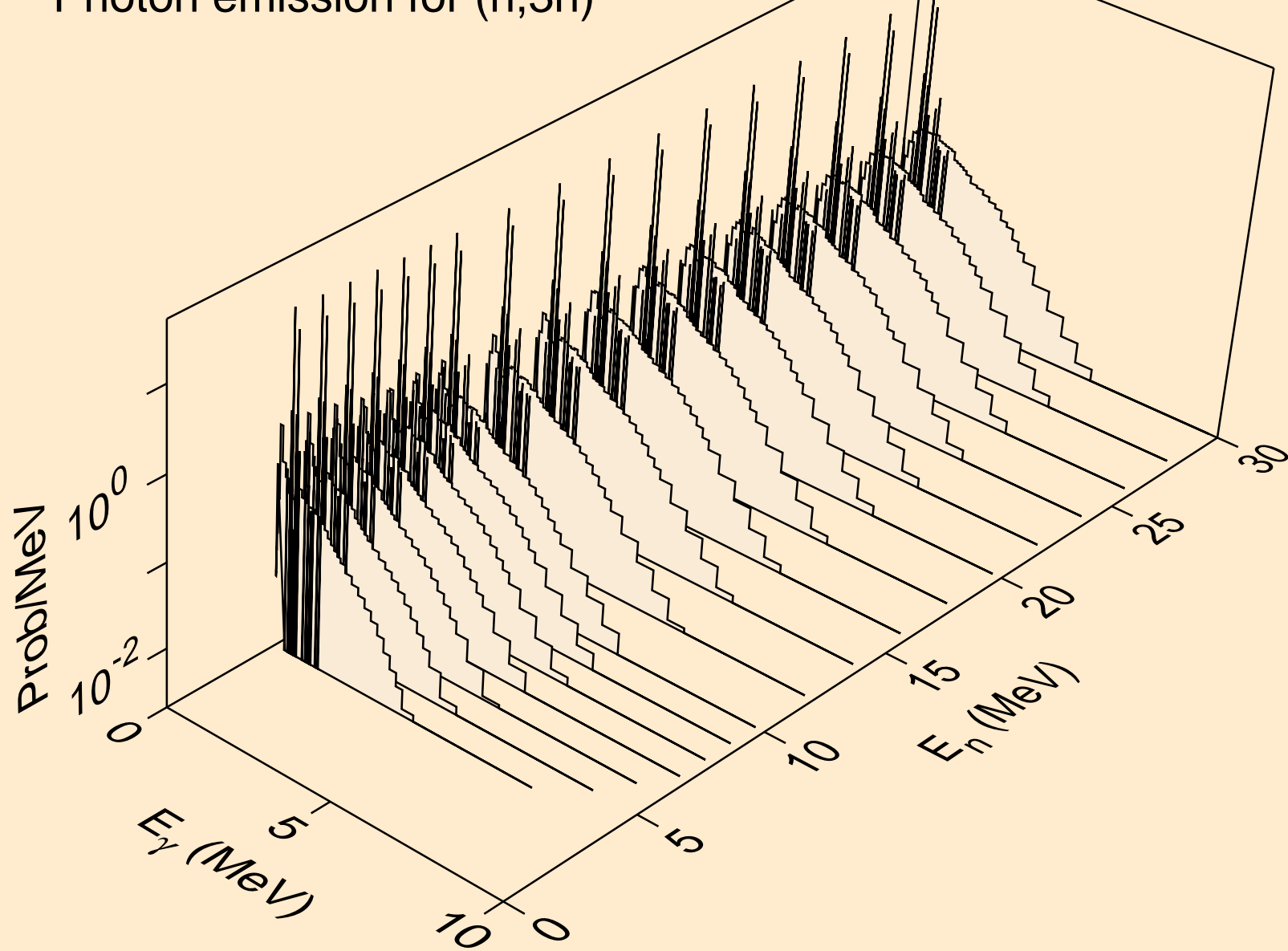

ZR102 HELION ACER TENDL-2021 LIBRARY; T=0.K  
Photon emission for (n,n\*)a

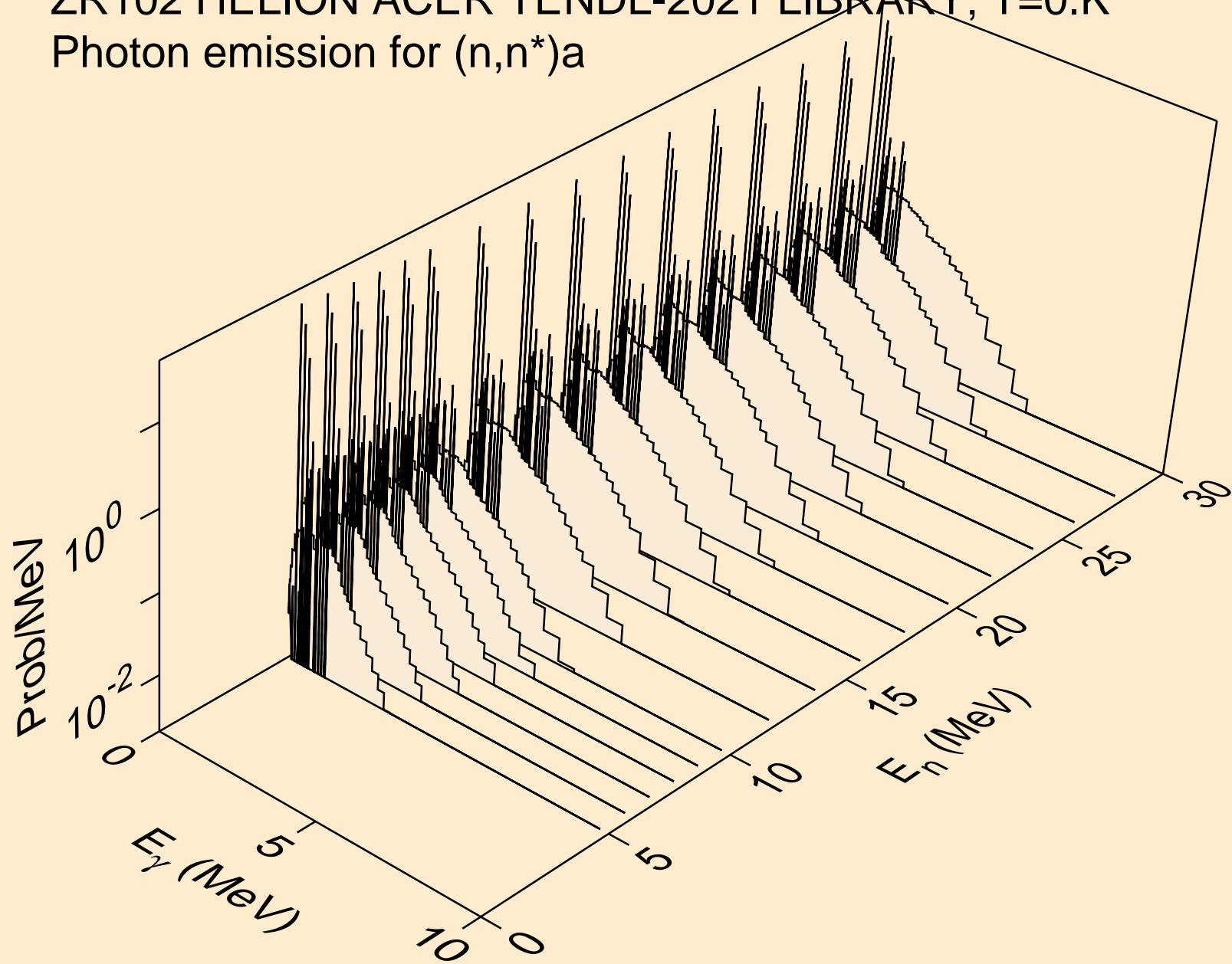

ZR102 HELION ACER TENDL-2021 LIBRARY; T=0.K  
Photon emission for (n,2n)a

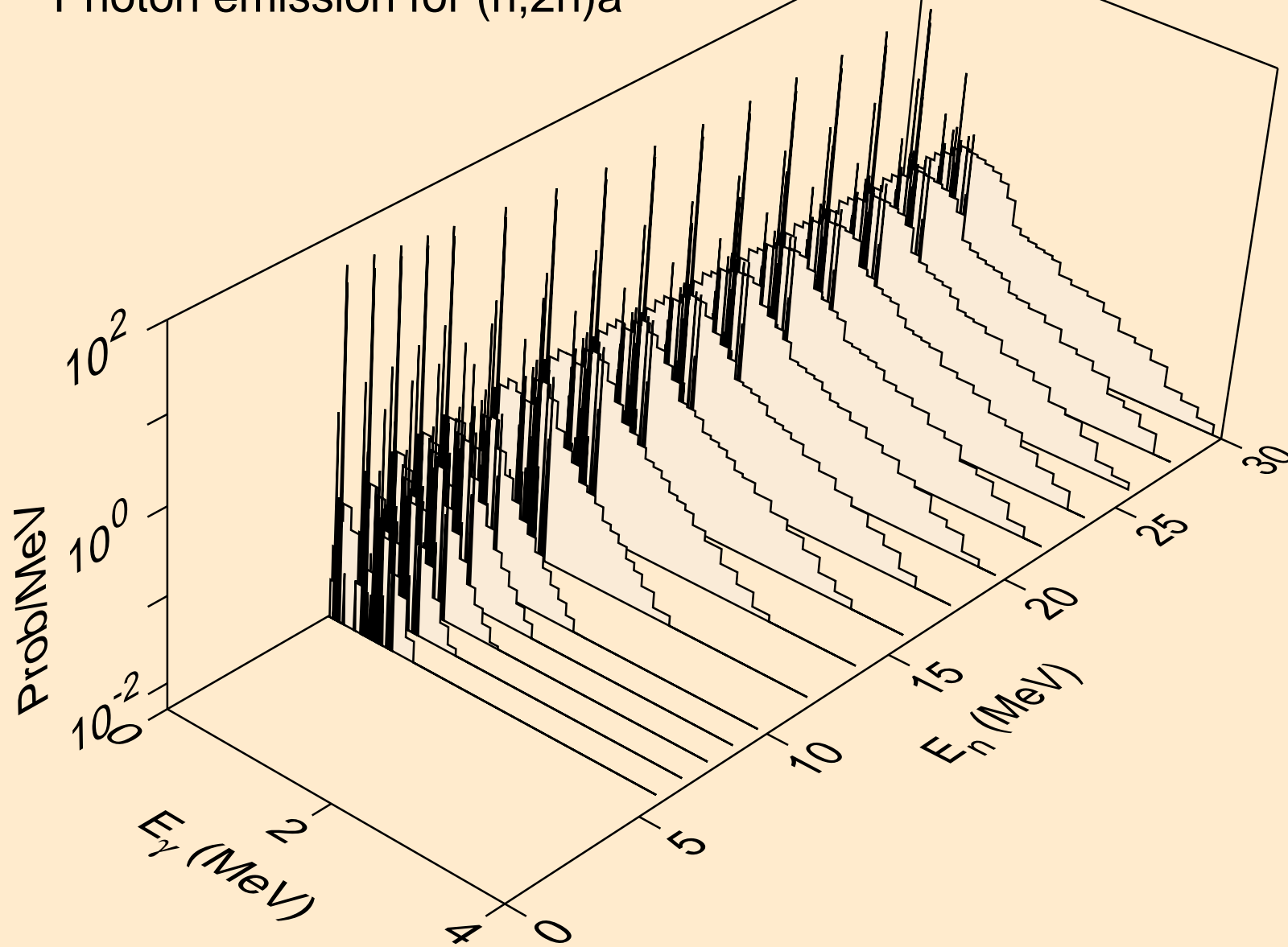



ZR102 HELION ACER TENDL-2021 LIBRARY; T=0.K  
Photon emission for (n,3n)a

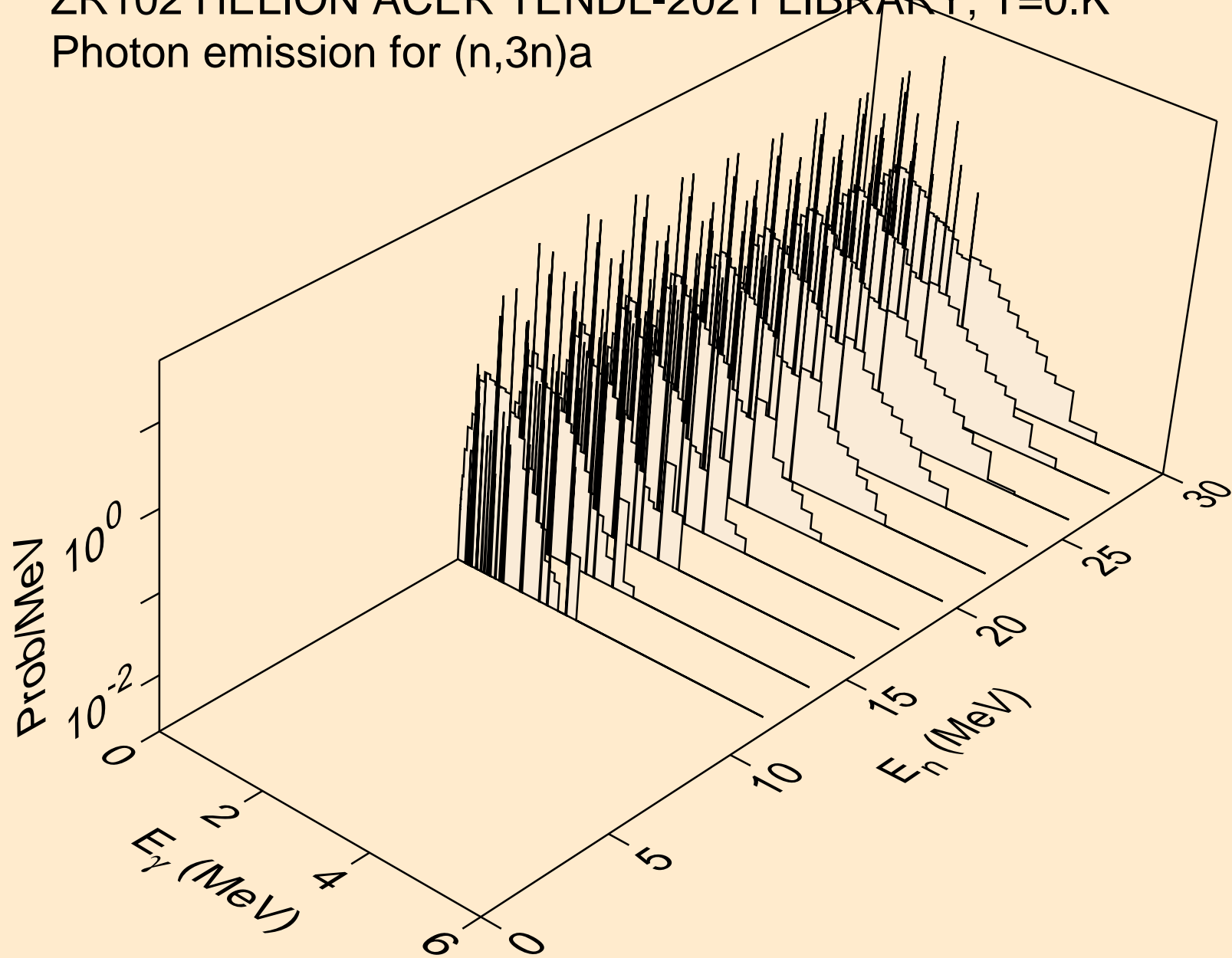

ZR102 HELION ACER TENDL-2021 LIBRARY; T=0.K  
Photon emission for (n,n\*)p

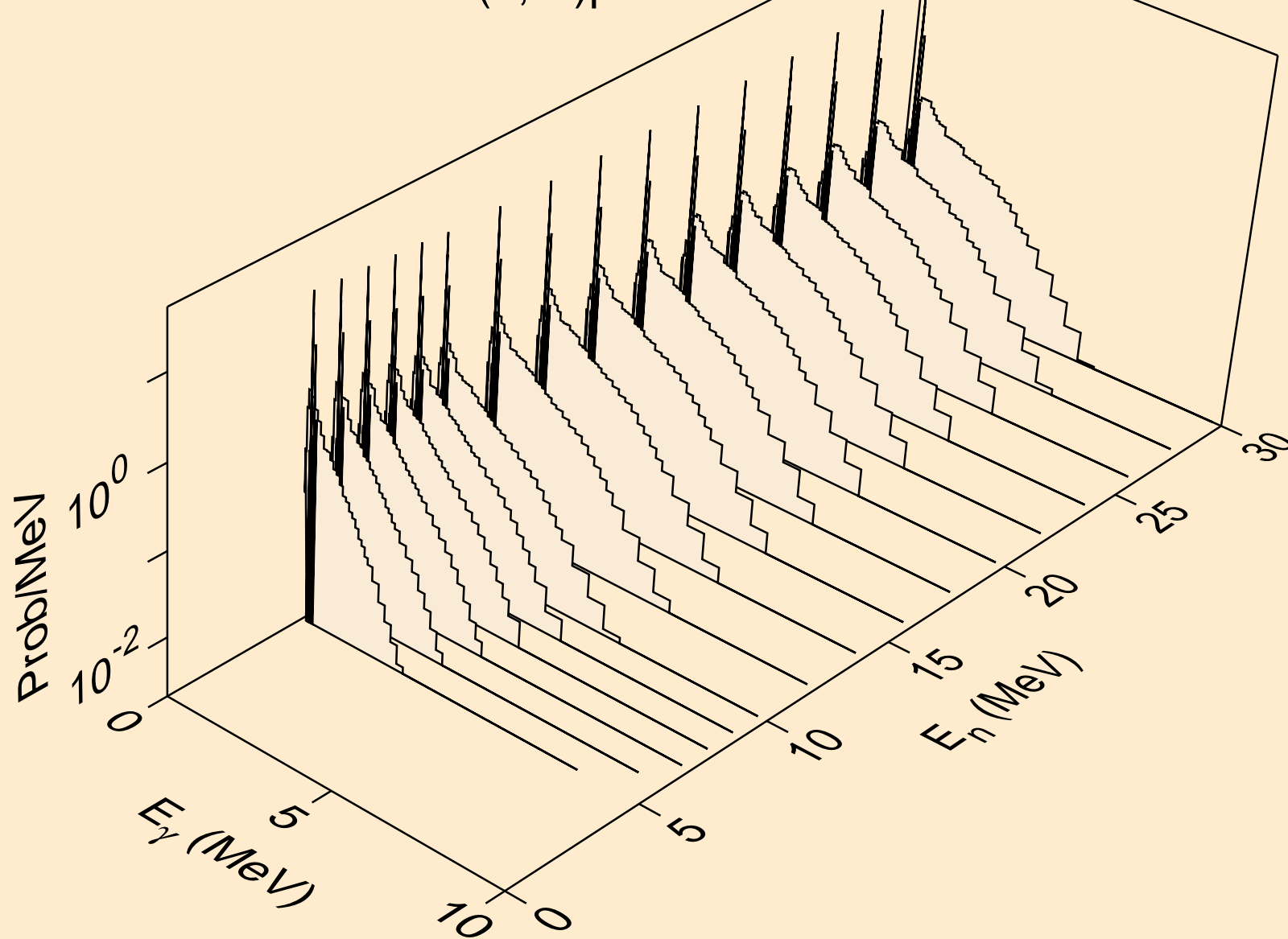

ZR102 HELION ACER TENDL-2021 LIBRARY; T=0.K  
Photon emission for (n,n\*)2a

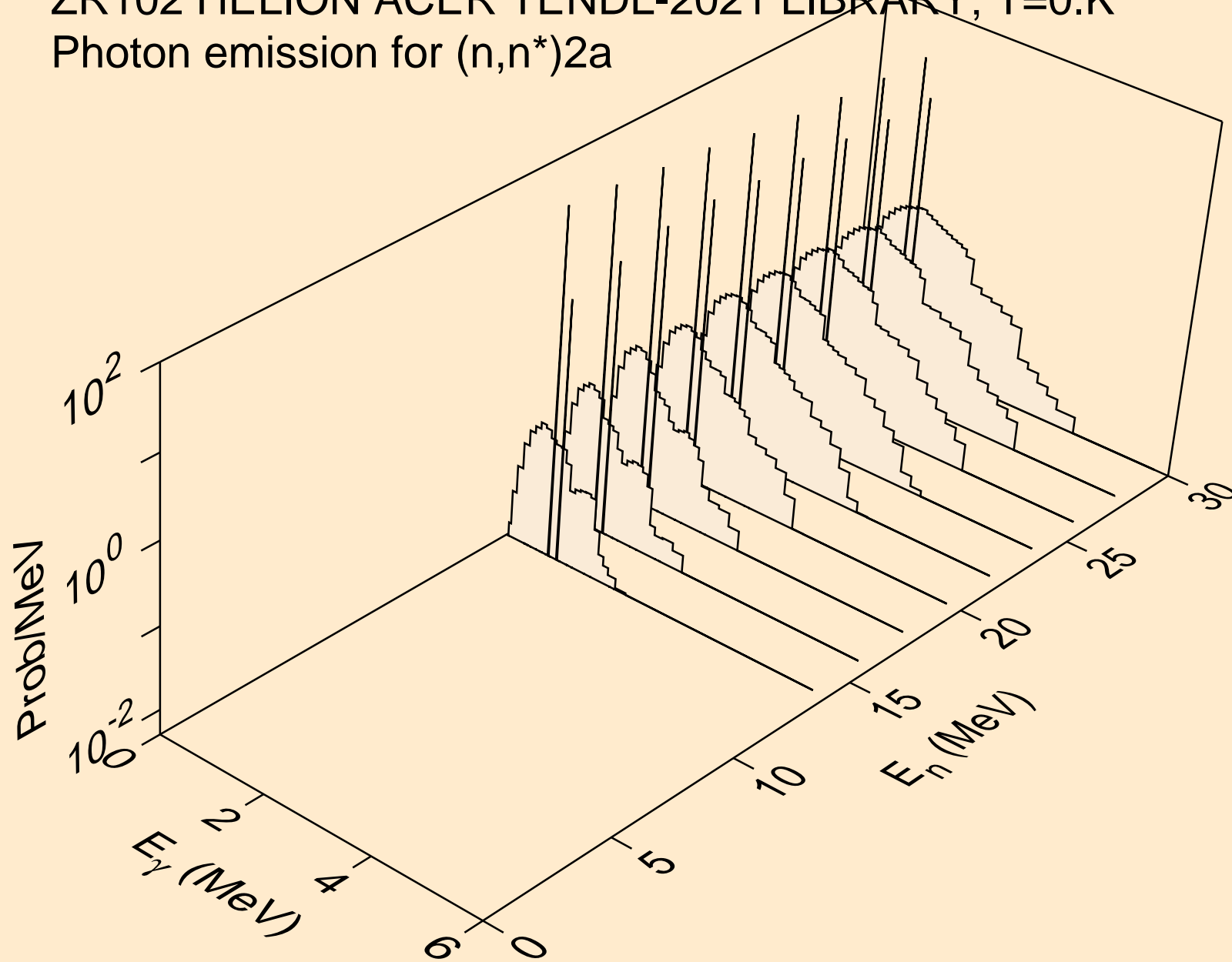

ZR102 HELION ACER TENDL-2021 LIBRARY; T=0.K  
Photon emission for (n,2n)2a

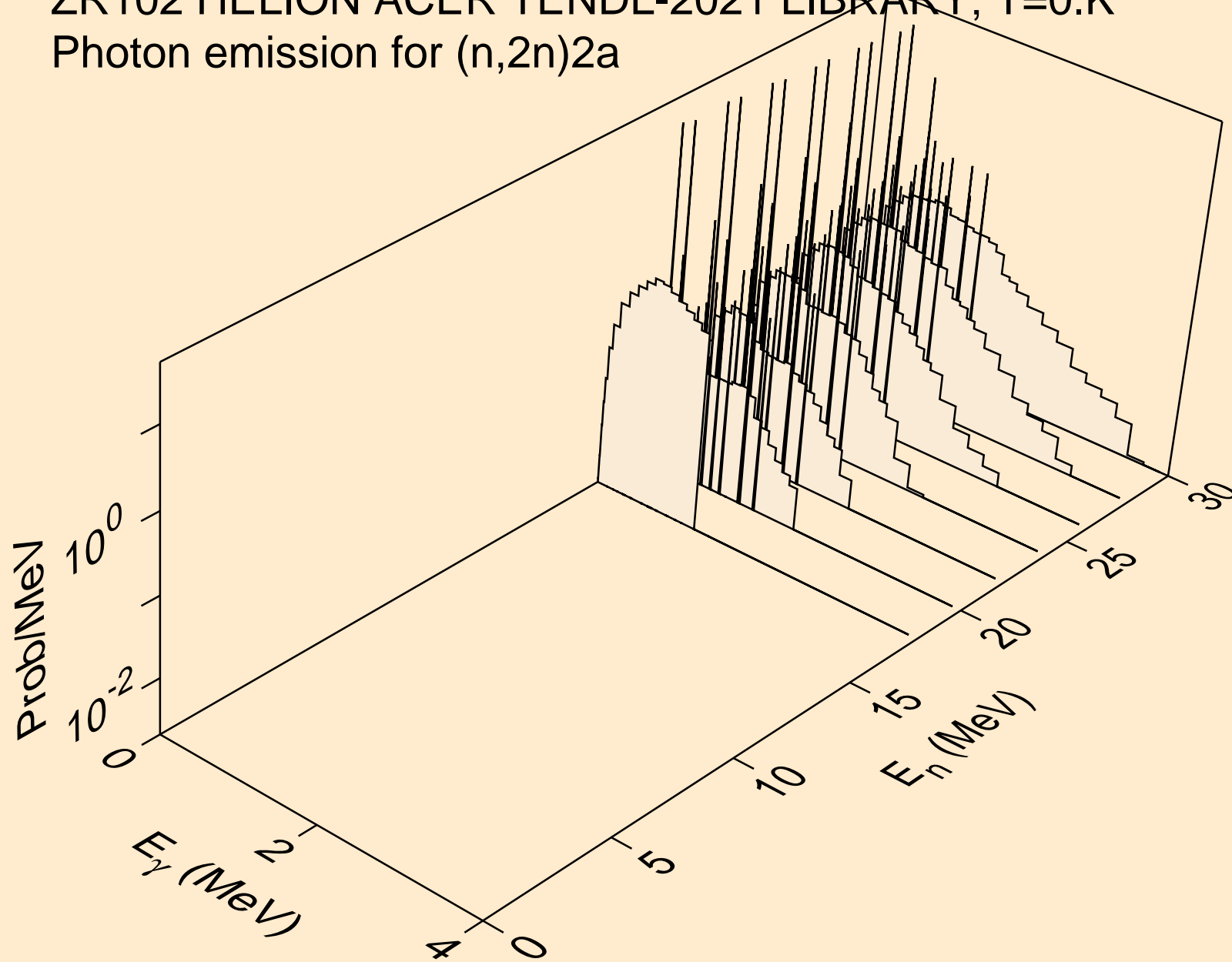

ZR102 HELION ACER TENDL-2021 LIBRARY; T=0.K  
Photon emission for (n,n\*)d

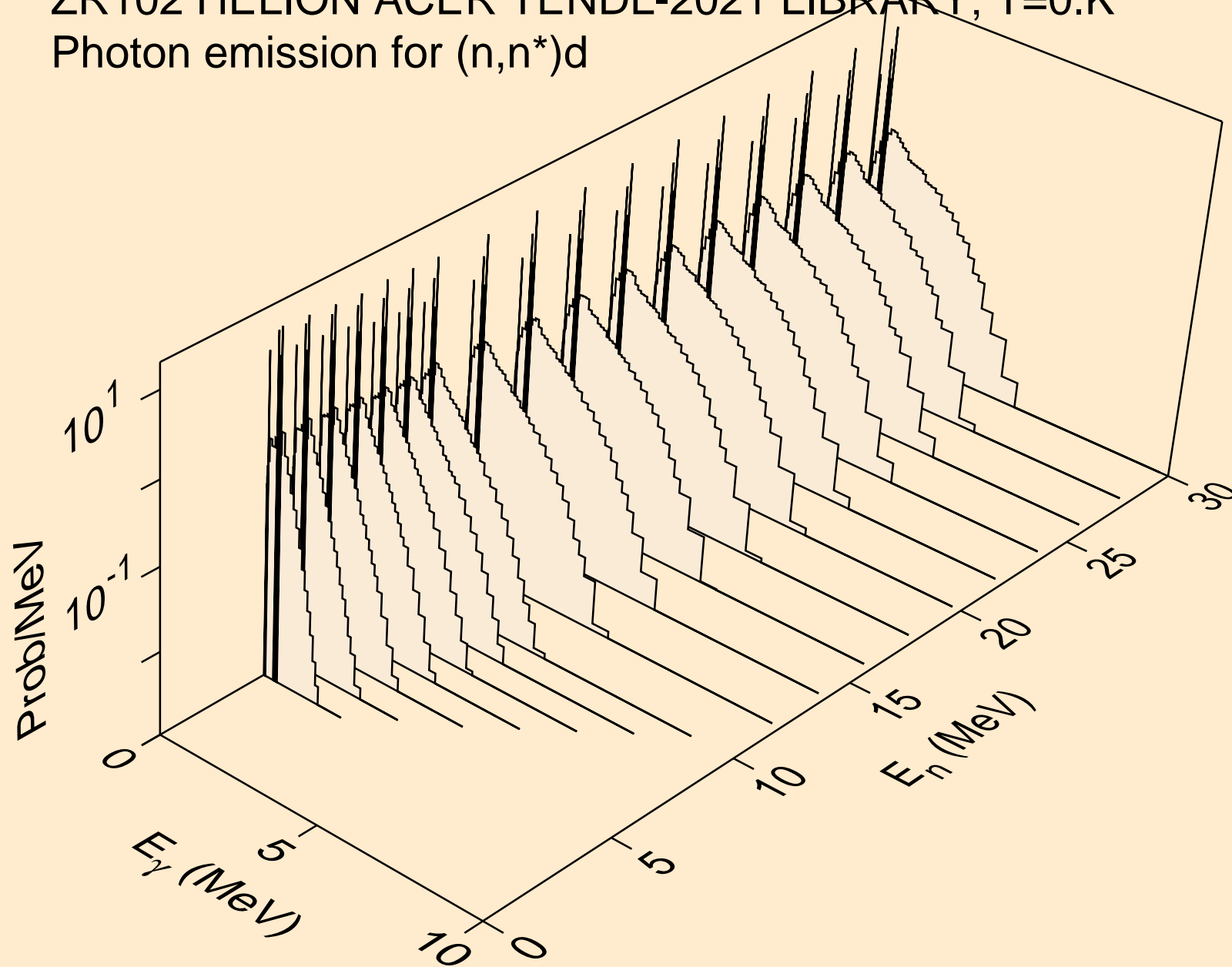

ZR102 HELION ACER TENDL-2021 LIBRARY; T=0.K  
Photon emission for (n,n\*)t

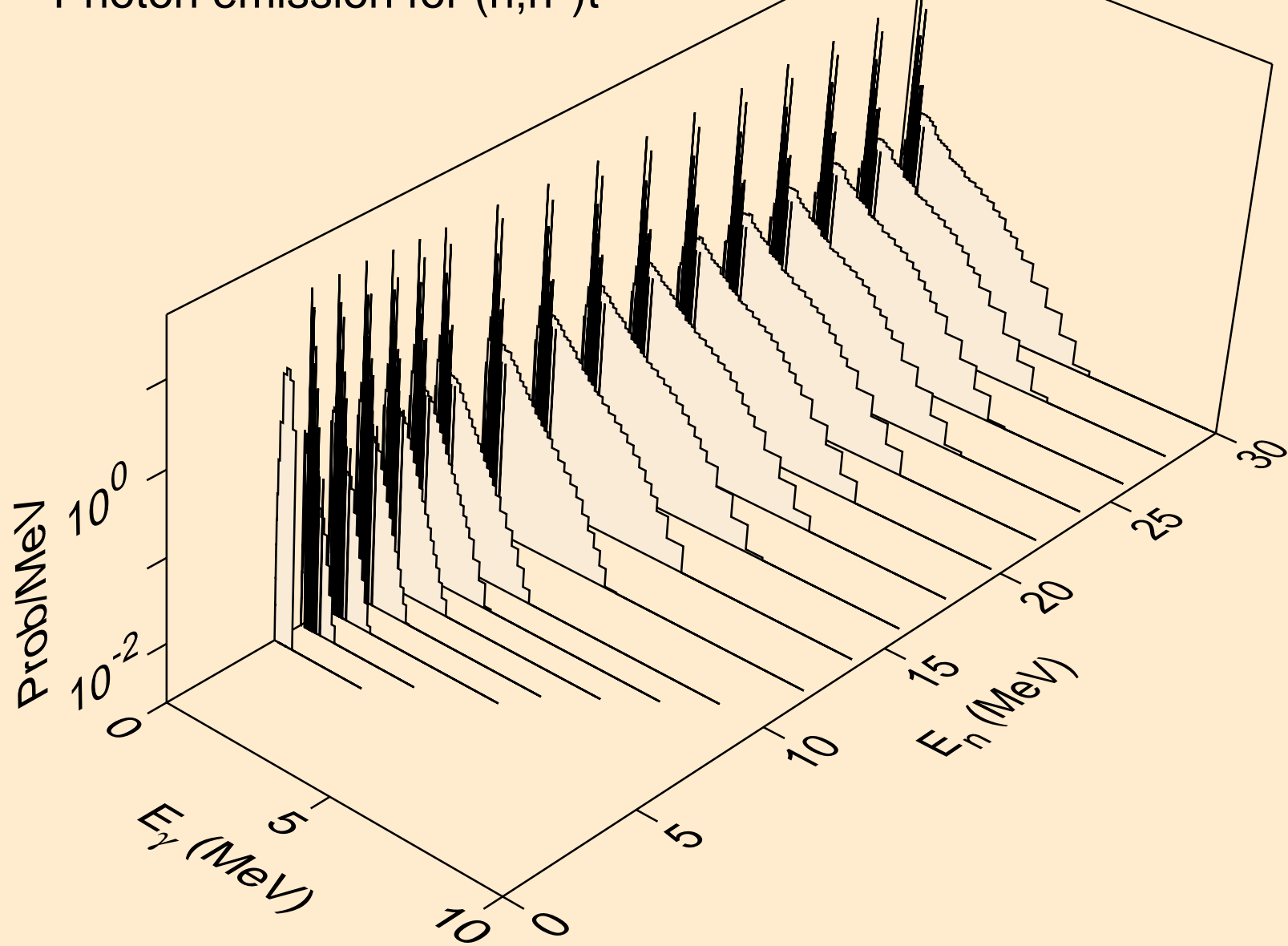

ZR102 HELION ACER TENDL-2021 LIBRARY; T=0.K  
Photon emission for (n,n\*)he3

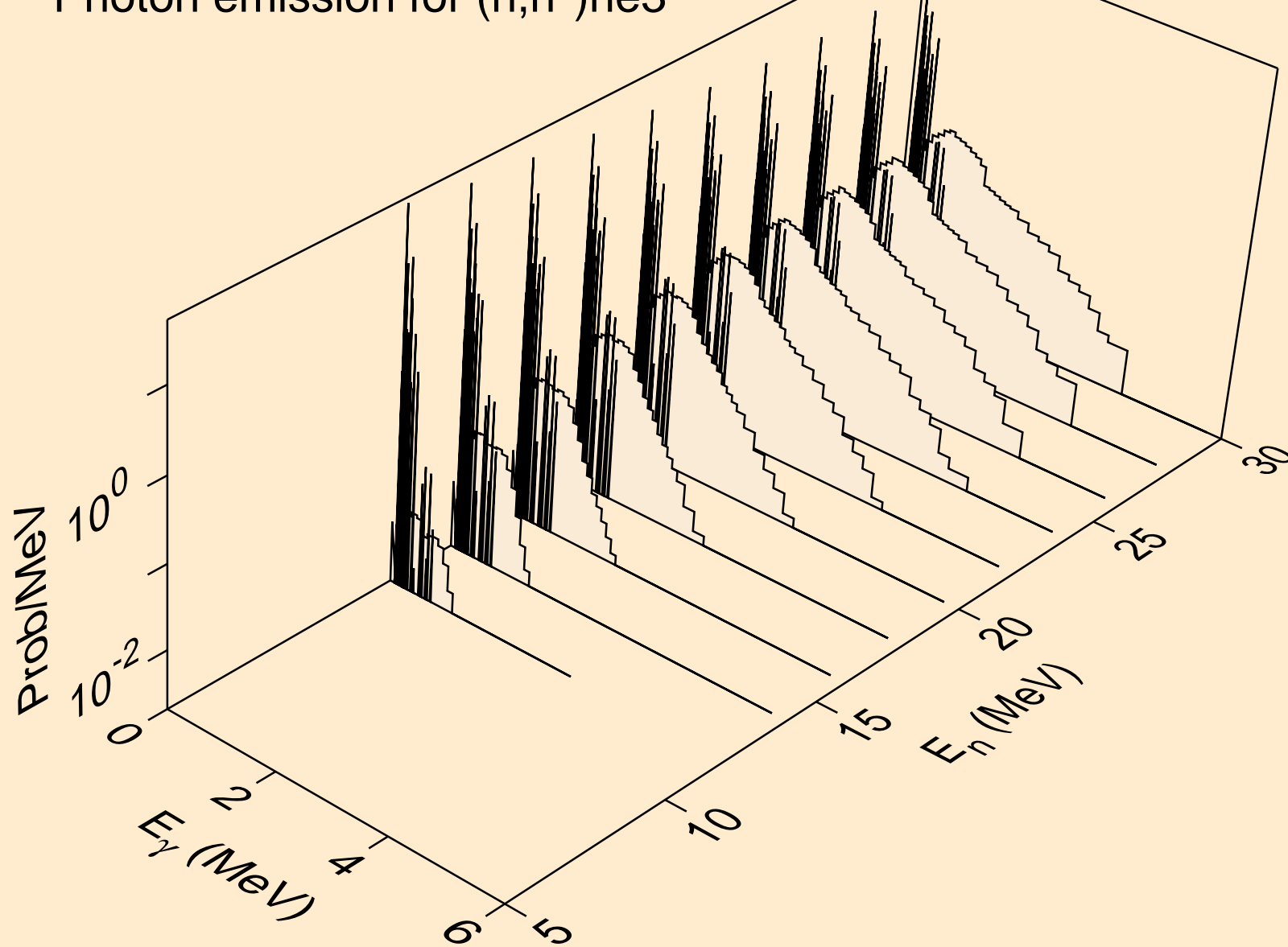

ZR102 HELION ACER TENDL-2021 LIBRARY; T=0.K  
Photon emission for (n,4n)

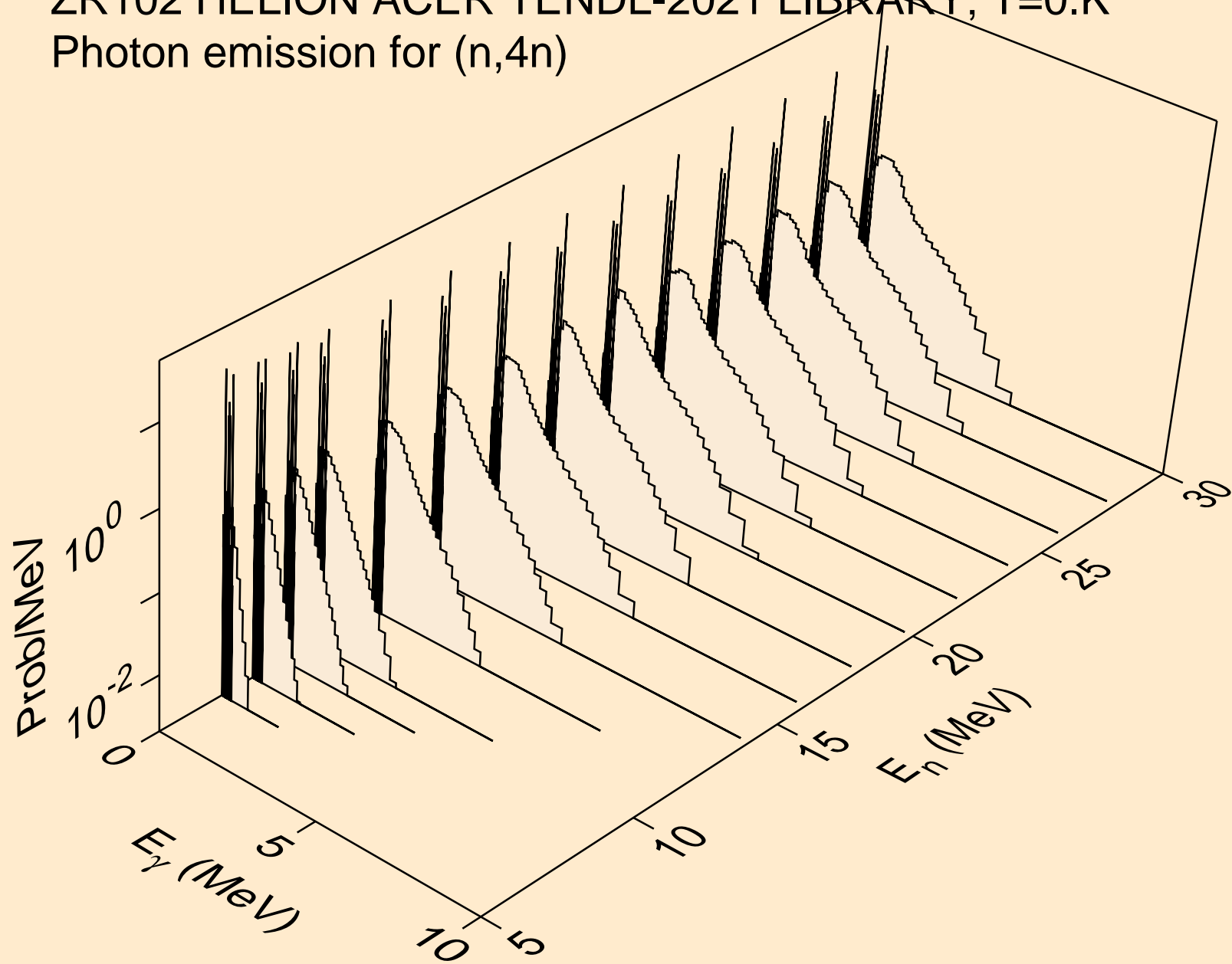



ZR102 HELION ACER TENDL-2021 LIBRARY; T=0.K  
Photon emission for (n,2np)

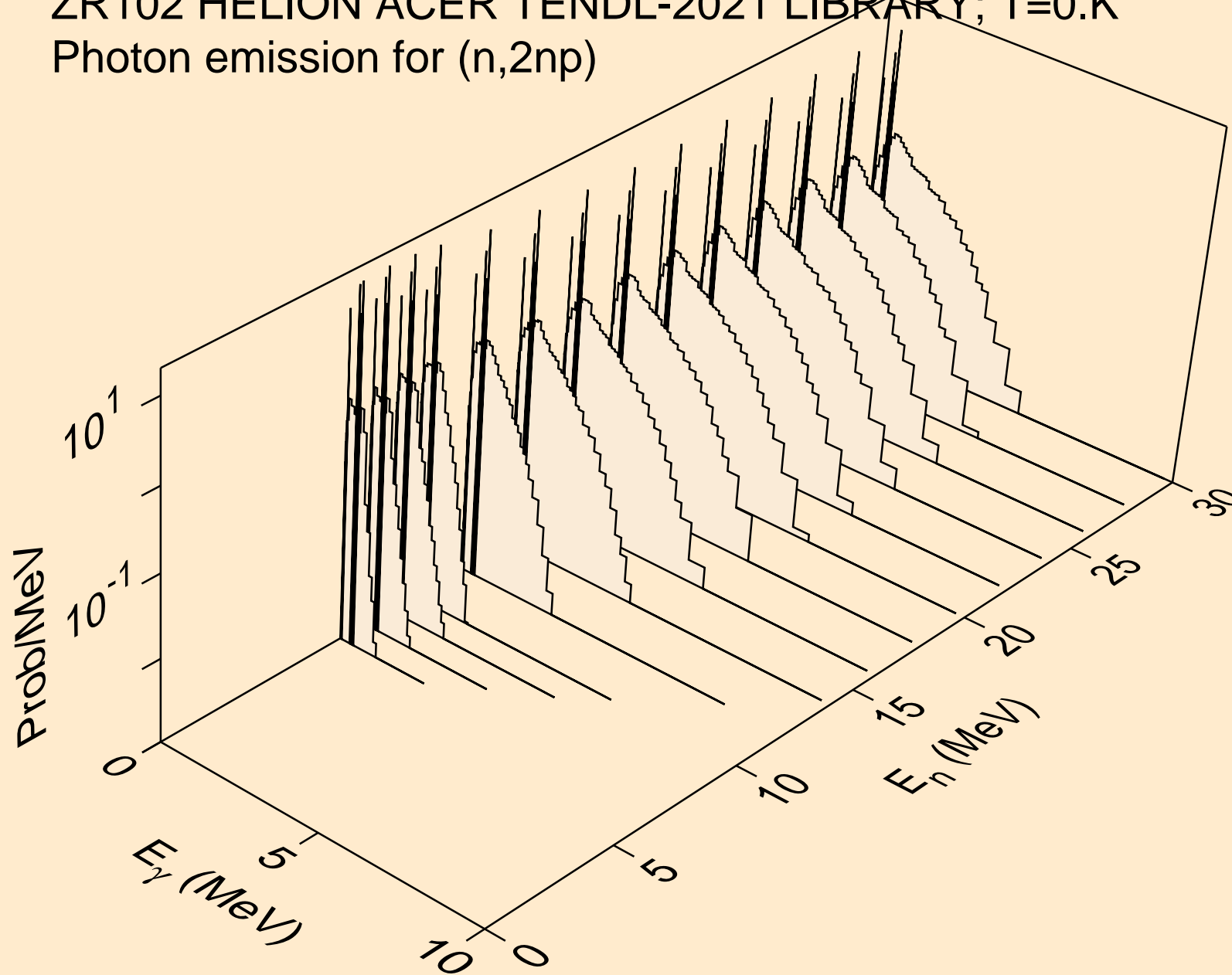

ZR102 HELION ACER TENDL-2021 LIBRARY; T=0.K  
Photon emission for (n,3np)

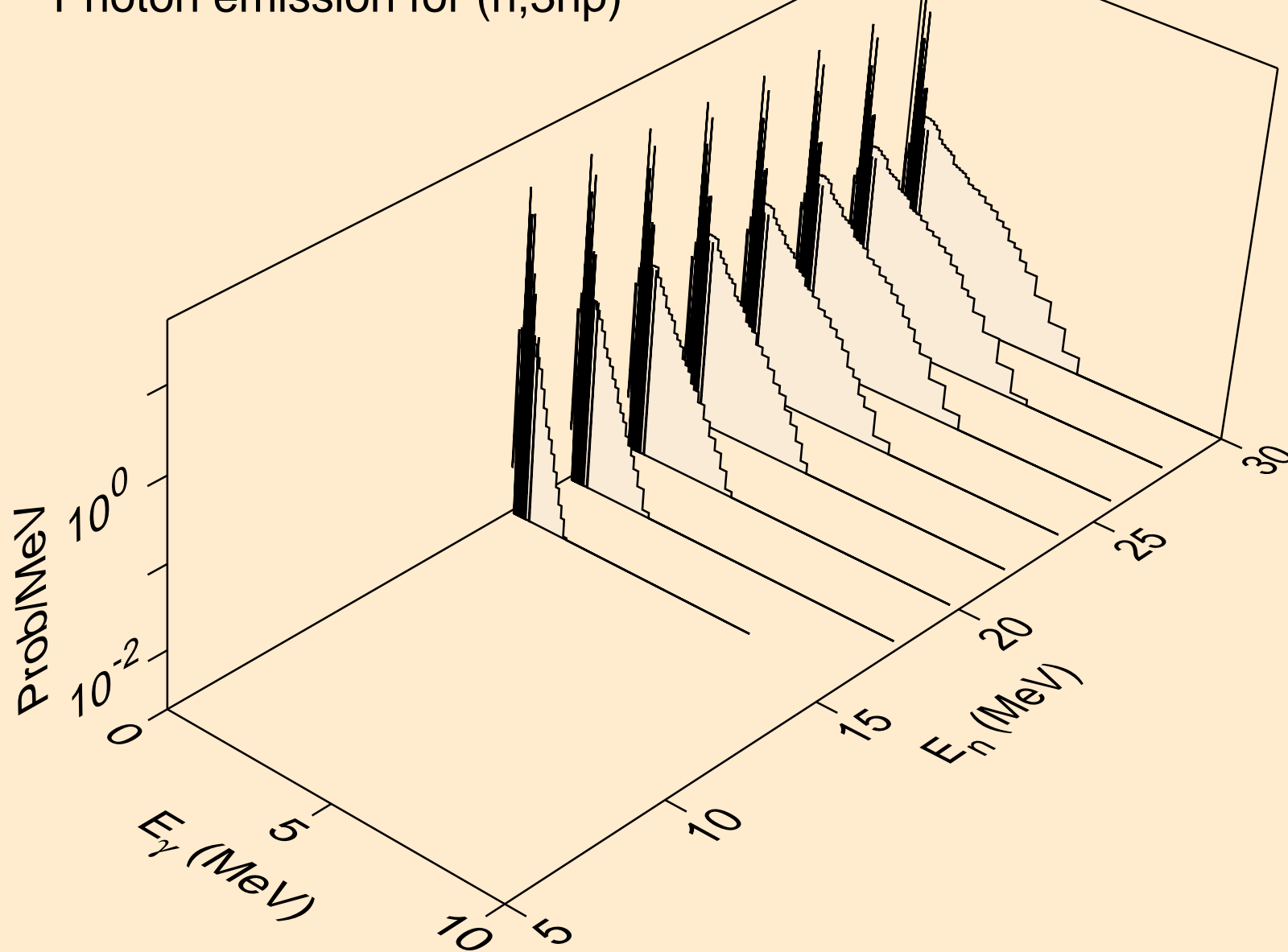

ZR102 HELION ACER TENDL-2021 LIBRARY; T=0.K  
Photon emission for (n,2np)

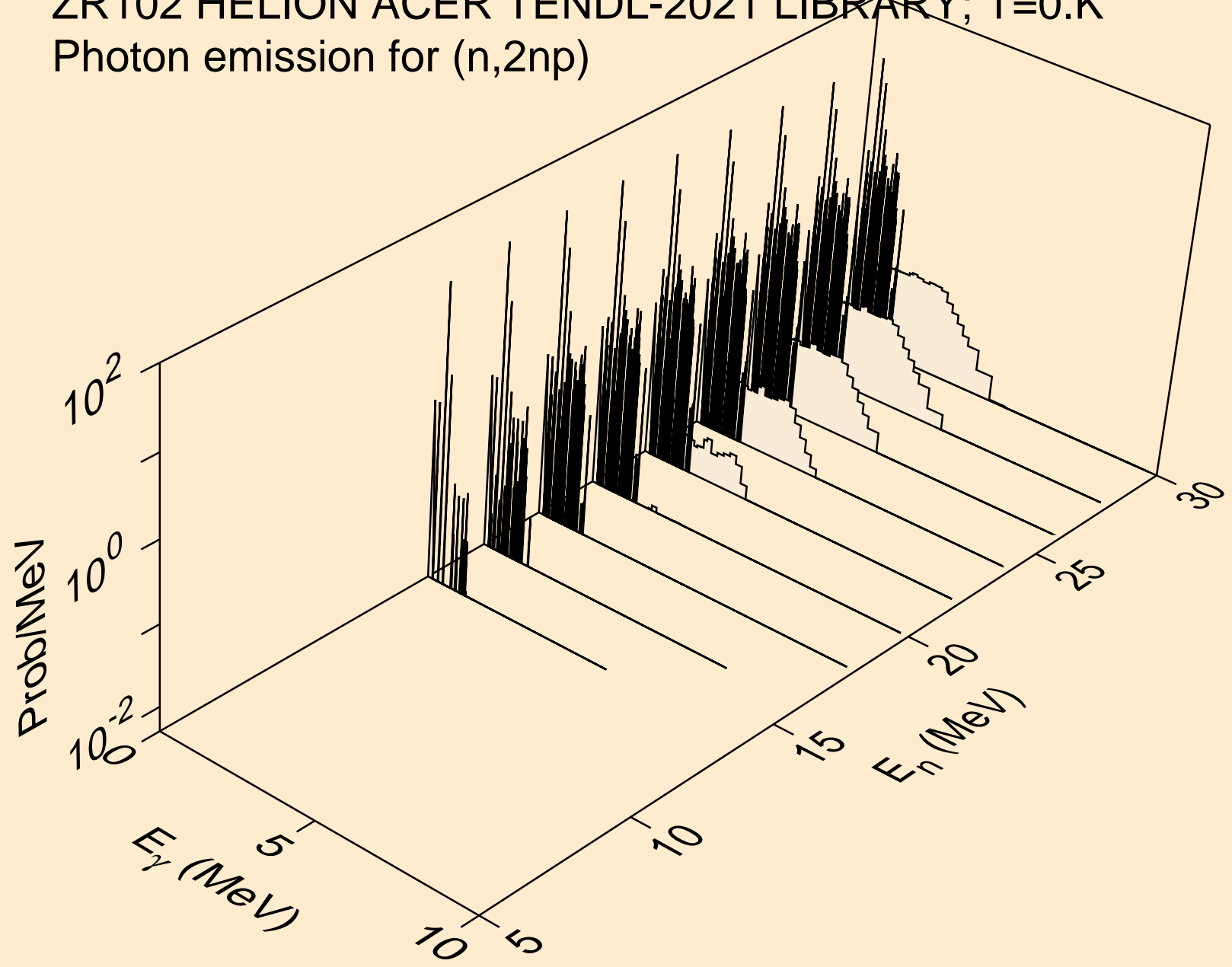

ZR102 HELION ACER TENDL-2021 LIBRARY; T=0.K  
Photon emission for (n,npa)

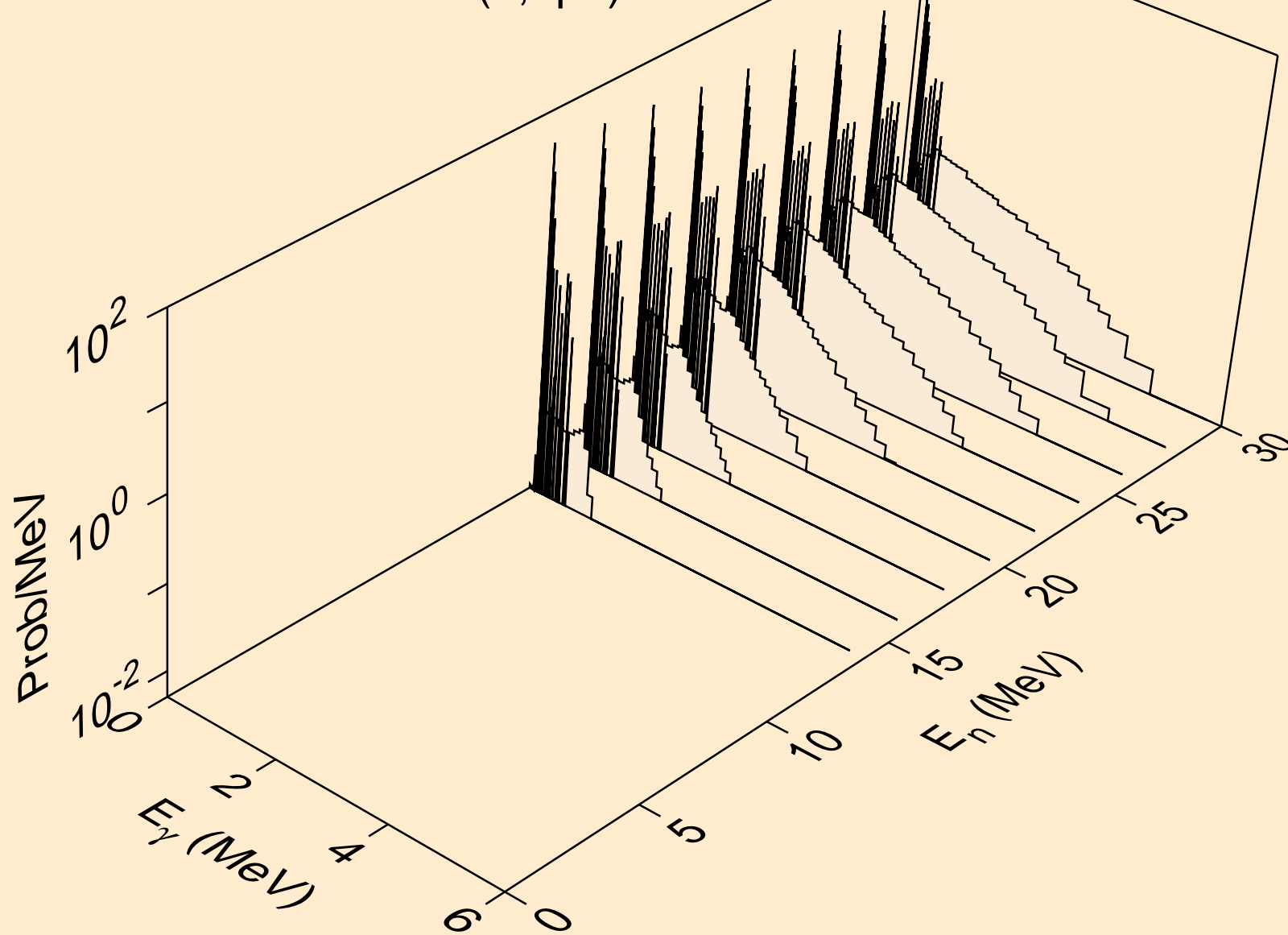

ZR102 HELION ACER TENDL-2021 LIBRARY; T=0.K  
Photon emission for (n,p)

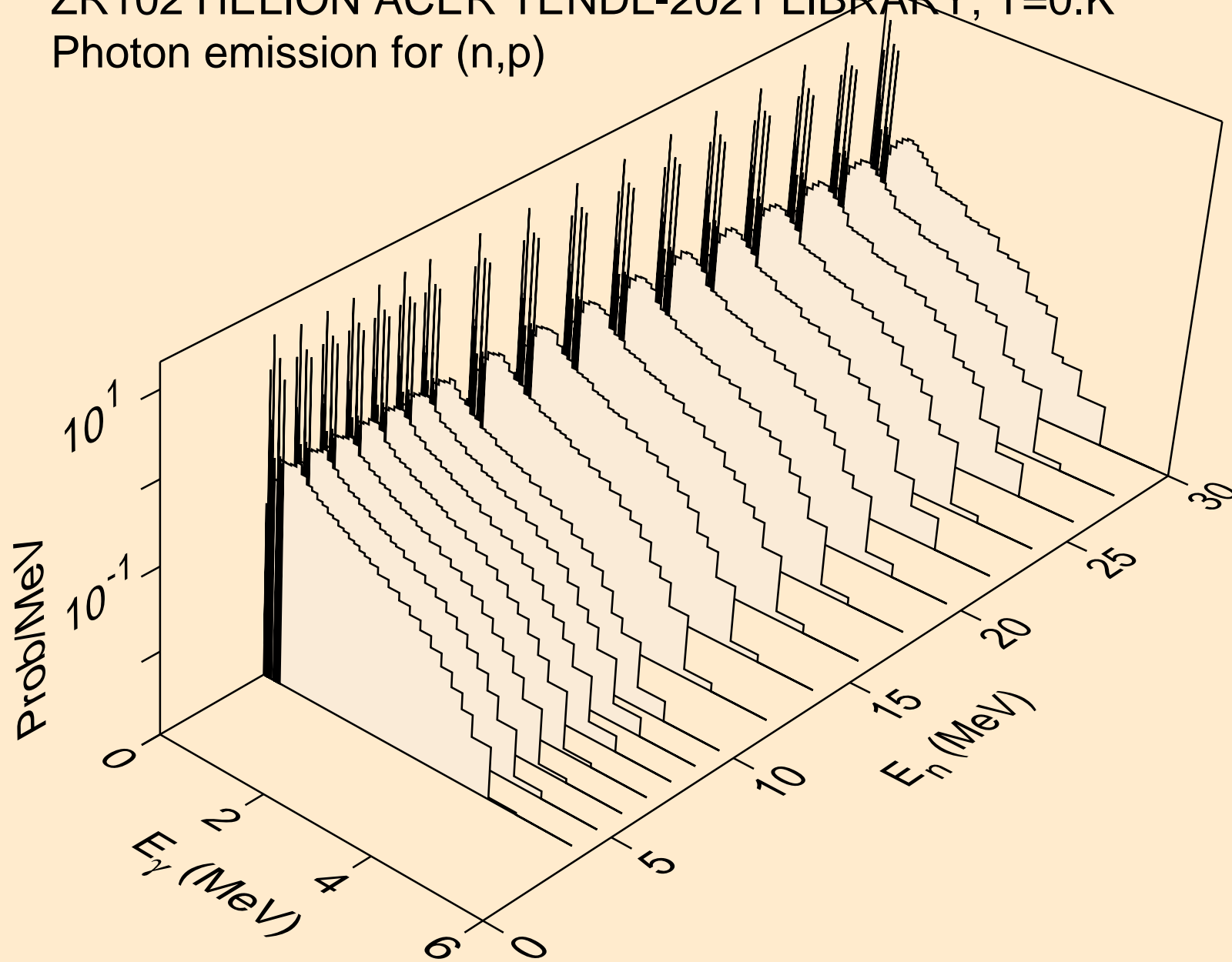

ZR102 HELION ACER TENDL-2021 LIBRARY; T=0.K  
Photon emission for (n,d)

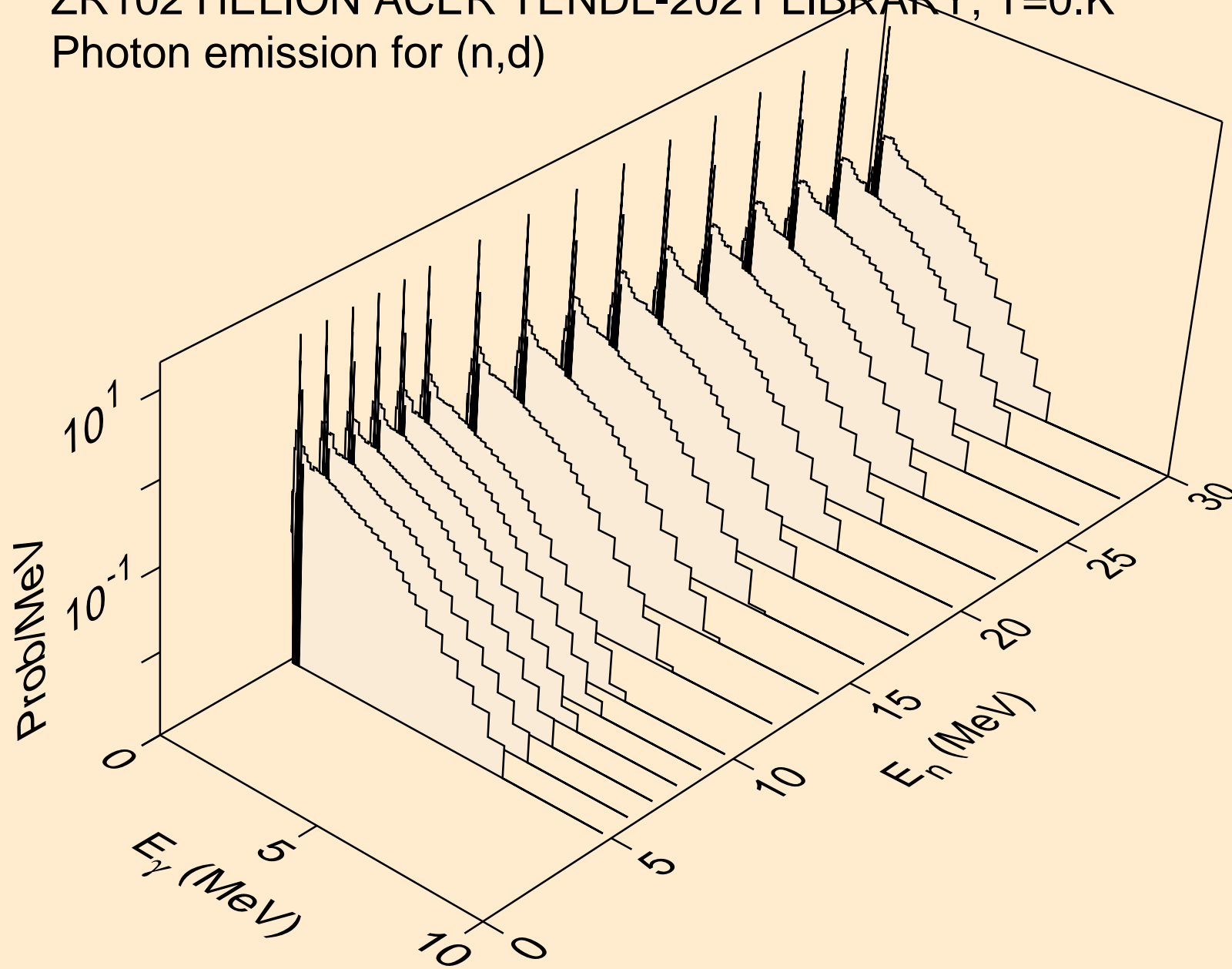

ZR102 HELION ACER TENDL-2021 LIBRARY; T=0.K  
Photon emission for (n,t)

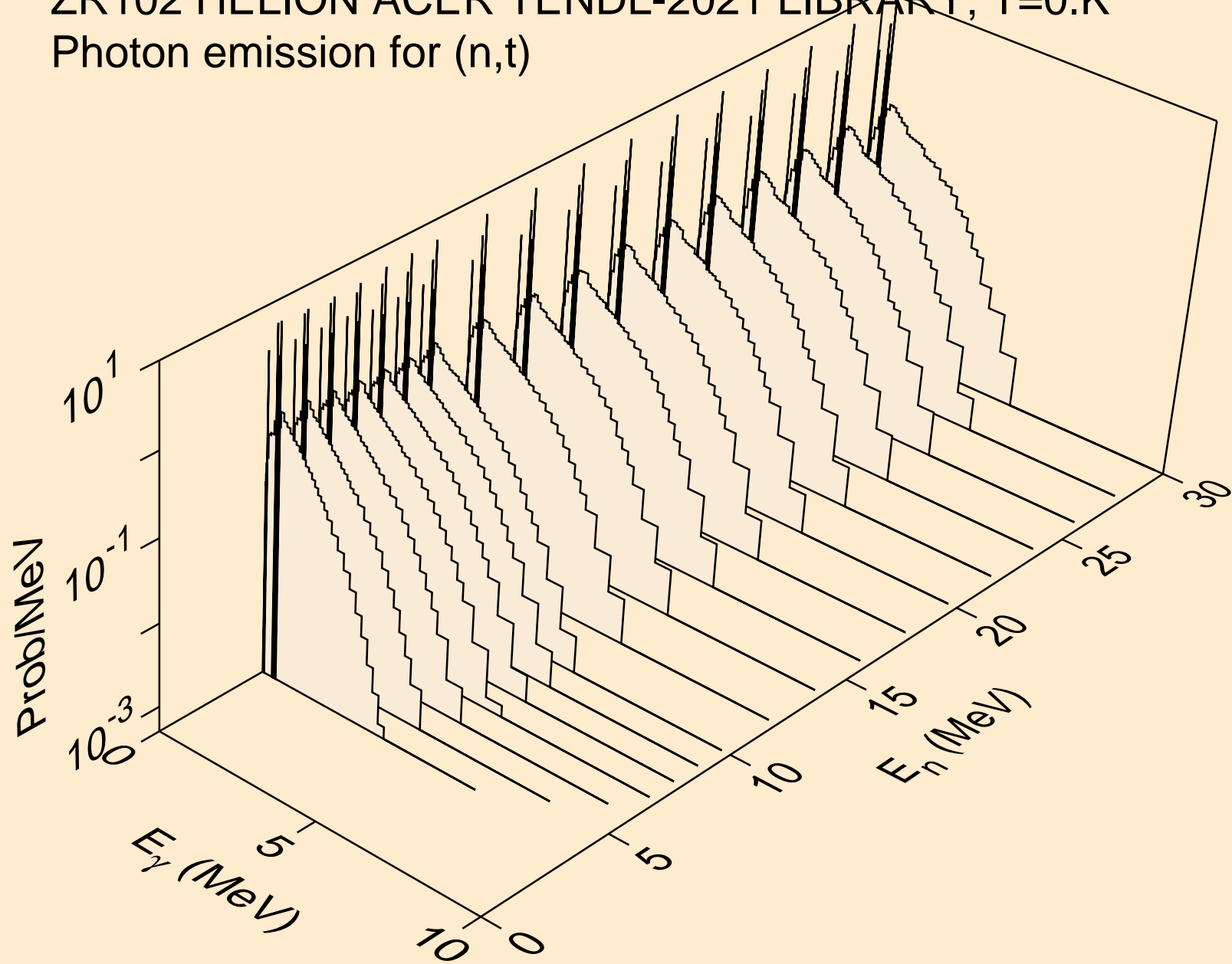

ZR102 HELION ACER TENDL-2021 LIBRARY; T=0.K  
Photon emission for inelastic

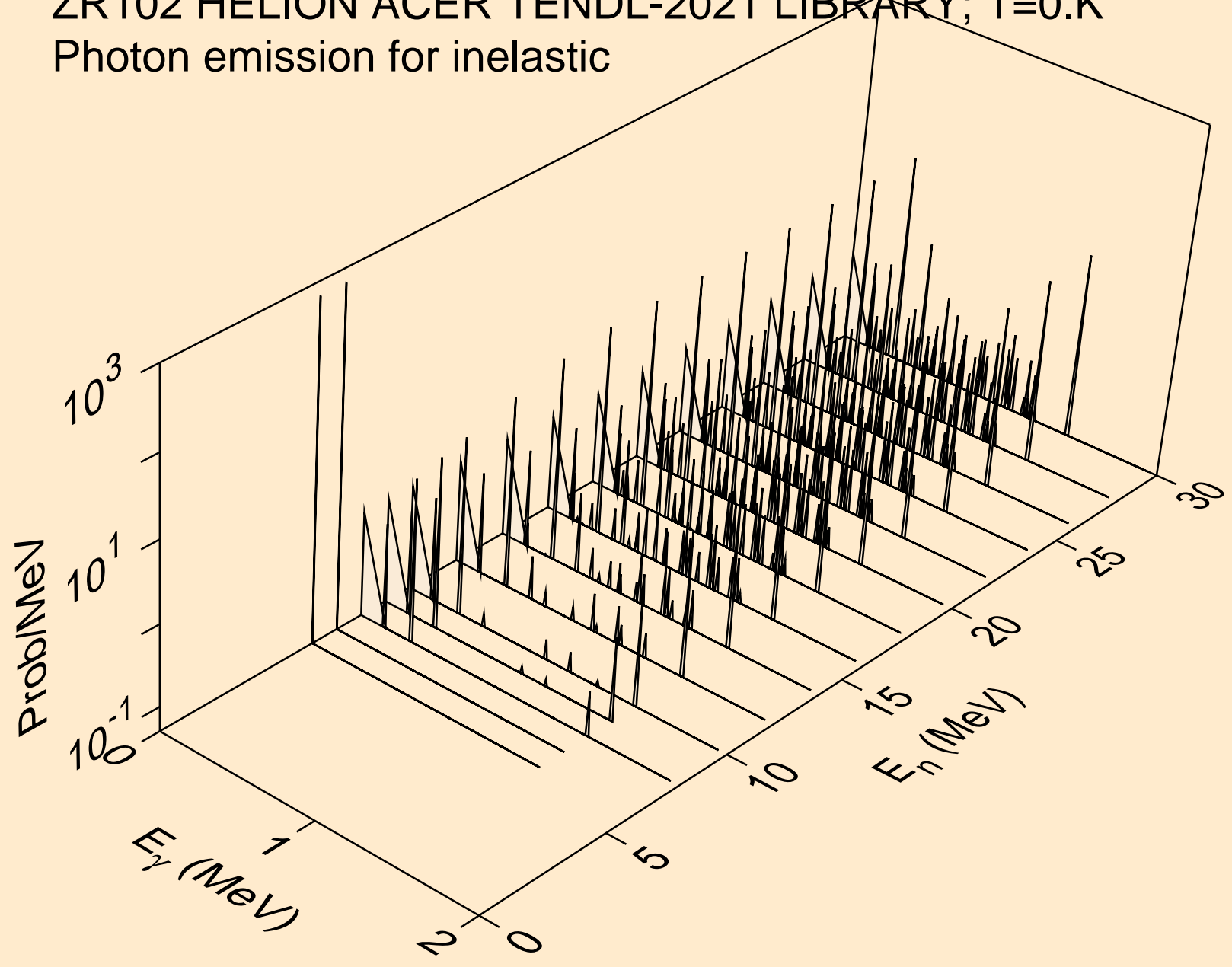



ZR102 HELION ACER TENDL-2021 LIBRARY; T=0.K  
Photon emission for (n,a)

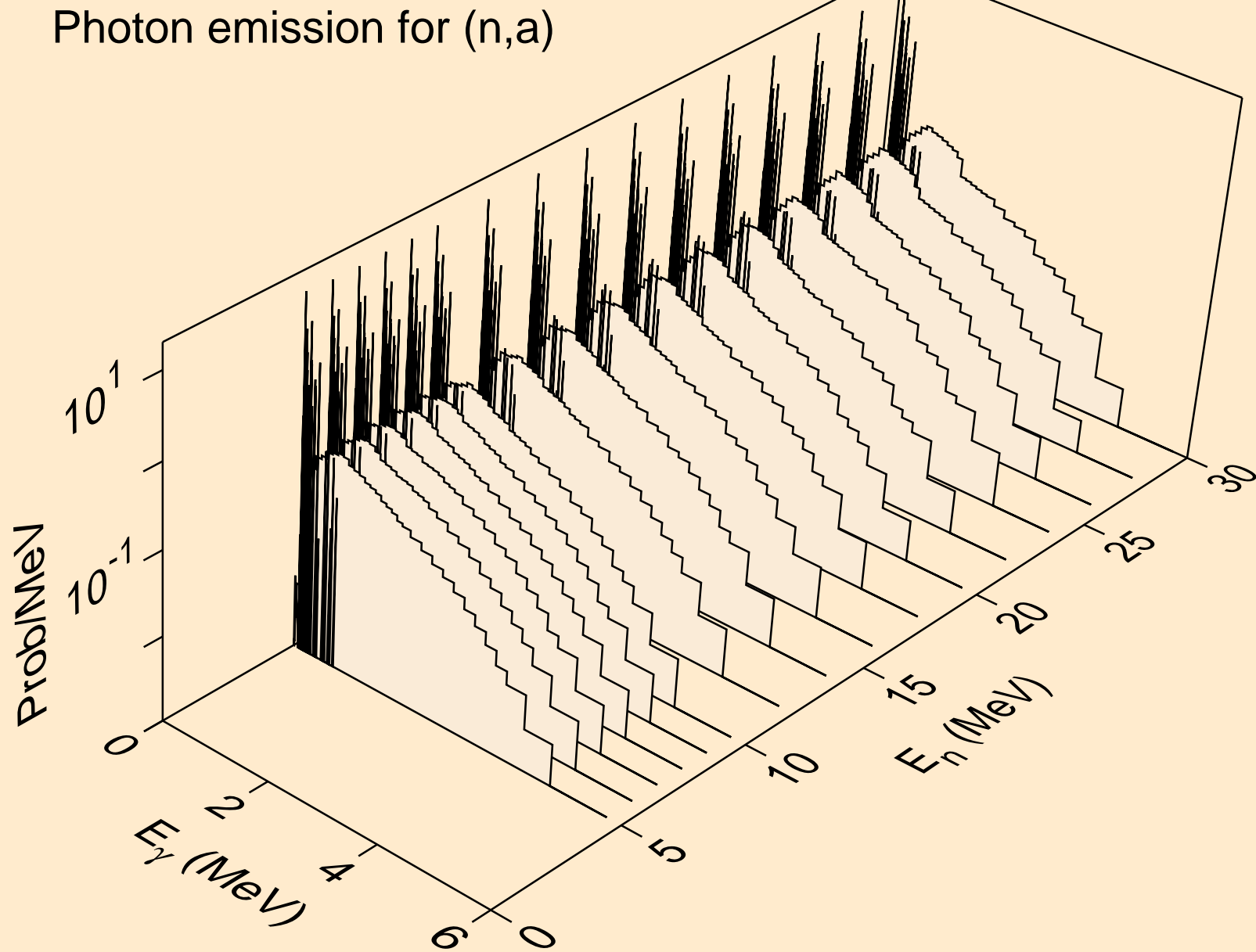

ZR102 HELION ACER TENDL-2021 LIBRARY; T=0.K  
Photon emission for (n,2p)

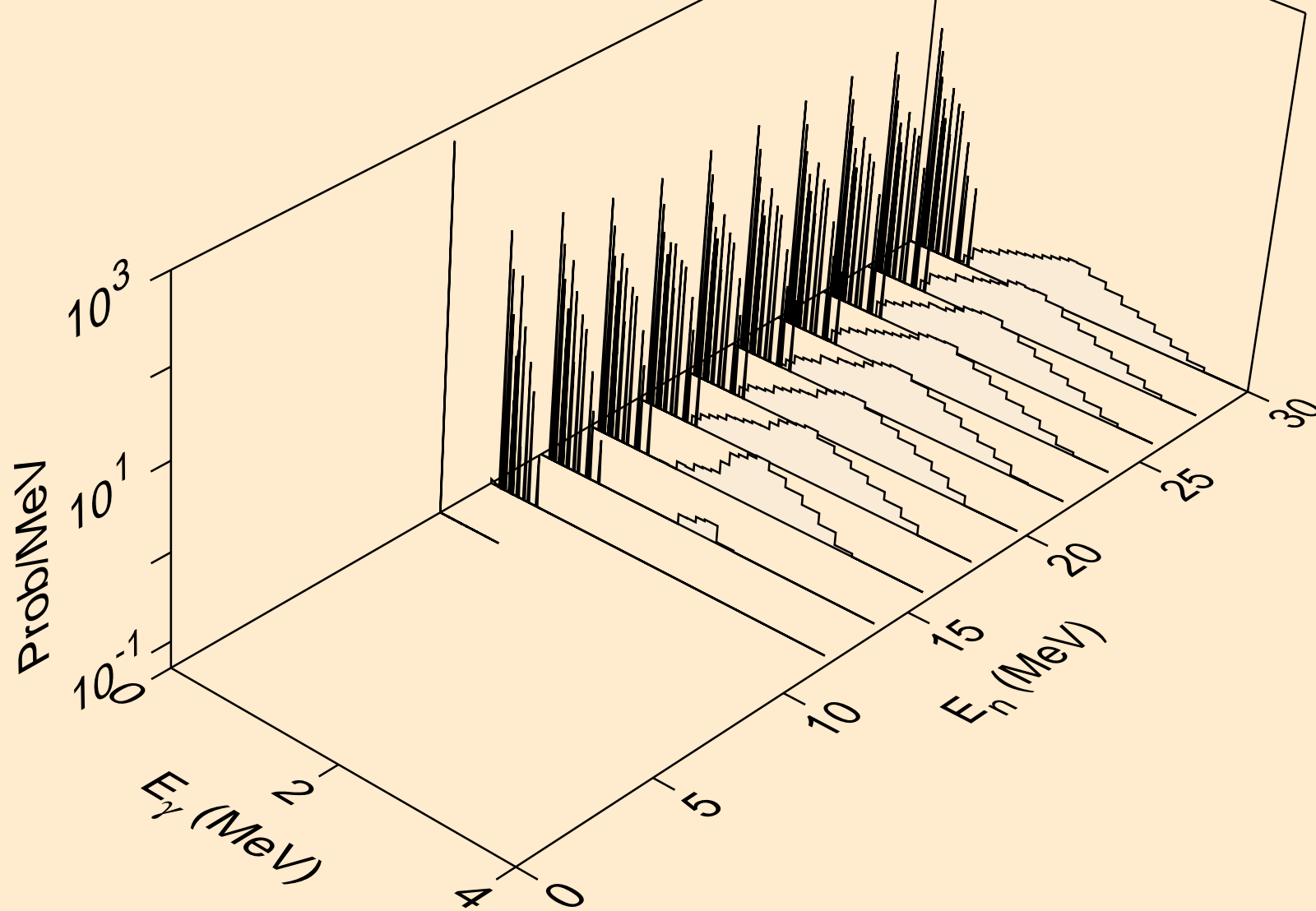

ZR102 HELION ACER TENDL-2021 LIBRARY; T=0.K  
Photon emission for (n,pa)

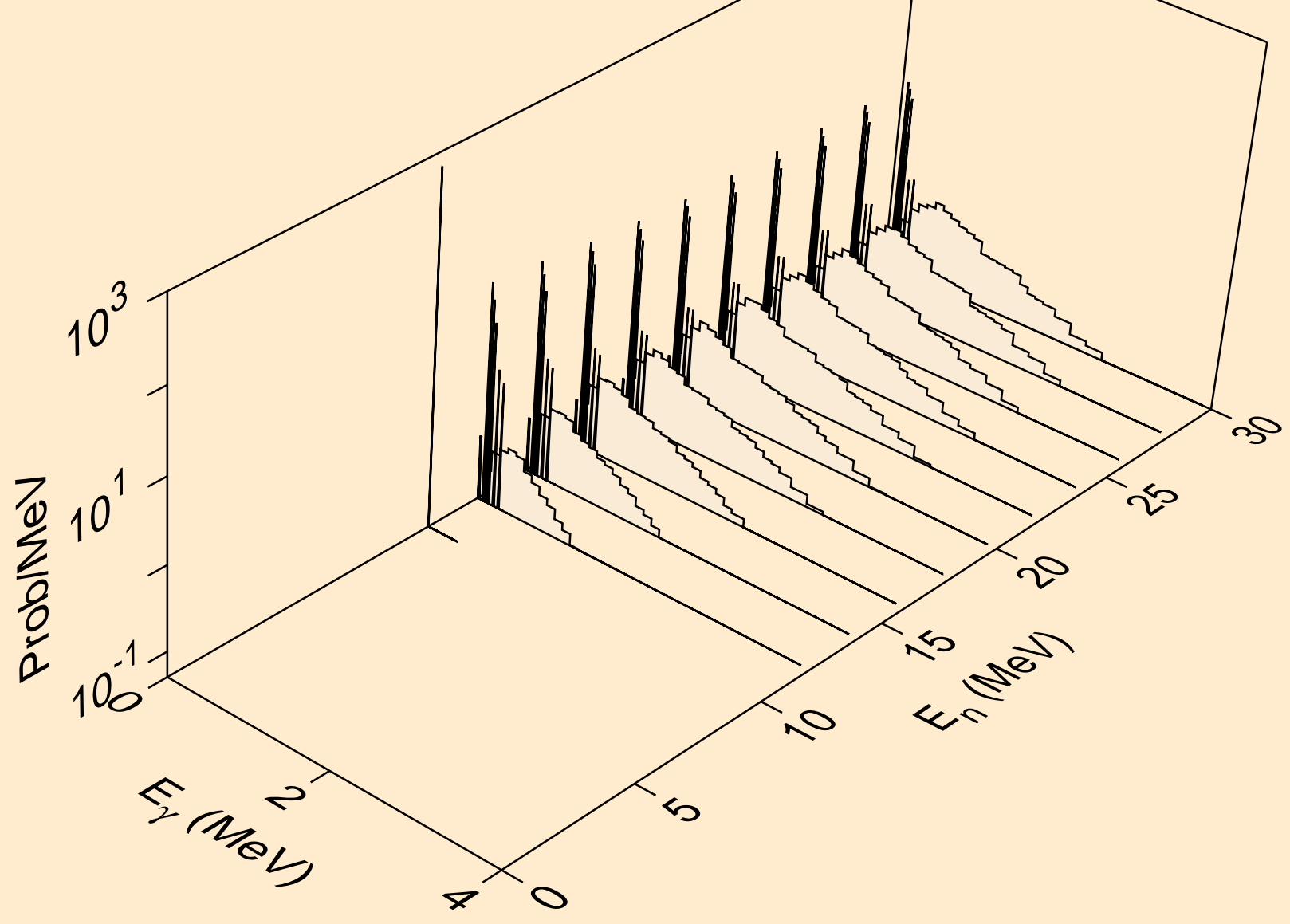

ZR102 HELION ACER TENDL-2021 LIBRARY; T=0.K  
Photon emission for (n,pd)

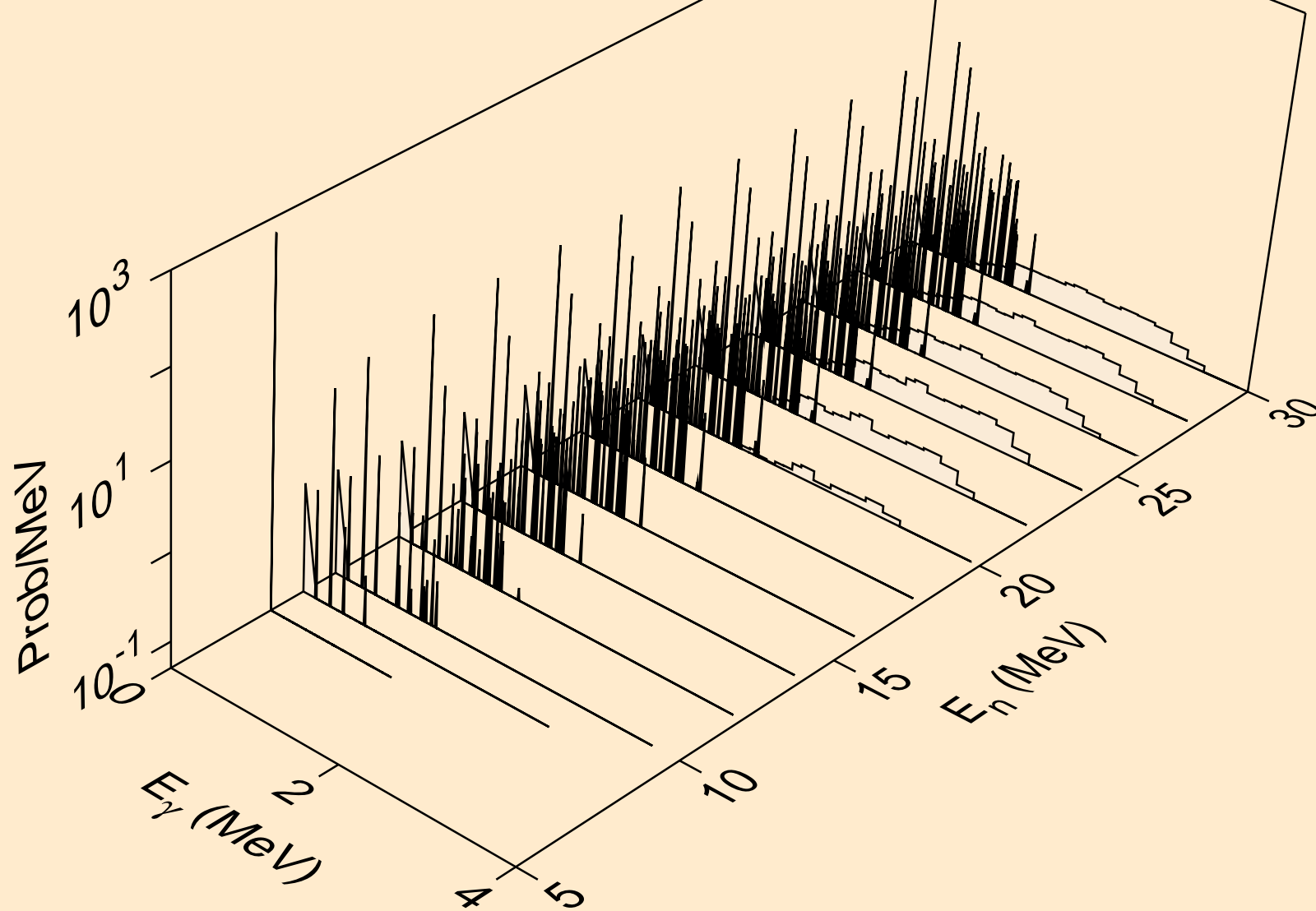

ZR102 HELION ACER TENDL-2021 LIBRARY; T=0.K  
Photon emission for (n,pt)

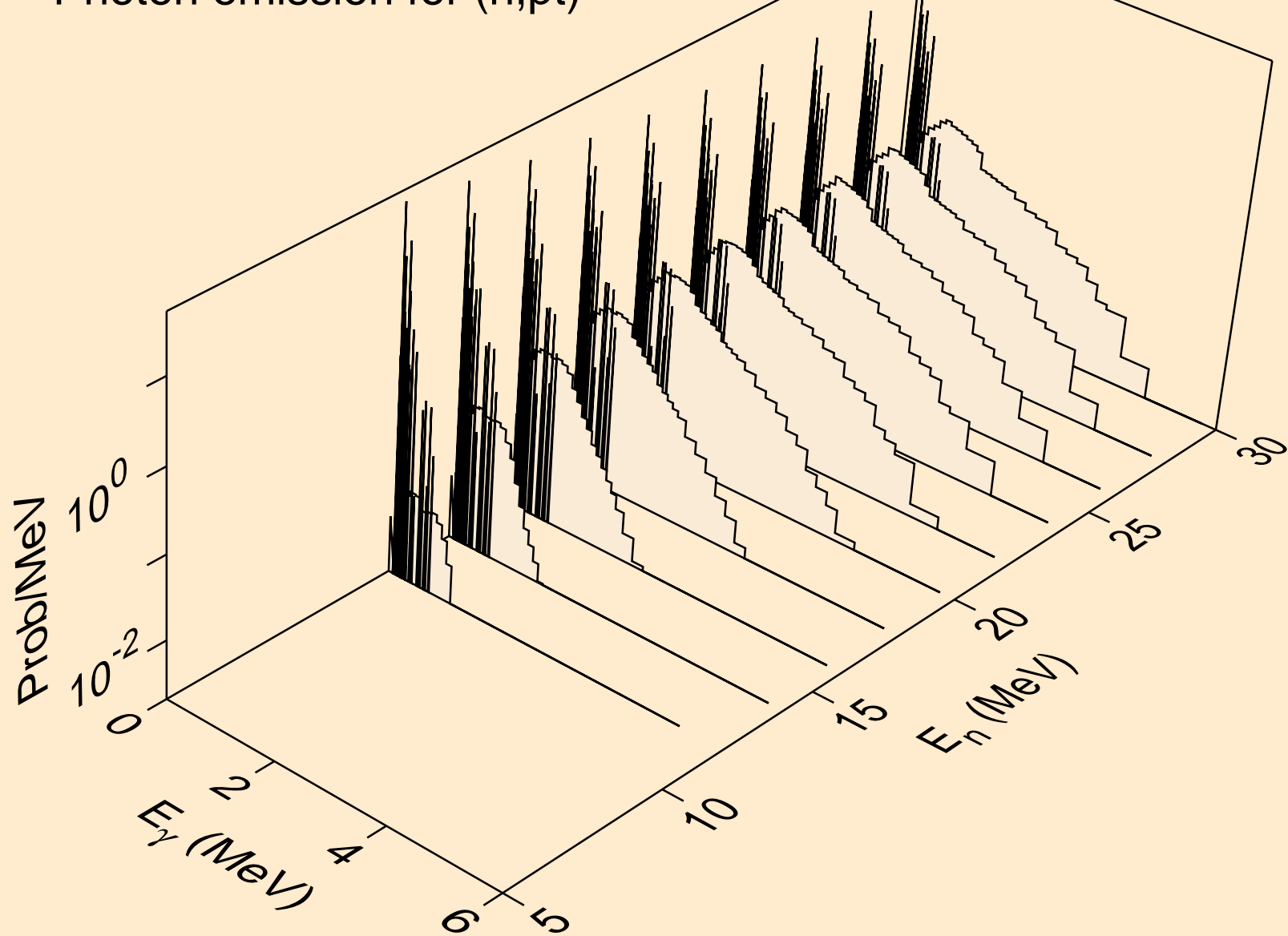

ZR102 HELION ACER TENDL-2021 LIBRARY; T=0.K  
Photon emission for (n,da)

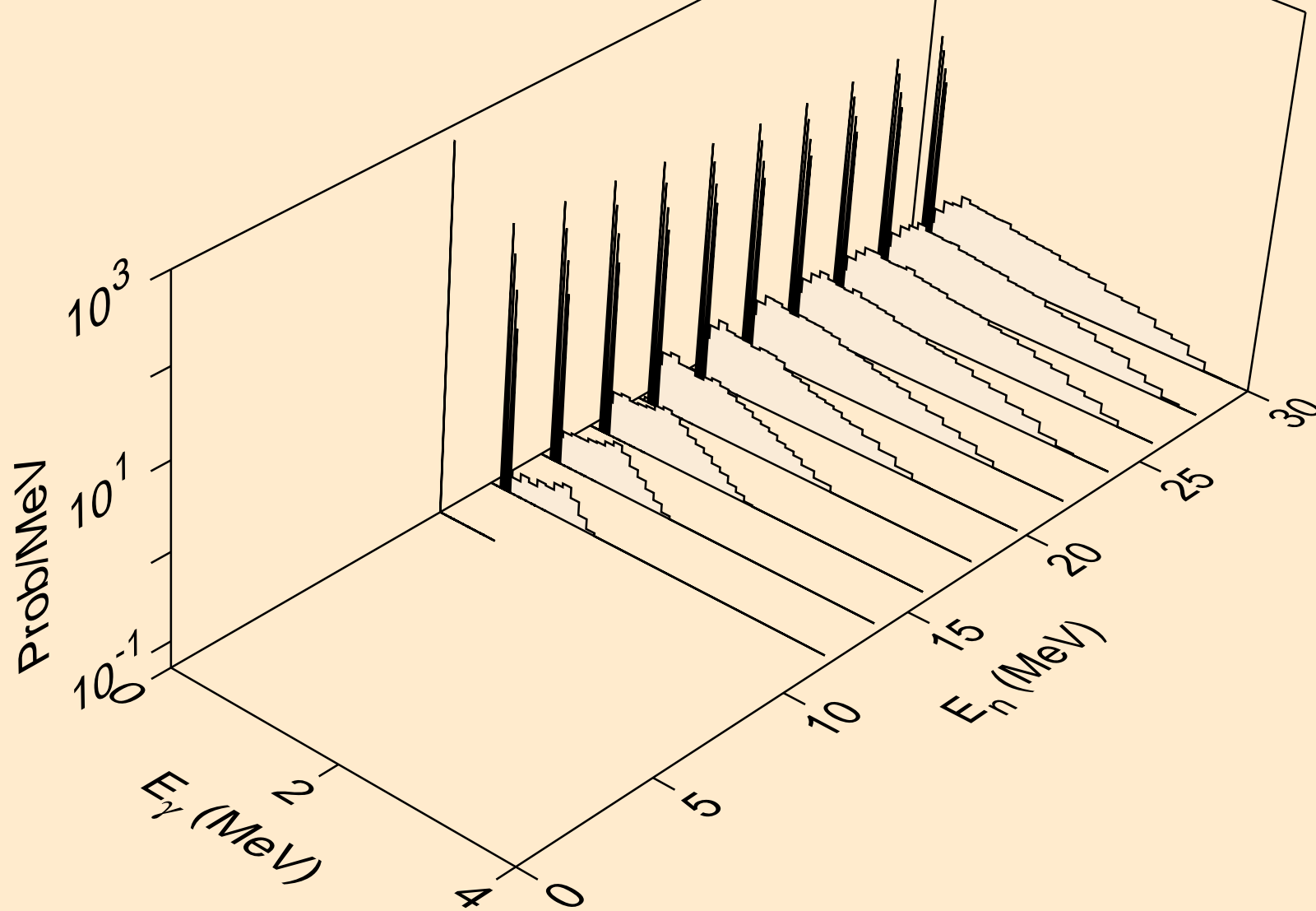

ZR102 HELION ACER TENDL-2021 LIBRARY; T=0.K  
Particle heating contributions

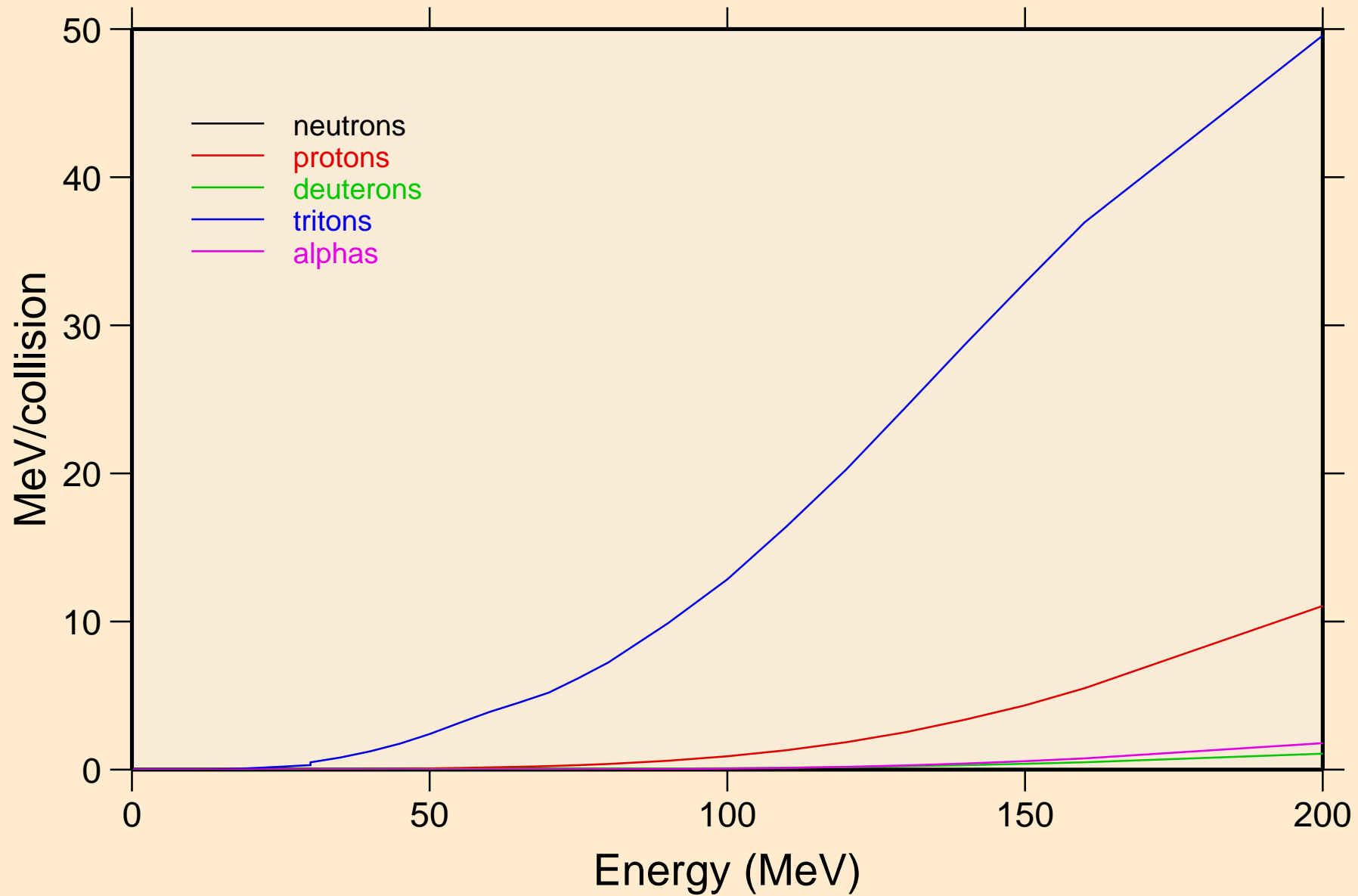

ZR102 HELION ACER TENDL-2021 LIBRARY; T=0.K  
Recoil Heating

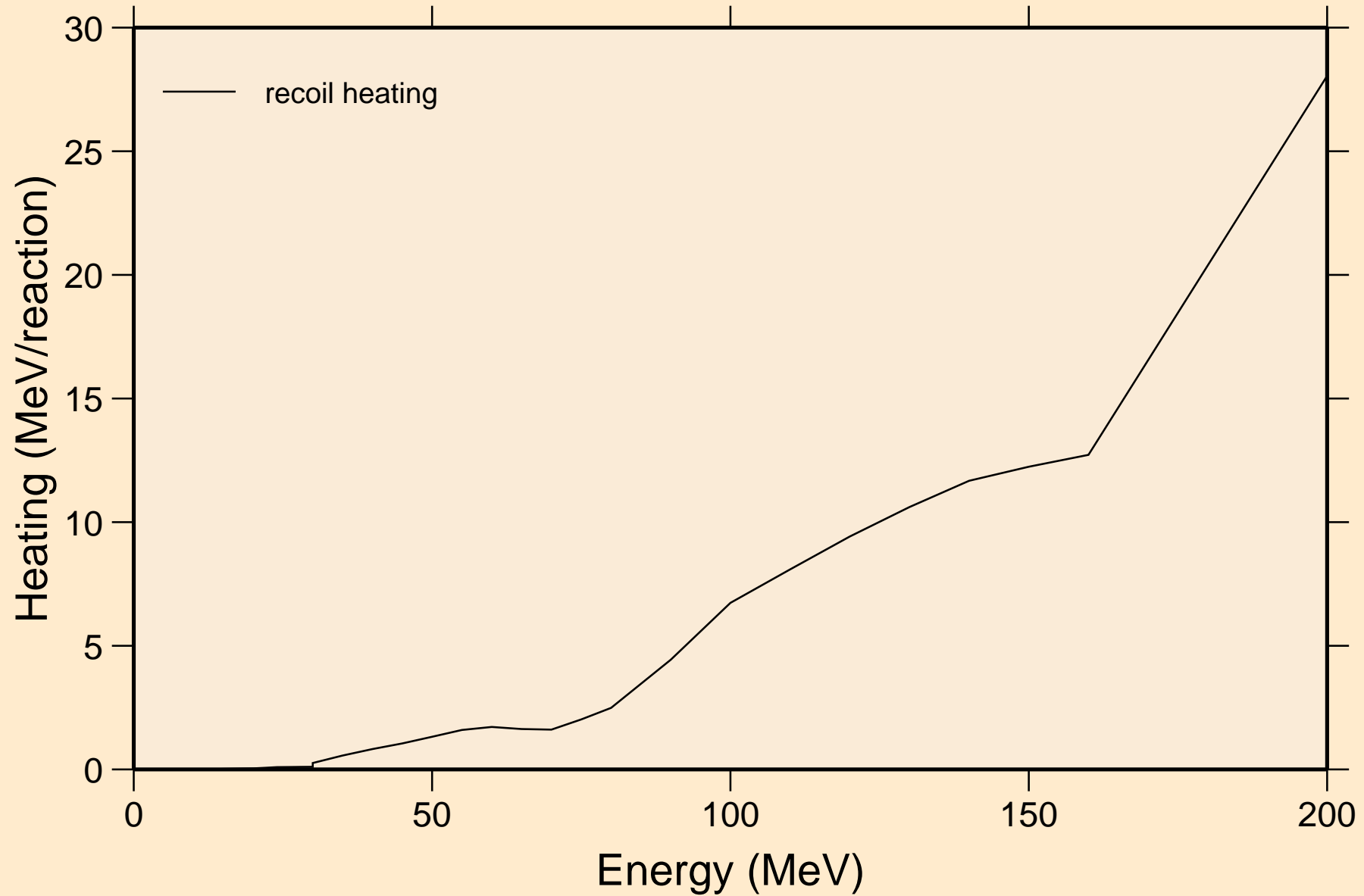



ZR102 HELION ACER TENDL-2021 LIBRARY; T=0.K  
Particle production cross sections

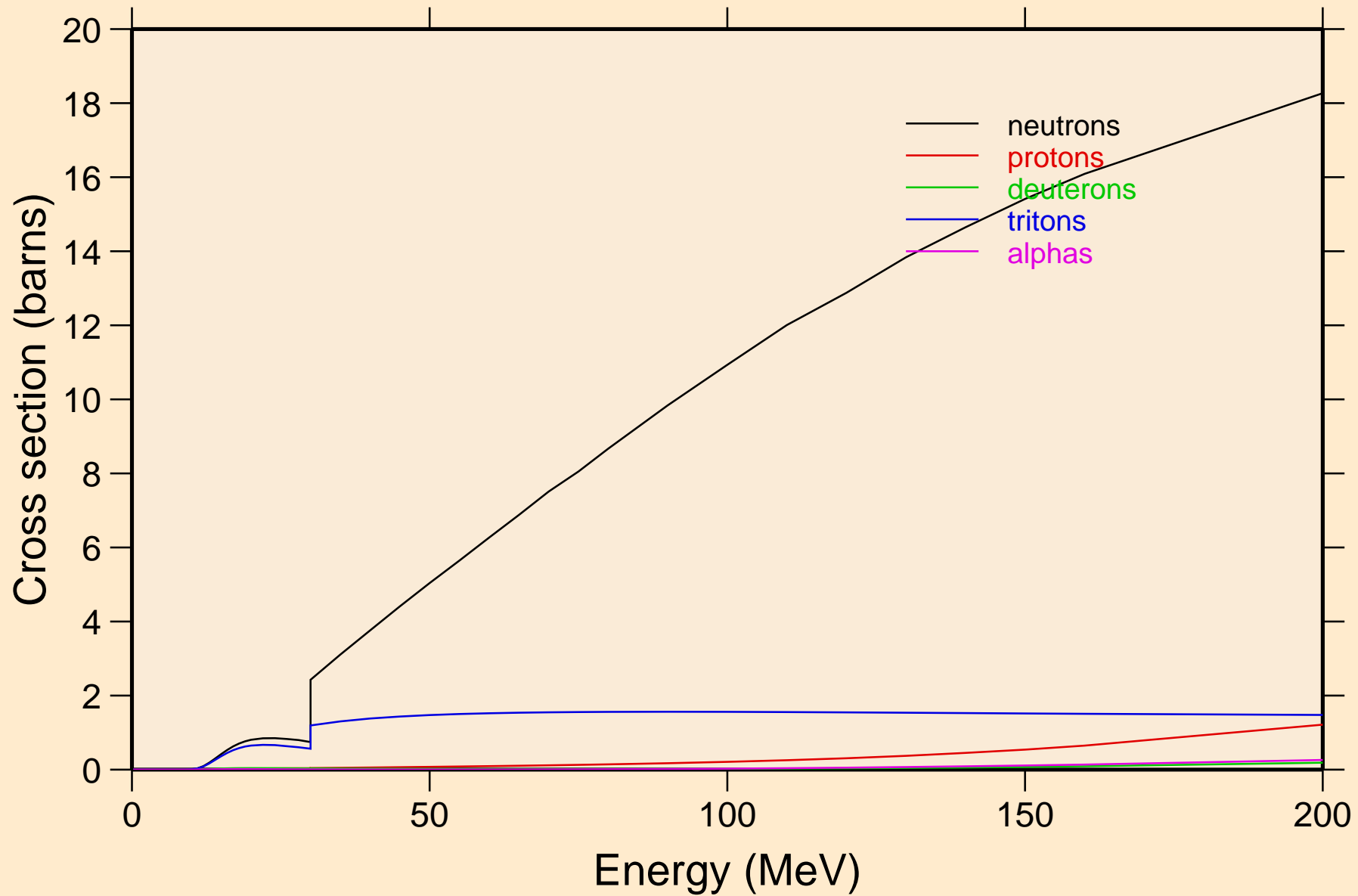

ZR102 HELION ACER TENDL-2021 LIBRARY; T=0.K  
neutrons from (s,n)

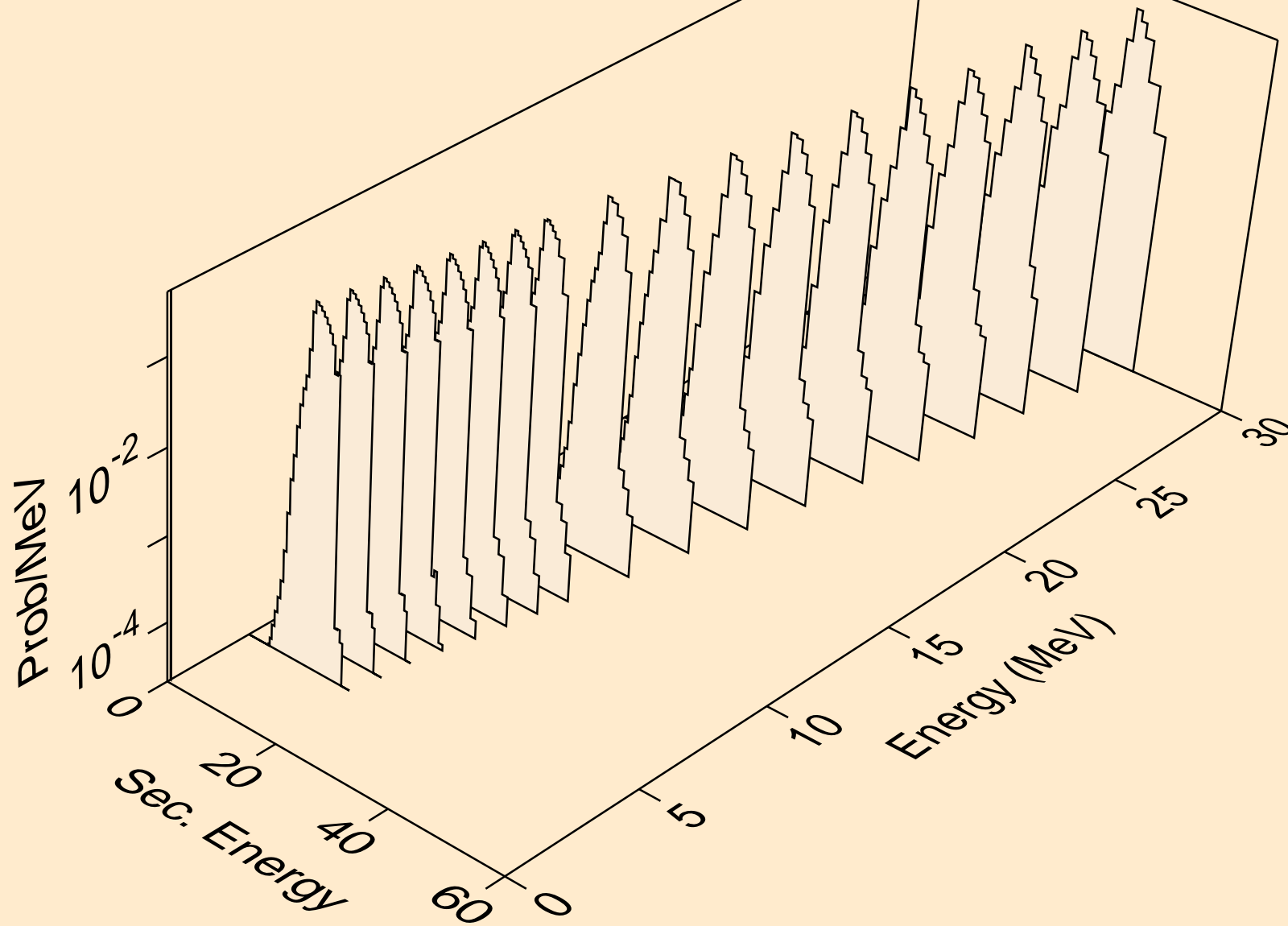

ZR102 HELION ACER TENDL-2021 LIBRARY; T=0.K  
neutrons from (s,x)

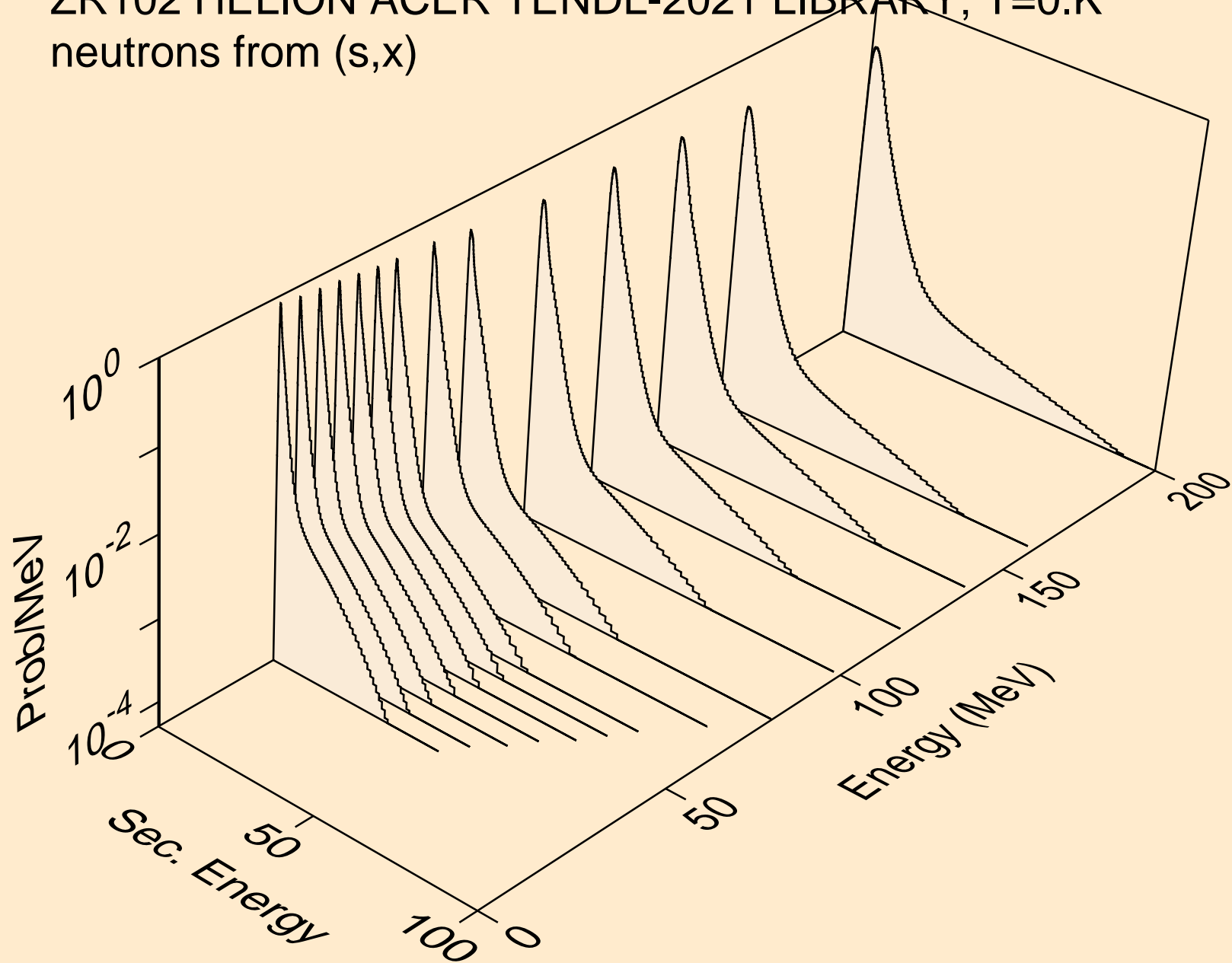

ZR102 HELION ACER TENDL-2021 LIBRARY; T=0.K  
neutrons from (s,2nd)

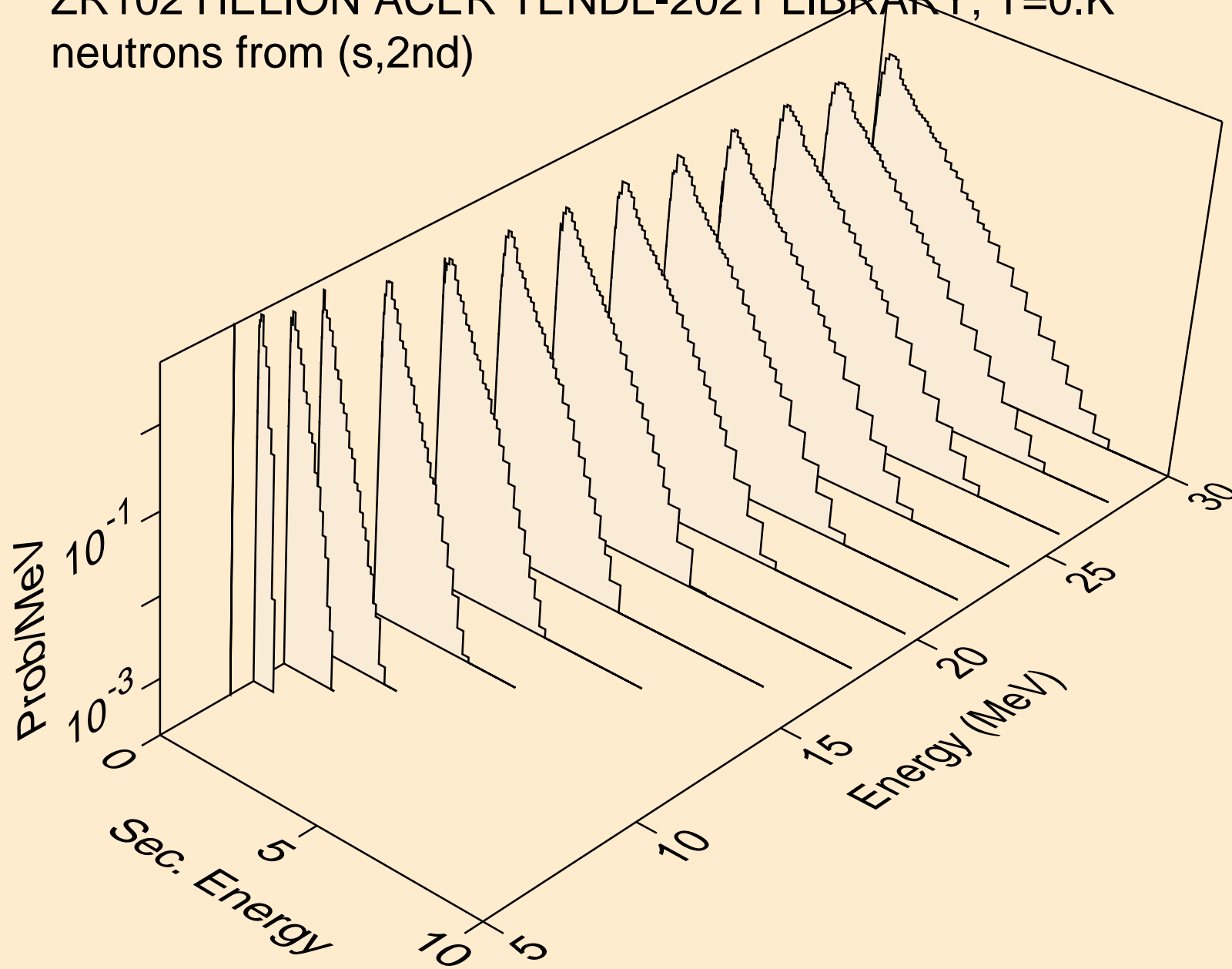

ZR102 HELION ACER TENDL-2021 LIBRARY; T=0.K  
neutrons from (s,2n)

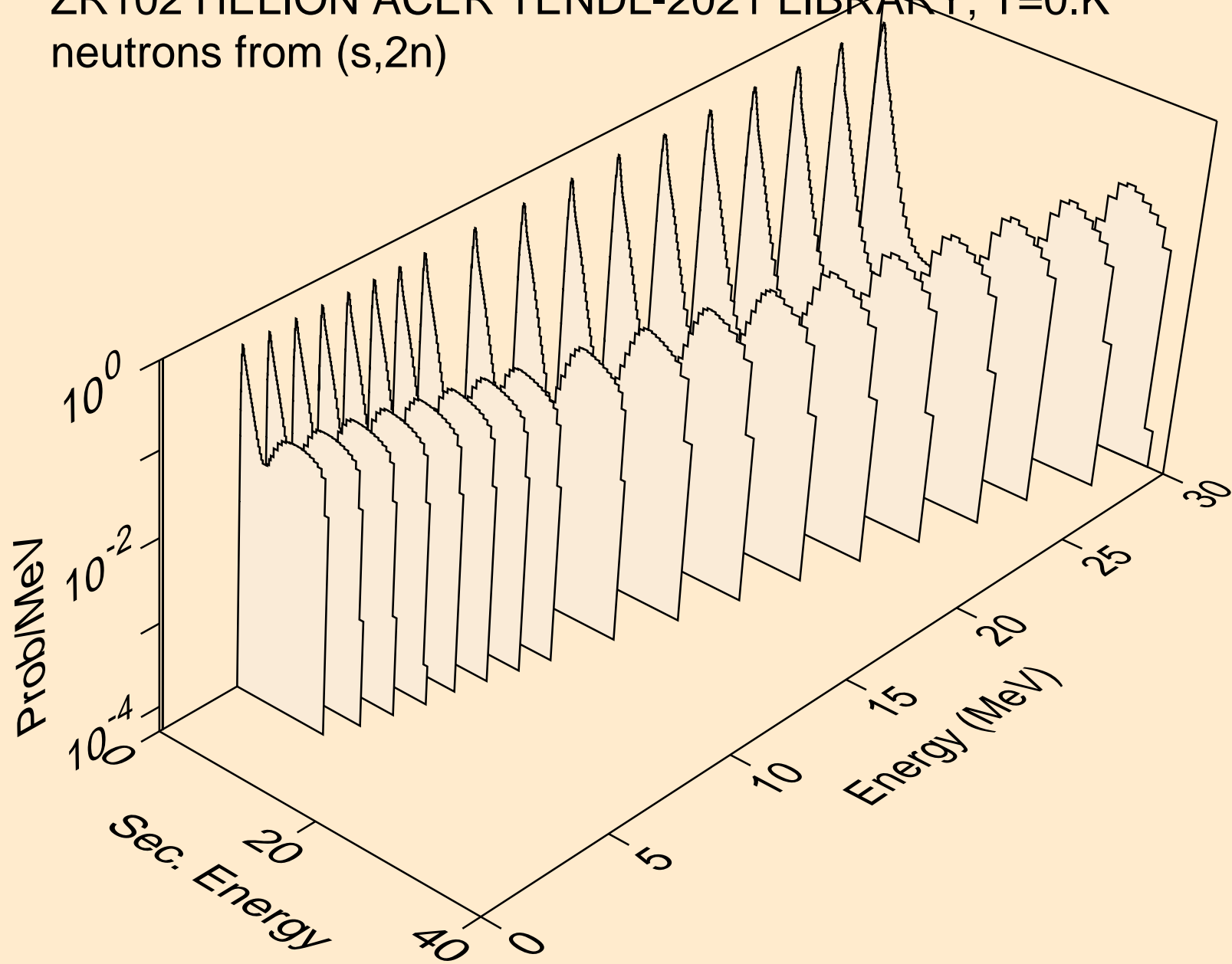

ZR102 HELION ACER TENDL-2021 LIBRARY; T=0.K  
neutrons from (s,3n)

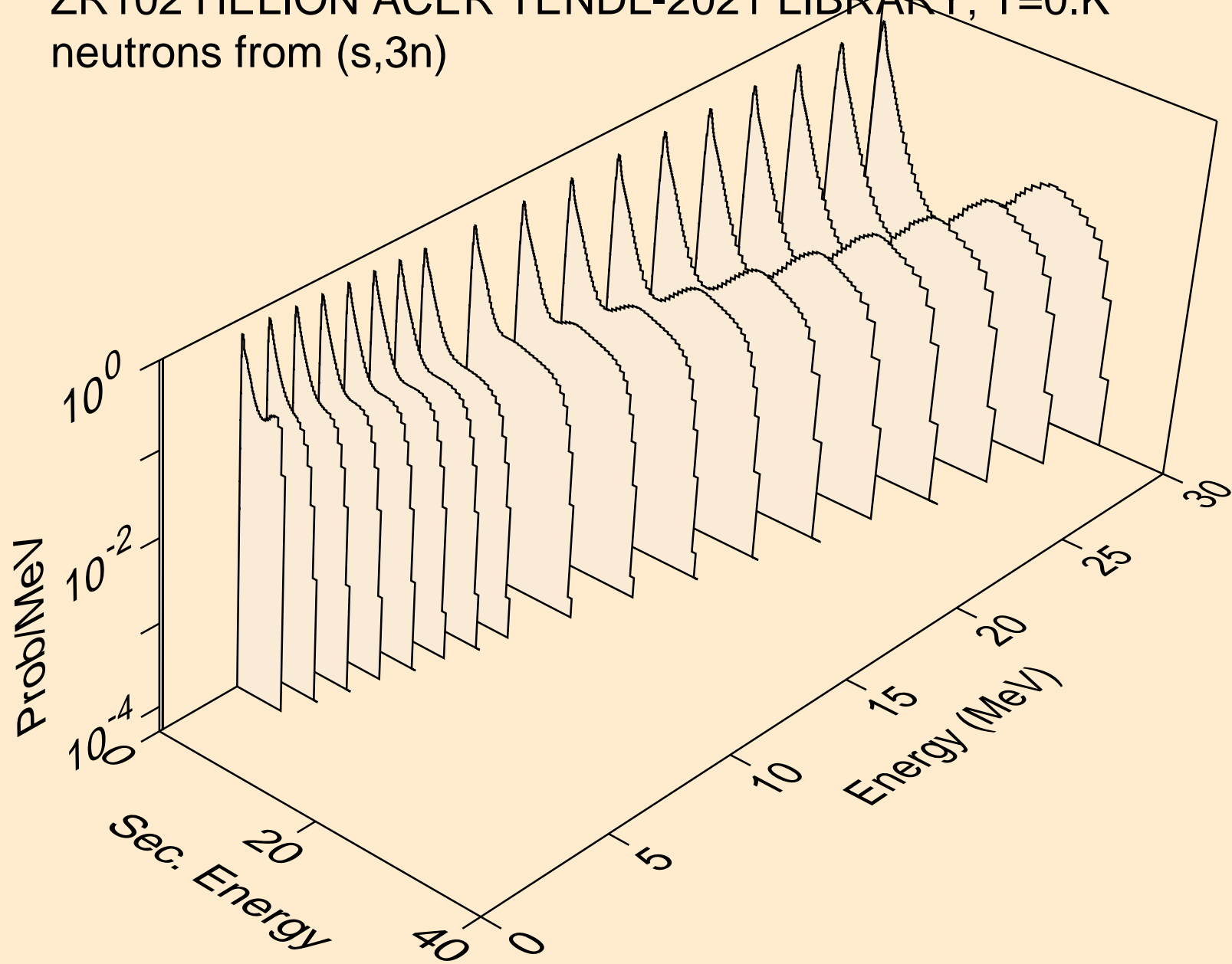

ZR102 HELION ACER TENDL-2021 LIBRARY; T=0.K  
neutrons from (s,n\*)a

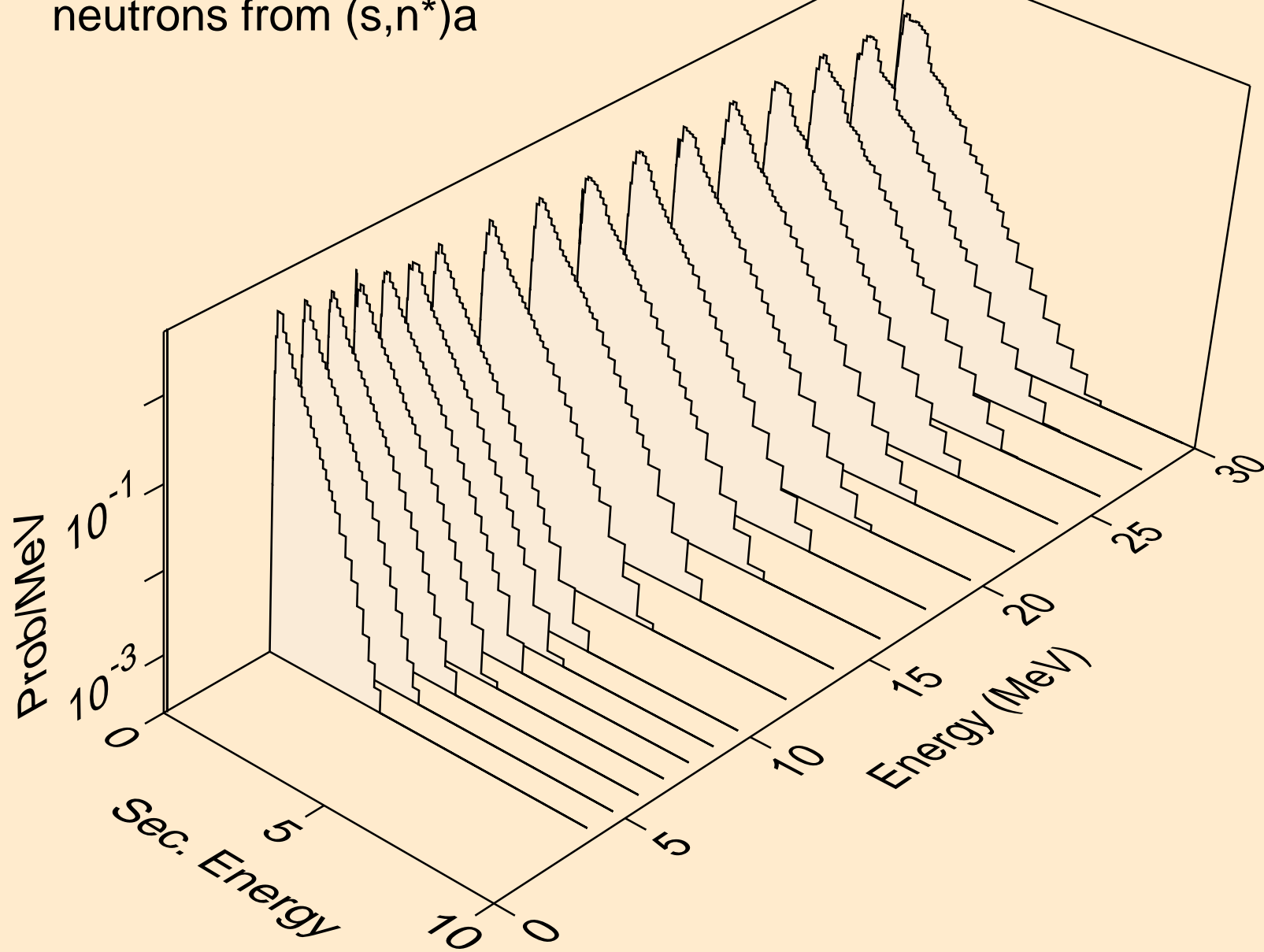

ZR102 HELION ACER TENDL-2021 LIBRARY; T=0.K  
neutrons from (s,2n)a

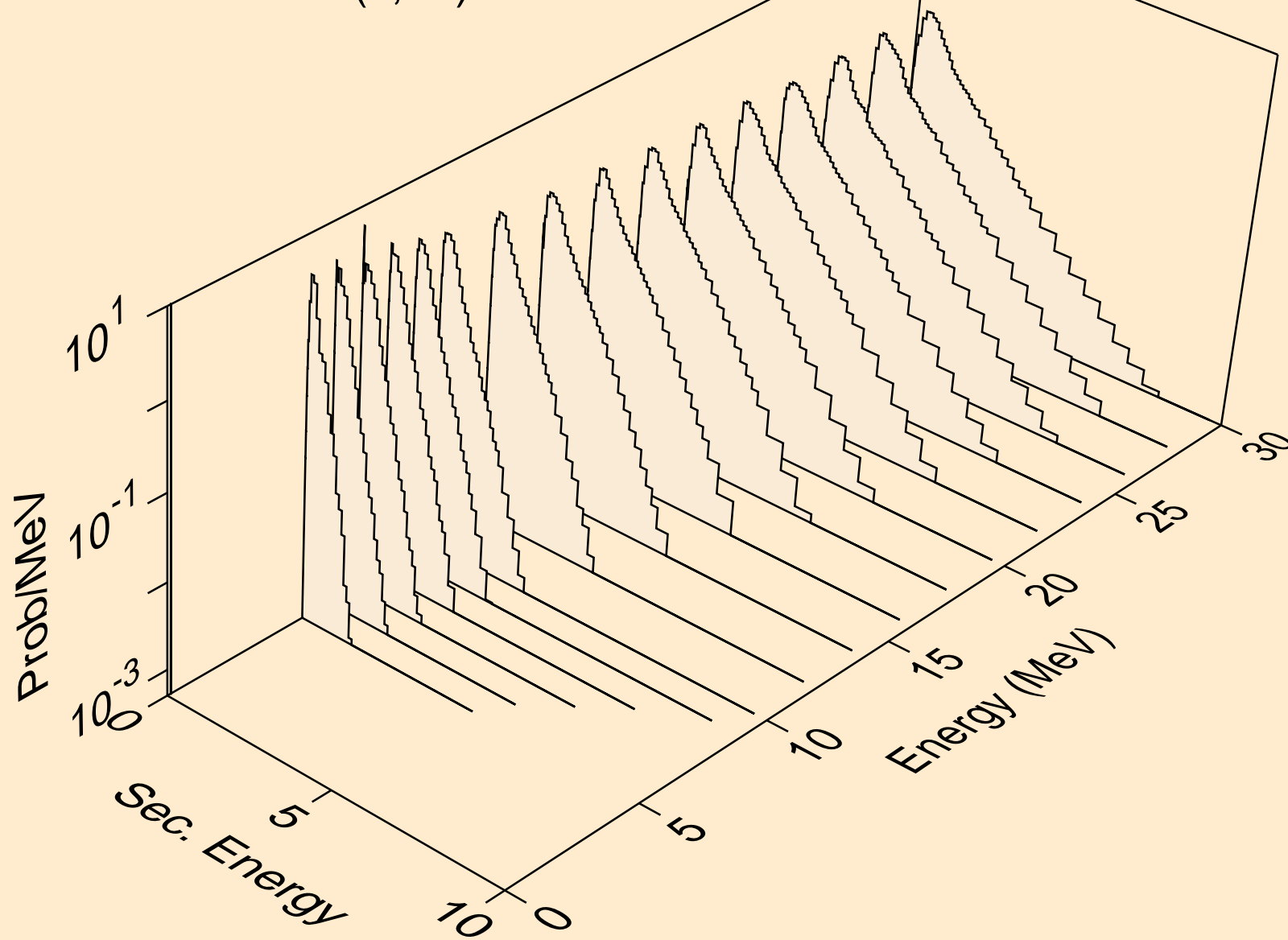



ZR102 HELION ACER TENDL-2021 LIBRARY; T=0.K  
neutrons from (s,3n)a

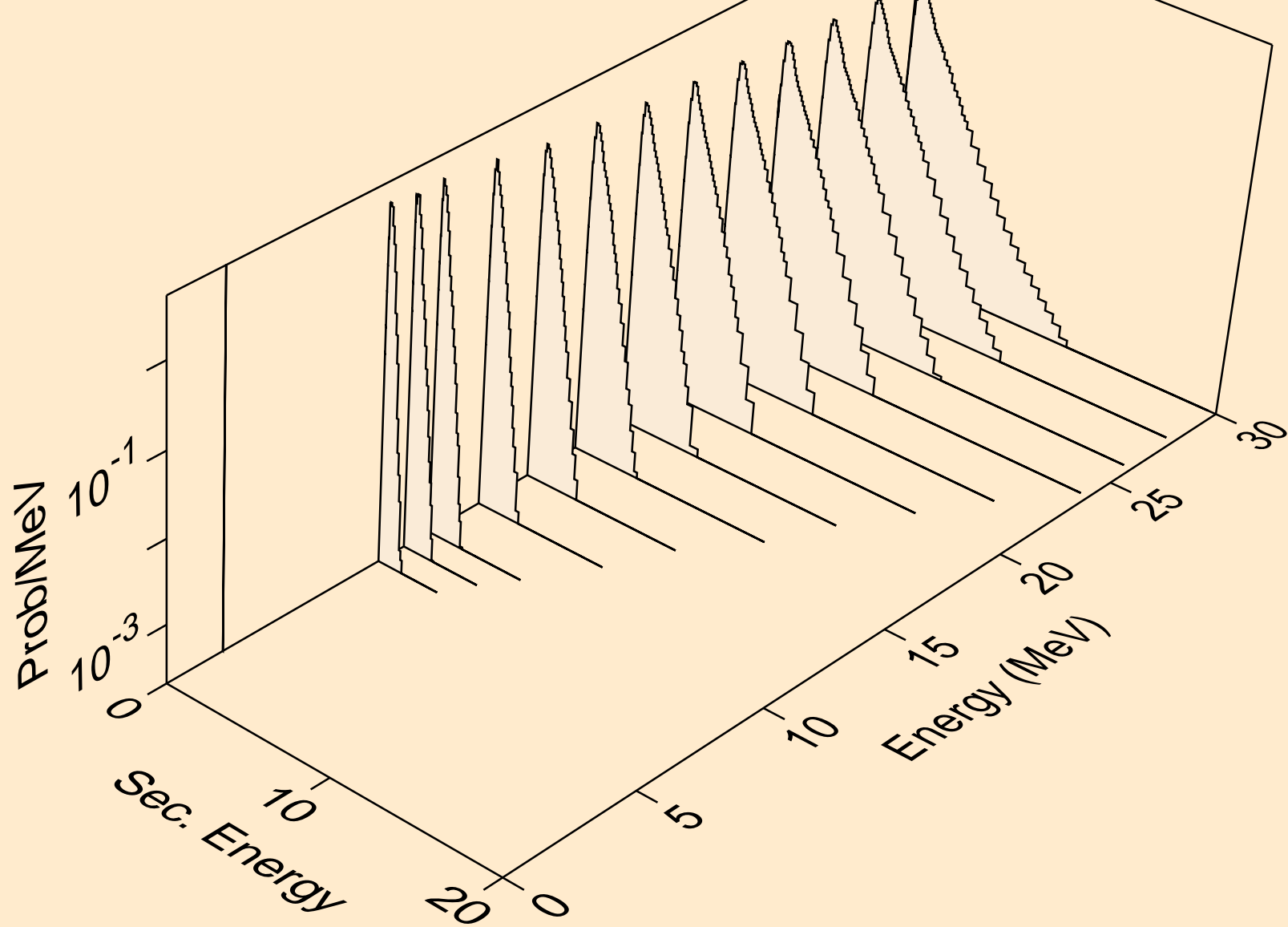

ZR102 HELION ACER TENDL-2021 LIBRARY; T=0.K  
neutrons from (s,n\*)p

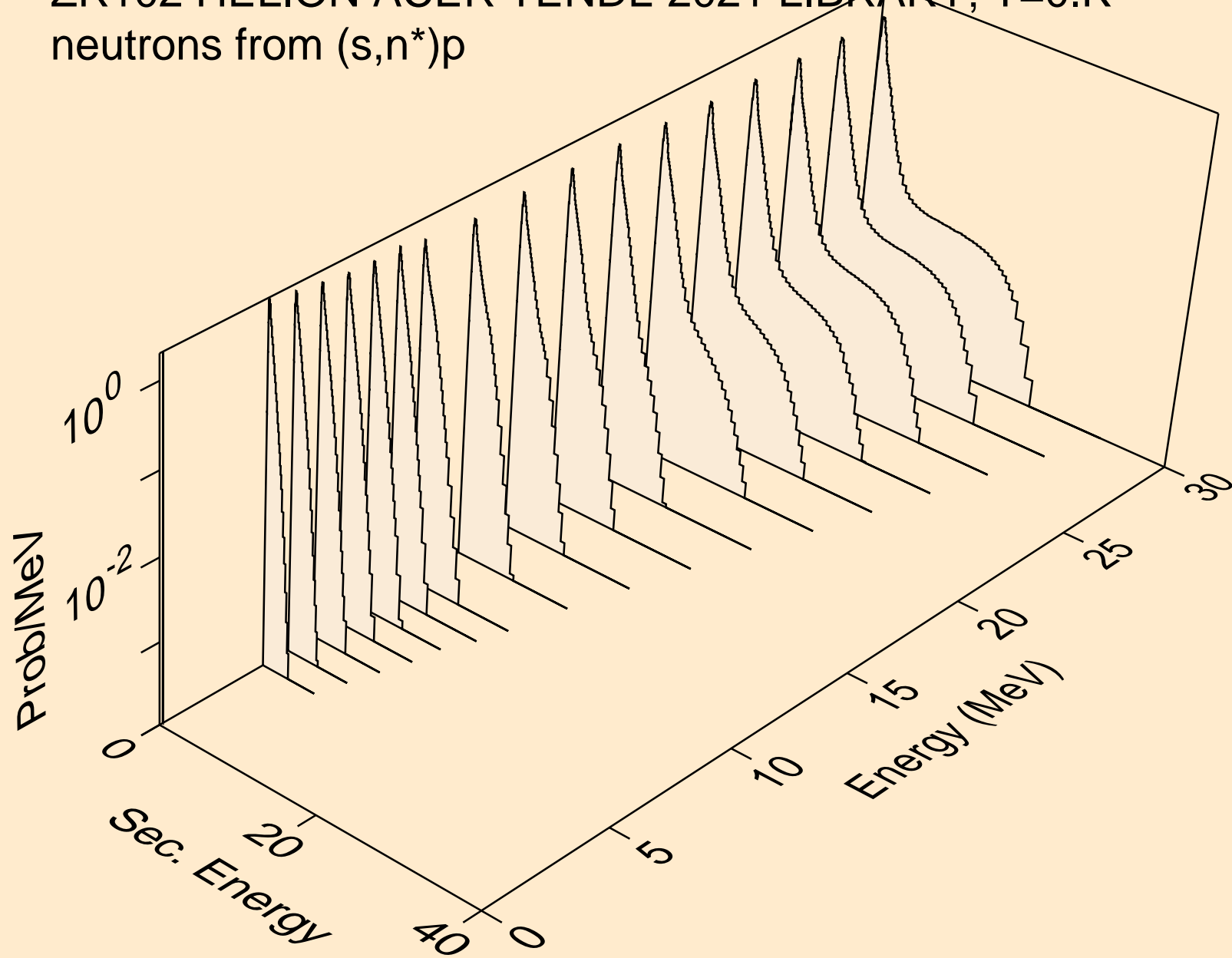

ZR102 HELION ACER TENDL-2021 LIBRARY; T=0.K  
neutrons from (s,n\*)2a

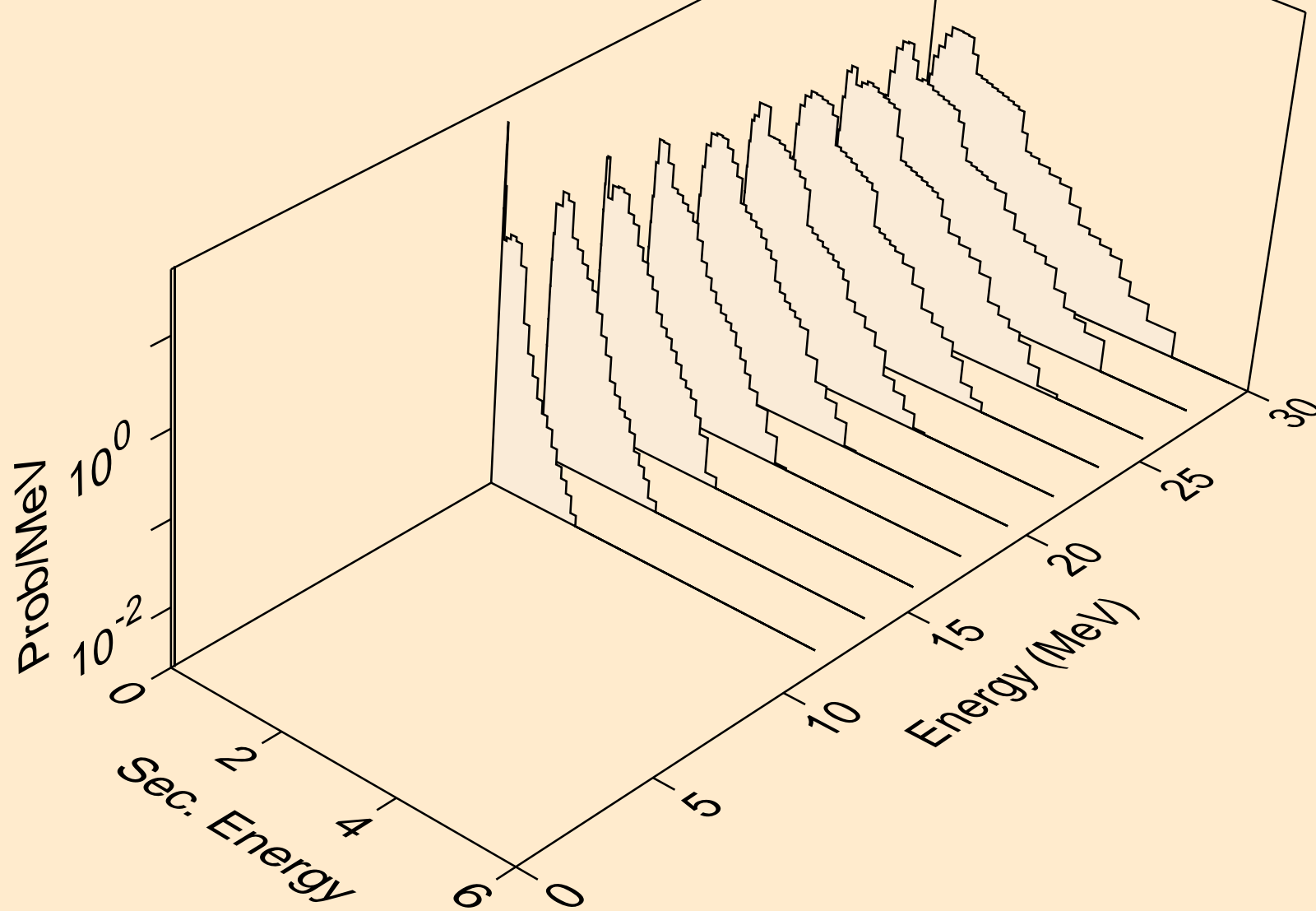

ZR102 HELION ACER TENDL-2021 LIBRARY; T=0.K  
neutrons from (s,2n)2a

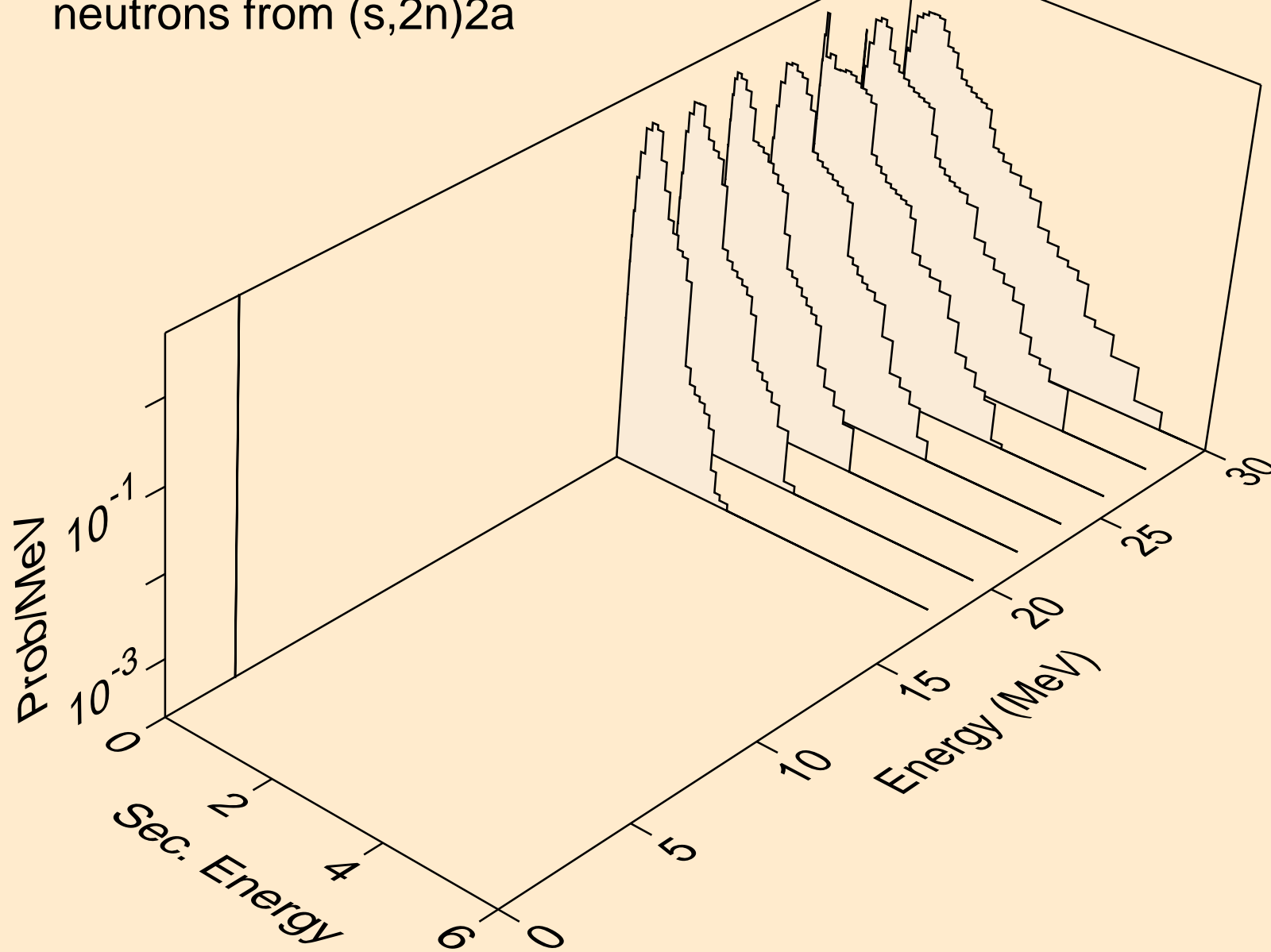

ZR102 HELION ACER TENDL-2021 LIBRARY; T=0.K  
neutrons from (s,n\*)d

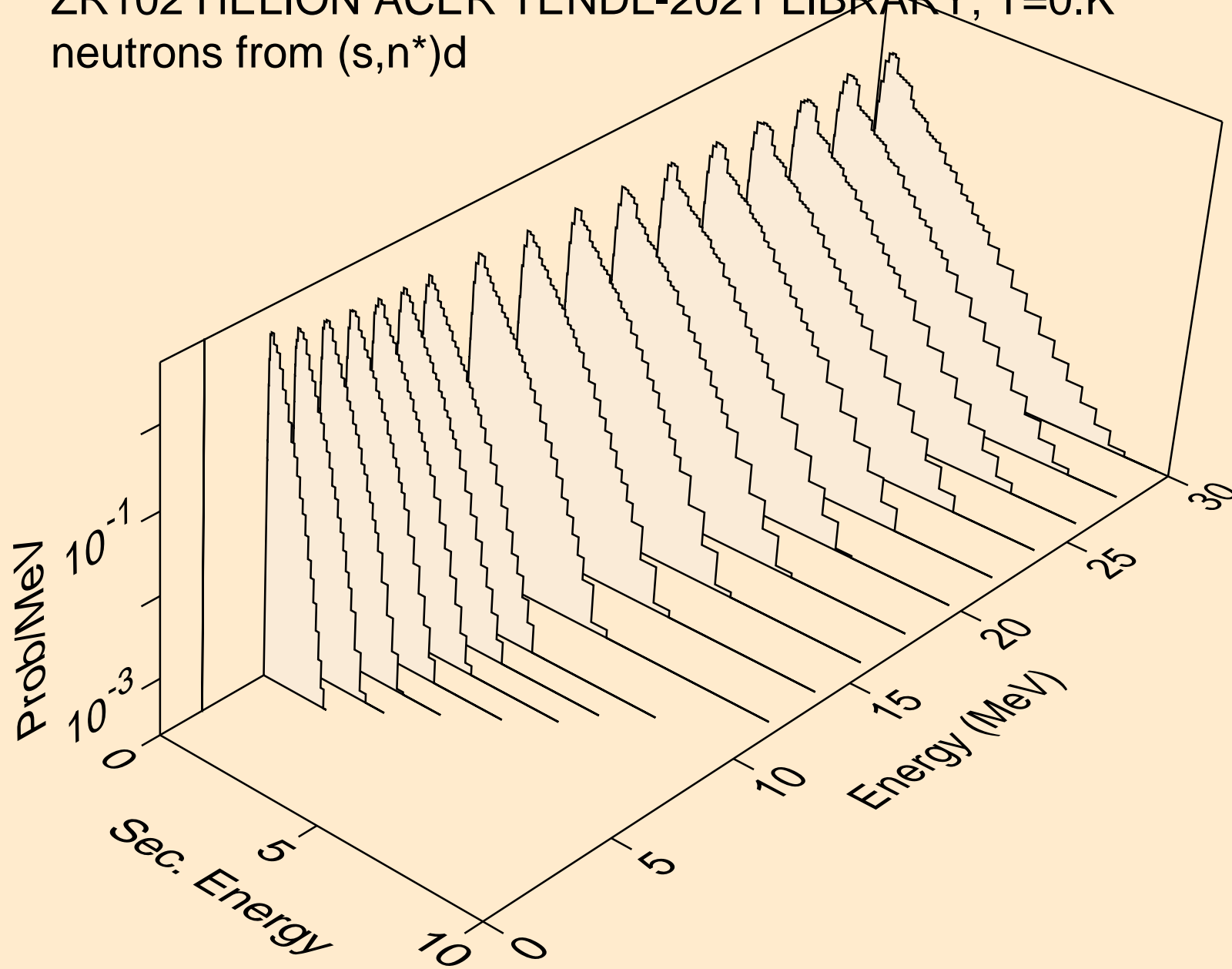

ZR102 HELION ACER TENDL-2021 LIBRARY; T=0.K  
neutrons from (s,n\*)t

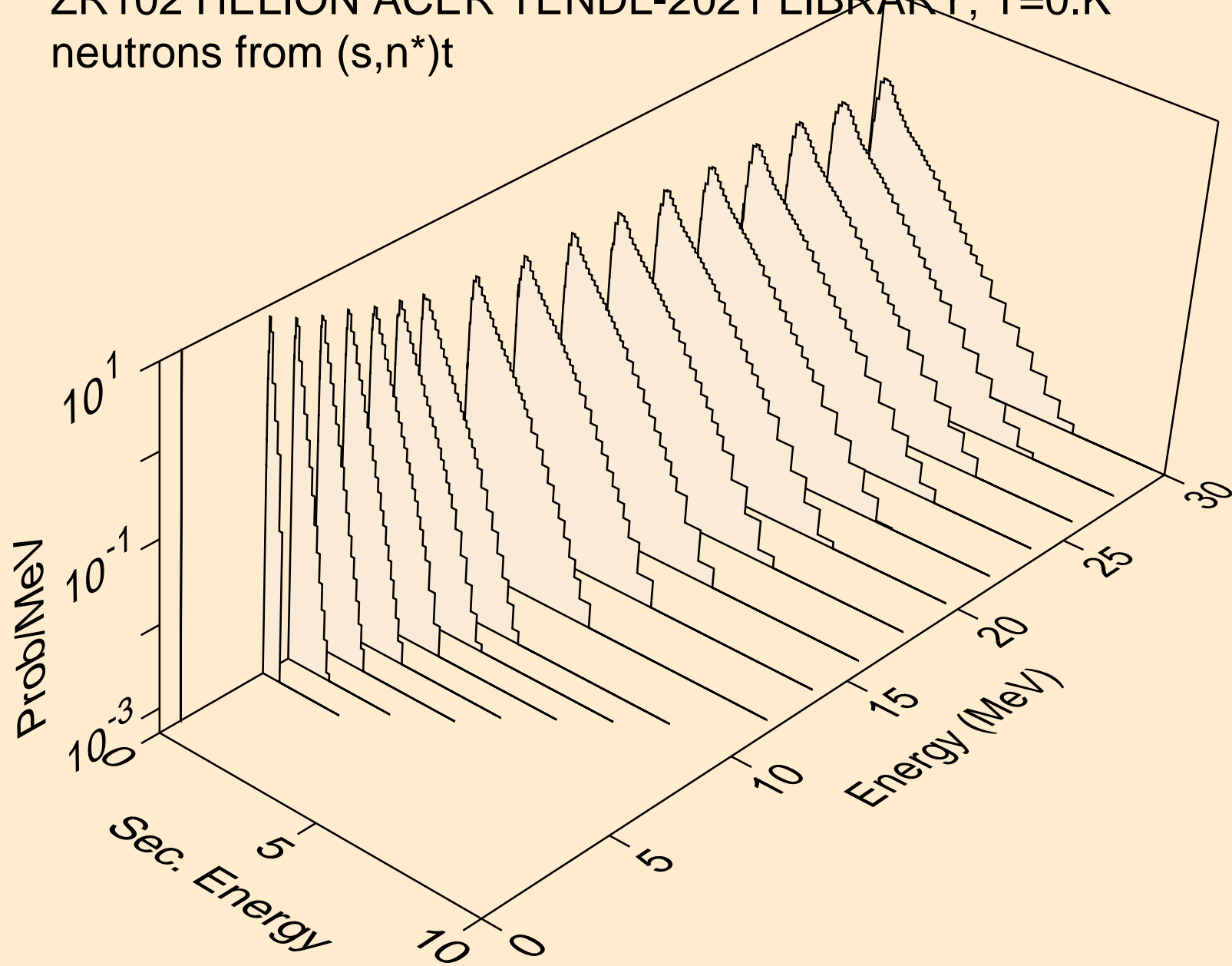

ZR102 HELION ACER TENDL-2021 LIBRARY; T=0.K  
neutrons from (s,n\*)he3

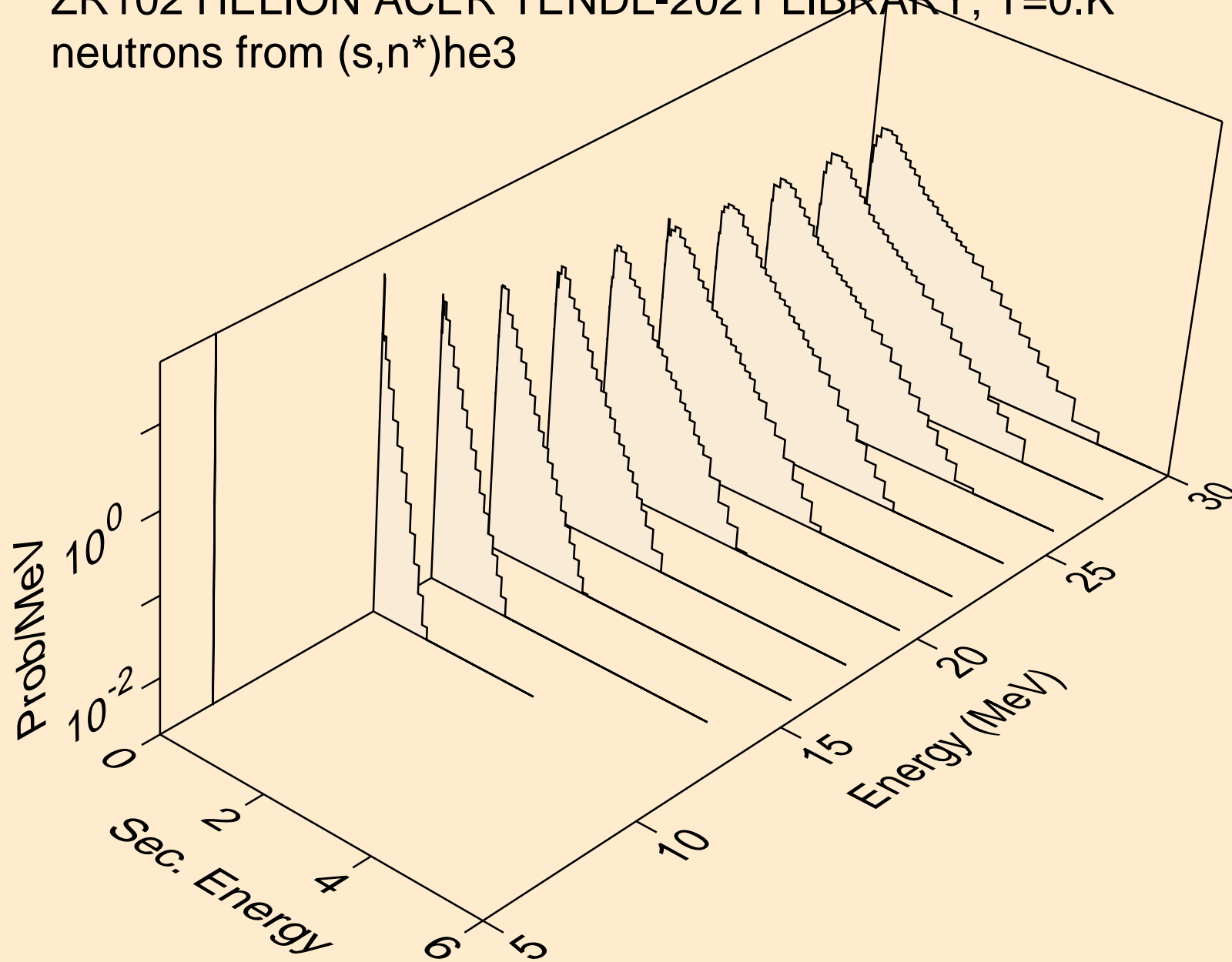

ZR102 HELION ACER TENDL-2021 LIBRARY; T=0.K  
neutrons from (s,4n)

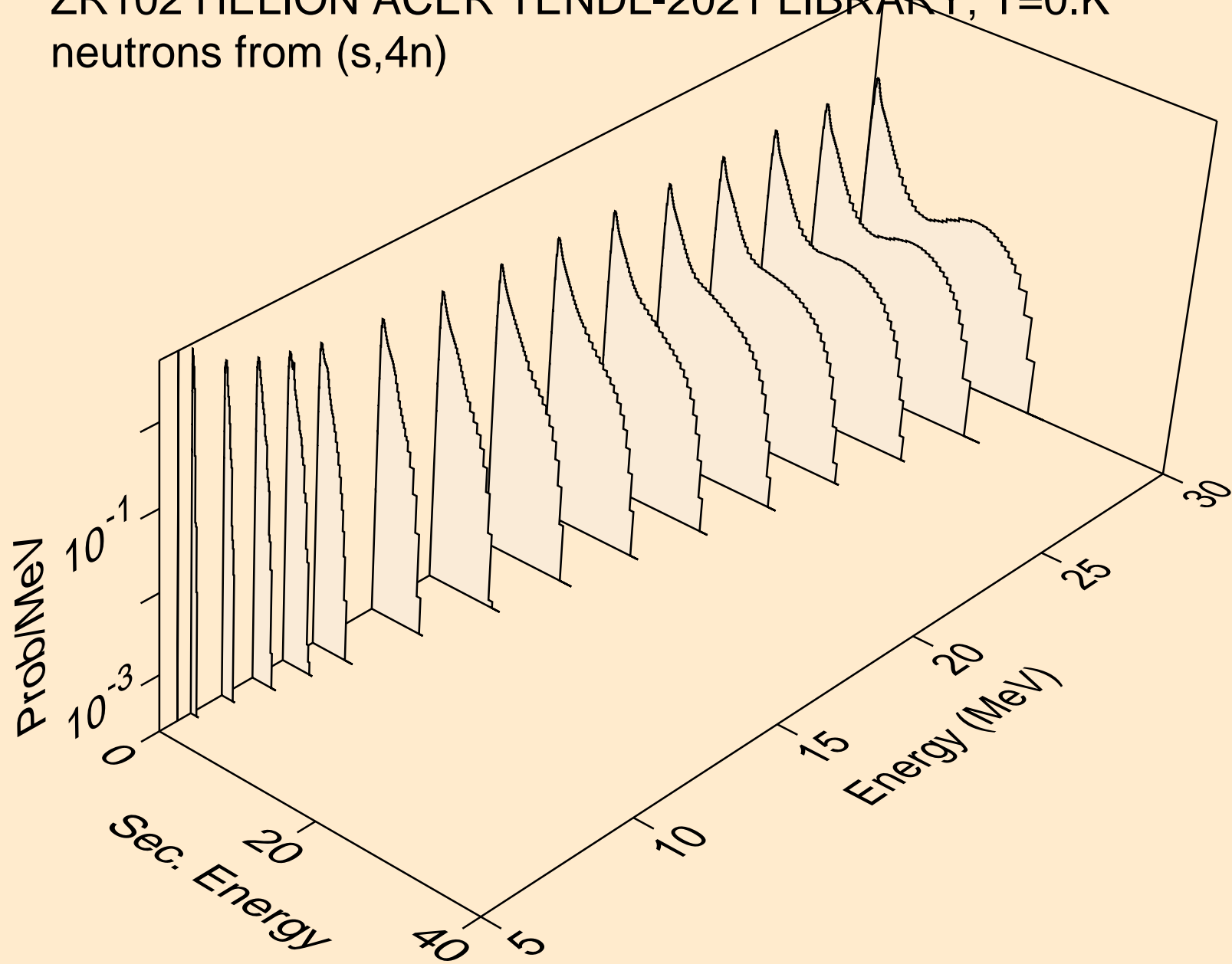



ZR102 HELION ACER TENDL-2021 LIBRARY; T=0.K  
neutrons from (s,2np)

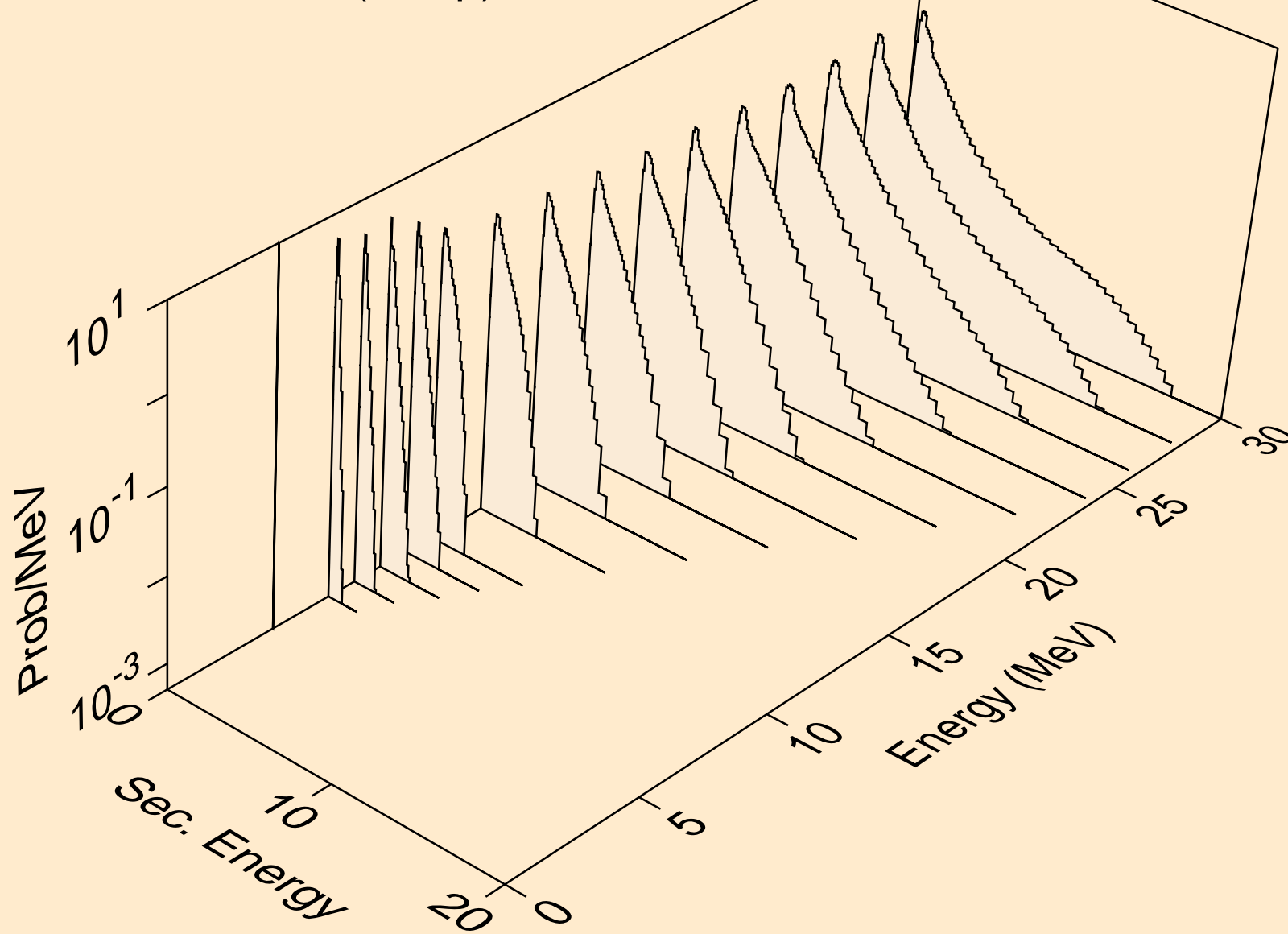

ZR102 HELION ACER TENDL-2021 LIBRARY; T=0.K  
neutrons from (s,3np)

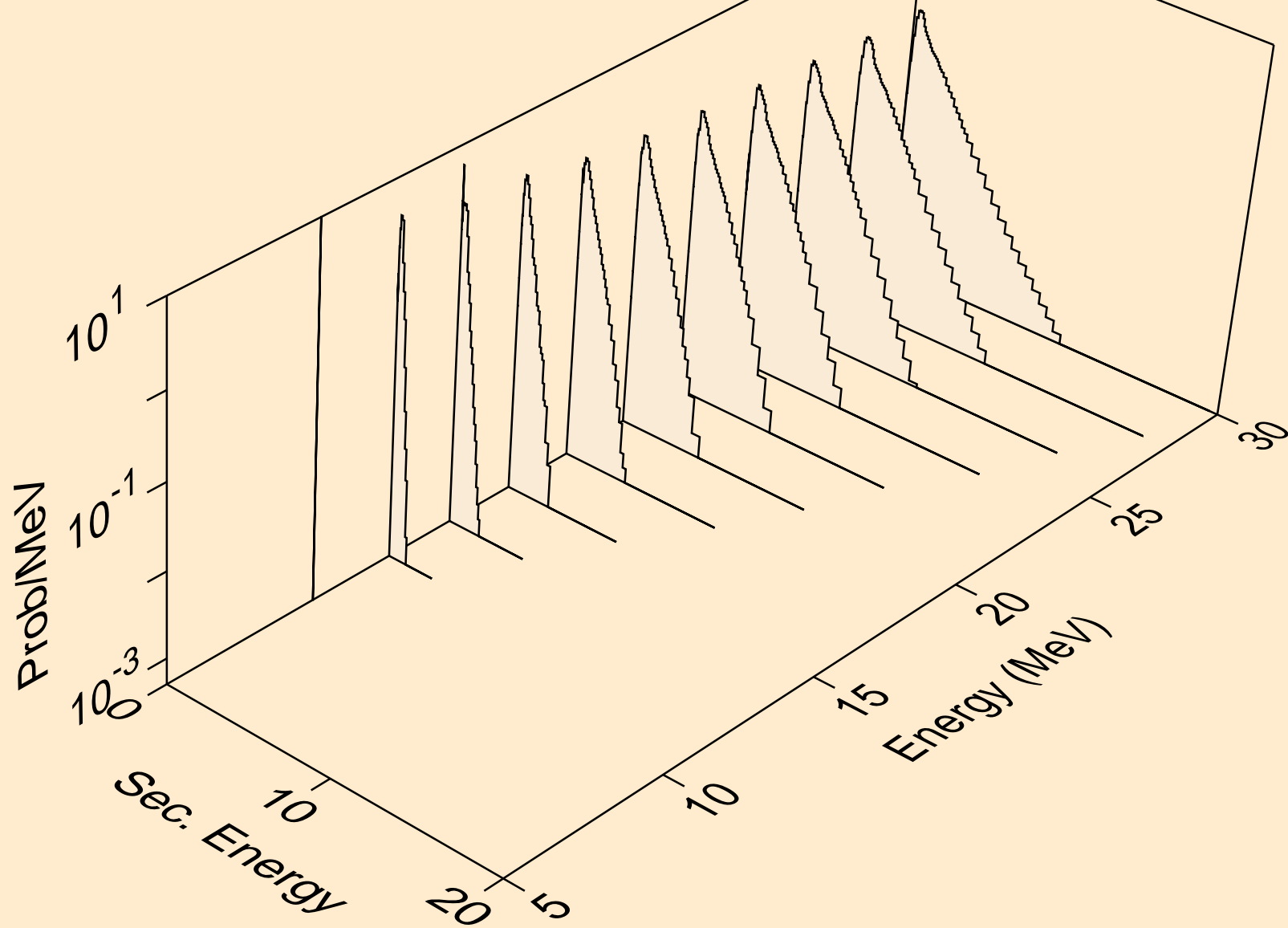

ZR102 HELION ACER TENDL-2021 LIBRARY; T=0.K  
neutrons from (s,2np)

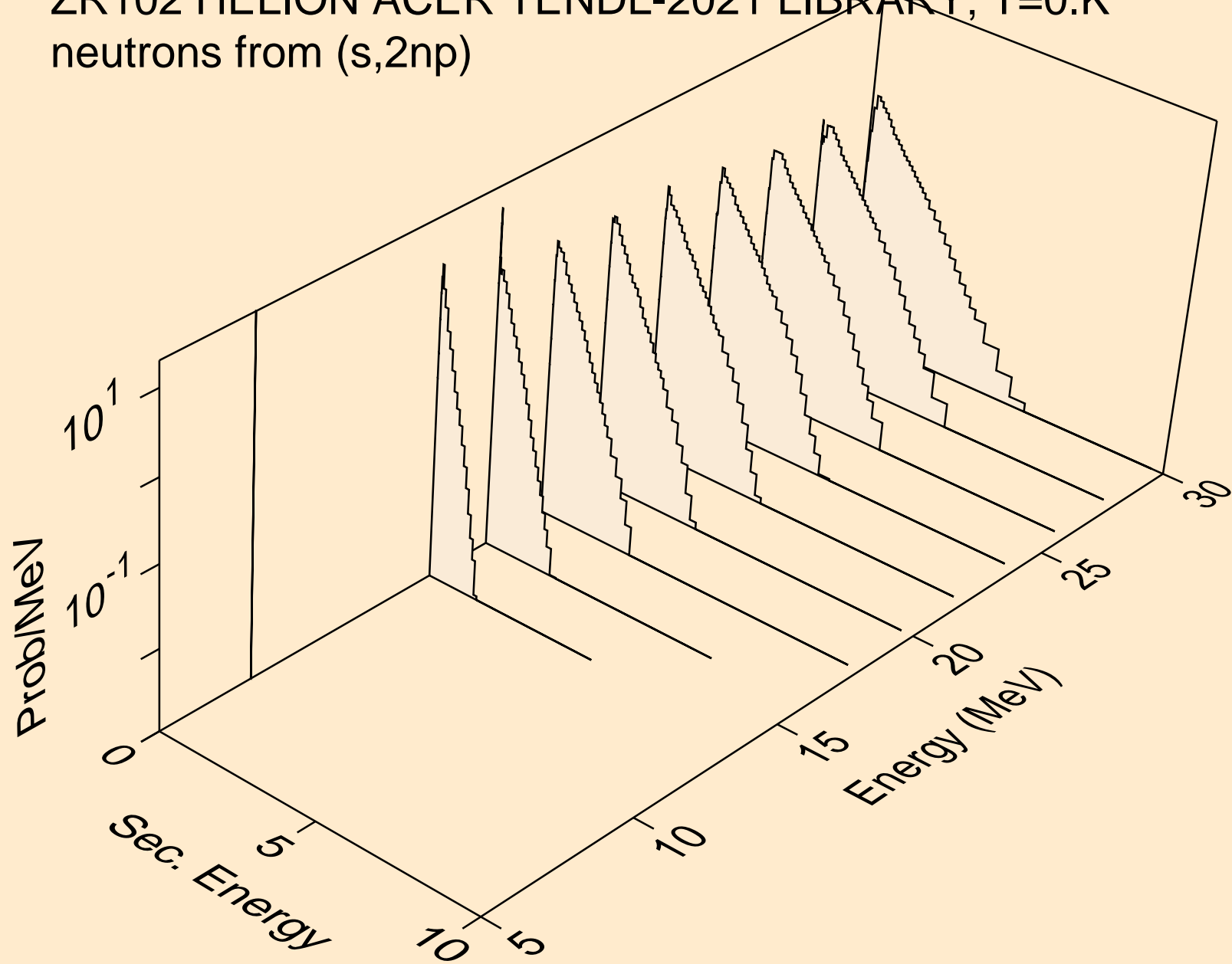

ZR102 HELION ACER TENDL-2021 LIBRARY; T=0.K  
neutrons from (s,npa)

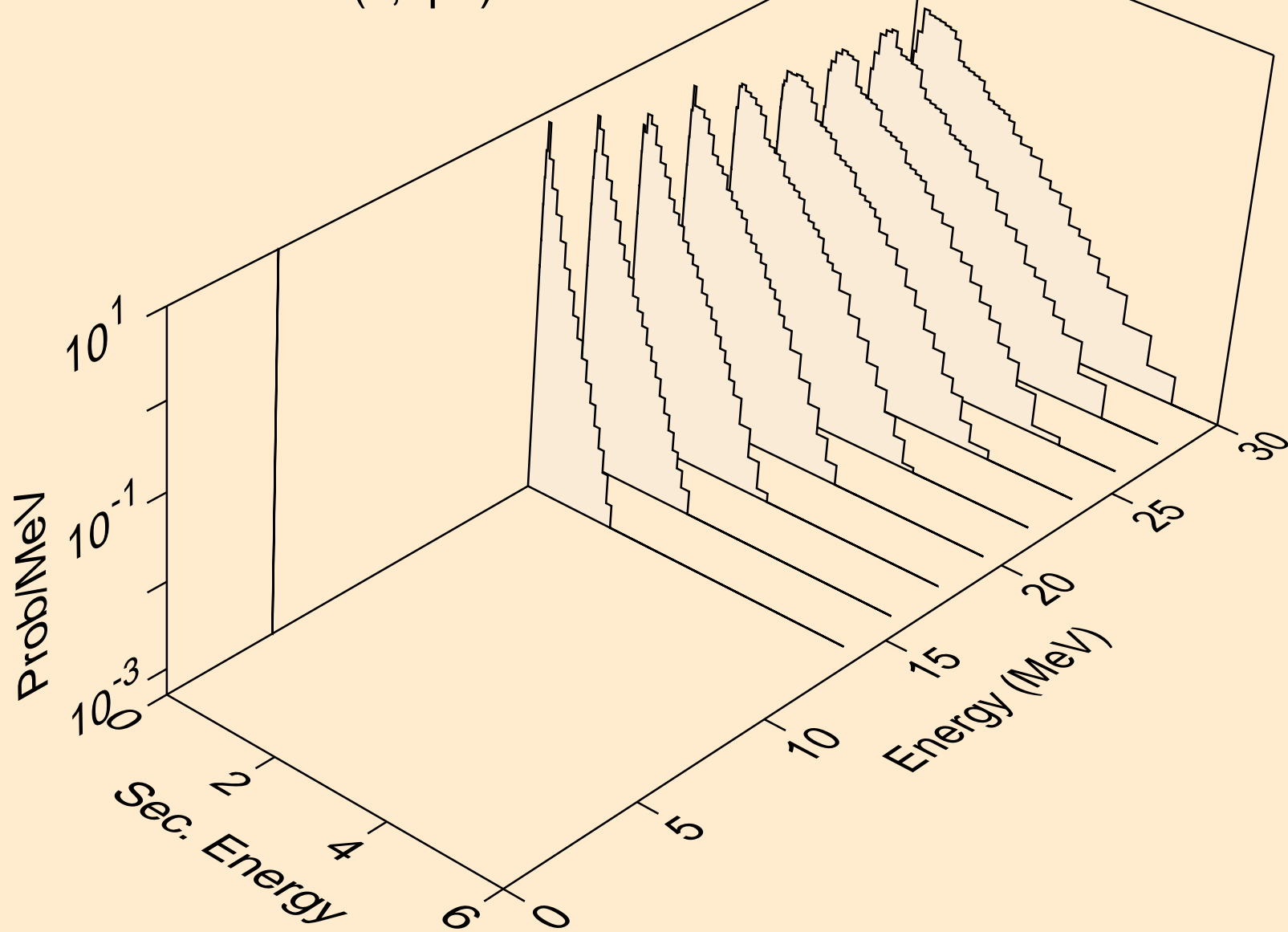

ZR102 HELION ACER TENDL-2021 LIBRARY; T=0.K  
protons from (s,x)

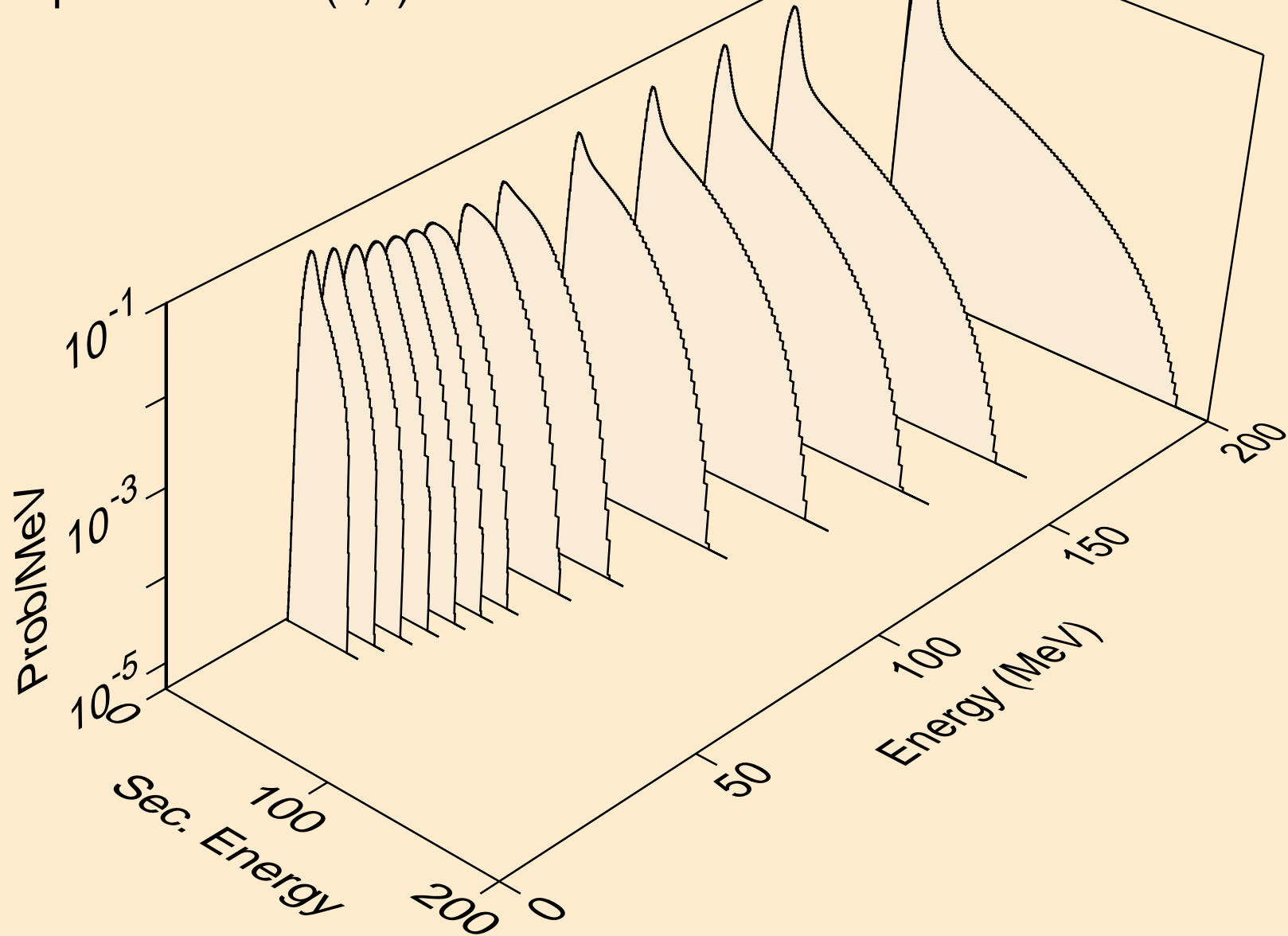

ZR102 HELION ACER TENDL-2021 LIBRARY; T=0.K  
protons from (s,n\*)p

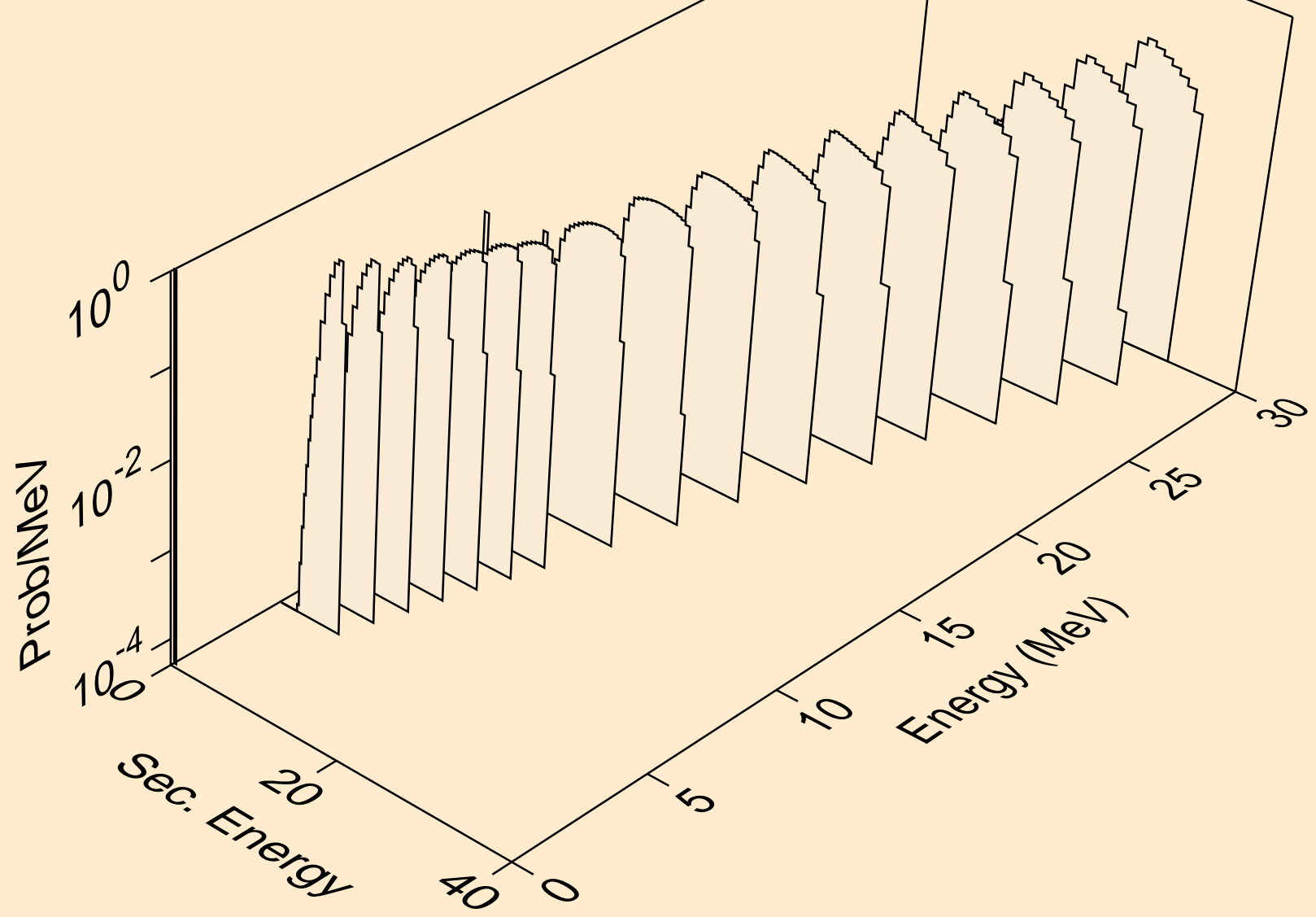

ZR102 HELION ACER TENDL-2021 LIBRARY; T=0.K  
protons from (s,2np)

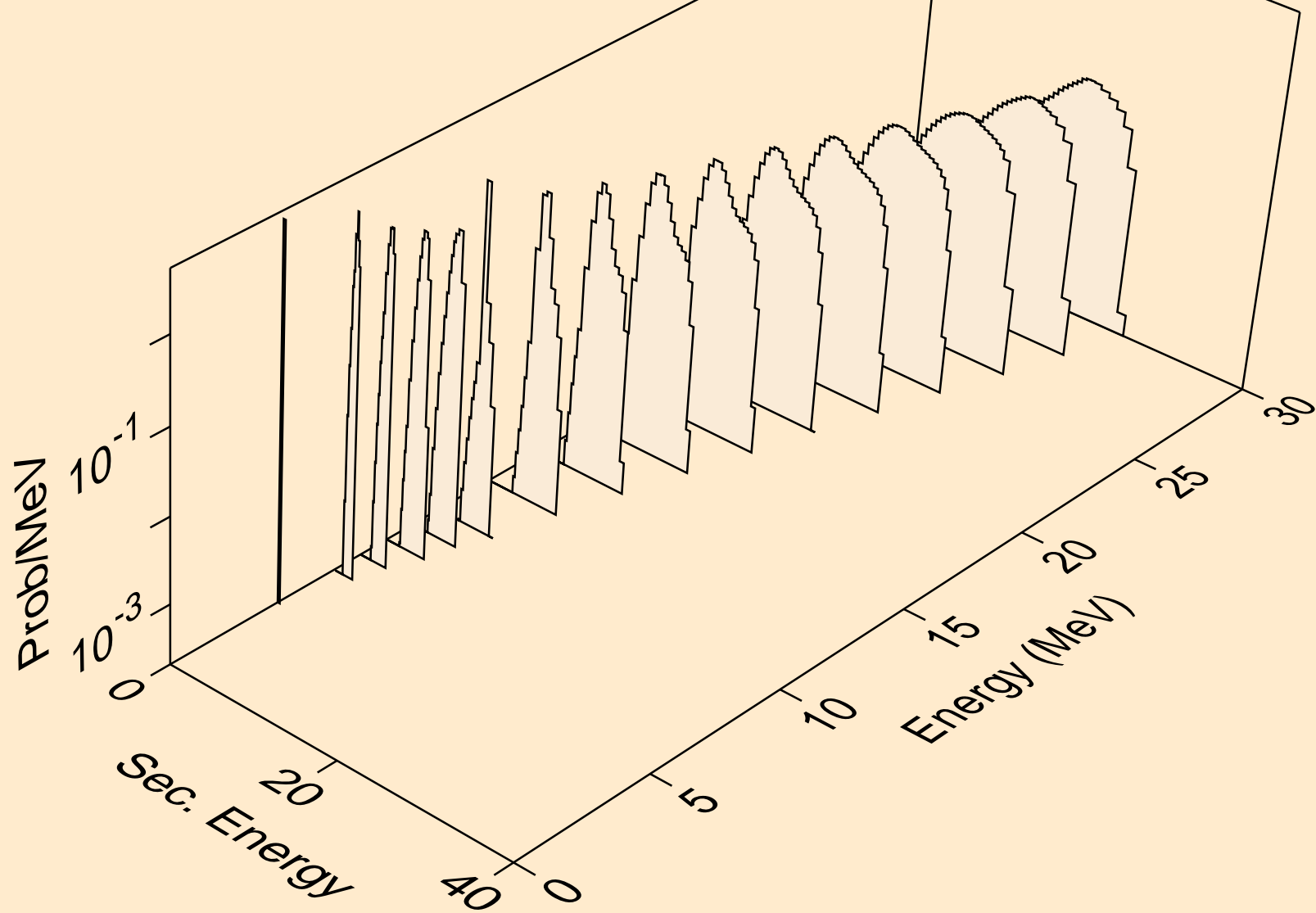

ZR102 HELION ACER TENDL-2021 LIBRARY; T=0.K  
protons from (s,3np)

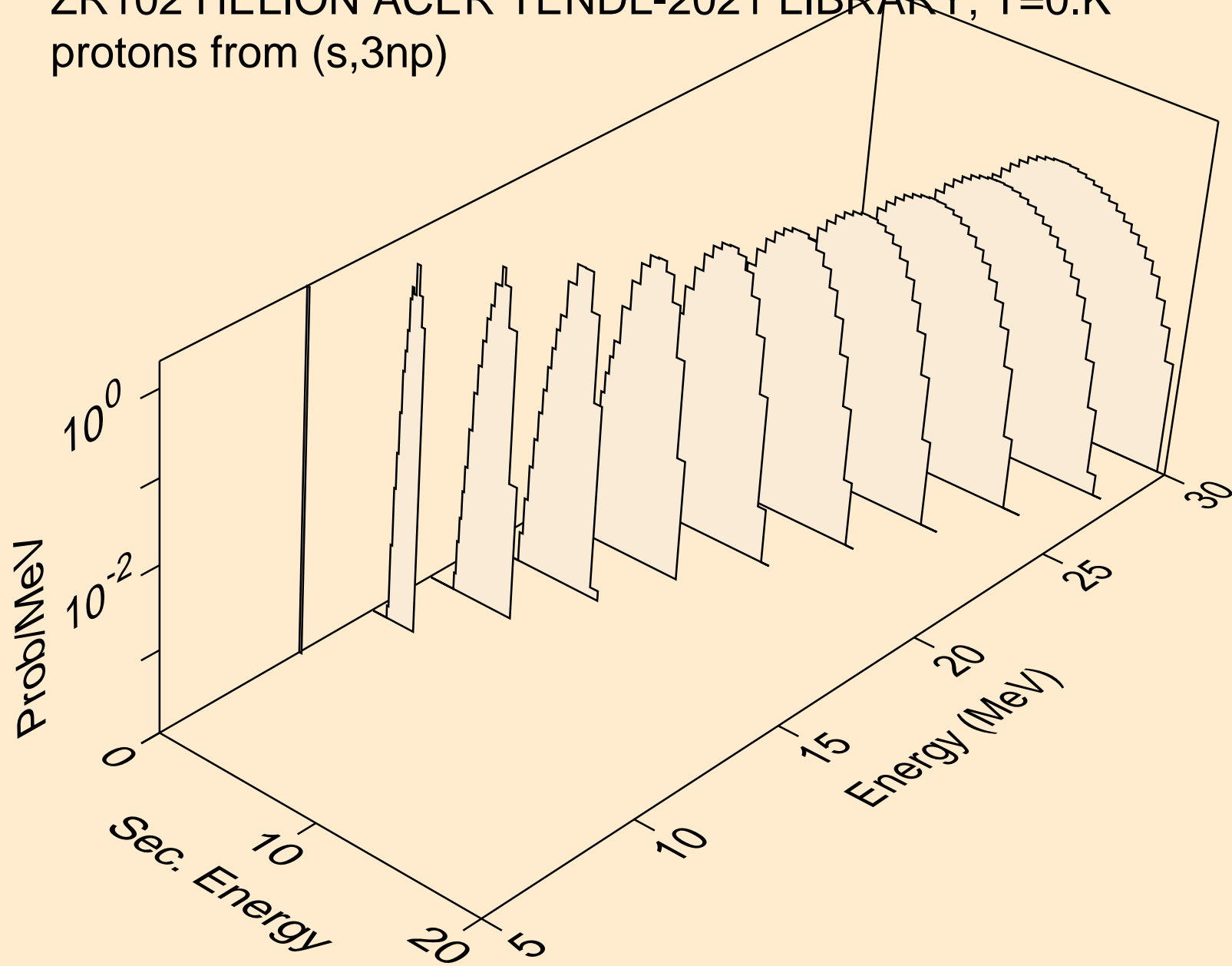



ZR102 HELION ACER TENDL-2021 LIBRARY; T=0.K  
protons from (s,2np)

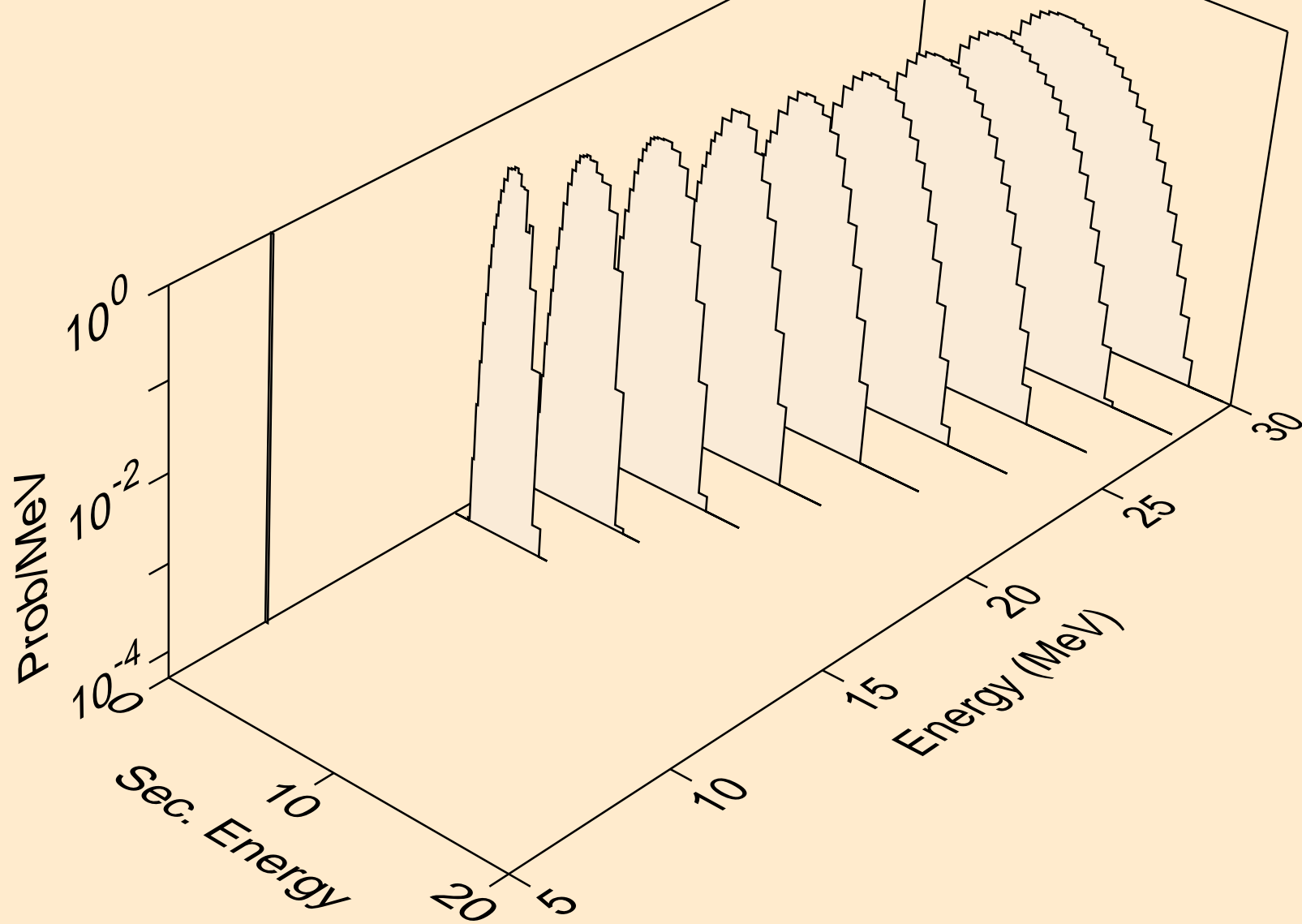

ZR102 HELION ACER TENDL-2021 LIBRARY; T=0.K  
protons from (s,npa)

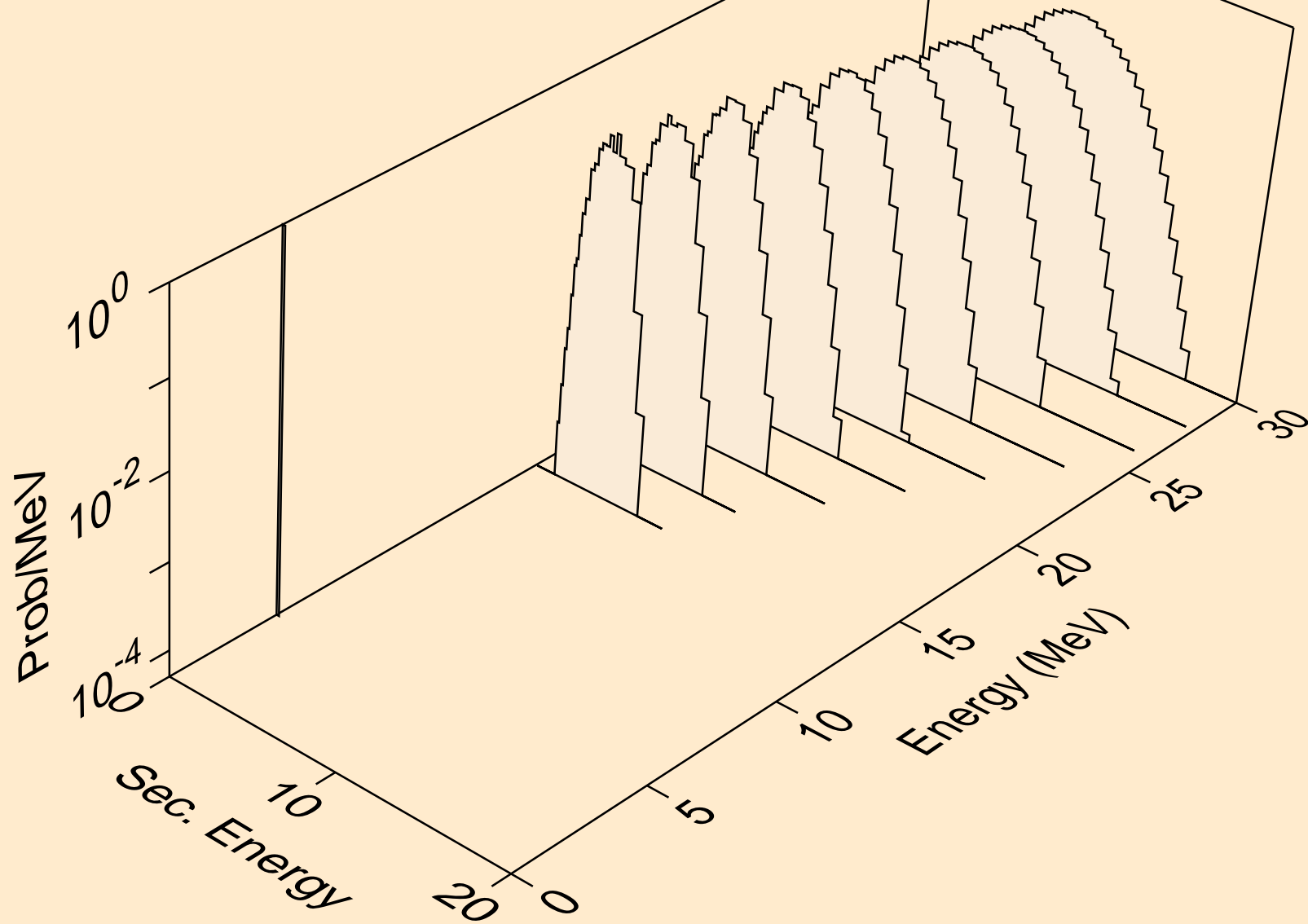

ZR102 HELION ACER TENDL-2021 LIBRARY; T=0.K  
protons from (s,p)

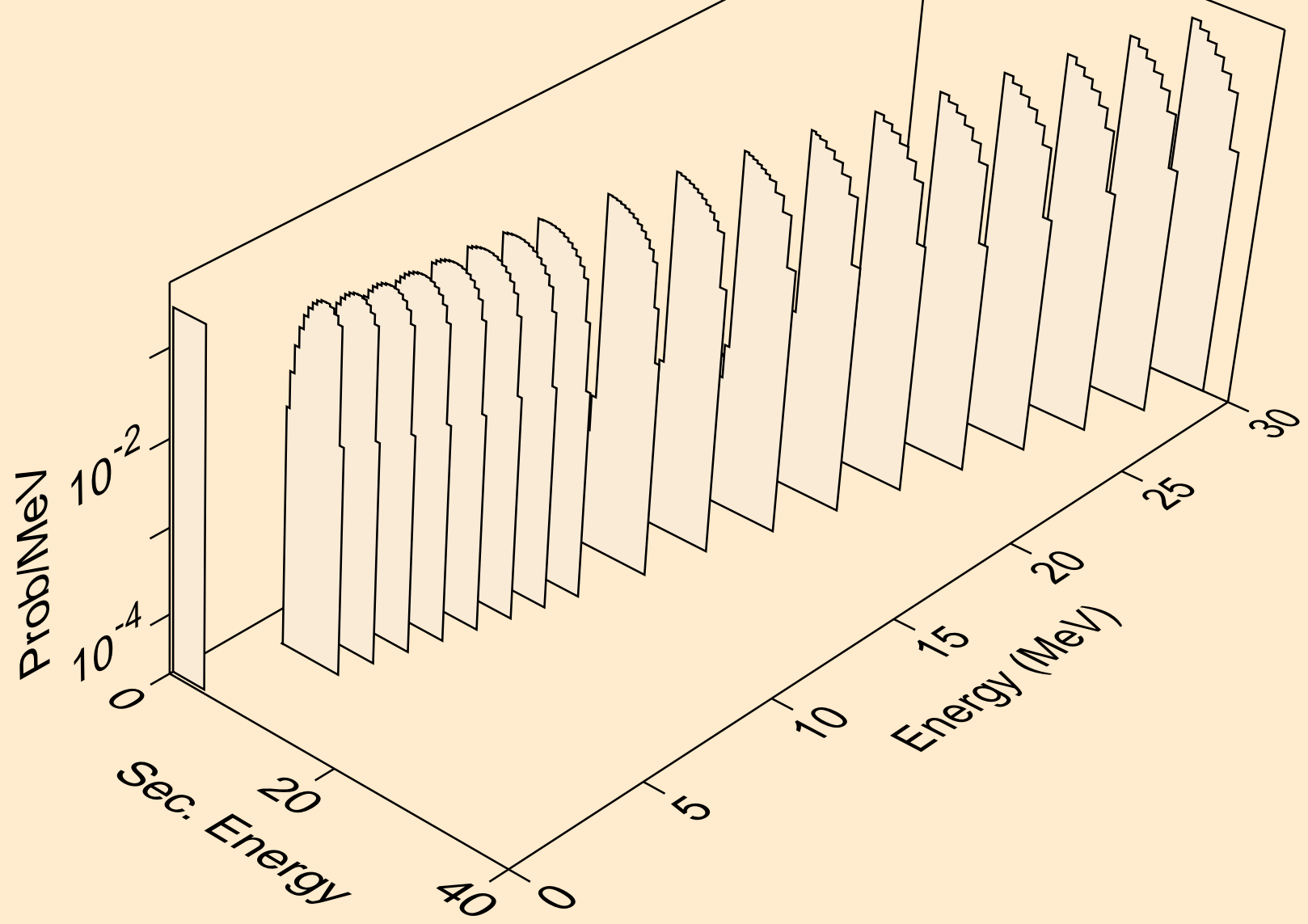

ZR102 HELION ACER TENDL-2021 LIBRARY; T=0.K  
protons from (s,2p)

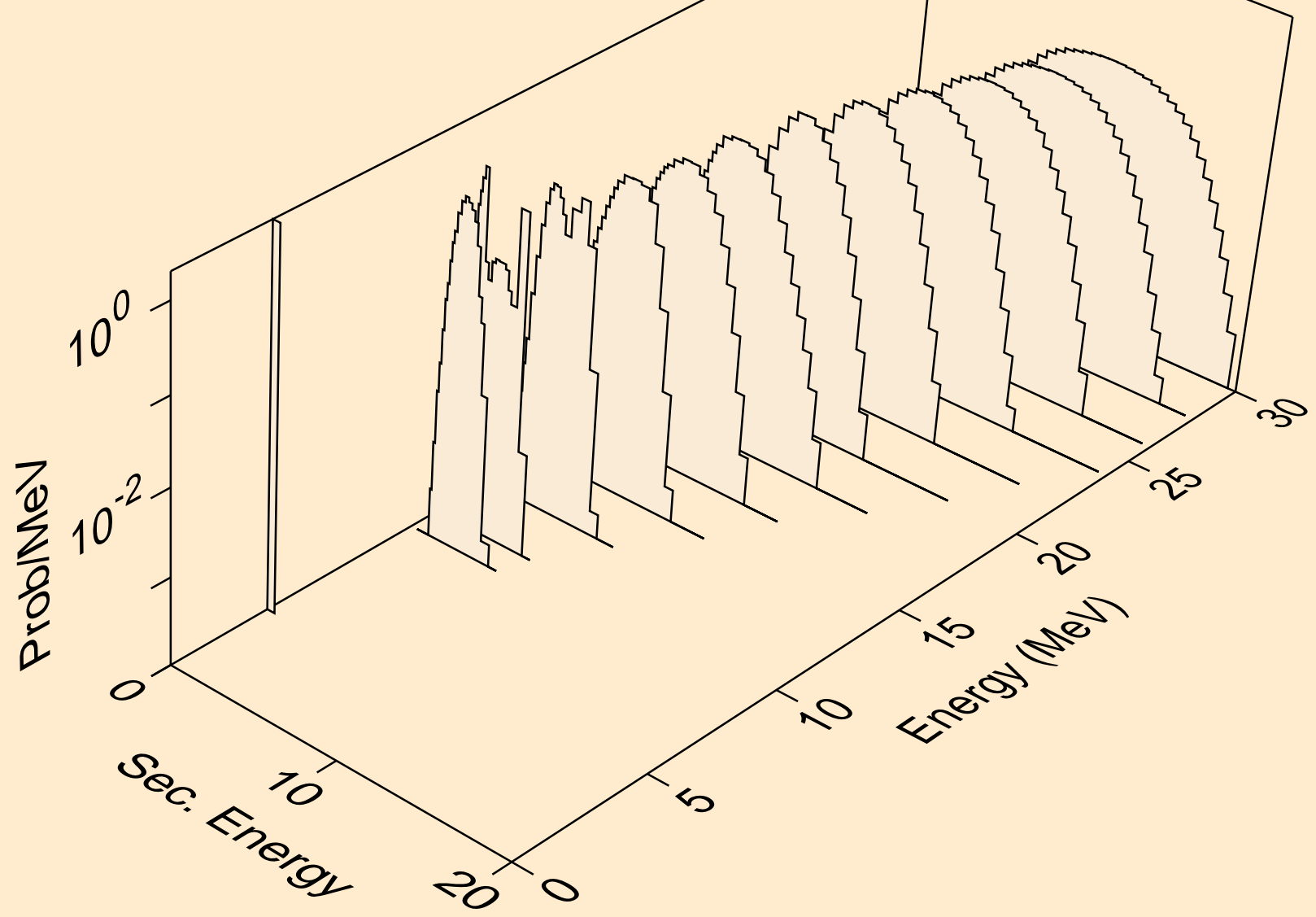

ZR102 HELION ACER TENDL-2021 LIBRARY; T=0.K  
protons from (s,pa)

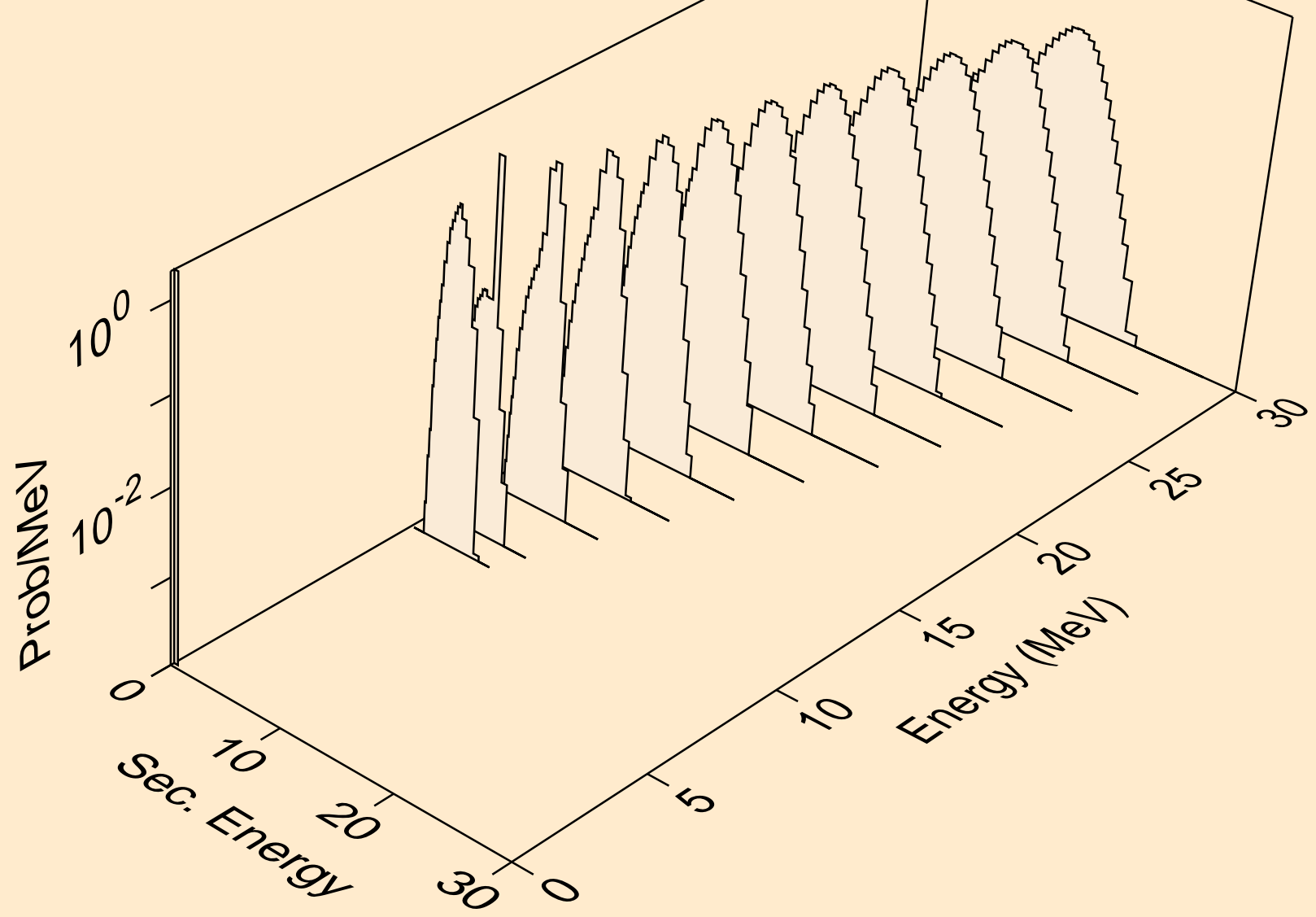

ZR102 HELION ACER TENDL-2021 LIBRARY; T=0.K  
protons from (s,pd)

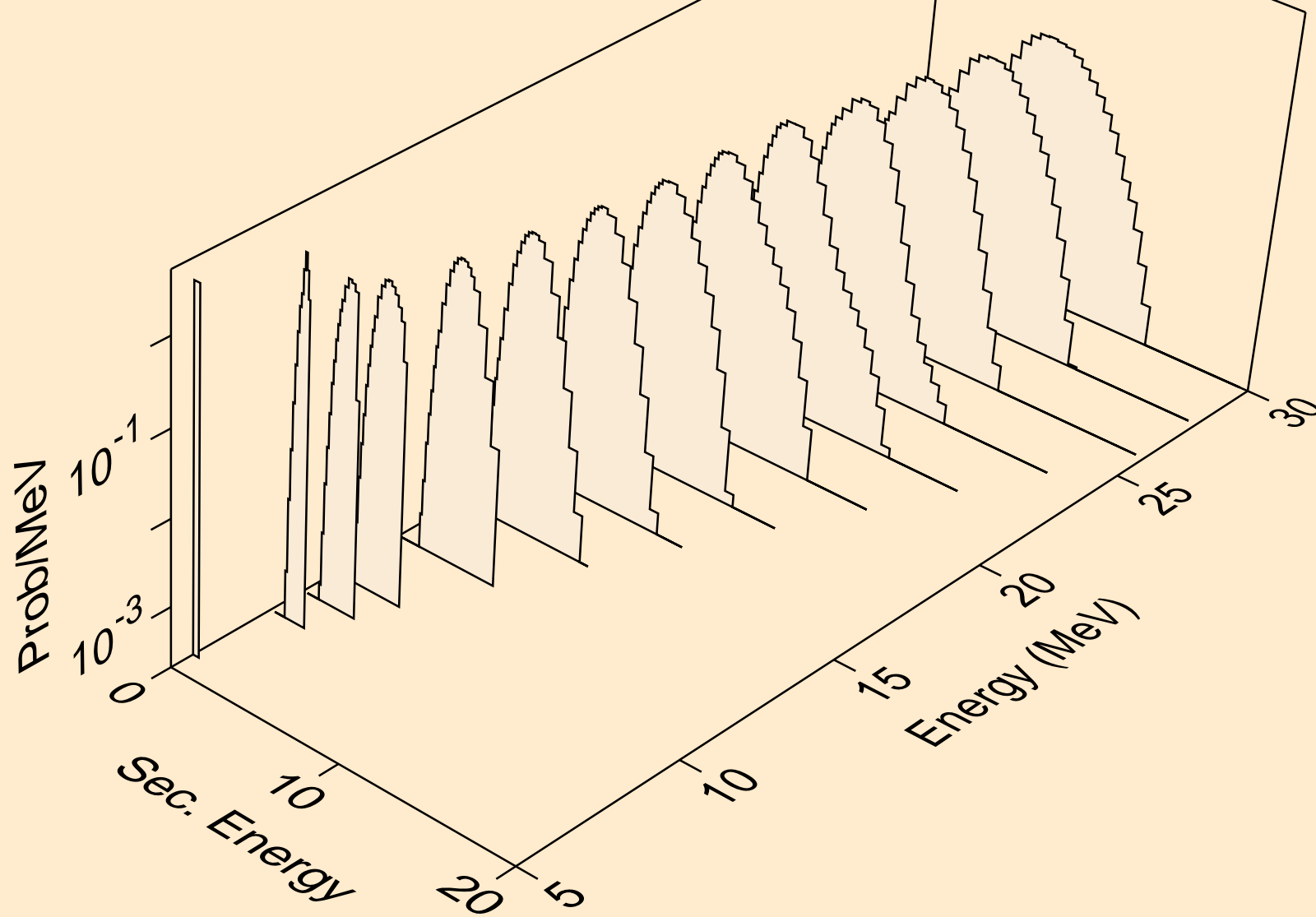

ZR102 HELION ACER TENDL-2021 LIBRARY; T=0.K  
protons from (s,pt)

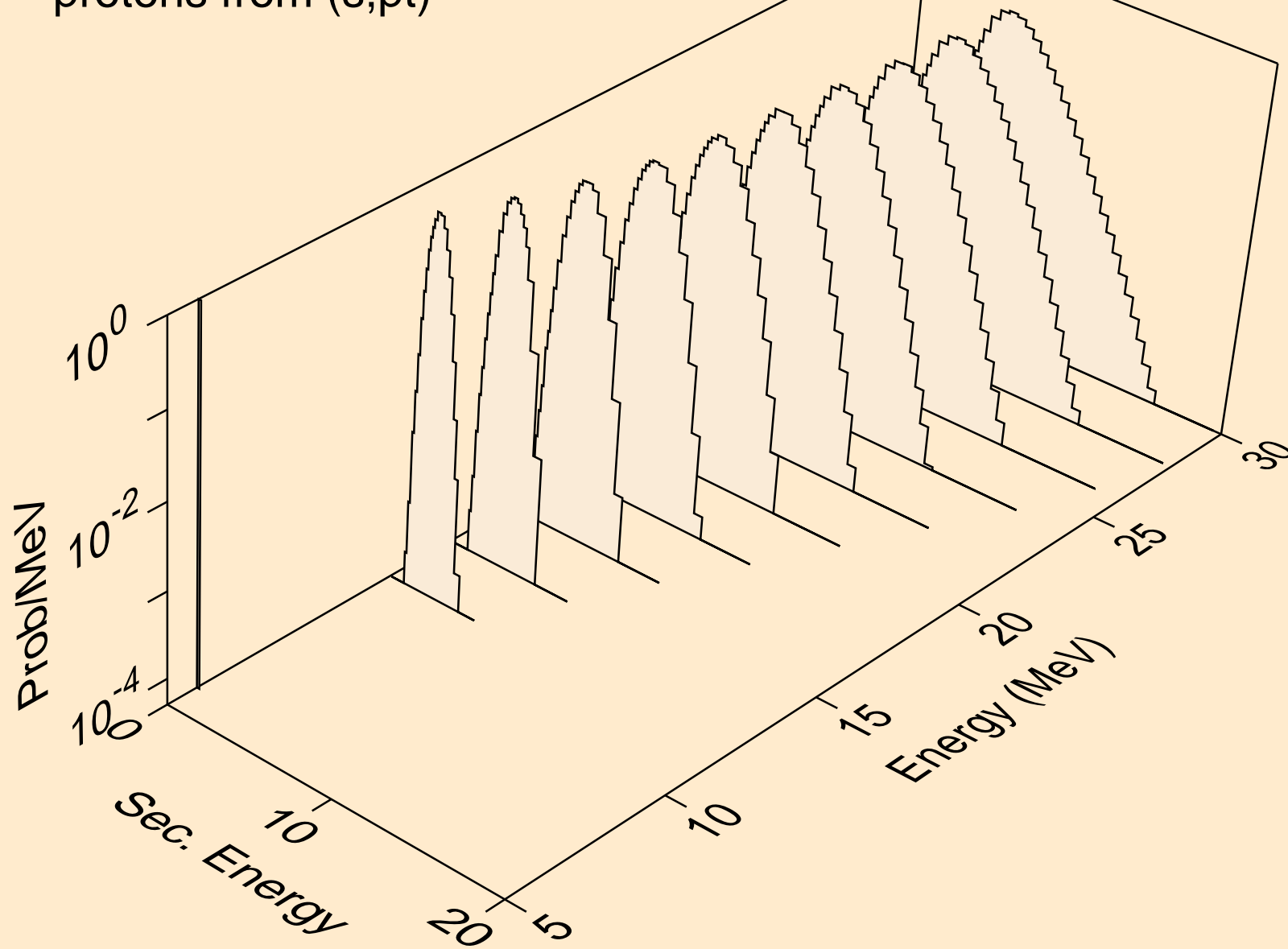

ZR102 HELION ACER TENDL-2021 LIBRARY; T=0.K  
deuterons from (s,x)

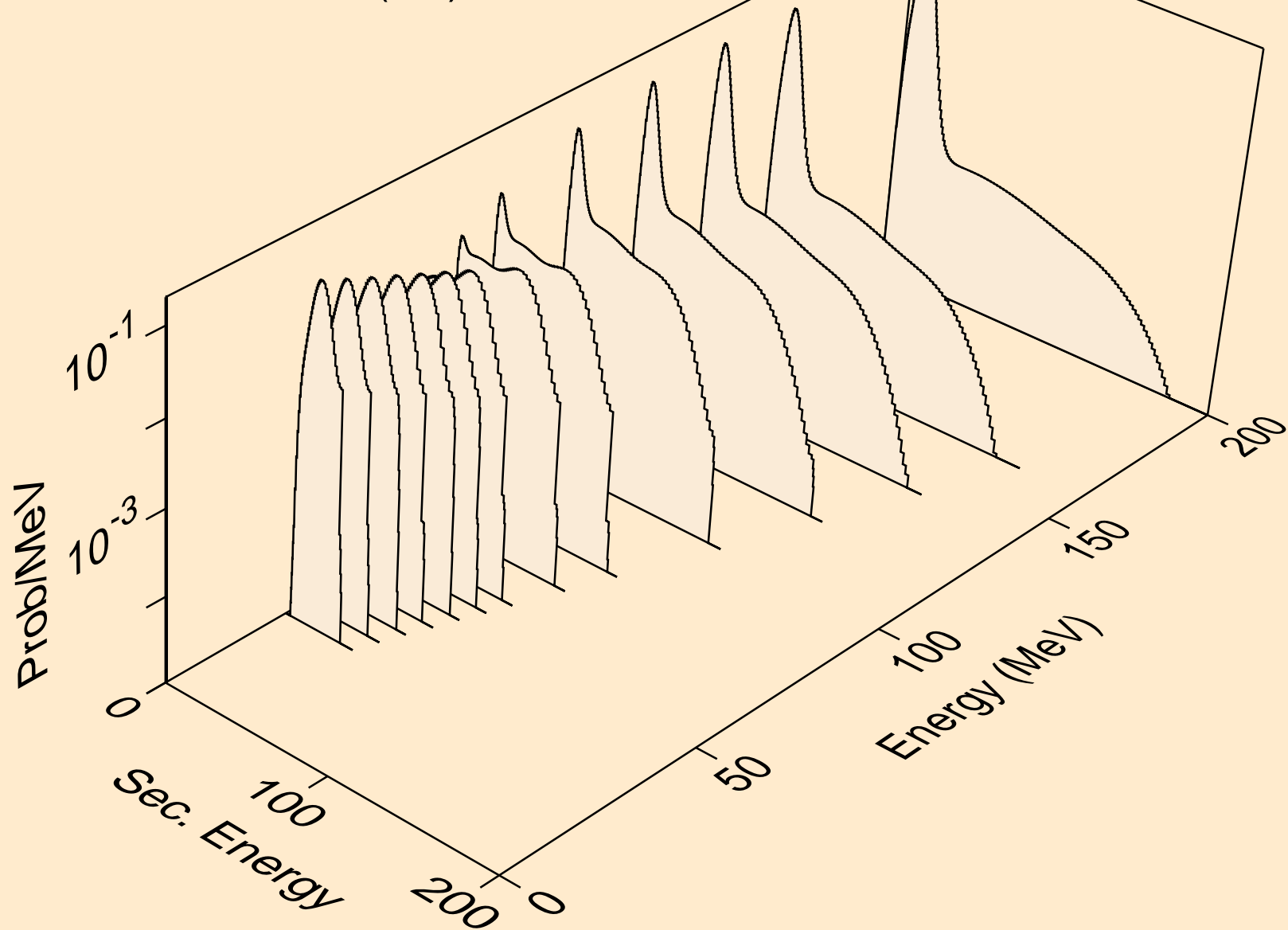



ZR102 HELION ACER TENDL-2021 LIBRARY; T=0.K  
deuterons from (s,2nd)

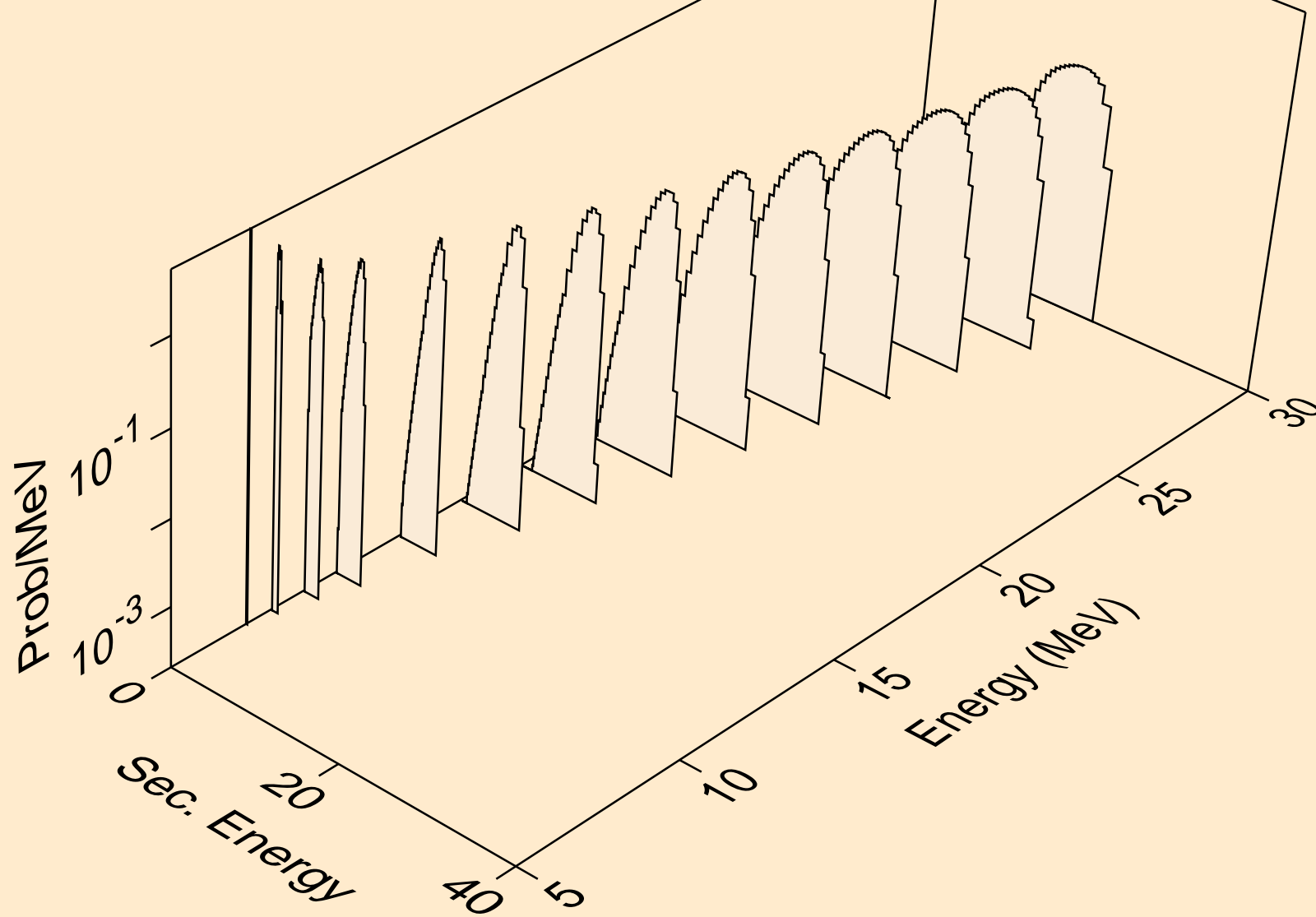

ZR102 HELION ACER TENDL-2021 LIBRARY; T=0.K  
deuterons from (s,n\*)d

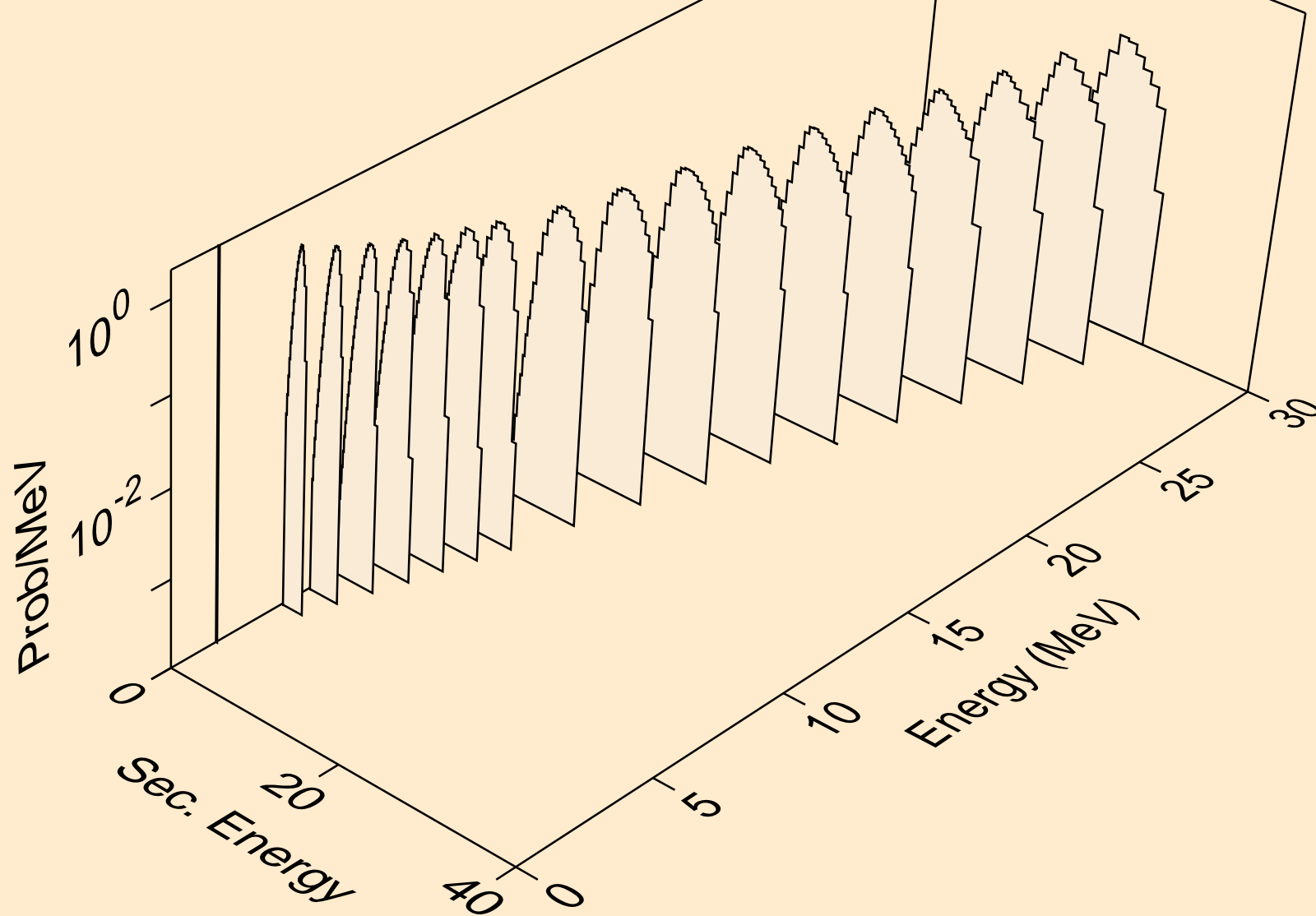

ZR102 HELION ACER TENDL-2021 LIBRARY; T=0.K  
deuterons from (s,d)

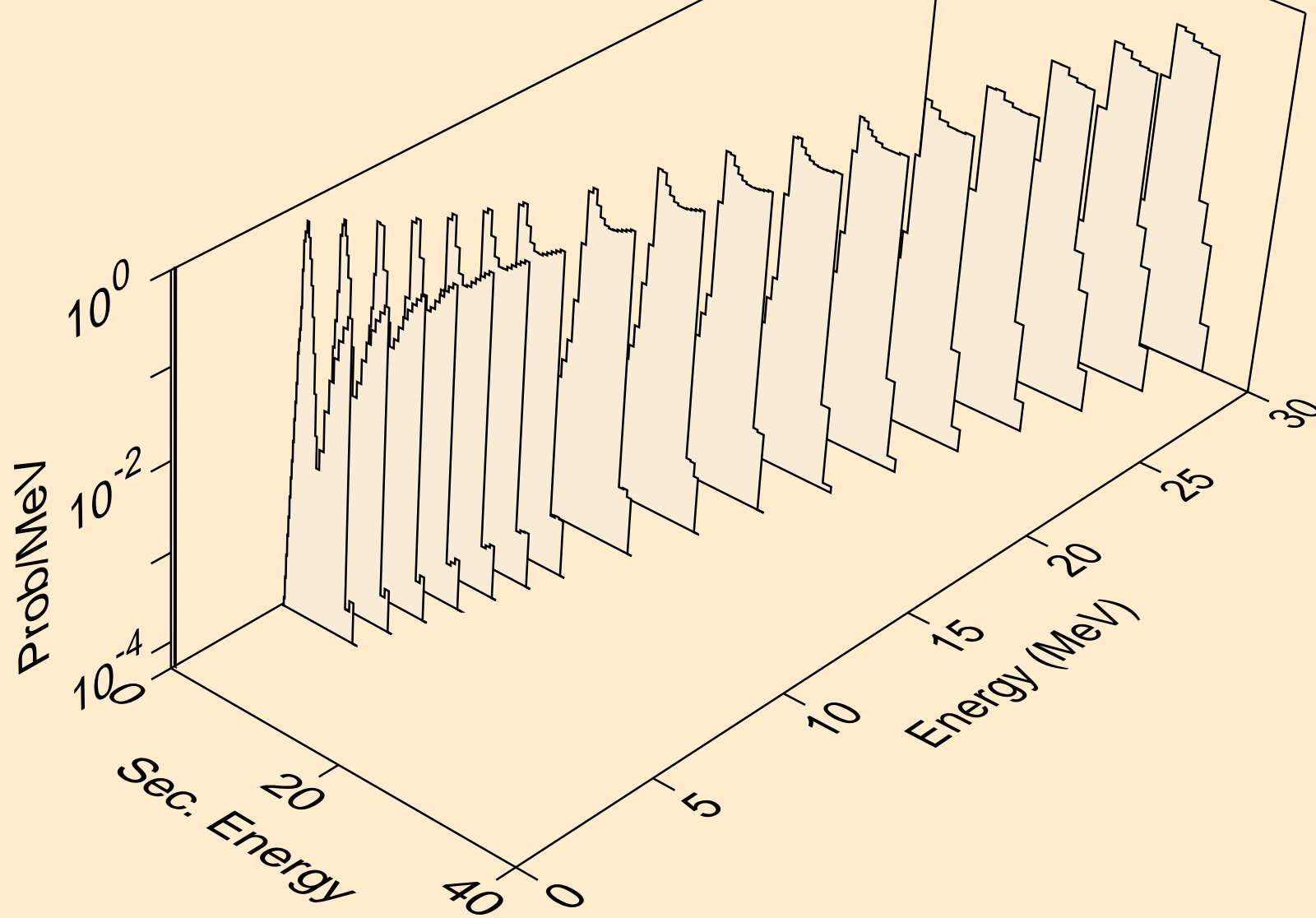

ZR102 HELION ACER TENDL-2021 LIBRARY; T=0.K  
deuterons from (s,pd)

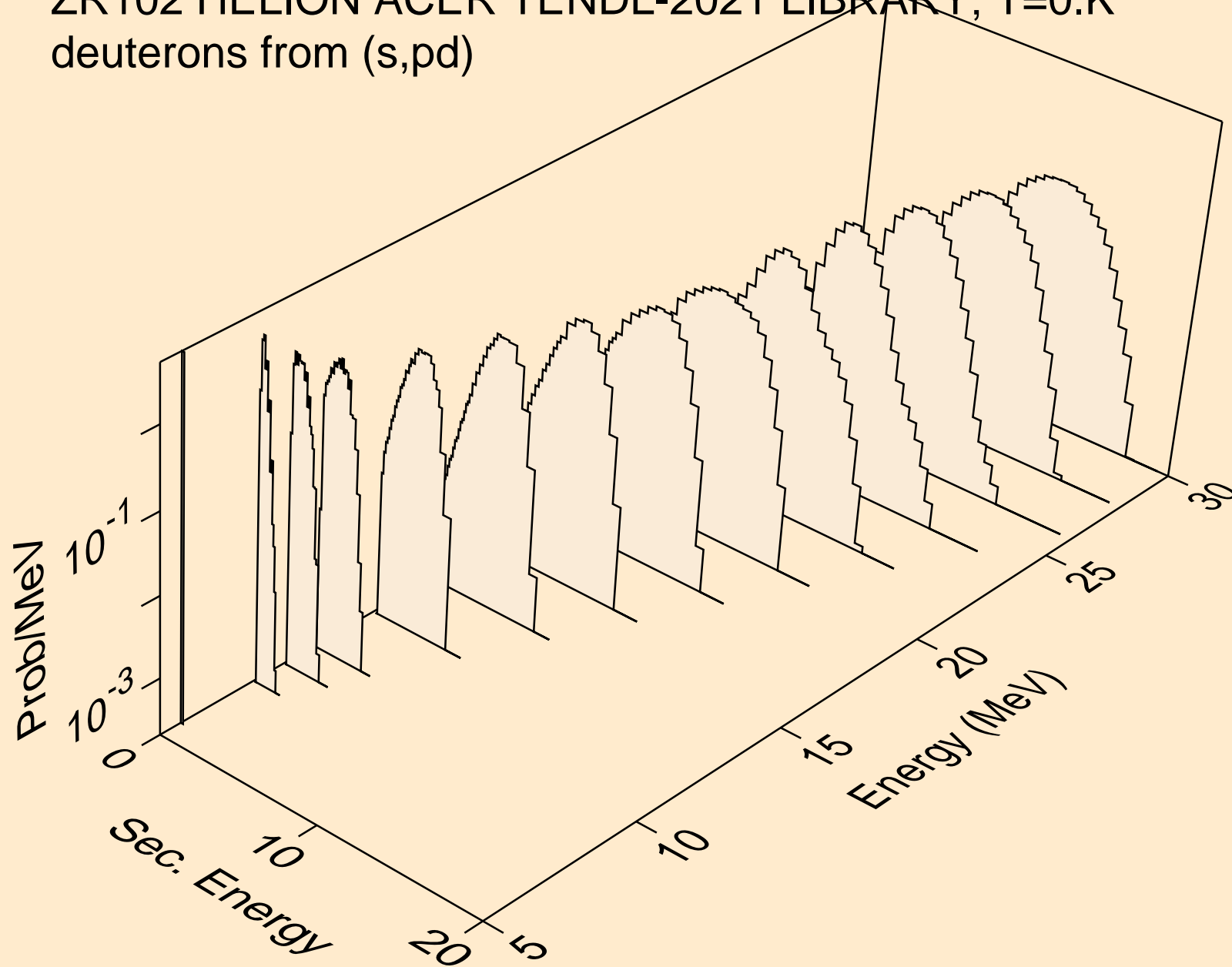

ZR102 HELION ACER TENDL-2021 LIBRARY; T=0.K  
deuterons from (s,da)

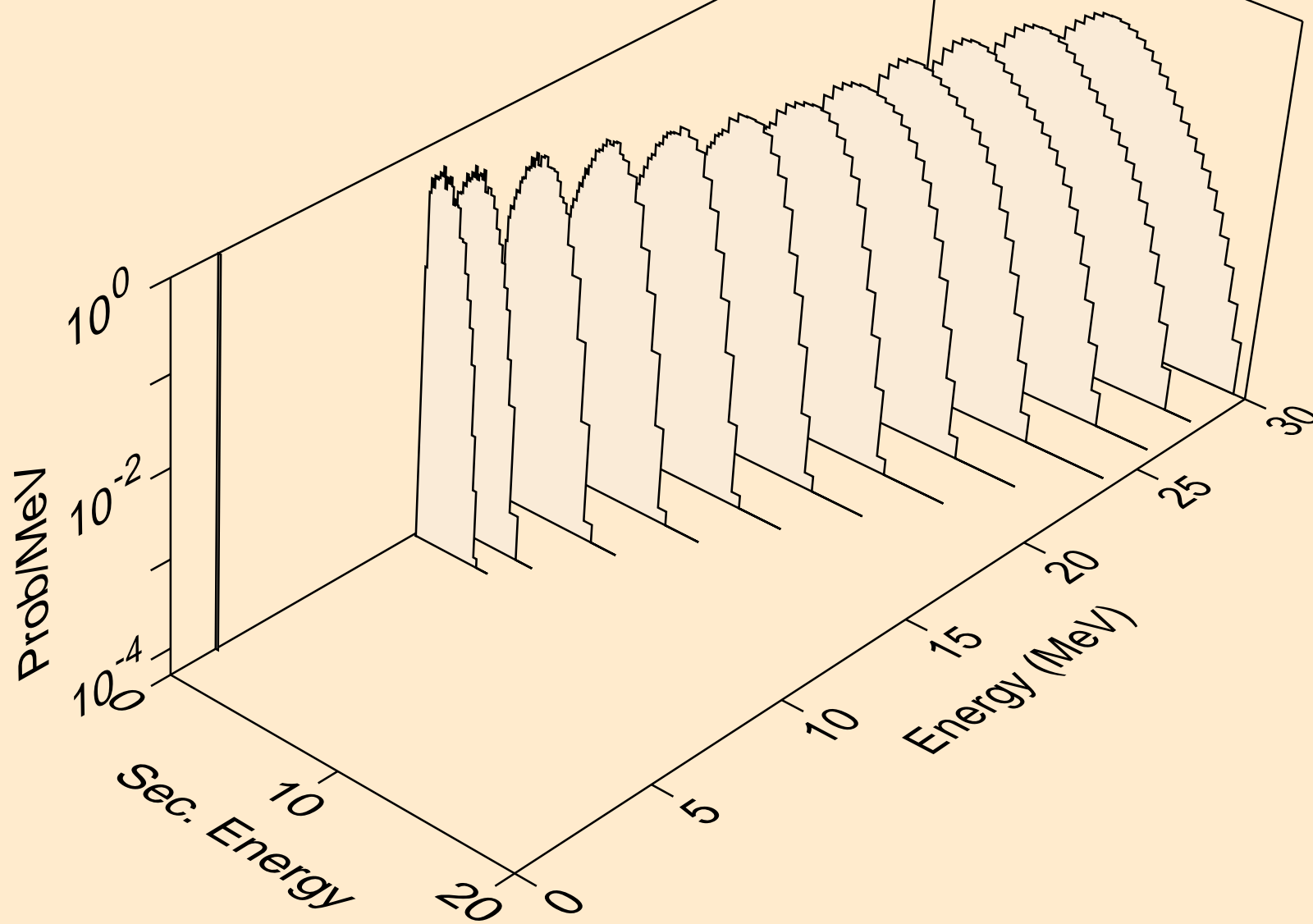

ZR102 HELION ACER TENDL-2021 LIBRARY; T=0.K  
tritons from (s,x)

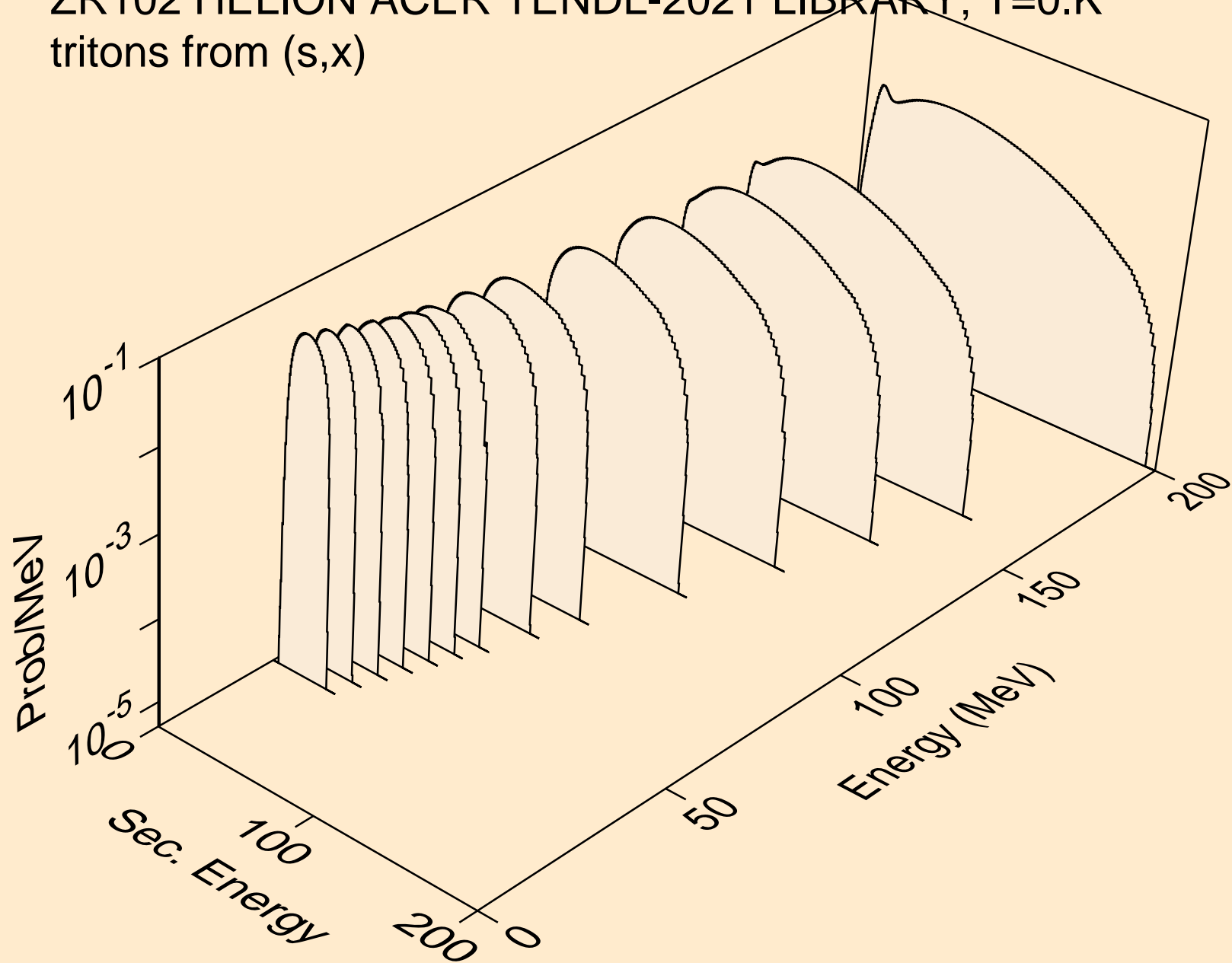

ZR102 HELION ACER TENDL-2021 LIBRARY; T=0.K  
tritons from (s,n\*)t

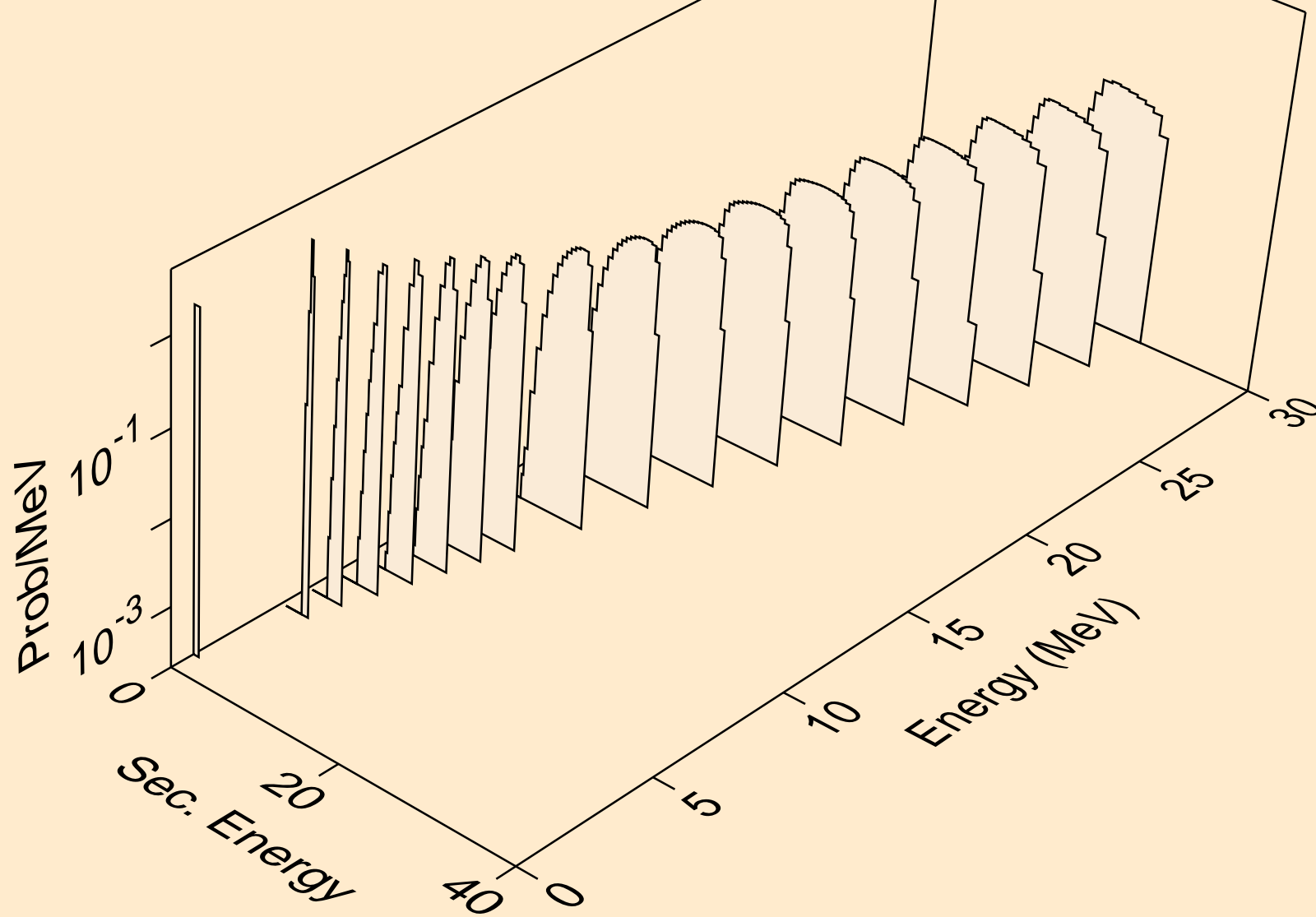

ZR102 HELION ACER TENDL-2021 LIBRARY; T=0.K  
tritons from (s,t)

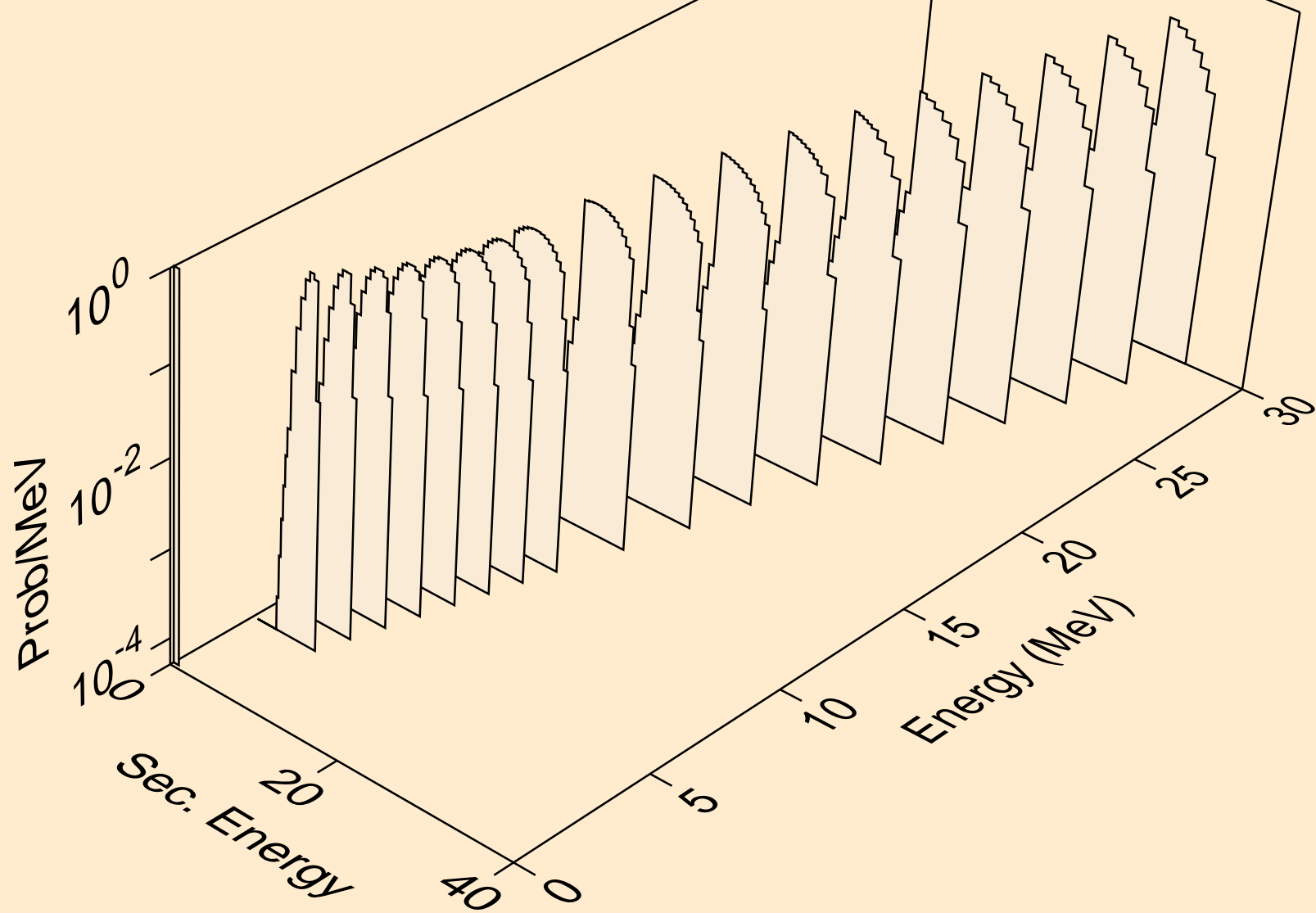



ZR102 HELION ACER TENDL-2021 LIBRARY; T=0.K  
tritons from (s,pt)

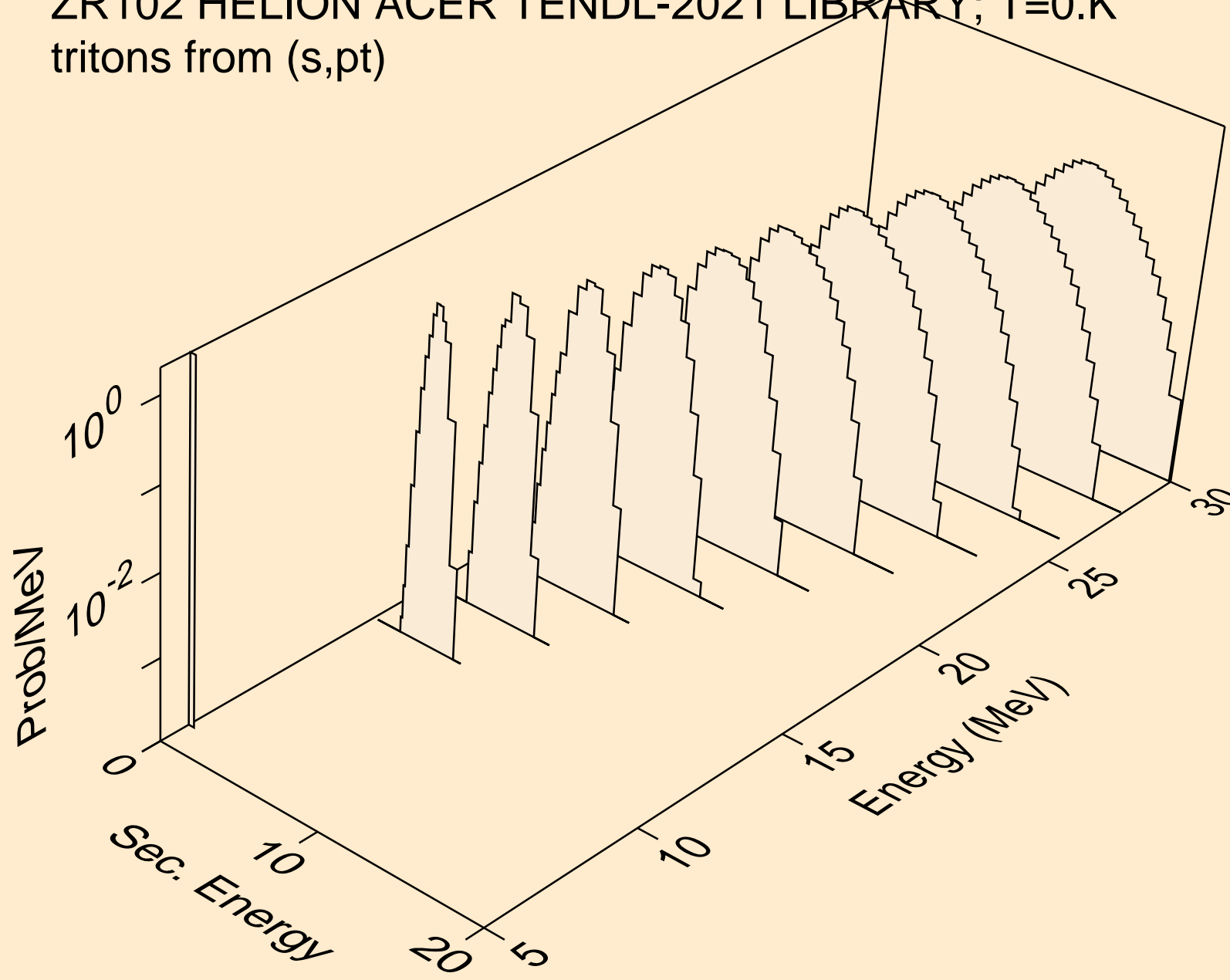

ZR102 HELION ACER TENDL-2021 LIBRARY; T=0.K  
alphas from (s,x)

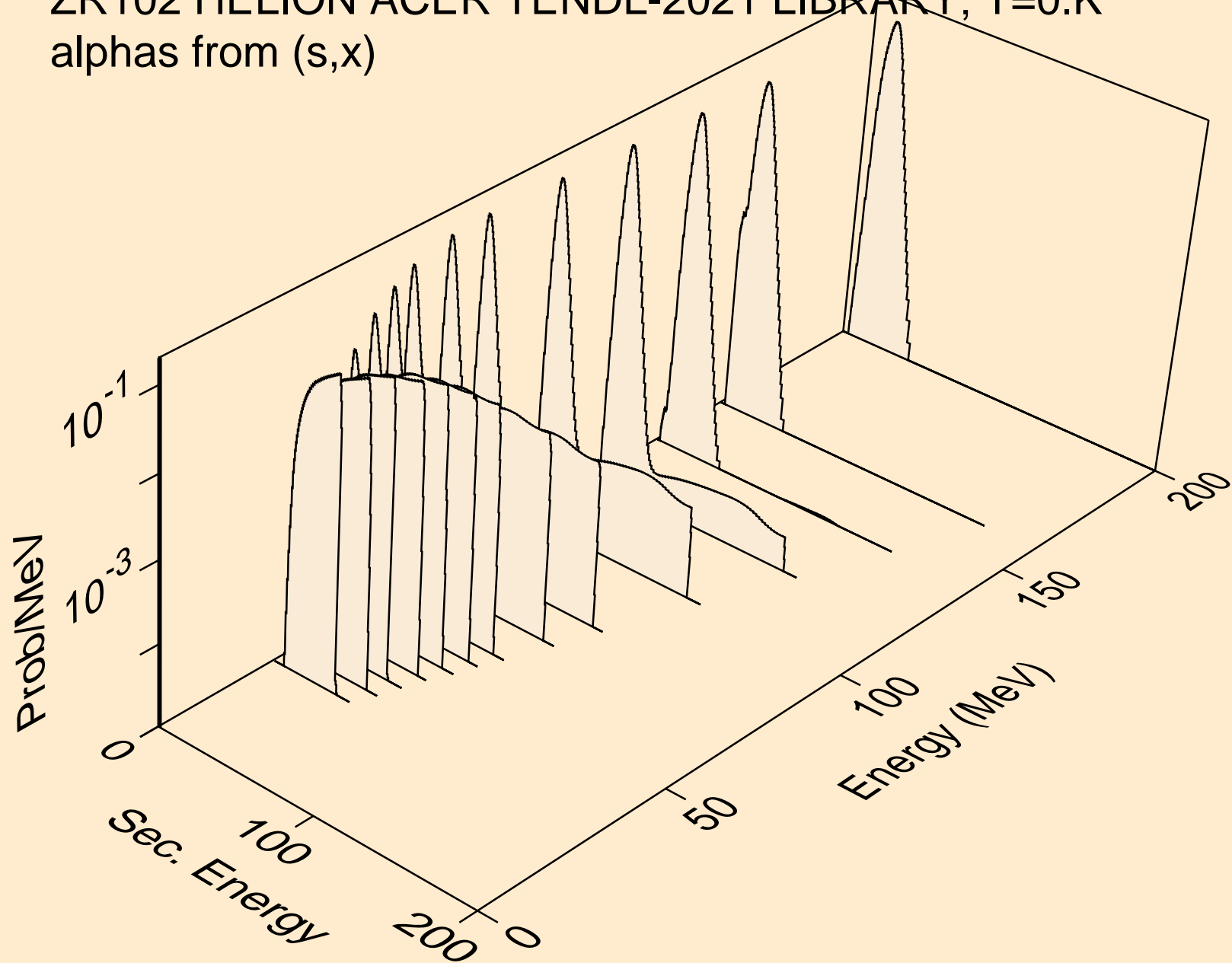

ZR102 HELION ACER TENDL-2021 LIBRARY; T=0.K  
alphas from (s,n\*)a

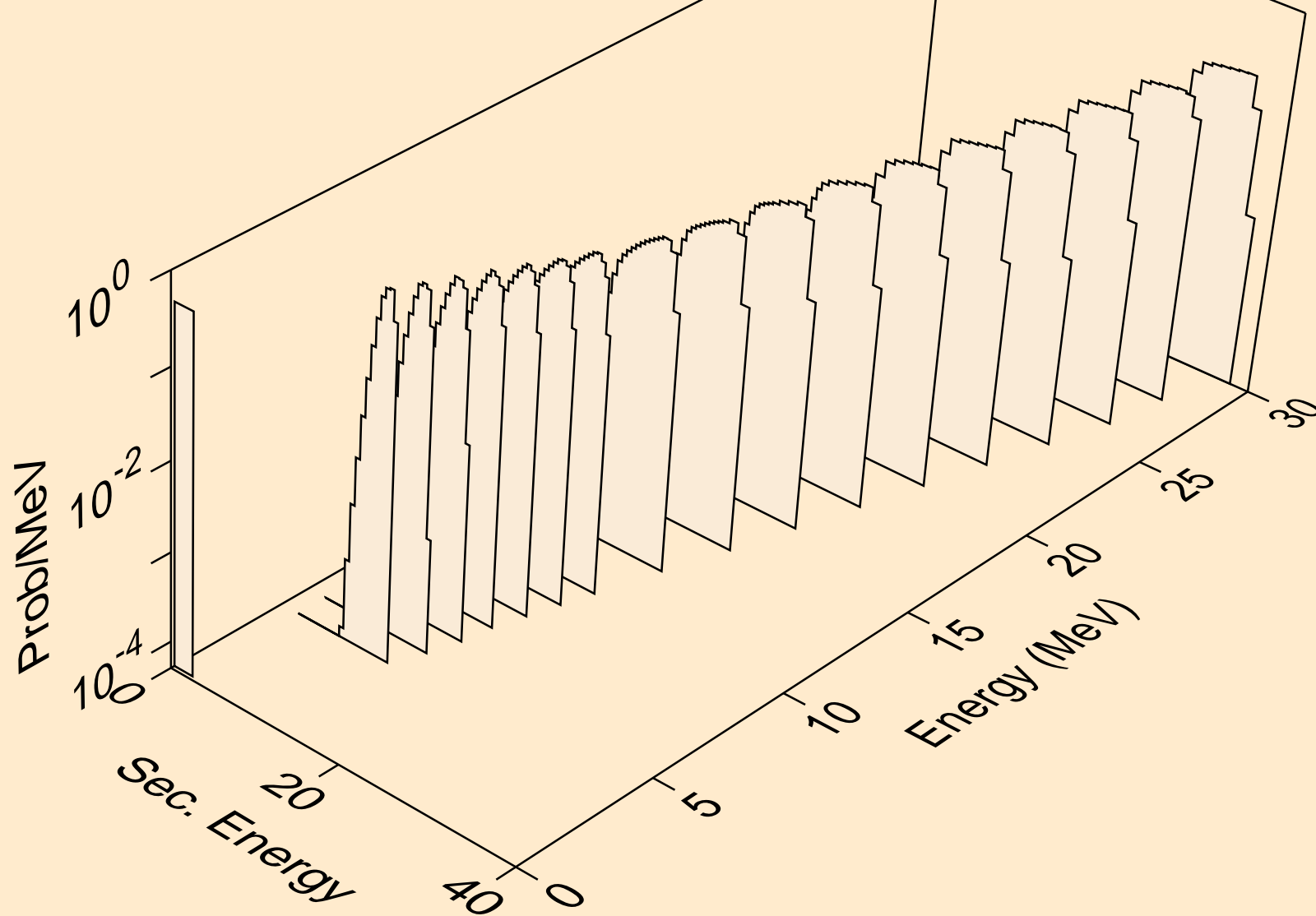

ZR102 HELION ACER TENDL-2021 LIBRARY; T=0.K  
alphas from (s,2n)a

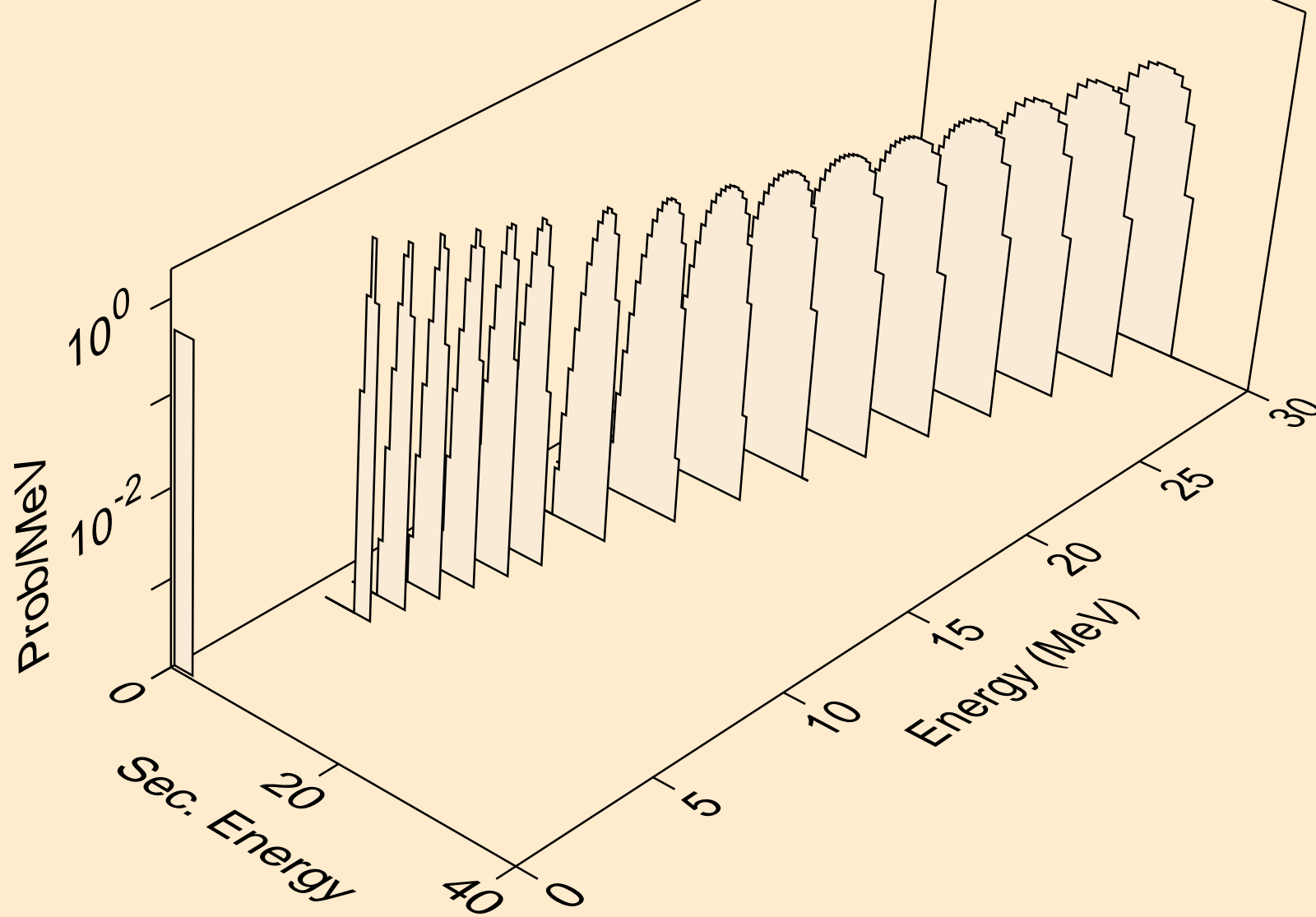

ZR102 HELION ACER TENDL-2021 LIBRARY; T=0.K  
alphas from (s,3n)a

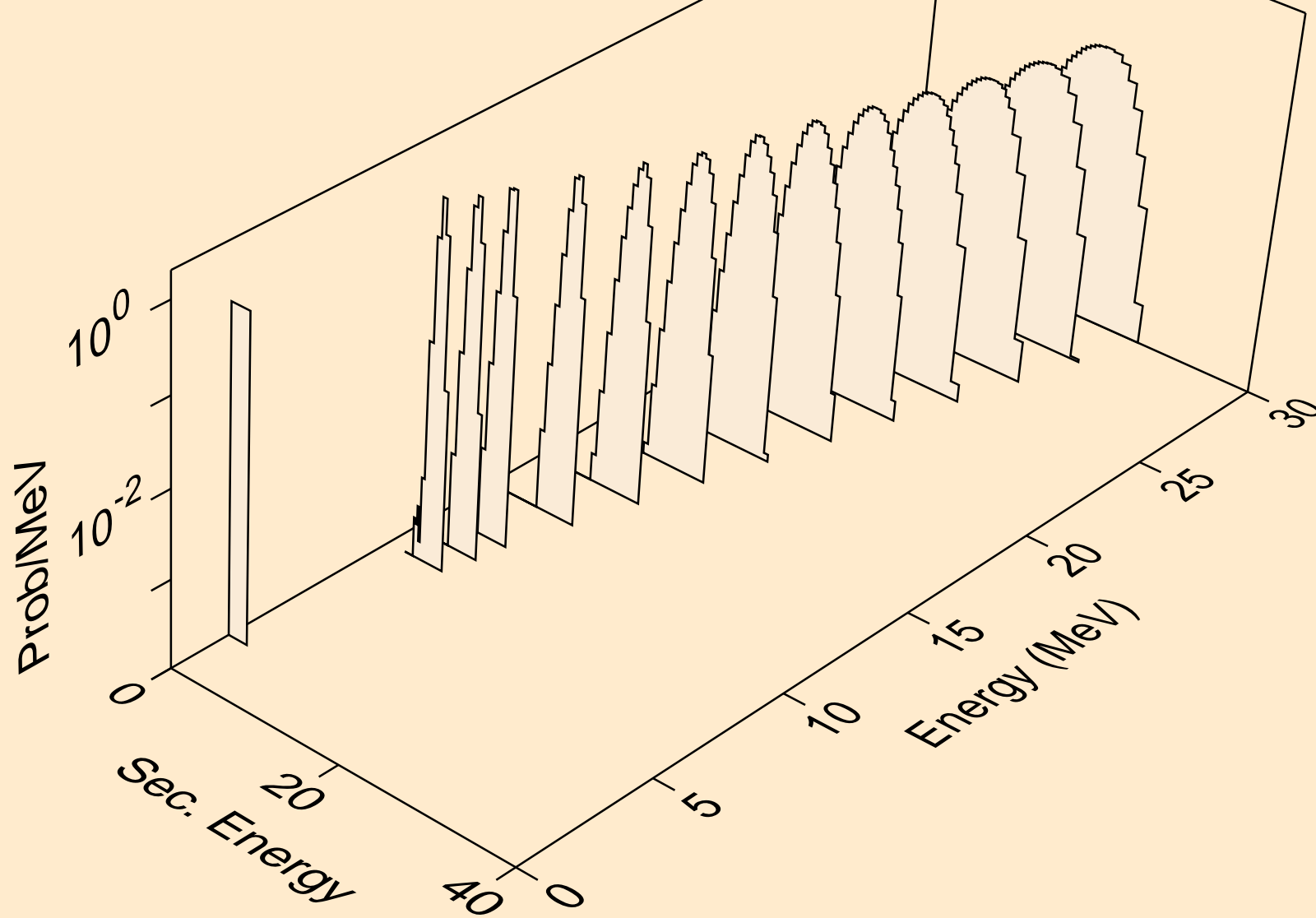

ZR102 HELION ACER TENDL-2021 LIBRARY; T=0.K  
alphas from (s,n\*)2a

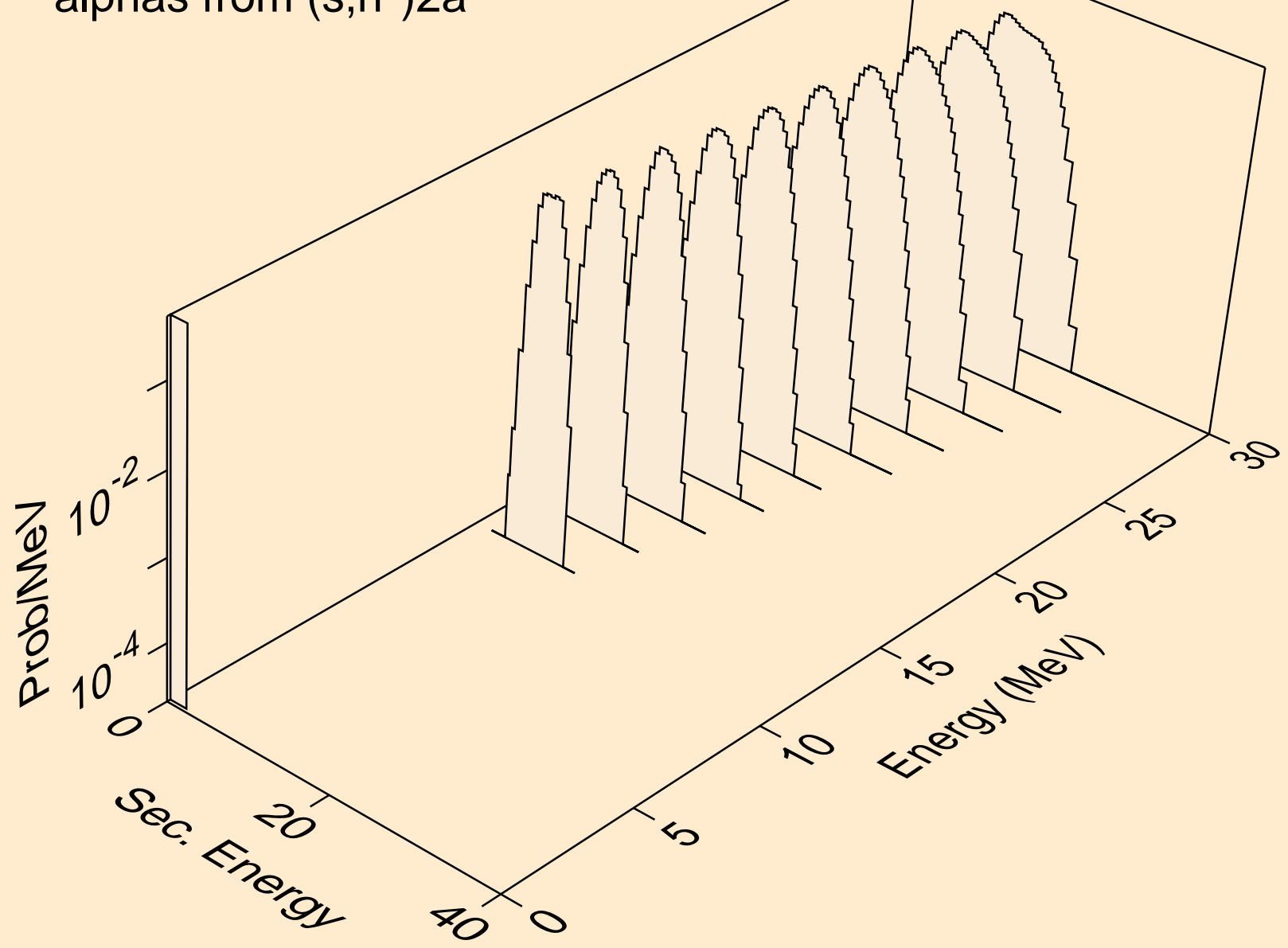

ZR102 HELION ACER TENDL-2021 LIBRARY; T=0.K  
alphas from (s,2n)2a

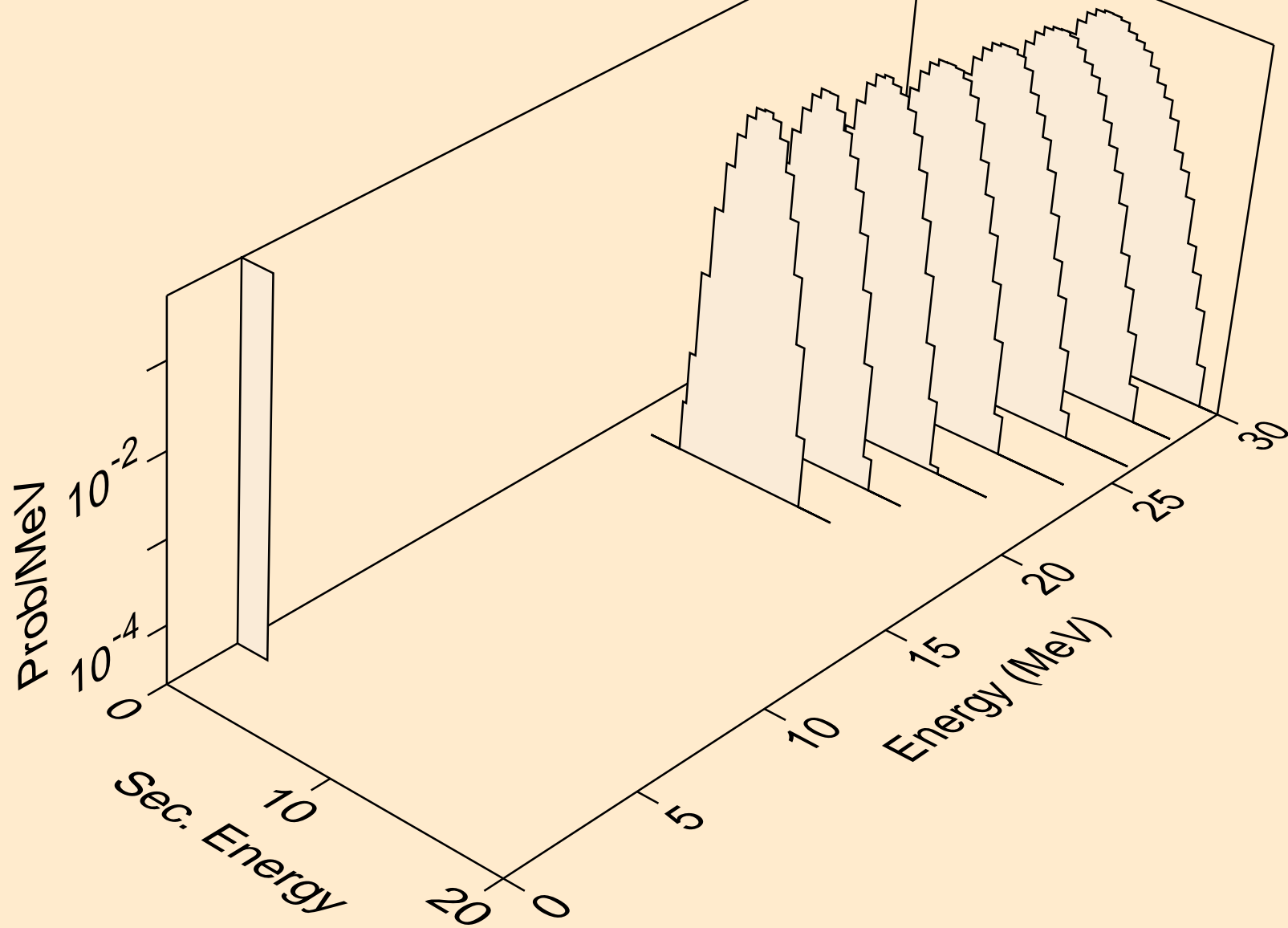

ZR102 HELION ACER TENDL-2021 LIBRARY; T=0.K  
alphas from (s,npa)

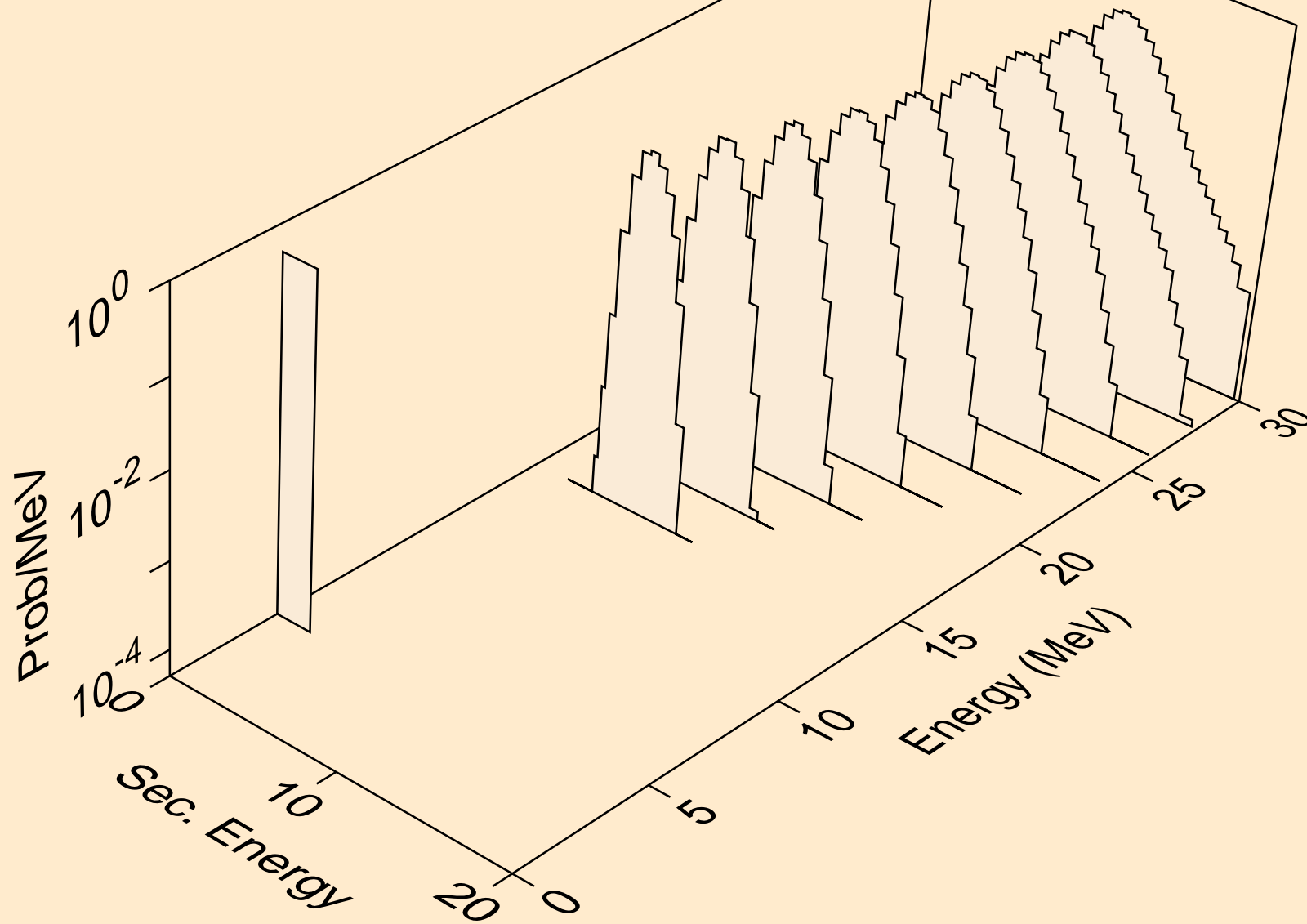



ZR102 HELION ACER TENDL-2021 LIBRARY; T=0.K  
alphas from (s,a)

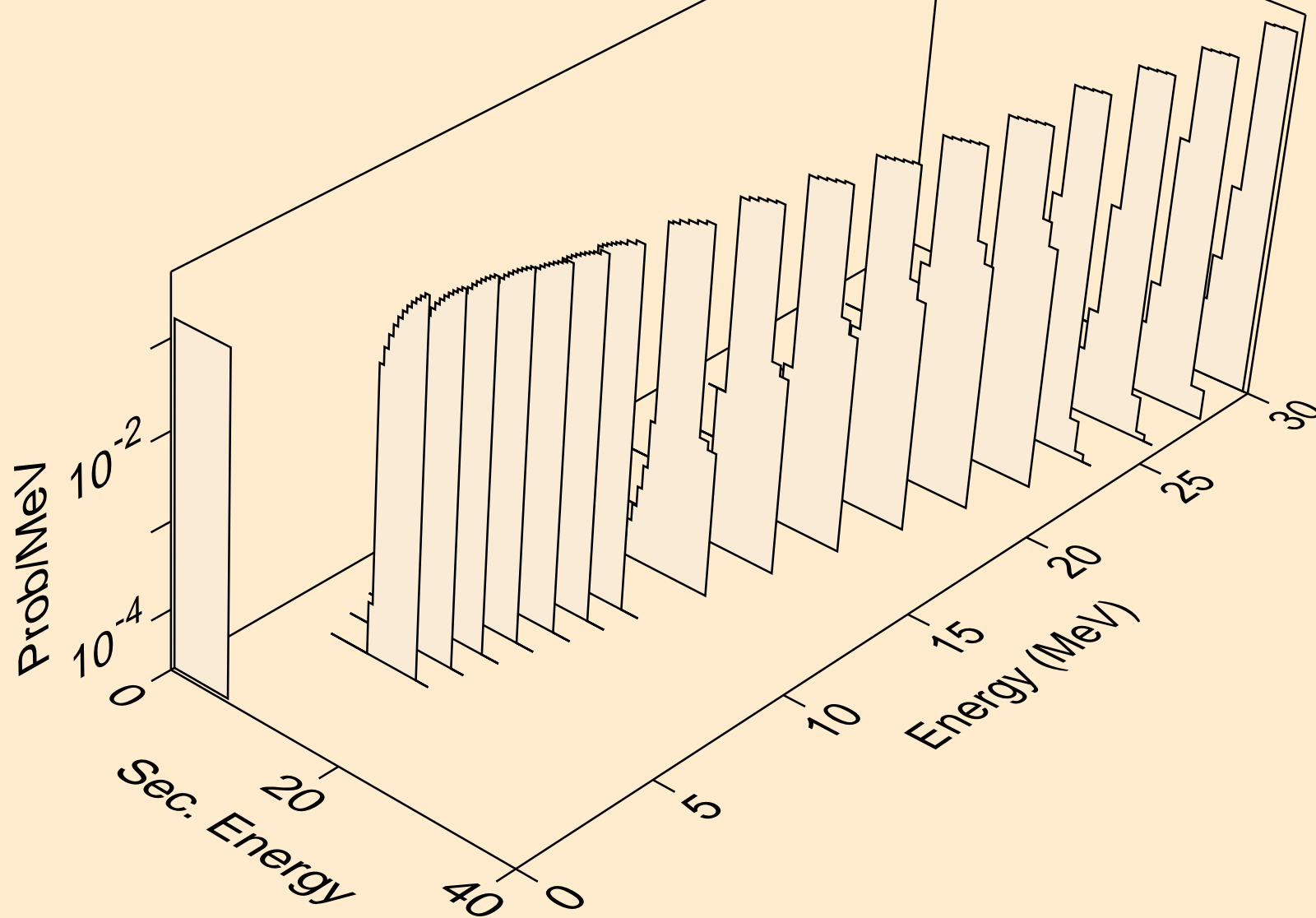

ZR102 HELION ACER TENDL-2021 LIBRARY; T=0.K  
alphas from (s,pa)

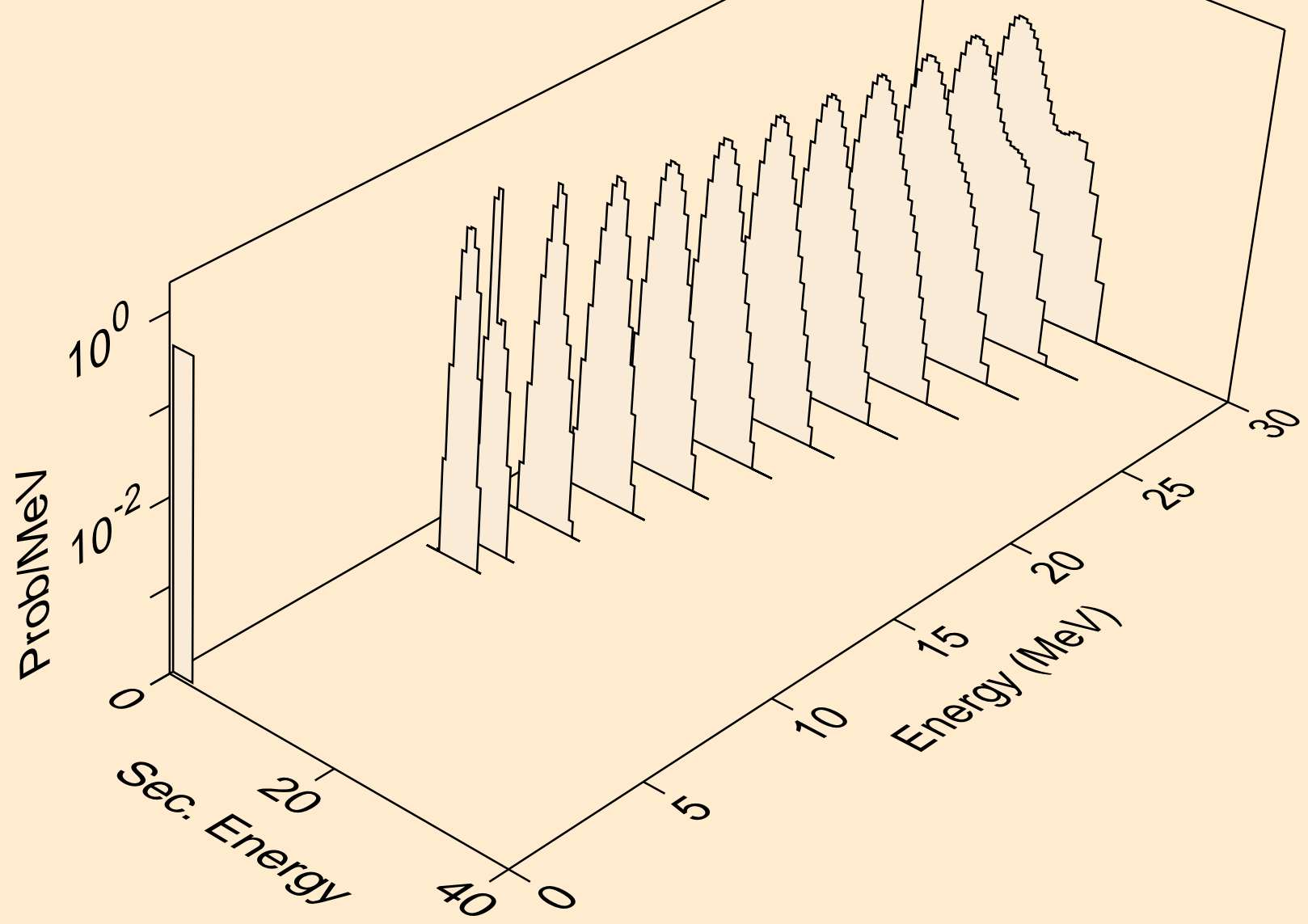

ZR102 HELION ACER TENDL-2021 LIBRARY; T=0.K  
alphas from (s,da)

