

AC230 NEUTRON ACER TENDL-2021 LIBRARY; T=293.6K
Principal cross sections

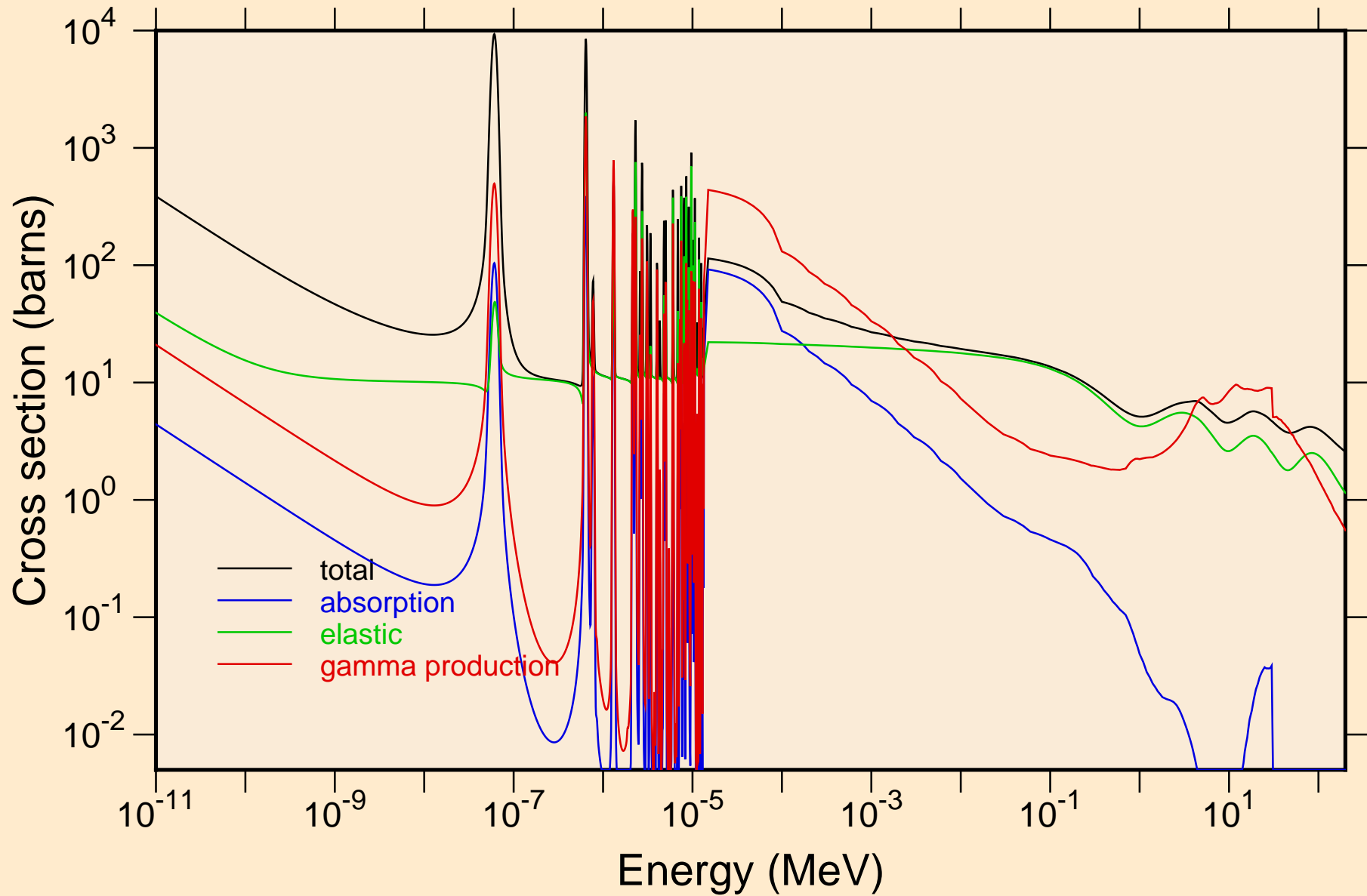

AC230 NEUTRON ACER TENDL-2021 LIBRARY; T=293.6K
resonance total cross section

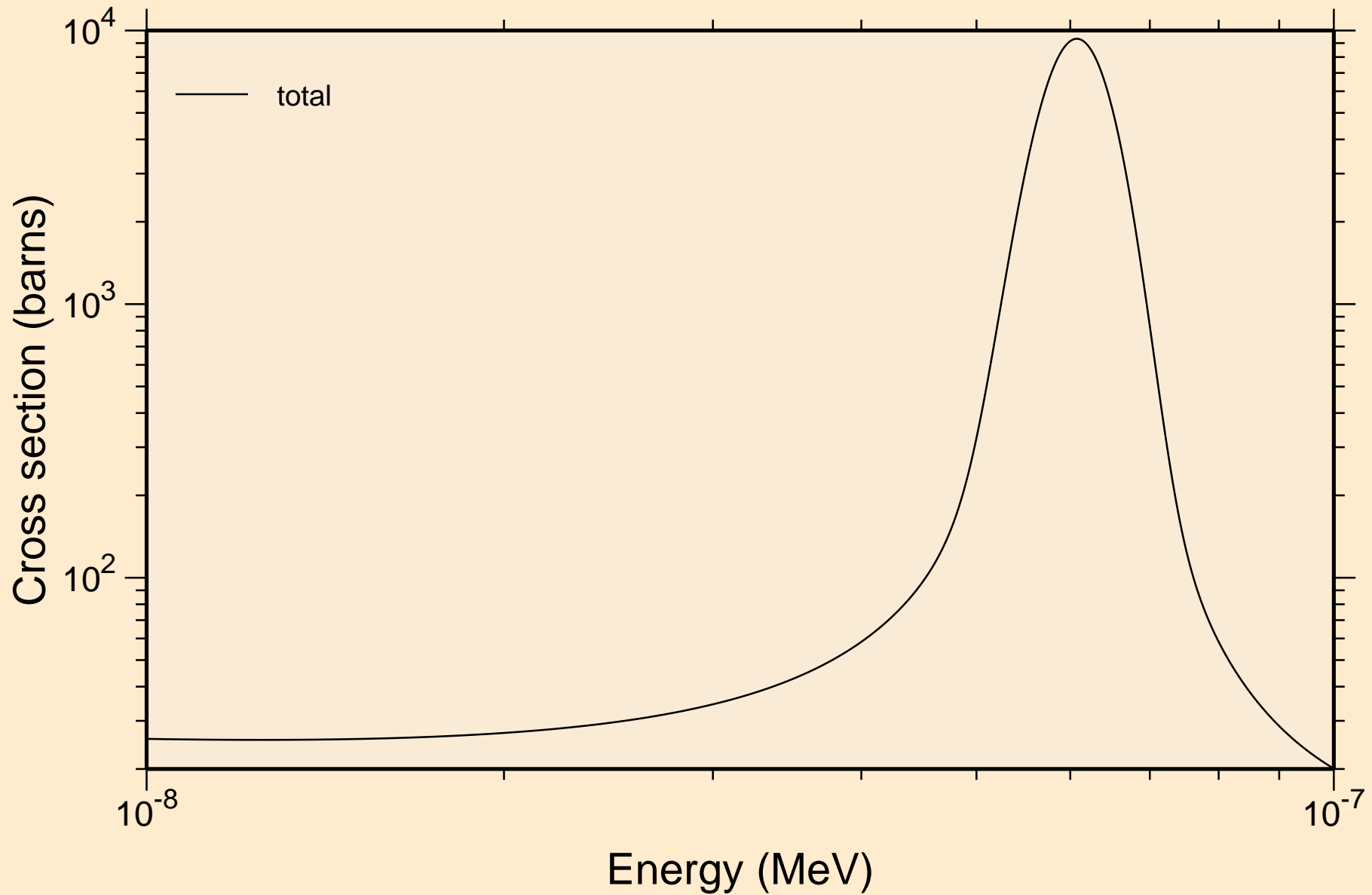

AC230 NEUTRON ACER TENDL-2021 LIBRARY; T=293.6K
resonance total cross section

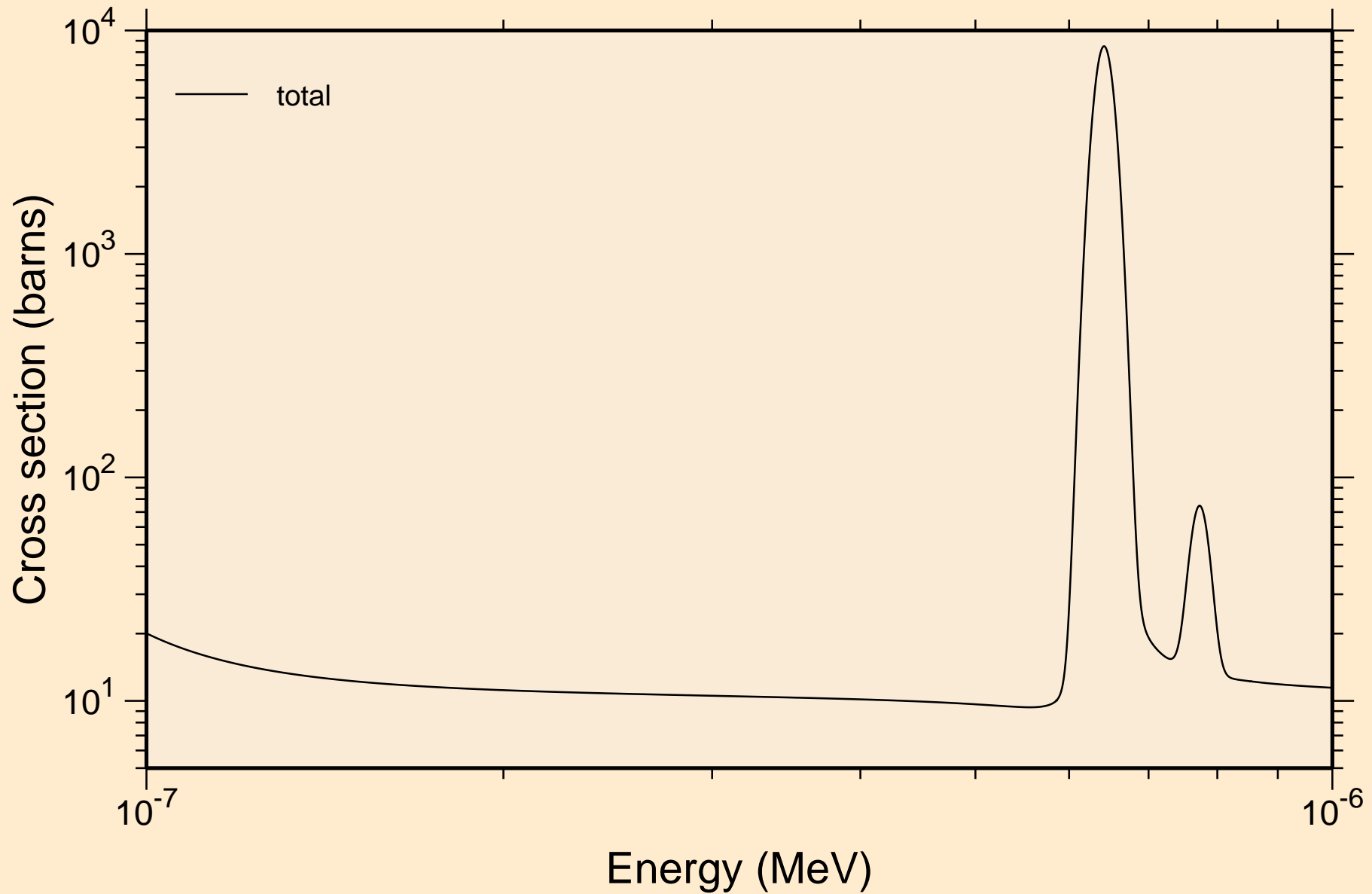

AC230 NEUTRON ACER TENDL-2021 LIBRARY; T=293.6K
resonance total cross section

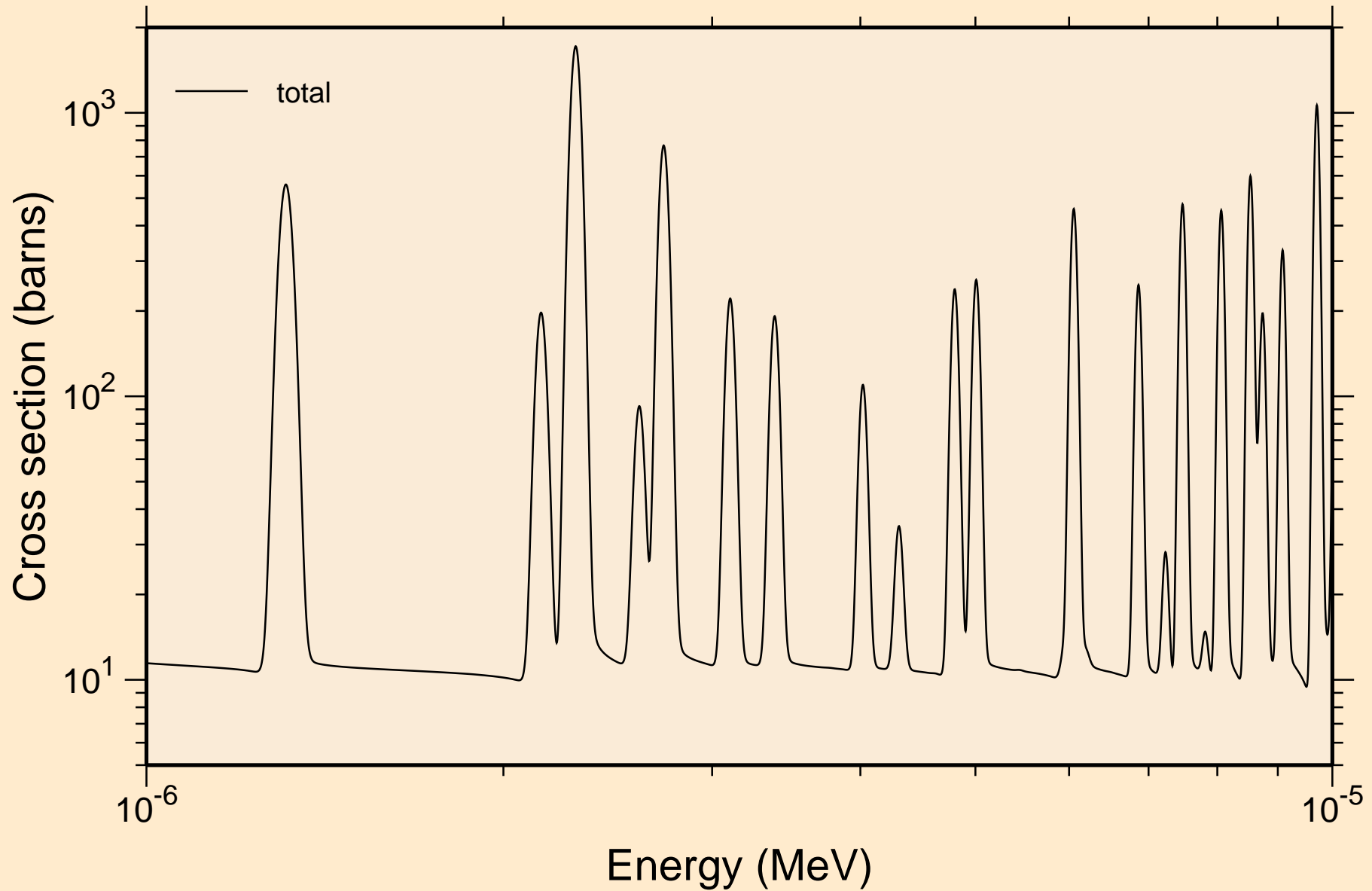

AC230 NEUTRON ACER TENDL-2021 LIBRARY; T=293.6K
resonance total cross section

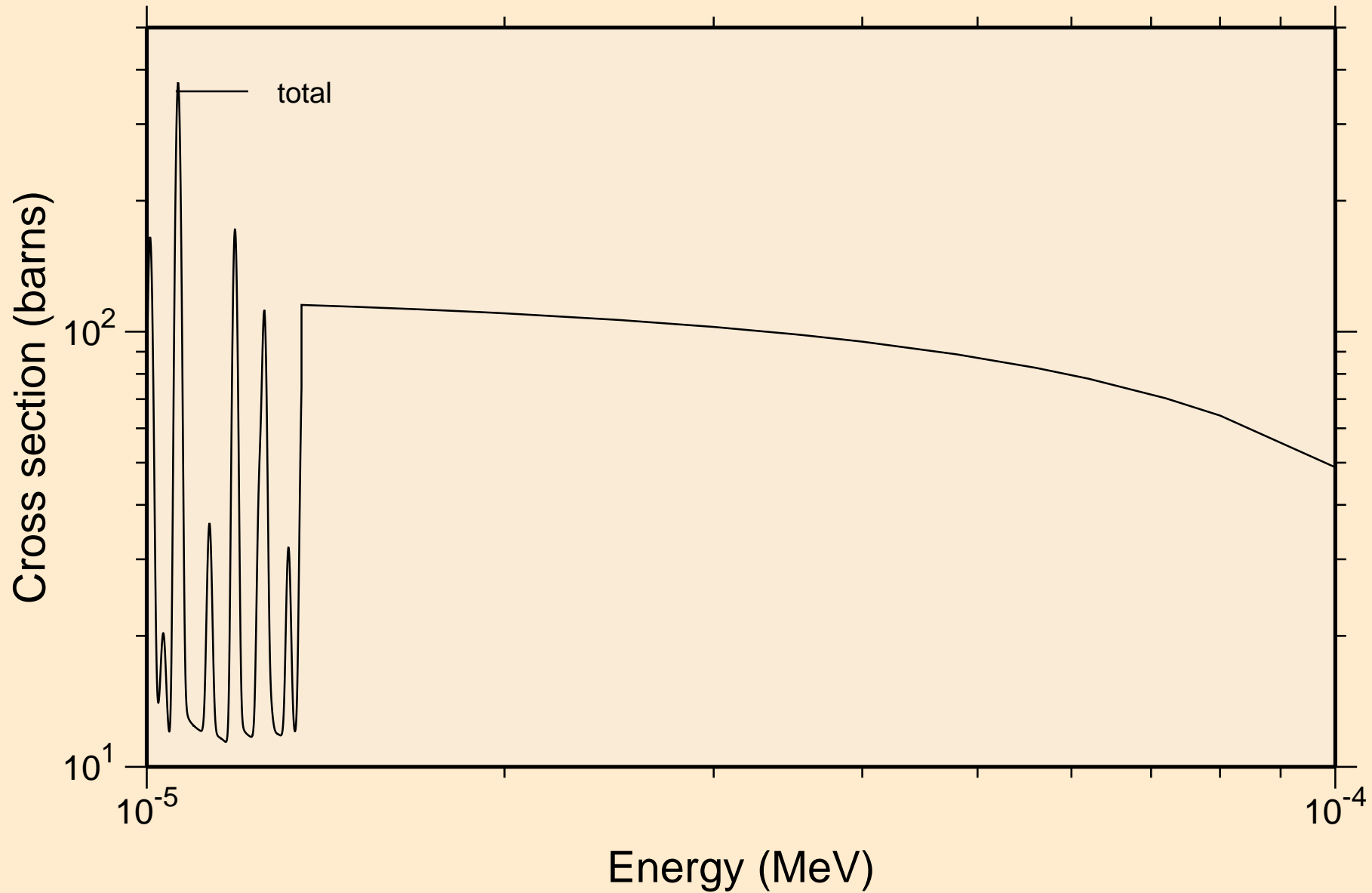

AC230 NEUTRON ACER TENDL-2021 LIBRARY; T=293.6K
resonance total cross section

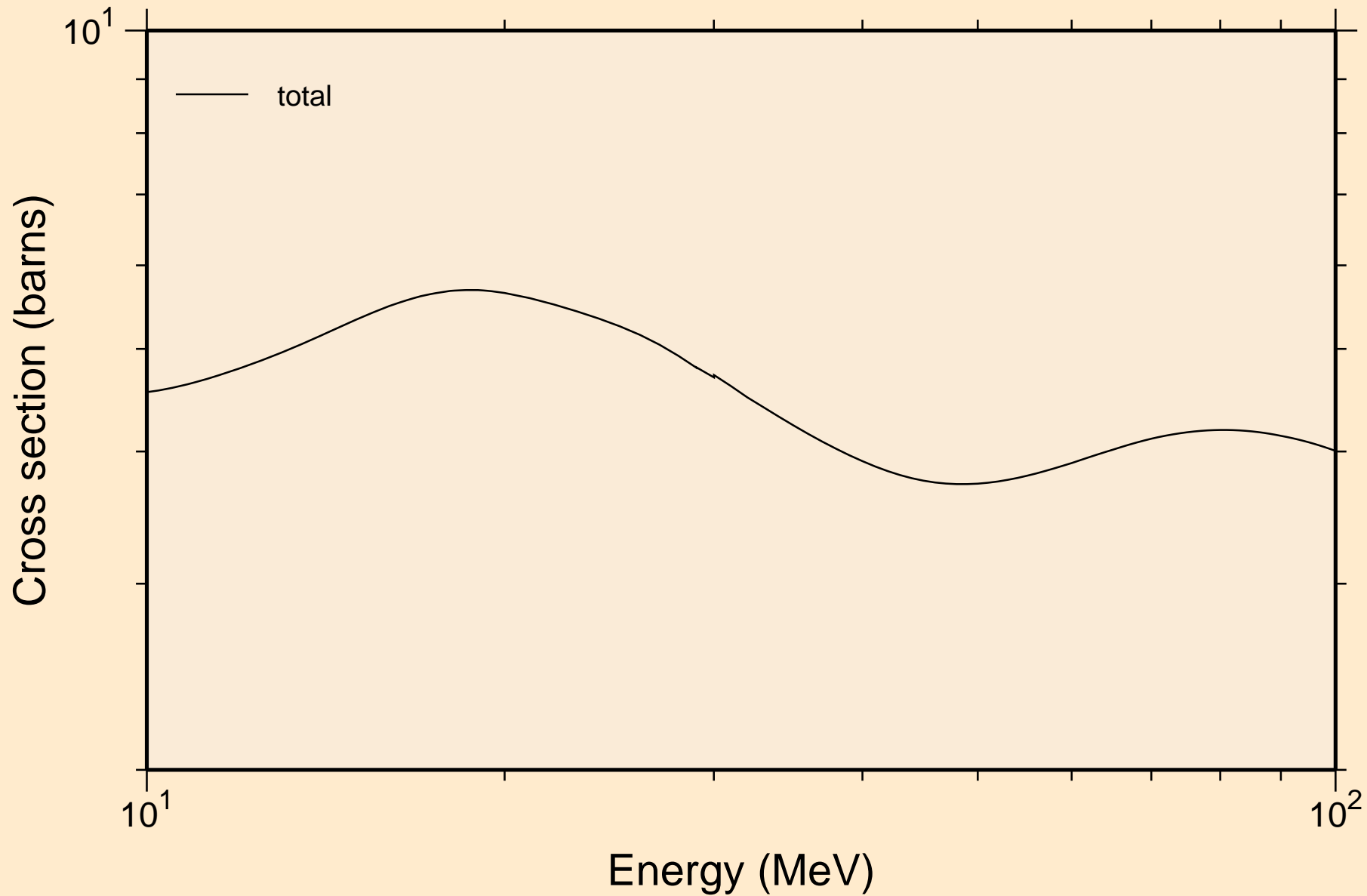

AC230 NEUTRON ACER TENDL-2021 LIBRARY; T=293.6K
resonance absorption cross sections

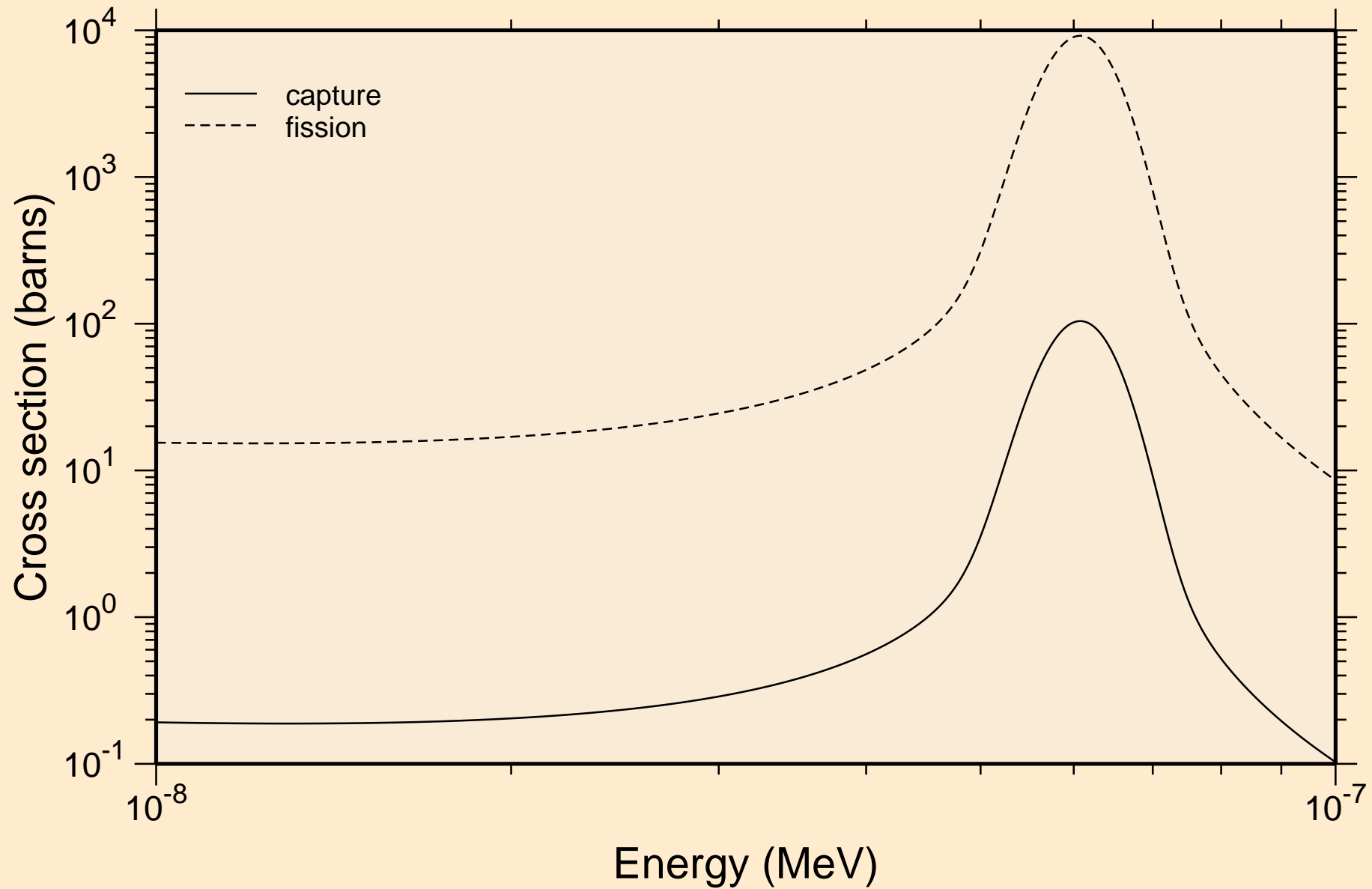

AC230 NEUTRON ACER TENDL-2021 LIBRARY; T=293.6K
resonance absorption cross sections

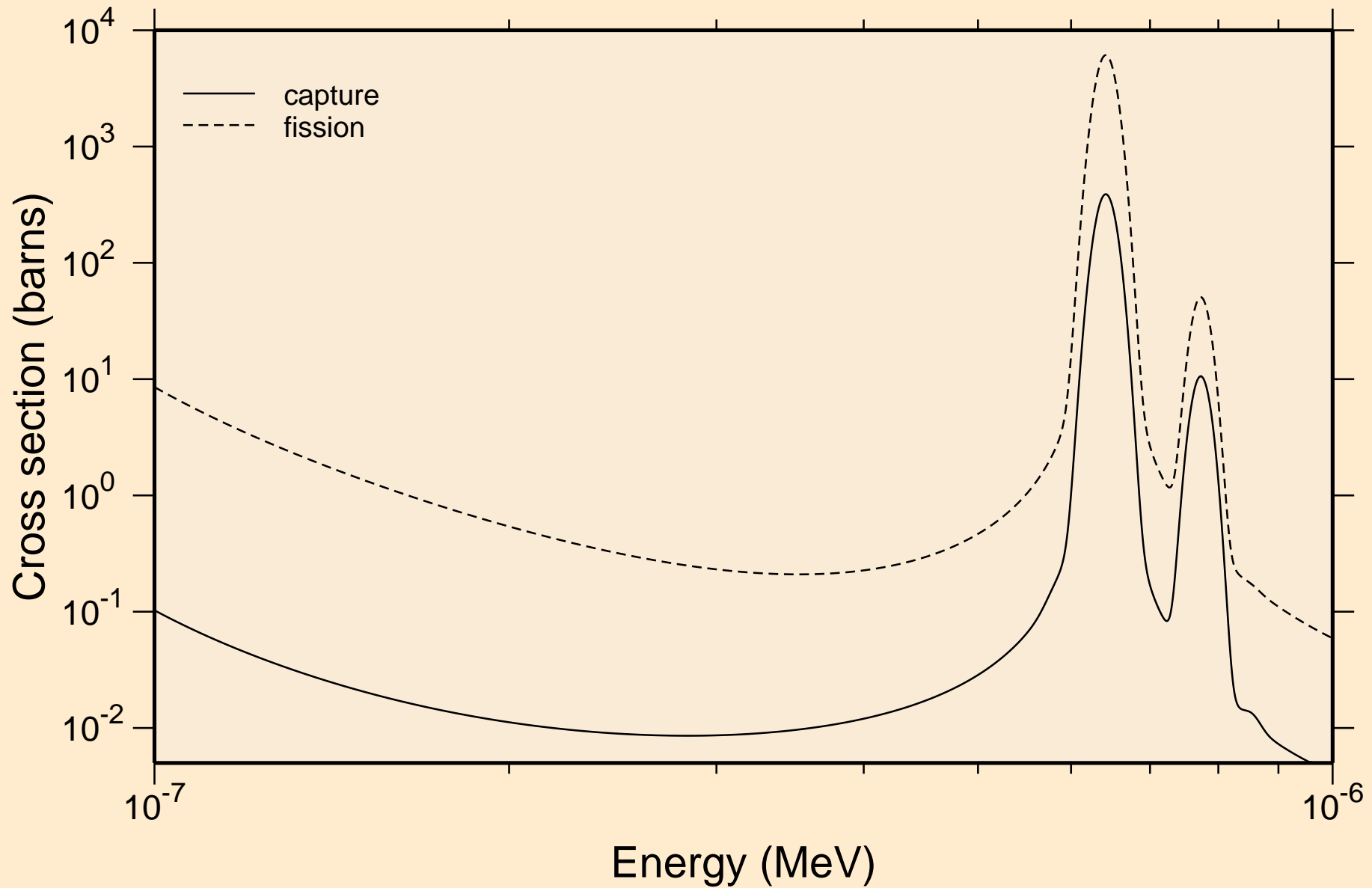

AC230 NEUTRON ACER TENDL-2021 LIBRARY; T=293.6K
resonance absorption cross sections

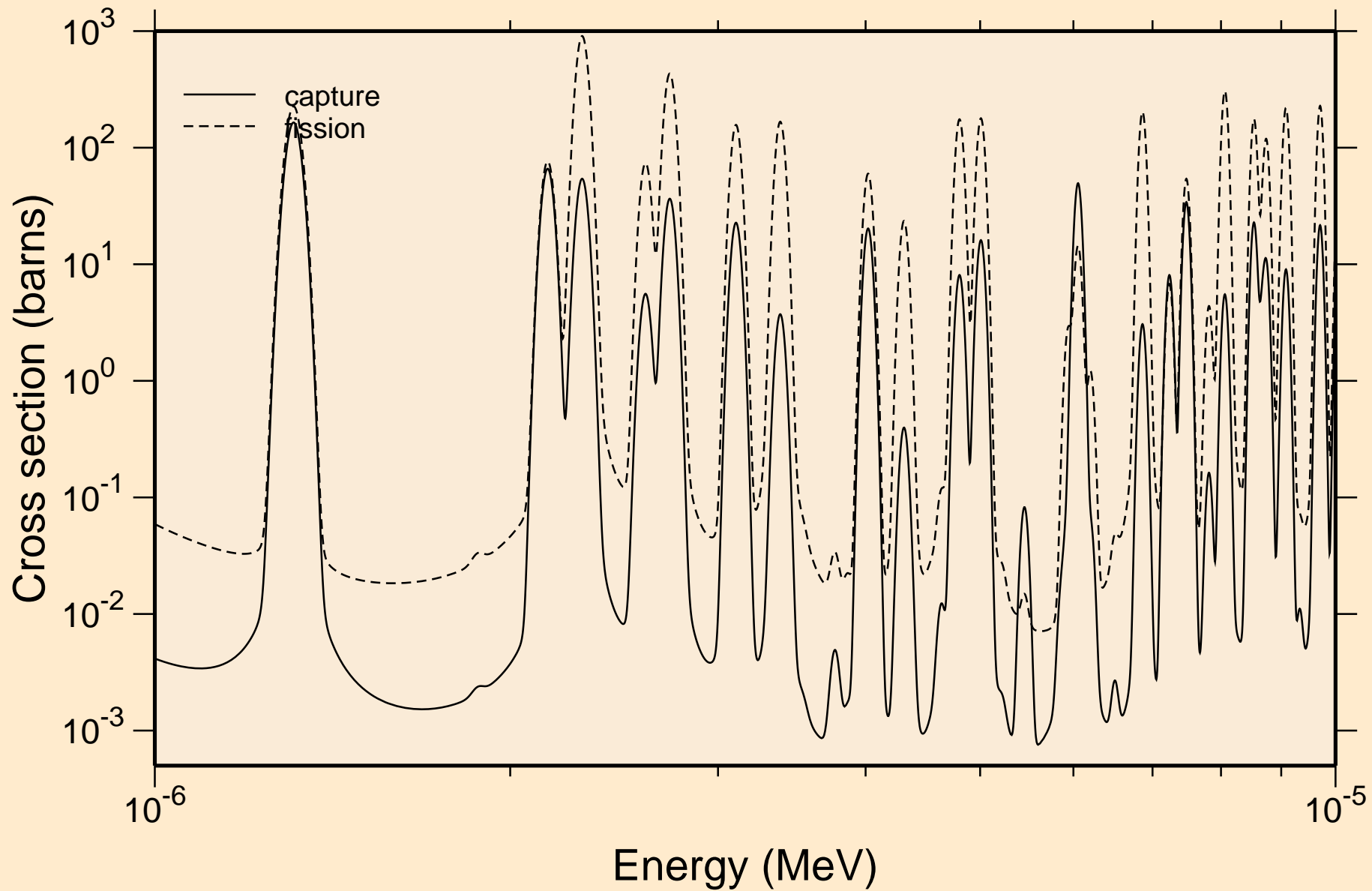

AC230 NEUTRON ACER TENDL-2021 LIBRARY; T=293.6K
resonance absorption cross sections

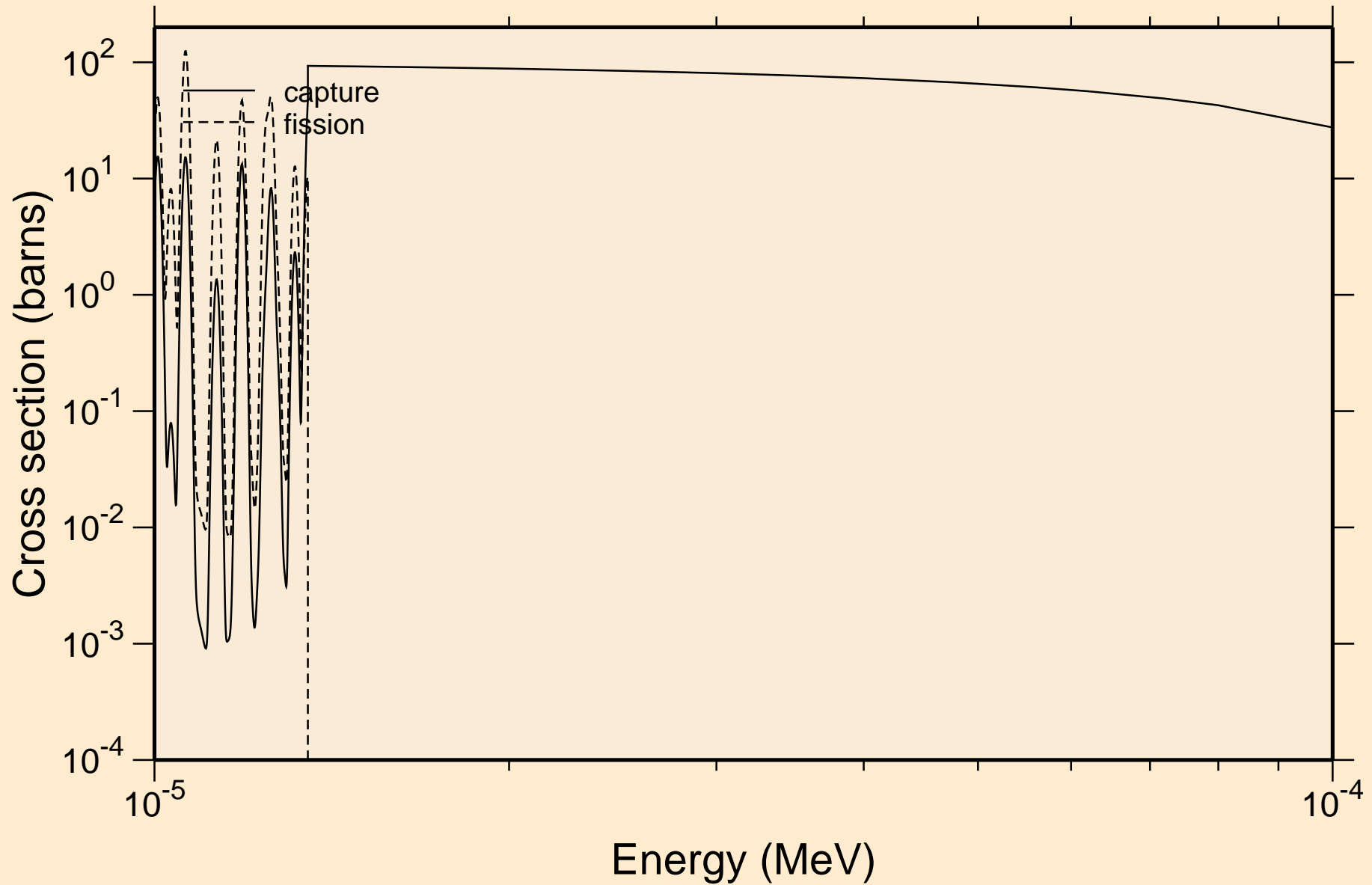

AC230 NEUTRON ACER TENDL-2021 LIBRARY; T=293.6K
resonance absorption cross sections

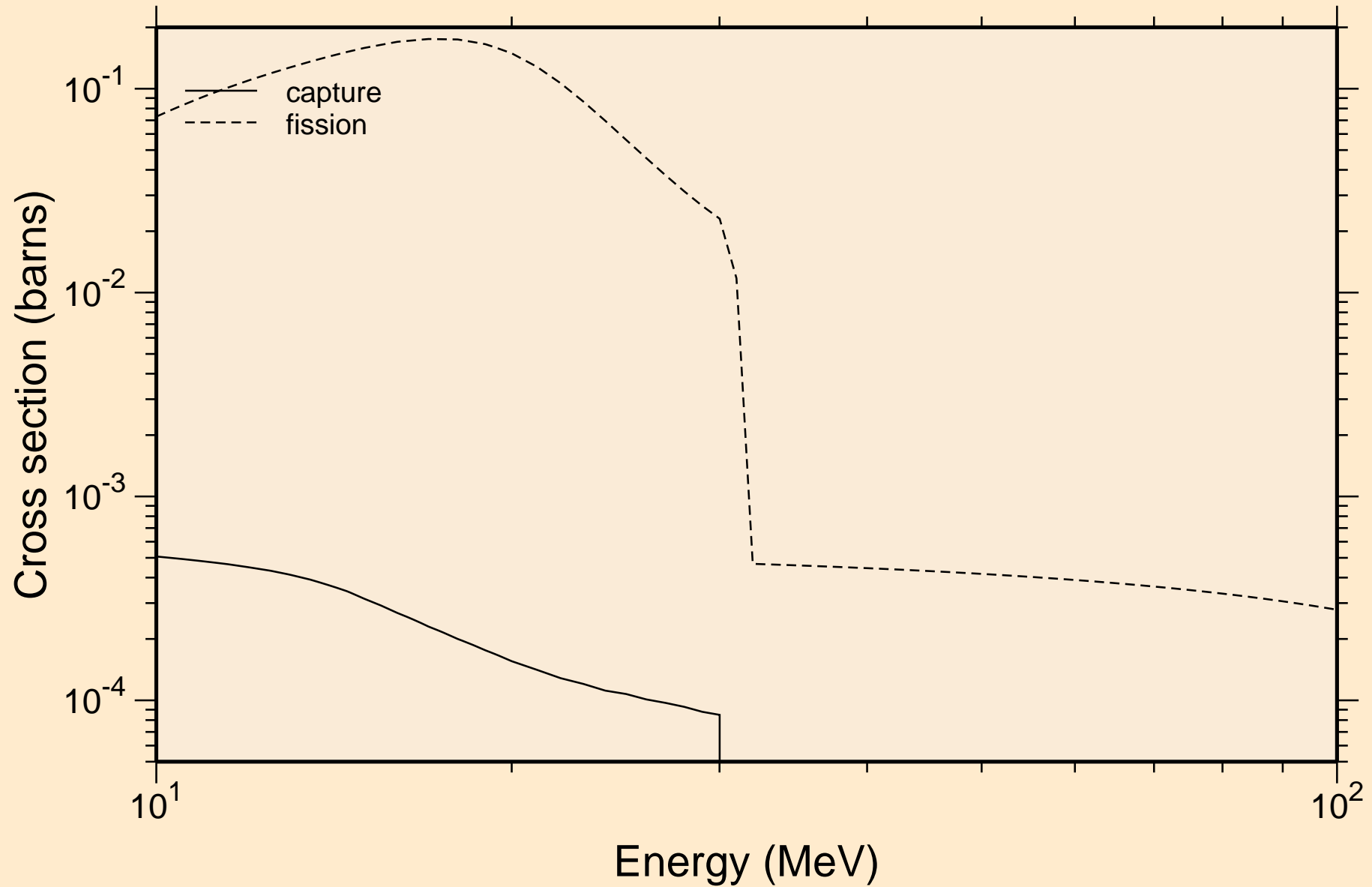

AC230 NEUTRON ACER TENDL-2021 LIBRARY; T=293.6K
Heating

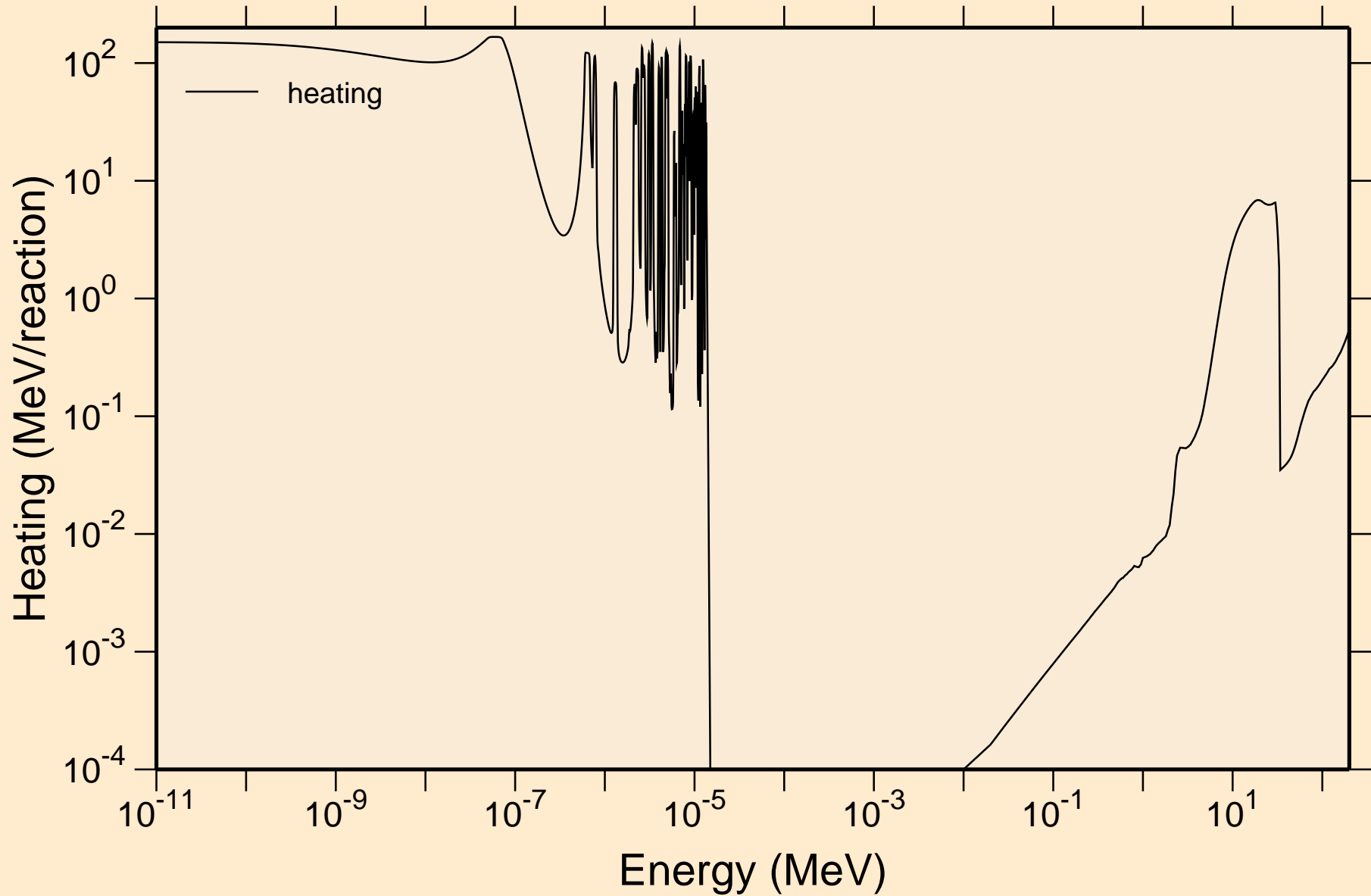

AC230 NEUTRON ACER TENDL-2021 LIBRARY; T=293.6K
Damage

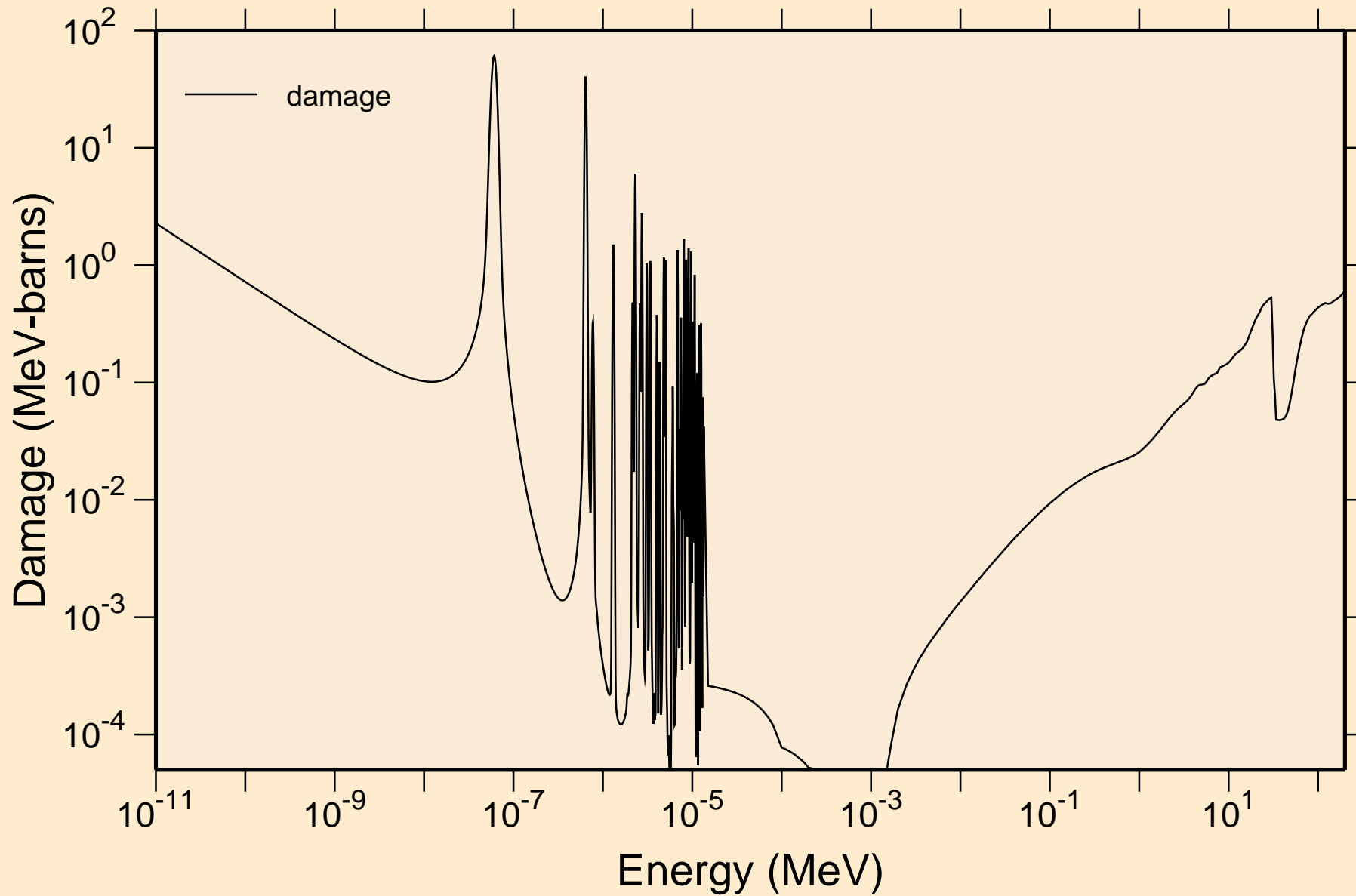

AC230 NEUTRON ACER TENDL-2021 LIBRARY; T=293.6K
Non-threshold reactions

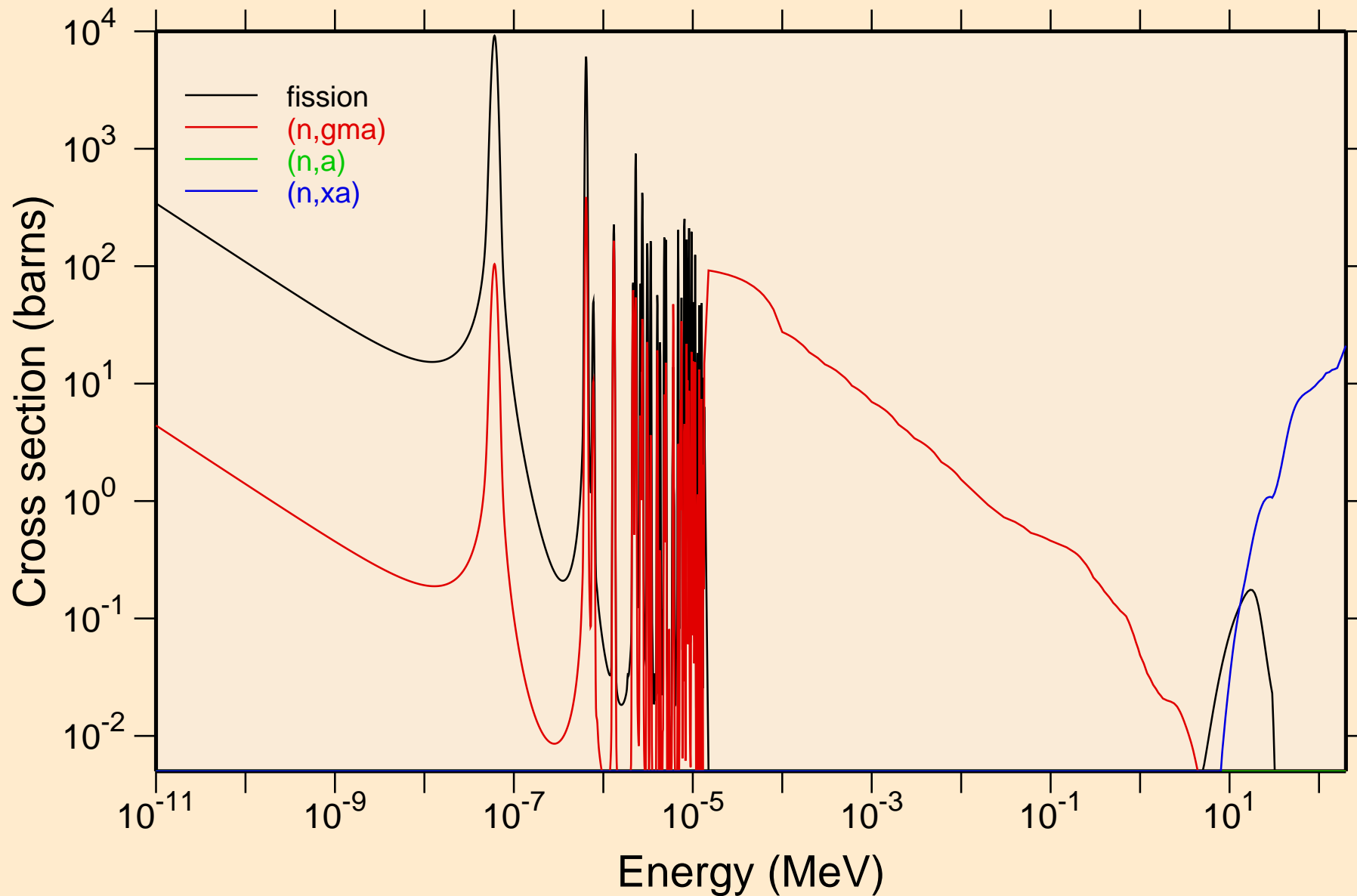

AC230 NEUTRON ACER TENDL-2021 LIBRARY; T=293.6K
Principal cross sections

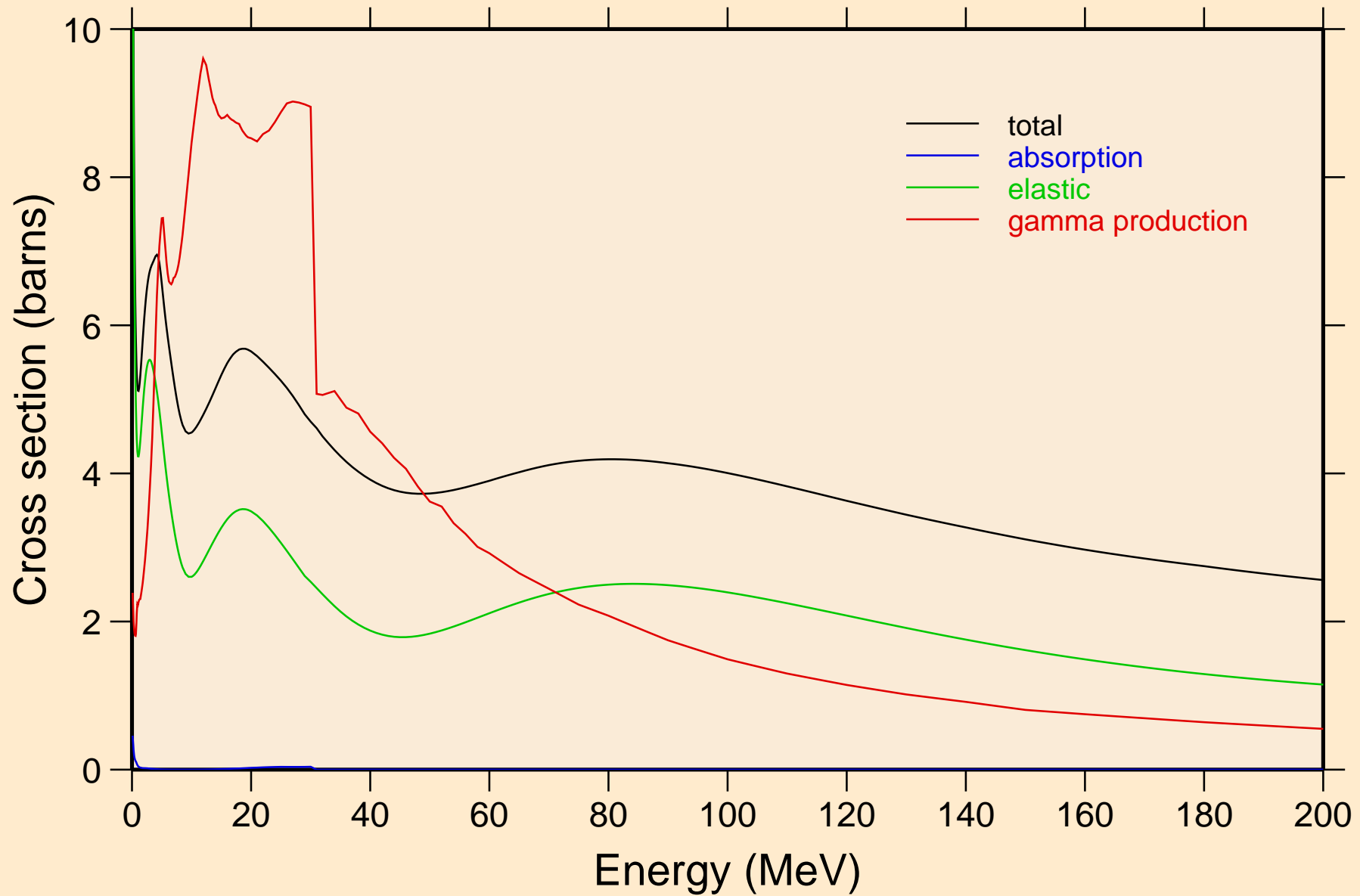

AC230 NEUTRON ACER TENDL-2021 LIBRARY; T=293.6K
Heating

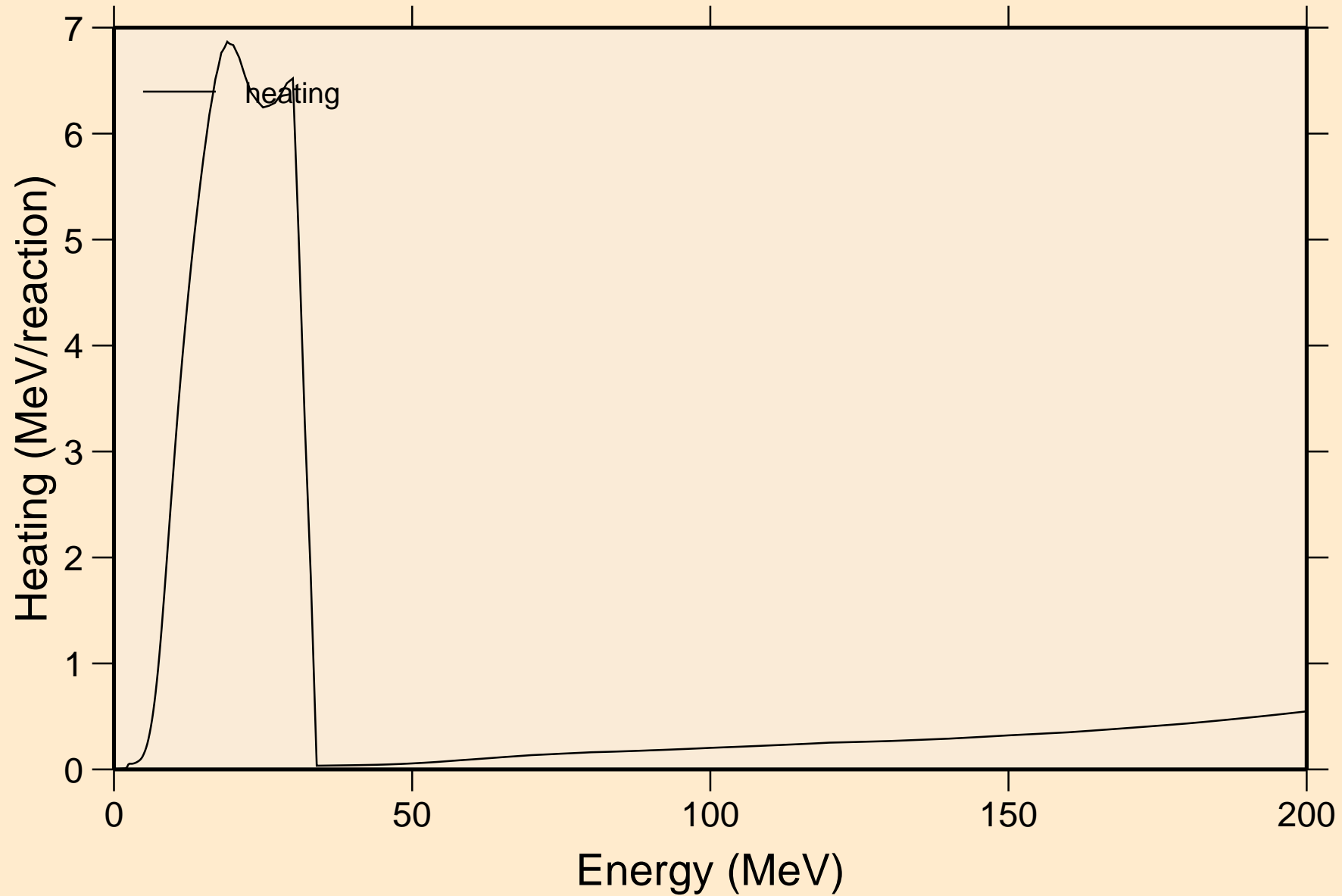

AC230 NEUTRON ACER TENDL-2021 LIBRARY; T=293.6K
Damage

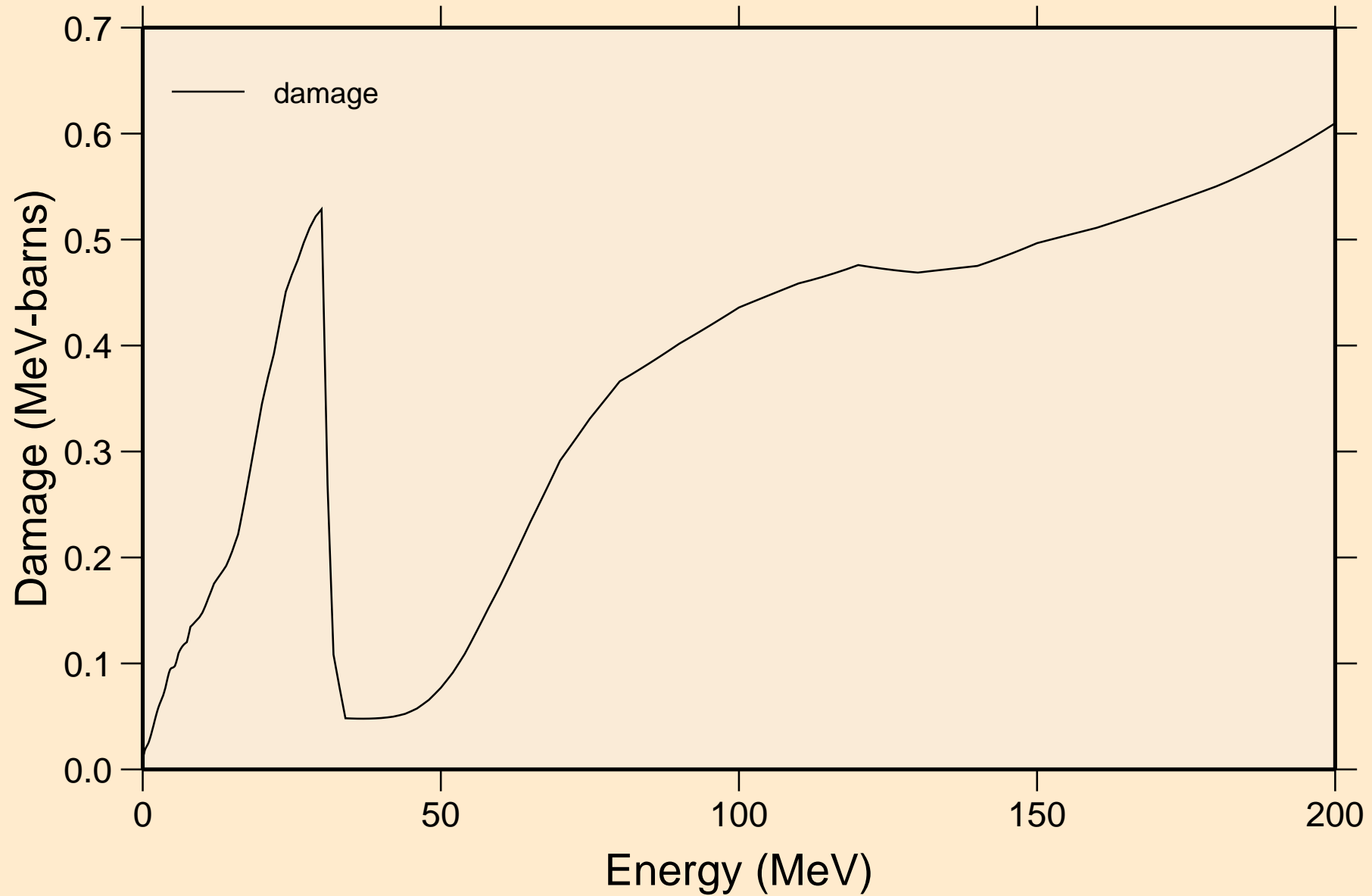

AC230 NEUTRON ACER TENDL-2021 LIBRARY; T=293.6K
Non-threshold reactions

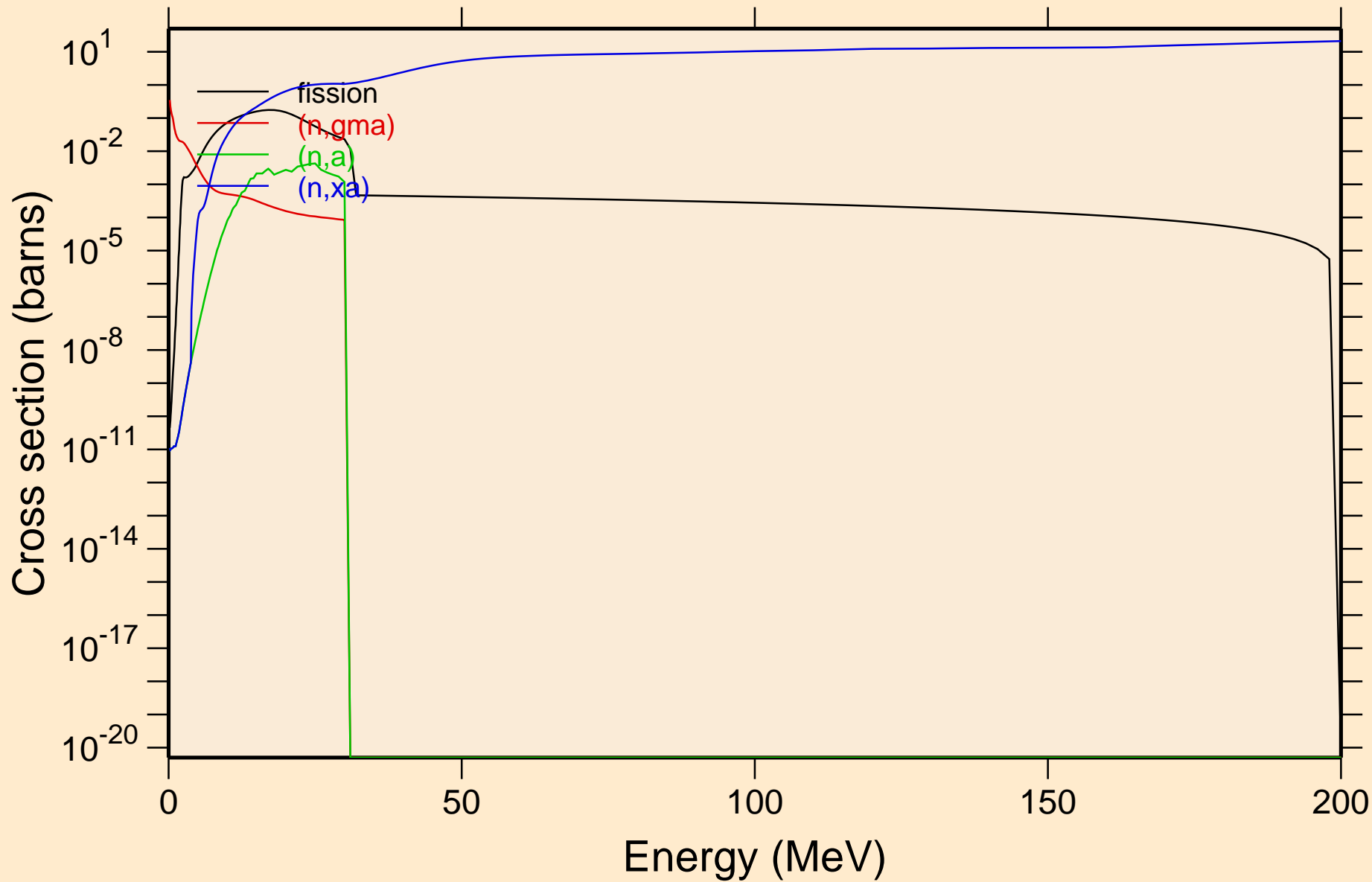

AC230 NEUTRON ACER TENDL-2021 LIBRARY; T=293.6K
Inelastic levels

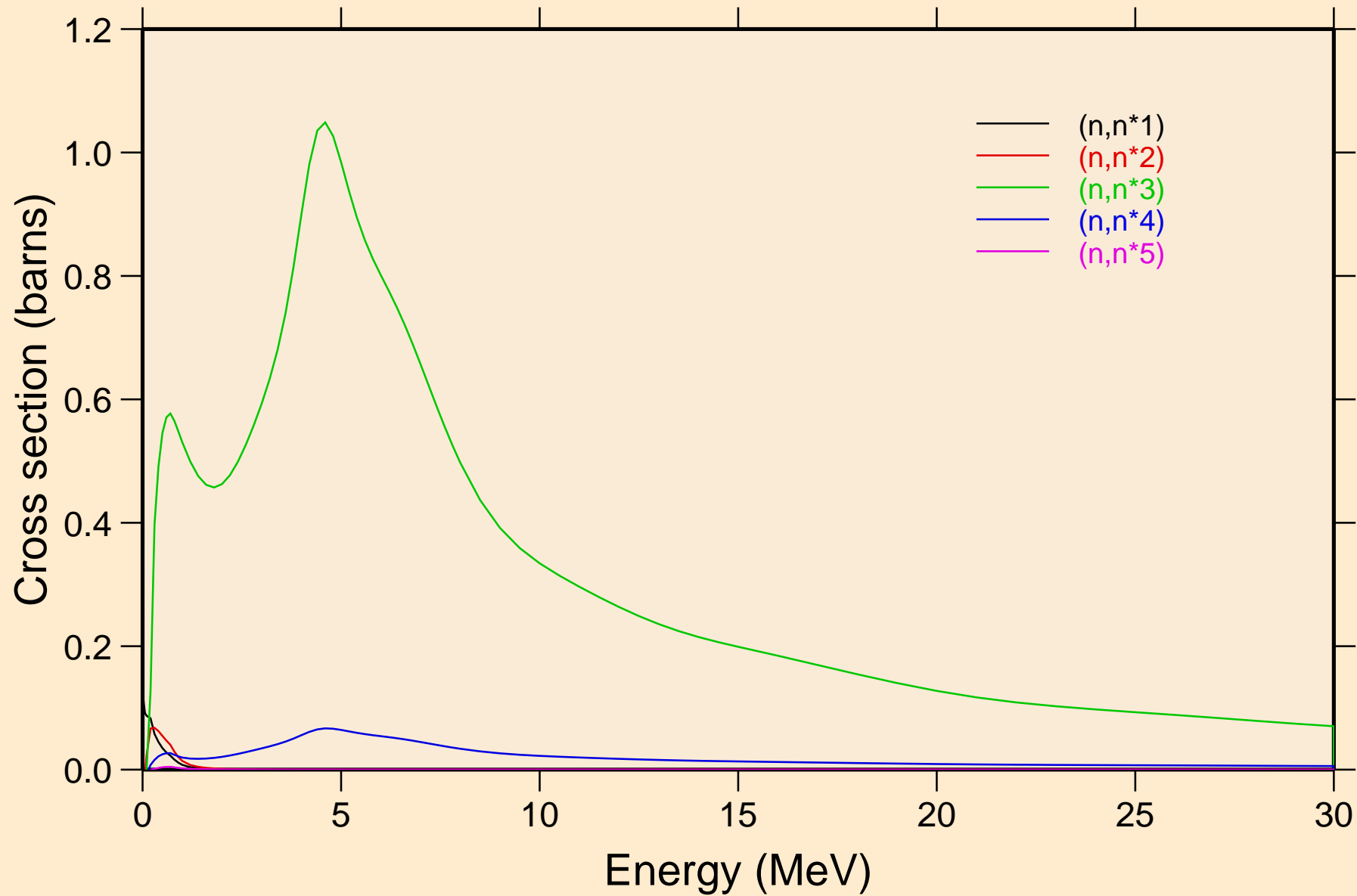

AC230 NEUTRON ACER TENDL-2021 LIBRARY; T=293.6K
Inelastic levels

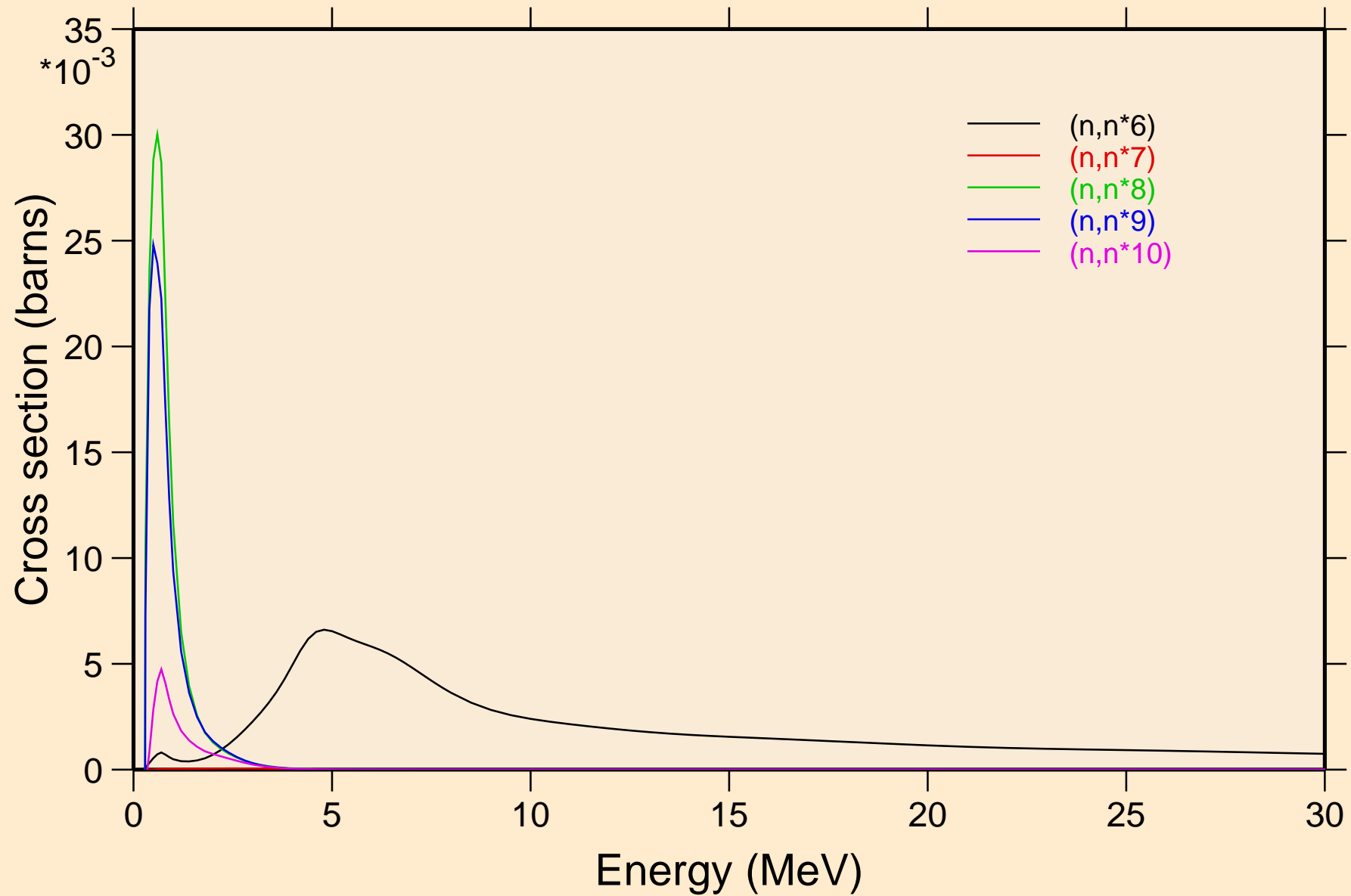

AC230 NEUTRON ACER TENDL-2021 LIBRARY; T=293.6K
Inelastic levels

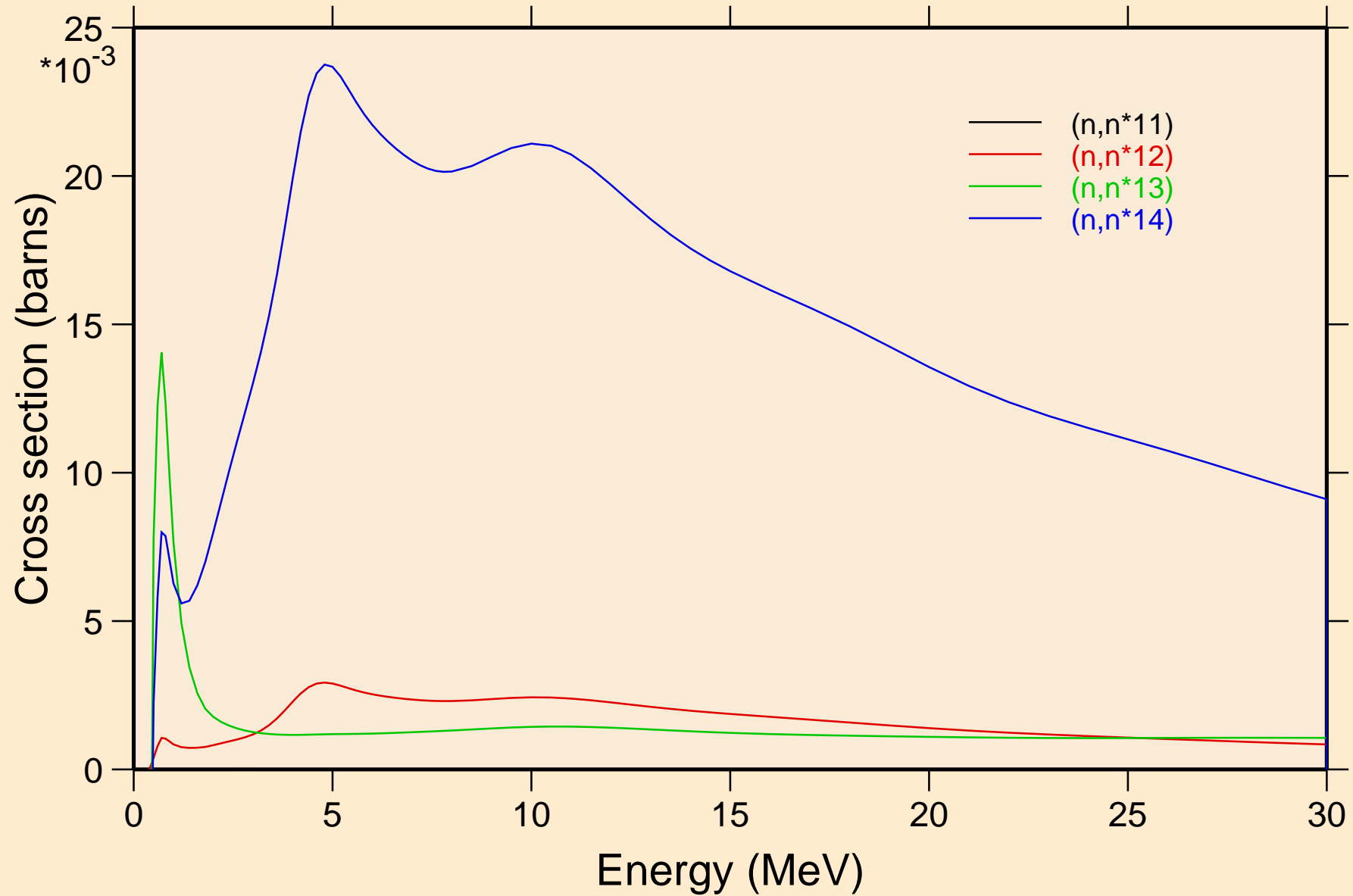

AC230 NEUTRON ACER TENDL-2021 LIBRARY; T=293.6K
Threshold reactions

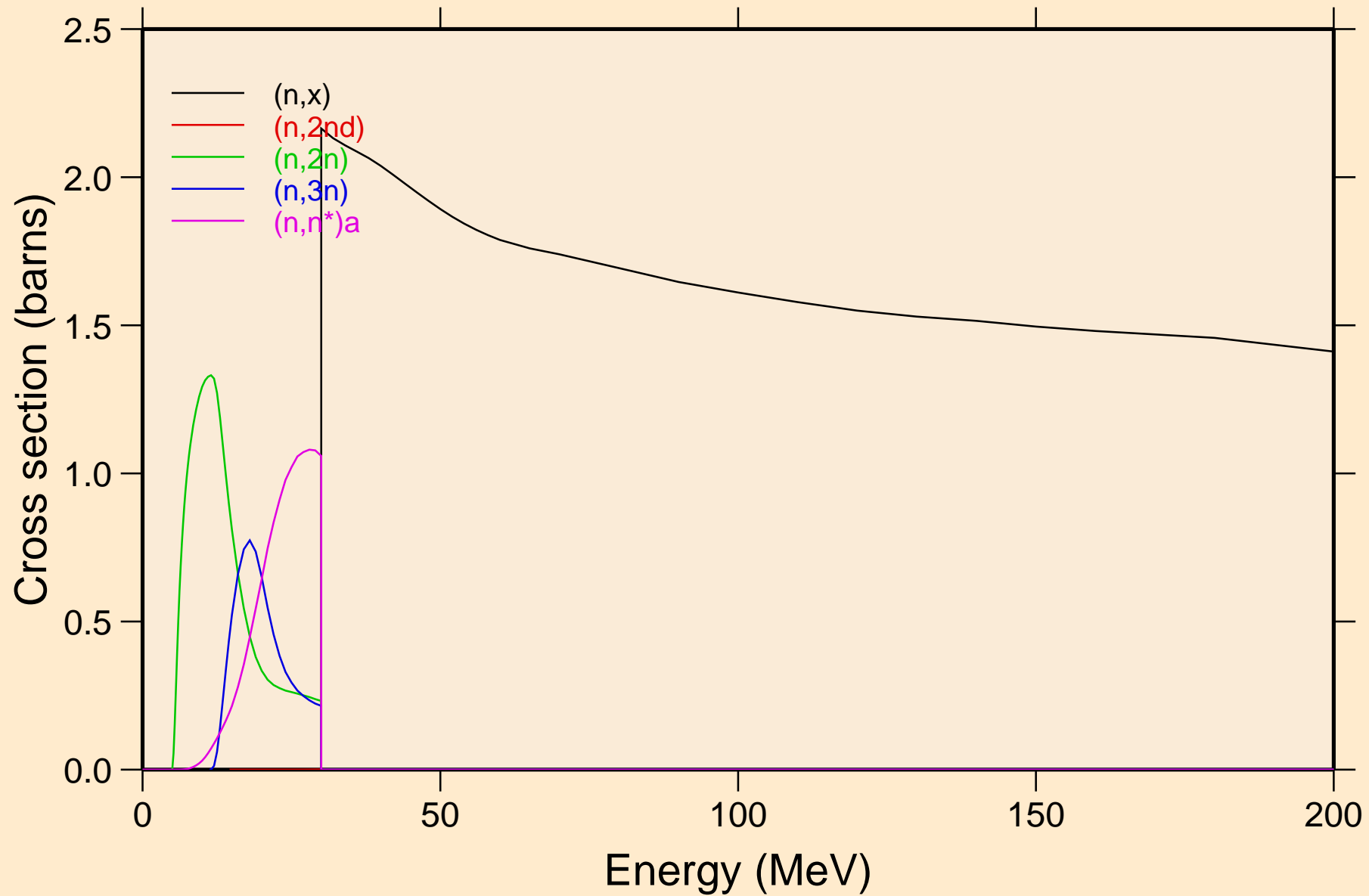

AC230 NEUTRON ACER TENDL-2021 LIBRARY; T=293.6K
Threshold reactions

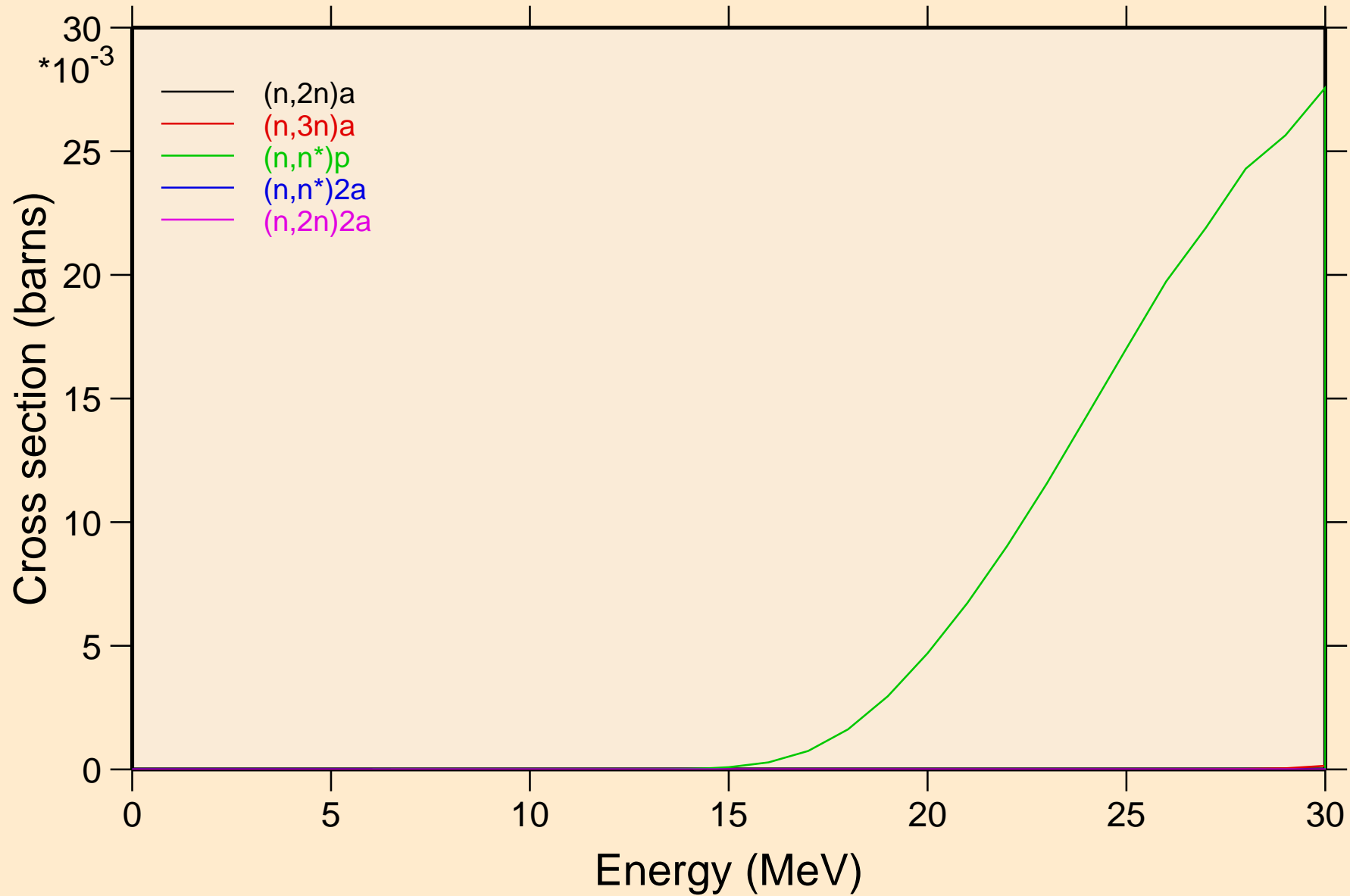

AC230 NEUTRON ACER TENDL-2021 LIBRARY; T=293.6K

Threshold reactions

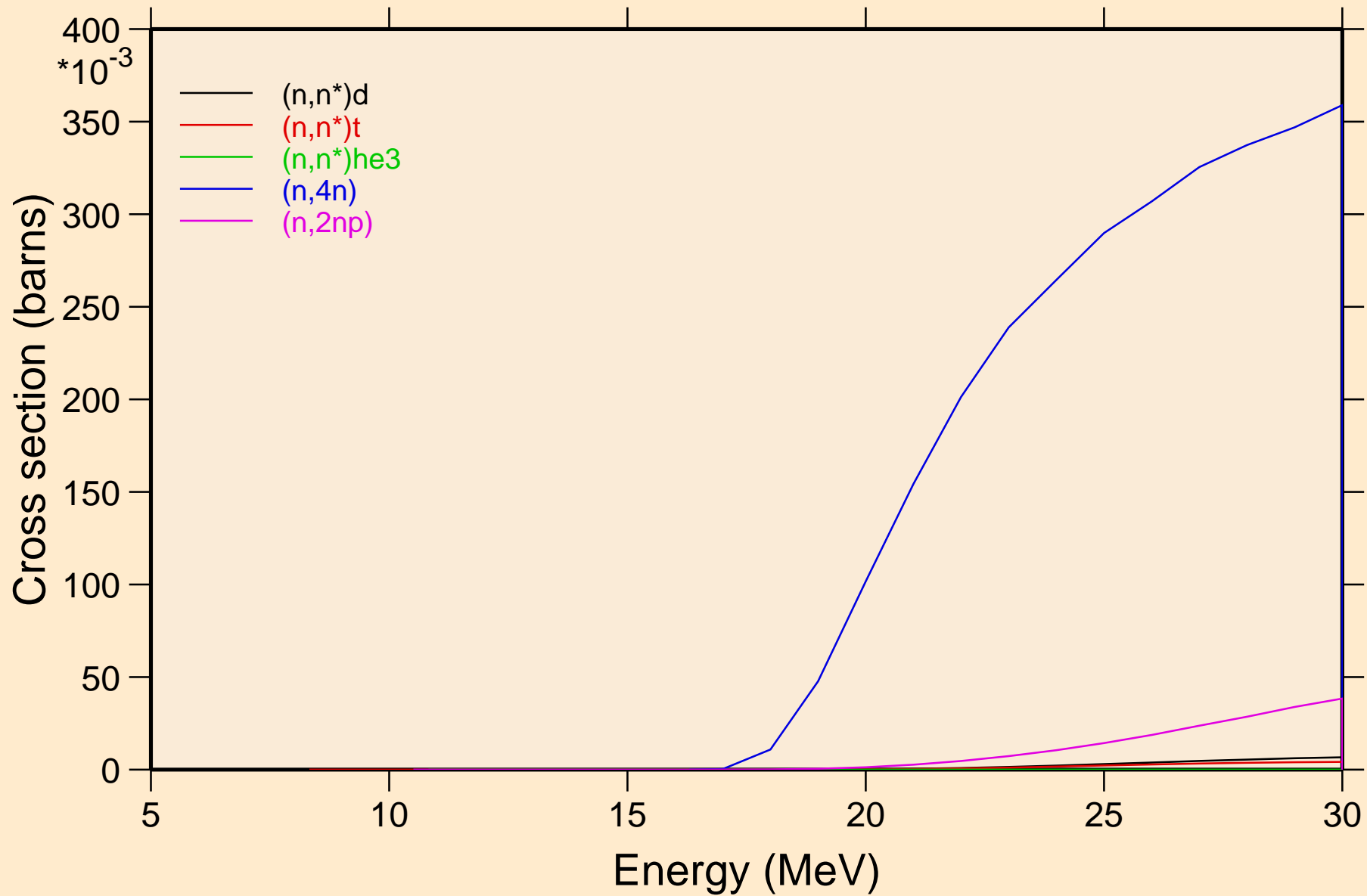

AC230 NEUTRON ACER TENDL-2021 LIBRARY; T=293.6K
Threshold reactions

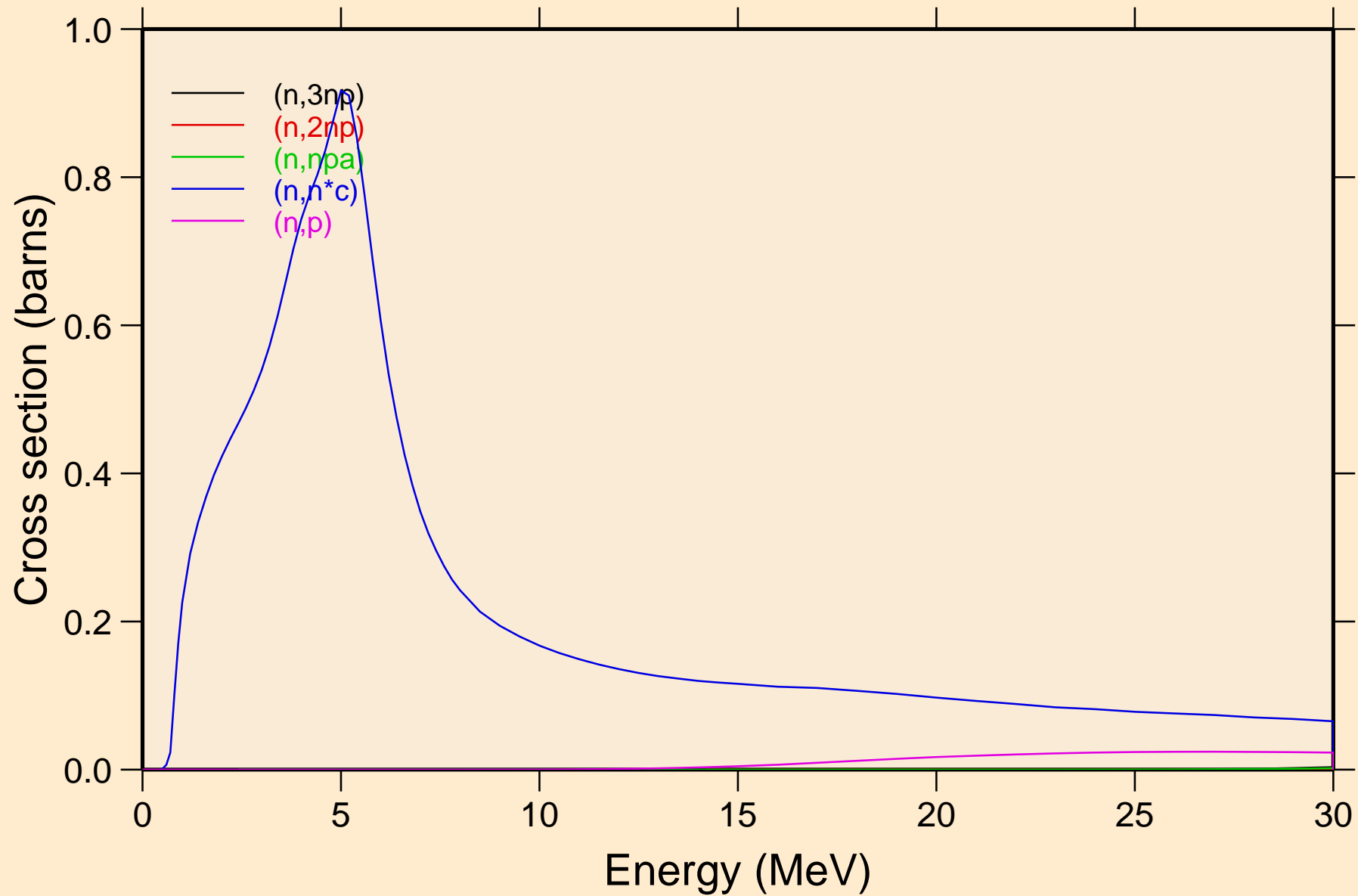

AC230 NEUTRON ACER TENDL-2021 LIBRARY; T=293.6K
Threshold reactions

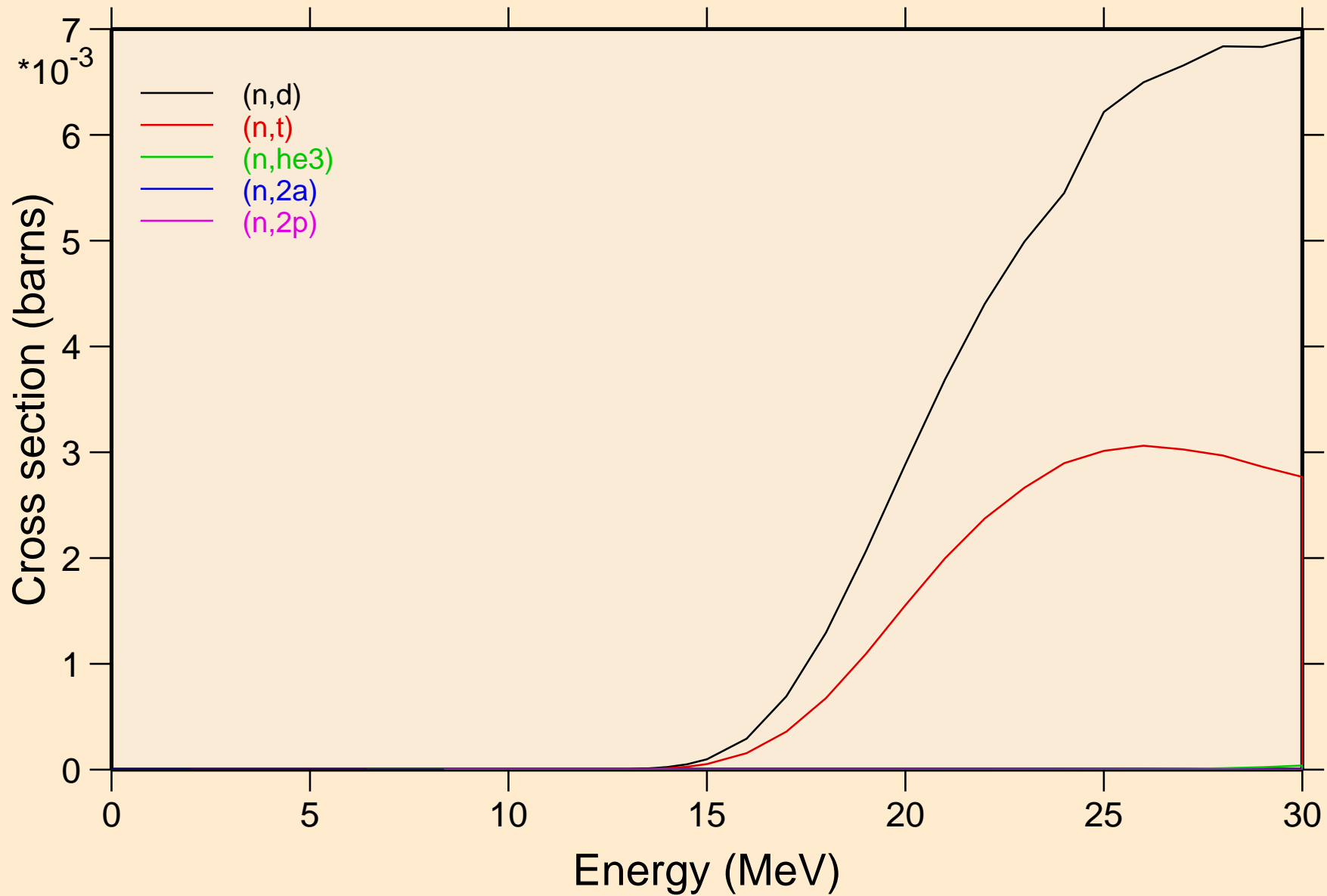

AC230 NEUTRON ACER TENDL-2021 LIBRARY; T=293.6K
Threshold reactions

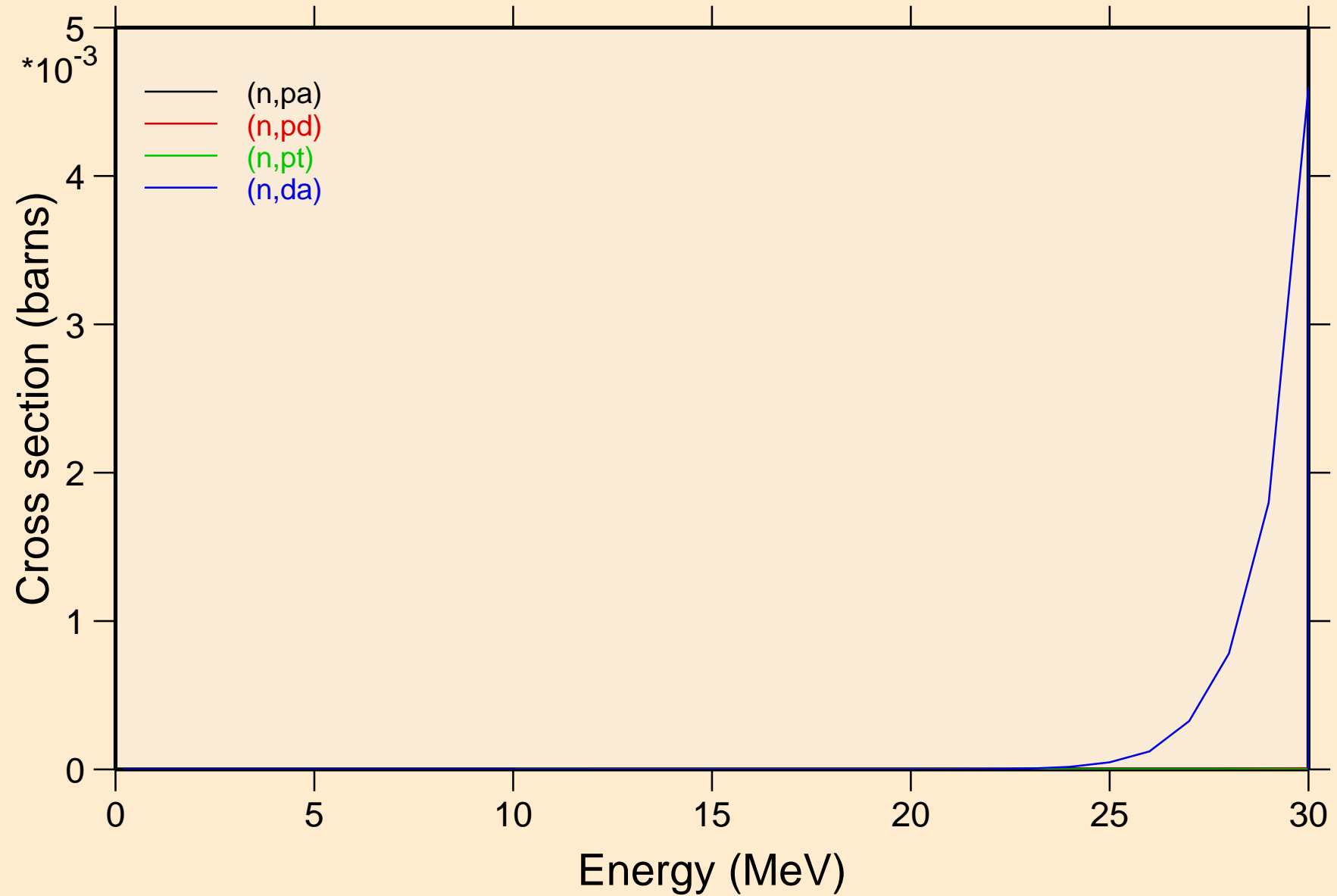

AC230 NEUTRON ACER TENDL-2021 LIBRARY; T=293.6K
Threshold reactions

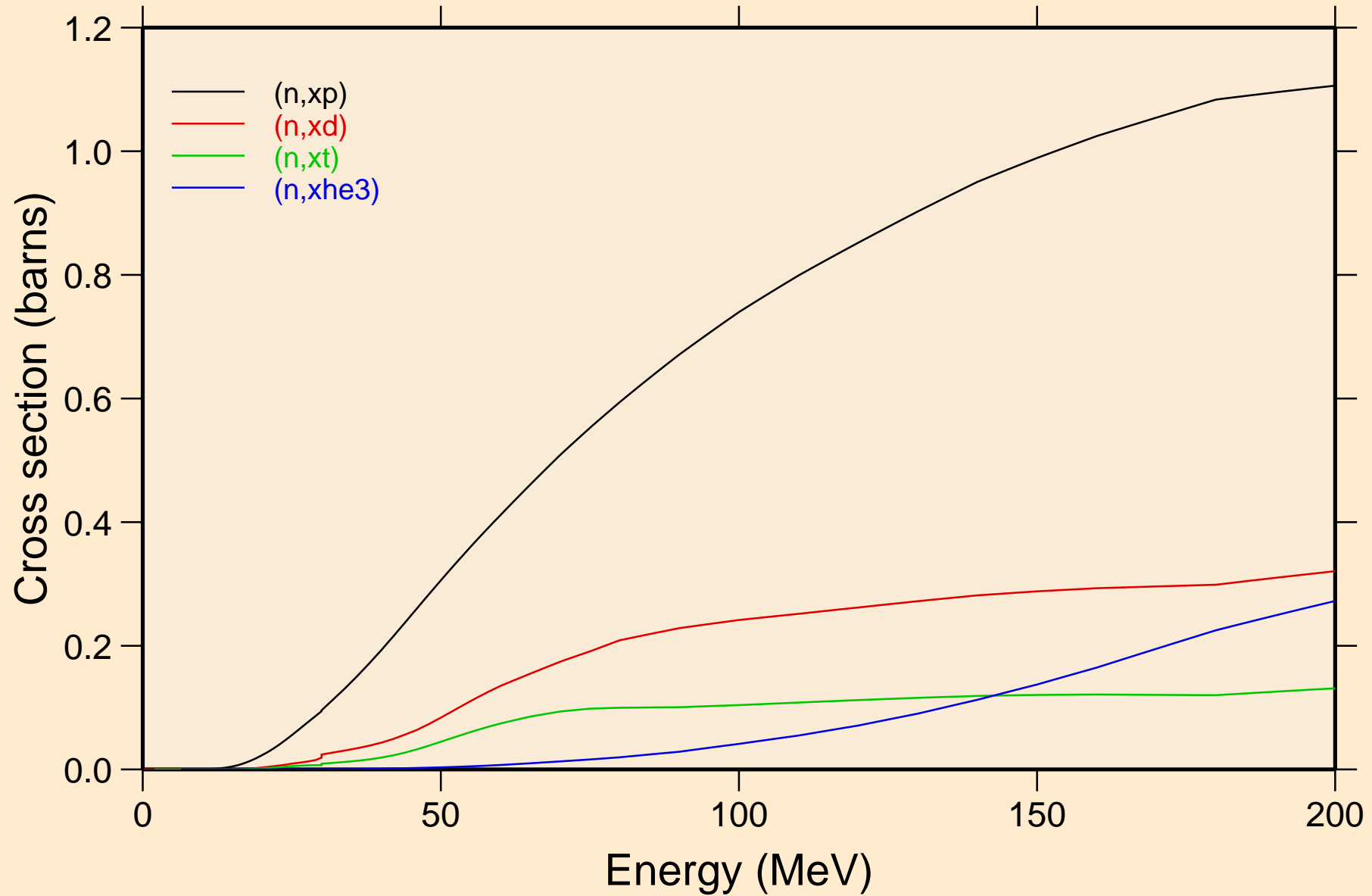

AC230 NEUTRON ACER TENDL-2021 LIBRARY; T=293.6K
angular distribution for elastic

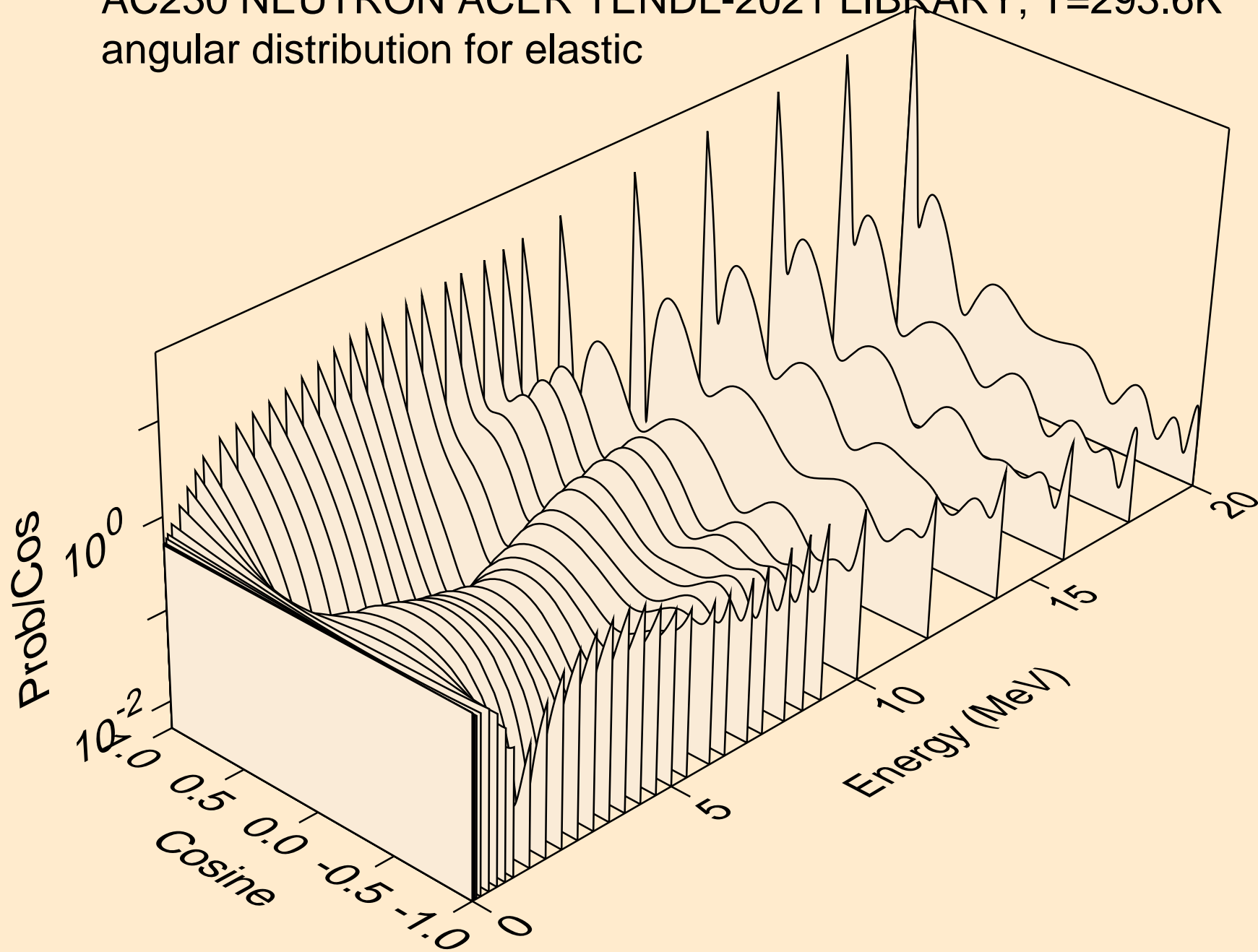

AC230 NEUTRON ACER TENDL-2021 LIBRARY; T=293.6K
angular distribution for elastic

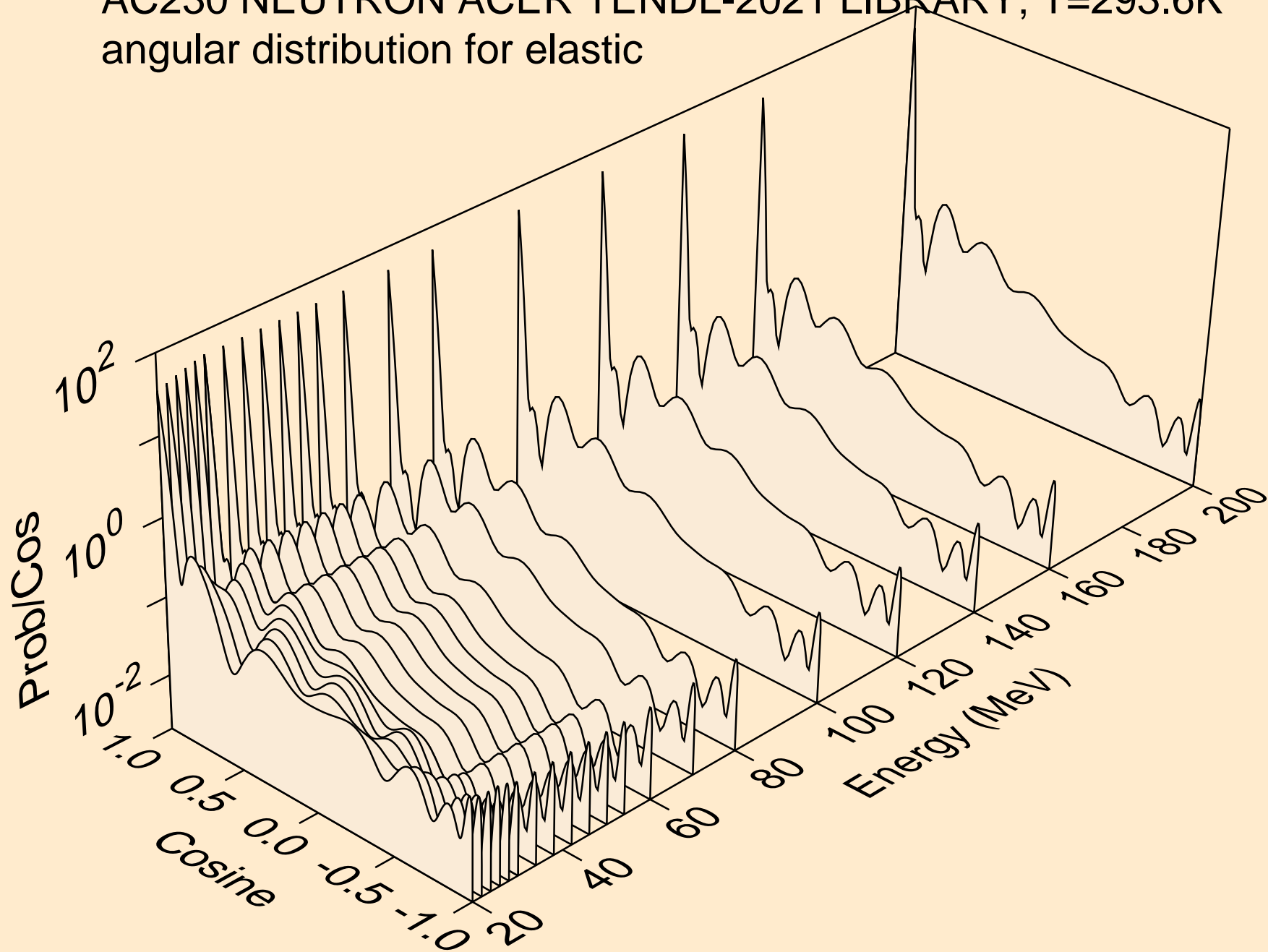

AC230 NEUTRON ACER TENDL-2021 LIBRARY; T=293.6K
angular distribution for (n,n*1)

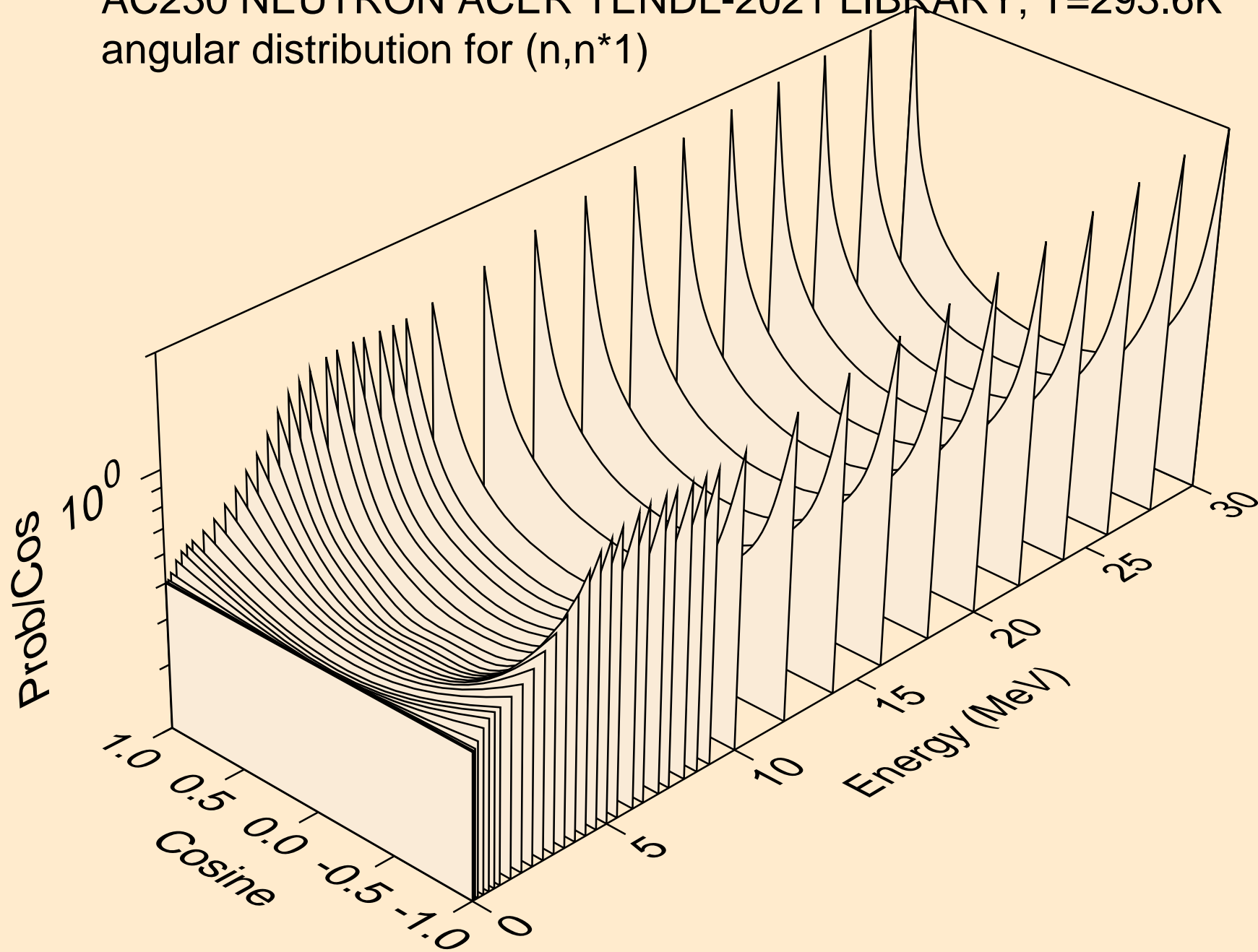

AC230 NEUTRON ACER TENDL-2021 LIBRARY; T=293.6K
angular distribution for (n,n*2)

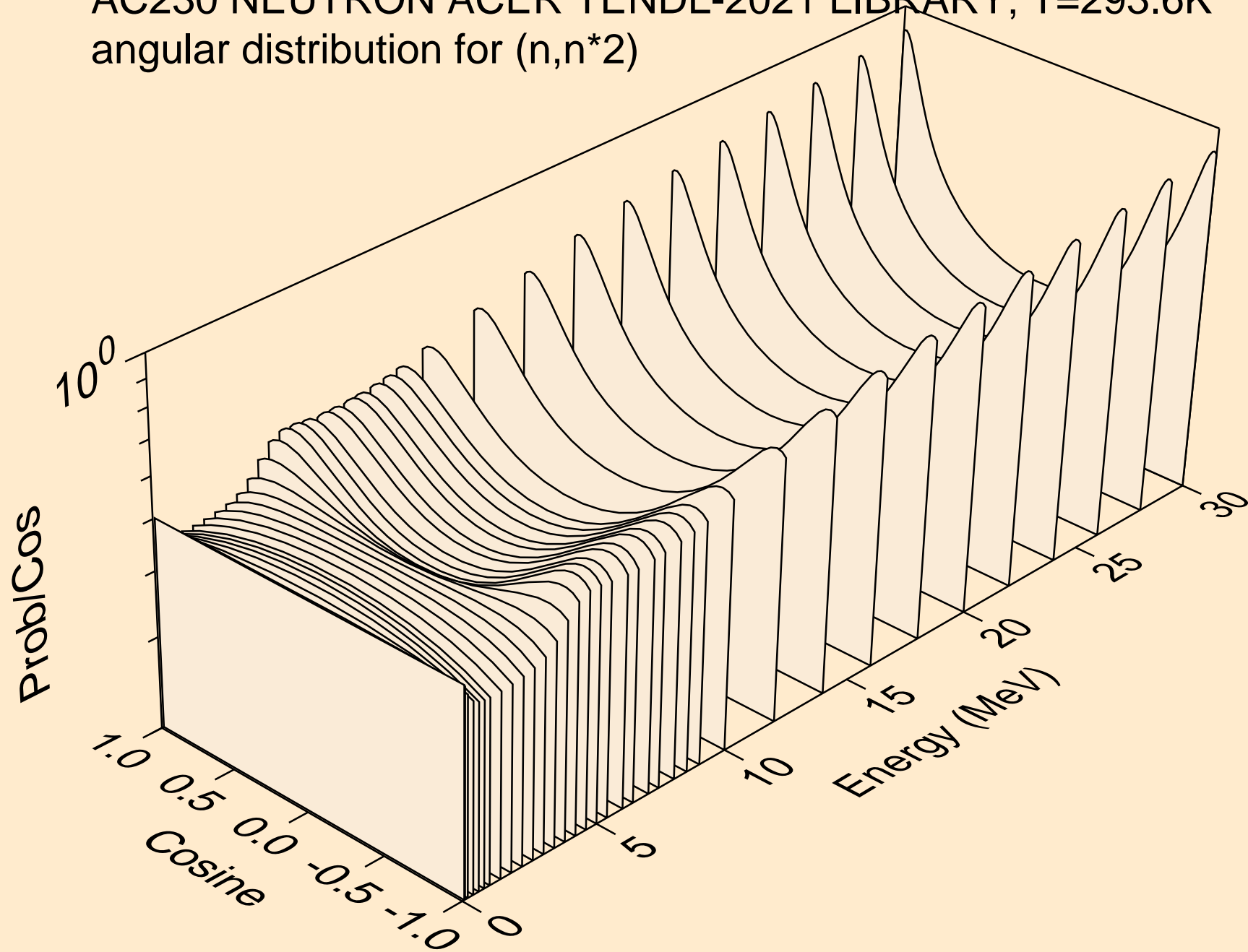

AC230 NEUTRON ACER TENDL-2021 LIBRARY; T=293.6K
angular distribution for (n,n*3)

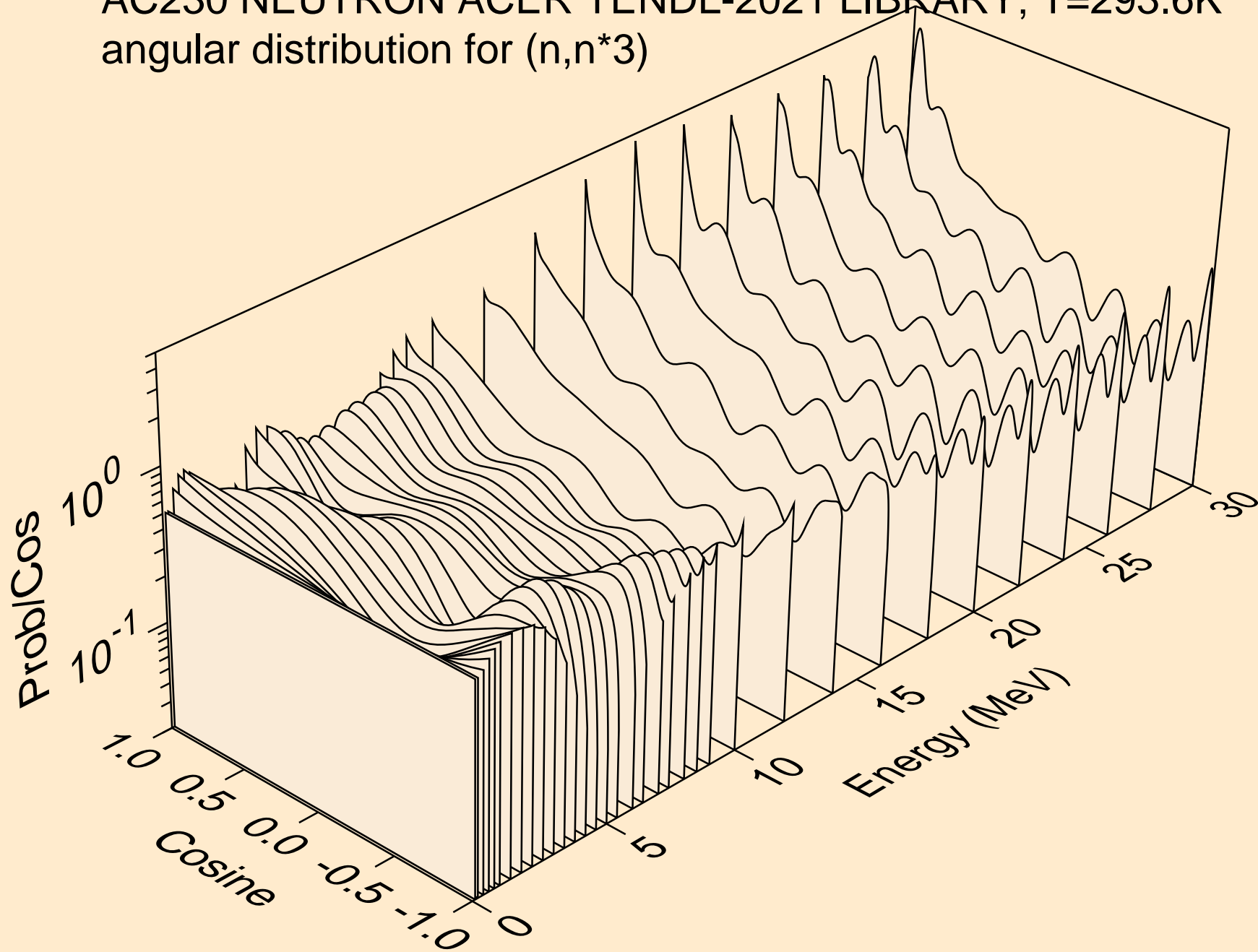

AC230 NEUTRON ACER TENDL-2021 LIBRARY; T=293.6K
angular distribution for (n,n*4)

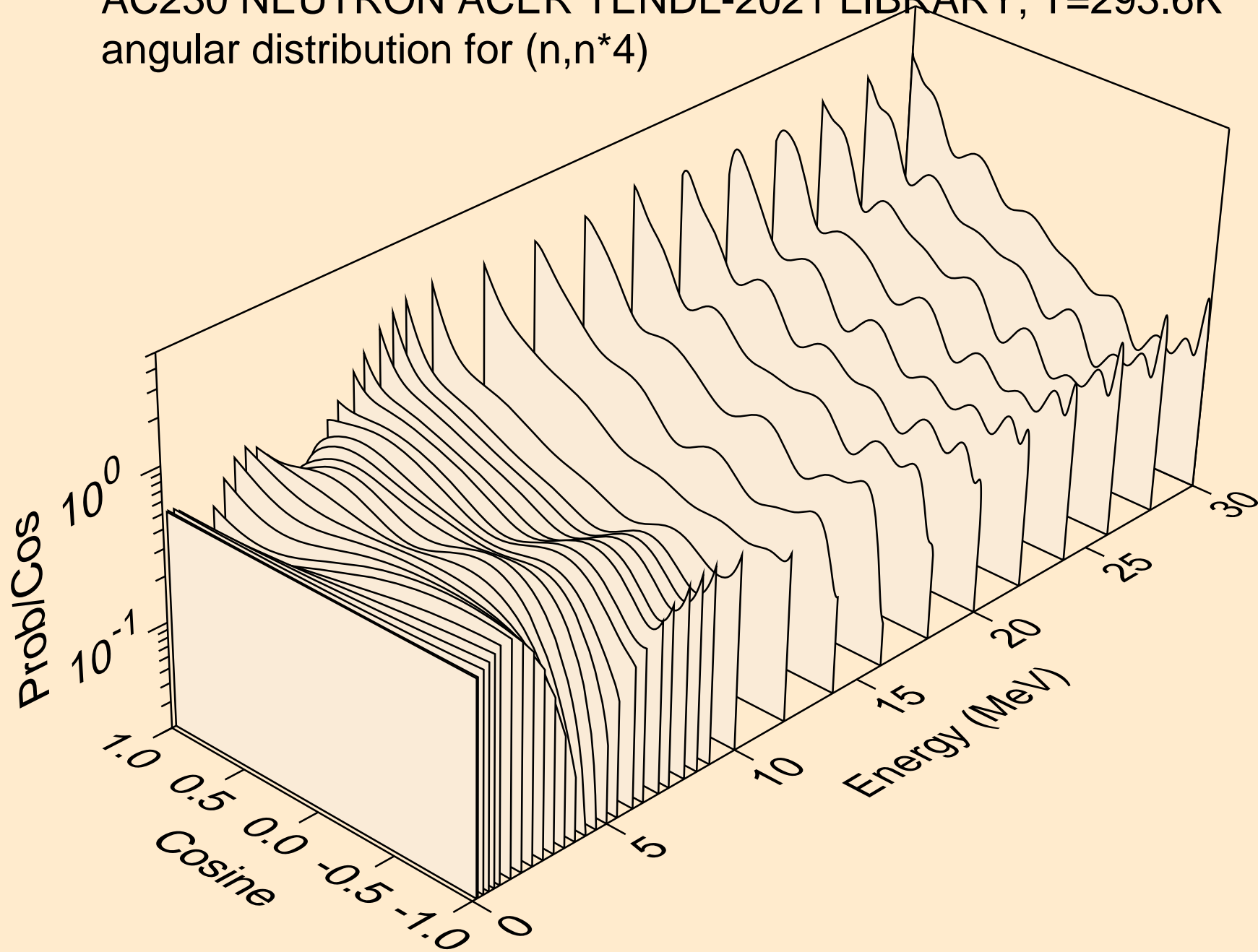

AC230 NEUTRON ACER TENDL-2021 LIBRARY; T=293.6K
angular distribution for (n,n*5)

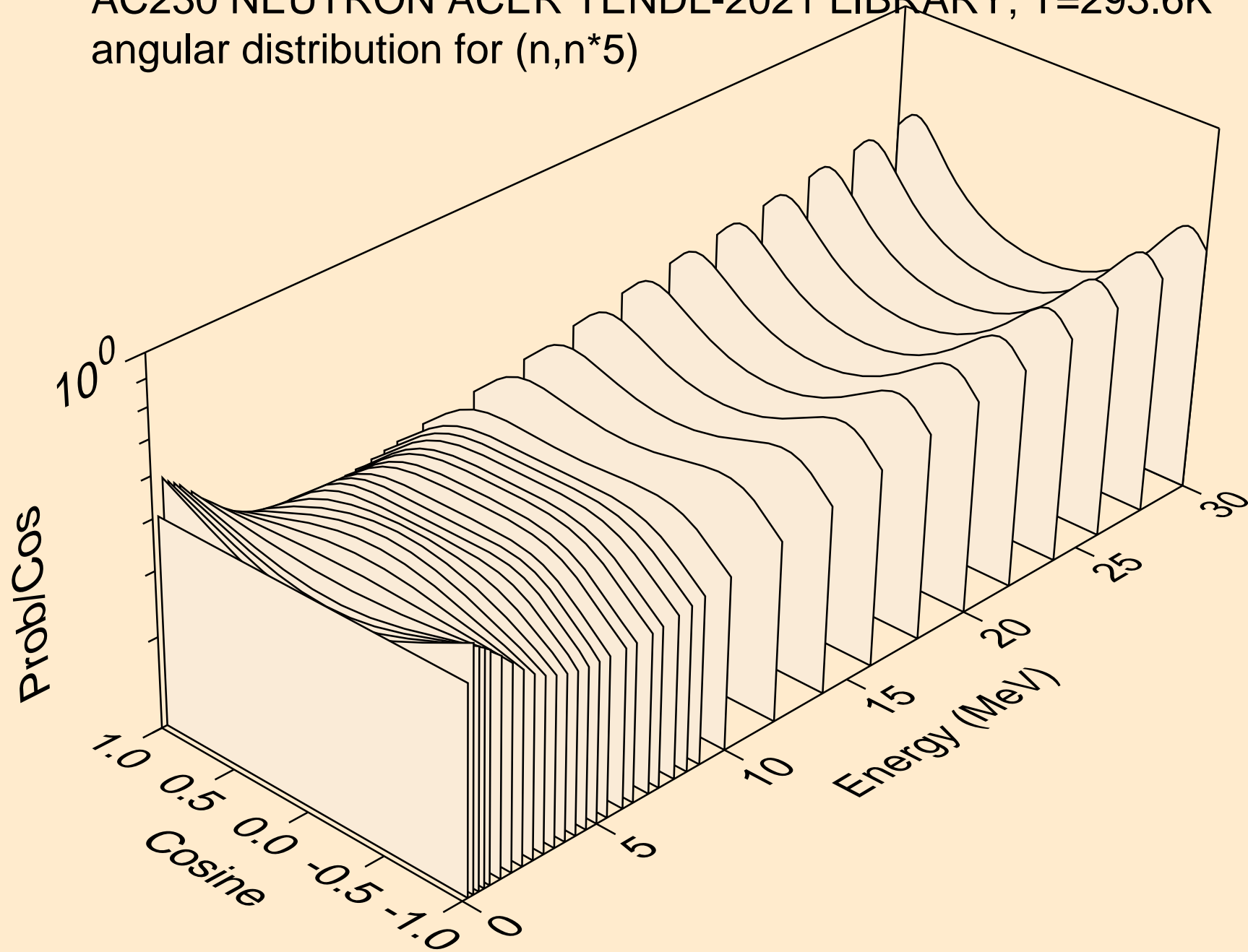

AC230 NEUTRON ACER TENDL-2021 LIBRARY; T=293.6K
angular distribution for (n,n*6)

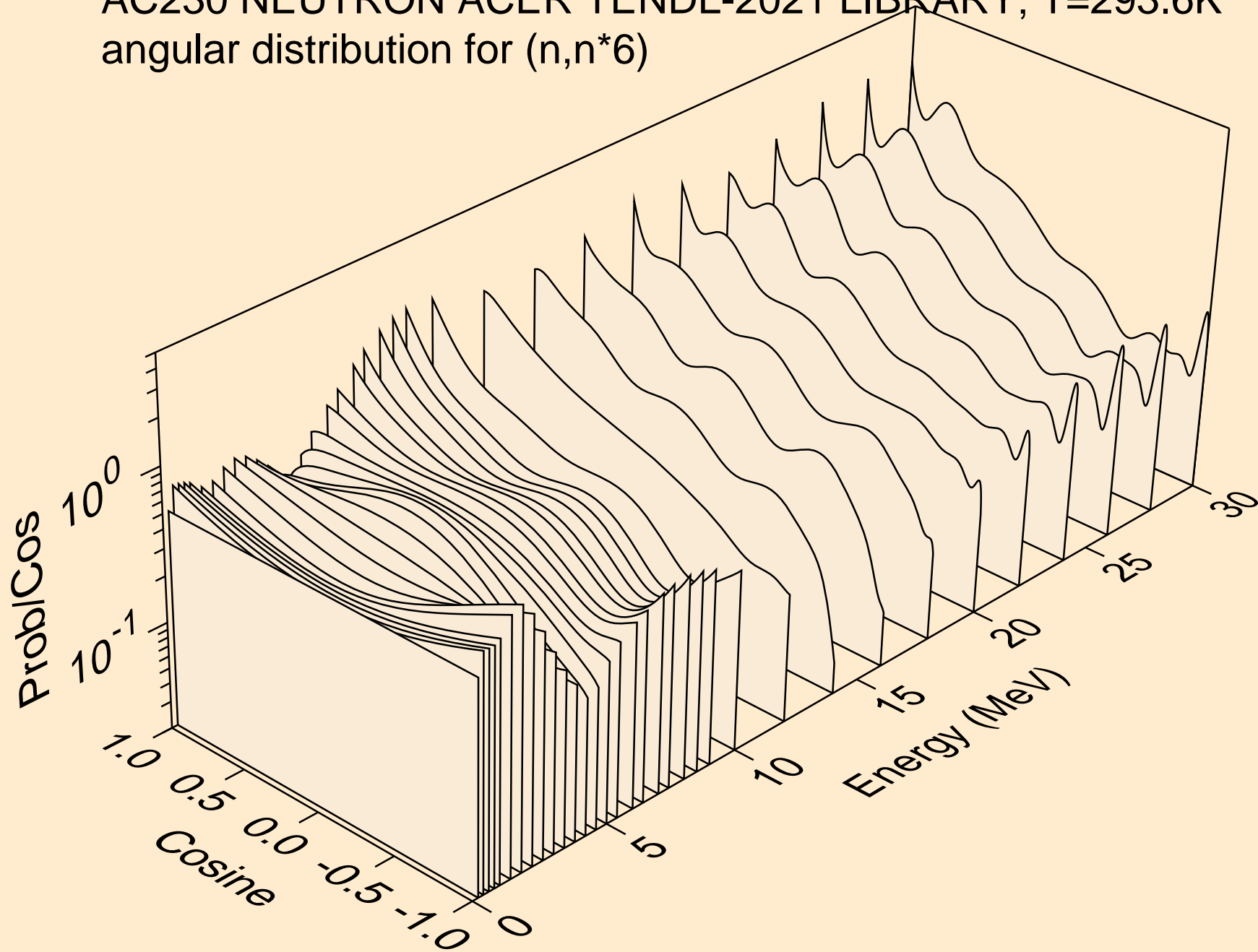

AC230 NEUTRON ACER TENDL-2021 LIBRARY; T=293.6K
angular distribution for (n,n*7)

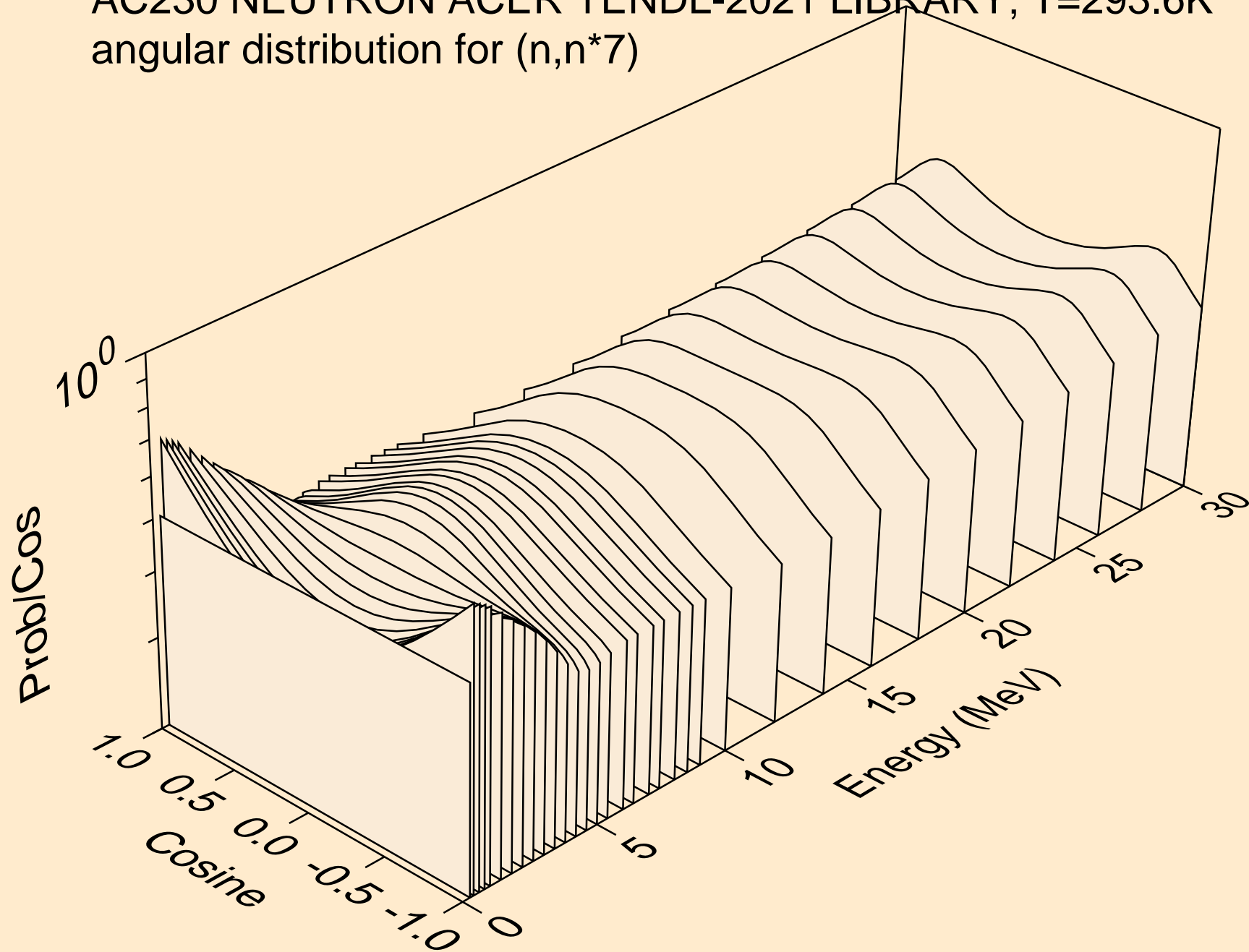

AC230 NEUTRON ACER TENDL-2021 LIBRARY; T=293.6K
angular distribution for (n,n*8)

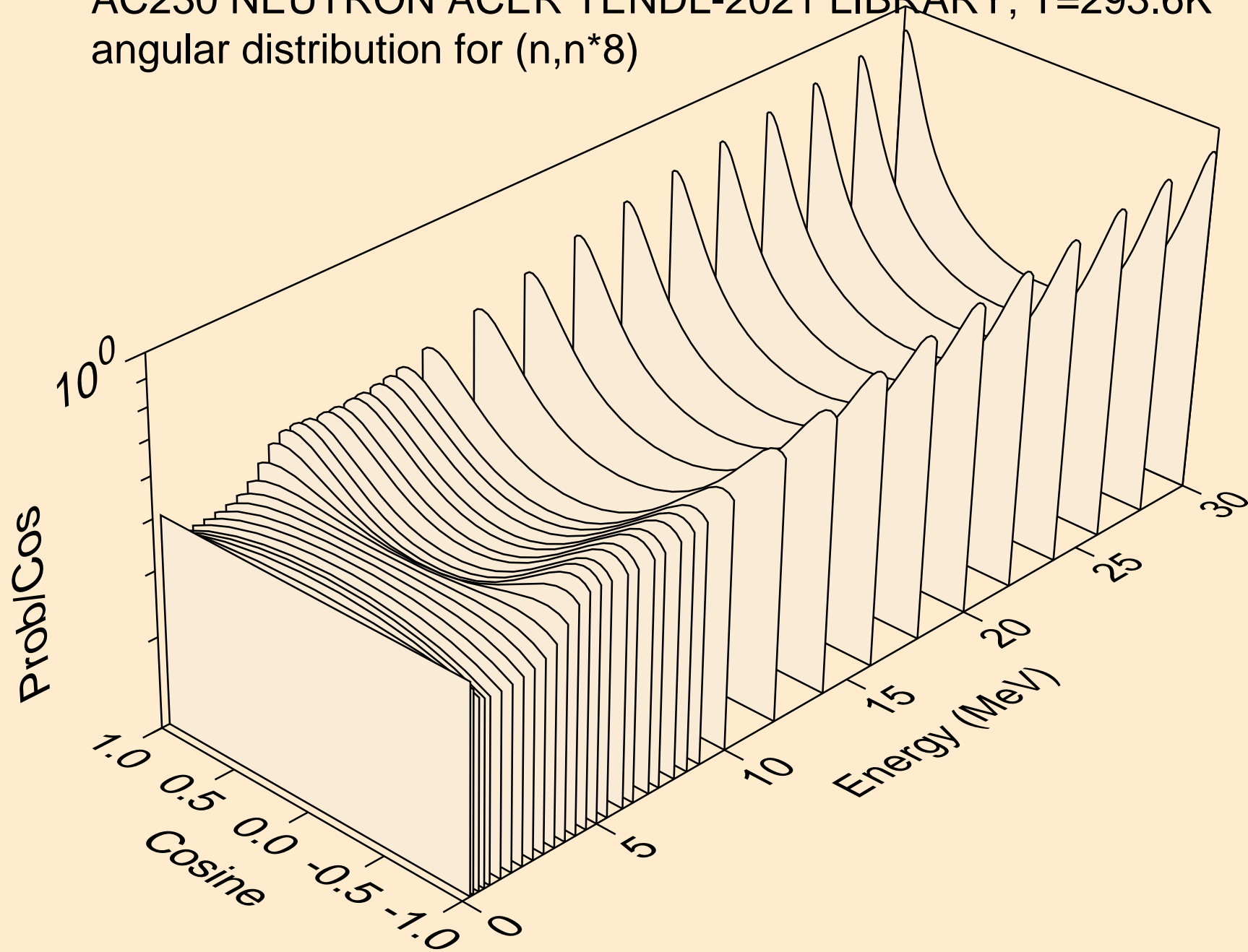

AC230 NEUTRON ACER TENDL-2021 LIBRARY; T=293.6K
angular distribution for (n,n*9)

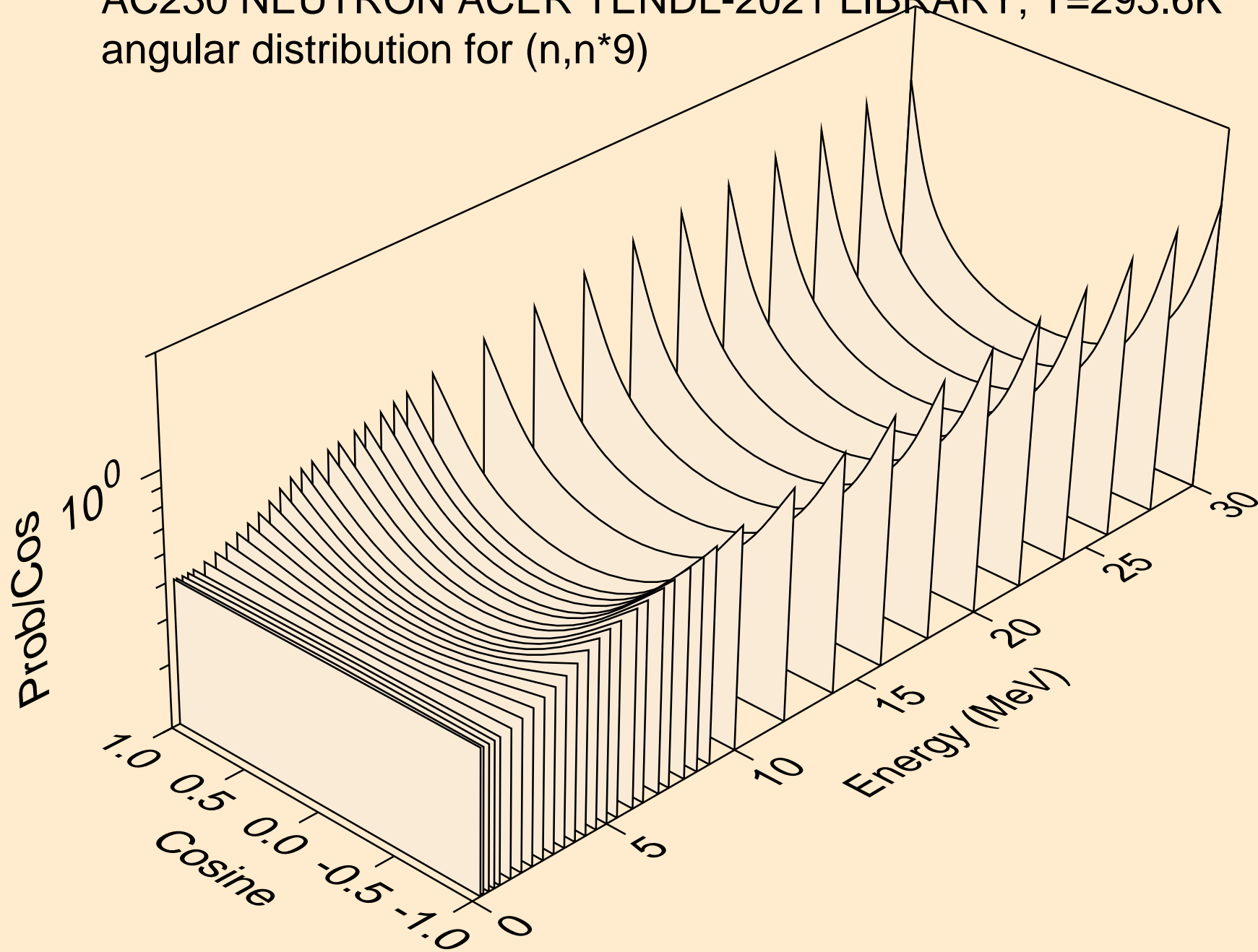

AC230 NEUTRON ACER TENDL-2021 LIBRARY; T=293.6K
angular distribution for (n,n*10)

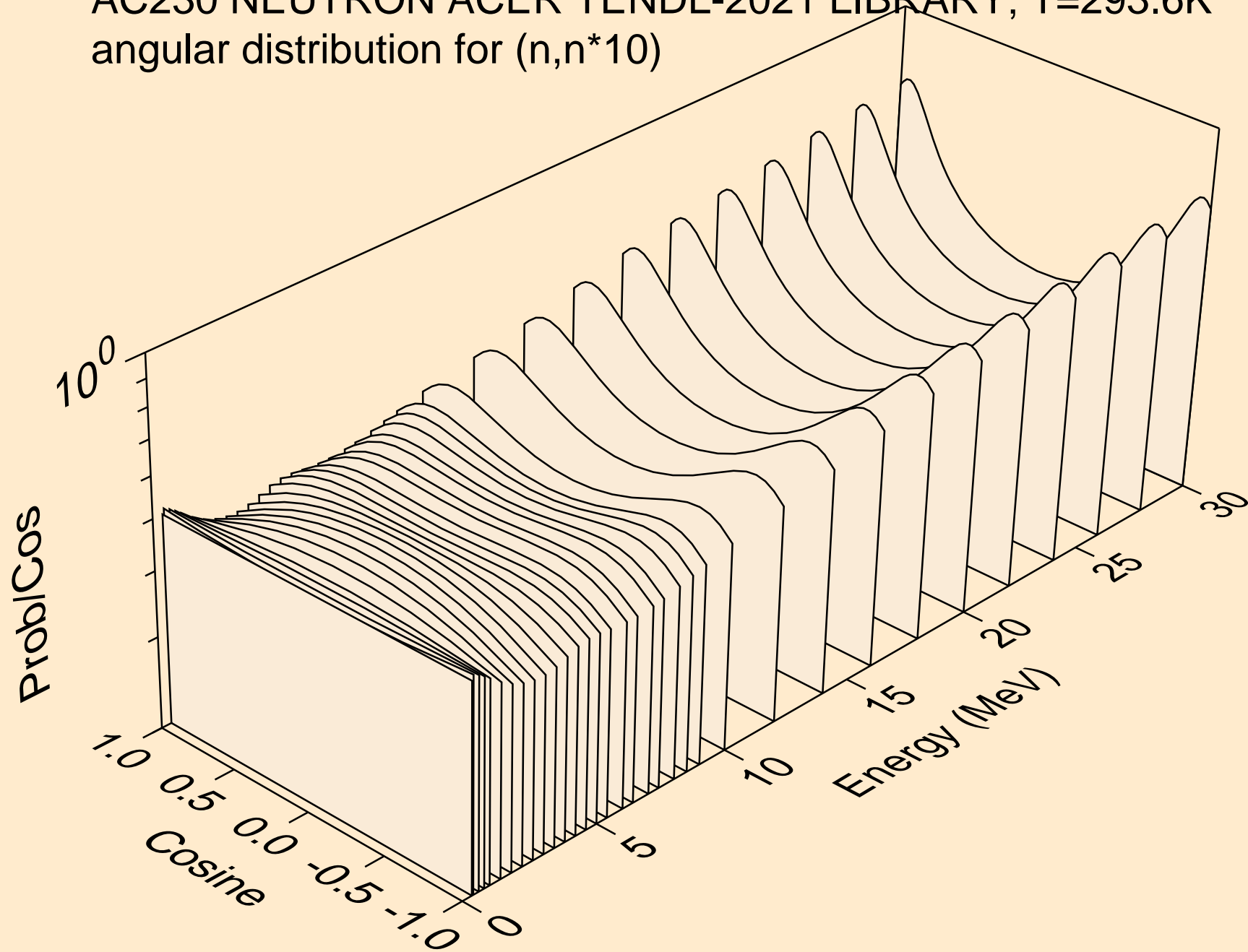

AC230 NEUTRON ACER TENDL-2021 LIBRARY; T=293.6K
angular distribution for (n,n*11)

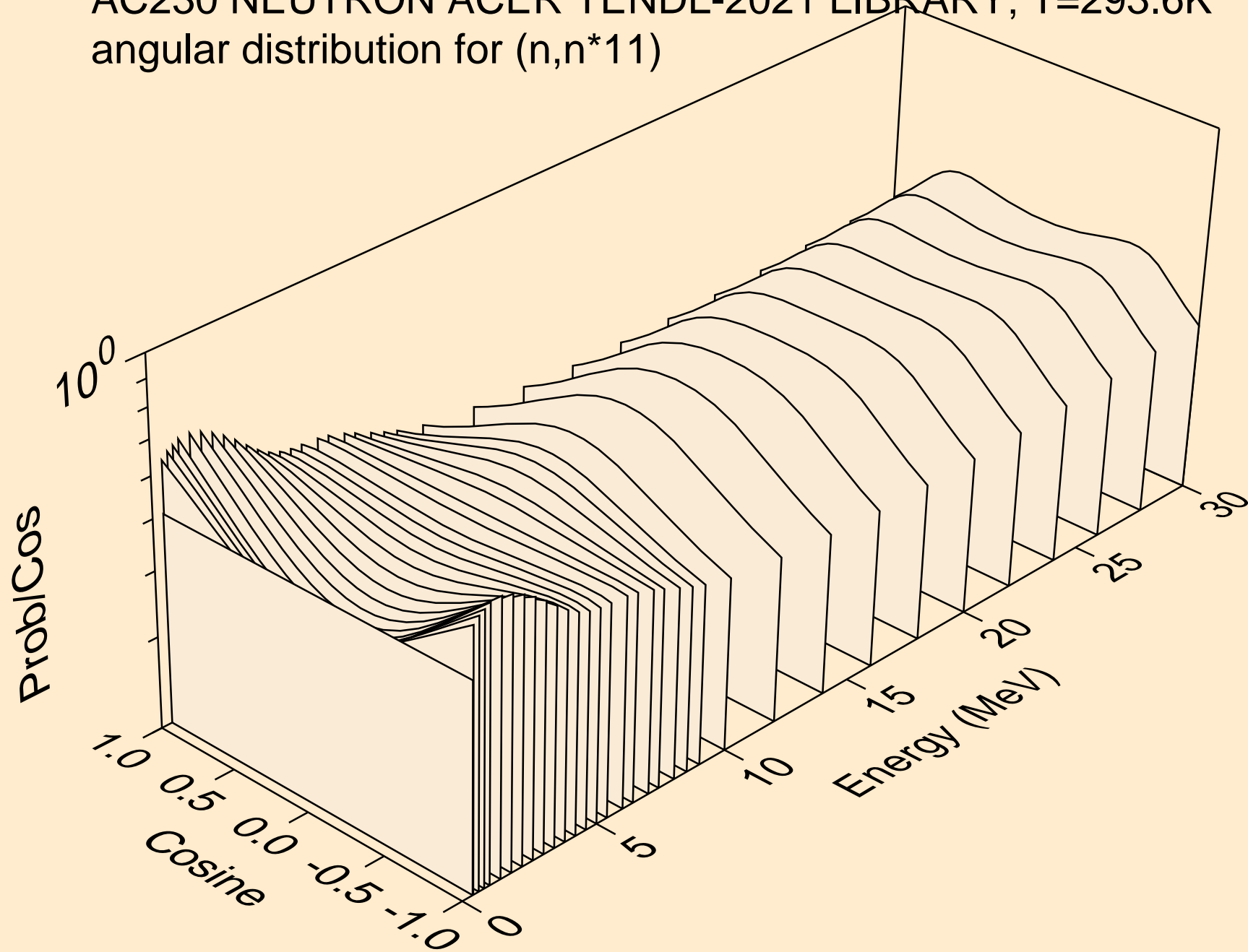

AC230 NEUTRON ACER TENDL-2021 LIBRARY; T=293.6K
angular distribution for (n,n*12)

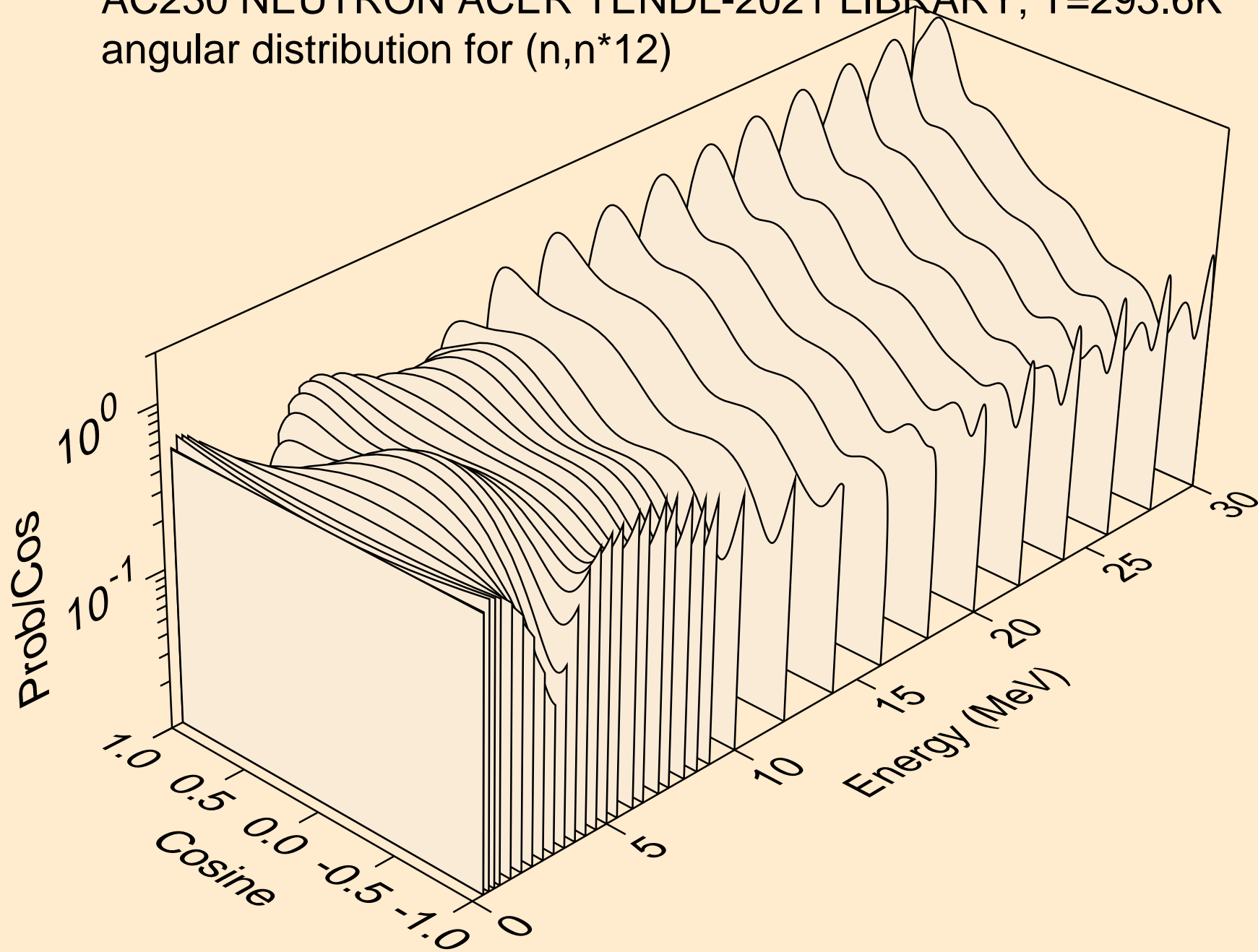

AC230 NEUTRON ACER TENDL-2021 LIBRARY; T=293.6K
angular distribution for (n,n*13)

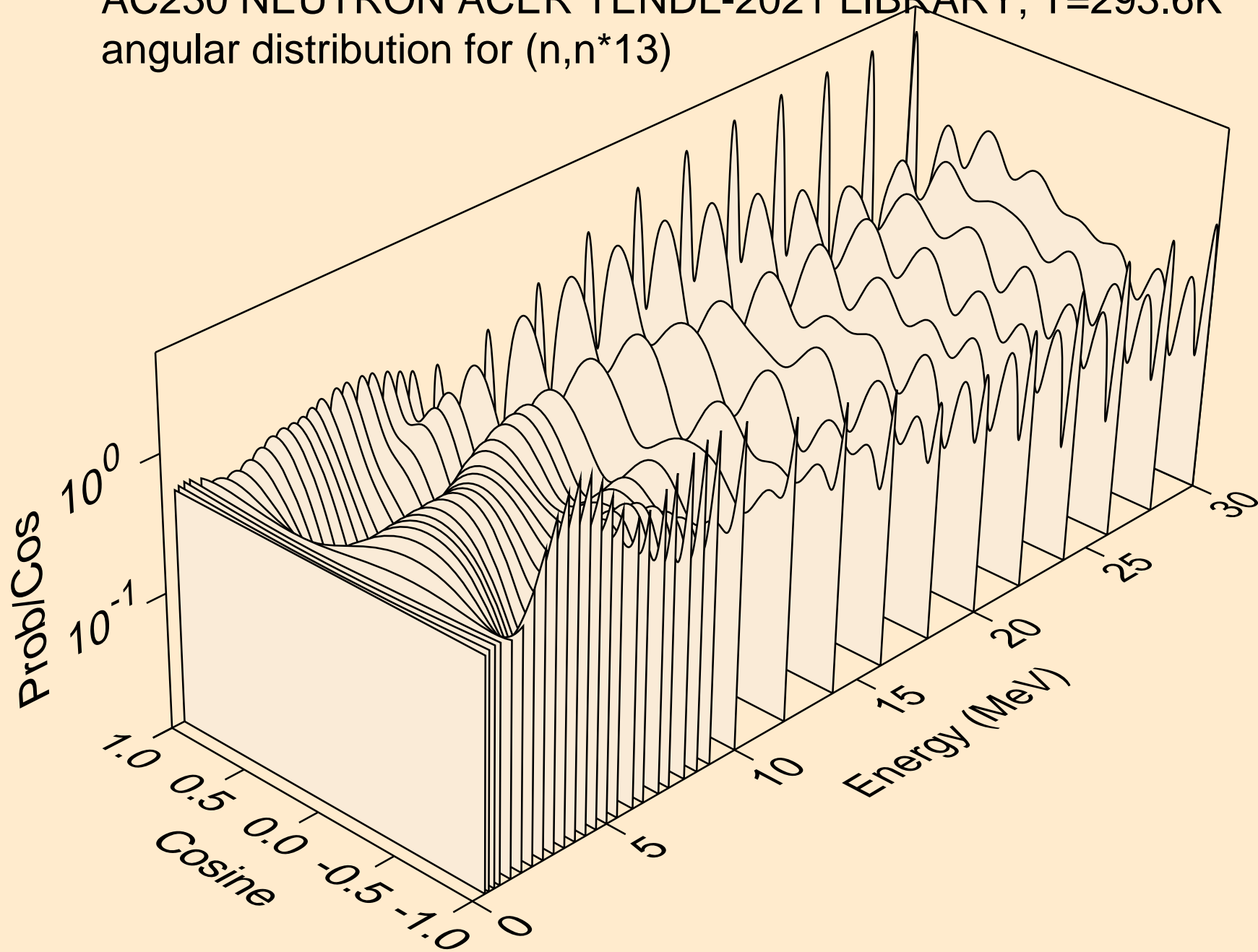

AC230 NEUTRON ACER TENDL-2021 LIBRARY; T=293.6K
angular distribution for (n,n*14)

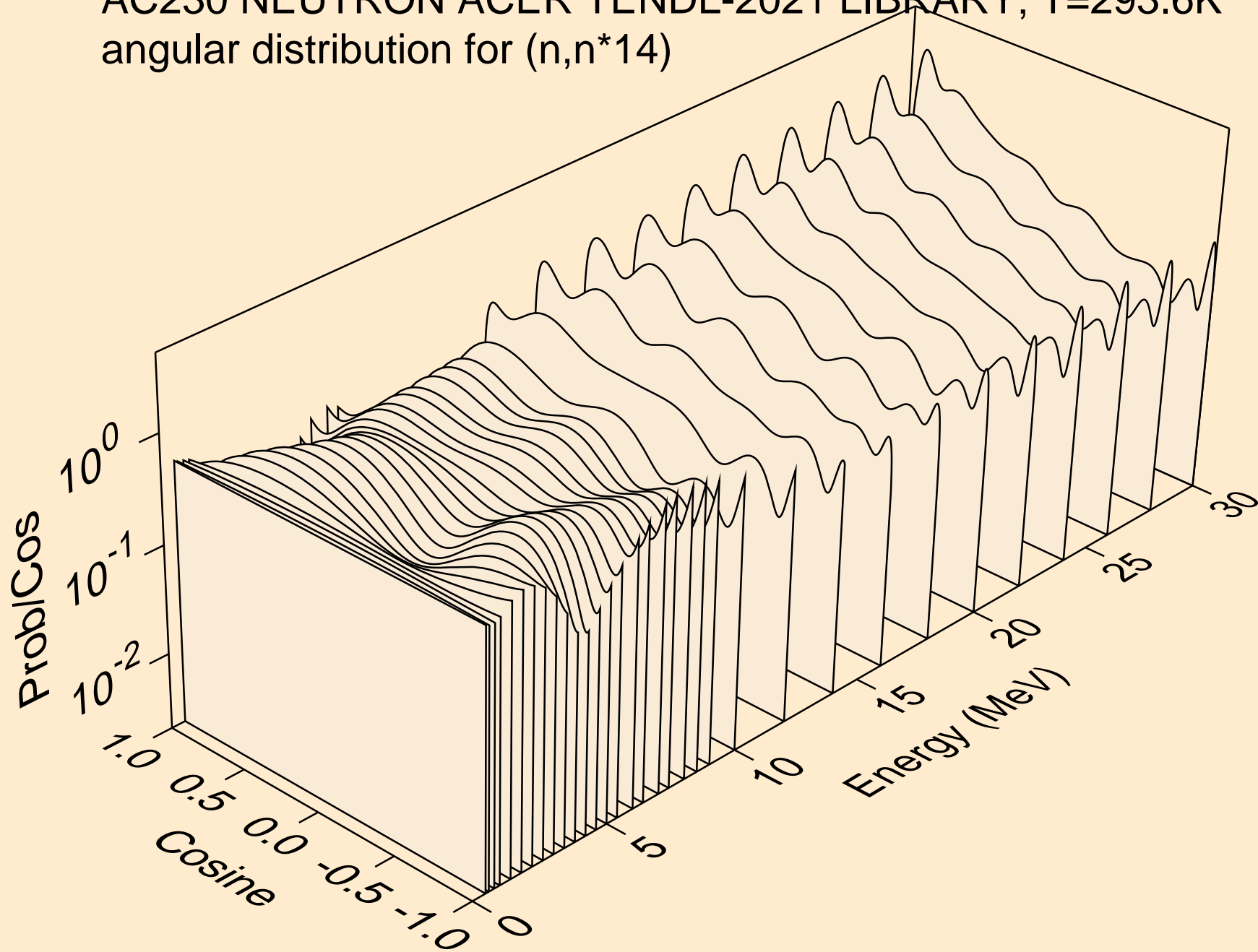

AC230 NEUTRON ACER TENDL-2021 LIBRARY; T=293.6K
Total fission nubar

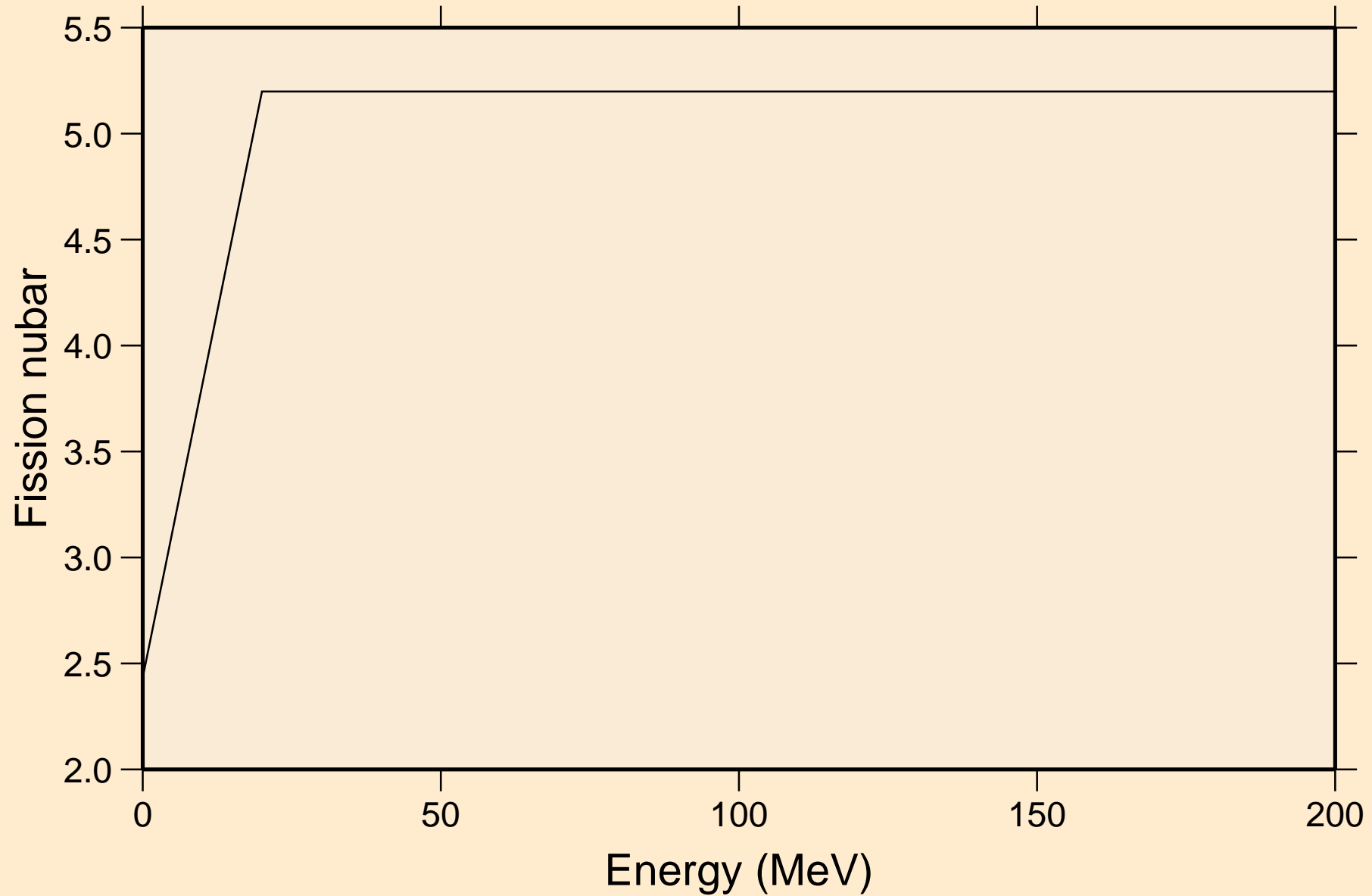

AC230 NEUTRON ACER TENDL-2021 LIBRARY; T=293.6K
Neutron emission for (n,x)

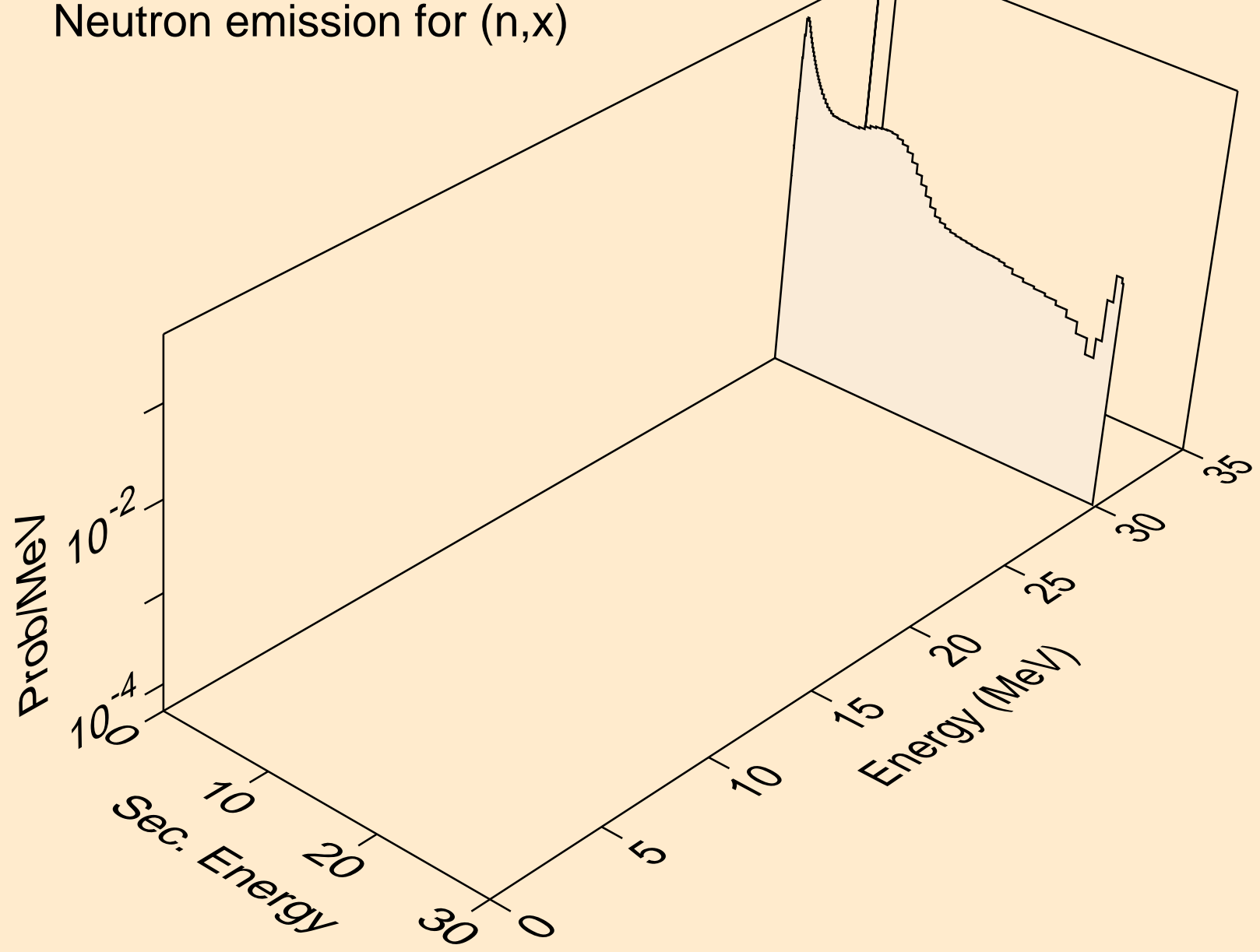

AC230 NEUTRON ACER TENDL-2021 LIBRARY; T=293.6K
Neutron emission for (n,2nd)

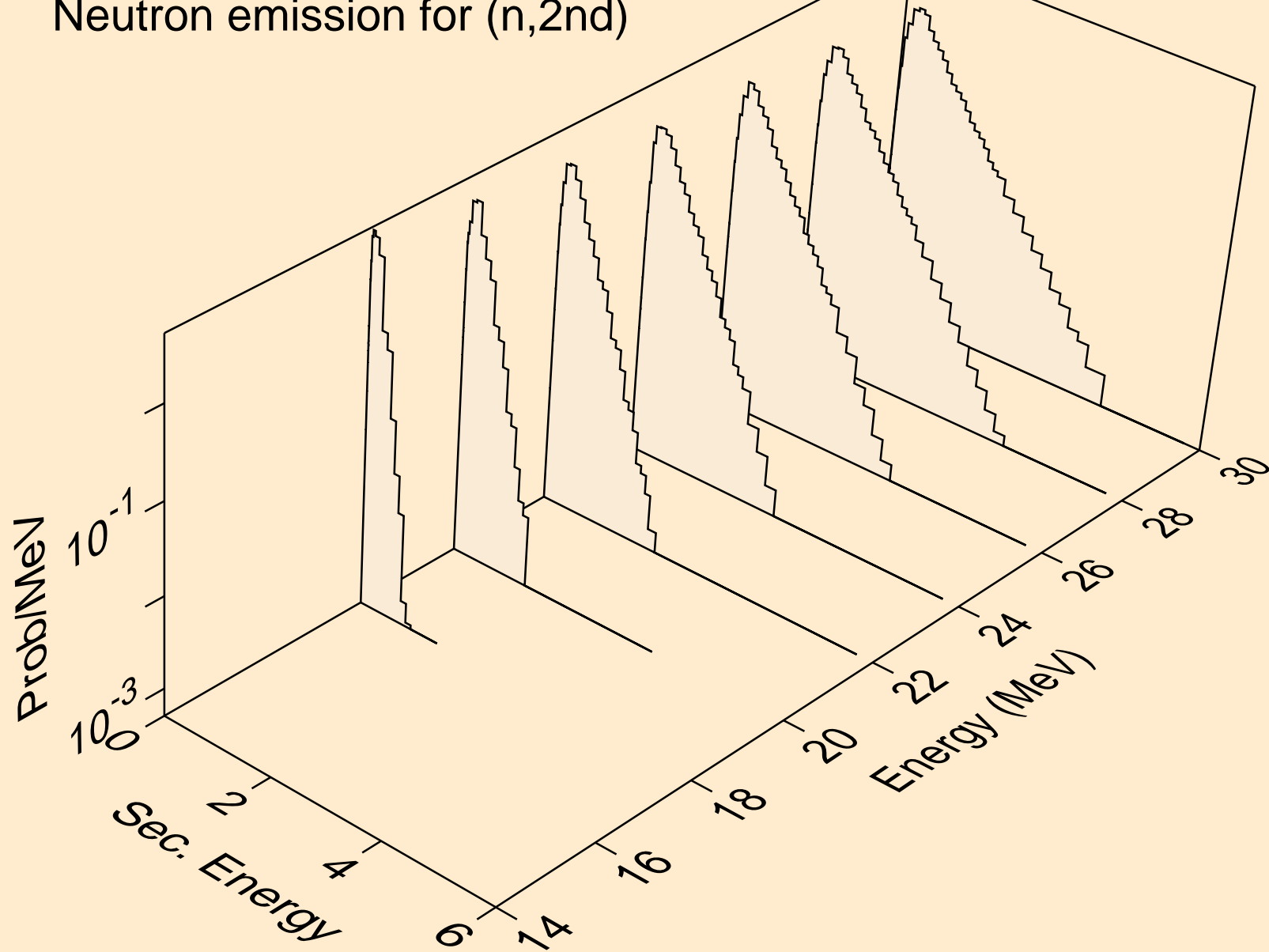

AC230 NEUTRON ACER TENDL-2021 LIBRARY; T=293.6K
Neutron emission for (n,2n)

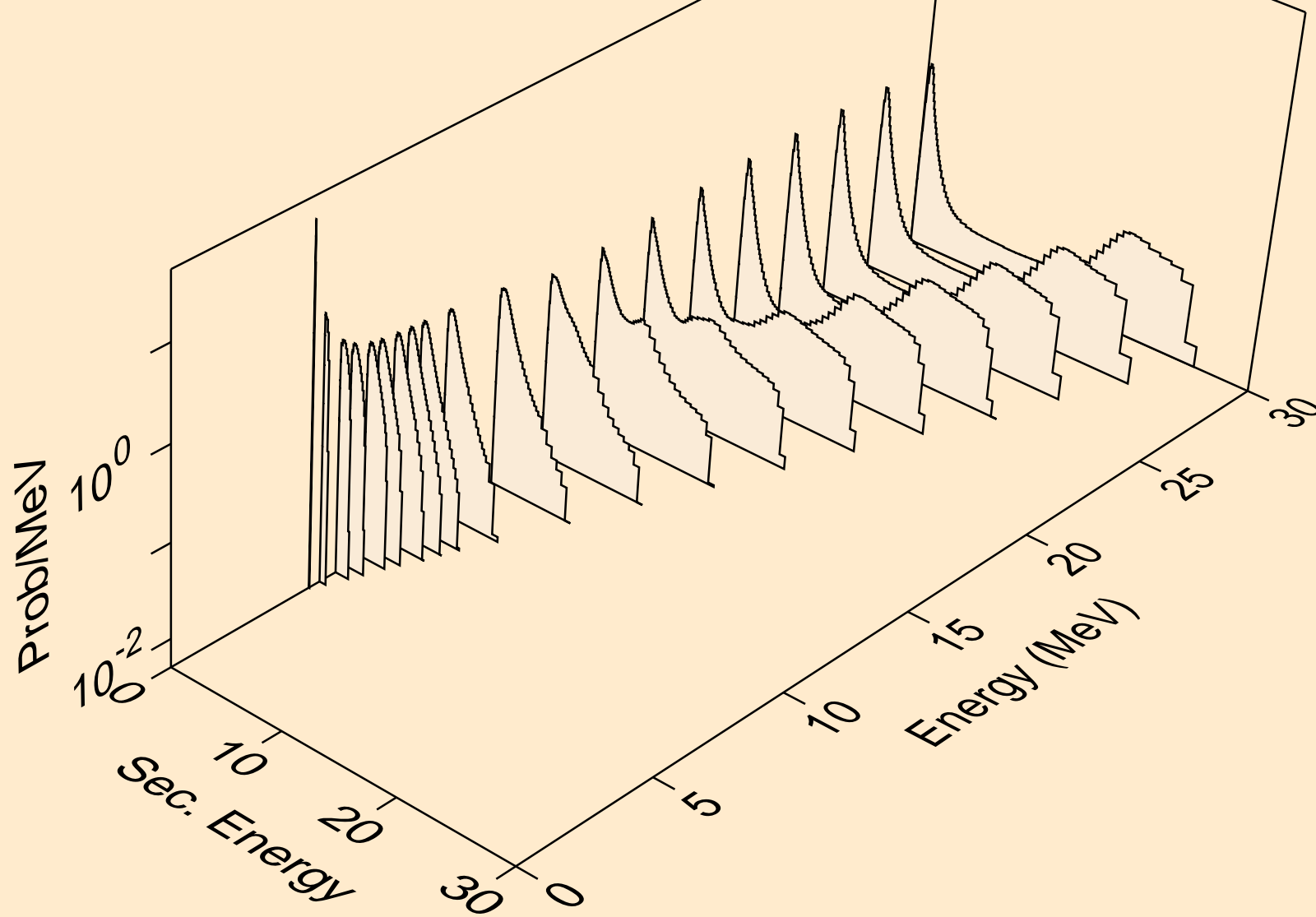

AC230 NEUTRON ACER TENDL-2021 LIBRARY; T=293.6K
Neutron emission for (n,3n)

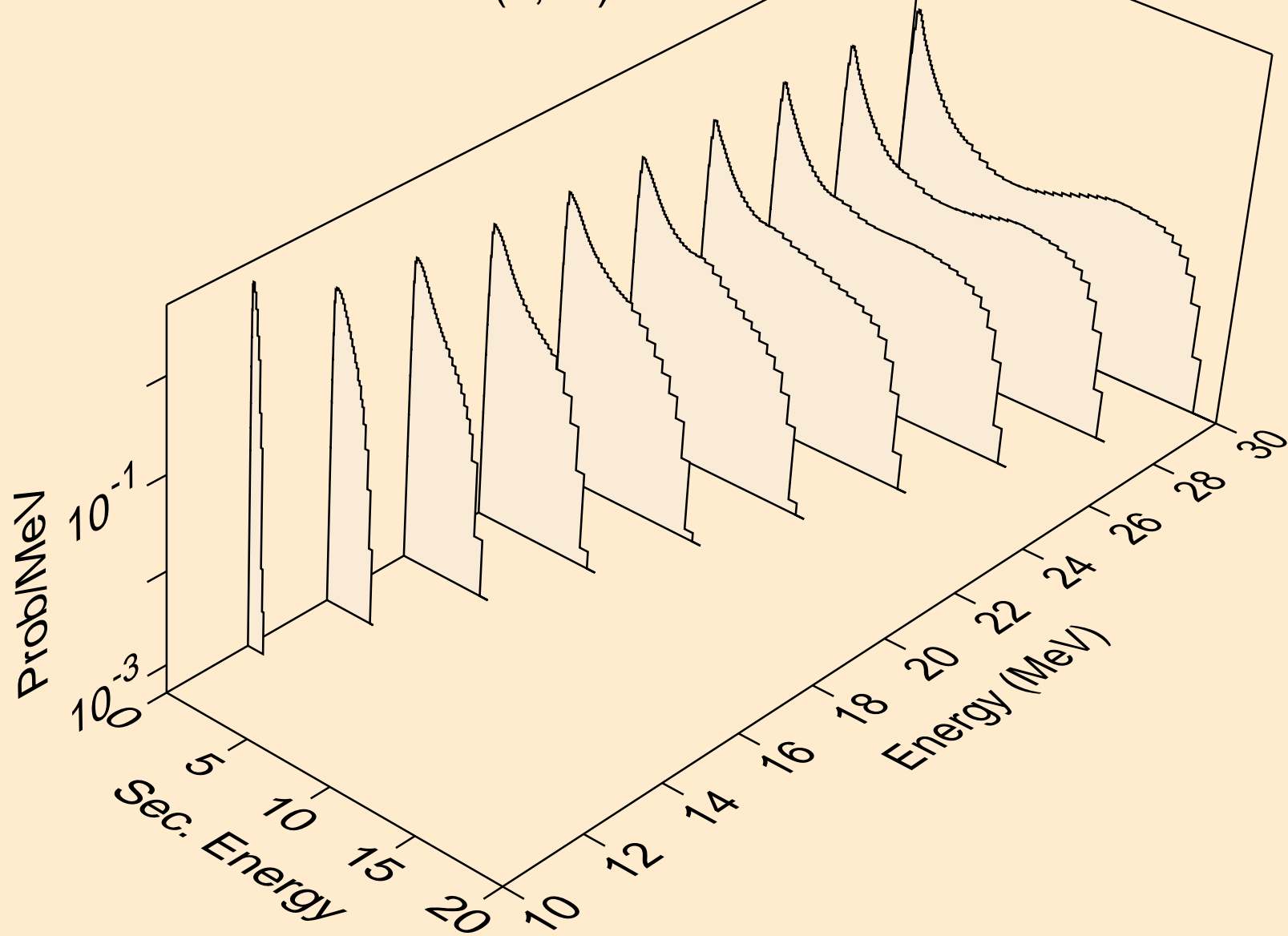

AC230 NEUTRON ACER TENDL-2021 LIBRARY; T=293.6K
Neutron emission for fission

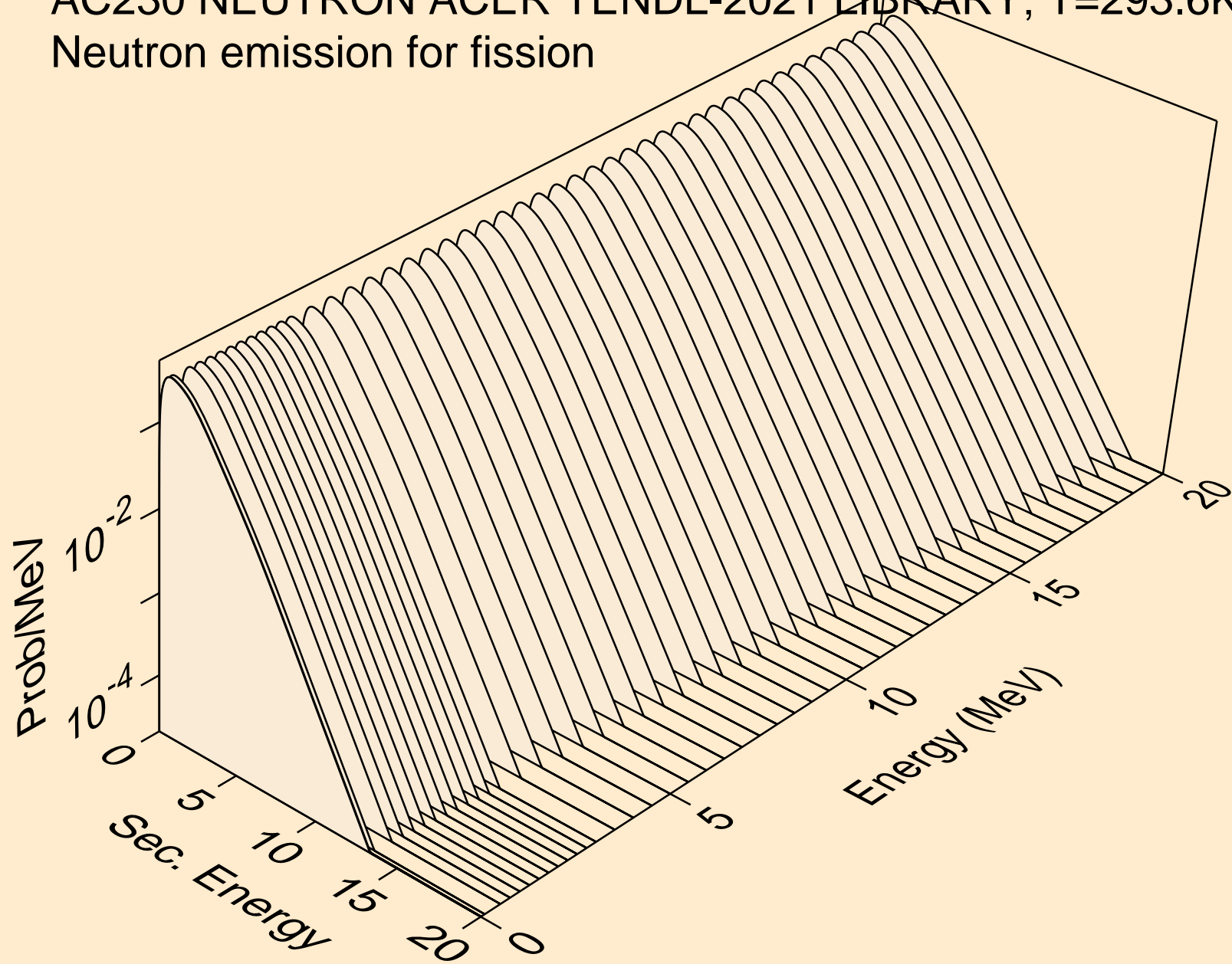

AC230 NEUTRON ACER TENDL-2021 LIBRARY; T=293.6K
Neutron emission for (n,n*)a

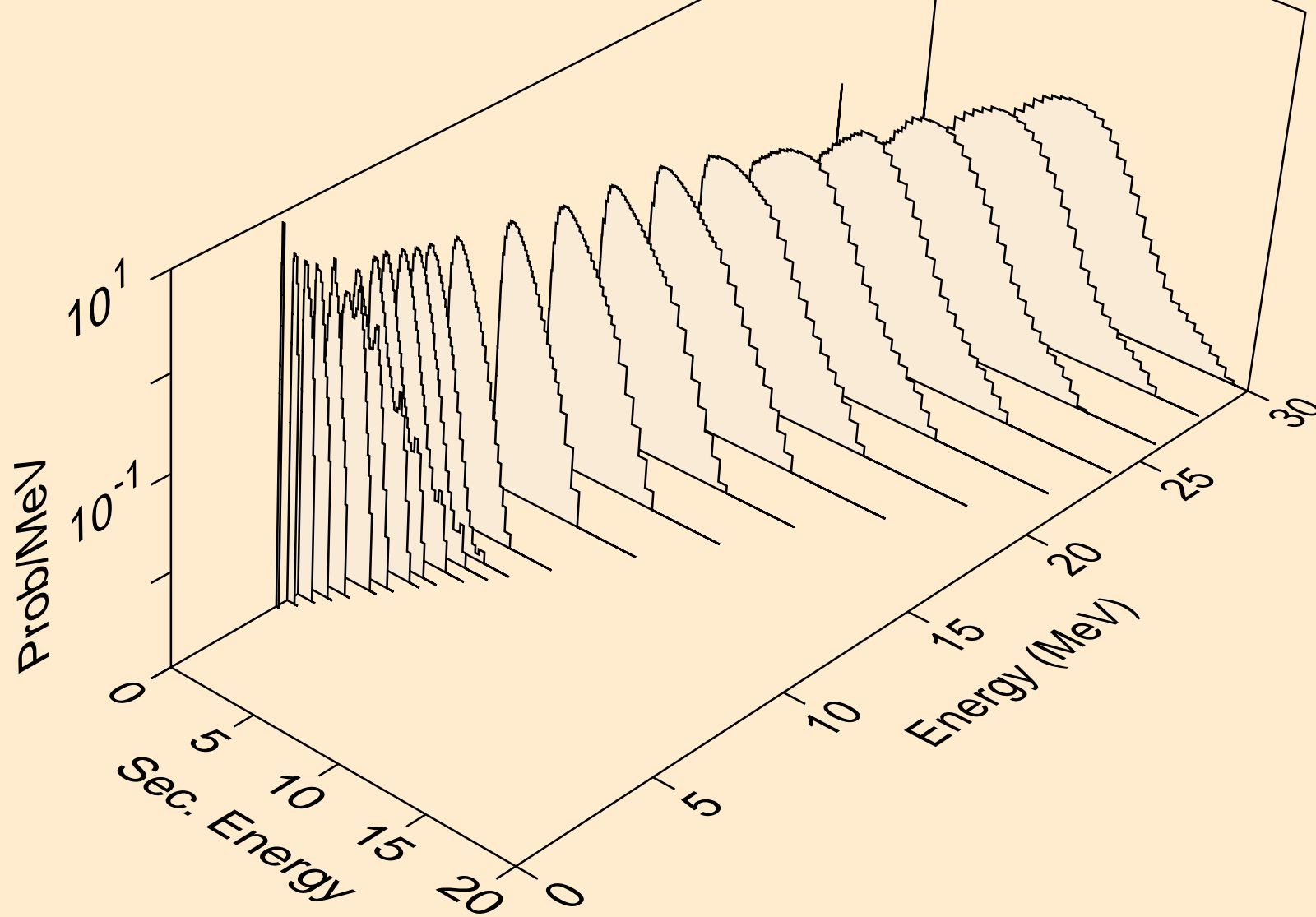

AC230 NEUTRON ACER TENDL-2021 LIBRARY; T=293.6K
Neutron emission for (n,2n)a

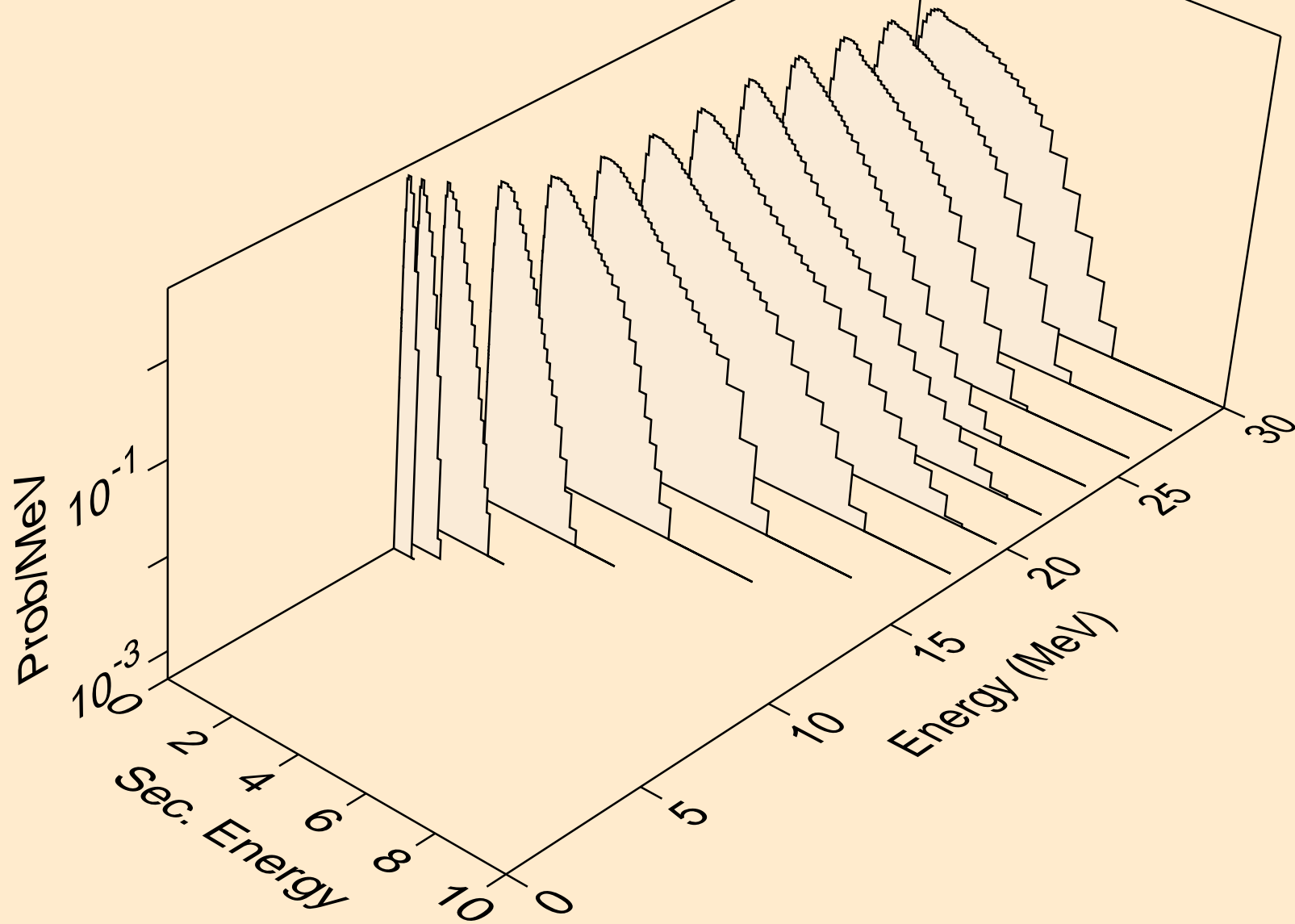

AC230 NEUTRON ACER TENDL-2021 LIBRARY; T=293.6K
Neutron emission for (n,3n)a

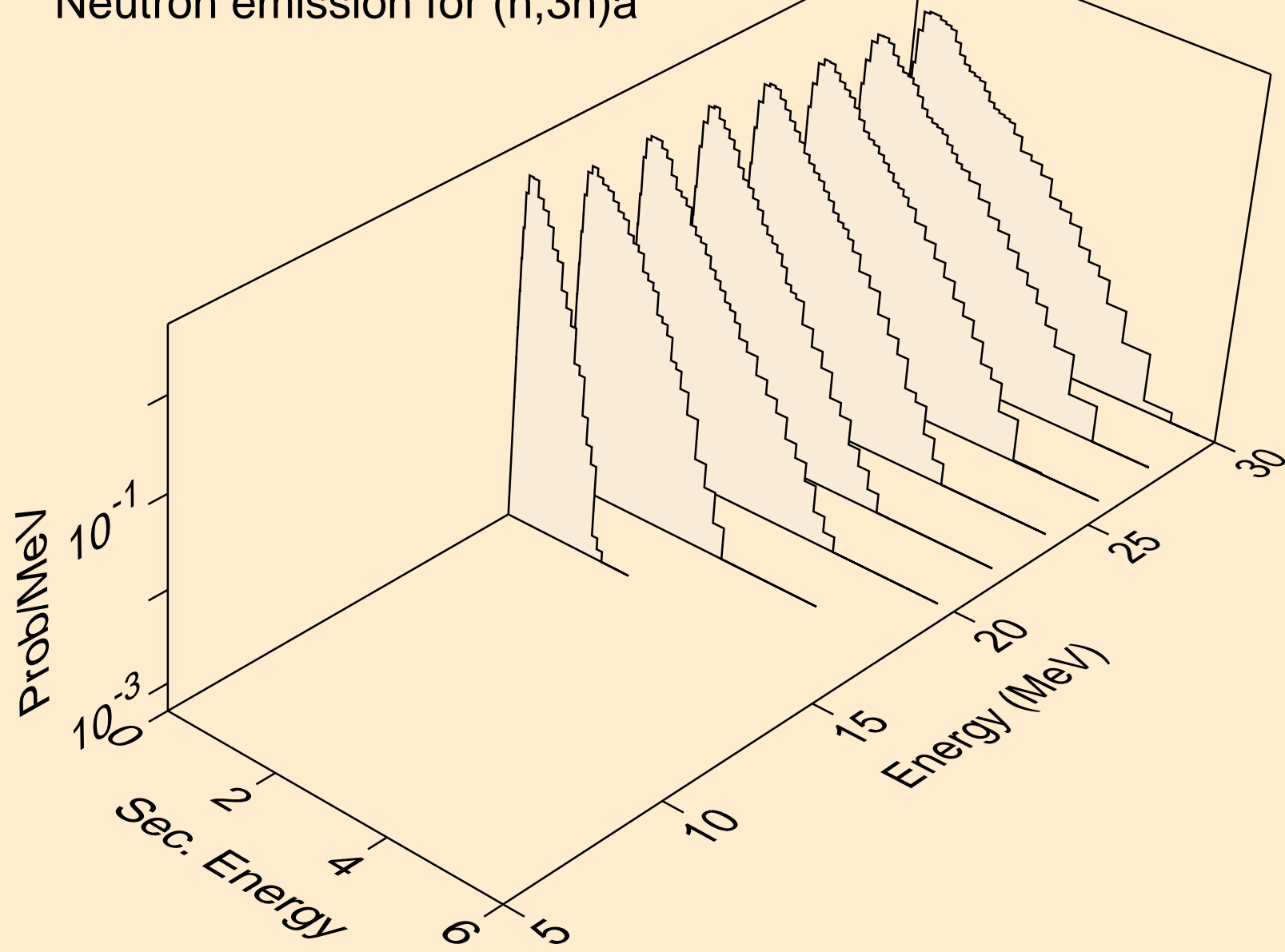

AC230 NEUTRON ACER TENDL-2021 LIBRARY; T=293.6K
Neutron emission for (n,n*)p

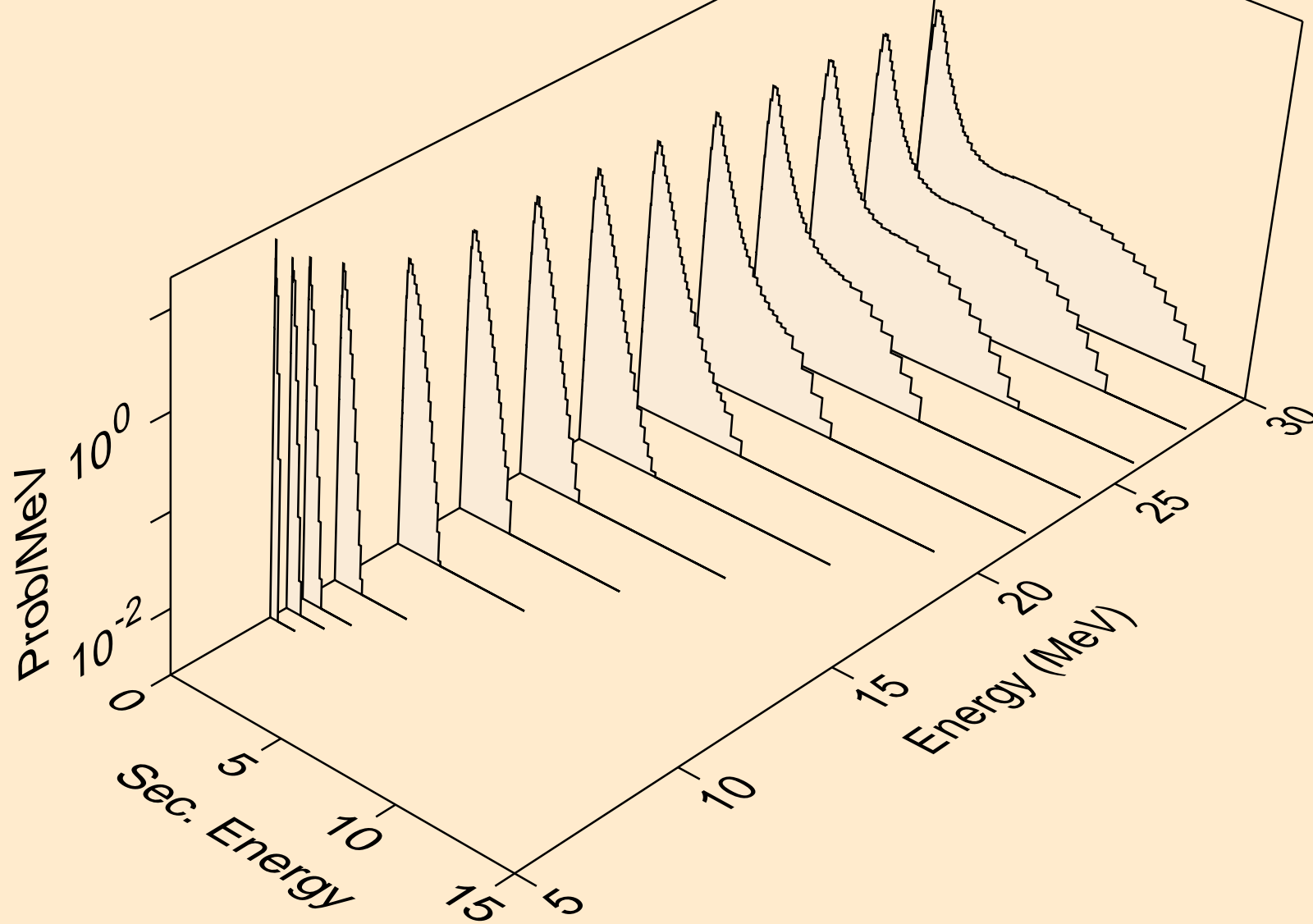

AC230 NEUTRON ACER TENDL-2021 LIBRARY; T=293.6K
Neutron emission for (n,n*)2a

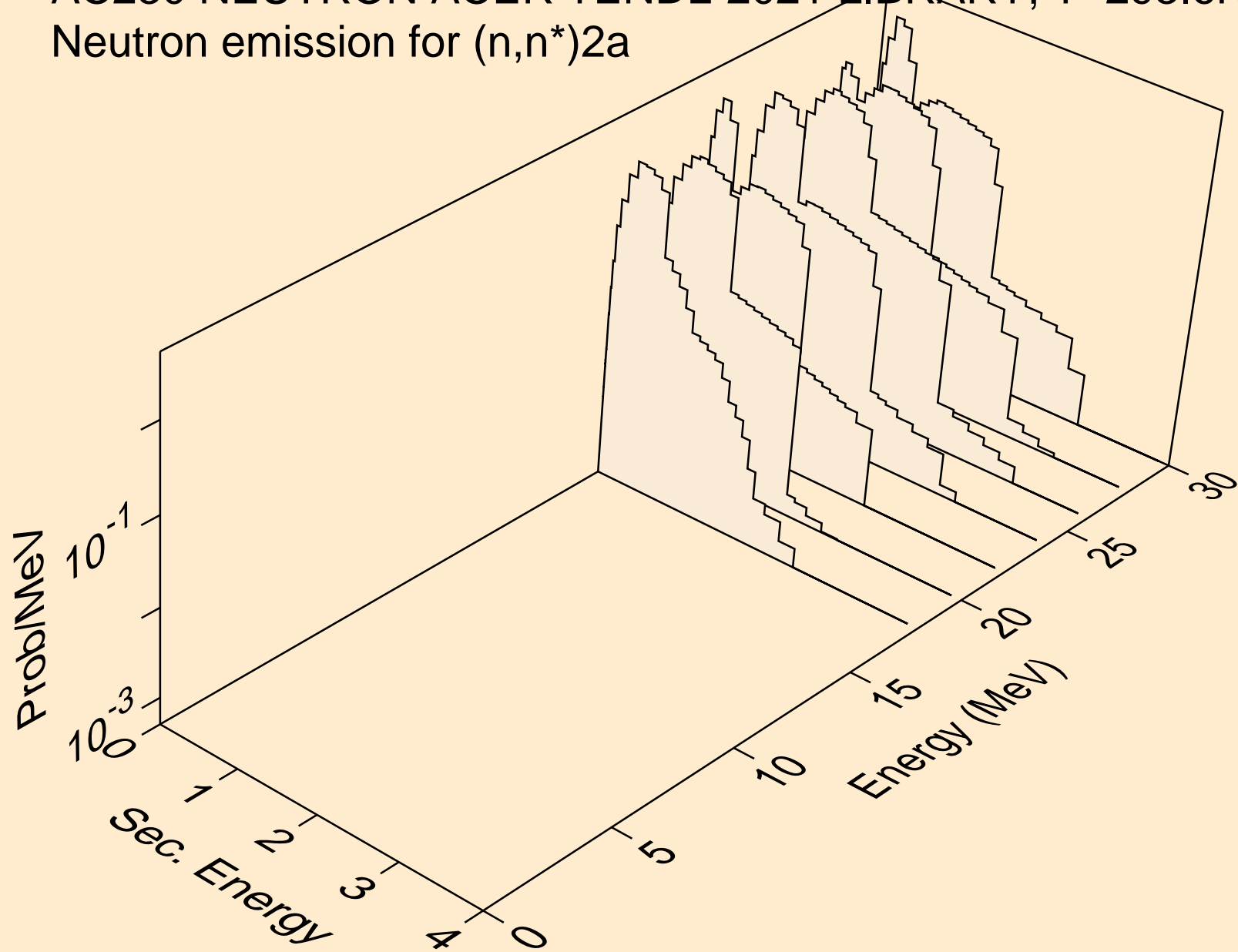

AC230 NEUTRON ACER TENDL-2021 LIBRARY; T=293.6K
Neutron emission for (n,2n)2a

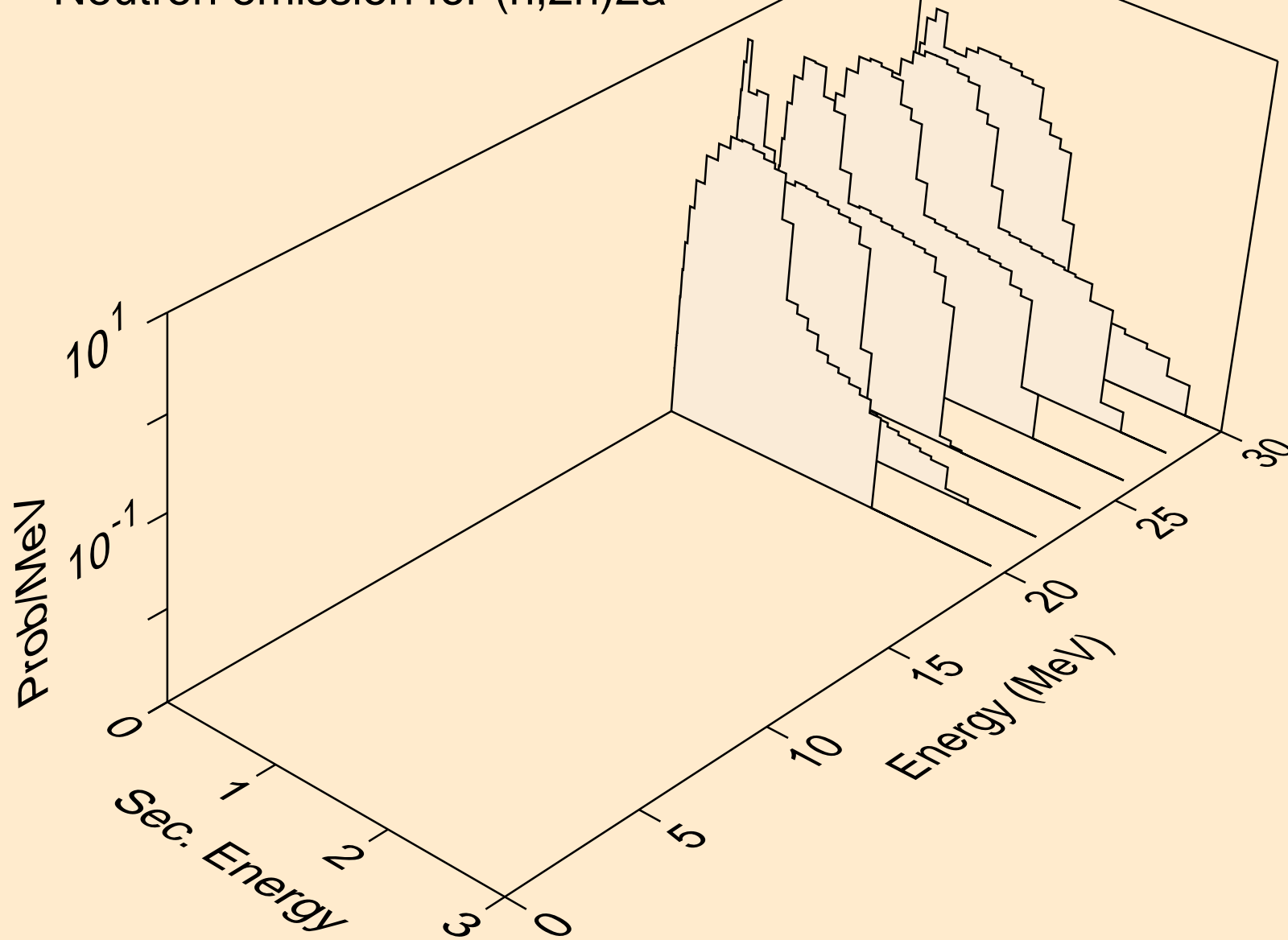

AC230 NEUTRON ACER TENDL-2021 LIBRARY; T=293.6K
Neutron emission for (n,n*)d

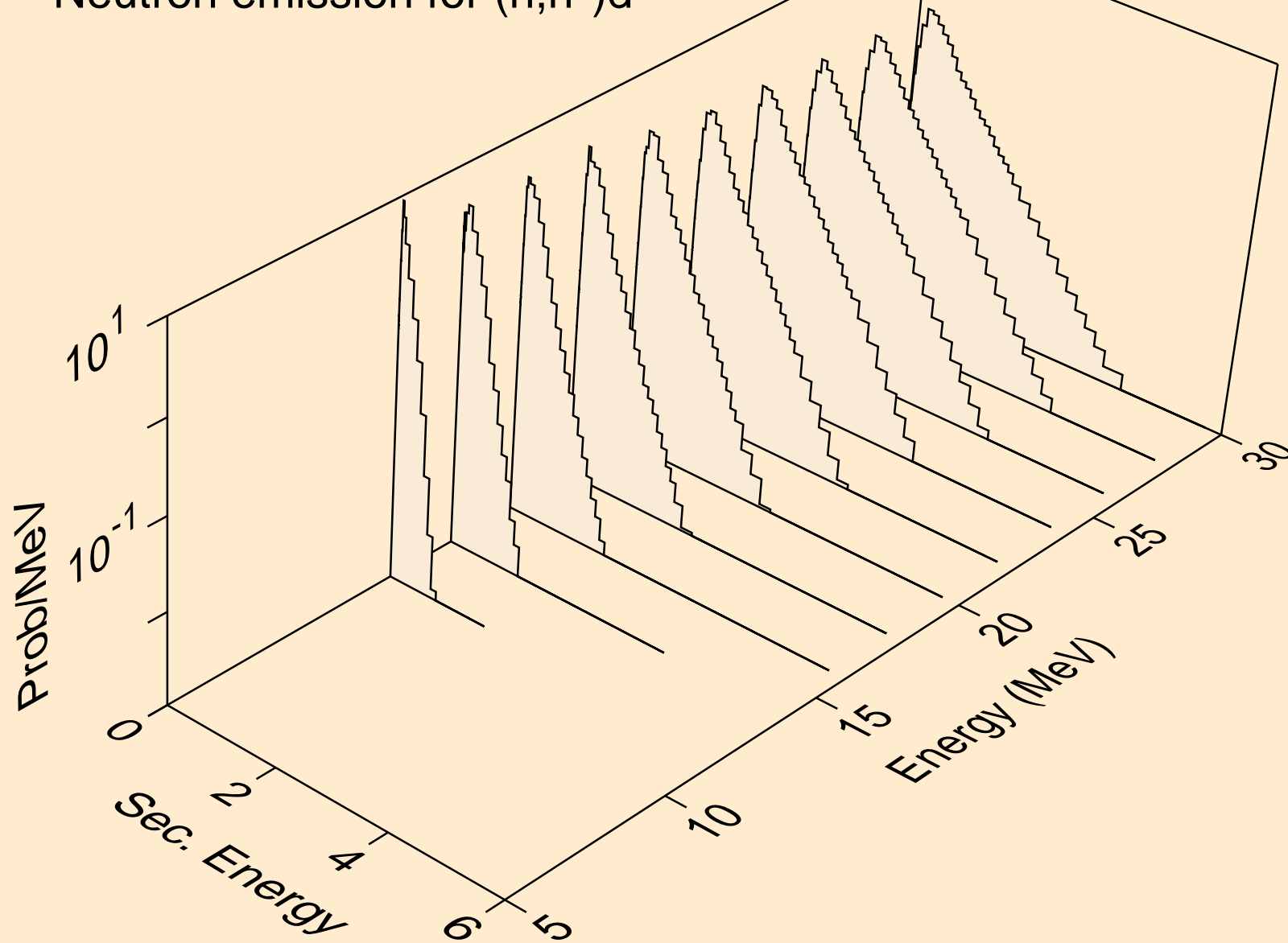

AC230 NEUTRON ACER TENDL-2021 LIBRARY; T=293.6K
Neutron emission for (n,n*)t

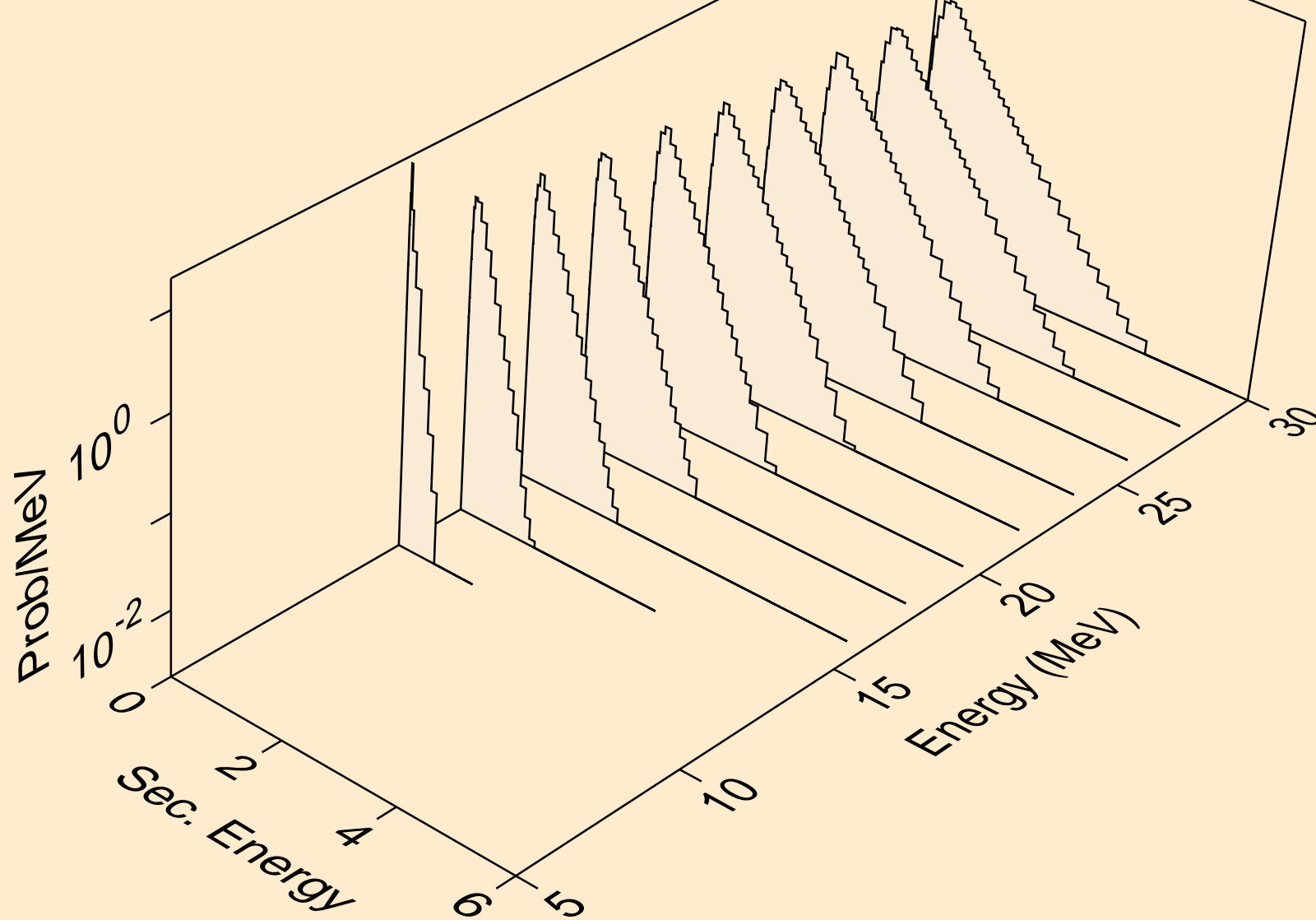

AC230 NEUTRON ACER TENDL-2021 LIBRARY; T=293.6K
Neutron emission for (n,n*)he3

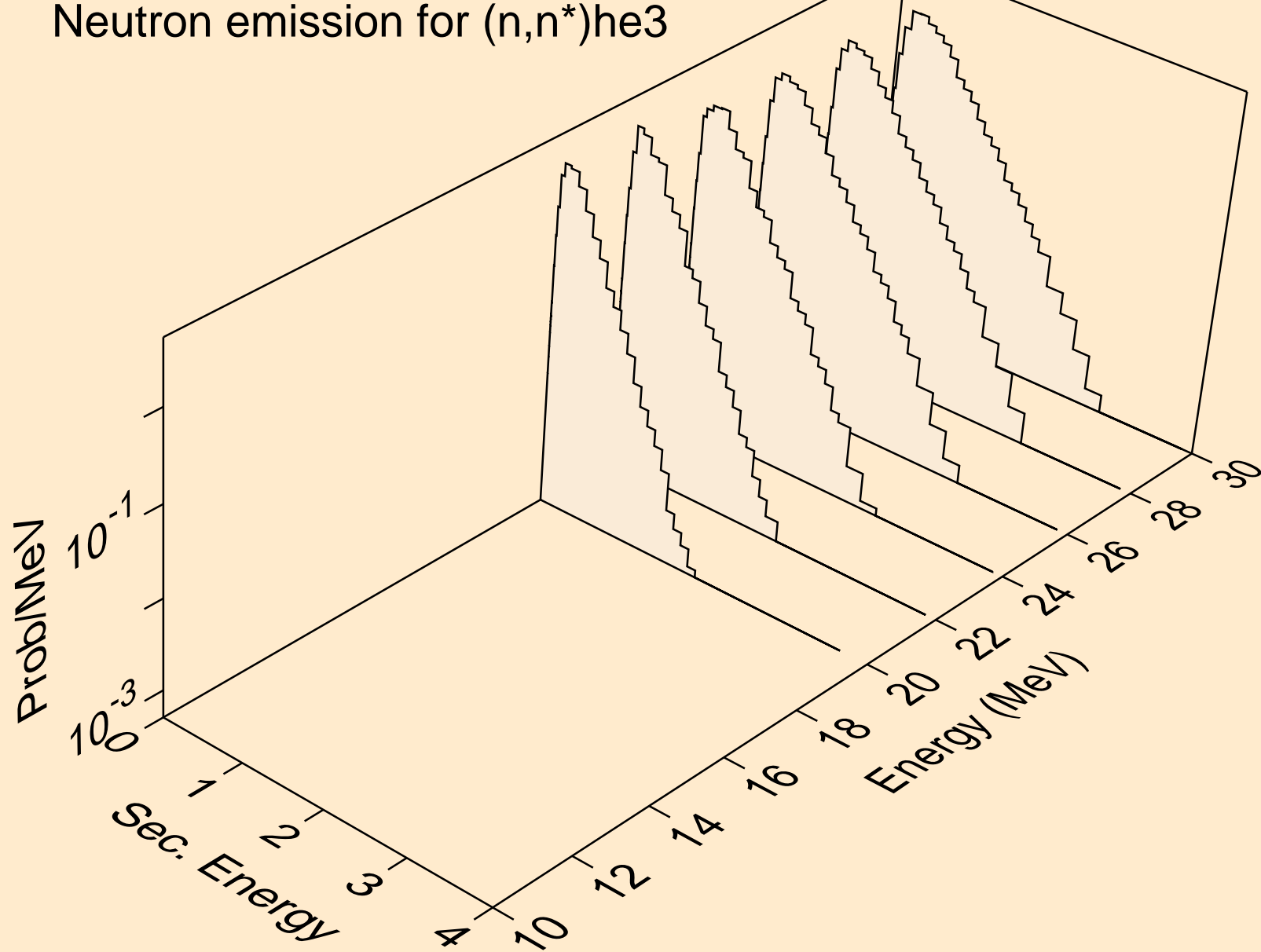

AC230 NEUTRON ACER TENDL-2021 LIBRARY; T=293.6K
Neutron emission for (n,4n)

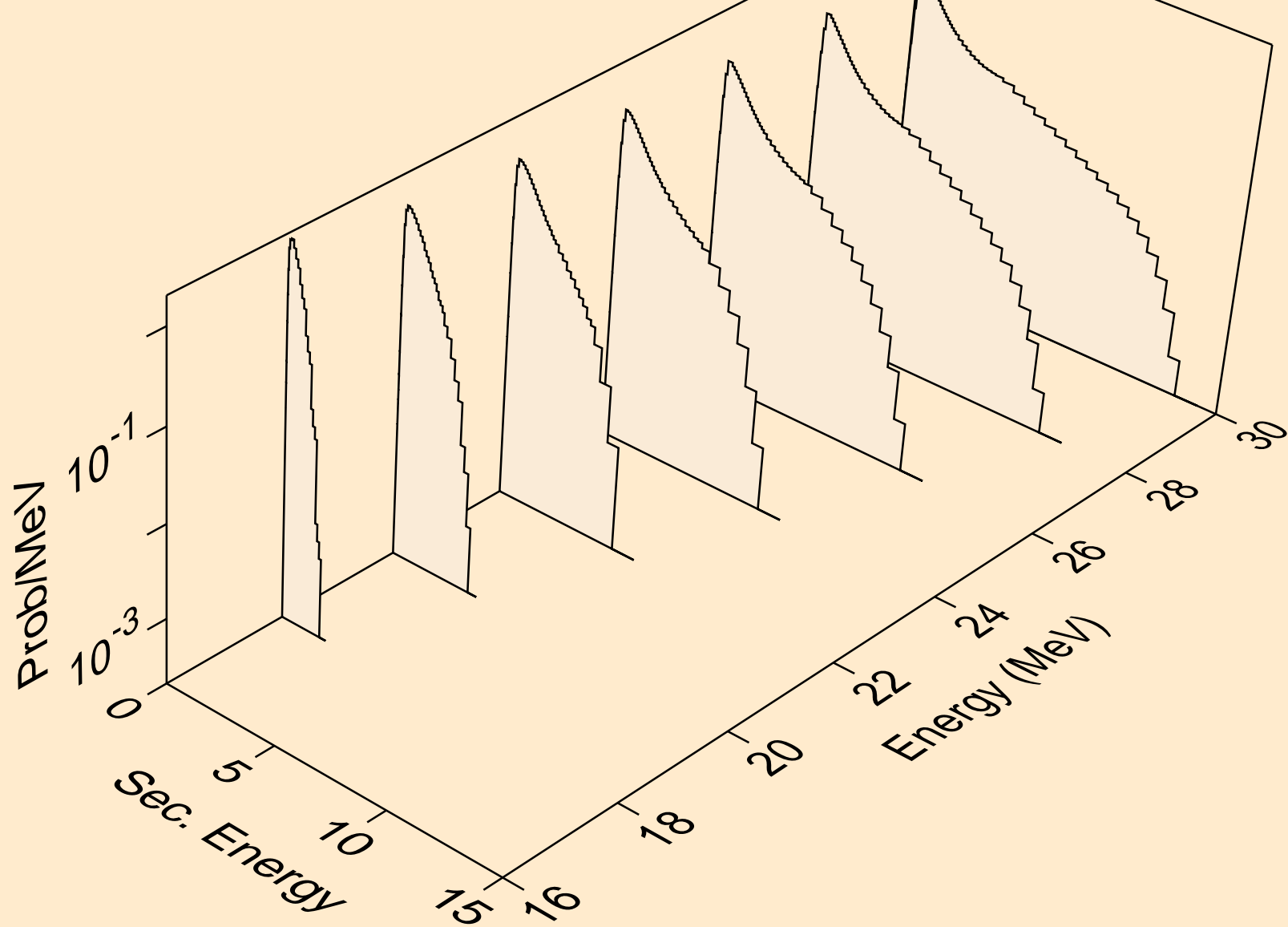

AC230 NEUTRON ACER TENDL-2021 LIBRARY; T=293.6K
Neutron emission for (n,2np)

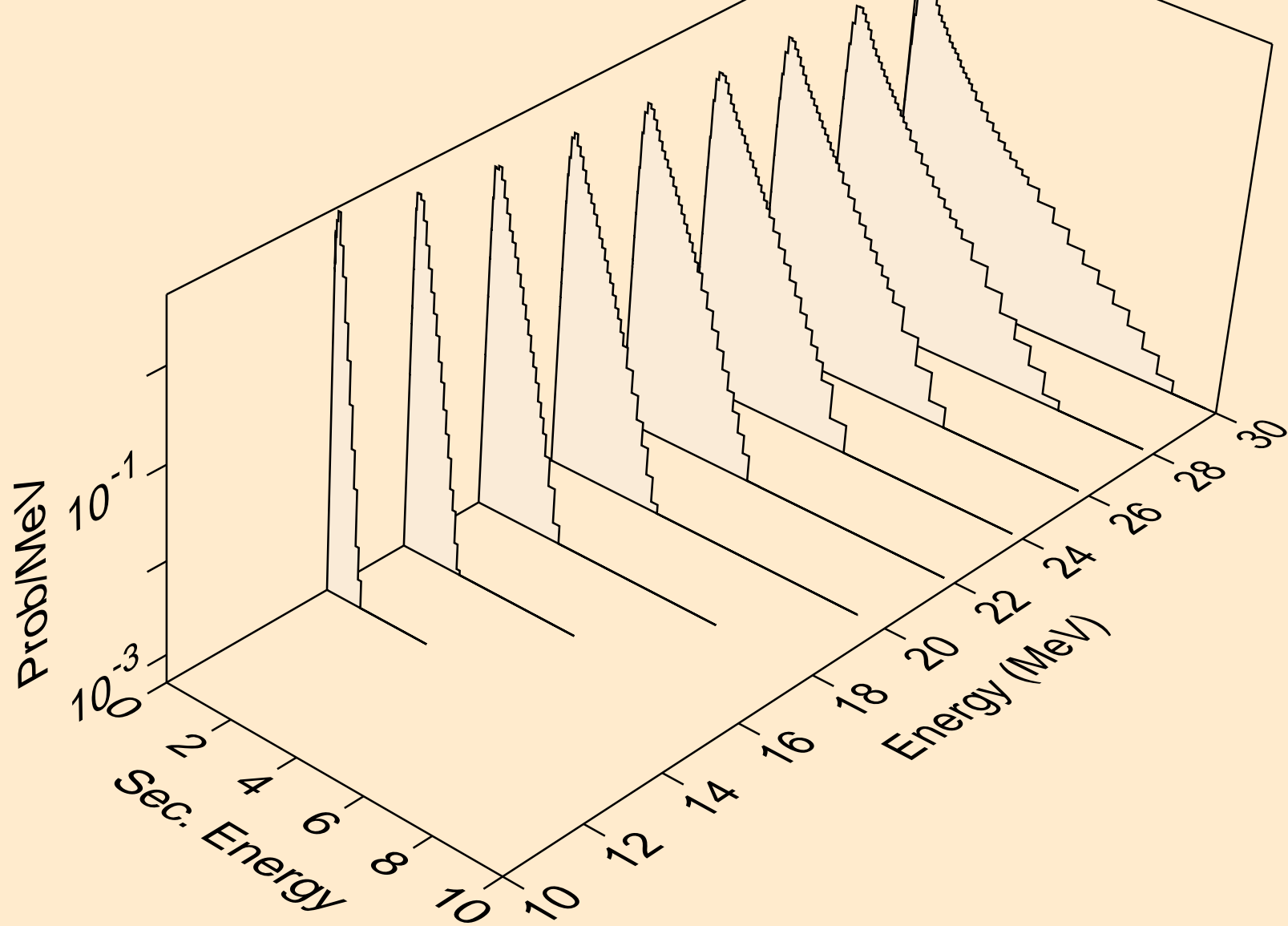

AC230 NEUTRON ACER TENDL-2021 LIBRARY; T=293.6K
Neutron emission for (n,3np)

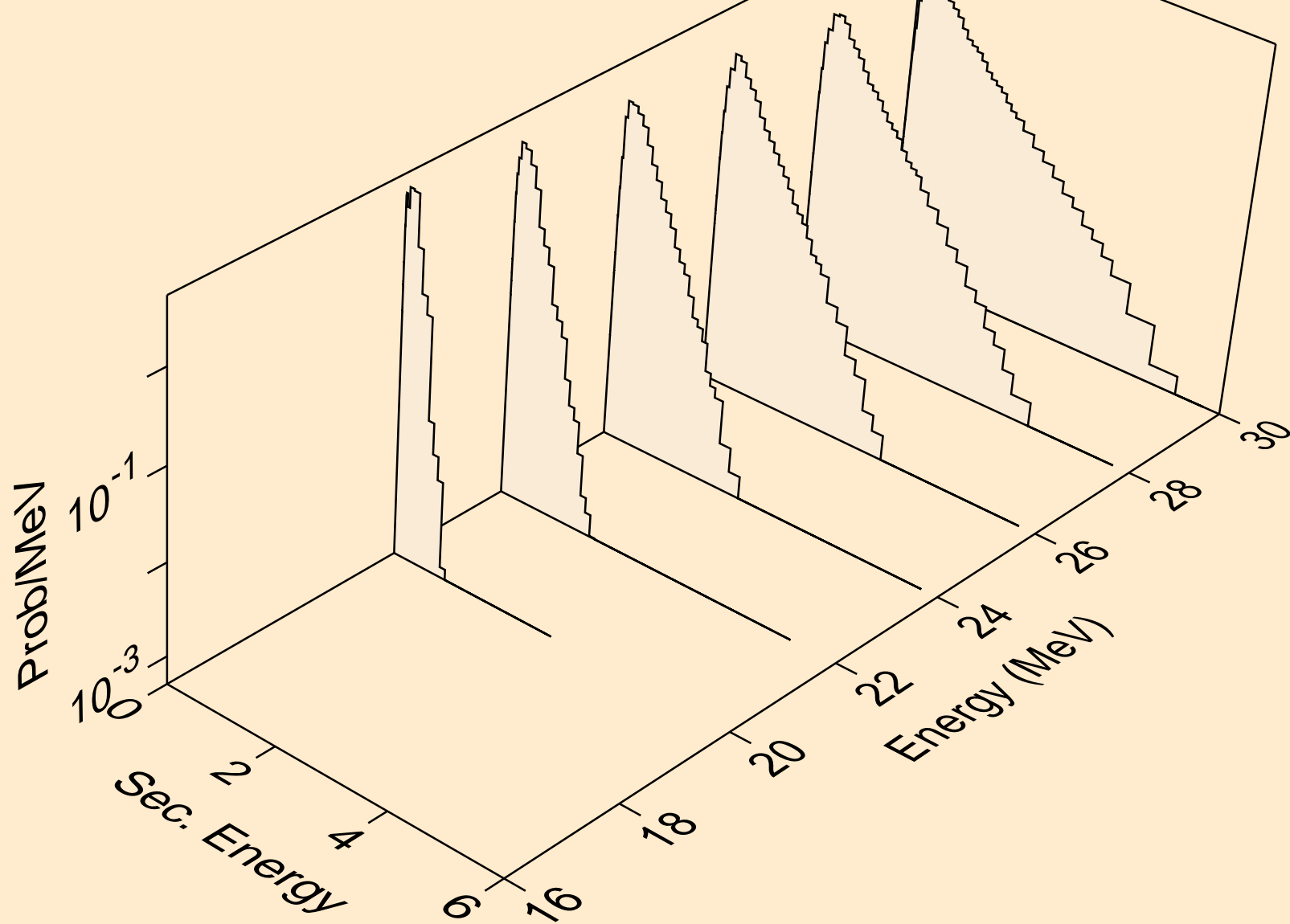

AC230 NEUTRON ACER TENDL-2021 LIBRARY; T=293.6K
Neutron emission for (n,2np)

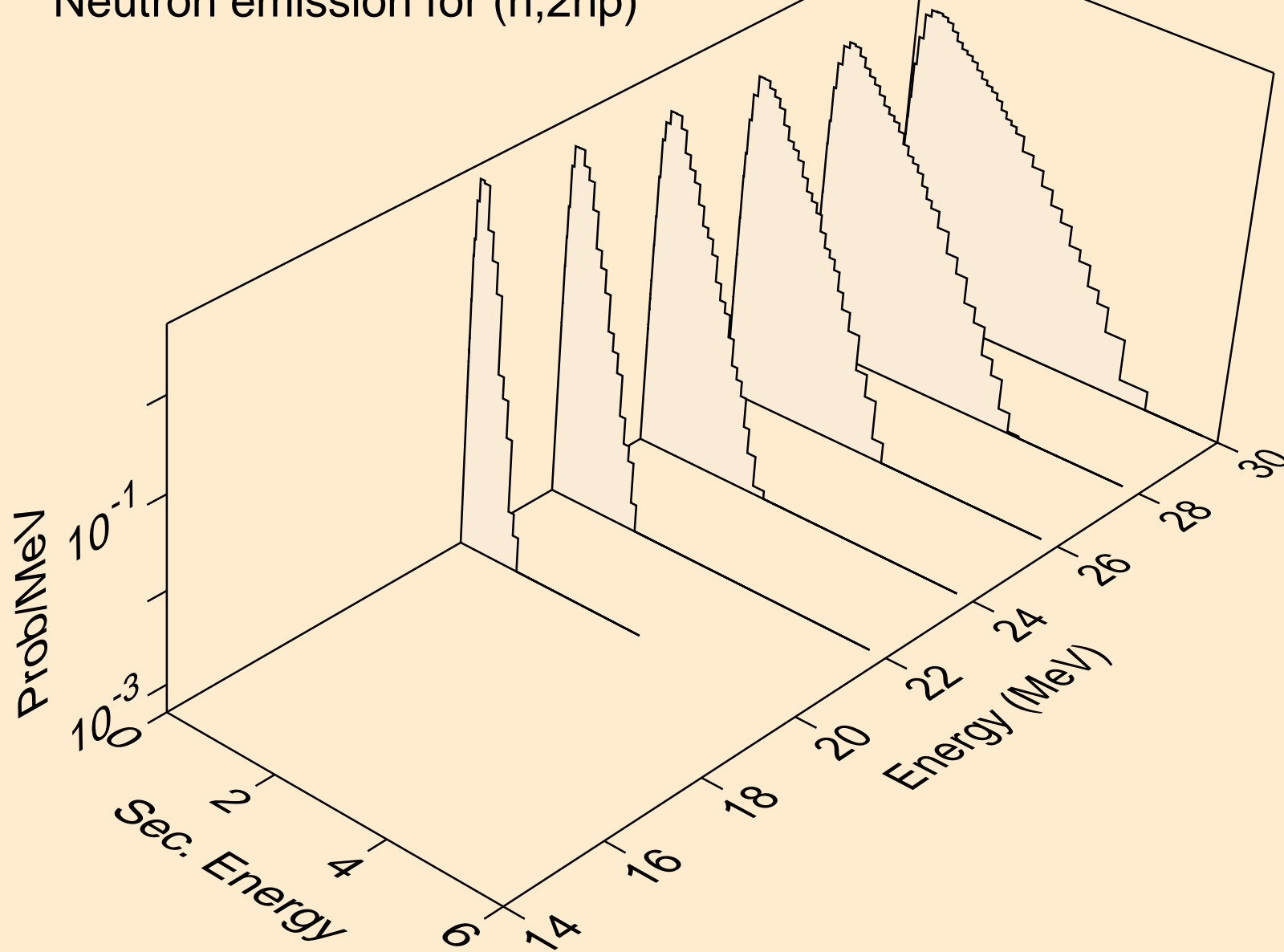

AC230 NEUTRON ACER TENDL-2021 LIBRARY; T=293.6K
Neutron emission for (n,npa)

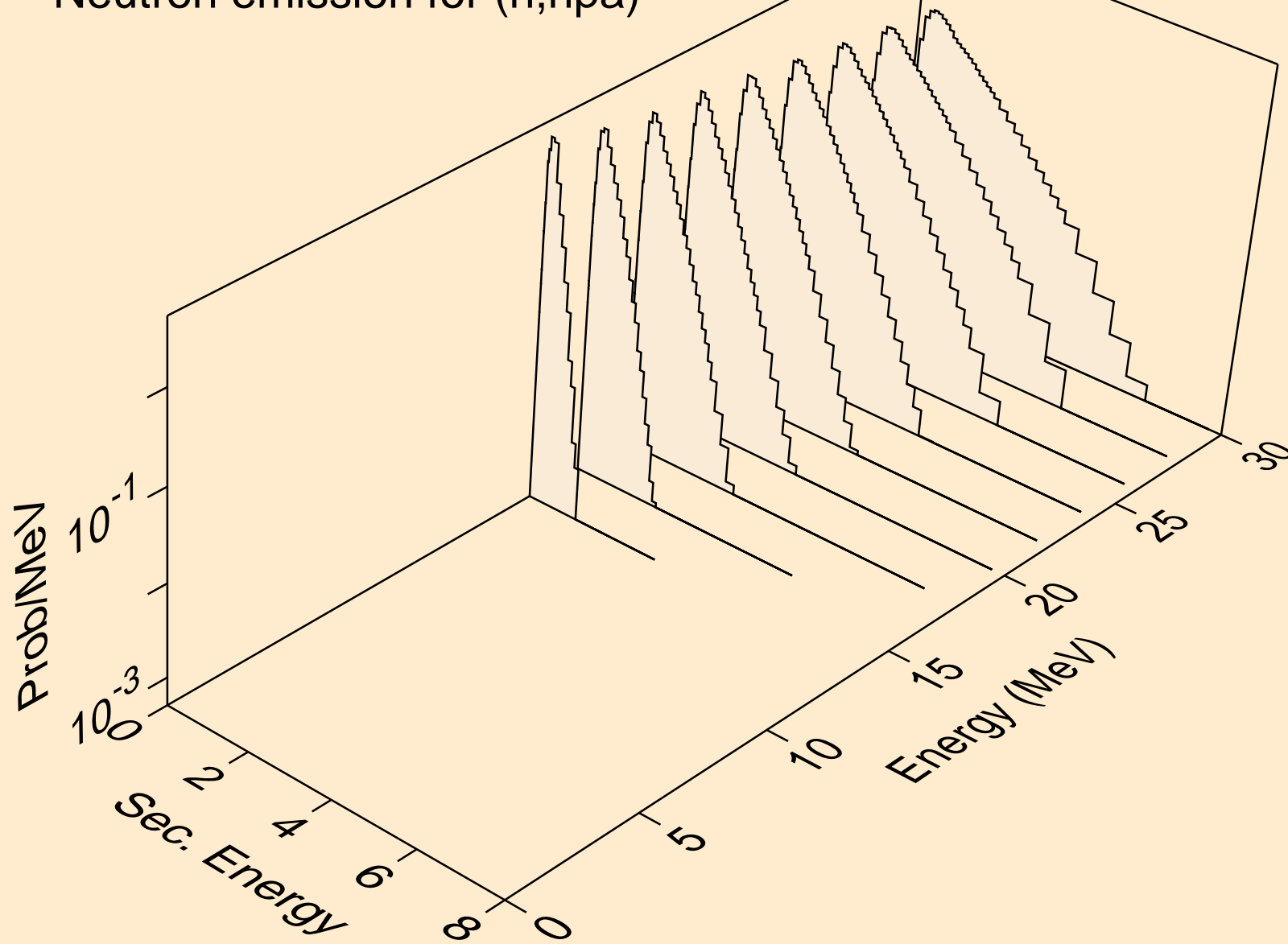

AC230 NEUTRON ACER TENDL-2021 LIBRARY; T=293.6K
Neutron emission for (n,n*c)

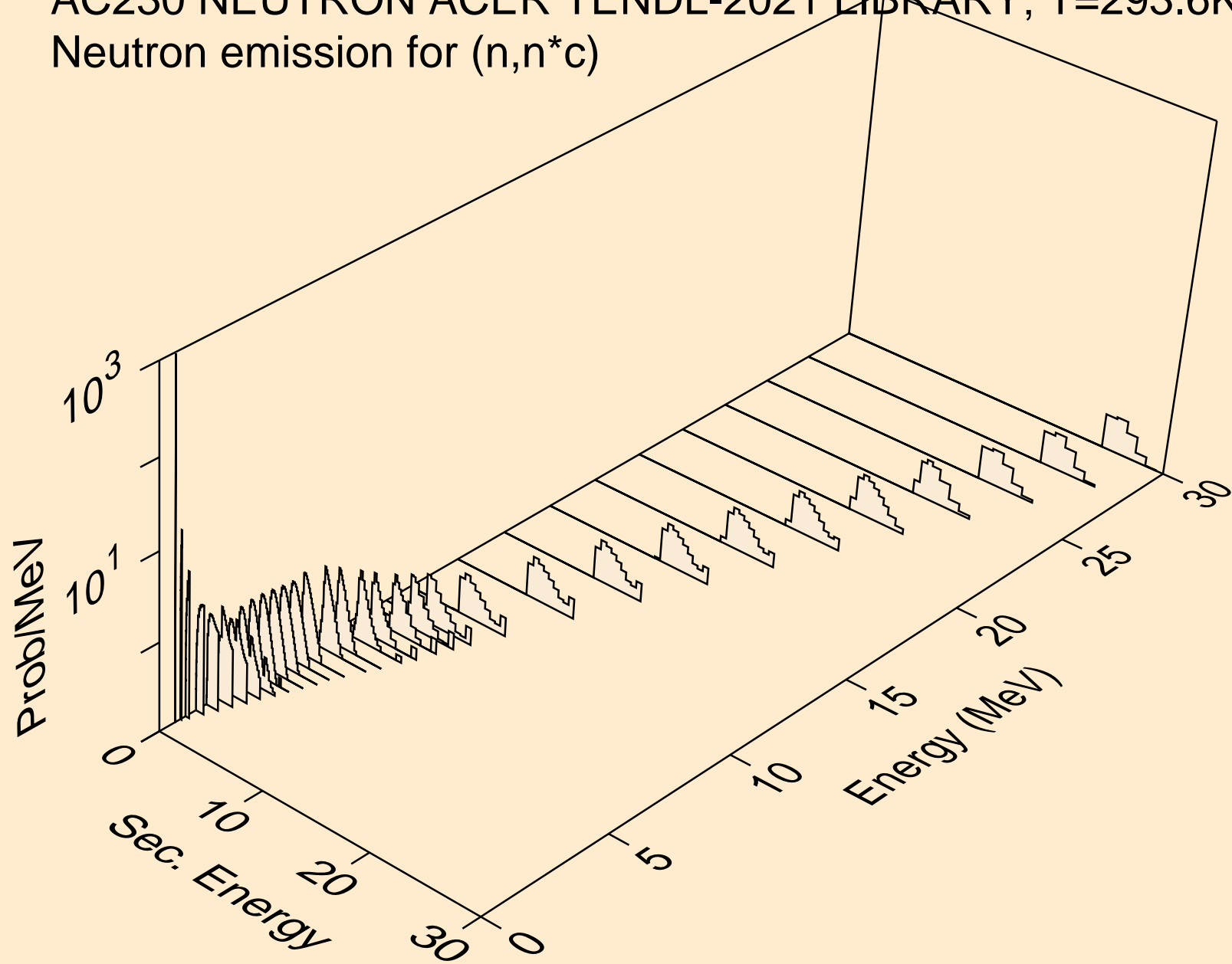

AC230 NEUTRON ACER TENDL-2021 LIBRARY; T=293.6K

Delayed nubar

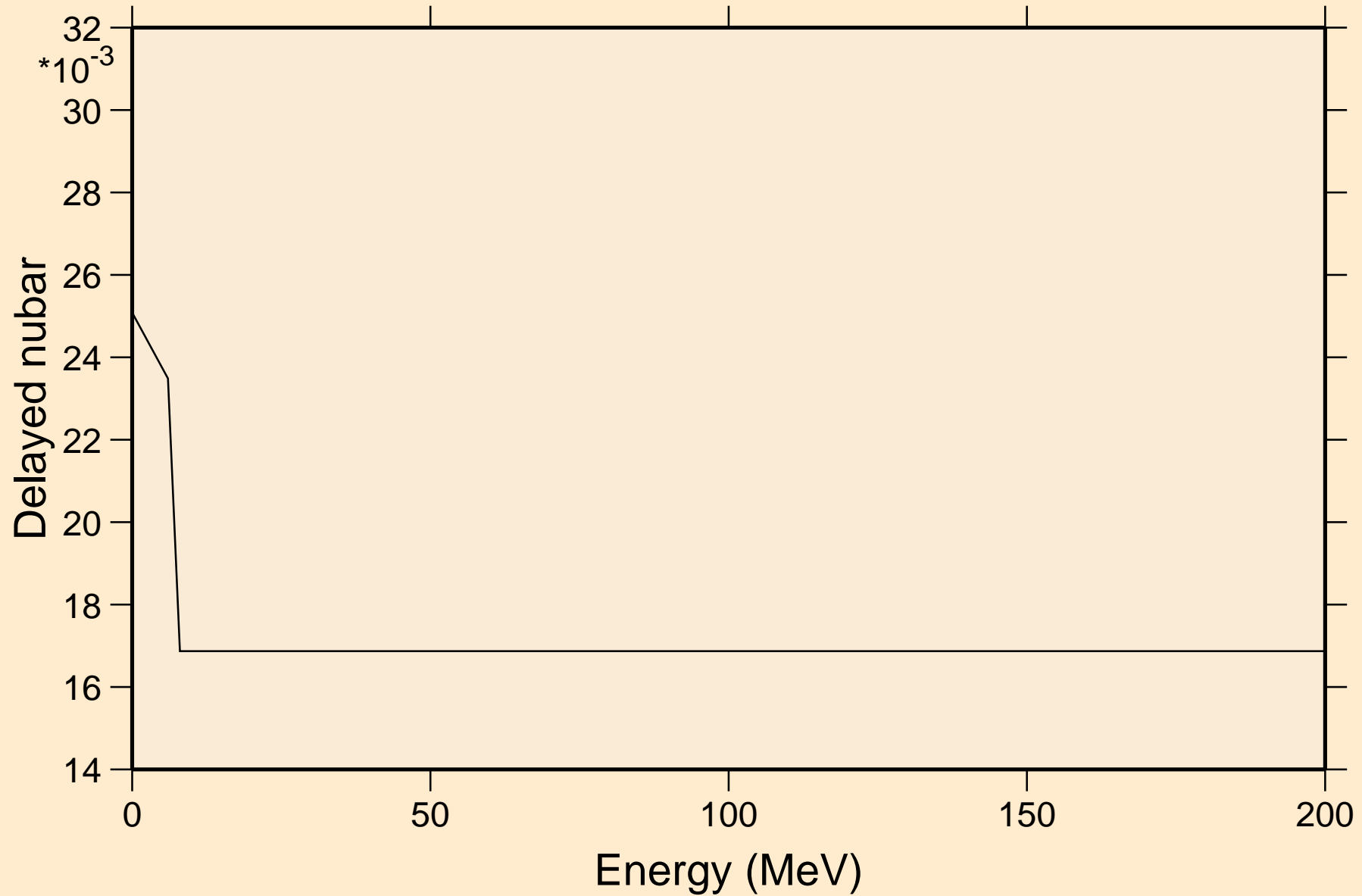

AC230 NEUTRON ACER TENDL-2021 LIBRARY; T=293.6K
Delayed neutron spectra

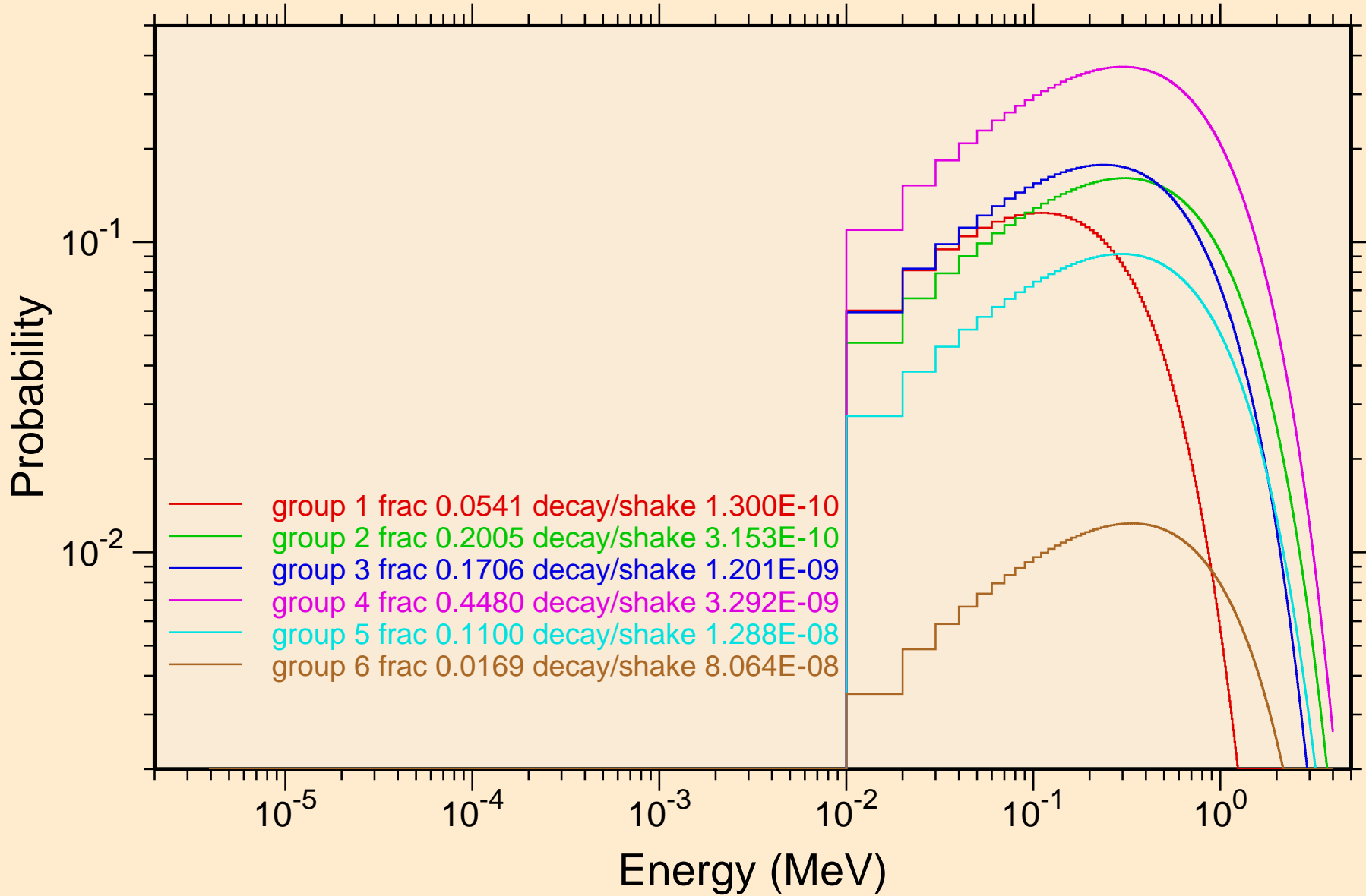

AC230 NEUTRON ACER TENDL-2021 LIBRARY; T=293.6K
Photon emission for (n,x)

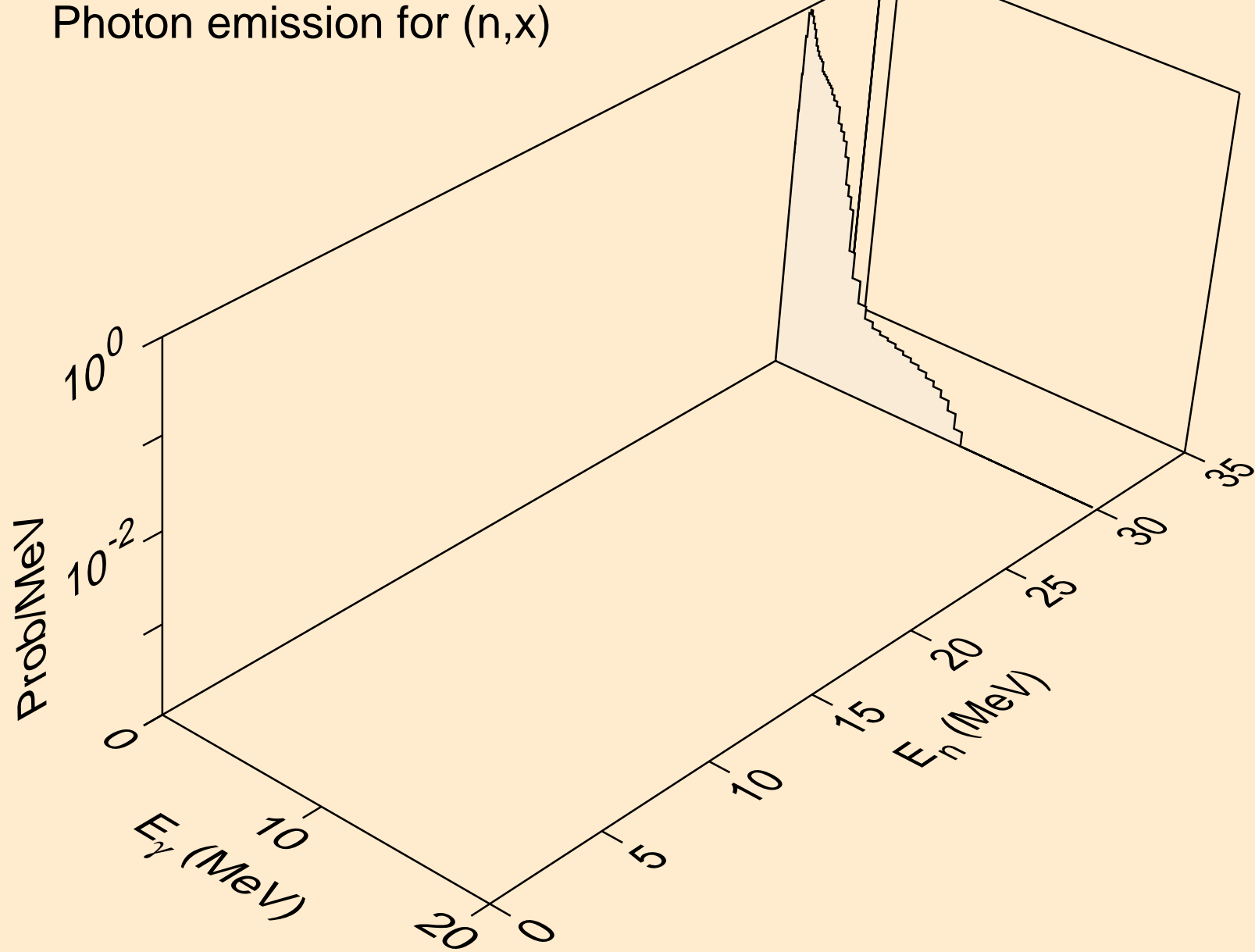

AC230 NEUTRON ACER TENDL-2021 LIBRARY; T=293.6K
Photon emission for (n,2nd)

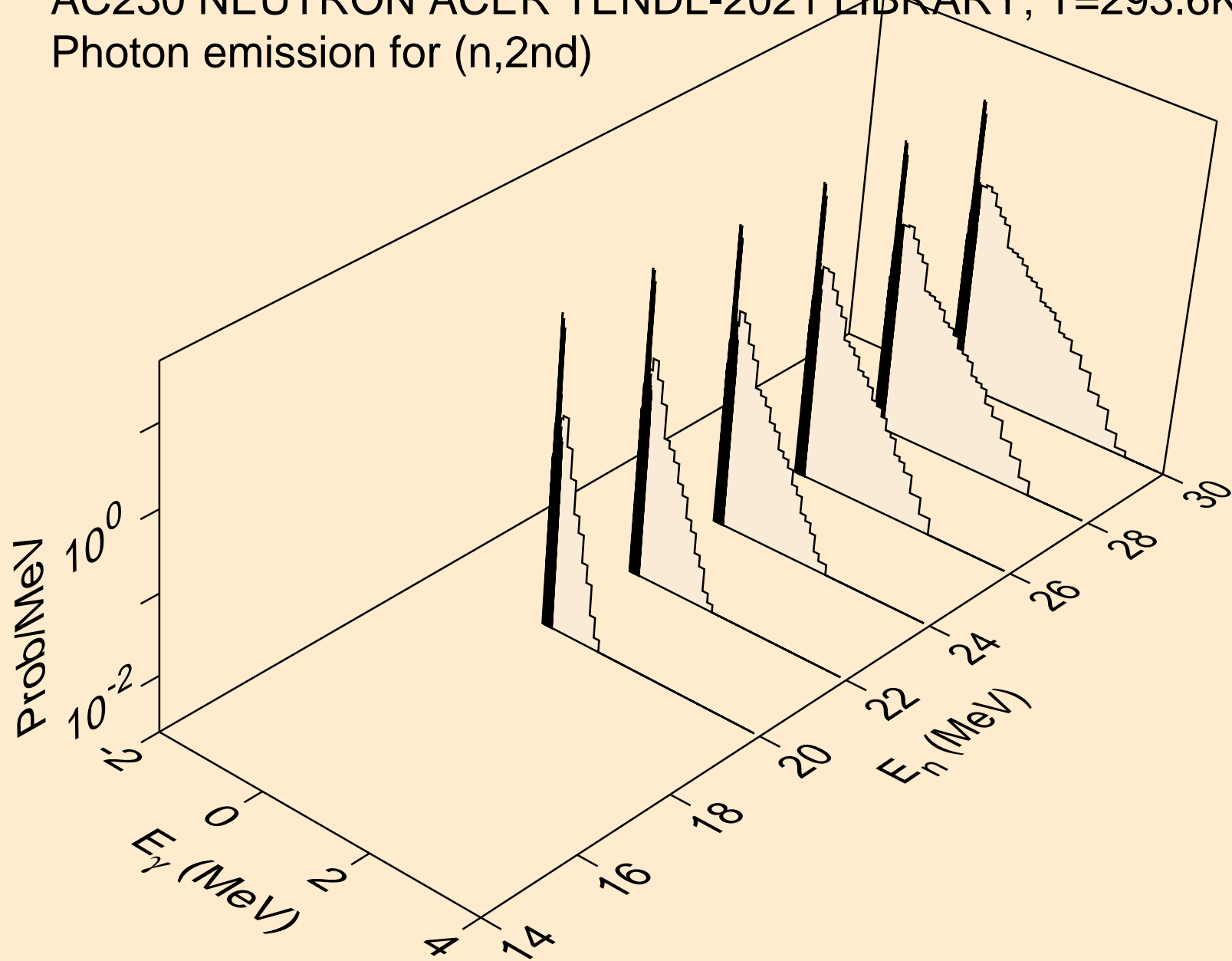

AC230 NEUTRON ACER TENDL-2021 LIBRARY; T=293.6K
Photon emission for (n,2n)

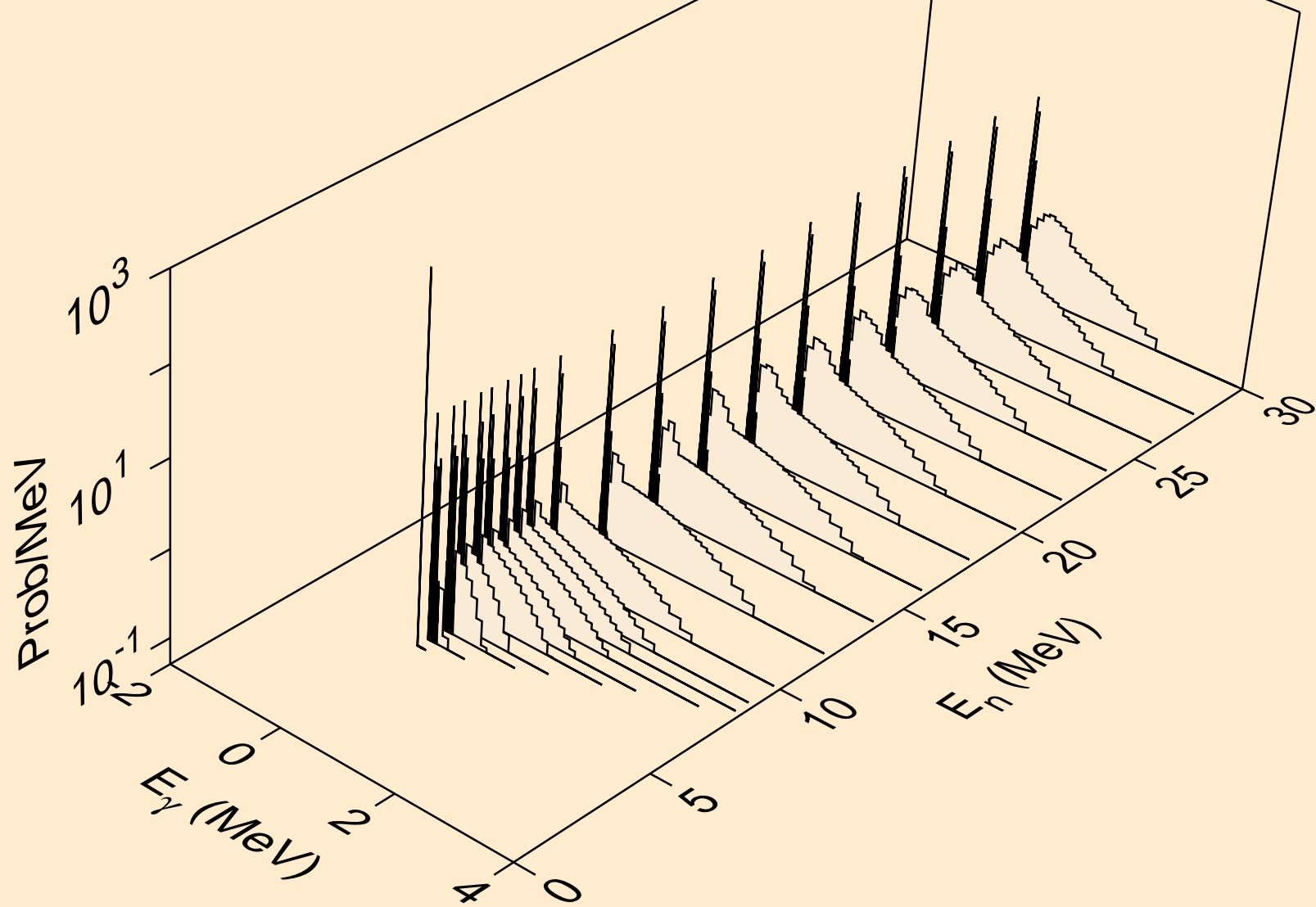

AC230 NEUTRON ACER TENDL-2021 LIBRARY; T=293.6K
Photon emission for (n,3n)

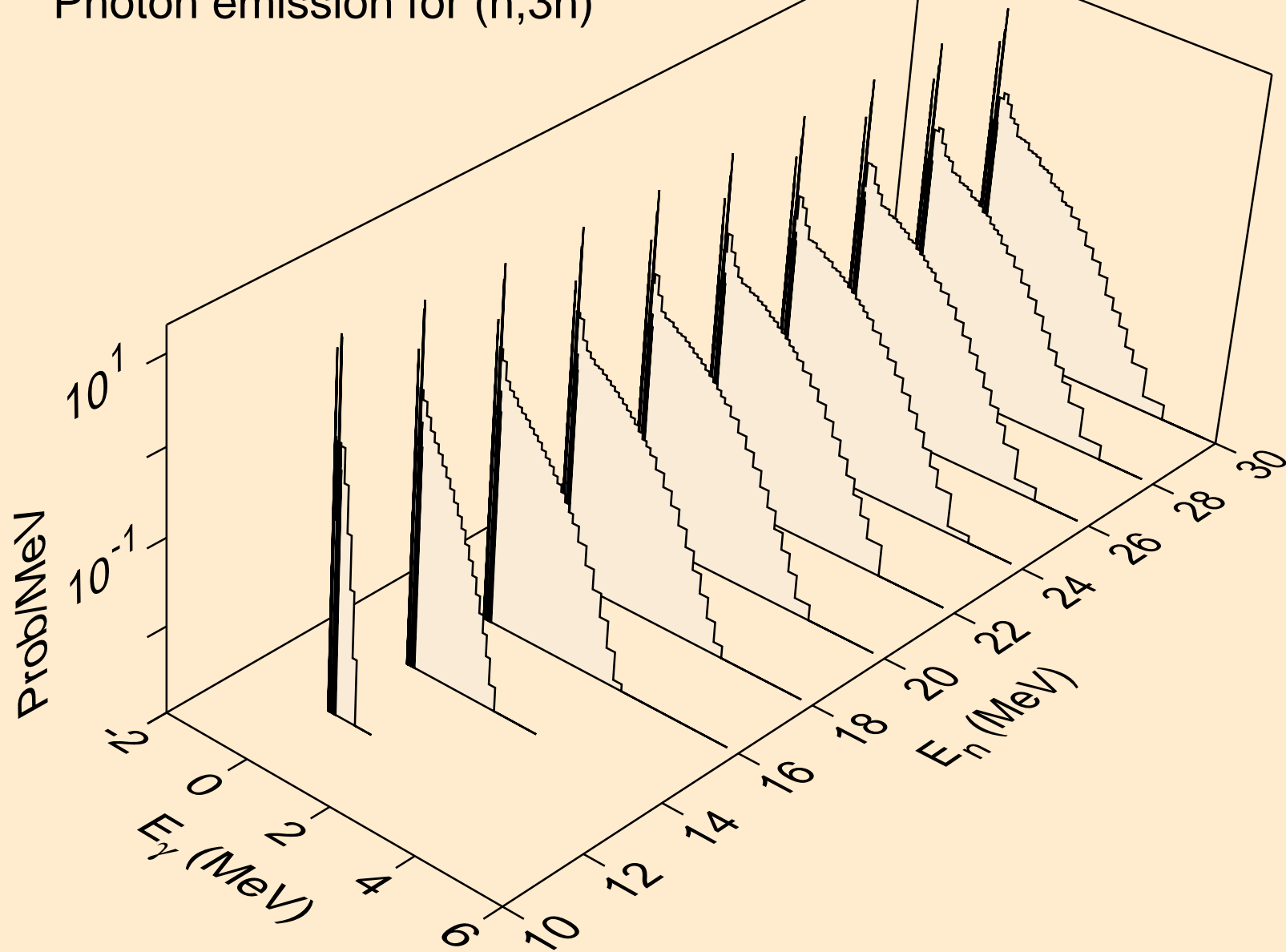

AC230 NEUTRON ACER TENDL-2021 LIBRARY; T=293.6K
Photon emission for (n,n*)a

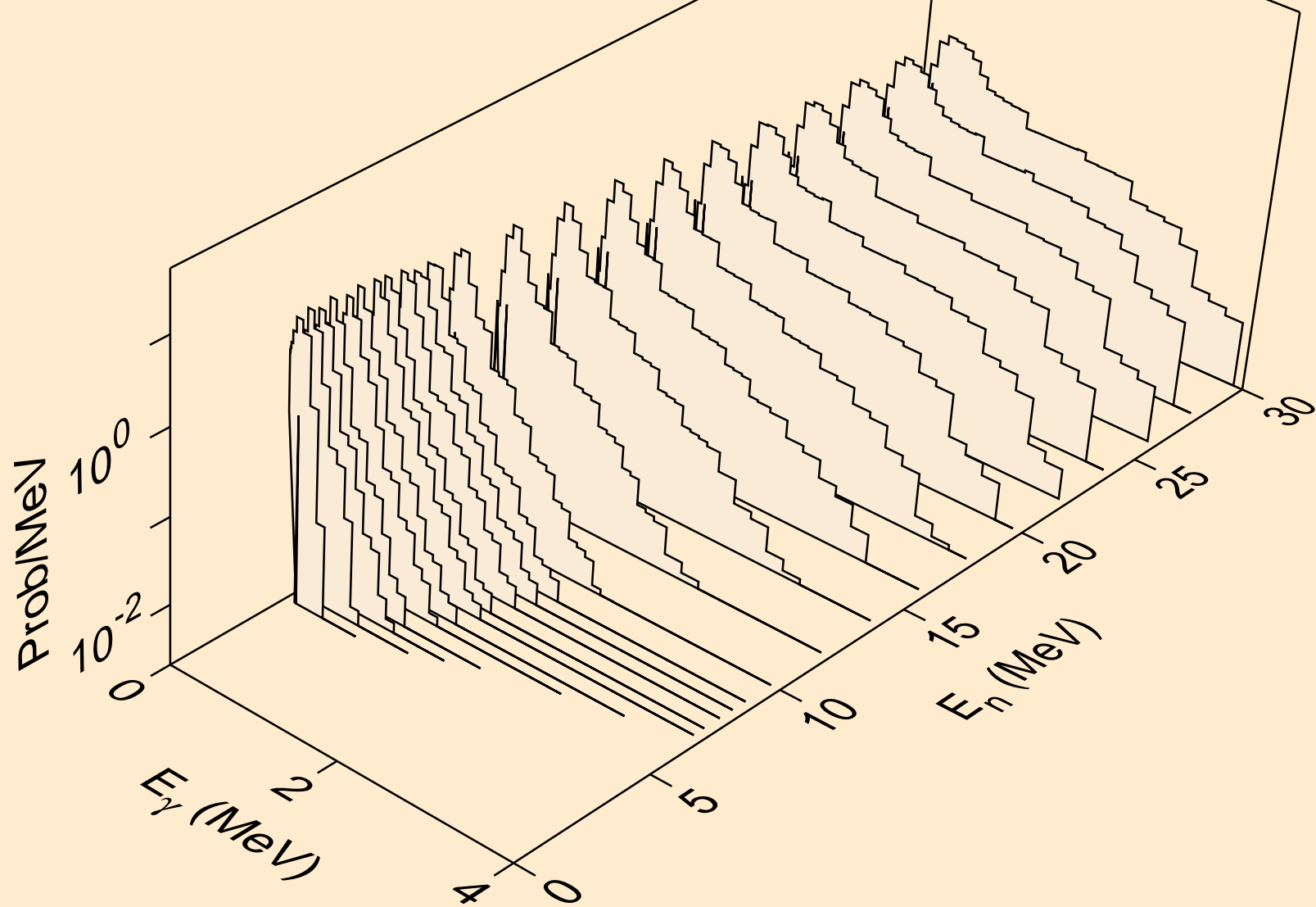

AC230 NEUTRON ACER TENDL-2021 LIBRARY; T=293.6K
Photon emission for (n,2n)a

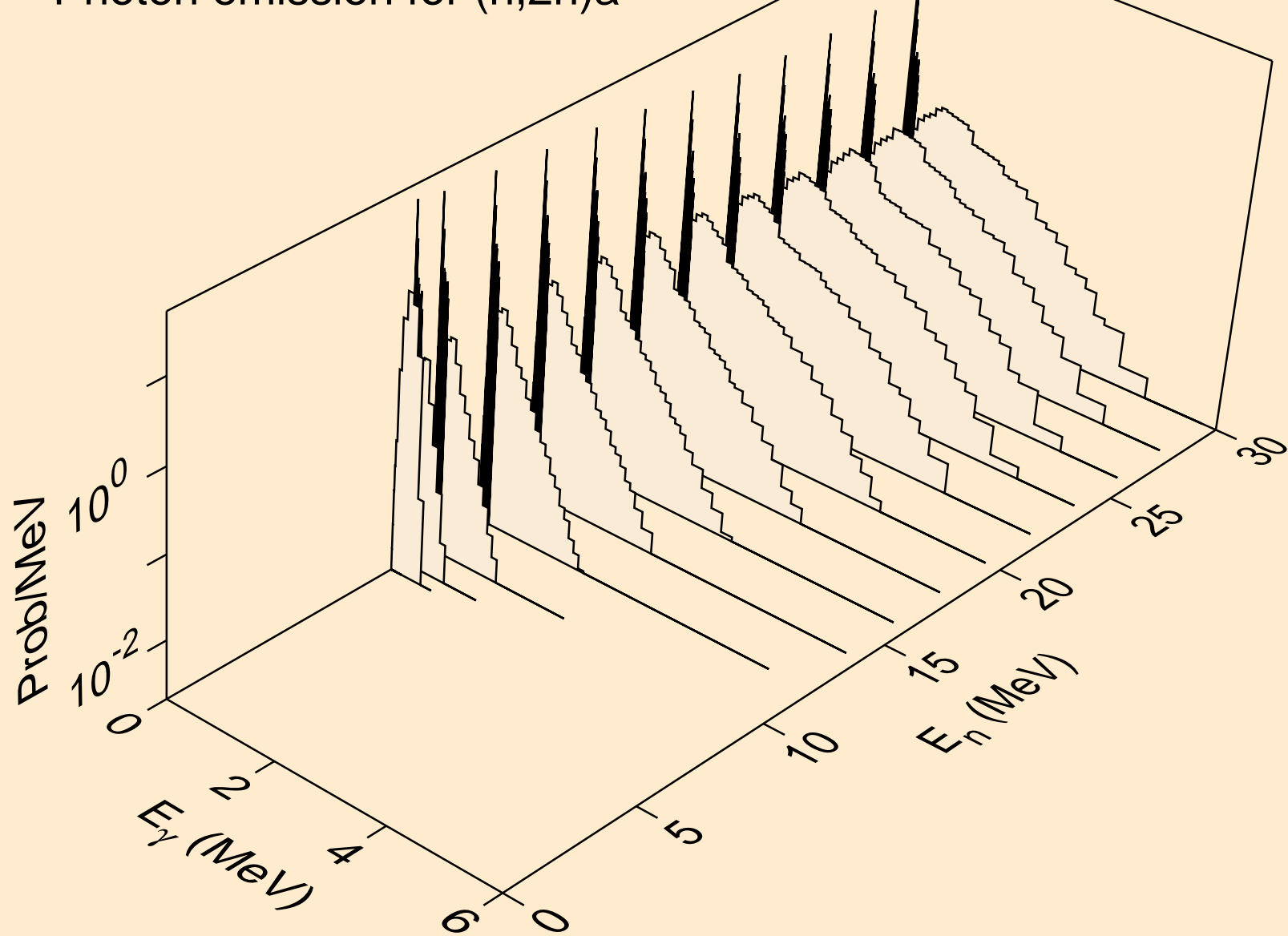

AC230 NEUTRON ACER TENDL-2021 LIBRARY; T=293.6K
Photon emission for (n,3n)a

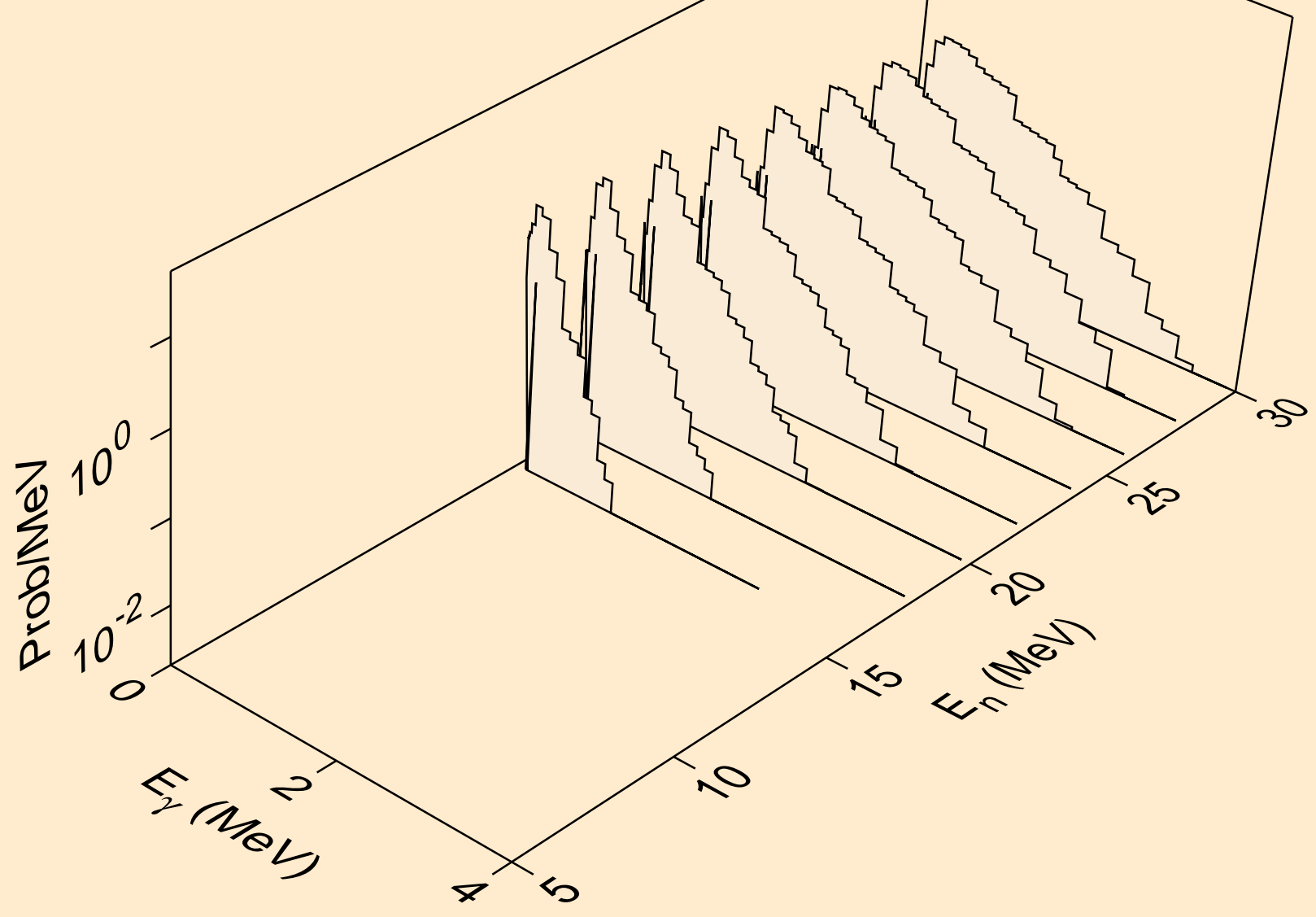

AC230 NEUTRON ACER TENDL-2021 LIBRARY; T=293.6K
Photon emission for (n,n*)p

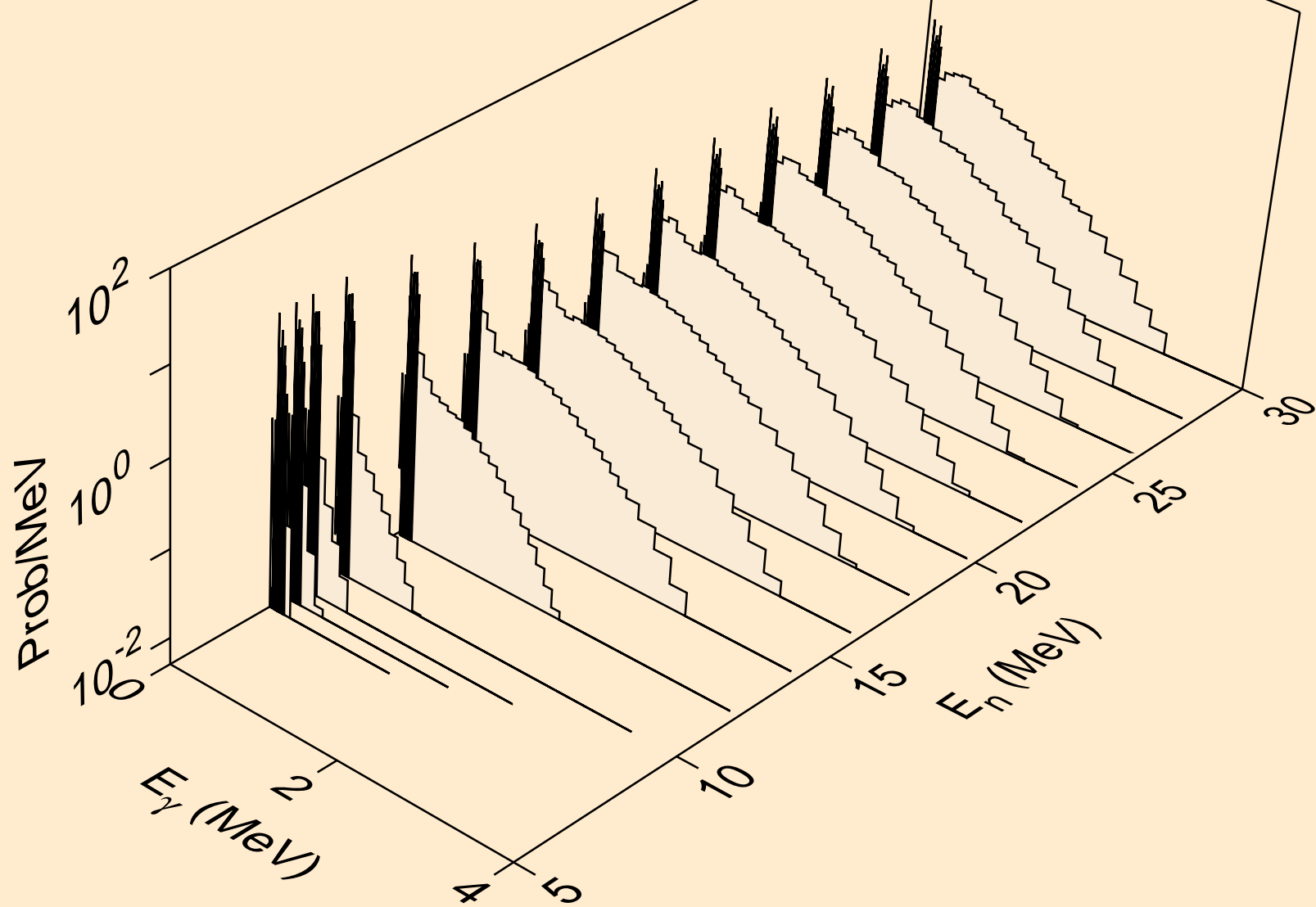

AC230 NEUTRON ACER TENDL-2021 LIBRARY; T=293.6K
Photon emission for (n,n*)2a

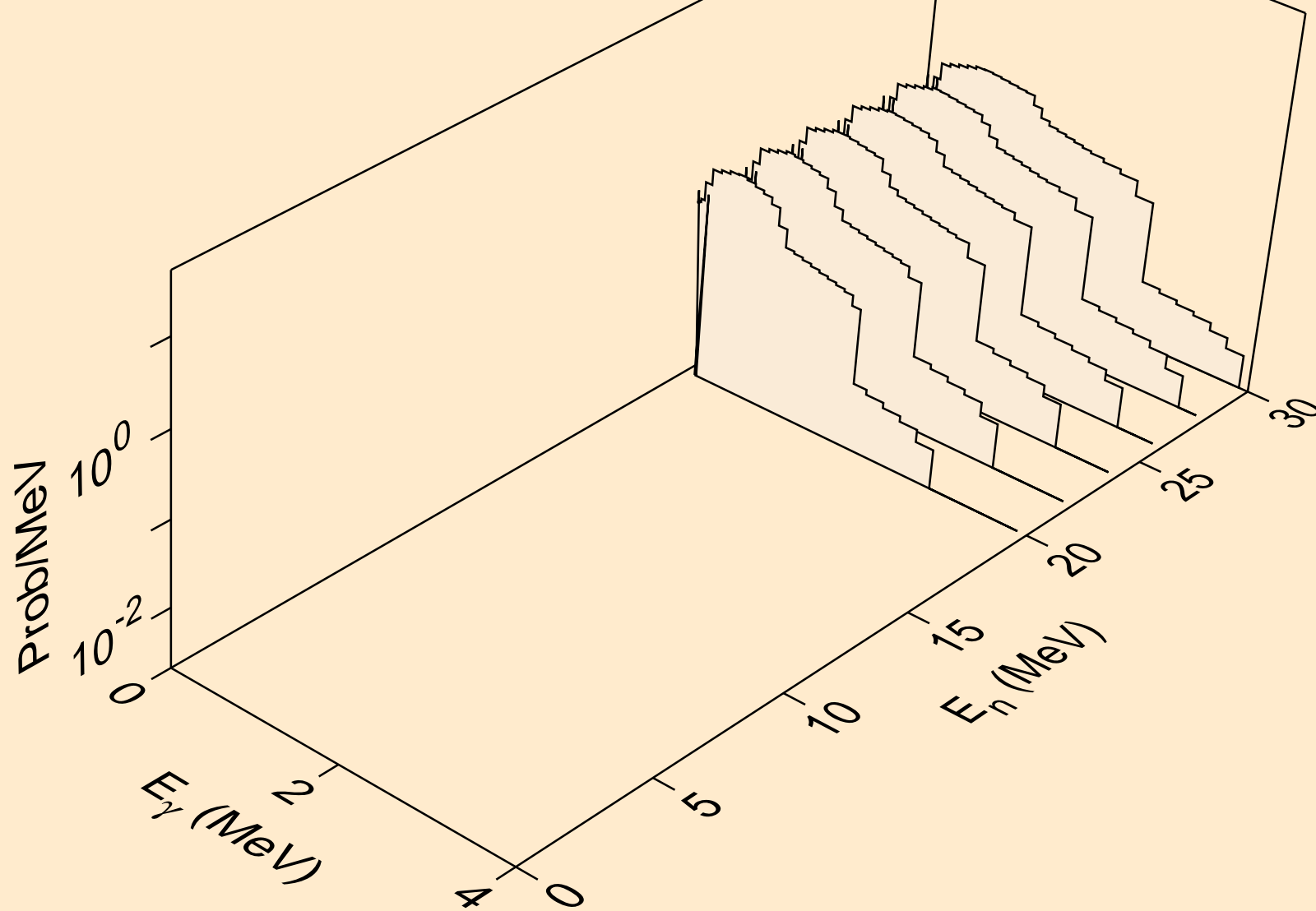

AC230 NEUTRON ACER TENDL-2021 LIBRARY; T=293.6K
Photon emission for (n,2n)2a

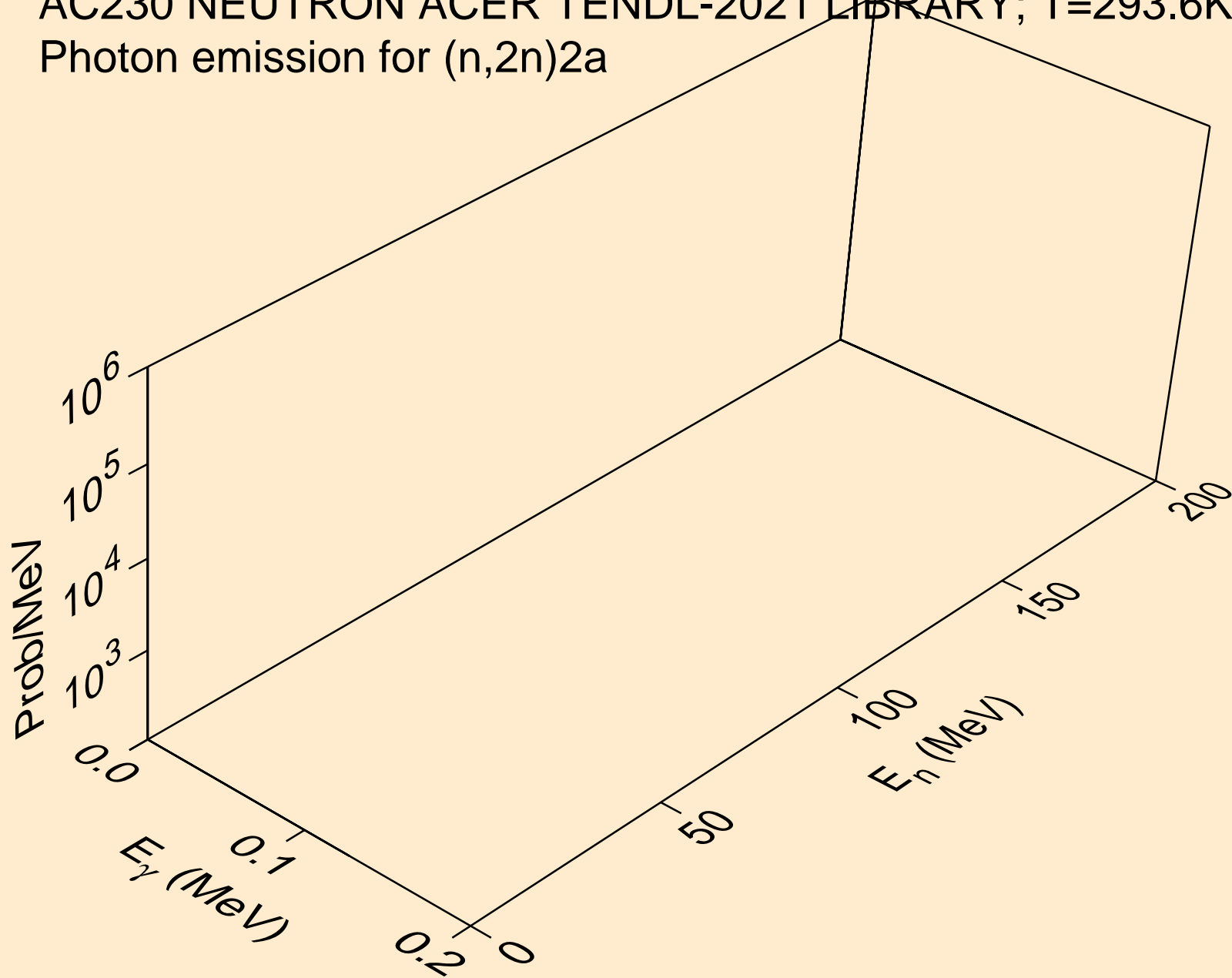

AC230 NEUTRON ACER TENDL-2021 LIBRARY; T=293.6K
Photon emission for (n,n*)d

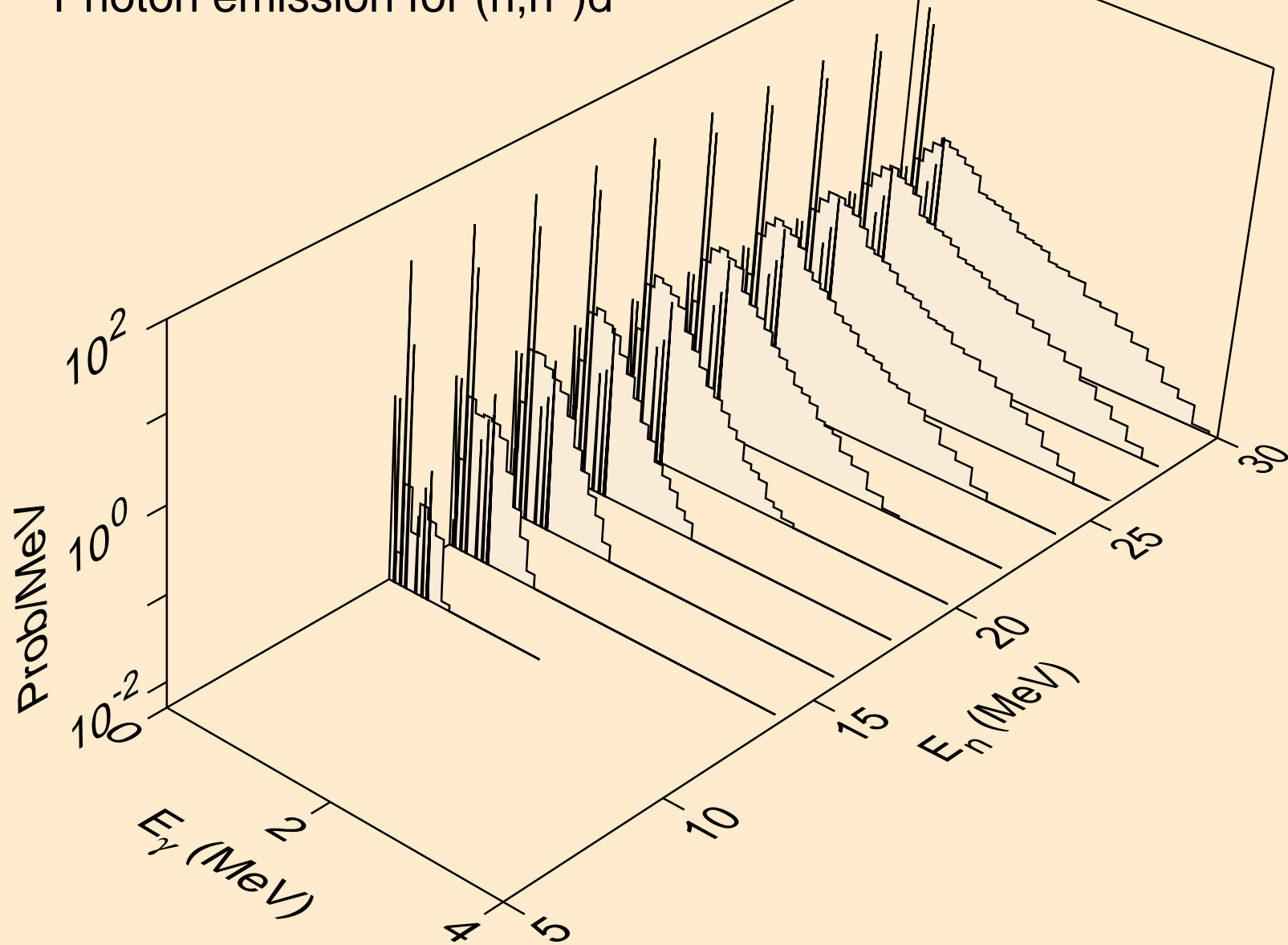

AC230 NEUTRON ACER TENDL-2021 LIBRARY; T=293.6K
Photon emission for (n,n*)t

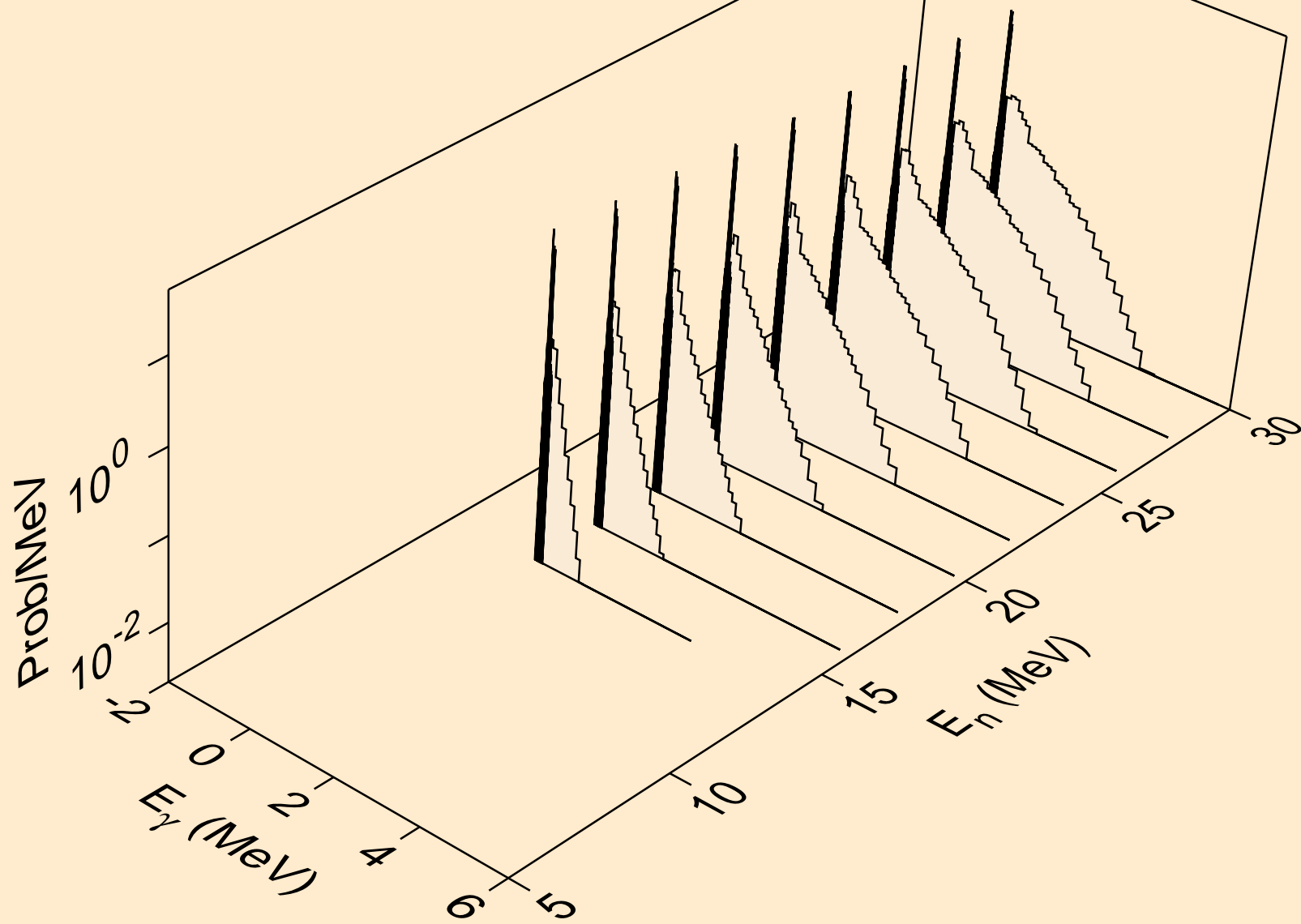

AC230 NEUTRON ACER TENDL-2021 LIBRARY; T=293.6K
Photon emission for (n,n*)he3

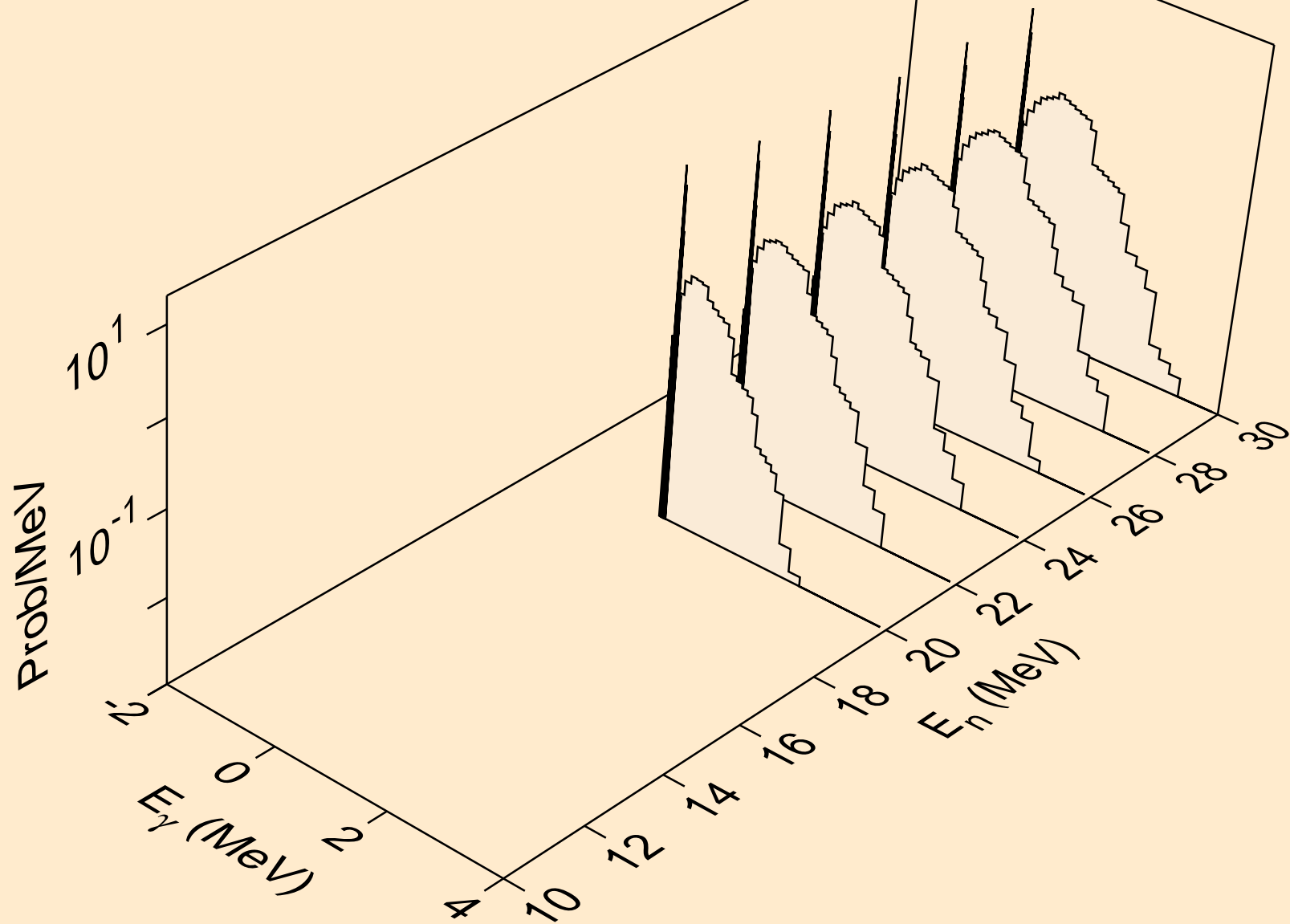

AC230 NEUTRON ACER TENDL-2021 LIBRARY; T=293.6K
Photon emission for (n,4n)

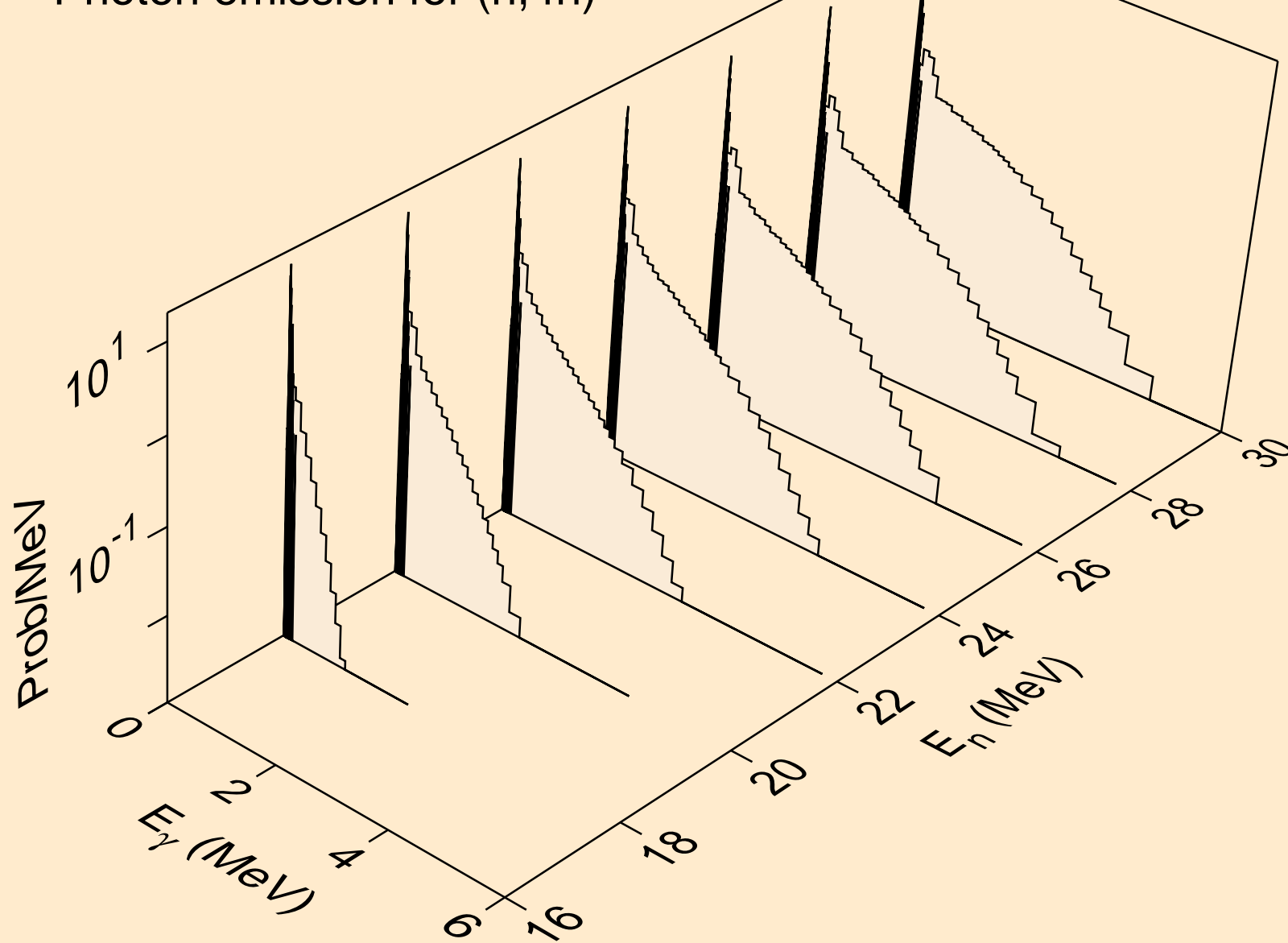

AC230 NEUTRON ACER TENDL-2021 LIBRARY; T=293.6K
Photon emission for (n,2np)

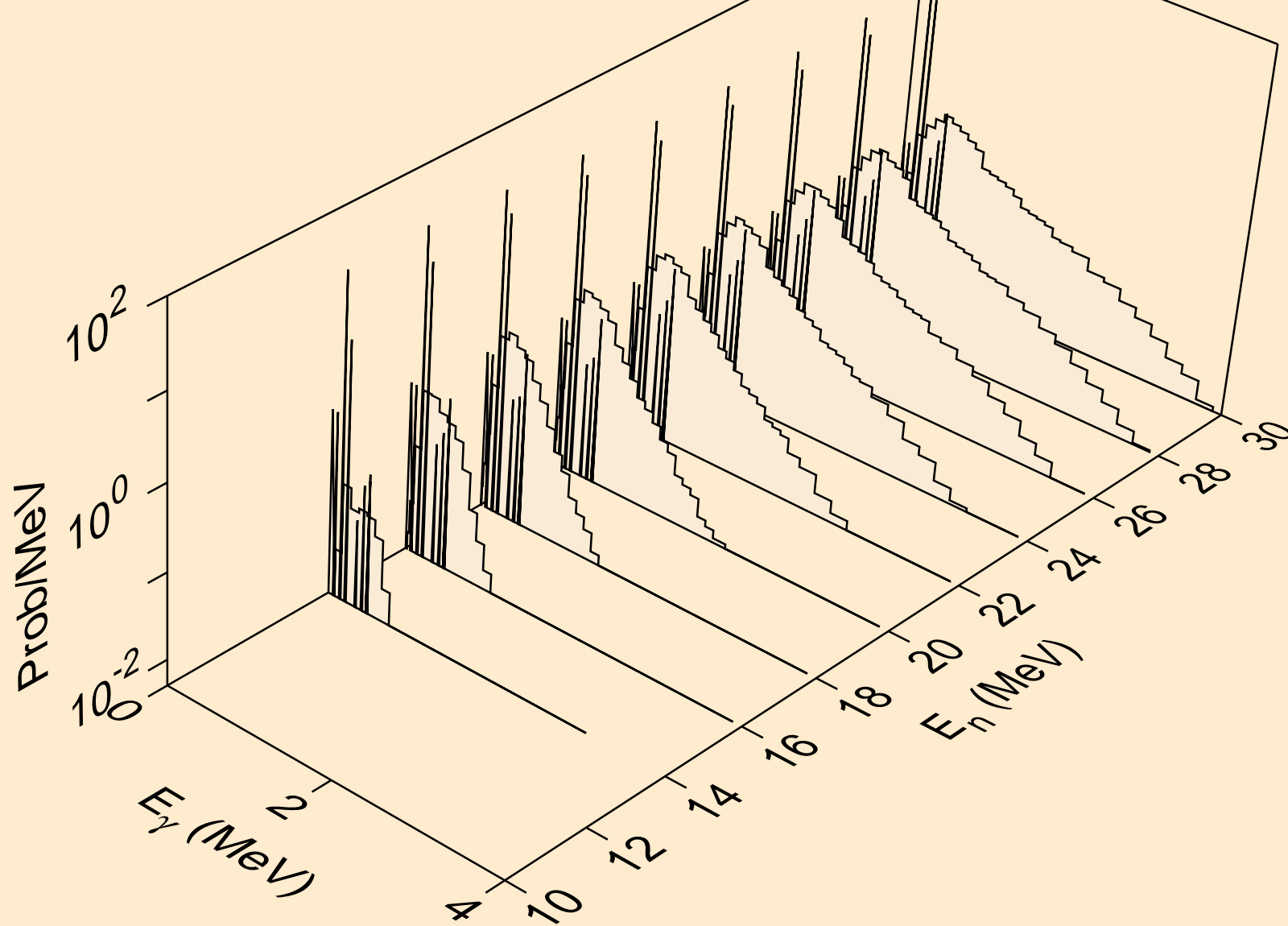

AC230 NEUTRON ACER TENDL-2021 LIBRARY; T=293.6K
Photon emission for (n,3np)

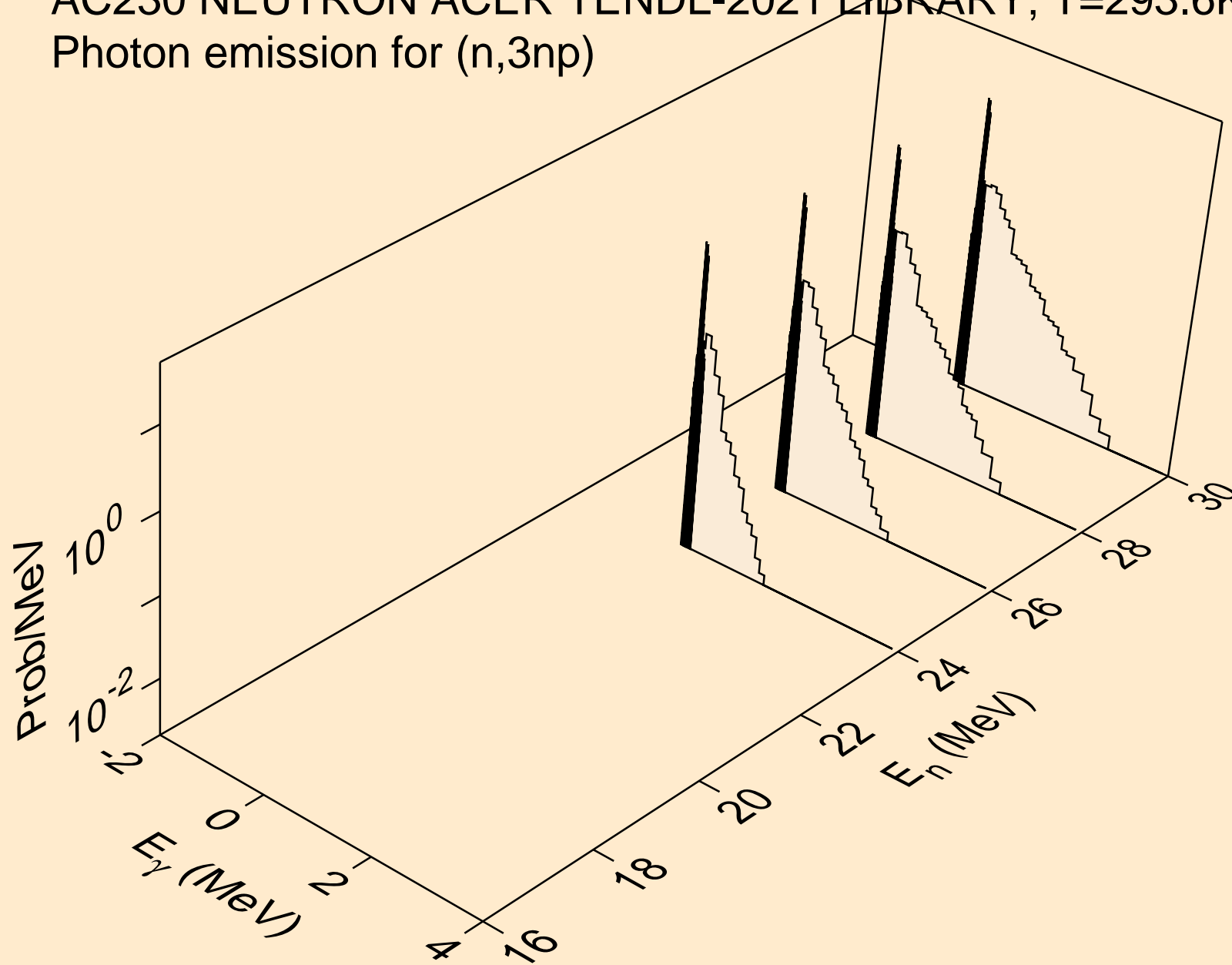

AC230 NEUTRON ACER TENDL-2021 LIBRARY; T=293.6K
Photon emission for (n,2np)

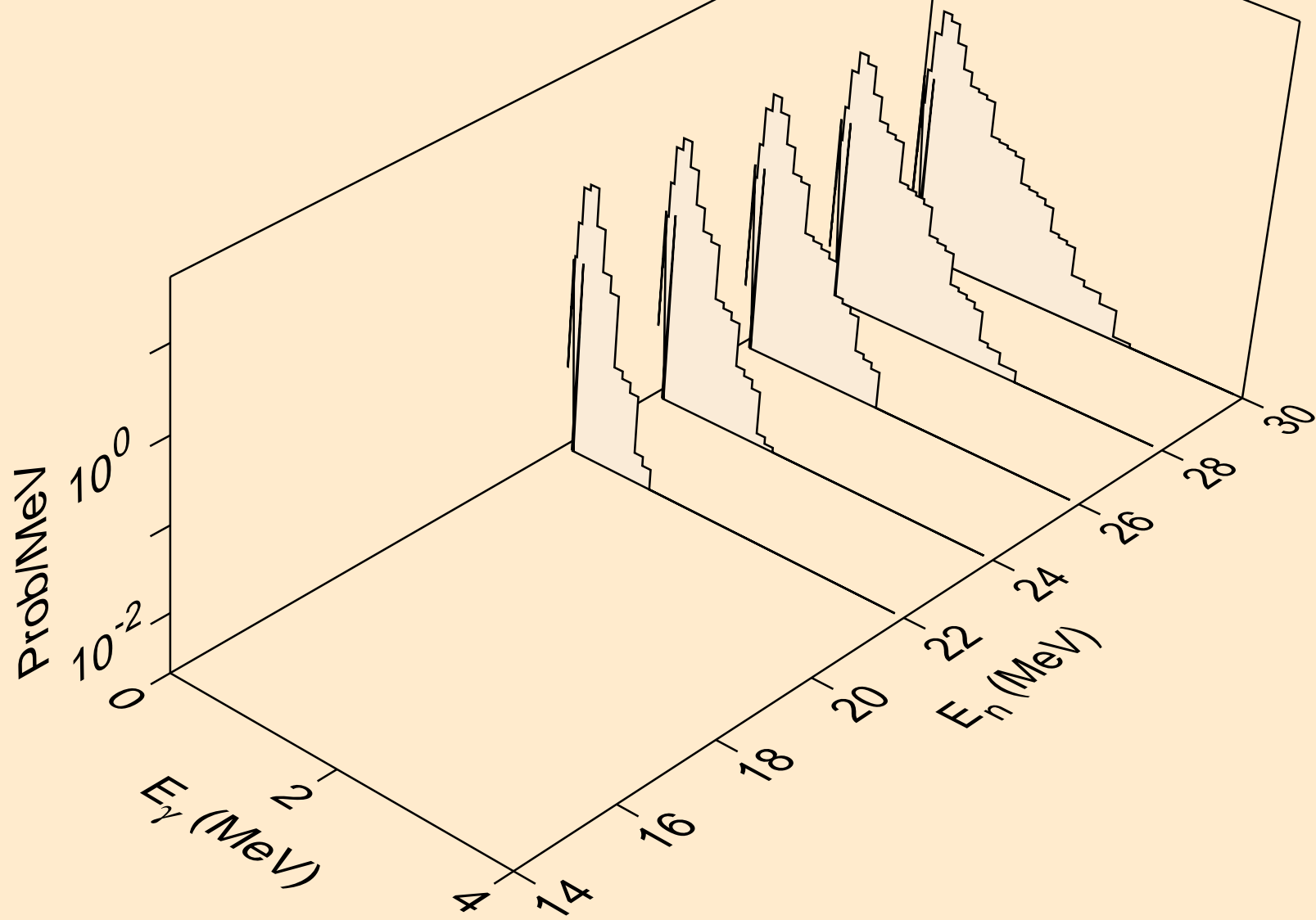

AC230 NEUTRON ACER TENDL-2021 LIBRARY; T=293.6K
Photon emission for (n,npa)

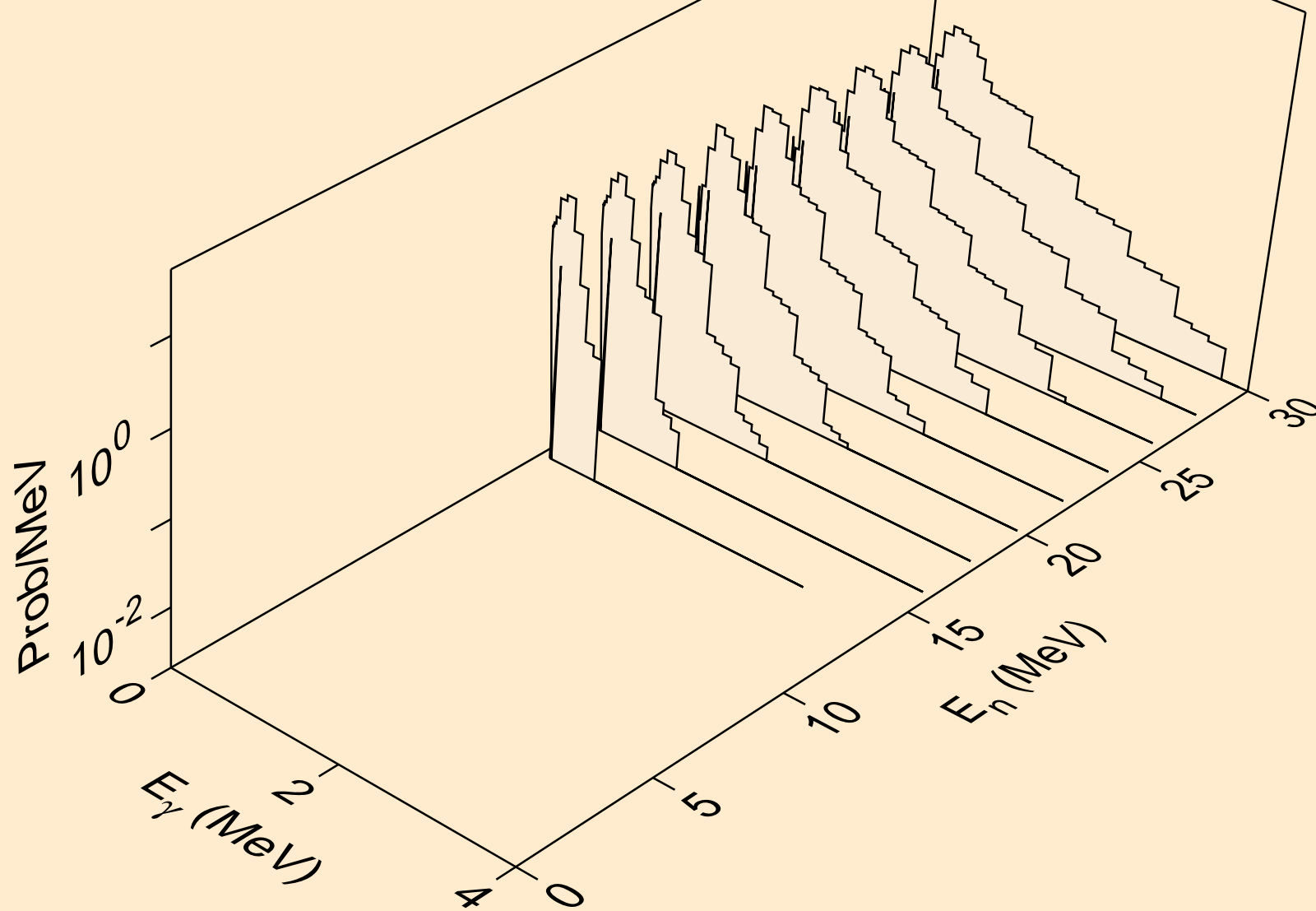

AC230 NEUTRON ACER TENDL-2021 LIBRARY; T=293.6K
Photon emission for (n,n*c)

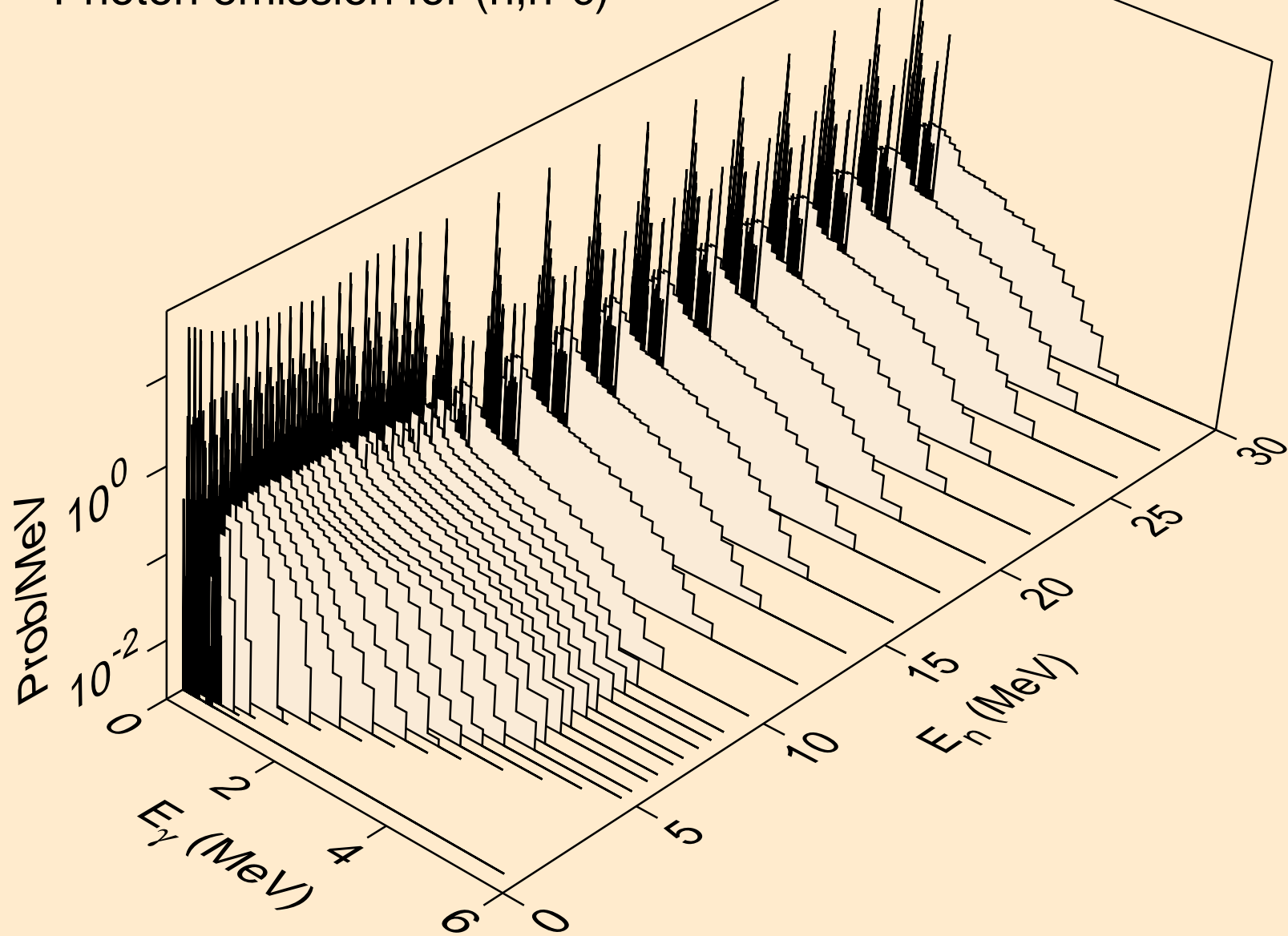

AC230 NEUTRON ACER TENDL-2021 LIBRARY; T=293.6K
Photon emission for (n,gma)

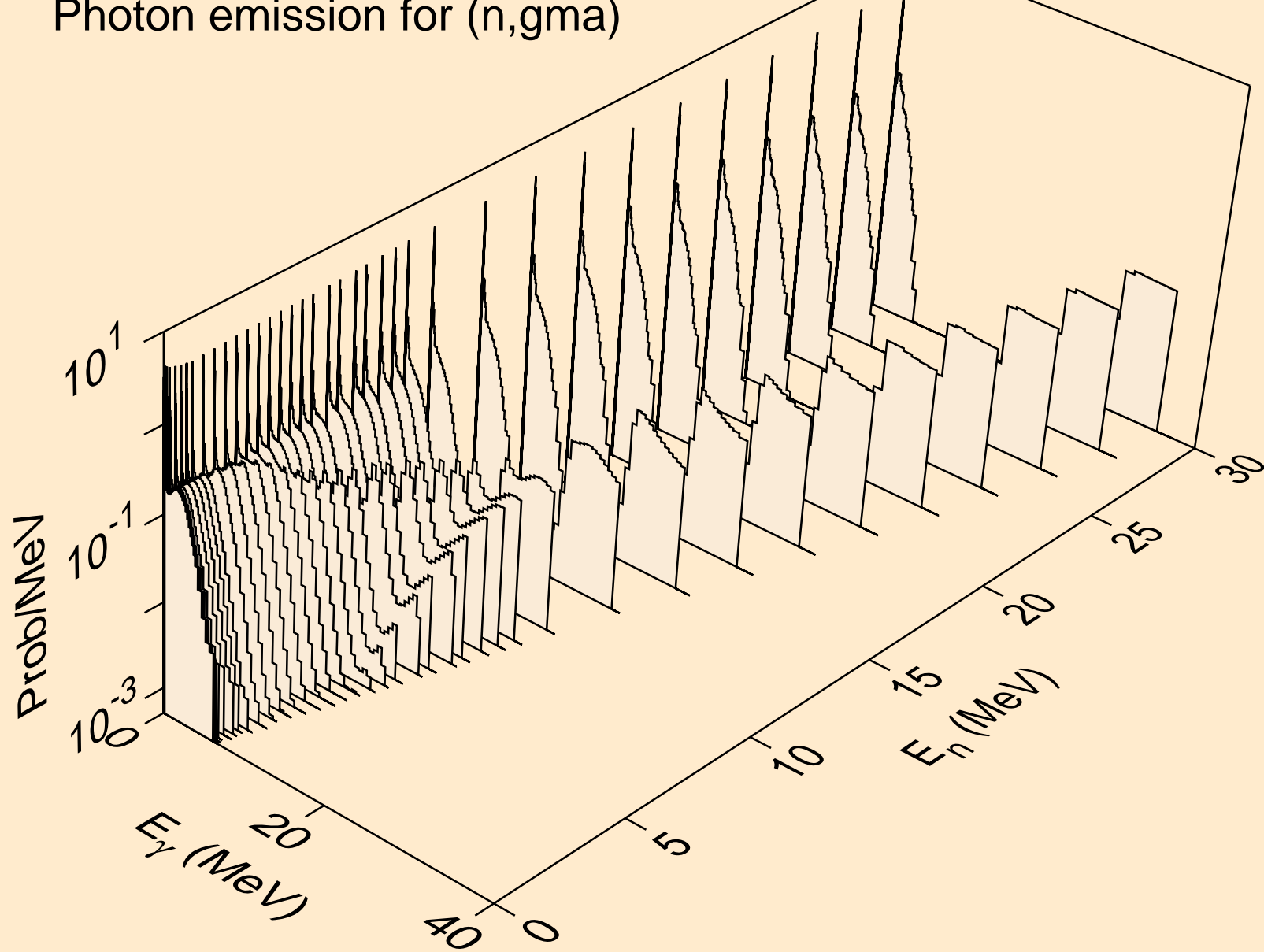

AC230 NEUTRON ACER TENDL-2021 LIBRARY; T=293.6K
Photon emission for (n,p)

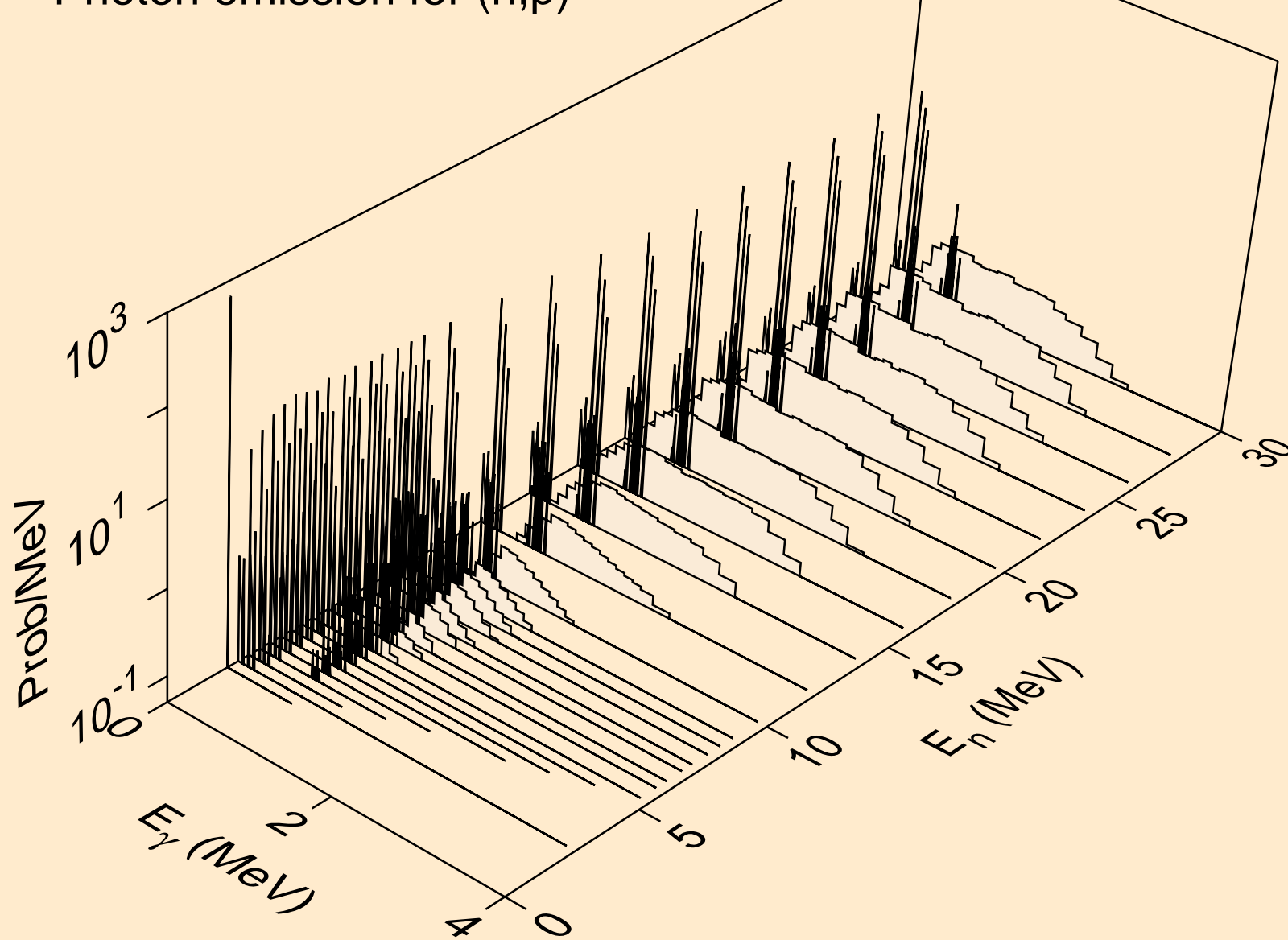

AC230 NEUTRON ACER TENDL-2021 LIBRARY; T=293.6K
Photon emission for (n,d)

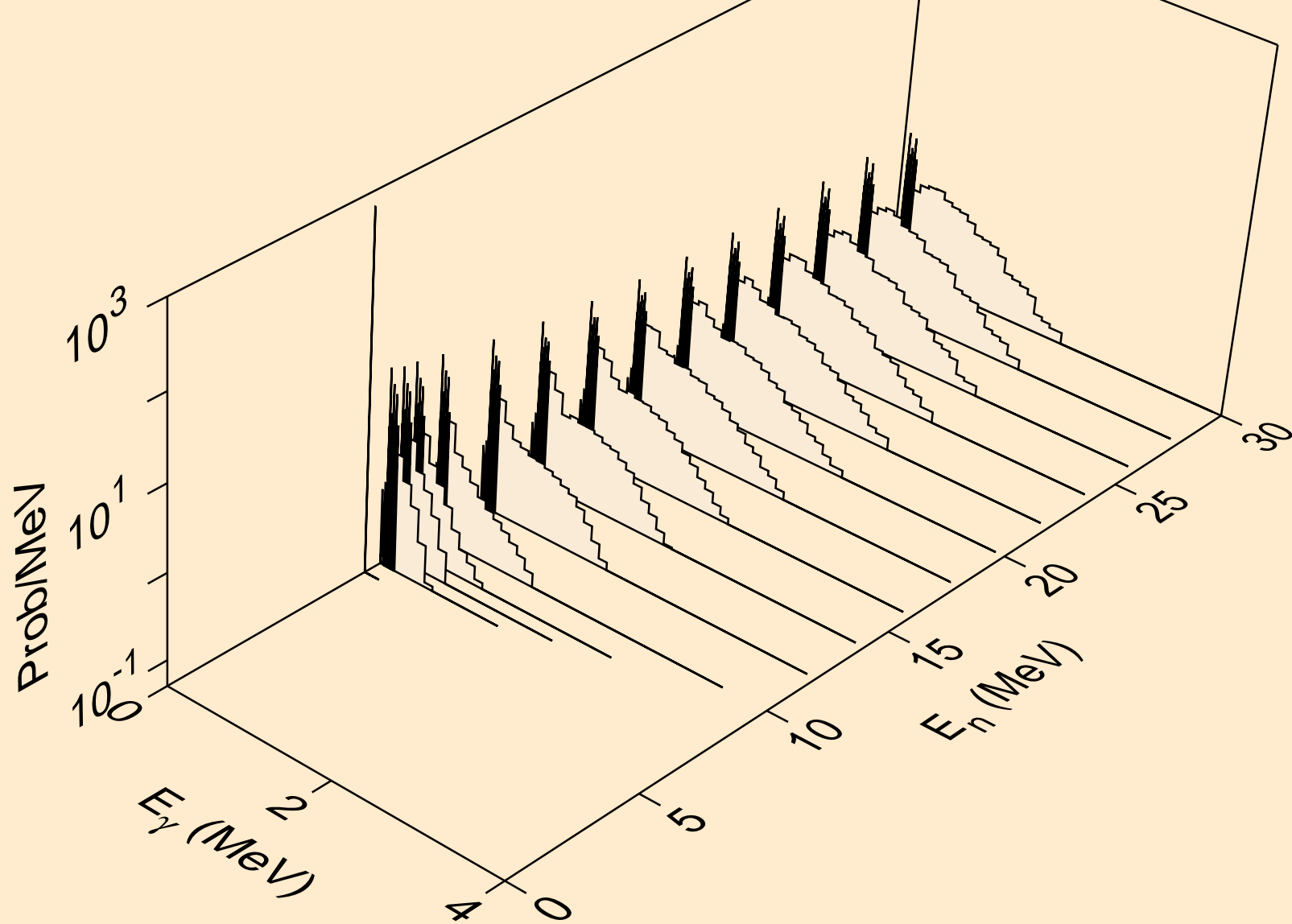

AC230 NEUTRON ACER TENDL-2021 LIBRARY; T=293.6K
Photon emission for (n,t)

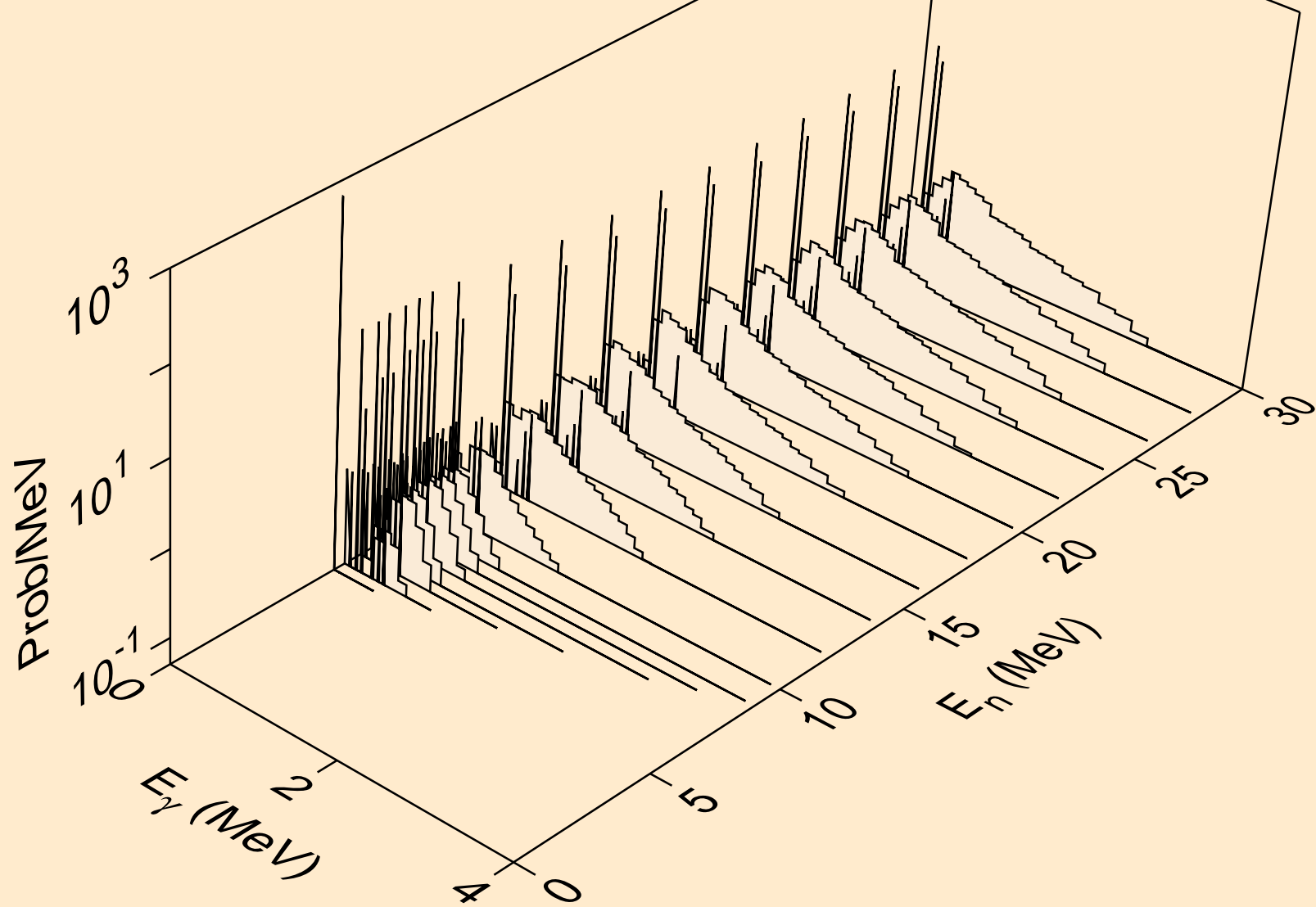

AC230 NEUTRON ACER TENDL-2021 LIBRARY; T=293.6K
Photon emission for (n,he3)

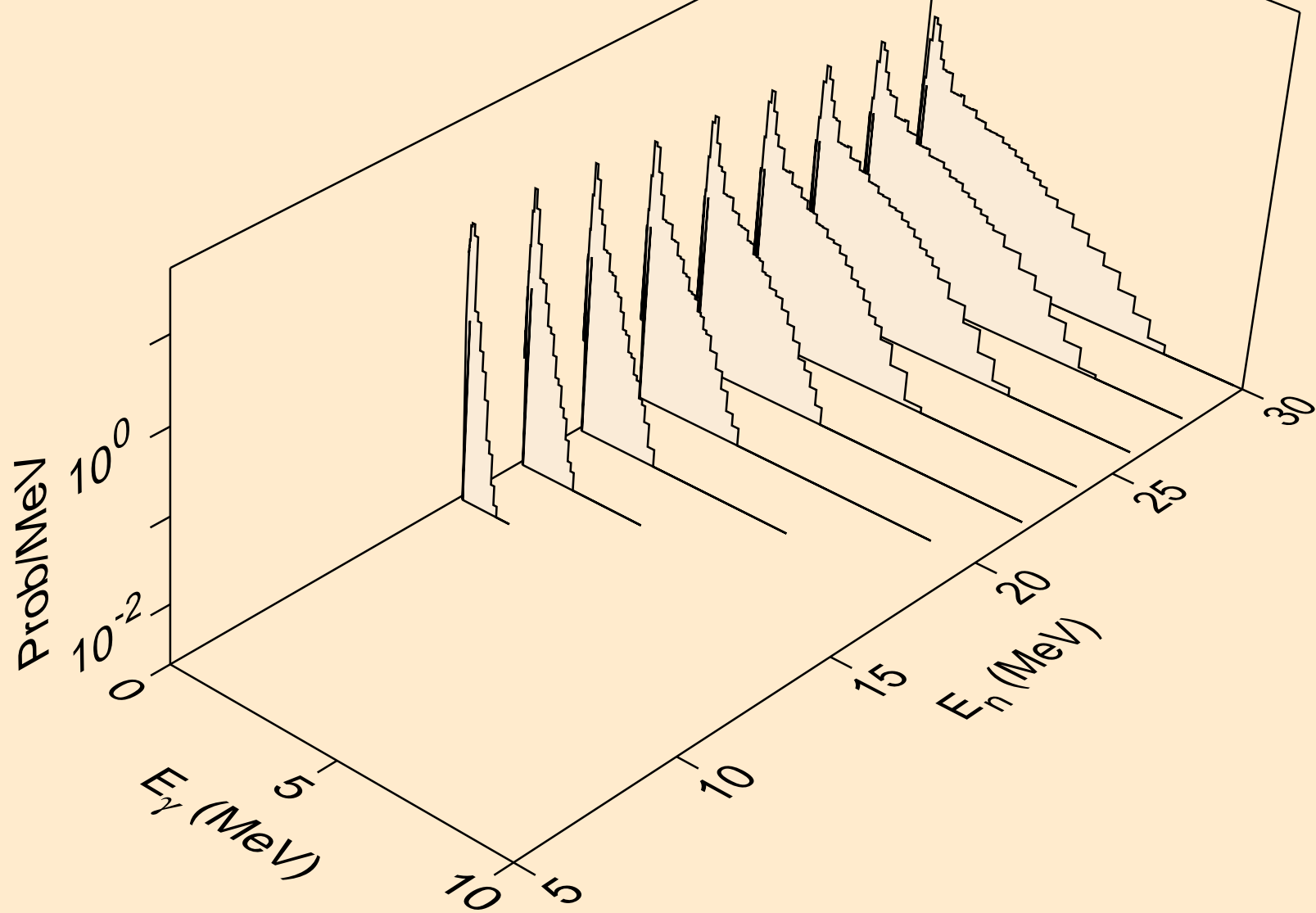

AC230 NEUTRON ACER TENDL-2021 LIBRARY; T=293.6K
Photon emission for (n,a)

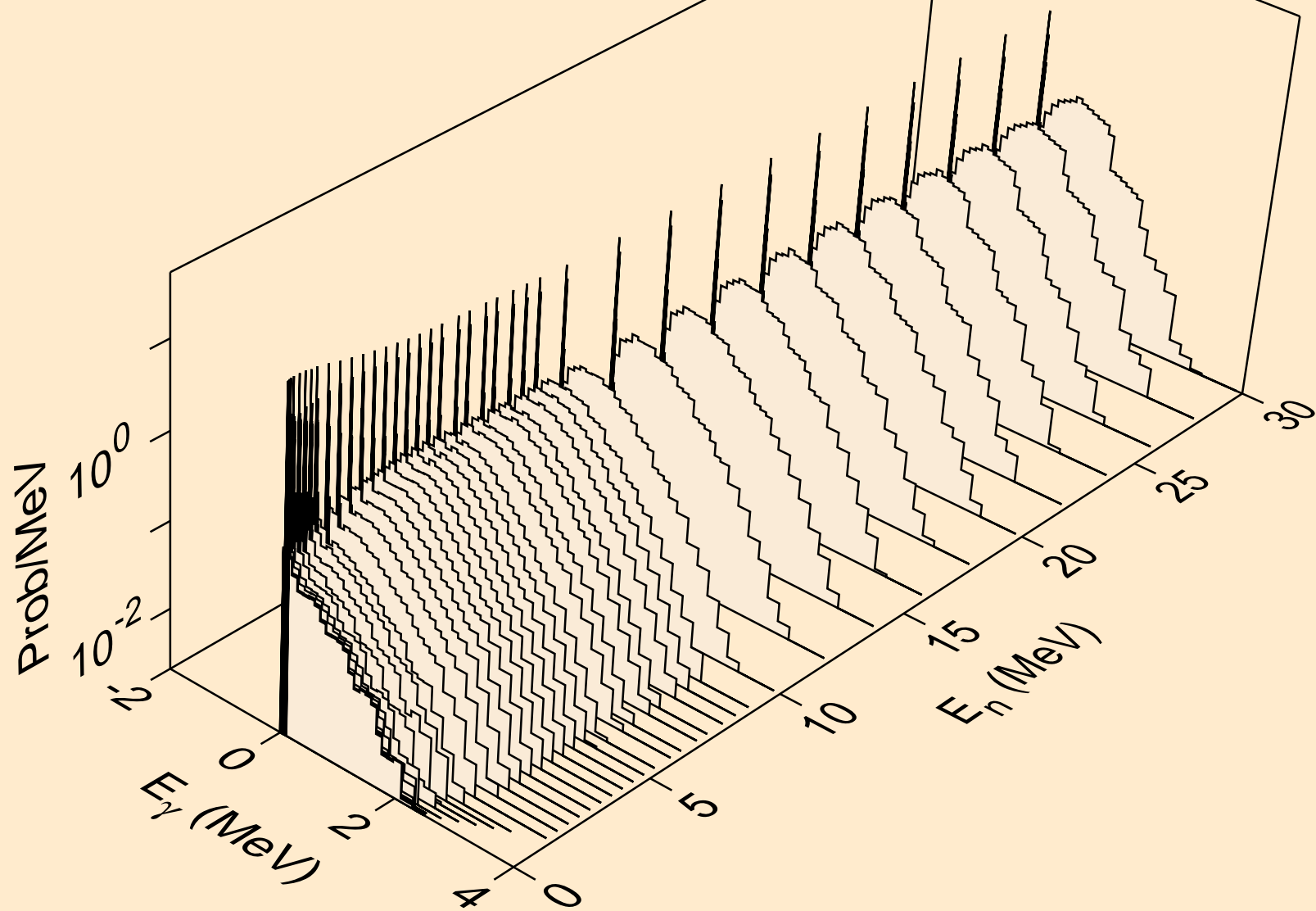

AC230 NEUTRON ACER TENDL-2021 LIBRARY; T=293.6K
Photon emission for (n,2a)

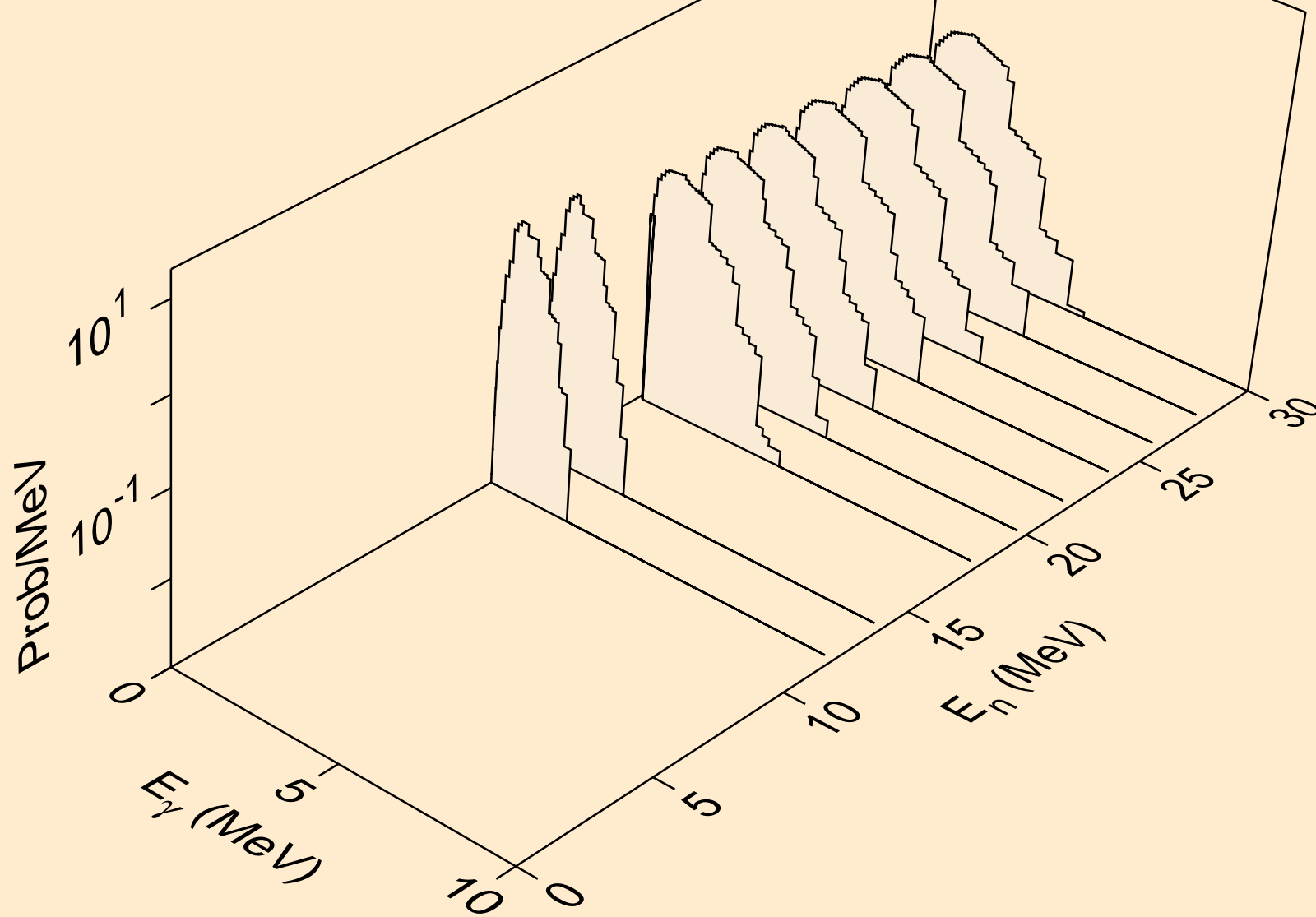

AC230 NEUTRON ACER TENDL-2021 LIBRARY; T=293.6K
Photon emission for (n,2p)

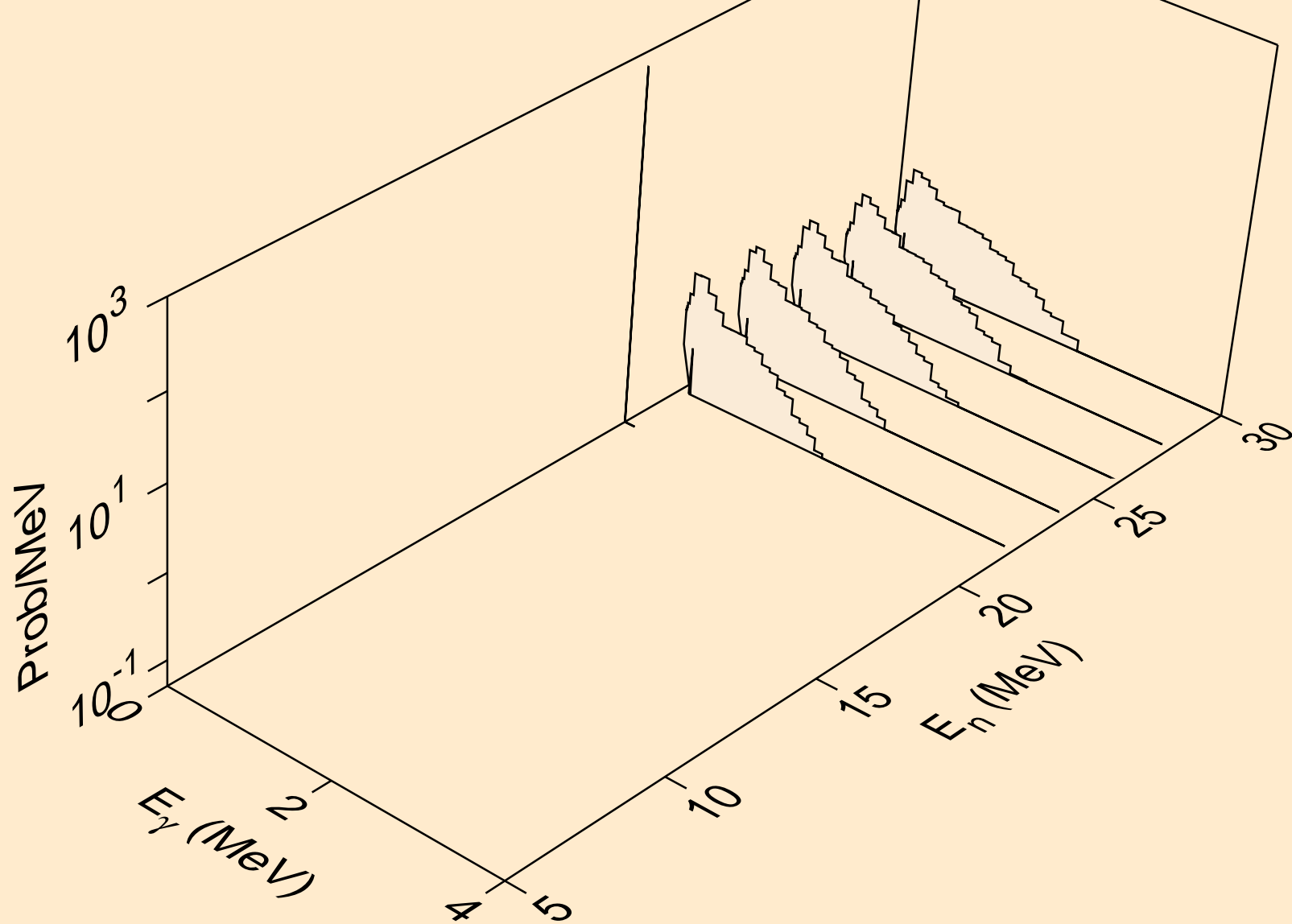

AC230 NEUTRON ACER TENDL-2021 LIBRARY; T=293.6K
Photon emission for (n,p α)

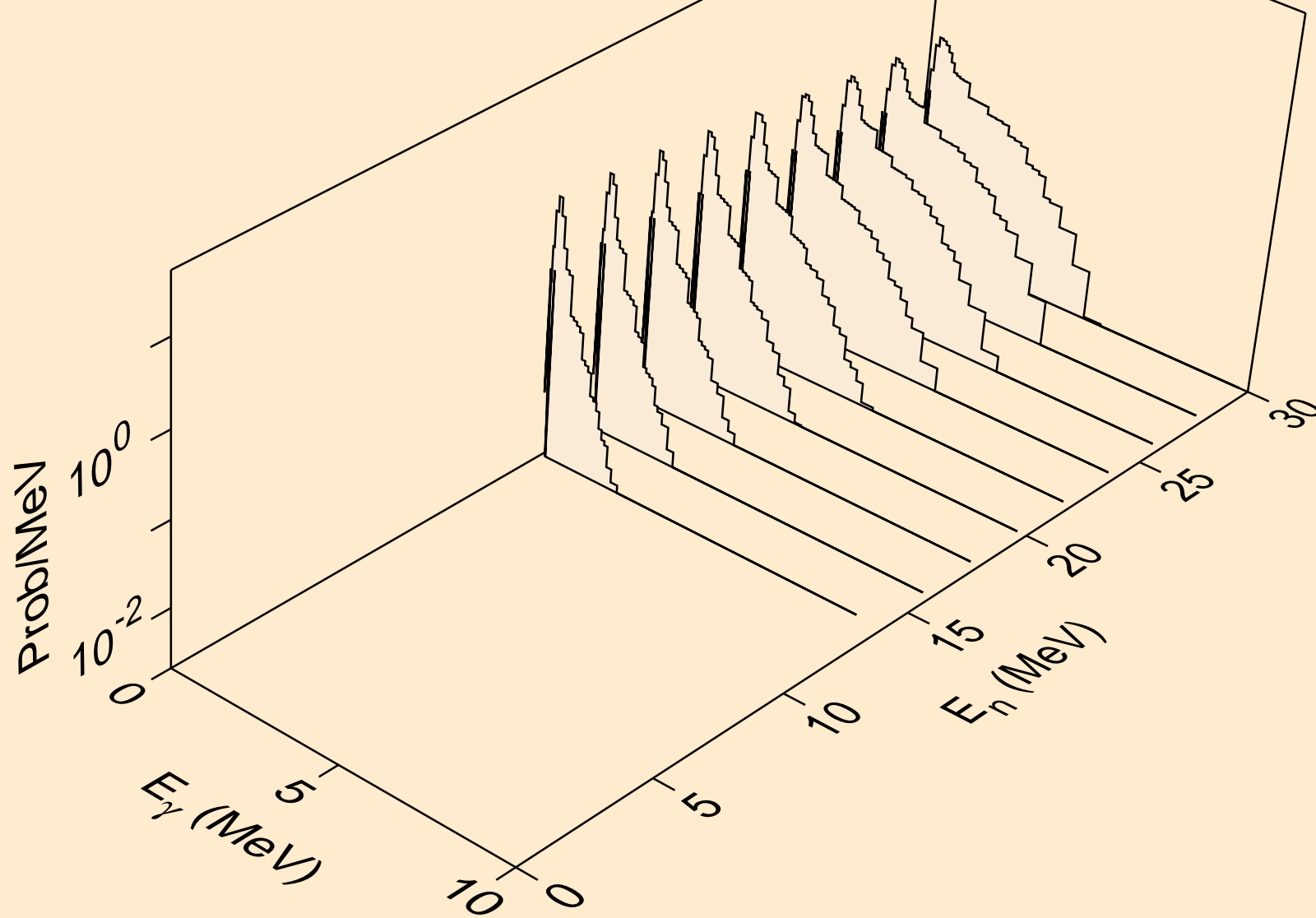

AC230 NEUTRON ACER TENDL-2021 LIBRARY; T=293.6K
Photon emission for (n,pd)

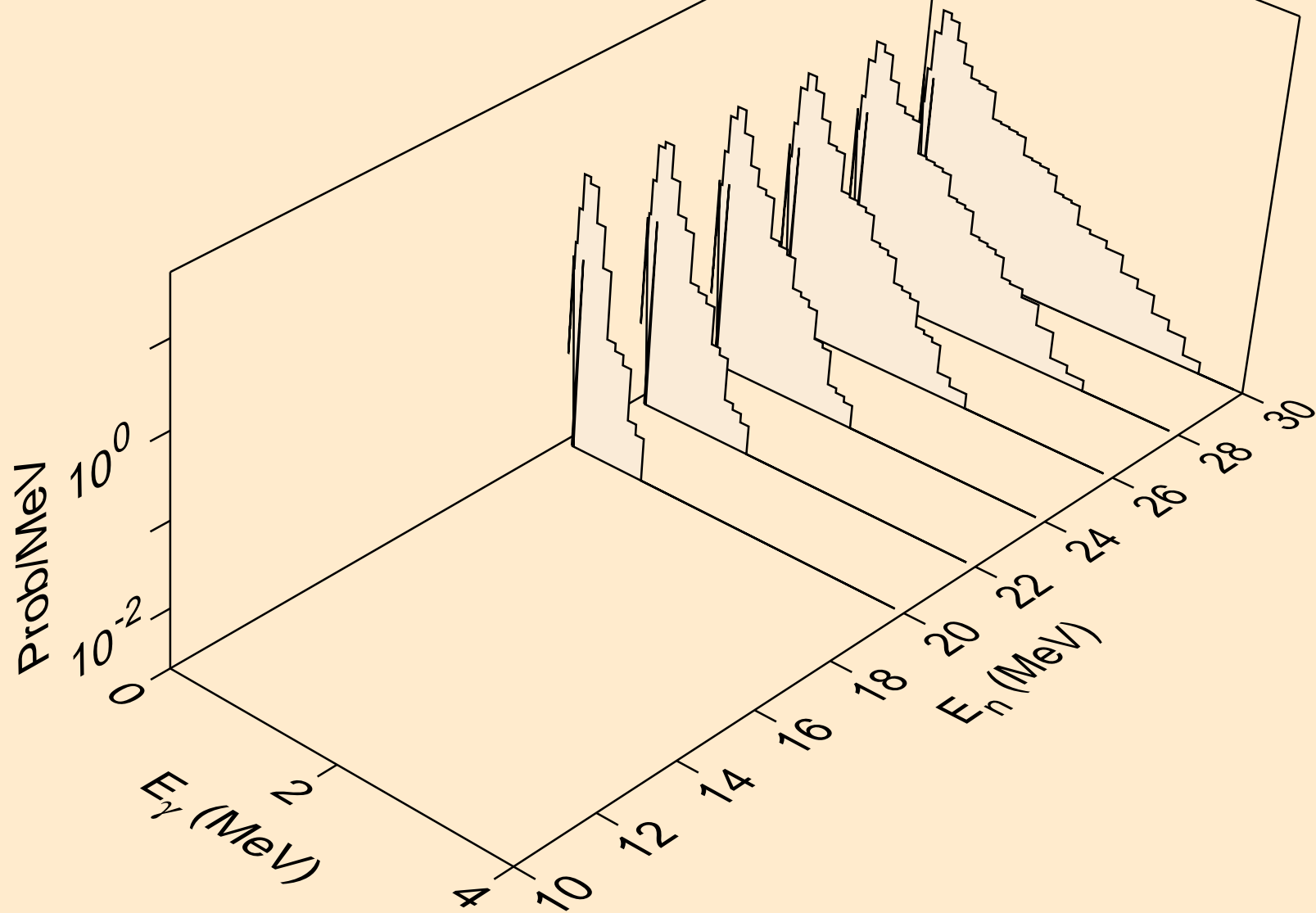

AC230 NEUTRON ACER TENDL-2021 LIBRARY; T=293.6K
Photon emission for (n,pt)

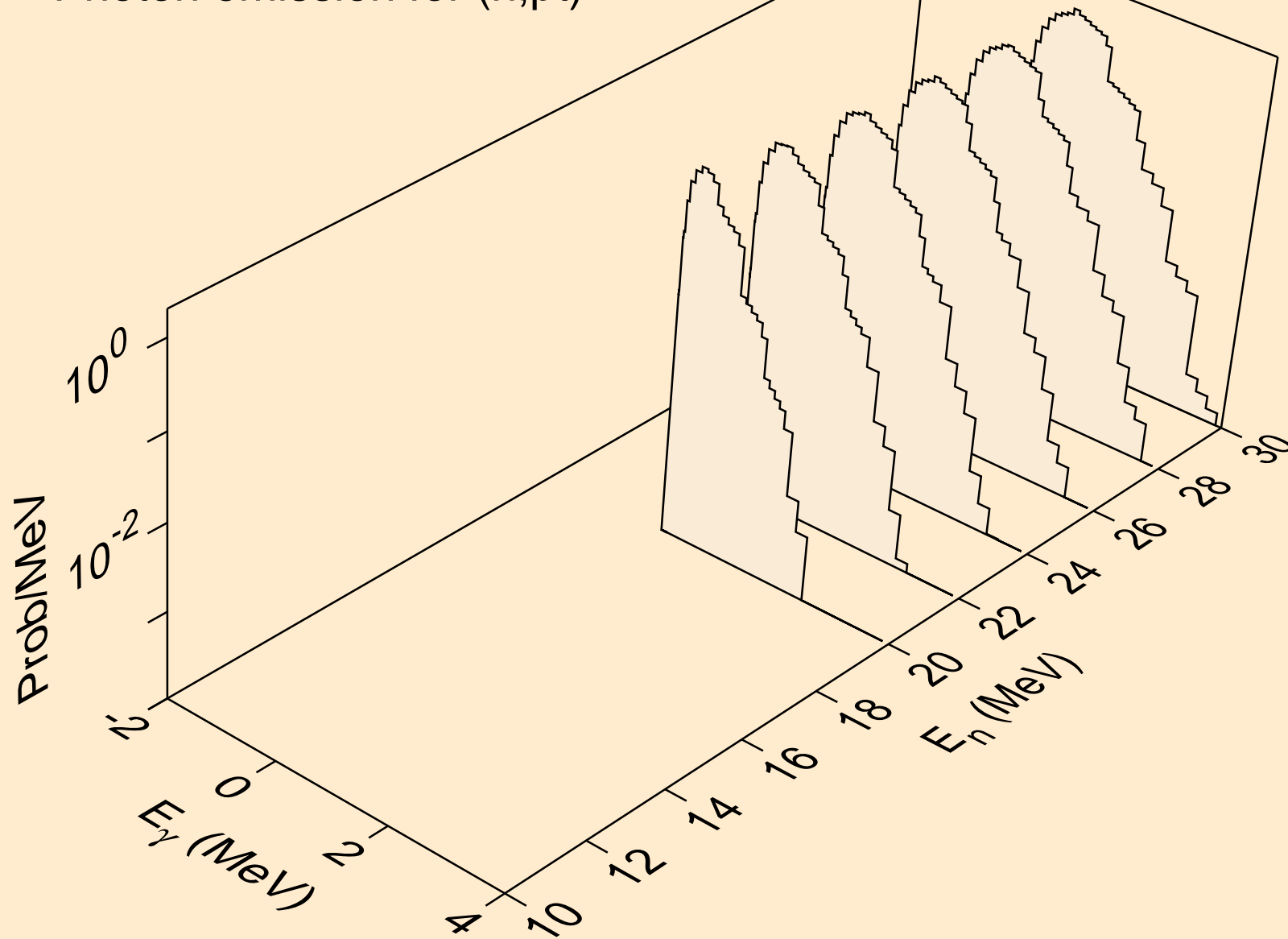

AC230 NEUTRON ACER TENDL-2021 LIBRARY; T=293.6K
Photon emission for (n,da)

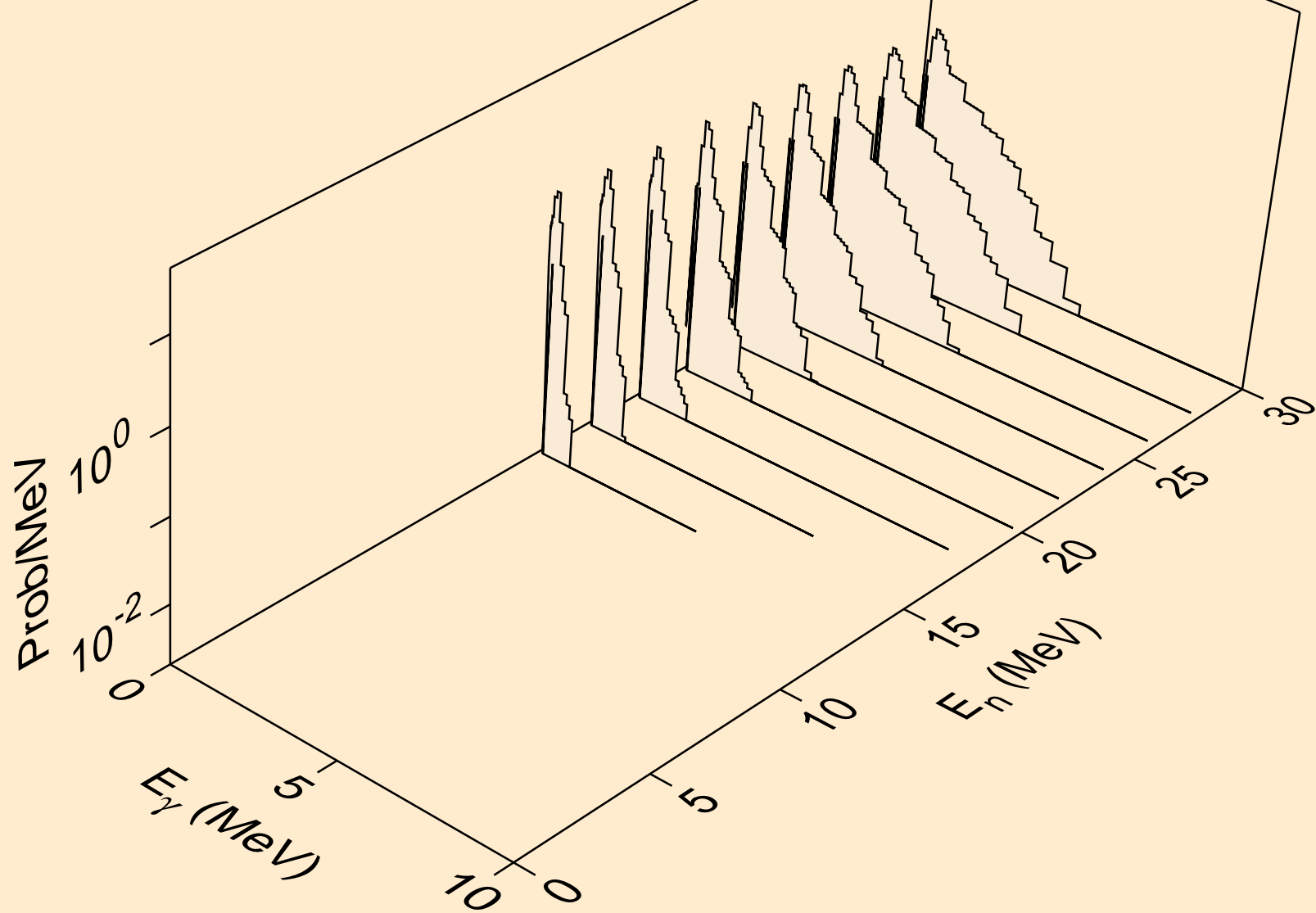

AC230 NEUTRON ACER TENDL-2021 LIBRARY; T=293.6K
thermal capture photon spectrum

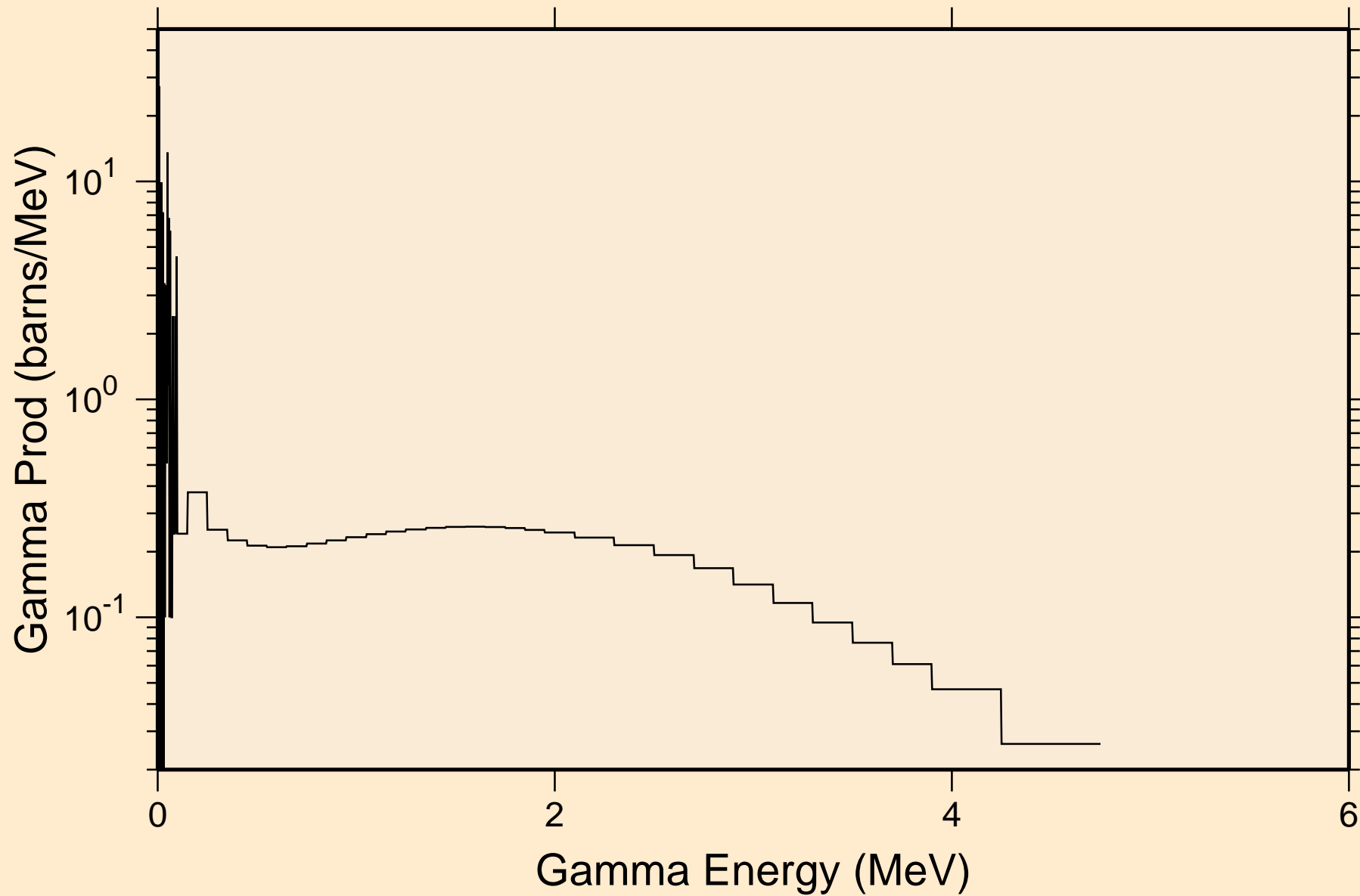

AC230 NEUTRON ACER TENDL-2021 LIBRARY; T=293.6K
14 MeV photon spectrum

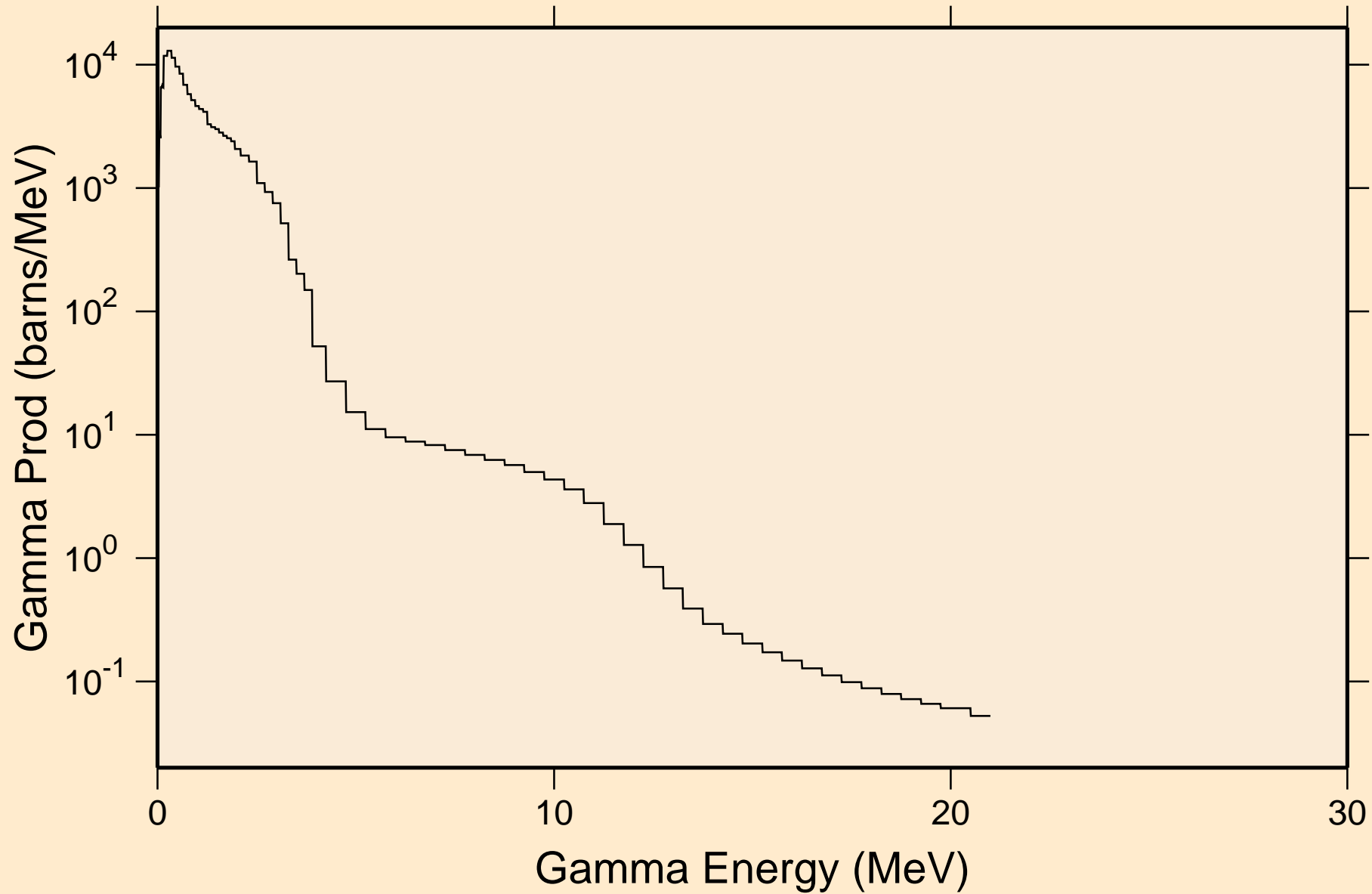

AC230 NEUTRON ACER TENDL-2021 LIBRARY; T=293.6K
Particle heating contributions

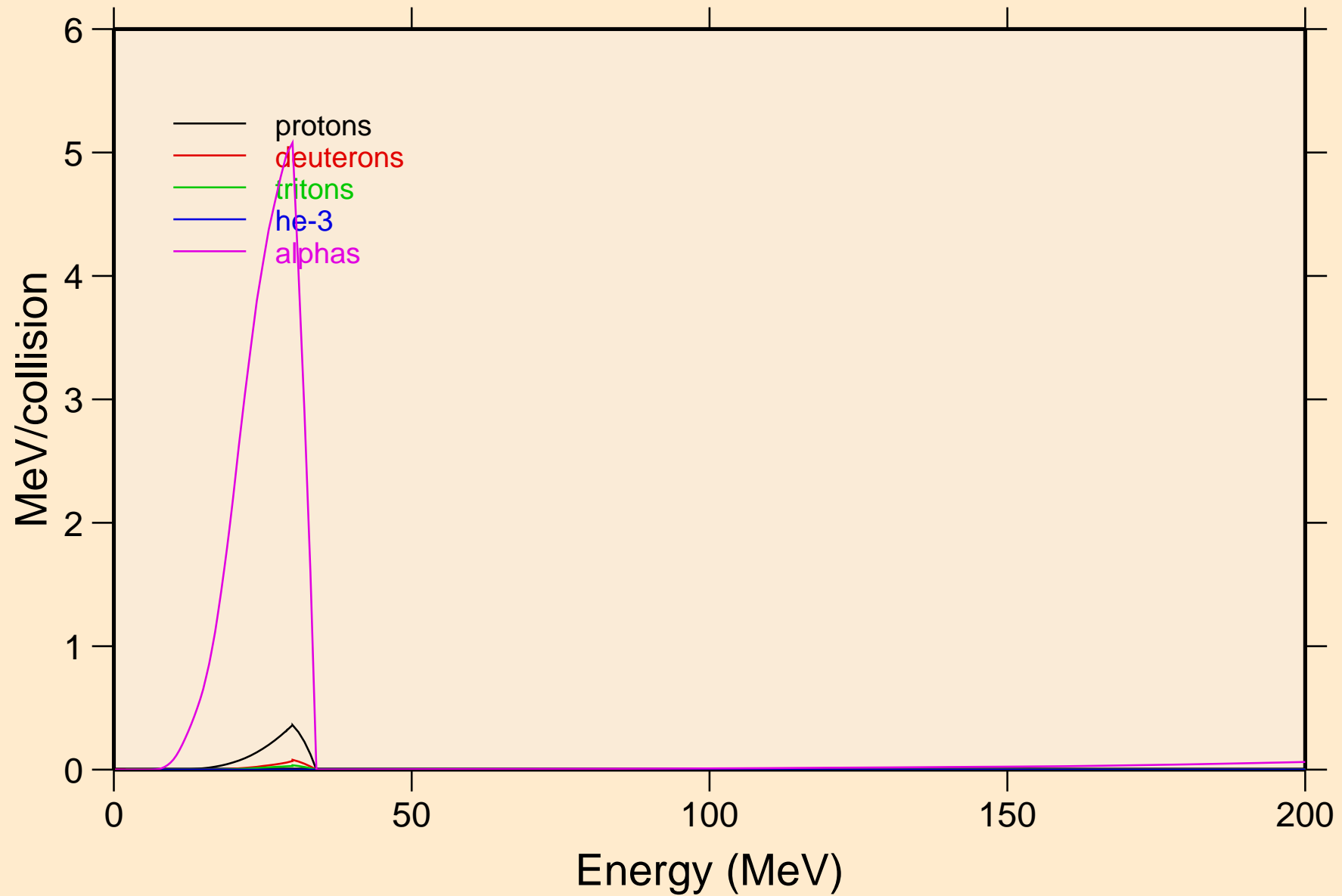

AC230 NEUTRON ACER TENDL-2021 LIBRARY; T=293.6K
Recoil Heating

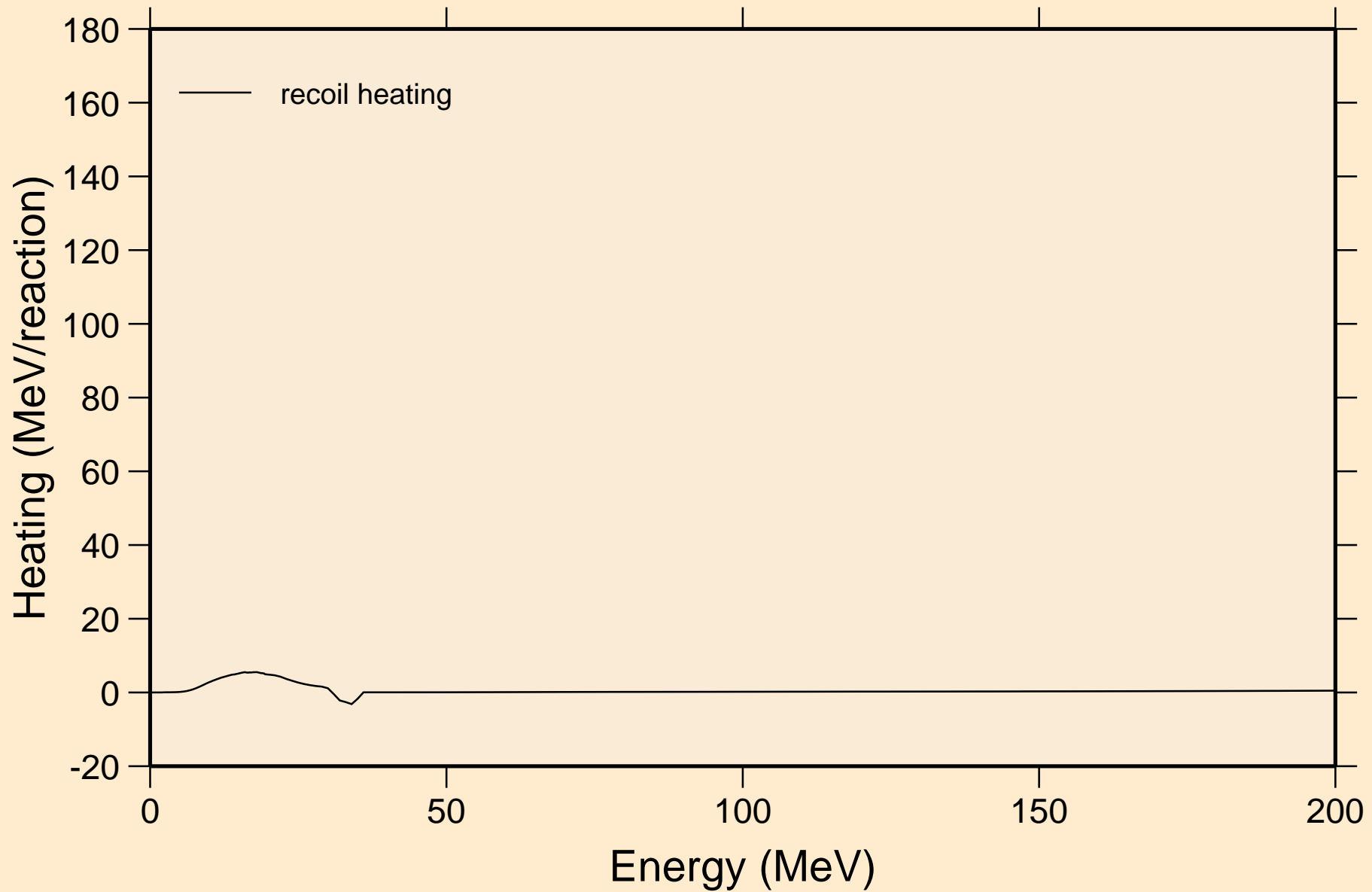

AC230 NEUTRON ACER TENDL-2021 LIBRARY; T=293.6K
Particle production cross sections

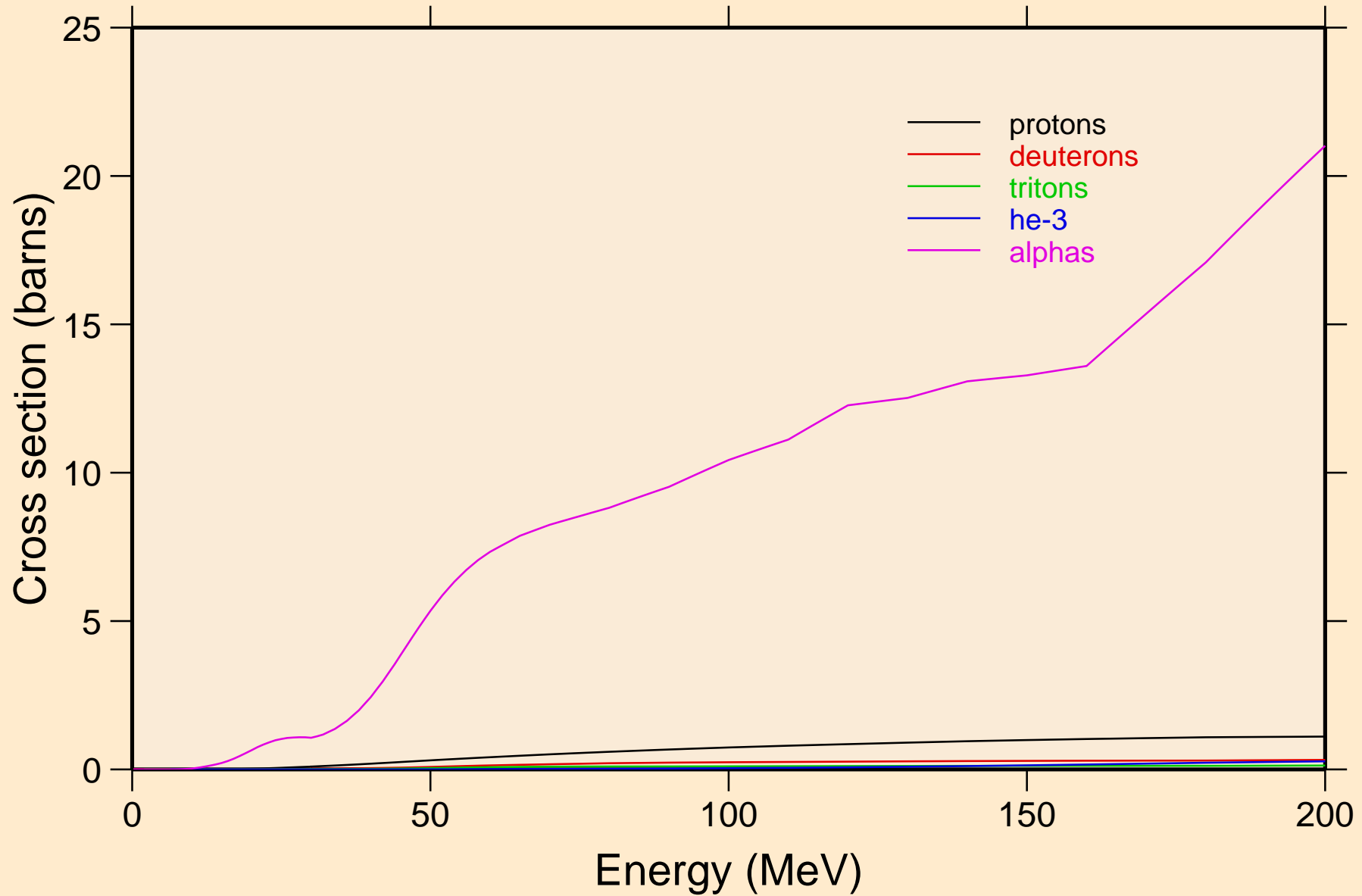

AC230 NEUTRON ACER TENDL-2021 LIBRARY; T=293.6K
protons from (n,x)

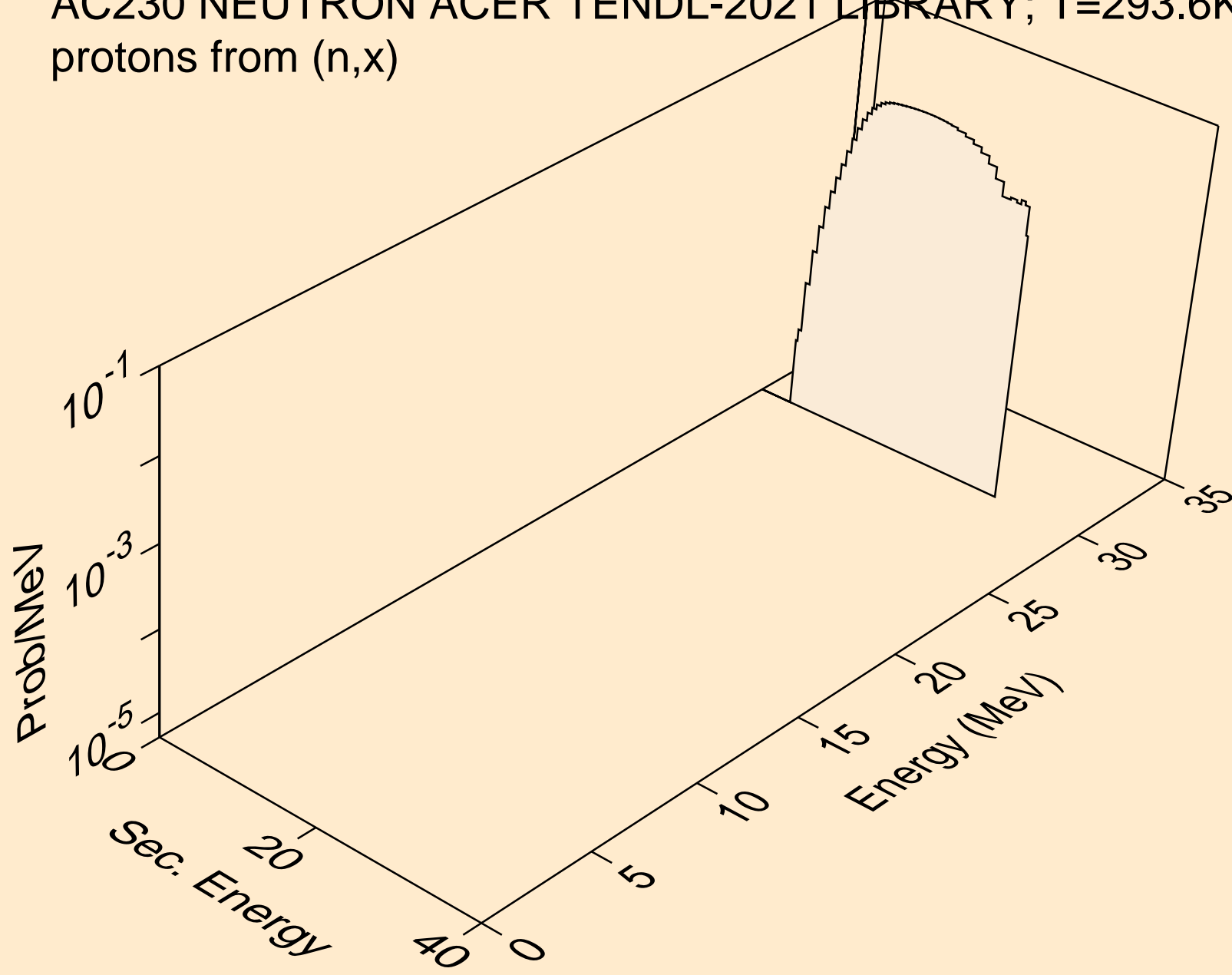

AC230 NEUTRON ACER TENDL-2021 LIBRARY; T=293.6K
protons from (n,n*)p

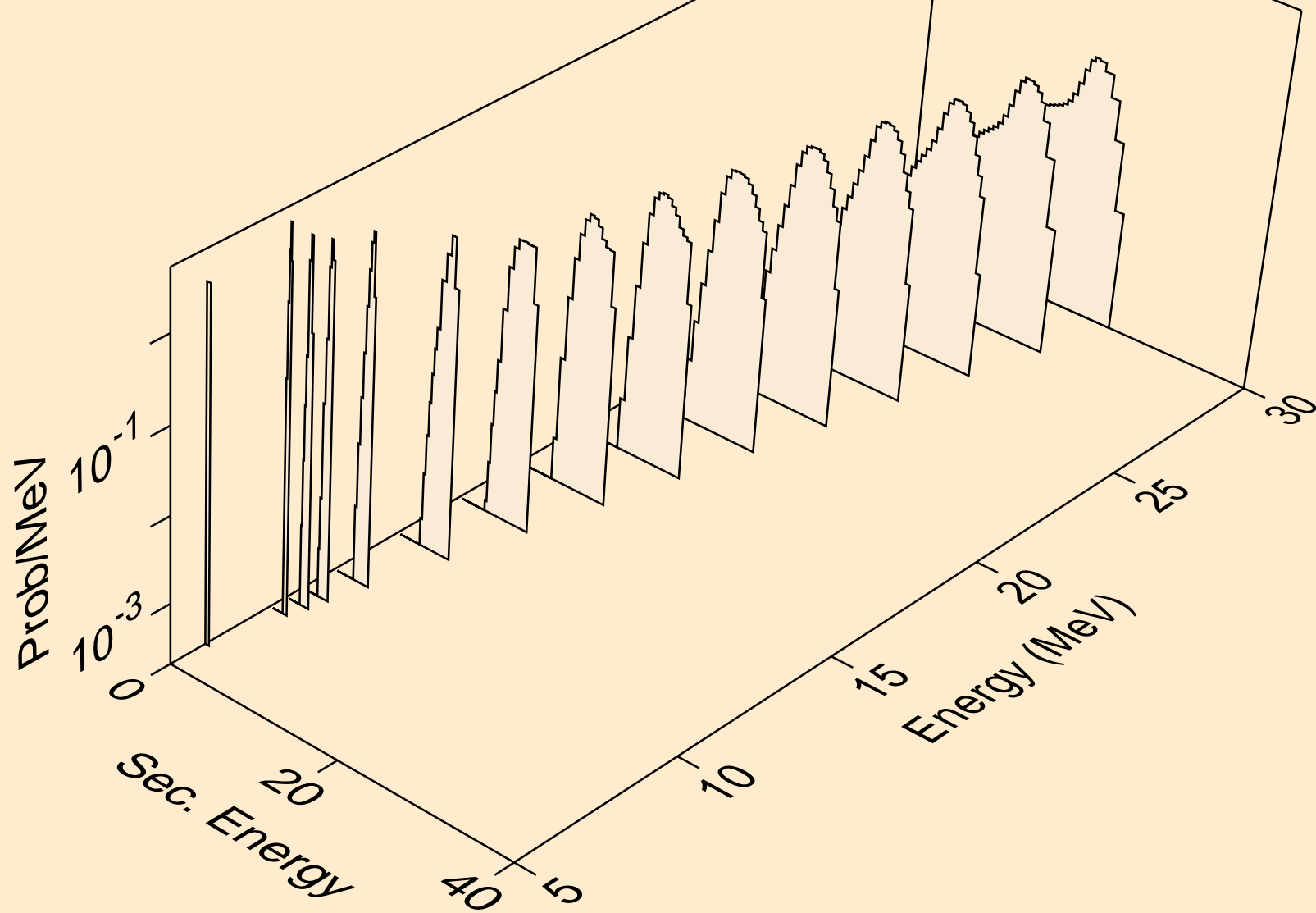

AC230 NEUTRON ACER TENDL-2021 LIBRARY; T=293.6K
protons from (n,2np)

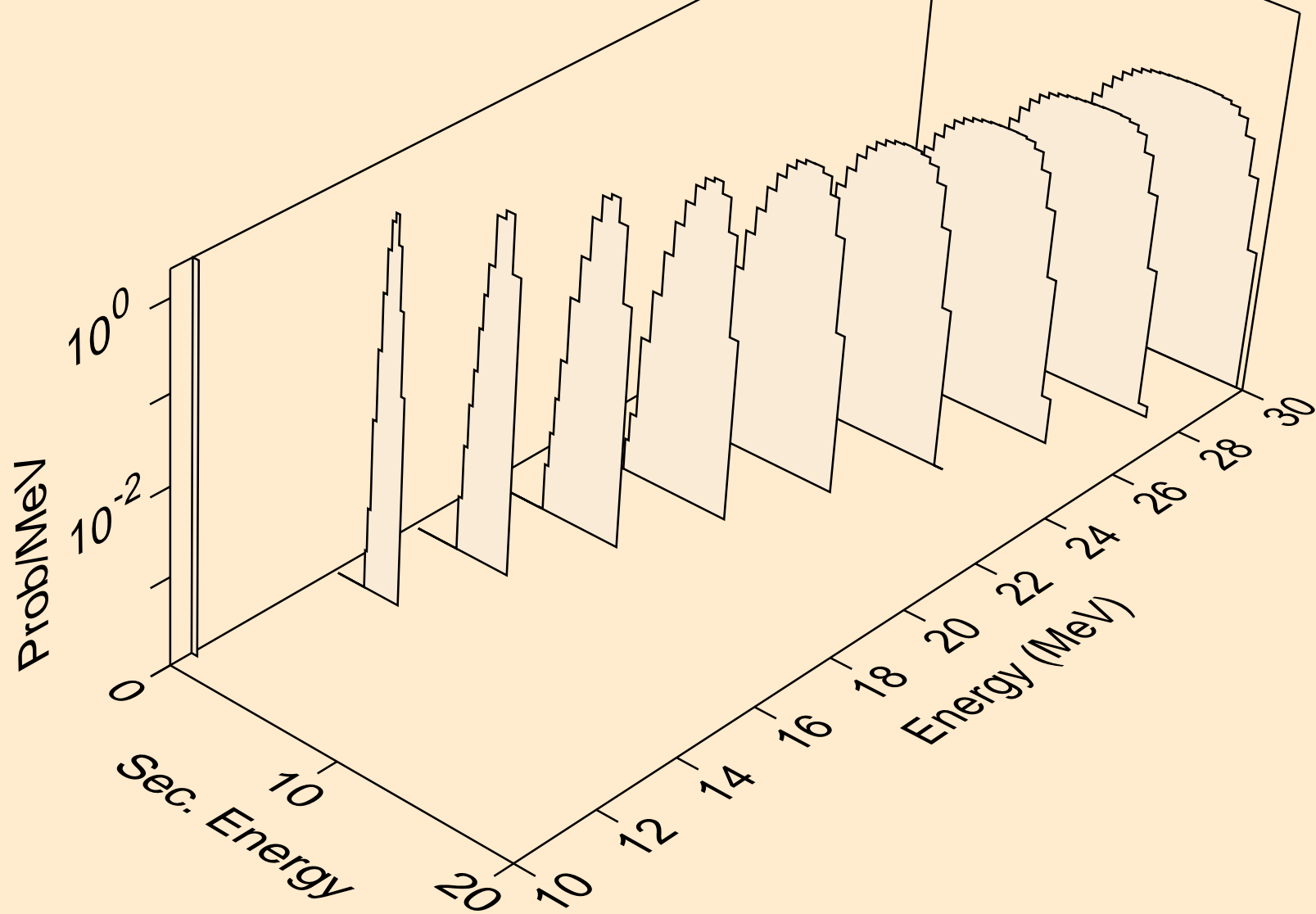

AC230 NEUTRON ACER TENDL-2021 LIBRARY; T=293.6K
protons from (n,3np)

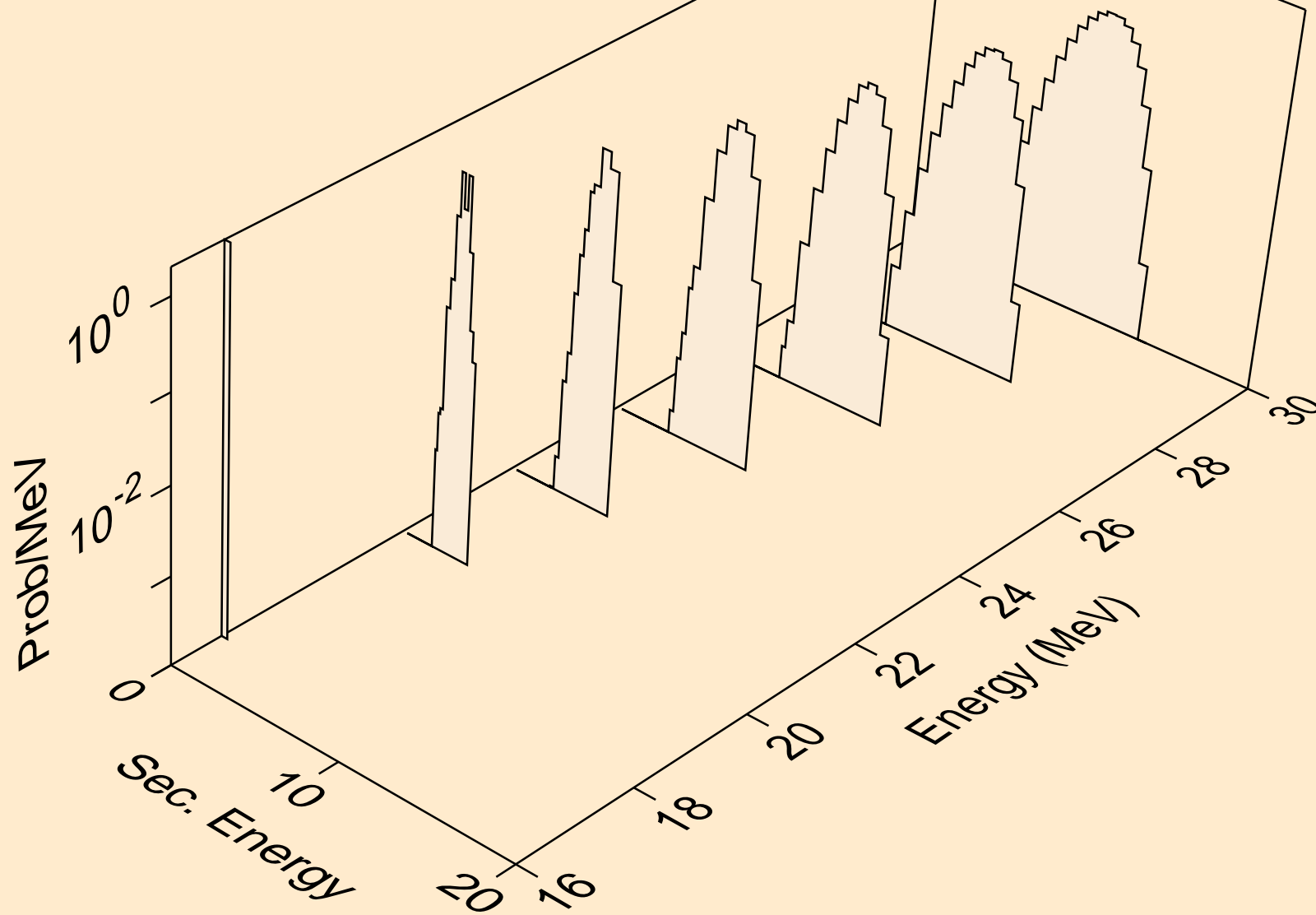

AC230 NEUTRON ACER TENDL-2021 LIBRARY; T=293.6K
protons from (n,2np)

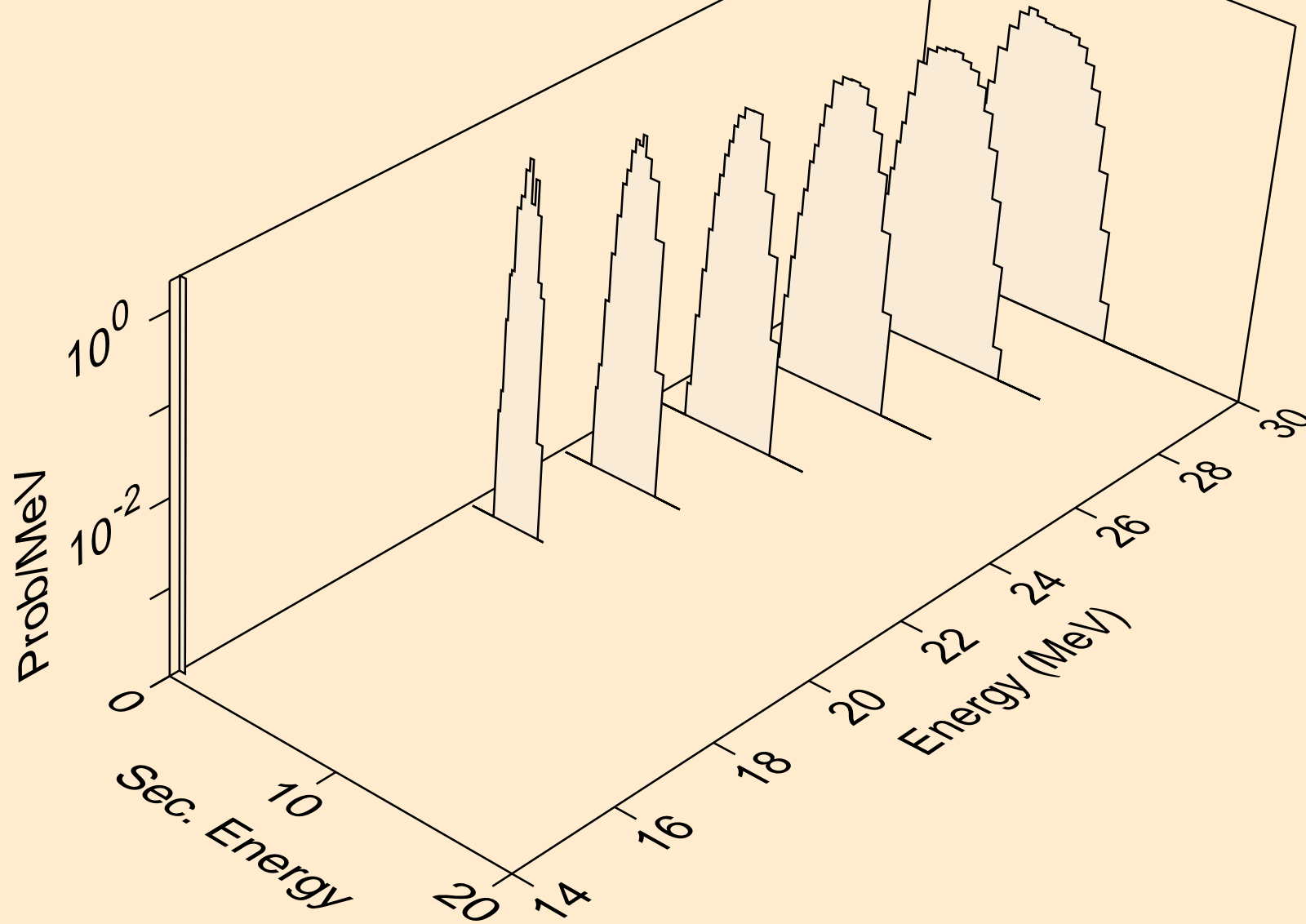

AC230 NEUTRON ACER TENDL-2021 LIBRARY; T=293.6K
protons from (n,npa)

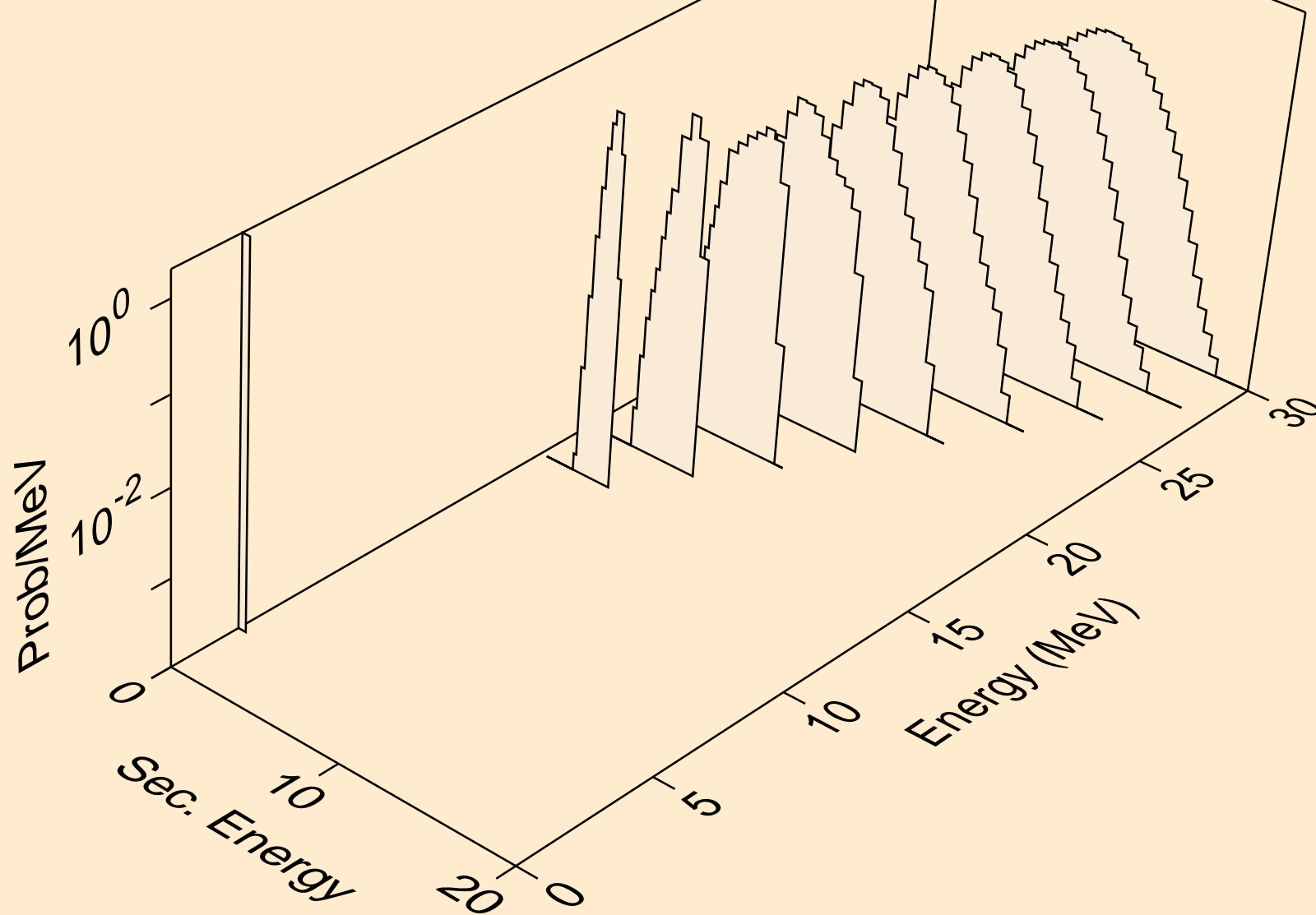

AC230 NEUTRON ACER TENDL-2021 LIBRARY; T=293.6K
protons from (n,p)

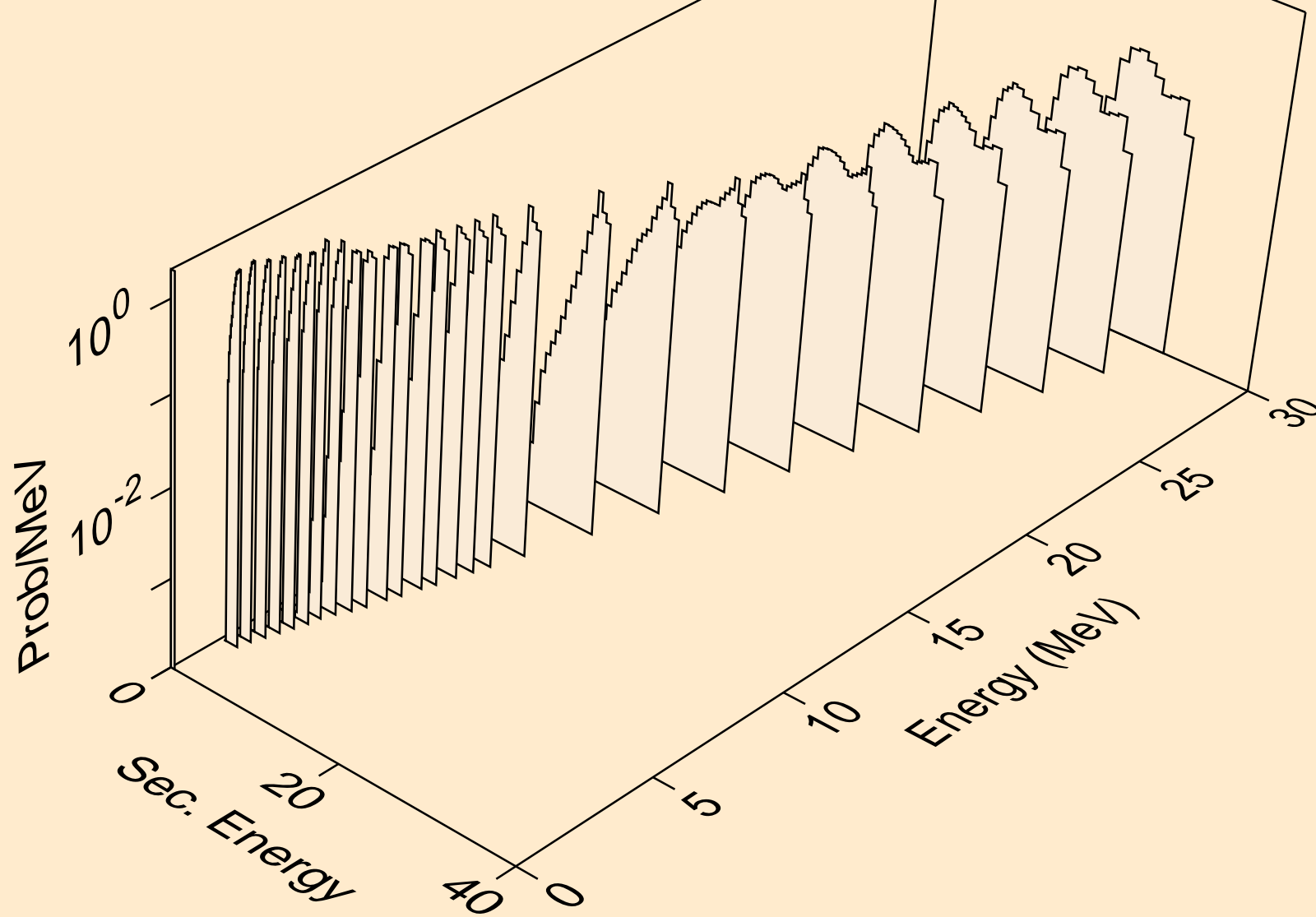

AC230 NEUTRON ACER TENDL-2021 LIBRARY; T=293.6K
protons from (n,2p)

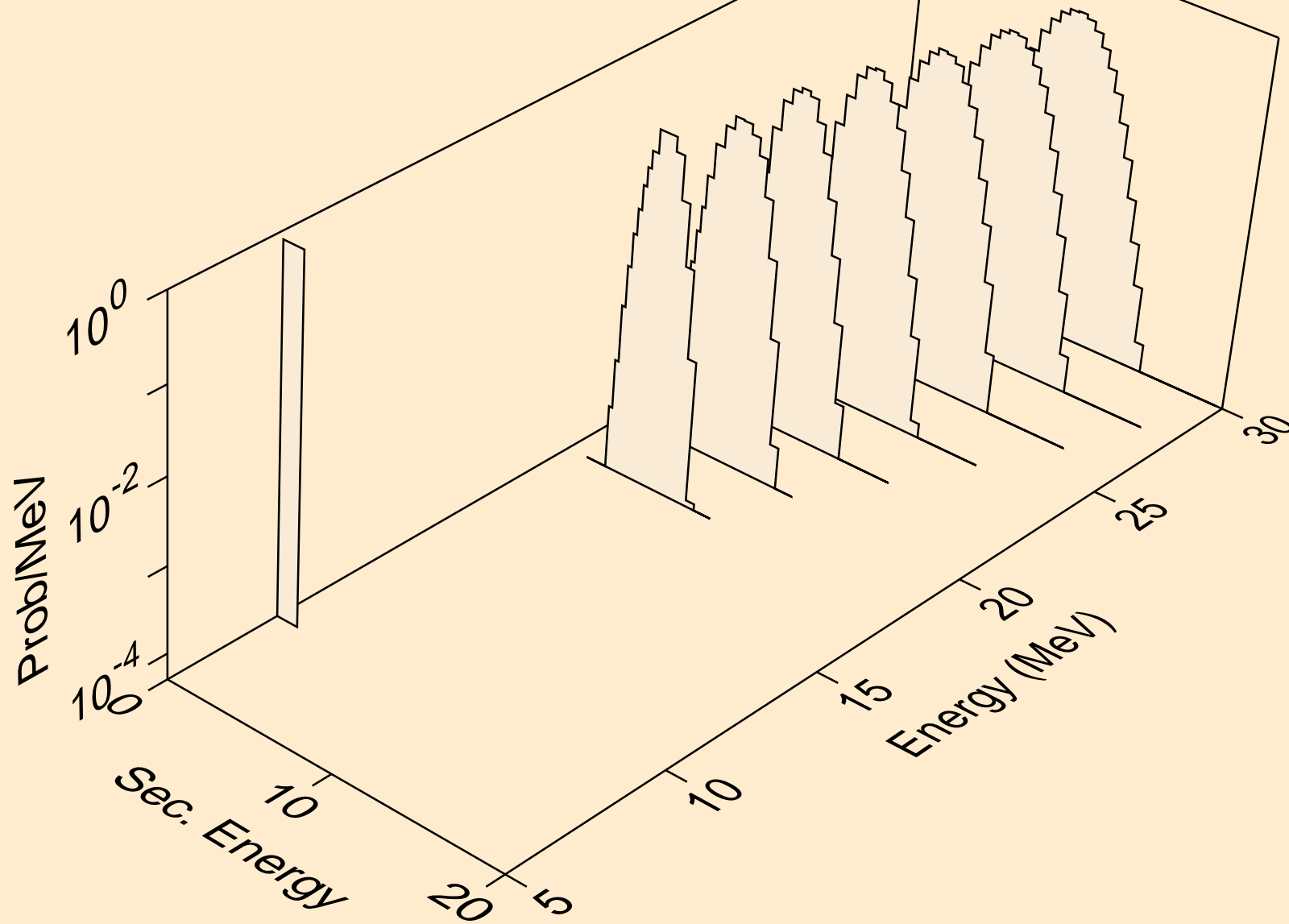

AC230 NEUTRON ACER TENDL-2021 LIBRARY; T=293.6K
protons from (n,p)

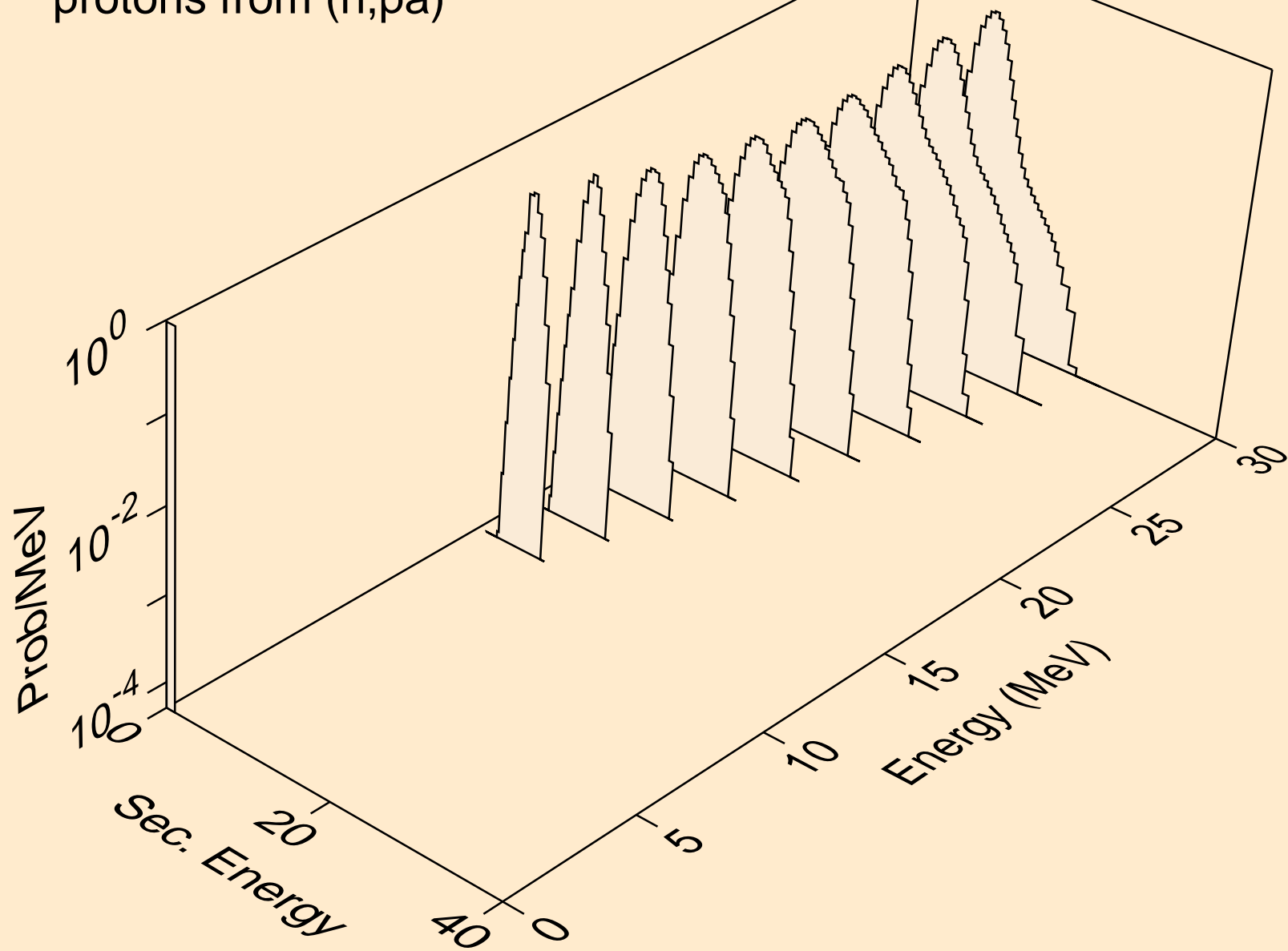

AC230 NEUTRON ACER TENDL-2021 LIBRARY; T=293.6K
protons from (n,pd)

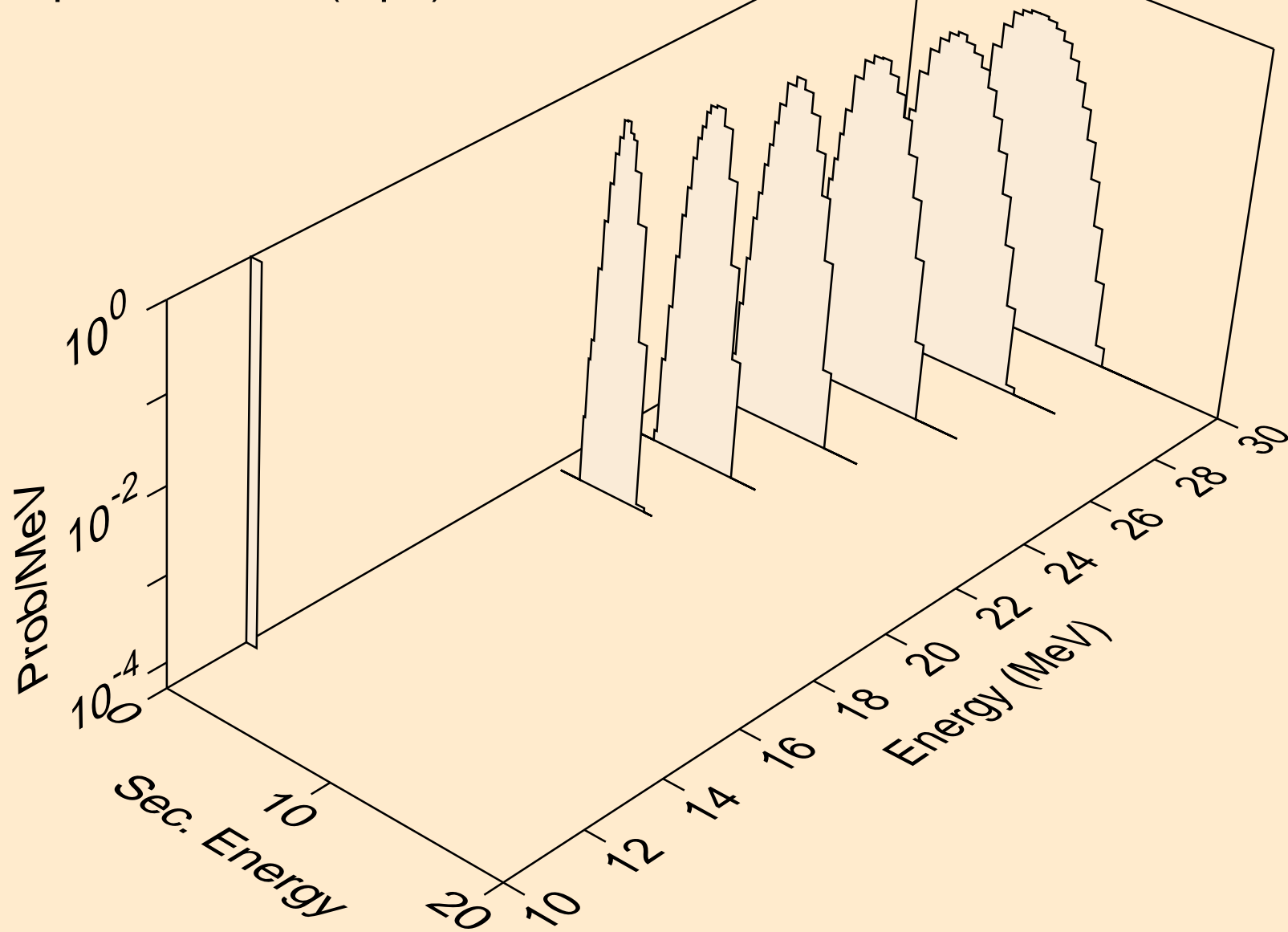

AC230 NEUTRON ACER TENDL-2021 LIBRARY; T=293.6K
protons from (n,pt)

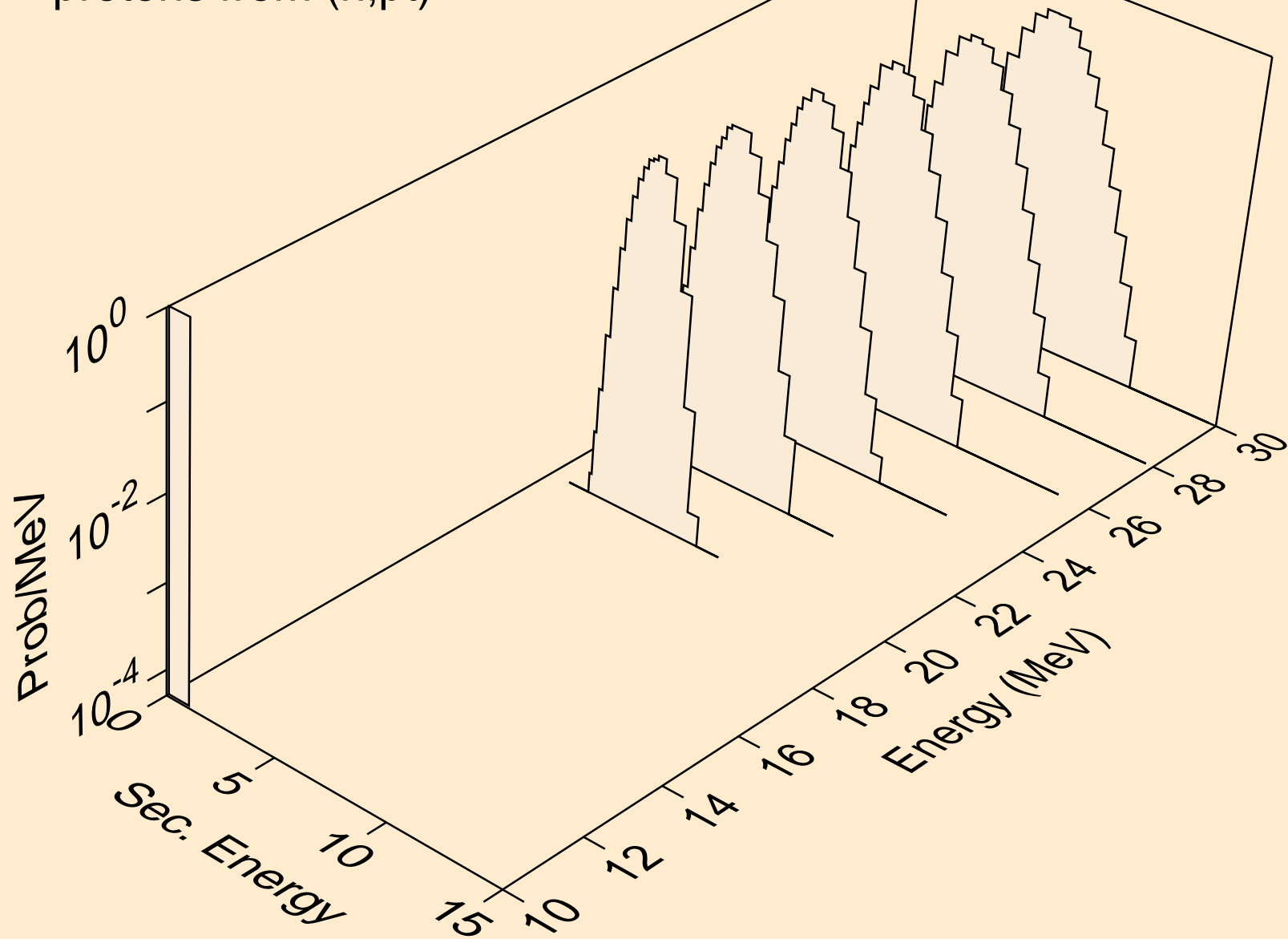

AC230 NEUTRON ACER TENDL-2021 LIBRARY; T=293.6K
deuterons from (n,x)

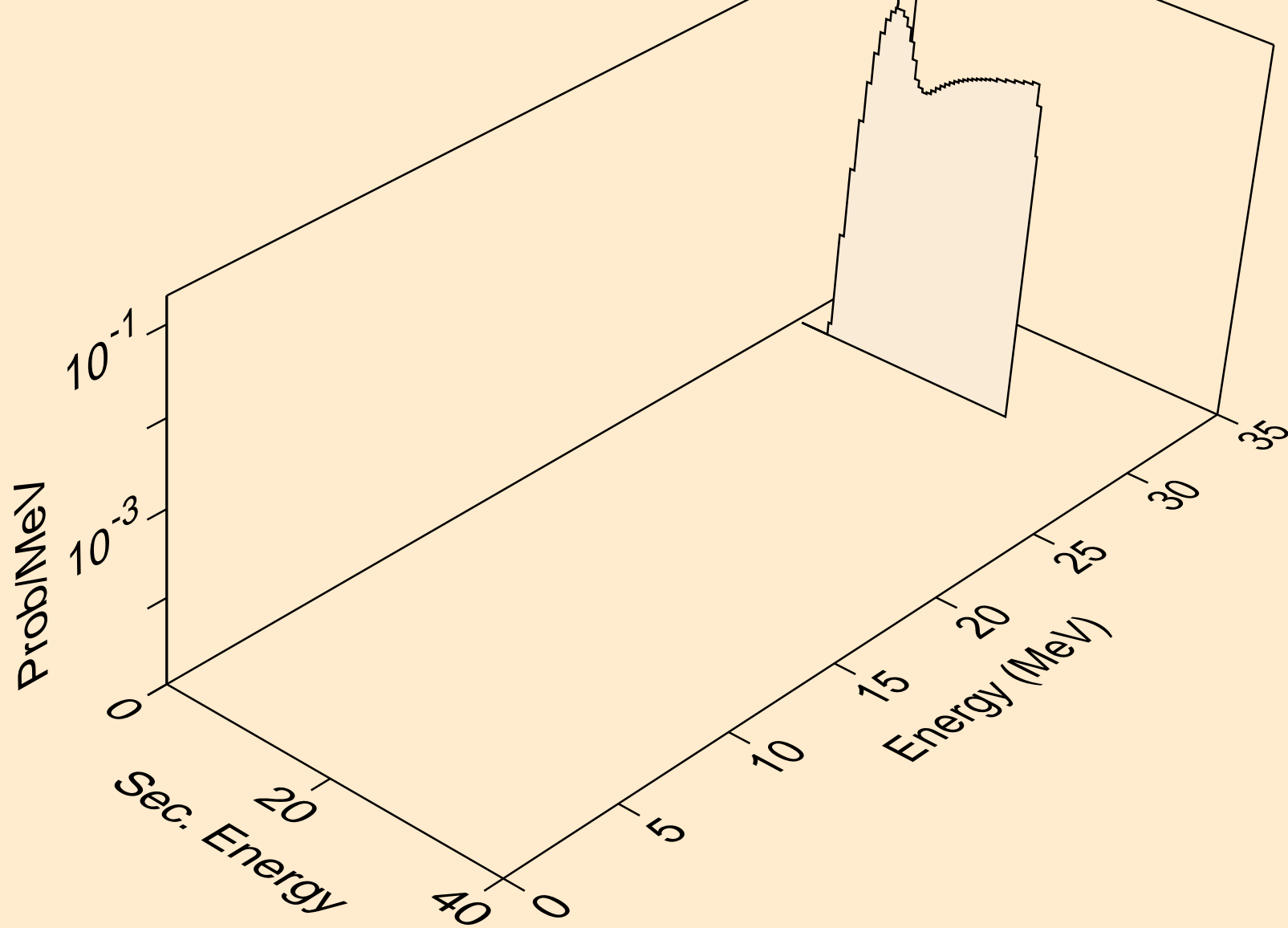

AC230 NEUTRON ACER TENDL-2021 LIBRARY; T=293.6K
deuterons from (n,2nd)

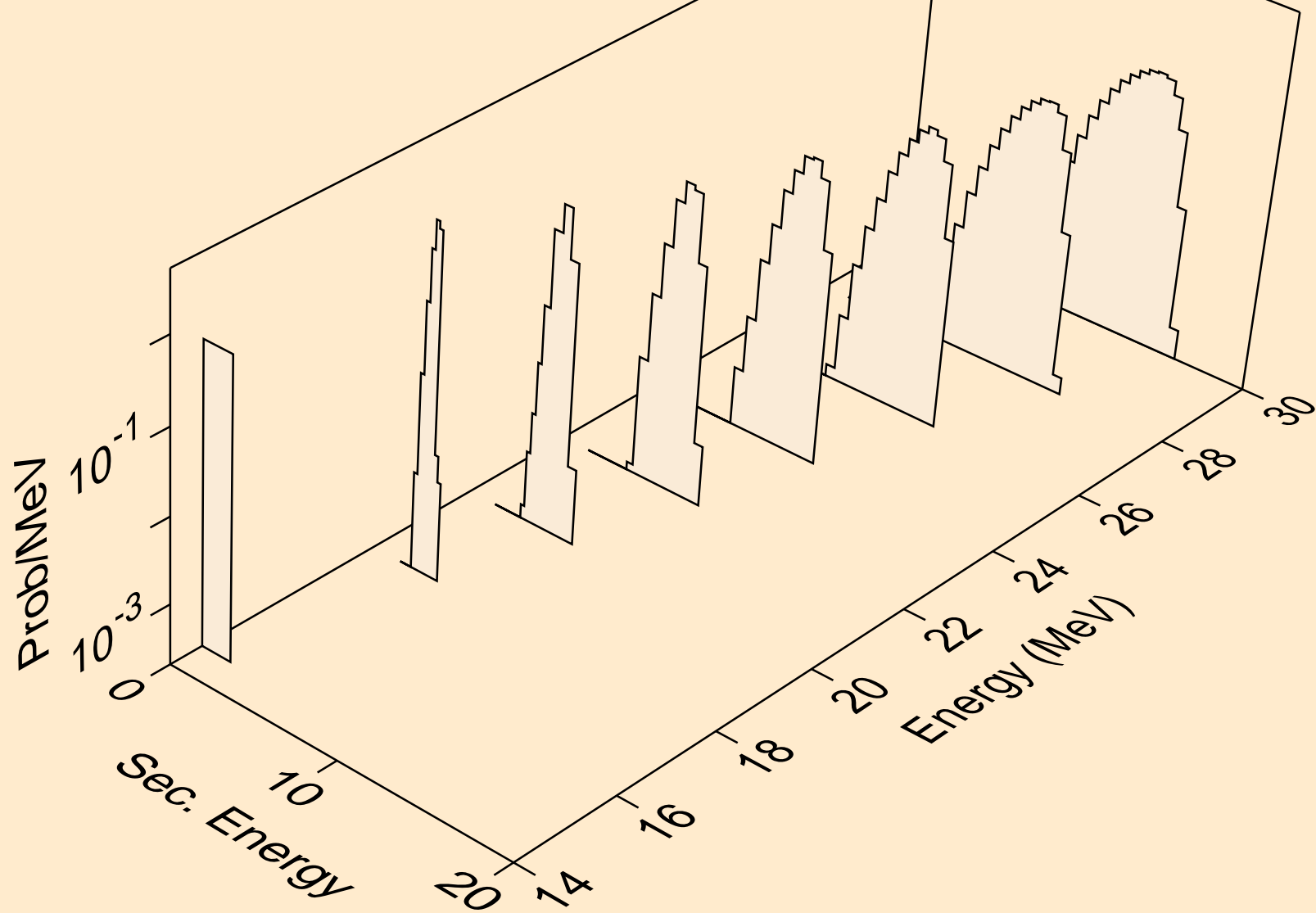

AC230 NEUTRON ACER TENDL-2021 LIBRARY; T=293.6K
deuterons from (n,n*)d

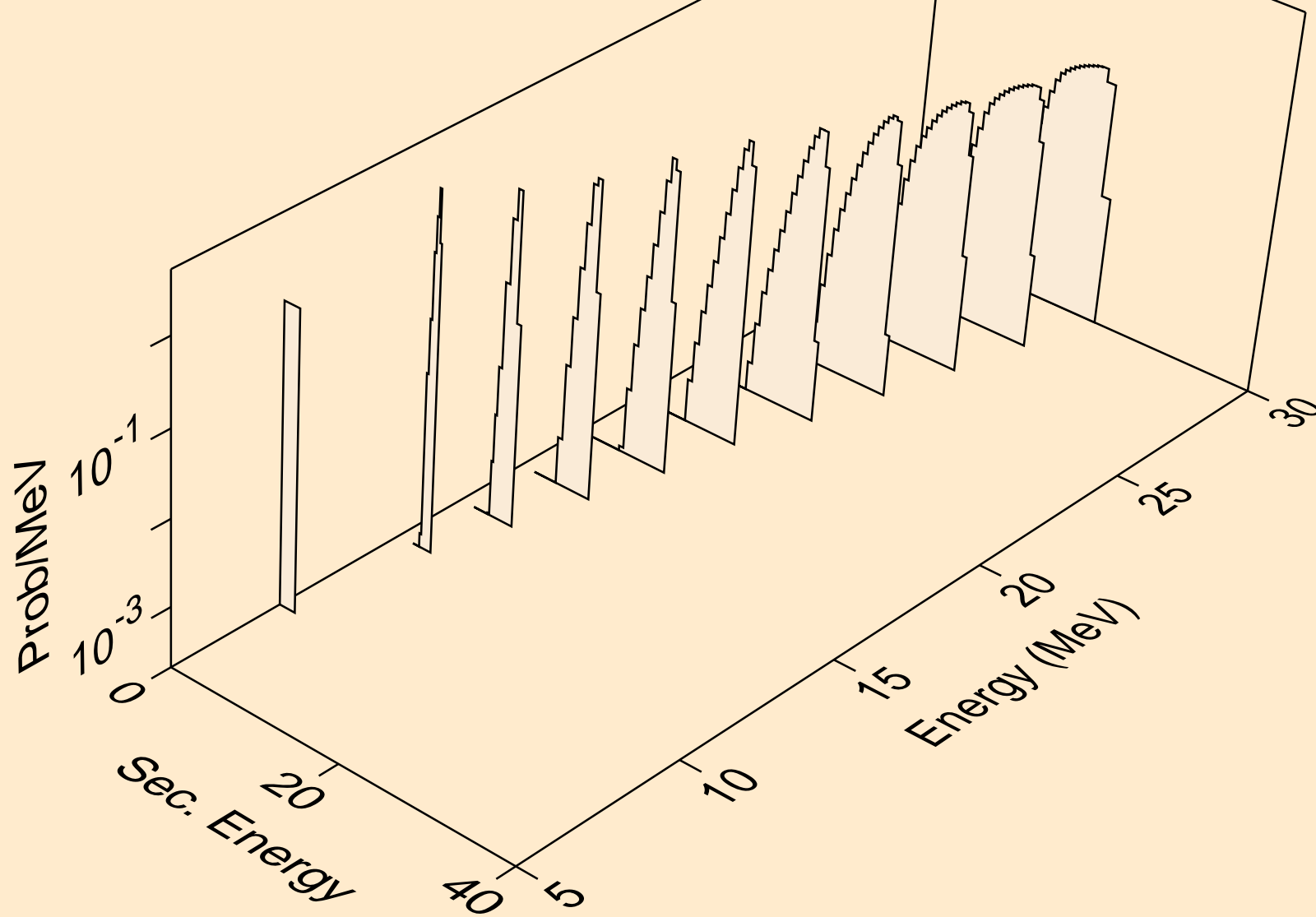

AC230 NEUTRON ACER TENDL-2021 LIBRARY; T=293.6K
deuterons from (n,d)

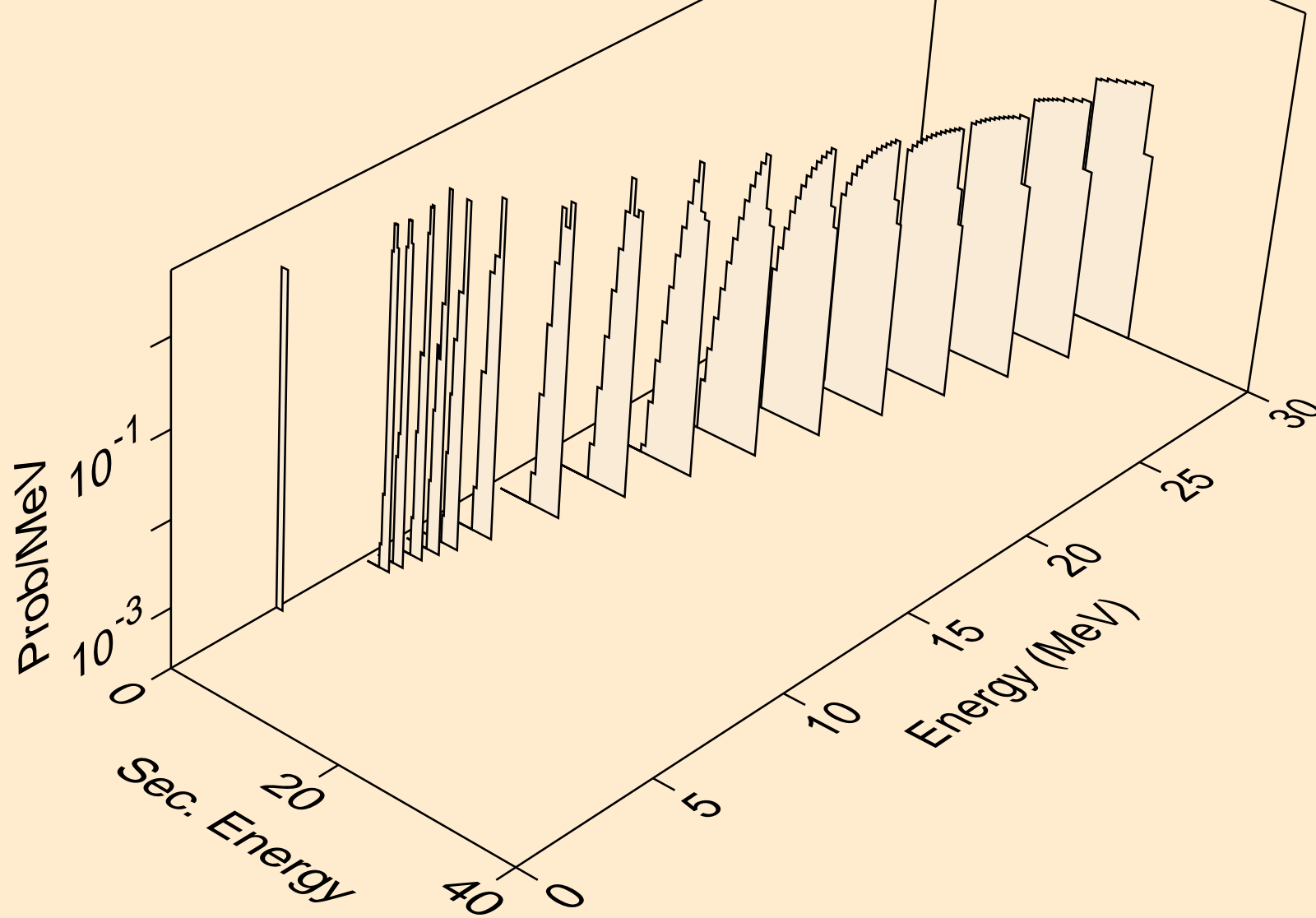

AC230 NEUTRON ACER TENDL-2021 LIBRARY; T=293.6K
deuterons from (n,pd)

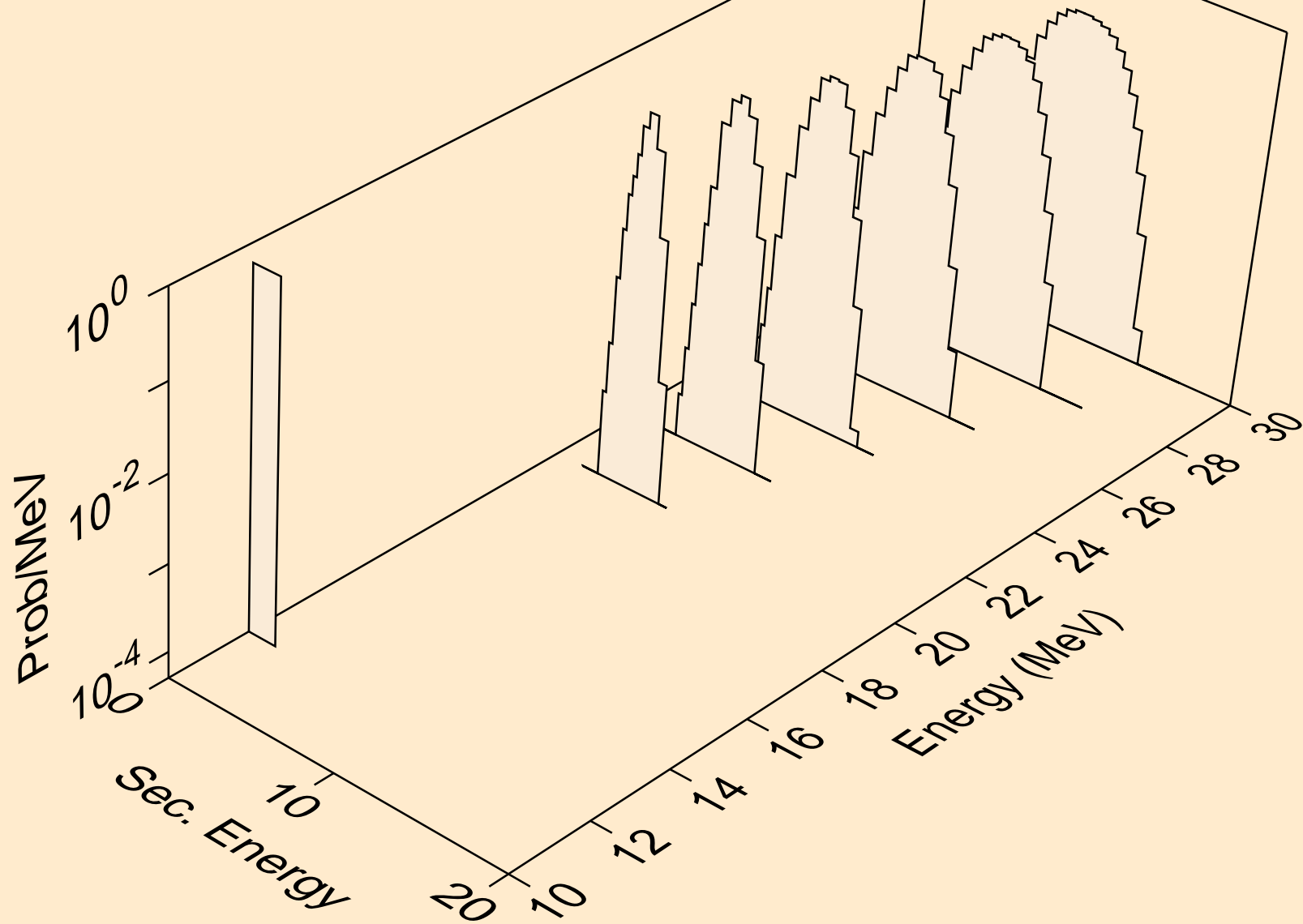

AC230 NEUTRON ACER TENDL-2021 LIBRARY; T=293.6K
deuterons from (n,da)

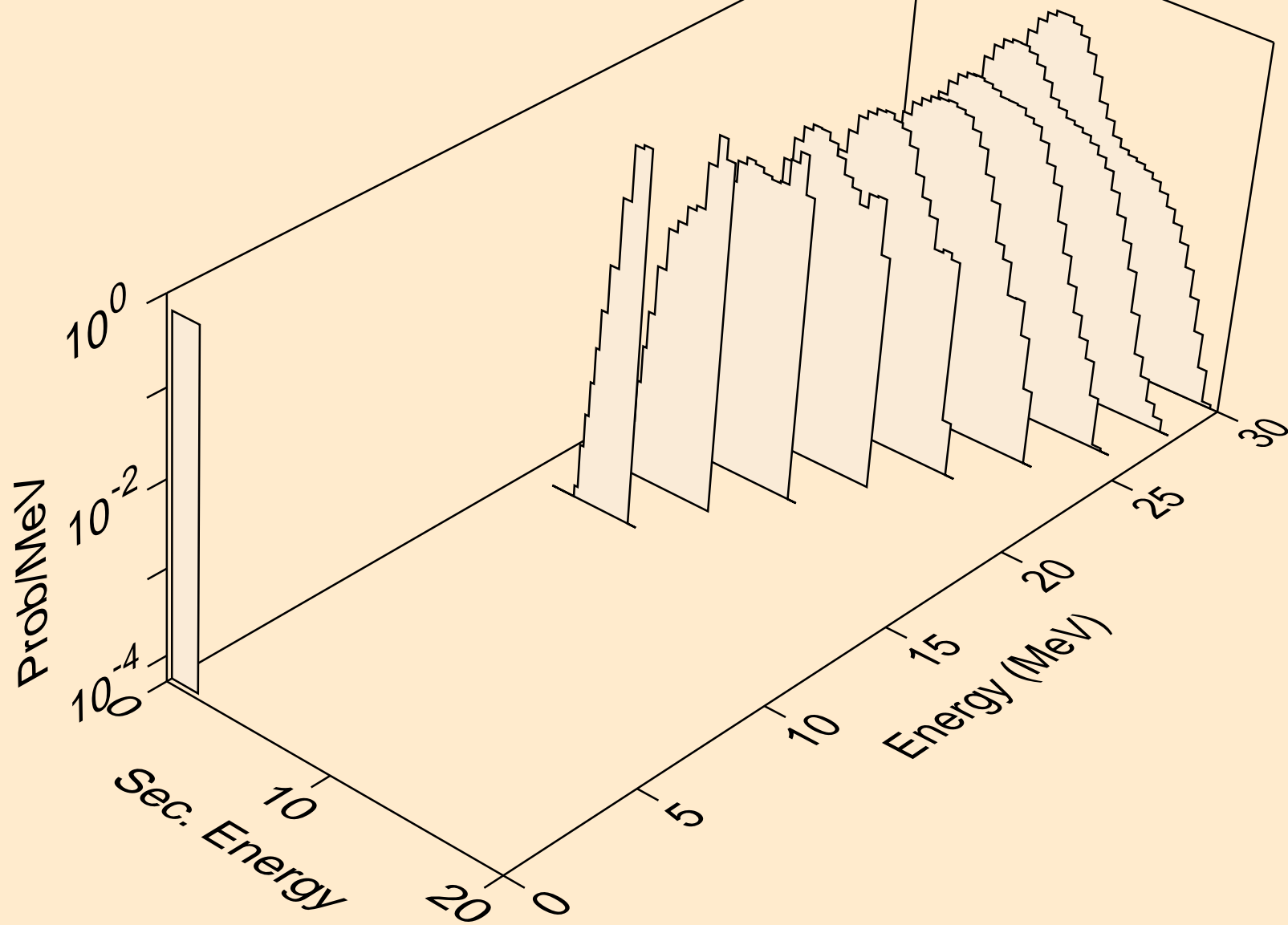

AC230 NEUTRON ACER TENDL-2021 LIBRARY; T=293.6K
tritons from (n,x)

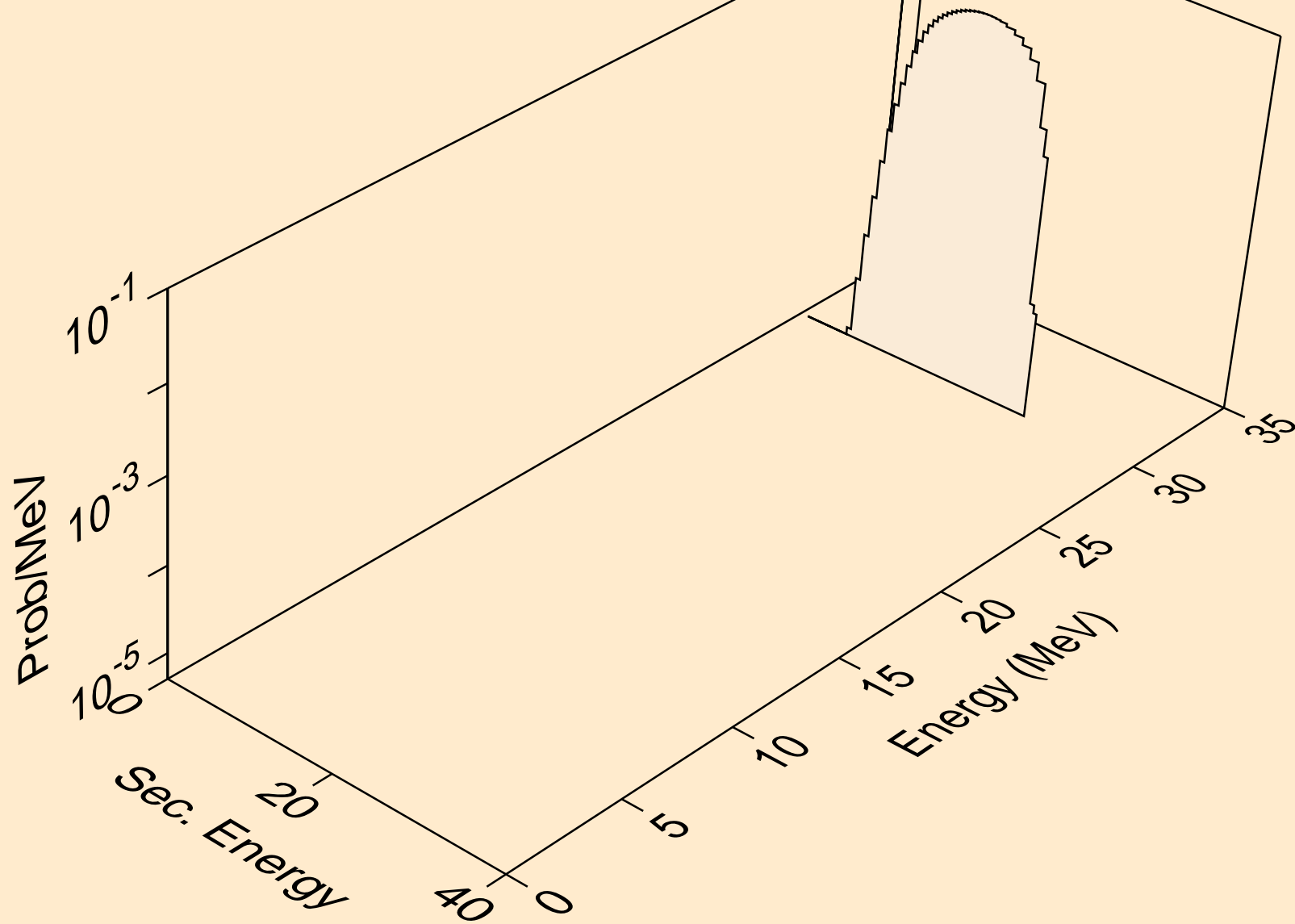

AC230 NEUTRON ACER TENDL-2021 LIBRARY; T=293.6K
tritons from (n,n*)t

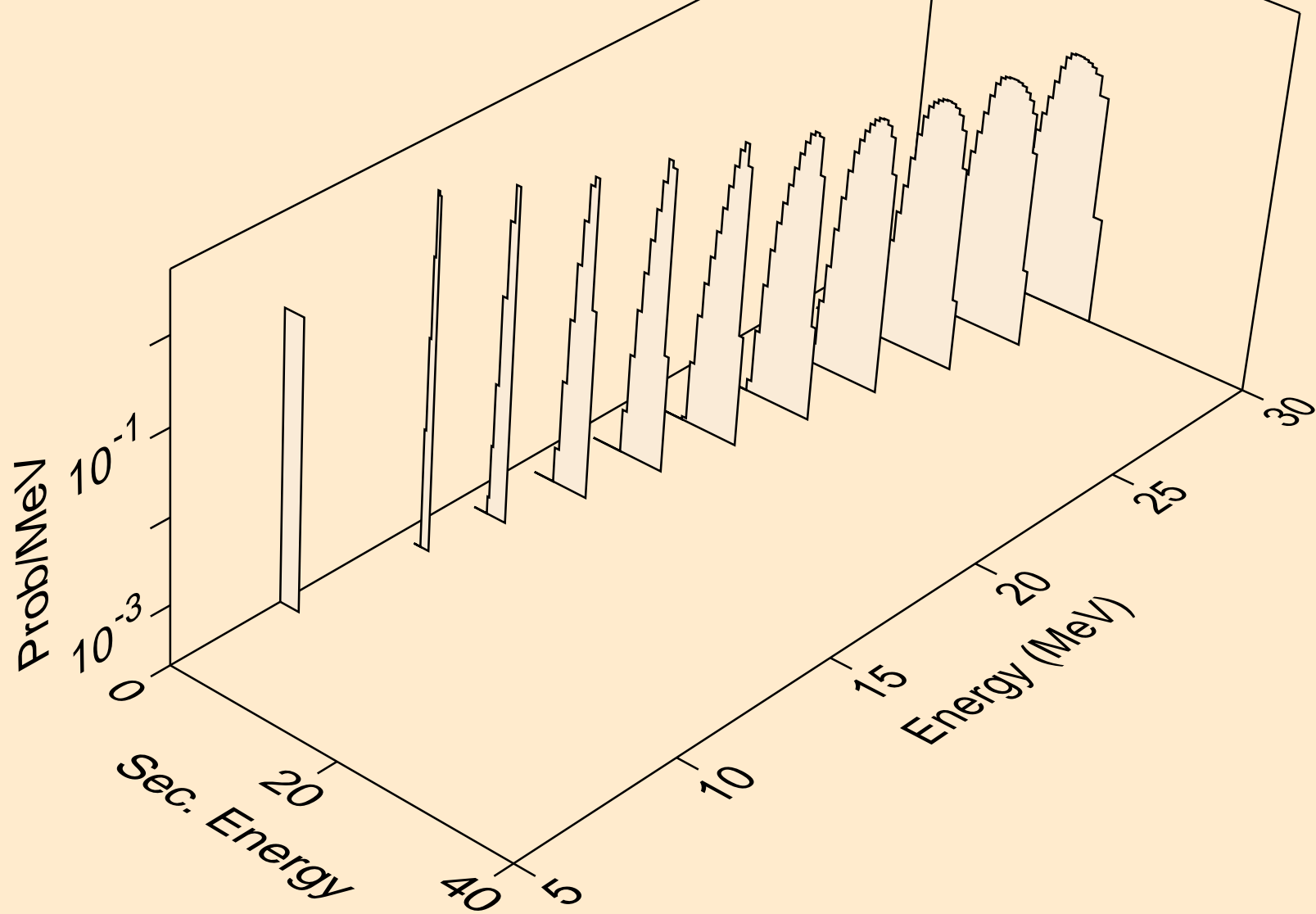

AC230 NEUTRON ACER TENDL-2021 LIBRARY; T=293.6K
tritons from (n,t)

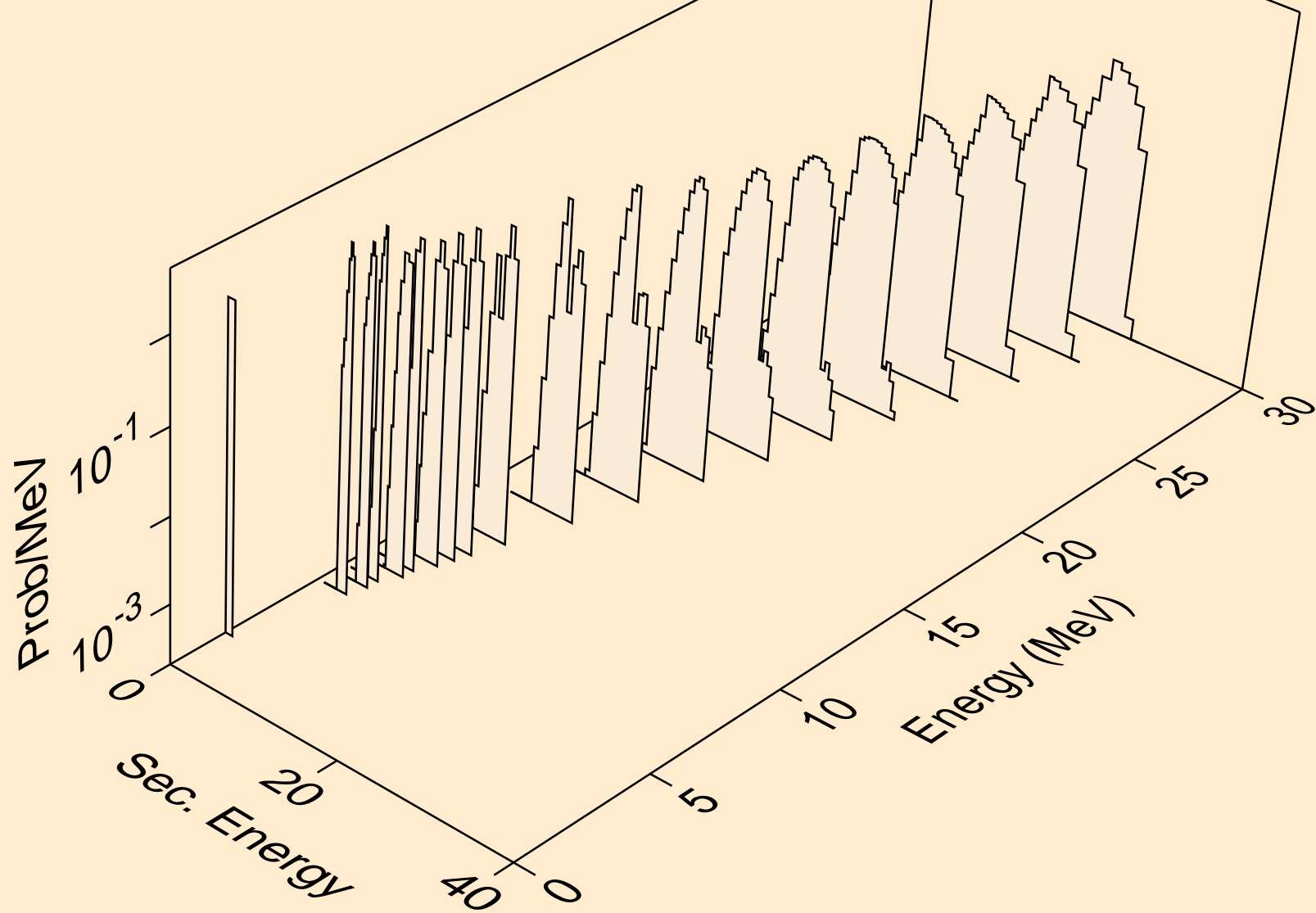

AC230 NEUTRON ACER TENDL-2021 LIBRARY; T=293.6K
tritons from (n,pt)

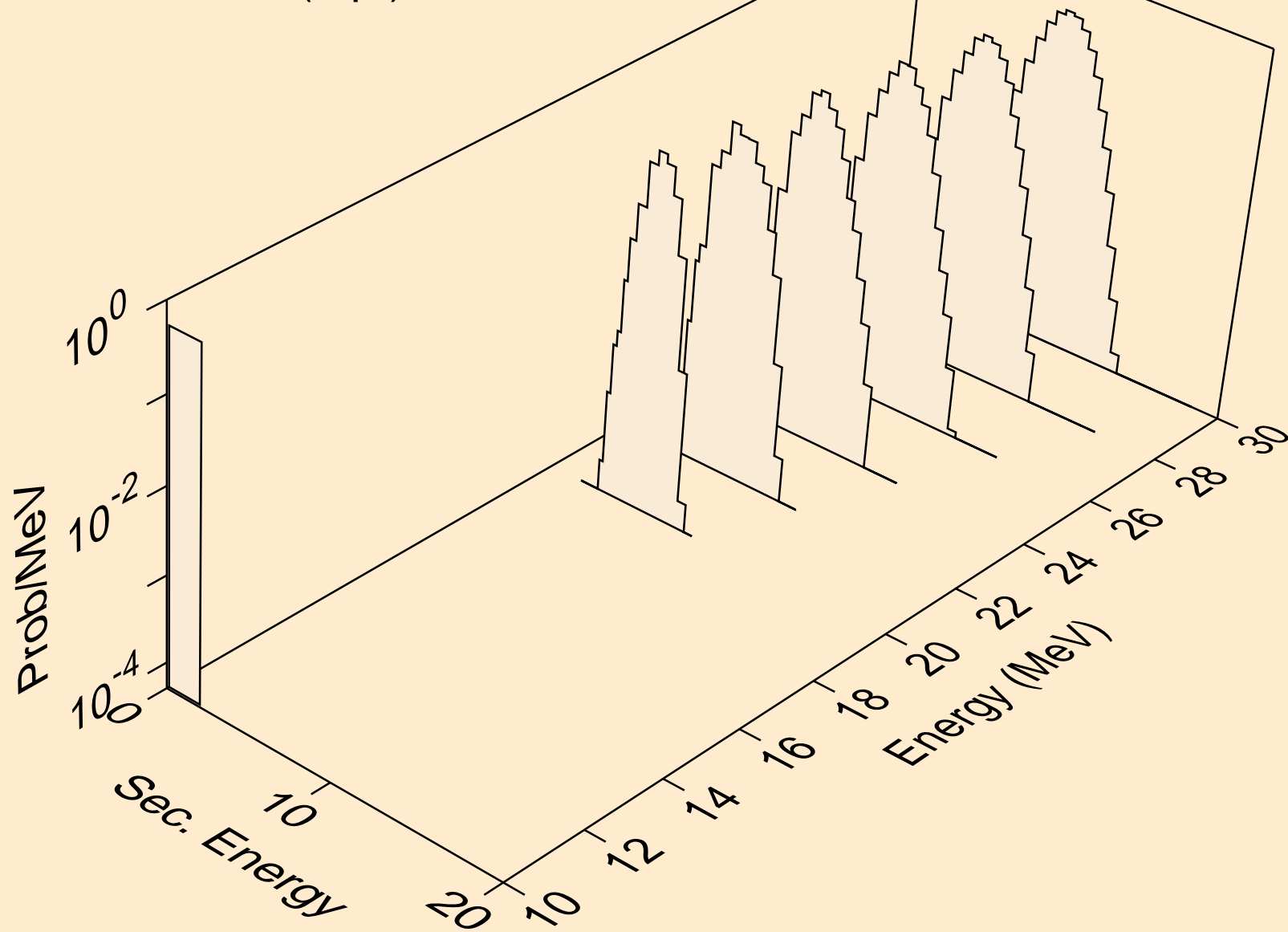

AC230 NEUTRON ACER TENDL-2021 LIBRARY; T=293.6K
he3s from (n,x)

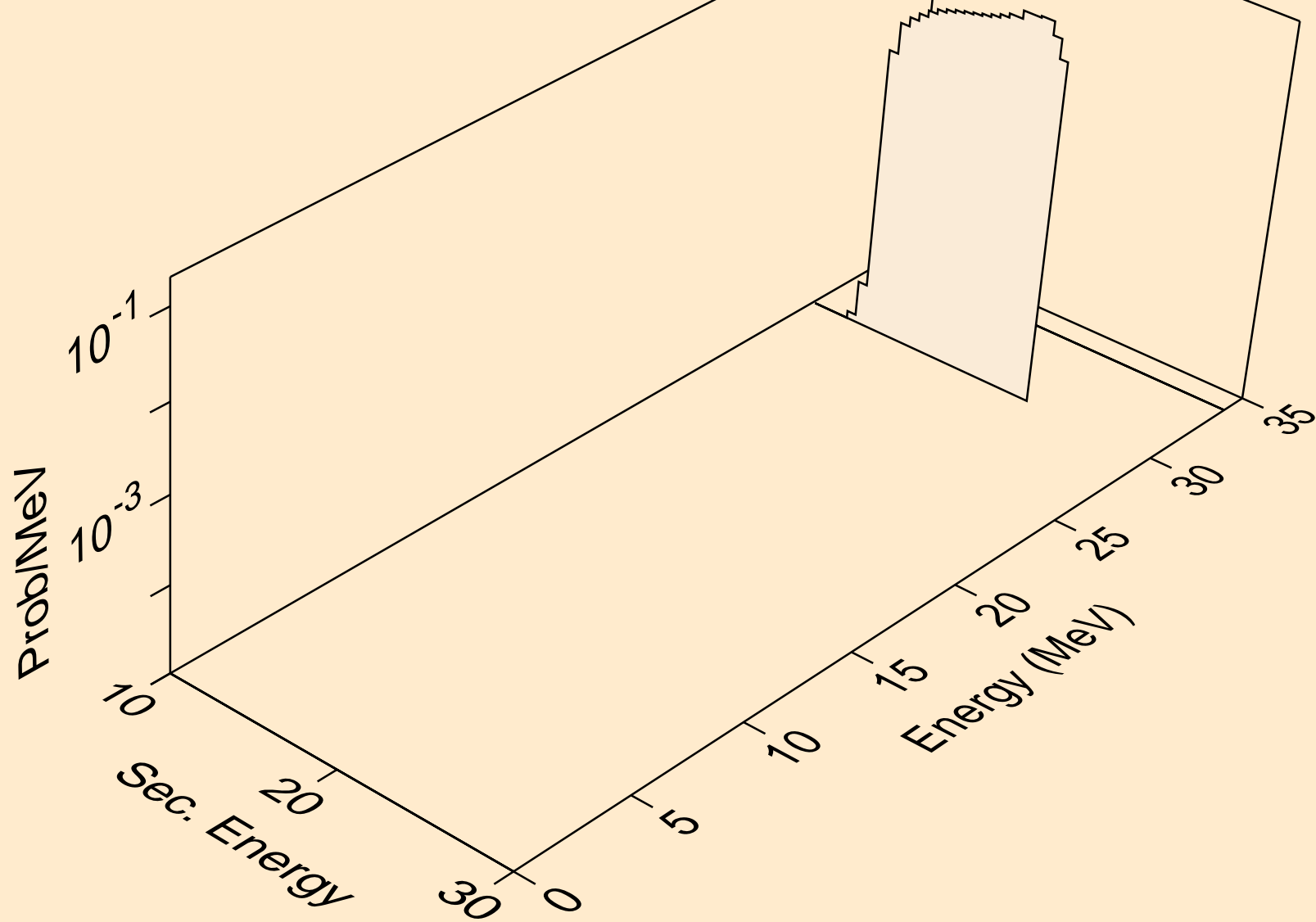

AC230 NEUTRON ACER TENDL-2021 LIBRARY; T=293.6K
he3s from (n,n*)he3

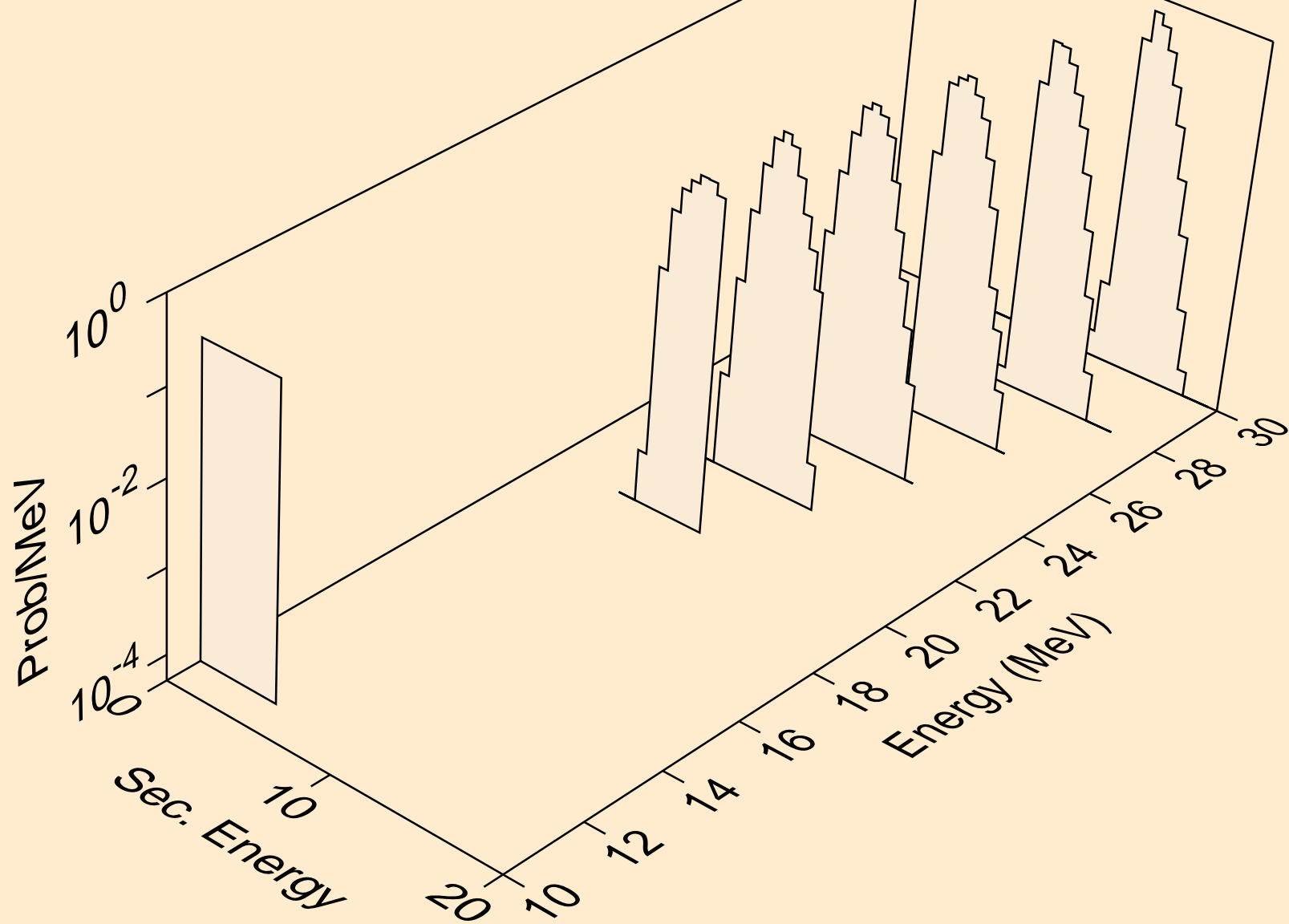

AC230 NEUTRON ACER TENDL-2021 LIBRARY; T=293.6K
he3s from (n,he3)

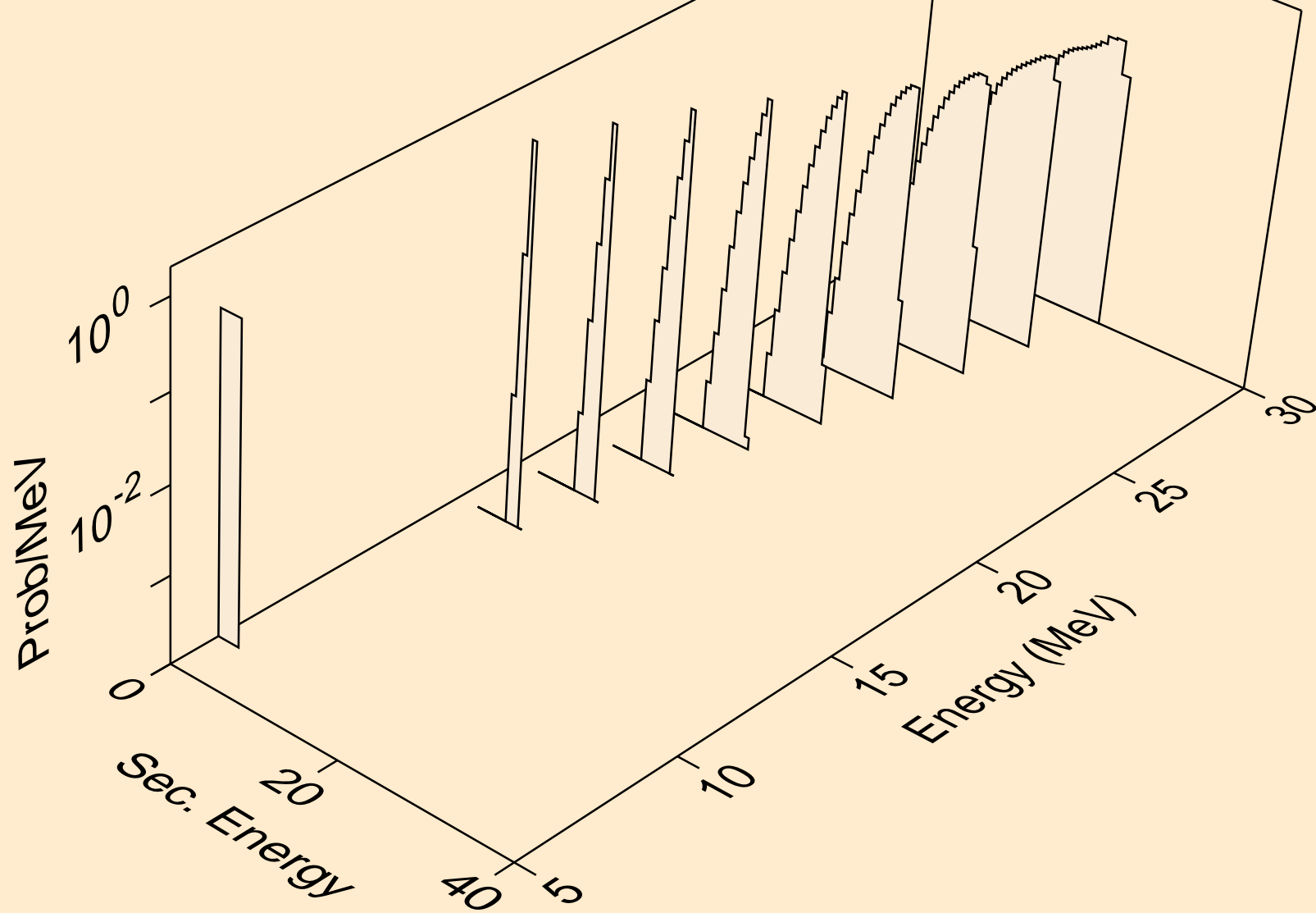

AC230 NEUTRON ACER TENDL-2021 LIBRARY; T=293.6K
alphas from (n,x)

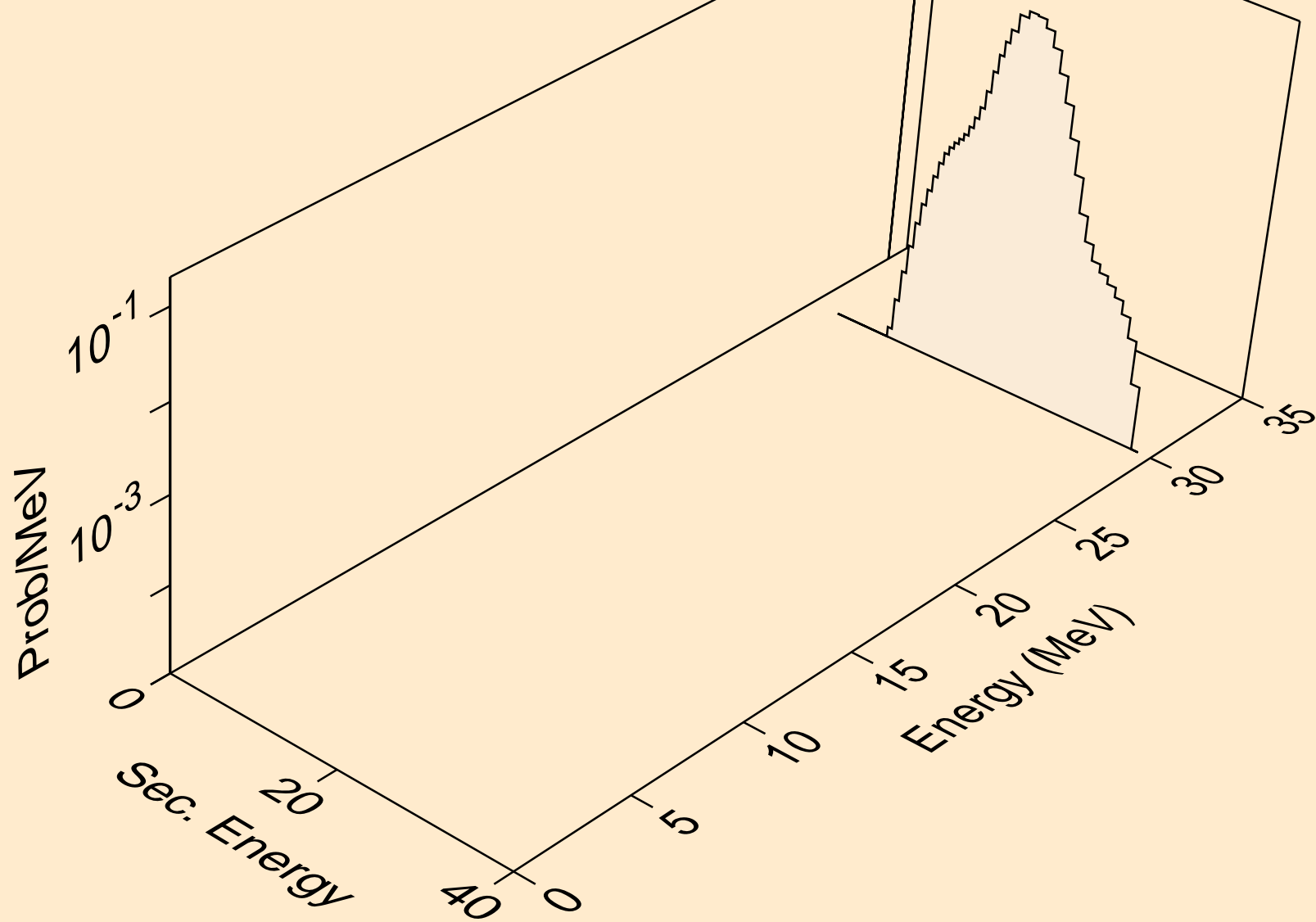

AC230 NEUTRON ACER TENDL-2021 LIBRARY; T=293.6K
alphas from (n,n*)a

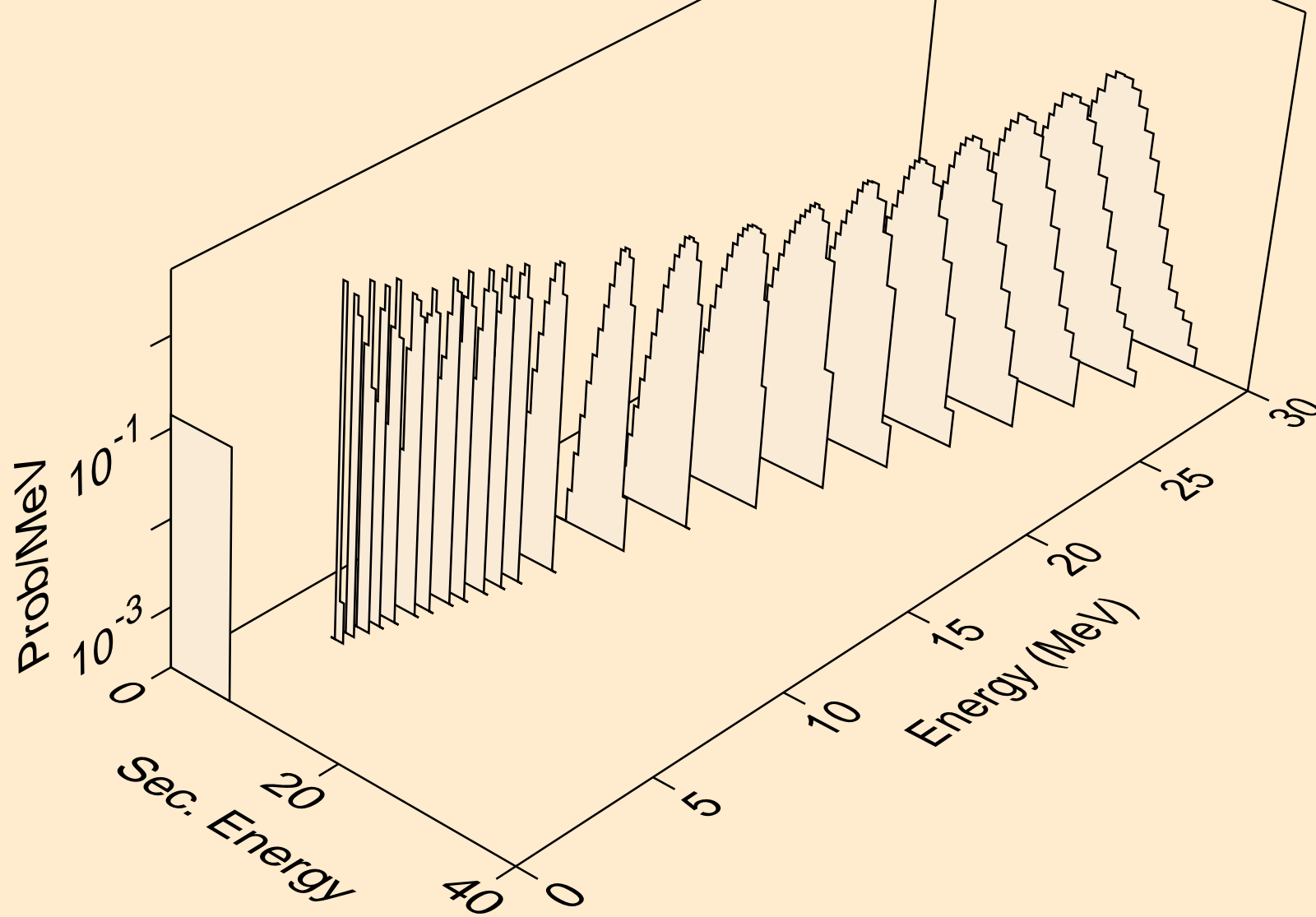

AC230 NEUTRON ACER TENDL-2021 LIBRARY; T=293.6K
alphas from (n,2n)a

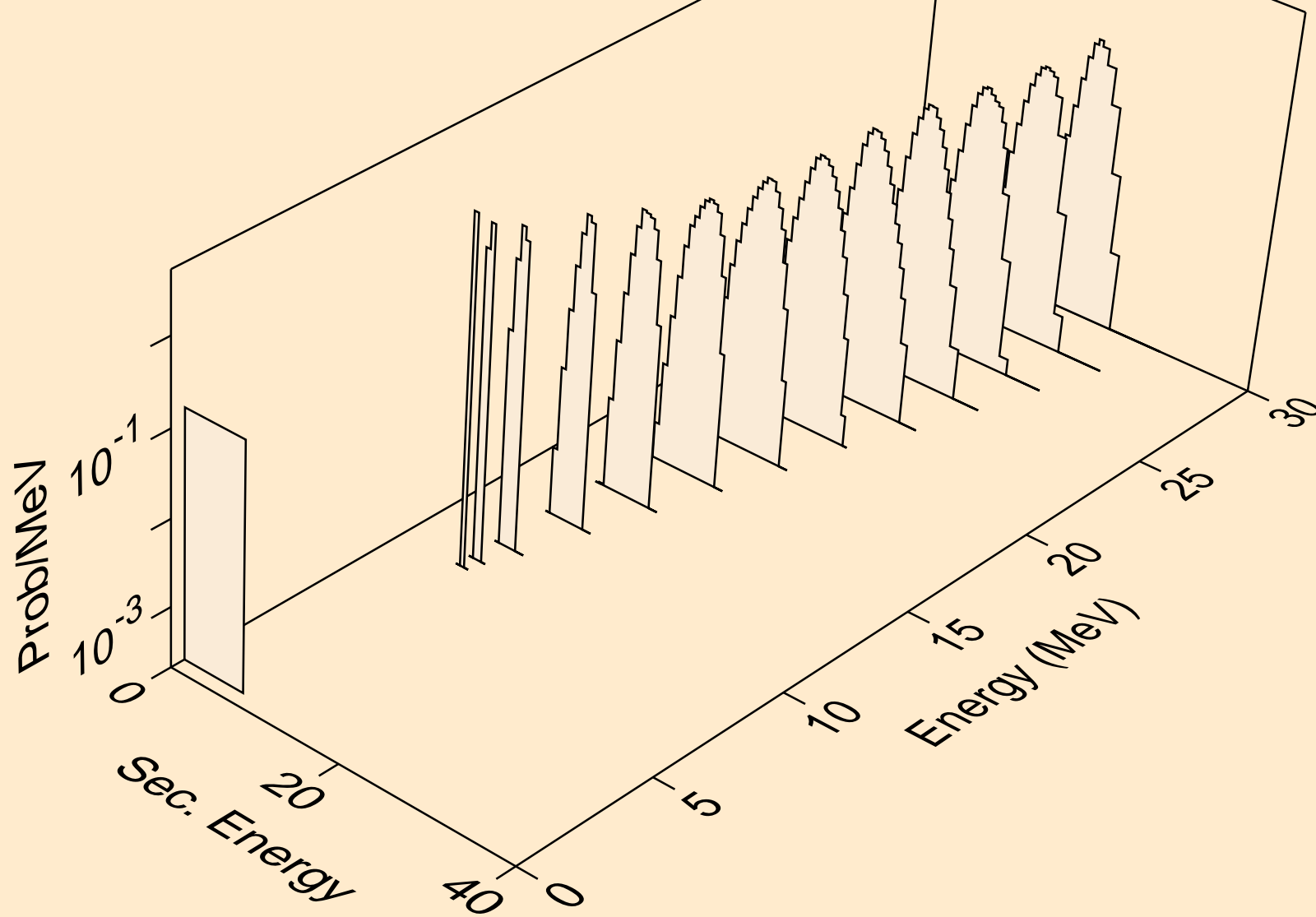

AC230 NEUTRON ACER TENDL-2021 LIBRARY; T=293.6K
alphas from (n,3n)a

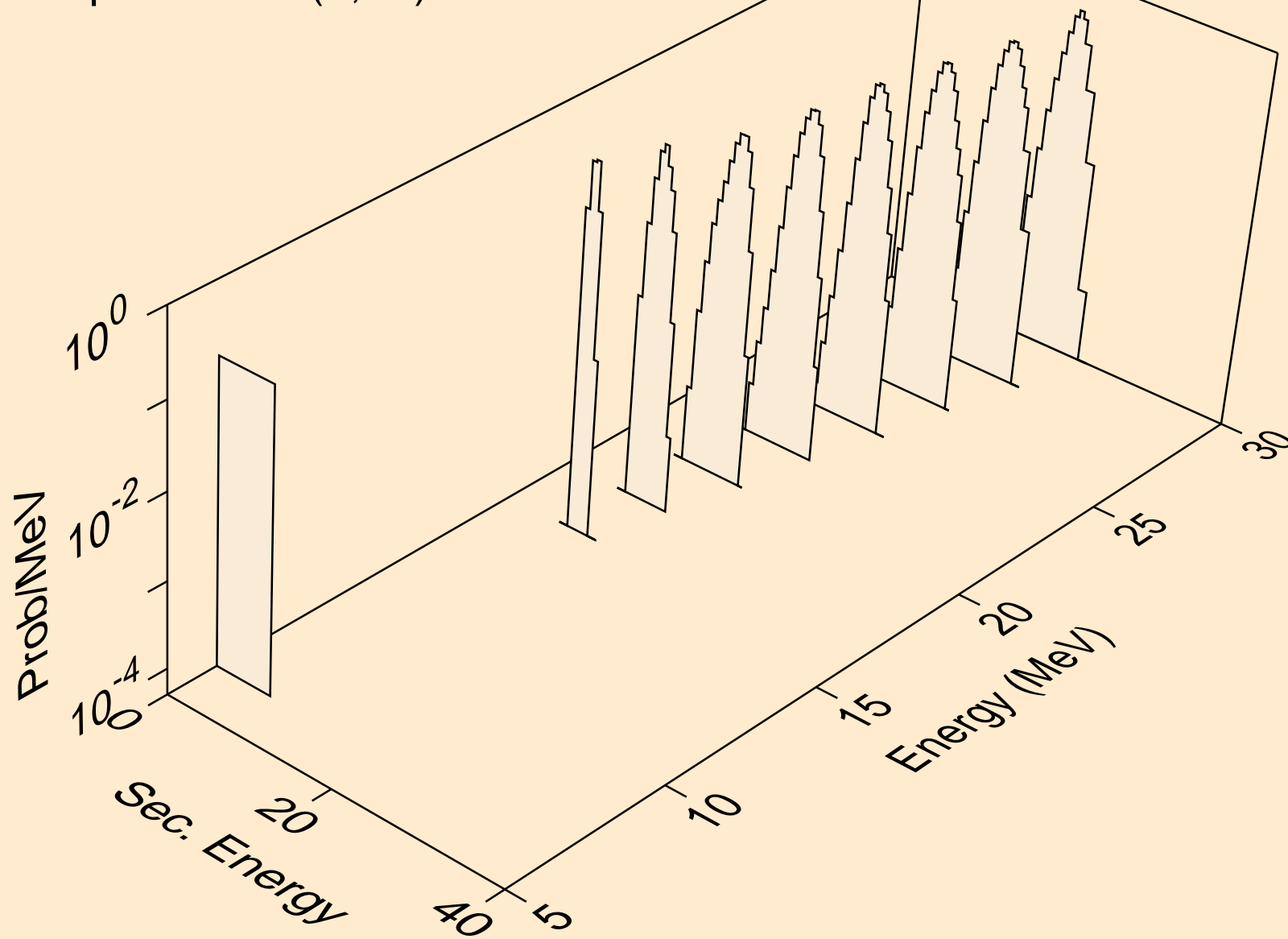

AC230 NEUTRON ACER TENDL-2021 LIBRARY; T=293.6K
alphas from (n,n*)2a

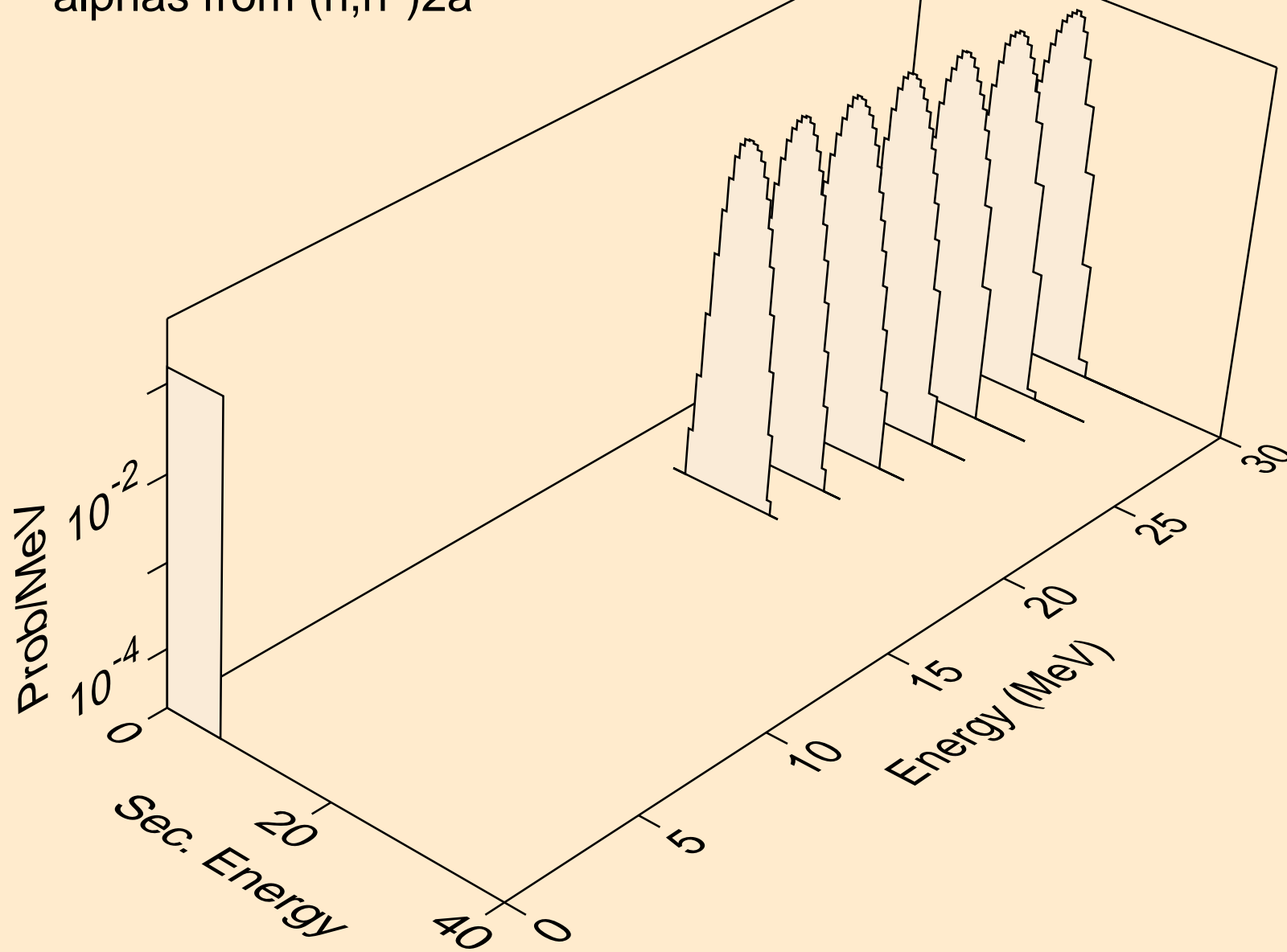

AC230 NEUTRON ACER TENDL-2021 LIBRARY; T=293.6K
alphas from (n,2n)2a

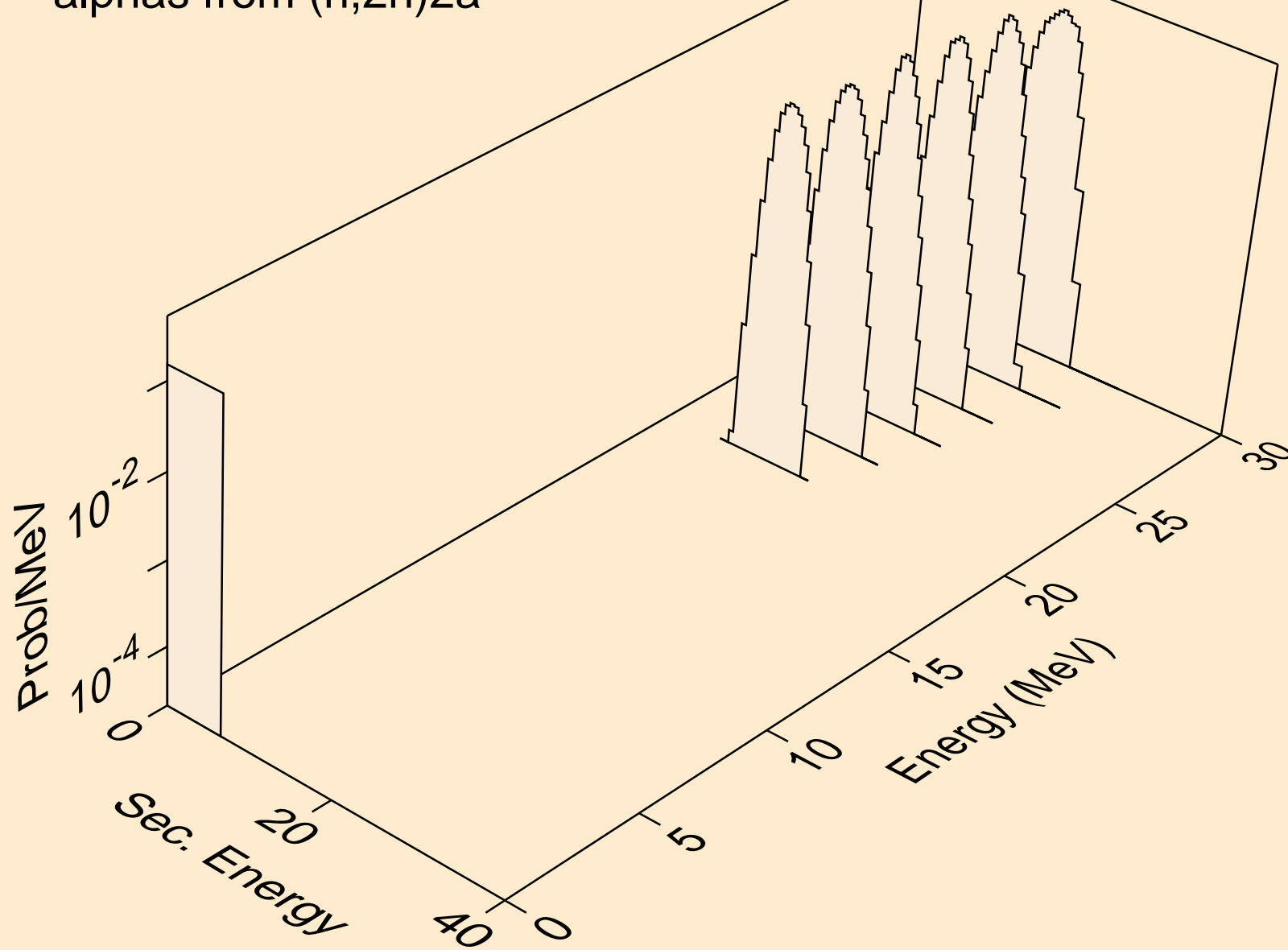

AC230 NEUTRON ACER TENDL-2021 LIBRARY; T=293.6K
alphas from (n,npa)

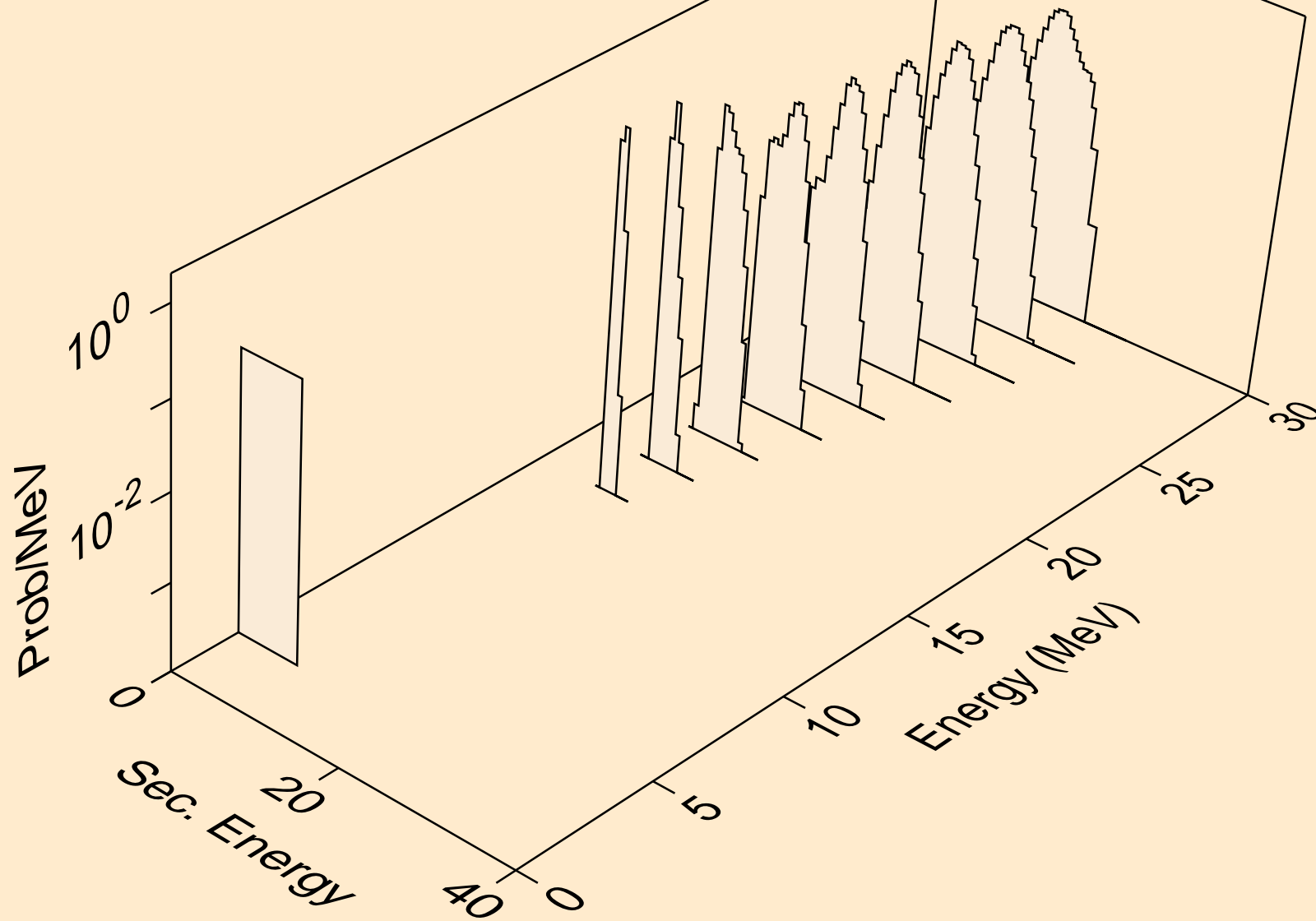

AC230 NEUTRON ACER TENDL-2021 LIBRARY; T=293.6K
alphas from (n,a)

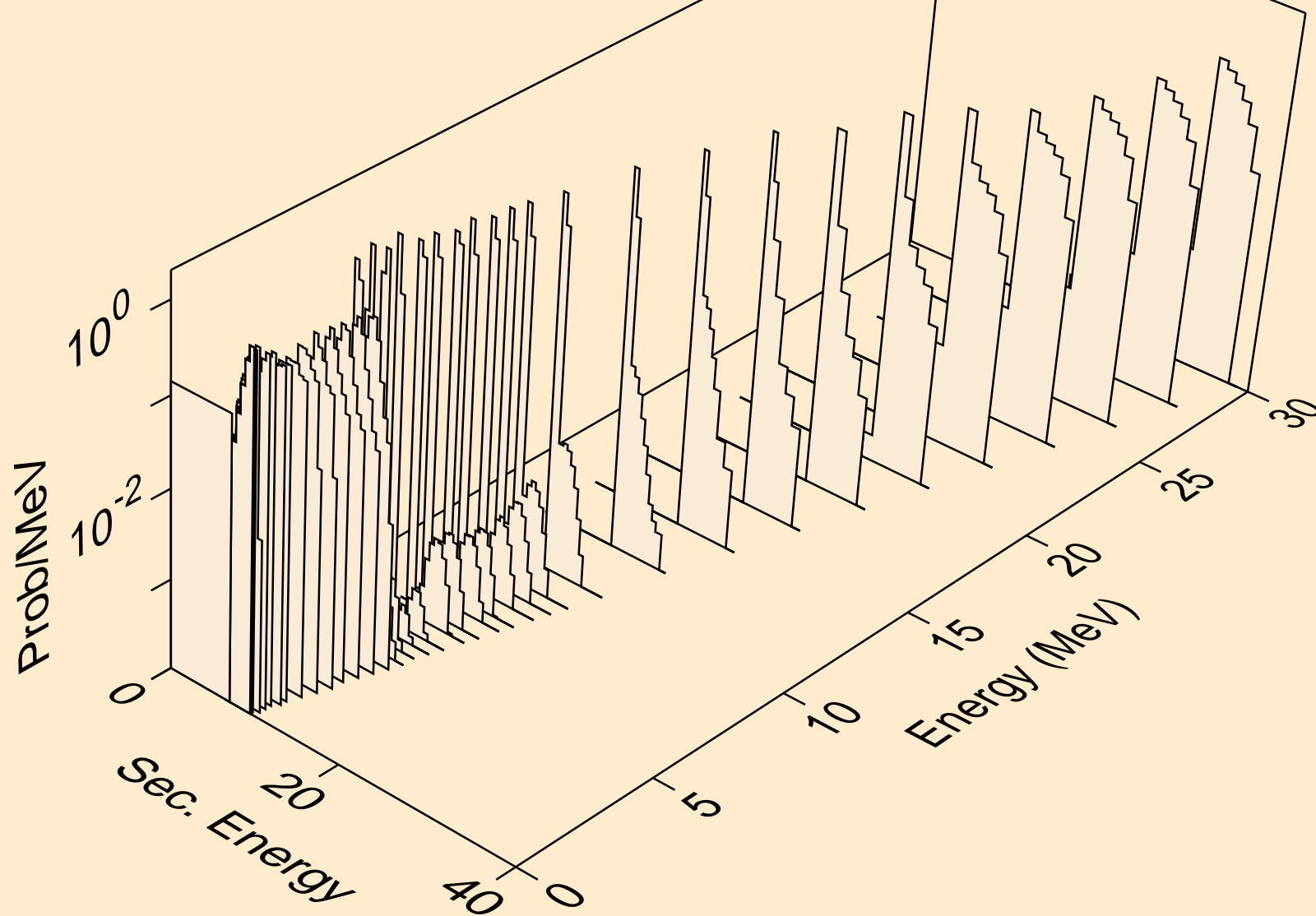

AC230 NEUTRON ACER TENDL-2021 LIBRARY; T=293.6K
alphas from (n,2a)

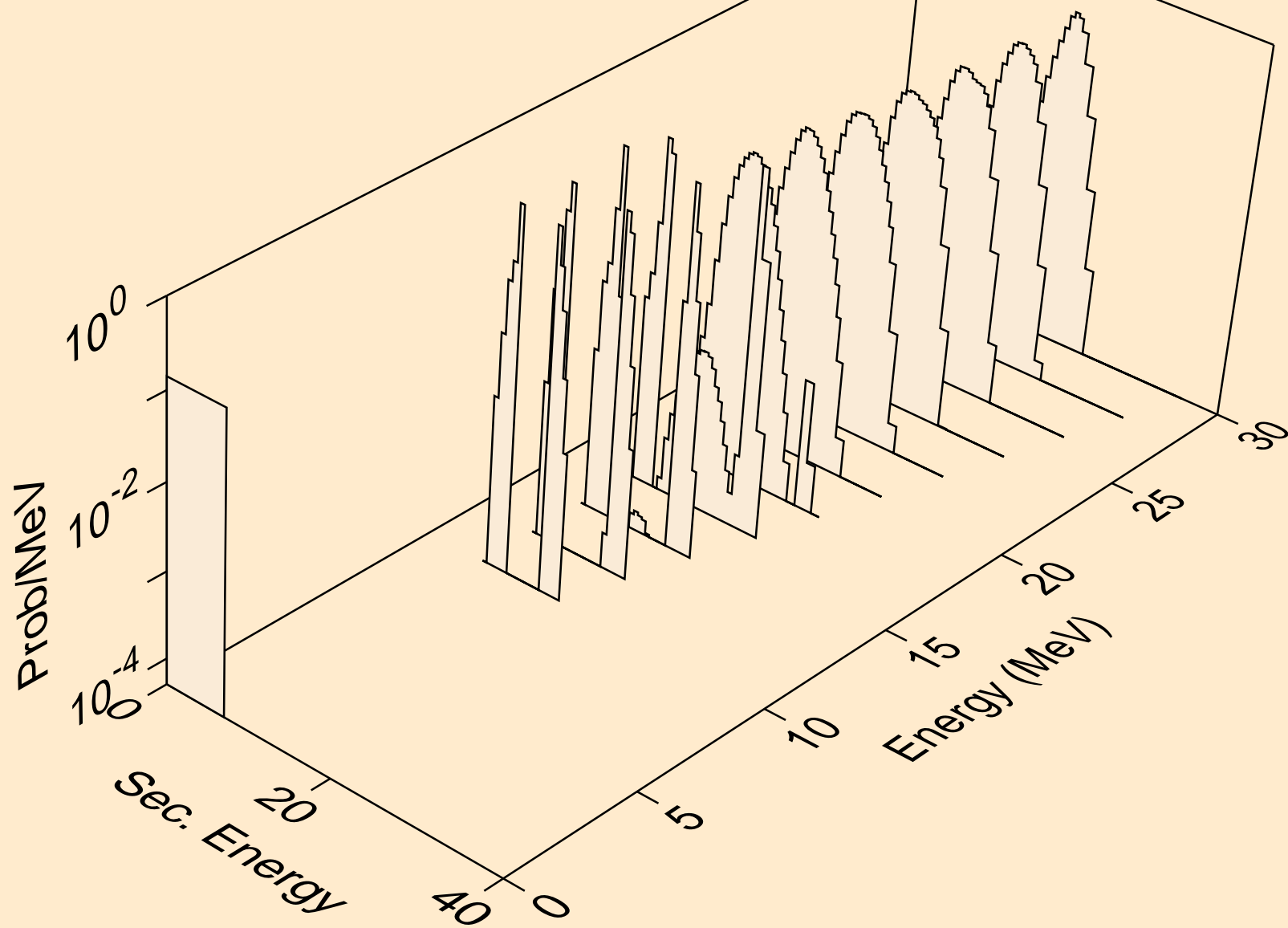

AC230 NEUTRON ACER TENDL-2021 LIBRARY; T=293.6K
alphas from (n,pa)

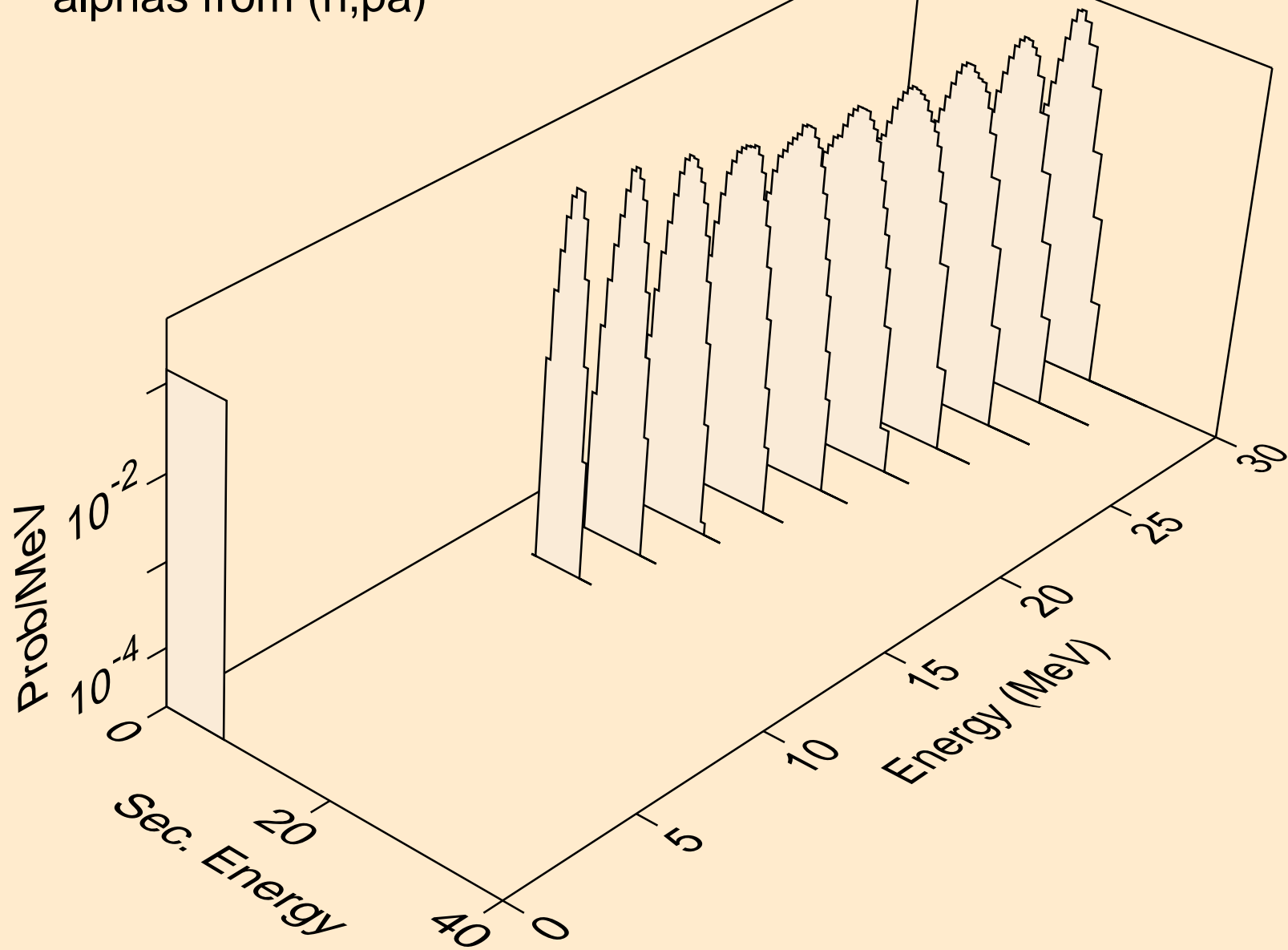

AC230 NEUTRON ACER TENDL-2021 LIBRARY; T=293.6K
alphas from (n,da)

