

AC236 NEUTRON ACER TENDL-2021 LIBRARY; T=293.6K
Principal cross sections

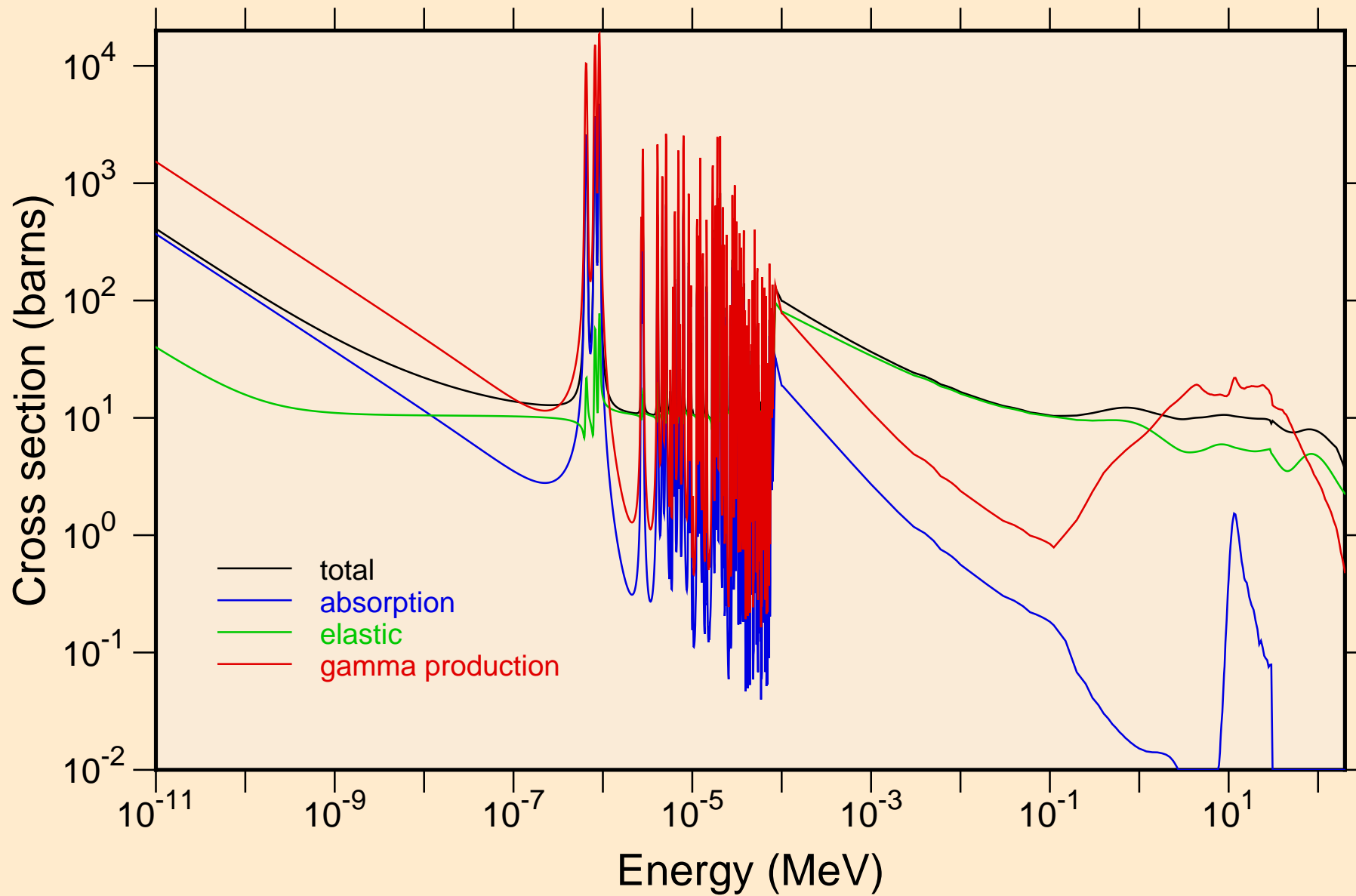

AC236 NEUTRON ACER TENDL-2021 LIBRARY; T=293.6K
resonance total cross section

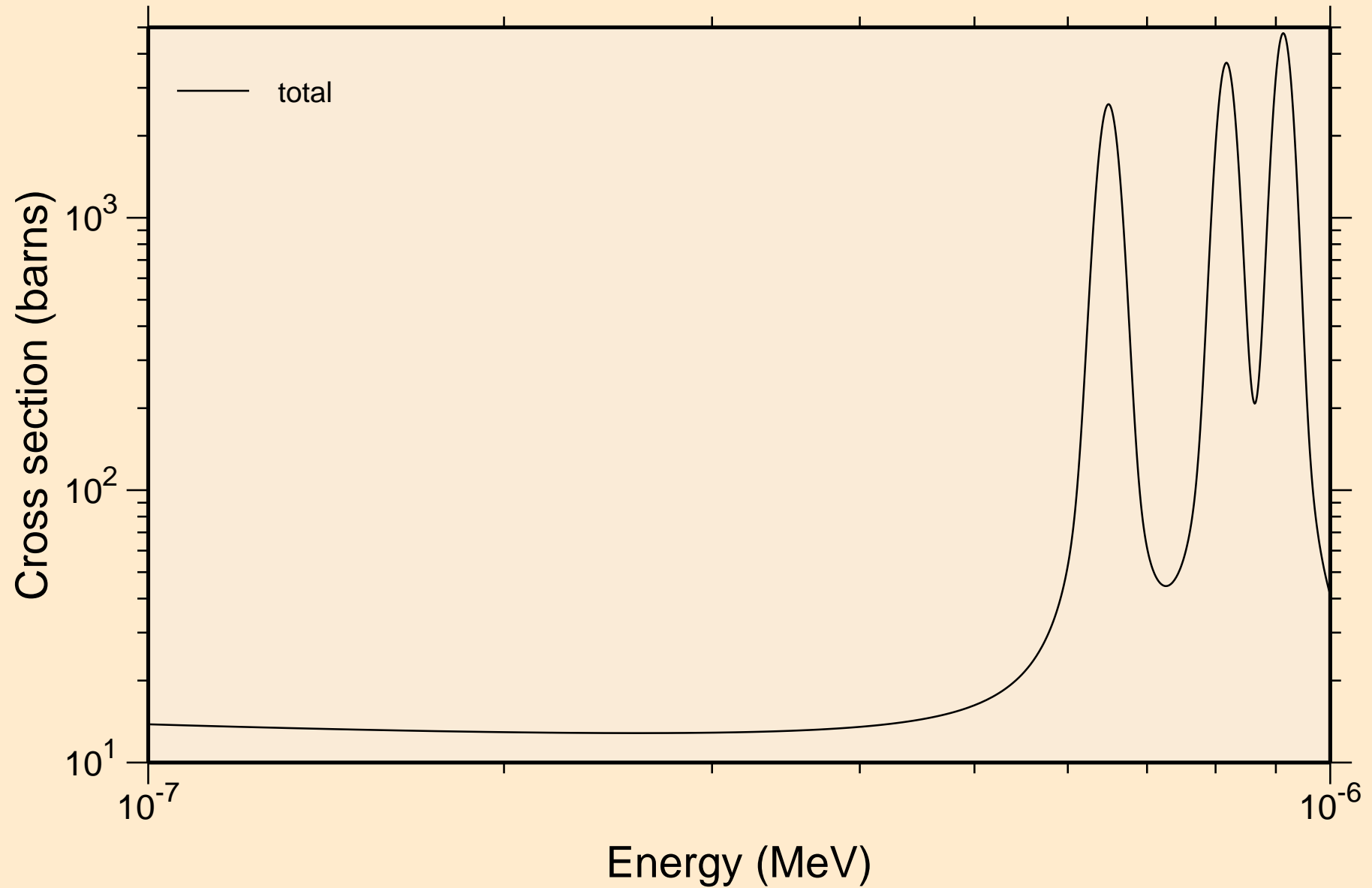

AC236 NEUTRON ACER TENDL-2021 LIBRARY; T=293.6K
resonance total cross section

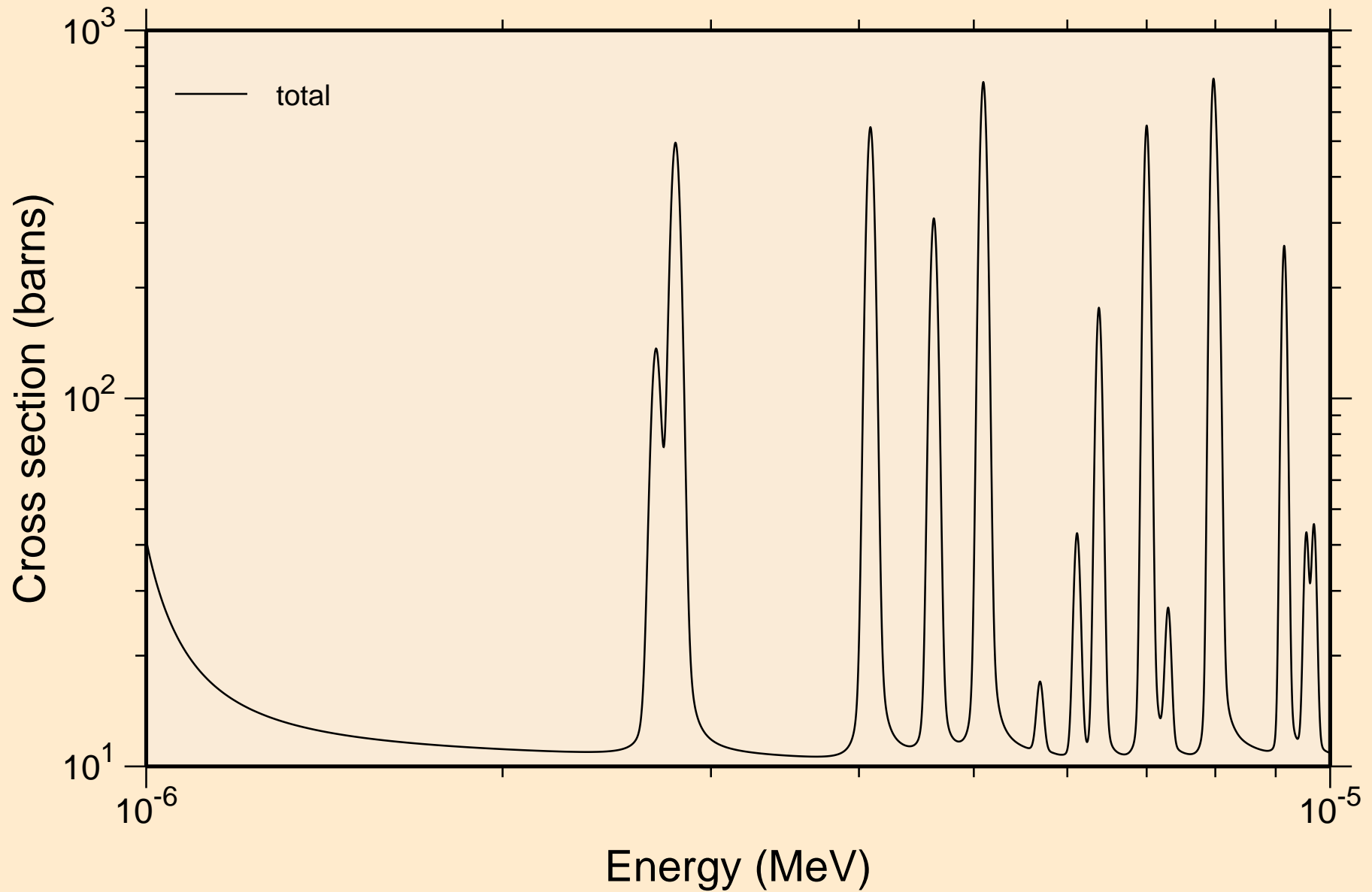

AC236 NEUTRON ACER TENDL-2021 LIBRARY; T=293.6K
resonance total cross section

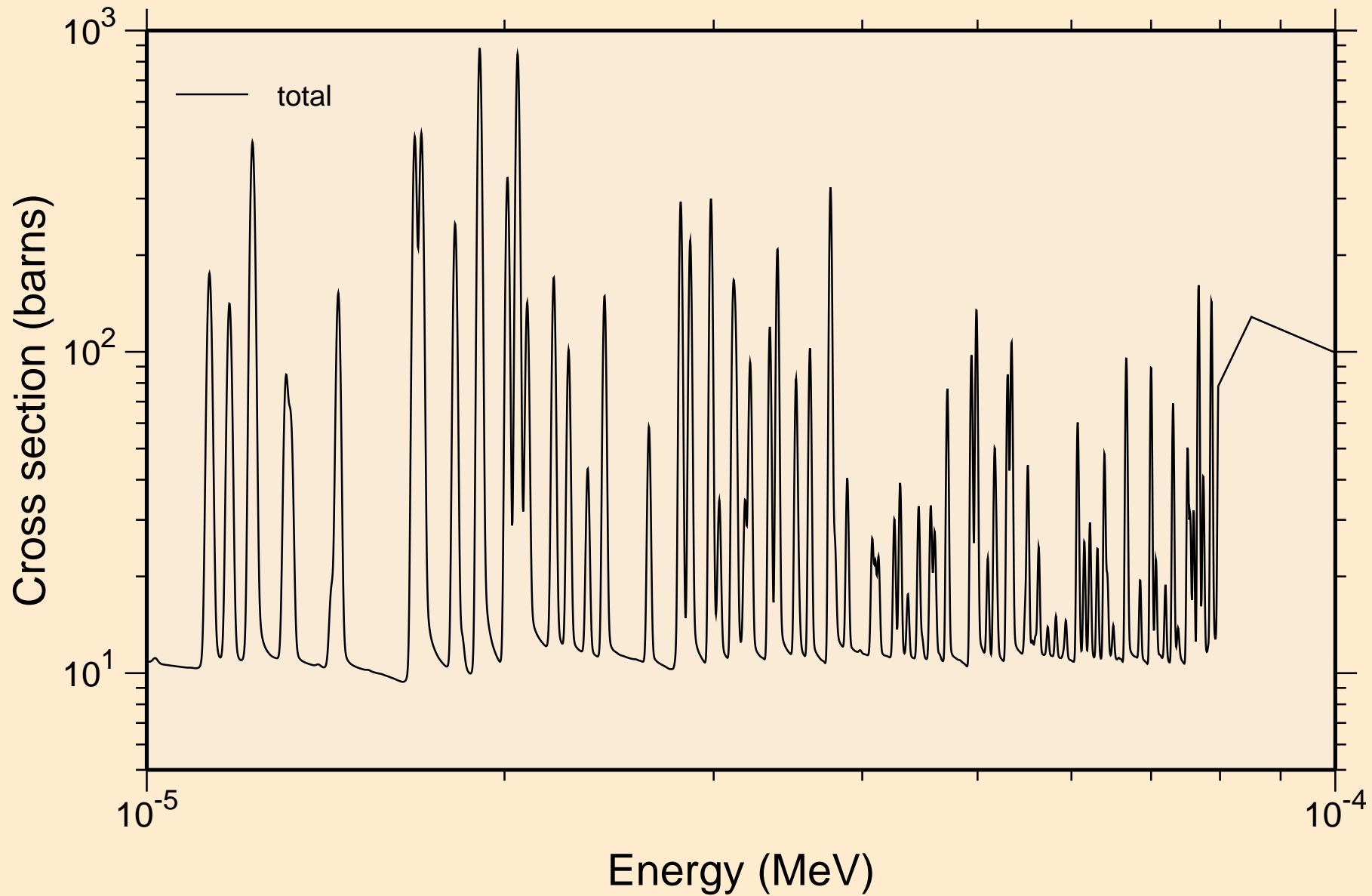

AC236 NEUTRON ACER TENDL-2021 LIBRARY; T=293.6K
resonance total cross section

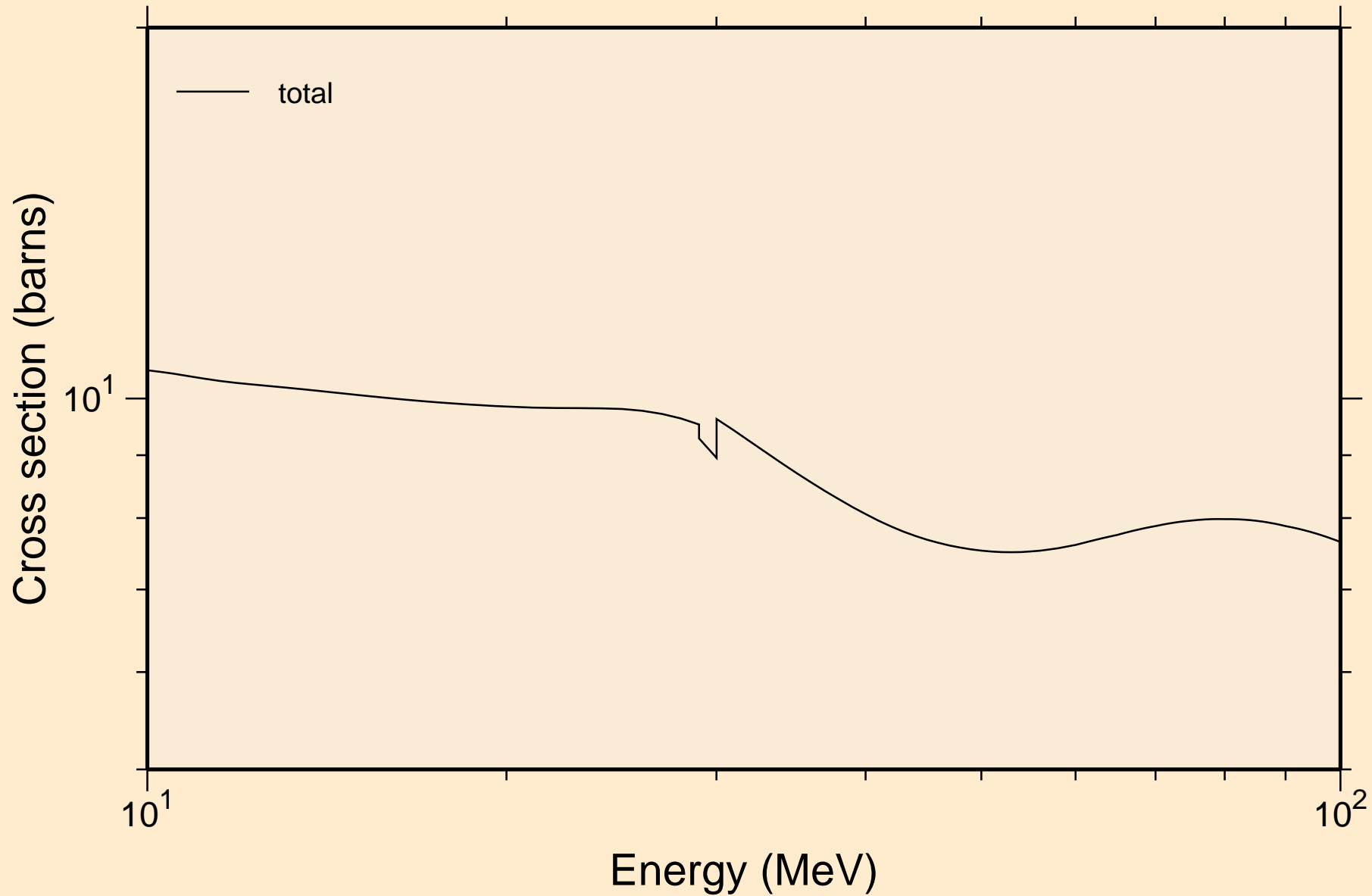

AC236 NEUTRON ACER TENDL-2021 LIBRARY; T=293.6K
resonance absorption cross sections

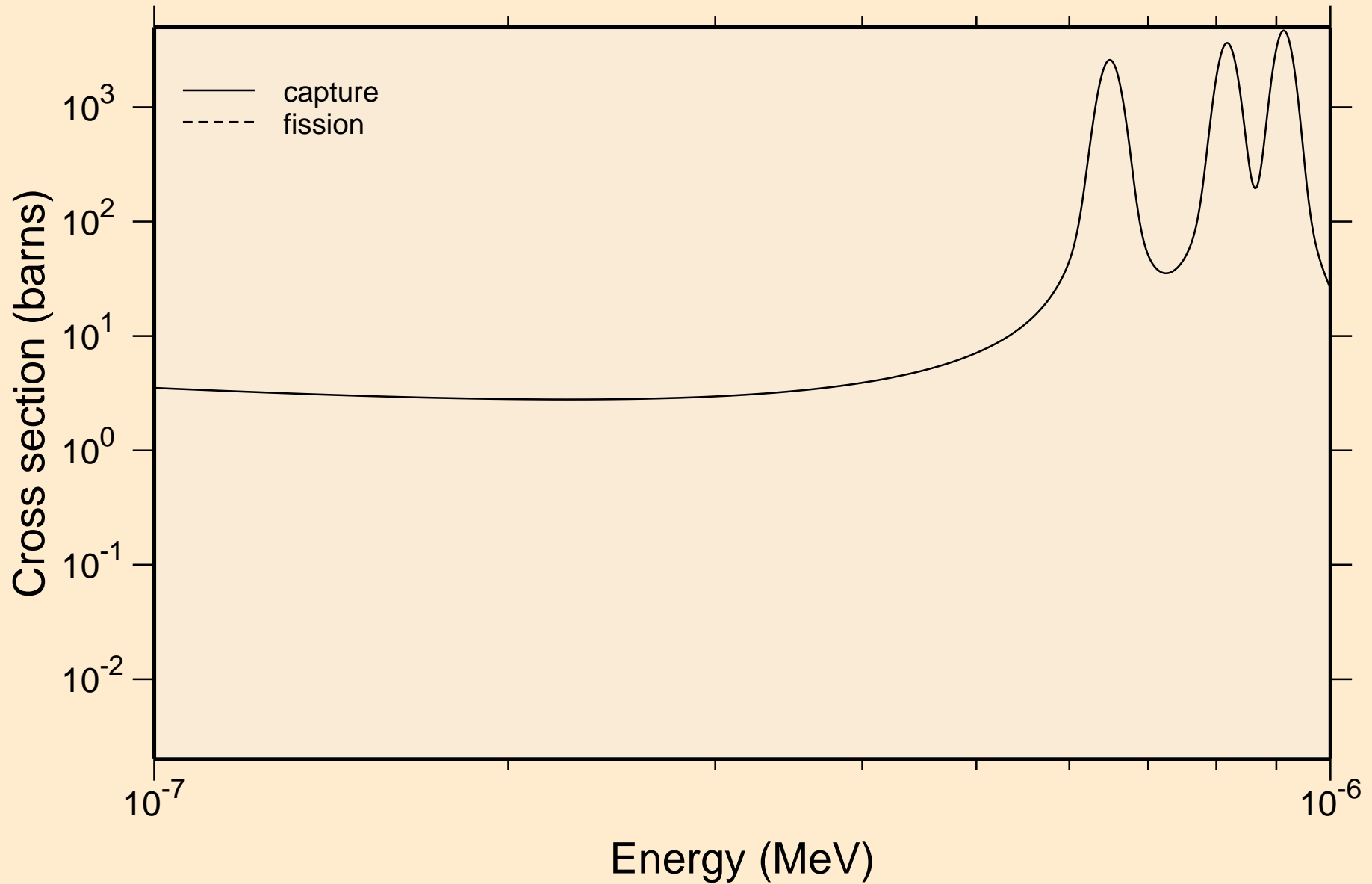

AC236 NEUTRON ACER TENDL-2021 LIBRARY; T=293.6K
resonance absorption cross sections

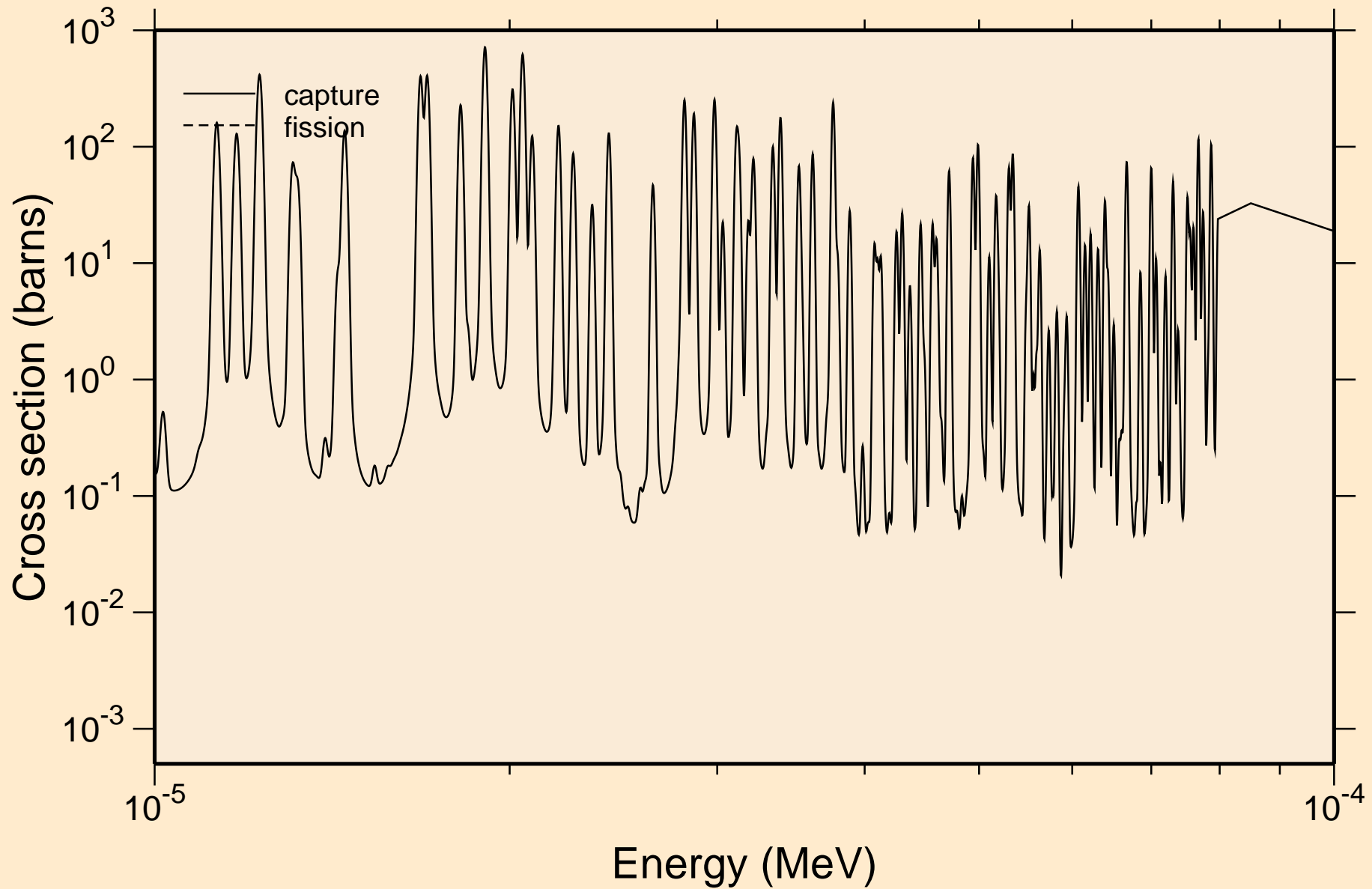

AC236 NEUTRON ACER TENDL-2021 LIBRARY; T=293.6K
resonance absorption cross sections

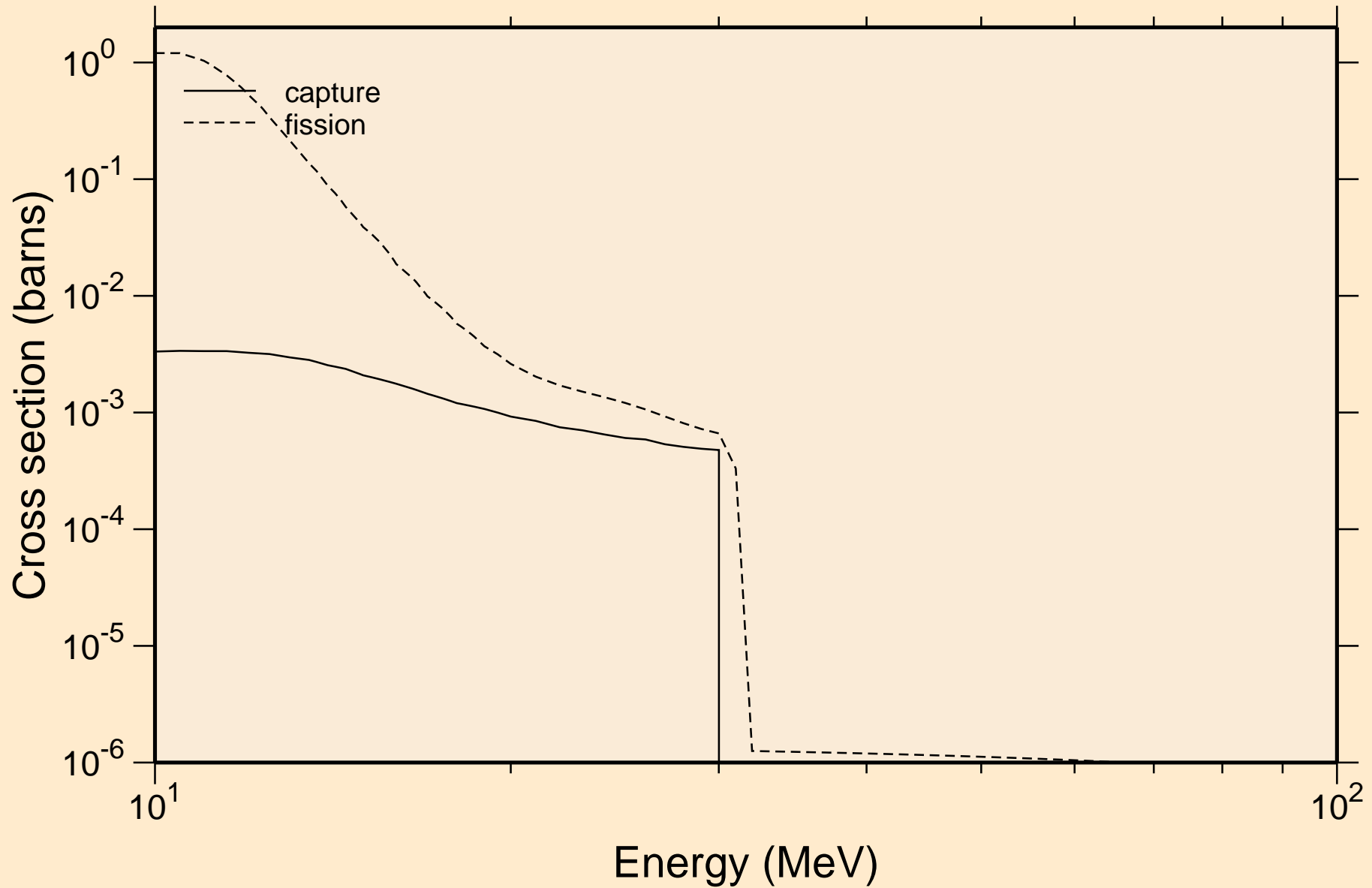

AC236 NEUTRON ACER TENDL-2021 LIBRARY; T=293.6K
Heating

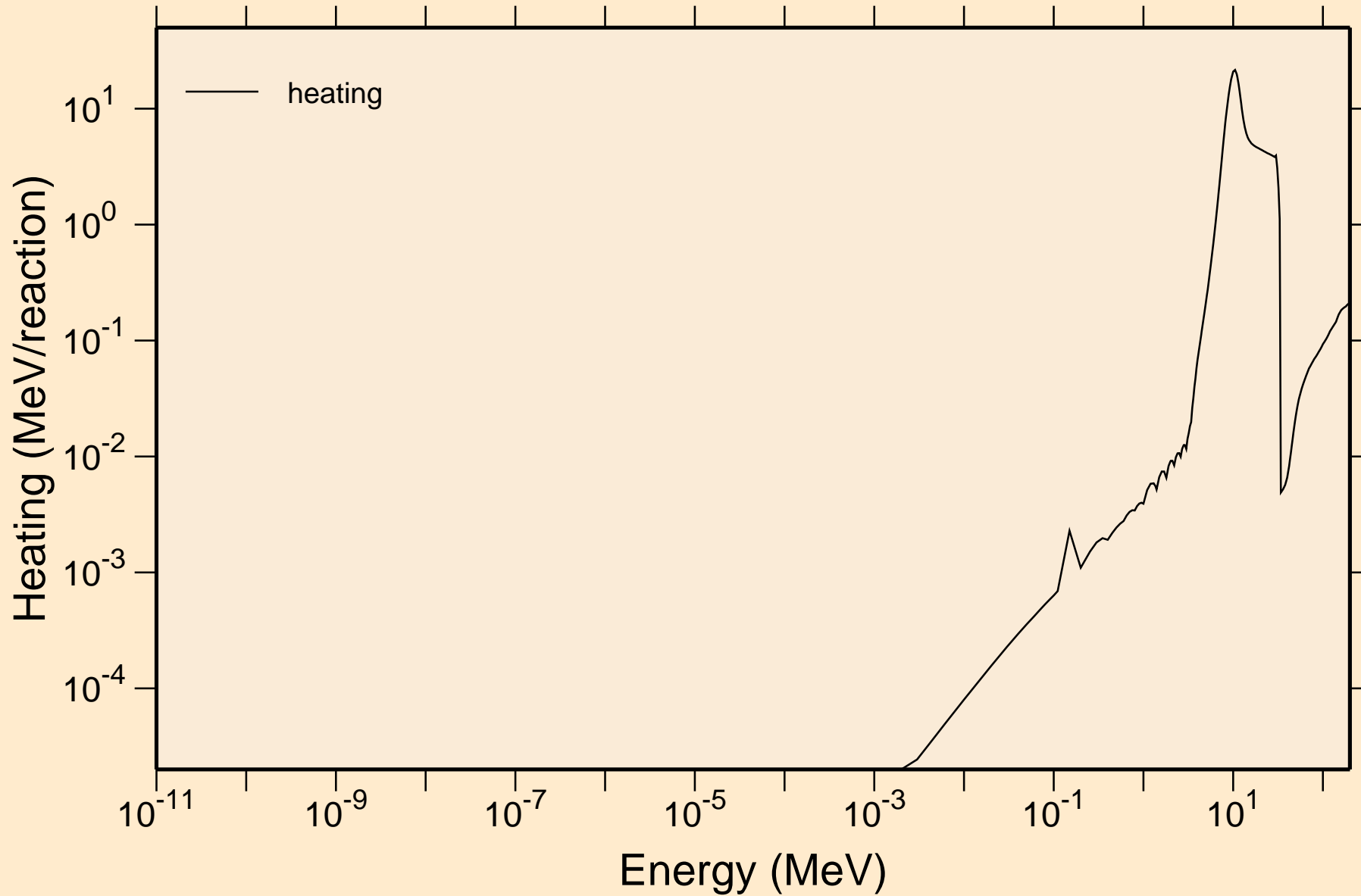

AC236 NEUTRON ACER TENDL-2021 LIBRARY; T=293.6K
Damage

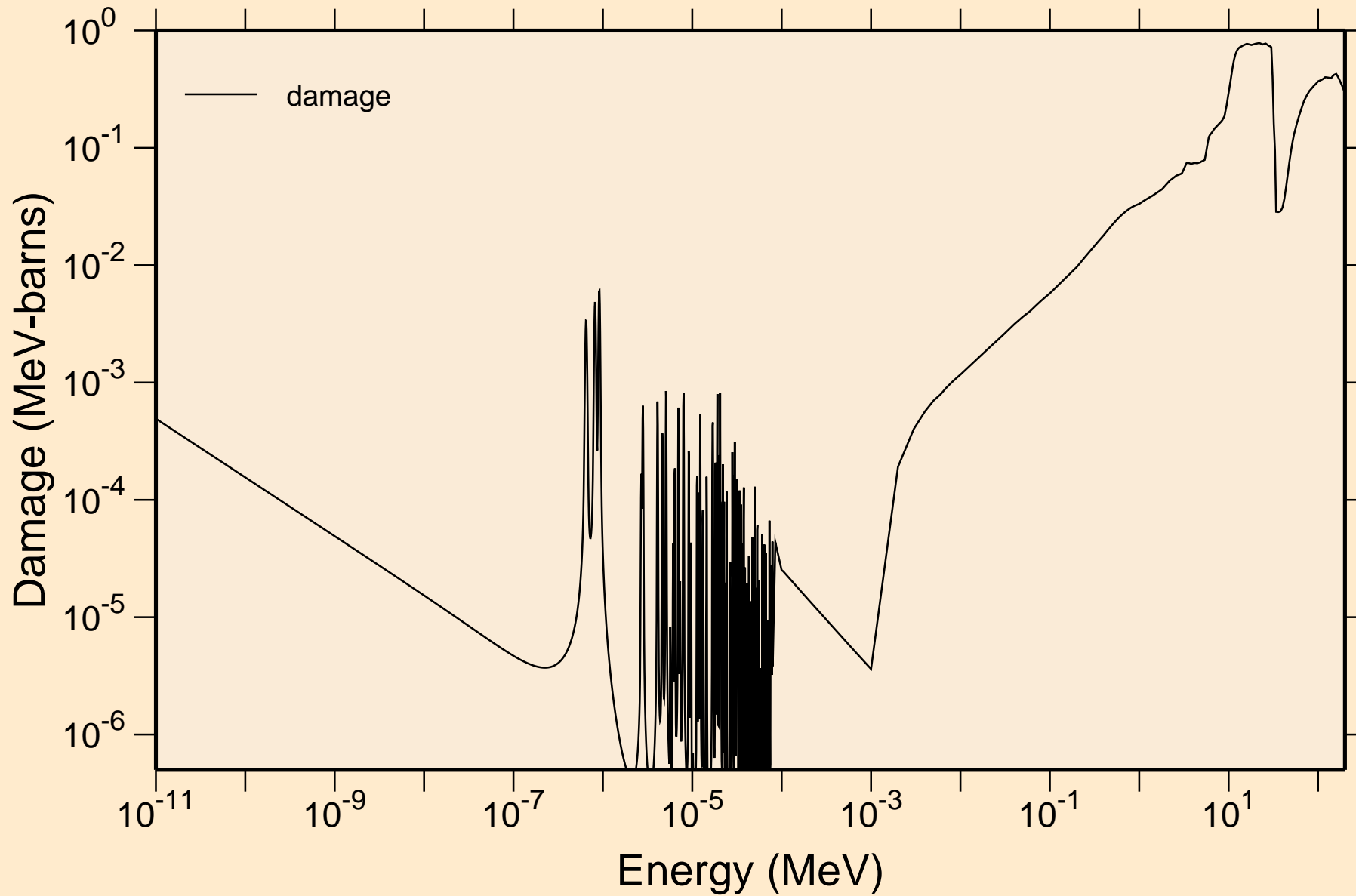

AC236 NEUTRON ACER TENDL-2021 LIBRARY; T=293.6K
Non-threshold reactions

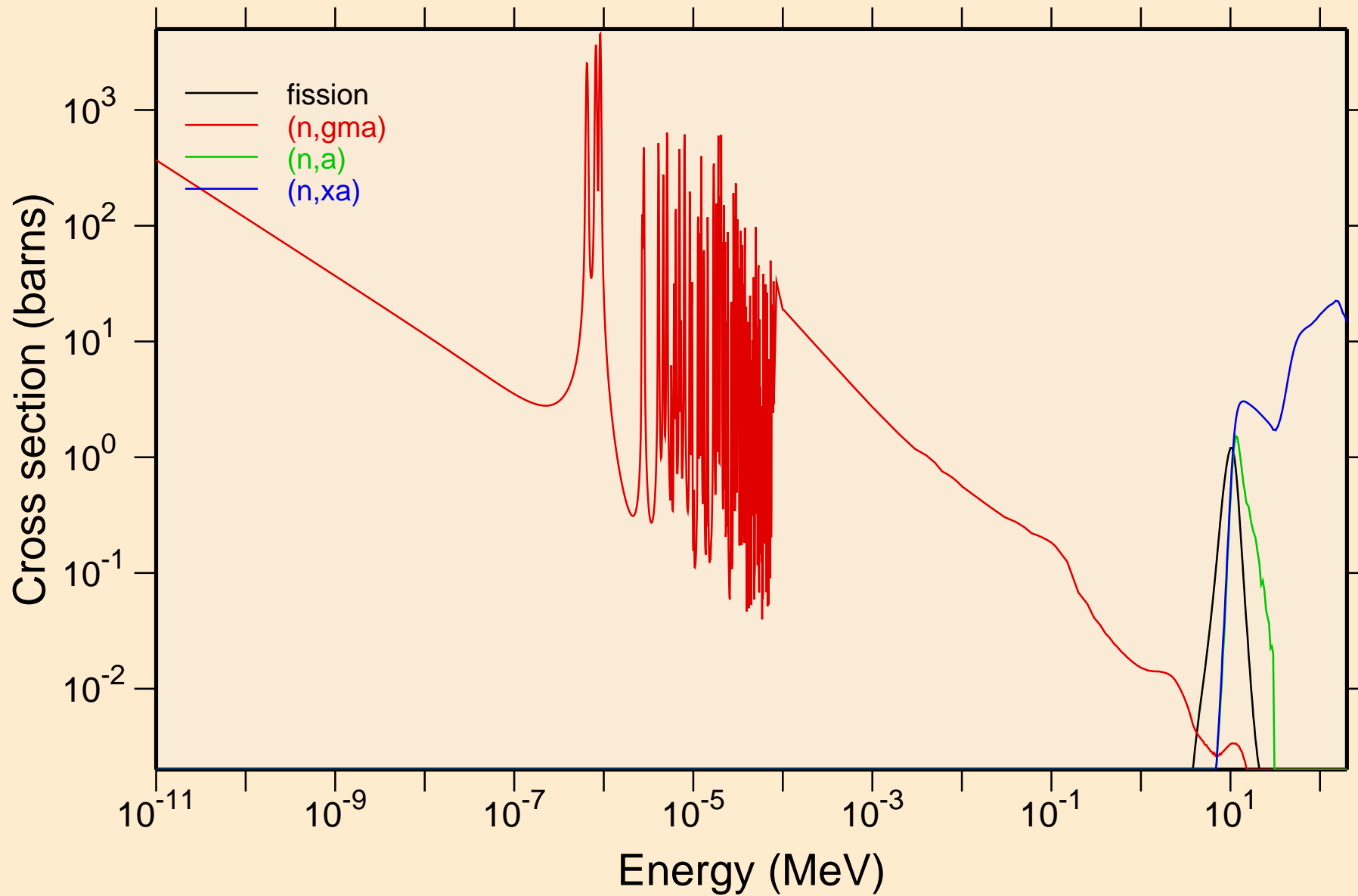

AC236 NEUTRON ACER TENDL-2021 LIBRARY; T=293.6K
Principal cross sections

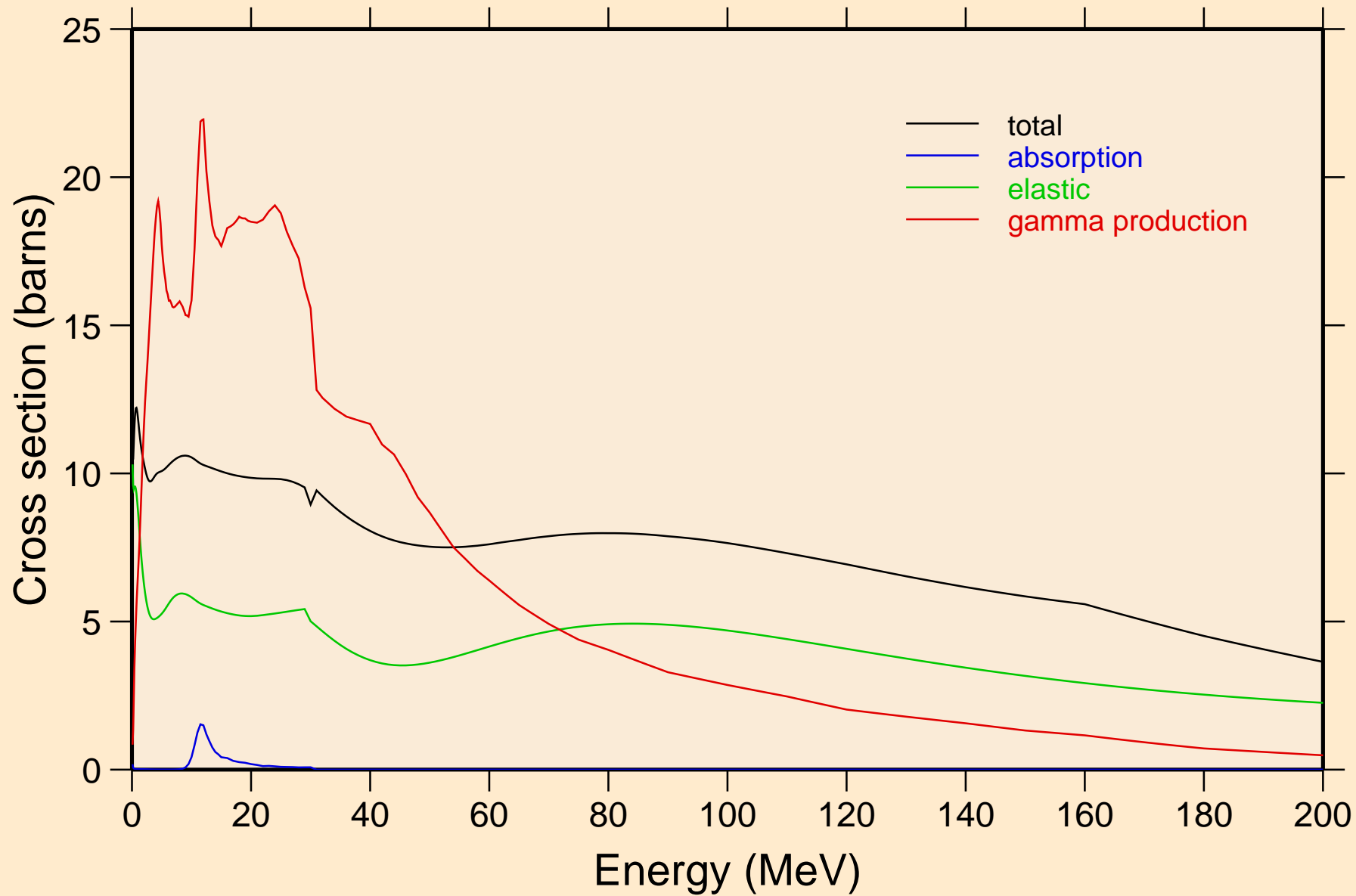

AC236 NEUTRON ACER TENDL-2021 LIBRARY; T=293.6K
Heating

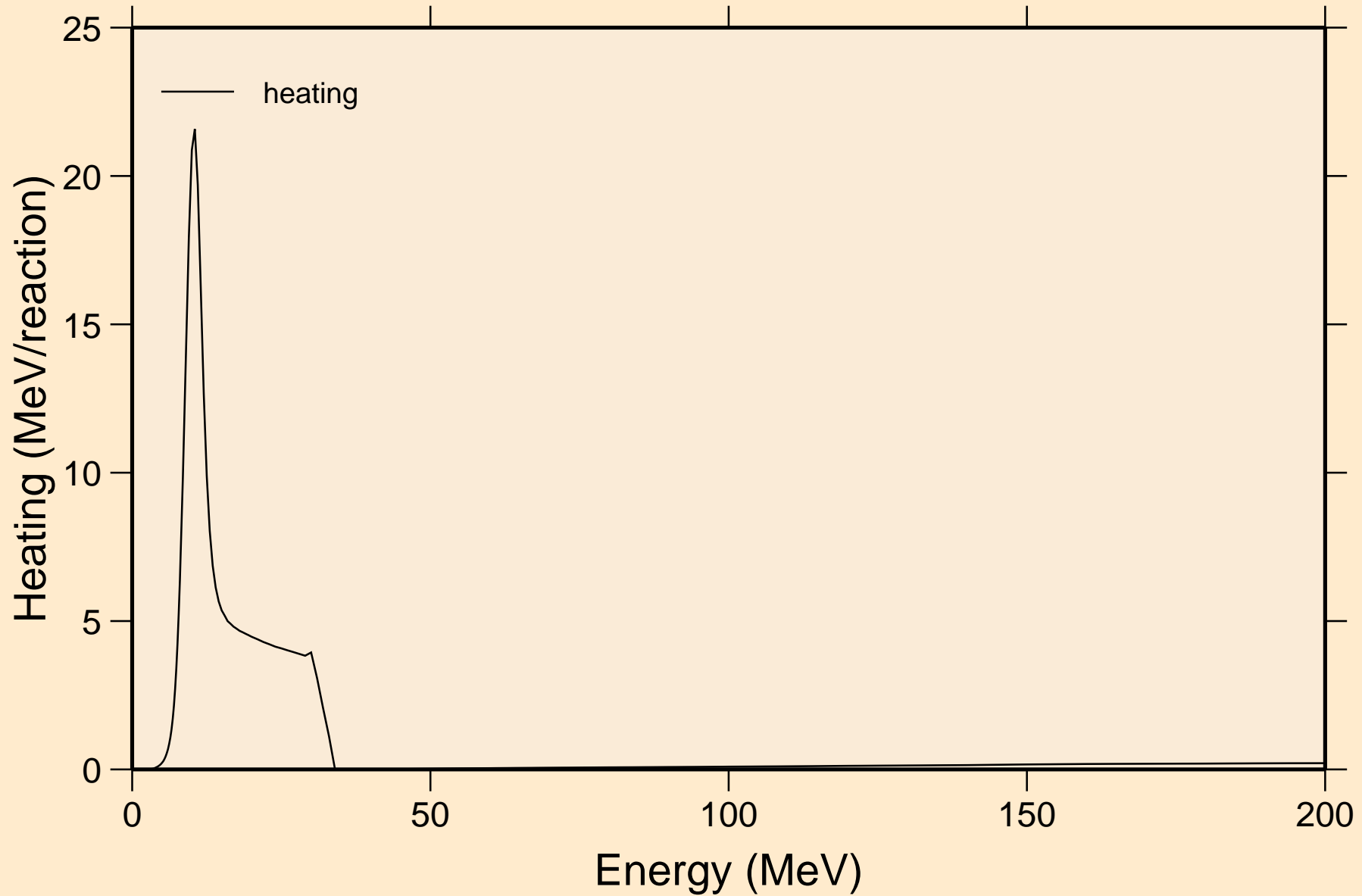

AC236 NEUTRON ACER TENDL-2021 LIBRARY; T=293.6K
Damage

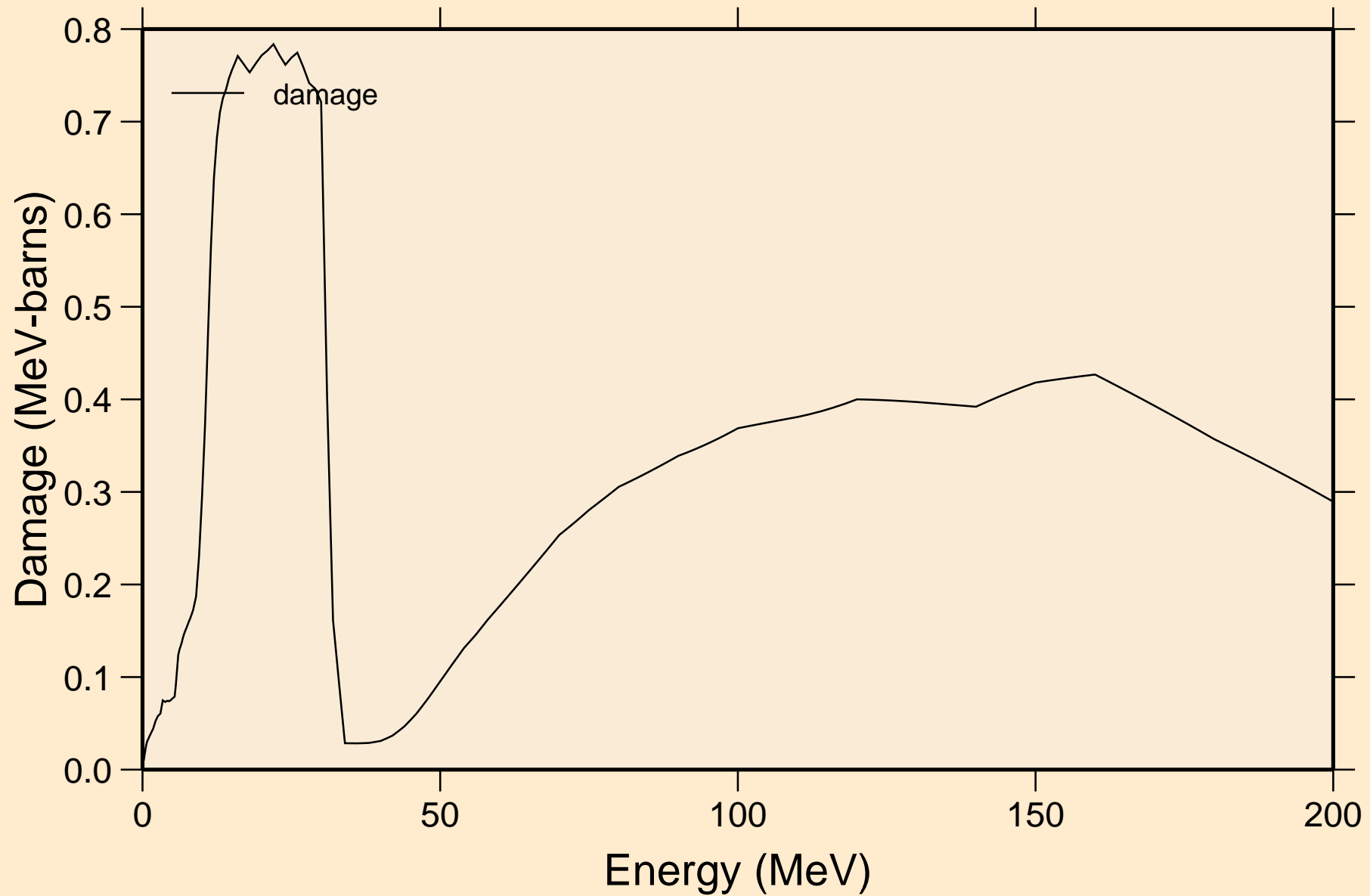

AC236 NEUTRON ACER TENDL-2021 LIBRARY; T=293.6K
Non-threshold reactions

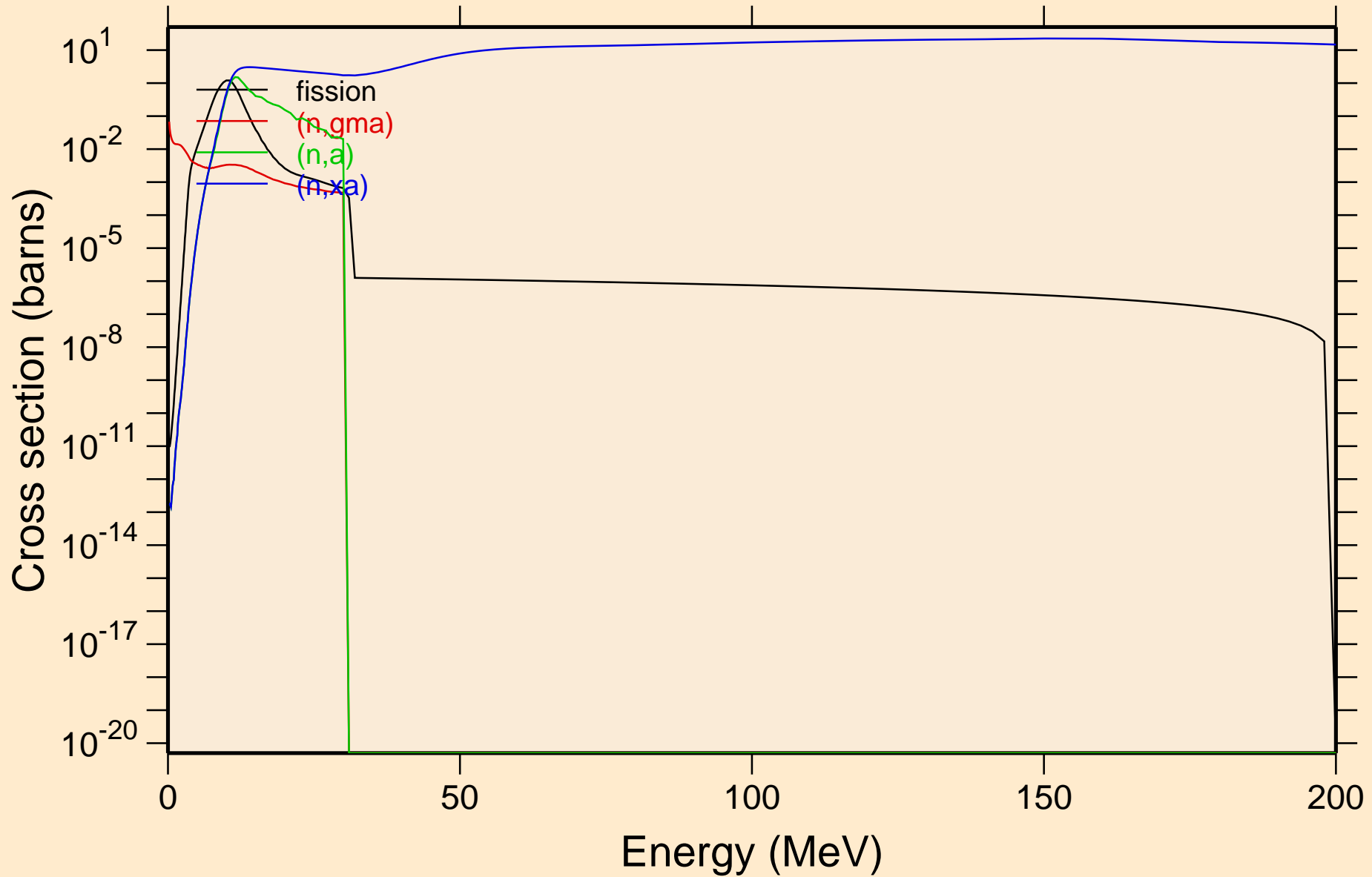

AC236 NEUTRON ACER TENDL-2021 LIBRARY; T=293.6K
Inelastic levels

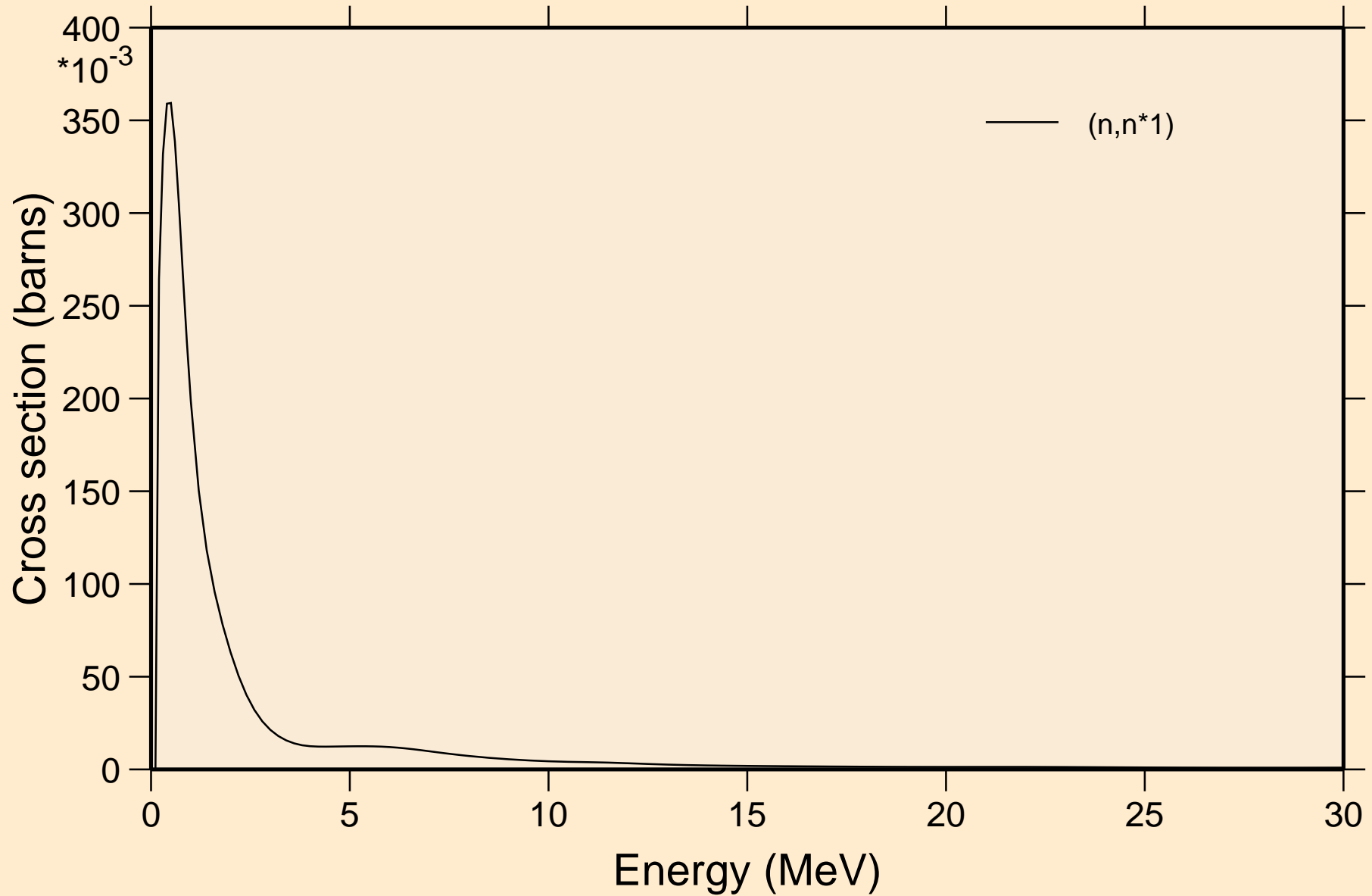

AC236 NEUTRON ACER TENDL-2021 LIBRARY; T=293.6K
Threshold reactions

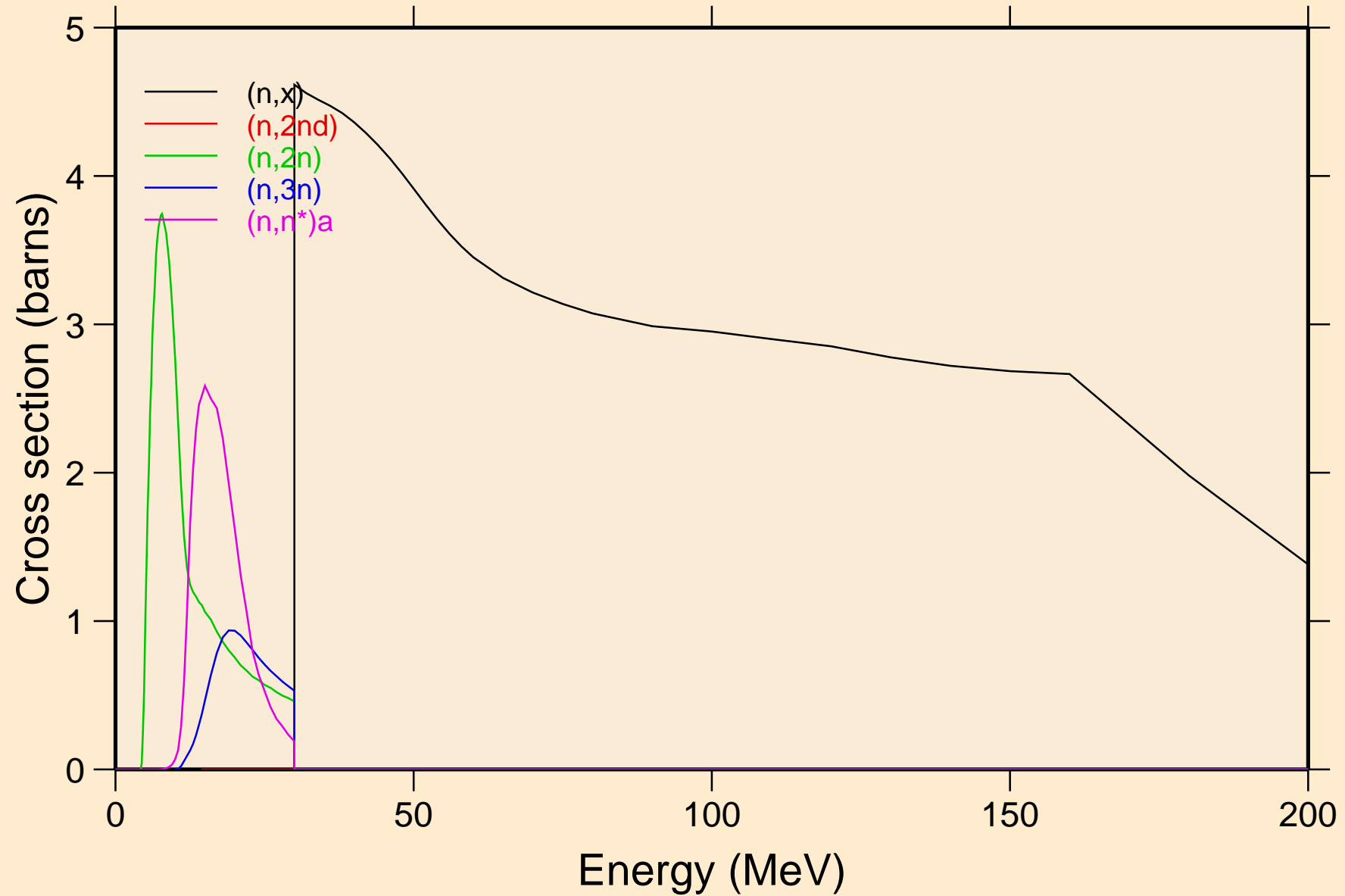

AC236 NEUTRON ACER TENDL-2021 LIBRARY; T=293.6K
Threshold reactions

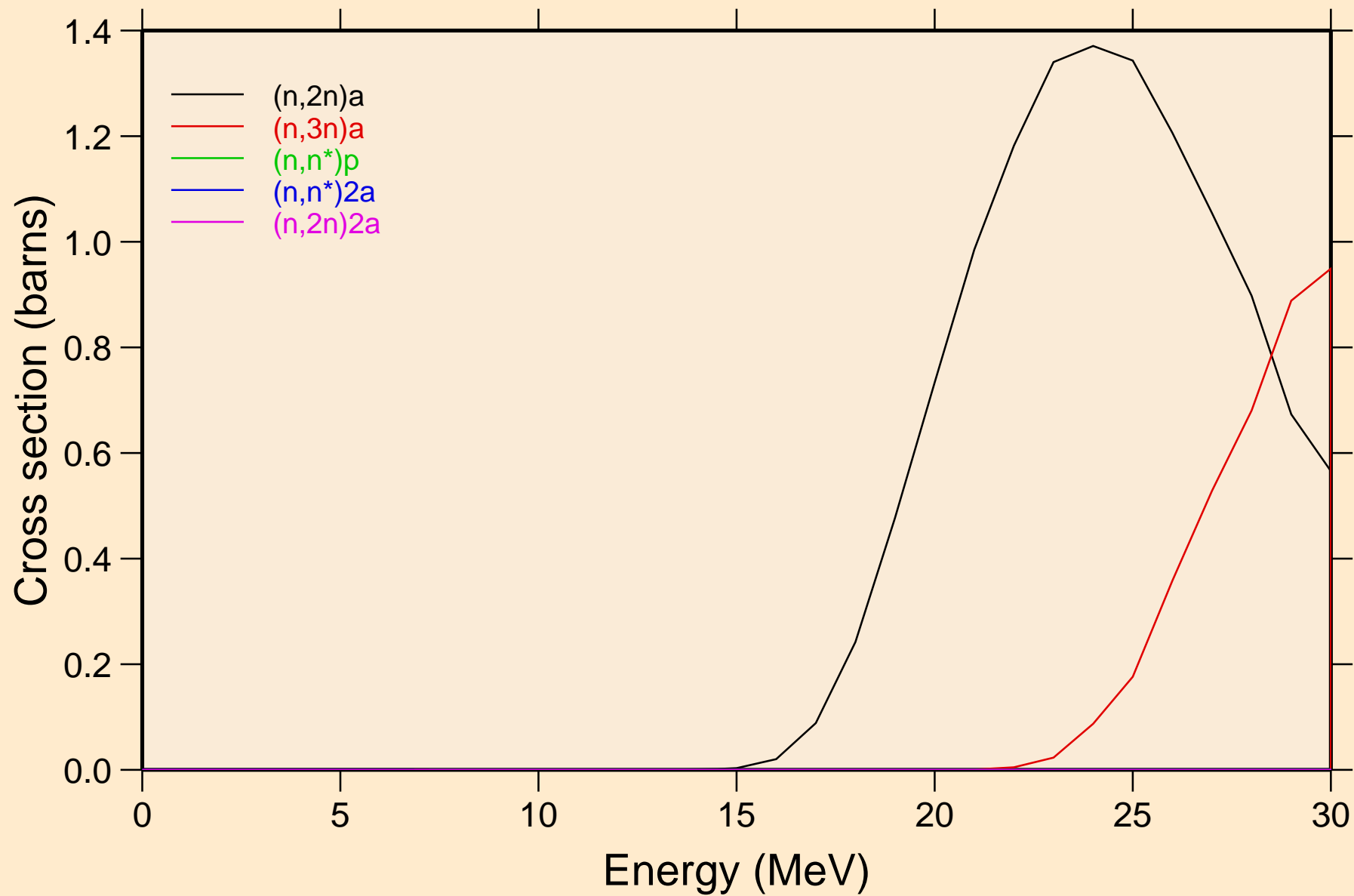

AC236 NEUTRON ACER TENDL-2021 LIBRARY; T=293.6K
Threshold reactions

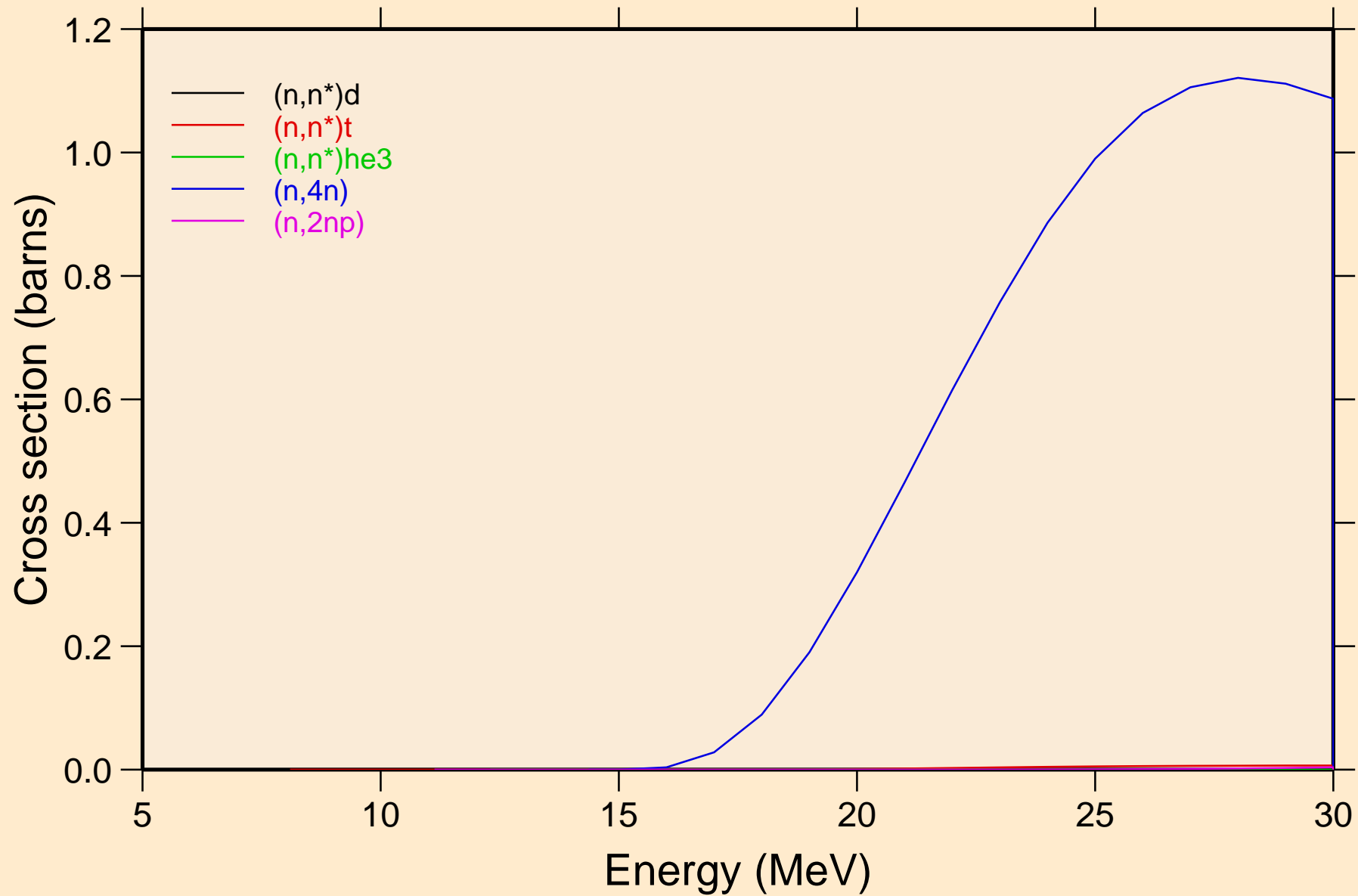

AC236 NEUTRON ACER TENDL-2021 LIBRARY; T=293.6K
Threshold reactions

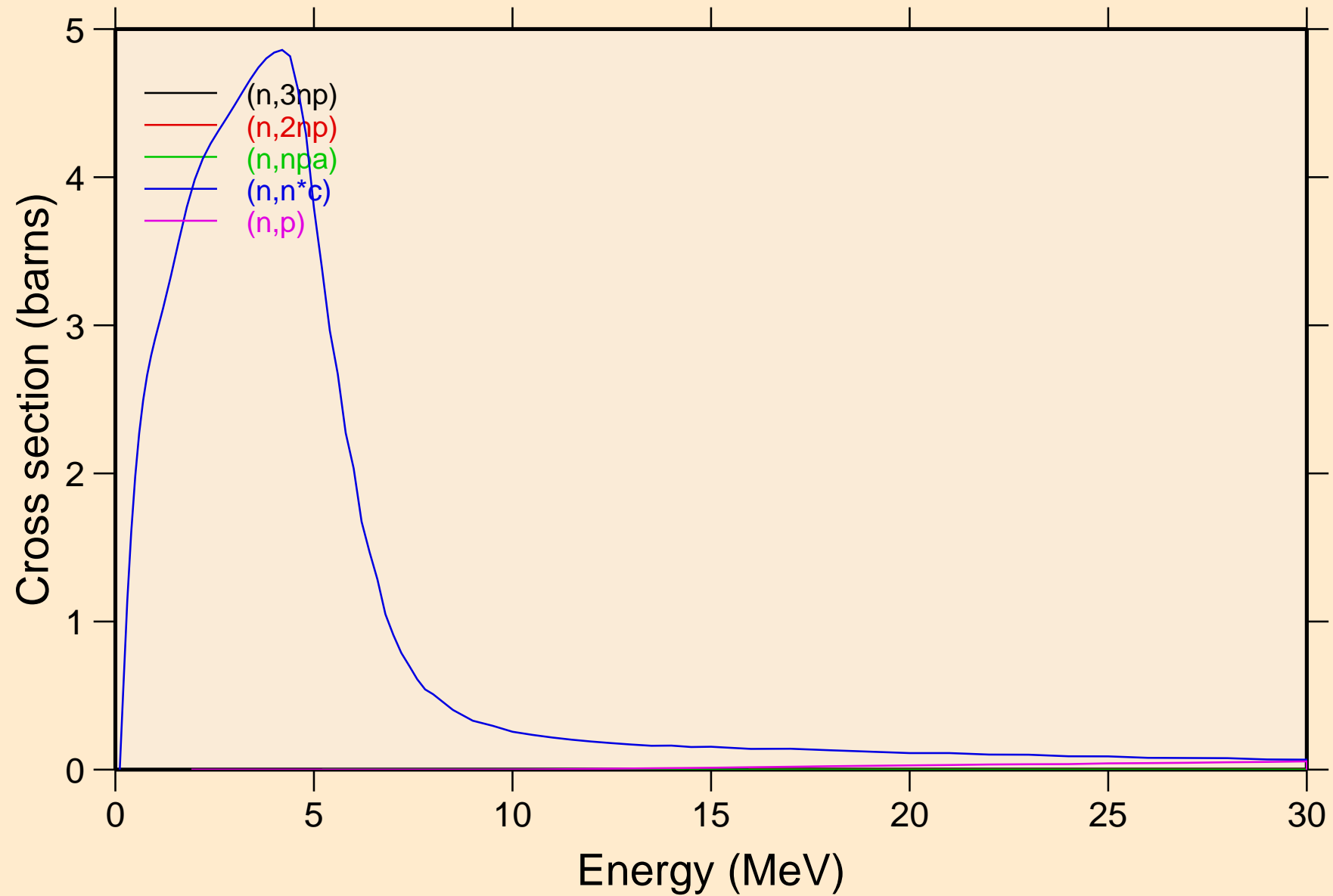

AC236 NEUTRON ACER TENDL-2021 LIBRARY; T=293.6K
Threshold reactions

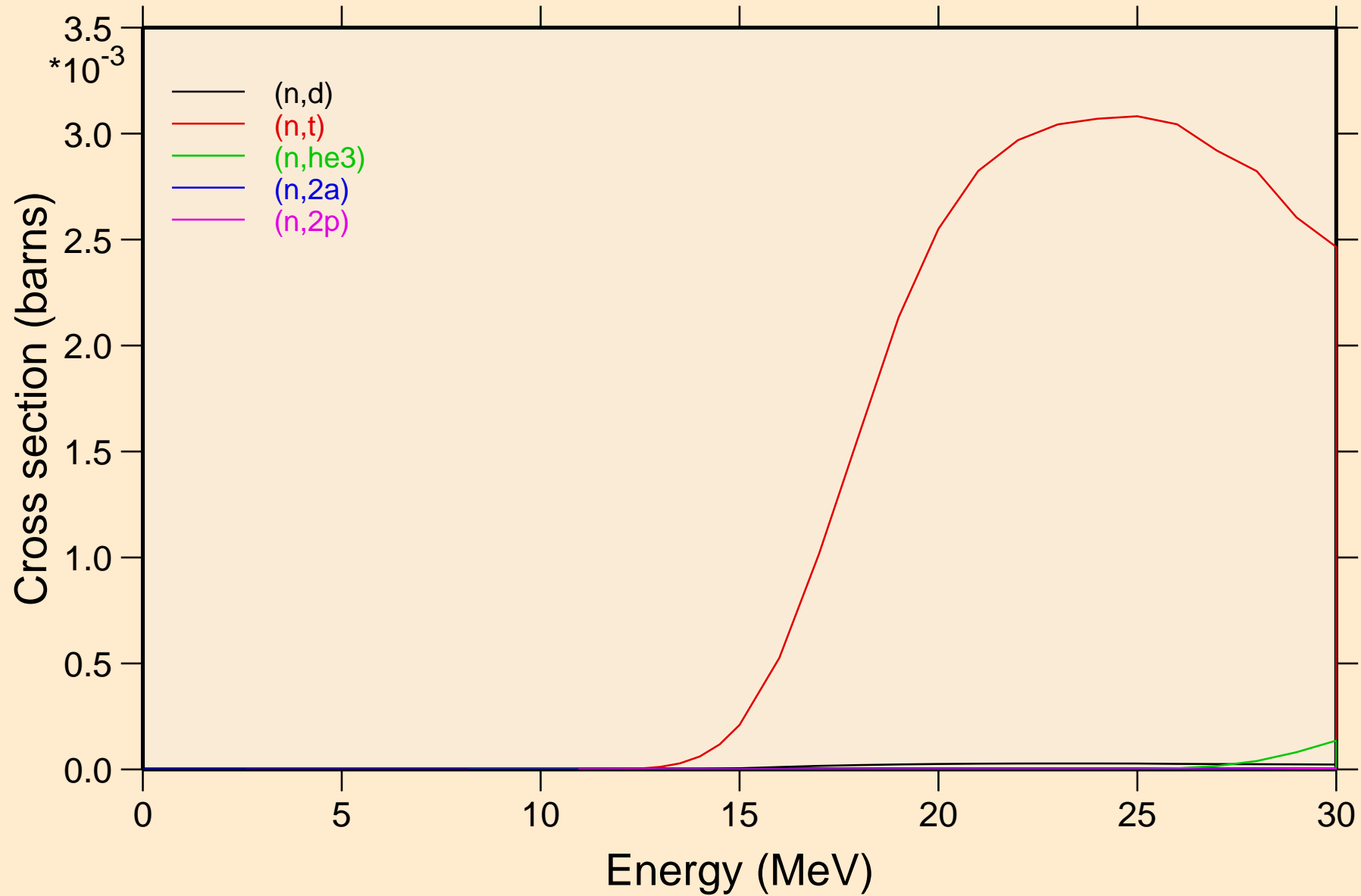

AC236 NEUTRON ACER TENDL-2021 LIBRARY; T=293.6K
Threshold reactions

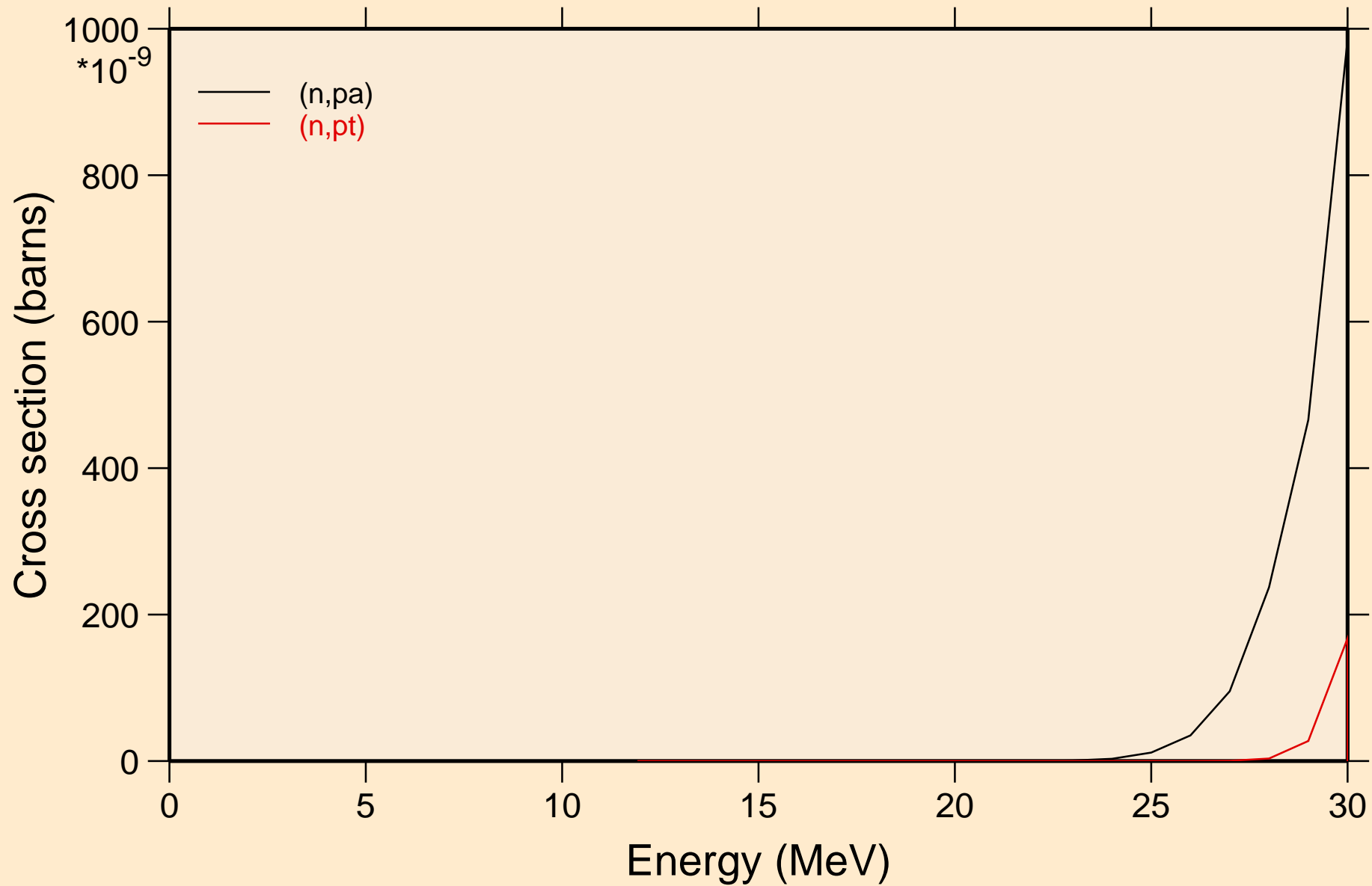

AC236 NEUTRON ACER TENDL-2021 LIBRARY; T=293.6K
Threshold reactions

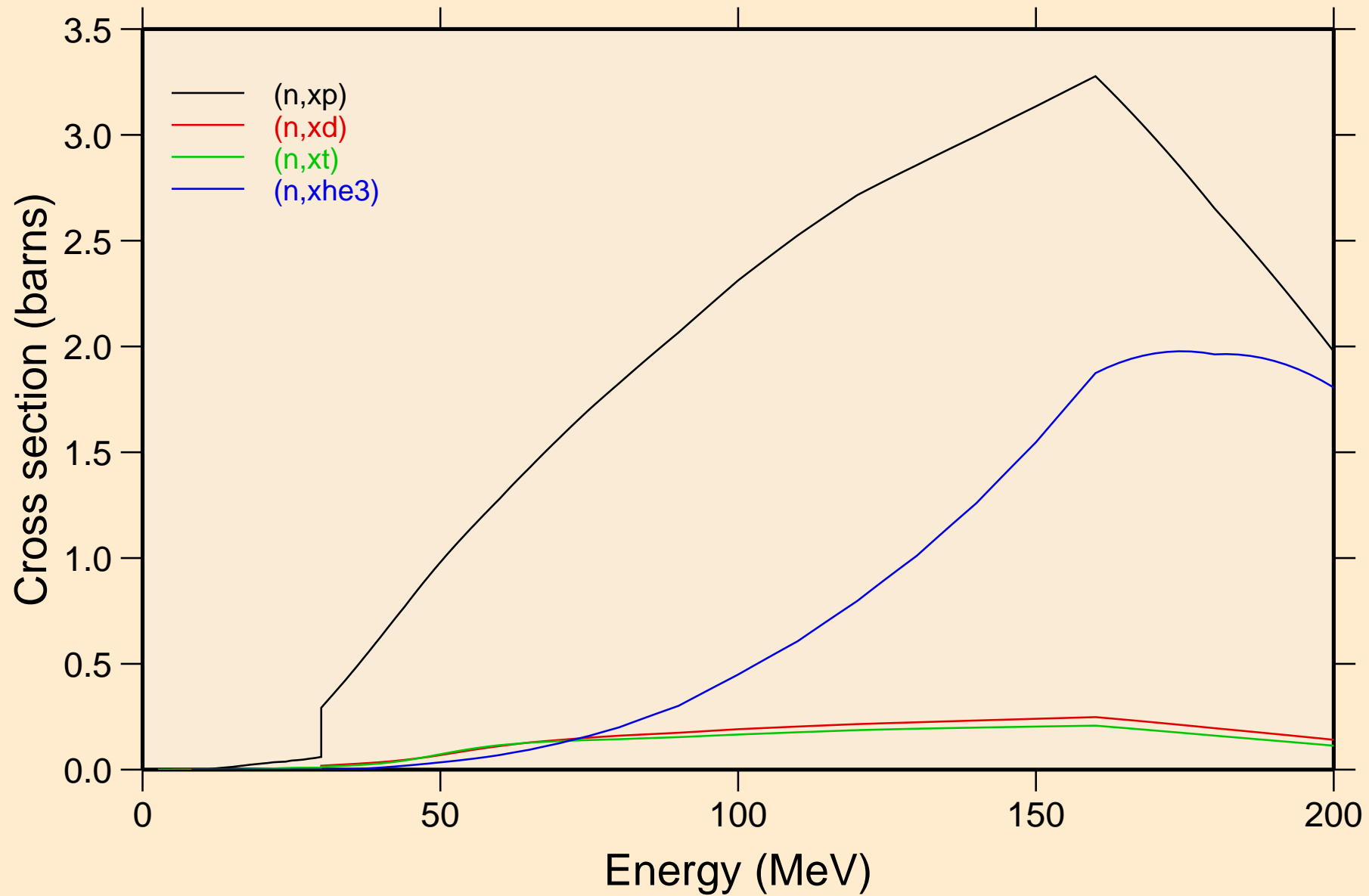

AC236 NEUTRON ACER TENDL-2021 LIBRARY; T=293.6K
angular distribution for elastic

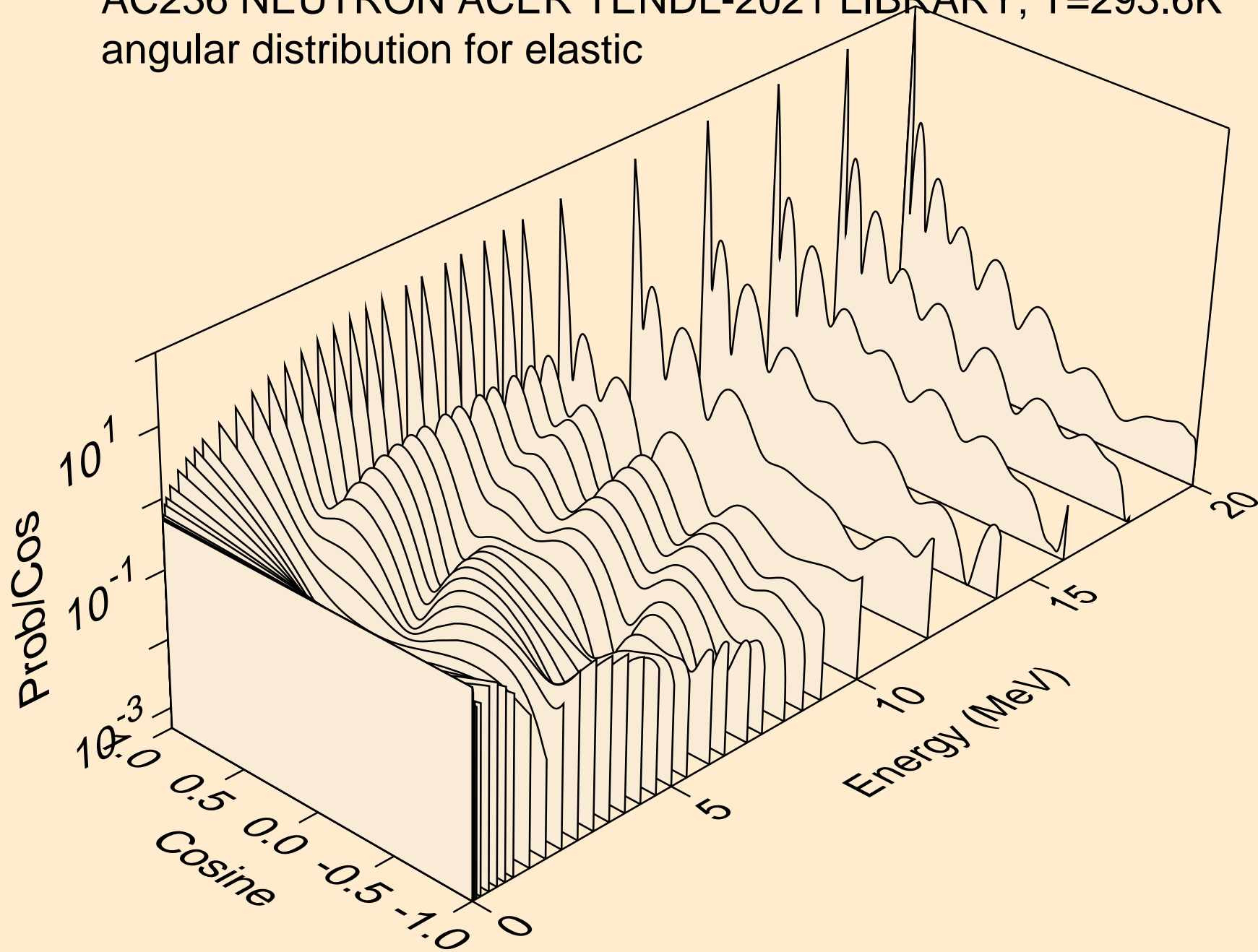

AC236 NEUTRON ACER TENDL-2021 LIBRARY; T=293.6K
angular distribution for elastic

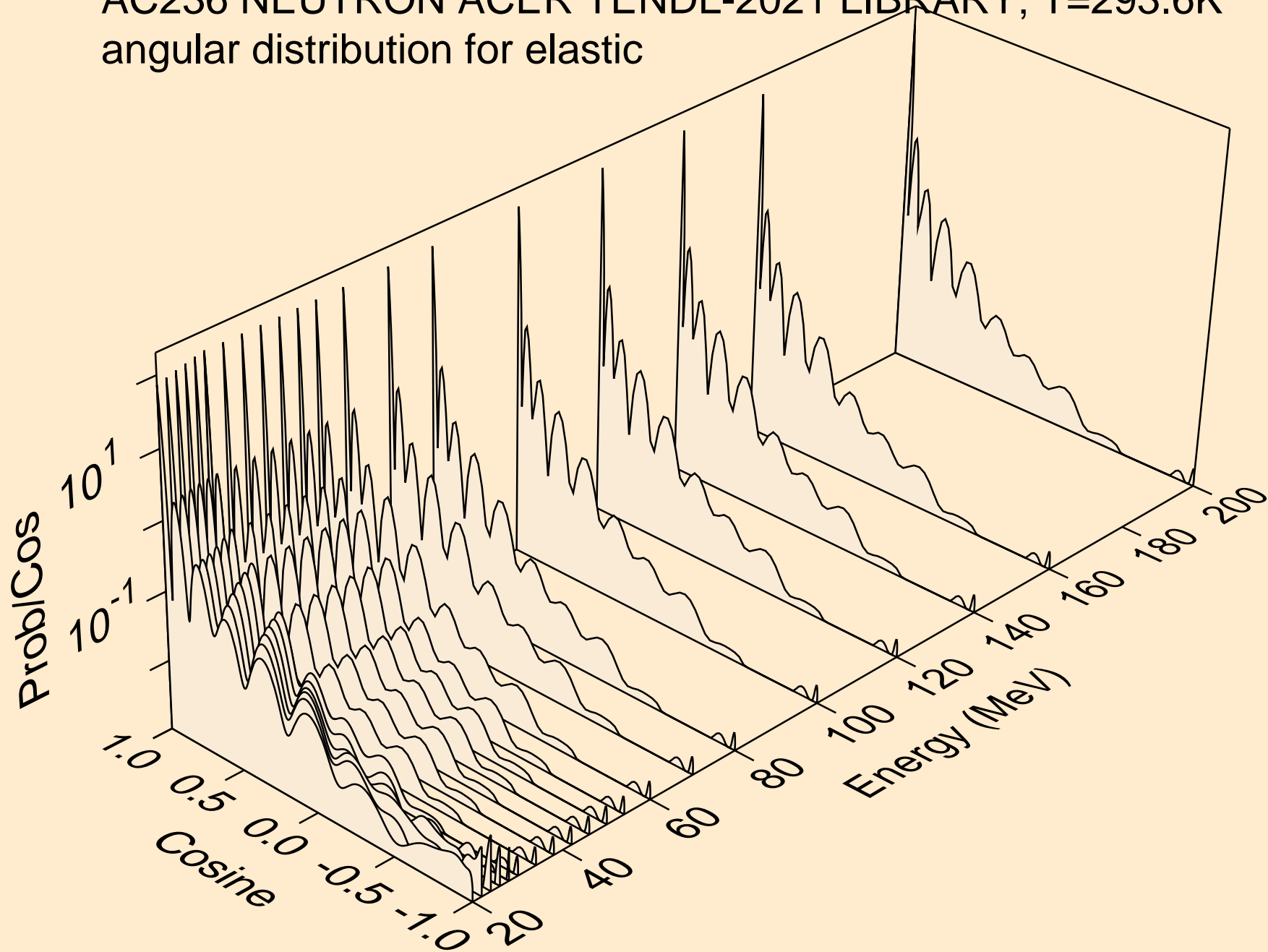

AC236 NEUTRON ACER TENDL-2021 LIBRARY; T=293.6K
angular distribution for (n,n*1)

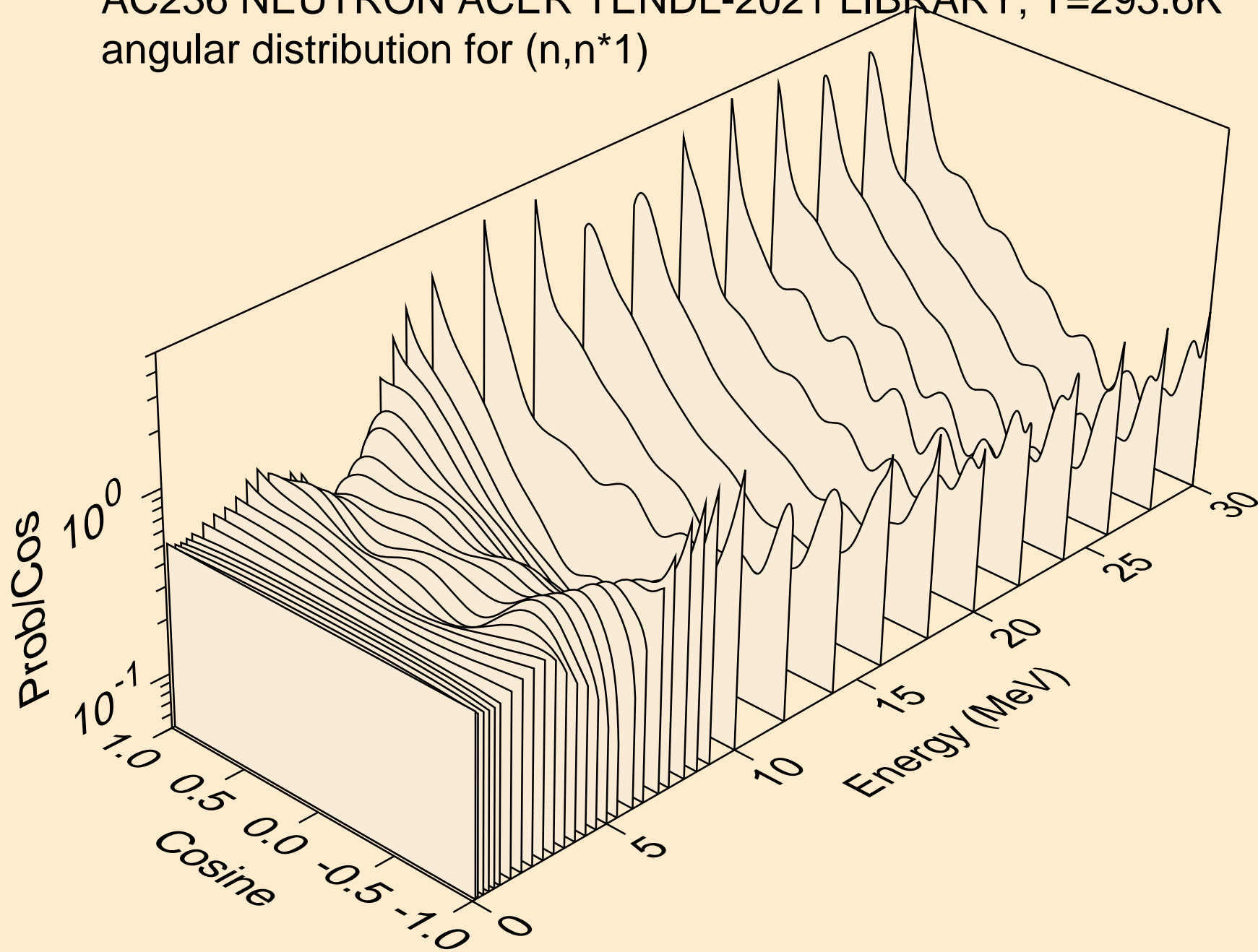

AC236 NEUTRON ACER TENDL-2021 LIBRARY; T=293.6K
Total fission nubar

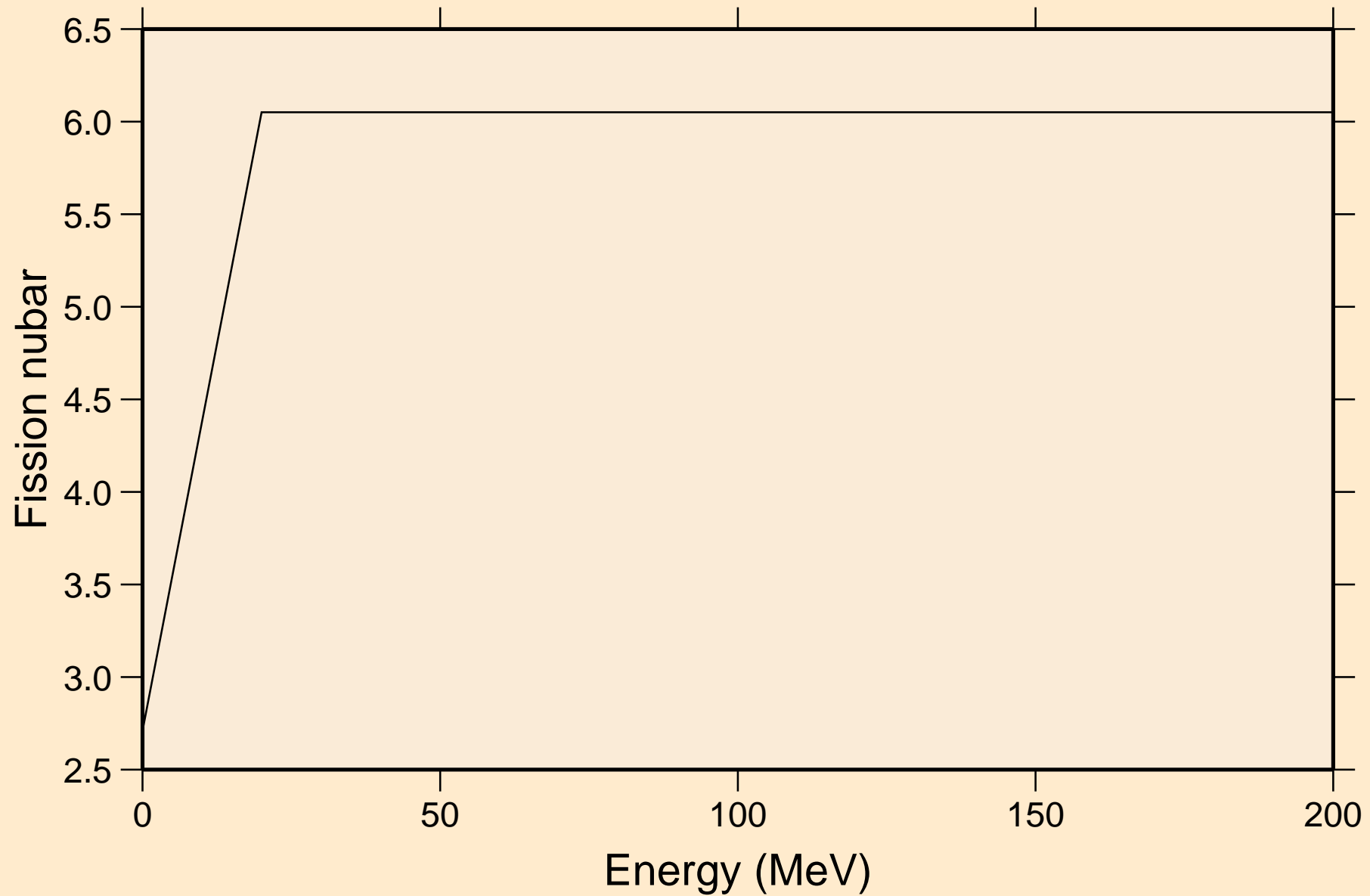

AC236 NEUTRON ACER TENDL-2021 LIBRARY; T=293.6K
Neutron emission for (n,x)

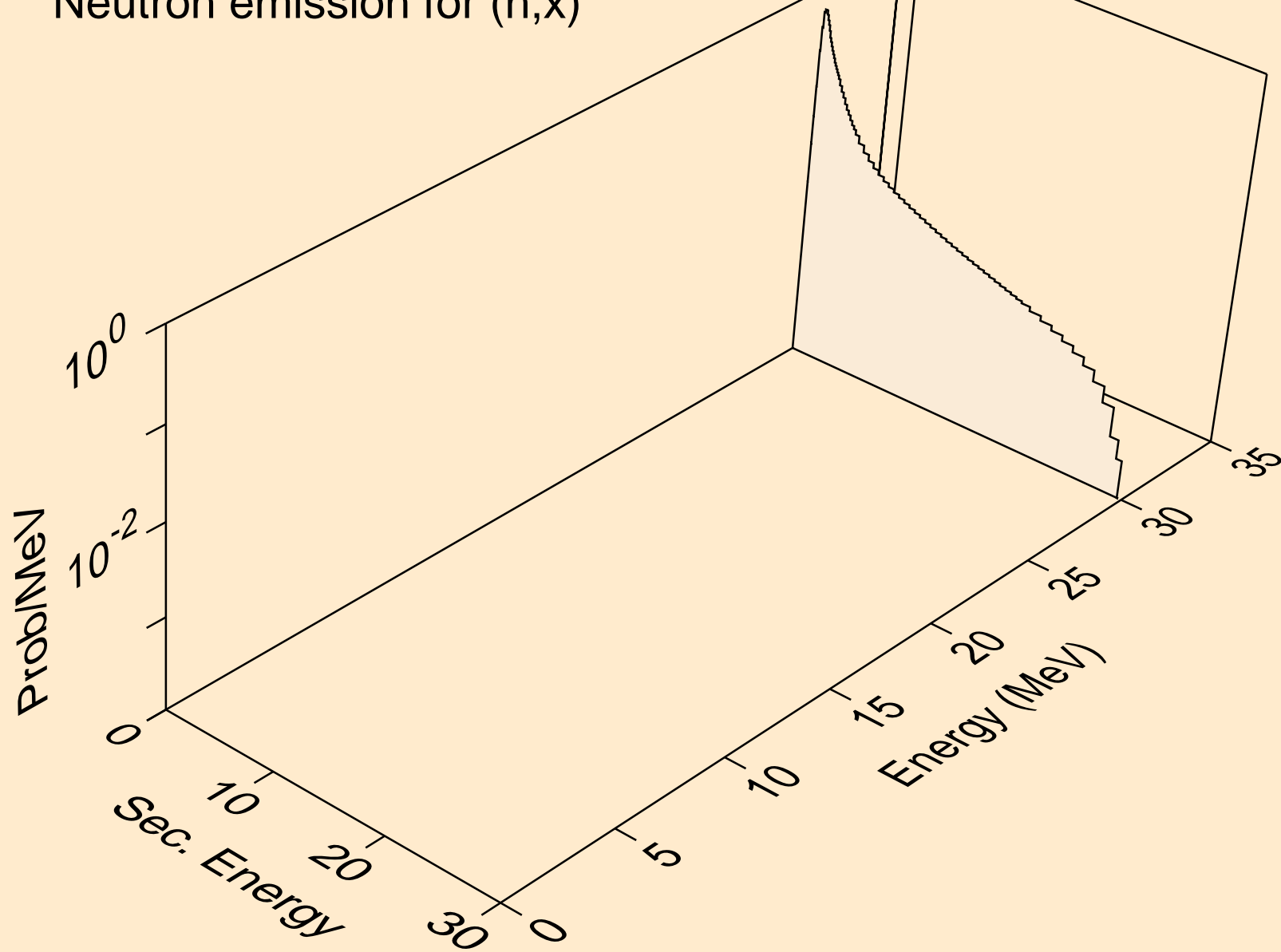

AC236 NEUTRON ACER TENDL-2021 LIBRARY; T=293.6K
Neutron emission for (n,2nd)

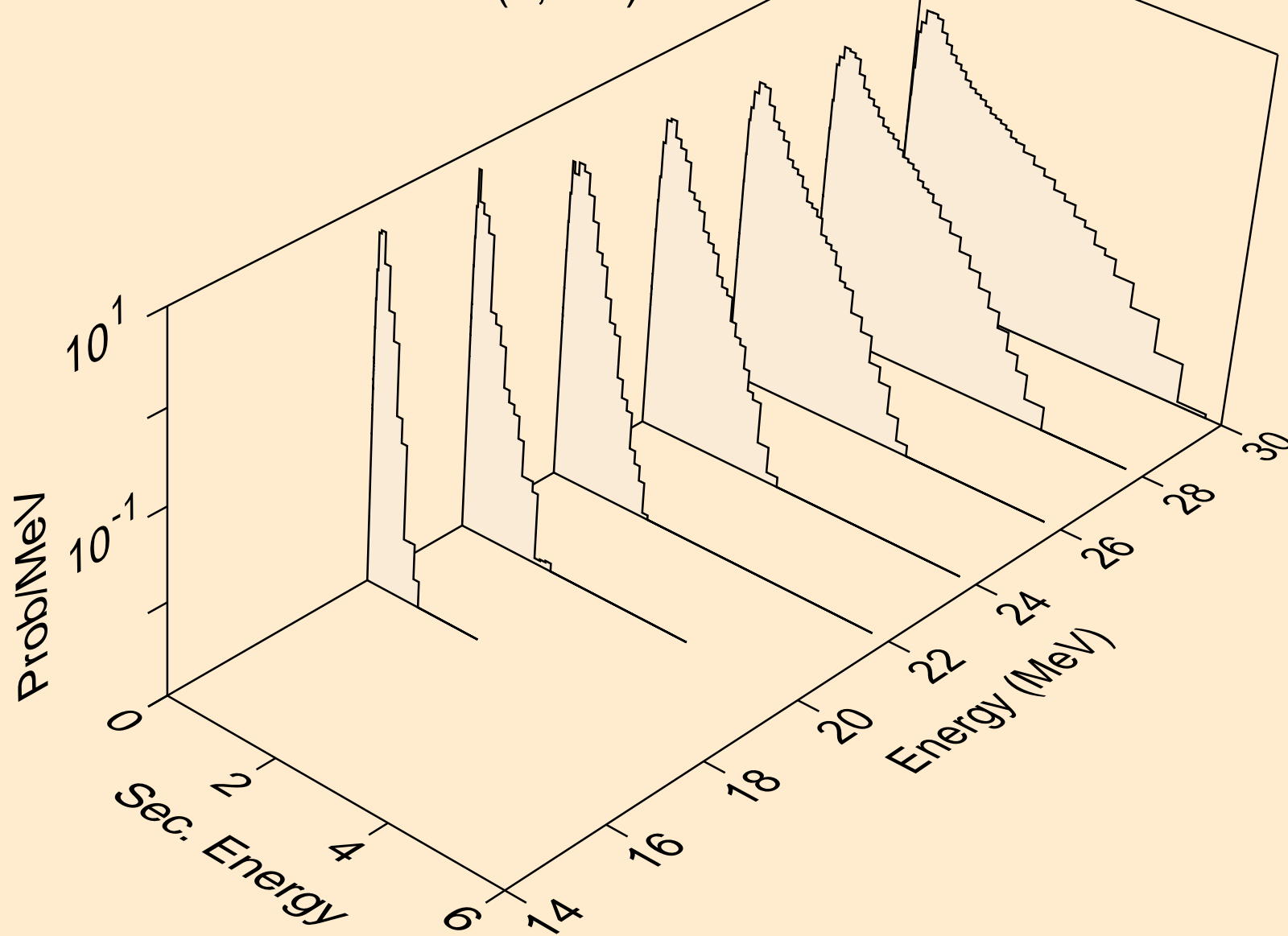

AC236 NEUTRON ACER TENDL-2021 LIBRARY; T=293.6K
Neutron emission for (n,2n)

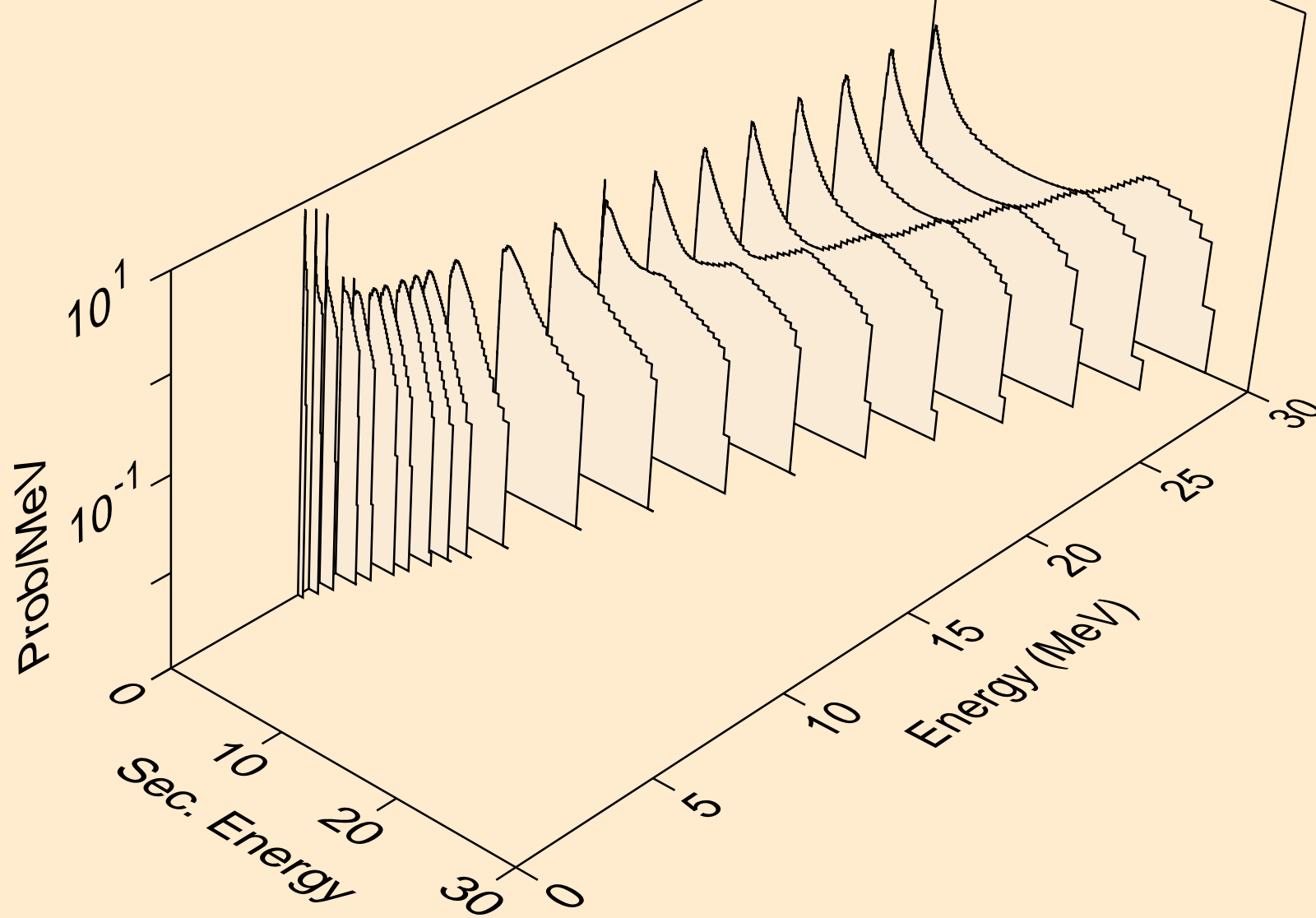

AC236 NEUTRON ACER TENDL-2021 LIBRARY; T=293.6K
Neutron emission for (n,3n)

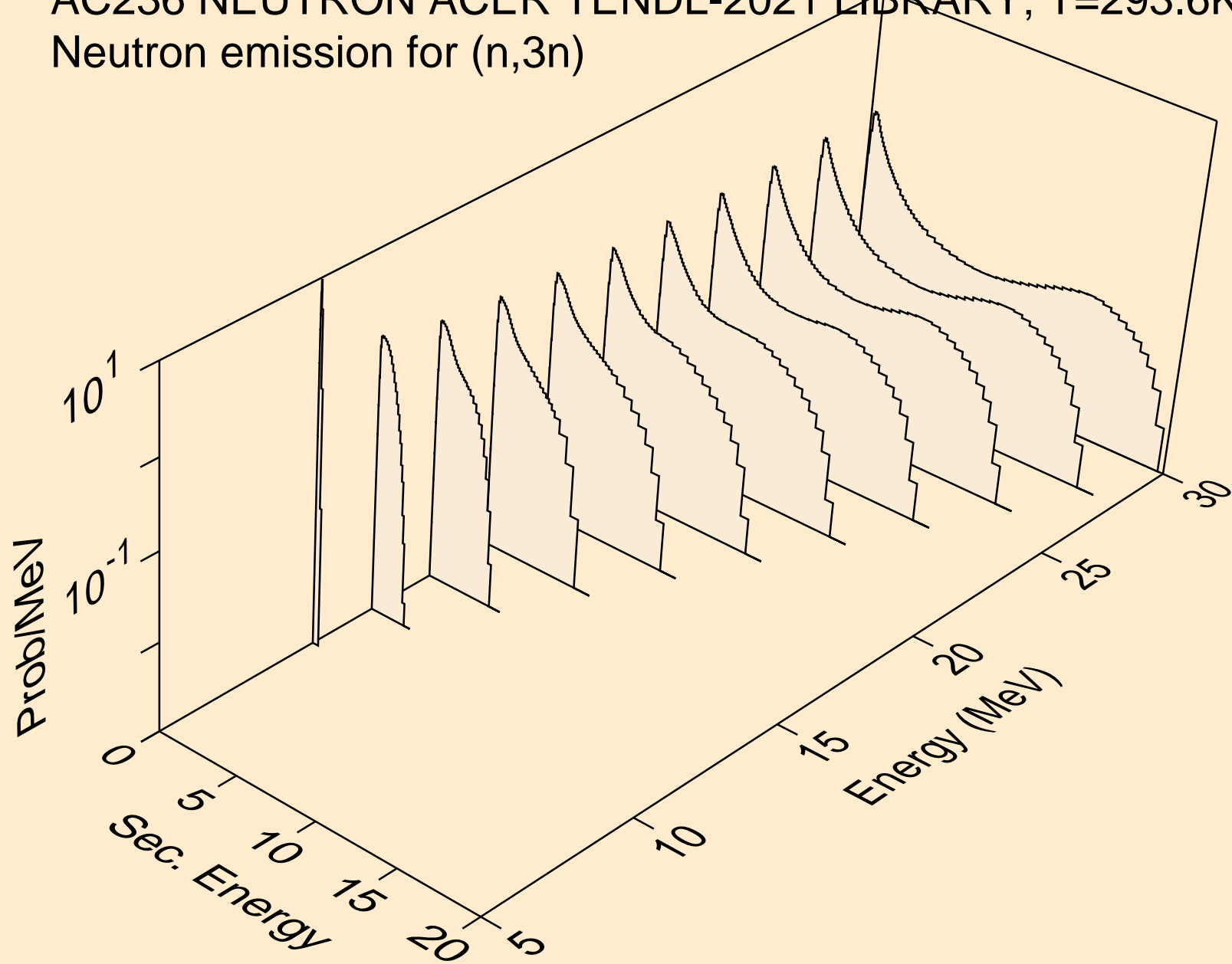

AC236 NEUTRON ACER TENDL-2021 LIBRARY; T=293.6K
Neutron emission for fission

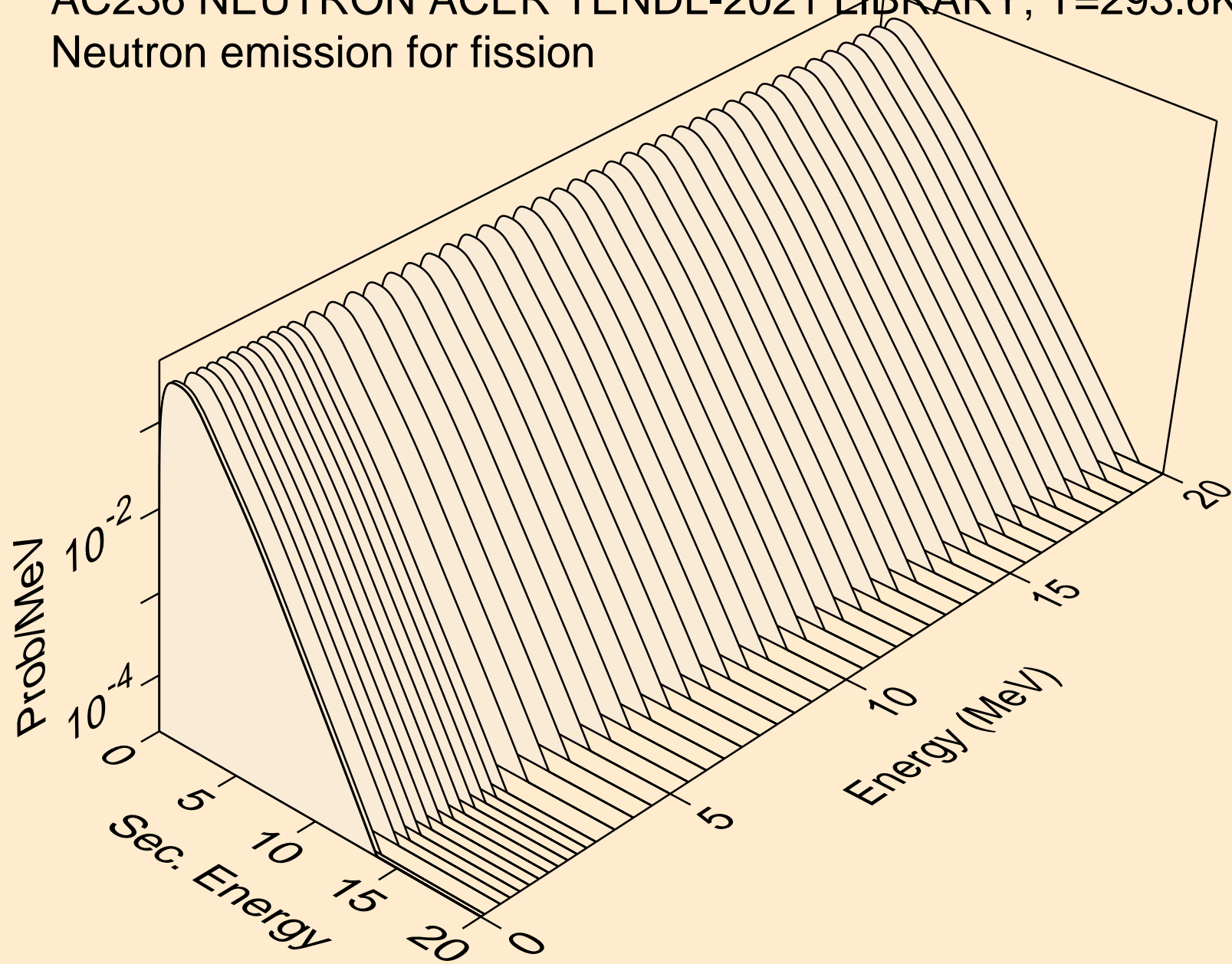

AC236 NEUTRON ACER TENDL-2021 LIBRARY; T=293.6K
Neutron emission for (n,n*)a

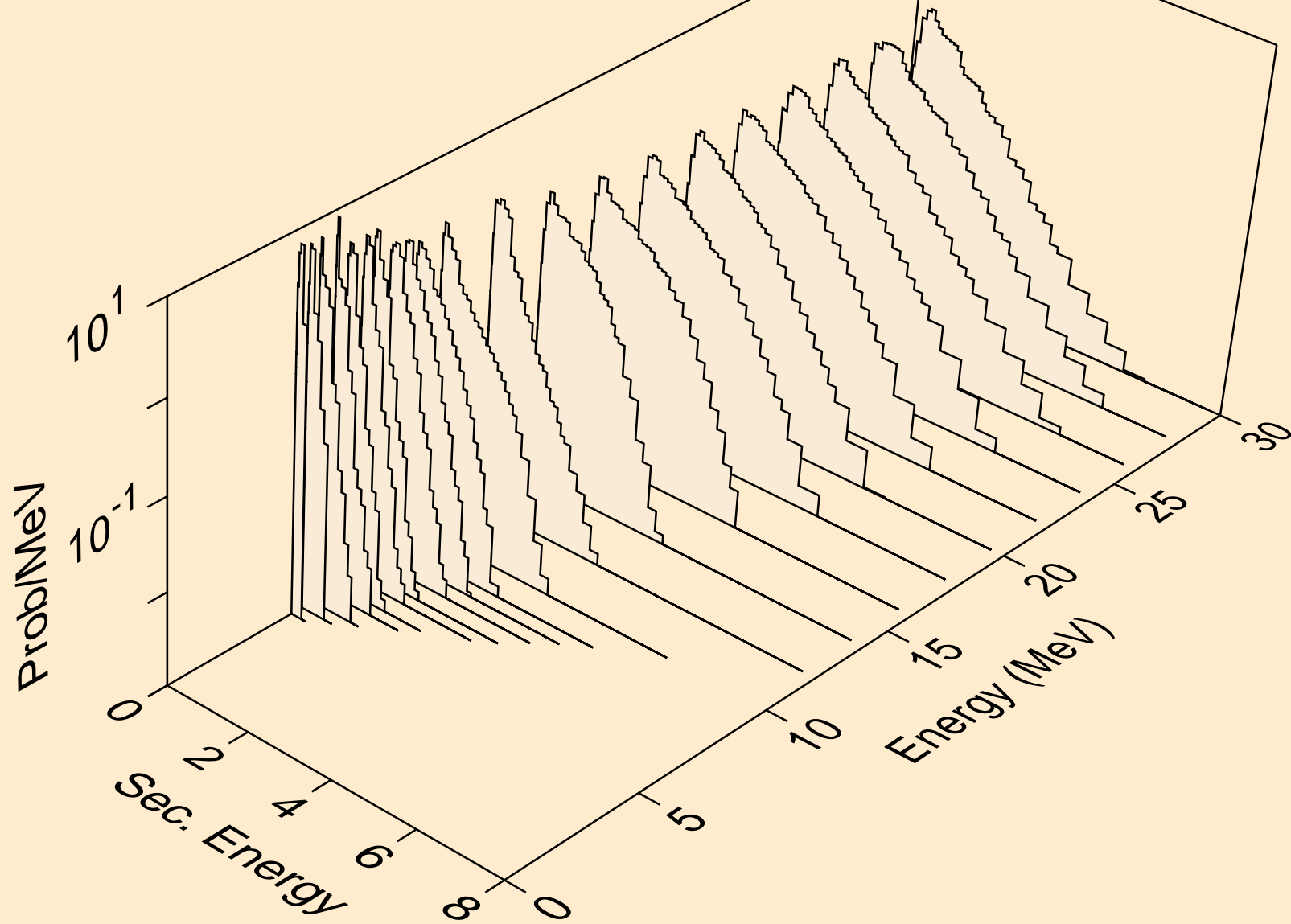

AC236 NEUTRON ACER TENDL-2021 LIBRARY; T=293.6K
Neutron emission for (n,2n)a

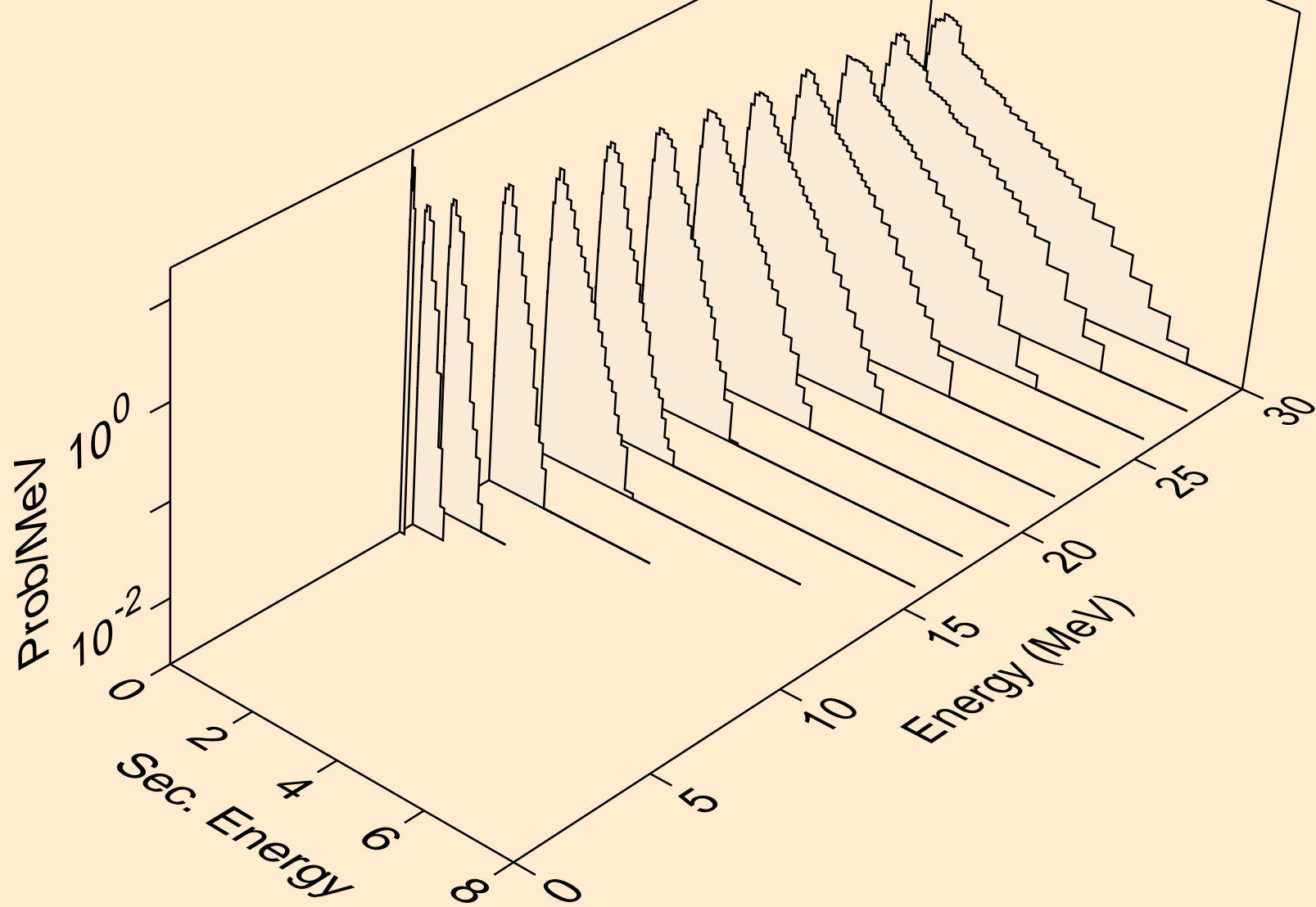

AC236 NEUTRON ACER TENDL-2021 LIBRARY; T=293.6K
Neutron emission for (n,3n)a

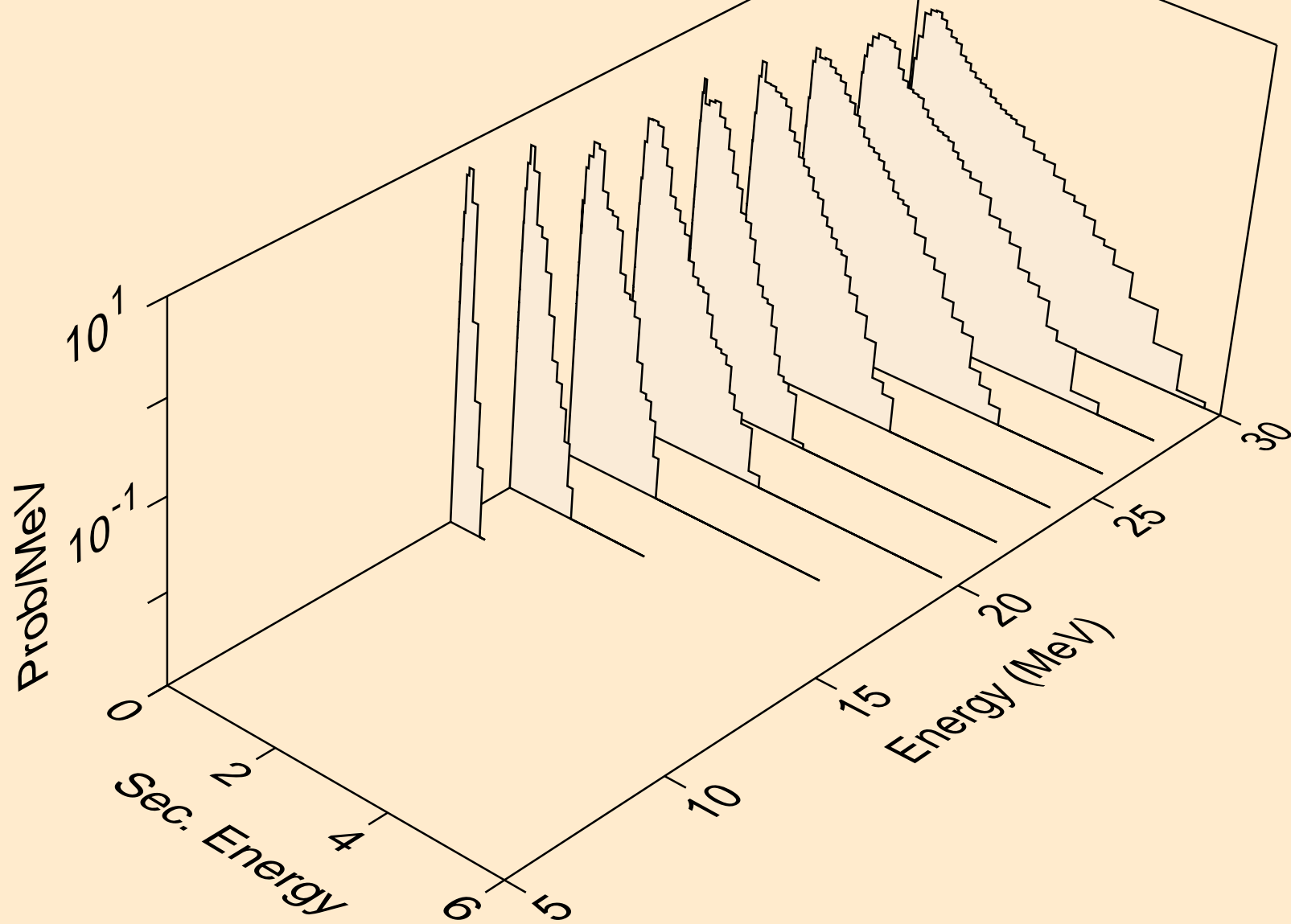

AC236 NEUTRON ACER TENDL-2021 LIBRARY; T=293.6K
Neutron emission for (n,n*)p

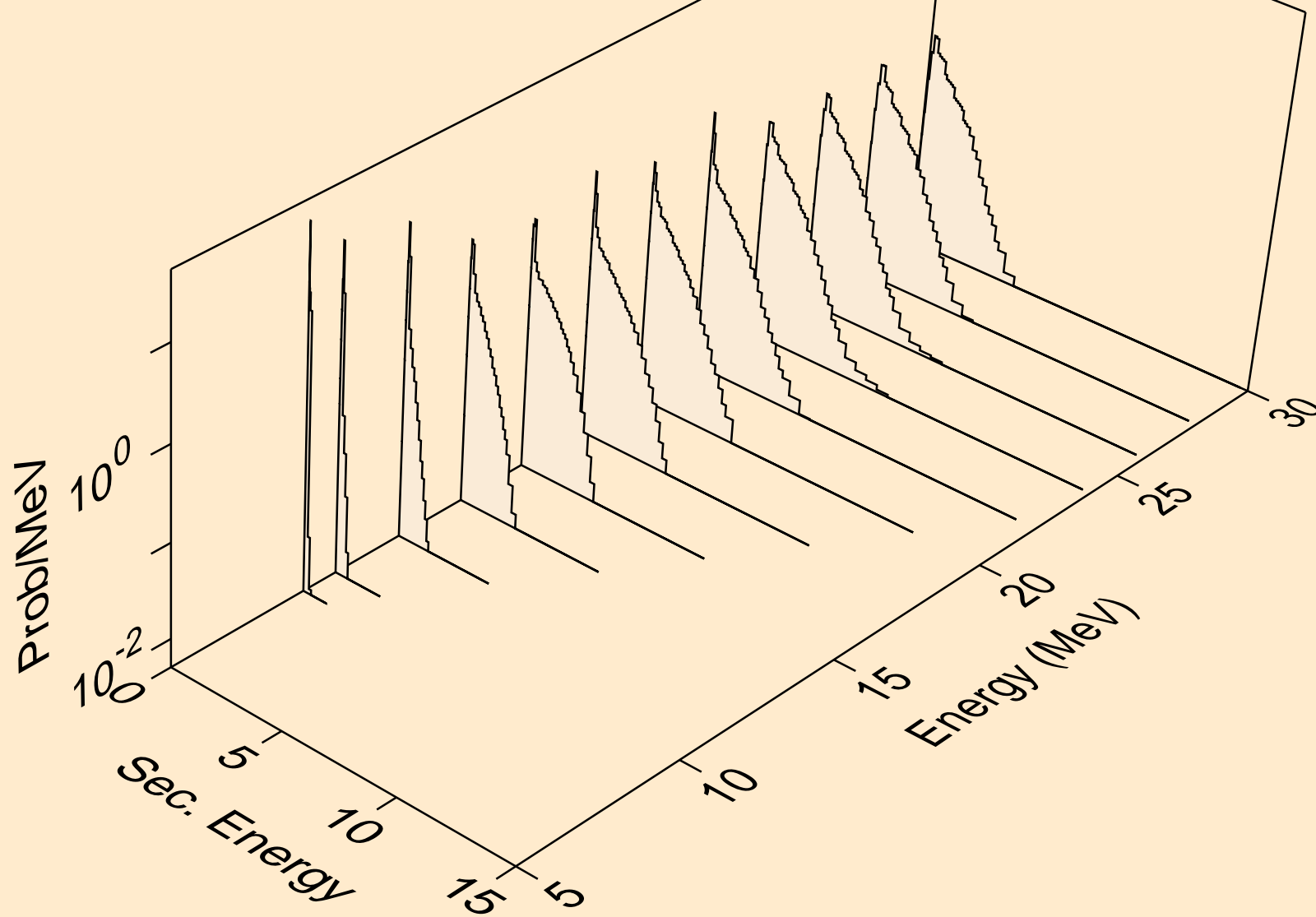

AC236 NEUTRON ACER TENDL-2021 LIBRARY; T=293.6K
Neutron emission for (n,n*)2a

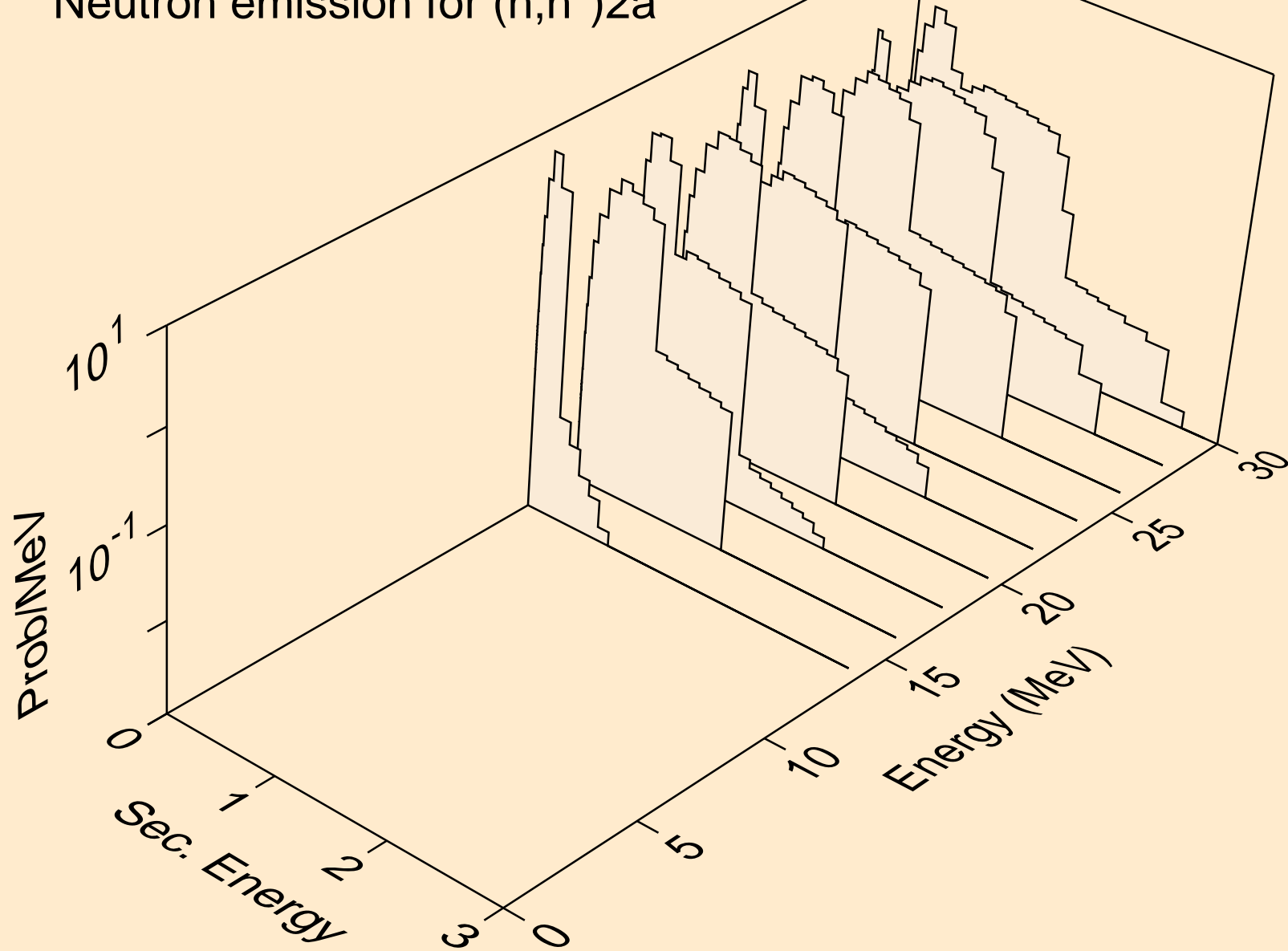

AC236 NEUTRON ACER TENDL-2021 LIBRARY; T=293.6K
Neutron emission for (n,2n)2a

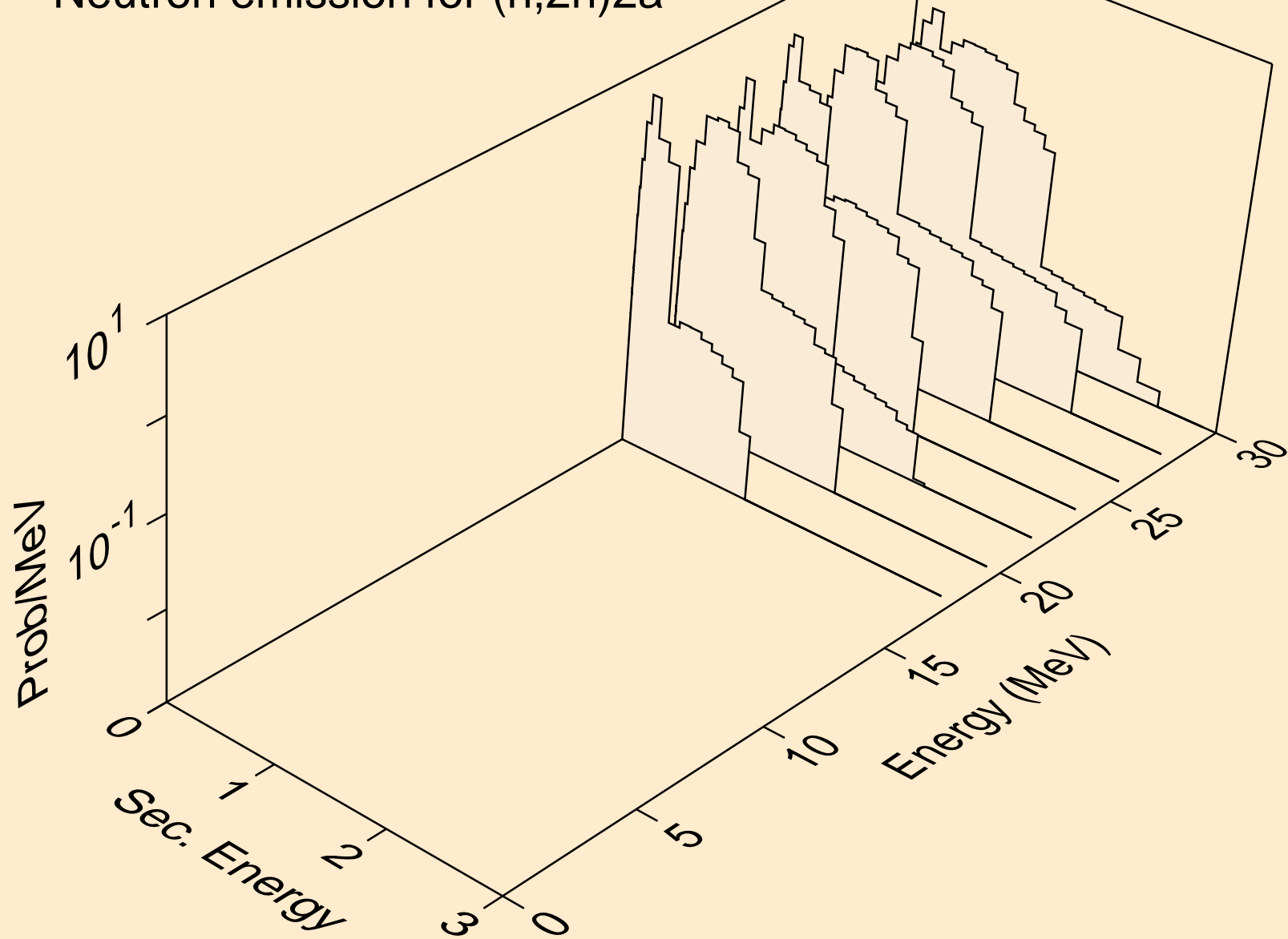

AC236 NEUTRON ACER TENDL-2021 LIBRARY; T=293.6K
Neutron emission for (n,n*)d

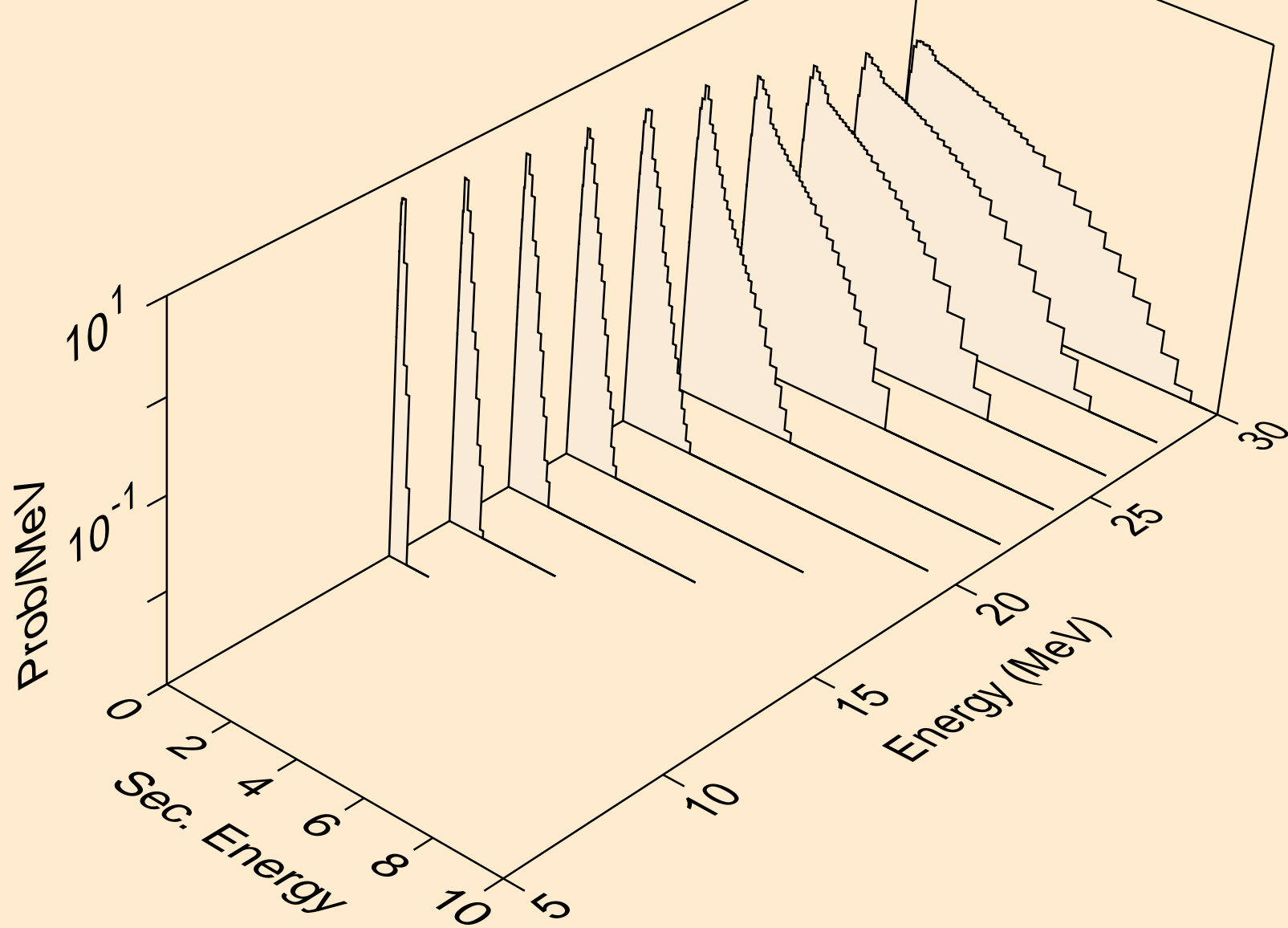

AC236 NEUTRON ACER TENDL-2021 LIBRARY; T=293.6K
Neutron emission for (n,n*)t

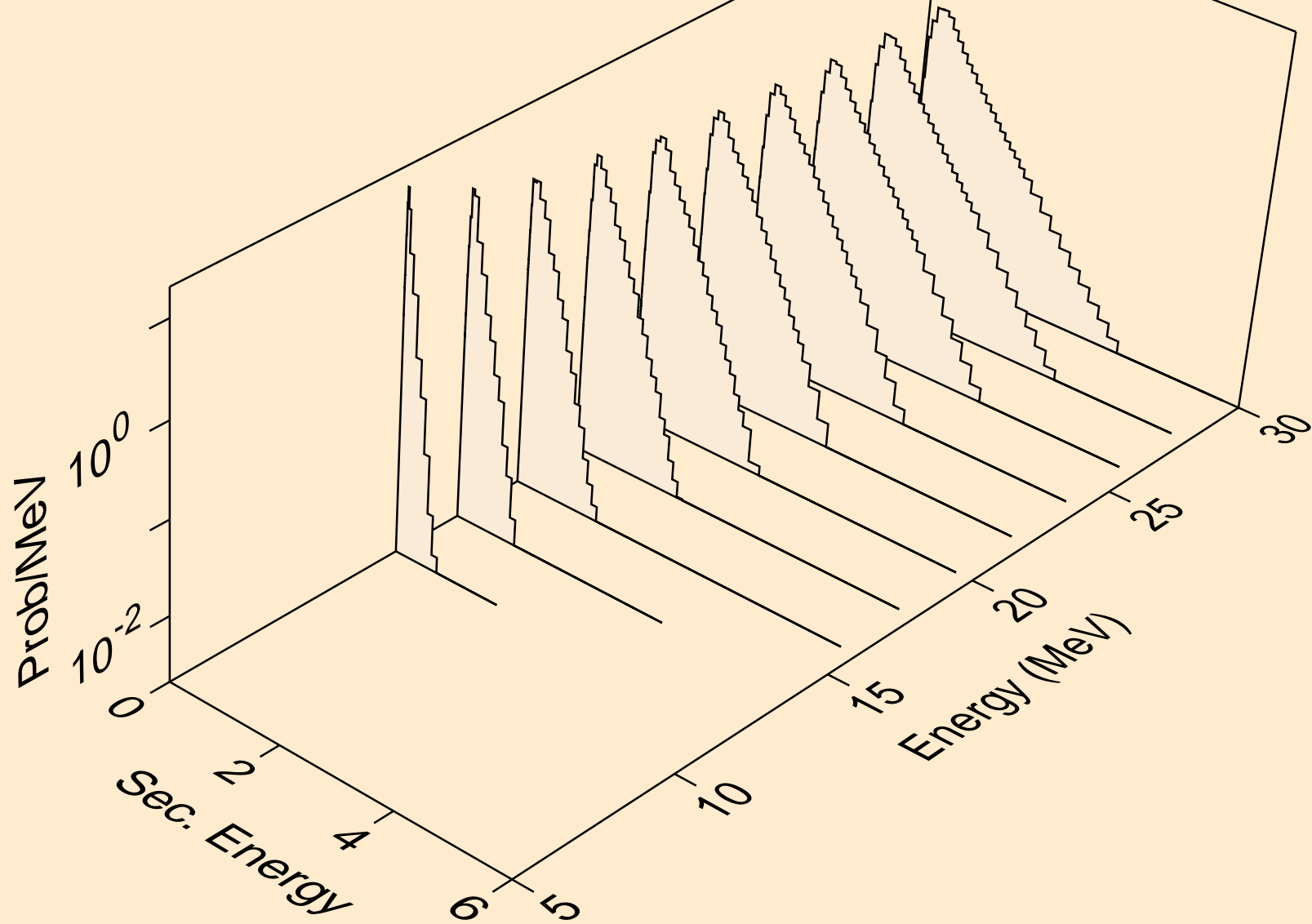

AC236 NEUTRON ACER TENDL-2021 LIBRARY; T=293.6K
Neutron emission for (n,n*)he3

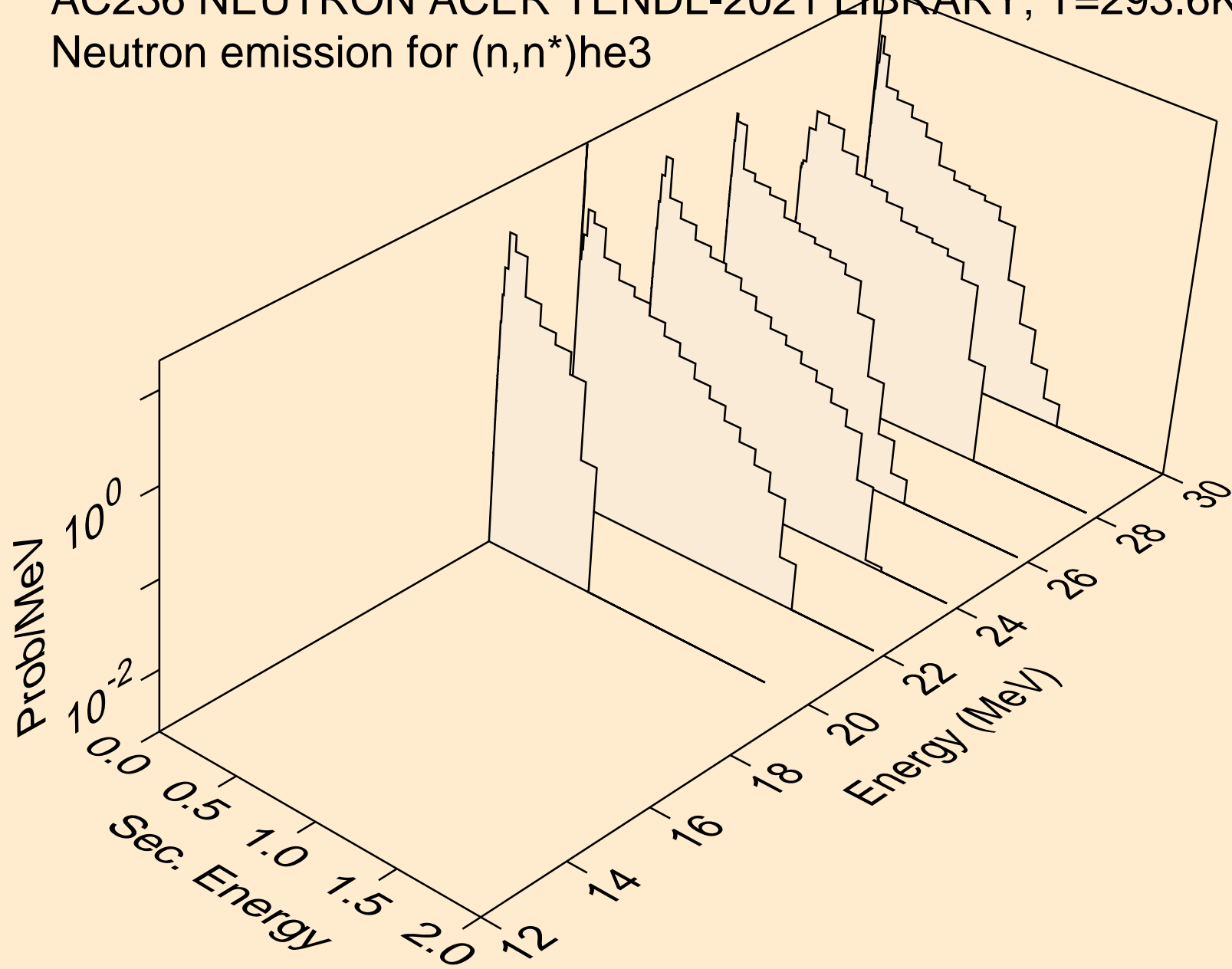

AC236 NEUTRON ACER TENDL-2021 LIBRARY; T=293.6K
Neutron emission for (n,4n)

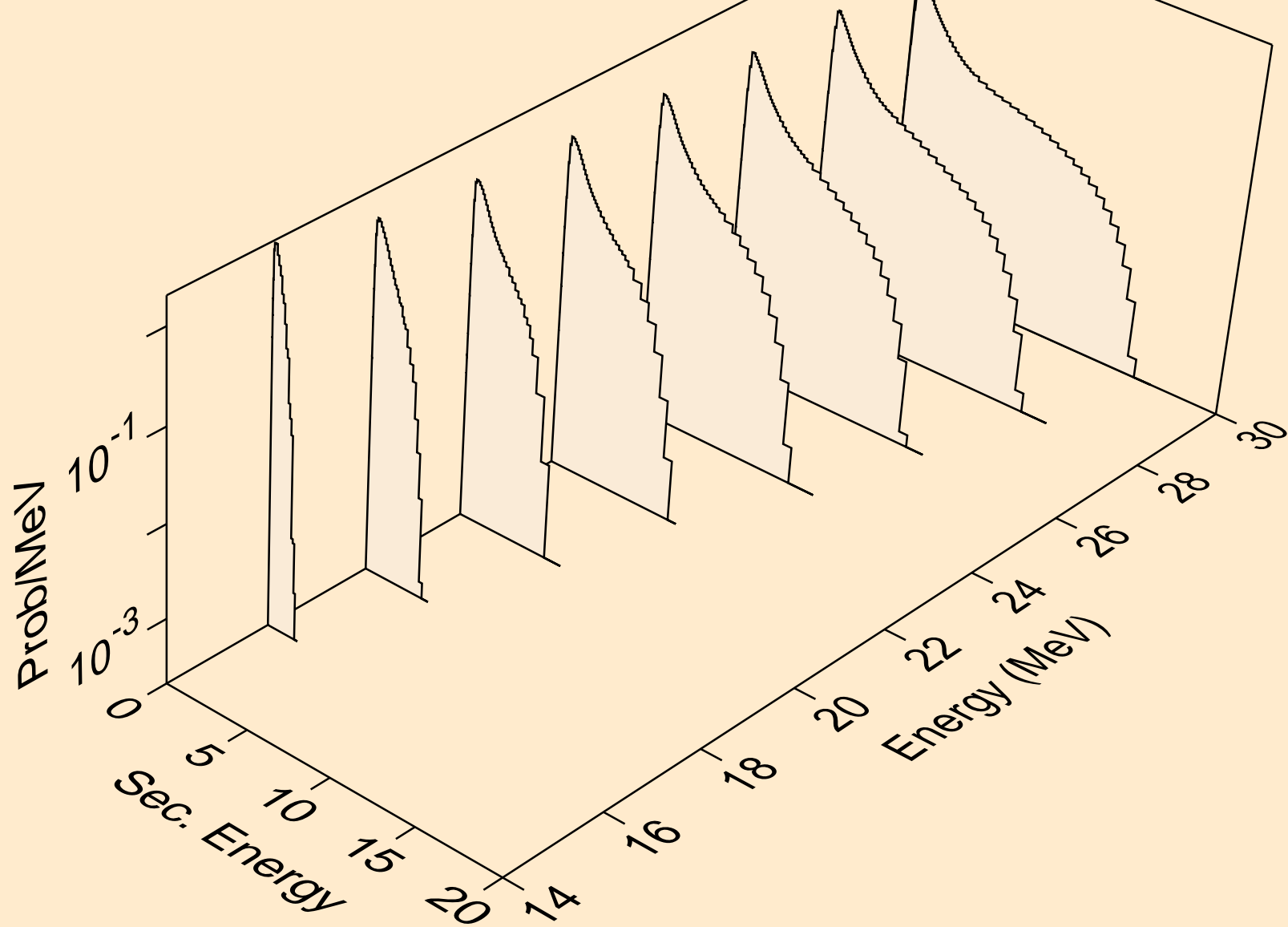

AC236 NEUTRON ACER TENDL-2021 LIBRARY; T=293.6K
Neutron emission for (n,2np)

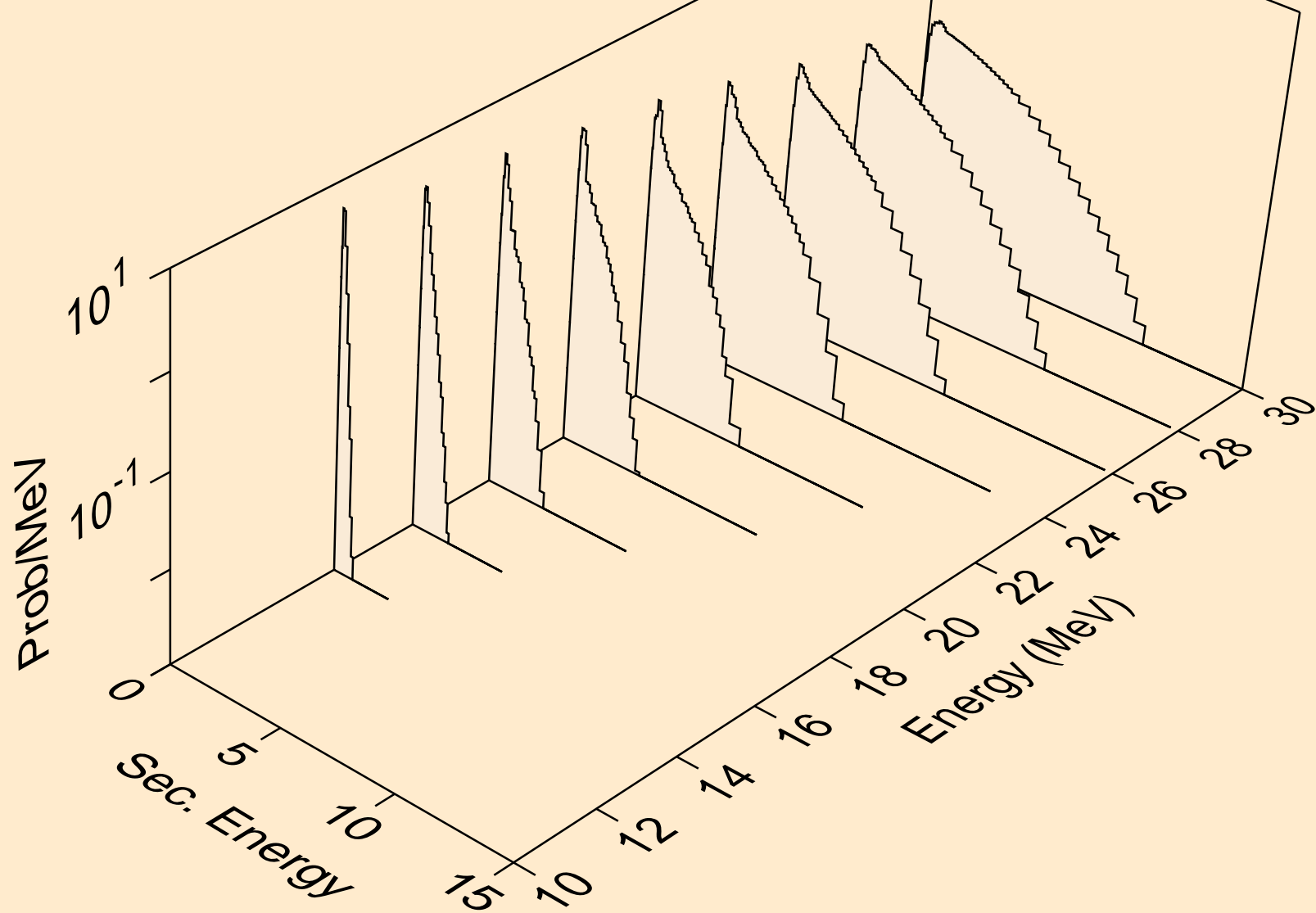

AC236 NEUTRON ACER TENDL-2021 LIBRARY; T=293.6K
Neutron emission for (n,3np)

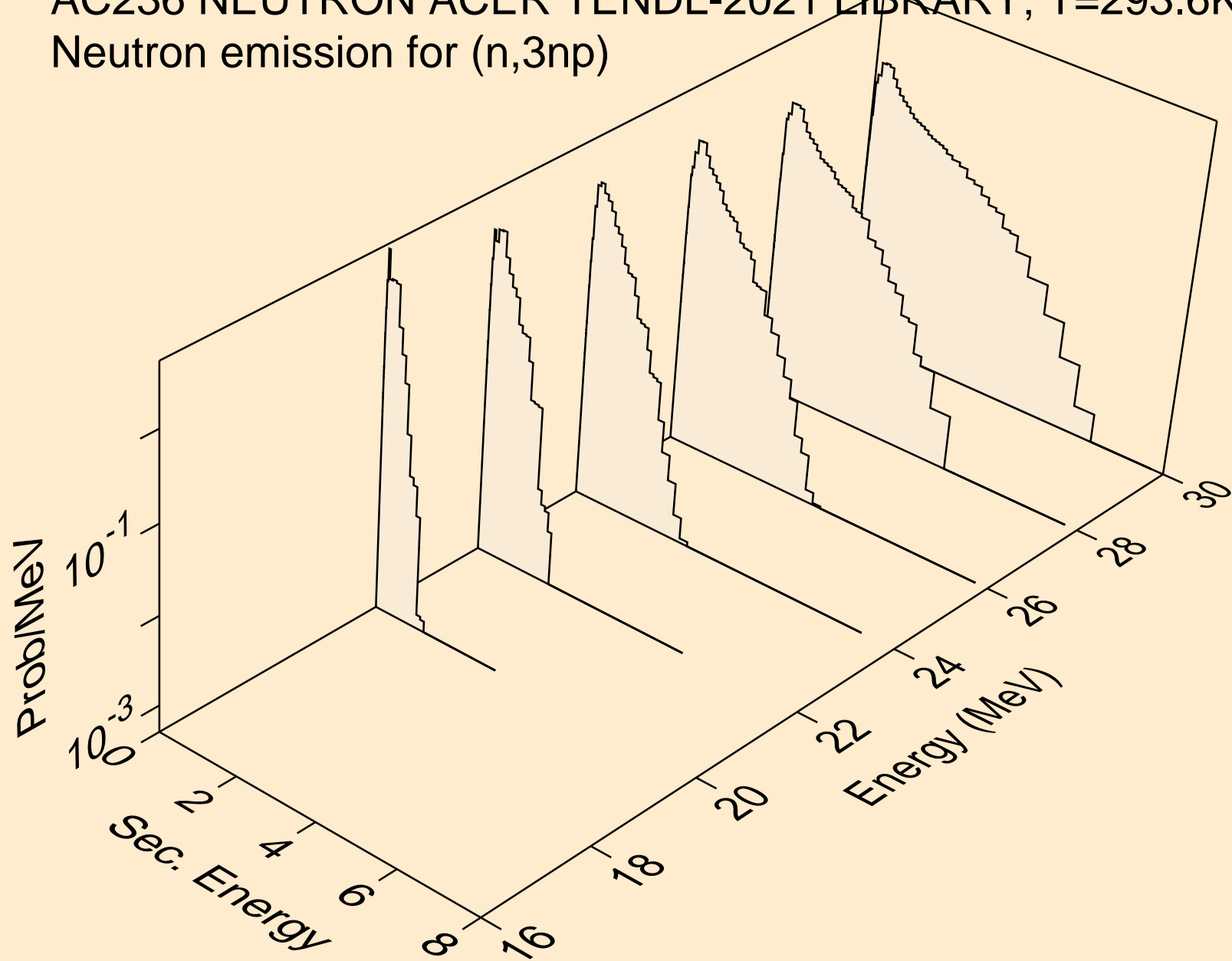

AC236 NEUTRON ACER TENDL-2021 LIBRARY; T=293.6K
Neutron emission for (n,2np)

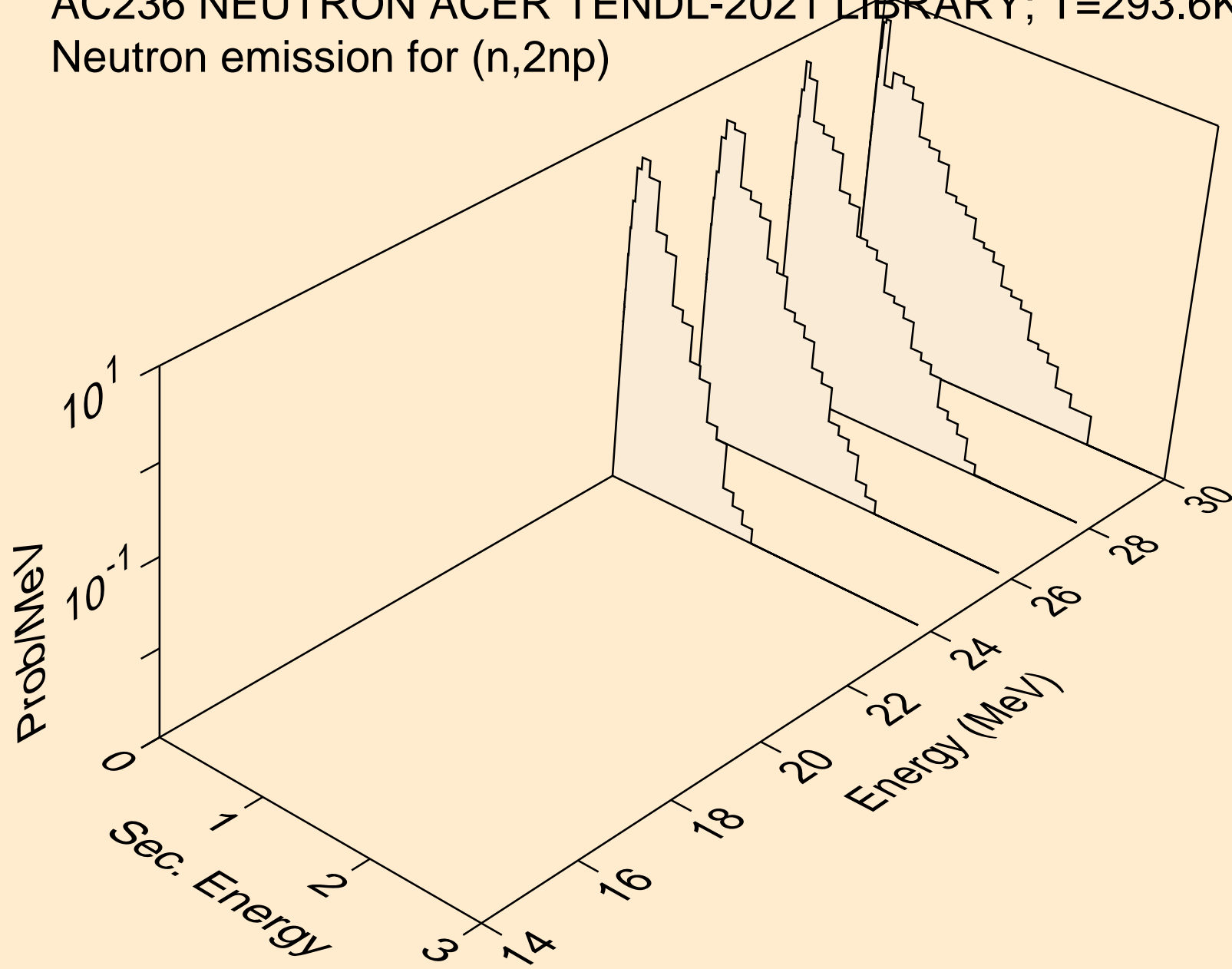

AC236 NEUTRON ACER TENDL-2021 LIBRARY; T=293.6K
Neutron emission for (n,npa)

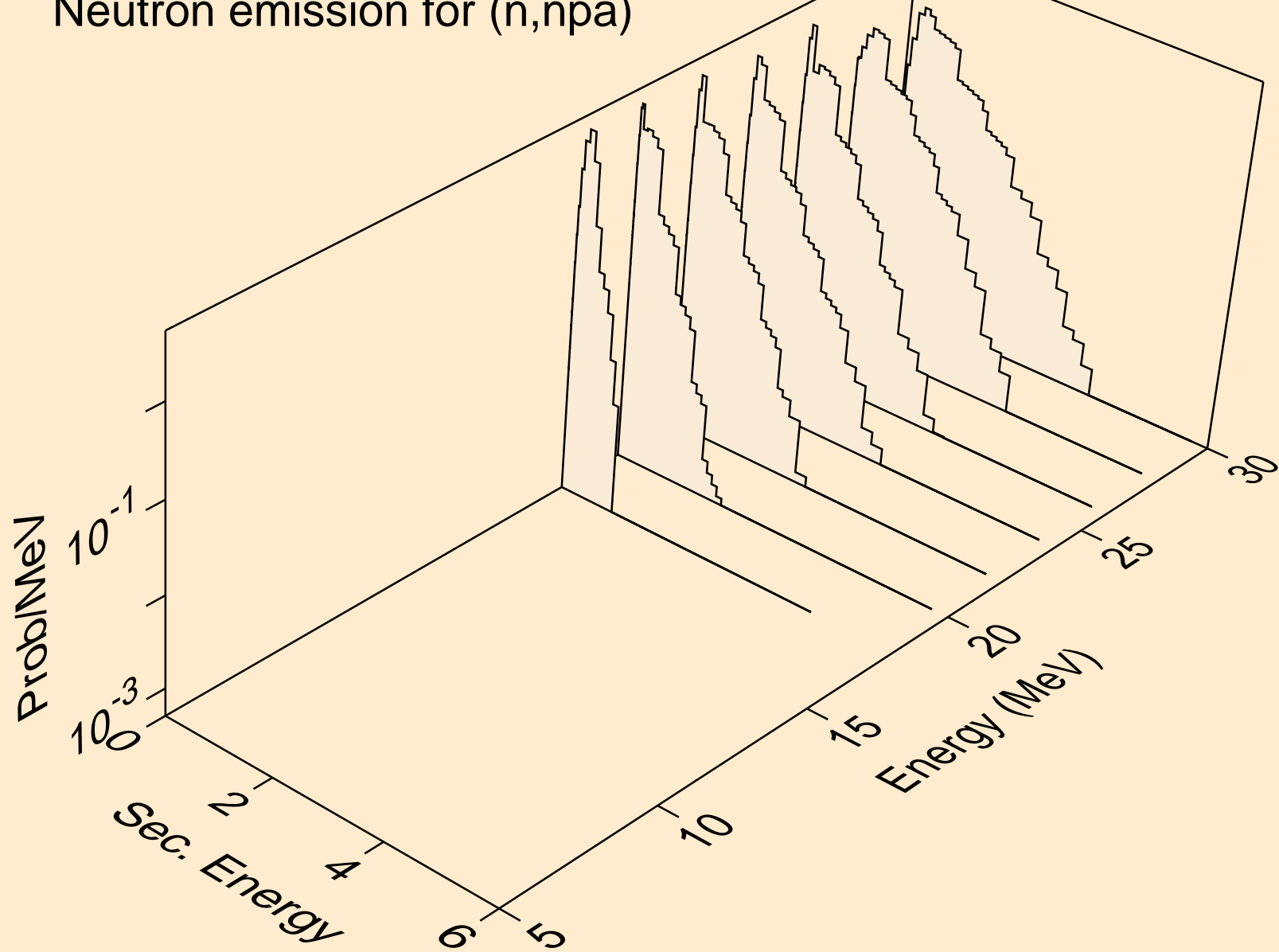

AC236 NEUTRON ACER TENDL-2021 LIBRARY; T=293.6K
Neutron emission for (n,n*c)

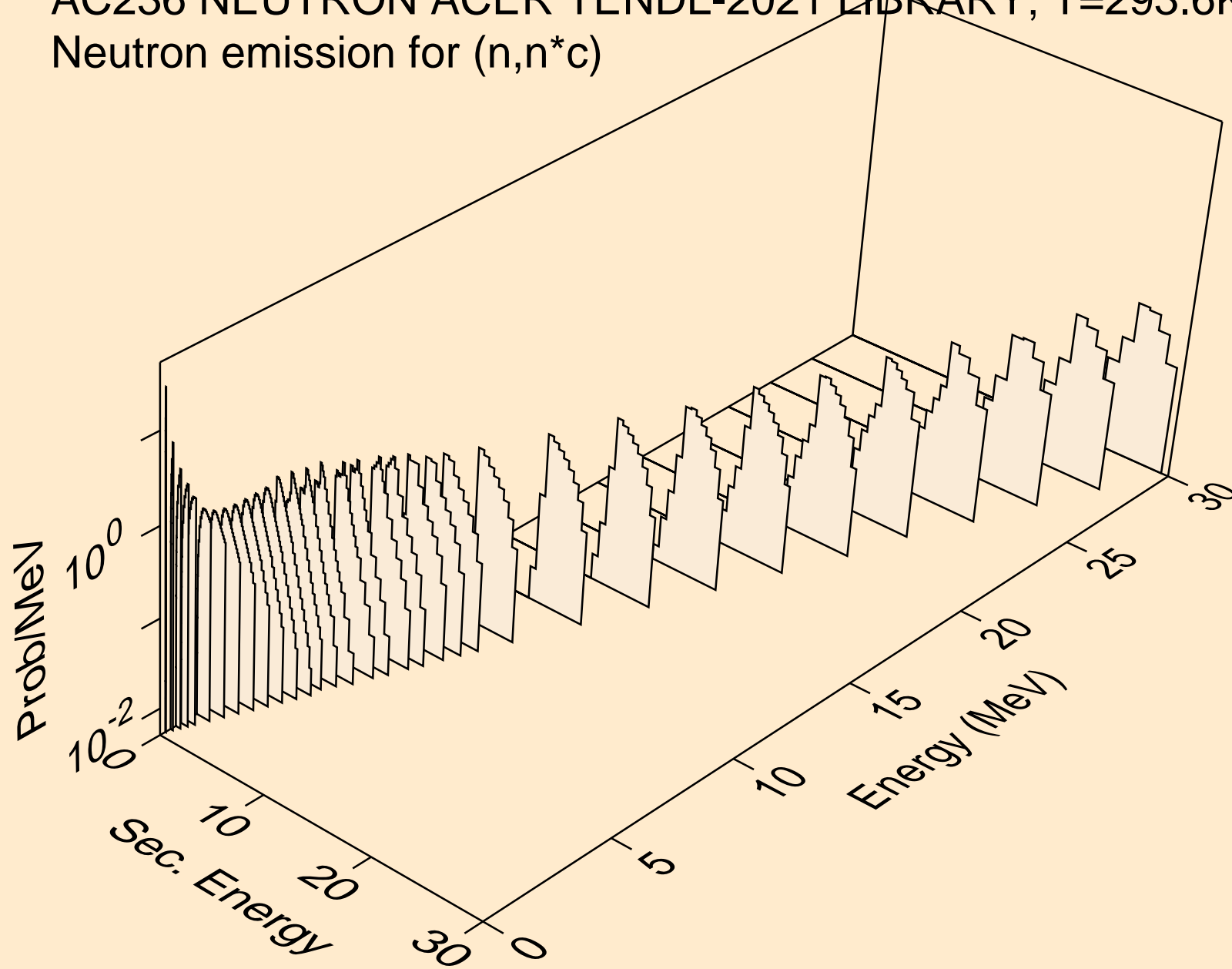

AC236 NEUTRON ACER TENDL-2021 LIBRARY; T=293.6K

Delayed nubar

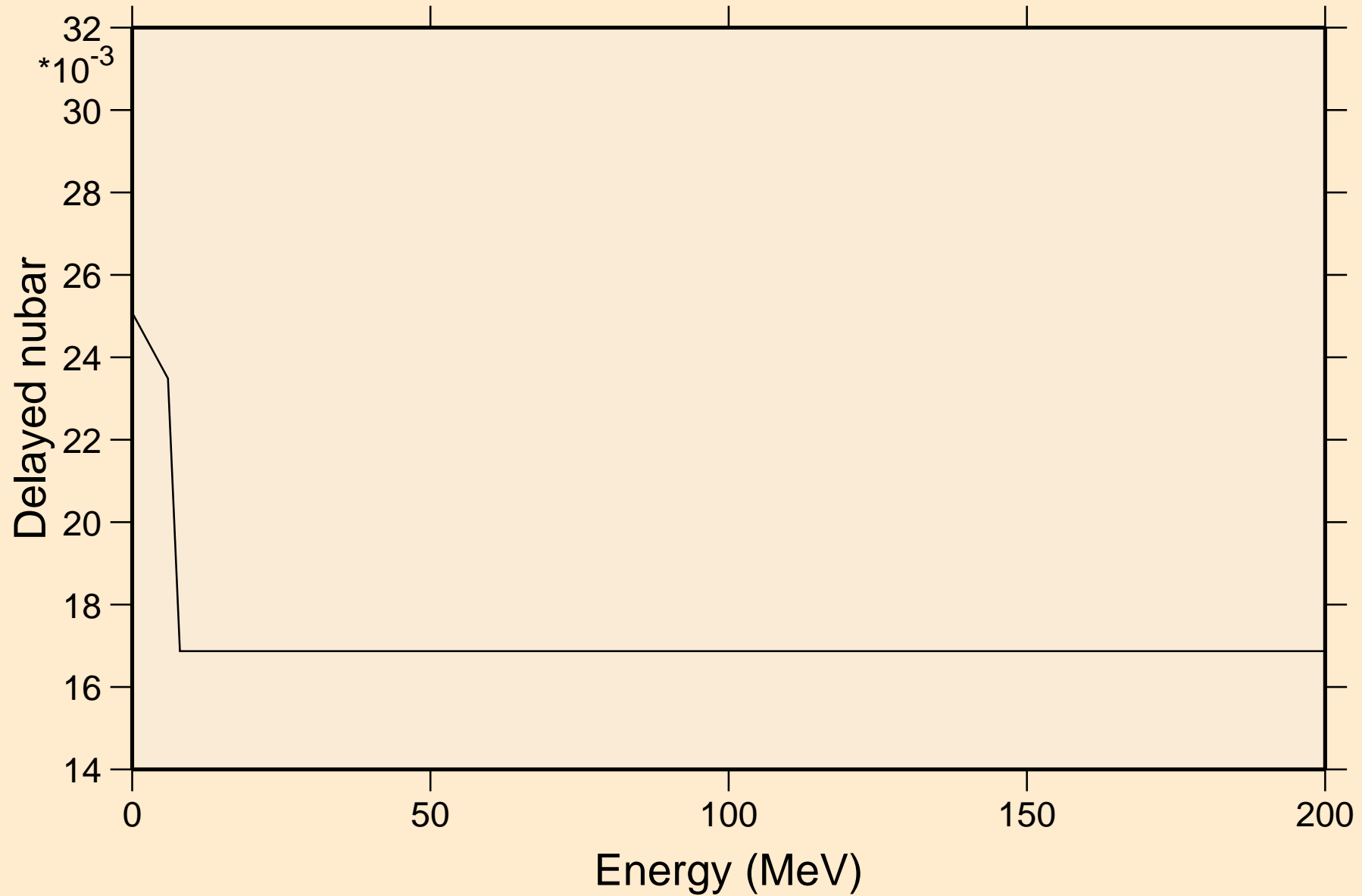

AC236 NEUTRON ACER TENDL-2021 LIBRARY; T=293.6K

Delayed neutron spectra

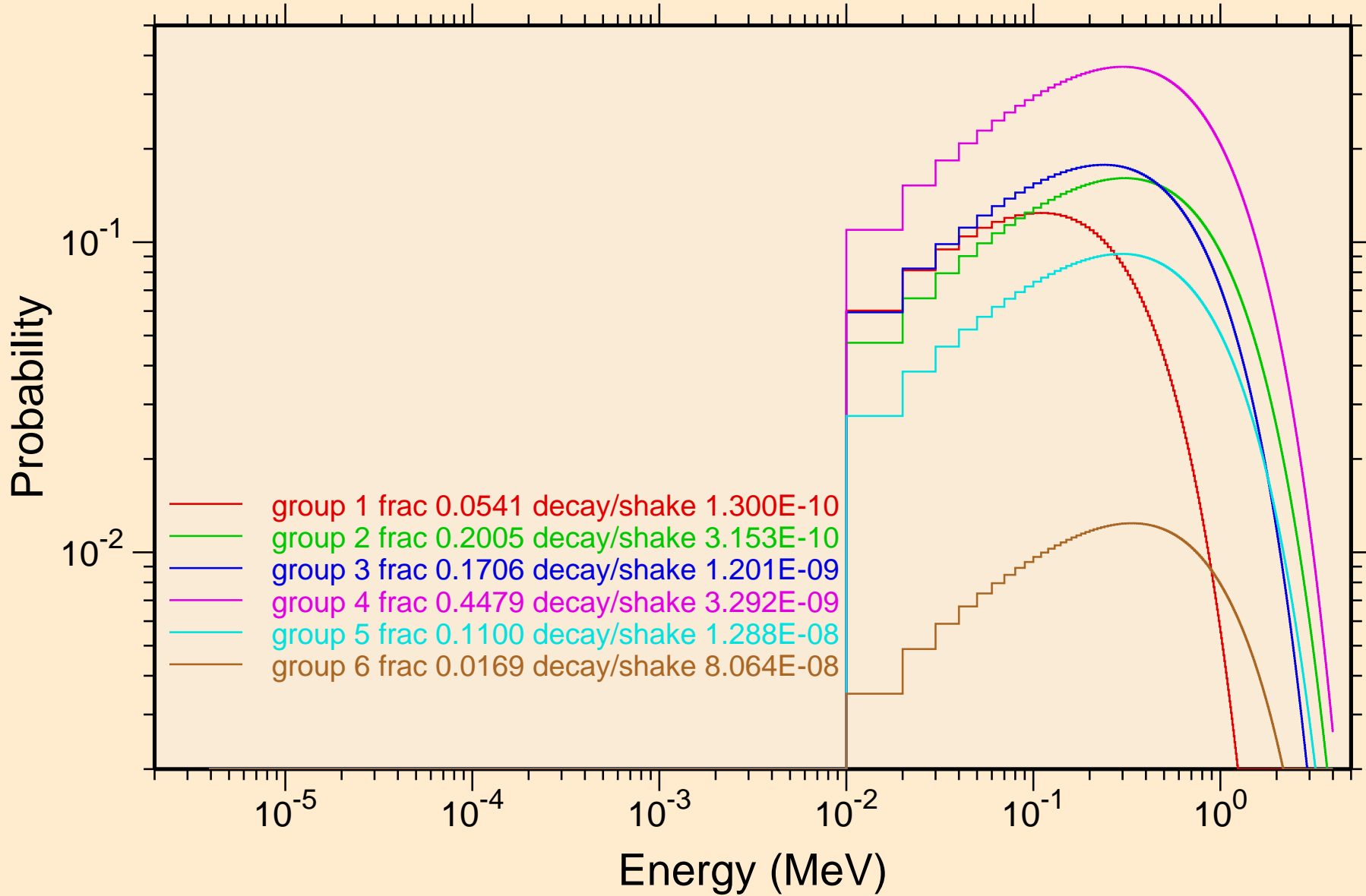

AC236 NEUTRON ACER TENDL-2021 LIBRARY; T=293.6K
Photon emission for (n,x)

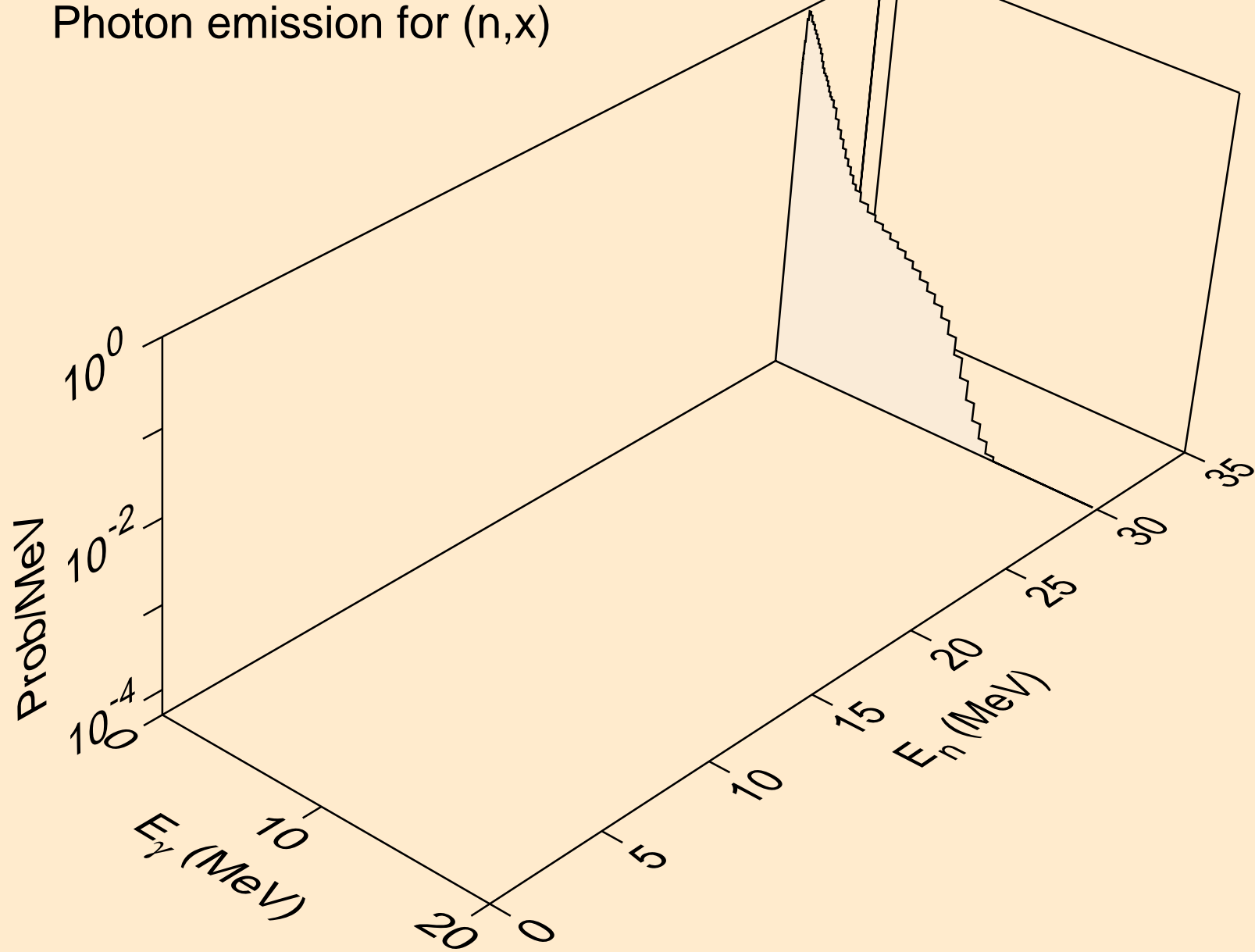

AC236 NEUTRON ACER TENDL-2021 LIBRARY; T=293.6K
Photon emission for (n,2nd)

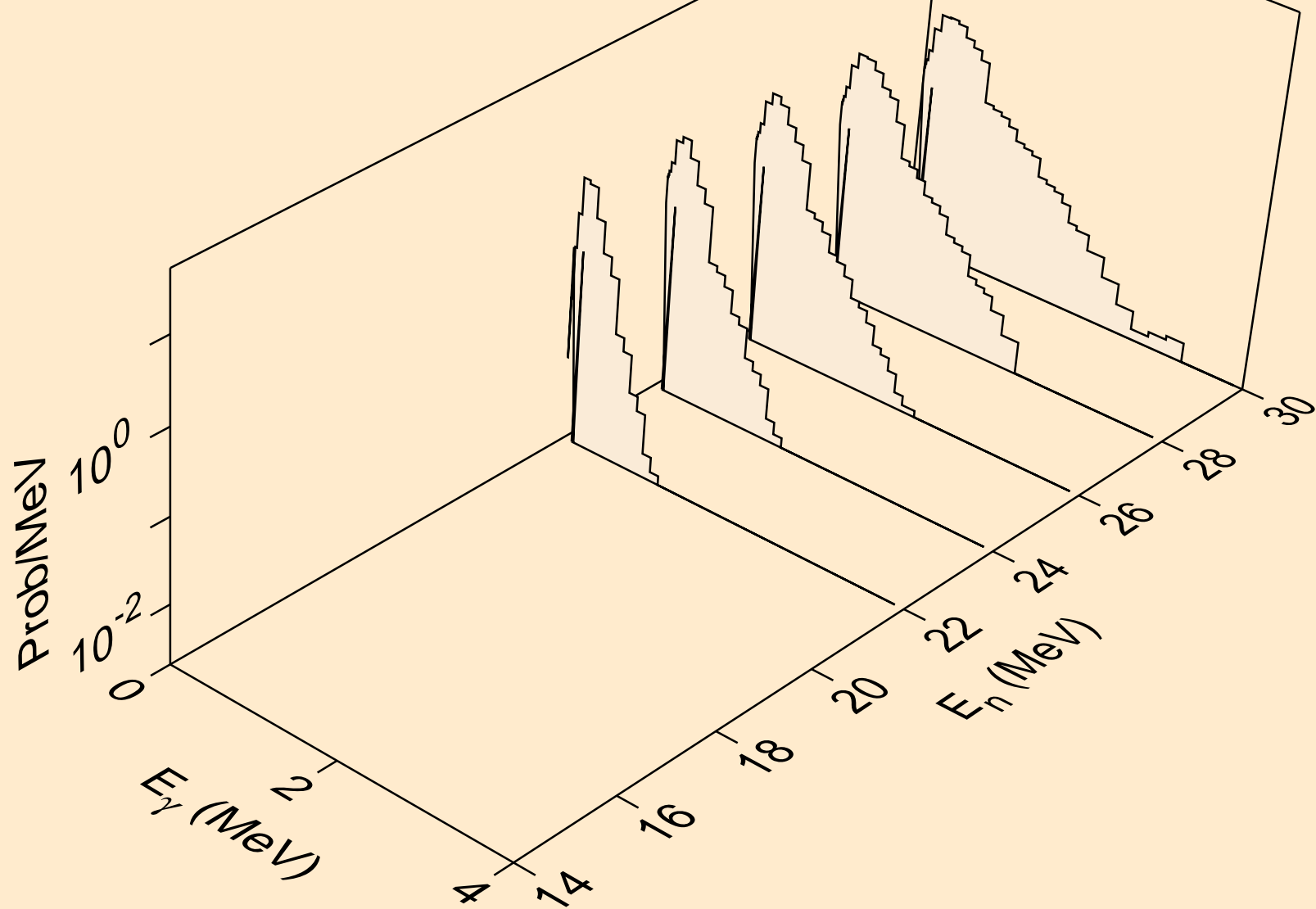

AC236 NEUTRON ACER TENDL-2021 LIBRARY; T=293.6K
Photon emission for (n,2n)

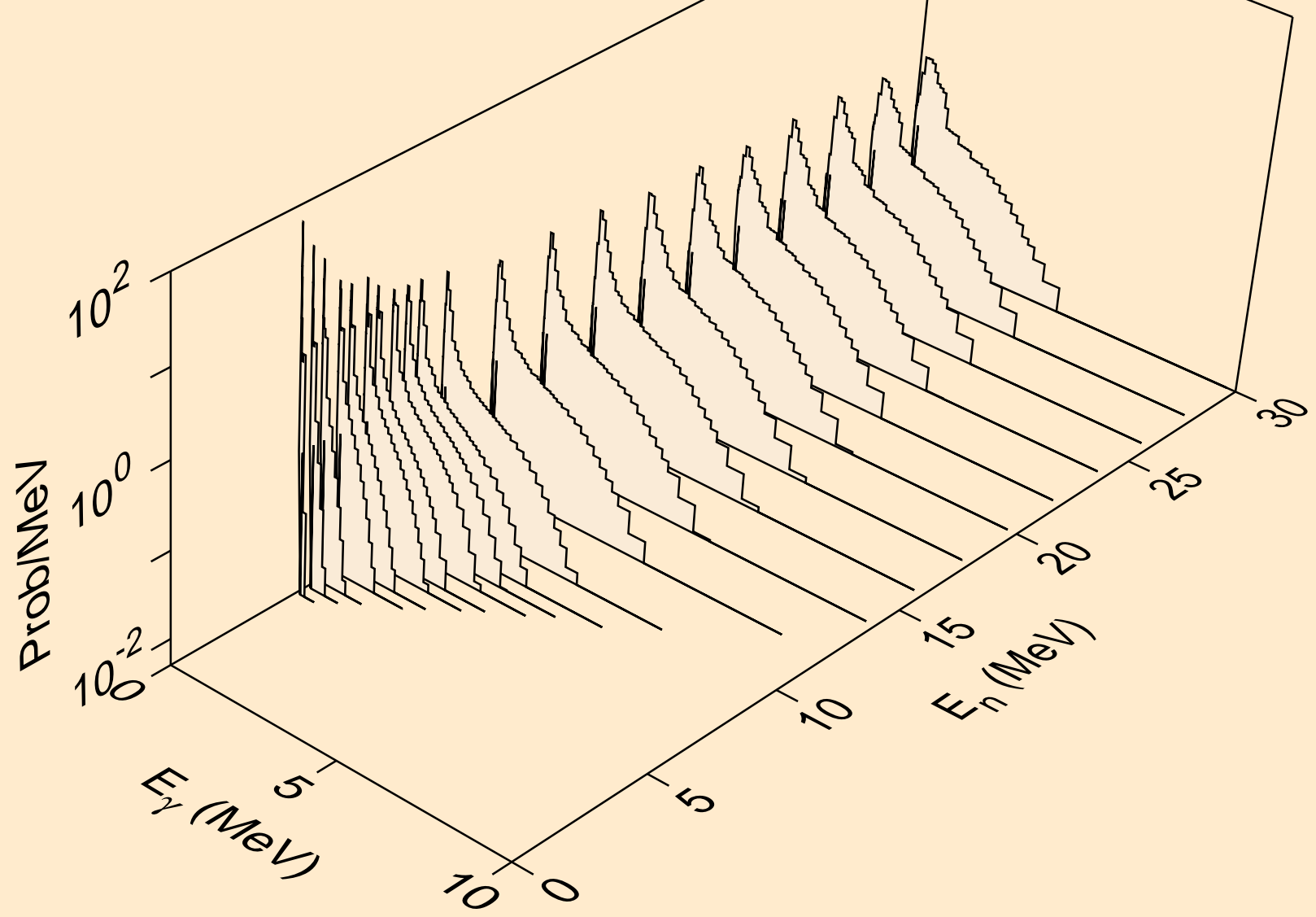

AC236 NEUTRON ACER TENDL-2021 LIBRARY; T=293.6K
Photon emission for (n,3n)

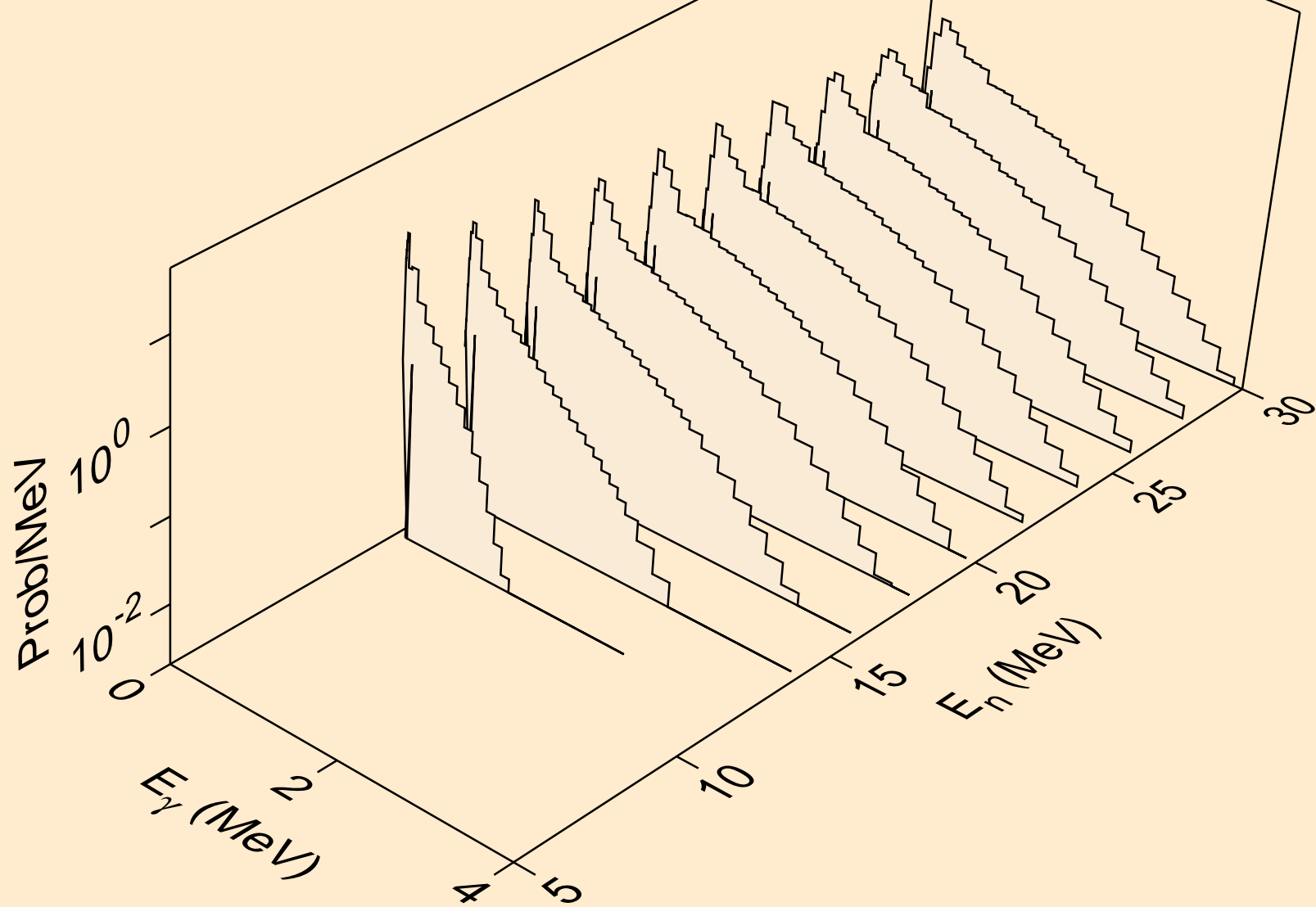

AC236 NEUTRON ACER TENDL-2021 LIBRARY; T=293.6K
Photon emission for (n,n*)a

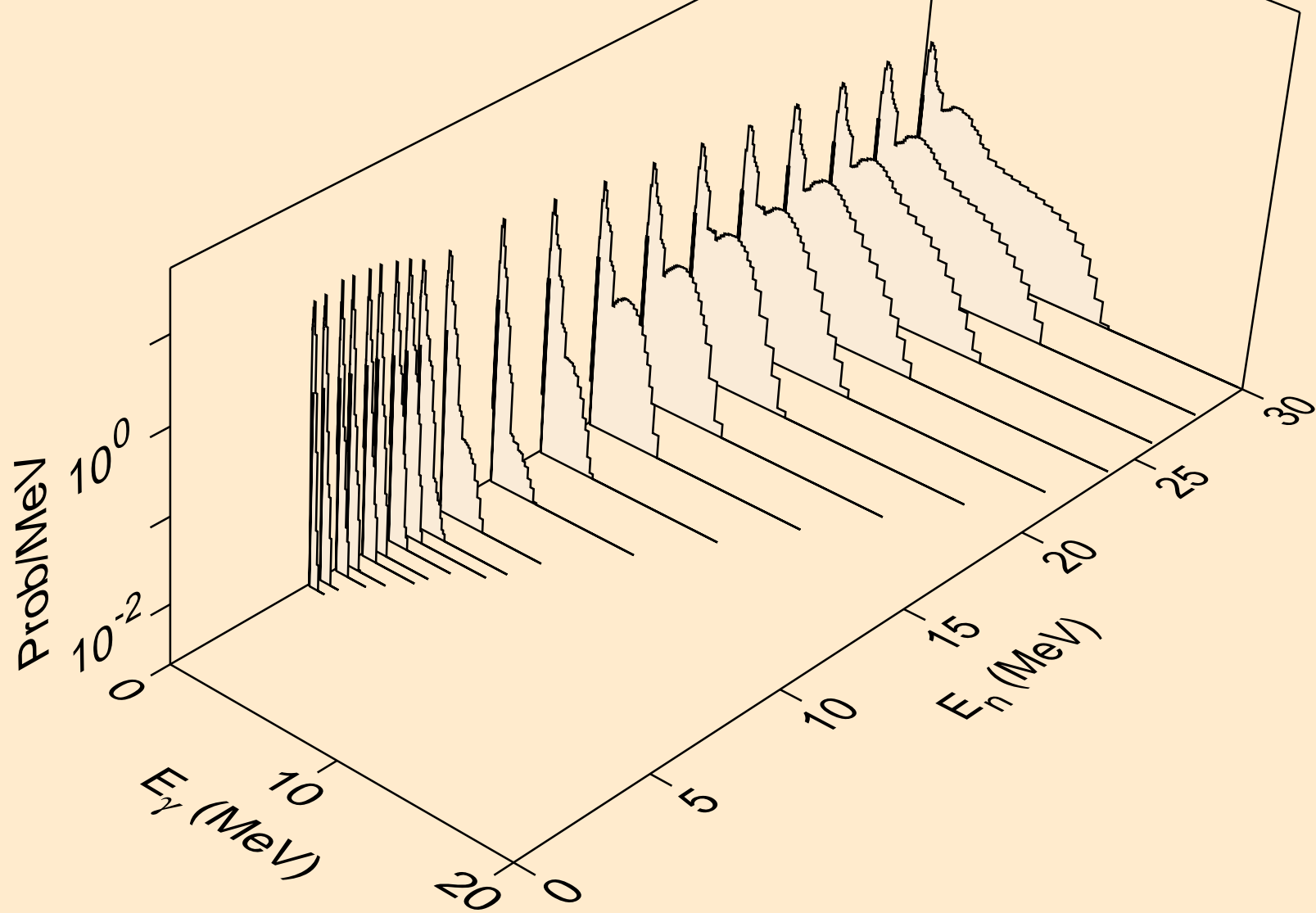

AC236 NEUTRON ACER TENDL-2021 LIBRARY; T=293.6K
Photon emission for (n,2n)a

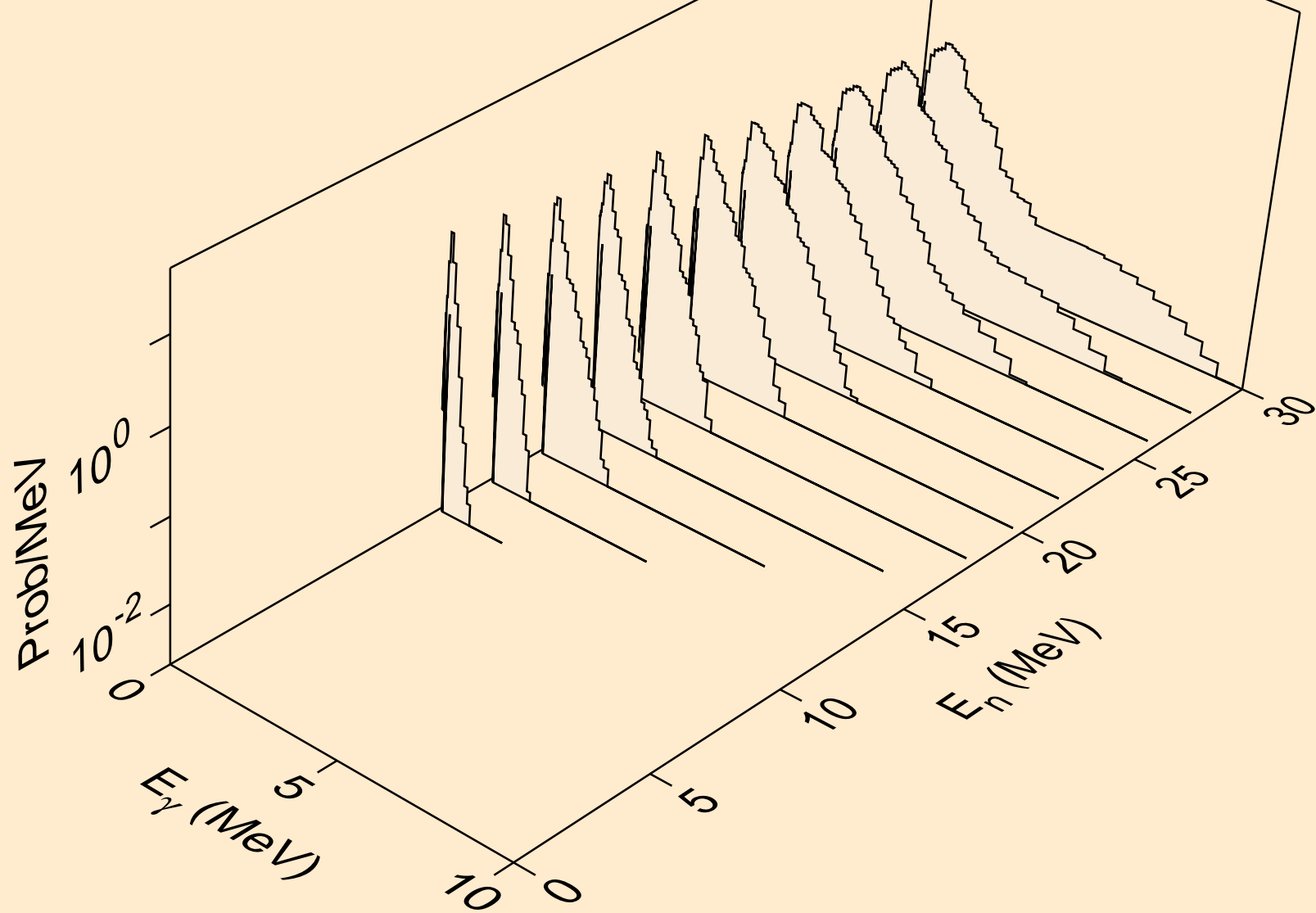

AC236 NEUTRON ACER TENDL-2021 LIBRARY; T=293.6K
Photon emission for (n,3n)a

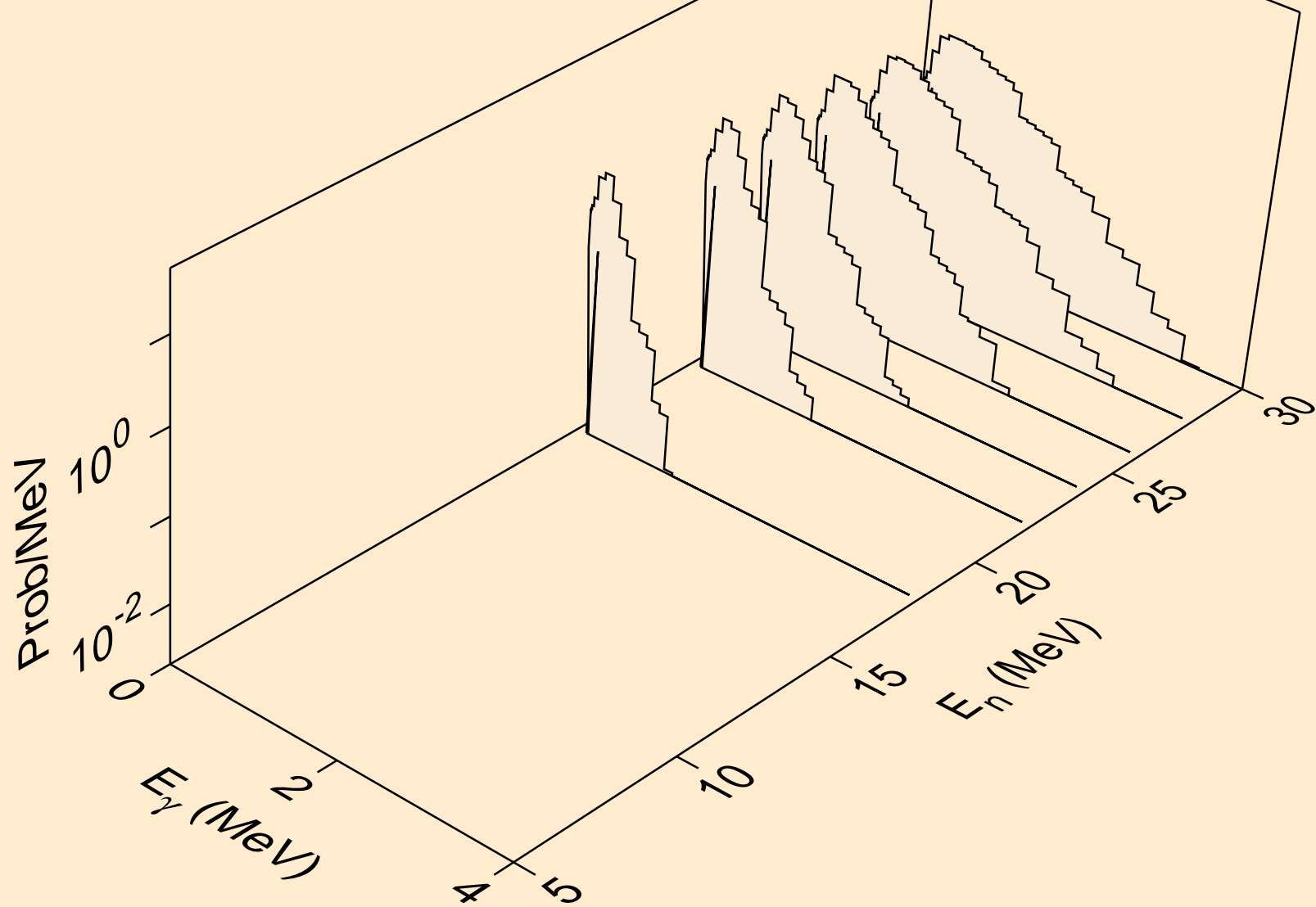

AC236 NEUTRON ACER TENDL-2021 LIBRARY; T=293.6K
Photon emission for (n,n*)p

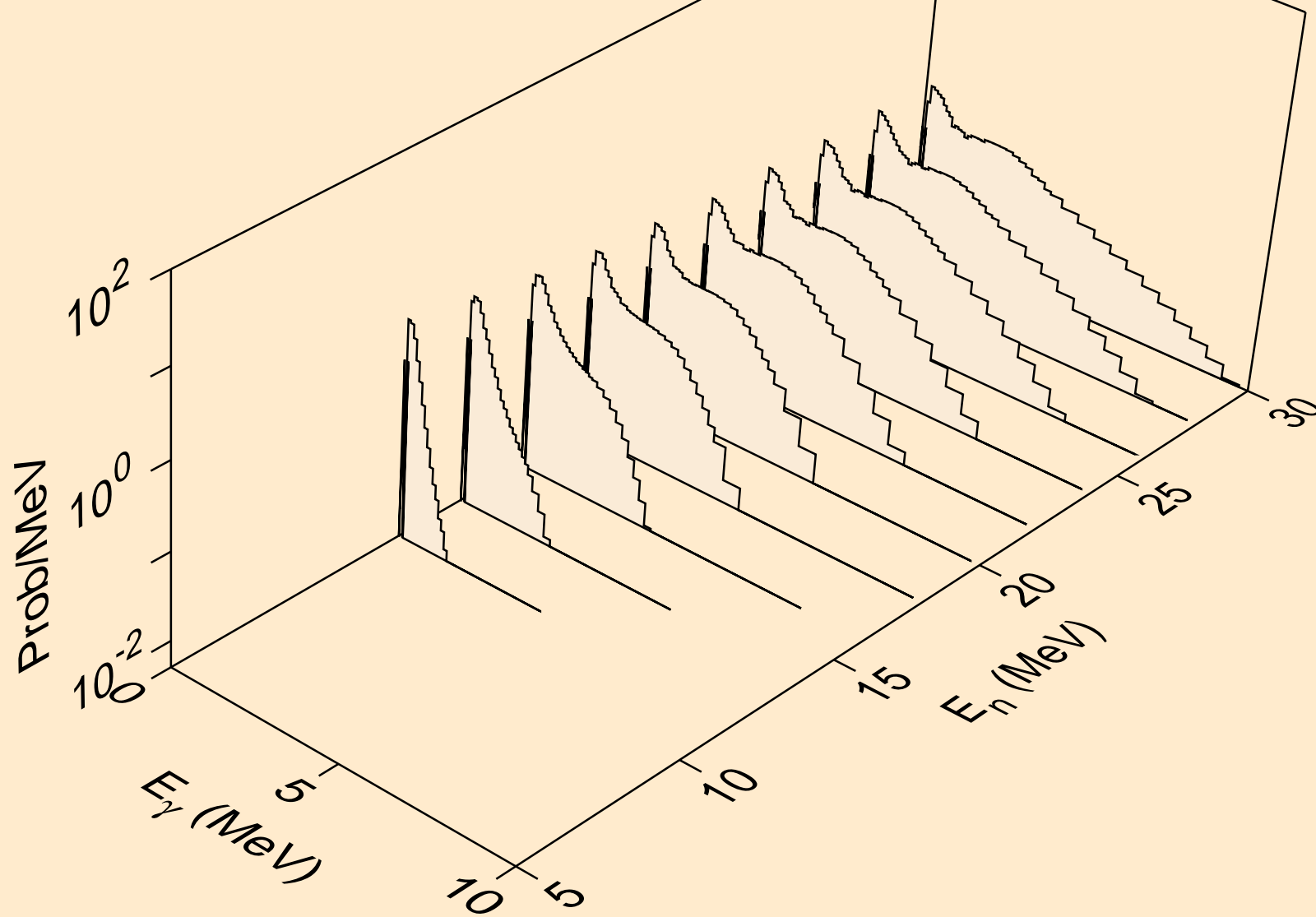

AC236 NEUTRON ACER TENDL-2021 LIBRARY; T=293.6K
Photon emission for (n,n*)2a

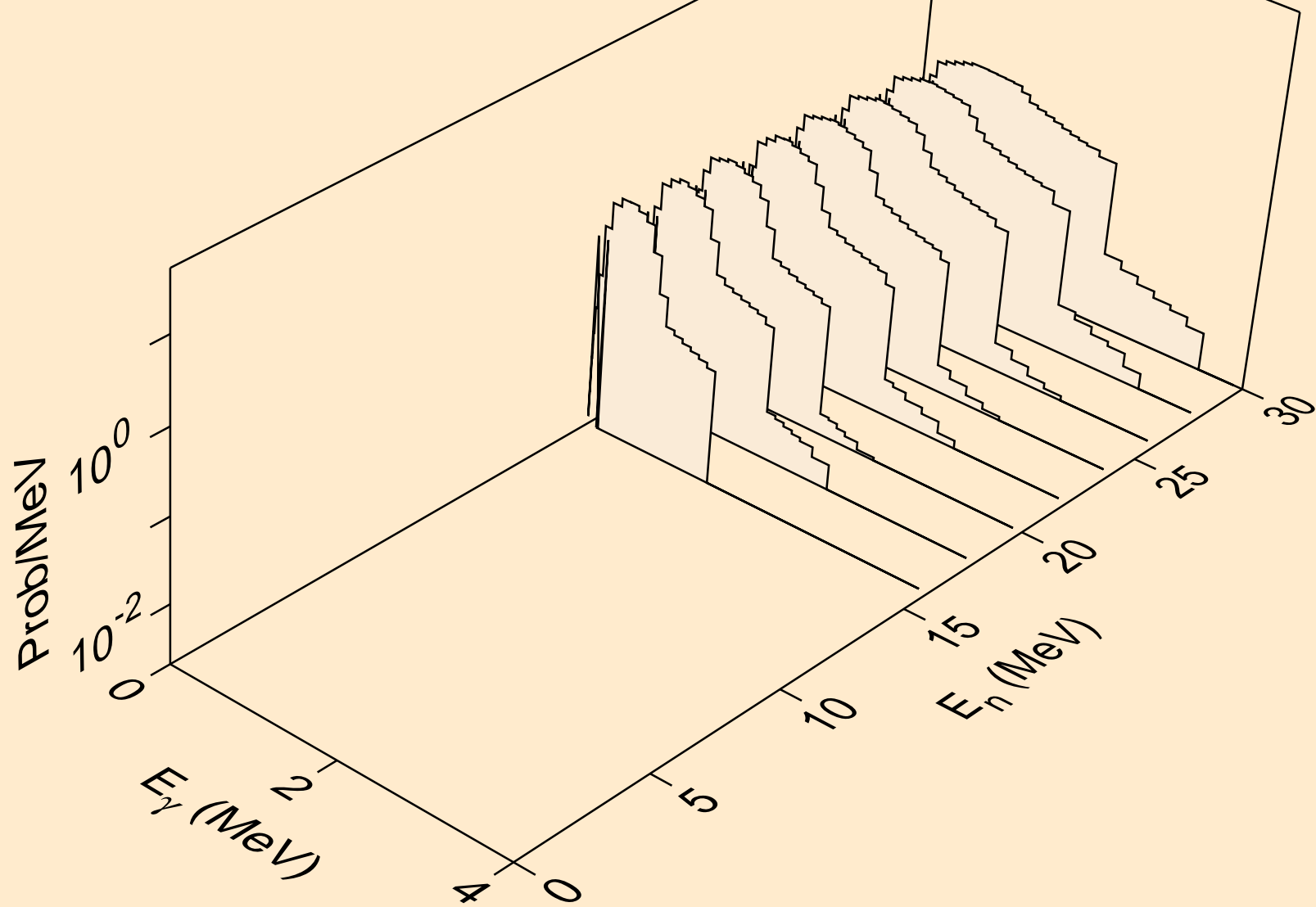

AC236 NEUTRON ACER TENDL-2021 LIBRARY; T=293.6K
Photon emission for (n,2n)2a

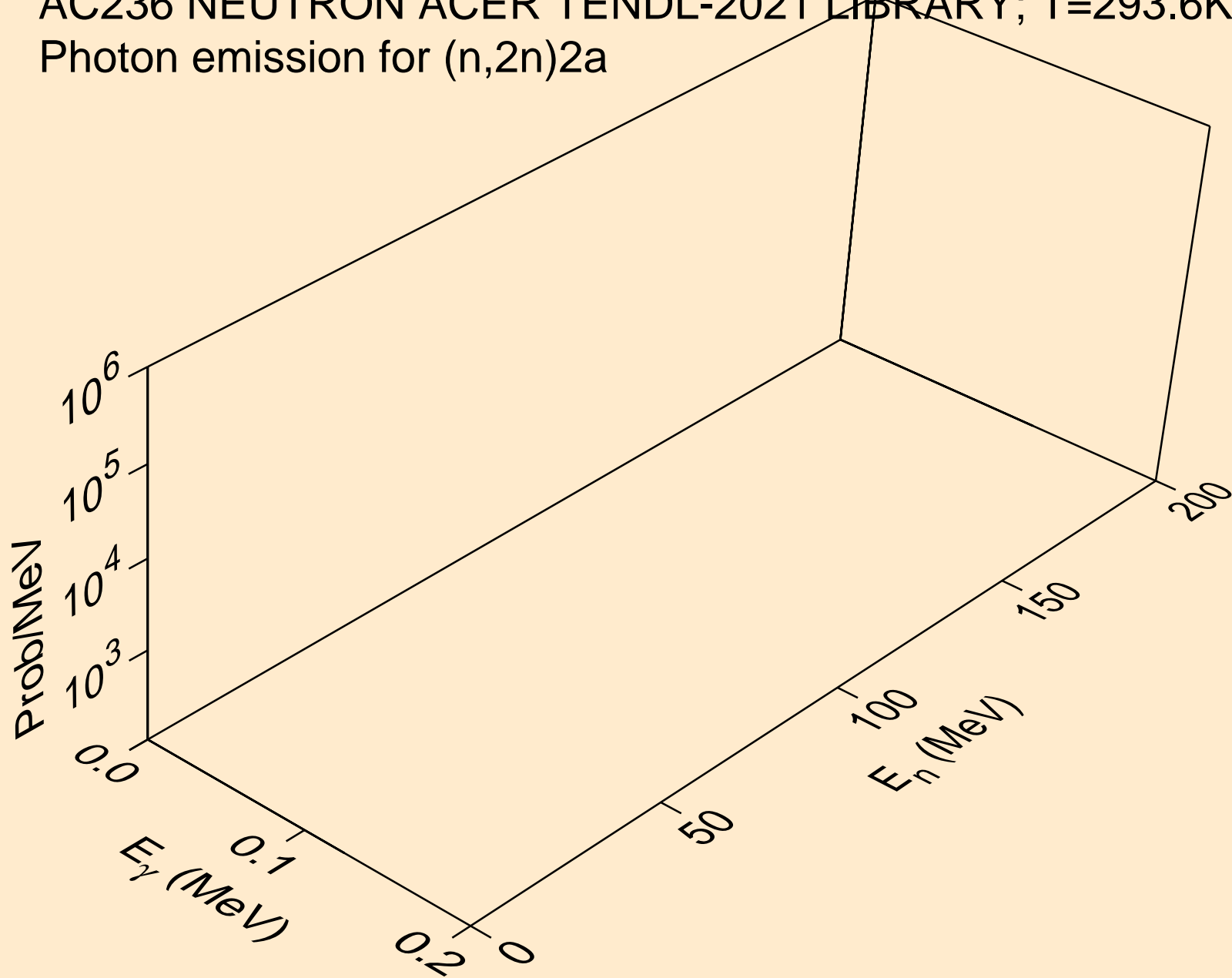

AC236 NEUTRON ACER TENDL-2021 LIBRARY; T=293.6K
Photon emission for (n,n*)d

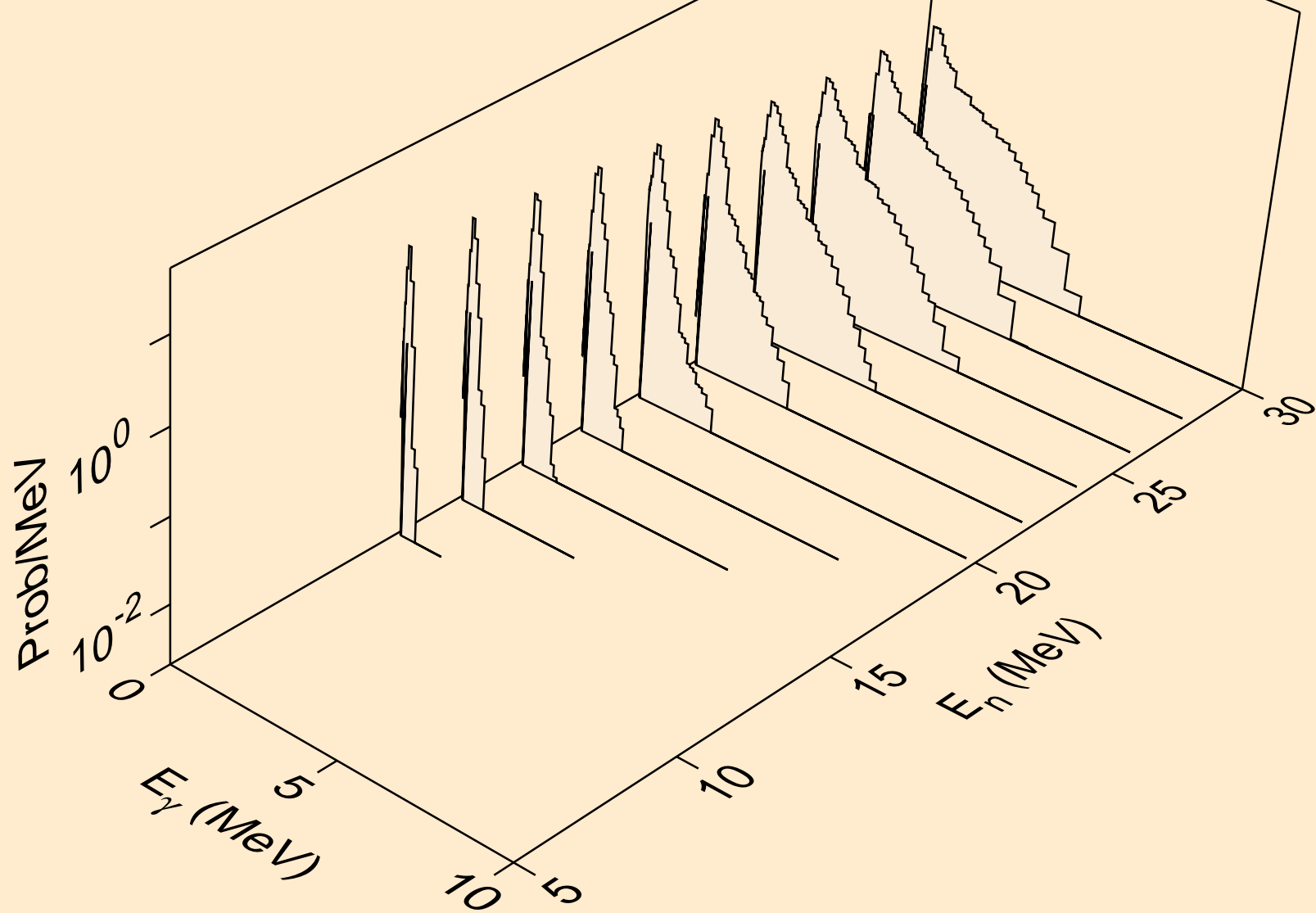

AC236 NEUTRON ACER TENDL-2021 LIBRARY; T=293.6K
Photon emission for (n,n*)t

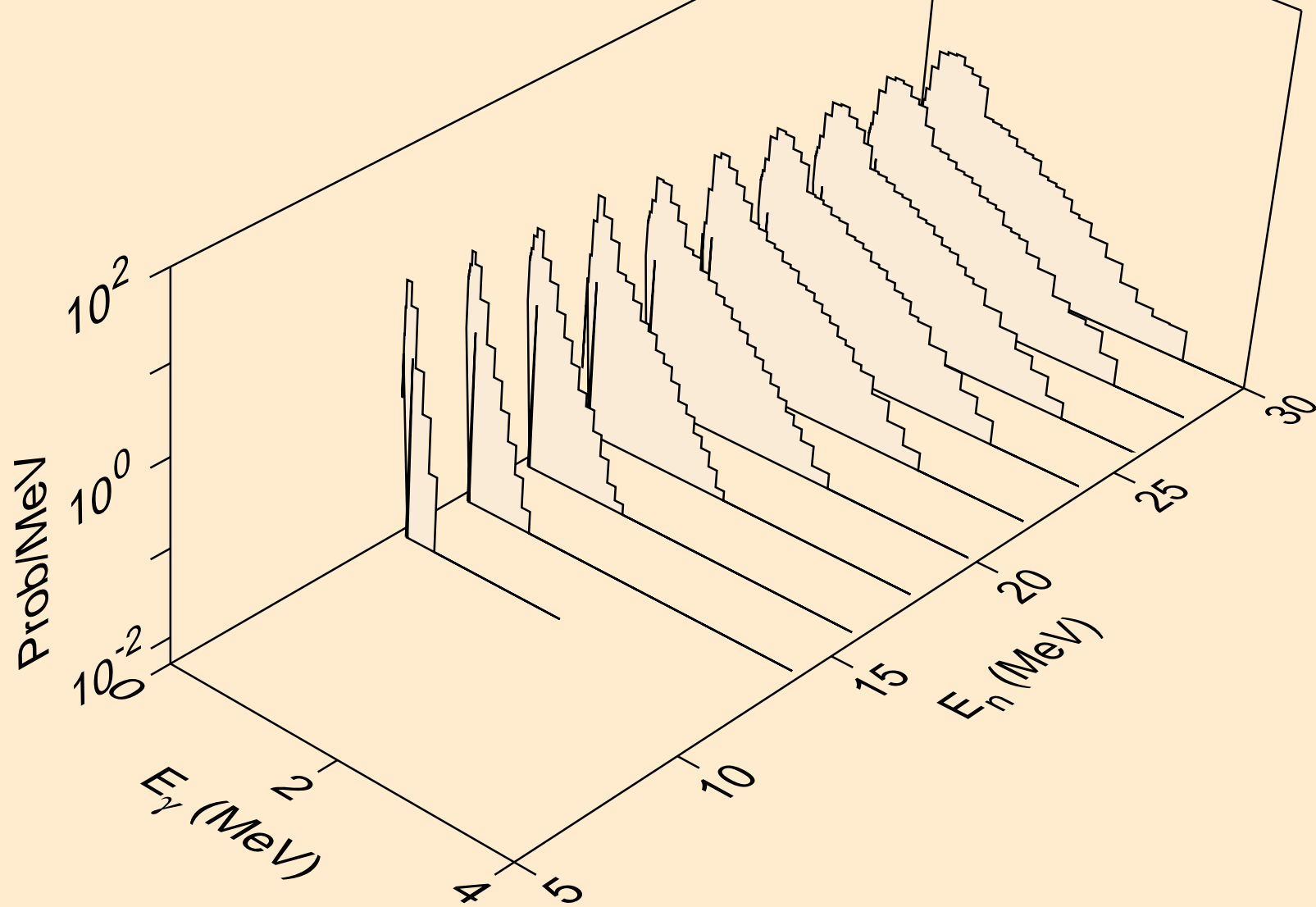

AC236 NEUTRON ACER TENDL-2021 LIBRARY; T=293.6K
Photon emission for (n,n*)he3

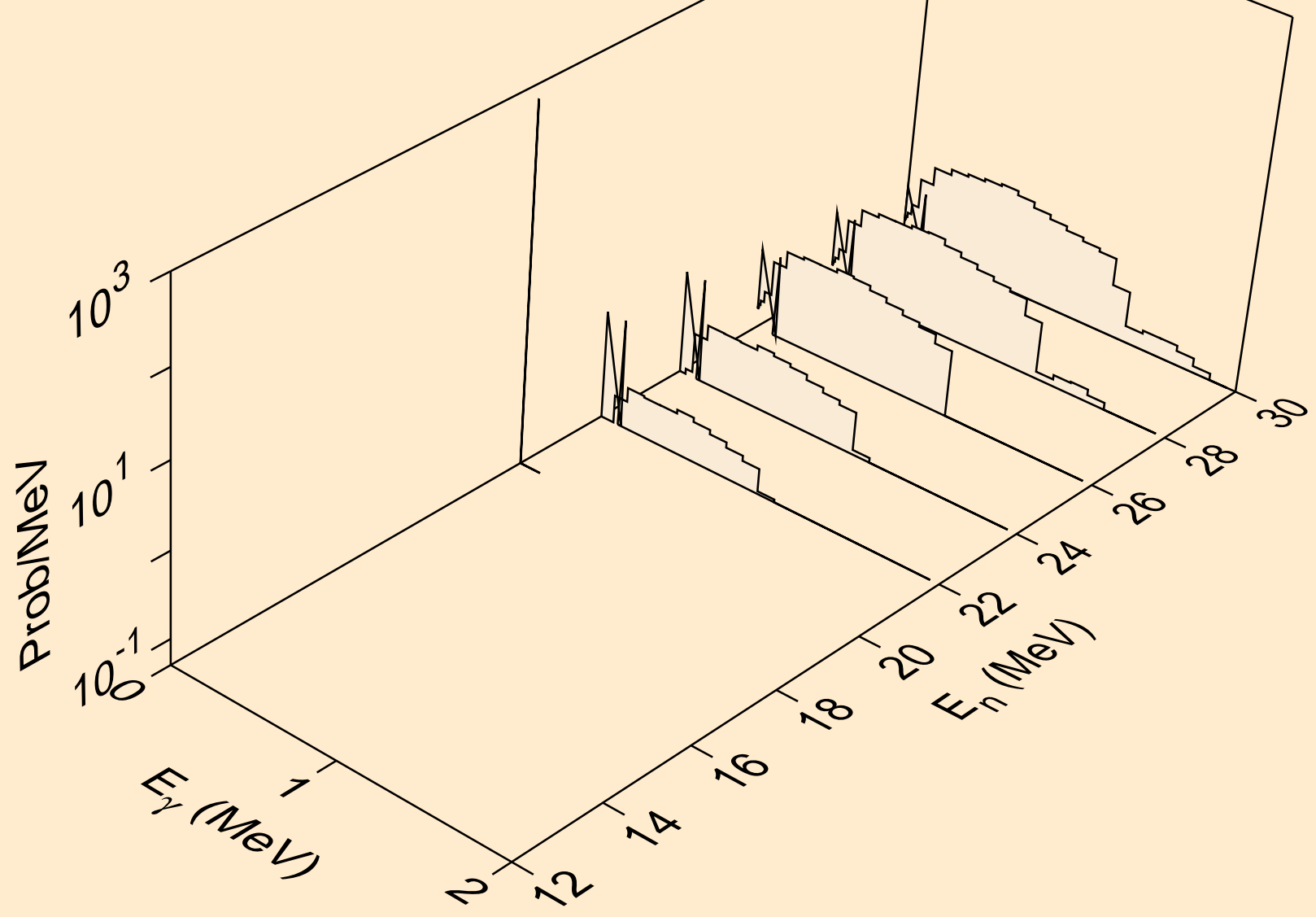

AC236 NEUTRON ACER TENDL-2021 LIBRARY; T=293.6K
Photon emission for (n,4n)

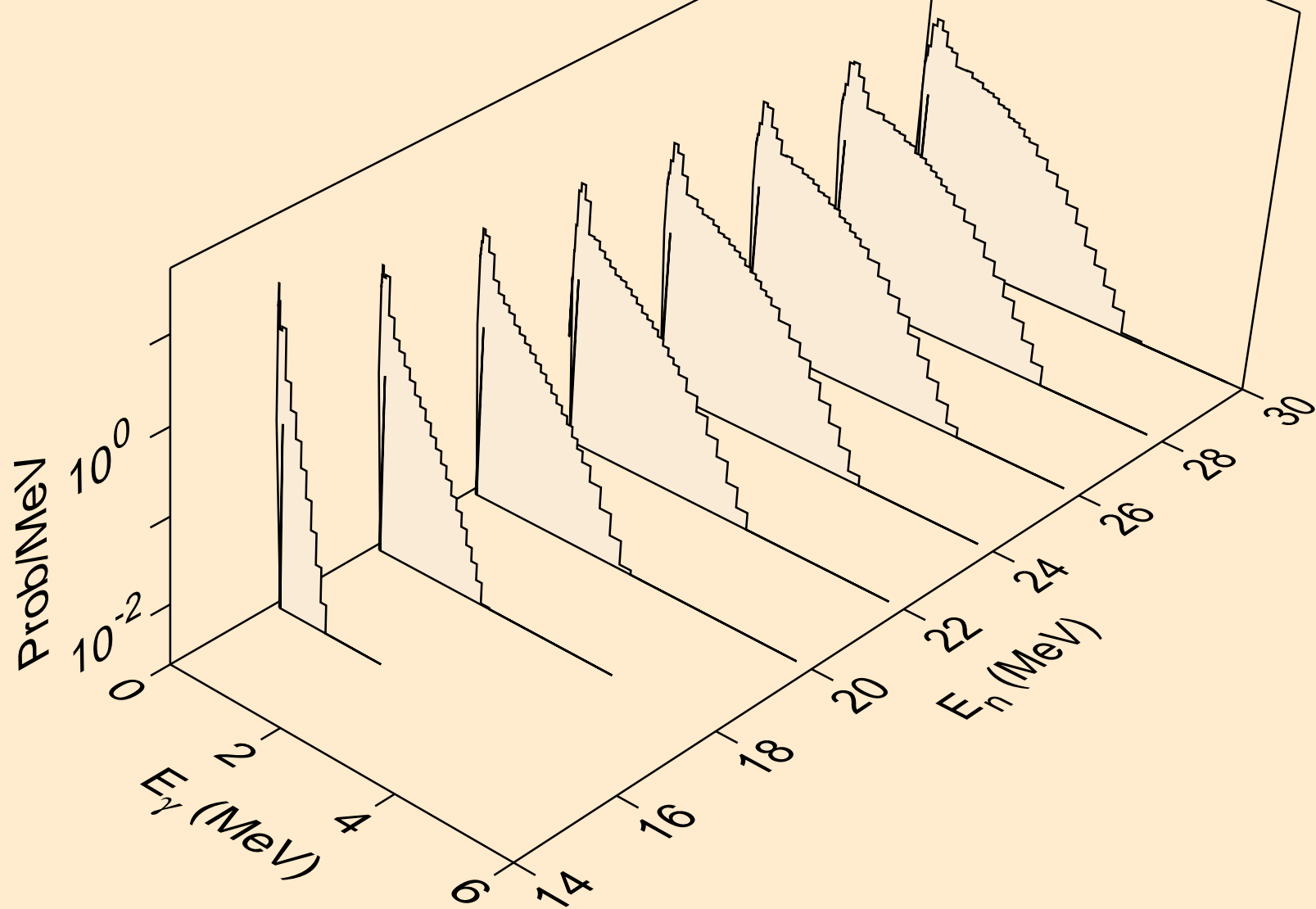

AC236 NEUTRON ACER TENDL-2021 LIBRARY; T=293.6K
Photon emission for (n,2np)

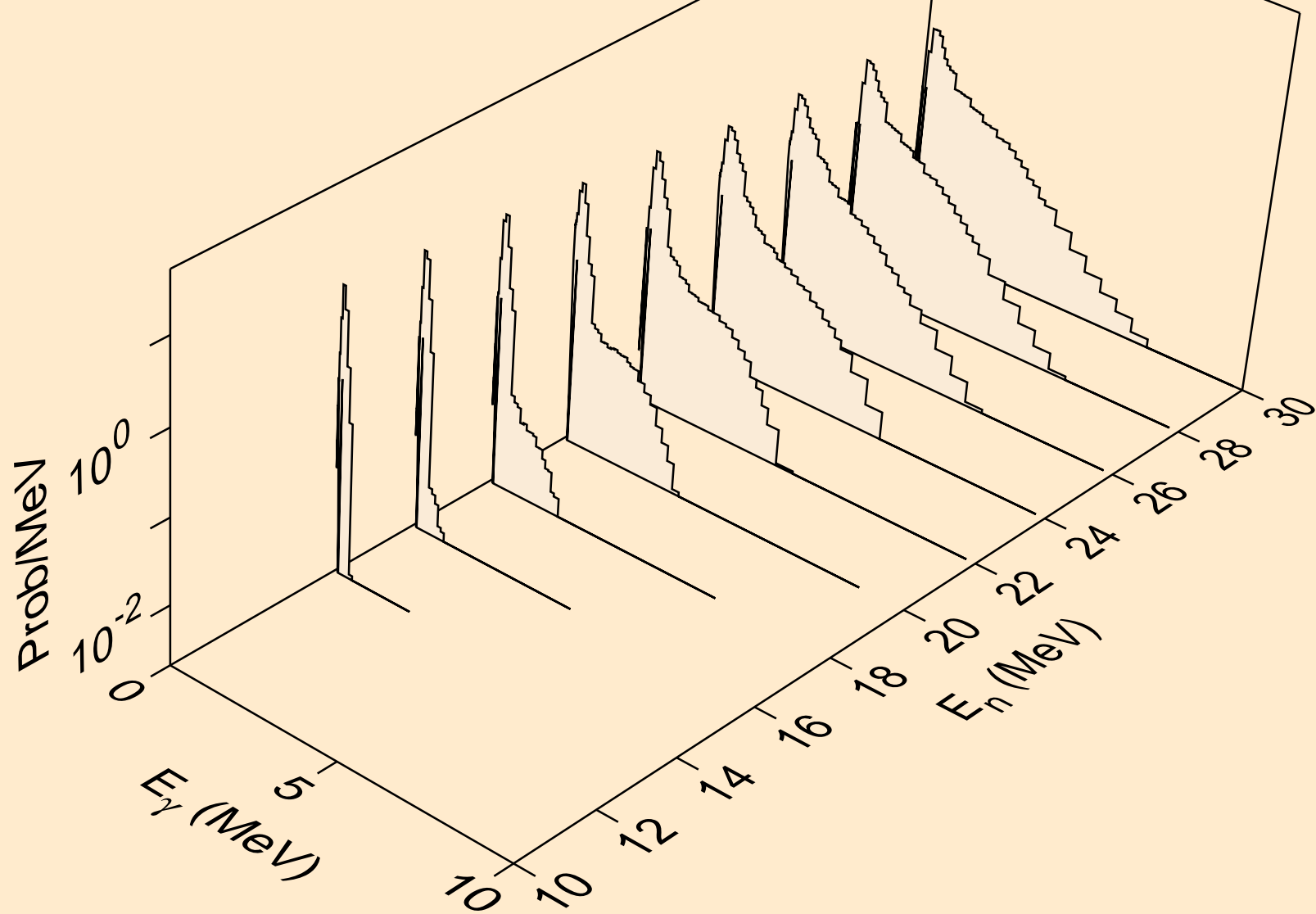

AC236 NEUTRON ACER TENDL-2021 LIBRARY; T=293.6K
Photon emission for (n,3np)

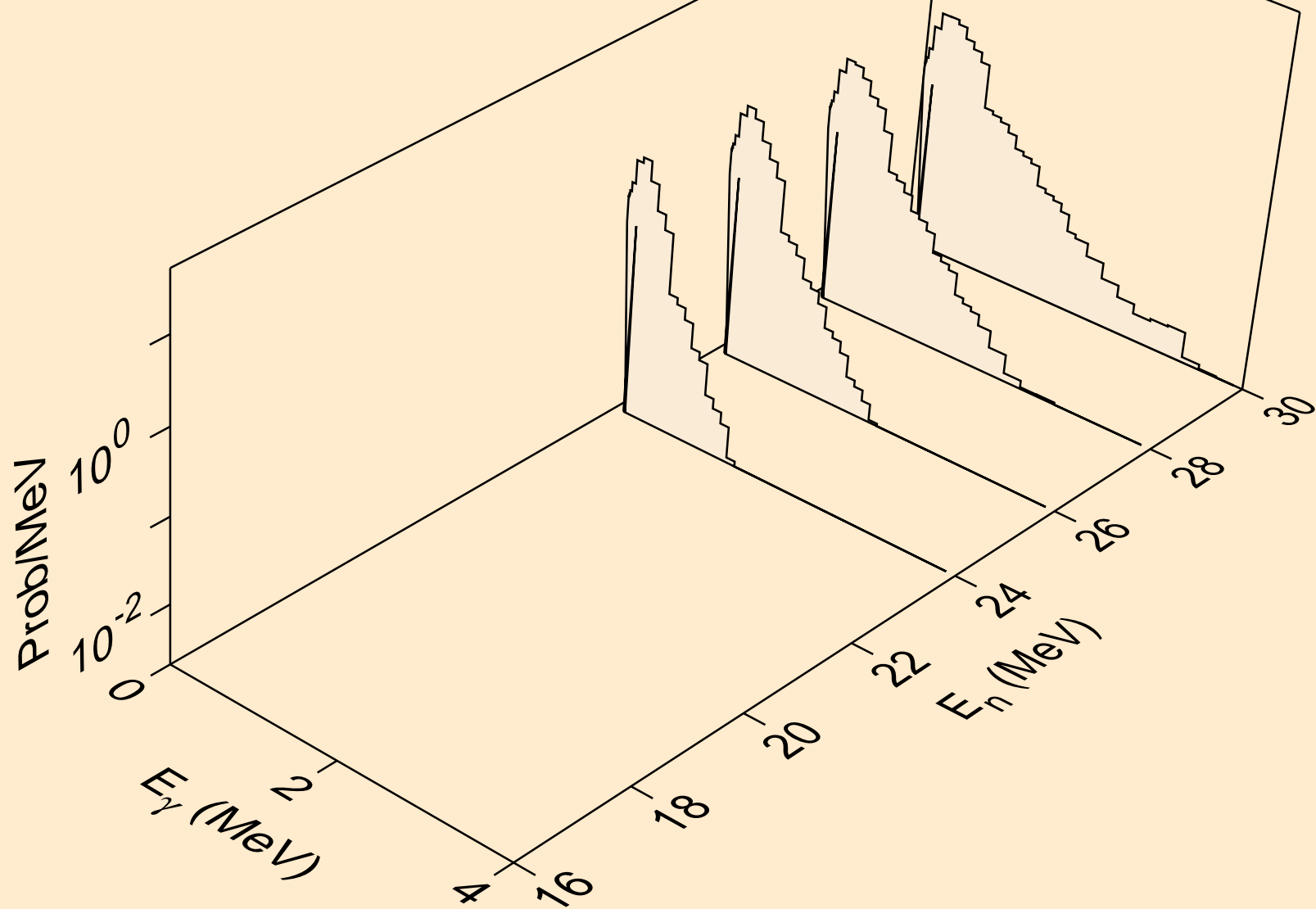

AC236 NEUTRON ACER TENDL-2021 LIBRARY; T=293.6K
Photon emission for (n,2np)

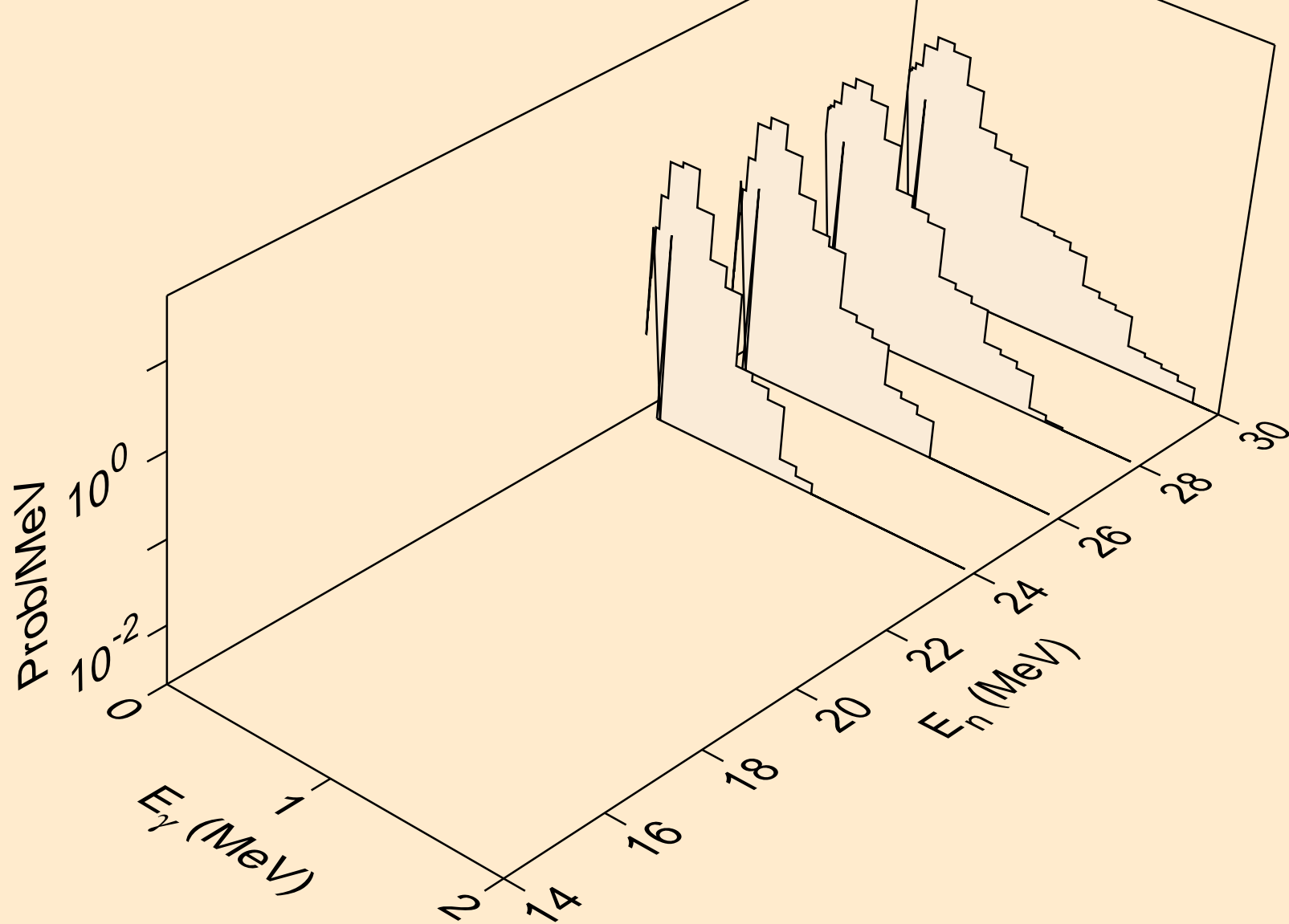

AC236 NEUTRON ACER TENDL-2021 LIBRARY; T=293.6K
Photon emission for (n,npa)

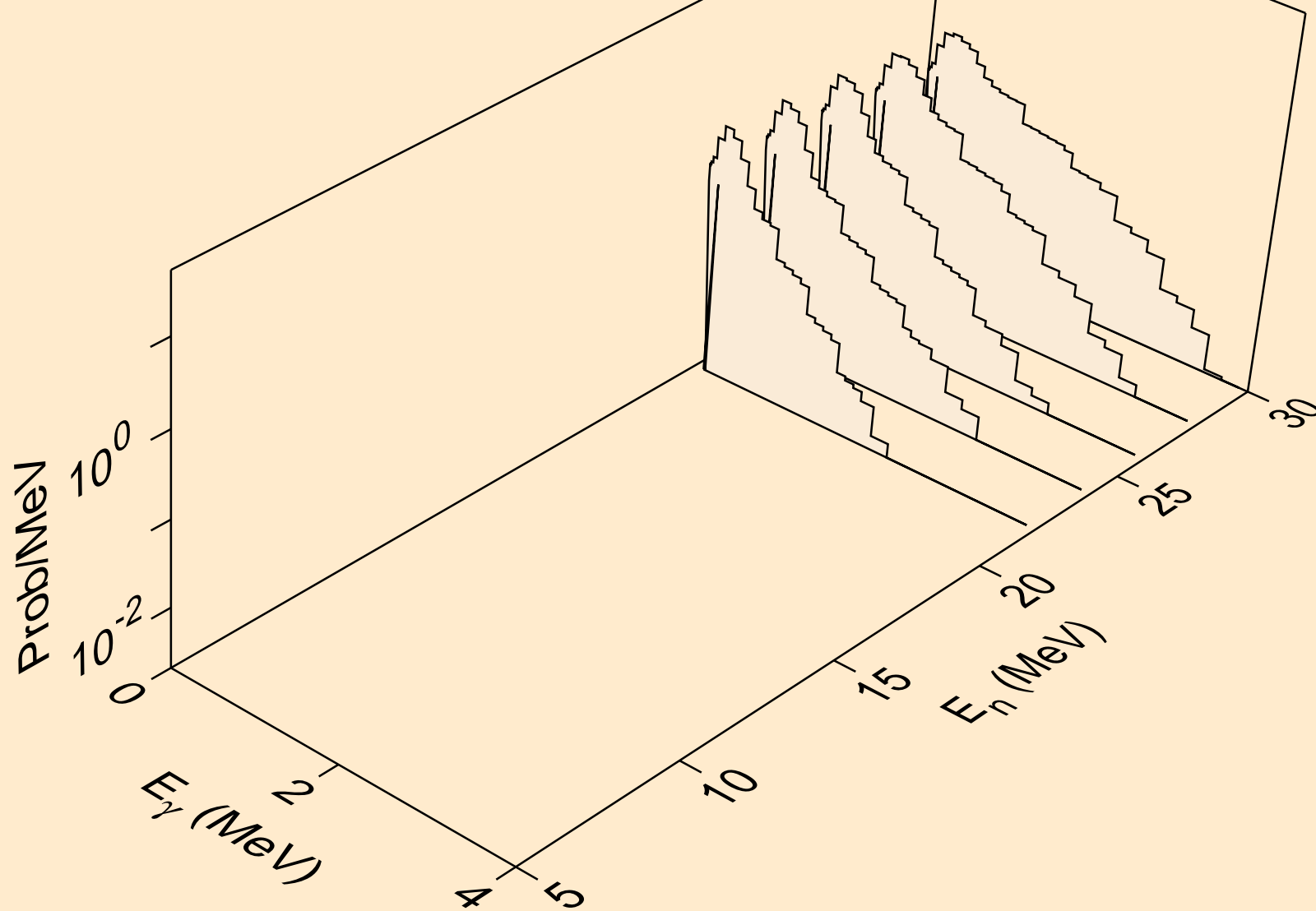

AC236 NEUTRON ACER TENDL-2021 LIBRARY; T=293.6K
Photon emission for (n,n*c)

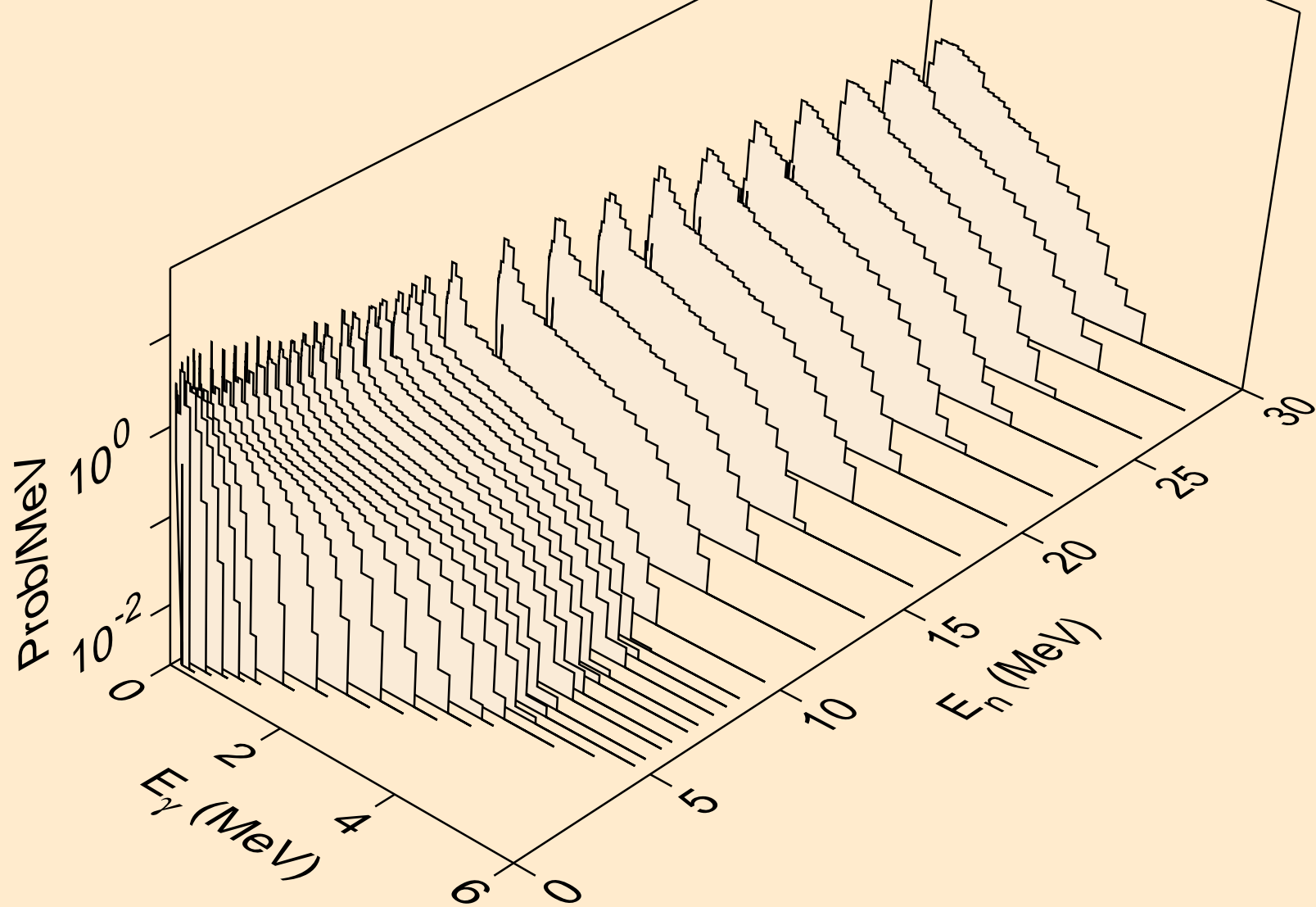

AC236 NEUTRON ACER TENDL-2021 LIBRARY; T=293.6K
Photon emission for (n,gma)

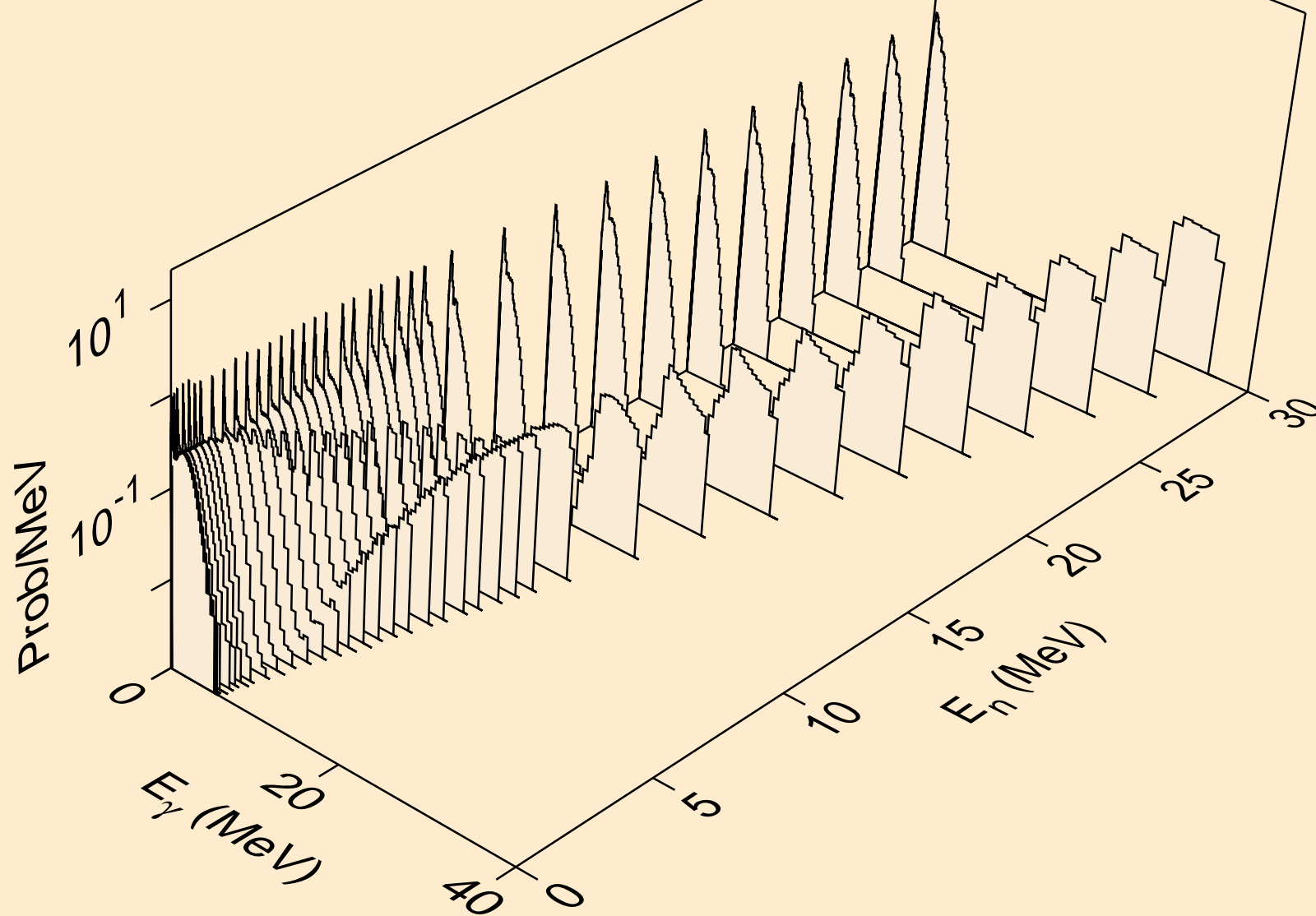

AC236 NEUTRON ACER TENDL-2021 LIBRARY; T=293.6K
Photon emission for (n,p)

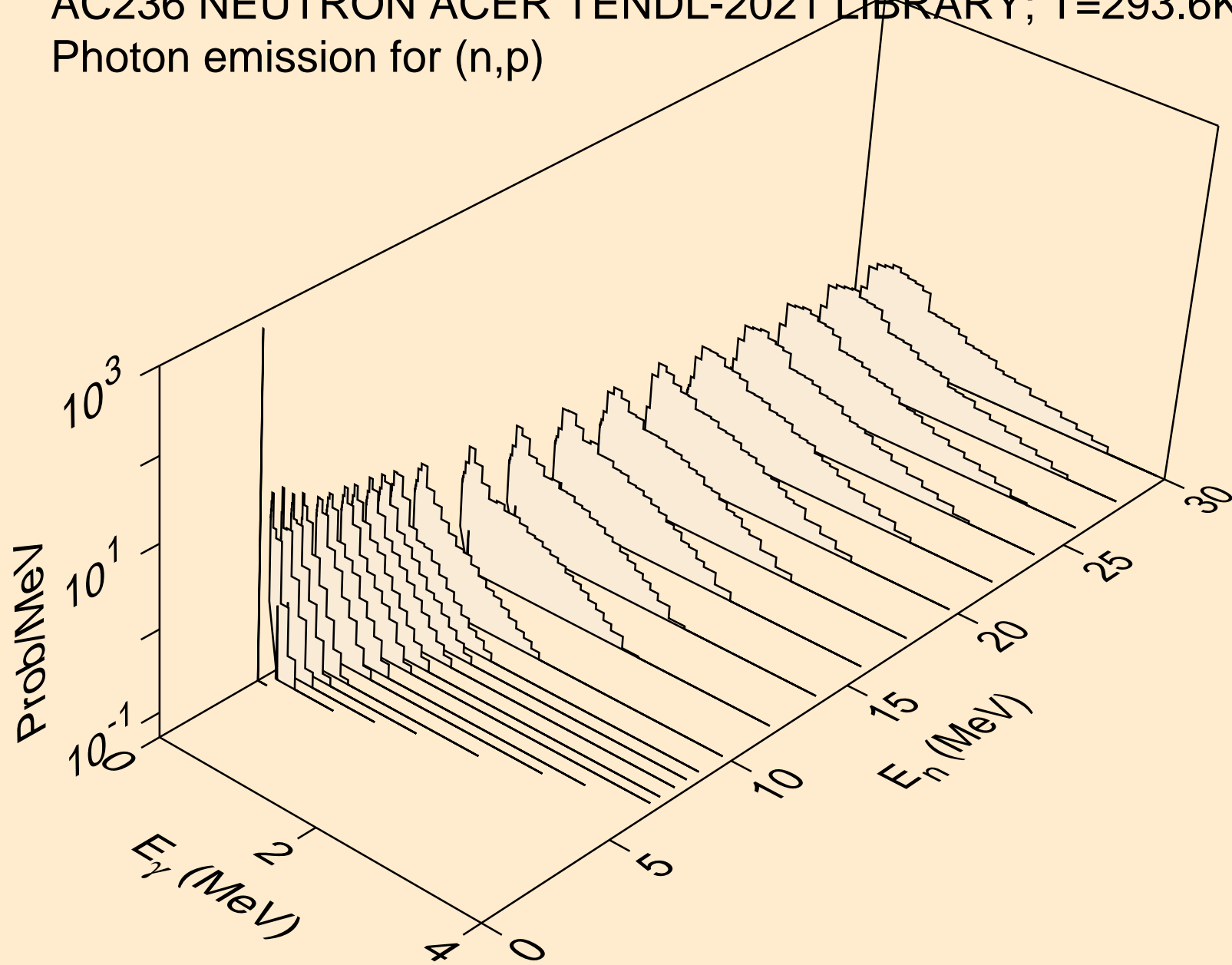

AC236 NEUTRON ACER TENDL-2021 LIBRARY; T=293.6K
Photon emission for (n,d)

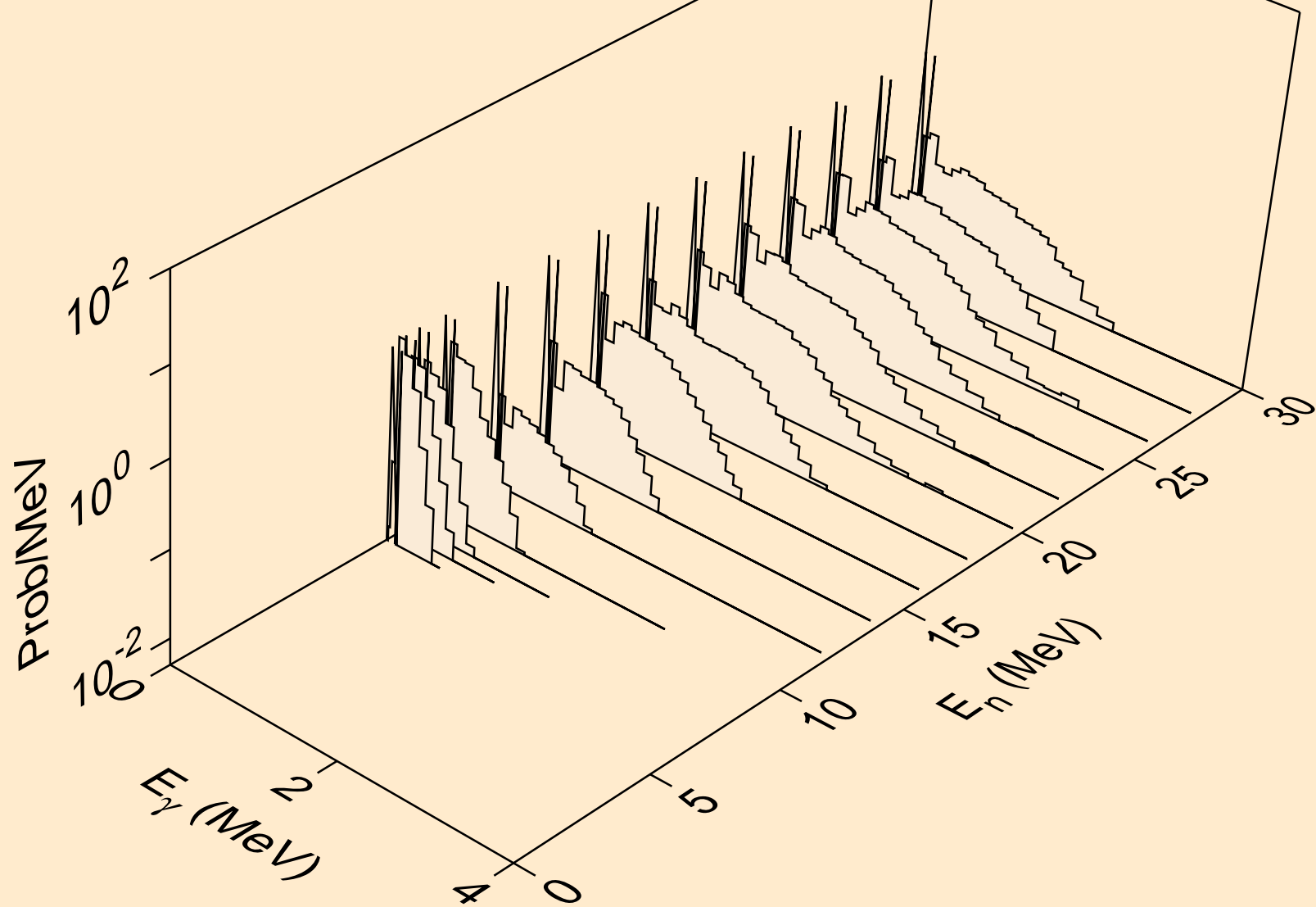

AC236 NEUTRON ACER TENDL-2021 LIBRARY; T=293.6K
Photon emission for (n,t)

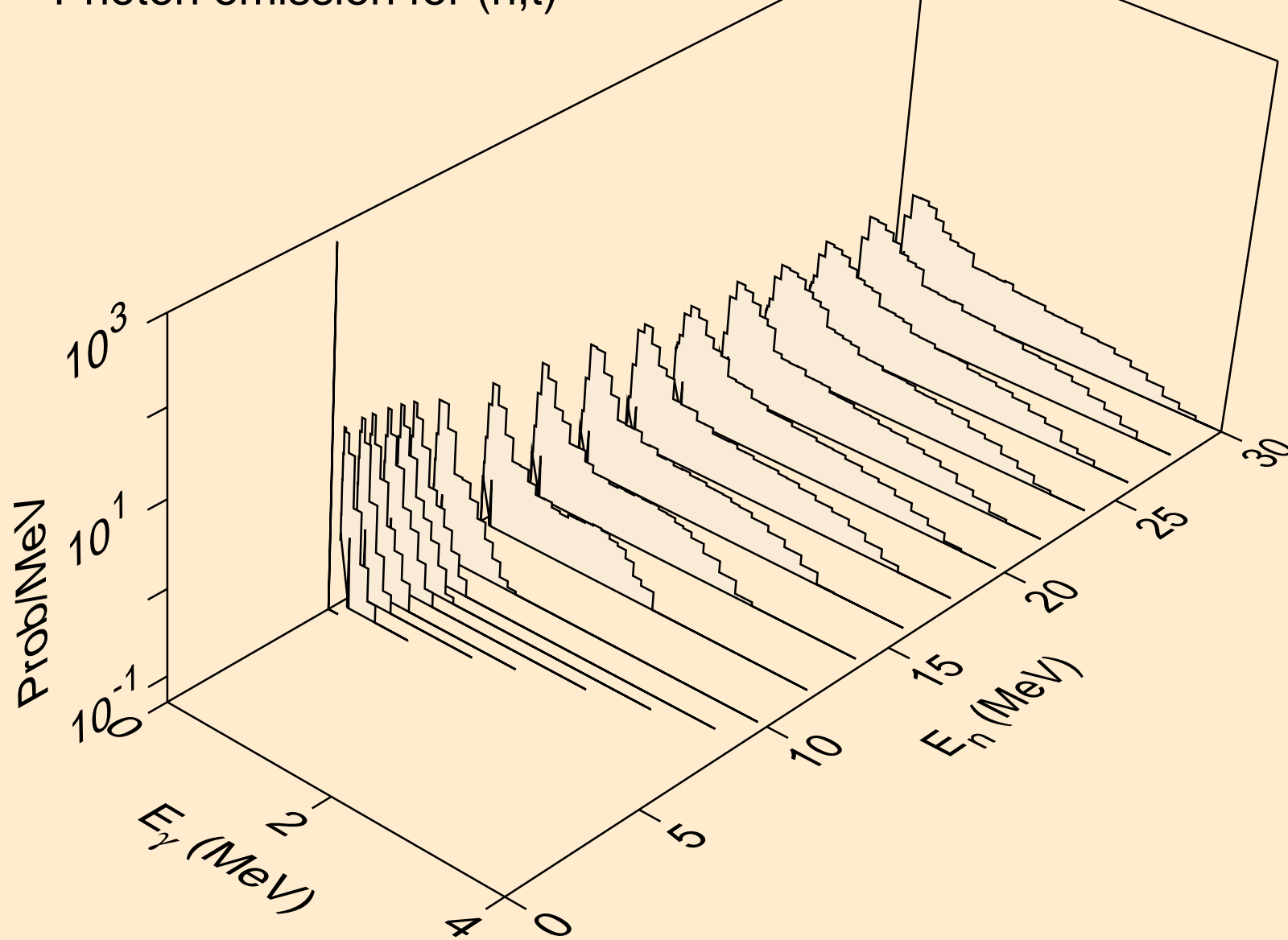

AC236 NEUTRON ACER TENDL-2021 LIBRARY; T=293.6K
Photon emission for (n,he3)

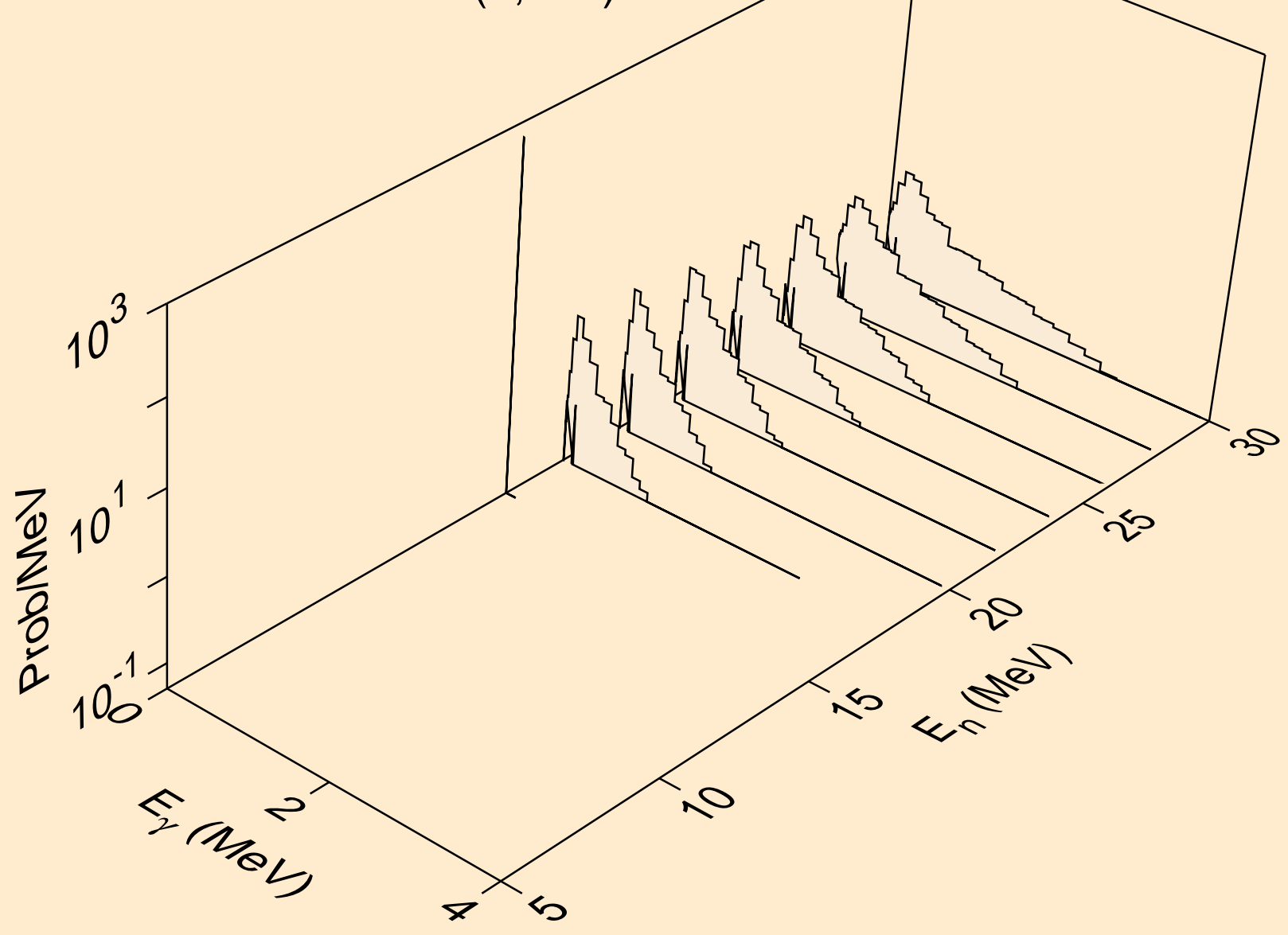

AC236 NEUTRON ACER TENDL-2021 LIBRARY; T=293.6K
Photon emission for (n,a)

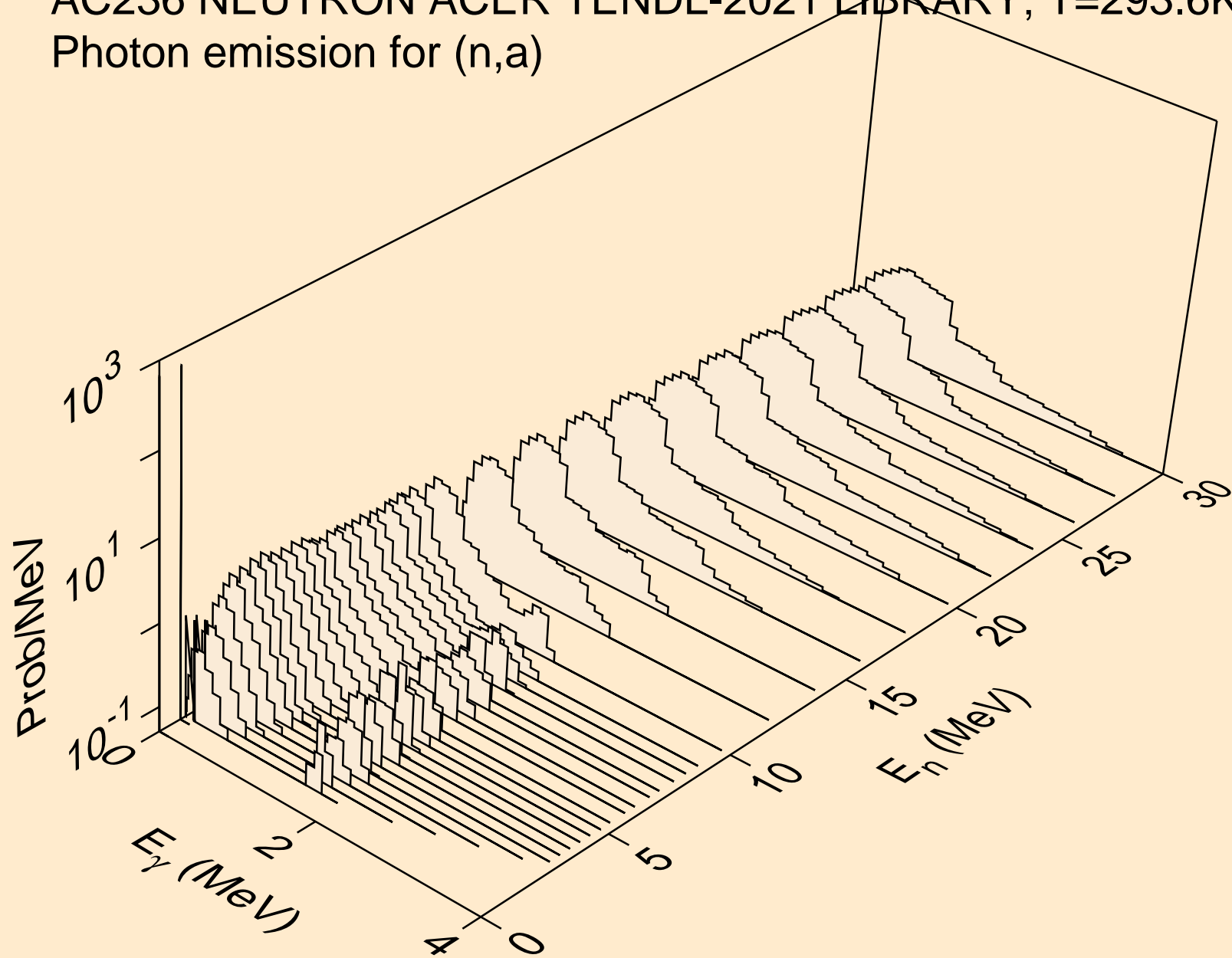

AC236 NEUTRON ACER TENDL-2021 LIBRARY; T=293.6K
Photon emission for (n,2a)

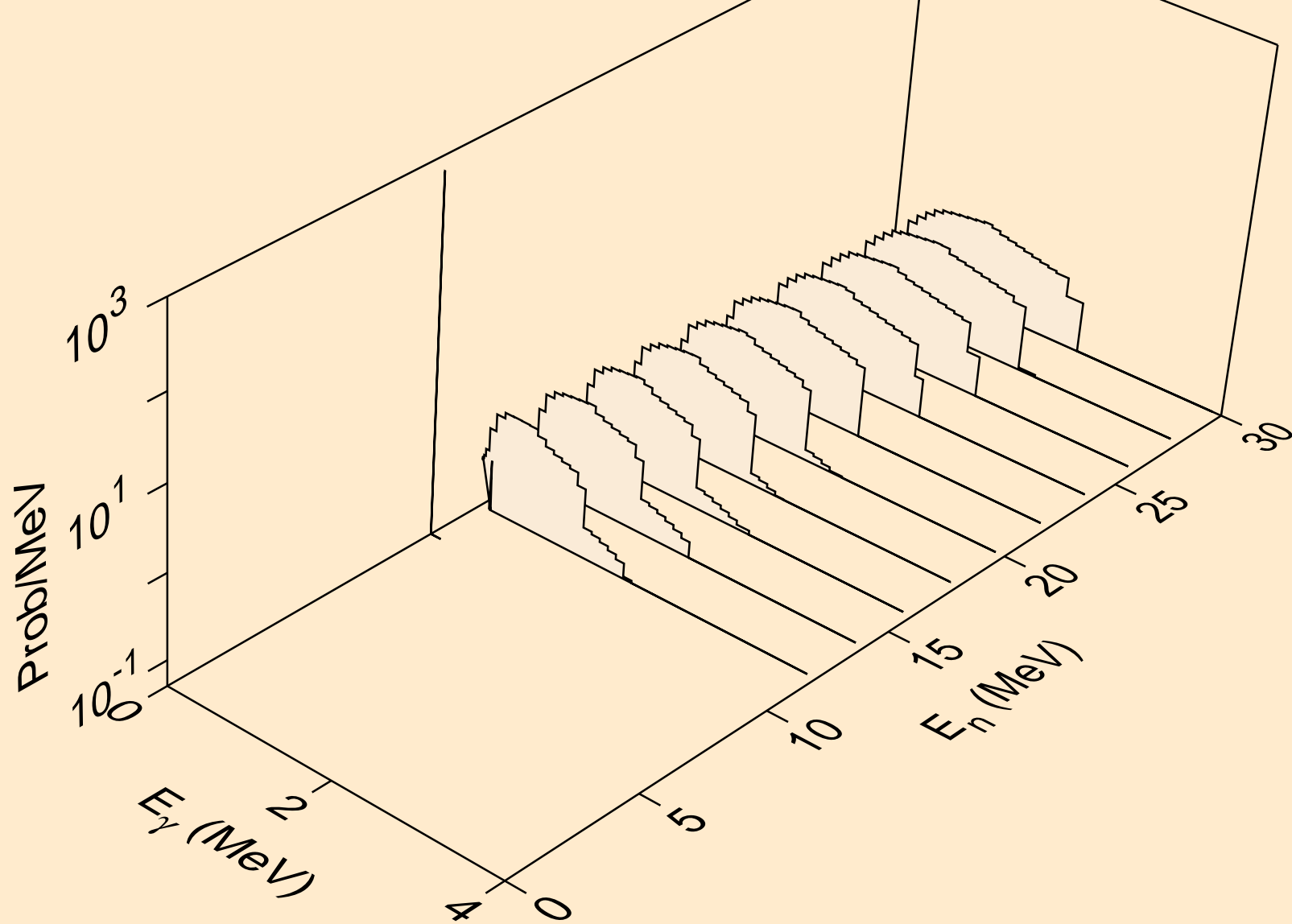

AC236 NEUTRON ACER TENDL-2021 LIBRARY; T=293.6K
Photon emission for (n,2p)

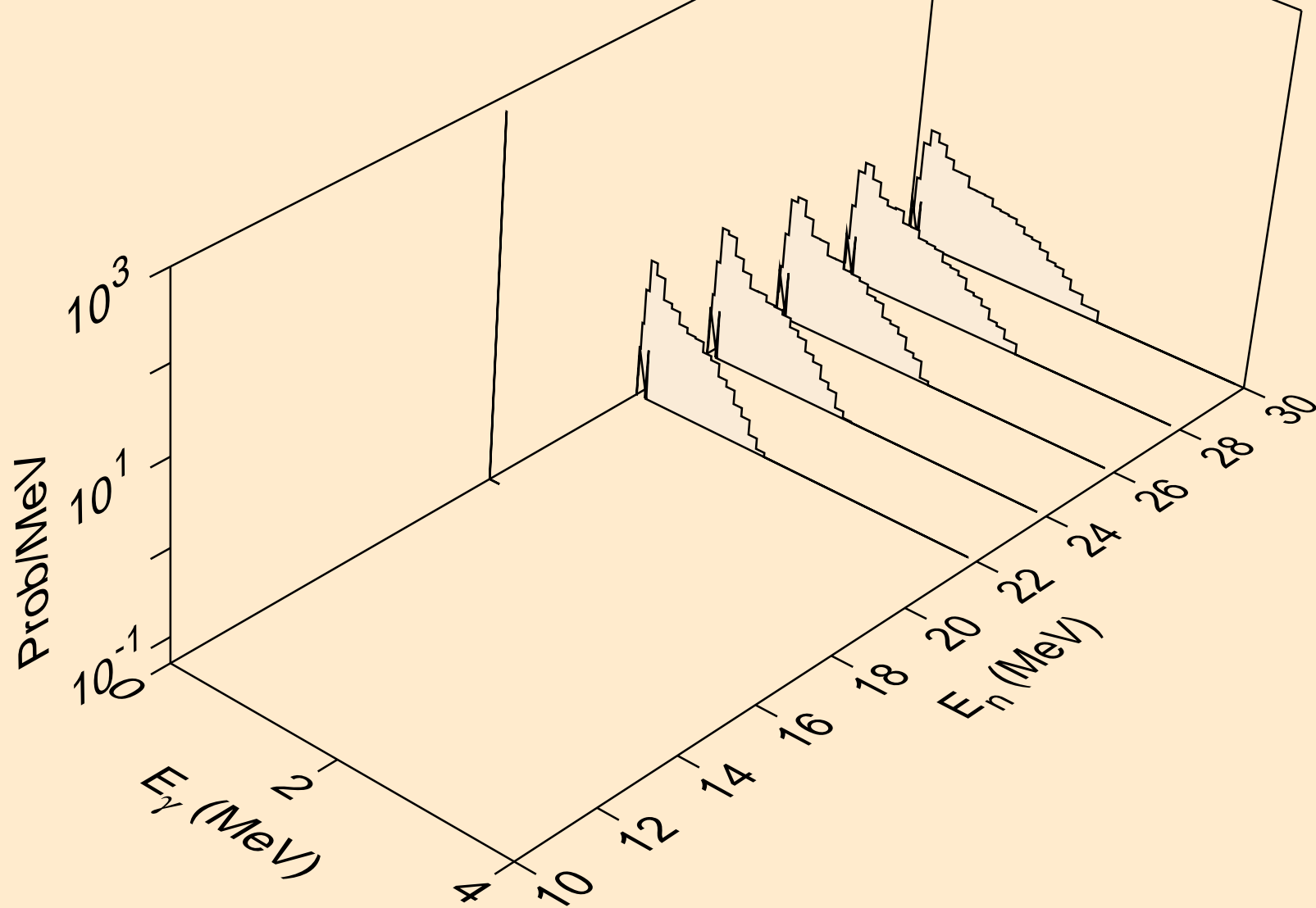

AC236 NEUTRON ACER TENDL-2021 LIBRARY; T=293.6K
Photon emission for (n,p α)

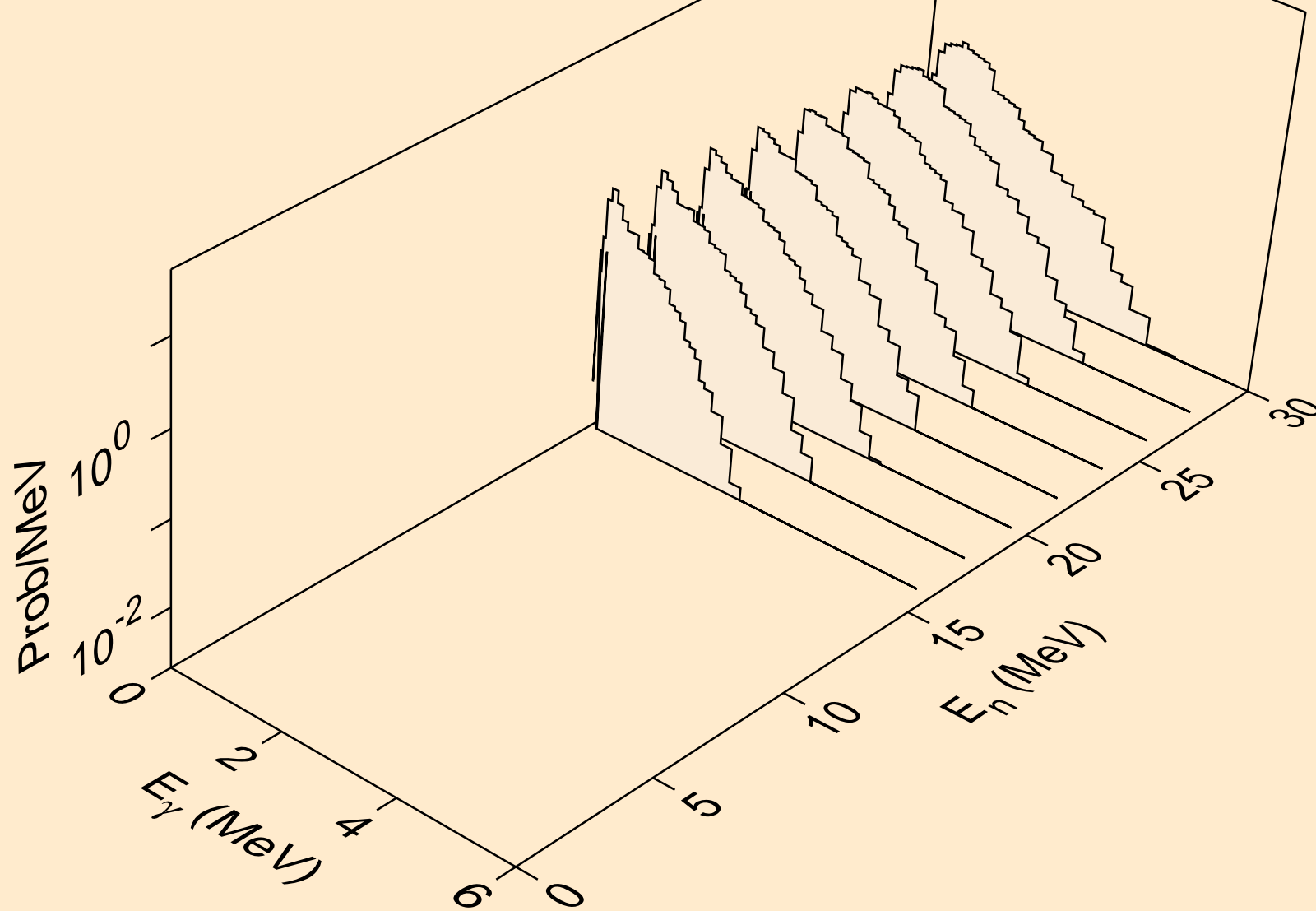

AC236 NEUTRON ACER TENDL-2021 LIBRARY; T=293.6K
Photon emission for (n,pt)

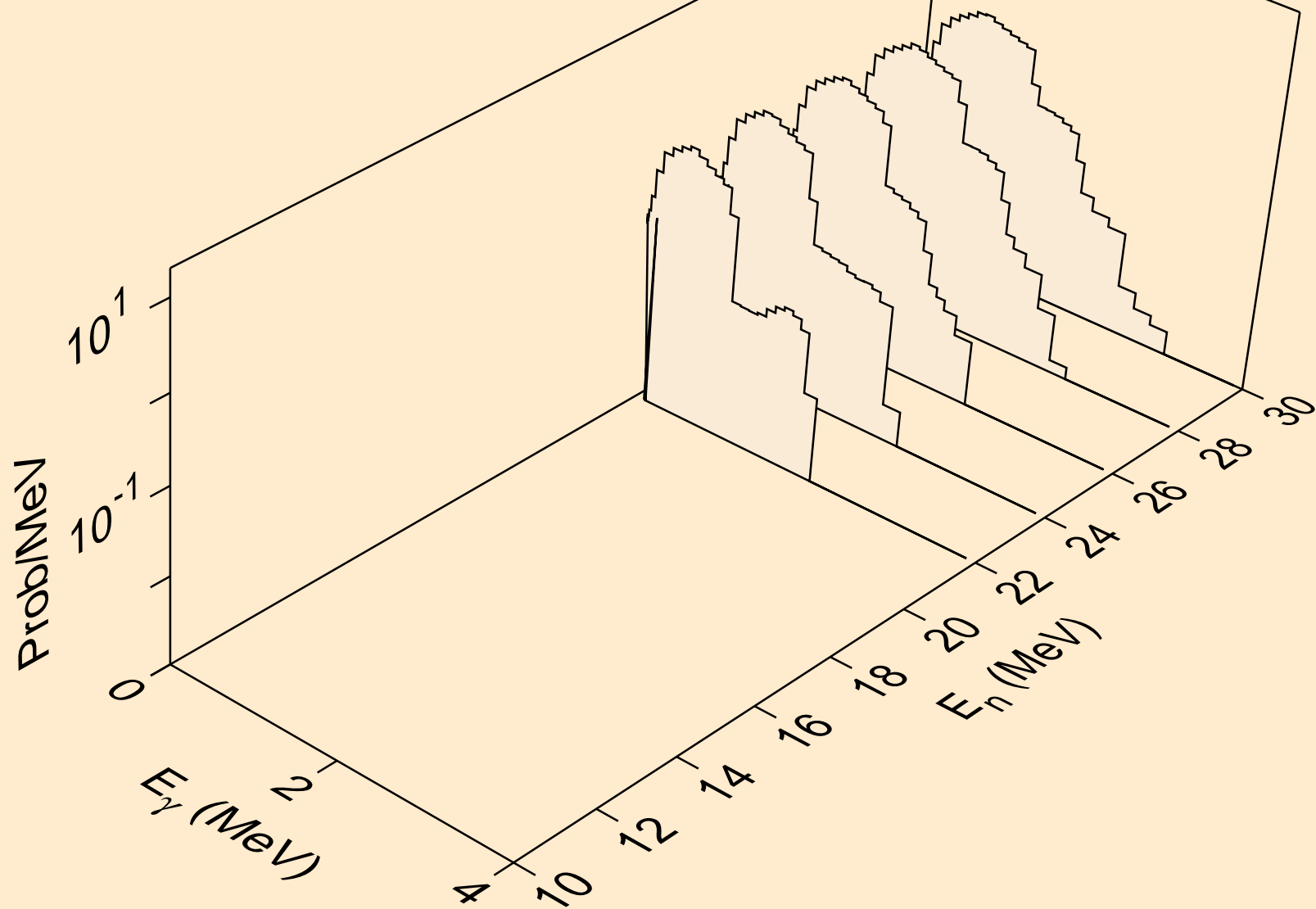

AC236 NEUTRON ACER TENDL-2021 LIBRARY; T=293.6K
thermal capture photon spectrum

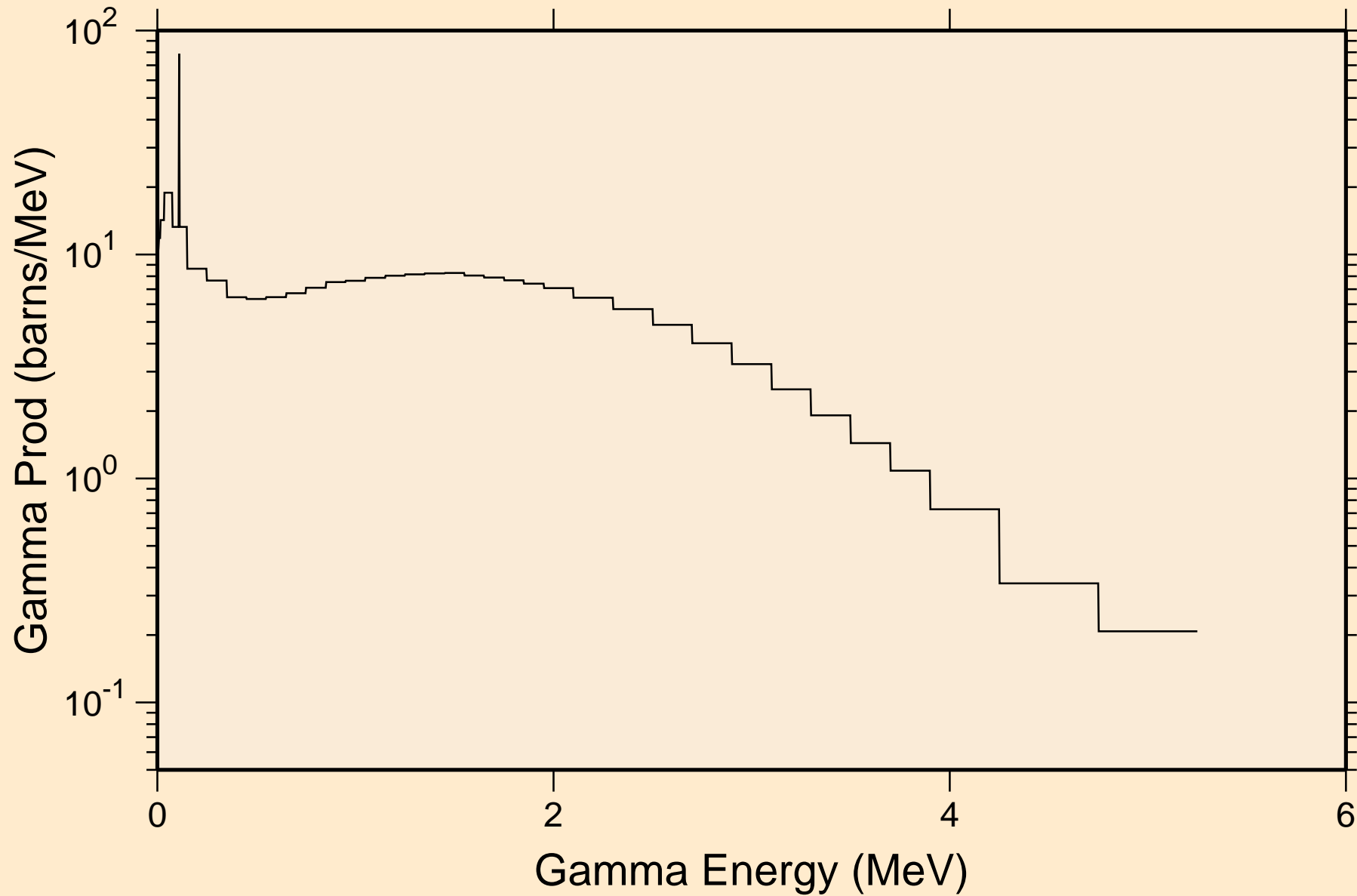

AC236 NEUTRON ACER TENDL-2021 LIBRARY; T=293.6K
14 MeV photon spectrum

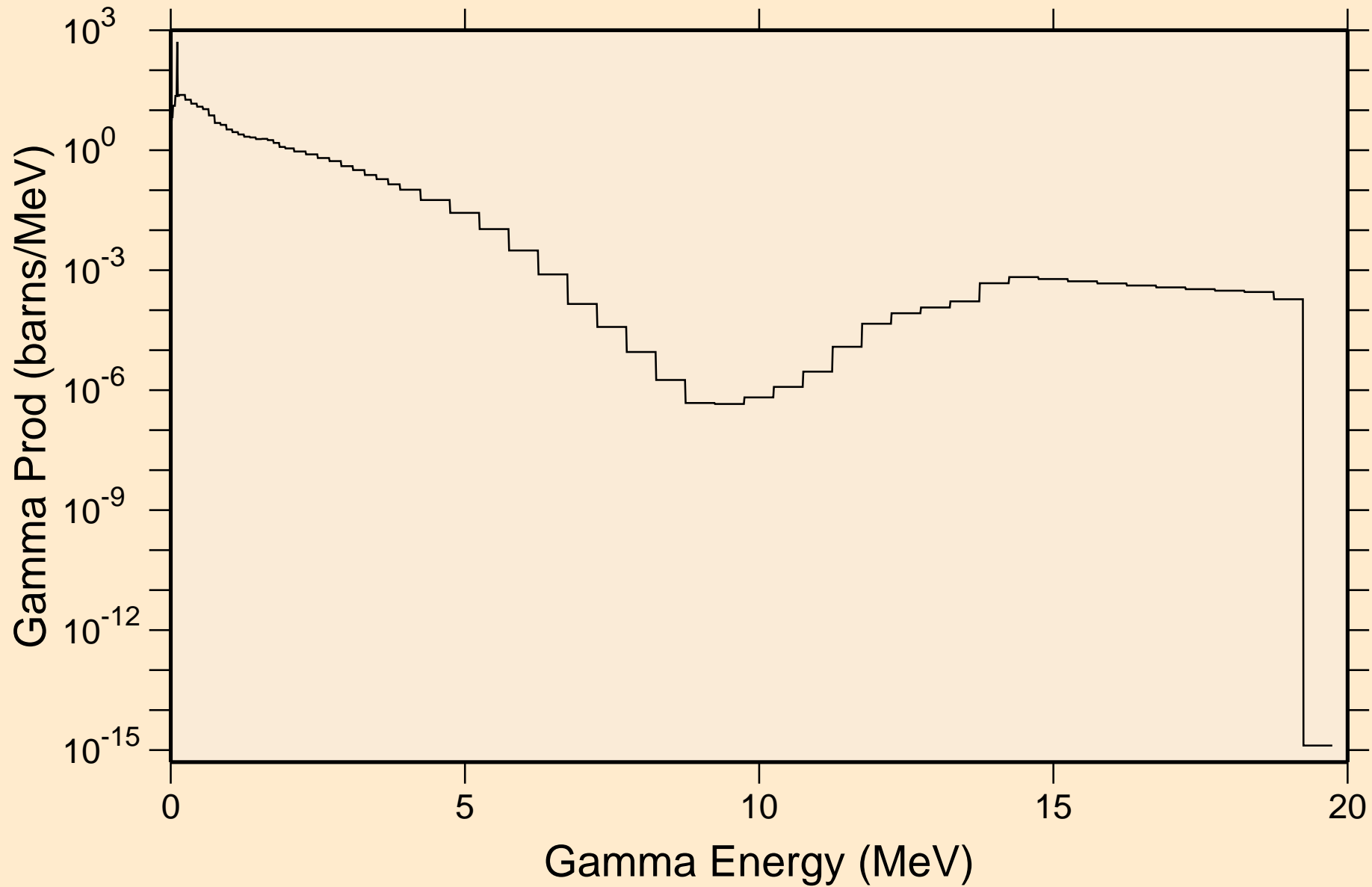

AC236 NEUTRON ACER TENDL-2021 LIBRARY; T=293.6K

Particle heating contributions

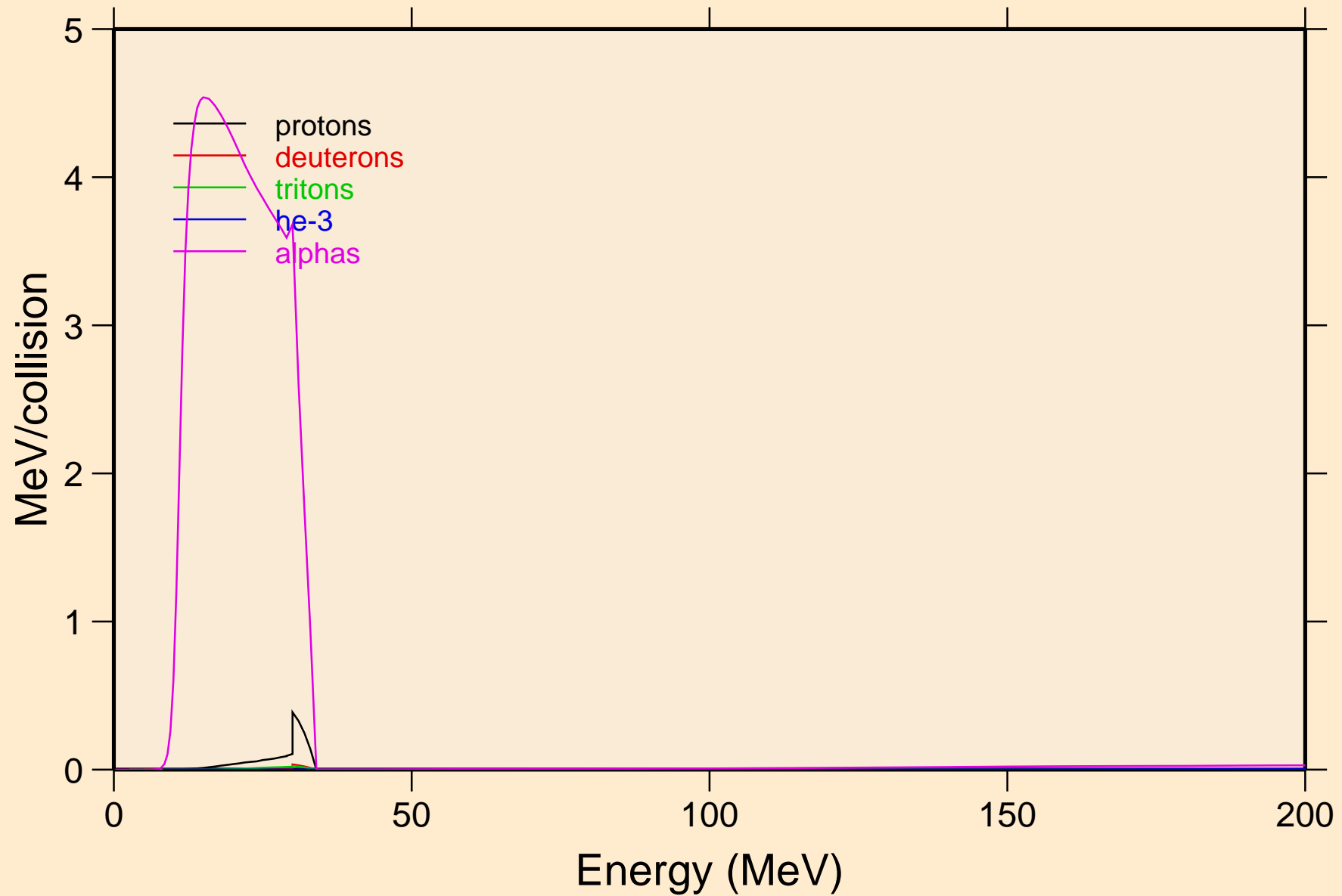

AC236 NEUTRON ACER TENDL-2021 LIBRARY; T=293.6K
Recoil Heating

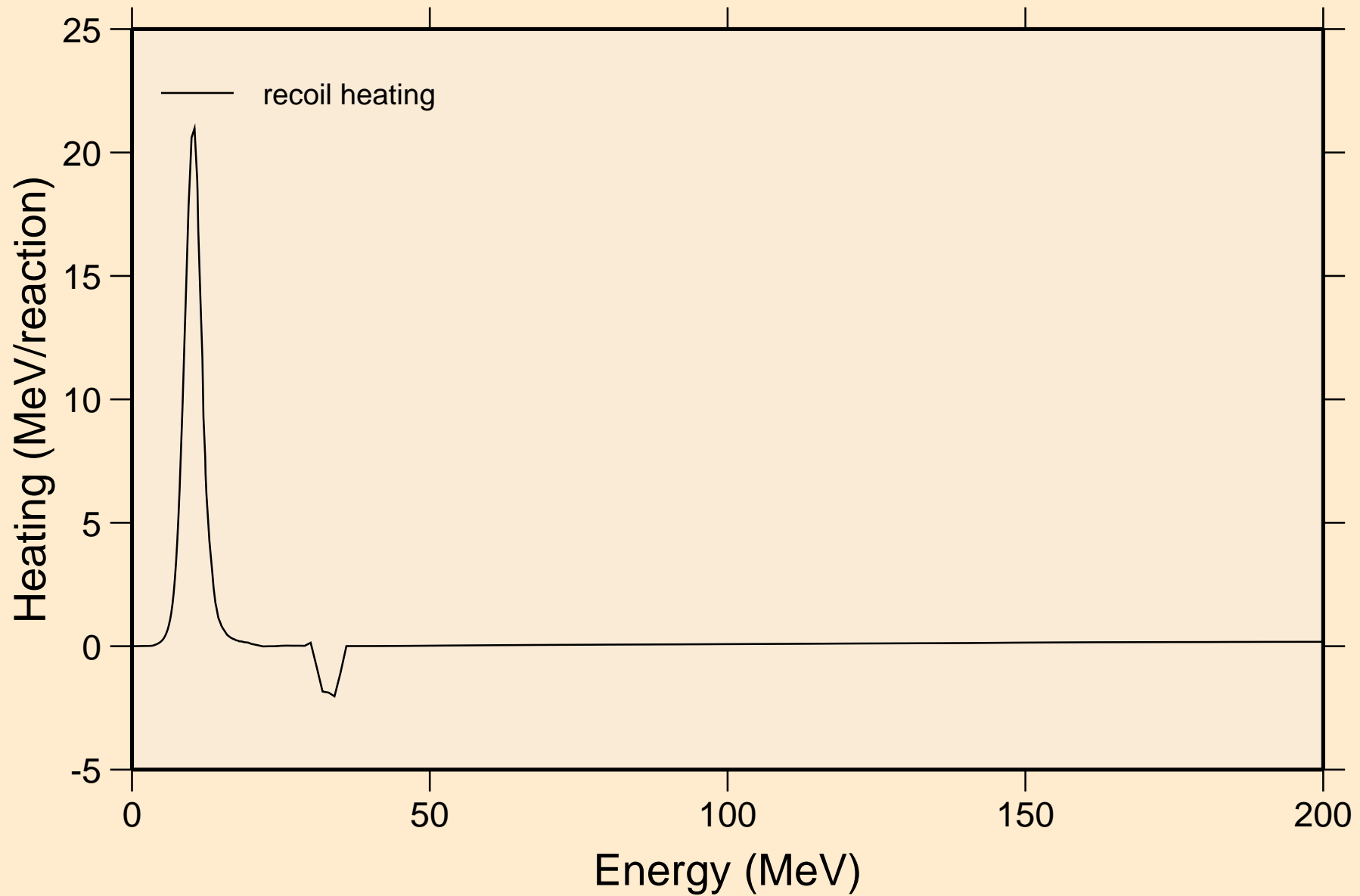

AC236 NEUTRON ACER TENDL-2021 LIBRARY; T=293.6K
Particle production cross sections

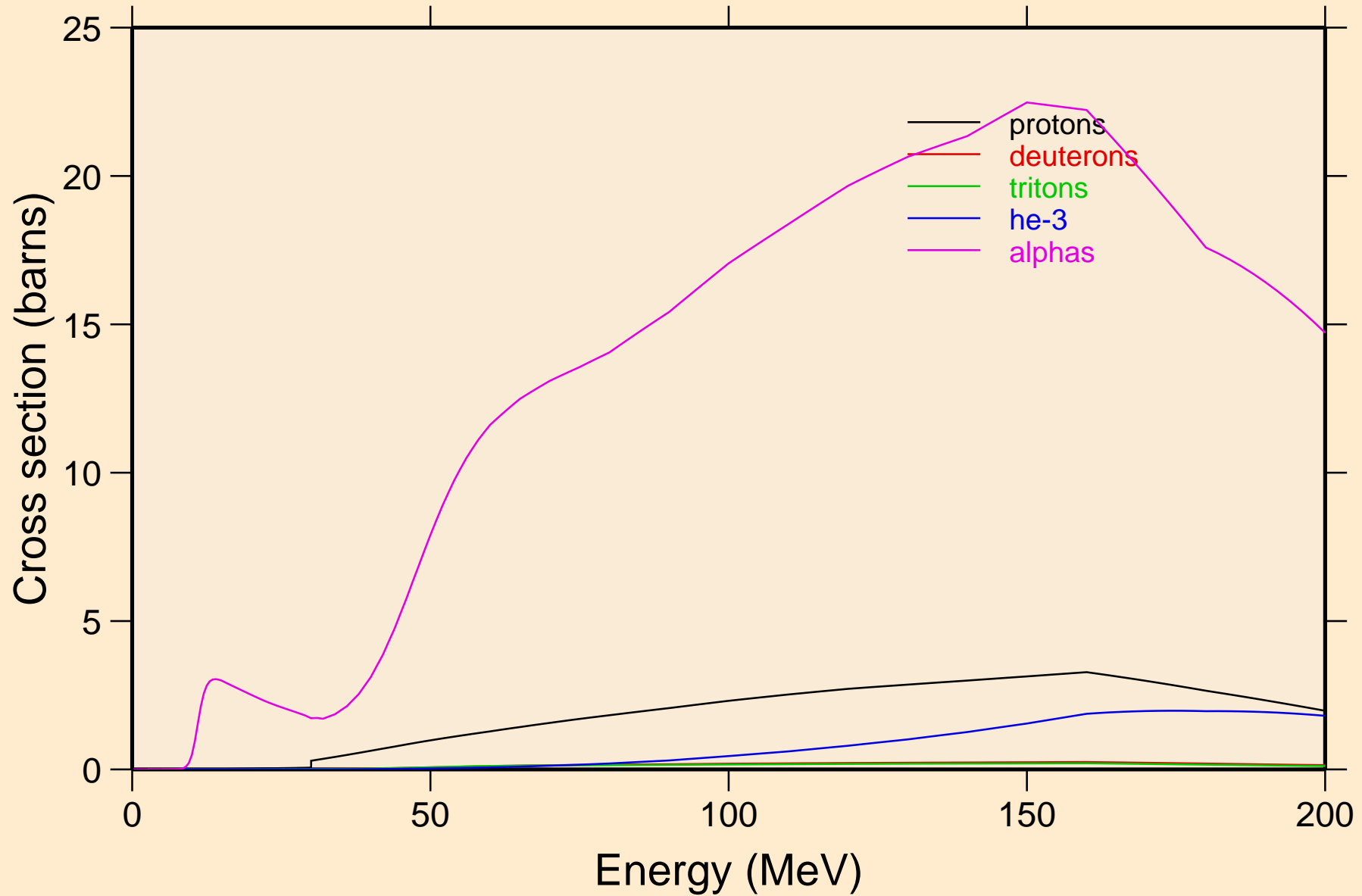

AC236 NEUTRON ACER TENDL-2021 LIBRARY; T=293.6K
protons from (n,x)

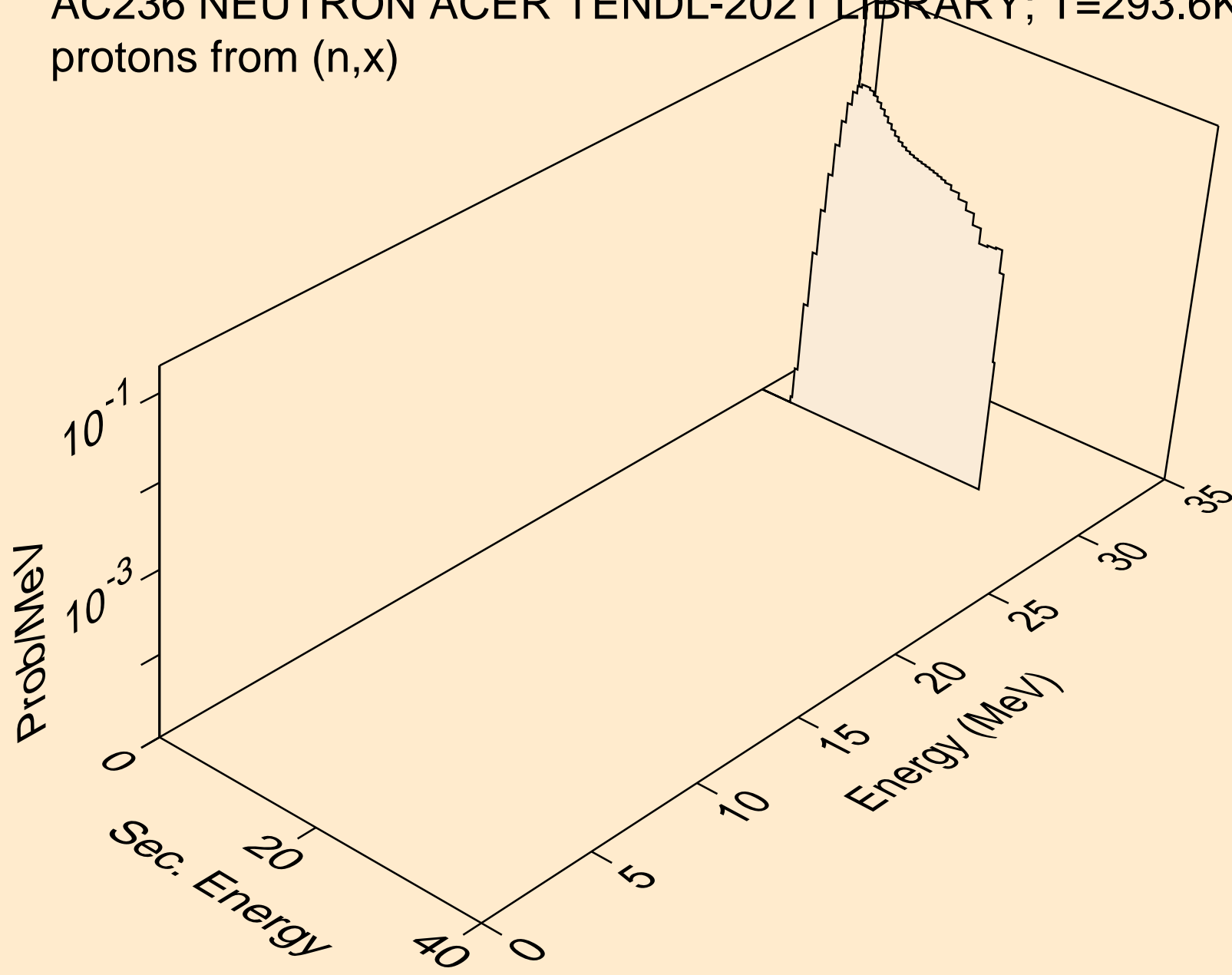

AC236 NEUTRON ACER TENDL-2021 LIBRARY; T=293.6K
protons from (n,n*)p

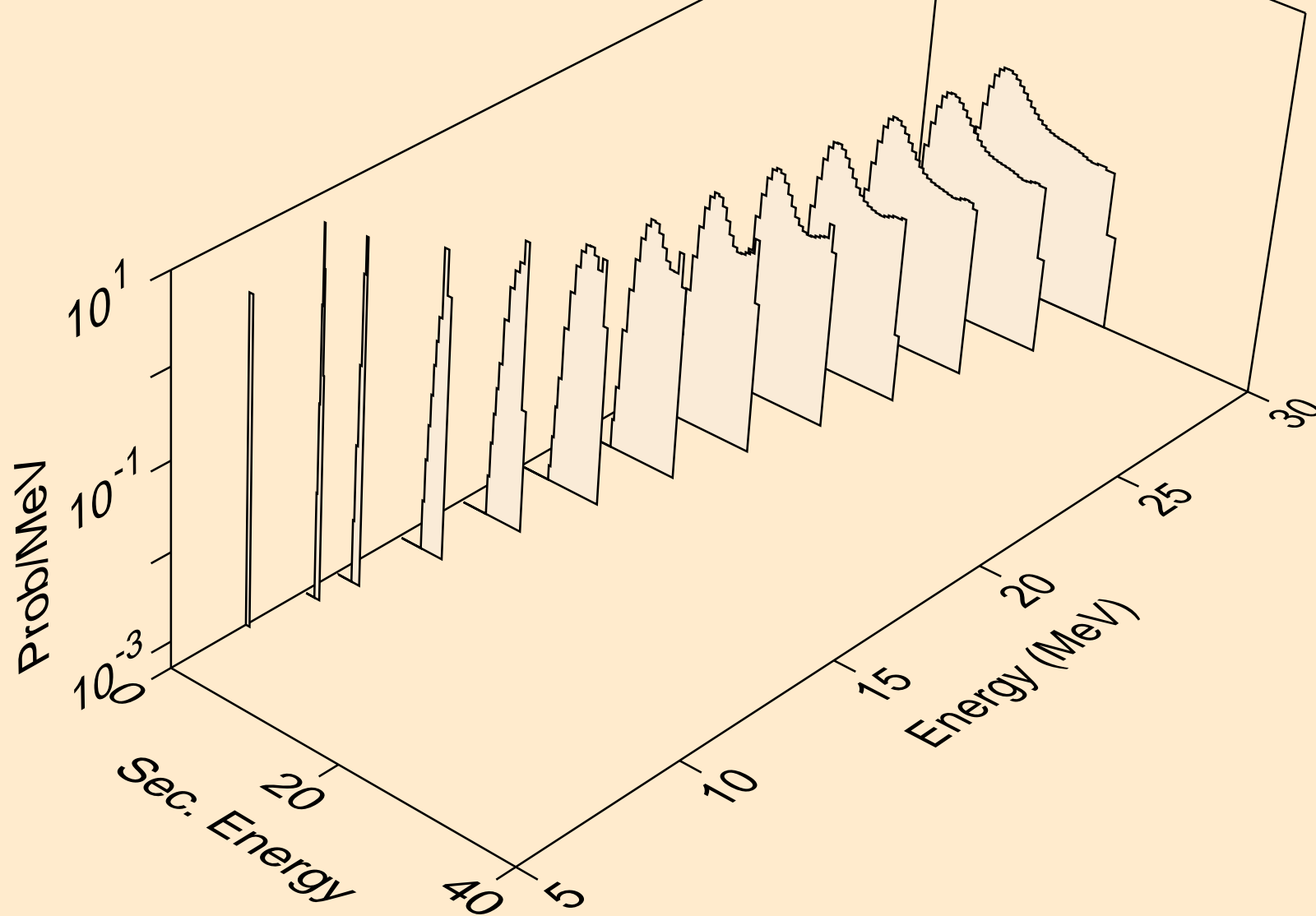

AC236 NEUTRON ACER TENDL-2021 LIBRARY; T=293.6K
protons from (n,2np)

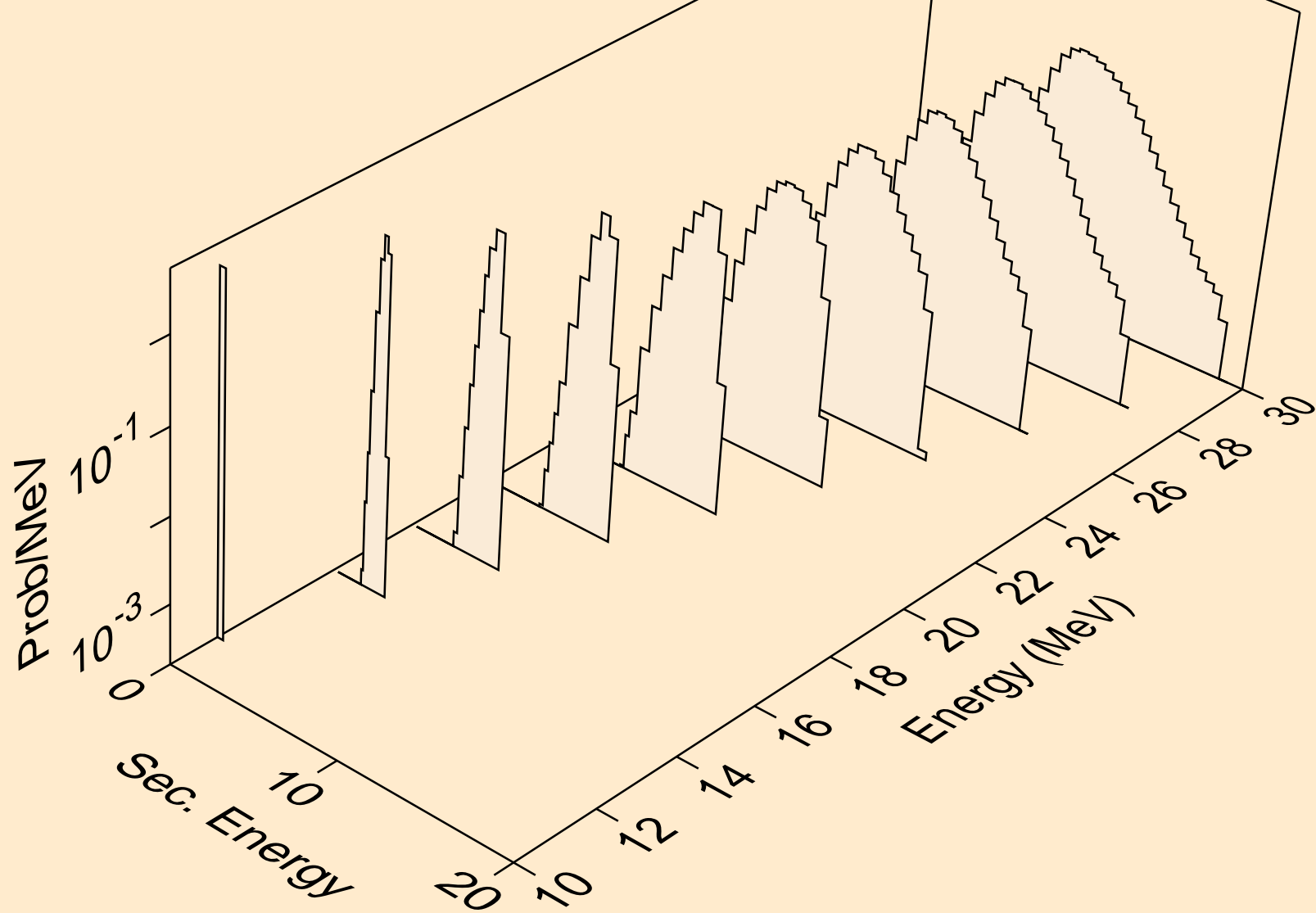

AC236 NEUTRON ACER TENDL-2021 LIBRARY; T=293.6K
protons from (n,3np)

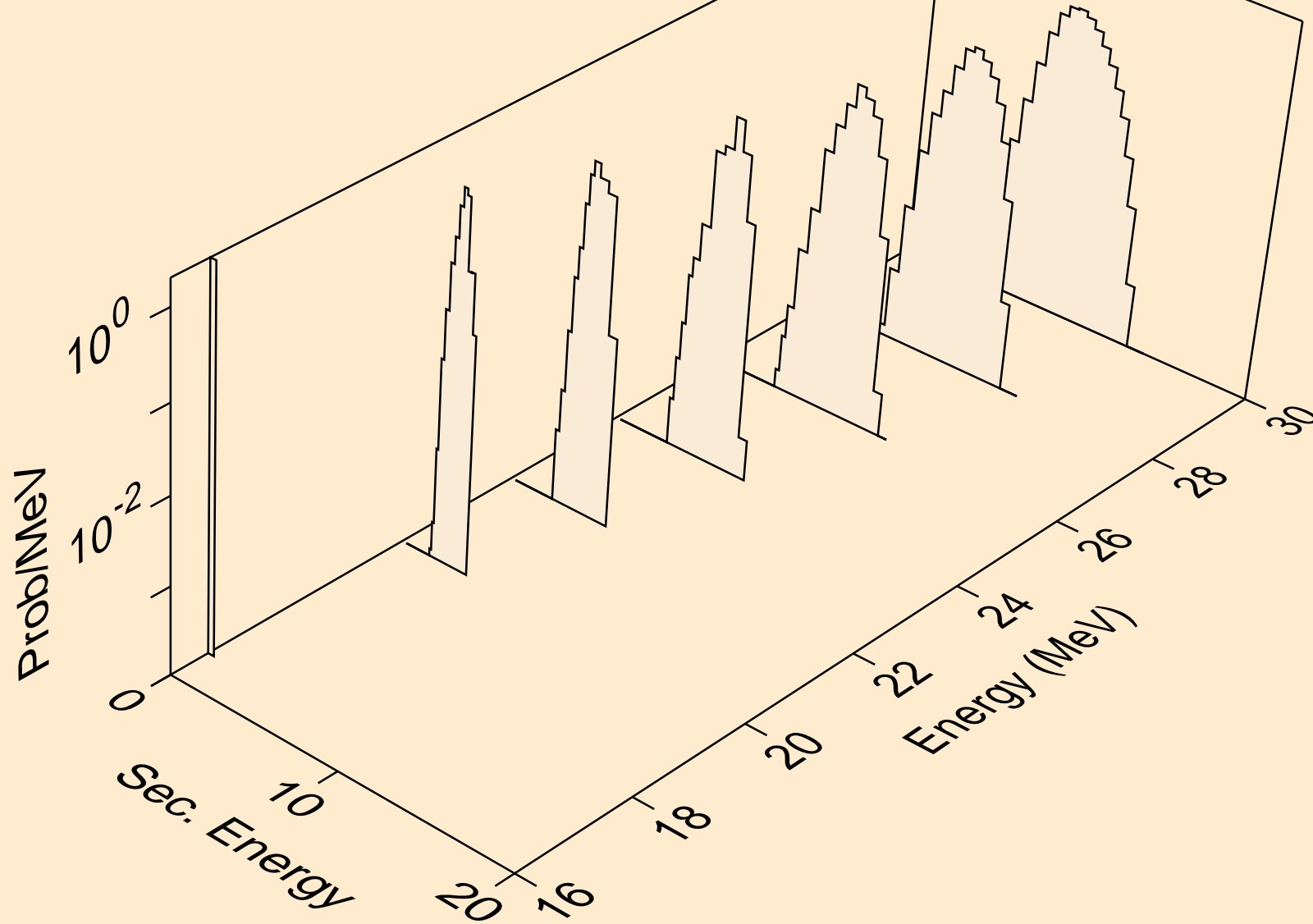

AC236 NEUTRON ACER TENDL-2021 LIBRARY; T=293.6K
protons from (n,2np)

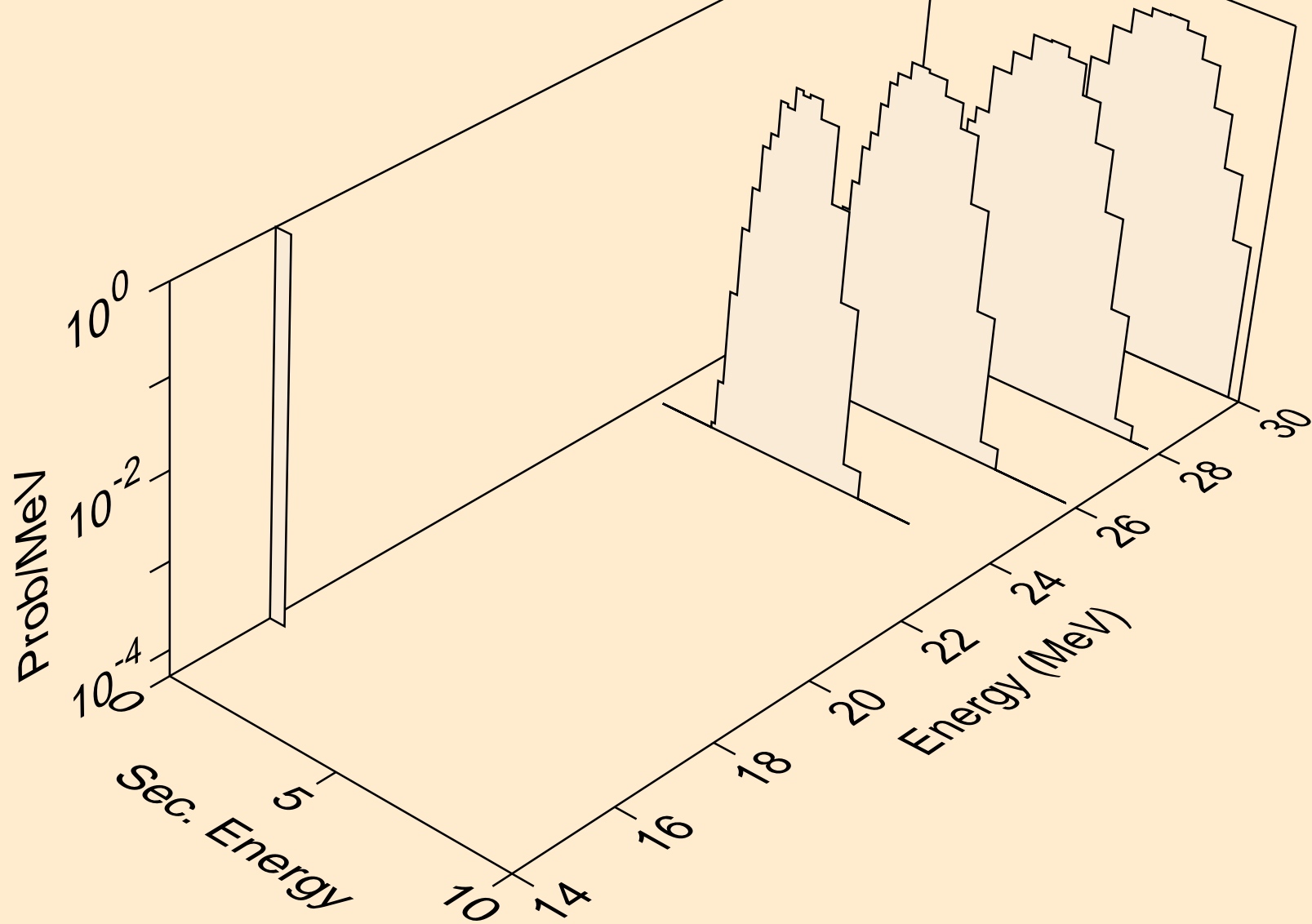

AC236 NEUTRON ACER TENDL-2021 LIBRARY; T=293.6K
protons from (n,npa)

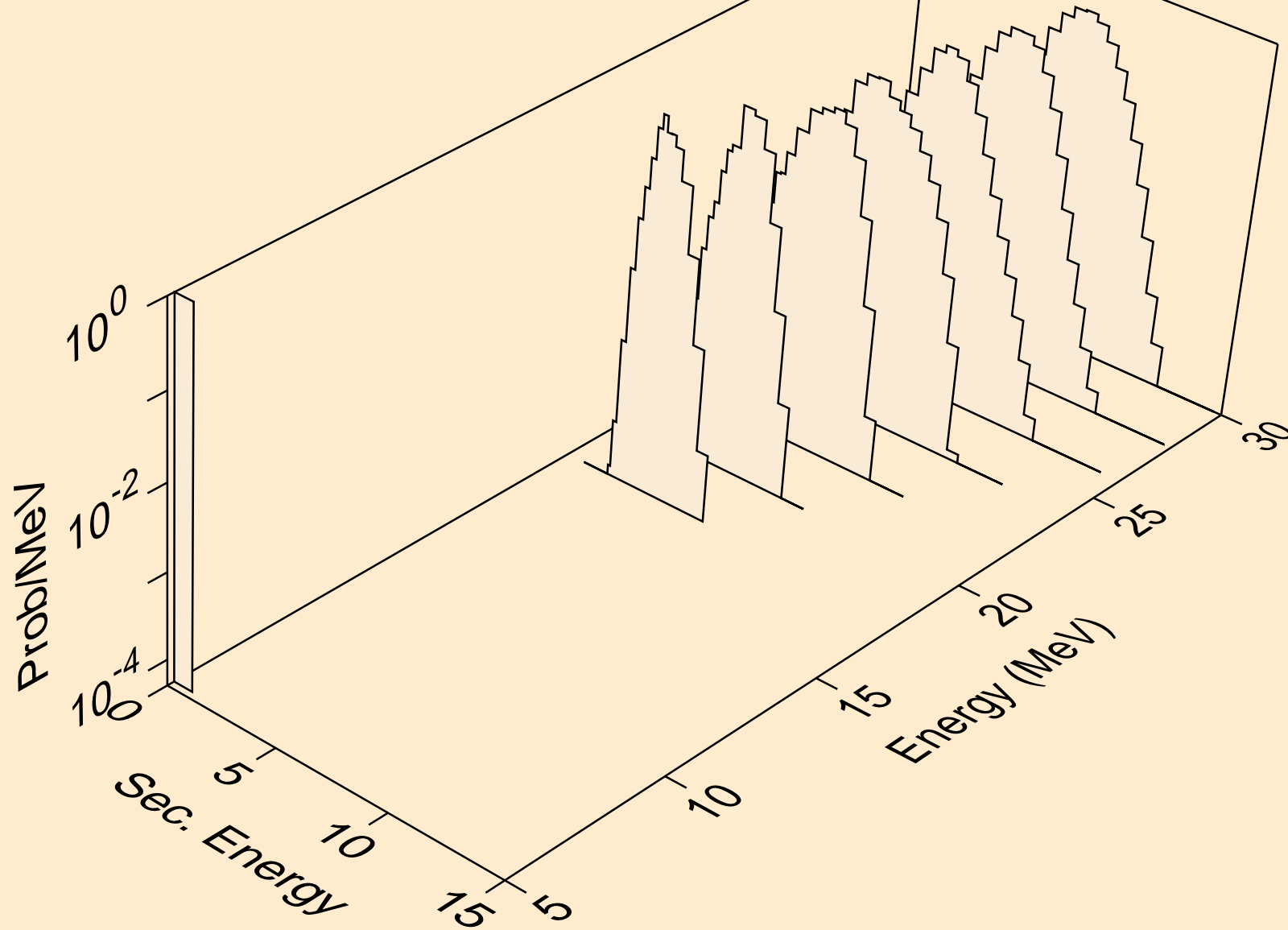

AC236 NEUTRON ACER TENDL-2021 LIBRARY; T=293.6K
protons from (n,p)

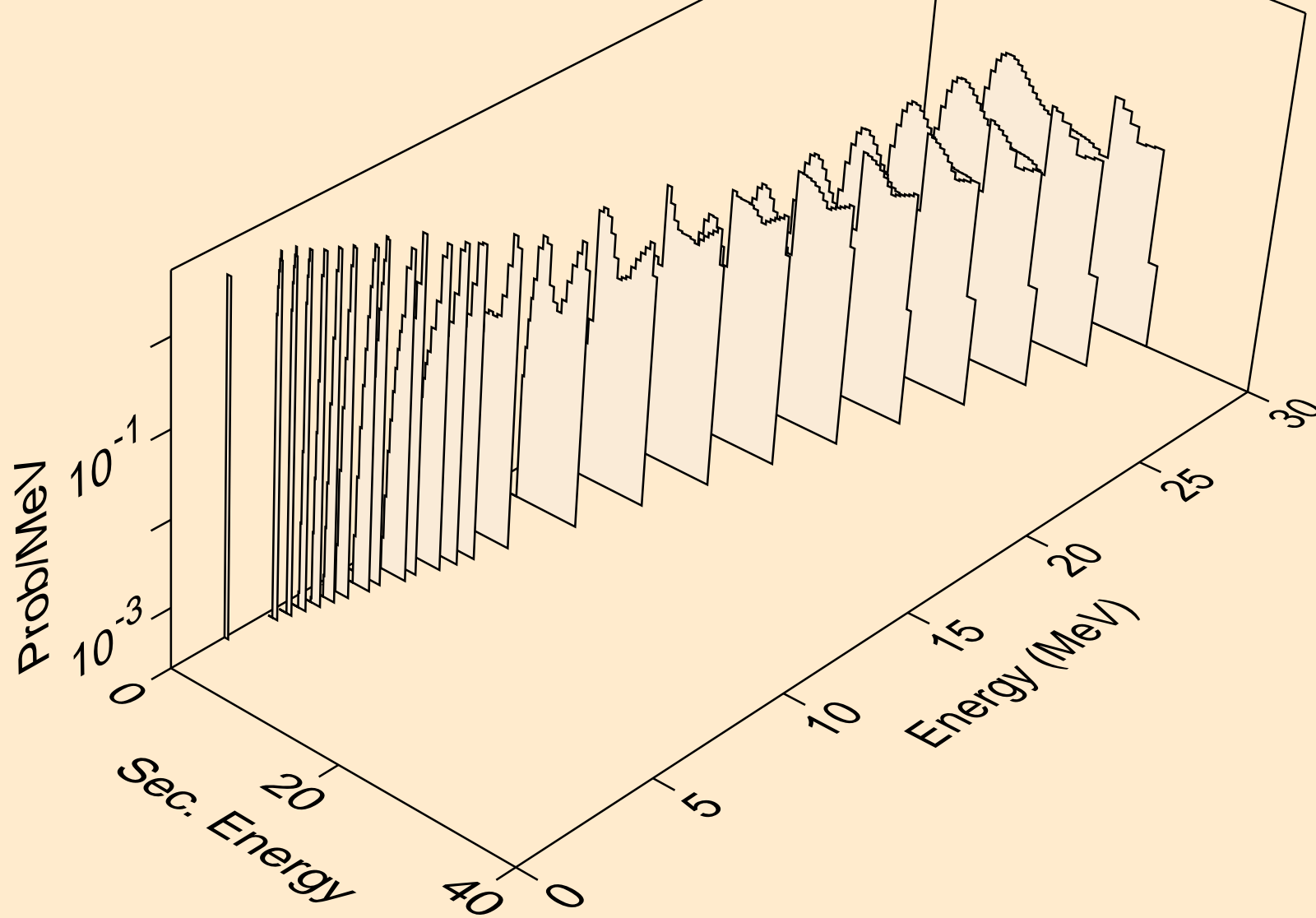

AC236 NEUTRON ACER TENDL-2021 LIBRARY; T=293.6K
protons from (n,2p)

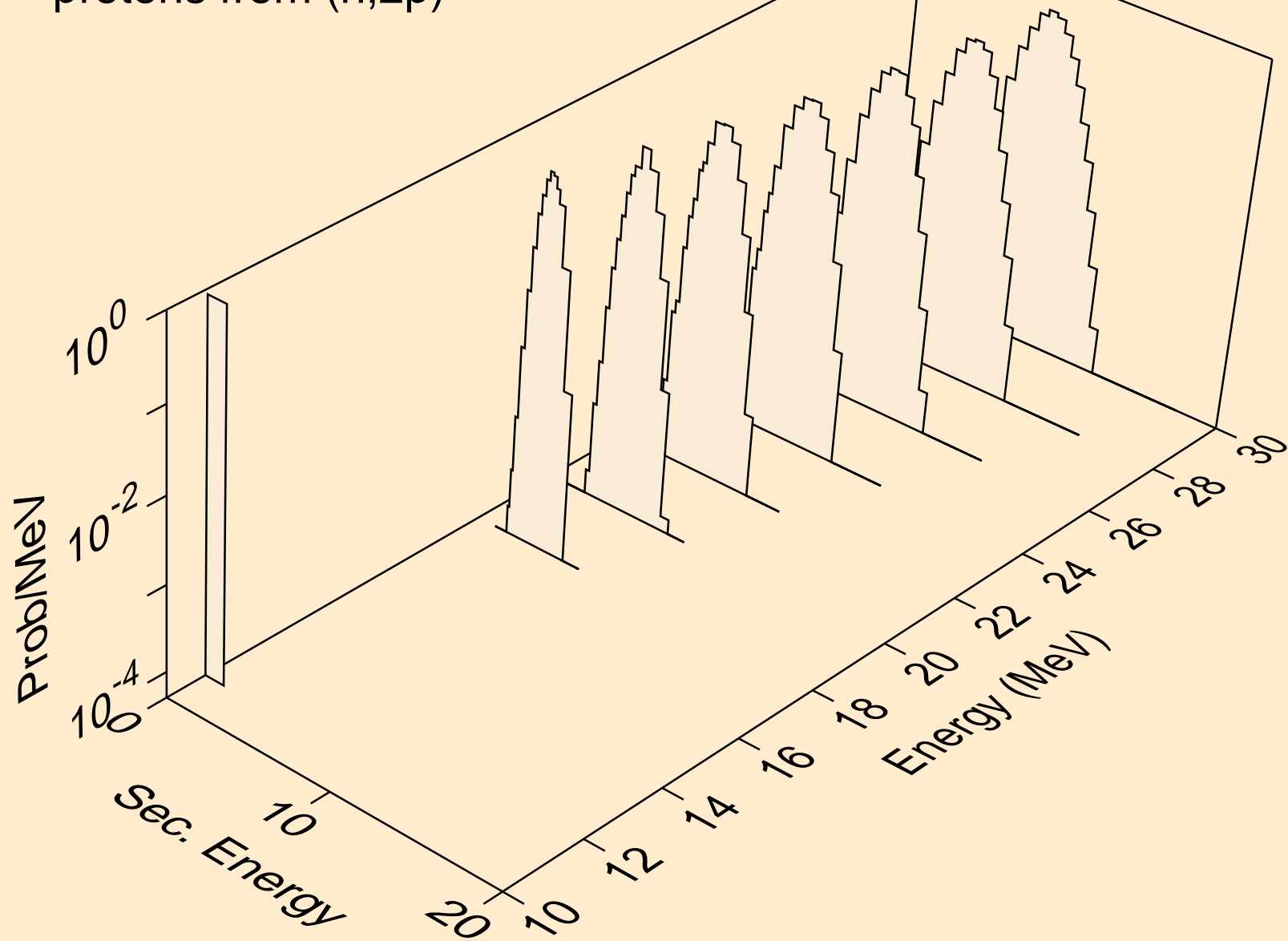

AC236 NEUTRON ACER TENDL-2021 LIBRARY; T=293.6K
protons from (n,pa)

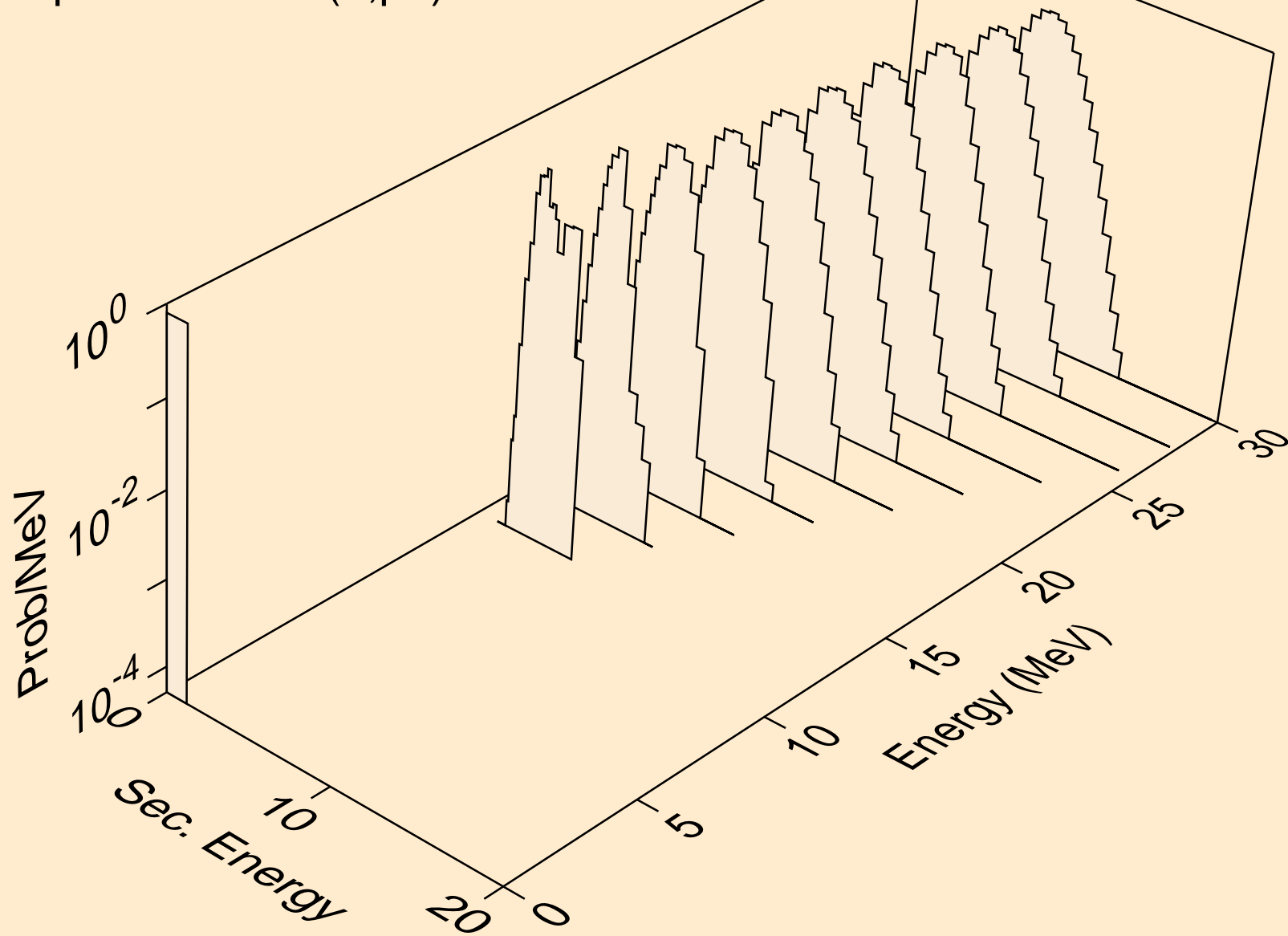

AC236 NEUTRON ACER TENDL-2021 LIBRARY; T=293.6K
protons from (n,pt)

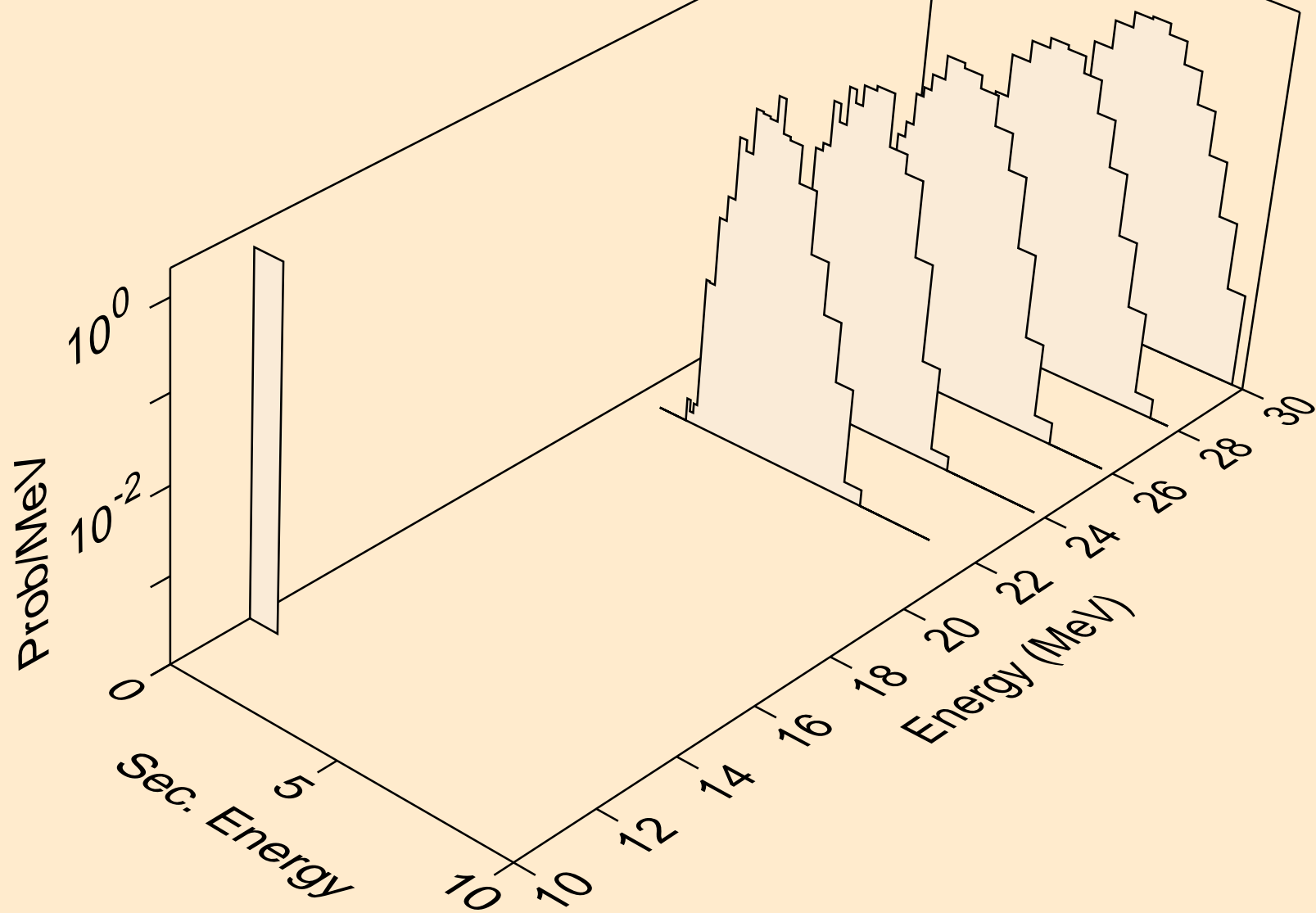

AC236 NEUTRON ACER TENDL-2021 LIBRARY; T=293.6K
deuterons from (n,x)

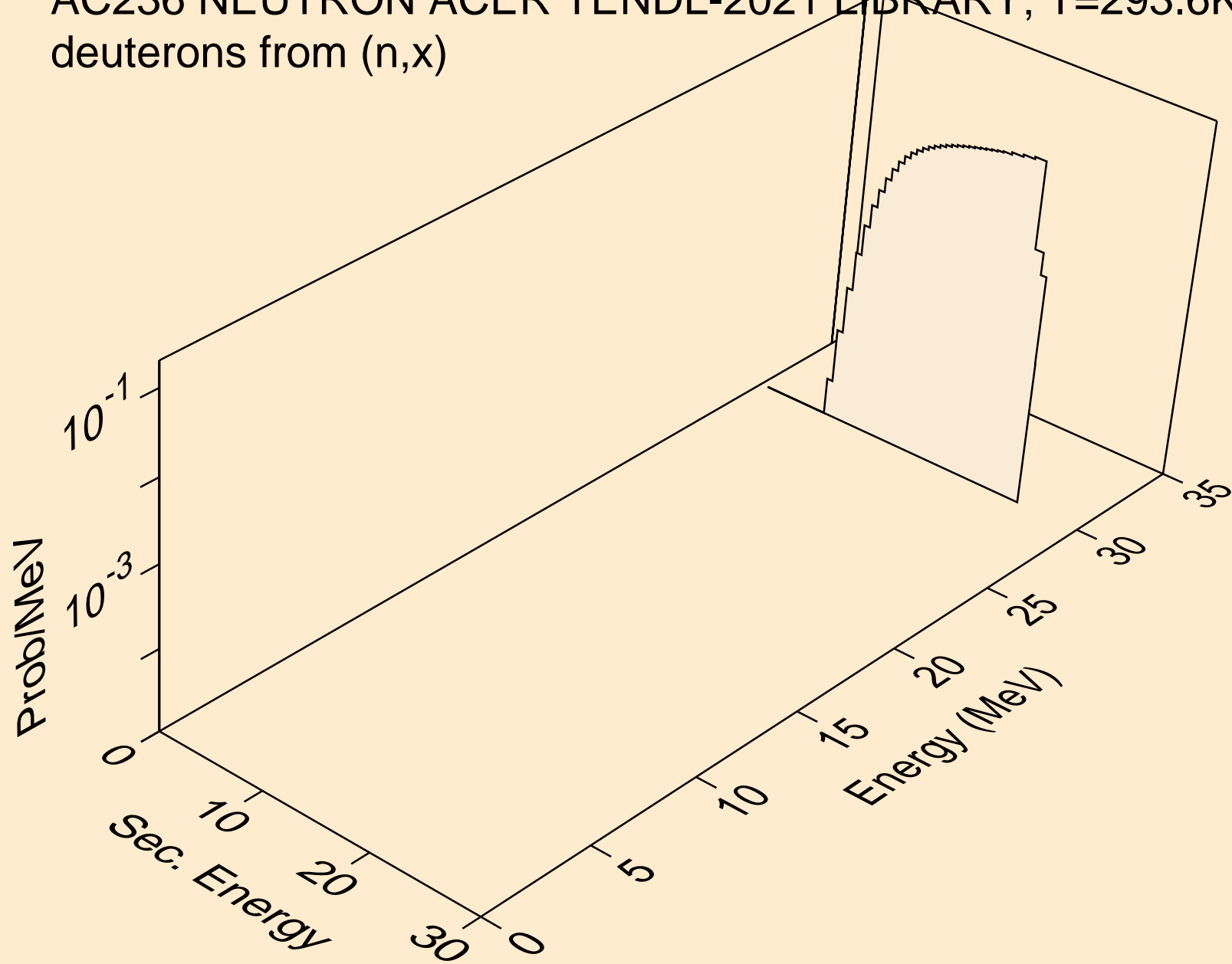

AC236 NEUTRON ACER TENDL-2021 LIBRARY; T=293.6K
deuterons from (n,2nd)

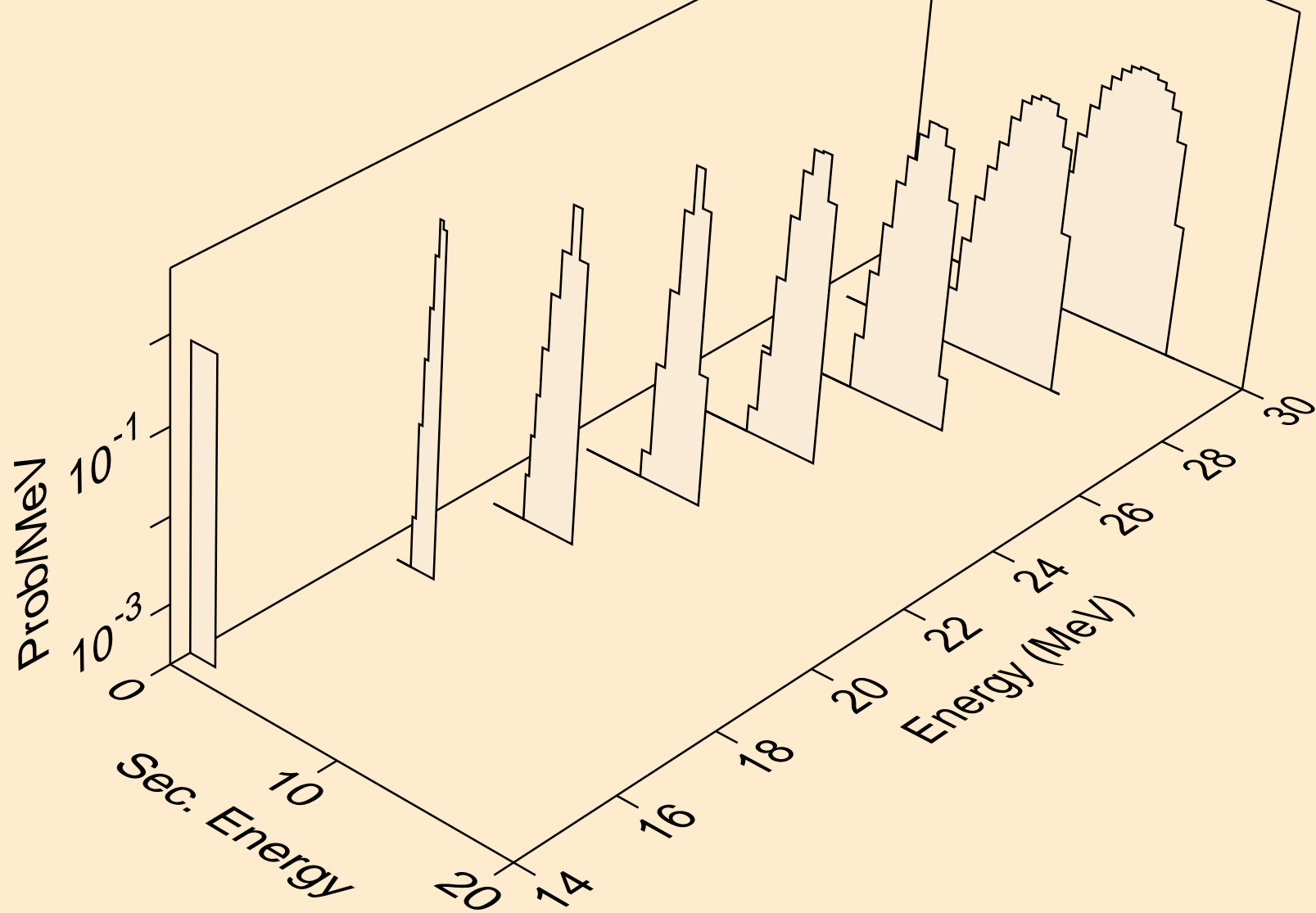

AC236 NEUTRON ACER TENDL-2021 LIBRARY; T=293.6K
deuterons from (n,n*)d

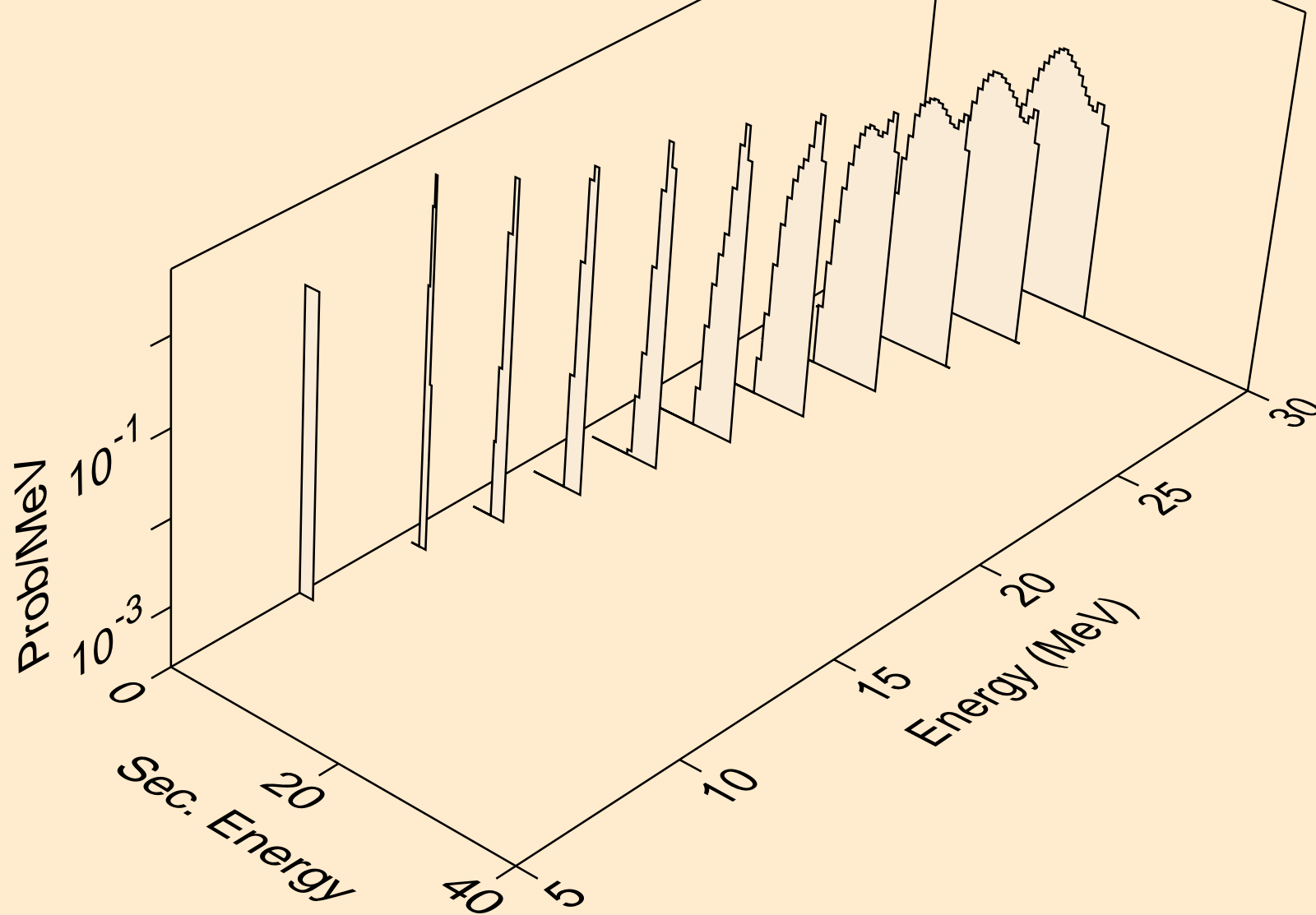

AC236 NEUTRON ACER TENDL-2021 LIBRARY; T=293.6K
deuterons from (n,d)

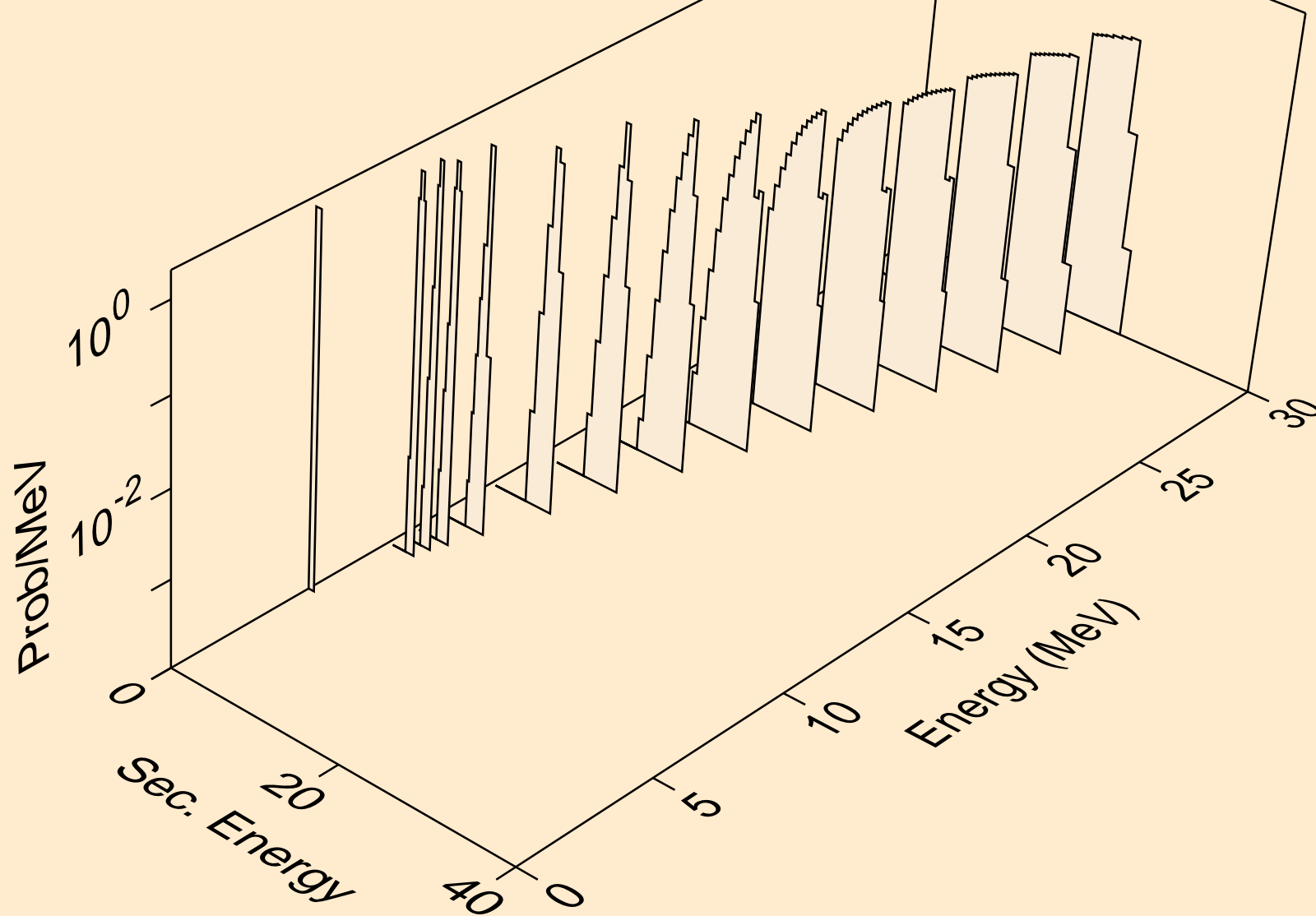

AC236 NEUTRON ACER TENDL-2021 LIBRARY; T=293.6K
tritons from (n,x)

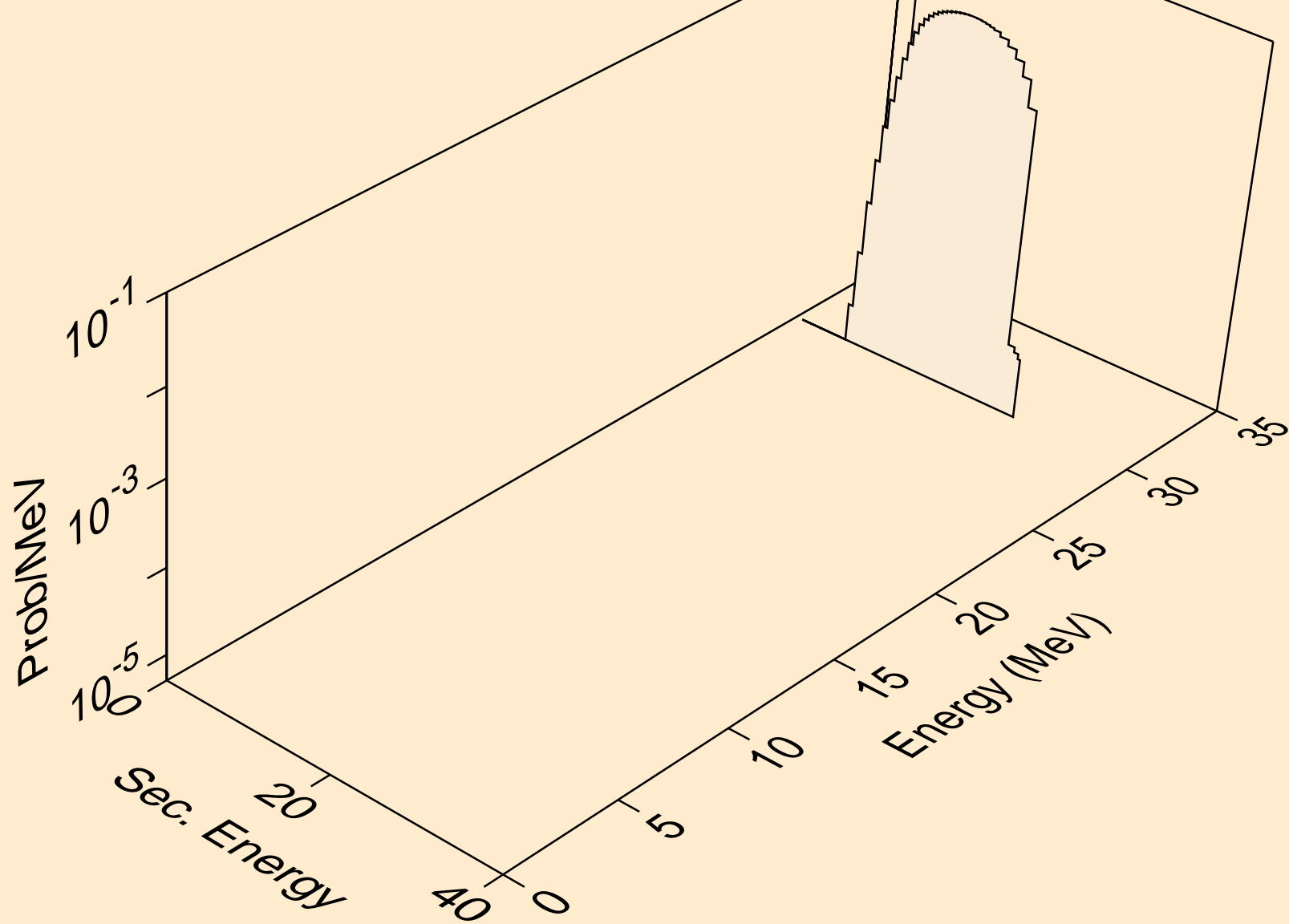

AC236 NEUTRON ACER TENDL-2021 LIBRARY; T=293.6K
tritons from (n,n*)t

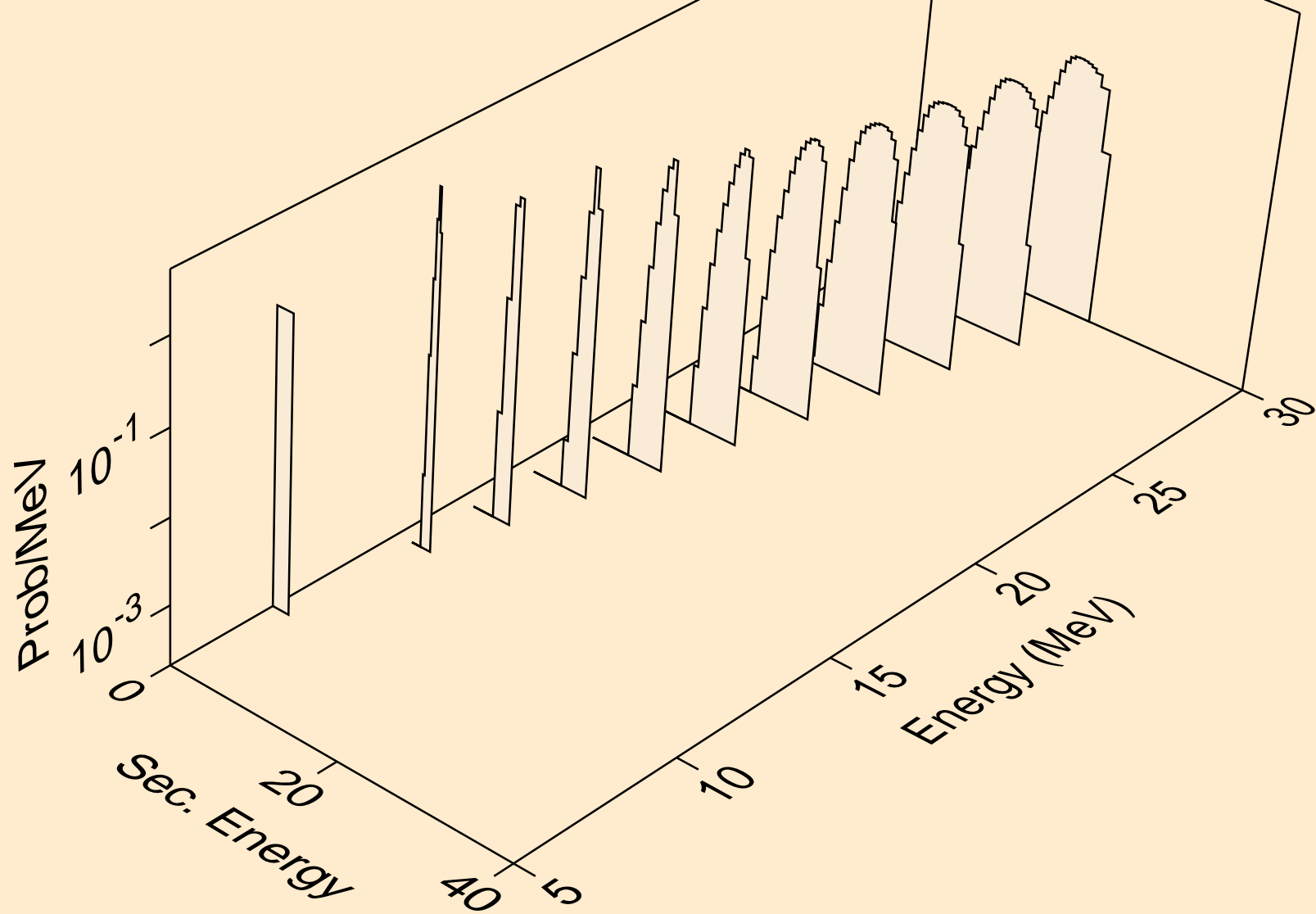

AC236 NEUTRON ACER TENDL-2021 LIBRARY; T=293.6K
tritons from (n,t)

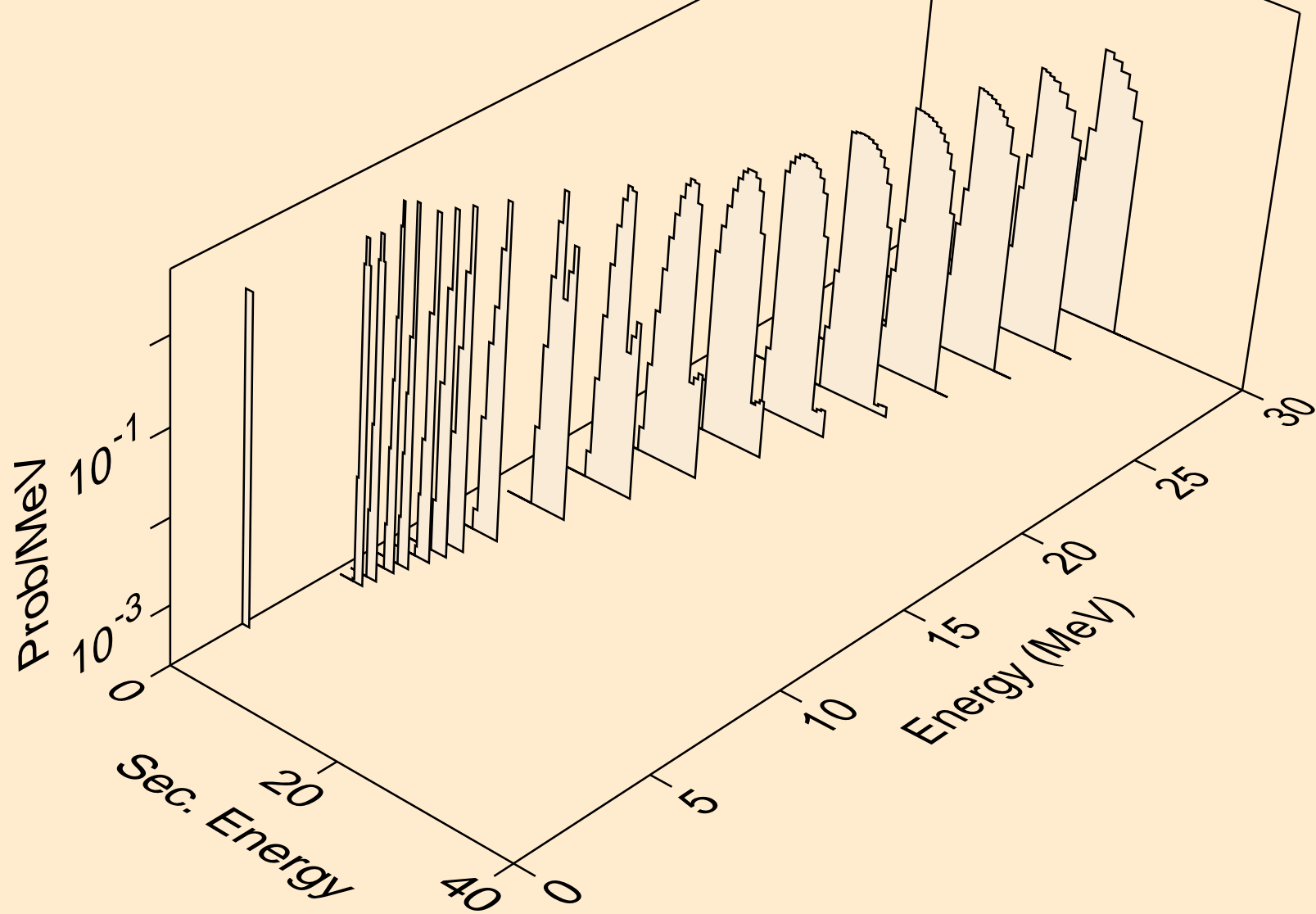

AC236 NEUTRON ACER TENDL-2021 LIBRARY; T=293.6K
tritons from (n,pt)

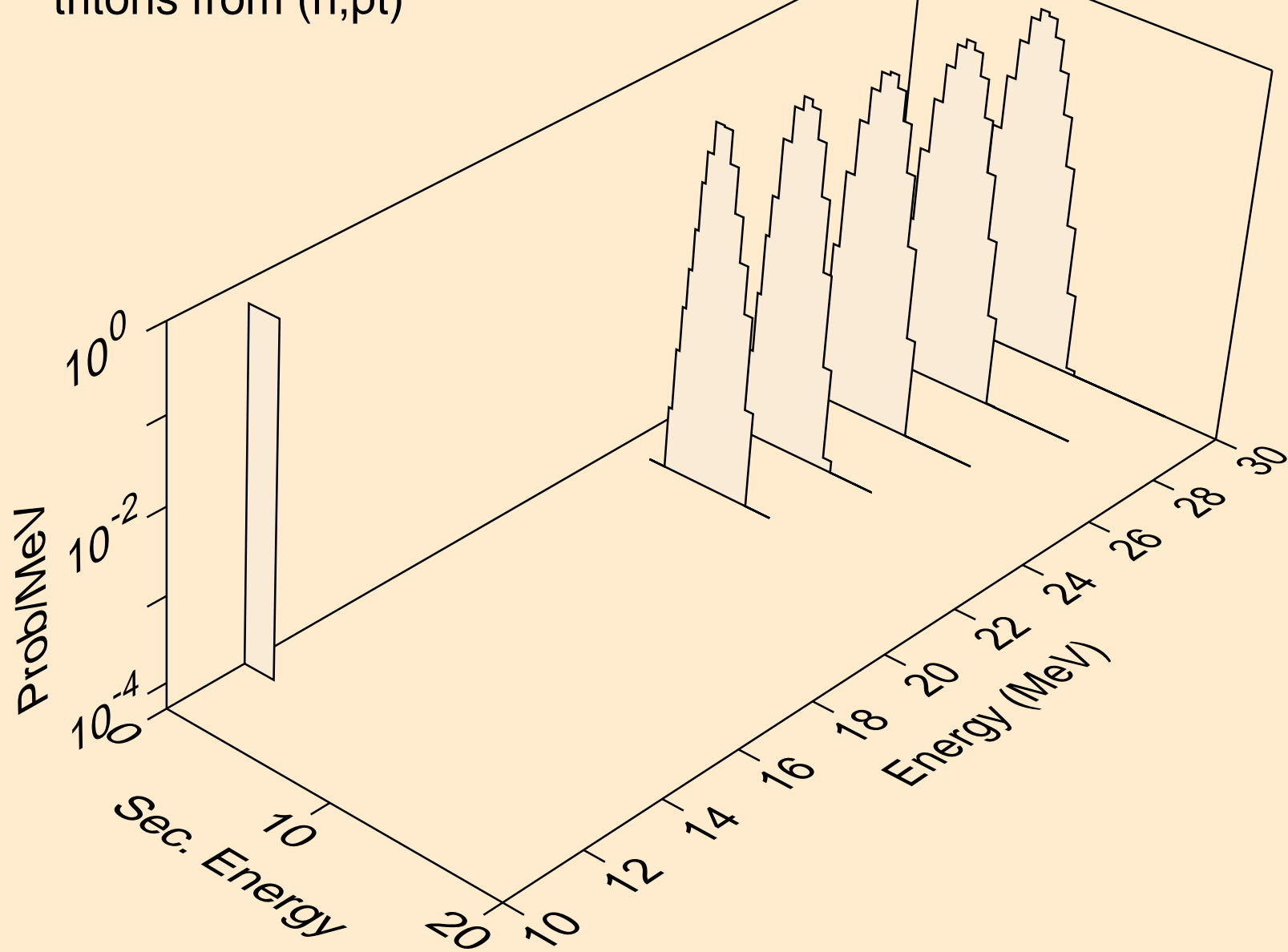

AC236 NEUTRON ACER TENDL-2021 LIBRARY; T=293.6K
he3s from (n,x)

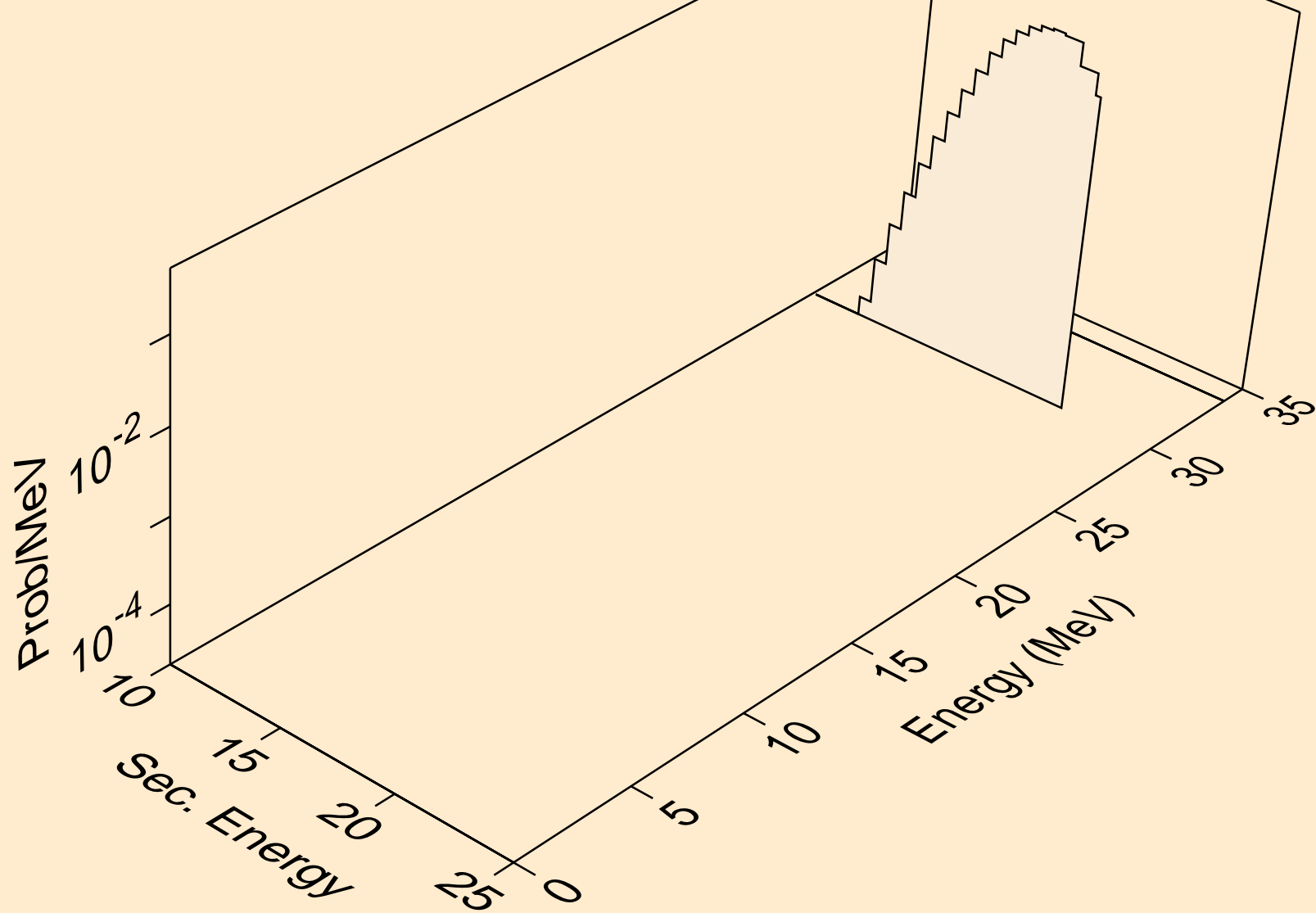

AC236 NEUTRON ACER TENDL-2021 LIBRARY; T=293.6K
he3s from (n,n*)he3

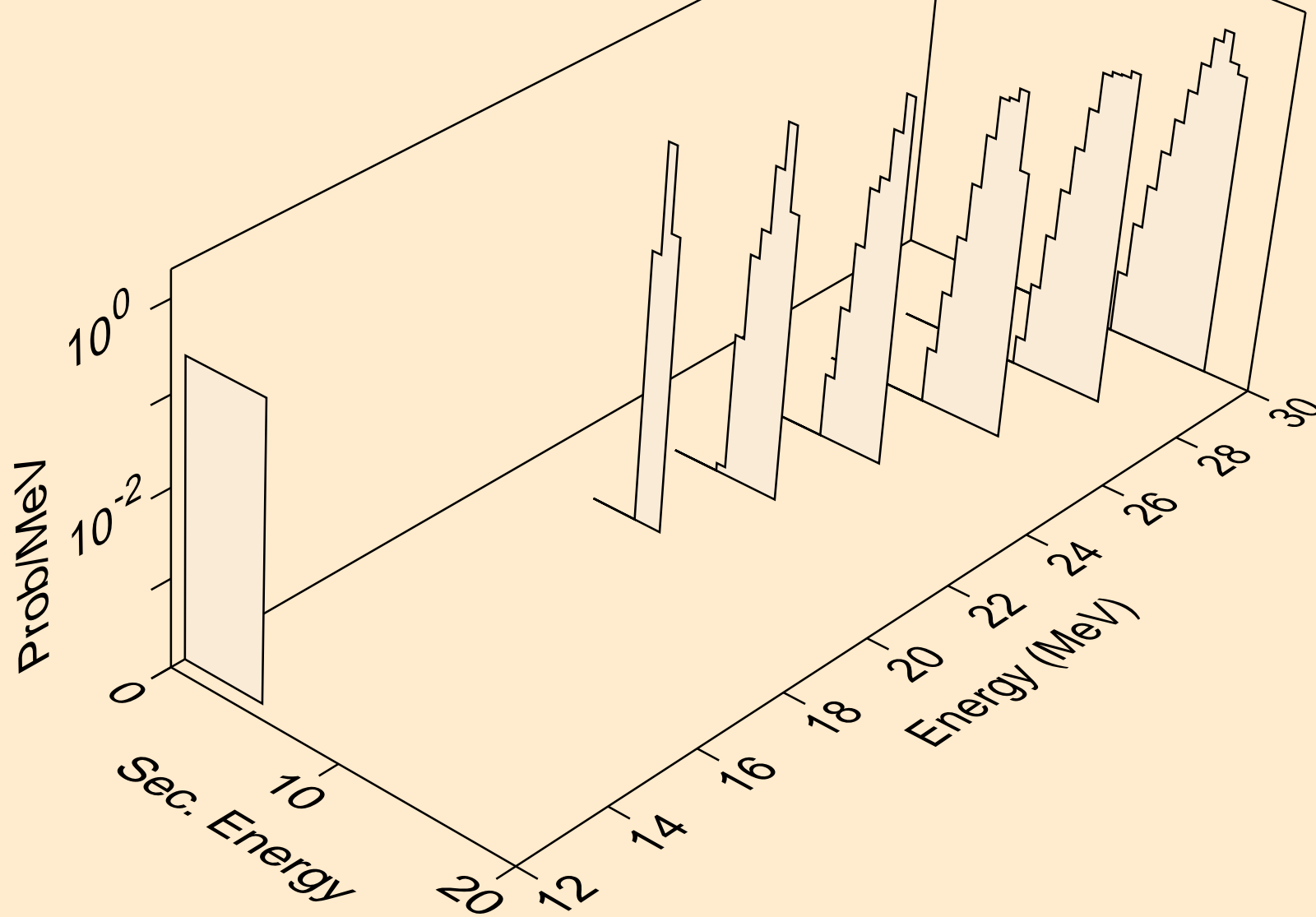

AC236 NEUTRON ACER TENDL-2021 LIBRARY; T=293.6K
he3s from (n,he3)

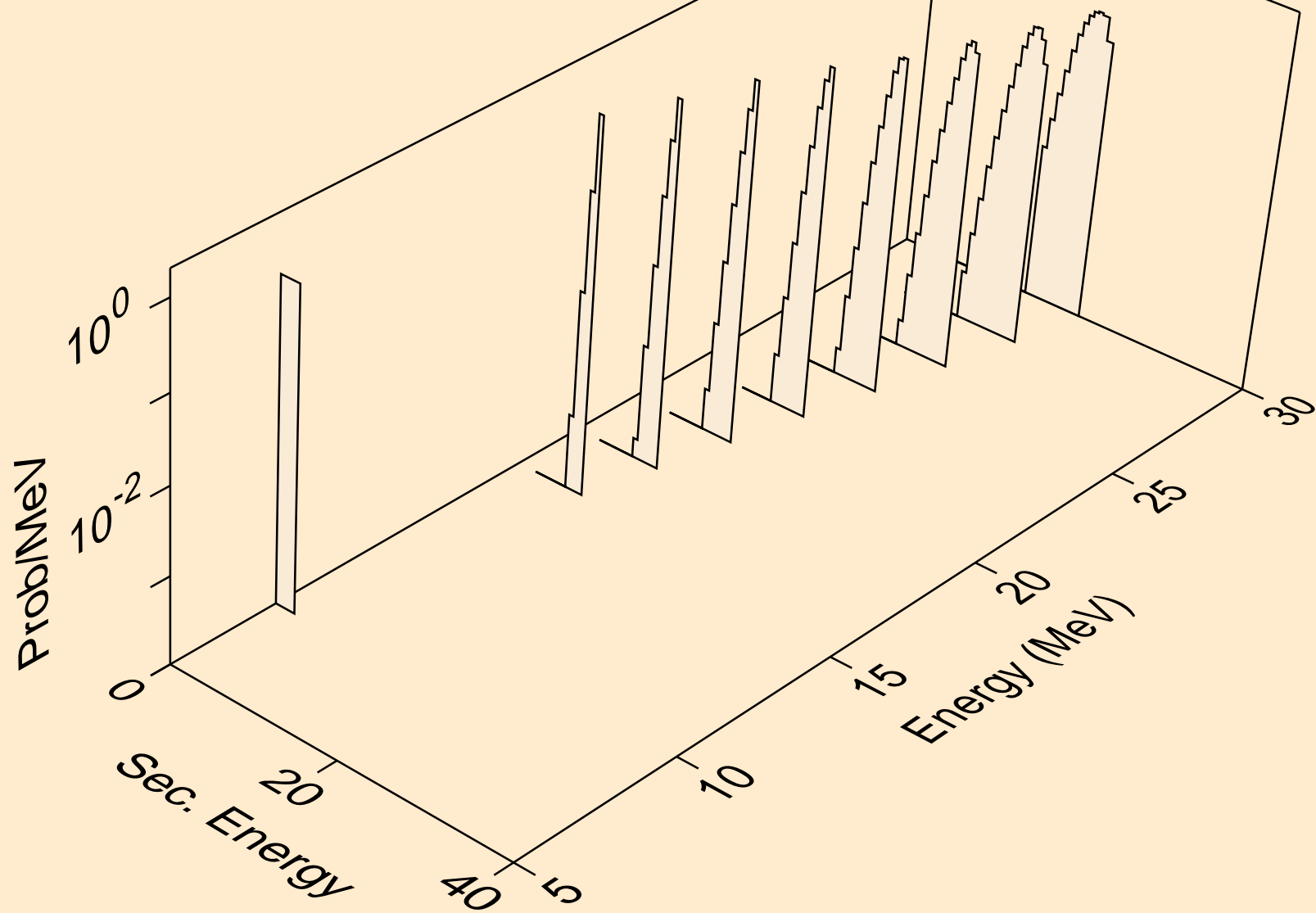

AC236 NEUTRON ACER TENDL-2021 LIBRARY; T=293.6K
alphas from (n,x)

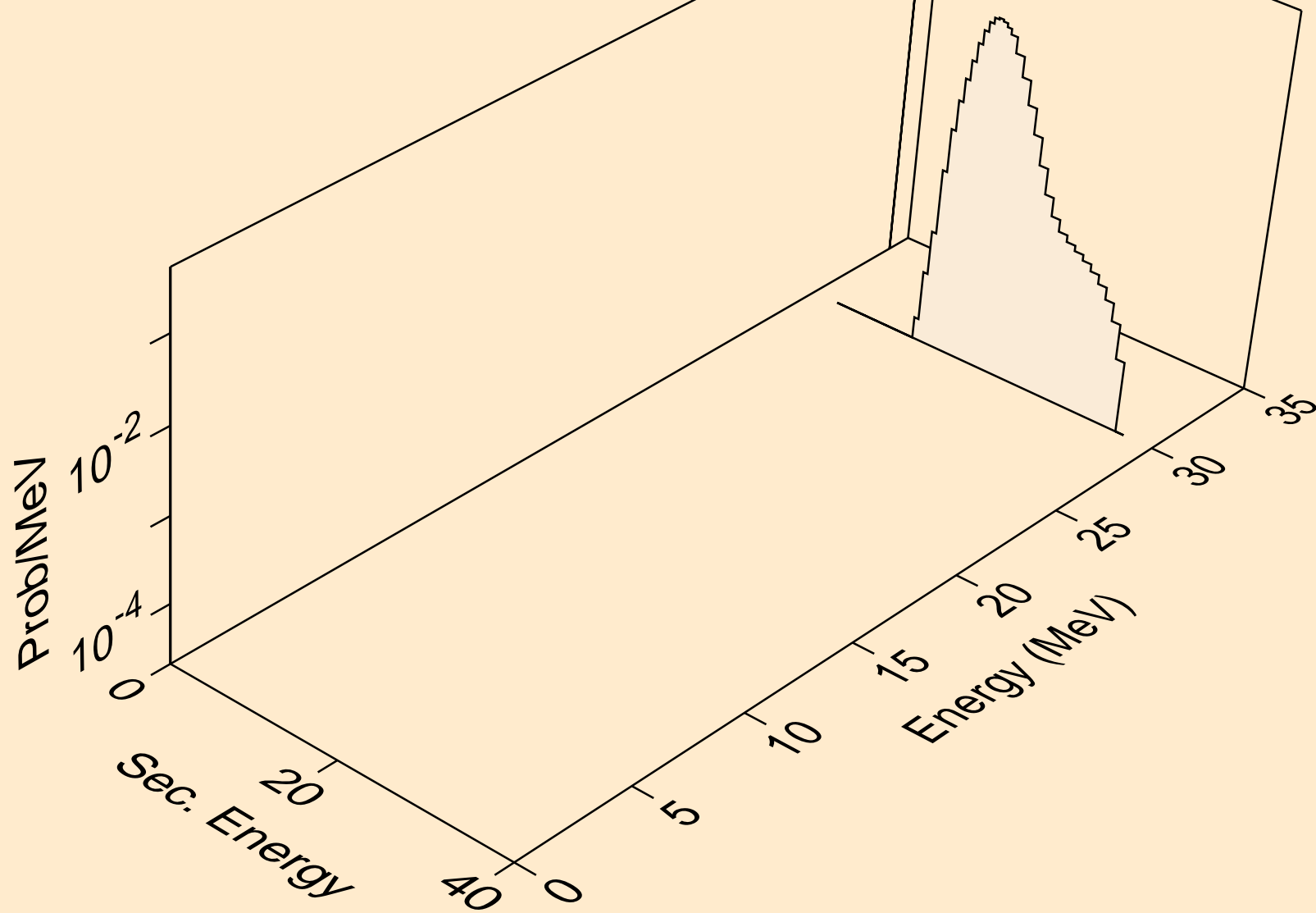

AC236 NEUTRON ACER TENDL-2021 LIBRARY; T=293.6K
alphas from (n,n*)a

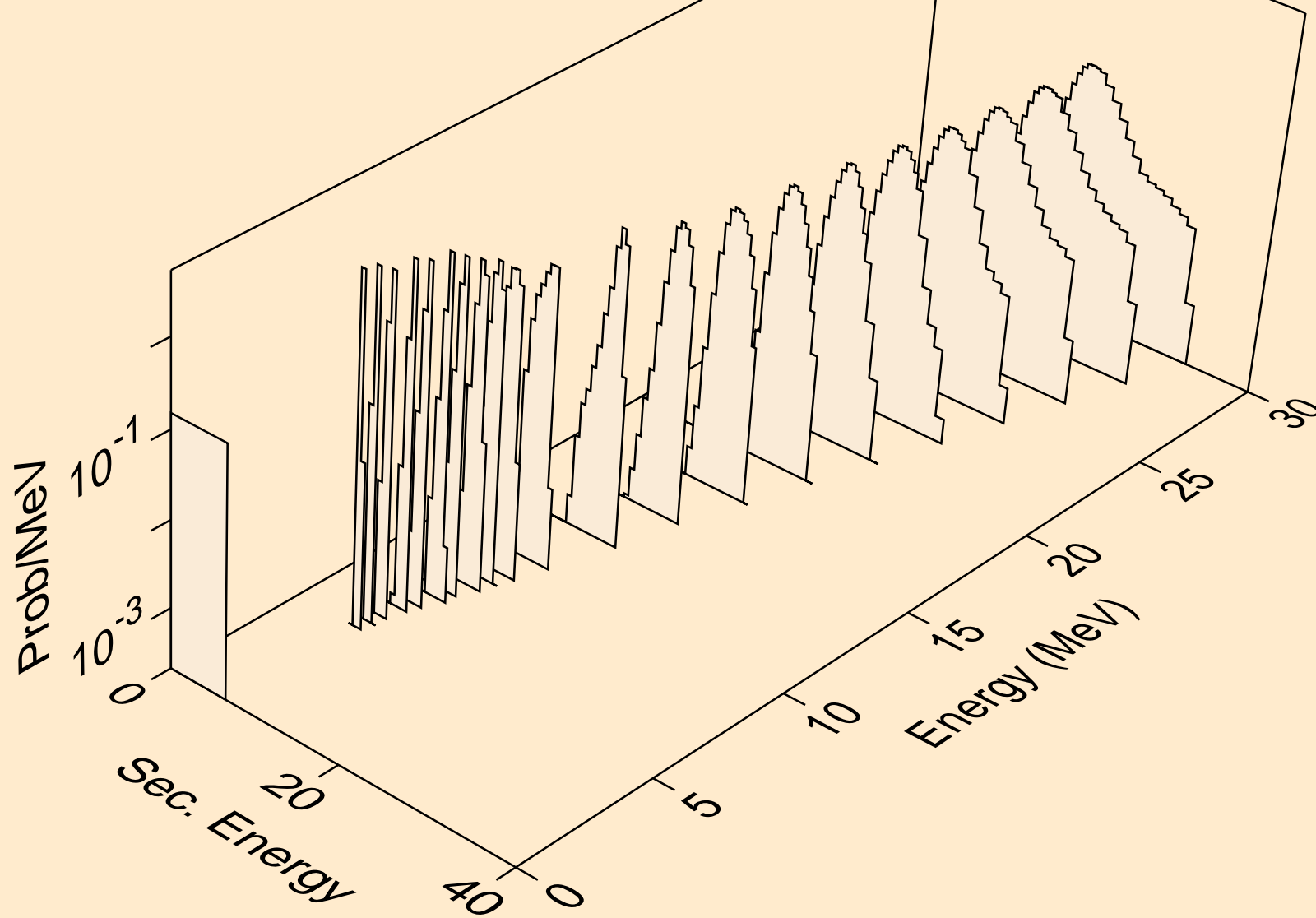

AC236 NEUTRON ACER TENDL-2021 LIBRARY; T=293.6K
alphas from (n,2n)a

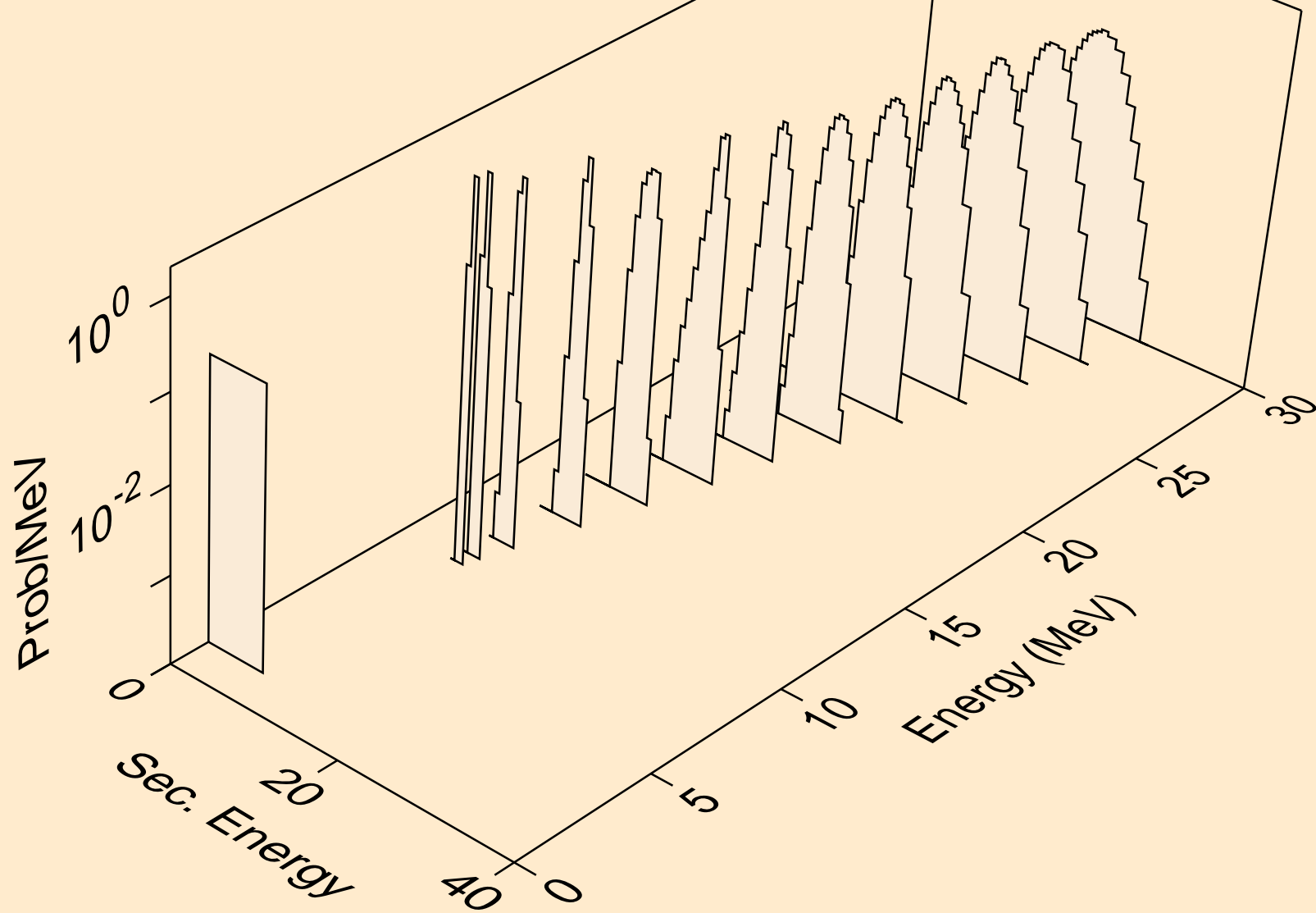

AC236 NEUTRON ACER TENDL-2021 LIBRARY; T=293.6K
alphas from (n,3n)a

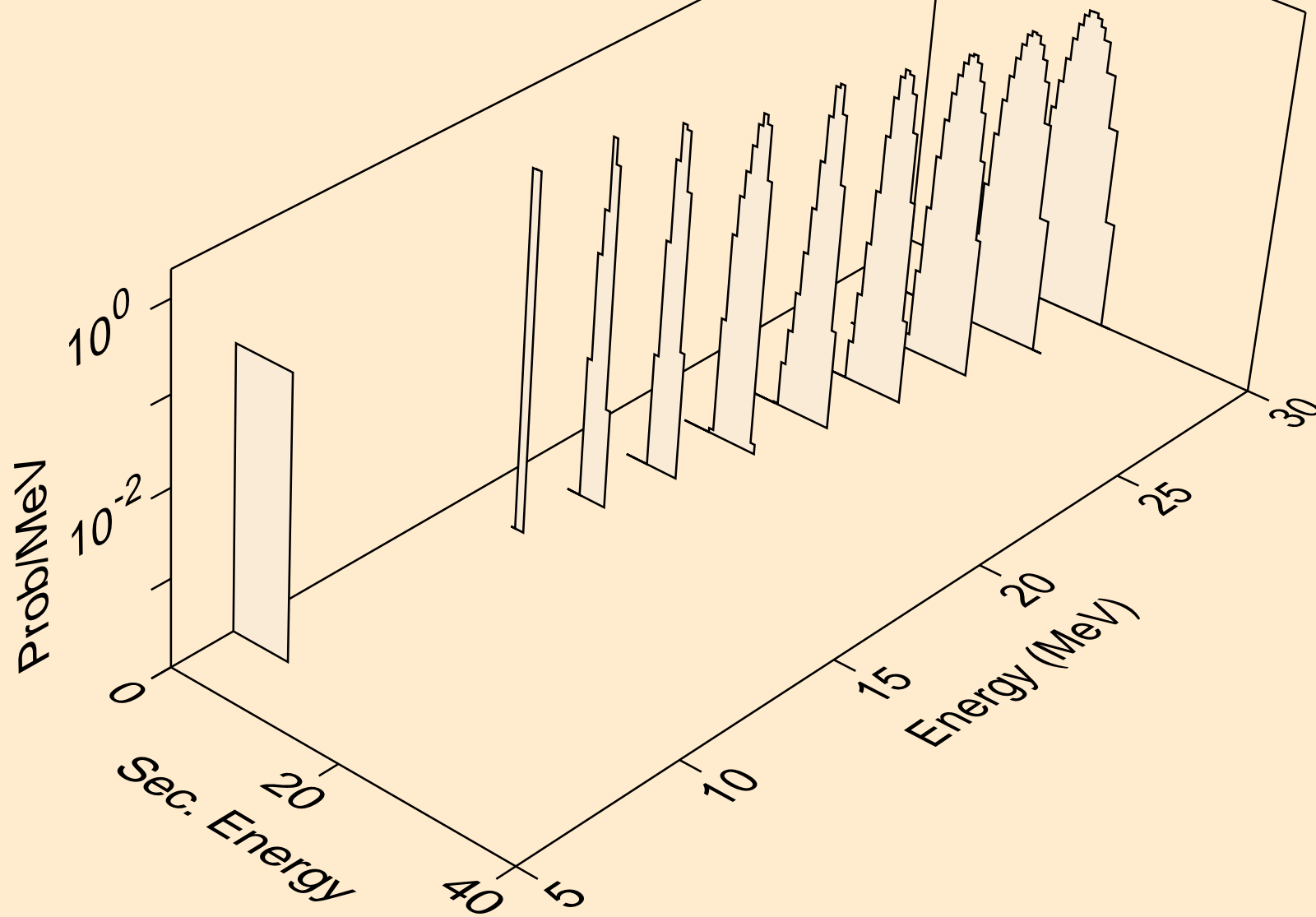

AC236 NEUTRON ACER TENDL-2021 LIBRARY; T=293.6K
alphas from (n,n*)2a

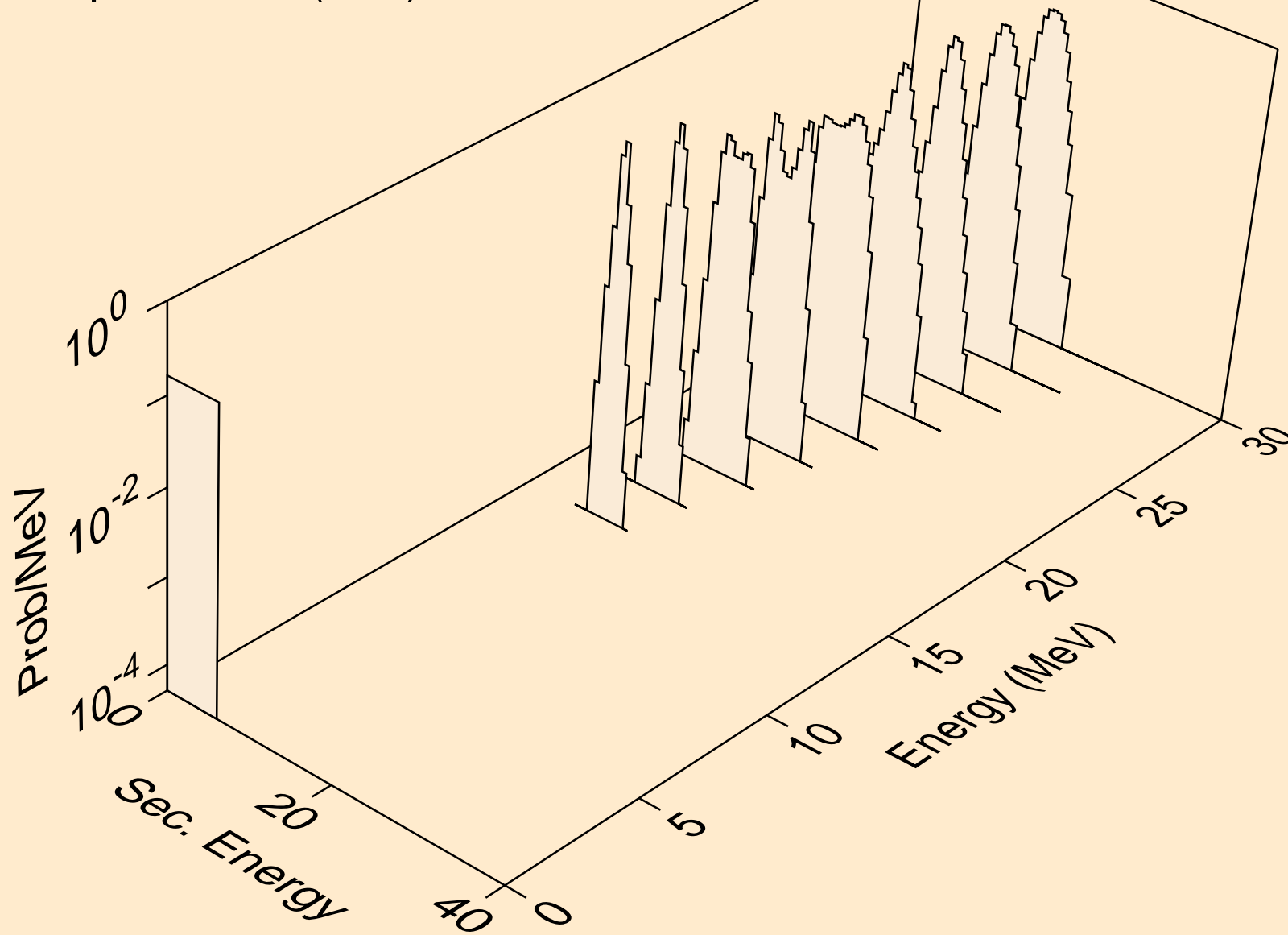

AC236 NEUTRON ACER TENDL-2021 LIBRARY; T=293.6K
alphas from (n,2n)2a

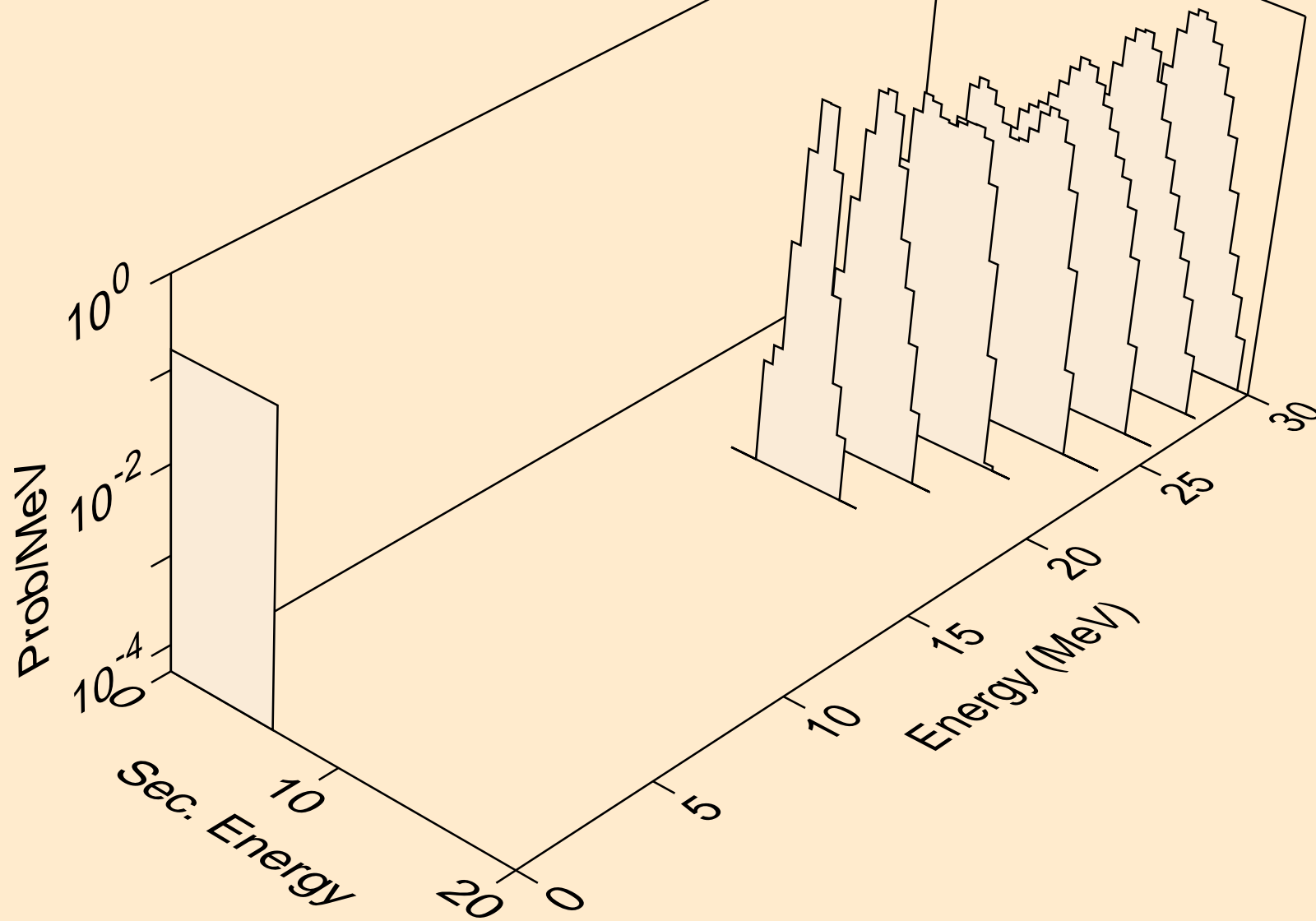

AC236 NEUTRON ACER TENDL-2021 LIBRARY; T=293.6K
alphas from (n,npa)

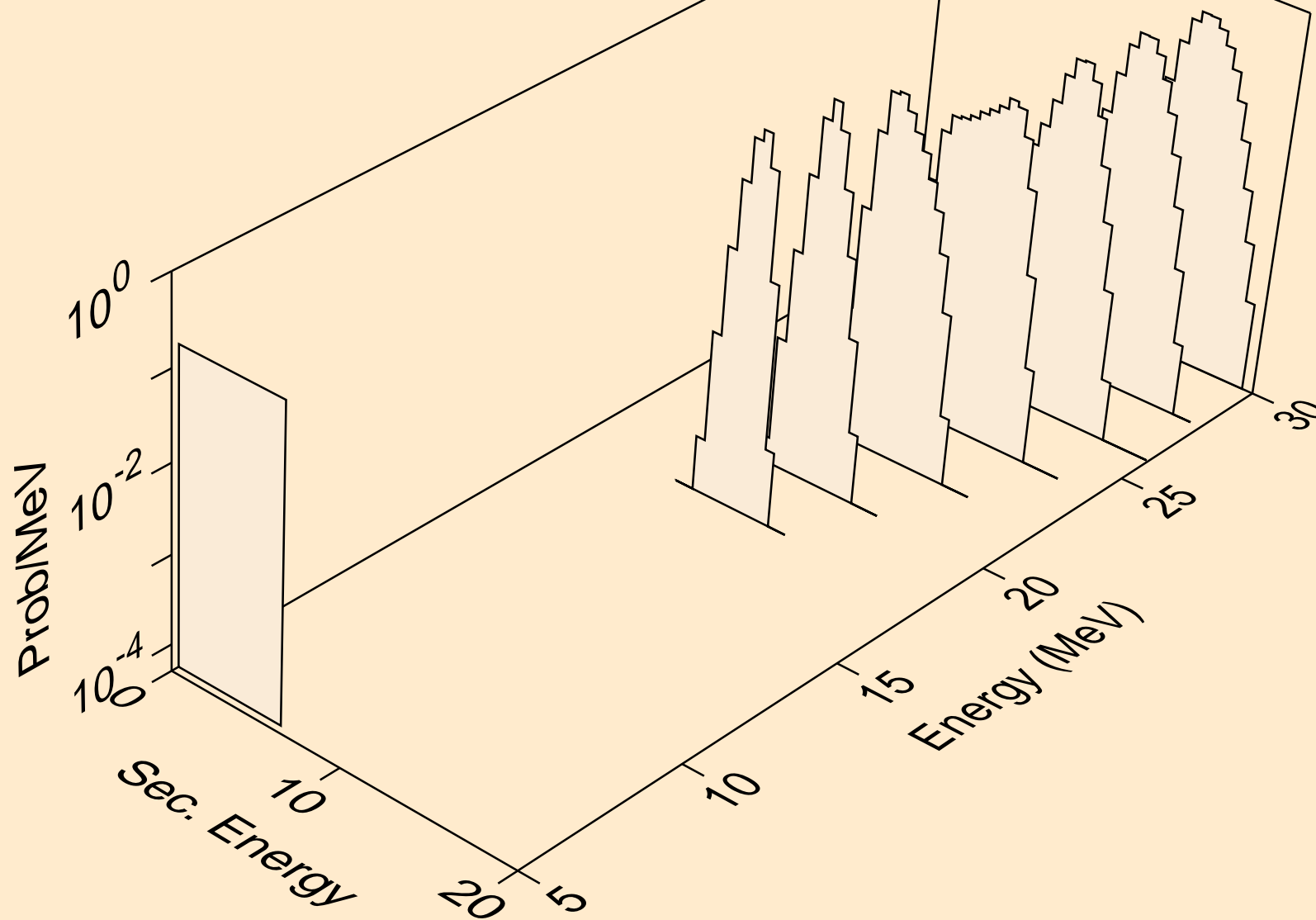

AC236 NEUTRON ACER TENDL-2021 LIBRARY; T=293.6K
alphas from (n,a)

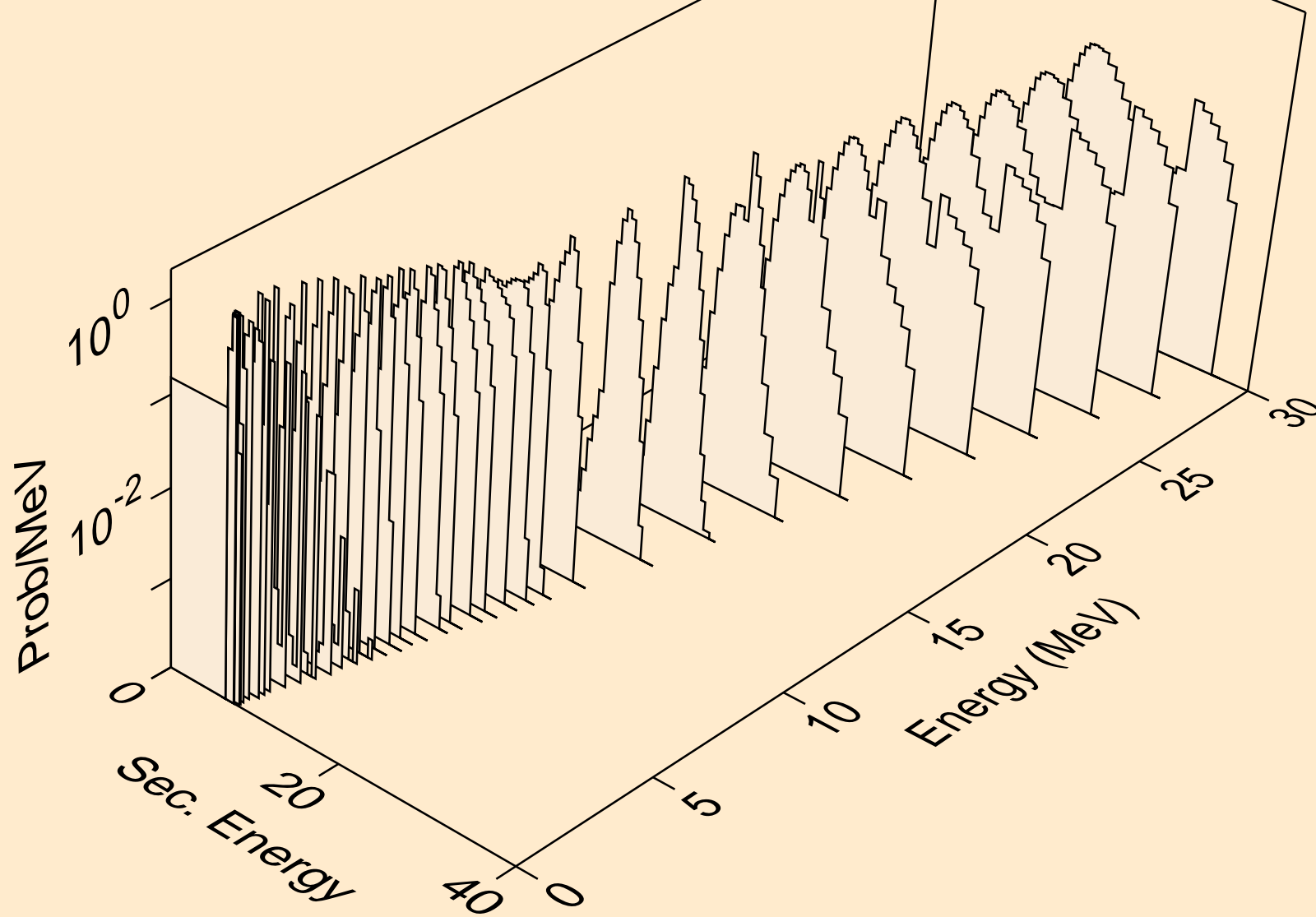

AC236 NEUTRON ACER TENDL-2021 LIBRARY; T=293.6K
alphas from (n,2a)

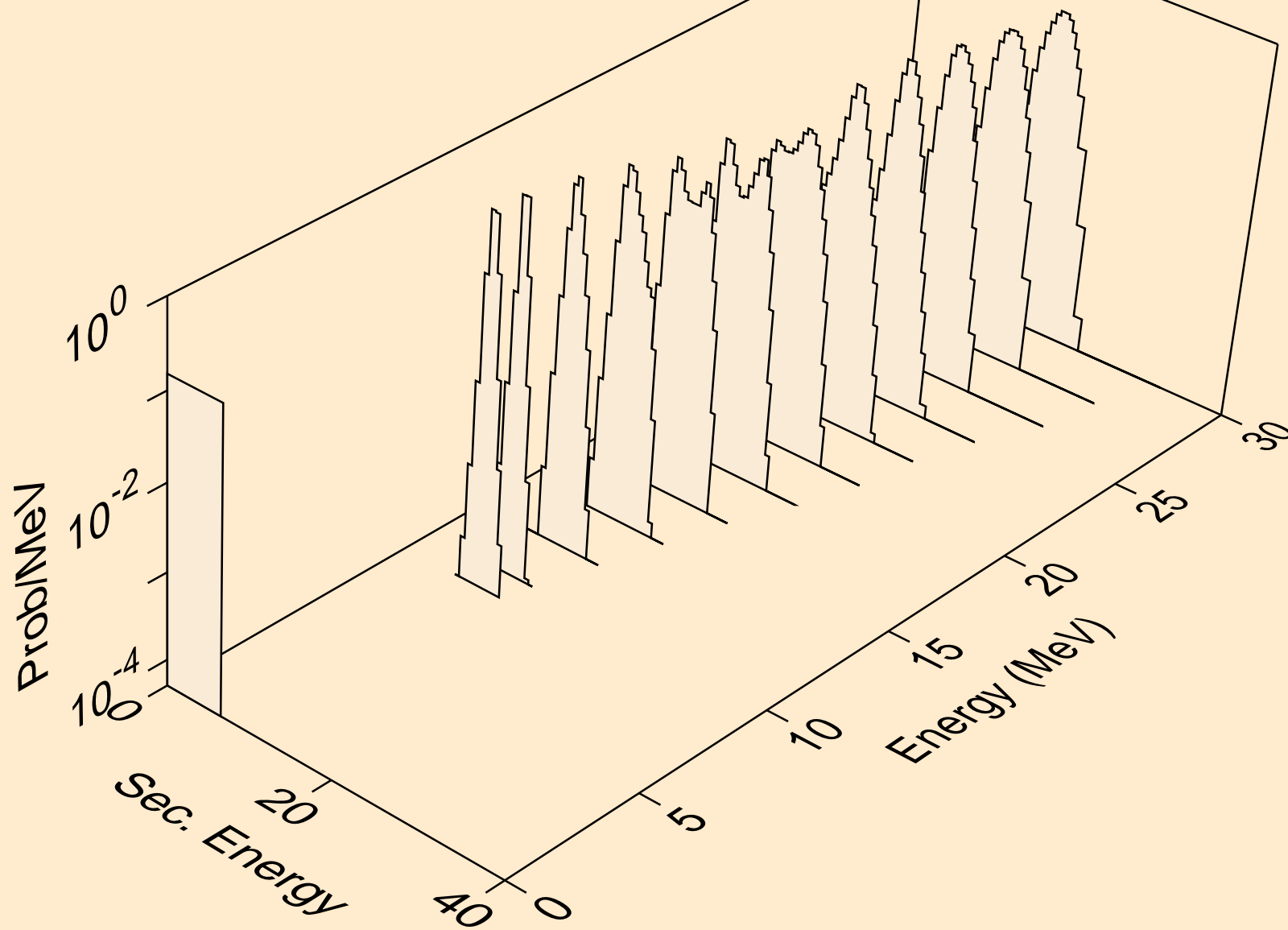

AC236 NEUTRON ACER TENDL-2021 LIBRARY; T=293.6K
alphas from (n,pa)

