

AG096M NEUTRON ACER TENDL-2021 LIBRARY; T=293.6K
Principal cross sections

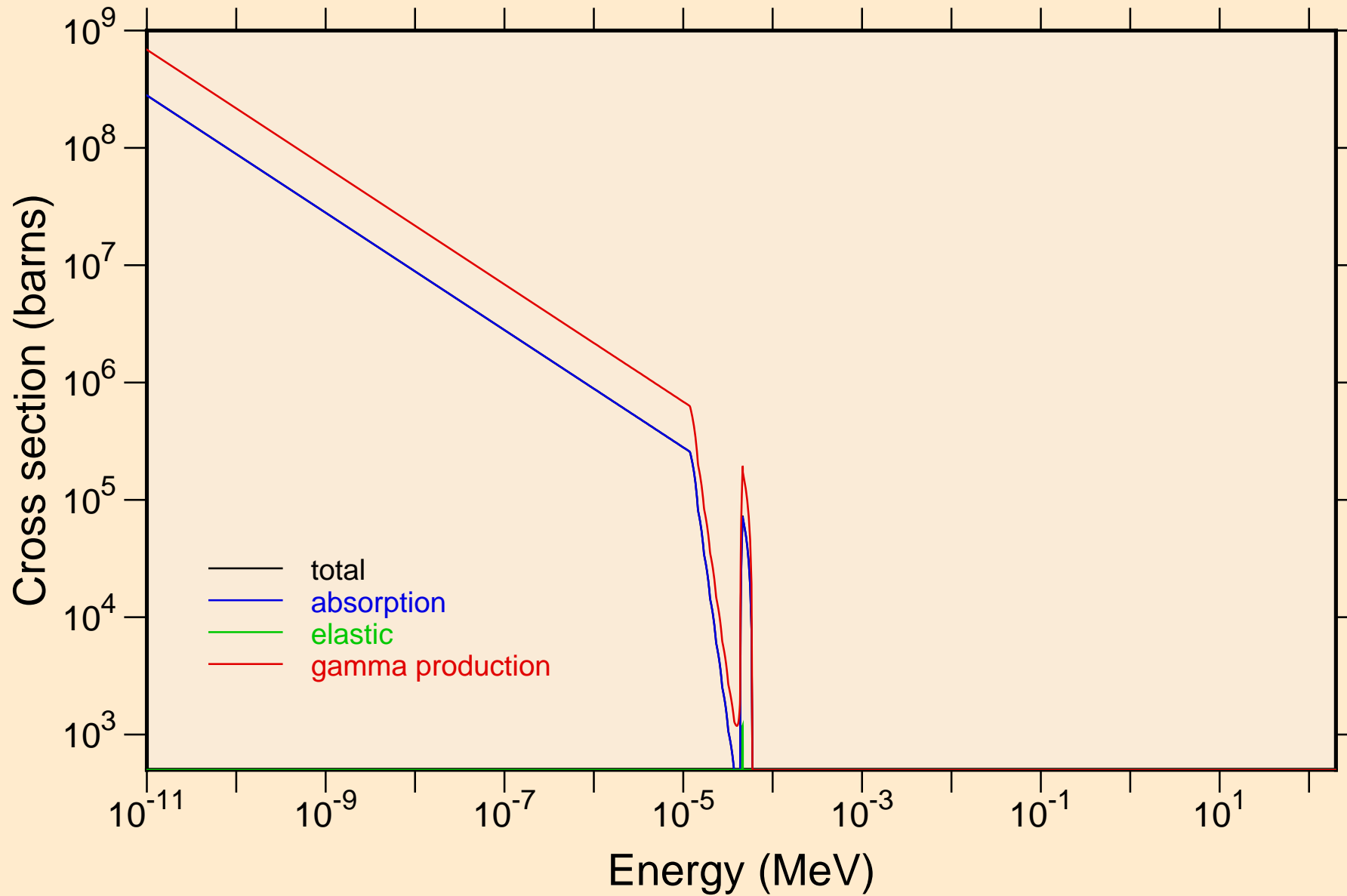

AG096M NEUTRON ACER TENDL-2021 LIBRARY; T=293.6K
Heating

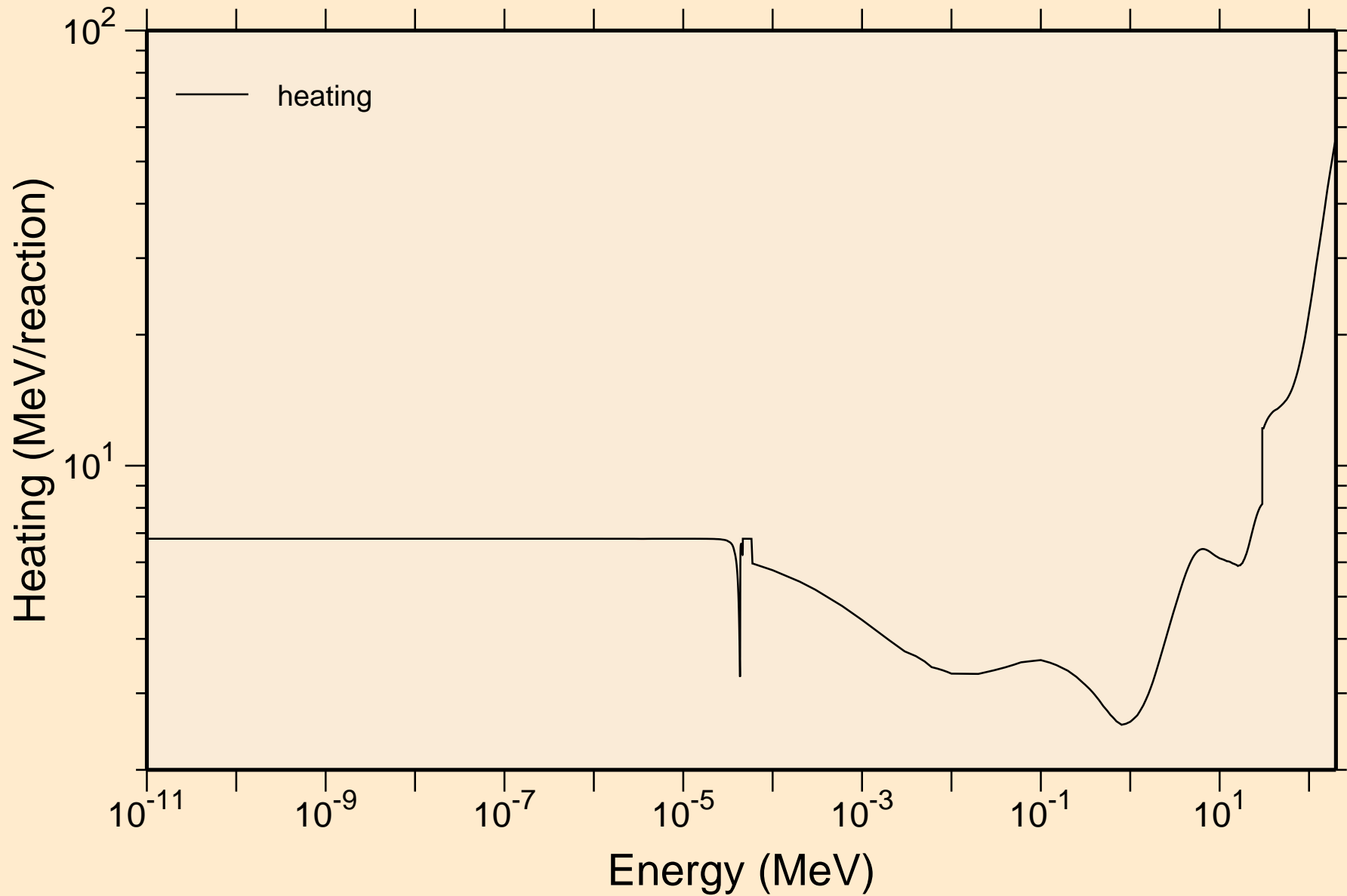

AG096M NEUTRON ACER TENDL-2021 LIBRARY; T=293.6K
Damage

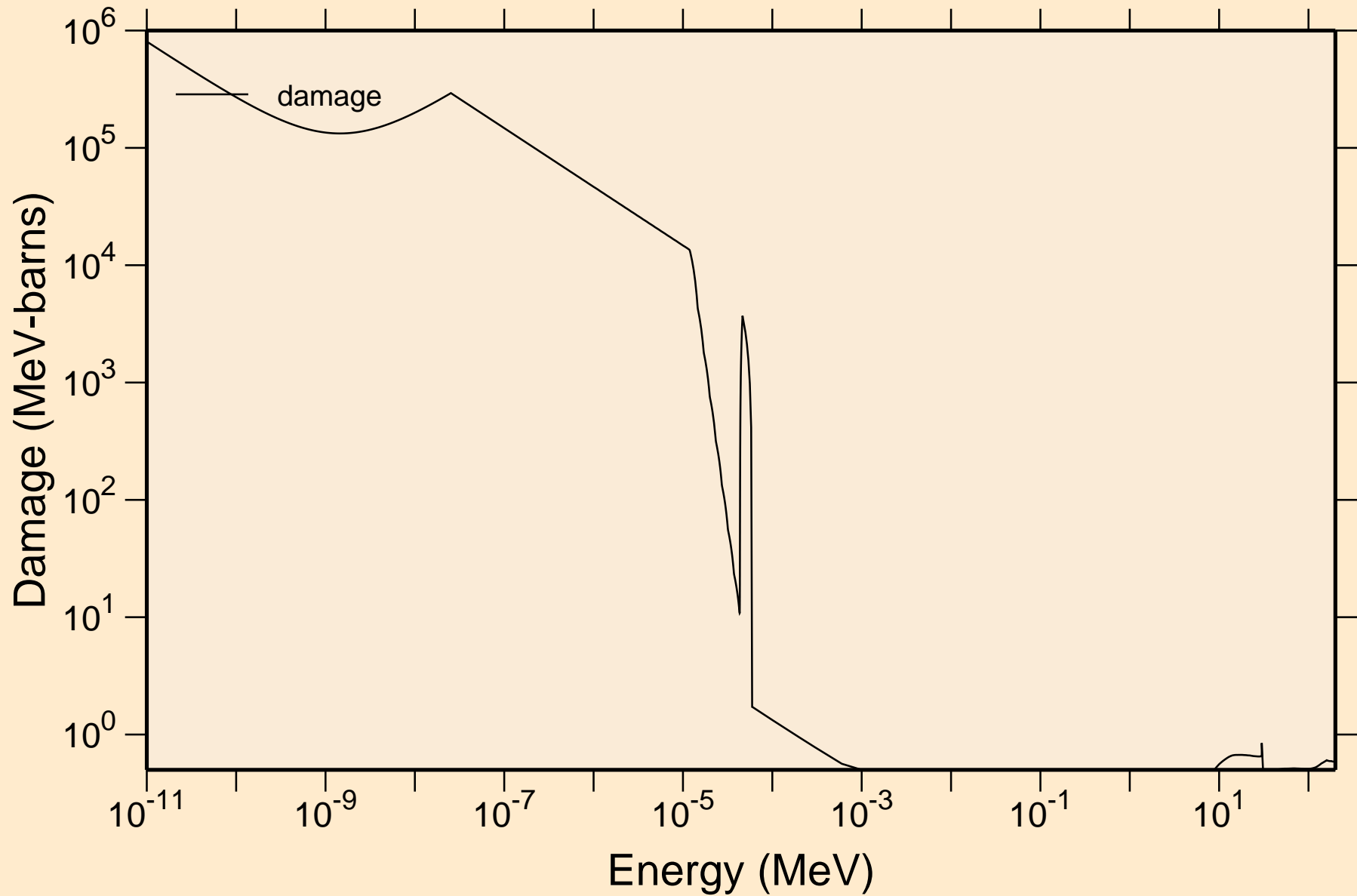

AG096M NEUTRON ACER TENDL-2021 LIBRARY; T=293.6K
Non-threshold reactions

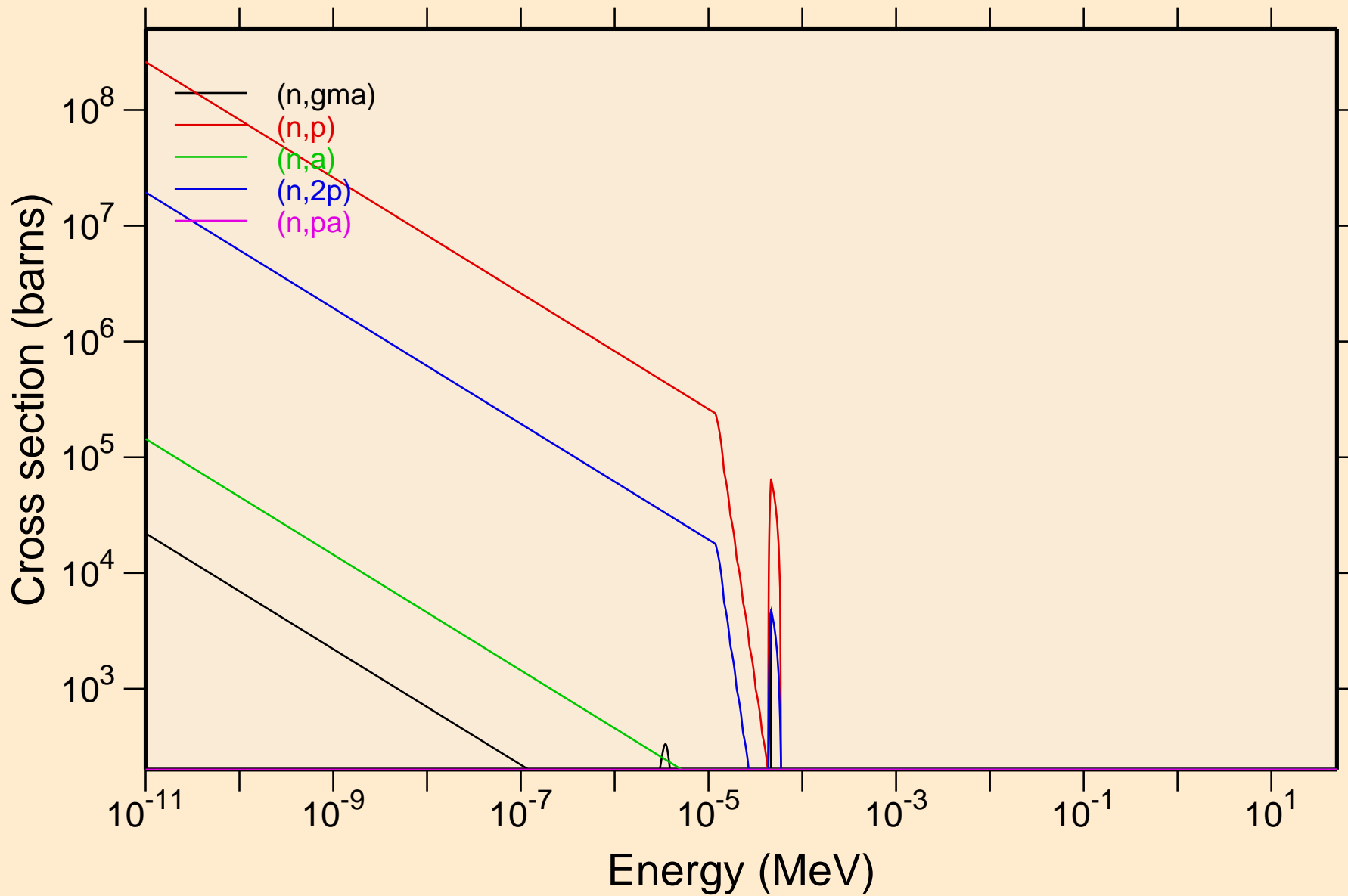

AG096M NEUTRON ACER TENDL-2021 LIBRARY; T=293.6K
Non-threshold reactions

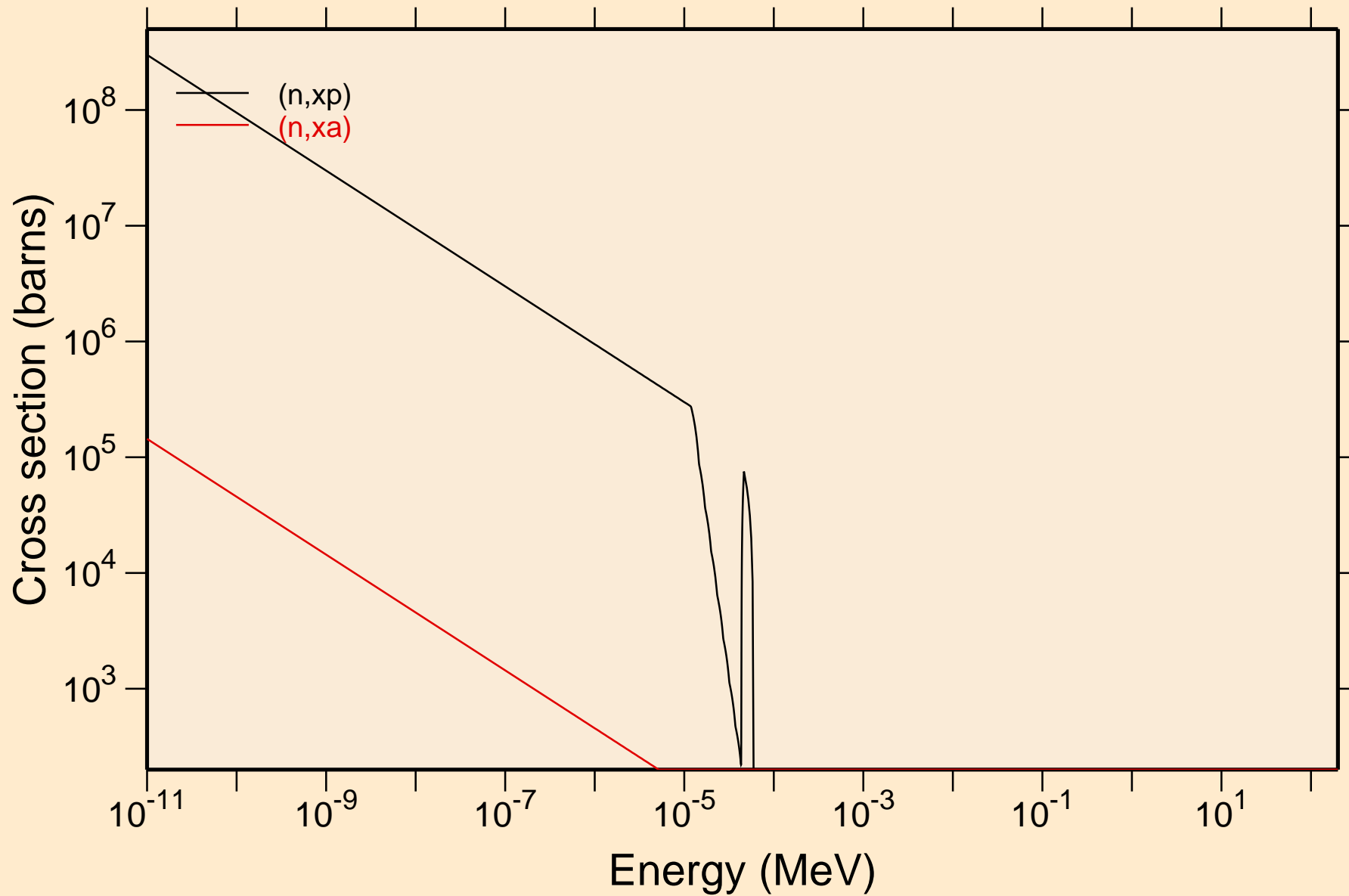

AG096M NEUTRON ACER TENDL-2021 LIBRARY; T=293.6K
Principal cross sections

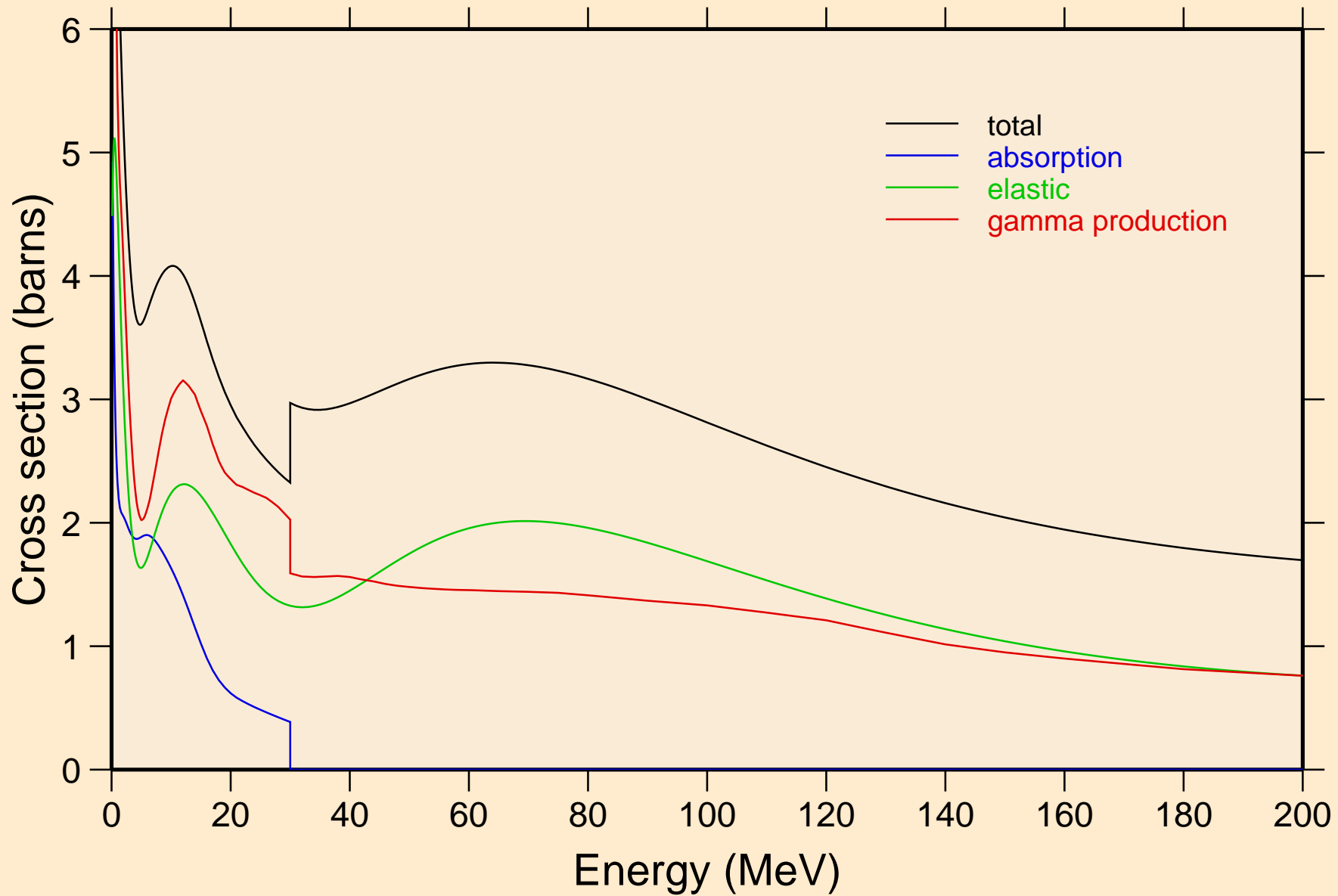

AG096M NEUTRON ACER TENDL-2021 LIBRARY; T=293.6K
Heating

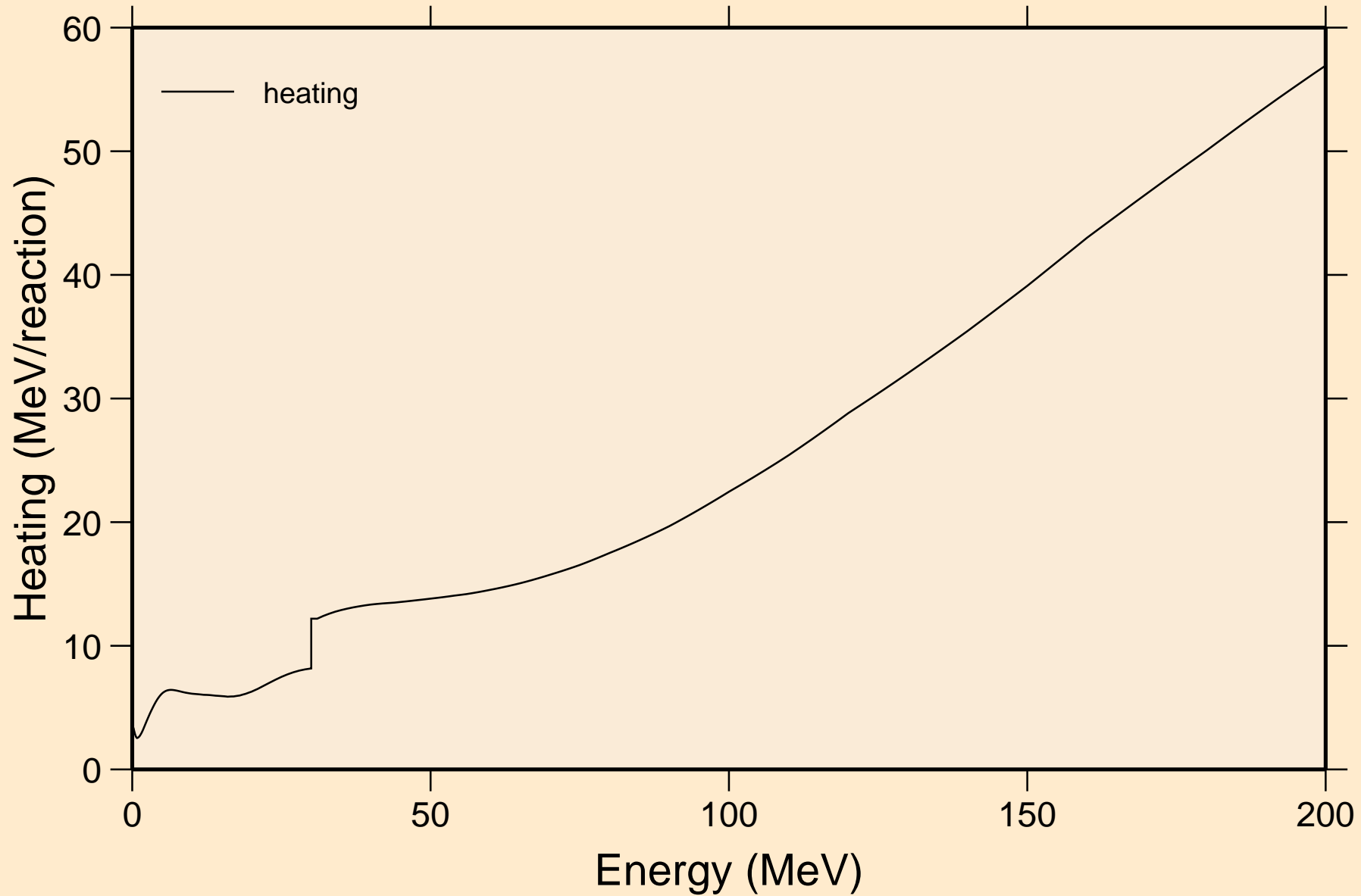

AG096M NEUTRON ACER TENDL-2021 LIBRARY; T=293.6K
Damage

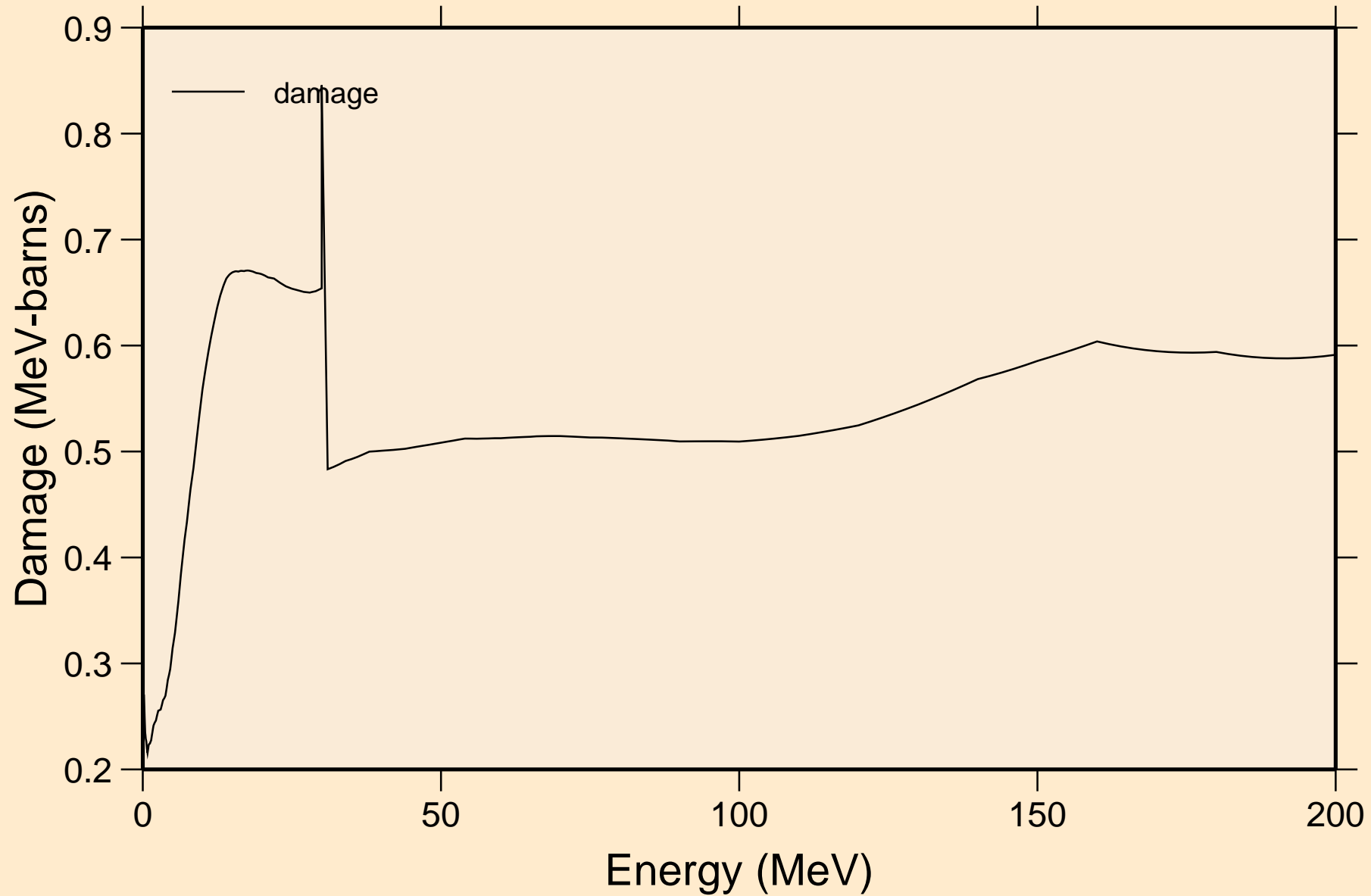

AG096M NEUTRON ACER TENDL-2021 LIBRARY; T=293.6K
Non-threshold reactions

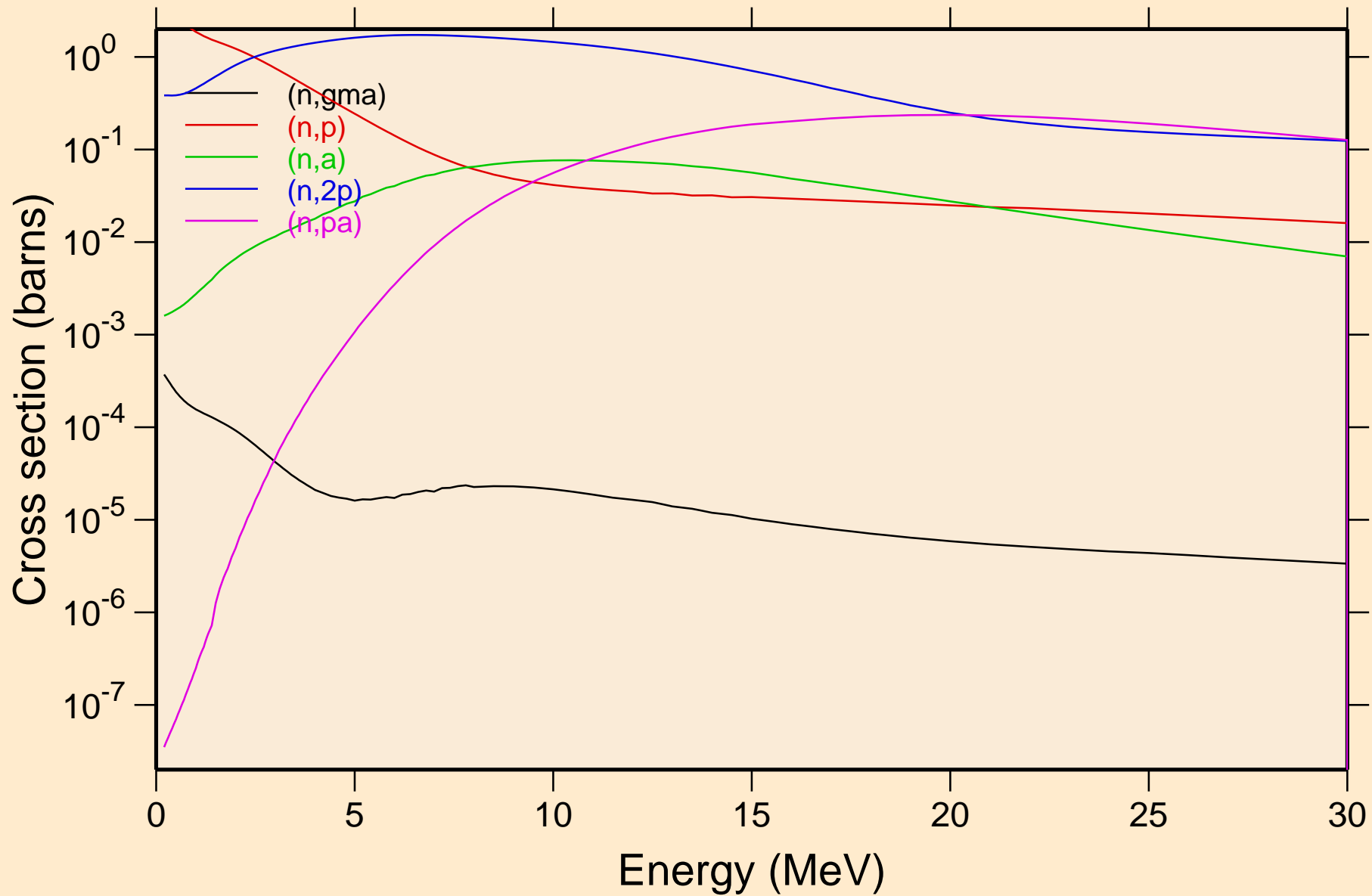

AG096M NEUTRON ACER TENDL-2021 LIBRARY; T=293.6K
Non-threshold reactions

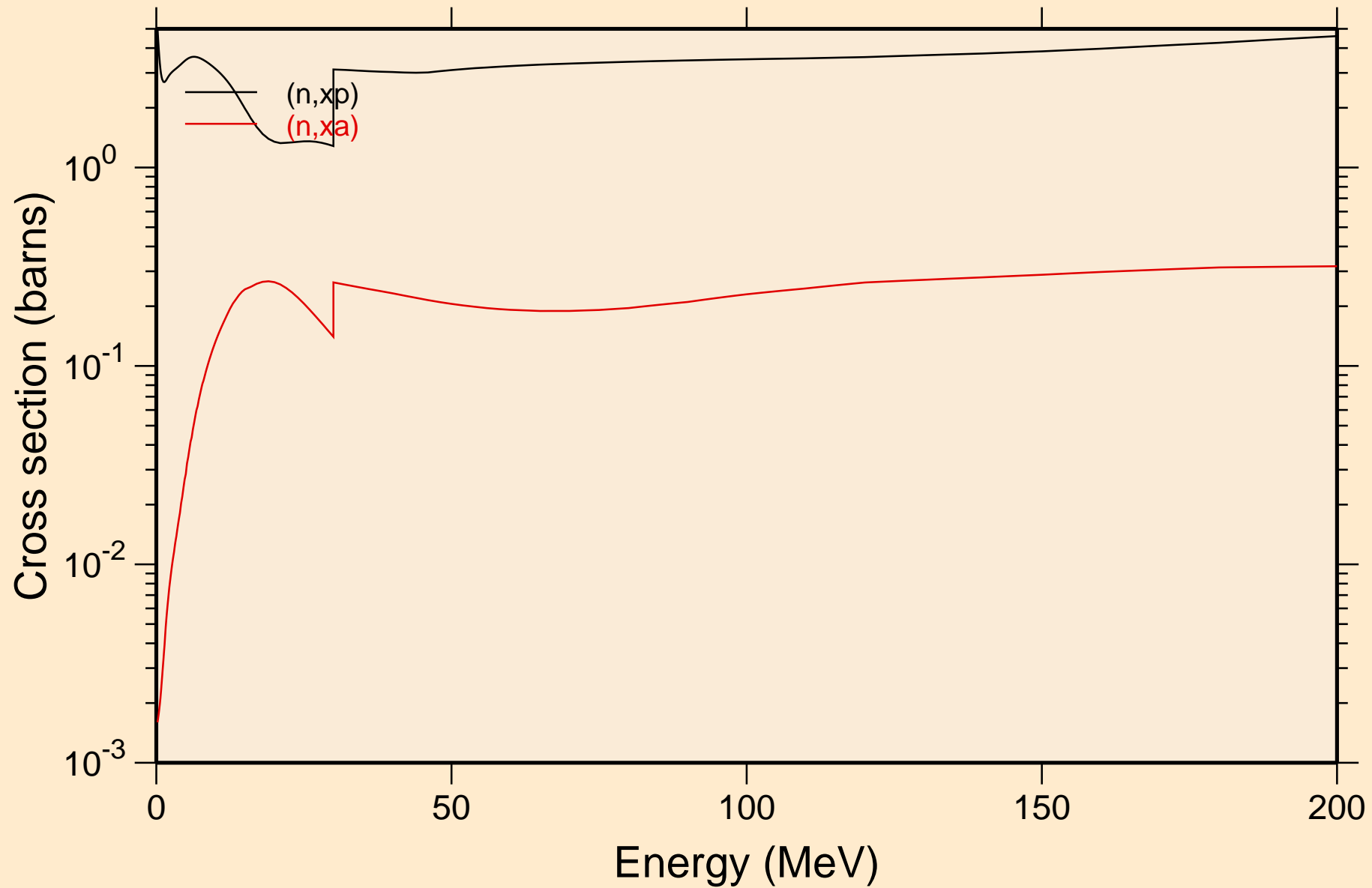

AG096M NEUTRON ACER TENDL-2021 LIBRARY; T=293.6K
Inelastic levels

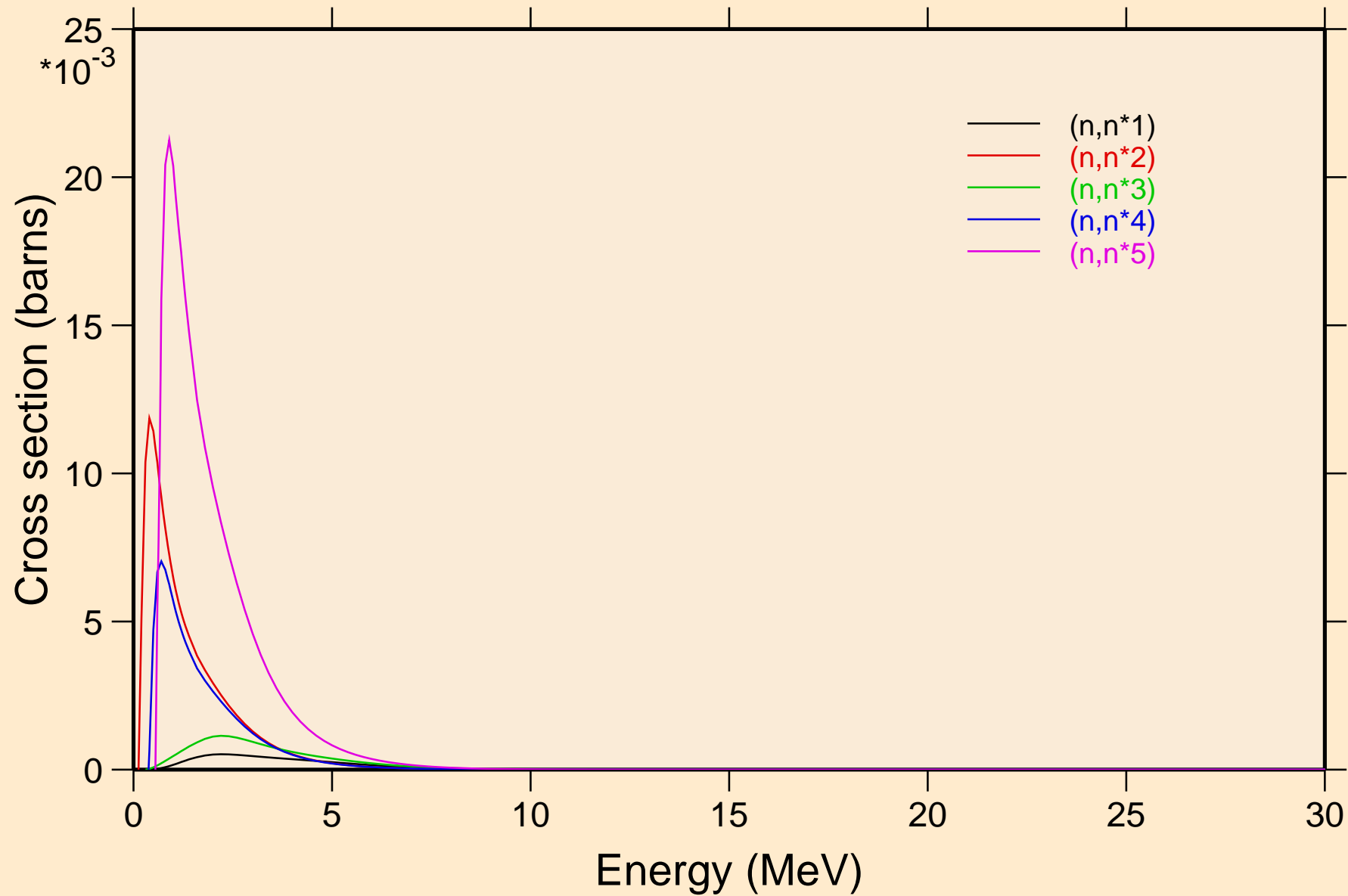

AG096M NEUTRON ACER TENDL-2021 LIBRARY; T=293.6K
Inelastic levels

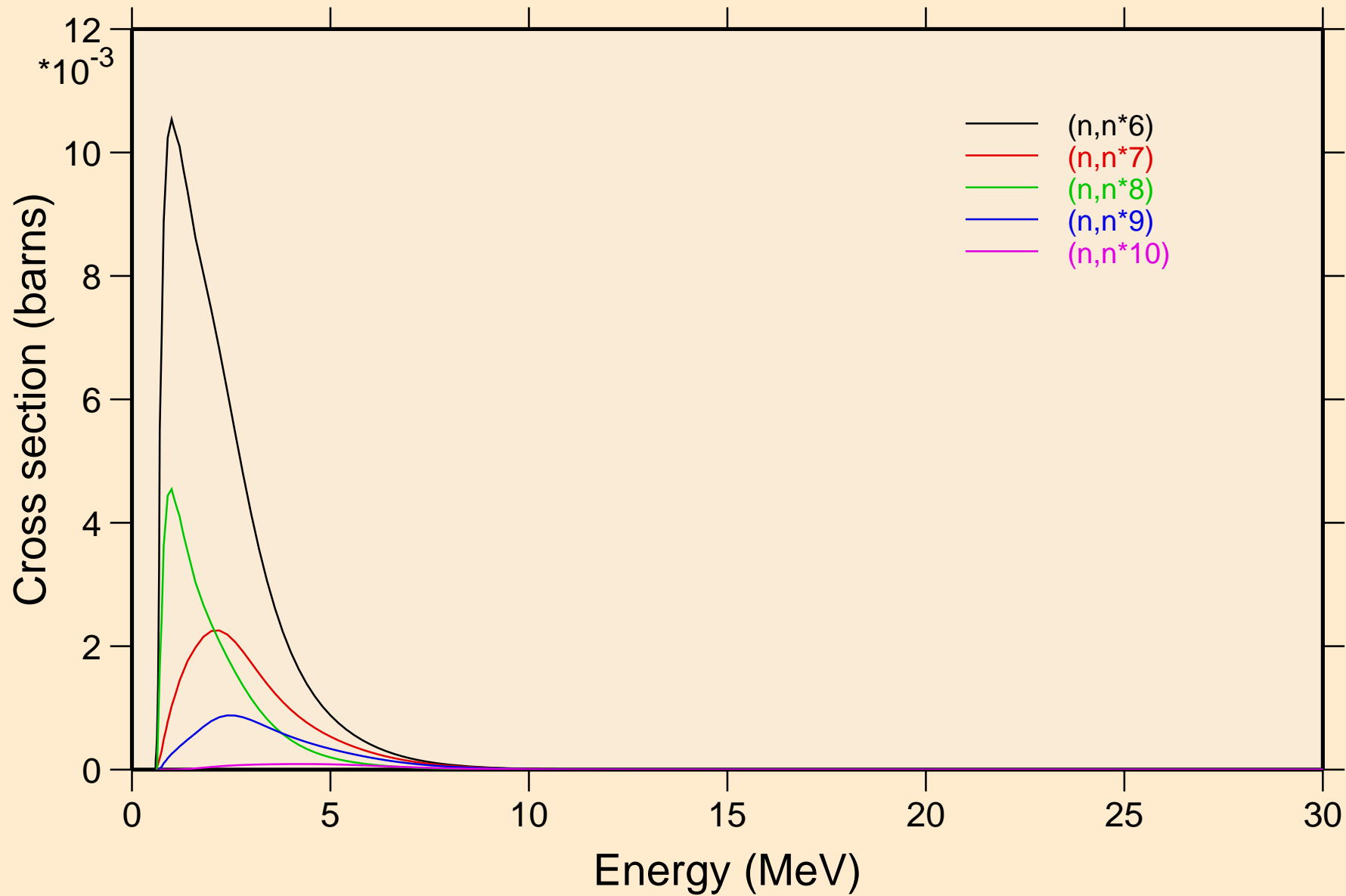

AG096M NEUTRON ACER TENDL-2021 LIBRARY; T=293.6K
Inelastic levels

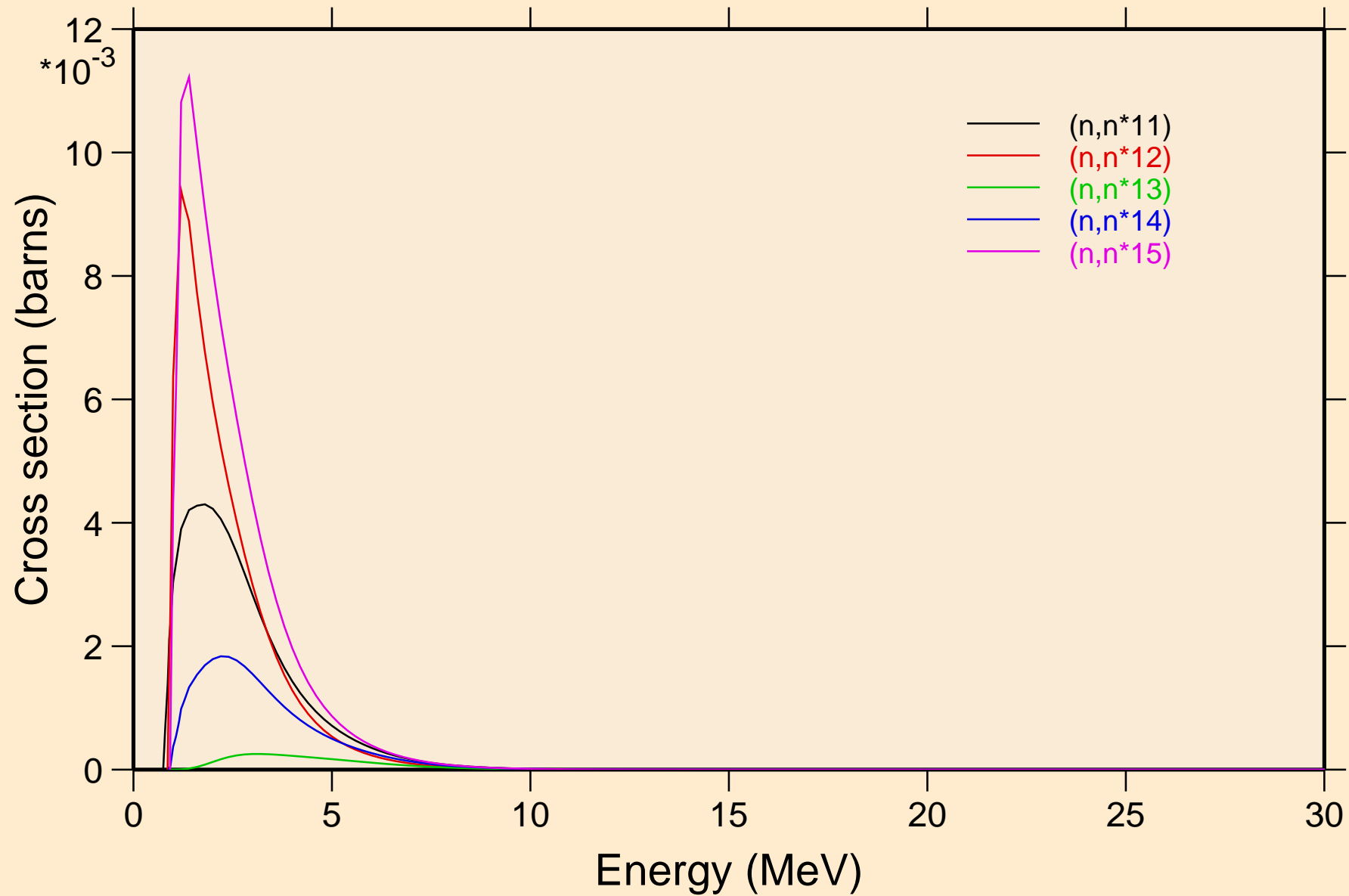

AG096M NEUTRON ACER TENDL-2021 LIBRARY; T=293.6K
Inelastic levels

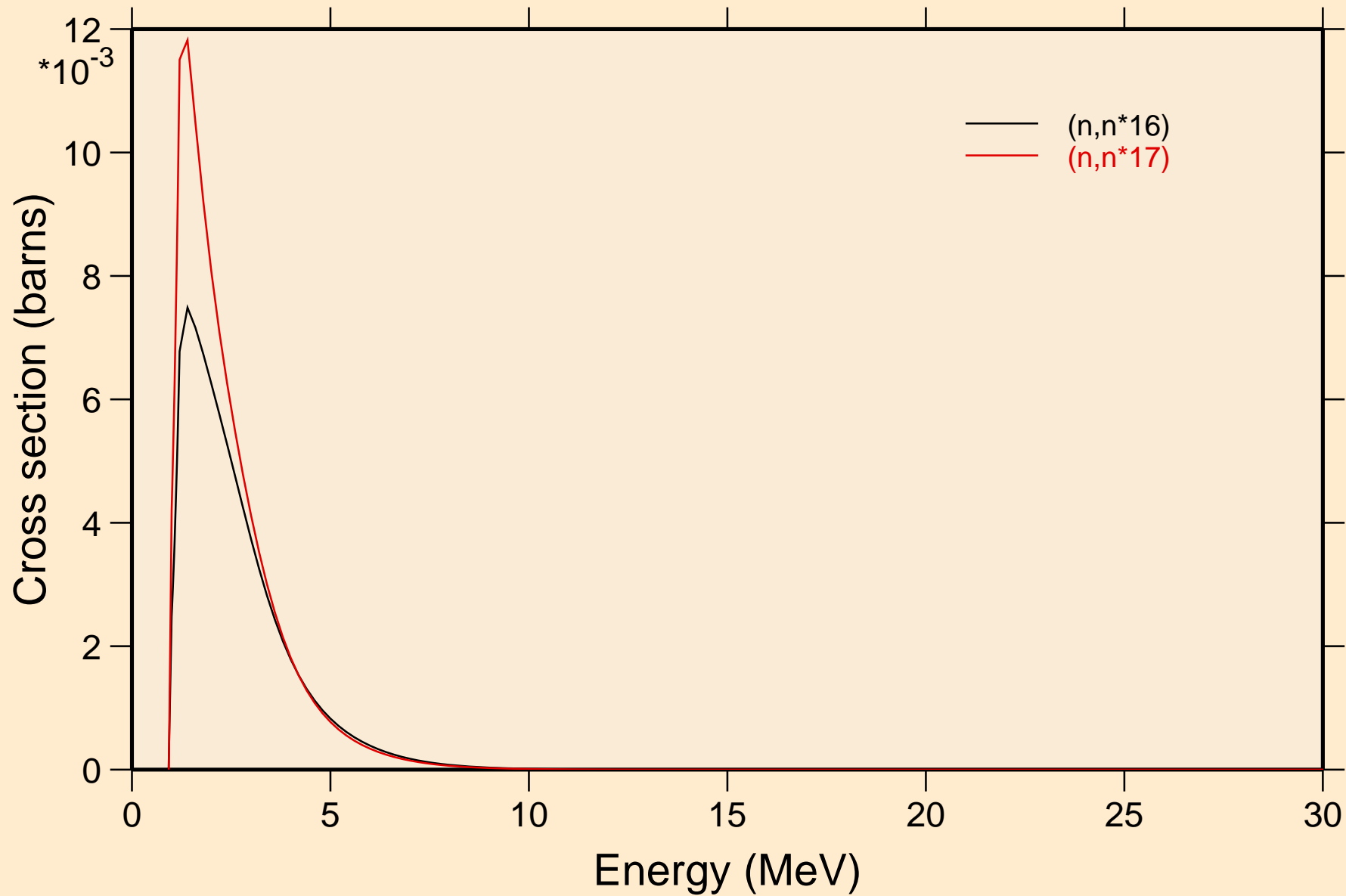

AG096M NEUTRON ACER TENDL-2021 LIBRARY; T=293.6K
Threshold reactions

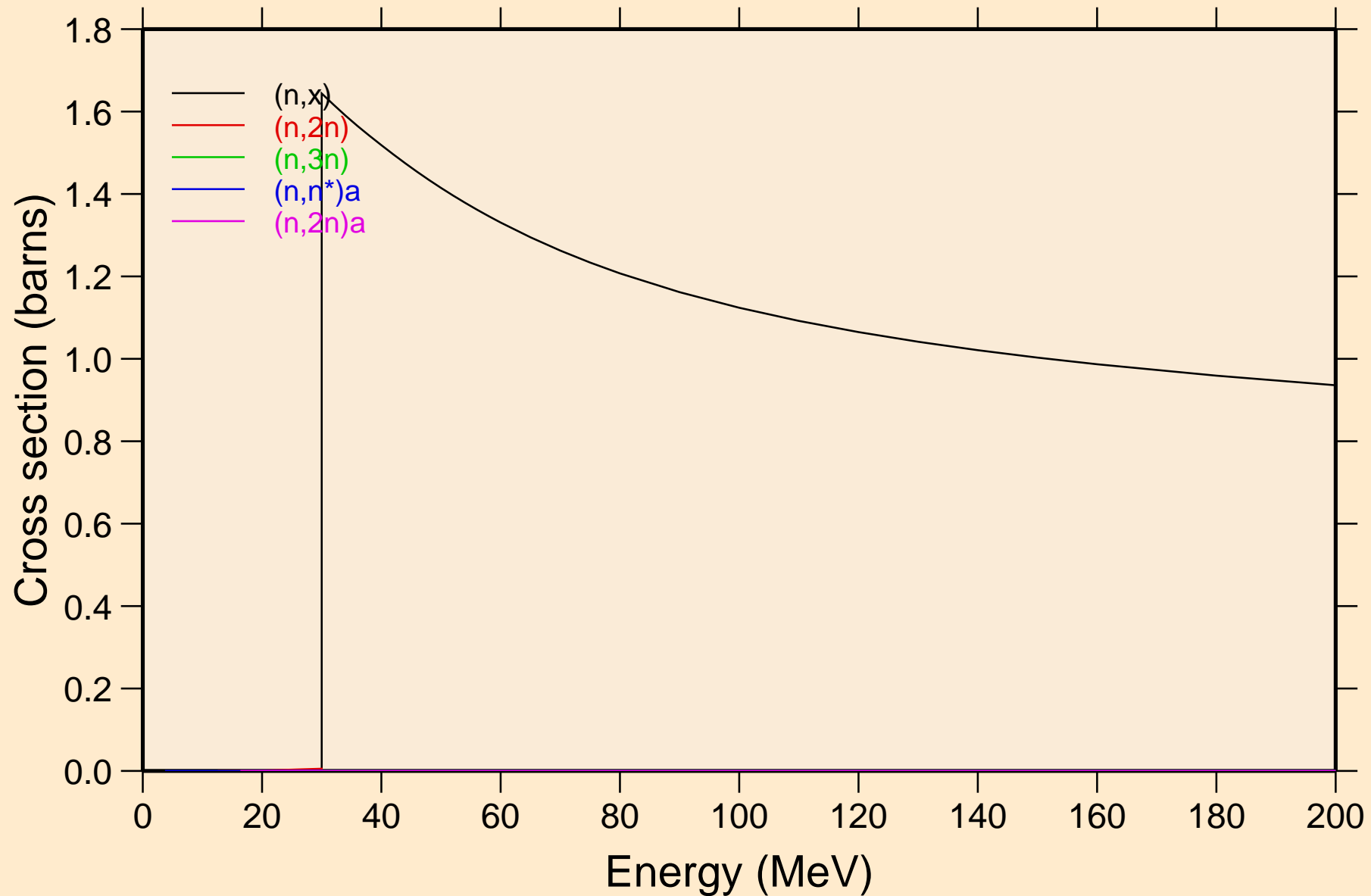

AG096M NEUTRON ACER TENDL-2021 LIBRARY; T=293.6K
Threshold reactions

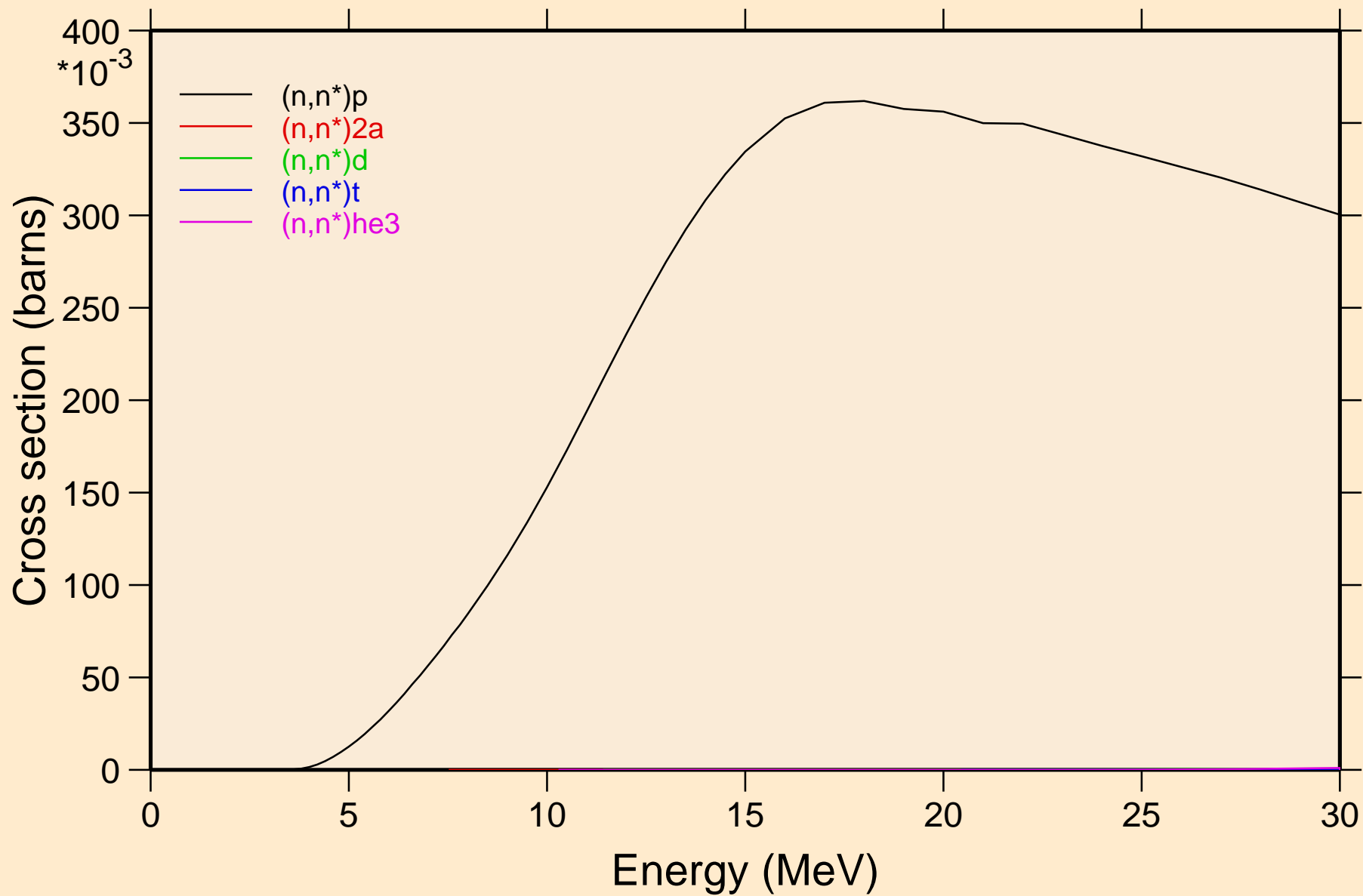

AG096M NEUTRON ACER TENDL-2021 LIBRARY; T=293.6K
Threshold reactions

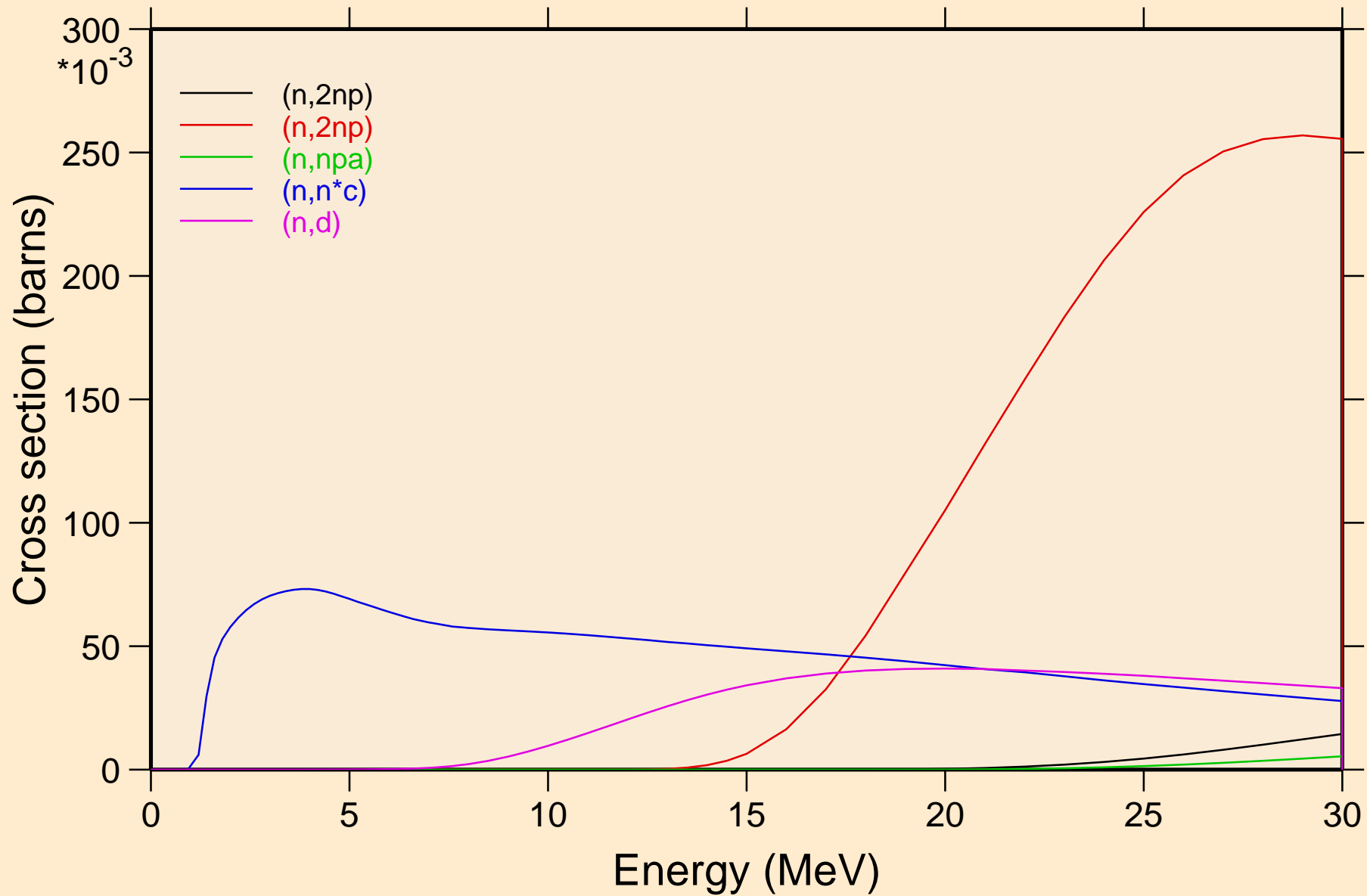

AG096M NEUTRON ACER TENDL-2021 LIBRARY; T=293.6K
Threshold reactions

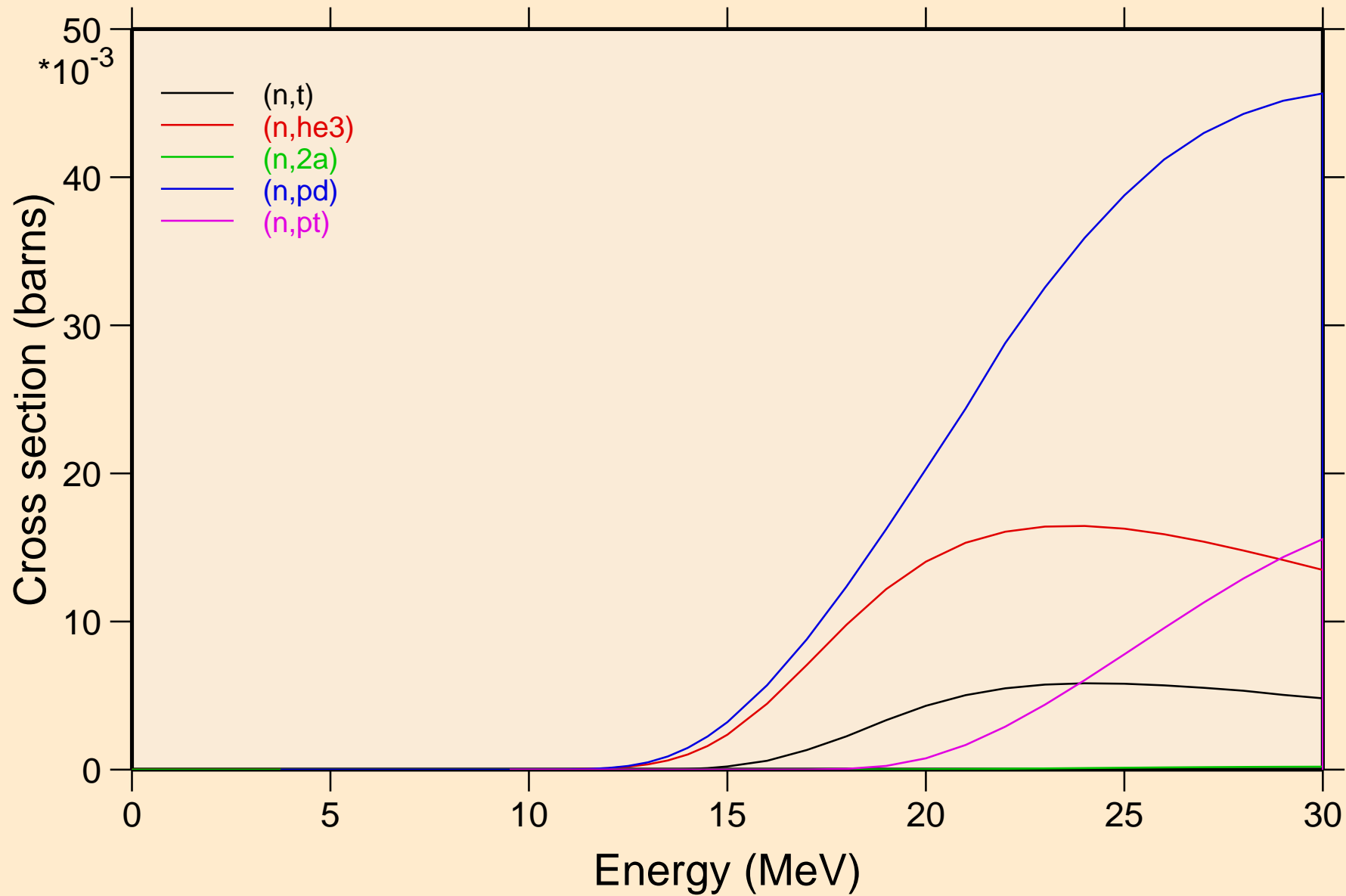

AG096M NEUTRON ACER TENDL-2021 LIBRARY; T=293.6K
Threshold reactions

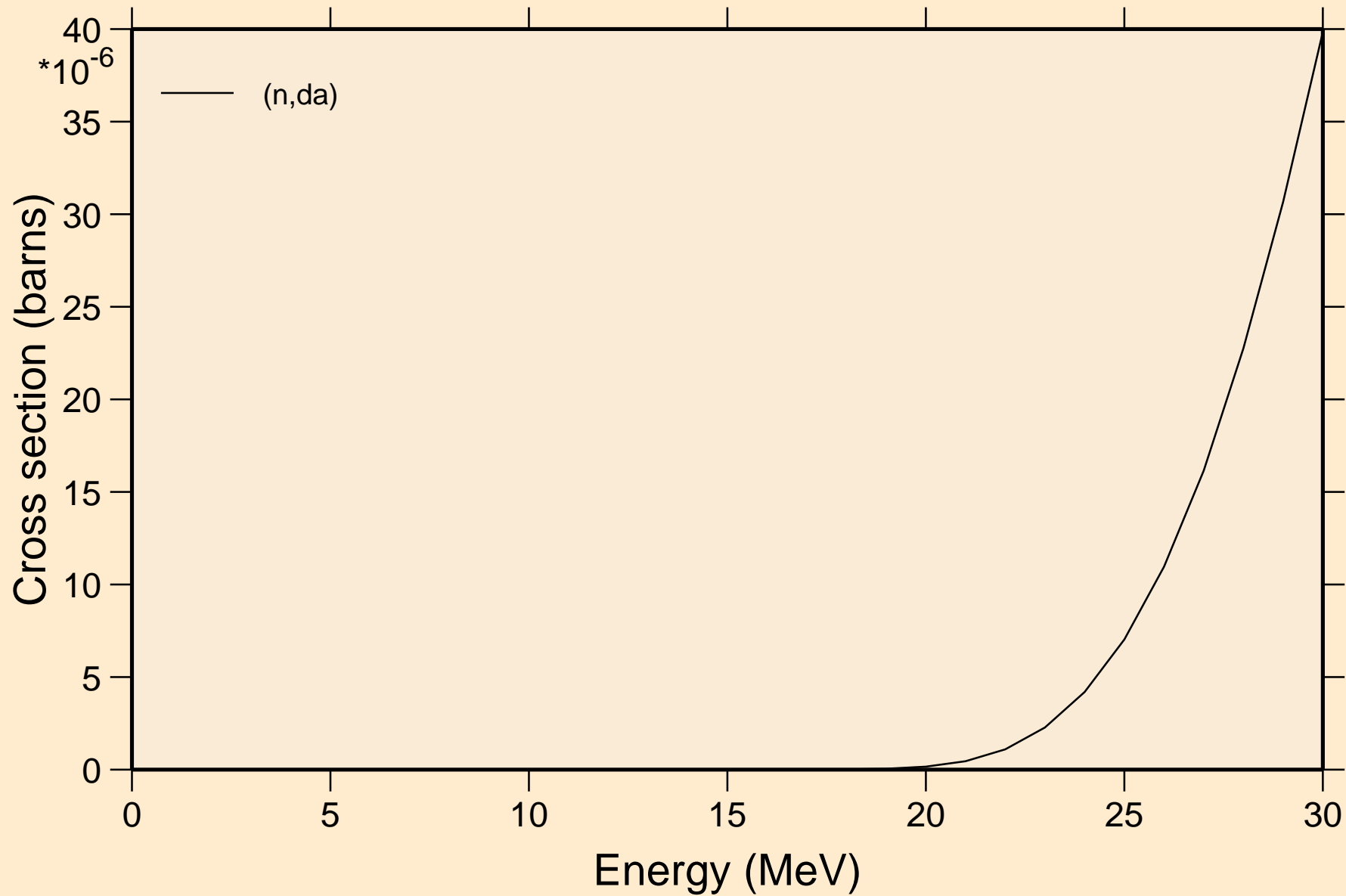

AG096M NEUTRON ACER TENDL-2021 LIBRARY; T=293.6K
Threshold reactions

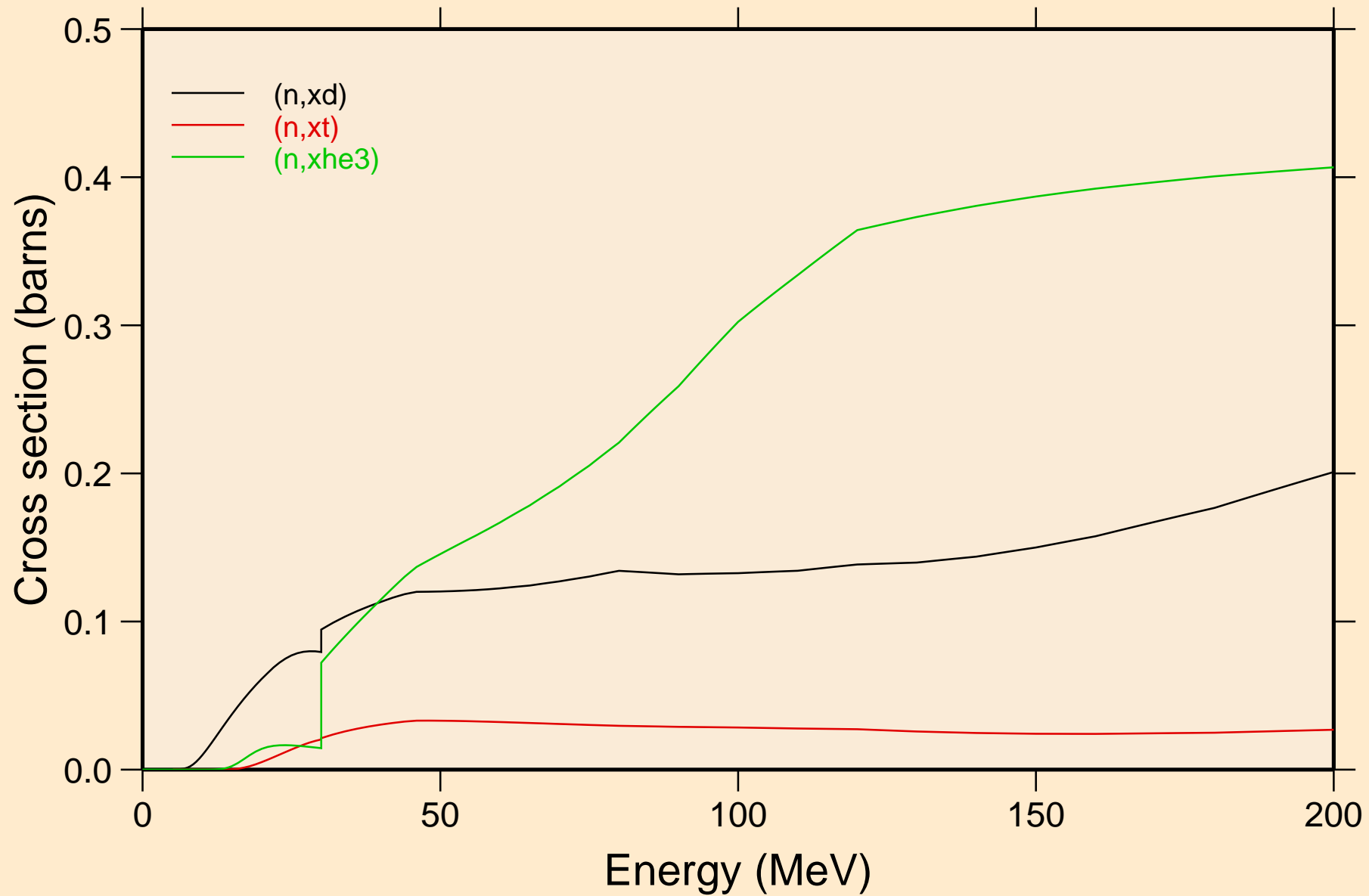

AG096M NEUTRON ACER TENDL-2021 LIBRARY; T=293.6K
angular distribution for elastic

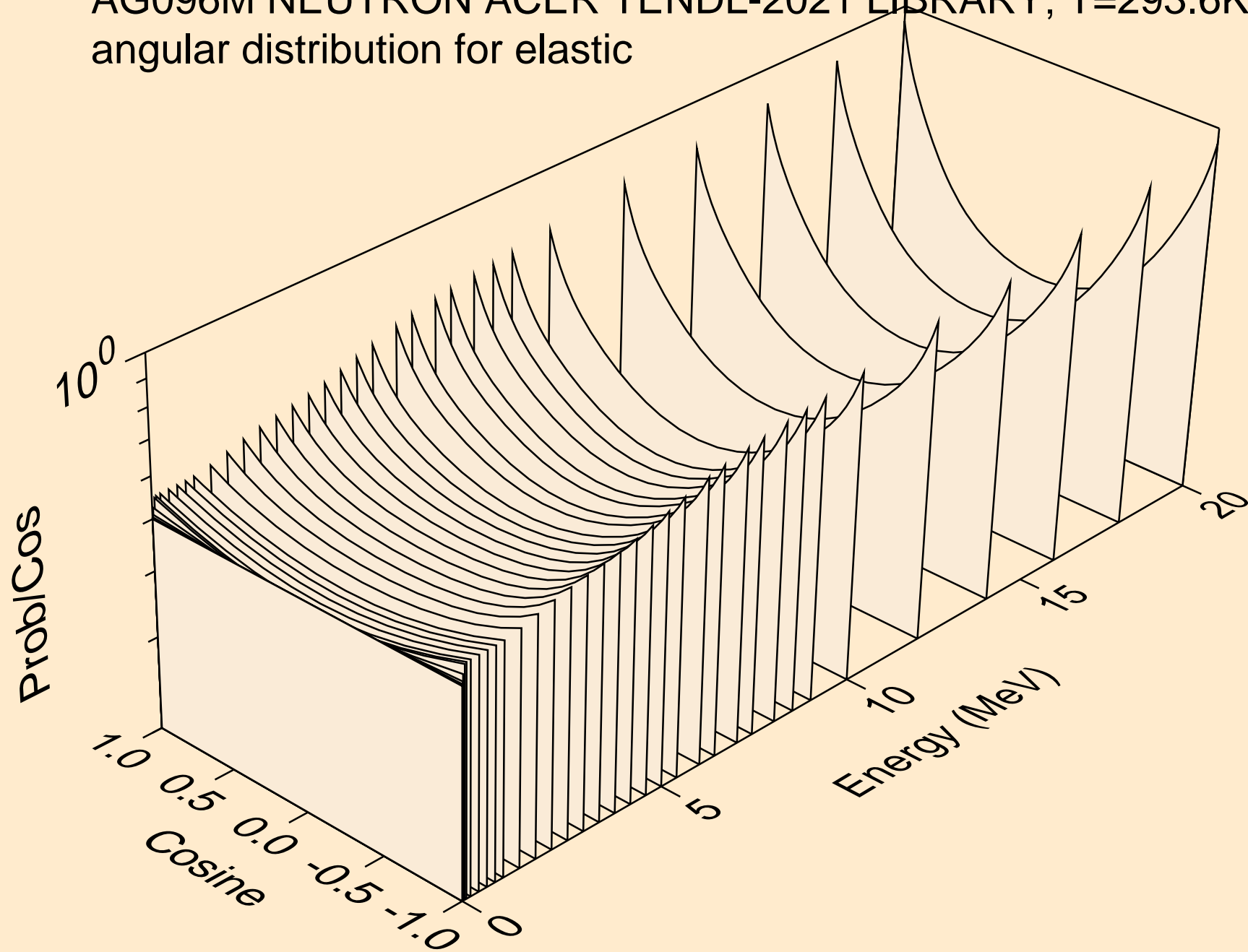

AG096M NEUTRON ACER TENDL-2021 LIBRARY; T=293.6K
angular distribution for elastic

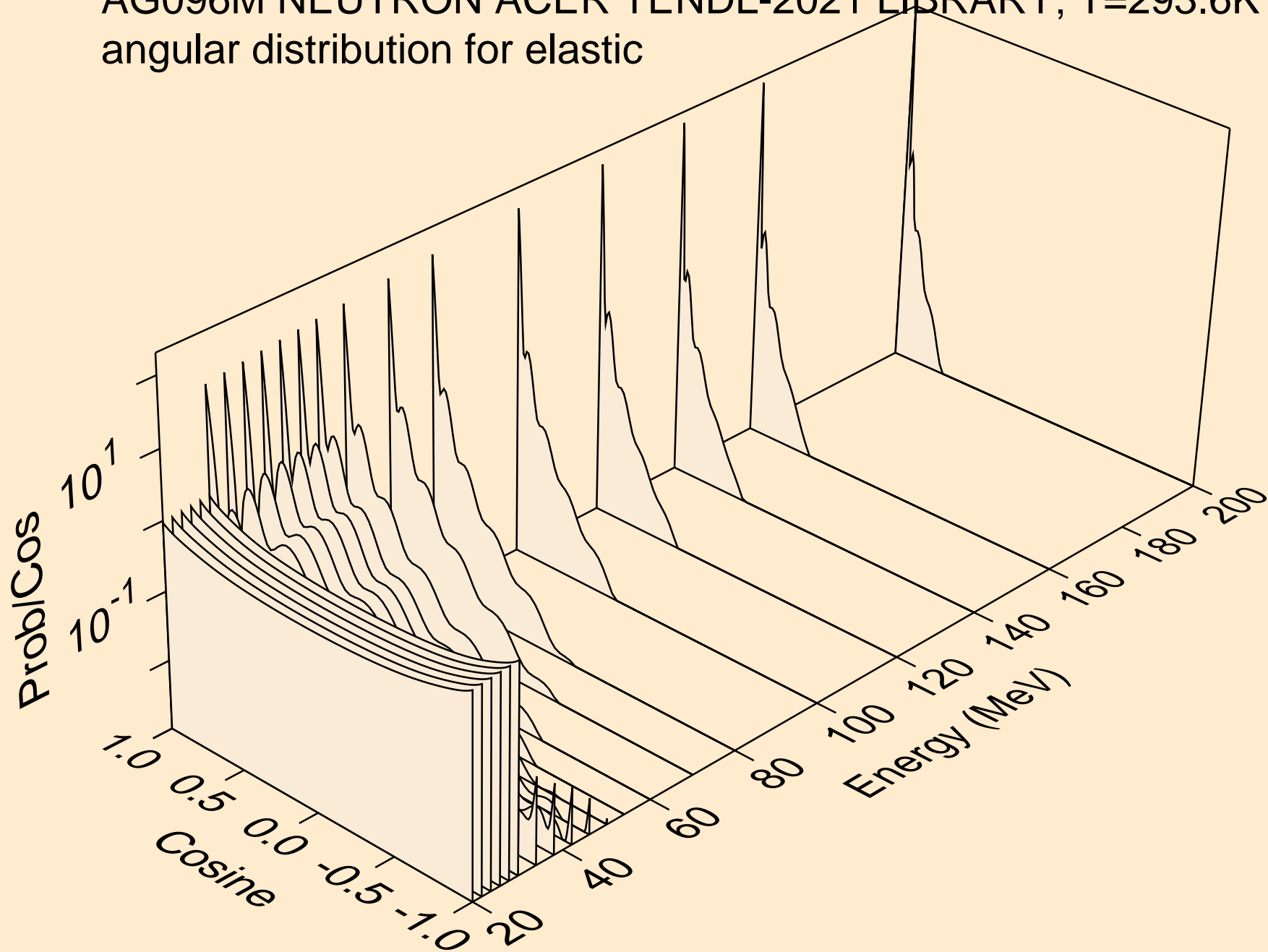

AG096M NEUTRON ACER TENDL-2021 LIBRARY; T=293.6K
angular distribution for (n,n*1)

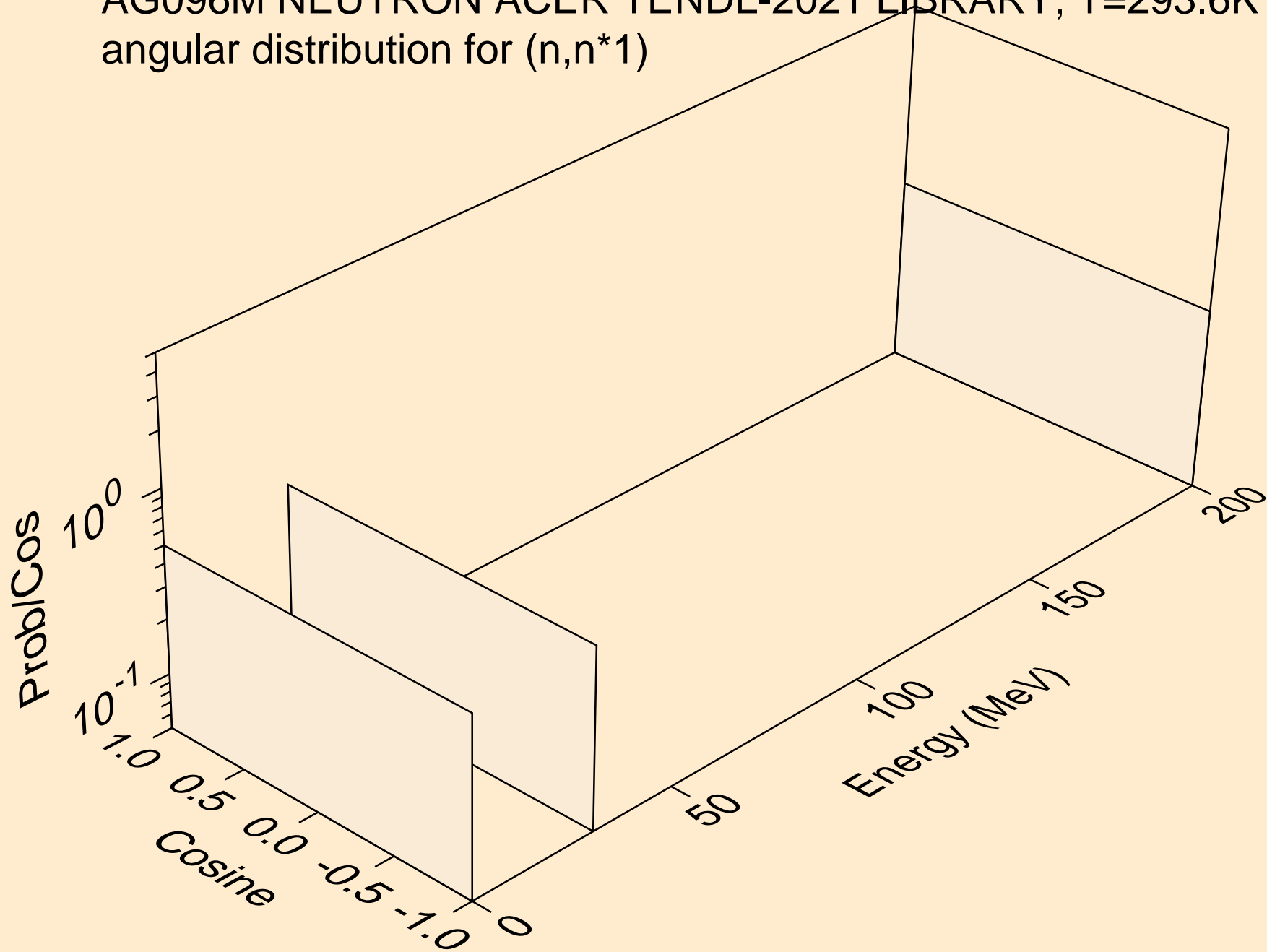

AG096M NEUTRON ACER TENDL-2021 LIBRARY; T=293.6K
angular distribution for (n,n*2)

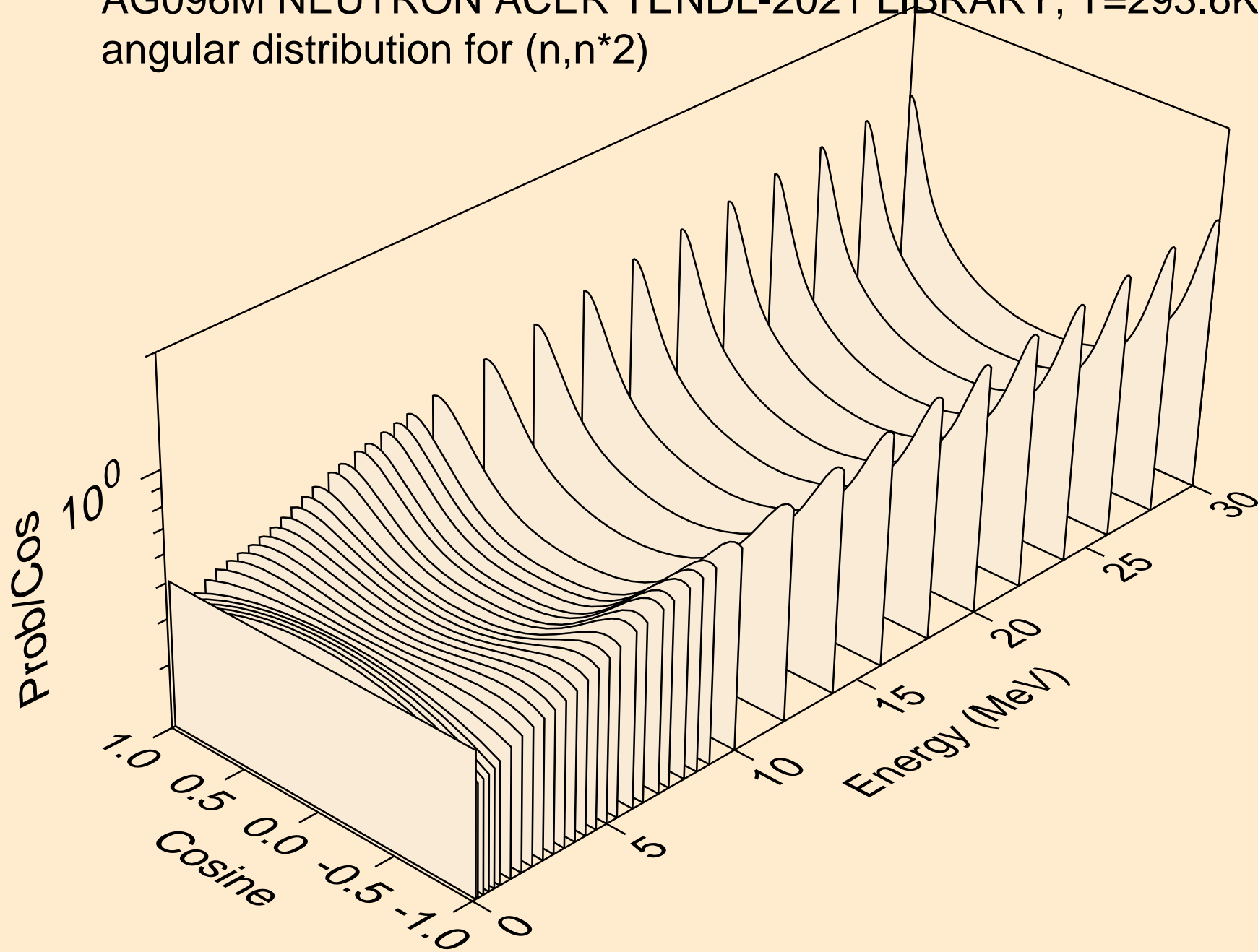

AG096M NEUTRON ACER TENDL-2021 LIBRARY; T=293.6K
angular distribution for (n,n*3)

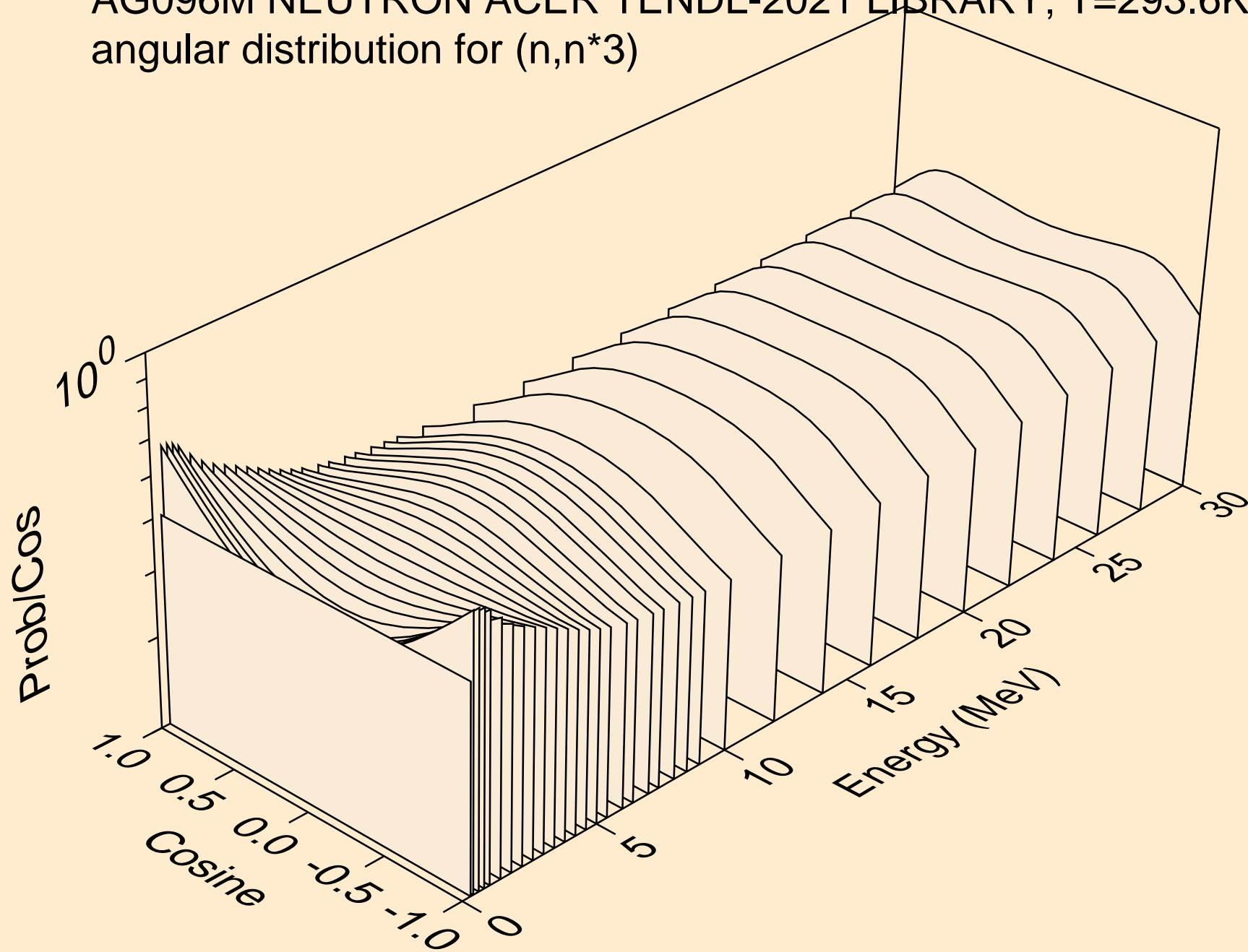

AG096M NEUTRON ACER TENDL-2021 LIBRARY; T=293.6K
angular distribution for (n,n*4)

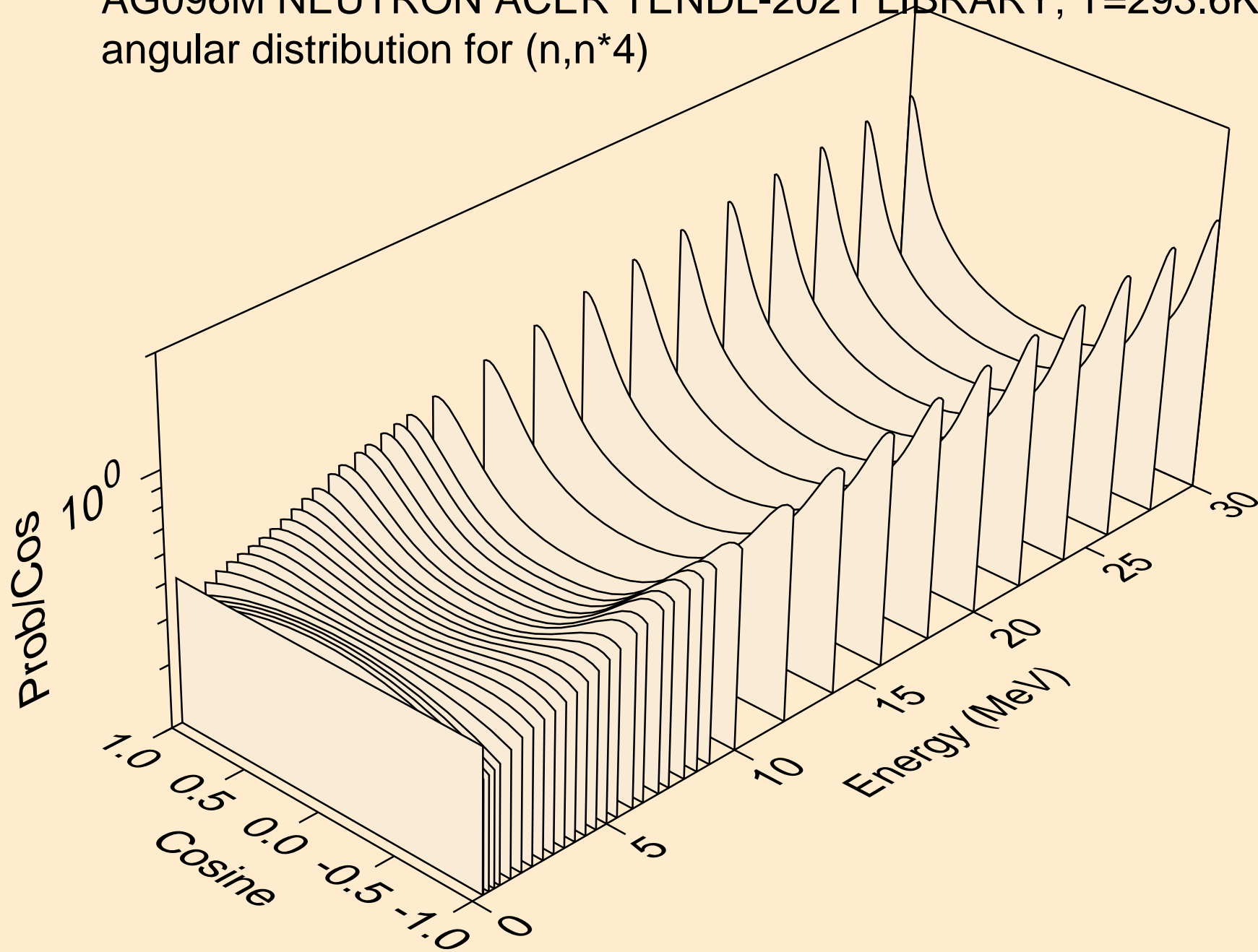

AG096M NEUTRON ACER TENDL-2021 LIBRARY; T=293.6K
angular distribution for (n,n*5)

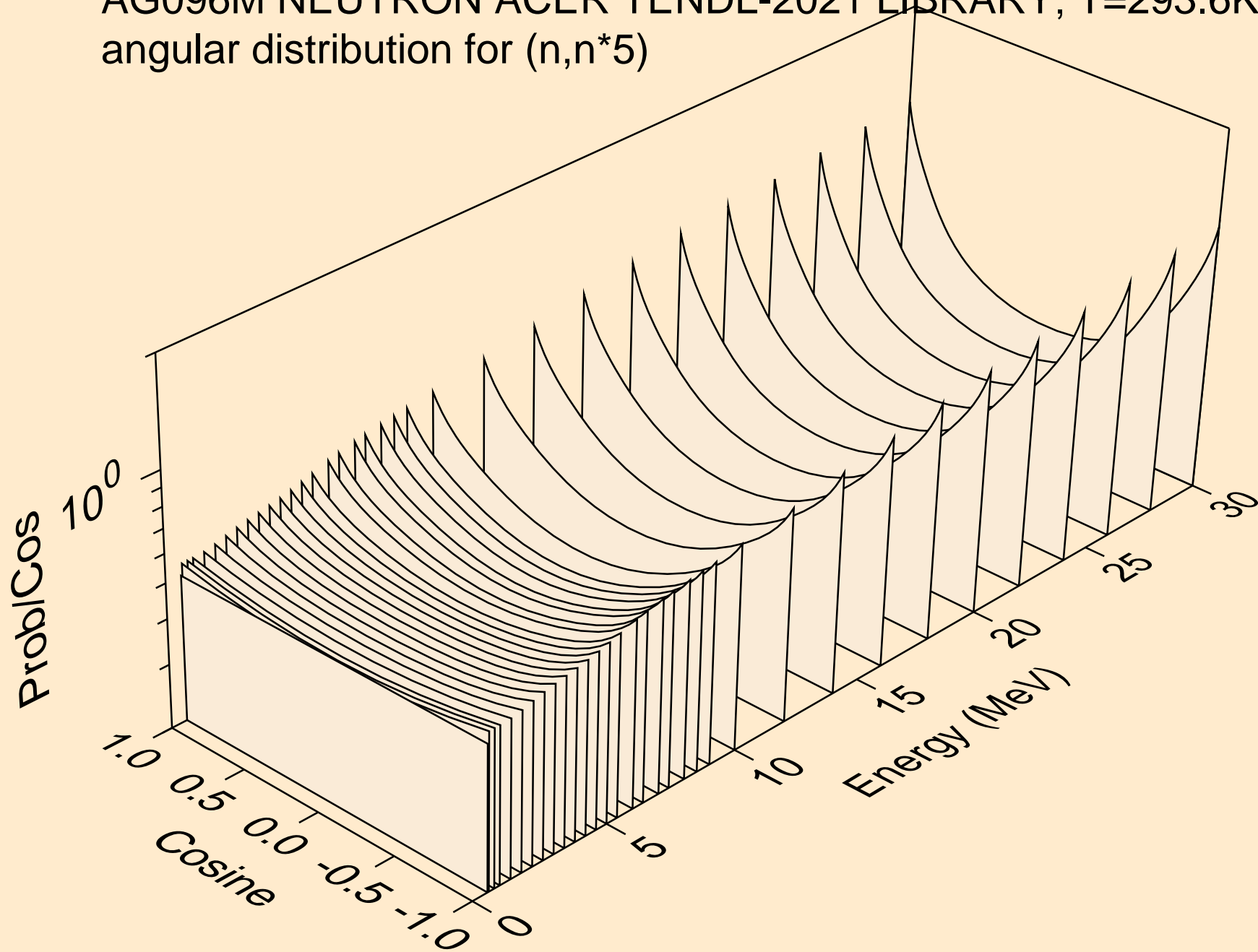

AG096M NEUTRON ACER TENDL-2021 LIBRARY; T=293.6K
angular distribution for (n,n*6)

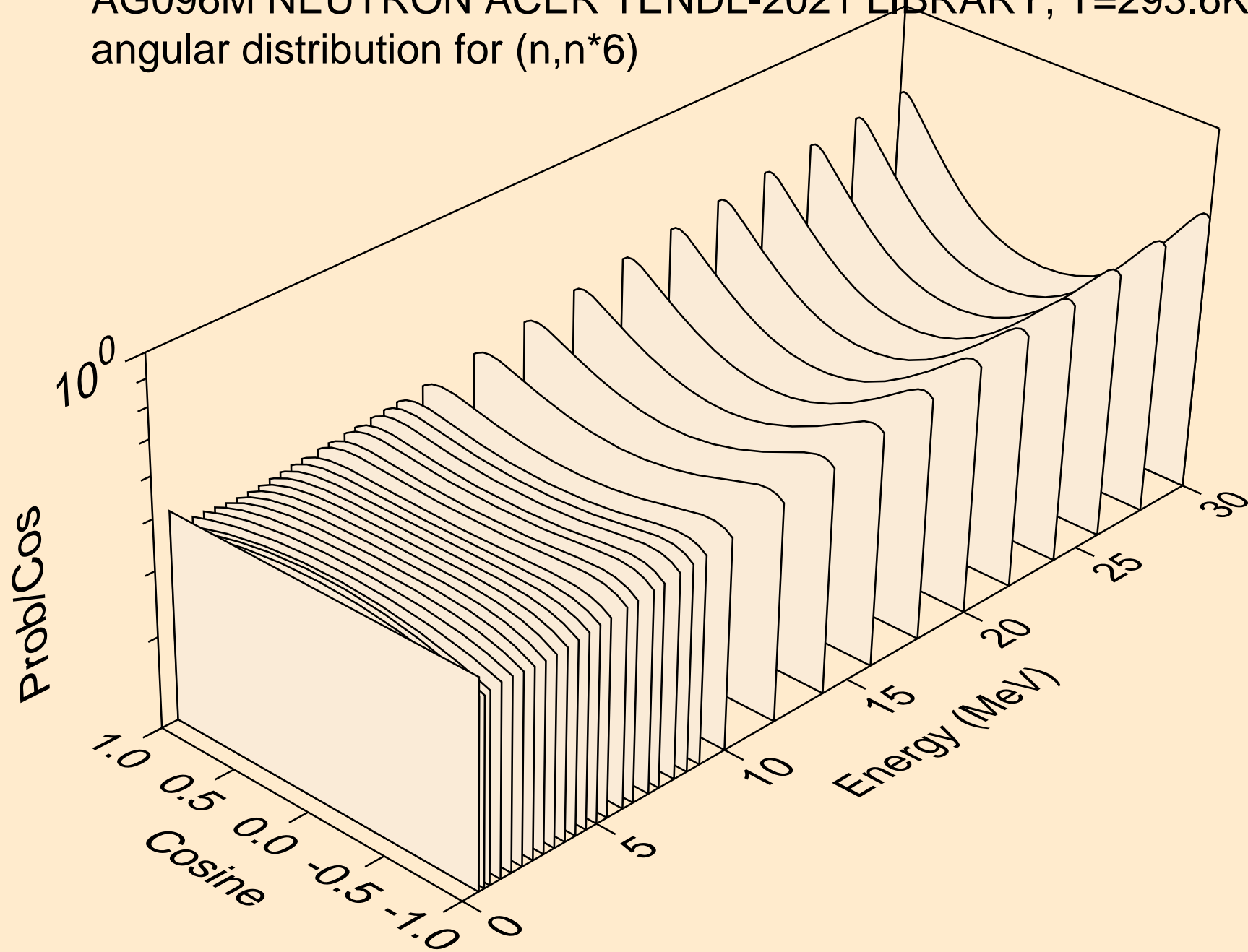

AG096M NEUTRON ACER TENDL-2021 LIBRARY; T=293.6K
angular distribution for (n,n*7)

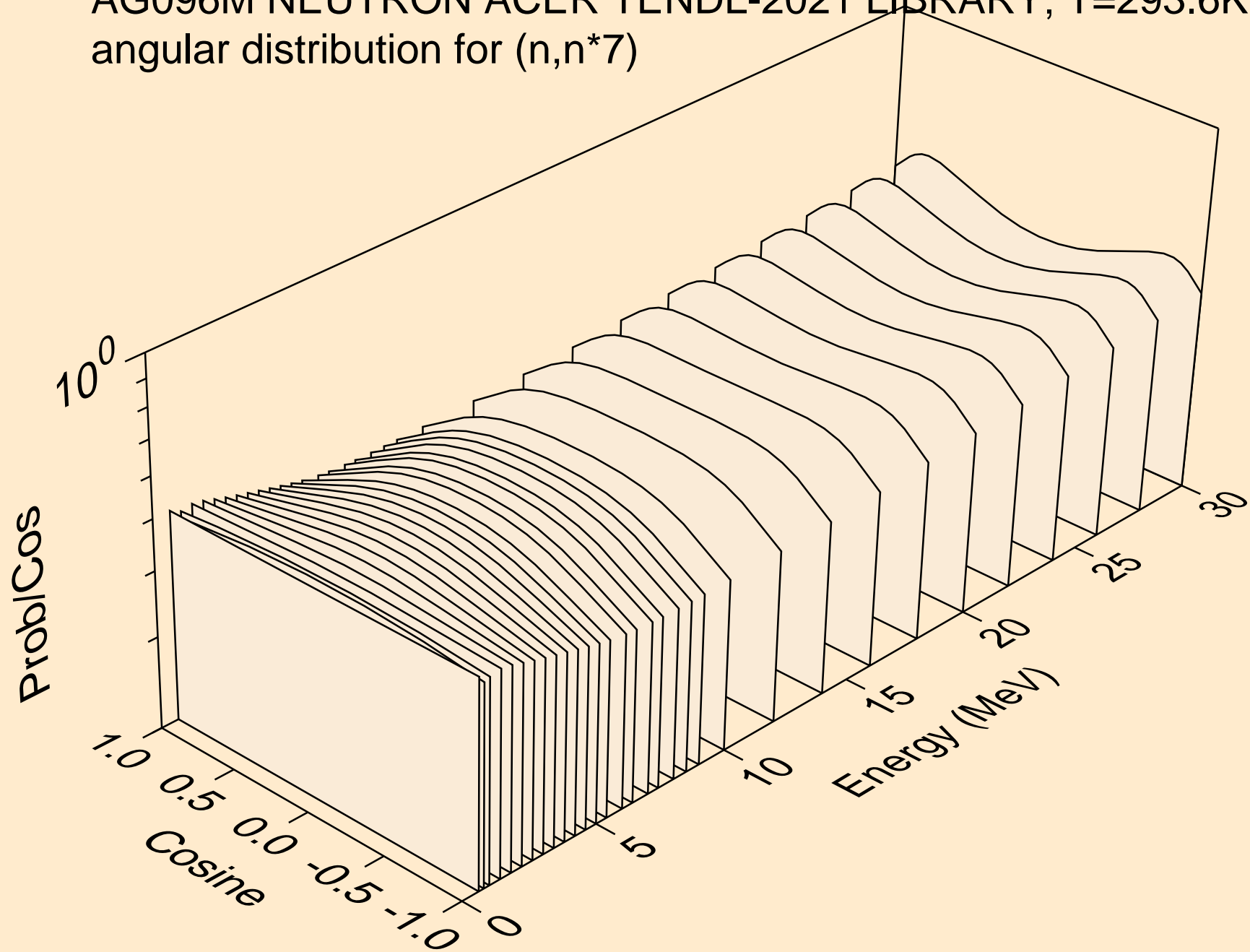

AG096M NEUTRON ACER TENDL-2021 LIBRARY; T=293.6K
angular distribution for (n,n*8)

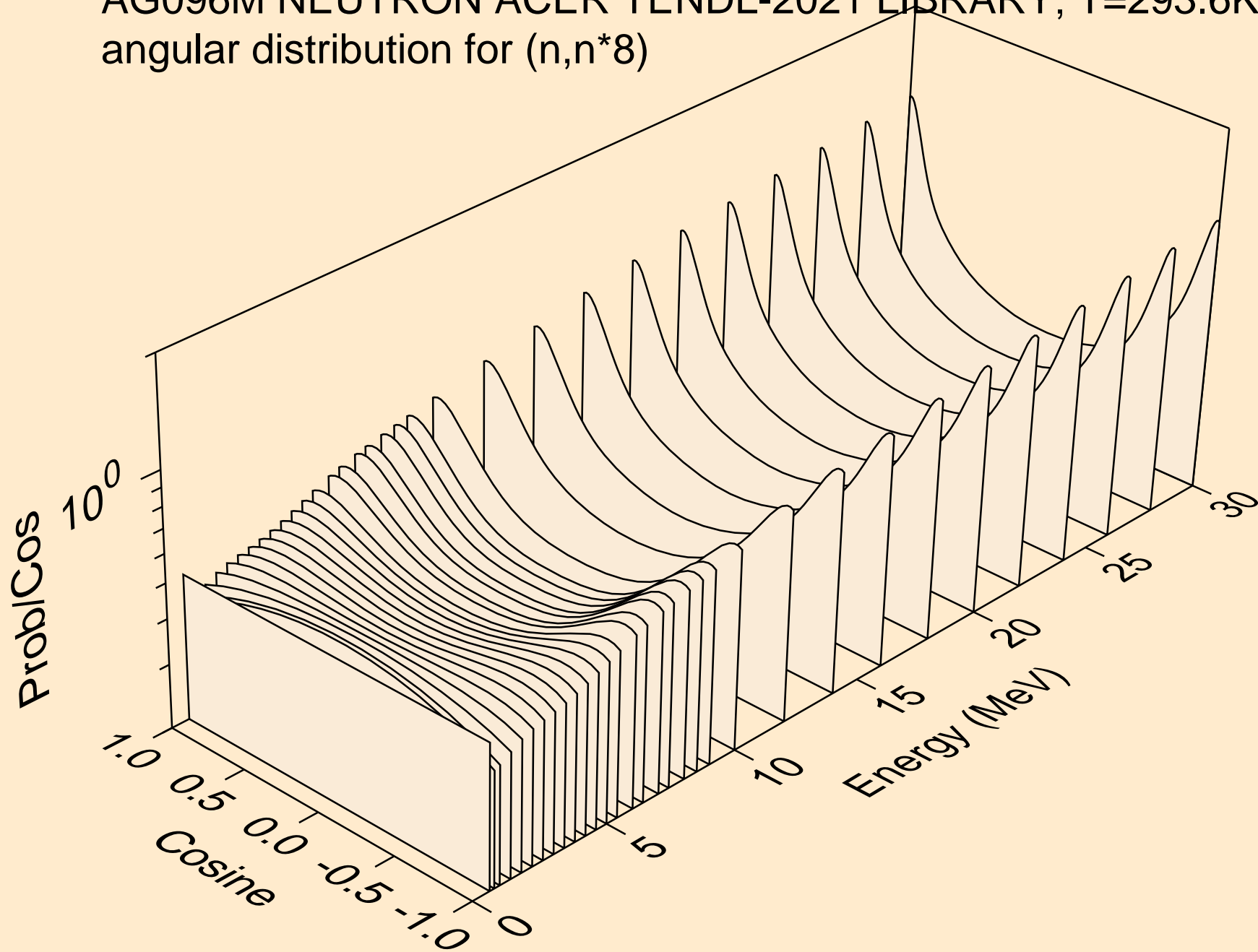

AG096M NEUTRON ACER TENDL-2021 LIBRARY; T=293.6K
angular distribution for (n,n*9)

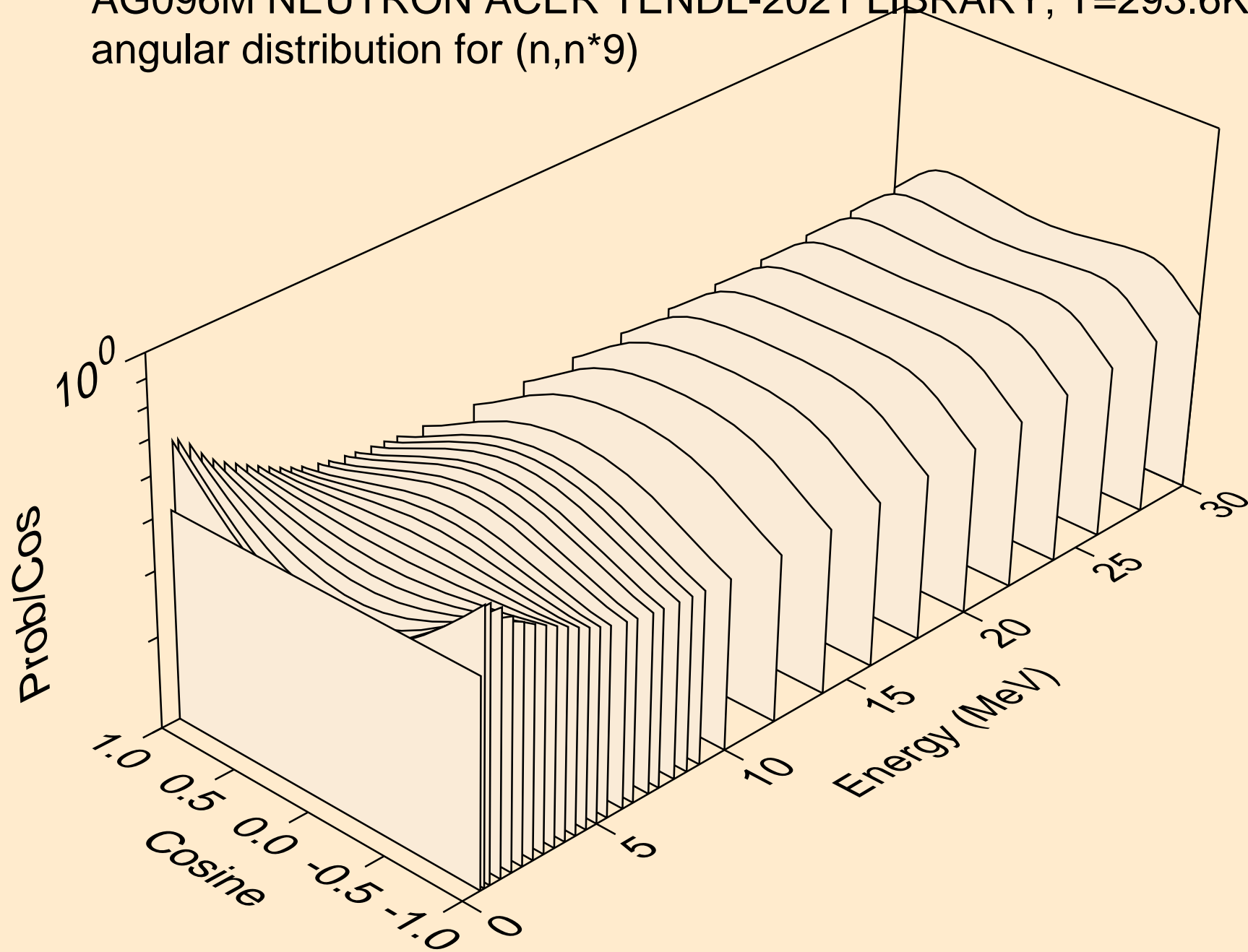

AG096M NEUTRON ACER TENDL-2021 LIBRARY; T=293.6K
angular distribution for (n,n*10)

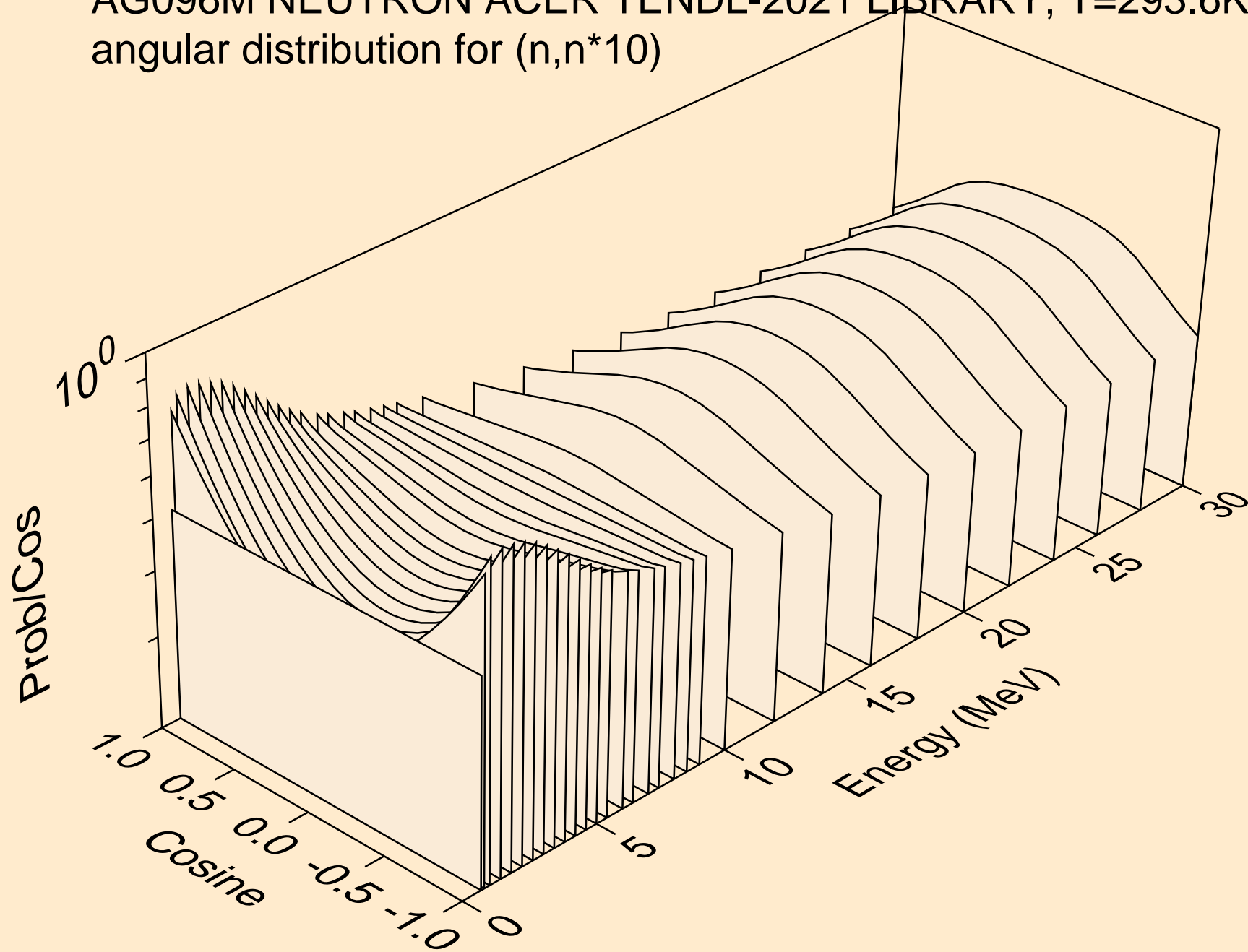

AG096M NEUTRON ACER TENDL-2021 LIBRARY; T=293.6K
angular distribution for (n,n*11)

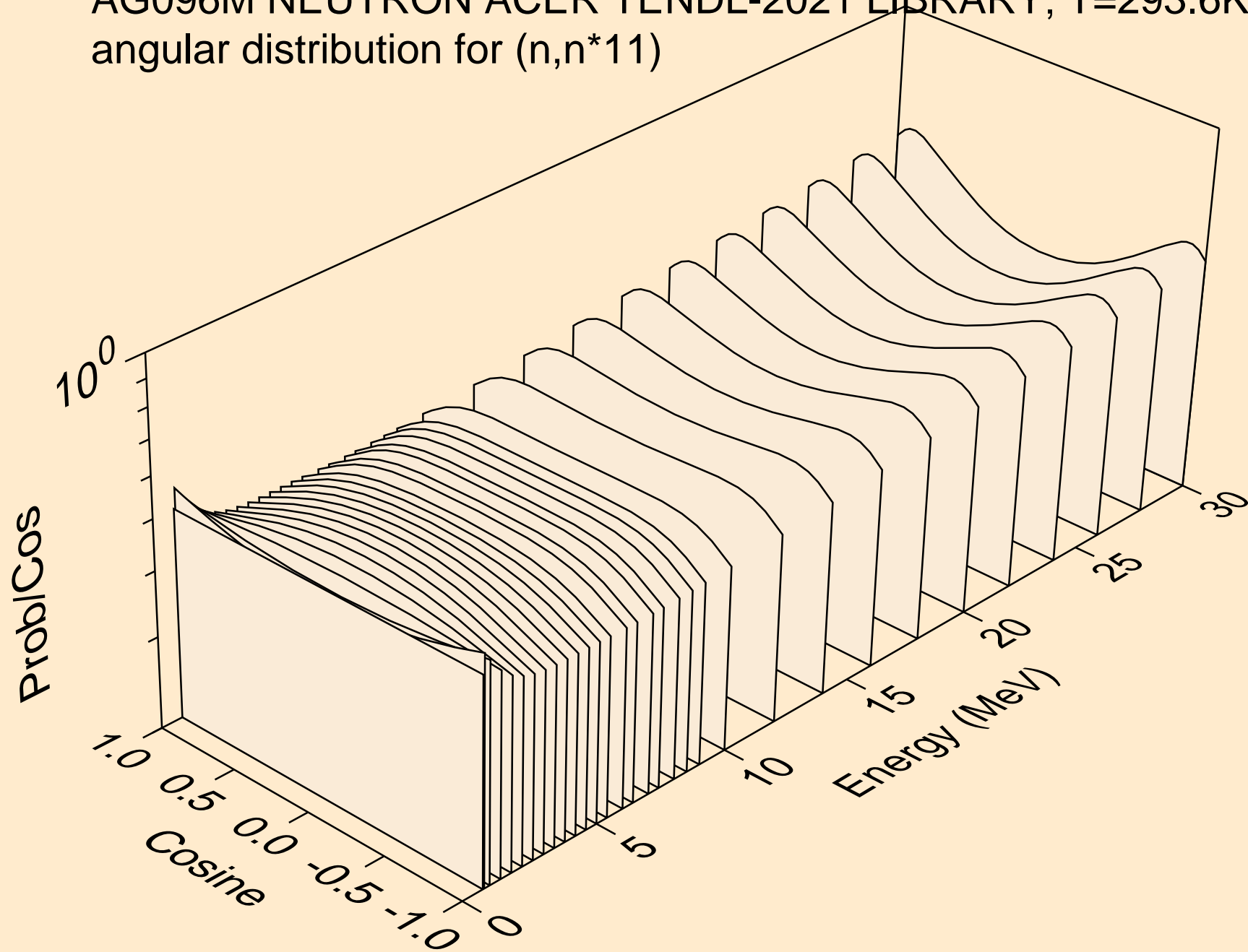

AG096M NEUTRON ACER TENDL-2021 LIBRARY; T=293.6K
angular distribution for (n,n*12)

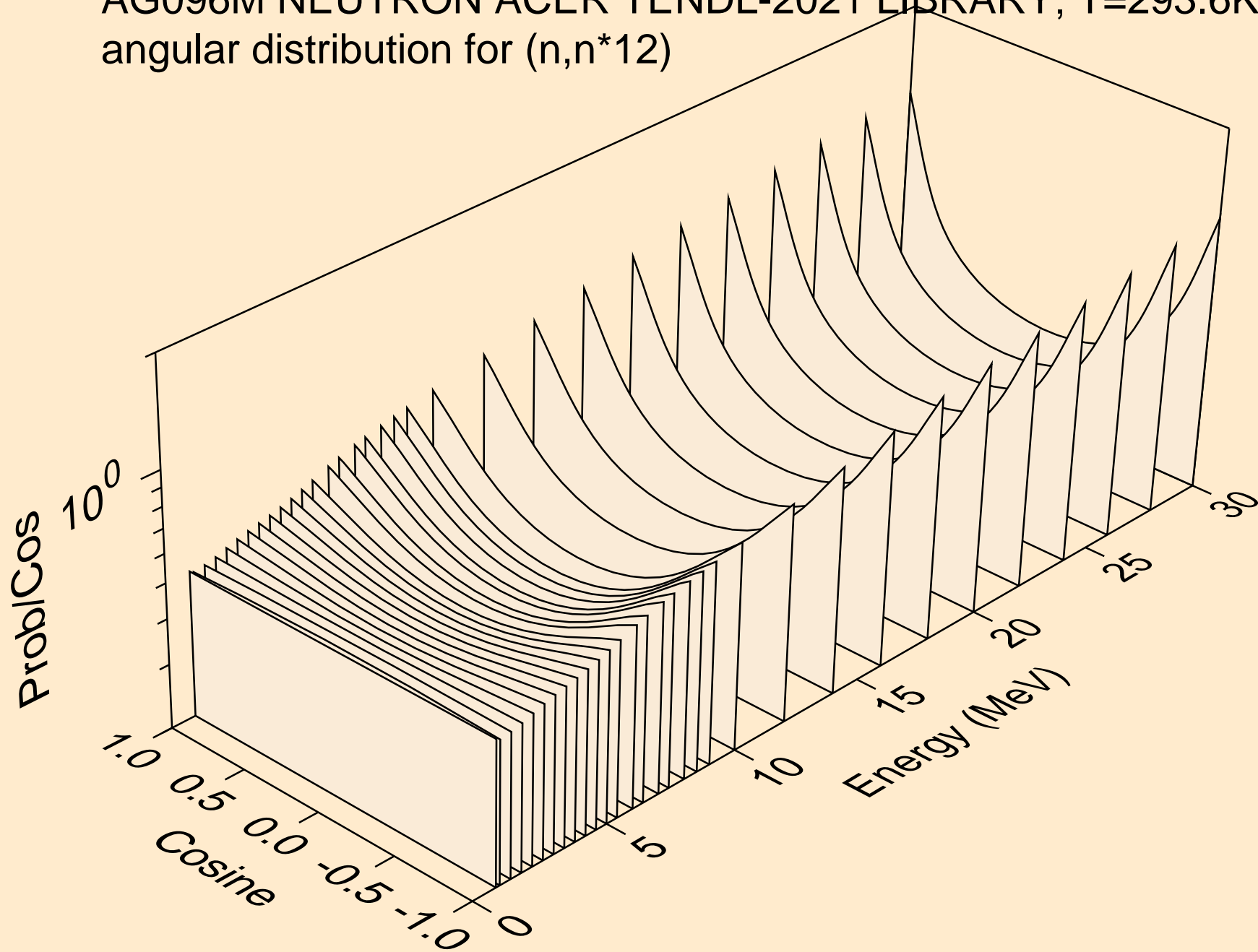

AG096M NEUTRON ACER TENDL-2021 LIBRARY; T=293.6K
angular distribution for (n,n*13)

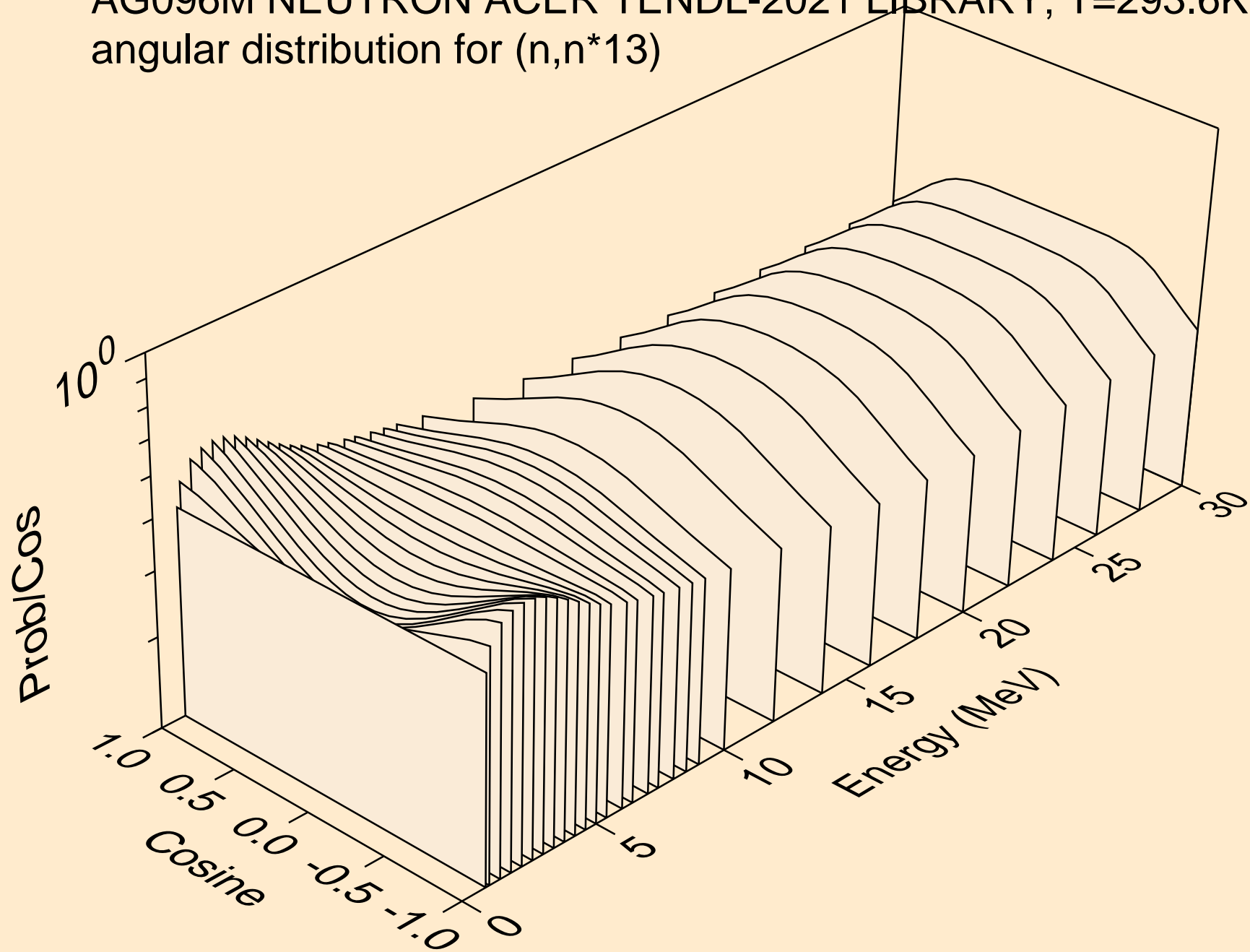

AG096M NEUTRON ACER TENDL-2021 LIBRARY; T=293.6K
angular distribution for (n,n*14)

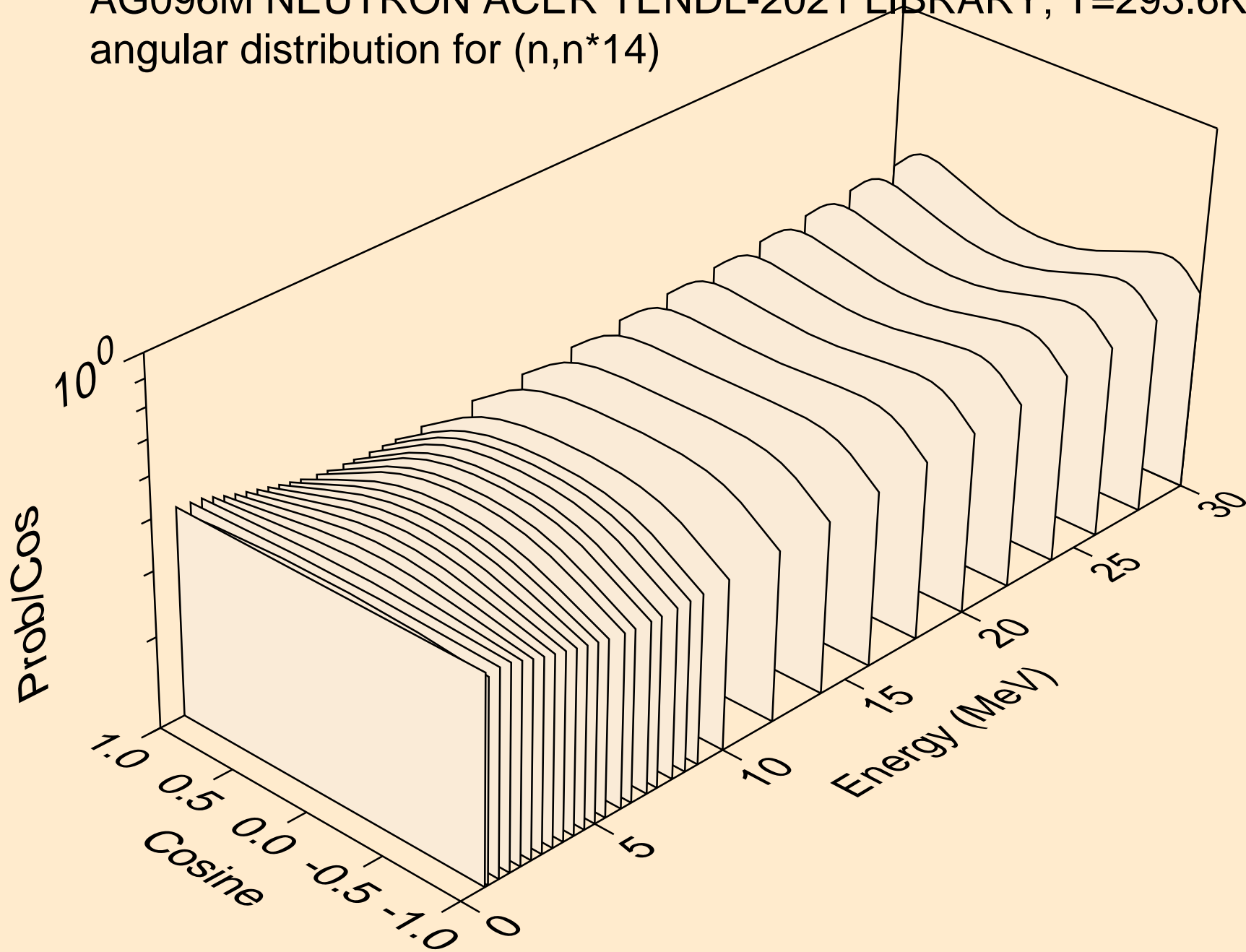

AG096M NEUTRON ACER TENDL-2021 LIBRARY; T=293.6K
angular distribution for (n,n*15)

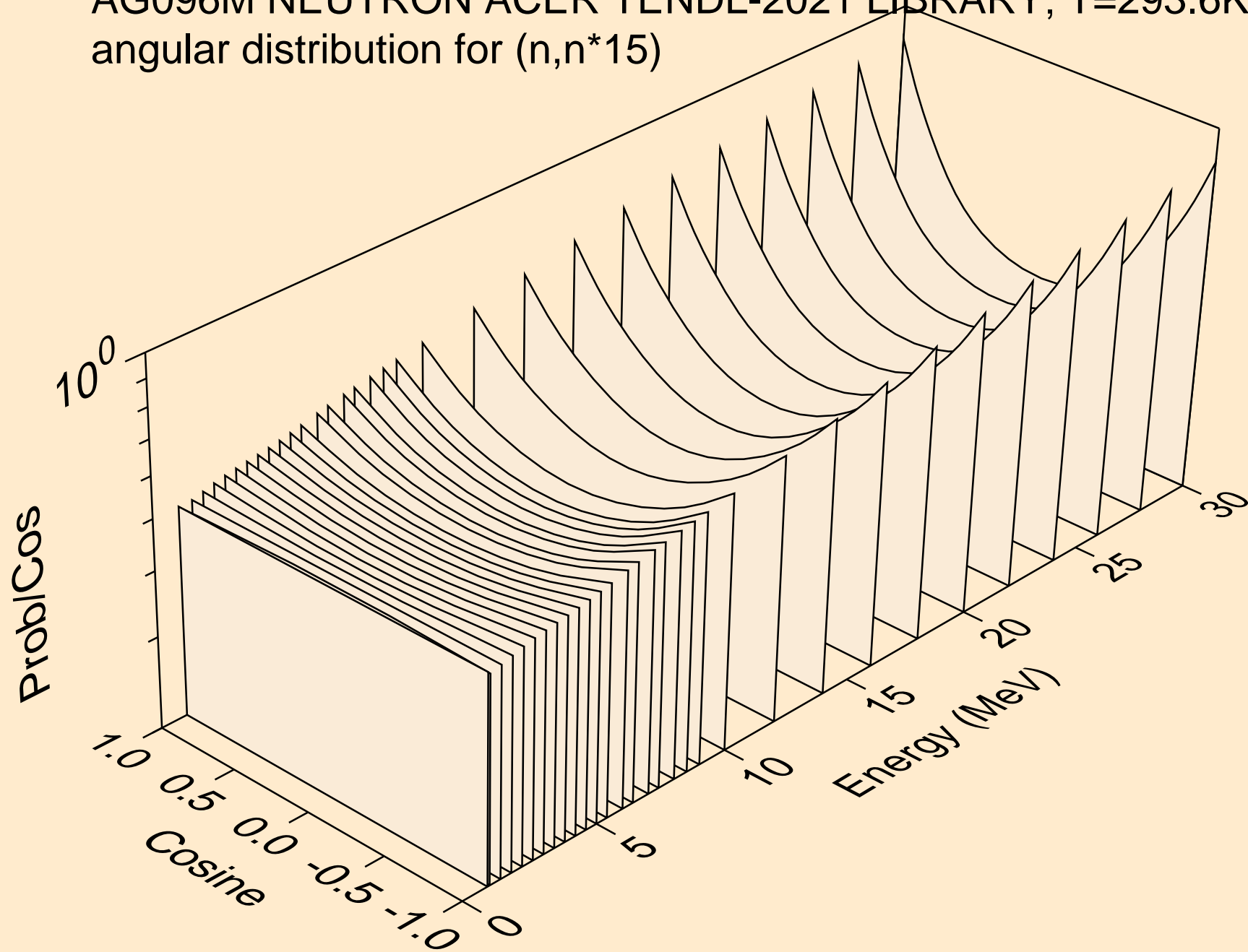

AG096M NEUTRON ACER TENDL-2021 LIBRARY; T=293.6K
angular distribution for (n,n*16)

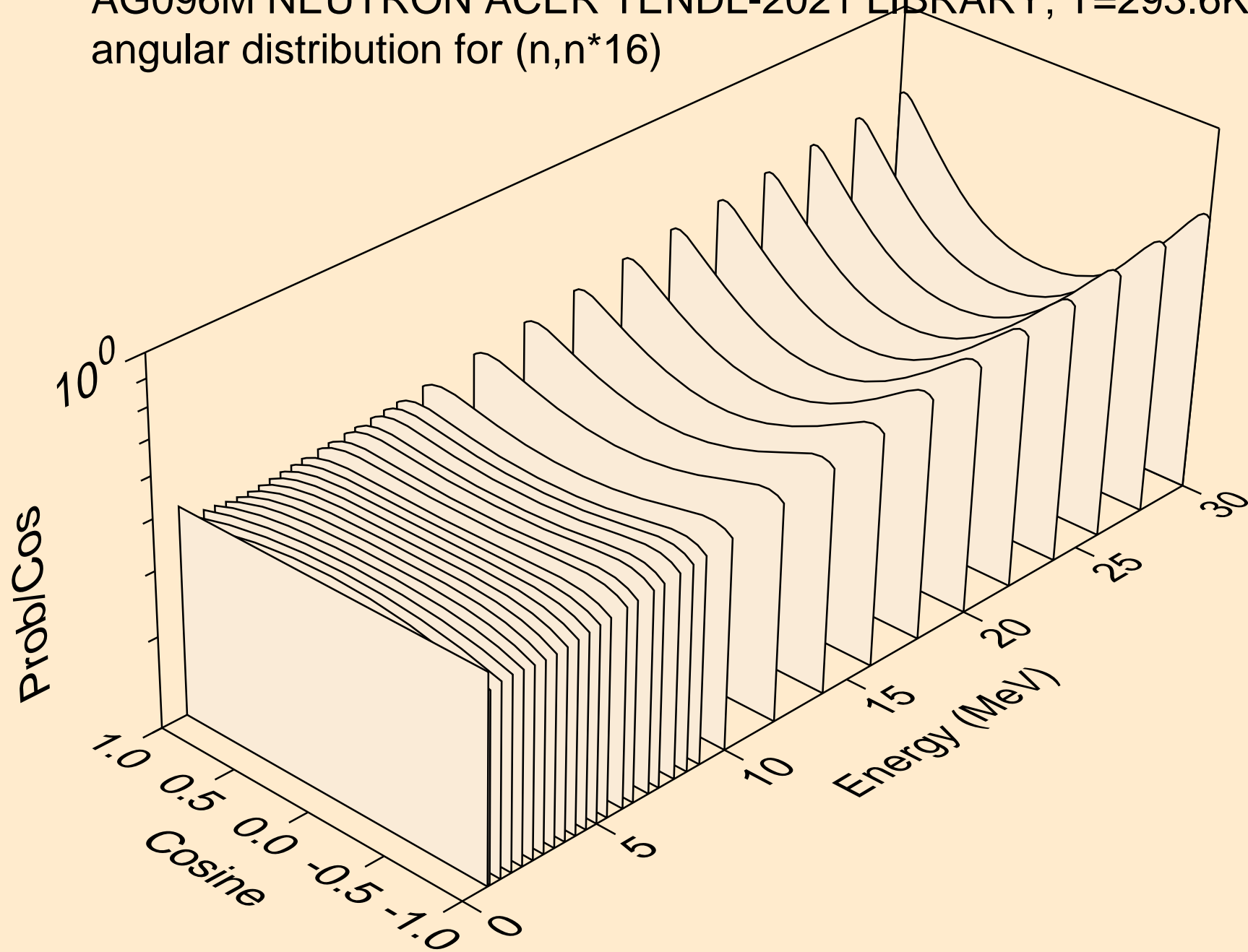

AG096M NEUTRON ACER TENDL-2021 LIBRARY; T=293.6K
angular distribution for (n,n*17)

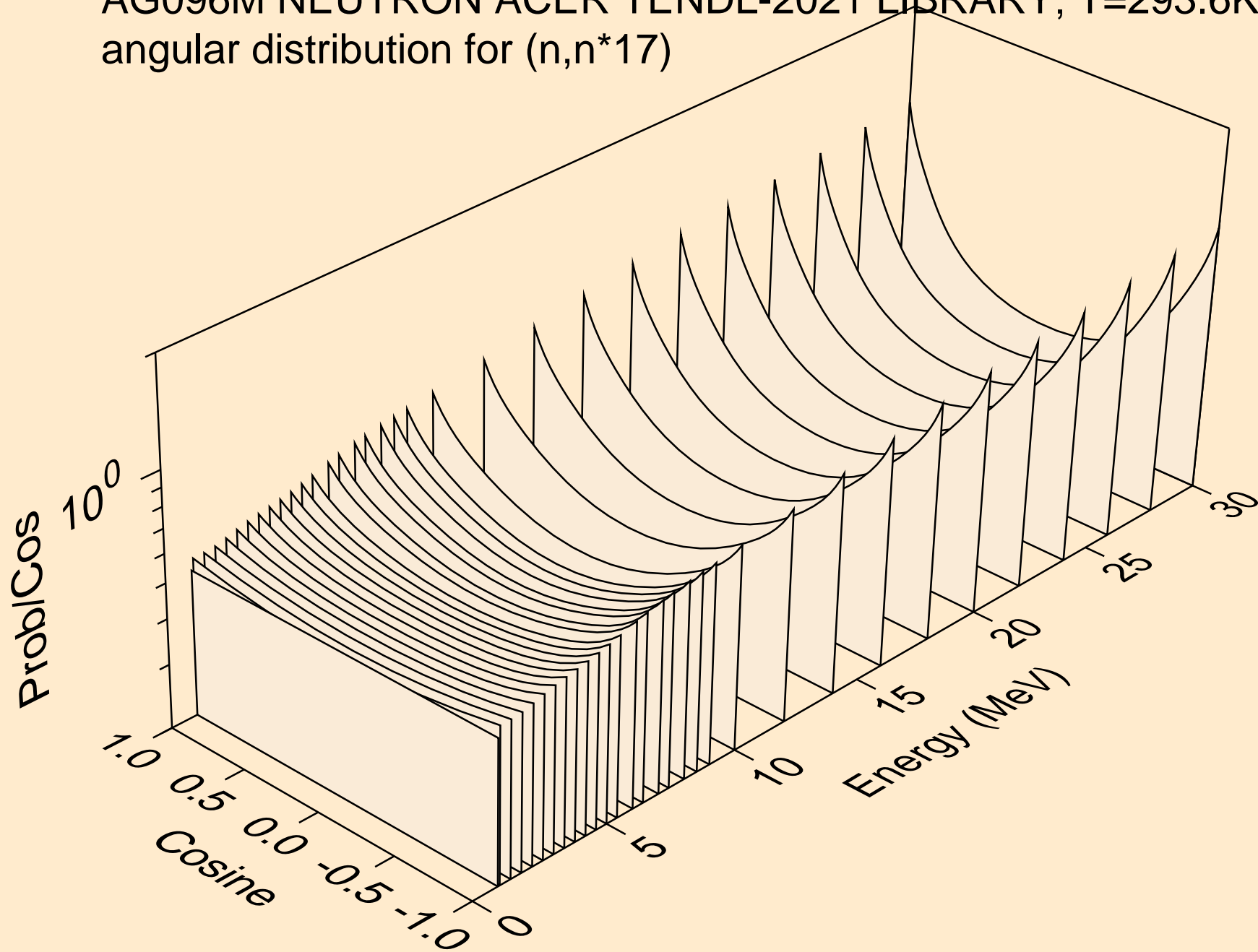

AG096M NEUTRON ACER TENDL-2021 LIBRARY; T=293.6K
Neutron emission for (n,x)

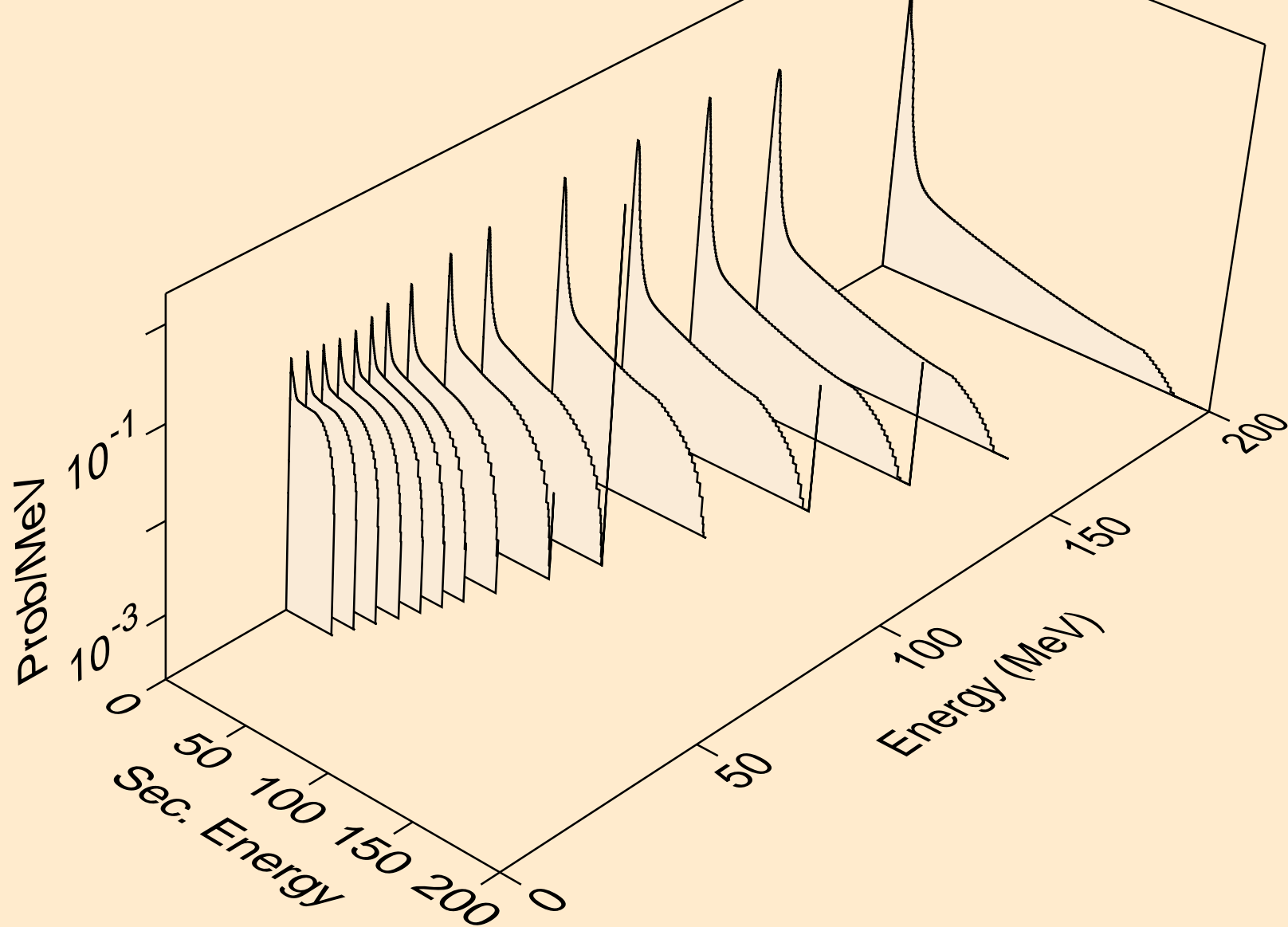

AG096M NEUTRON ACER TENDL-2021 LIBRARY; T=293.6K
Neutron emission for (n,2n)

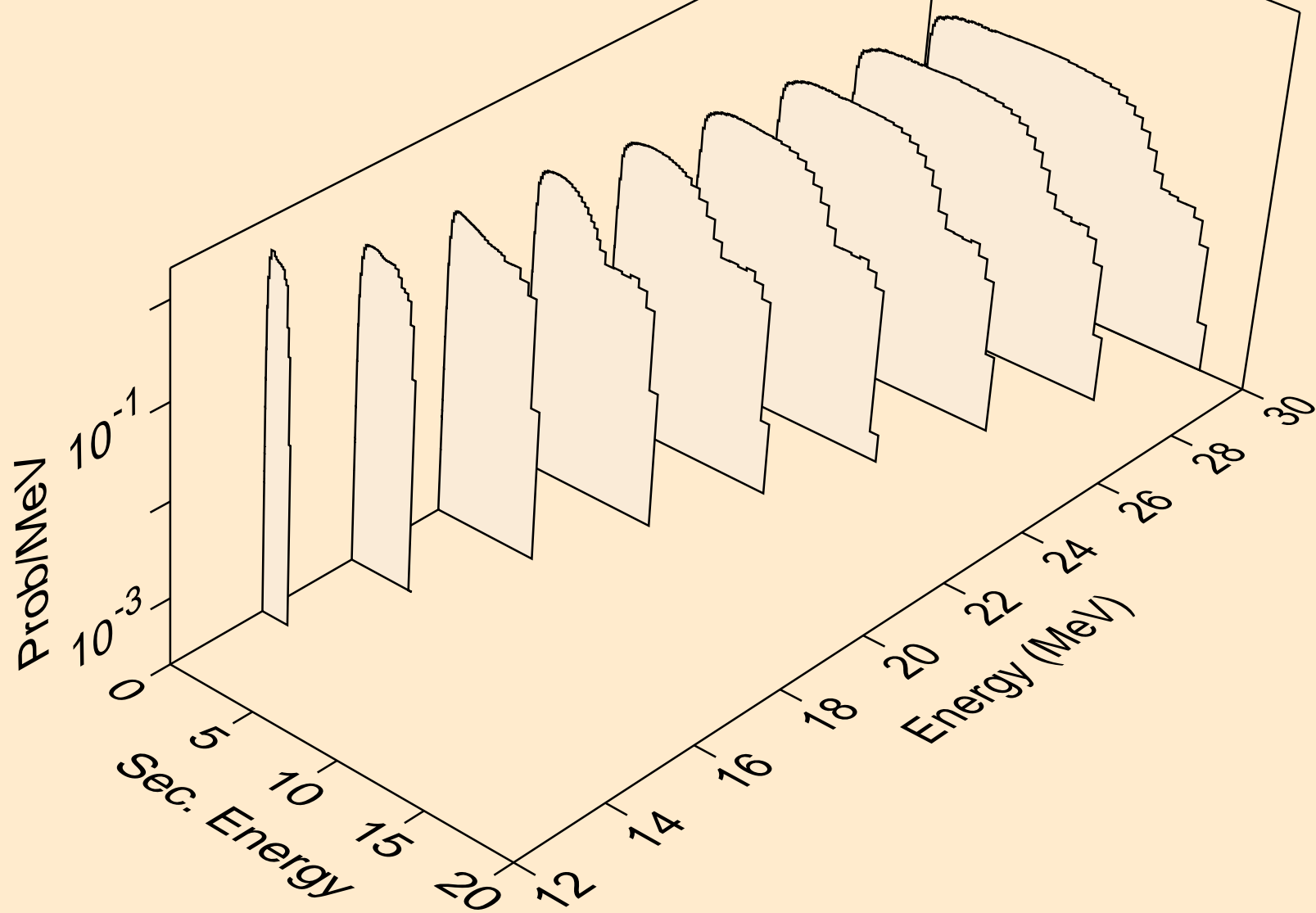

AG096M NEUTRON ACER TENDL-2021 LIBRARY; T=293.6K
Neutron emission for (n,3n)

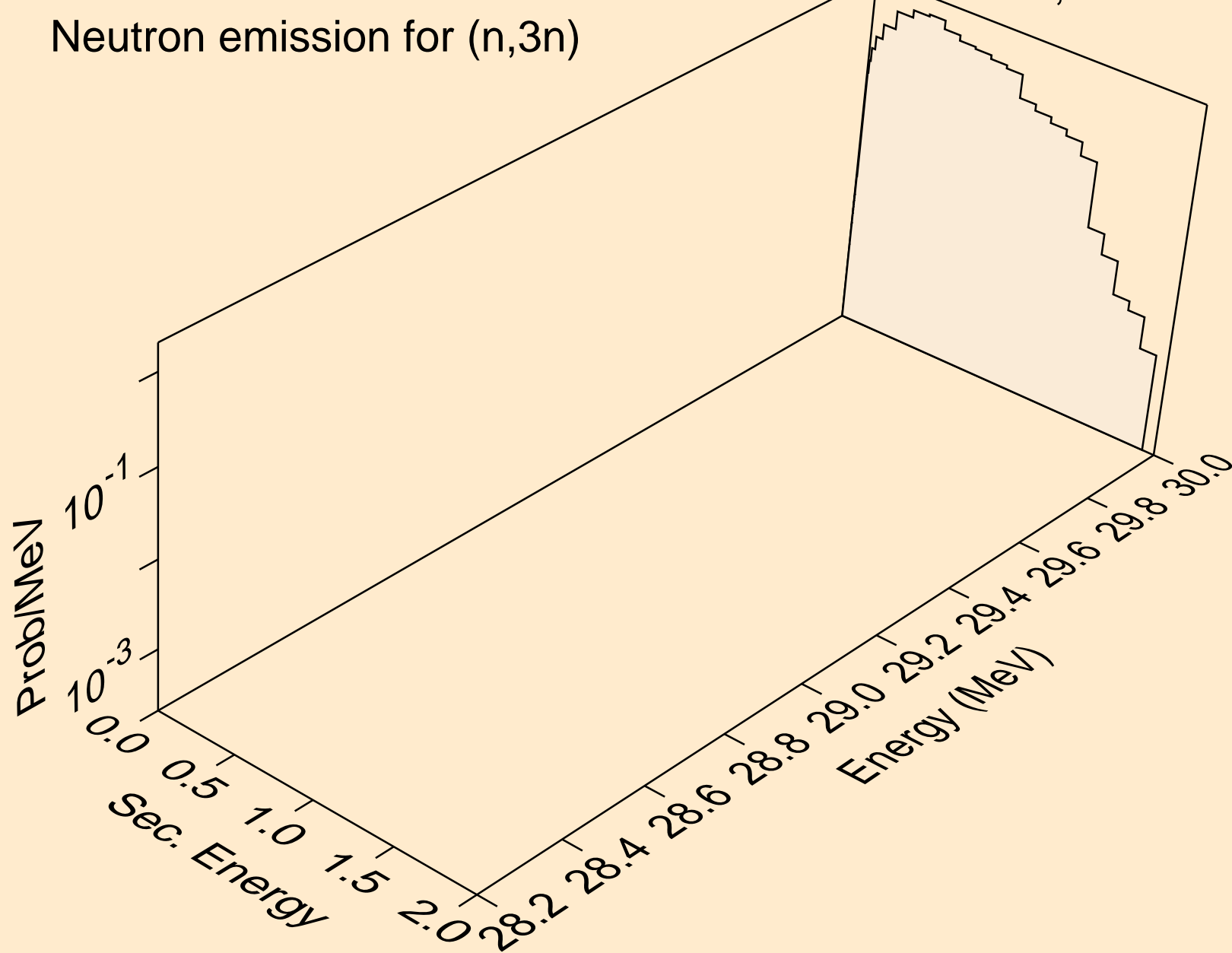

AG096M NEUTRON ACER TENDL-2021 LIBRARY; T=293.6K
Neutron emission for (n,n*)a

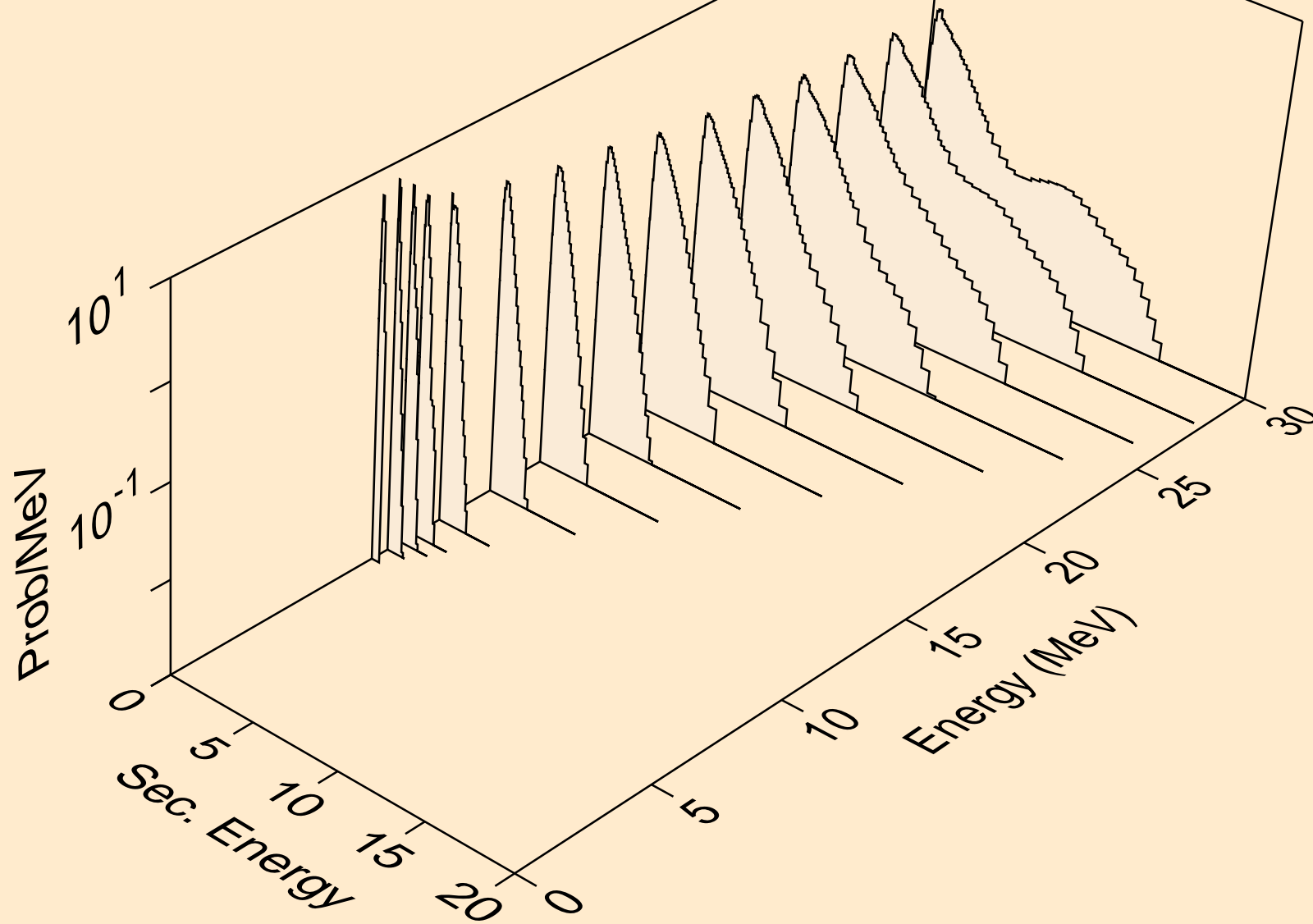

AG096M NEUTRON ACER TENDL-2021 LIBRARY; T=293.6K
Neutron emission for (n,2n)a

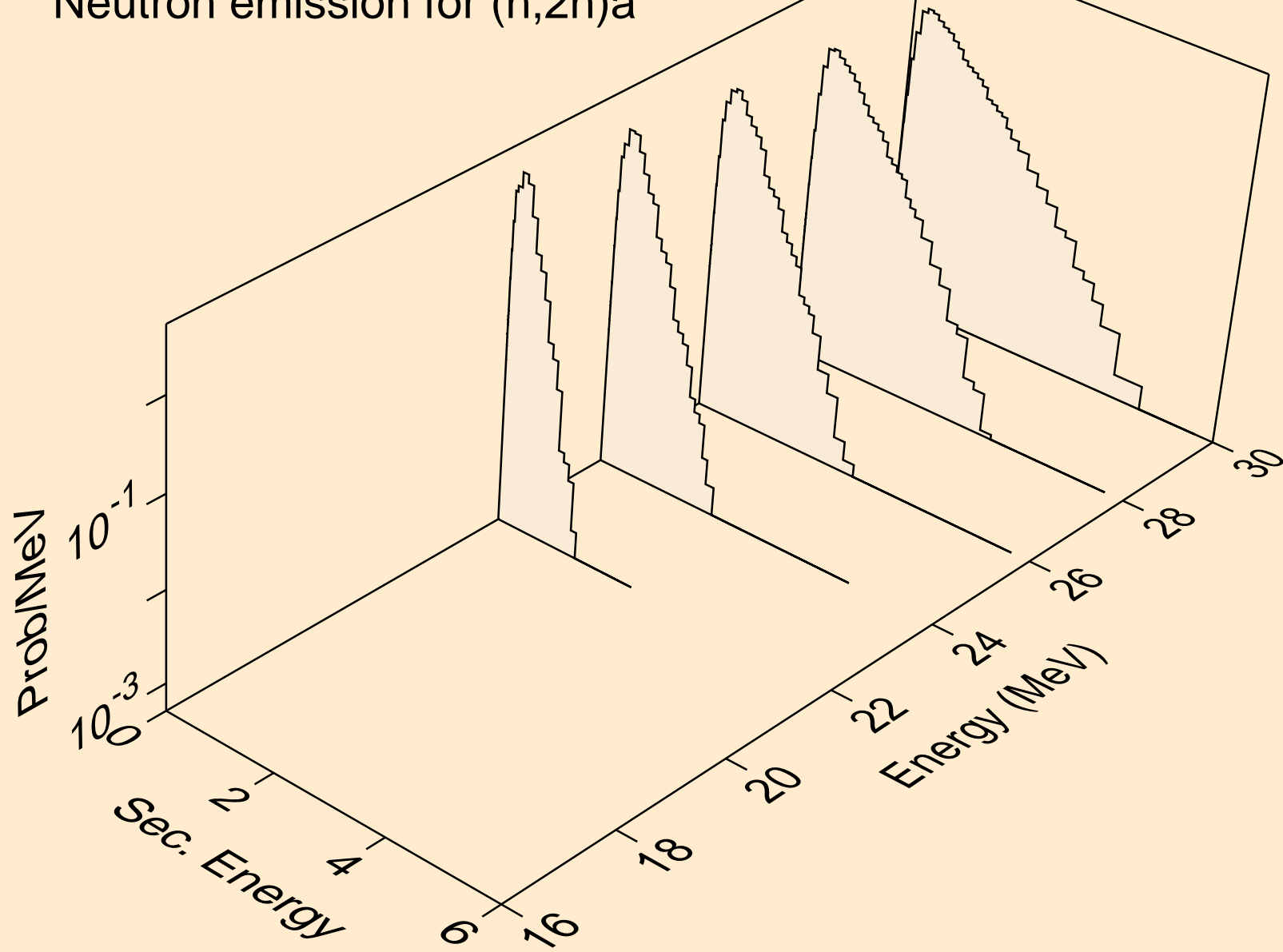

AG096M NEUTRON ACER TENDL-2021 LIBRARY; T=293.6K
Neutron emission for (n,n*)p

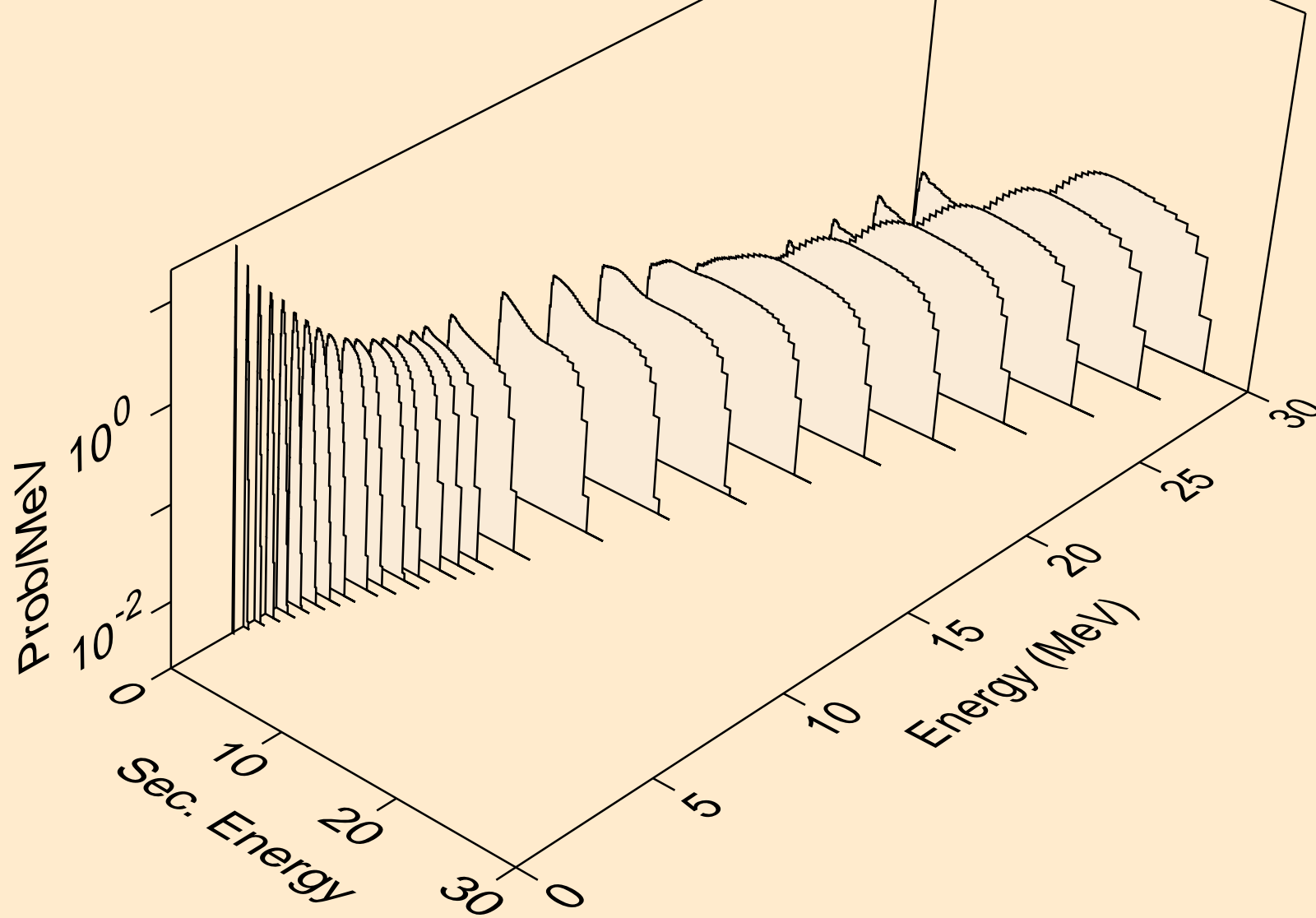

AG096M NEUTRON ACER TENDL-2021 LIBRARY; T=293.6K
Neutron emission for (n,n*)2a

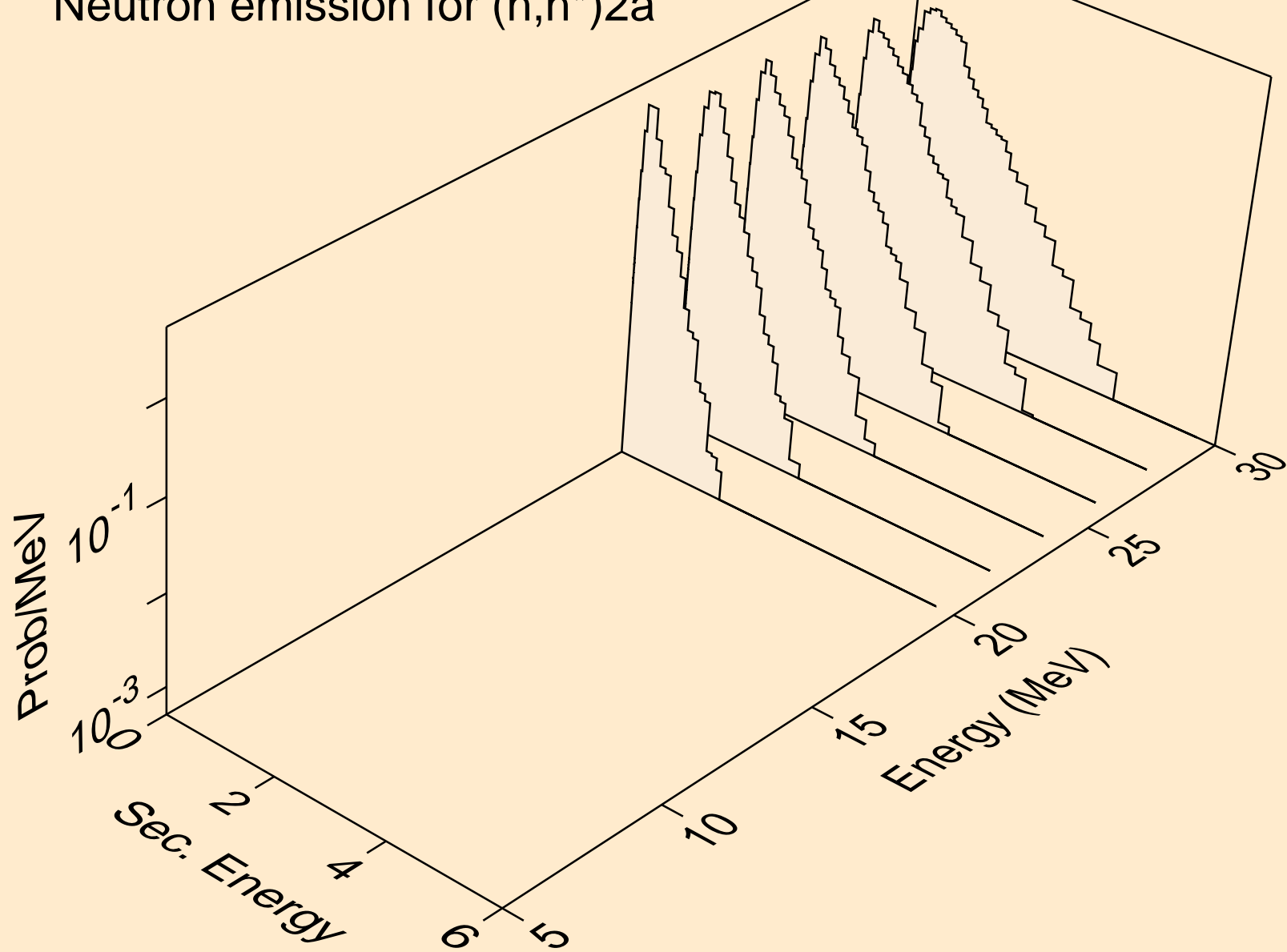

AG096M NEUTRON ACER TENDL-2021 LIBRARY; T=293.6K
Neutron emission for (n,n*)d

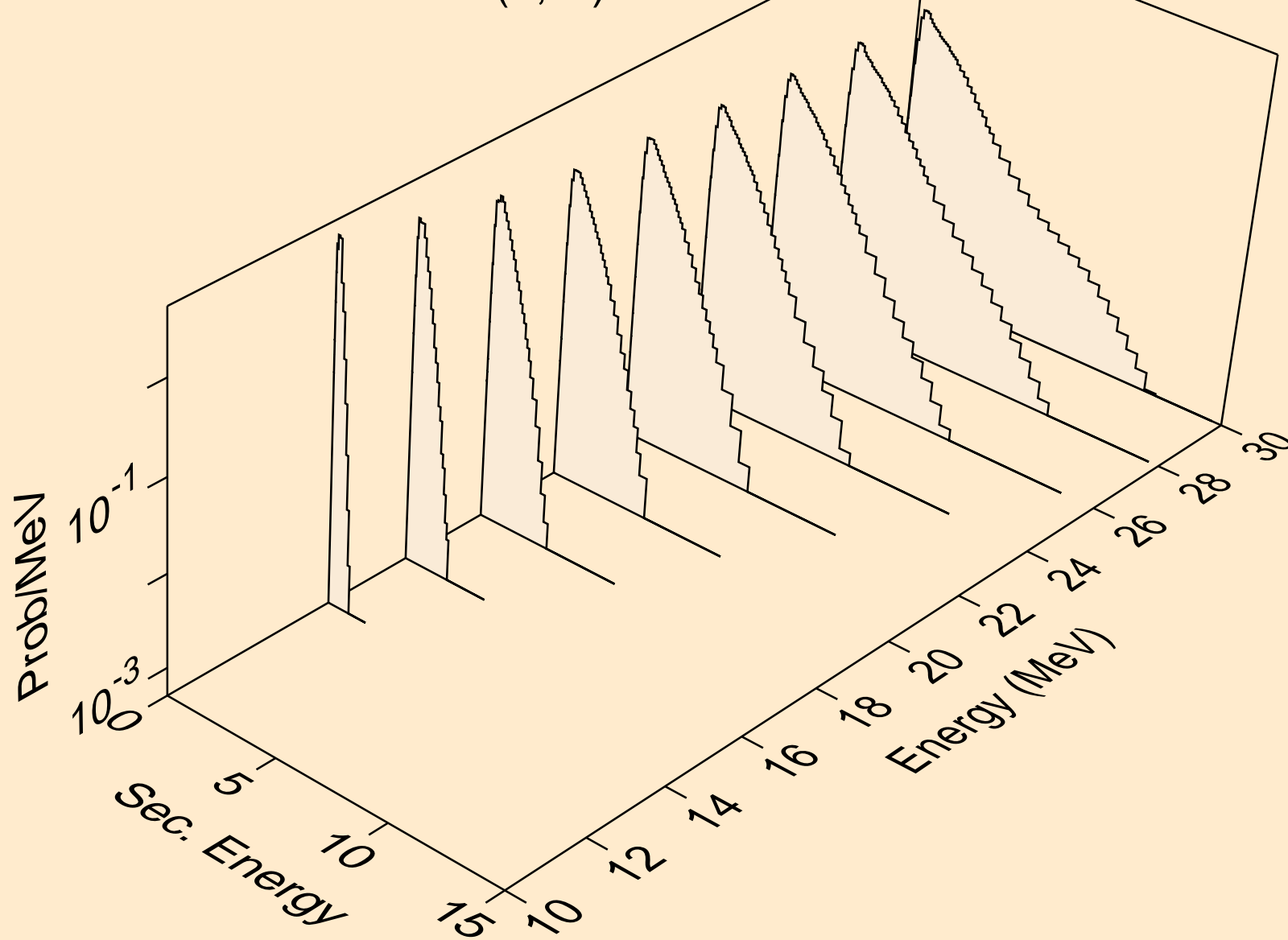

AG096M NEUTRON ACER TENDL-2021 LIBRARY; T=293.6K
Neutron emission for (n,n*)t

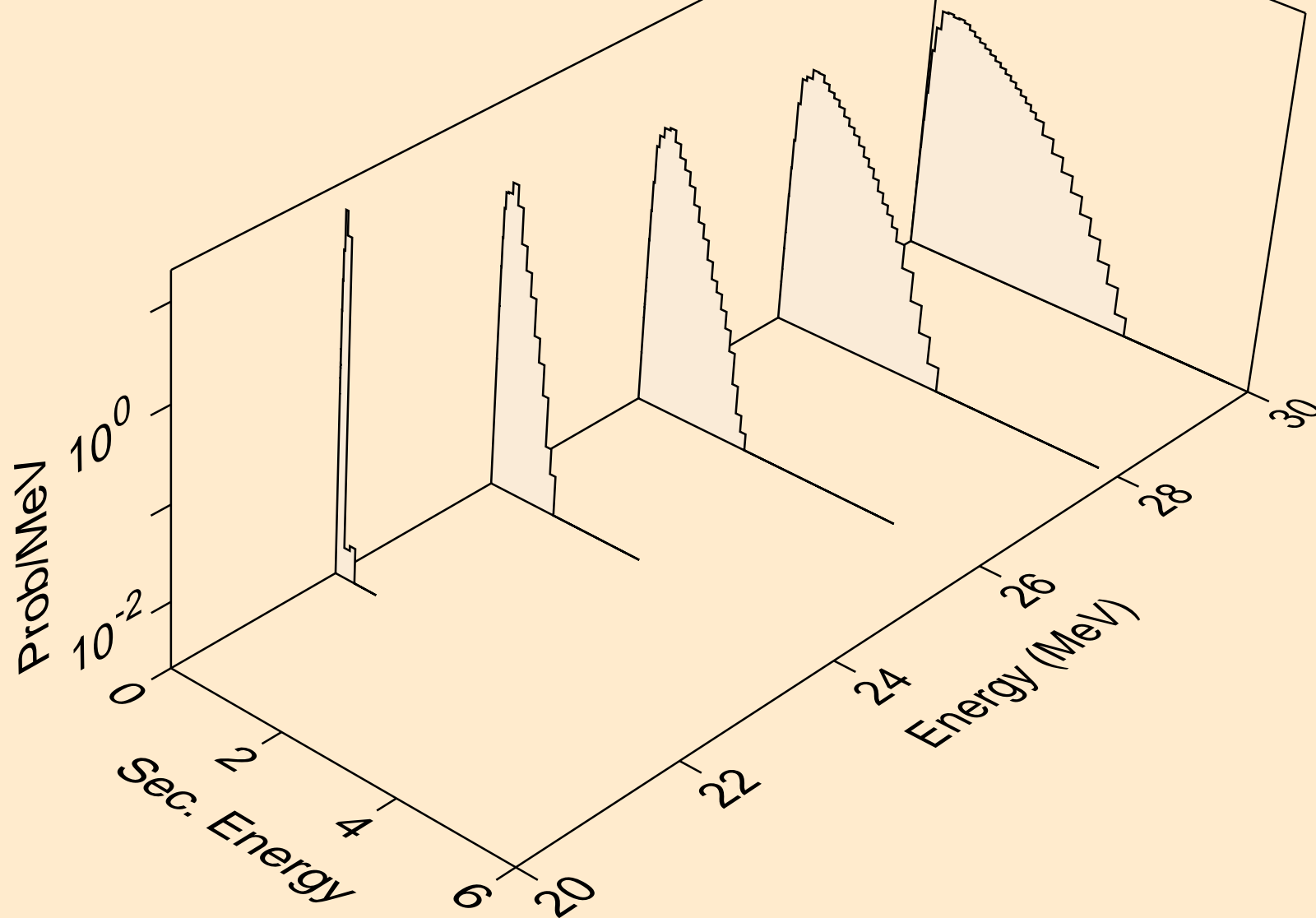

AG096M NEUTRON ACER TENDL-2021 LIBRARY; T=293.6K
Neutron emission for (n,n*)he3

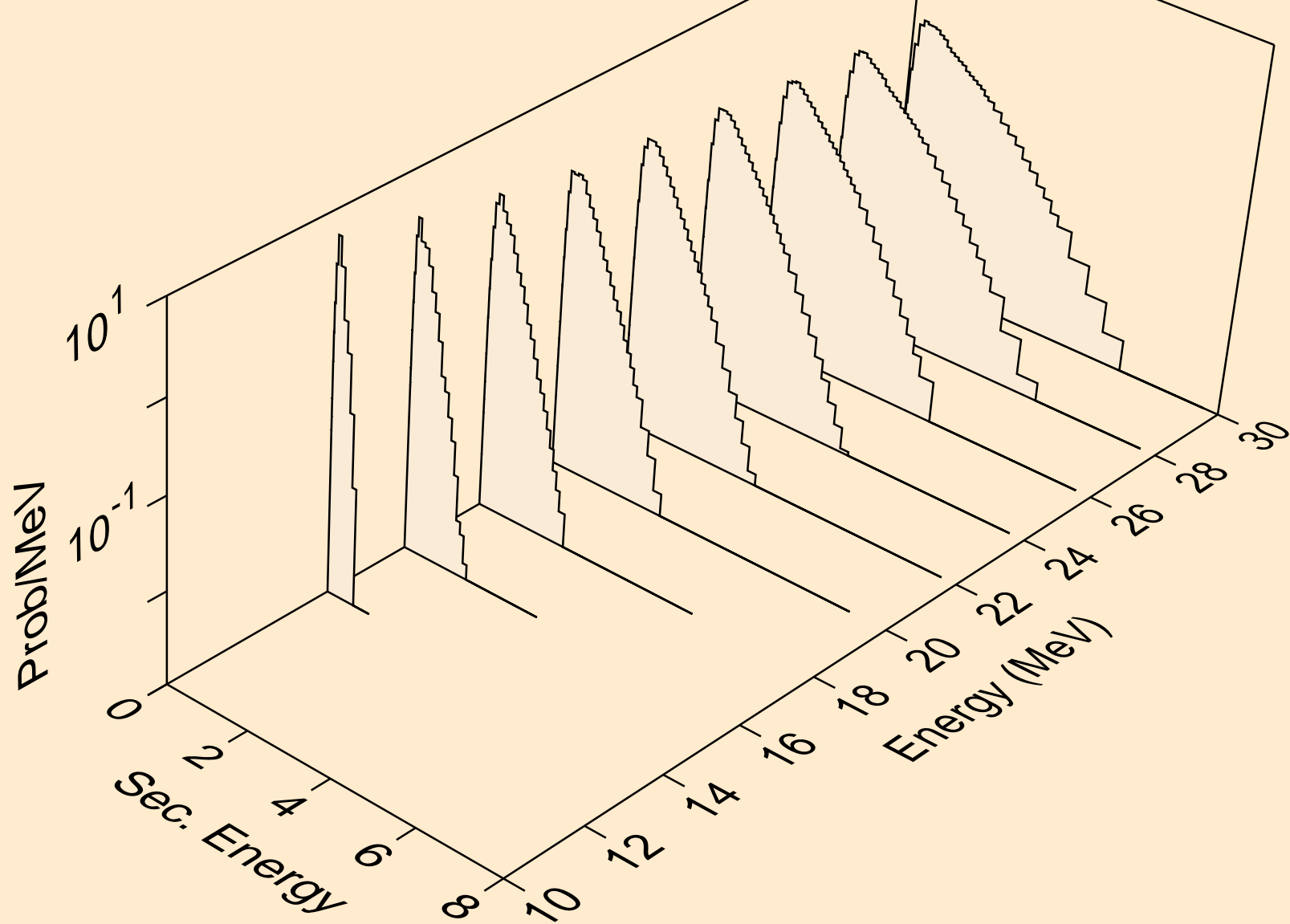

AG096M NEUTRON ACER TENDL-2021 LIBRARY; T=293.6K
Neutron emission for (n,2np)

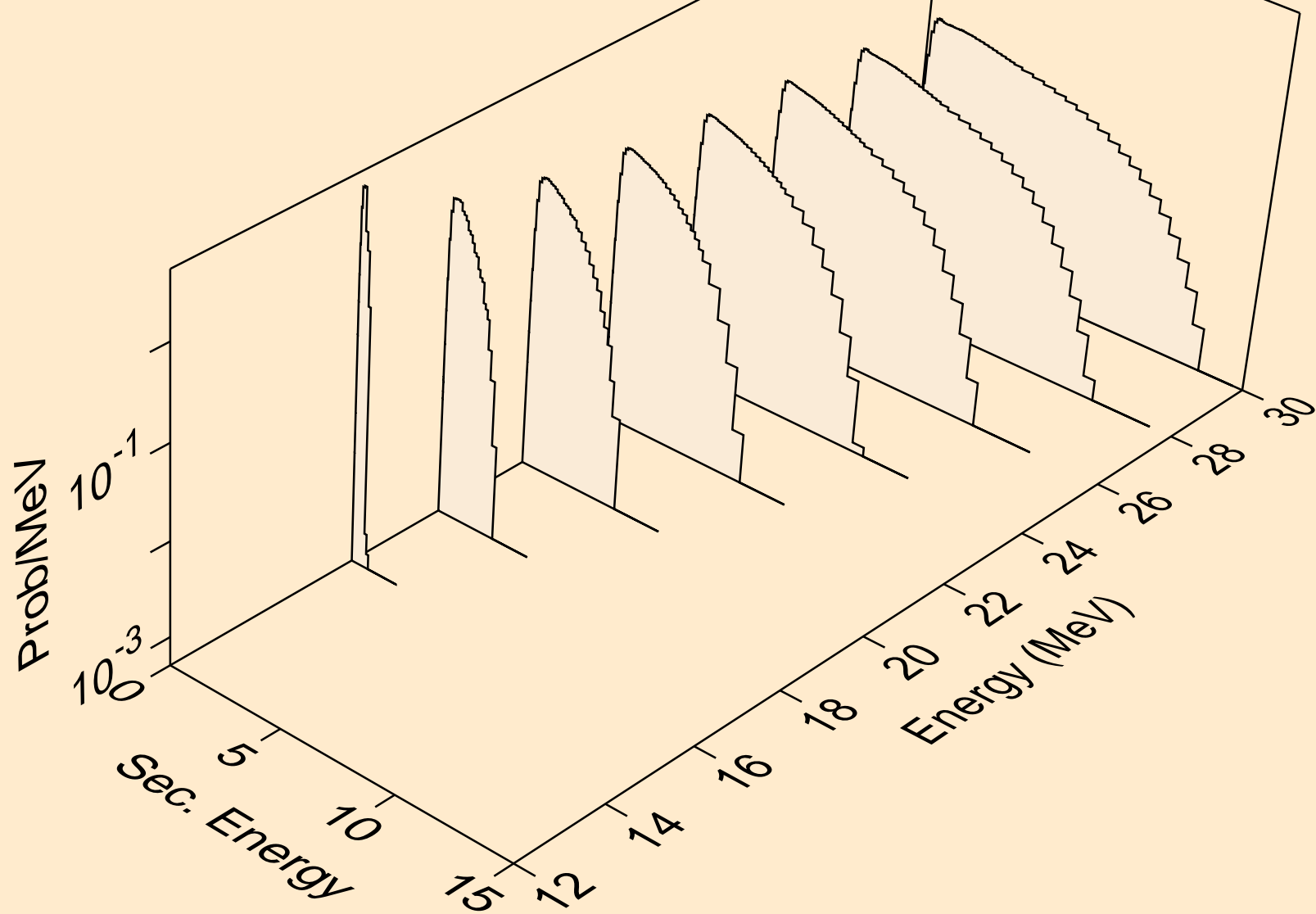

AG096M NEUTRON ACER TENDL-2021 LIBRARY; T=293.6K
Neutron emission for (n,2np)

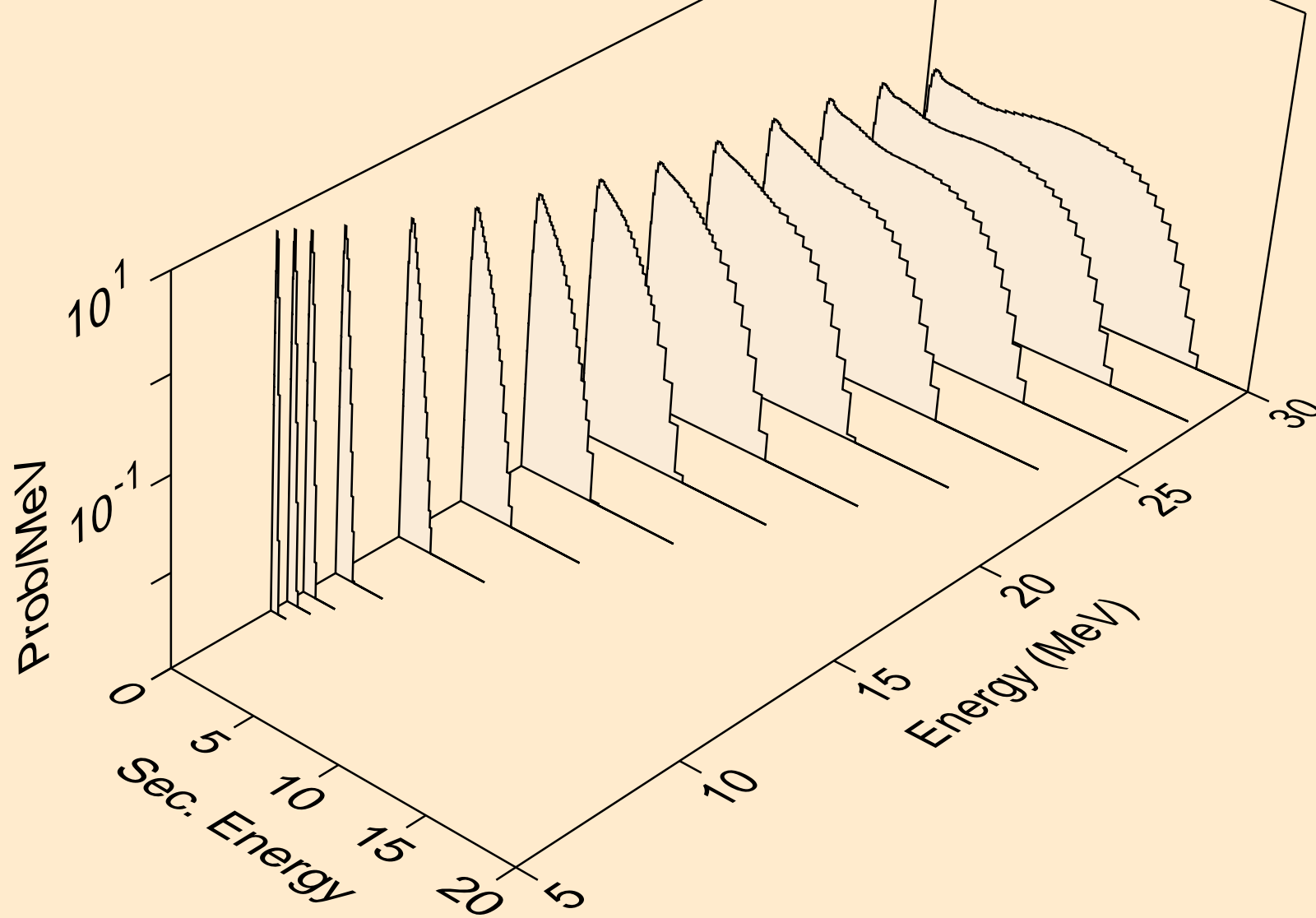

AG096M NEUTRON ACER TENDL-2021 LIBRARY; T=293.6K
Neutron emission for (n,npa)

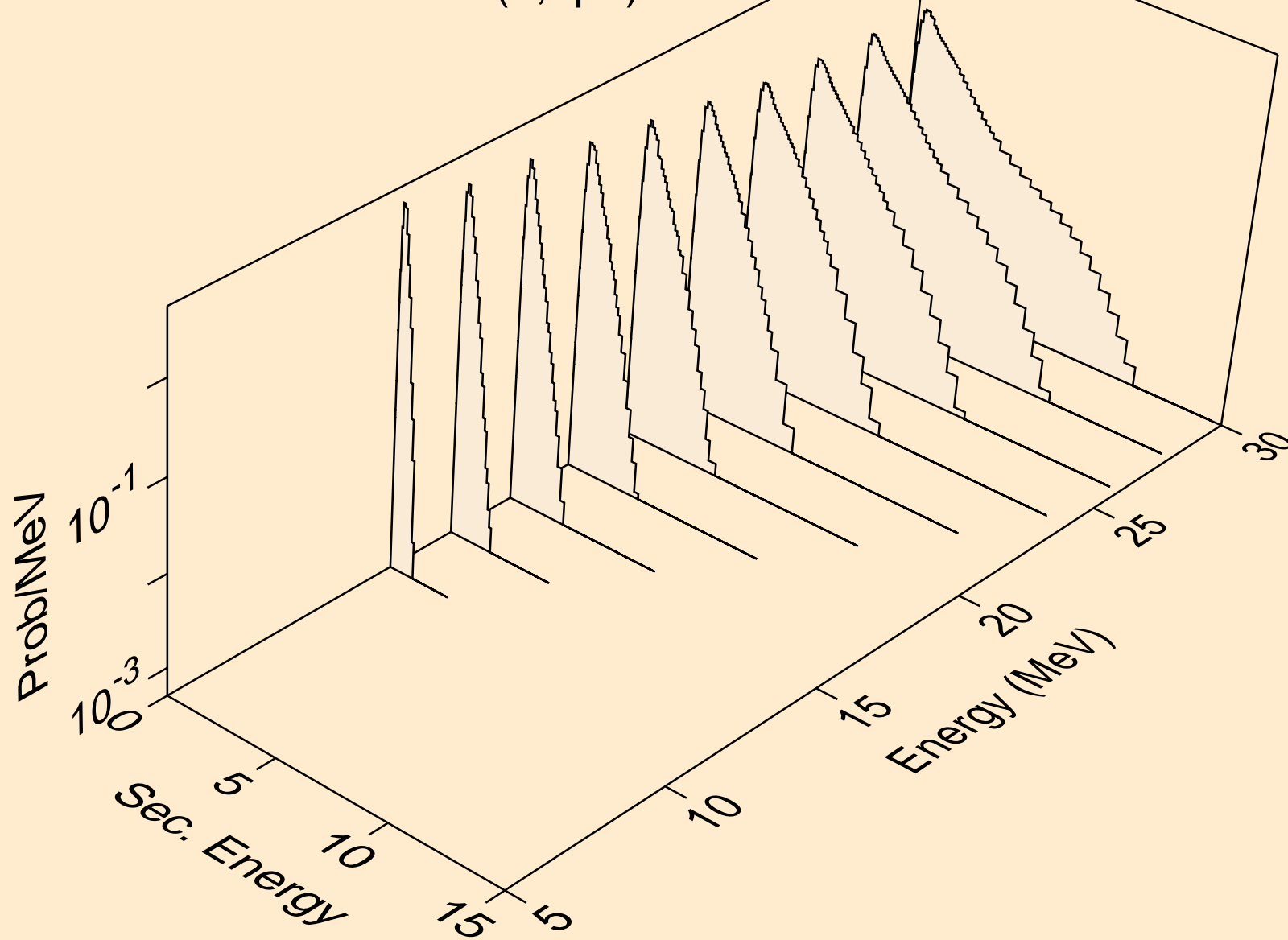

AG096M NEUTRON ACER TENDL-2021 LIBRARY; T=293.6K
Neutron emission for (n,n*c)

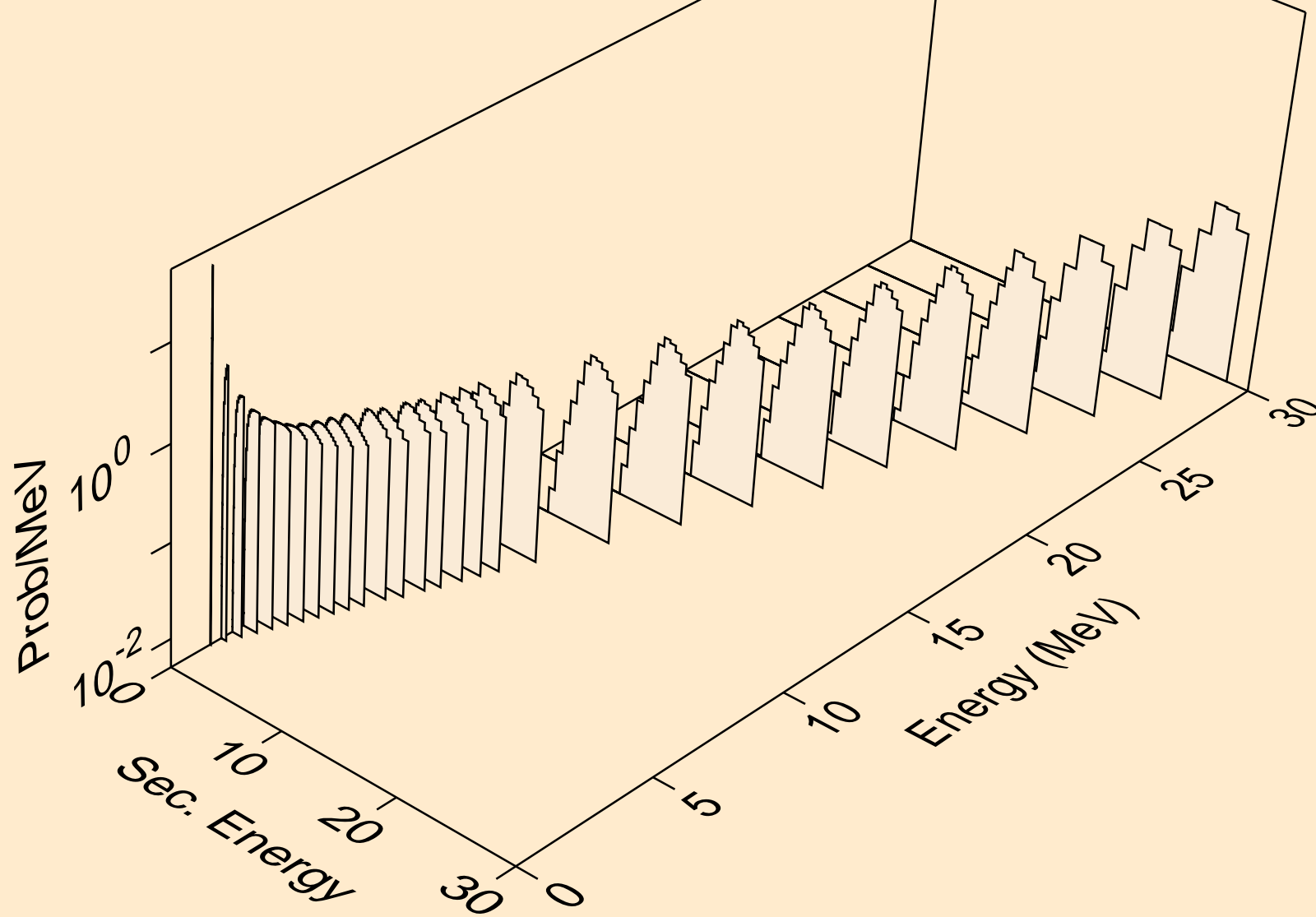

AG096M NEUTRON ACER TENDL-2021 LIBRARY; T=293.6K
Photon emission for (n,x)

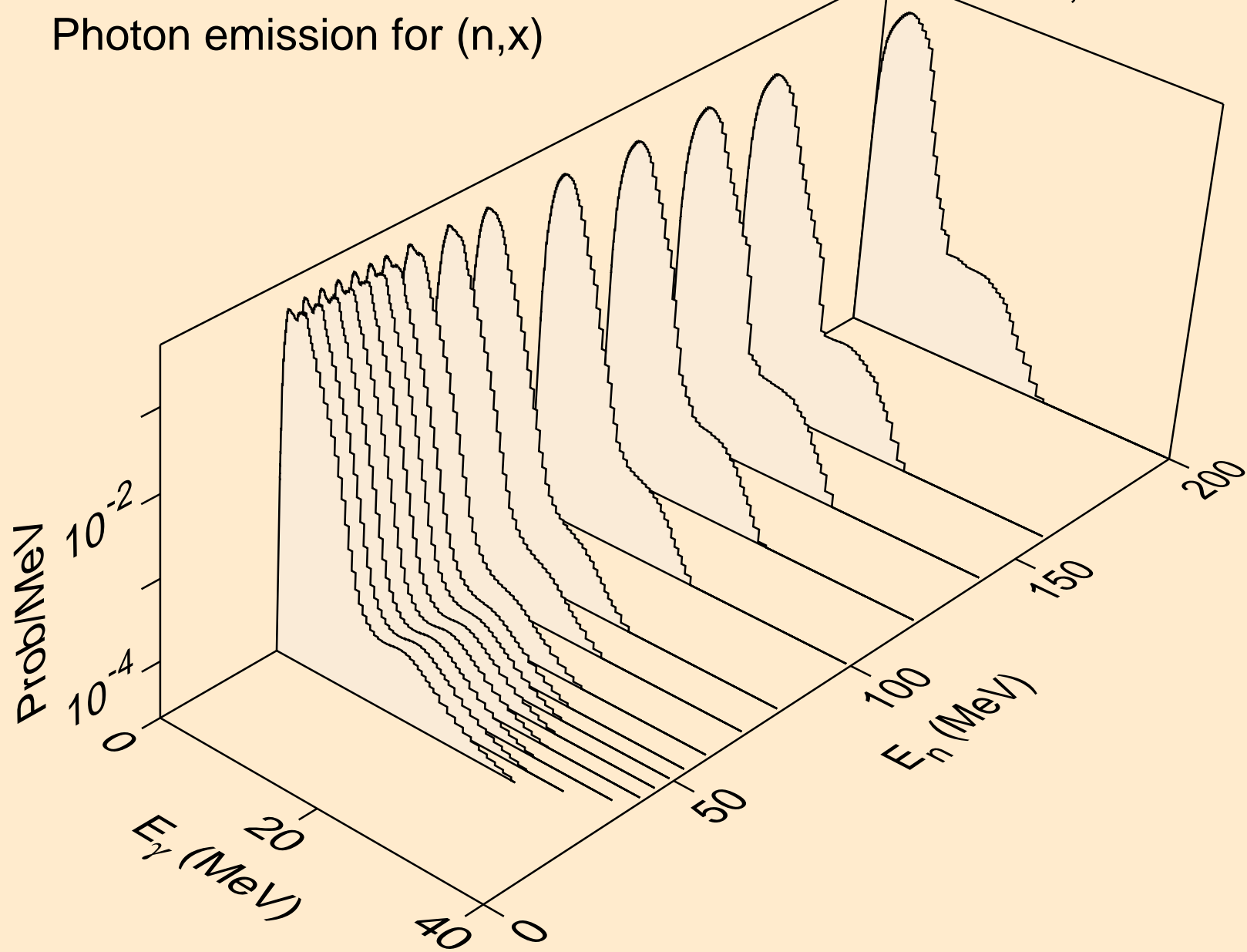

AG096M NEUTRON ACER TENDL-2021 LIBRARY; T=293.6K
Photon emission for (n,2n)

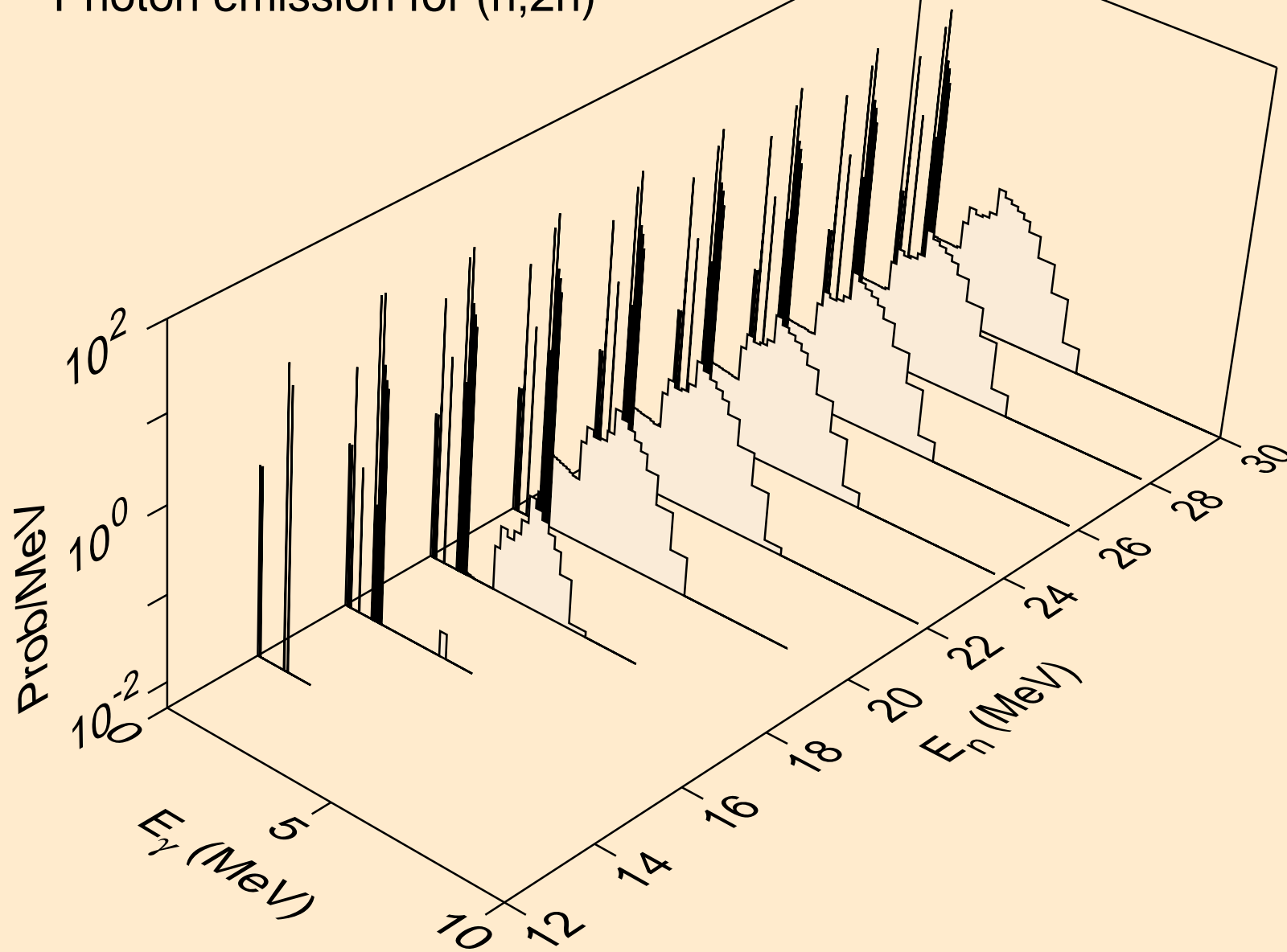

AG096M NEUTRON ACER TENDL-2021 LIBRARY; T=293.6K
Photon emission for (n,3n)

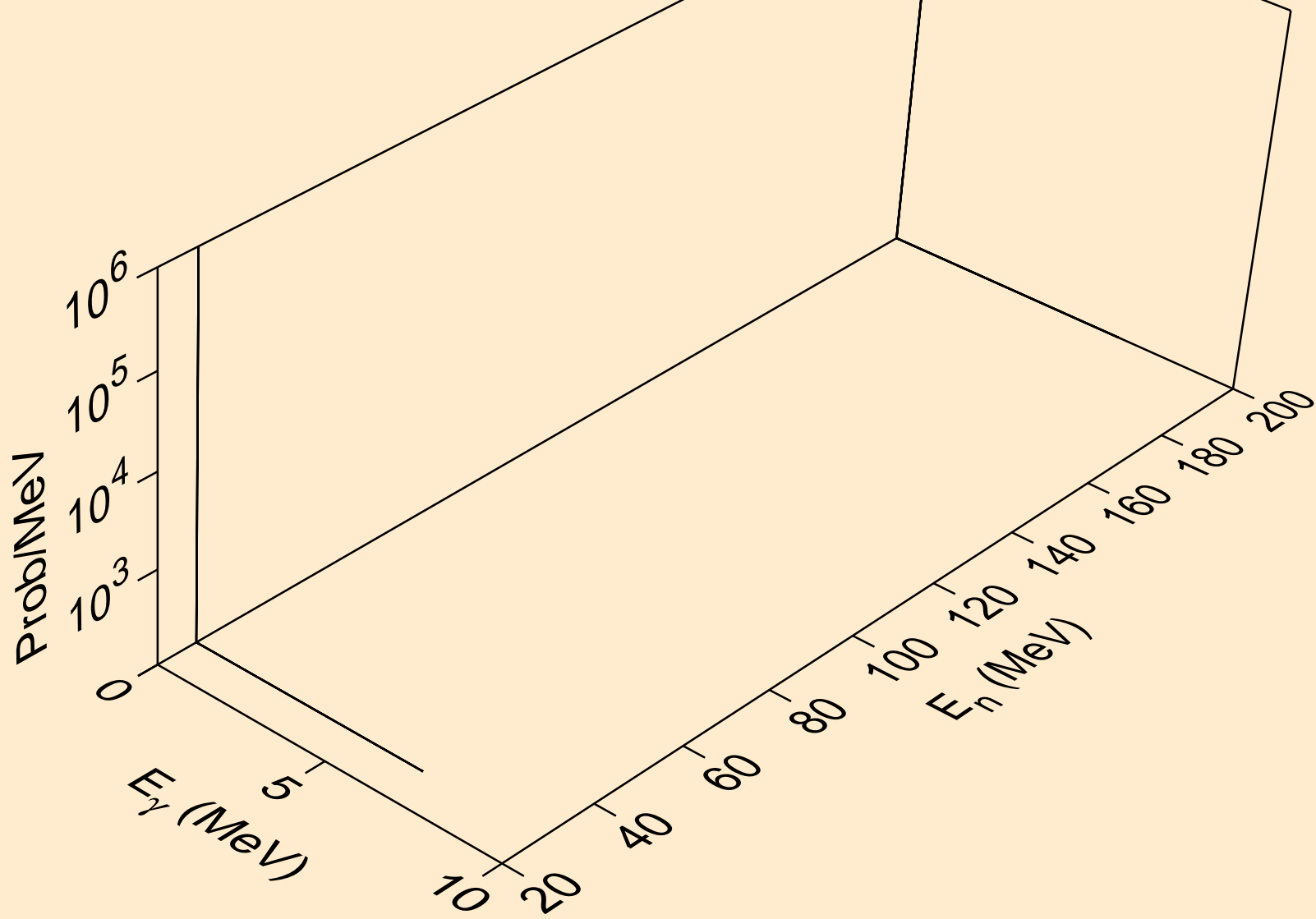

AG096M NEUTRON ACER TENDL-2021 LIBRARY; T=293.6K
Photon emission for (n,n*)a

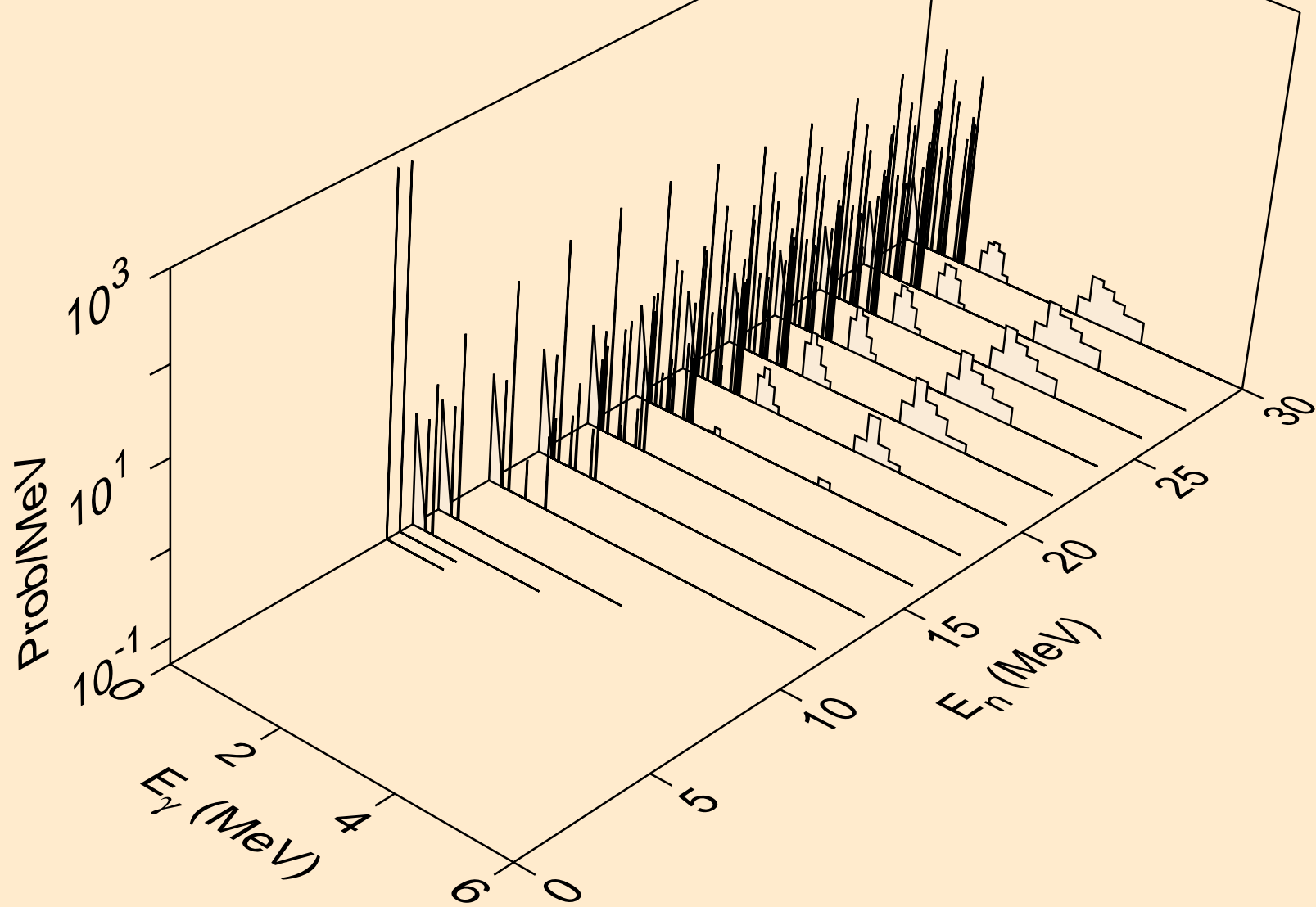

AG096M NEUTRON ACER TENDL-2021 LIBRARY; T=293.6K
Photon emission for (n,2n)a

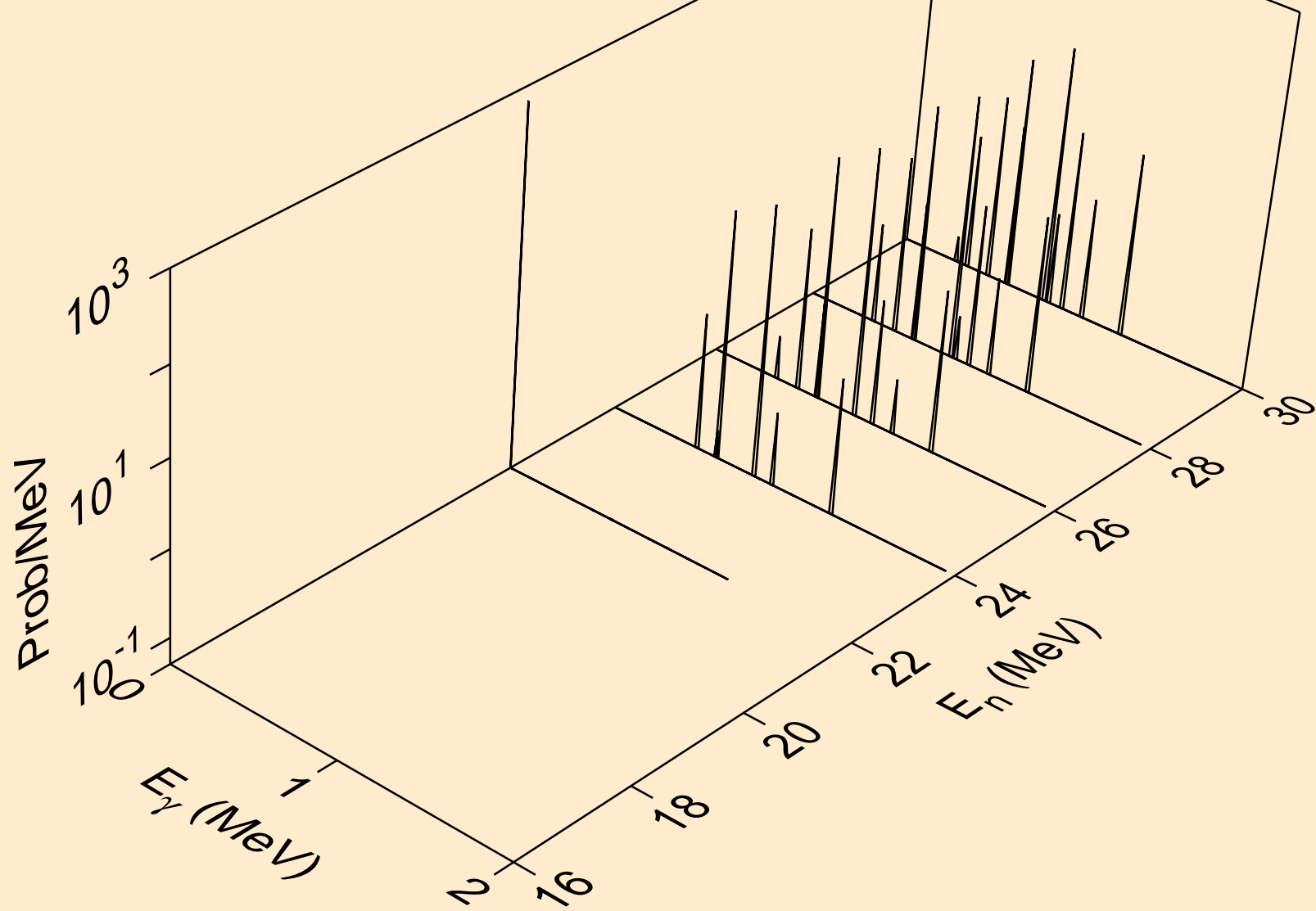

AG096M NEUTRON ACER TENDL-2021 LIBRARY; T=293.6K
Photon emission for (n,n*)p

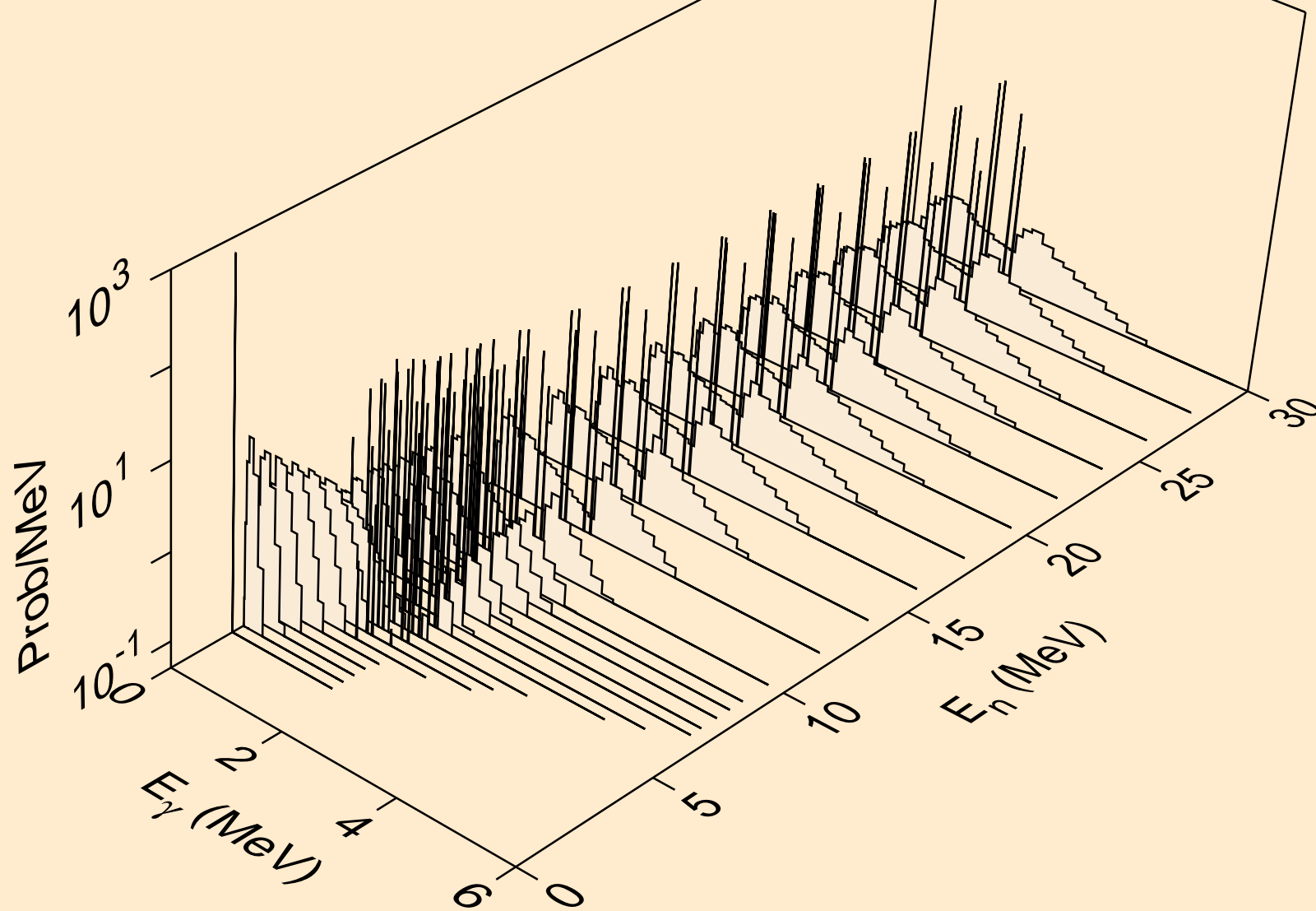

AG096M NEUTRON ACER TENDL-2021 LIBRARY; T=293.6K
Photon emission for (n,n*)2a

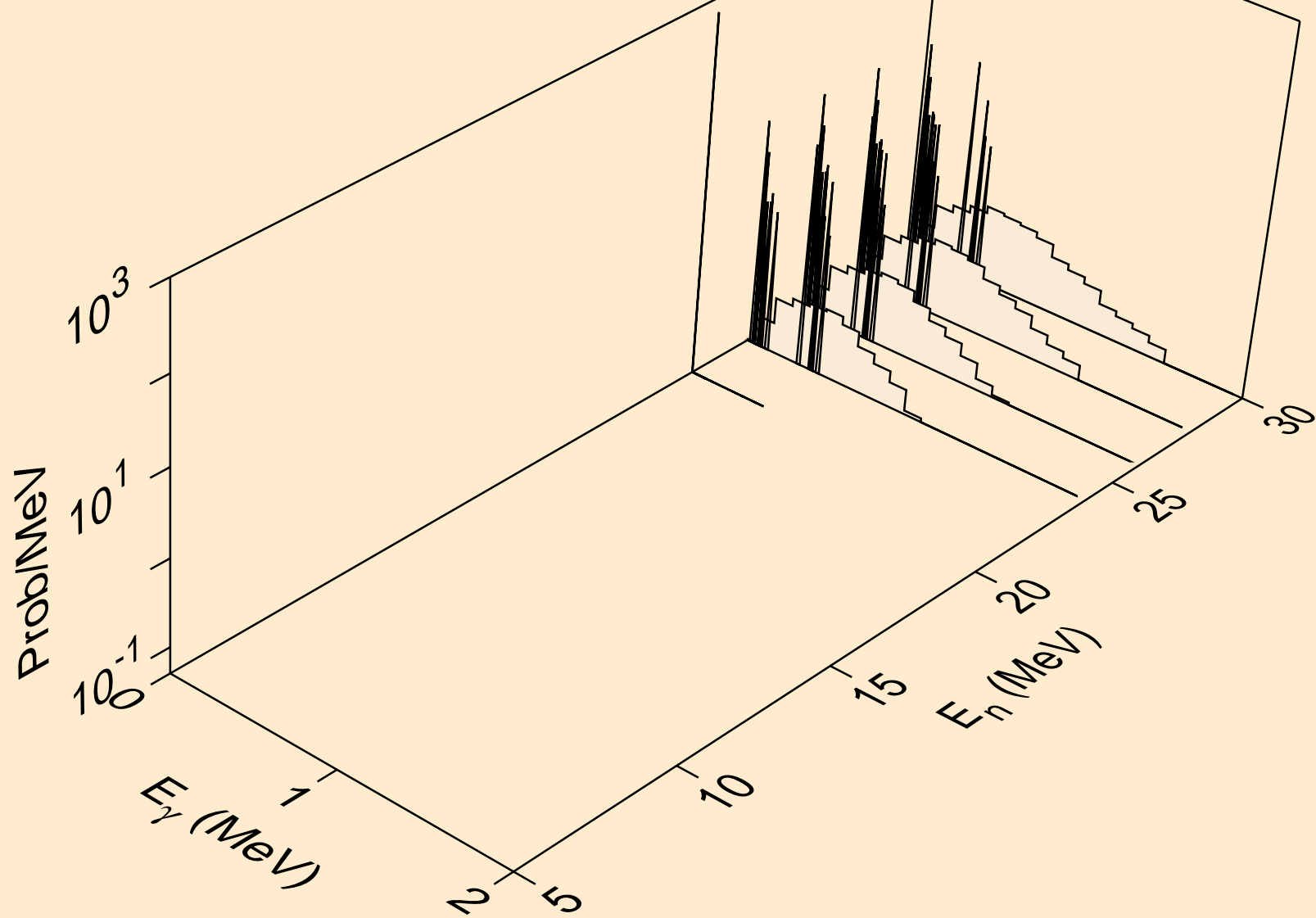

AG096M NEUTRON ACER TENDL-2021 LIBRARY; T=293.6K
Photon emission for (n,n*)d

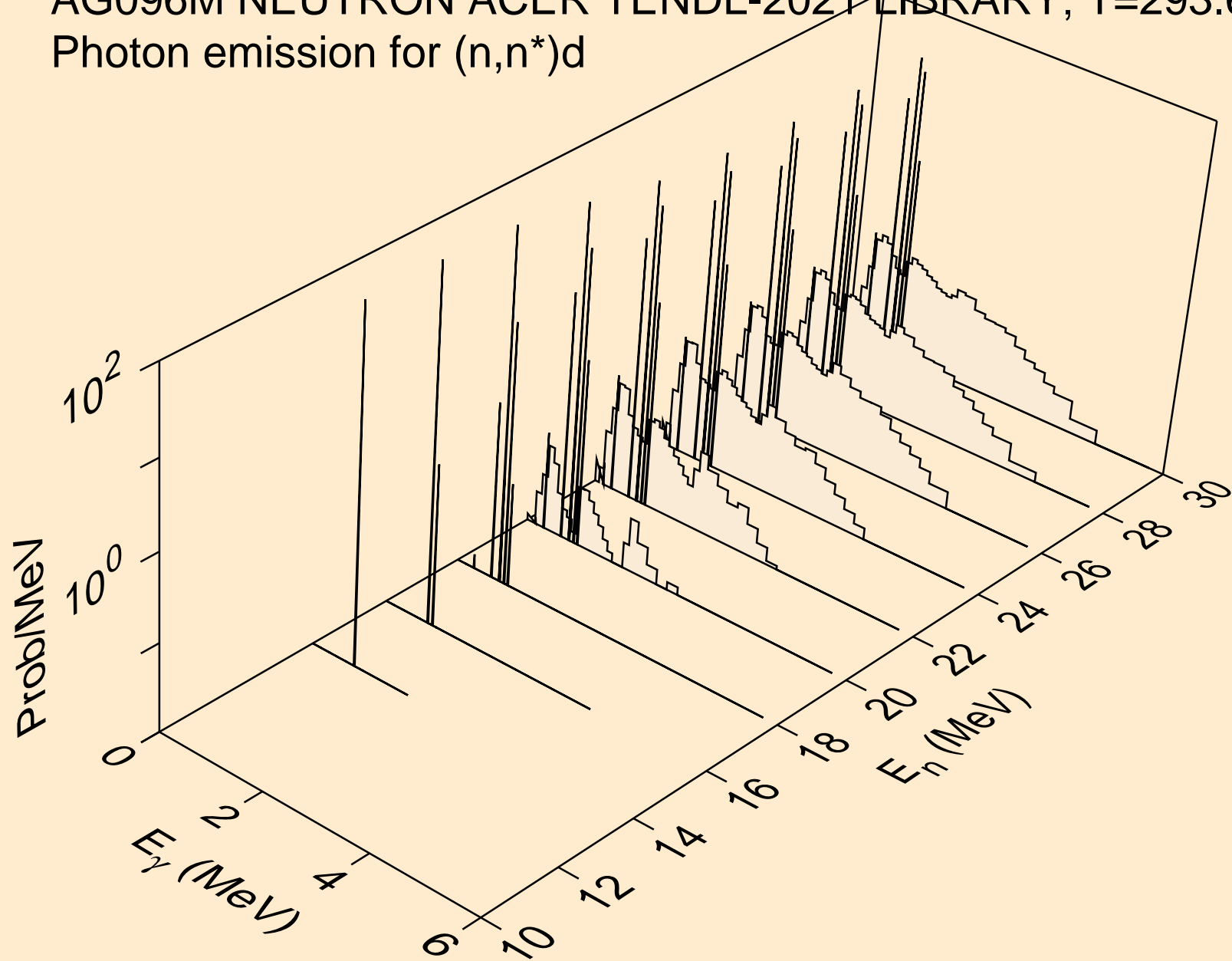

AG096M NEUTRON ACER TENDL-2021 LIBRARY; T=293.6K
Photon emission for (n,n*)t

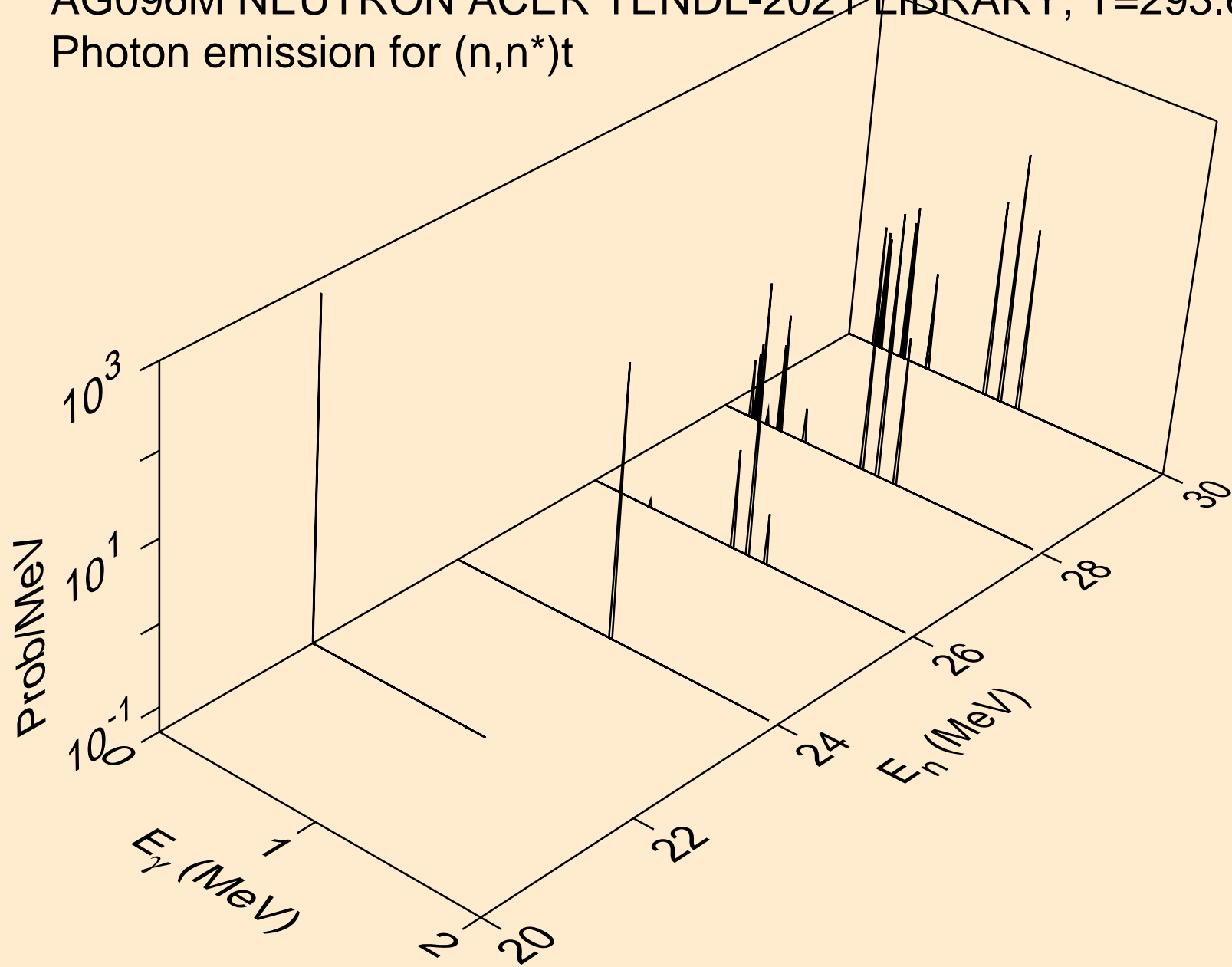

AG096M NEUTRON ACER TENDL-2021 LIBRARY; T=293.6K
Photon emission for (n,n*)he3

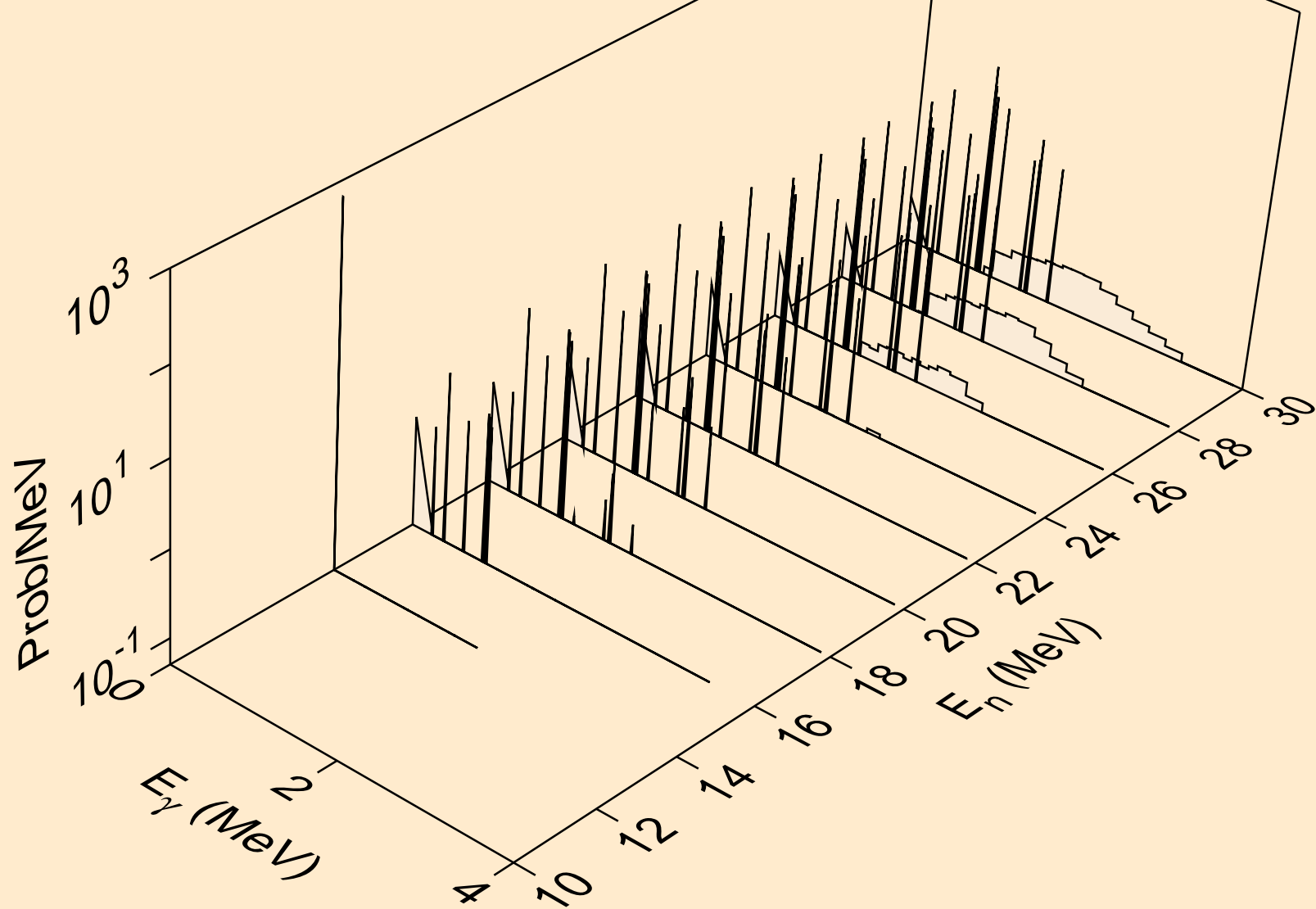

AG096M NEUTRON ACER TENDL-2021 LIBRARY; T=293.6K
Photon emission for (n,2np)

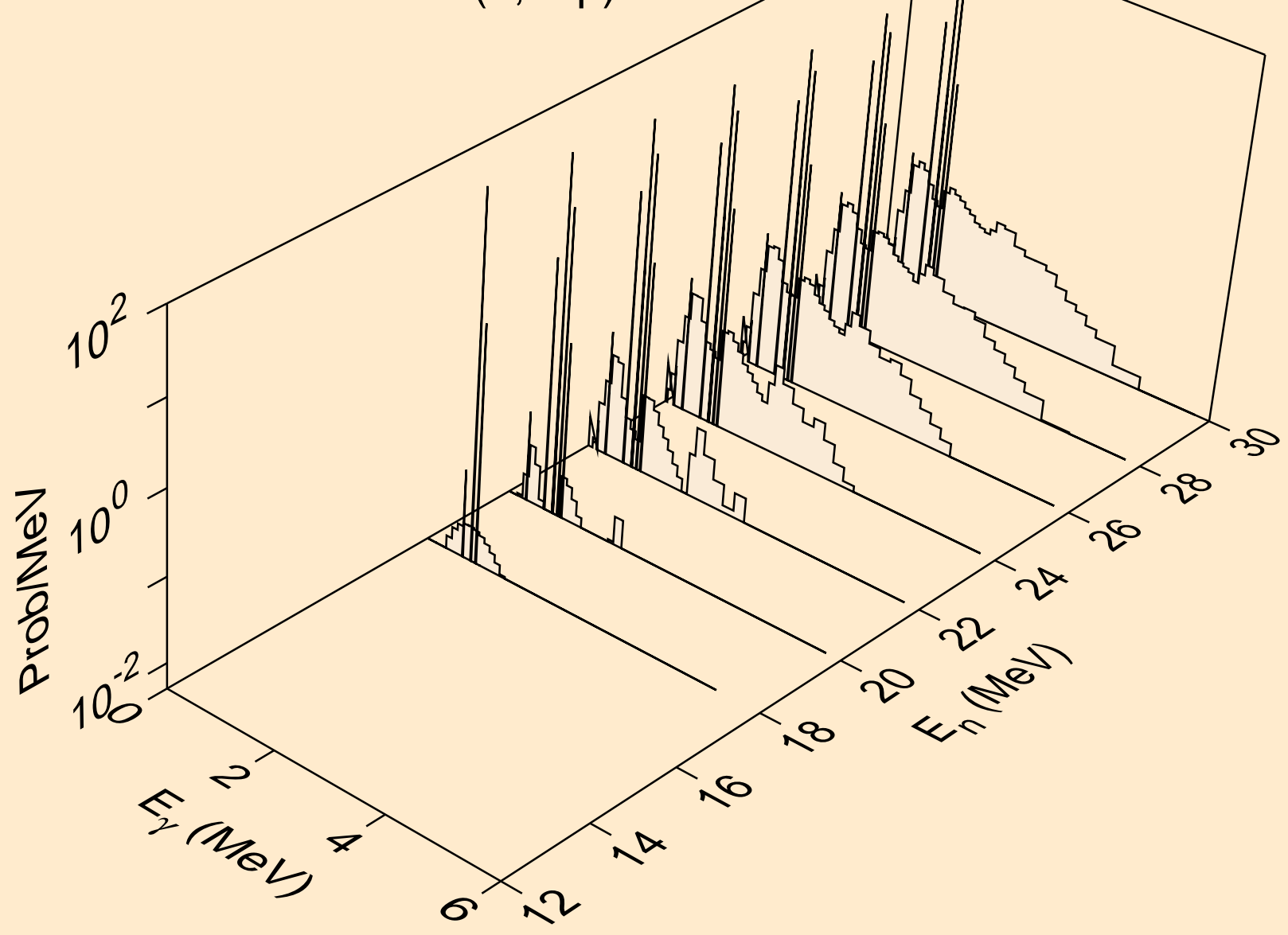

AG096M NEUTRON ACER TENDL-2021 LIBRARY; T=293.6K
Photon emission for (n,2np)

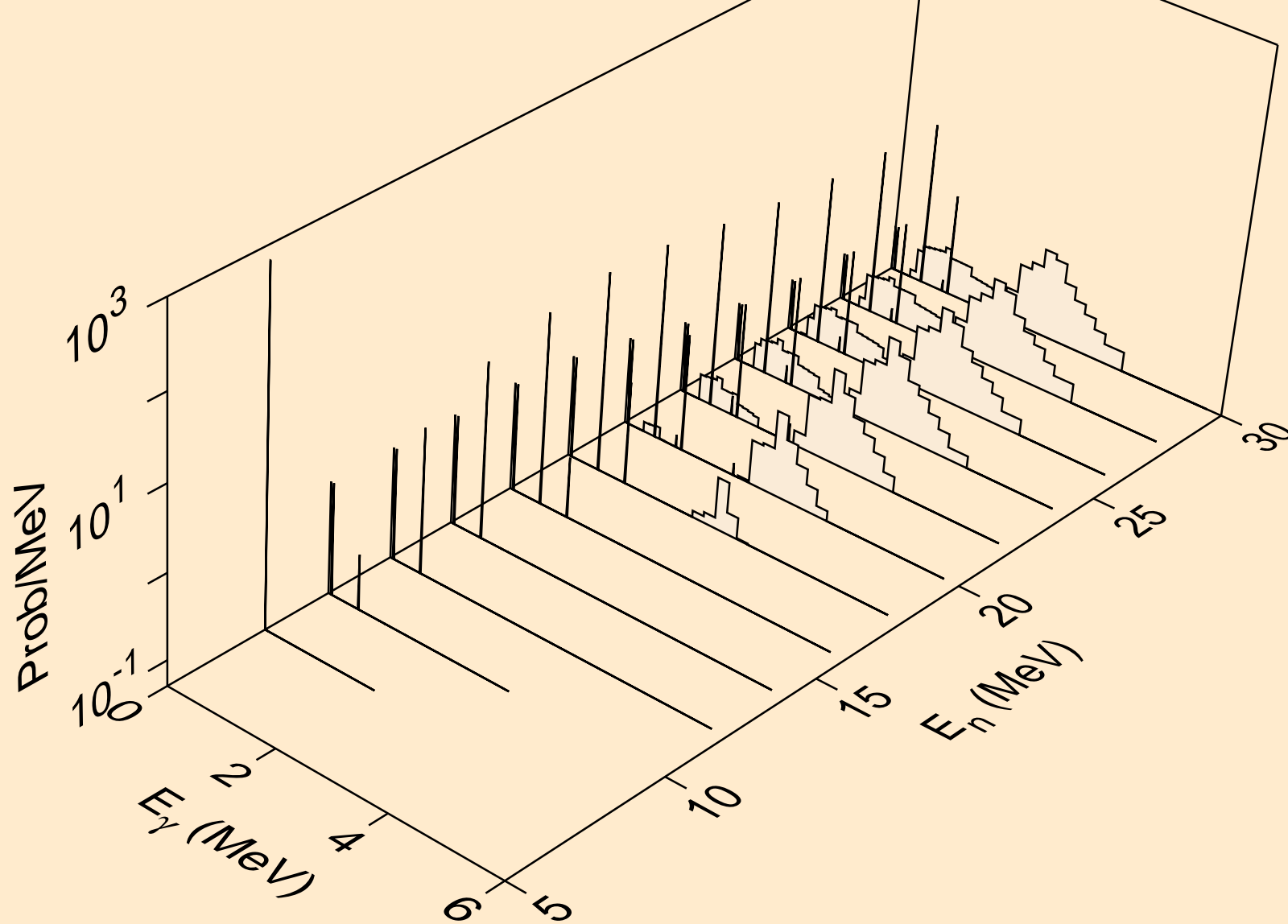

AG096M NEUTRON ACER TENDL-2021 LIBRARY; T=293.6K
Photon emission for (n,npa)

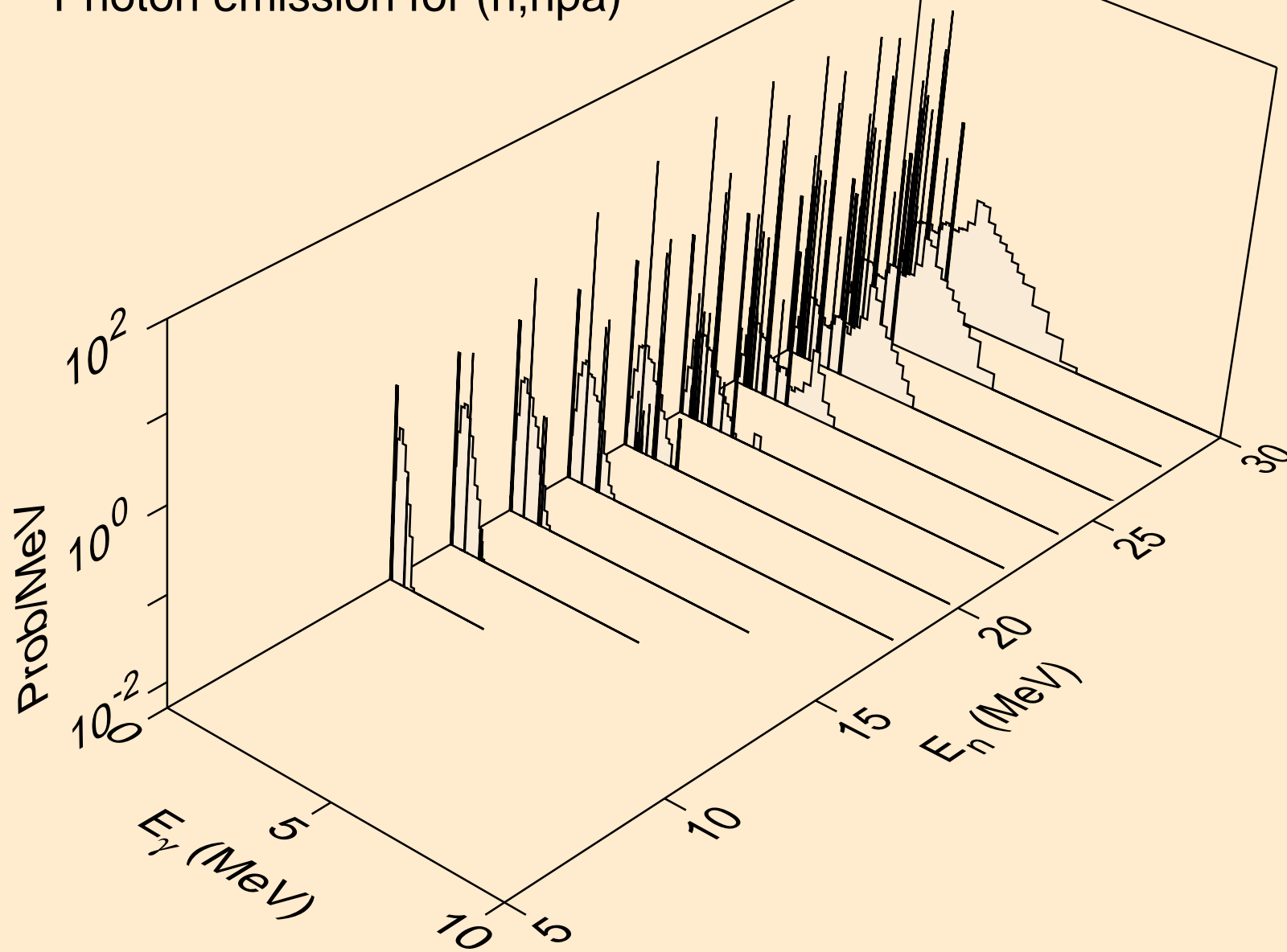

AG096M NEUTRON ACER TENDL-2021 LIBRARY; T=293.6K
Photon emission for (n,n*2)

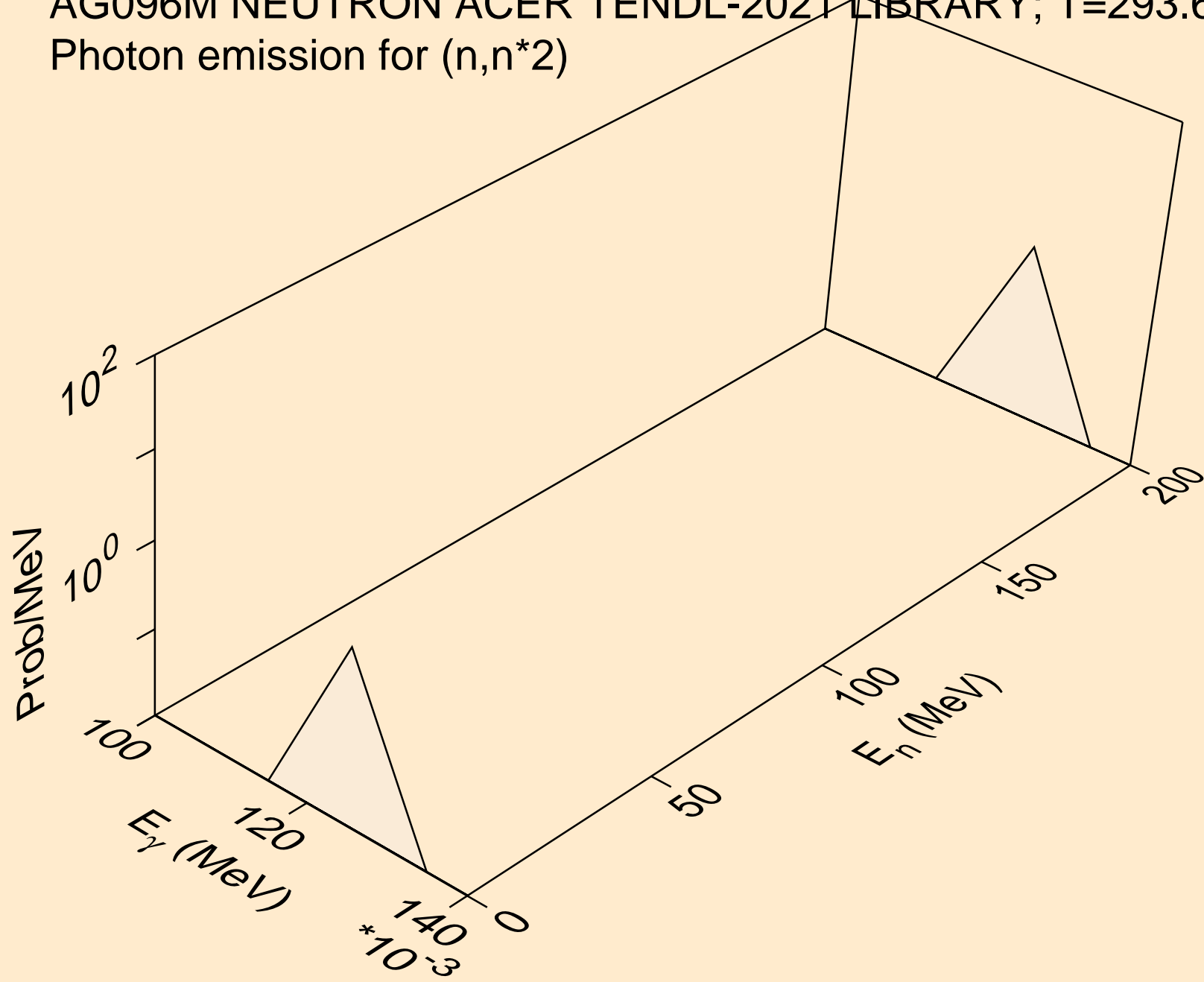

AG096M NEUTRON ACER TENDL-2021 LIBRARY; T=293.6K
Photon emission for (n,n*3)

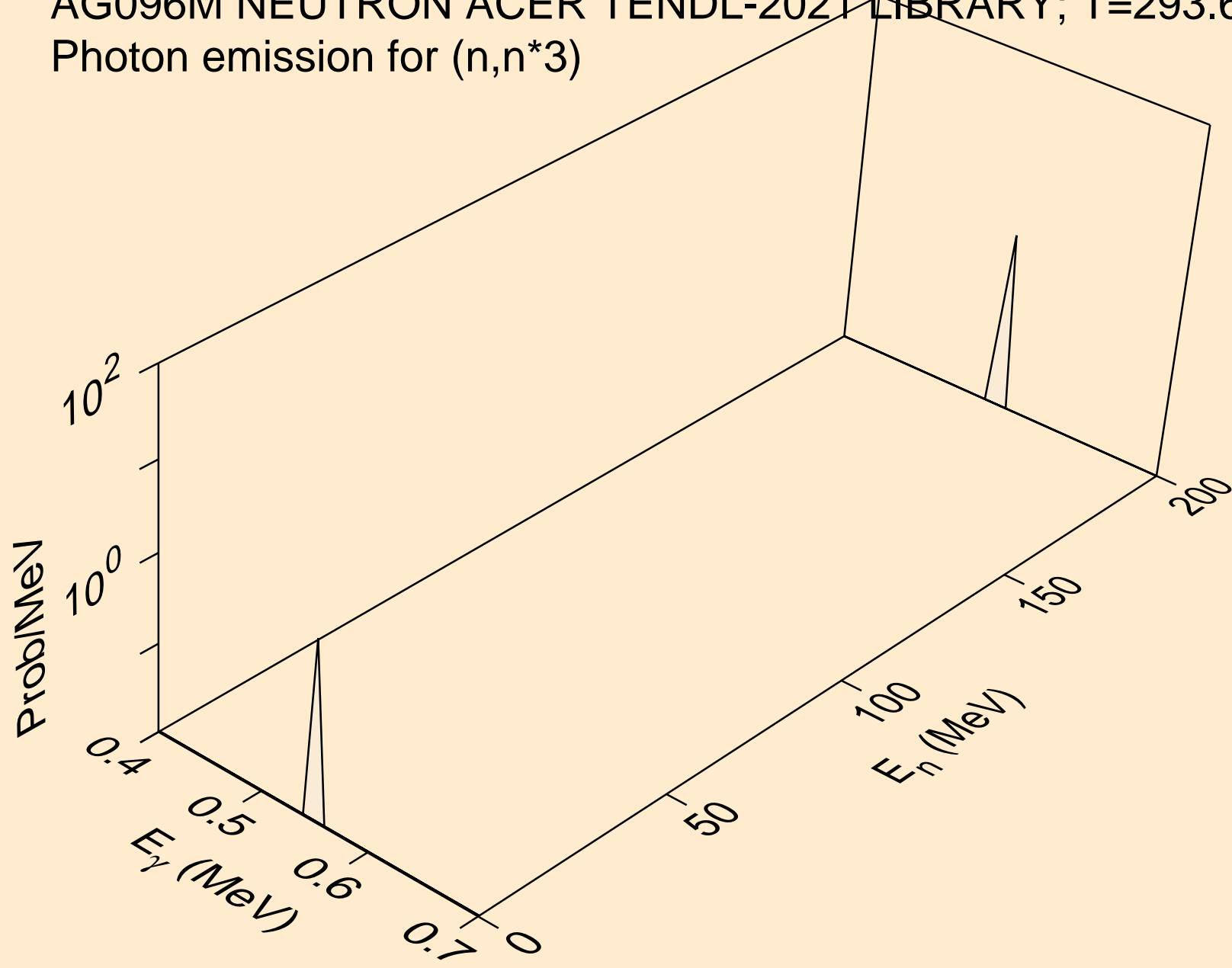

AG096M NEUTRON ACER TENDL-2021 LIBRARY; T=293.6K
Photon emission for (n,n*4)

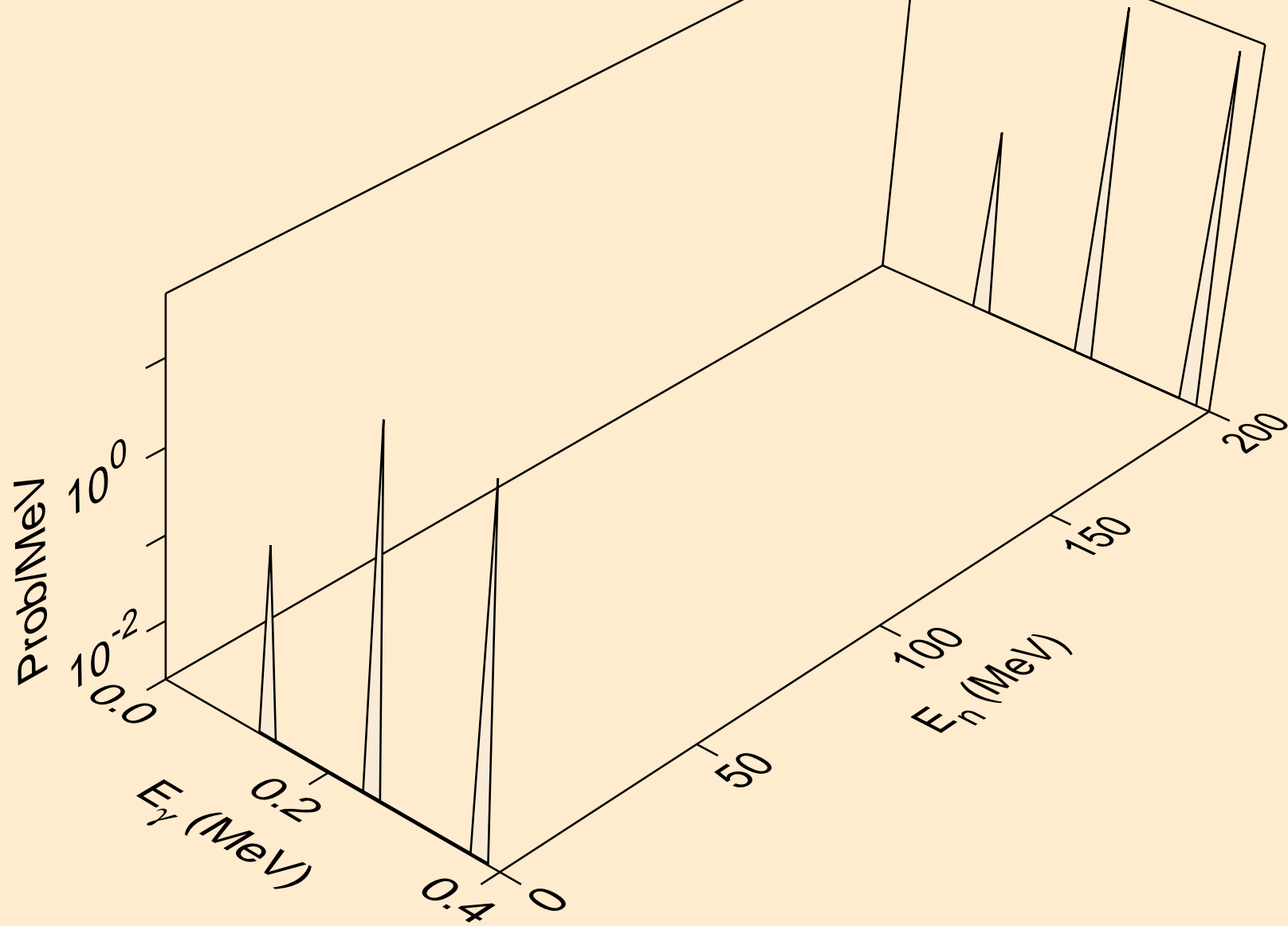

AG096M NEUTRON ACER TENDL-2021 LIBRARY; T=293.6K
Photon emission for (n,n*5)

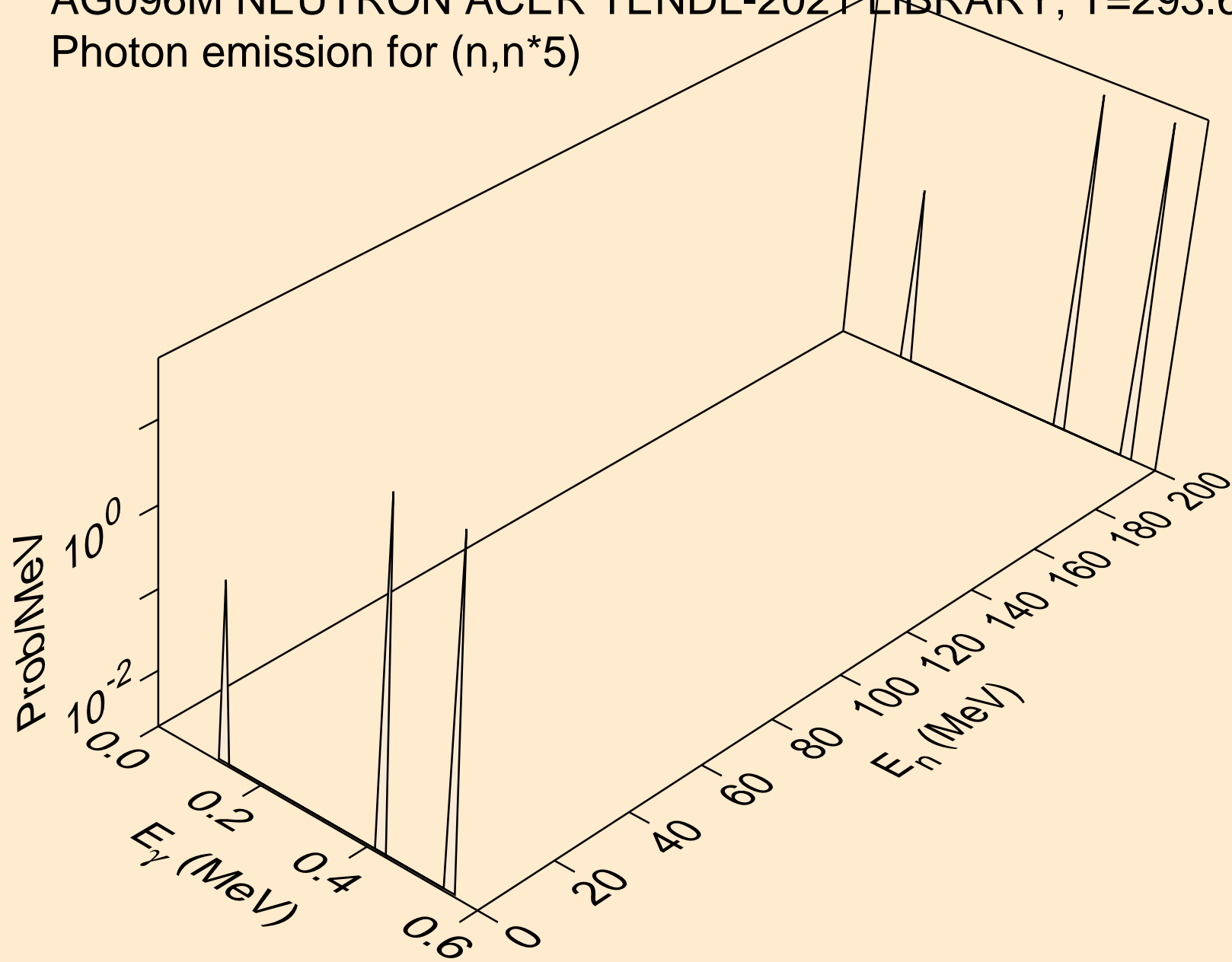

AG096M NEUTRON ACER TENDL-2021 LIBRARY; T=293.6K
Photon emission for (n,n*6)

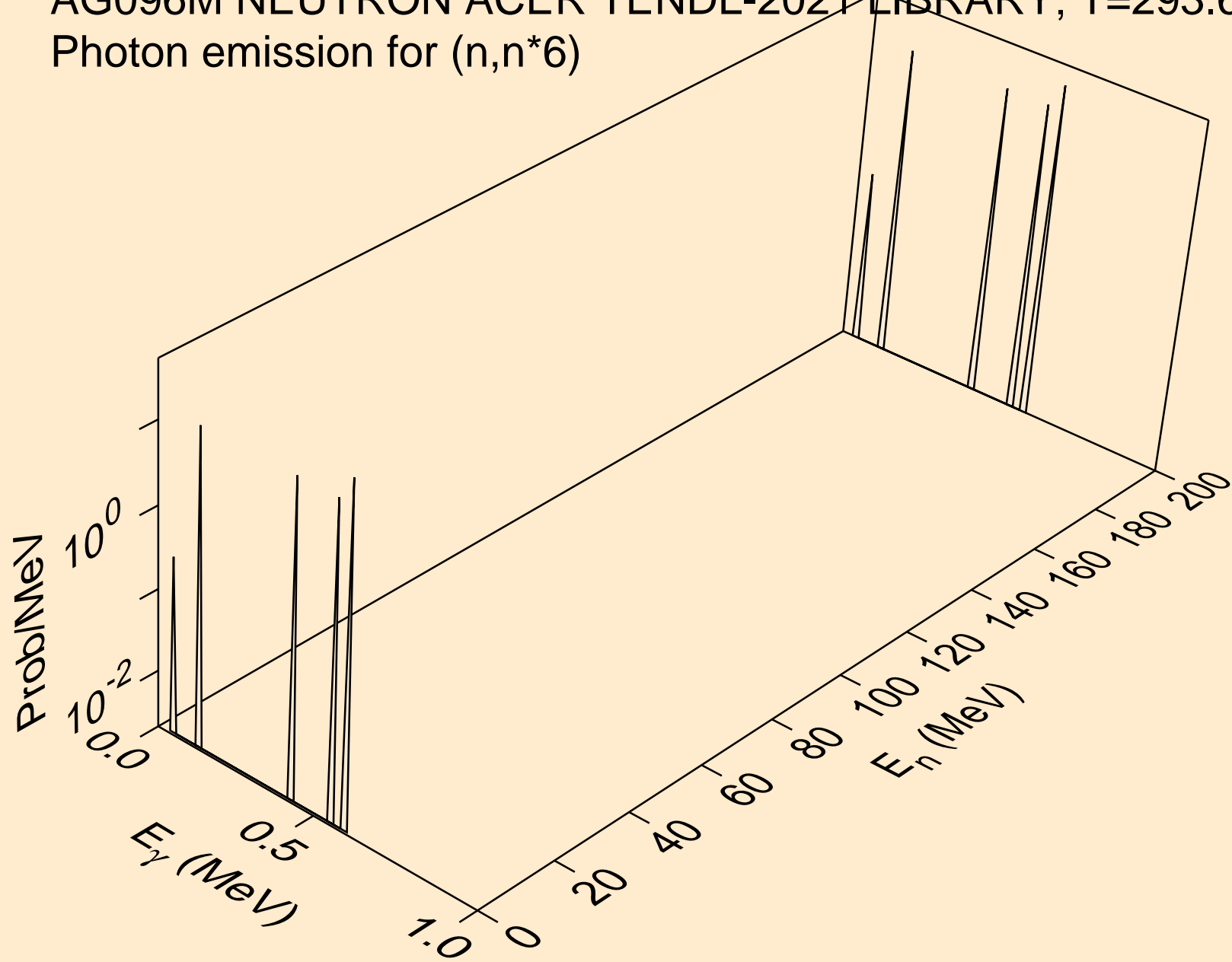

AG096M NEUTRON ACER TENDL-2021 LIBRARY; T=293.6K
Photon emission for (n,n*7)

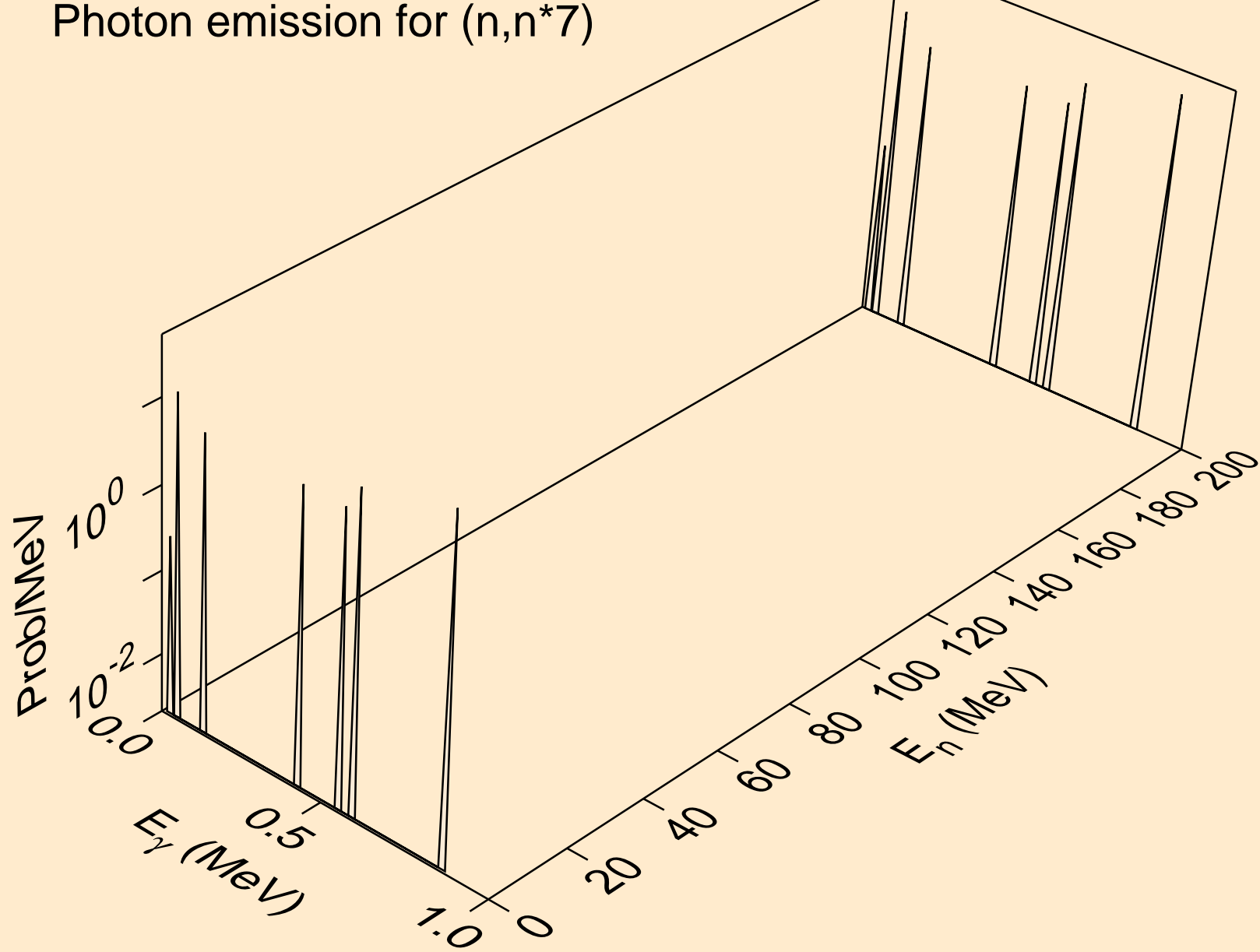

AG096M NEUTRON ACER TENDL-2021 LIBRARY; T=293.6K
Photon emission for (n,n*8)

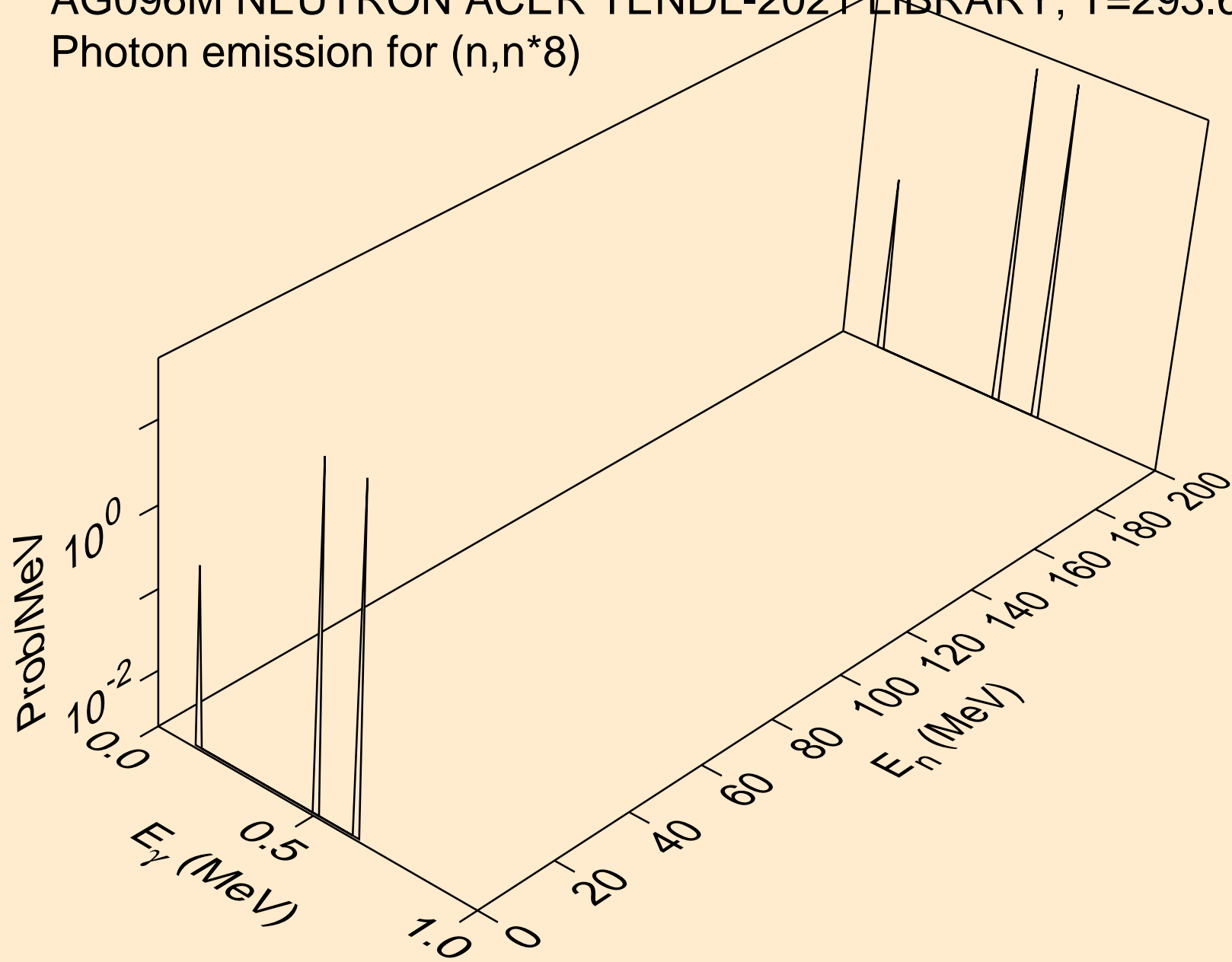

AG096M NEUTRON ACER TENDL-2021 LIBRARY; T=293.6K
Photon emission for (n,n*9)

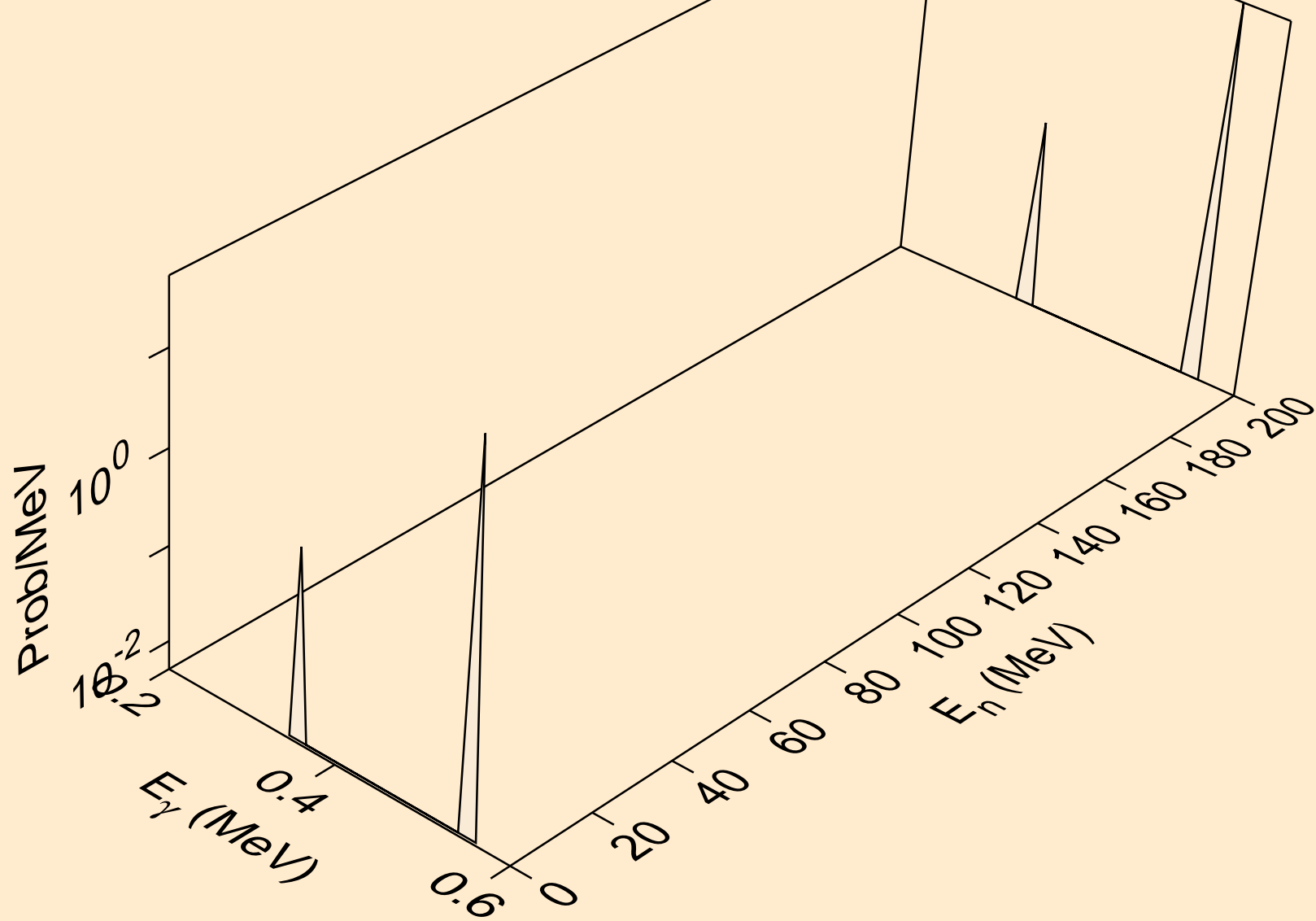

AG096M NEUTRON ACER TENDL-2021 LIBRARY; T=293.6K
Photon emission for (n,n*10)

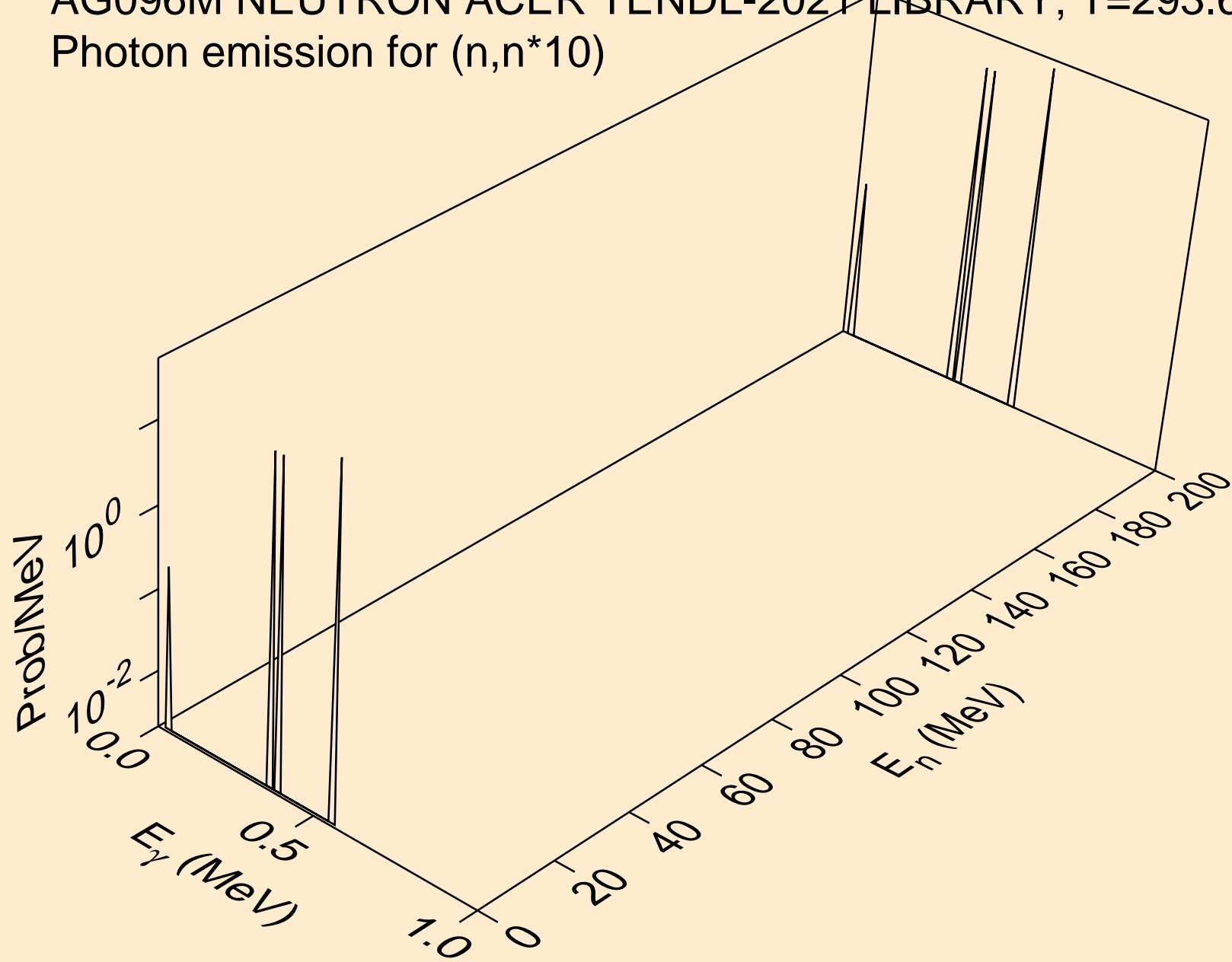

AG096M NEUTRON ACER TENDL-2021 LIBRARY; T=293.6K
Photon emission for (n,n*11)

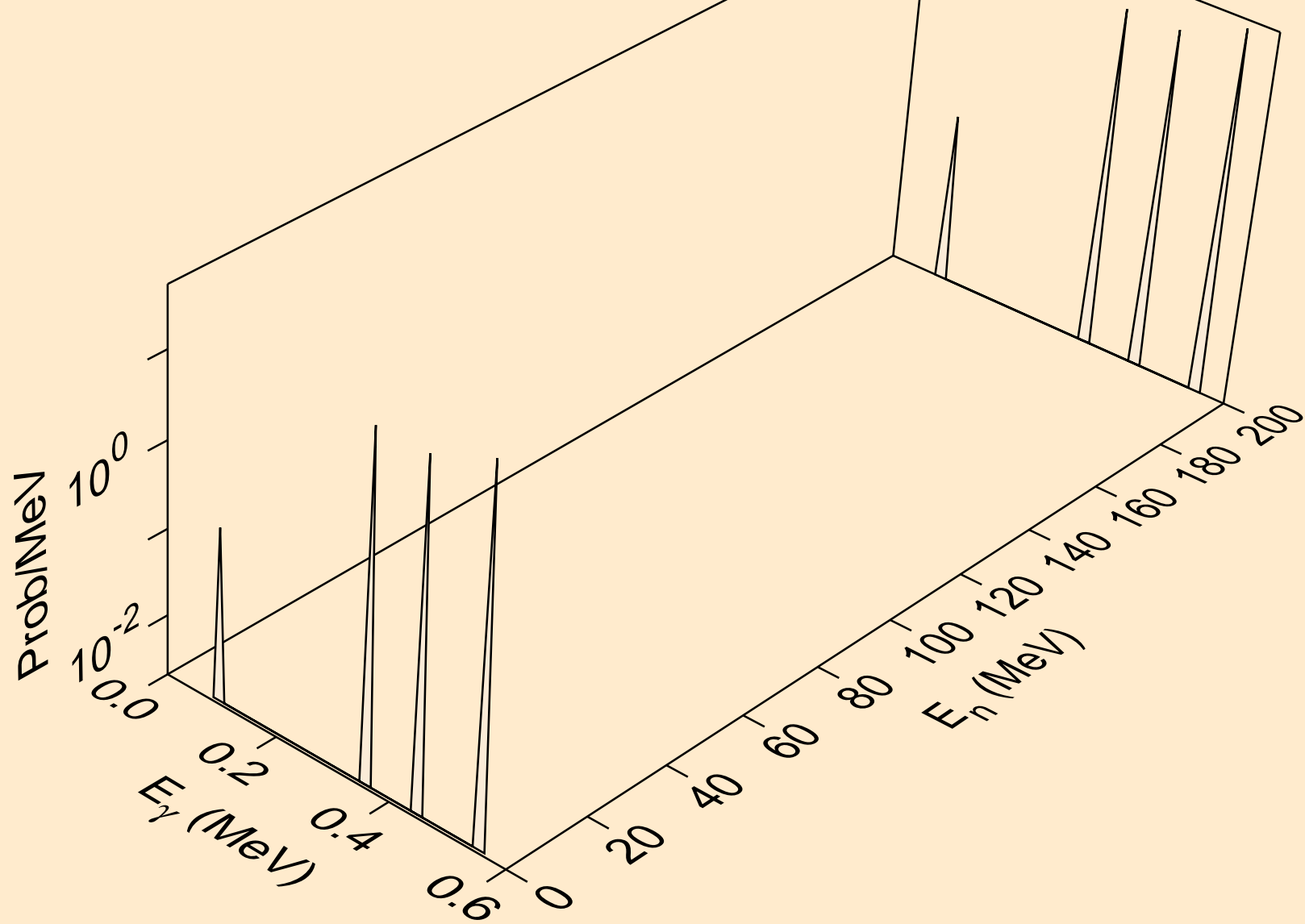

AG096M NEUTRON ACER TENDL-2021 LIBRARY; T=293.6K
Photon emission for (n,n*12)

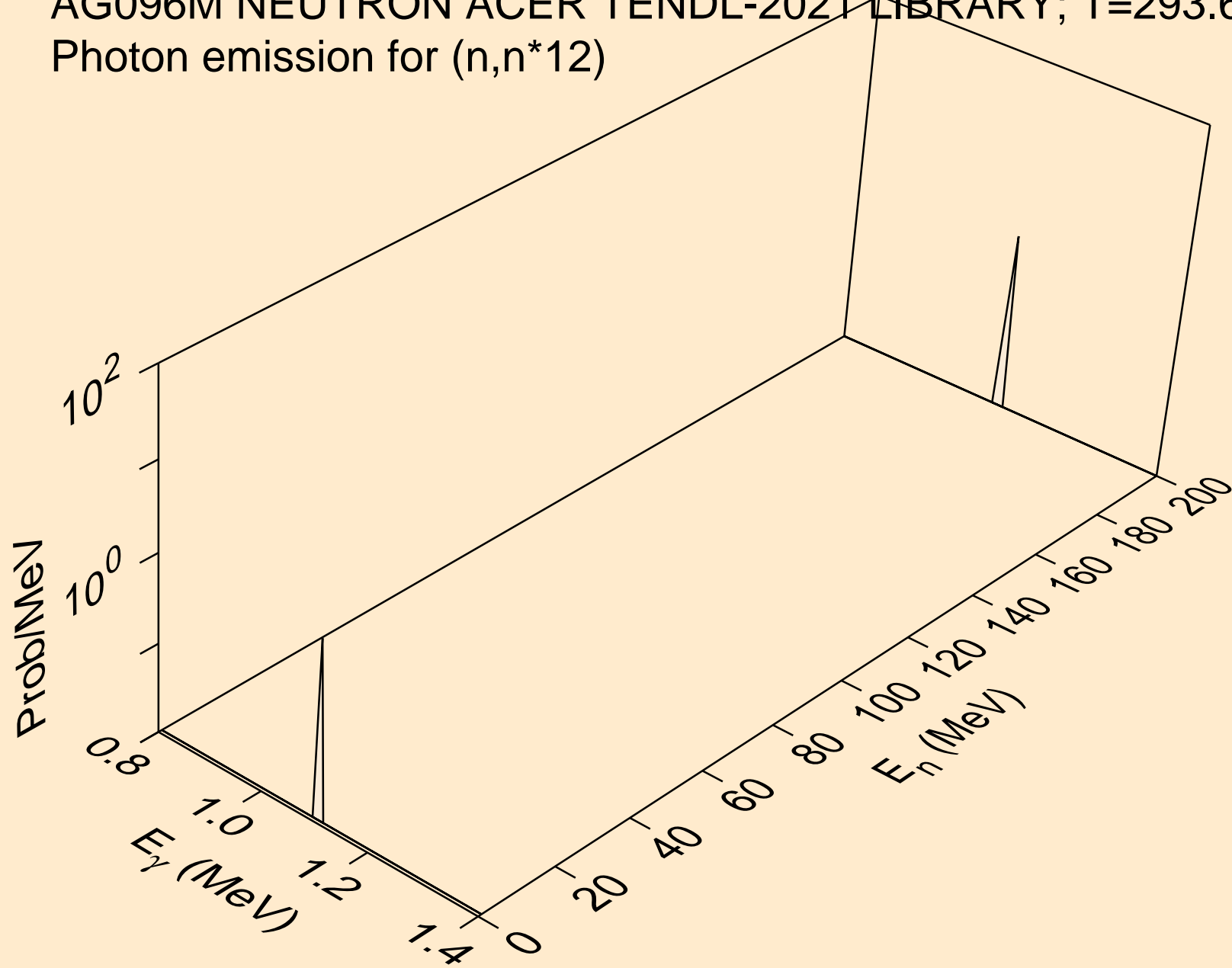

AG096M NEUTRON ACER TENDL-2021 LIBRARY; T=293.6K
Photon emission for (n,n*13)

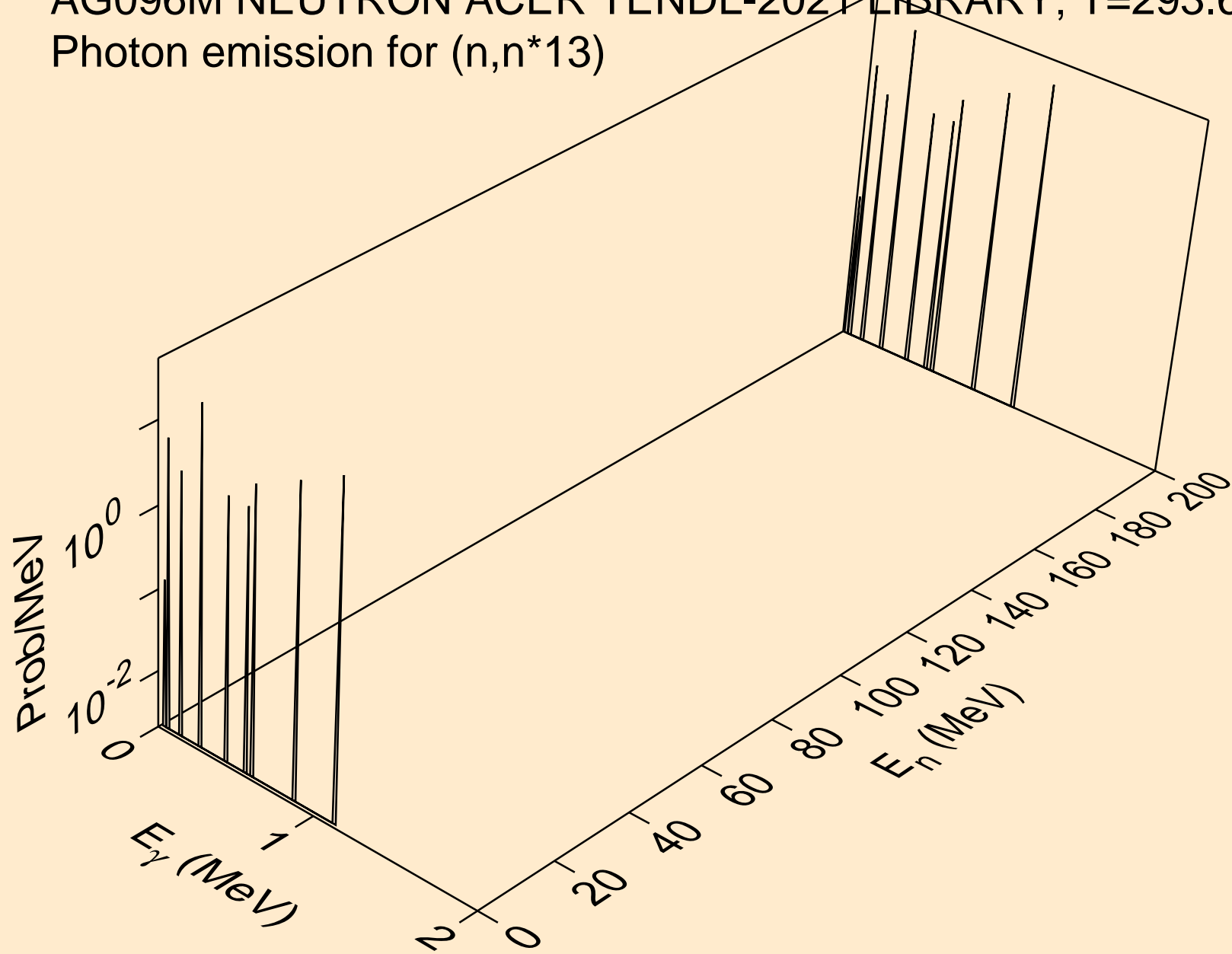

AG096M NEUTRON ACER TENDL-2021 LIBRARY; T=293.6K
Photon emission for (n,n*14)

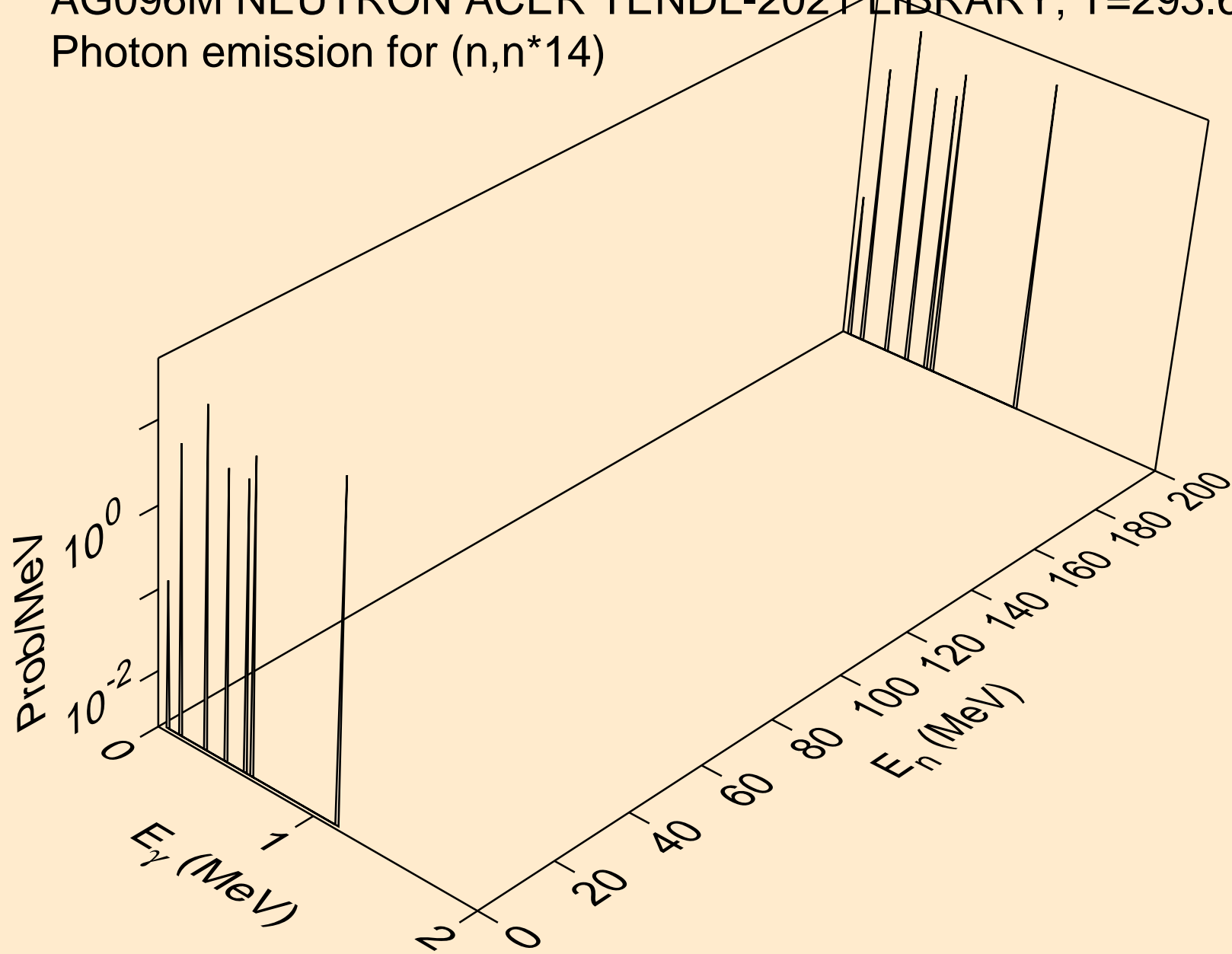

AG096M NEUTRON ACER TENDL-2021 LIBRARY; T=293.6K
Photon emission for (n,n*15)

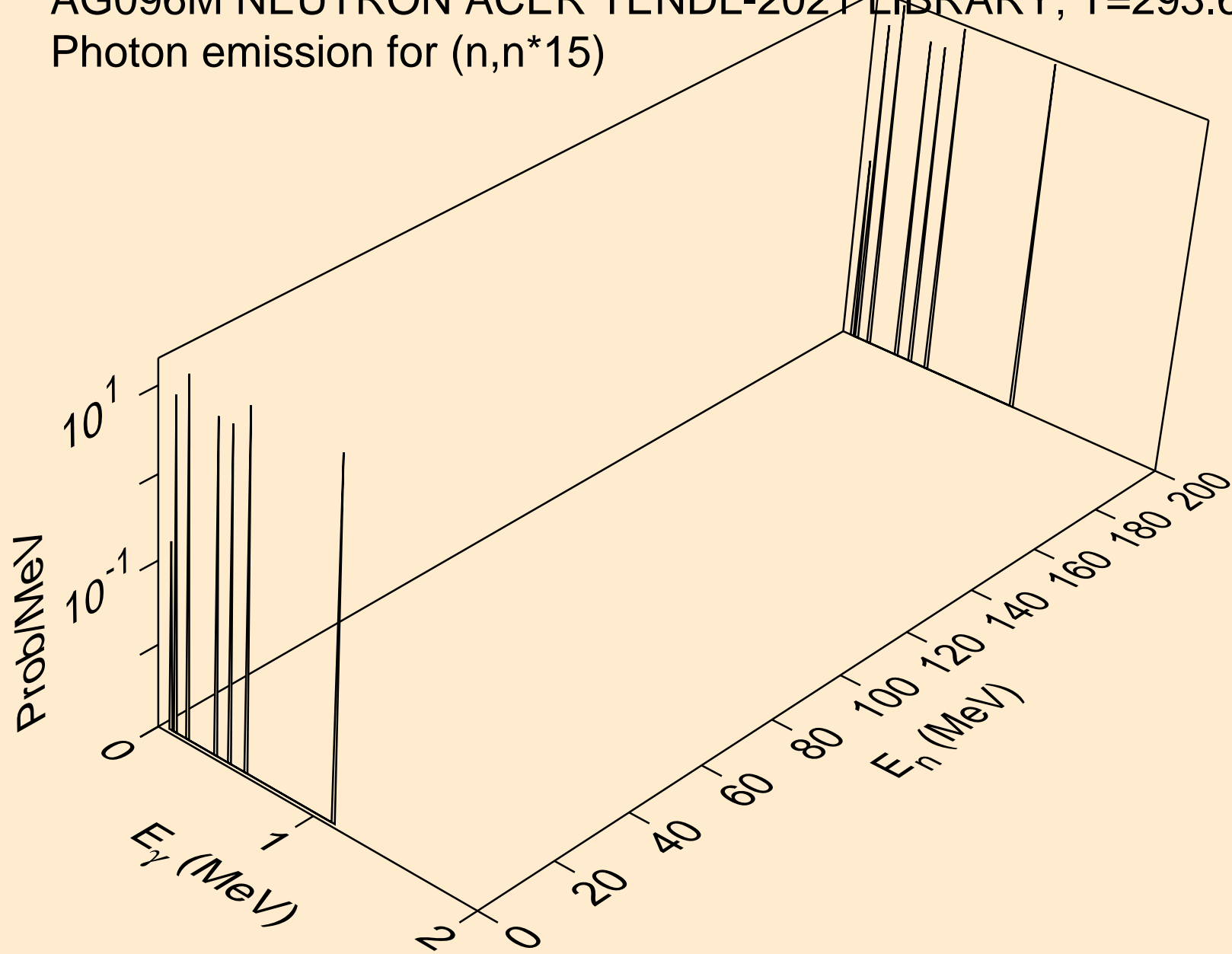

AG096M NEUTRON ACER TENDL-2021 LIBRARY; T=293.6K
Photon emission for (n,n*16)

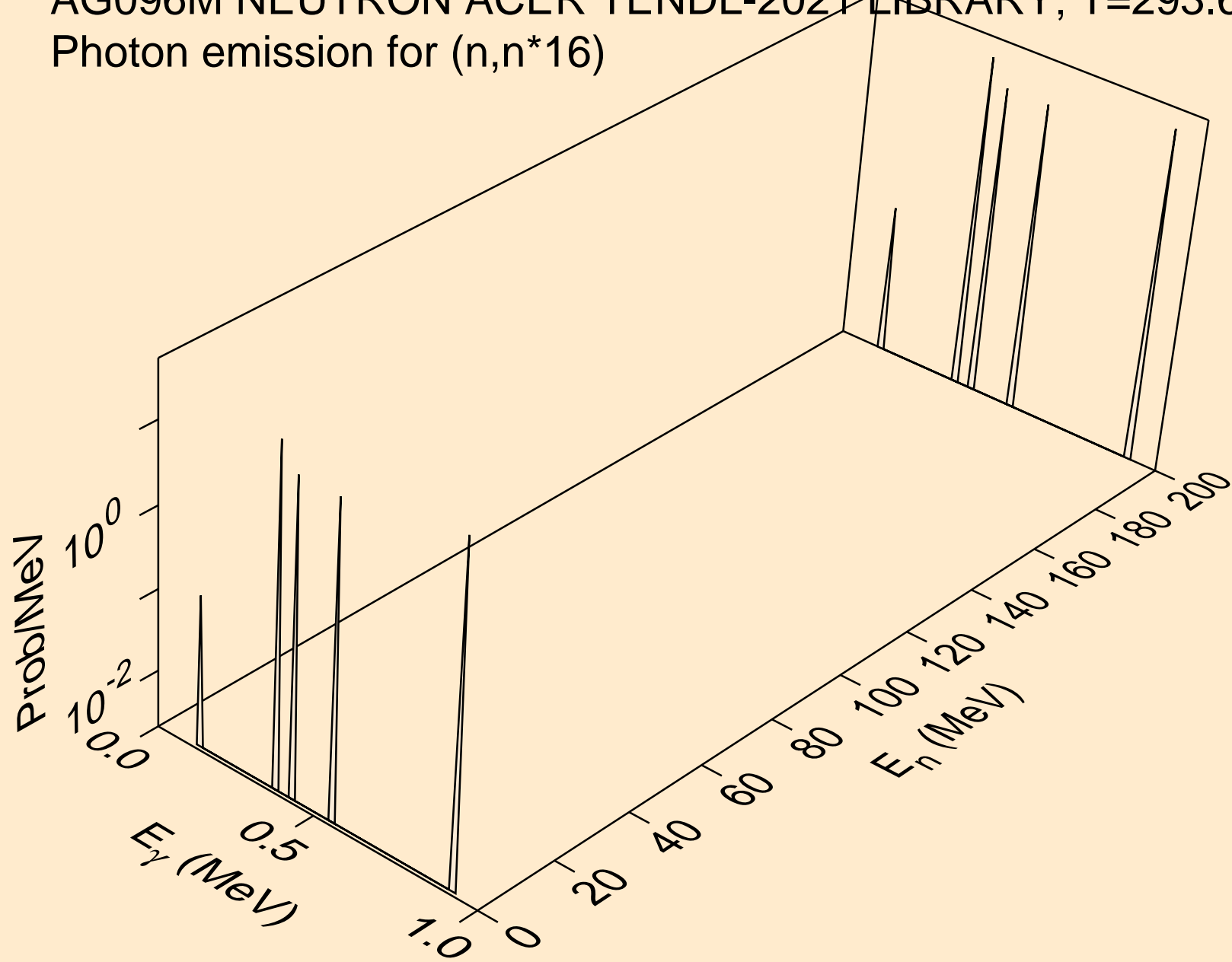

AG096M NEUTRON ACER TENDL-2021 LIBRARY; T=293.6K
Photon emission for (n,n*17)

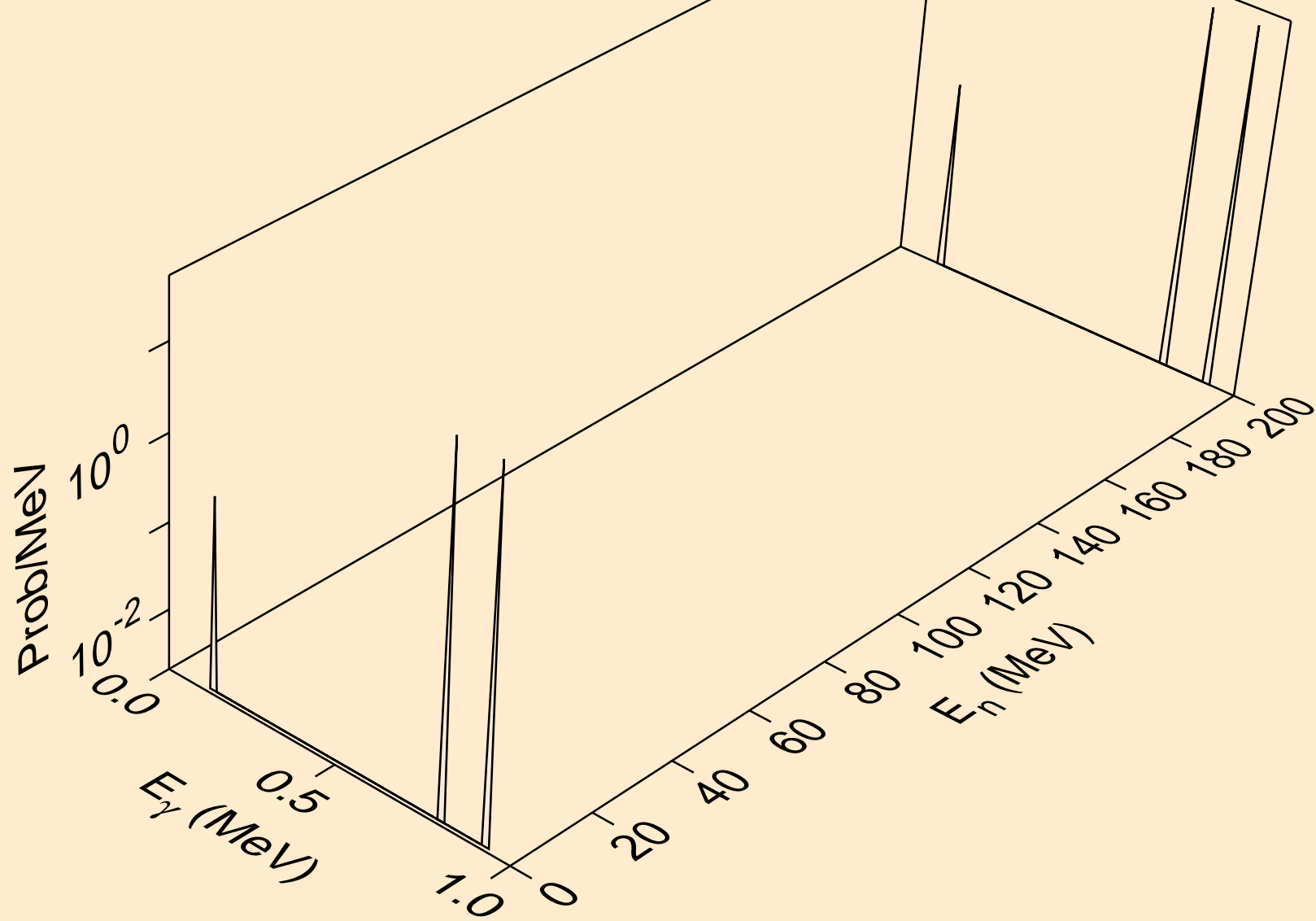

AG096M NEUTRON ACER TENDL-2021 LIBRARY; T=293.6K
Photon emission for (n,n*c)

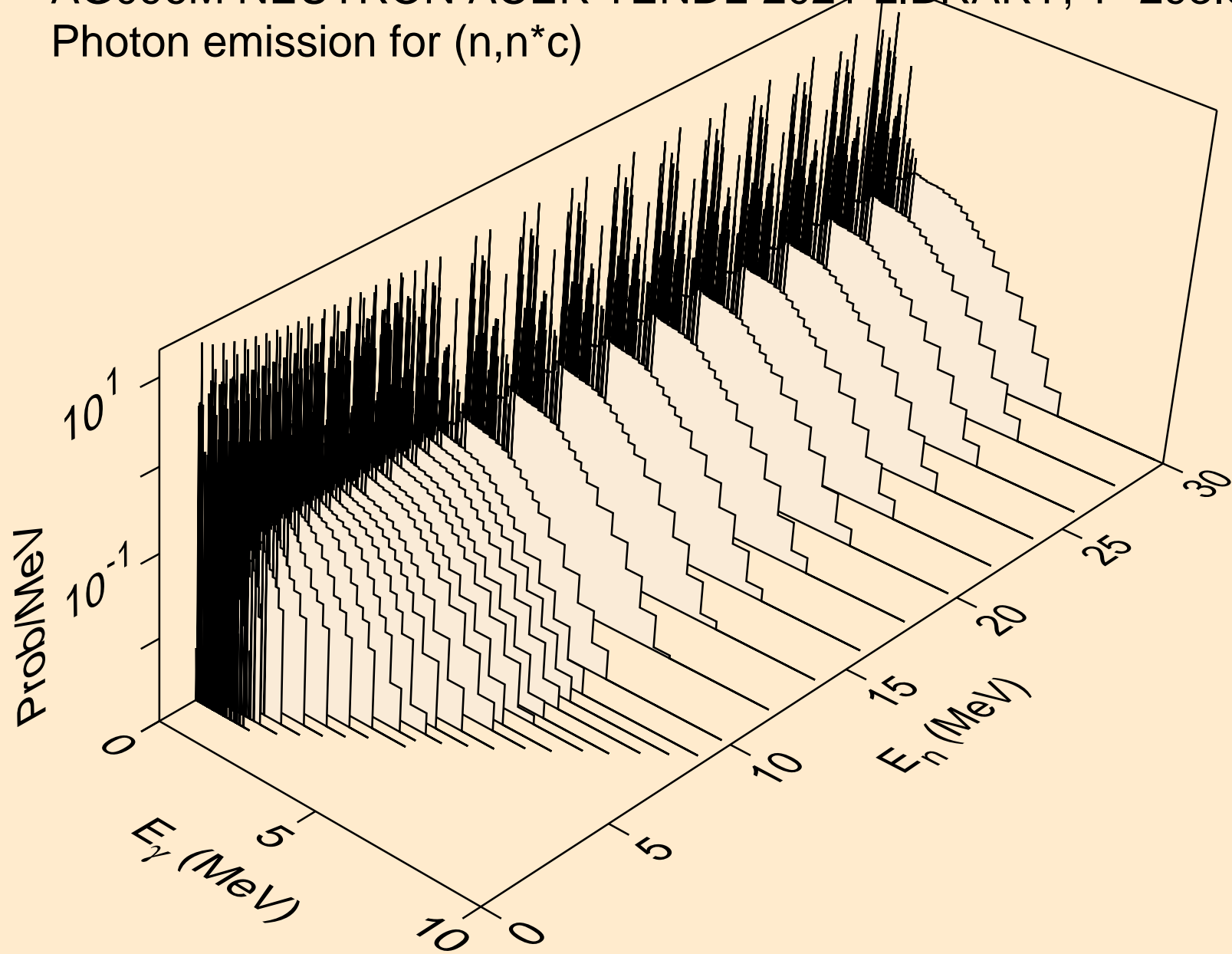

AG096M NEUTRON ACER TENDL-2021 LIBRARY; T=293.6K
Photon emission for (n,gma)

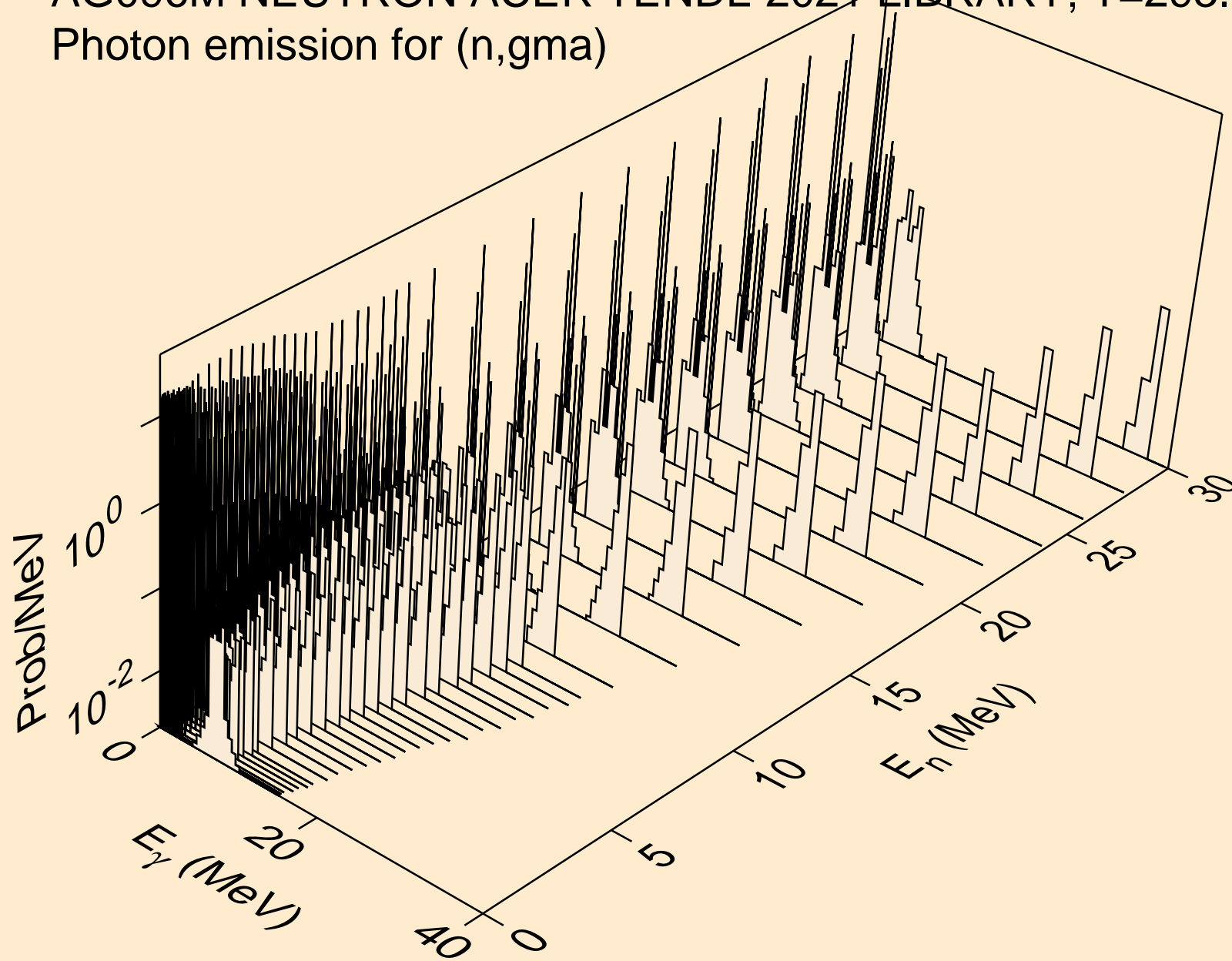

AG096M NEUTRON ACER TENDL-2021 LIBRARY; T=293.6K
Photon emission for (n,p)

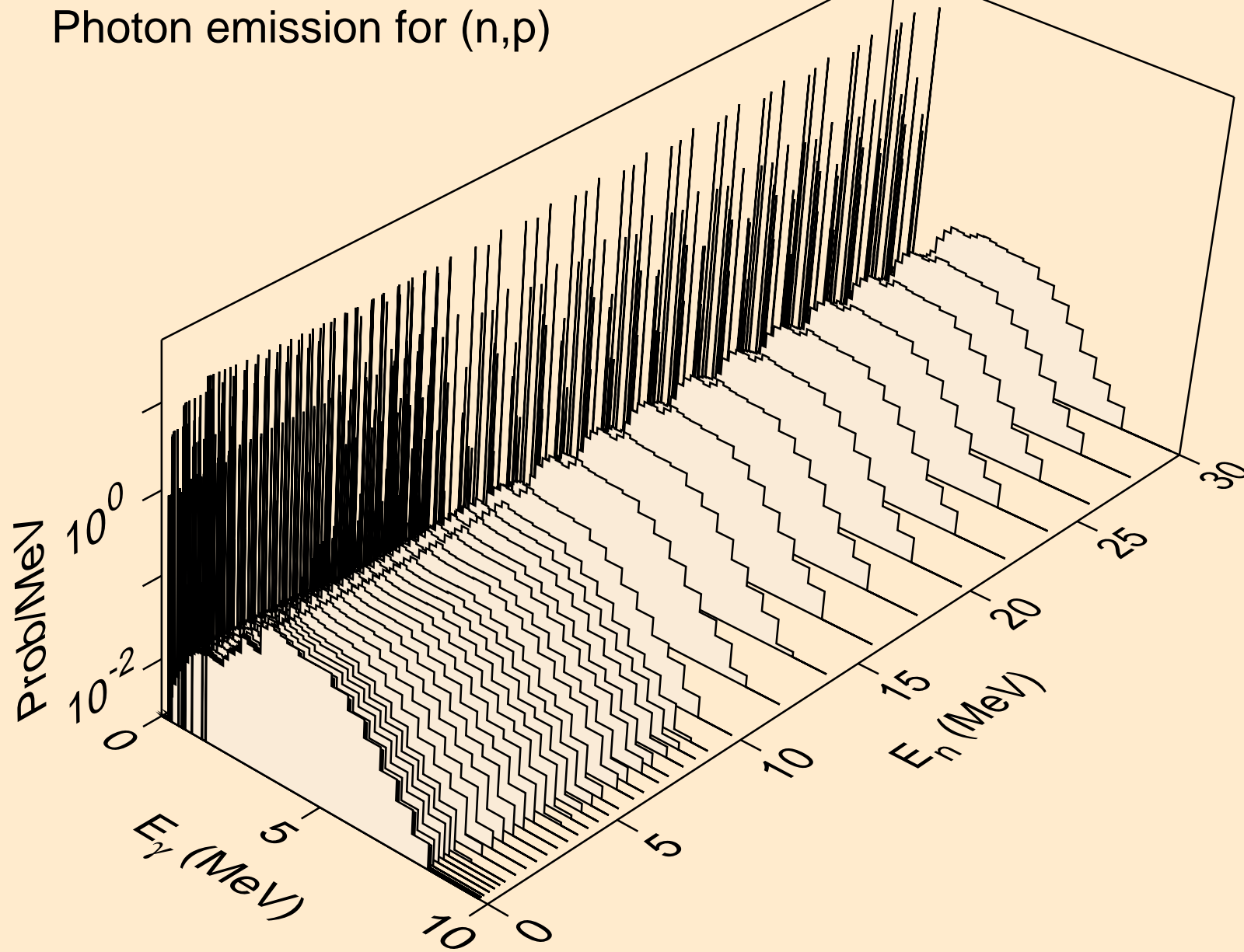

AG096M NEUTRON ACER TENDL-2021 LIBRARY; T=293.6K
Photon emission for (n,d)

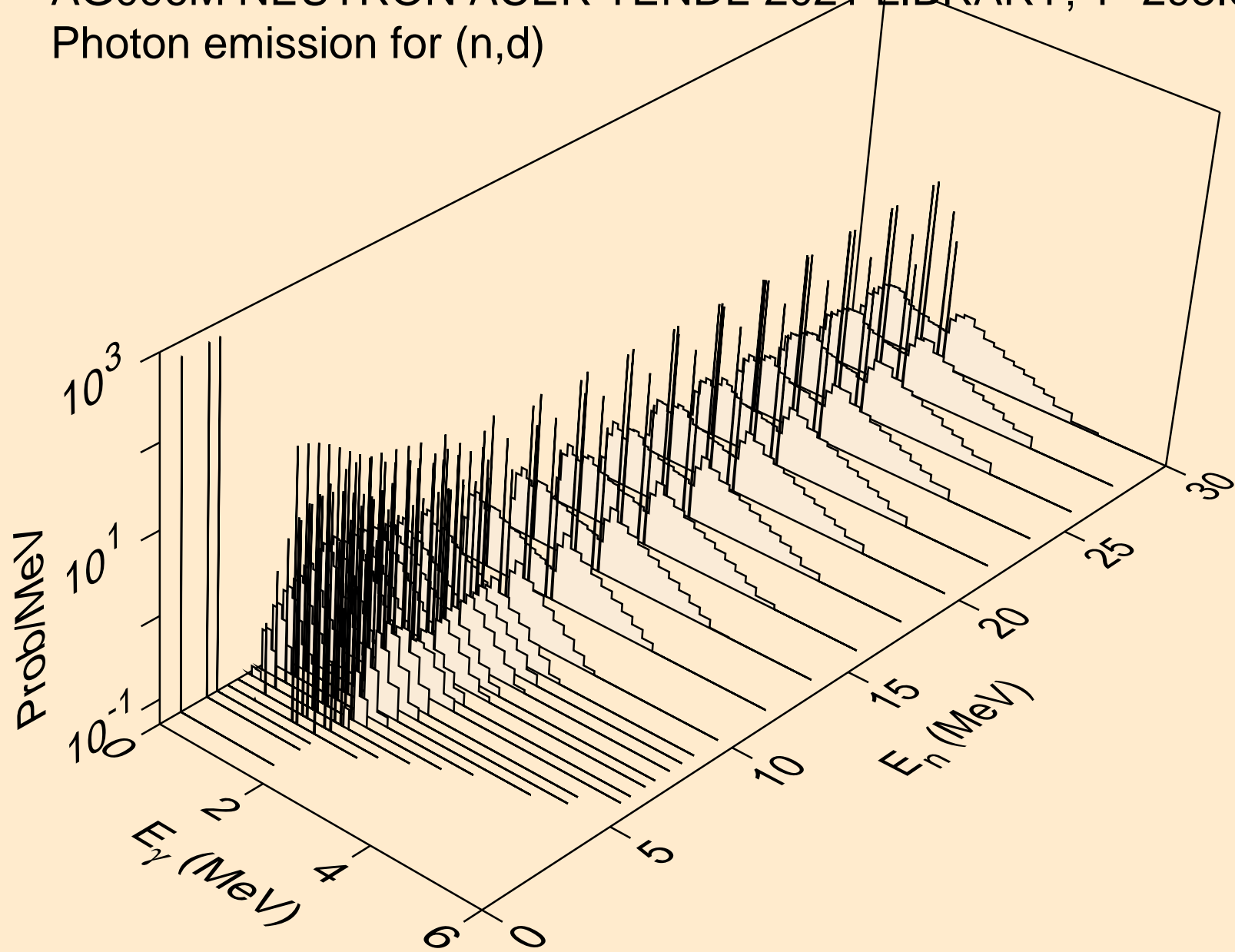

AG096M NEUTRON ACER TENDL-2021 LIBRARY; T=293.6K
Photon emission for (n,t)

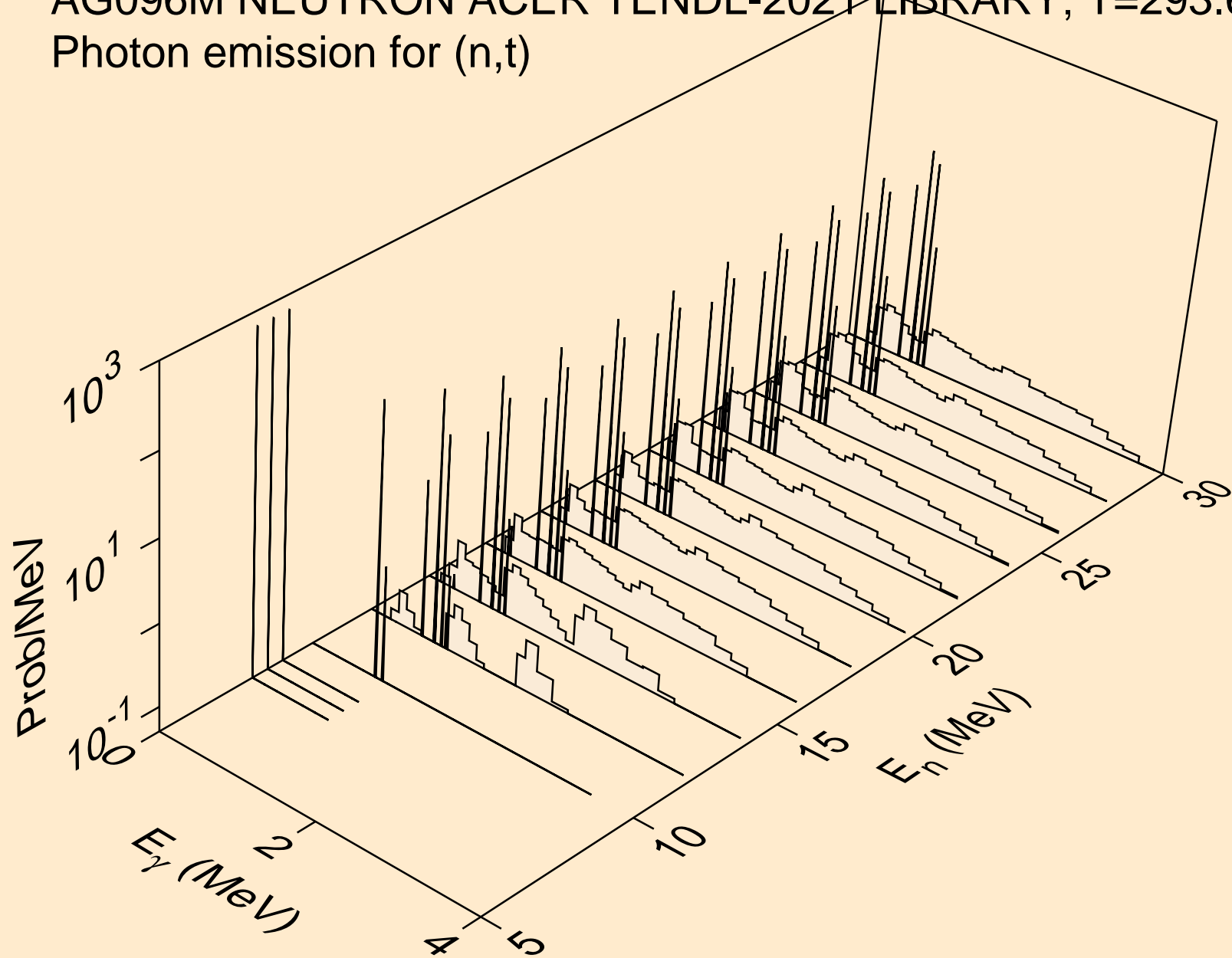

AG096M NEUTRON ACER TENDL-2021 LIBRARY; T=293.6K
Photon emission for (n,he3)

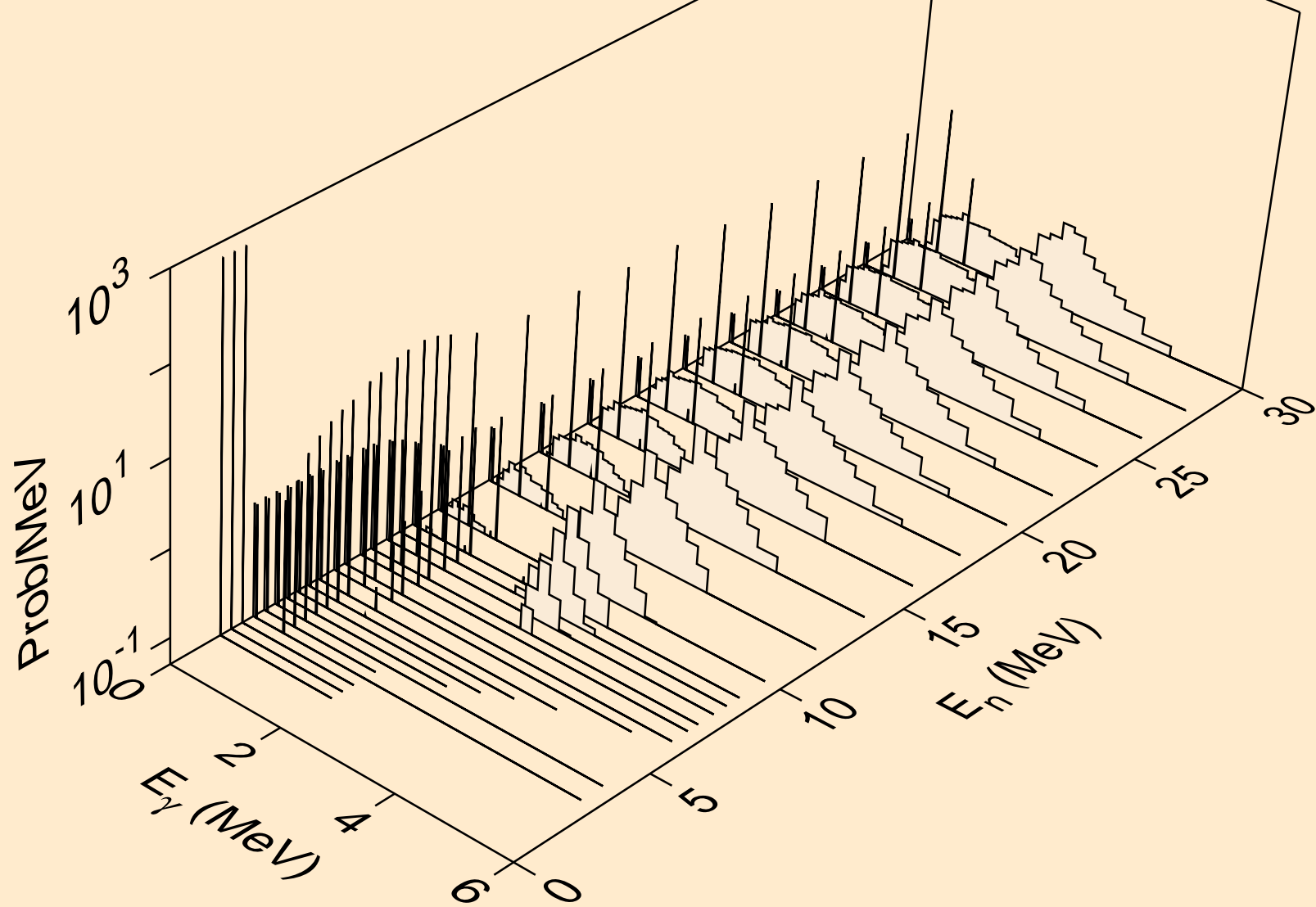

AG096M NEUTRON ACER TENDL-2021 LIBRARY; T=293.6K
Photon emission for (n,a)

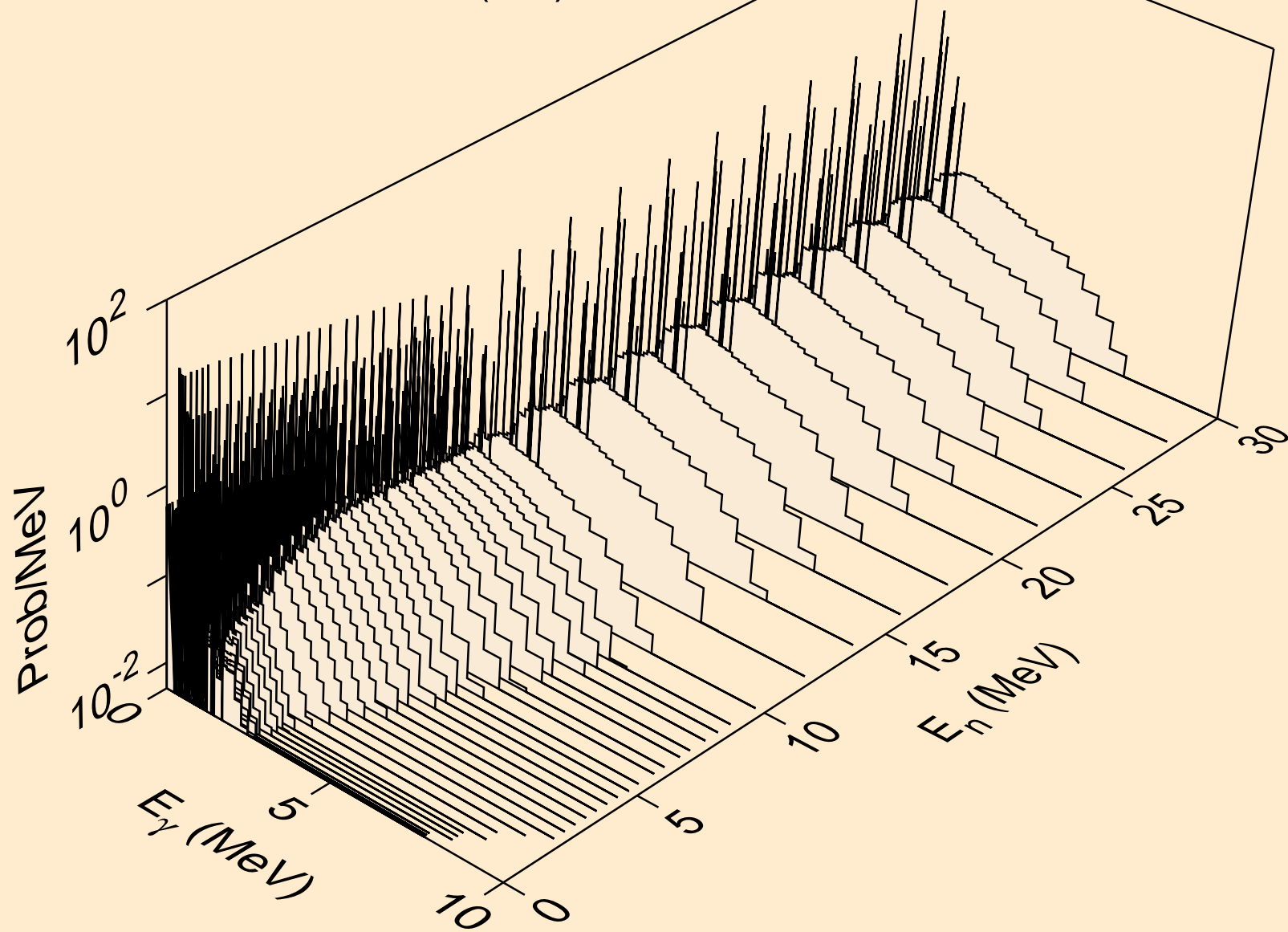

AG096M NEUTRON ACER TENDL-2021 LIBRARY; T=293.6K
Photon emission for (n,2a)

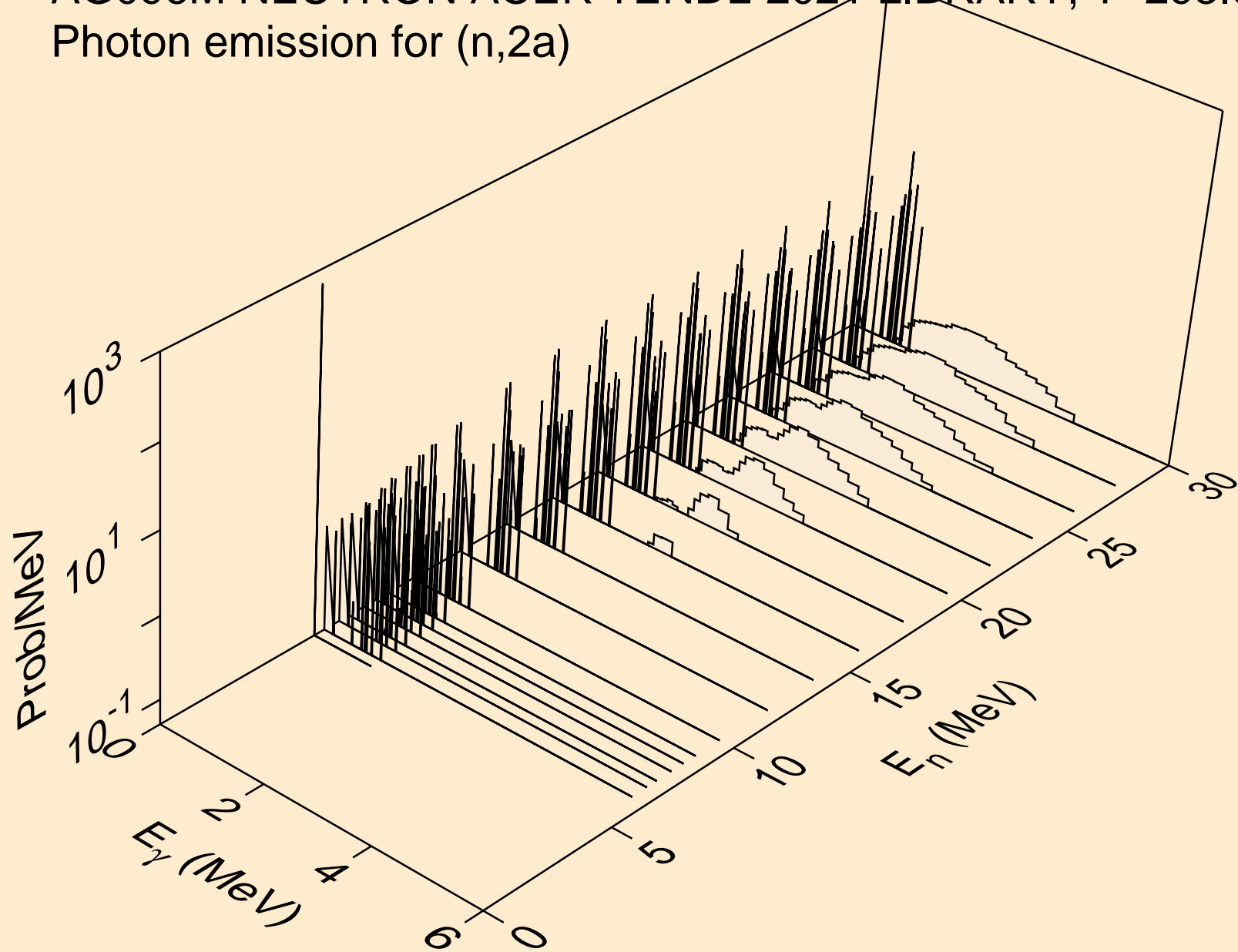

AG096M NEUTRON ACER TENDL-2021 LIBRARY; T=293.6K
Photon emission for (n,2p)

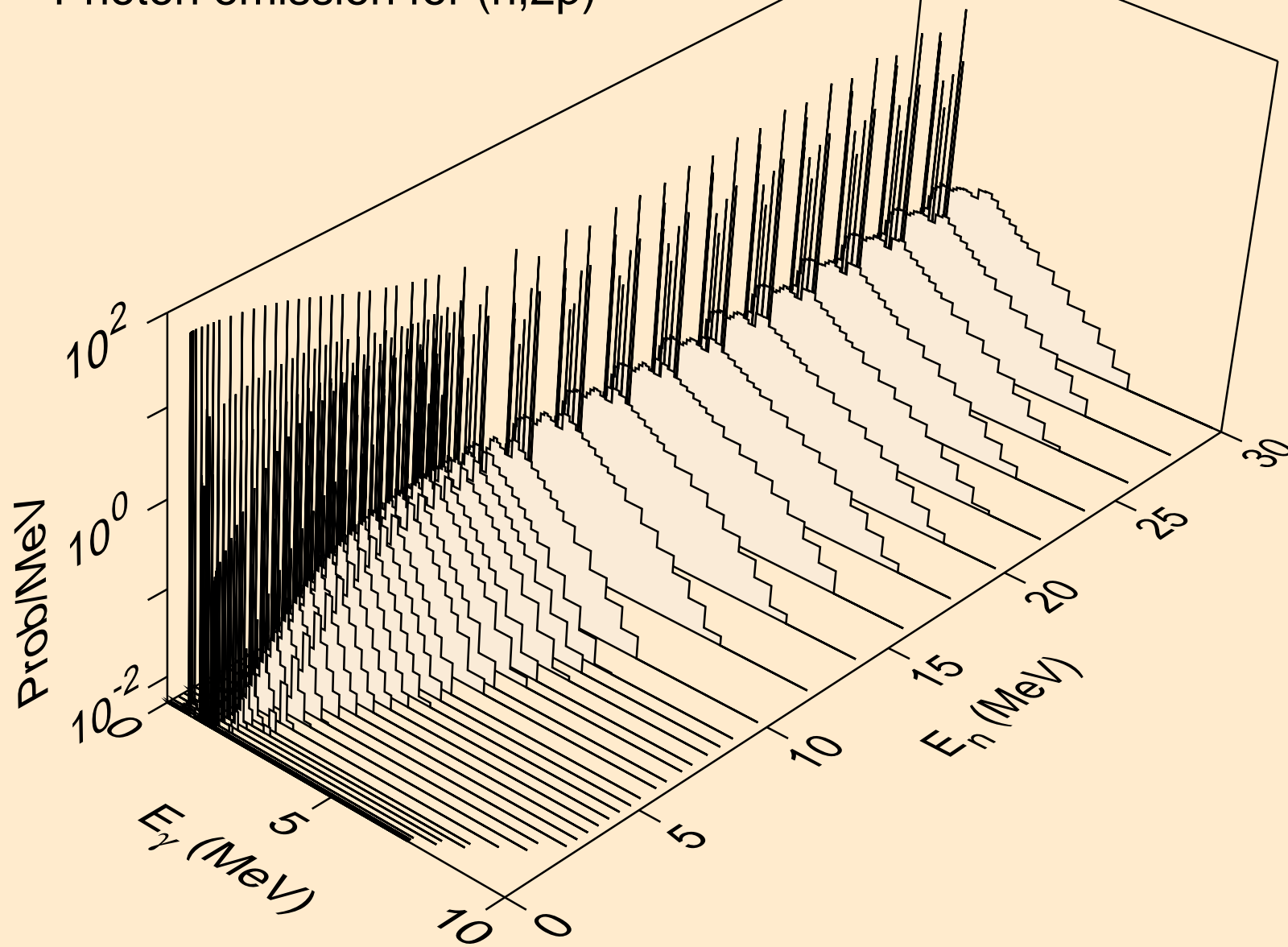

AG096M NEUTRON ACER TENDL-2021 LIBRARY; T=293.6K
Photon emission for (n,p)

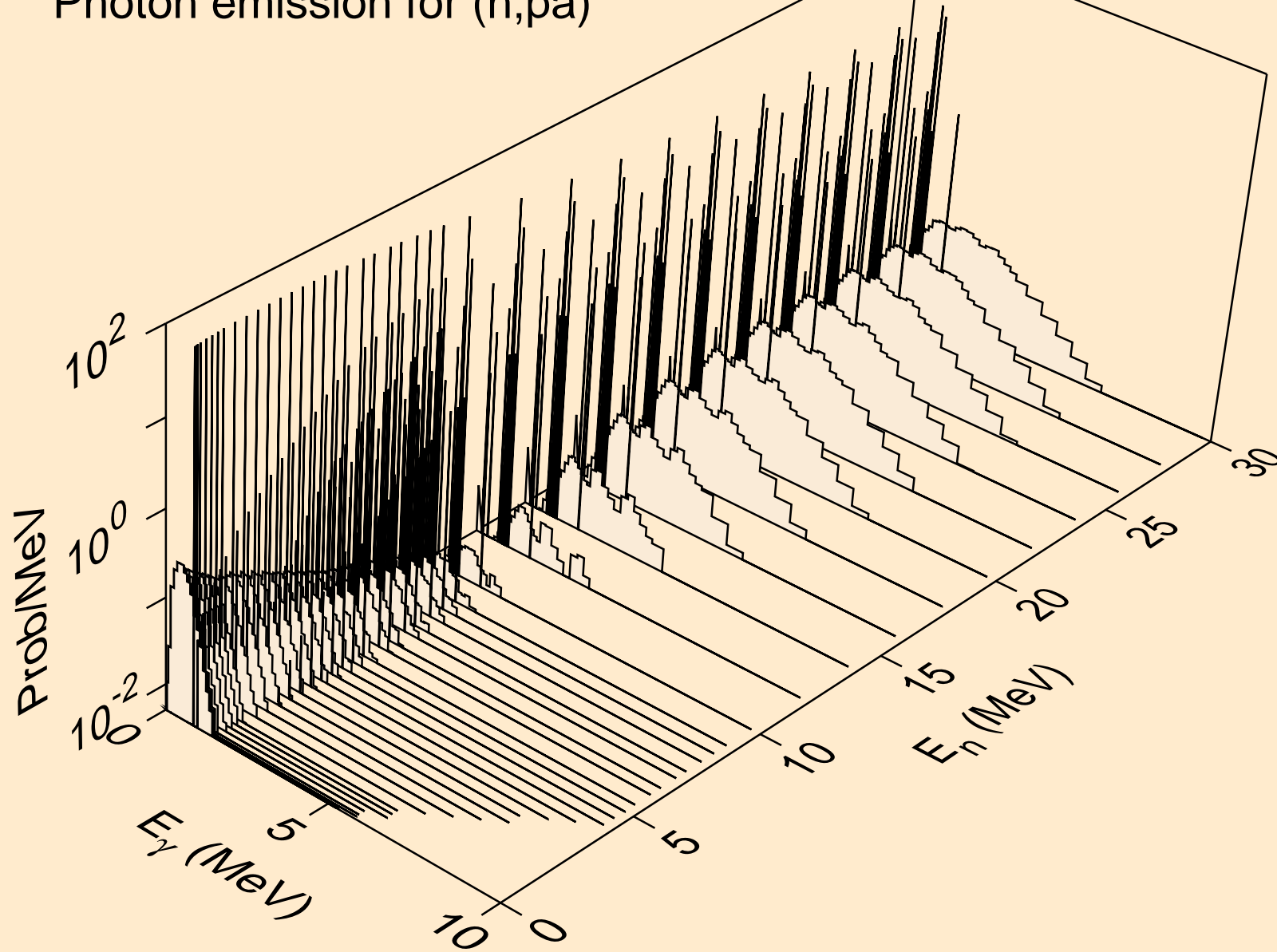

AG096M NEUTRON ACER TENDL-2021 LIBRARY; T=293.6K
Photon emission for (n,pd)

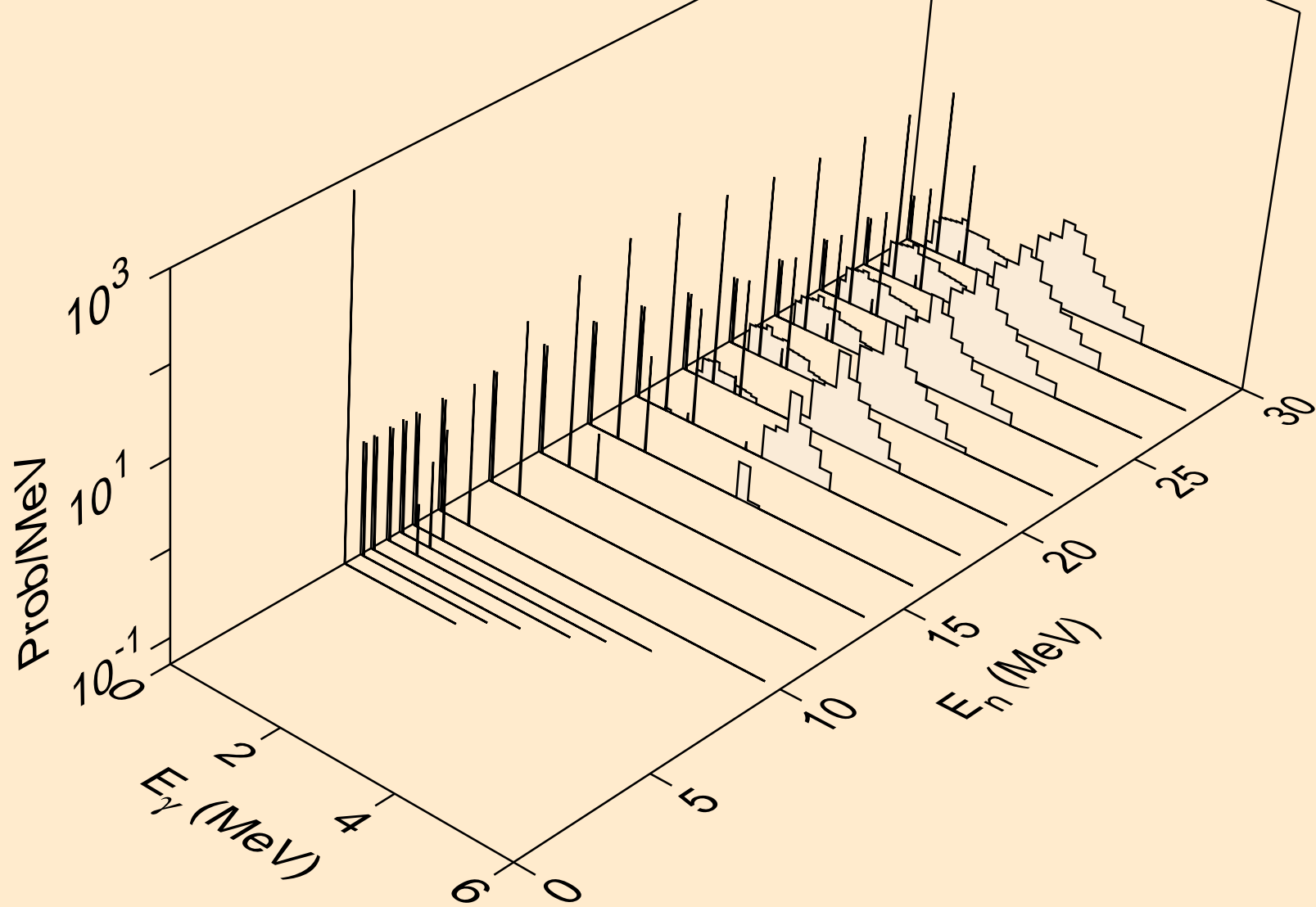

AG096M NEUTRON ACER TENDL-2021 LIBRARY; T=293.6K
Photon emission for (n,pt)

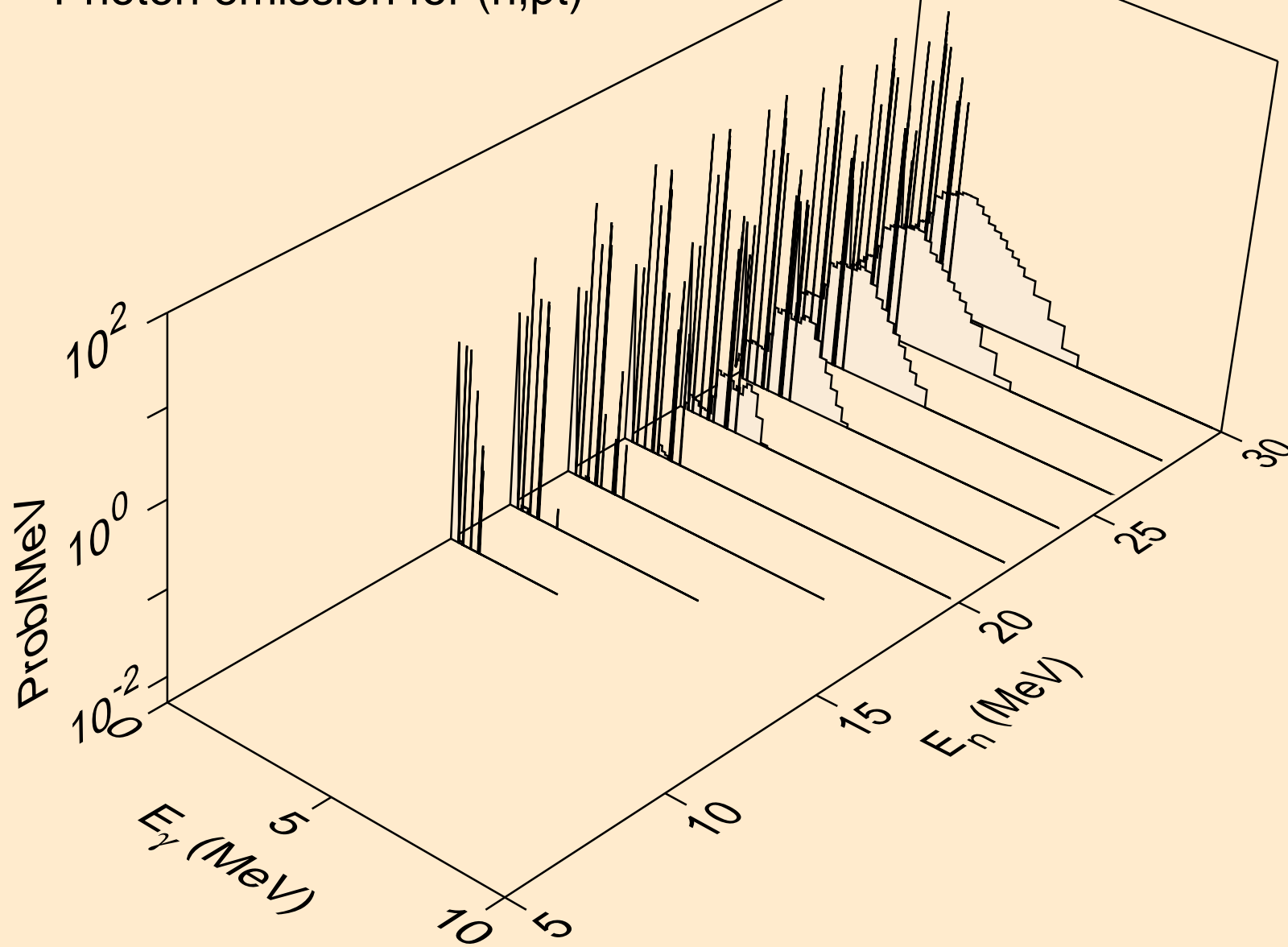

AG096M NEUTRON ACER TENDL-2021 LIBRARY; T=293.6K
Photon emission for (n,da)

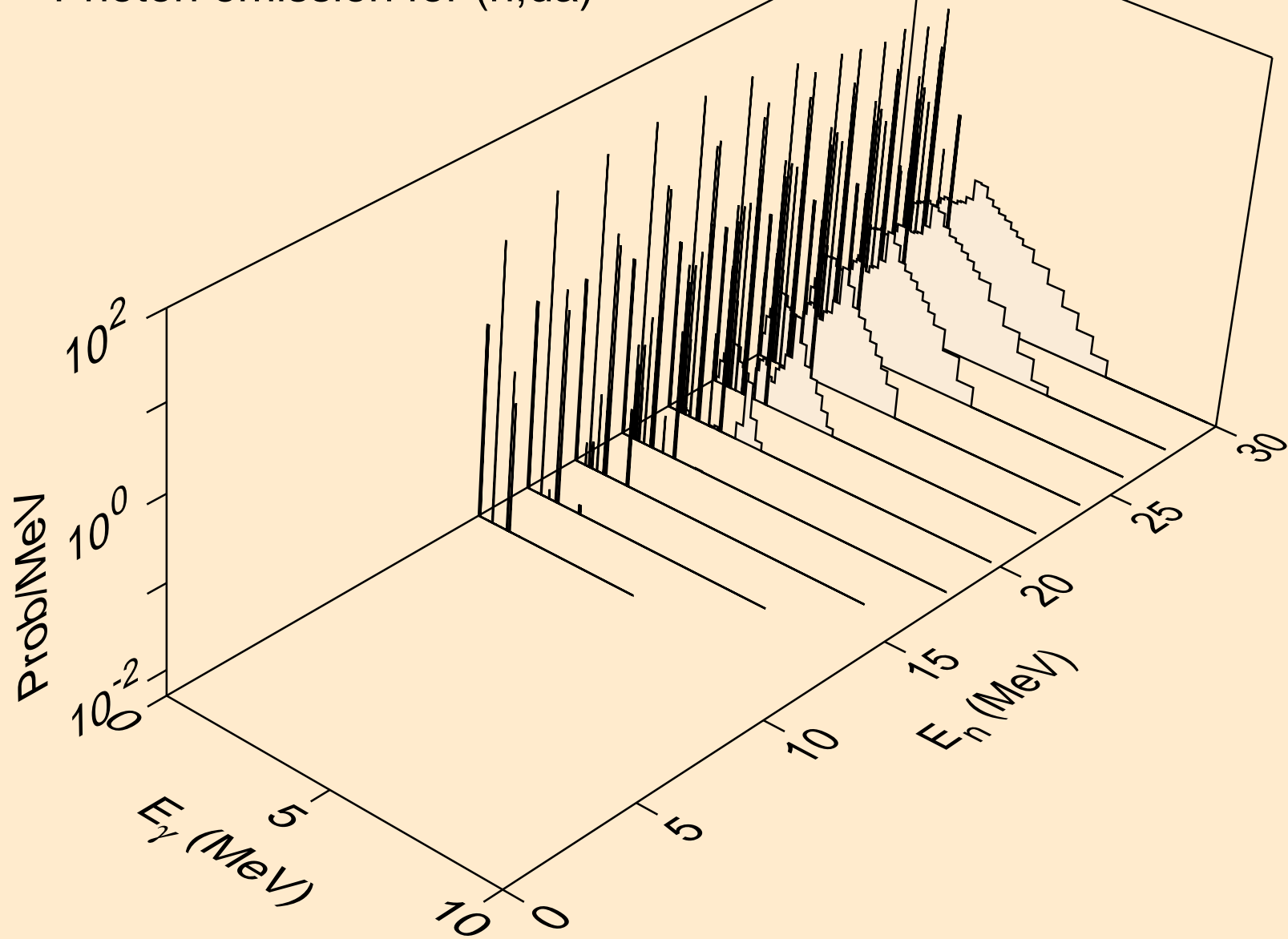

AG096M NEUTRON ACER TENDL-2021 LIBRARY; T=293.6K
thermal capture photon spectrum

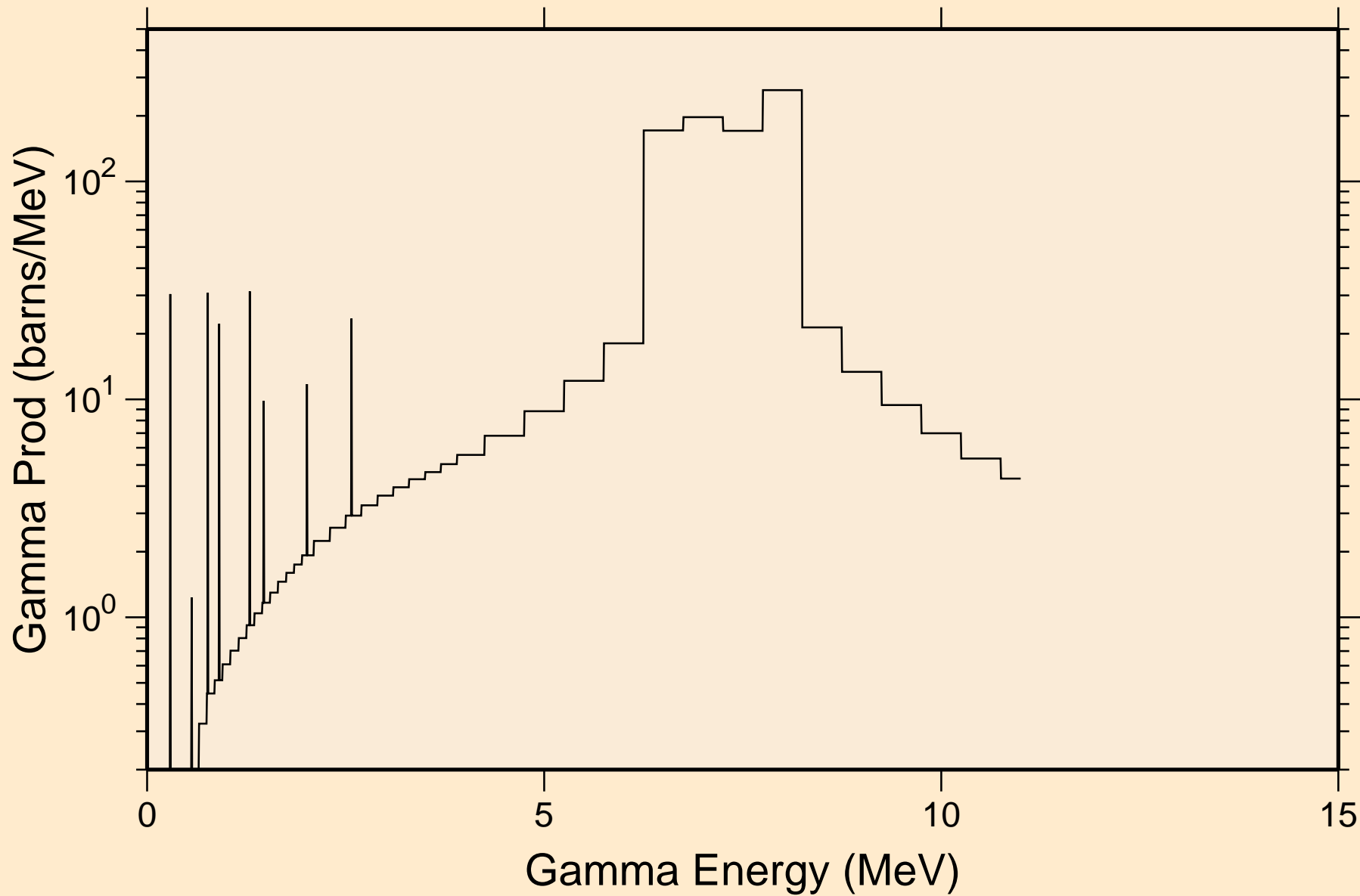

AG096M NEUTRON ACER TENDL-2021 LIBRARY; T=293.6K
14 MeV photon spectrum

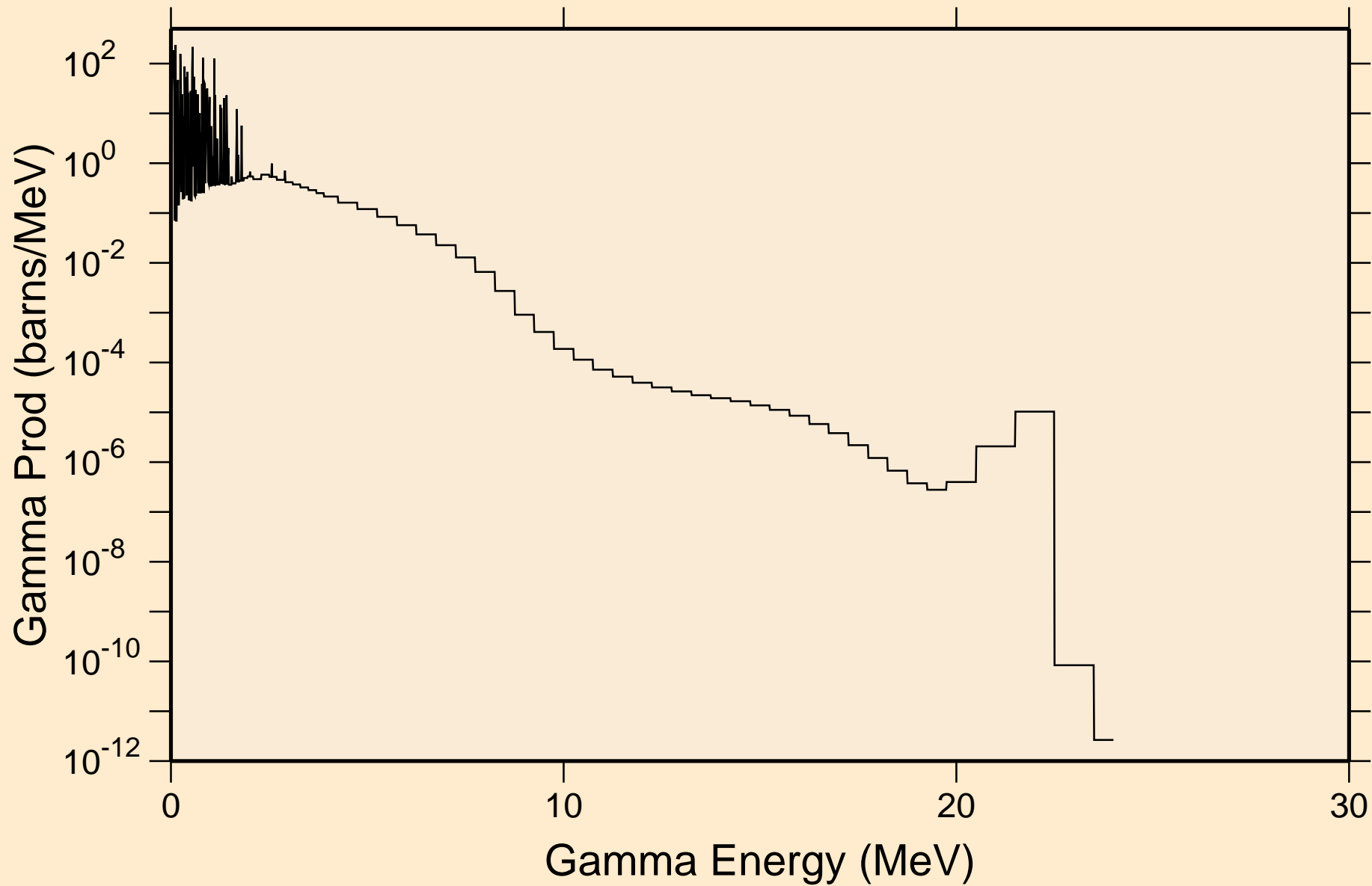

AG096M NEUTRON ACER TENDL-2021 LIBRARY; T=293.6K
Particle heating contributions

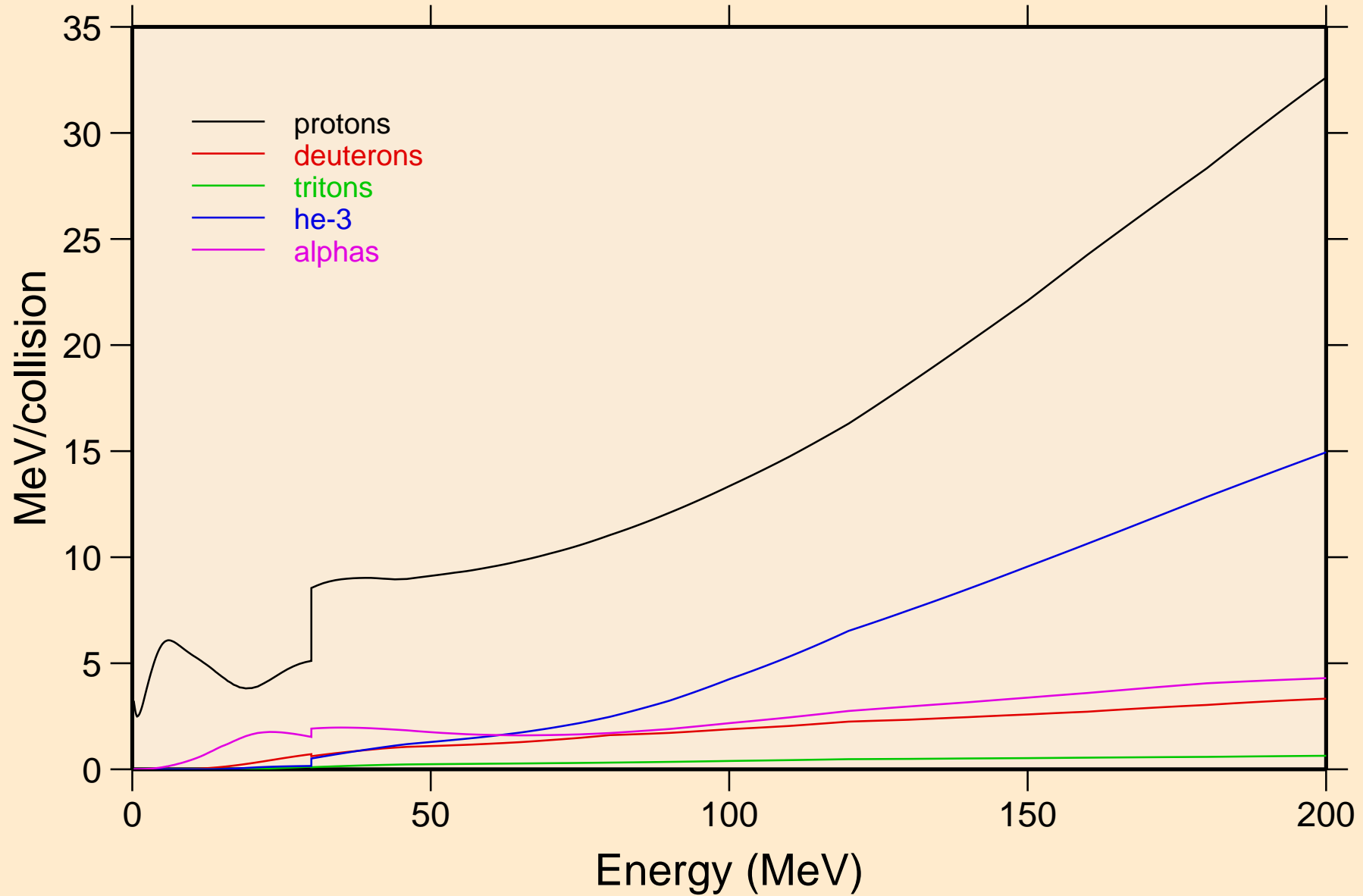

AG096M NEUTRON ACER TENDL-2021 LIBRARY; T=293.6K
Recoil Heating

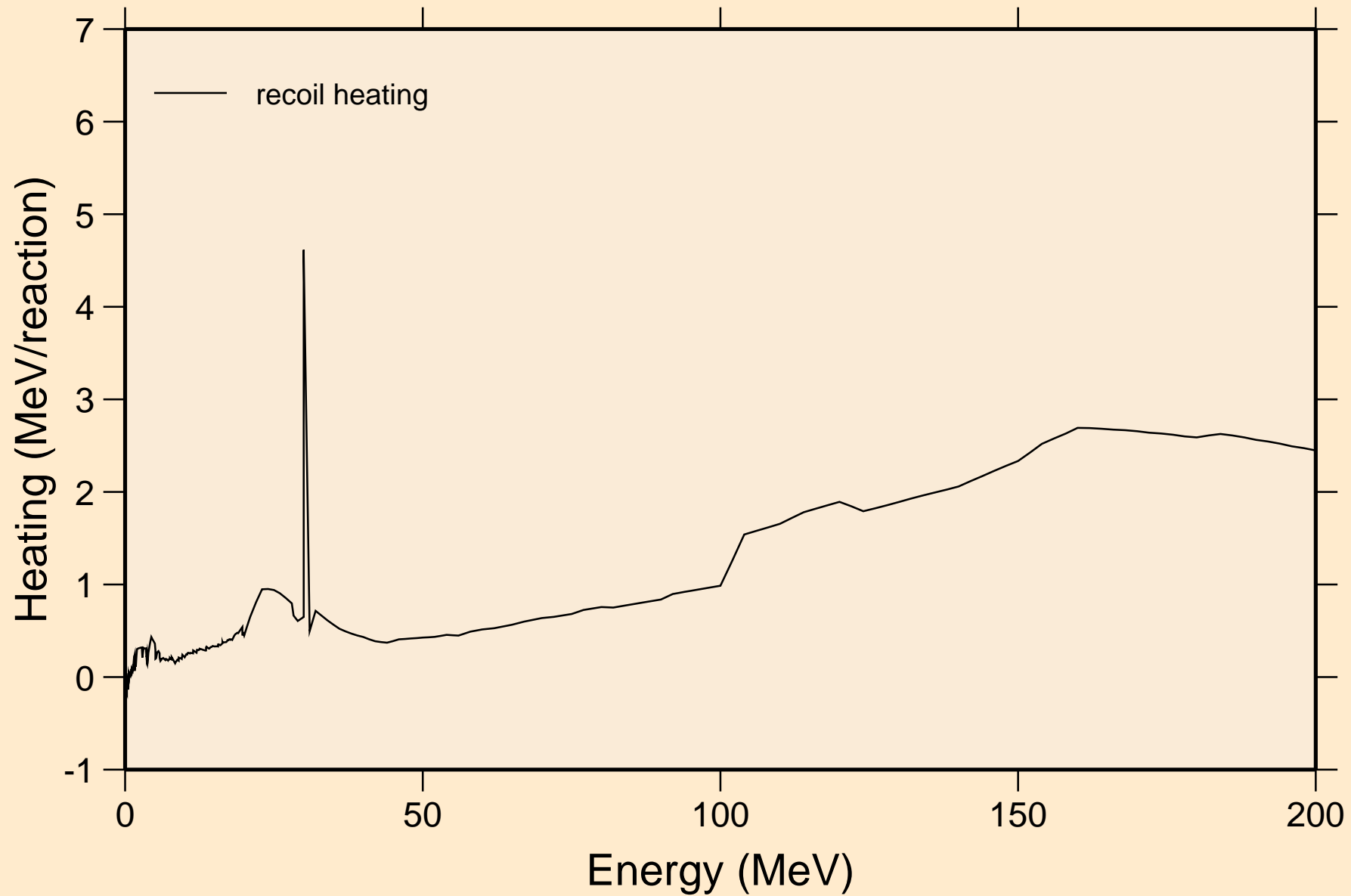

AG096M NEUTRON ACER TENDL-2021 LIBRARY; T=293.6K
Particle production cross sections

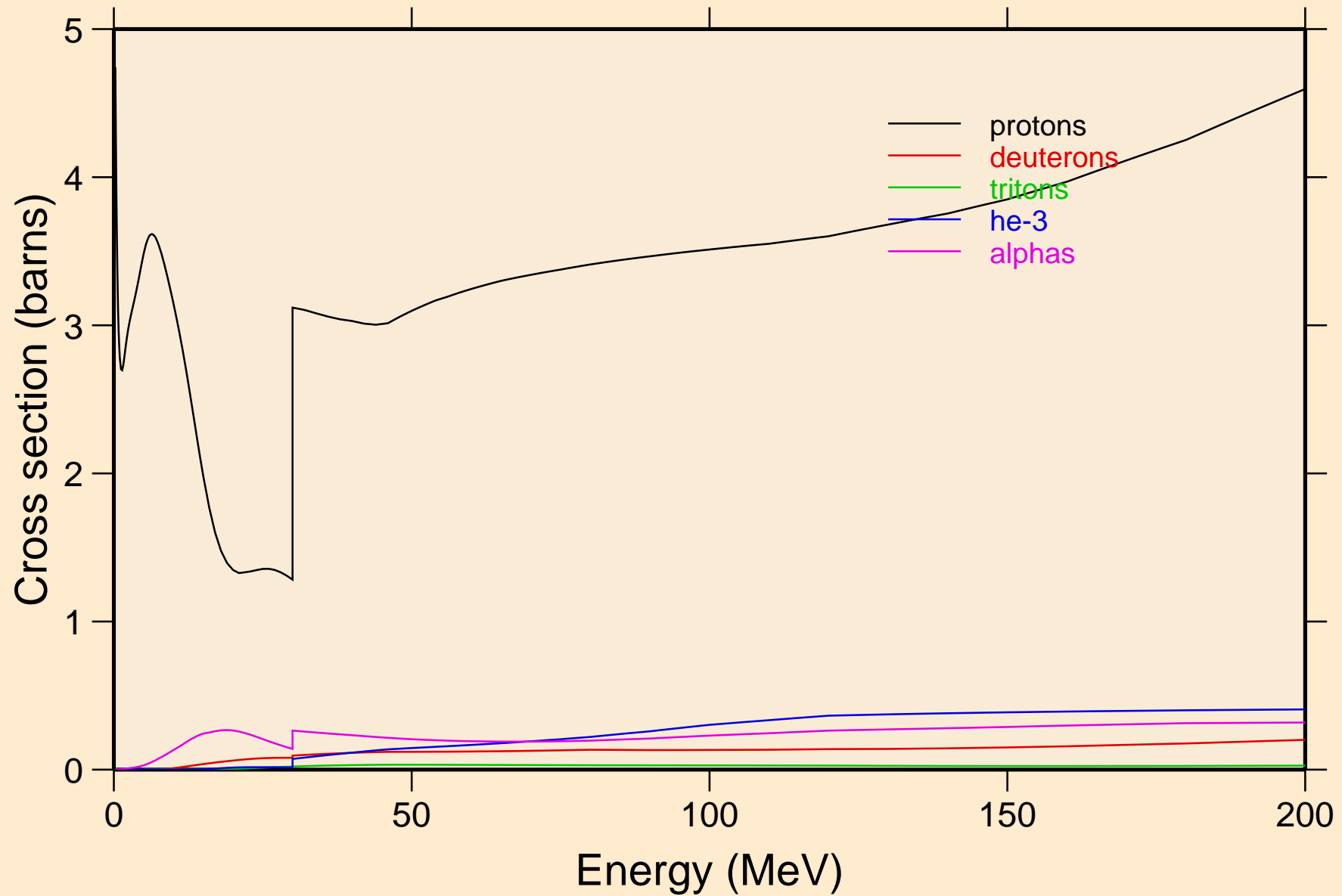

AG096M NEUTRON ACER TENDL-2021 LIBRARY; T=293.6K
protons from (n,x)

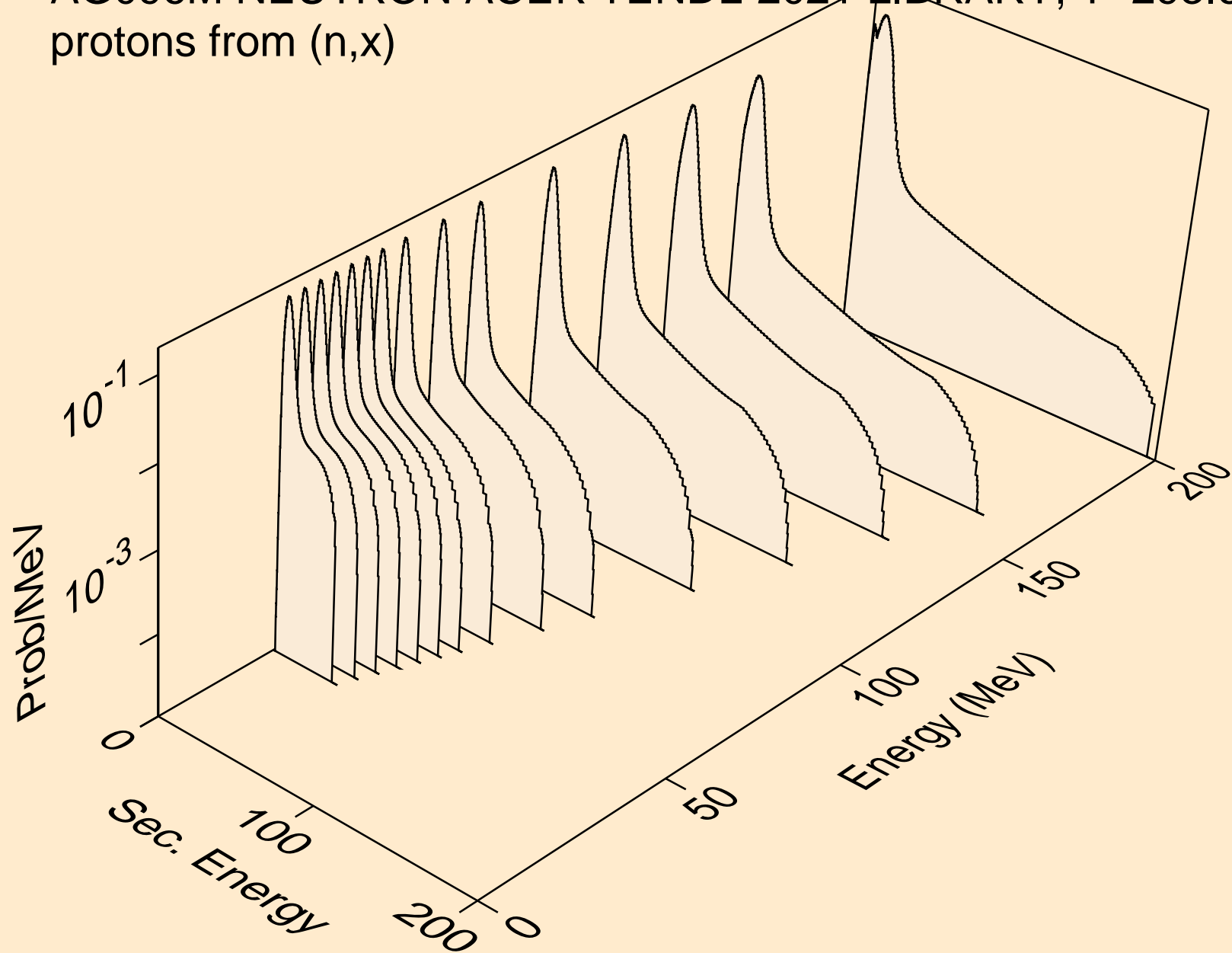

AG096M NEUTRON ACER TENDL-2021 LIBRARY; T=293.6K
protons from (n,n*)p

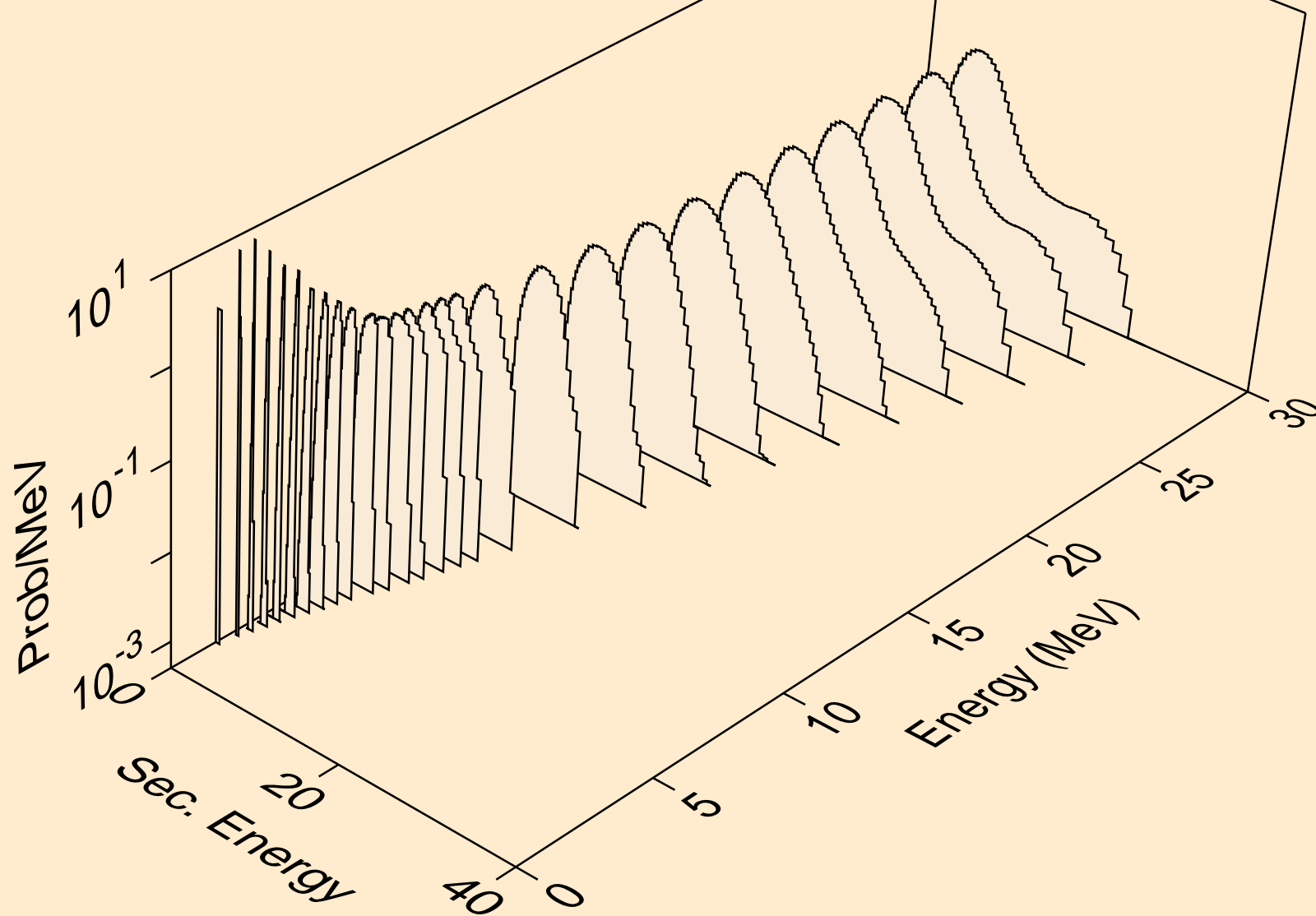

AG096M NEUTRON ACER TENDL-2021 LIBRARY; T=293.6K
protons from (n,2np)

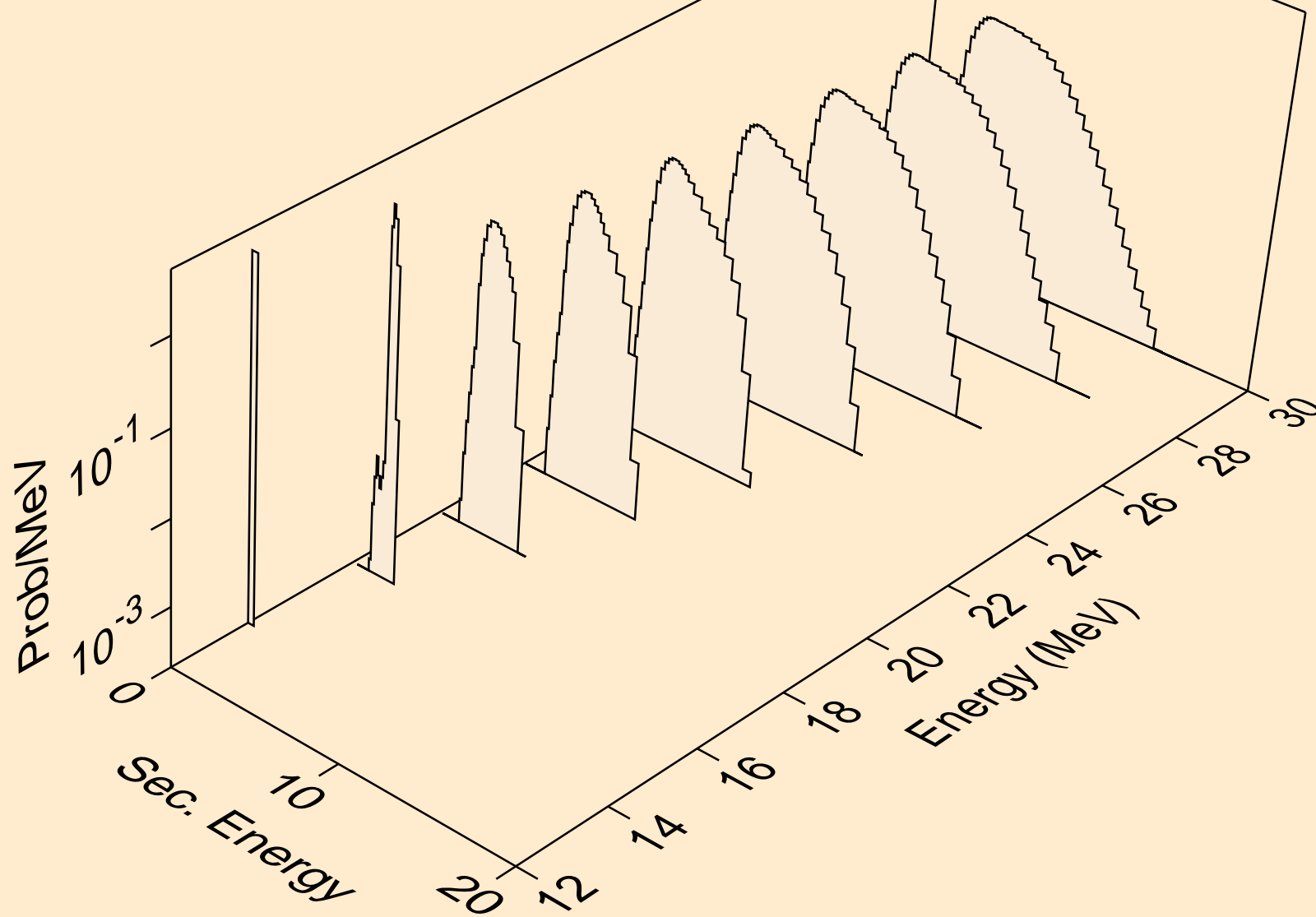

AG096M NEUTRON ACER TENDL-2021 LIBRARY; T=293.6K
protons from (n,2np)

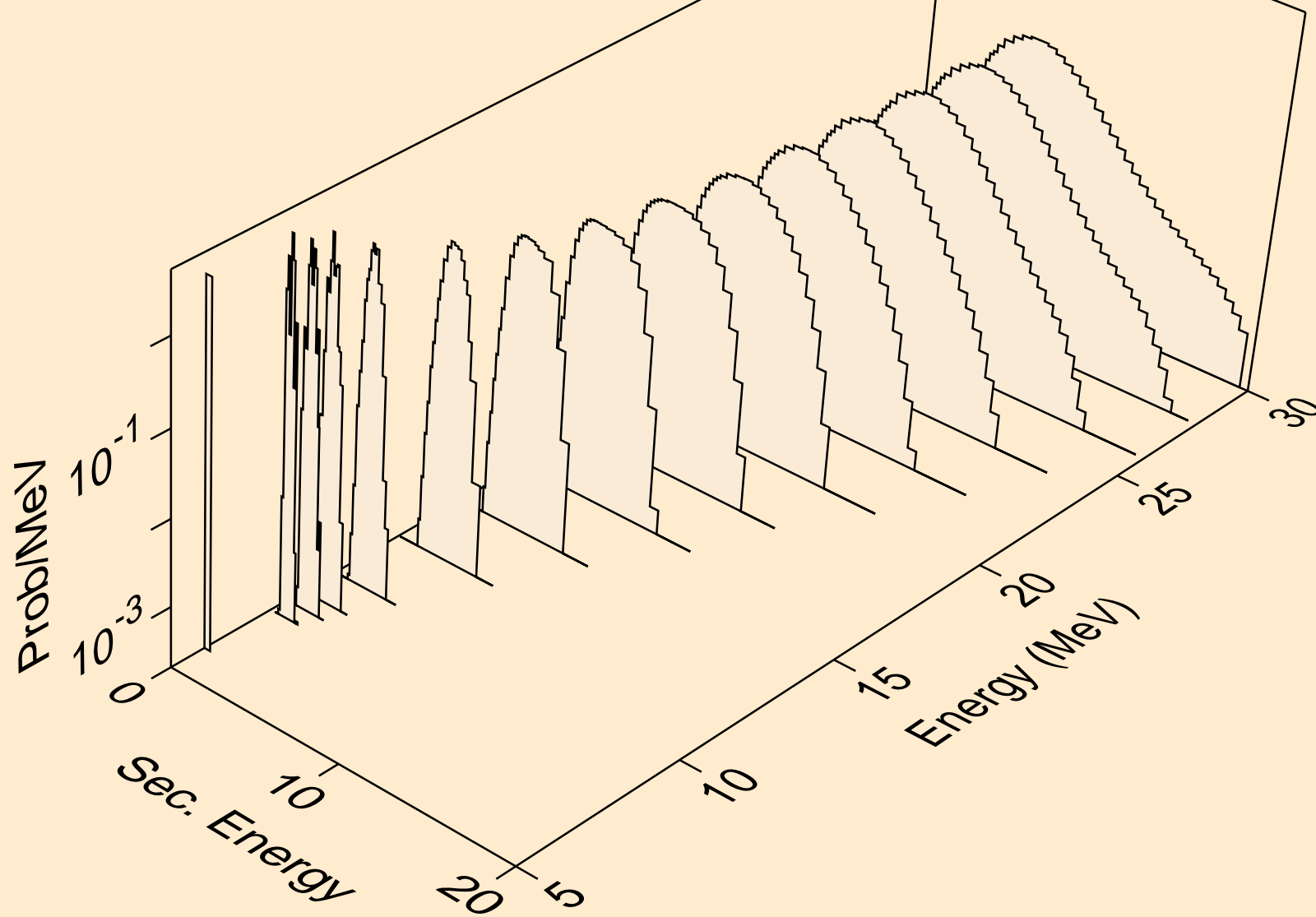

AG096M NEUTRON ACER TENDL-2021 LIBRARY; T=293.6K
protons from (n,npa)

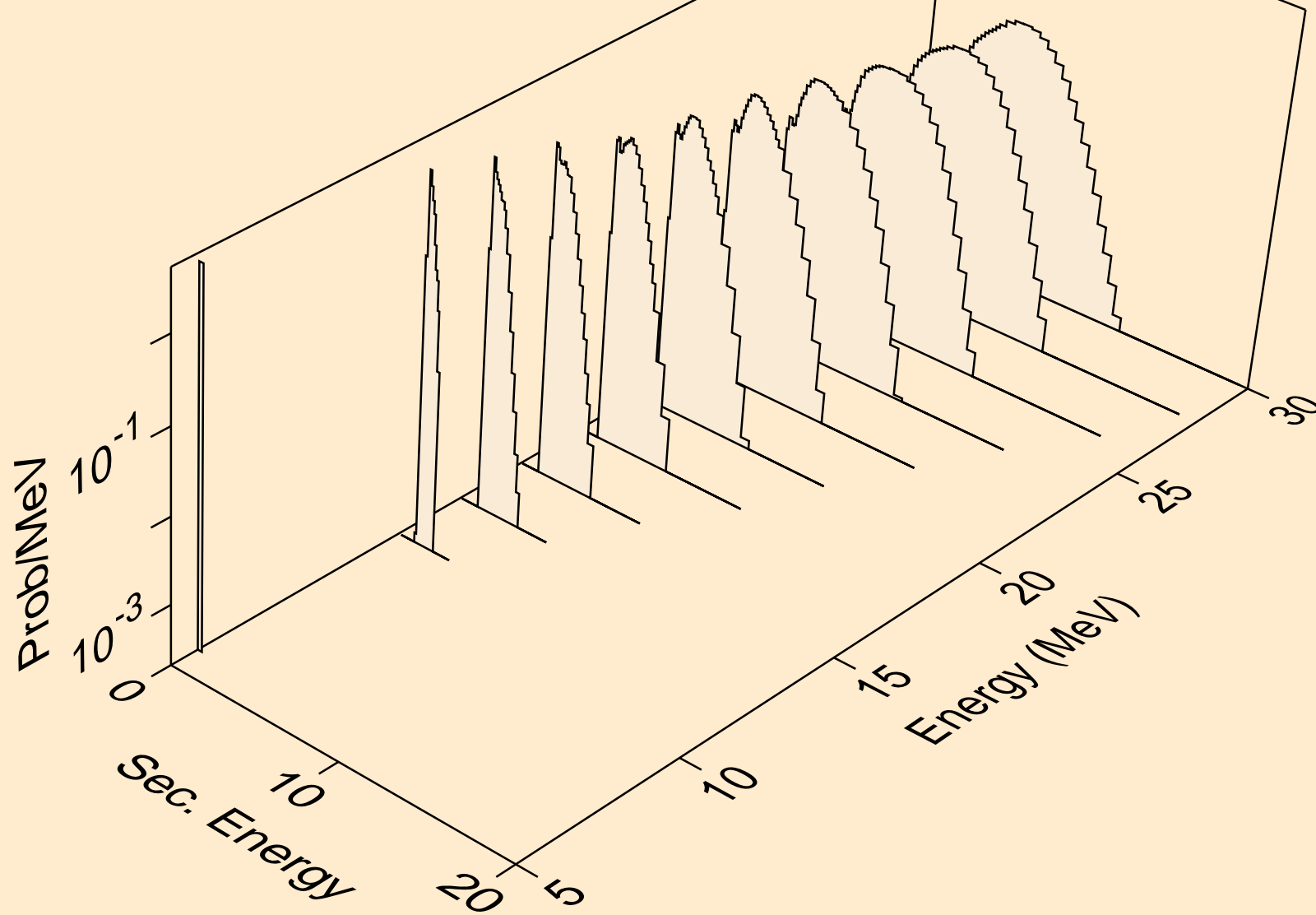

AG096M NEUTRON ACER TENDL-2021 LIBRARY; T=293.6K
protons from (n,p)

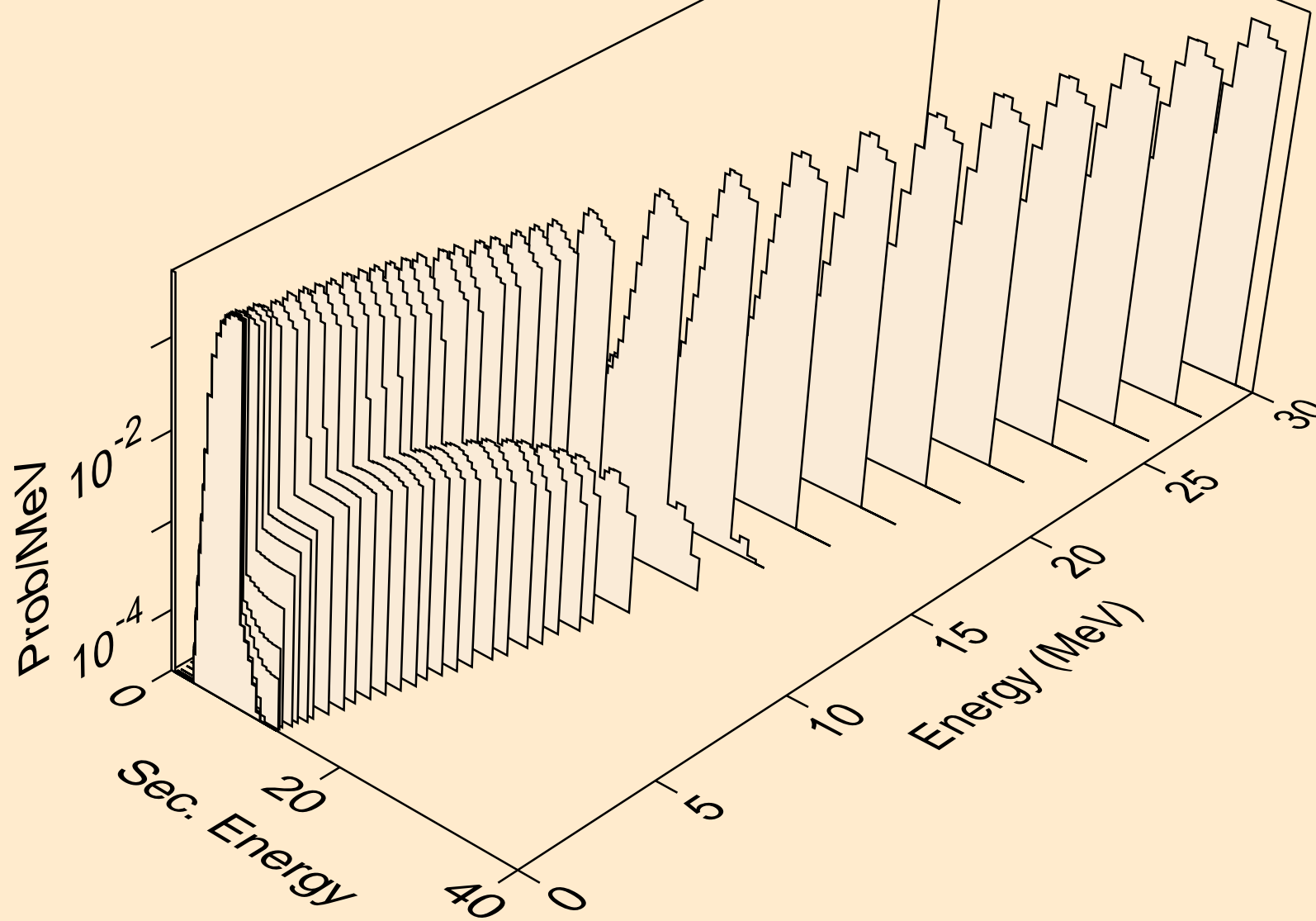

AG096M NEUTRON ACER TENDL-2021 LIBRARY; T=293.6K
protons from (n,2p)

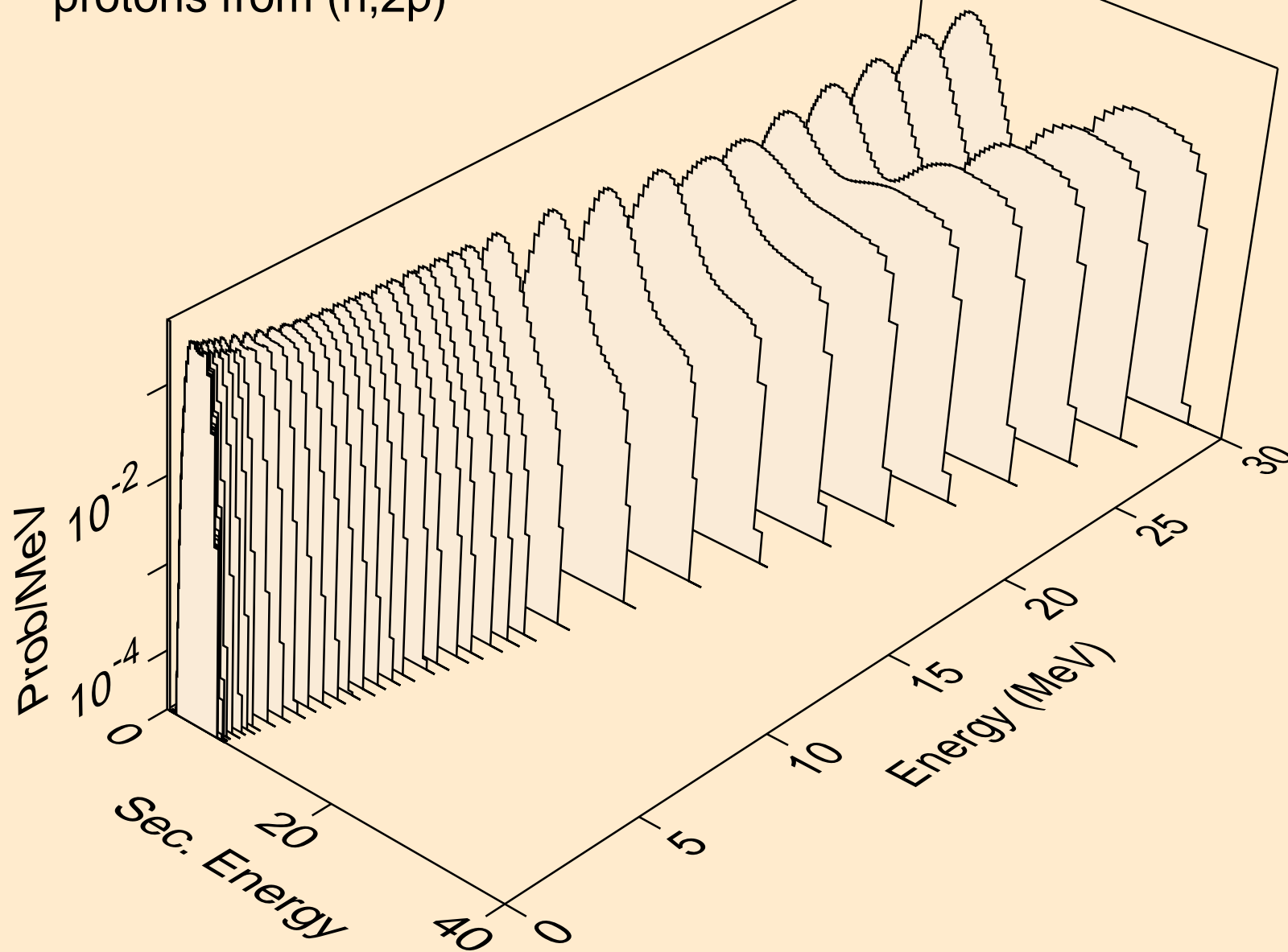

AG096M NEUTRON ACER TENDL-2021 LIBRARY; T=293.6K
protons from (n,p)

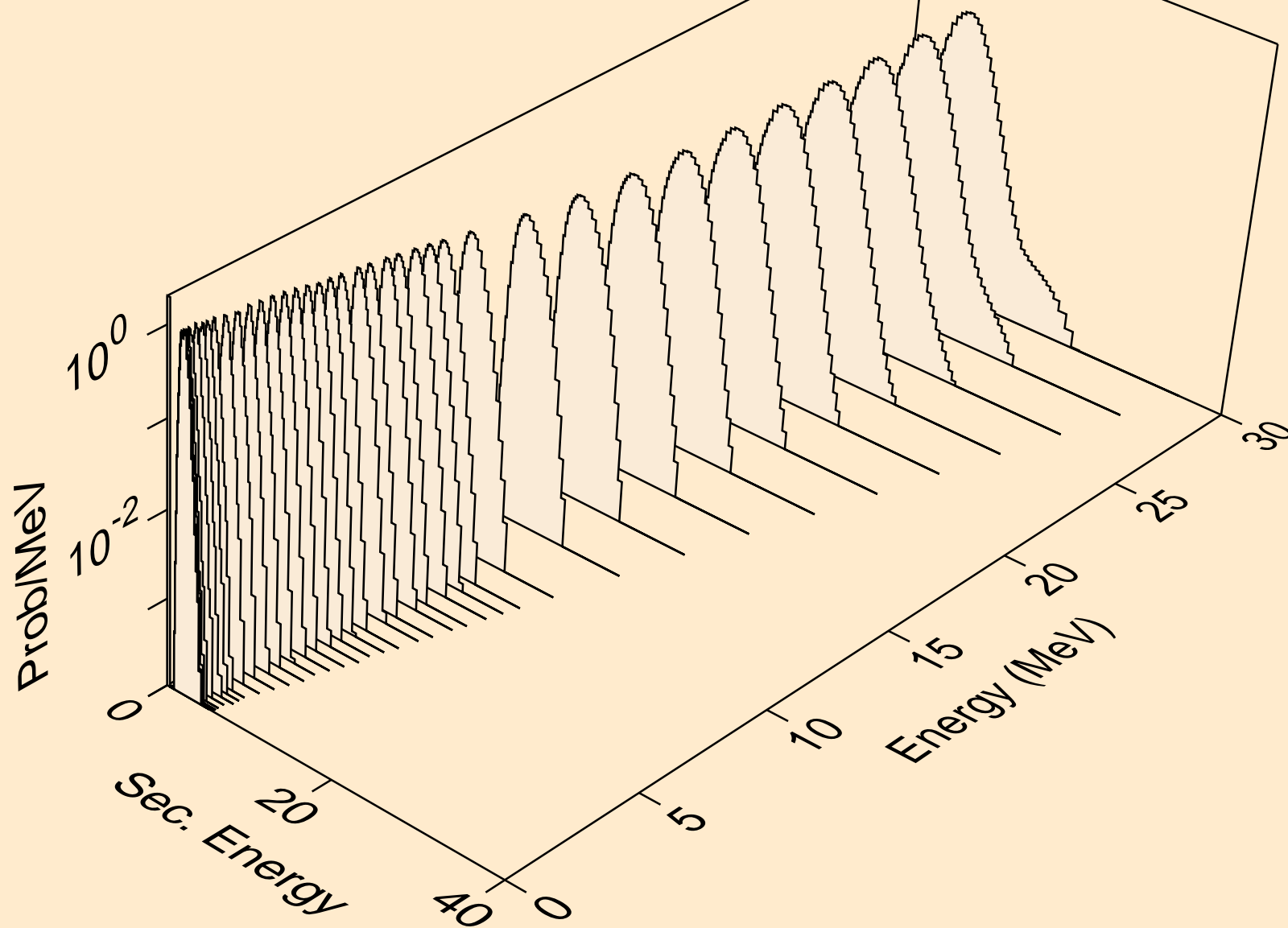

AG096M NEUTRON ACER TENDL-2021 LIBRARY; T=293.6K
protons from (n,pd)

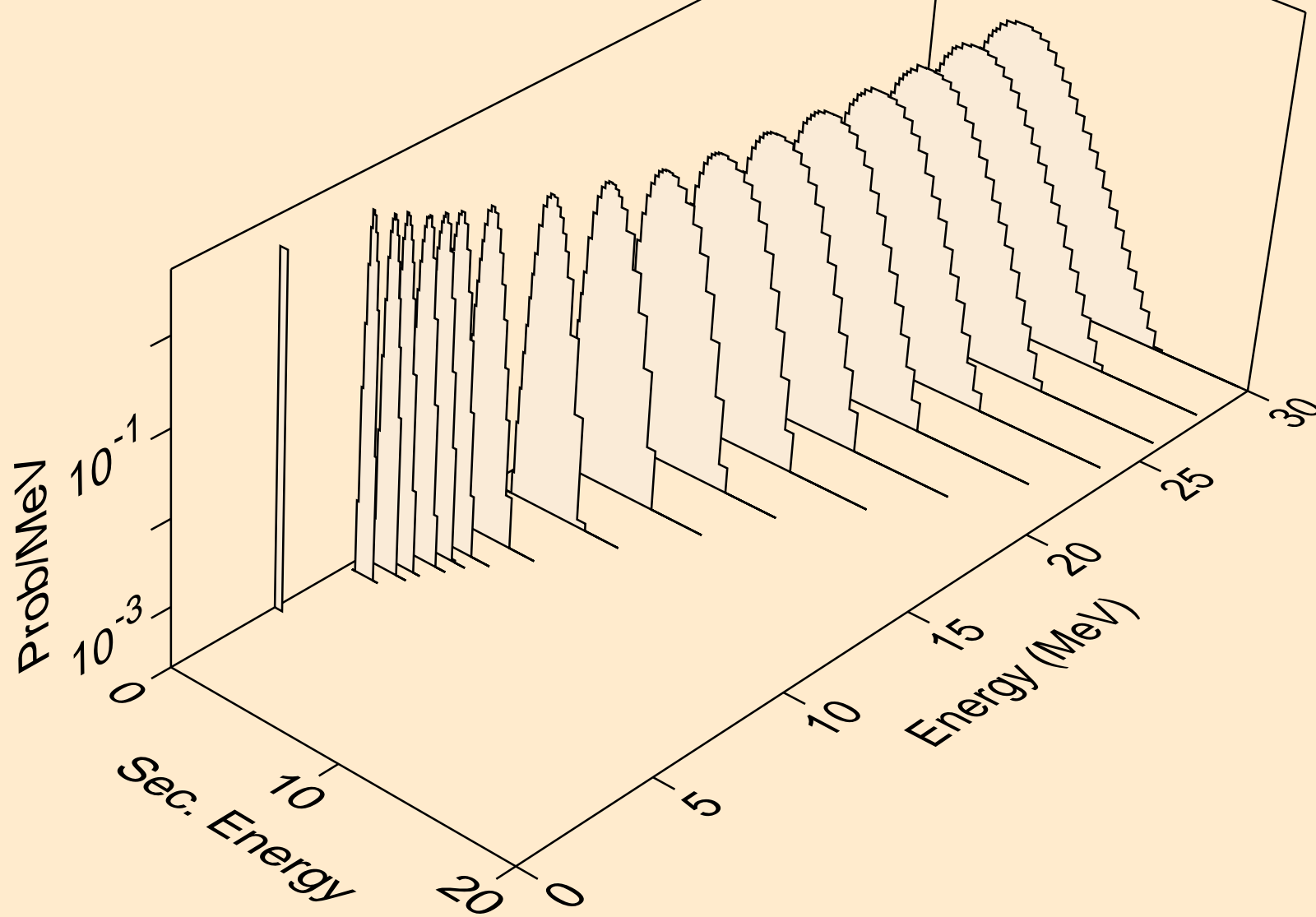

AG096M NEUTRON ACER TENDL-2021 LIBRARY; T=293.6K
protons from (n,pt)

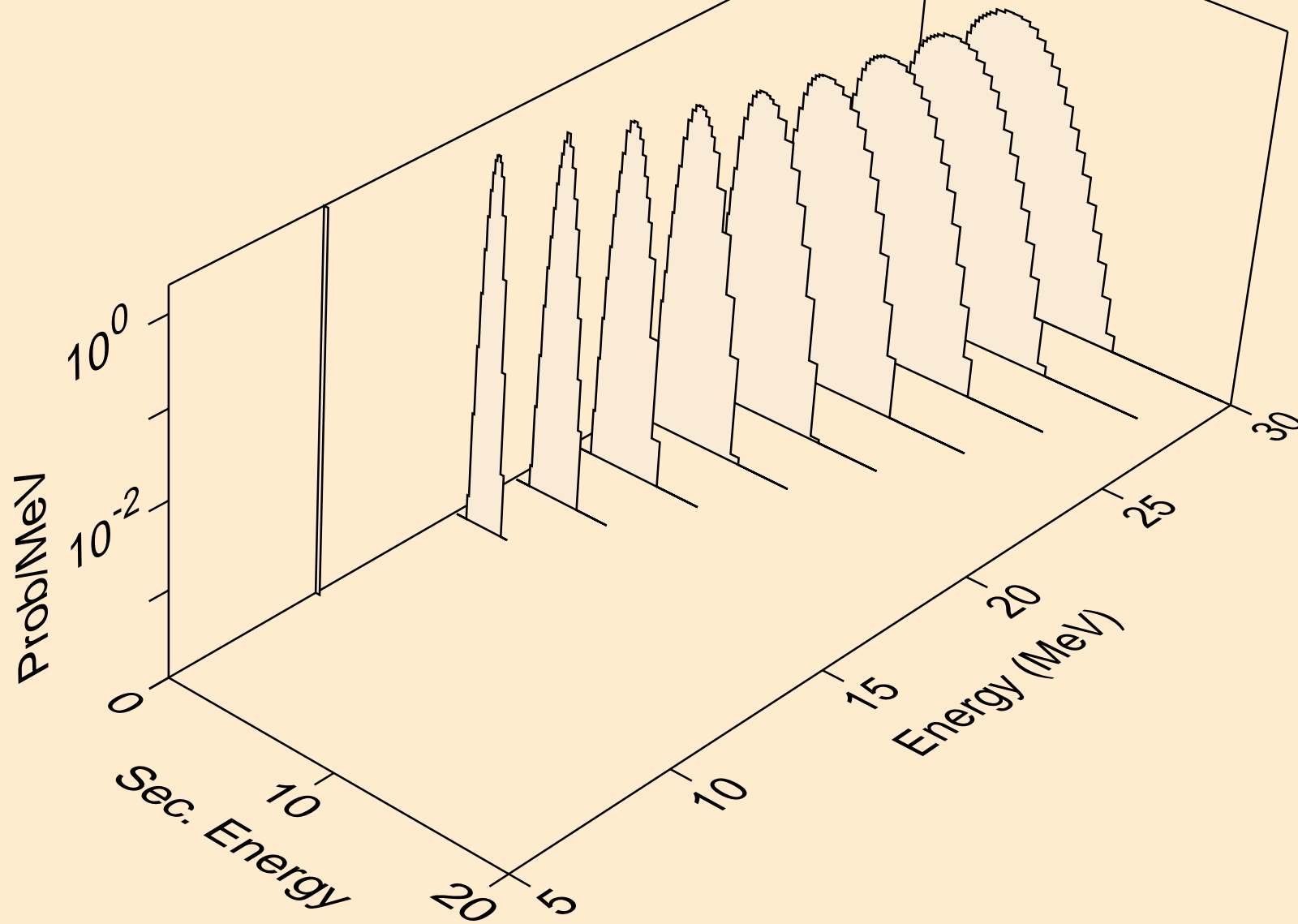

AG096M NEUTRON ACER TENDL-2021 LIBRARY; T=293.6K
deuterons from (n,x)

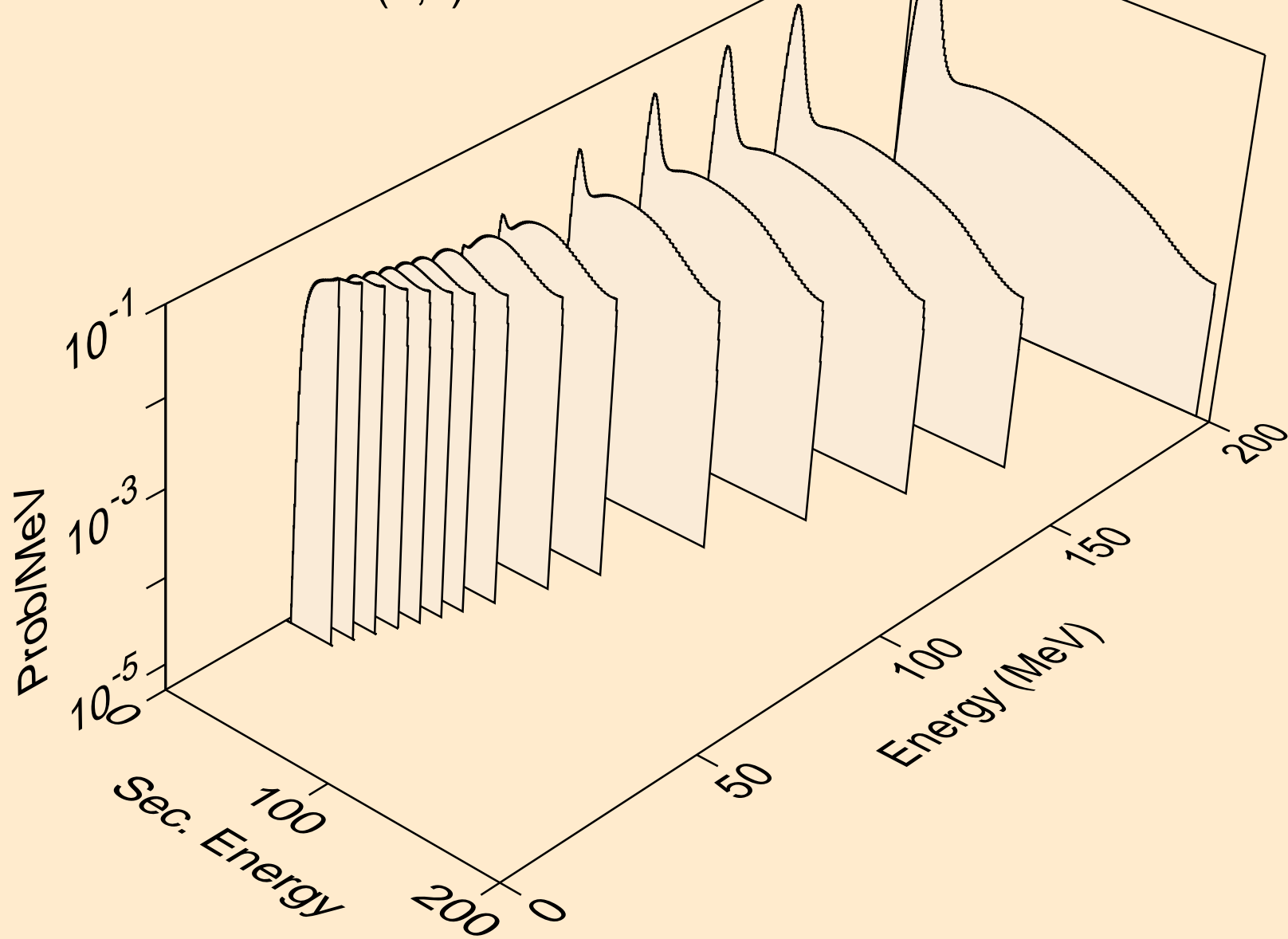

AG096M NEUTRON ACER TENDL-2021 LIBRARY; T=293.6K
deuterons from (n,n*)d

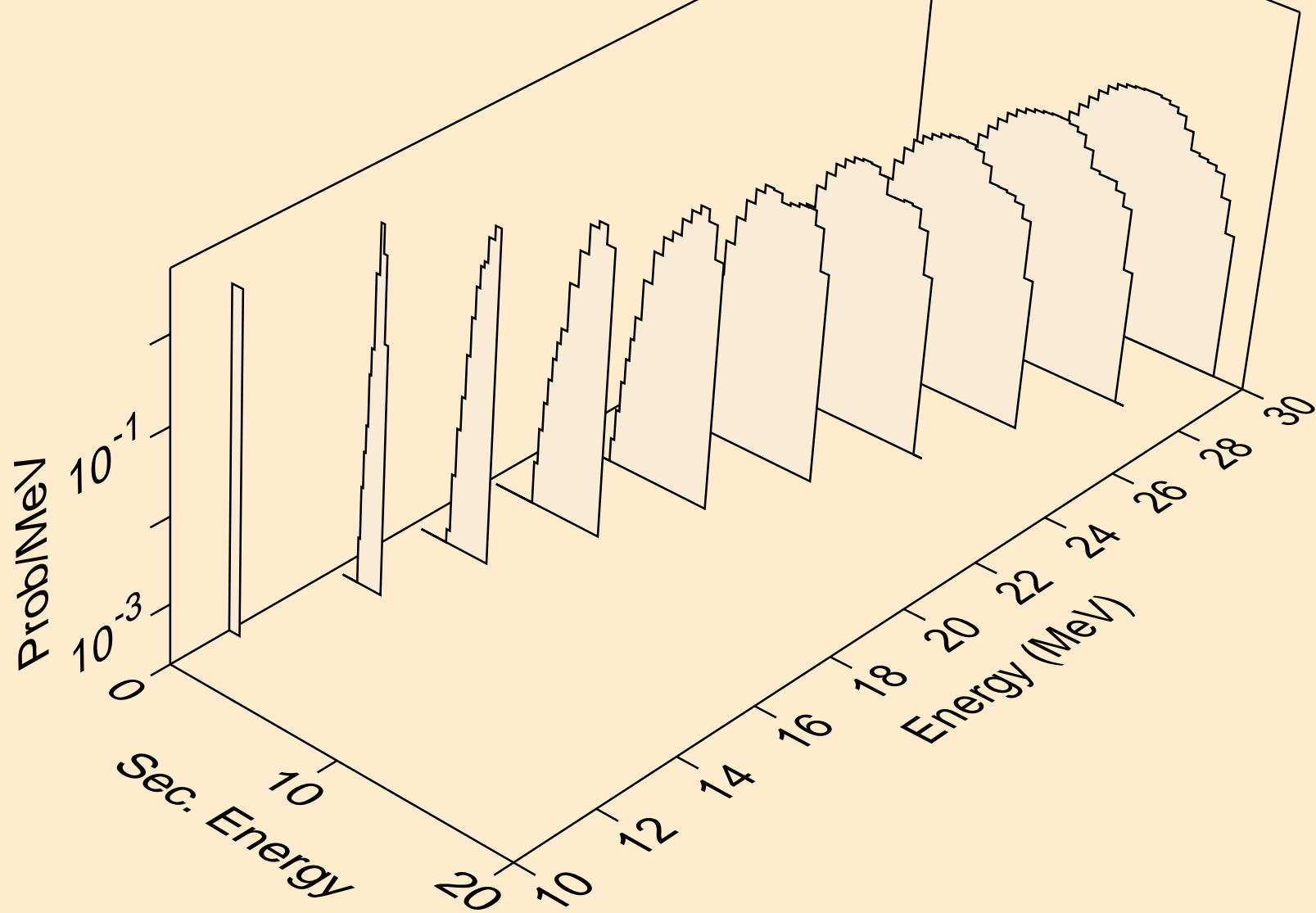

AG096M NEUTRON ACER TENDL-2021 LIBRARY; T=293.6K
deuterons from (n,d)

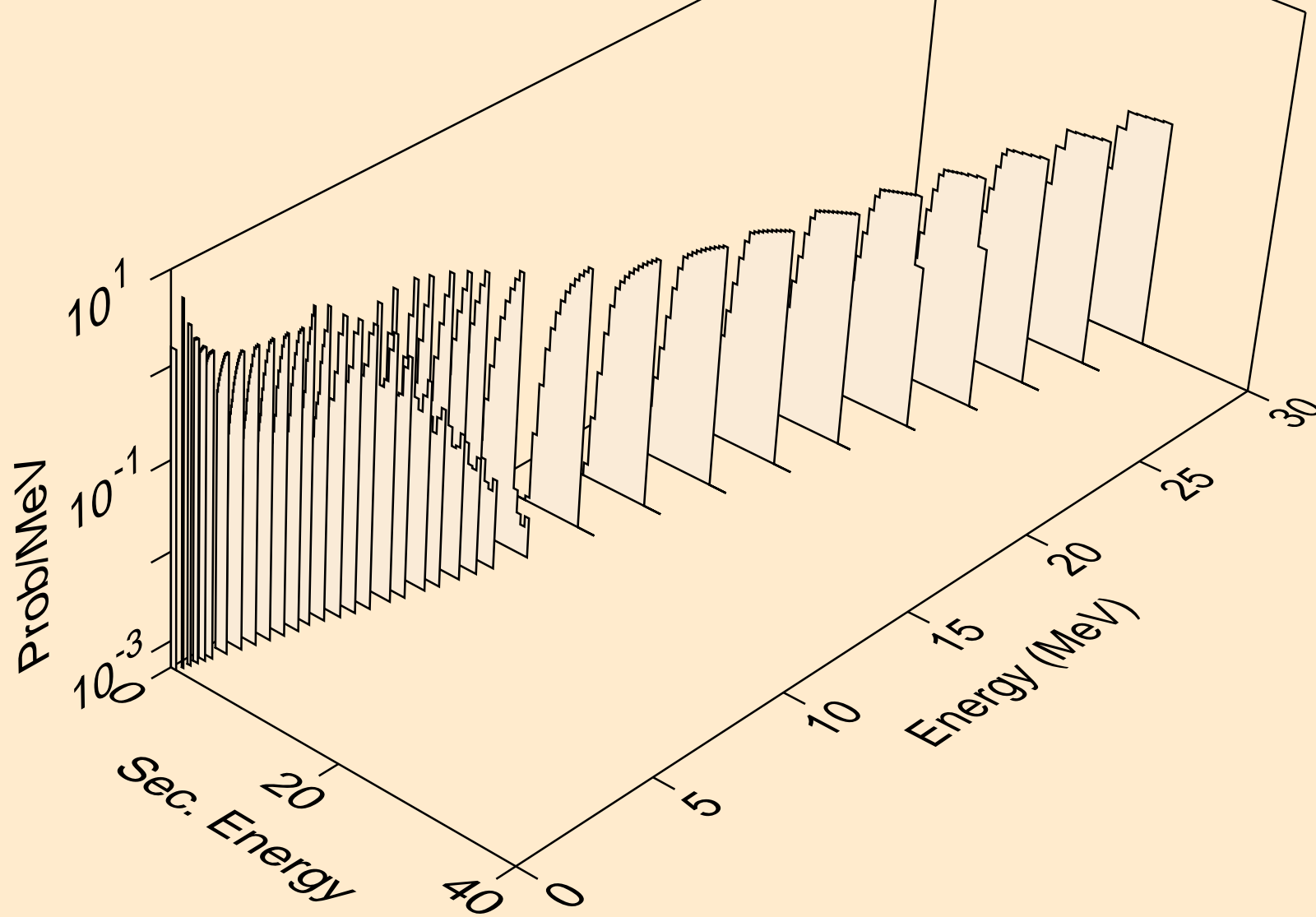

AG096M NEUTRON ACER TENDL-2021 LIBRARY; T=293.6K
deuterons from (n,pd)

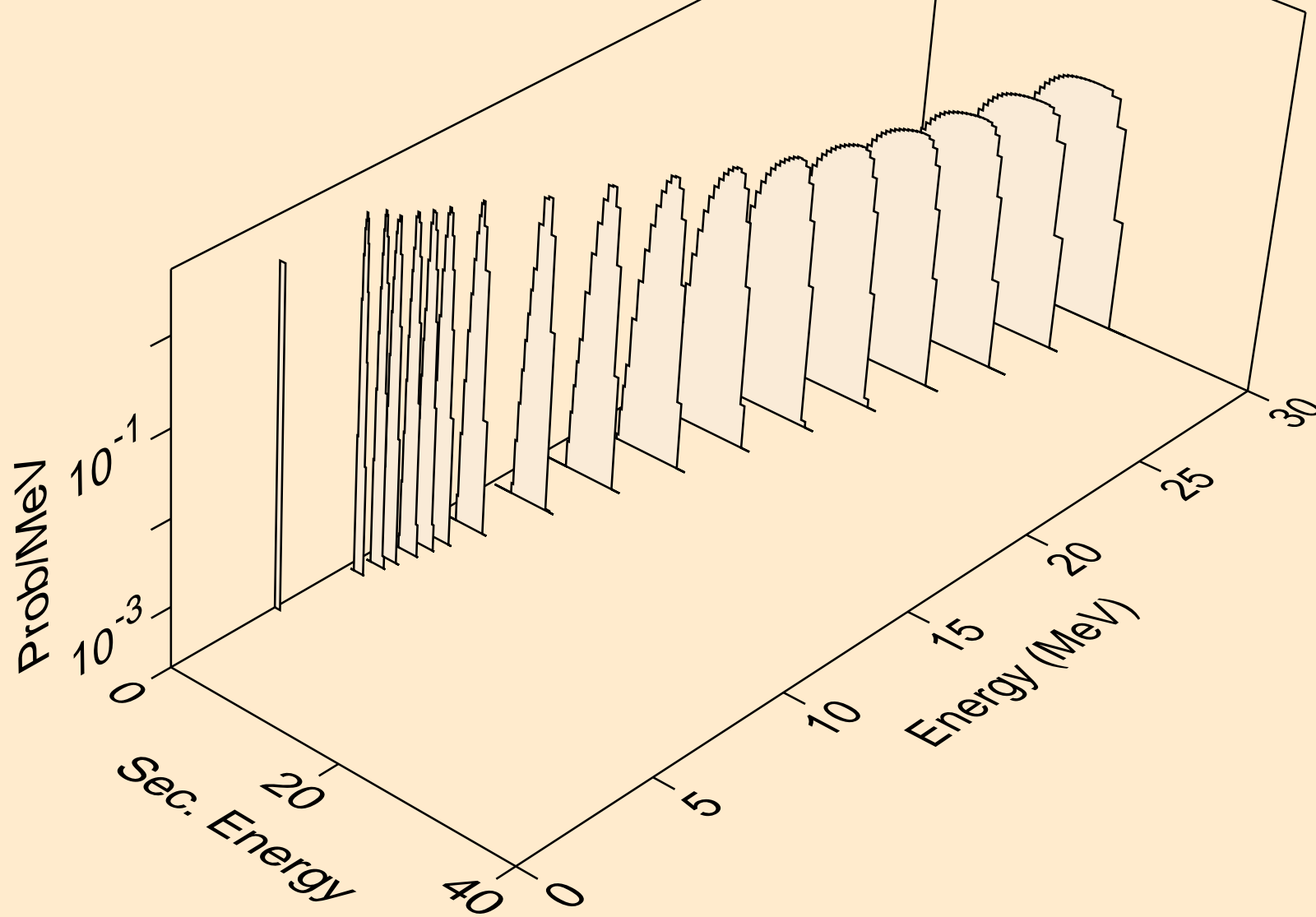

AG096M NEUTRON ACER TENDL-2021 LIBRARY; T=293.6K
deuterons from (n,da)

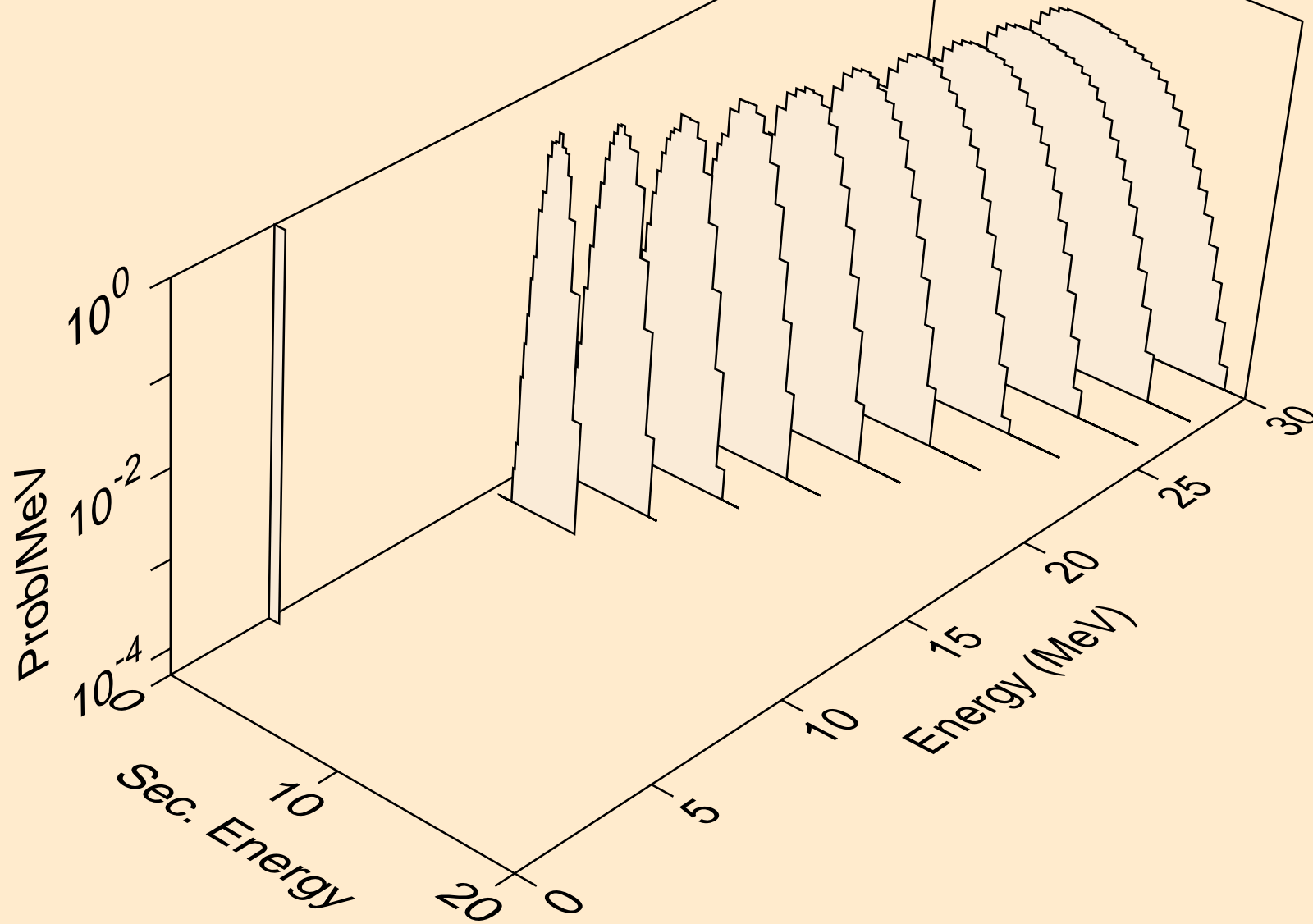

AG096M NEUTRON ACER TENDL-2021 LIBRARY; T=293.6K
tritons from (n,x)

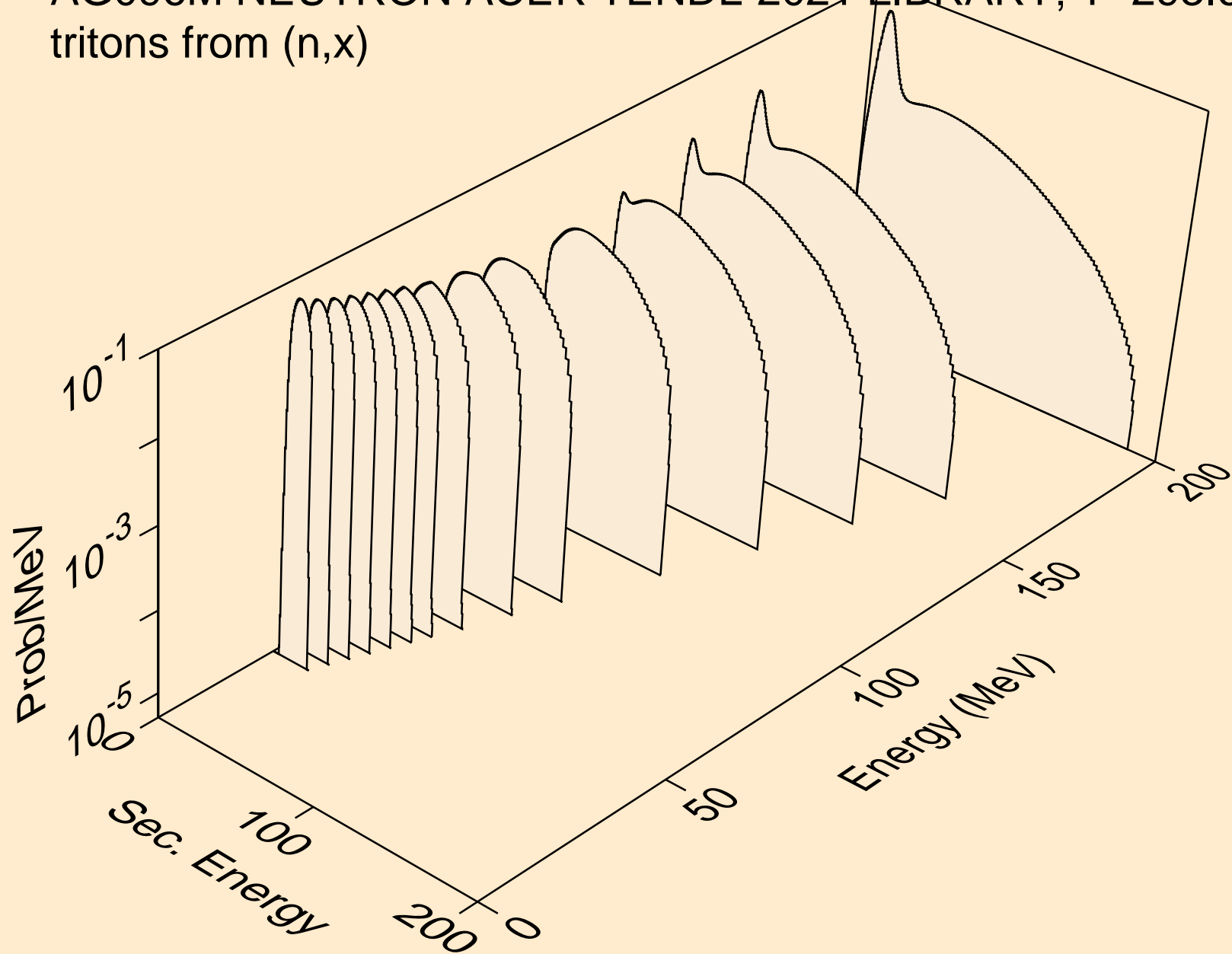

AG096M NEUTRON ACER TENDL-2021 LIBRARY; T=293.6K
tritons from (n,n*)t

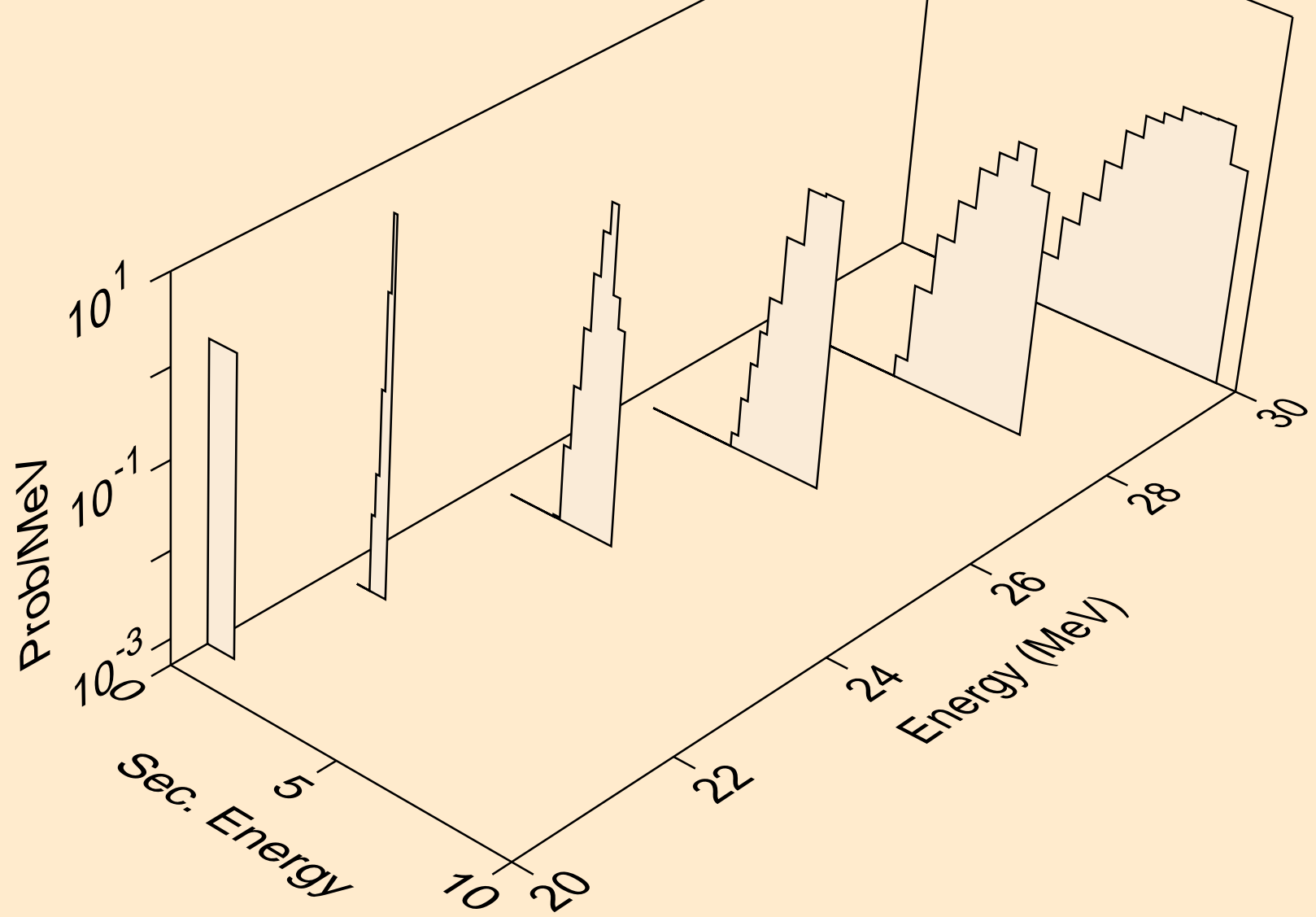

AG096M NEUTRON ACER TENDL-2021 LIBRARY; T=293.6K
tritons from (n,t)

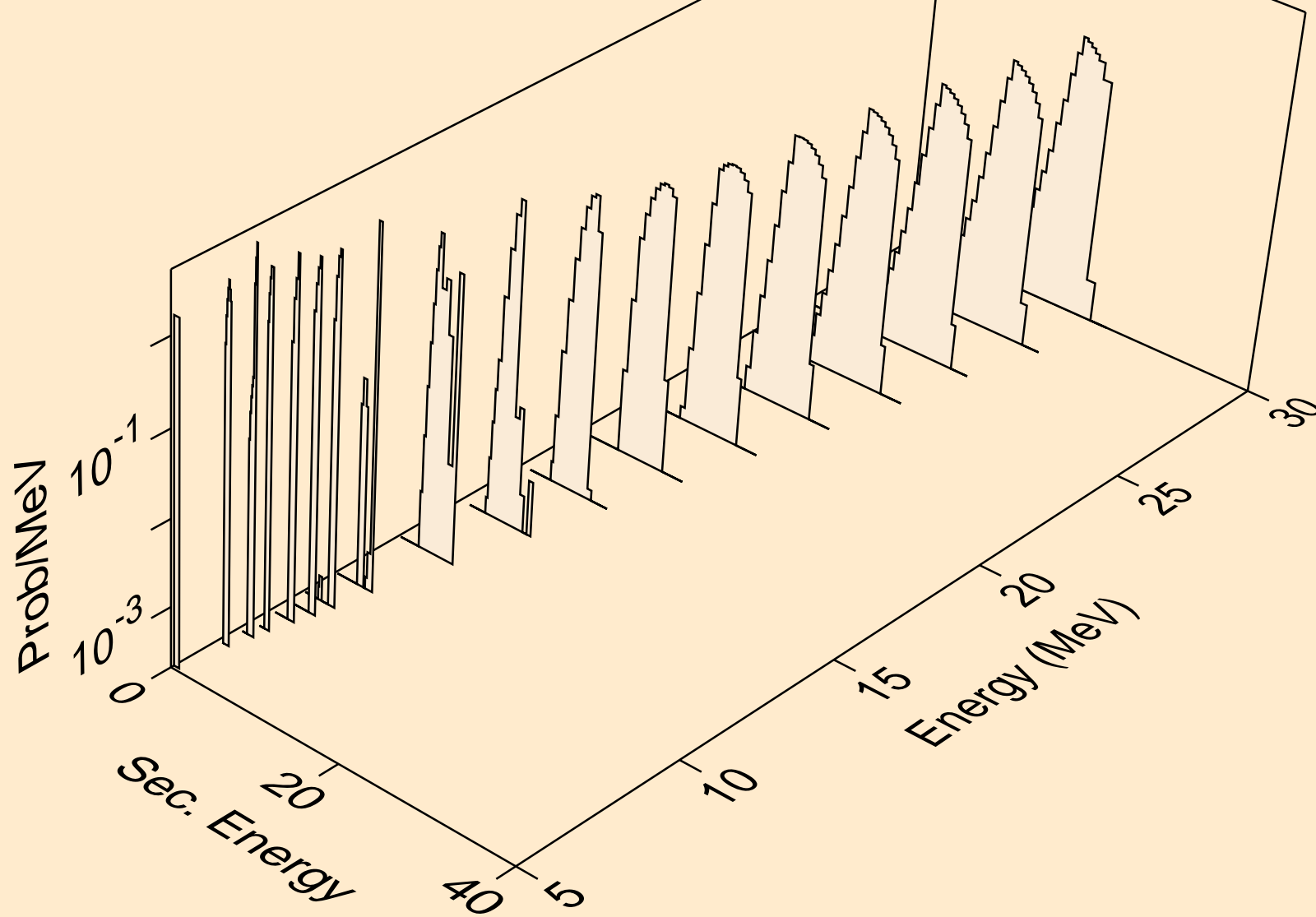

AG096M NEUTRON ACER TENDL-2021 LIBRARY; T=293.6K
tritons from (n,pt)

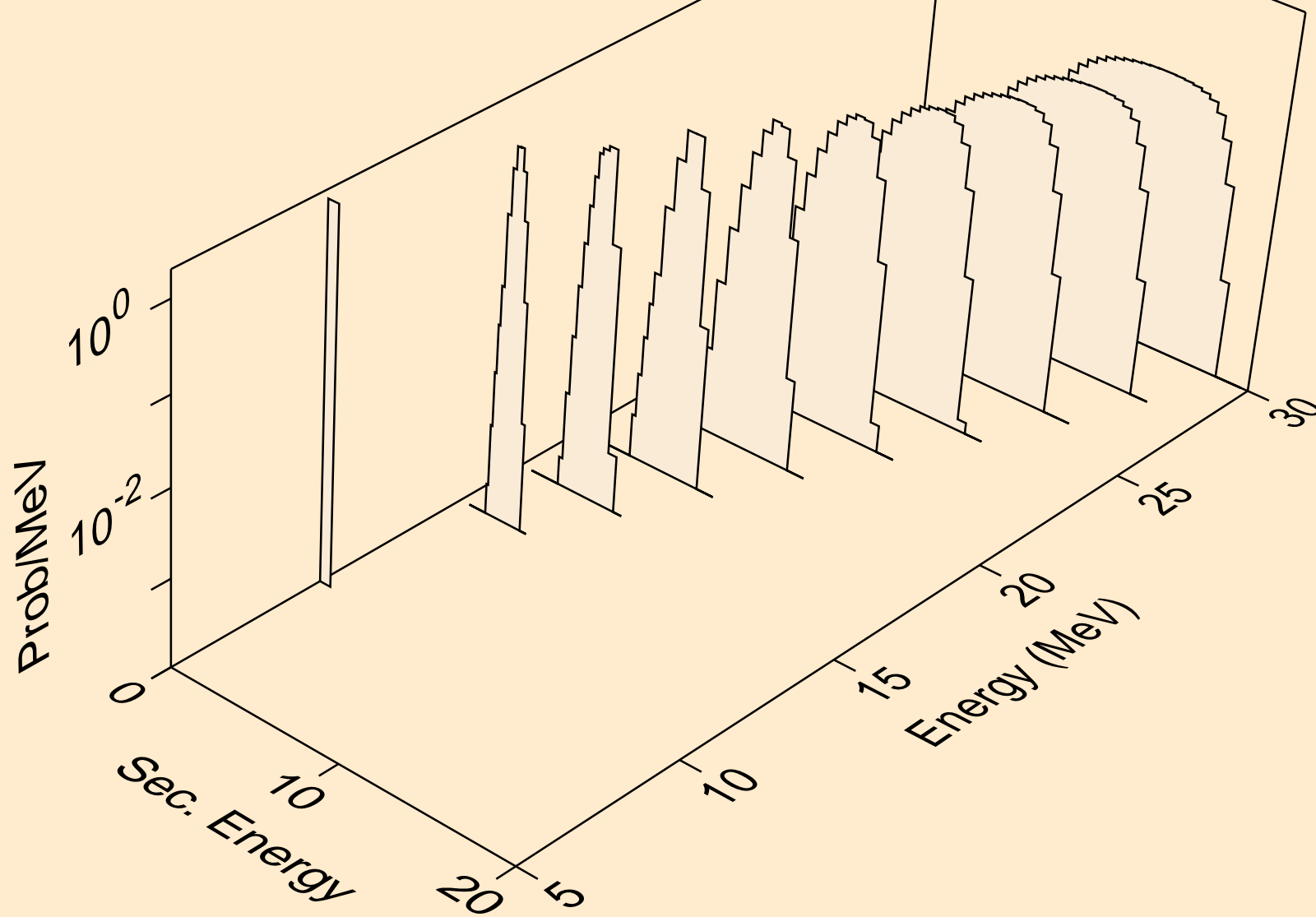

AG096M NEUTRON ACER TENDL-2021 LIBRARY; T=293.6K
he3s from (n,x)

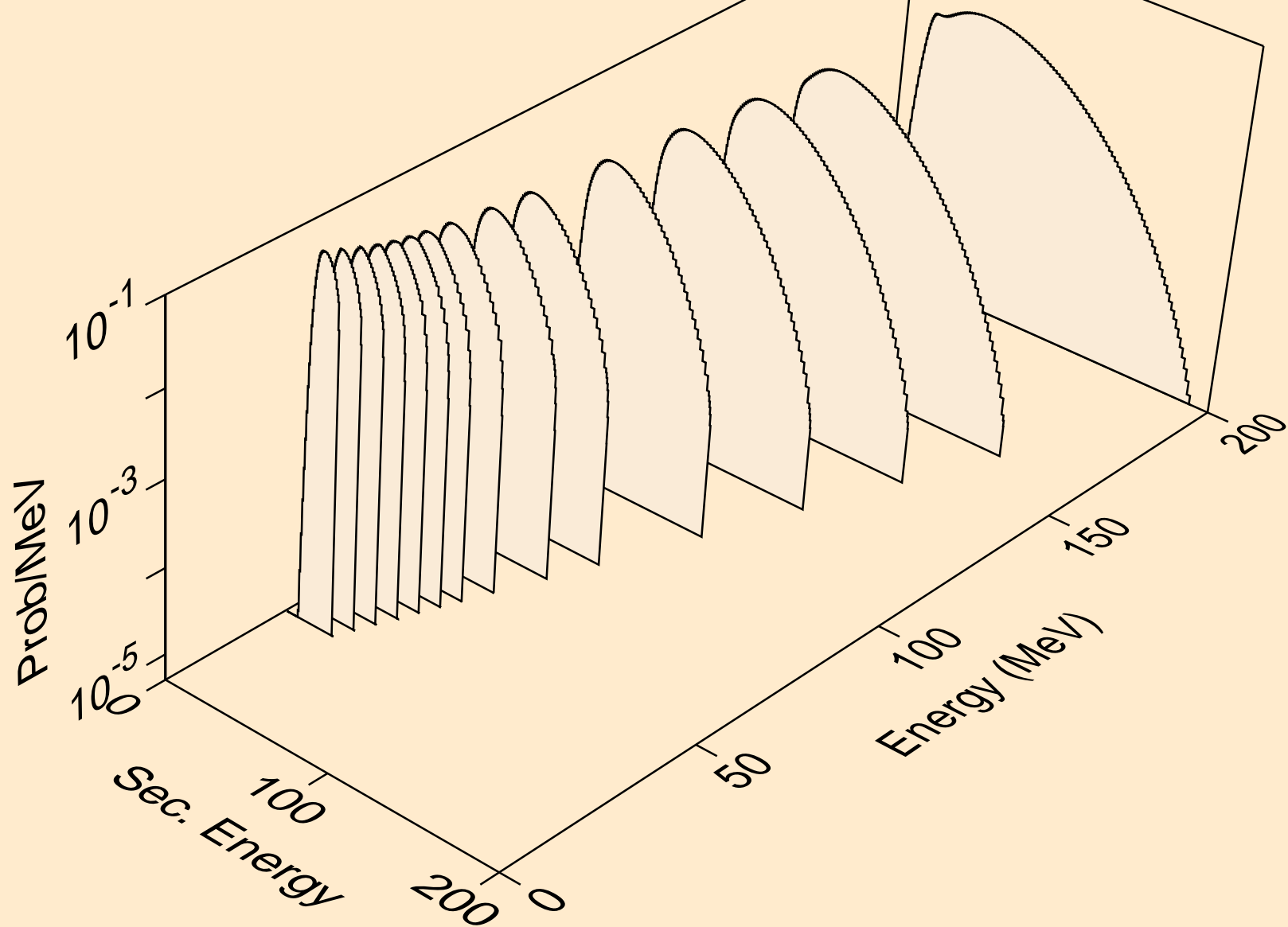

AG096M NEUTRON ACER TENDL-2021 LIBRARY; T=293.6K
he3s from (n,n*)he3

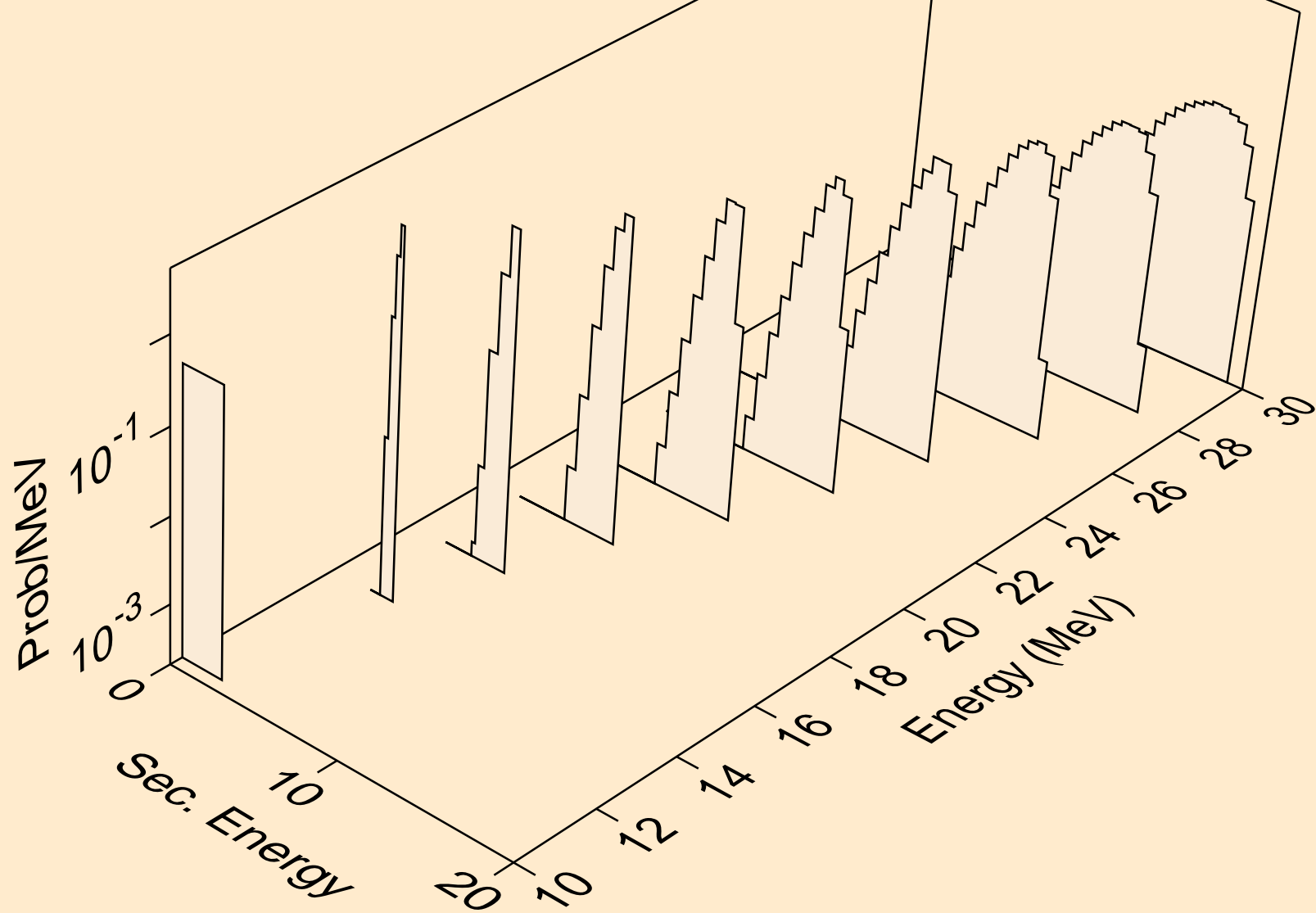

AG096M NEUTRON ACER TENDL-2021 LIBRARY; T=293.6K
he3s from (n,he3)

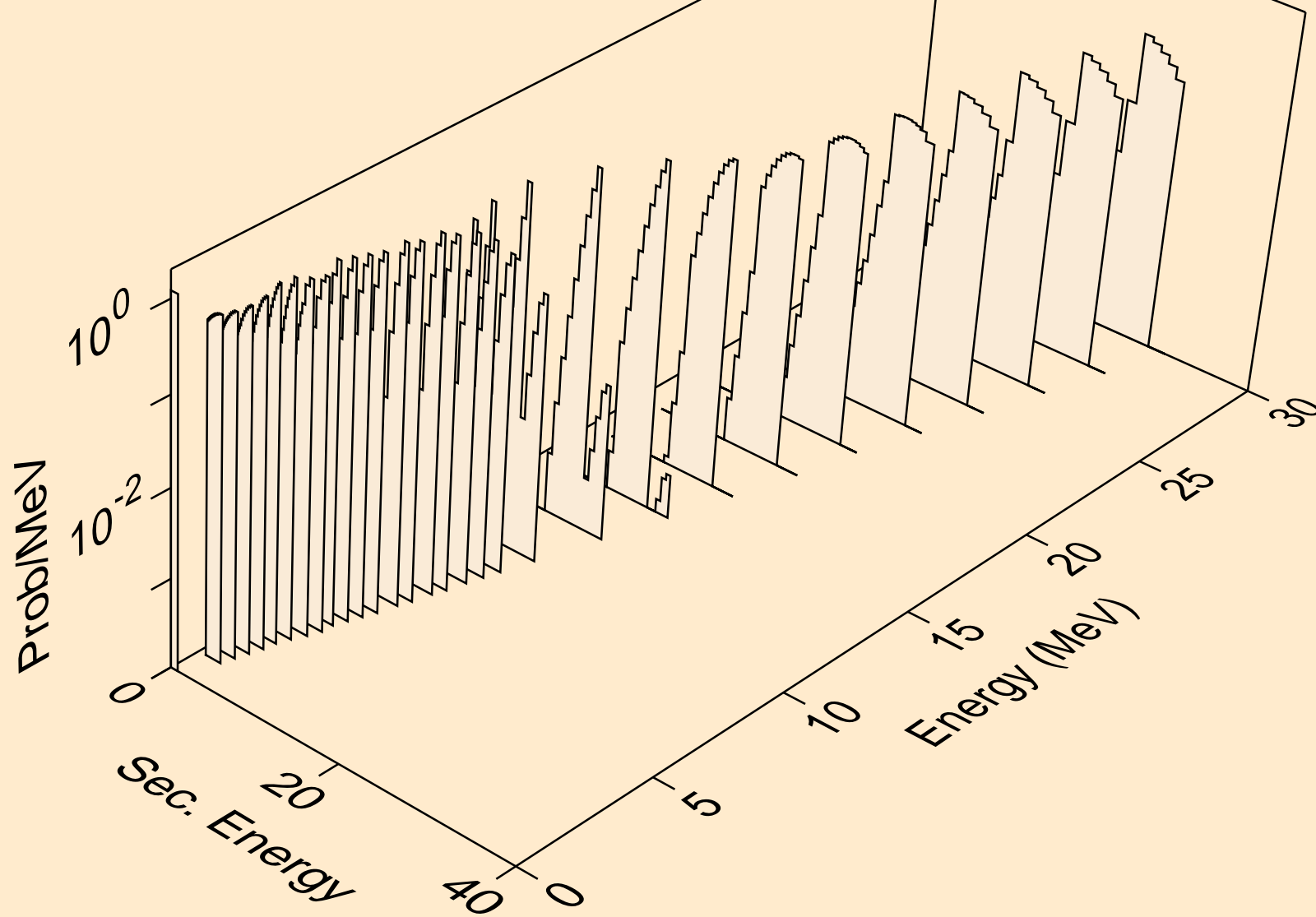

AG096M NEUTRON ACER TENDL-2021 LIBRARY; T=293.6K
alphas from (n,x)

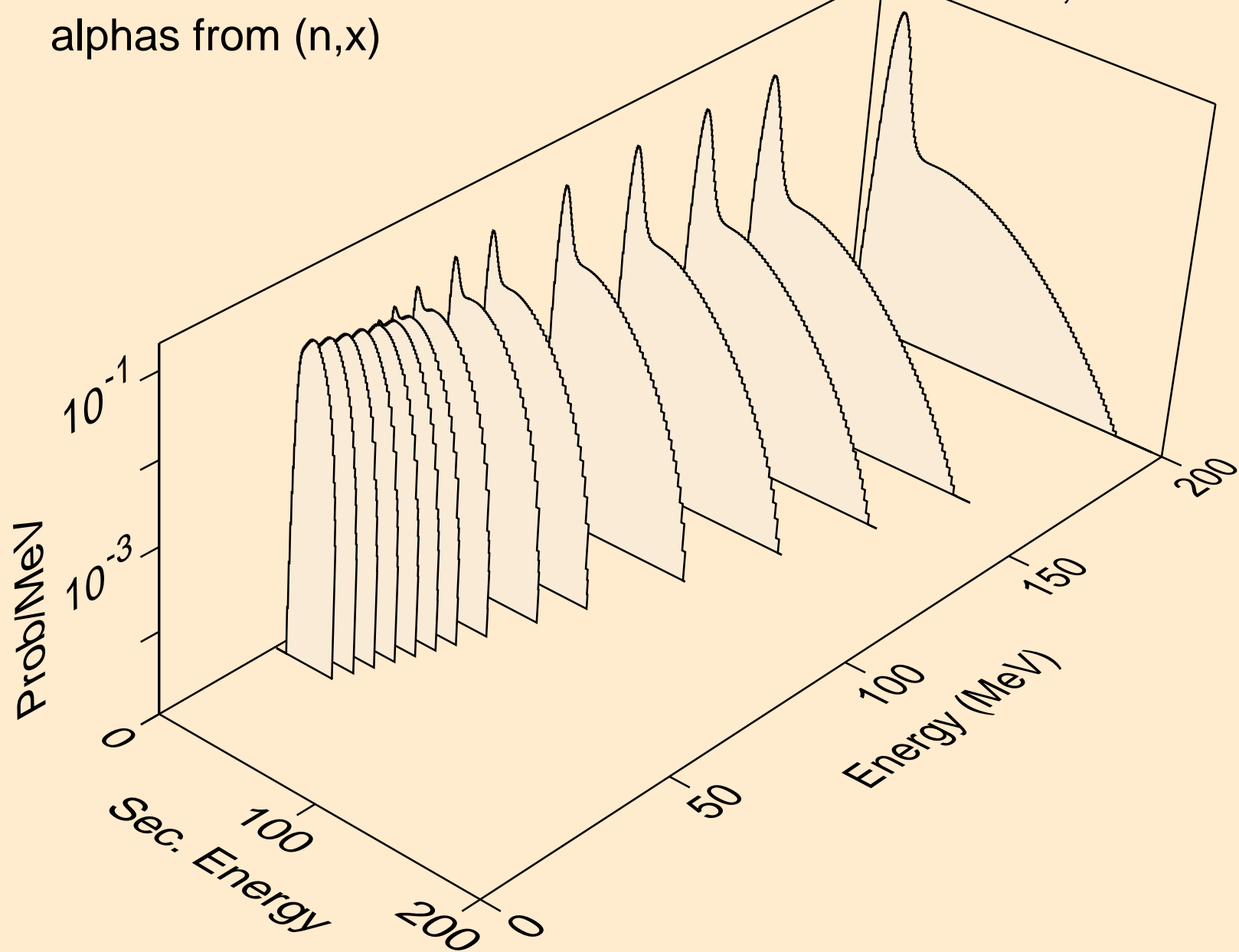

AG096M NEUTRON ACER TENDL-2021 LIBRARY; T=293.6K
alphas from (n,n*)a

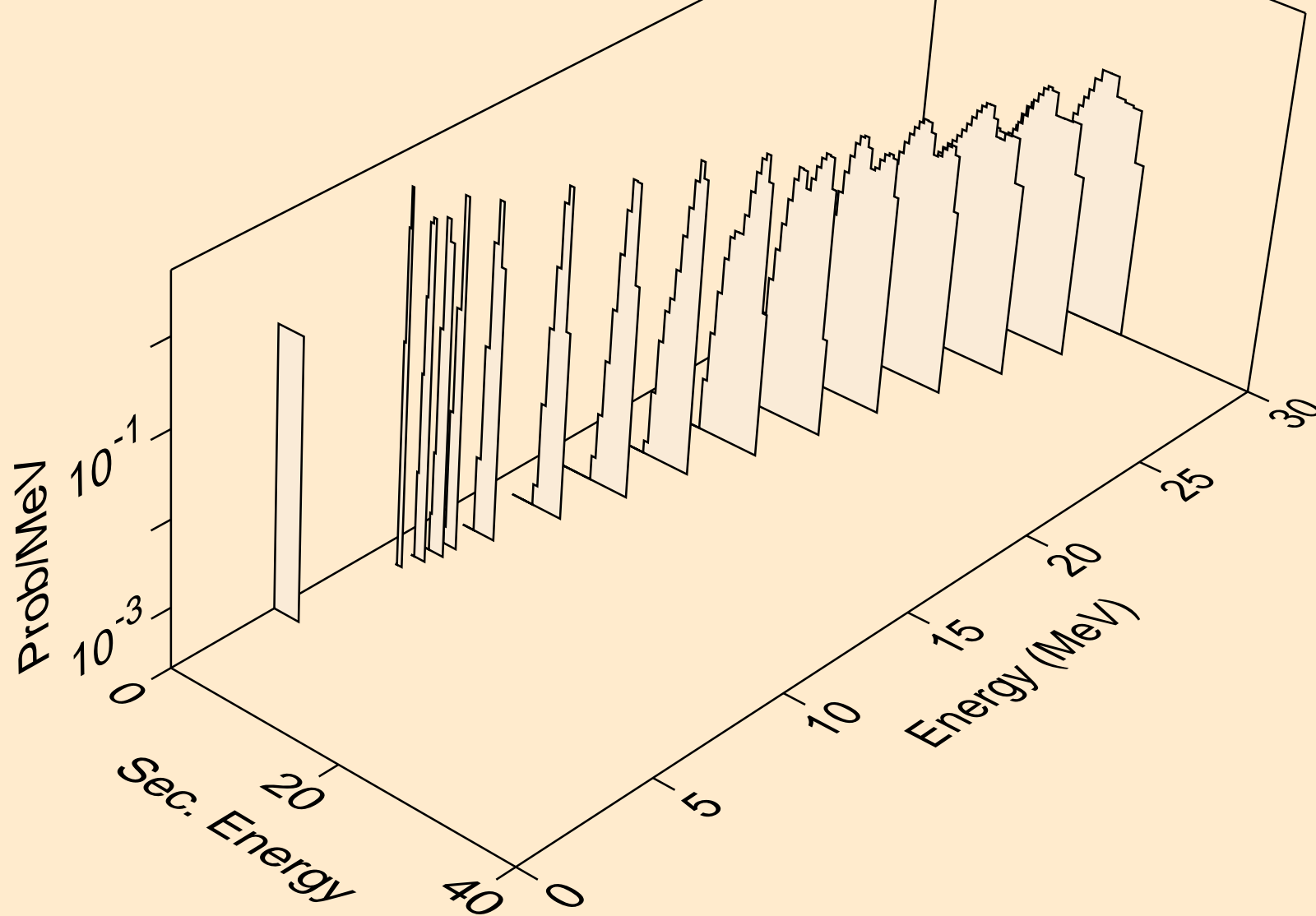

AG096M NEUTRON ACER TENDL-2021 LIBRARY; T=293.6K
alphas from (n,2n)a

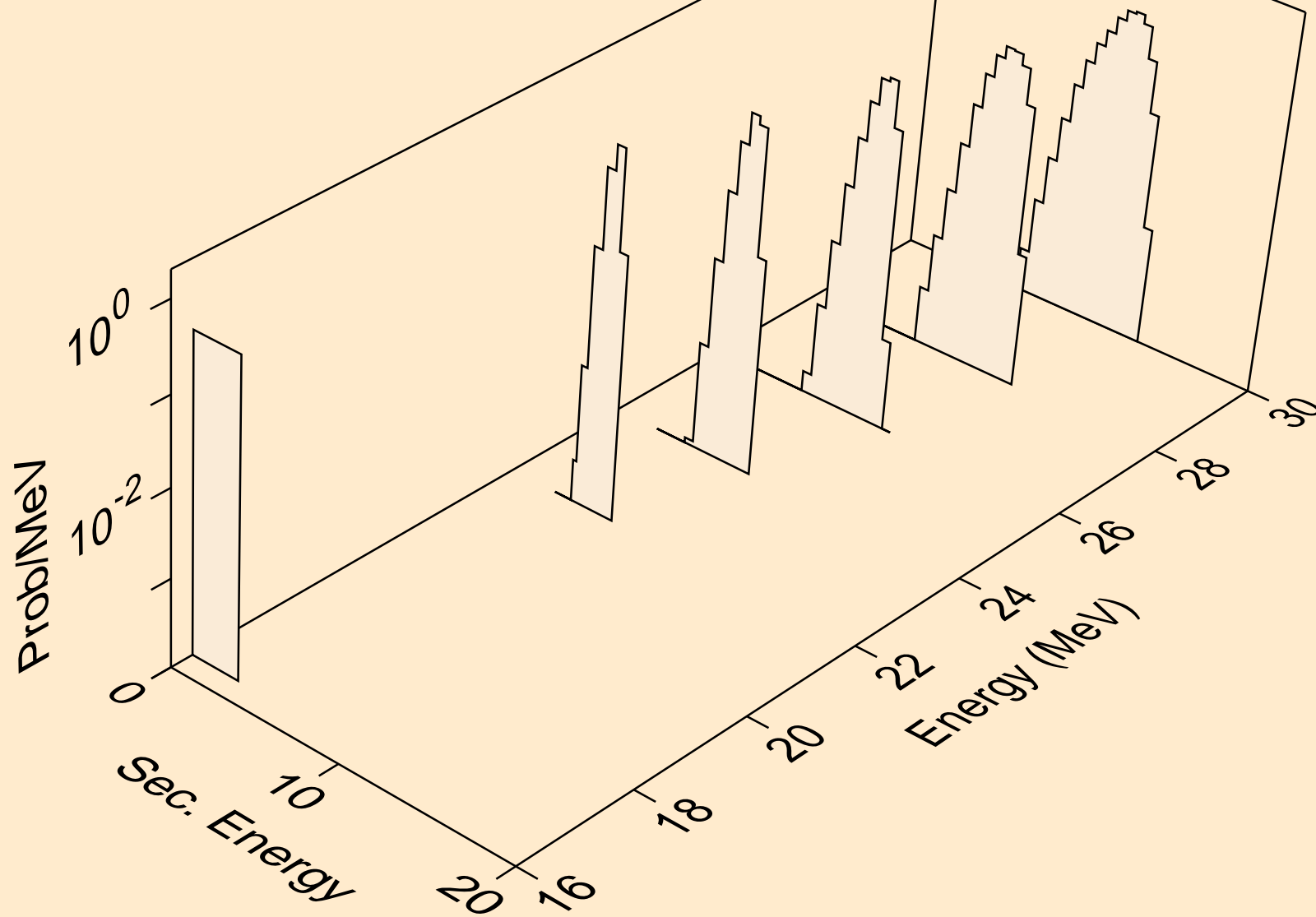

AG096M NEUTRON ACER TENDL-2021 LIBRARY; T=293.6K
alphas from (n,n*)2a

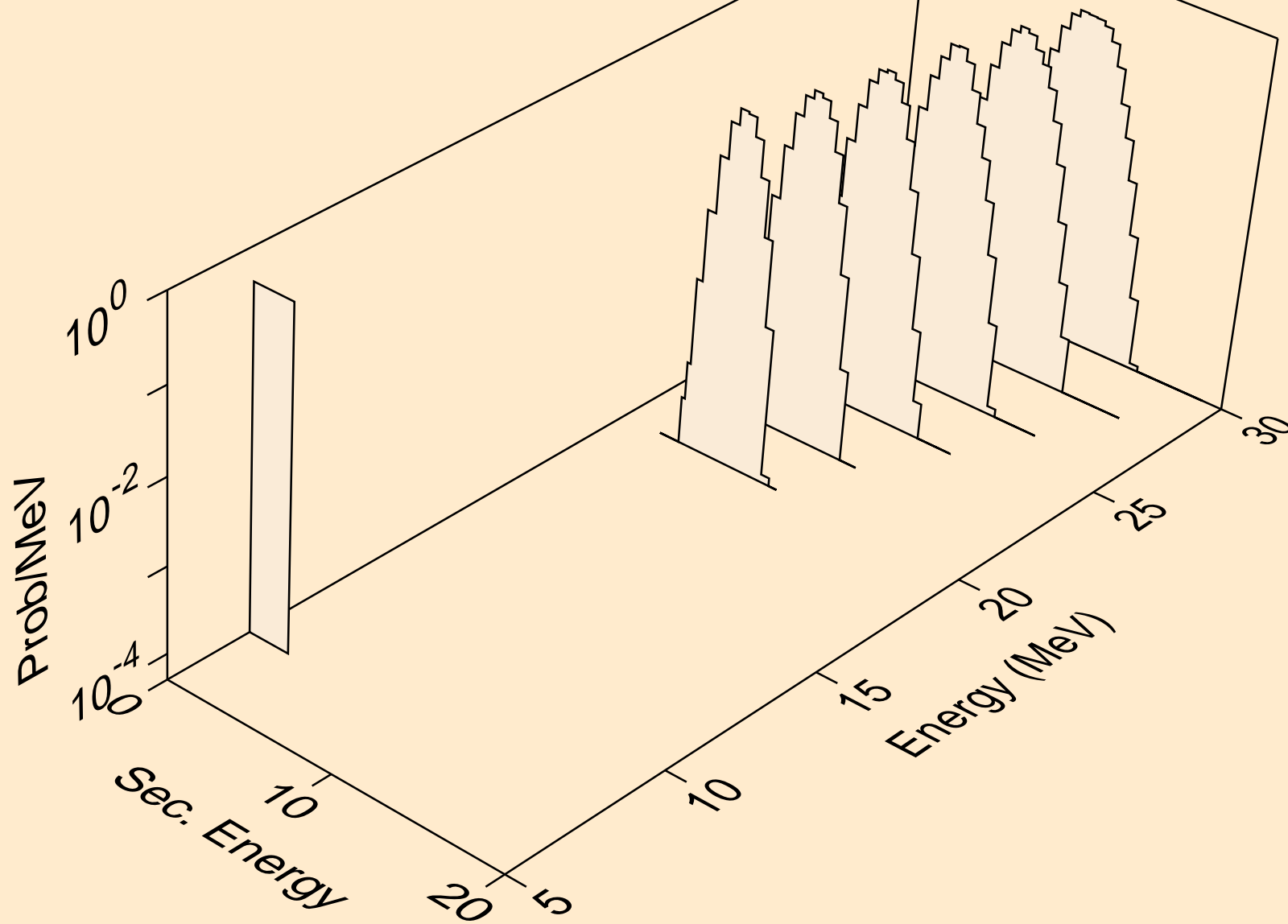

AG096M NEUTRON ACER TENDL-2021 LIBRARY; T=293.6K
alphas from (n,npa)

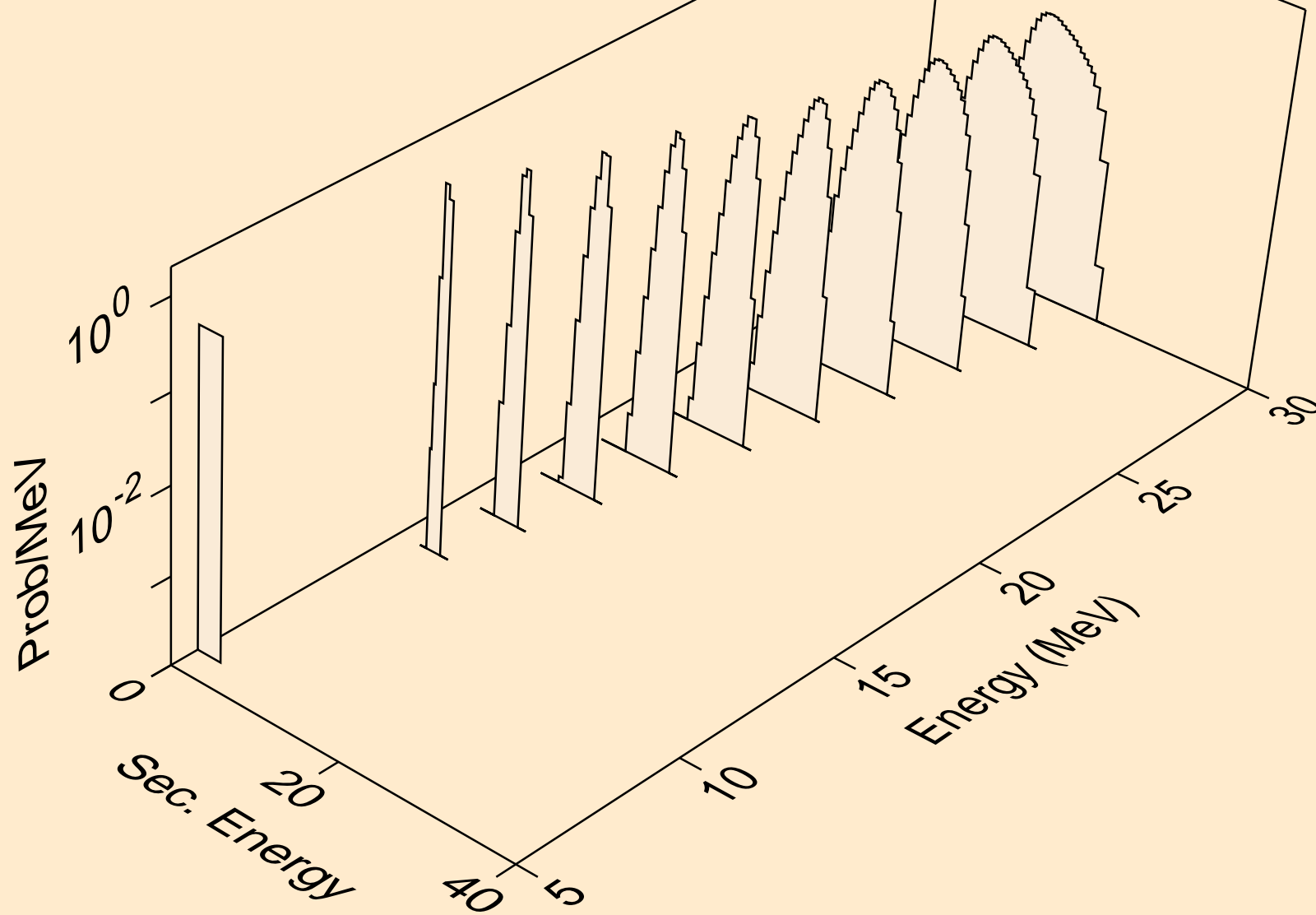

AG096M NEUTRON ACER TENDL-2021 LIBRARY; T=293.6K
alphas from (n,a)

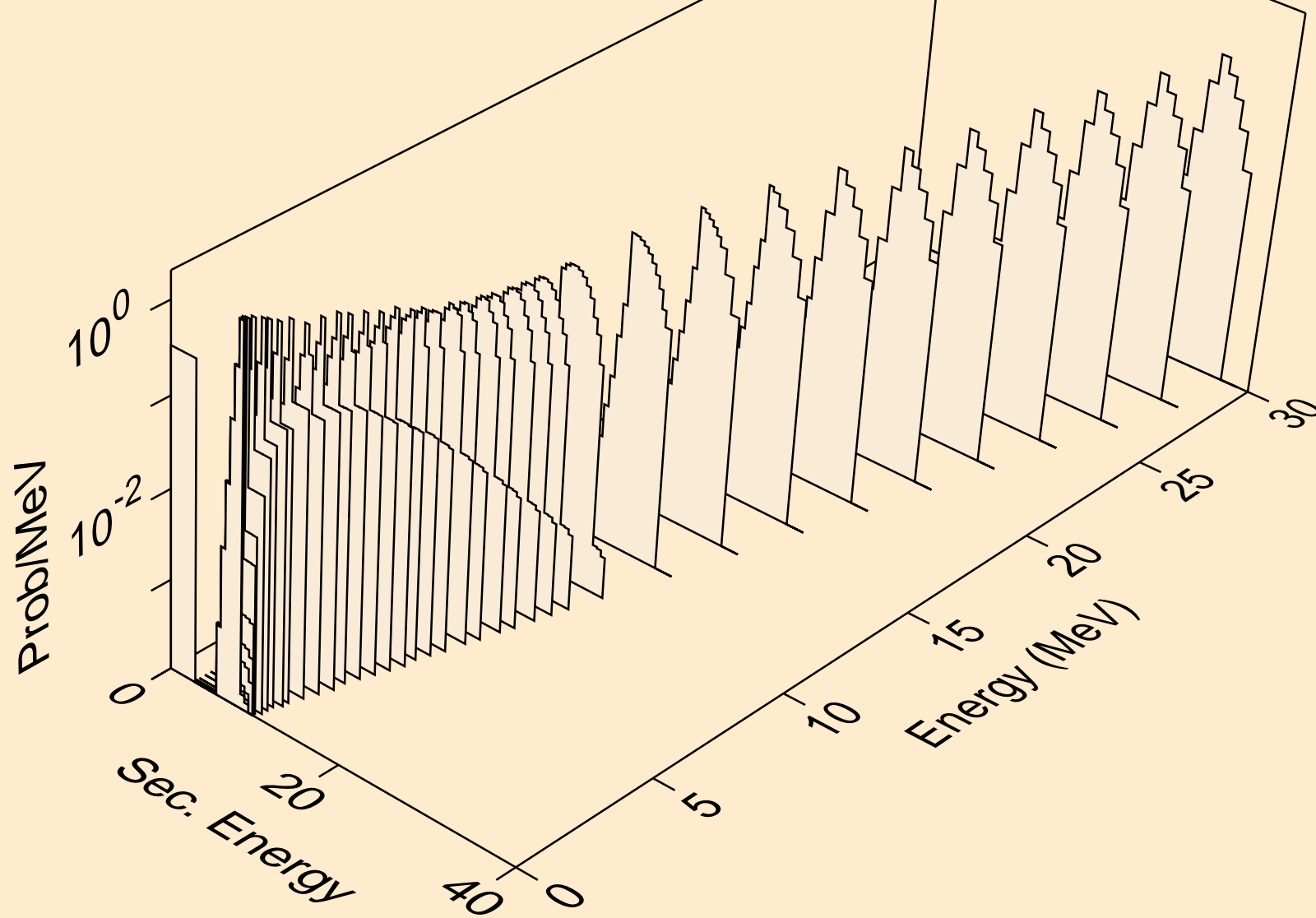

AG096M NEUTRON ACER TENDL-2021 LIBRARY; T=293.6K
alphas from (n,2a)

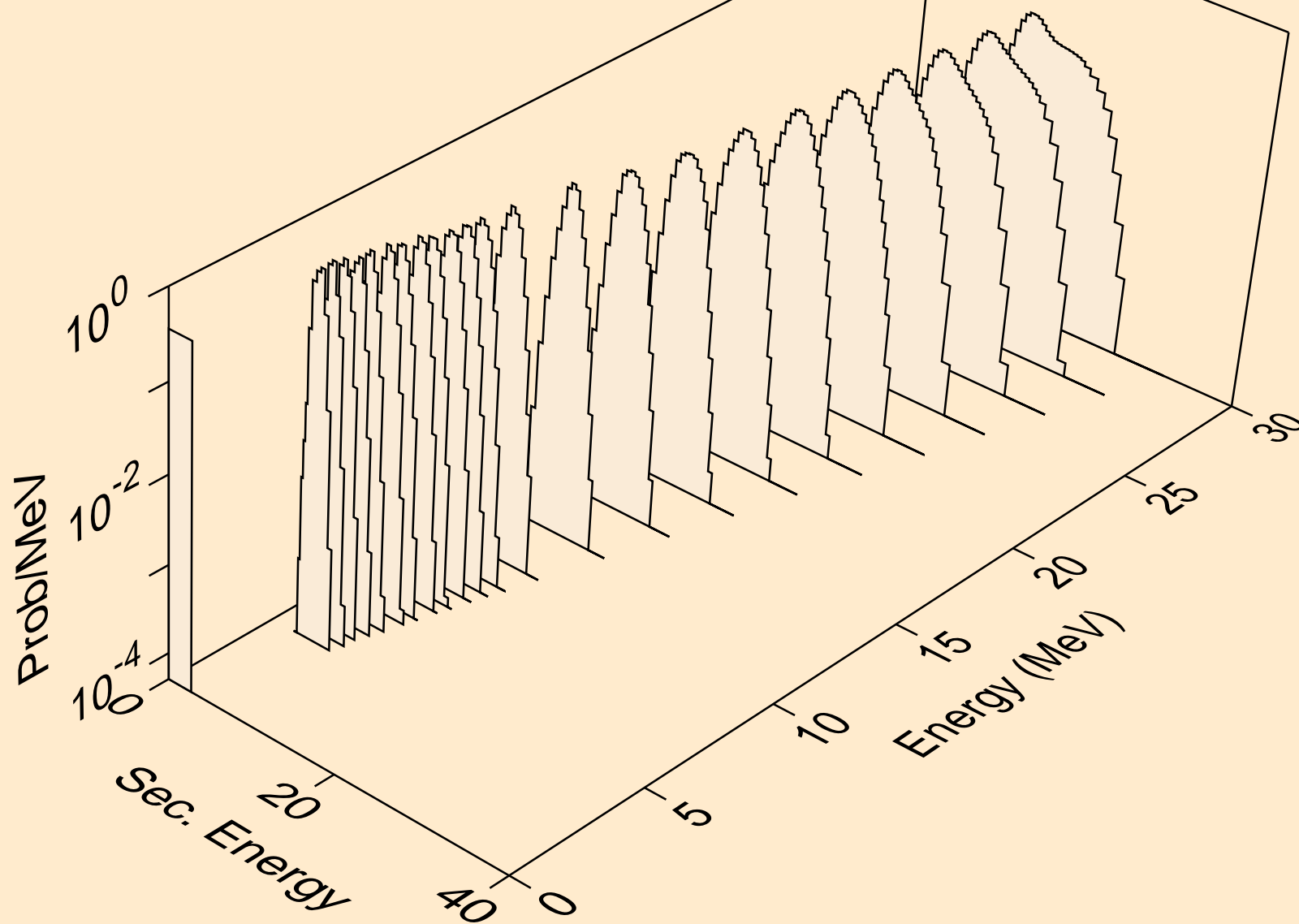

AG096M NEUTRON ACER TENDL-2021 LIBRARY; T=293.6K
alphas from (n,pa)

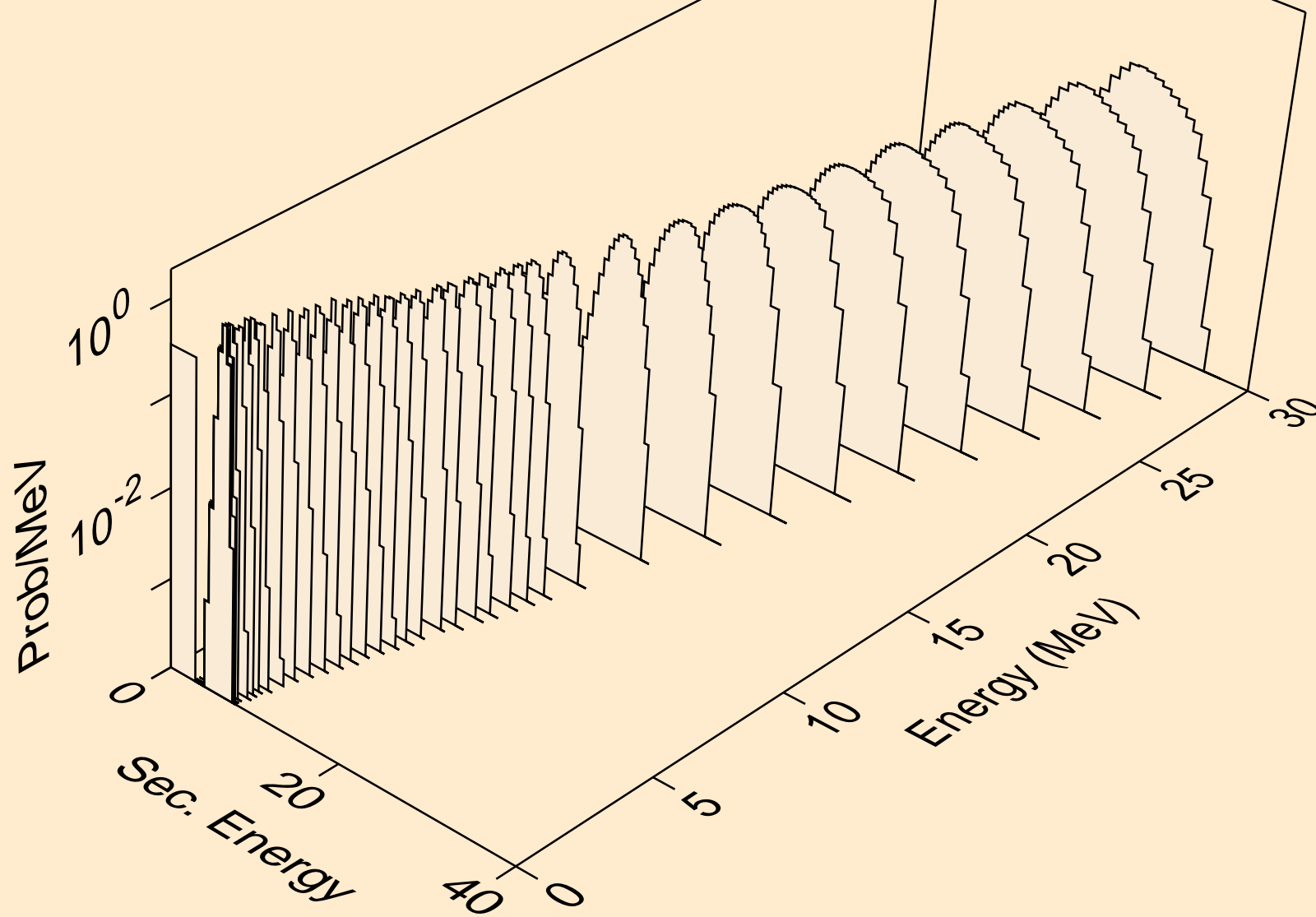

AG096M NEUTRON ACER TENDL-2021 LIBRARY; T=293.6K
alphas from (n,da)

