

AG099 NEUTRON ACER TENDL-2021 LIBRARY; T=293.6K
Principal cross sections

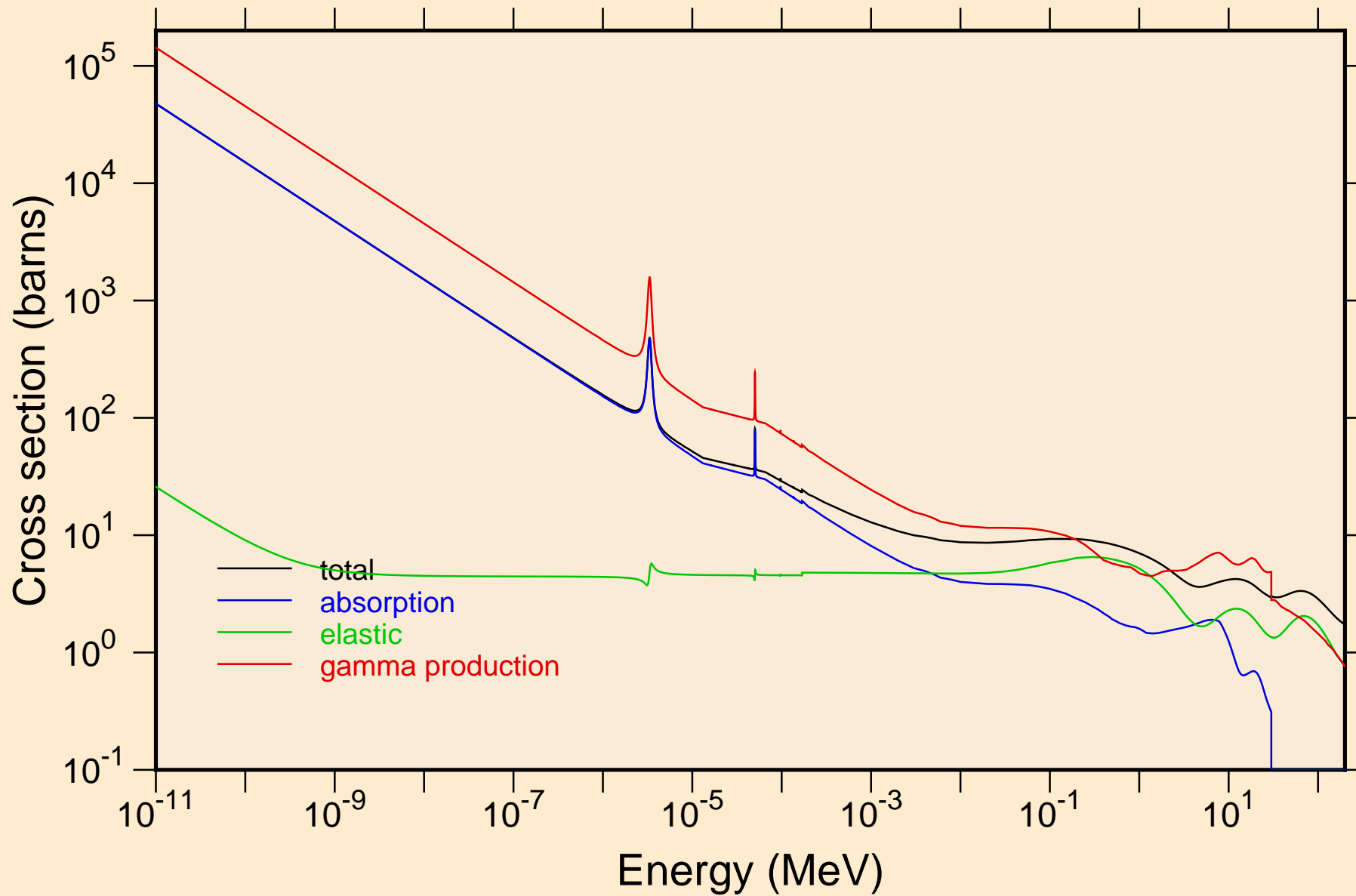

AG099 NEUTRON ACER TENDL-2021 LIBRARY; T=293.6K
resonance total cross section

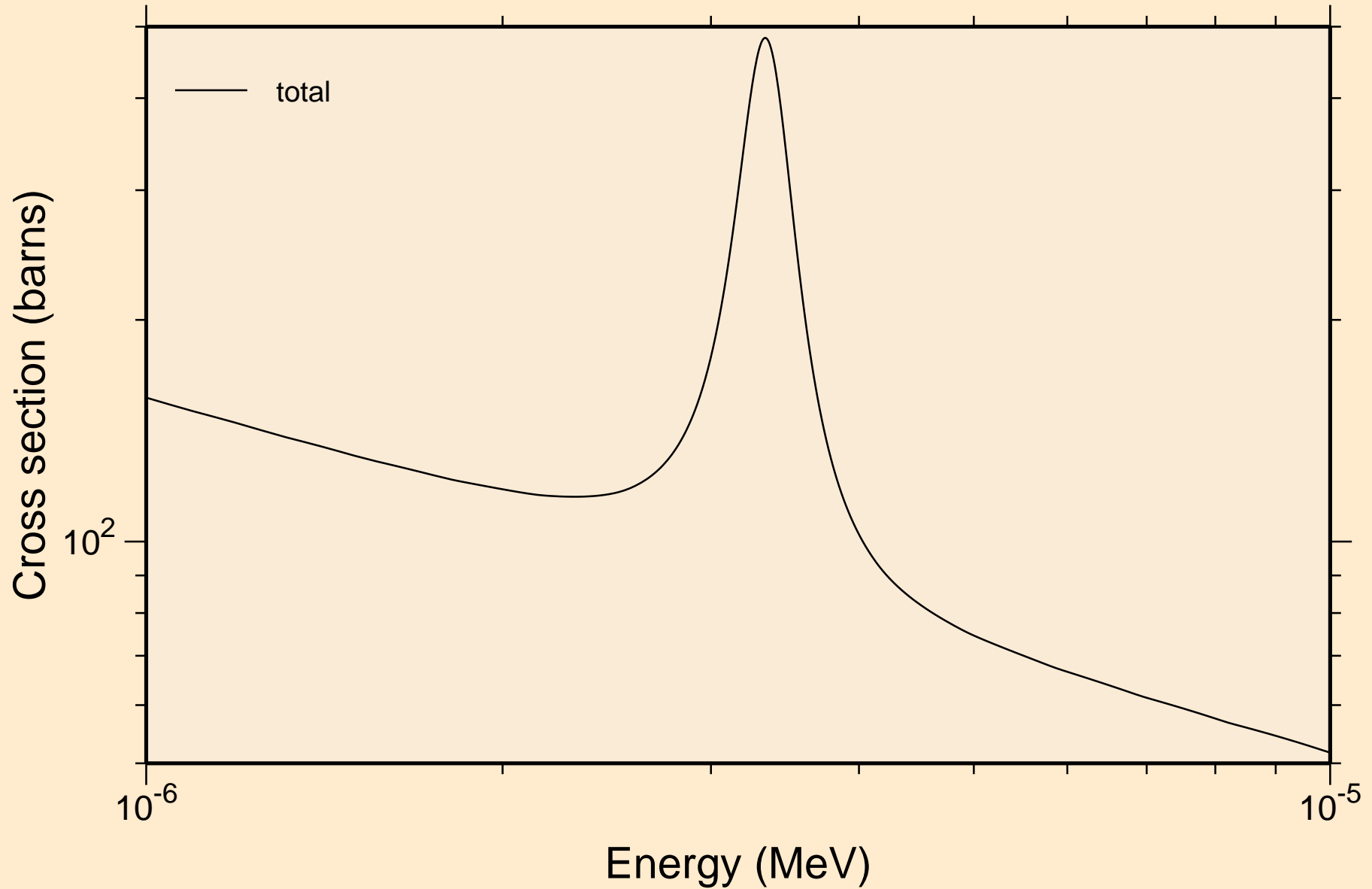

AG099 NEUTRON ACER TENDL-2021 LIBRARY; T=293.6K
resonance total cross section

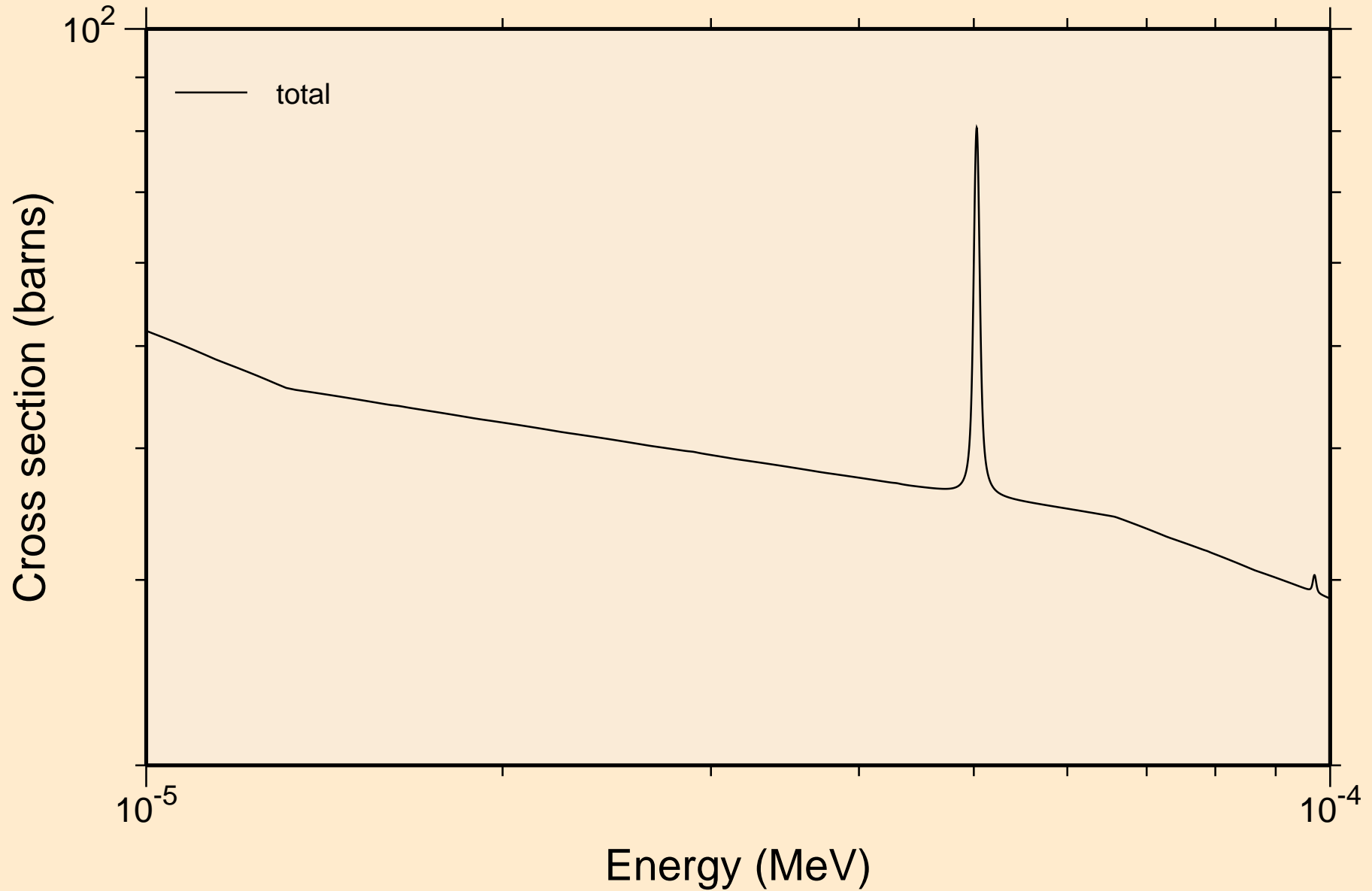

AG099 NEUTRON ACER TENDL-2021 LIBRARY; T=293.6K
resonance total cross section

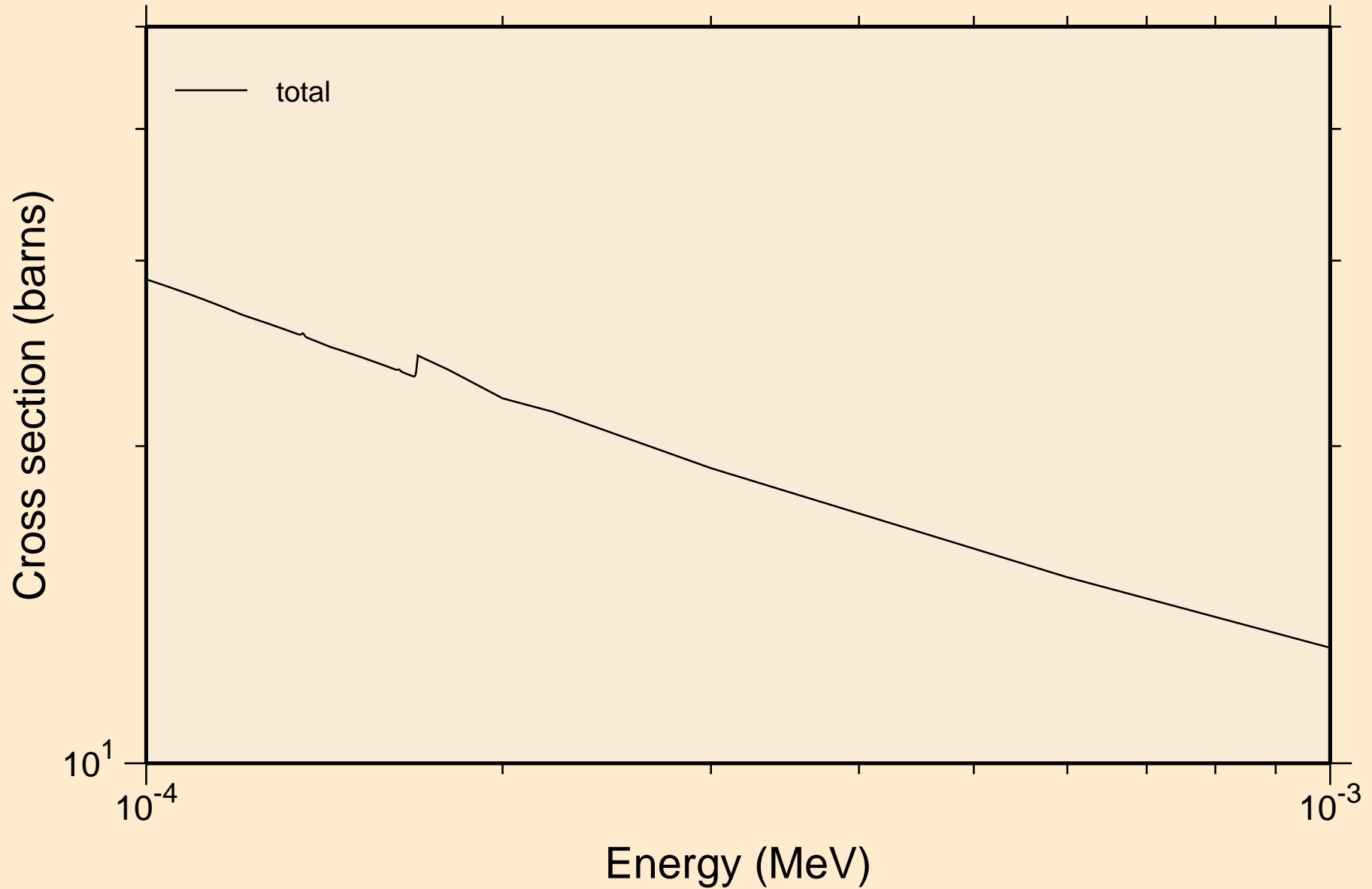

AG099 NEUTRON ACER TENDL-2021 LIBRARY; T=293.6K
resonance total cross section

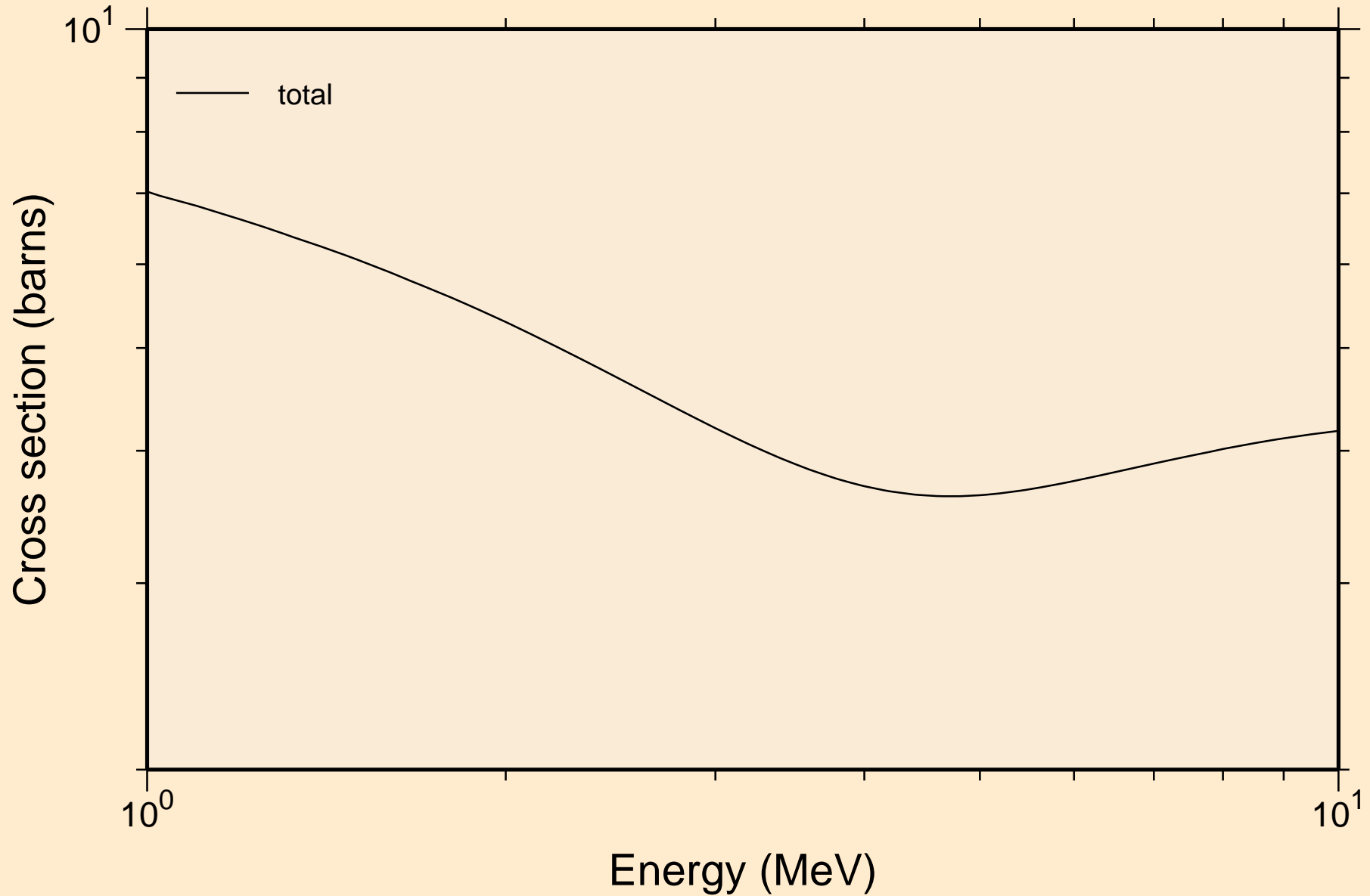

AG099 NEUTRON ACER TENDL-2021 LIBRARY; T=293.6K
resonance absorption cross sections

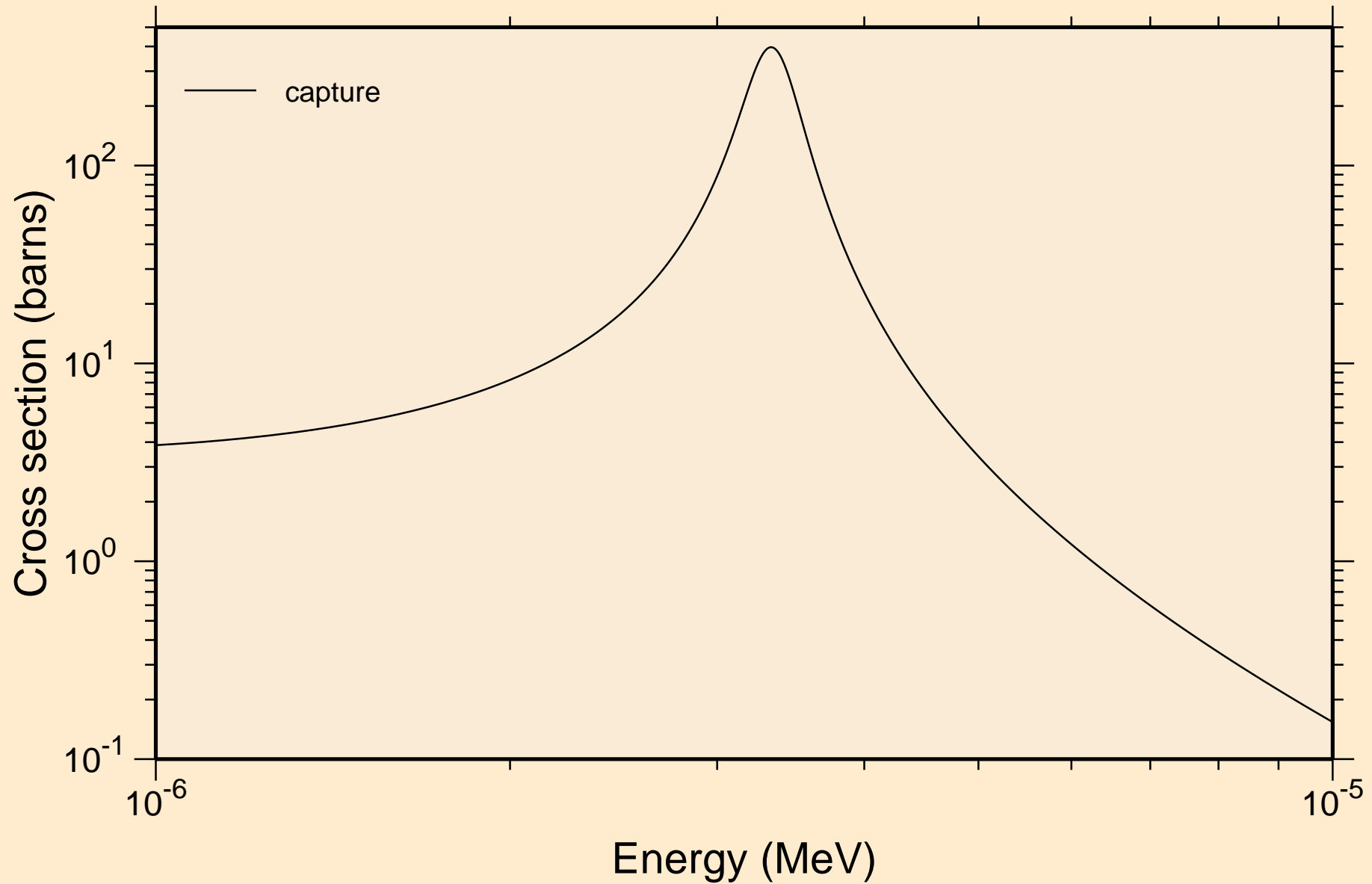

AG099 NEUTRON ACER TENDL-2021 LIBRARY; T=293.6K
resonance absorption cross sections

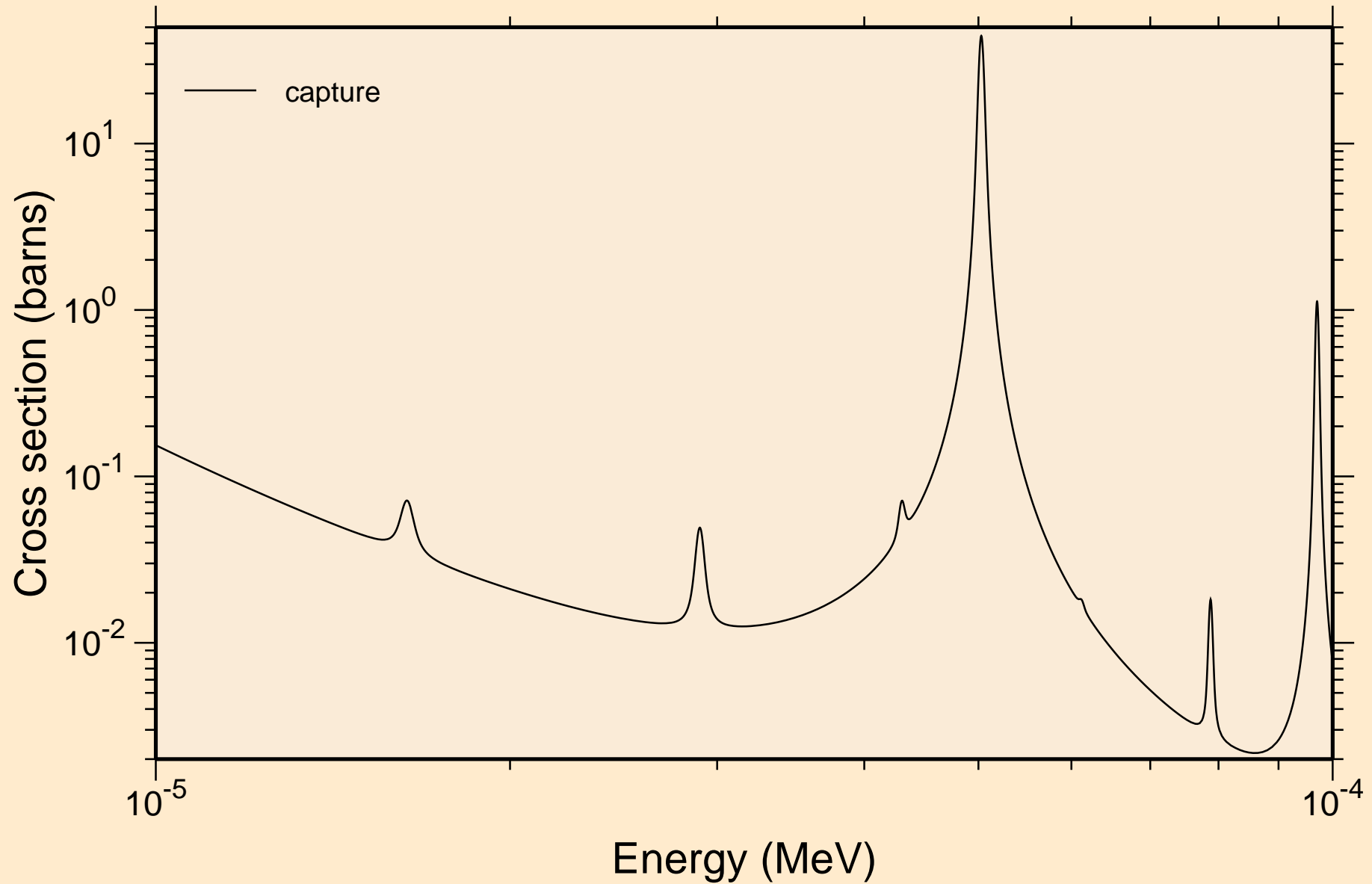

AG099 NEUTRON ACER TENDL-2021 LIBRARY; T=293.6K
resonance absorption cross sections

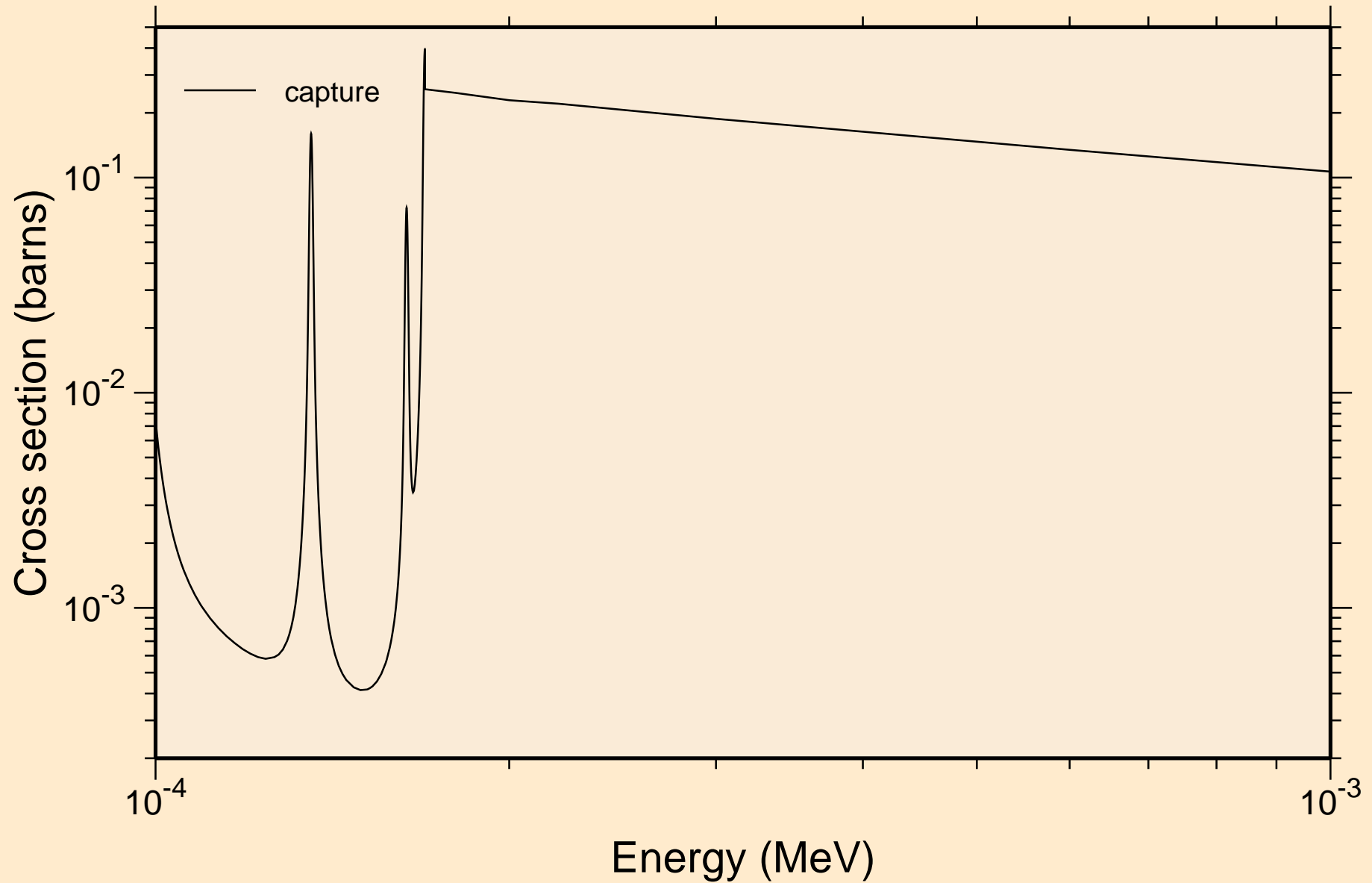

AG099 NEUTRON ACER TENDL-2021 LIBRARY; T=293.6K
resonance absorption cross sections

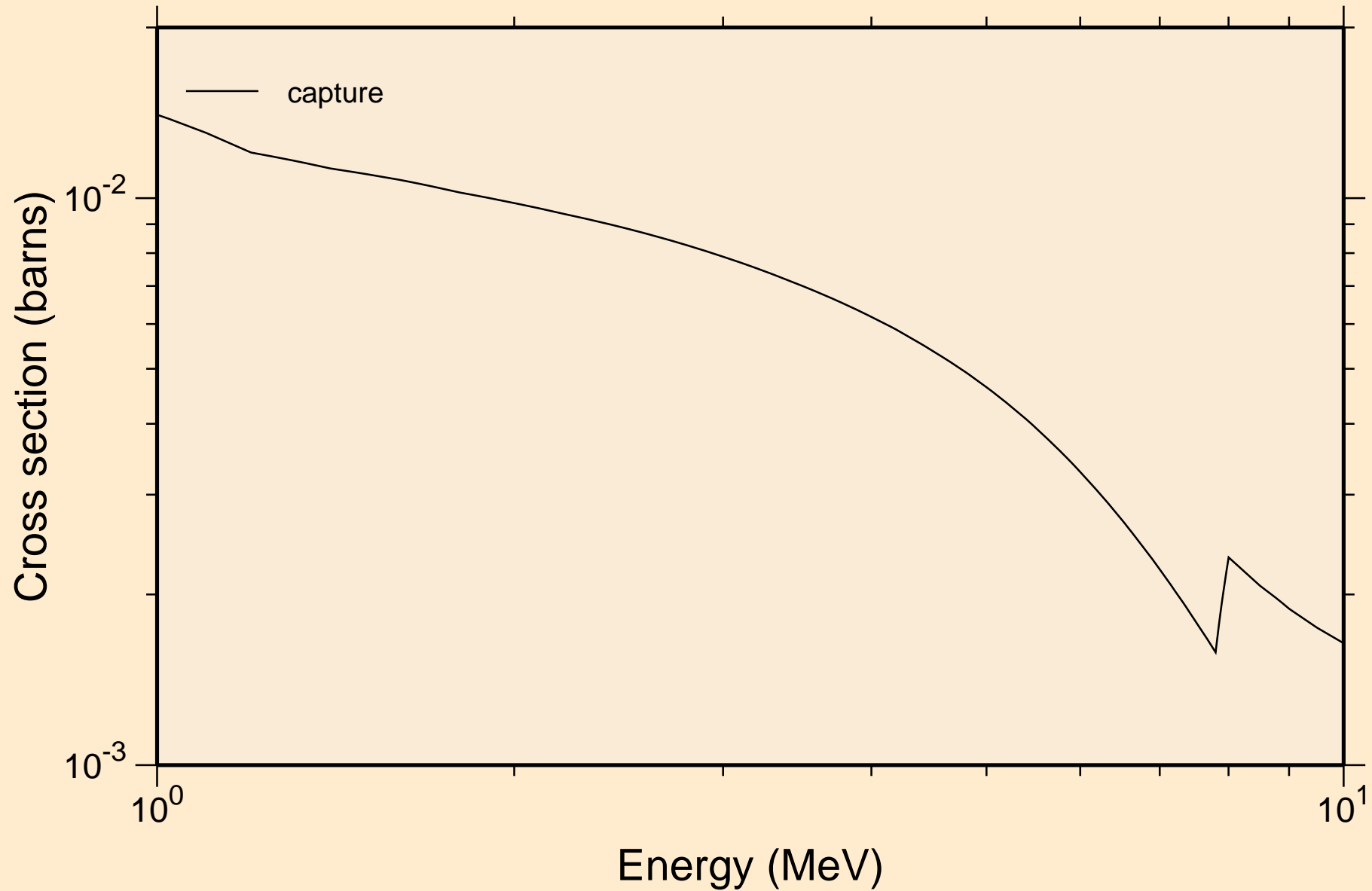

AG099 NEUTRON ACER TENDL-2021 LIBRARY; T=293.6K
Heating

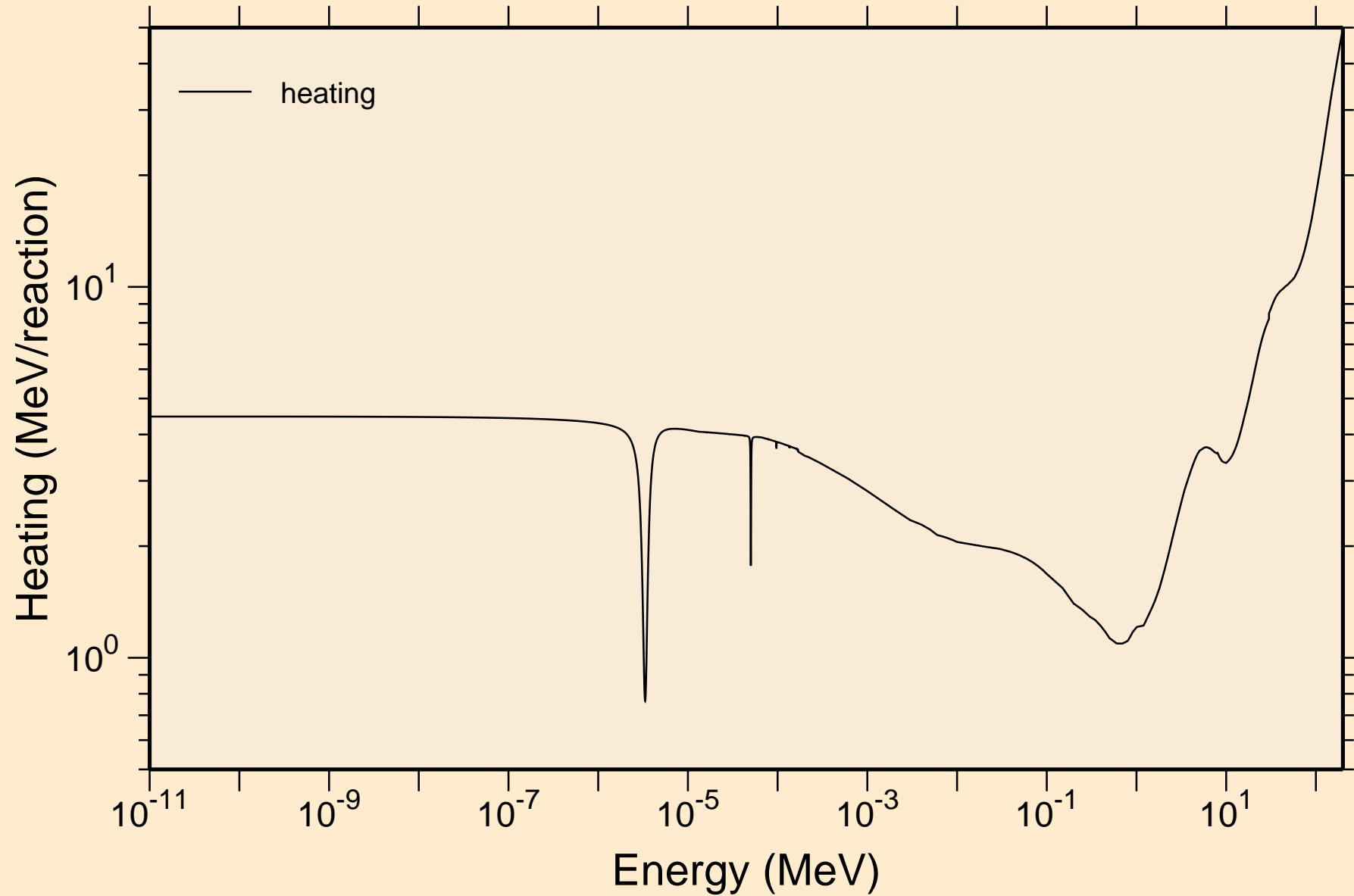

AG099 NEUTRON ACER TENDL-2021 LIBRARY; T=293.6K
Damage

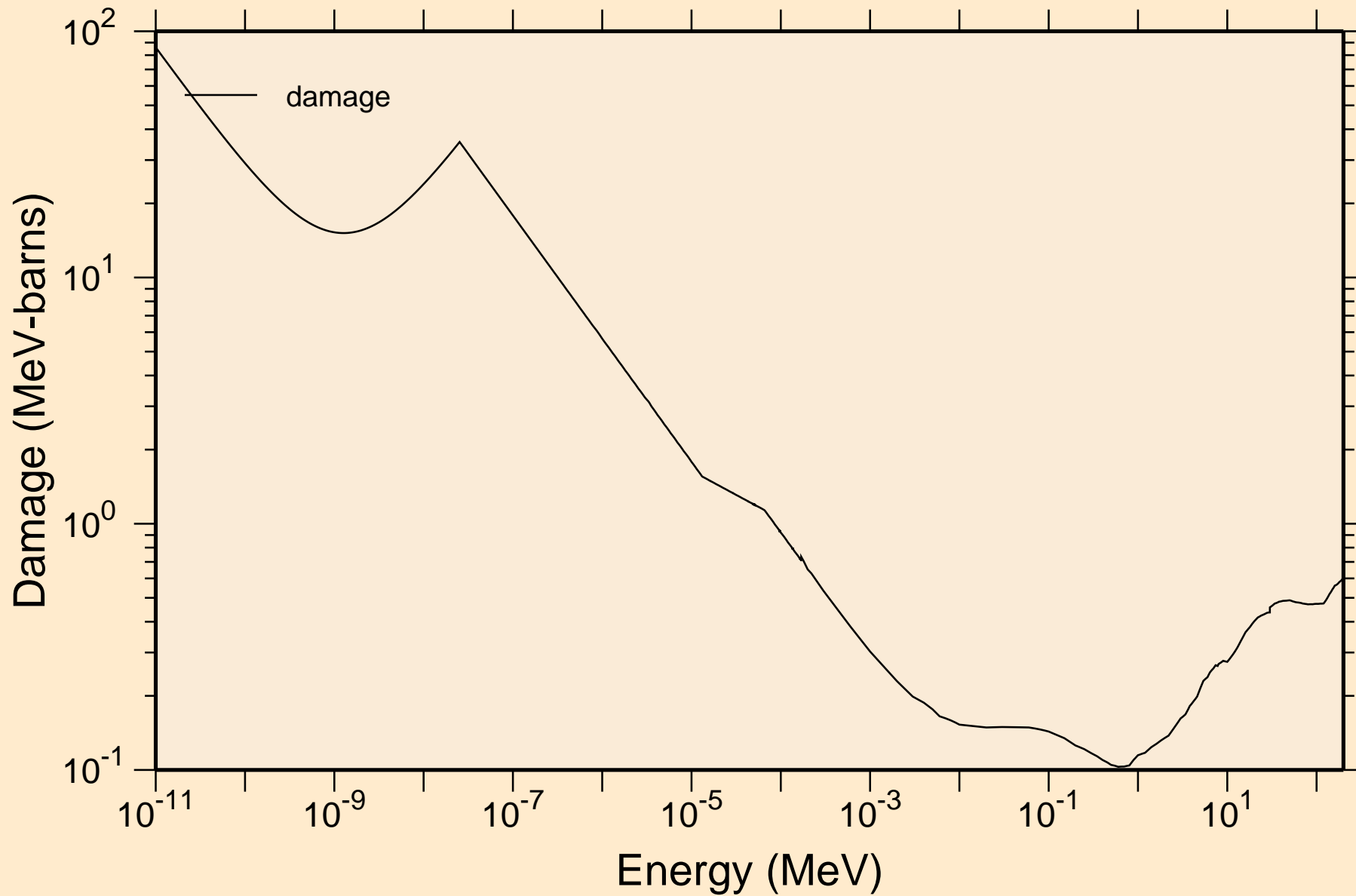

AG099 NEUTRON ACER TENDL-2021 LIBRARY; T=293.6K
Non-threshold reactions

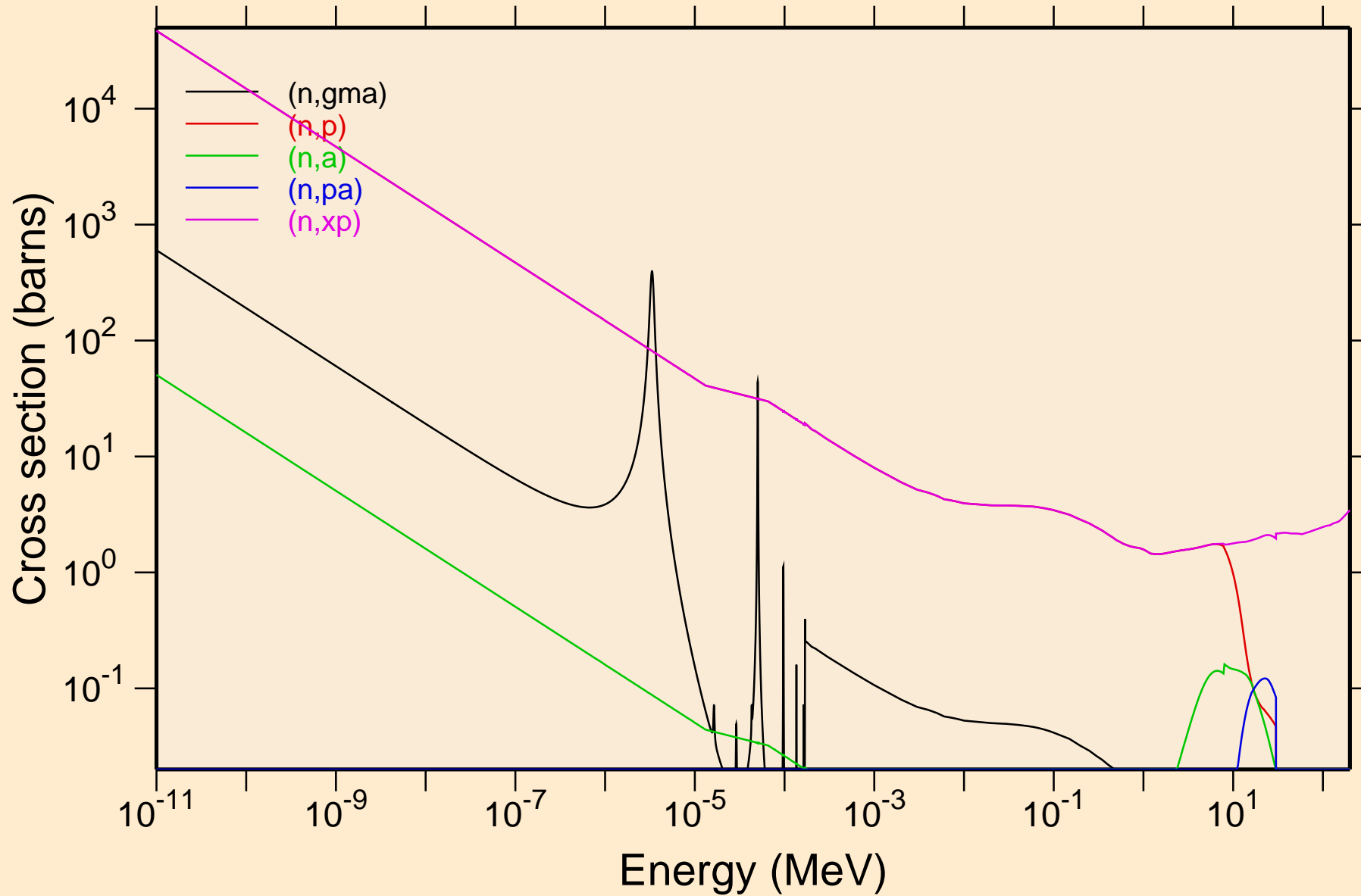

AG099 NEUTRON ACER TENDL-2021 LIBRARY; T=293.6K
Non-threshold reactions

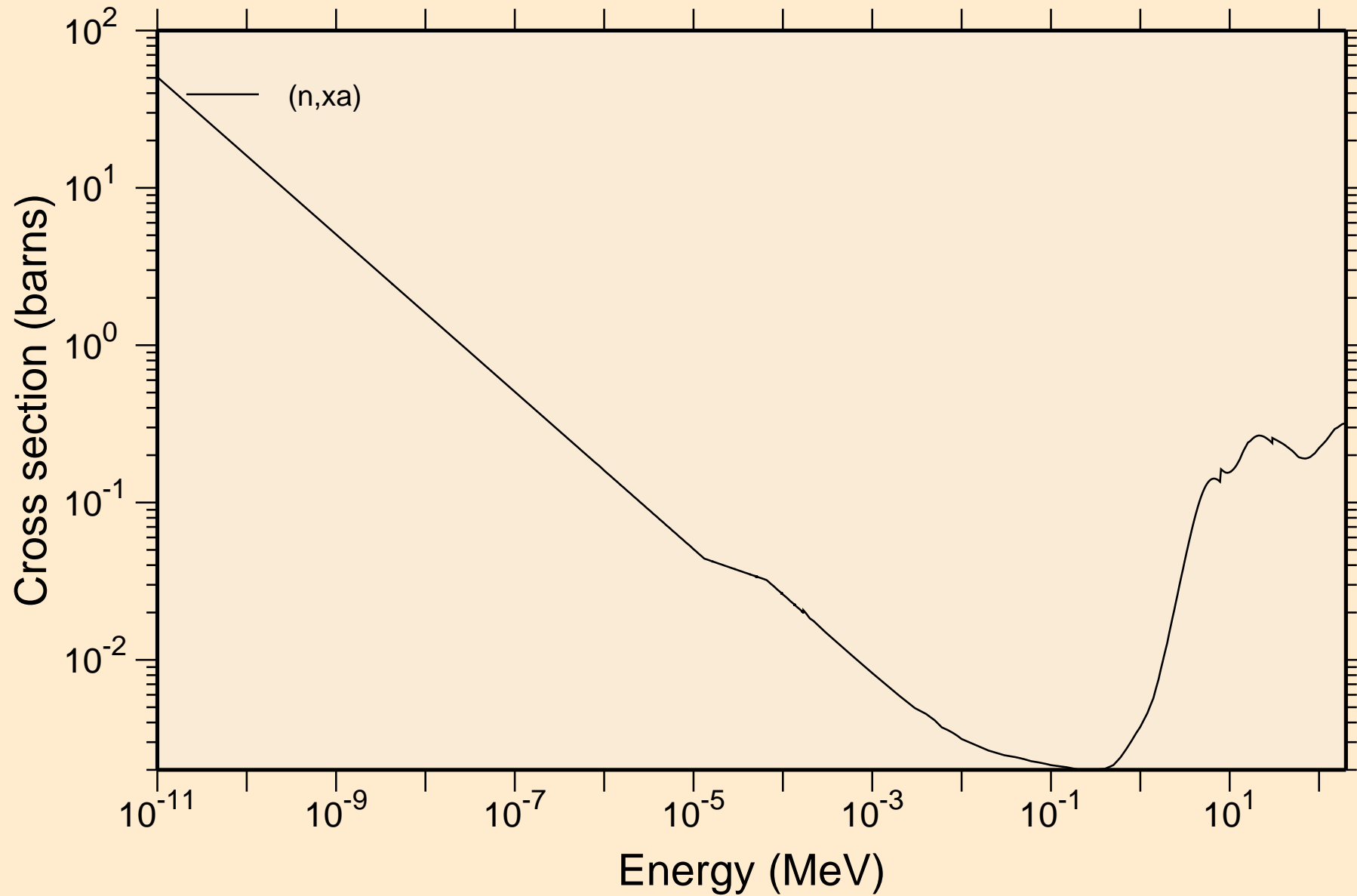

AG099 NEUTRON ACER TENDL-2021 LIBRARY; T=293.6K
Principal cross sections

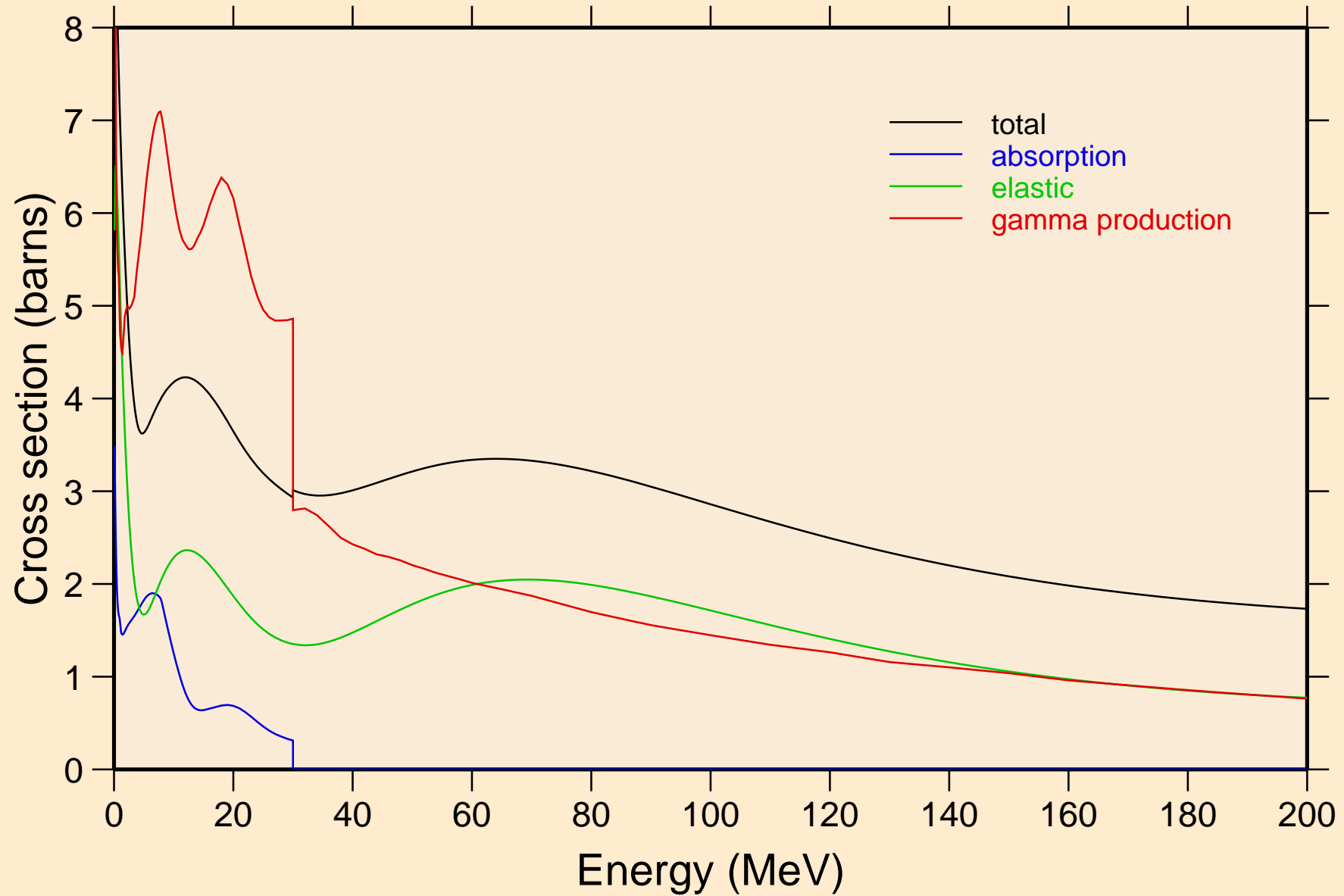

AG099 NEUTRON ACER TENDL-2021 LIBRARY; T=293.6K
Heating

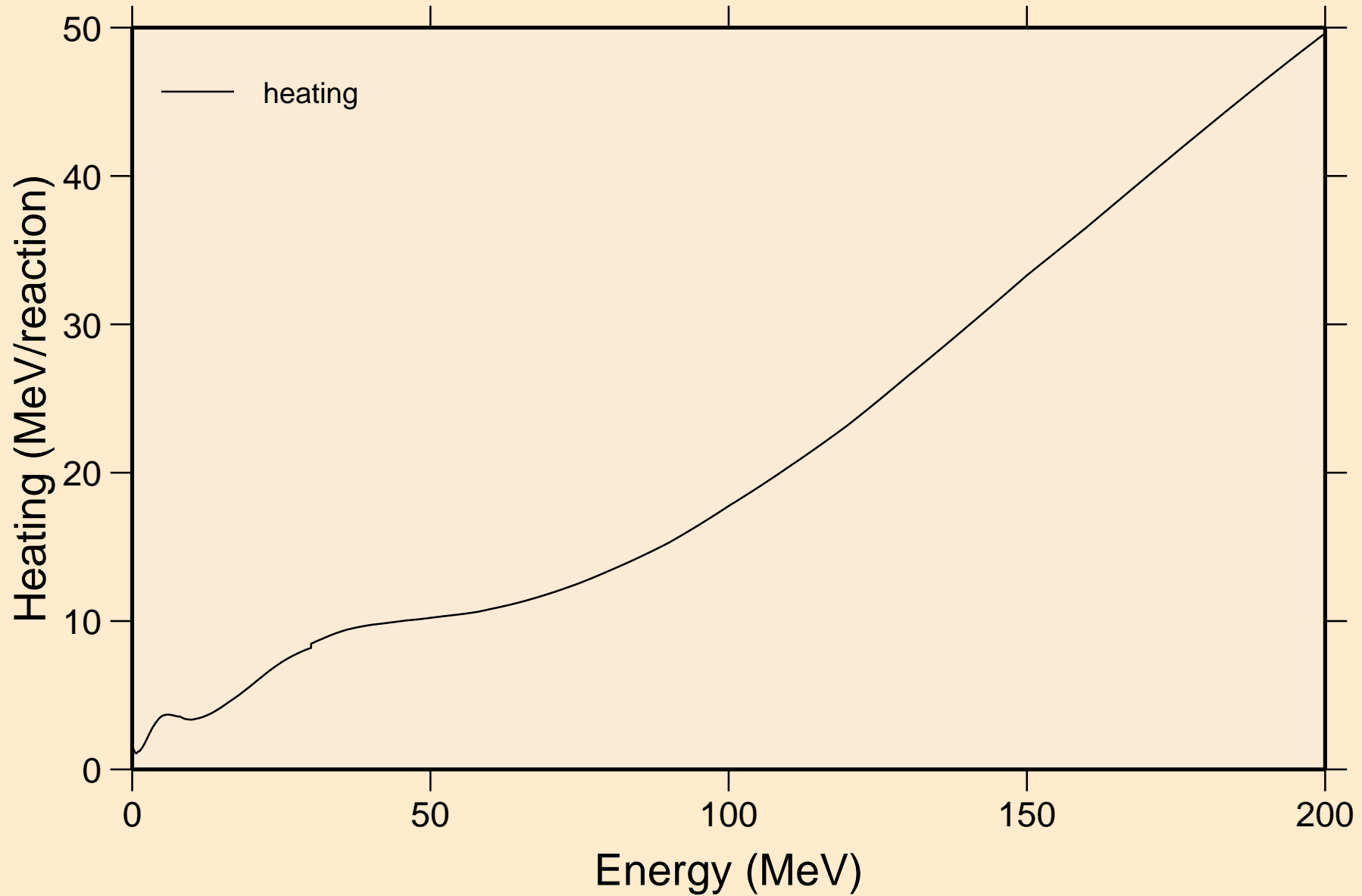

AG099 NEUTRON ACER TENDL-2021 LIBRARY; T=293.6K
Damage

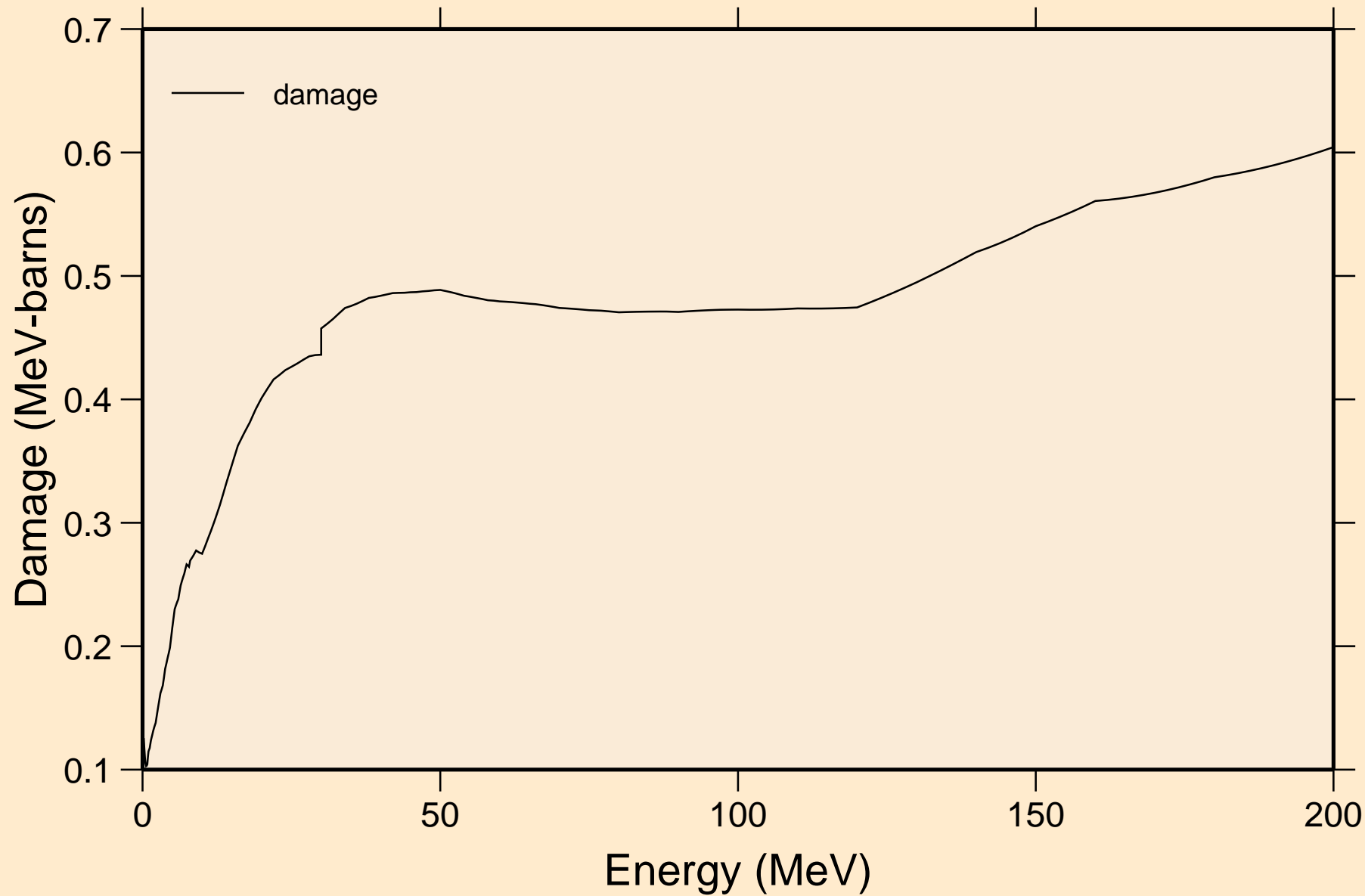

AG099 NEUTRON ACER TENDL-2021 LIBRARY; T=293.6K
Non-threshold reactions

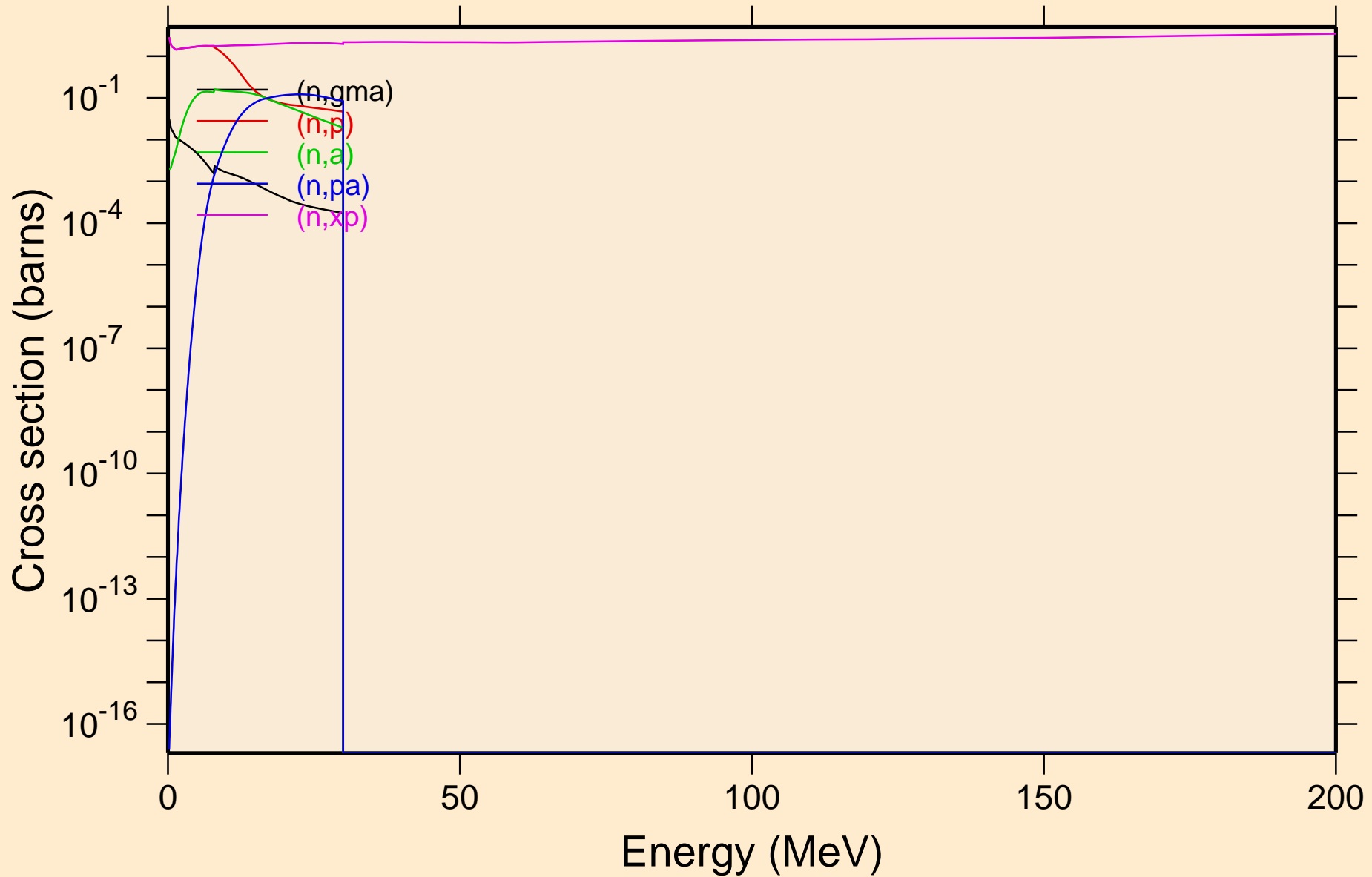

AG099 NEUTRON ACER TENDL-2021 LIBRARY; T=293.6K
Non-threshold reactions

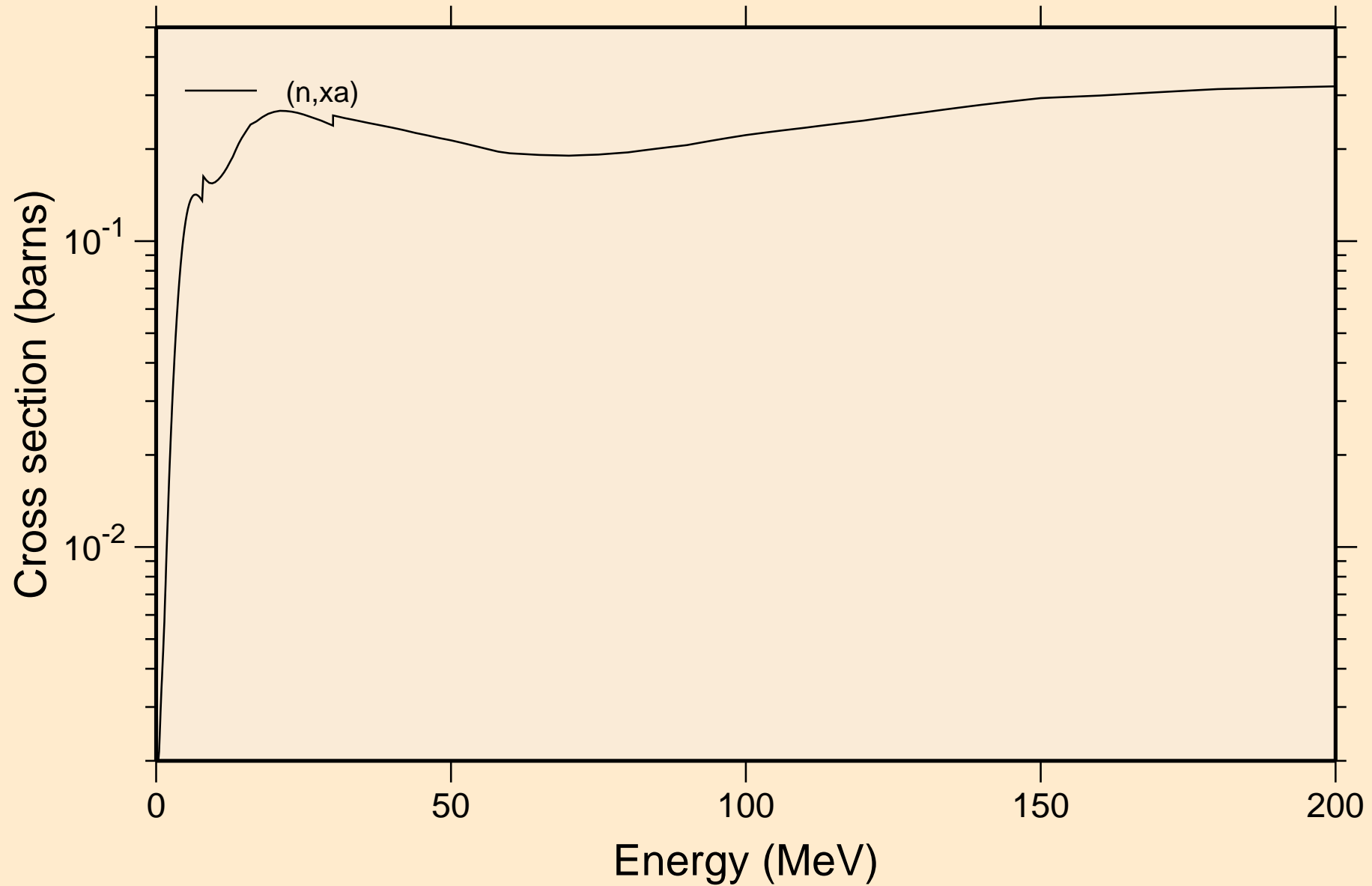

AG099 NEUTRON ACER TENDL-2021 LIBRARY; T=293.6K
Inelastic levels

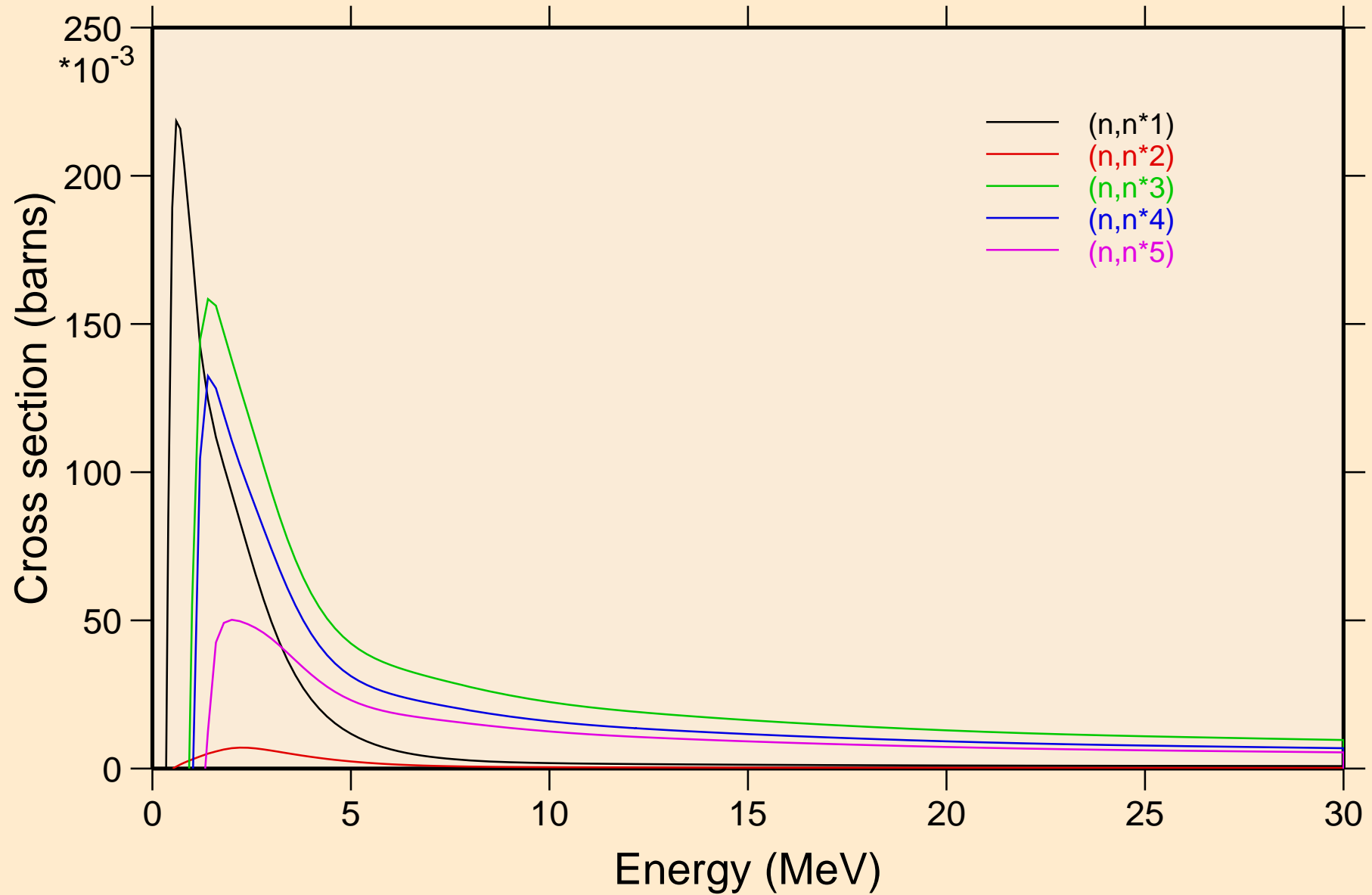

AG099 NEUTRON ACER TENDL-2021 LIBRARY; T=293.6K
Inelastic levels

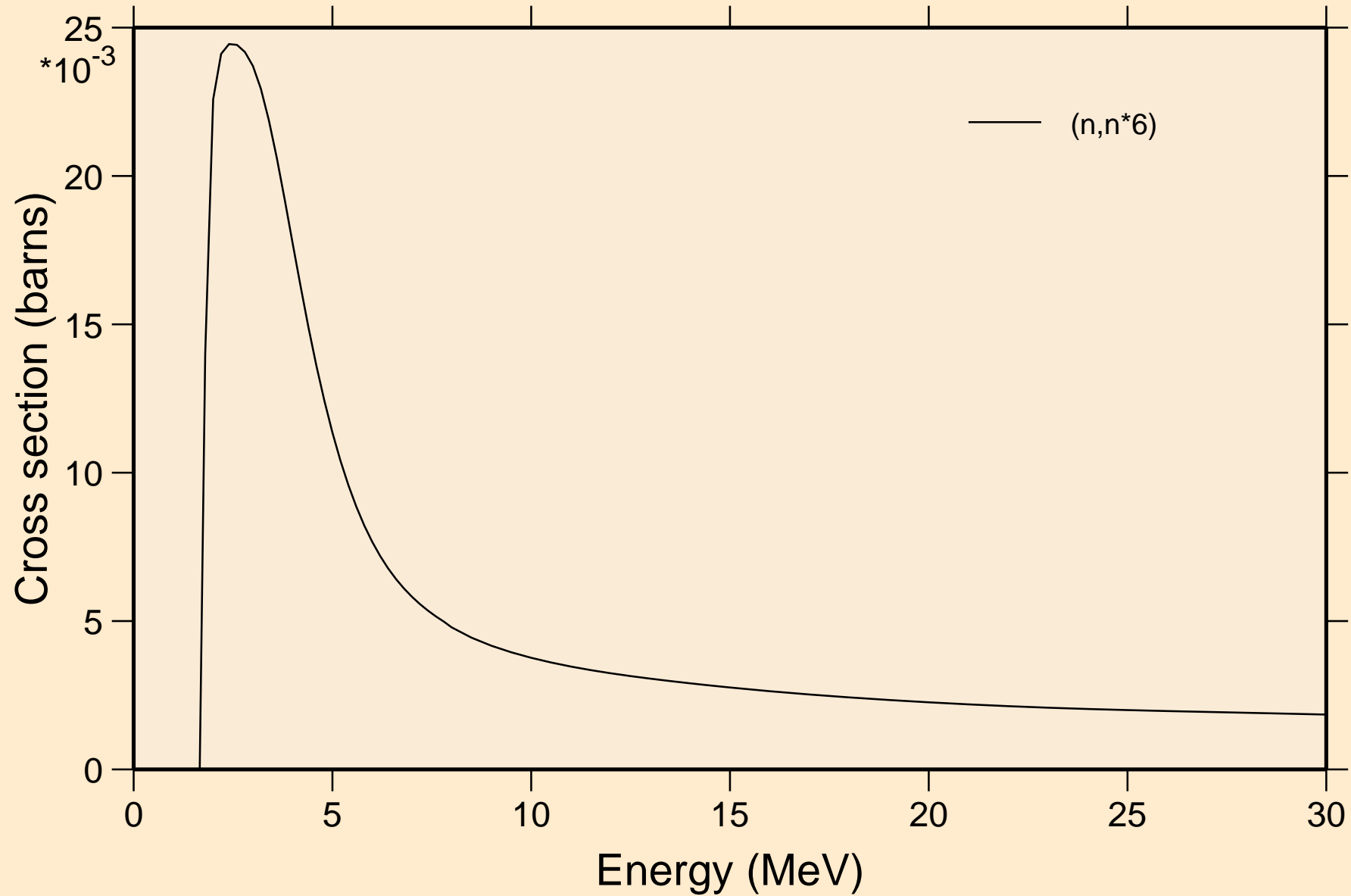

AG099 NEUTRON ACER TENDL-2021 LIBRARY; T=293.6K
Threshold reactions

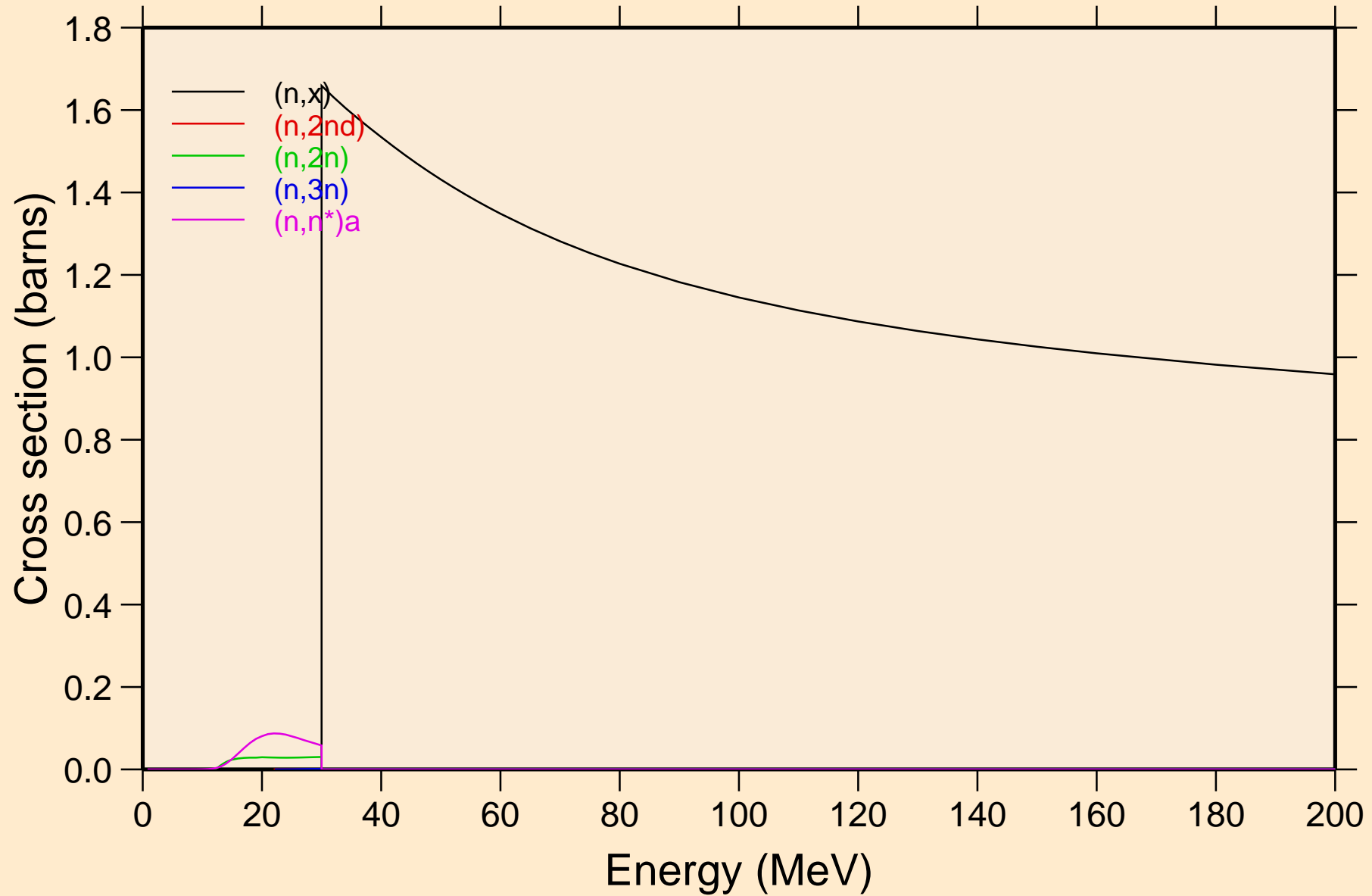

AG099 NEUTRON ACER TENDL-2021 LIBRARY; T=293.6K
Threshold reactions

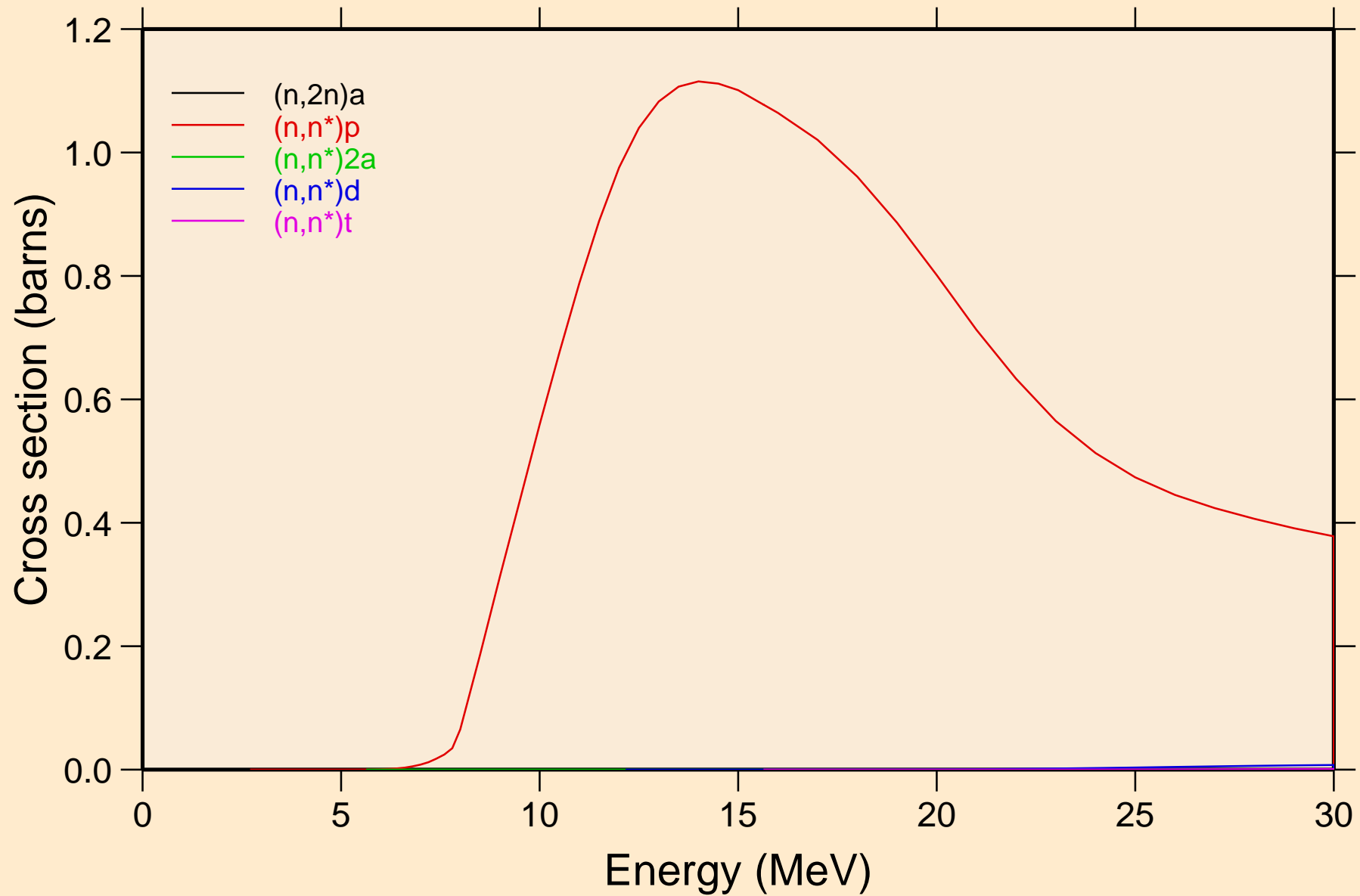

AG099 NEUTRON ACER TENDL-2021 LIBRARY; T=293.6K
Threshold reactions

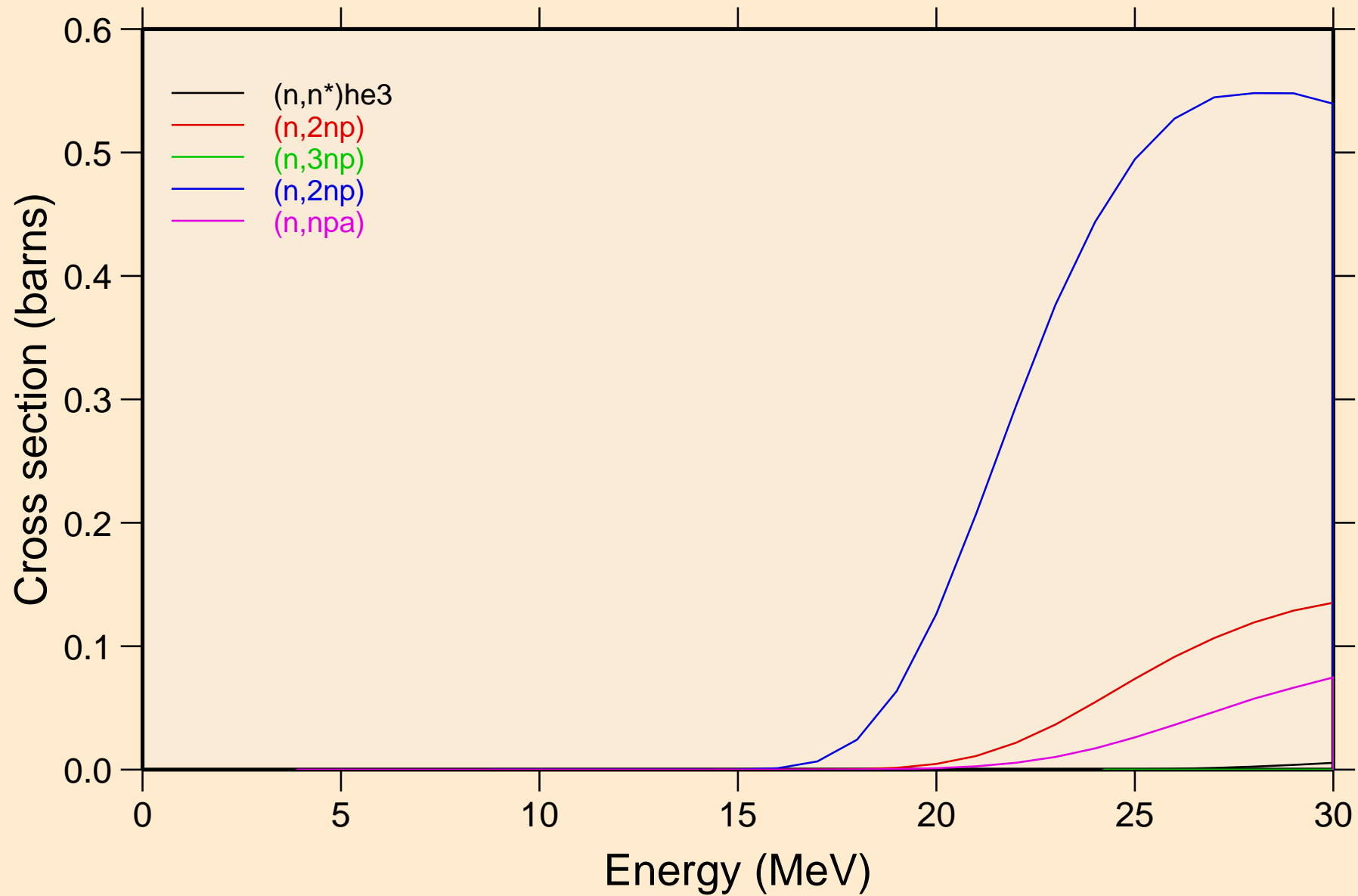

AG099 NEUTRON ACER TENDL-2021 LIBRARY; T=293.6K
Threshold reactions

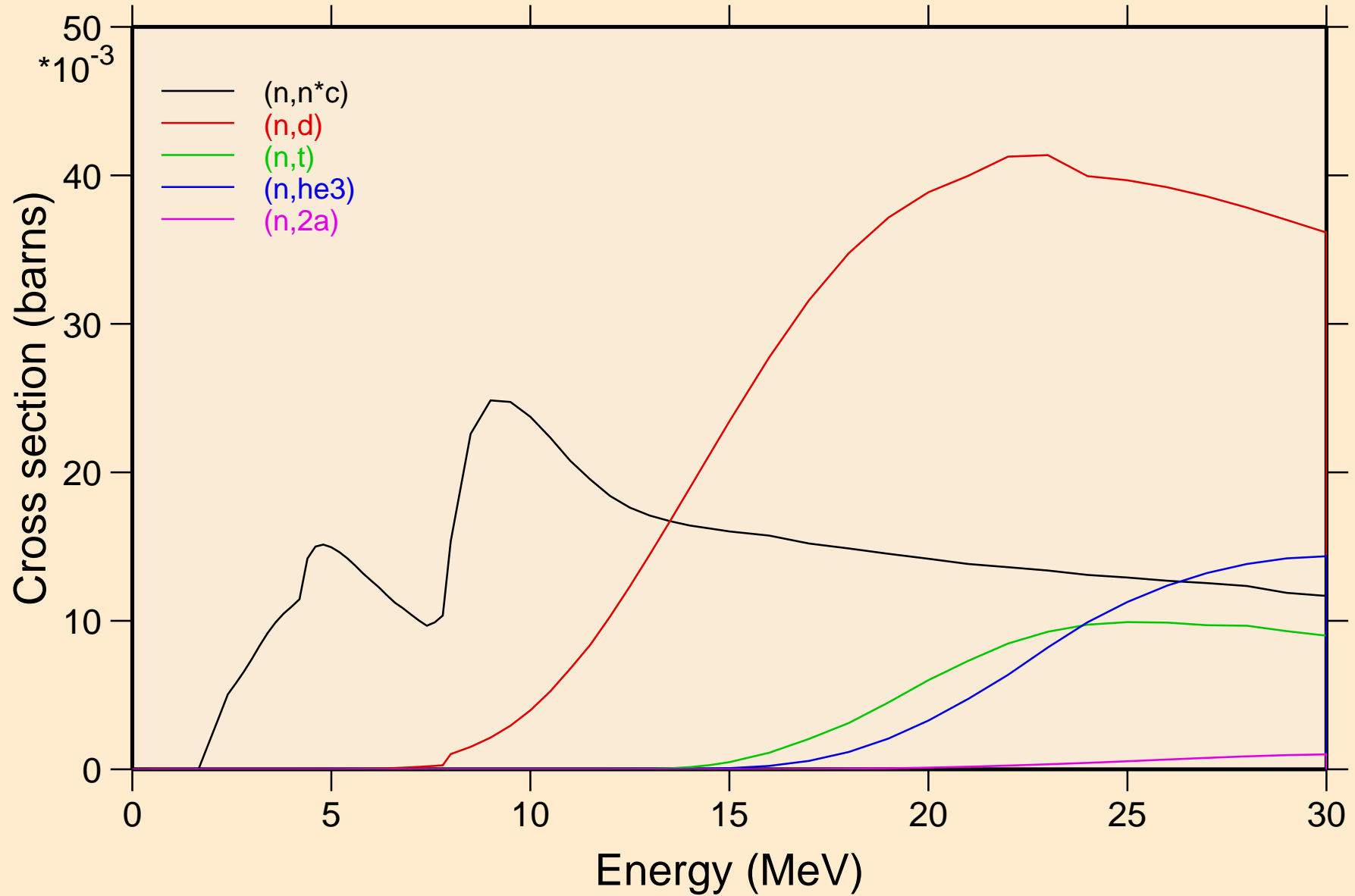

AG099 NEUTRON ACER TENDL-2021 LIBRARY; T=293.6K
Threshold reactions

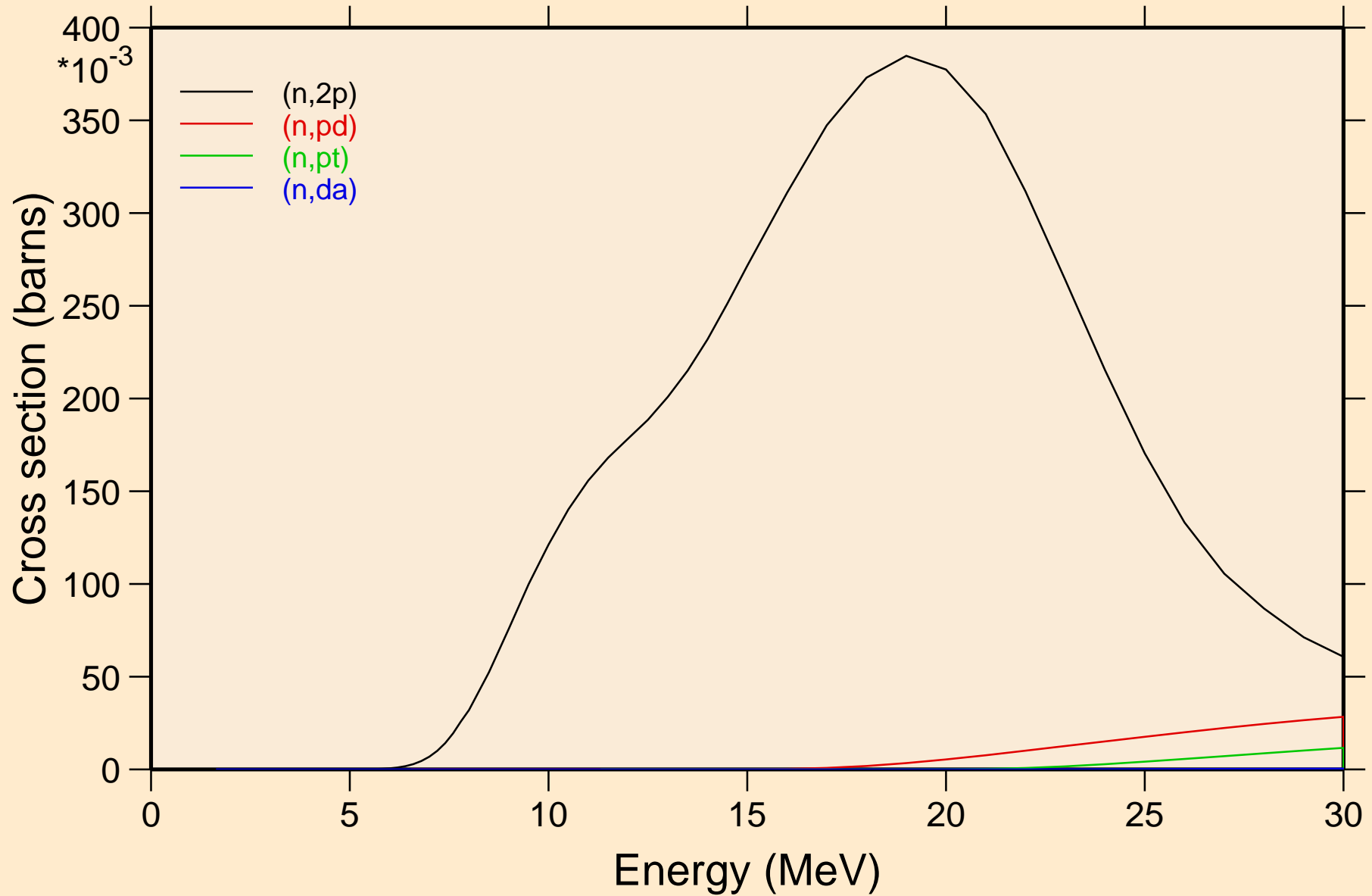

AG099 NEUTRON ACER TENDL-2021 LIBRARY; T=293.6K
Threshold reactions

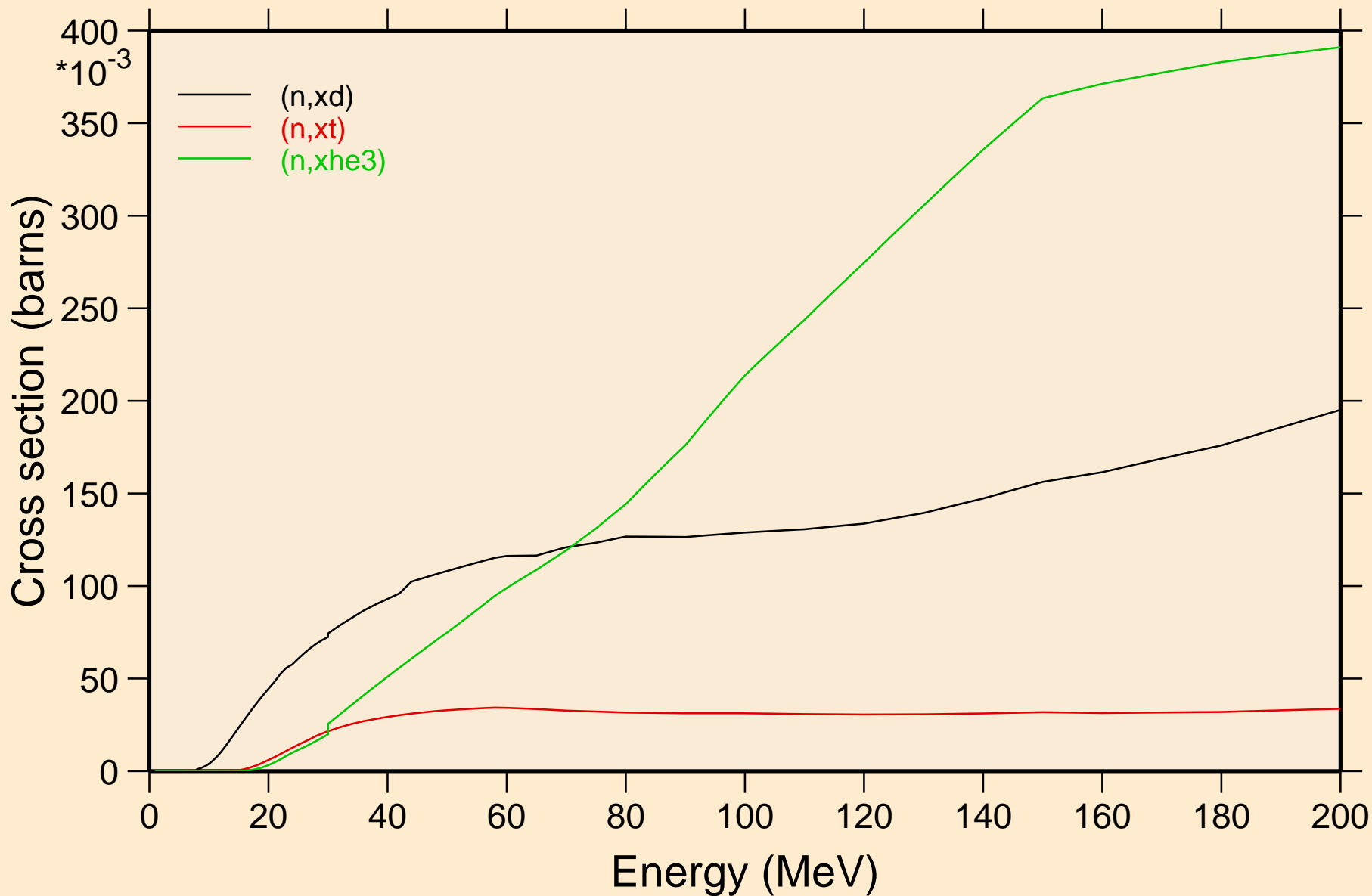

AG099 NEUTRON ACER TENDL-2021 LIBRARY; T=293.6K
angular distribution for elastic

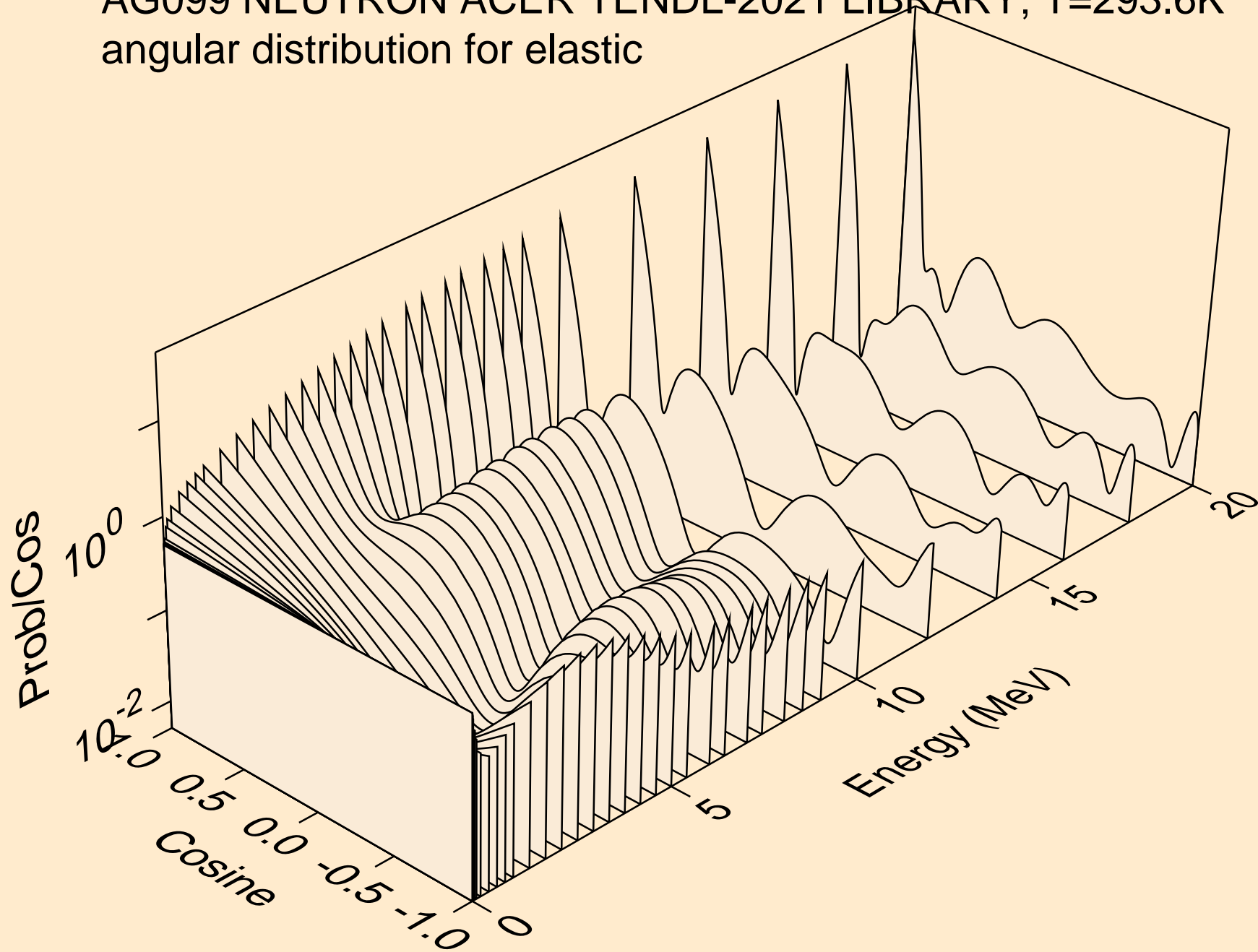

AG099 NEUTRON ACER TENDL-2021 LIBRARY; T=293.6K
angular distribution for elastic

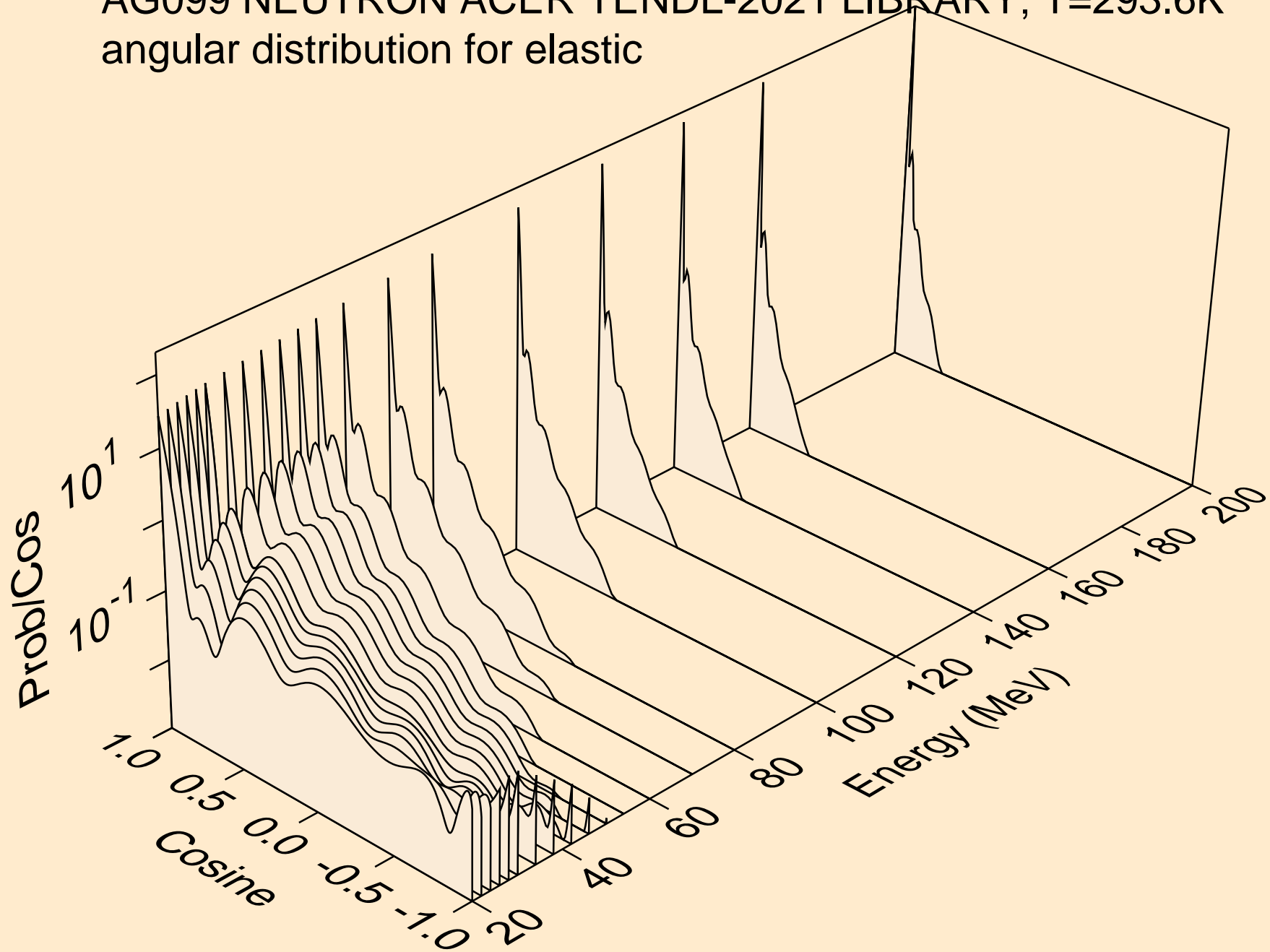

AG099 NEUTRON ACER TENDL-2021 LIBRARY; T=293.6K
angular distribution for (n,n*1)

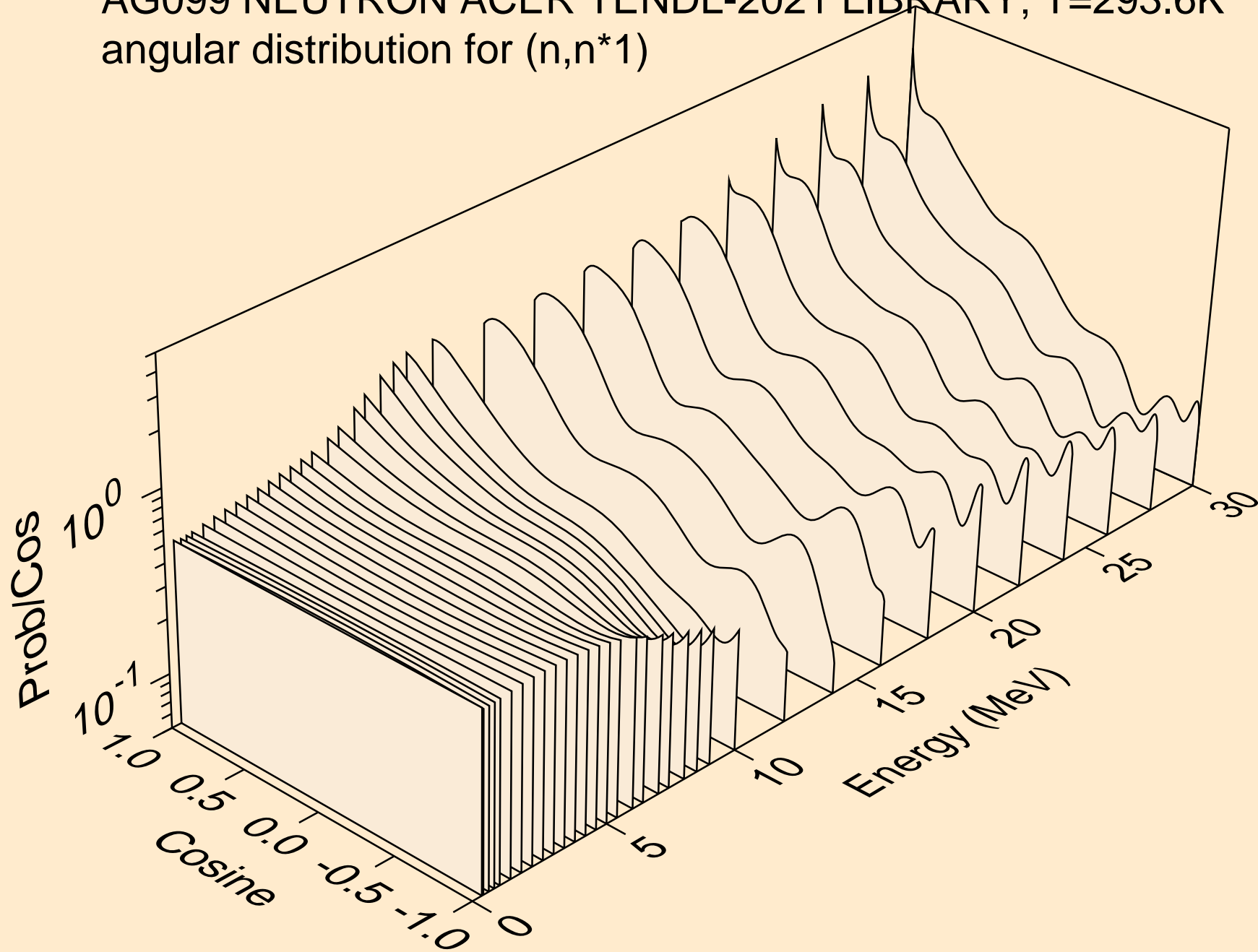

AG099 NEUTRON ACER TENDL-2021 LIBRARY; T=293.6K
angular distribution for (n,n*2)

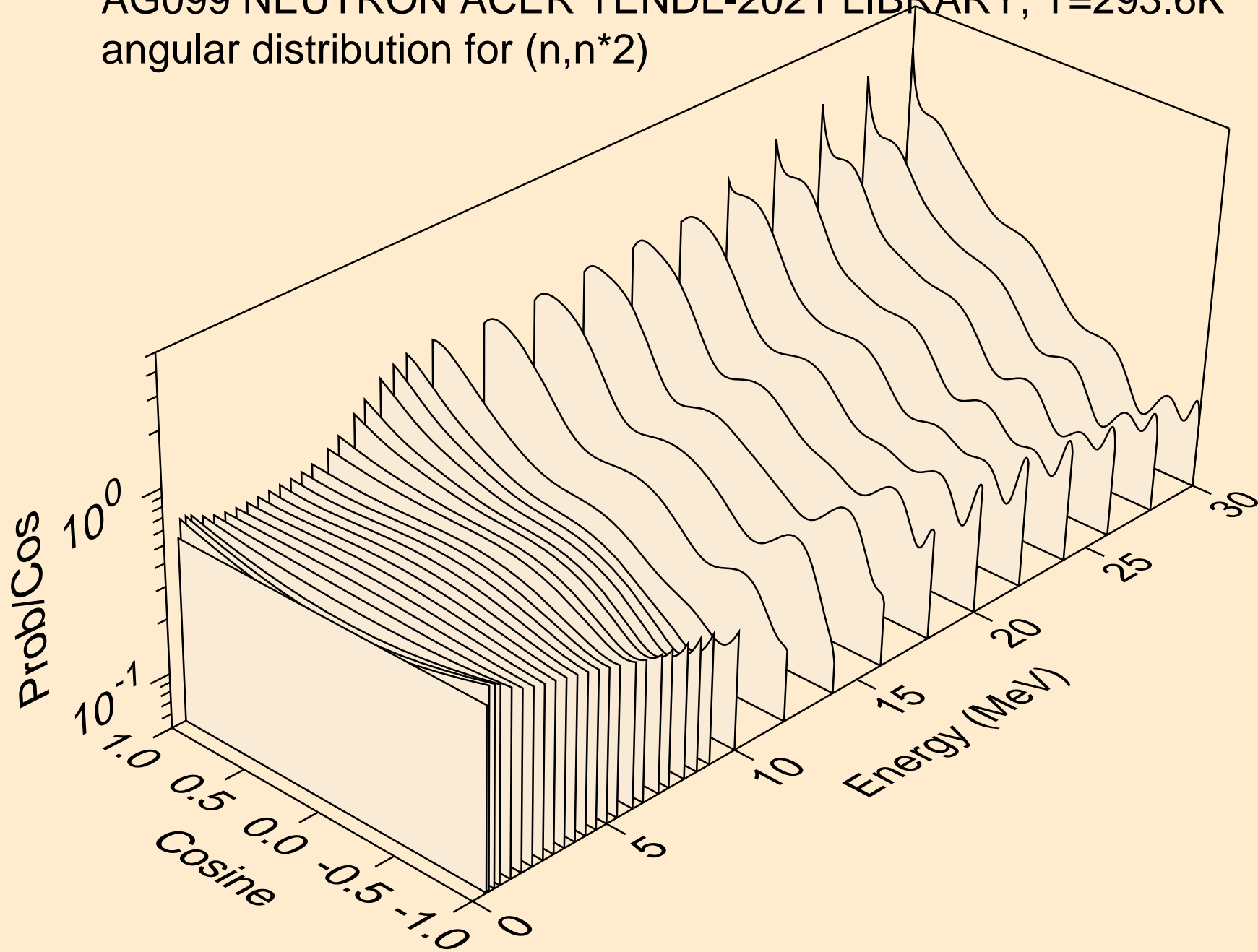

AG099 NEUTRON ACER TENDL-2021 LIBRARY; T=293.6K
angular distribution for (n,n*3)

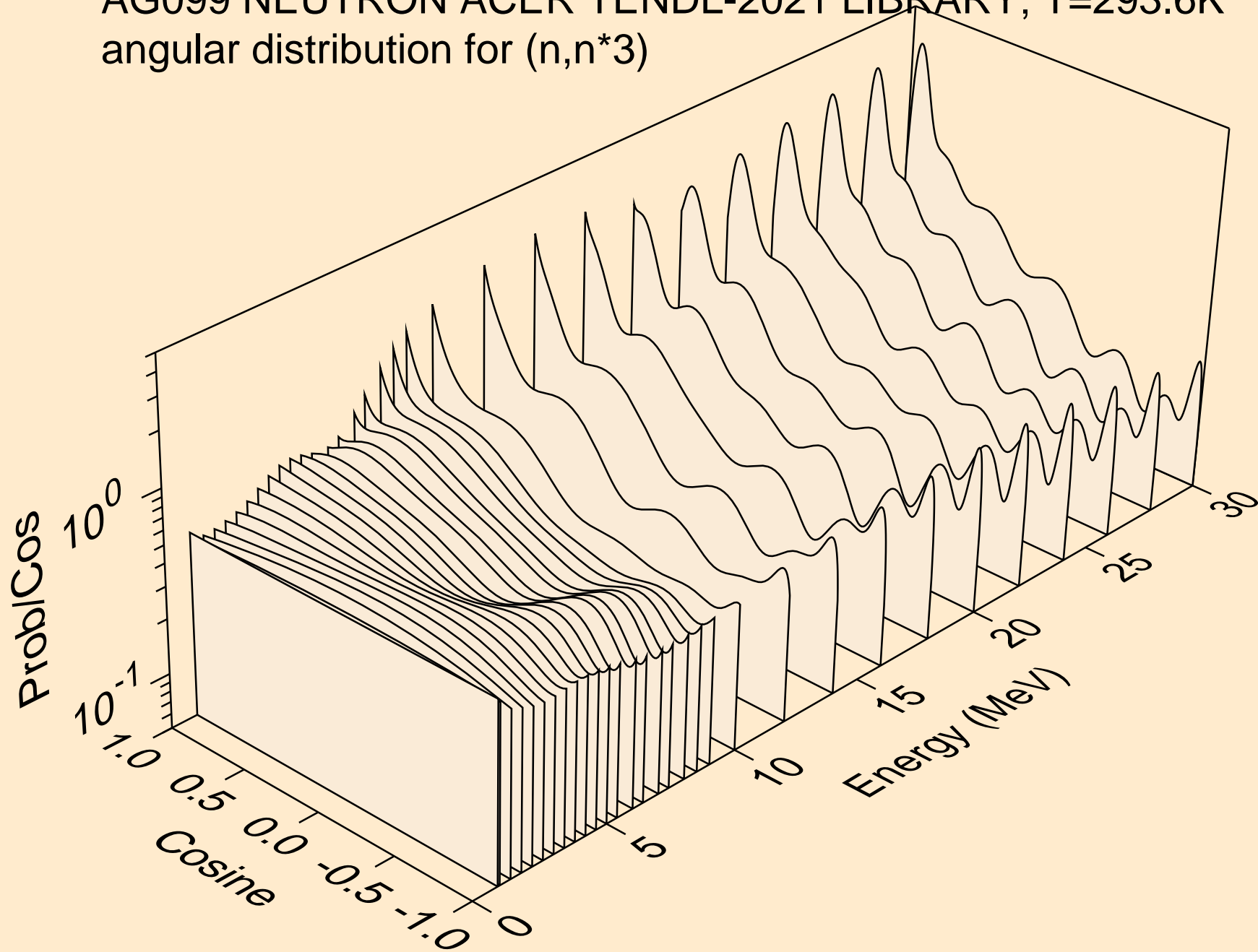

AG099 NEUTRON ACER TENDL-2021 LIBRARY; T=293.6K
angular distribution for (n,n*4)

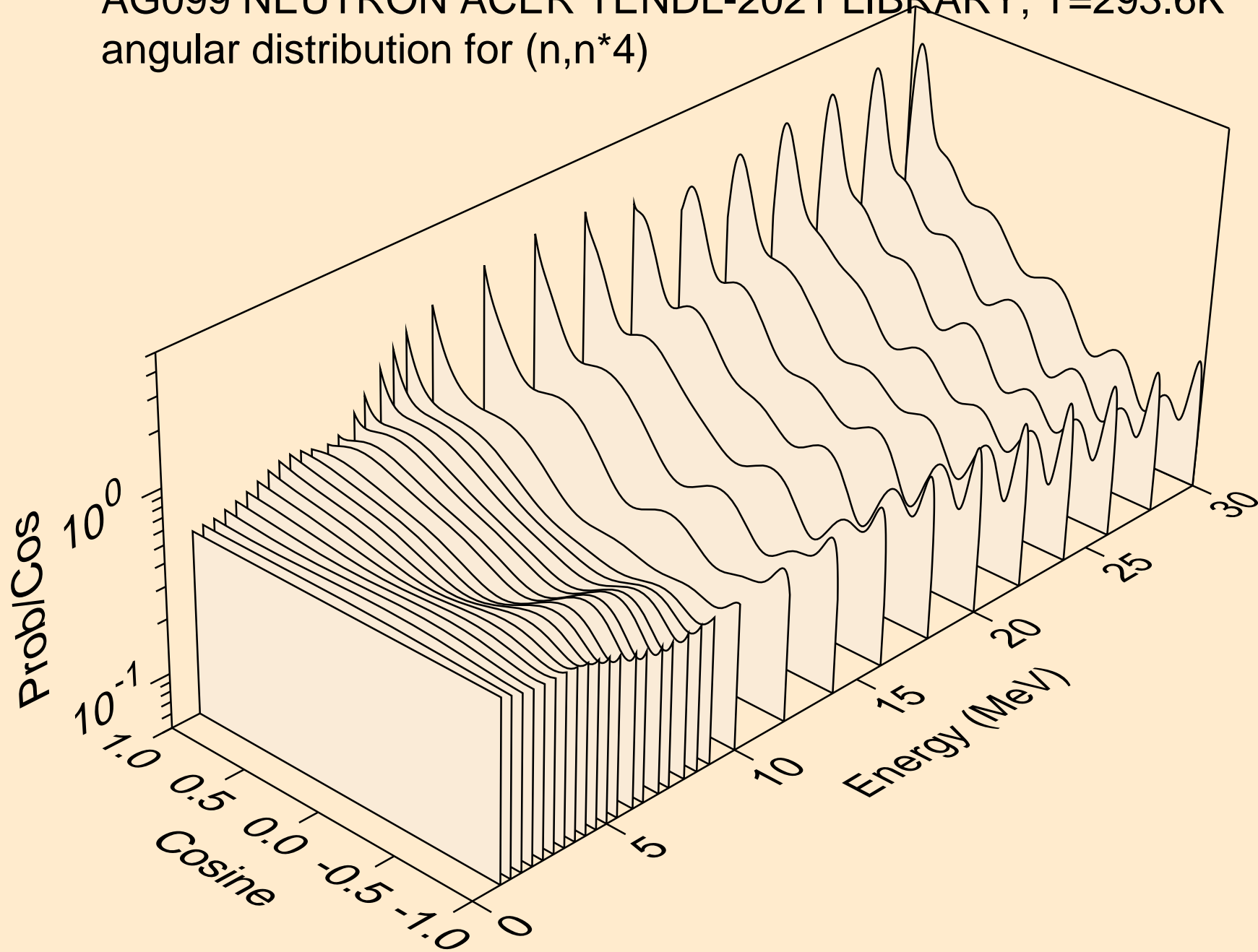

AG099 NEUTRON ACER TENDL-2021 LIBRARY; T=293.6K
angular distribution for (n,n*5)

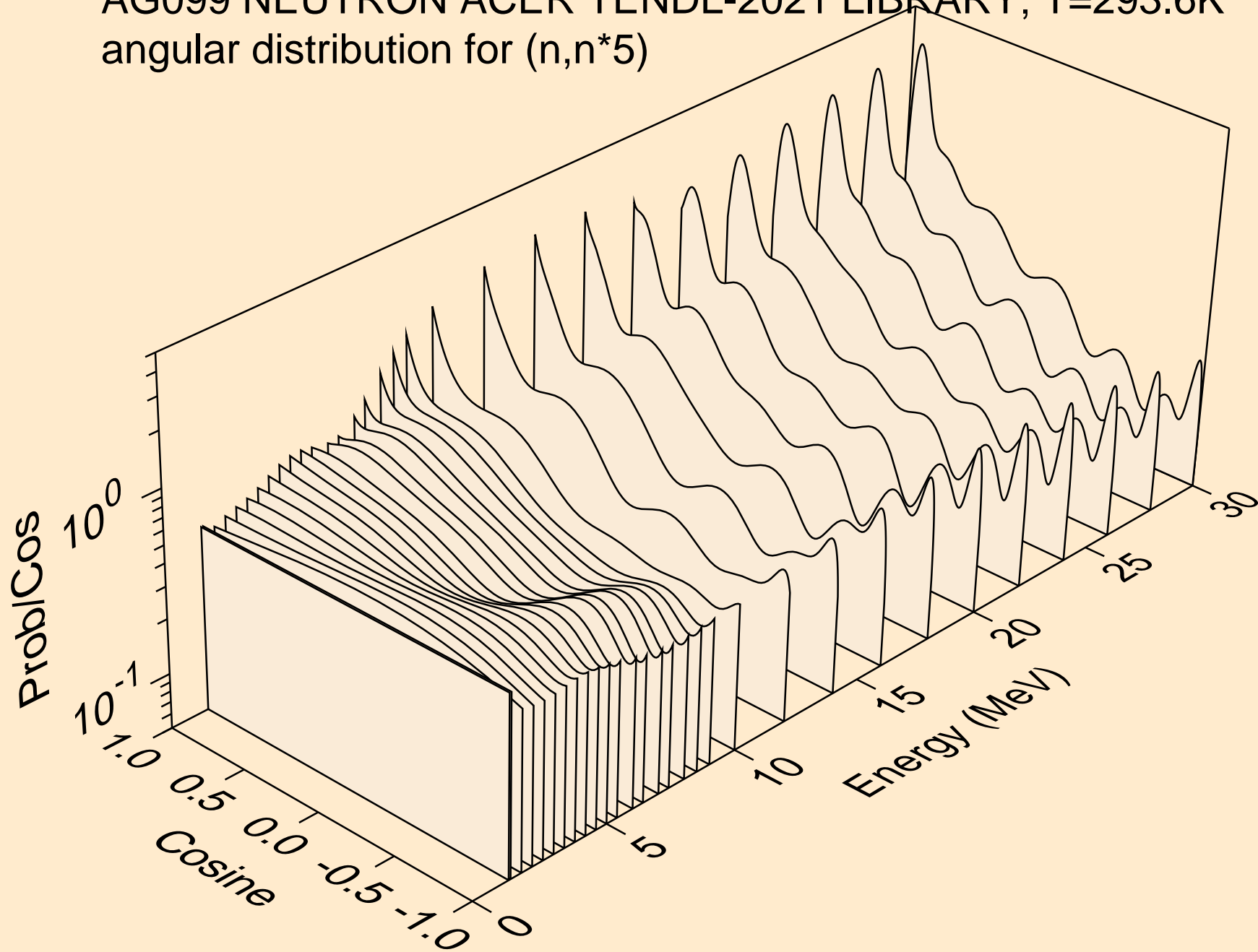

AG099 NEUTRON ACER TENDL-2021 LIBRARY; T=293.6K
angular distribution for (n,n*6)

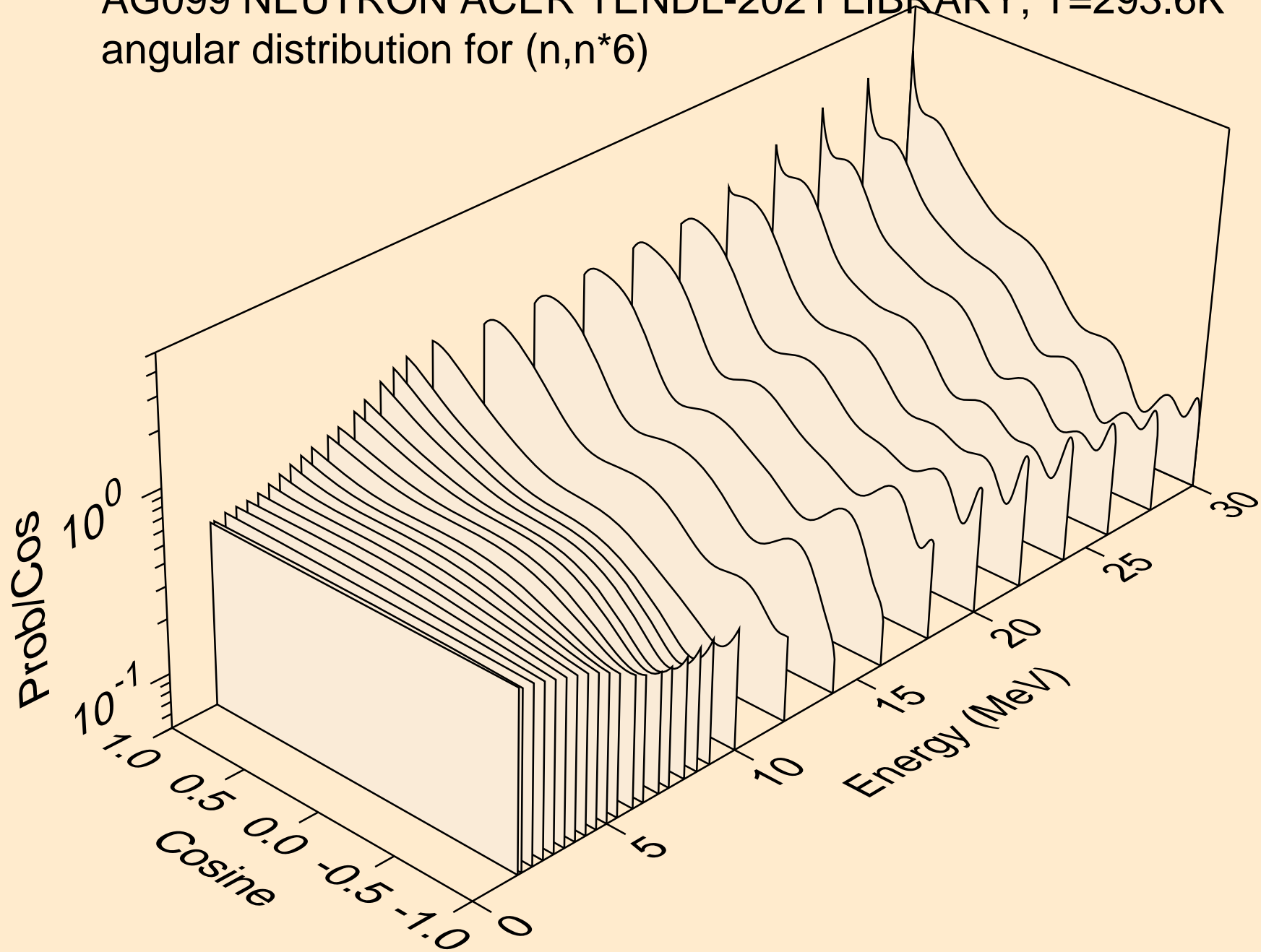

AG099 NEUTRON ACER TENDL-2021 LIBRARY; T=293.6K
Neutron emission for (n,x)

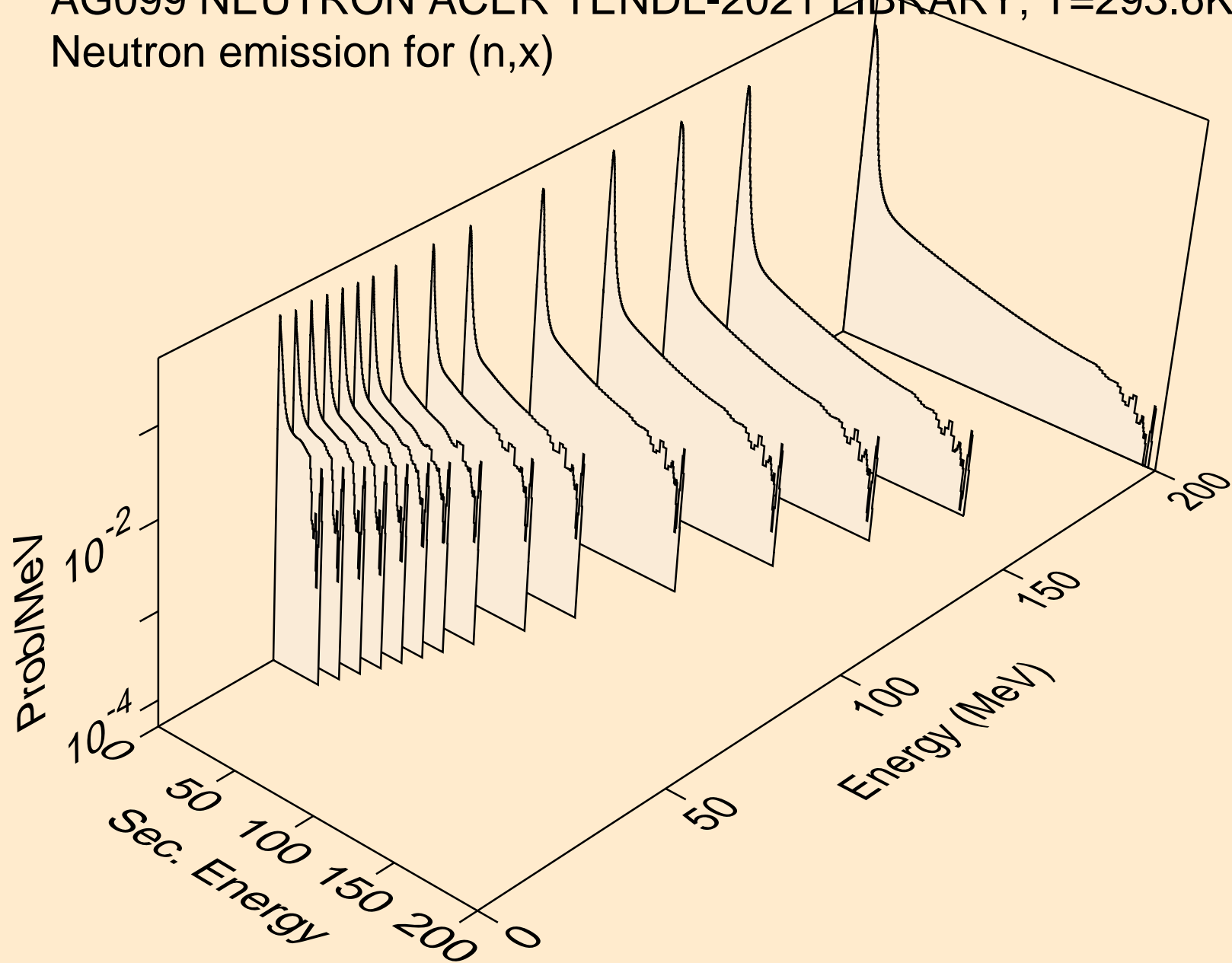

AG099 NEUTRON ACER TENDL-2021 LIBRARY; T=293.6K
Neutron emission for (n,2nd)

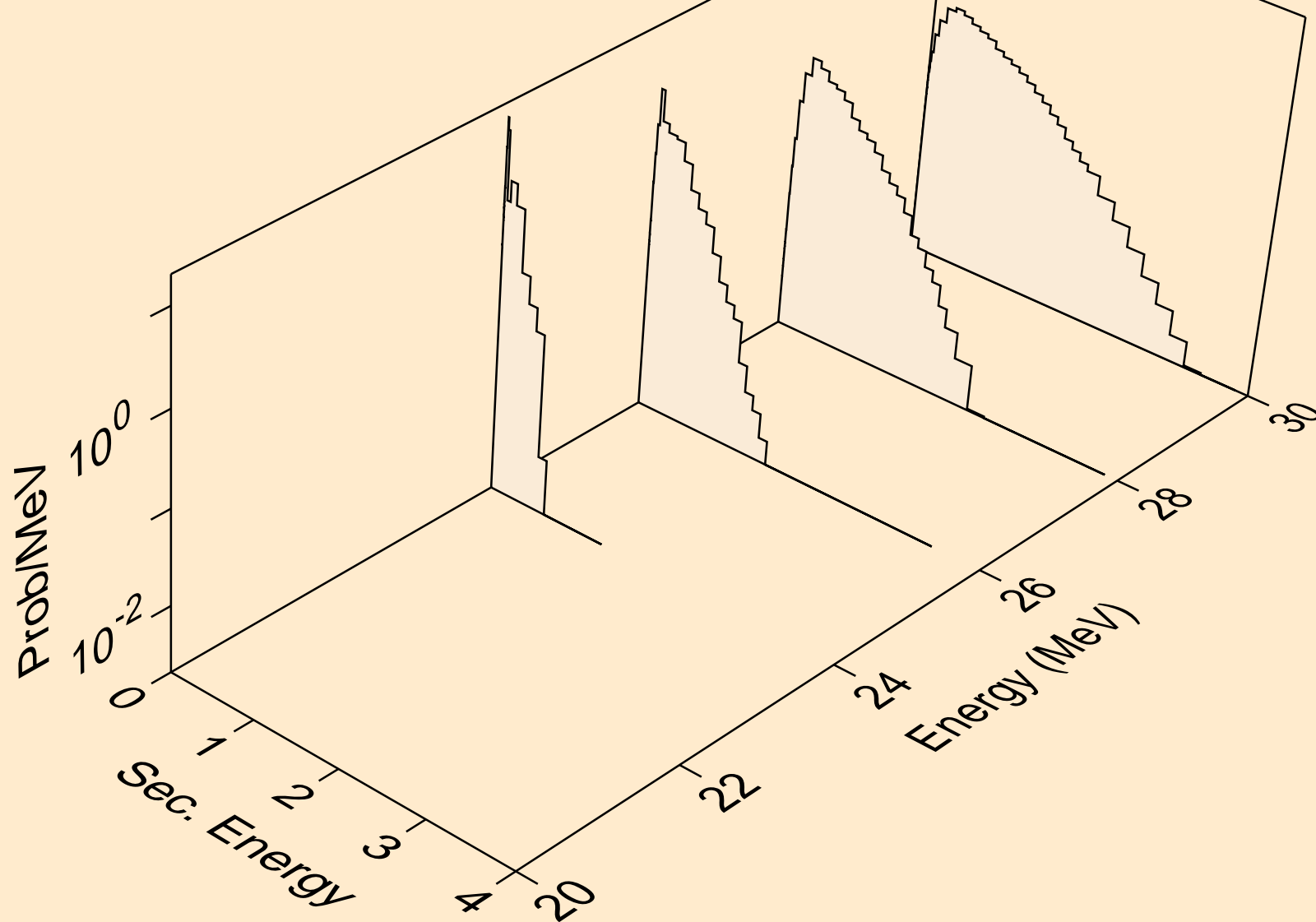

AG099 NEUTRON ACER TENDL-2021 LIBRARY; T=293.6K
Neutron emission for (n,2n)

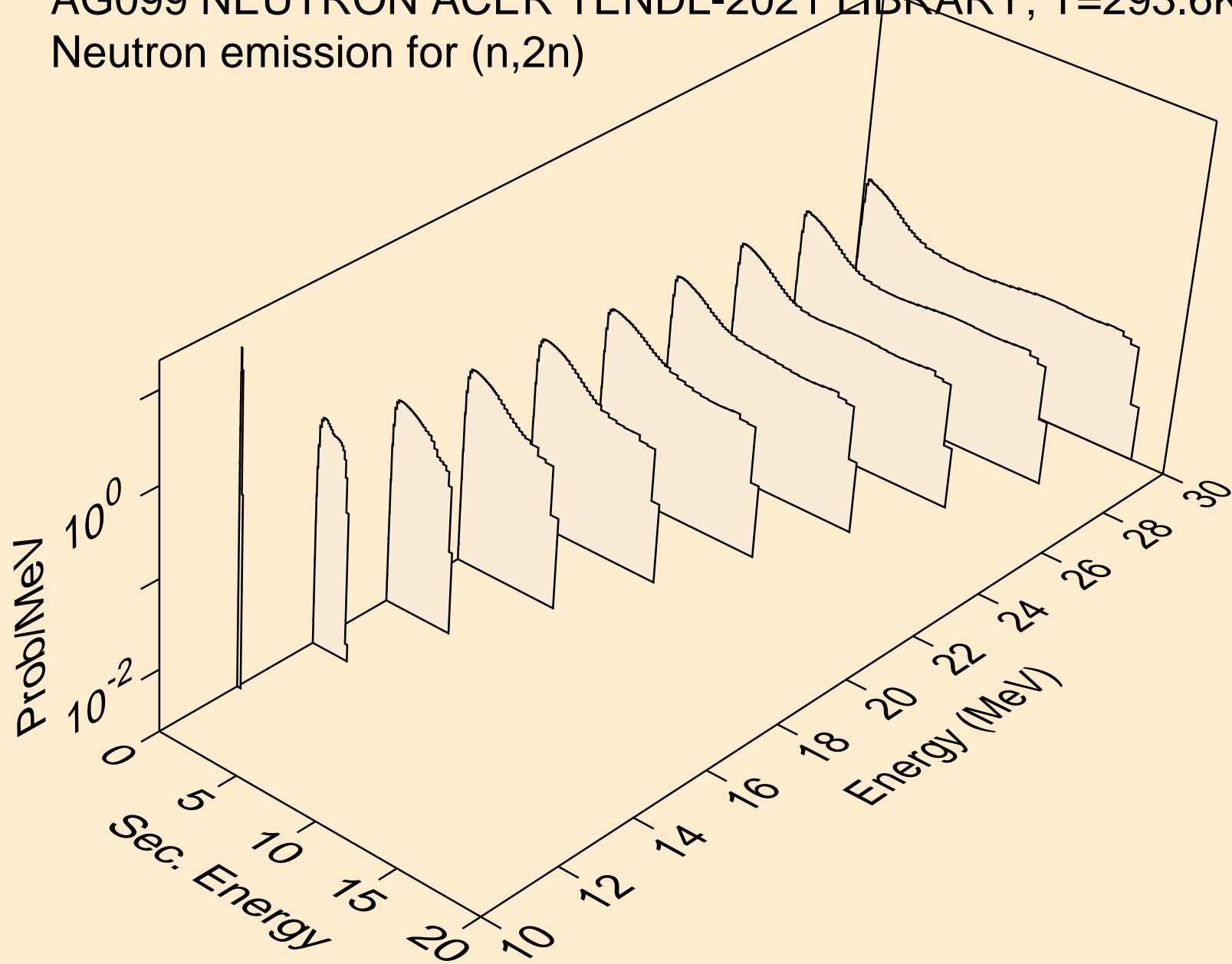

AG099 NEUTRON ACER TENDL-2021 LIBRARY; T=293.6K
Neutron emission for (n,3n)

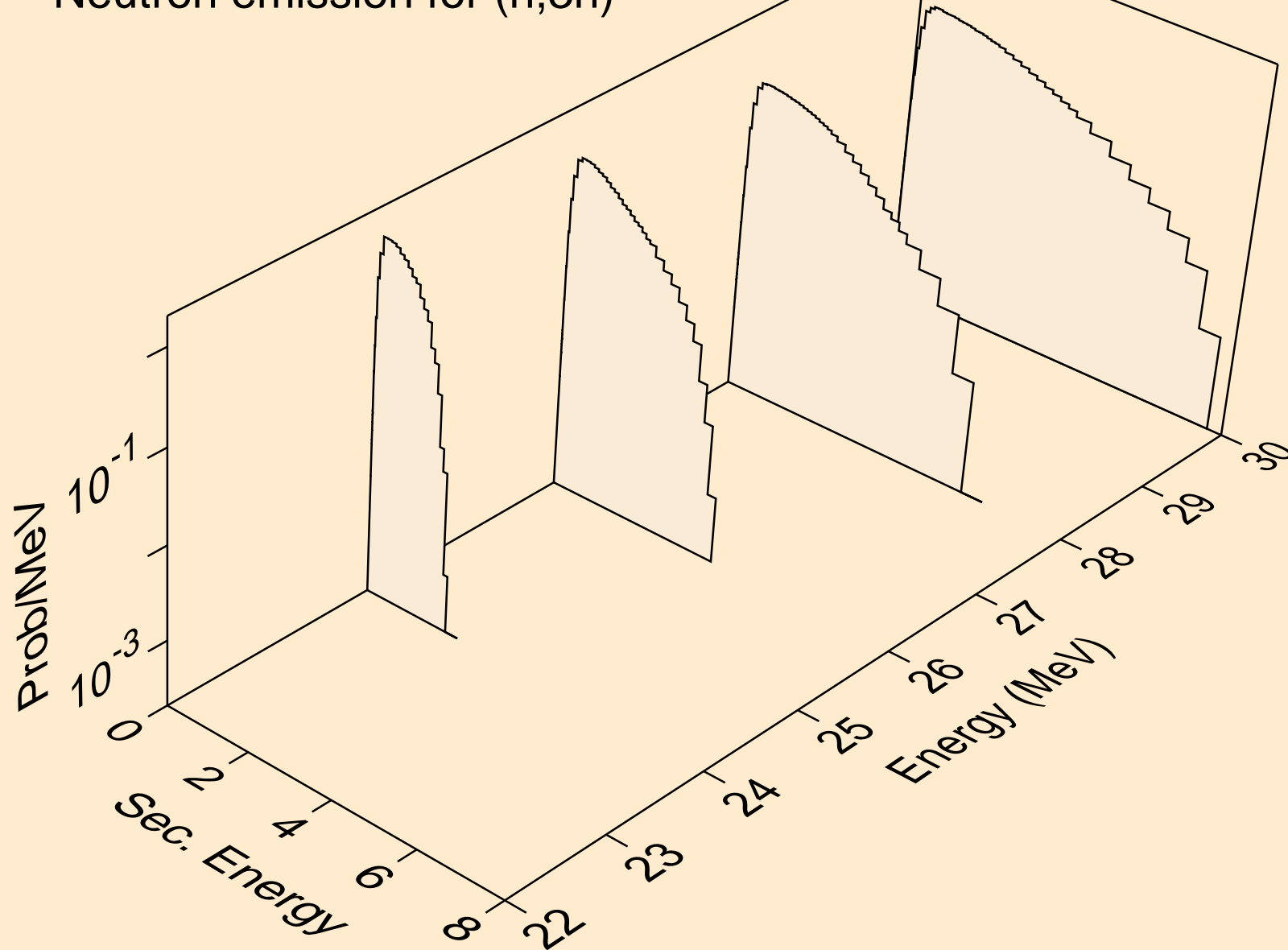

AG099 NEUTRON ACER TENDL-2021 LIBRARY; T=293.6K
Neutron emission for (n,n*)a

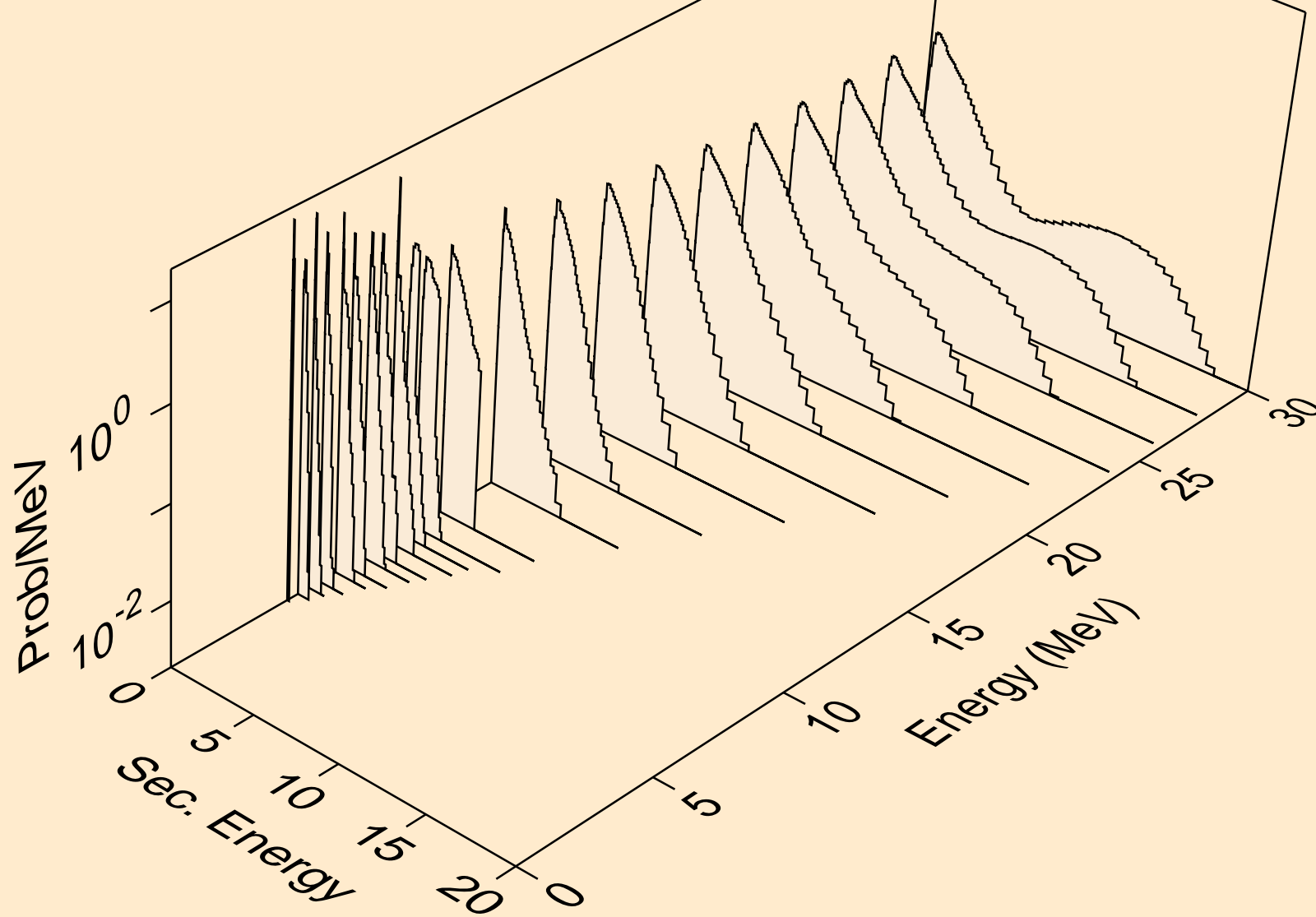

AG099 NEUTRON ACER TENDL-2021 LIBRARY; T=293.6K
Neutron emission for (n,2n)a

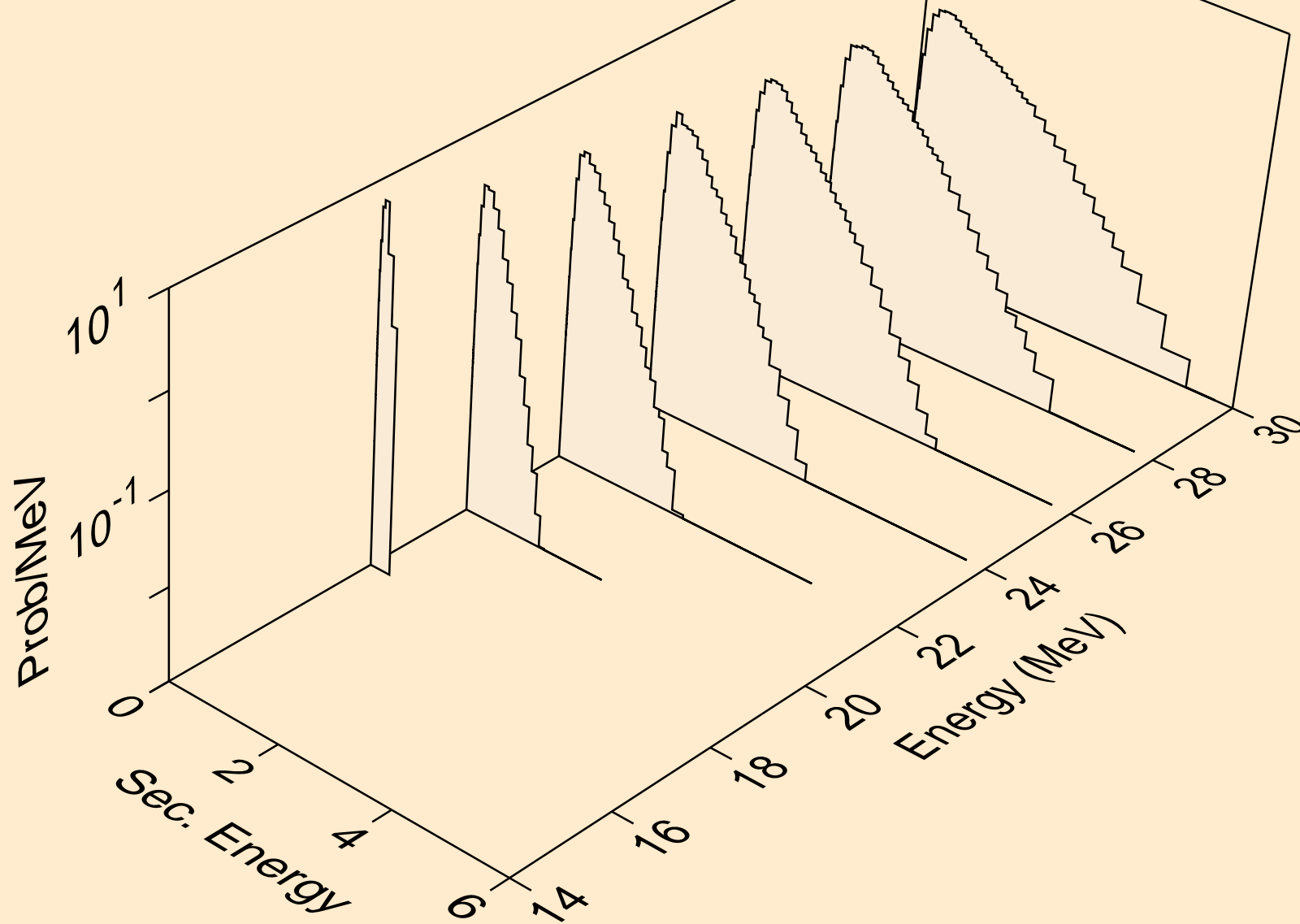

AG099 NEUTRON ACER TENDL-2021 LIBRARY; T=293.6K
Neutron emission for (n,n*)p

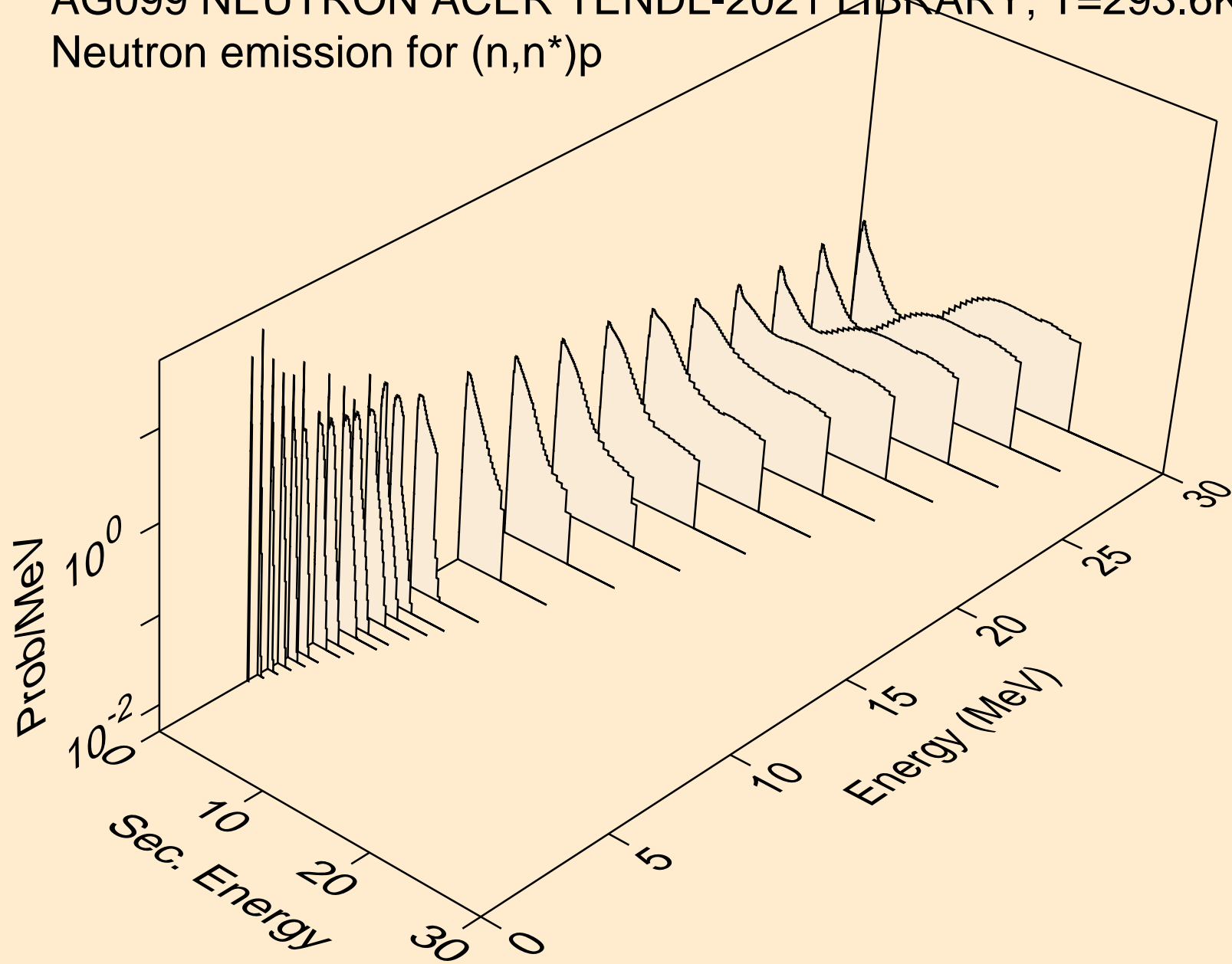

AG099 NEUTRON ACER TENDL-2021 LIBRARY; T=293.6K
Neutron emission for (n,n*)2a

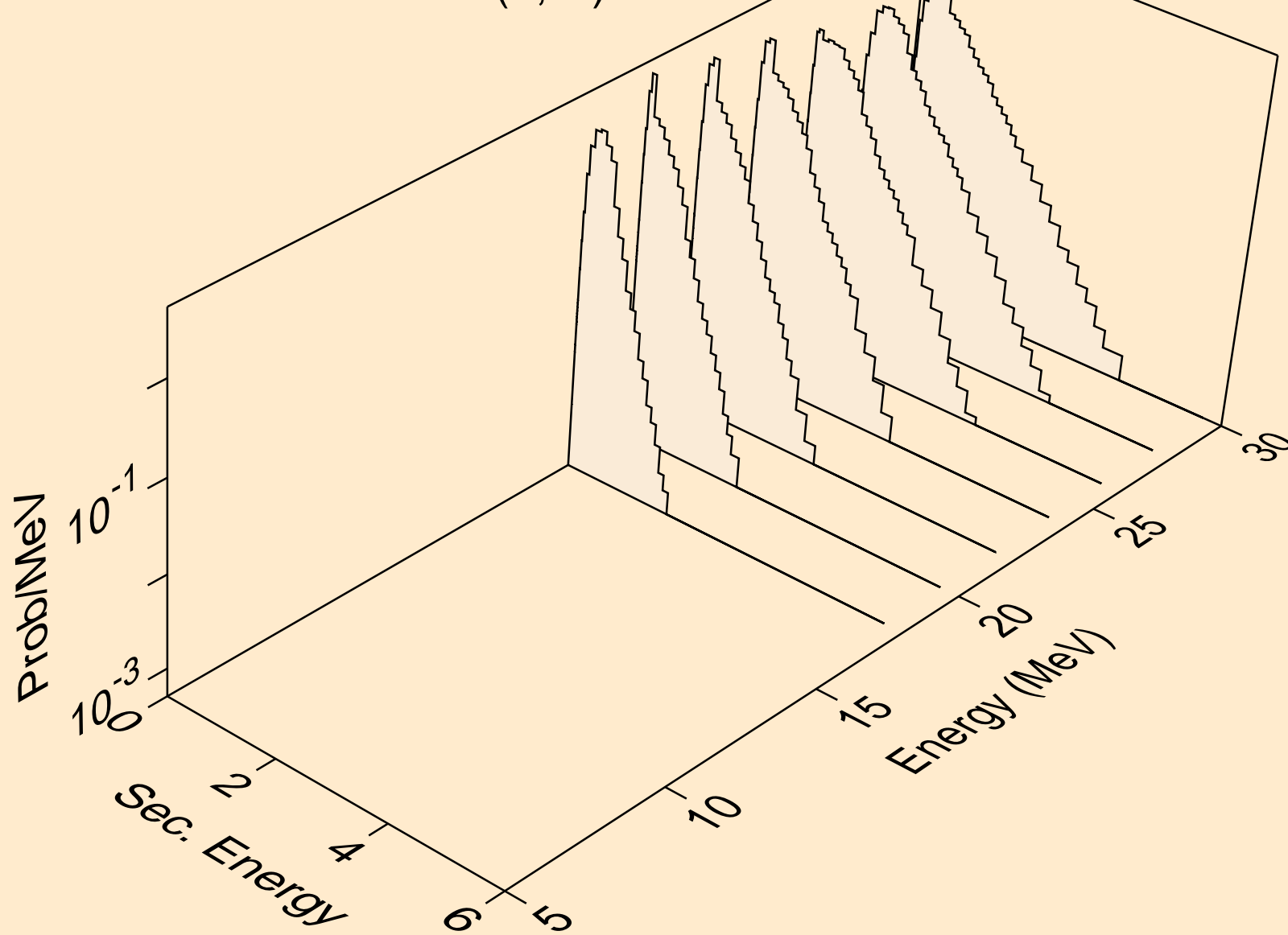

AG099 NEUTRON ACER TENDL-2021 LIBRARY; T=293.6K
Neutron emission for (n,n*)d

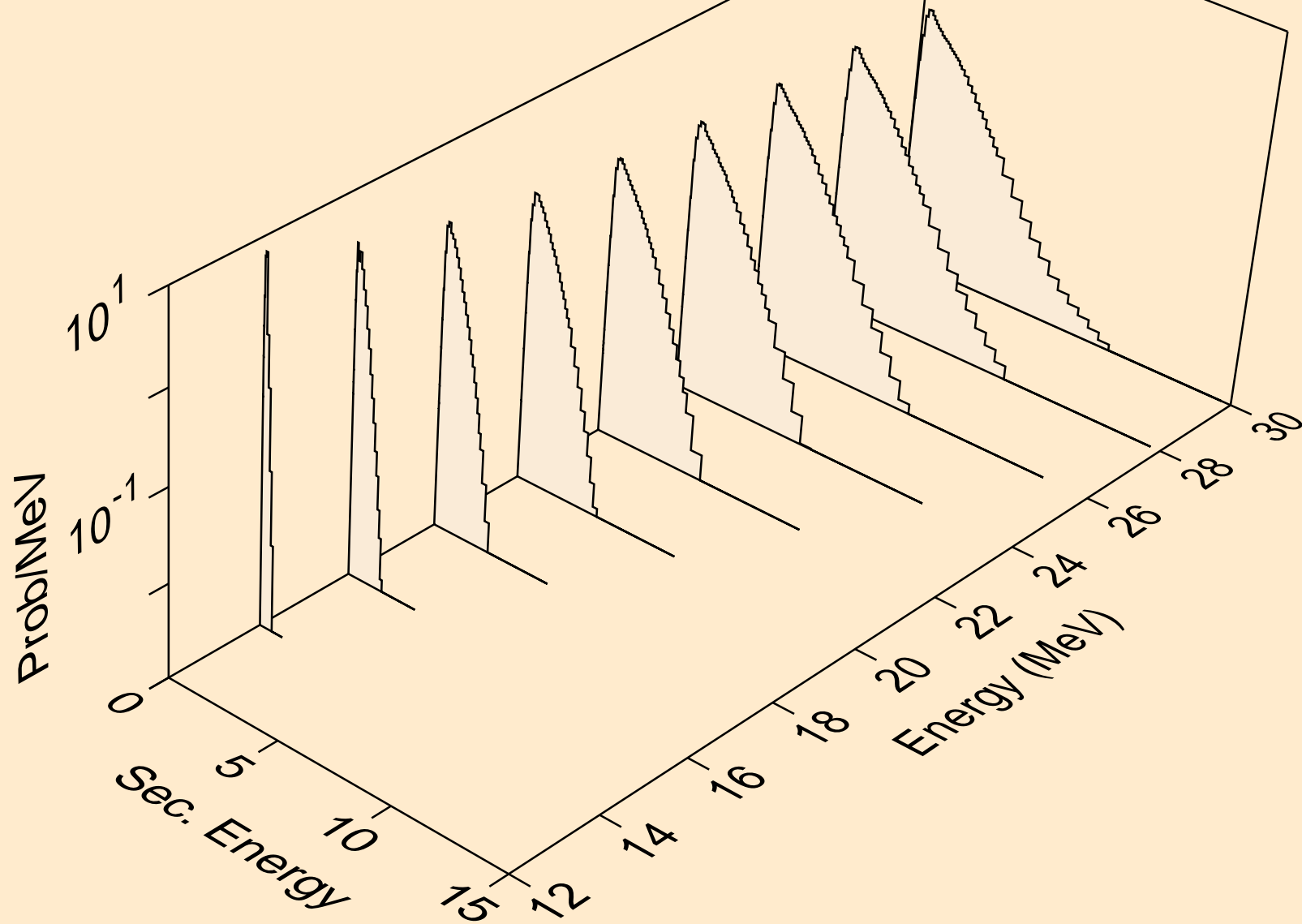

AG099 NEUTRON ACER TENDL-2021 LIBRARY; T=293.6K
Neutron emission for (n,n*)t

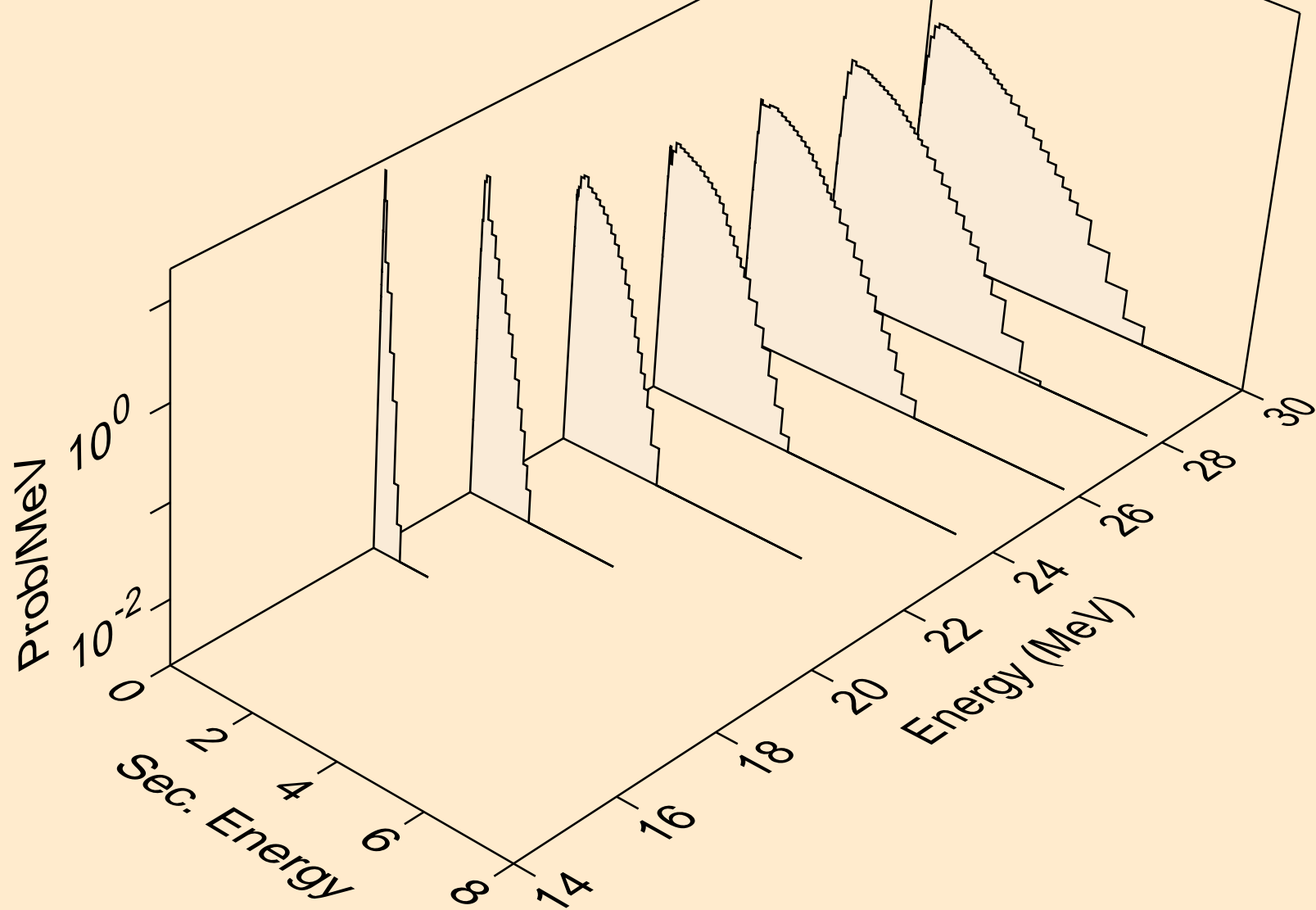

AG099 NEUTRON ACER TENDL-2021 LIBRARY; T=293.6K
Neutron emission for (n,n*)he3

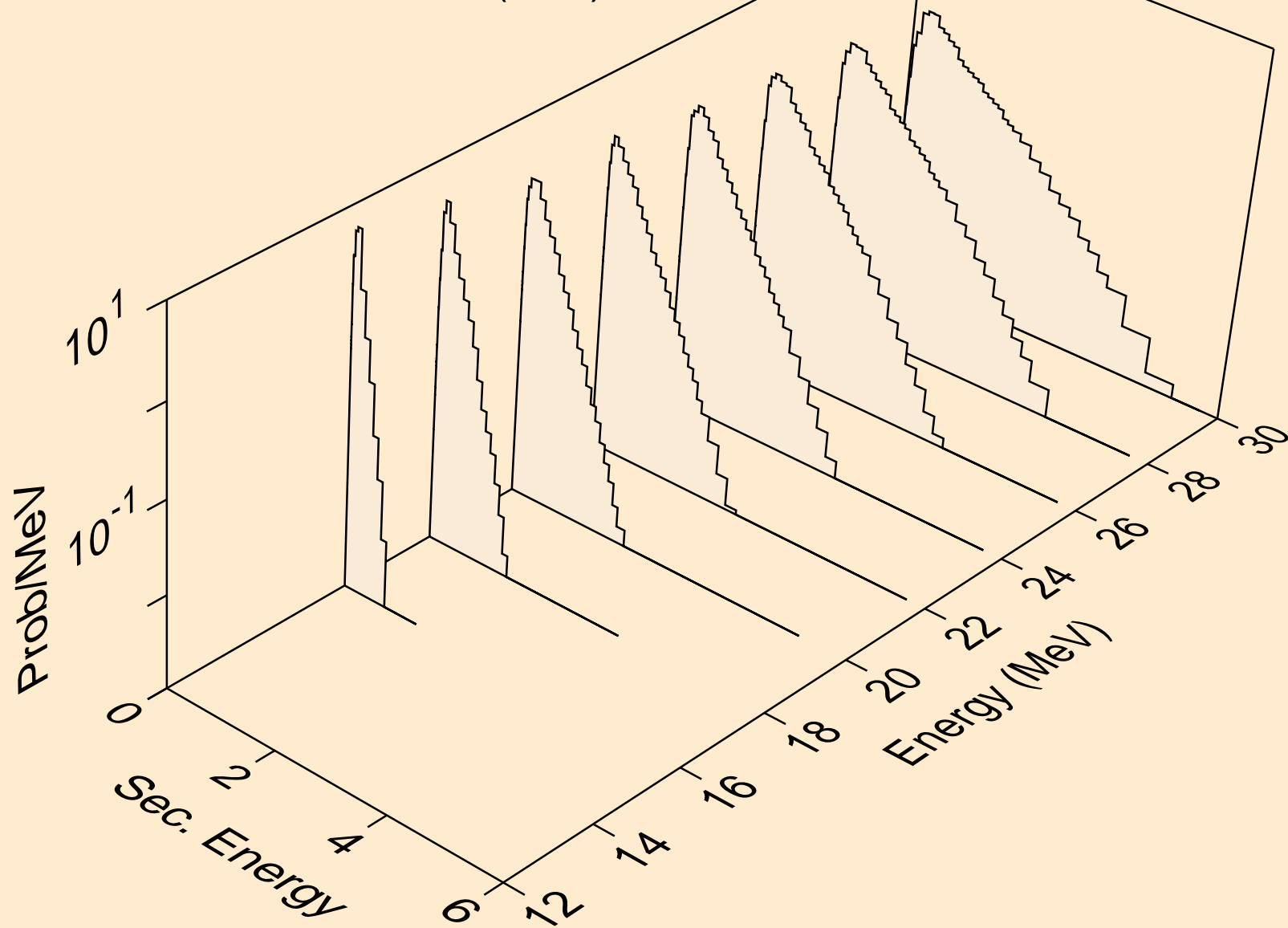

AG099 NEUTRON ACER TENDL-2021 LIBRARY; T=293.6K
Neutron emission for (n,2np)

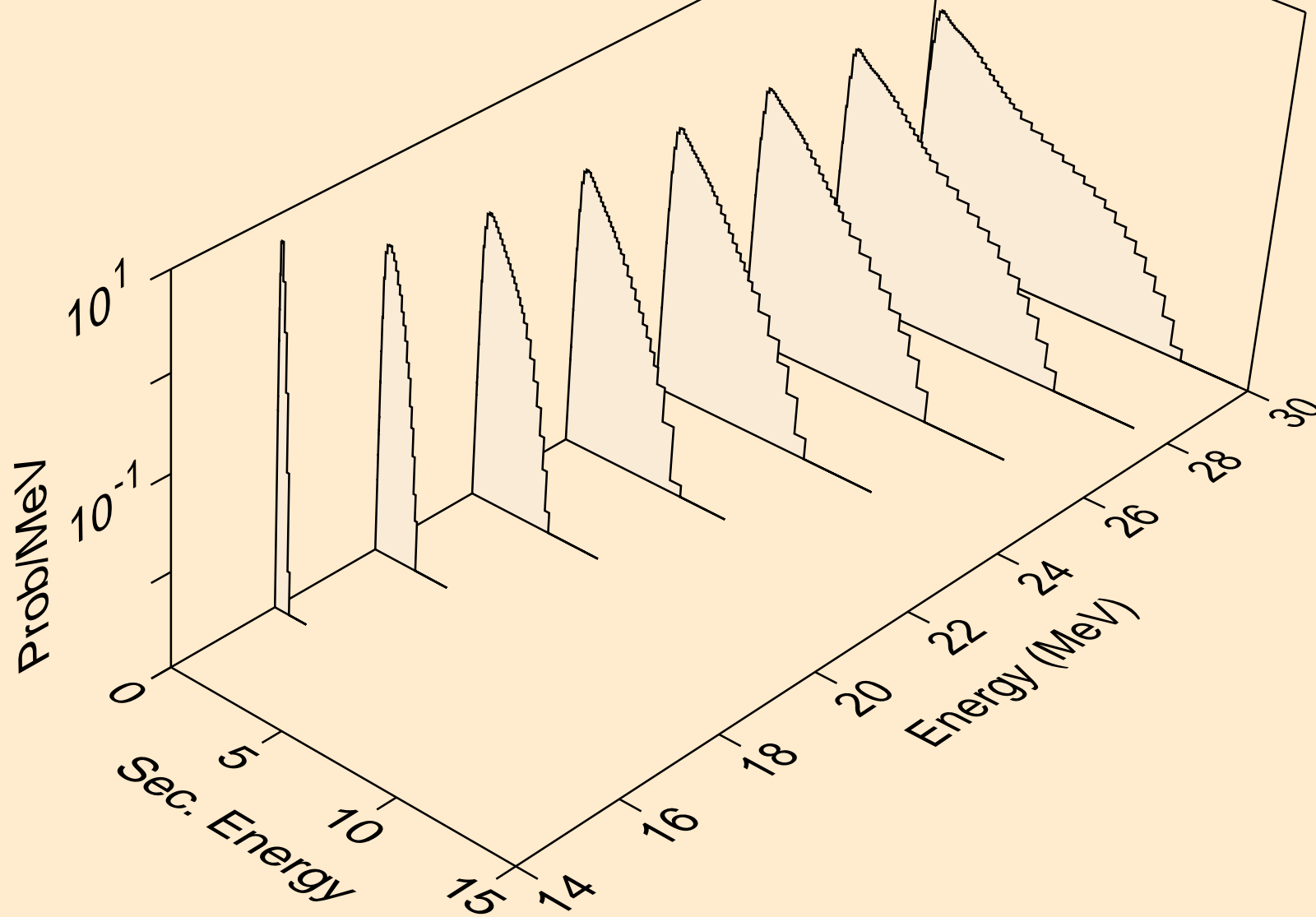

AG099 NEUTRON ACER TENDL-2021 LIBRARY; T=293.6K
Neutron emission for (n,3np)

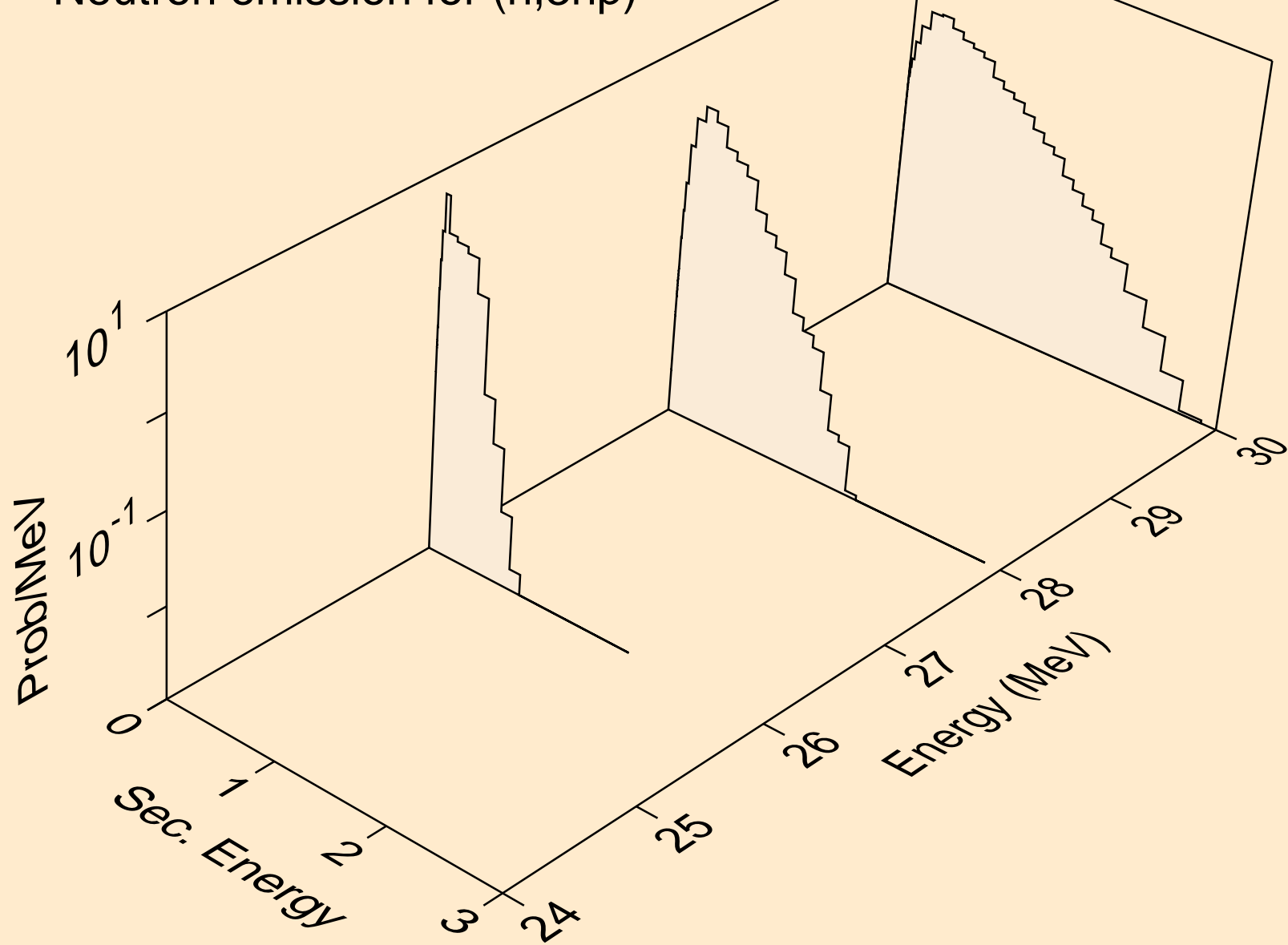

AG099 NEUTRON ACER TENDL-2021 LIBRARY; T=293.6K
Neutron emission for (n,2np)

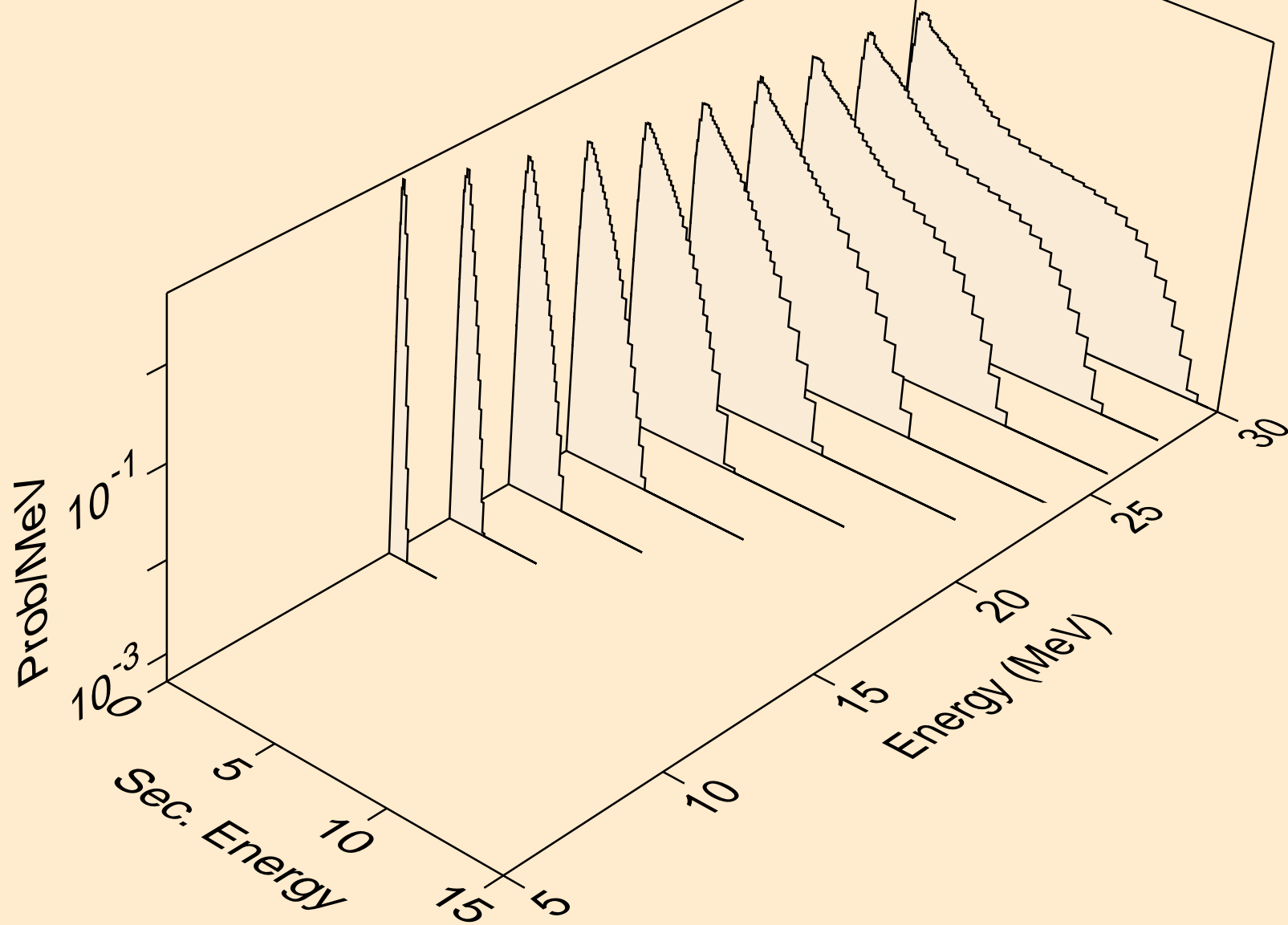

AG099 NEUTRON ACER TENDL-2021 LIBRARY; T=293.6K
Neutron emission for (n,npa)

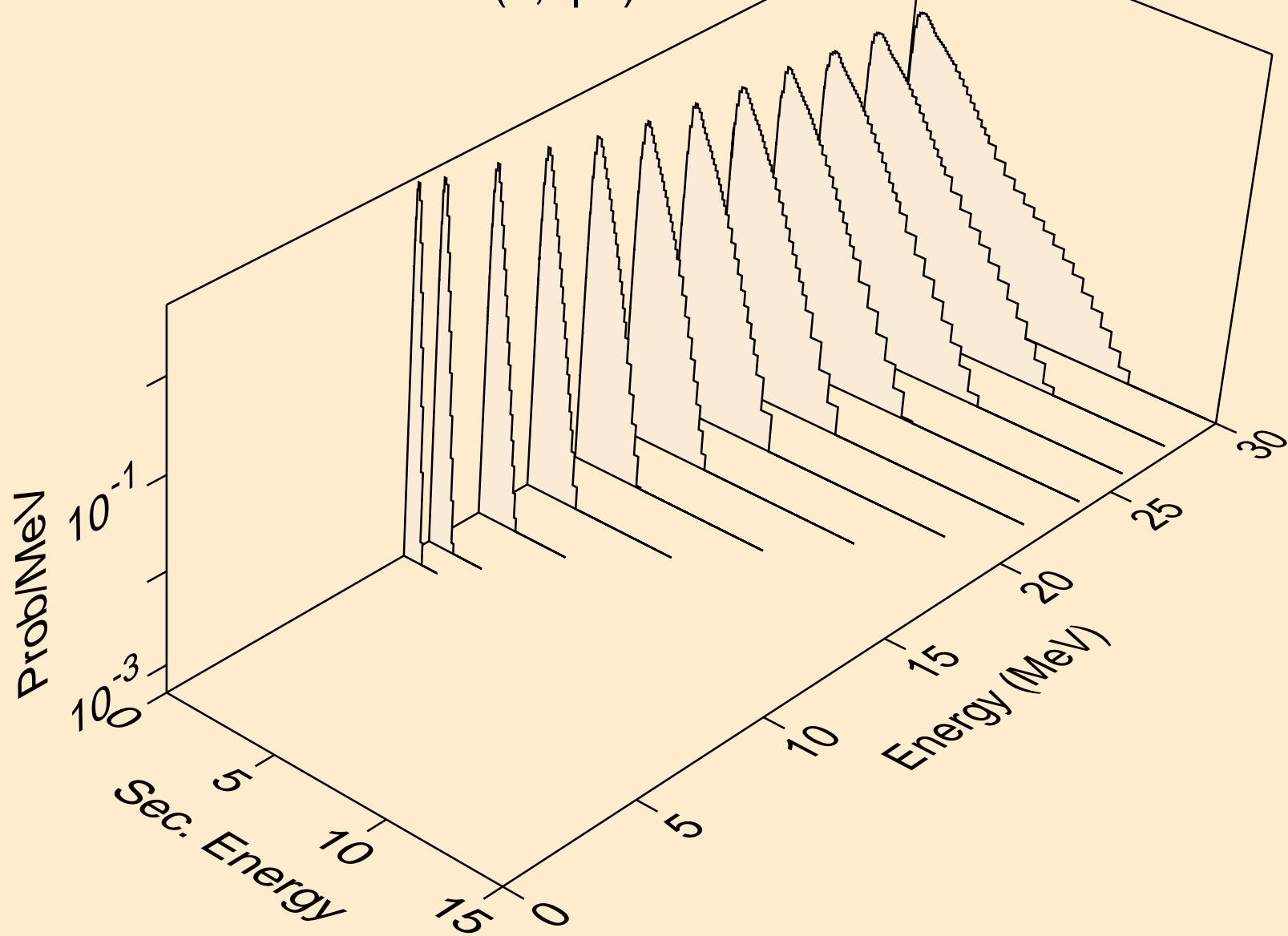

AG099 NEUTRON ACER TENDL-2021 LIBRARY; T=293.6K
Neutron emission for (n,n*c)

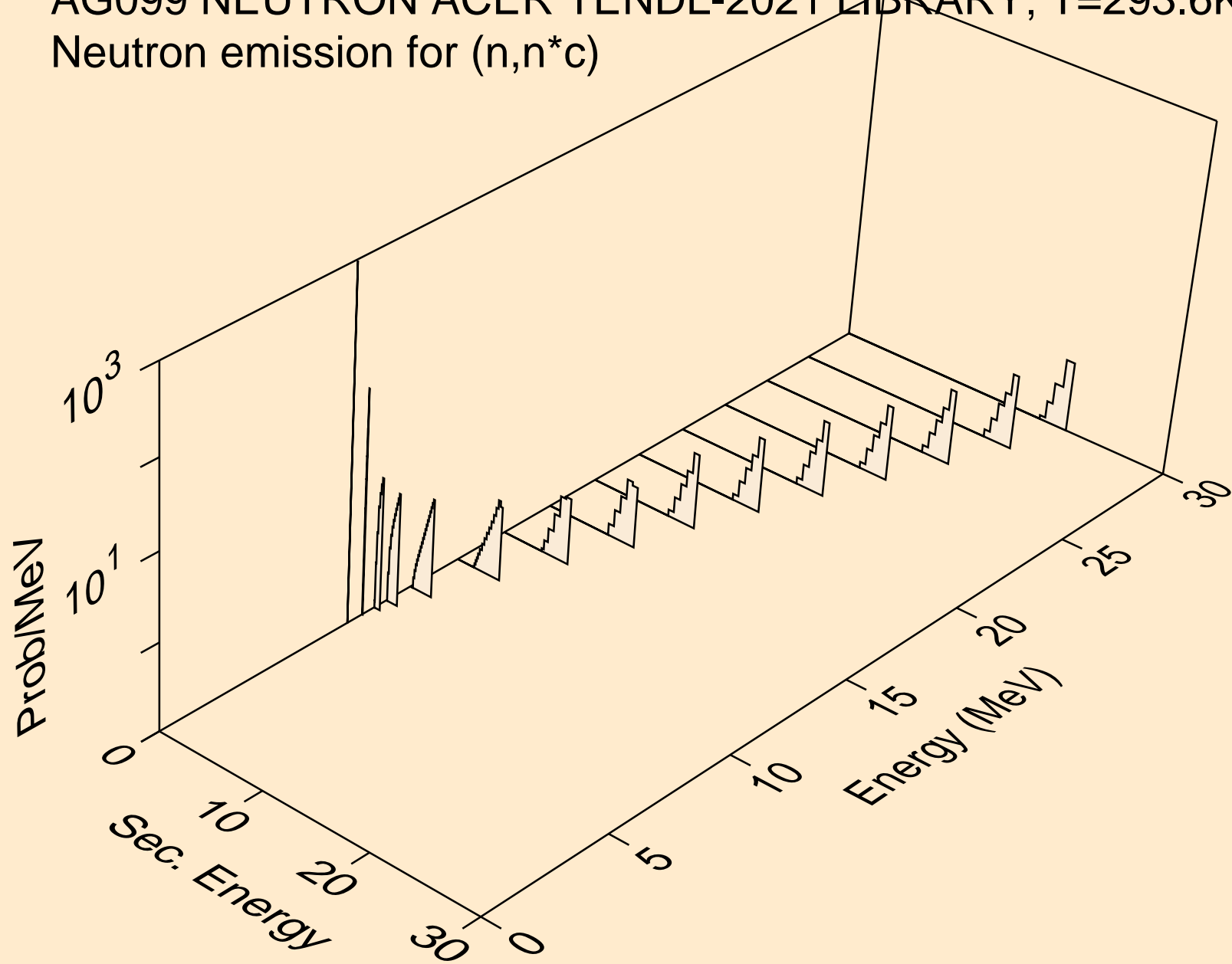

AG099 NEUTRON ACER TENDL-2021 LIBRARY; T=293.6K
Photon emission for (n,x)

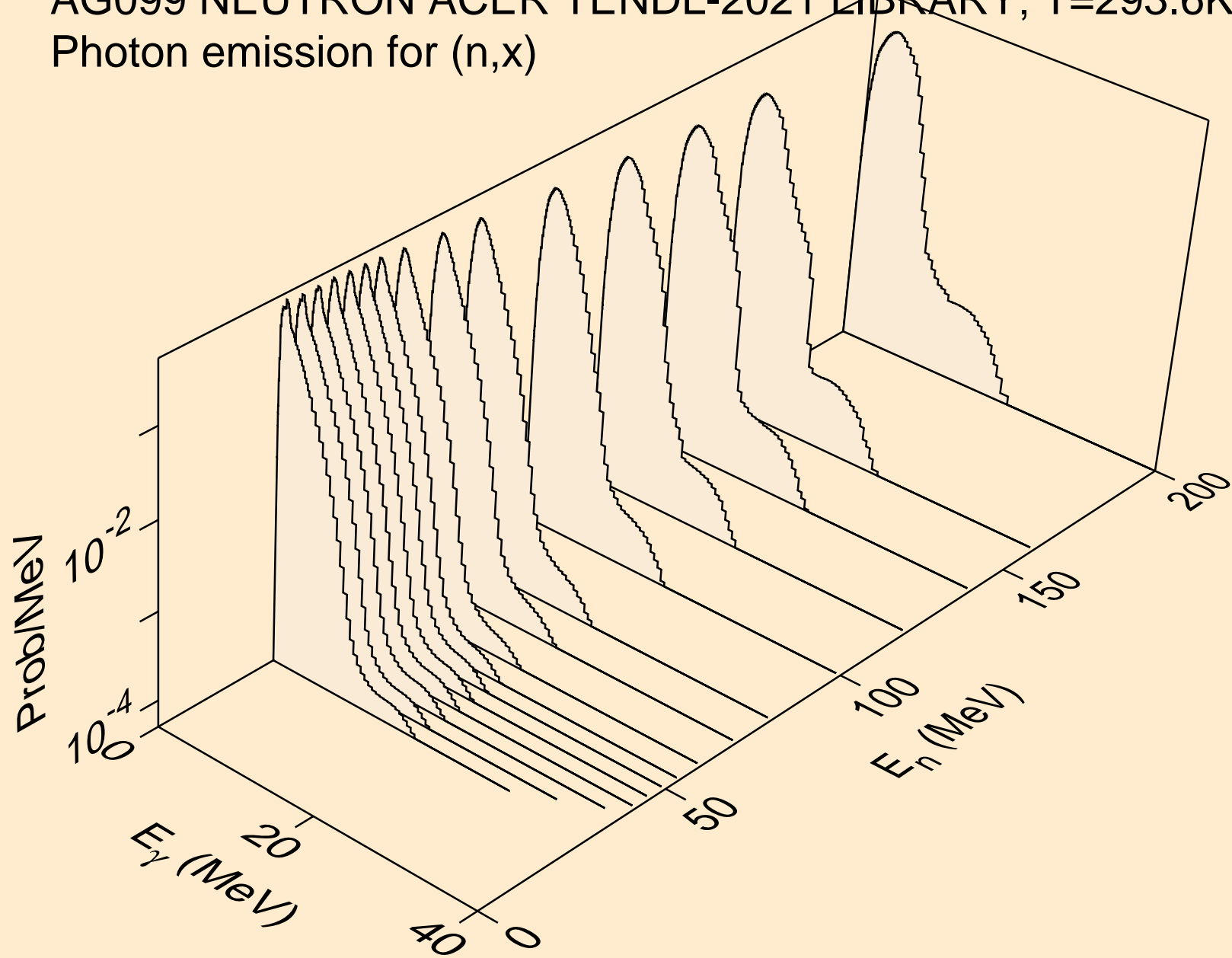

AG099 NEUTRON ACER TENDL-2021 LIBRARY; T=293.6K
Photon emission for (n,2nd)

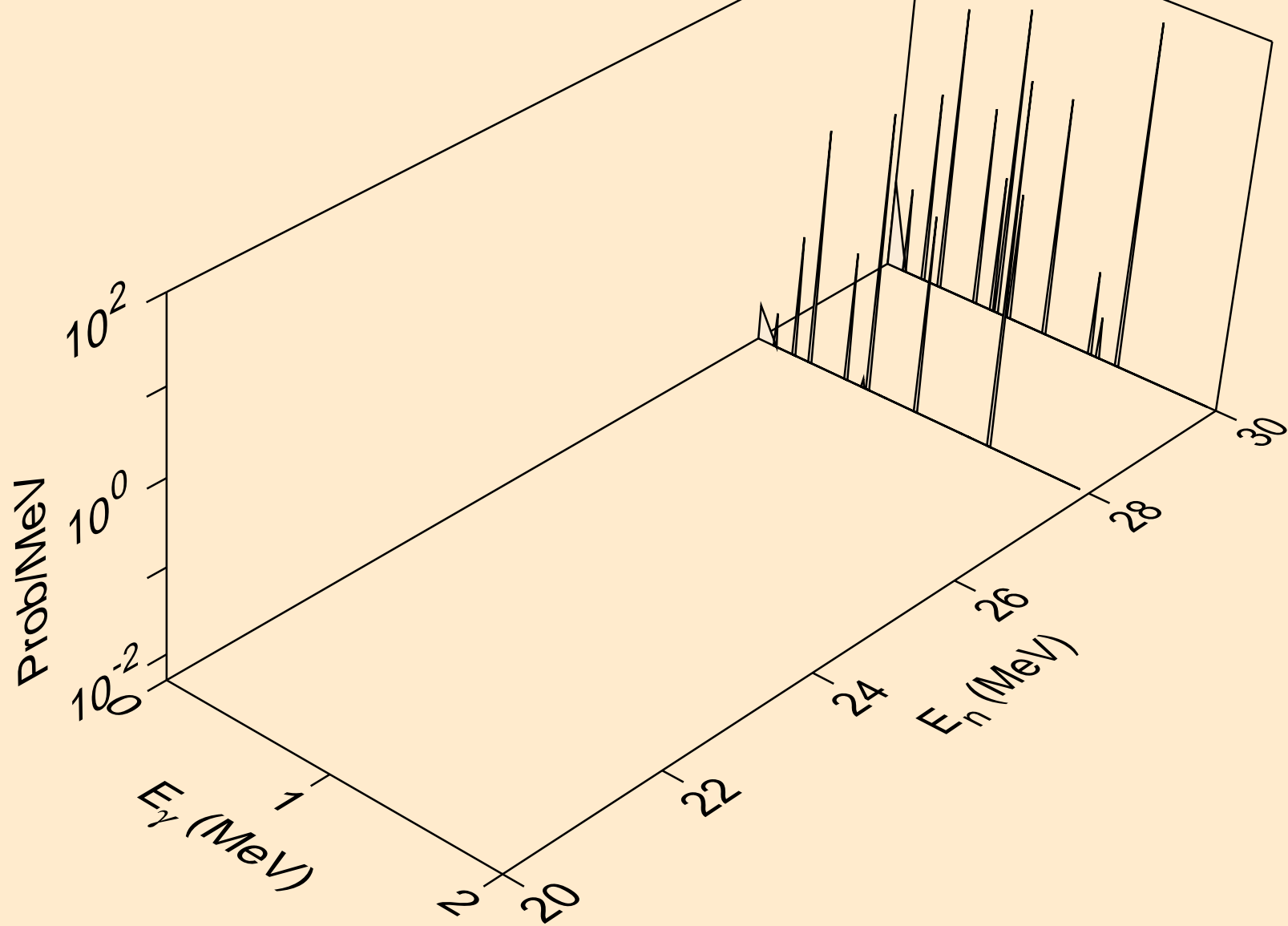

AG099 NEUTRON ACER TENDL-2021 LIBRARY; T=293.6K
Photon emission for (n,2n)

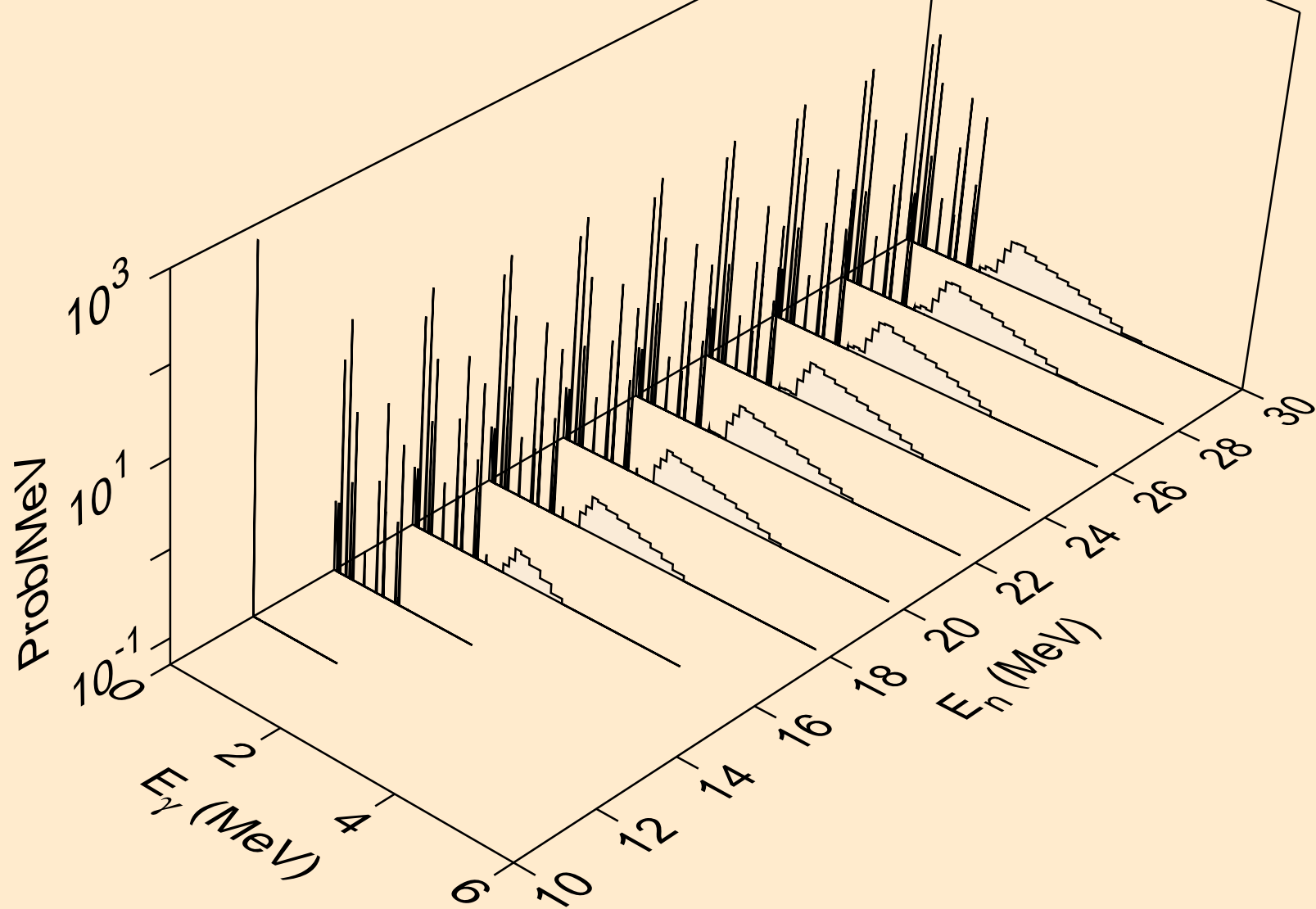

AG099 NEUTRON ACER TENDL-2021 LIBRARY; T=293.6K
Photon emission for (n,3n)

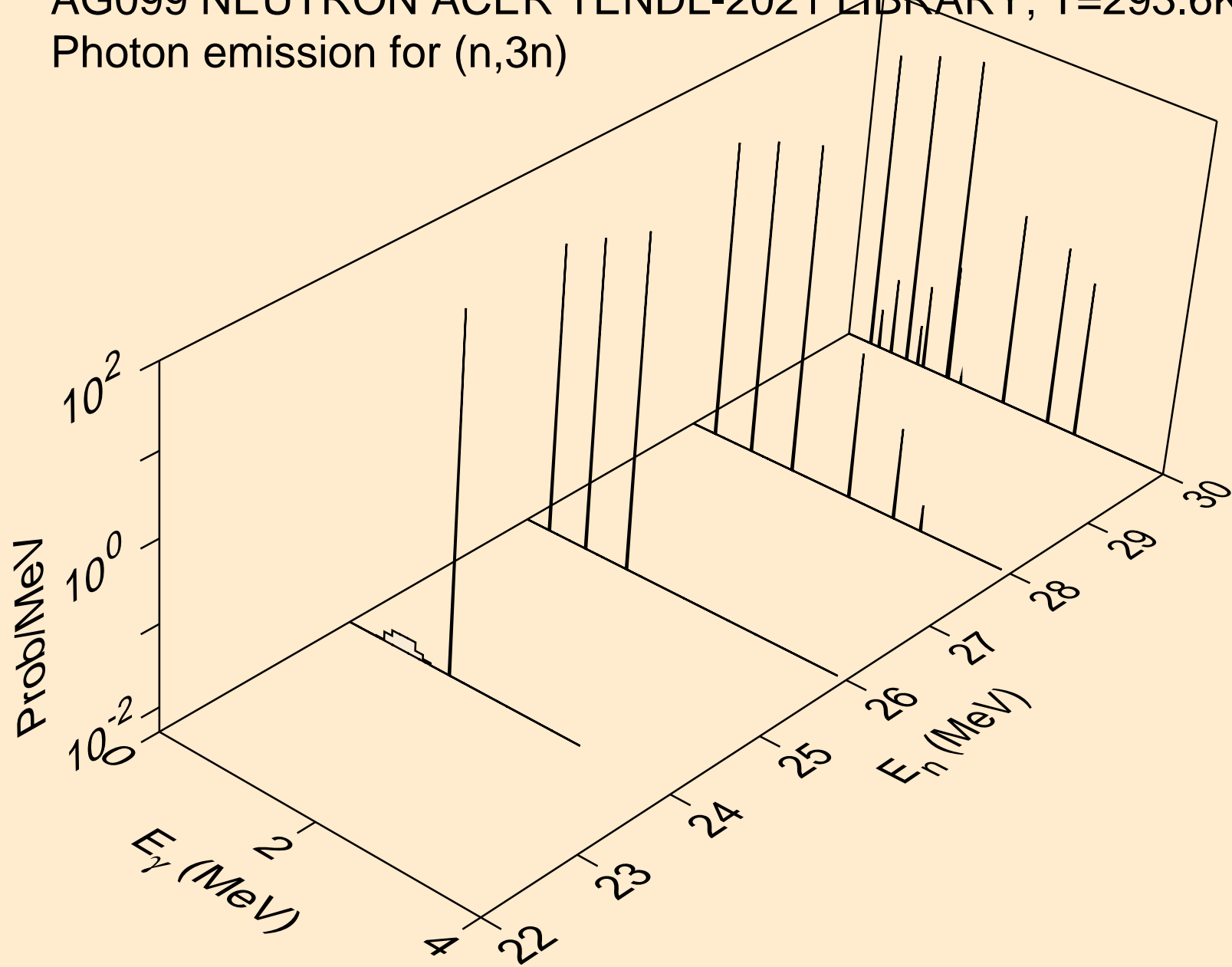

AG099 NEUTRON ACER TENDL-2021 LIBRARY; T=293.6K
Photon emission for (n,n*)a

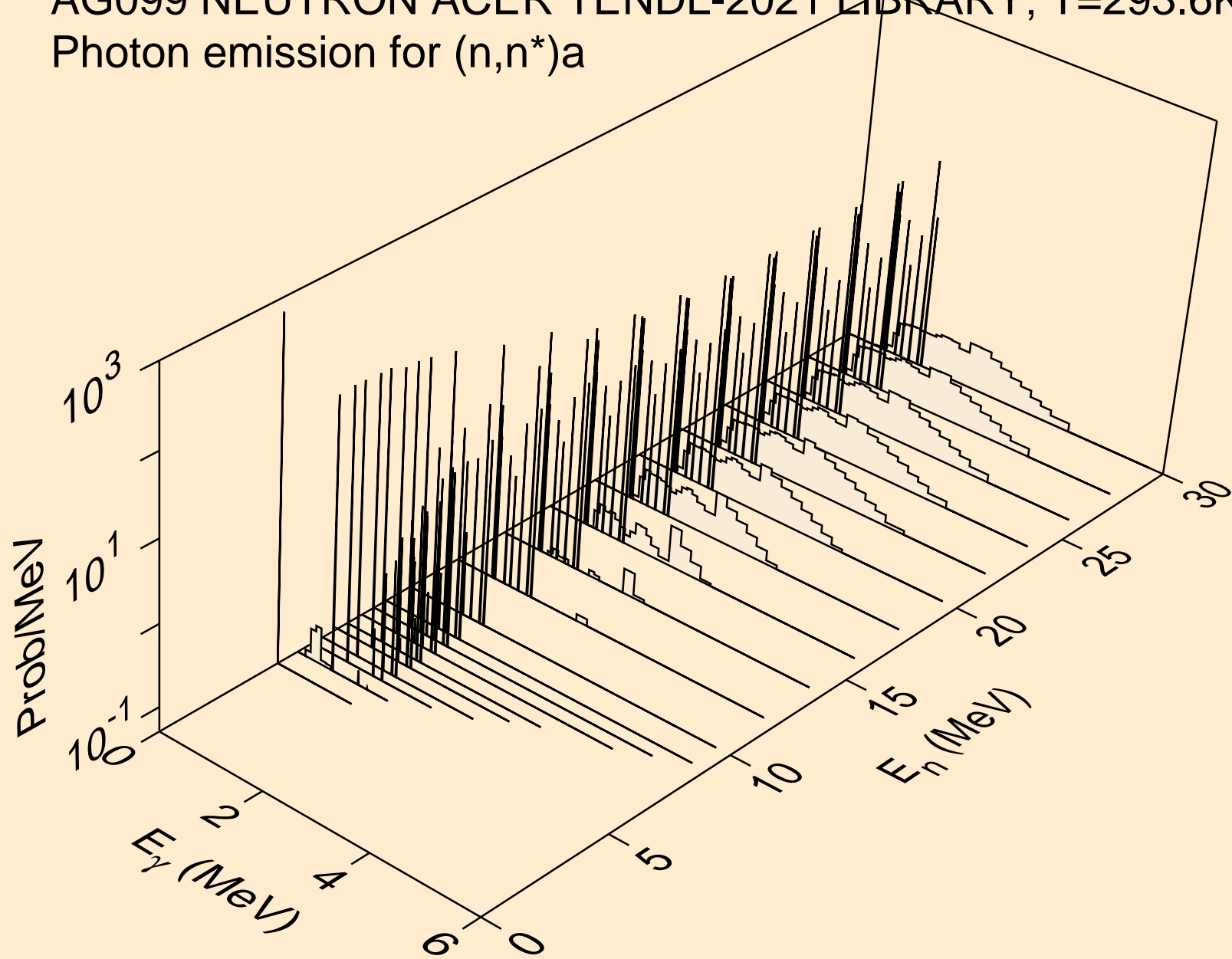

AG099 NEUTRON ACER TENDL-2021 LIBRARY; T=293.6K
Photon emission for (n,2n)a

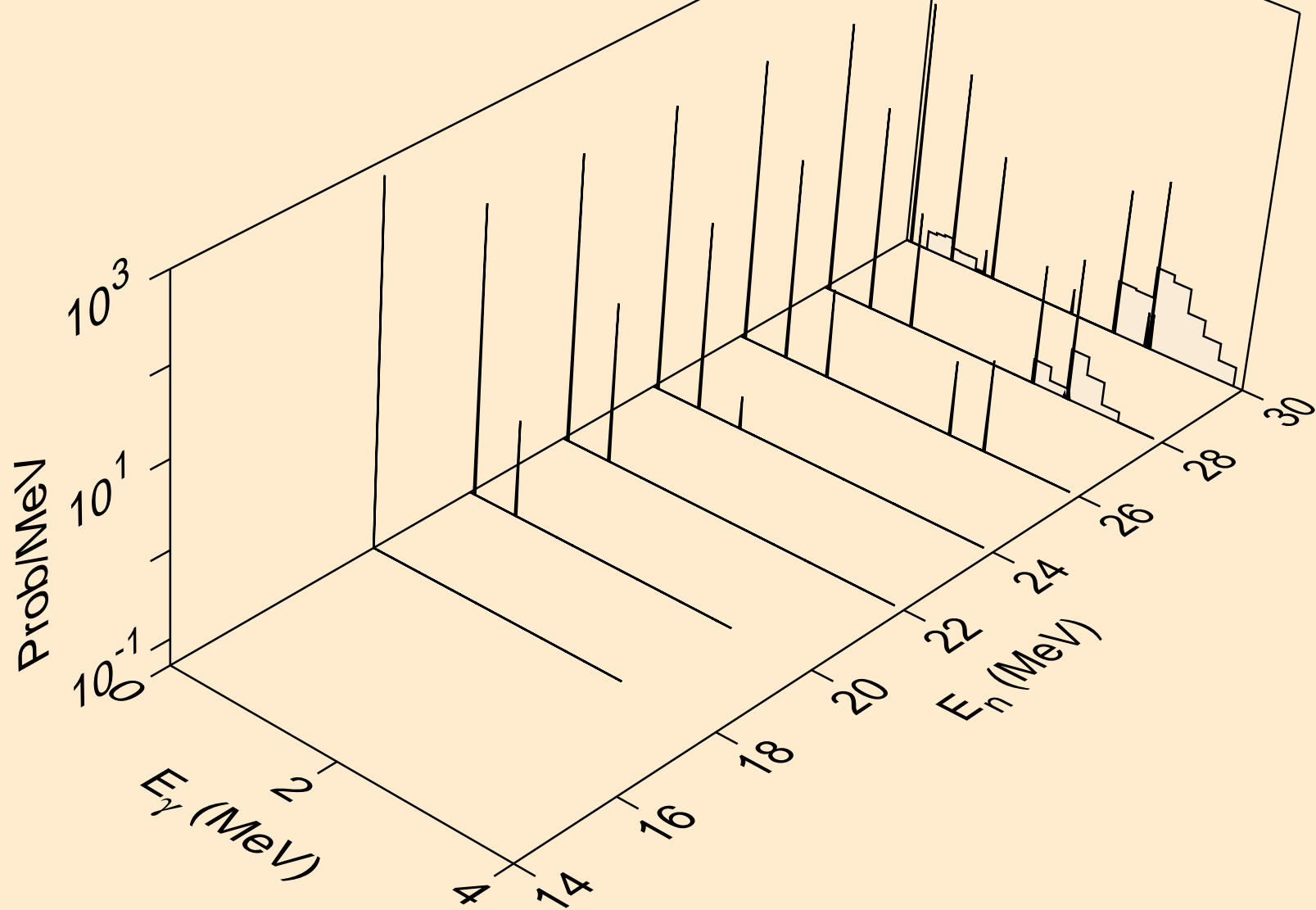

AG099 NEUTRON ACER TENDL-2021 LIBRARY; T=293.6K
Photon emission for (n,n*)p

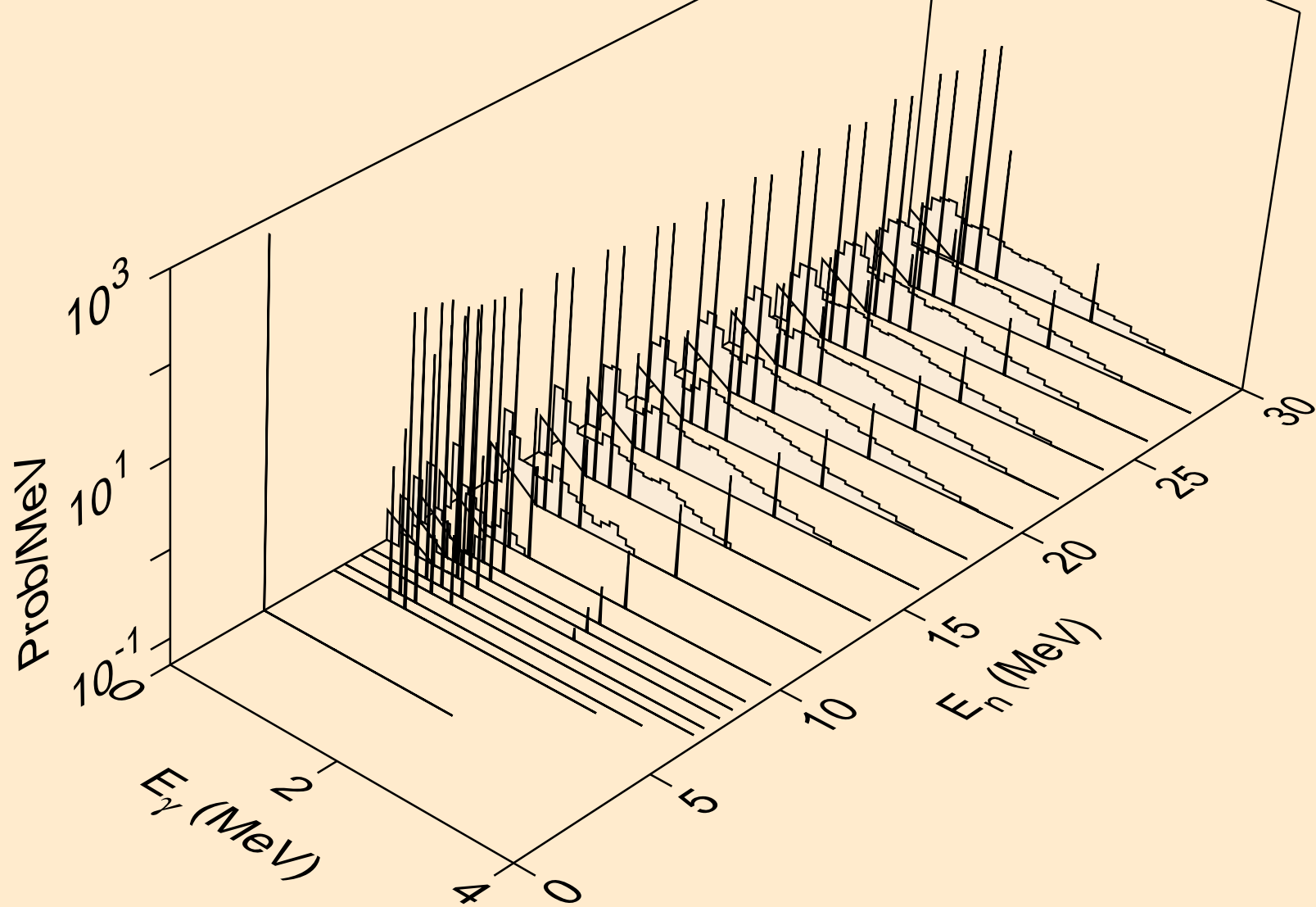

AG099 NEUTRON ACER TENDL-2021 LIBRARY; T=293.6K
Photon emission for (n,n*)2a

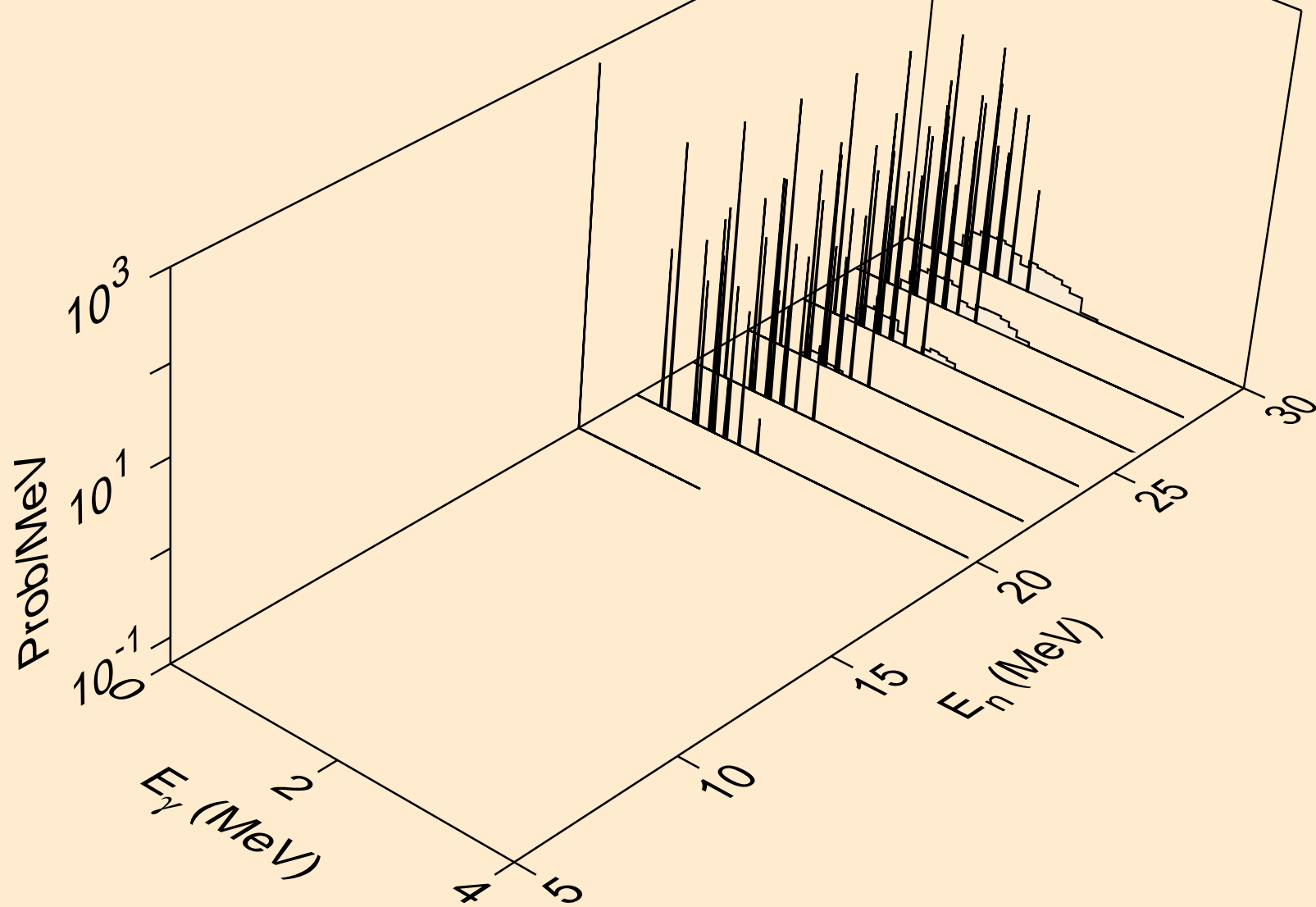

AG099 NEUTRON ACER TENDL-2021 LIBRARY; T=293.6K
Photon emission for (n,n*)d

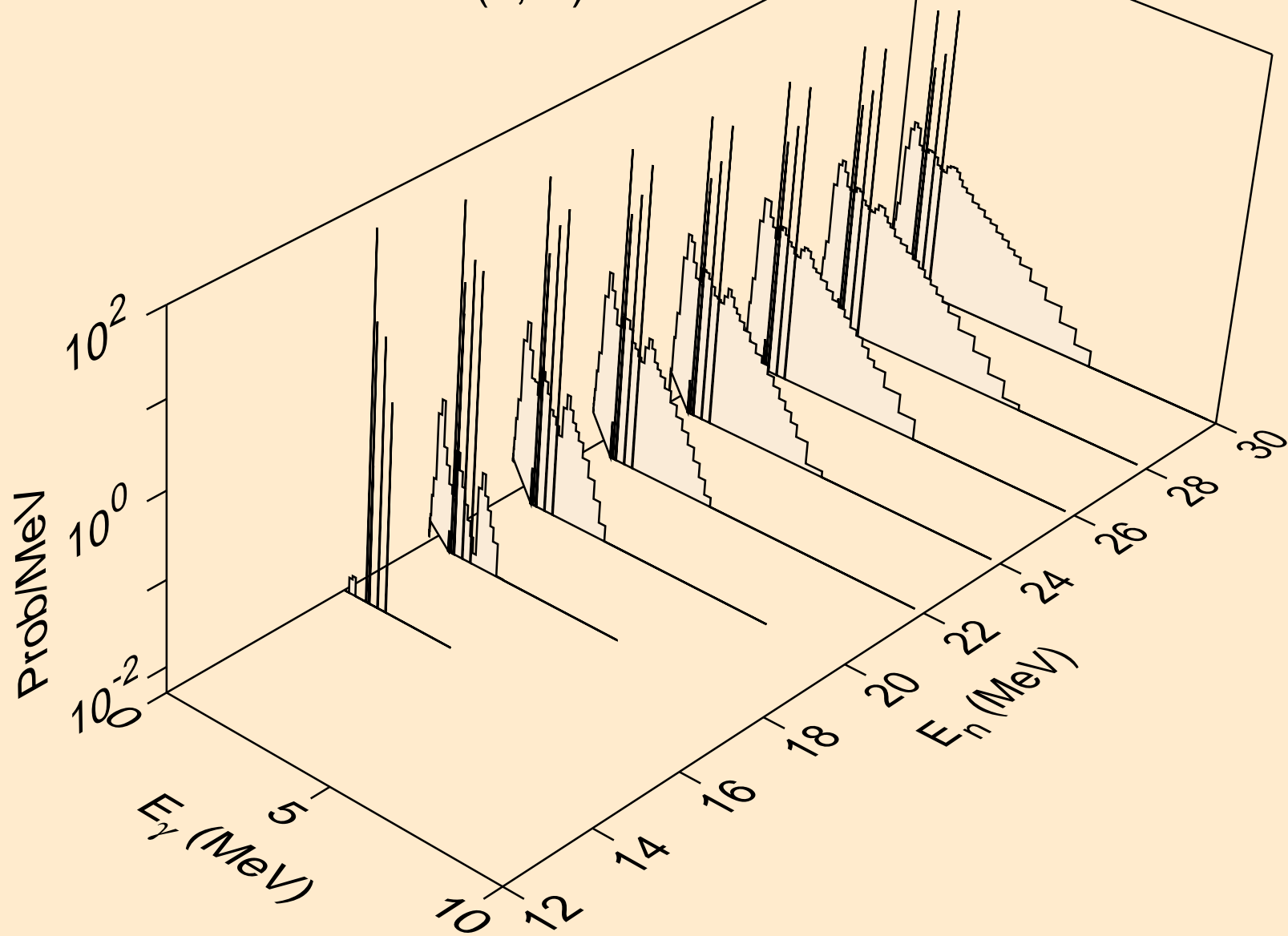

AG099 NEUTRON ACER TENDL-2021 LIBRARY; T=293.6K
Photon emission for (n,n*)t

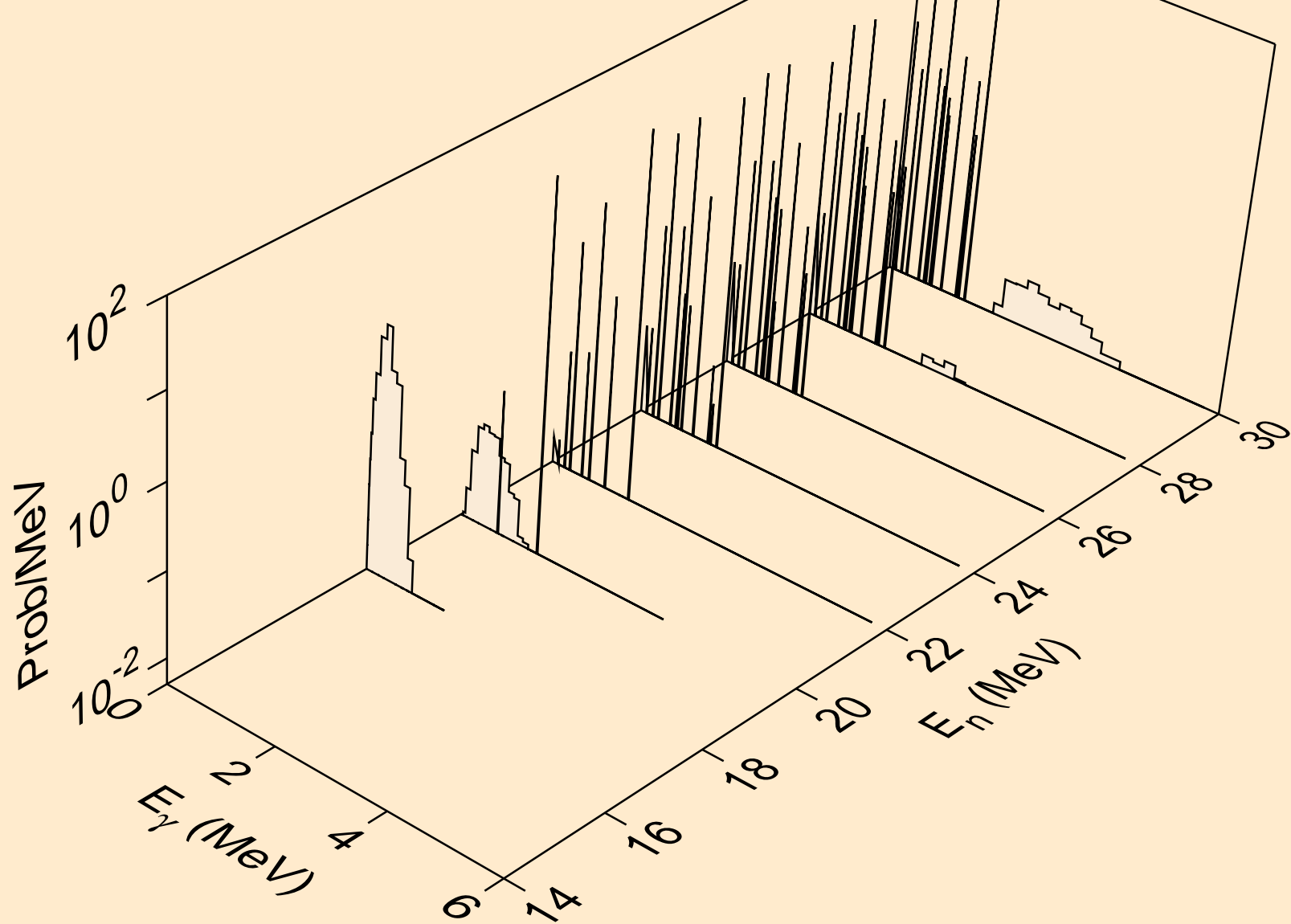

AG099 NEUTRON ACER TENDL-2021 LIBRARY; T=293.6K
Photon emission for (n,n*)he3

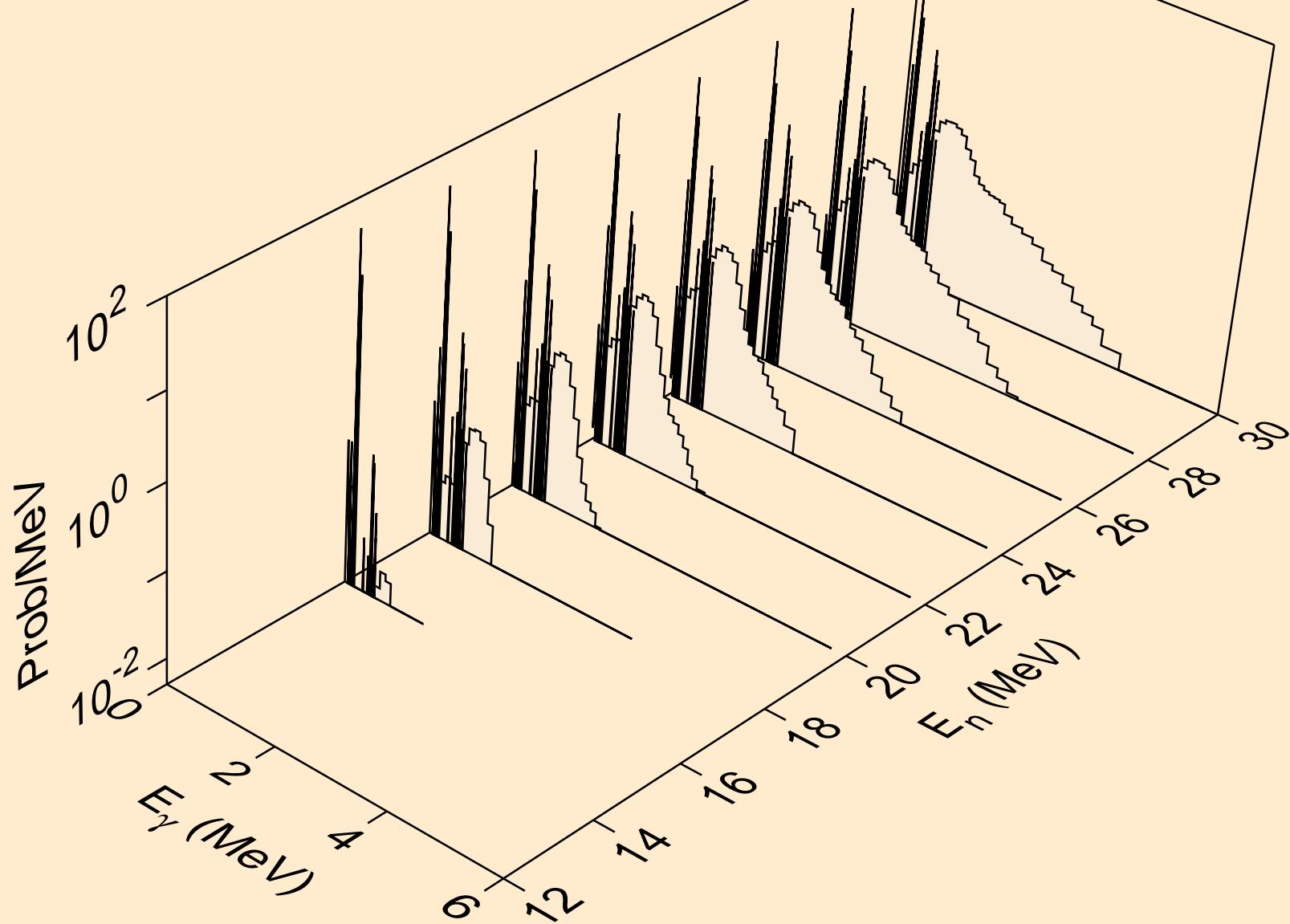

AG099 NEUTRON ACER TENDL-2021 LIBRARY; T=293.6K
Photon emission for (n,2np)

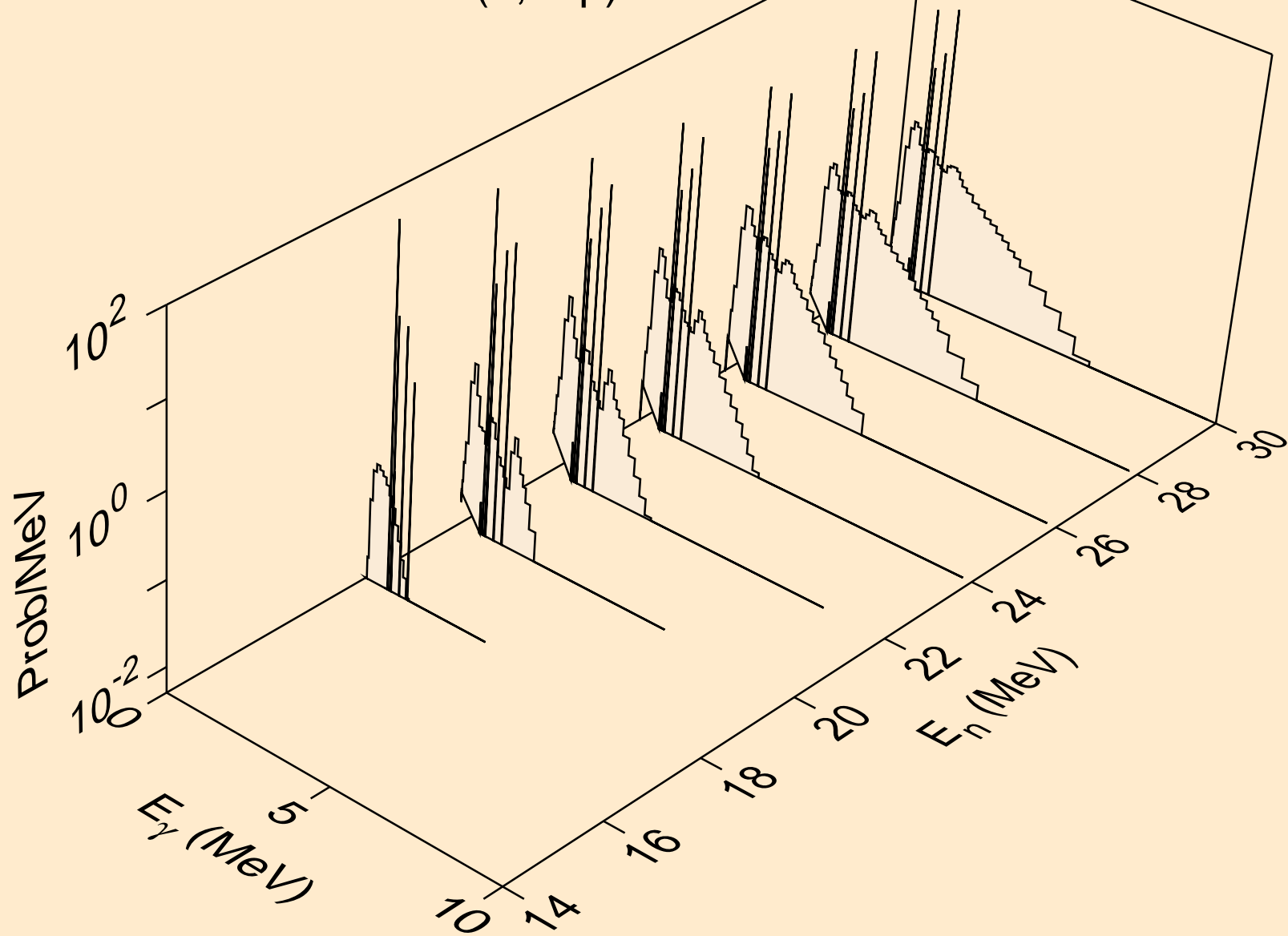

AG099 NEUTRON ACER TENDL-2021 LIBRARY; T=293.6K
Photon emission for (n,3np)

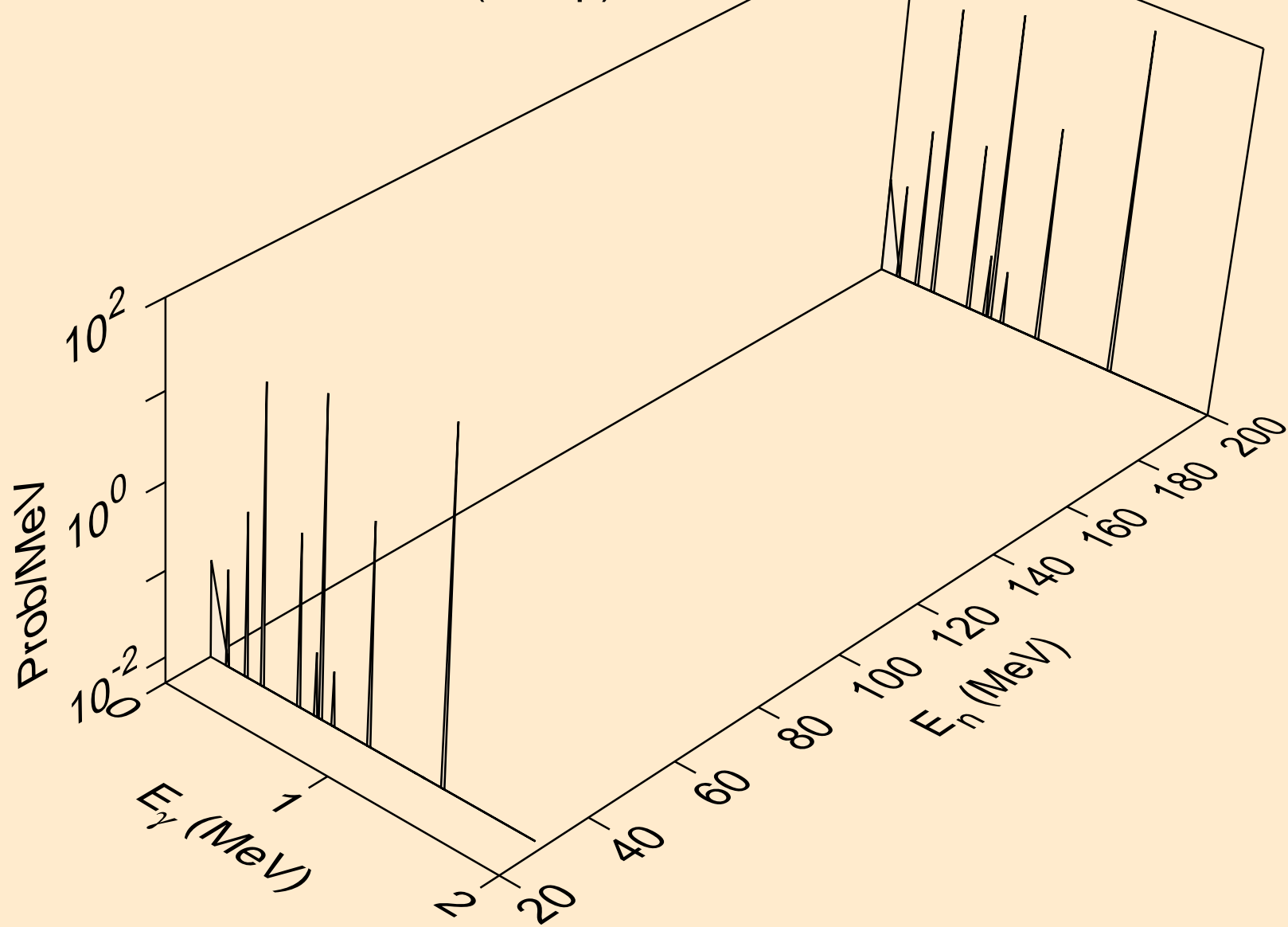

AG099 NEUTRON ACER TENDL-2021 LIBRARY; T=293.6K
Photon emission for (n,2np)

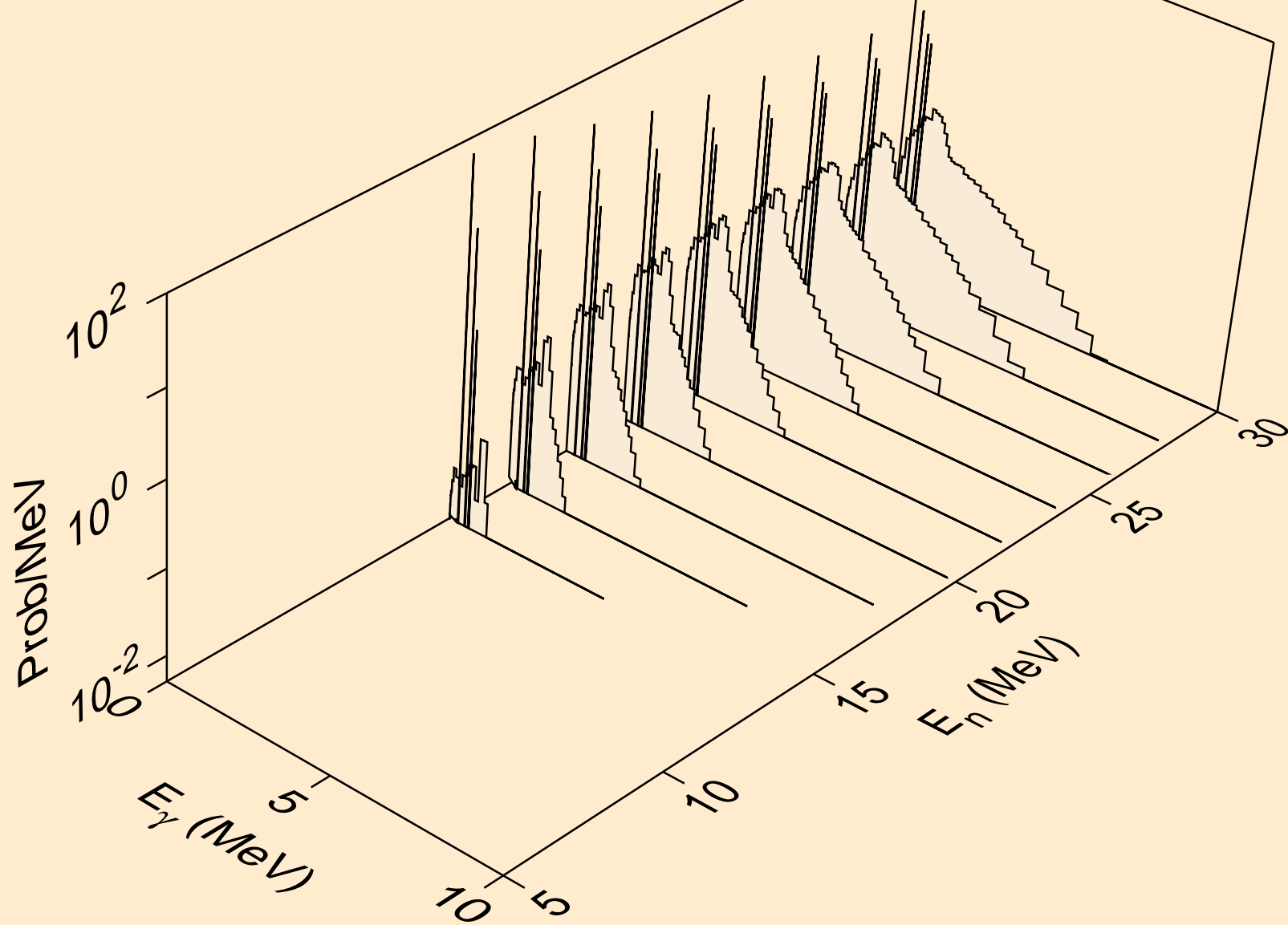

AG099 NEUTRON ACER TENDL-2021 LIBRARY; T=293.6K
Photon emission for (n,npa)

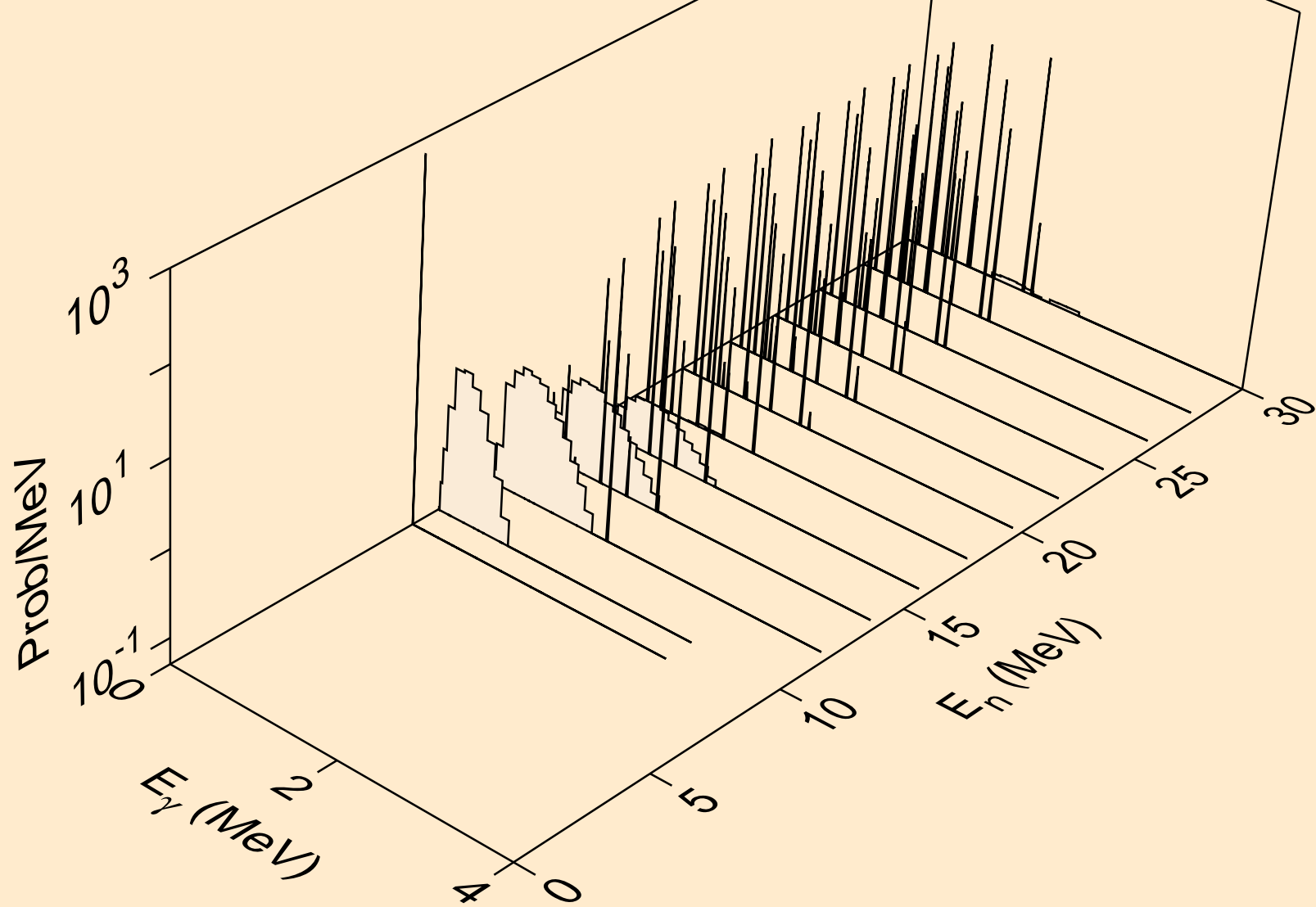

AG099 NEUTRON ACER TENDL-2021 LIBRARY; T=293.6K
Photon emission for (n,n*c)

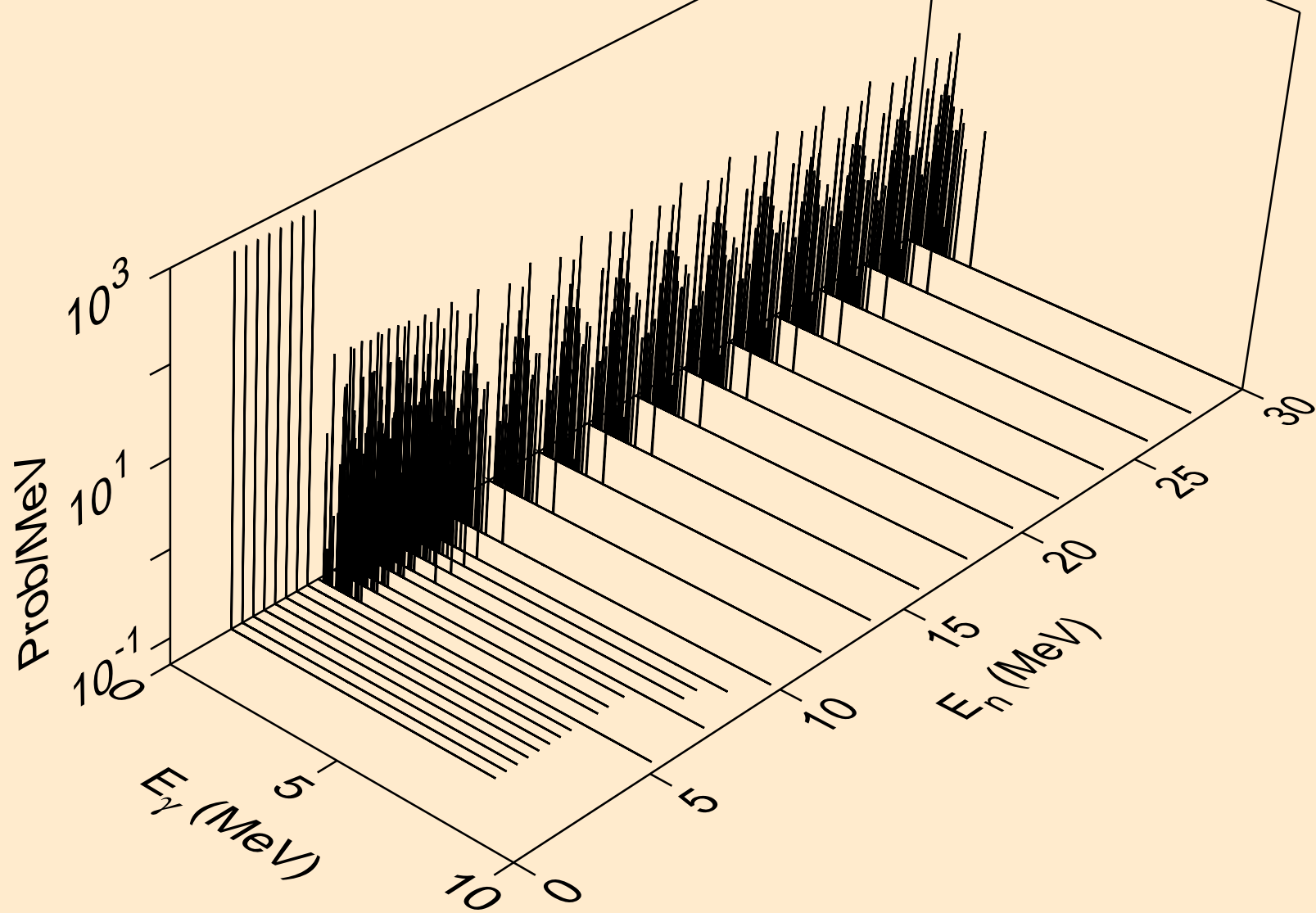

AG099 NEUTRON ACER TENDL-2021 LIBRARY; T=293.6K
Photon emission for (n,gma)

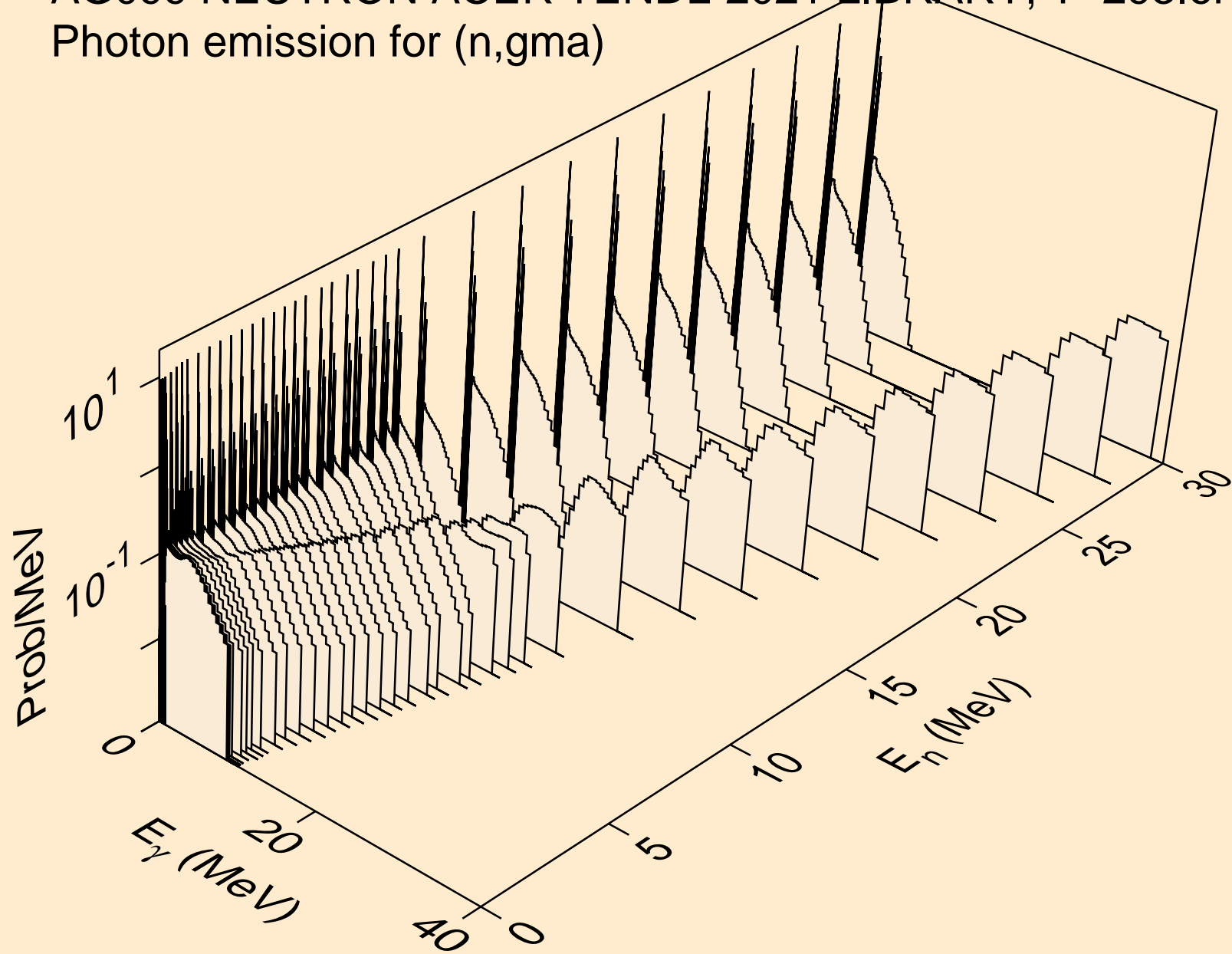

AG099 NEUTRON ACER TENDL-2021 LIBRARY; T=293.6K
Photon emission for (n,p)

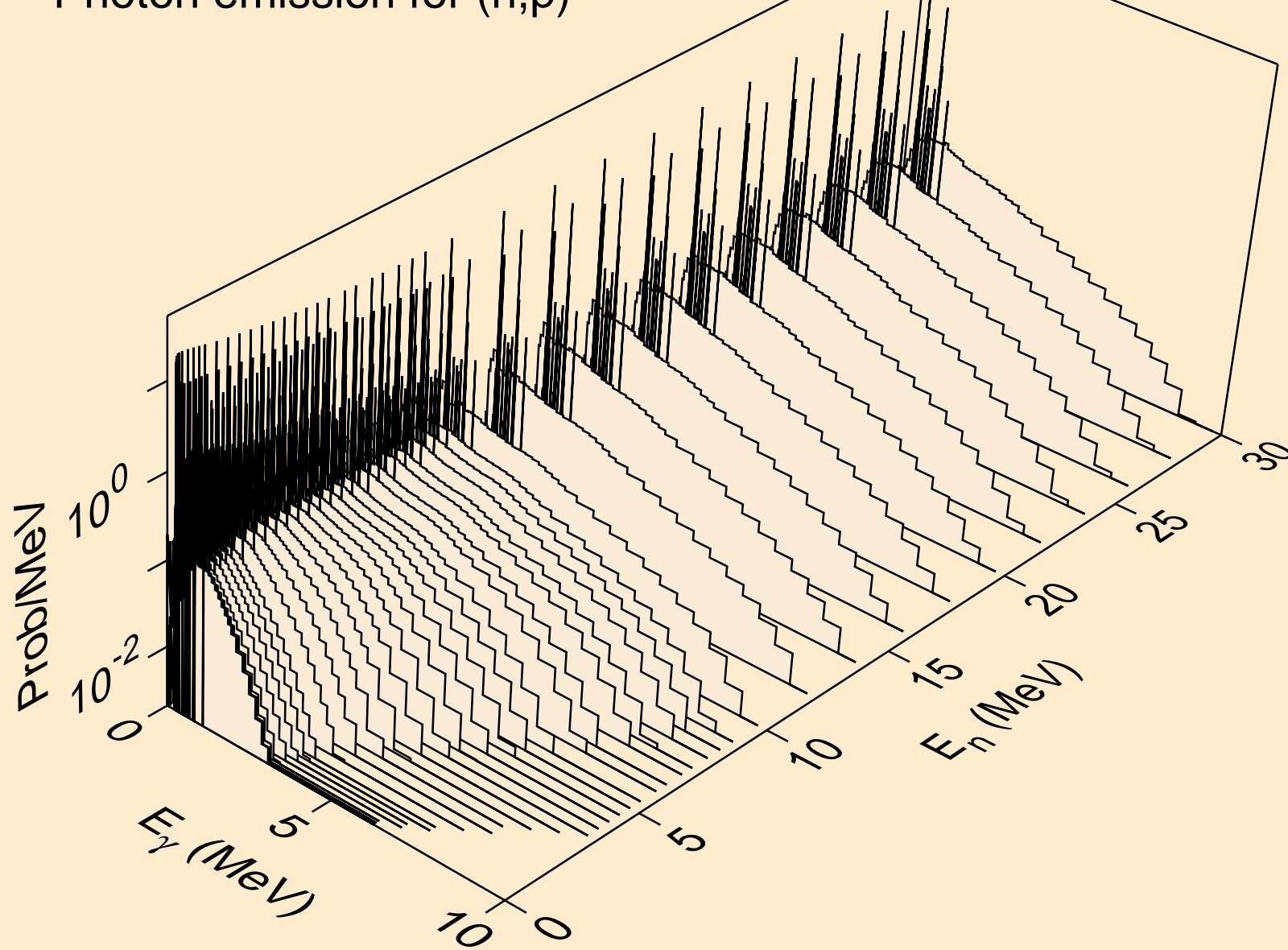

AG099 NEUTRON ACER TENDL-2021 LIBRARY; T=293.6K
Photon emission for (n,d)

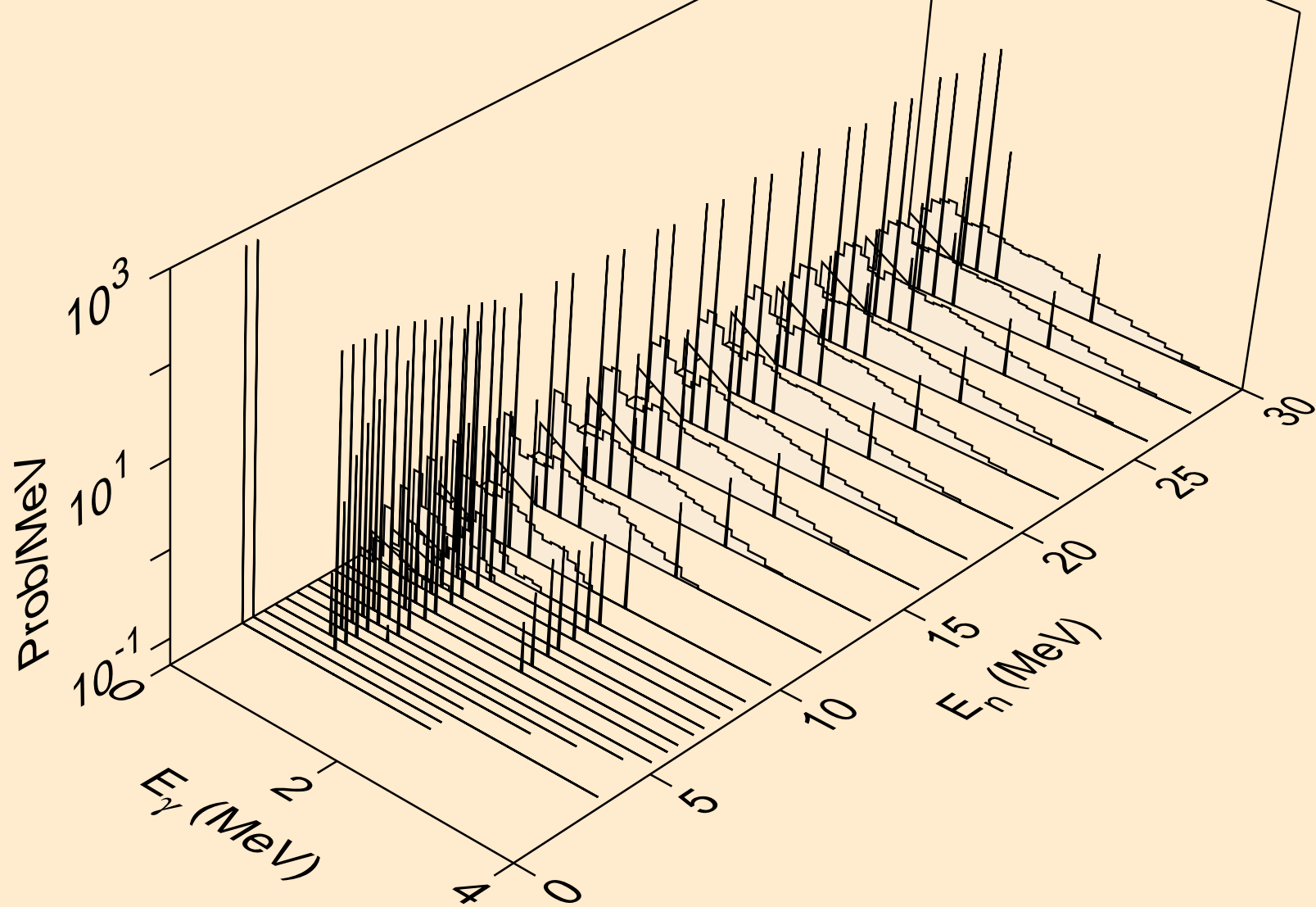

AG099 NEUTRON ACER TENDL-2021 LIBRARY; T=293.6K
Photon emission for (n,t)

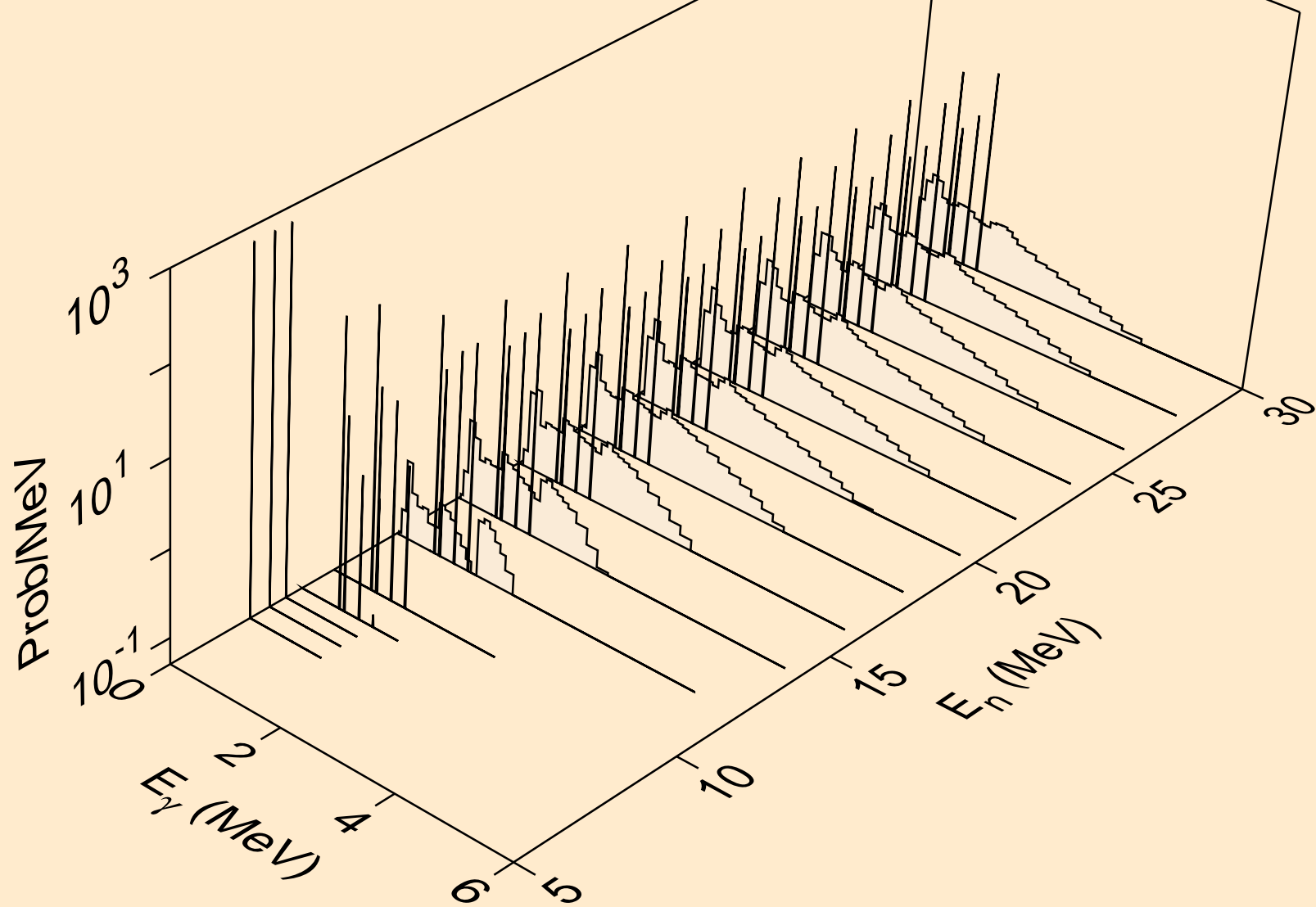

AG099 NEUTRON ACER TENDL-2021 LIBRARY; T=293.6K
Photon emission for (n,he3)

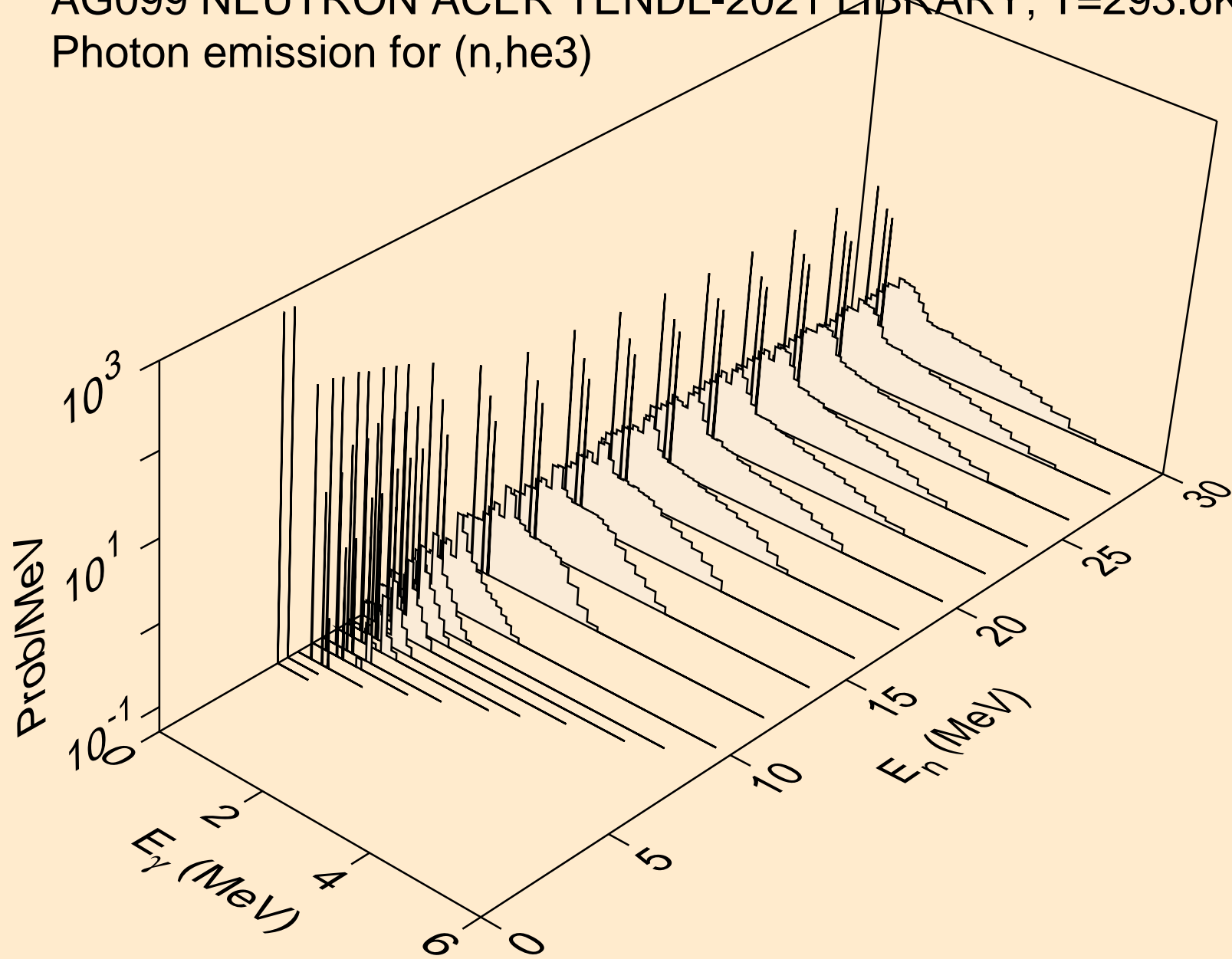

AG099 NEUTRON ACER TENDL-2021 LIBRARY; T=293.6K
Photon emission for (n,a)

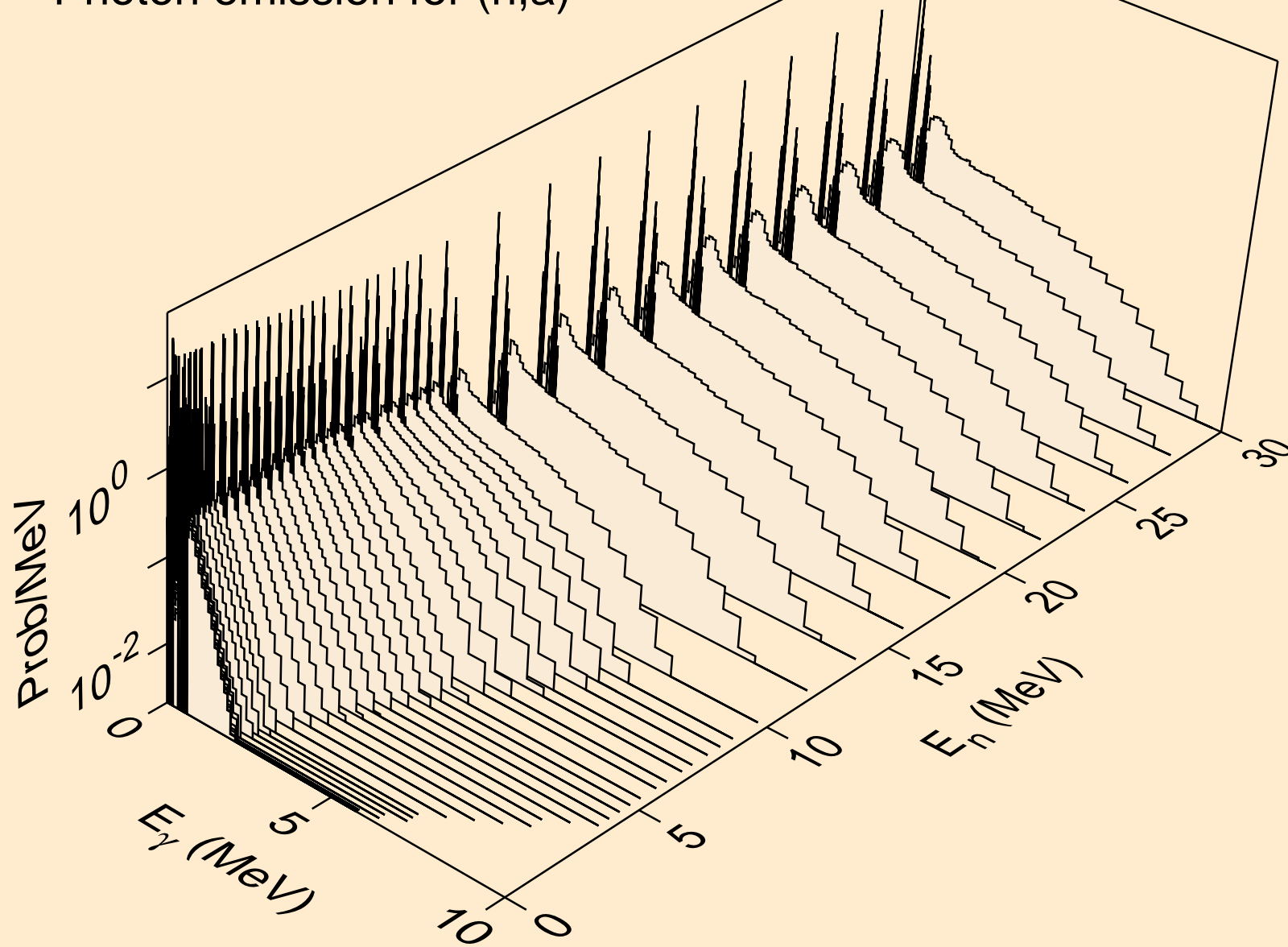

AG099 NEUTRON ACER TENDL-2021 LIBRARY; T=293.6K
Photon emission for (n,2a)

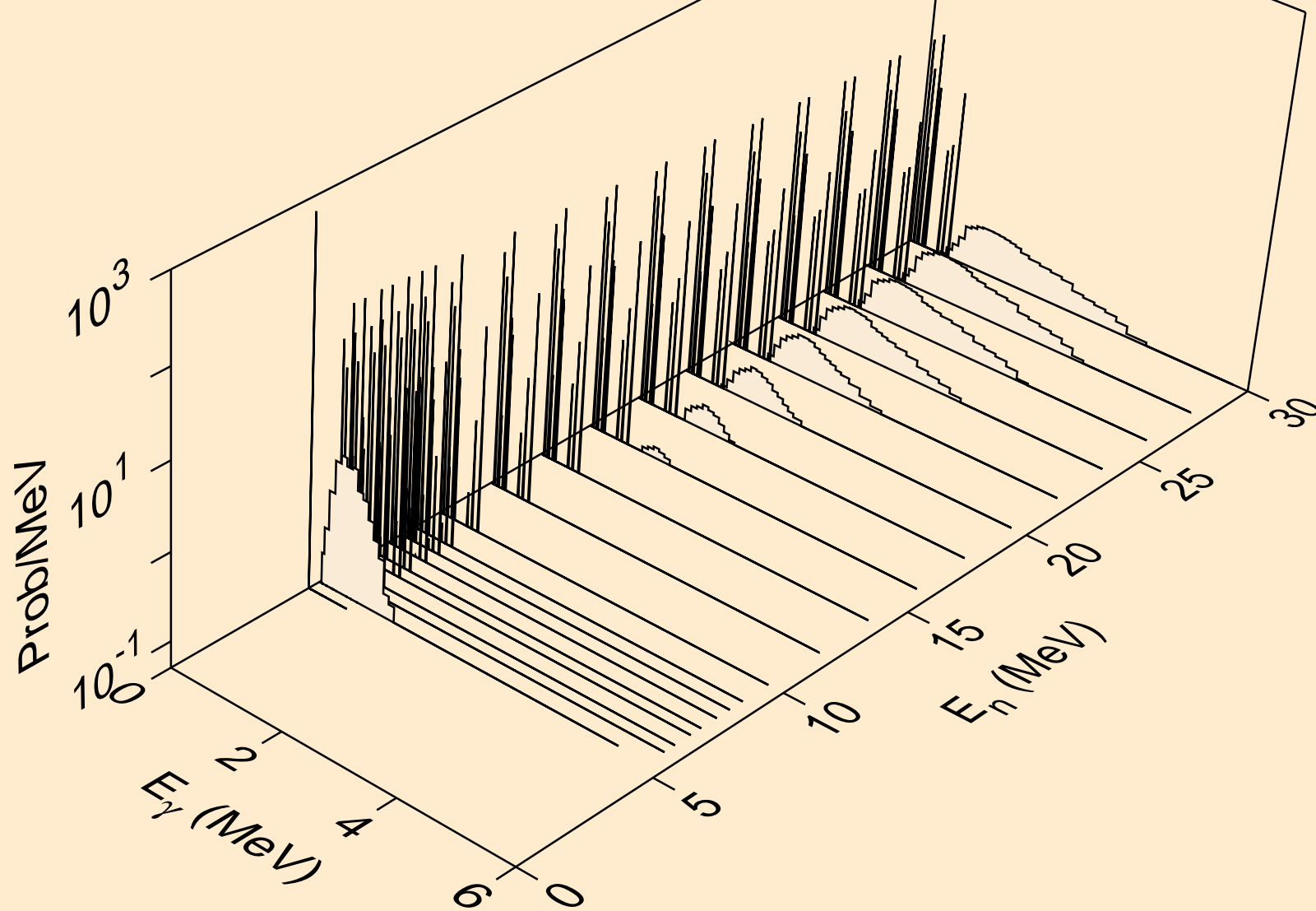

AG099 NEUTRON ACER TENDL-2021 LIBRARY; T=293.6K
Photon emission for (n,2p)

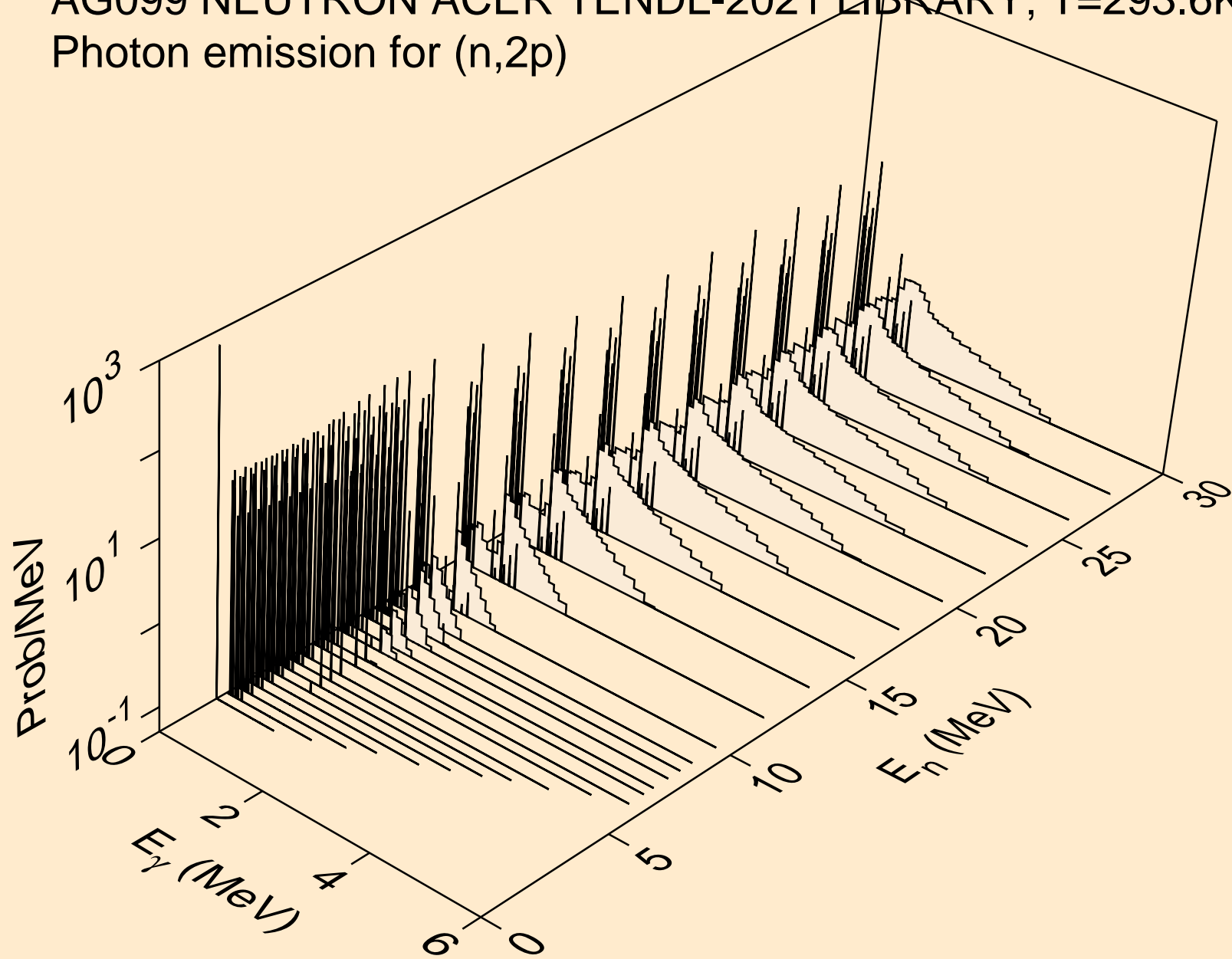

AG099 NEUTRON ACER TENDL-2021 LIBRARY; T=293.6K
Photon emission for (n,p α)

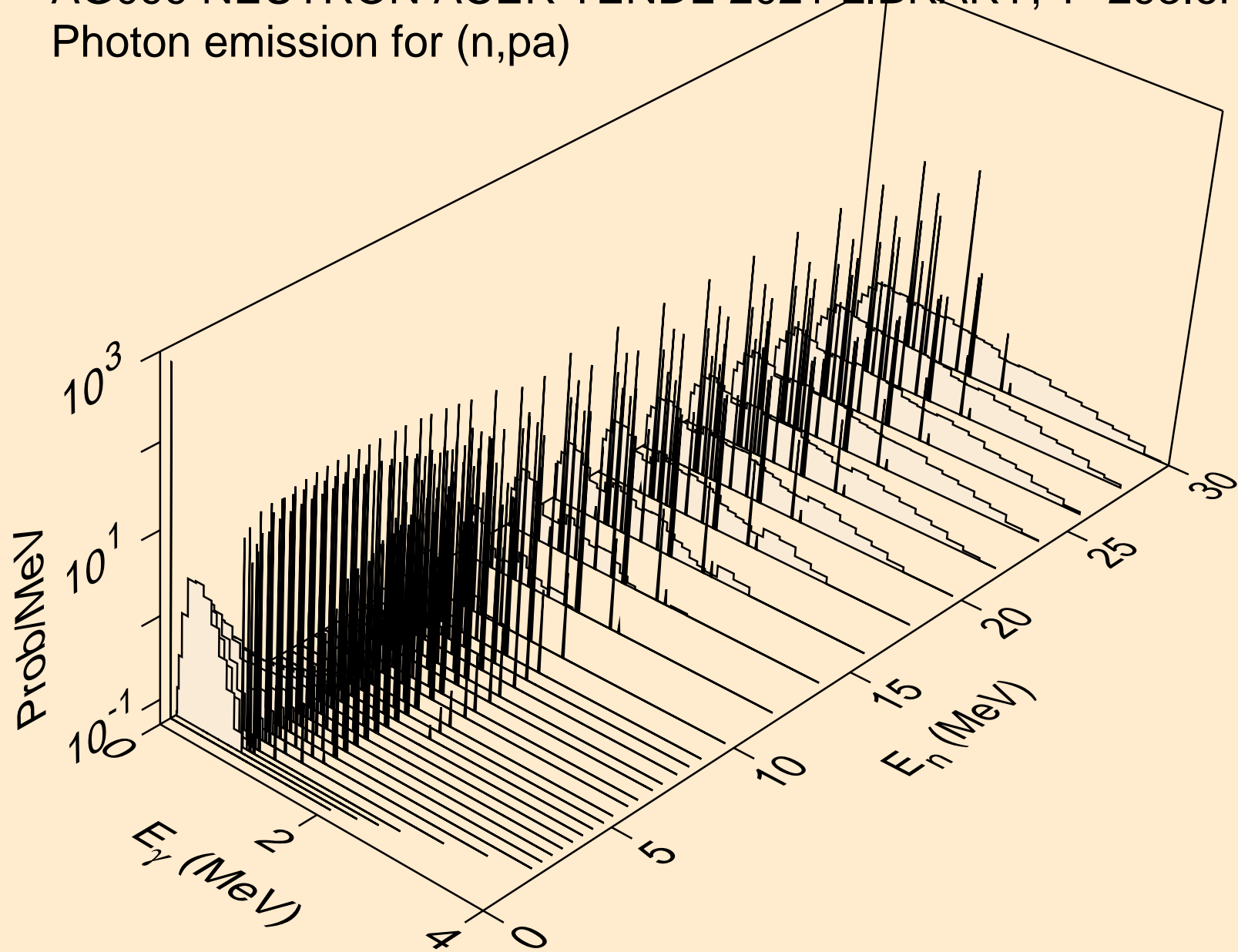

AG099 NEUTRON ACER TENDL-2021 LIBRARY; T=293.6K
Photon emission for (n,pd)

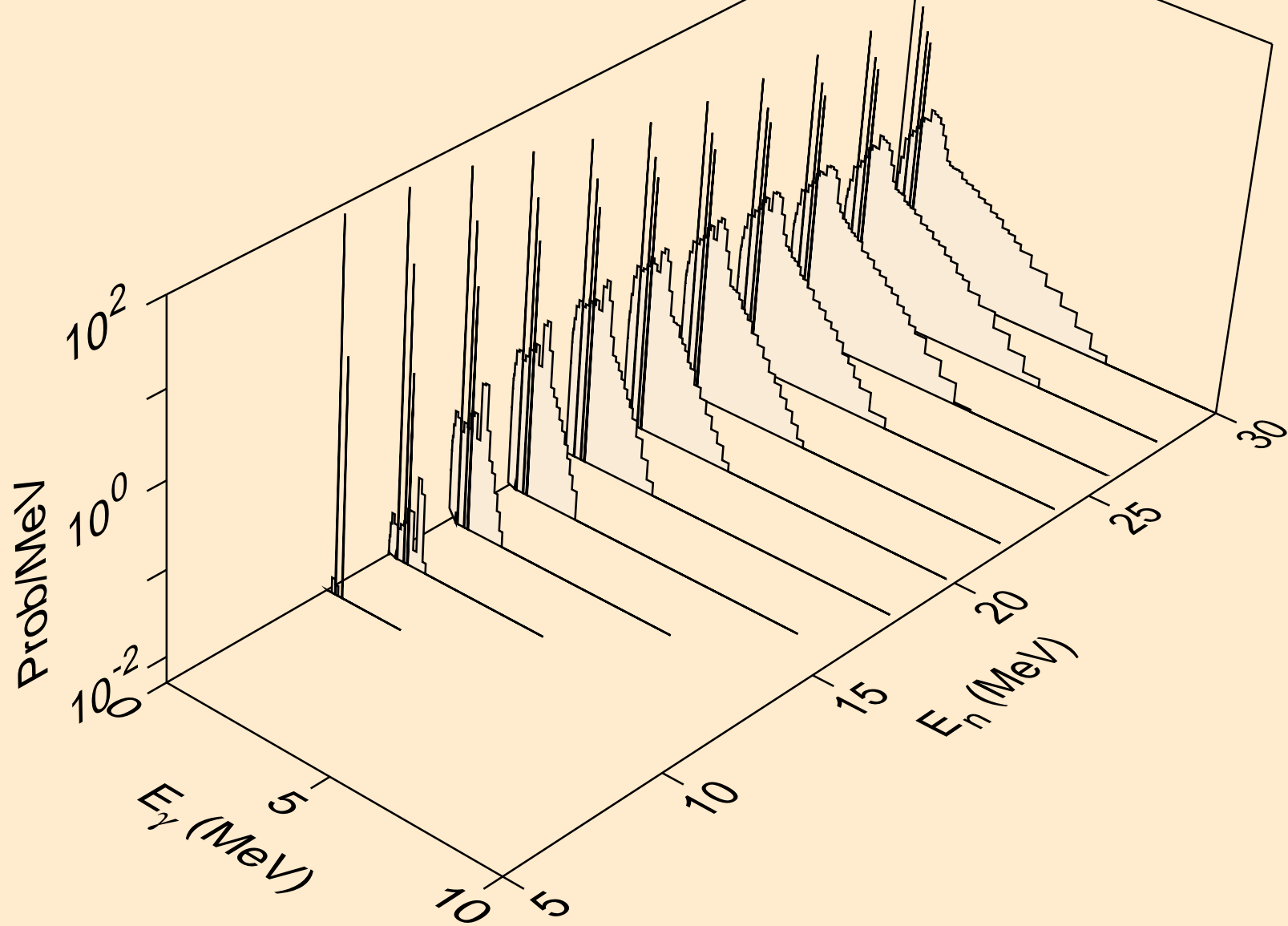

AG099 NEUTRON ACER TENDL-2021 LIBRARY; T=293.6K
Photon emission for (n,pt)

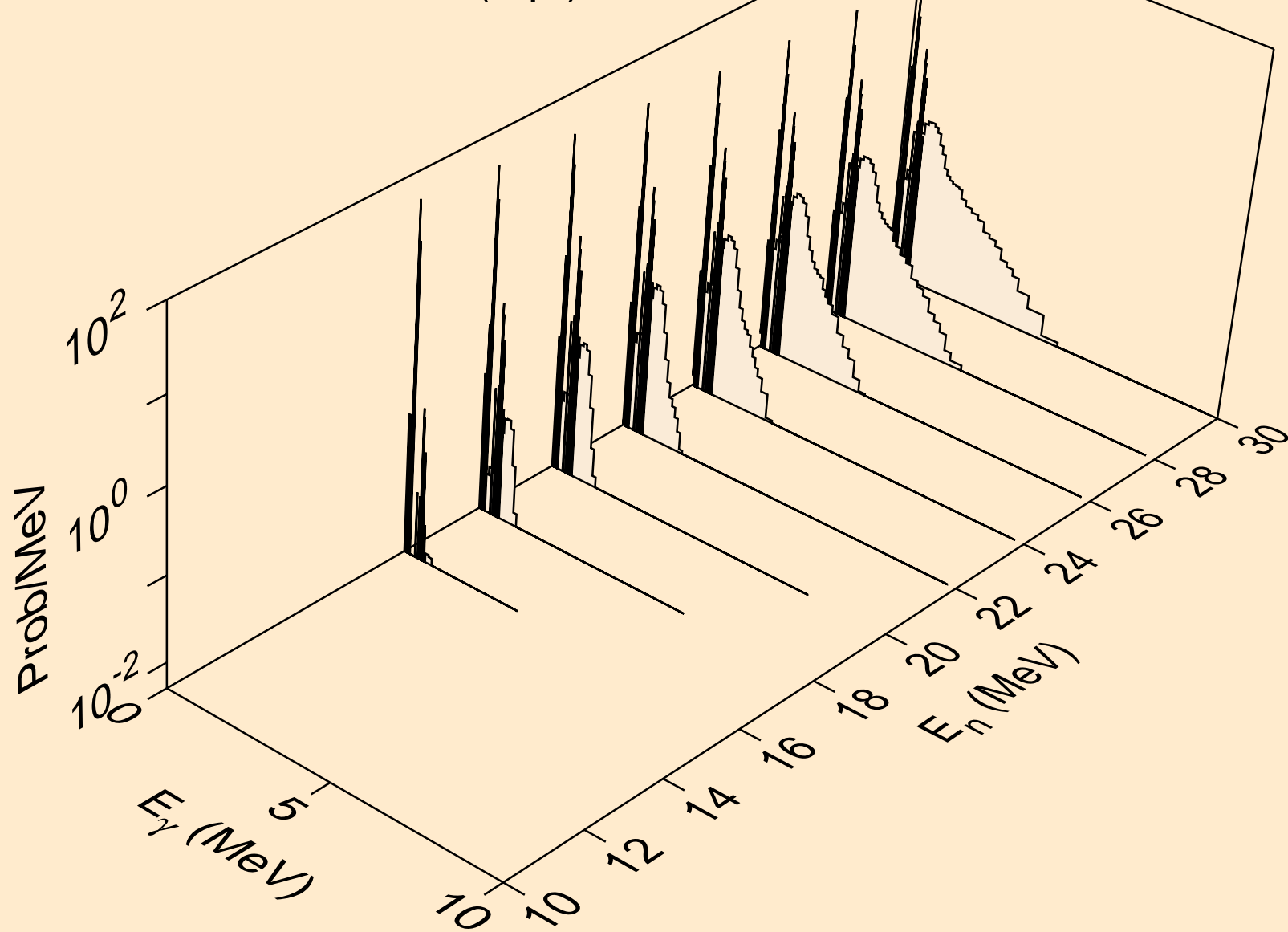

AG099 NEUTRON ACER TENDL-2021 LIBRARY; T=293.6K
Photon emission for (n,da)

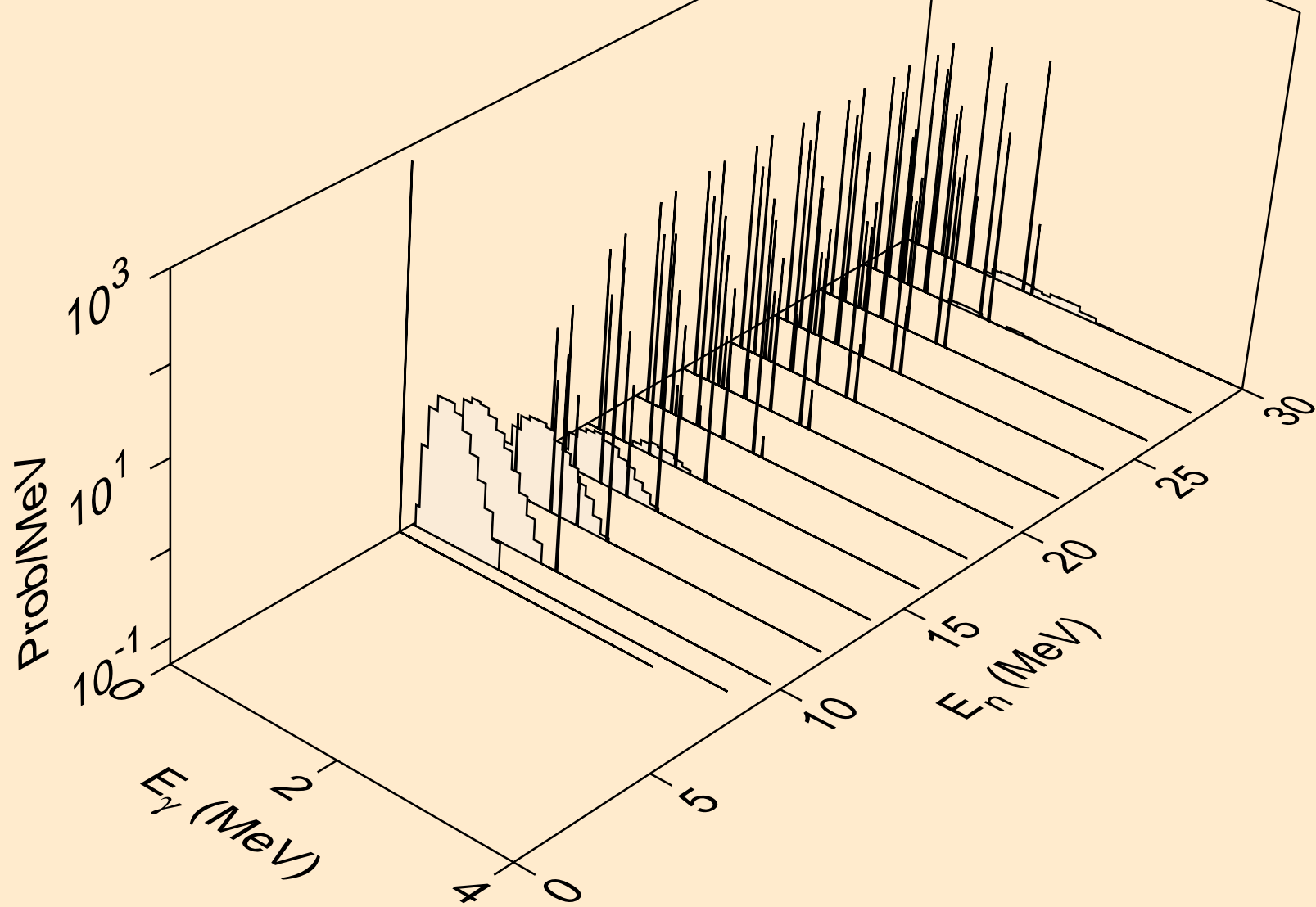

AG099 NEUTRON ACER TENDL-2021 LIBRARY; T=293.6K
thermal capture photon spectrum

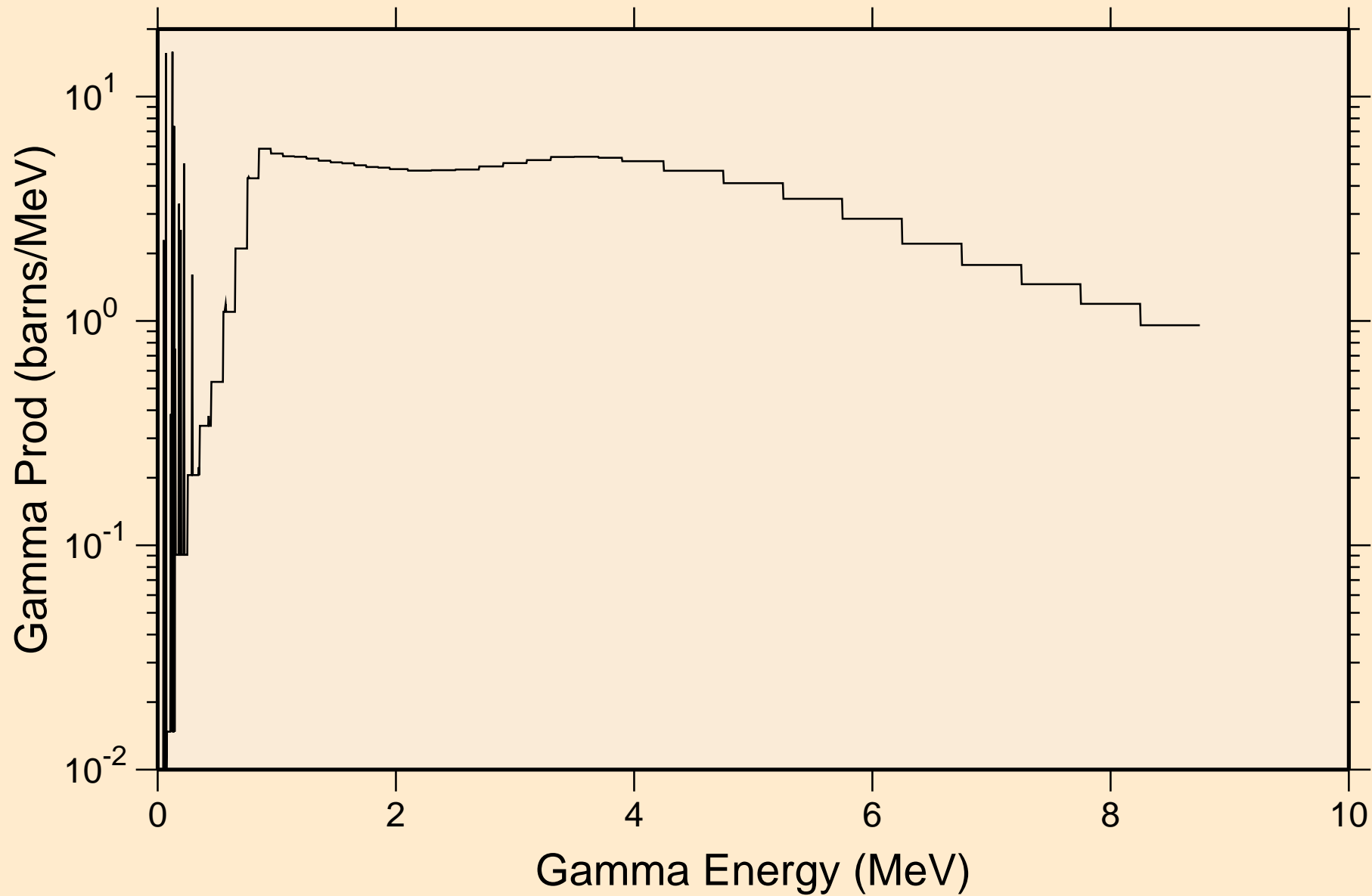

AG099 NEUTRON ACER TENDL-2021 LIBRARY; T=293.6K
14 MeV photon spectrum

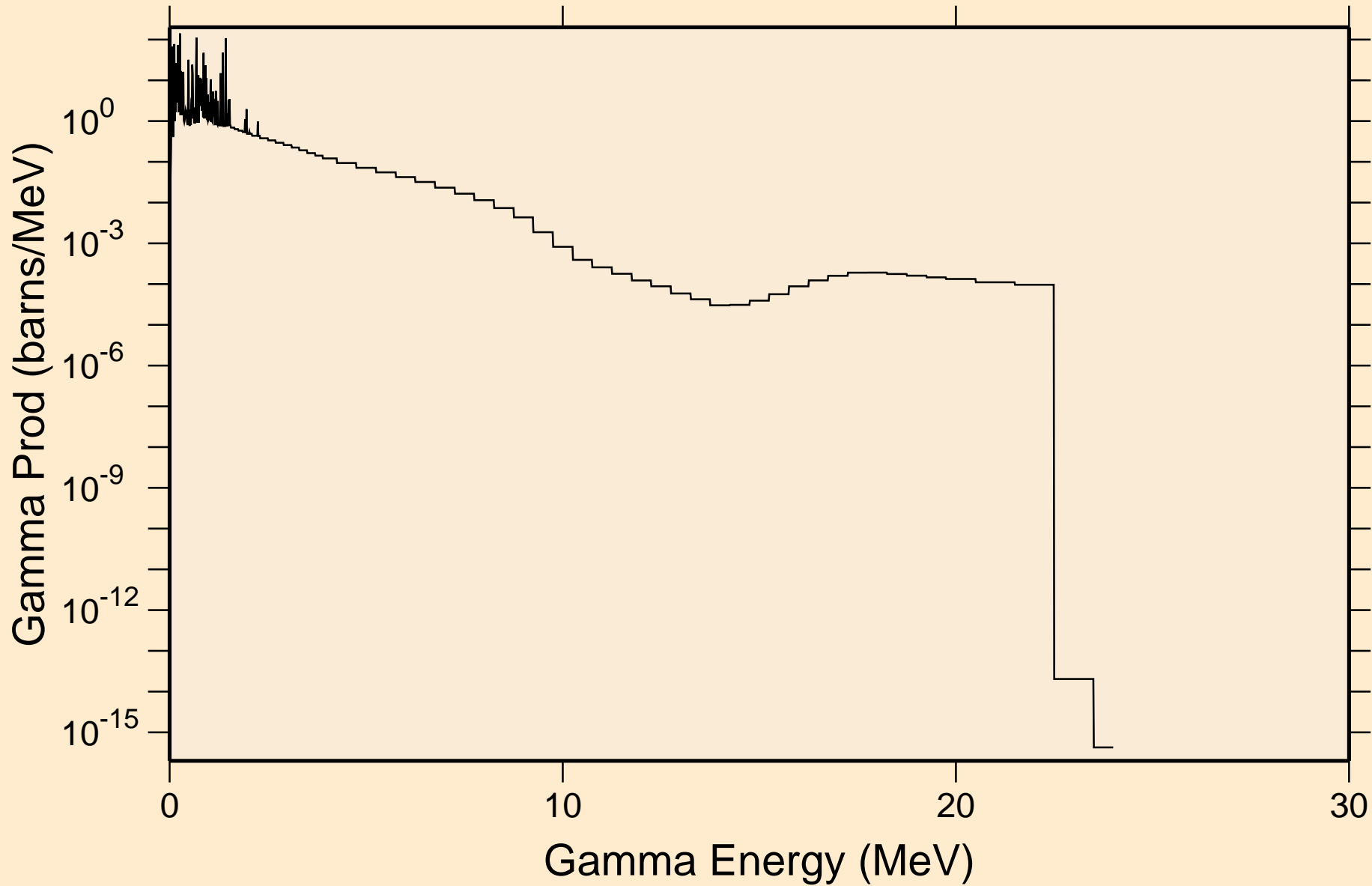

AG099 NEUTRON ACER TENDL-2021 LIBRARY; T=293.6K
Particle heating contributions

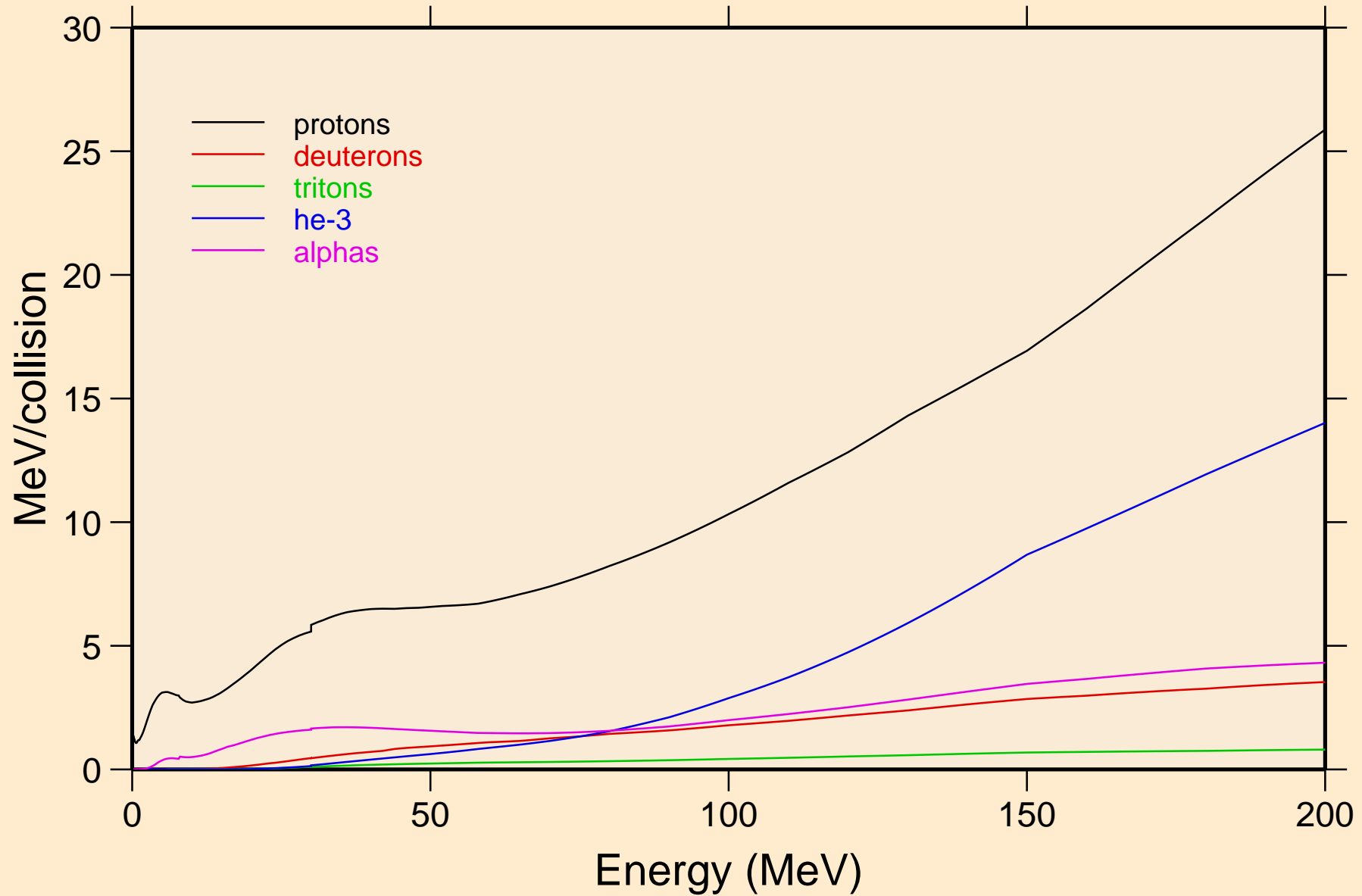

AG099 NEUTRON ACER TENDL-2021 LIBRARY; T=293.6K
Recoil Heating

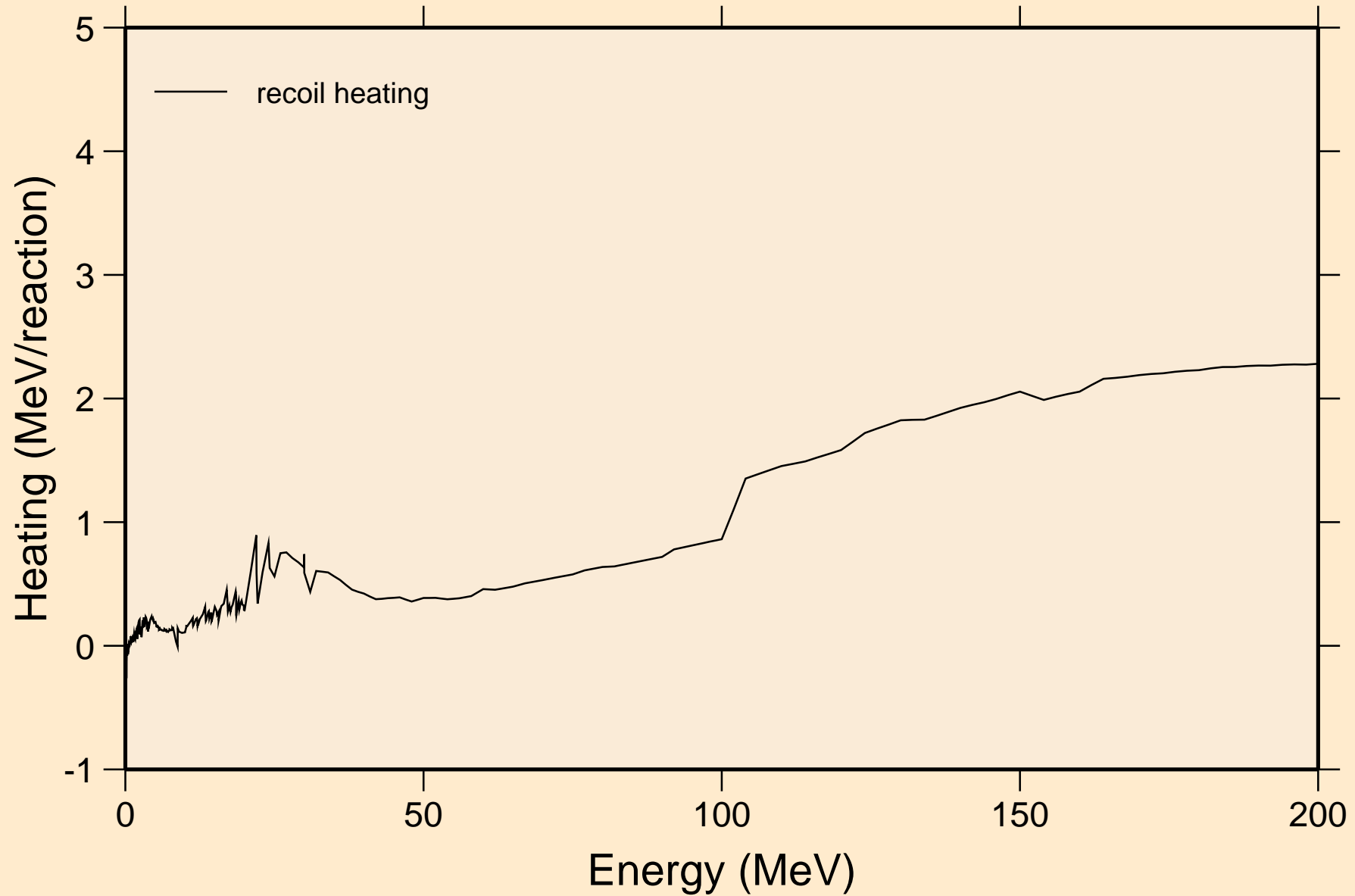

AG099 NEUTRON ACER TENDL-2021 LIBRARY; T=293.6K
Particle production cross sections

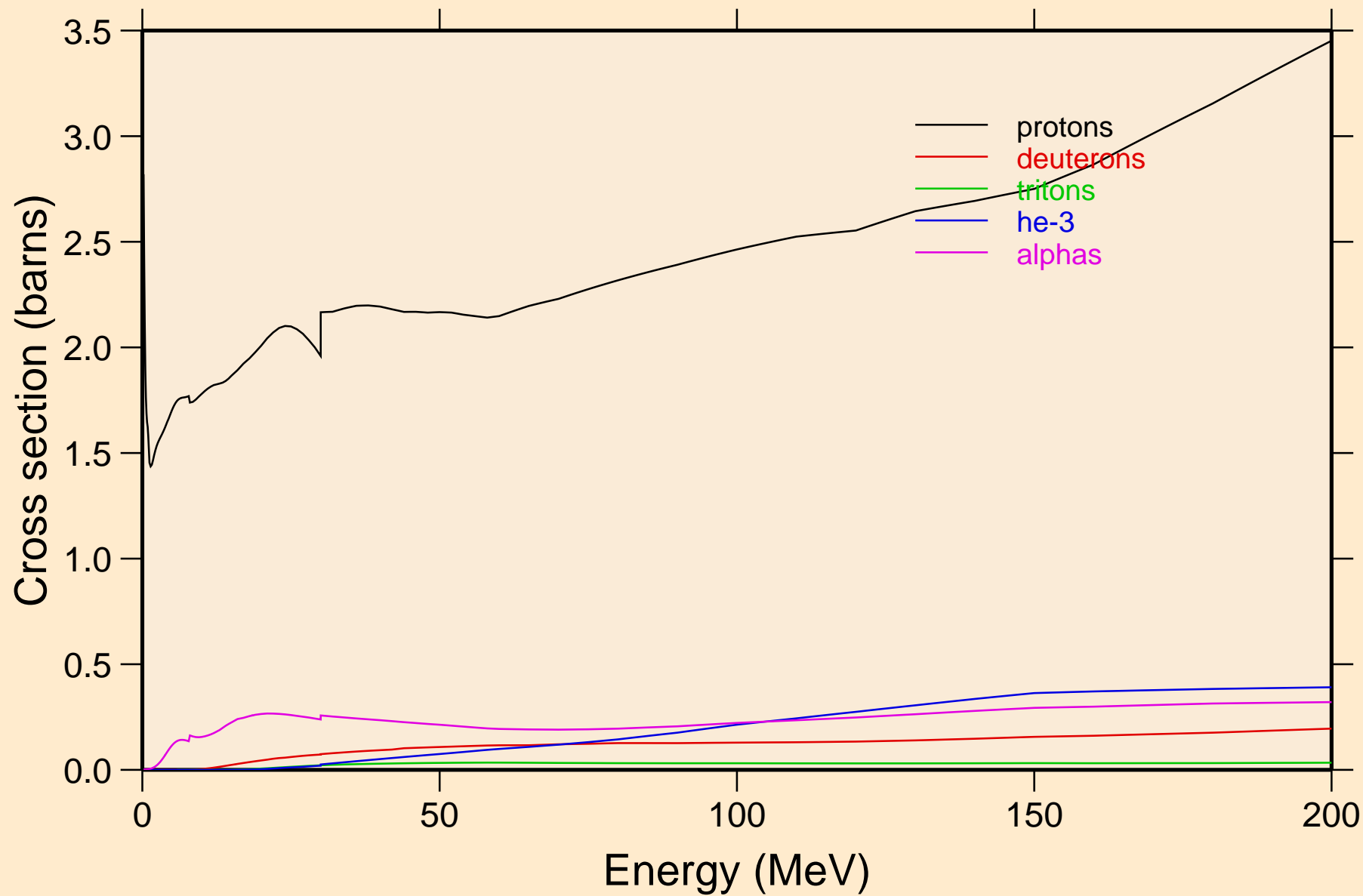

AG099 NEUTRON ACER TENDL-2021 LIBRARY; T=293.6K
protons from (n,x)

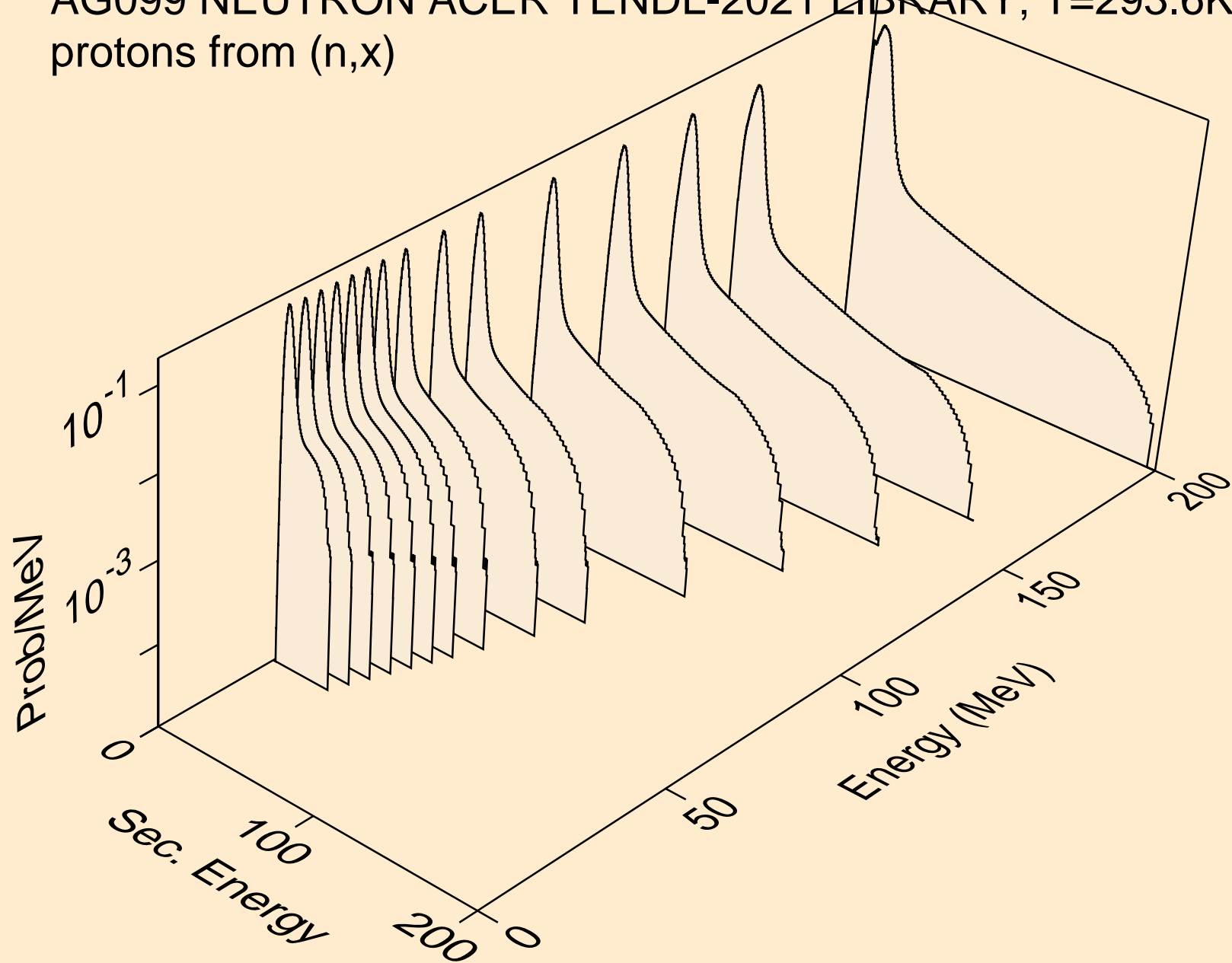

AG099 NEUTRON ACER TENDL-2021 LIBRARY; T=293.6K
protons from (n,n*)p

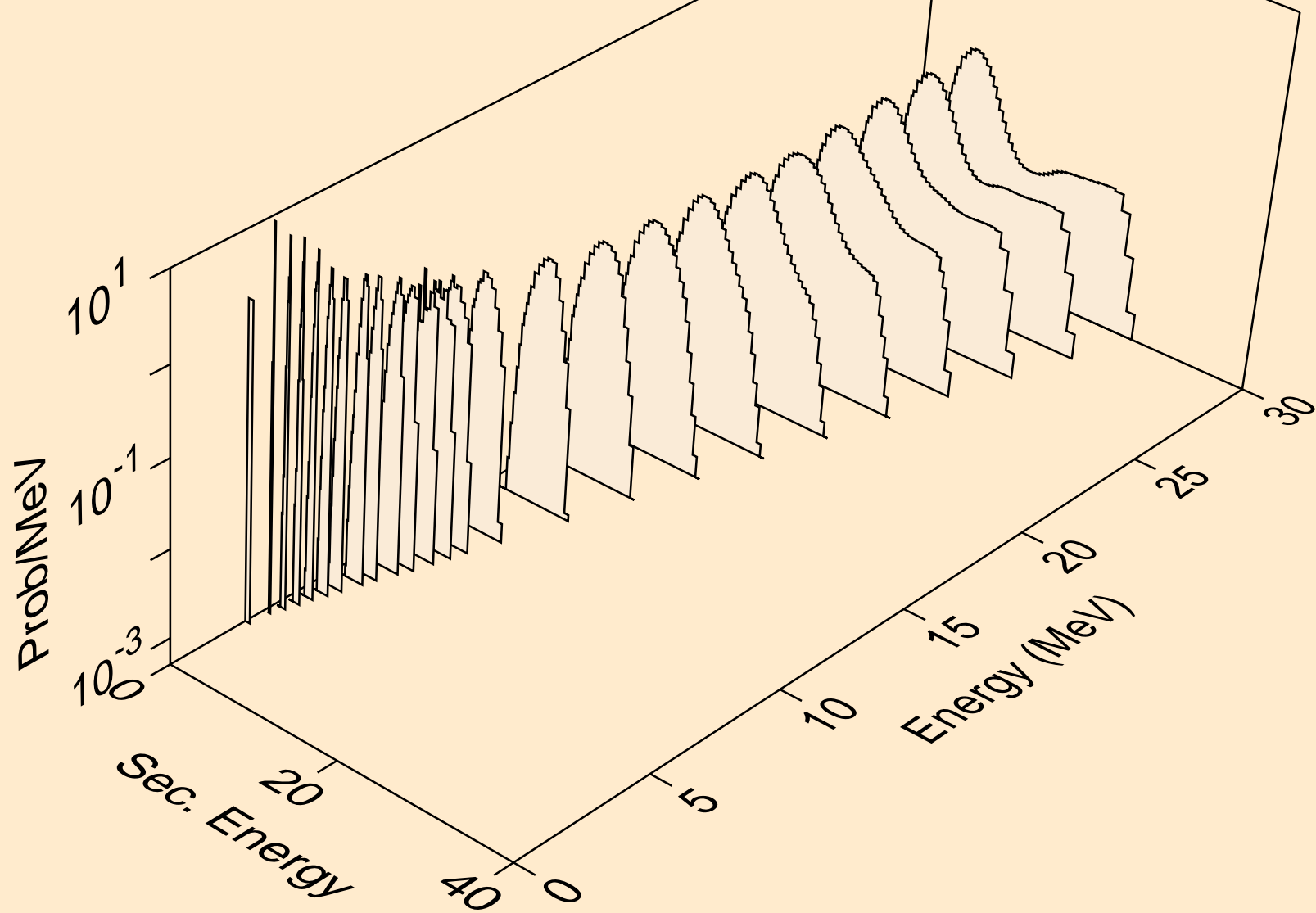

AG099 NEUTRON ACER TENDL-2021 LIBRARY; T=293.6K
protons from (n,2np)

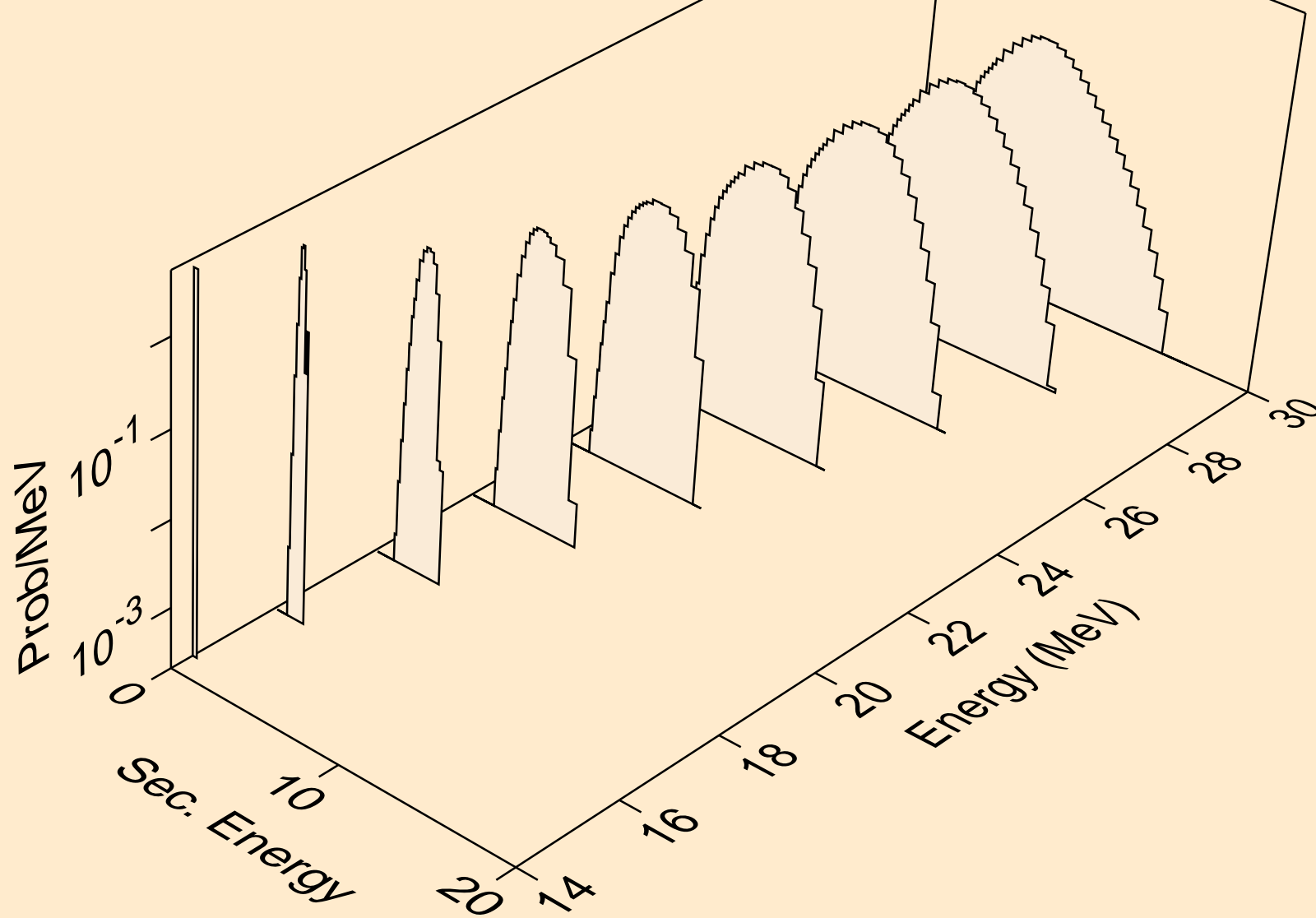

AG099 NEUTRON ACER TENDL-2021 LIBRARY; T=293.6K
protons from (n,3np)

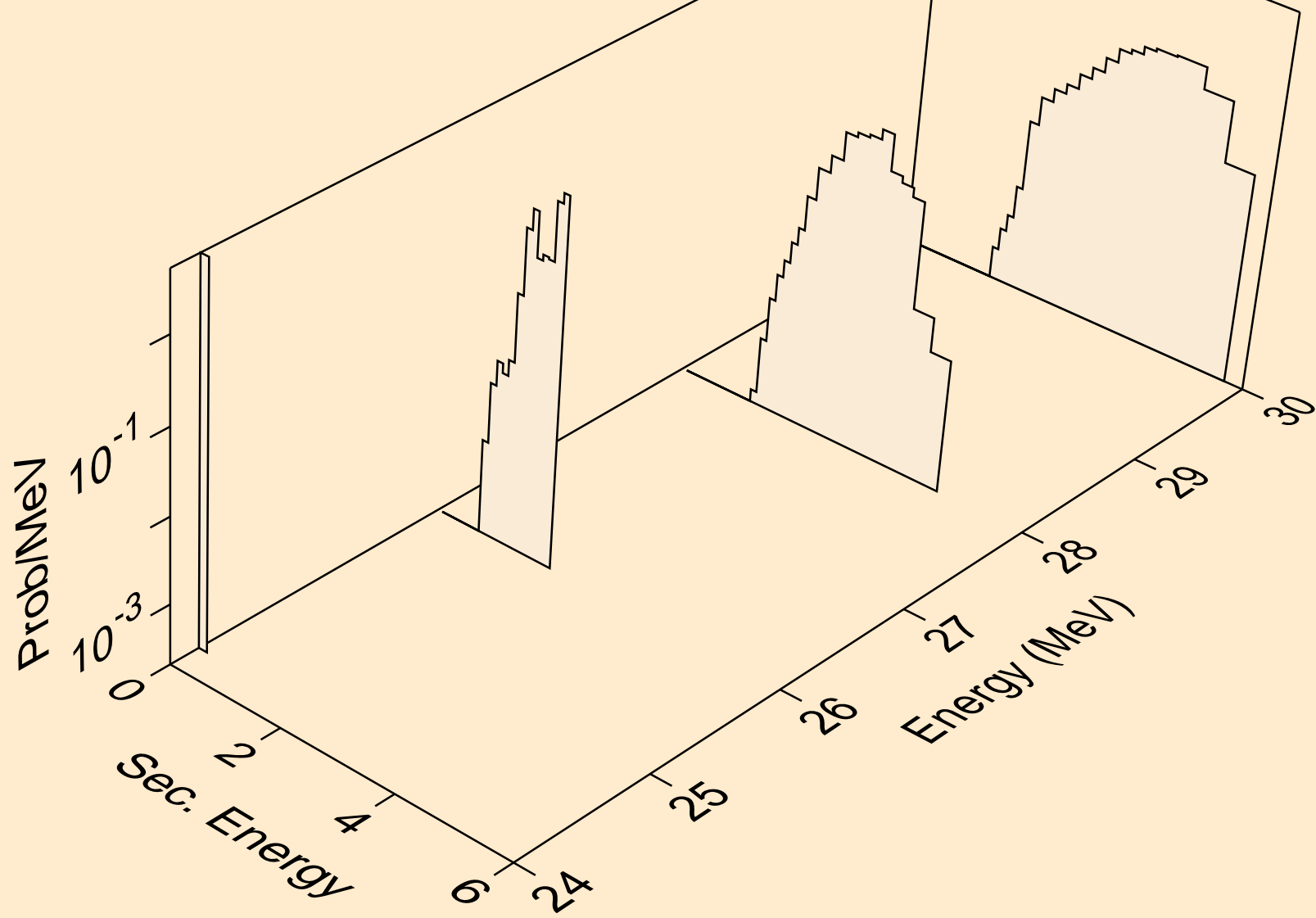

AG099 NEUTRON ACER TENDL-2021 LIBRARY; T=293.6K
protons from (n,2np)

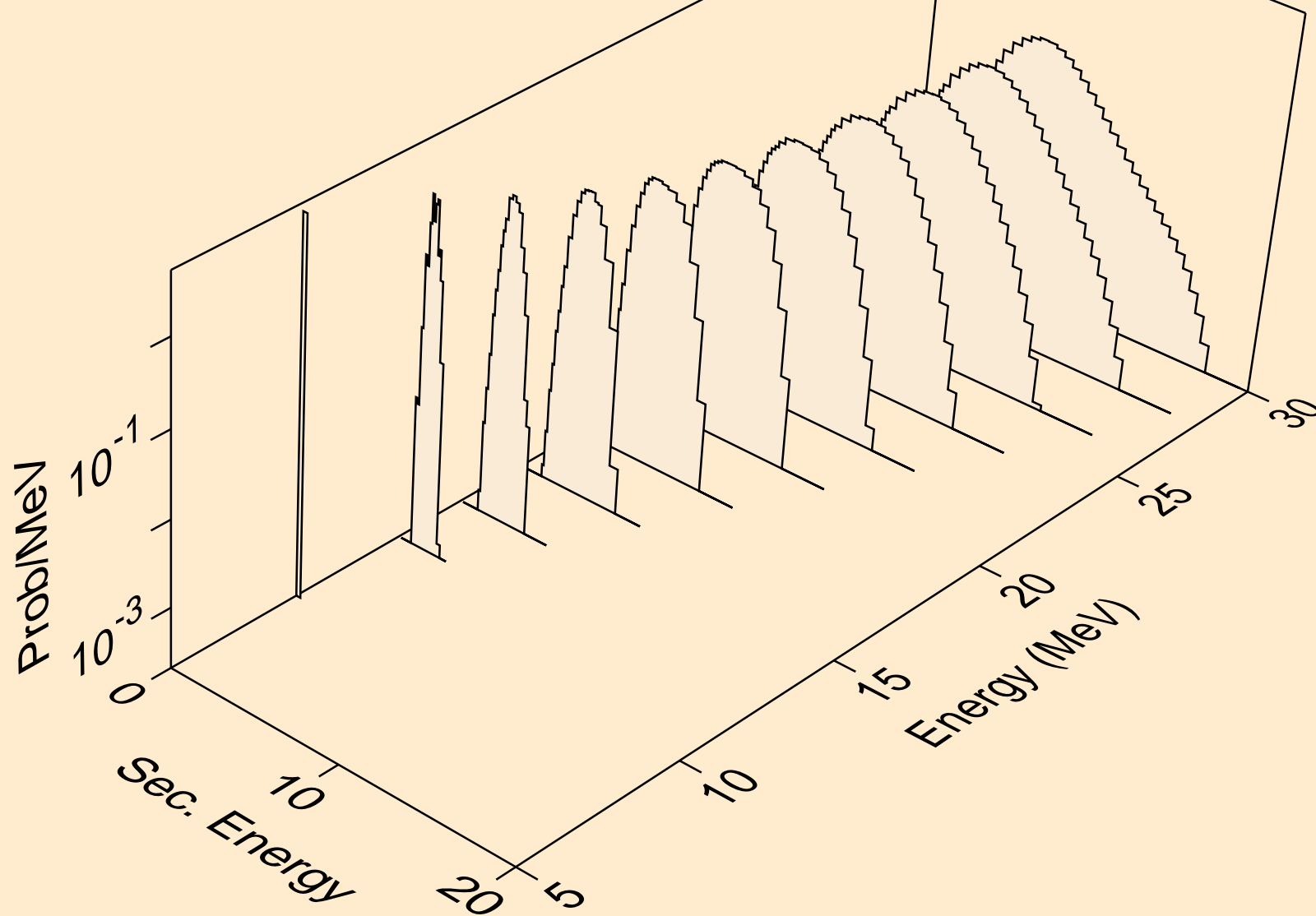

AG099 NEUTRON ACER TENDL-2021 LIBRARY; T=293.6K
protons from (n,npa)

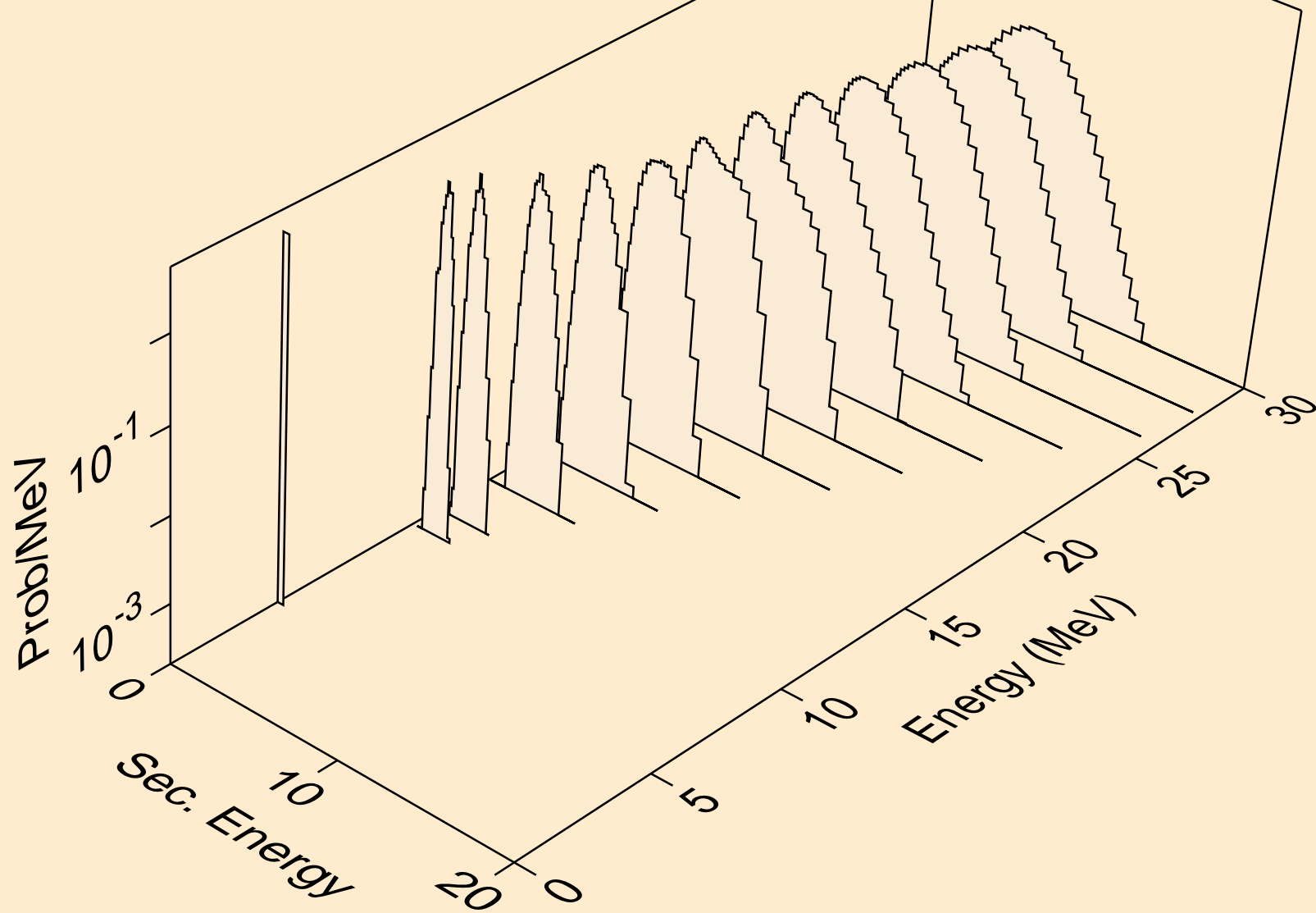

AG099 NEUTRON ACER TENDL-2021 LIBRARY; T=293.6K
protons from (n,p)

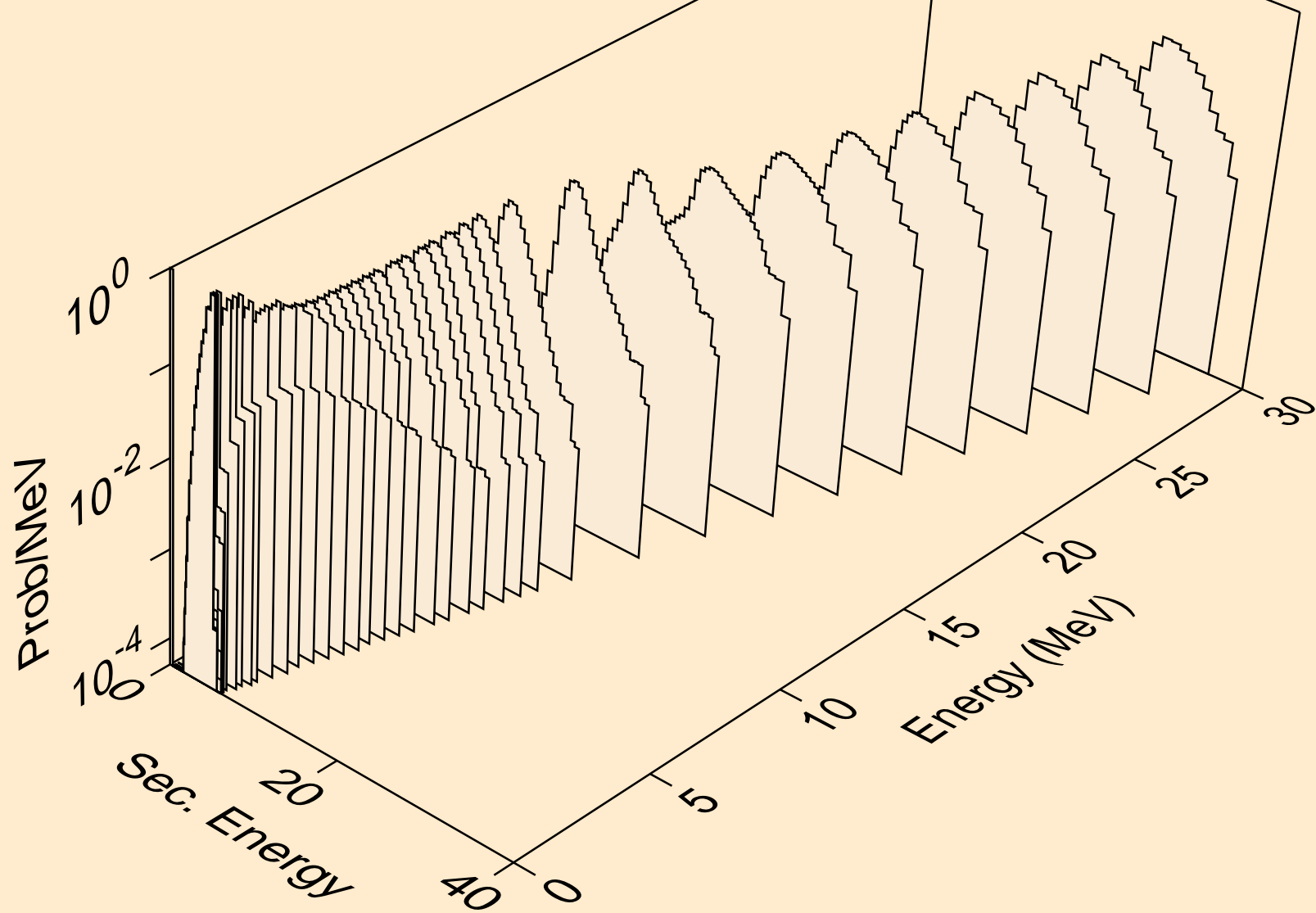

AG099 NEUTRON ACER TENDL-2021 LIBRARY; T=293.6K
protons from (n,2p)

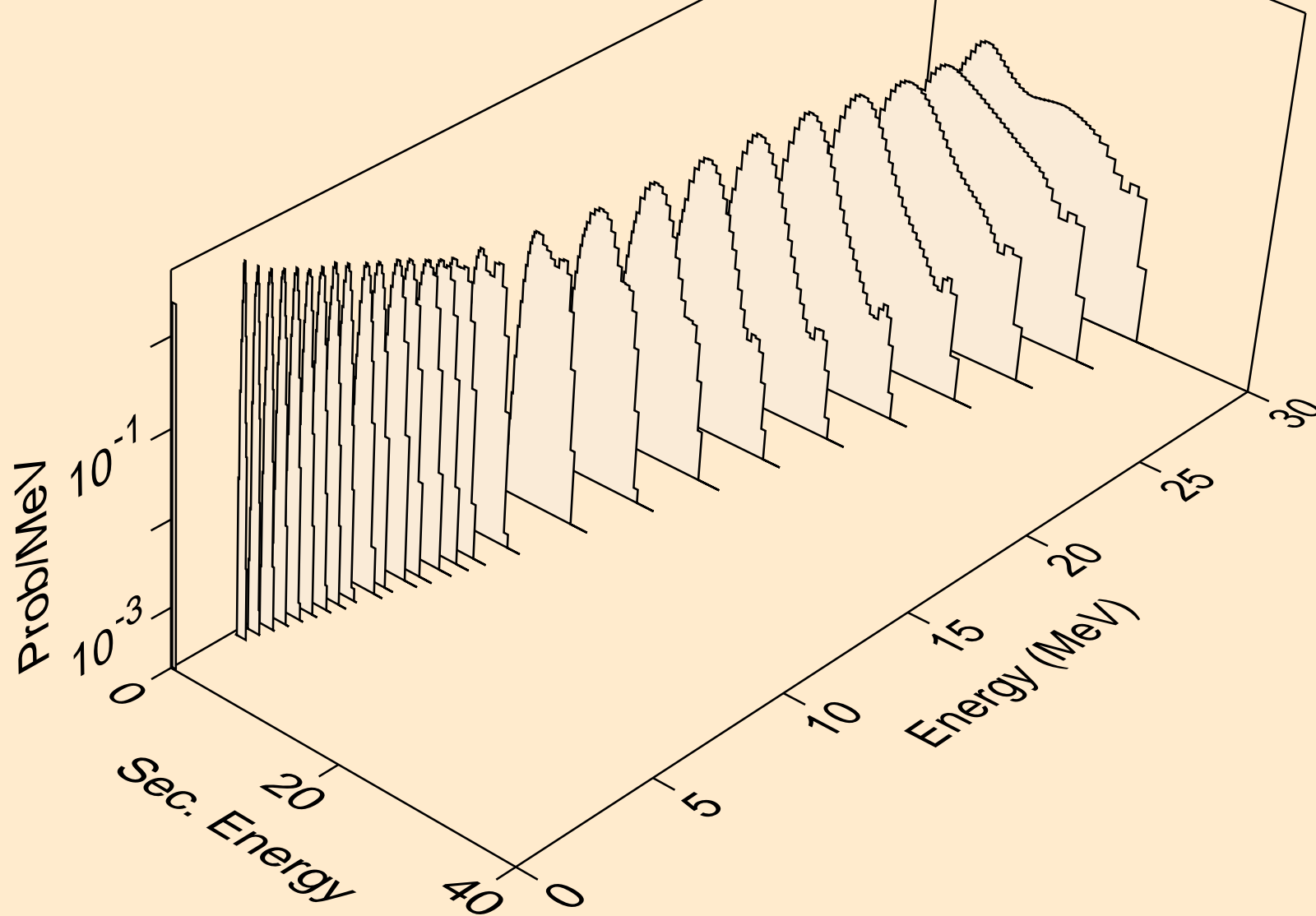

AG099 NEUTRON ACER TENDL-2021 LIBRARY; T=293.6K
protons from (n,p)

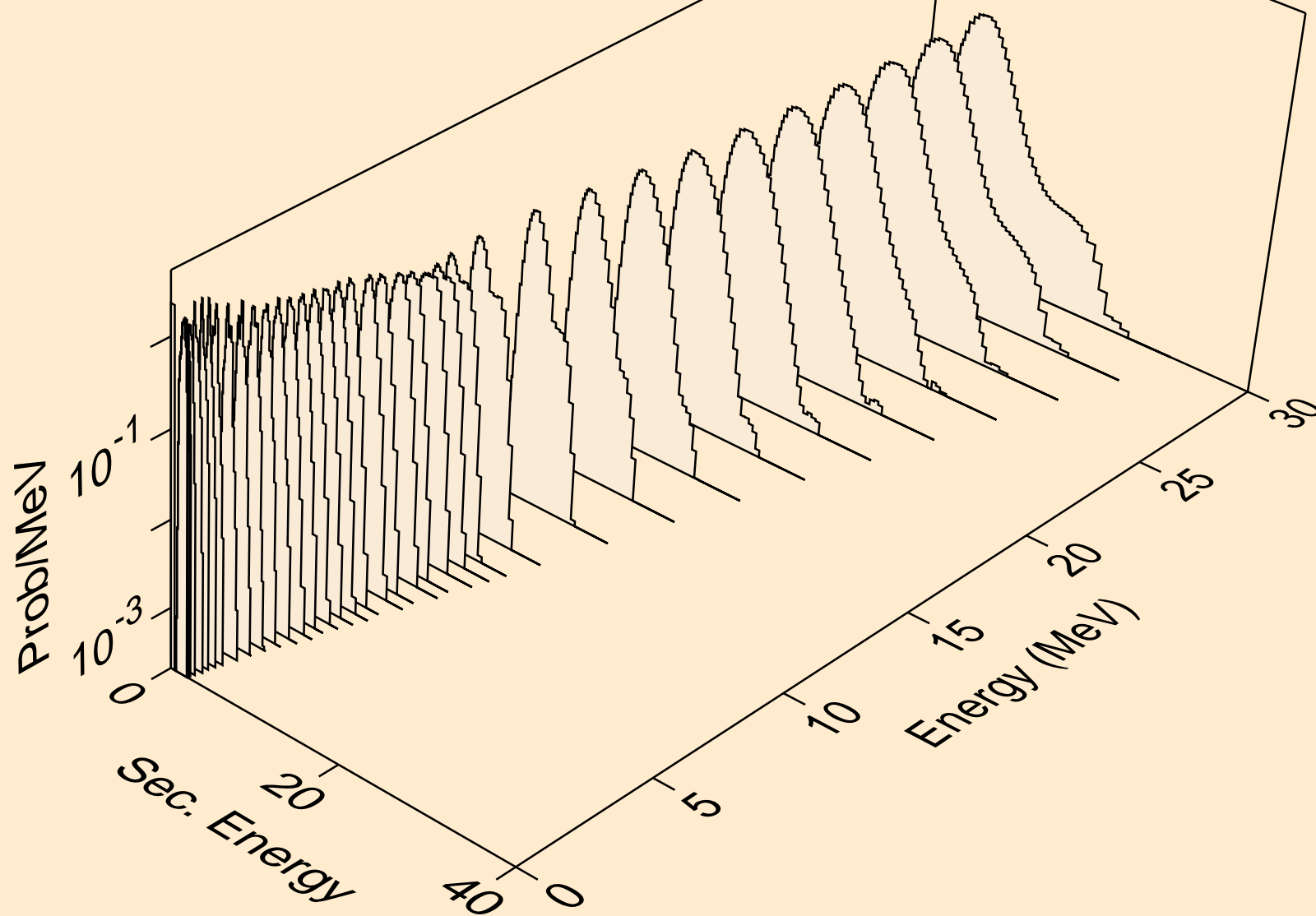

AG099 NEUTRON ACER TENDL-2021 LIBRARY; T=293.6K
protons from (n,pd)

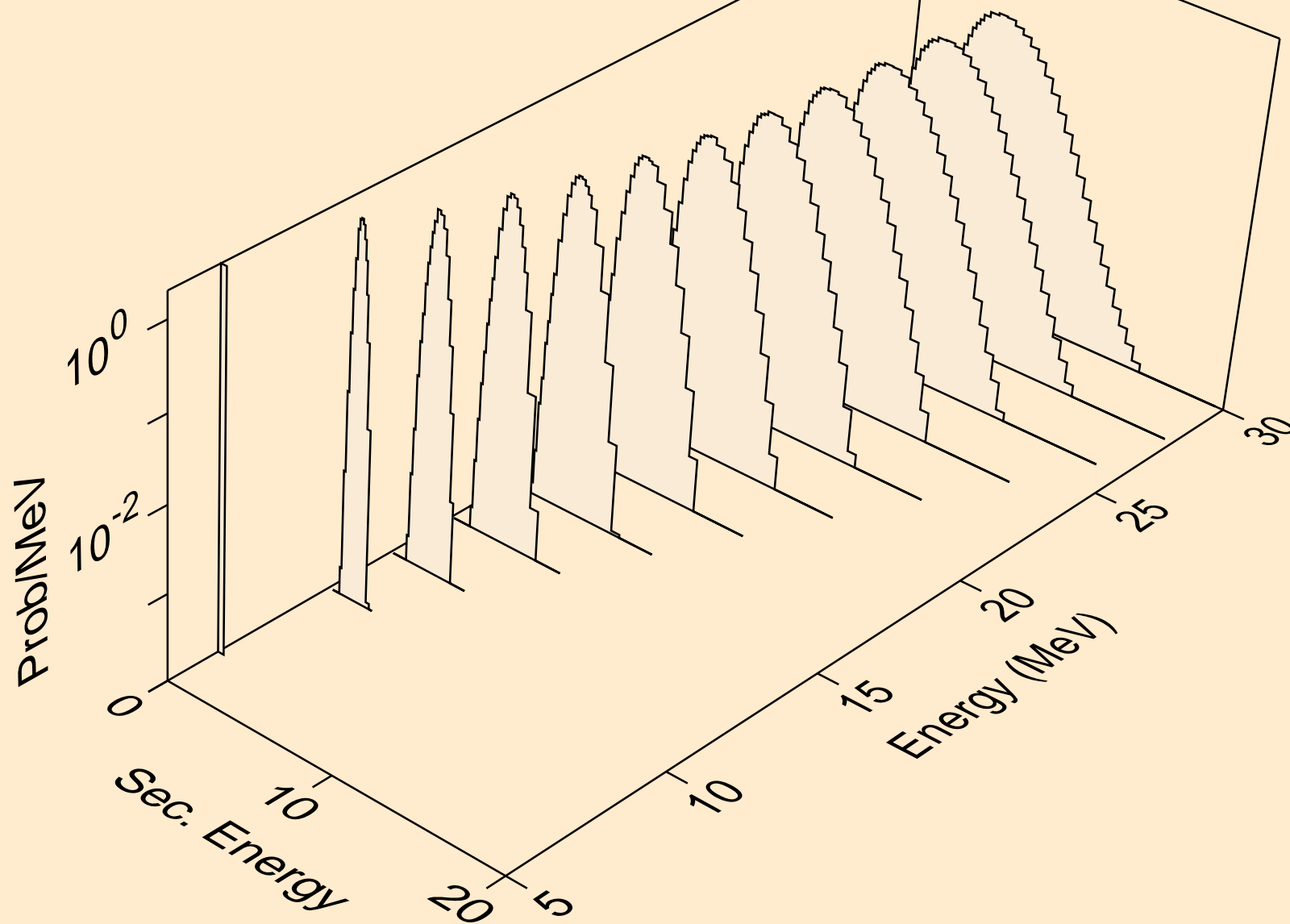

AG099 NEUTRON ACER TENDL-2021 LIBRARY; T=293.6K
protons from (n,pt)

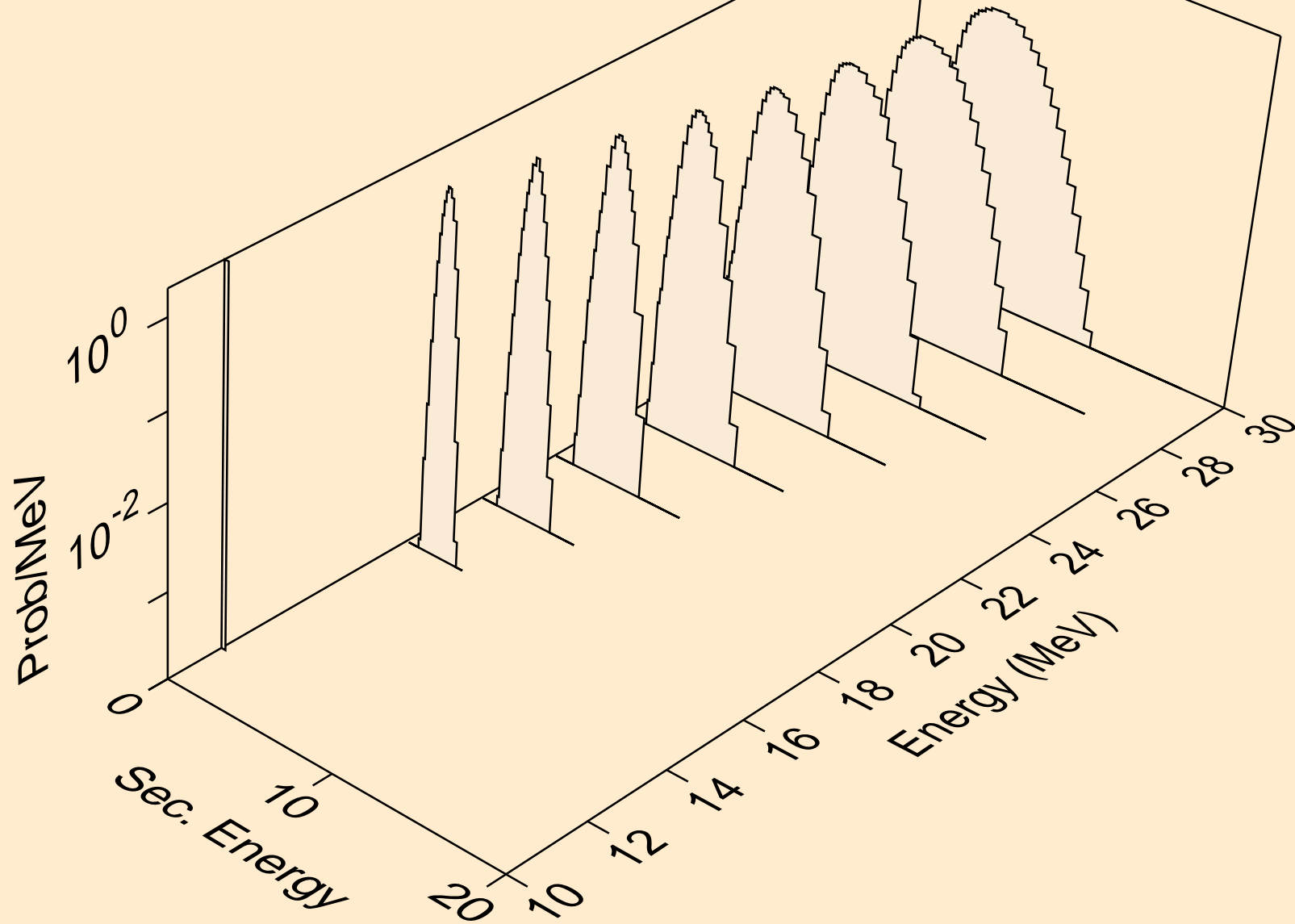

AG099 NEUTRON ACER TENDL-2021 LIBRARY; T=293.6K
deuterons from (n,x)

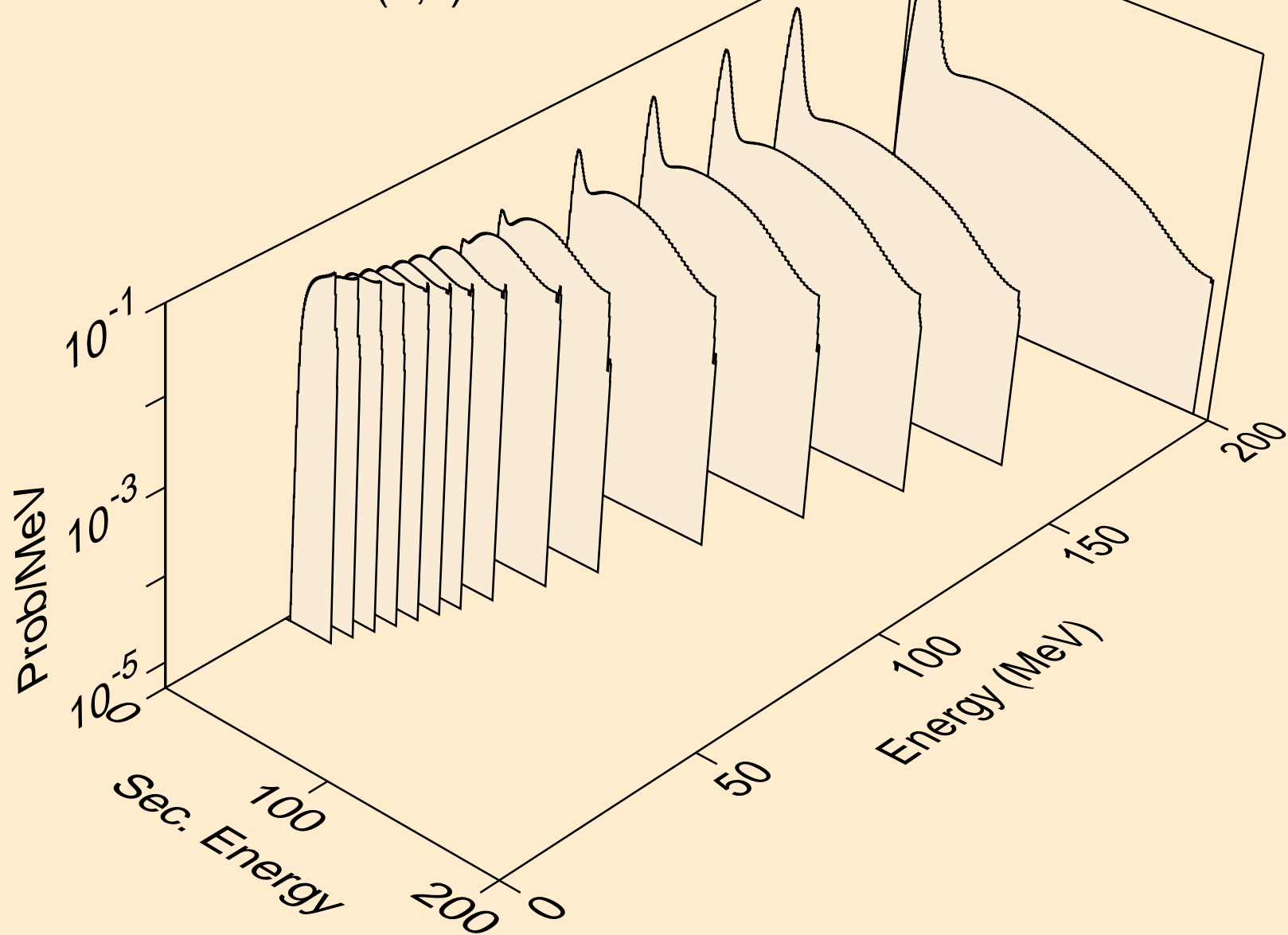

AG099 NEUTRON ACER TENDL-2021 LIBRARY; T=293.6K
deuterons from (n,2nd)

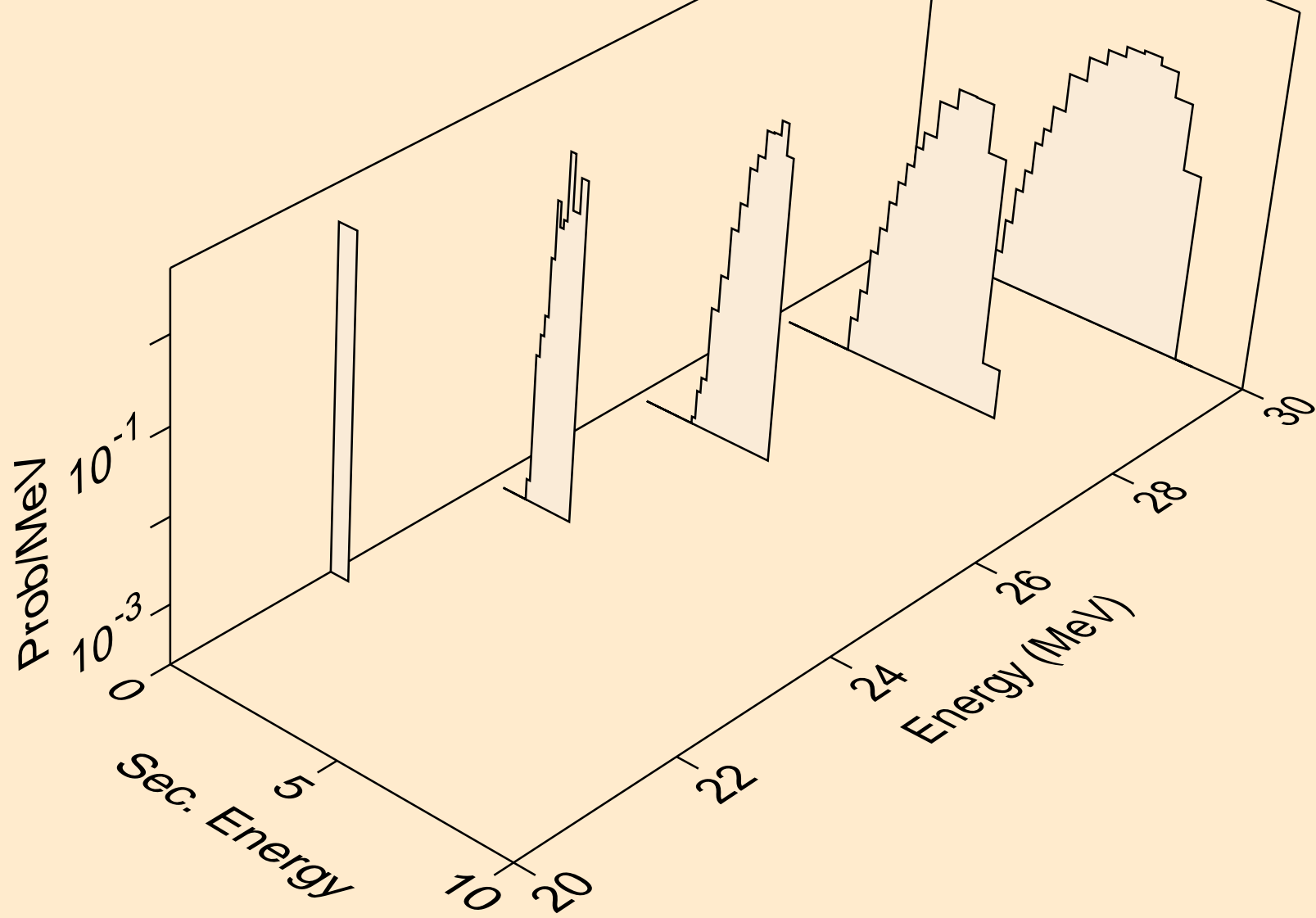

AG099 NEUTRON ACER TENDL-2021 LIBRARY; T=293.6K
deuterons from (n,n*)d

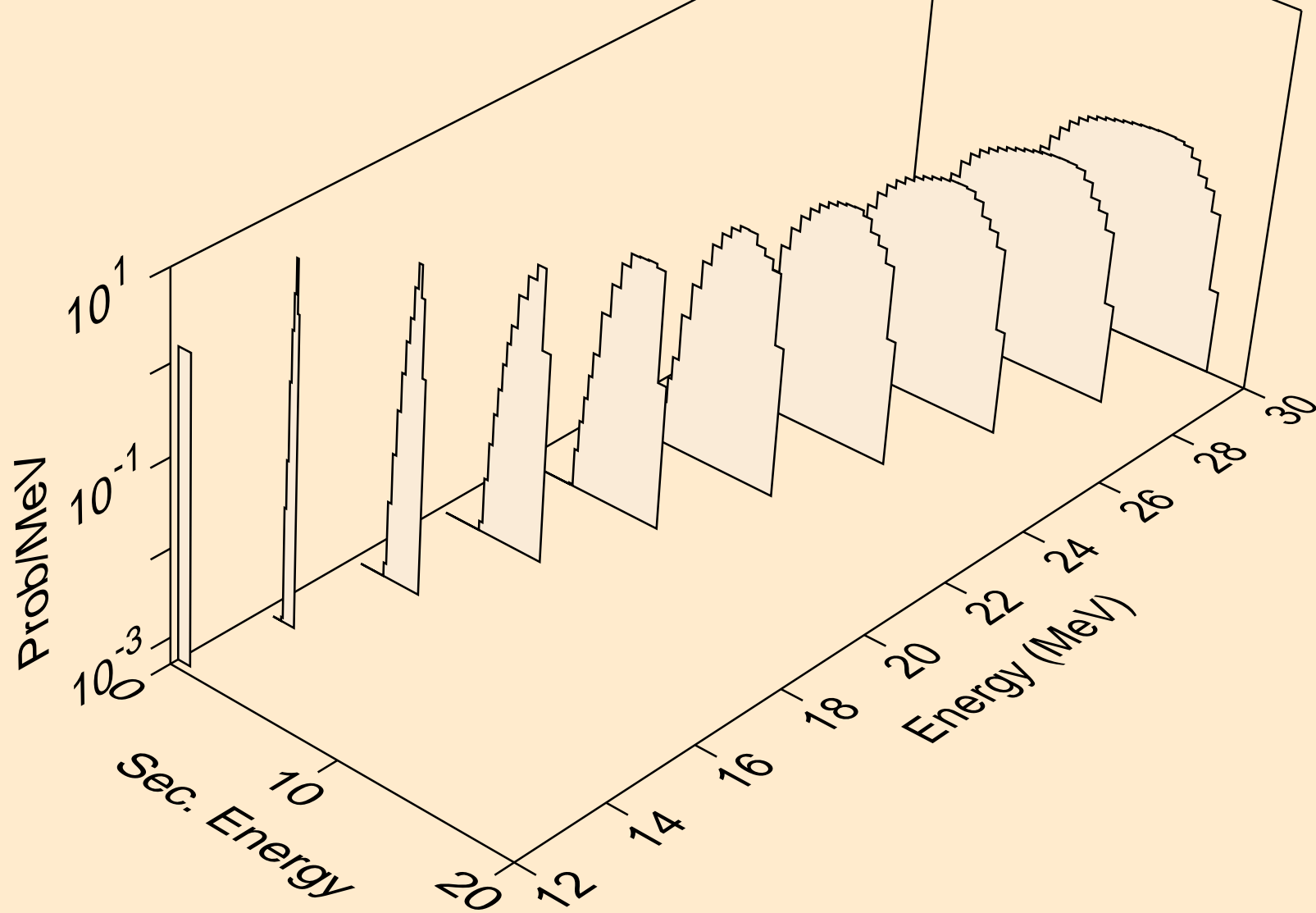

AG099 NEUTRON ACER TENDL-2021 LIBRARY; T=293.6K
deuterons from (n,d)

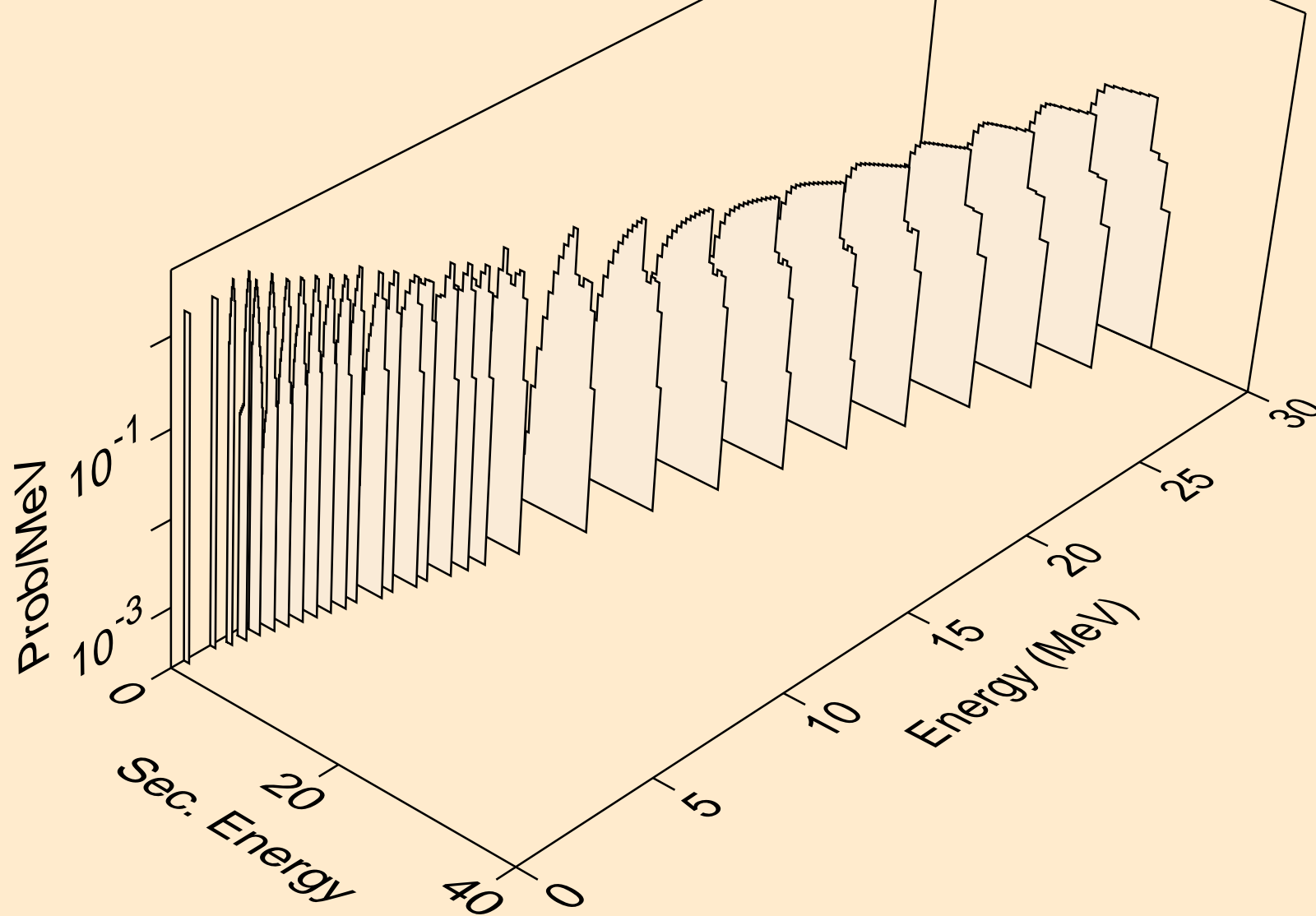

AG099 NEUTRON ACER TENDL-2021 LIBRARY; T=293.6K
deuterons from (n,pd)

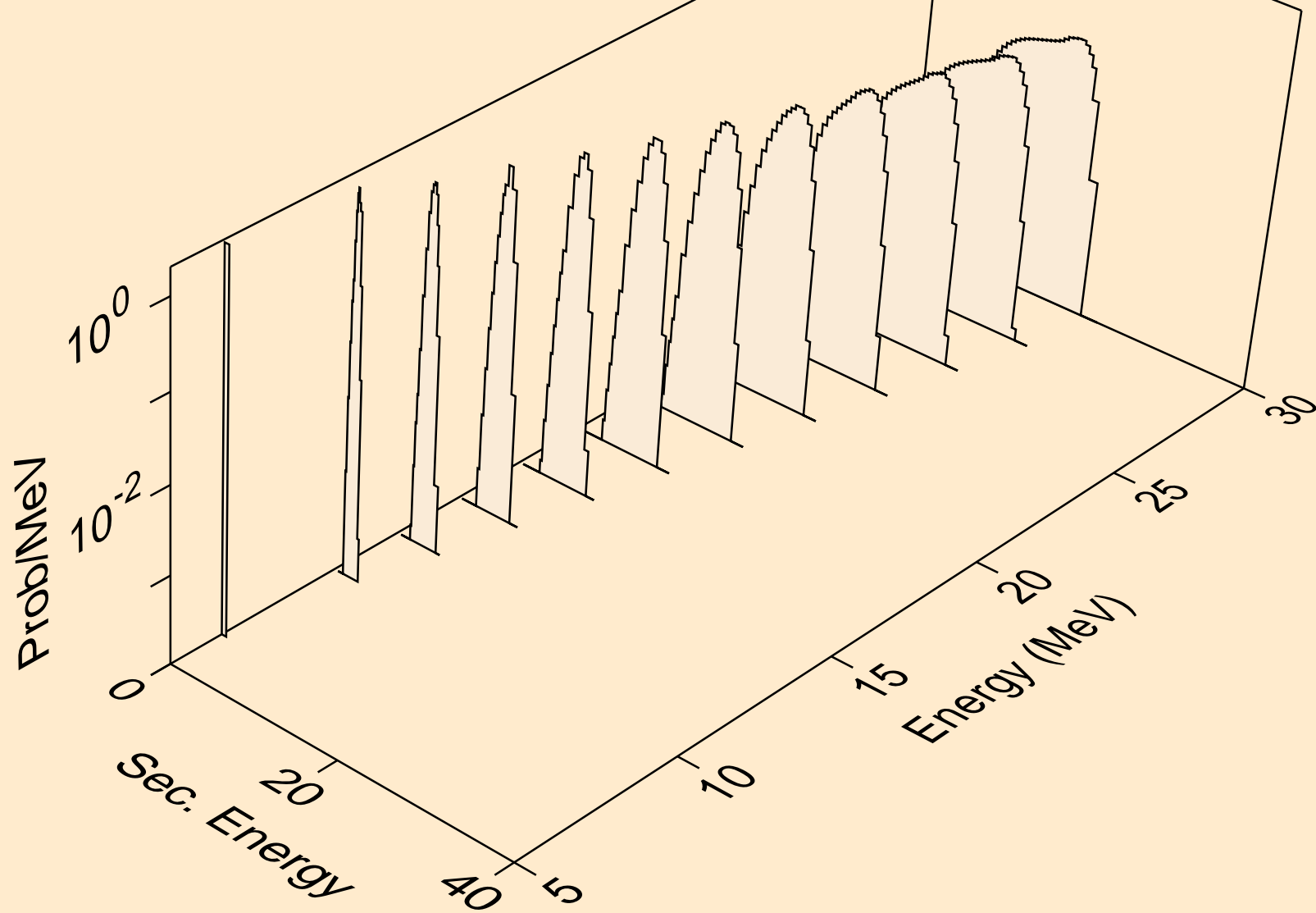

AG099 NEUTRON ACER TENDL-2021 LIBRARY; T=293.6K
deuterons from (n,da)

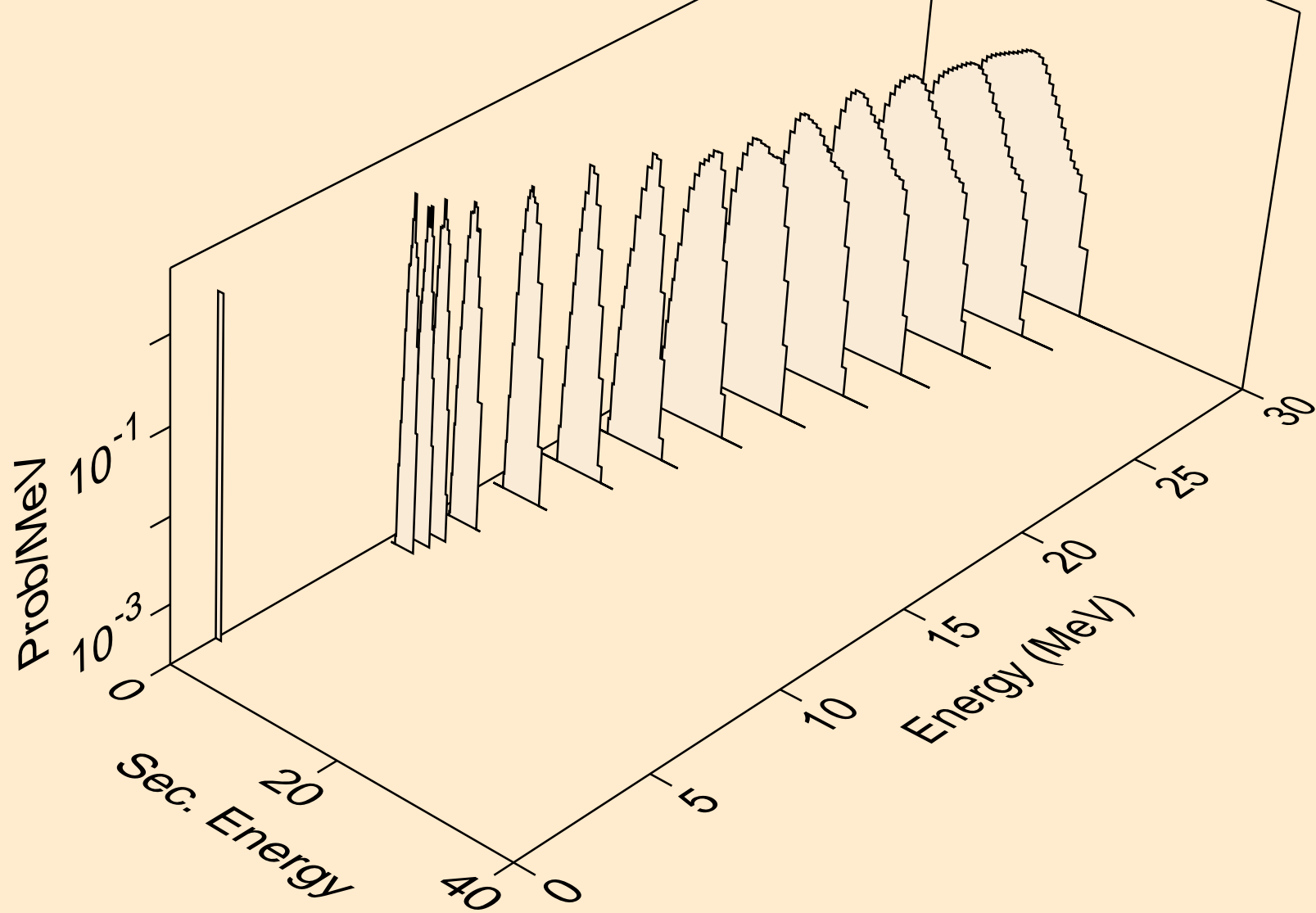

AG099 NEUTRON ACER TENDL-2021 LIBRARY; T=293.6K
tritons from (n,x)

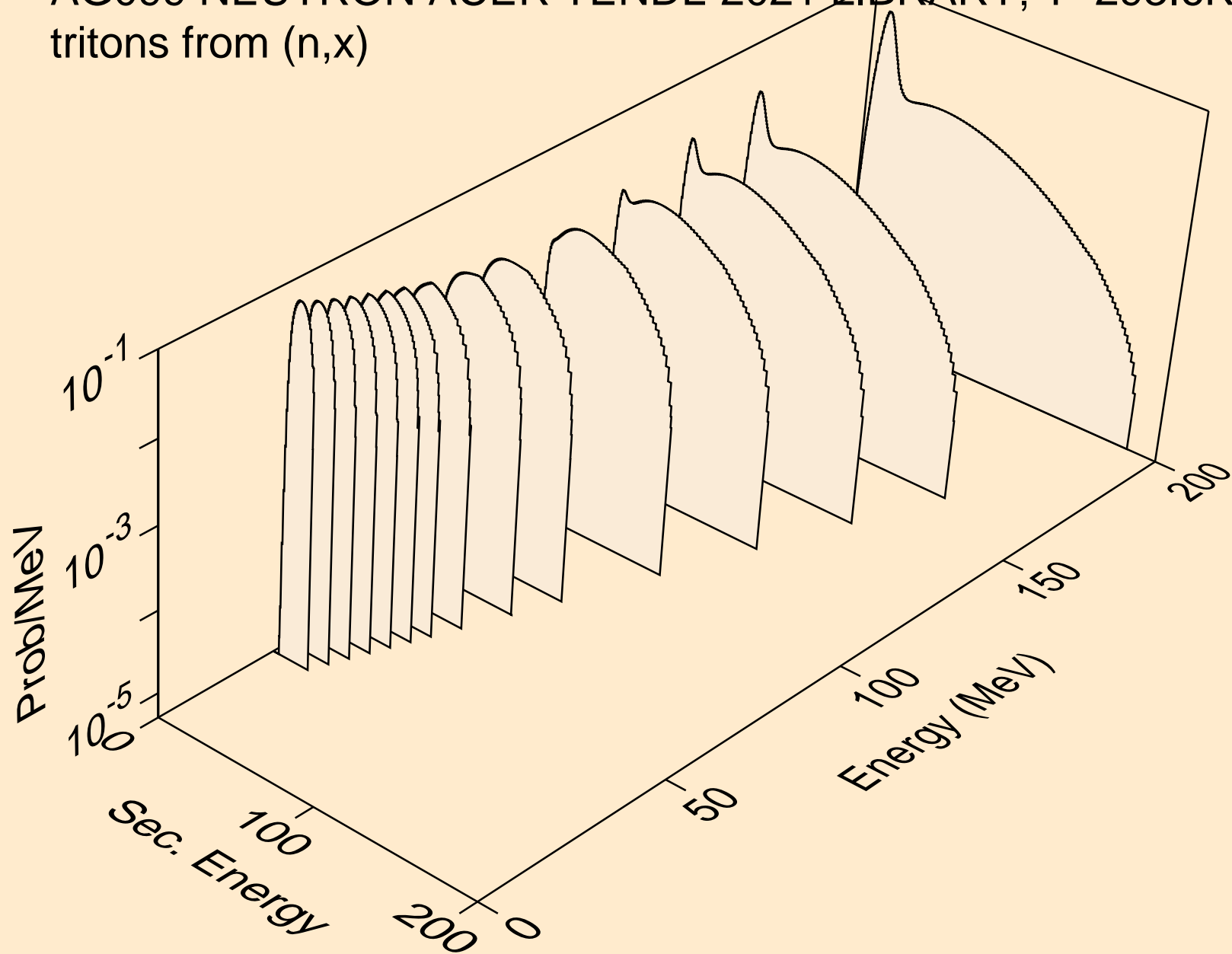

AG099 NEUTRON ACER TENDL-2021 LIBRARY; T=293.6K
tritons from (n,n*)t

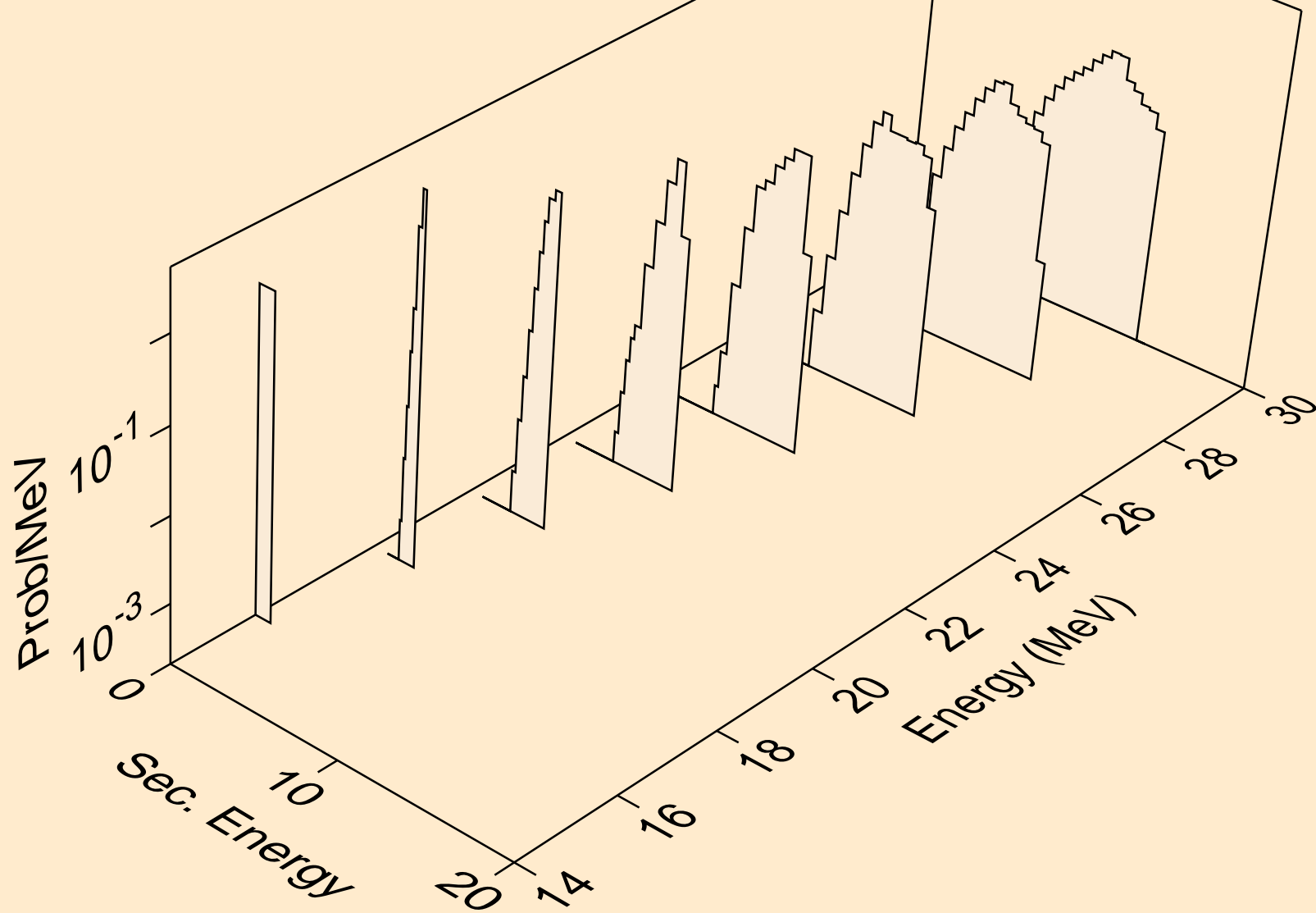

AG099 NEUTRON ACER TENDL-2021 LIBRARY; T=293.6K
tritons from (n,t)

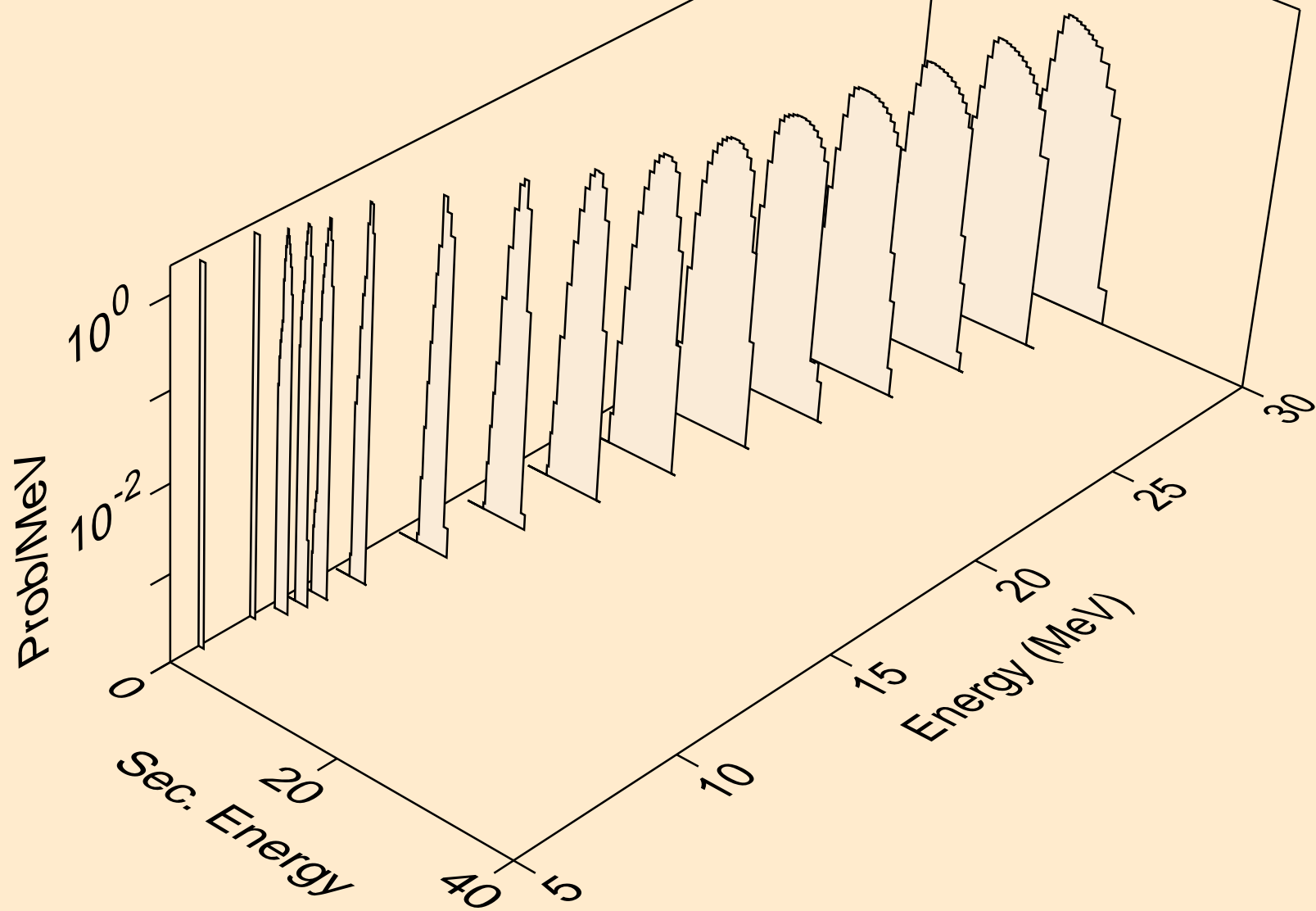

AG099 NEUTRON ACER TENDL-2021 LIBRARY; T=293.6K
tritons from (n,pt)

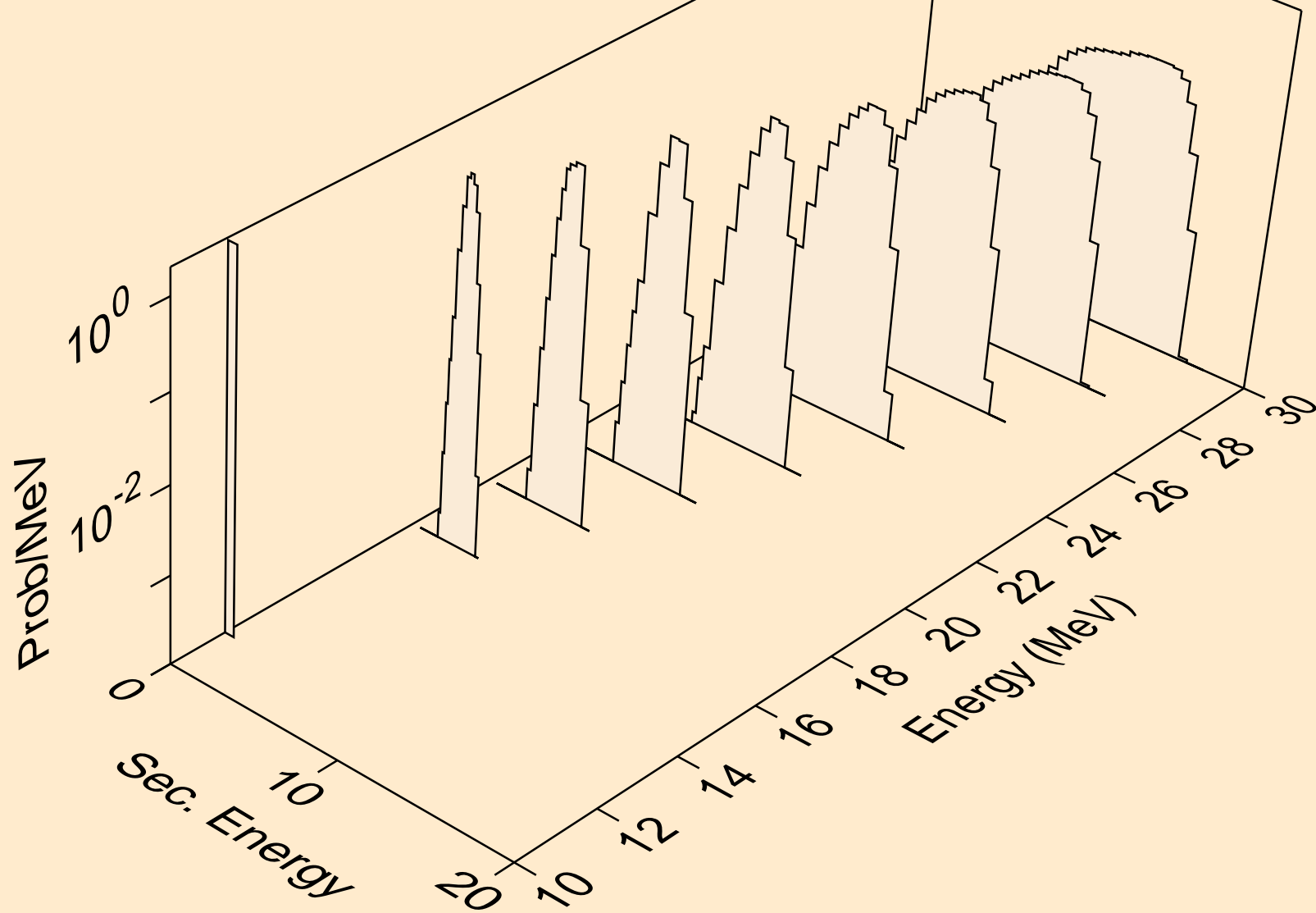

AG099 NEUTRON ACER TENDL-2021 LIBRARY; T=293.6K
he3s from (n,x)

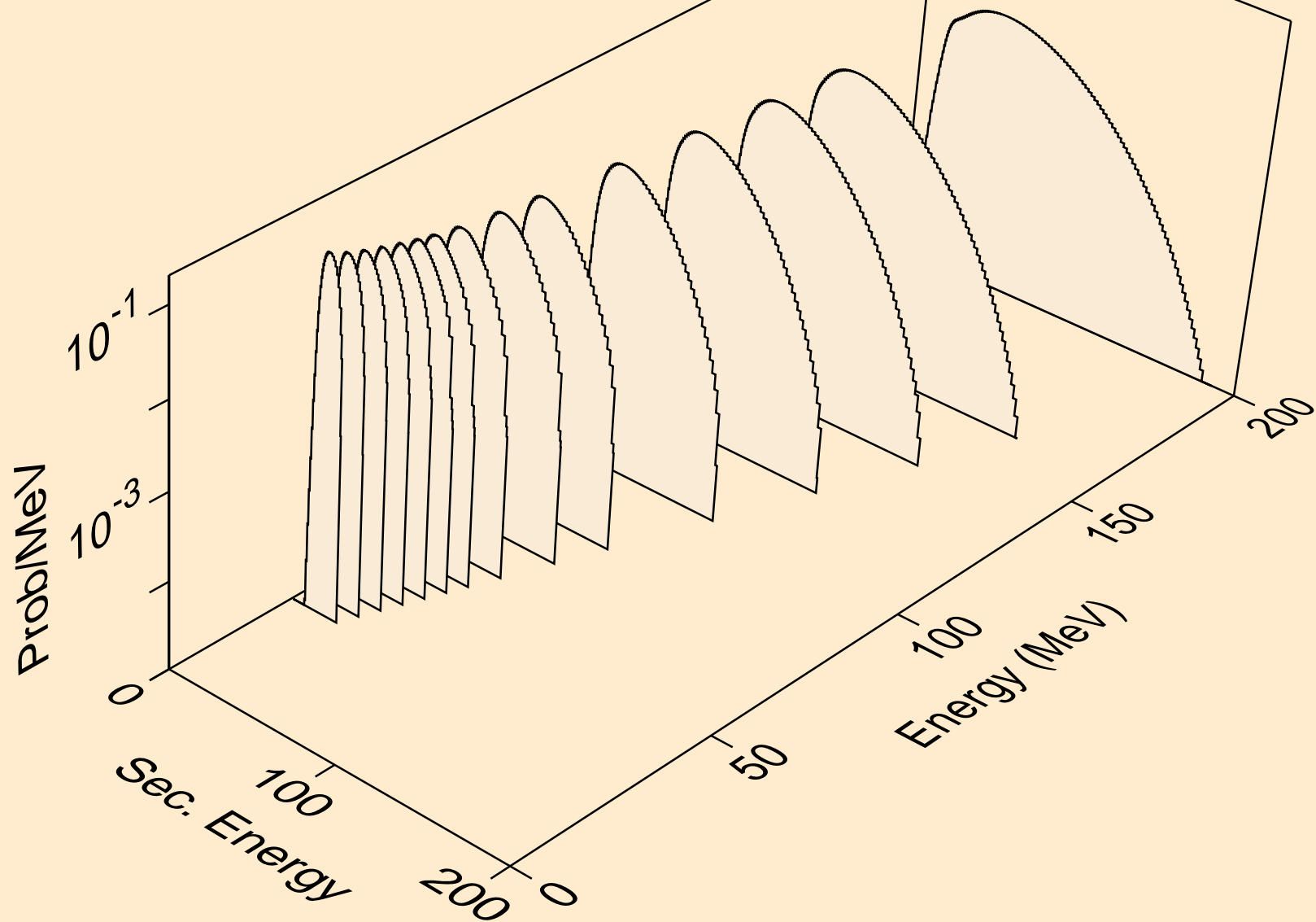

AG099 NEUTRON ACER TENDL-2021 LIBRARY; T=293.6K
he3s from (n,n*)he3

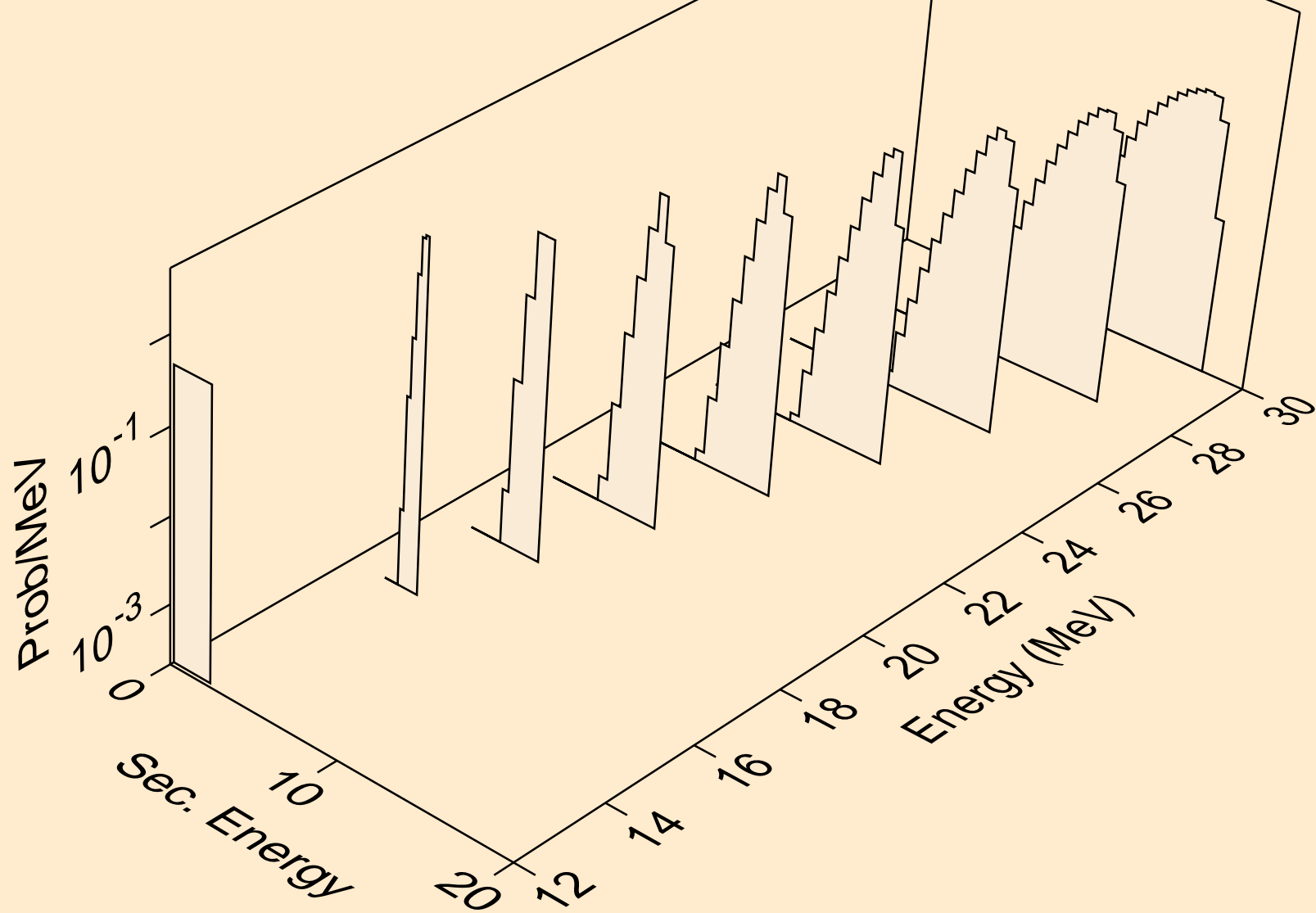

AG099 NEUTRON ACER TENDL-2021 LIBRARY; T=293.6K
he3s from (n,he3)

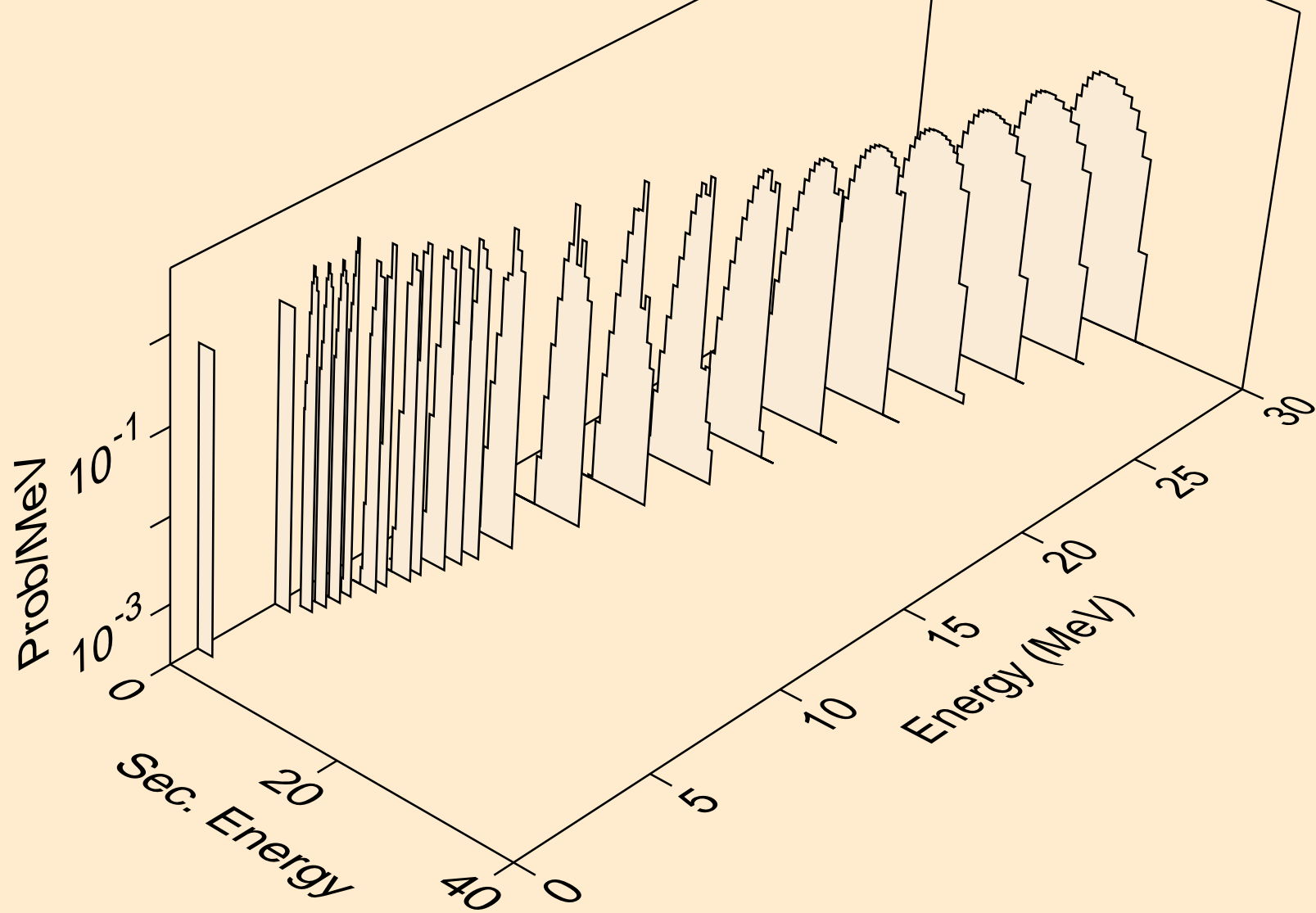

AG099 NEUTRON ACER TENDL-2021 LIBRARY; T=293.6K
alphas from (n,x)

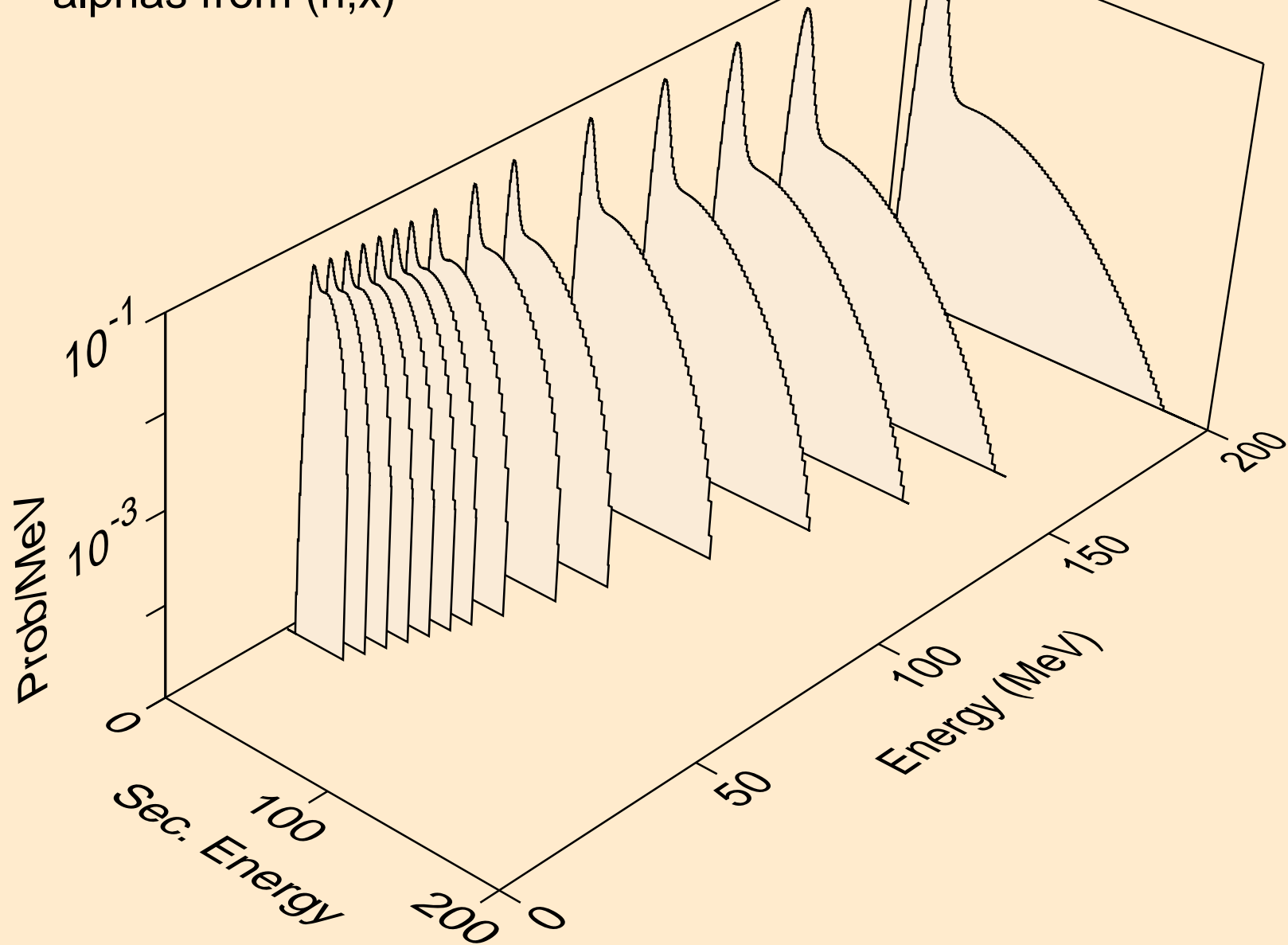

AG099 NEUTRON ACER TENDL-2021 LIBRARY; T=293.6K
alphas from (n,n*)a

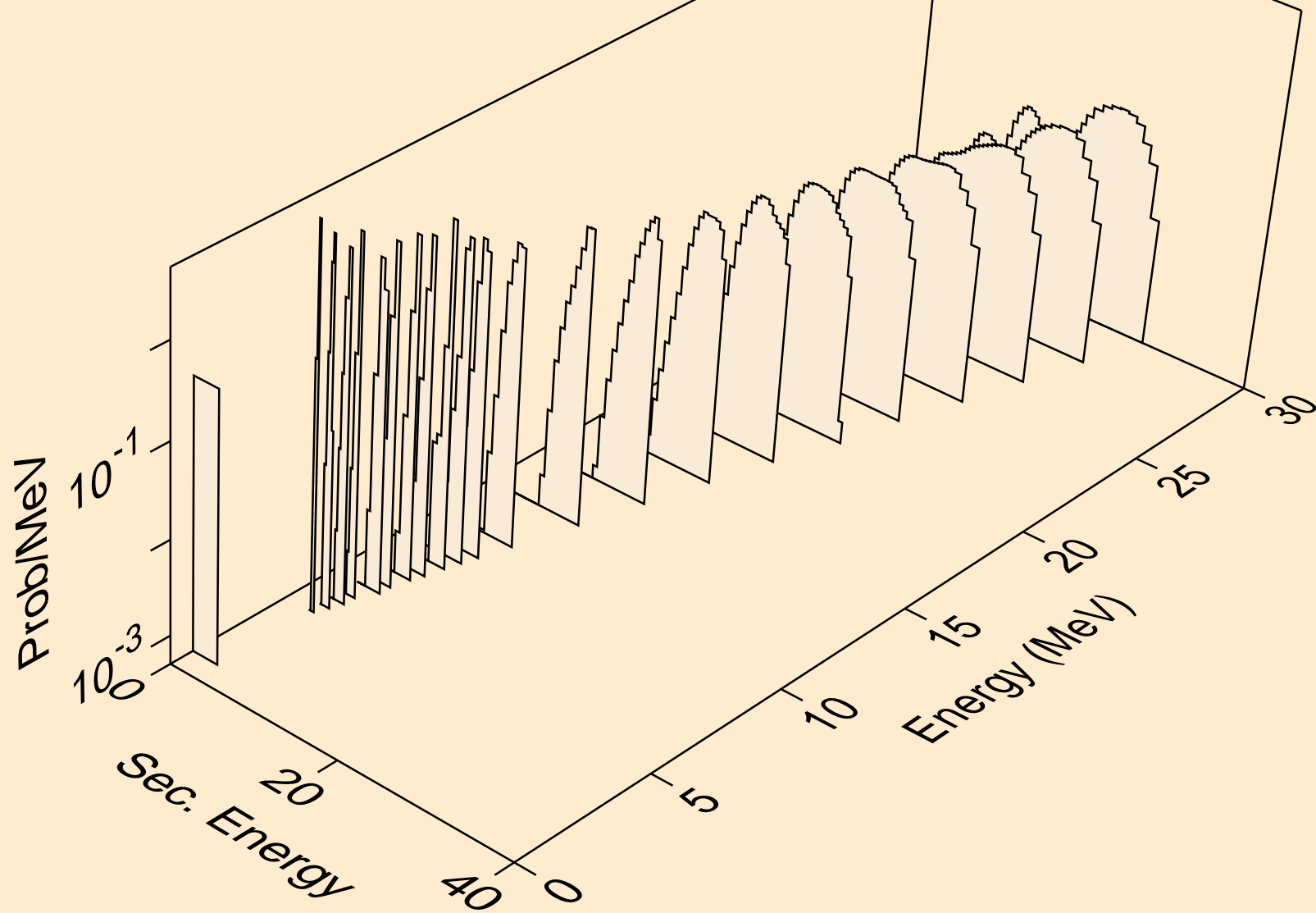

AG099 NEUTRON ACER TENDL-2021 LIBRARY; T=293.6K
alphas from (n,2n)a

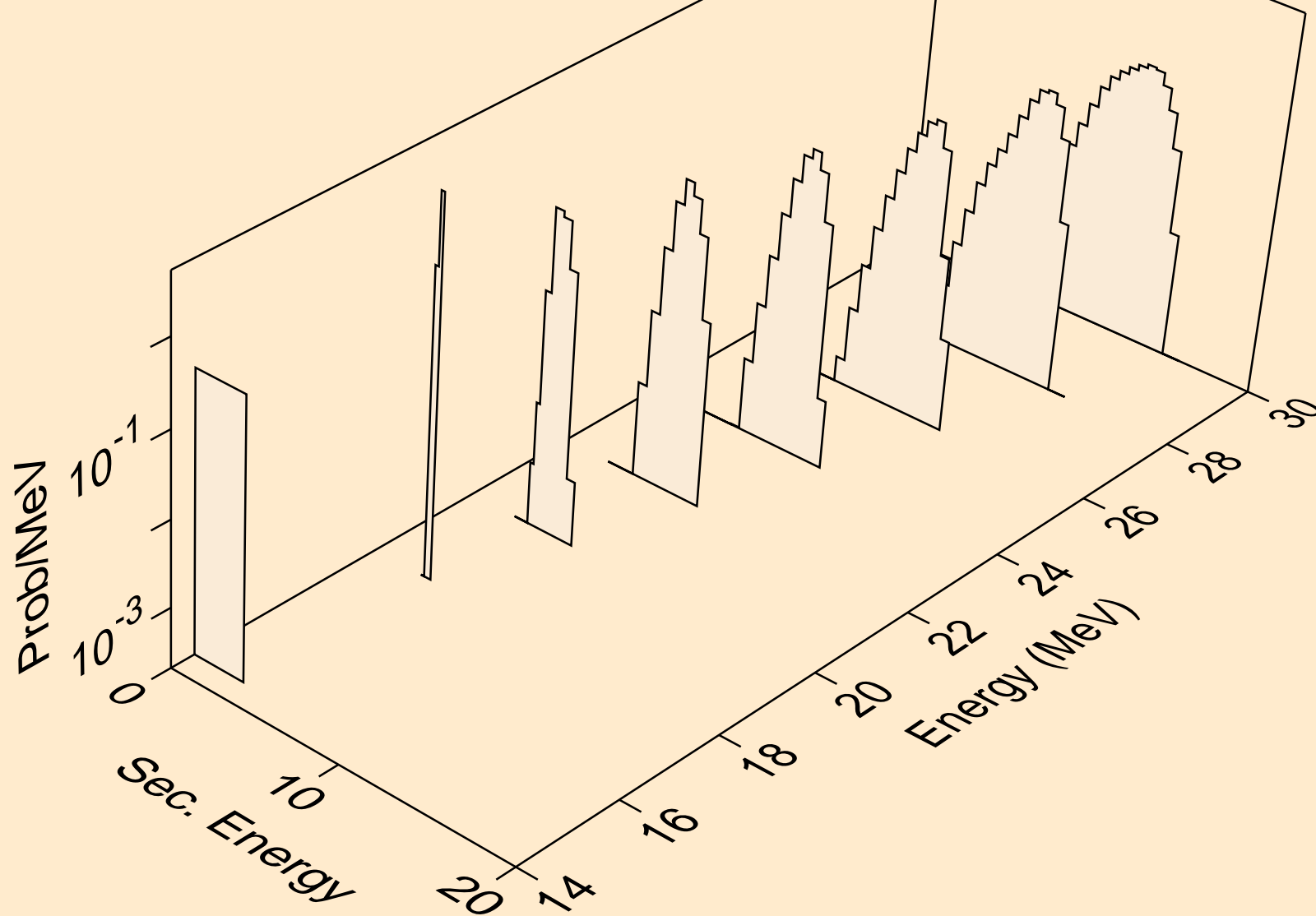

AG099 NEUTRON ACER TENDL-2021 LIBRARY; T=293.6K
alphas from (n,n*)2a

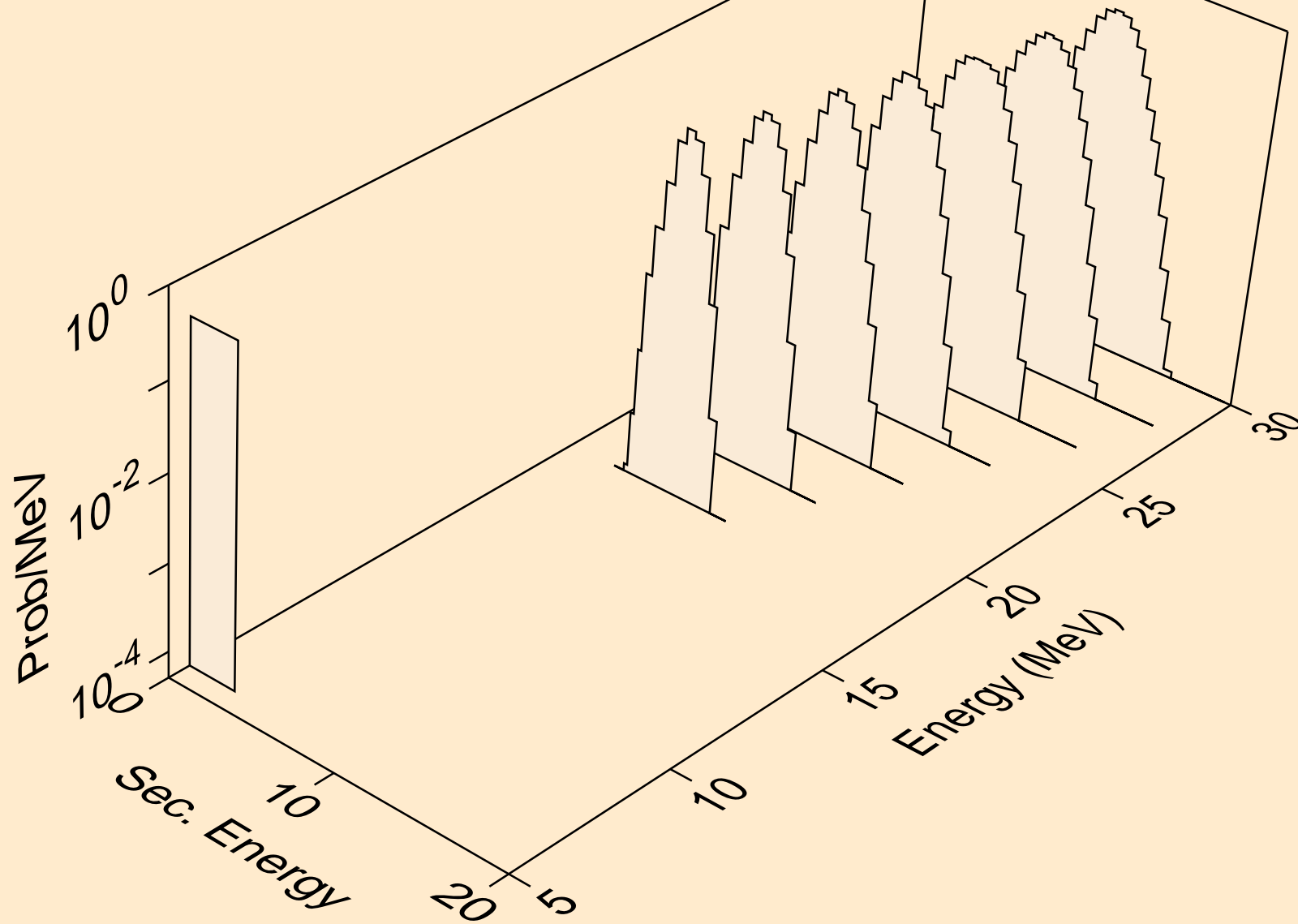

AG099 NEUTRON ACER TENDL-2021 LIBRARY; T=293.6K
alphas from (n,npa)

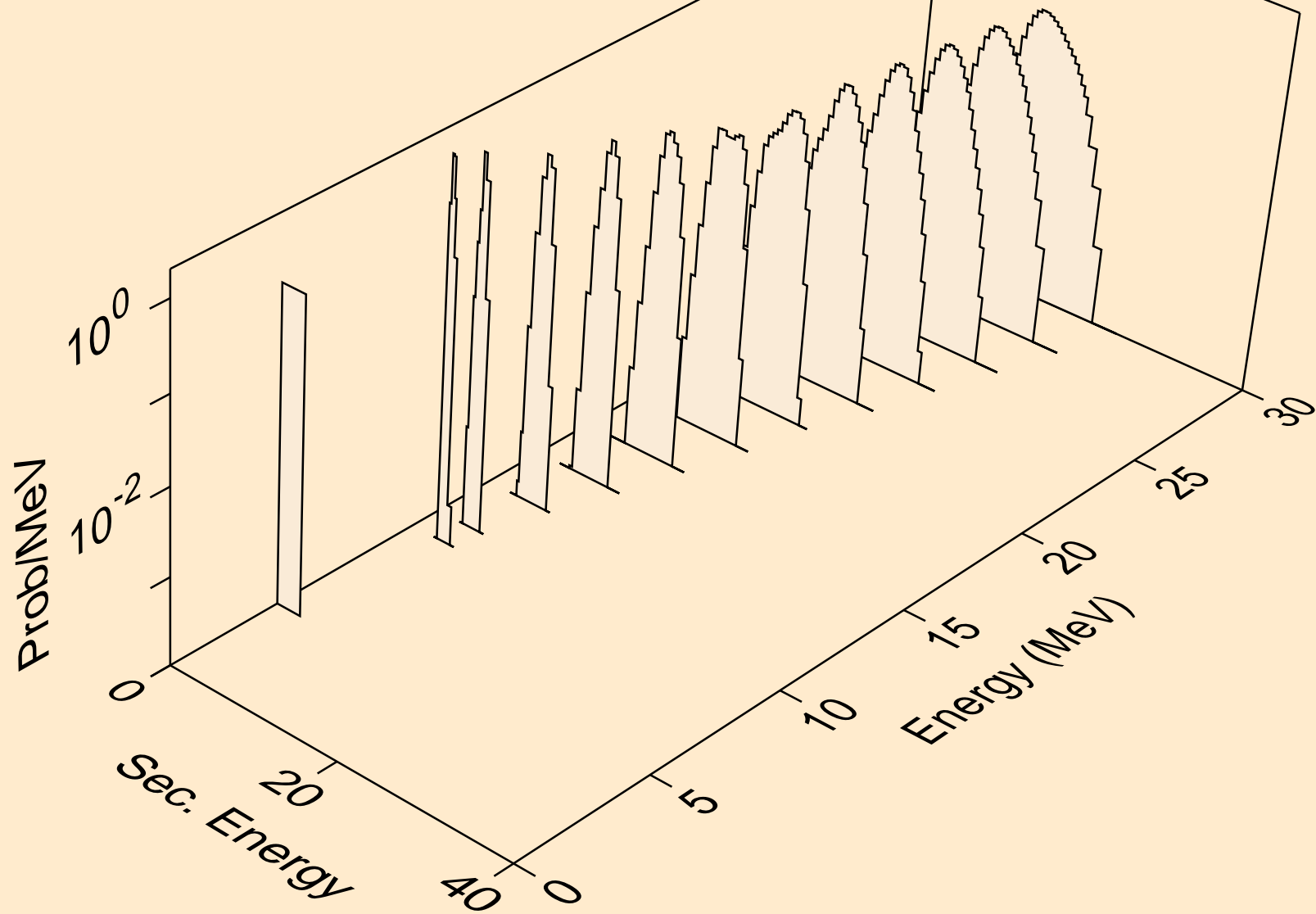

AG099 NEUTRON ACER TENDL-2021 LIBRARY; T=293.6K
alphas from (n,a)

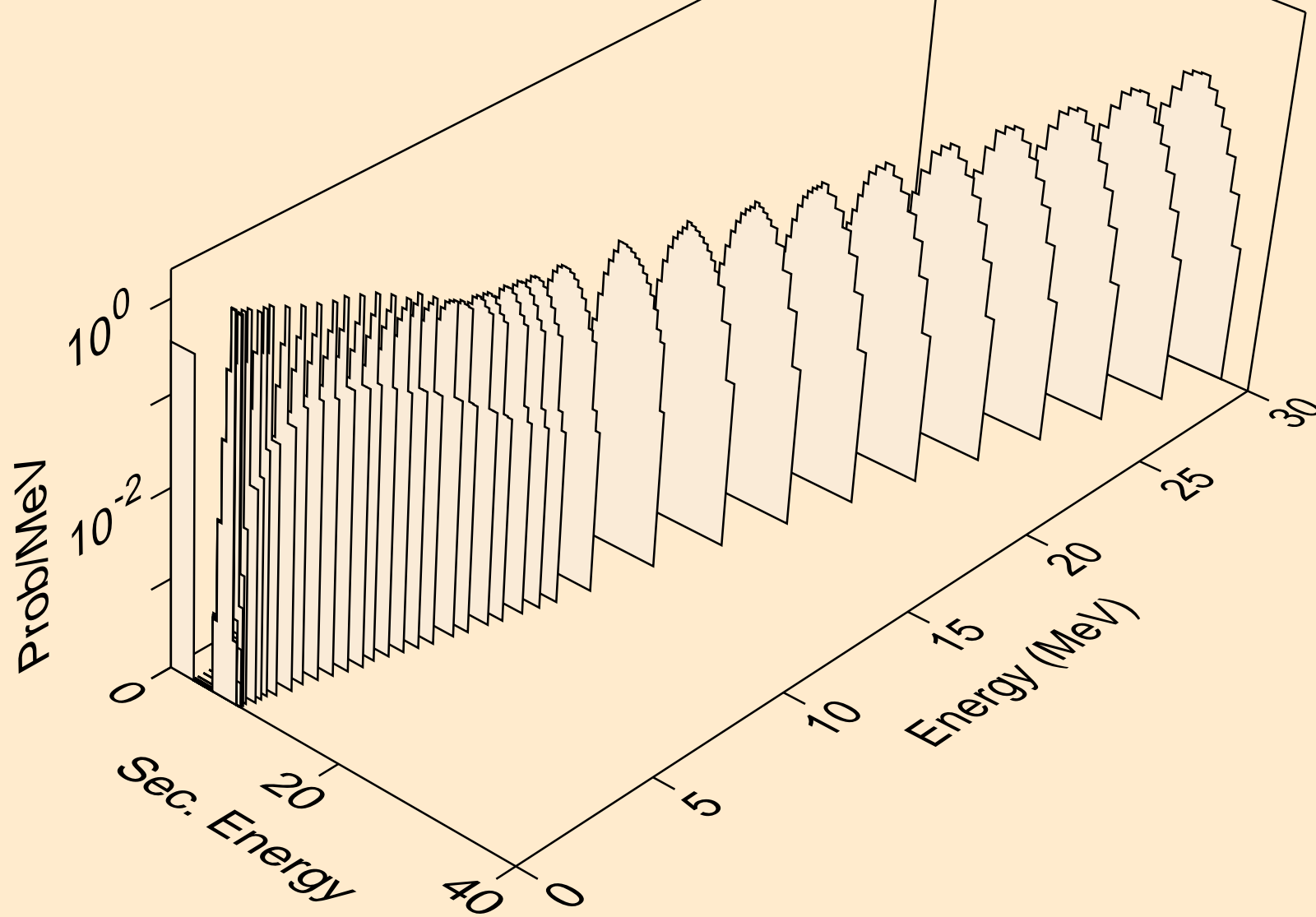

AG099 NEUTRON ACER TENDL-2021 LIBRARY; T=293.6K
alphas from (n,2a)

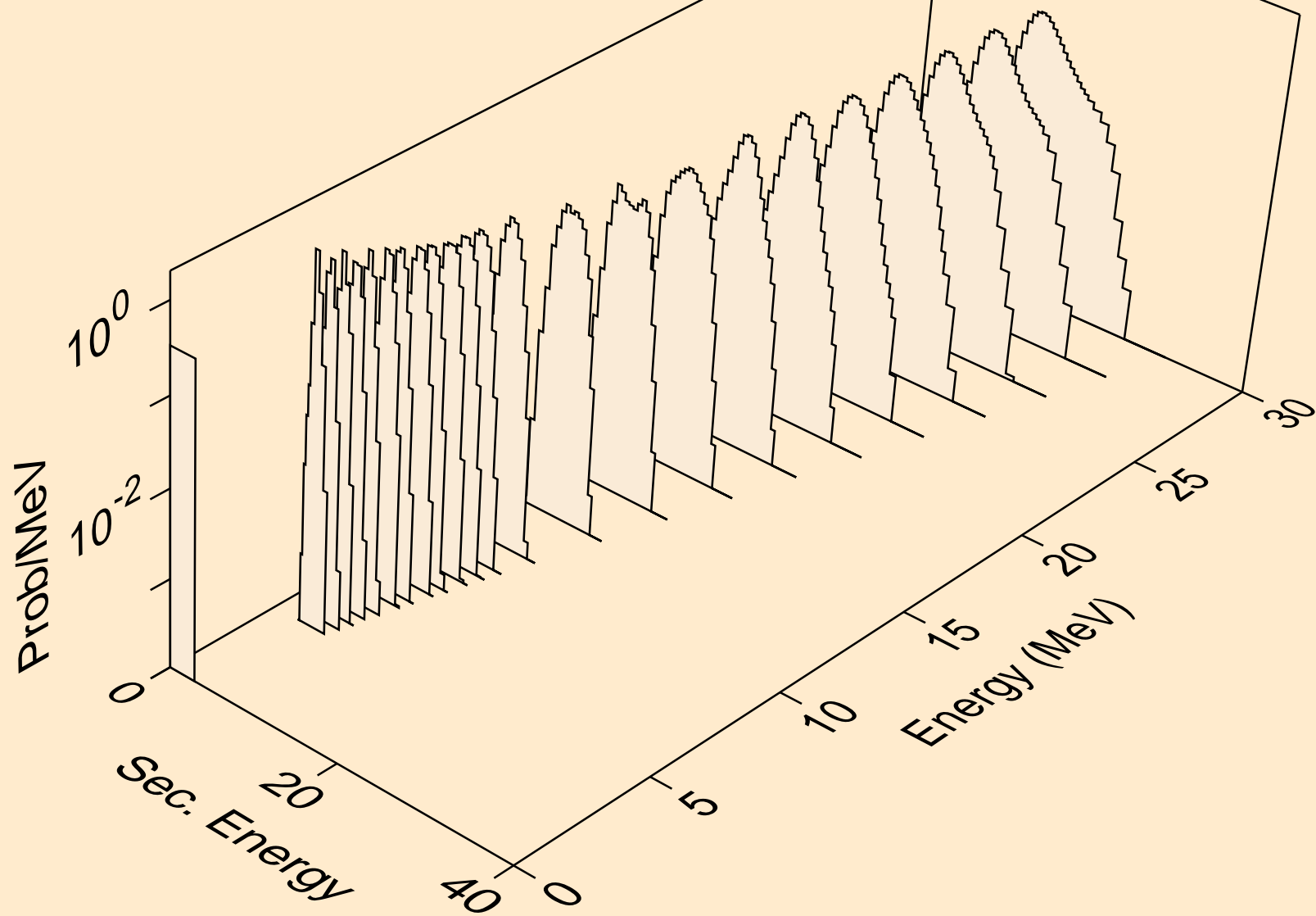

AG099 NEUTRON ACER TENDL-2021 LIBRARY; T=293.6K
alphas from (n,pa)

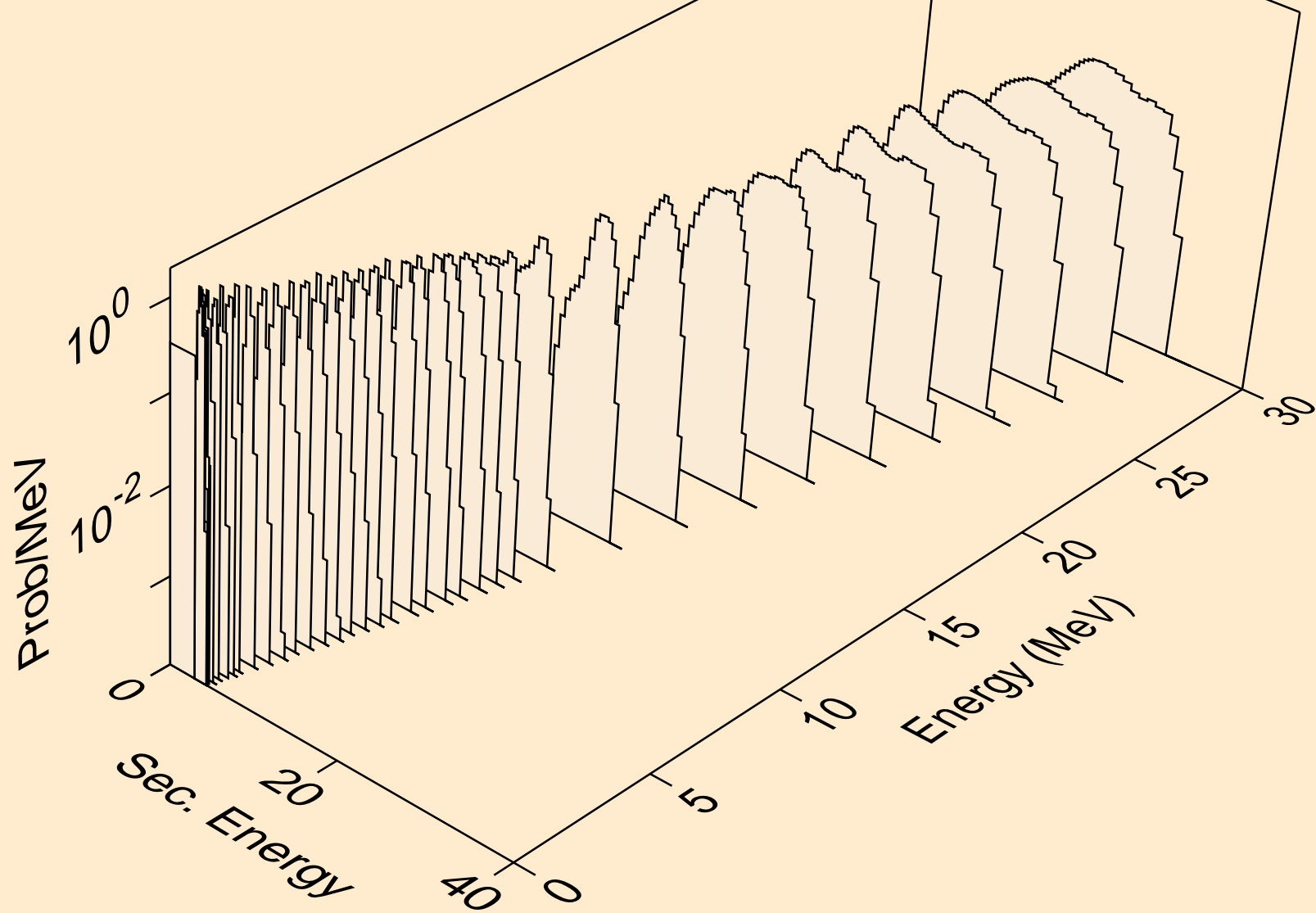

AG099 NEUTRON ACER TENDL-2021 LIBRARY; T=293.6K
alphas from (n,da)

