

AS072 NEUTRON ACER TENDL-2021 LIBRARY; T=293.6K

Principal cross sections

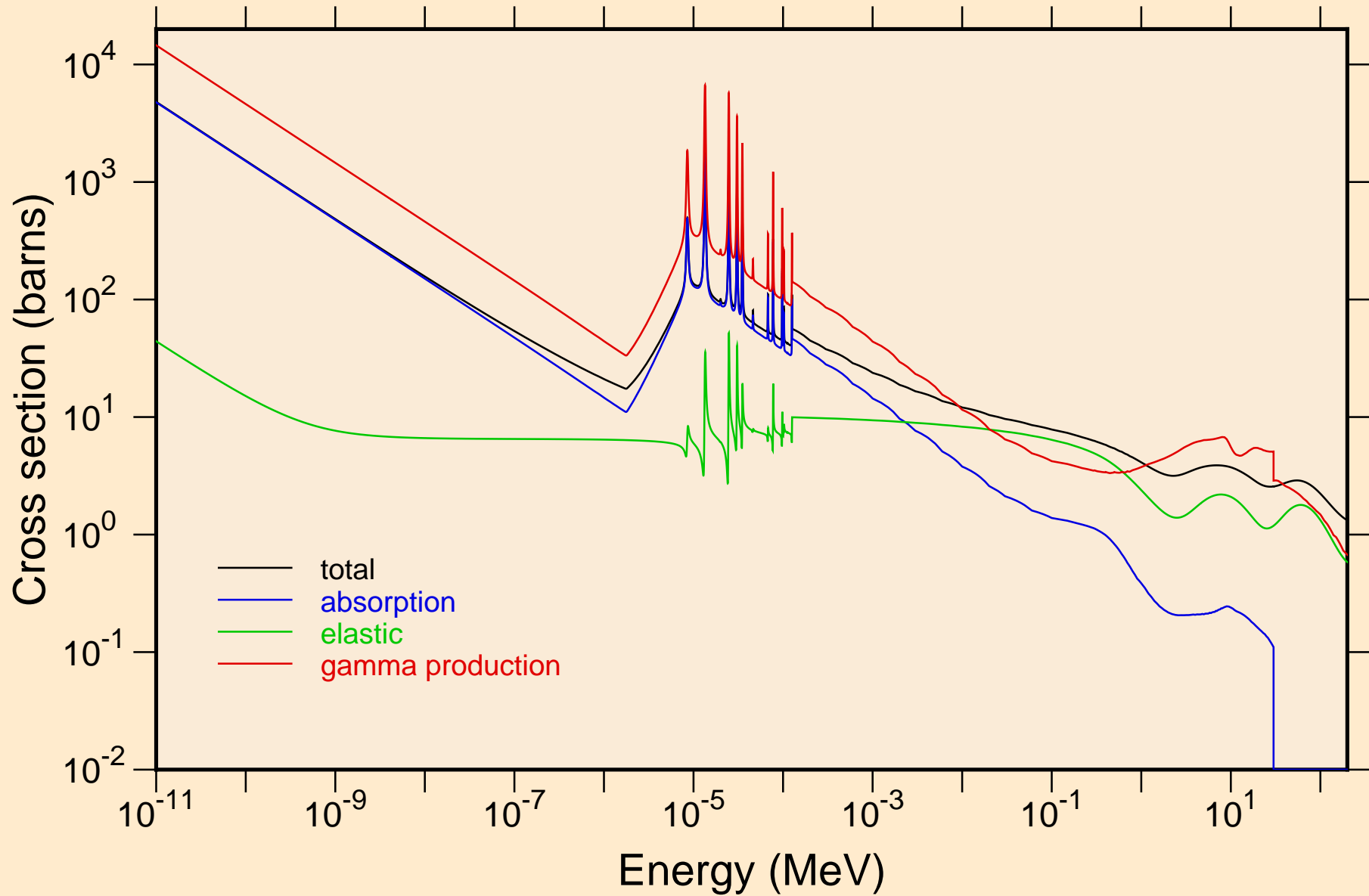

AS072 NEUTRON ACER TENDL-2021 LIBRARY; T=293.6K
resonance total cross section

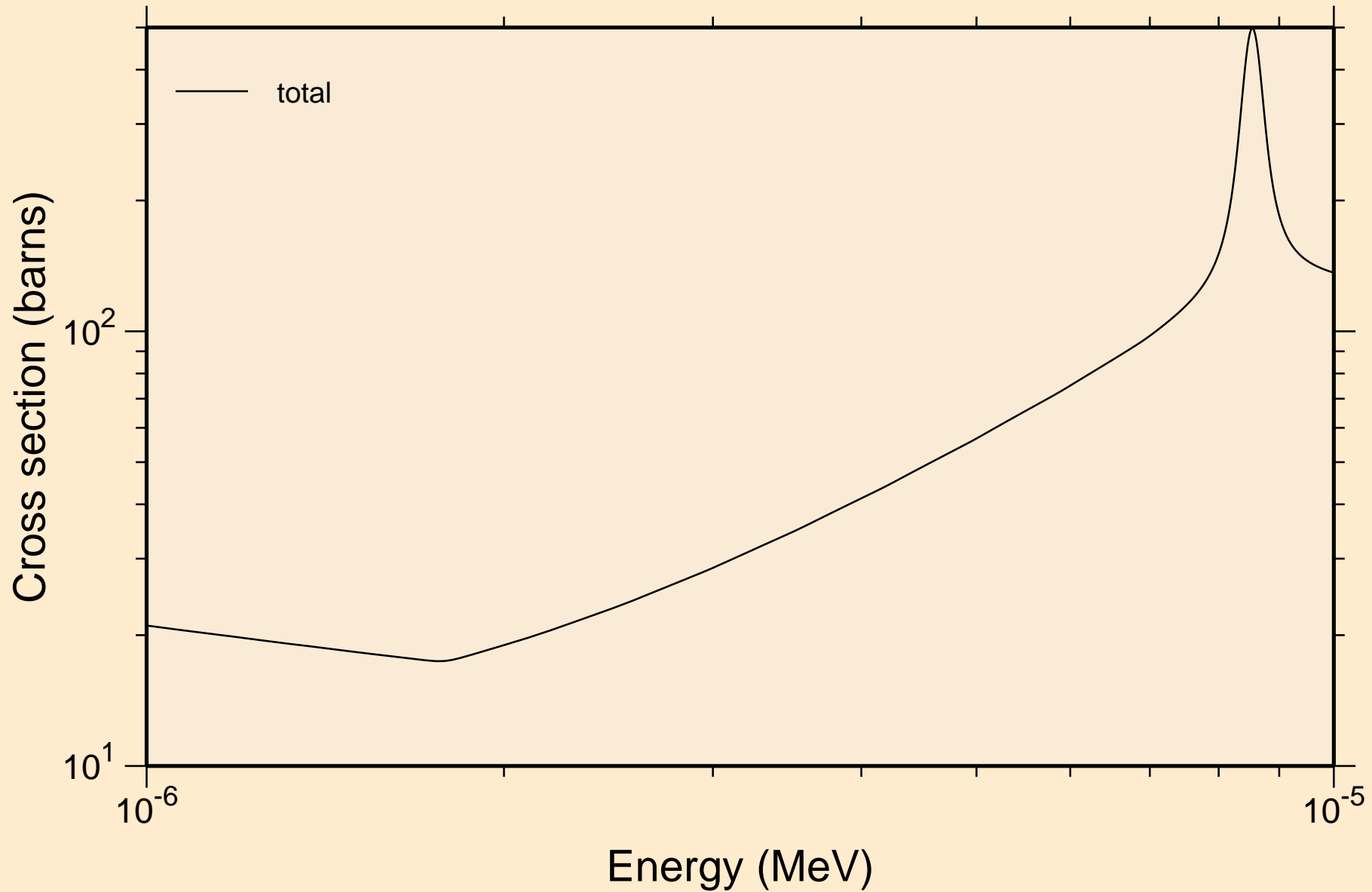

AS072 NEUTRON ACER TENDL-2021 LIBRARY; T=293.6K
resonance total cross section

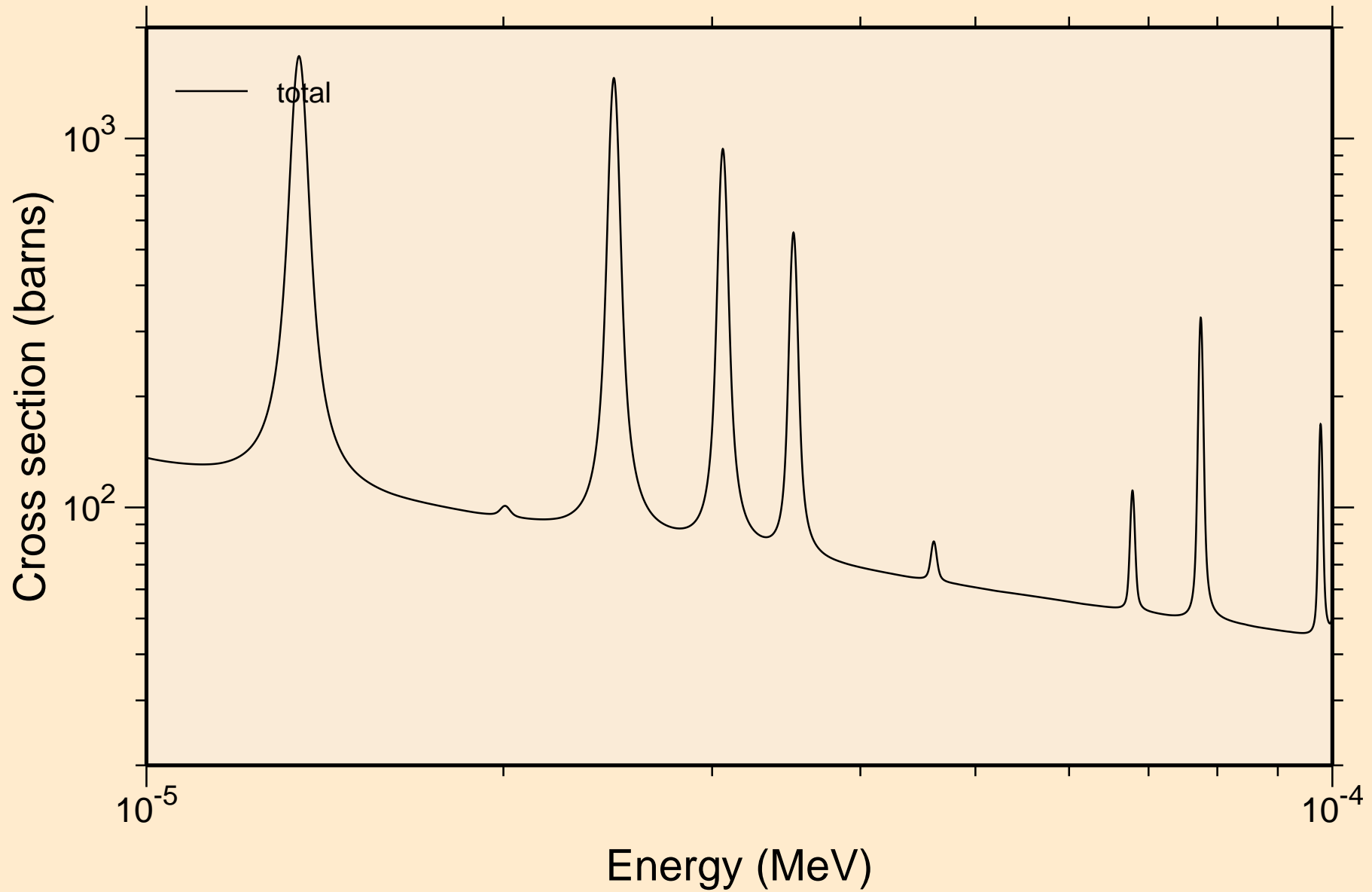

AS072 NEUTRON ACER TENDL-2021 LIBRARY; T=293.6K
resonance total cross section

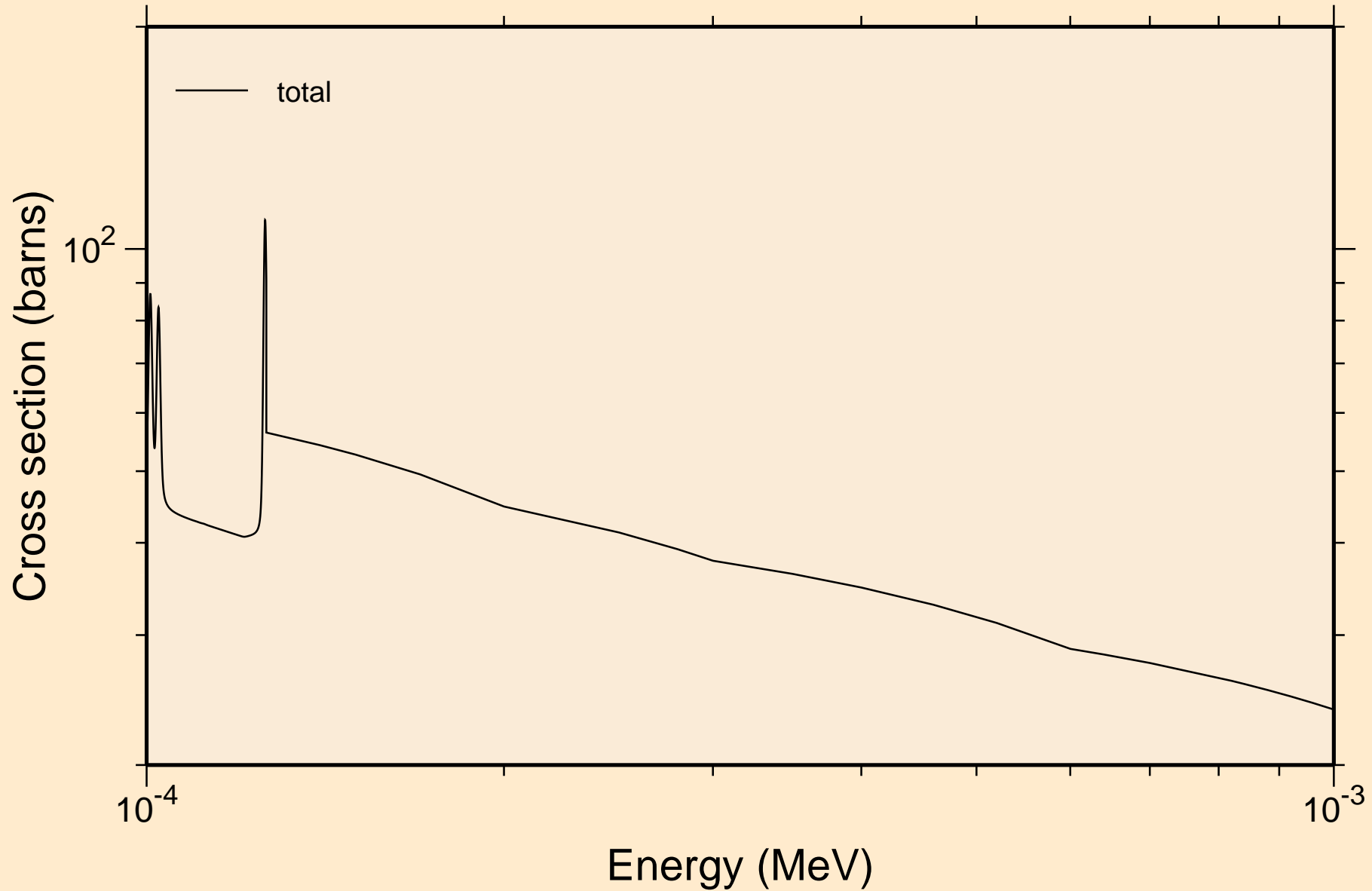

A5072 NEUTRON ACER TENDL-2021 LIBRARY; T=293.6K
resonance total cross section

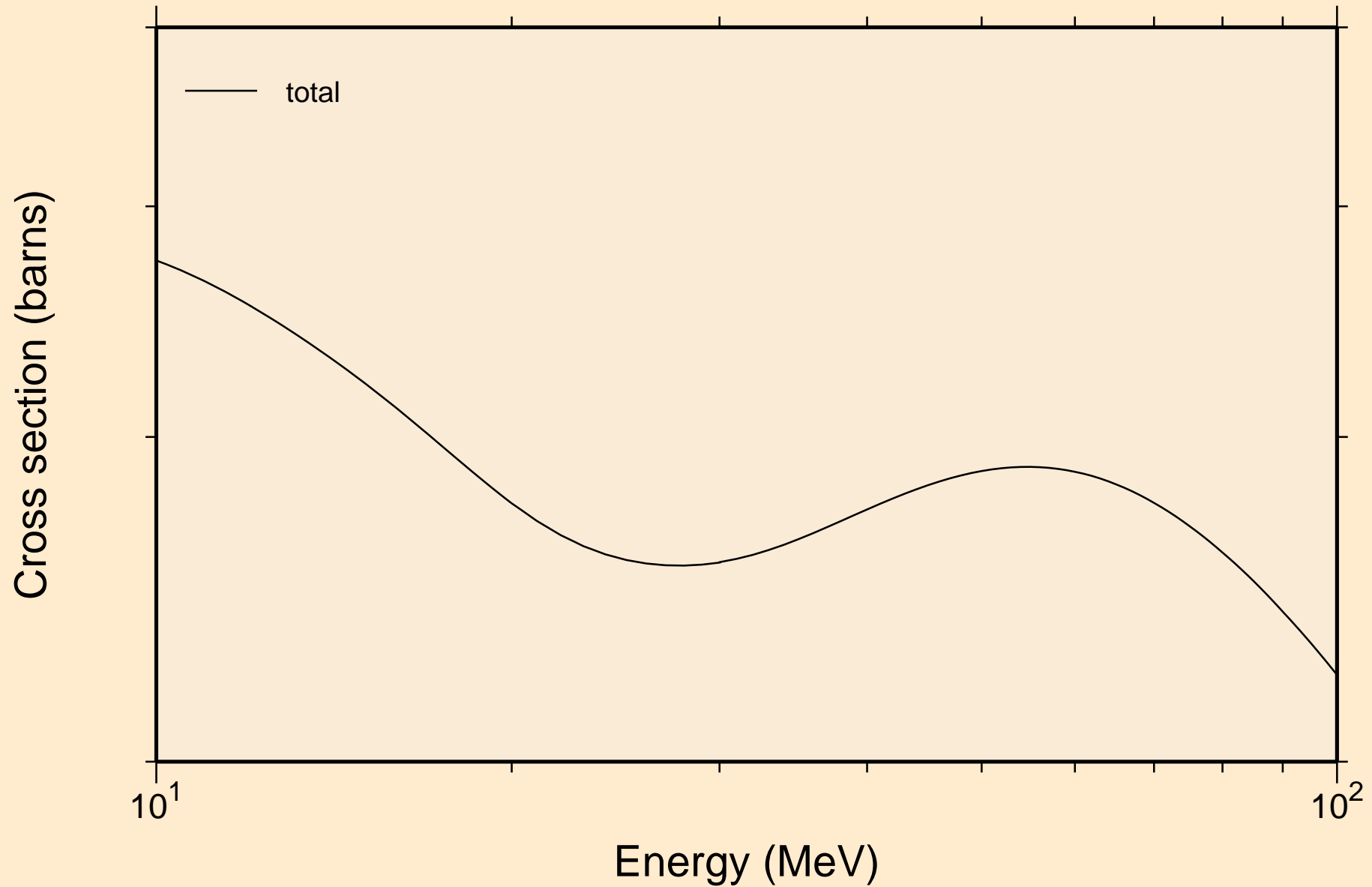

AS072 NEUTRON ACER TENDL-2021 LIBRARY; T=293.6K
resonance absorption cross sections

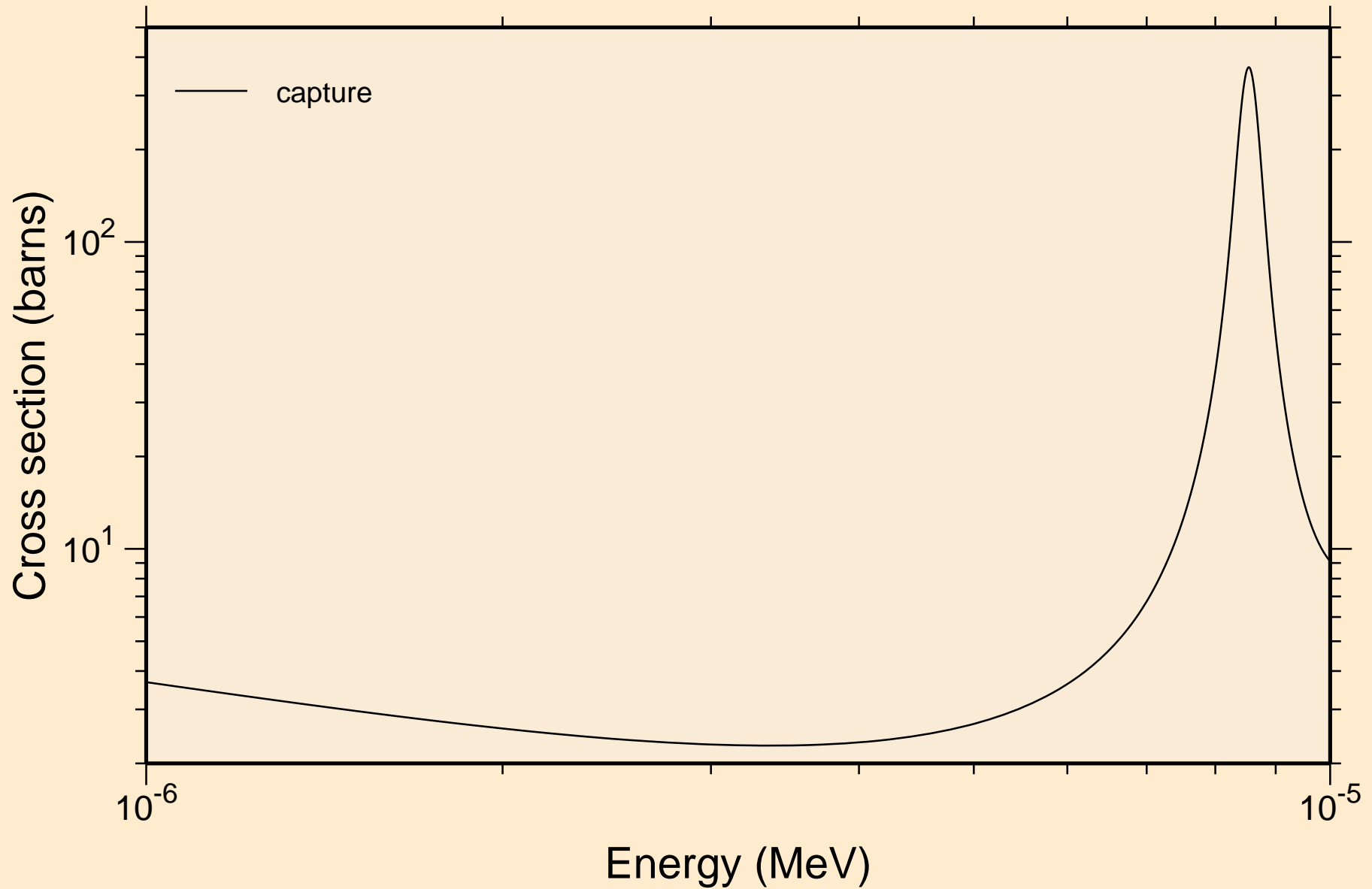

AS072 NEUTRON ACER TENDL-2021 LIBRARY; T=293.6K
resonance absorption cross sections

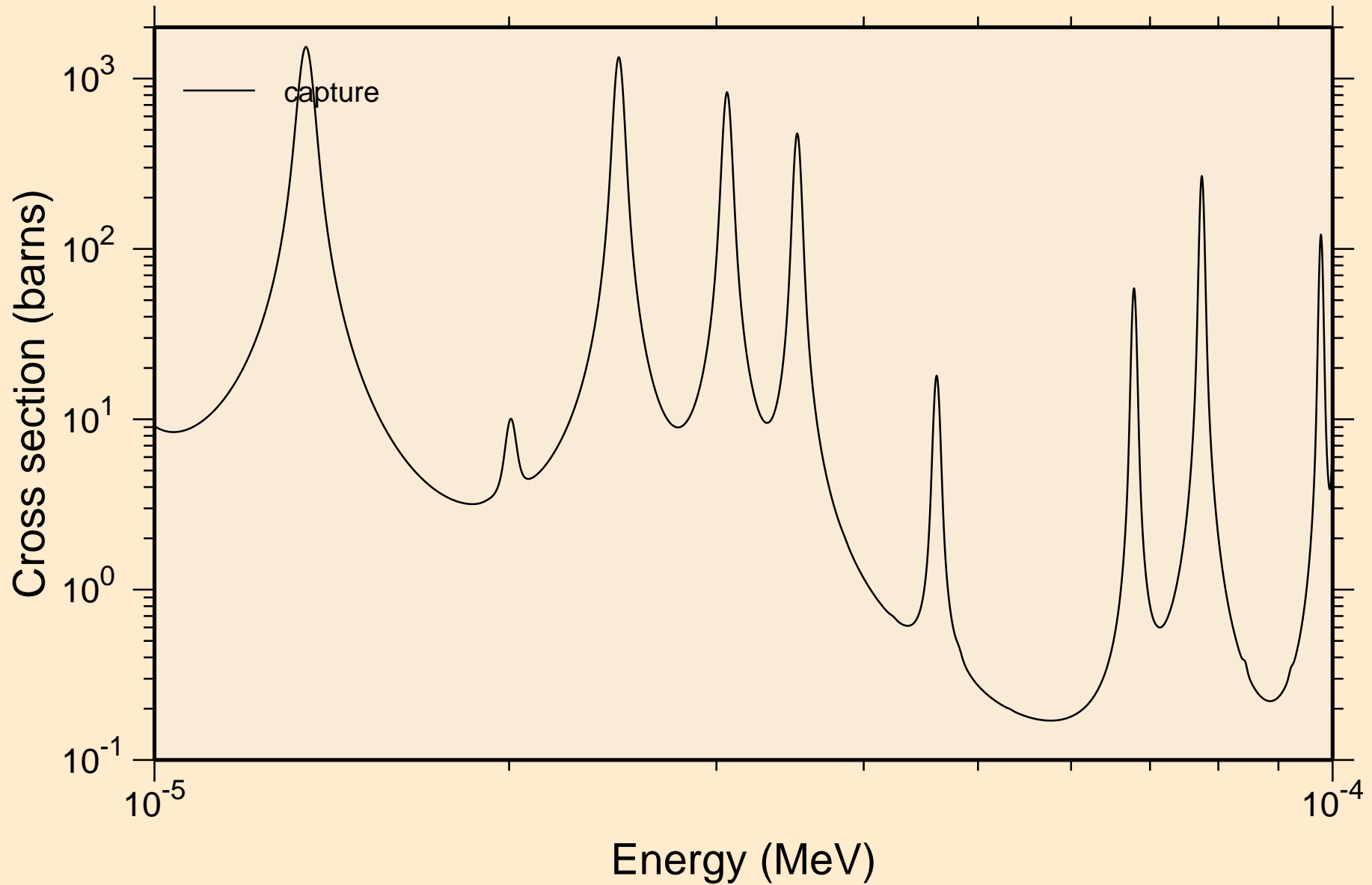

AS072 NEUTRON ACER TENDL-2021 LIBRARY; T=293.6K
resonance absorption cross sections

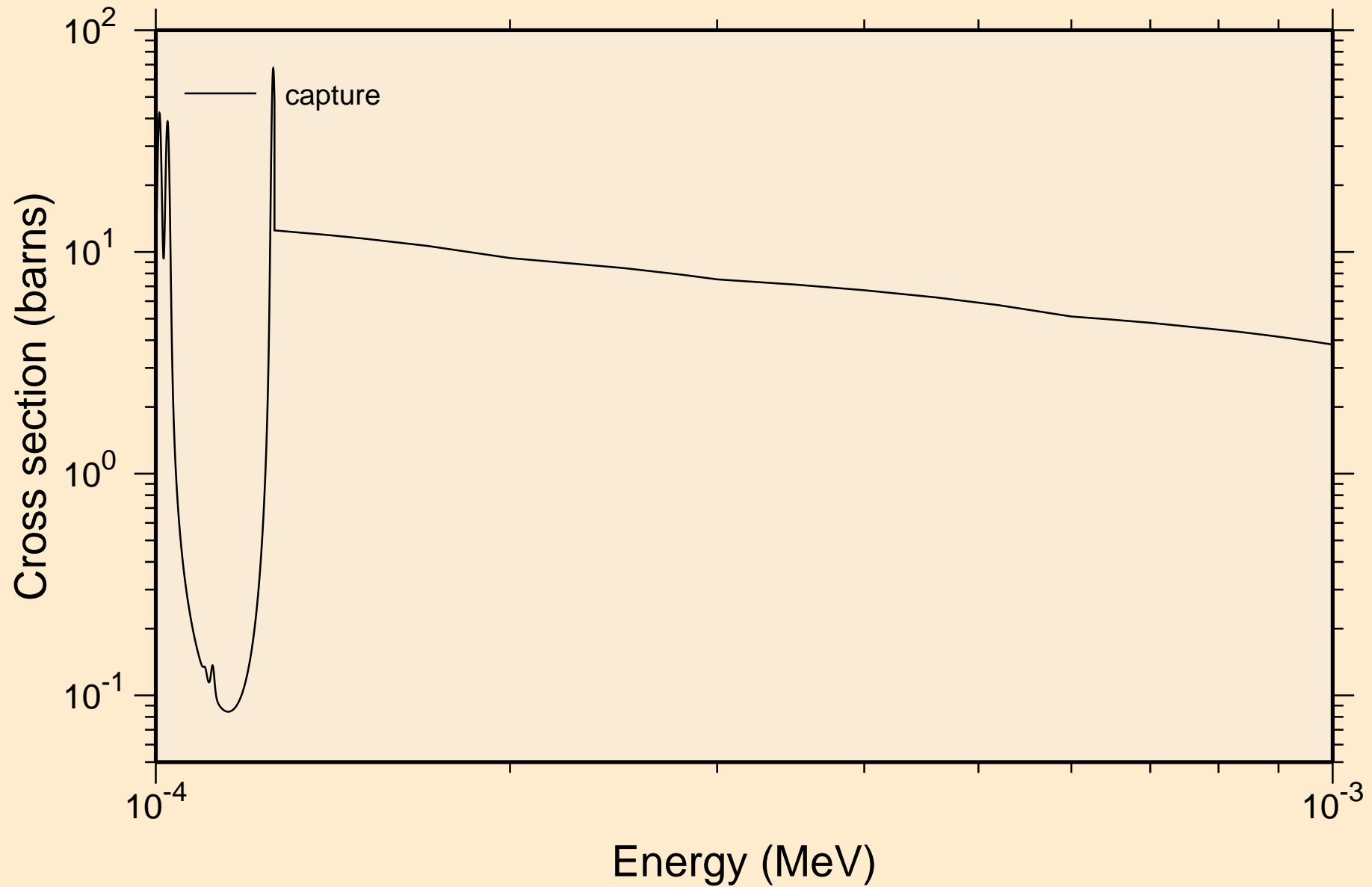

AS072 NEUTRON ACER TENDL-2021 LIBRARY; T=293.6K
resonance absorption cross sections

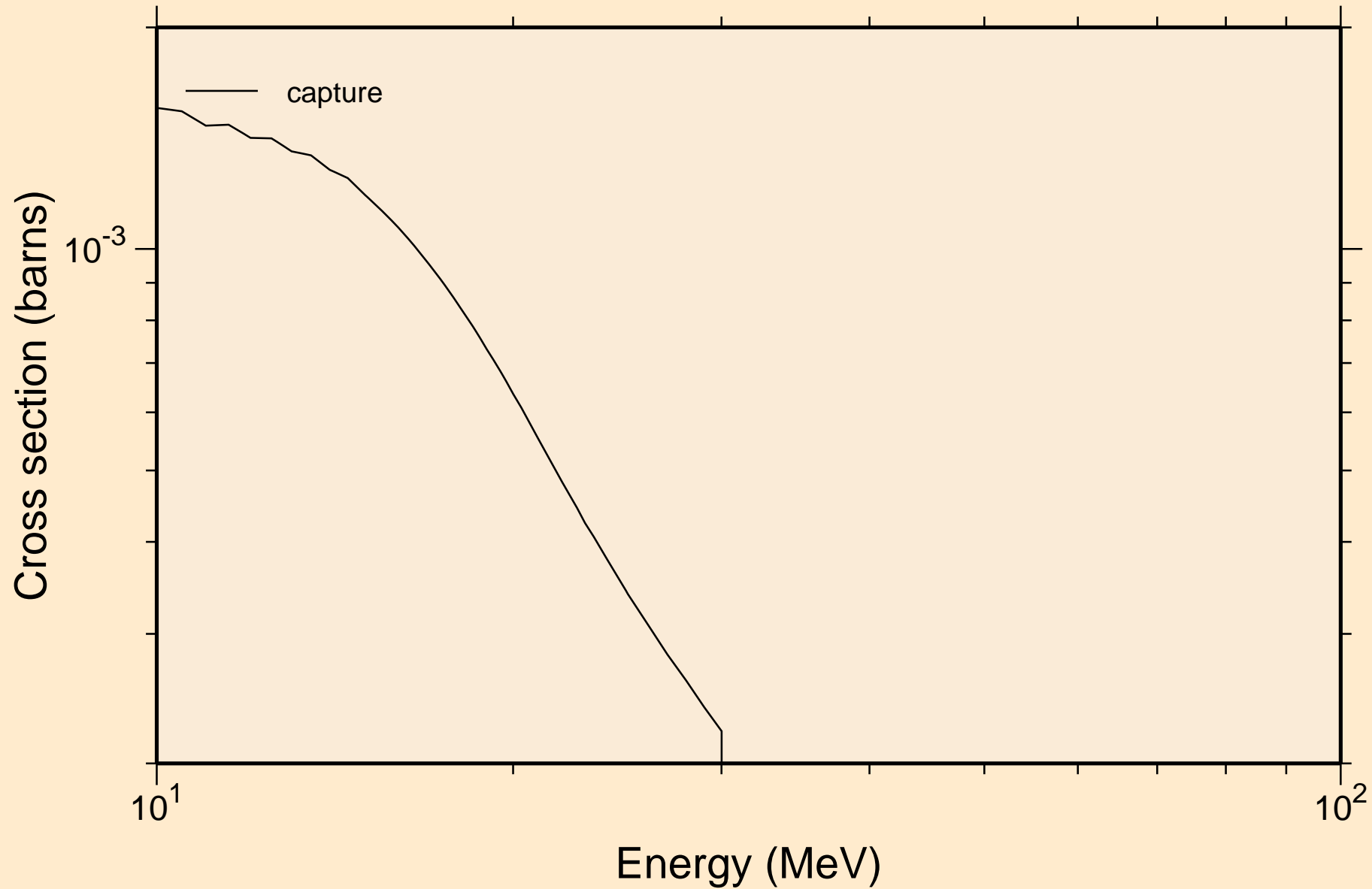

AS072 NEUTRON ACER TENDL-2021 LIBRARY; T=293.6K
Heating

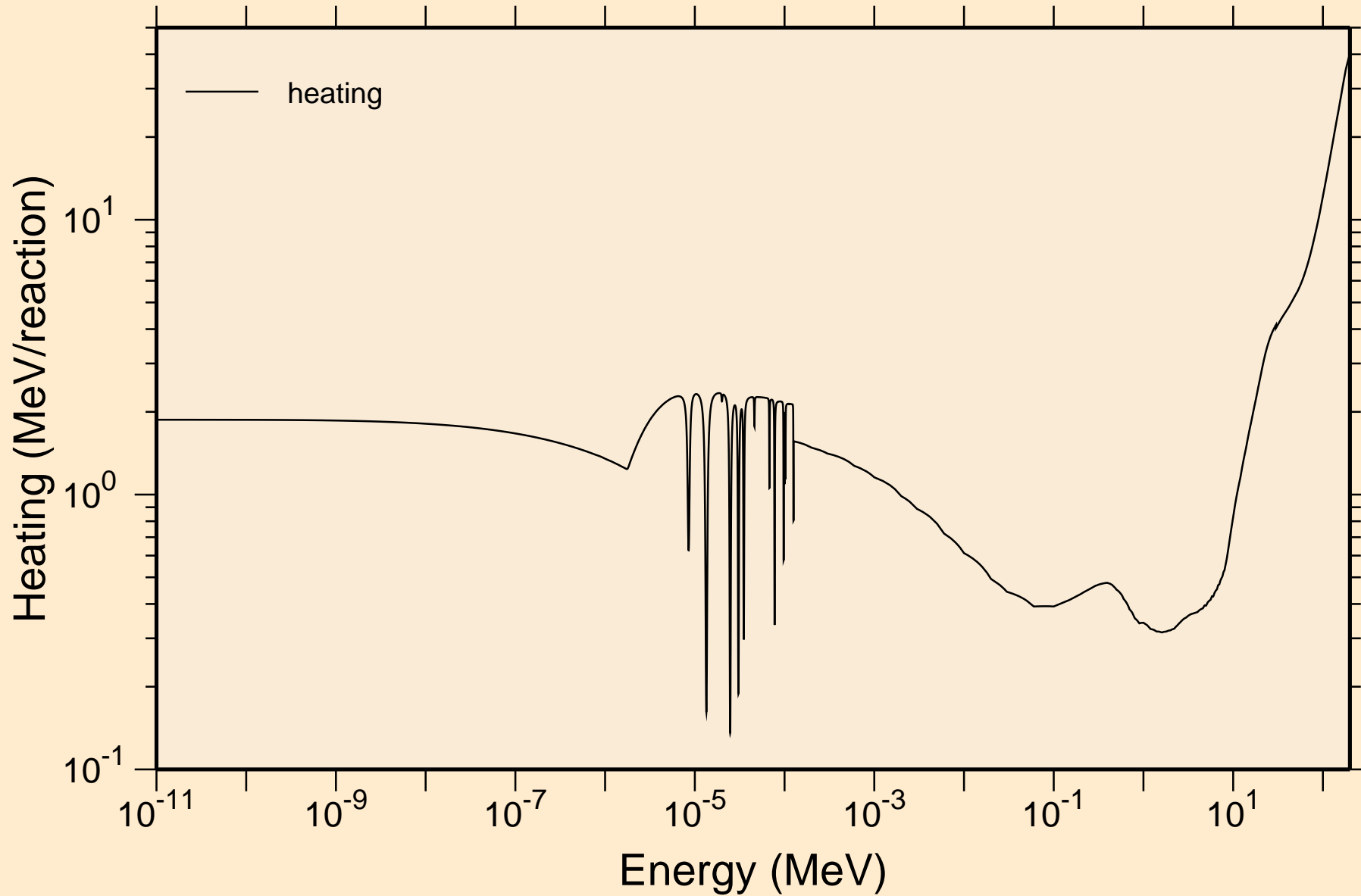

AS072 NEUTRON ACER TENDL-2021 LIBRARY; T=293.6K
Damage

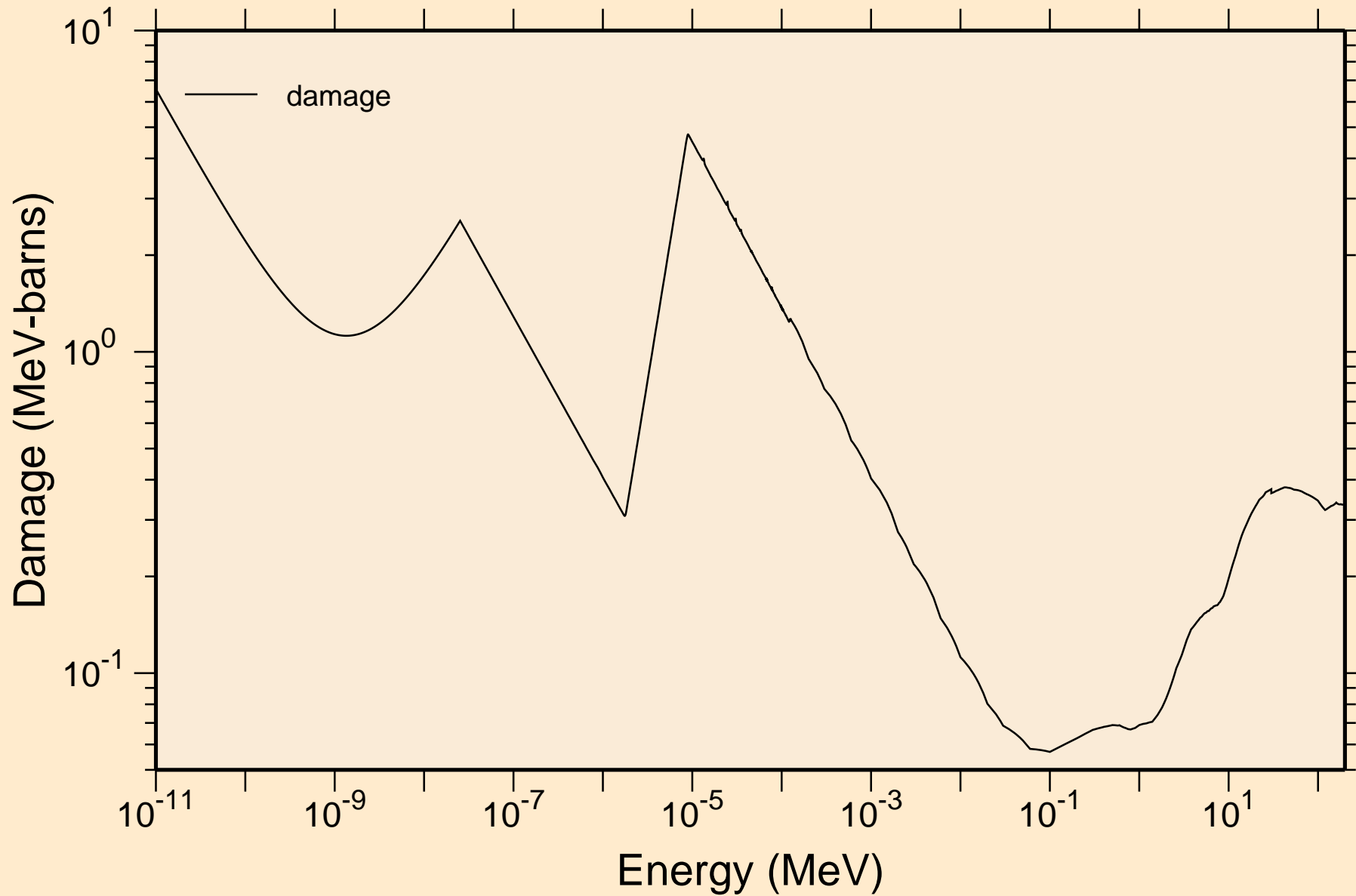

AS072 NEUTRON ACER TENDL-2021 LIBRARY; T=293.6K
Non-threshold reactions

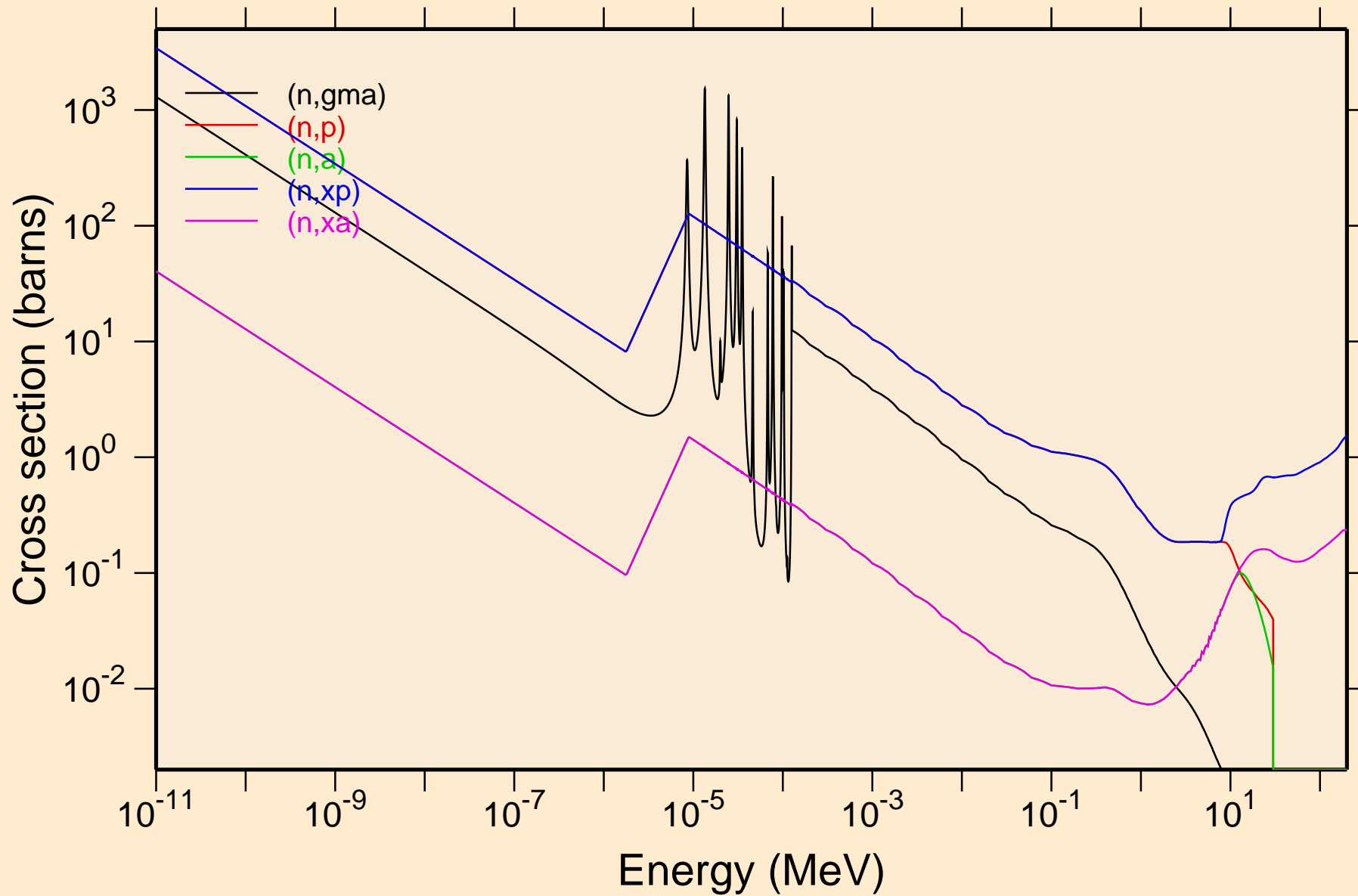

AS072 NEUTRON ACER TENDL-2021 LIBRARY; T=293.6K
Principal cross sections

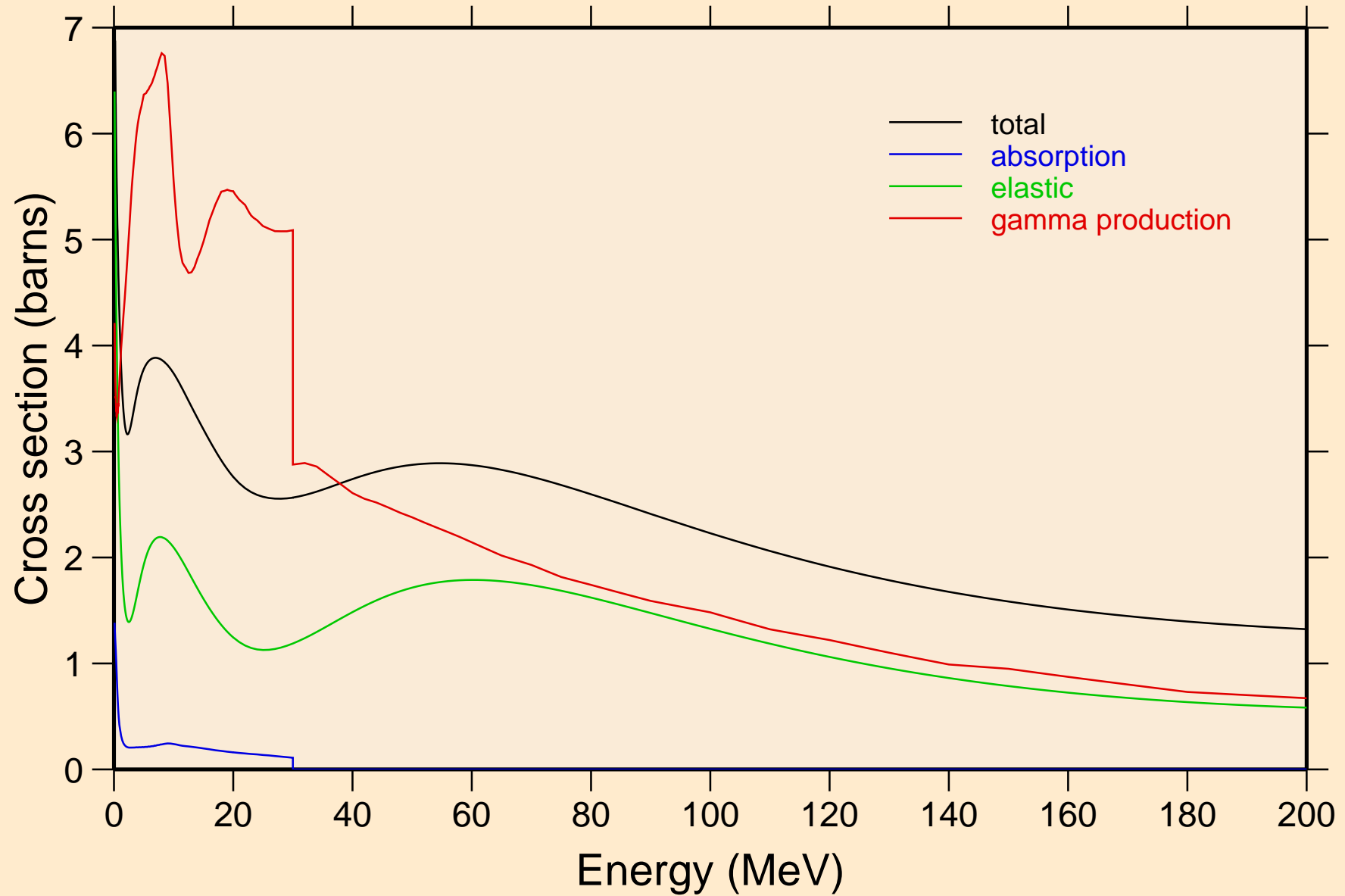

AS072 NEUTRON ACER TENDL-2021 LIBRARY; T=293.6K

Heating

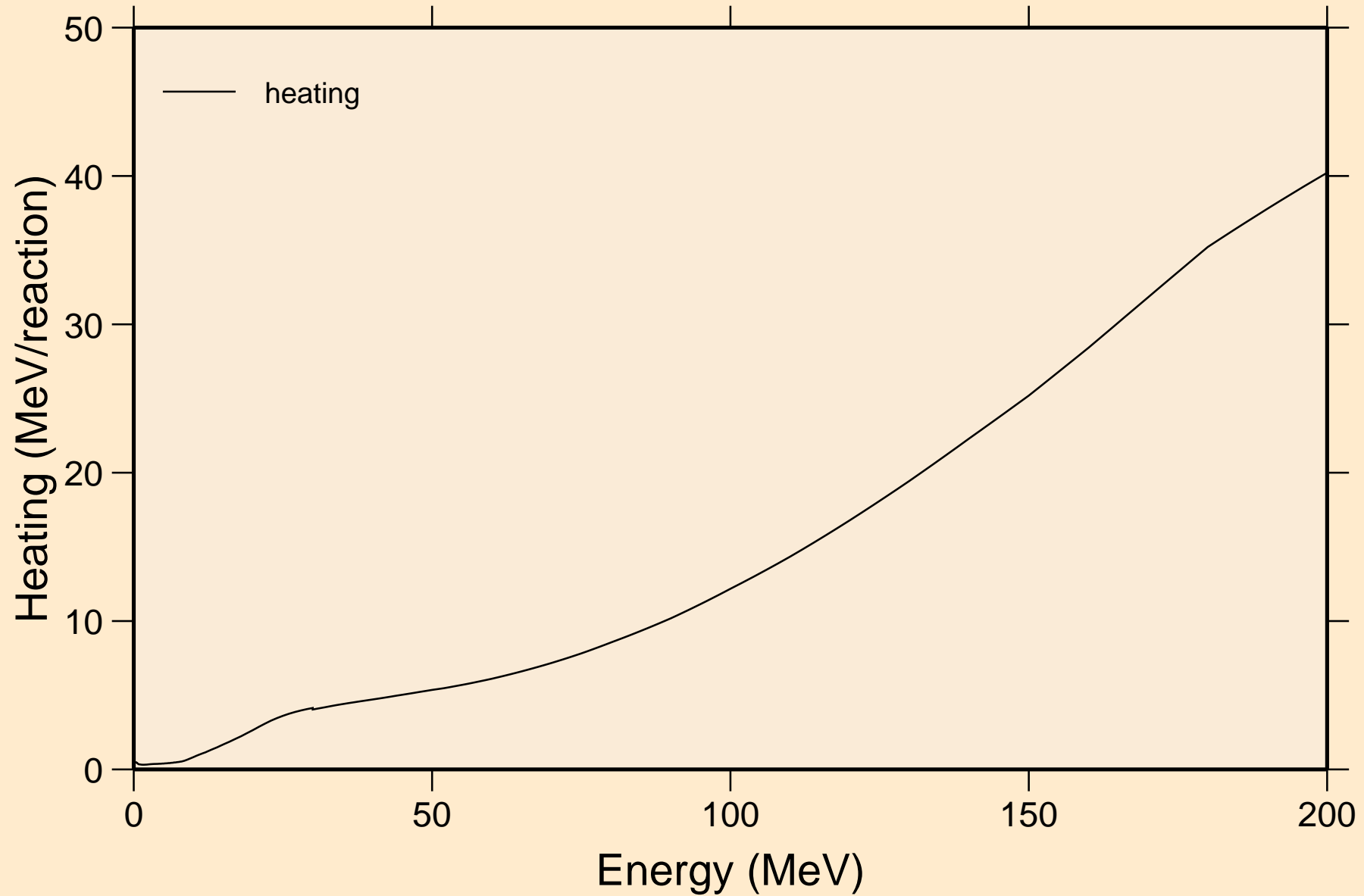

AS072 NEUTRON ACER TENDL-2021 LIBRARY; T=293.6K
Damage

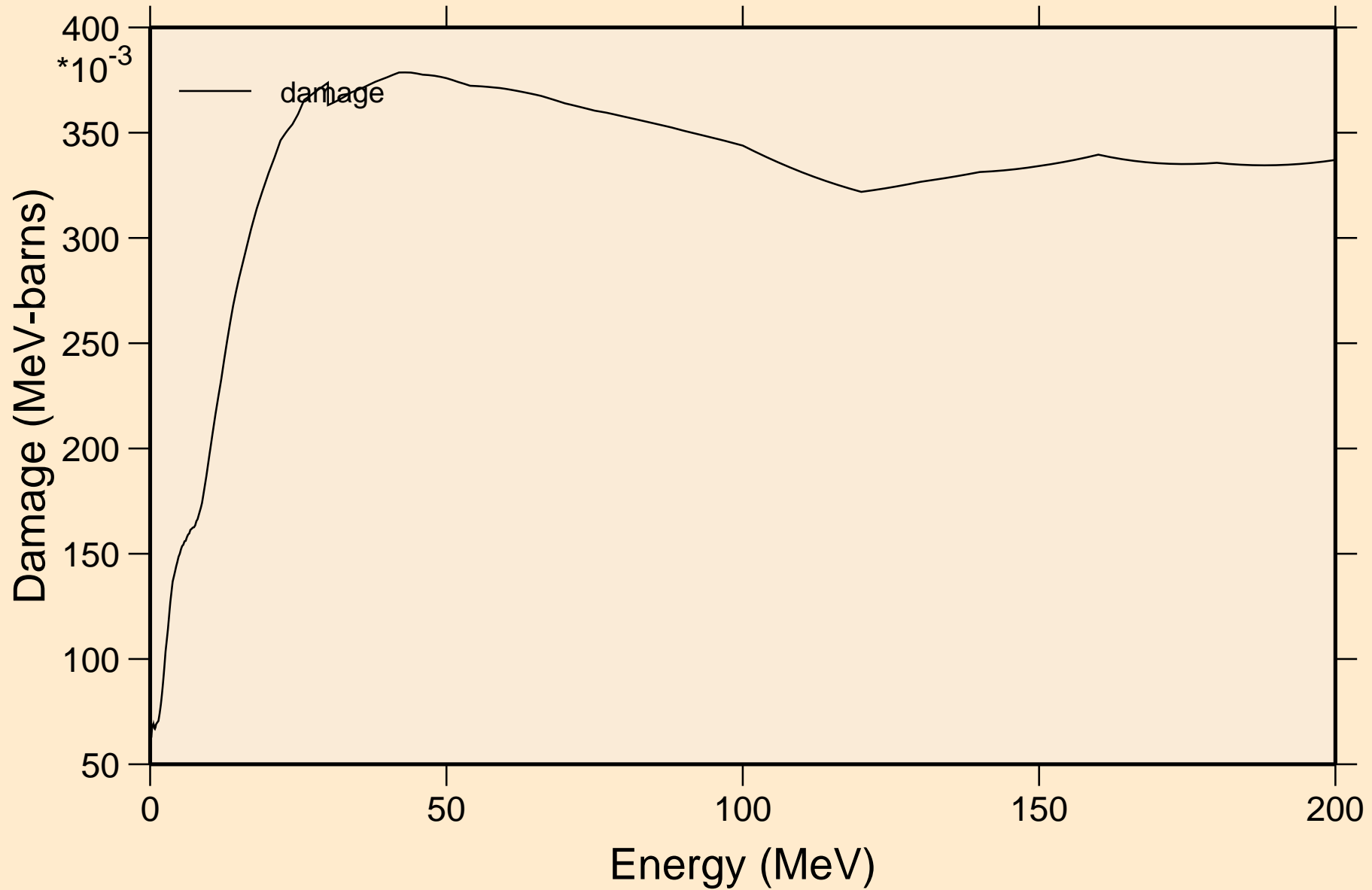

AS072 NEUTRON ACER TENDL-2021 LIBRARY; T=293.6K
Non-threshold reactions

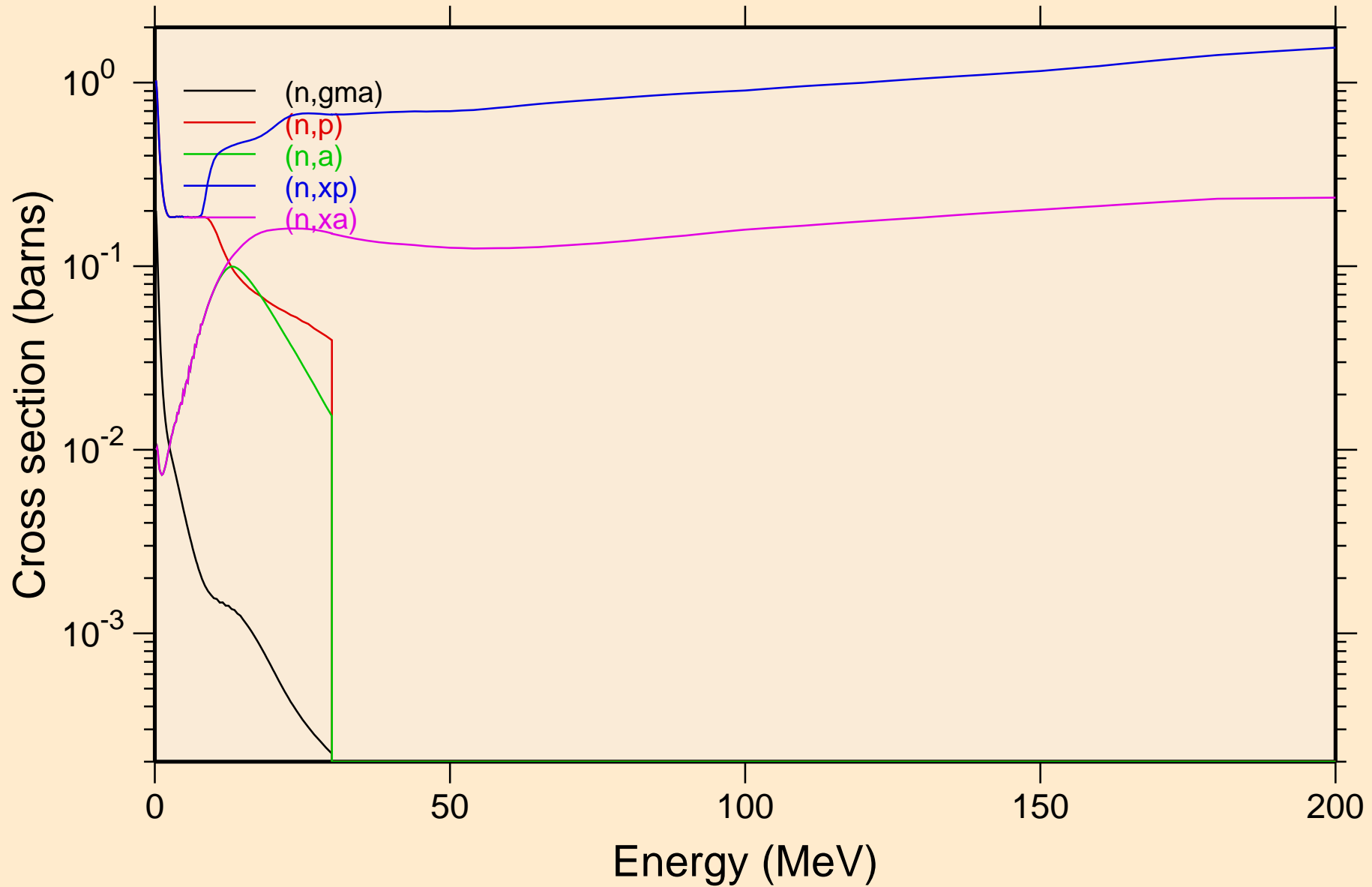

AS072 NEUTRON ACER TENDL-2021 LIBRARY; T=293.6K
Inelastic levels

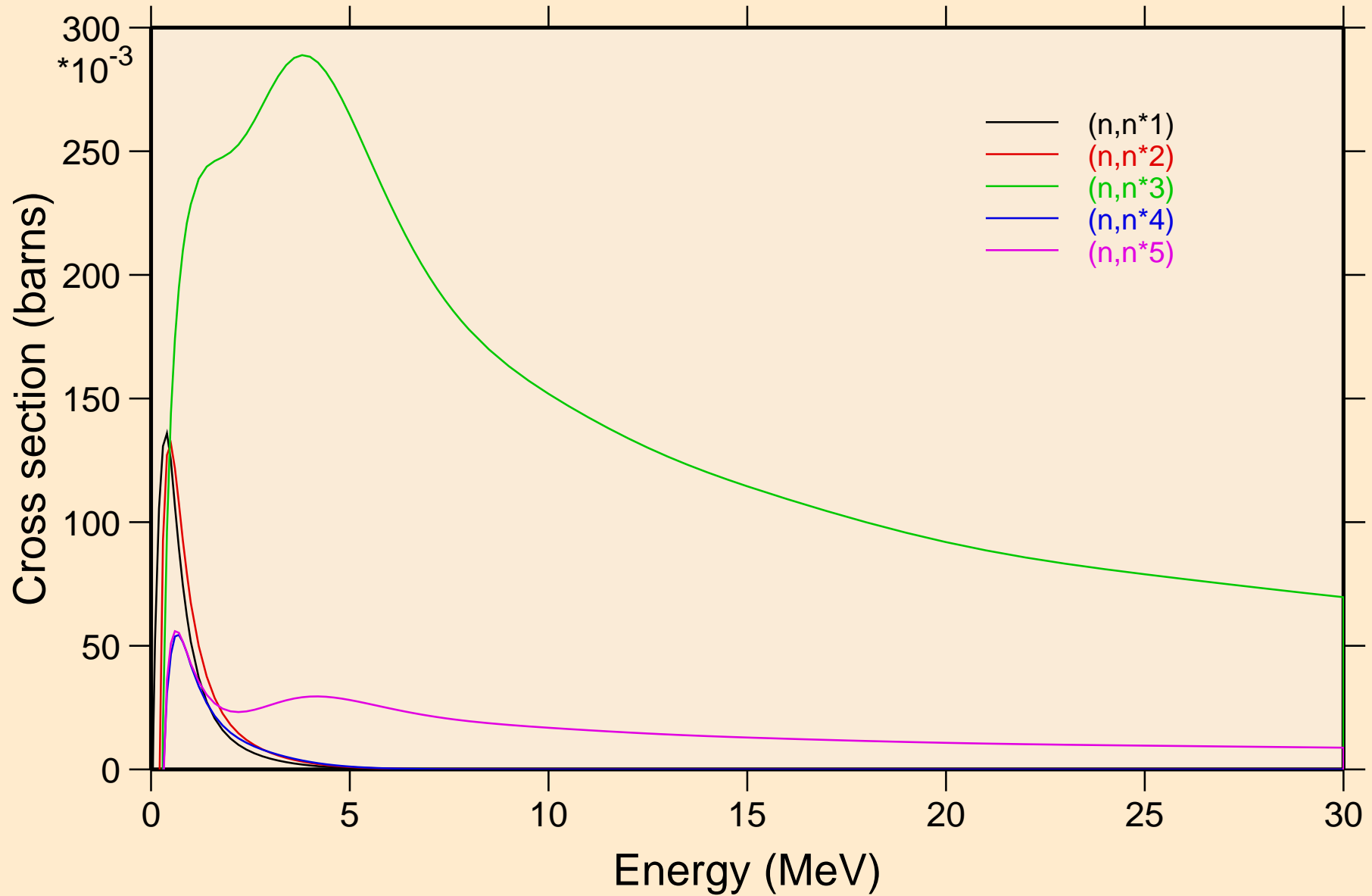

AS072 NEUTRON ACER TENDL-2021 LIBRARY; T=293.6K
Inelastic levels

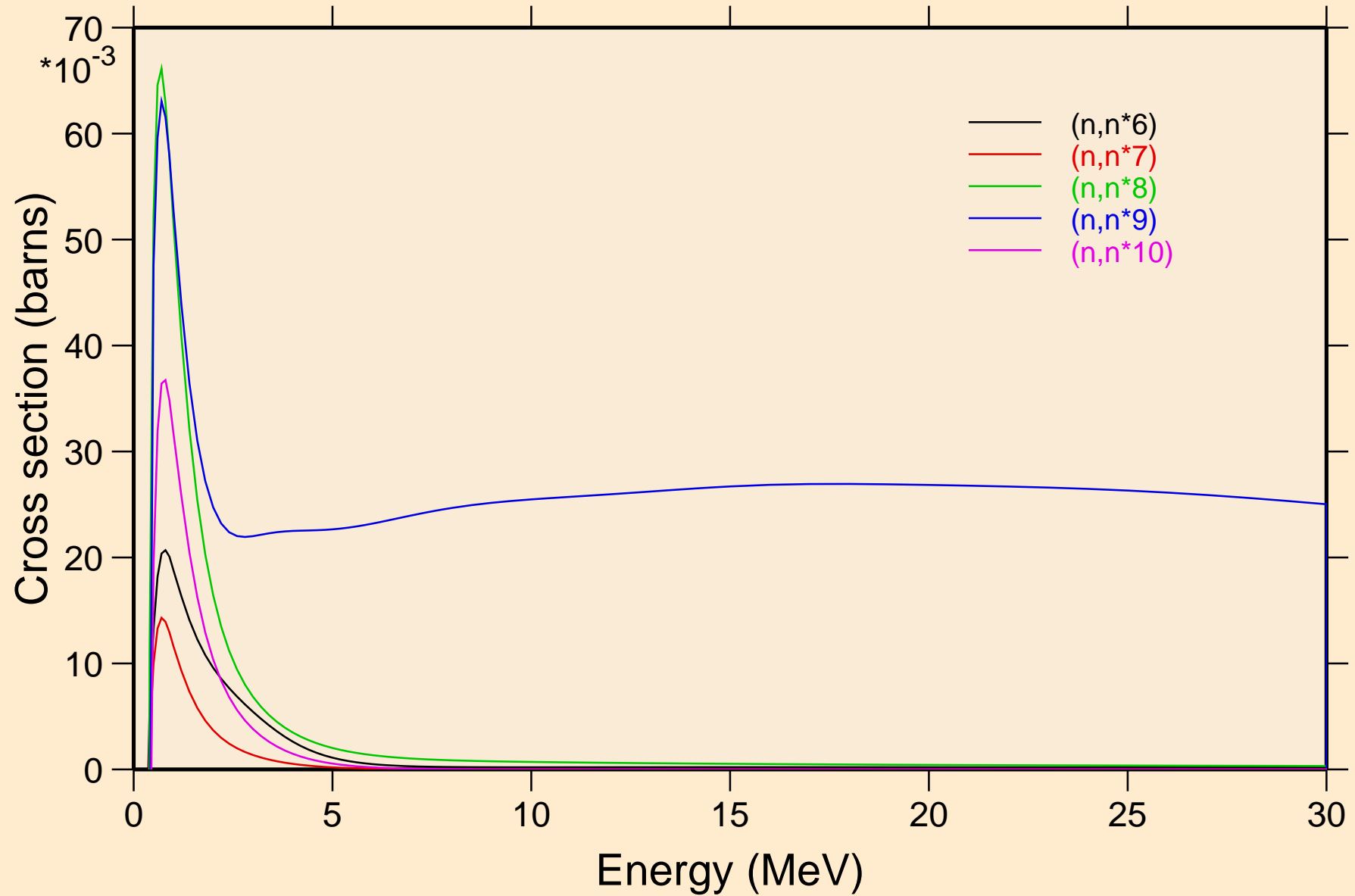

AS072 NEUTRON ACER TENDL-2021 LIBRARY; T=293.6K
Inelastic levels

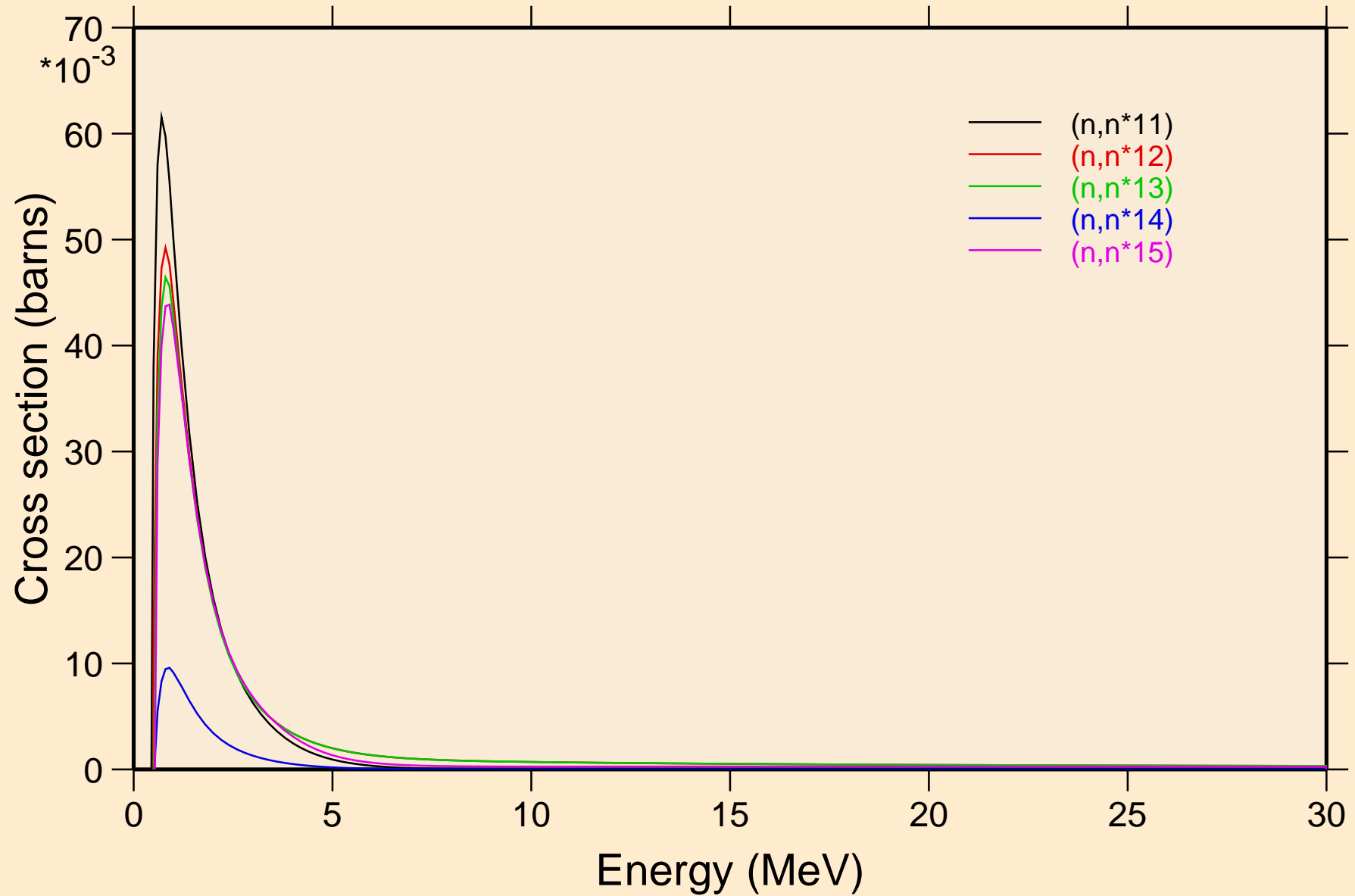

AS072 NEUTRON ACER TENDL-2021 LIBRARY; T=293.6K
Inelastic levels

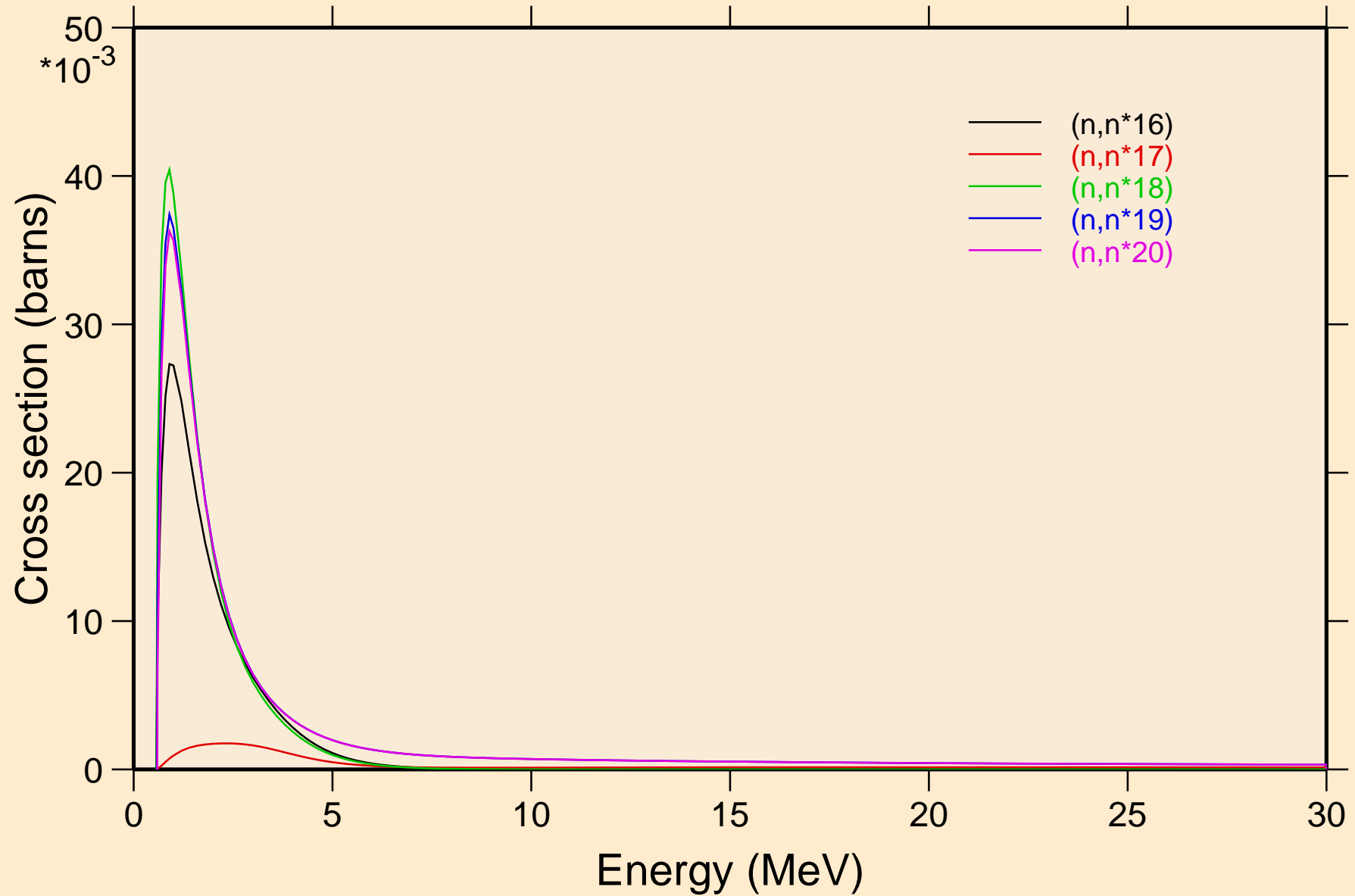

AS072 NEUTRON ACER TENDL-2021 LIBRARY; T=293.6K
Inelastic levels

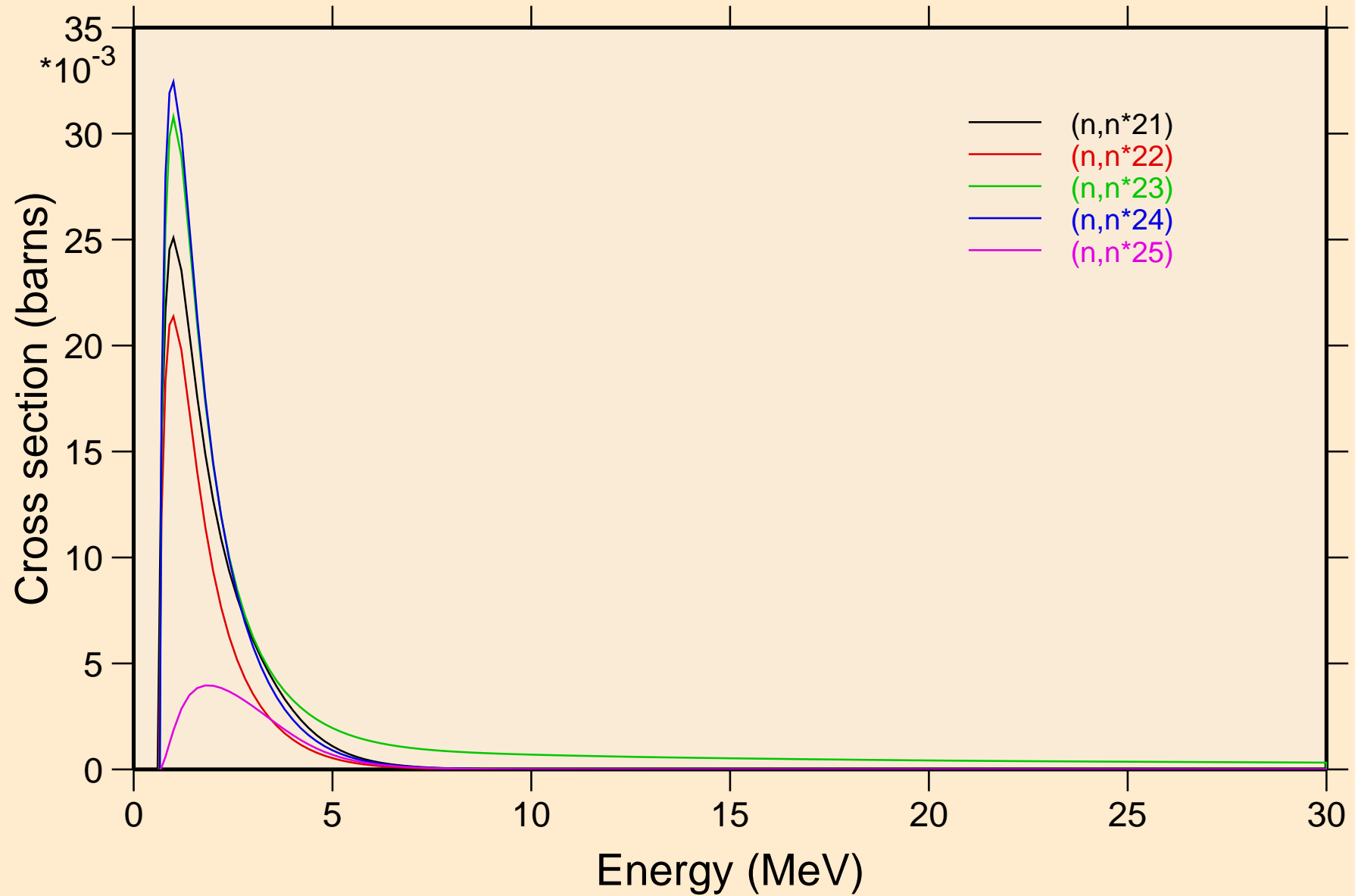

AS072 NEUTRON ACER TENDL-2021 LIBRARY; T=293.6K
Inelastic levels

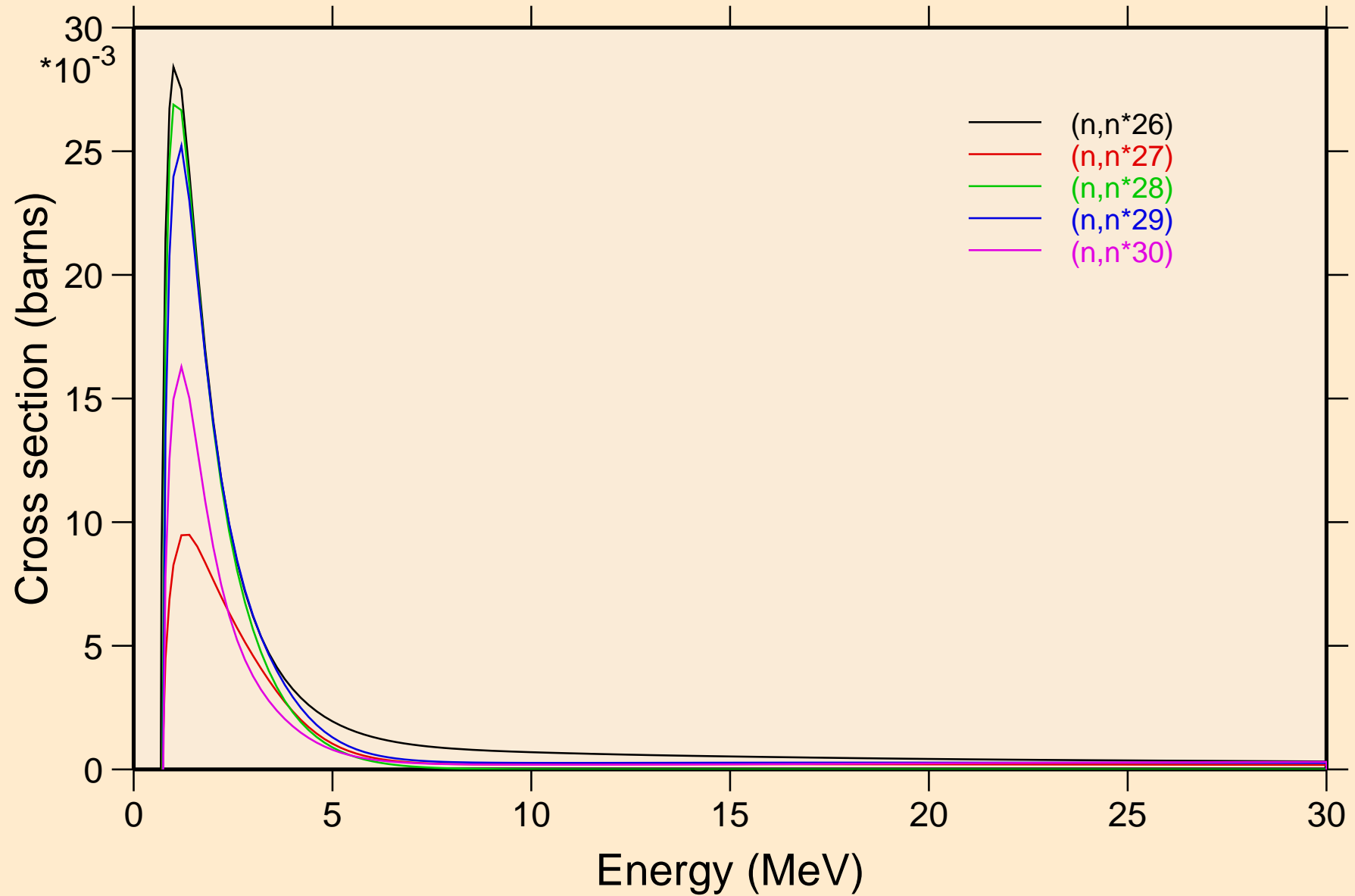

AS072 NEUTRON ACER TENDL-2021 LIBRARY; T=293.6K
Threshold reactions

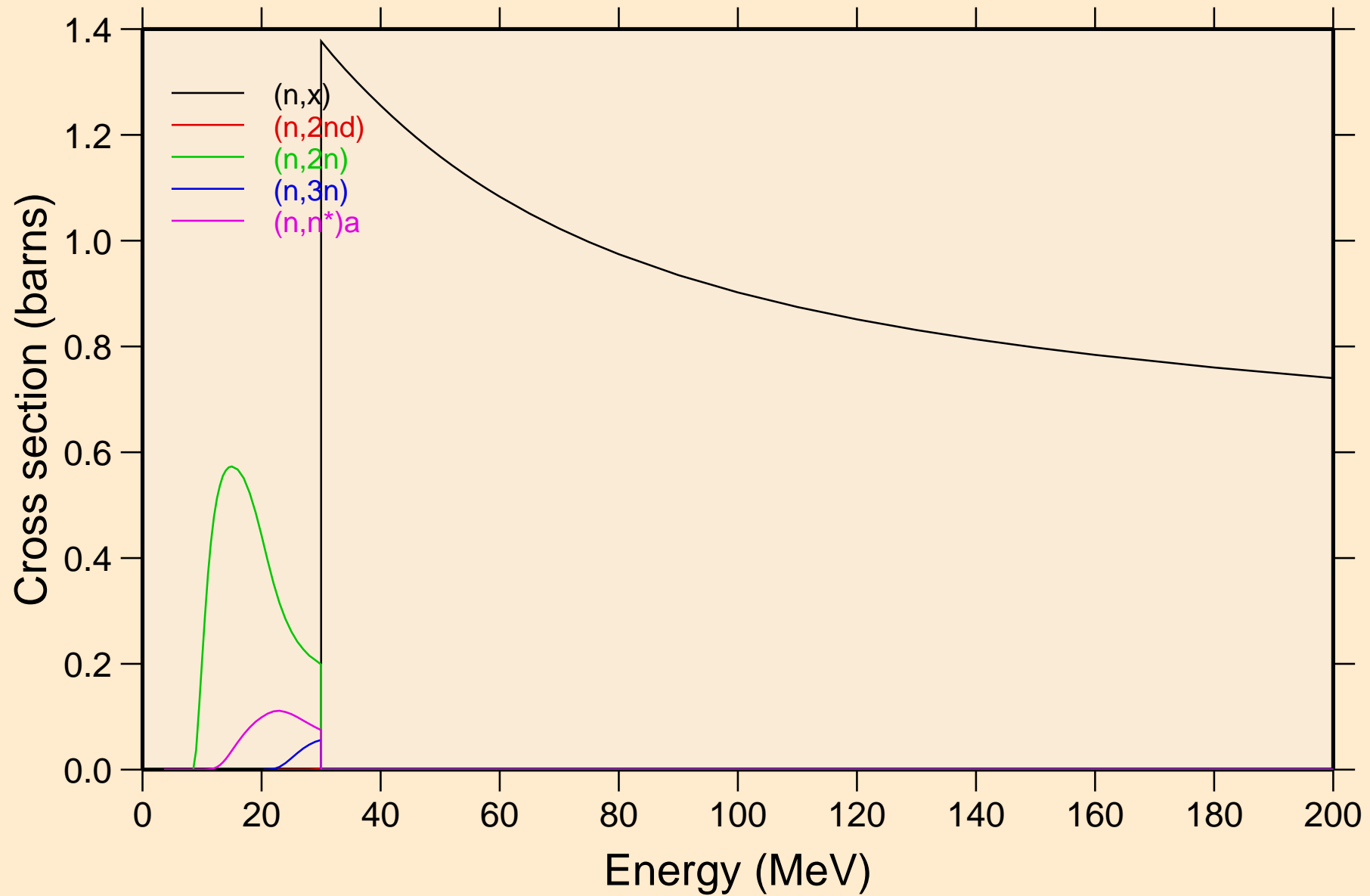

AS072 NEUTRON ACER TENDL-2021 LIBRARY; T=293.6K
Threshold reactions

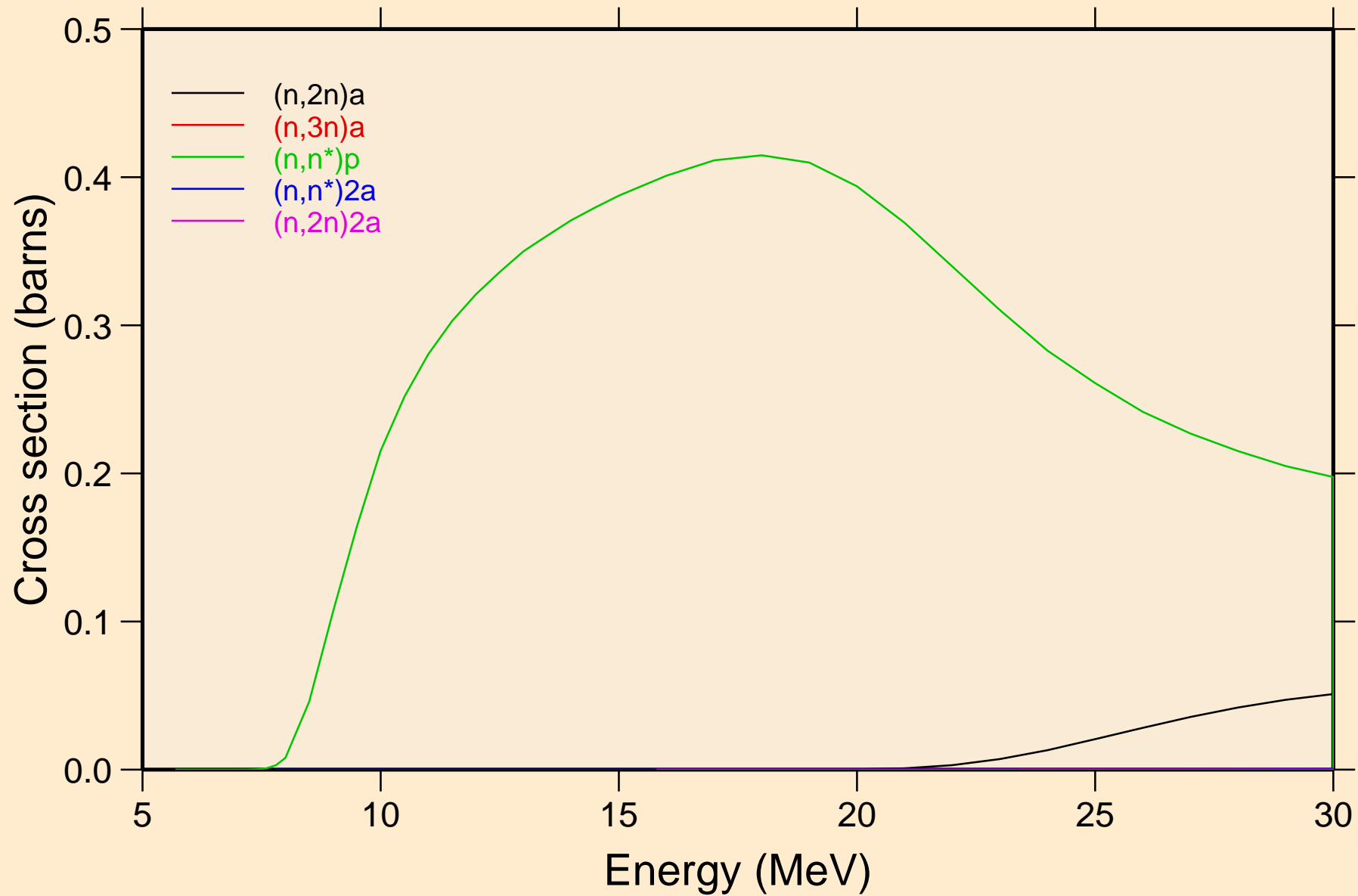

AS072 NEUTRON ACER TENDL-2021 LIBRARY; T=293.6K

Threshold reactions

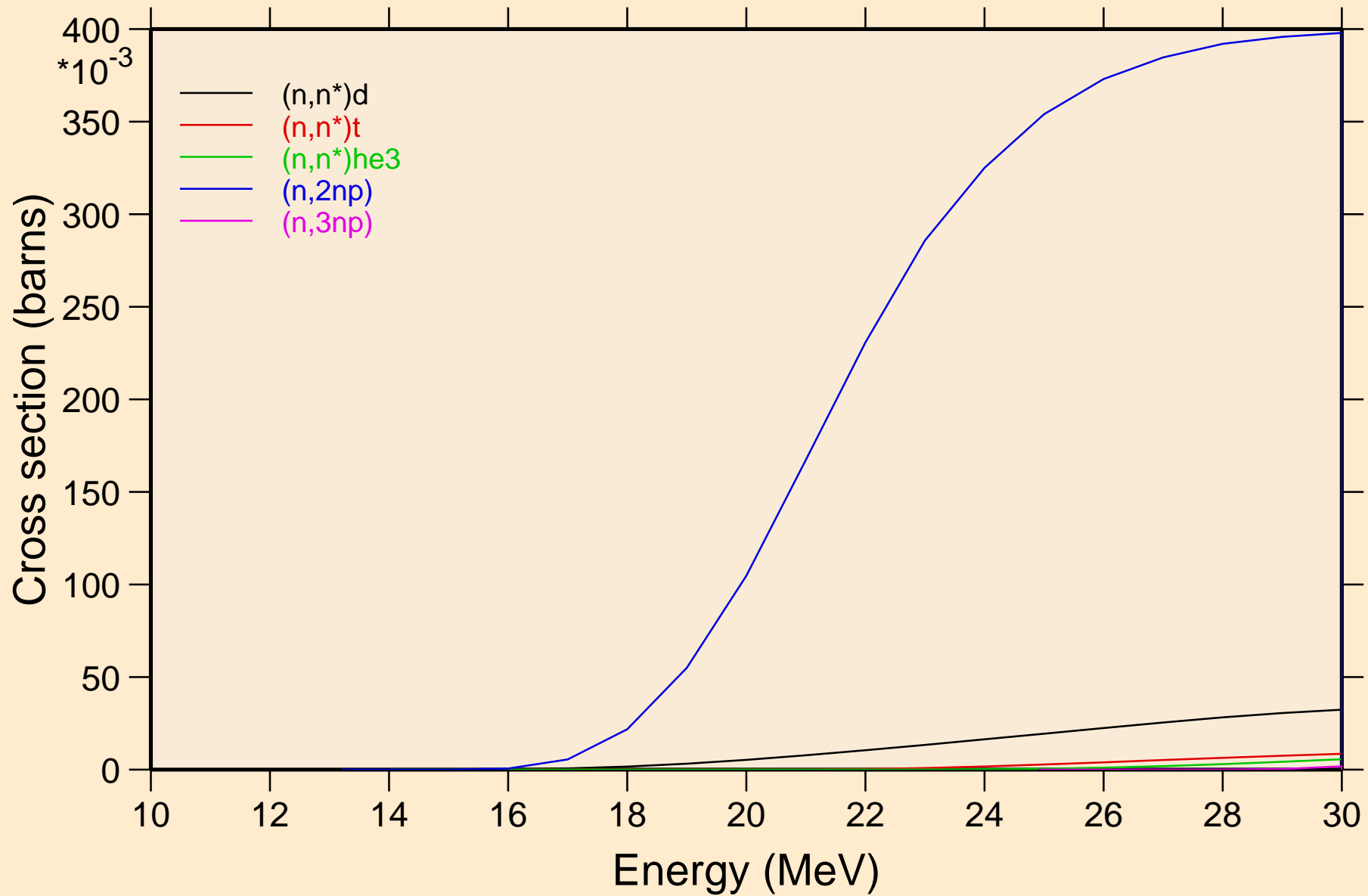

AS072 NEUTRON ACER TENDL-2021 LIBRARY; T=293.6K
Threshold reactions

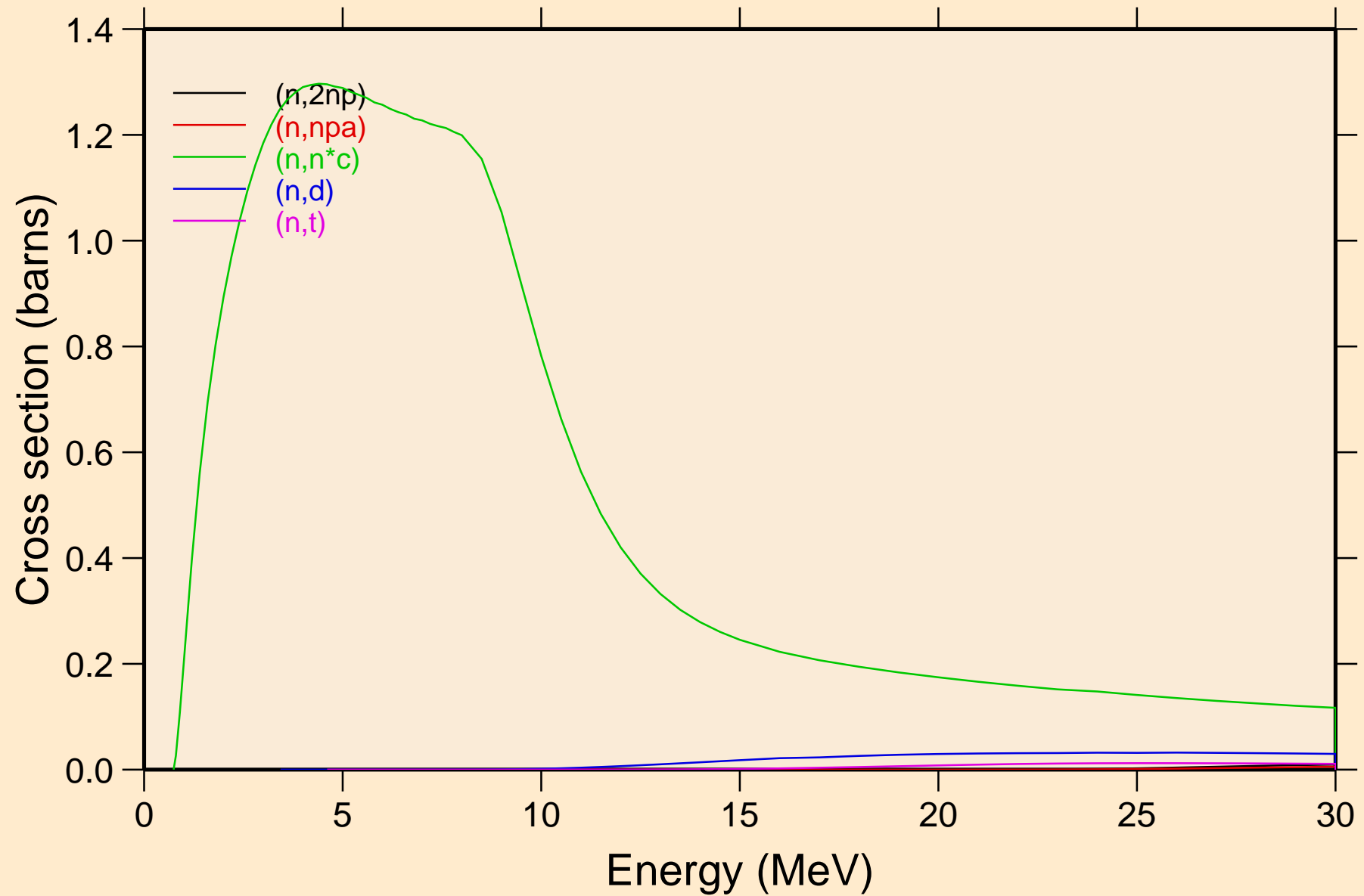

AS072 NEUTRON ACER TENDL-2021 LIBRARY; T=293.6K
Threshold reactions

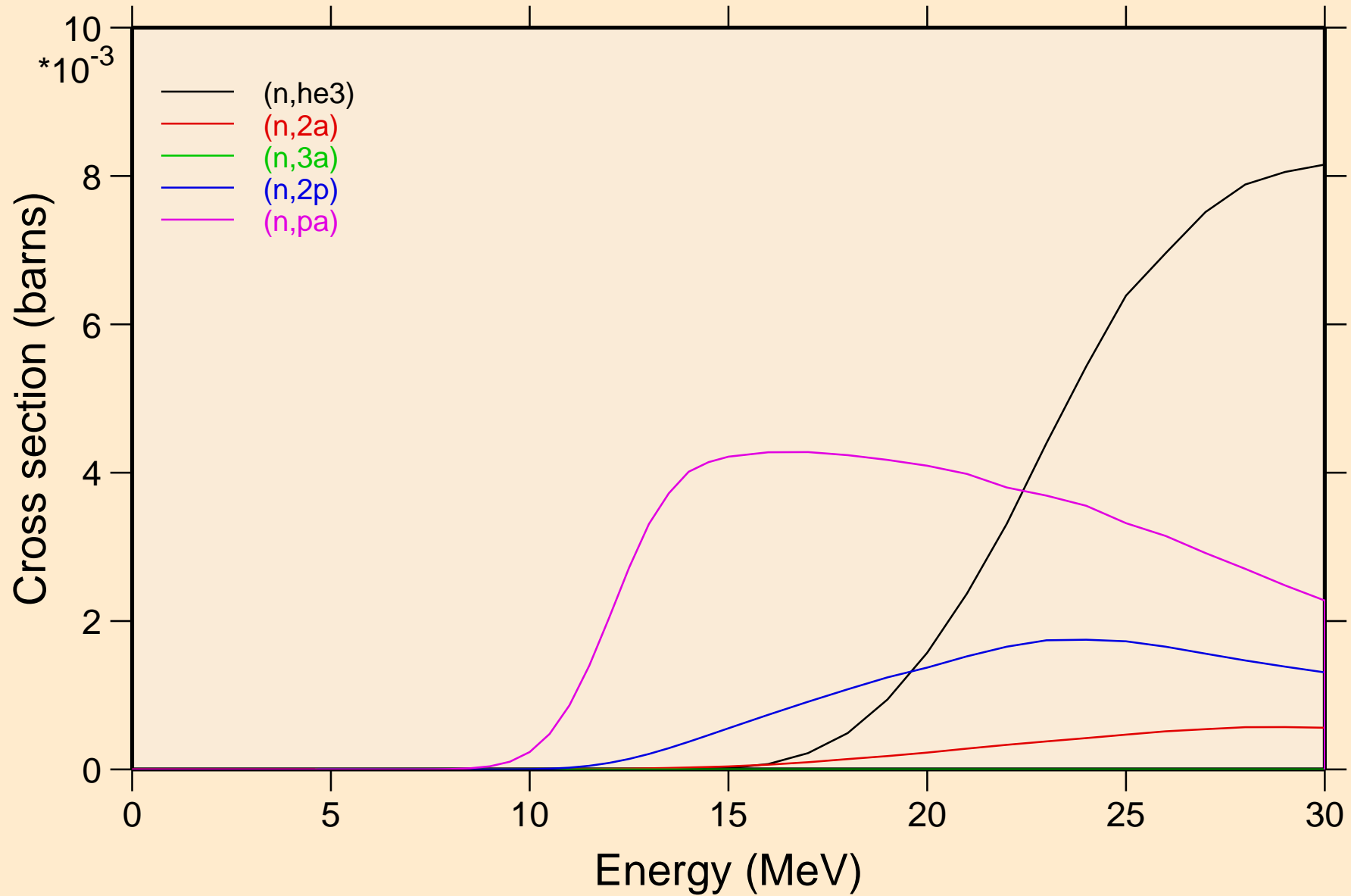

AS072 NEUTRON ACER TENDL-2021 LIBRARY; T=293.6K

Threshold reactions

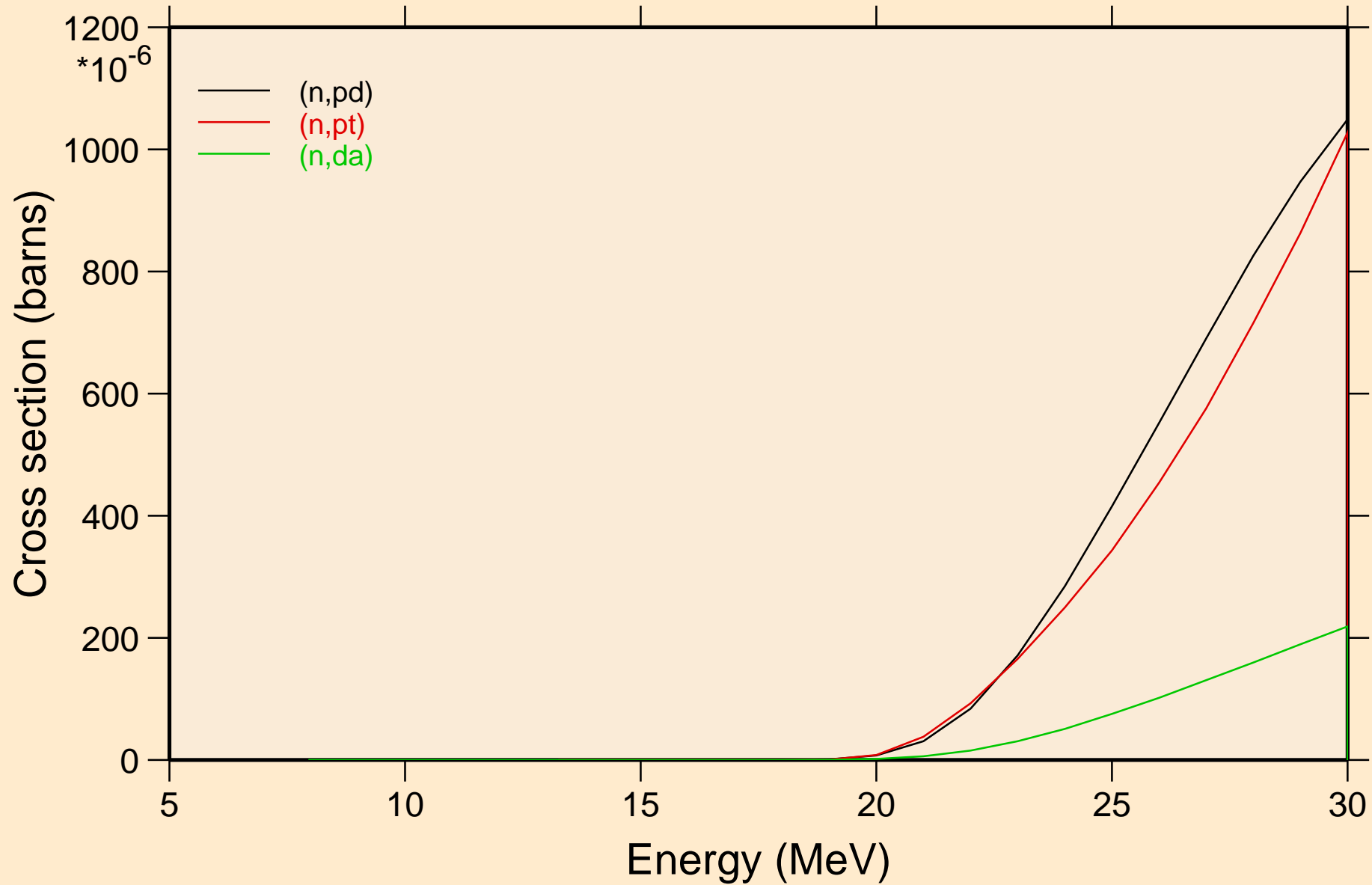

AS072 NEUTRON ACER TENDL-2021 LIBRARY; T=293.6K
Threshold reactions

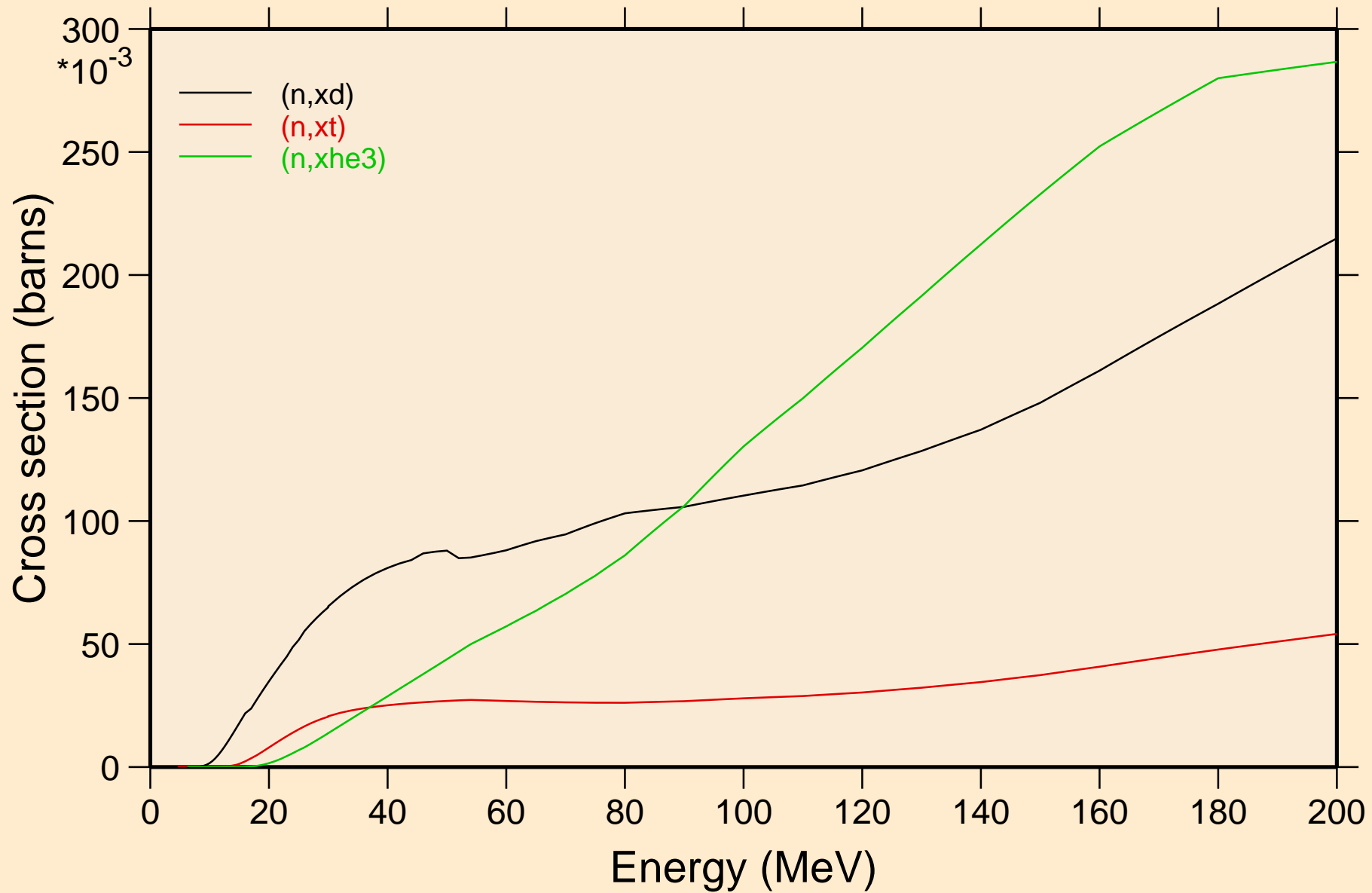

AS072 NEUTRON ACER TENDL-2021 LIBRARY; T=293.6K
angular distribution for elastic

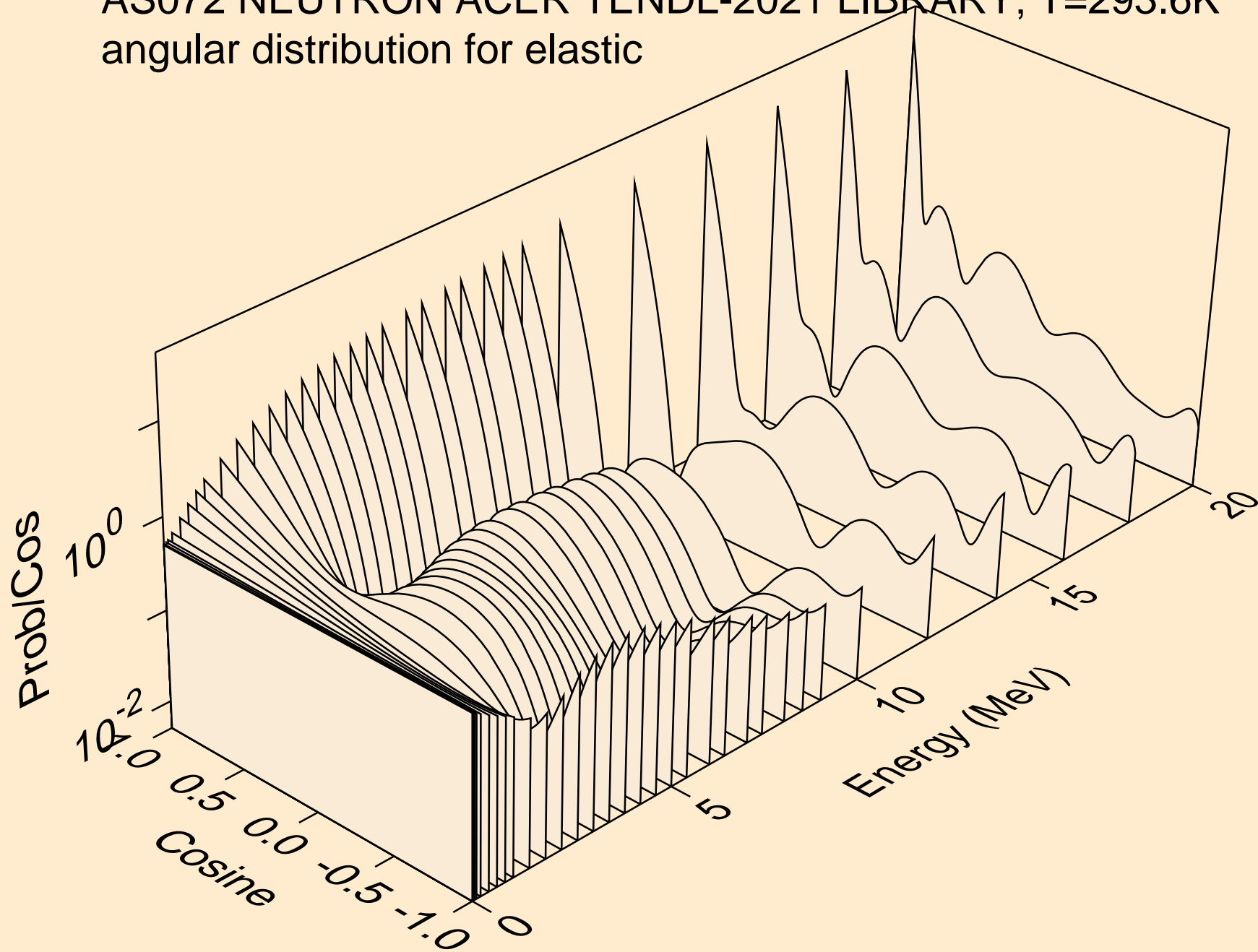

AS072 NEUTRON ACER TENDL-2021 LIBRARY; T=293.6K
angular distribution for elastic

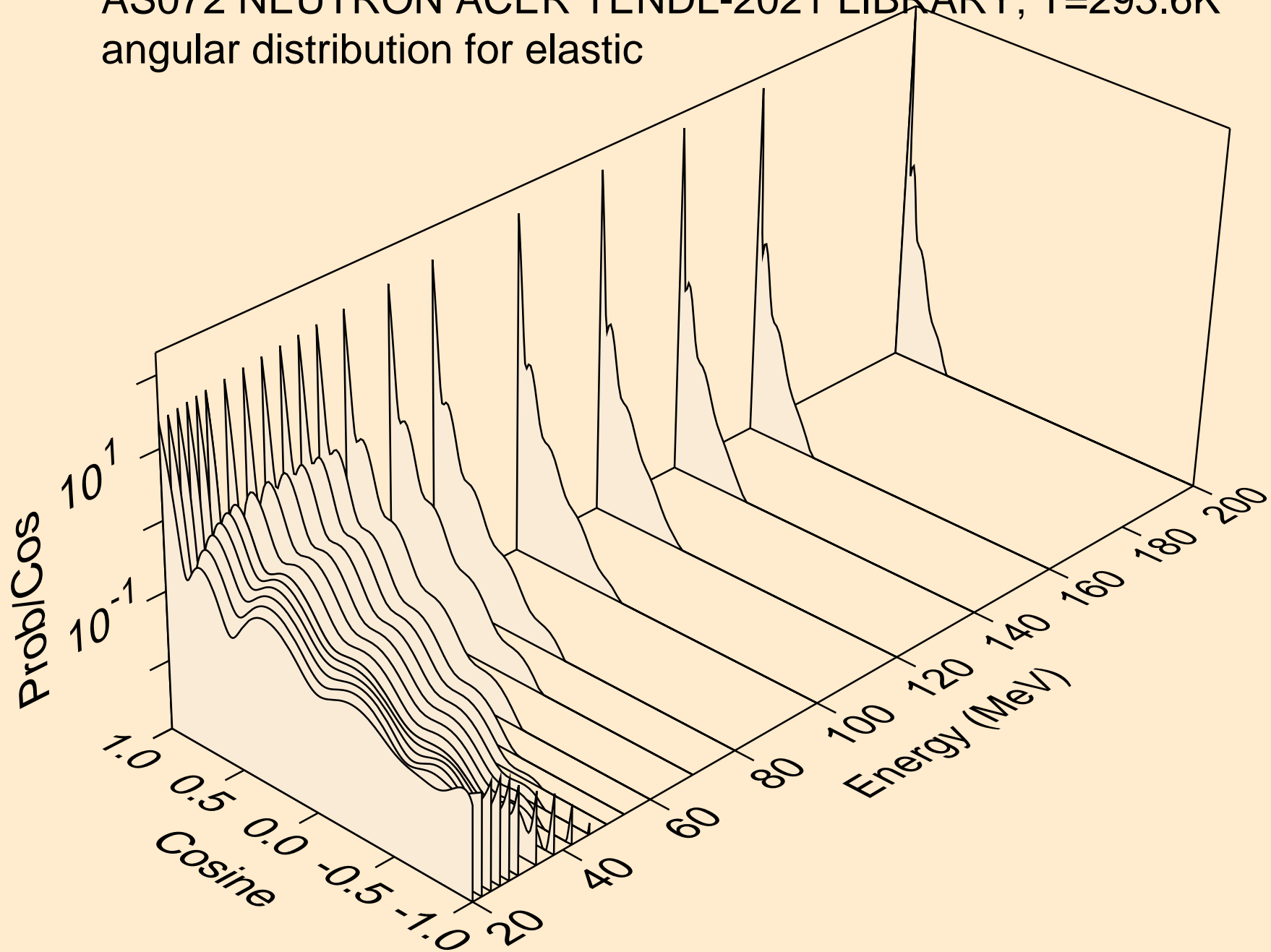

AS072 NEUTRON ACER TENDL-2021 LIBRARY; T=293.6K
angular distribution for (n,n*1)

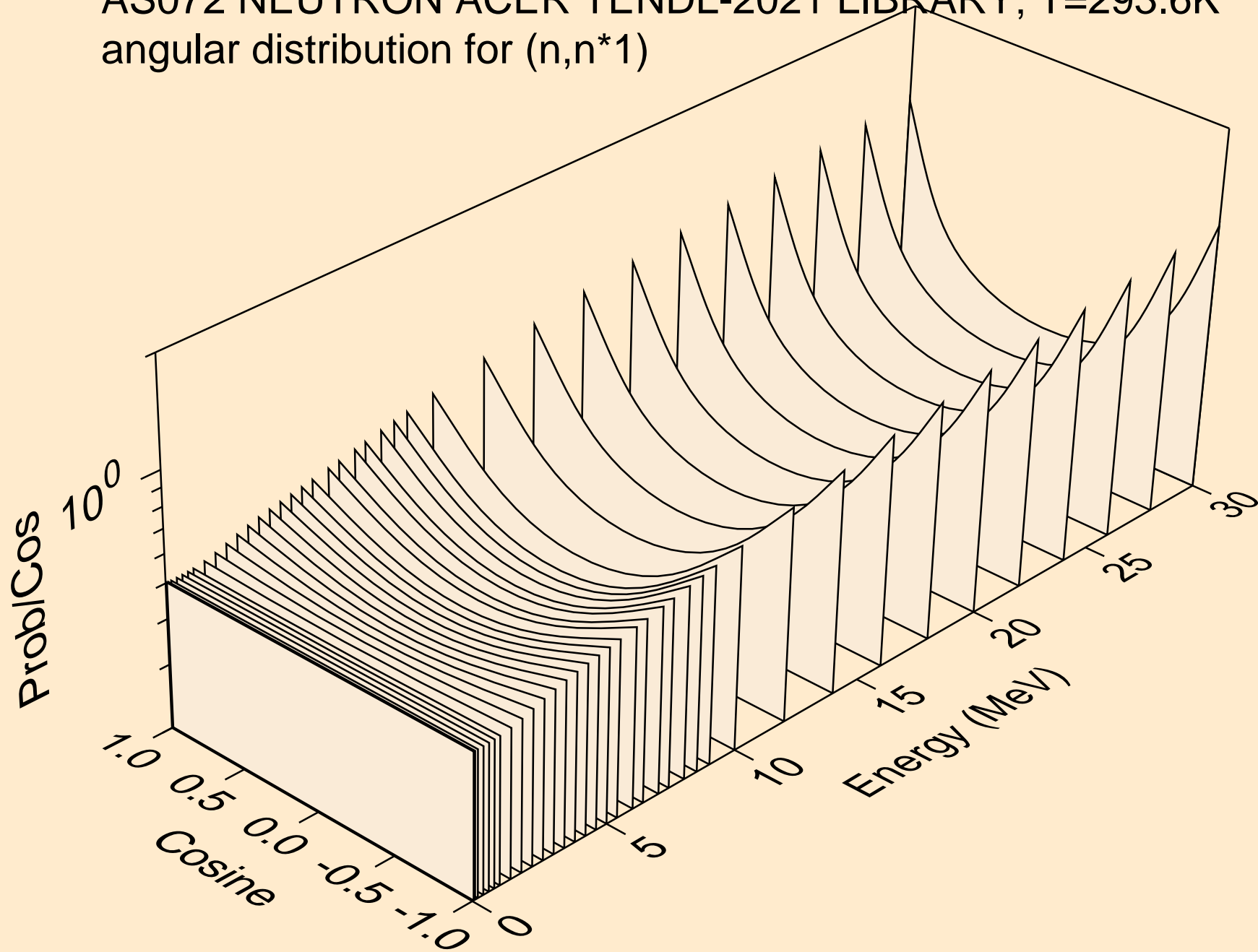

AS072 NEUTRON ACER TENDL-2021 LIBRARY; T=293.6K
angular distribution for (n,n*2)

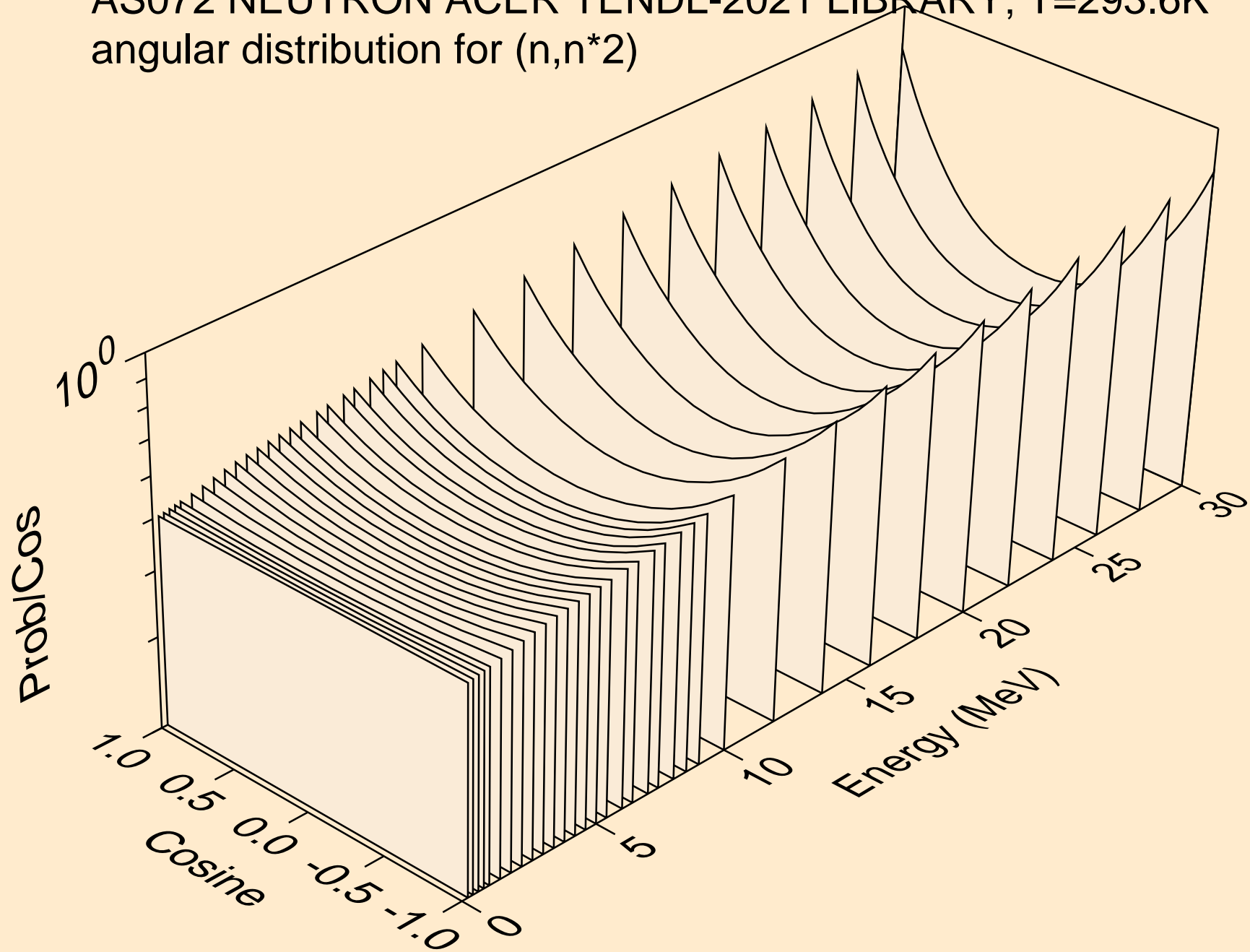

AS072 NEUTRON ACER TENDL-2021 LIBRARY; T=293.6K
angular distribution for (n,n*3)

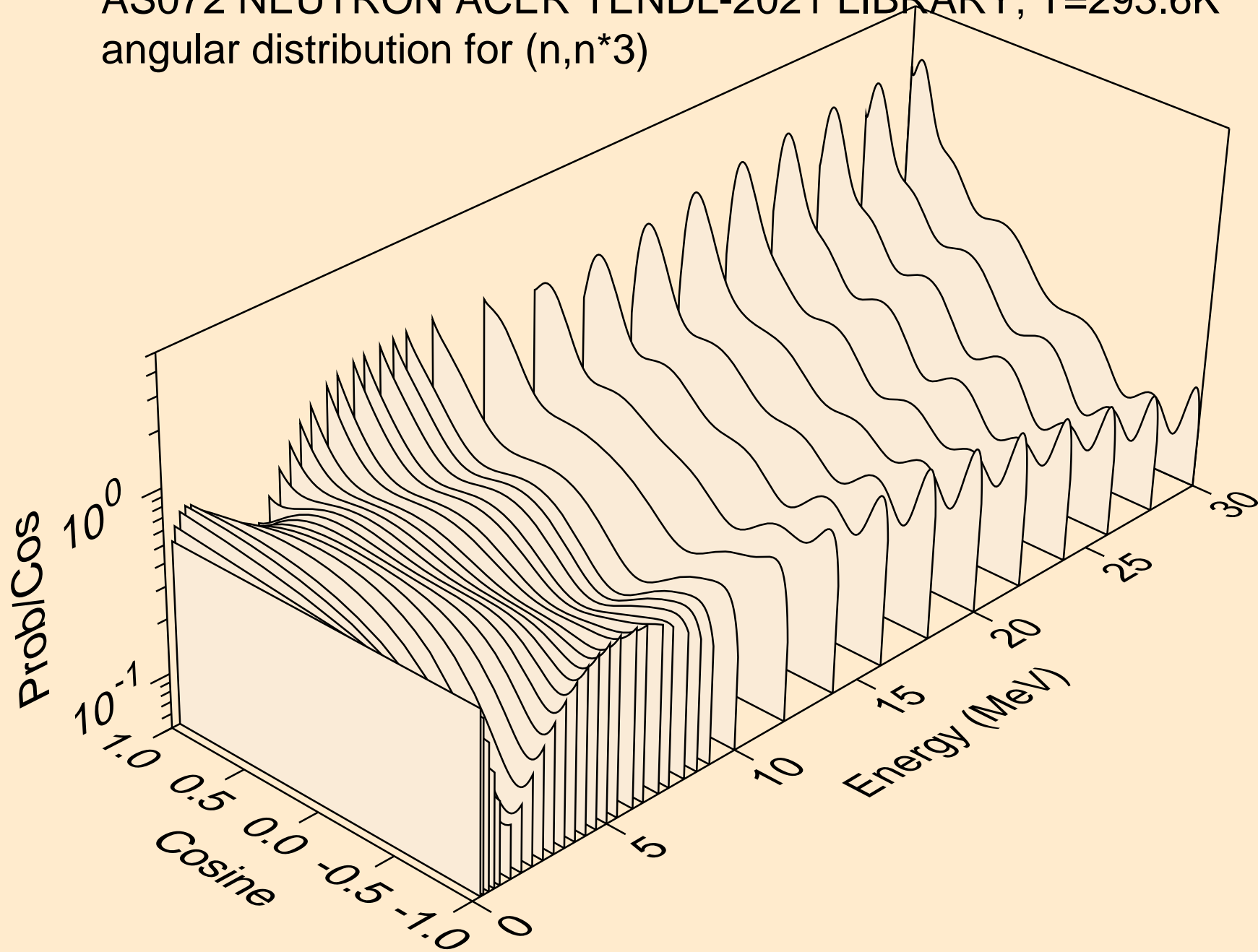

AS072 NEUTRON ACER TENDL-2021 LIBRARY; T=293.6K
angular distribution for (n,n*4)

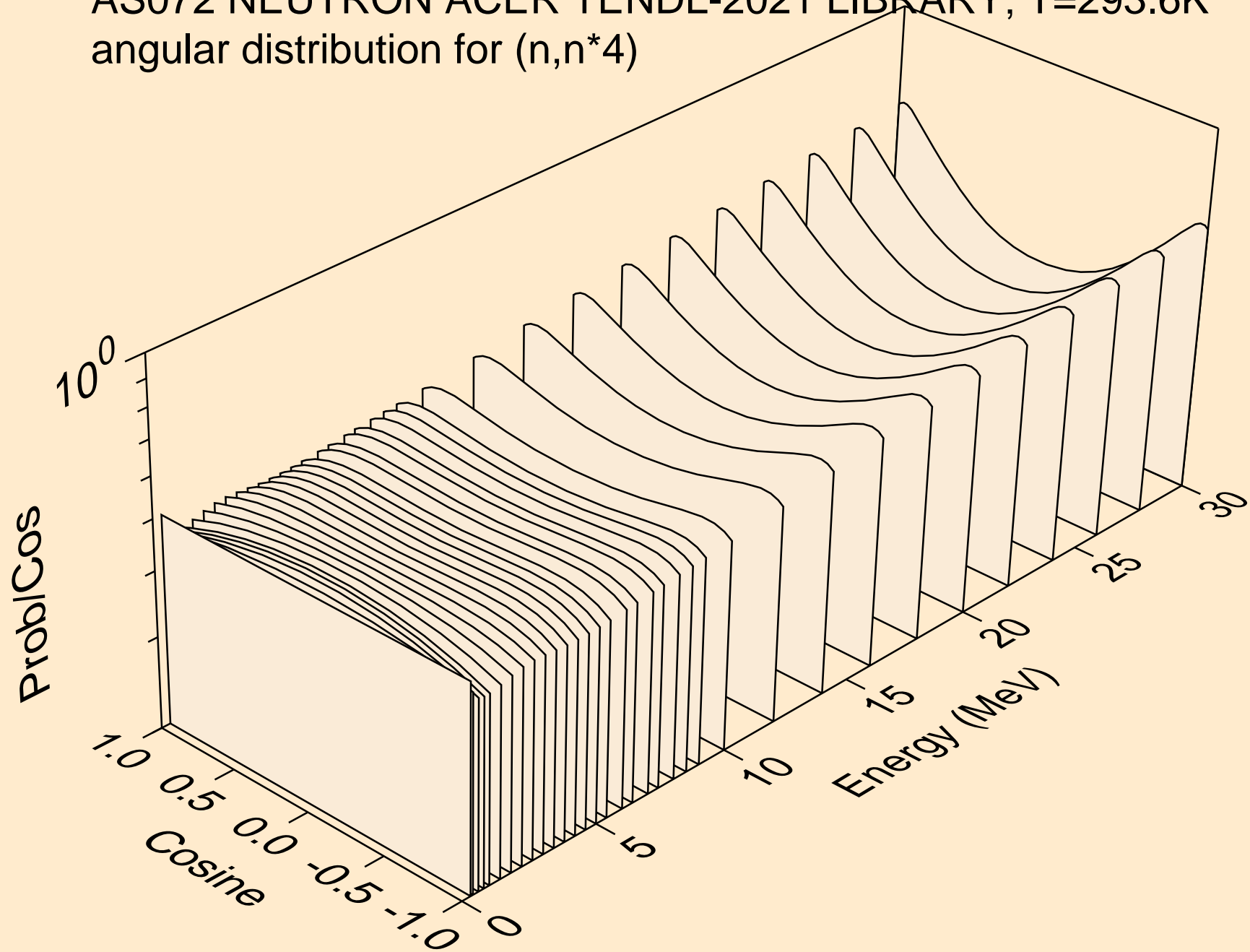

AS072 NEUTRON ACER TENDL-2021 LIBRARY; T=293.6K
angular distribution for (n,n*5)

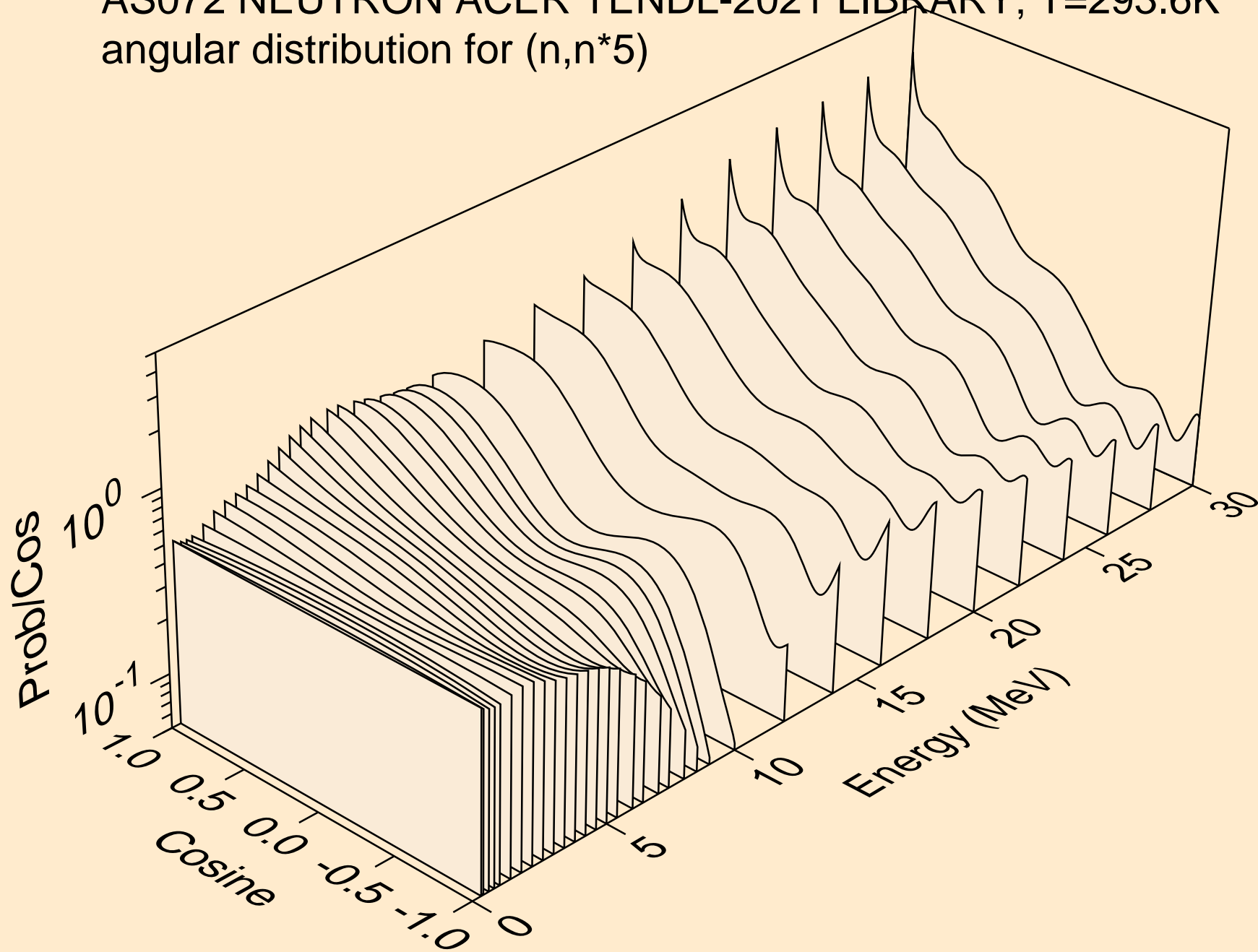

AS072 NEUTRON ACER TENDL-2021 LIBRARY; T=293.6K
angular distribution for (n,n*6)

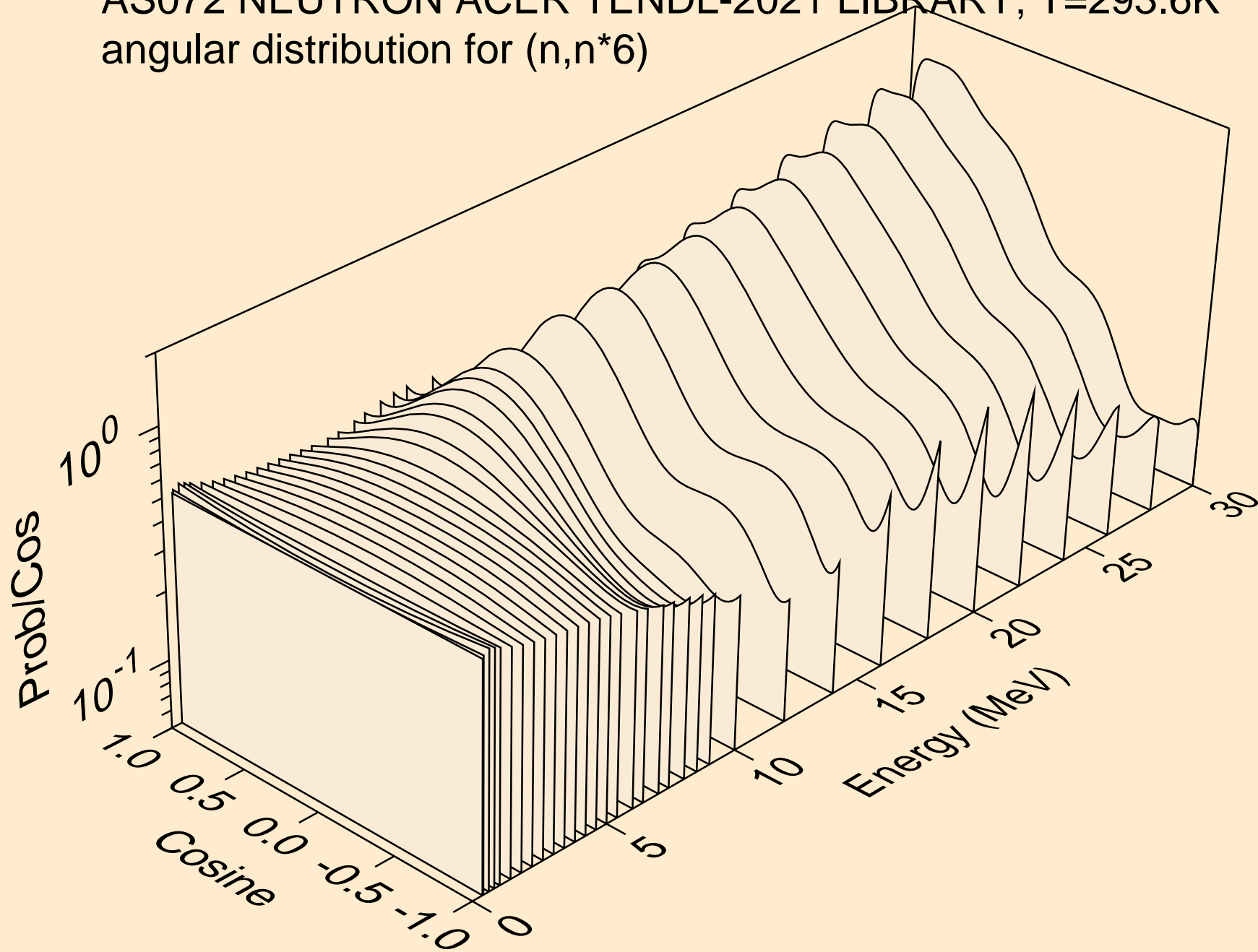

AS072 NEUTRON ACER TENDL-2021 LIBRARY; T=293.6K
angular distribution for (n,n*7)

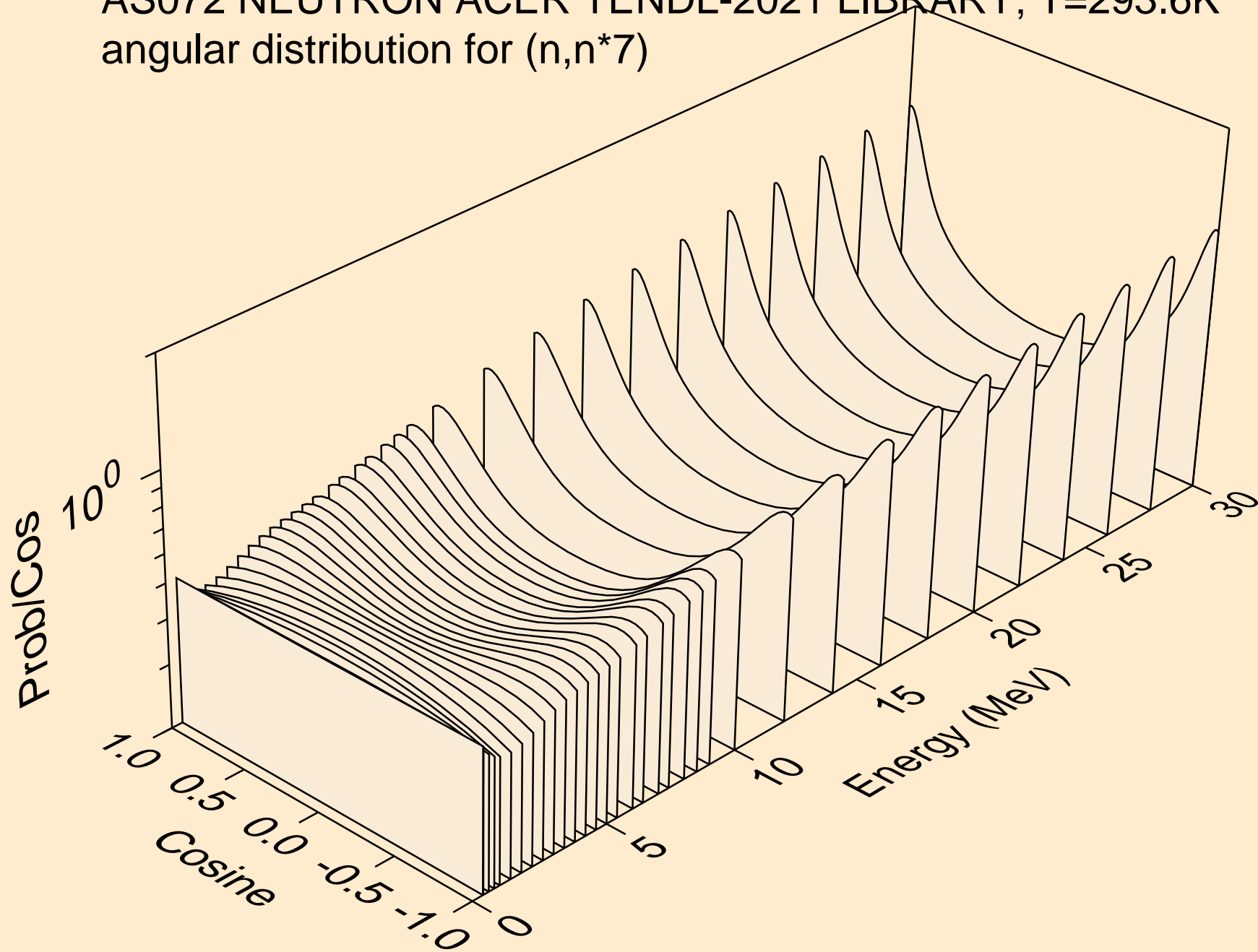

AS072 NEUTRON ACER TENDL-2021 LIBRARY; T=293.6K
angular distribution for (n,n*8)

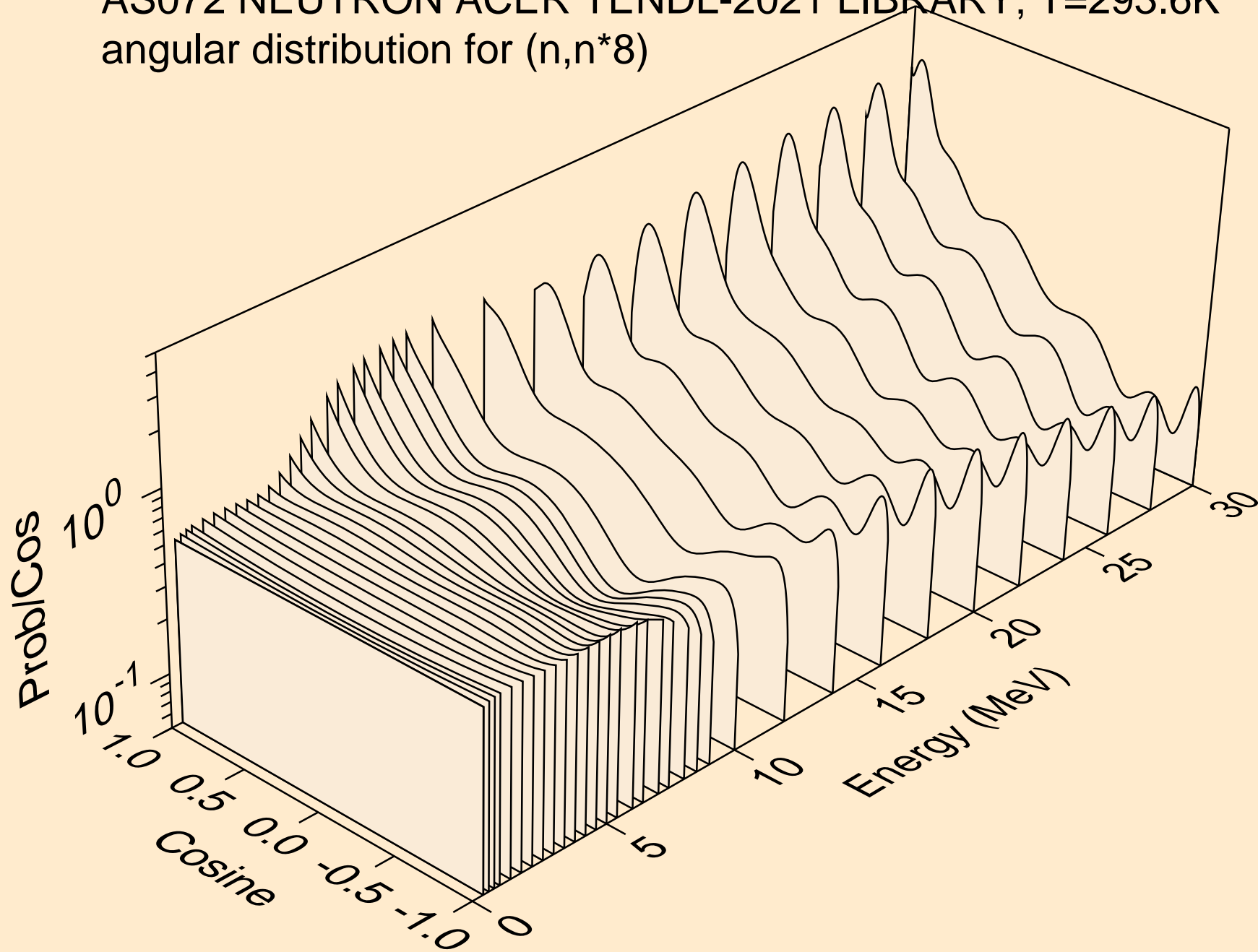

AS072 NEUTRON ACER TENDL-2021 LIBRARY; T=293.6K
angular distribution for (n,n*9)

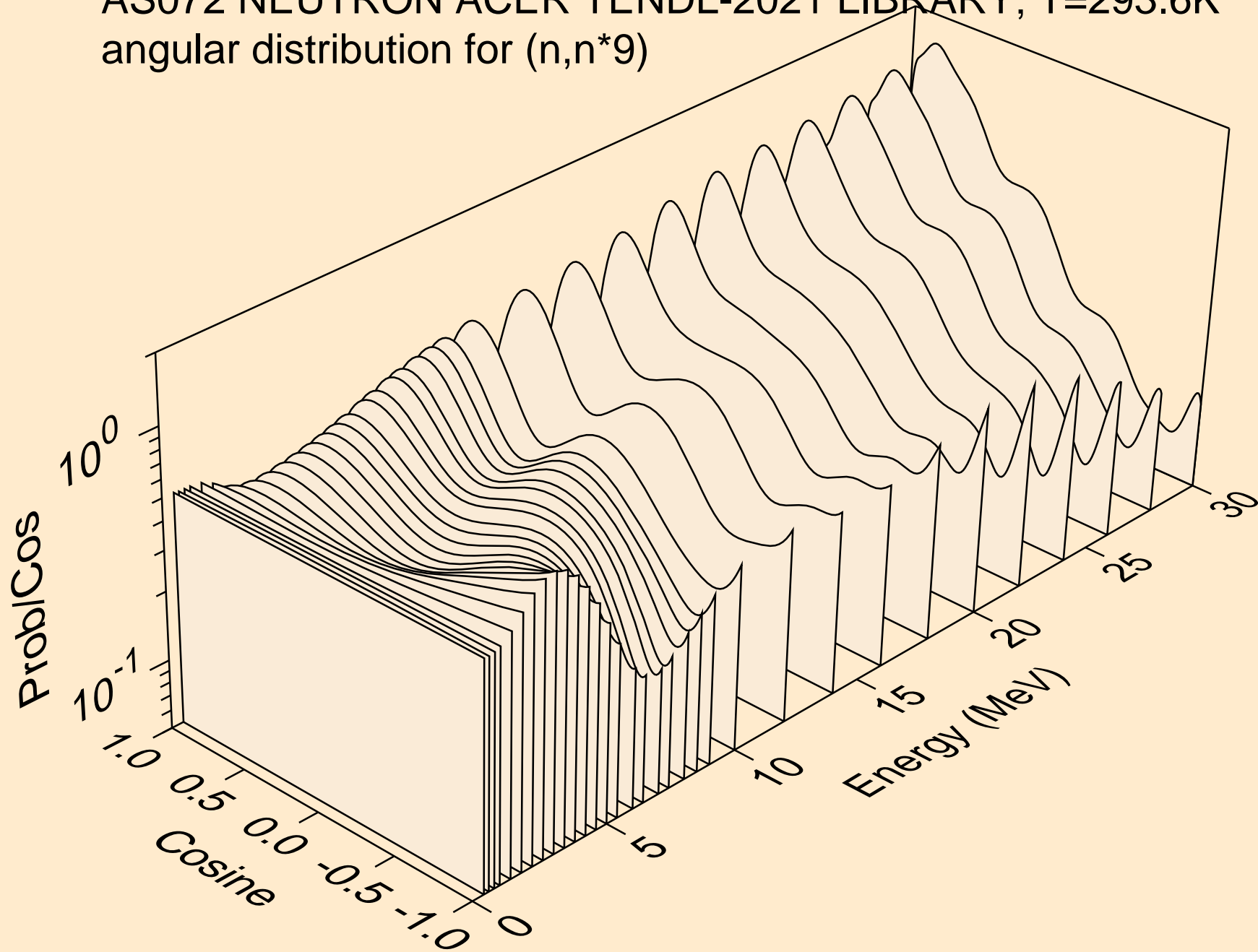

AS072 NEUTRON ACER TENDL-2021 LIBRARY; T=293.6K
angular distribution for (n,n*10)

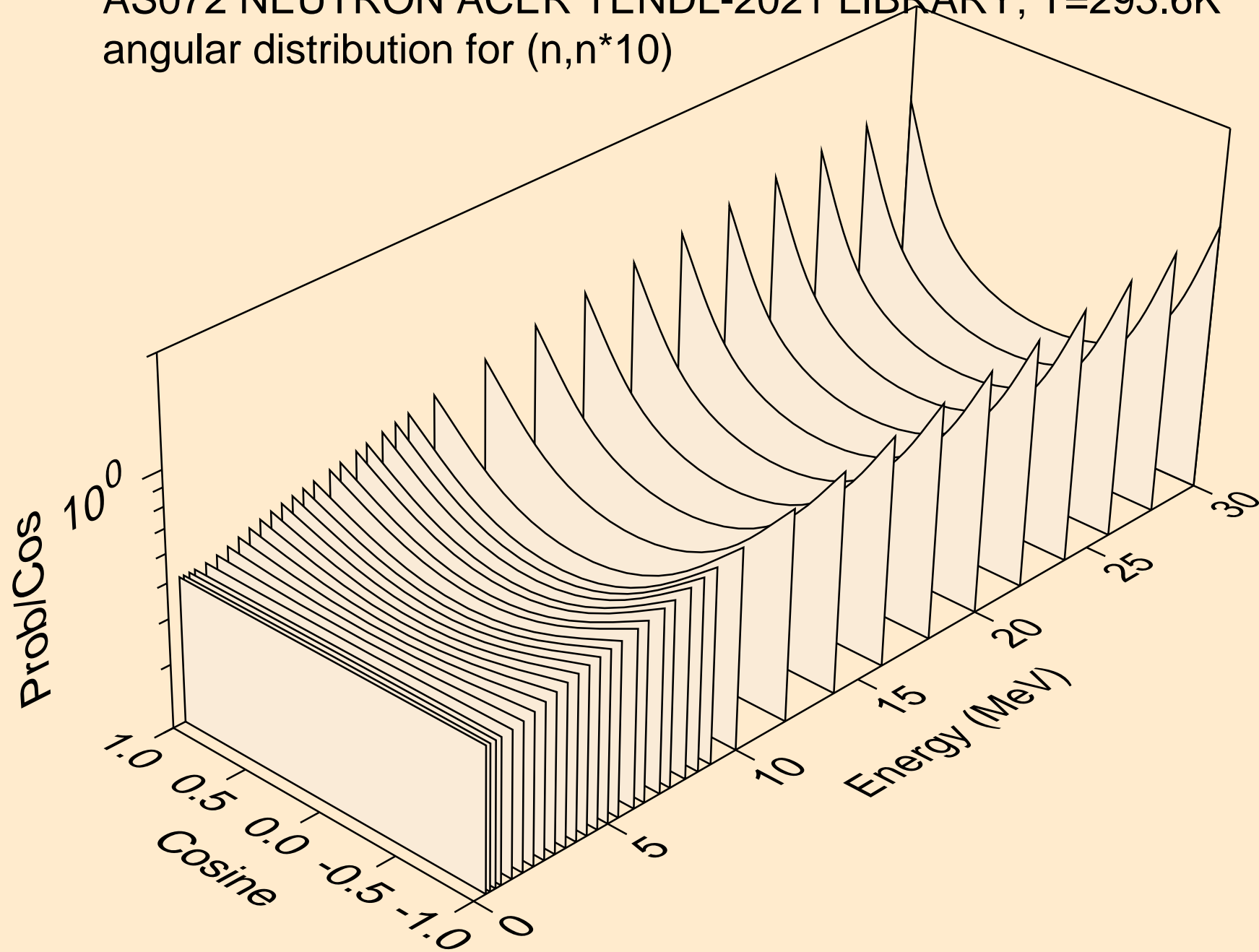

AS072 NEUTRON ACER TENDL-2021 LIBRARY; T=293.6K
angular distribution for (n,n*11)

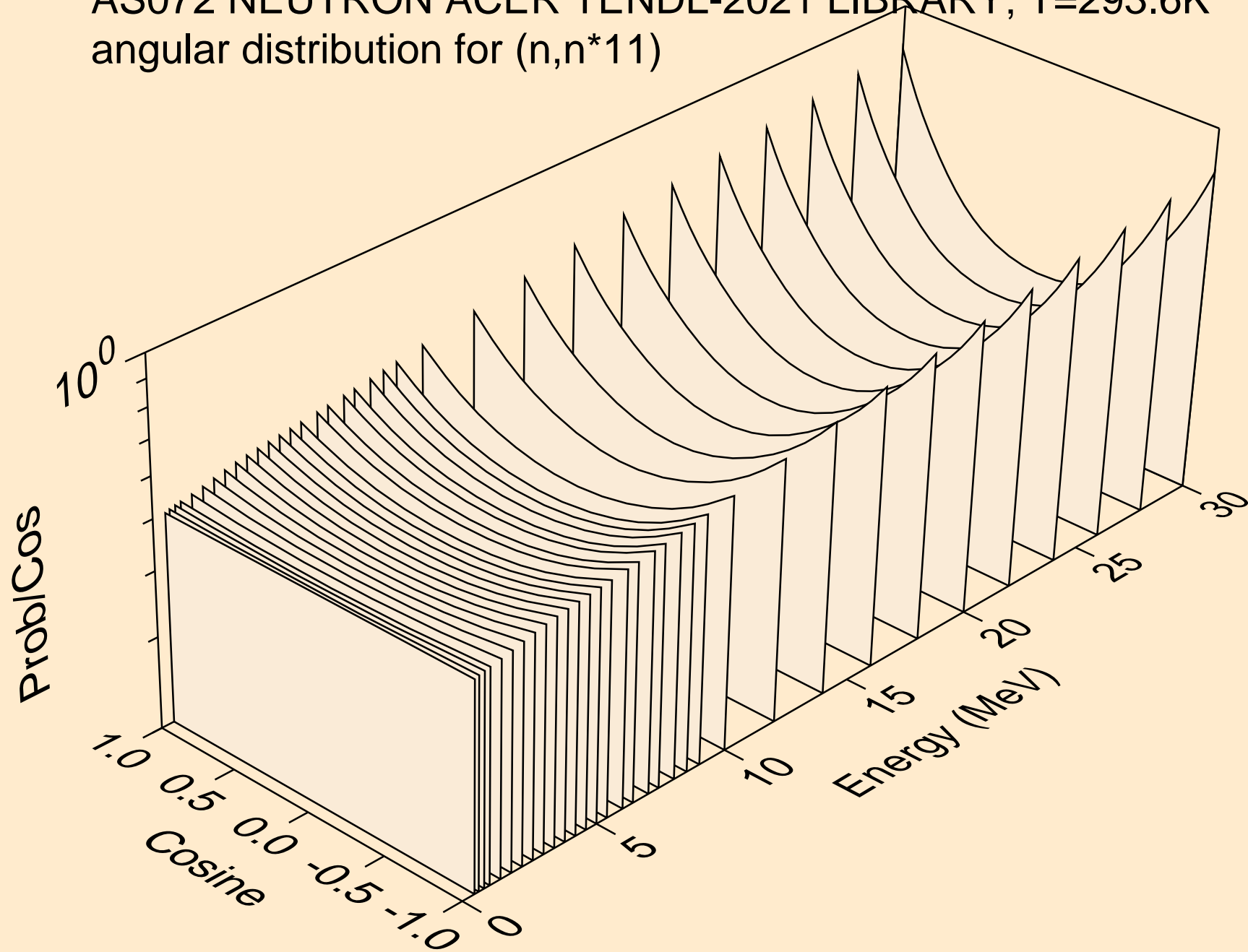

AS072 NEUTRON ACER TENDL-2021 LIBRARY; T=293.6K
angular distribution for (n,n*12)

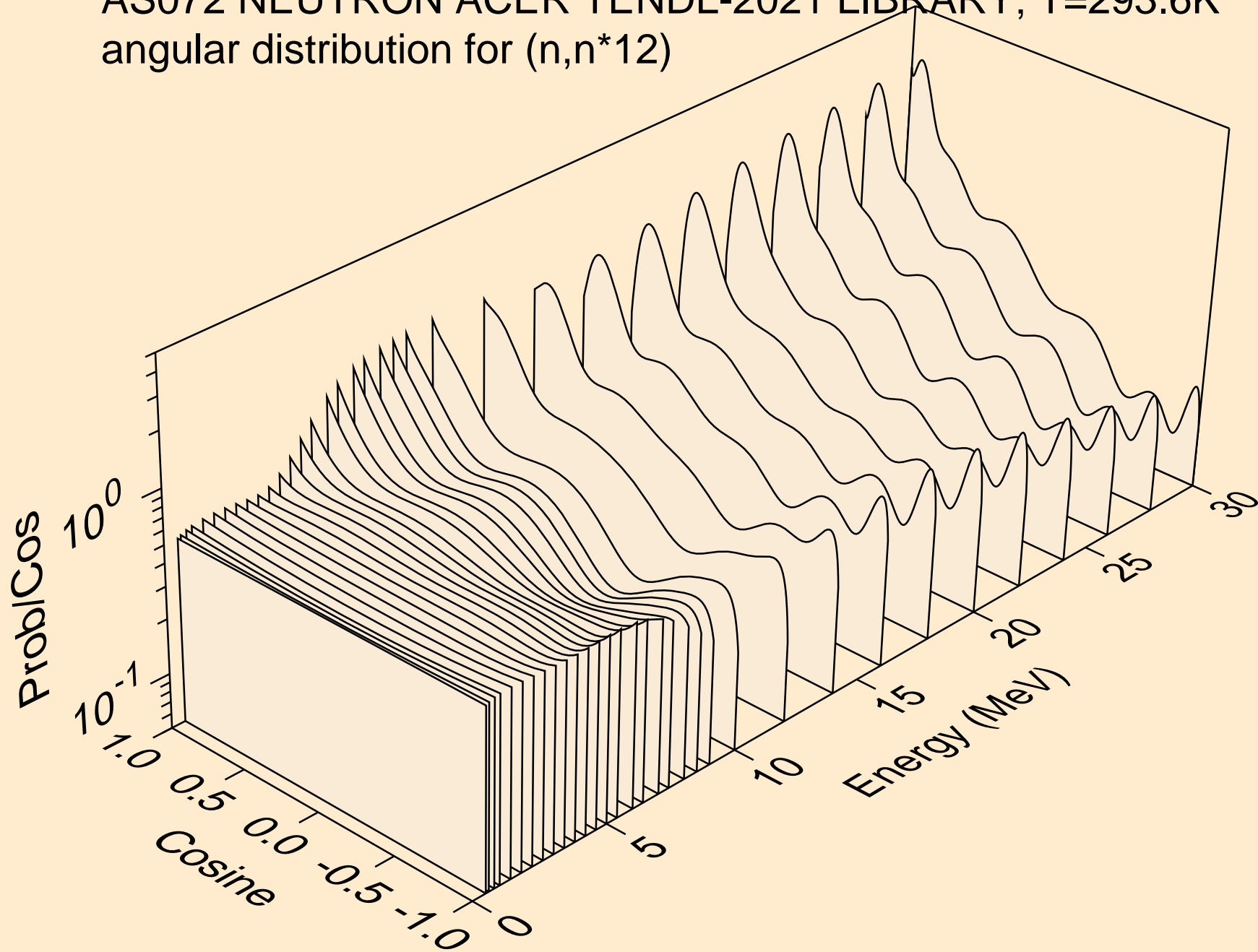

AS072 NEUTRON ACER TENDL-2021 LIBRARY; T=293.6K
angular distribution for (n,n*13)

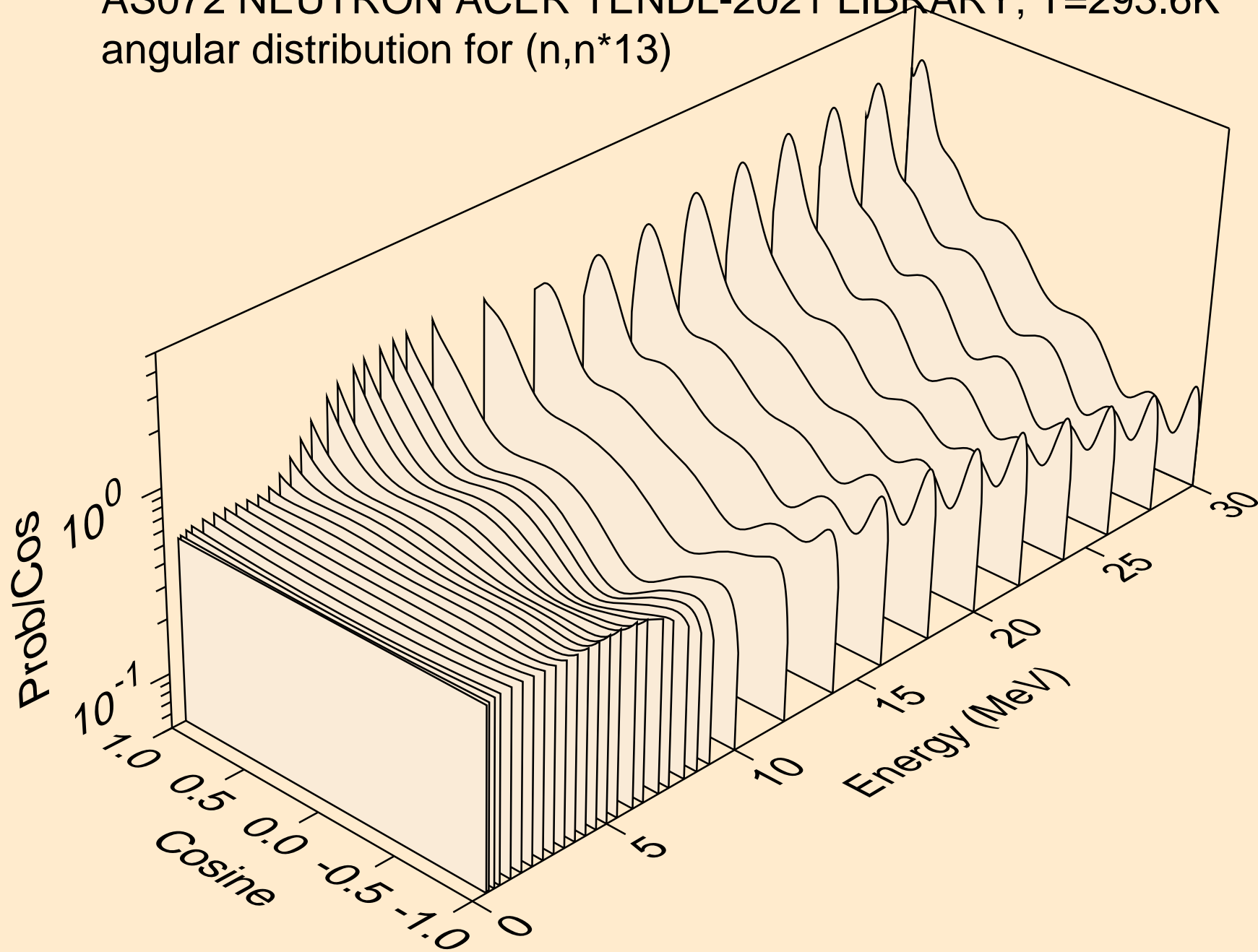

AS072 NEUTRON ACER TENDL-2021 LIBRARY; T=293.6K
angular distribution for (n,n*14)

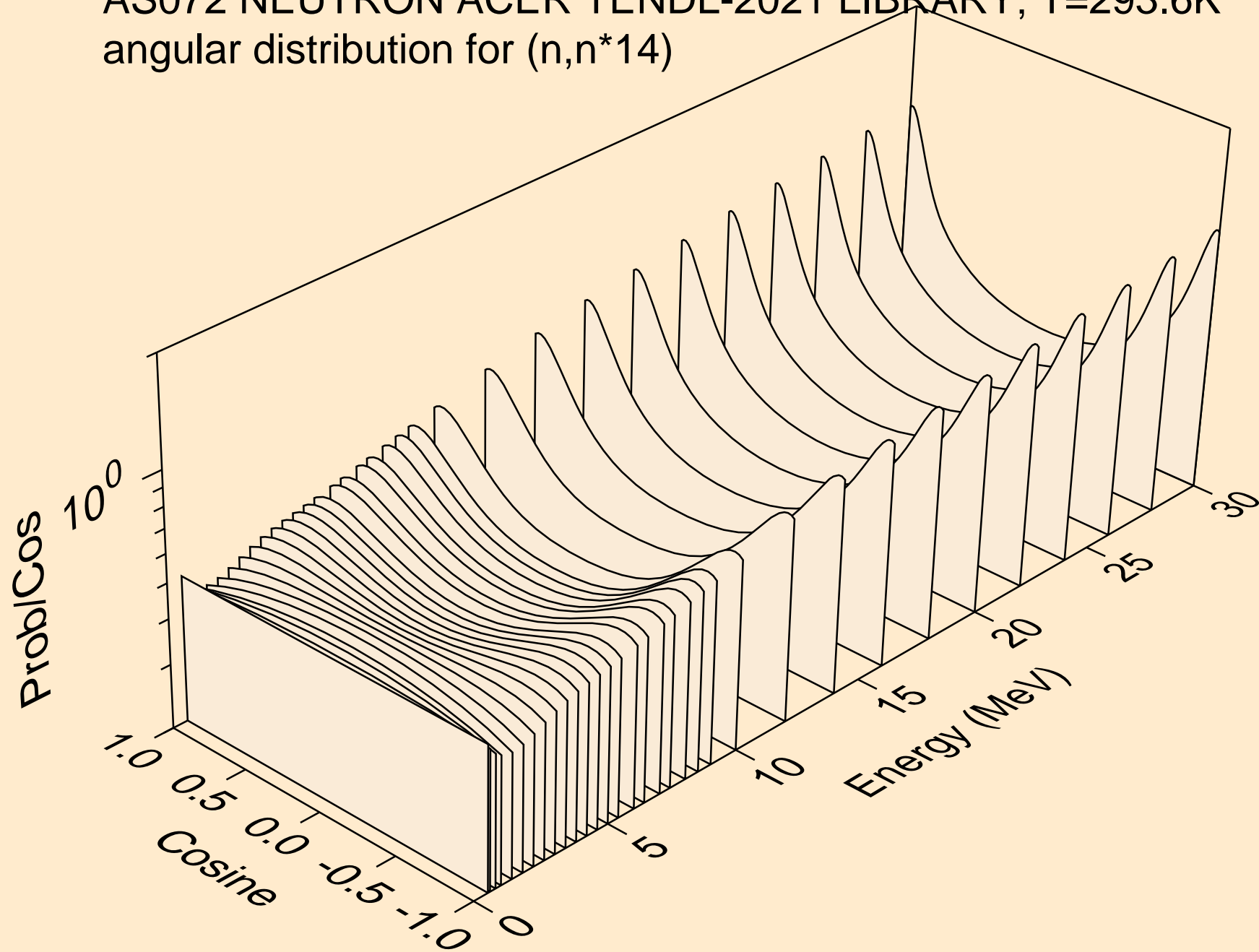

AS072 NEUTRON ACER TENDL-2021 LIBRARY; T=293.6K
angular distribution for (n,n*15)

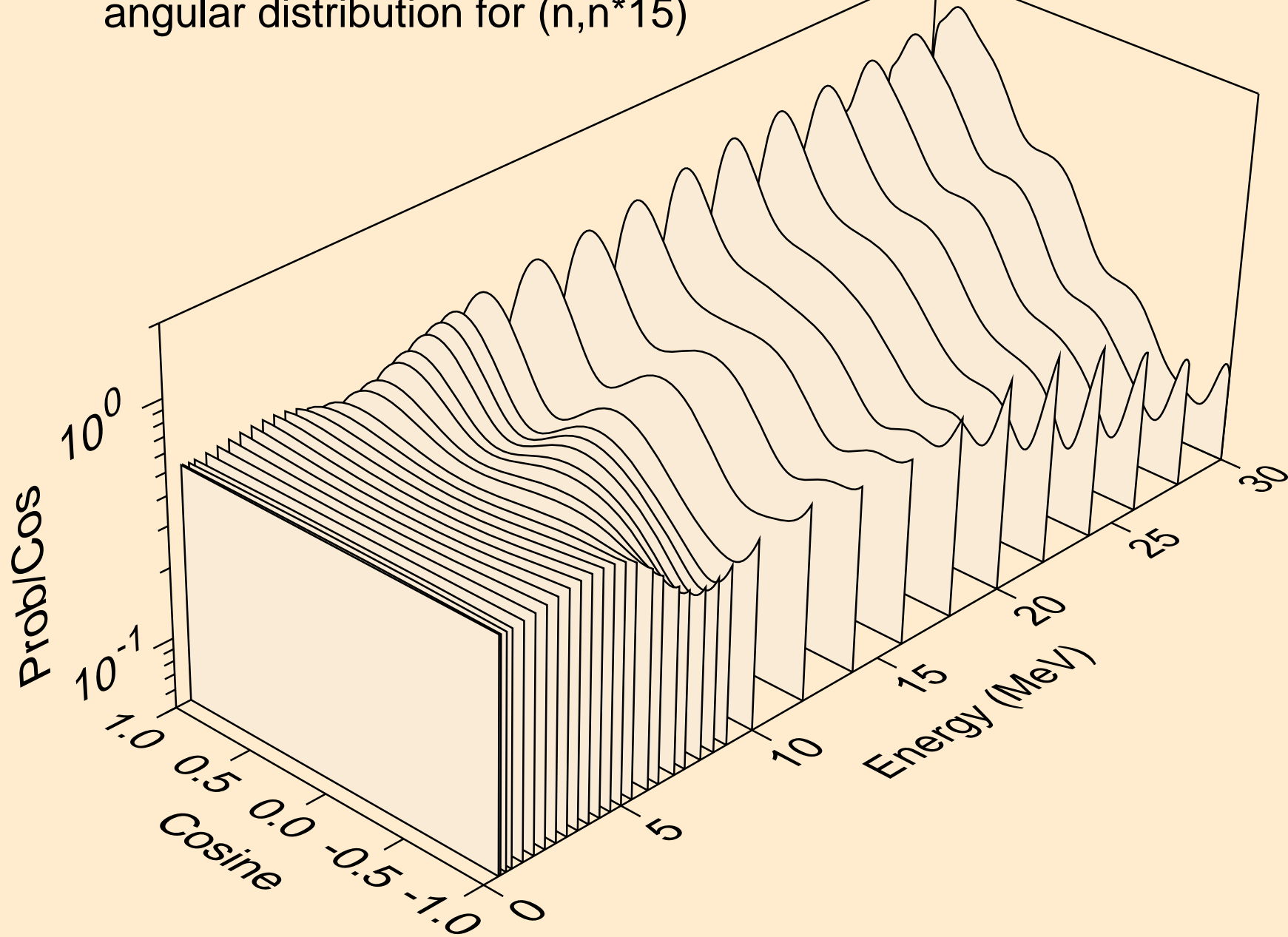

AS072 NEUTRON ACER TENDL-2021 LIBRARY; T=293.6K
angular distribution for (n,n*16)

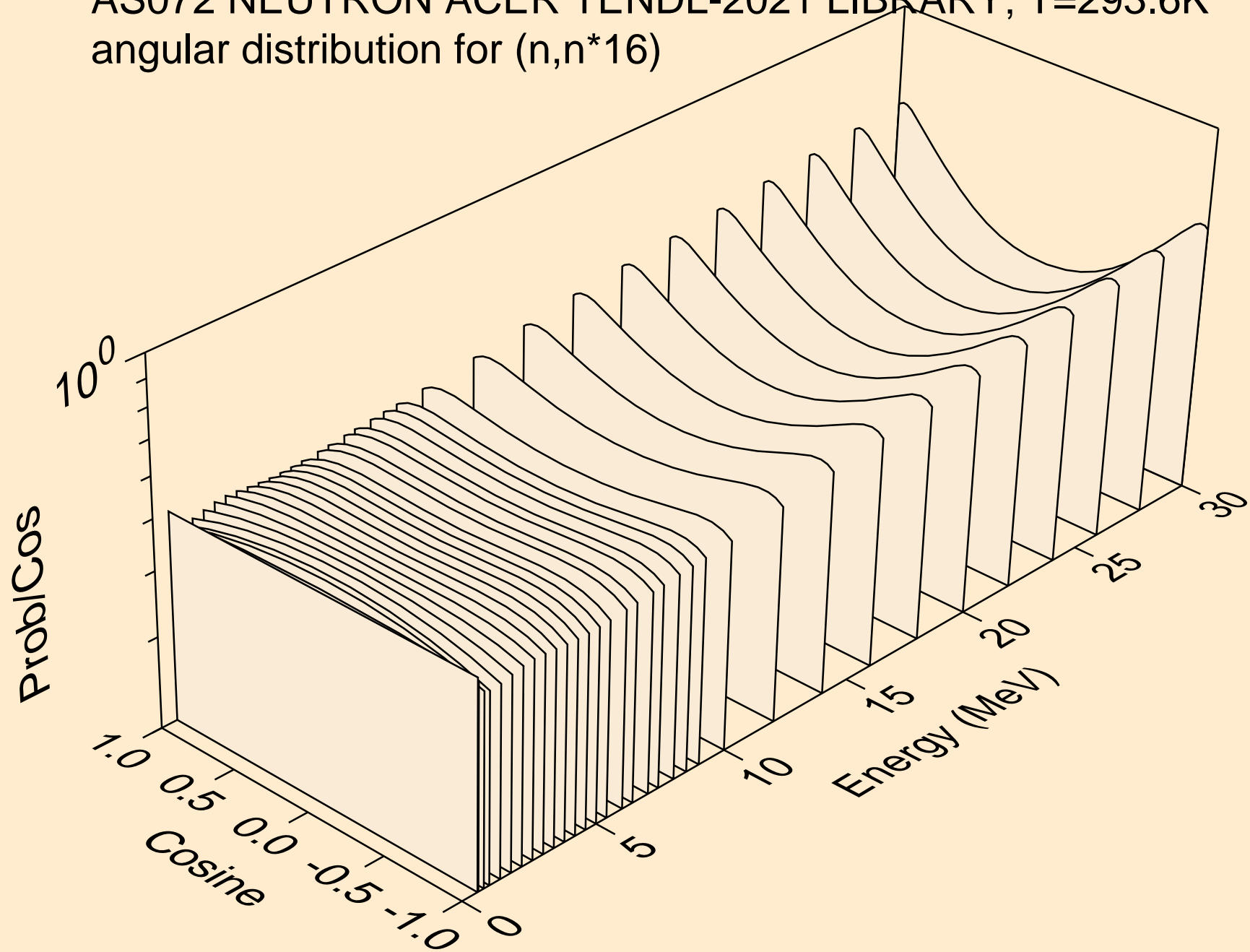

AS072 NEUTRON ACER TENDL-2021 LIBRARY; T=293.6K
angular distribution for (n,n*17)

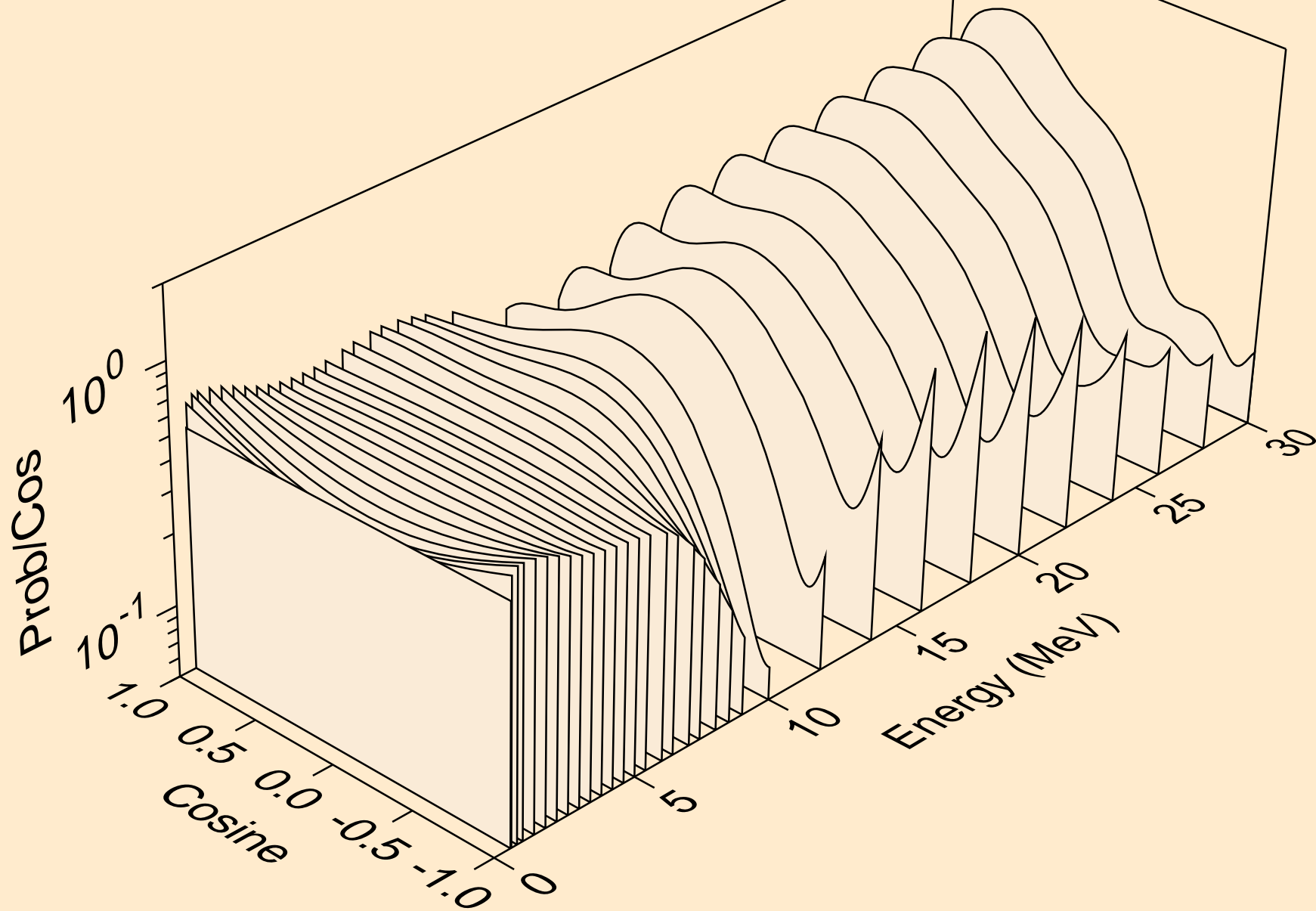

AS072 NEUTRON ACER TENDL-2021 LIBRARY; T=293.6K
angular distribution for (n,n*18)

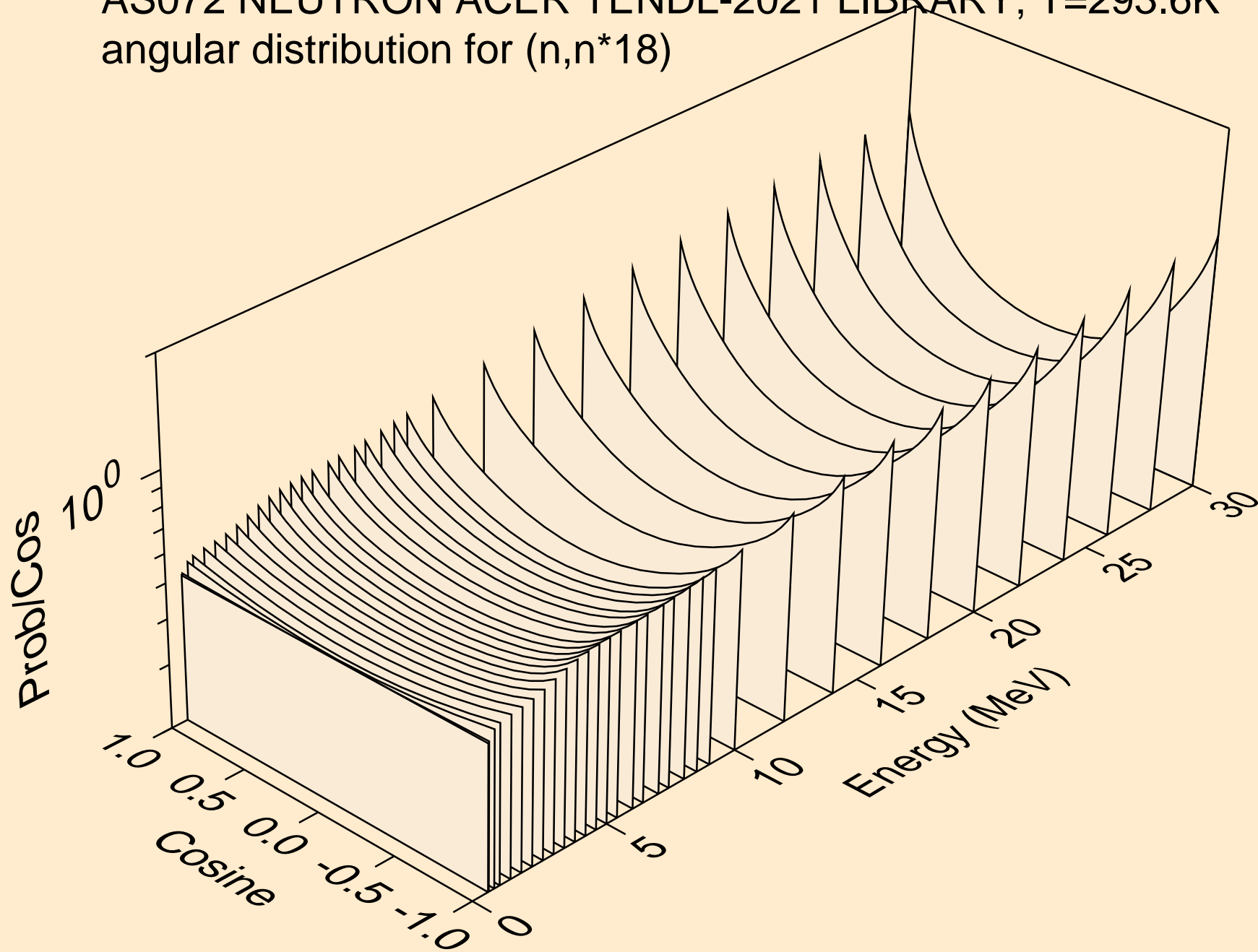

AS072 NEUTRON ACER TENDL-2021 LIBRARY; T=293.6K
angular distribution for (n,n*19)

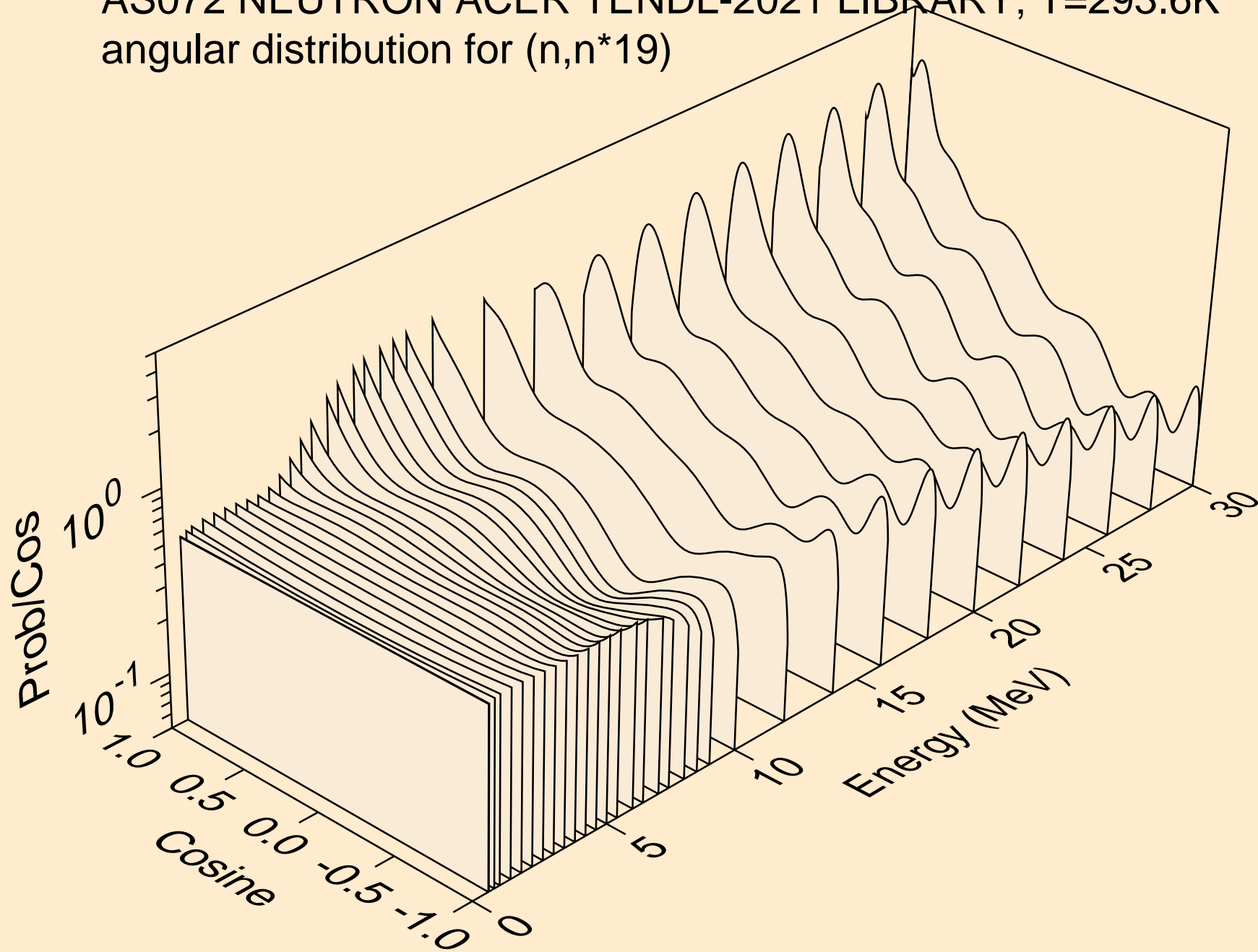

AS072 NEUTRON ACER TENDL-2021 LIBRARY; T=293.6K
angular distribution for (n,n*20)

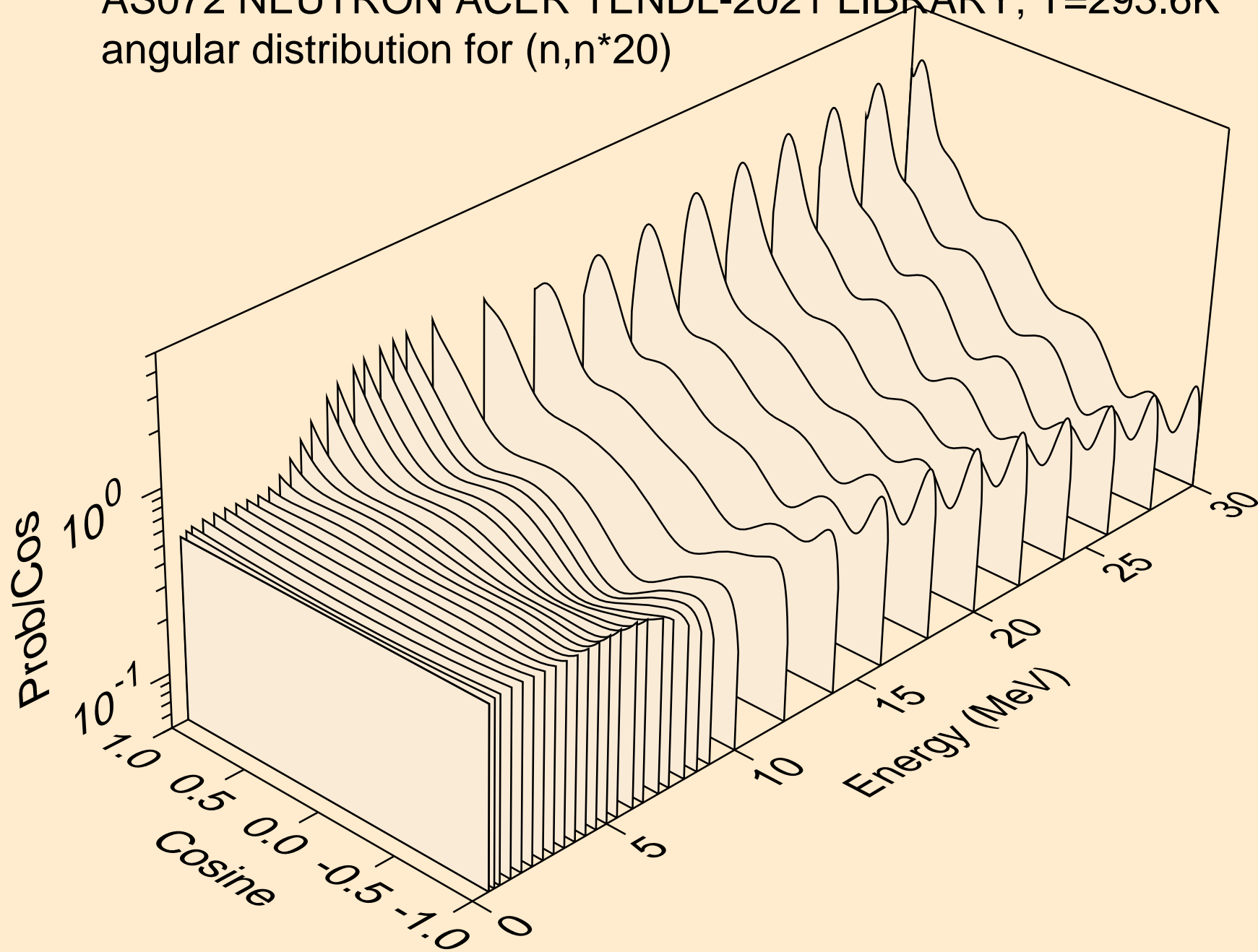

AS072 NEUTRON ACER TENDL-2021 LIBRARY; T=293.6K
angular distribution for (n,n*21)

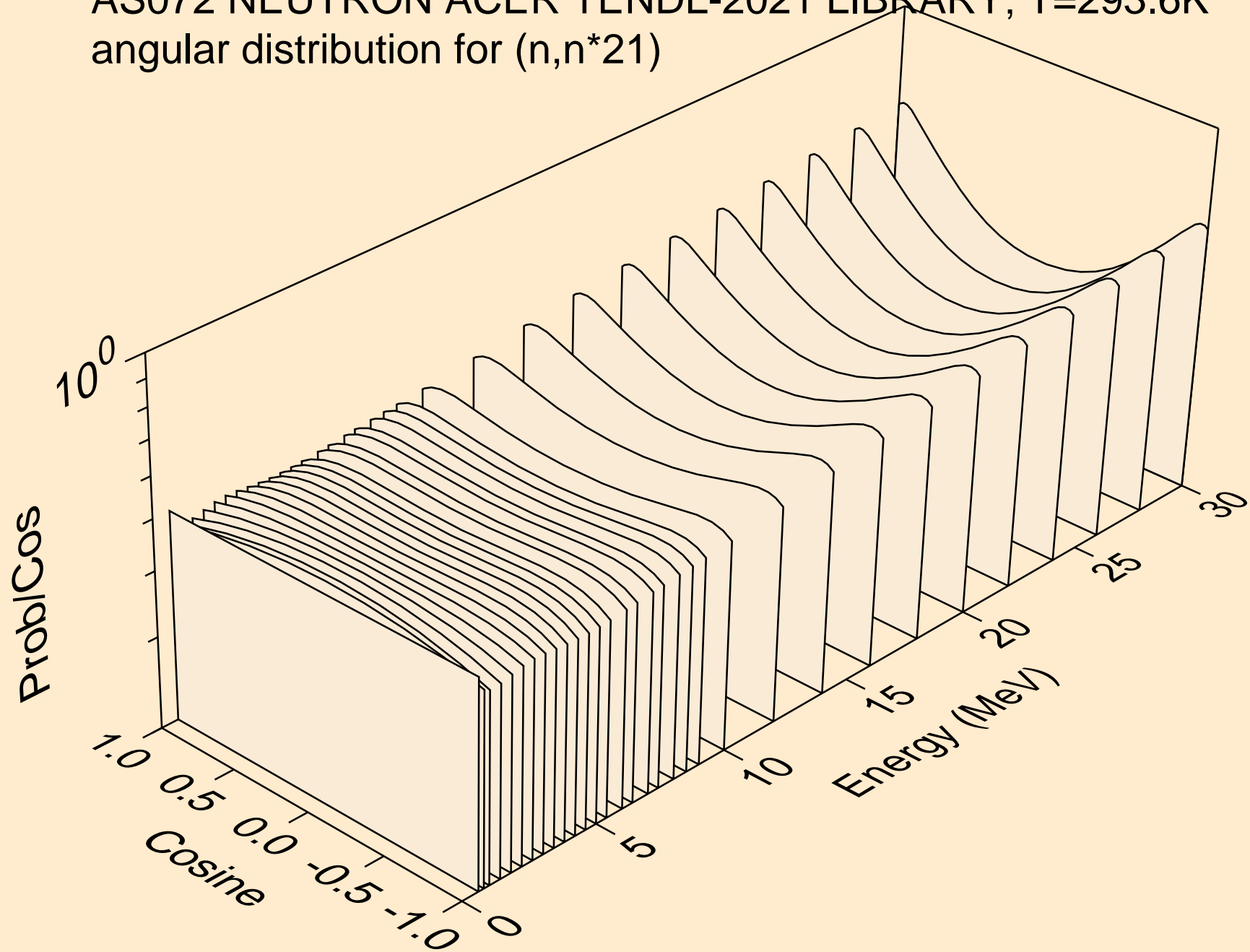

AS072 NEUTRON ACER TENDL-2021 LIBRARY; T=293.6K
angular distribution for (n,n*22)

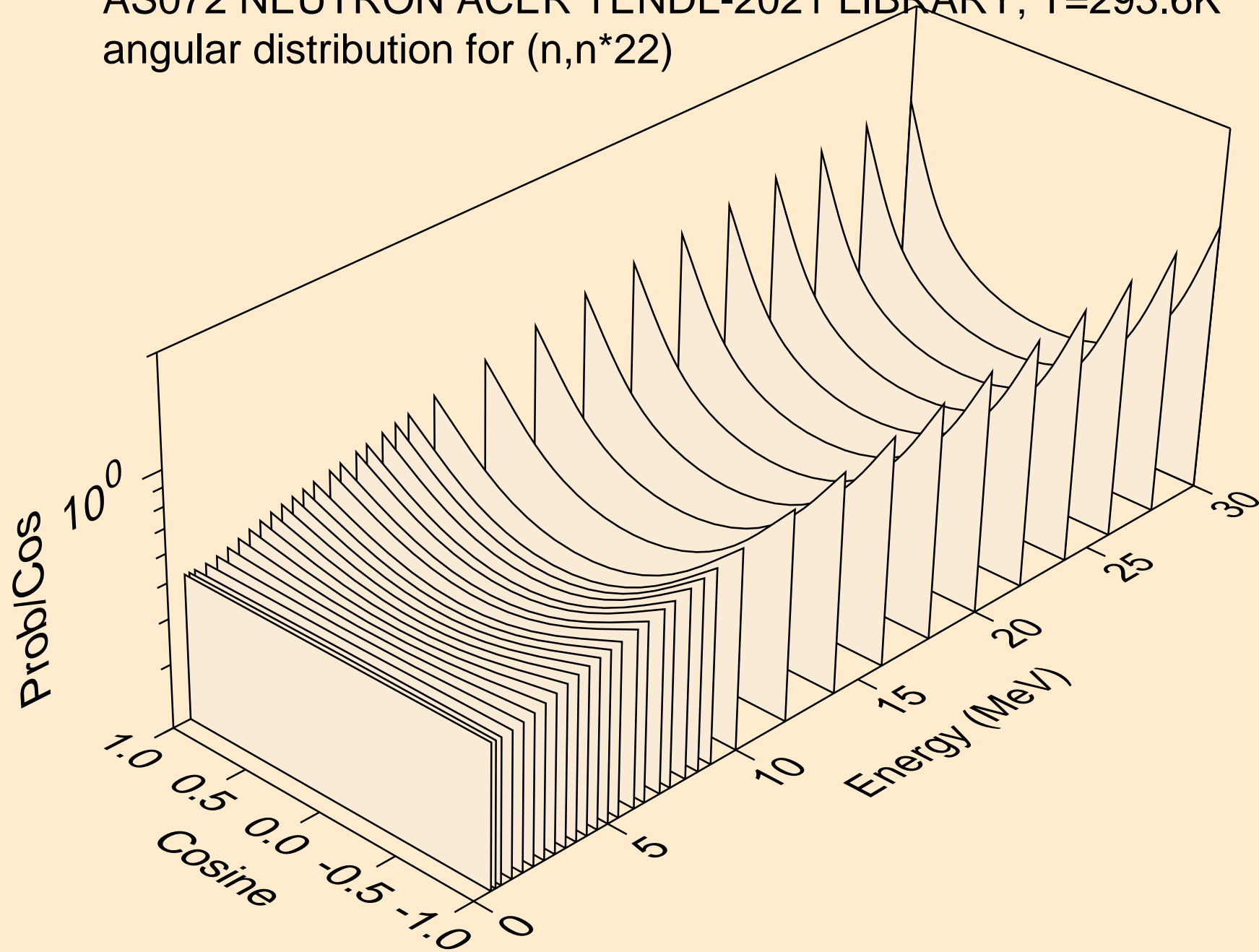

AS072 NEUTRON ACER TENDL-2021 LIBRARY; T=293.6K
angular distribution for (n,n*23)

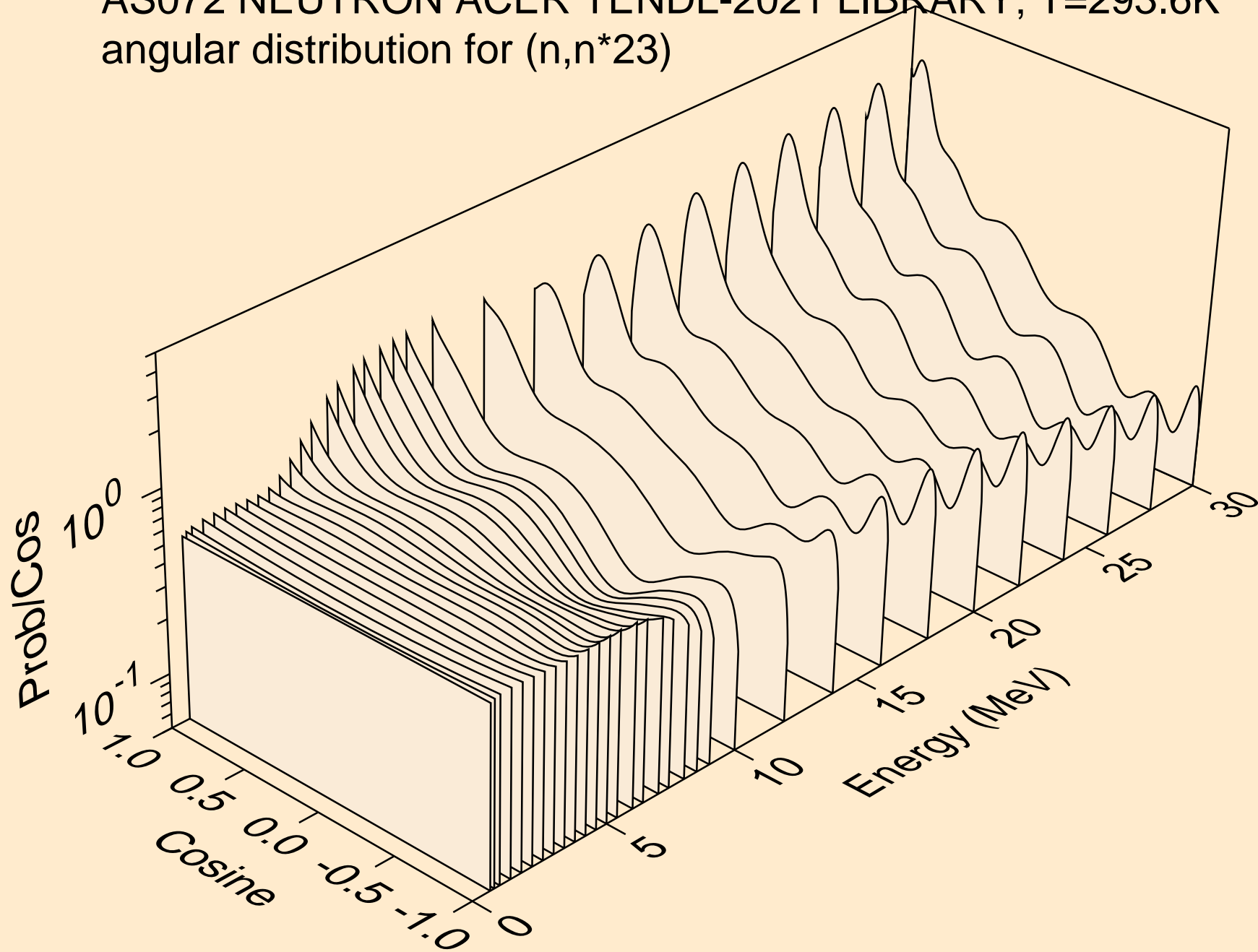

AS072 NEUTRON ACER TENDL-2021 LIBRARY; T=293.6K
angular distribution for (n,n*24)

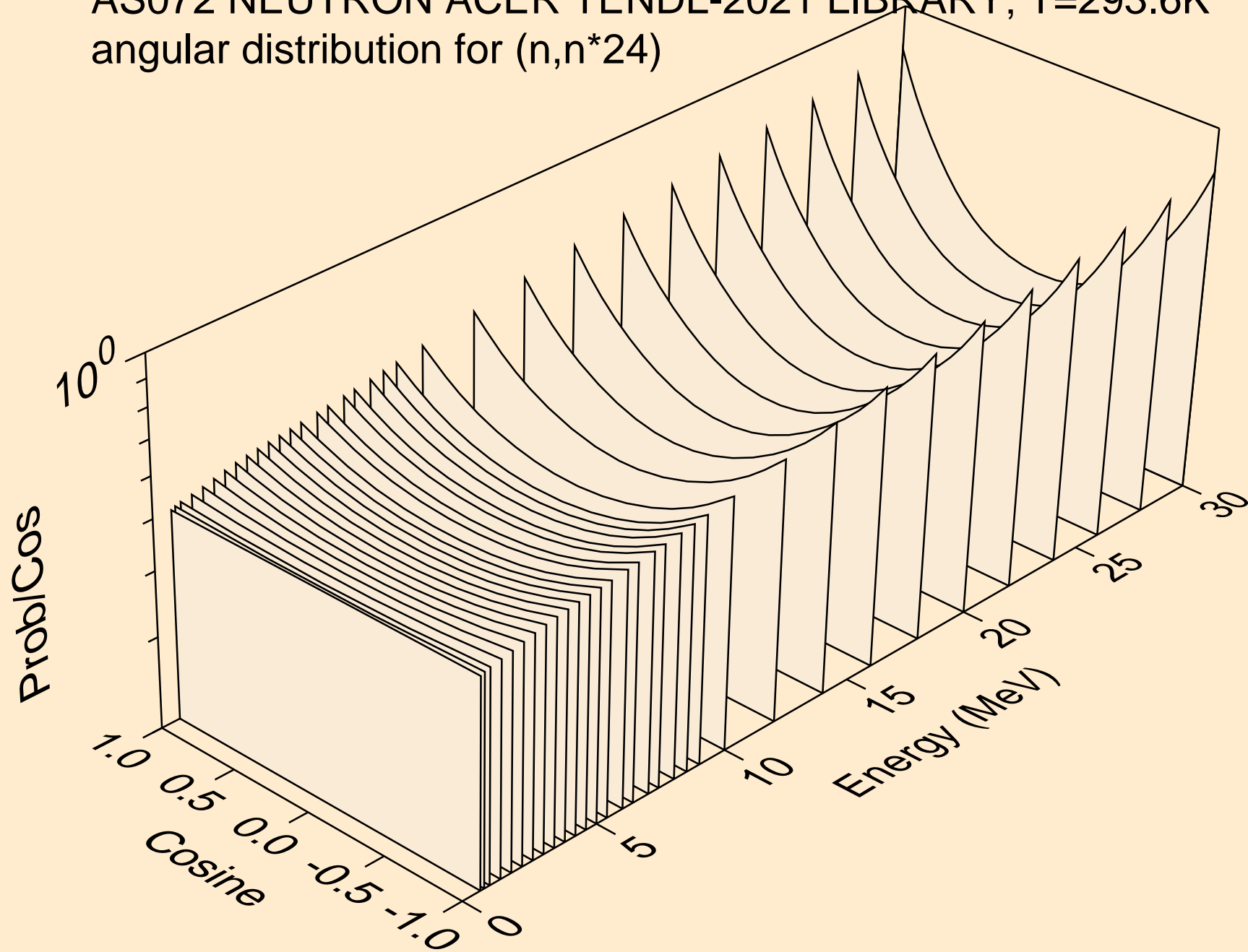

AS072 NEUTRON ACER TENDL-2021 LIBRARY; T=293.6K
angular distribution for (n,n*25)

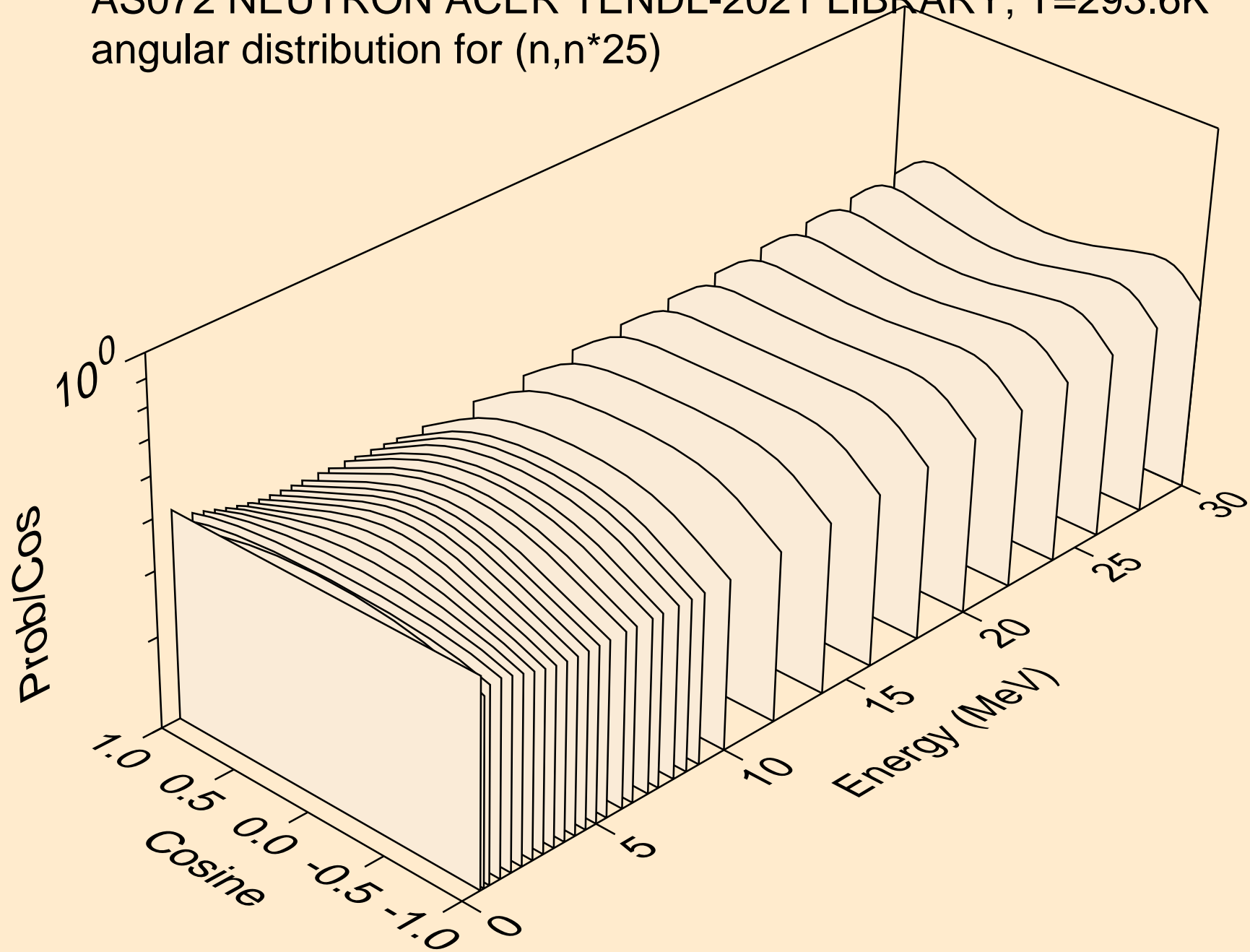

AS072 NEUTRON ACER TENDL-2021 LIBRARY; T=293.6K
angular distribution for (n,n*26)

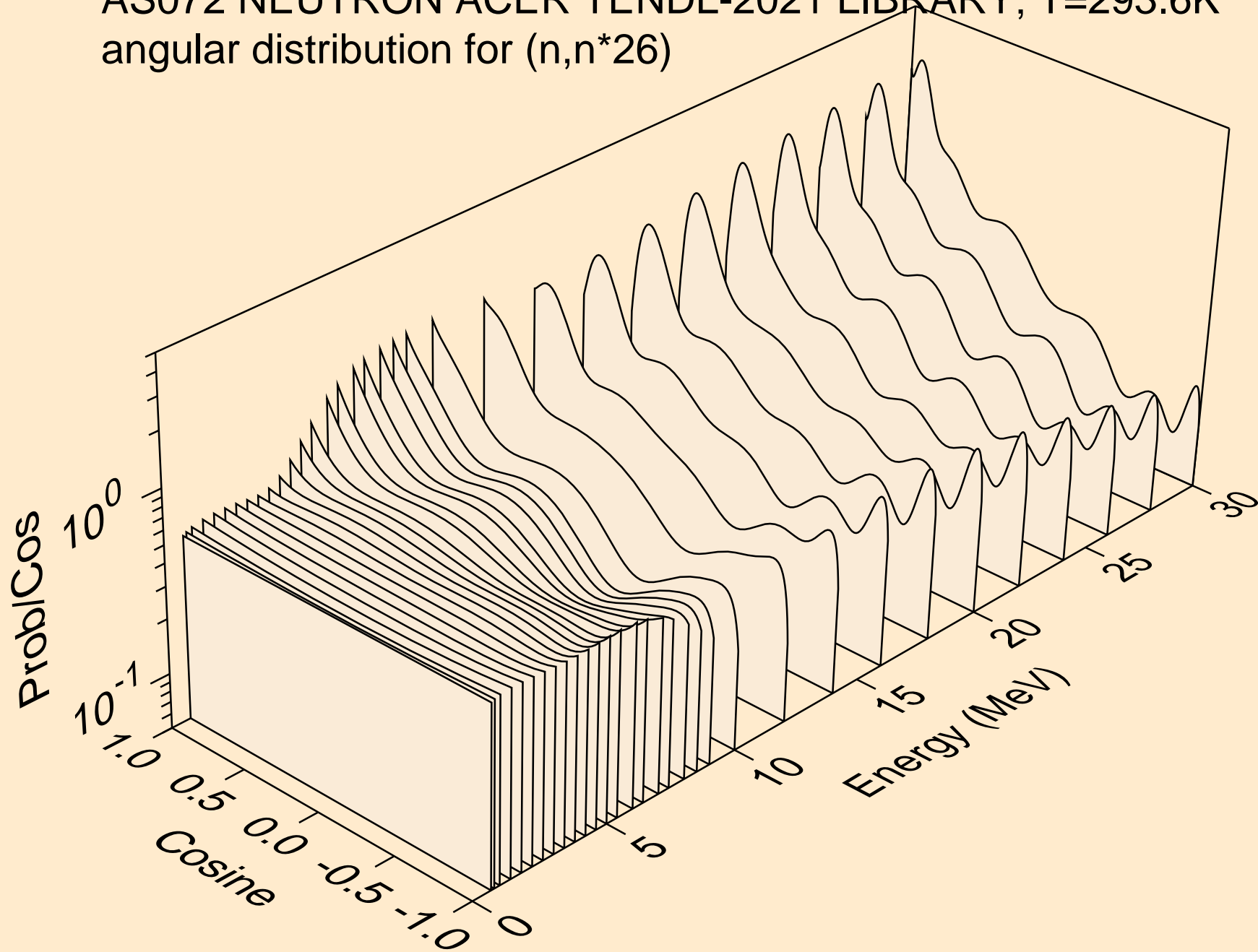

AS072 NEUTRON ACER TENDL-2021 LIBRARY; T=293.6K
angular distribution for (n,n*27)

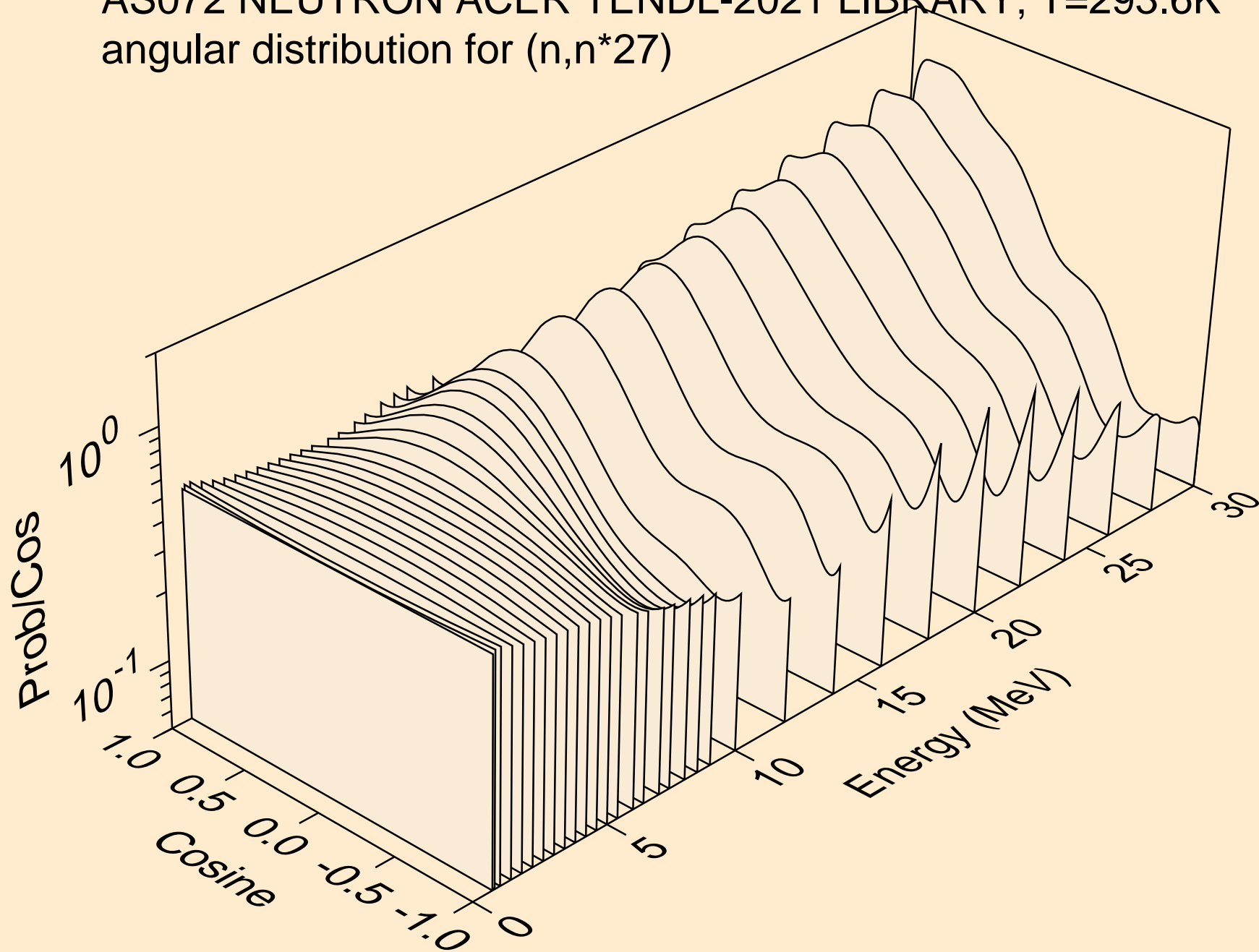

AS072 NEUTRON ACER TENDL-2021 LIBRARY; T=293.6K
angular distribution for (n,n*28)

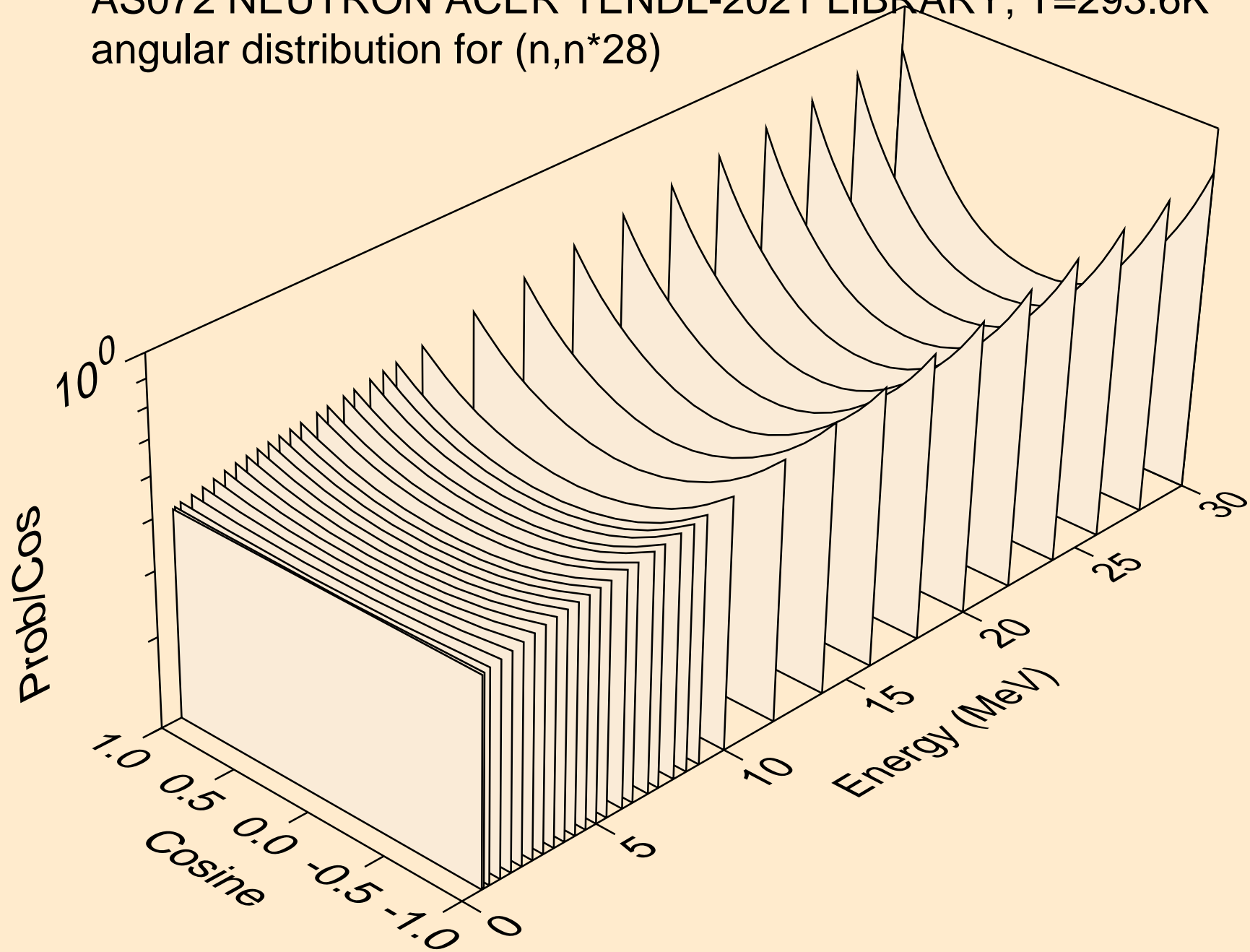

AS072 NEUTRON ACER TENDL-2021 LIBRARY; T=293.6K
angular distribution for (n,n*29)

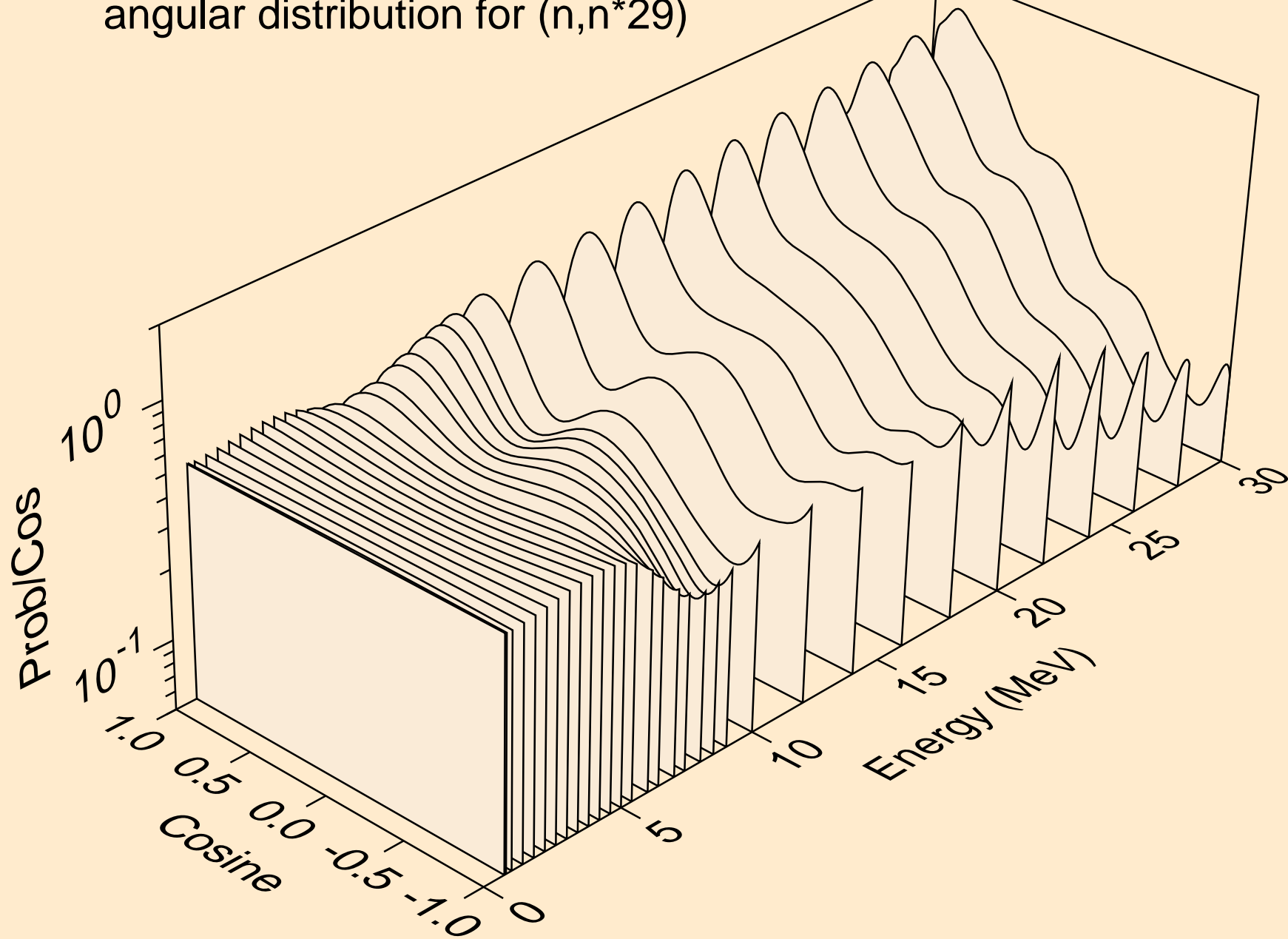

AS072 NEUTRON ACER TENDL-2021 LIBRARY; T=293.6K
angular distribution for (n,n*30)

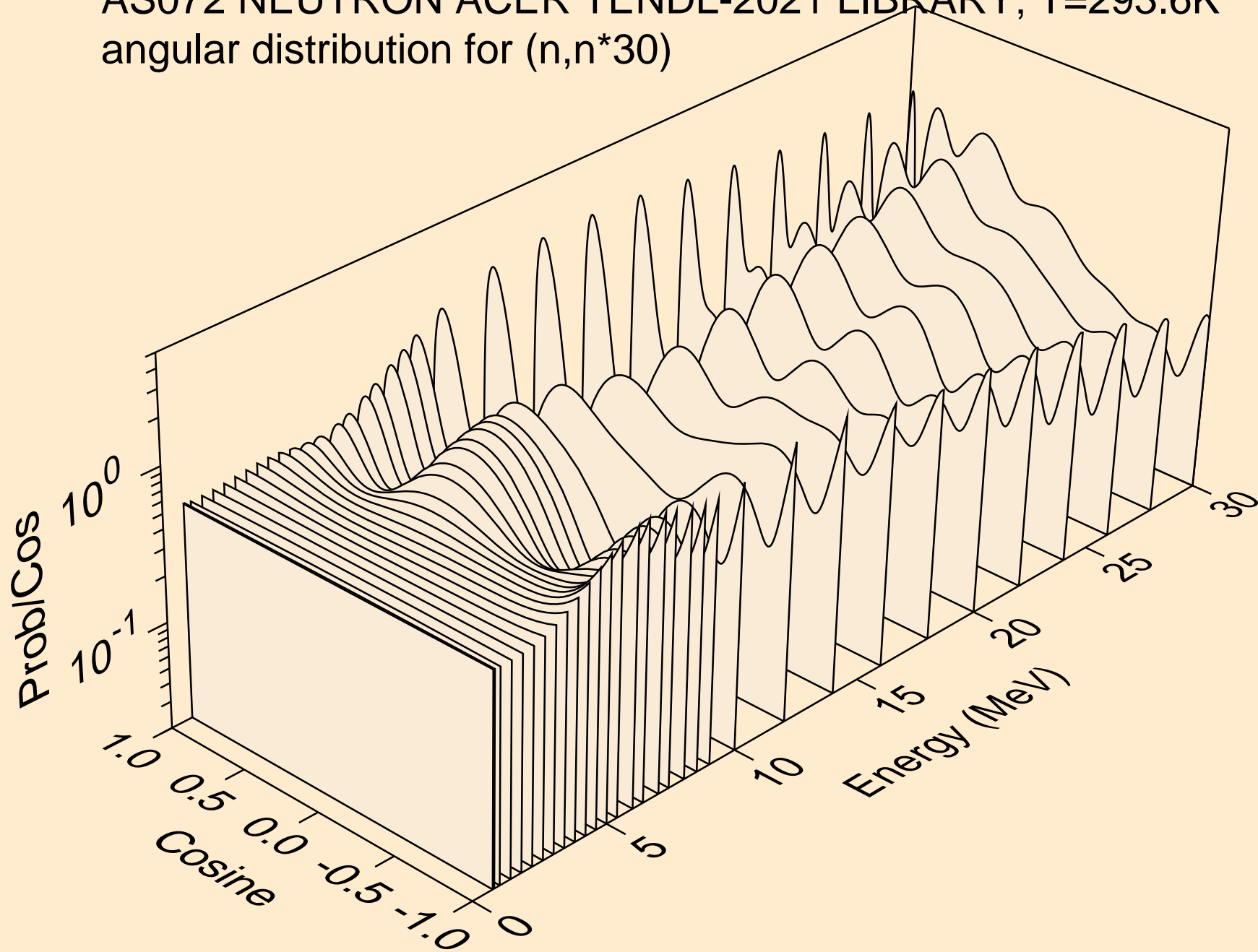

AS072 NEUTRON ACER TENDL-2021 LIBRARY; T=293.6K
Neutron emission for (n,x)

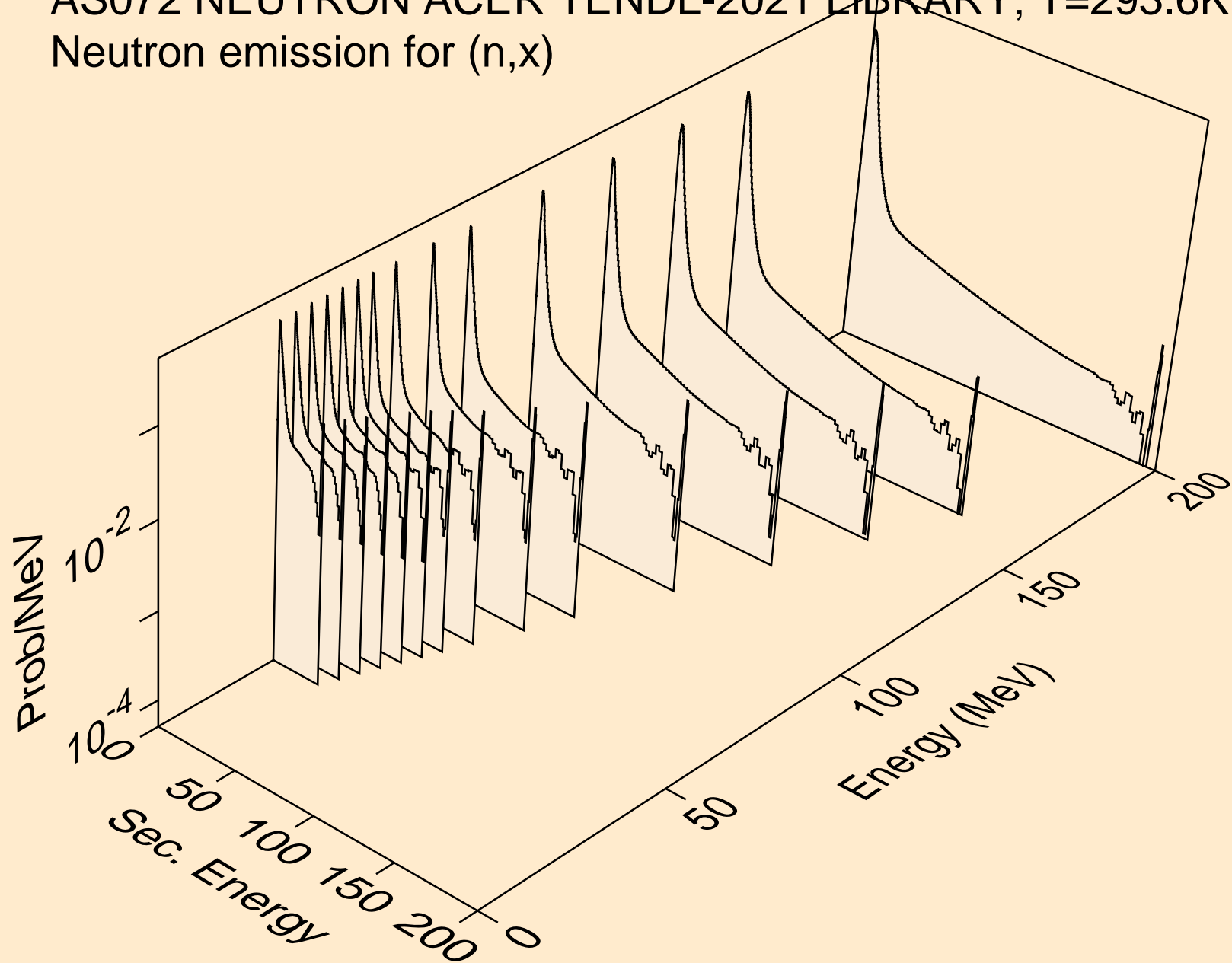

AS072 NEUTRON ACER TENDL-2021 LIBRARY; T=293.6K
Neutron emission for (n,2nd)

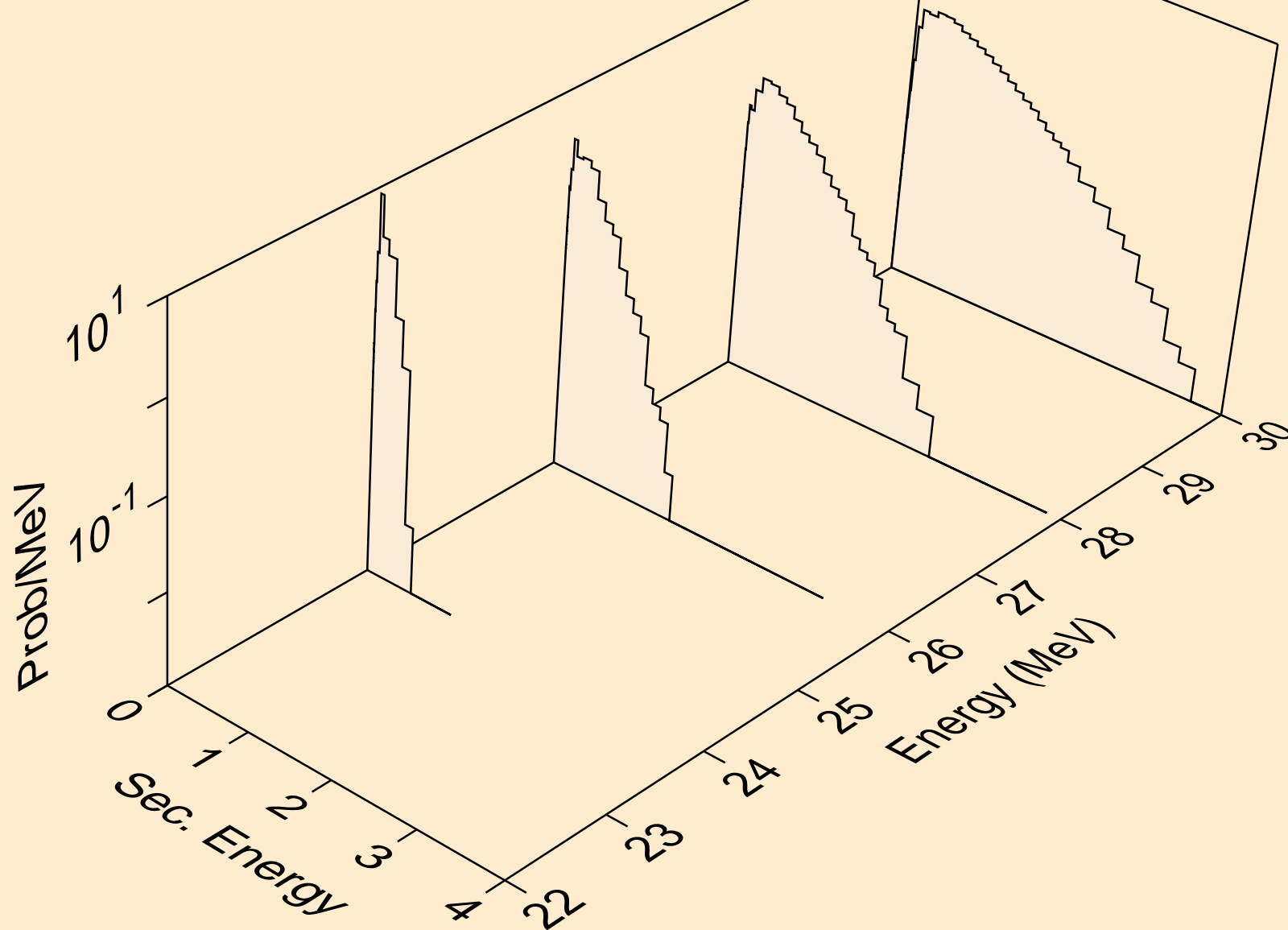

AS072 NEUTRON ACER TENDL-2021 LIBRARY; T=293.6K
Neutron emission for (n,2n)

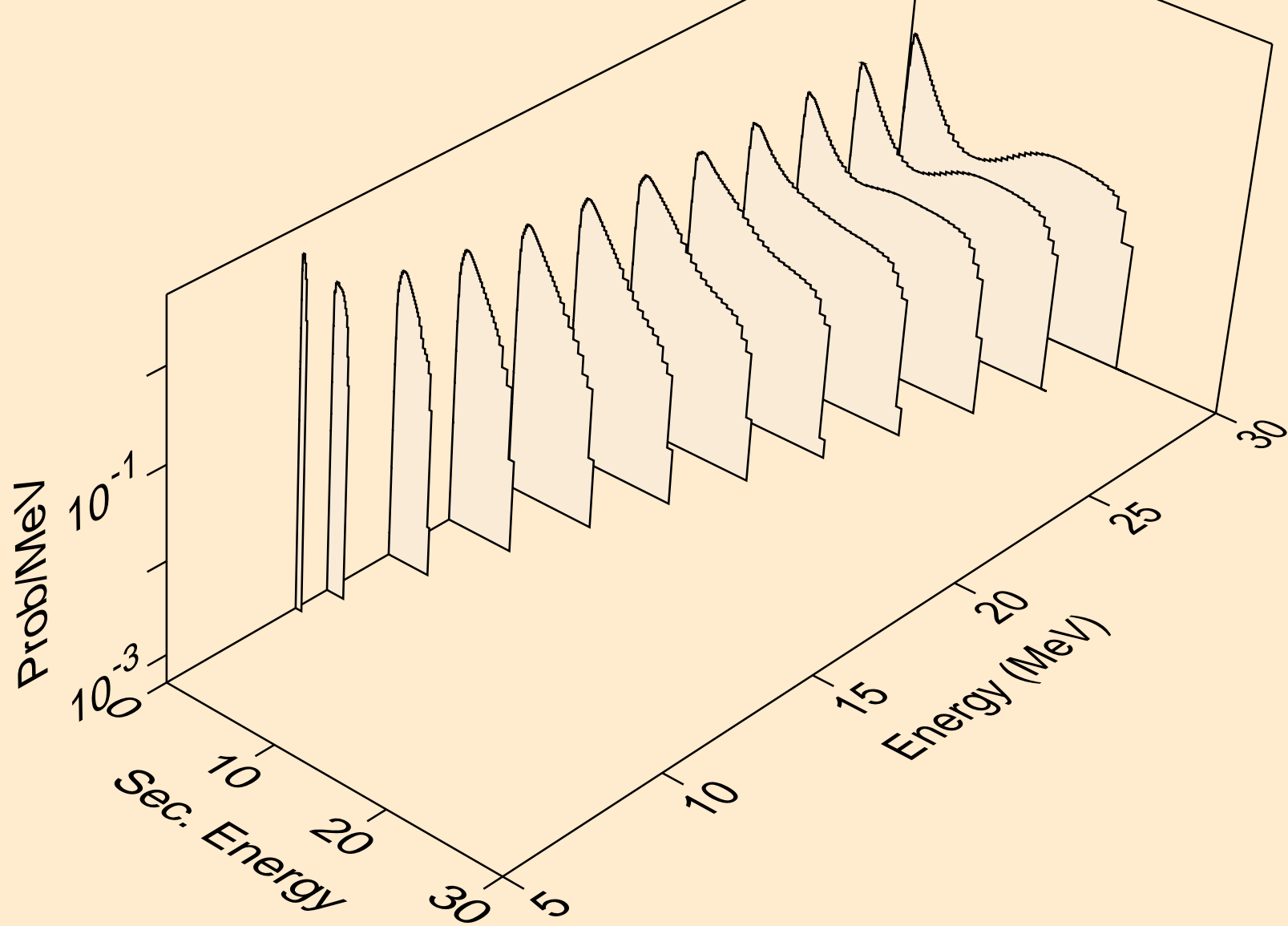

AS072 NEUTRON ACER TENDL-2021 LIBRARY; T=293.6K
Neutron emission for (n,3n)

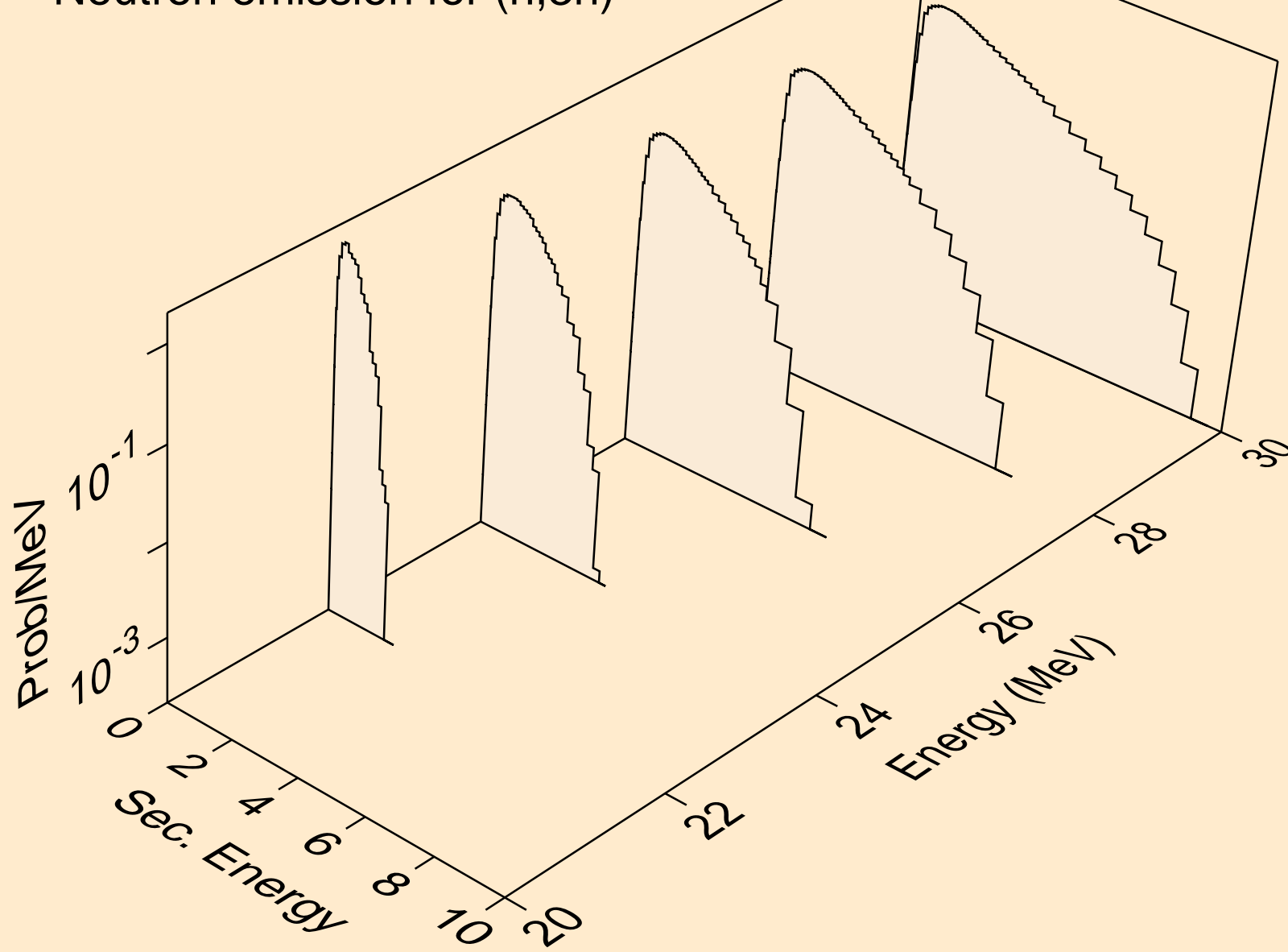

AS072 NEUTRON ACER TENDL-2021 LIBRARY; T=293.6K
Neutron emission for (n,n*)a

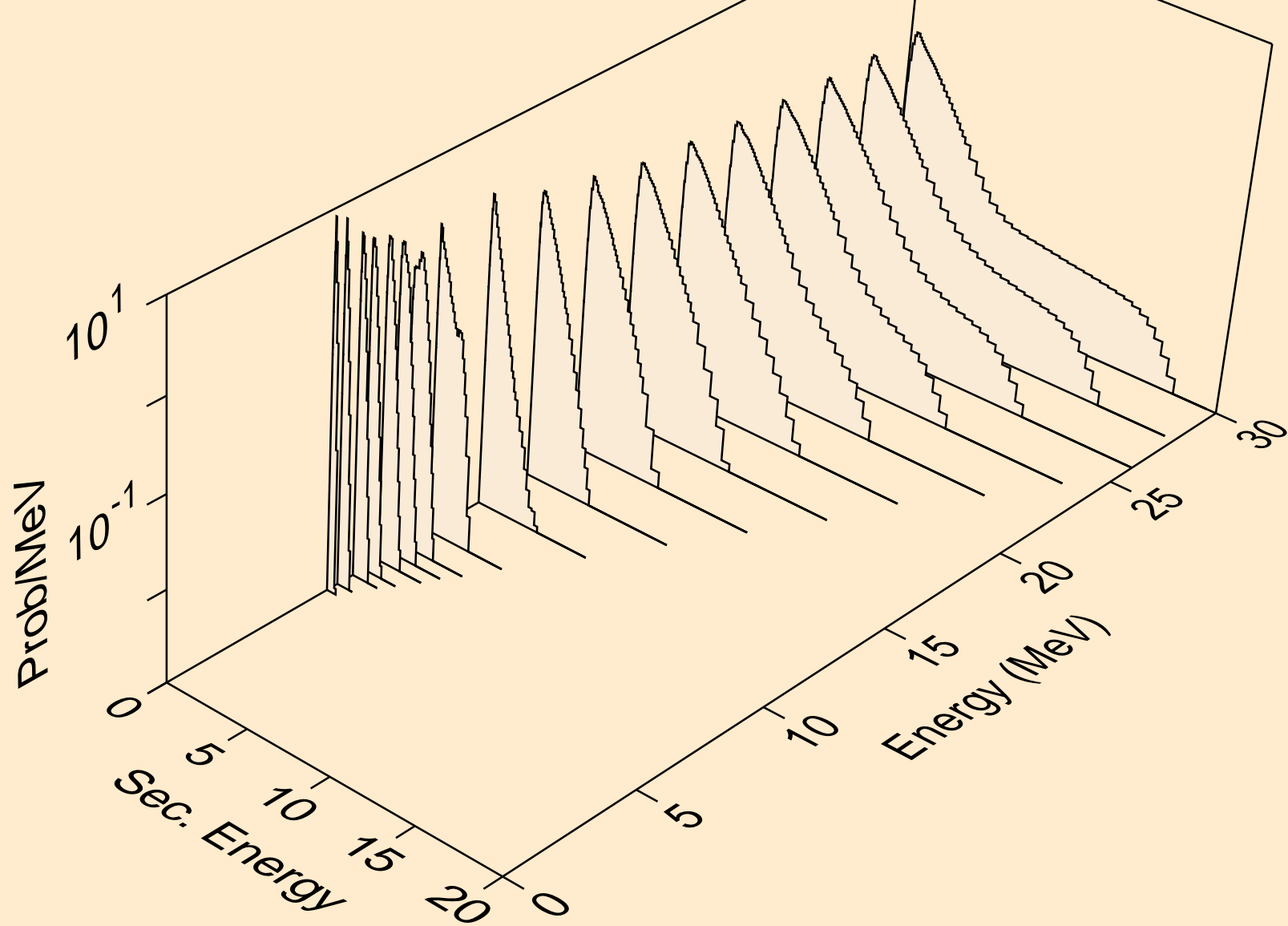

AS072 NEUTRON ACER TENDL-2021 LIBRARY; T=293.6K
Neutron emission for (n,2n)_a

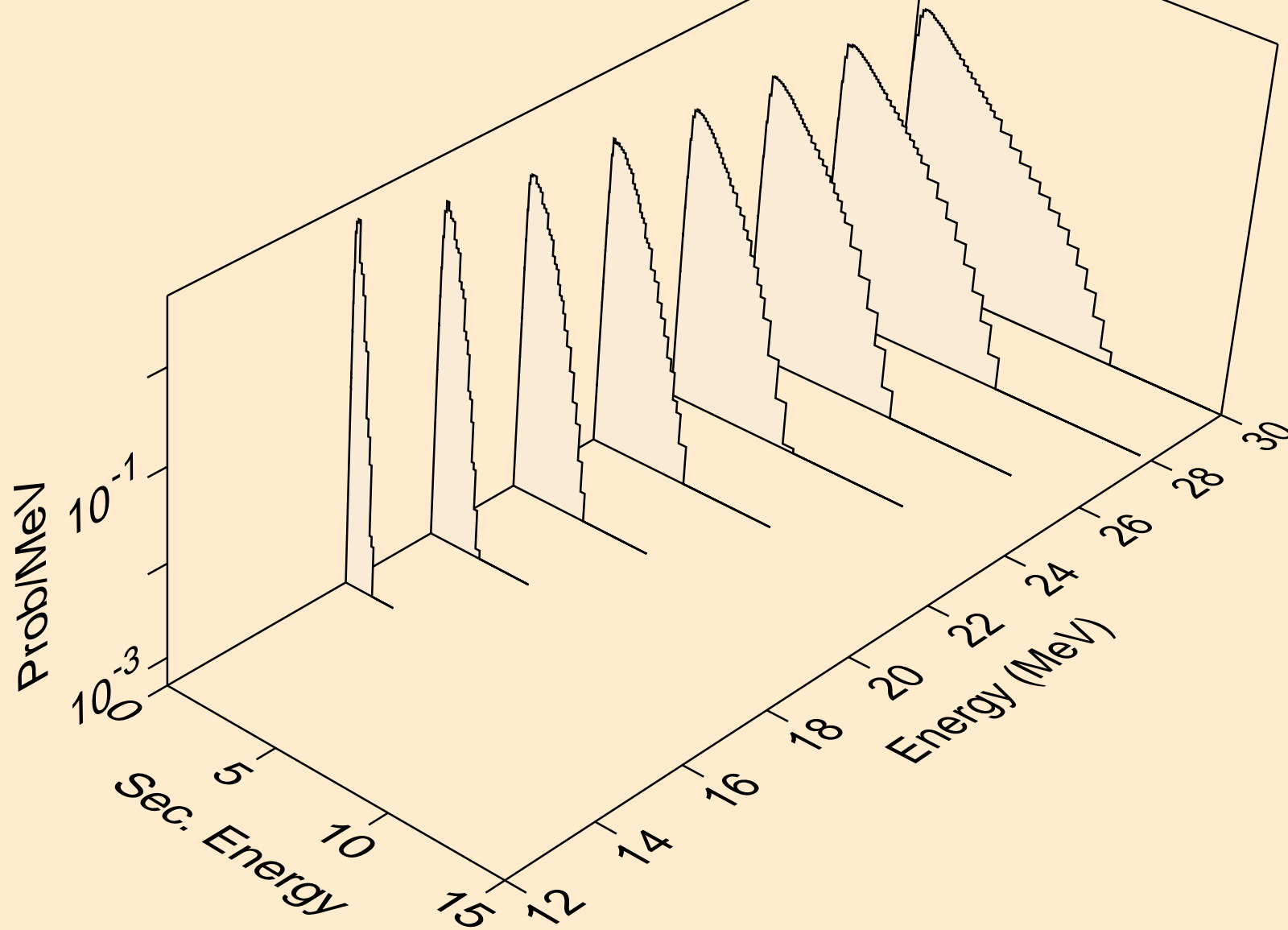

AS072 NEUTRON ACER TENDL-2021 LIBRARY; T=293.6K
Neutron emission for (n,3n)a

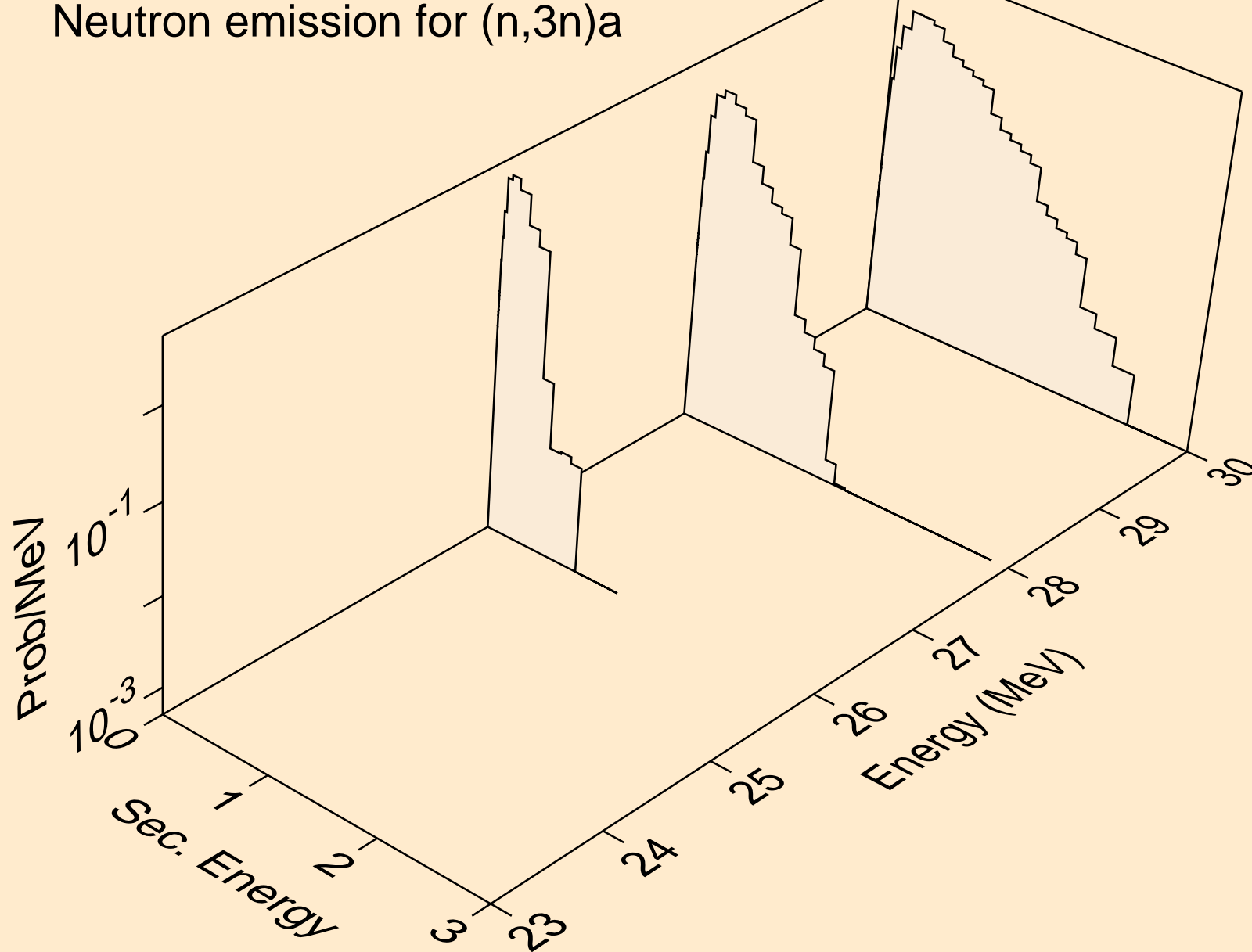

AS072 NEUTRON ACER TENDL-2021 LIBRARY; T=293.6K
Neutron emission for (n,n*)p

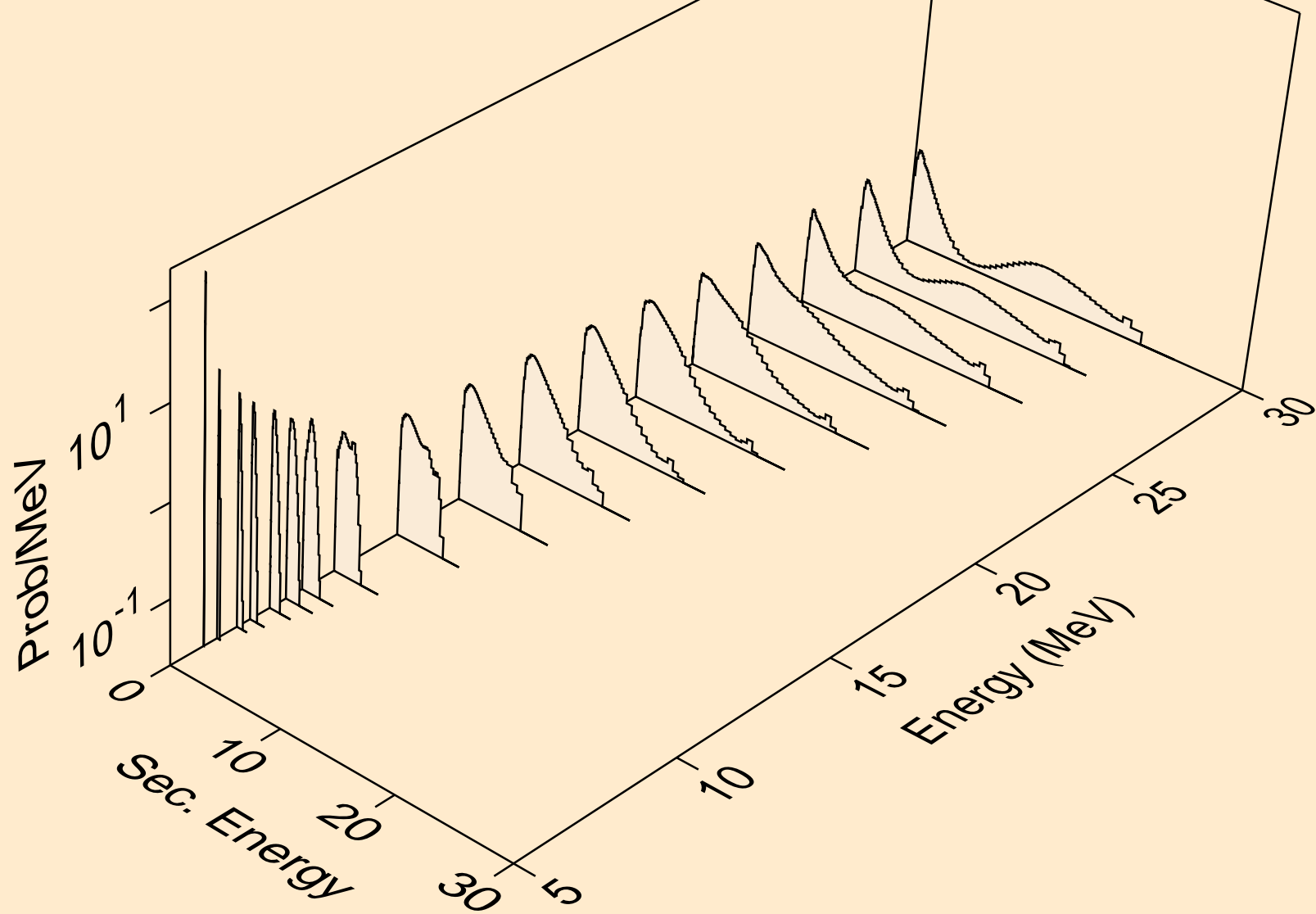

AS072 NEUTRON ACER TENDL-2021 LIBRARY; T=293.6K
Neutron emission for (n,n*)2a

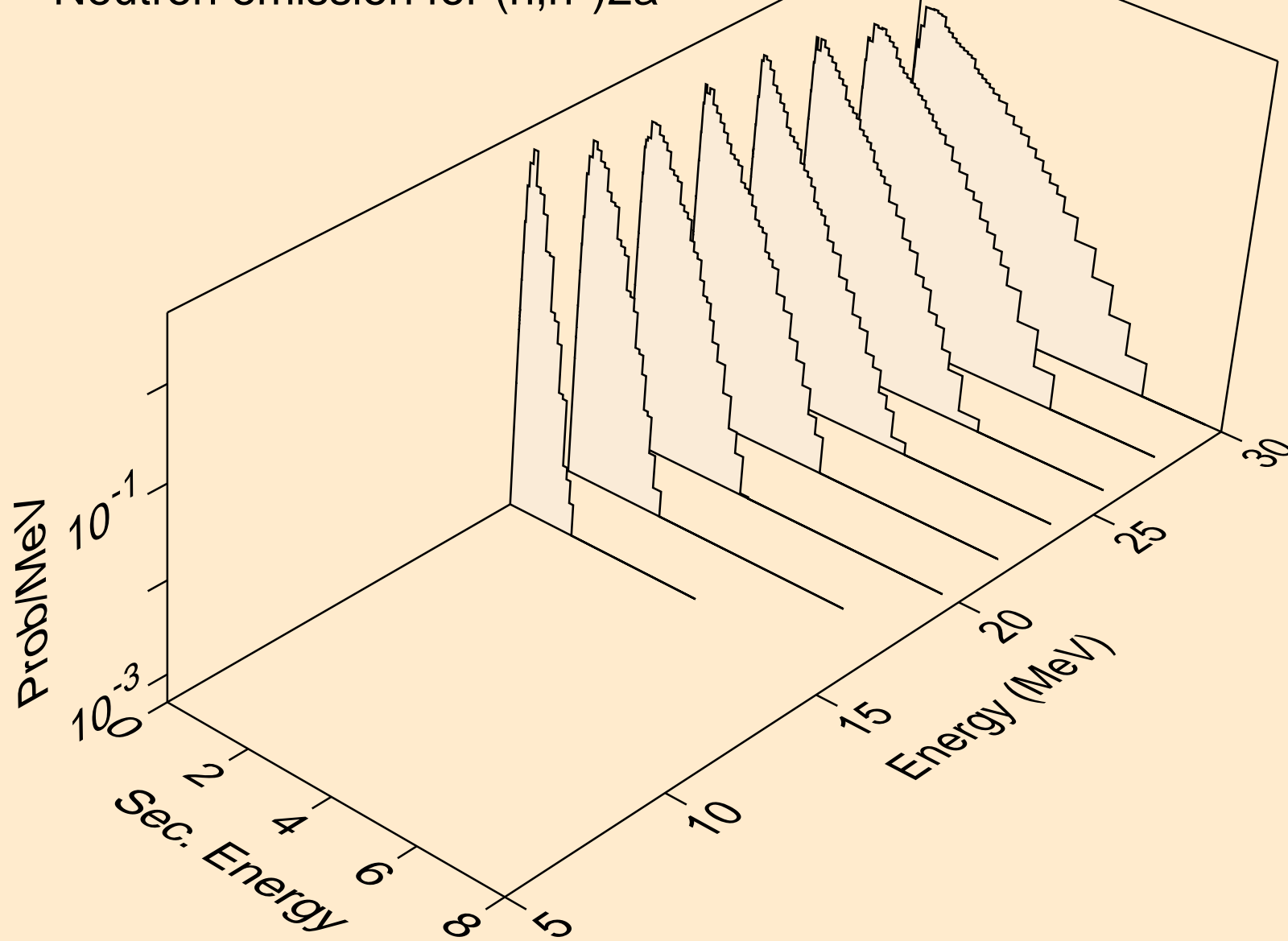

AS072 NEUTRON ACER TENDL-2021 LIBRARY; T=293.6K
Neutron emission for (n,2n)2a

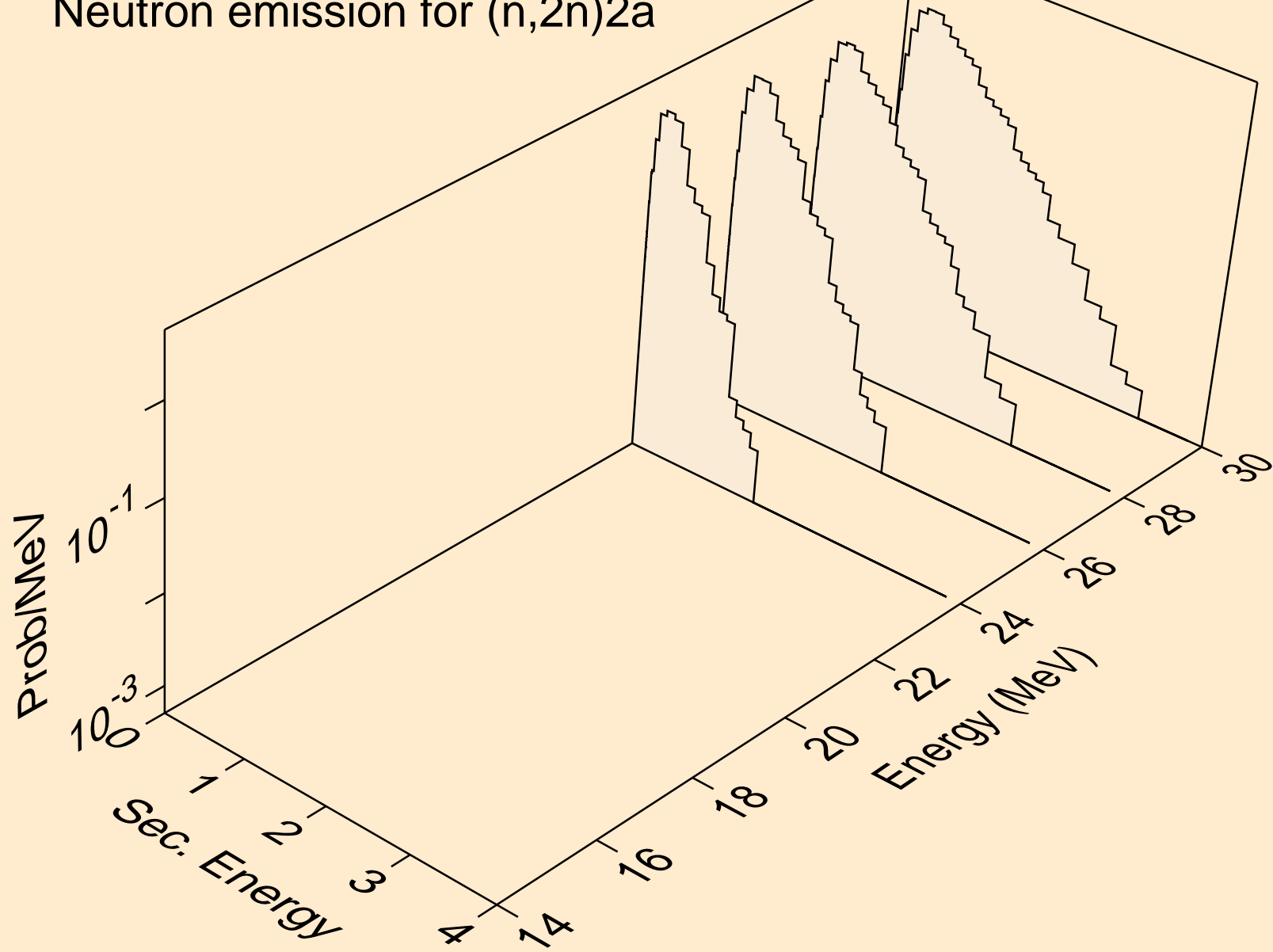

AS072 NEUTRON ACER TENDL-2021 LIBRARY; T=293.6K
Neutron emission for (n,n*)d

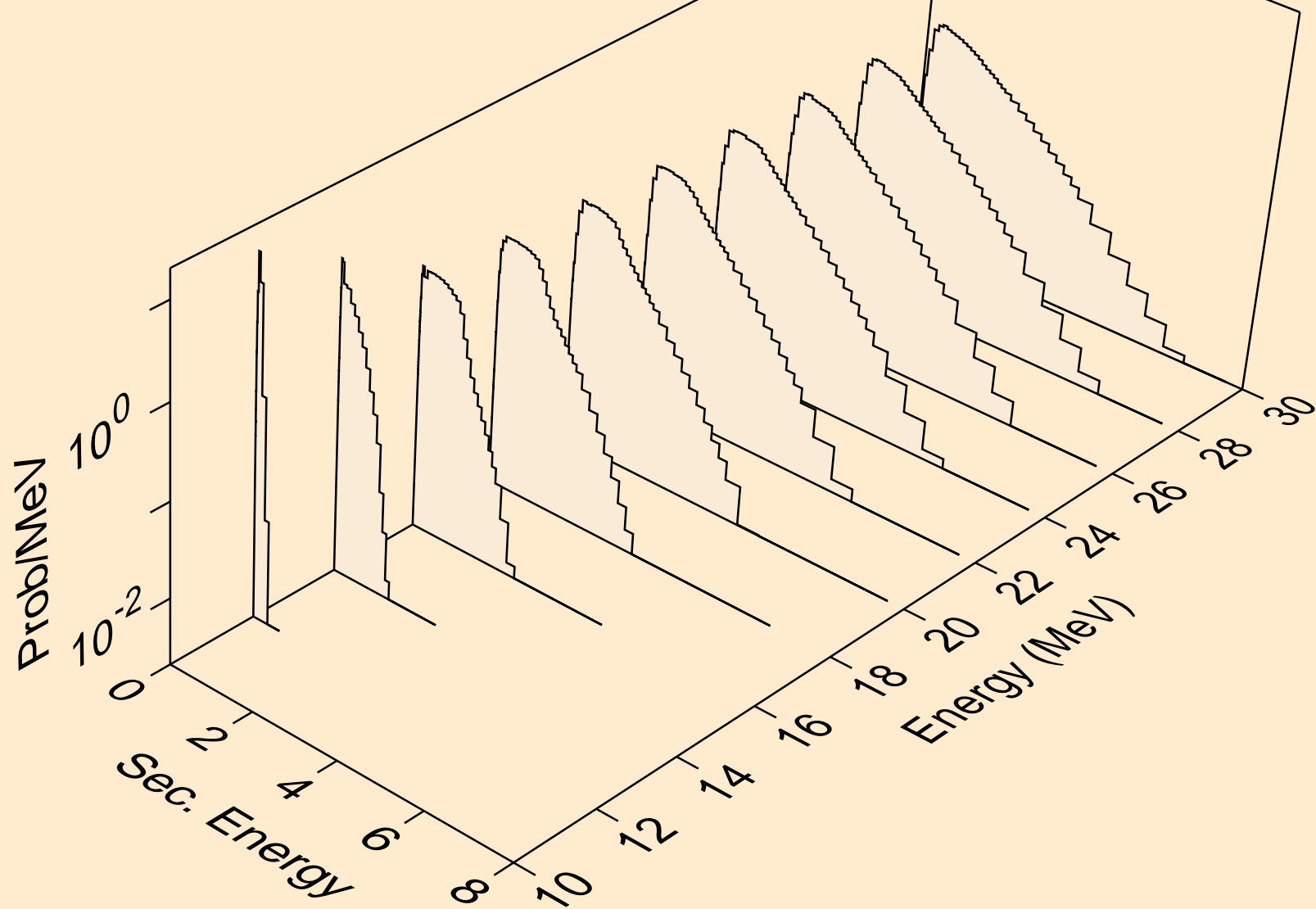

AS072 NEUTRON ACER TENDL-2021 LIBRARY; T=293.6K
Neutron emission for (n,n*)t

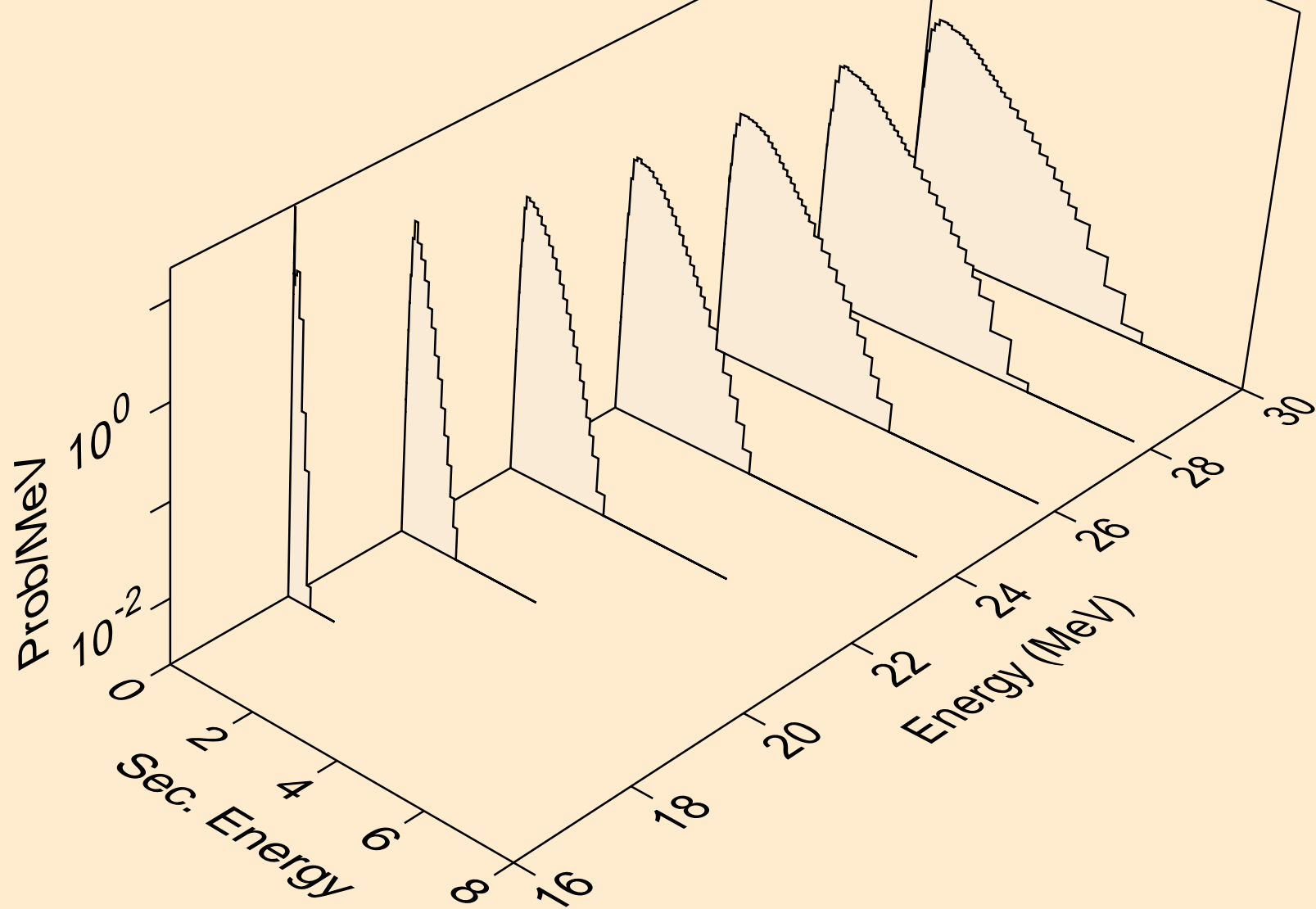

AS072 NEUTRON ACER TENDL-2021 LIBRARY; T=293.6K
Neutron emission for (n,n*)he3

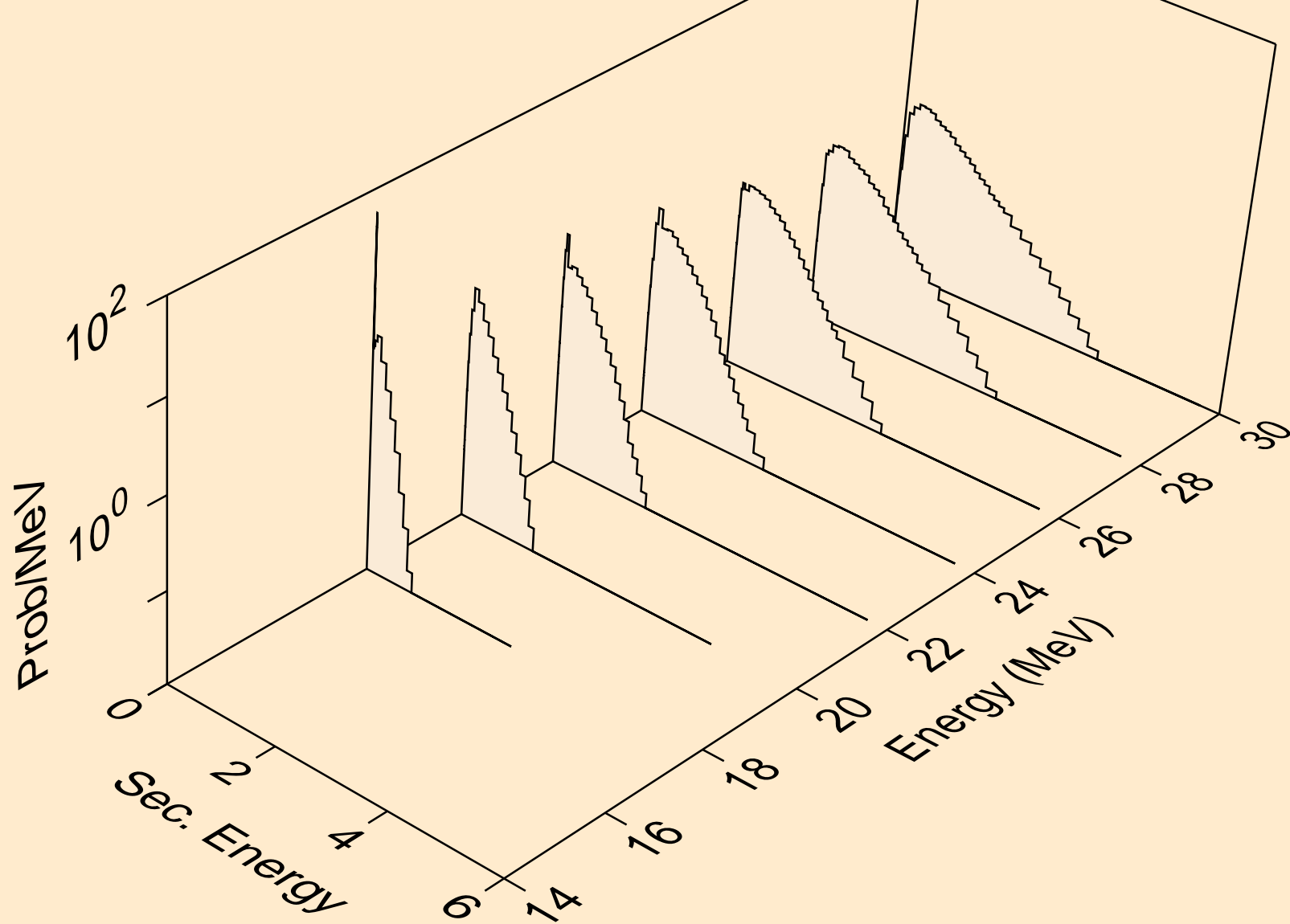

AS072 NEUTRON ACER TENDL-2021 LIBRARY; T=293.6K
Neutron emission for (n,2np)

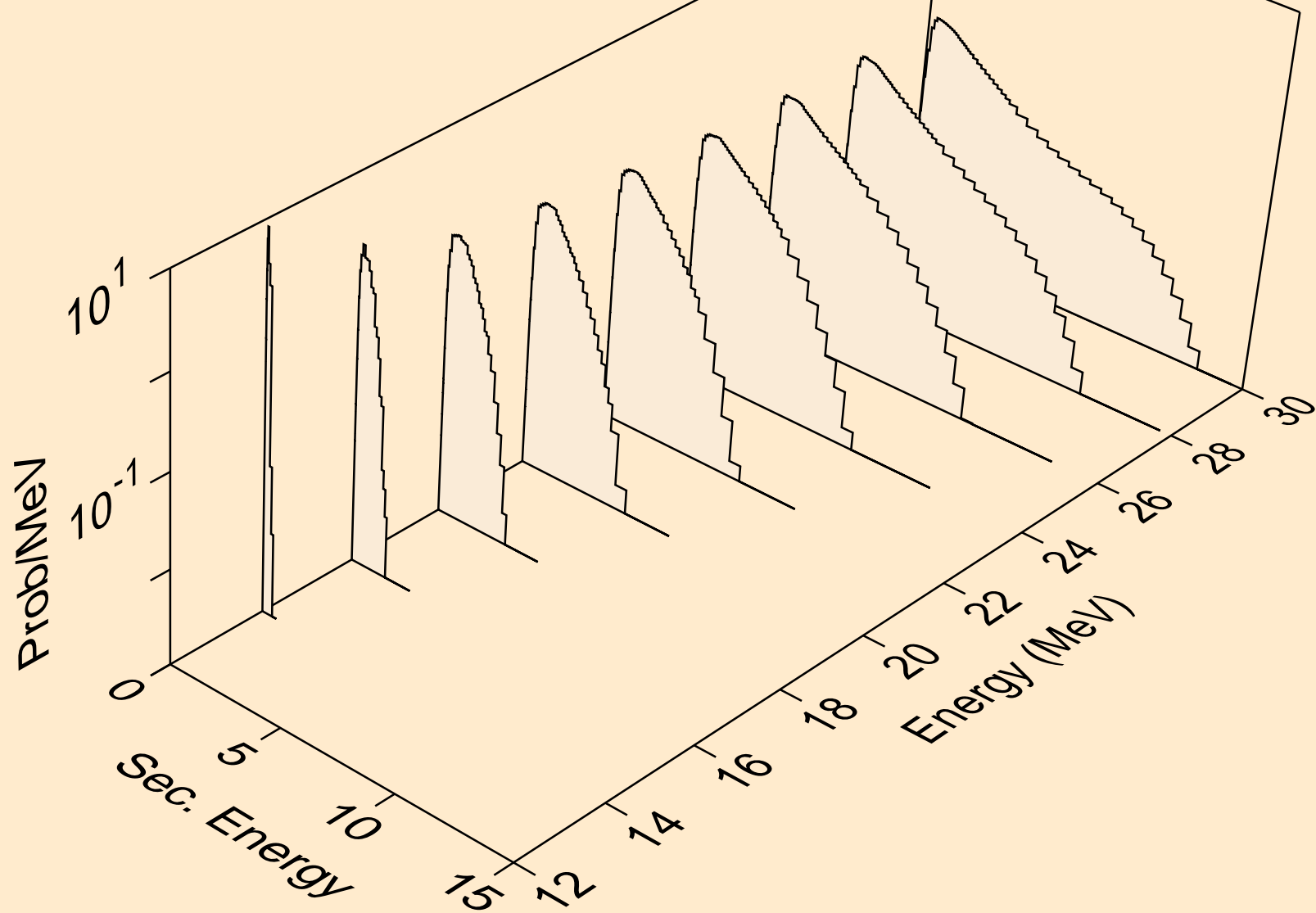

AS072 NEUTRON ACER TENDL-2021 LIBRARY; T=293.6K
Neutron emission for (n,3np)

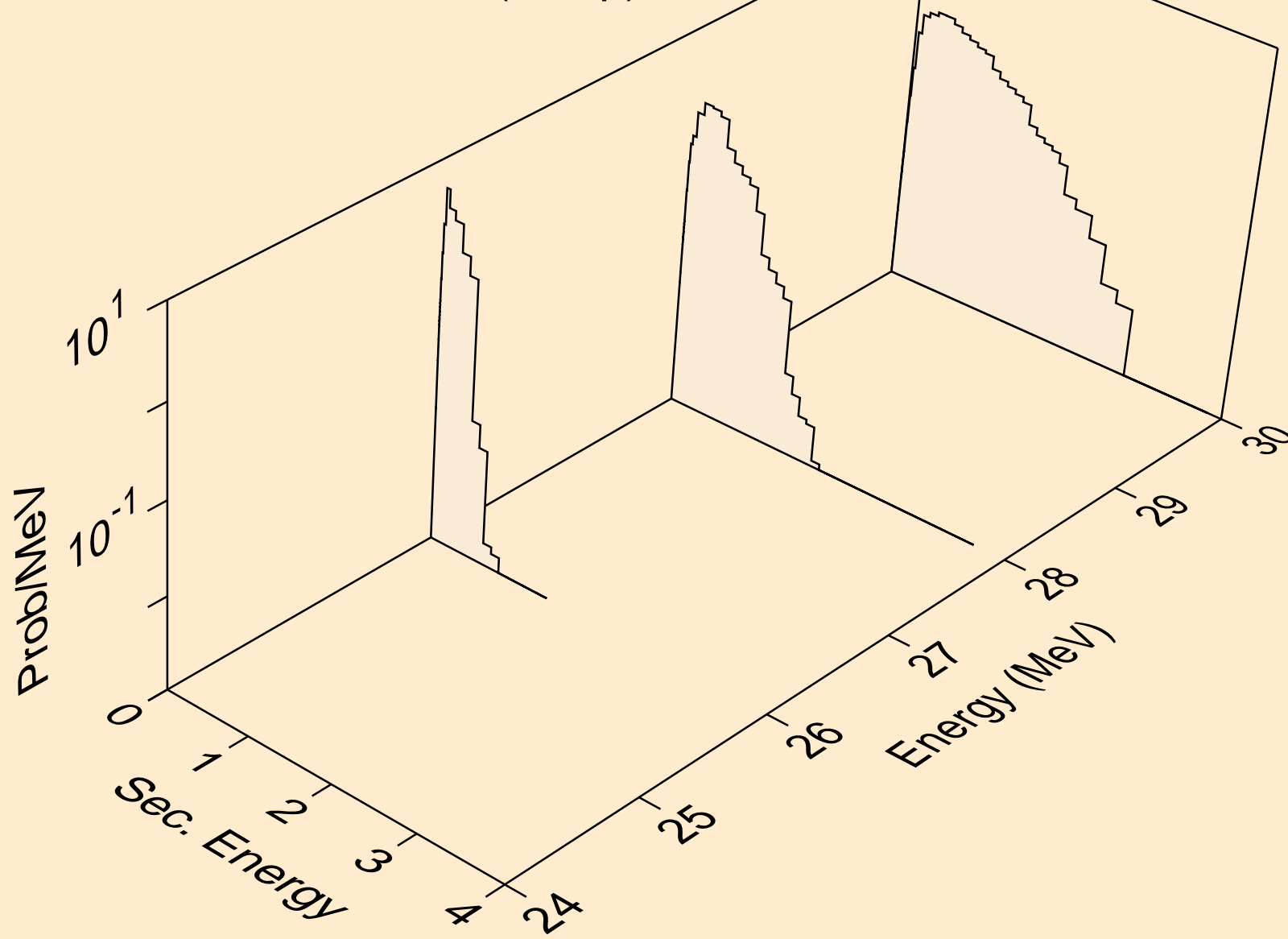

AS072 NEUTRON ACER TENDL-2021 LIBRARY; T=293.6K
Neutron emission for (n,2np)

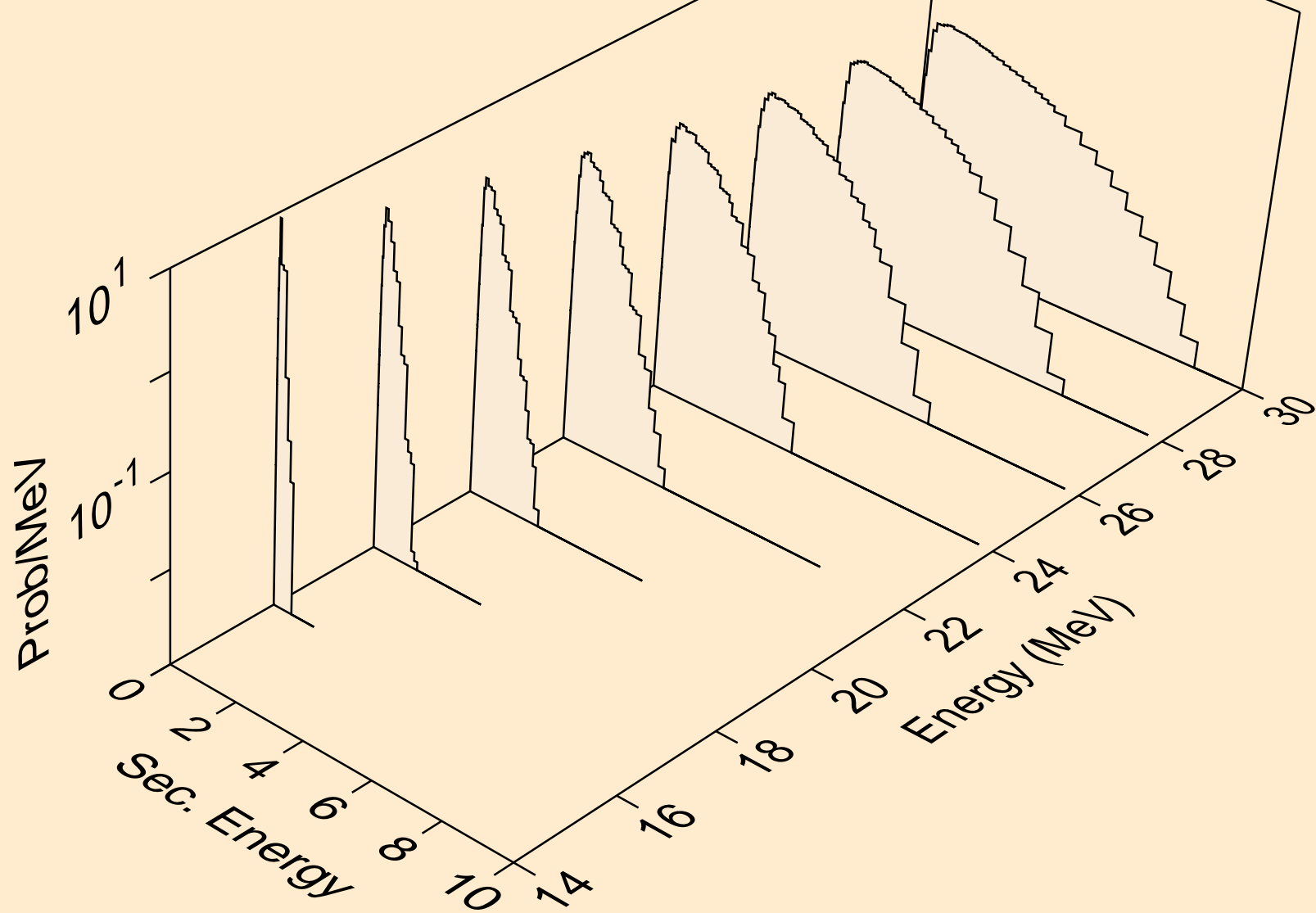

AS072 NEUTRON ACER TENDL-2021 LIBRARY; T=293.6K
Neutron emission for (n,npa)

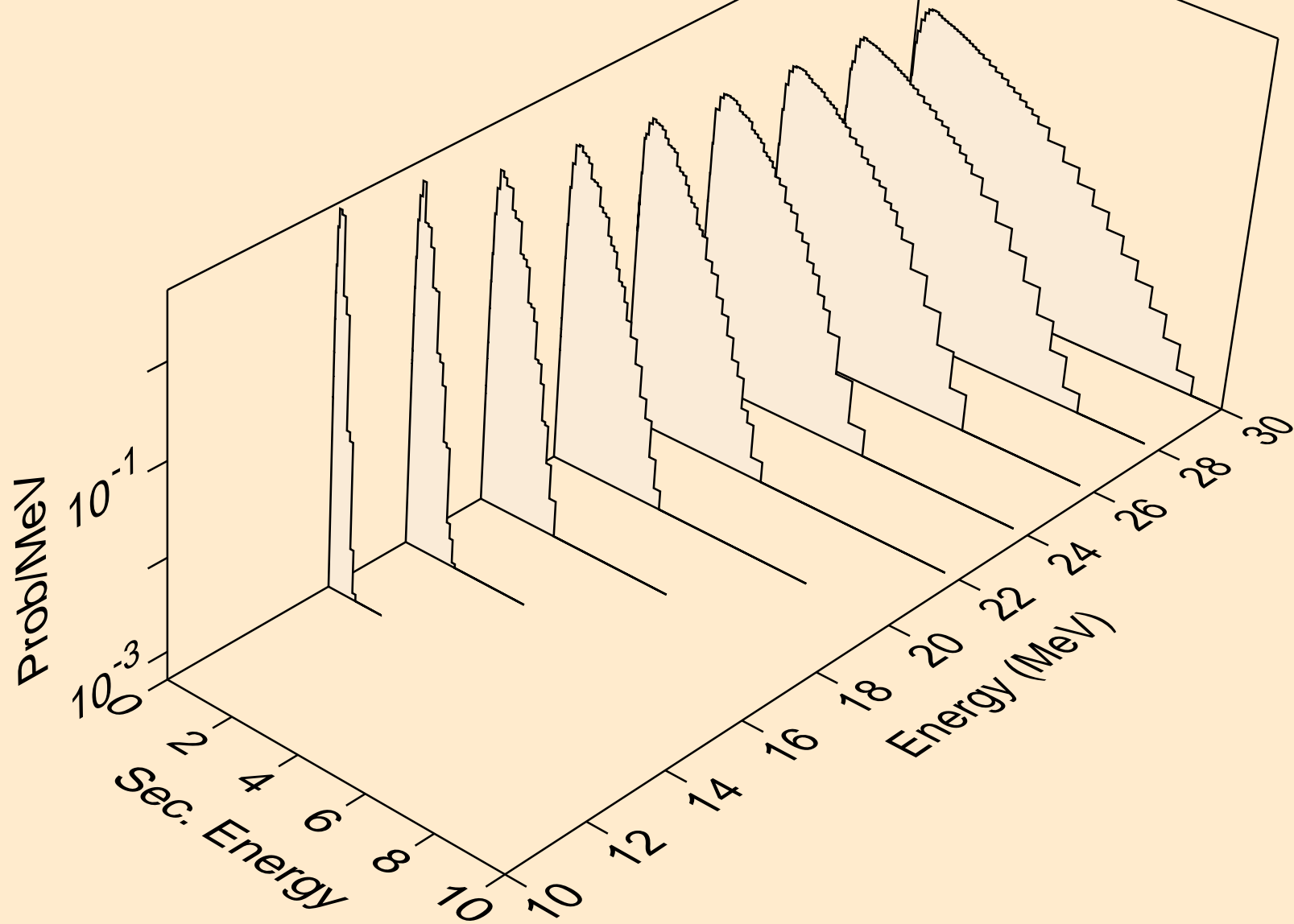

AS072 NEUTRON ACER TENDL-2021 LIBRARY; T=293.6K
Neutron emission for (n,n*c)

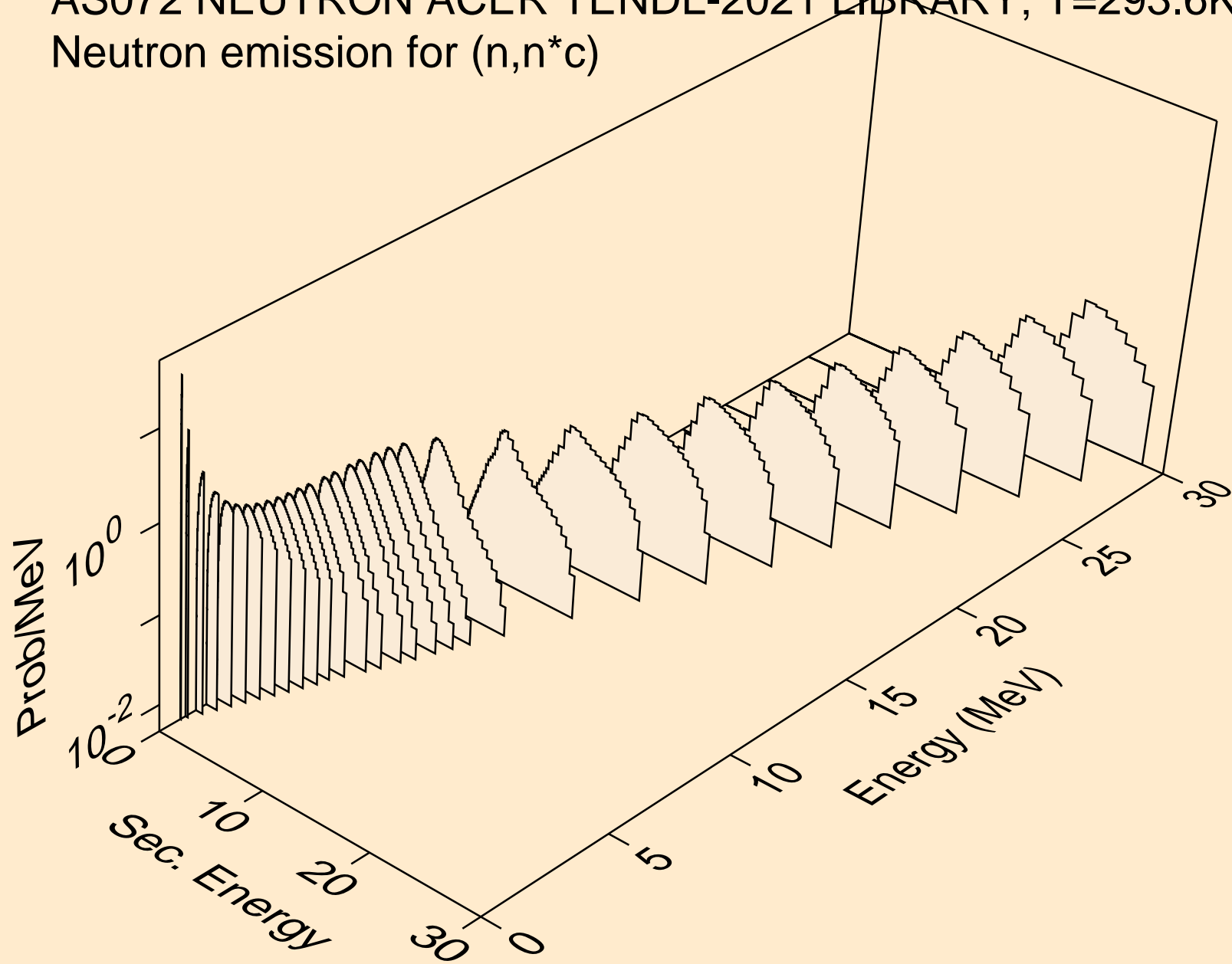

AS072 NEUTRON ACER TENDL-2021 LIBRARY; T=293.6K
Photon emission for (n,x)

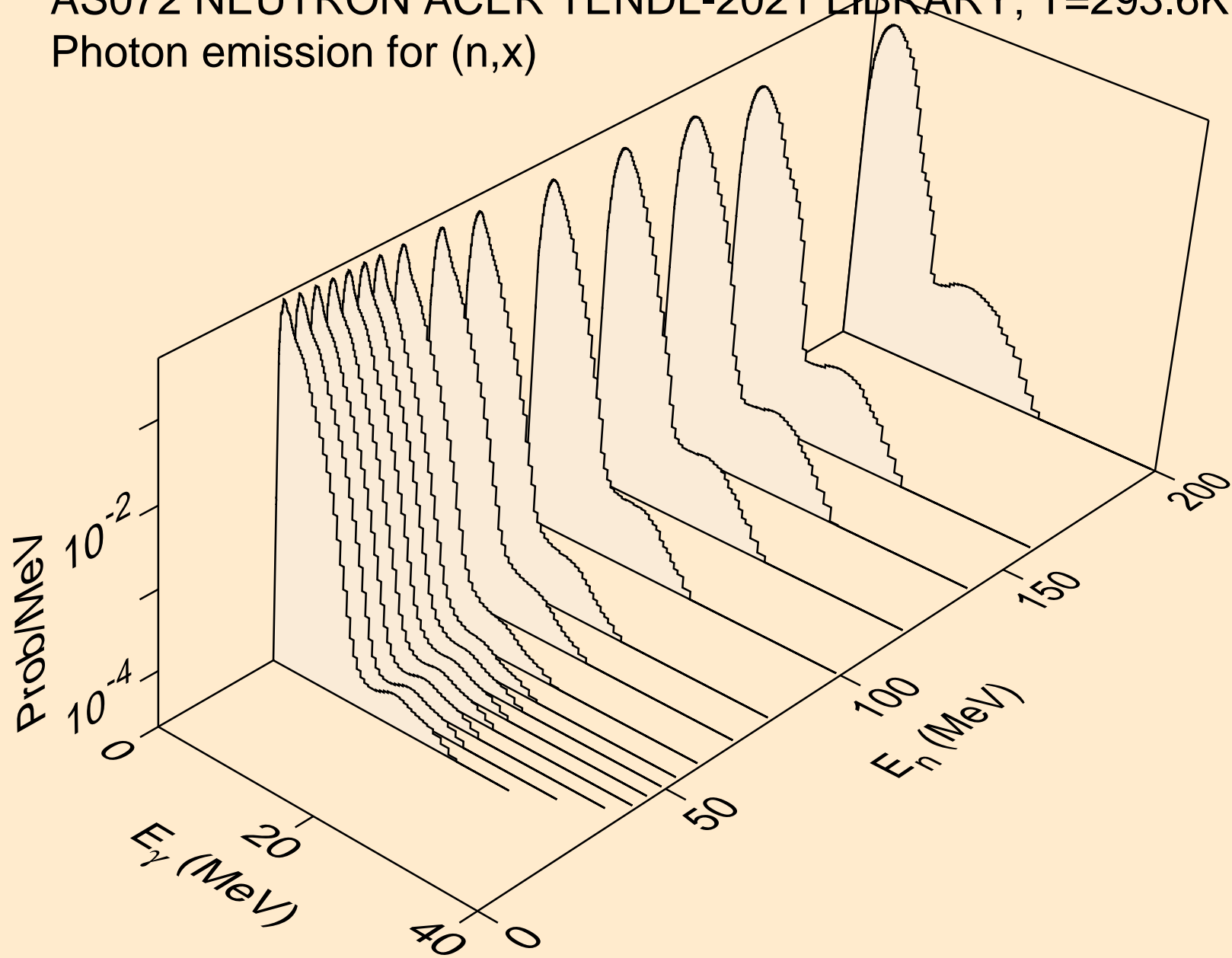

AS072 NEUTRON ACER TENDL-2021 LIBRARY; T=293.6K
Photon emission for (n,2nd)

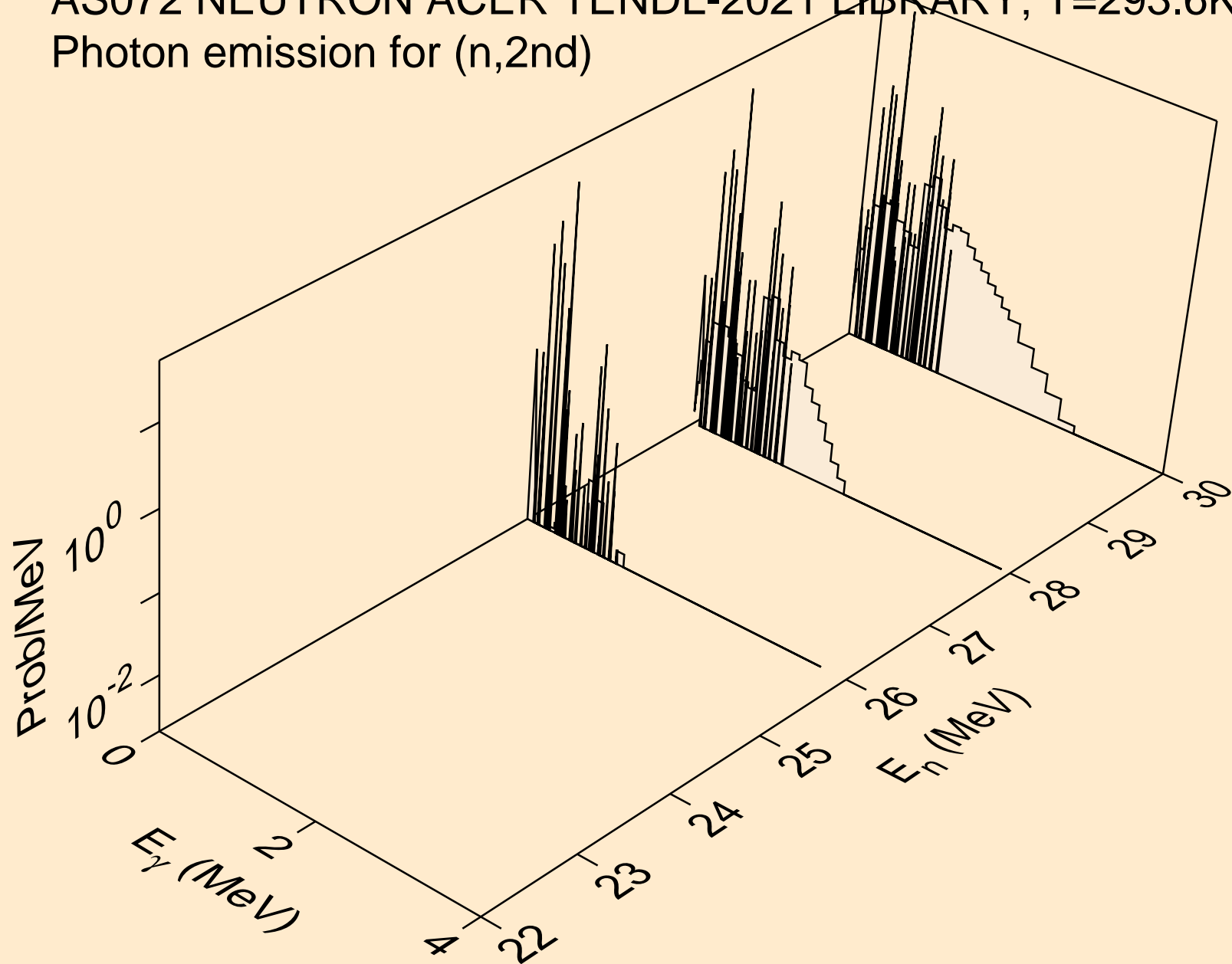

AS072 NEUTRON ACER TENDL-2021 LIBRARY; T=293.6K
Photon emission for (n,2n)

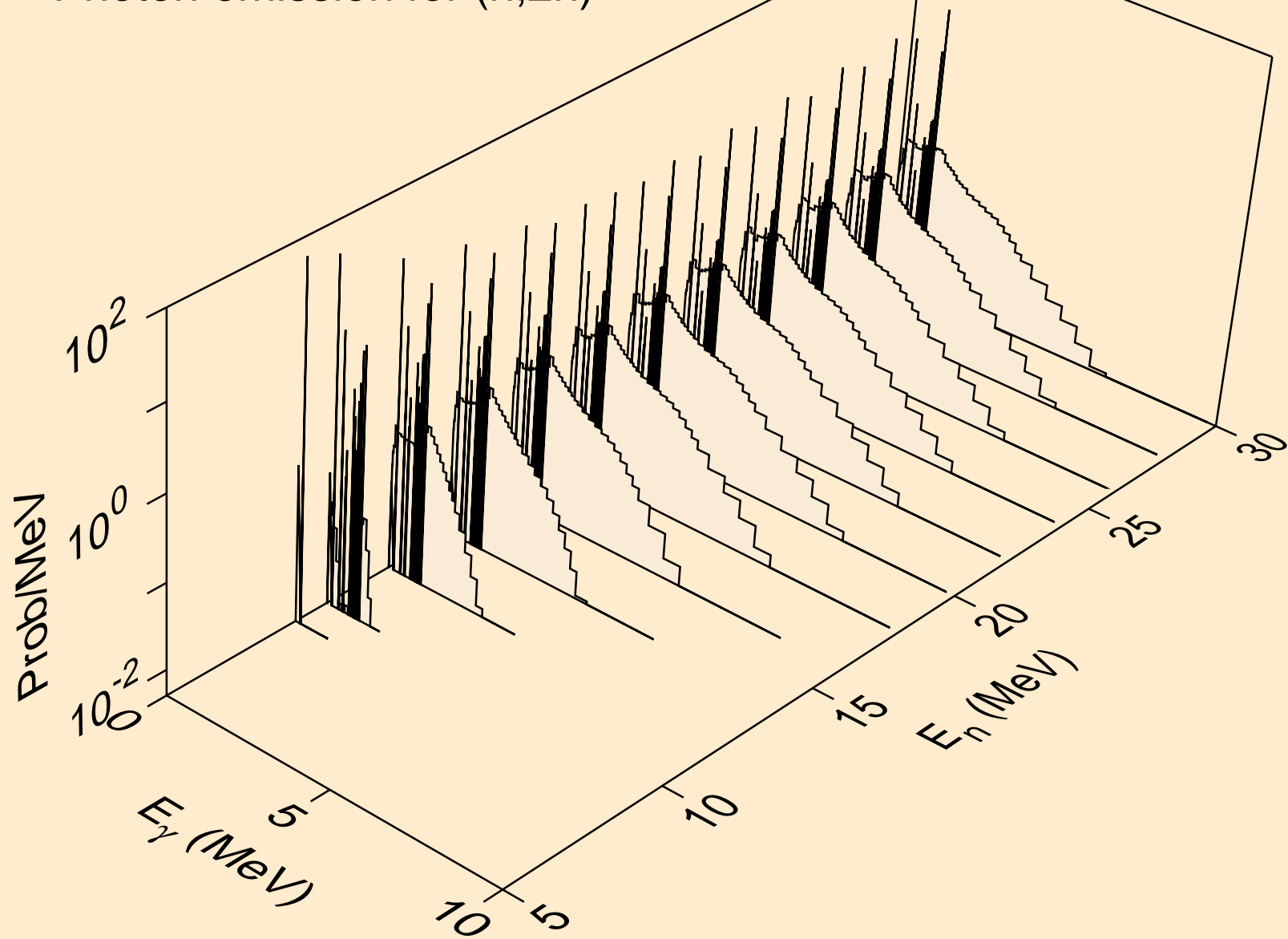

AS072 NEUTRON ACER TENDL-2021 LIBRARY; T=293.6K
Photon emission for (n,3n)

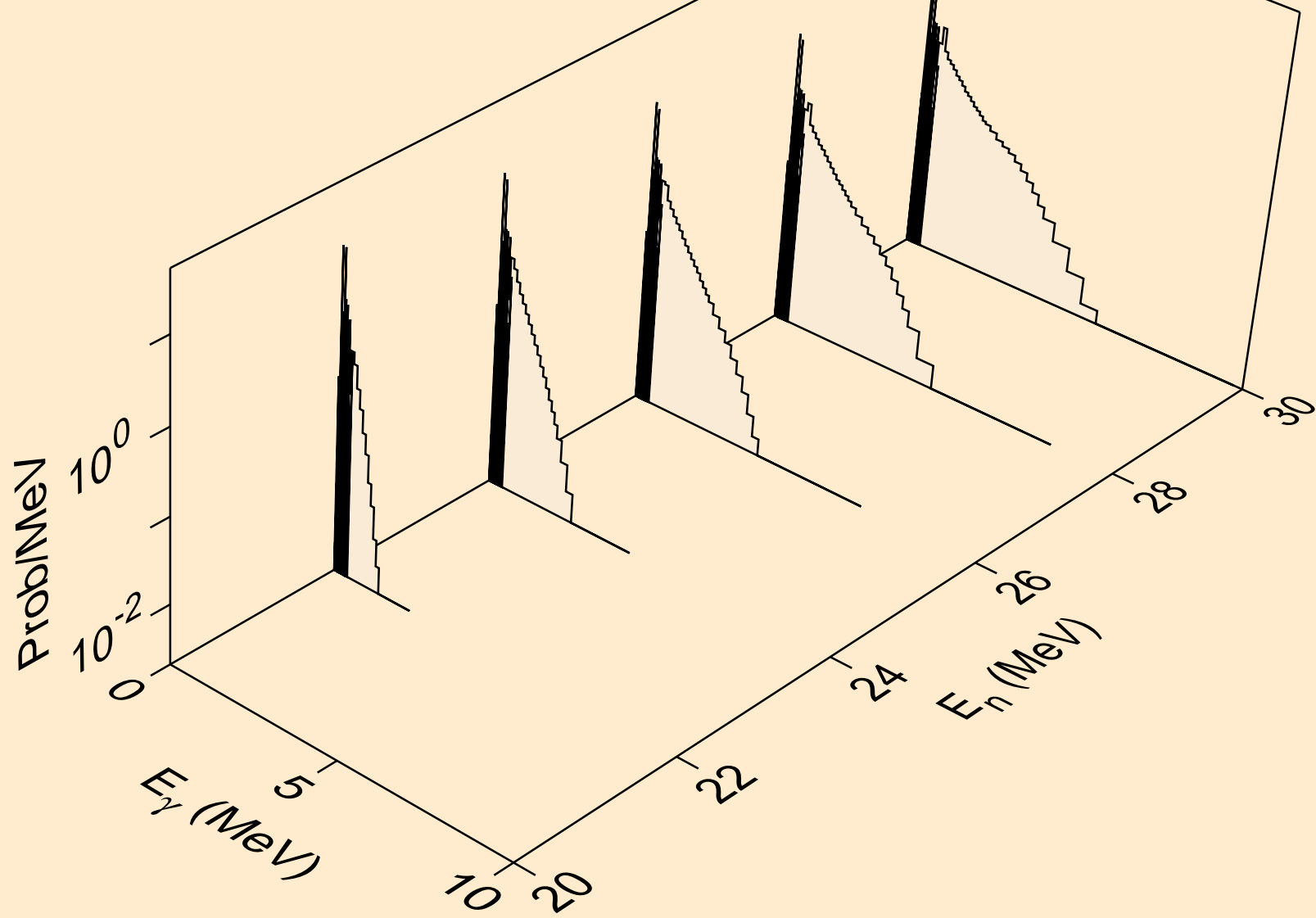

AS072 NEUTRON ACER TENDL-2021 LIBRARY; T=293.6K
Photon emission for (n,n*)a

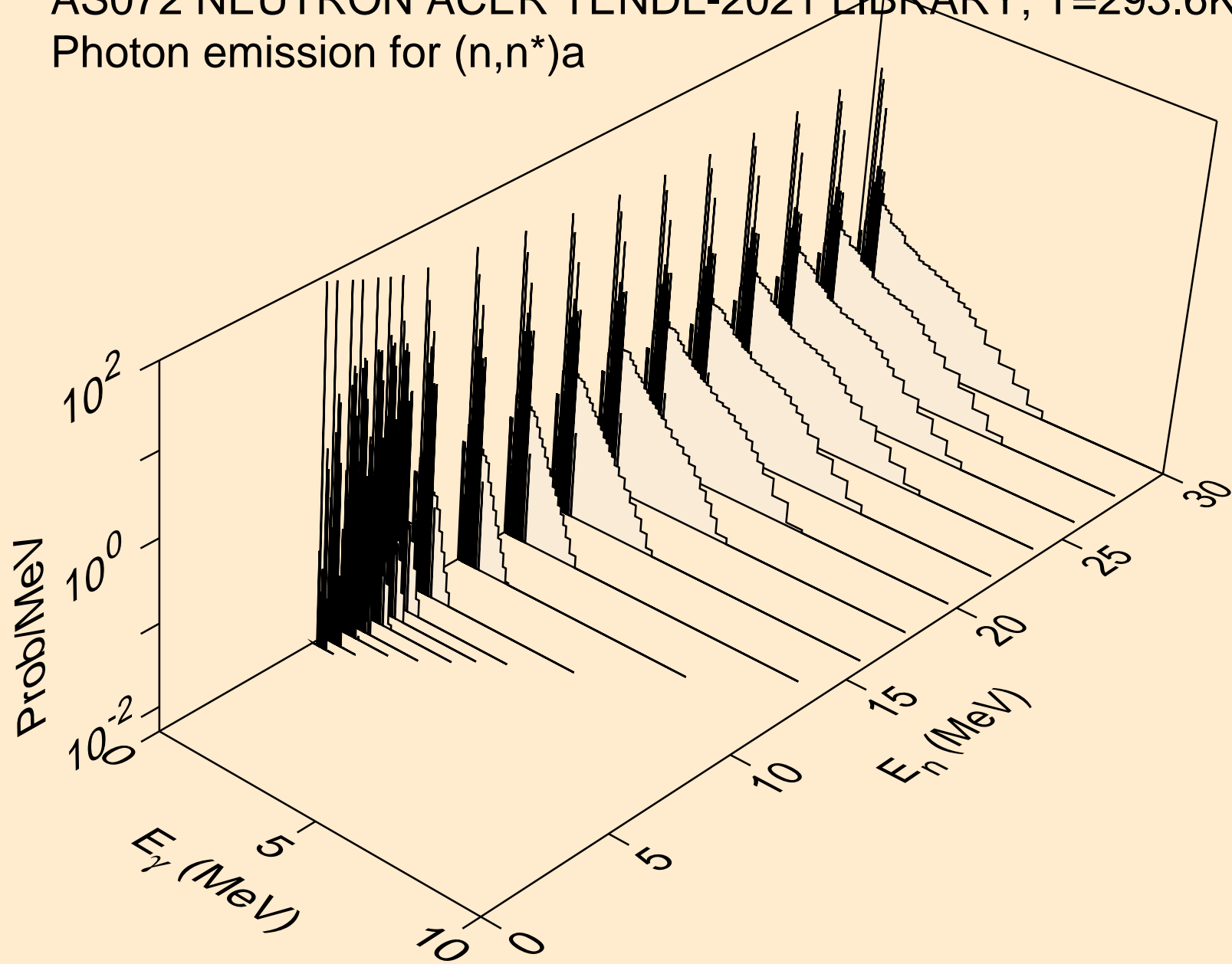

AS072 NEUTRON ACER TENDL-2021 LIBRARY; T=293.6K
Photon emission for (n,2n)a

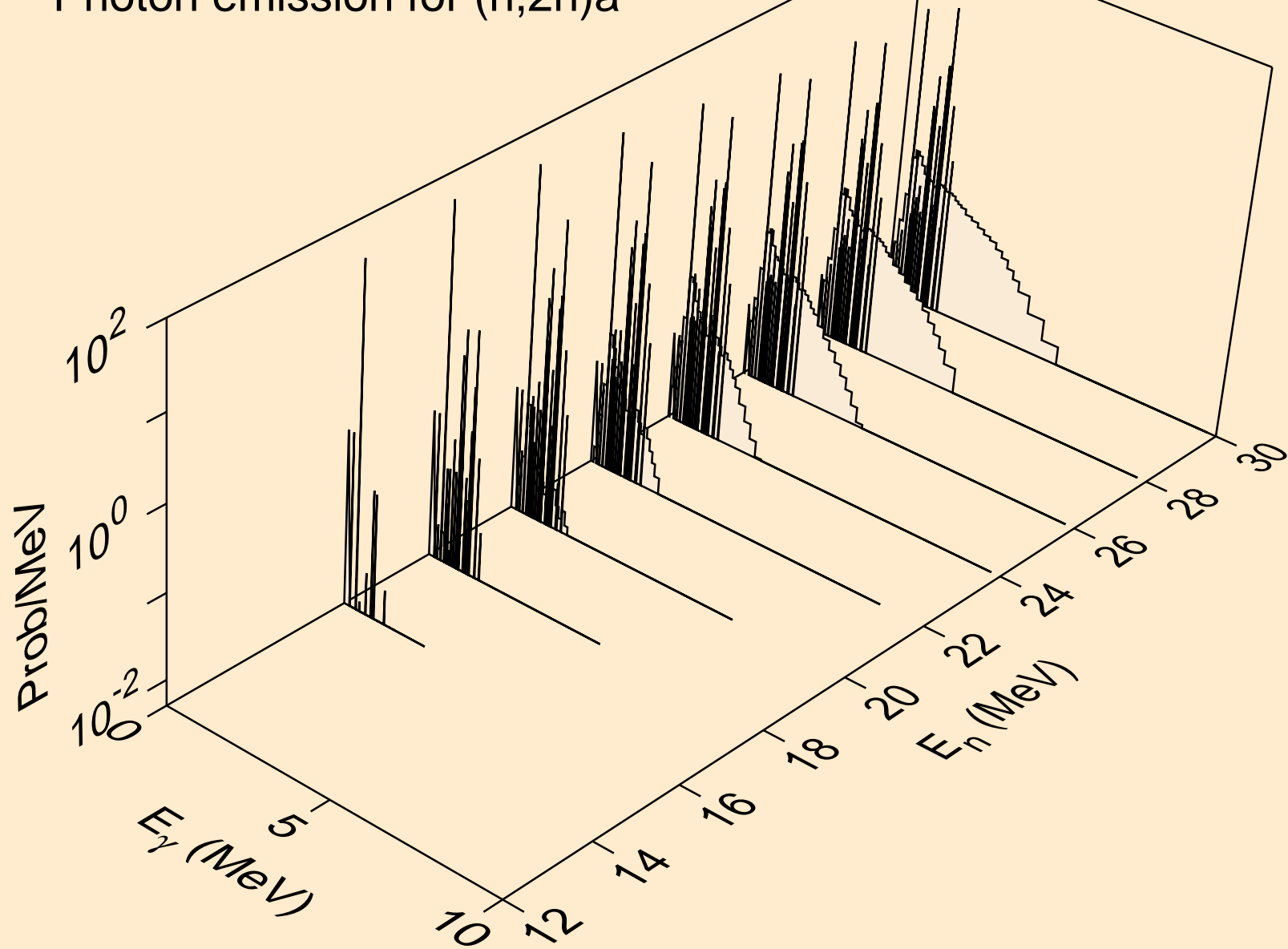

AS072 NEUTRON ACER TENDL-2021 LIBRARY; T=293.6K
Photon emission for (n,3n)a

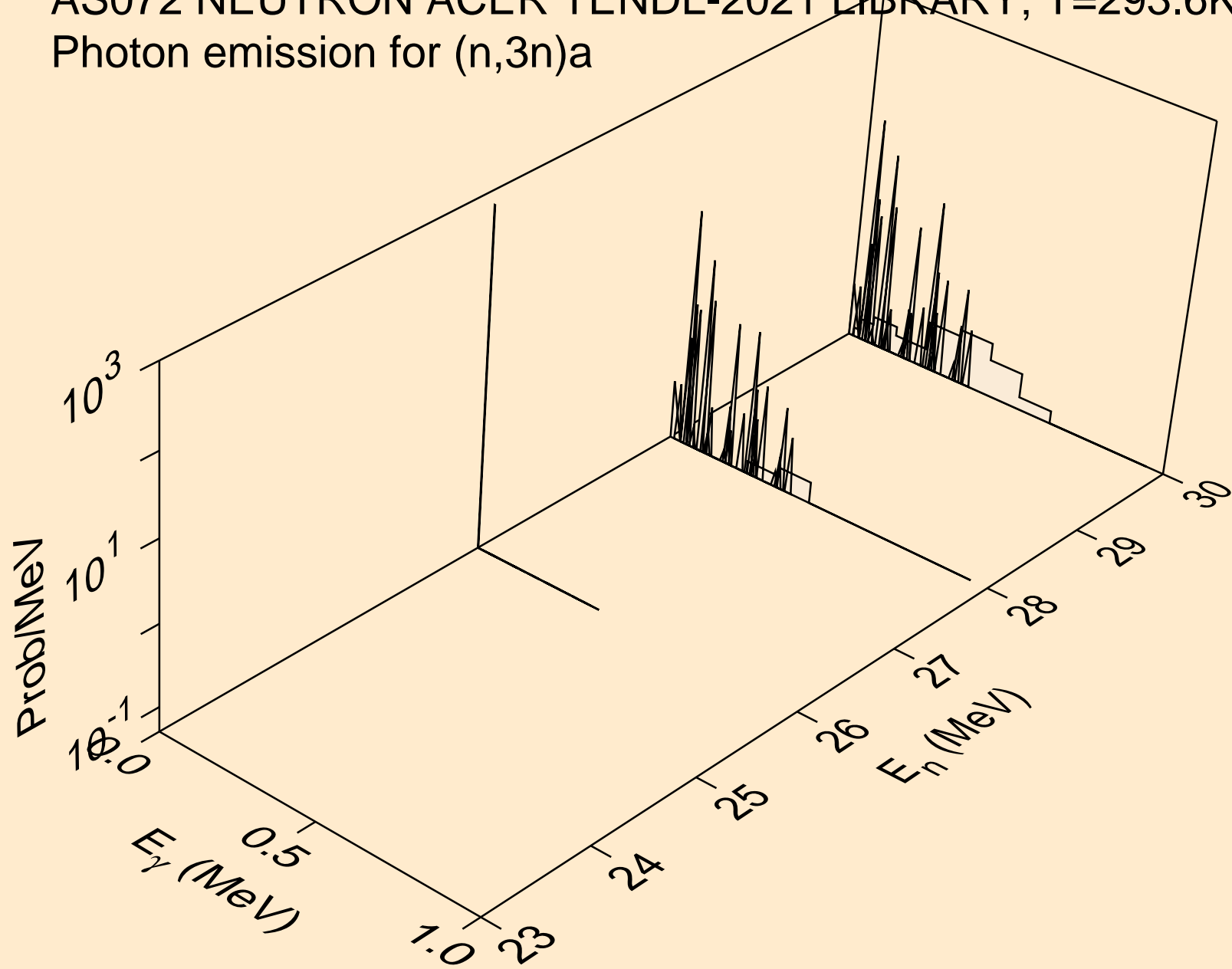

AS072 NEUTRON ACER TENDL-2021 LIBRARY; T=293.6K
Photon emission for (n,n*)p

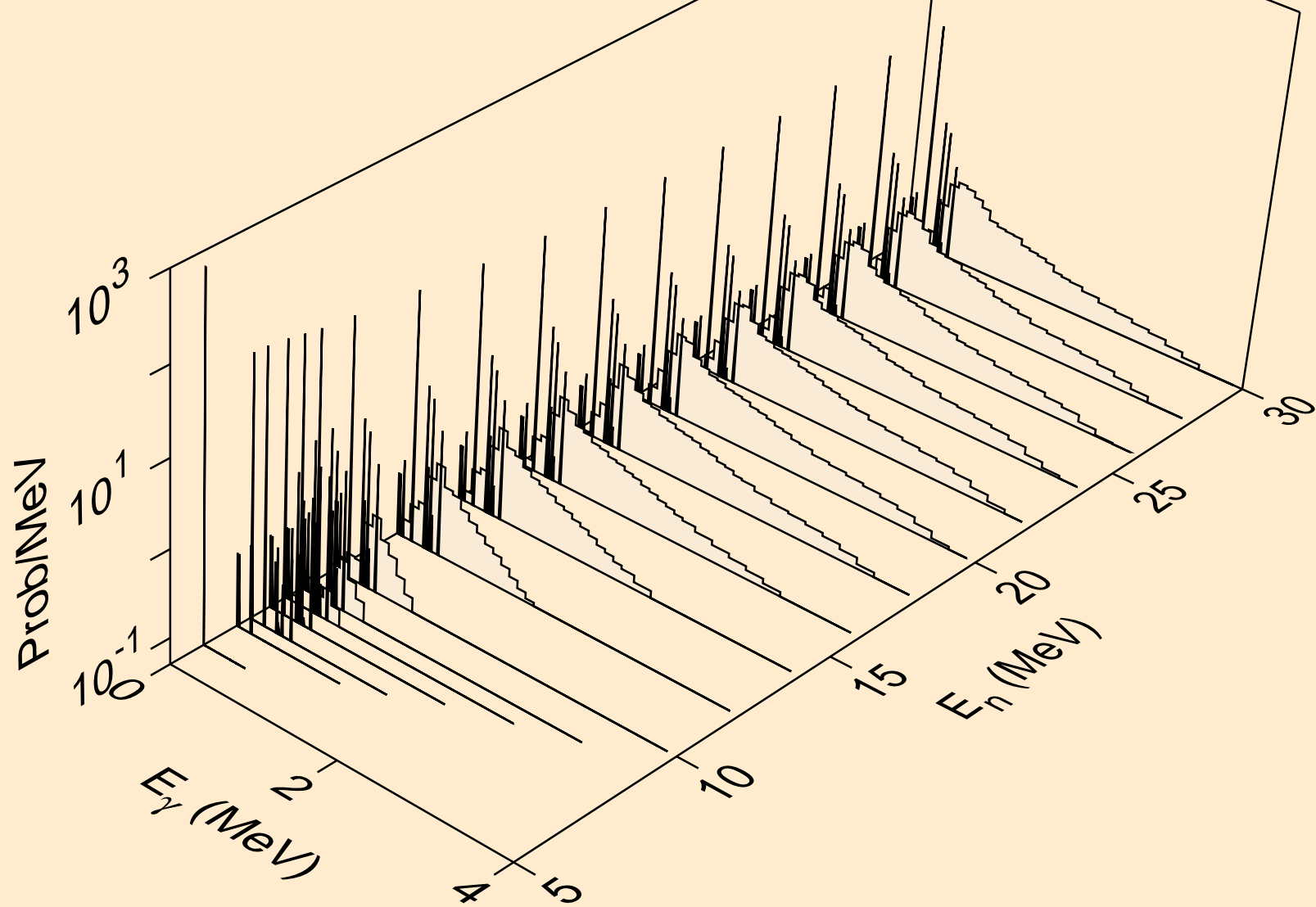

AS072 NEUTRON ACER TENDL-2021 LIBRARY; T=293.6K
Photon emission for (n,n*)2a

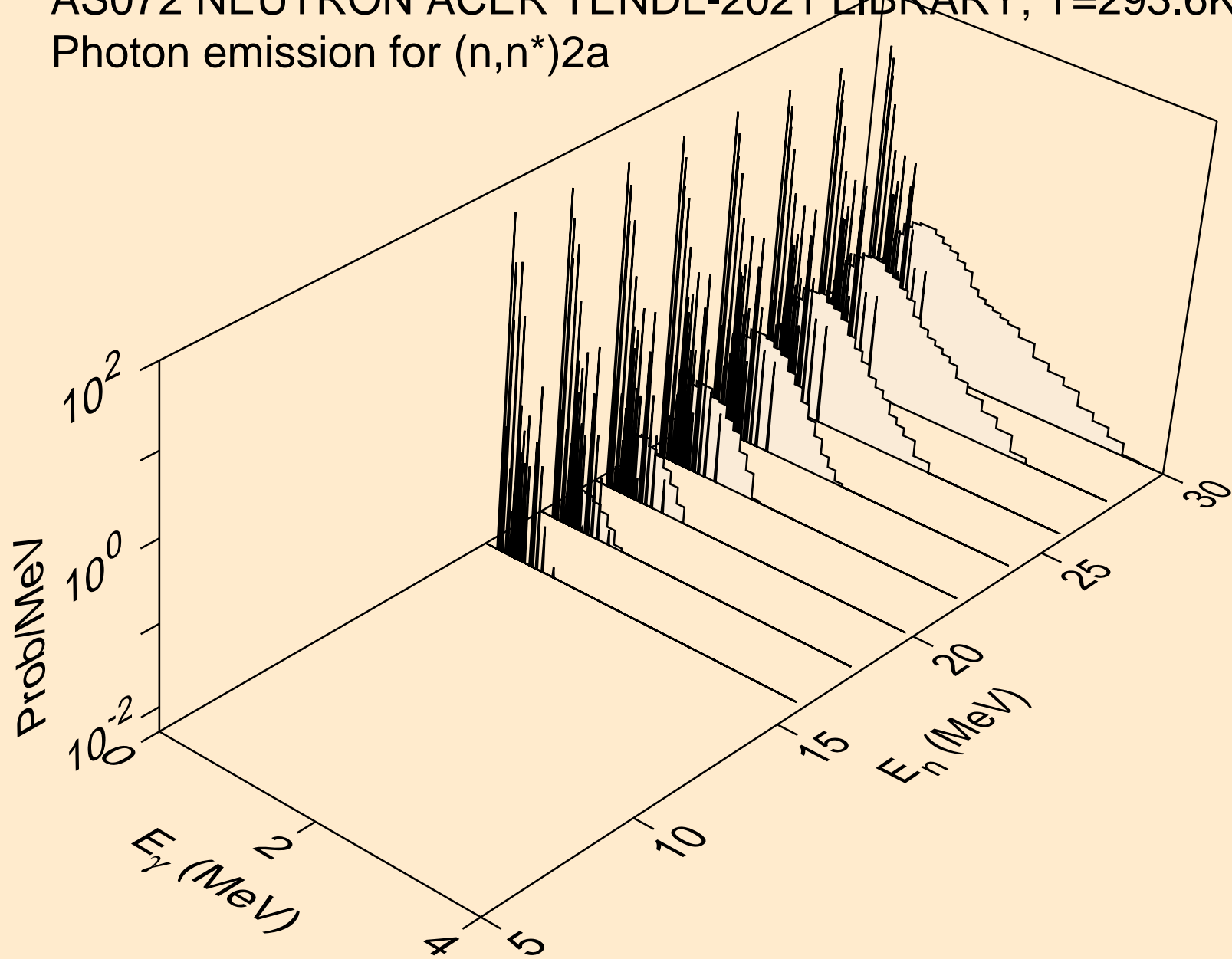

AS072 NEUTRON ACER TENDL-2021 LIBRARY; T=293.6K
Photon emission for (n,2n)2a

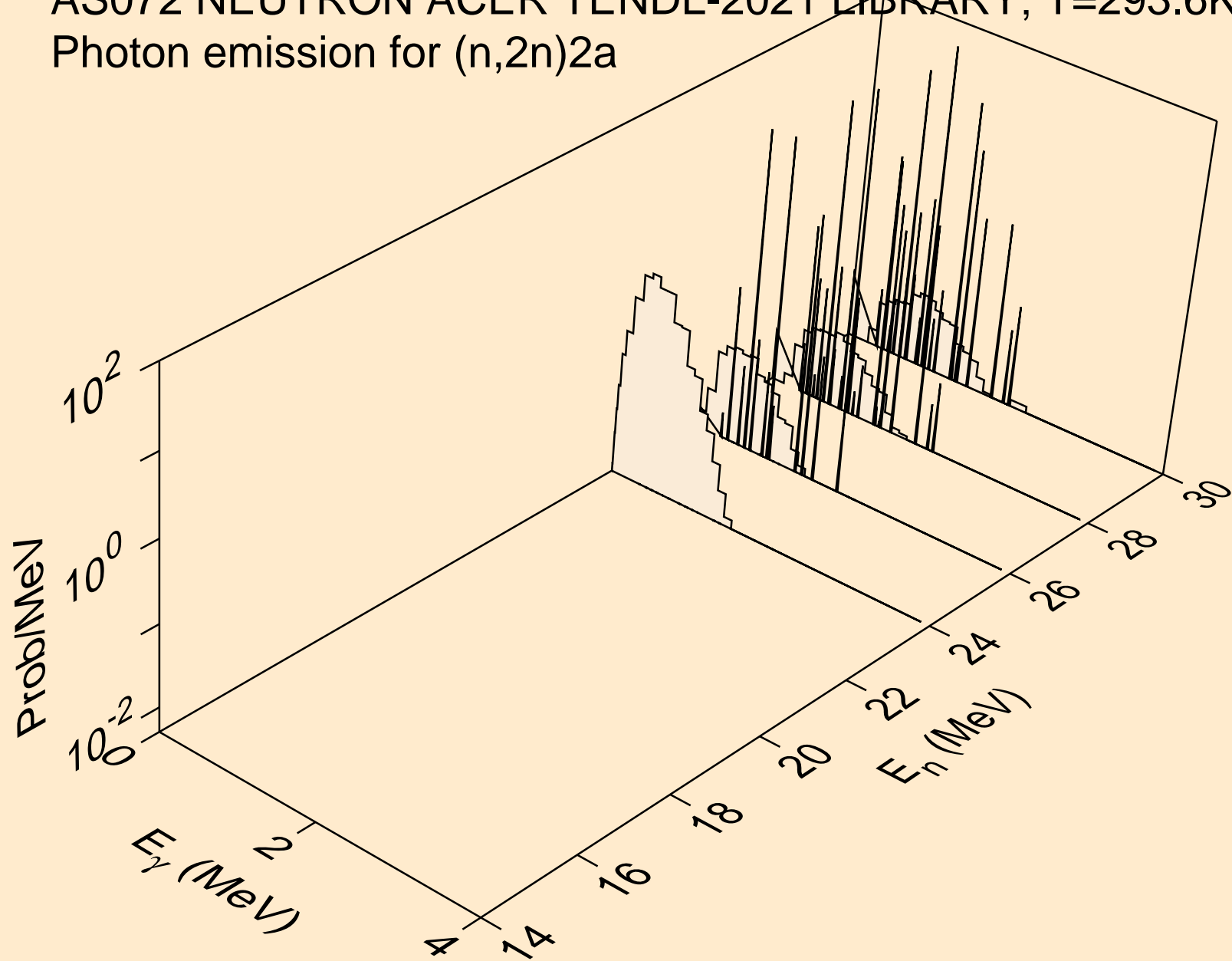

AS072 NEUTRON ACER TENDL-2021 LIBRARY; T=293.6K
Photon emission for (n,n*)d

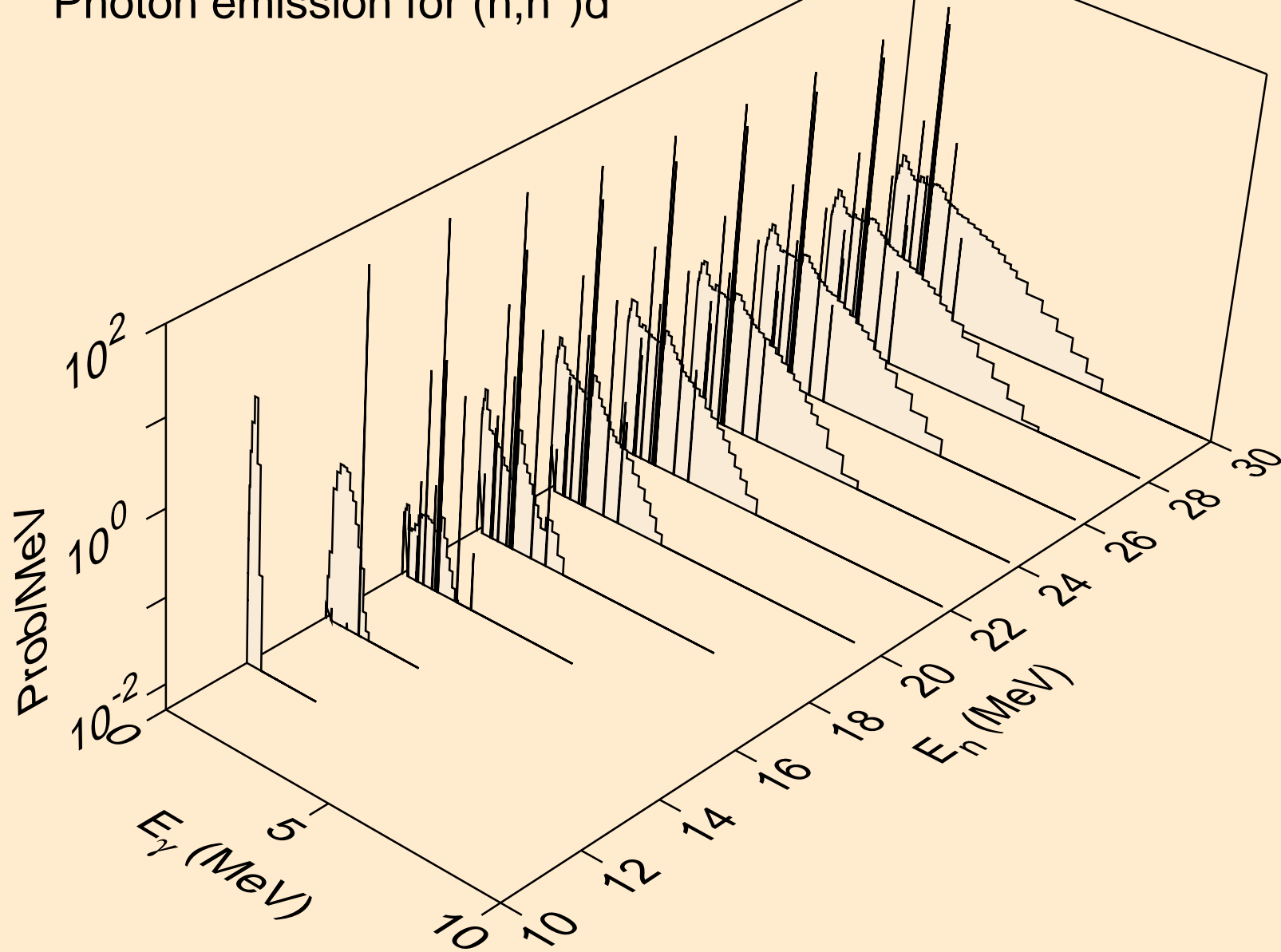

AS072 NEUTRON ACER TENDL-2021 LIBRARY; T=293.6K
Photon emission for (n,n*)t

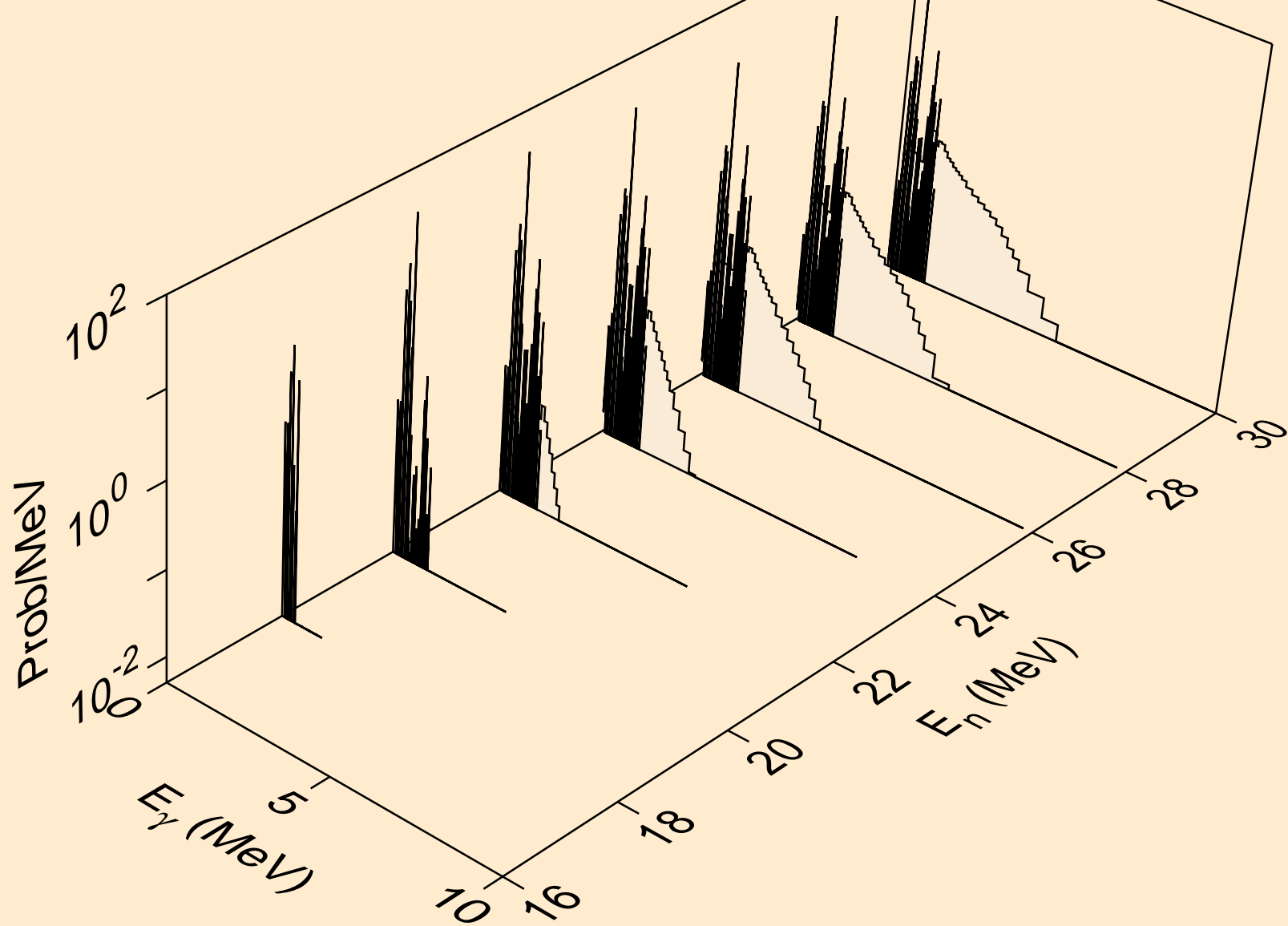

AS072 NEUTRON ACER TENDL-2021 LIBRARY; T=293.6K
Photon emission for (n,n*)he3

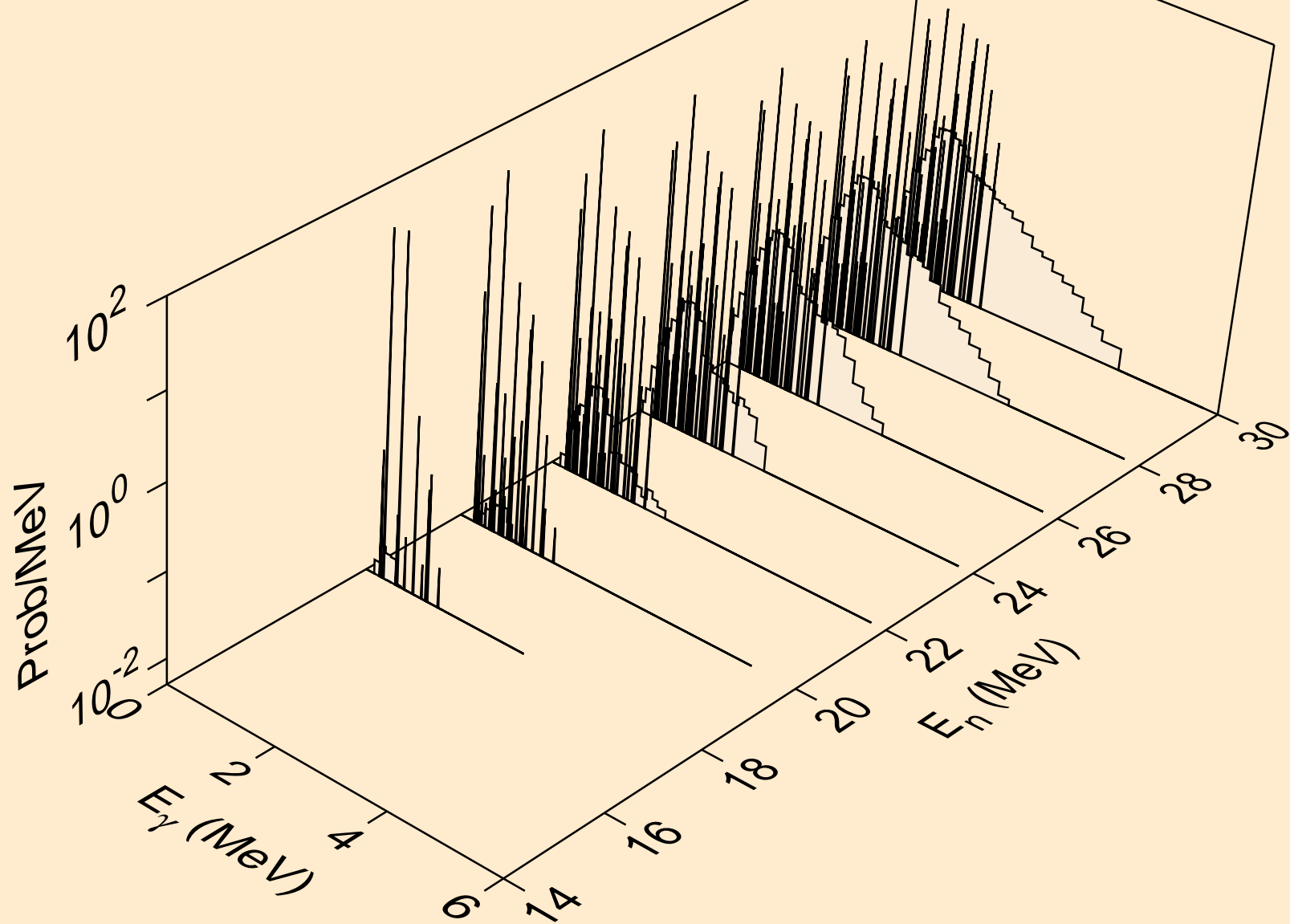

AS072 NEUTRON ACER TENDL-2021 LIBRARY; T=293.6K
Photon emission for (n,2np)

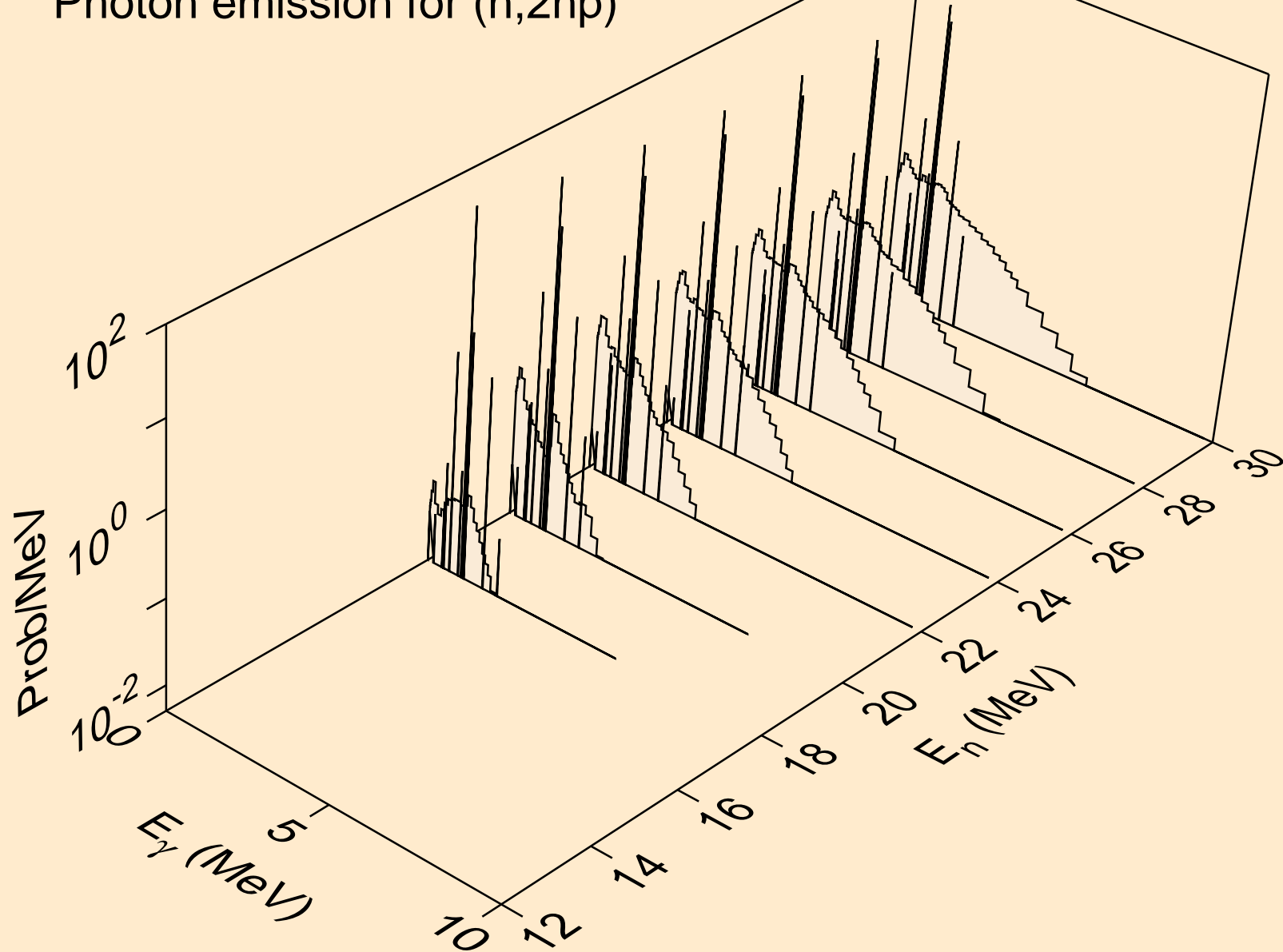

AS072 NEUTRON ACER TENDL-2021 LIBRARY; T=293.6K
Photon emission for (n,3np)

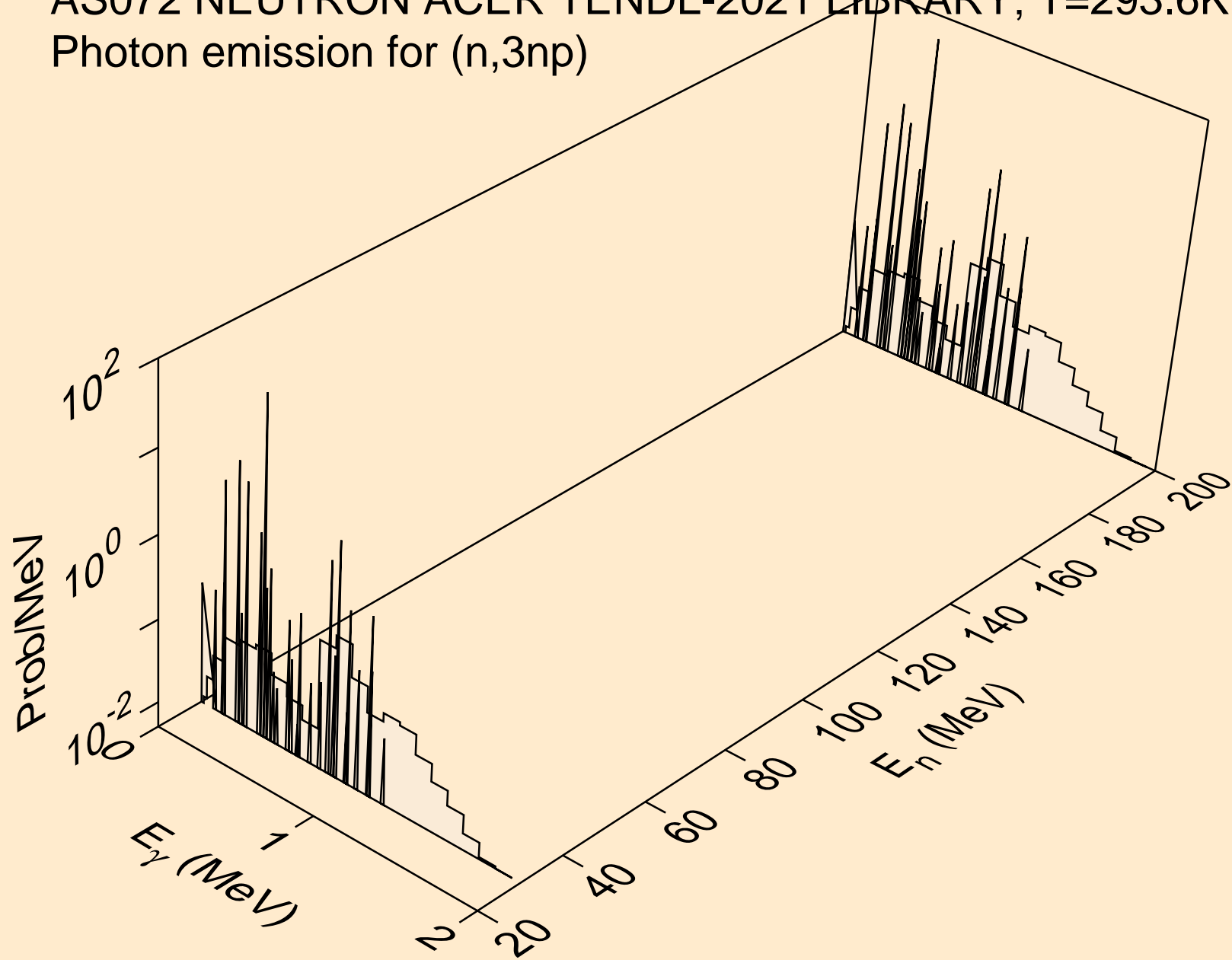

AS072 NEUTRON ACER TENDL-2021 LIBRARY; T=293.6K
Photon emission for (n,2np)

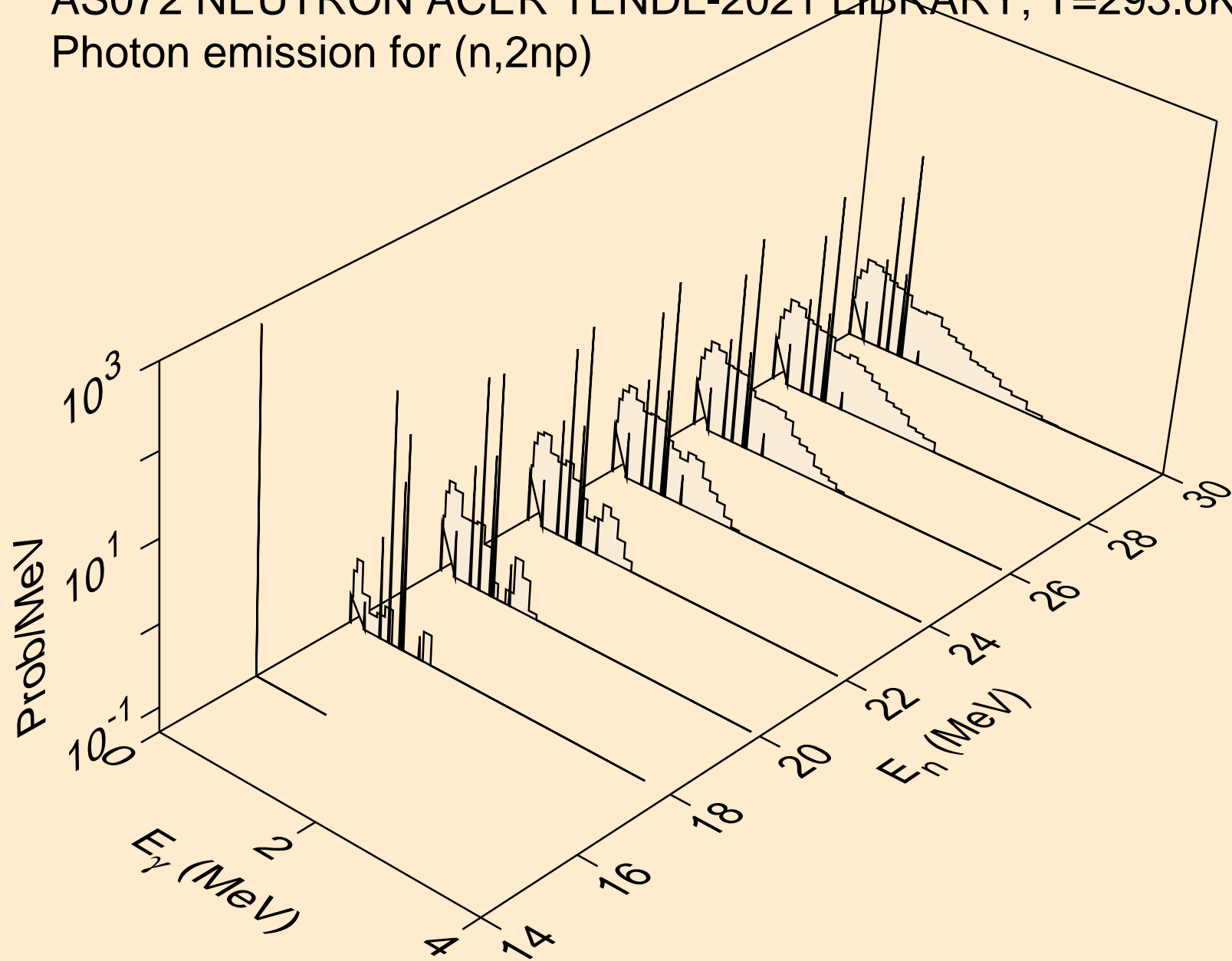

AS072 NEUTRON ACER TENDL-2021 LIBRARY; T=293.6K
Photon emission for (n,npa)

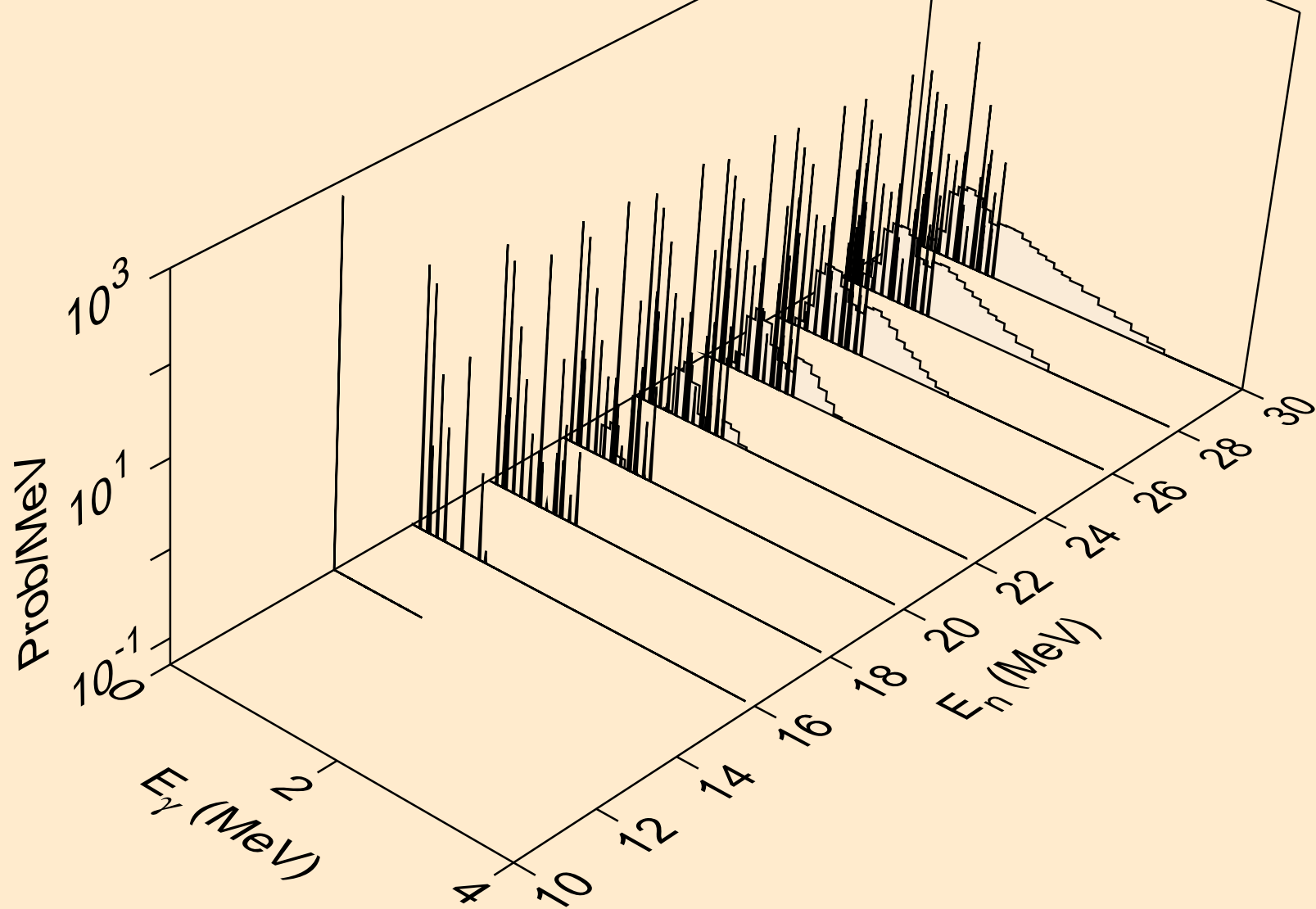

AS072 NEUTRON ACER TENDL-2021 LIBRARY; T=293.6K
Photon emission for (n,n*c)

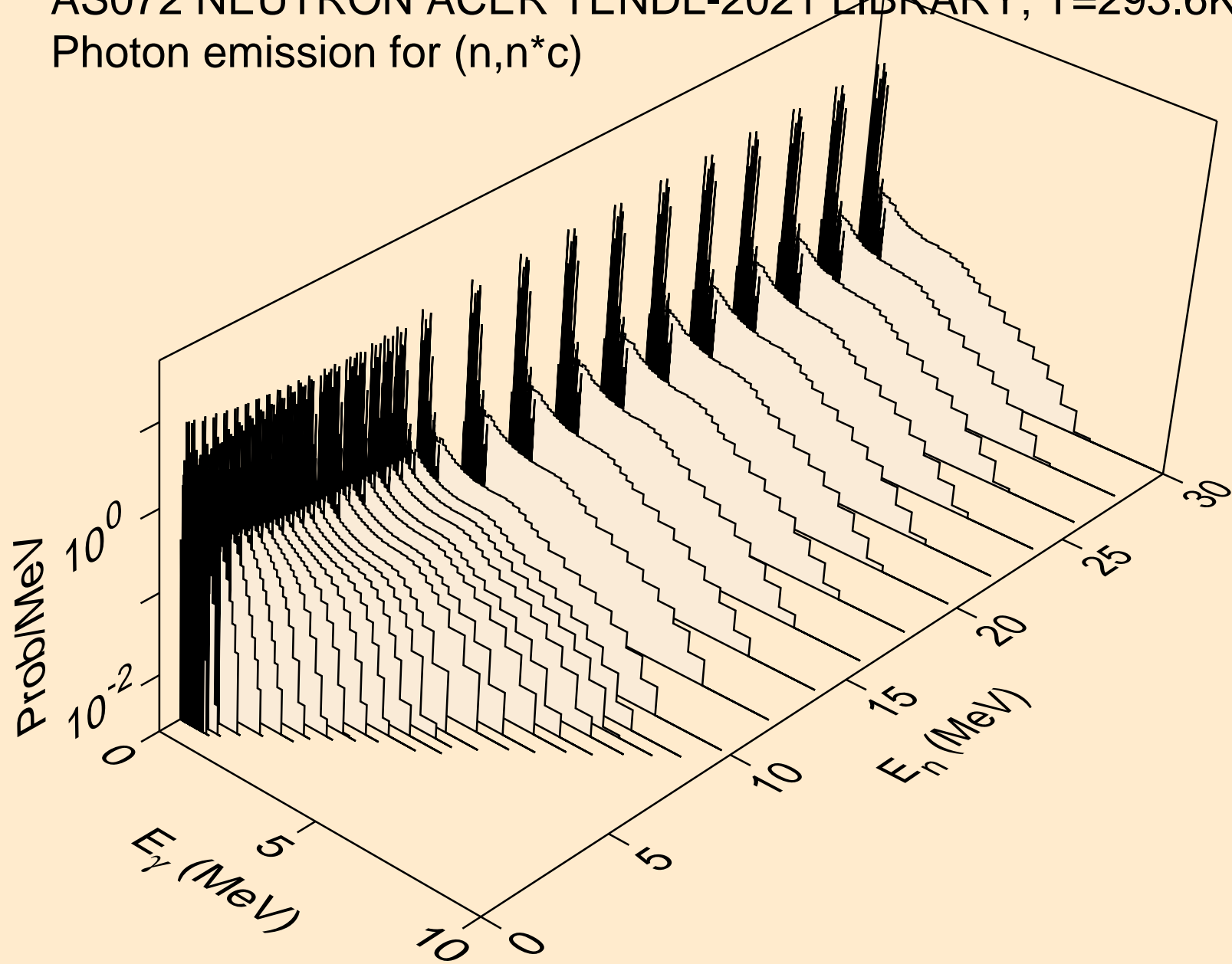

AS072 NEUTRON ACER TENDL-2021 LIBRARY; T=293.6K
Photon emission for (n,gma)

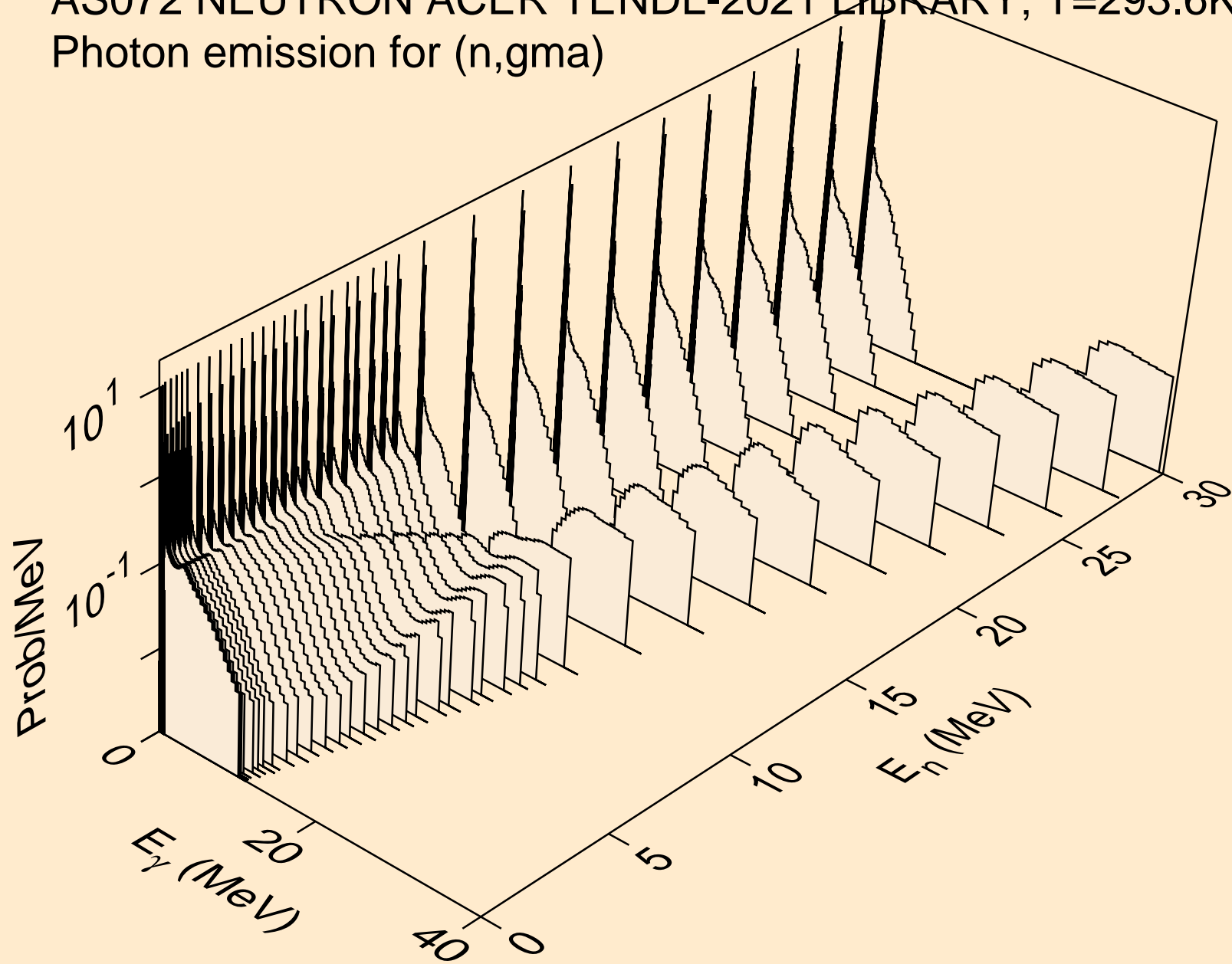

AS072 NEUTRON ACER TENDL-2021 LIBRARY; T=293.6K
Photon emission for (n,p)

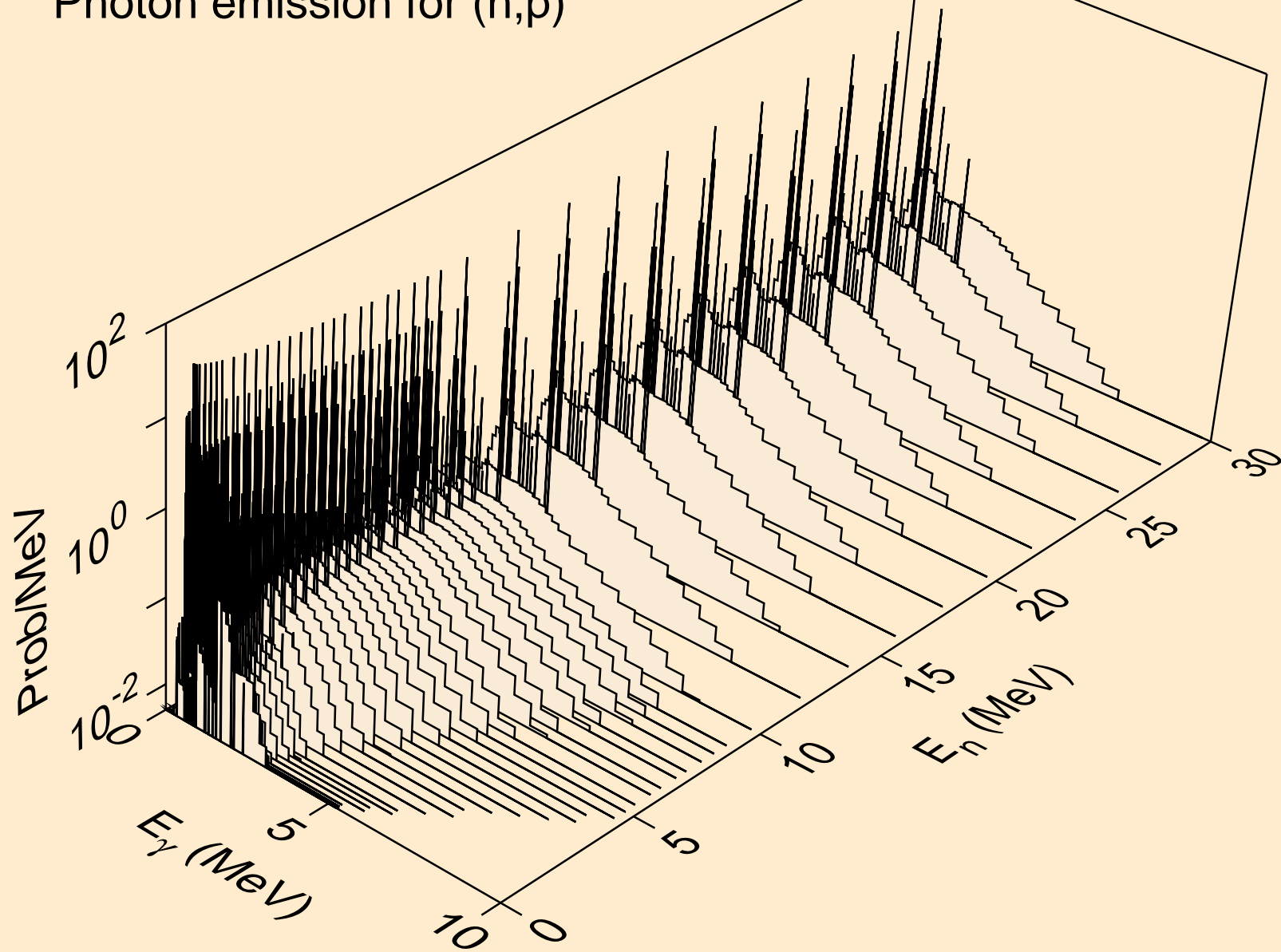

AS072 NEUTRON ACER TENDL-2021 LIBRARY; T=293.6K
Photon emission for (n,d)

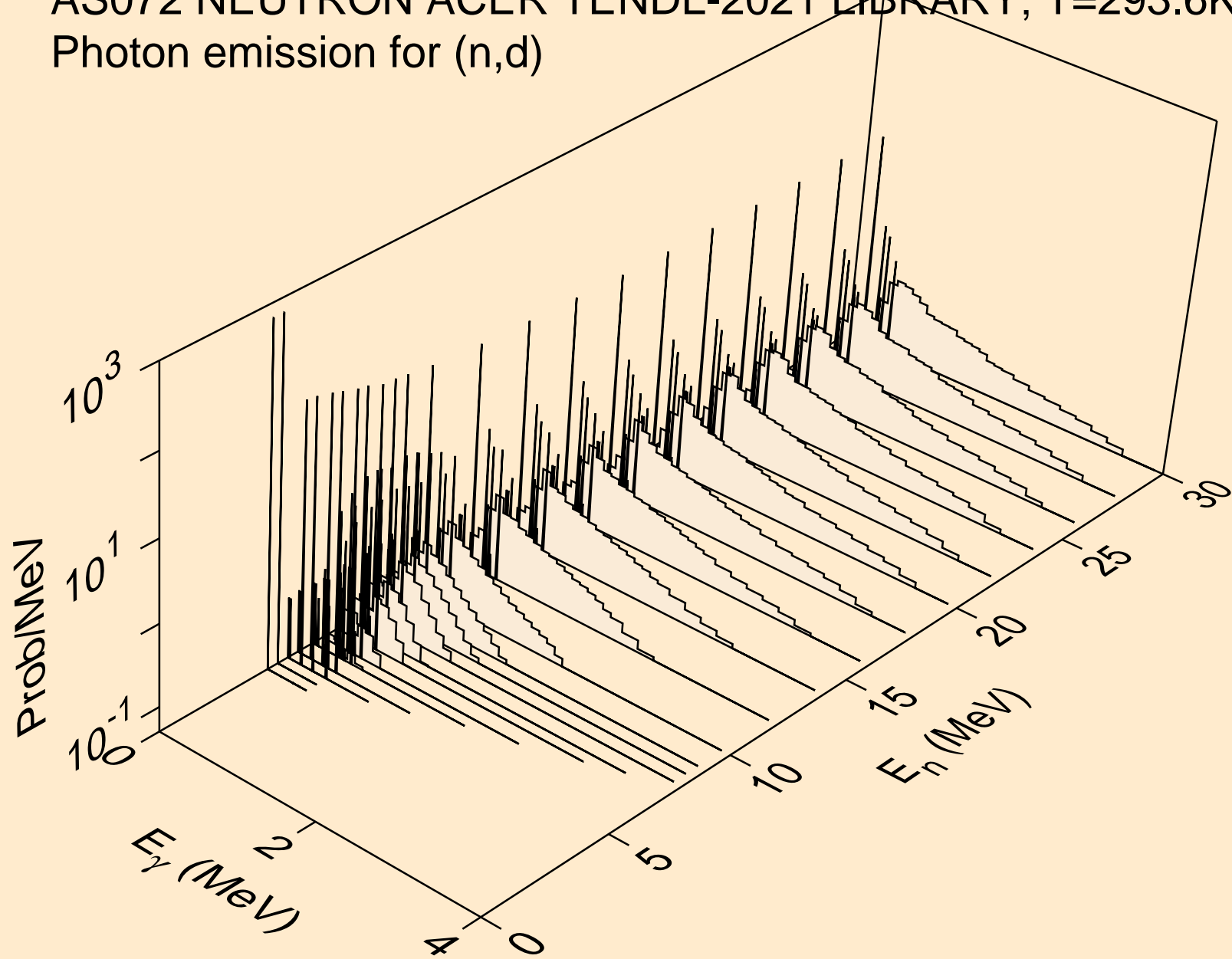

AS072 NEUTRON ACER TENDL-2021 LIBRARY; T=293.6K
Photon emission for (n,t)

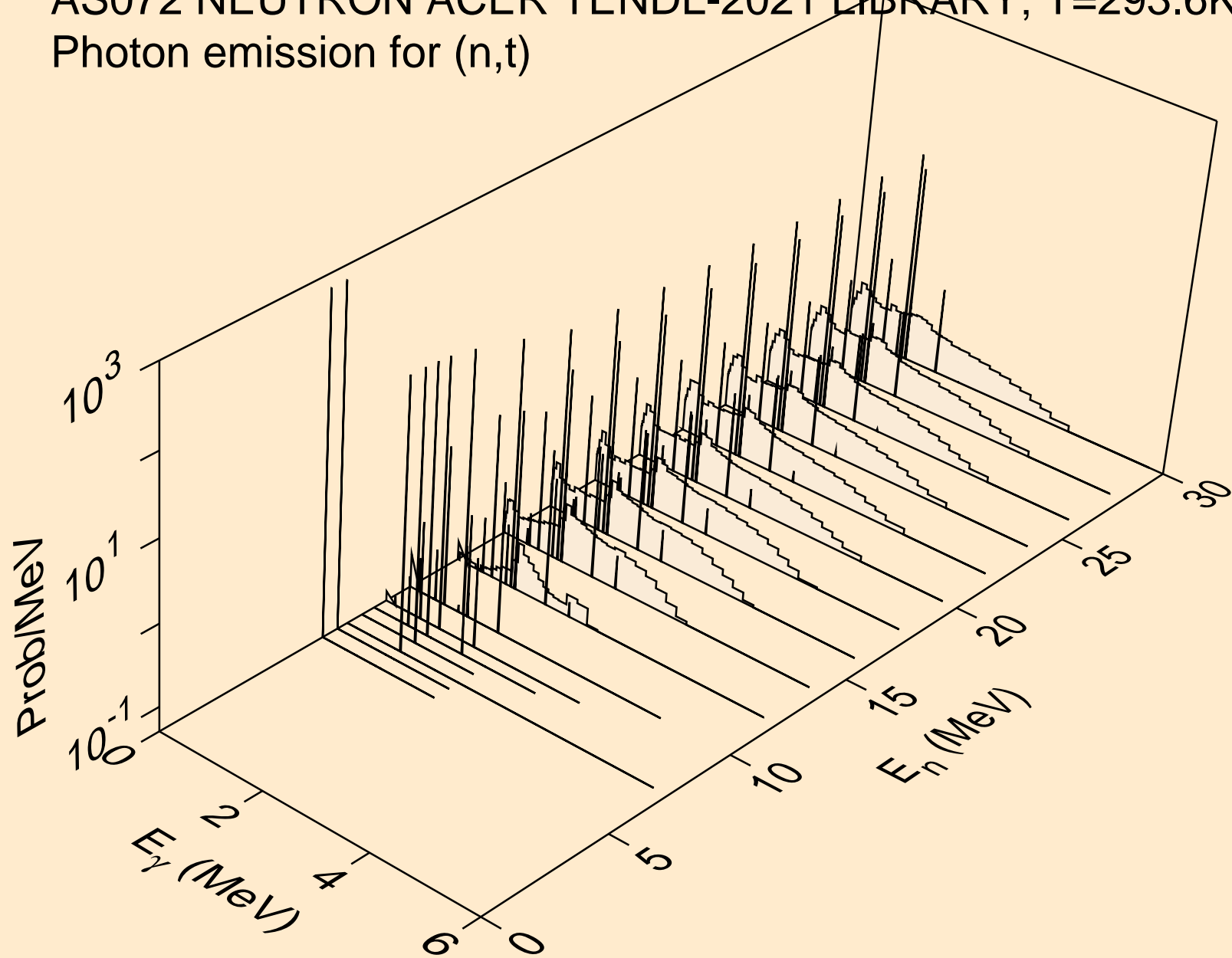

AS072 NEUTRON ACER TENDL-2021 LIBRARY; T=293.6K
Photon emission for (n,he3)

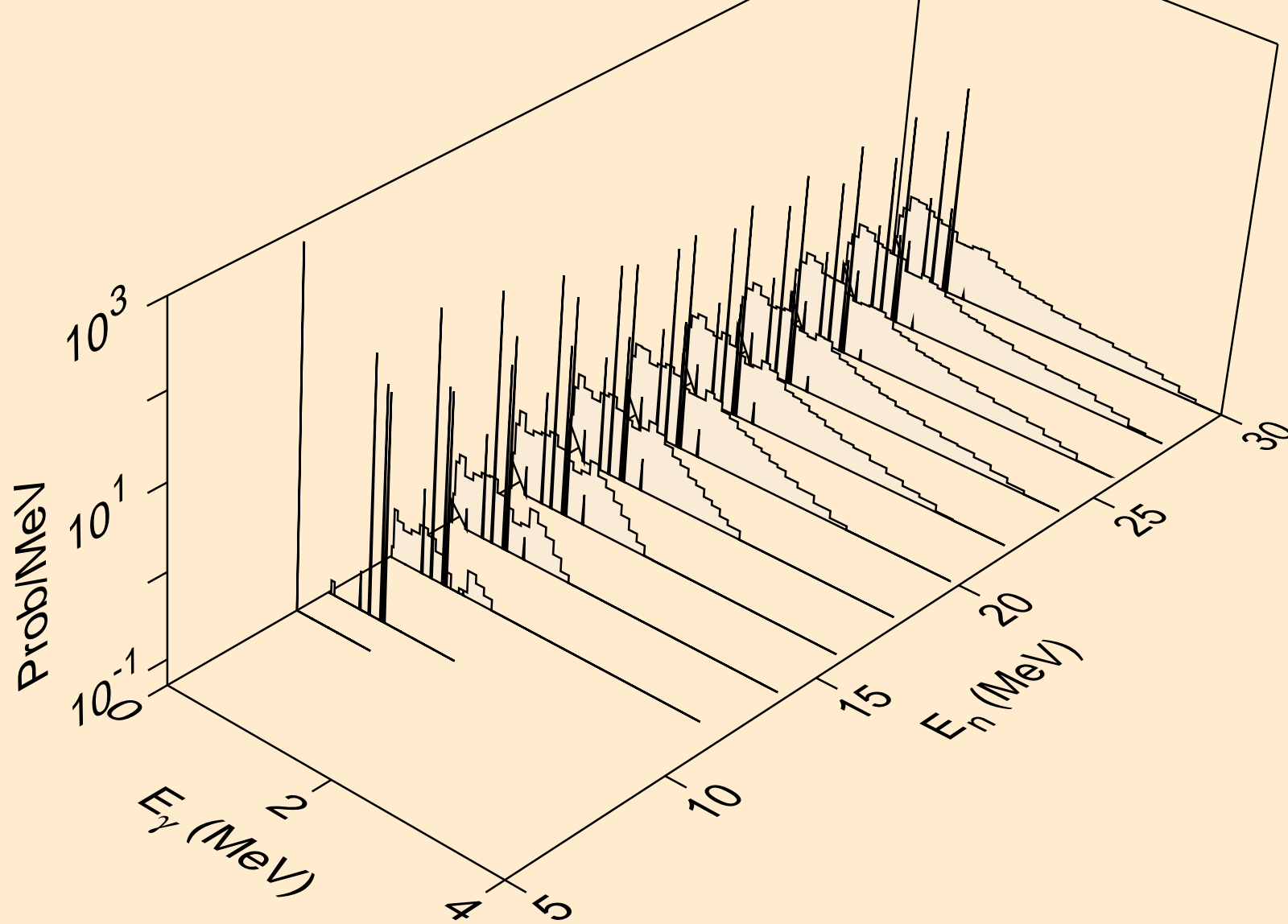

AS072 NEUTRON ACER TENDL-2021 LIBRARY; T=293.6K
Photon emission for (n,a)

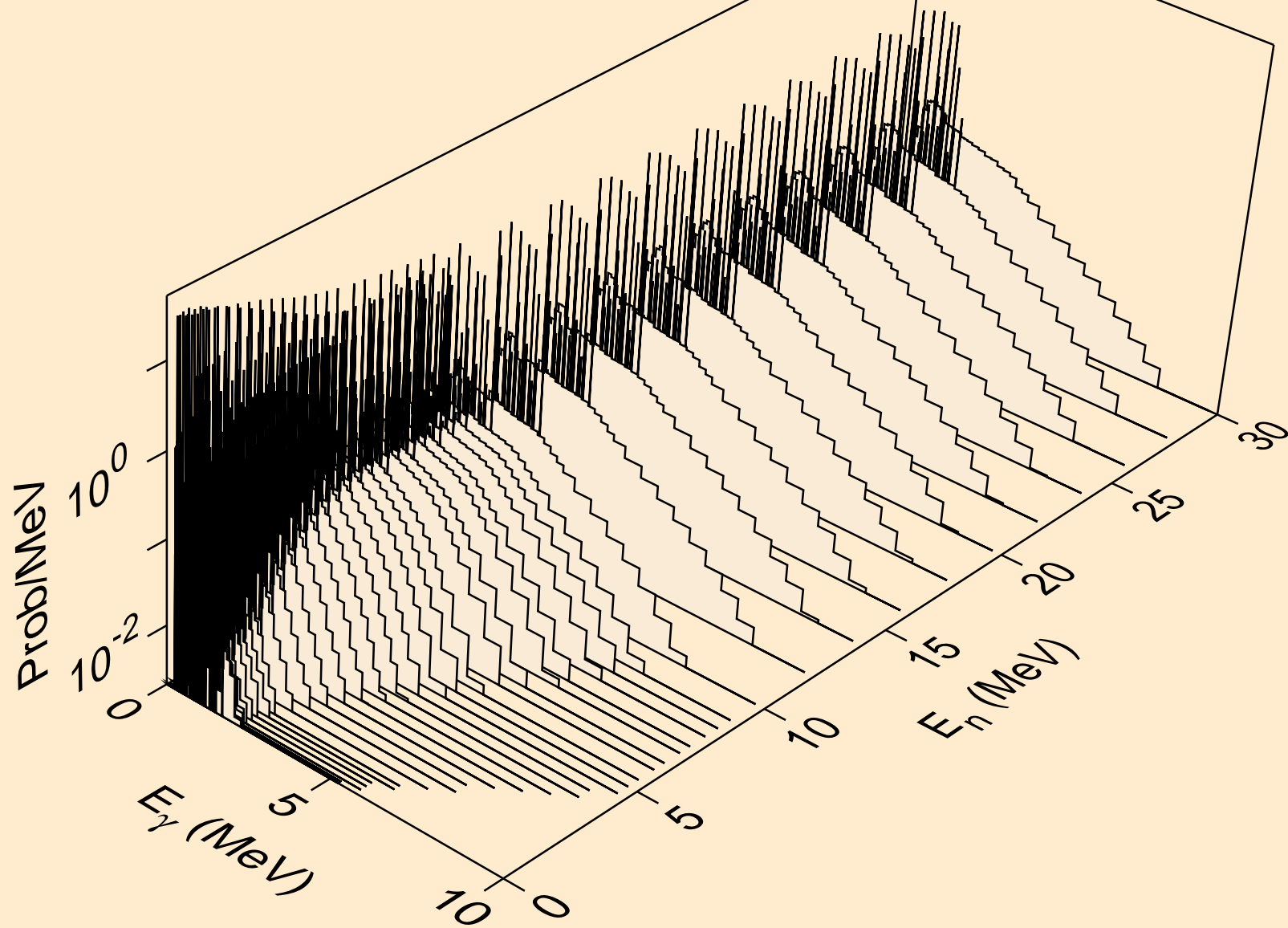

AS072 NEUTRON ACER TENDL-2021 LIBRARY; T=293.6K
Photon emission for (n,2a)

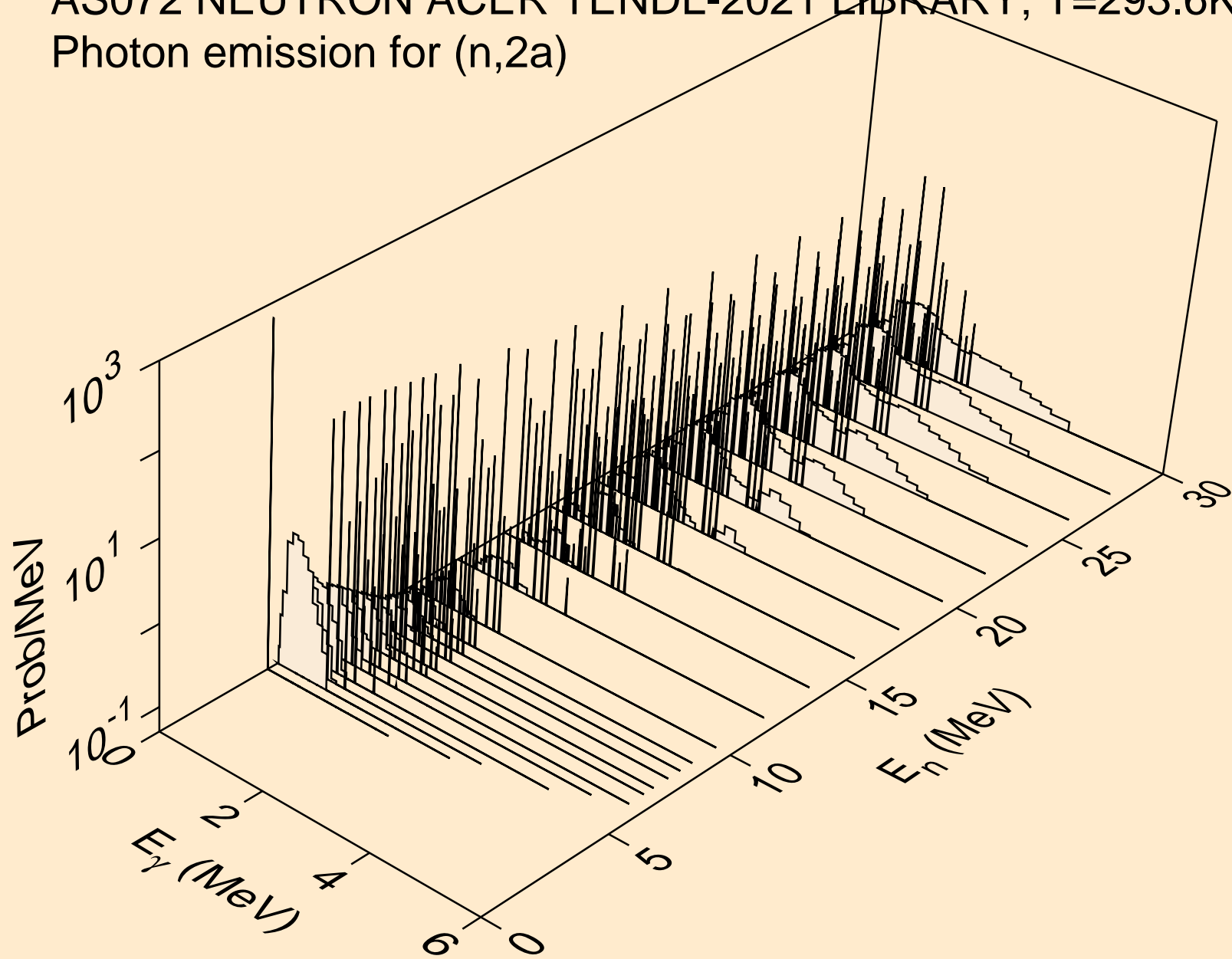

AS072 NEUTRON ACER TENDL-2021 LIBRARY; T=293.6K
Photon emission for (n,3a)

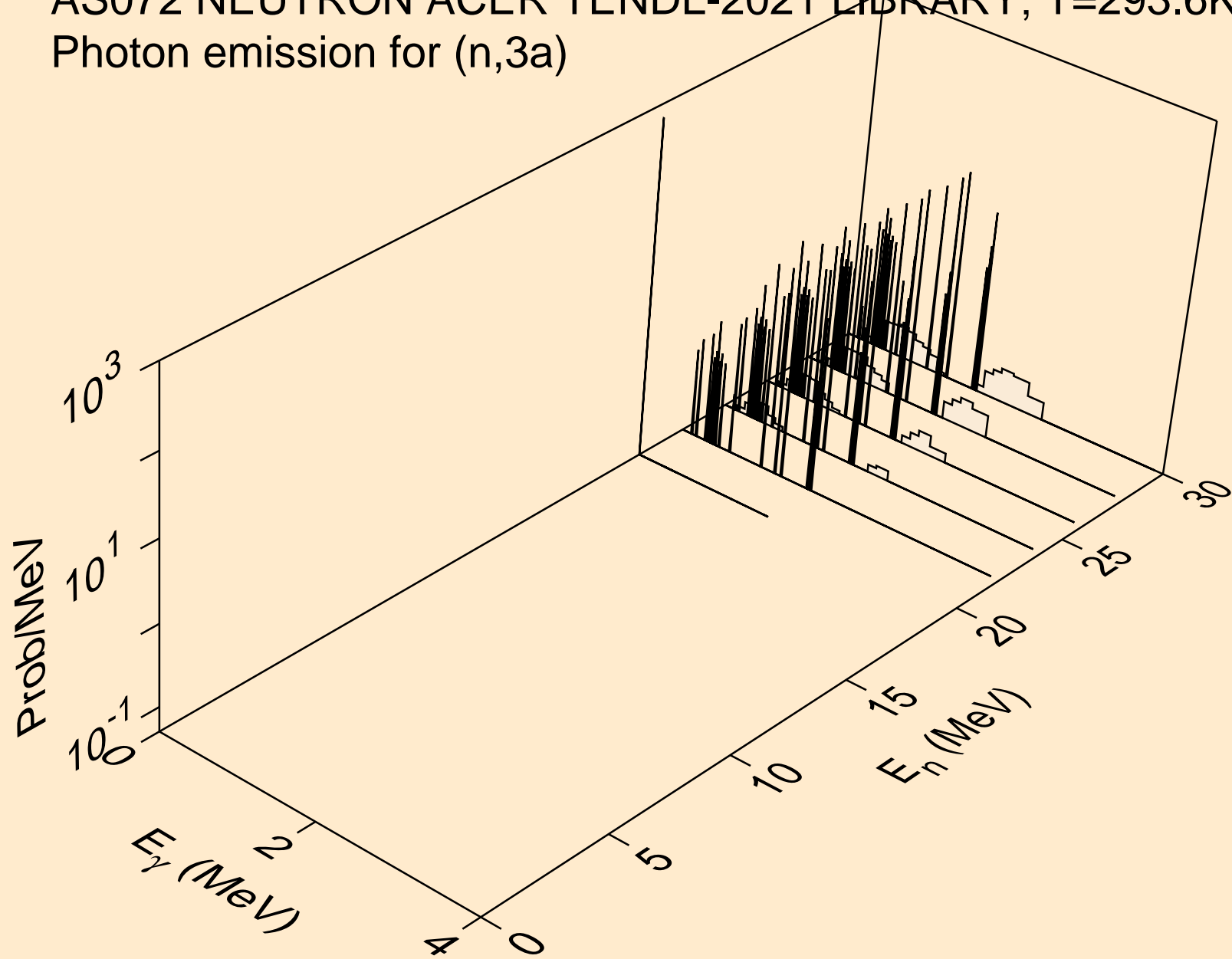

AS072 NEUTRON ACER TENDL-2021 LIBRARY; T=293.6K
Photon emission for (n,2p)

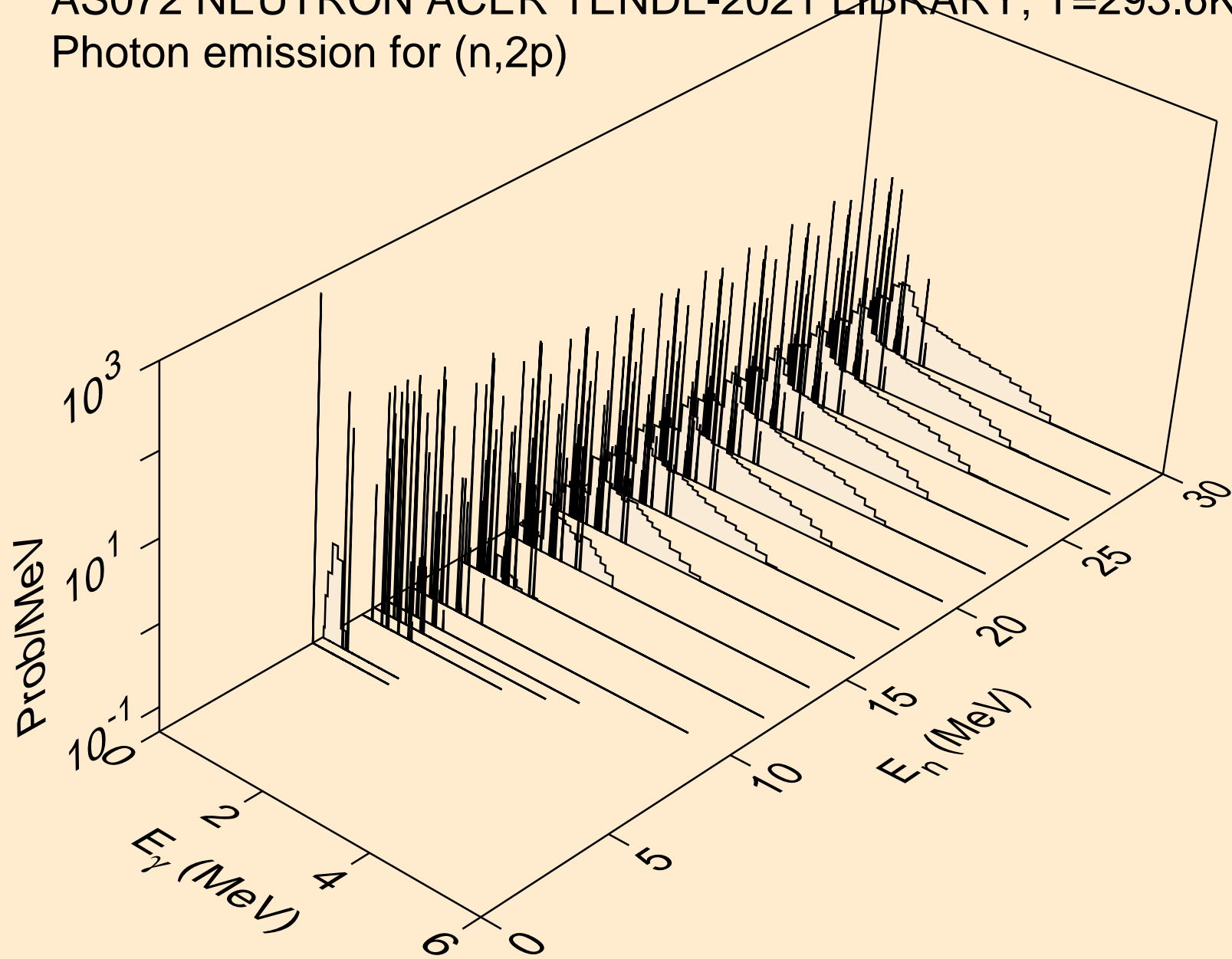

AS072 NEUTRON ACER TENDL-2021 LIBRARY; T=293.6K
Photon emission for (n,p α)

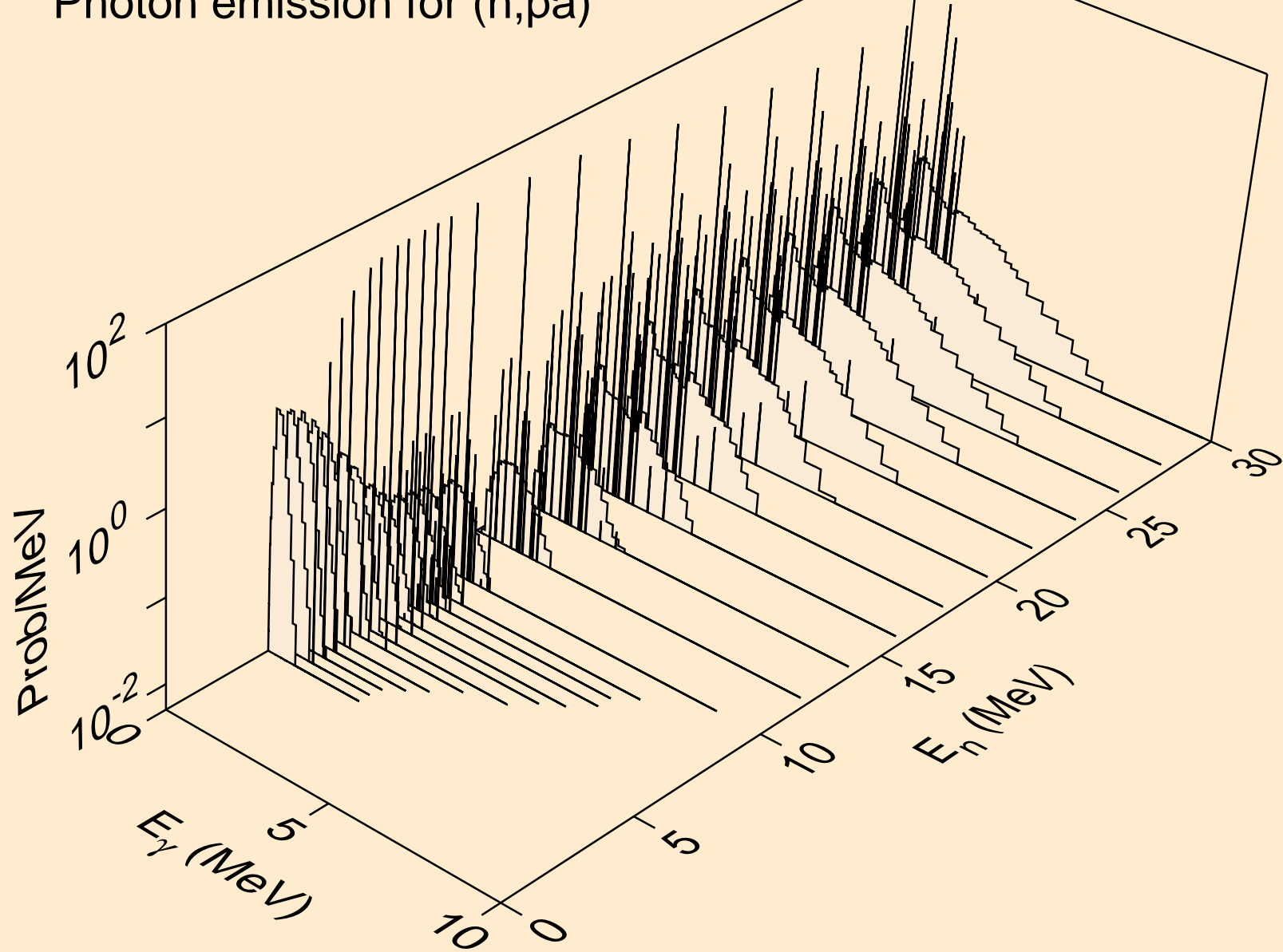

AS072 NEUTRON ACER TENDL-2021 LIBRARY; T=293.6K
Photon emission for (n,pd)

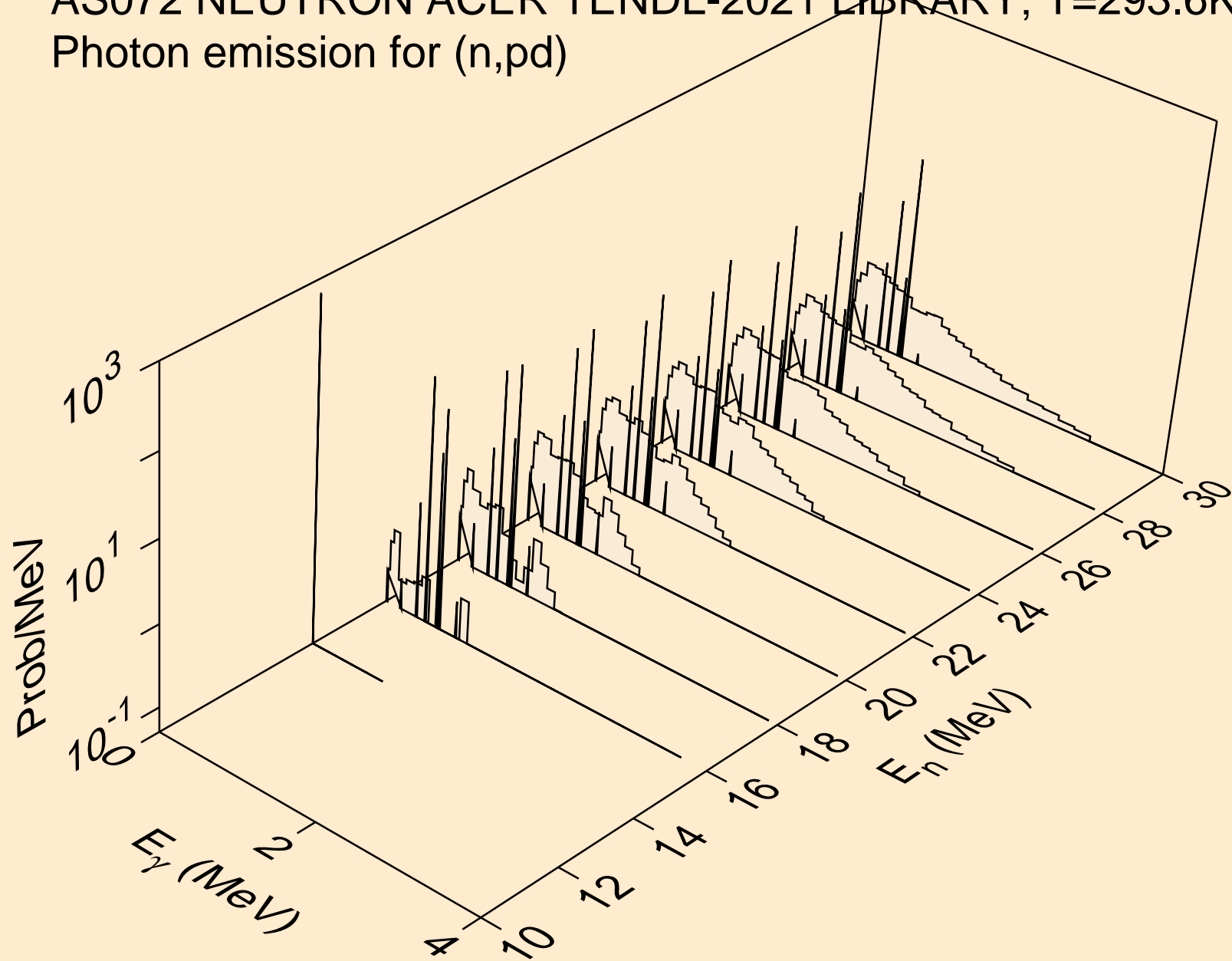

AS072 NEUTRON ACER TENDL-2021 LIBRARY; T=293.6K
Photon emission for (n,pt)

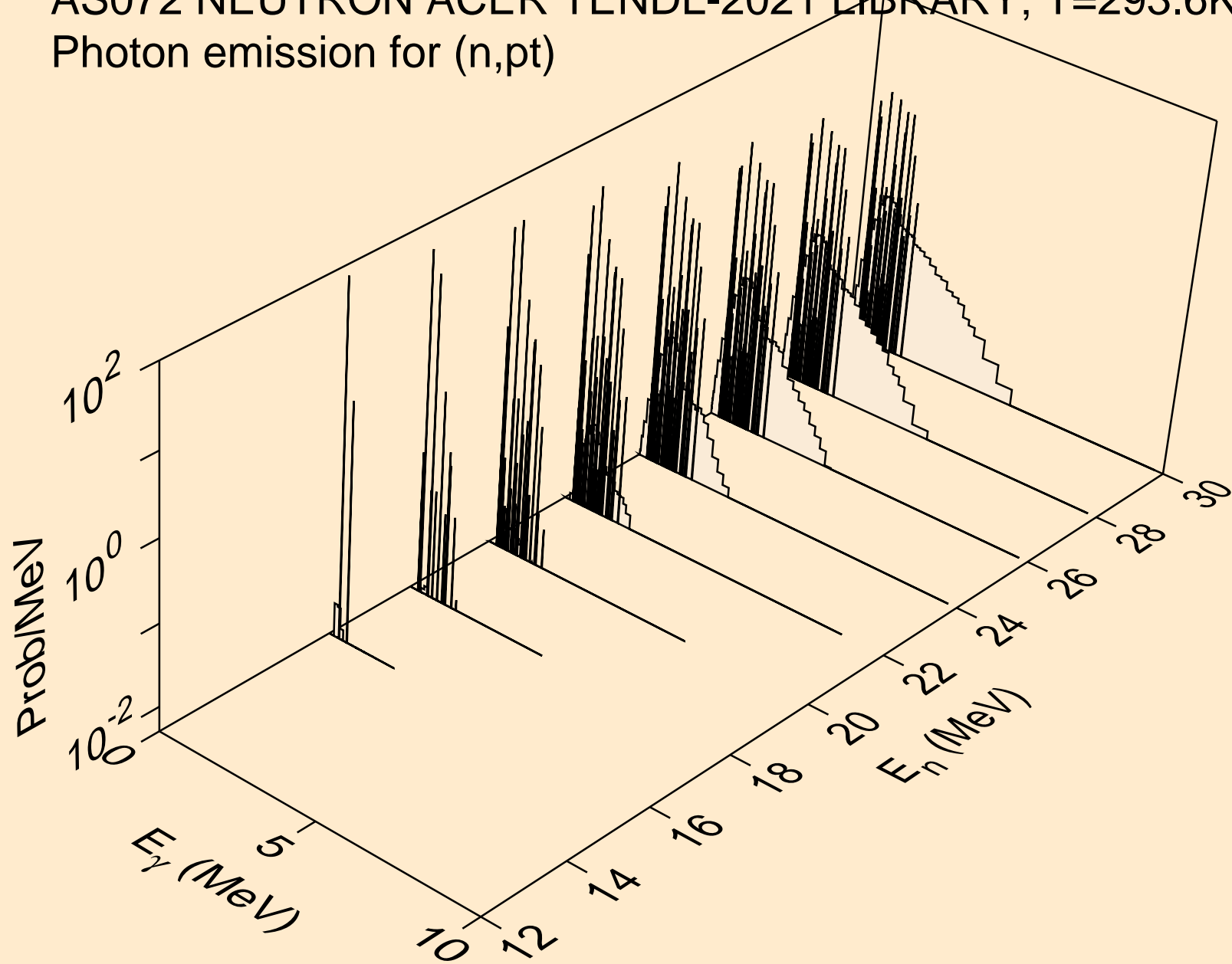

AS072 NEUTRON ACER TENDL-2021 LIBRARY; T=293.6K
Photon emission for (n,da)

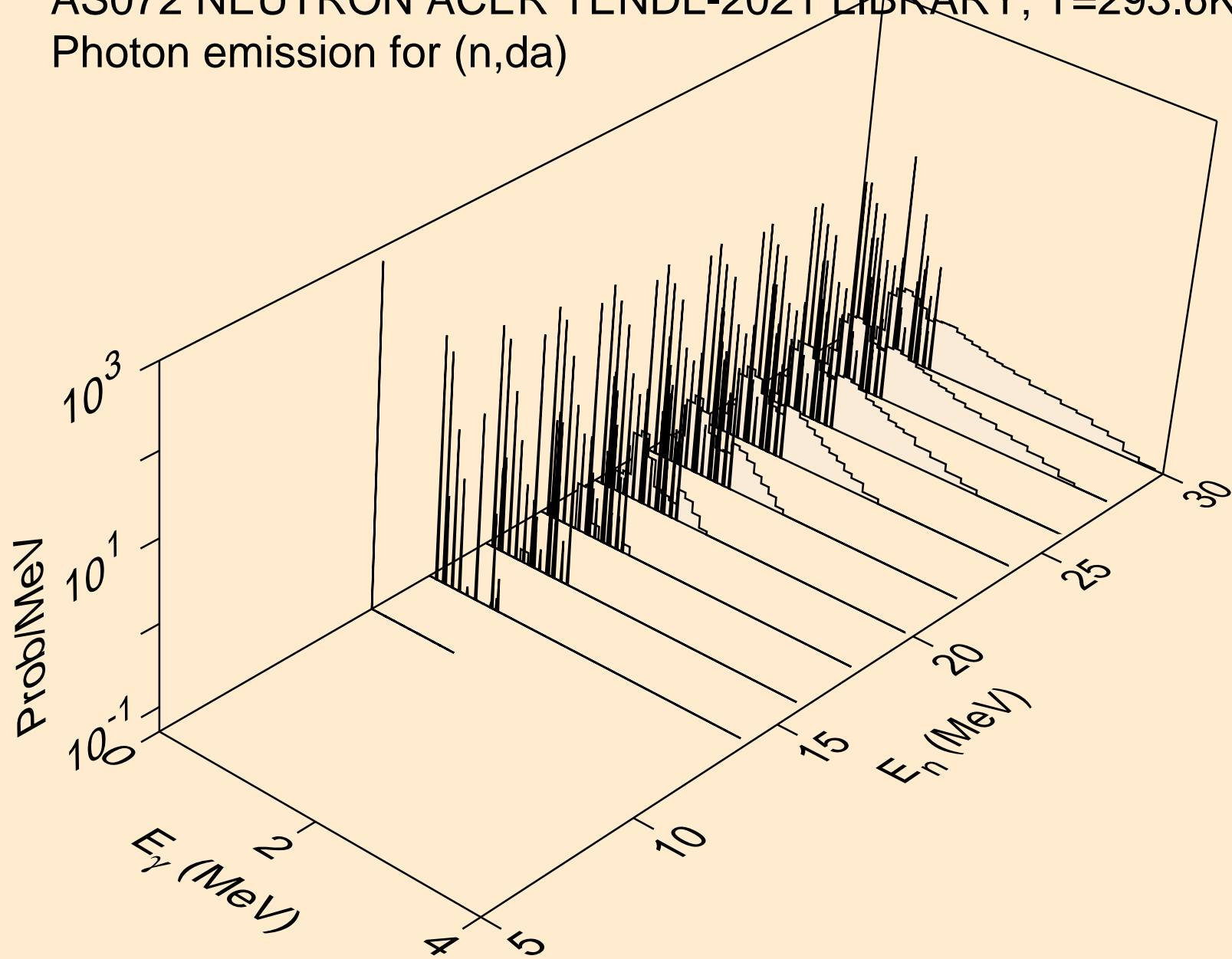

AS072 NEUTRON ACER TENDL-2021 LIBRARY; T=293.6K
thermal capture photon spectrum

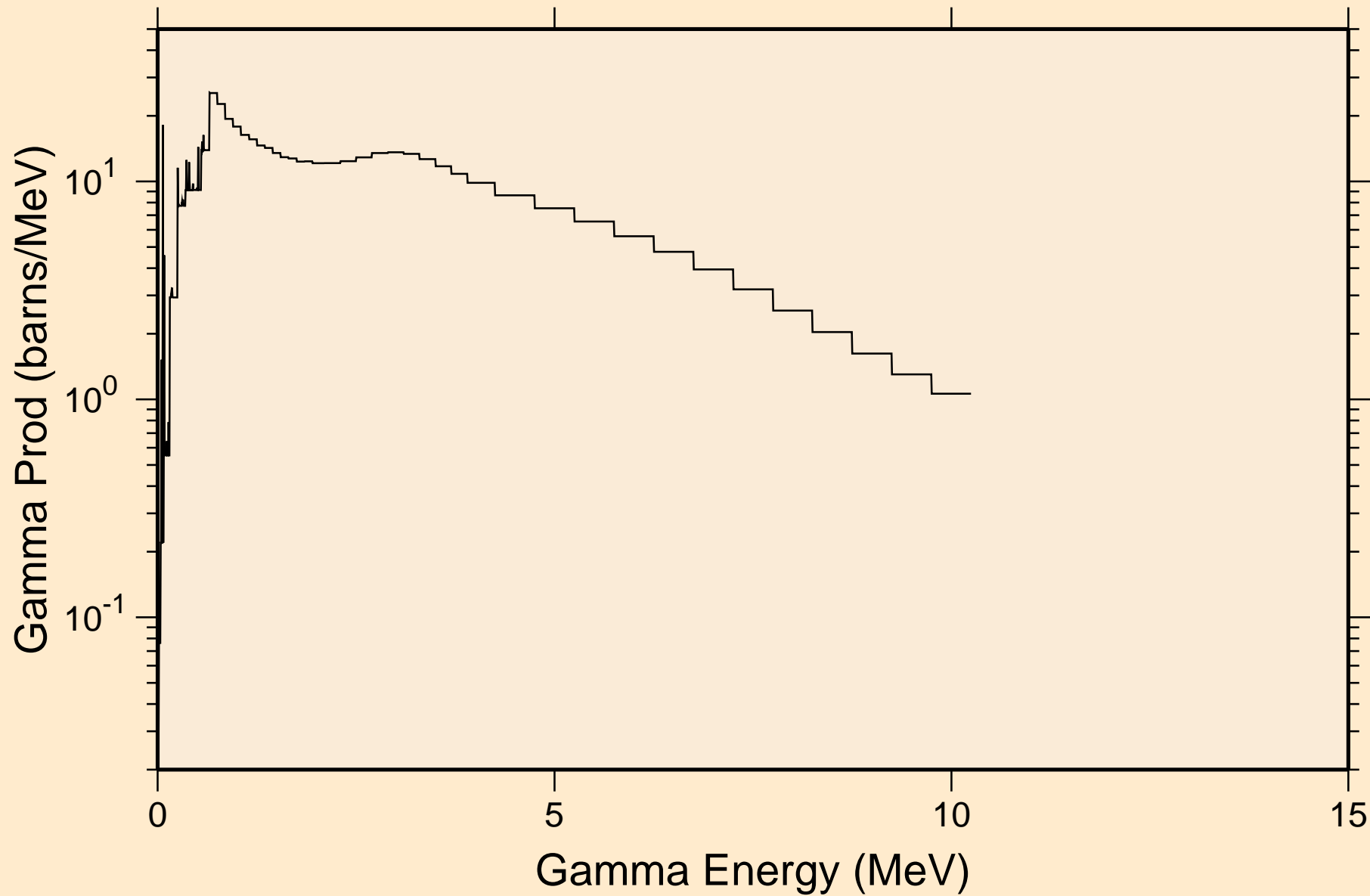

AS072 NEUTRON ACER TENDL-2021 LIBRARY; T=293.6K
14 MeV photon spectrum

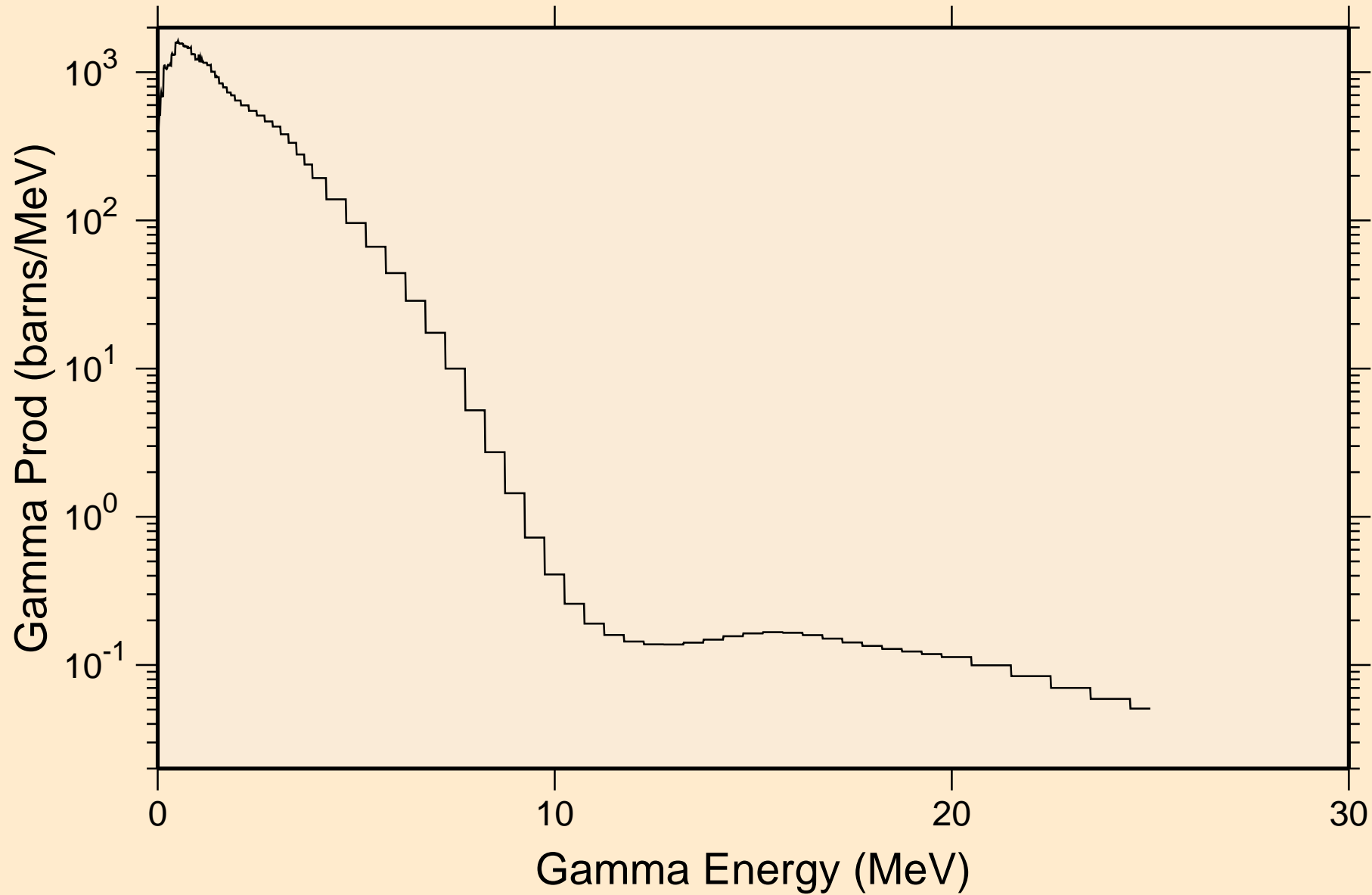

AS072 NEUTRON ACER TENDL-2021 LIBRARY; T=293.6K
Particle heating contributions

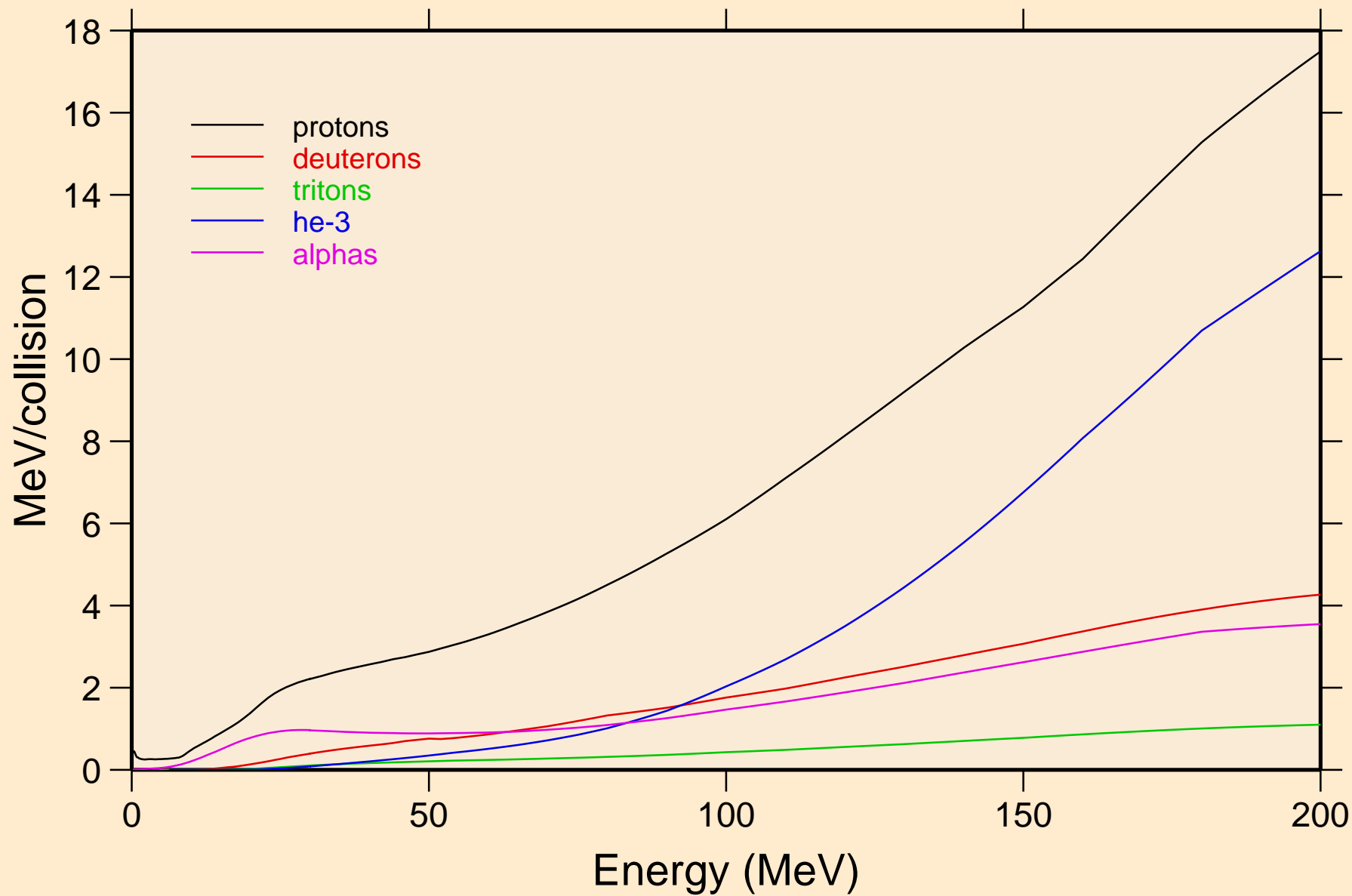

AS072 NEUTRON ACER TENDL-2021 LIBRARY; T=293.6K
Recoil Heating

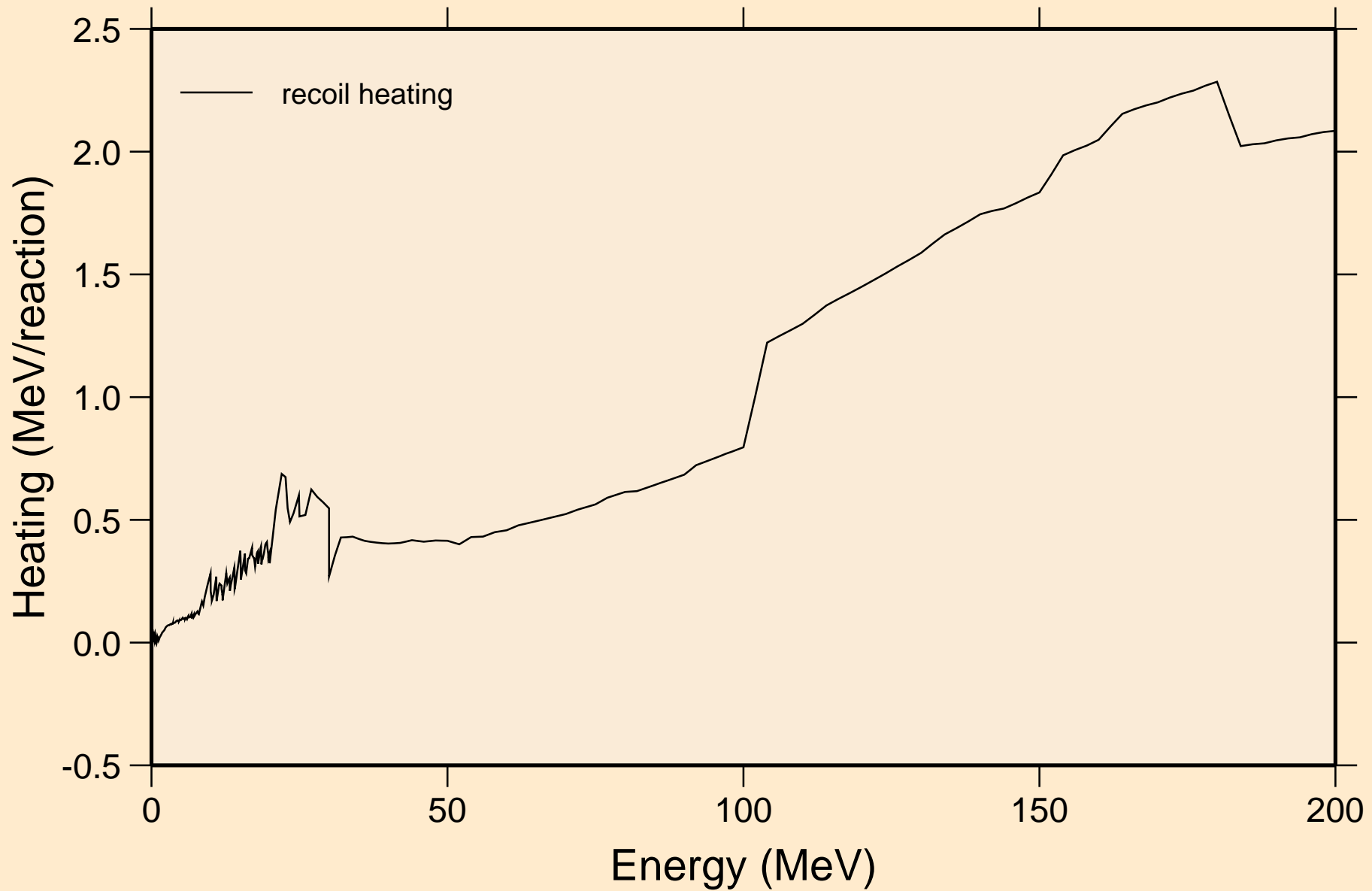

AS072 NEUTRON ACER TENDL-2021 LIBRARY; T=293.6K
Particle production cross sections

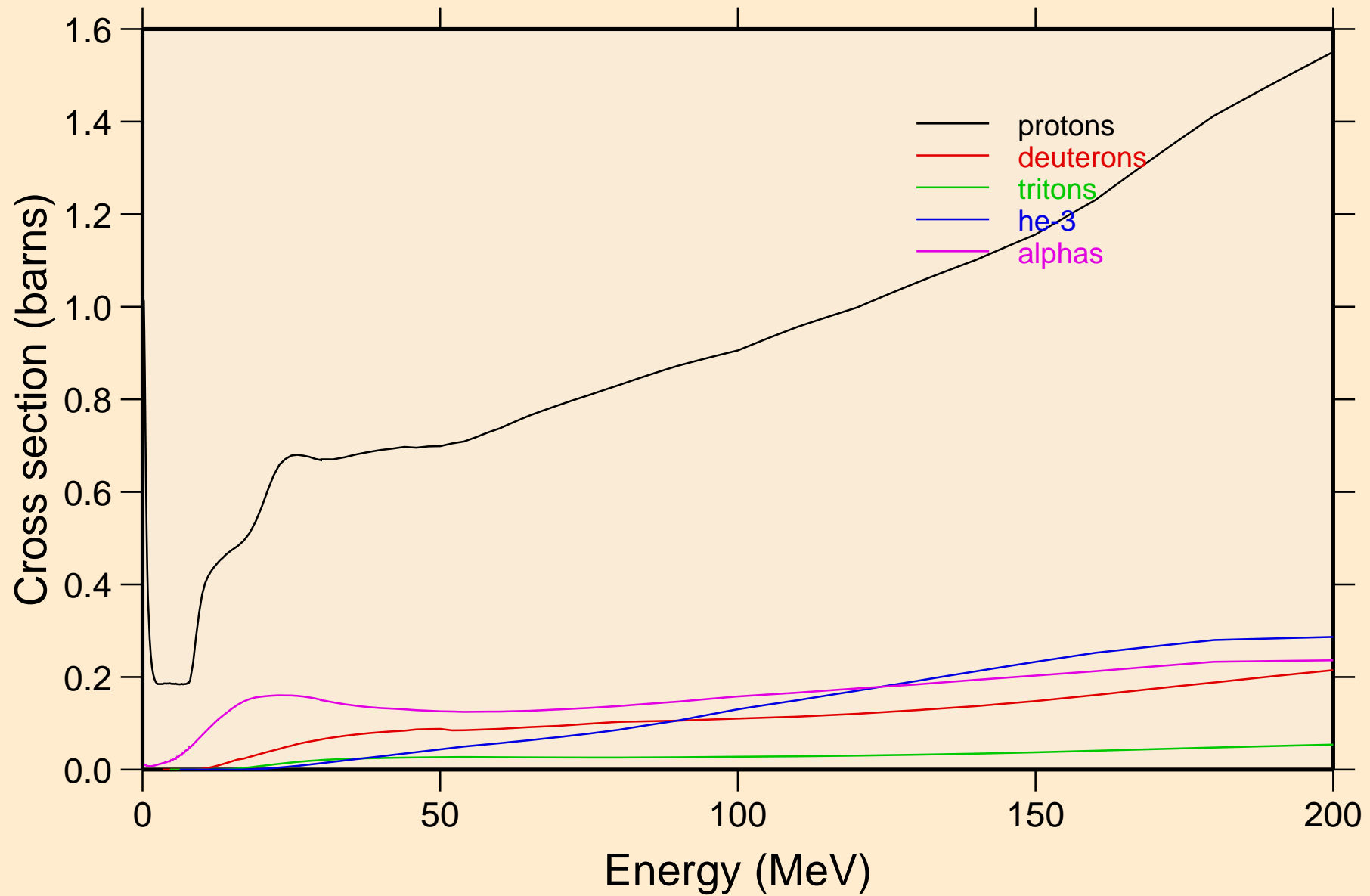

AS072 NEUTRON ACER TENDL-2021 LIBRARY; T=293.6K
protons from (n,x)

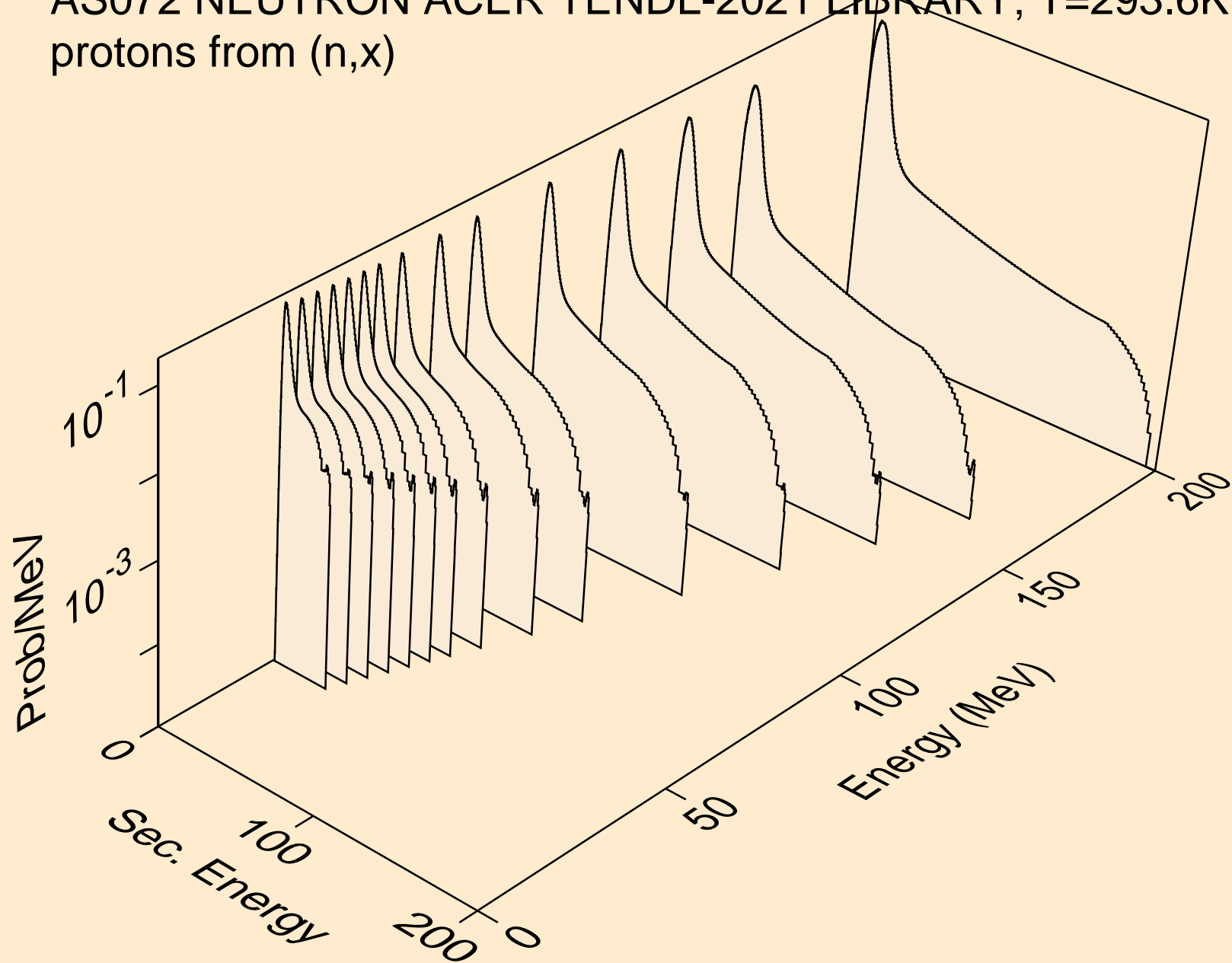

AS072 NEUTRON ACER TENDL-2021 LIBRARY; T=293.6K
protons from (n,n*)p

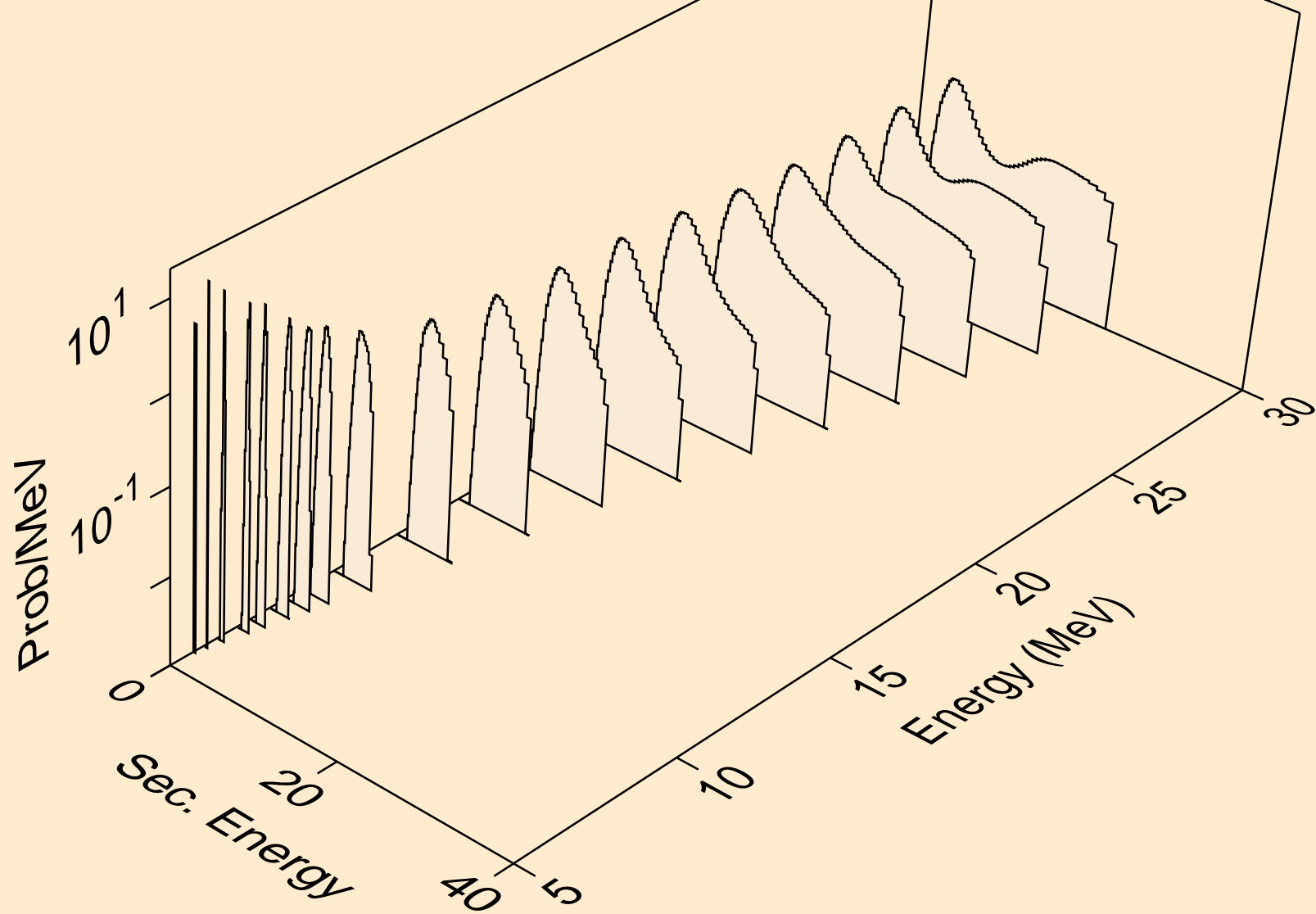

AS072 NEUTRON ACER TENDL-2021 LIBRARY; T=293.6K
protons from (n,2np)

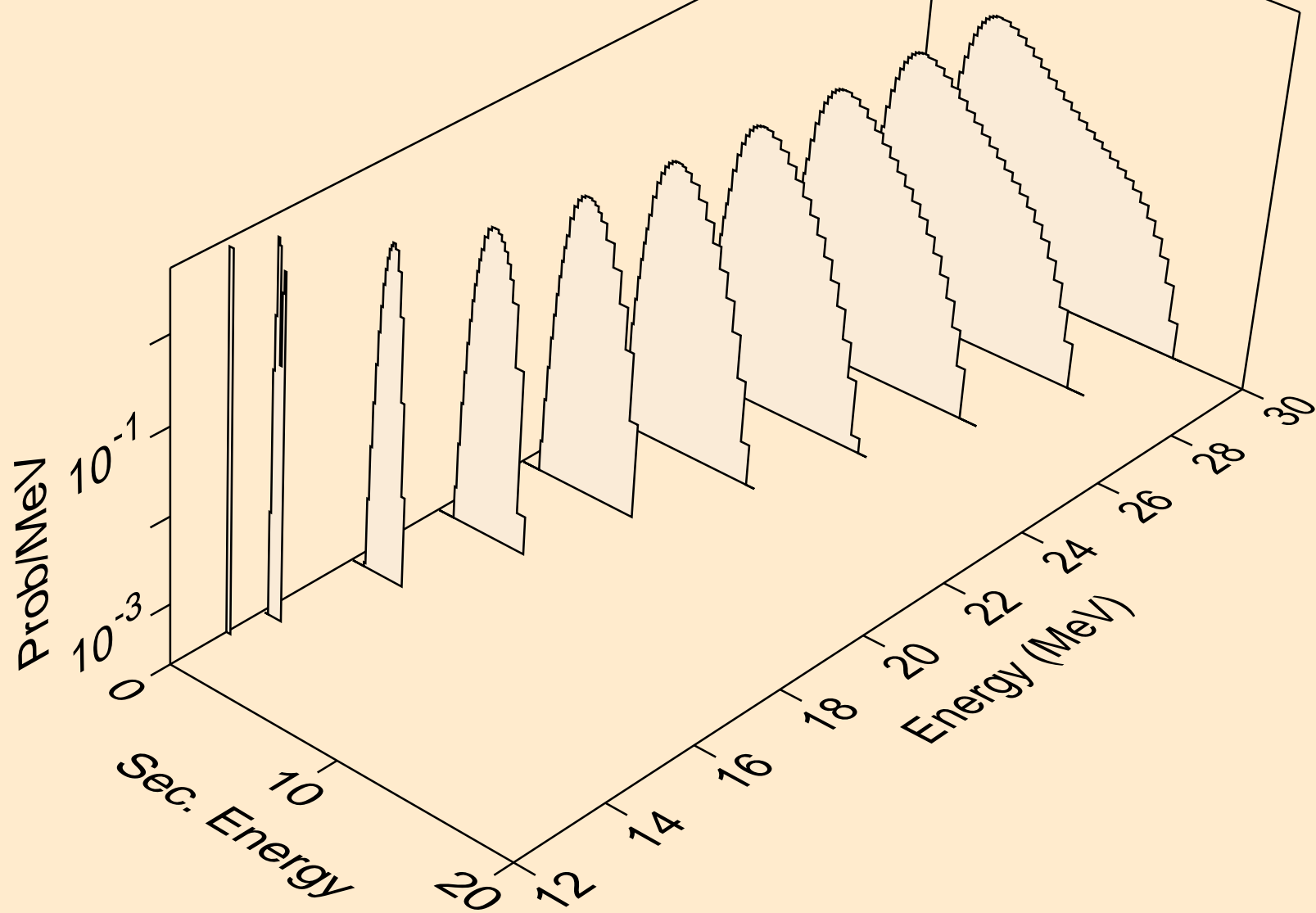

AS072 NEUTRON ACER TENDL-2021 LIBRARY; T=293.6K
protons from (n,3np)

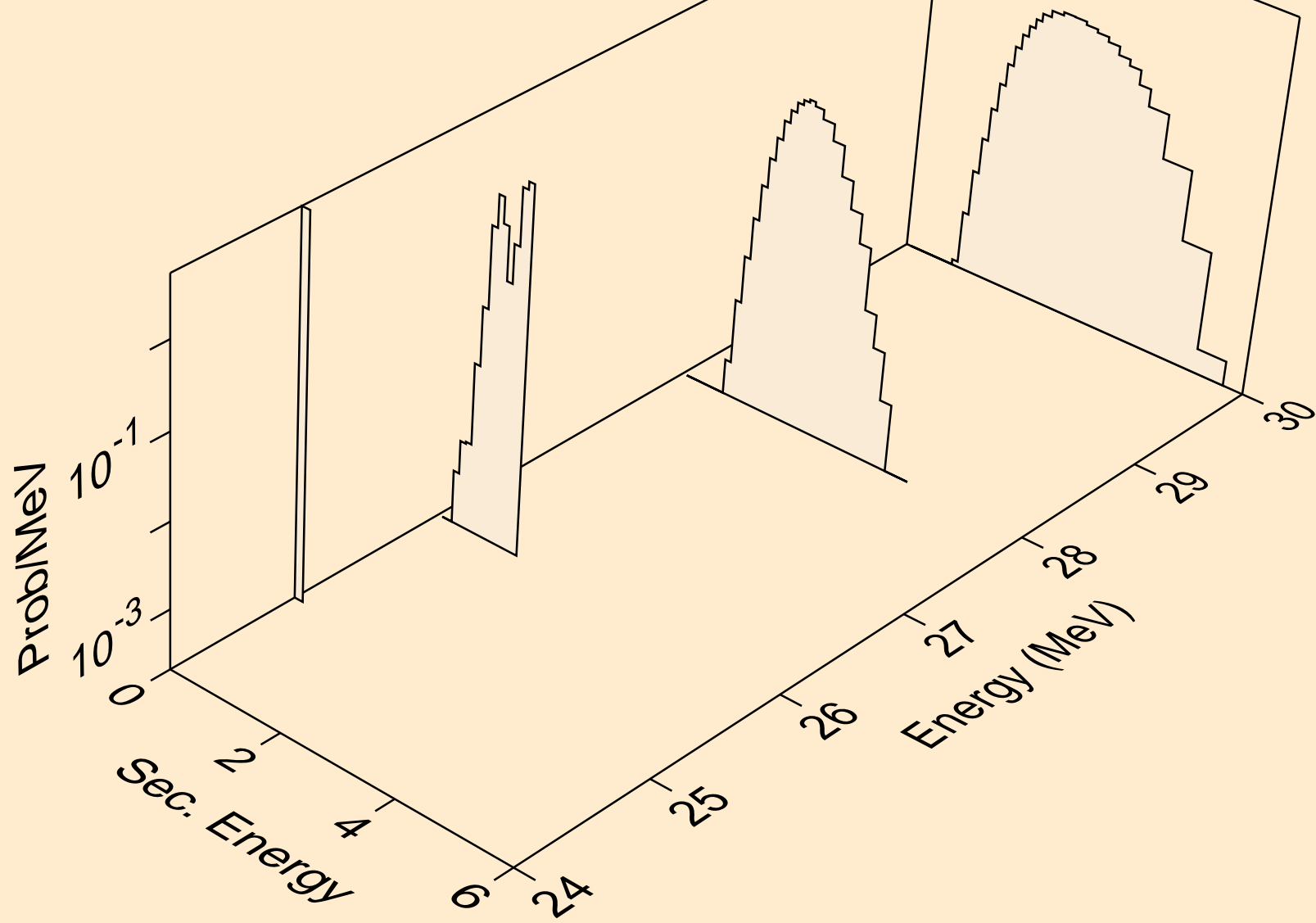

AS072 NEUTRON ACER TENDL-2021 LIBRARY; T=293.6K
protons from (n,2np)

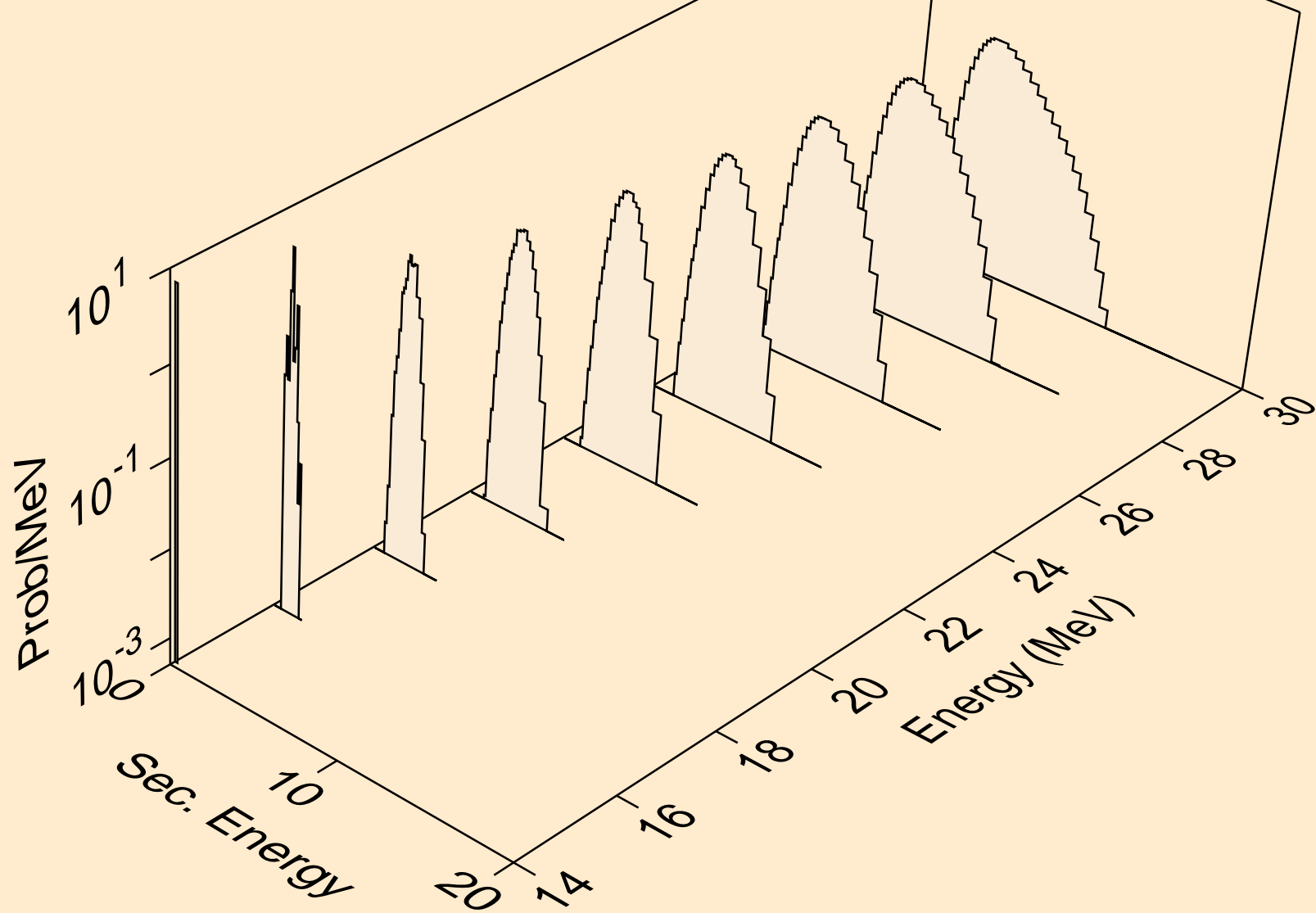

AS072 NEUTRON ACER TENDL-2021 LIBRARY; T=293.6K
protons from (n,npa)

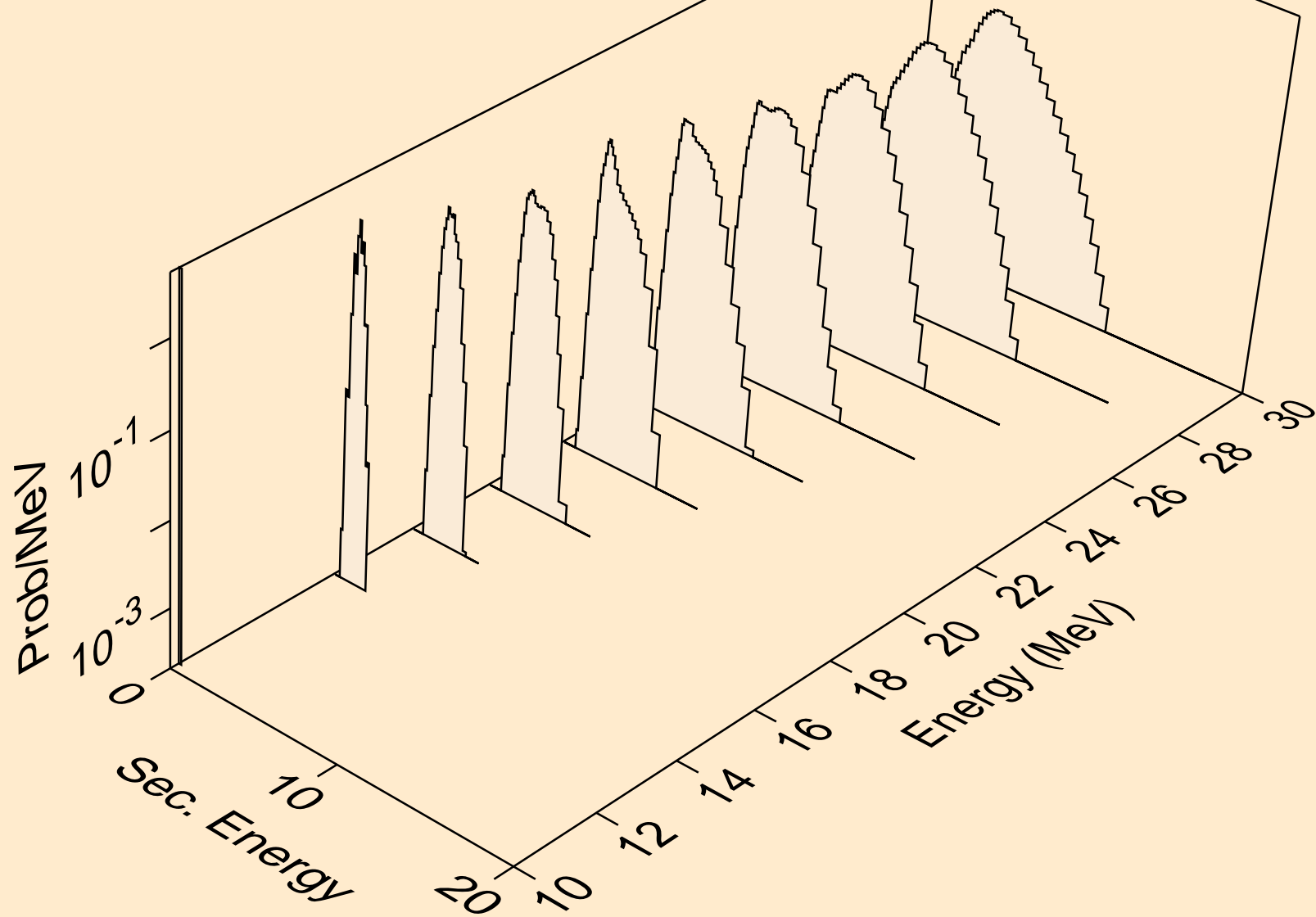

AS072 NEUTRON ACER TENDL-2021 LIBRARY; T=293.6K
protons from (n,p)

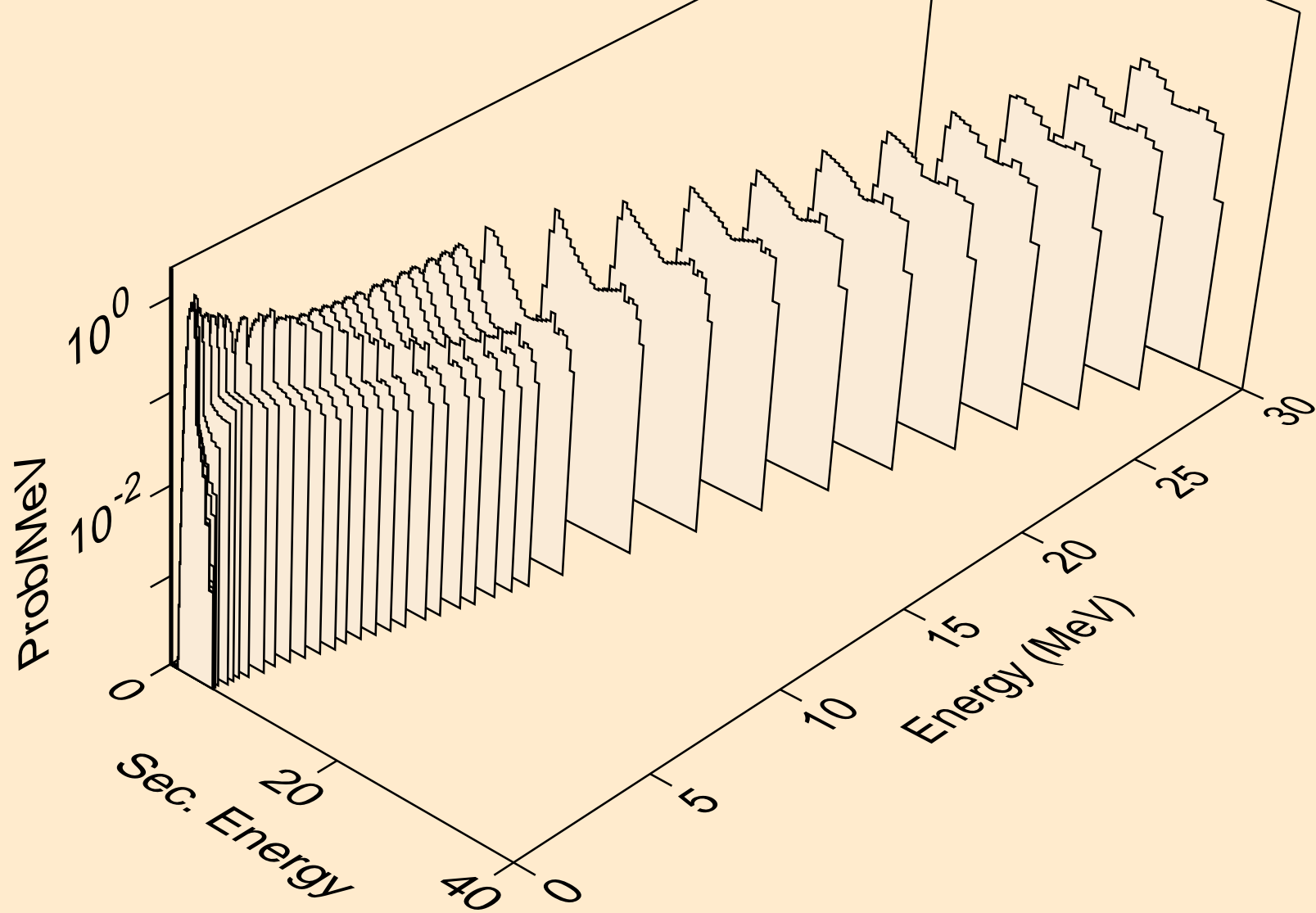

AS072 NEUTRON ACER TENDL-2021 LIBRARY; T=293.6K
protons from (n,2p)

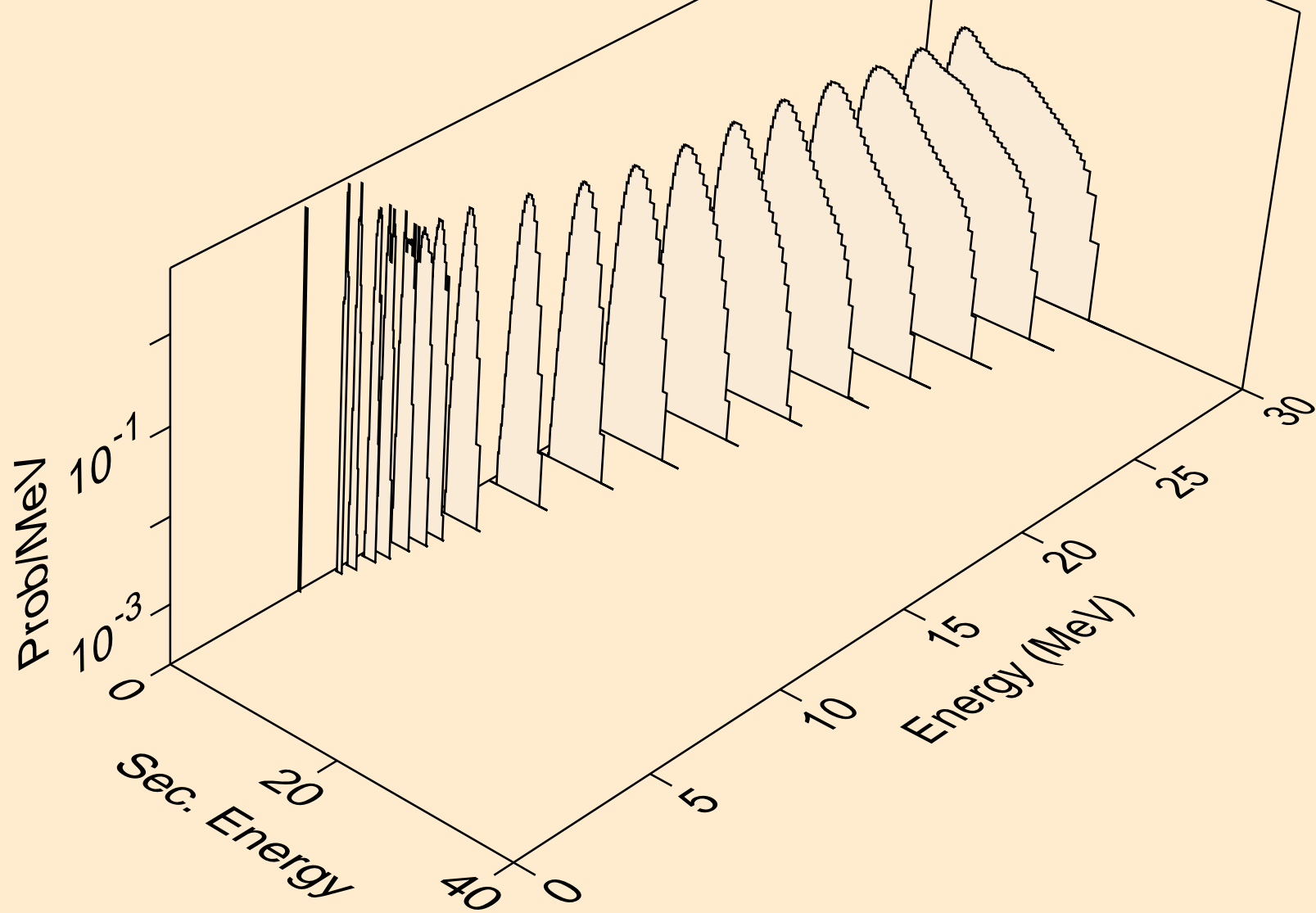

AS072 NEUTRON ACER TENDL-2021 LIBRARY; T=293.6K
protons from (n,p)

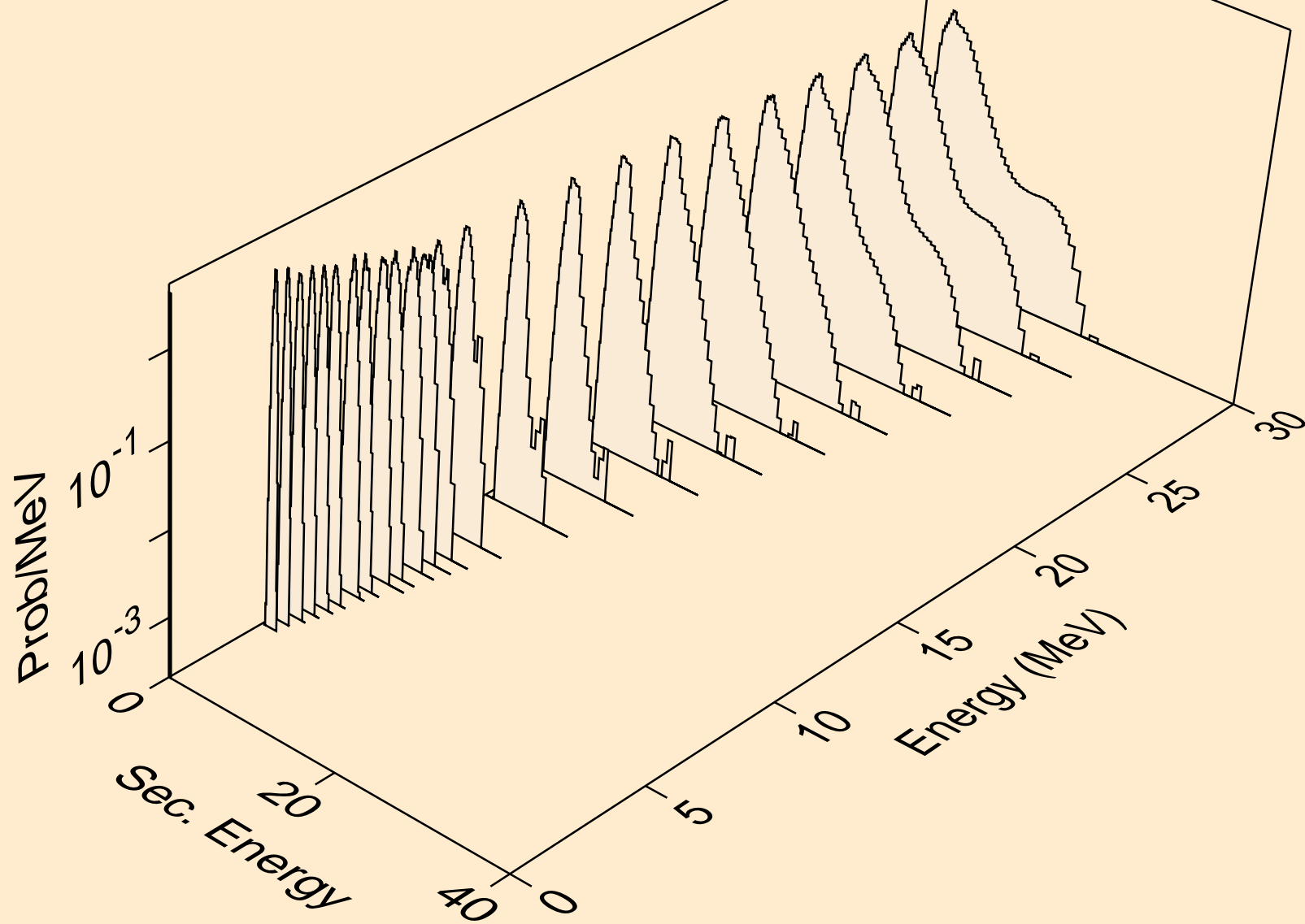

AS072 NEUTRON ACER TENDL-2021 LIBRARY; T=293.6K
protons from (n,pd)

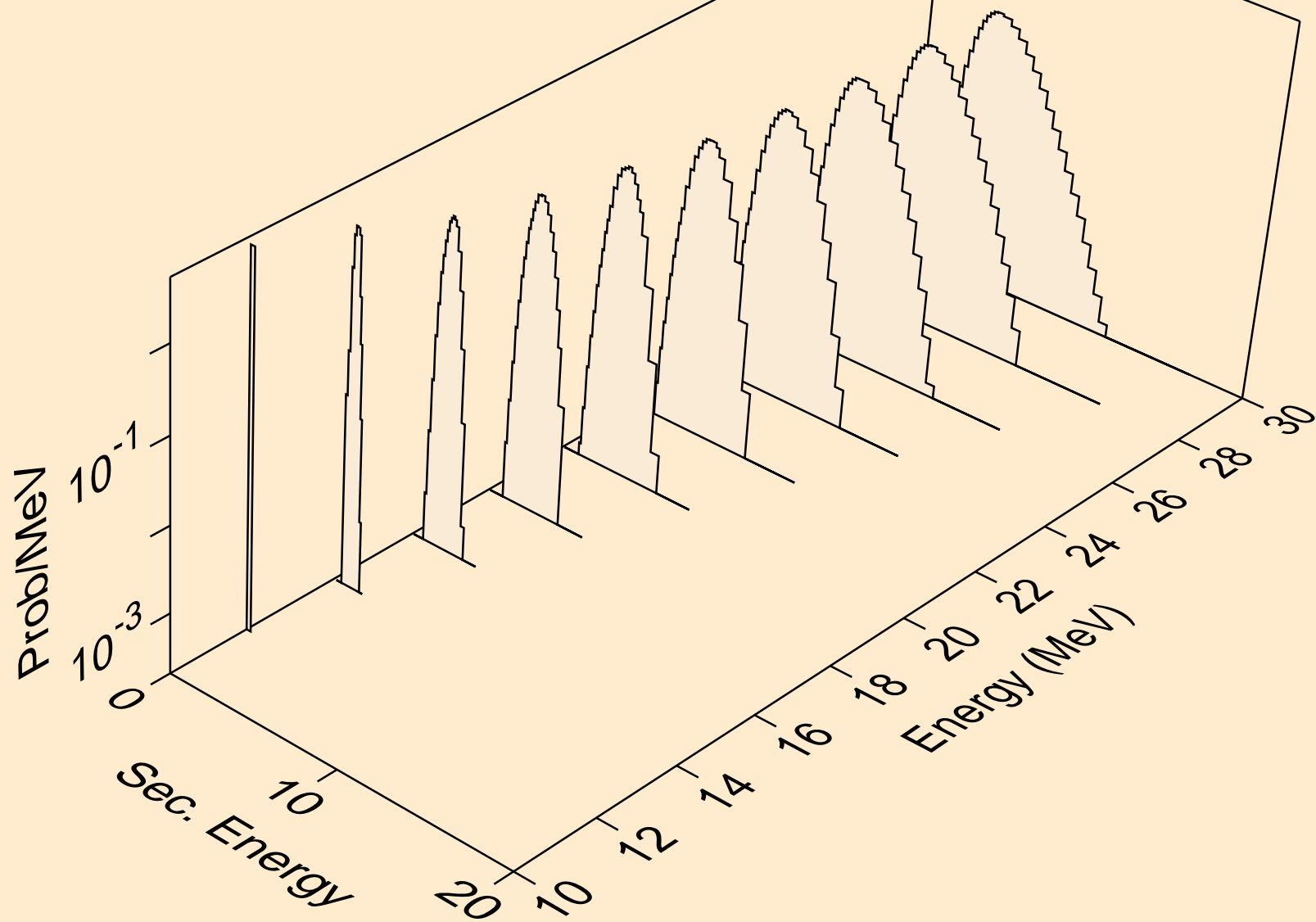

AS072 NEUTRON ACER TENDL-2021 LIBRARY; T=293.6K
protons from (n,pt)

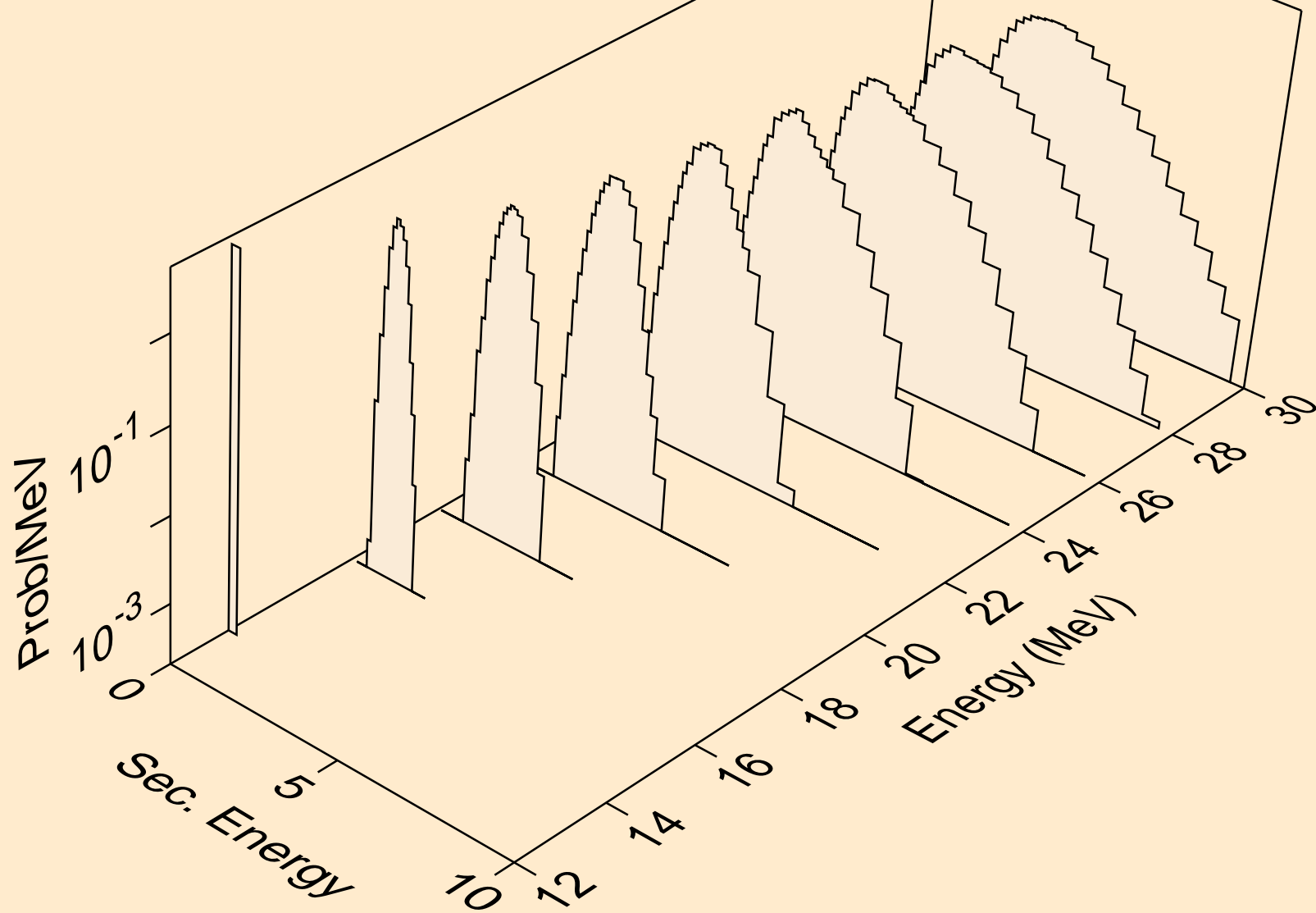

AS072 NEUTRON ACER TENDL-2021 LIBRARY; T=293.6K
deuterons from (n,x)

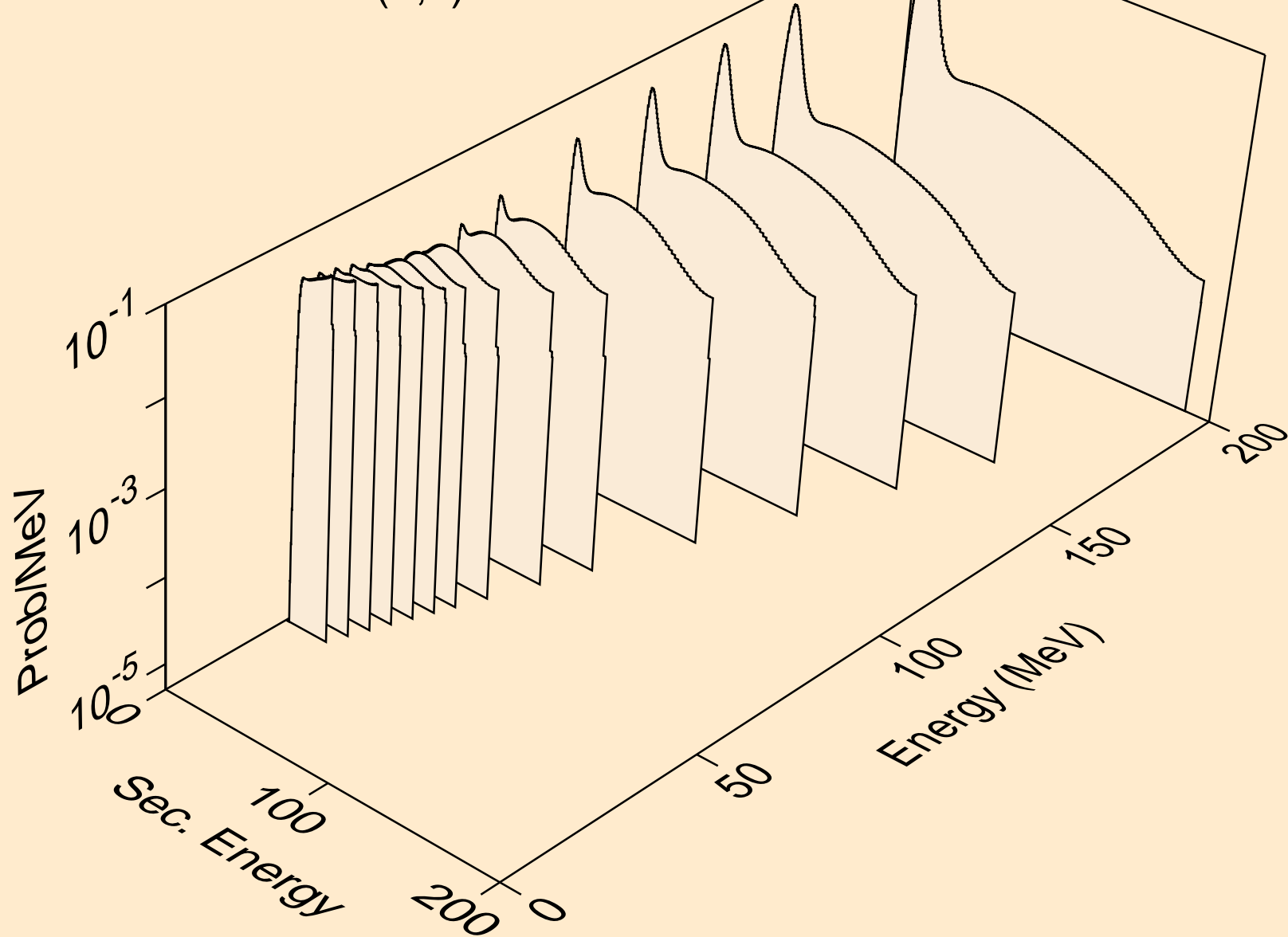

AS072 NEUTRON ACER TENDL-2021 LIBRARY; T=293.6K
deuterons from (n,2nd)

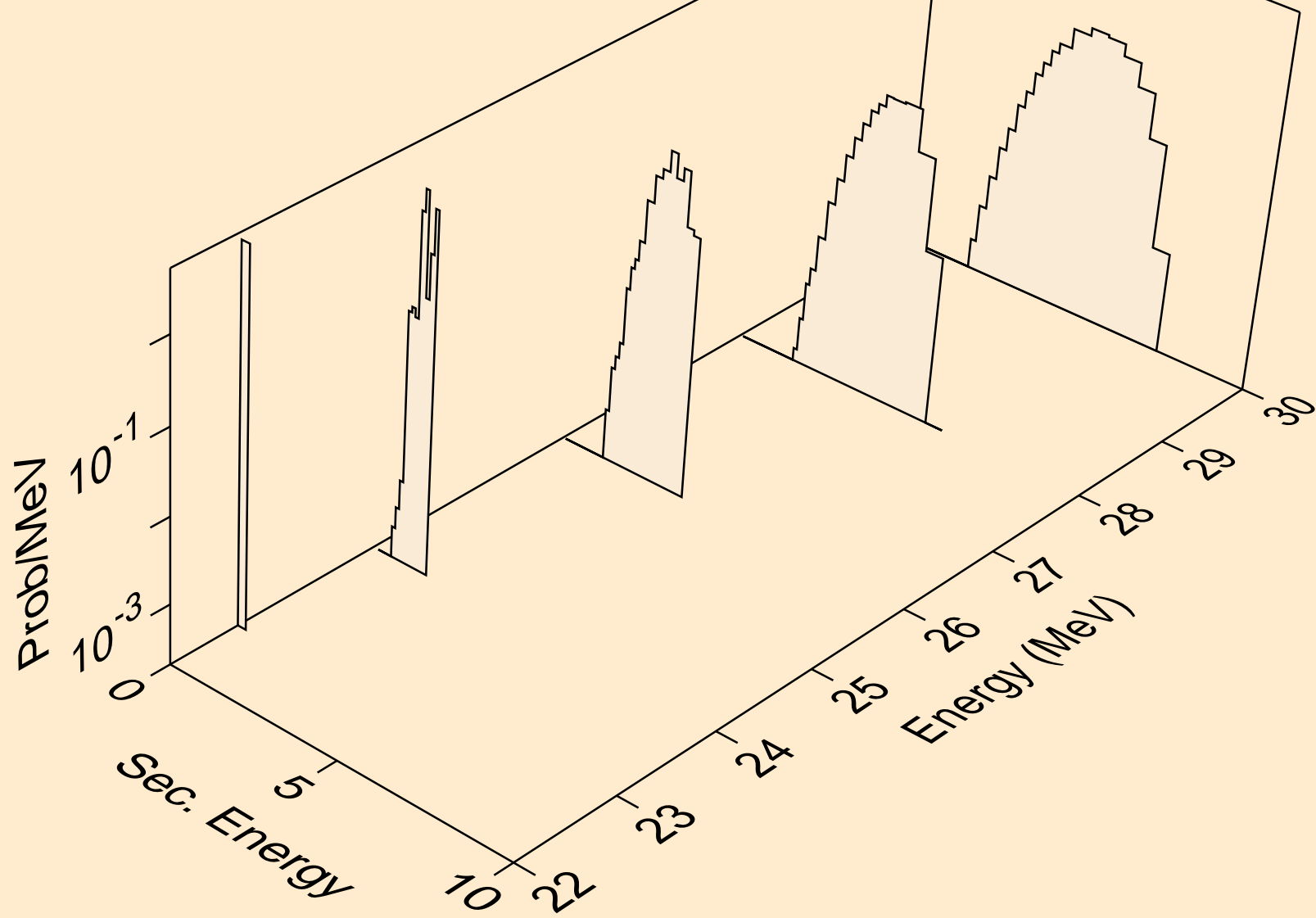

AS072 NEUTRON ACER TENDL-2021 LIBRARY; T=293.6K
deuterons from (n,n*)d

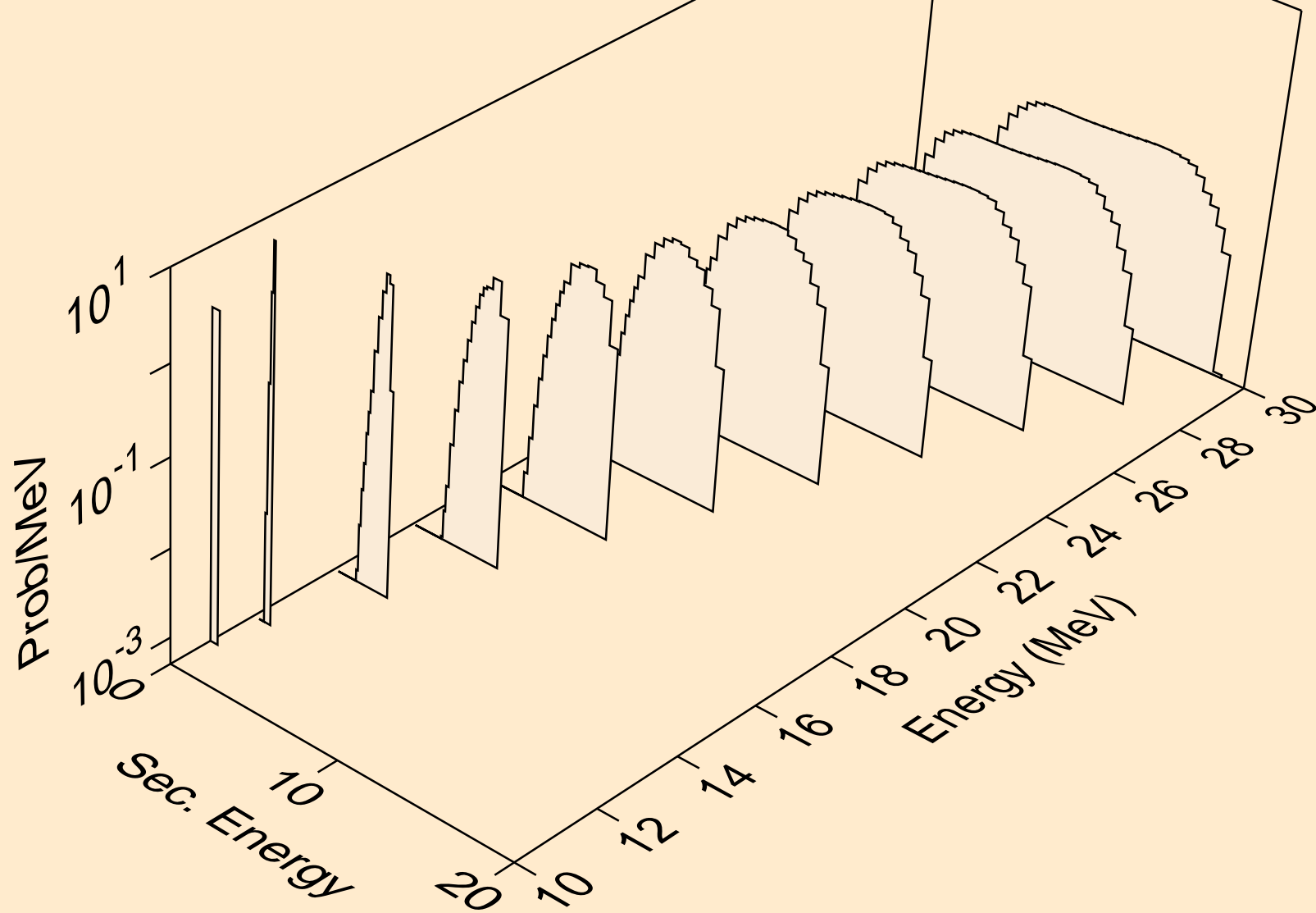

AS072 NEUTRON ACER TENDL-2021 LIBRARY; T=293.6K
deuterons from (n,d)

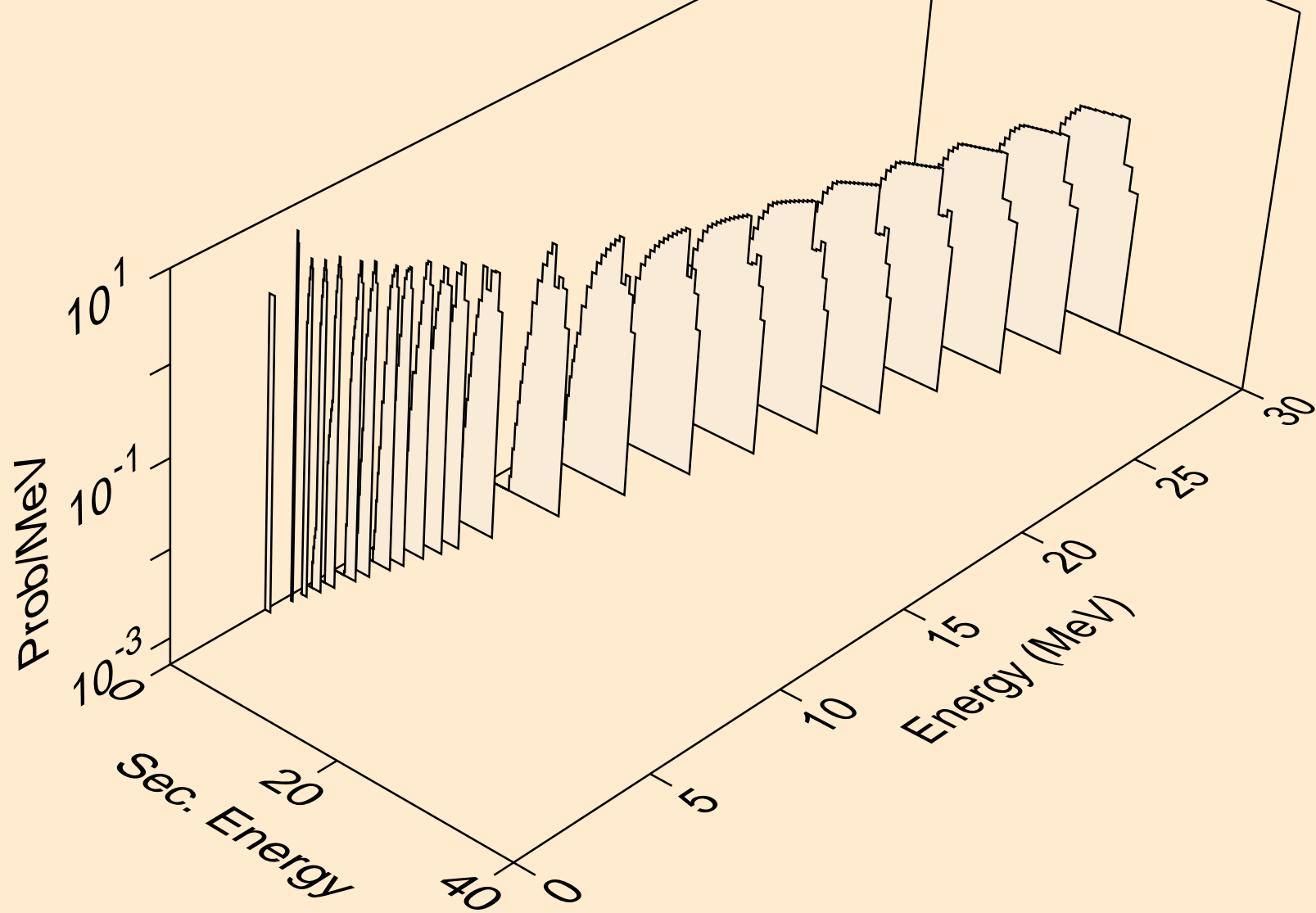

AS072 NEUTRON ACER TENDL-2021 LIBRARY; T=293.6K
deuterons from (n,pd)

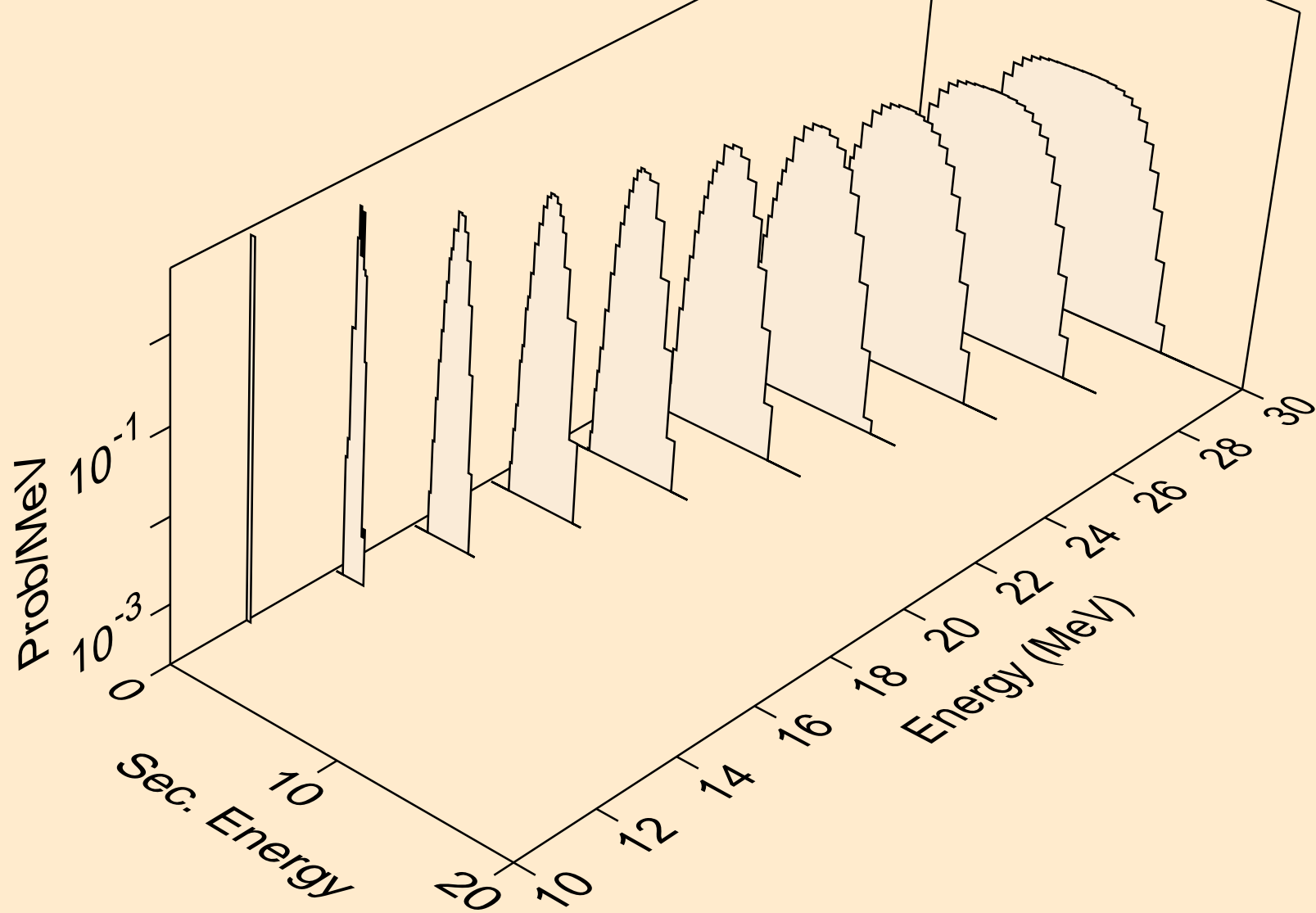

AS072 NEUTRON ACER TENDL-2021 LIBRARY; T=293.6K
deuterons from (n,da)

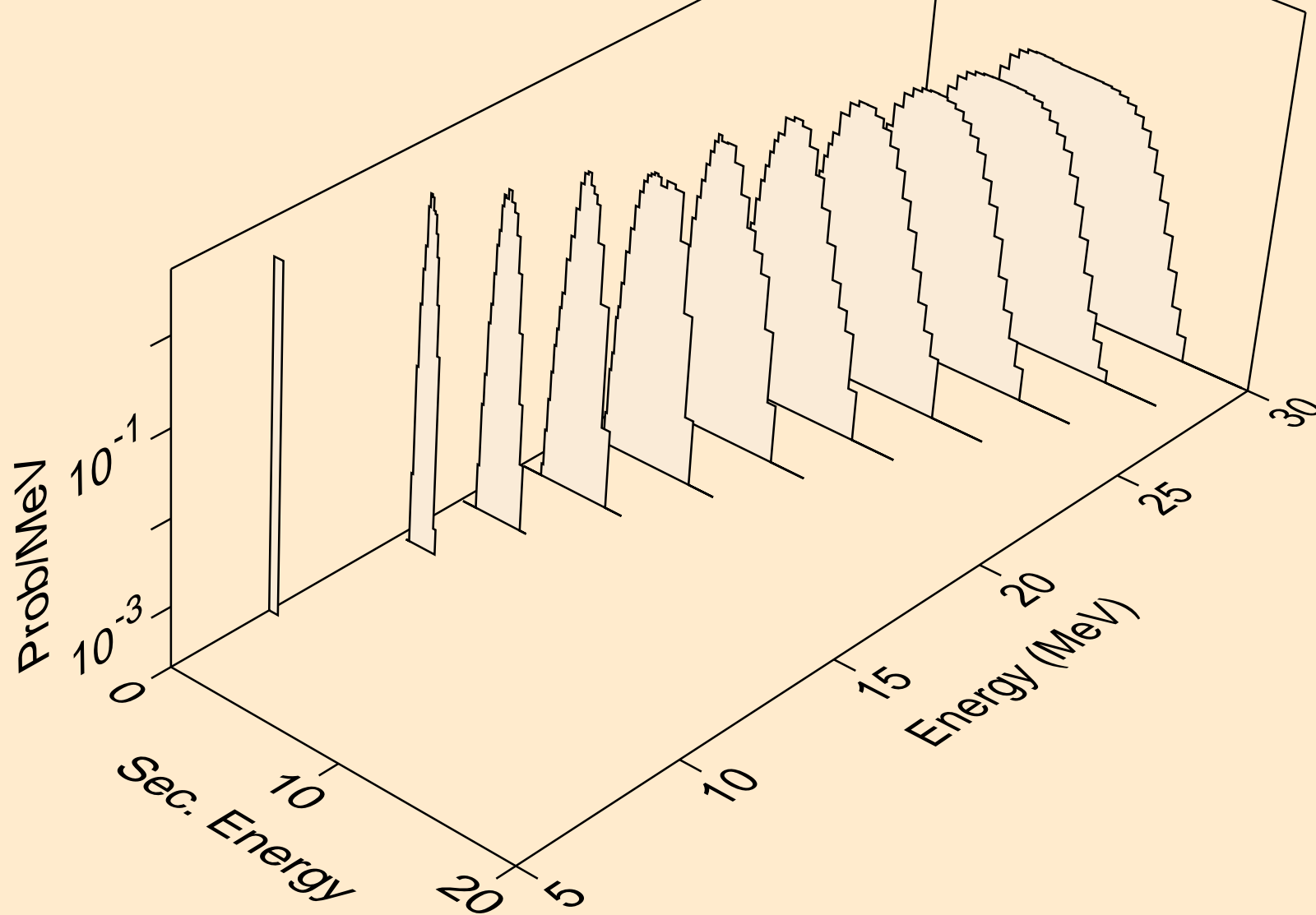

AS072 NEUTRON ACER TENDL-2021 LIBRARY; T=293.6K
tritons from (n,x)

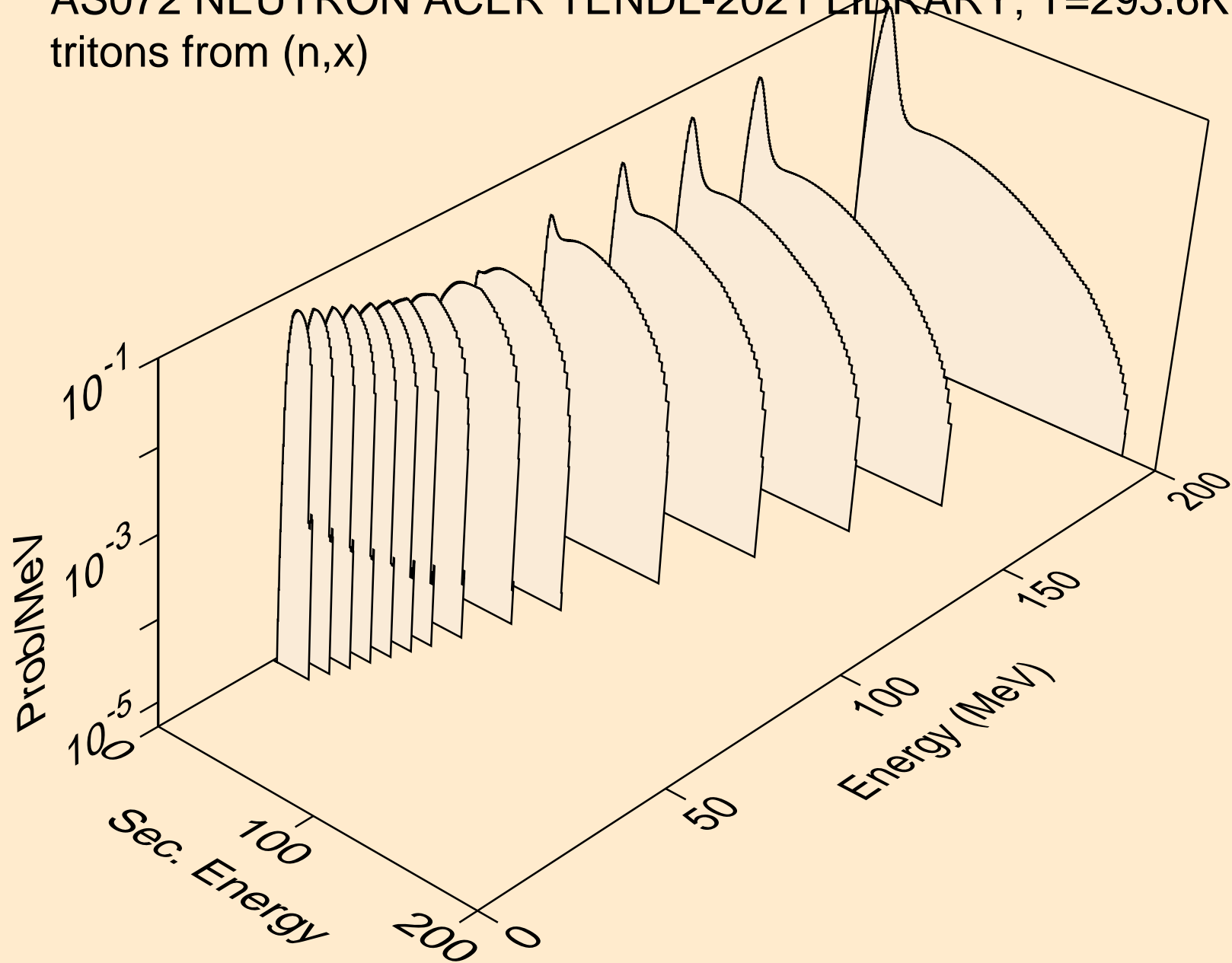

AS072 NEUTRON ACER TENDL-2021 LIBRARY; T=293.6K
tritons from (n,n*)t

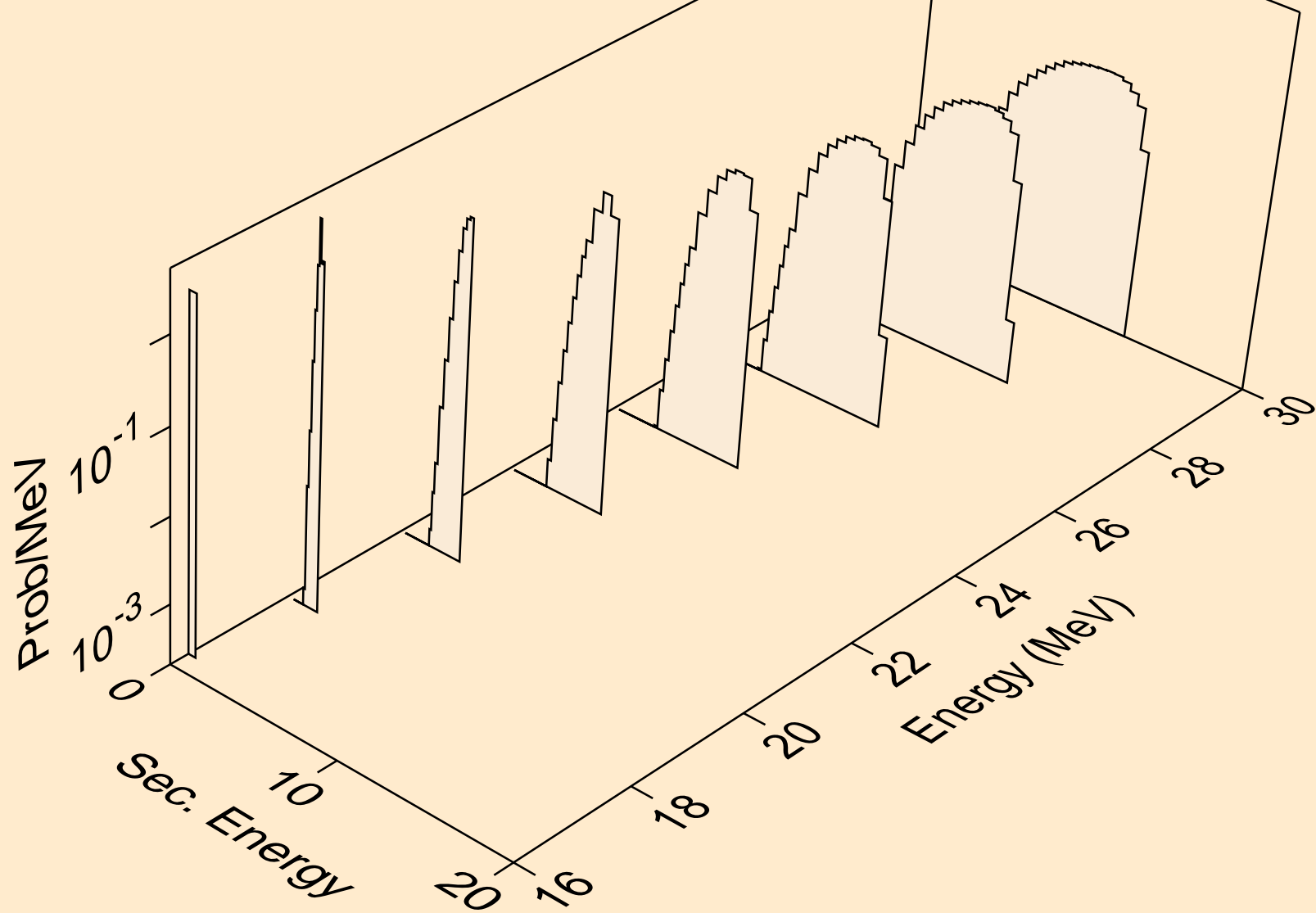

AS072 NEUTRON ACER TENDL-2021 LIBRARY; T=293.6K
tritons from (n,t)

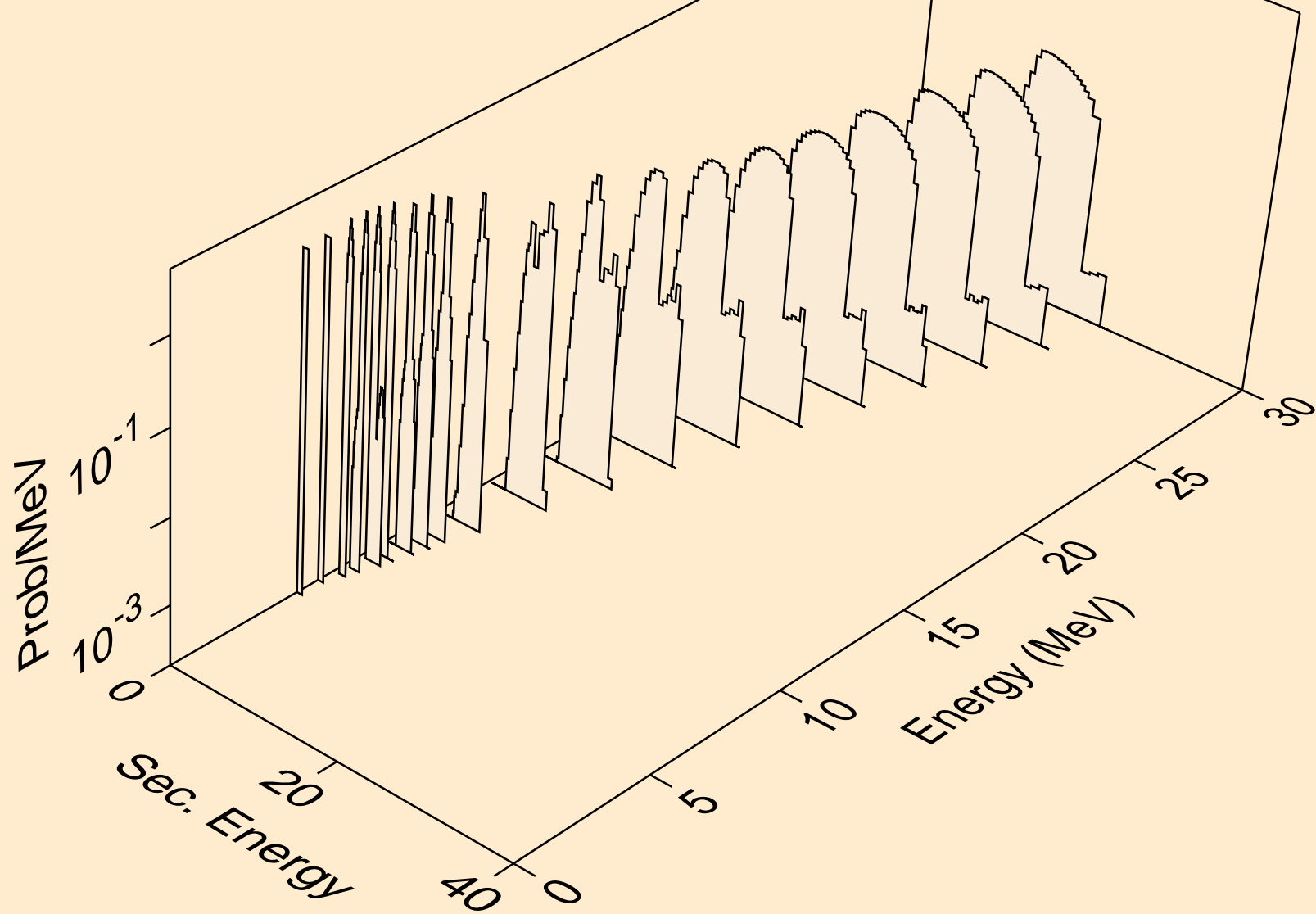

AS072 NEUTRON ACER TENDL-2021 LIBRARY; T=293.6K
tritons from (n,pt)

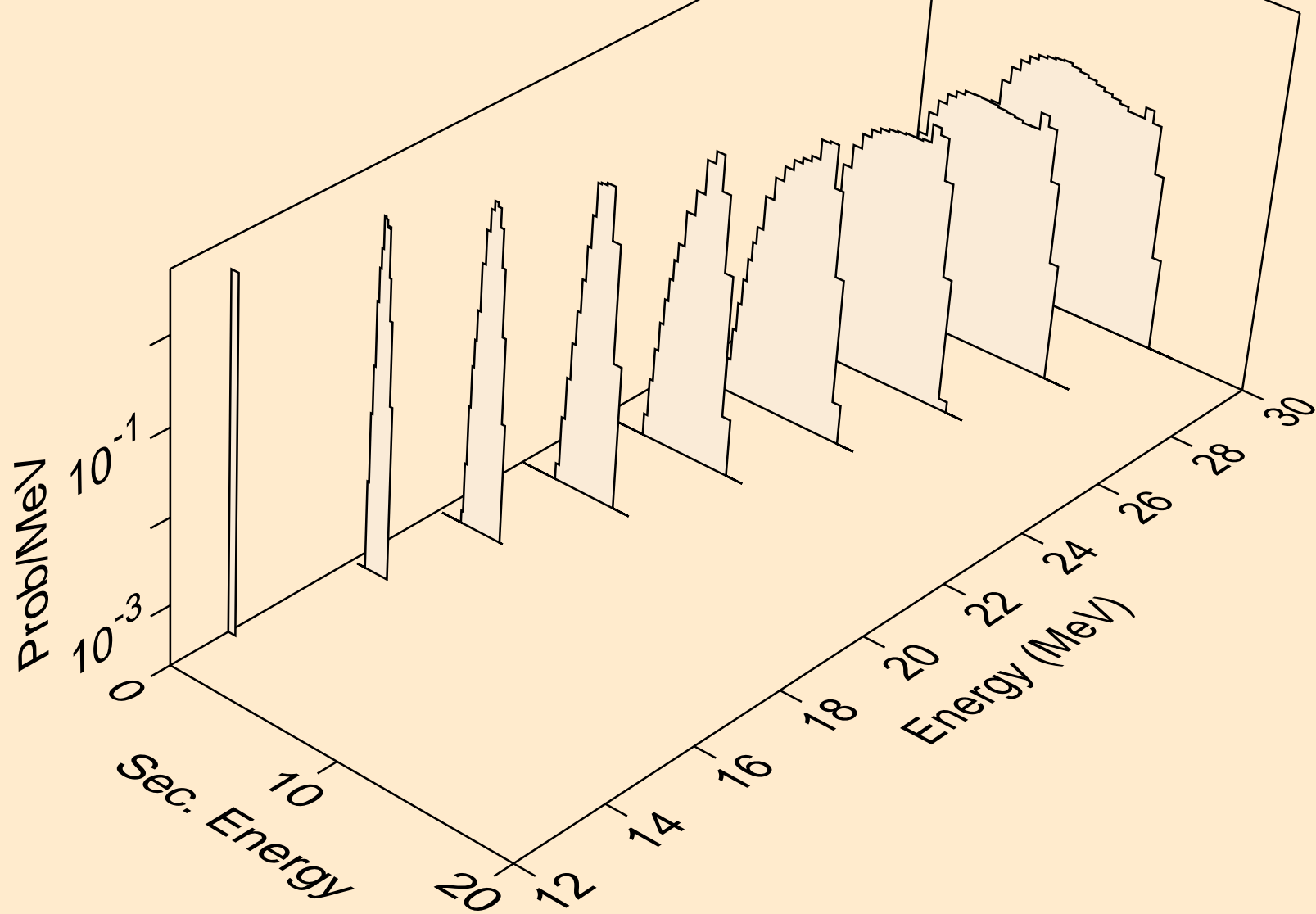

AS072 NEUTRON ACER TENDL-2021 LIBRARY; T=293.6K
he3s from (n,x)

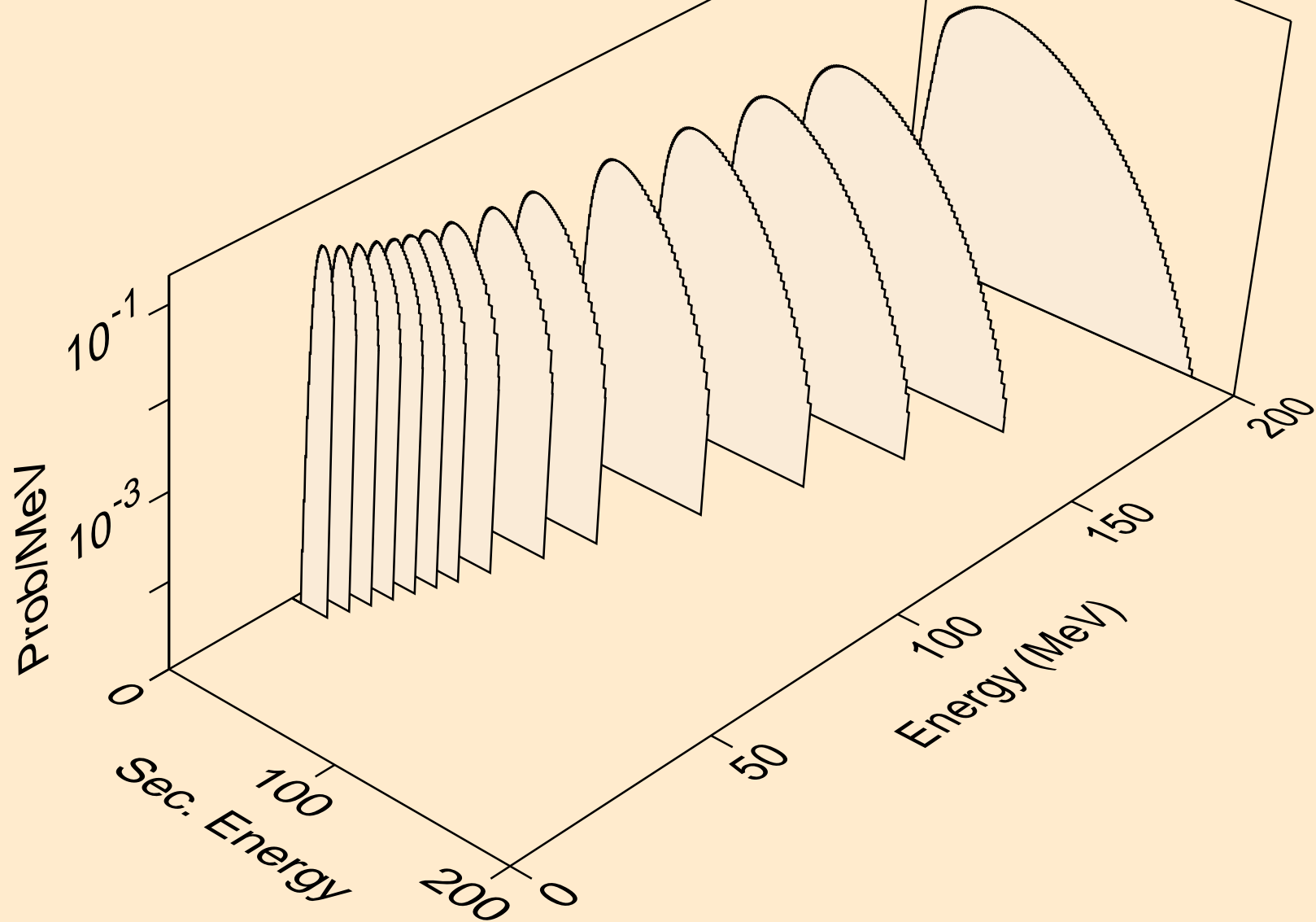

AS072 NEUTRON ACER TENDL-2021 LIBRARY; T=293.6K
he3s from (n,n*)he3

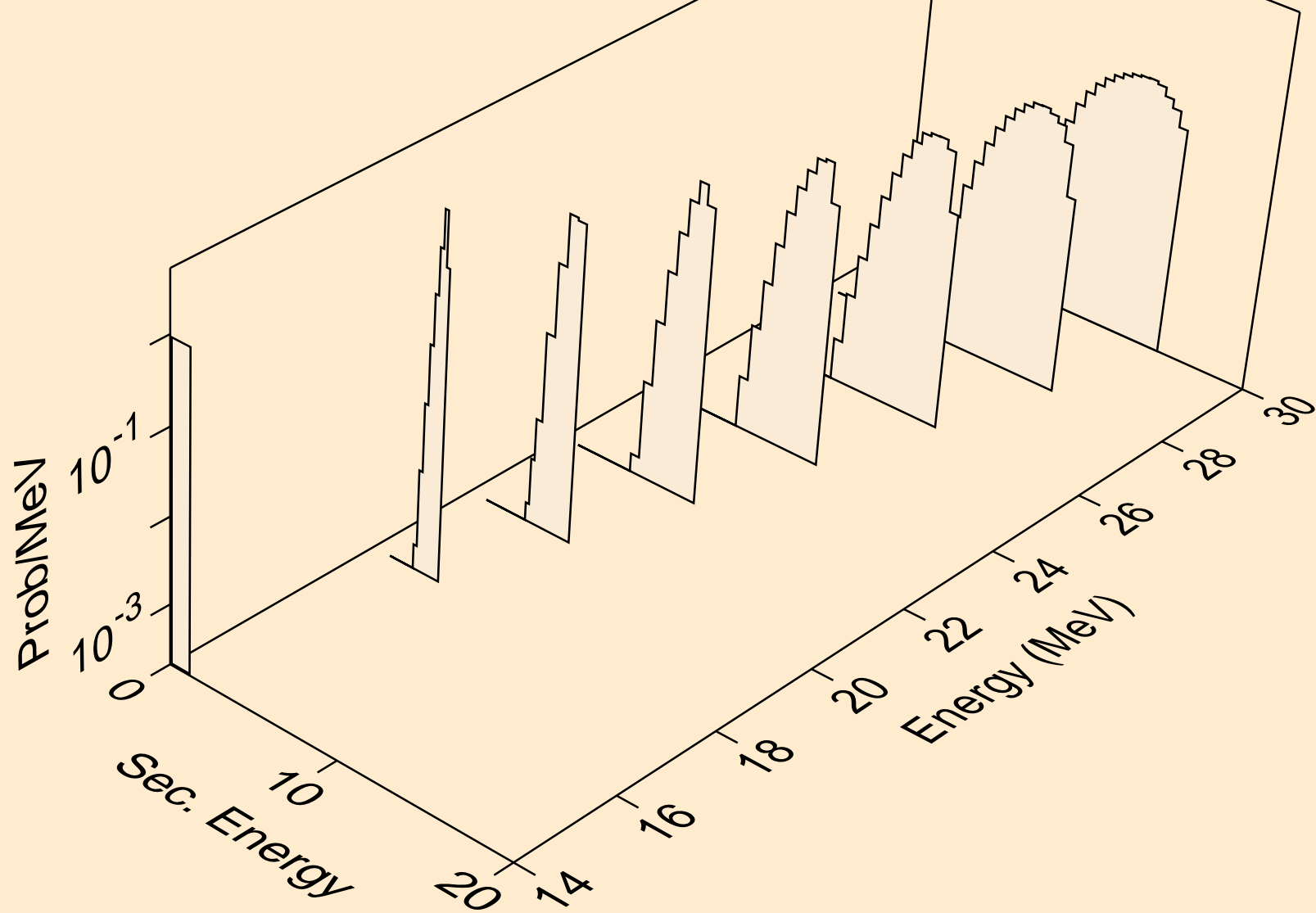

AS072 NEUTRON ACER TENDL-2021 LIBRARY; T=293.6K
he3s from (n,he3)

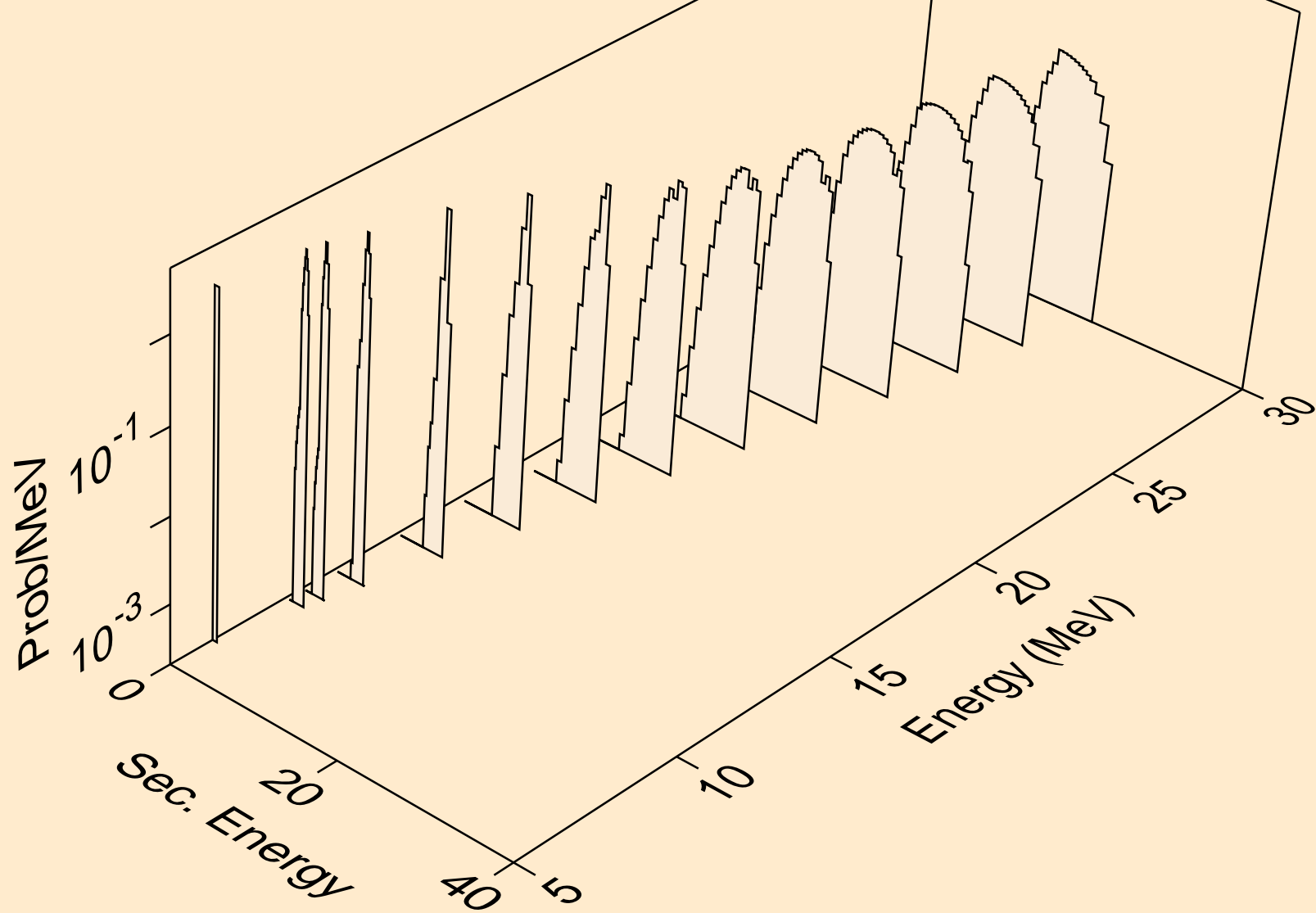

AS072 NEUTRON ACER TENDL-2021 LIBRARY; T=293.6K
alphas from (n,x)

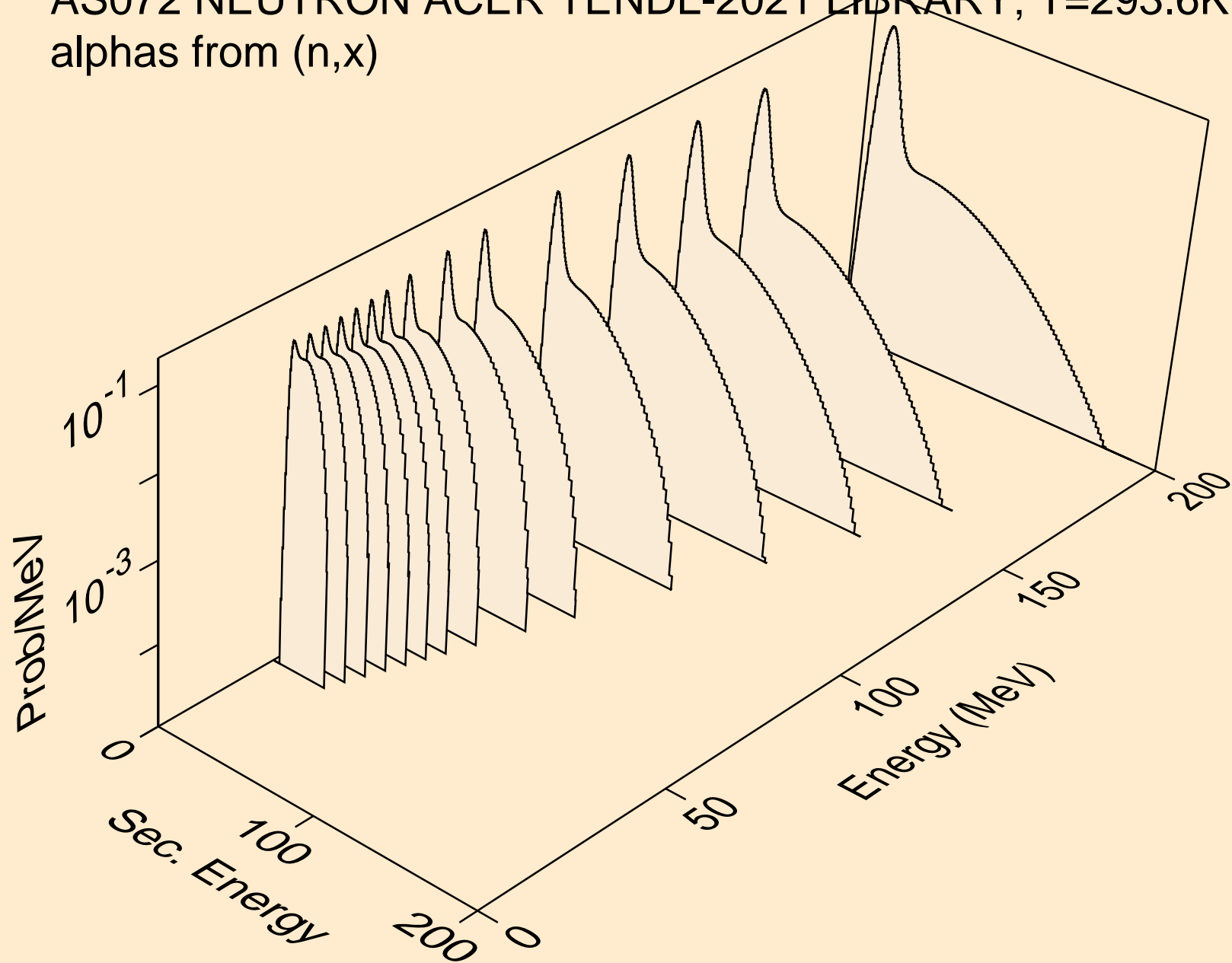

AS072 NEUTRON ACER TENDL-2021 LIBRARY; T=293.6K
alphas from (n,n*)a

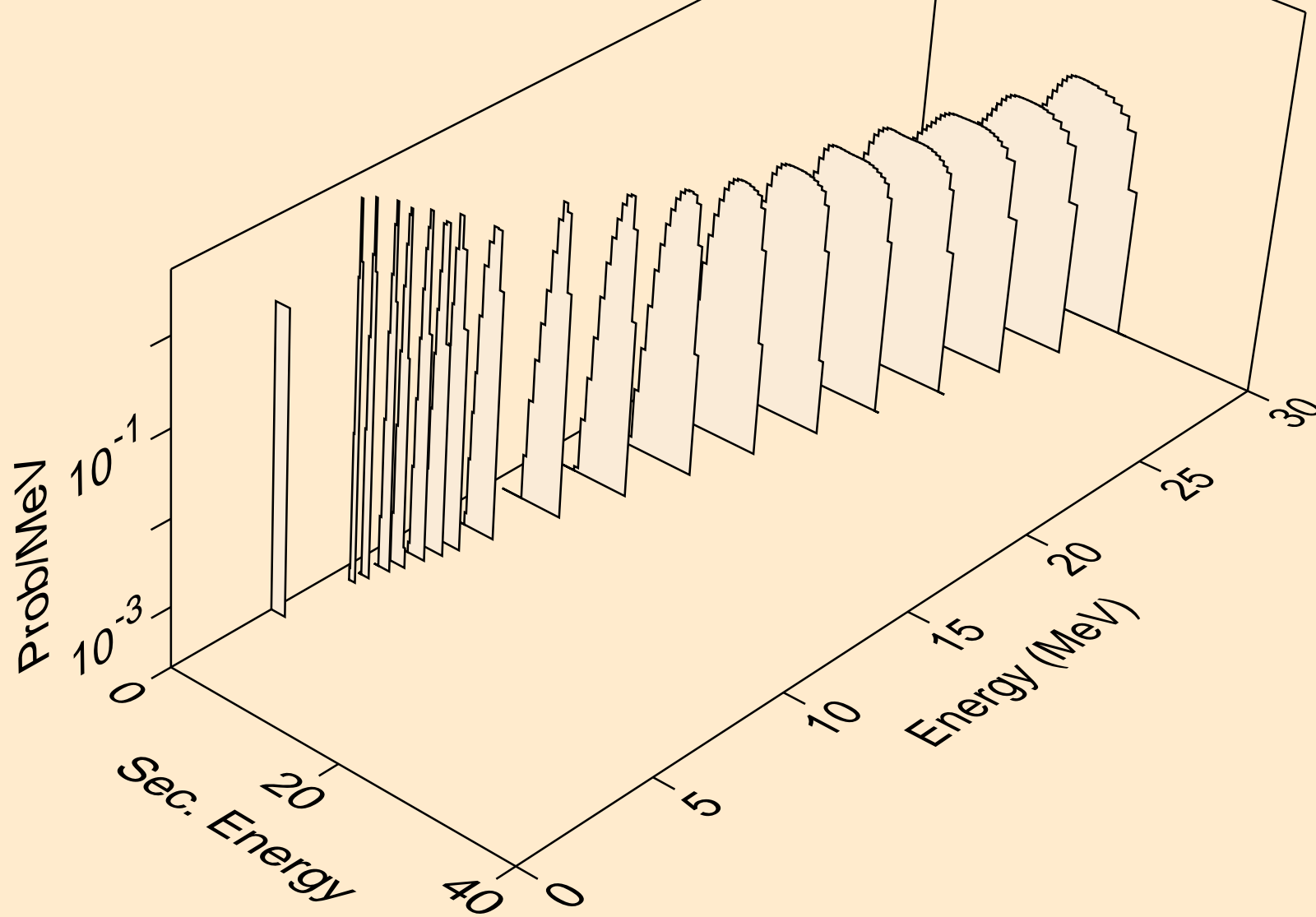

AS072 NEUTRON ACER TENDL-2021 LIBRARY; T=293.6K
alphas from (n,2n)a

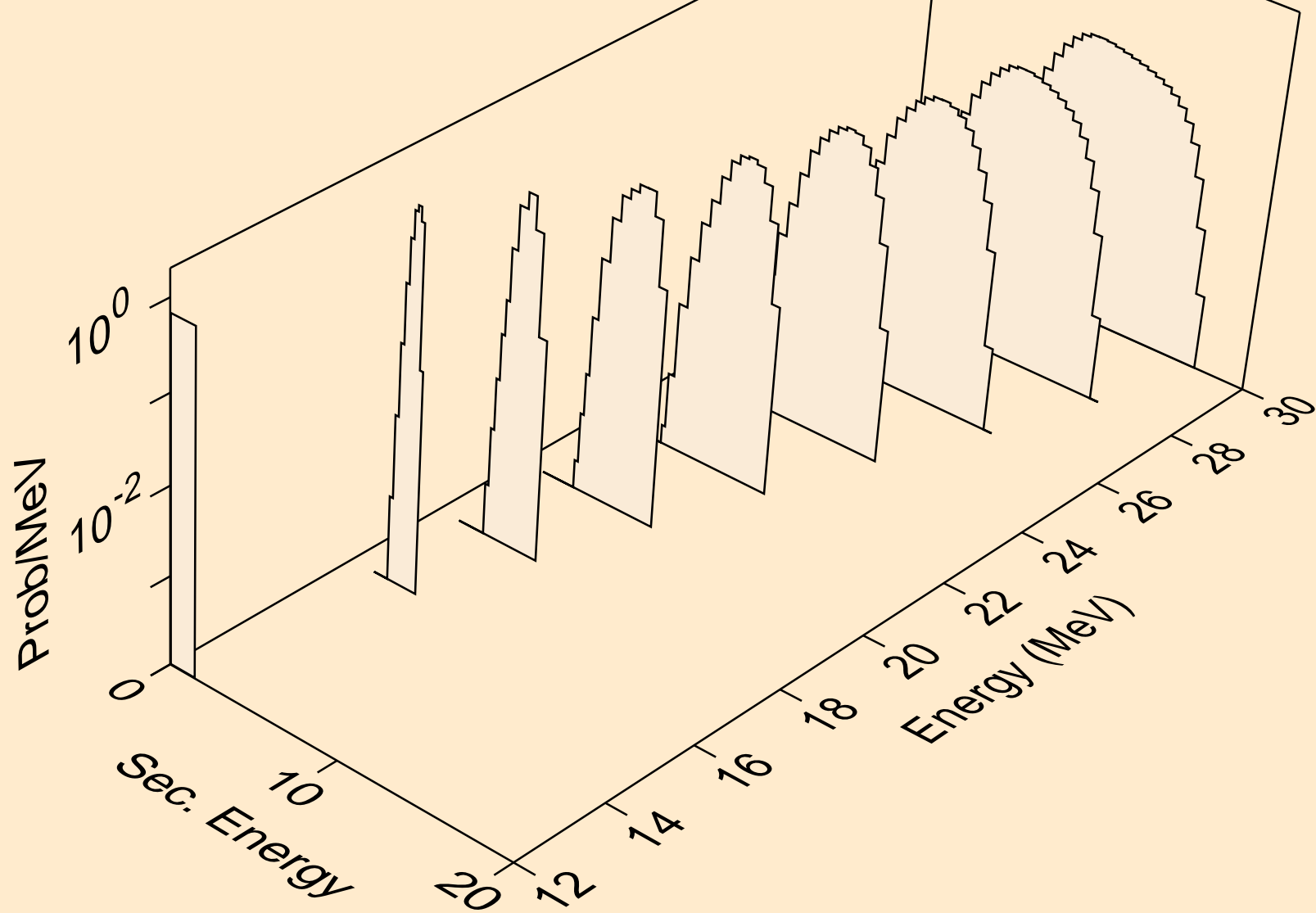

AS072 NEUTRON ACER TENDL-2021 LIBRARY; T=293.6K
alphas from (n,3n)a

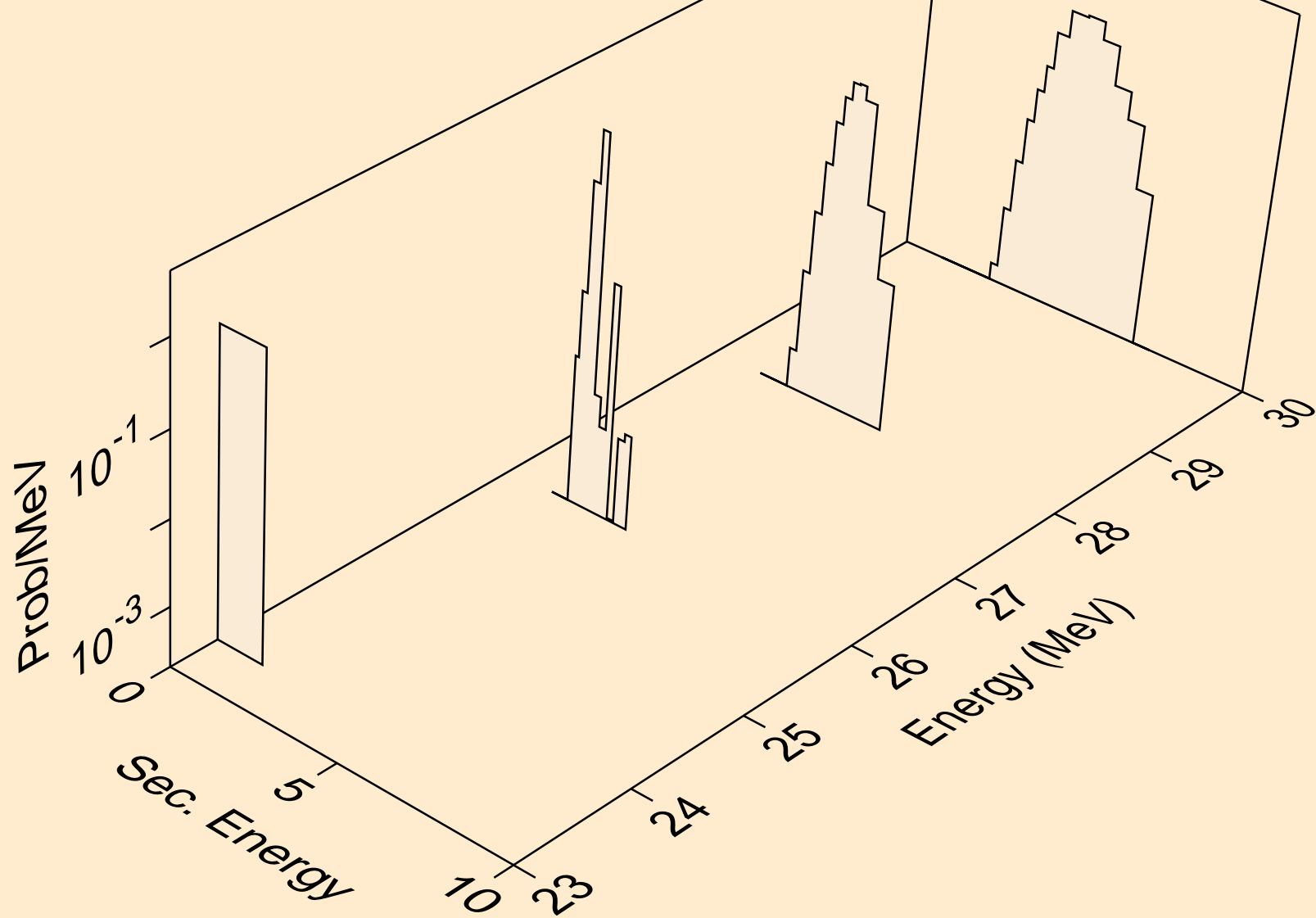

AS072 NEUTRON ACER TENDL-2021 LIBRARY; T=293.6K
alphas from (n,n*)2a

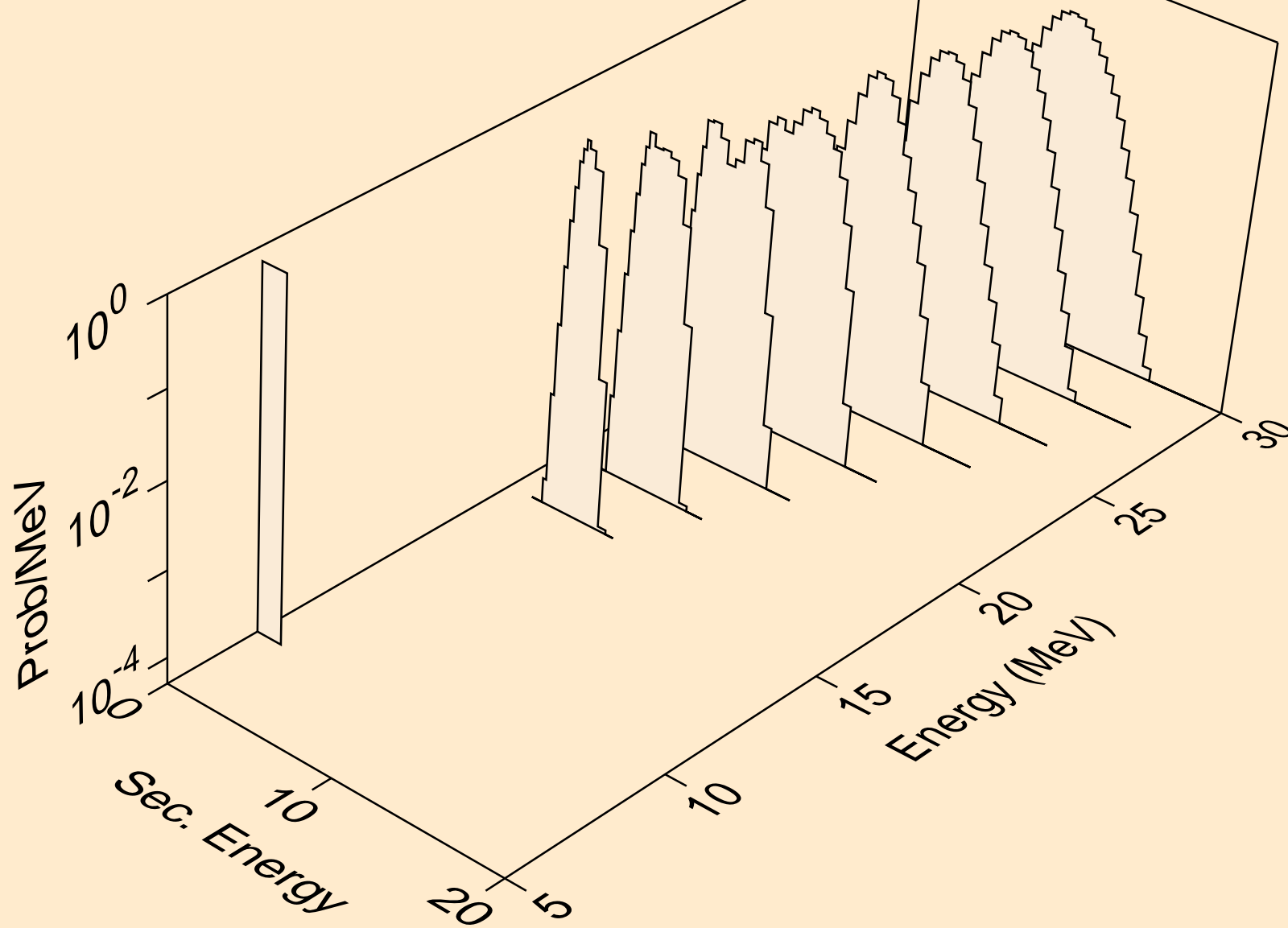

AS072 NEUTRON ACER TENDL-2021 LIBRARY; T=293.6K
alphas from (n,2n)2a

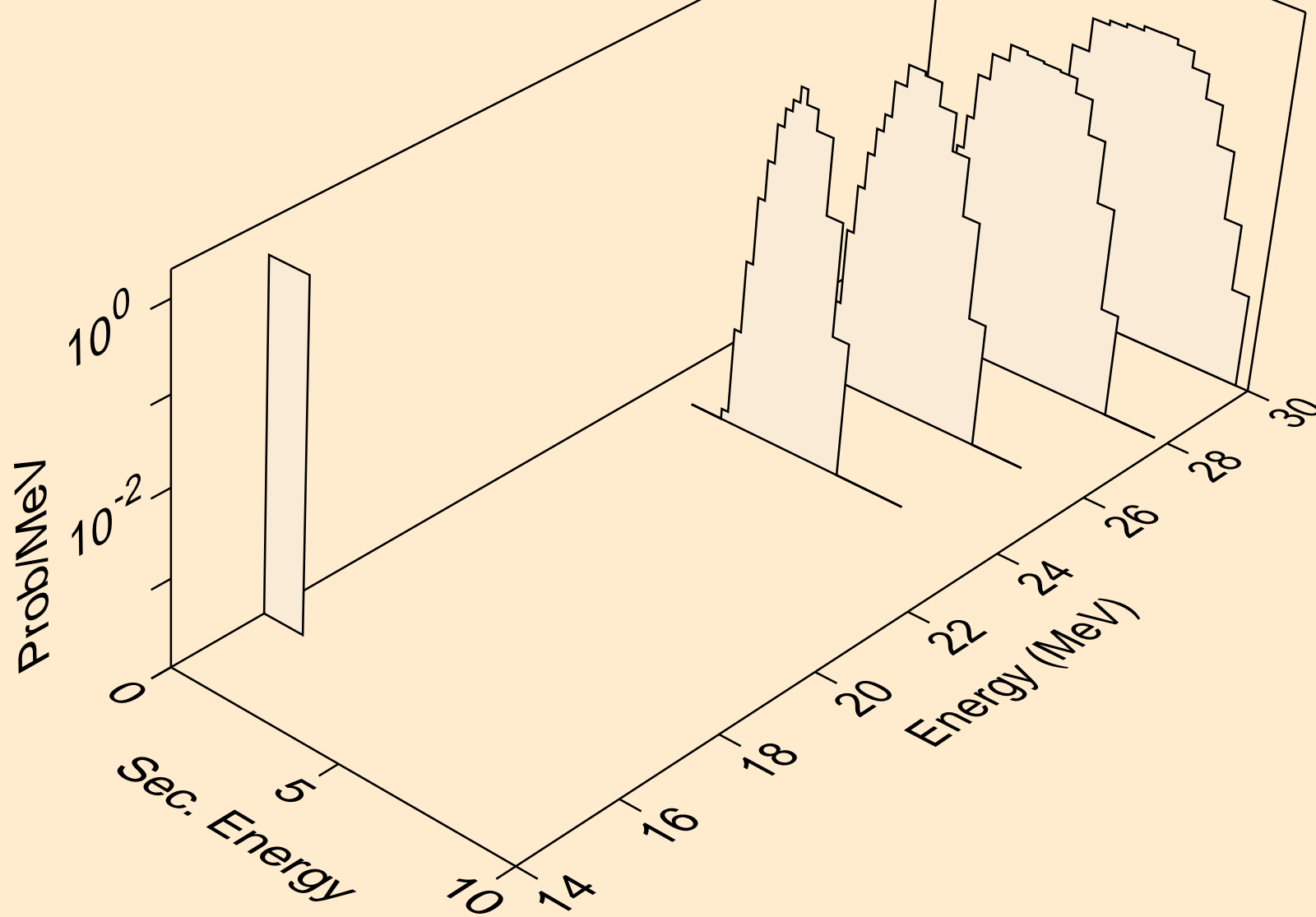

AS072 NEUTRON ACER TENDL-2021 LIBRARY; T=293.6K
alphas from (n,npa)

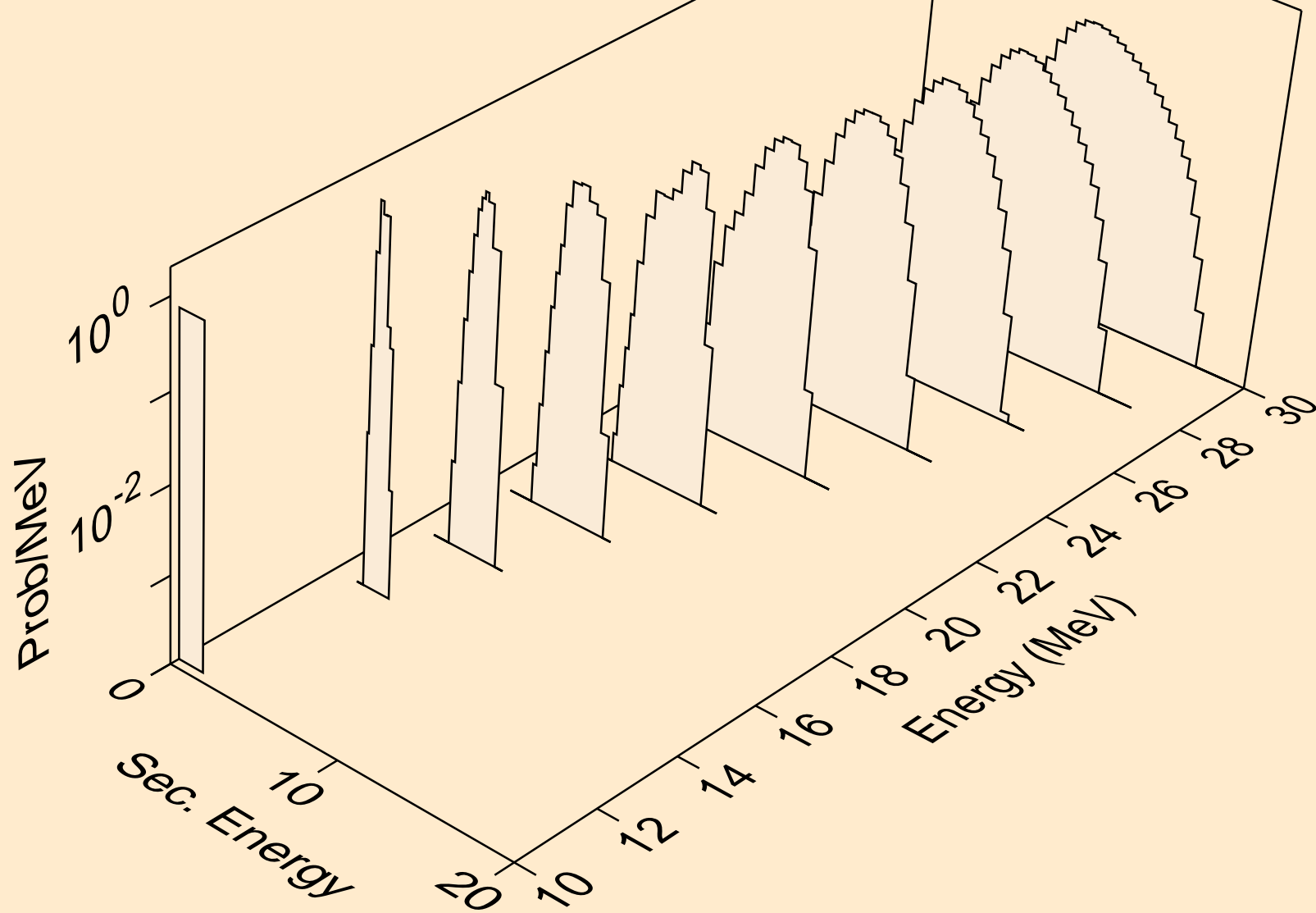

AS072 NEUTRON ACER TENDL-2021 LIBRARY; T=293.6K
alphas from (n,a)

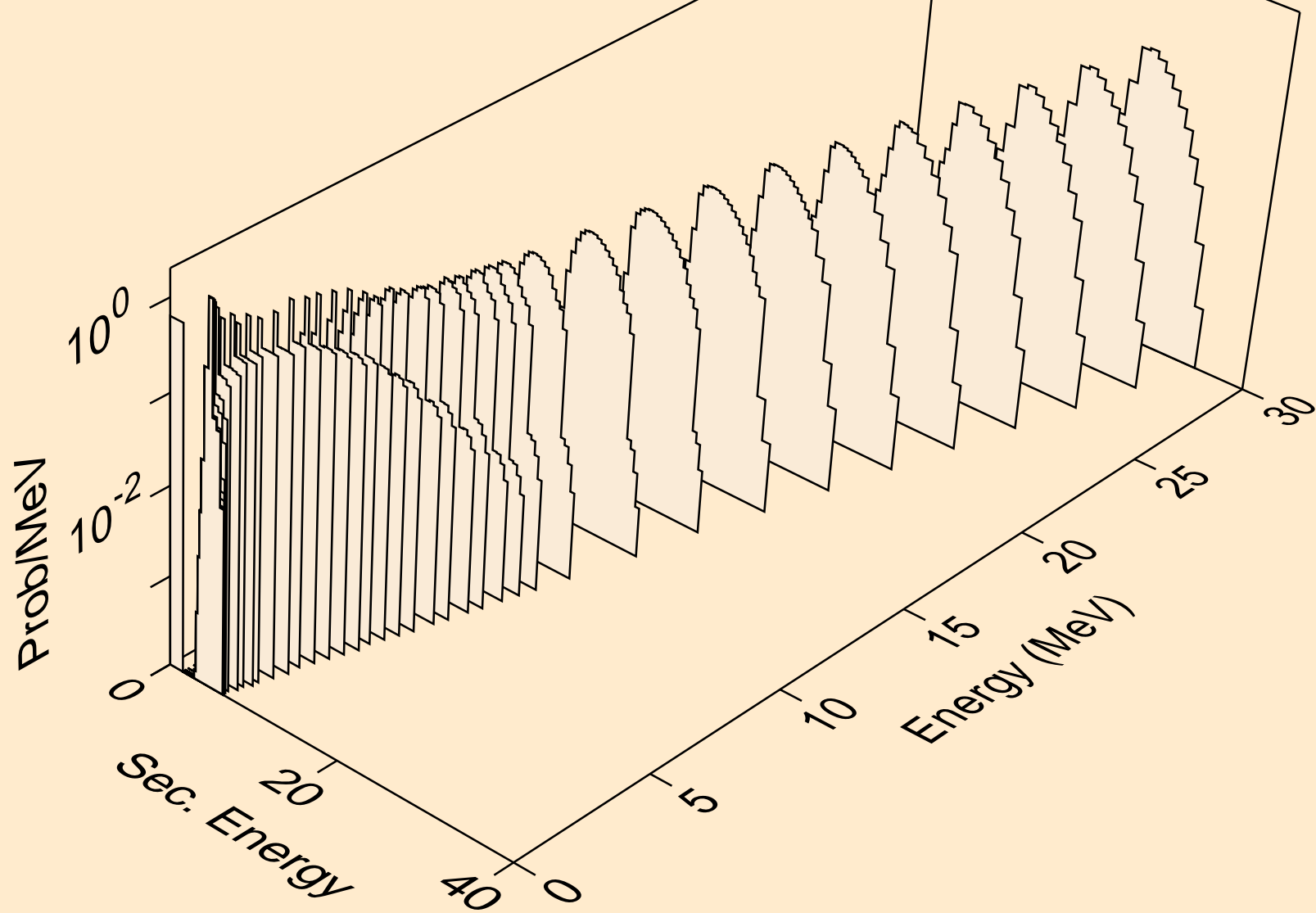

AS072 NEUTRON ACER TENDL-2021 LIBRARY; T=293.6K
alphas from (n,2a)

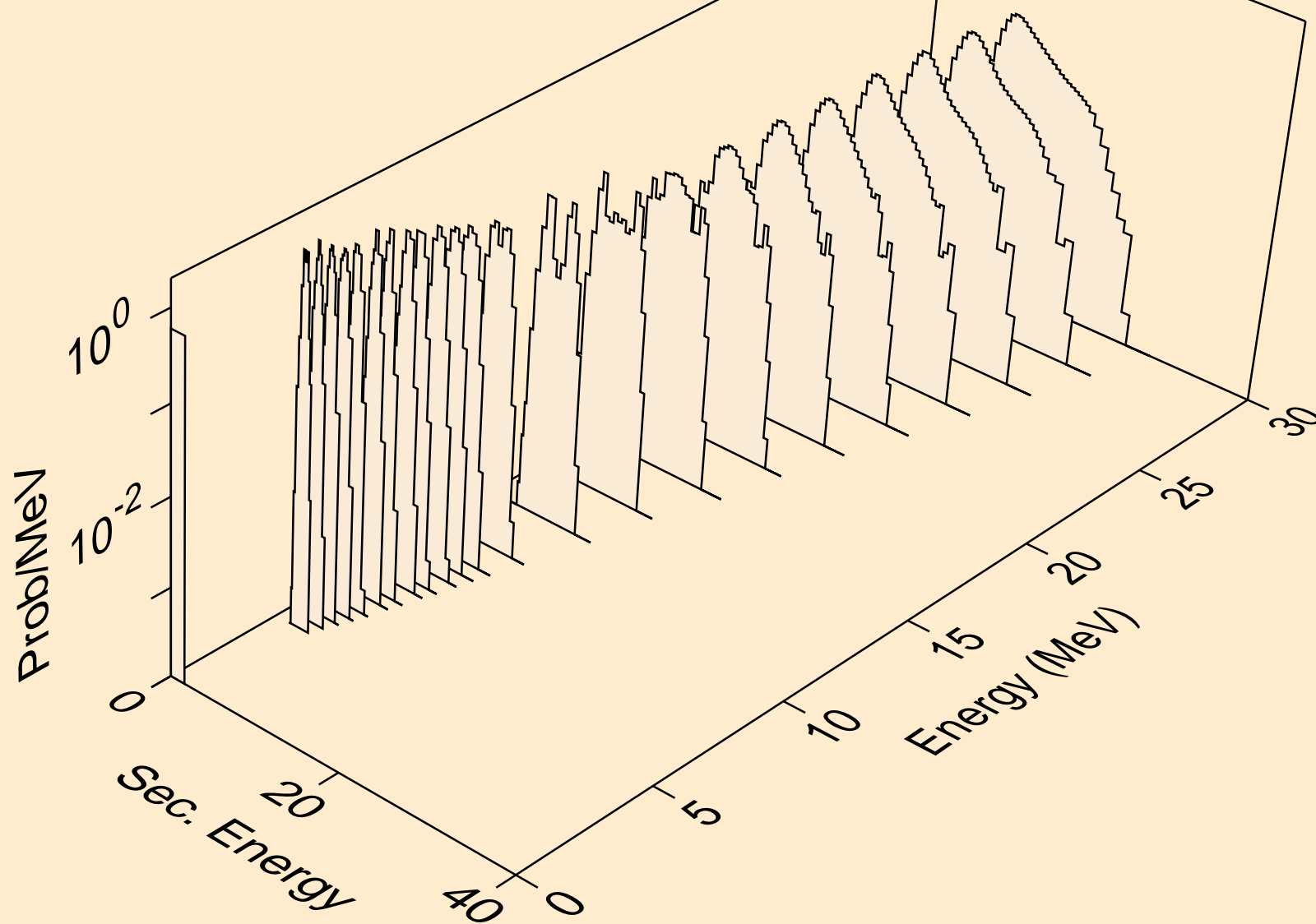

AS072 NEUTRON ACER TENDL-2021 LIBRARY; T=293.6K
alphas from (n,3a)

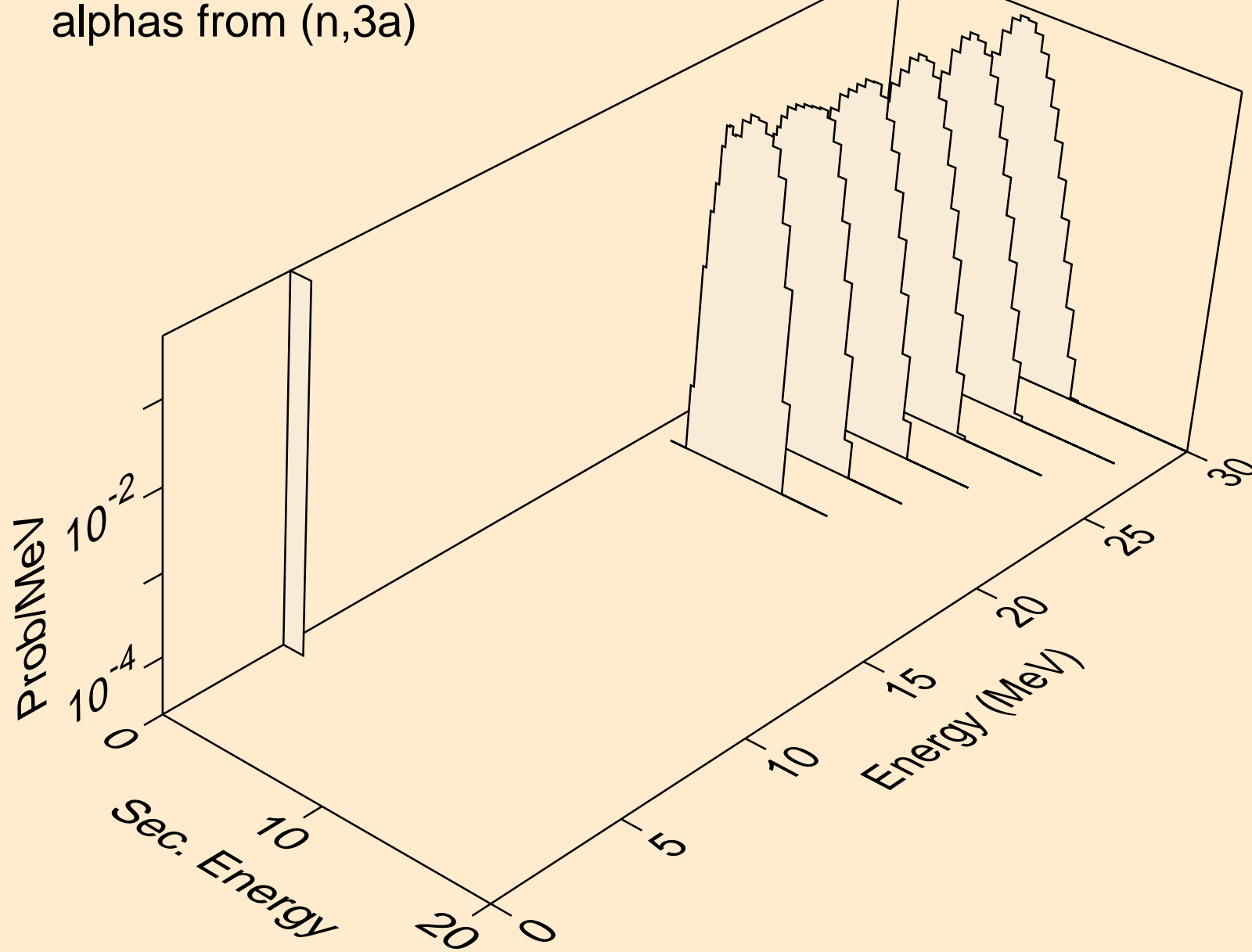

AS072 NEUTRON ACER TENDL-2021 LIBRARY; T=293.6K
alphas from (n,pa)

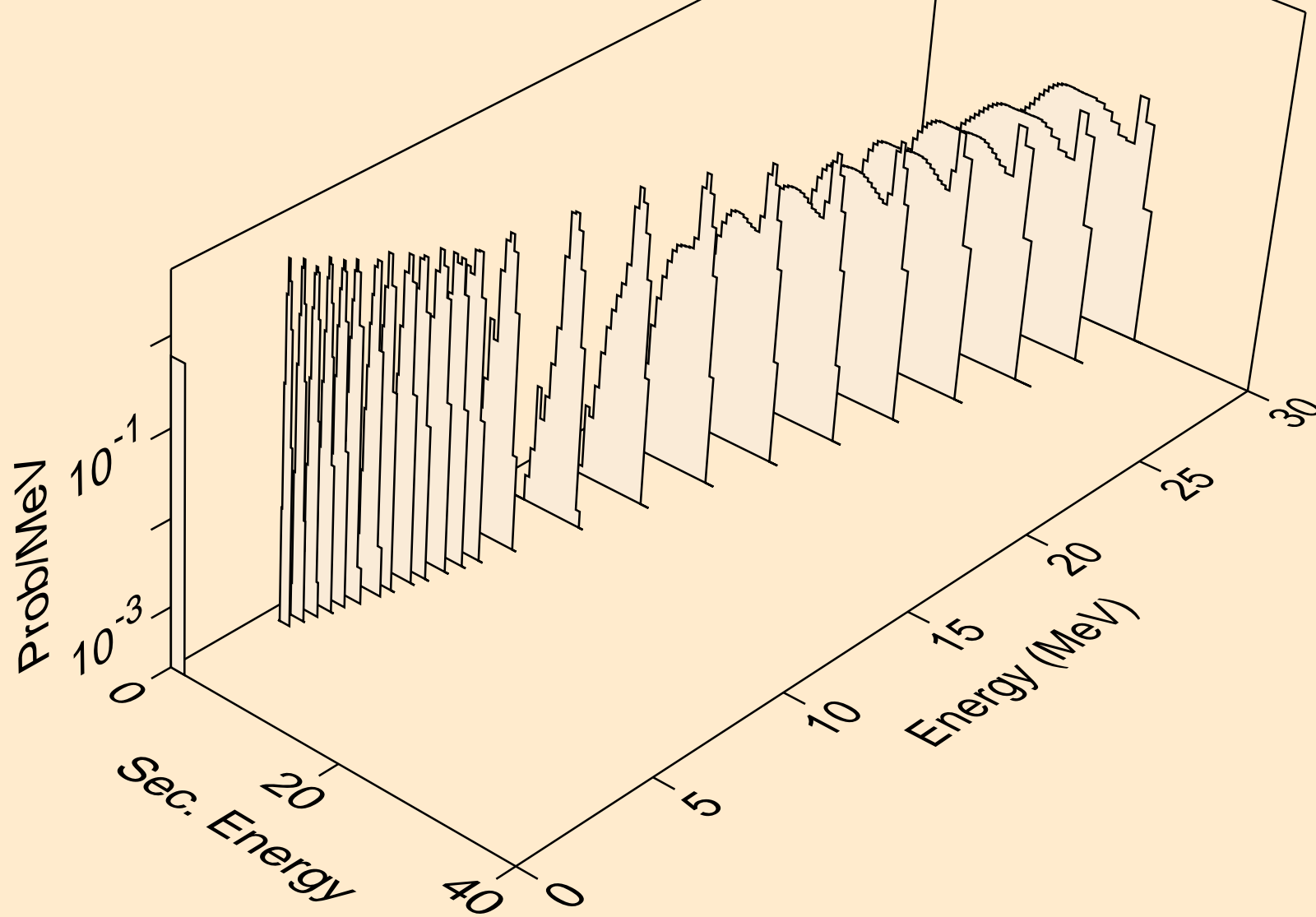

AS072 NEUTRON ACER TENDL-2021 LIBRARY; T=293.6K
alphas from (n,da)

