

AT198M NEUTRON ACER TENDL-2021 LIBRARY; T=293.6K  
Principal cross sections

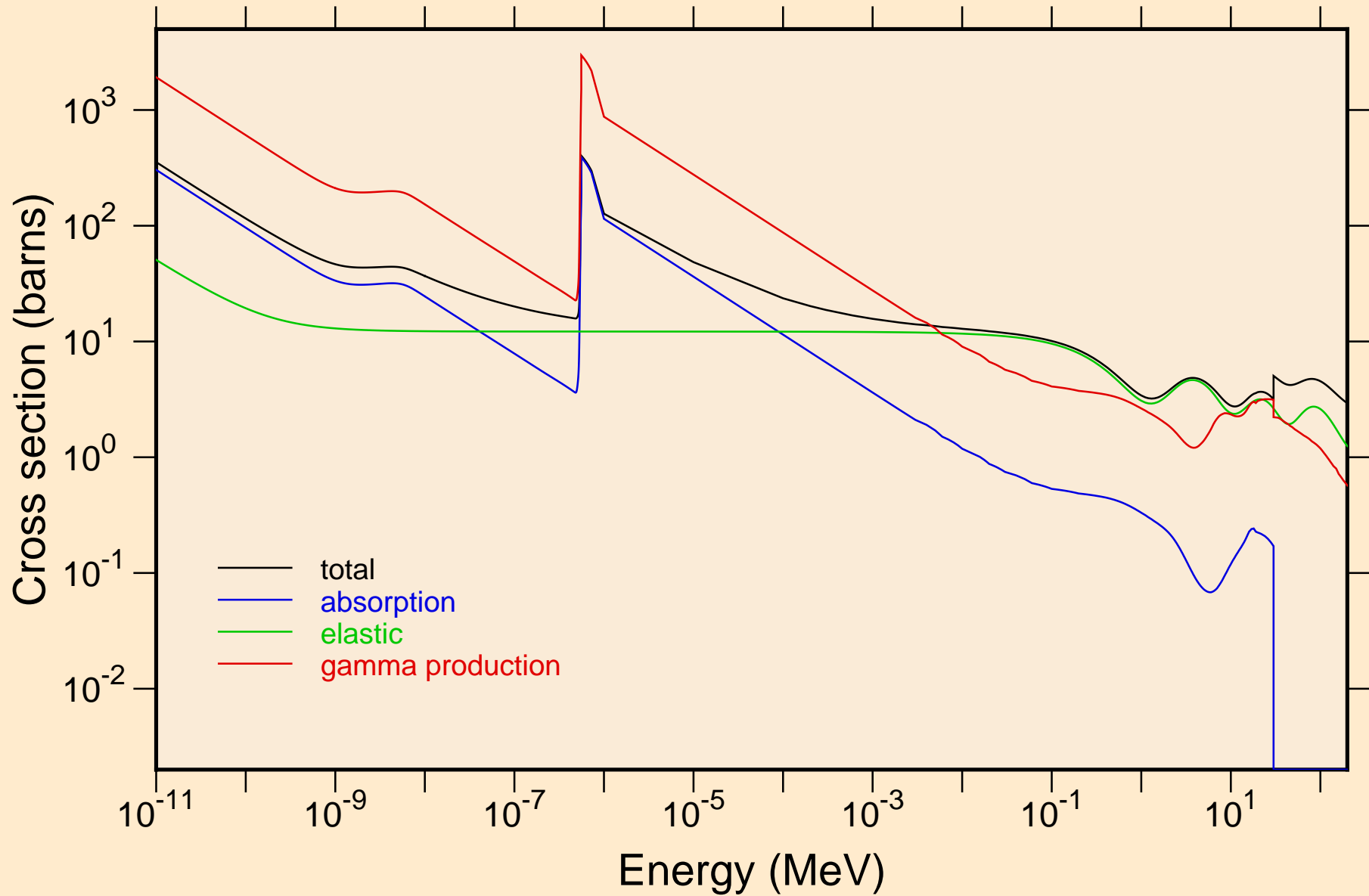

AT198M NEUTRON ACER TENDL-2021 LIBRARY; T=293.6K  
Heating

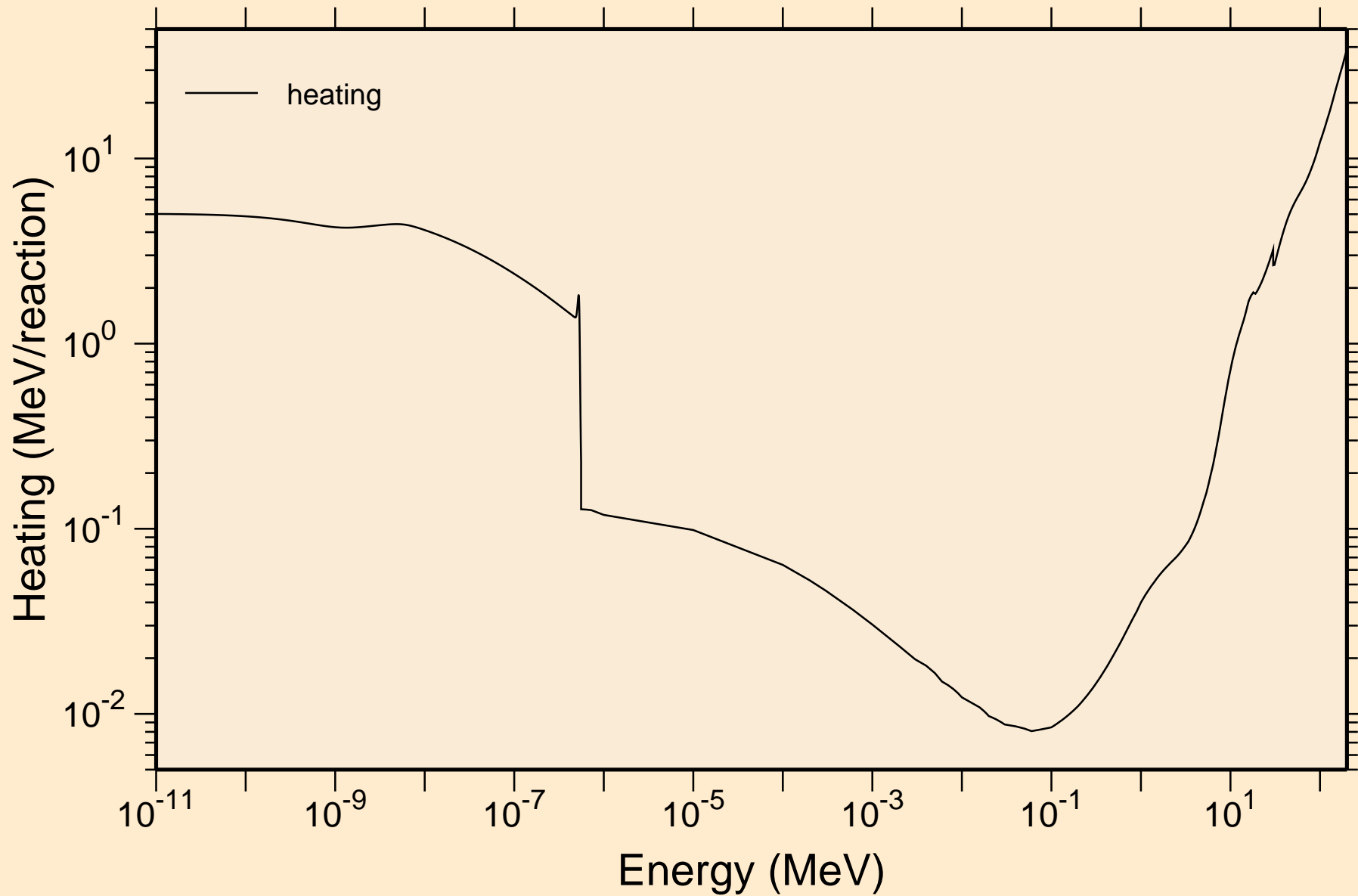

AT198M NEUTRON ACER TENDL-2021 LIBRARY; T=293.6K  
Damage

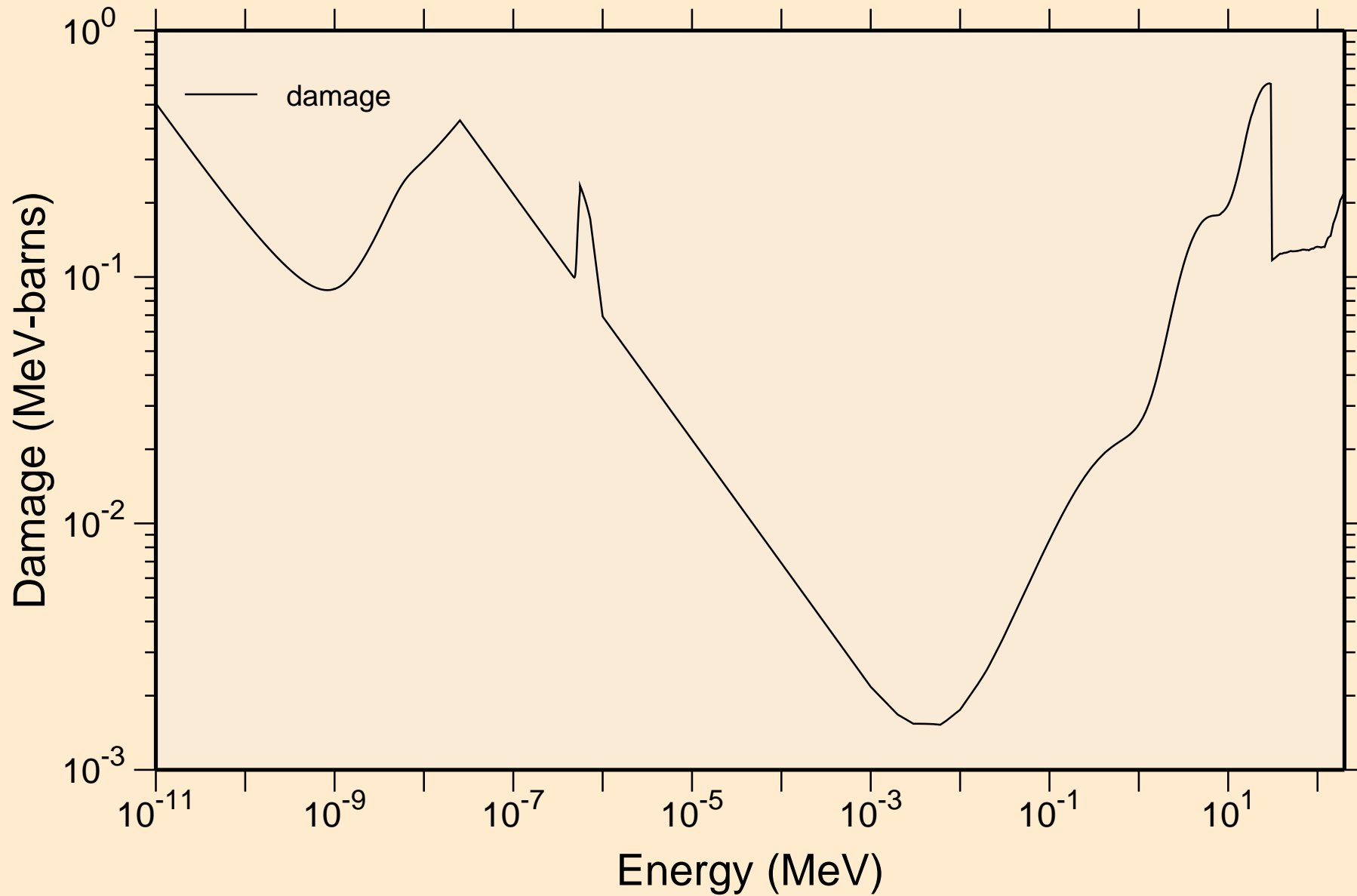

AT198M NEUTRON ACER TENDL-2021 LIBRARY; T=293.6K  
Non-threshold reactions

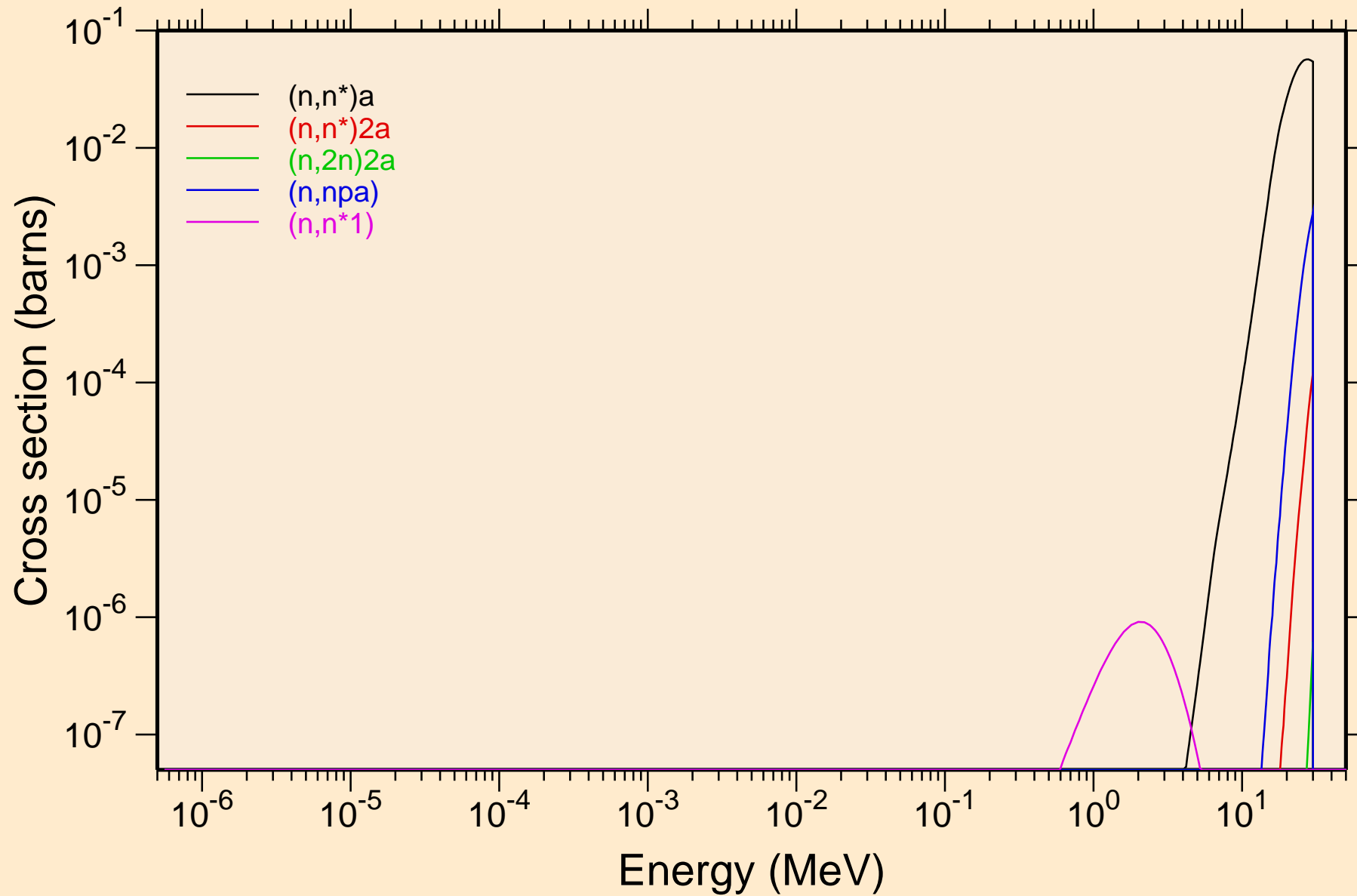

AT198M NEUTRON ACER TENDL-2021 LIBRARY; T=293.6K  
Non-threshold reactions

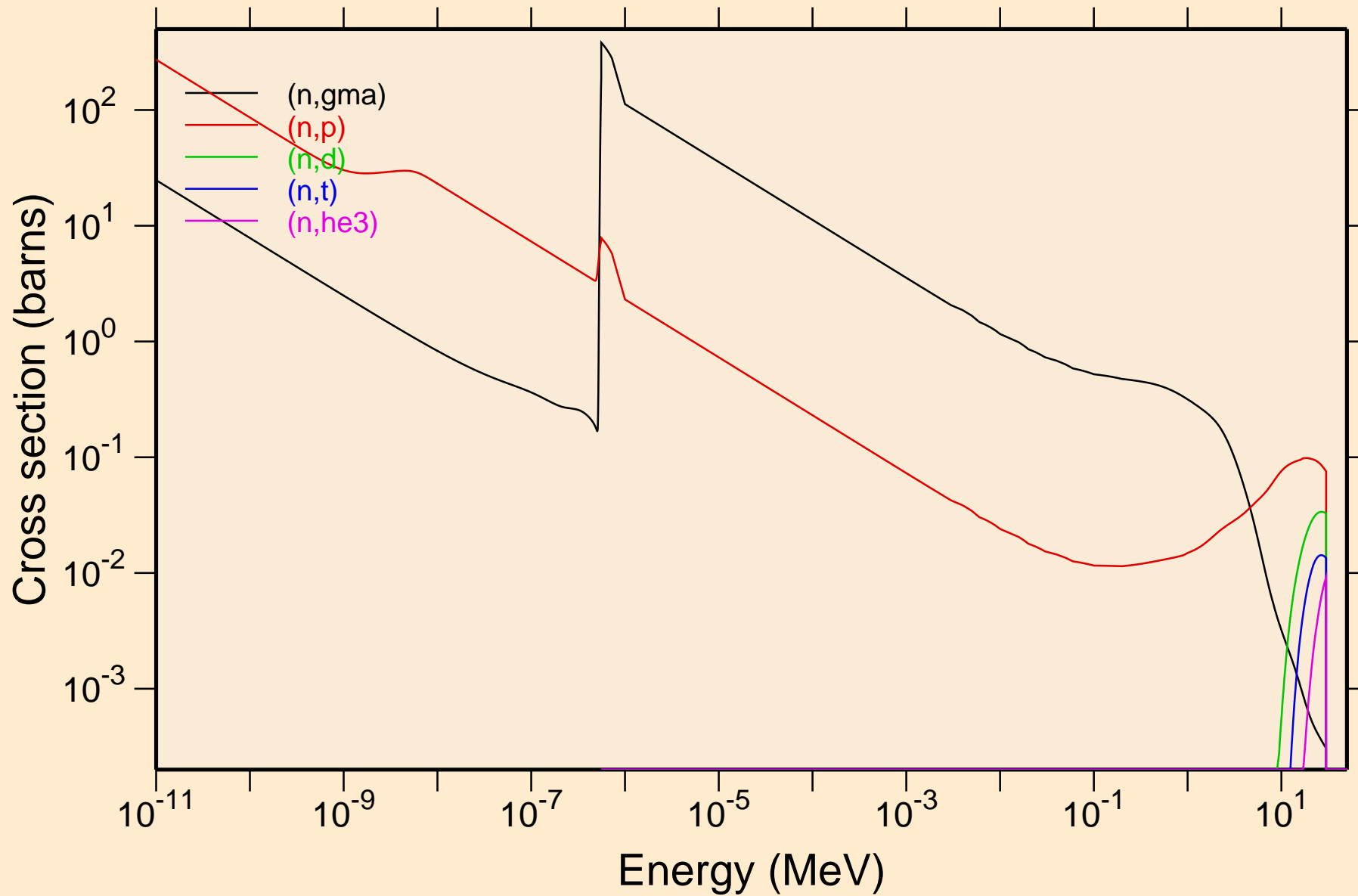

AT198M NEUTRON ACER TENDL-2021 LIBRARY; T=293.6K  
Non-threshold reactions

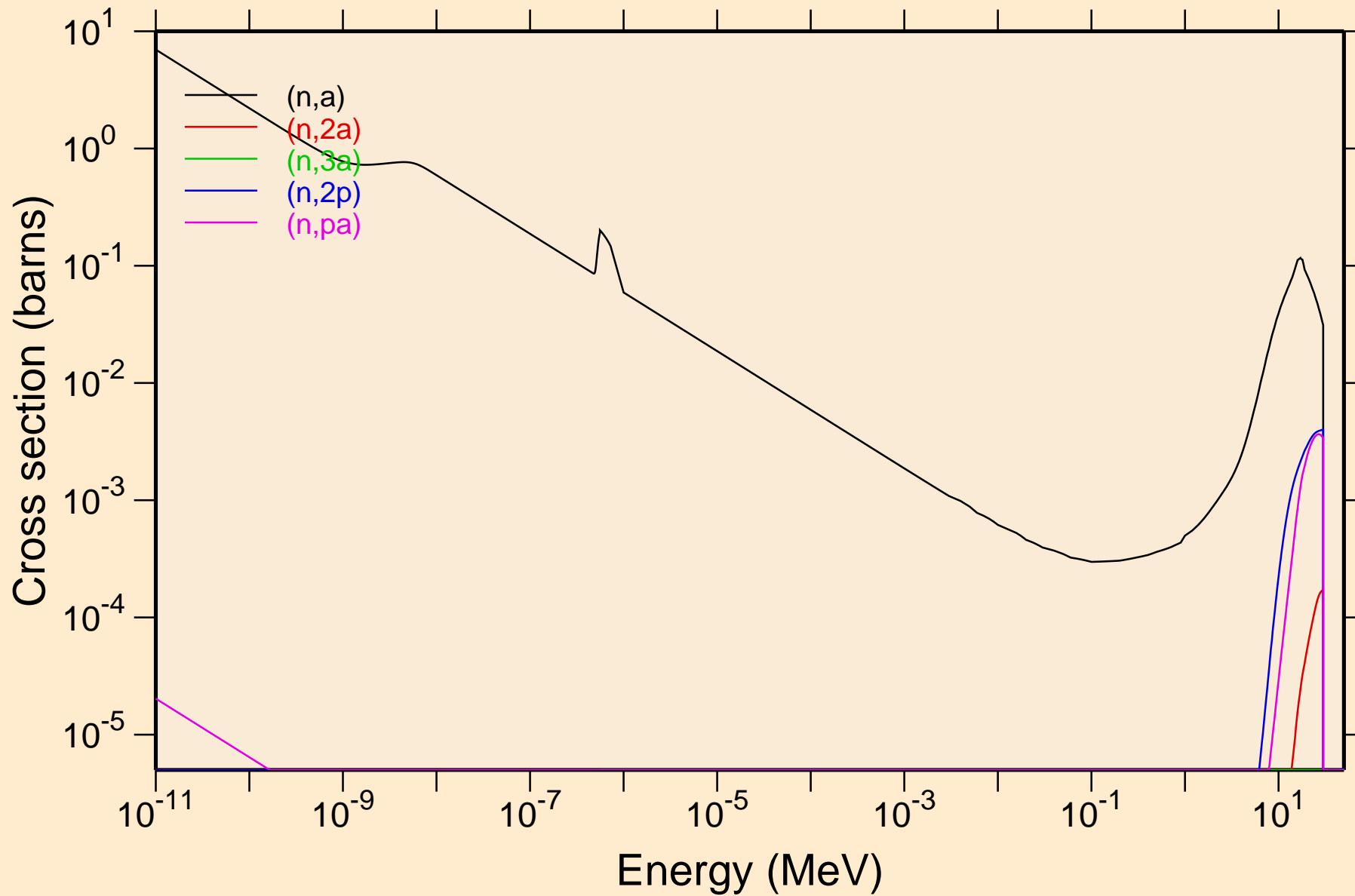

AT198M NEUTRON ACER TENDL-2021 LIBRARY; T=293.6K  
Non-threshold reactions

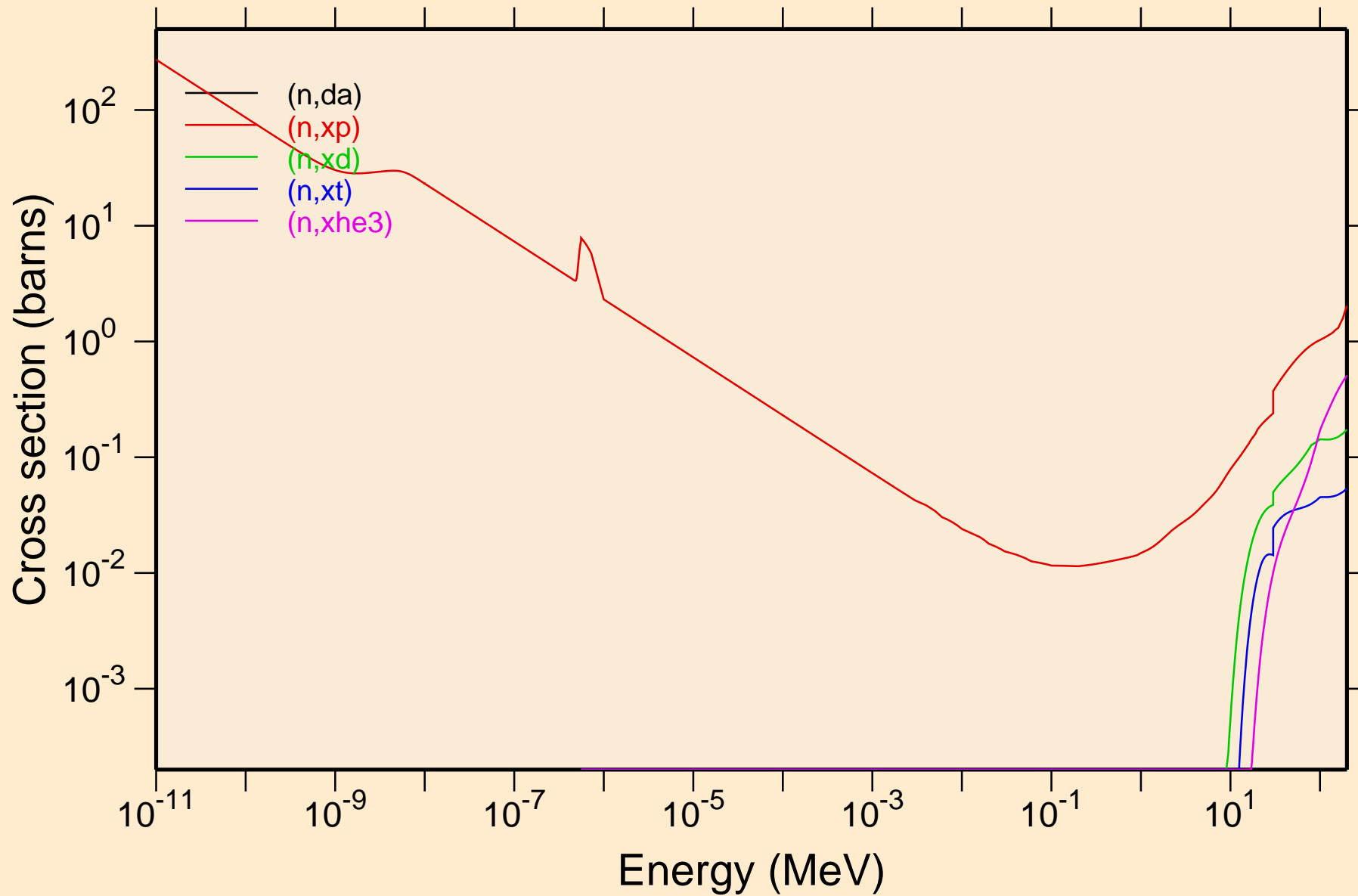

AT198M NEUTRON ACER TENDL-2021 LIBRARY; T=293.6K  
Non-threshold reactions

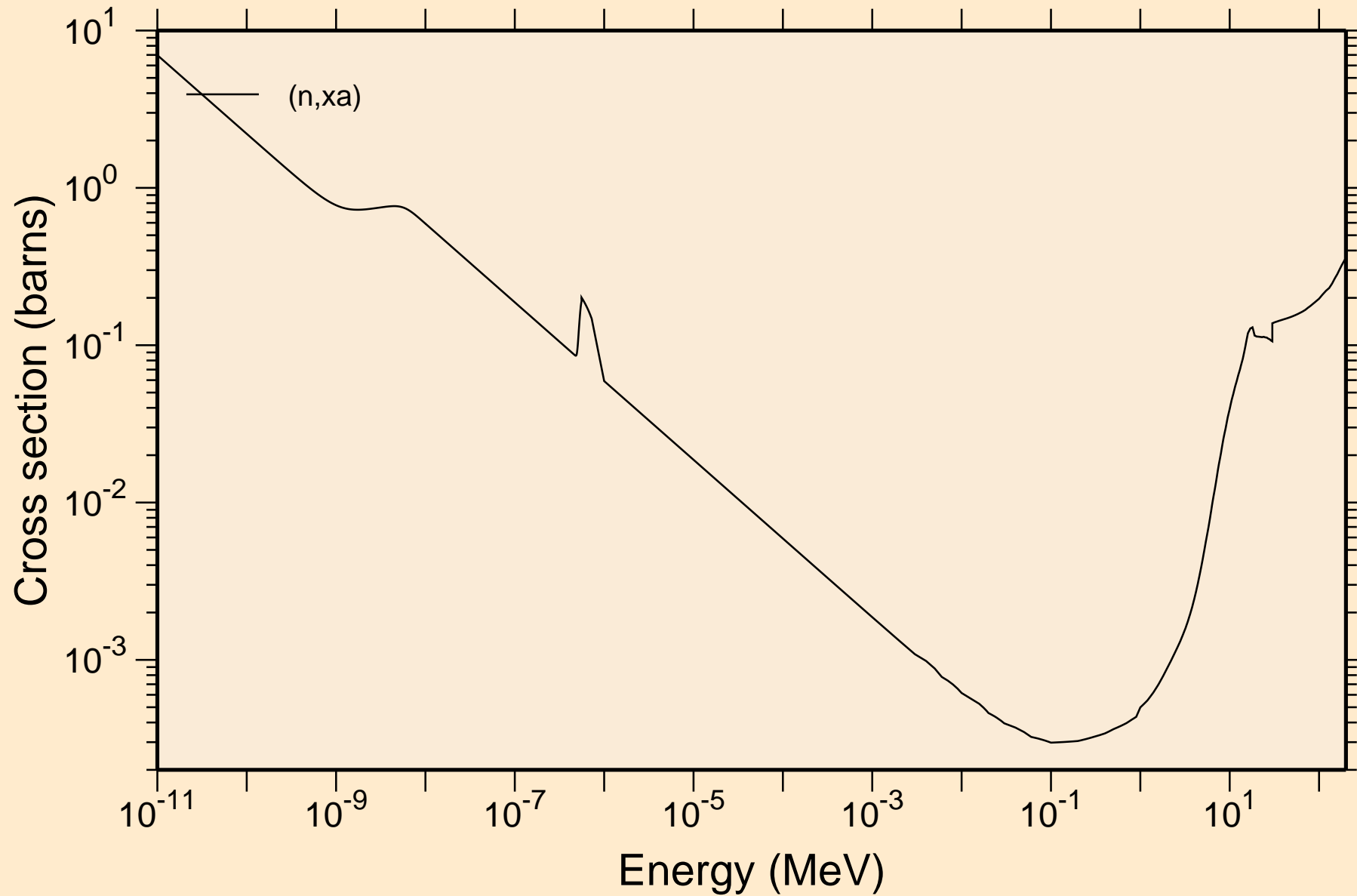



AT198M NEUTRON ACER TENDL-2021 LIBRARY; T=293.6K  
Principal cross sections

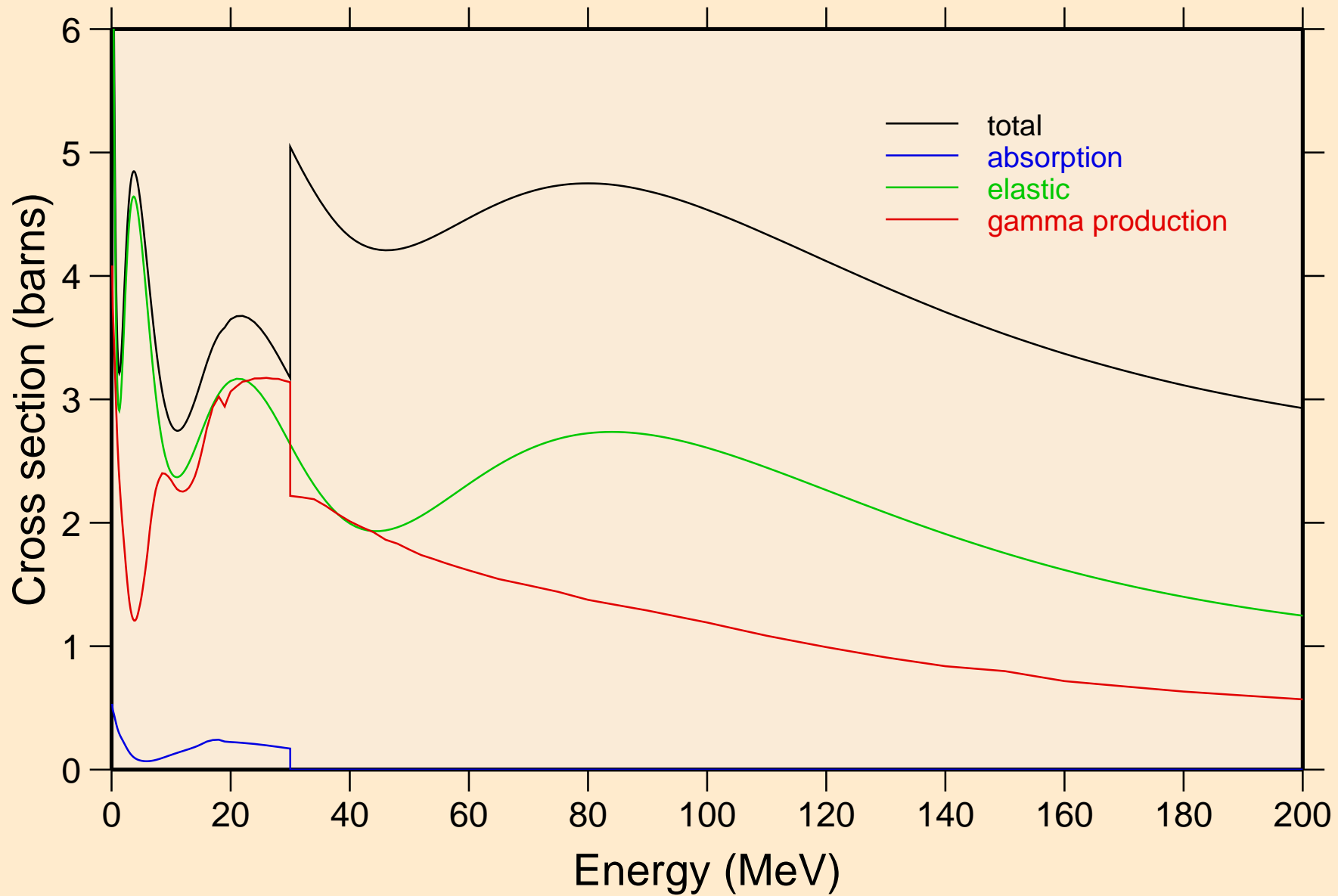

AT198M NEUTRON ACER TENDL-2021 LIBRARY; T=293.6K  
Heating

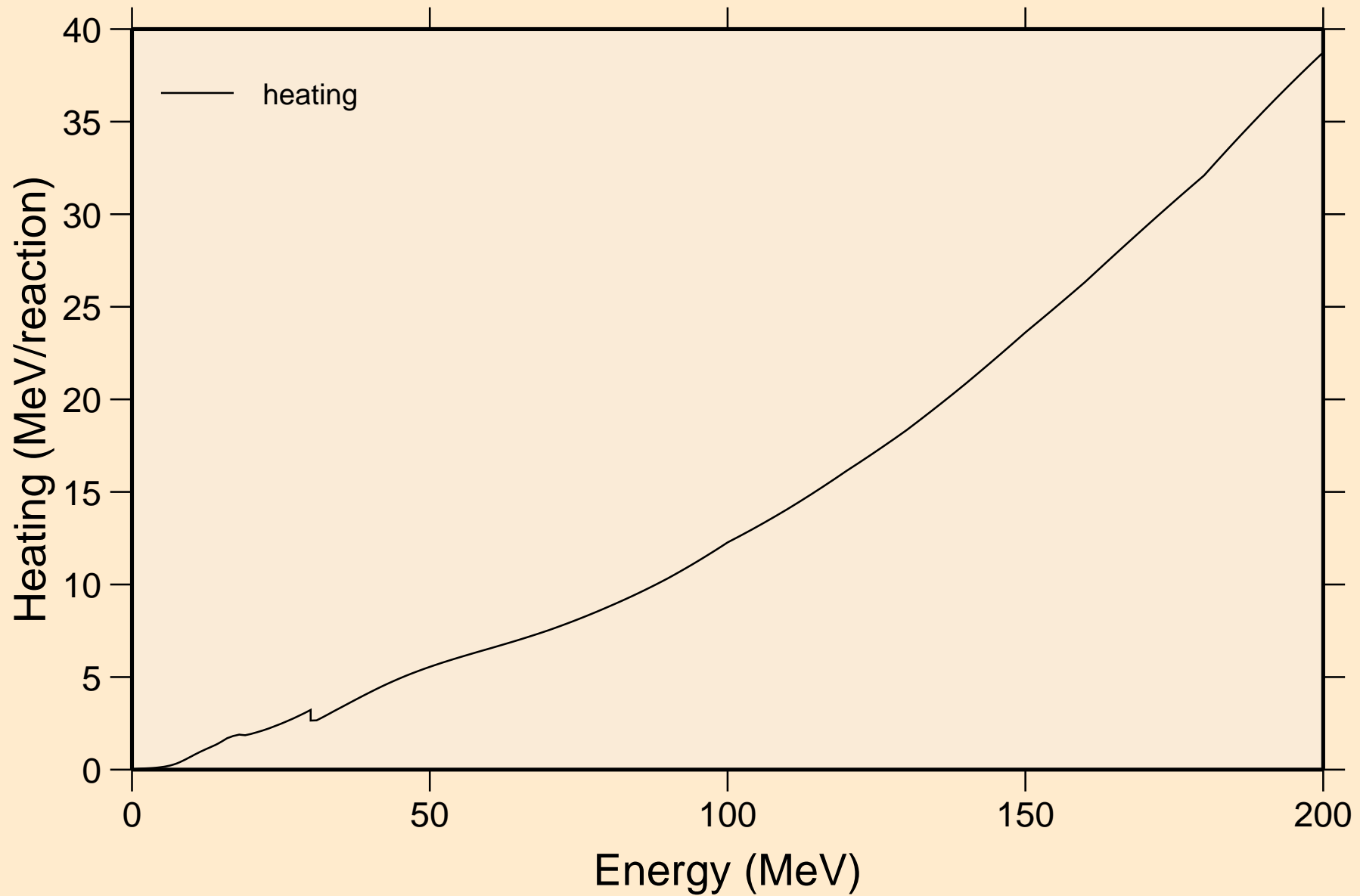

AT198M NEUTRON ACER TENDL-2021 LIBRARY; T=293.6K  
Damage

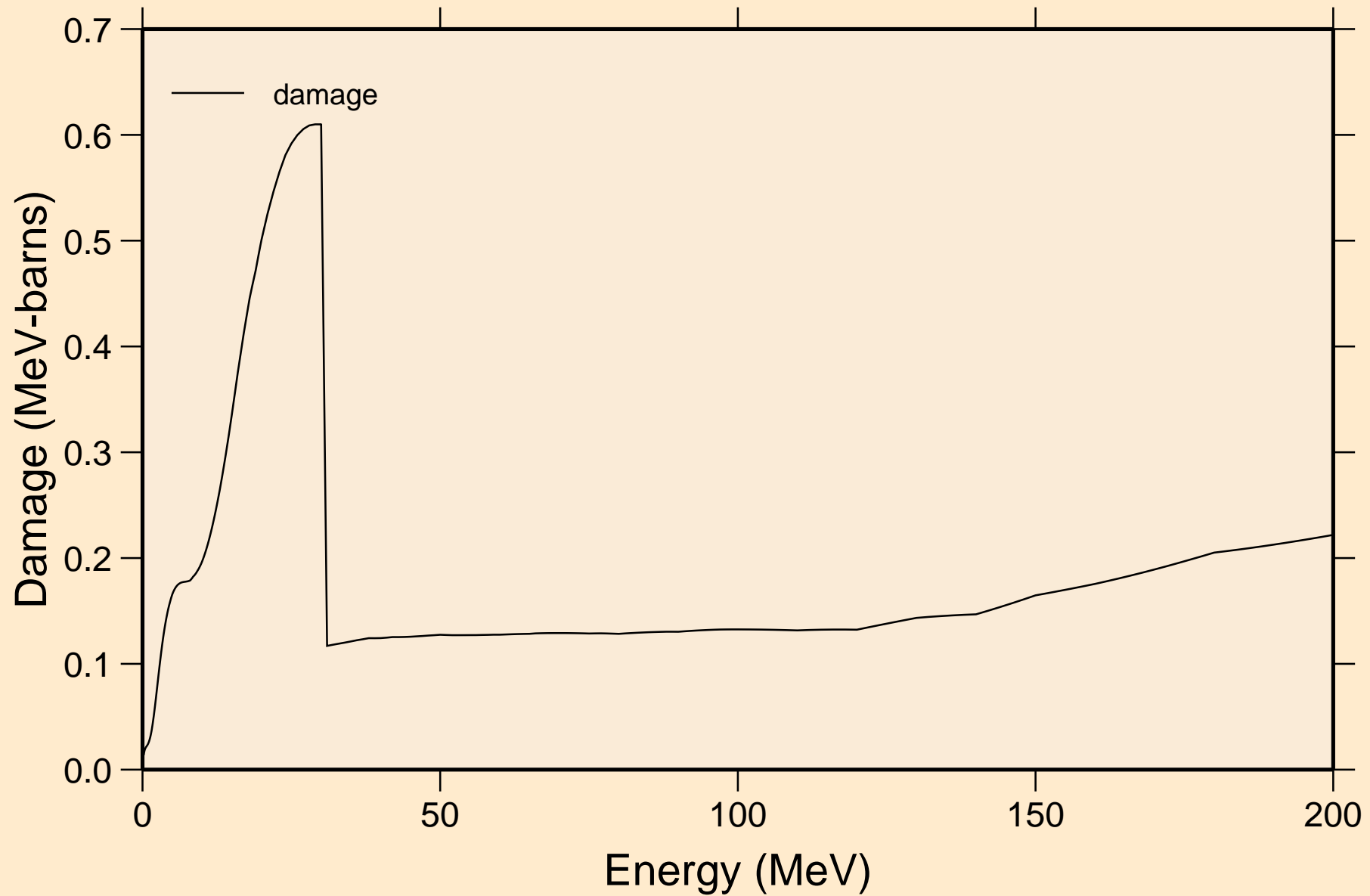

AT198M NEUTRON ACER TENDL-2021 LIBRARY; T=293.6K  
Non-threshold reactions

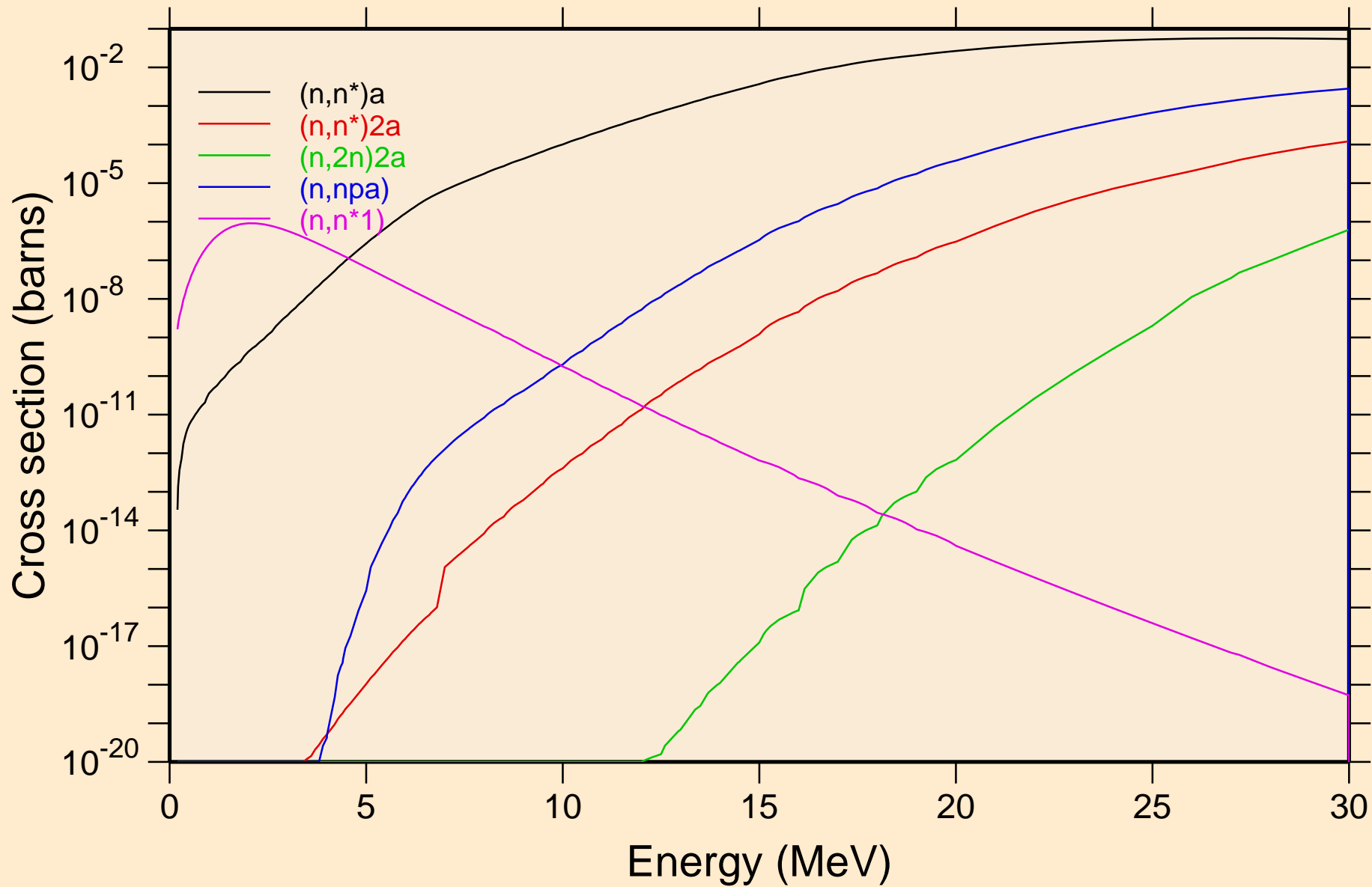

AT198M NEUTRON ACER TENDL-2021 LIBRARY; T=293.6K  
Non-threshold reactions

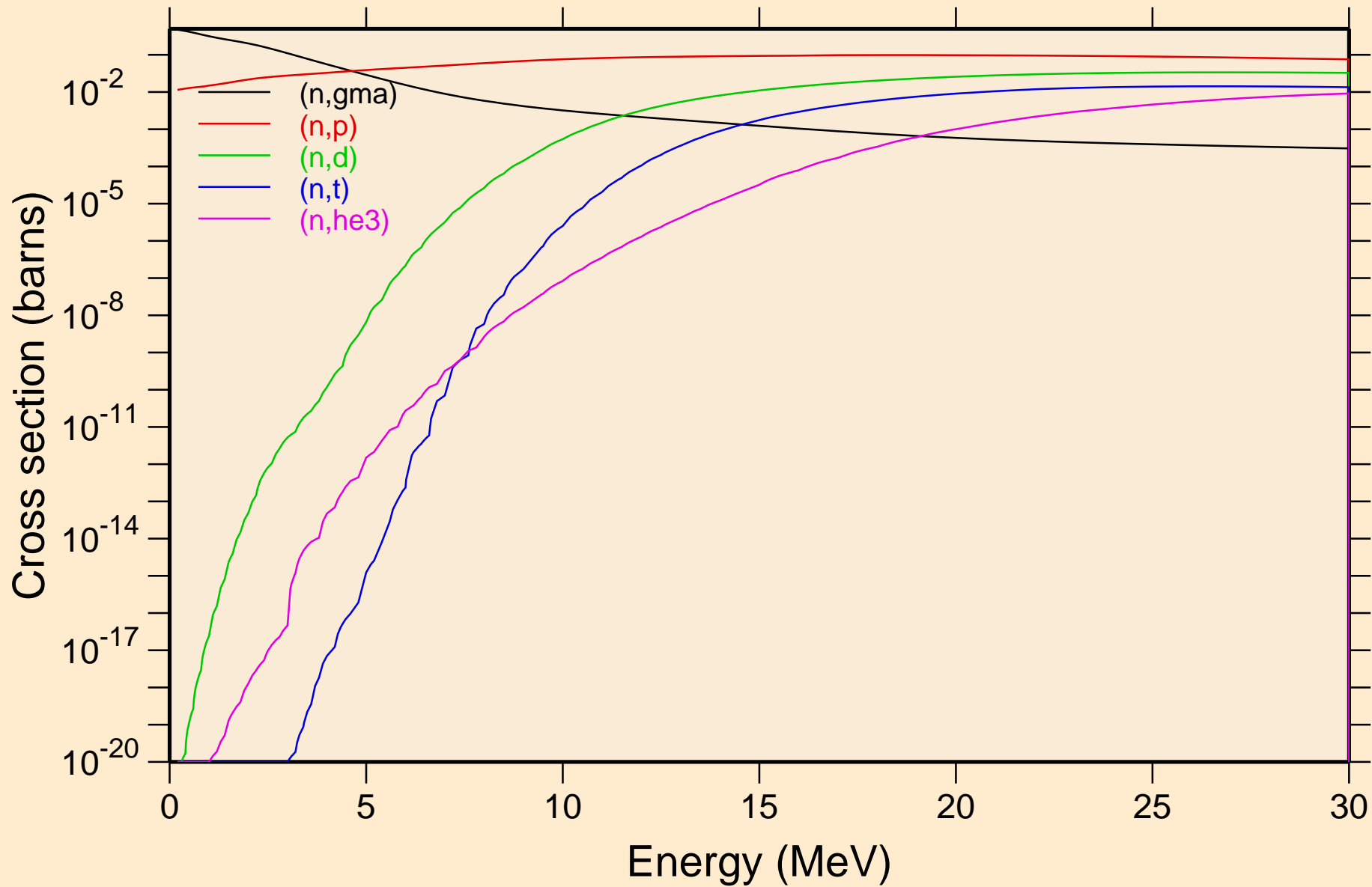

AT198M NEUTRON ACER TENDL-2021 LIBRARY; T=293.6K  
Non-threshold reactions

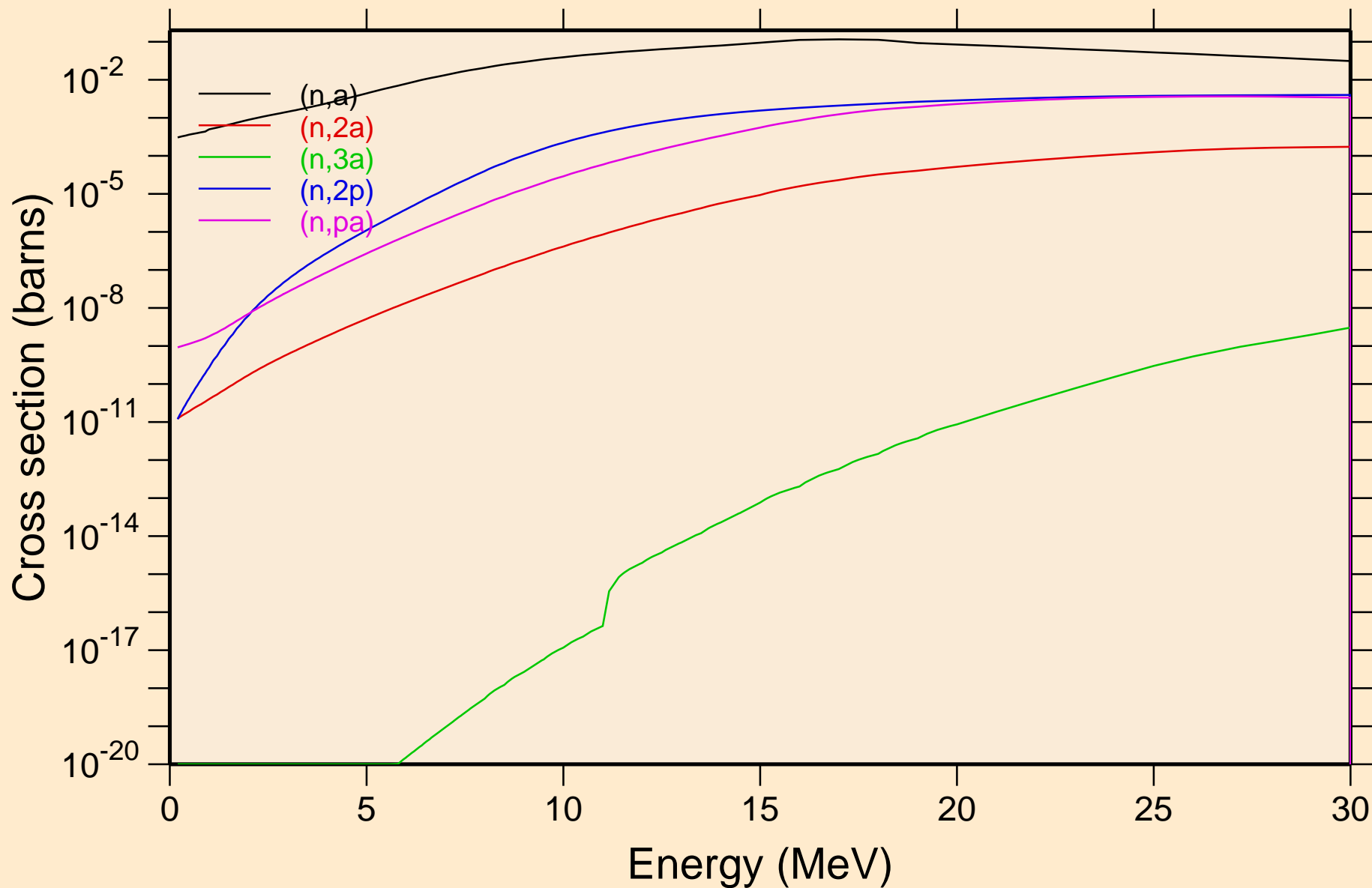

AT198M NEUTRON ACER TENDL-2021 LIBRARY; T=293.6K  
Non-threshold reactions

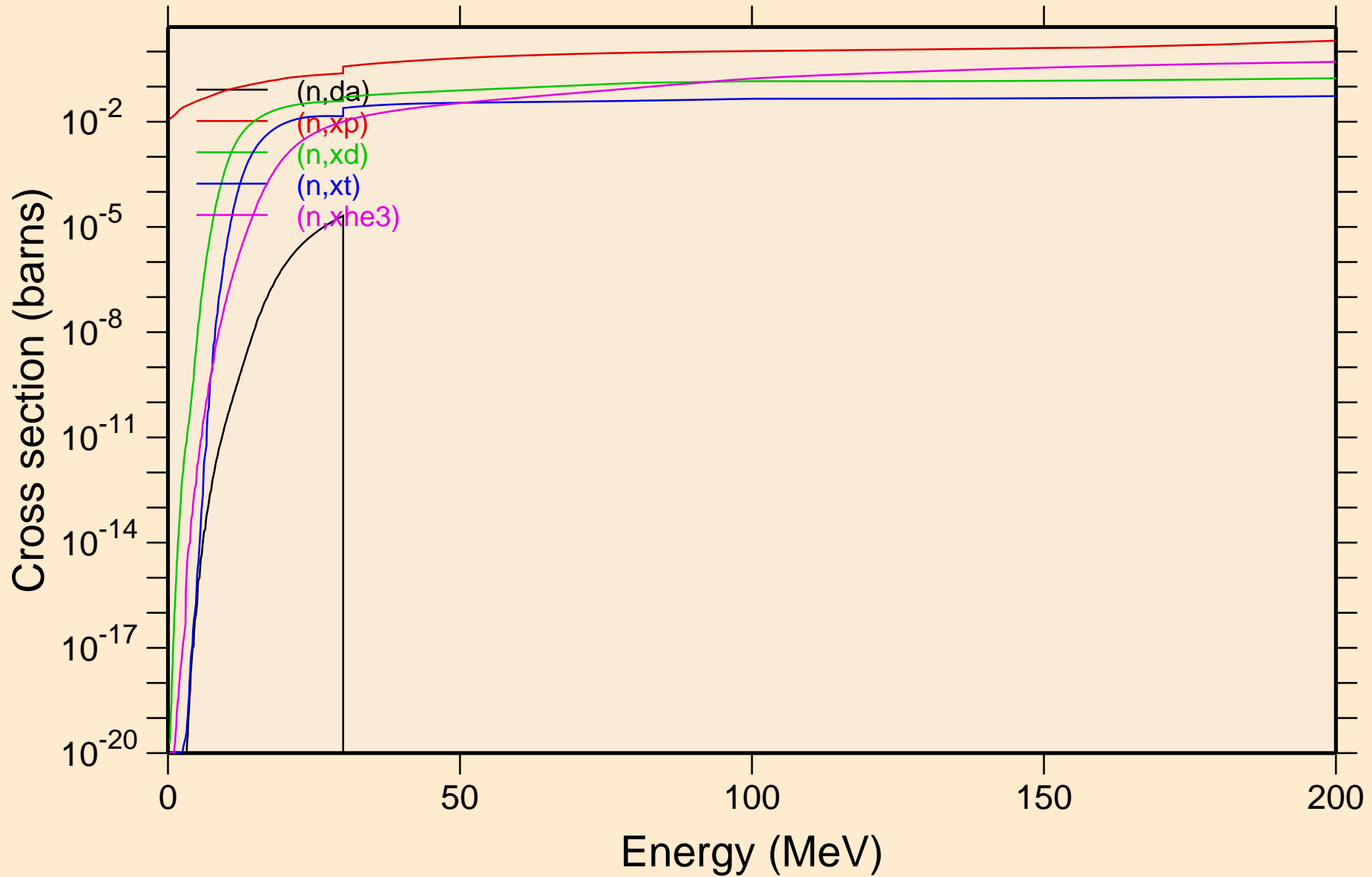

AT198M NEUTRON ACER TENDL-2021 LIBRARY; T=293.6K  
Non-threshold reactions

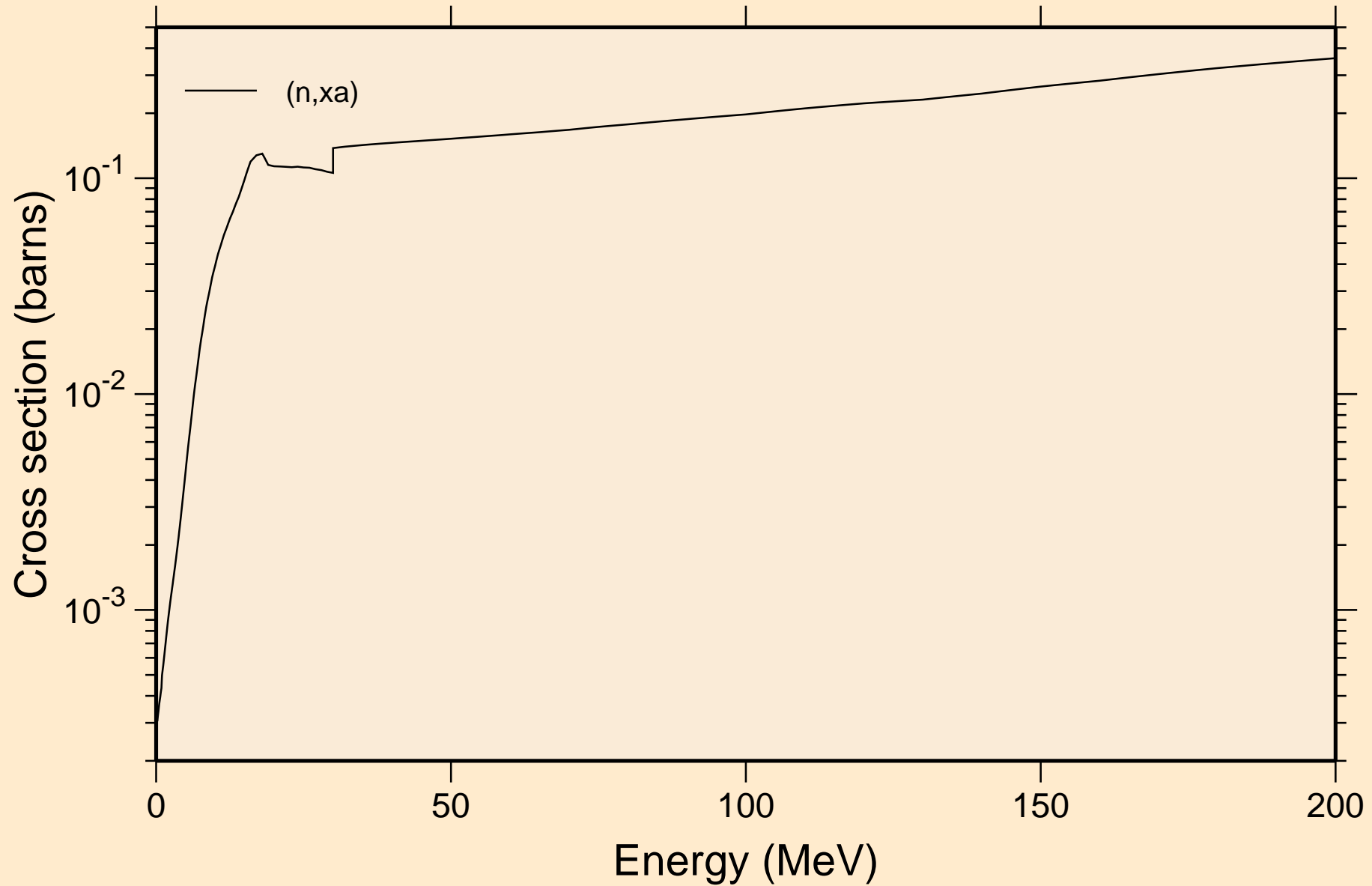



AT198M NEUTRON ACER TENDL-2021 LIBRARY; T=293.6K  
Inelastic levels

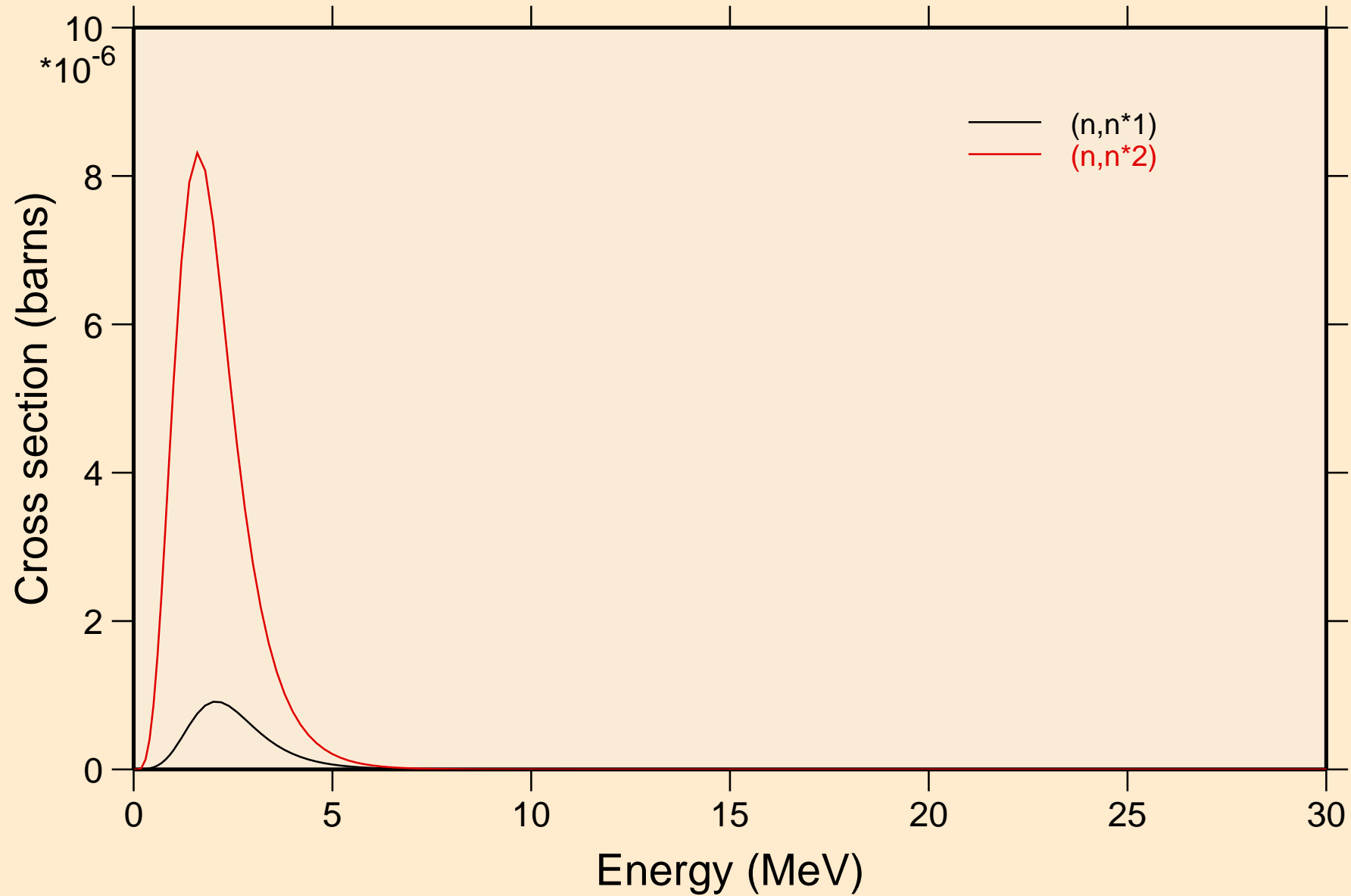

AT198M NEUTRON ACER TENDL-2021 LIBRARY; T=293.6K  
Threshold reactions

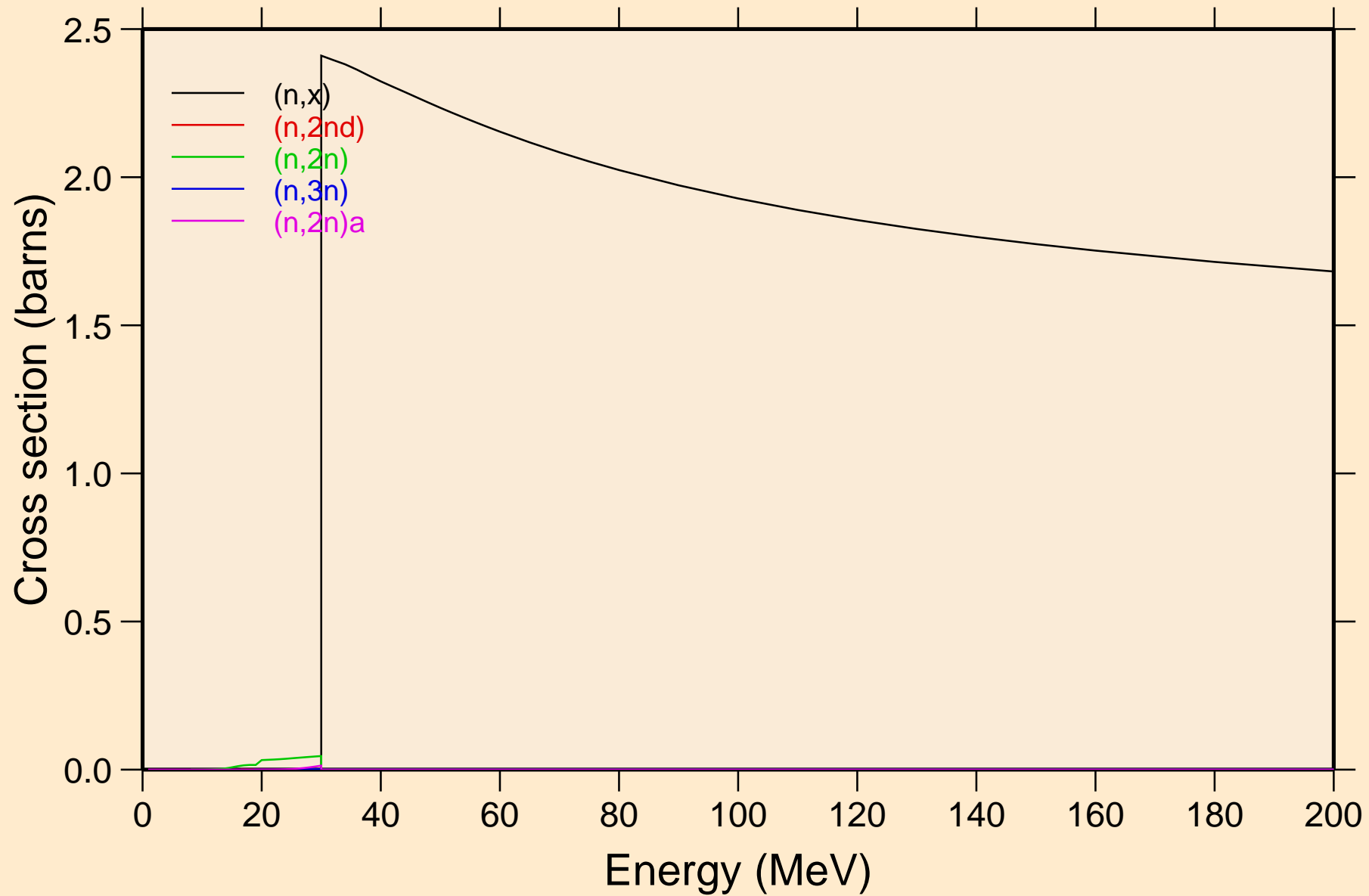

AT198M NEUTRON ACER TENDL-2021 LIBRARY; T=293.6K  
Threshold reactions

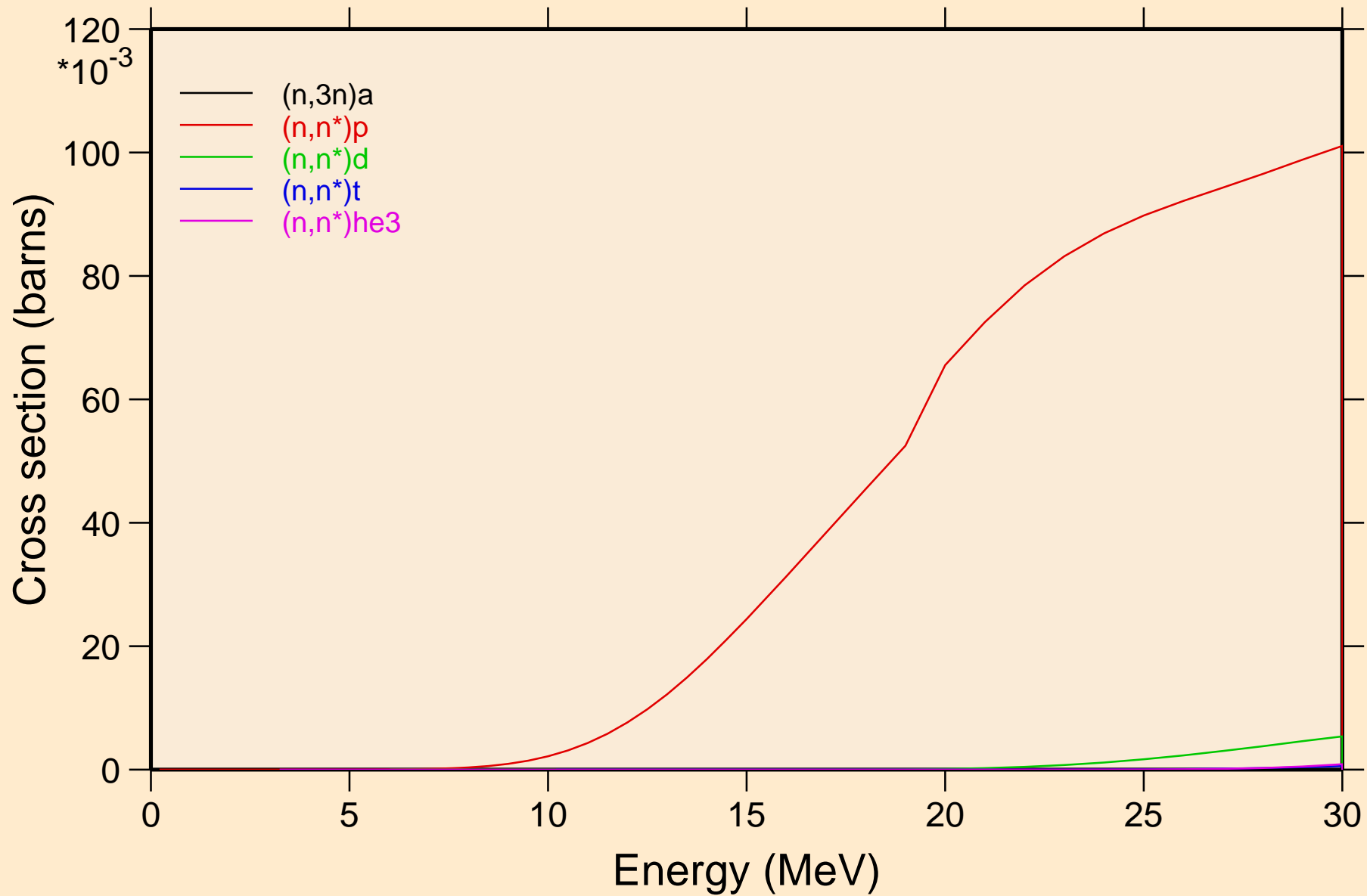

AT198M NEUTRON ACER TENDL-2021 LIBRARY; T=293.6K  
Threshold reactions

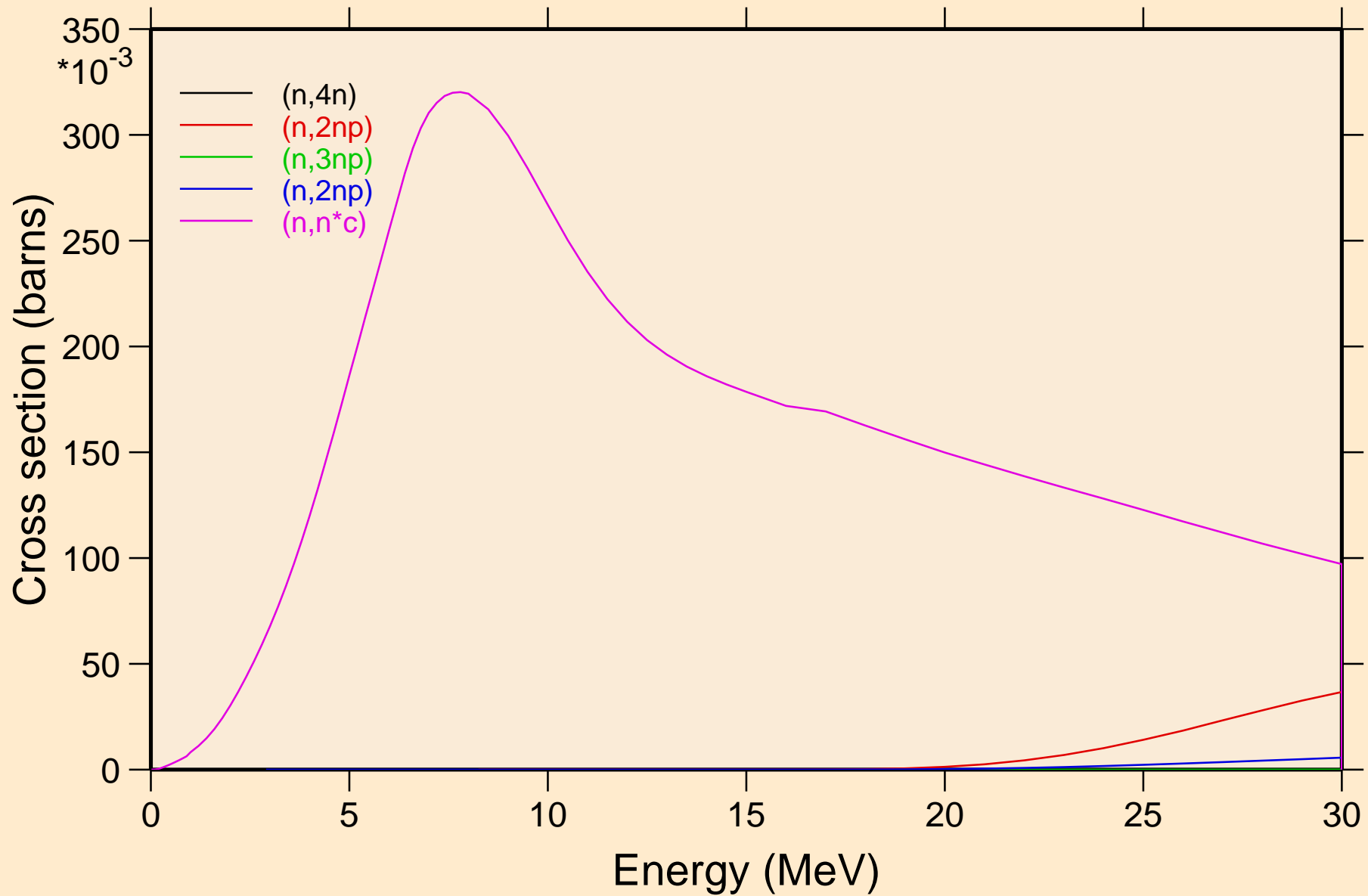

AT198M NEUTRON ACER TENDL-2021 LIBRARY; T=293.6K  
Threshold reactions

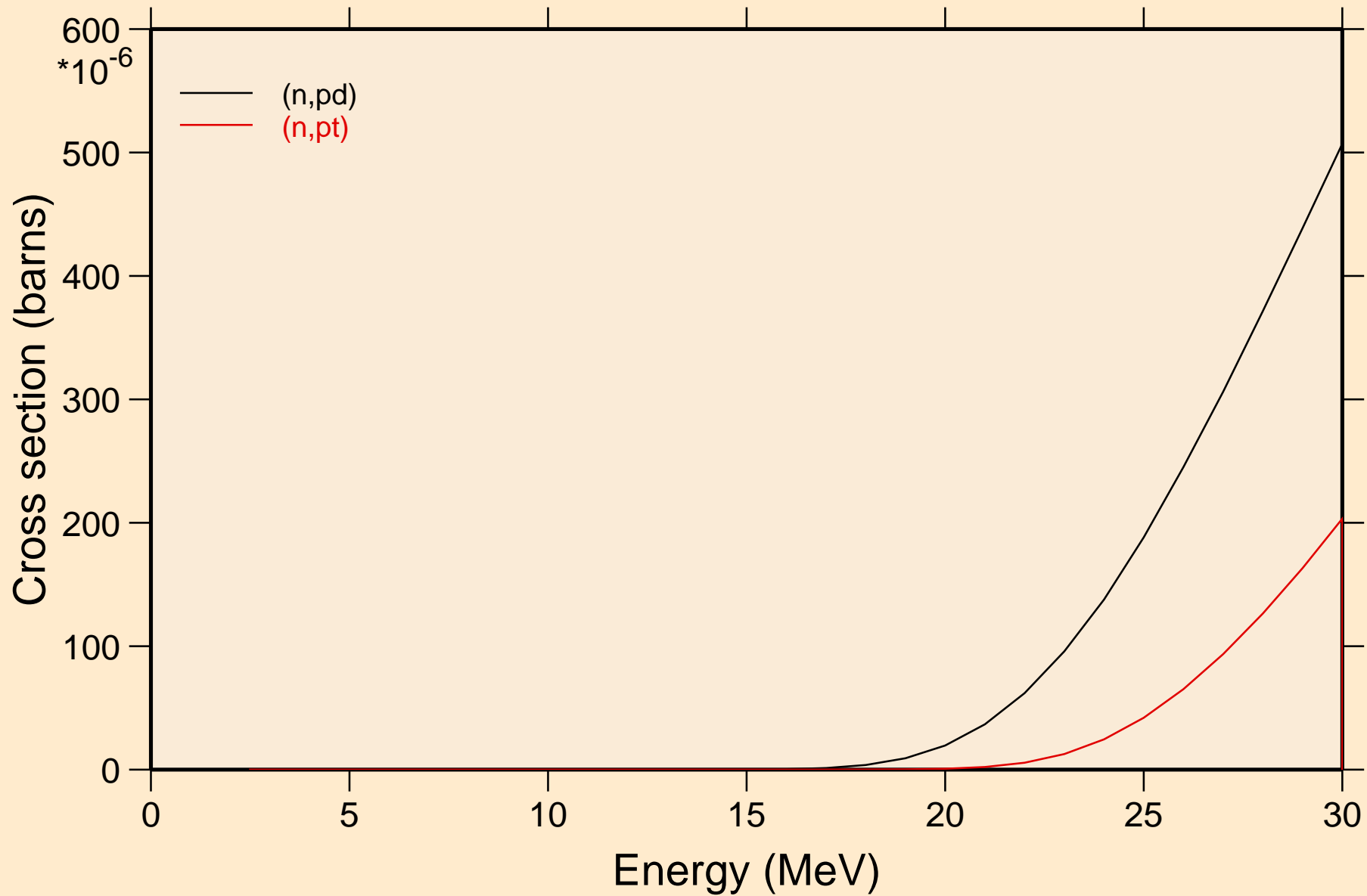

AT198M NEUTRON ACER TENDL-2021 LIBRARY; T=293.6K  
angular distribution for elastic

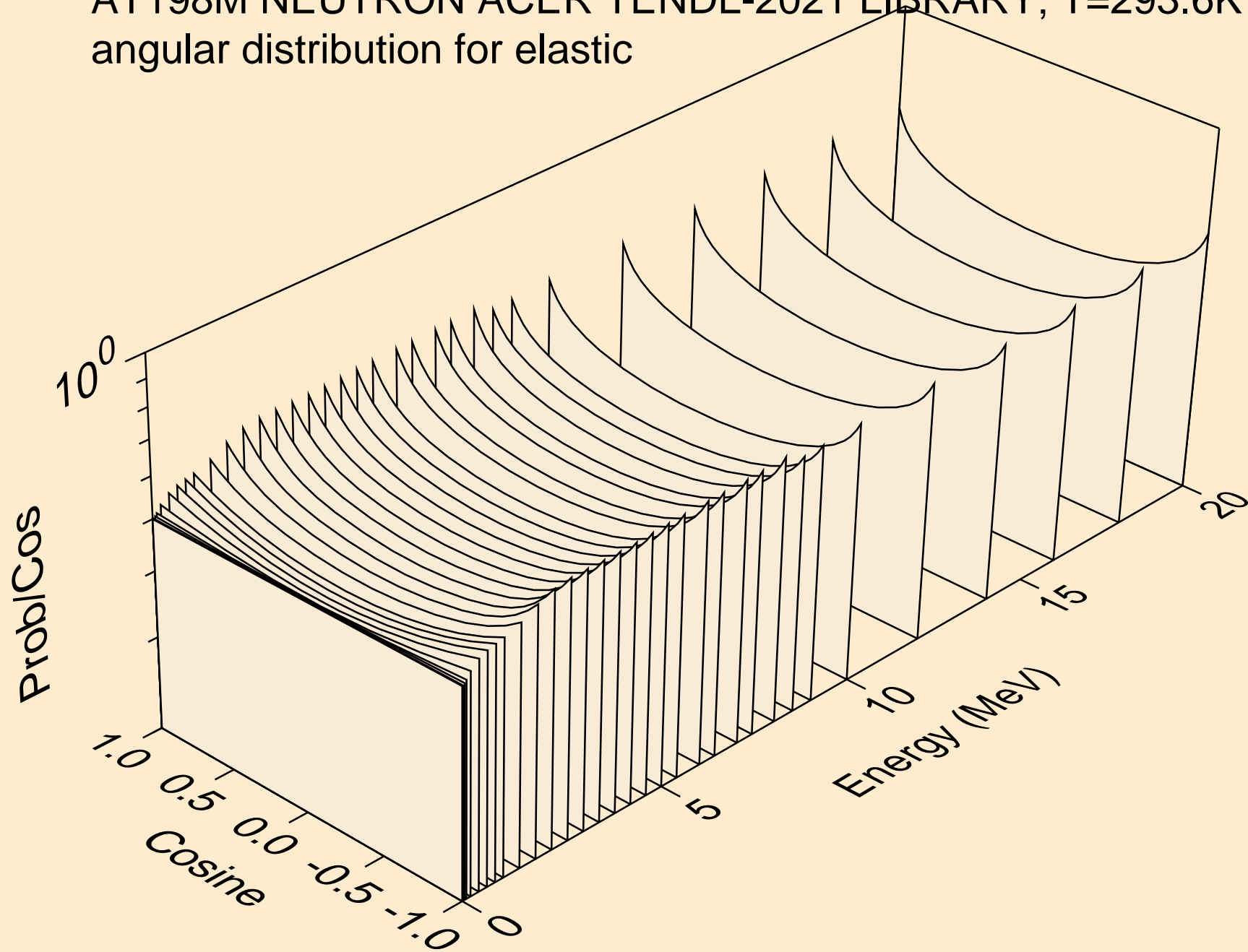

AT198M NEUTRON ACER TENDL-2021 LIBRARY; T=293.6K  
angular distribution for elastic

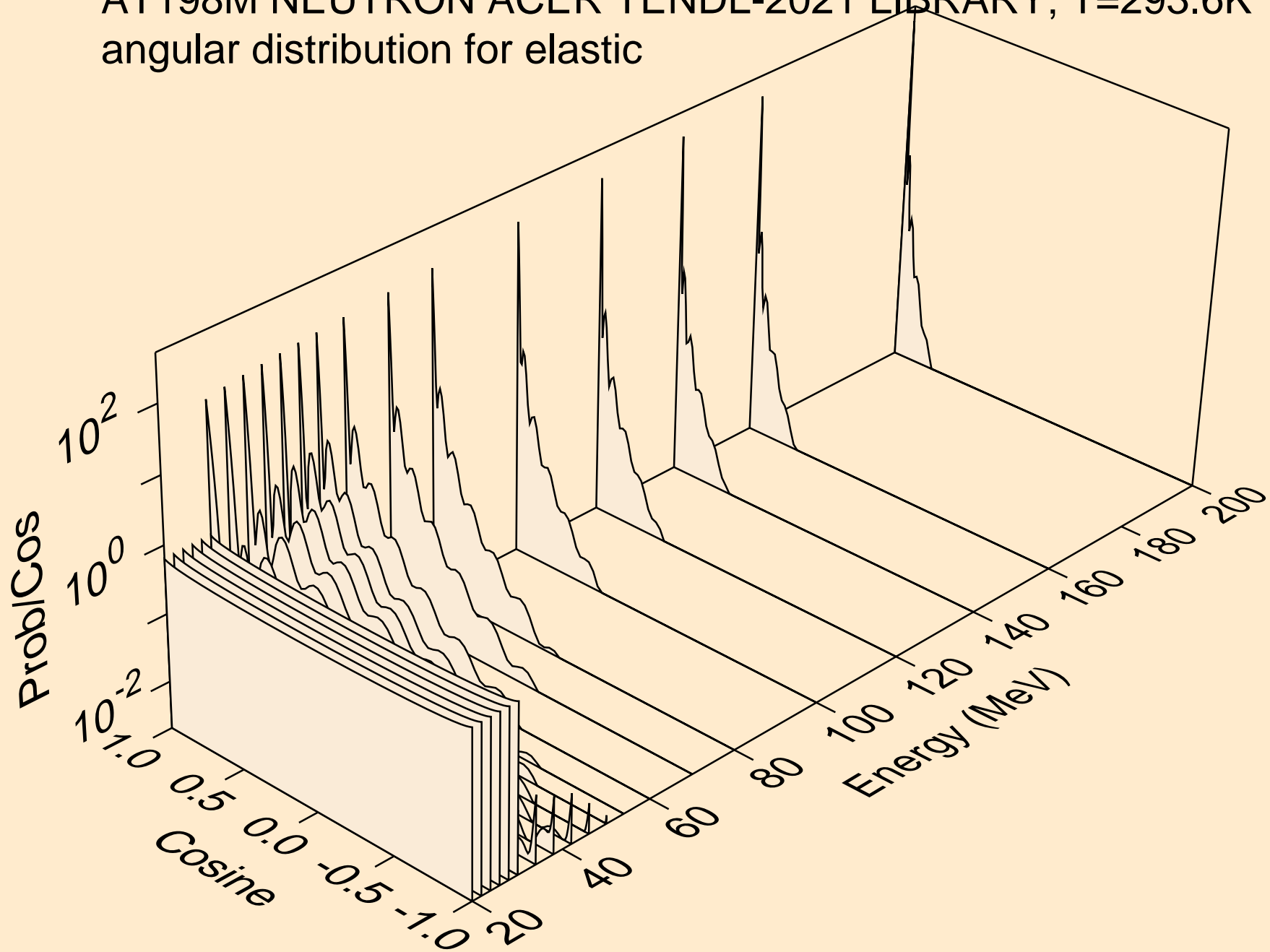

AT198M NEUTRON ACER TENDL-2021 LIBRARY; T=293.6K  
angular distribution for (n,n\*1)

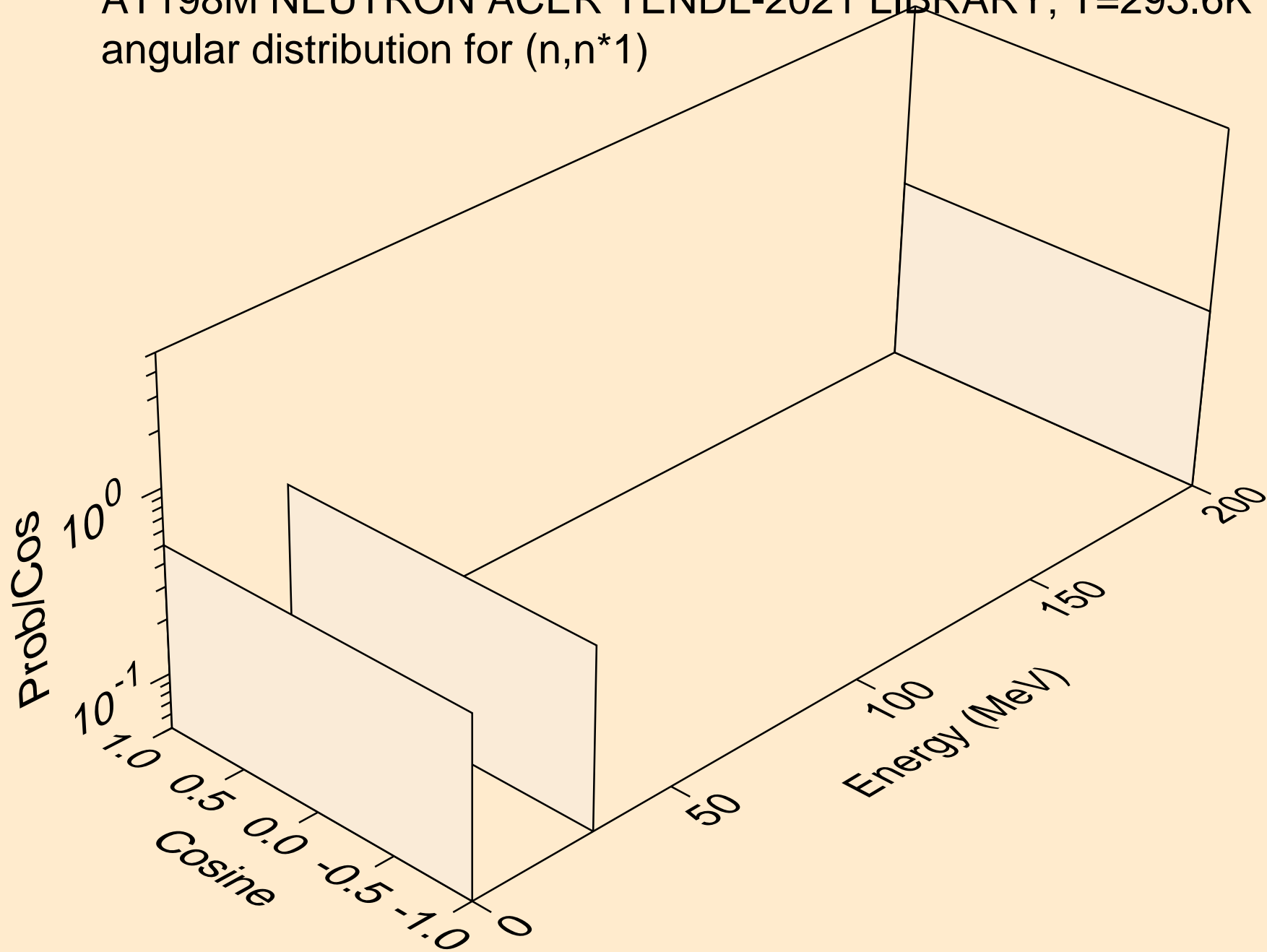



AT198M NEUTRON ACER TENDL-2021 LIBRARY; T=293.6K  
angular distribution for (n,n\*2)

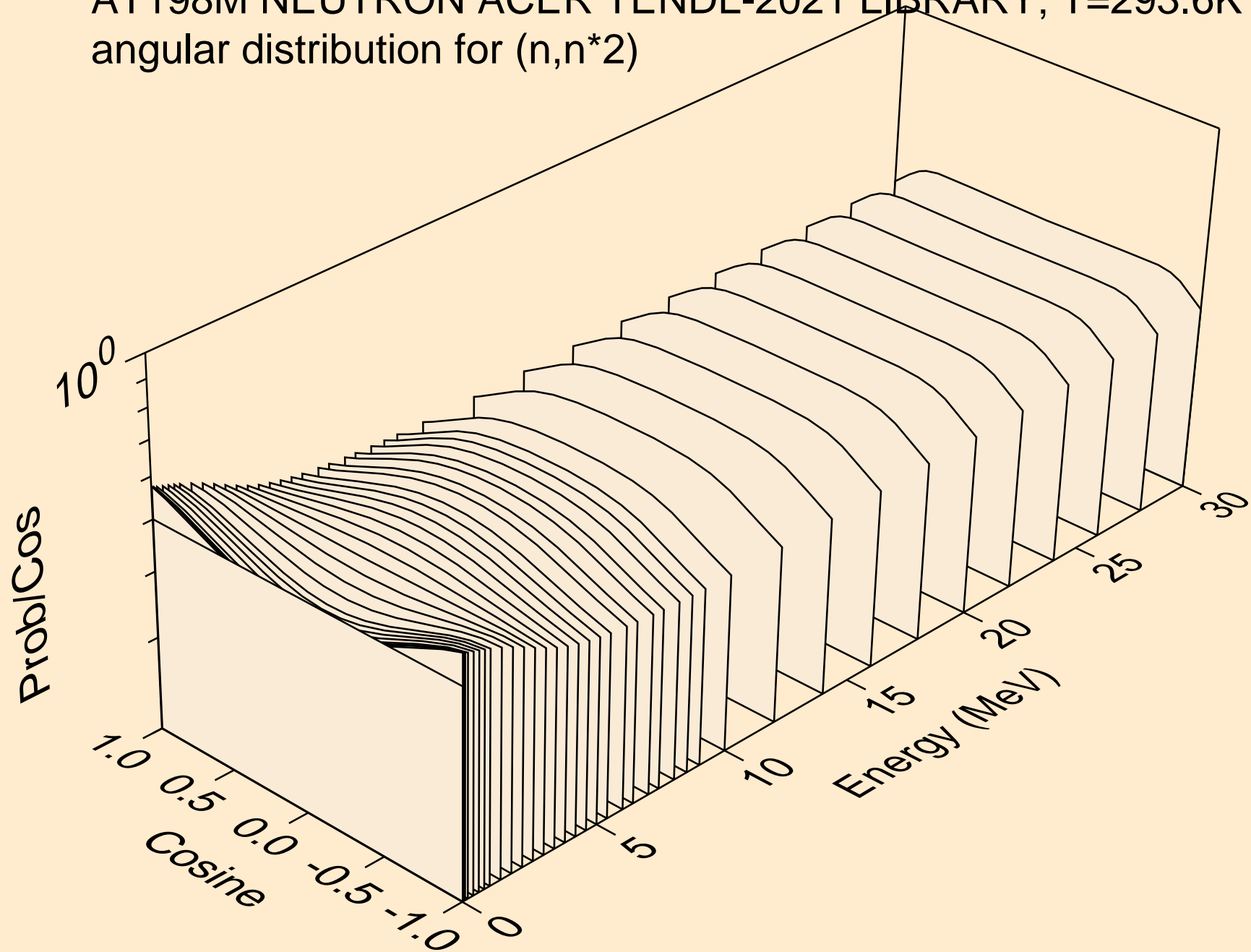

AT198M NEUTRON ACER TENDL-2021 LIBRARY; T=293.6K  
Neutron emission for (n,x)

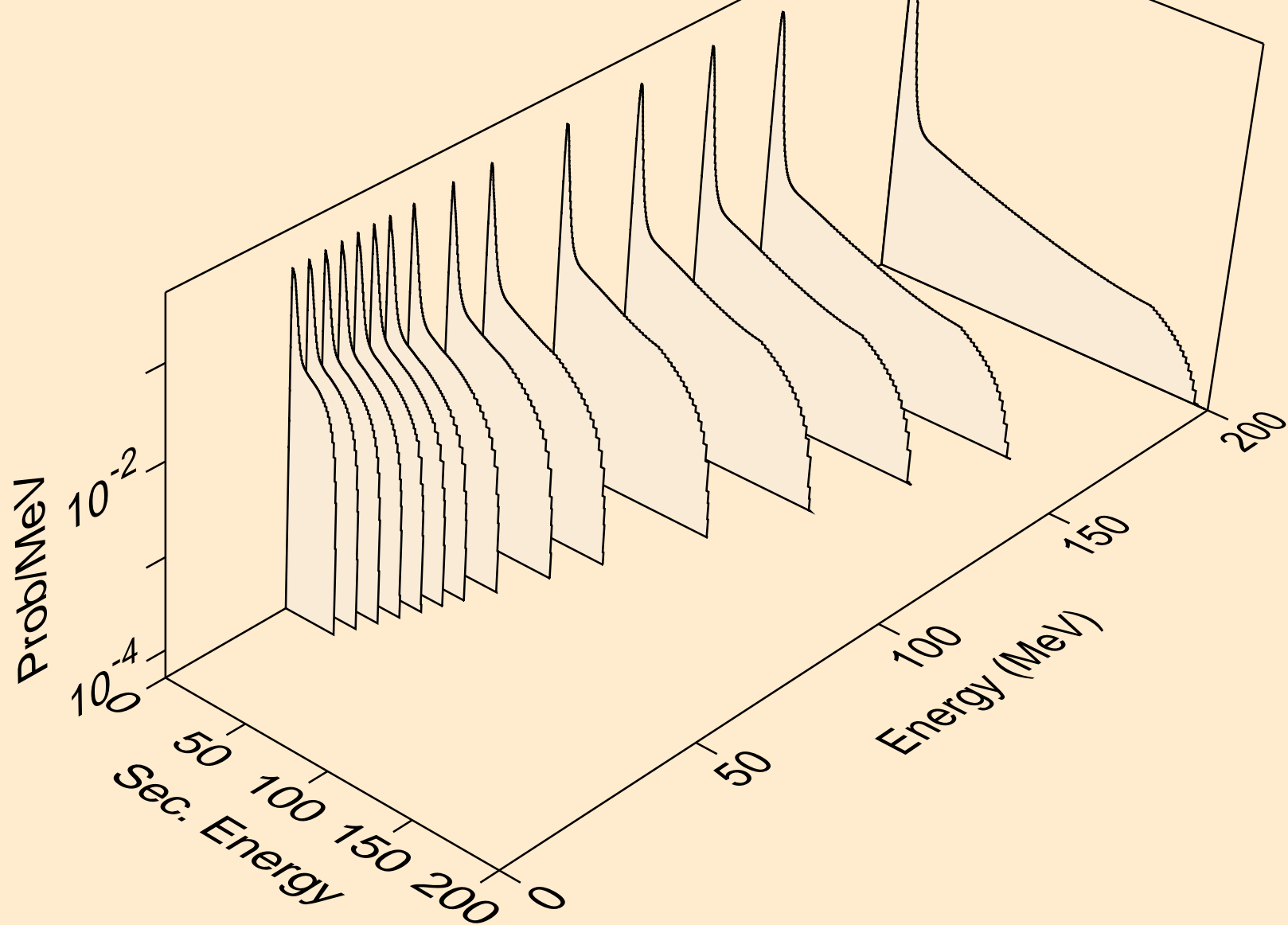

AT198M NEUTRON ACER TENDL-2021 LIBRARY; T=293.6K  
Neutron emission for (n,2nd)

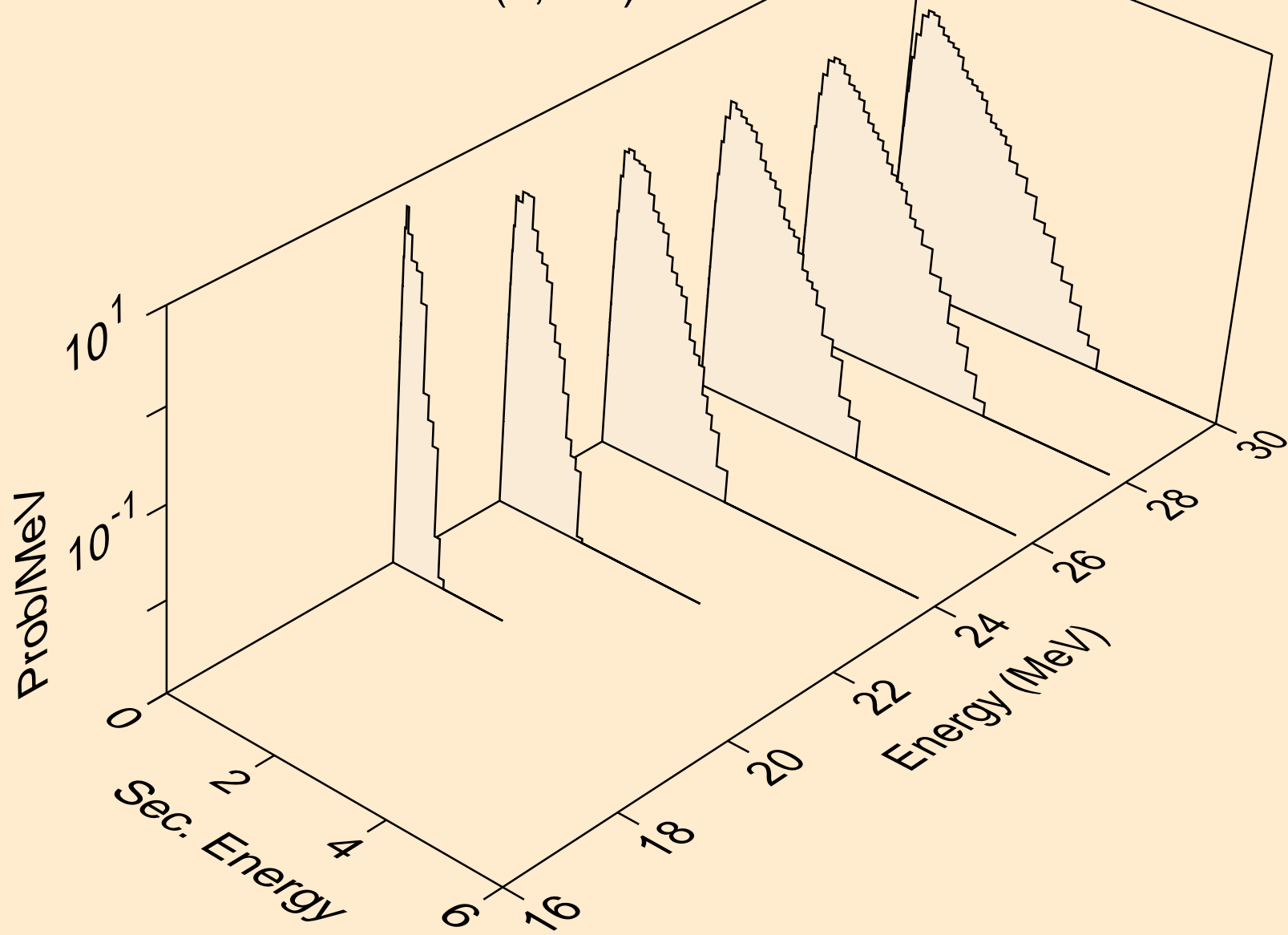

AT198M NEUTRON ACER TENDL-2021 LIBRARY; T=293.6K  
Neutron emission for (n,2n)

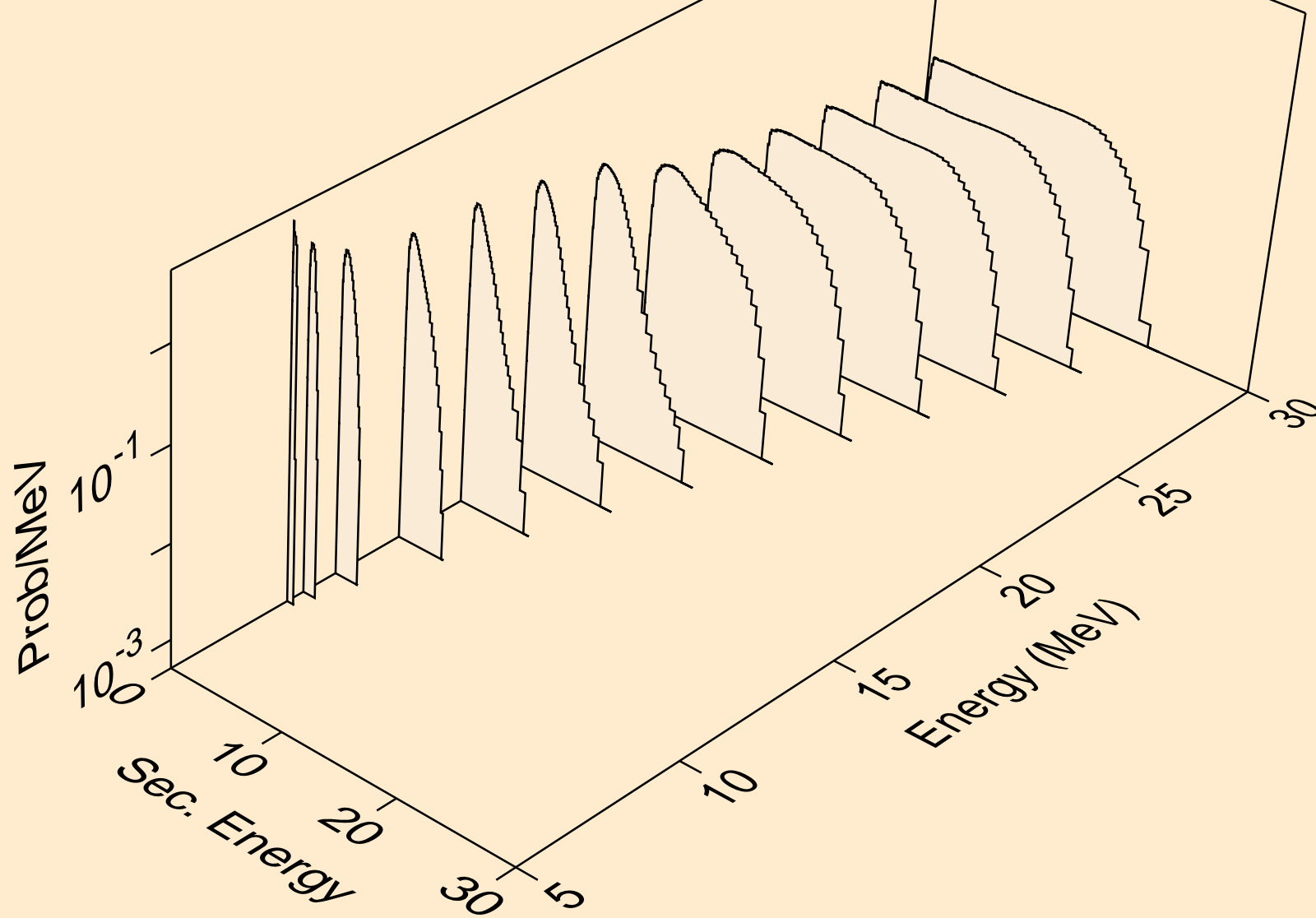

AT198M NEUTRON ACER TENDL-2021 LIBRARY; T=293.6K  
Neutron emission for (n,3n)

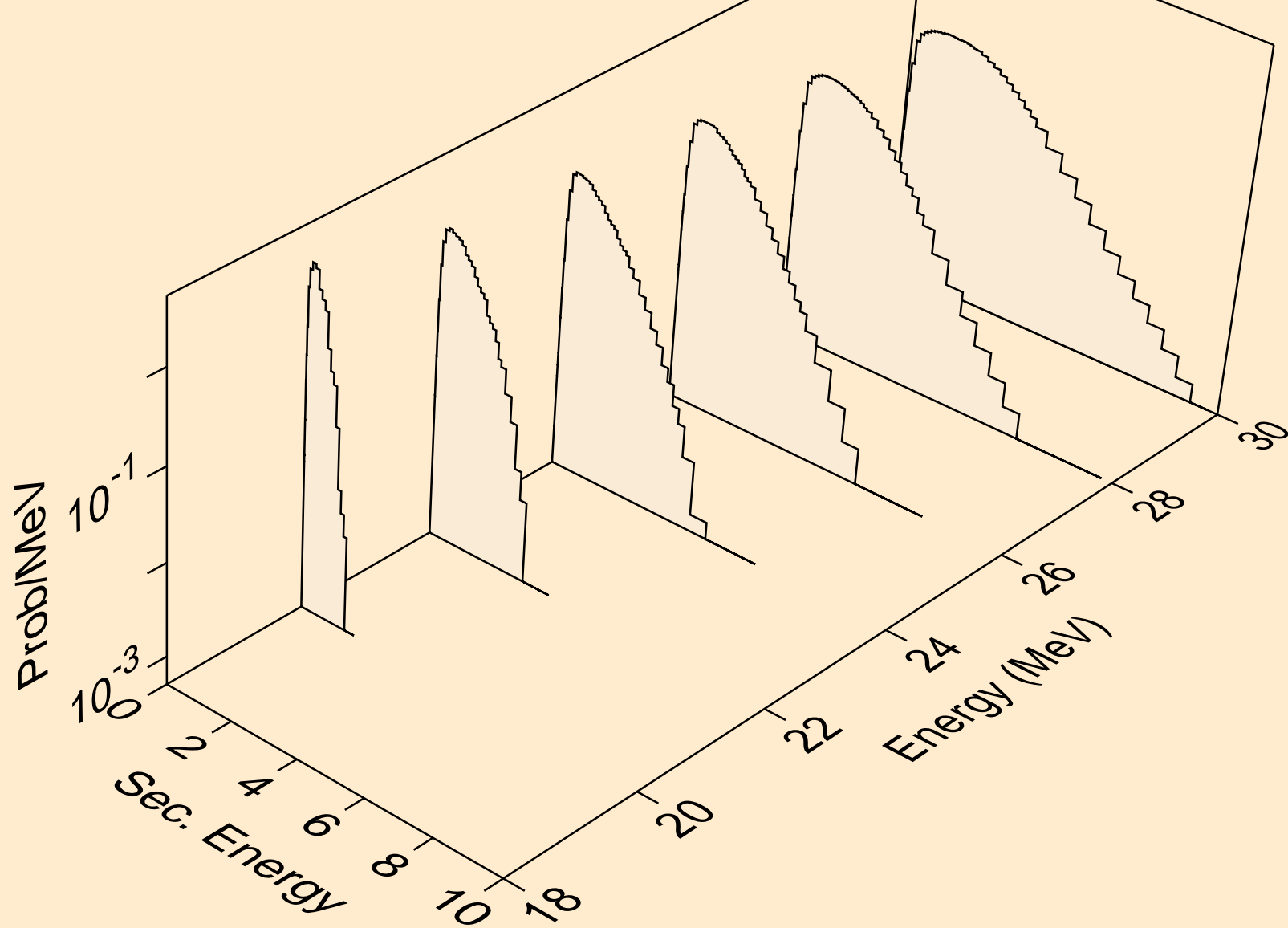

AT198M NEUTRON ACER TENDL-2021 LIBRARY; T=293.6K  
Neutron emission for (n,n\*)a

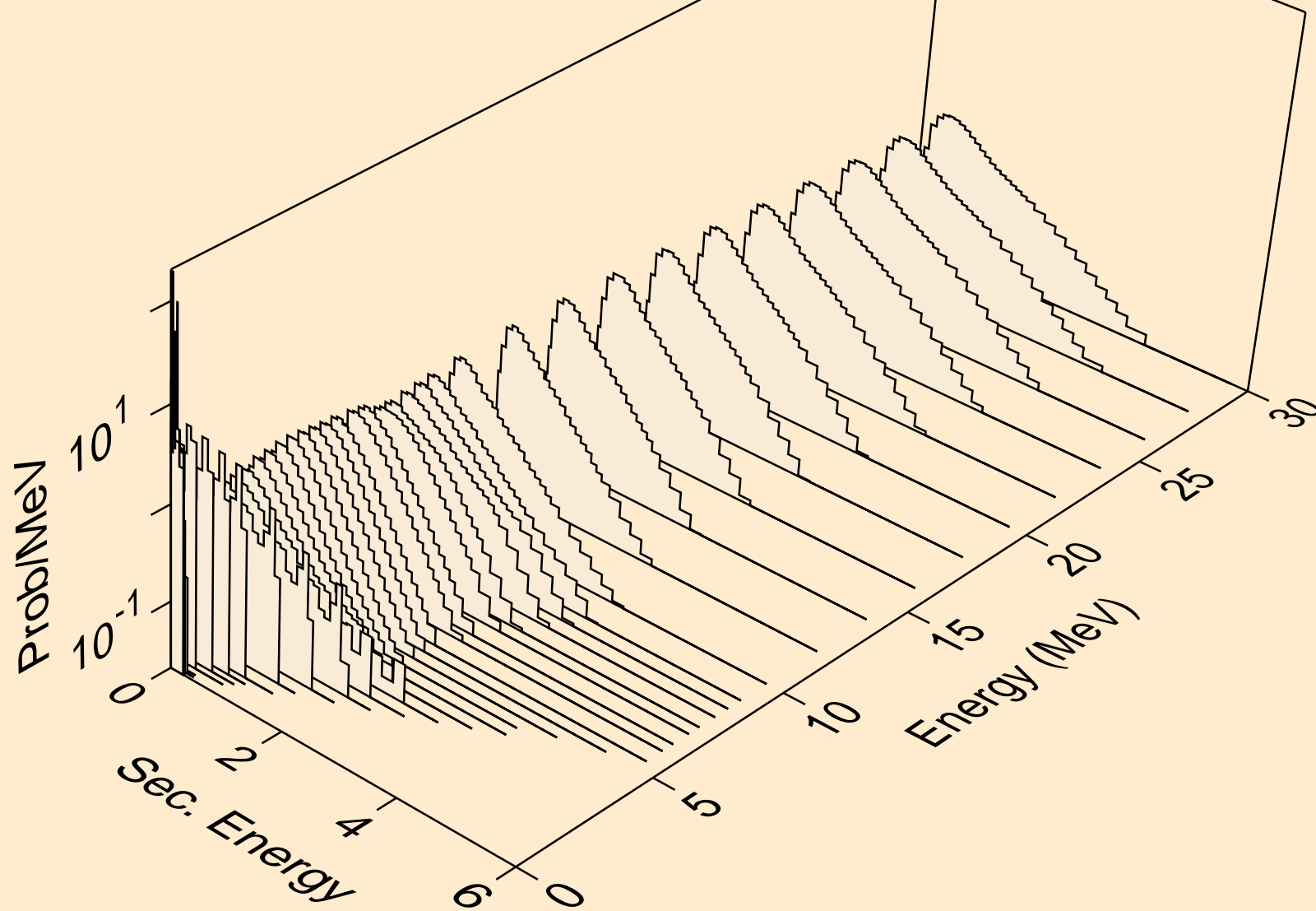

AT198M NEUTRON ACER TENDL-2021 LIBRARY; T=293.6K  
Neutron emission for (n,2n)a

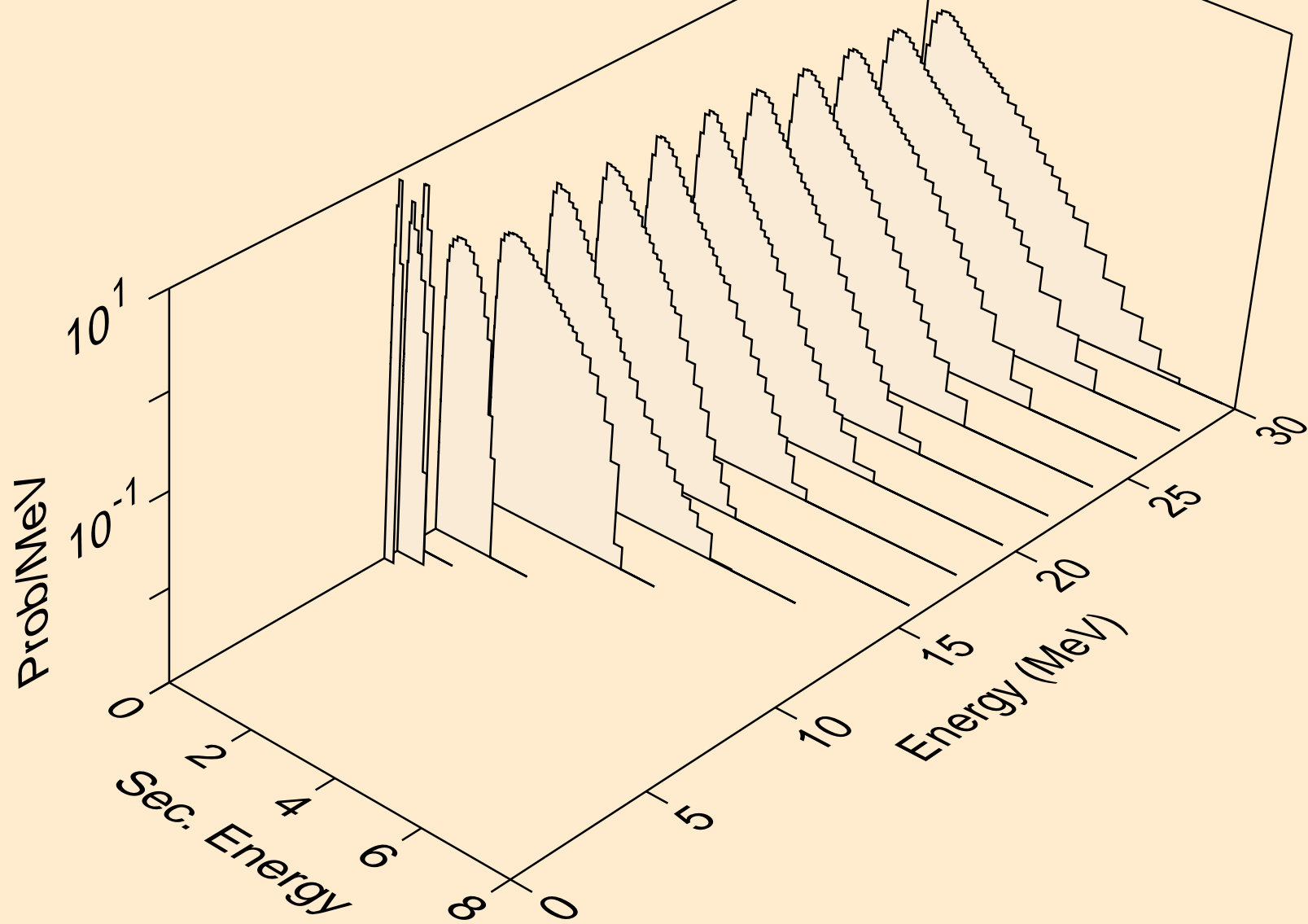

AT198M NEUTRON ACER TENDL-2021 LIBRARY; T=293.6K  
Neutron emission for (n,3n)a

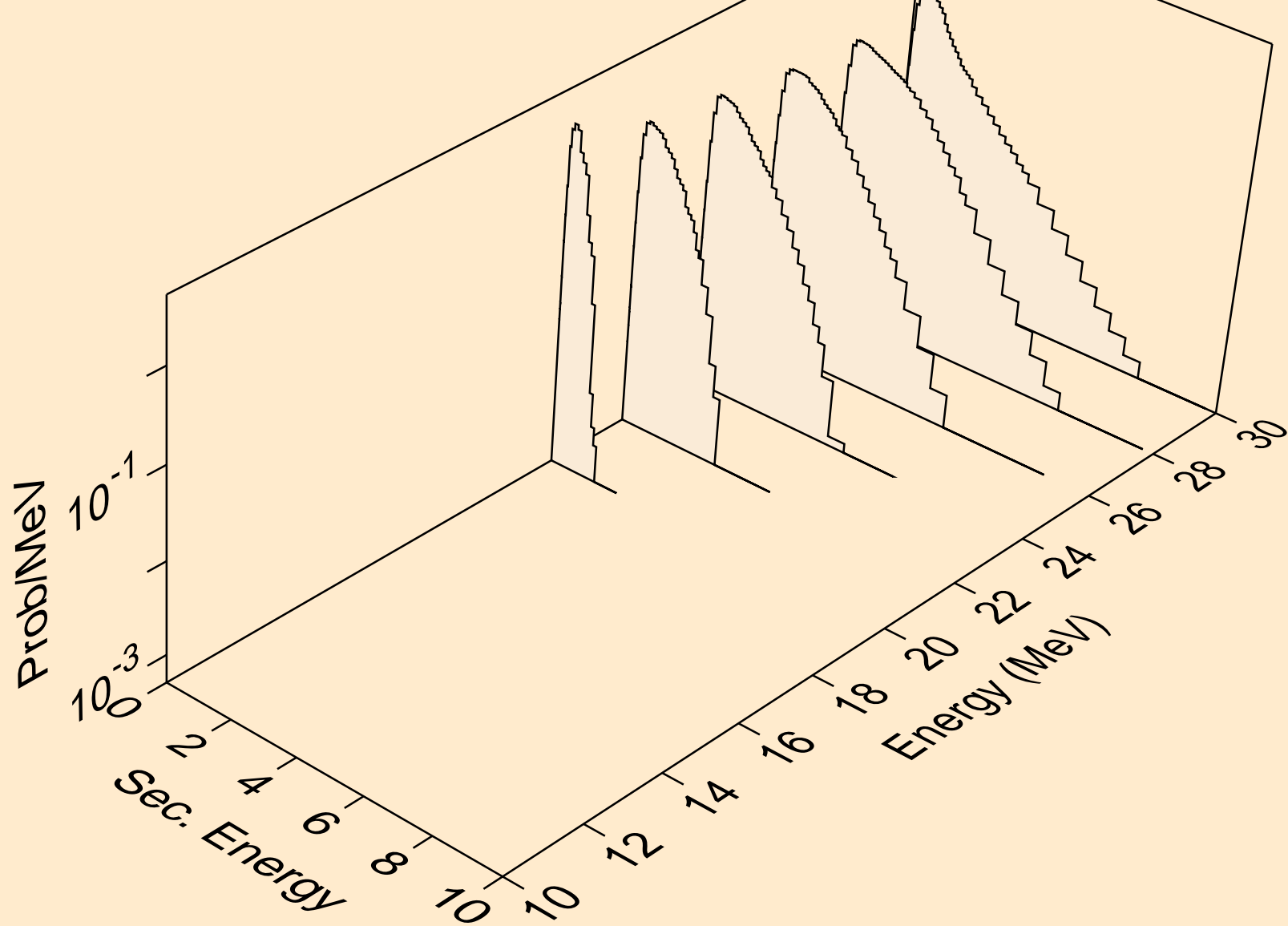



AT198M NEUTRON ACER TENDL-2021 LIBRARY; T=293.6K  
Neutron emission for (n,n\*)p

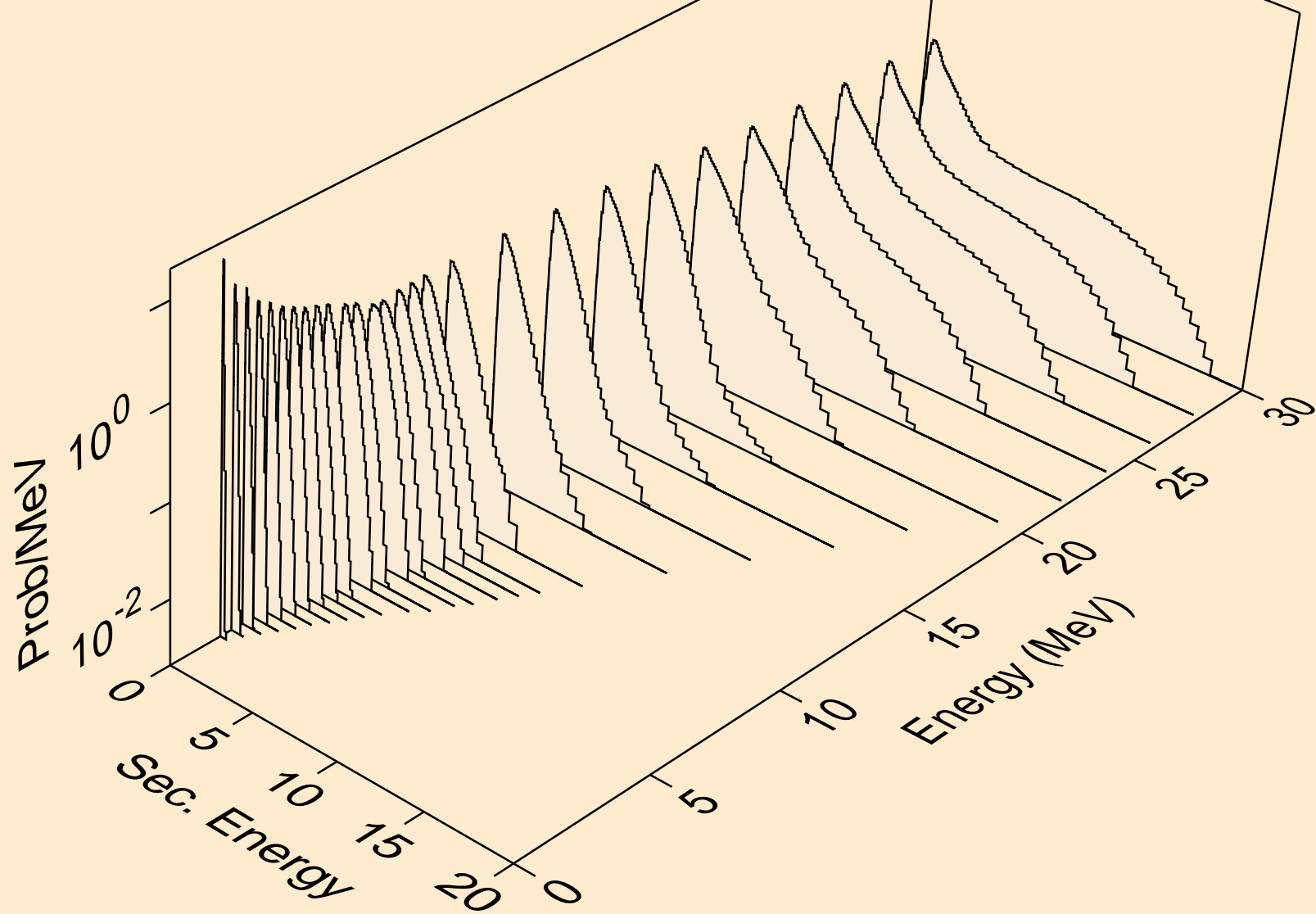

AT198M NEUTRON ACER TENDL-2021 LIBRARY; T=293.6K  
Neutron emission for (n,n\*)2a

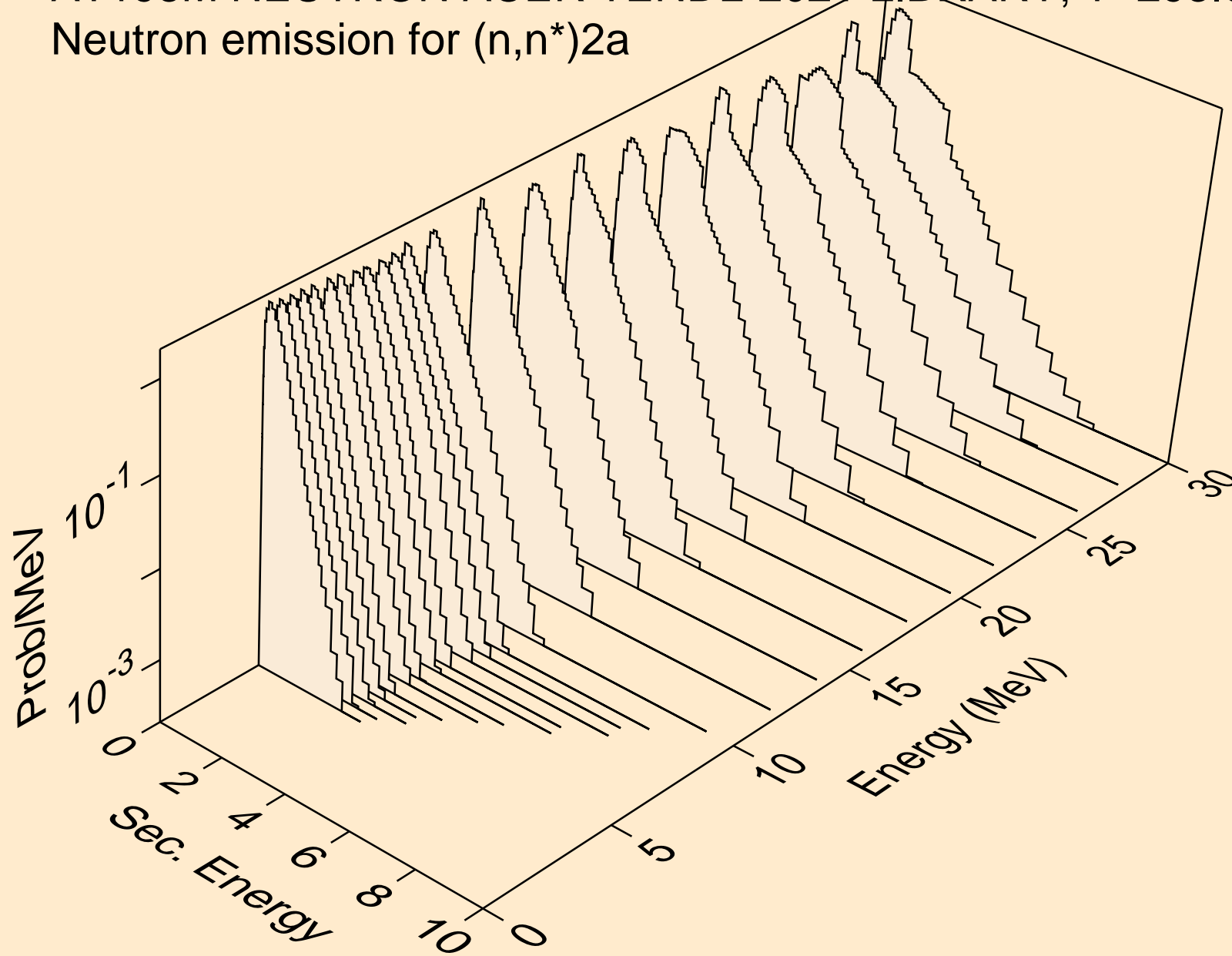

AT198M NEUTRON ACER TENDL-2021 LIBRARY; T=293.6K  
Neutron emission for (n,2n)2a

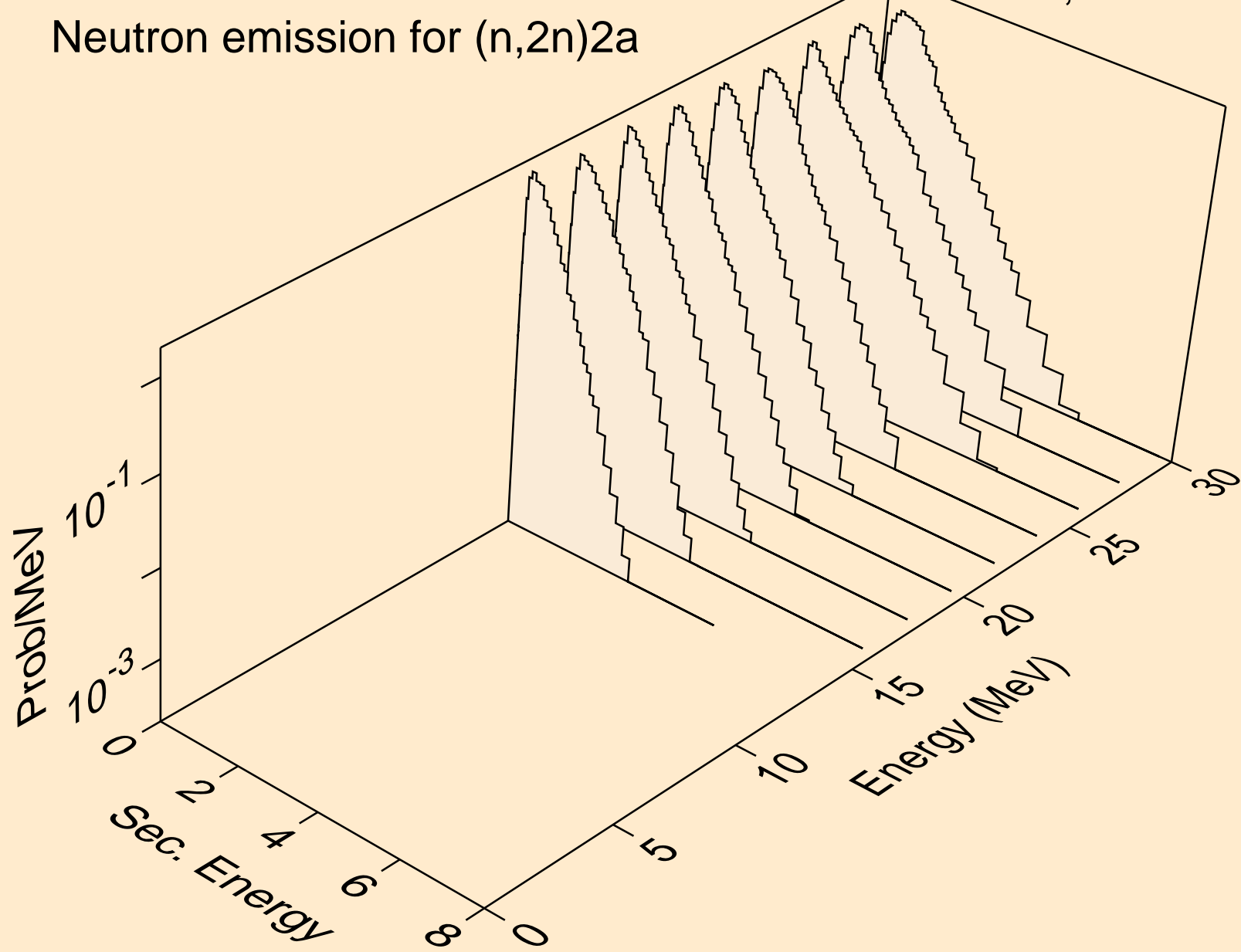

AT198M NEUTRON ACER TENDL-2021 LIBRARY; T=293.6K  
Neutron emission for (n,n\*)d

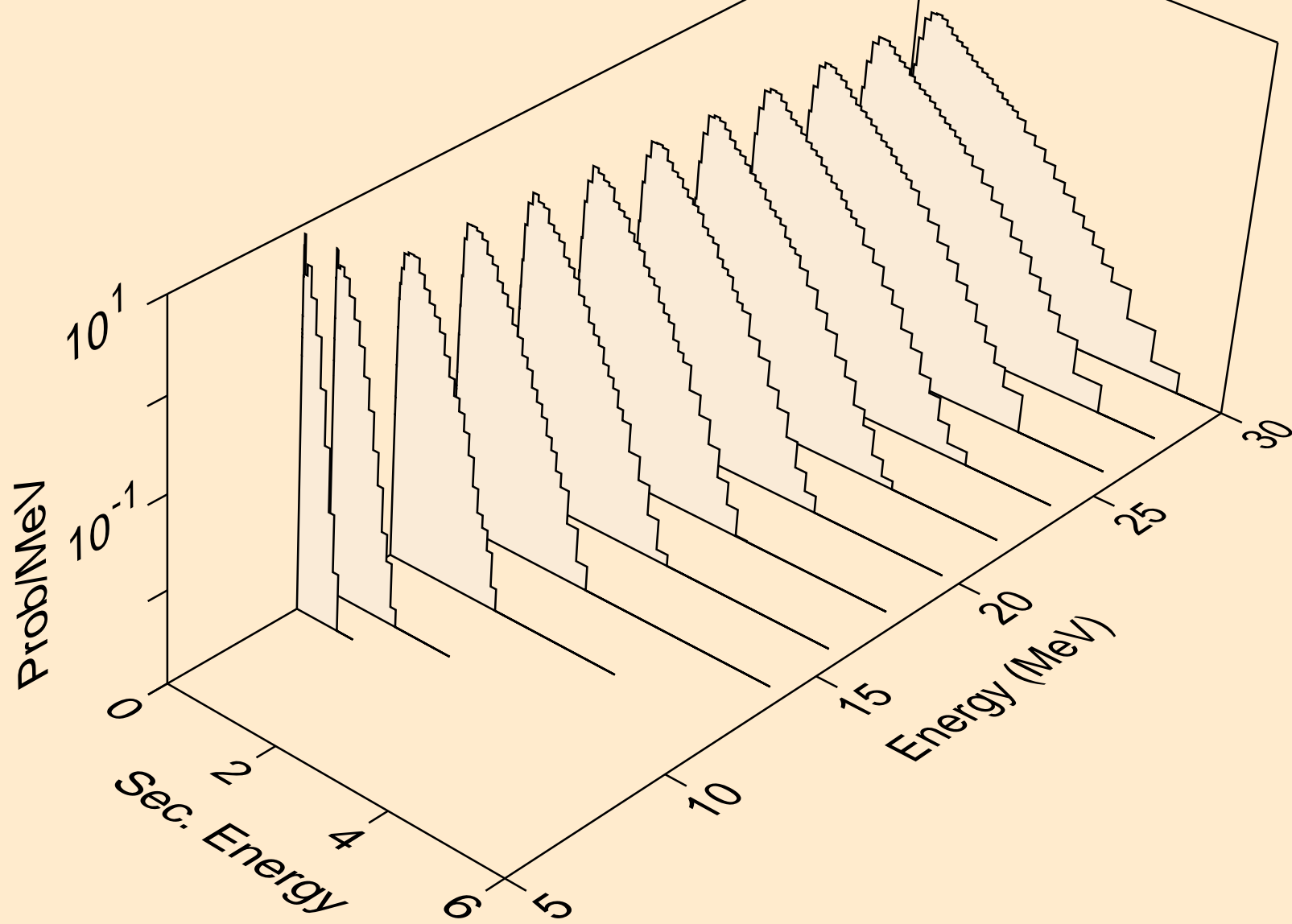

AT198M NEUTRON ACER TENDL-2021 LIBRARY; T=293.6K  
Neutron emission for (n,n\*)t

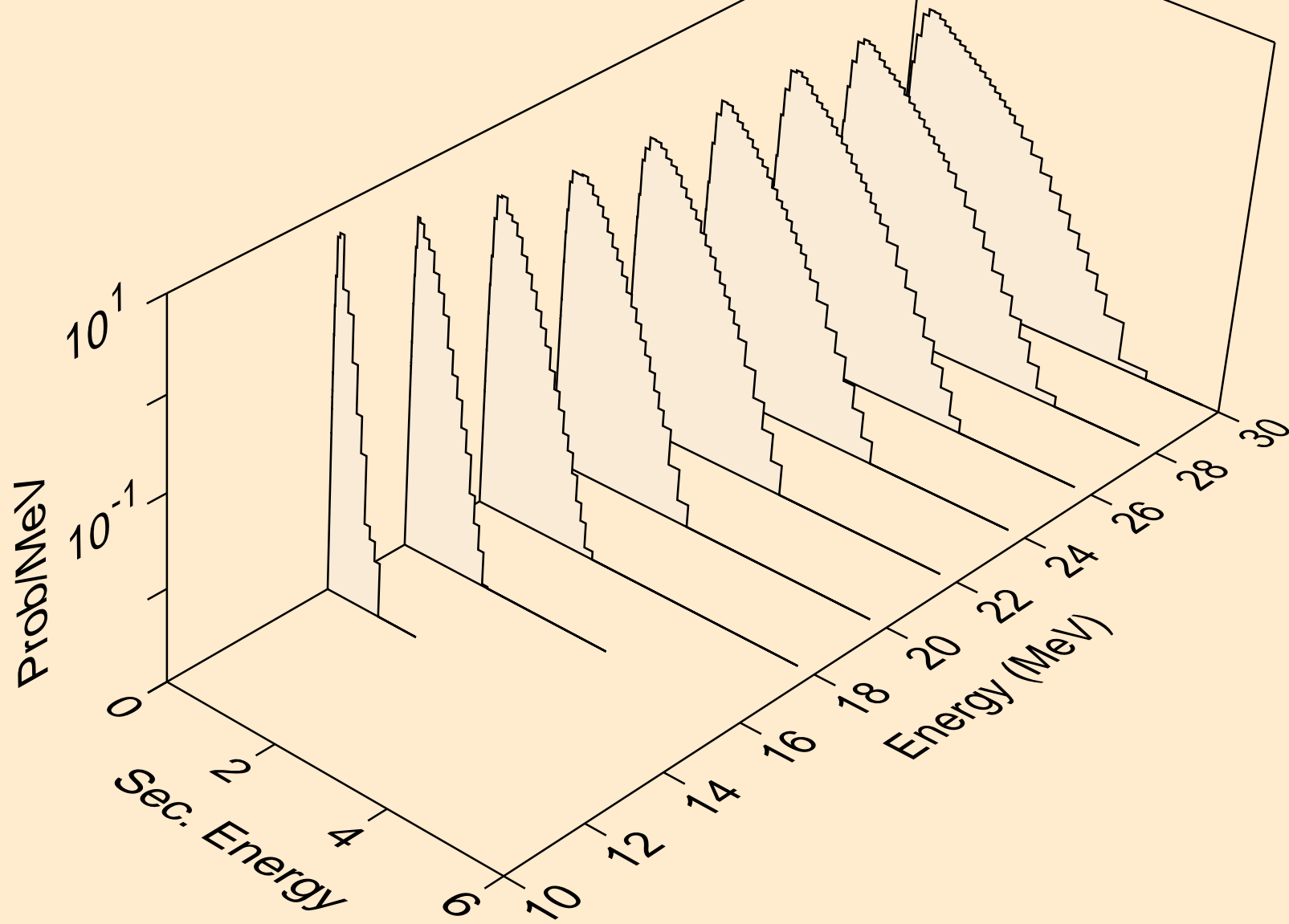

AT198M NEUTRON ACER TENDL-2021 LIBRARY; T=293.6K  
Neutron emission for (n,n\*)he3

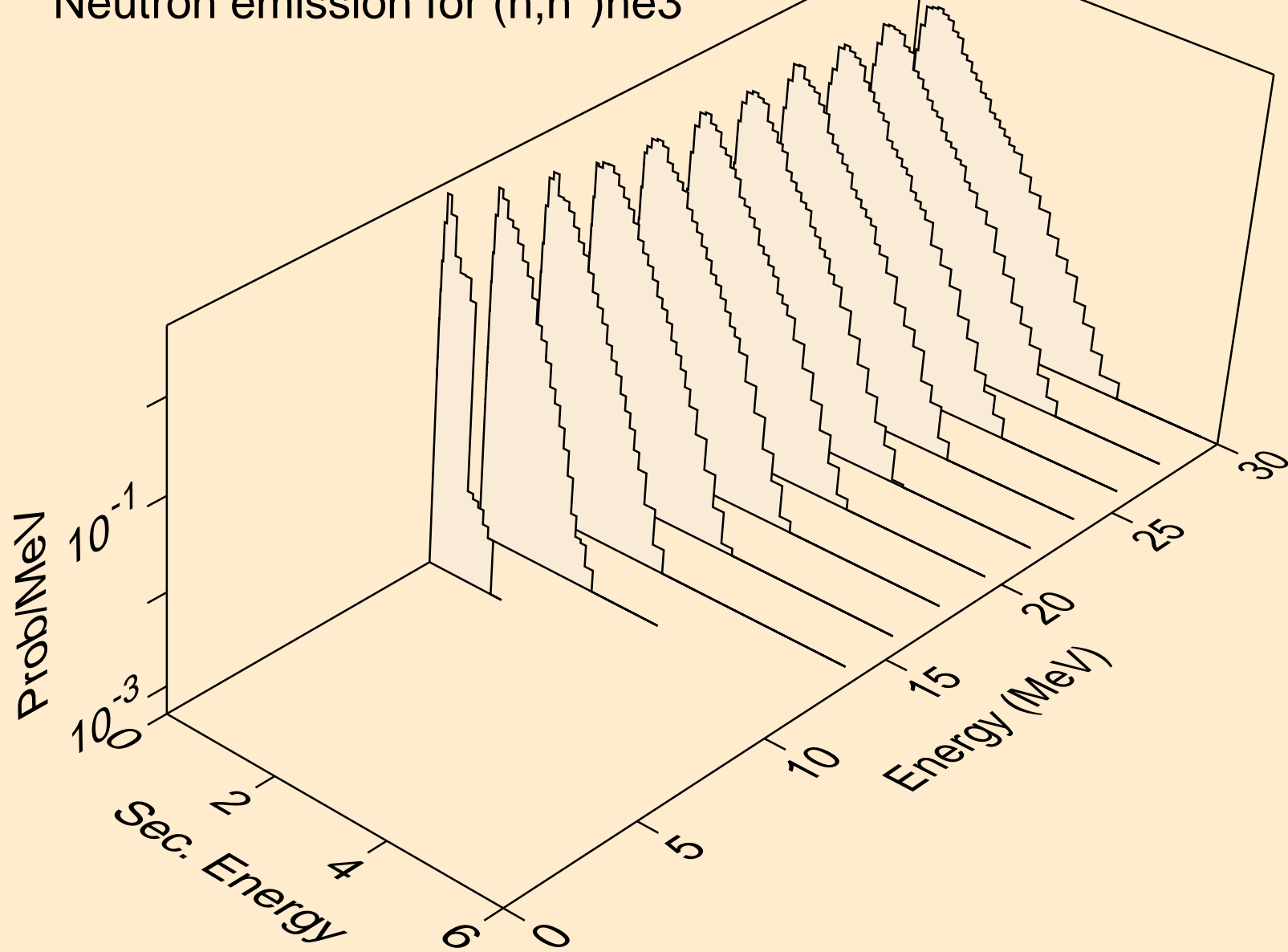

AT198M NEUTRON ACER TENDL-2021 LIBRARY; T=293.6K  
Neutron emission for (n,4n)

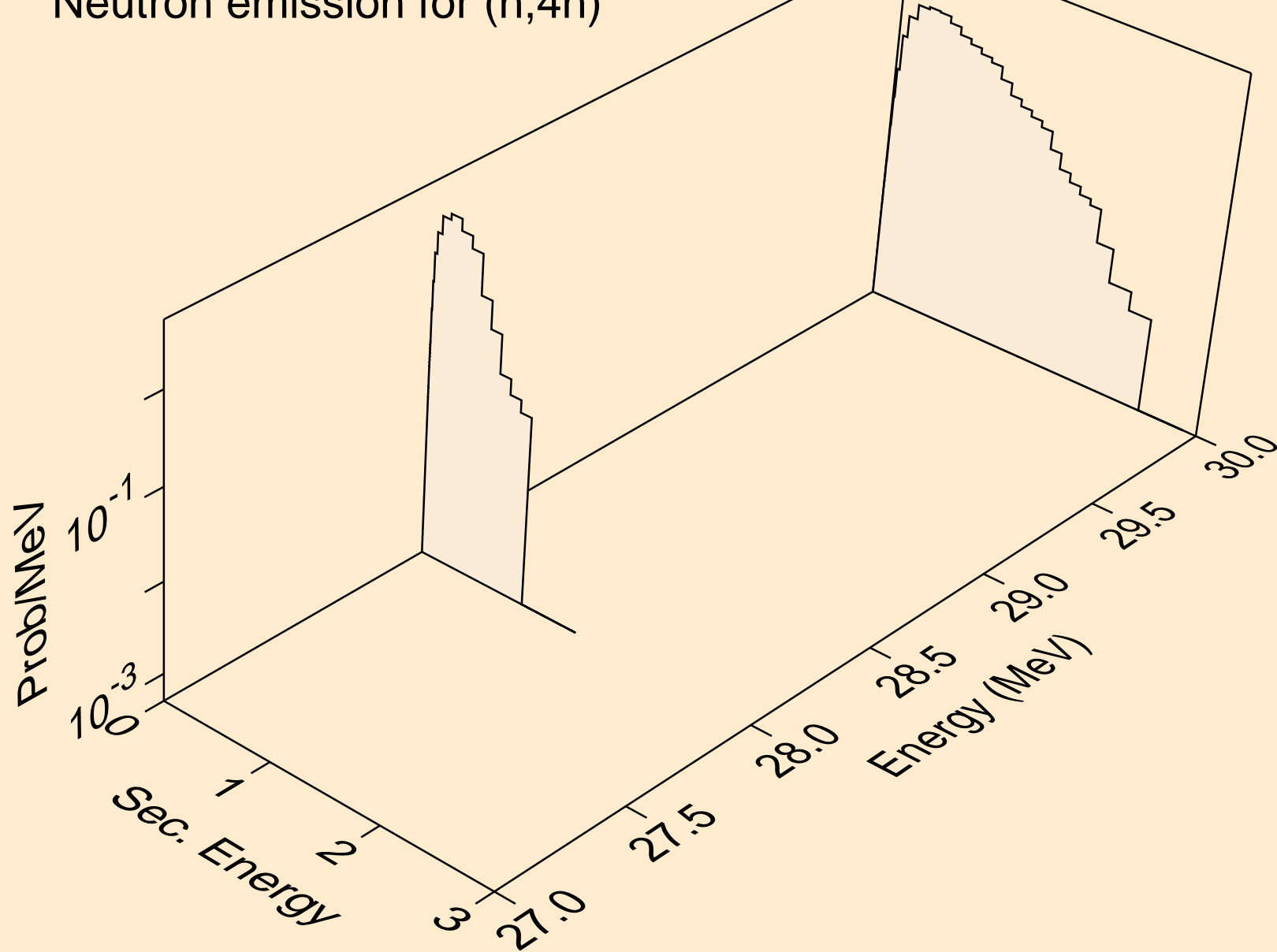

AT198M NEUTRON ACER TENDL-2021 LIBRARY; T=293.6K  
Neutron emission for (n,2np)

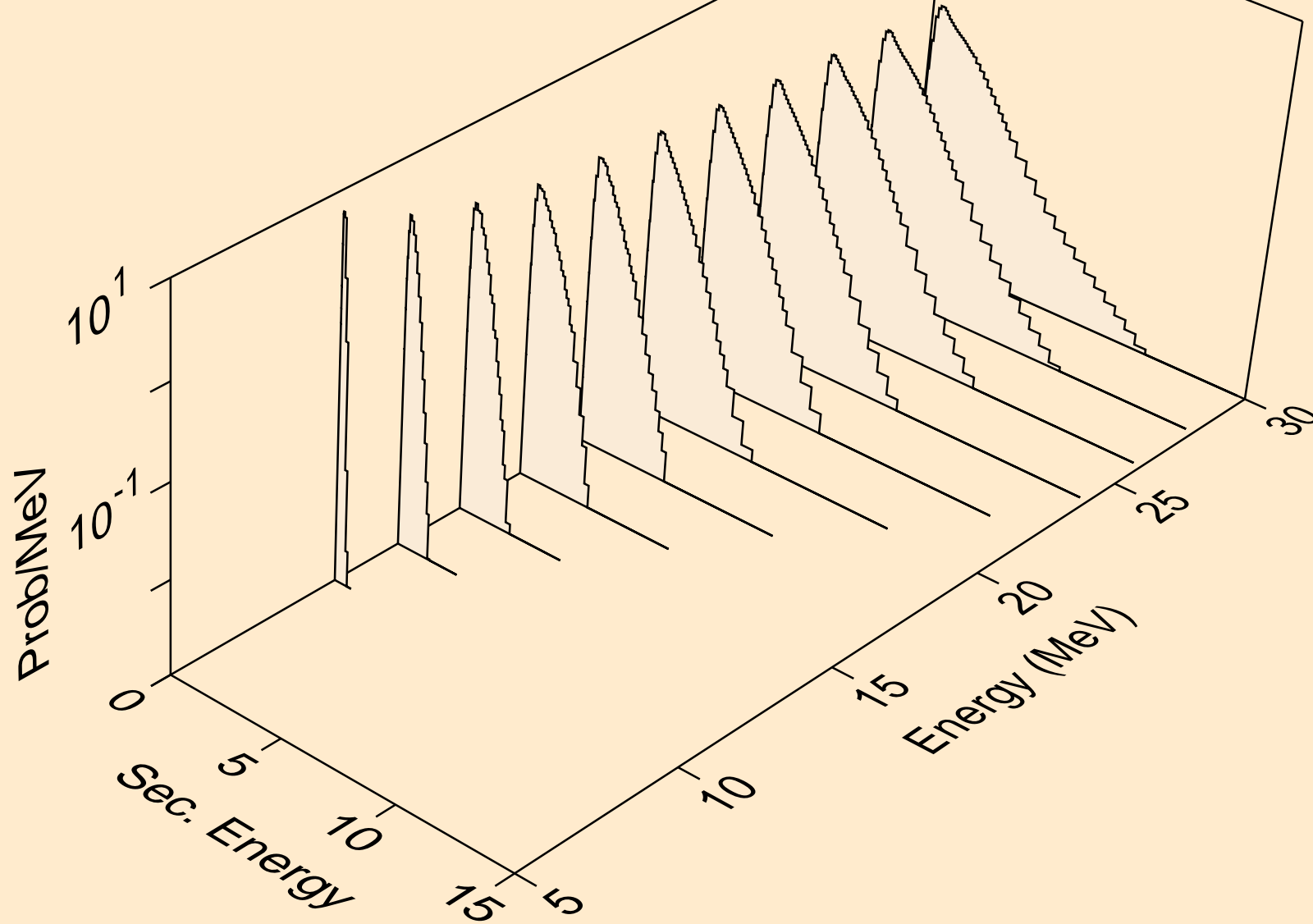



AT198M NEUTRON ACER TENDL-2021 LIBRARY; T=293.6K  
Neutron emission for (n,3np)

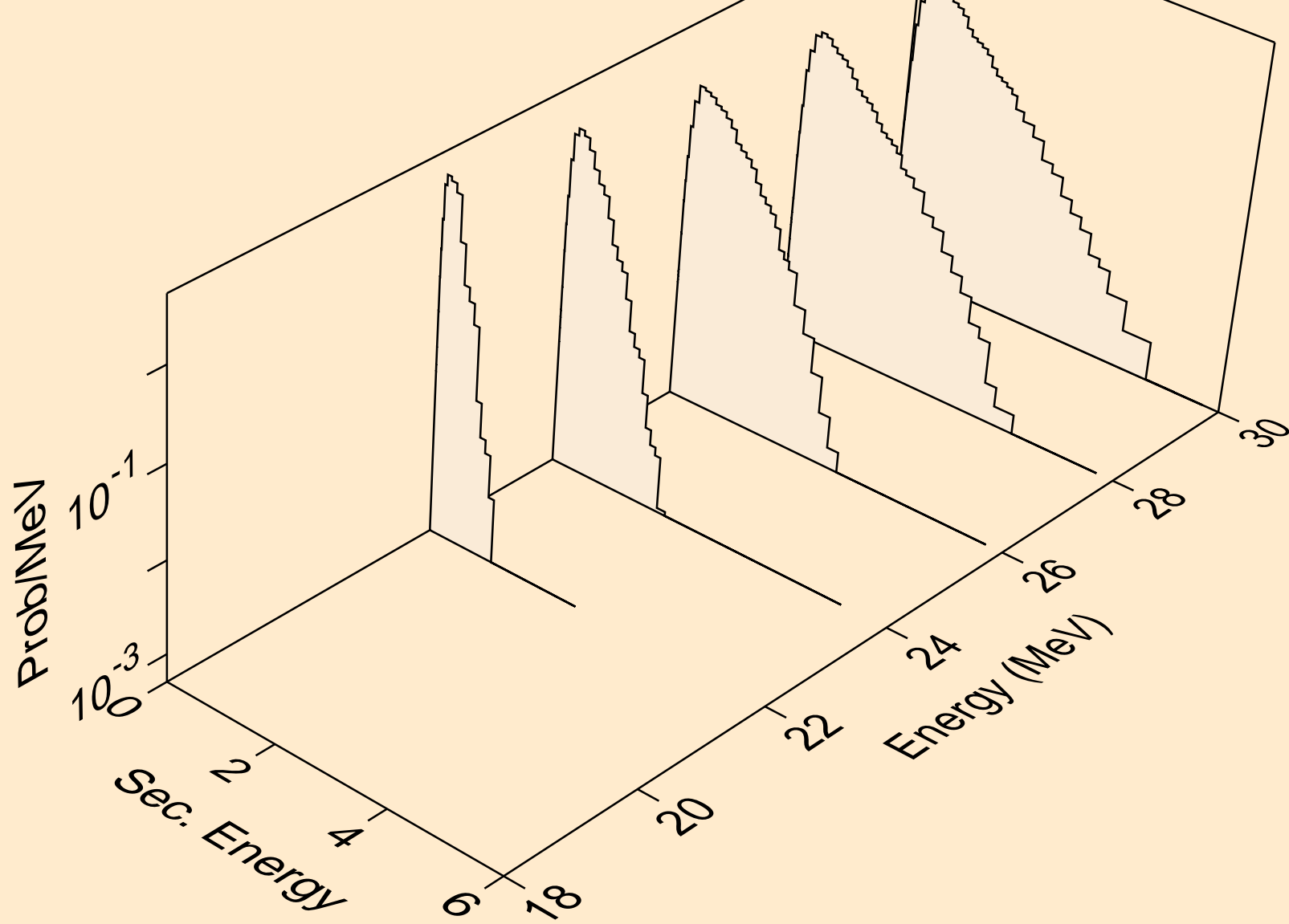

AT198M NEUTRON ACER TENDL-2021 LIBRARY; T=293.6K  
Neutron emission for (n,2np)

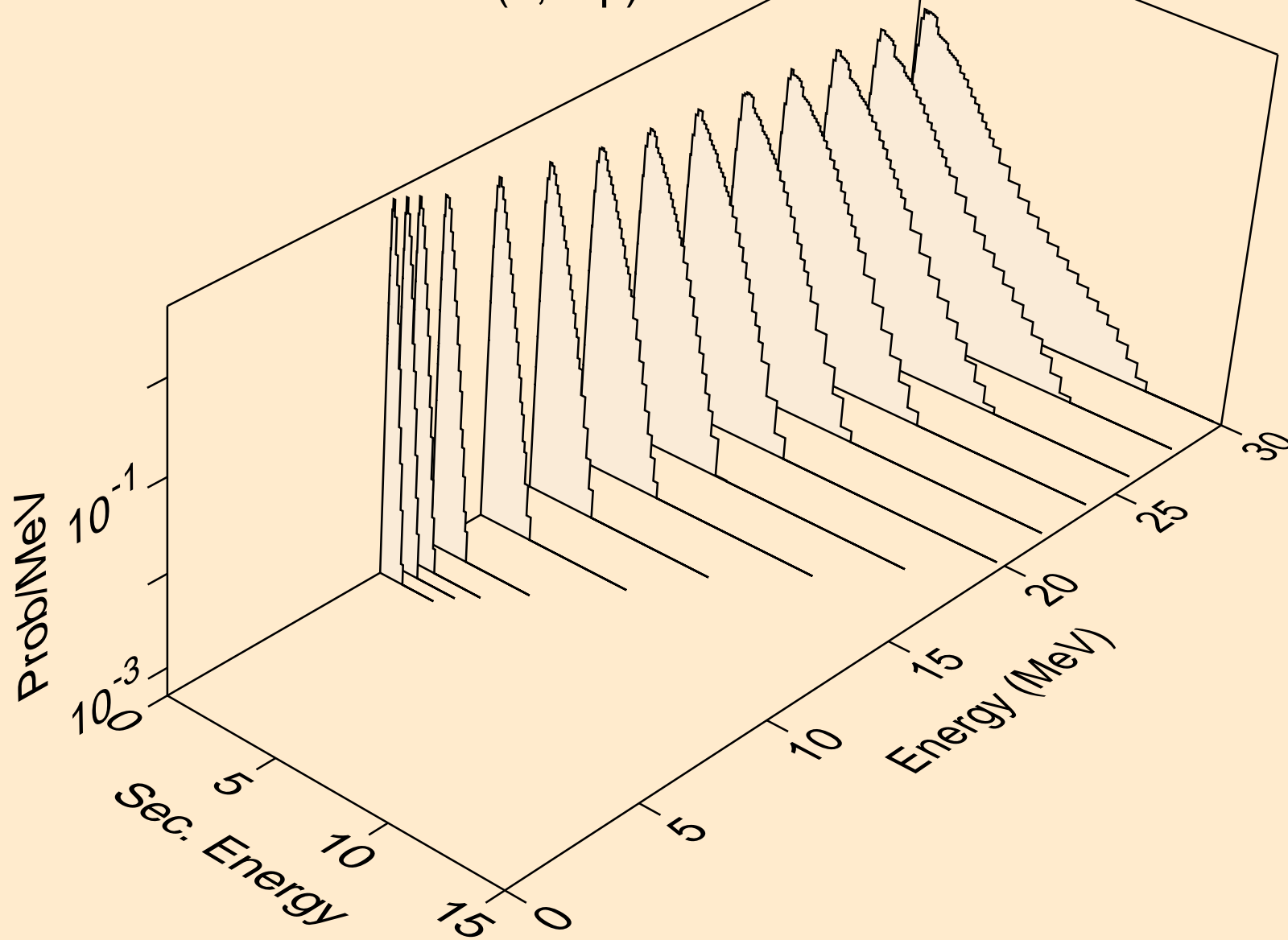

AT198M NEUTRON ACER TENDL-2021 LIBRARY; T=293.6K  
Neutron emission for (n,npa)

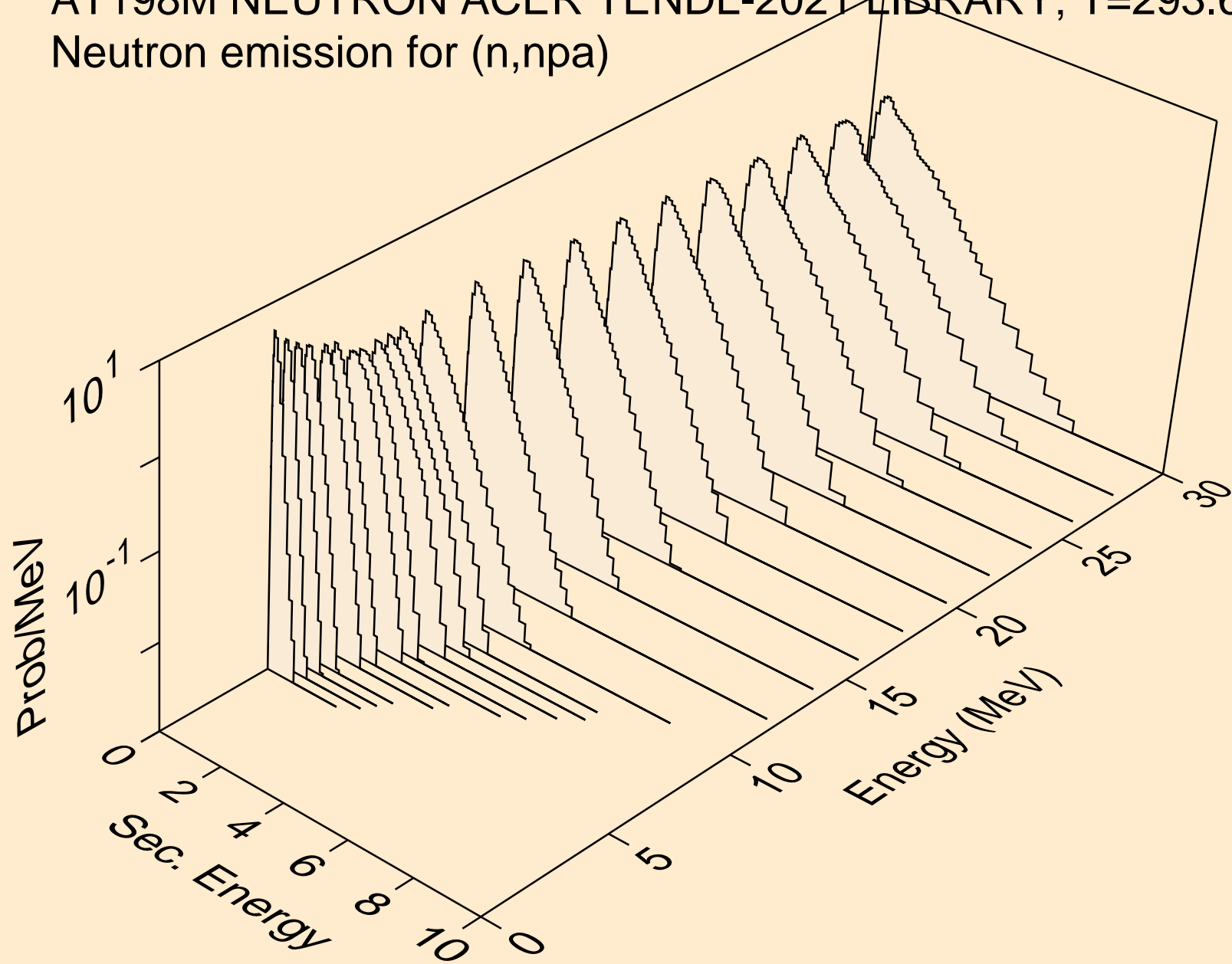

AT198M NEUTRON ACER TENDL-2021 LIBRARY; T=293.6K  
Neutron emission for (n,n\*c)

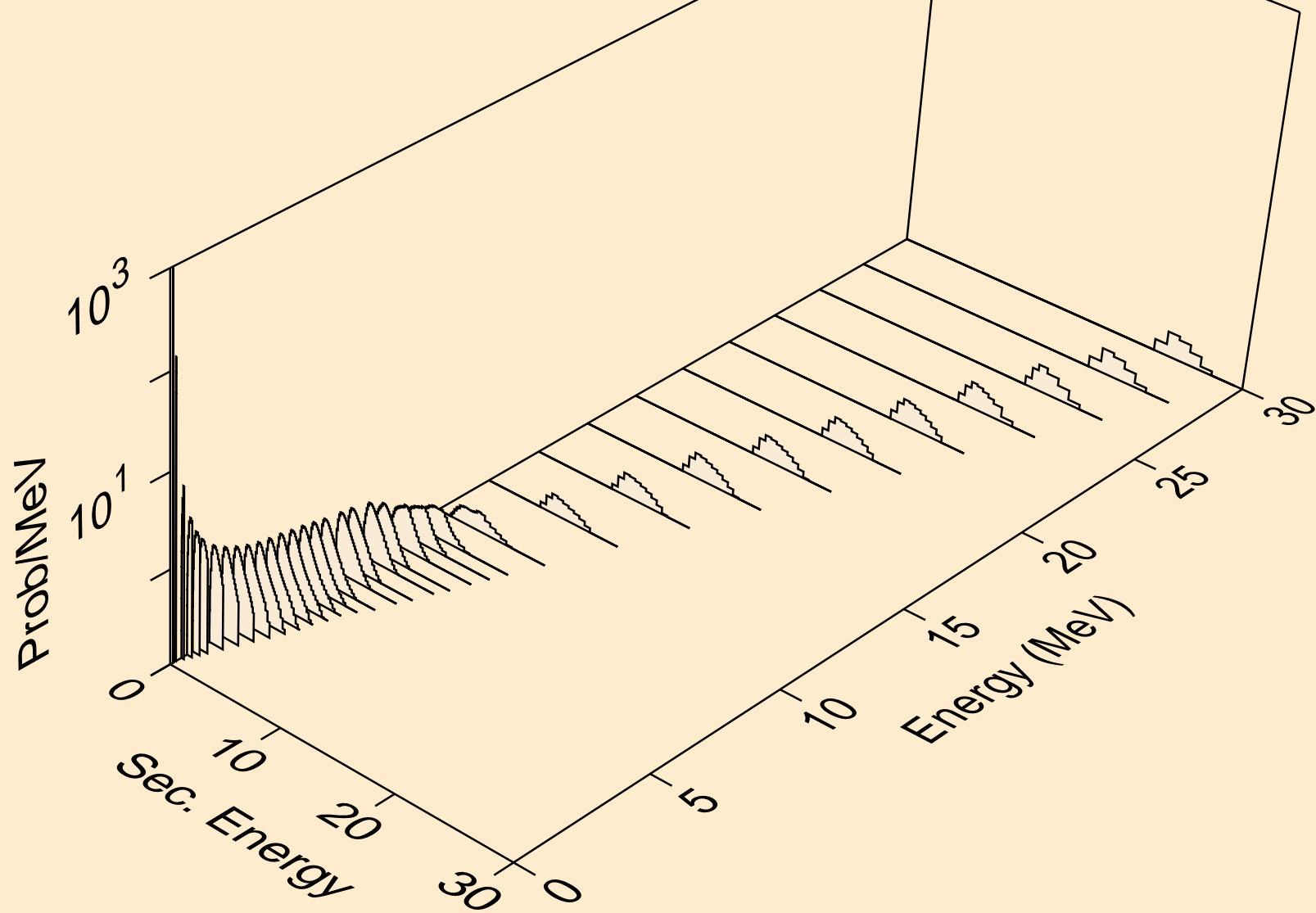

AT198M NEUTRON ACER TENDL-2021 LIBRARY; T=293.6K  
Photon emission for (n,x)

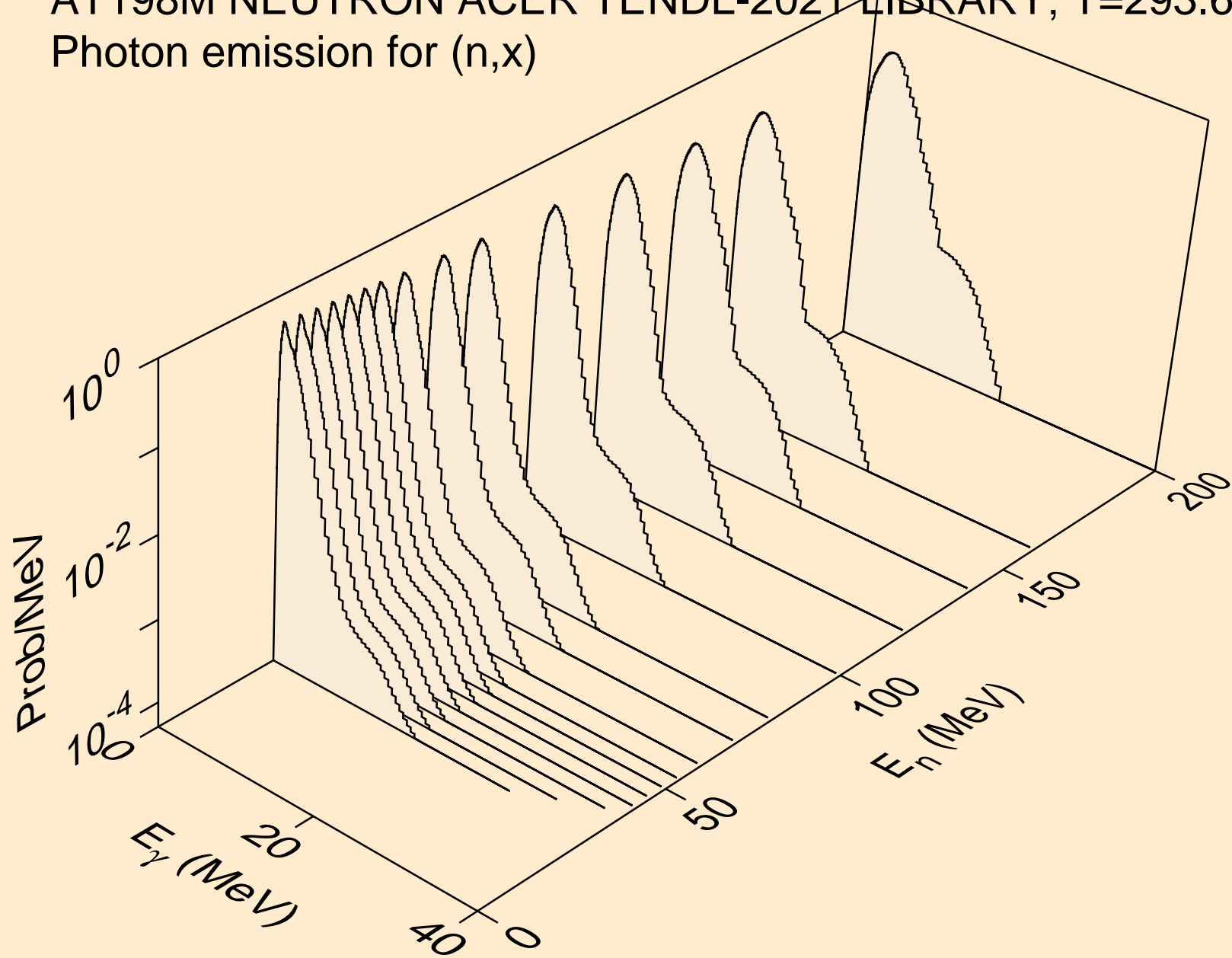

AT198M NEUTRON ACER TENDL-2021 LIBRARY; T=293.6K  
Photon emission for (n,2nd)

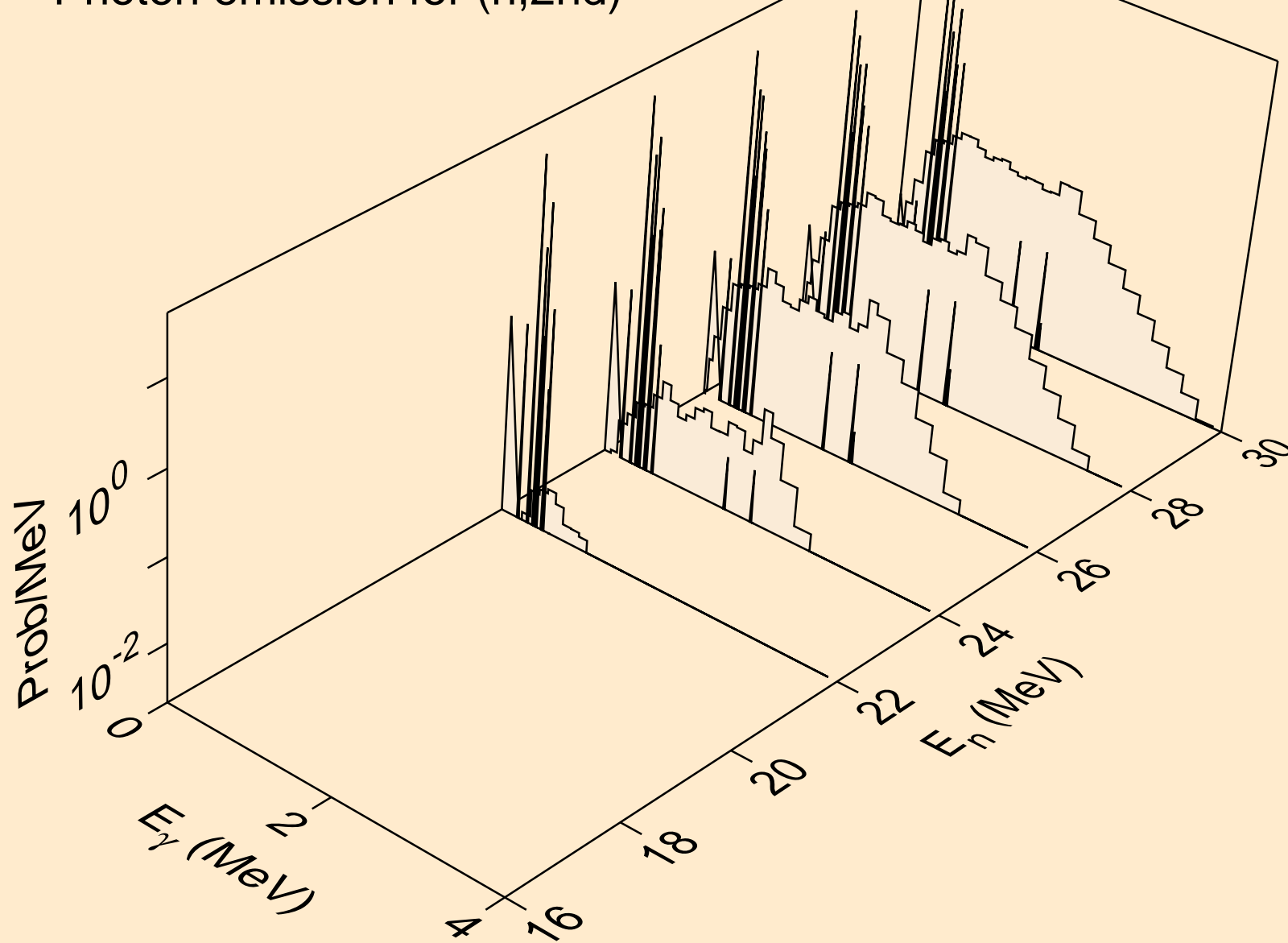

AT198M NEUTRON ACER TENDL-2021 LIBRARY; T=293.6K  
Photon emission for (n,2n)

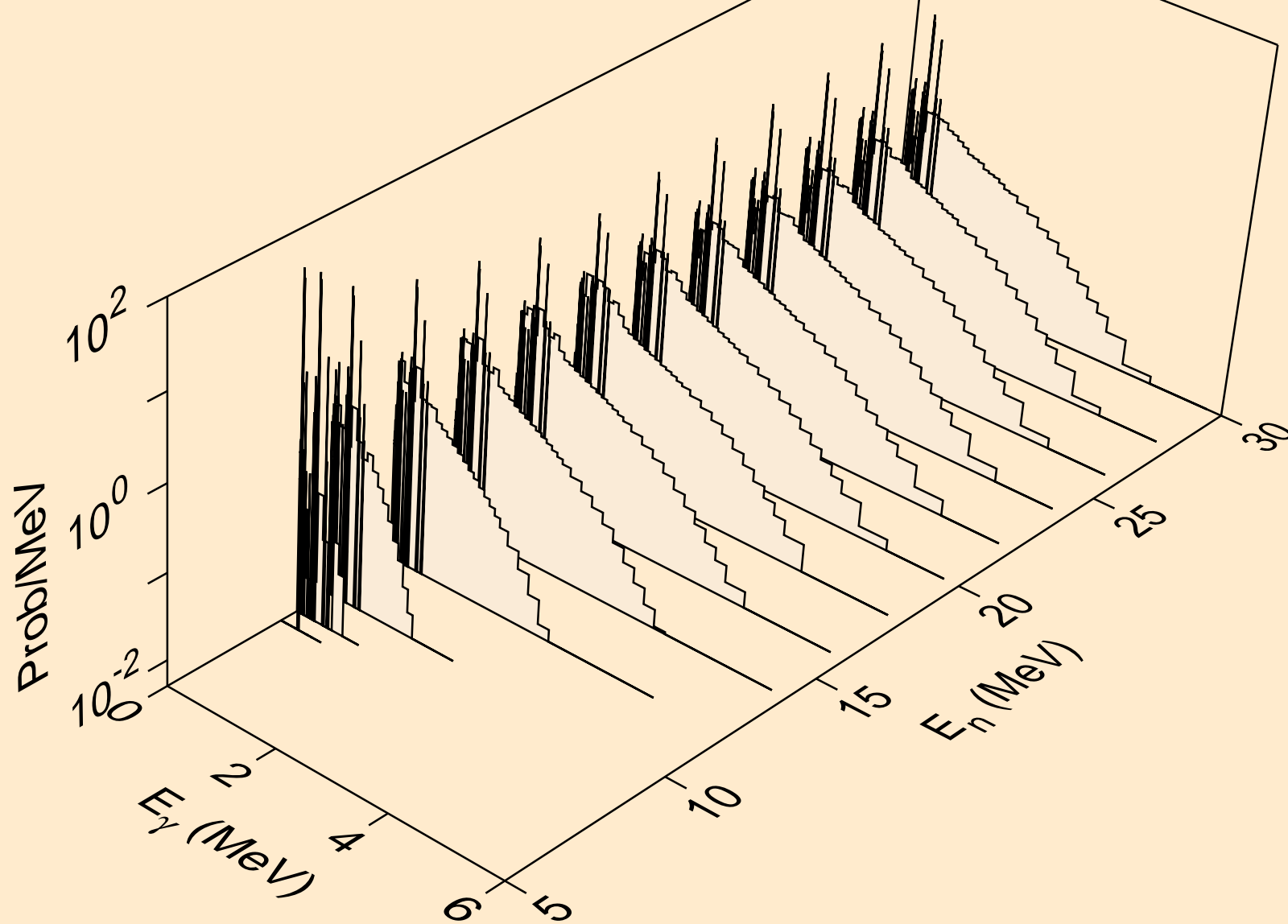

AT198M NEUTRON ACER TENDL-2021 LIBRARY; T=293.6K  
Photon emission for (n,3n)

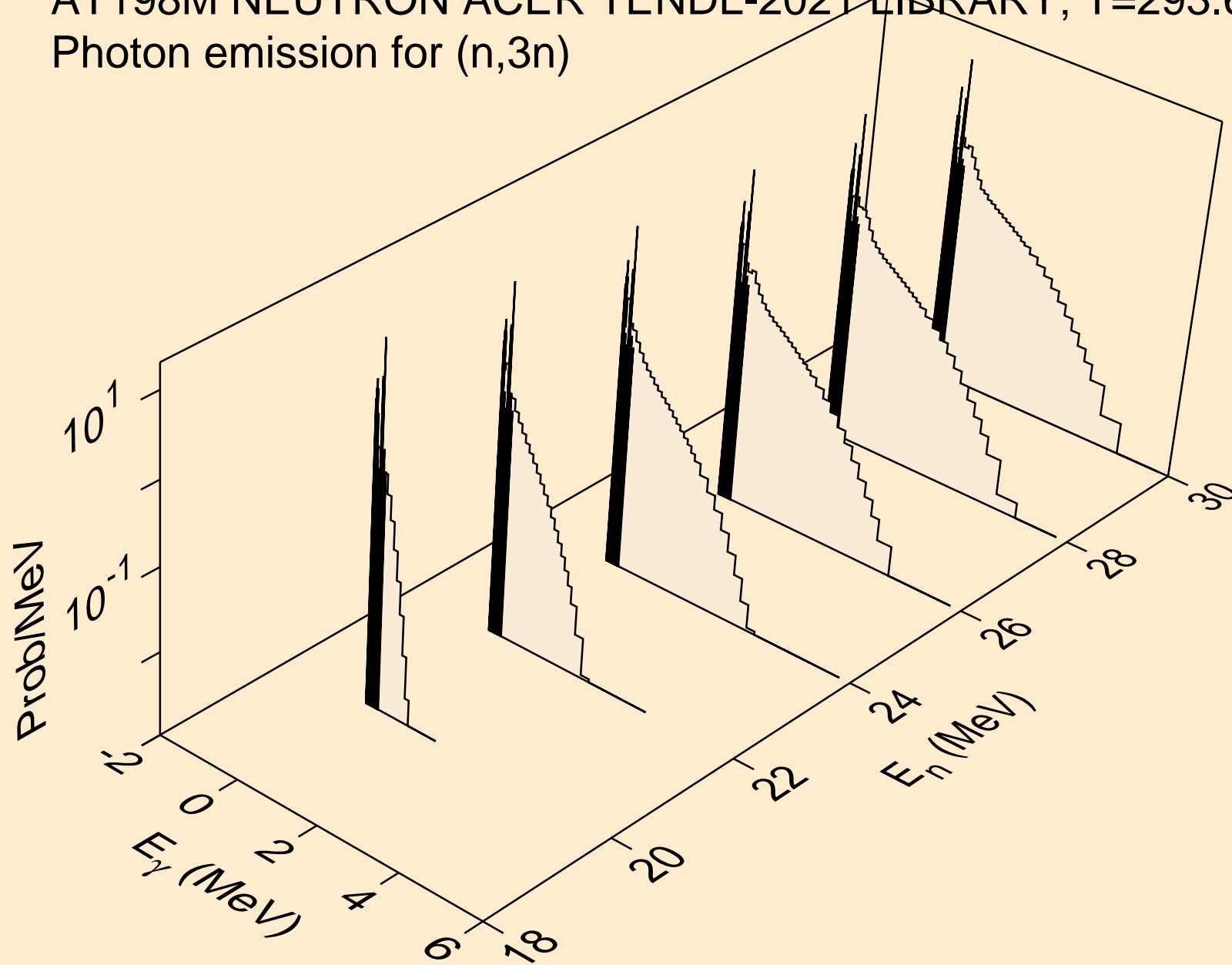



AT198M NEUTRON ACER TENDL-2021 LIBRARY; T=293.6K  
Photon emission for (n,n\*)a

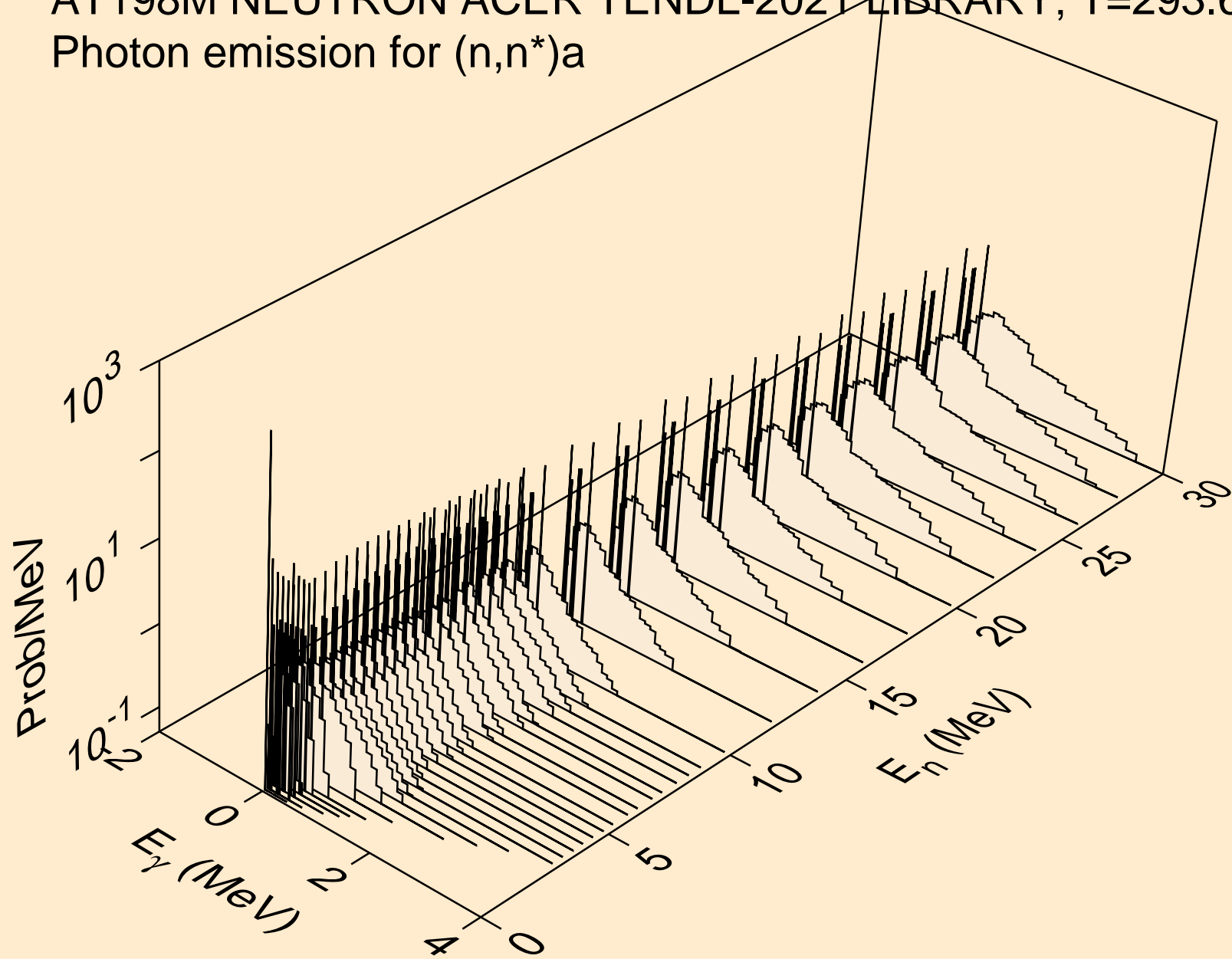

AT198M NEUTRON ACER TENDL-2021 LIBRARY; T=293.6K  
Photon emission for (n,2n)a

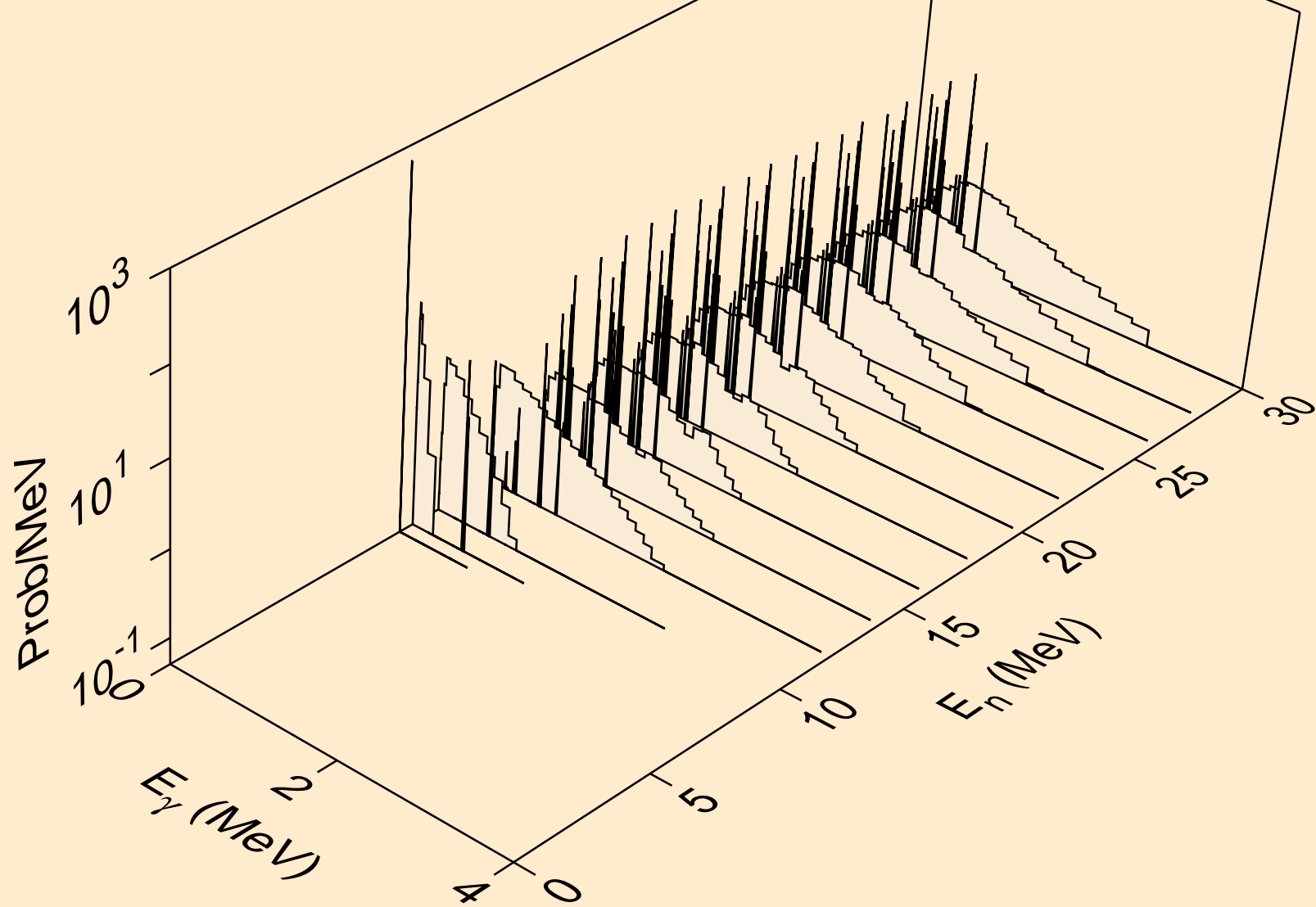

AT198M NEUTRON ACER TENDL-2021 LIBRARY; T=293.6K  
Photon emission for (n,3n)a

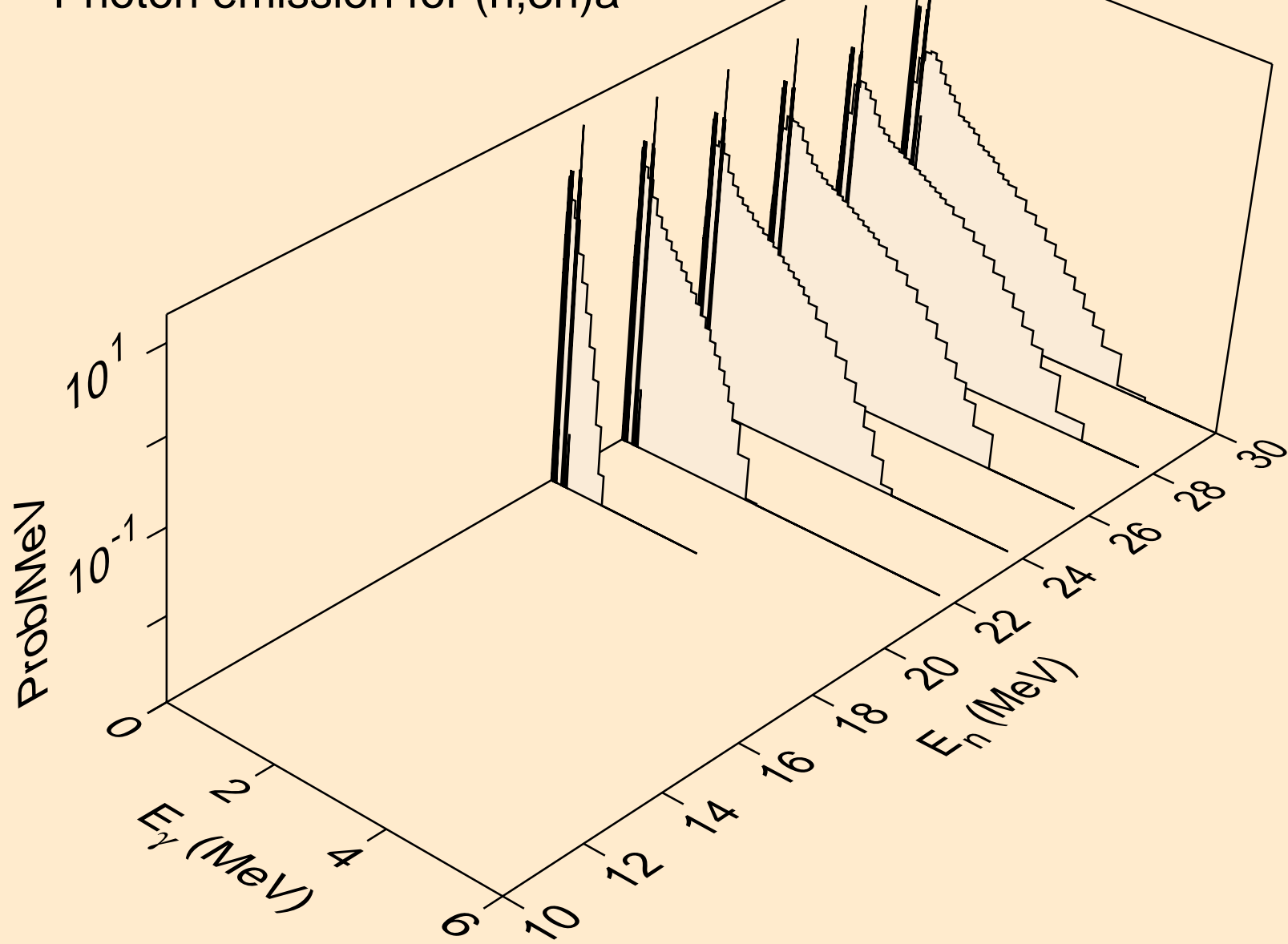

AT198M NEUTRON ACER TENDL-2021 LIBRARY; T=293.6K  
Photon emission for (n,n\*)p

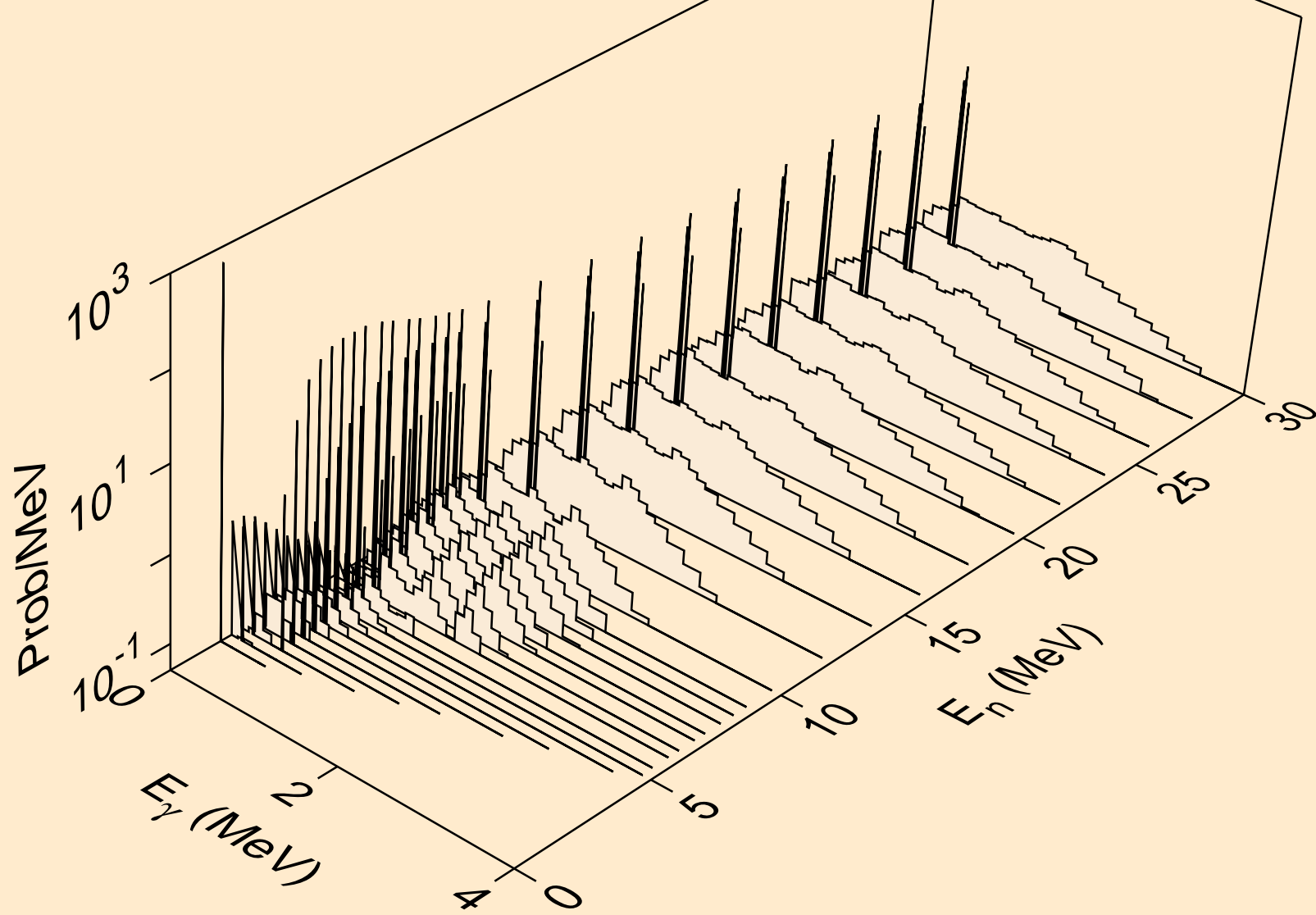

AT198M NEUTRON ACER TENDL-2021 LIBRARY; T=293.6K  
Photon emission for (n,n\*)2a

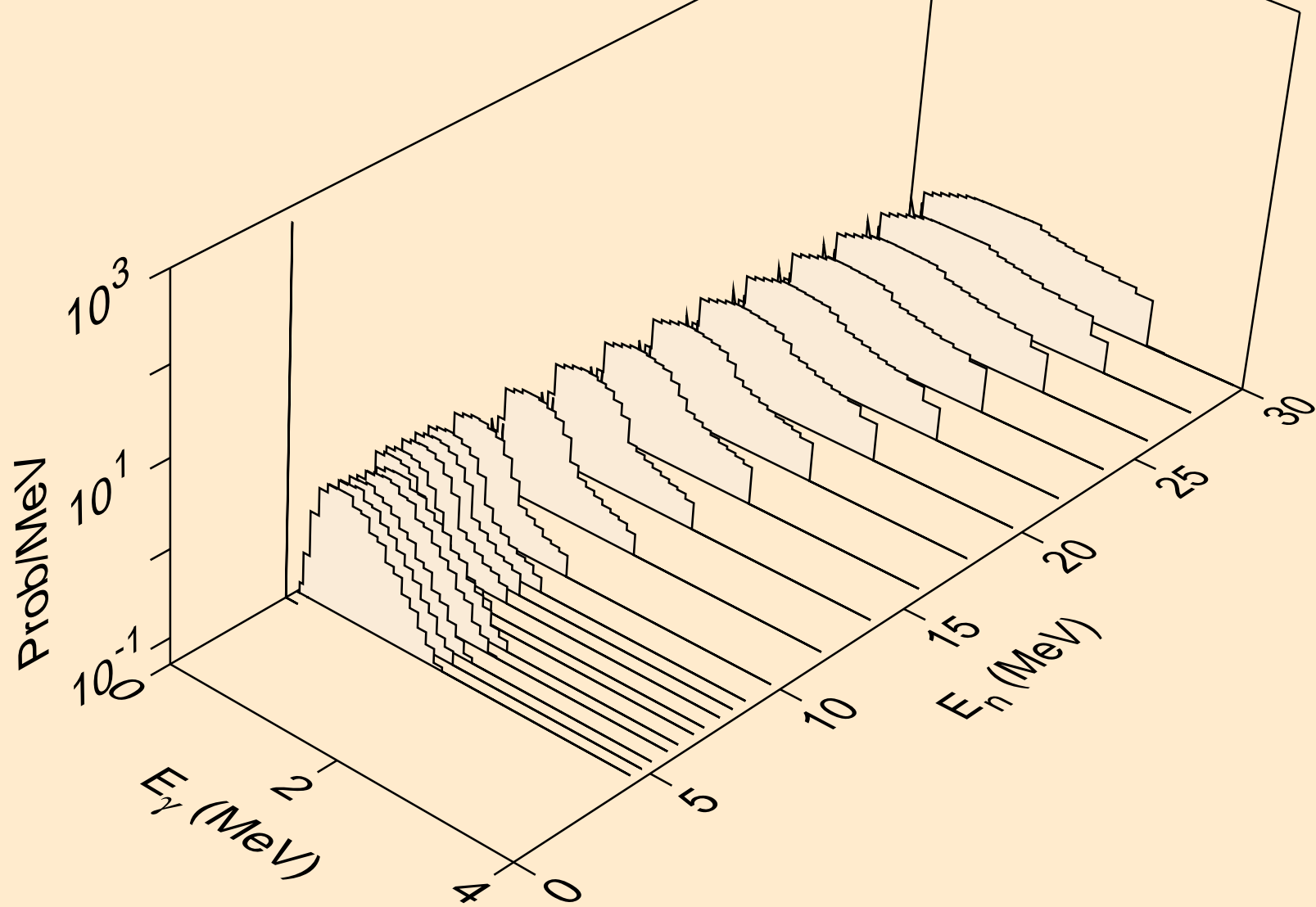

AT198M NEUTRON ACER TENDL-2021 LIBRARY; T=293.6K  
Photon emission for (n,2n)2a

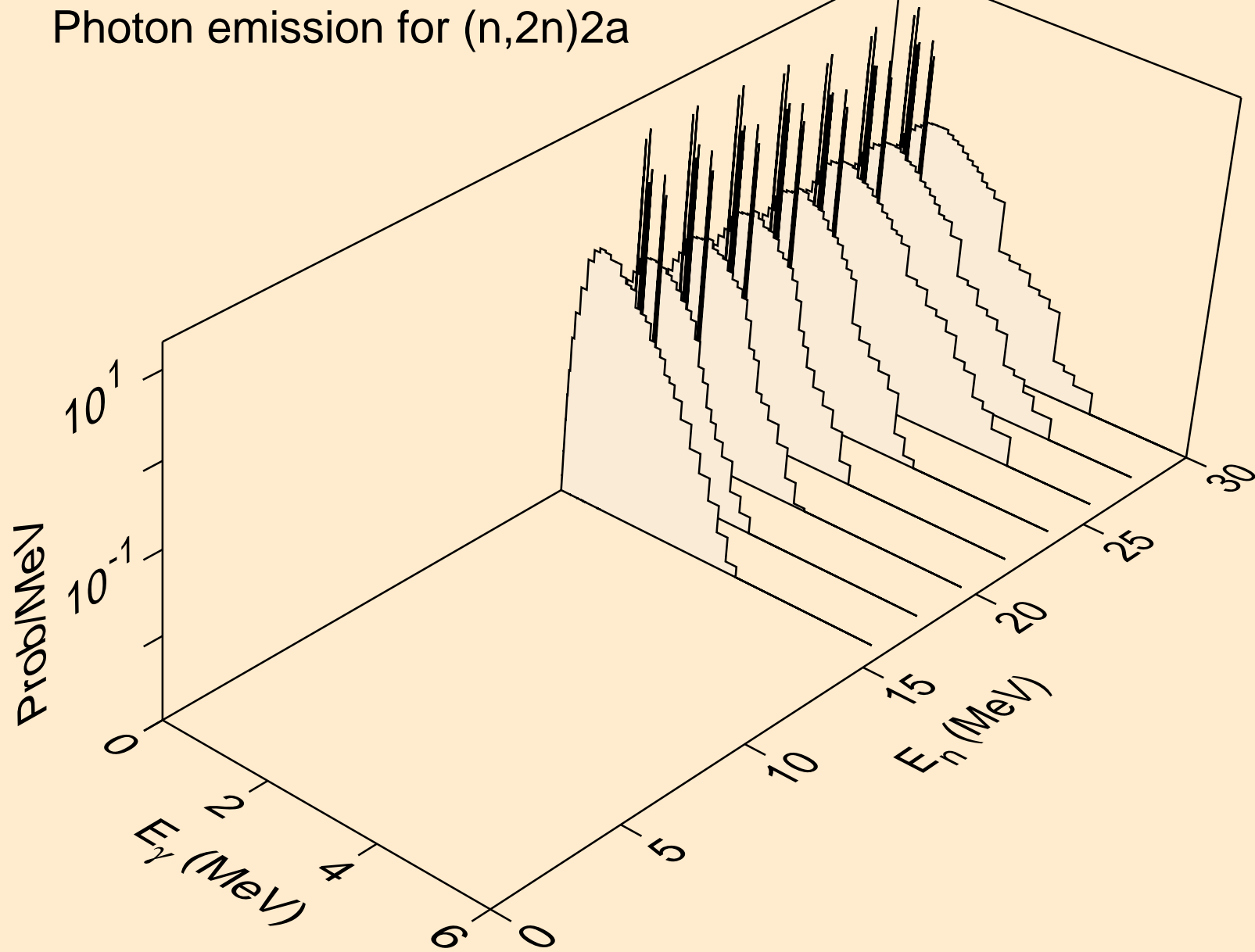

AT198M NEUTRON ACER TENDL-2021 LIBRARY; T=293.6K  
Photon emission for (n,n\*)d

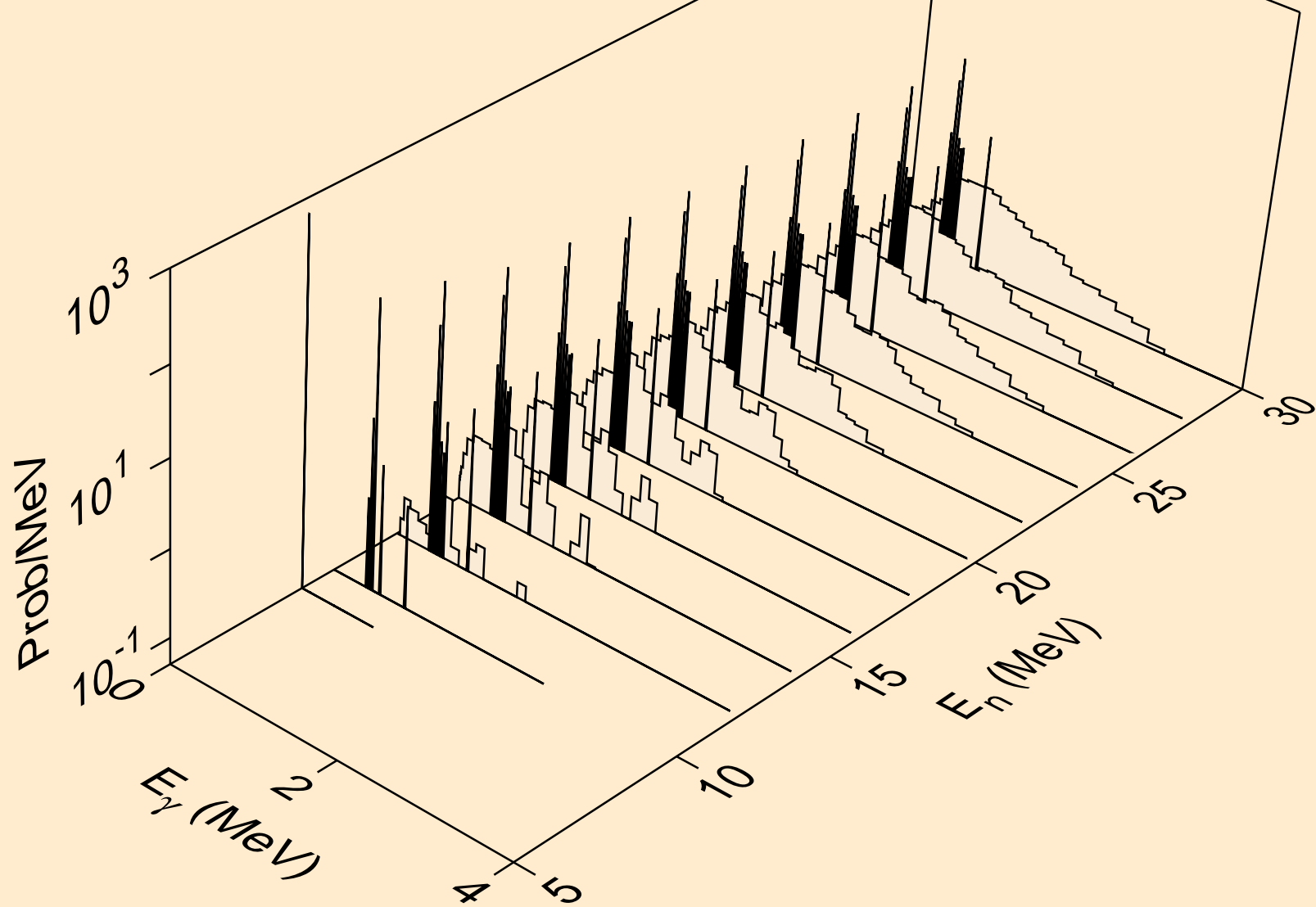

AT198M NEUTRON ACER TENDL-2021 LIBRARY; T=293.6K  
Photon emission for (n,n\*)t

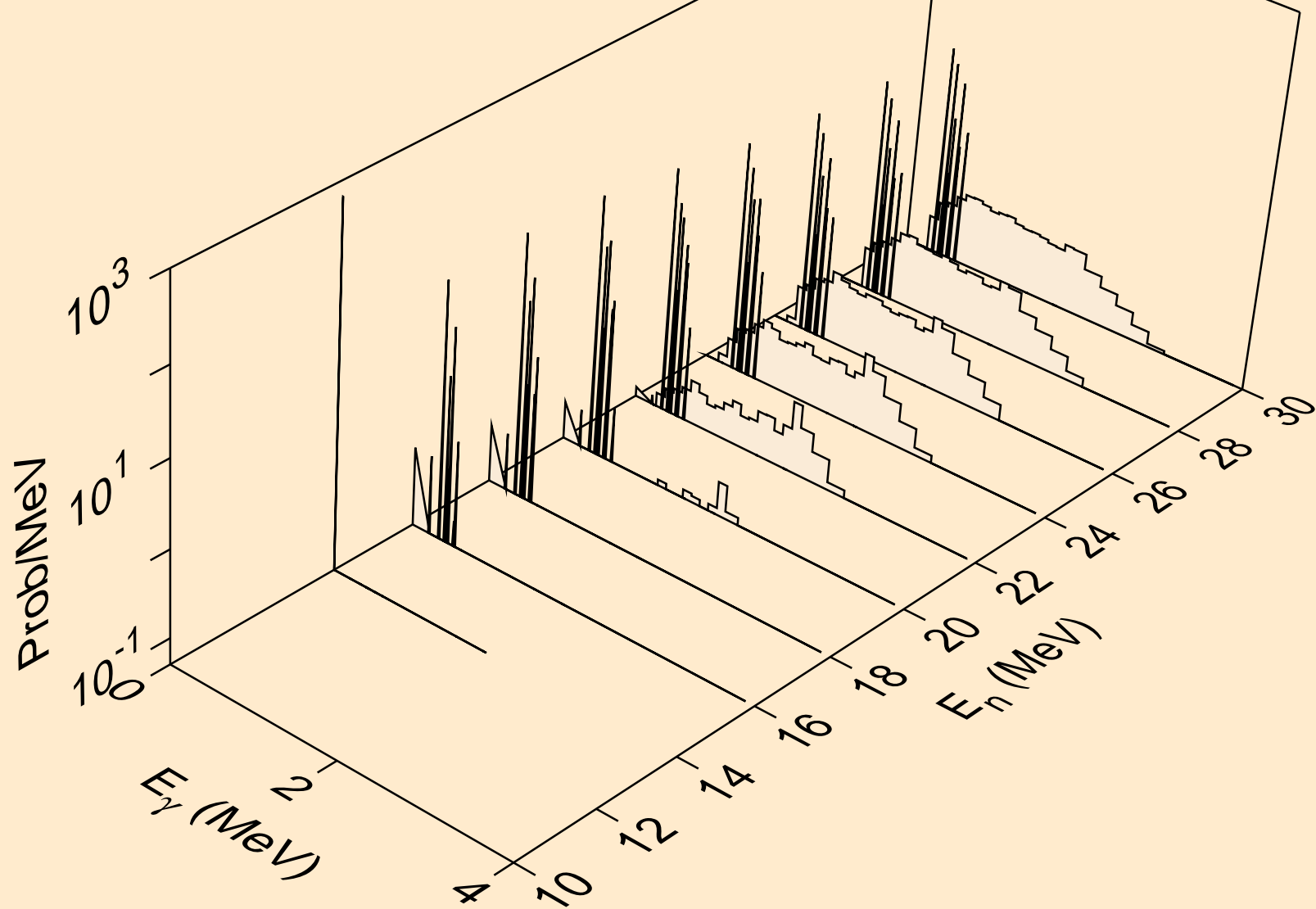



AT198M NEUTRON ACER TENDL-2021 LIBRARY; T=293.6K  
Photon emission for (n,n\*)he3

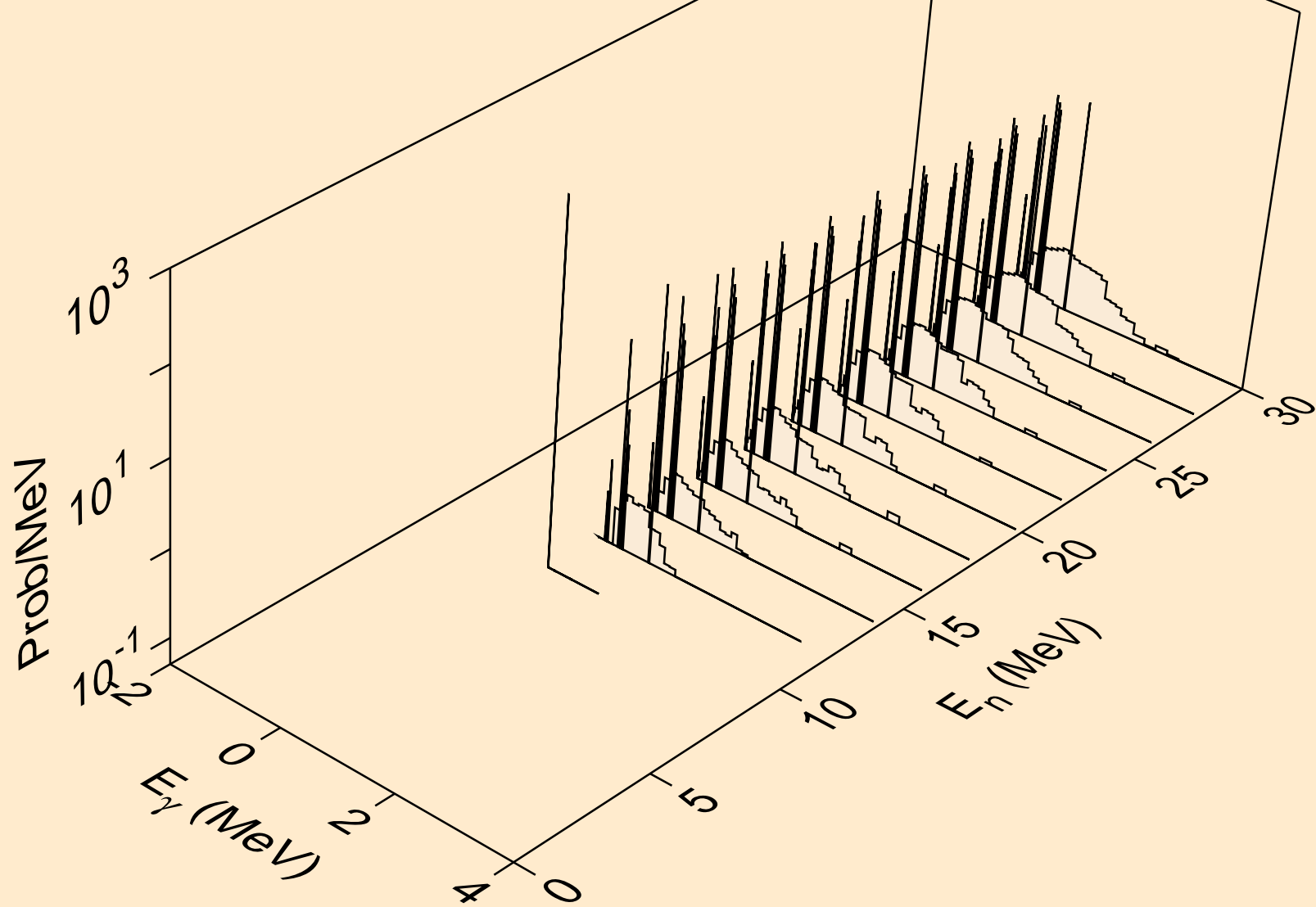

AT198M NEUTRON ACER TENDL-2021 LIBRARY; T=293.6K  
Photon emission for (n,4n)

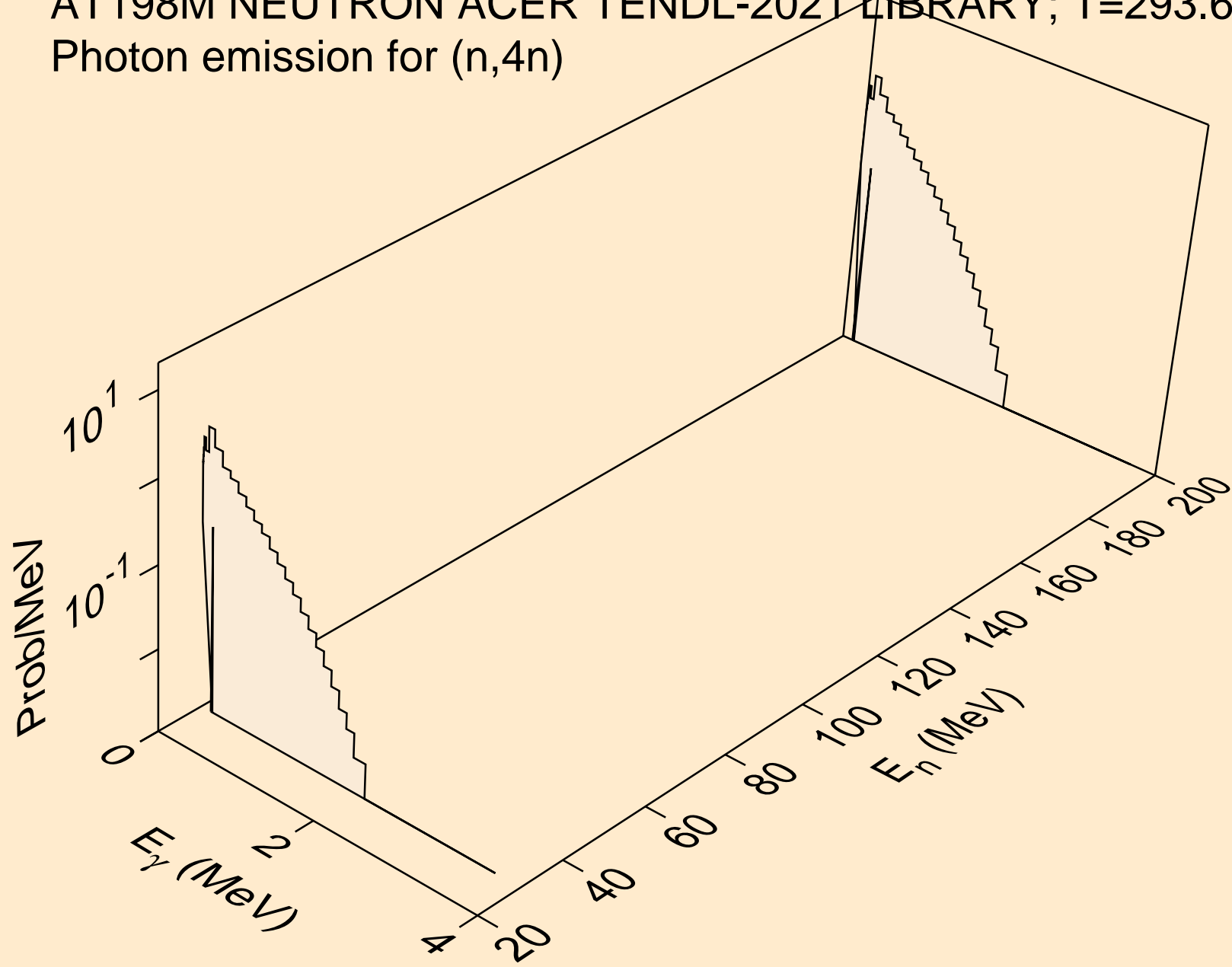

AT198M NEUTRON ACER TENDL-2021 LIBRARY; T=293.6K  
Photon emission for (n,2np)

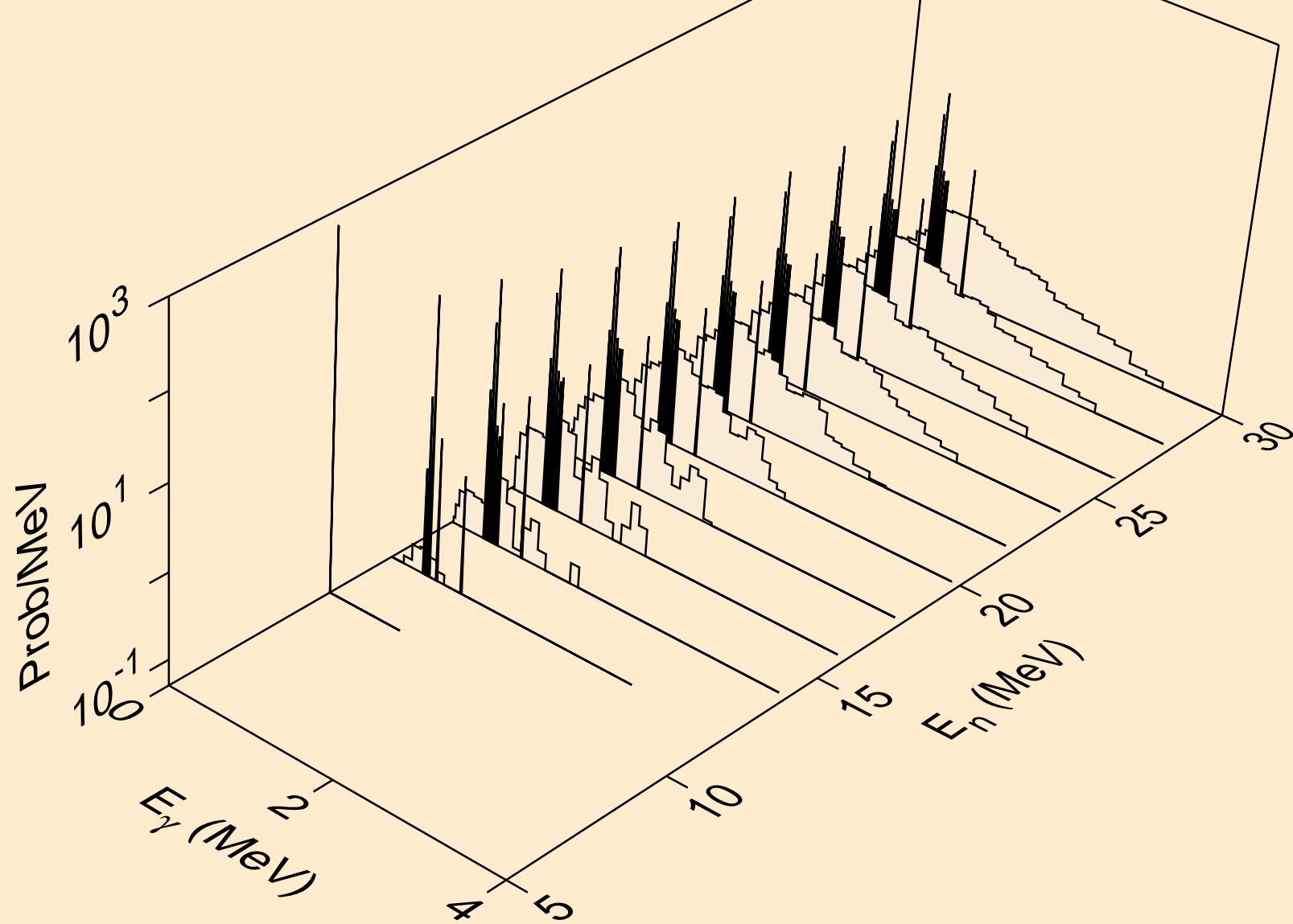

AT198M NEUTRON ACER TENDL-2021 LIBRARY; T=293.6K  
Photon emission for (n,3np)

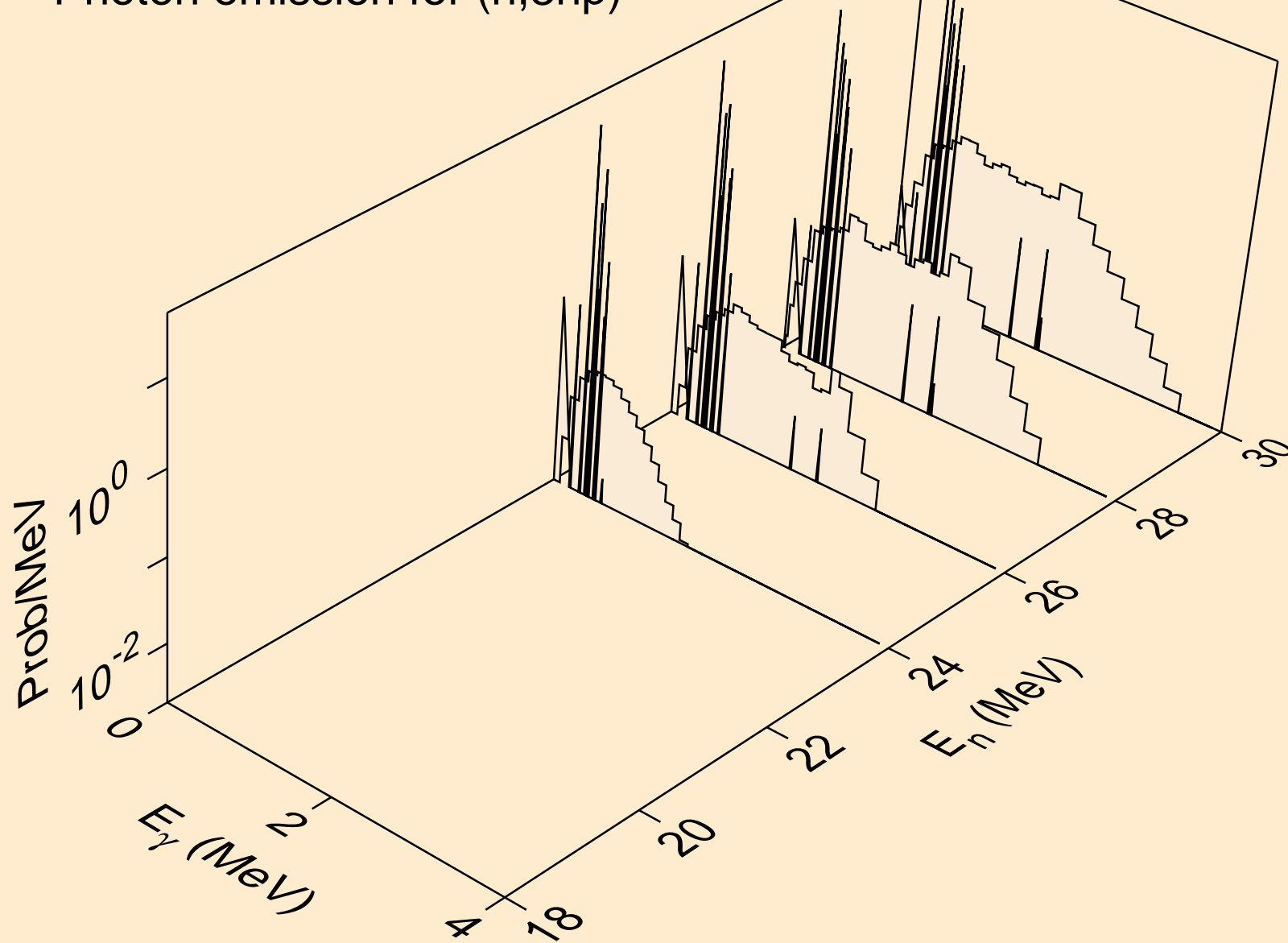

AT198M NEUTRON ACER TENDL-2021 LIBRARY; T=293.6K  
Photon emission for (n,2np)

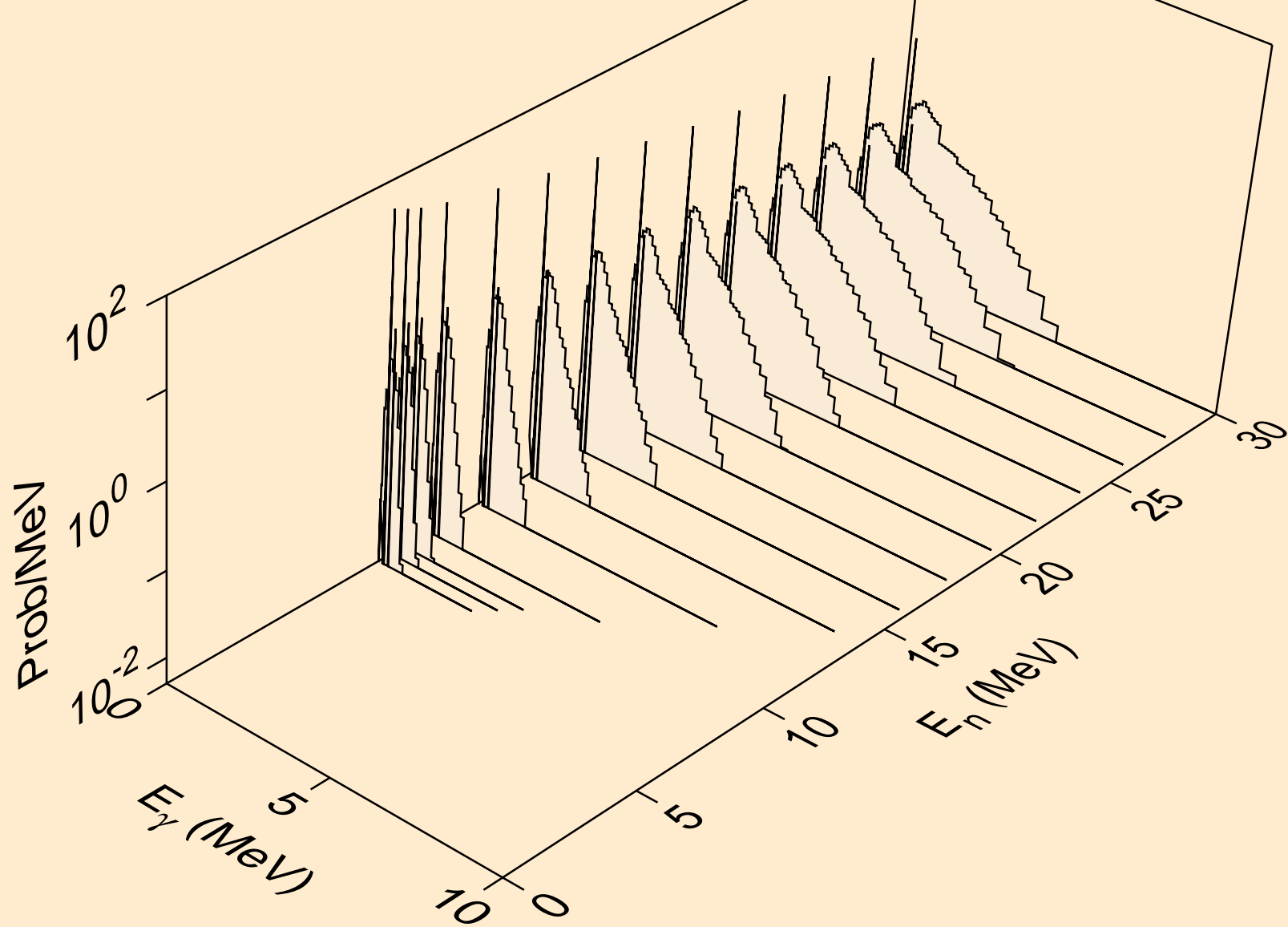

AT198M NEUTRON ACER TENDL-2021 LIBRARY; T=293.6K  
Photon emission for (n,npa)

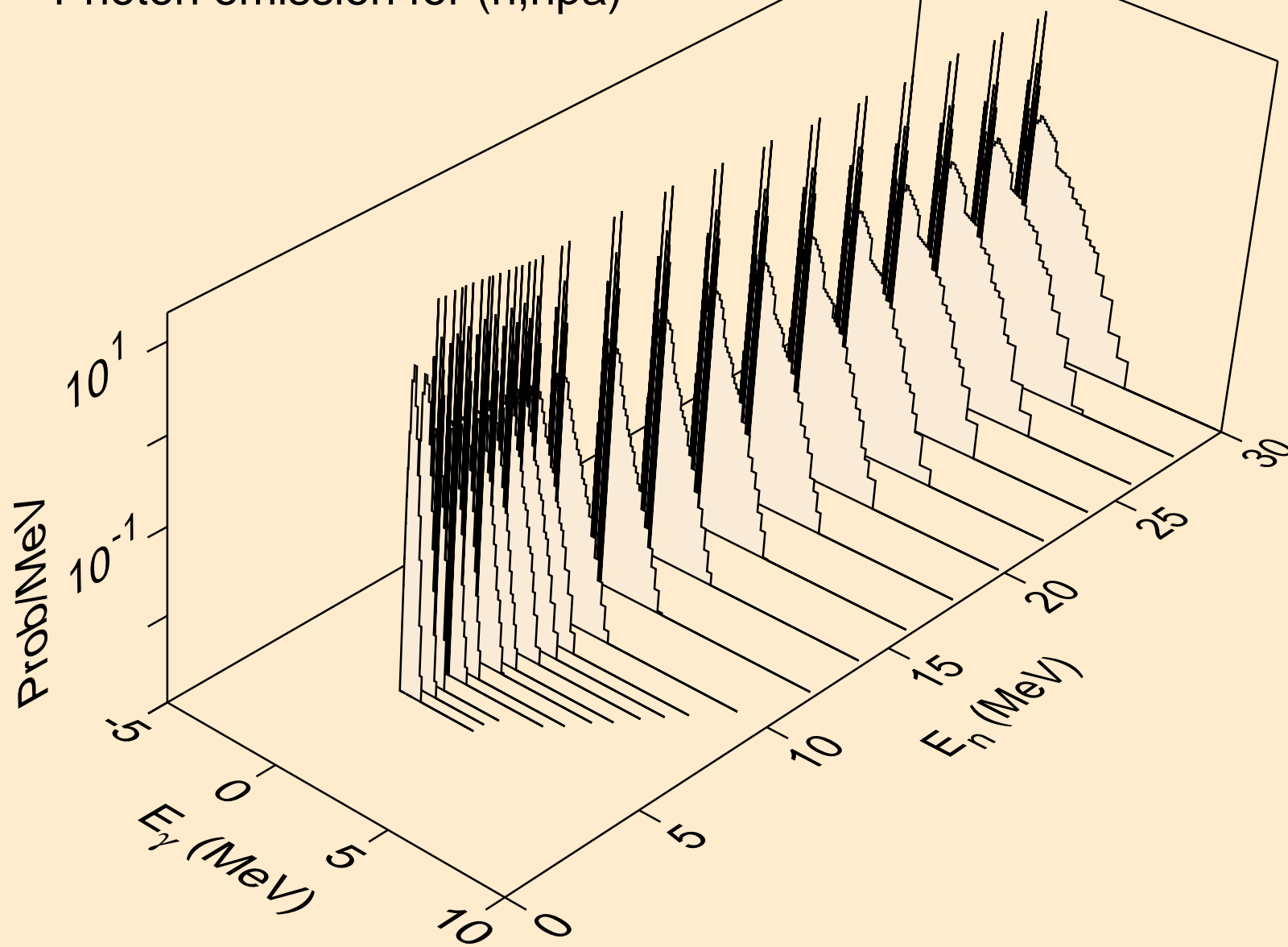

AT198M NEUTRON ACER TENDL-2021 LIBRARY; T=293.6K  
Photon emission for (n,n\*2)

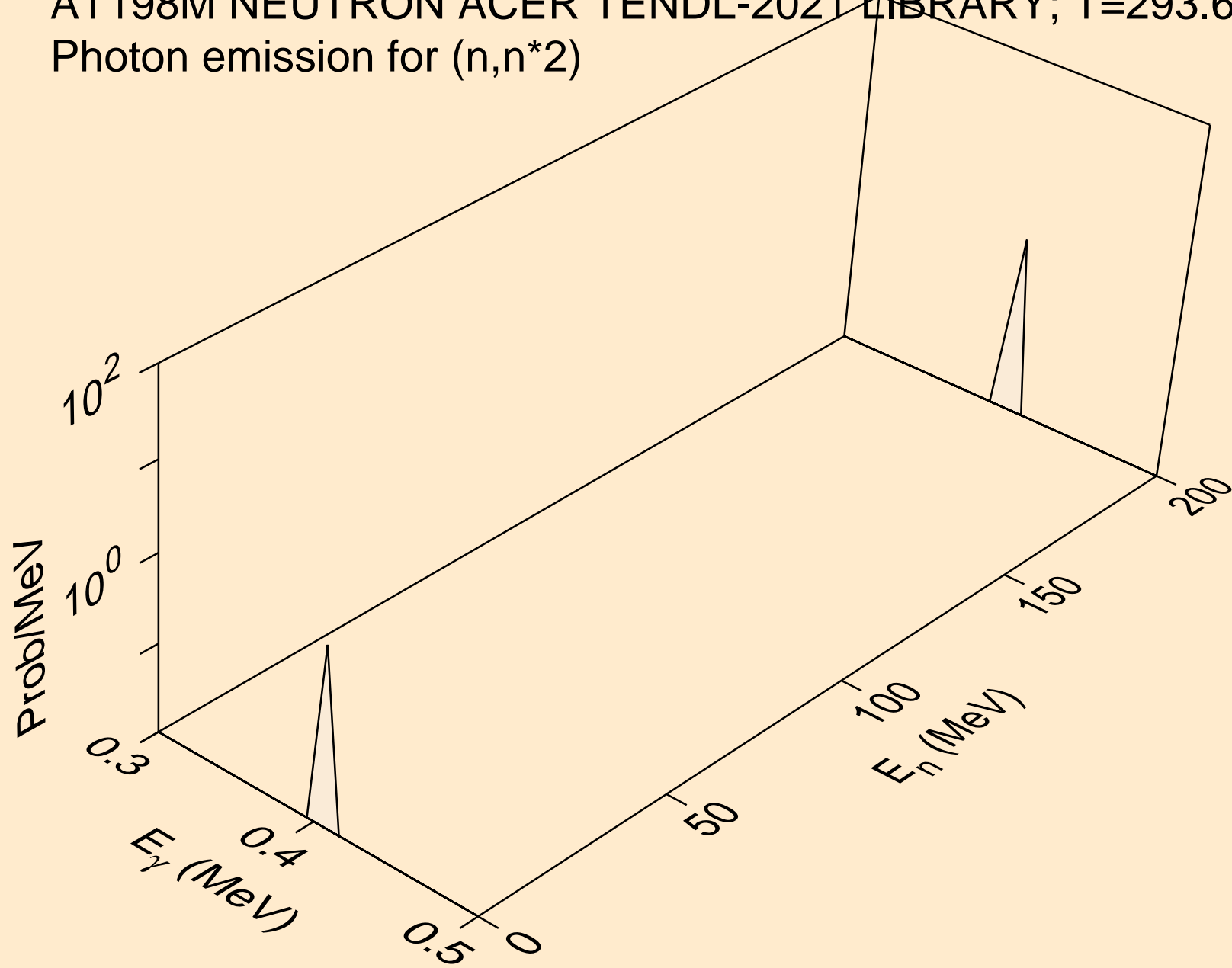

AT198M NEUTRON ACER TENDL-2021 LIBRARY; T=293.6K  
Photon emission for (n,n\*c)

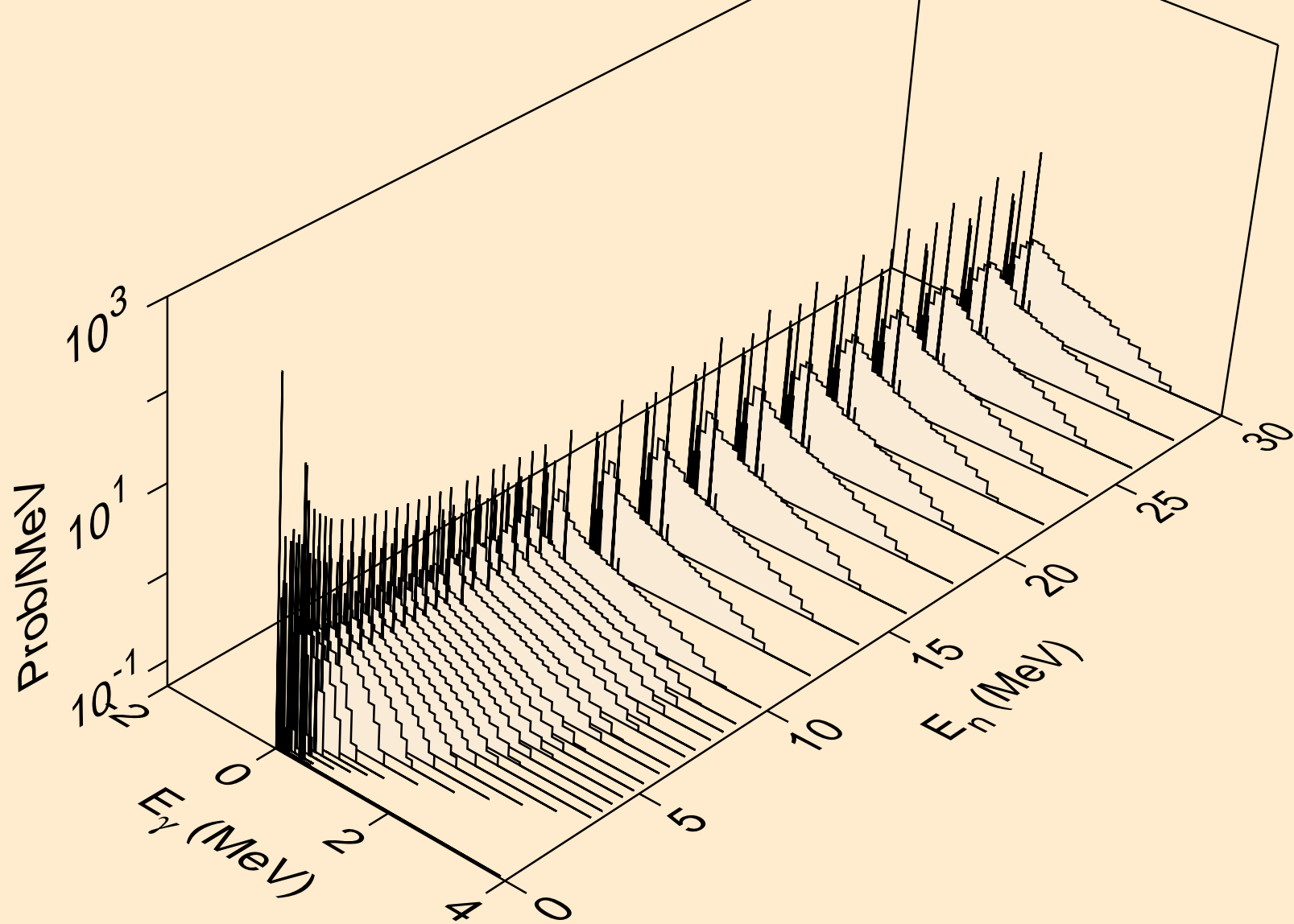



AT198M NEUTRON ACER TENDL-2021 LIBRARY; T=293.6K  
Photon emission for (n,gma)

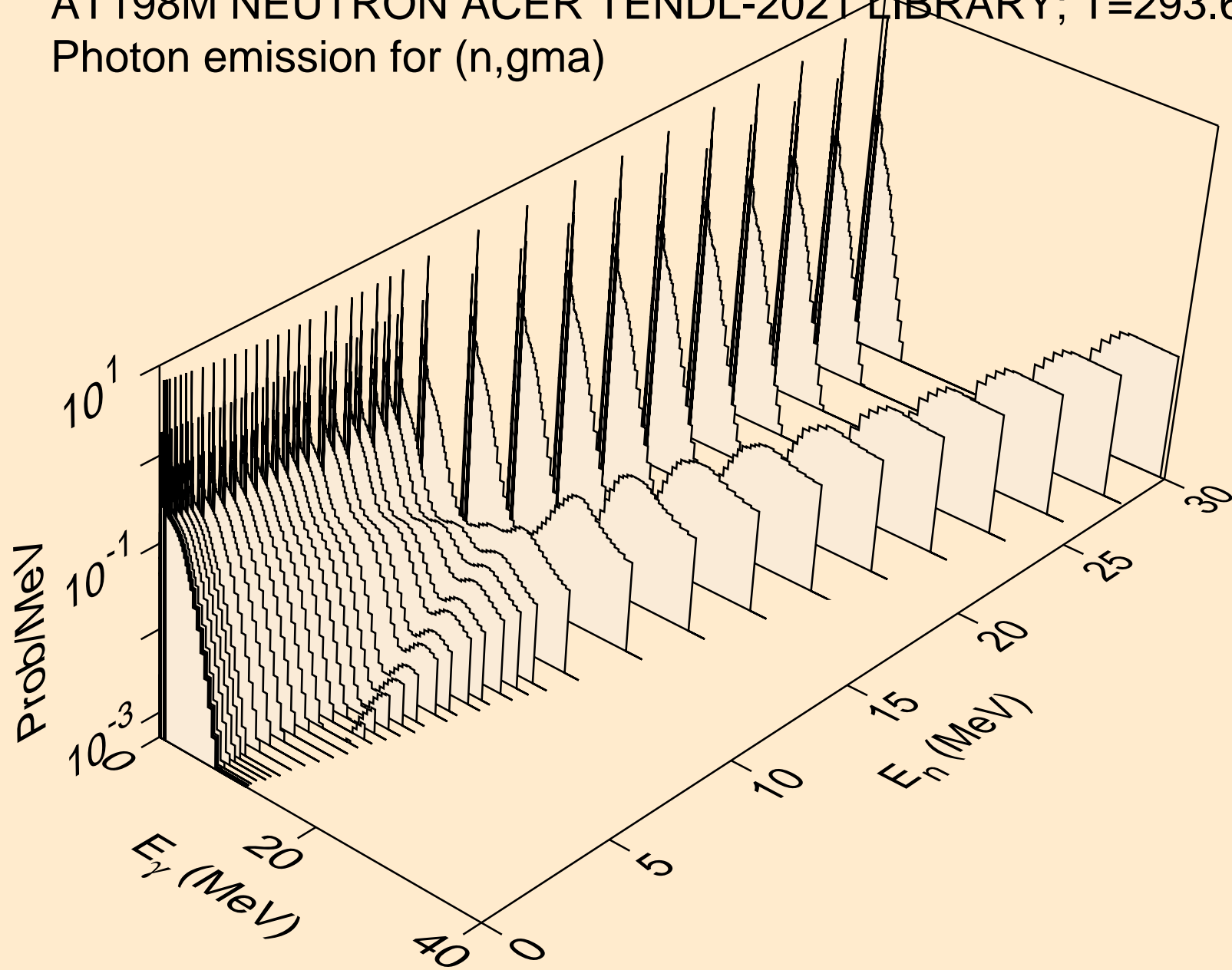

AT198M NEUTRON ACER TENDL-2021 LIBRARY; T=293.6K  
Photon emission for (n,p)

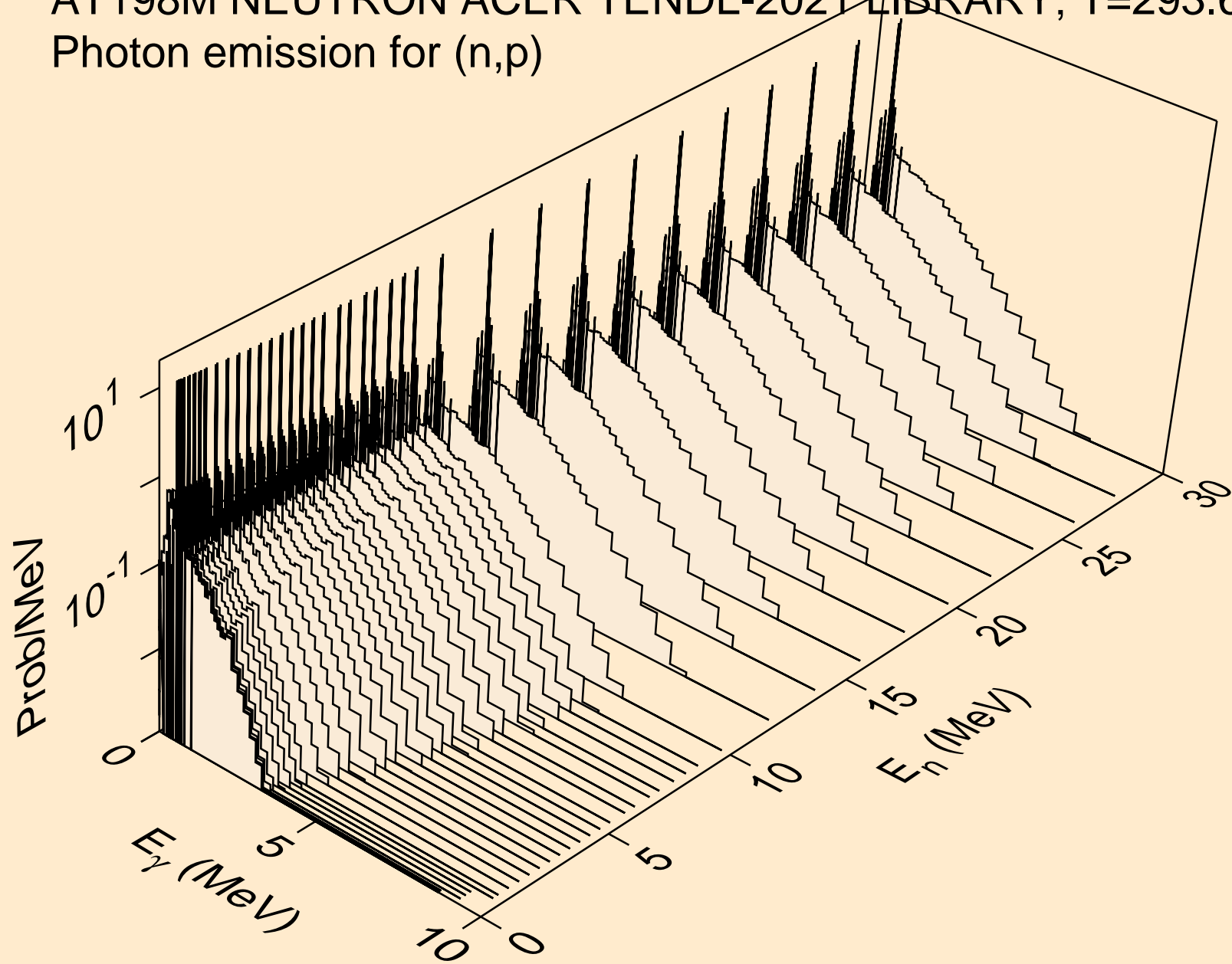

AT198M NEUTRON ACER TENDL-2021 LIBRARY; T=293.6K  
Photon emission for (n,d)

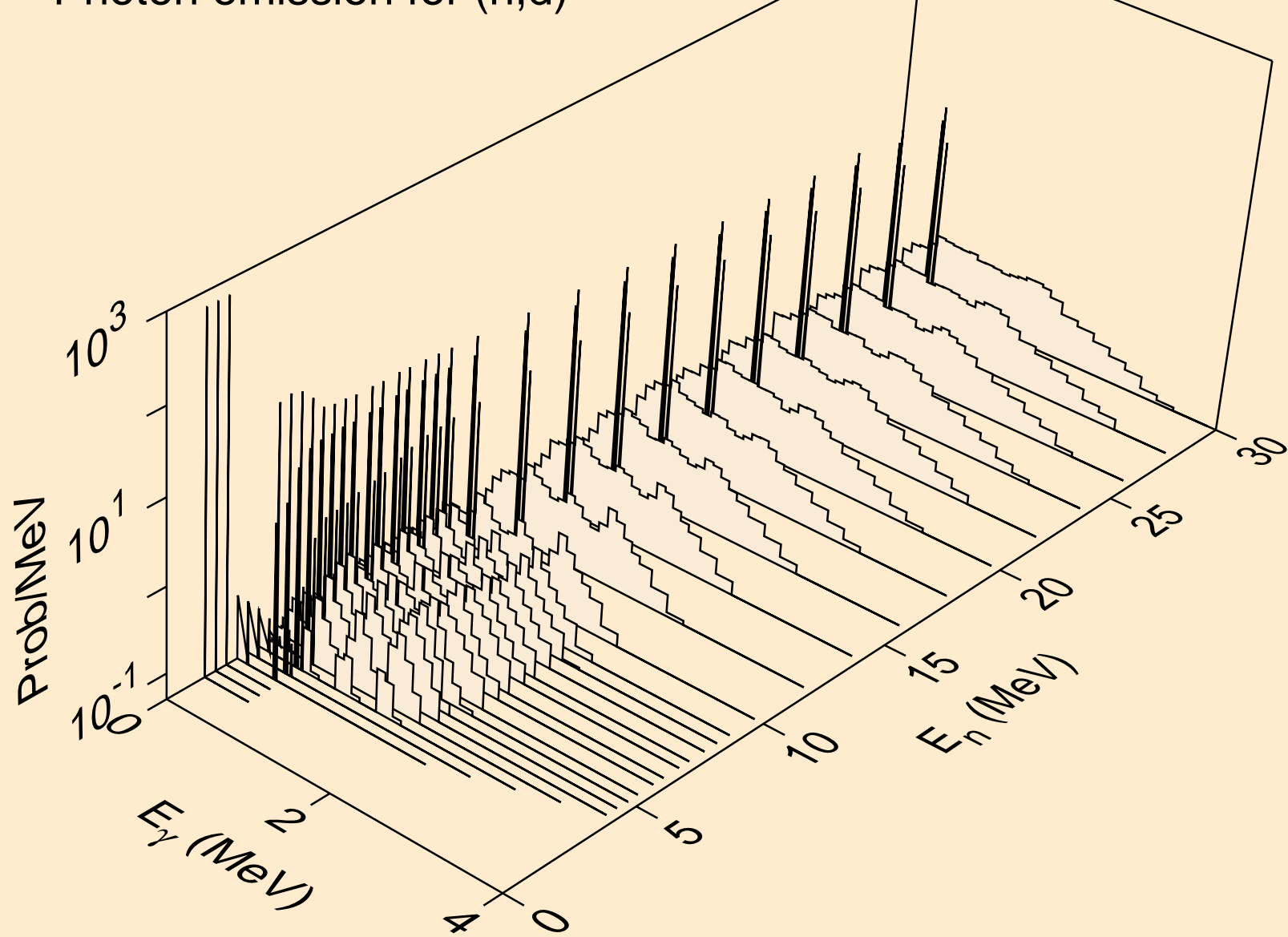

AT198M NEUTRON ACER TENDL-2021 LIBRARY; T=293.6K  
Photon emission for (n,t)

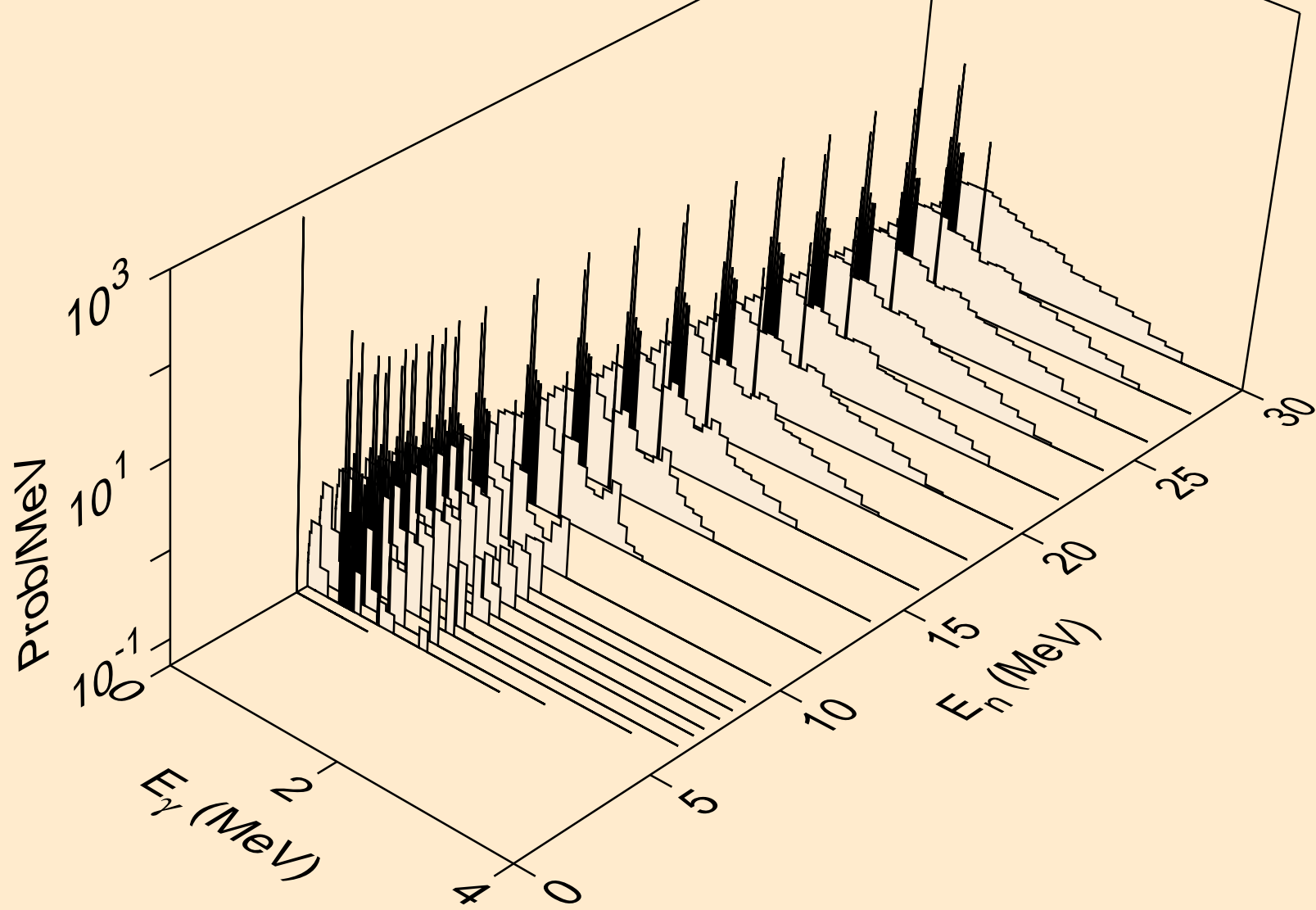

AT198M NEUTRON ACER TENDL-2021 LIBRARY; T=293.6K  
Photon emission for (n,he3)

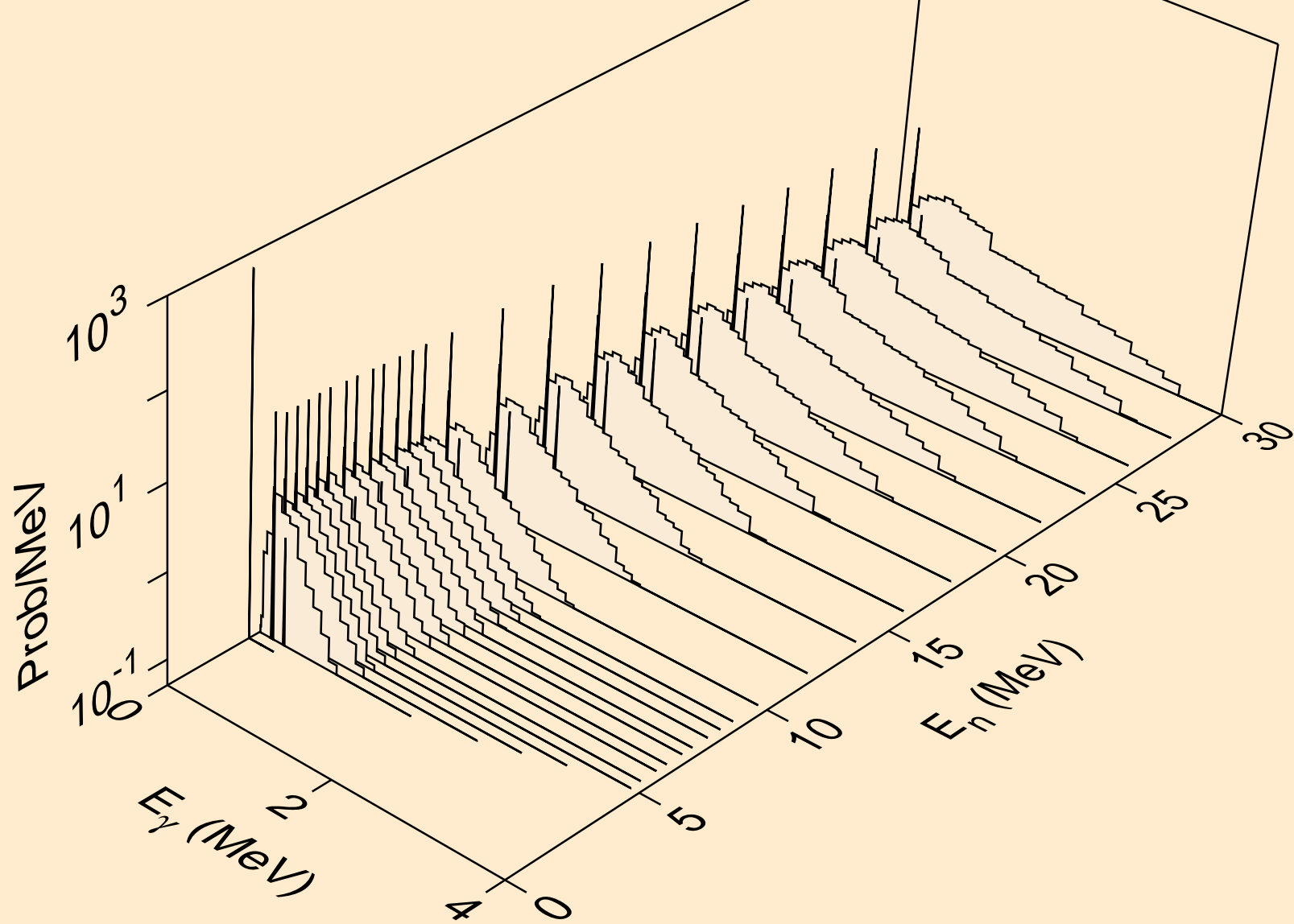

AT198M NEUTRON ACER TENDL-2021 LIBRARY; T=293.6K  
Photon emission for (n,a)

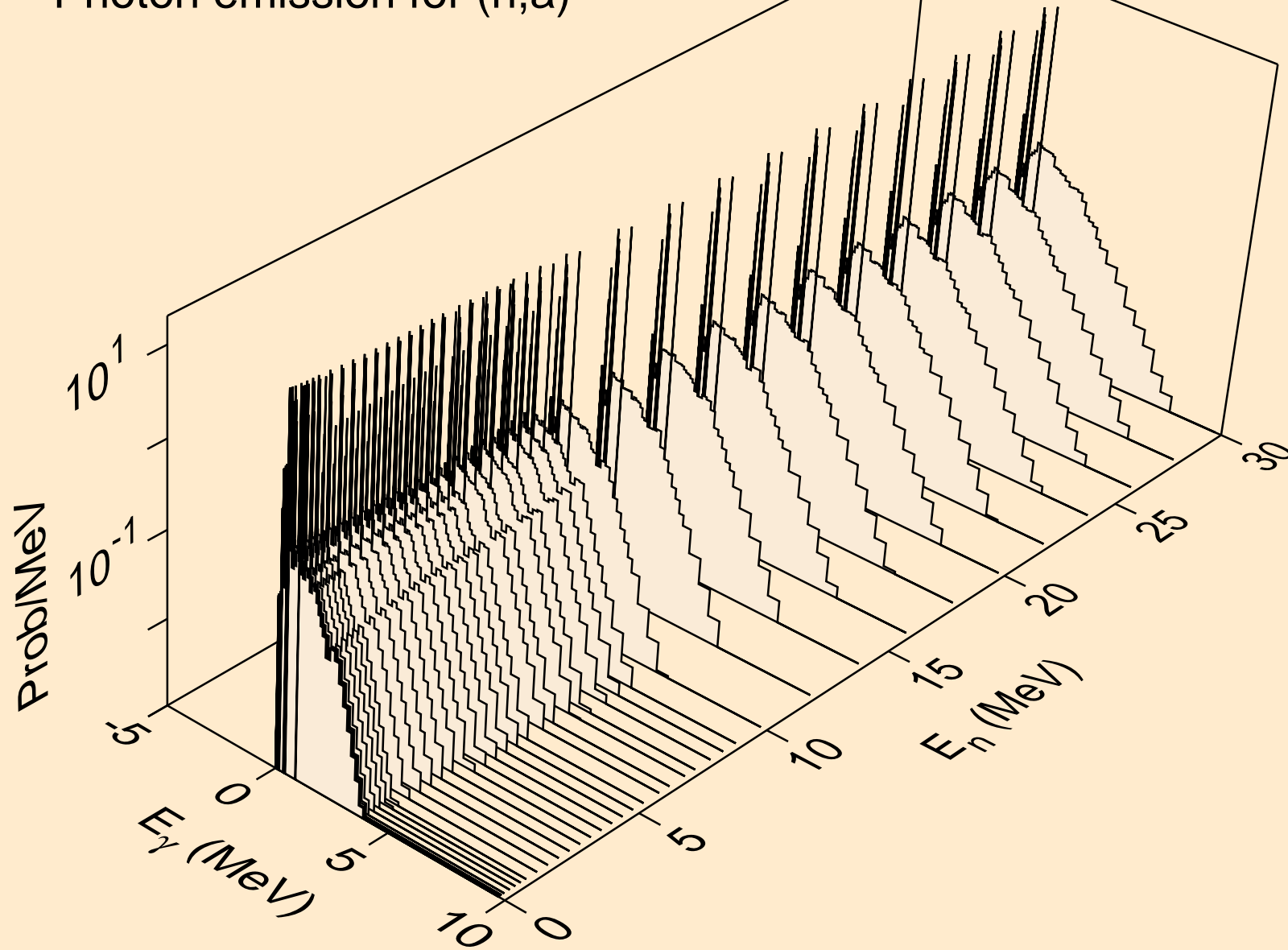

AT198M NEUTRON ACER TENDL-2021 LIBRARY; T=293.6K  
Photon emission for (n,2a)

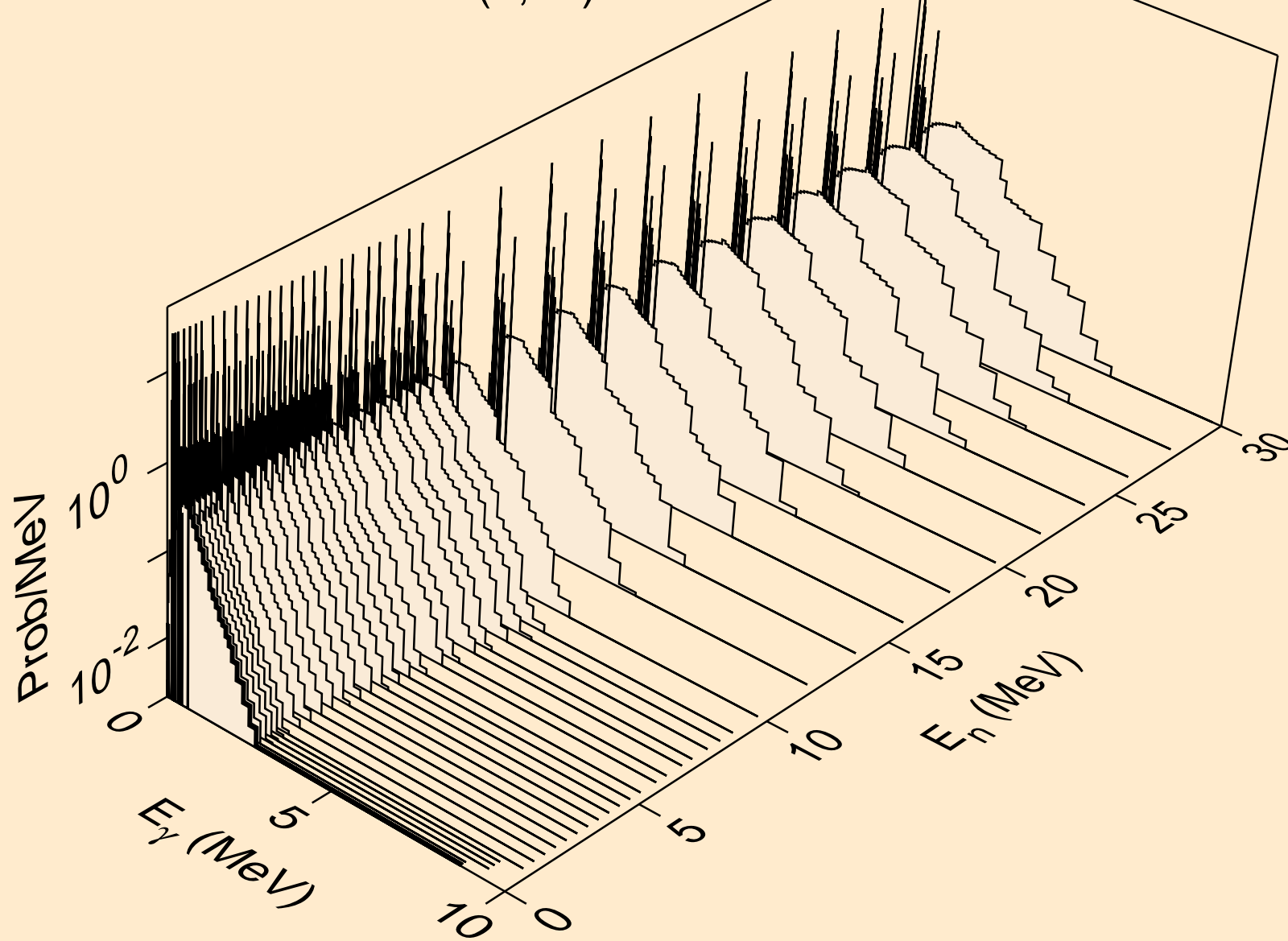

AT198M NEUTRON ACER TENDL-2021 LIBRARY; T=293.6K  
Photon emission for (n,3a)

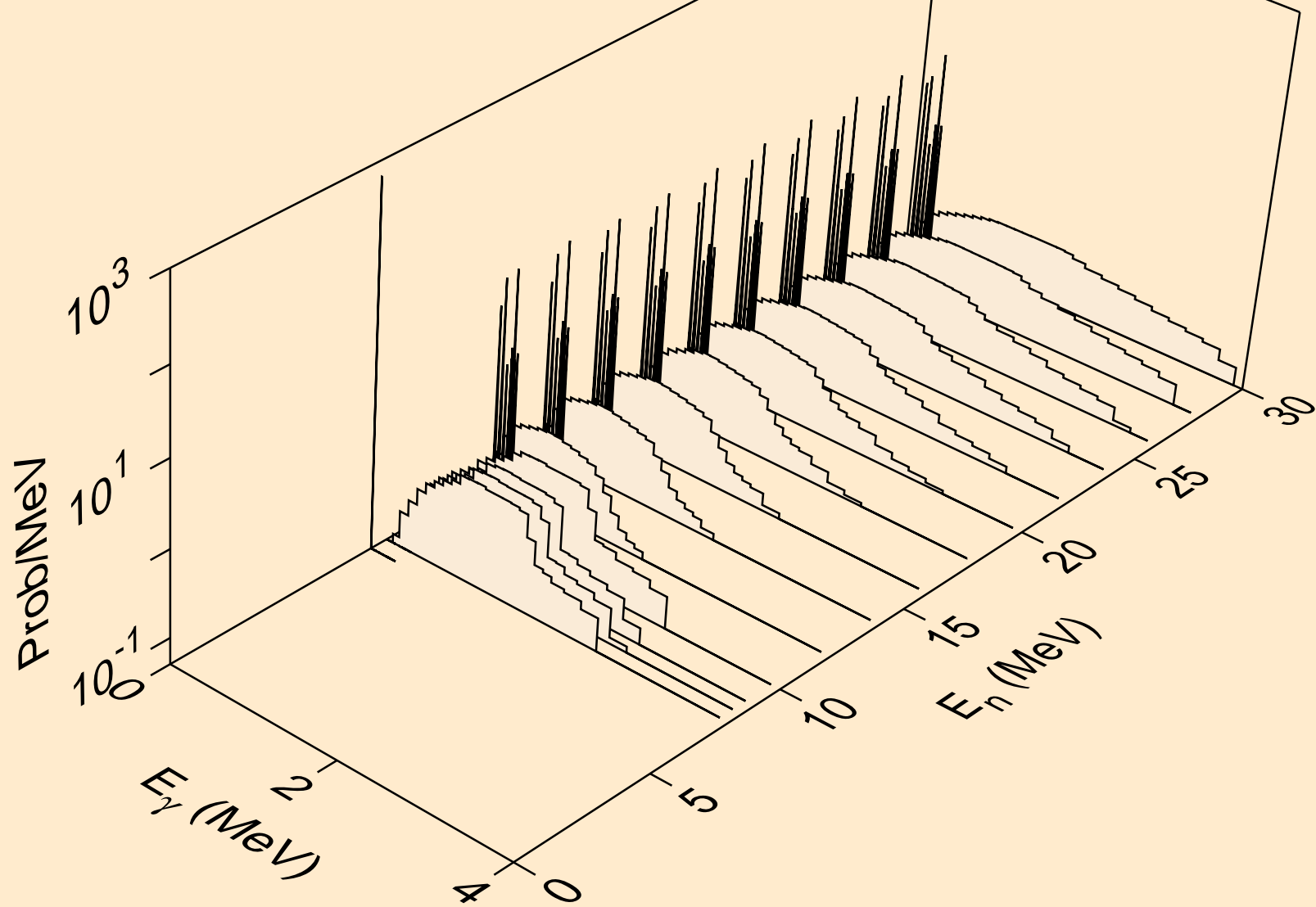



AT198M NEUTRON ACER TENDL-2021 LIBRARY; T=293.6K  
Photon emission for (n,2p)

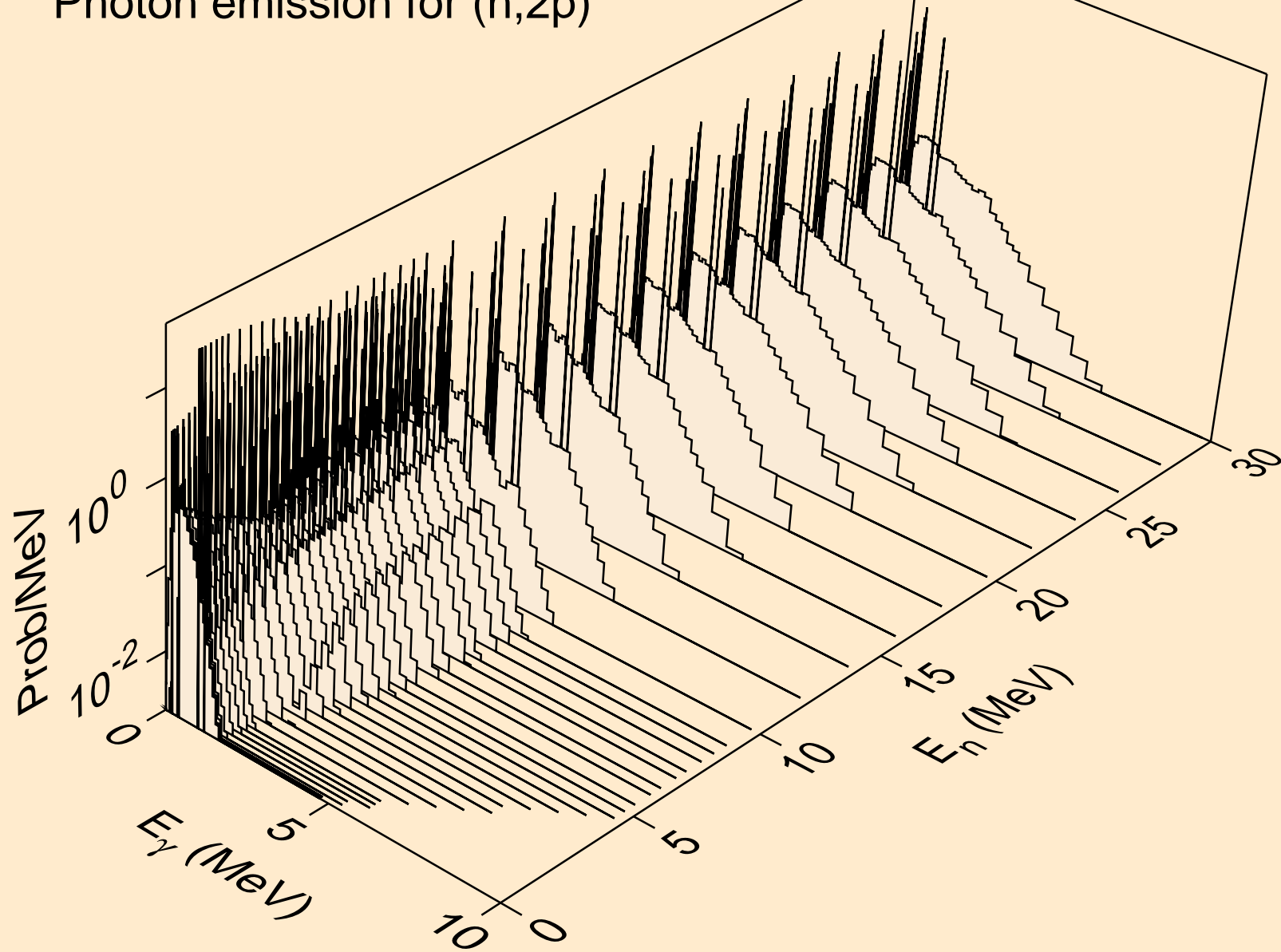

AT198M NEUTRON ACER TENDL-2021 LIBRARY; T=293.6K  
Photon emission for (n,p $\alpha$ )

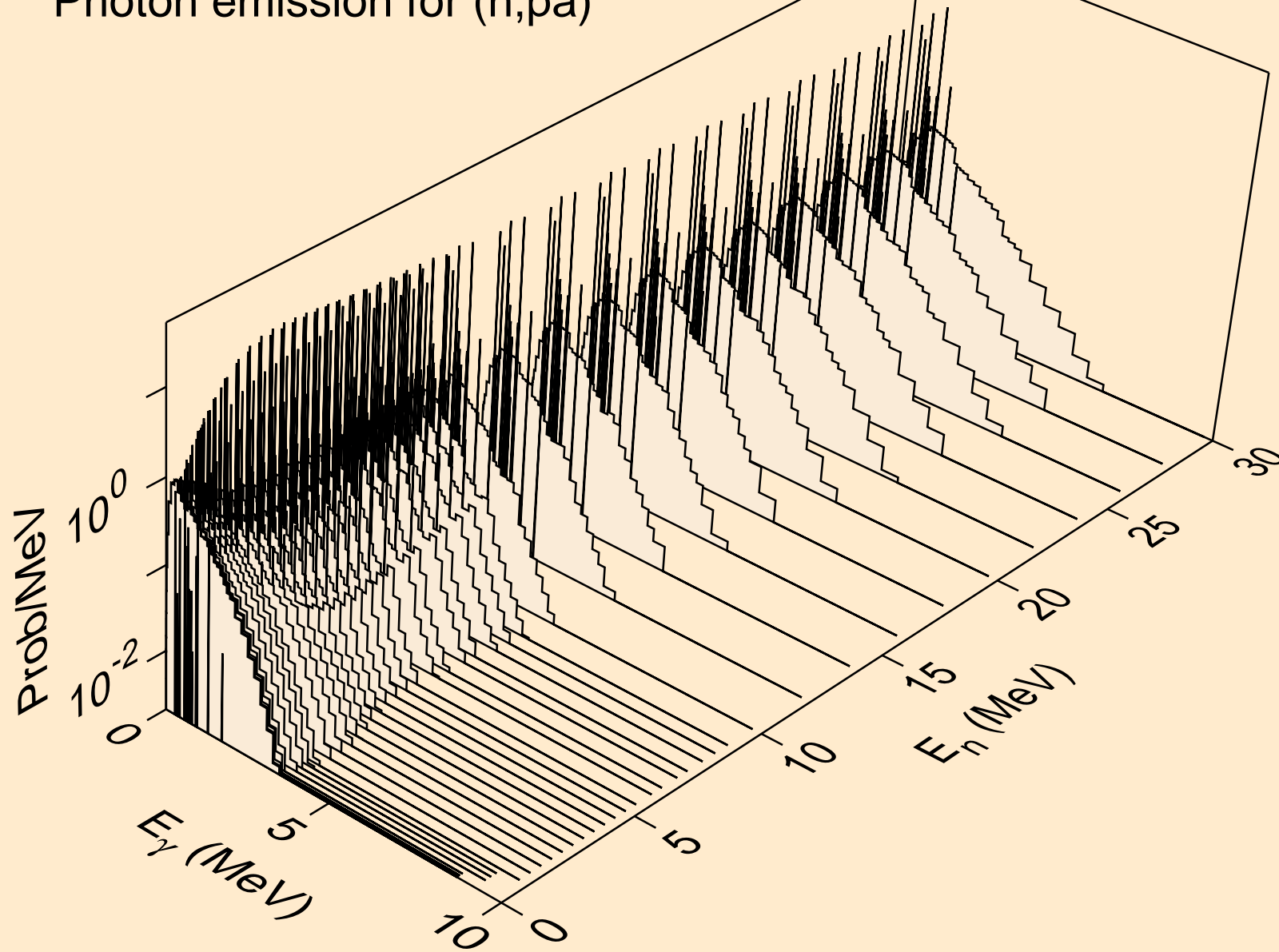

AT198M NEUTRON ACER TENDL-2021 LIBRARY; T=293.6K  
Photon emission for (n,pd)

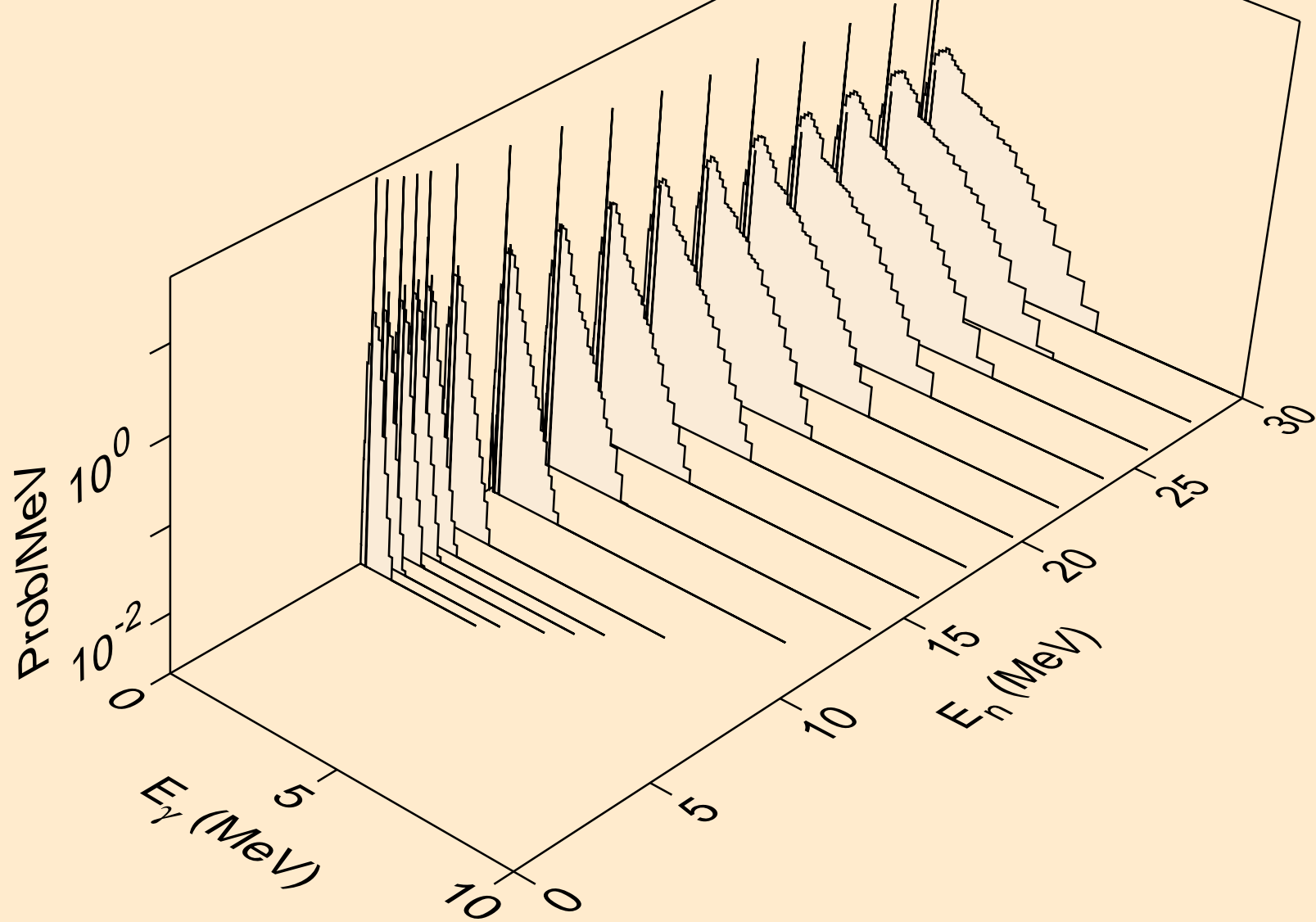

AT198M NEUTRON ACER TENDL-2021 LIBRARY; T=293.6K  
Photon emission for (n,pt)

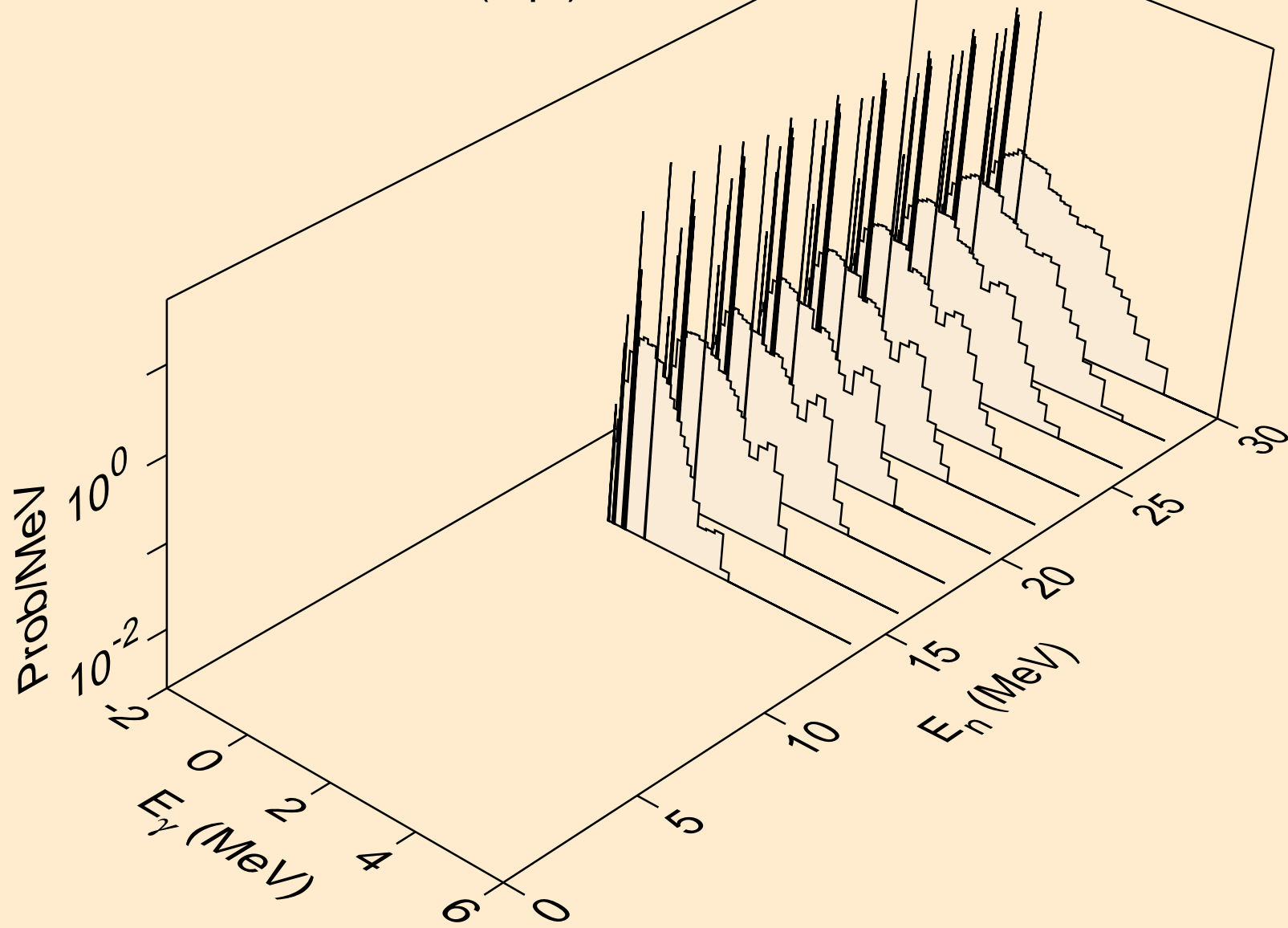

AT198M NEUTRON ACER TENDL-2021 LIBRARY; T=293.6K  
Photon emission for (n,da)

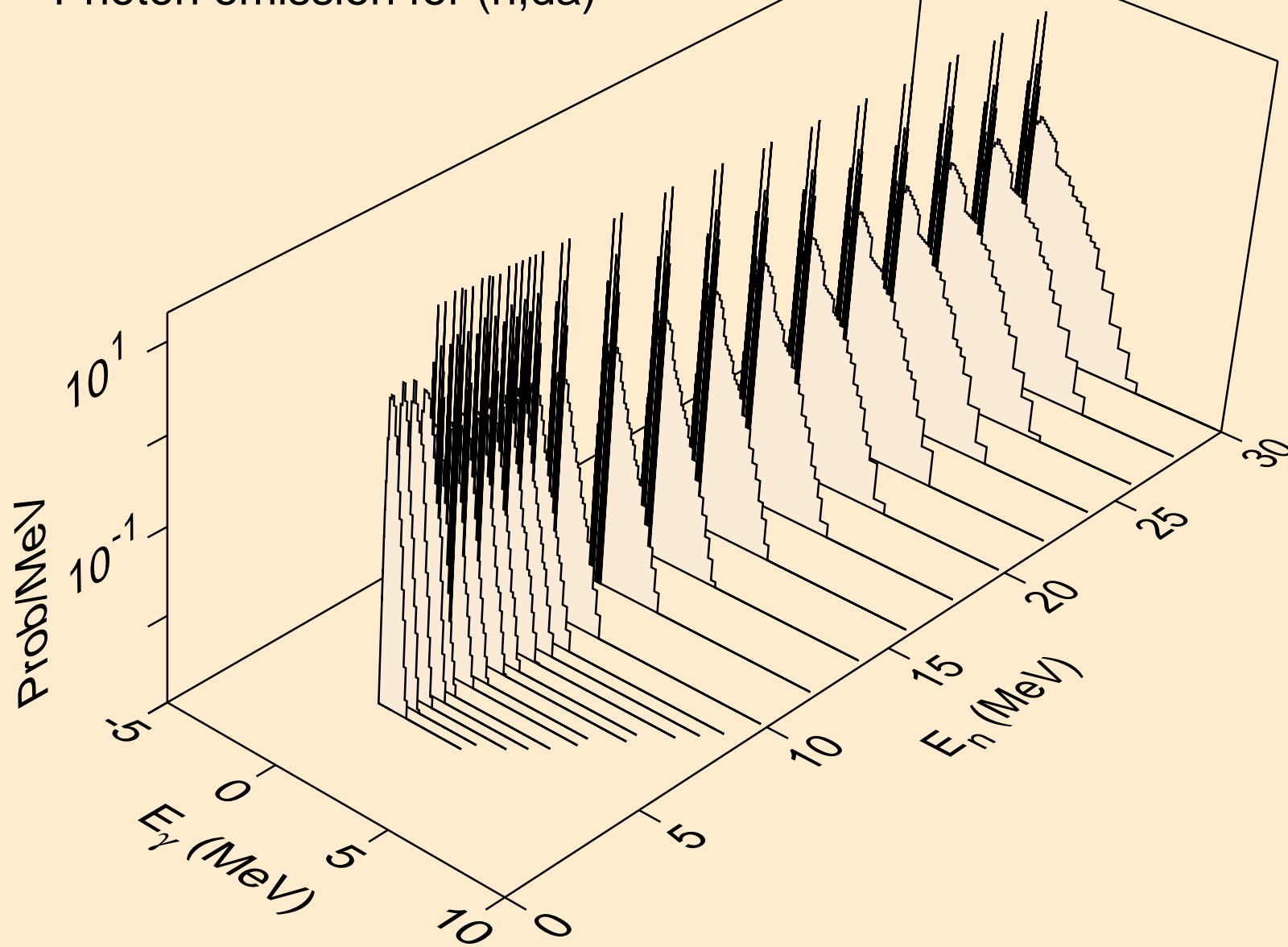

AT198M NEUTRON ACER TENDL-2021 LIBRARY; T=293.6K  
thermal capture photon spectrum

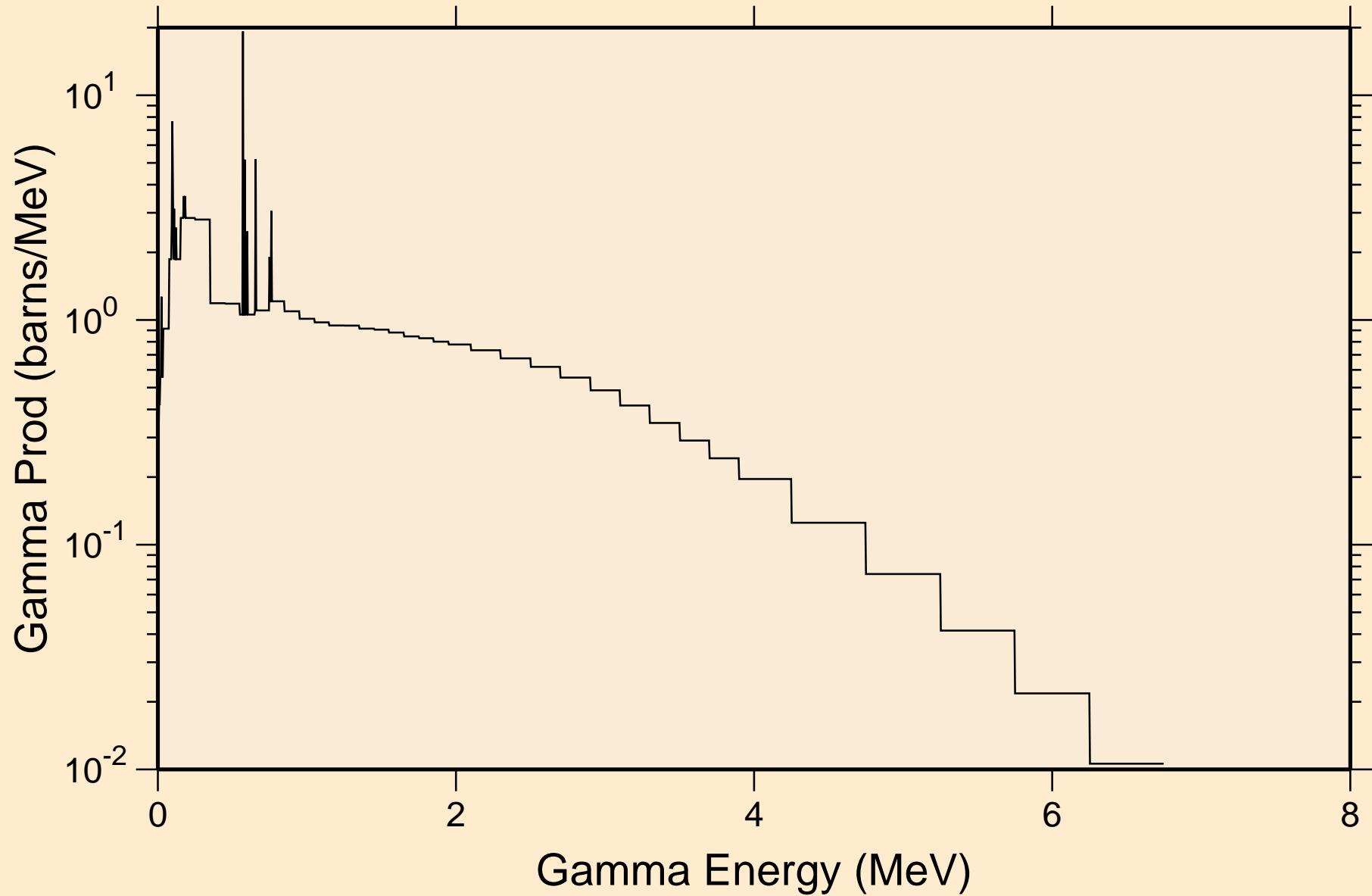

AT198M NEUTRON ACER TENDL-2021 LIBRARY; T=293.6K  
14 MeV photon spectrum

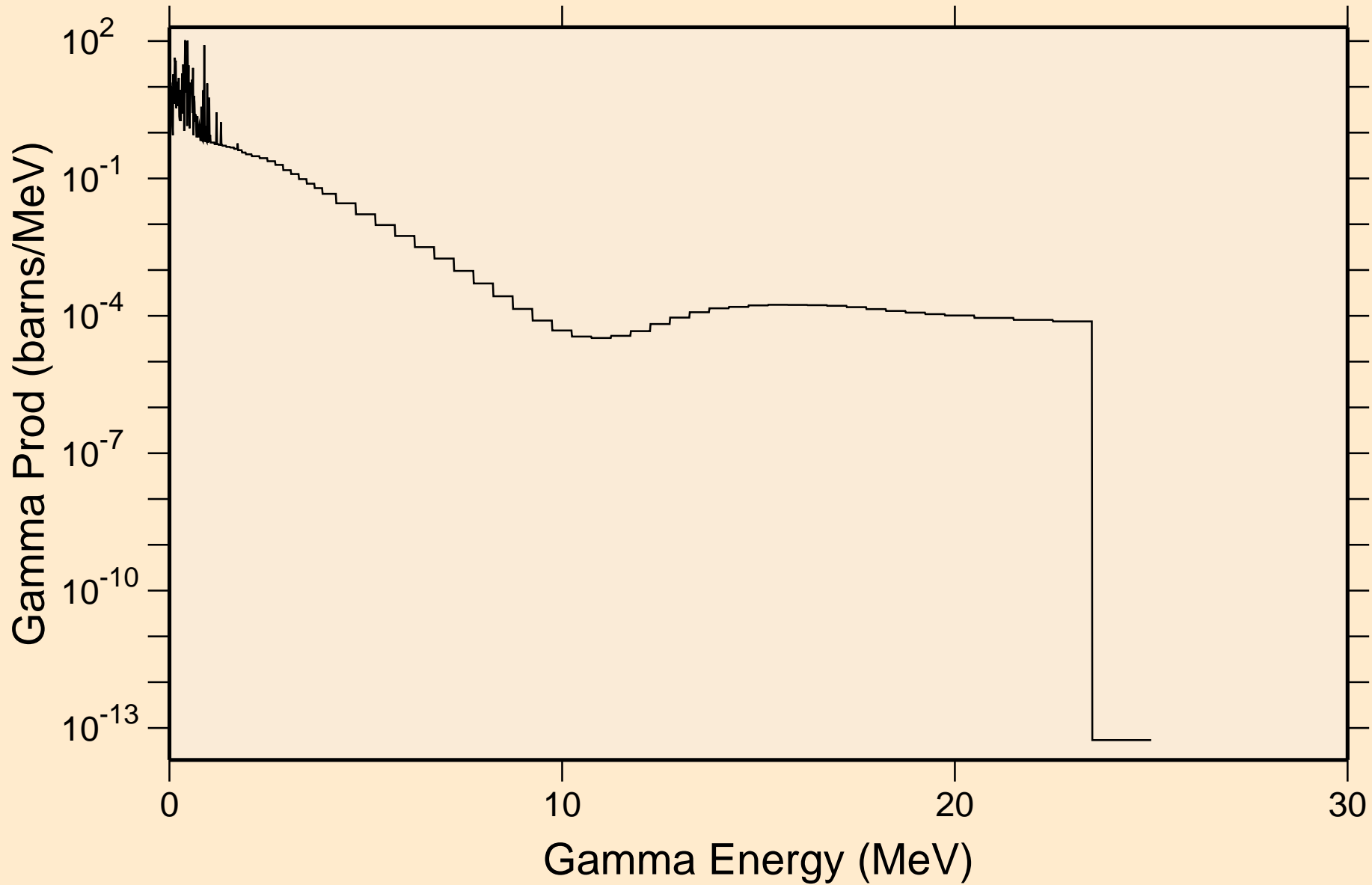

AT198M NEUTRON ACER TENDL-2021 LIBRARY; T=293.6K  
Particle heating contributions

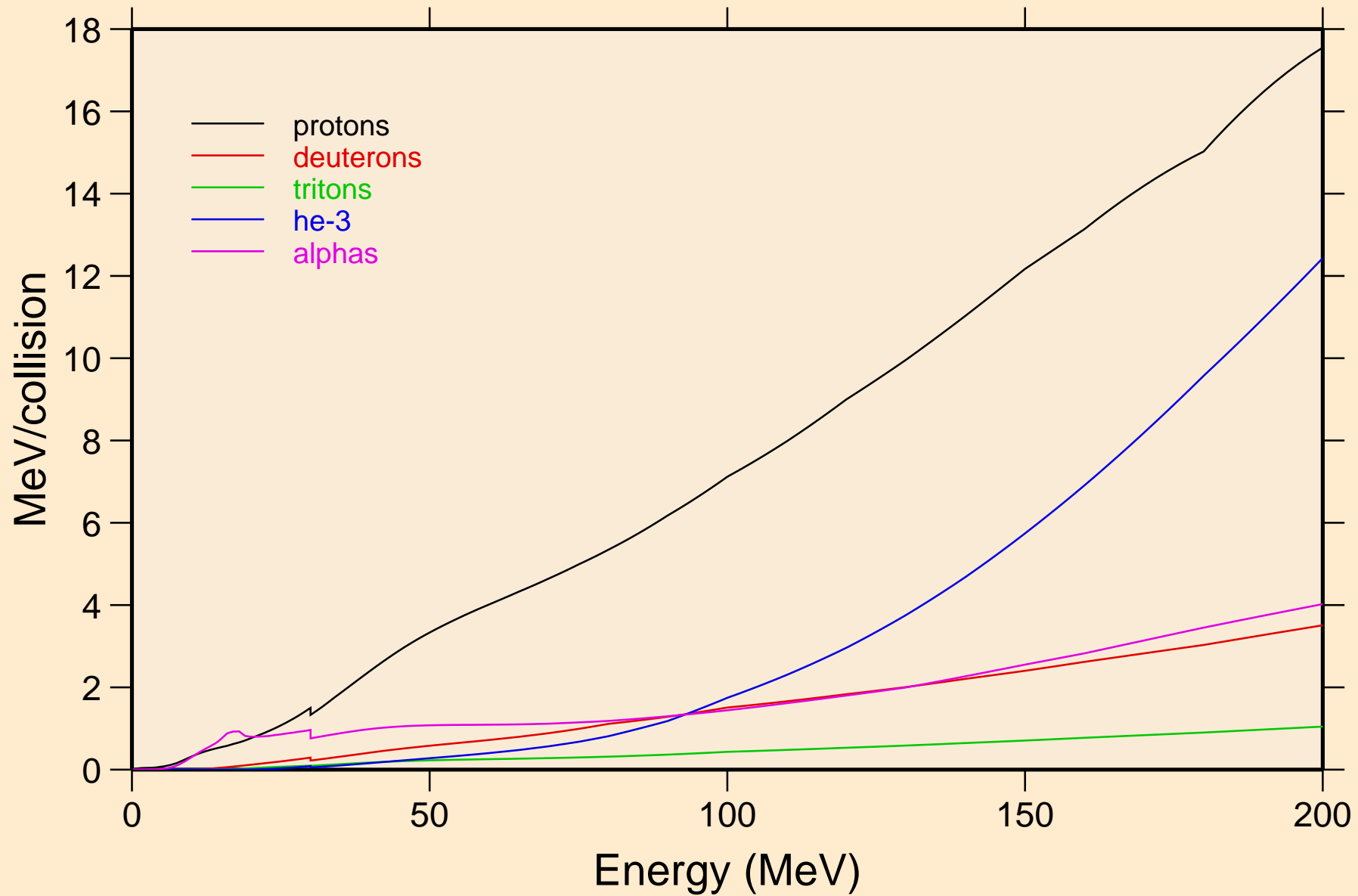



AT198M NEUTRON ACER TENDL-2021 LIBRARY; T=293.6K  
Recoil Heating

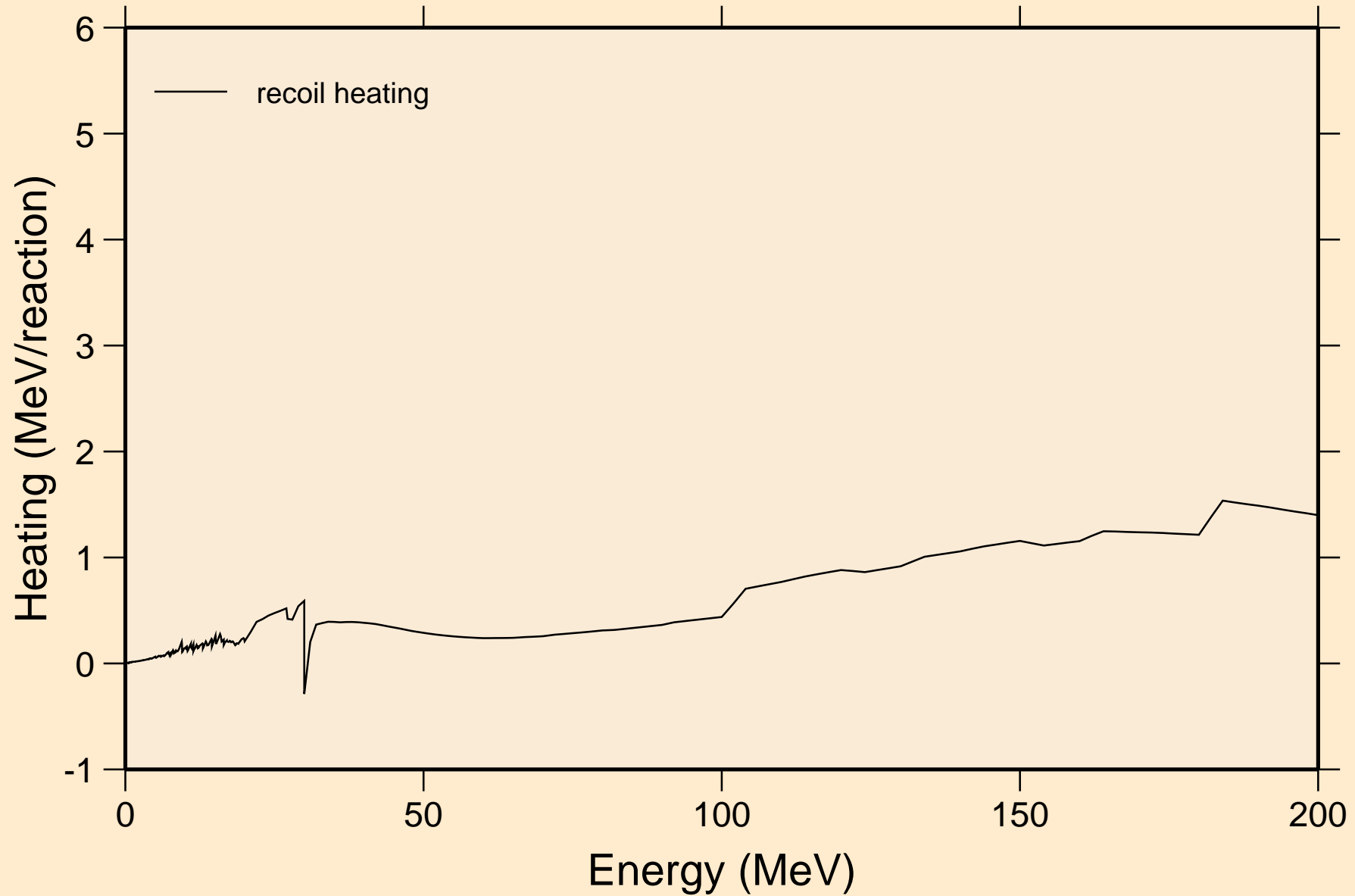

AT198M NEUTRON ACER TENDL-2021 LIBRARY; T=293.6K  
Particle production cross sections

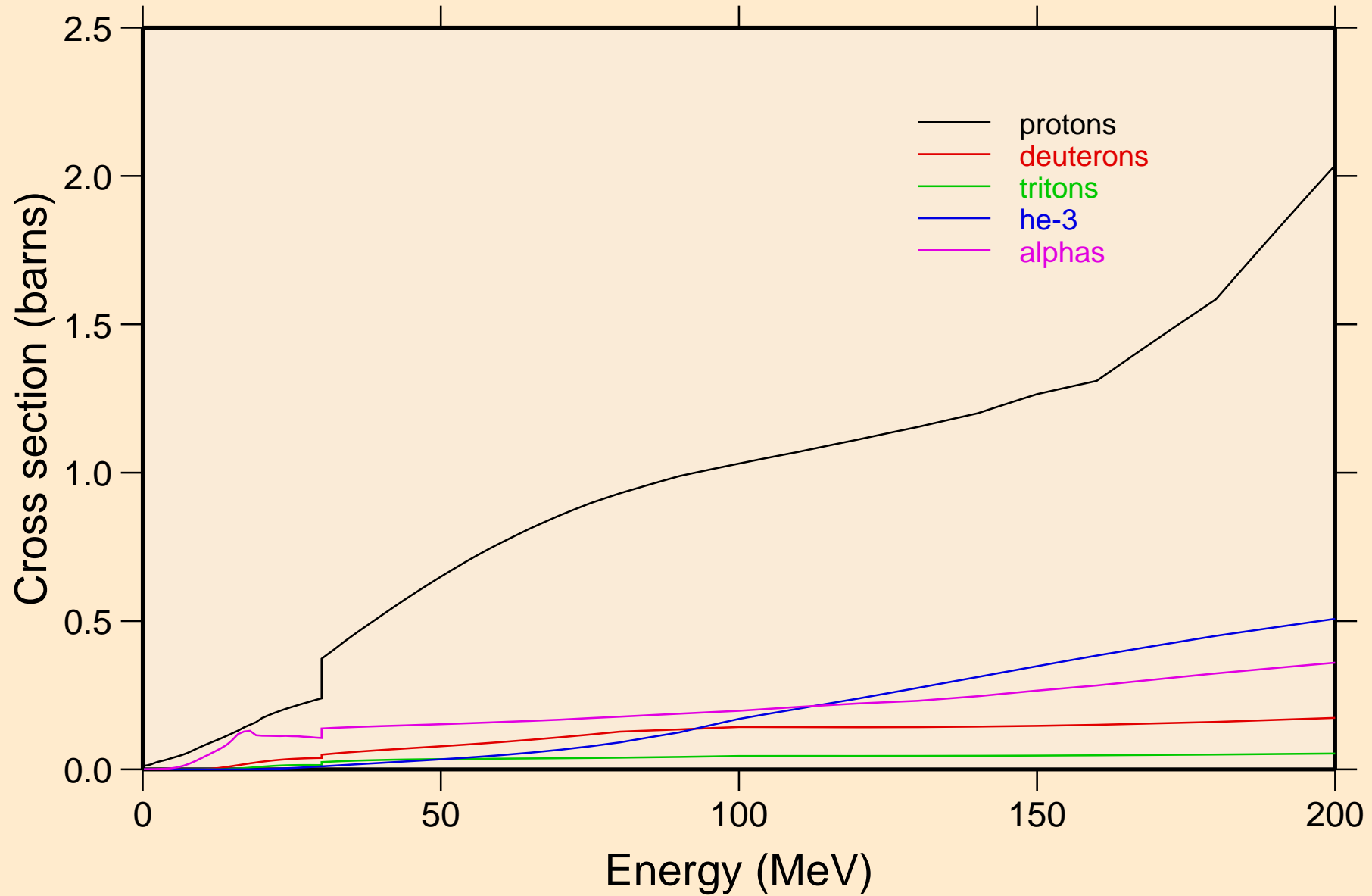

AT198M NEUTRON ACER TENDL-2021 LIBRARY; T=293.6K  
protons from (n,x)

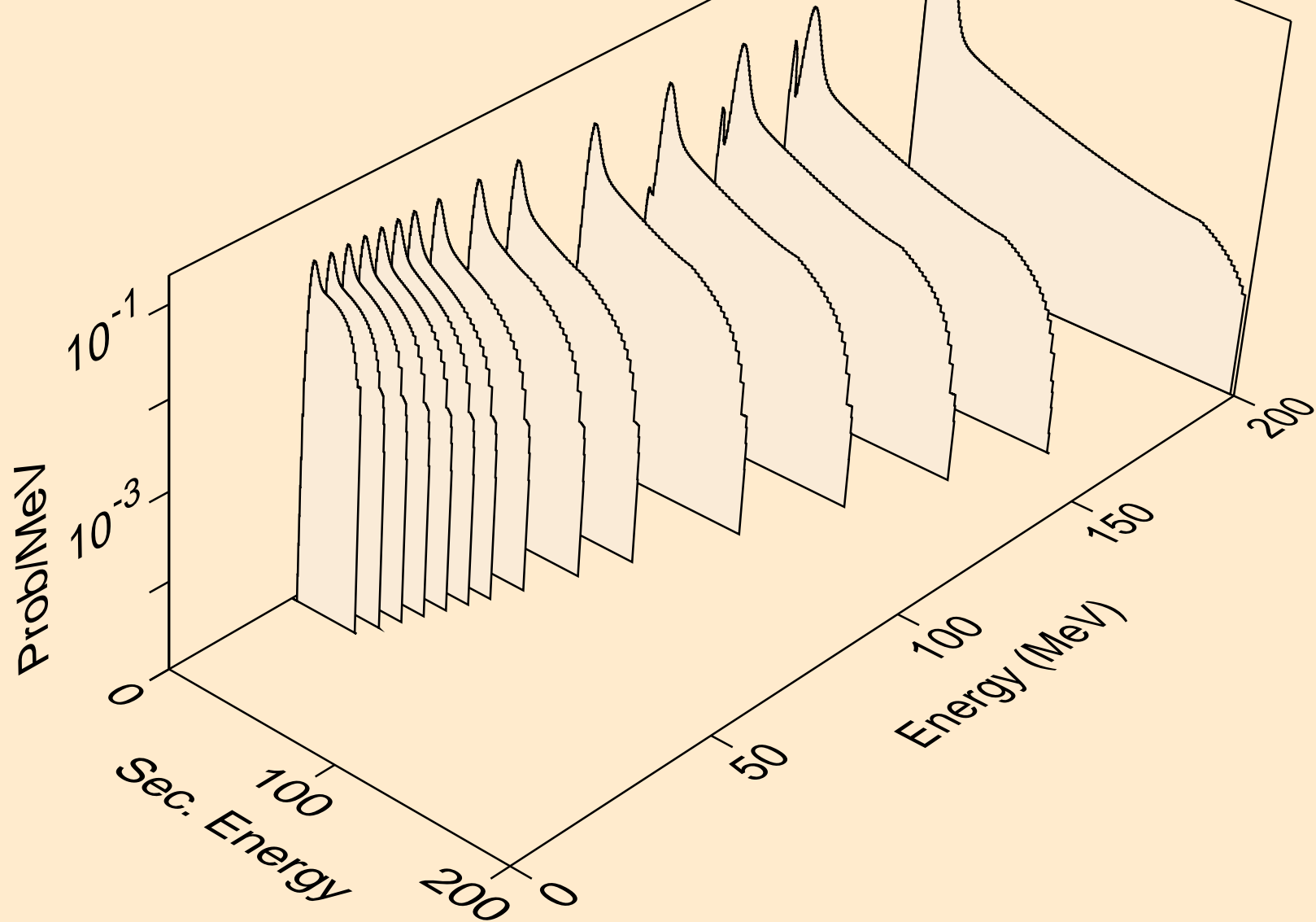

AT198M NEUTRON ACER TENDL-2021 LIBRARY; T=293.6K  
protons from (n,n\*)p

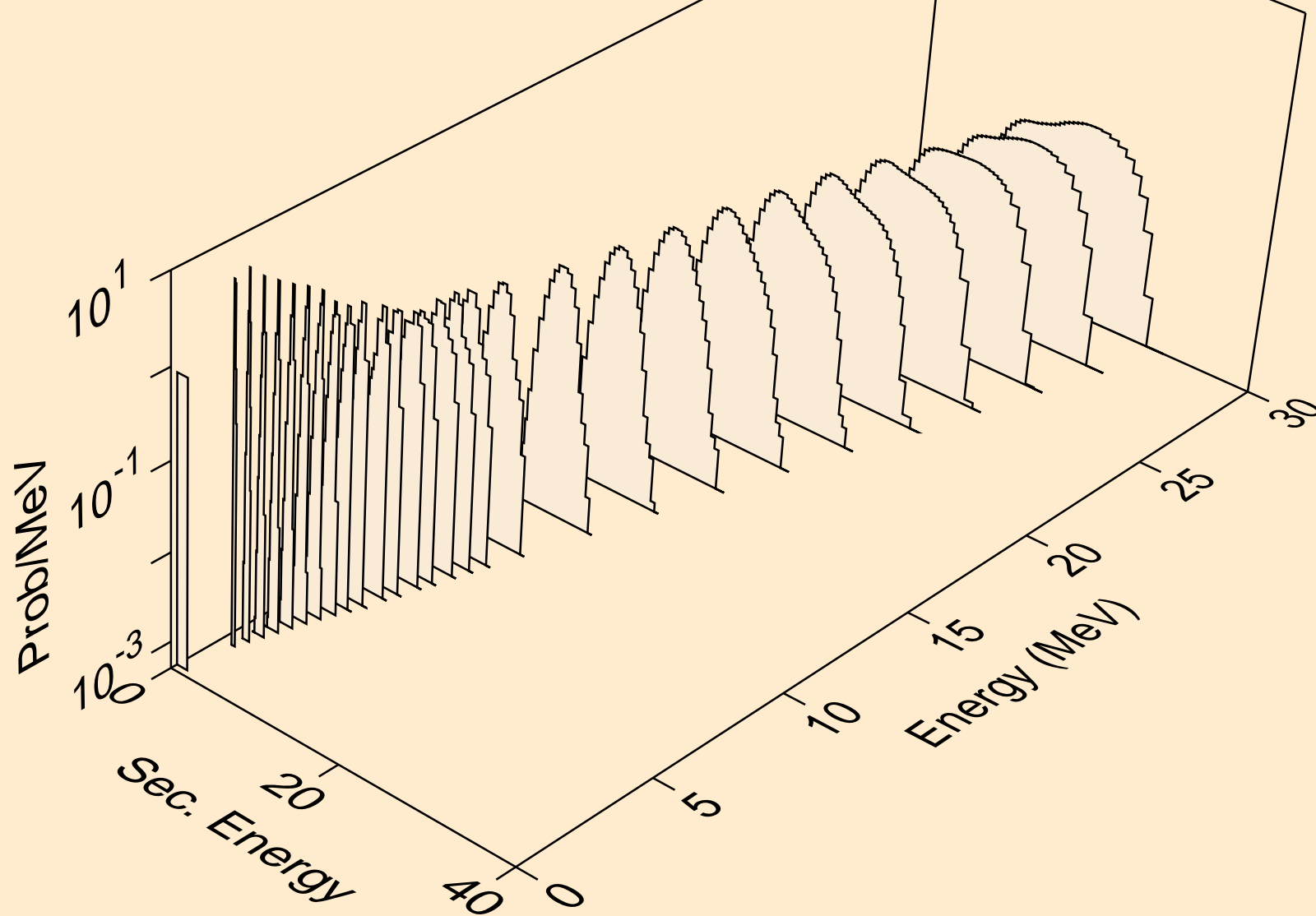

AT198M NEUTRON ACER TENDL-2021 LIBRARY; T=293.6K  
protons from (n,2np)

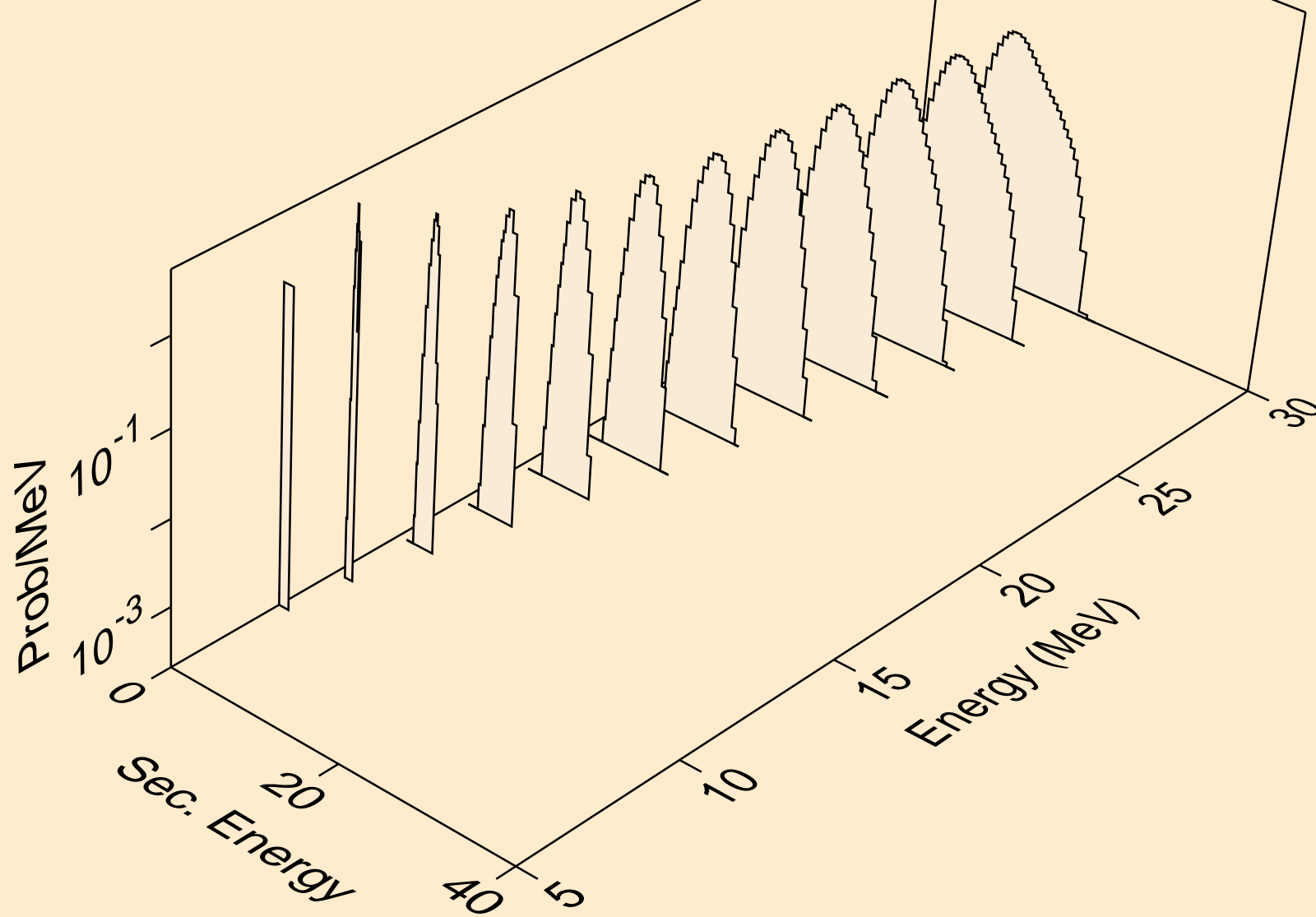

AT198M NEUTRON ACER TENDL-2021 LIBRARY; T=293.6K  
protons from (n,3np)

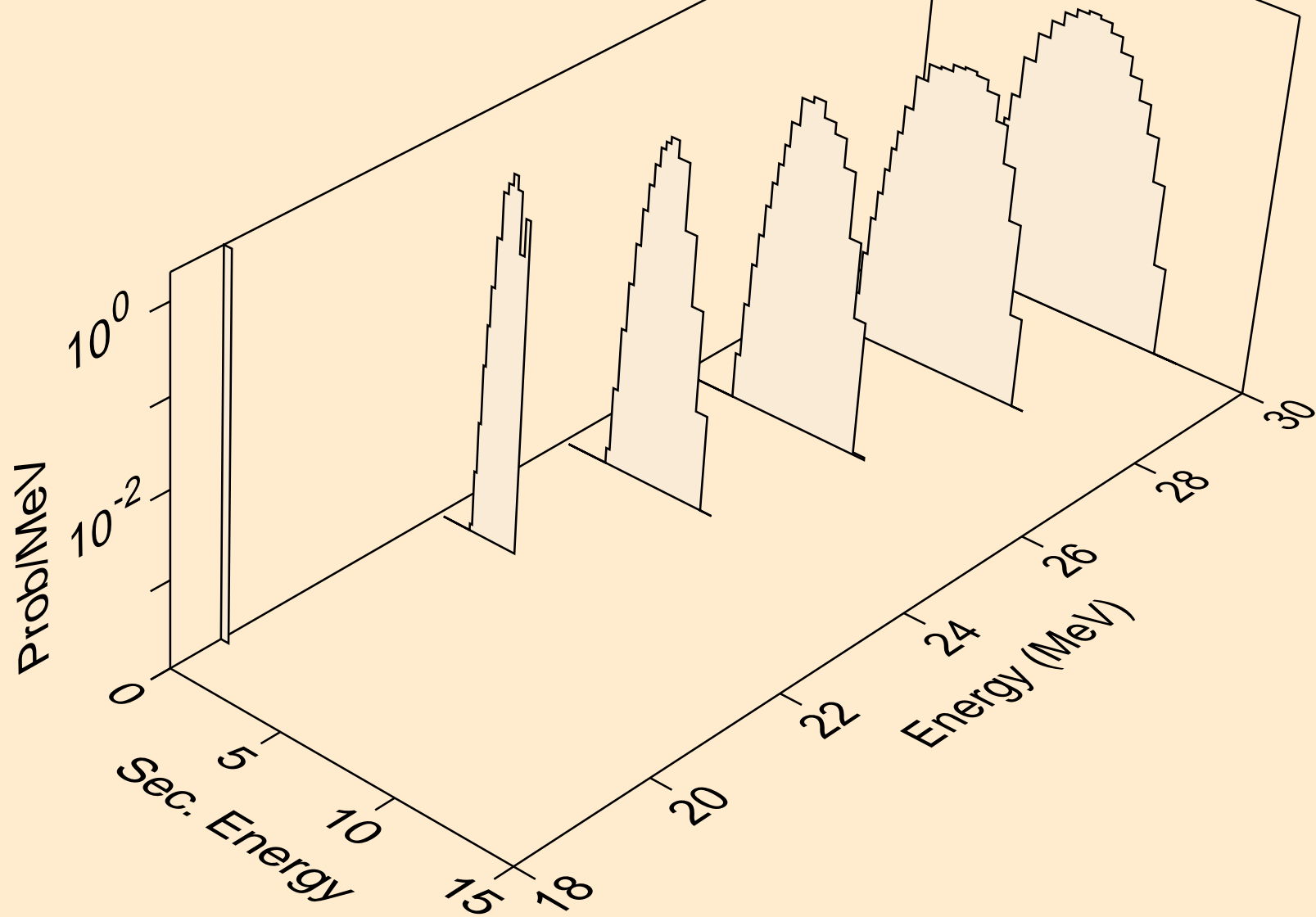

AT198M NEUTRON ACER TENDL-2021 LIBRARY; T=293.6K  
protons from (n,2np)

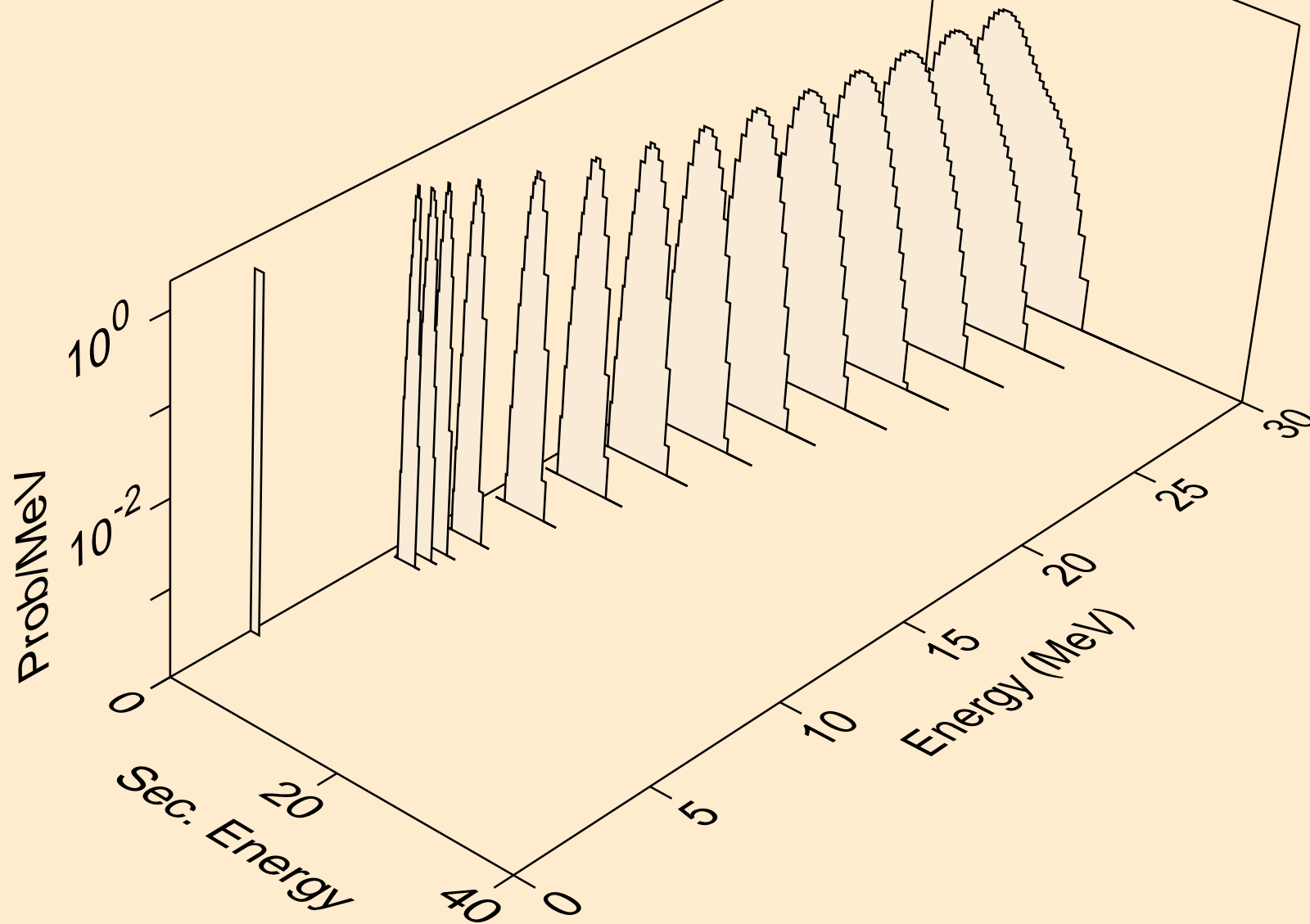

AT198M NEUTRON ACER TENDL-2021 LIBRARY; T=293.6K  
protons from (n,npa)

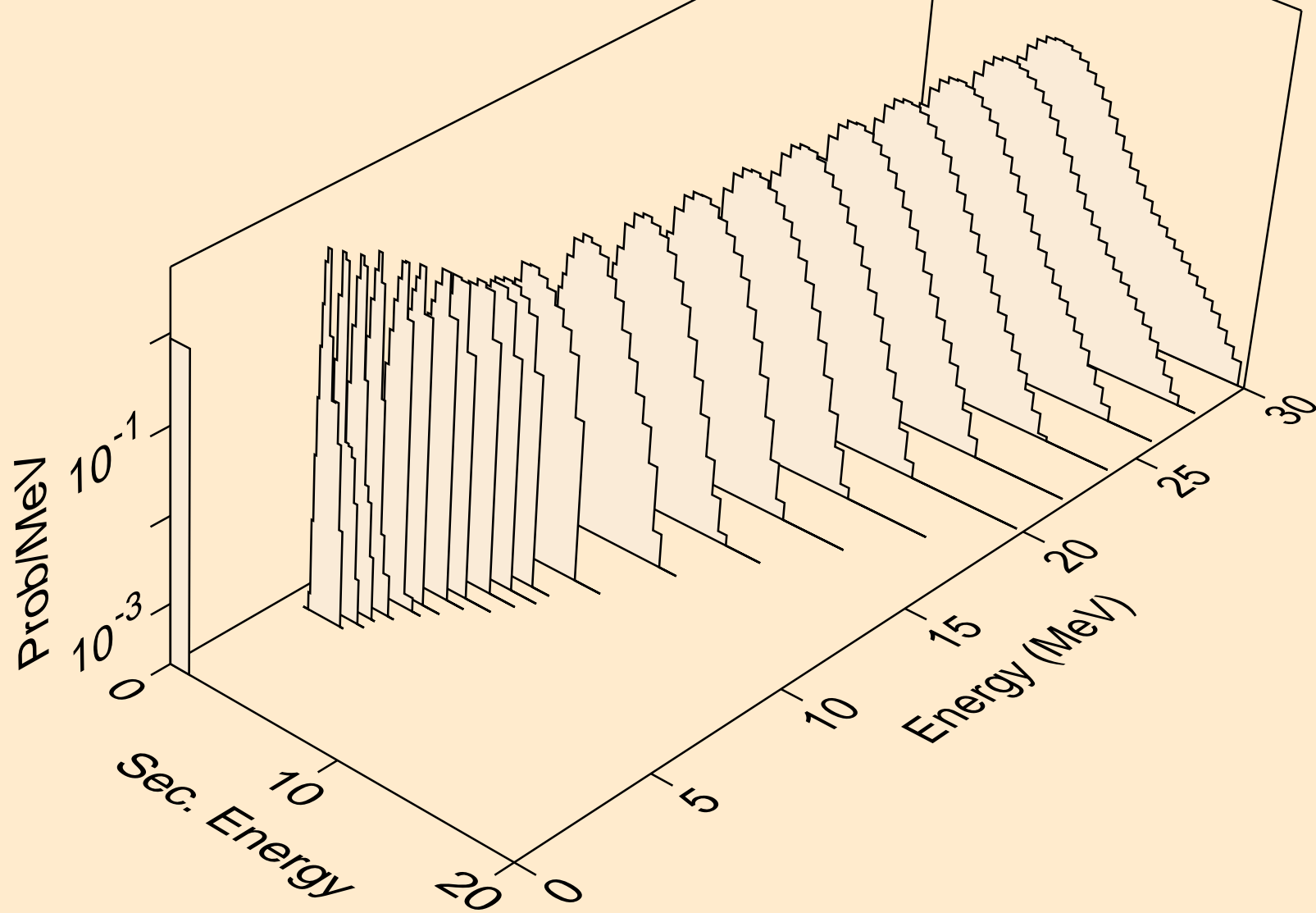



AT198M NEUTRON ACER TENDL-2021 LIBRARY; T=293.6K  
protons from (n,p)

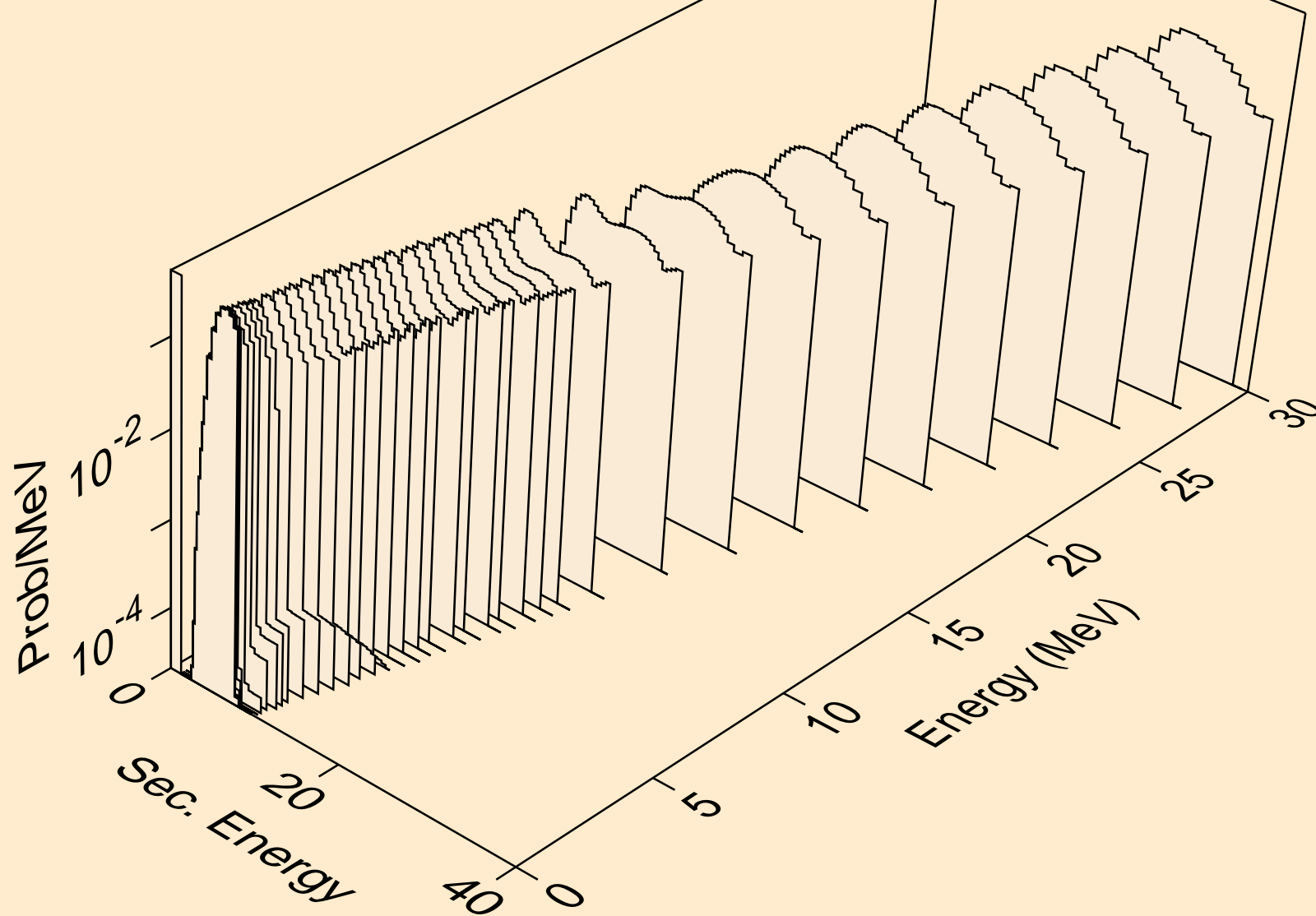

AT198M NEUTRON ACER TENDL-2021 LIBRARY; T=293.6K  
protons from (n,2p)

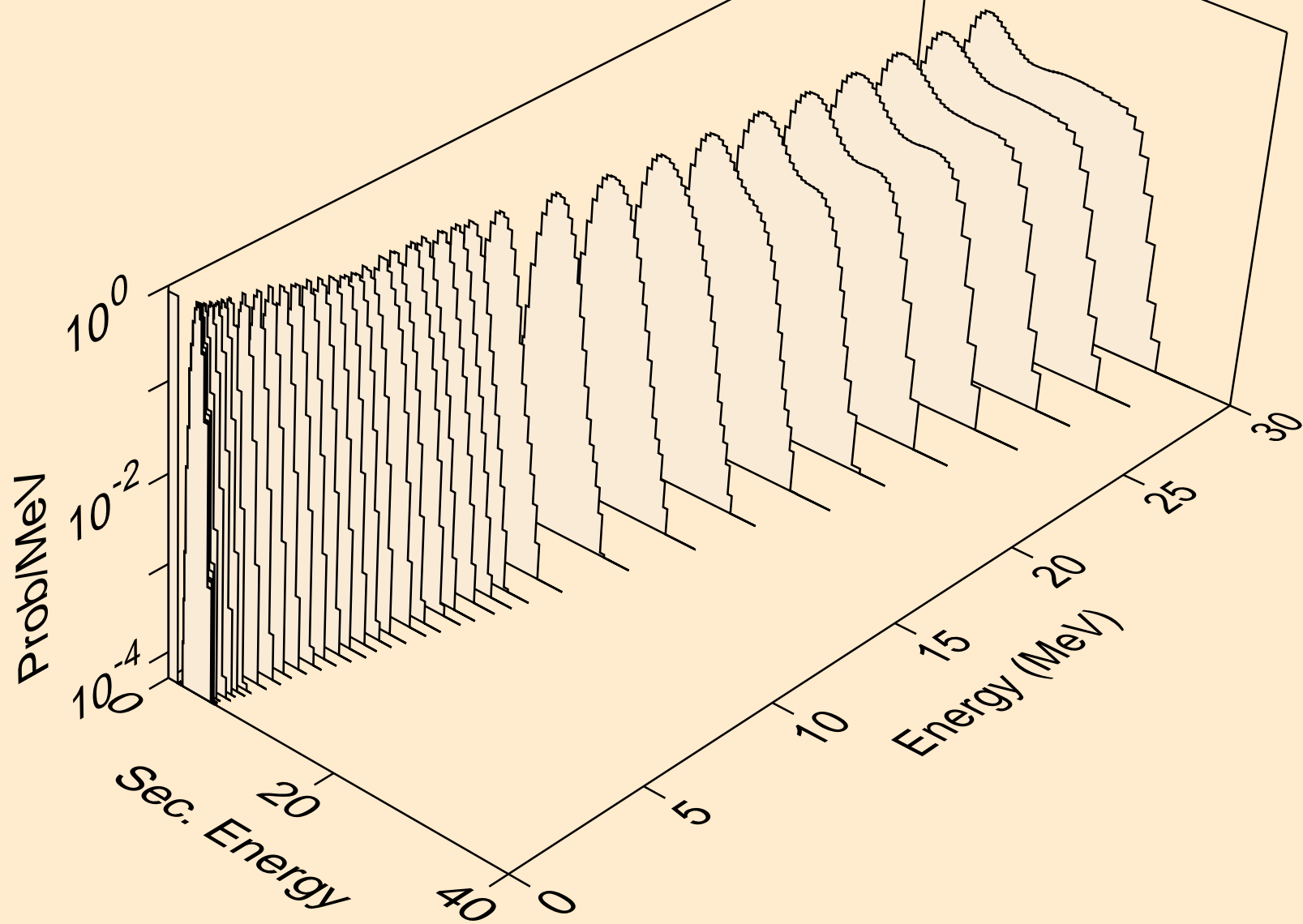

AT198M NEUTRON ACER TENDL-2021 LIBRARY; T=293.6K  
protons from (n,p)

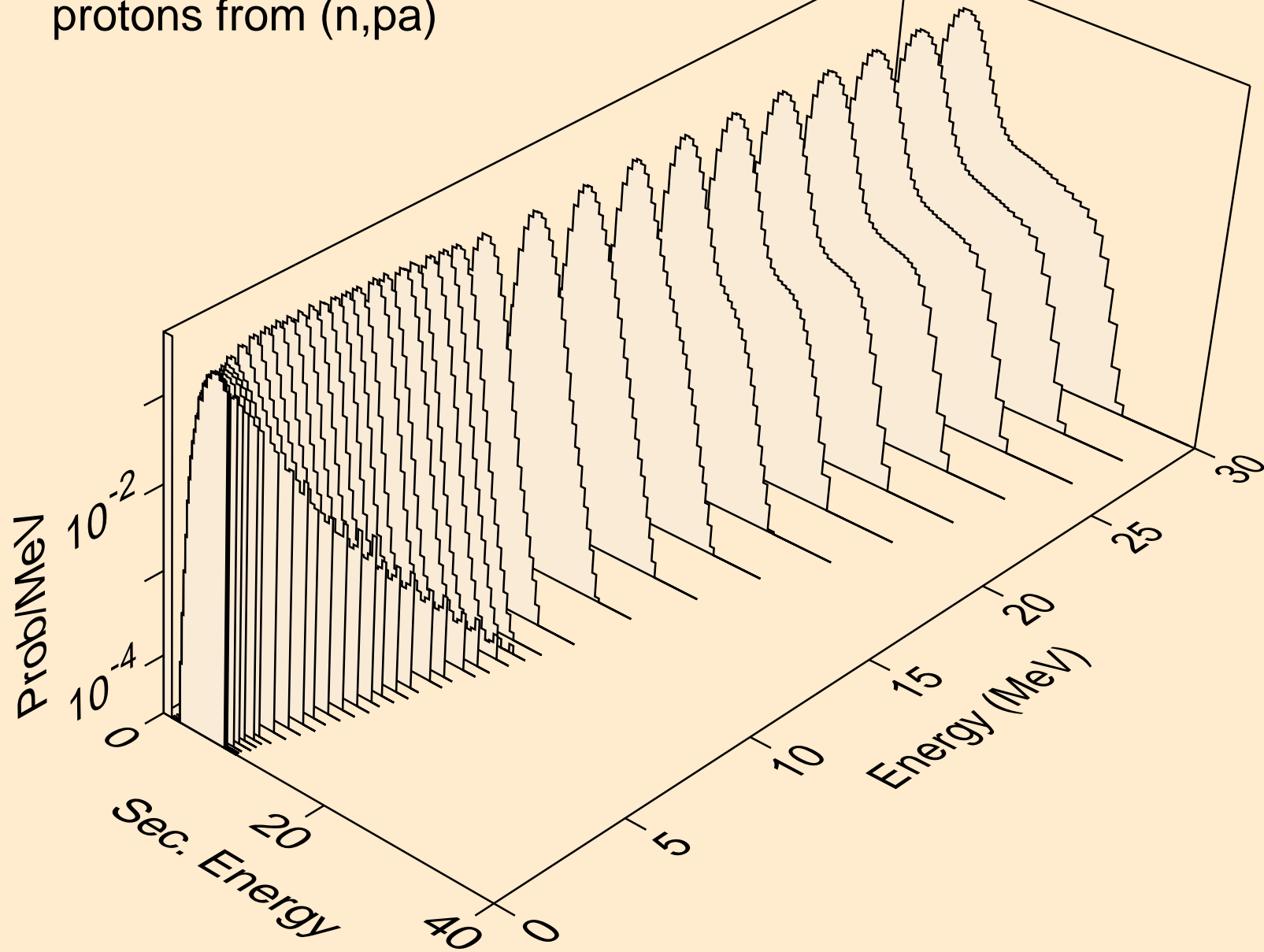

AT198M NEUTRON ACER TENDL-2021 LIBRARY; T=293.6K  
protons from (n,pd)

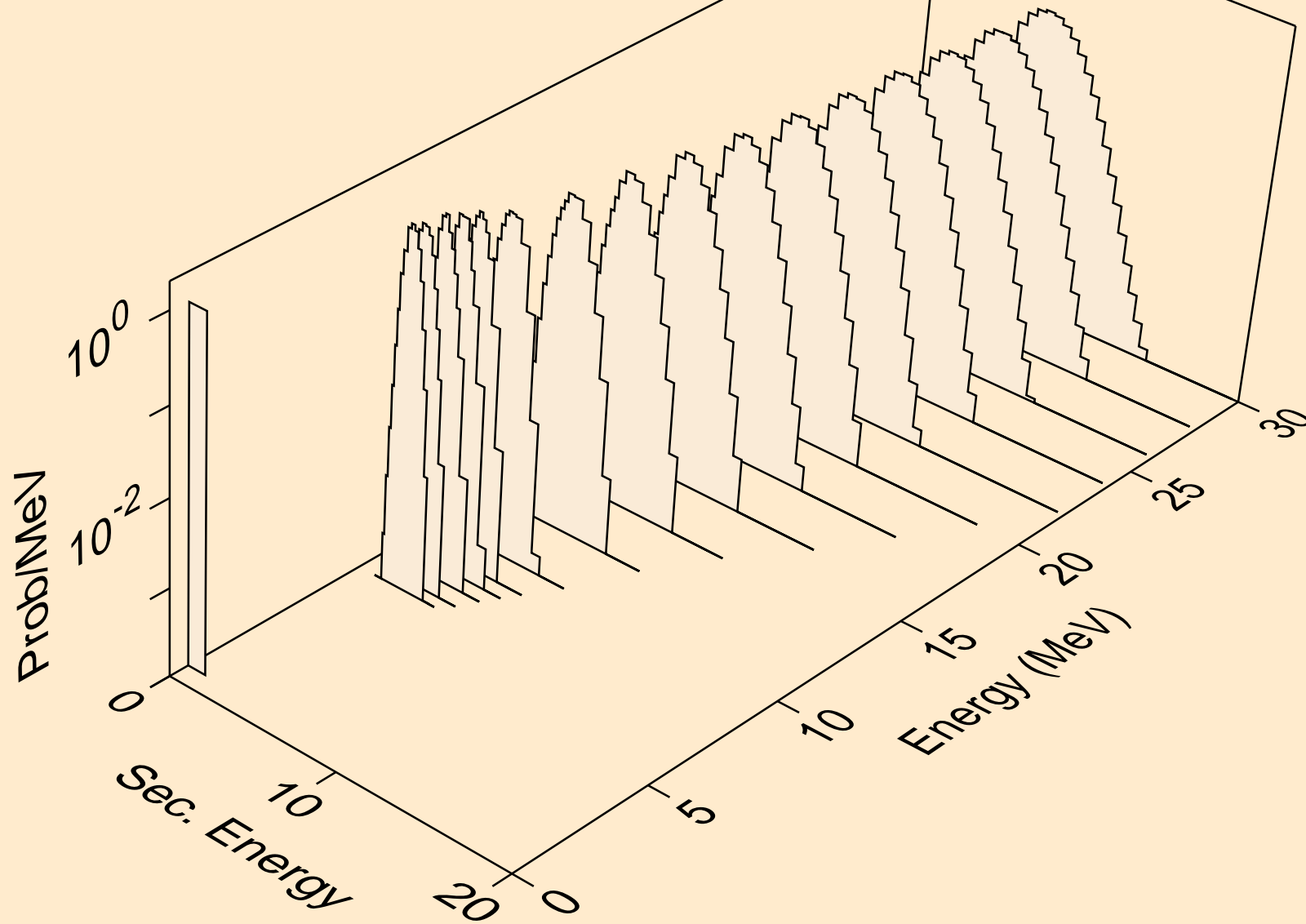

AT198M NEUTRON ACER TENDL-2021 LIBRARY; T=293.6K  
protons from (n,pt)

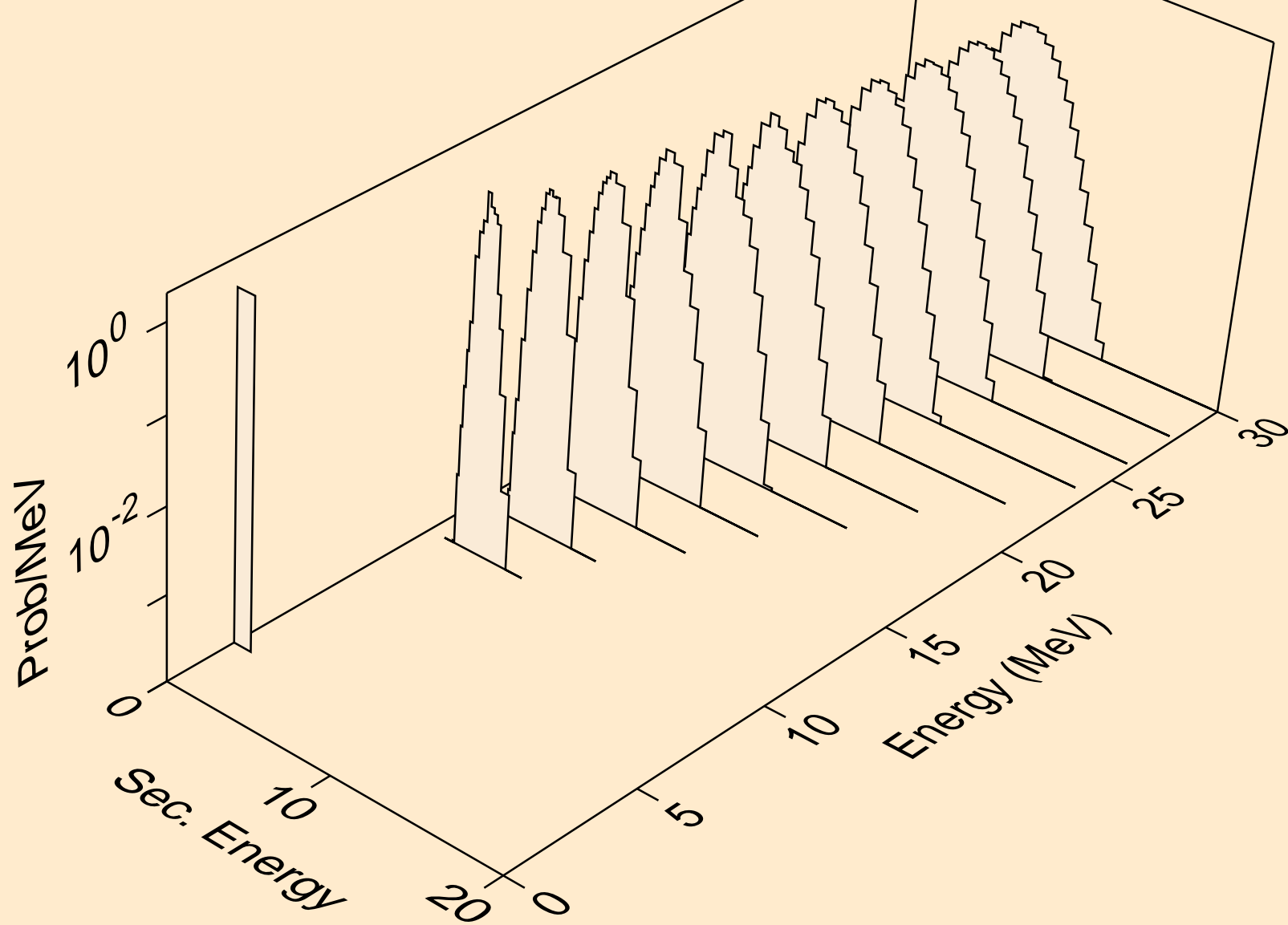

AT198M NEUTRON ACER TENDL-2021 LIBRARY; T=293.6K  
deuterons from (n,x)

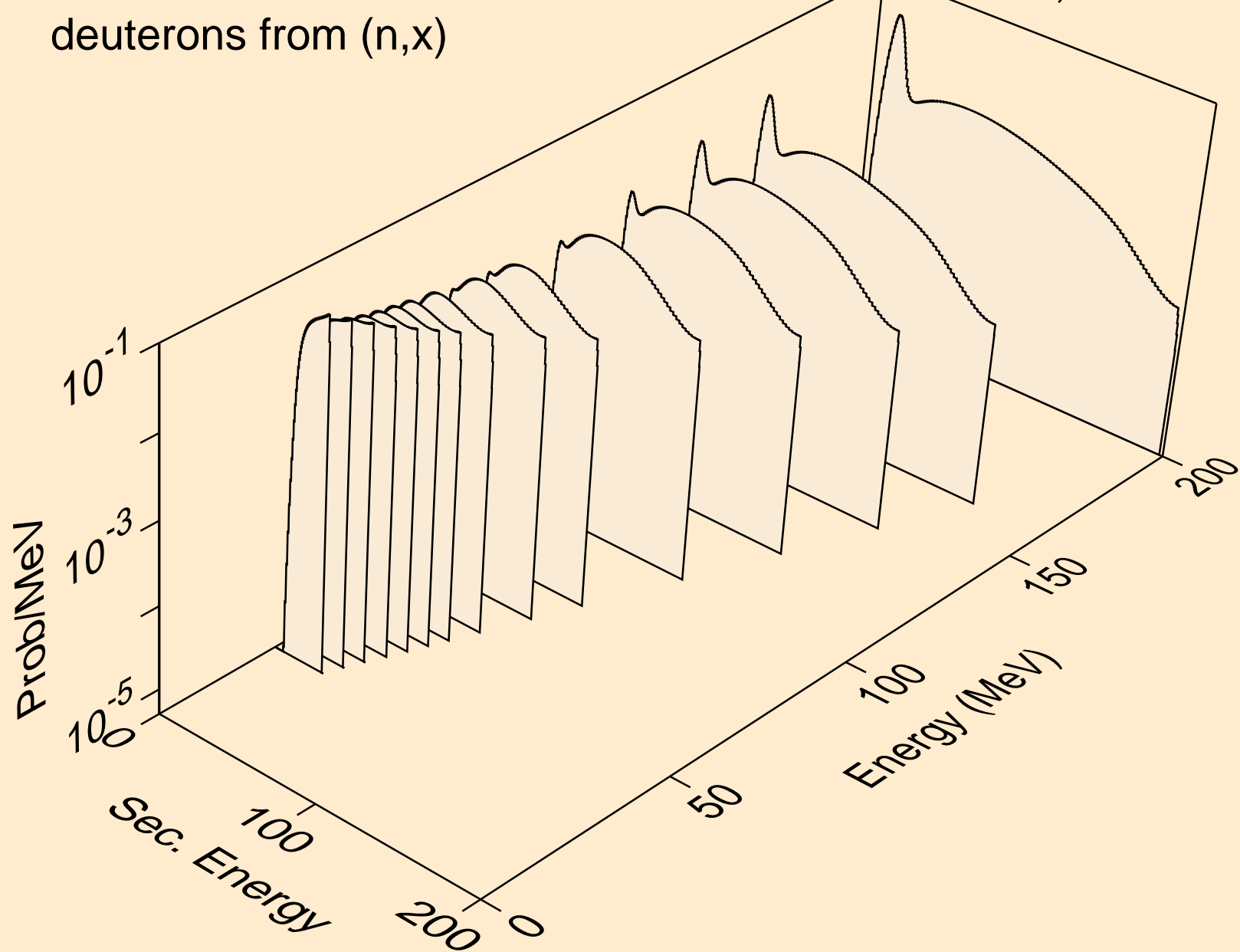

AT198M NEUTRON ACER TENDL-2021 LIBRARY; T=293.6K  
deuterons from (n,2nd)

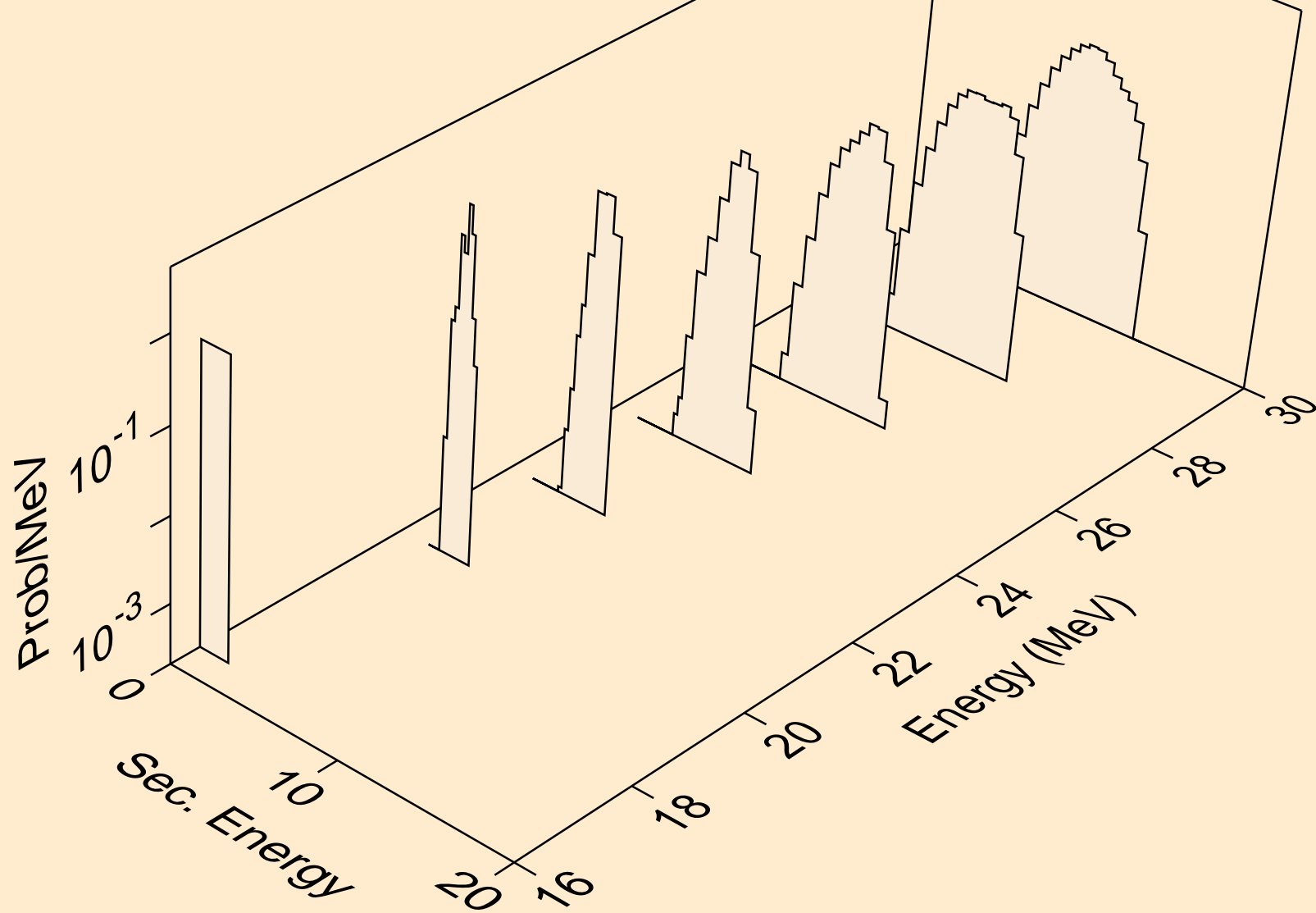

AT198M NEUTRON ACER TENDL-2021 LIBRARY; T=293.6K  
deuterons from (n,n\*)d

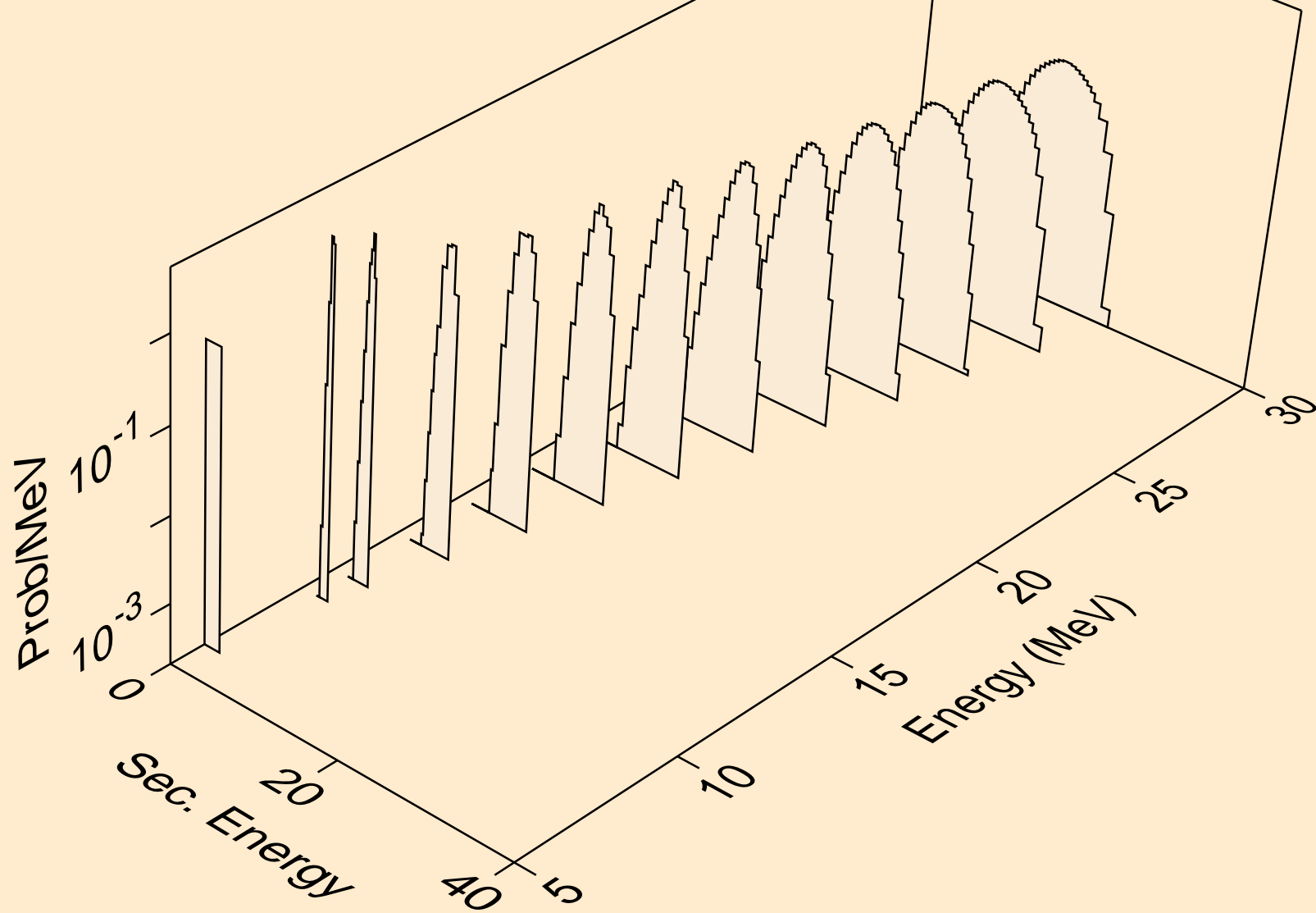



AT198M NEUTRON ACER TENDL-2021 LIBRARY; T=293.6K  
deuterons from (n,d)

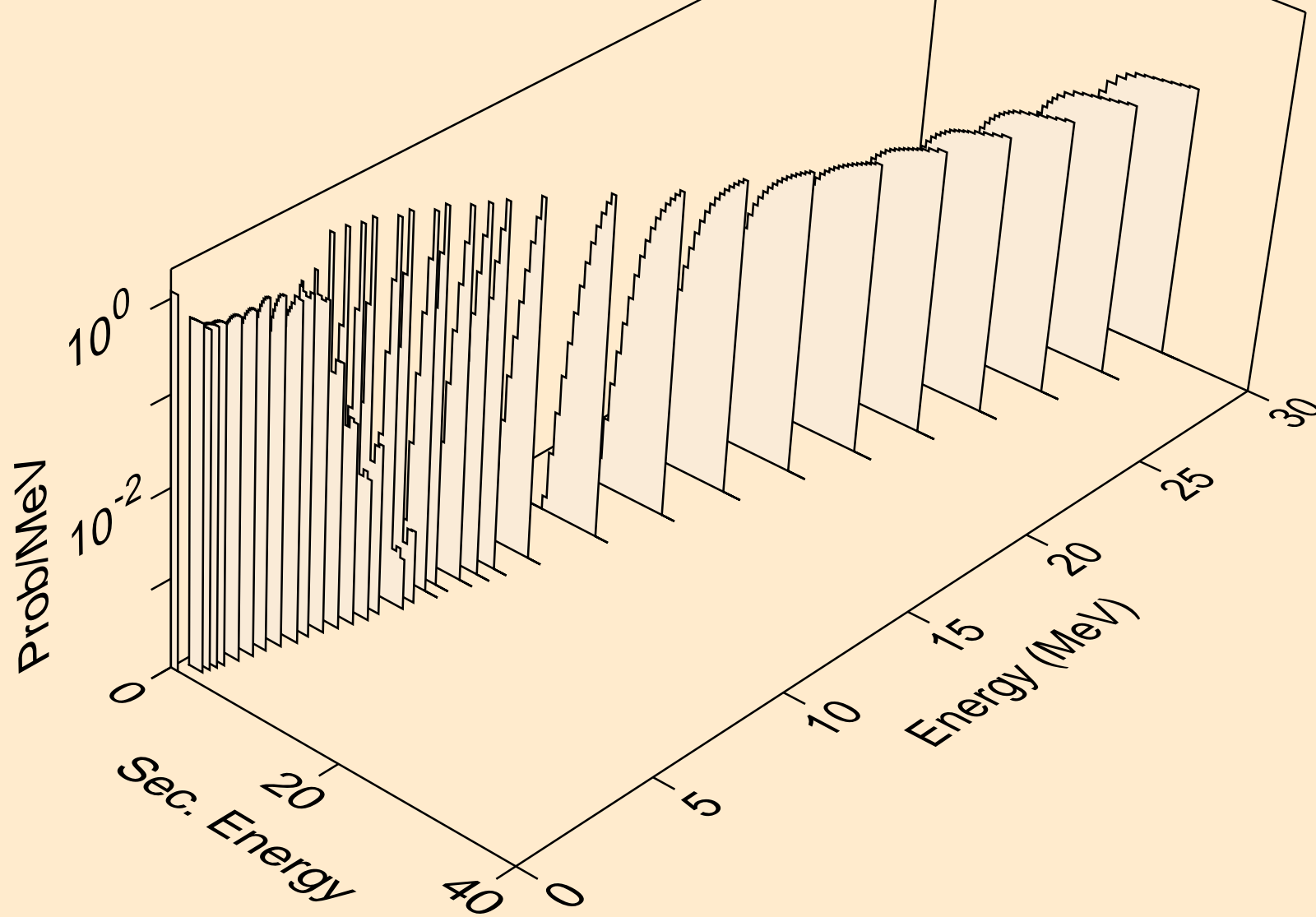

AT198M NEUTRON ACER TENDL-2021 LIBRARY; T=293.6K  
deuterons from (n,pd)

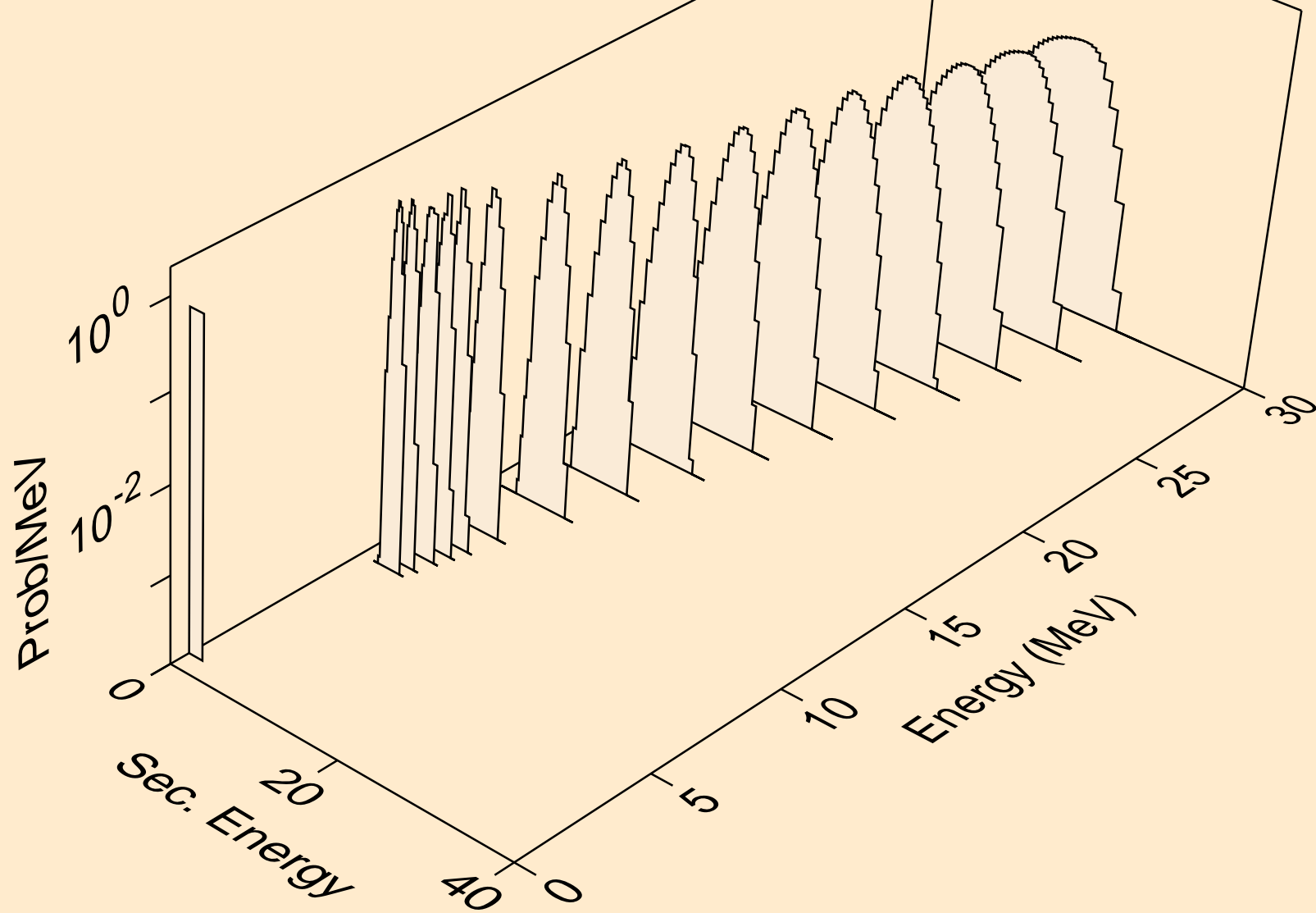

AT198M NEUTRON ACER TENDL-2021 LIBRARY; T=293.6K  
deuterons from (n,da)

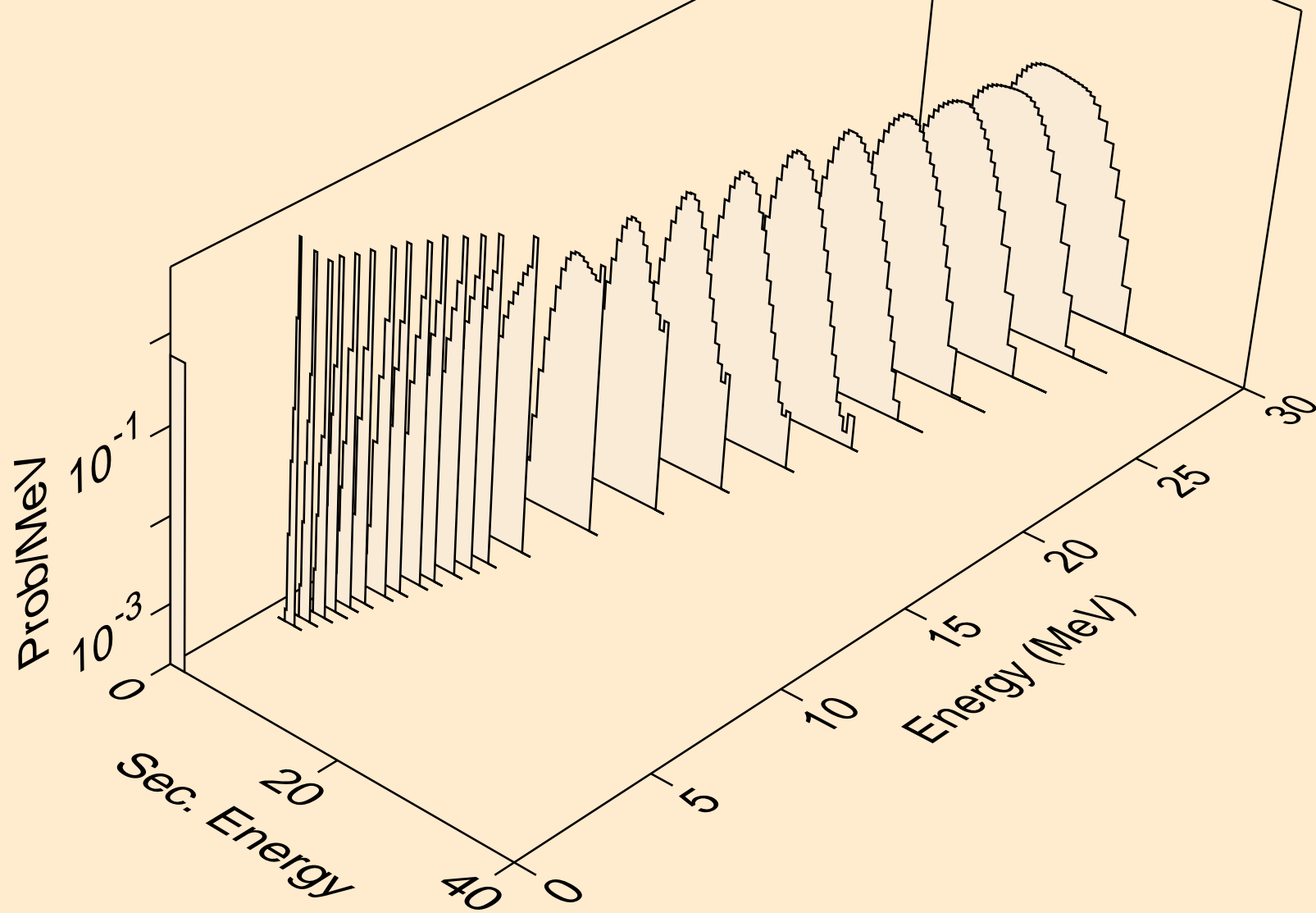

AT198M NEUTRON ACER TENDL-2021 LIBRARY; T=293.6K  
tritons from (n,x)

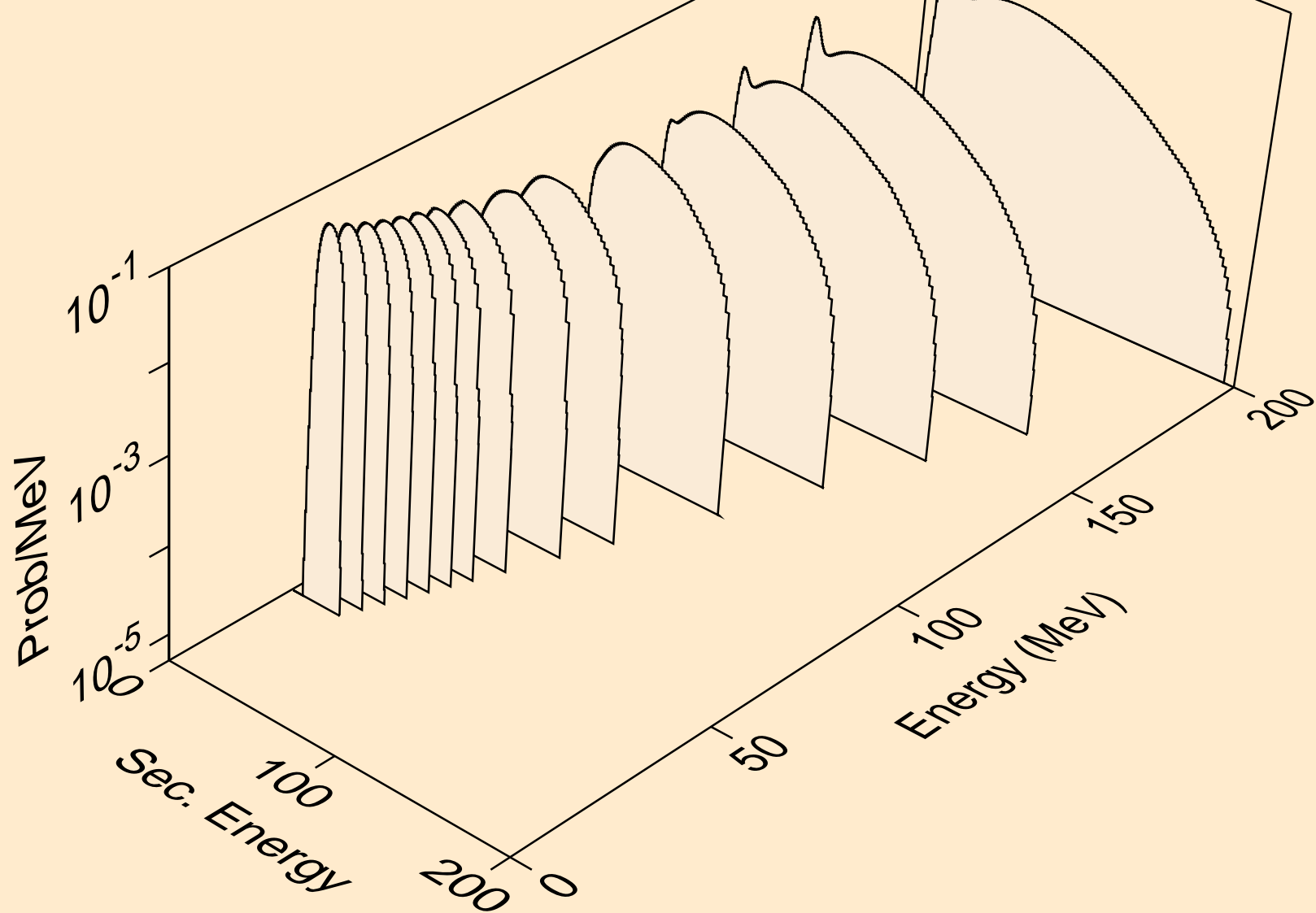

AT198M NEUTRON ACER TENDL-2021 LIBRARY; T=293.6K  
tritons from (n,n\*)t

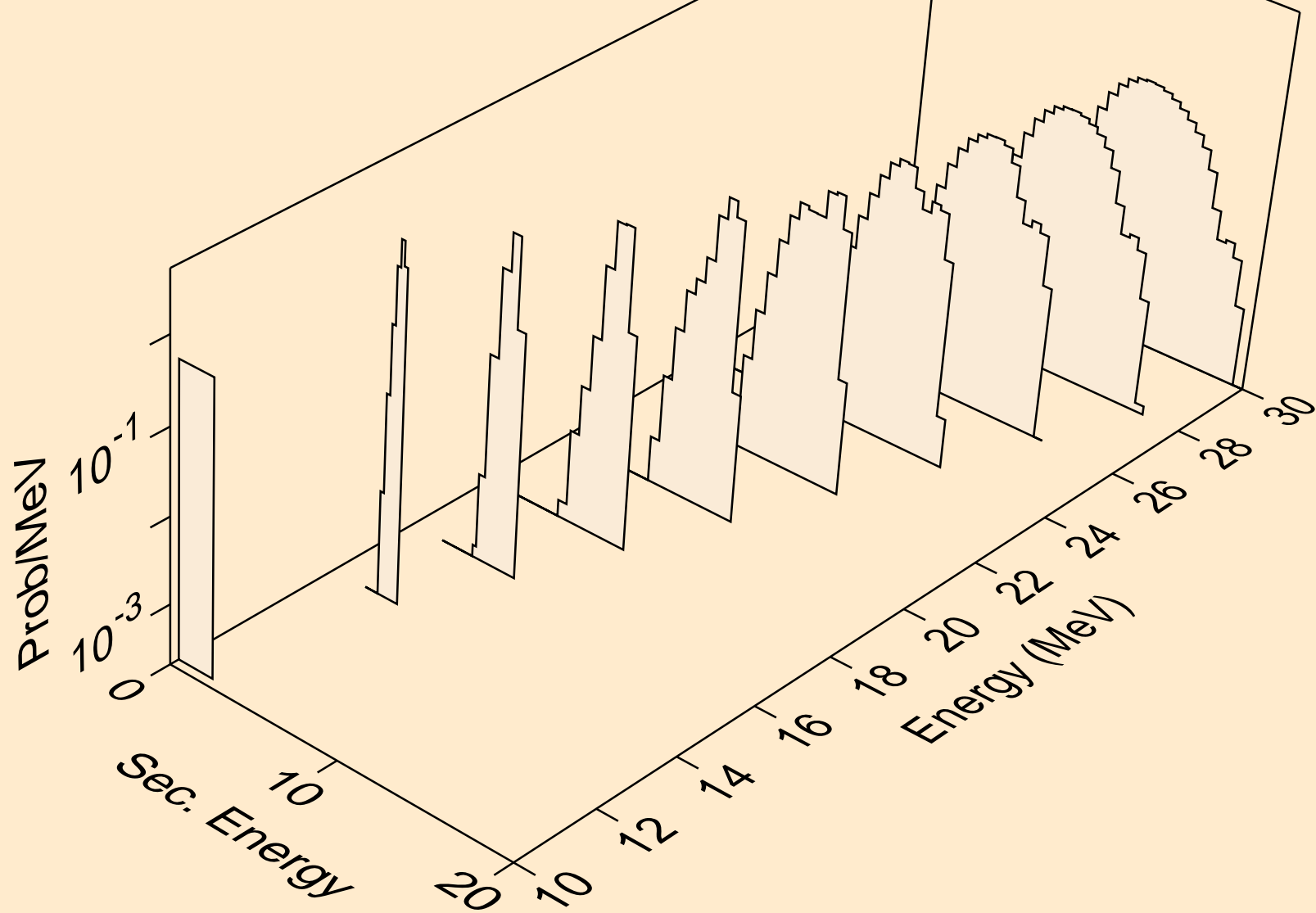

AT198M NEUTRON ACER TENDL-2021 LIBRARY; T=293.6K  
tritons from (n,t)

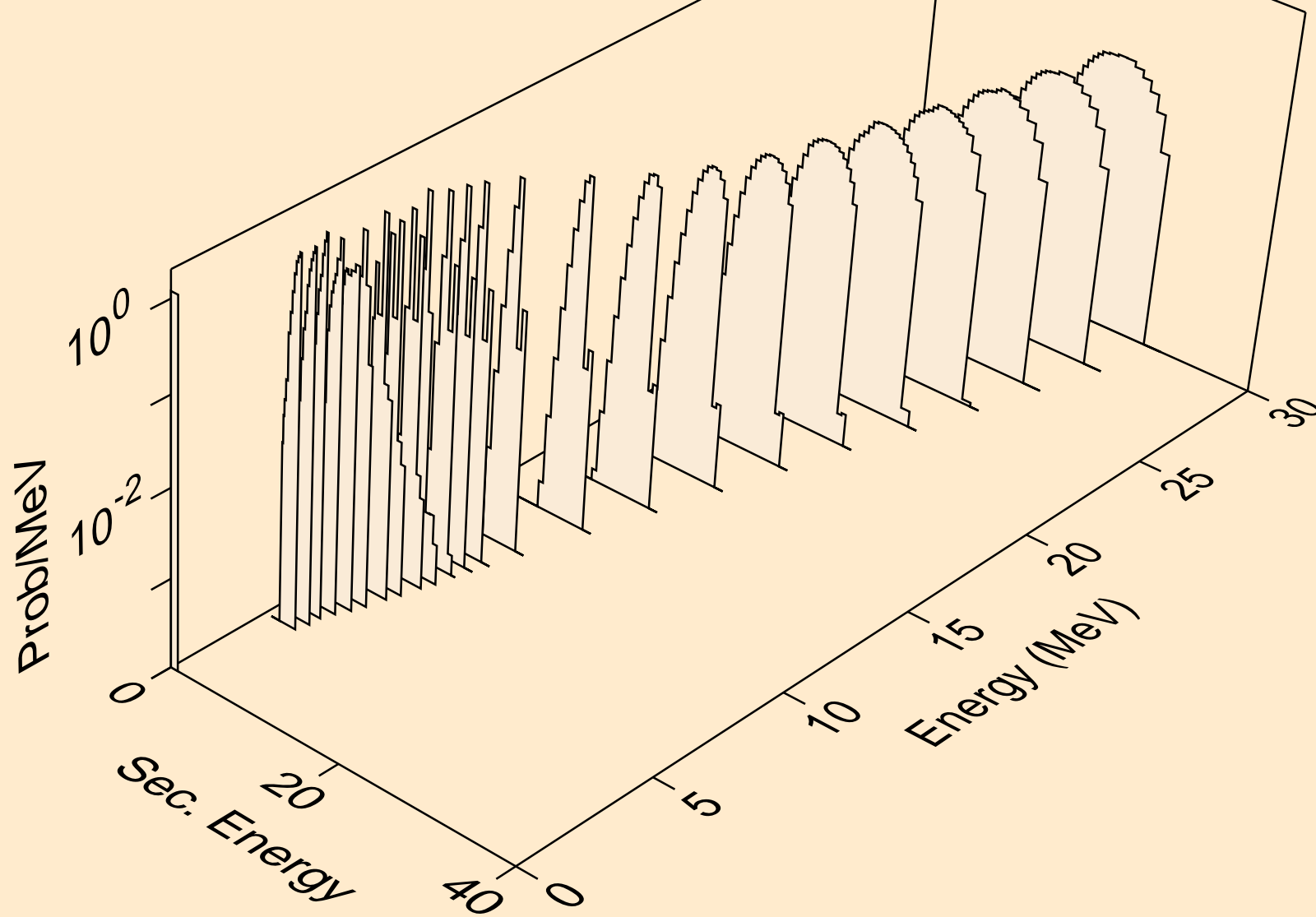

AT198M NEUTRON ACER TENDL-2021 LIBRARY; T=293.6K  
tritons from (n,pt)

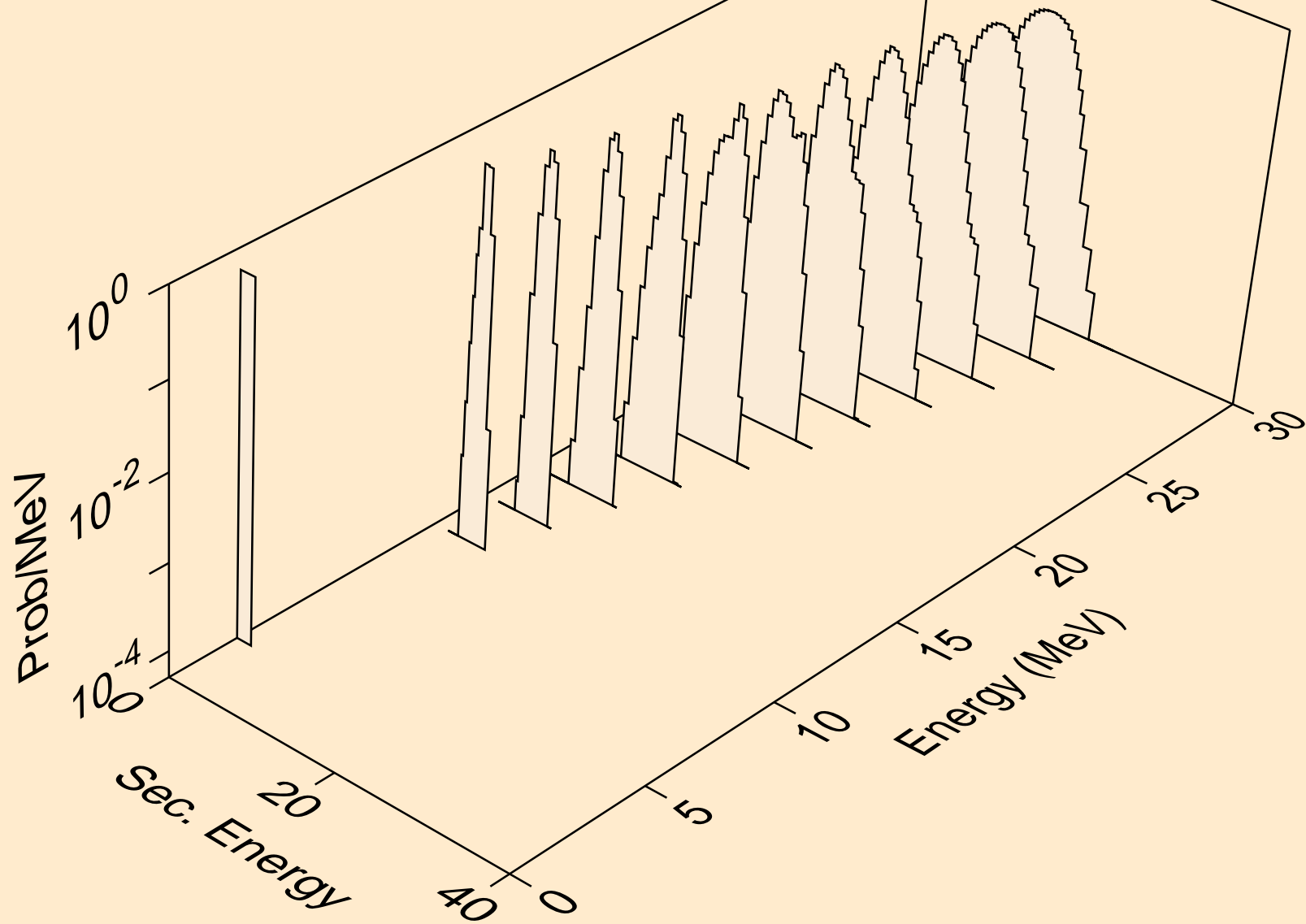

AT198M NEUTRON ACER TENDL-2021 LIBRARY; T=293.6K  
he3s from (n,x)

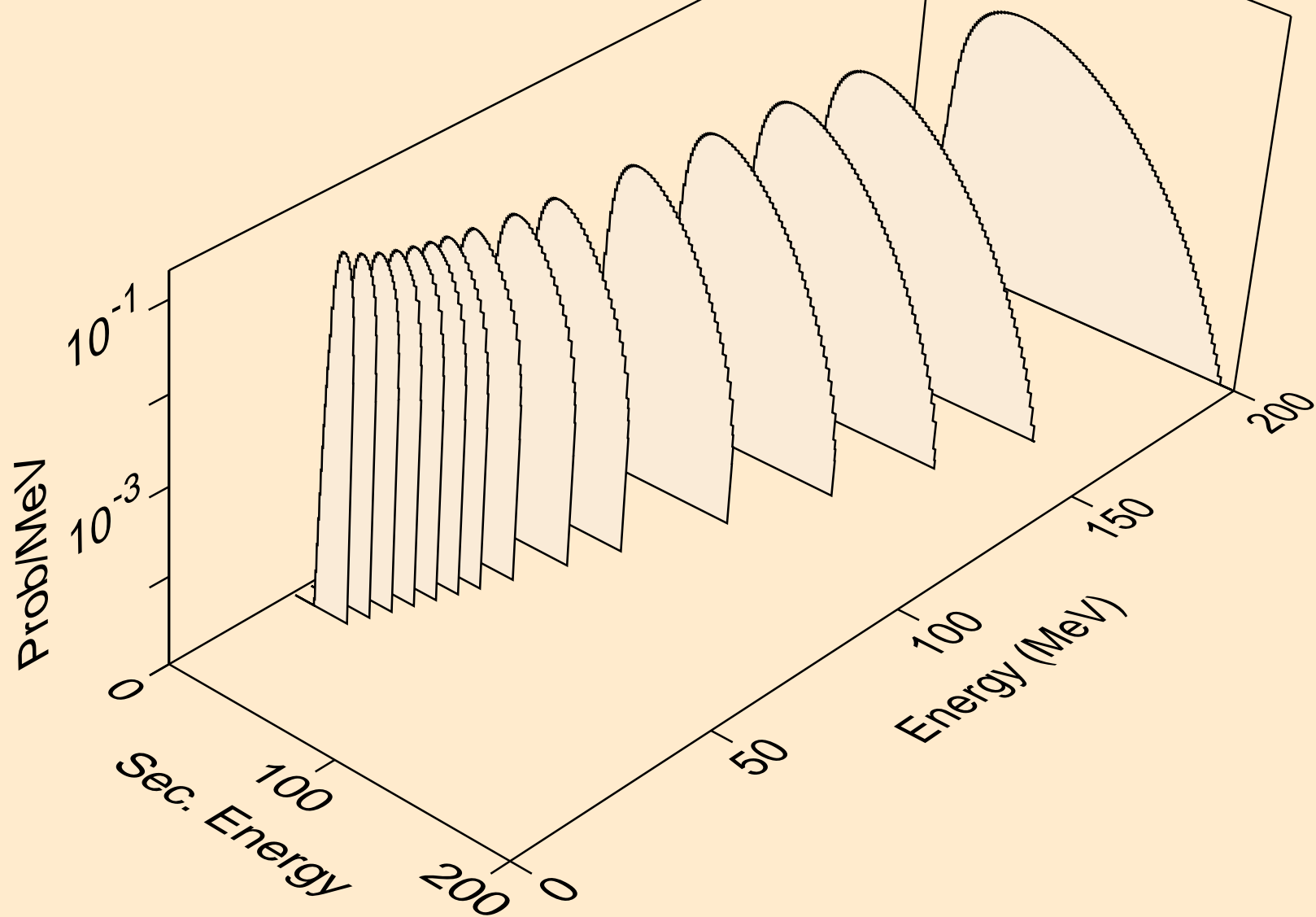



AT198M NEUTRON ACER TENDL-2021 LIBRARY; T=293.6K  
he3s from (n,n\*)he3

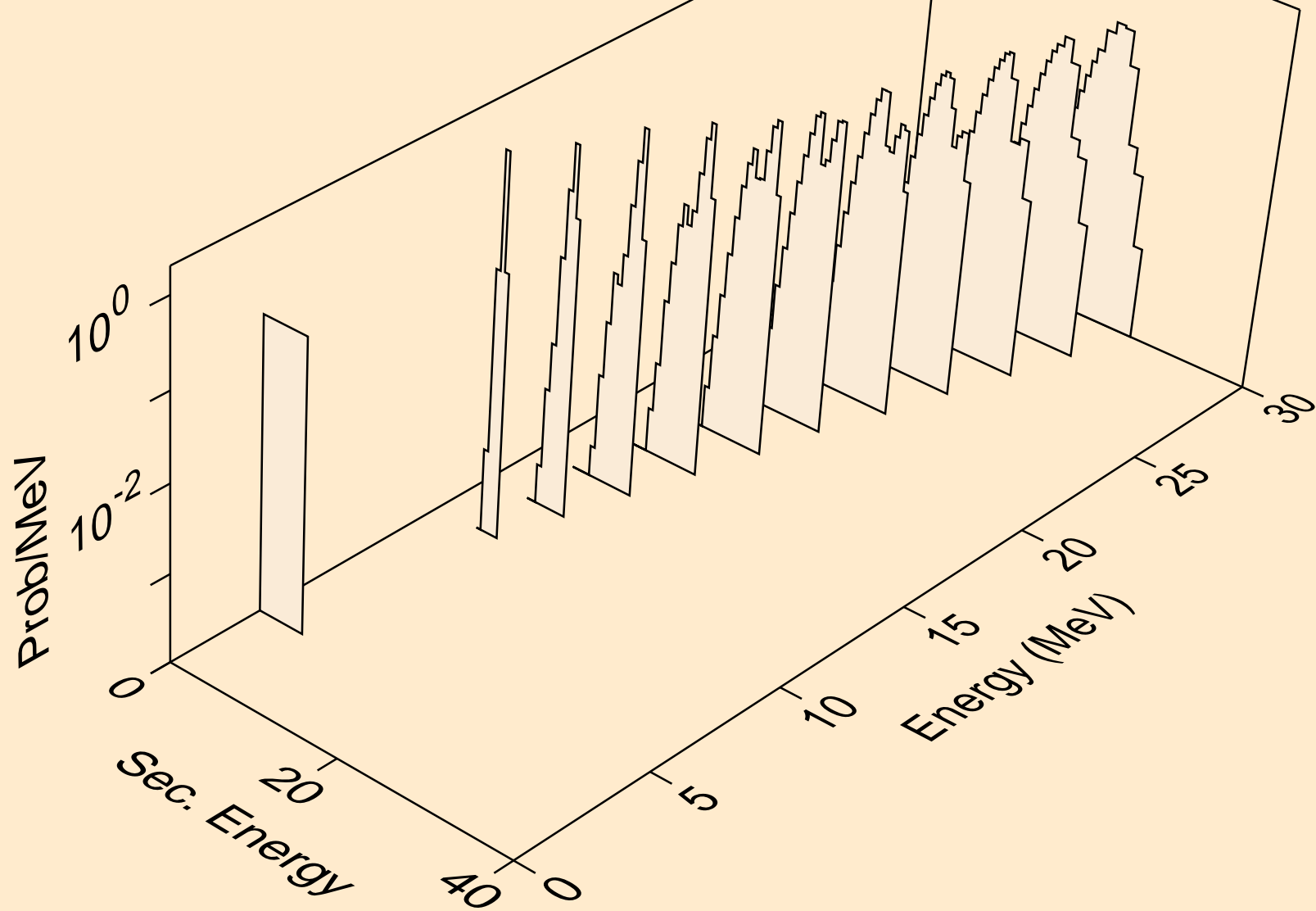

AT198M NEUTRON ACER TENDL-2021 LIBRARY; T=293.6K  
he3s from (n,he3)

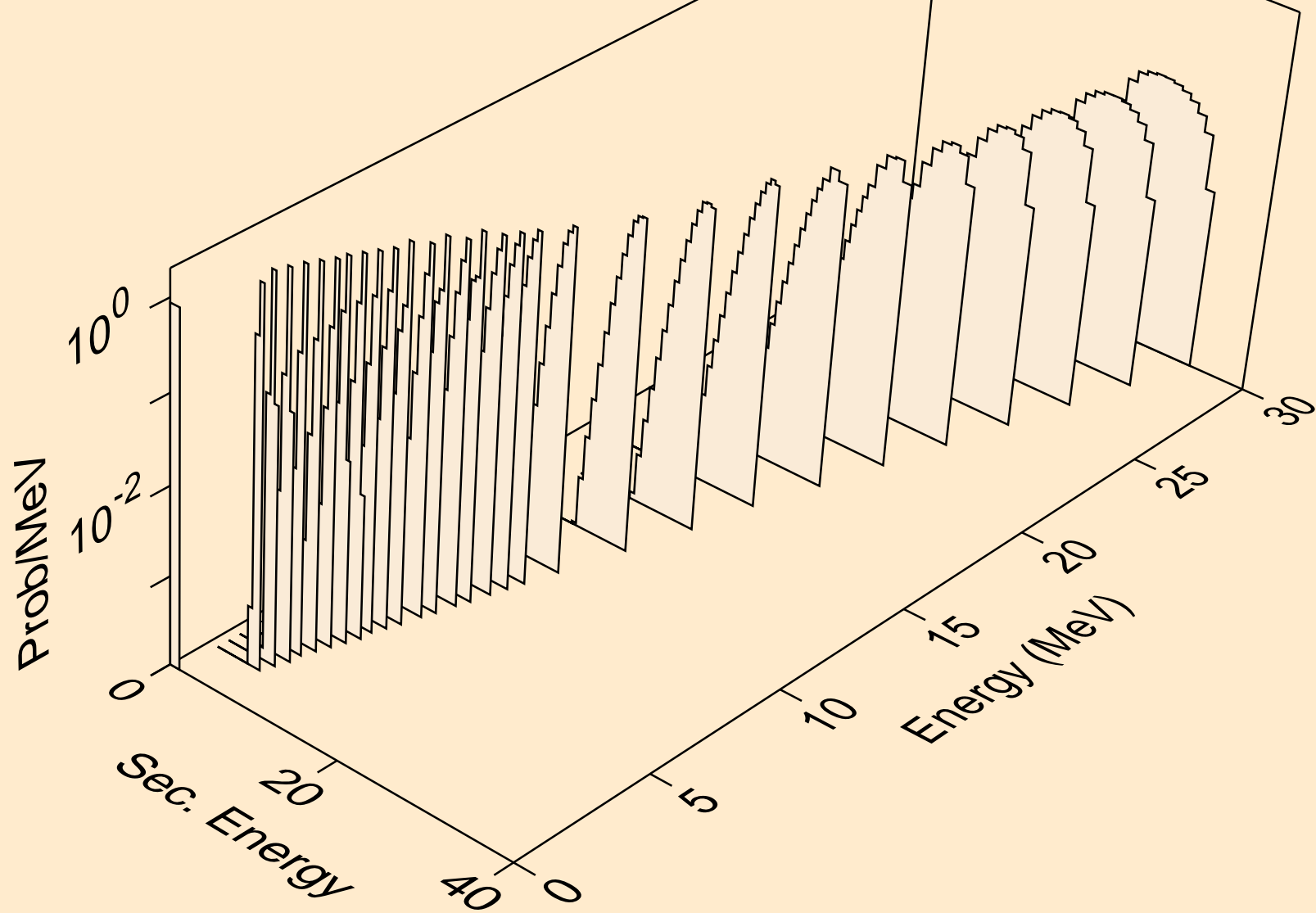

AT198M NEUTRON ACER TENDL-2021 LIBRARY; T=293.6K  
alphas from (n,x)

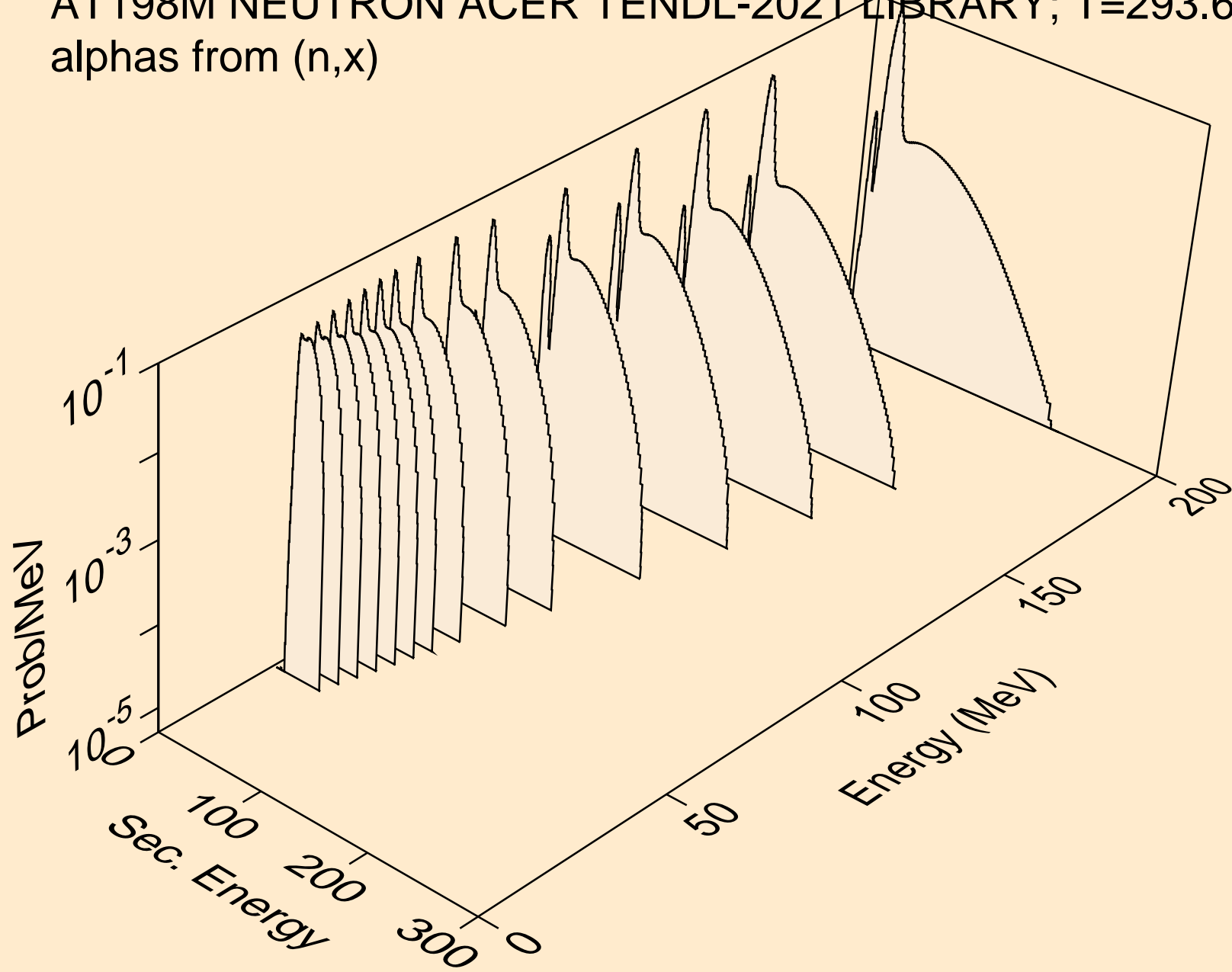

AT198M NEUTRON ACER TENDL-2021 LIBRARY; T=293.6K  
alphas from (n,n\*)a

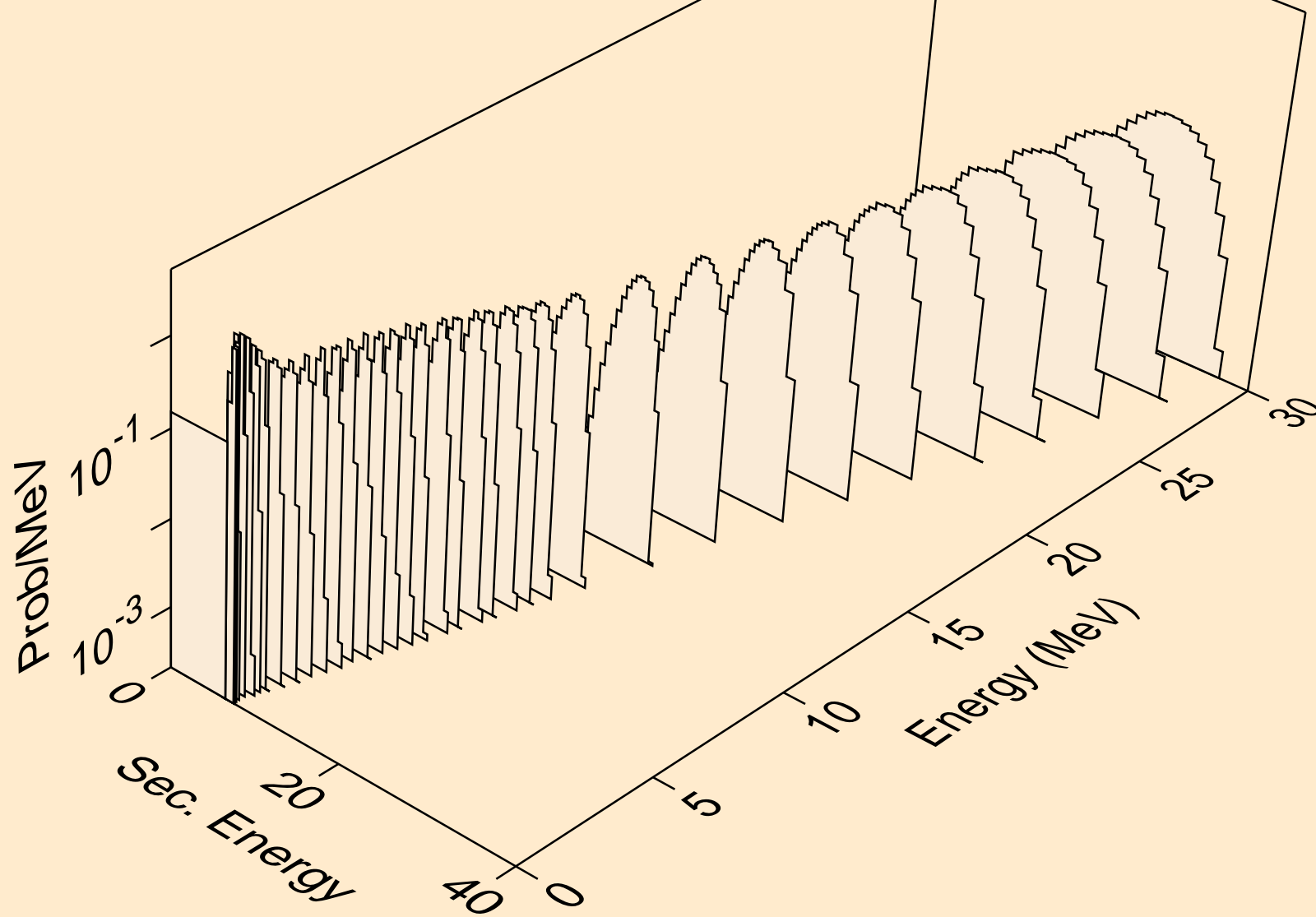

AT198M NEUTRON ACER TENDL-2021 LIBRARY; T=293.6K  
alphas from (n,2n)a

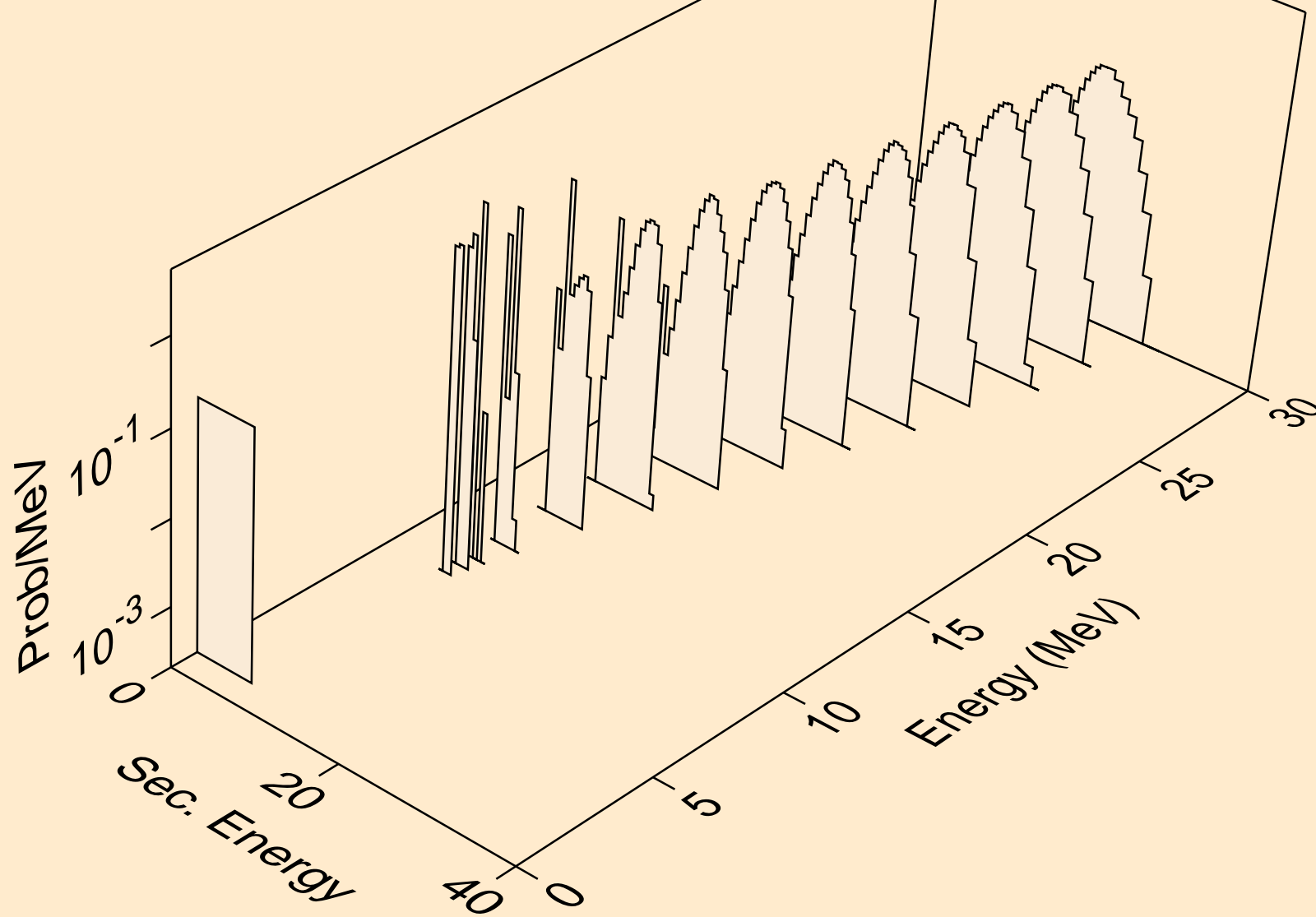

AT198M NEUTRON ACER TENDL-2021 LIBRARY; T=293.6K  
alphas from (n,3n)a

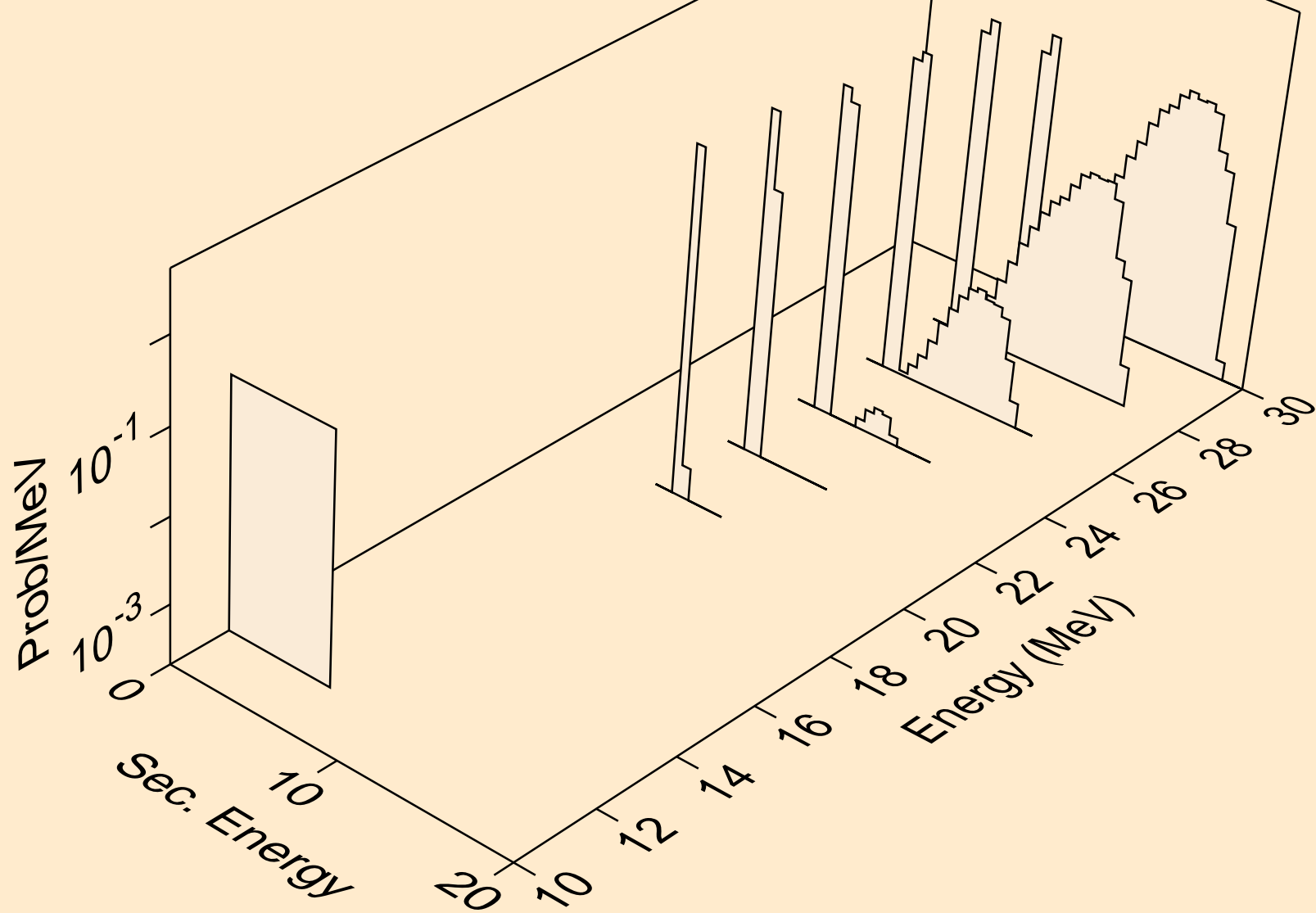

AT198M NEUTRON ACER TENDL-2021 LIBRARY; T=293.6K  
alphas from (n,n\*)2a

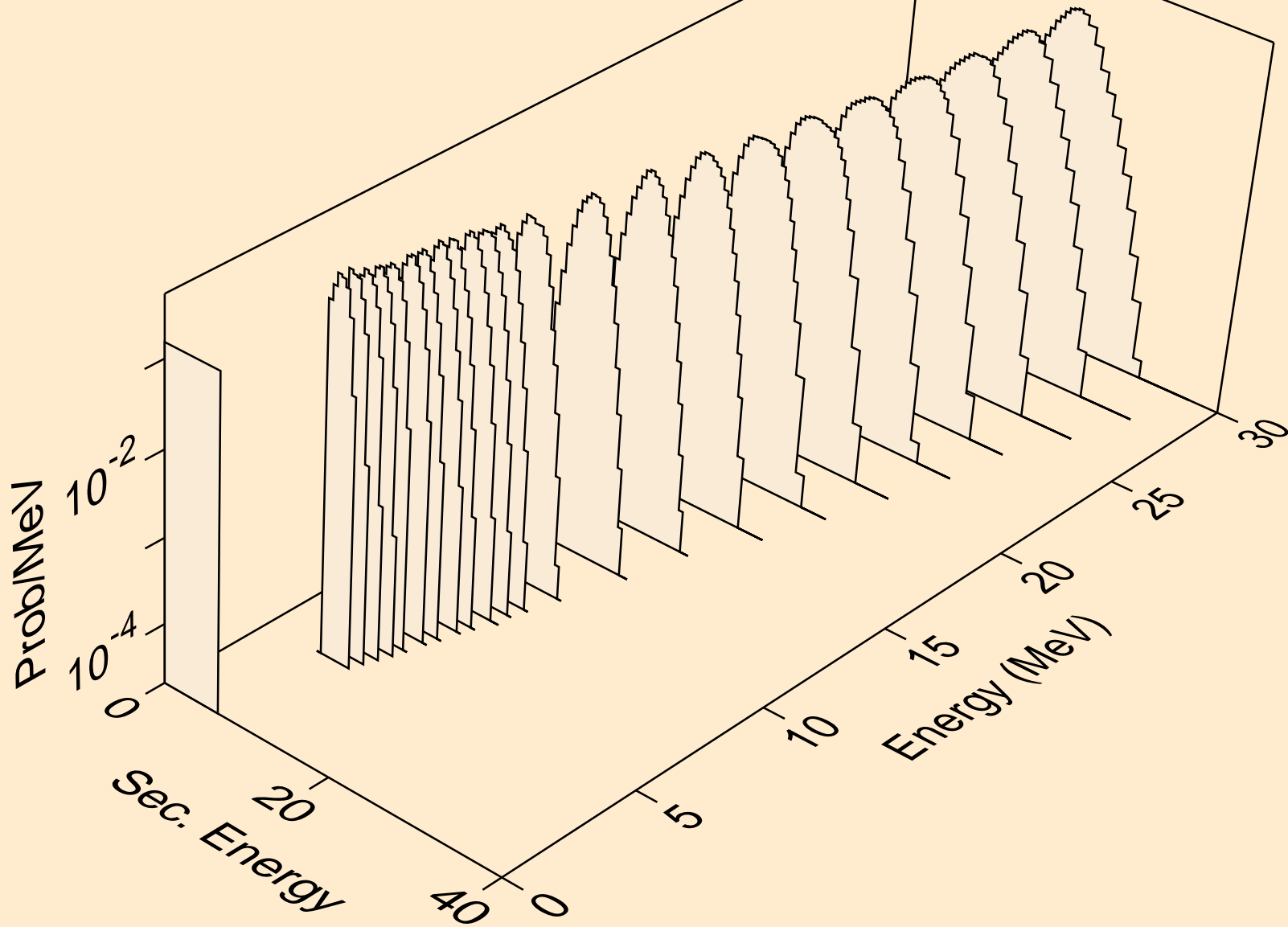

AT198M NEUTRON ACER TENDL-2021 LIBRARY; T=293.6K  
alphas from (n,2n)2a

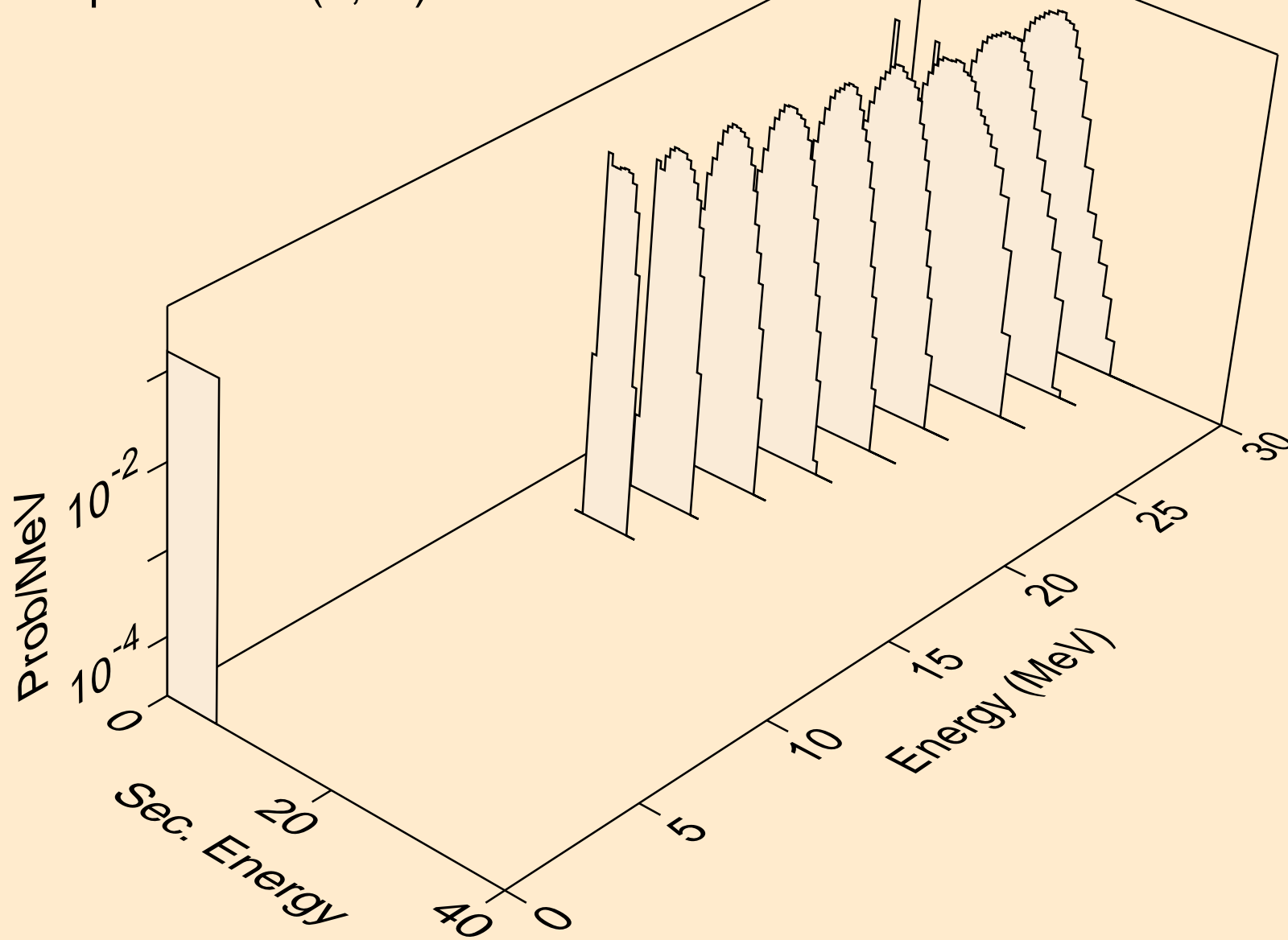



AT198M NEUTRON ACER TENDL-2021 LIBRARY; T=293.6K  
alphas from (n,npa)

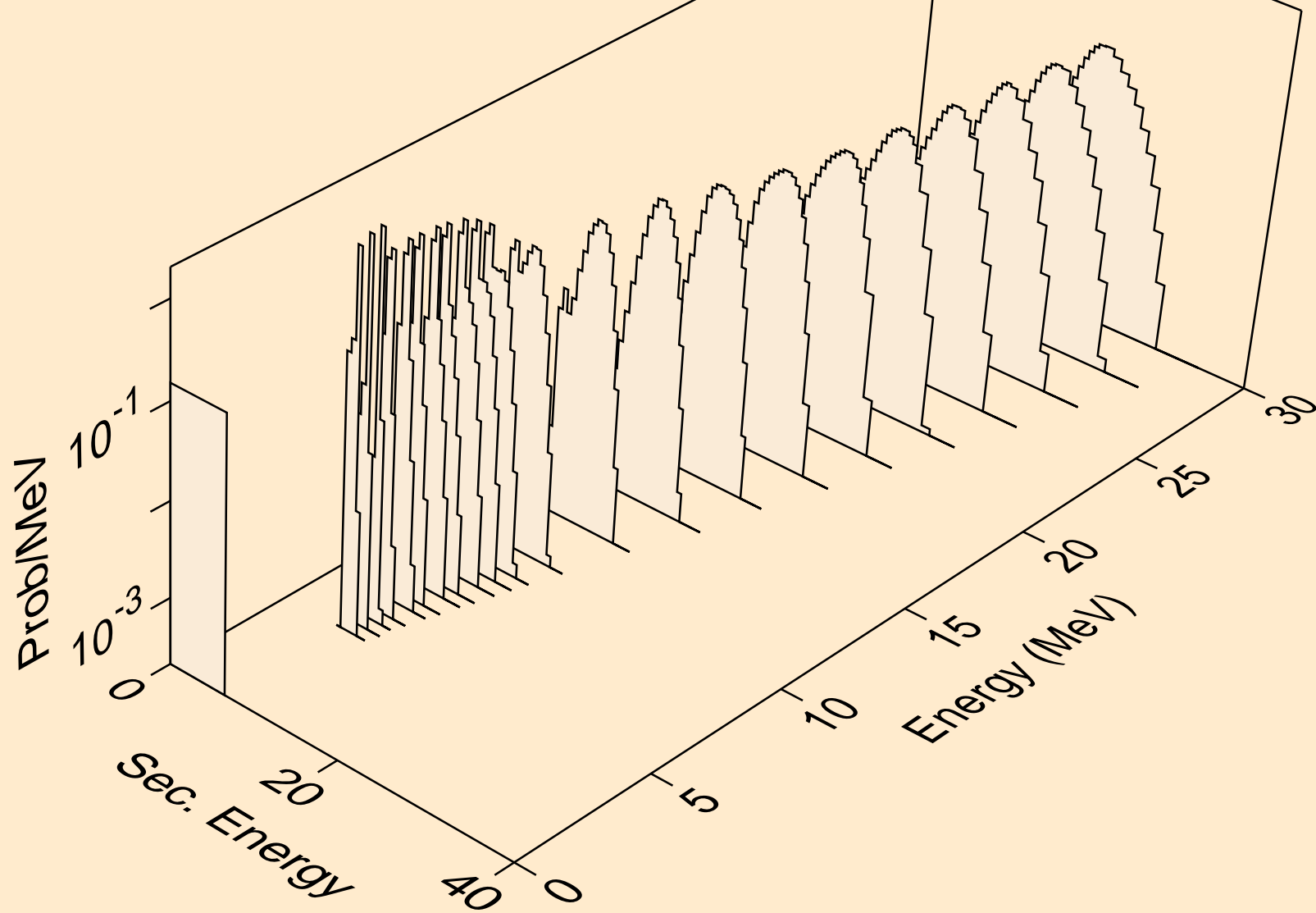

AT198M NEUTRON ACER TENDL-2021 LIBRARY; T=293.6K  
alphas from (n,a)

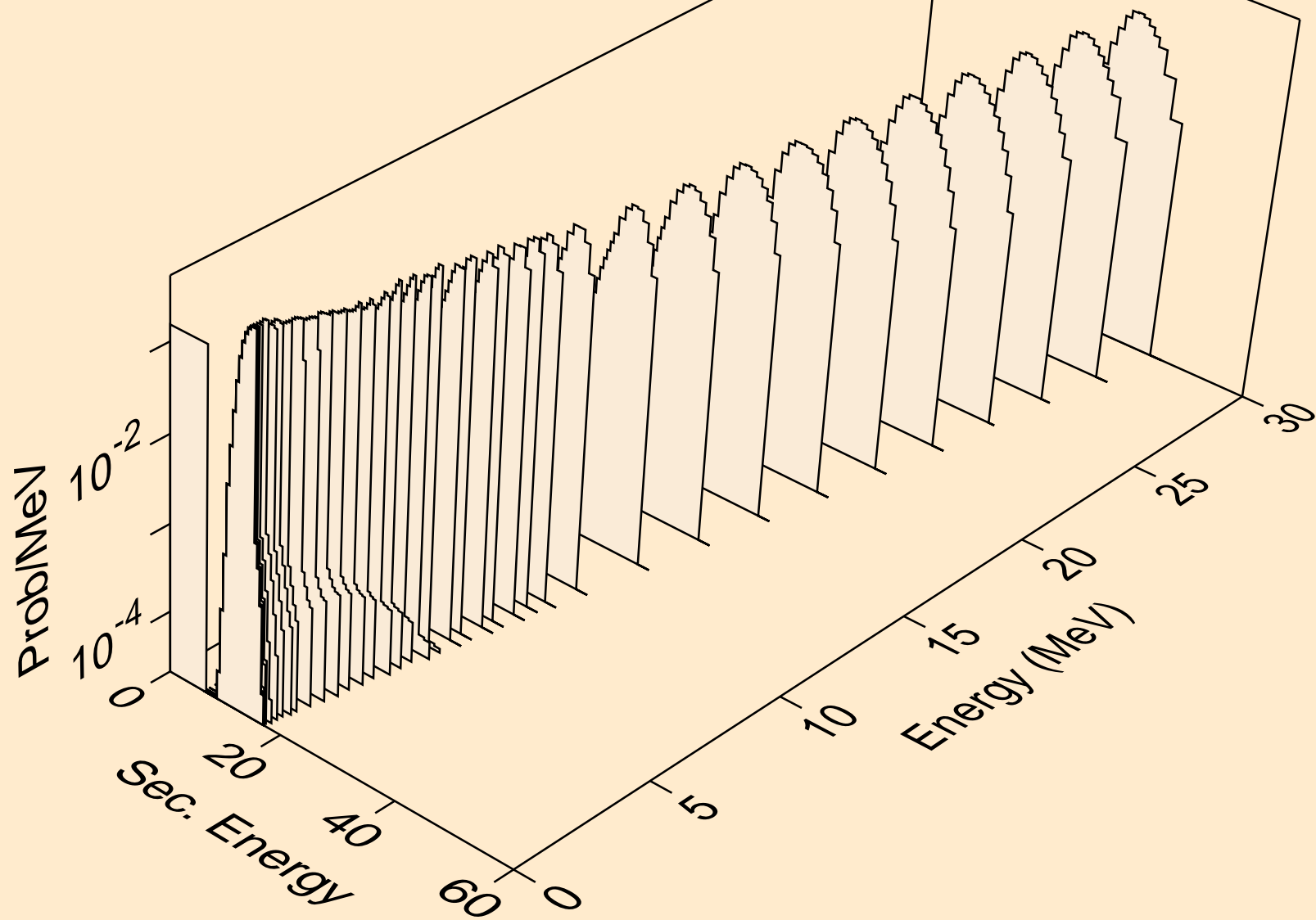

AT198M NEUTRON ACER TENDL-2021 LIBRARY; T=293.6K  
alphas from (n,2a)

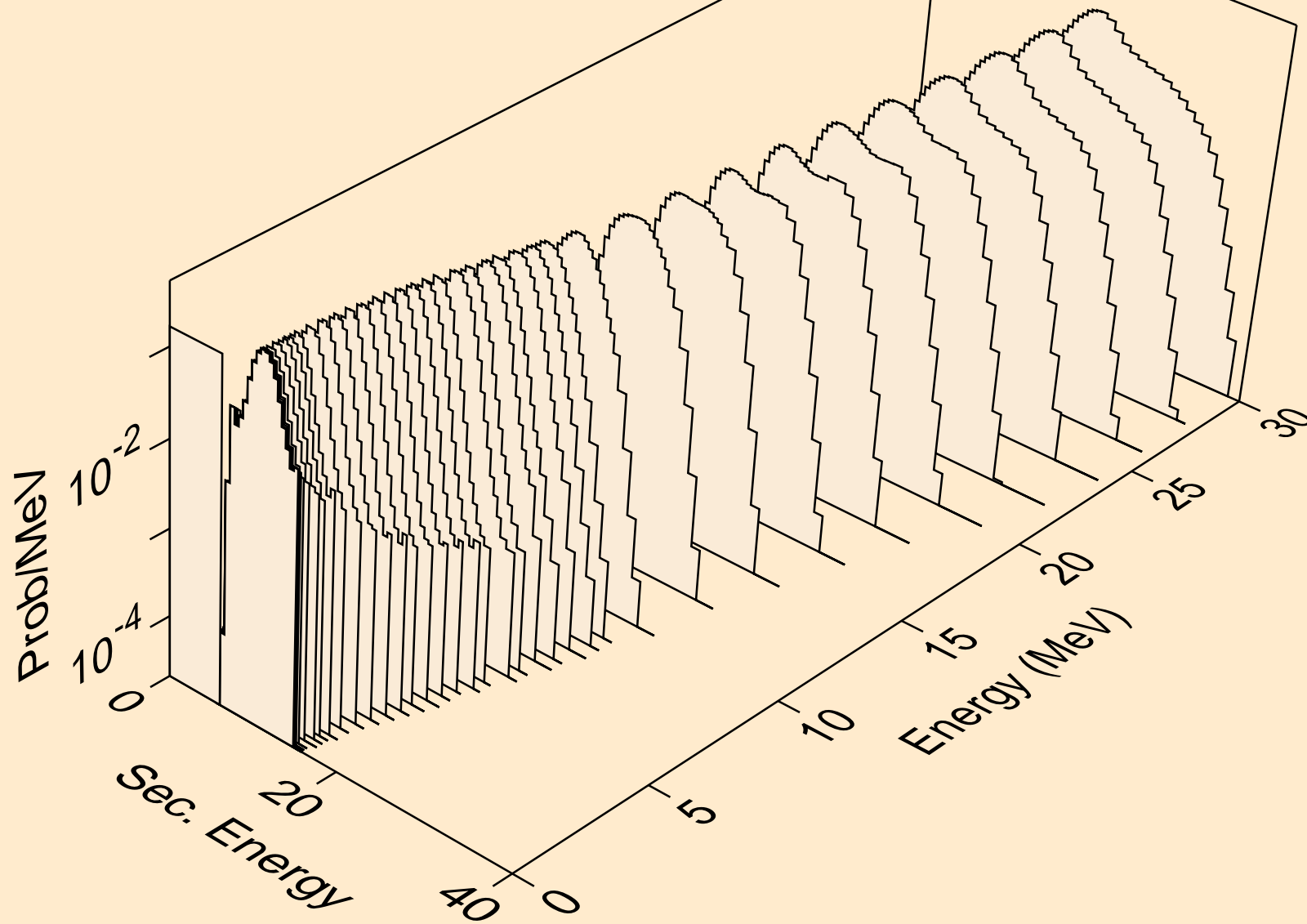

AT198M NEUTRON ACER TENDL-2021 LIBRARY; T=293.6K  
alphas from (n,3a)

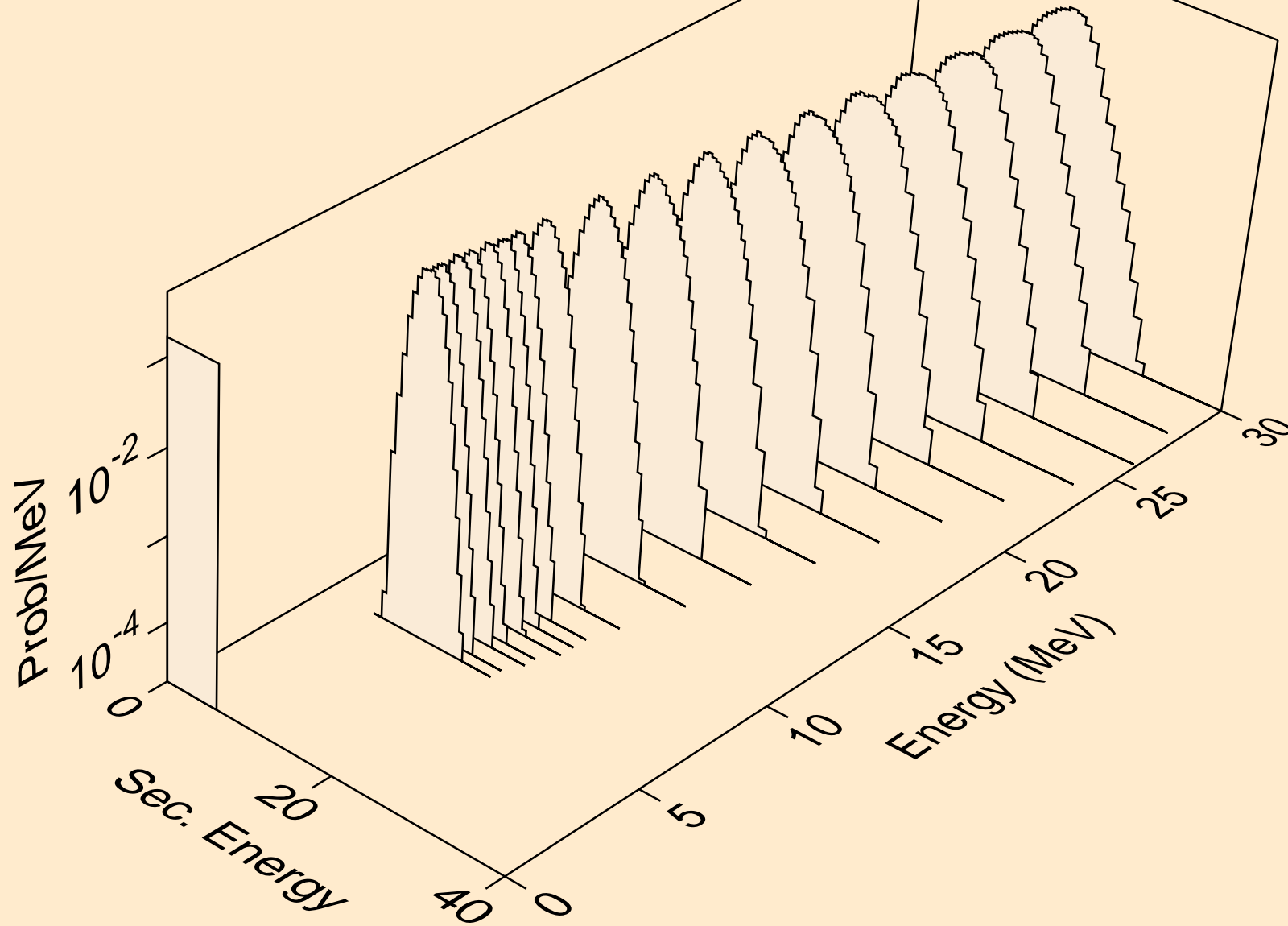

AT198M NEUTRON ACER TENDL-2021 LIBRARY; T=293.6K  
alphas from (n,pa)

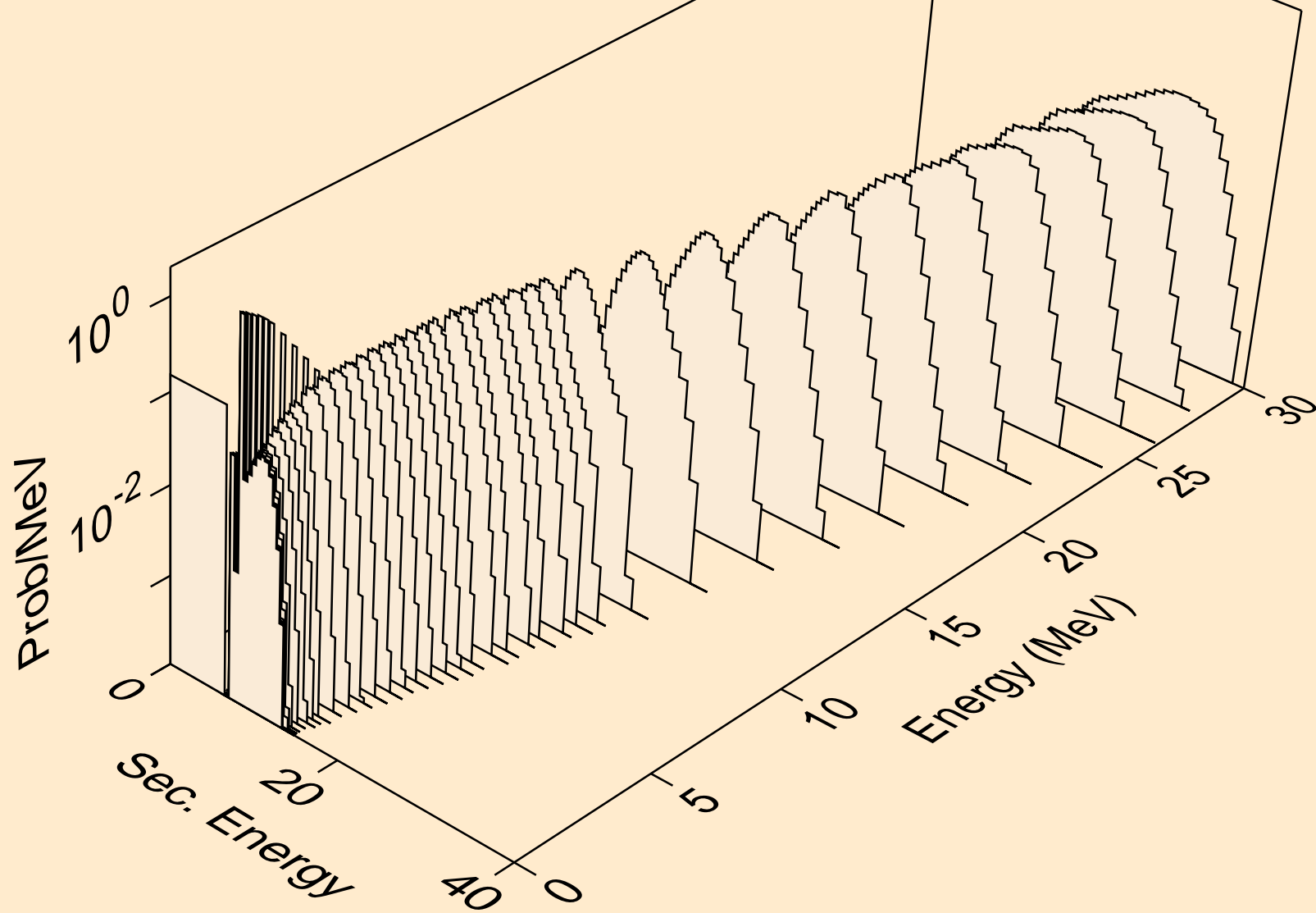

AT198M NEUTRON ACER TENDL-2021 LIBRARY; T=293.6K  
alphas from (n,da)

