

AT201 NEUTRON ACER TENDL-2021 LIBRARY; T=293.6K
Principal cross sections

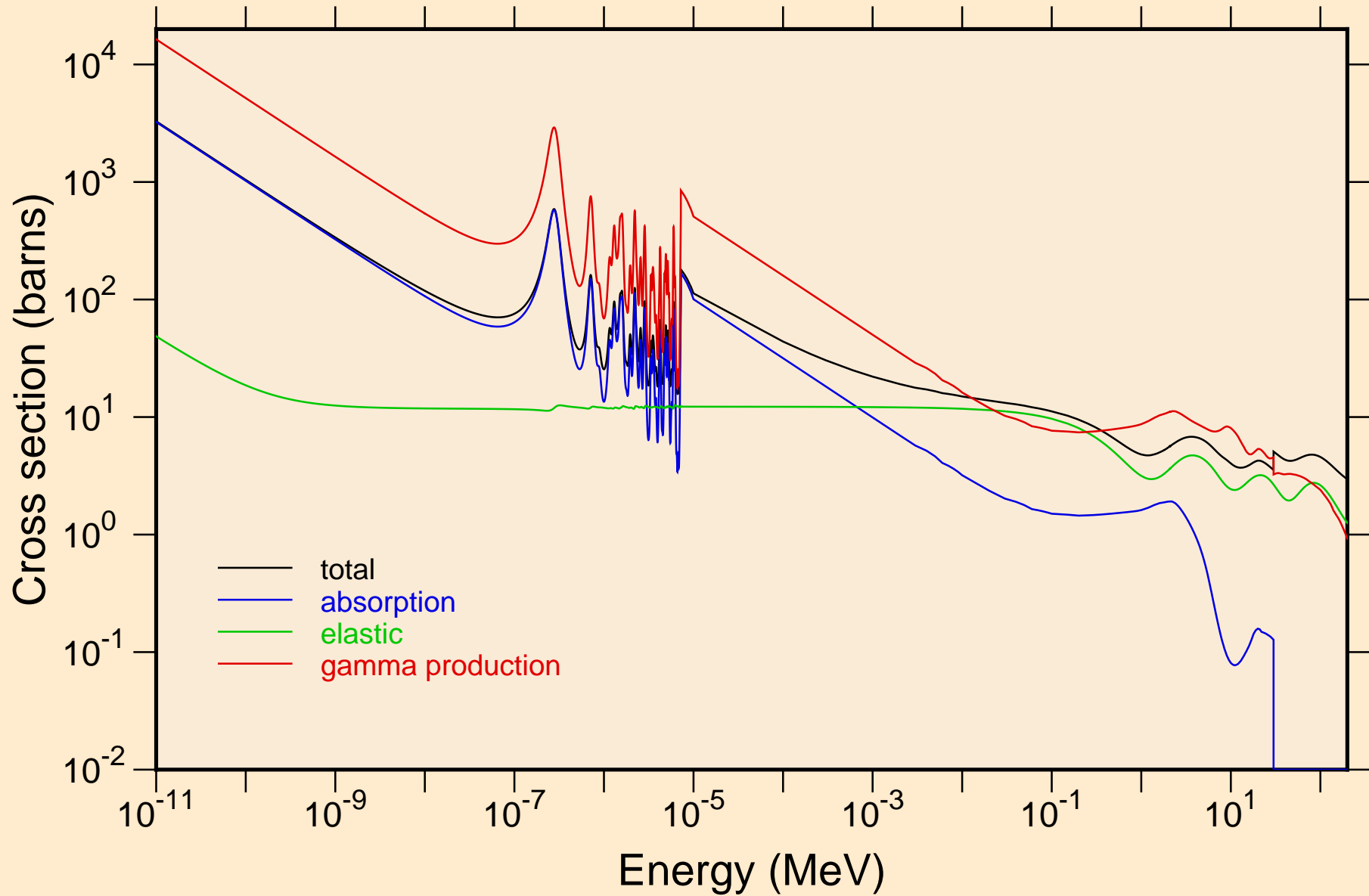

AT201 NEUTRON ACER TENDL-2021 LIBRARY; T=293.6K
resonance total cross section

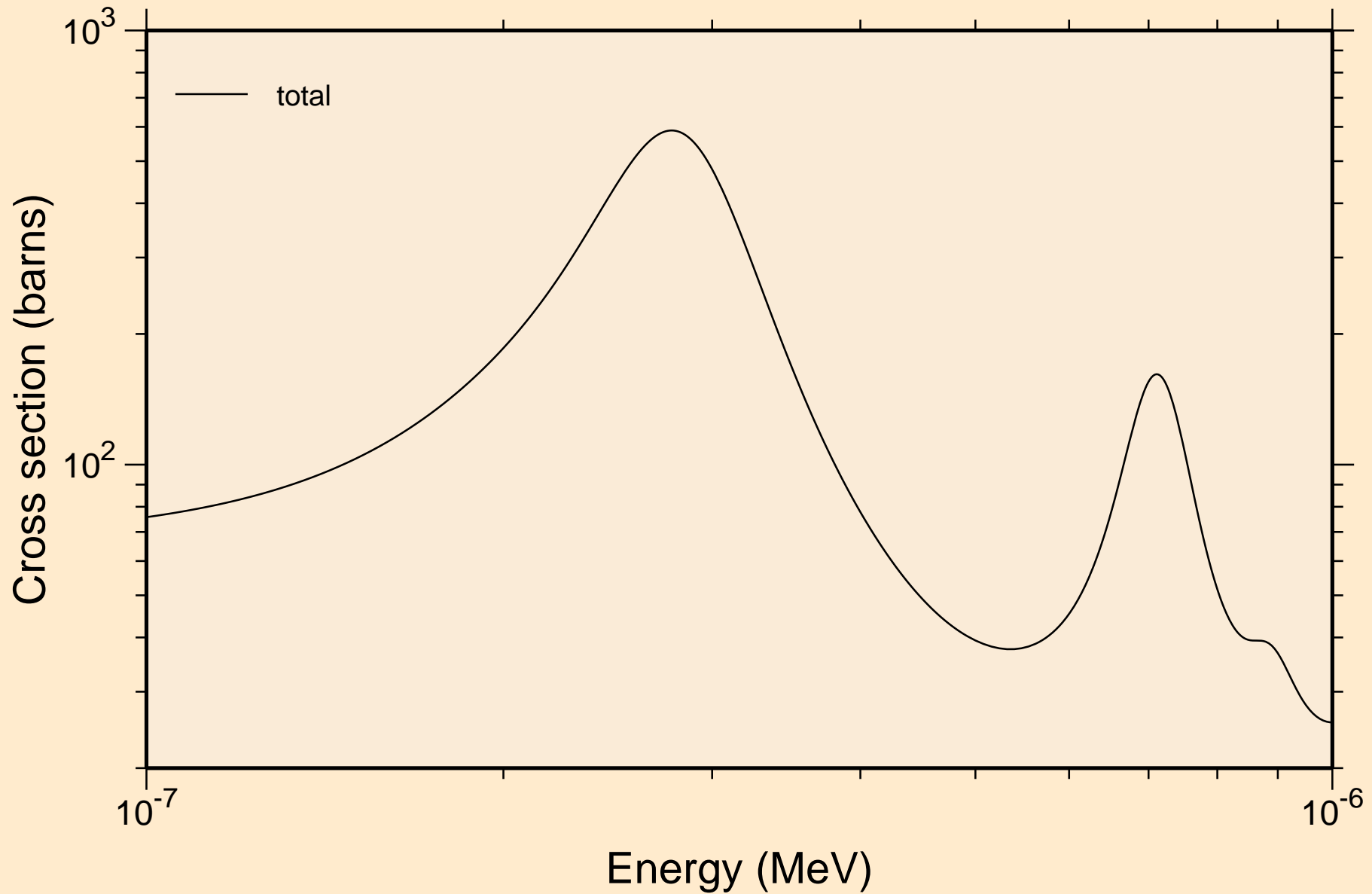

AT201 NEUTRON ACER TENDL-2021 LIBRARY; T=293.6K
resonance total cross section

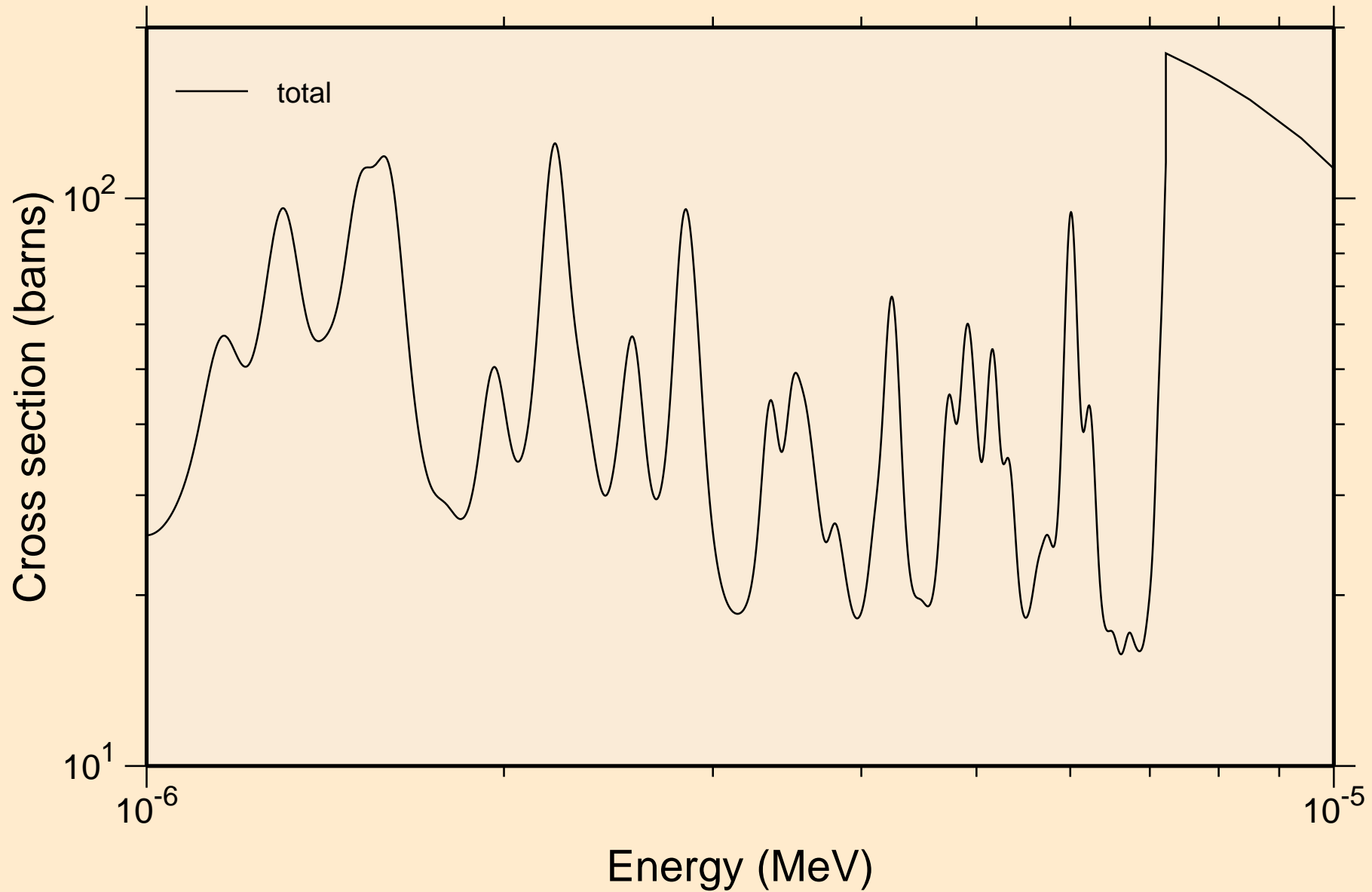

AT201 NEUTRON ACER TENDL-2021 LIBRARY; T=293.6K
resonance total cross section

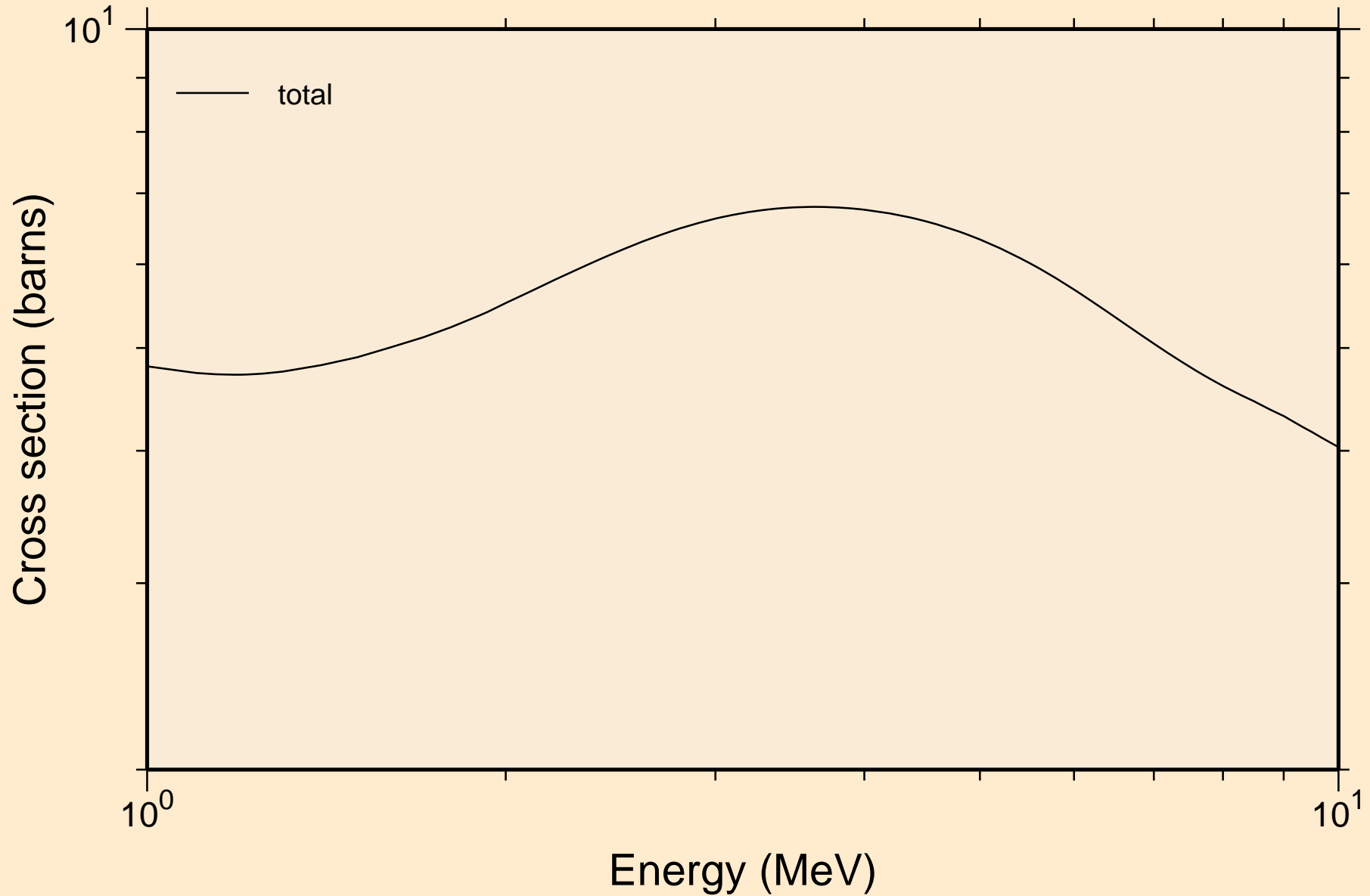

AT201 NEUTRON ACER TENDL-2021 LIBRARY; T=293.6K
resonance absorption cross sections

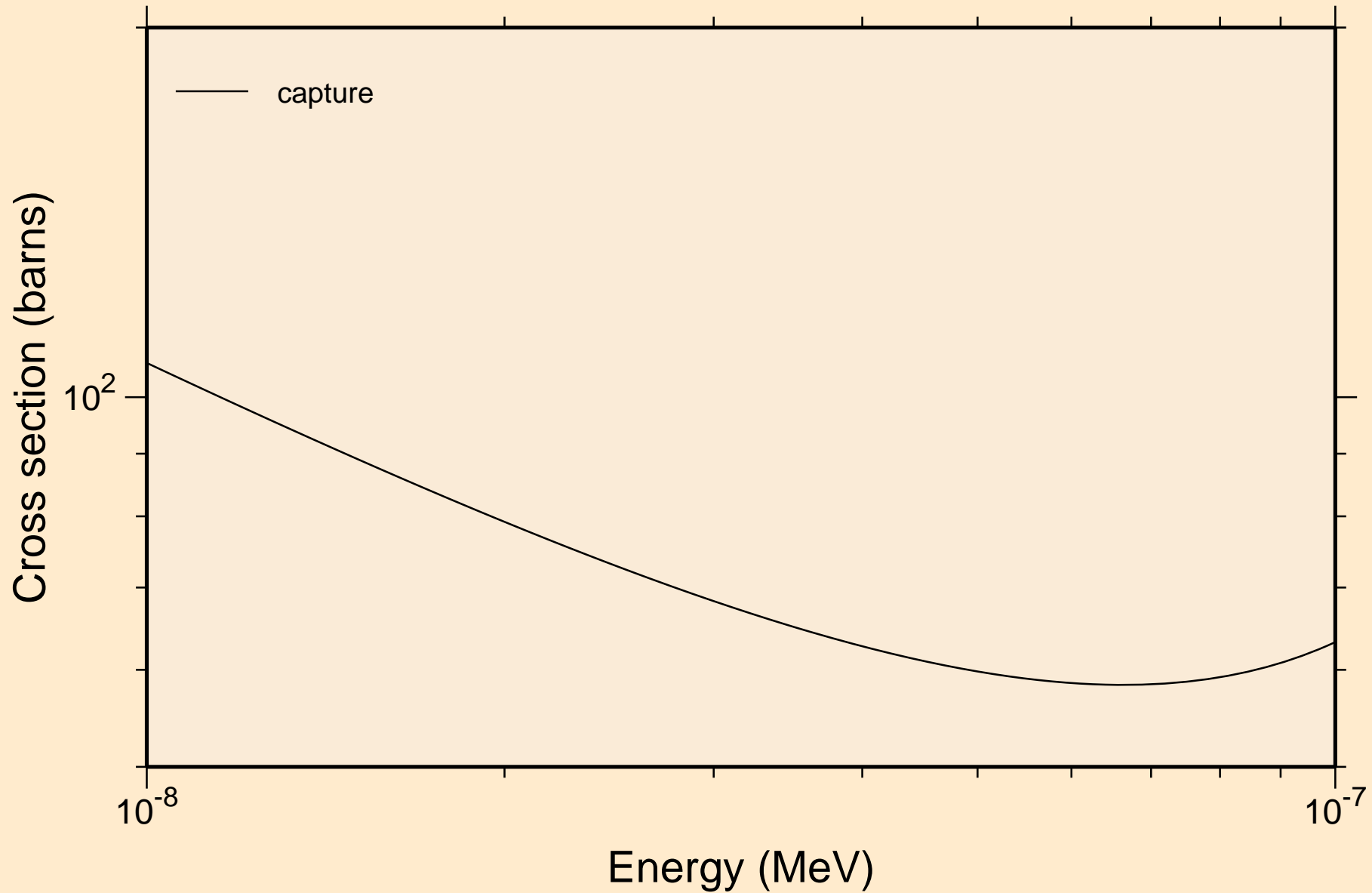

AT201 NEUTRON ACER TENDL-2021 LIBRARY; T=293.6K
resonance absorption cross sections

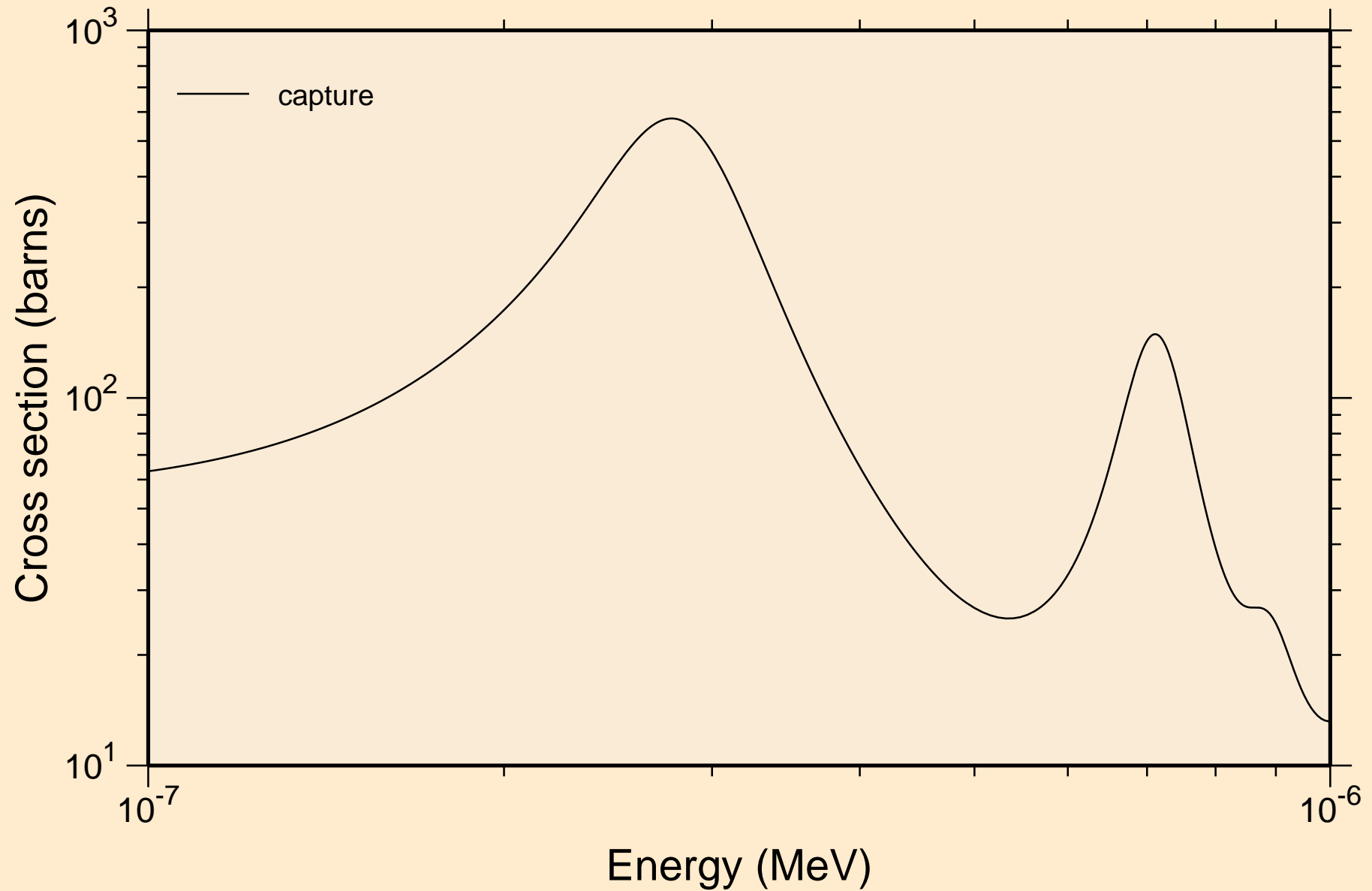

AT201 NEUTRON ACER TENDL-2021 LIBRARY; T=293.6K
resonance absorption cross sections

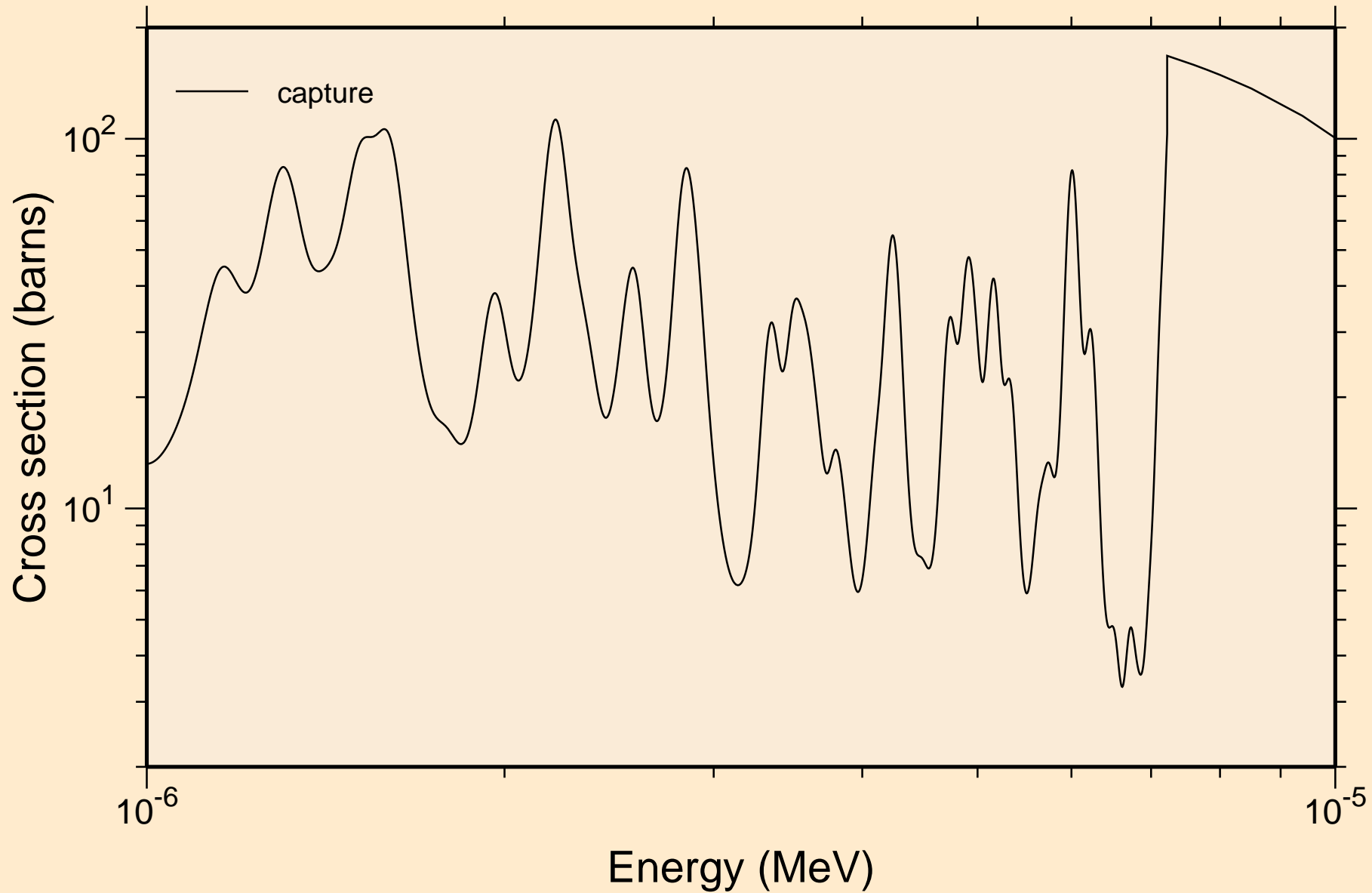

AT201 NEUTRON ACER TENDL-2021 LIBRARY; T=293.6K
resonance absorption cross sections

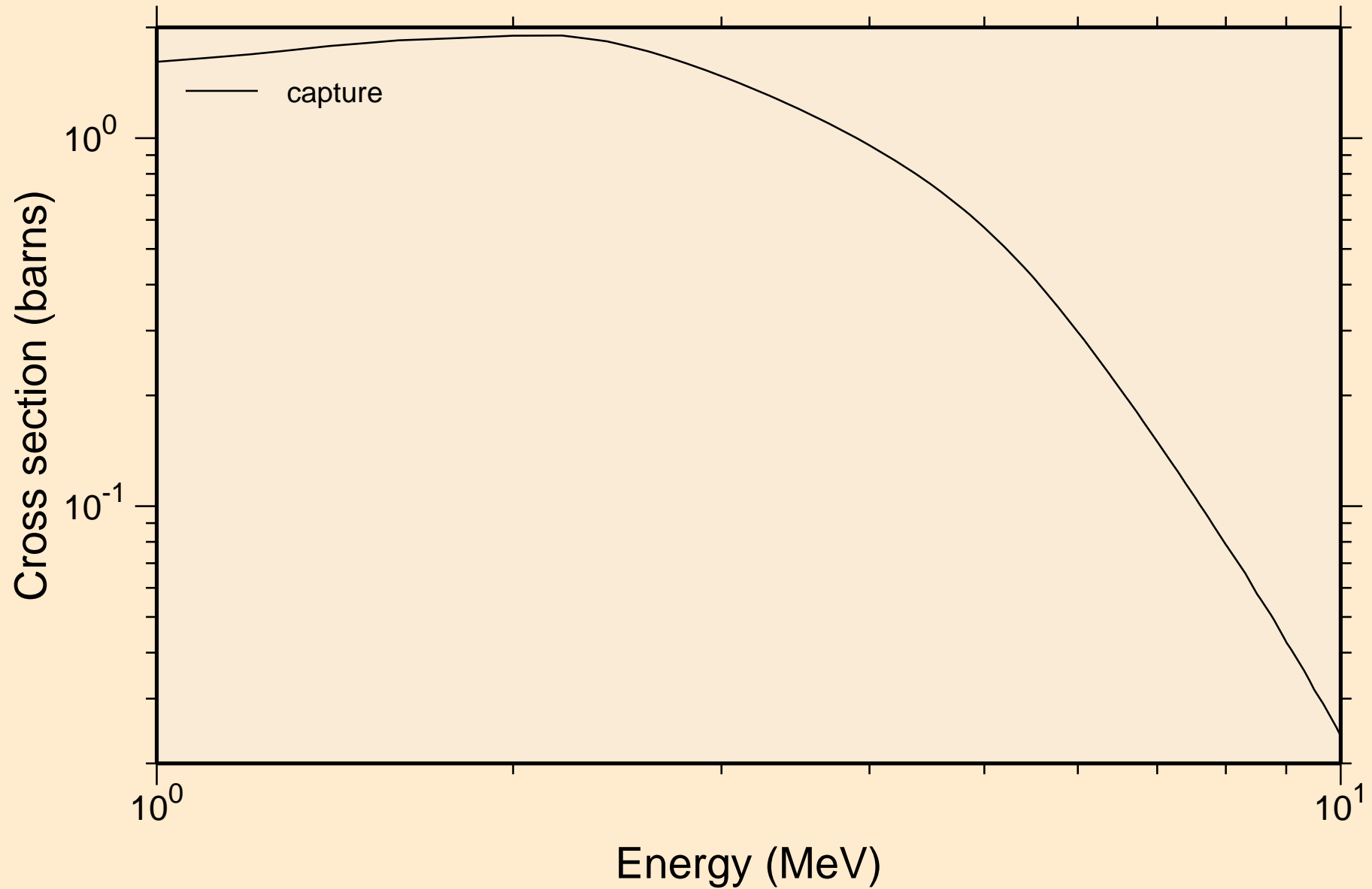

AT201 NEUTRON ACER TENDL-2021 LIBRARY; T=293.6K
Heating

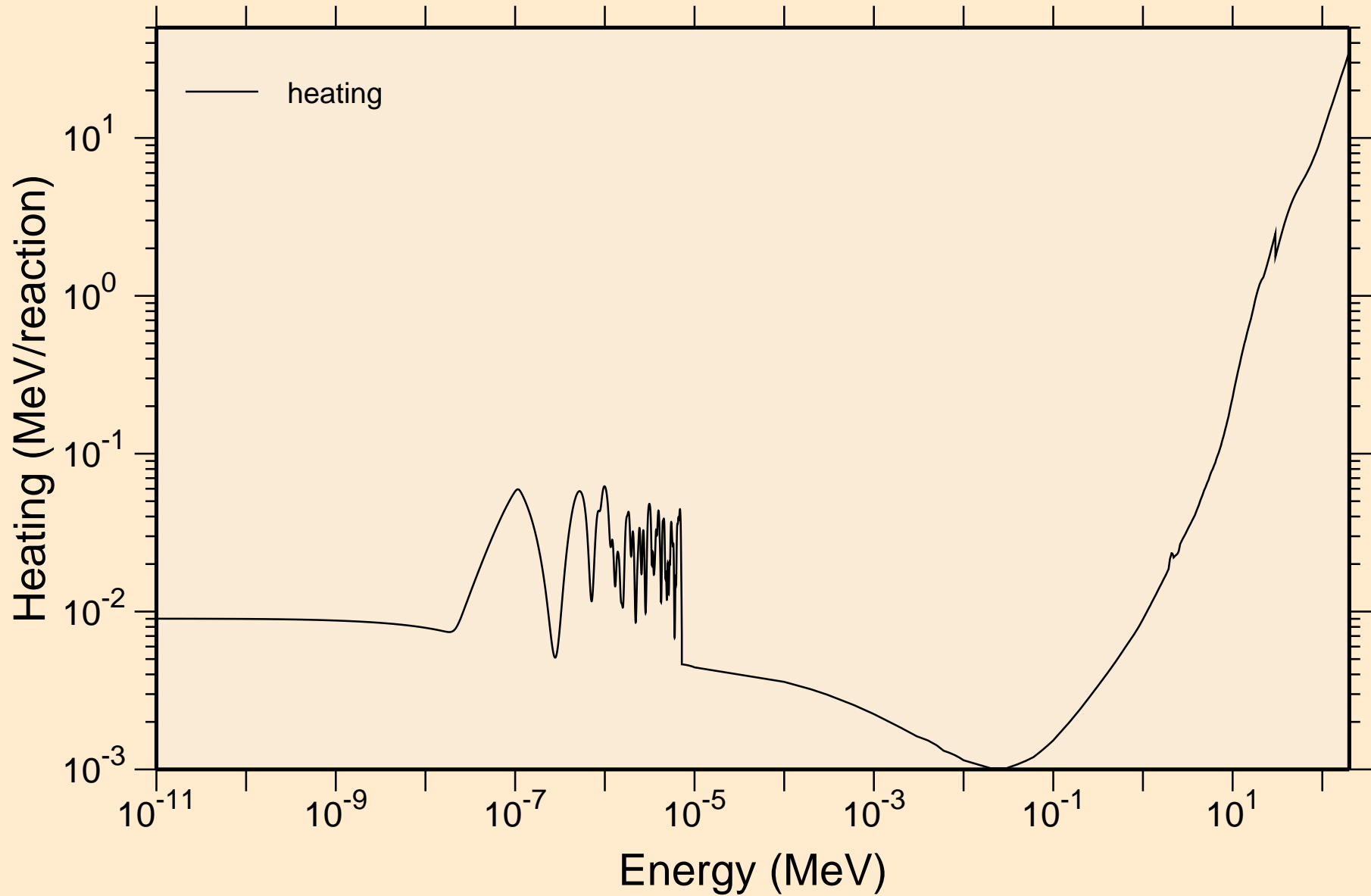

AT201 NEUTRON ACER TENDL-2021 LIBRARY; T=293.6K
Damage

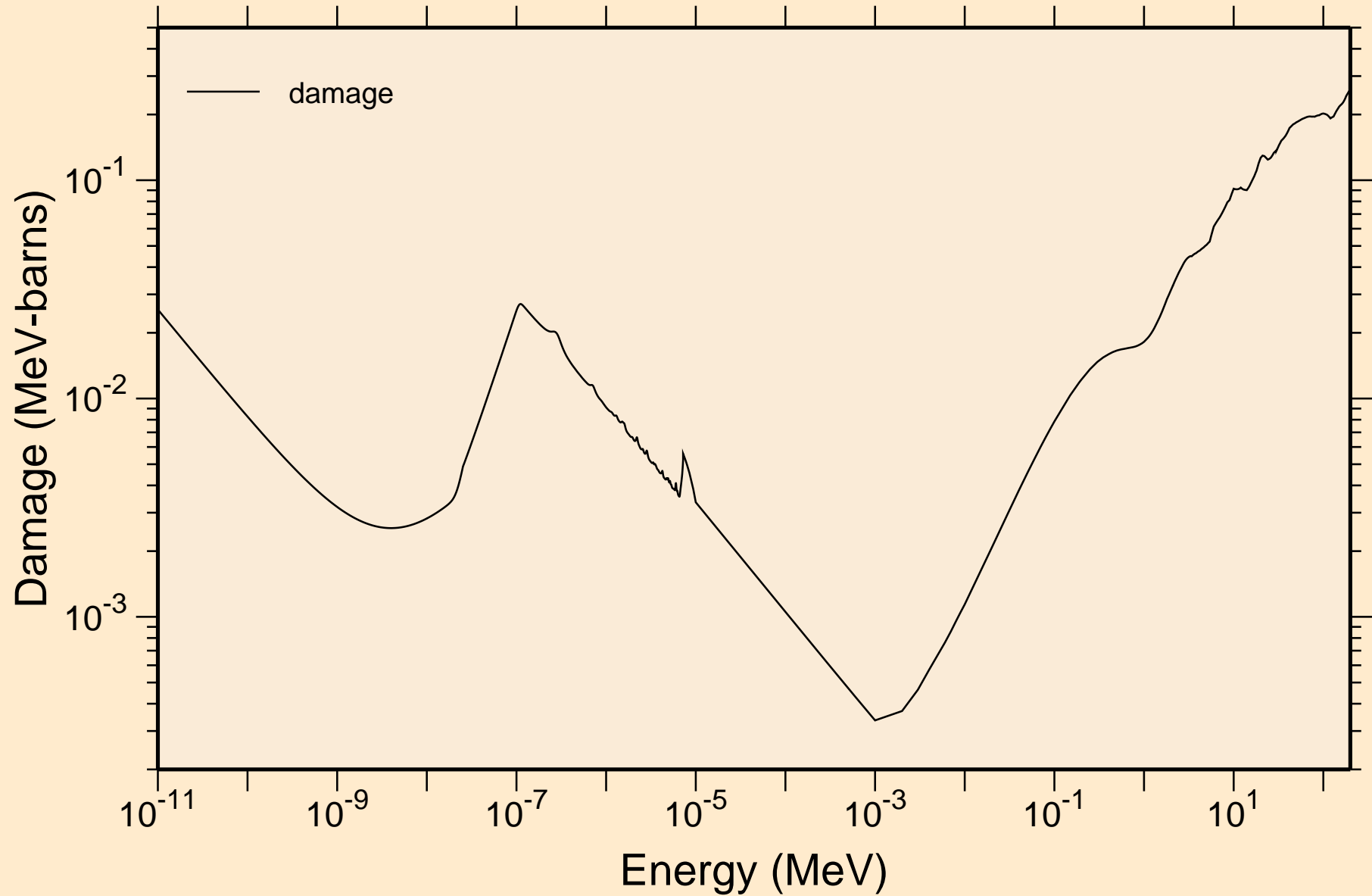

AT201 NEUTRON ACER TENDL-2021 LIBRARY; T=293.6K
Non-threshold reactions

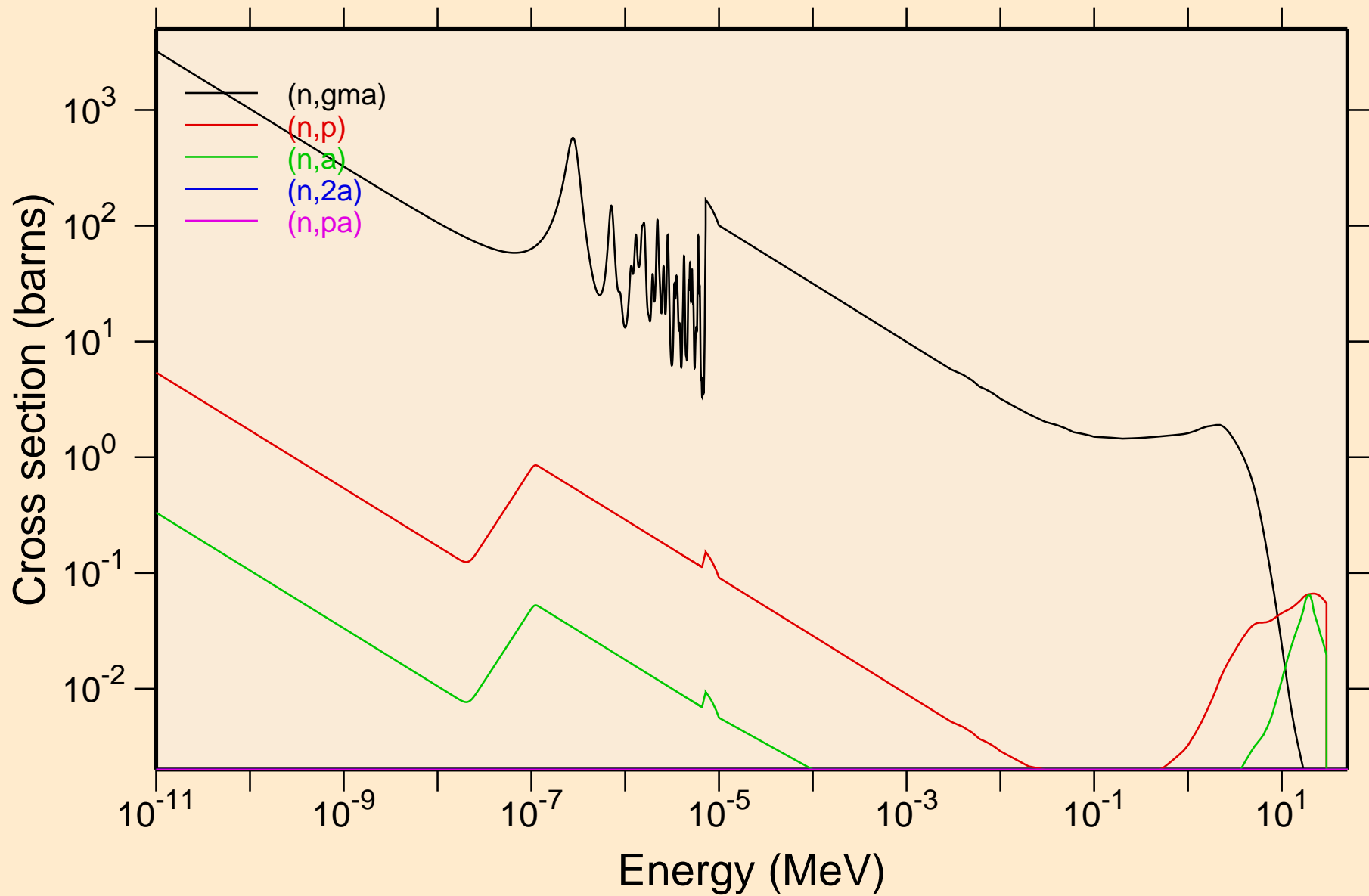

AT201 NEUTRON ACER TENDL-2021 LIBRARY; T=293.6K
Non-threshold reactions

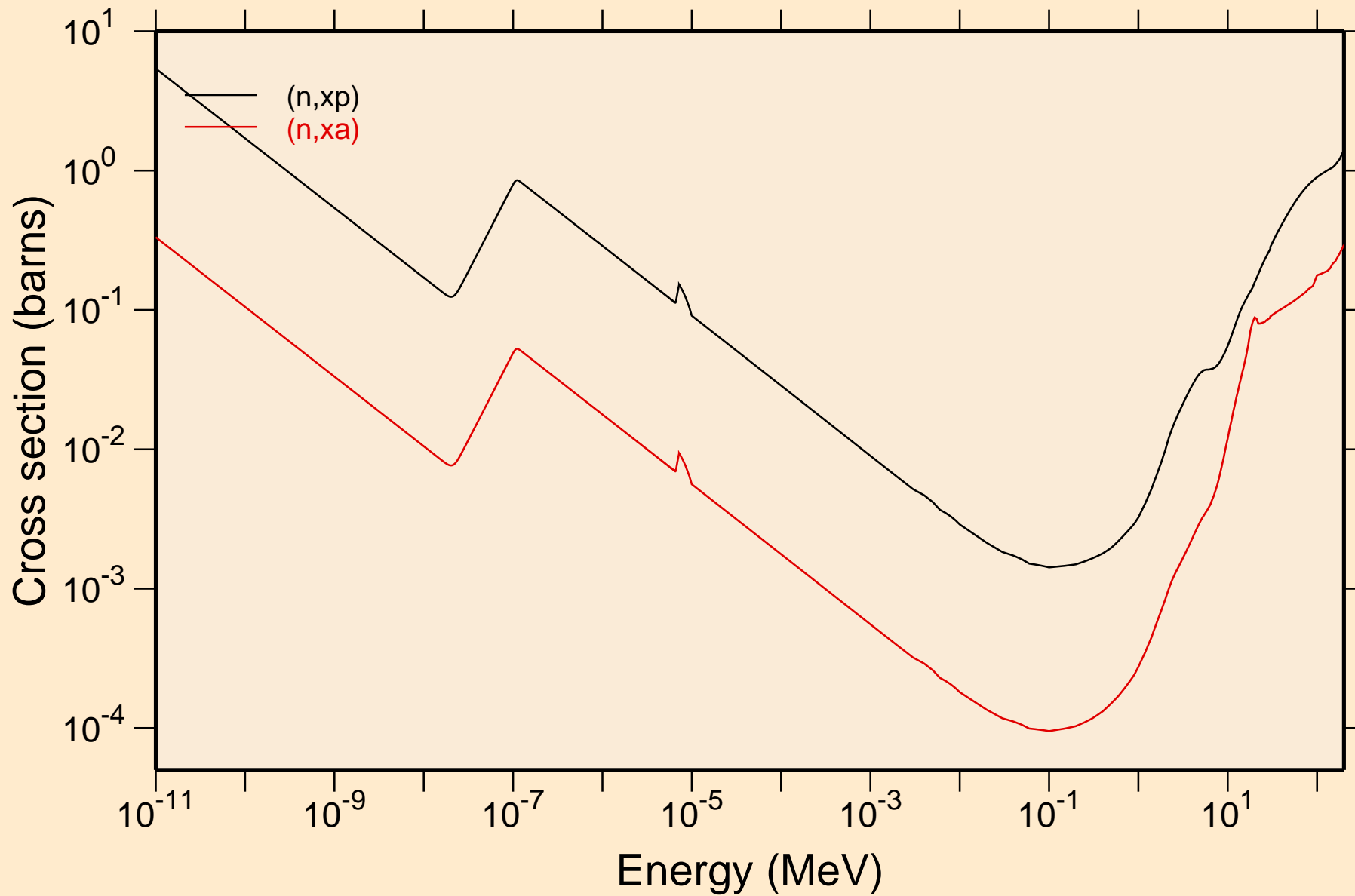

AT201 NEUTRON ACER TENDL-2021 LIBRARY; T=293.6K
Principal cross sections

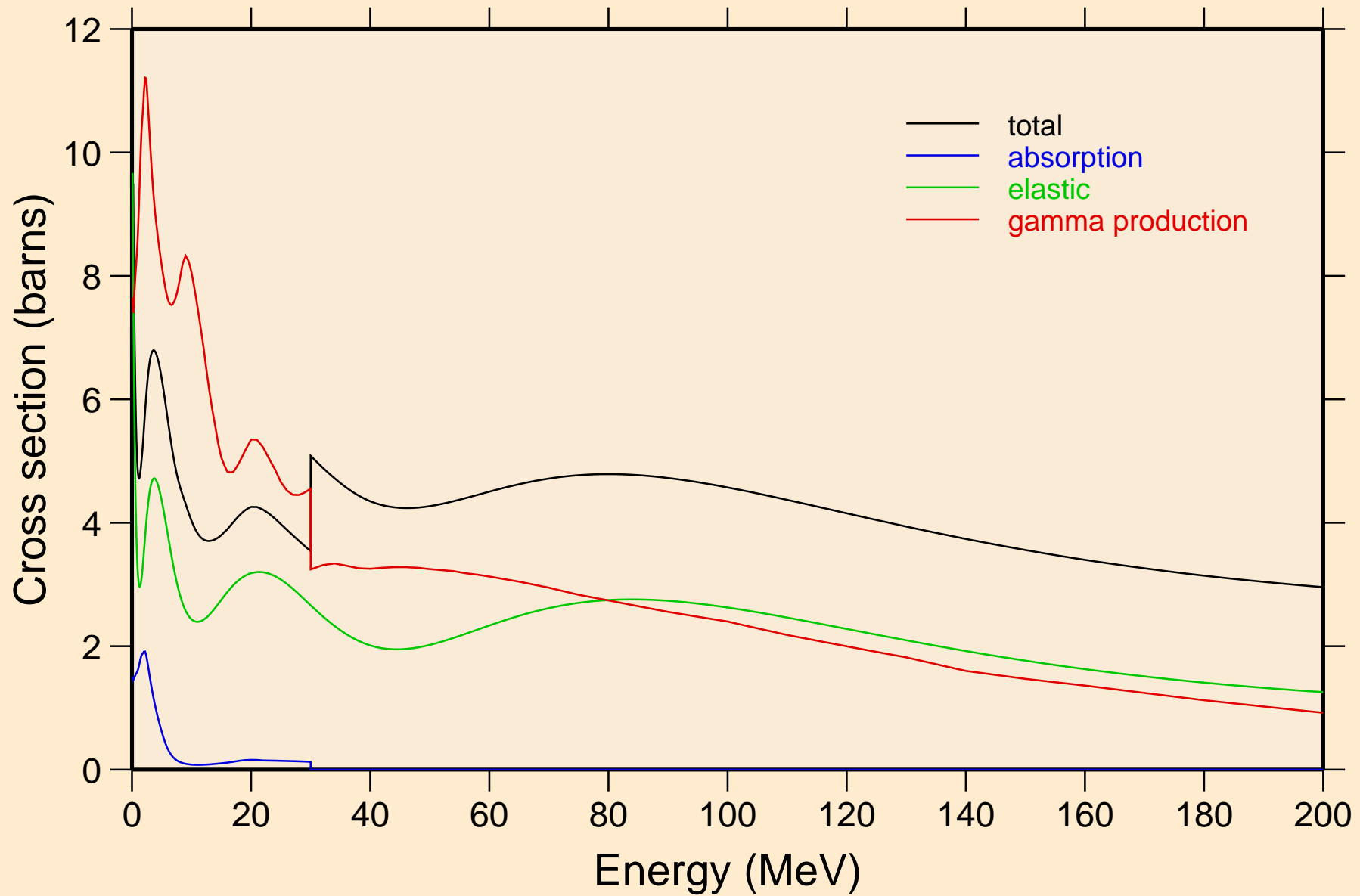

AT201 NEUTRON ACER TENDL-2021 LIBRARY; T=293.6K

Heating

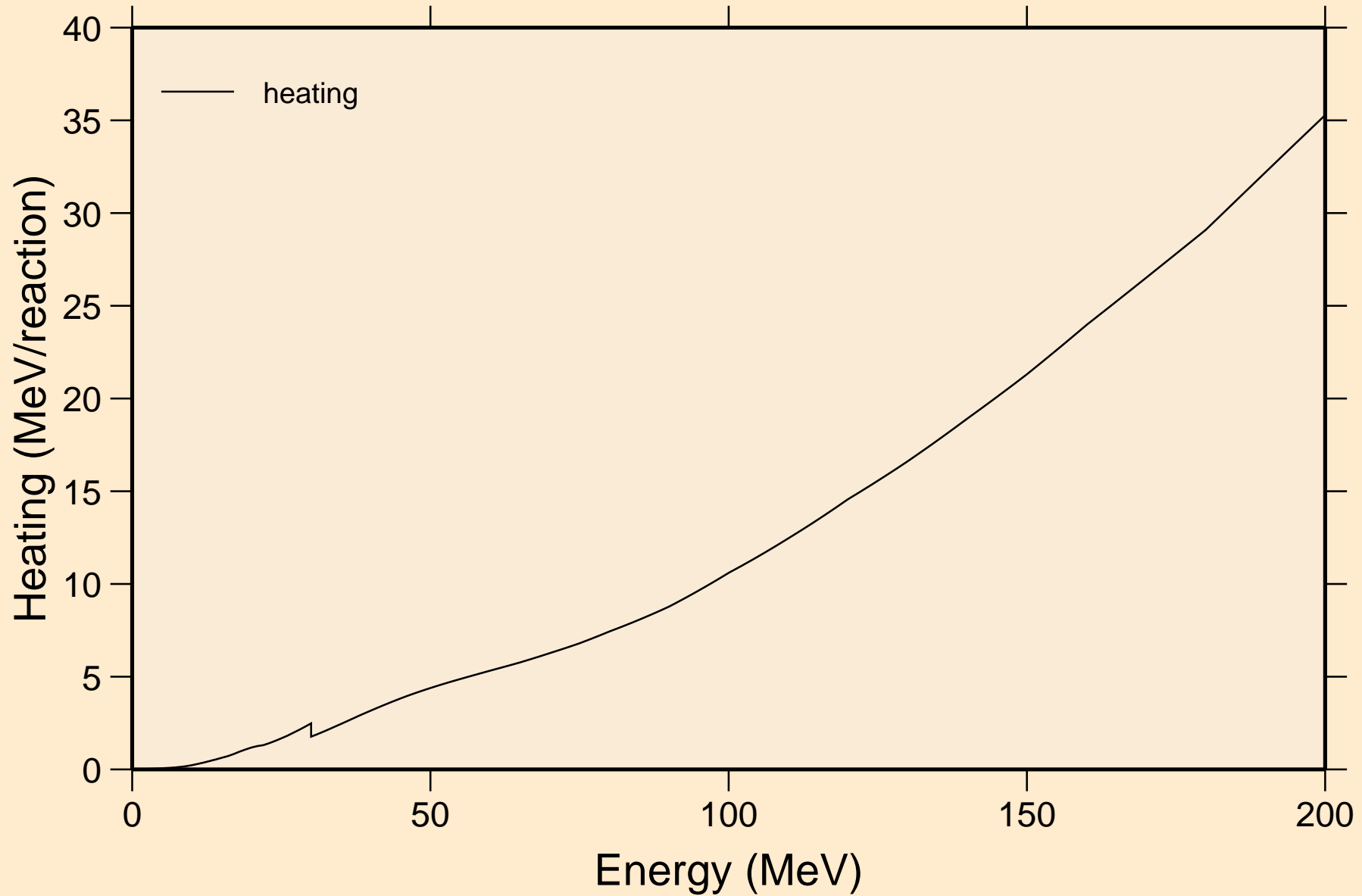

AT201 NEUTRON ACER TENDL-2021 LIBRARY; T=293.6K
Damage

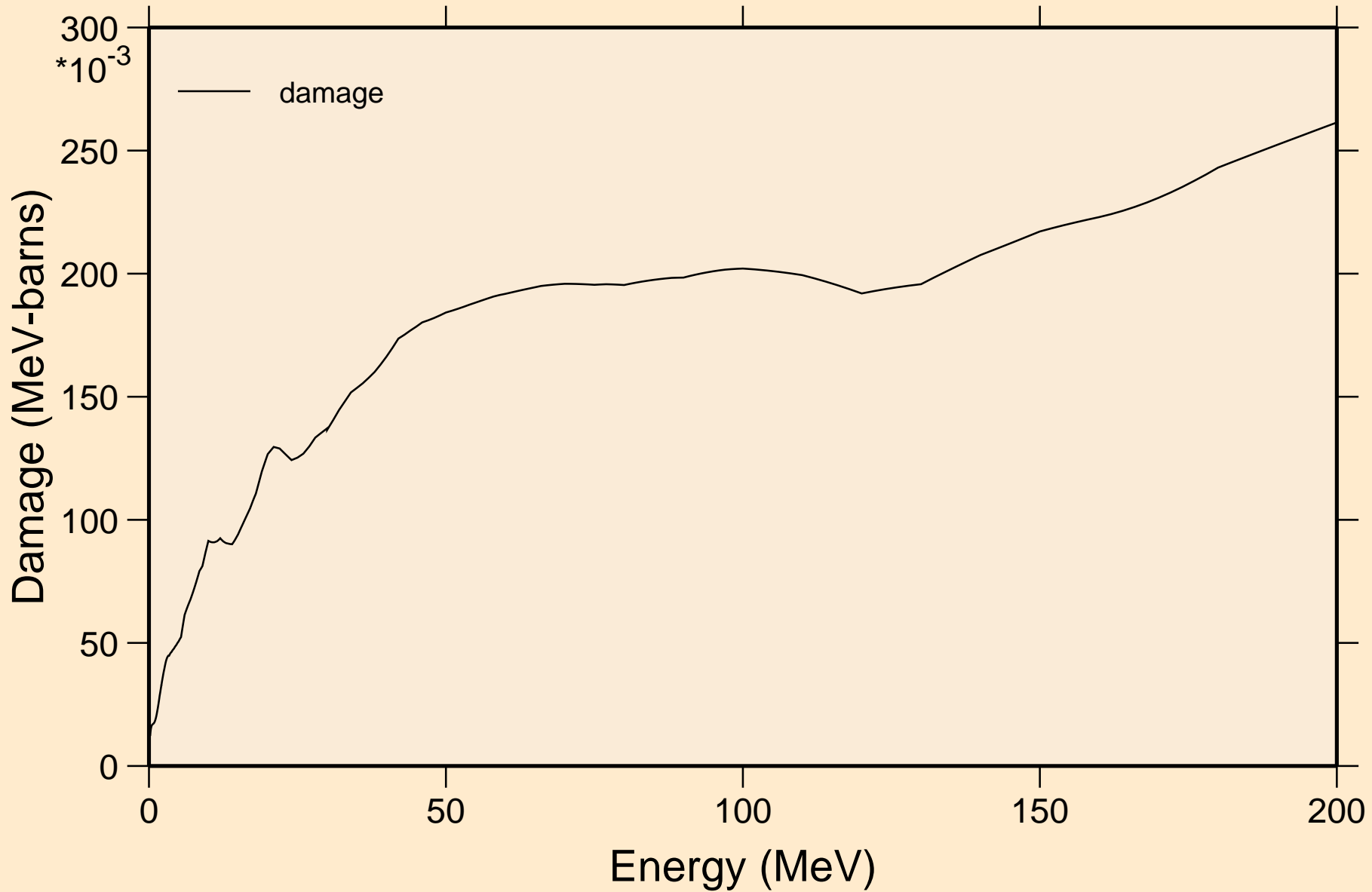

AT201 NEUTRON ACER TENDL-2021 LIBRARY; T=293.6K
Non-threshold reactions

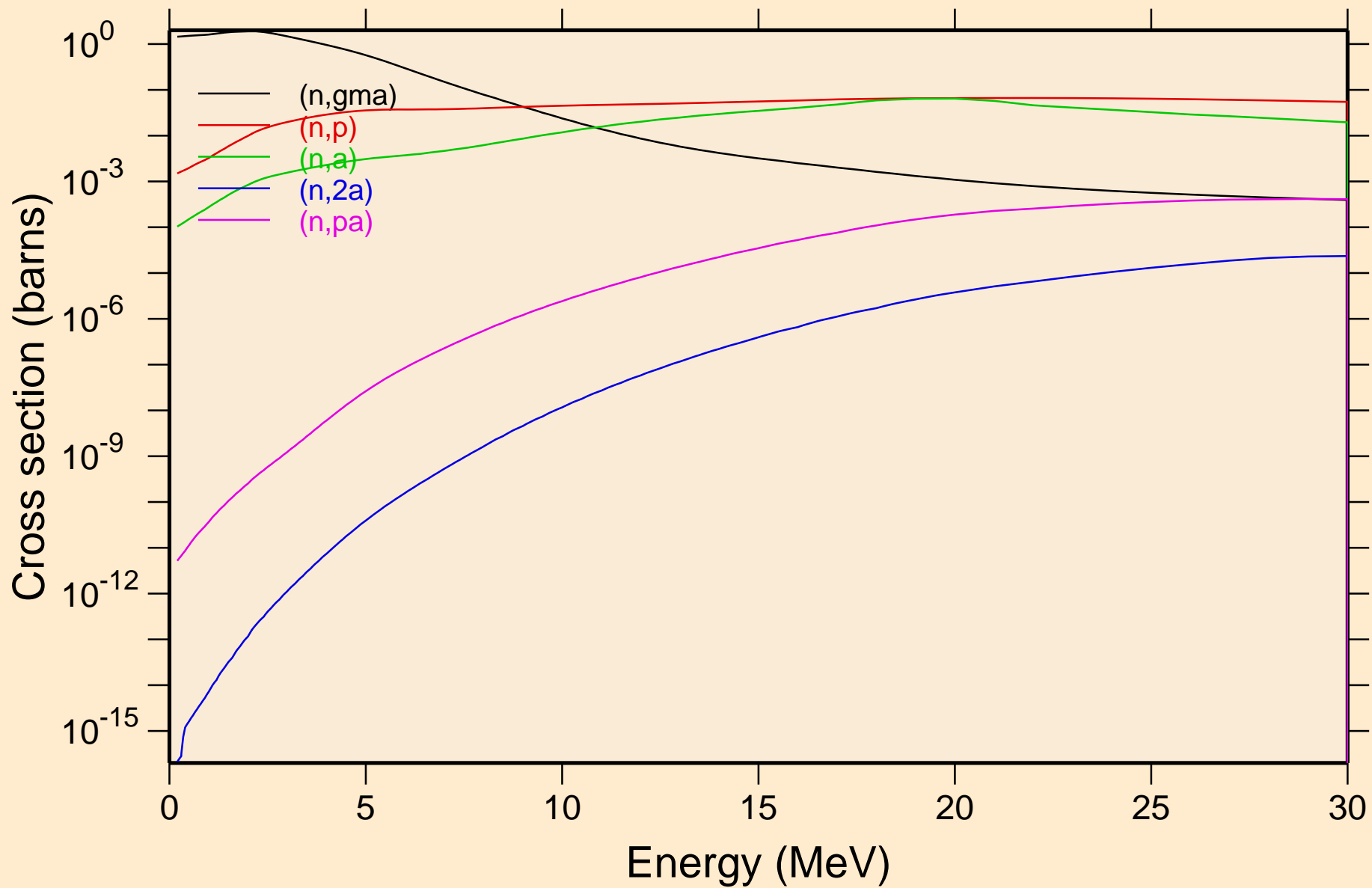

AT201 NEUTRON ACER TENDL-2021 LIBRARY; T=293.6K
Non-threshold reactions

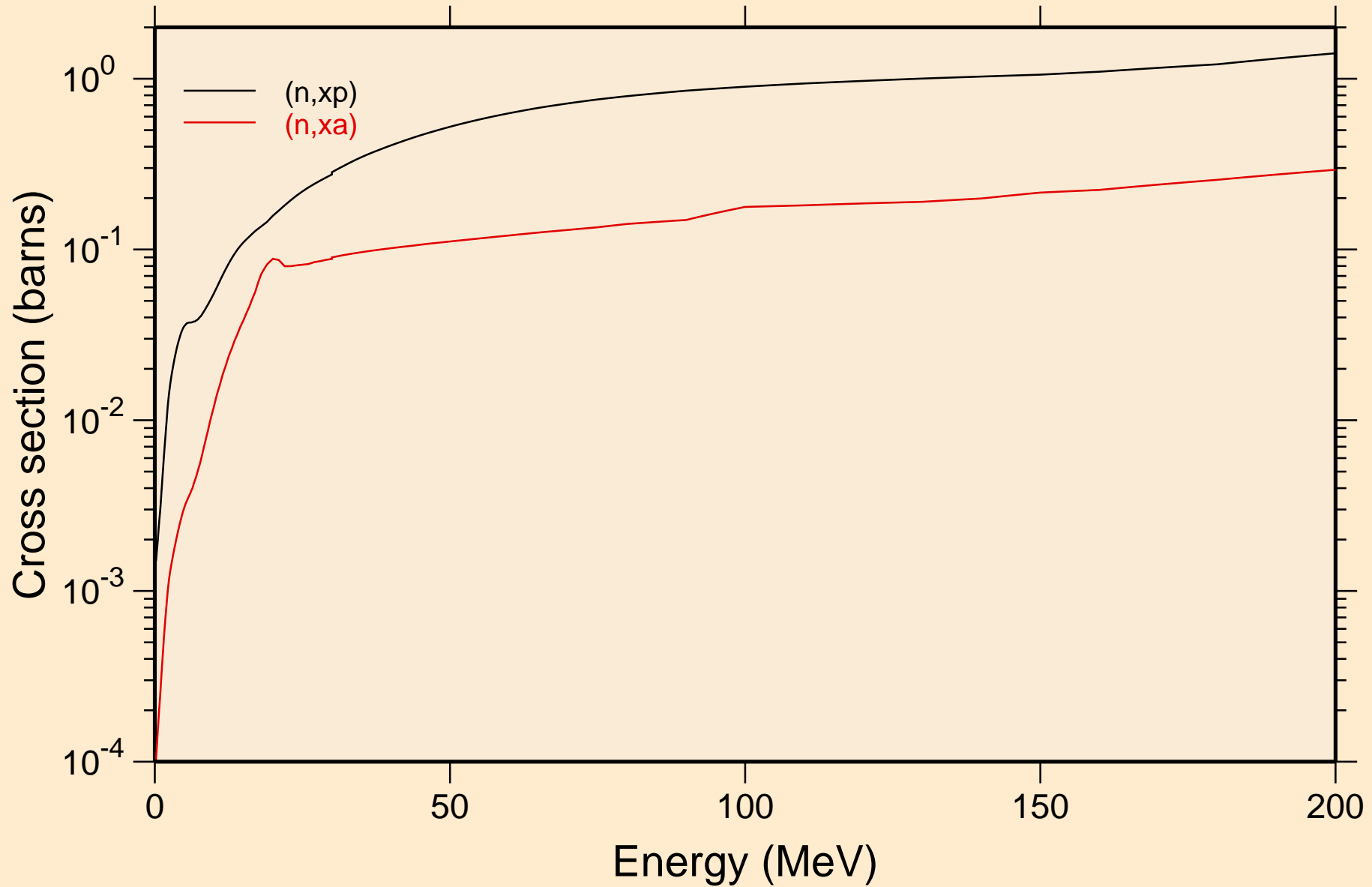

AT201 NEUTRON ACER TENDL-2021 LIBRARY; T=293.6K
Inelastic levels

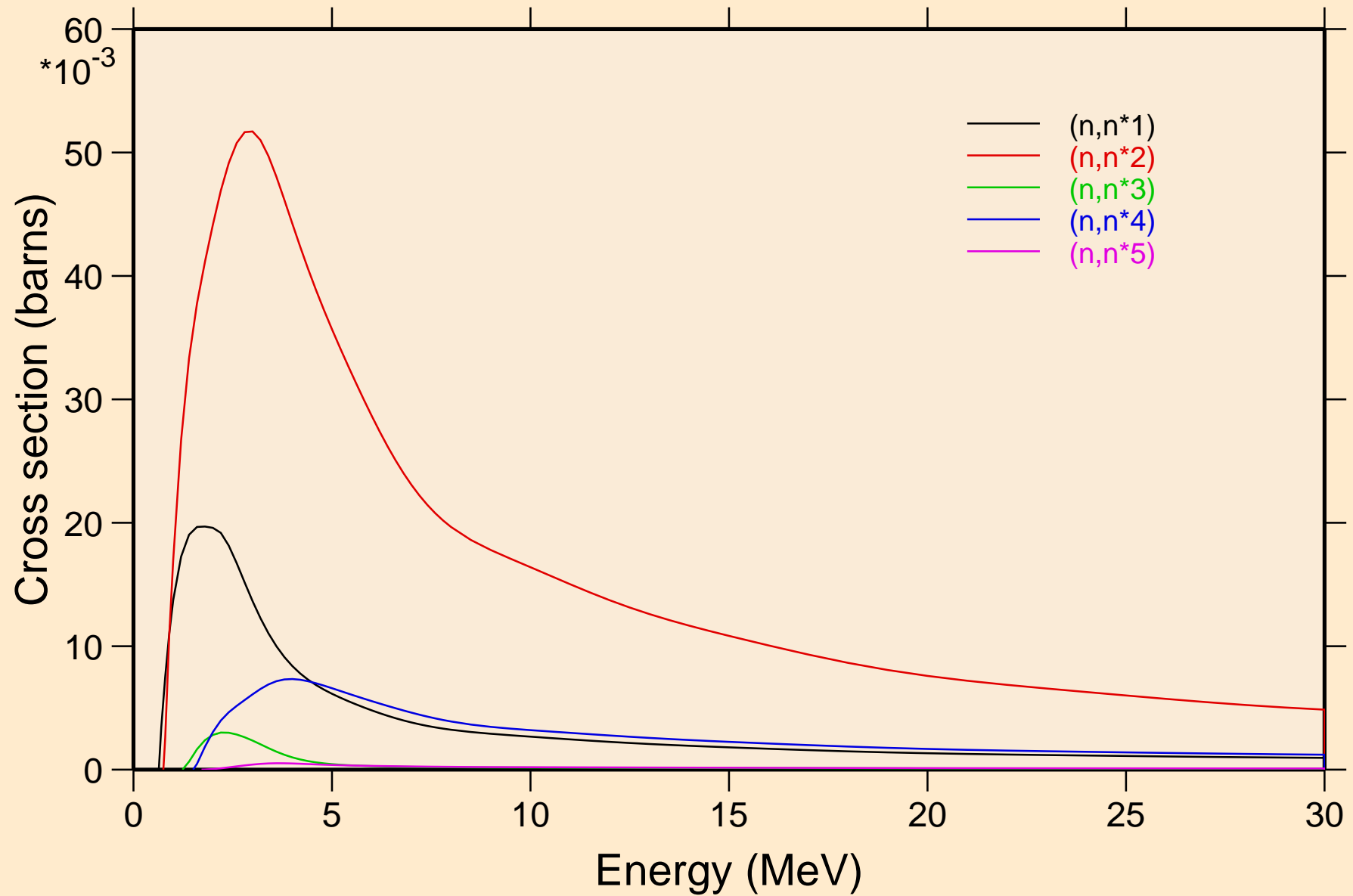

AT201 NEUTRON ACER TENDL-2021 LIBRARY; T=293.6K
Inelastic levels

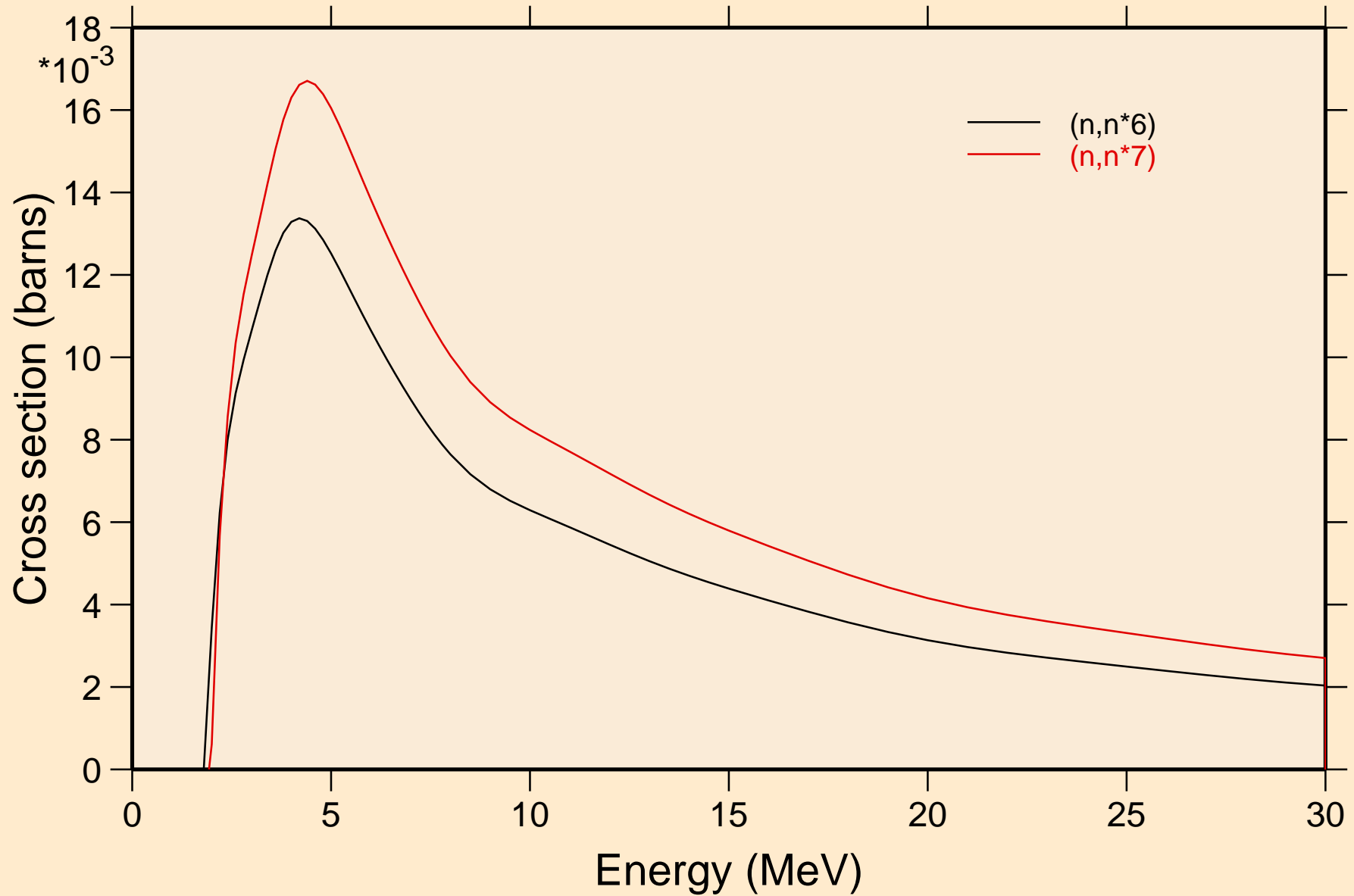

AT201 NEUTRON ACER TENDL-2021 LIBRARY; T=293.6K
Threshold reactions

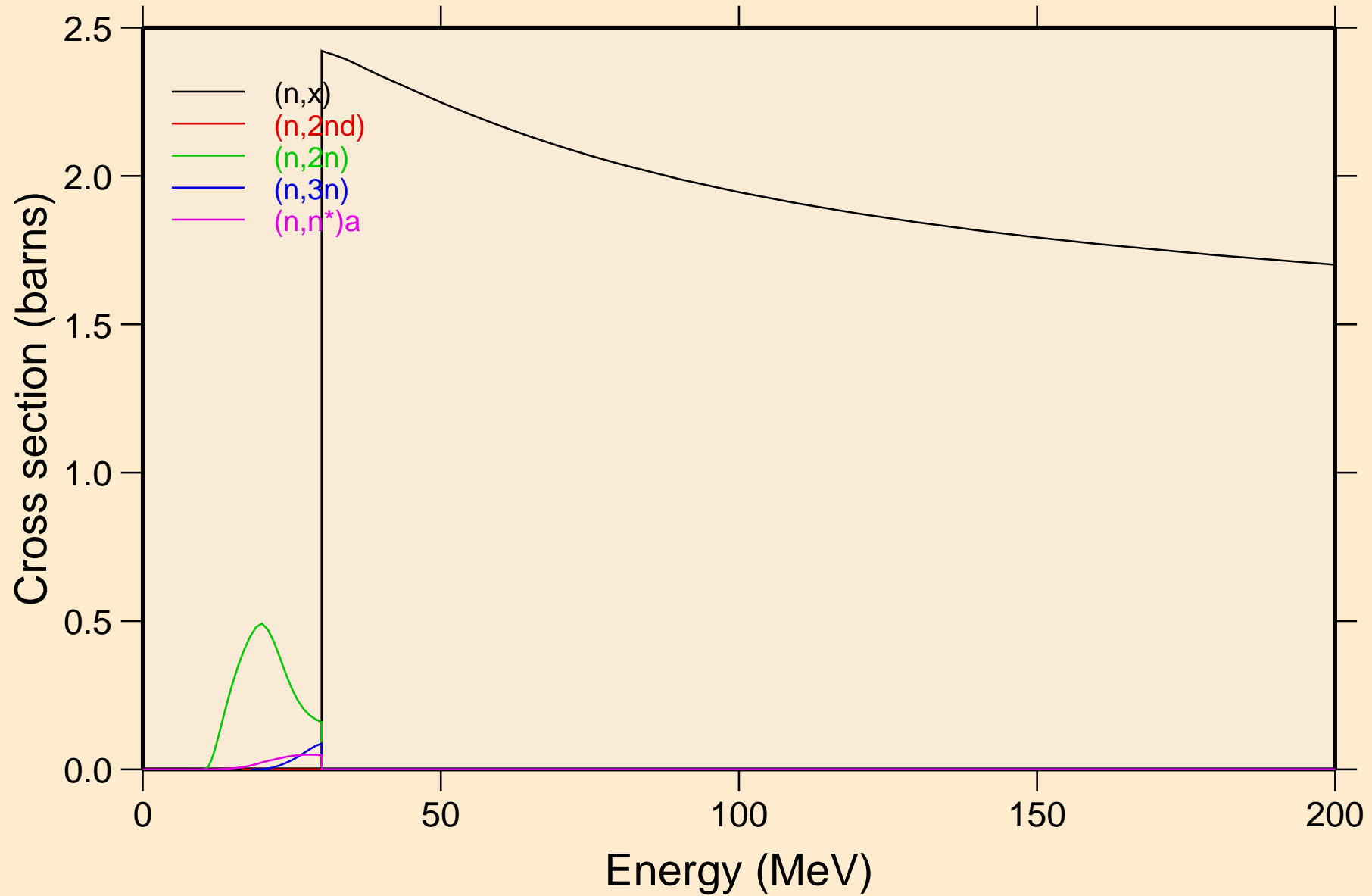

AT201 NEUTRON ACER TENDL-2021 LIBRARY; T=293.6K
Threshold reactions

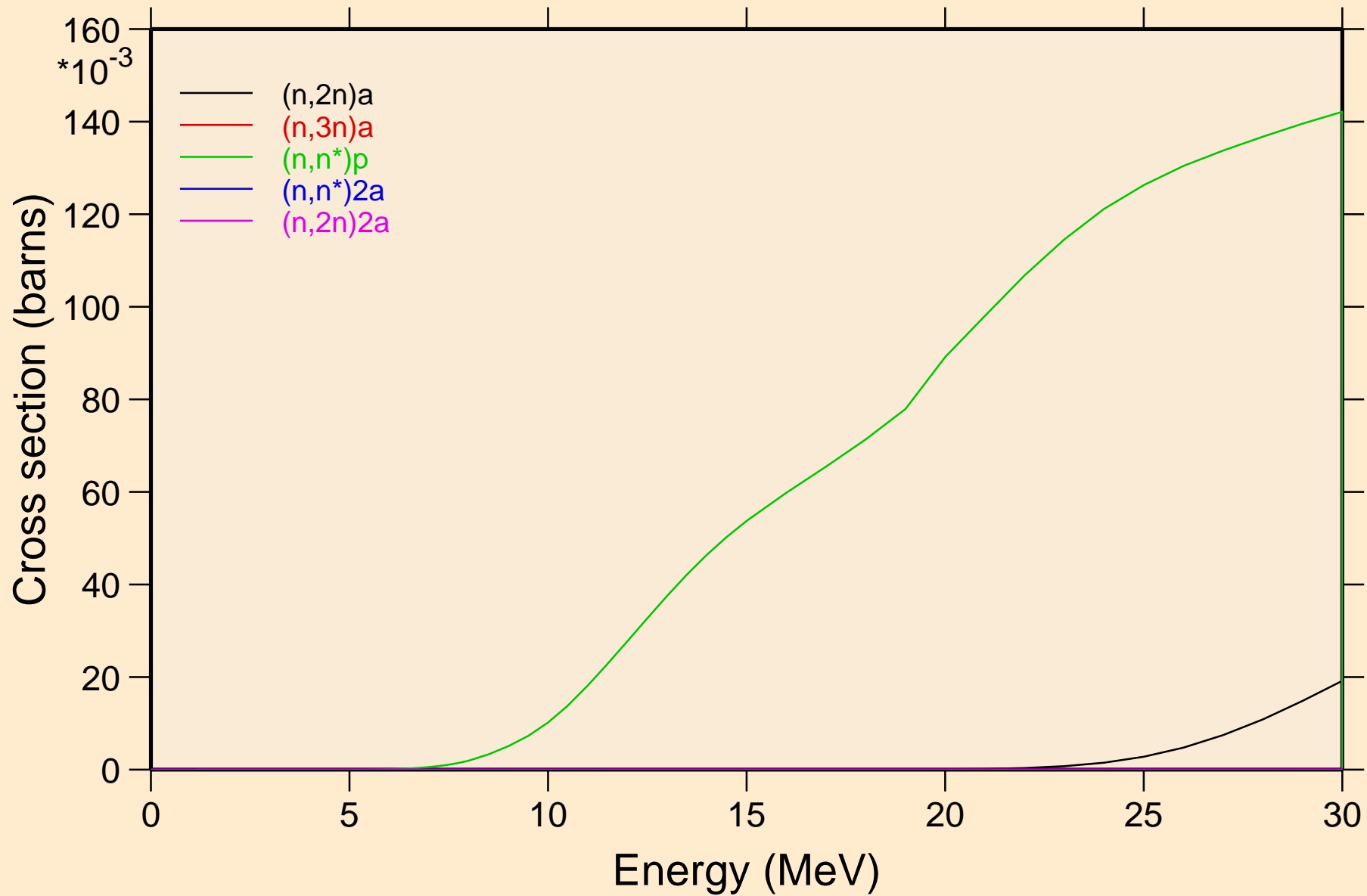

AT201 NEUTRON ACER TENDL-2021 LIBRARY; T=293.6K
Threshold reactions

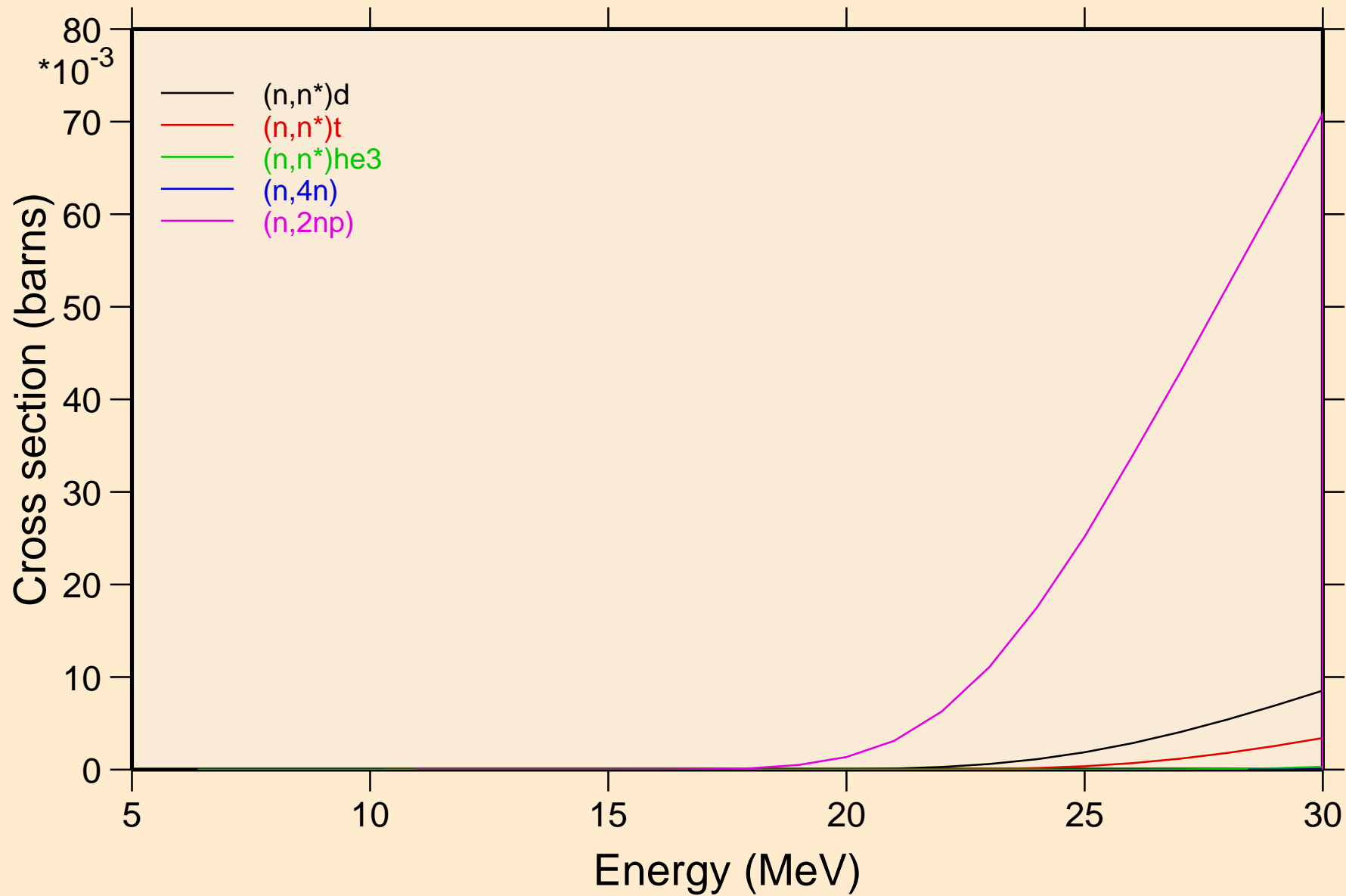

AT201 NEUTRON ACER TENDL-2021 LIBRARY; T=293.6K
Threshold reactions

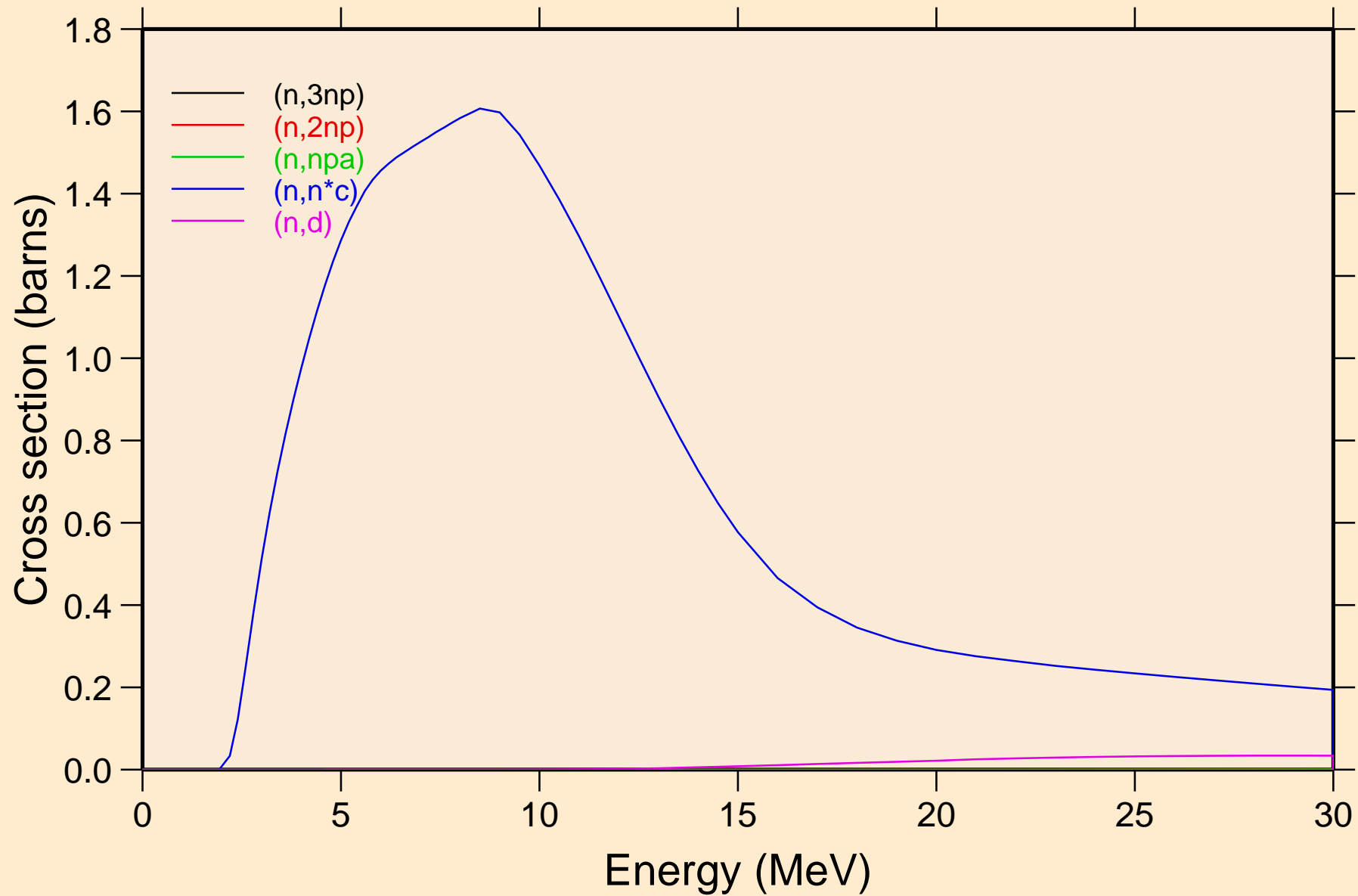

AT201 NEUTRON ACER TENDL-2021 LIBRARY; T=293.6K
Threshold reactions

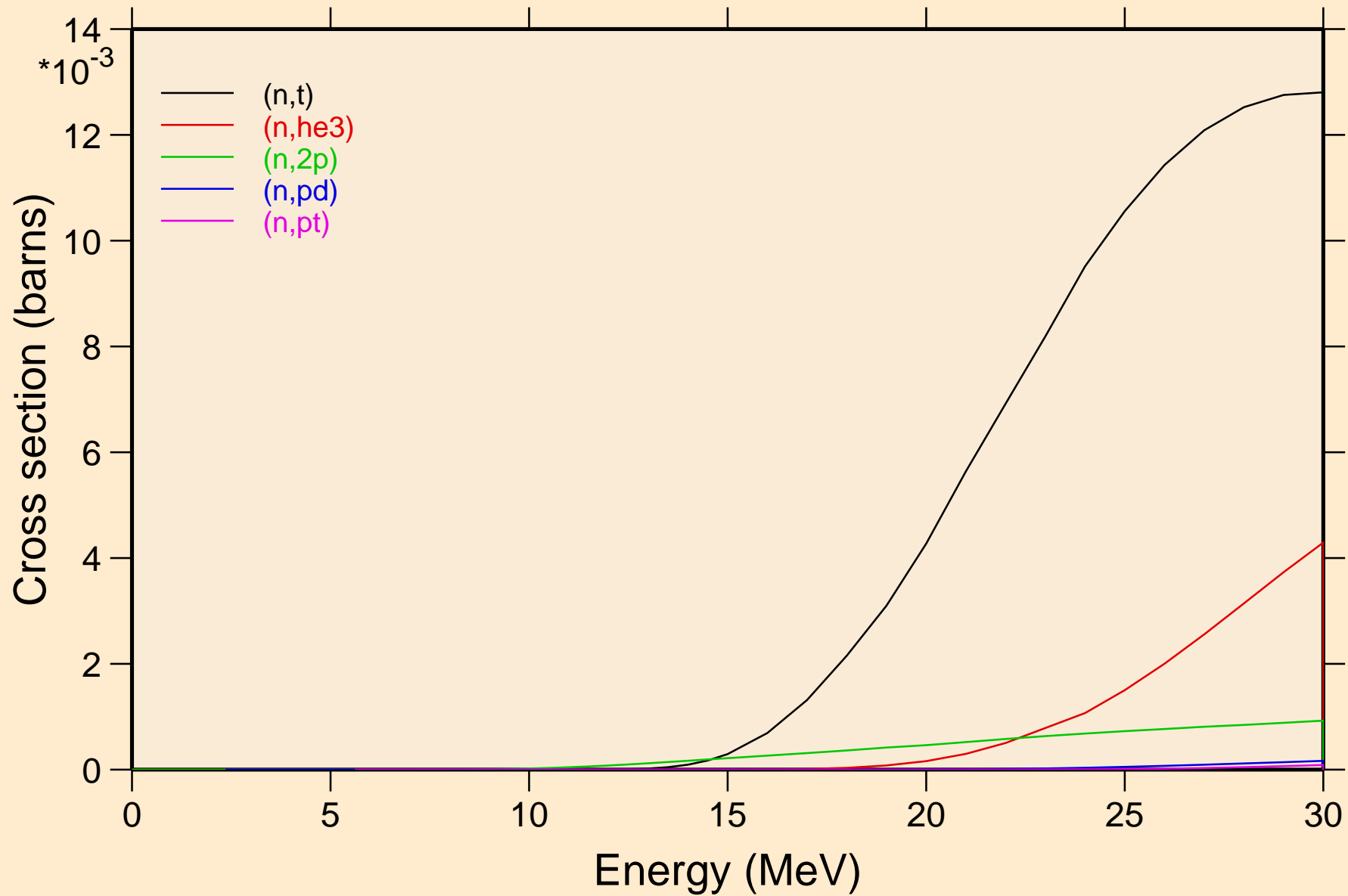

AT201 NEUTRON ACER TENDL-2021 LIBRARY; T=293.6K
Threshold reactions

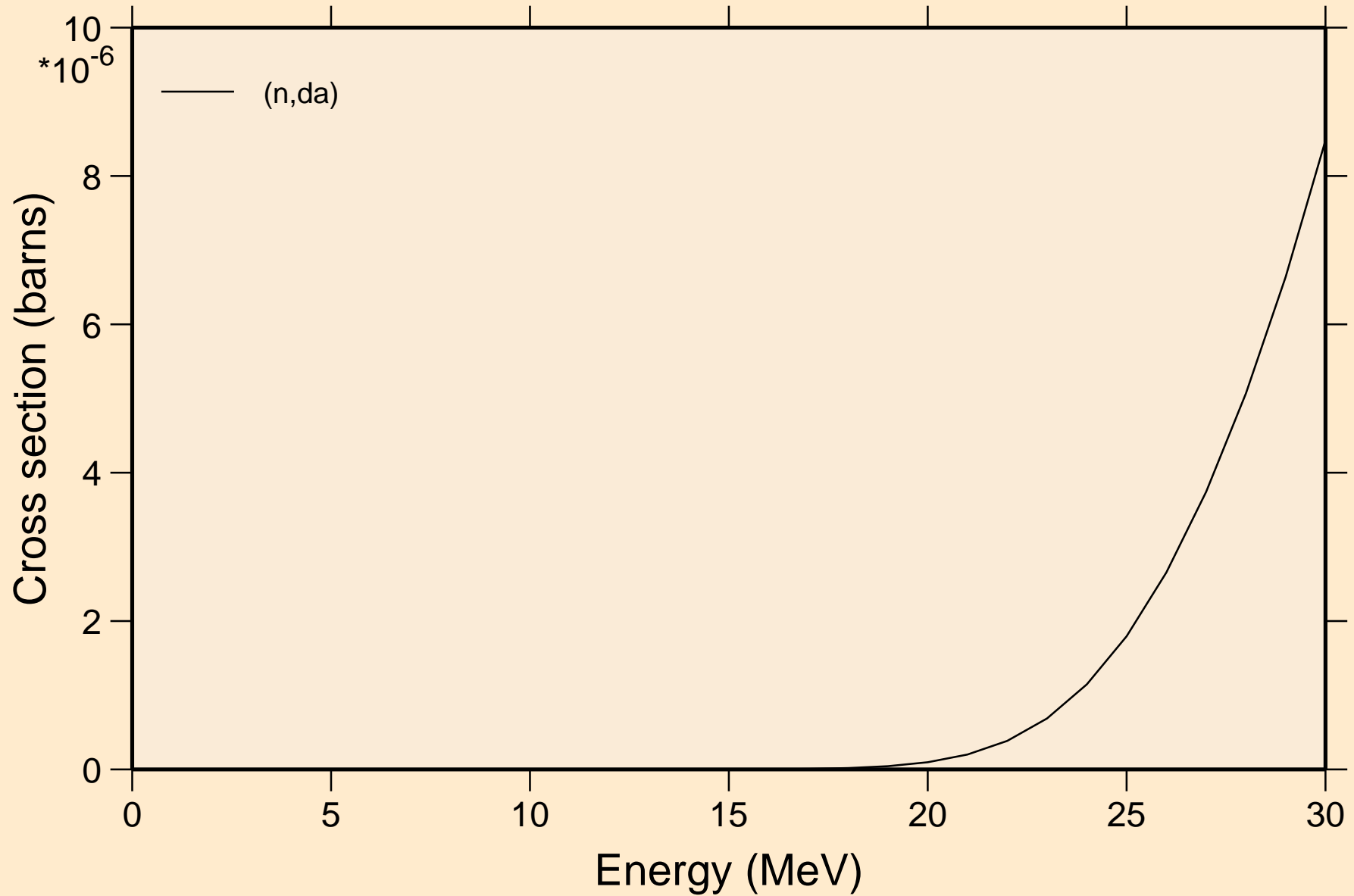

AT201 NEUTRON ACER TENDL-2021 LIBRARY; T=293.6K
Threshold reactions

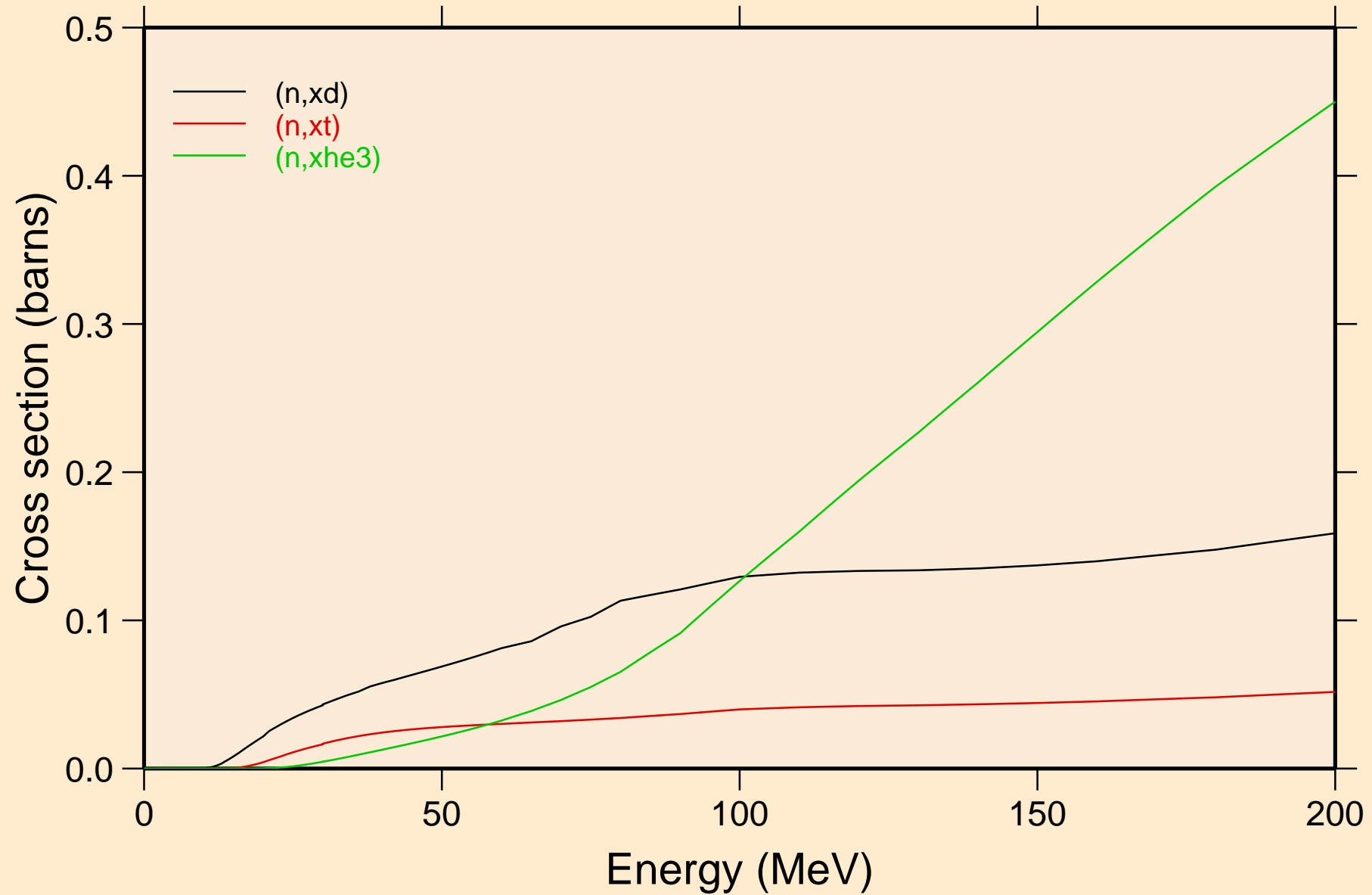

AT201 NEUTRON ACER TENDL-2021 LIBRARY; T=293.6K
angular distribution for elastic

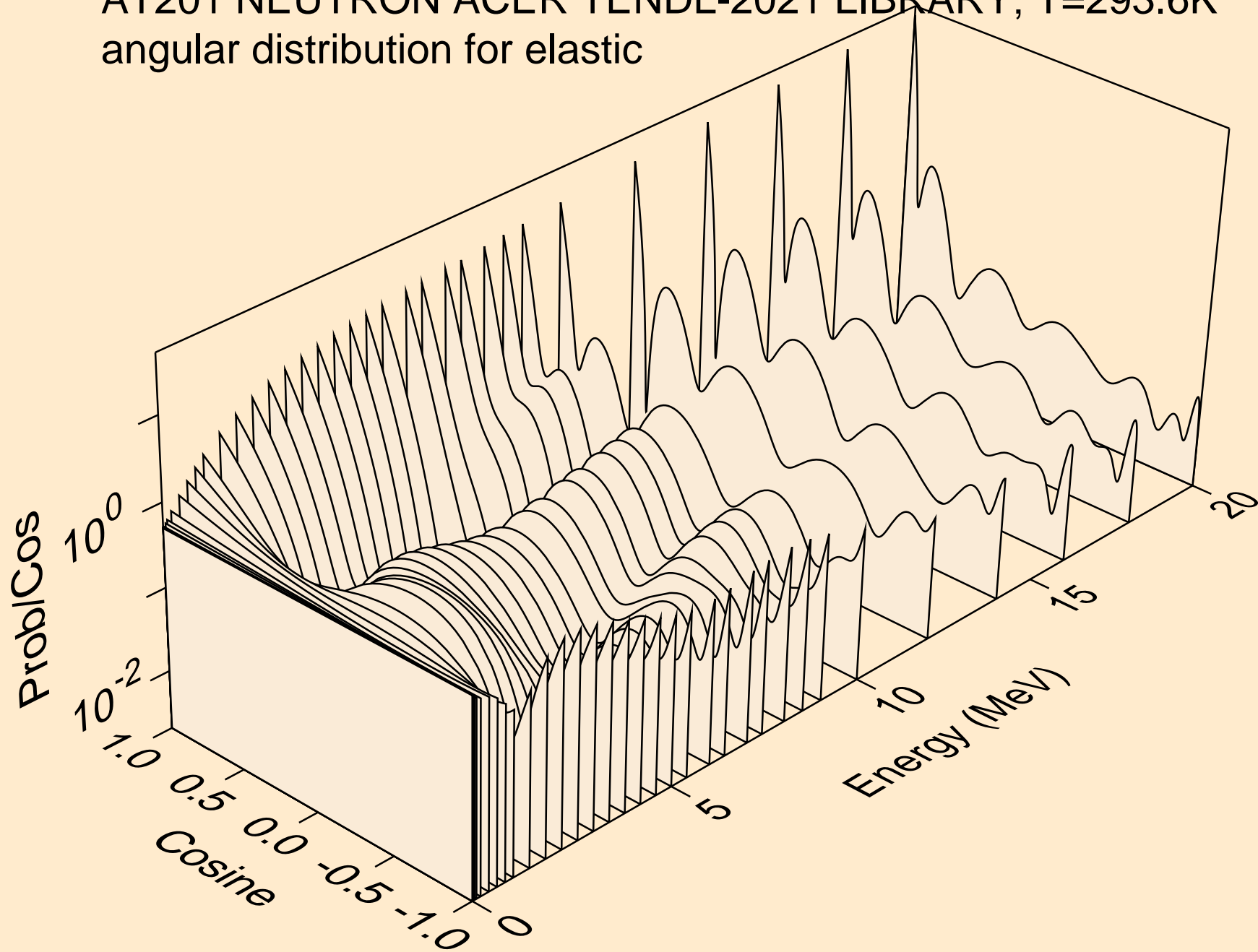

AT201 NEUTRON ACER TENDL-2021 LIBRARY; T=293.6K
angular distribution for elastic

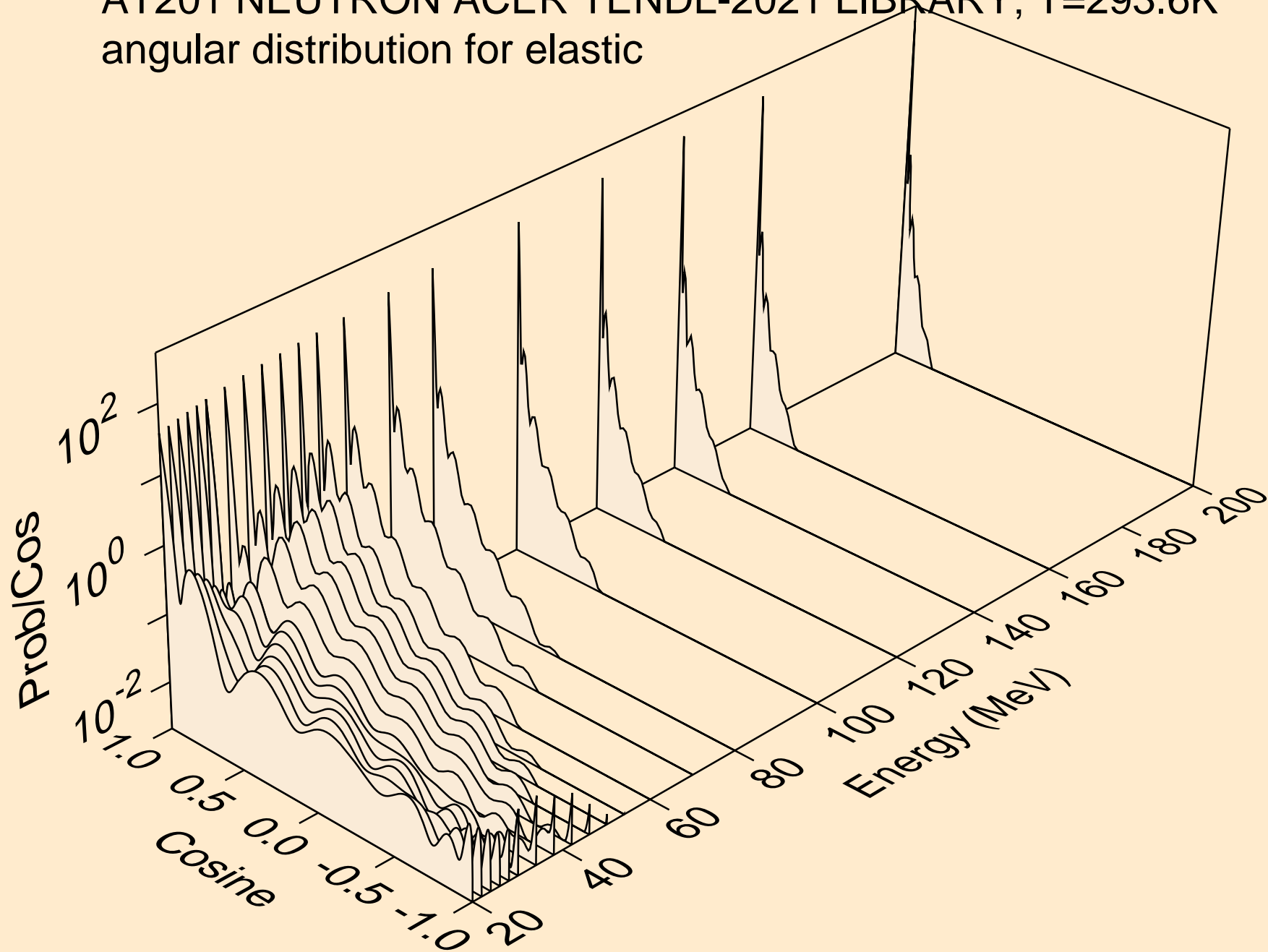

AT201 NEUTRON ACER TENDL-2021 LIBRARY; T=293.6K
angular distribution for (n,n*1)

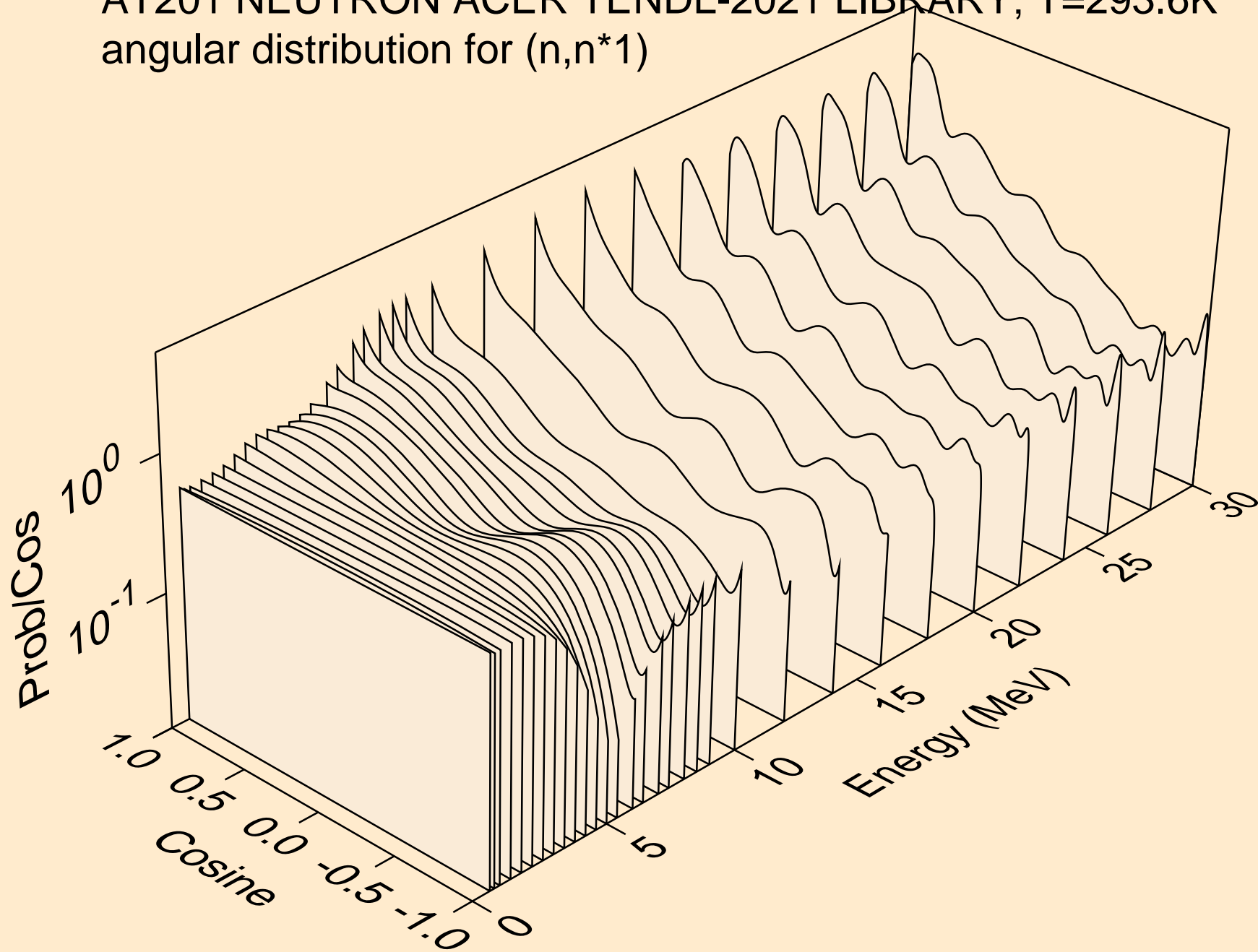

AT201 NEUTRON ACER TENDL-2021 LIBRARY; T=293.6K
angular distribution for (n,n*2)

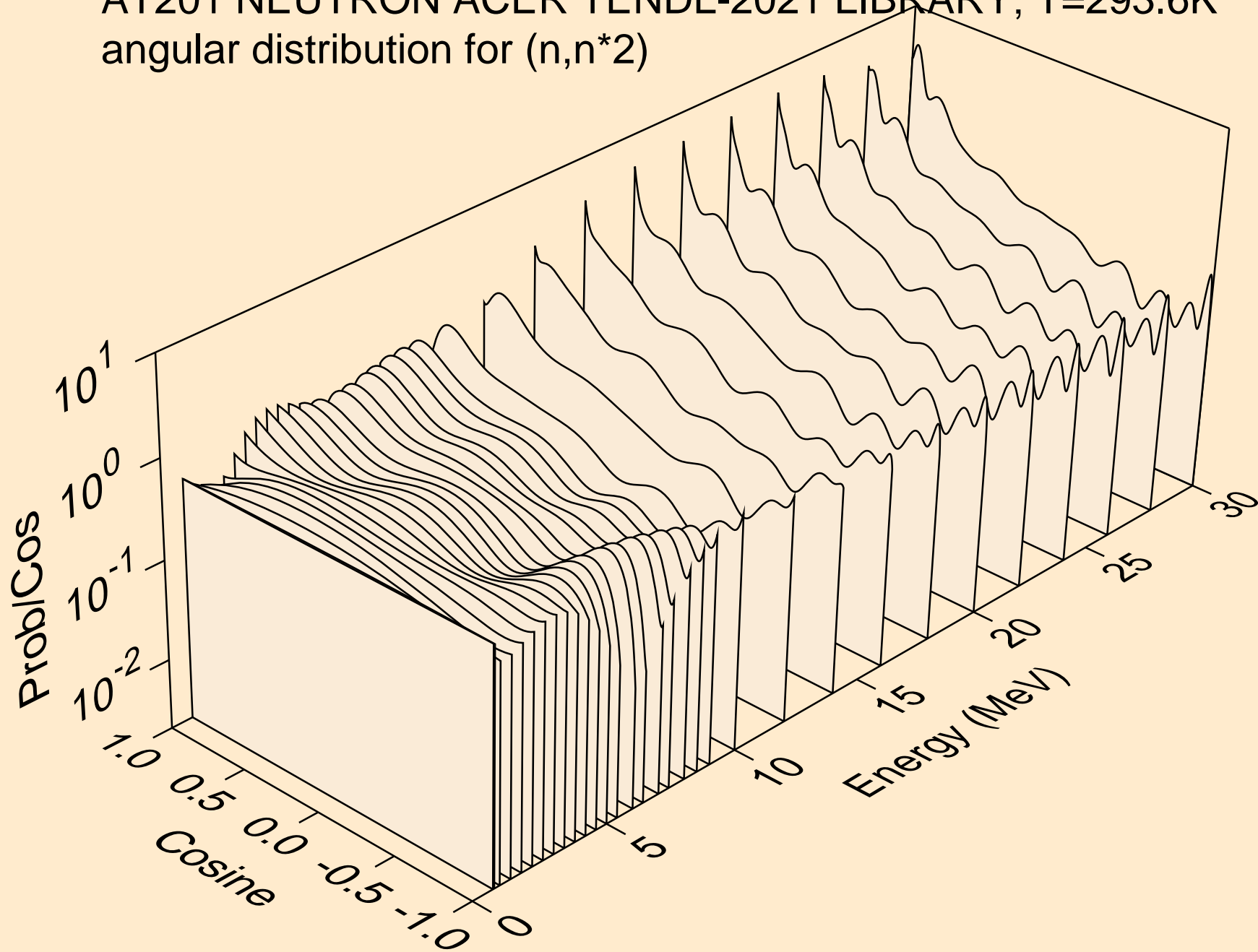

AT201 NEUTRON ACER TENDL-2021 LIBRARY; T=293.6K
angular distribution for (n,n*3)

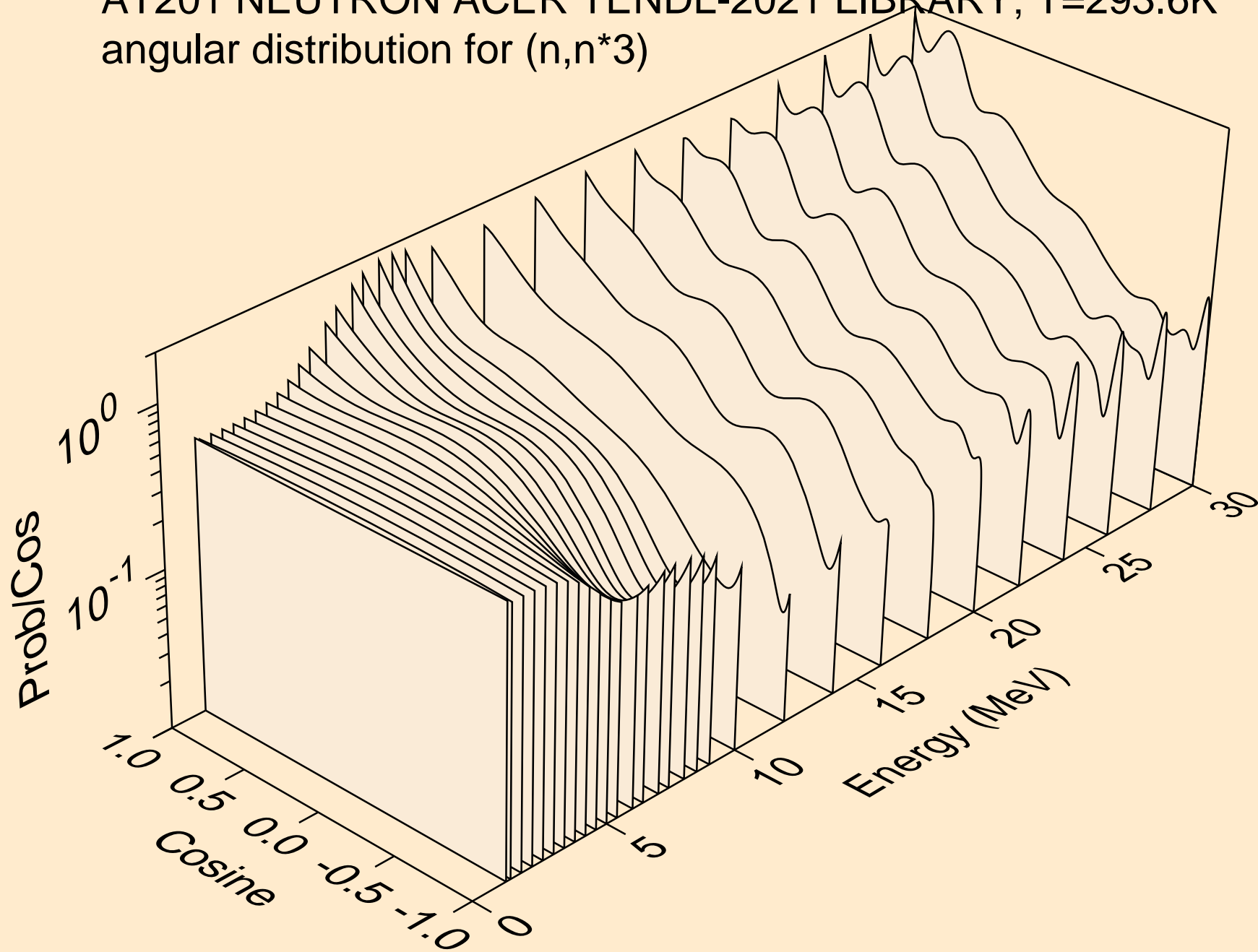

AT201 NEUTRON ACER TENDL-2021 LIBRARY; T=293.6K
angular distribution for (n,n*4)

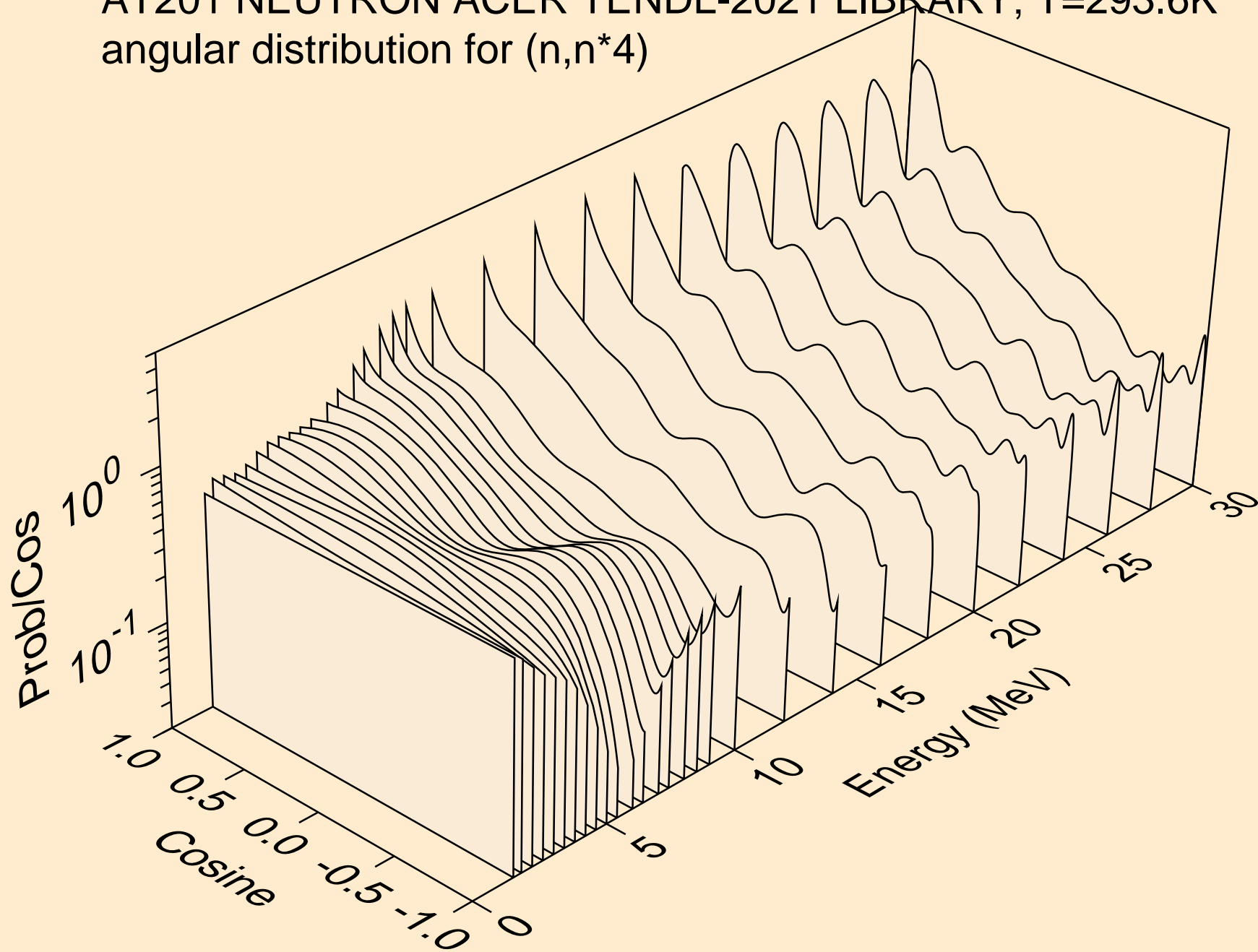

AT201 NEUTRON ACER TENDL-2021 LIBRARY; T=293.6K
angular distribution for (n,n*5)

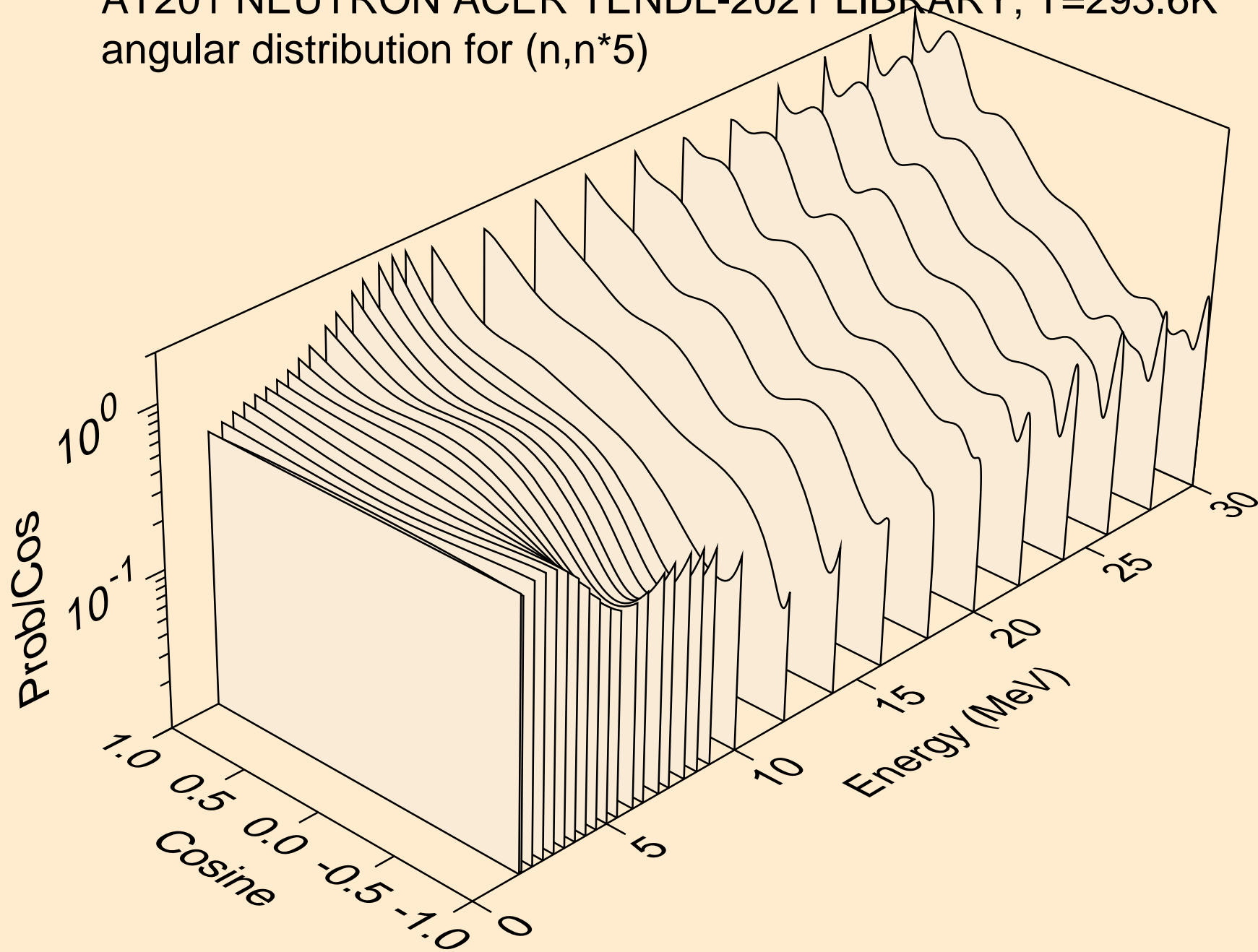

AT201 NEUTRON ACER TENDL-2021 LIBRARY; T=293.6K
angular distribution for (n,n*6)

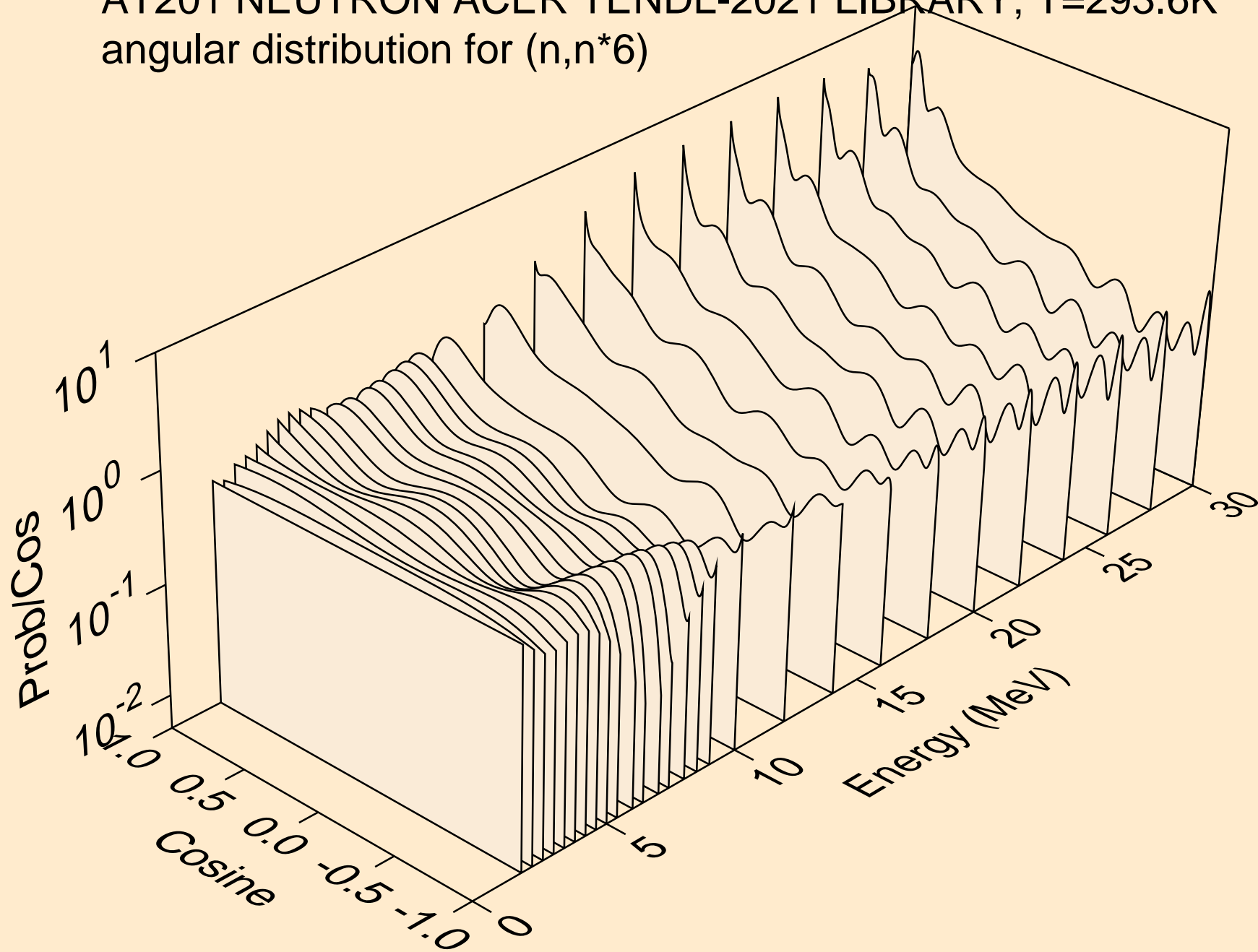

AT201 NEUTRON ACER TENDL-2021 LIBRARY; T=293.6K
angular distribution for (n,n*7)

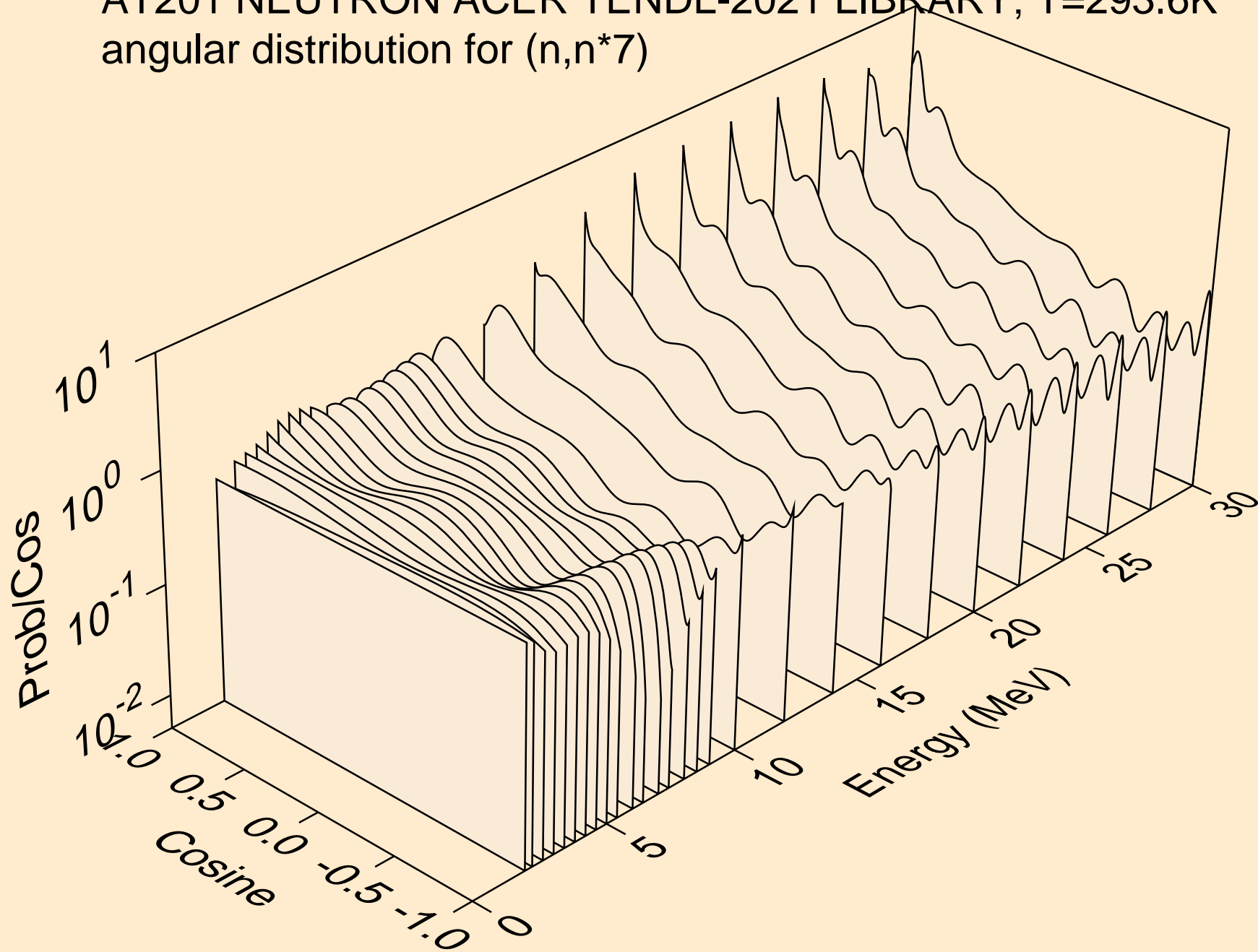

AT201 NEUTRON ACER TENDL-2021 LIBRARY; T=293.6K
Neutron emission for (n,x)

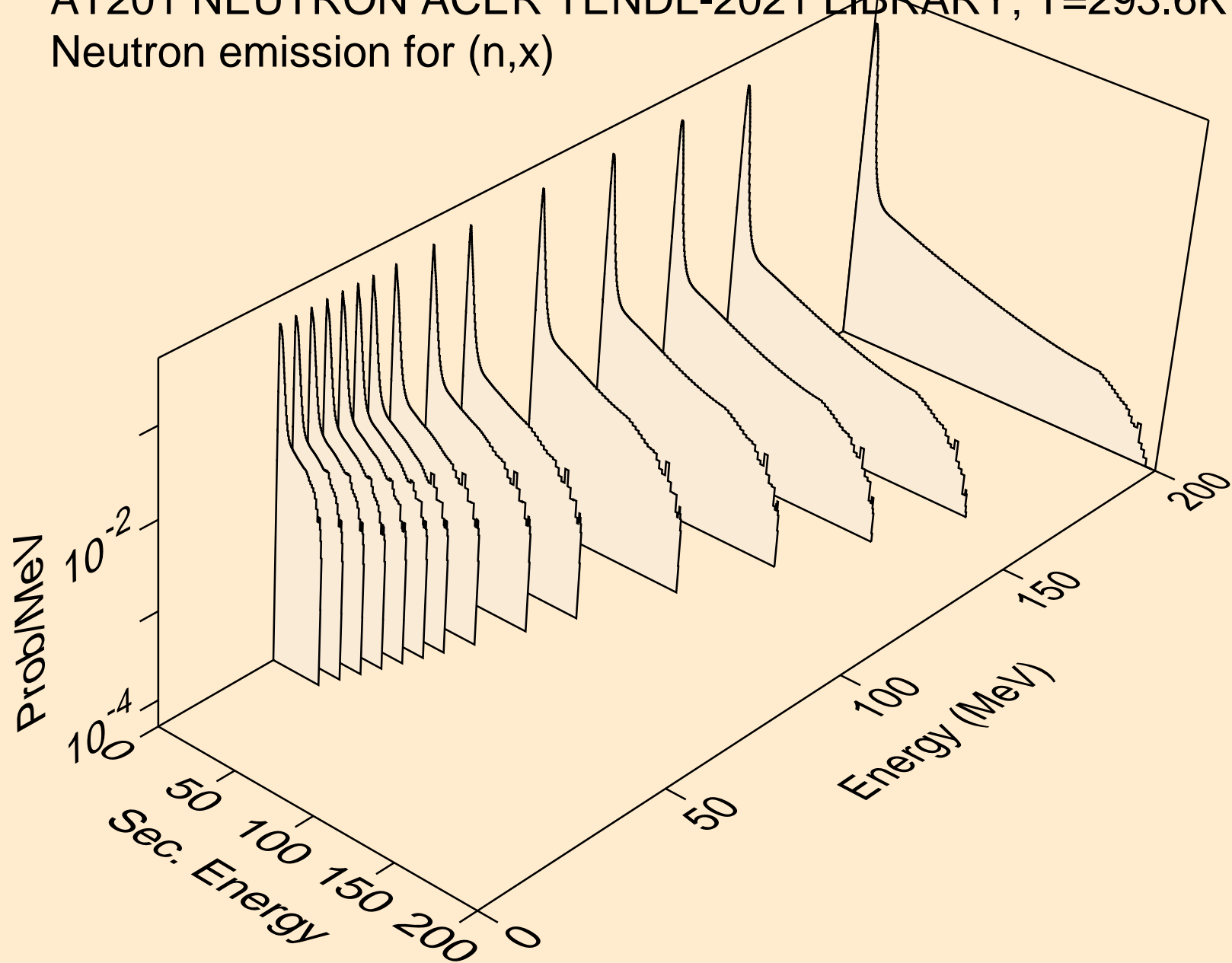

AT201 NEUTRON ACER TENDL-2021 LIBRARY; T=293.6K
Neutron emission for (n,2nd)

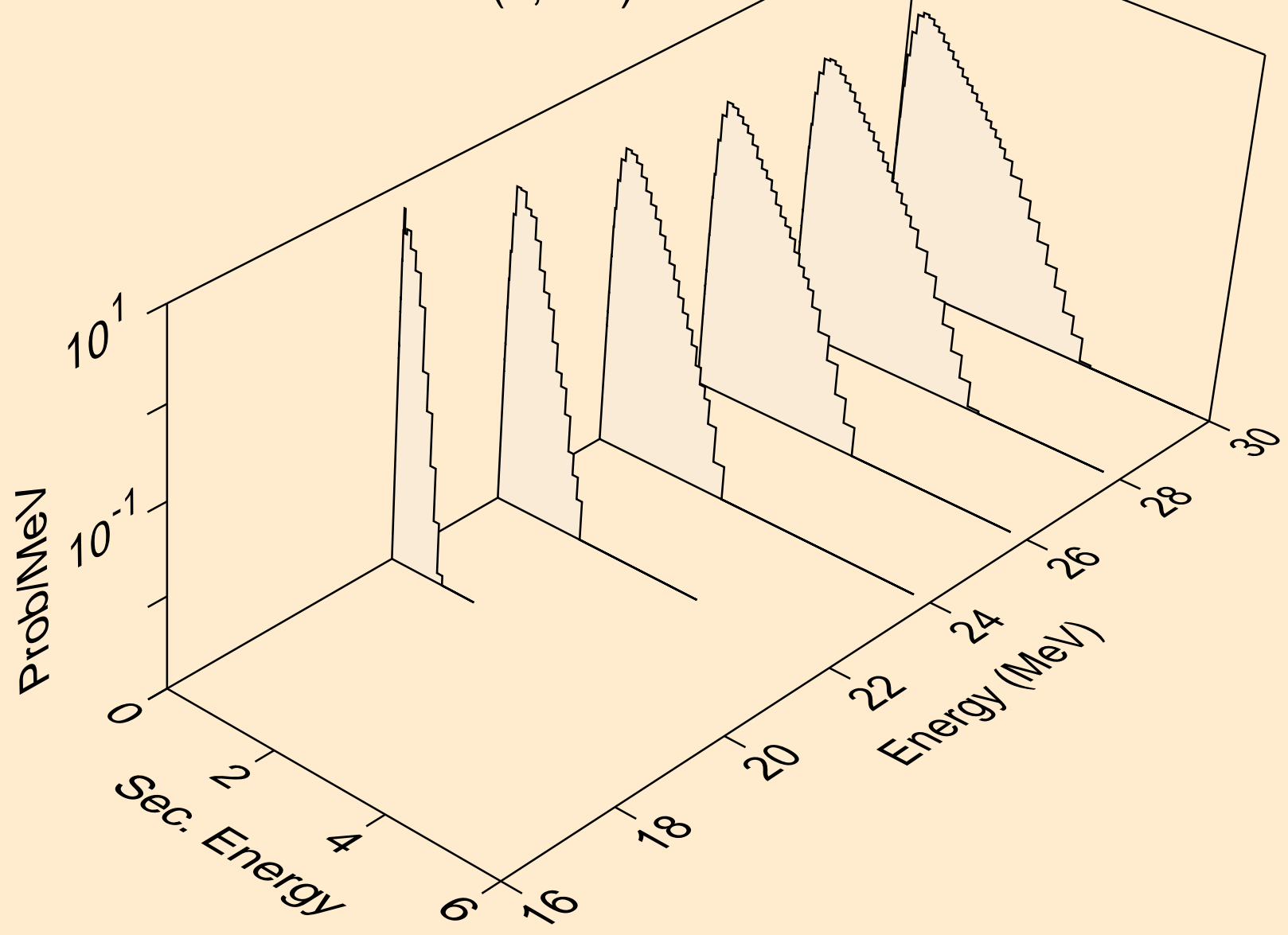

AT201 NEUTRON ACER TENDL-2021 LIBRARY; T=293.6K
Neutron emission for (n,2n)

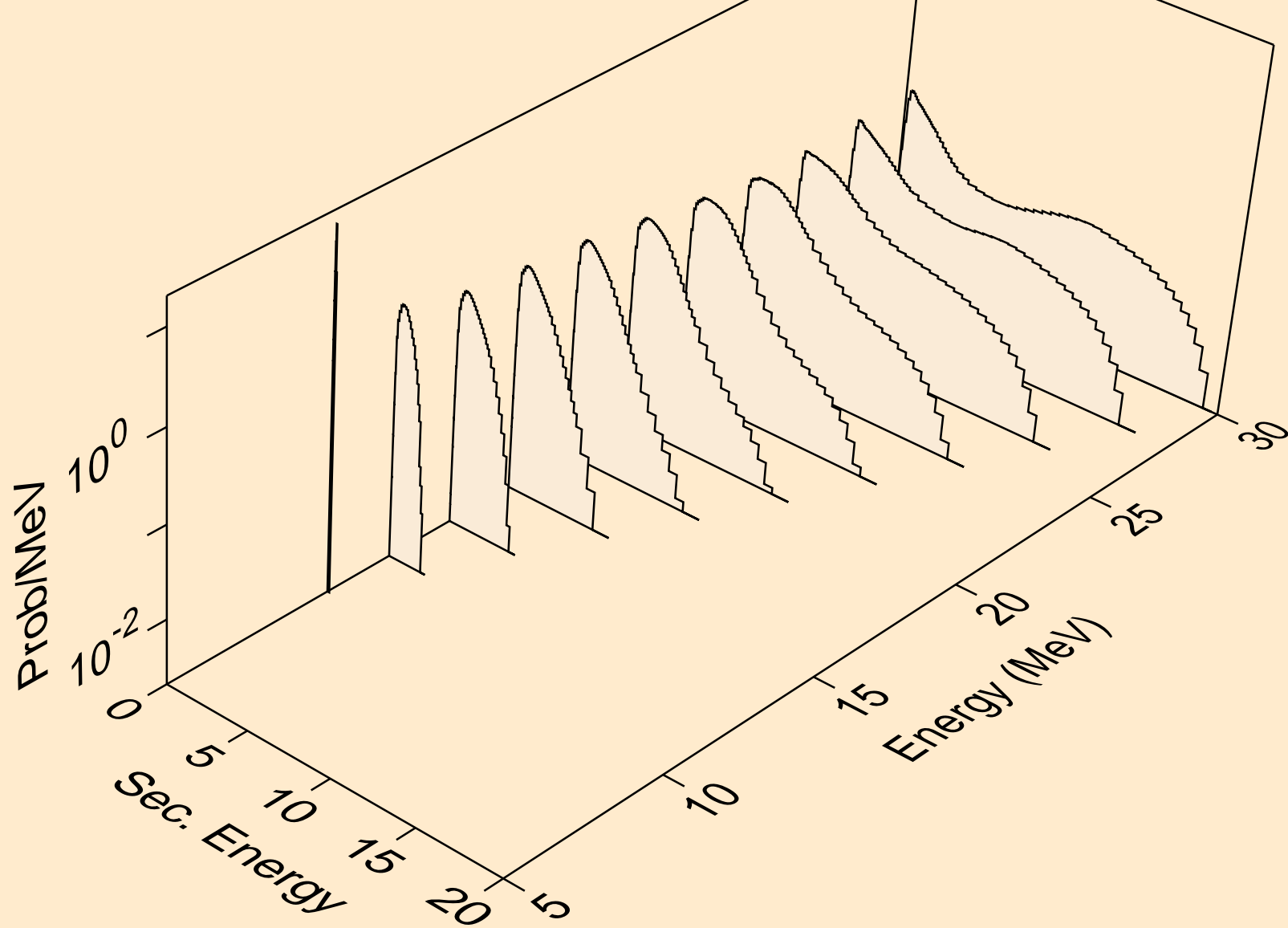

AT201 NEUTRON ACER TENDL-2021 LIBRARY; T=293.6K
Neutron emission for (n,3n)

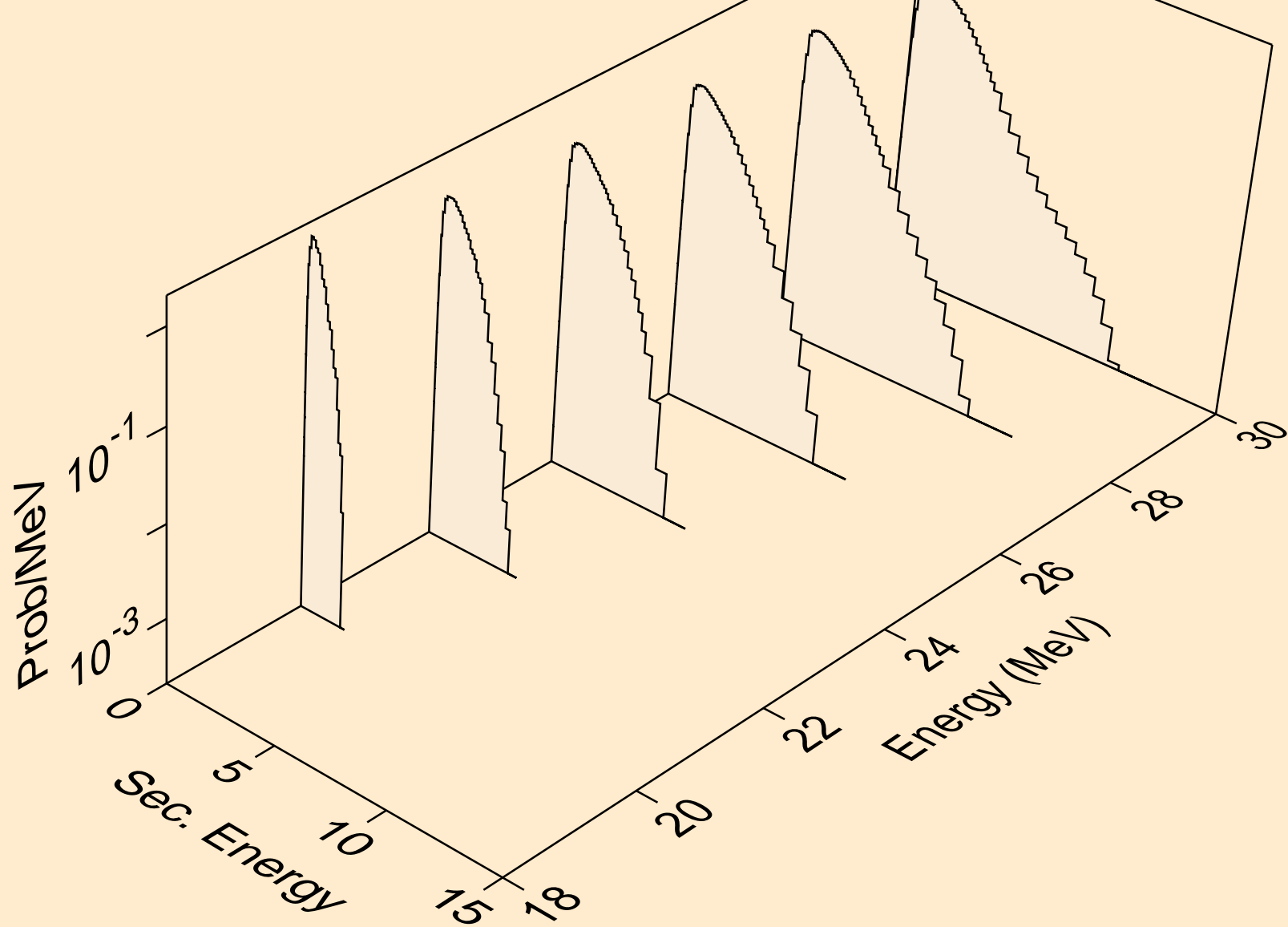

AT201 NEUTRON ACER TENDL-2021 LIBRARY; T=293.6K
Neutron emission for (n,n*)a

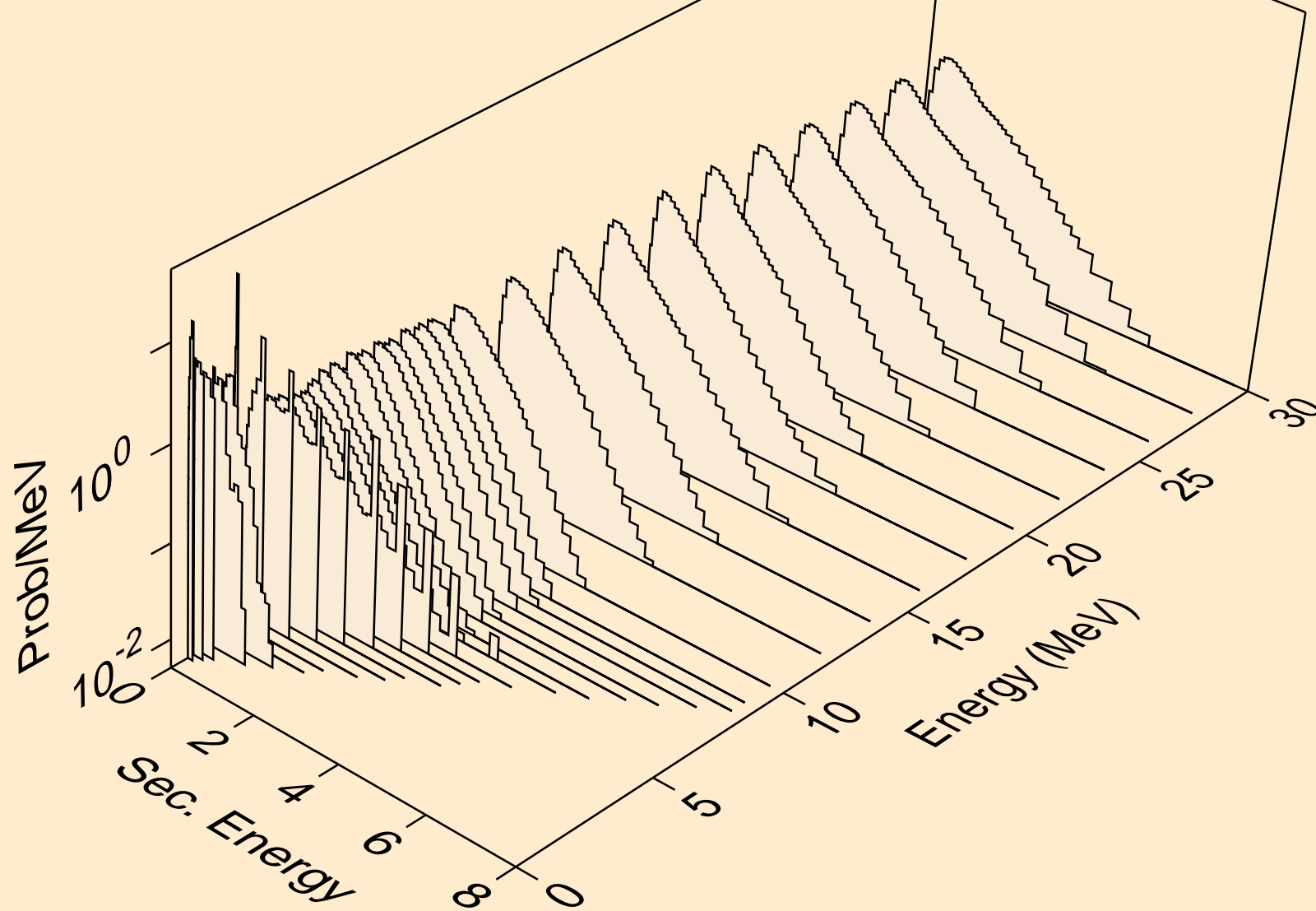

AT201 NEUTRON ACER TENDL-2021 LIBRARY; T=293.6K
Neutron emission for (n,2n)a

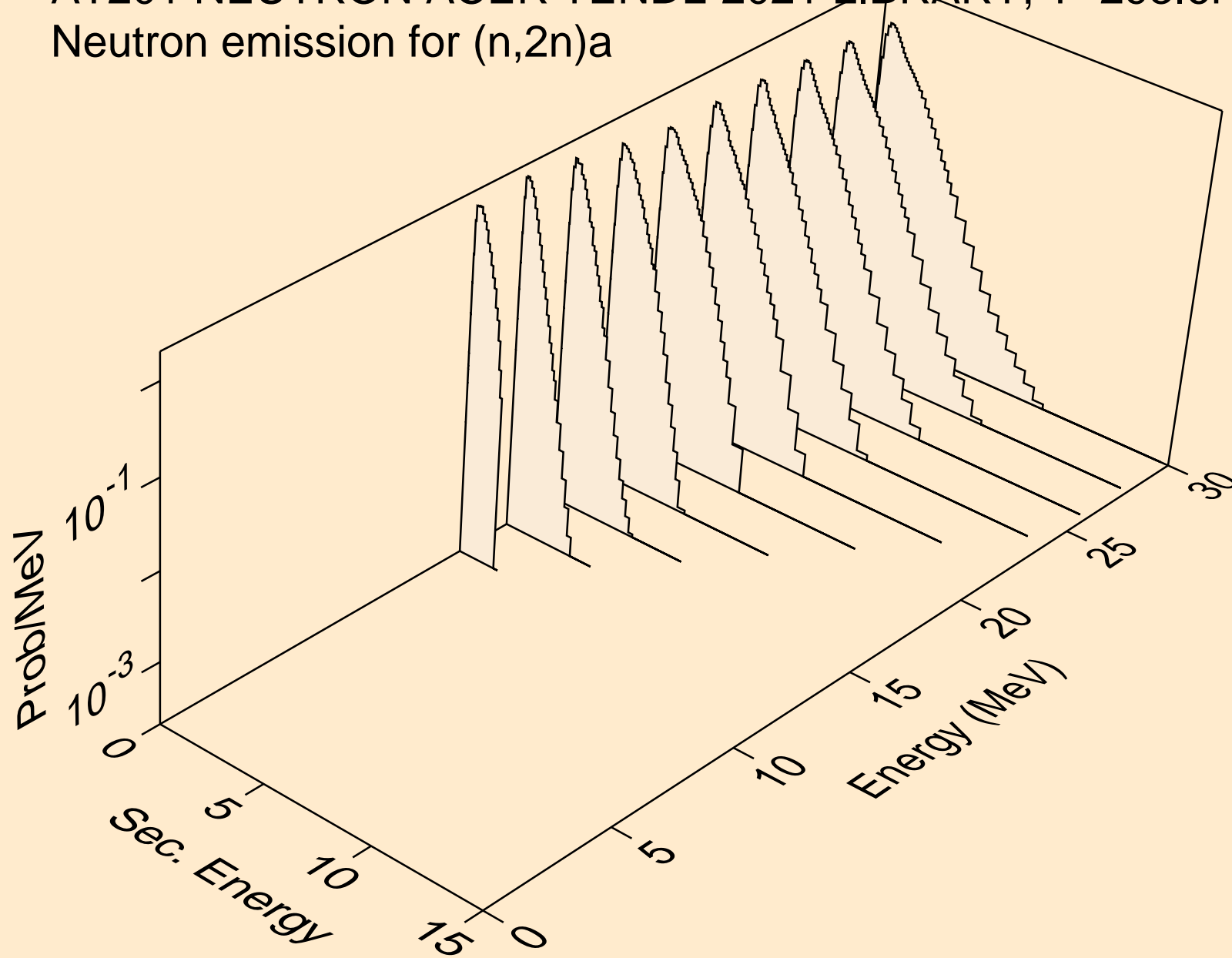

AT201 NEUTRON ACER TENDL-2021 LIBRARY; T=293.6K
Neutron emission for (n,3n)a

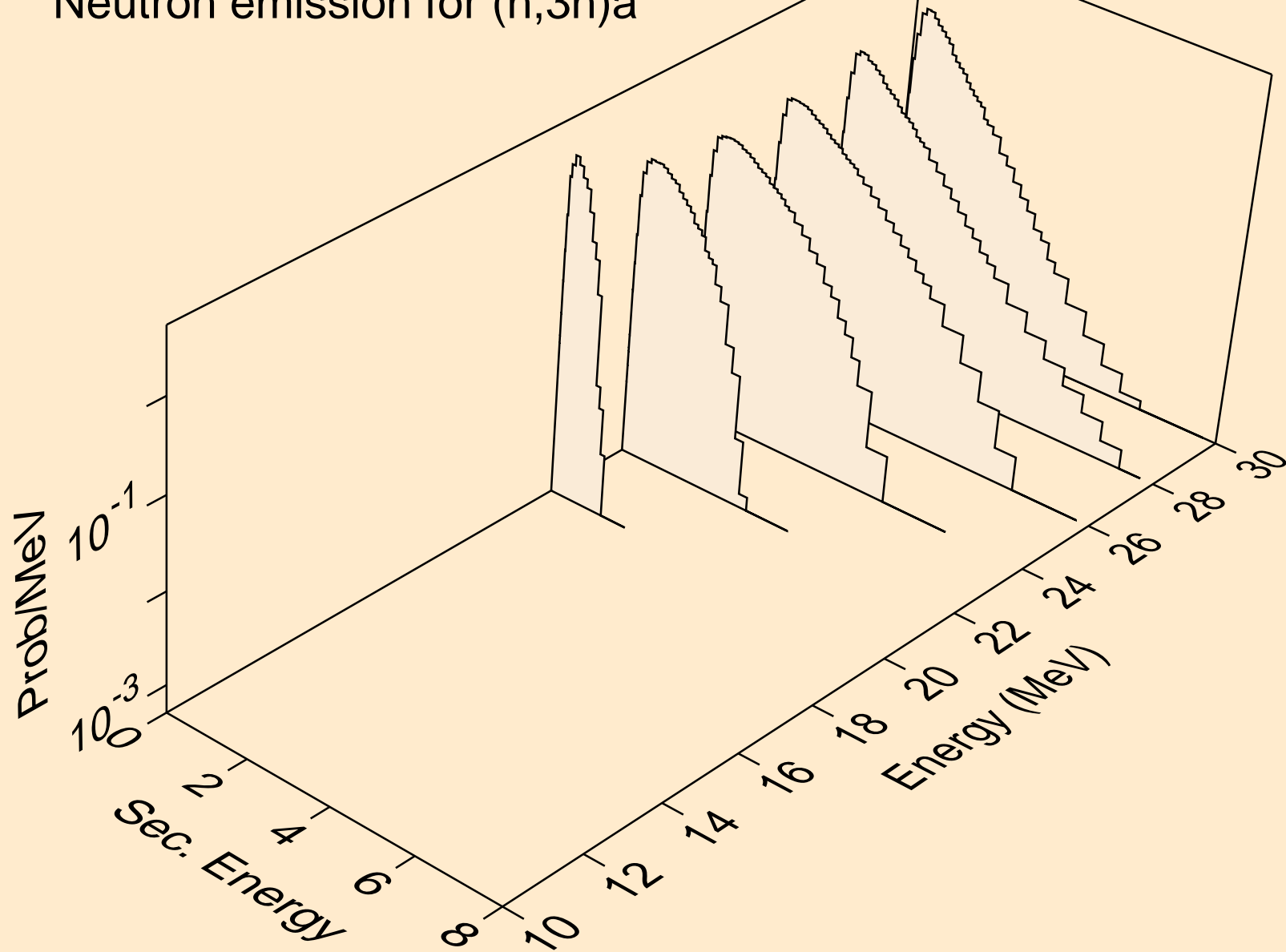

AT201 NEUTRON ACER TENDL-2021 LIBRARY; T=293.6K
Neutron emission for (n,n*)p

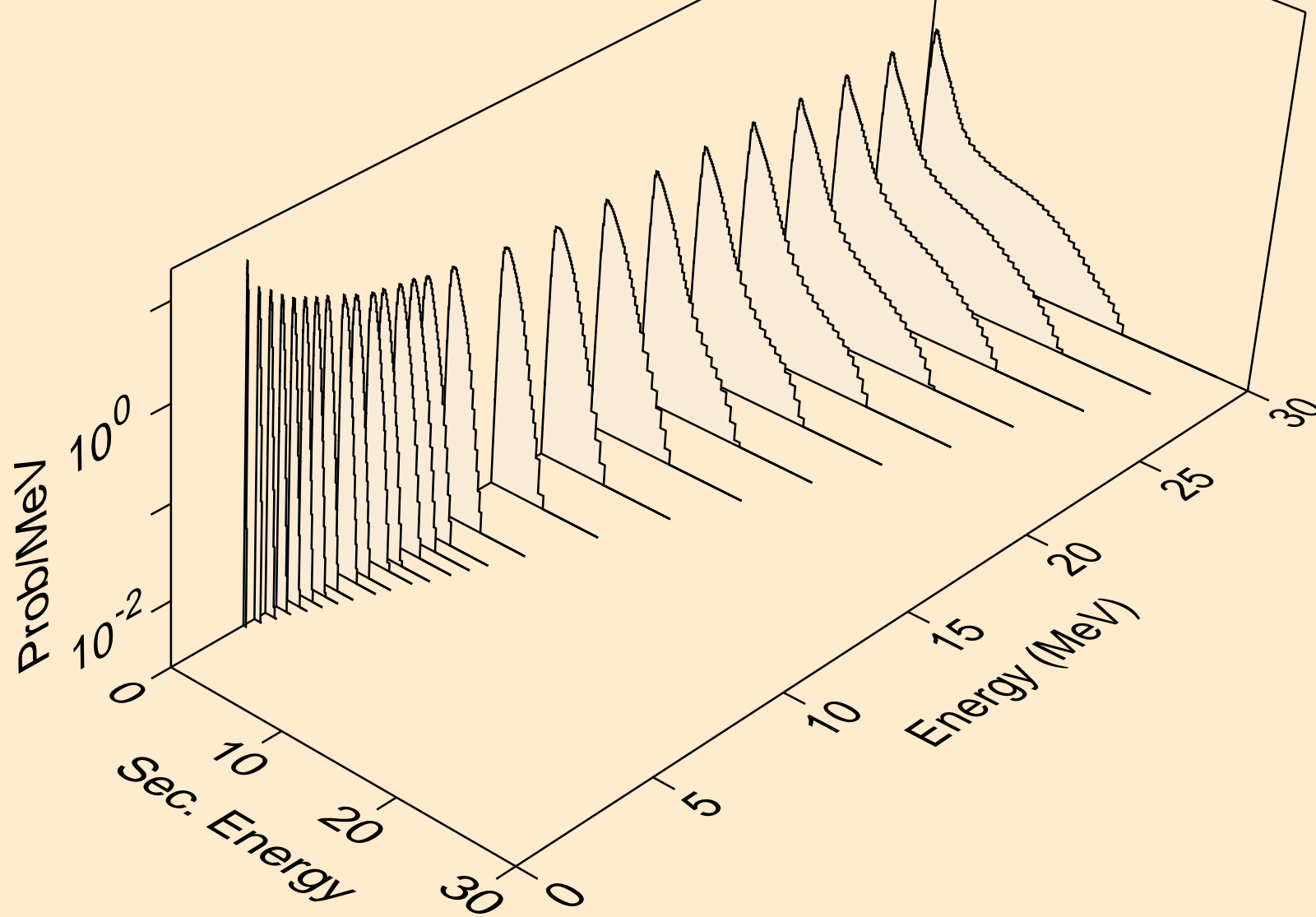

AT201 NEUTRON ACER TENDL-2021 LIBRARY; T=293.6K
Neutron emission for (n,n*)2a

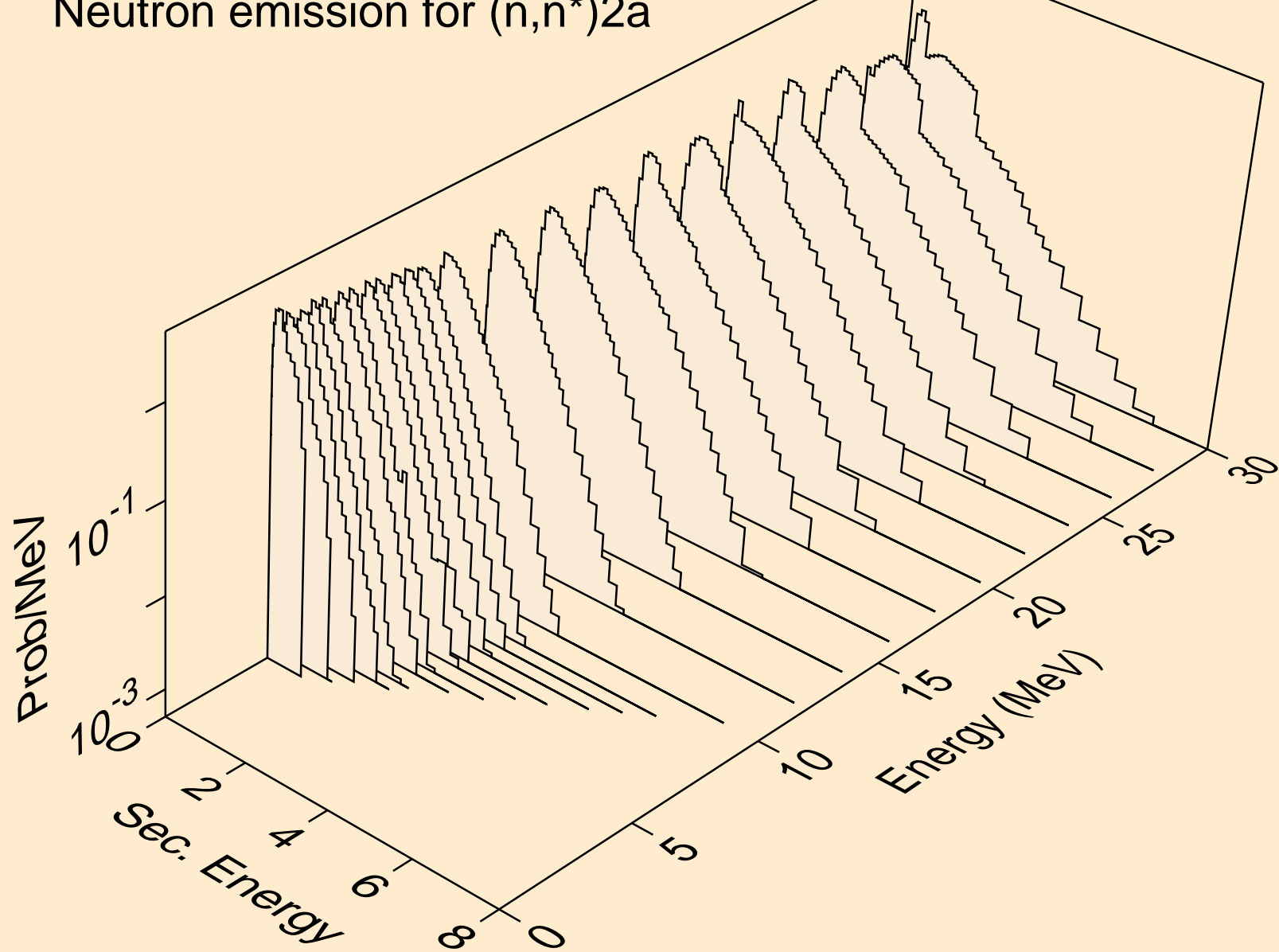

AT201 NEUTRON ACER TENDL-2021 LIBRARY; T=293.6K
Neutron emission for (n,2n)2a

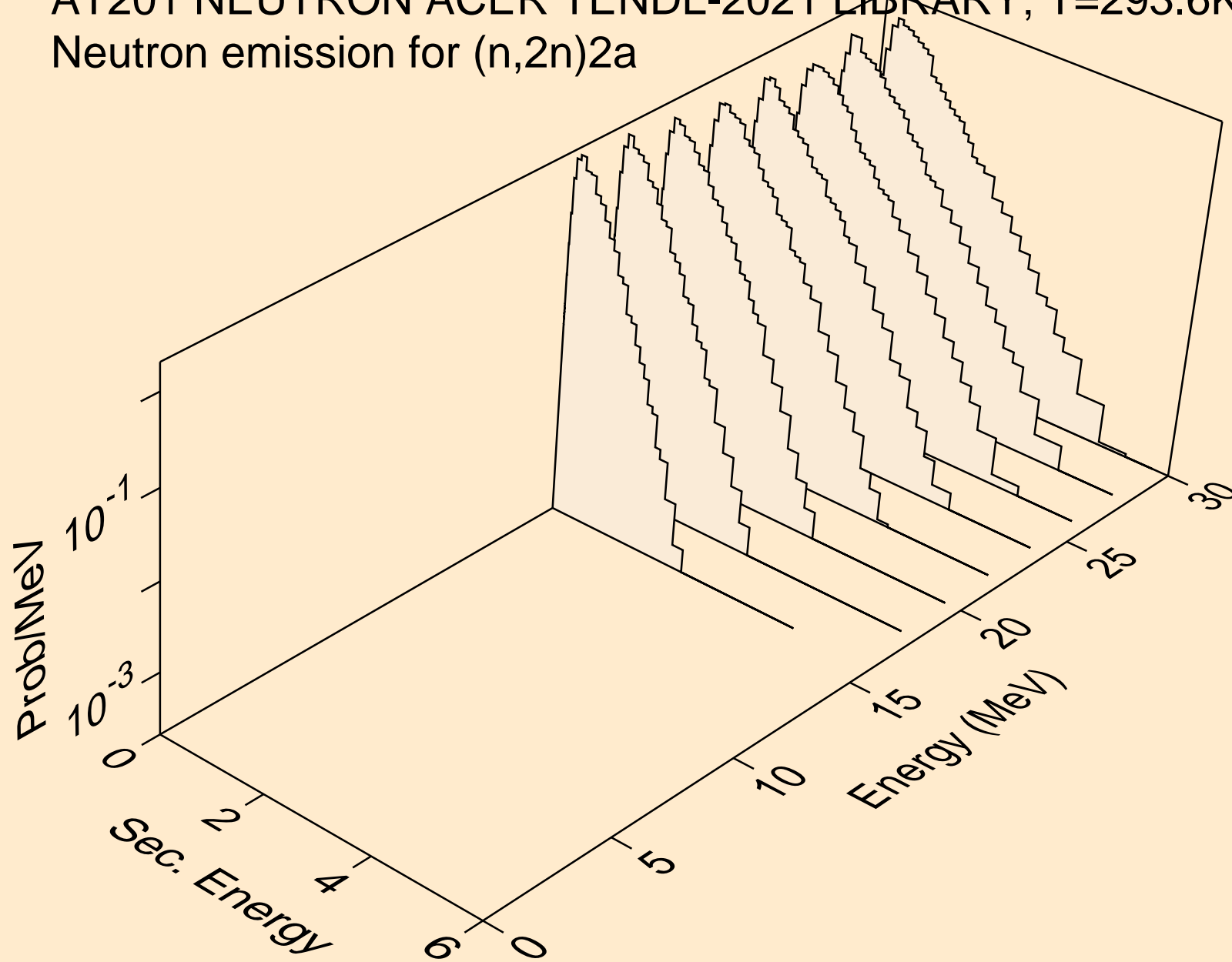

AT201 NEUTRON ACER TENDL-2021 LIBRARY; T=293.6K
Neutron emission for (n,n*)d

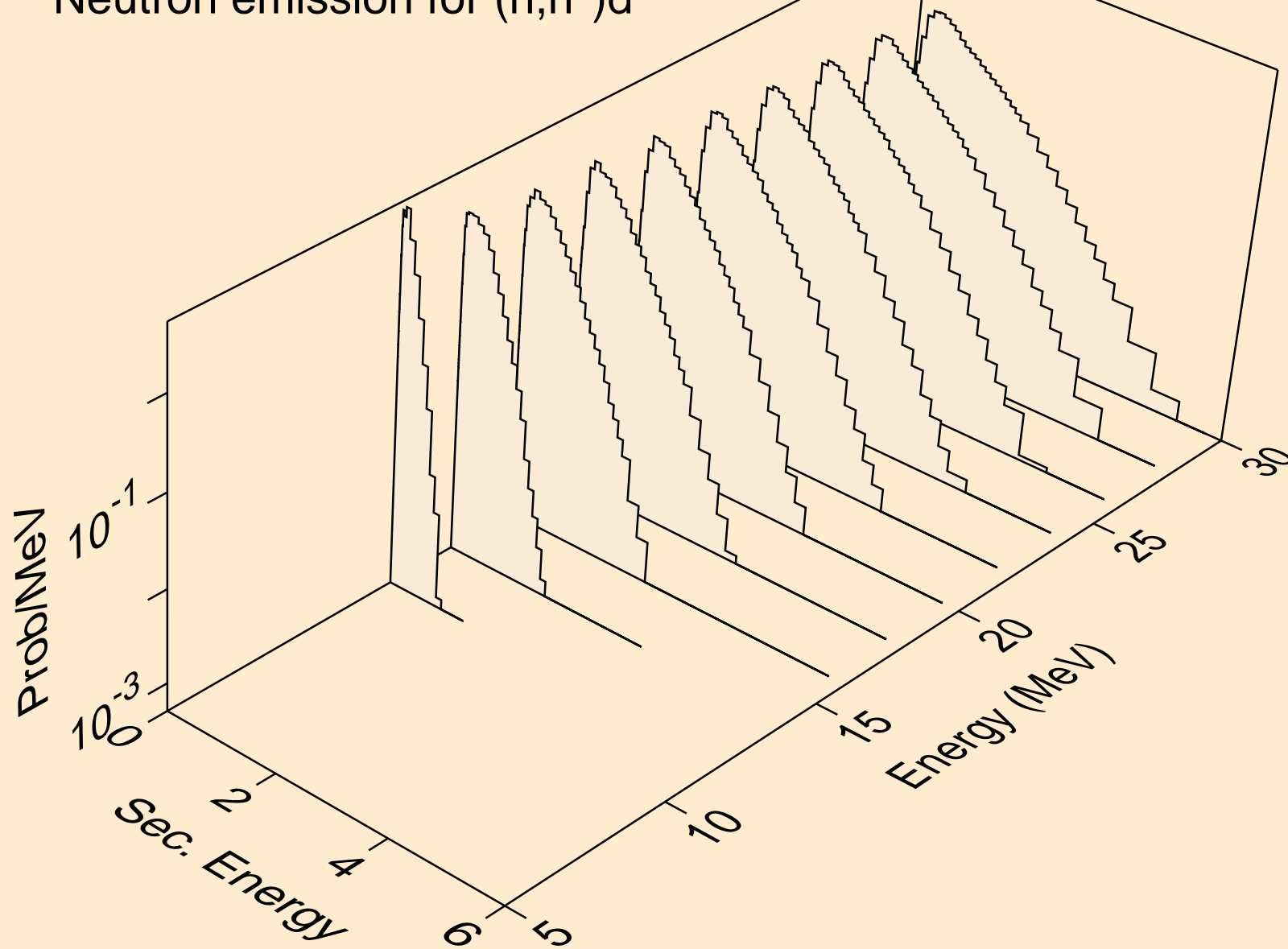

AT201 NEUTRON ACER TENDL-2021 LIBRARY; T=293.6K
Neutron emission for (n,n*)t

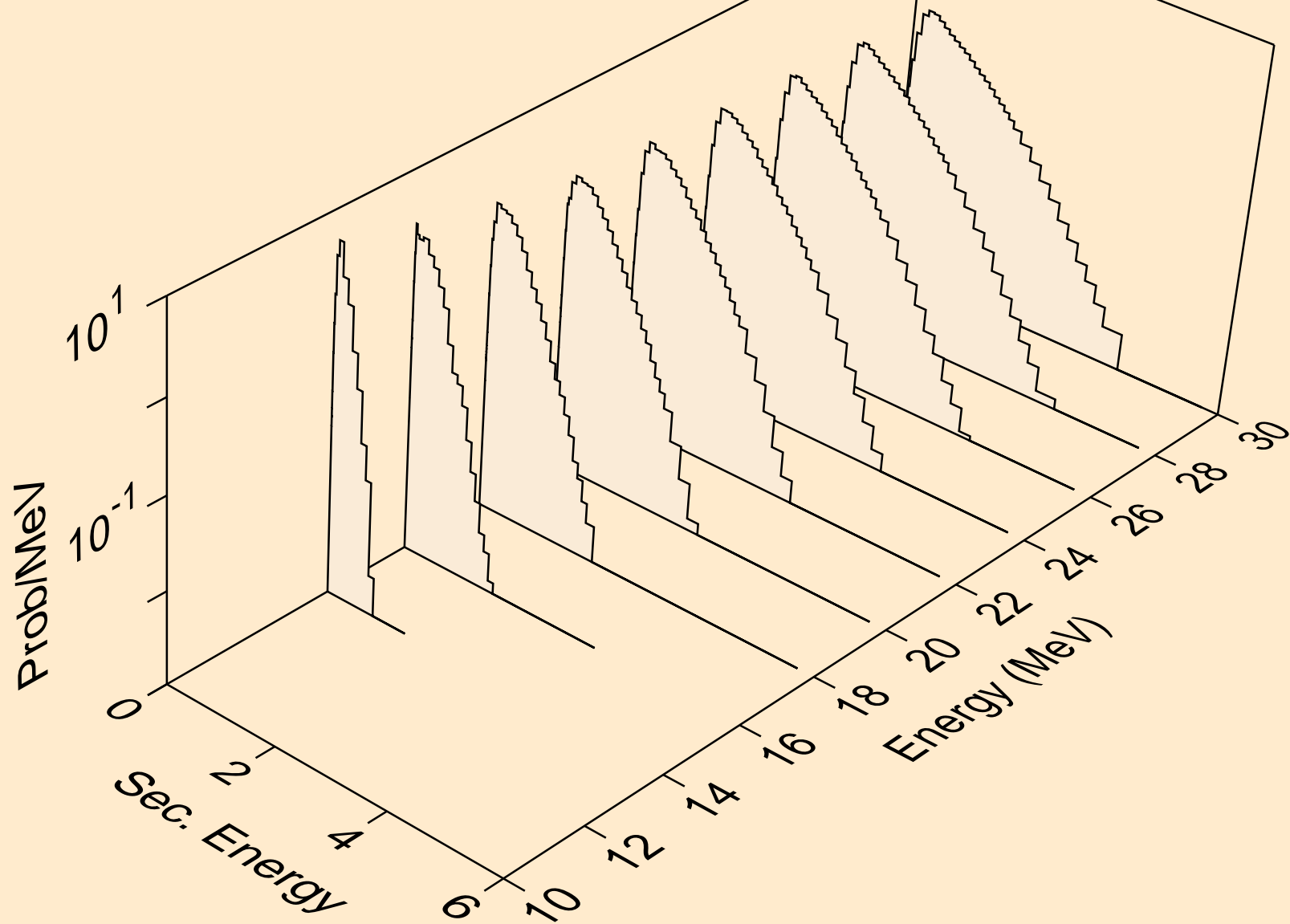

AT201 NEUTRON ACER TENDL-2021 LIBRARY; T=293.6K
Neutron emission for (n,n*)he3

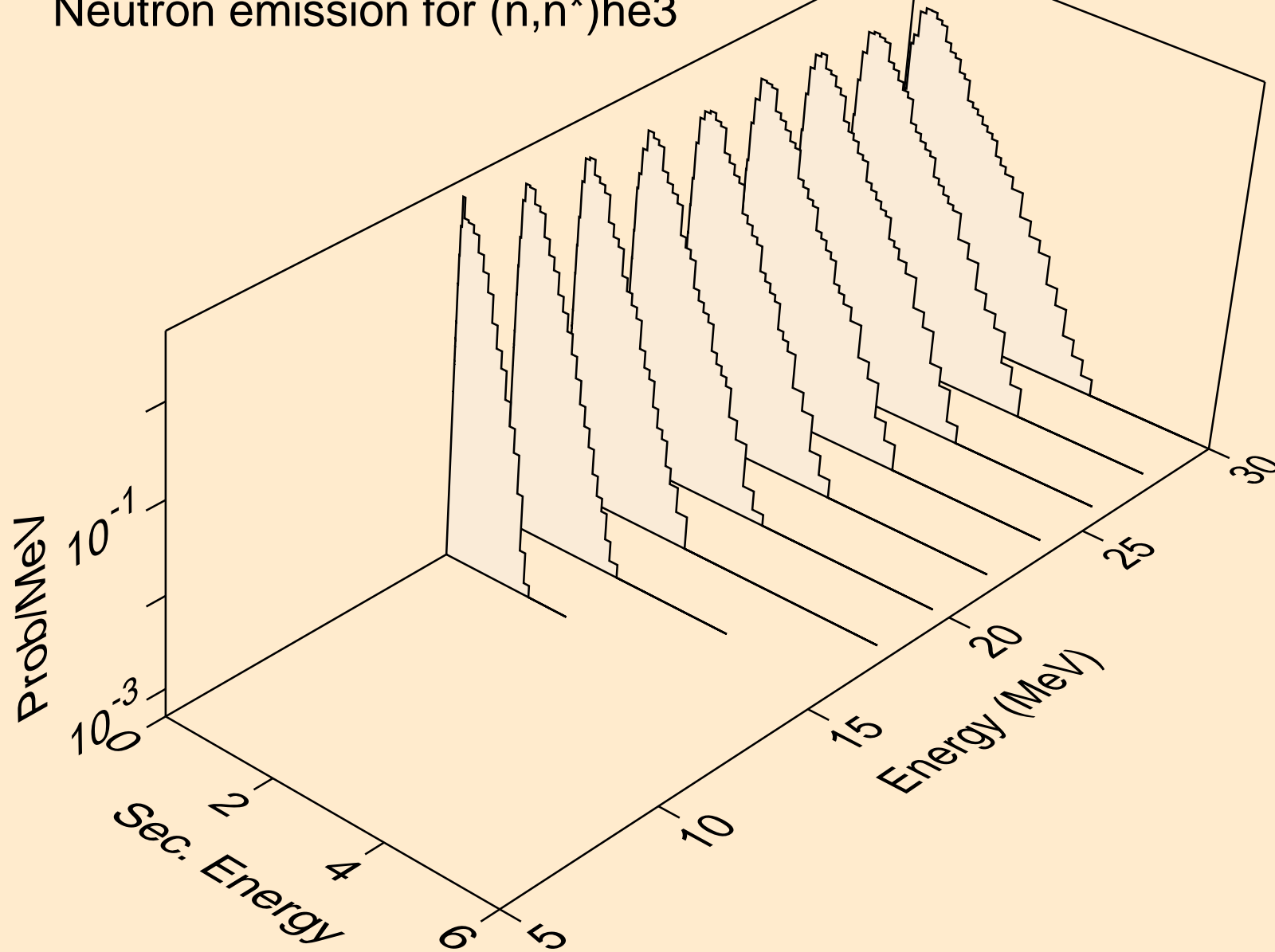

AT201 NEUTRON ACER TENDL-2021 LIBRARY; T=293.6K
Neutron emission for (n,4n)

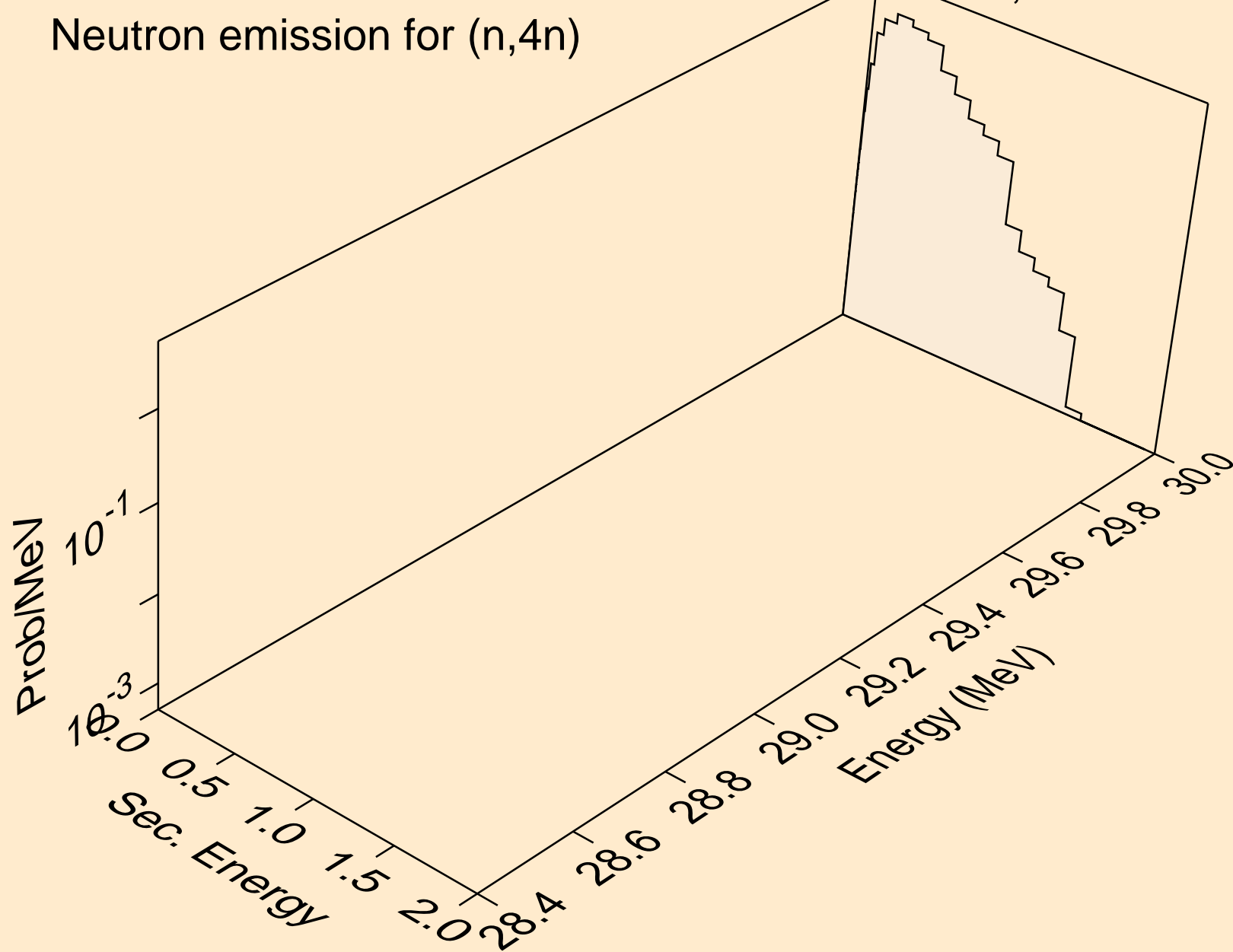

AT201 NEUTRON ACER TENDL-2021 LIBRARY; T=293.6K
Neutron emission for (n,2np)

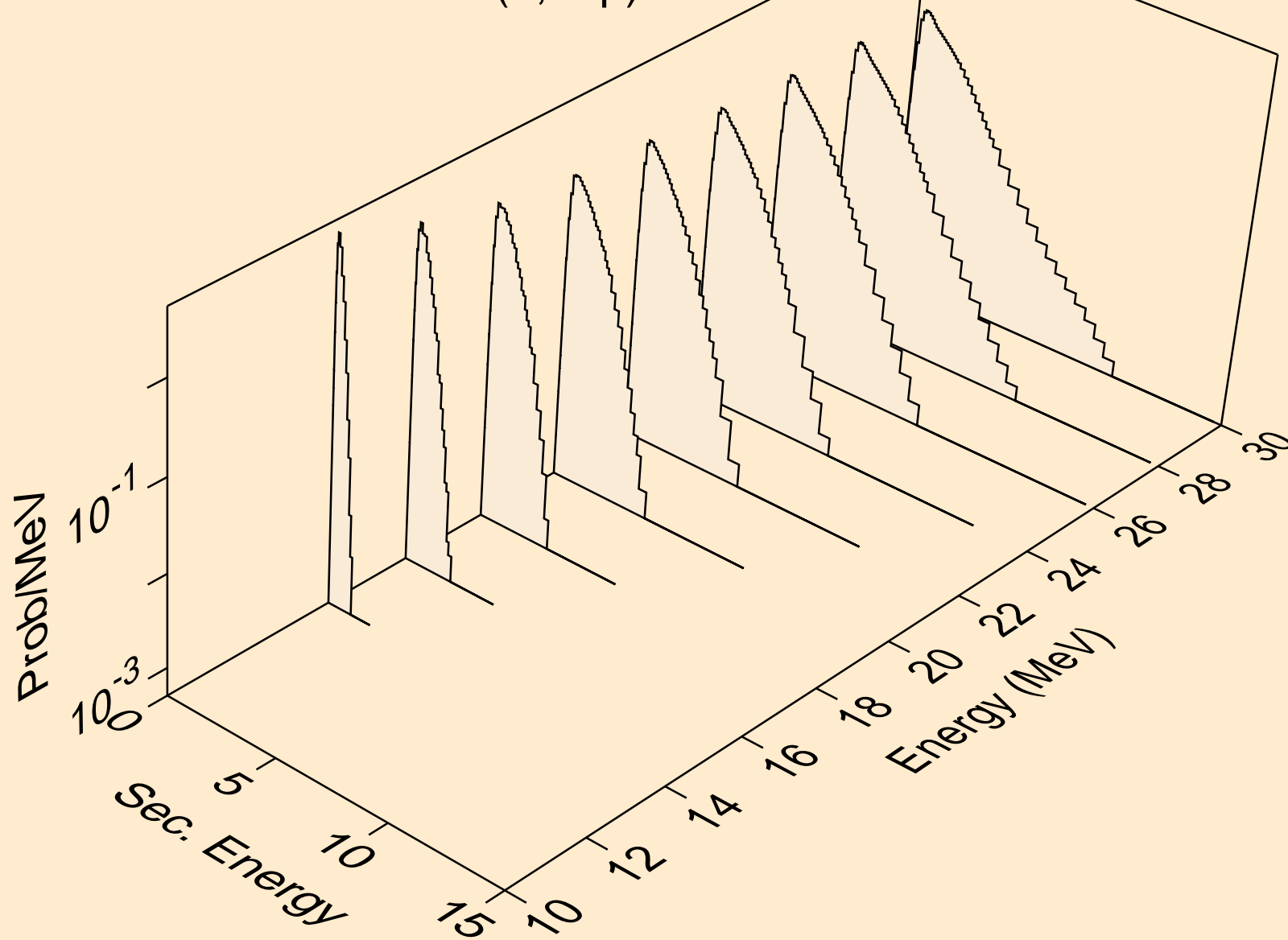

AT201 NEUTRON ACER TENDL-2021 LIBRARY; T=293.6K
Neutron emission for (n,3np)

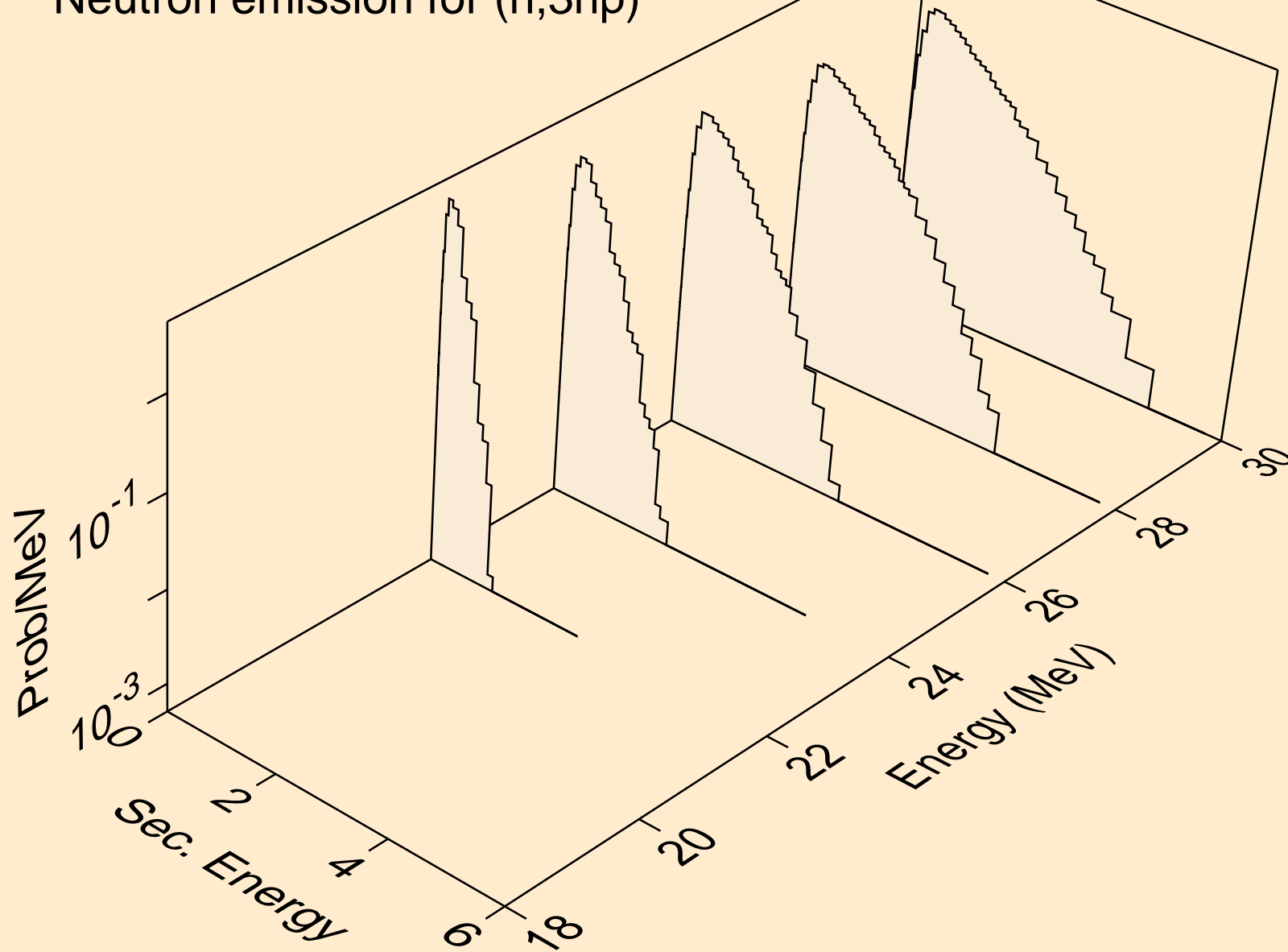

AT201 NEUTRON ACER TENDL-2021 LIBRARY; T=293.6K
Neutron emission for (n,2np)

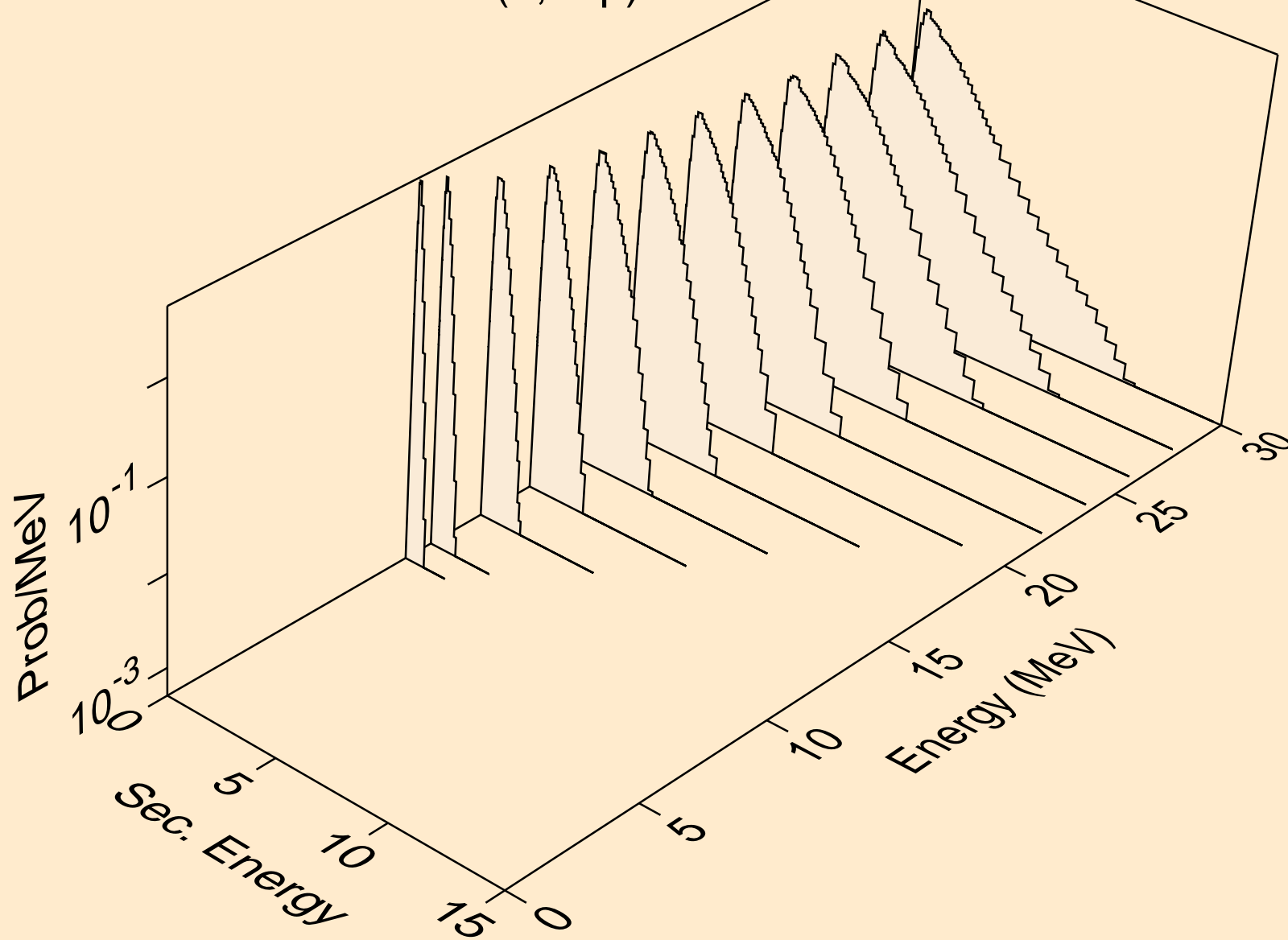

AT201 NEUTRON ACER TENDL-2021 LIBRARY; T=293.6K
Neutron emission for (n,npa)

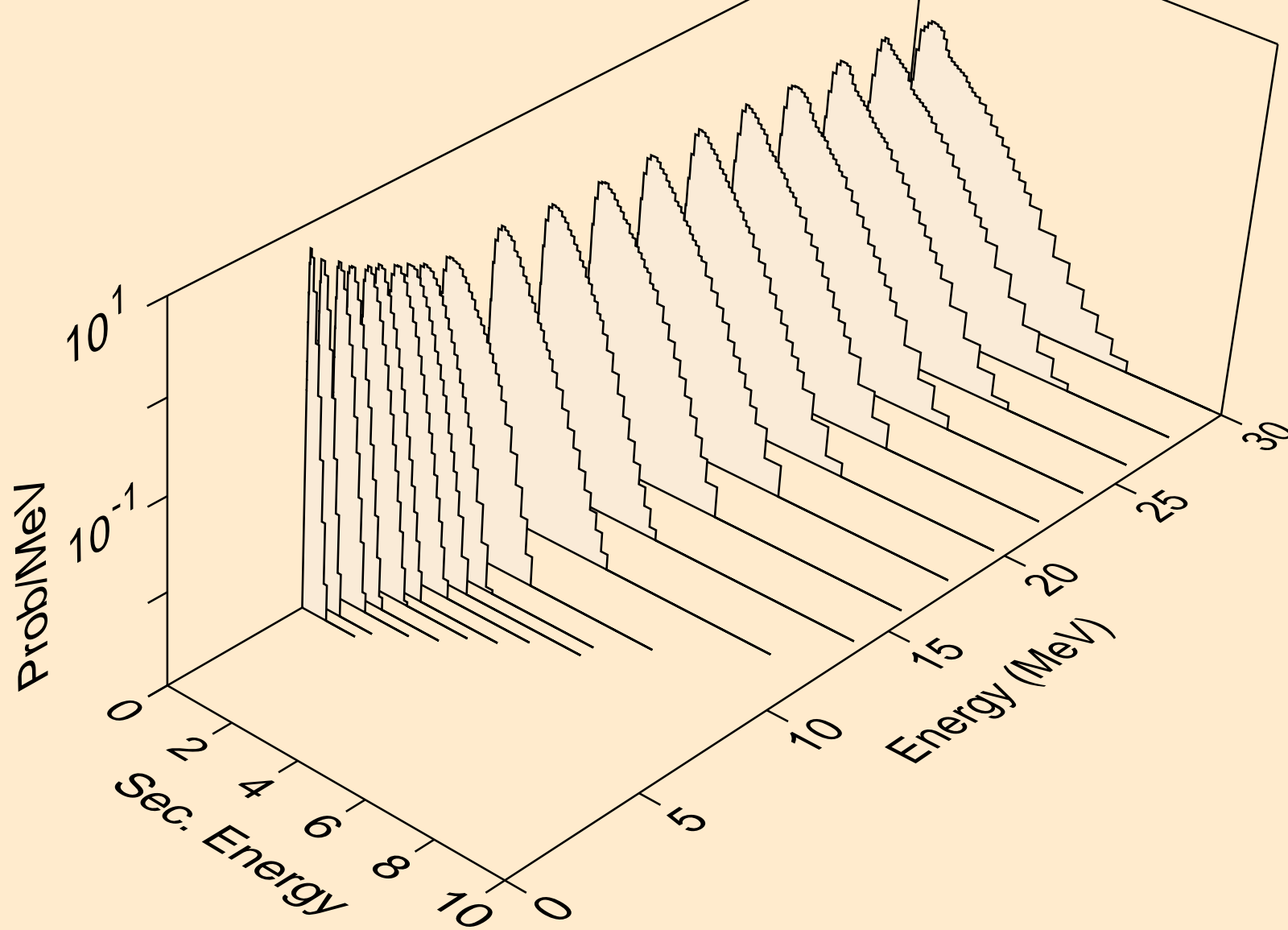

AT201 NEUTRON ACER TENDL-2021 LIBRARY; T=293.6K
Neutron emission for (n,n*c)

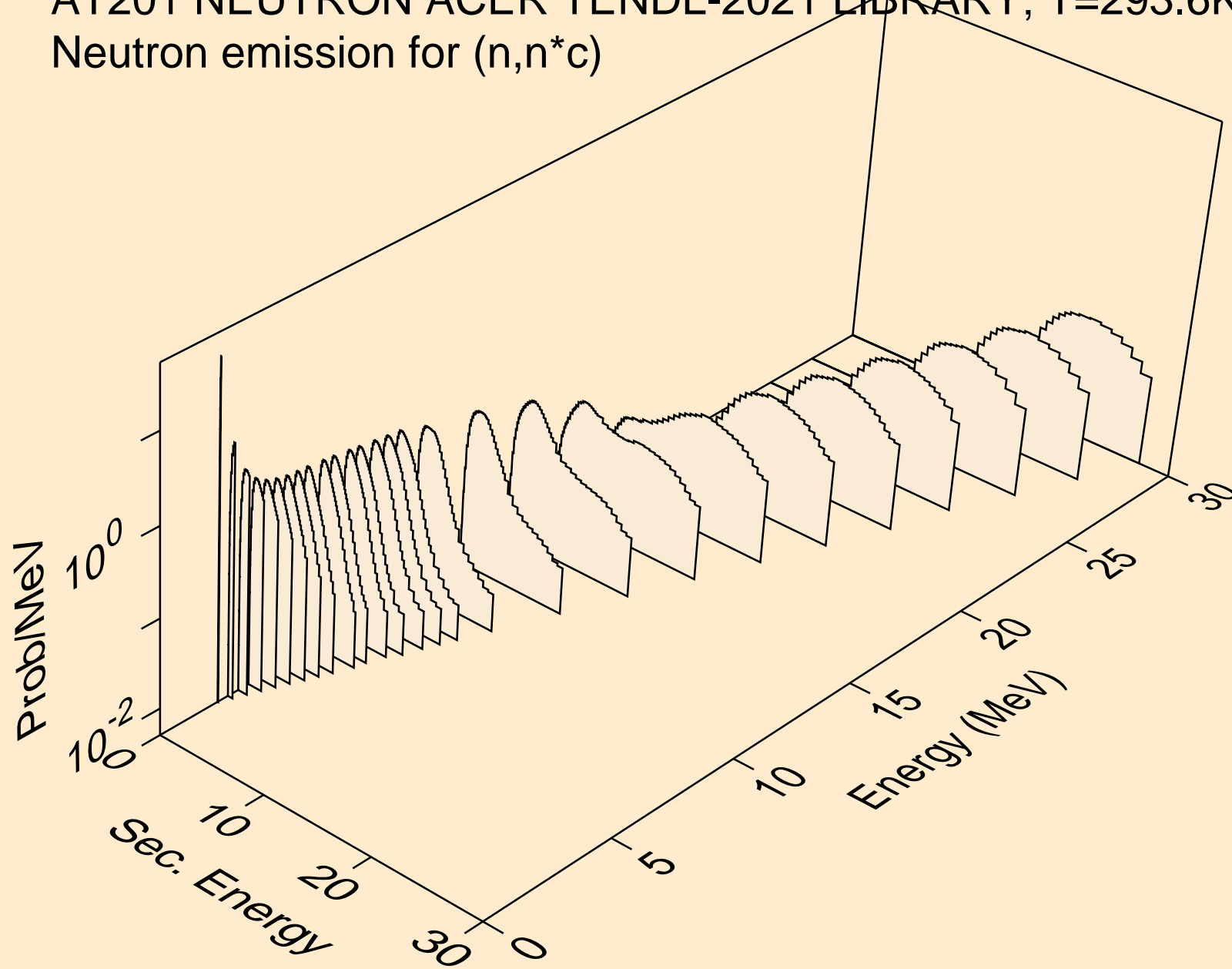

AT201 NEUTRON ACER TENDL-2021 LIBRARY; T=293.6K
Photon emission for (n,x)

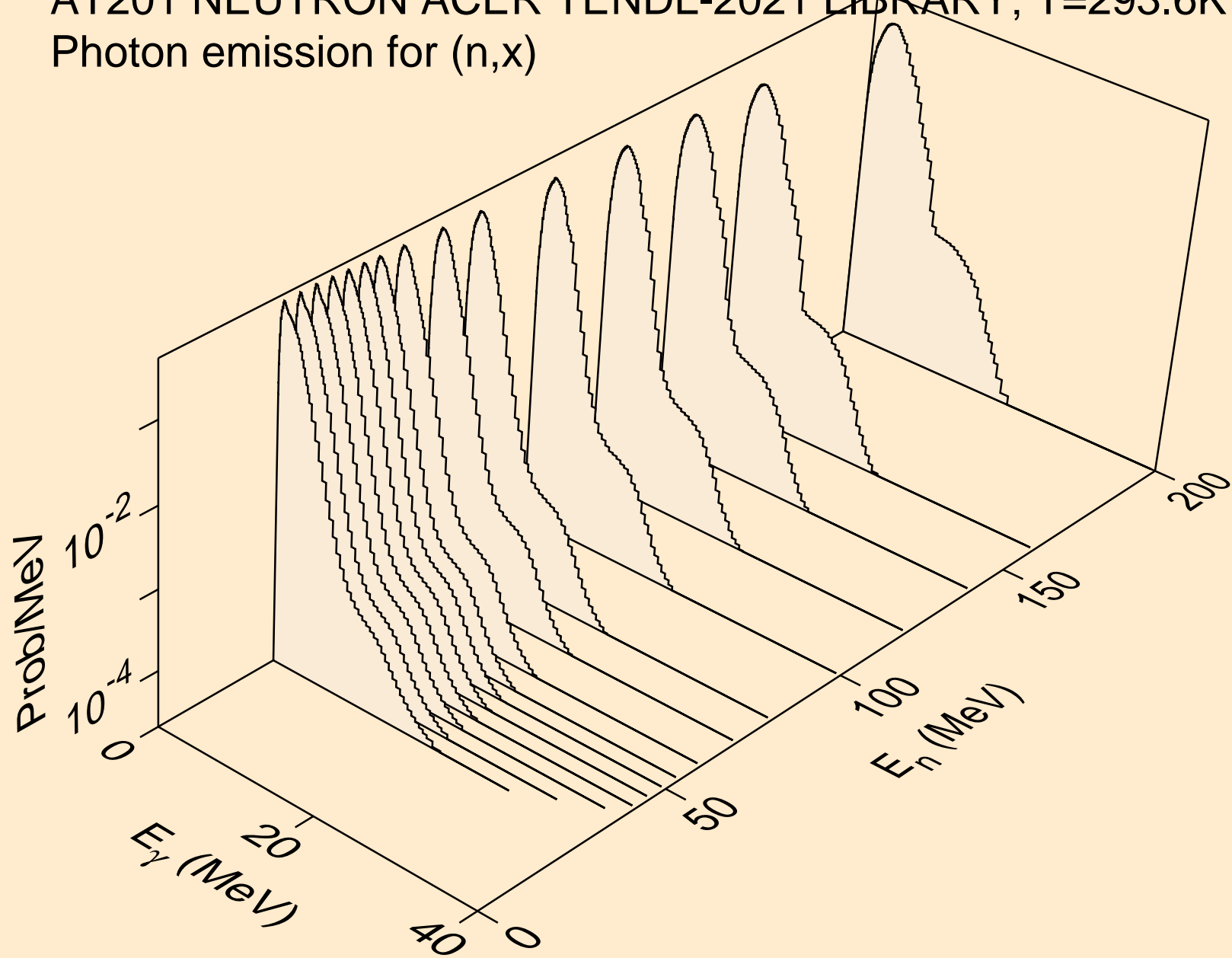

AT201 NEUTRON ACER TENDL-2021 LIBRARY; T=293.6K
Photon emission for (n,2nd)

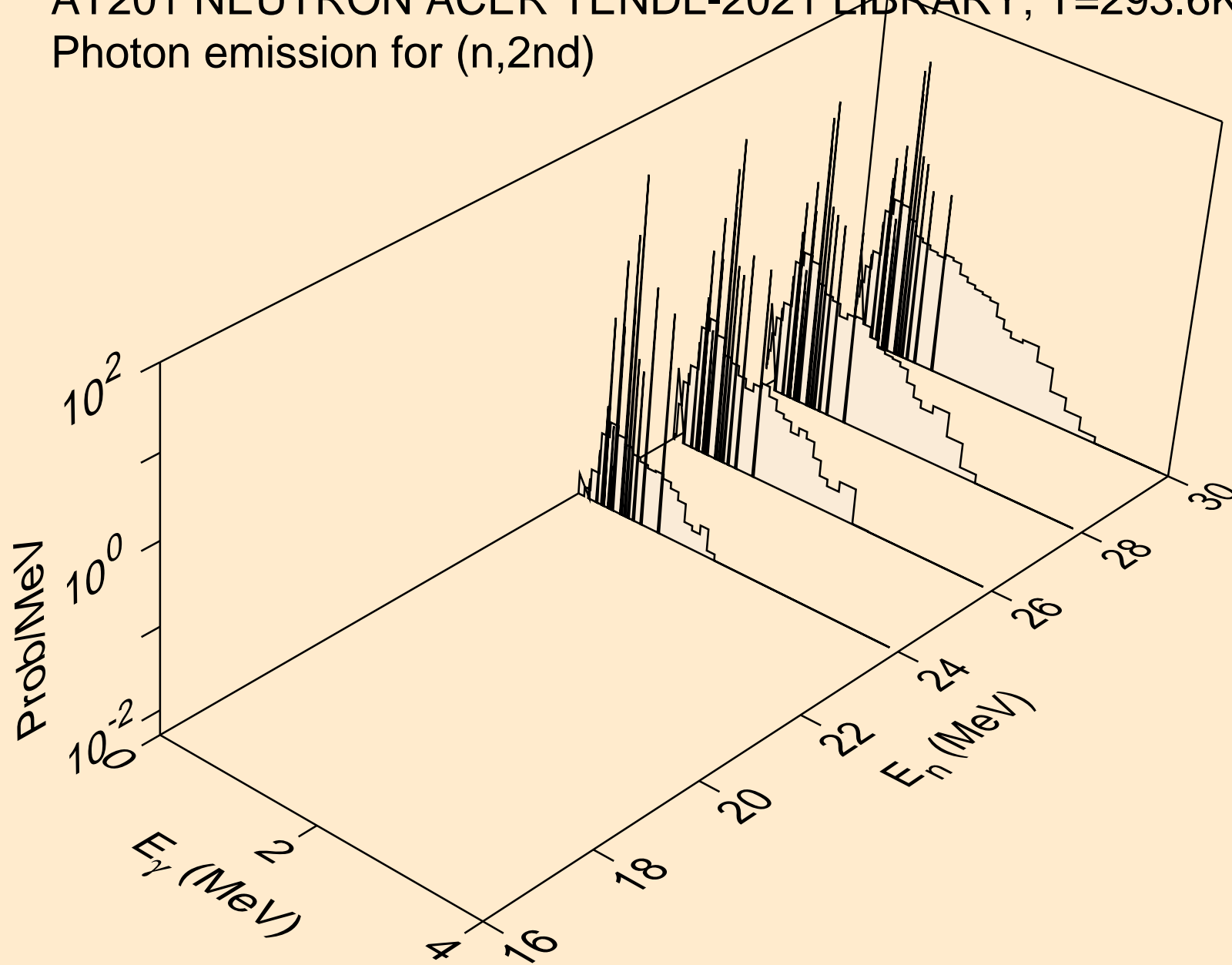

AT201 NEUTRON ACER TENDL-2021 LIBRARY; T=293.6K
Photon emission for (n,2n)

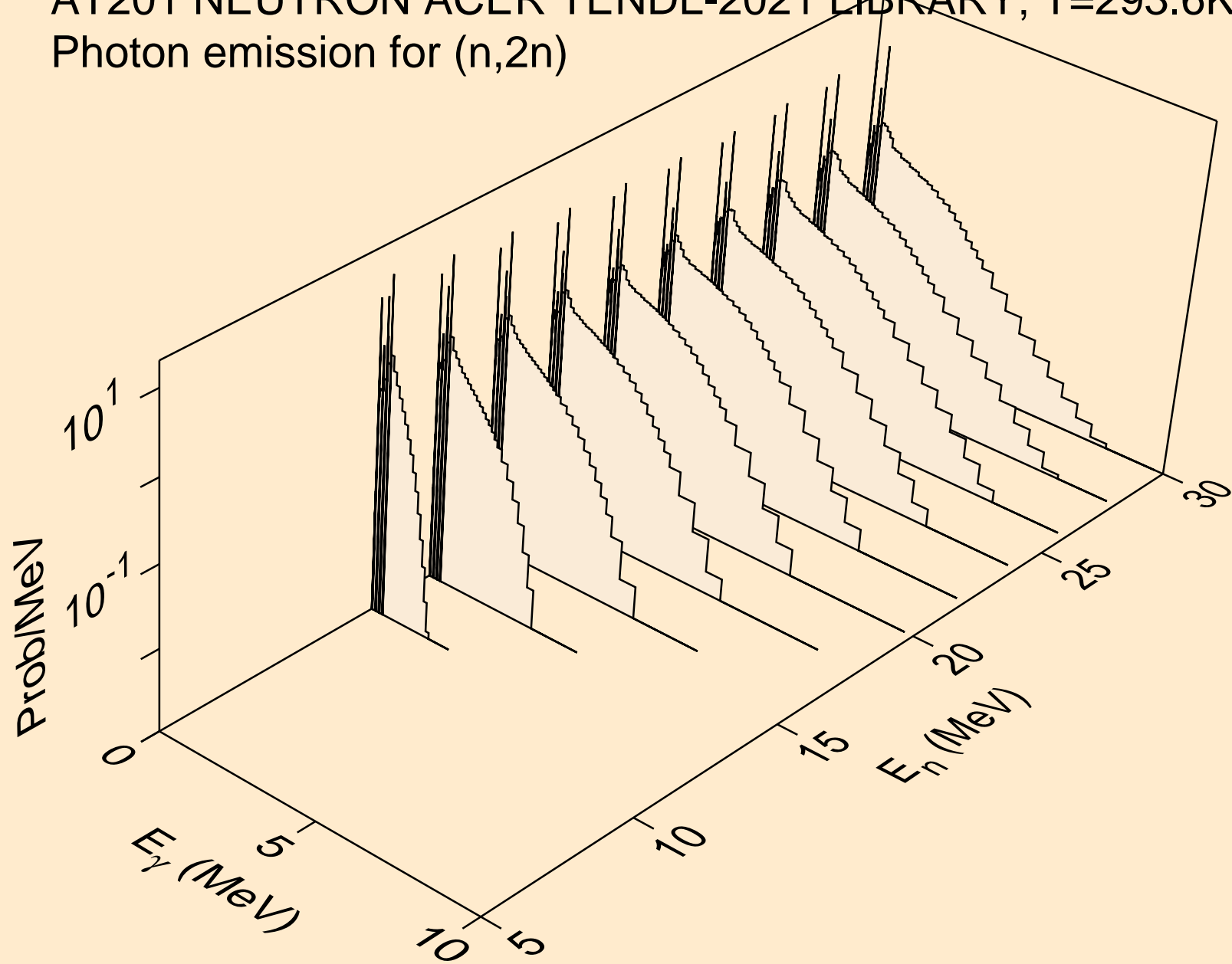

AT201 NEUTRON ACER TENDL-2021 LIBRARY; T=293.6K
Photon emission for (n,3n)

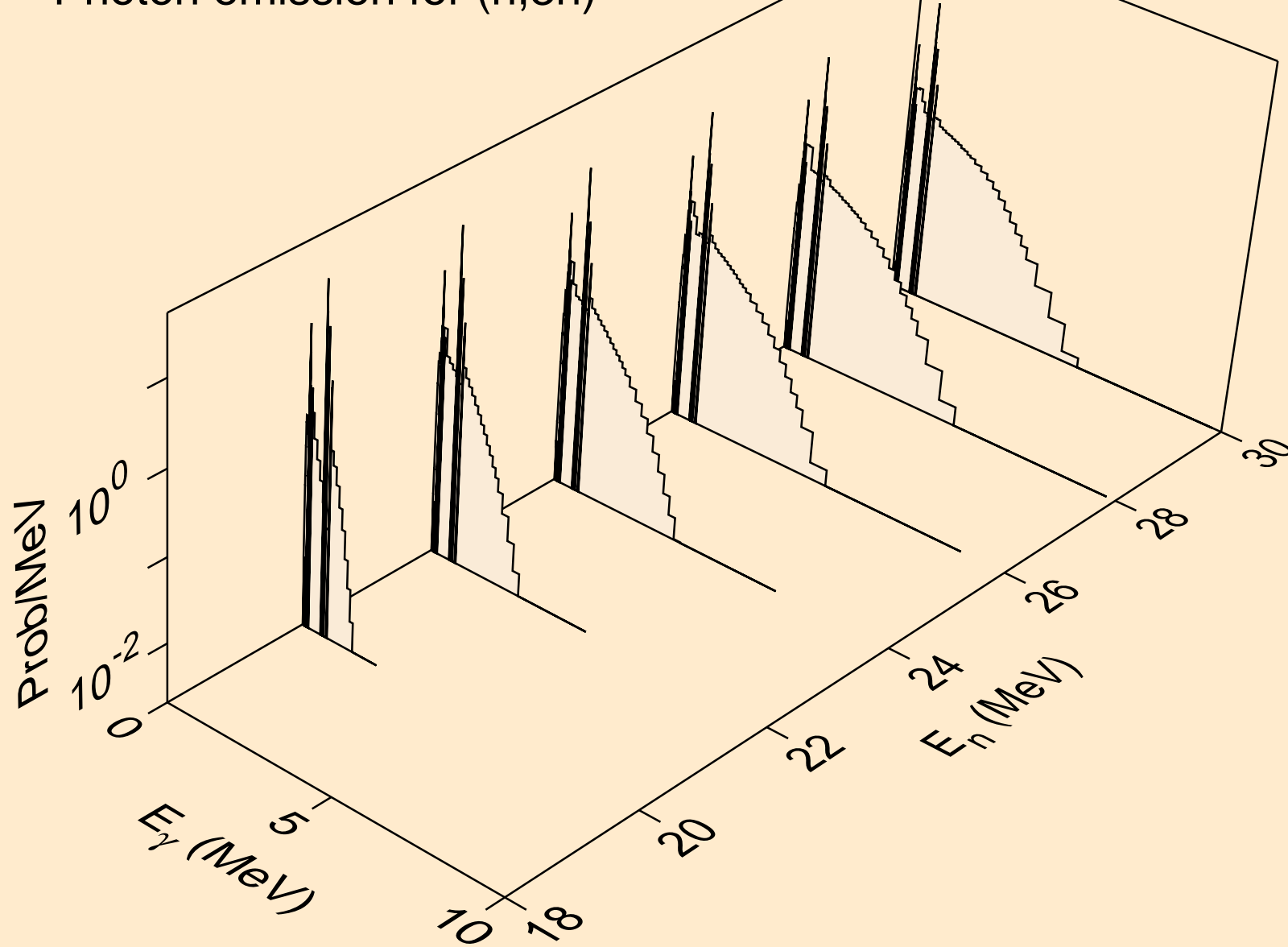

AT201 NEUTRON ACER TENDL-2021 LIBRARY; T=293.6K
Photon emission for (n,n*)a

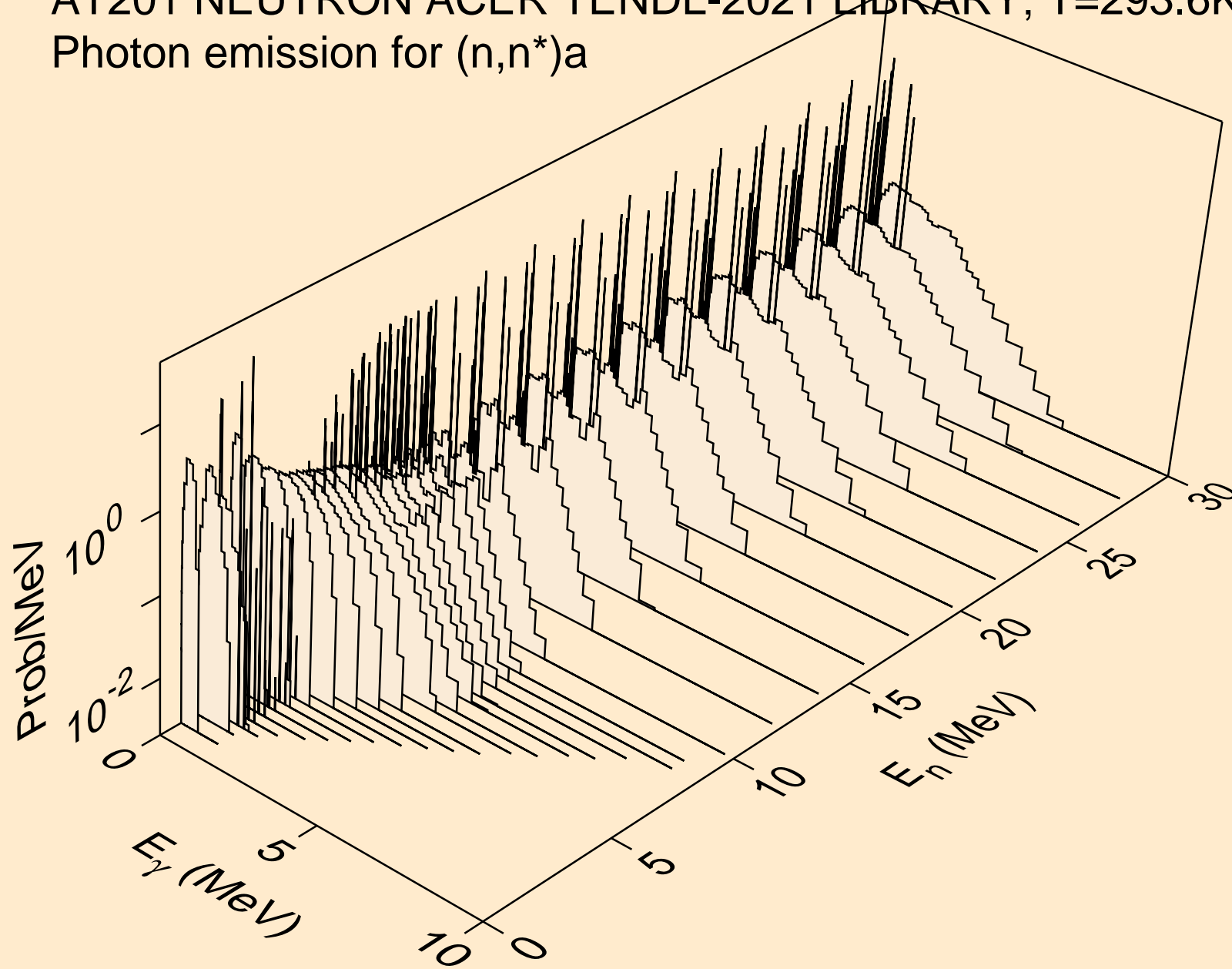

AT201 NEUTRON ACER TENDL-2021 LIBRARY; T=293.6K
Photon emission for (n,2n)a

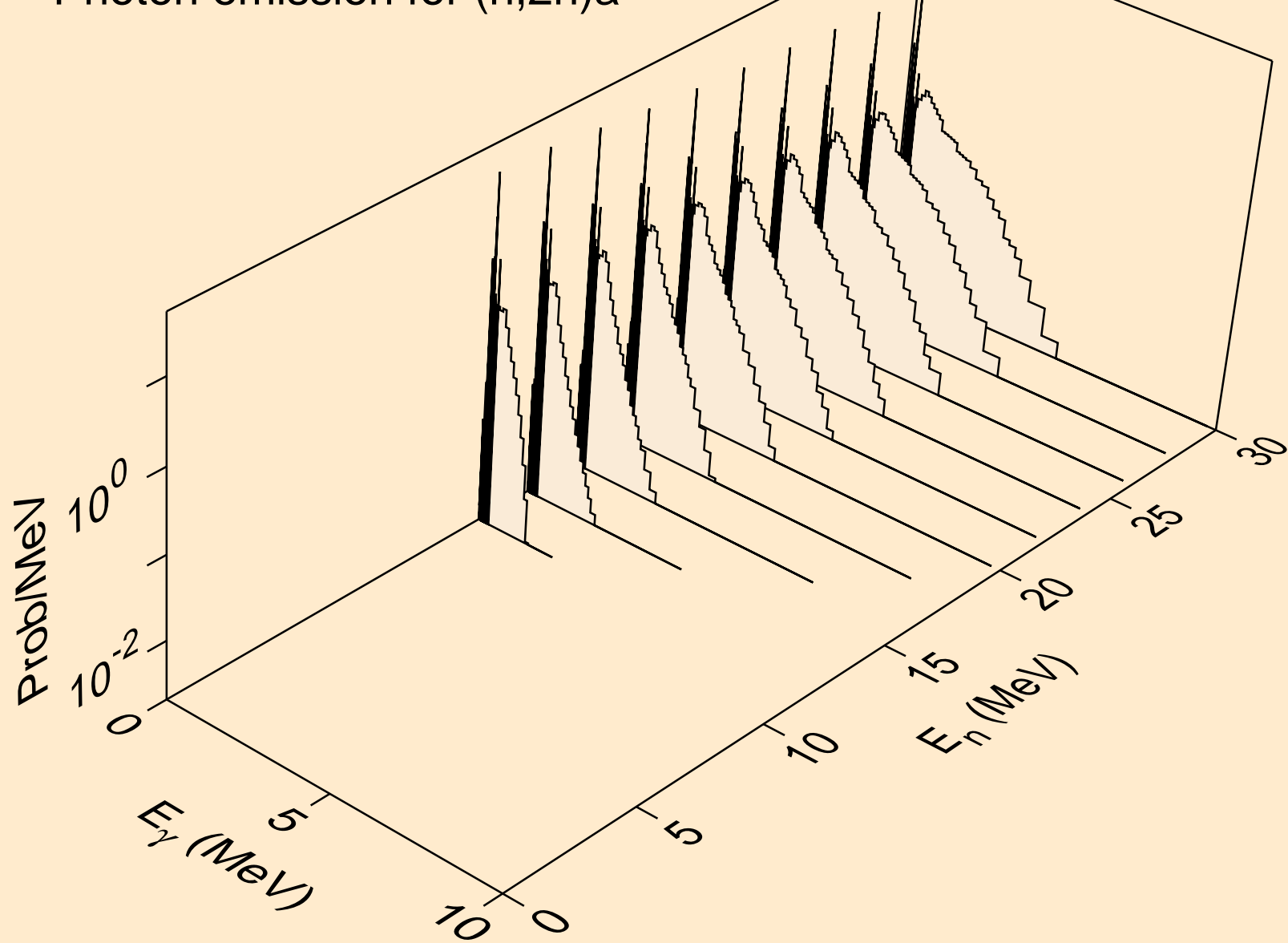

AT201 NEUTRON ACER TENDL-2021 LIBRARY; T=293.6K
Photon emission for (n,3n)a

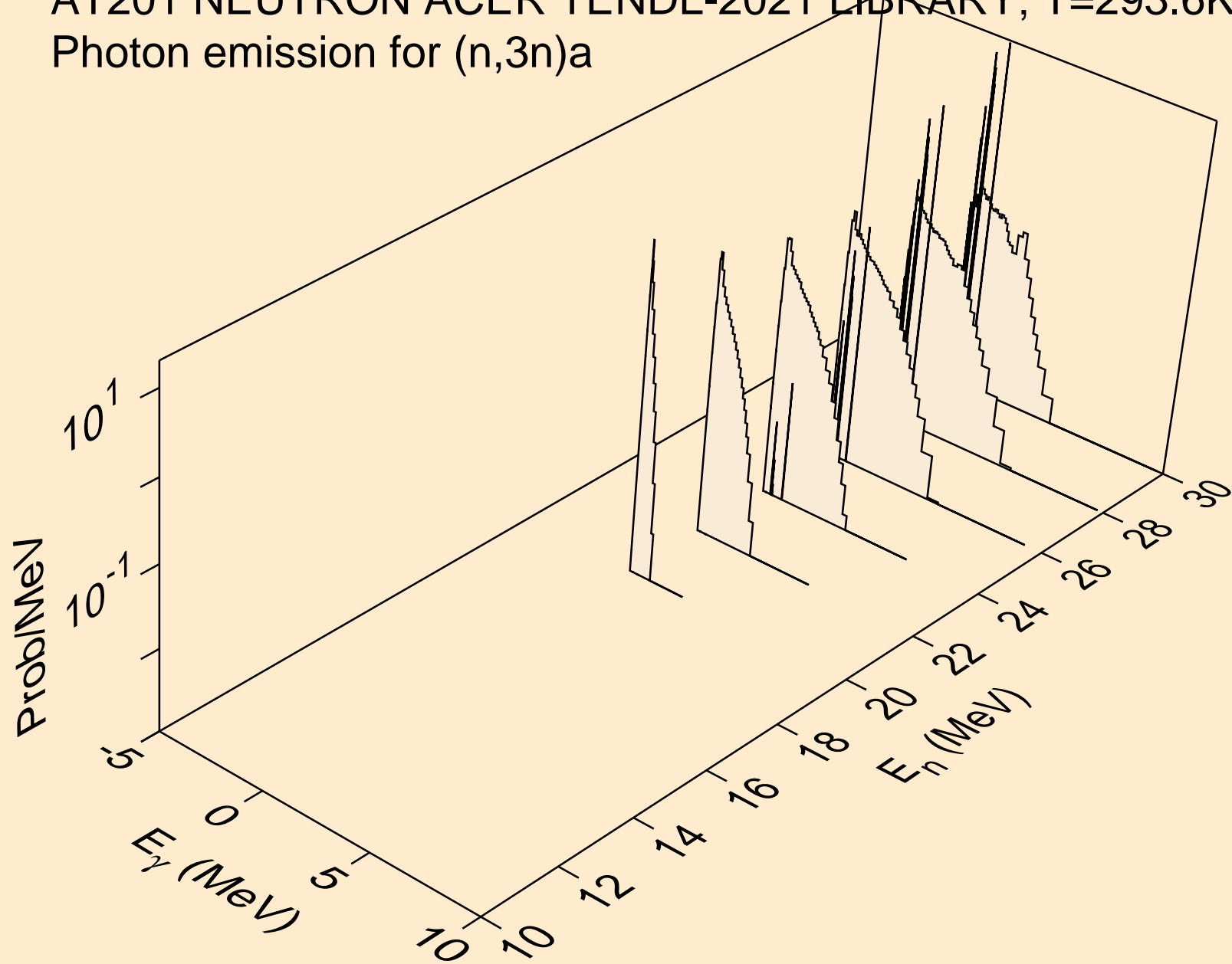

AT201 NEUTRON ACER TENDL-2021 LIBRARY; T=293.6K
Photon emission for (n,n*)p

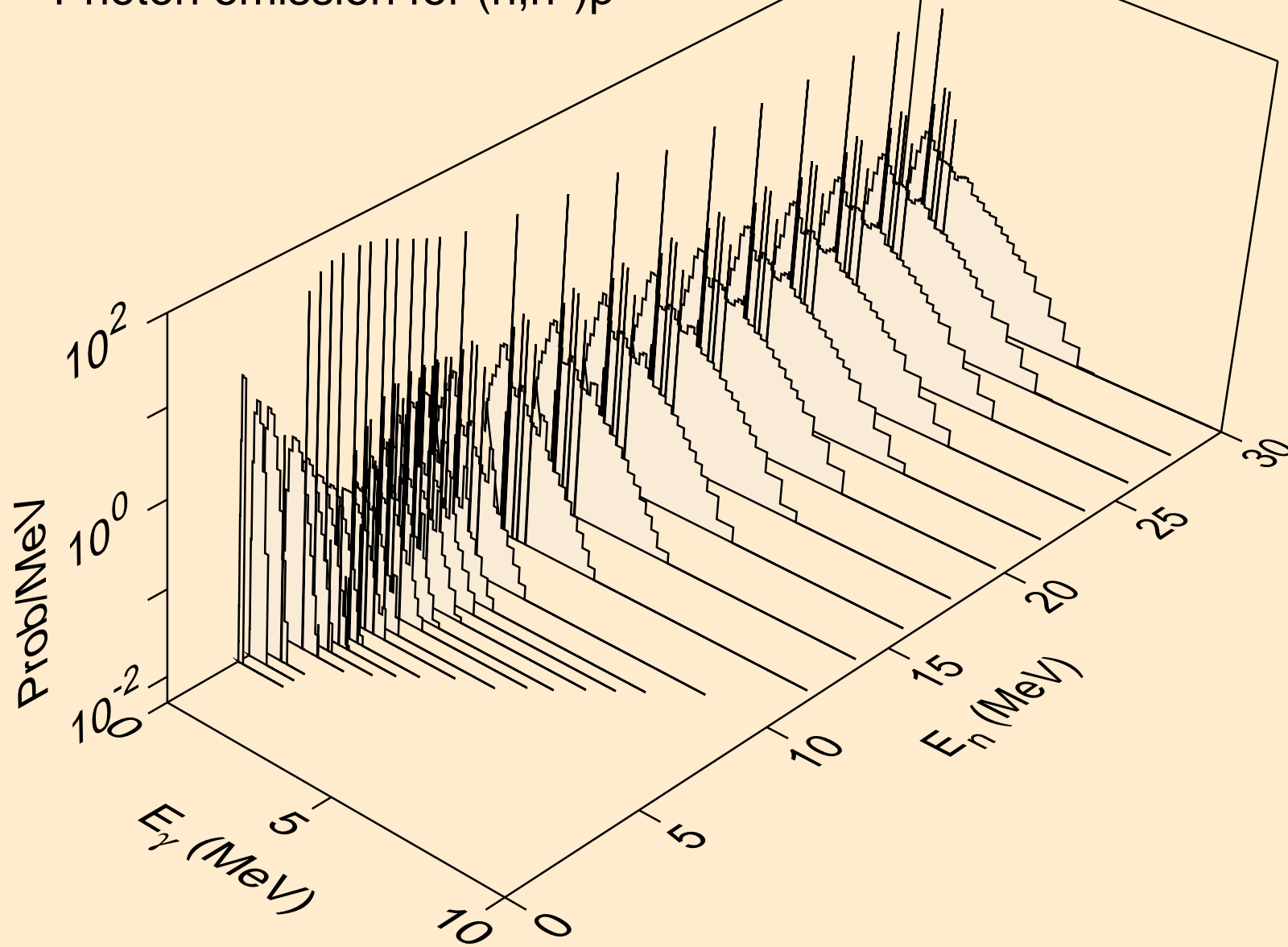

AT201 NEUTRON ACER TENDL-2021 LIBRARY; T=293.6K
Photon emission for (n,n*)2a

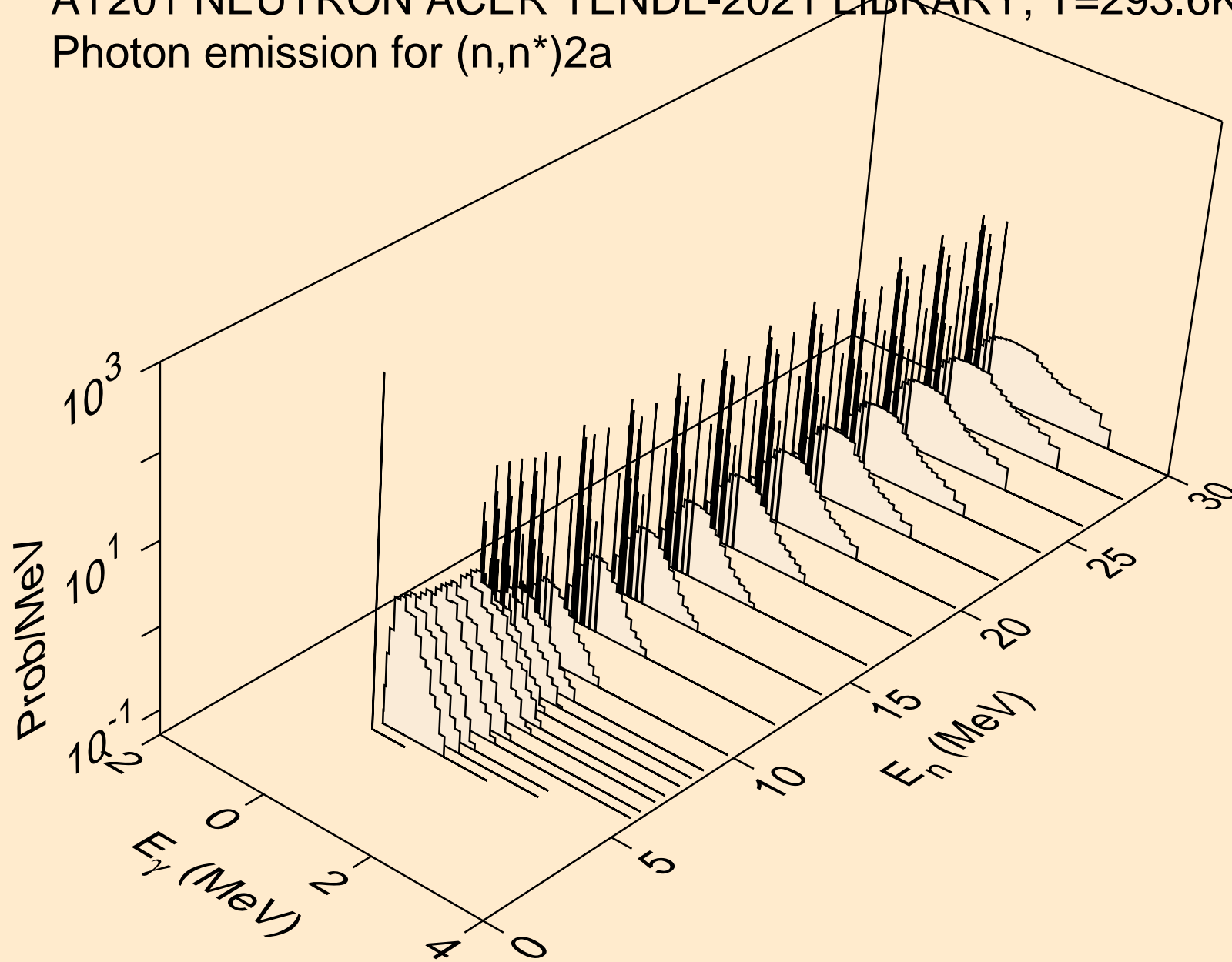

AT201 NEUTRON ACER TENDL-2021 LIBRARY; T=293.6K
Photon emission for (n,2n)2a

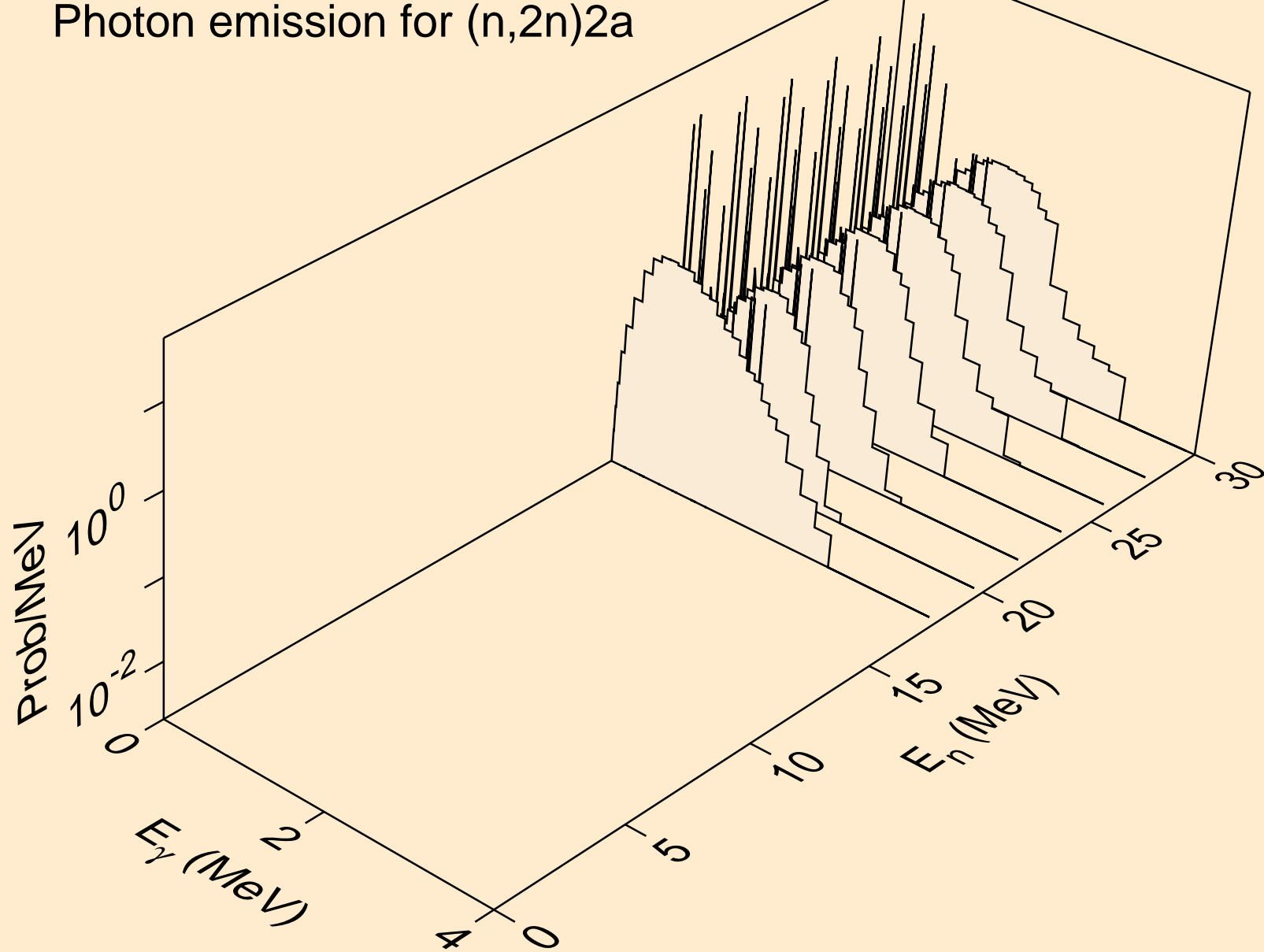

AT201 NEUTRON ACER TENDL-2021 LIBRARY; T=293.6K
Photon emission for (n,n*)d

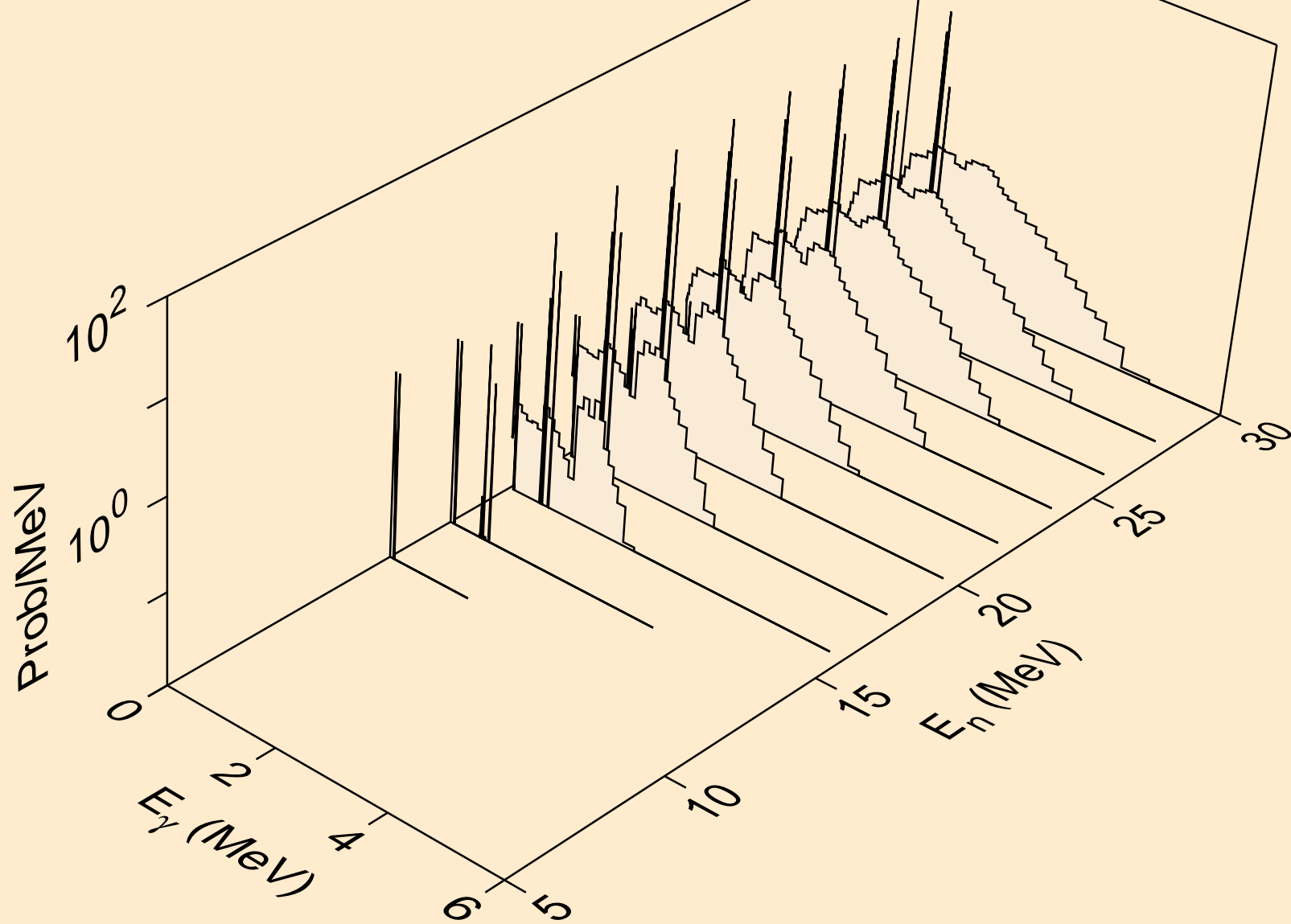

AT201 NEUTRON ACER TENDL-2021 LIBRARY; T=293.6K
Photon emission for (n,n*)t

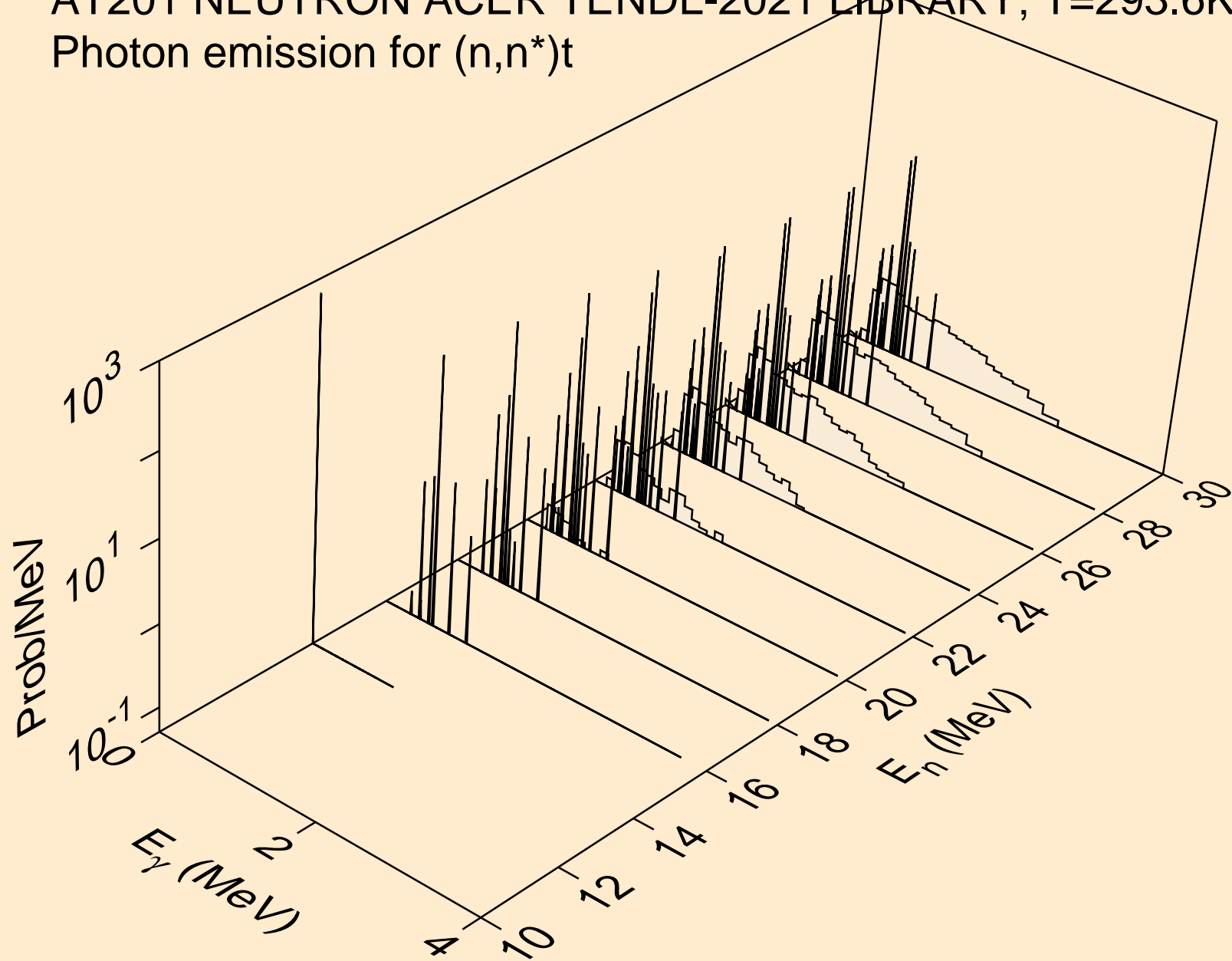

AT201 NEUTRON ACER TENDL-2021 LIBRARY; T=293.6K
Photon emission for (n,n*)he3

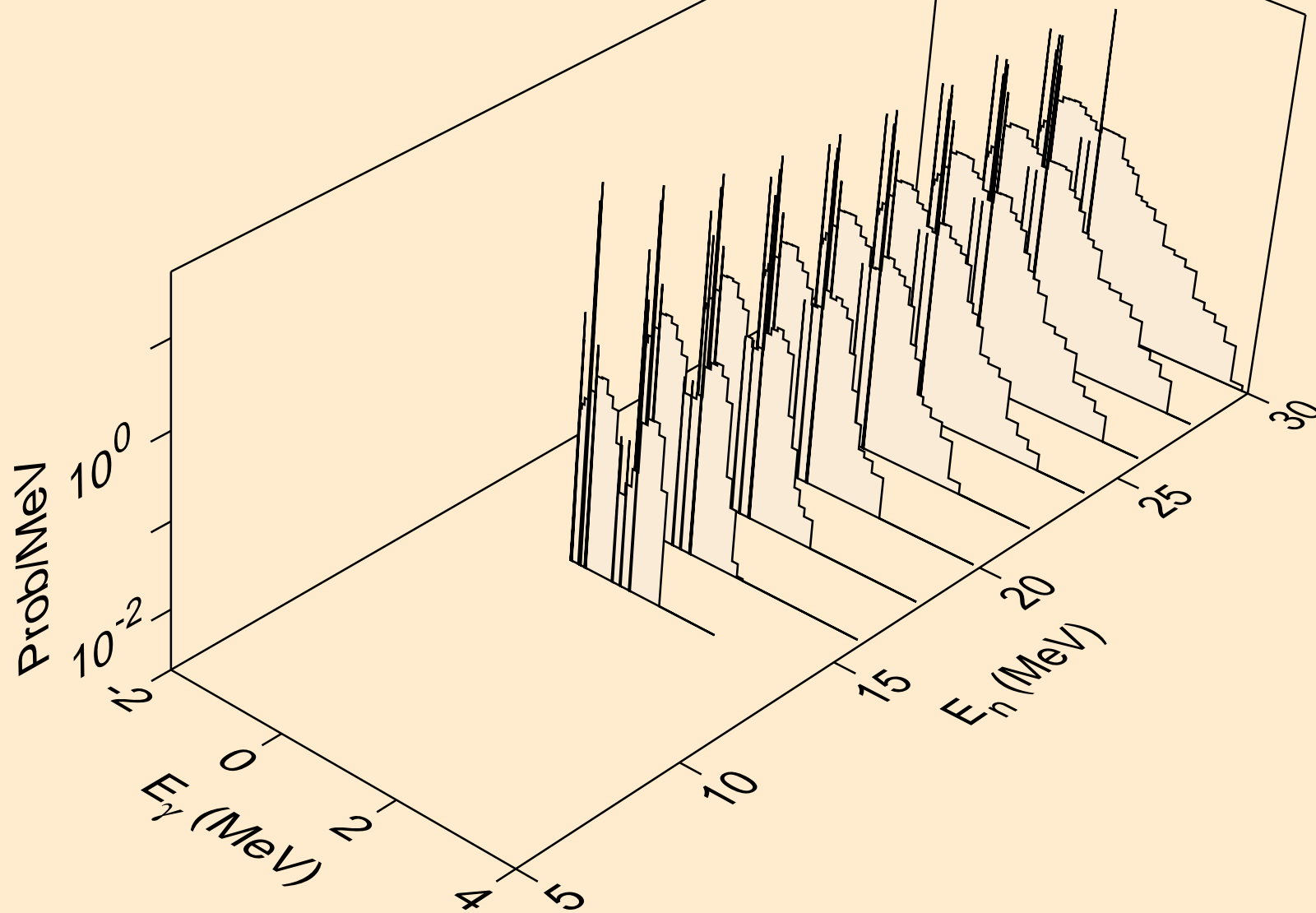

AT201 NEUTRON ACER TENDL-2021 LIBRARY; T=293.6K
Photon emission for (n,4n)

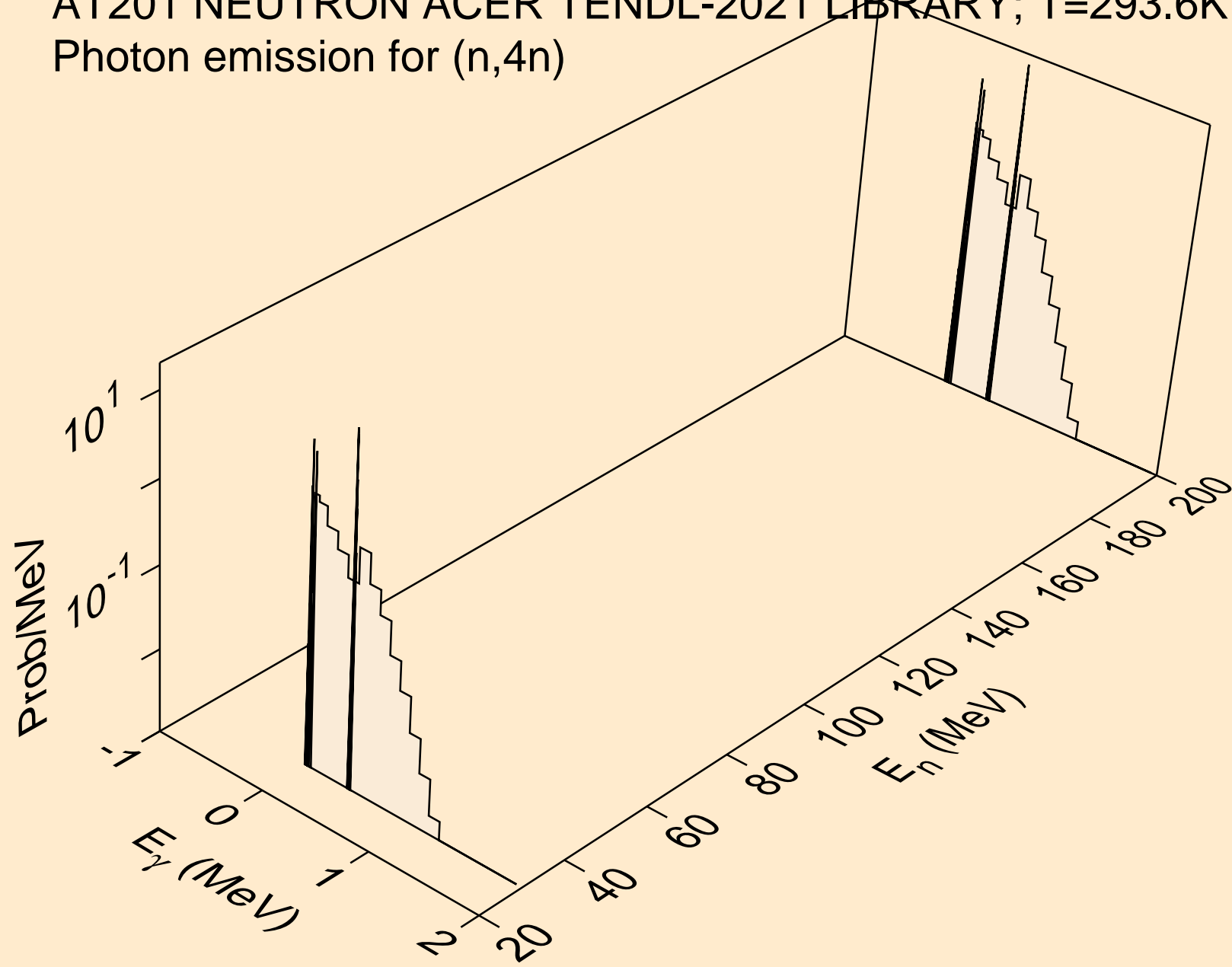

AT201 NEUTRON ACER TENDL-2021 LIBRARY; T=293.6K
Photon emission for (n,2np)

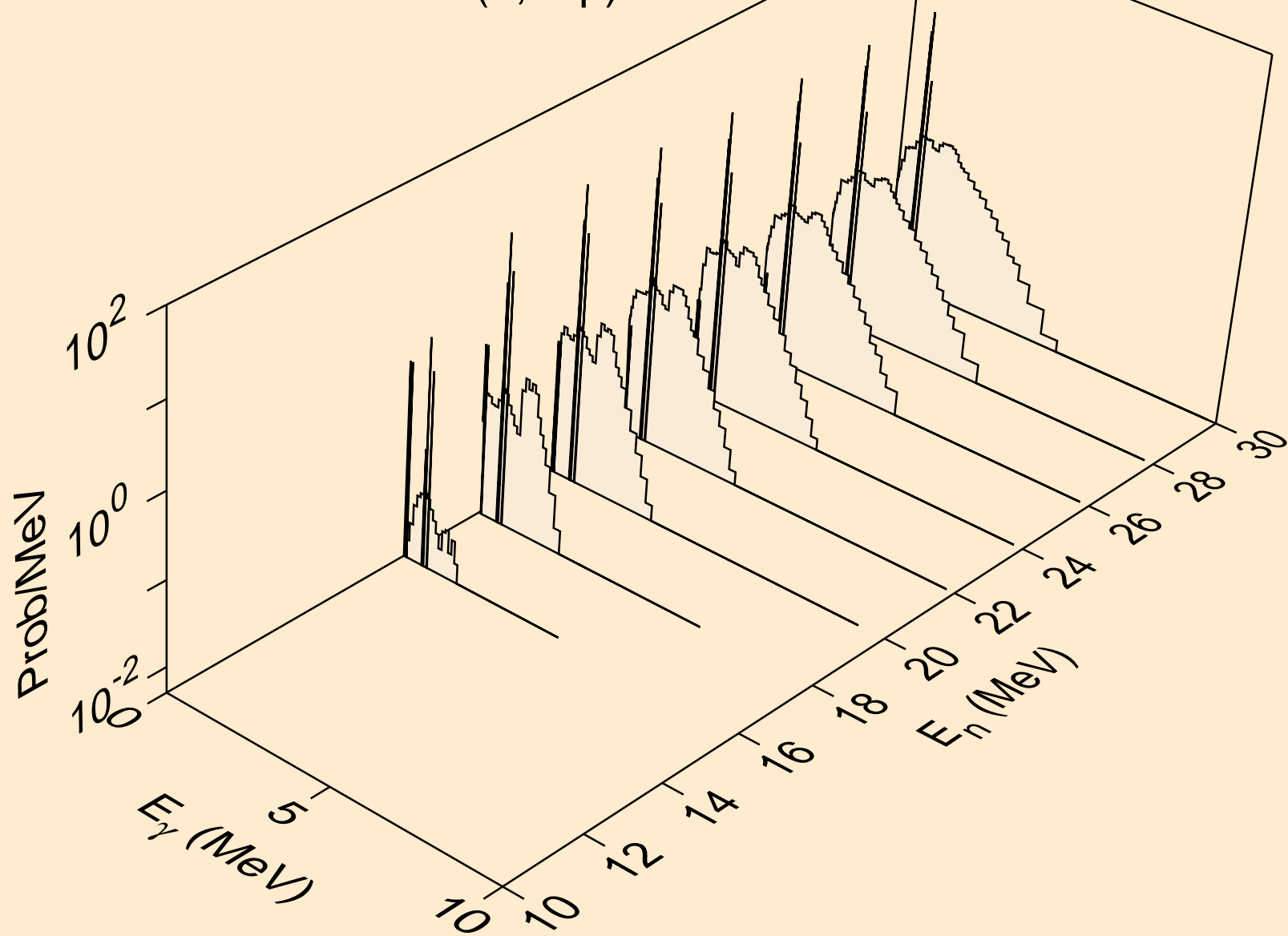

AT201 NEUTRON ACER TENDL-2021 LIBRARY; T=293.6K
Photon emission for (n,3np)

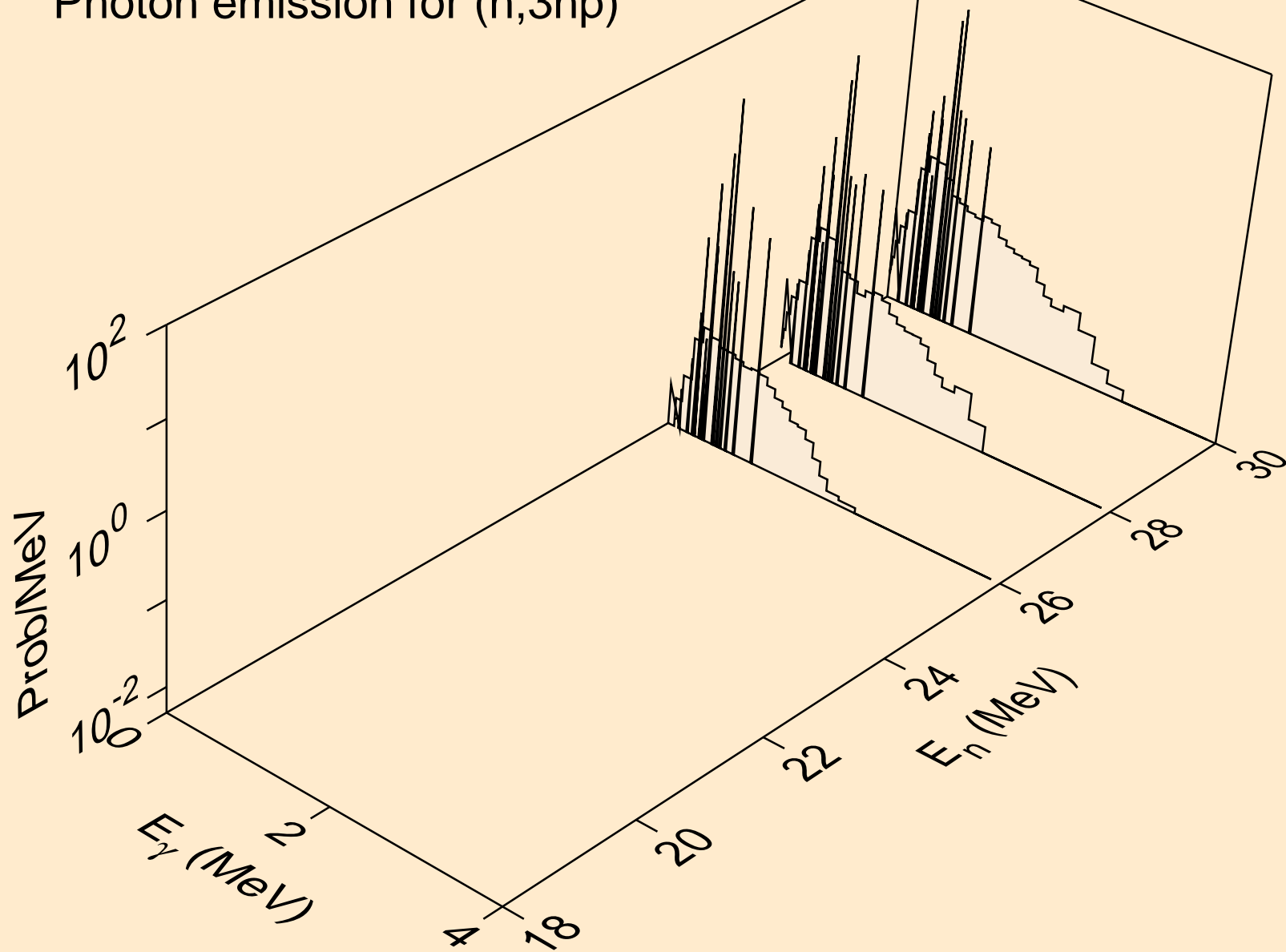

AT201 NEUTRON ACER TENDL-2021 LIBRARY; T=293.6K
Photon emission for (n,2np)

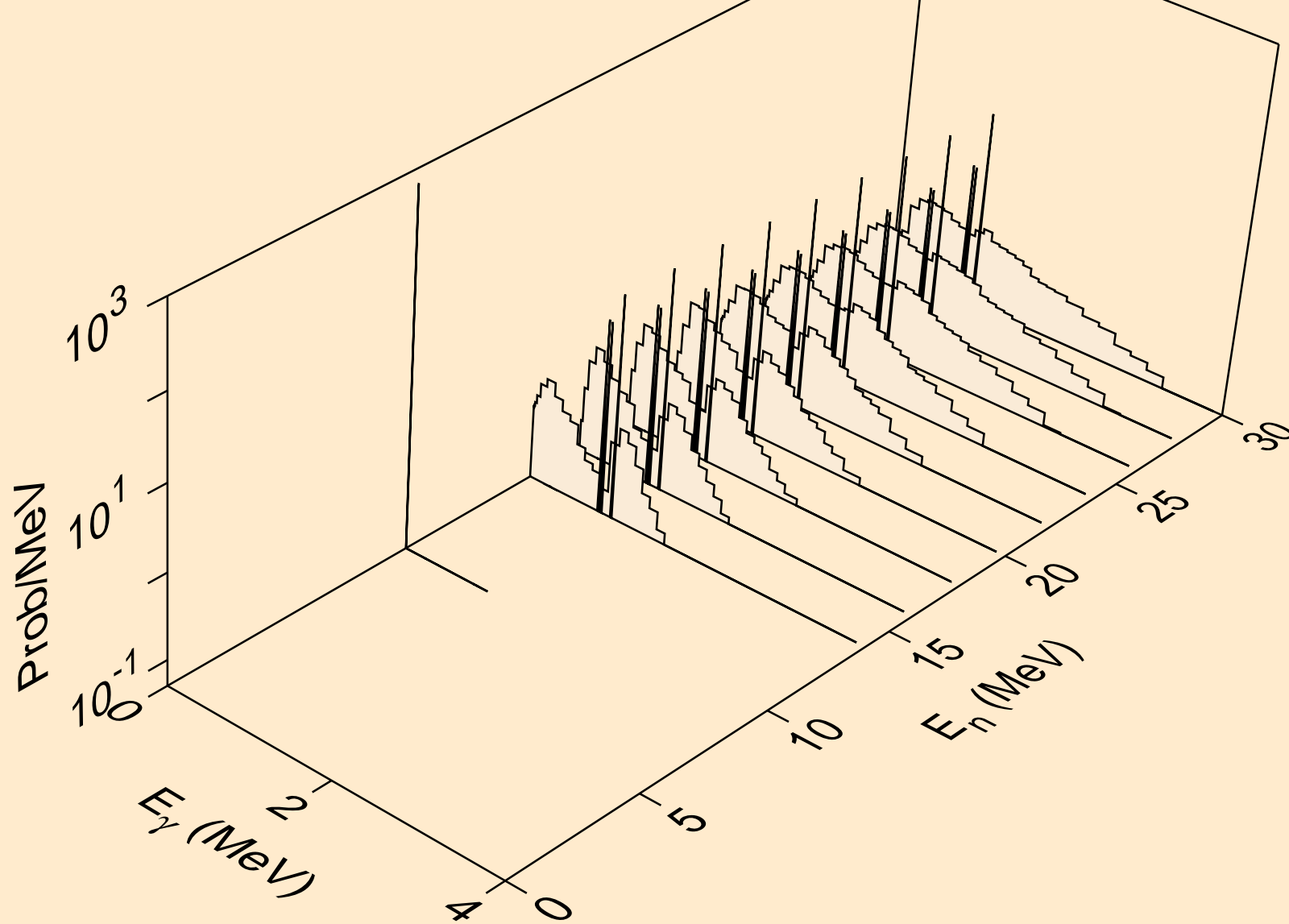

AT201 NEUTRON ACER TENDL-2021 LIBRARY; T=293.6K
Photon emission for (n,npa)

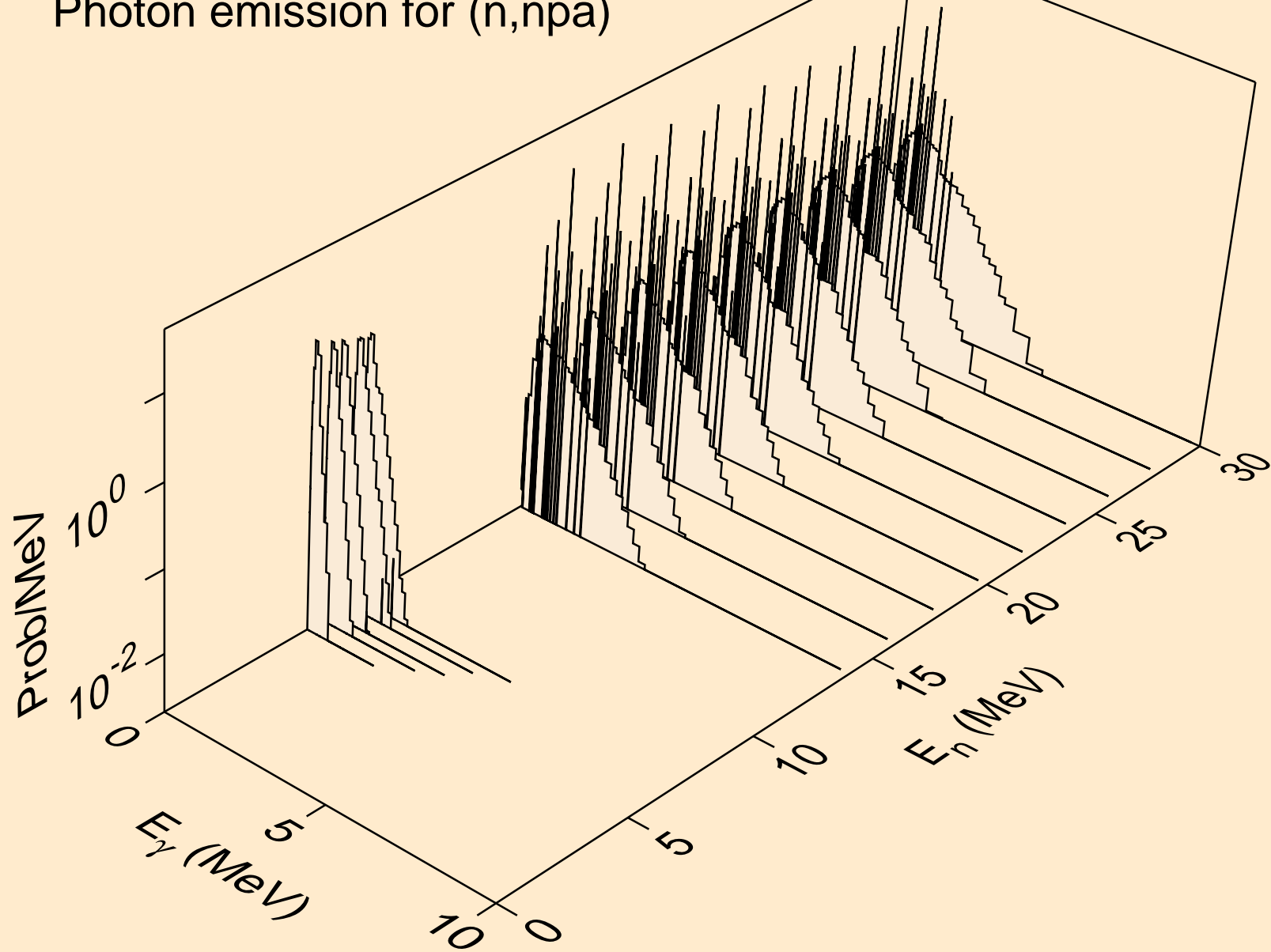

AT201 NEUTRON ACER TENDL-2021 LIBRARY; T=293.6K
Photon emission for (n,n*c)

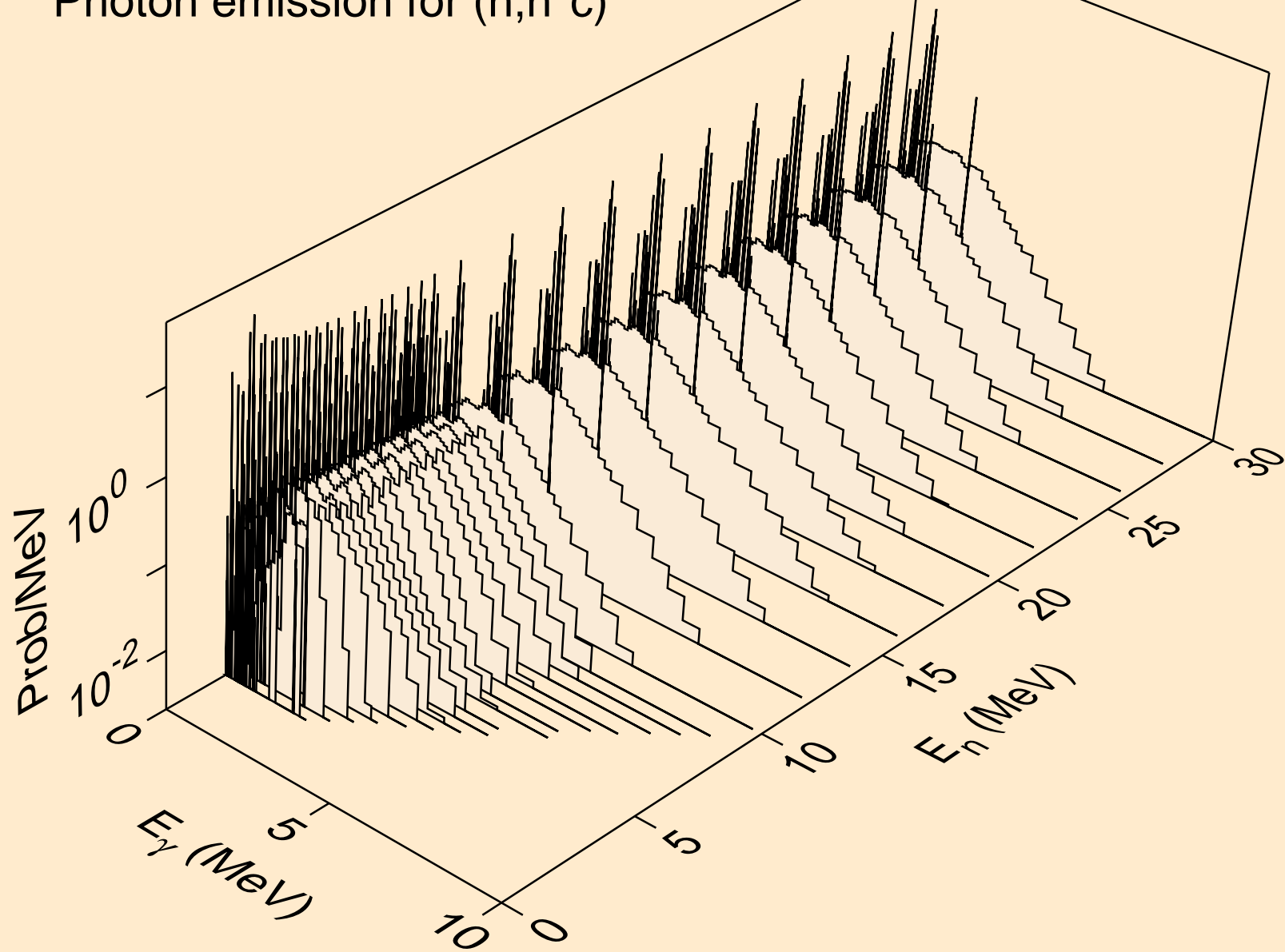

AT201 NEUTRON ACER TENDL-2021 LIBRARY; T=293.6K
Photon emission for (n,gma)

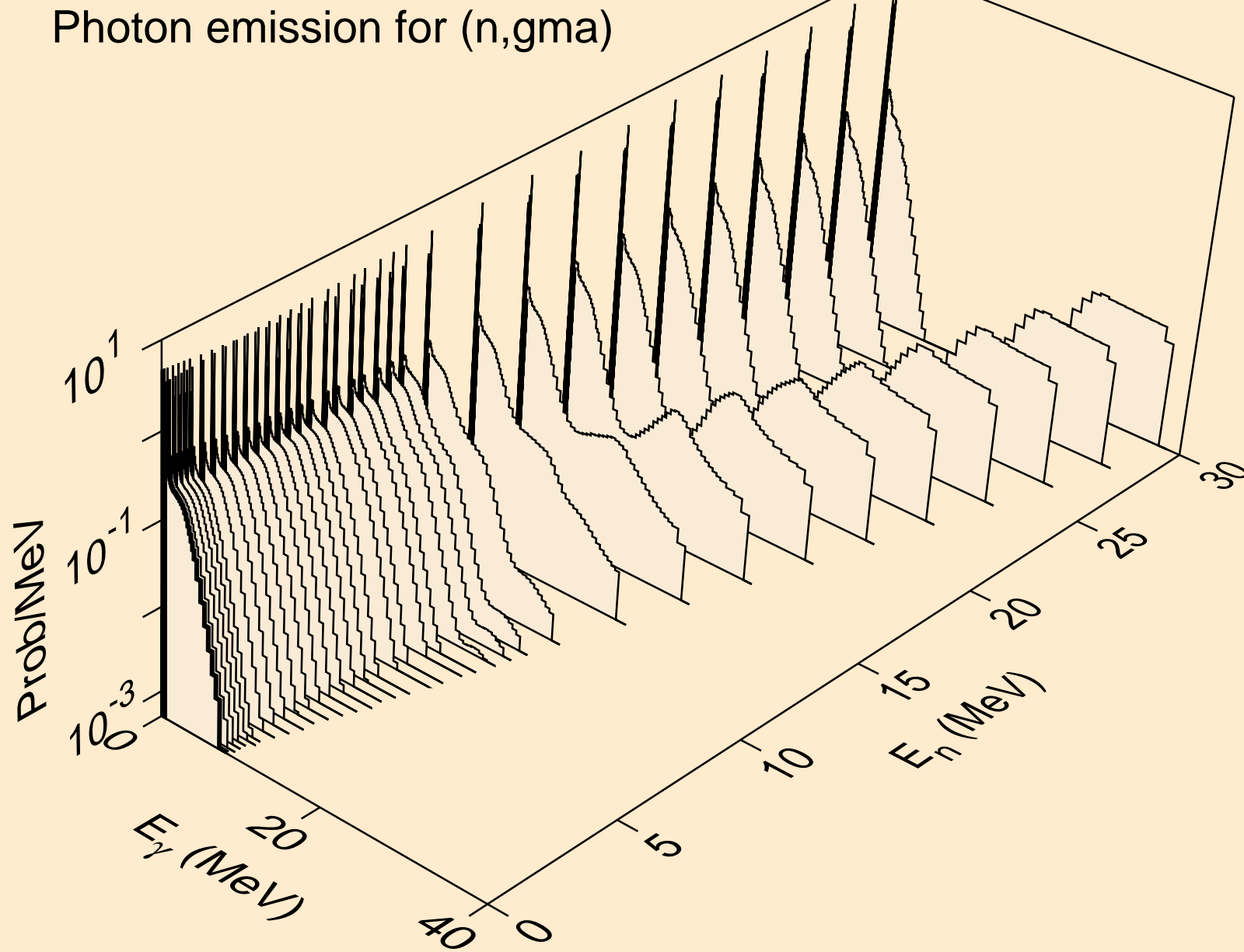

AT201 NEUTRON ACER TENDL-2021 LIBRARY; T=293.6K
Photon emission for (n,p)

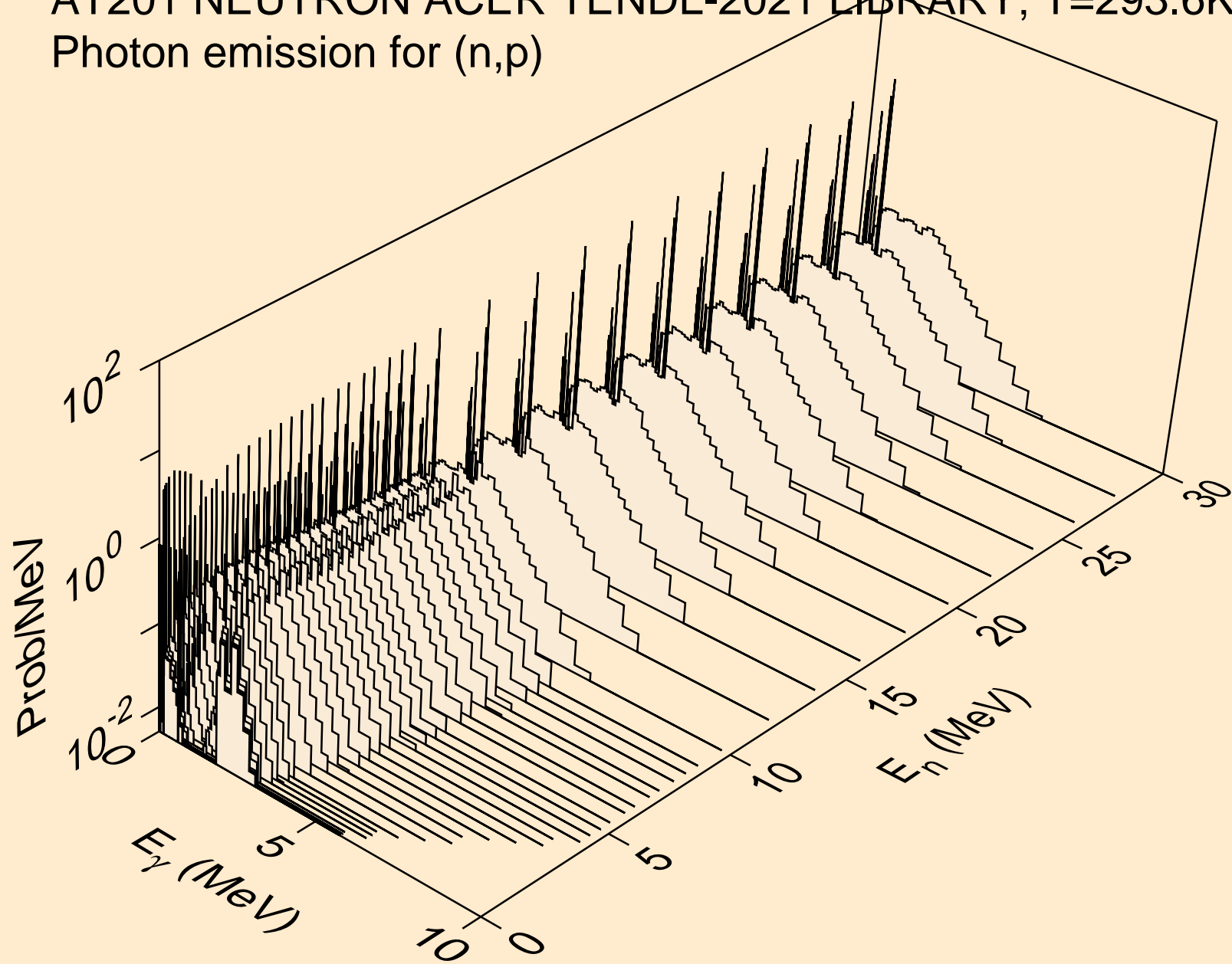

AT201 NEUTRON ACER TENDL-2021 LIBRARY; T=293.6K
Photon emission for (n,d)

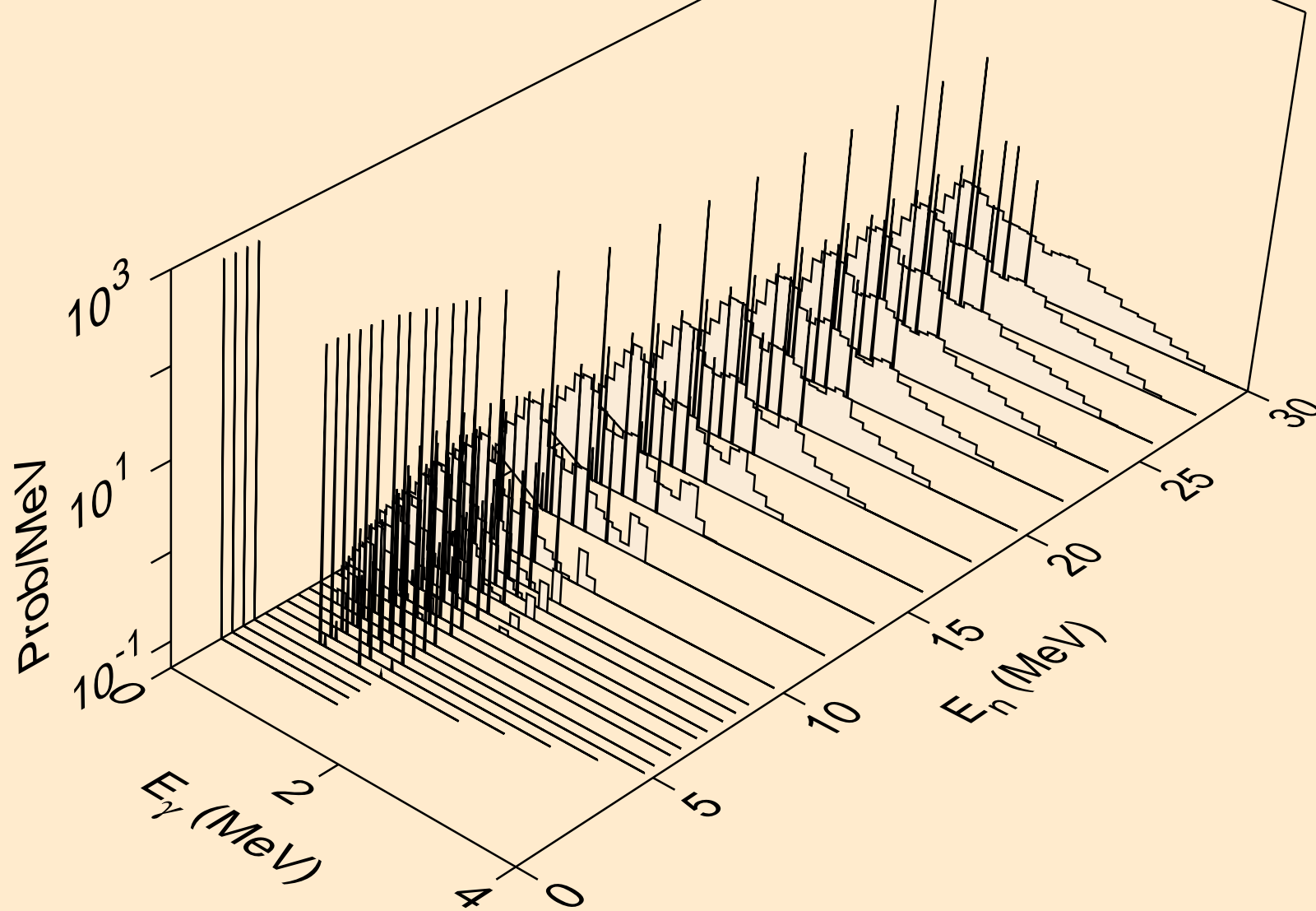

AT201 NEUTRON ACER TENDL-2021 LIBRARY; T=293.6K
Photon emission for (n,t)

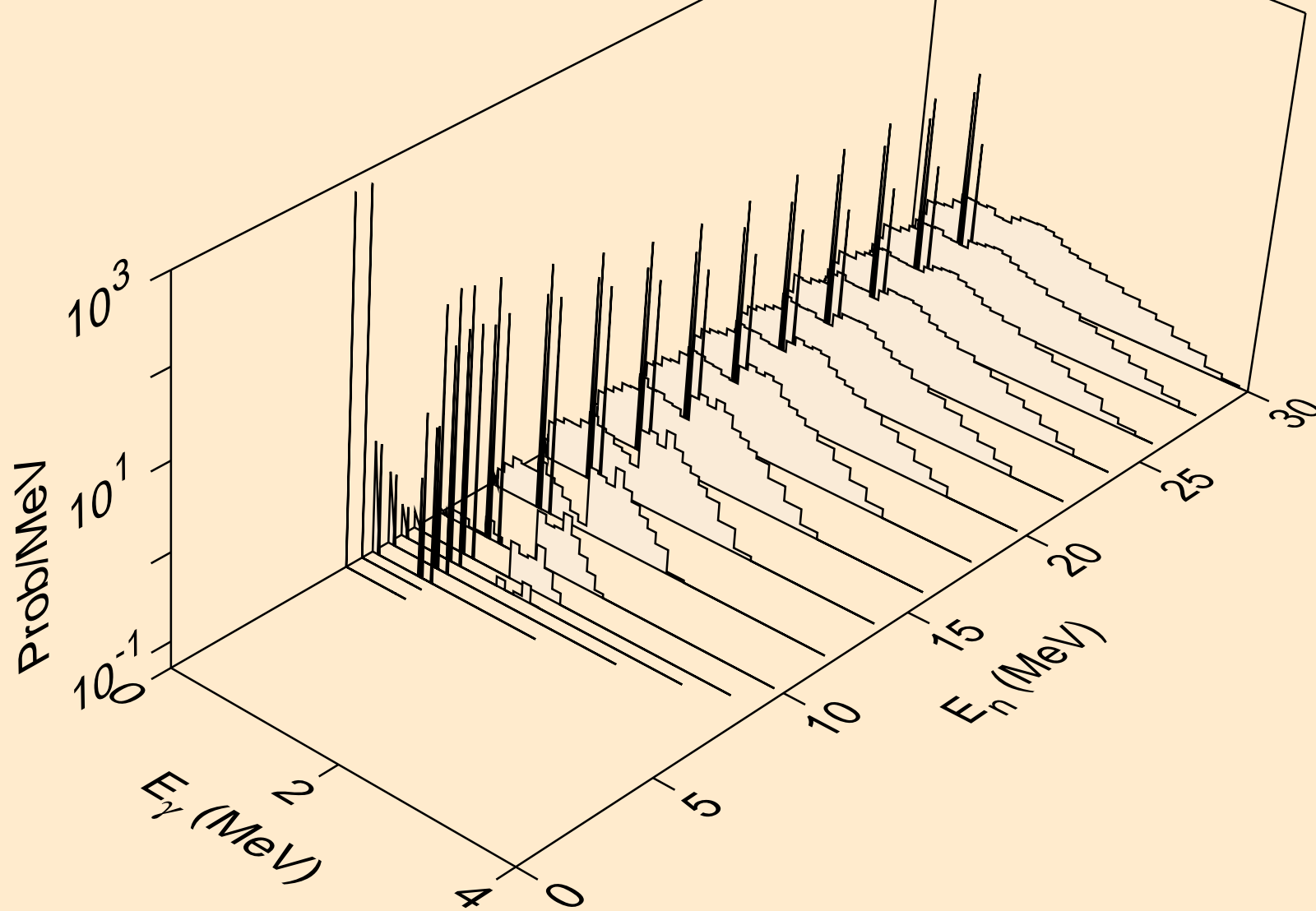

AT201 NEUTRON ACER TENDL-2021 LIBRARY; T=293.6K
Photon emission for (n,he3)

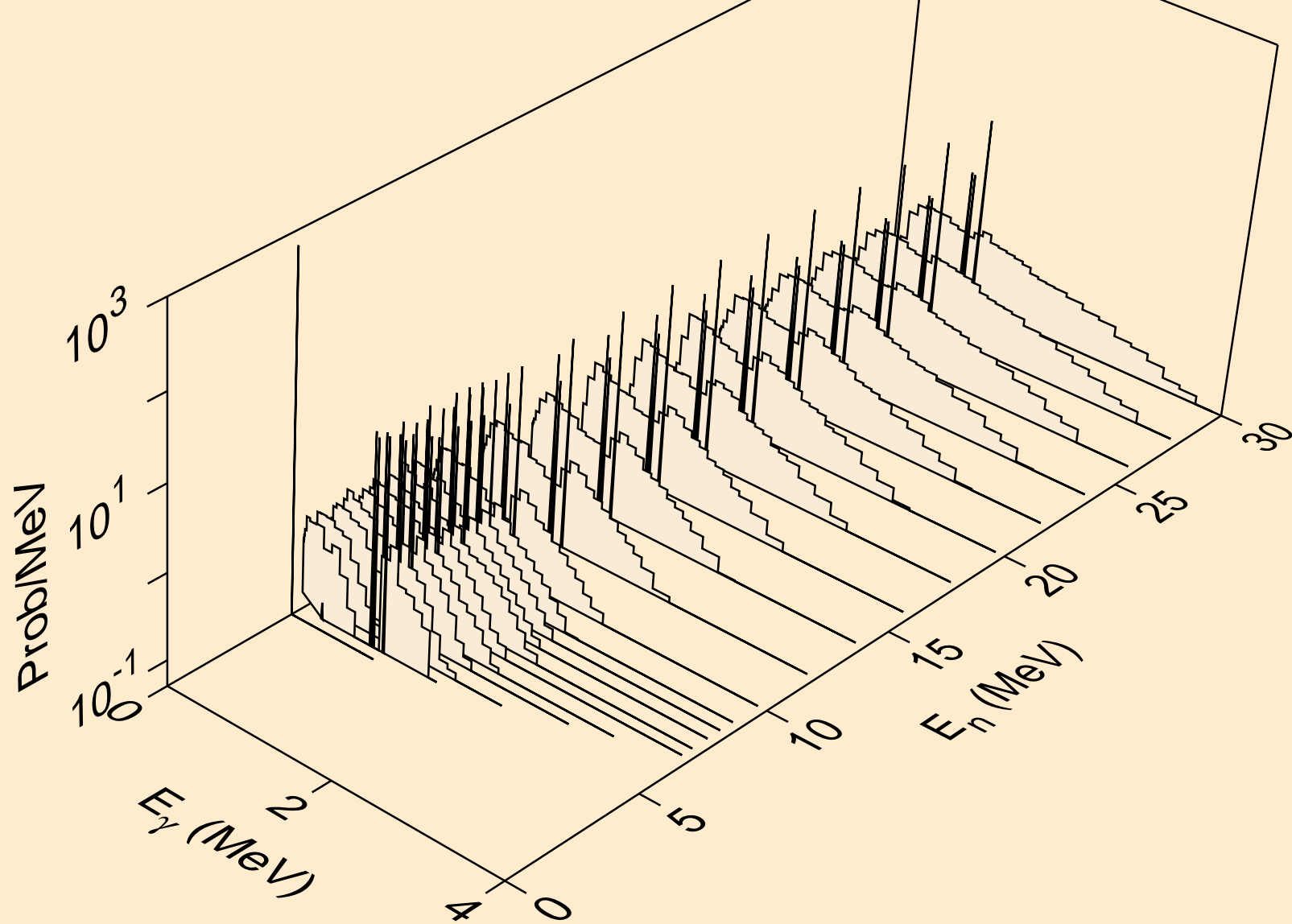

AT201 NEUTRON ACER TENDL-2021 LIBRARY; T=293.6K
Photon emission for (n,a)

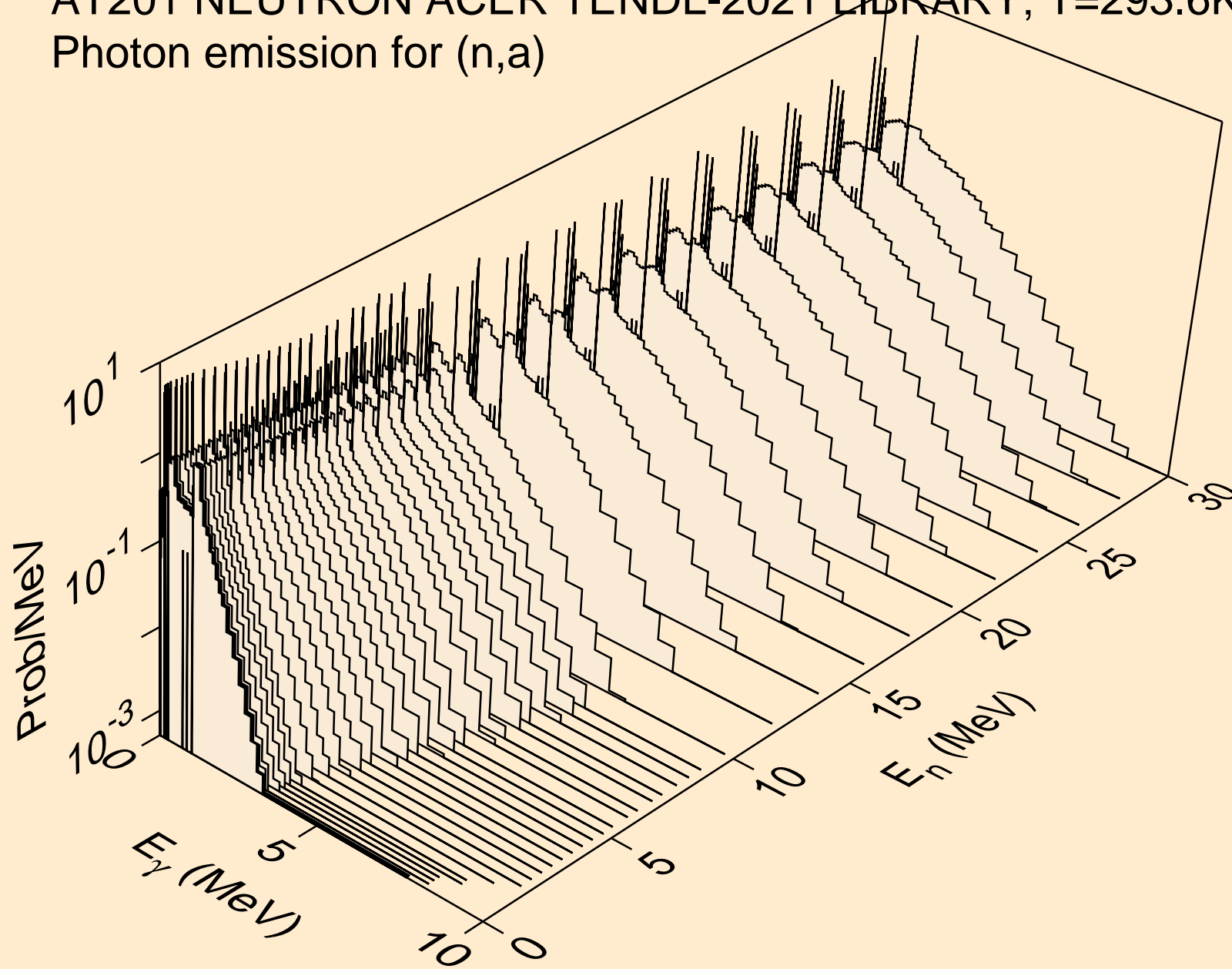

AT201 NEUTRON ACER TENDL-2021 LIBRARY; T=293.6K
Photon emission for (n,2a)

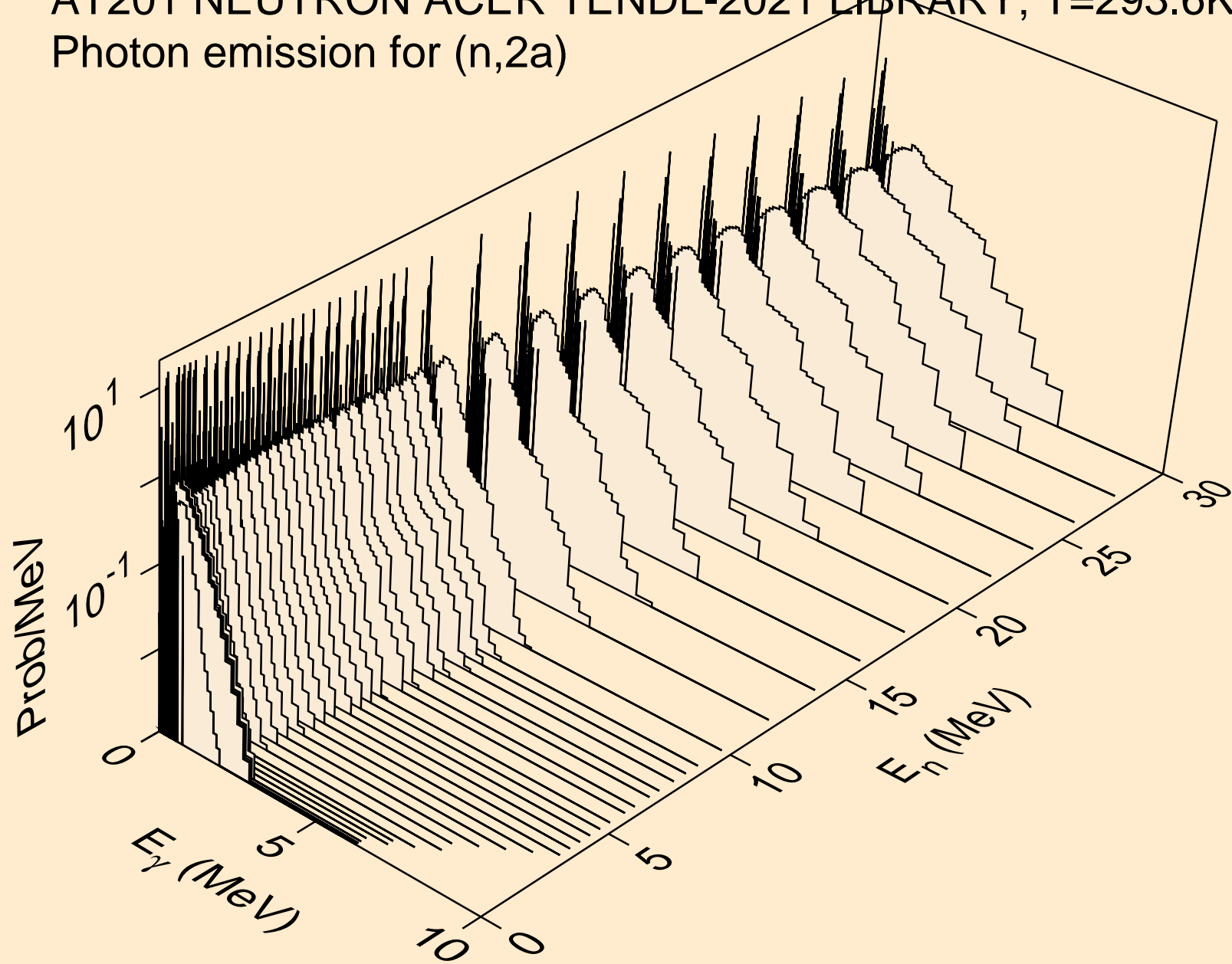

AT201 NEUTRON ACER TENDL-2021 LIBRARY; T=293.6K
Photon emission for (n,2p)

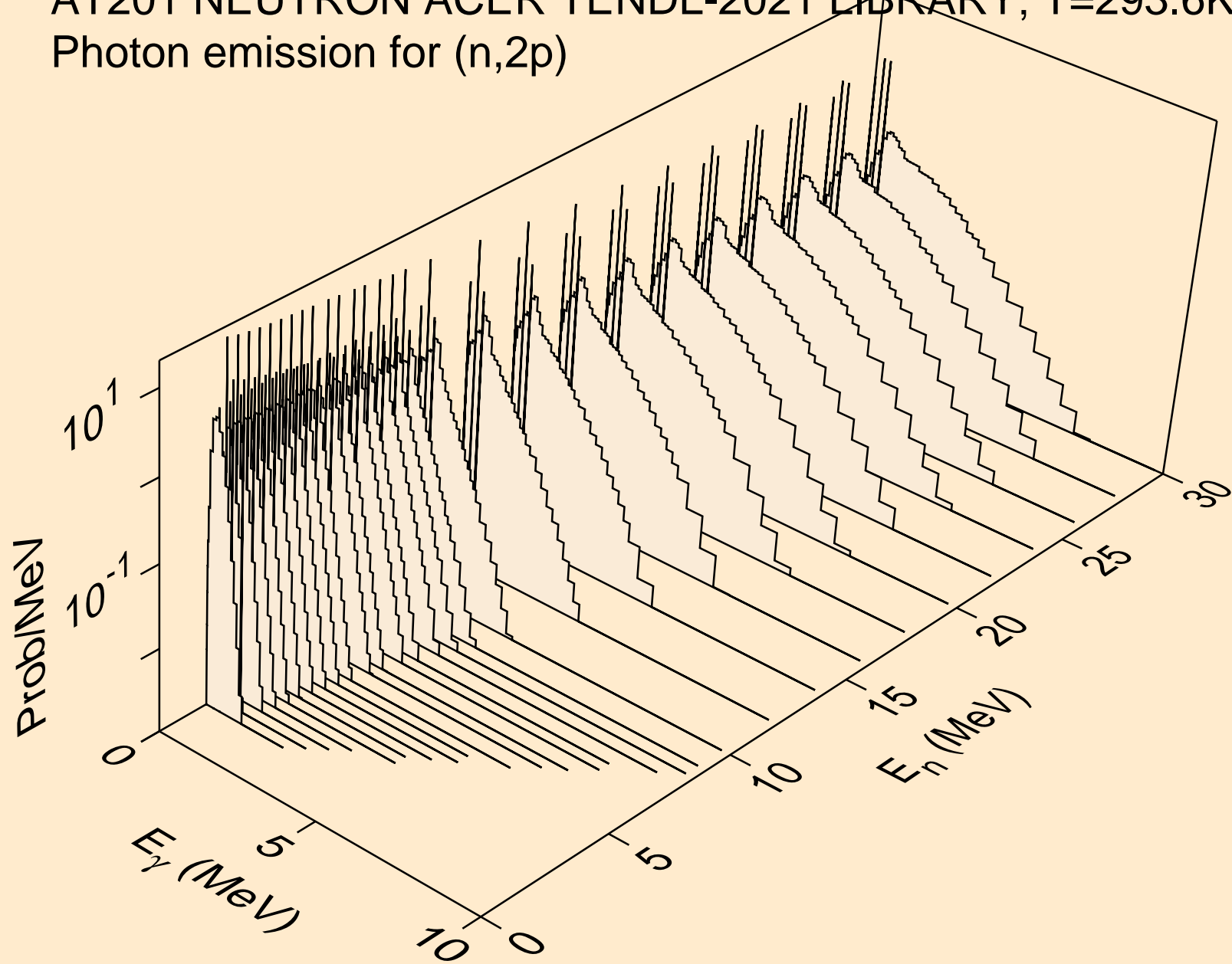

AT201 NEUTRON ACER TENDL-2021 LIBRARY; T=293.6K
Photon emission for (n,p α)

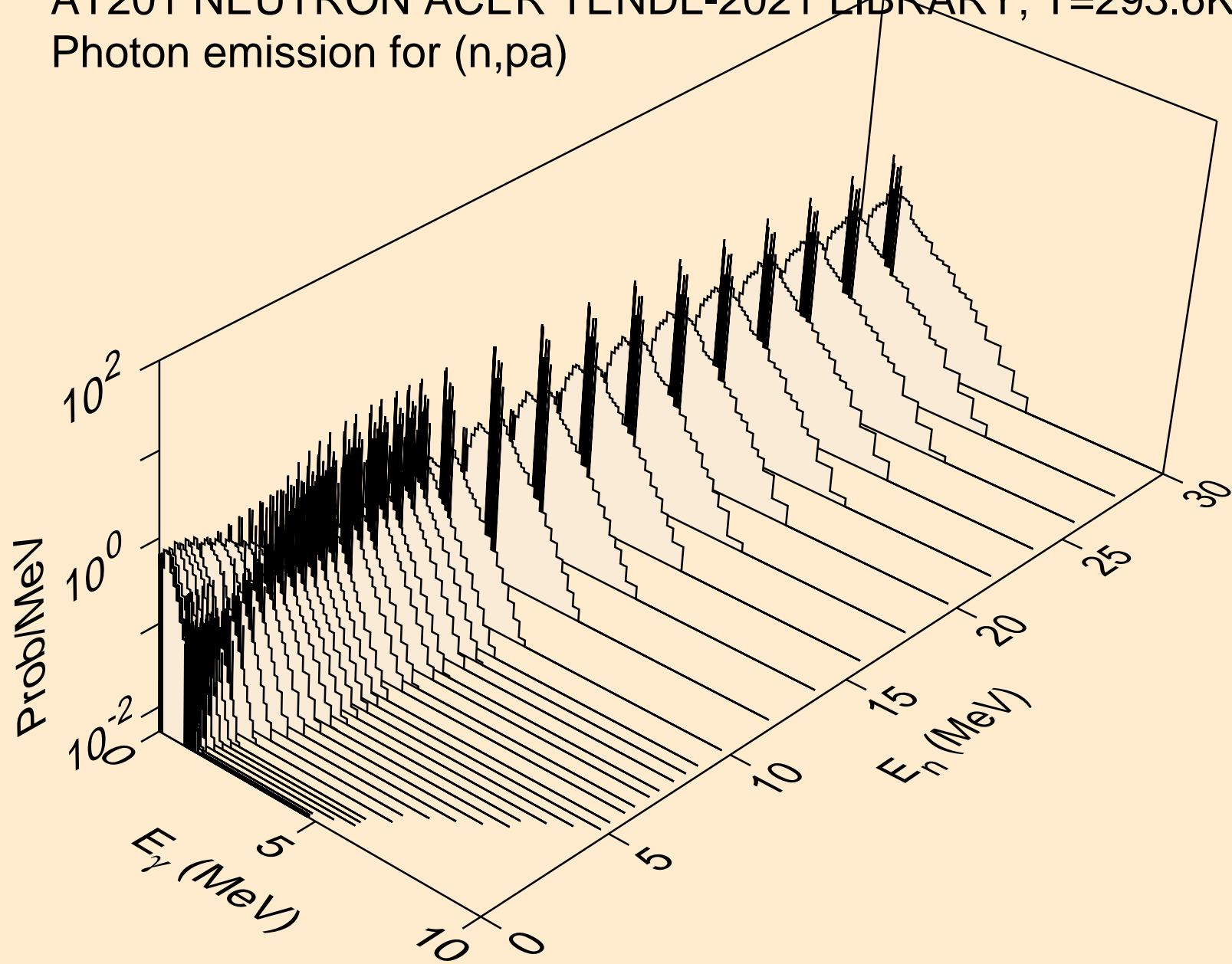

AT201 NEUTRON ACER TENDL-2021 LIBRARY; T=293.6K
Photon emission for (n,pd)

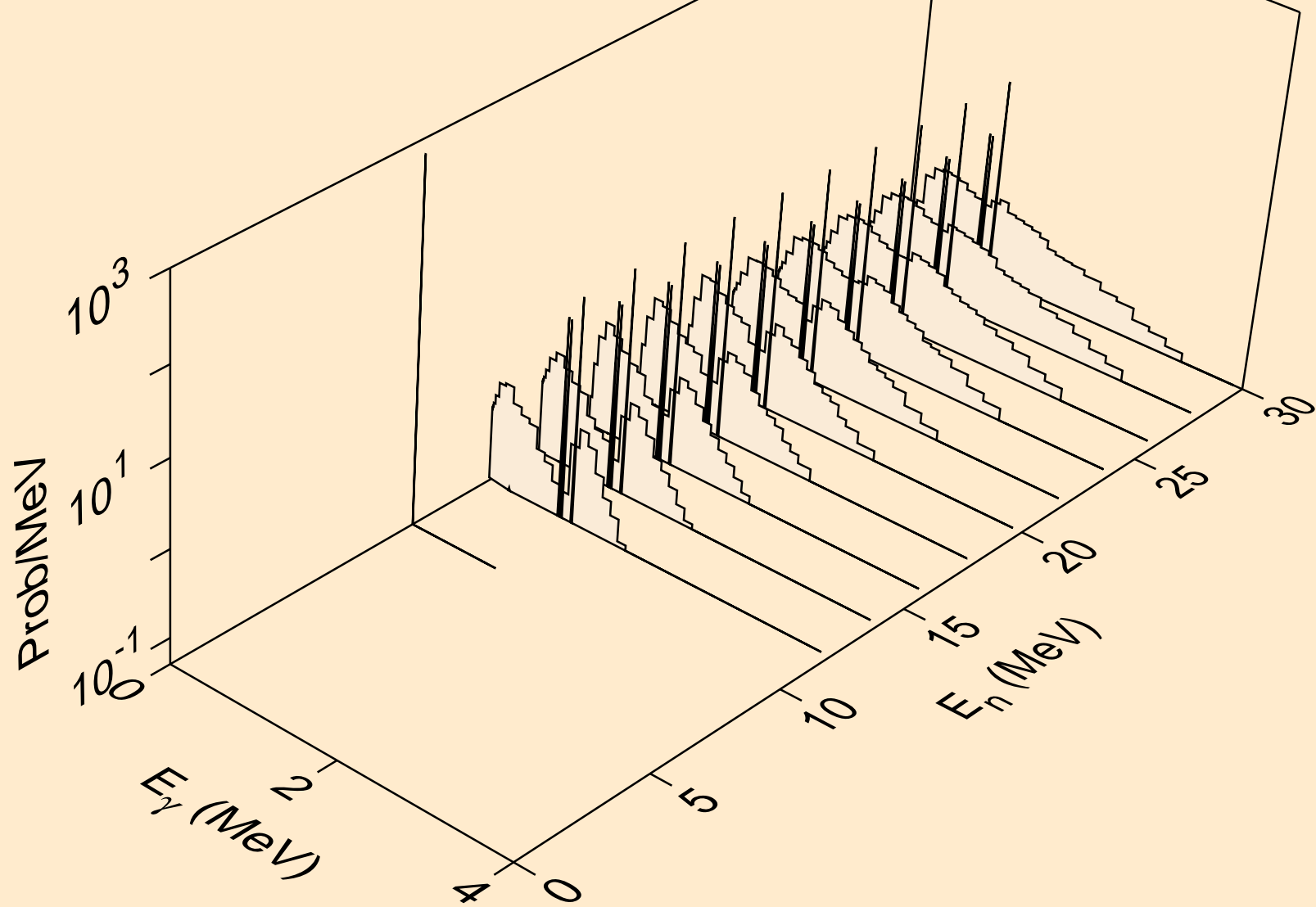

AT201 NEUTRON ACER TENDL-2021 LIBRARY; T=293.6K
Photon emission for (n,pt)

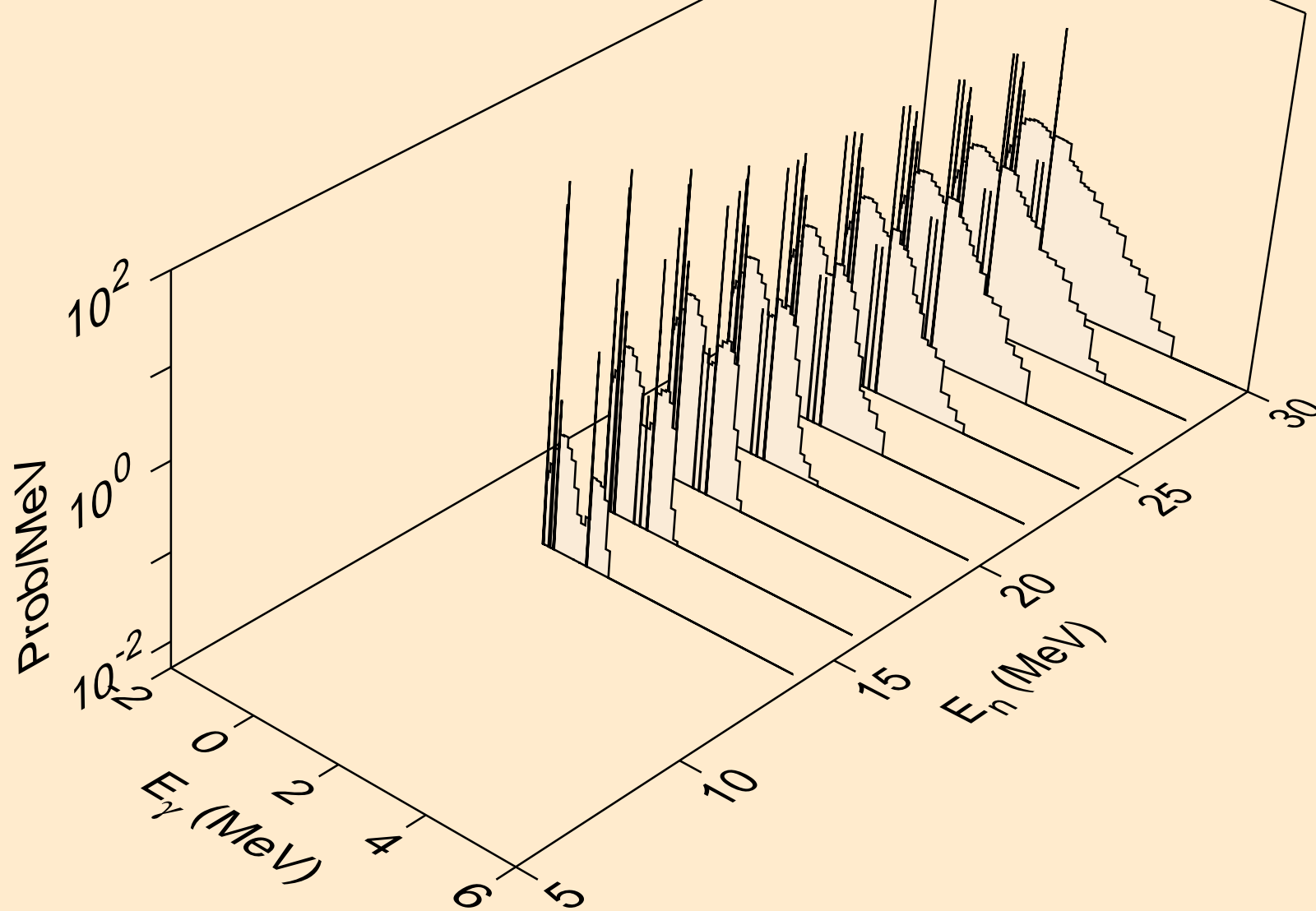

AT201 NEUTRON ACER TENDL-2021 LIBRARY; T=293.6K
Photon emission for (n,da)

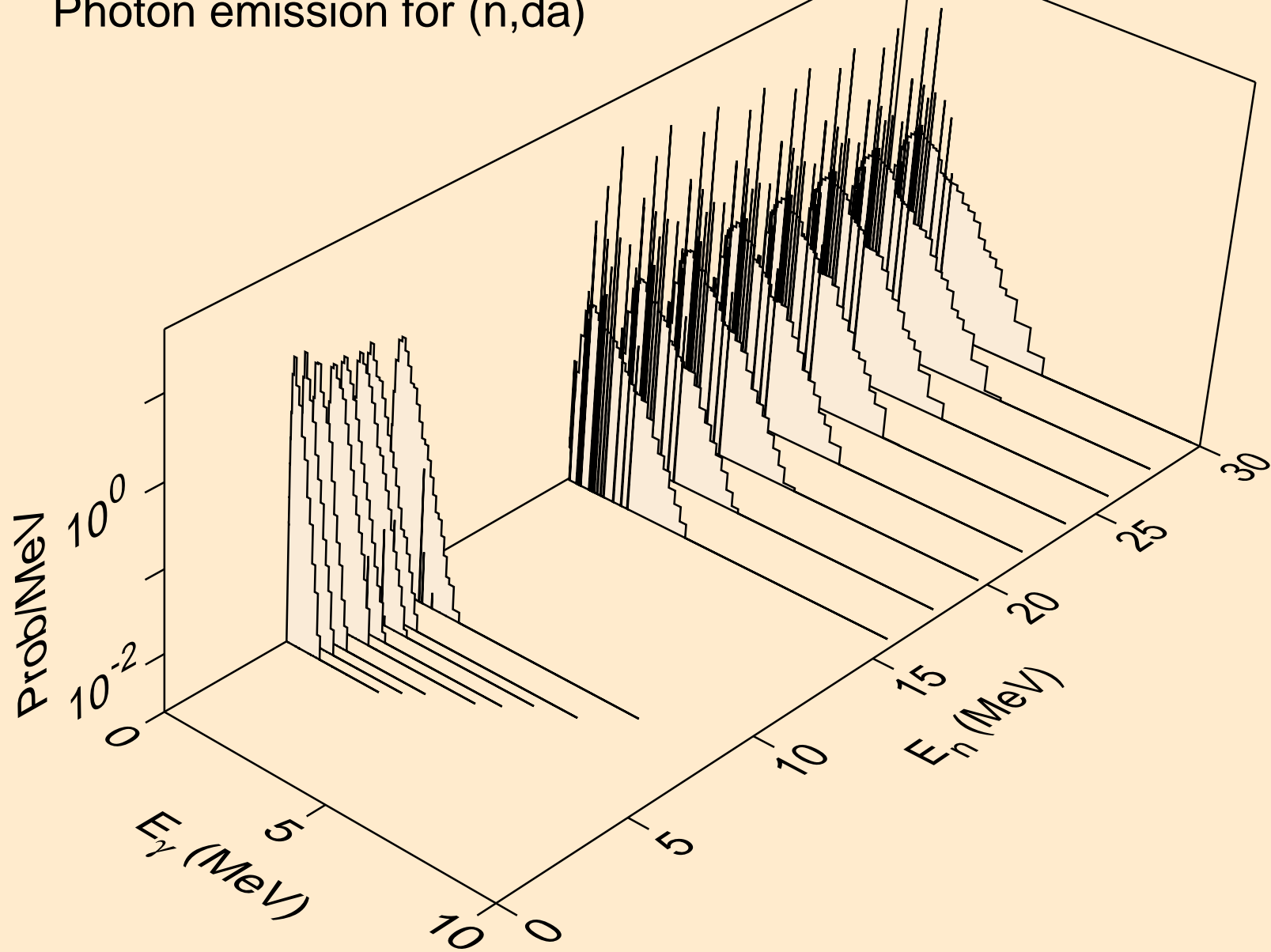

AT201 NEUTRON ACER TENDL-2021 LIBRARY; T=293.6K
thermal capture photon spectrum

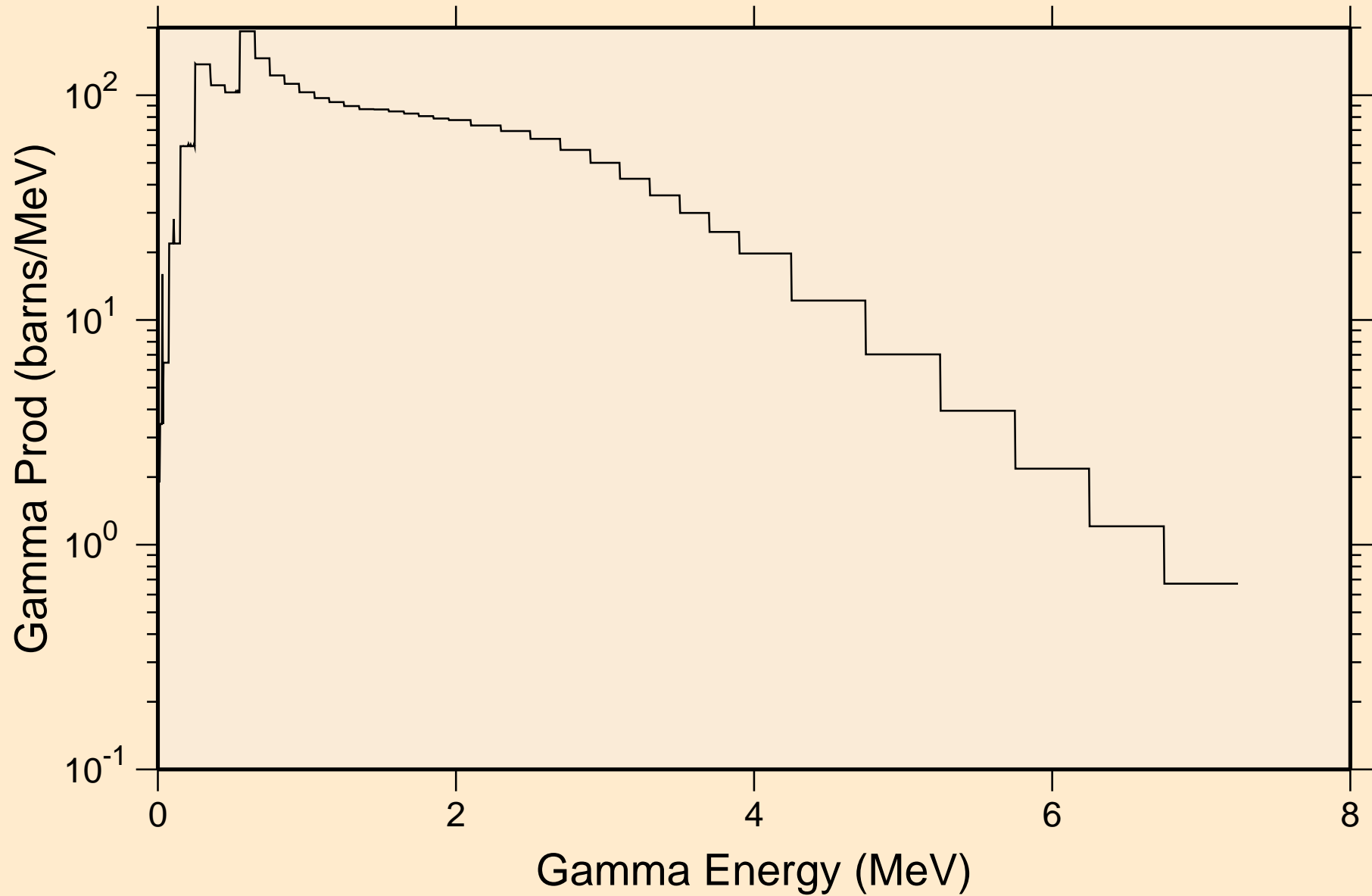

AT201 NEUTRON ACER TENDL-2021 LIBRARY; T=293.6K
14 MeV photon spectrum

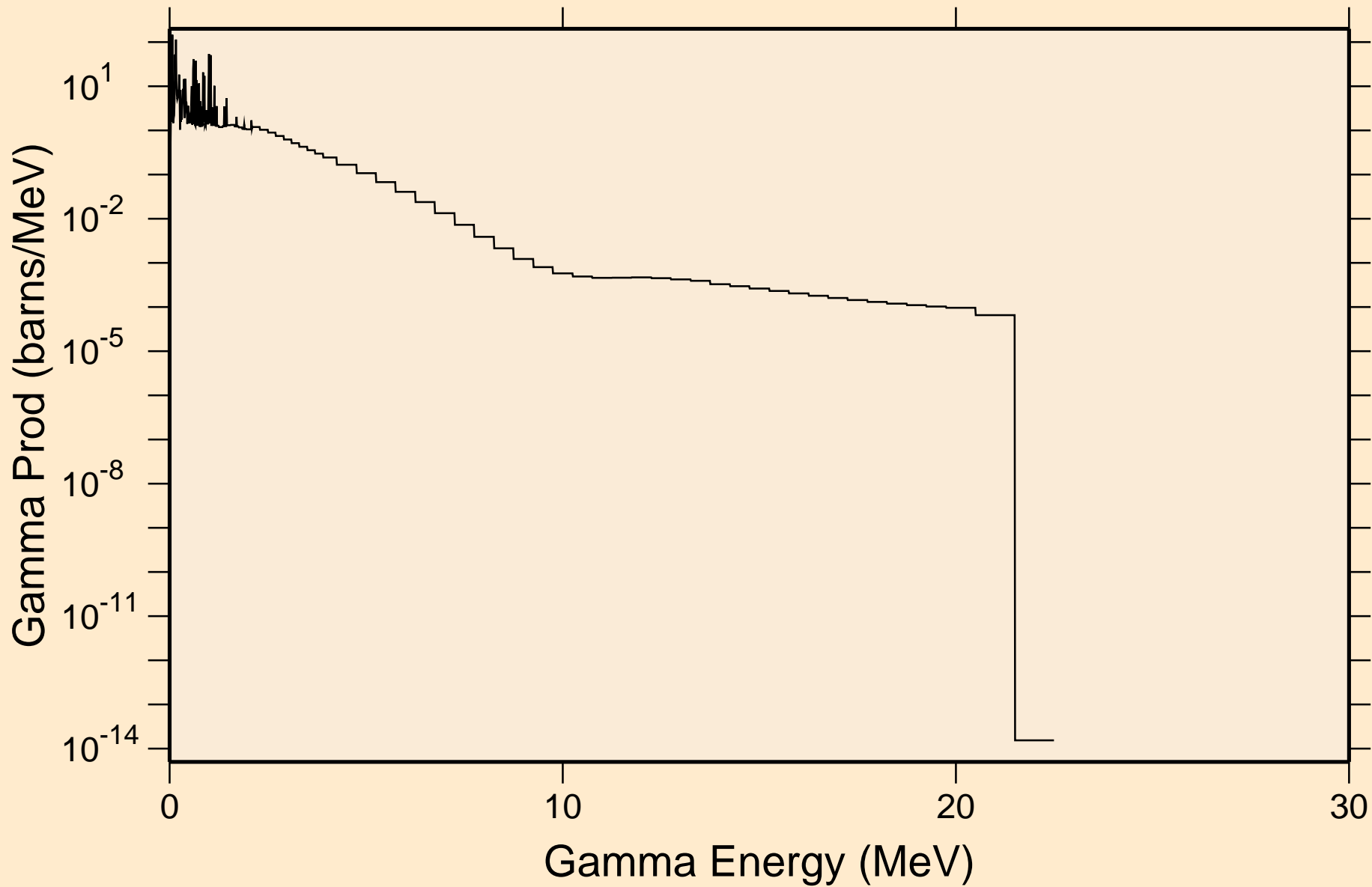

AT201 NEUTRON ACER TENDL-2021 LIBRARY; T=293.6K
Particle heating contributions

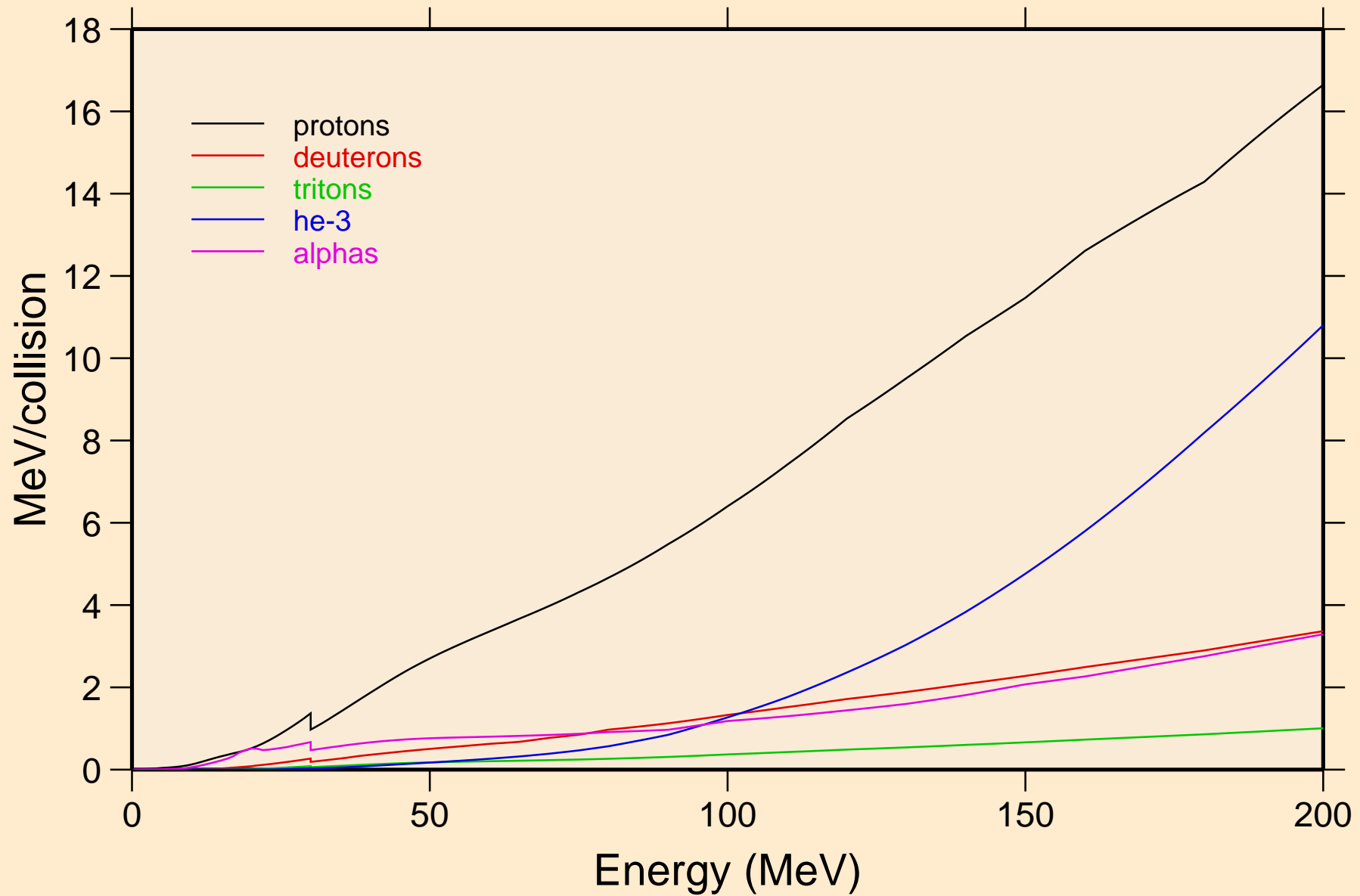

AT201 NEUTRON ACER TENDL-2021 LIBRARY; T=293.6K
Recoil Heating

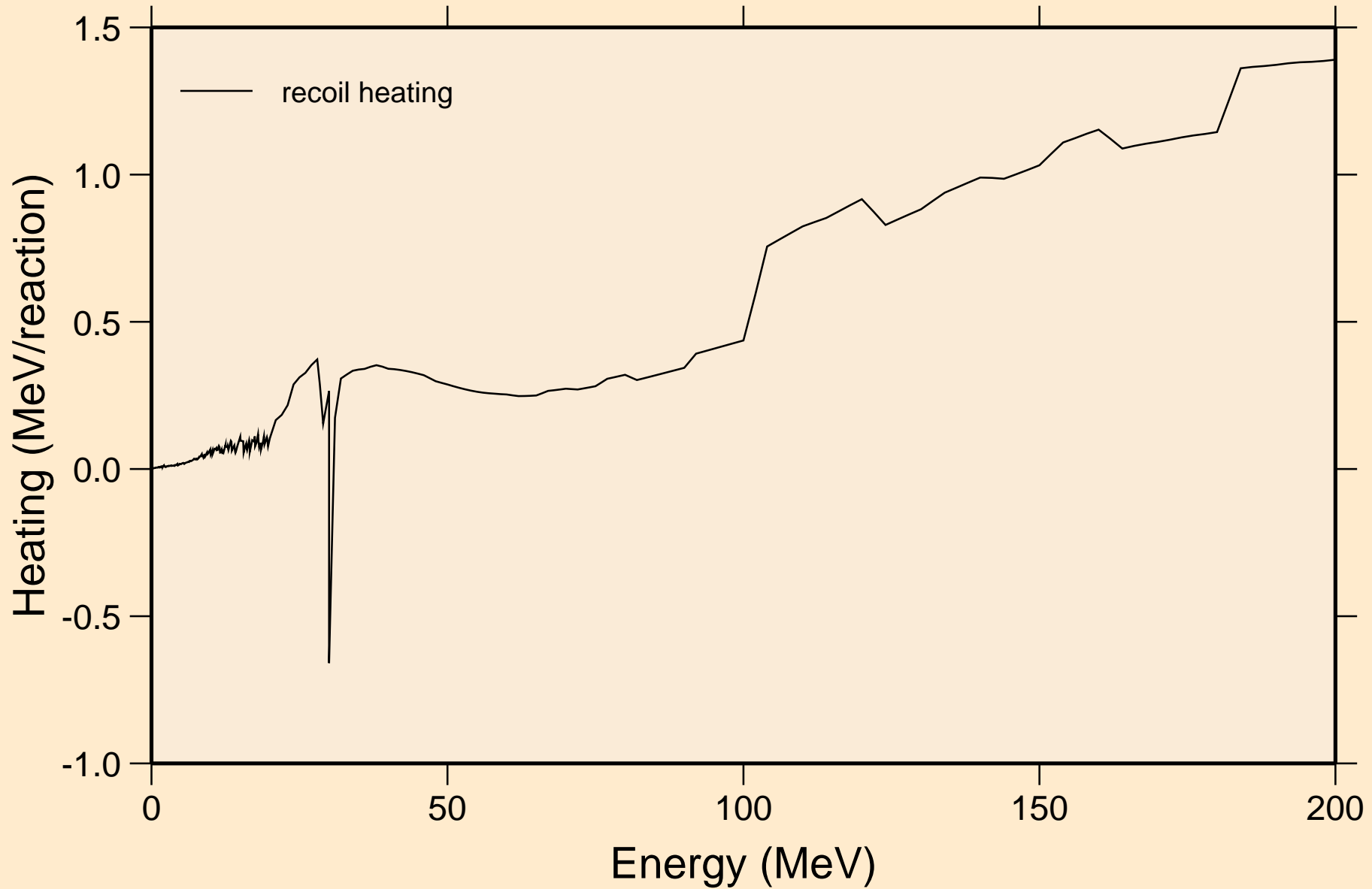

AT201 NEUTRON ACER TENDL-2021 LIBRARY; T=293.6K
Particle production cross sections

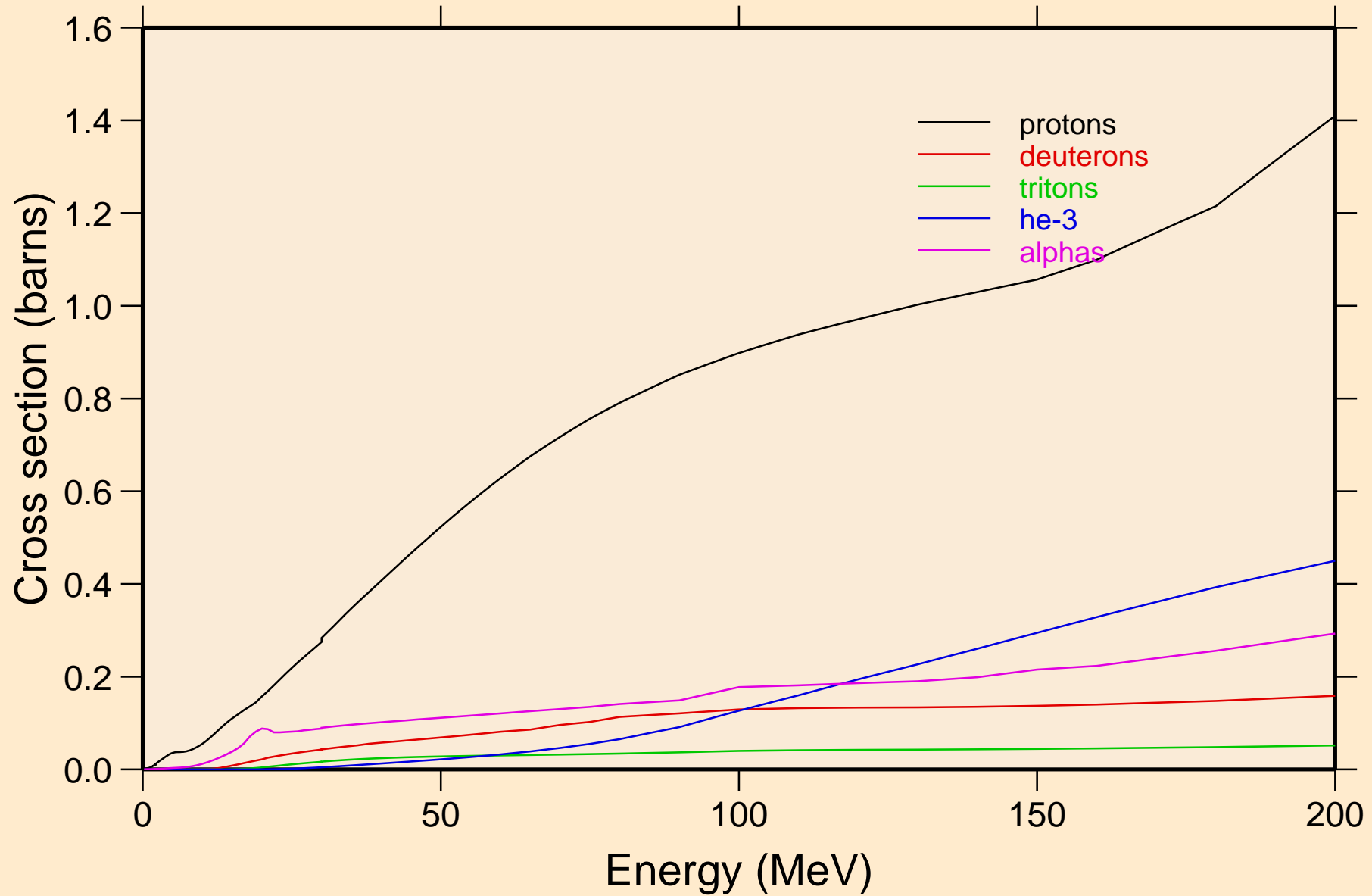

AT201 NEUTRON ACER TENDL-2021 LIBRARY; T=293.6K
protons from (n,x)

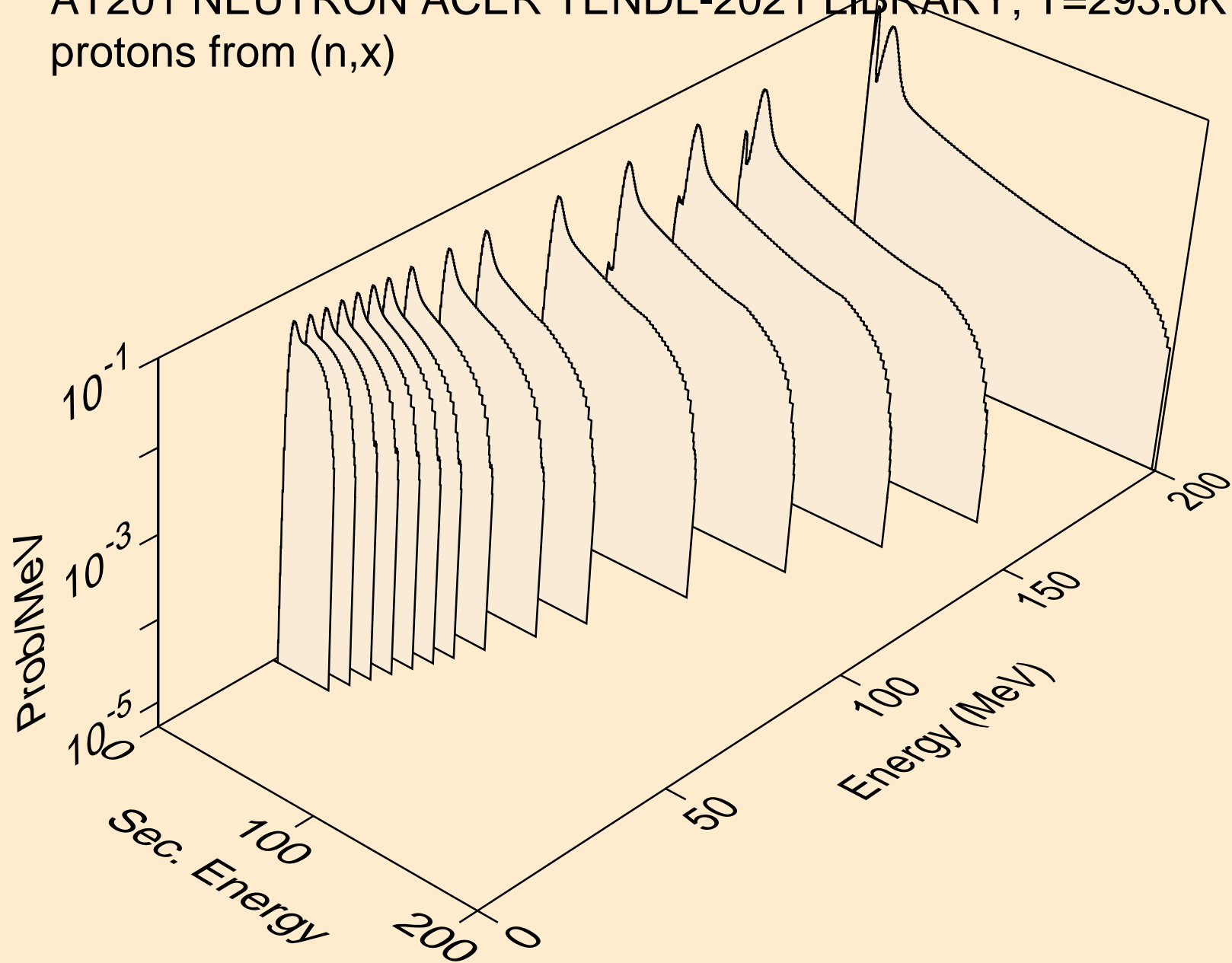

AT201 NEUTRON ACER TENDL-2021 LIBRARY; T=293.6K
protons from (n,n*)p

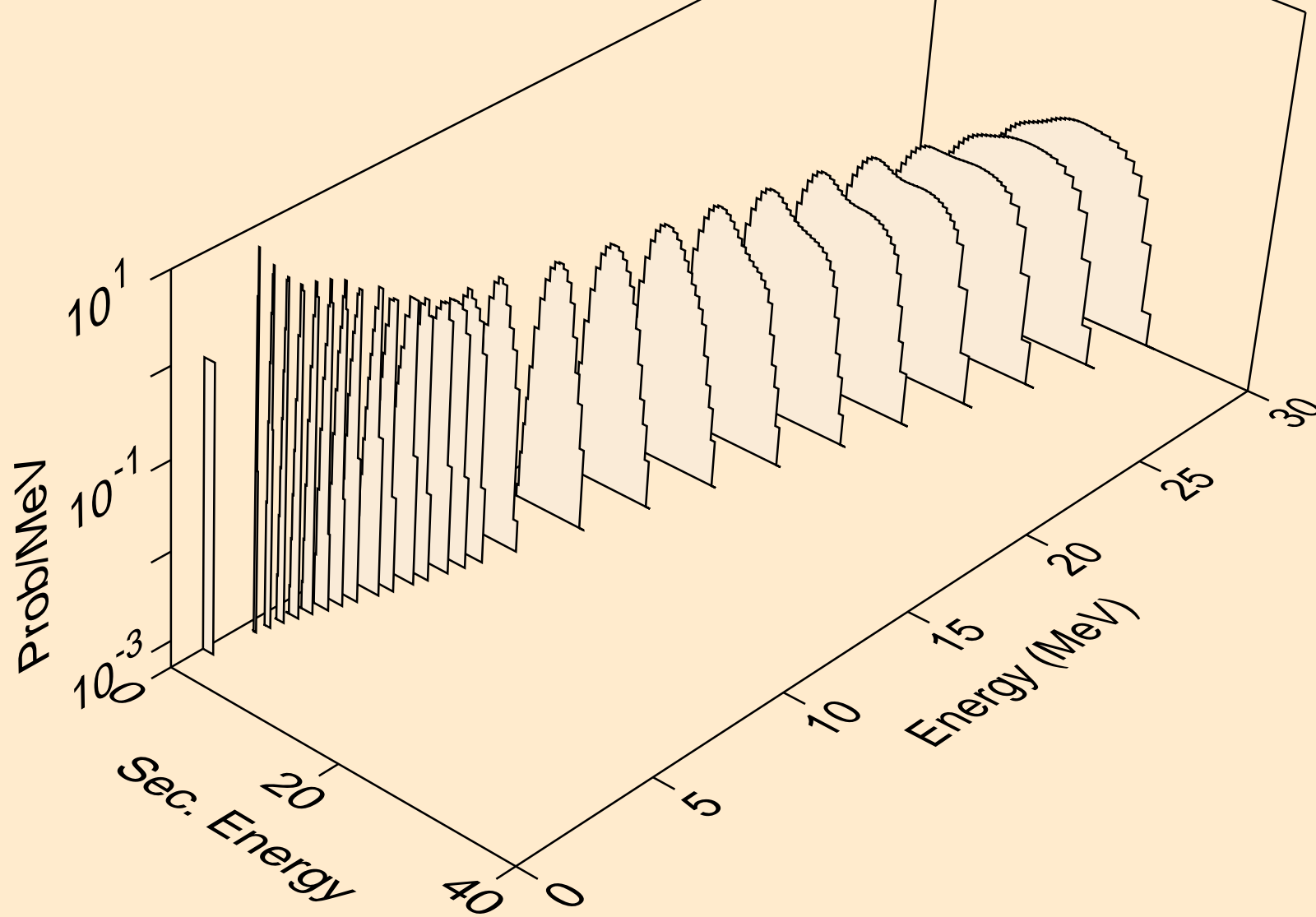

AT201 NEUTRON ACER TENDL-2021 LIBRARY; T=293.6K
protons from (n,2np)

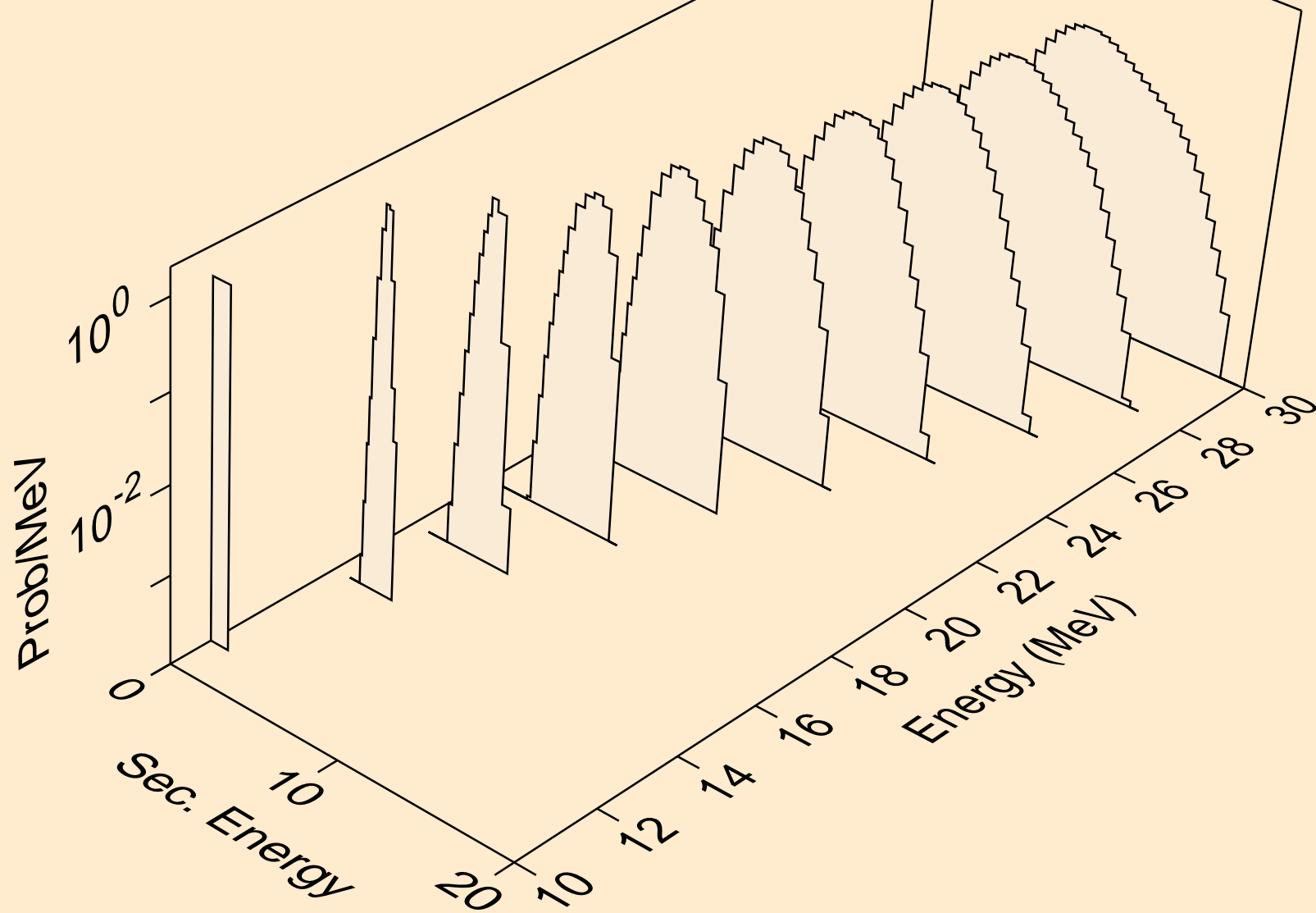

AT201 NEUTRON ACER TENDL-2021 LIBRARY; T=293.6K
protons from (n,3np)

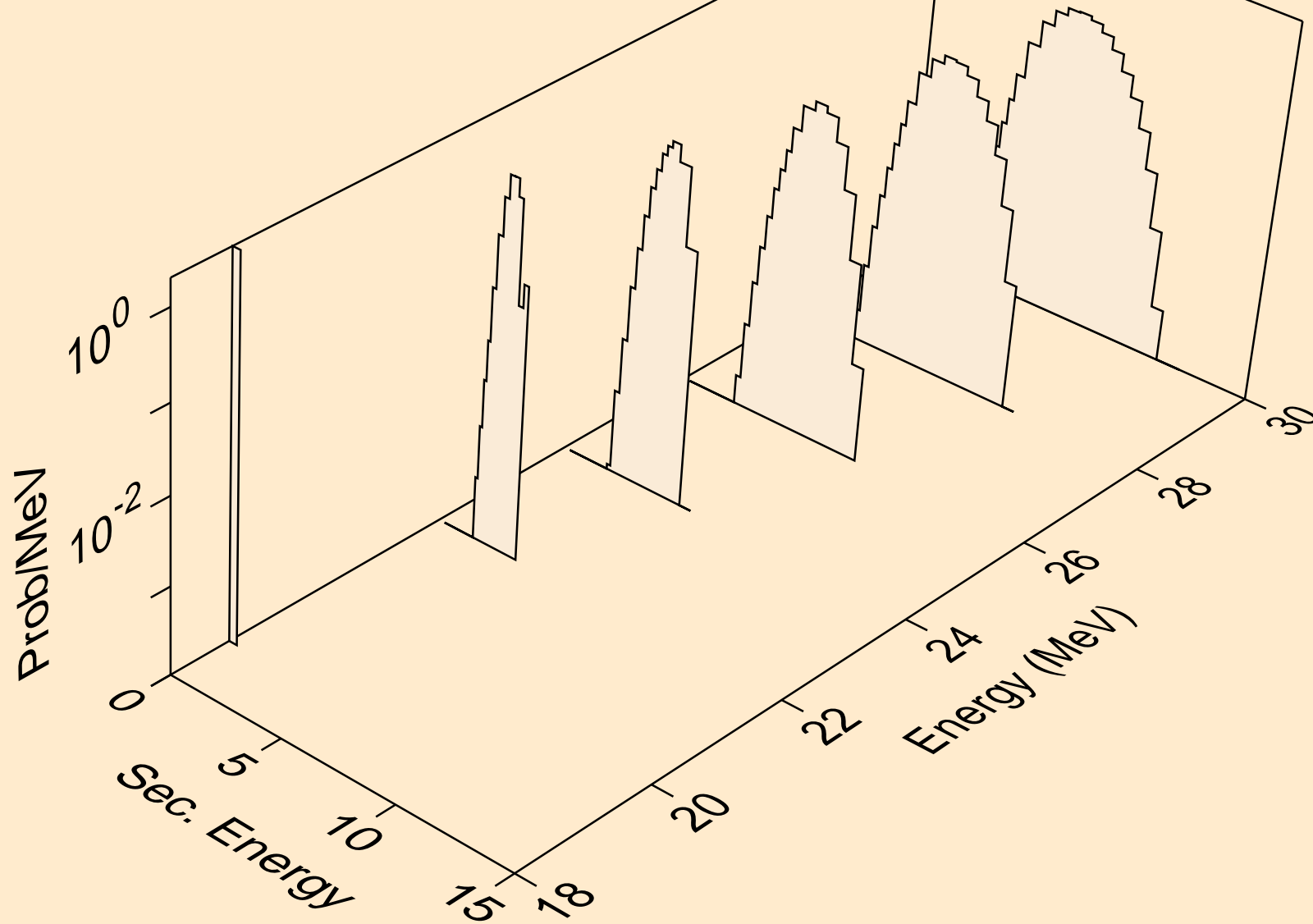

AT201 NEUTRON ACER TENDL-2021 LIBRARY; T=293.6K
protons from (n,2np)

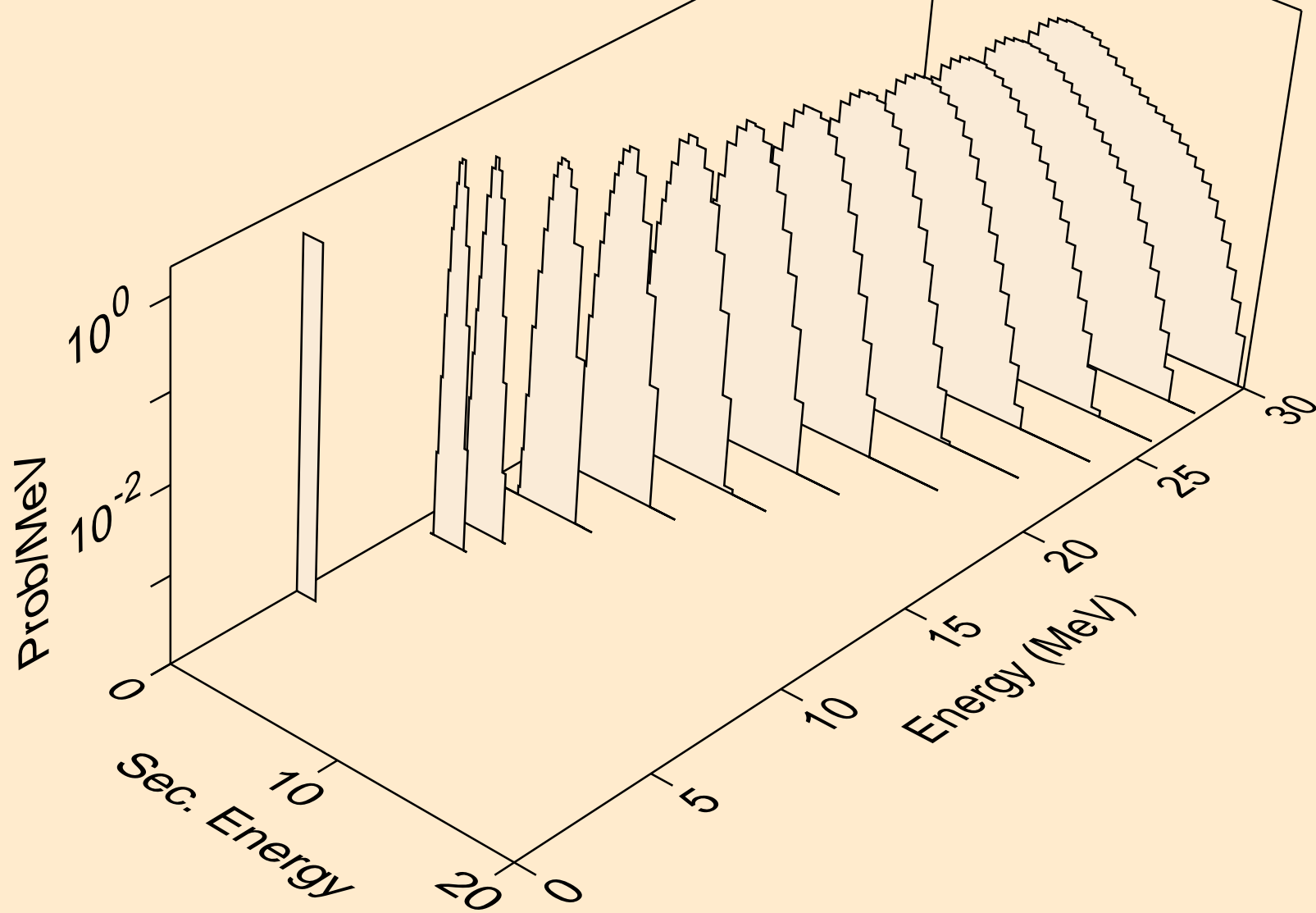

AT201 NEUTRON ACER TENDL-2021 LIBRARY; T=293.6K
protons from (n,npa)

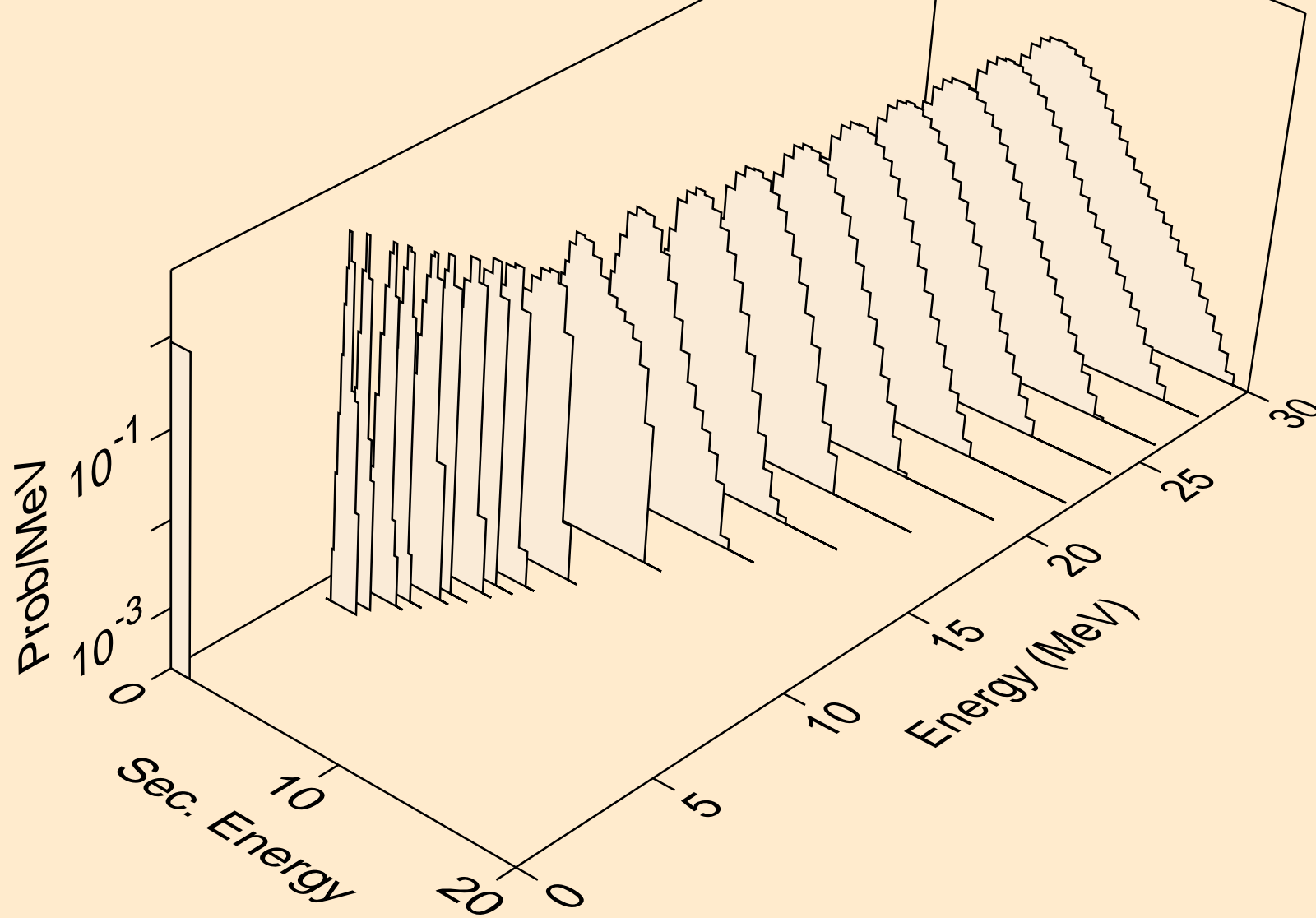

AT201 NEUTRON ACER TENDL-2021 LIBRARY; T=293.6K
protons from (n,p)

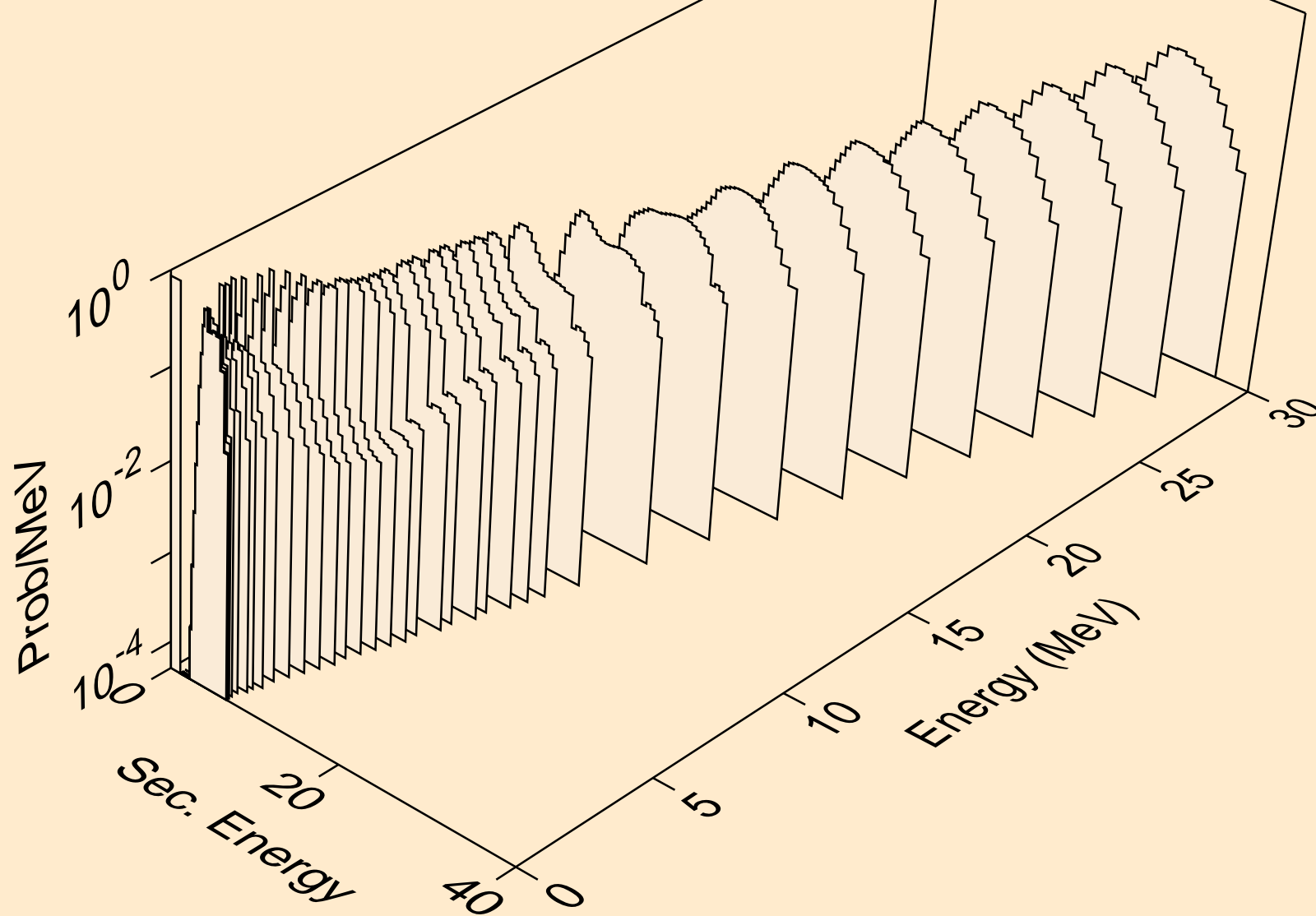

AT201 NEUTRON ACER TENDL-2021 LIBRARY; T=293.6K
protons from (n,2p)

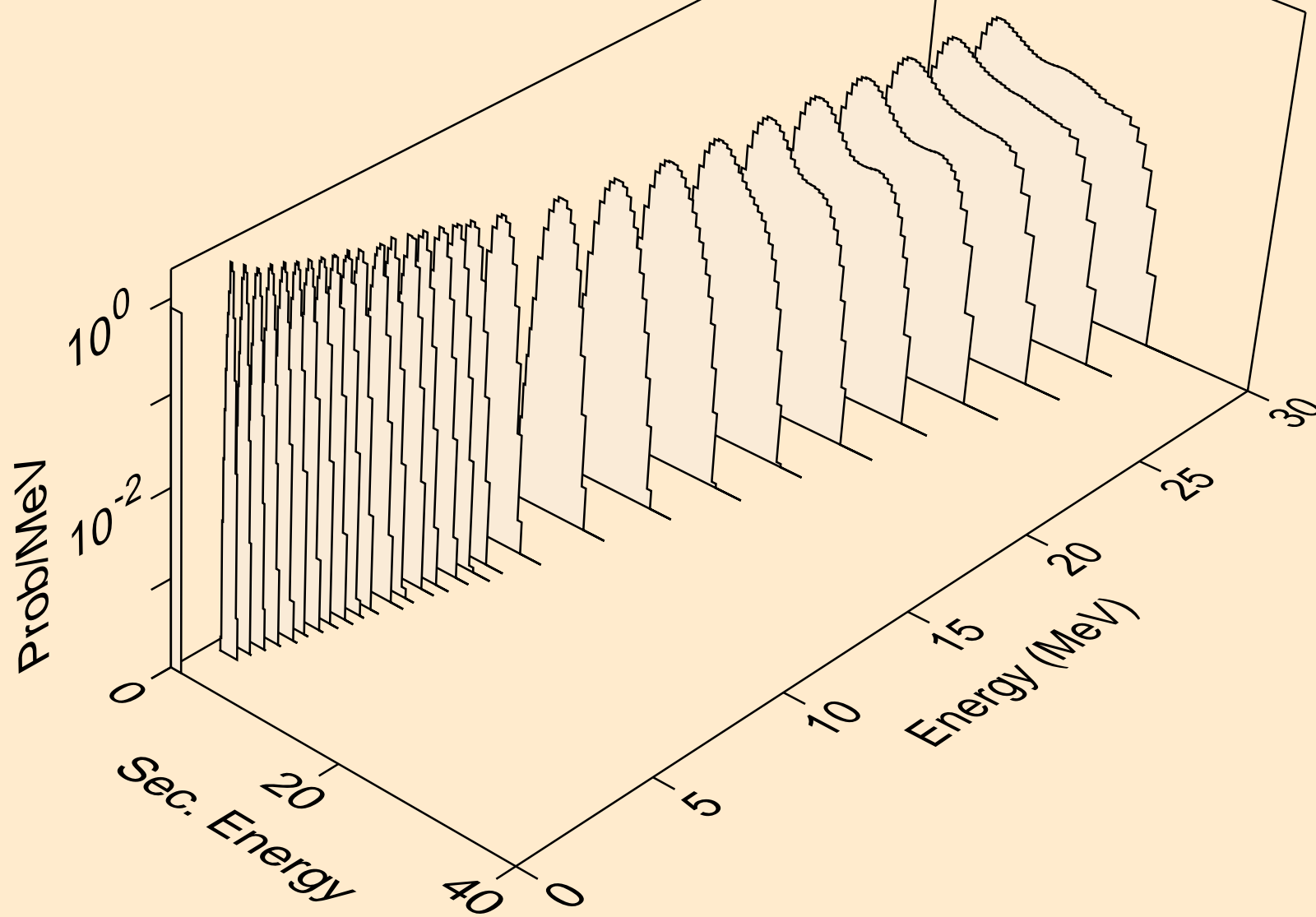

AT201 NEUTRON ACER TENDL-2021 LIBRARY; T=293.6K
protons from (n,p)

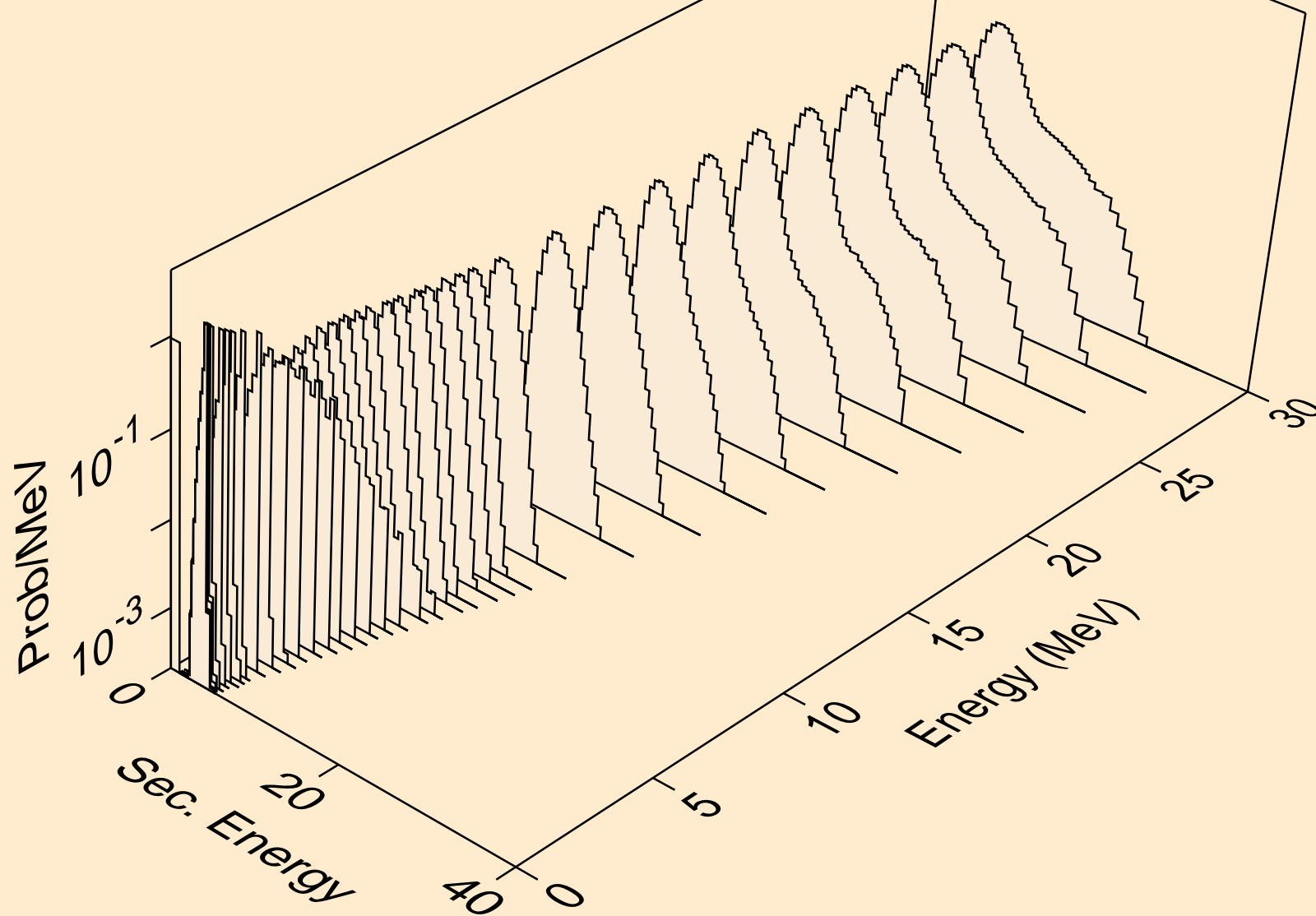

AT201 NEUTRON ACER TENDL-2021 LIBRARY; T=293.6K
protons from (n,pd)

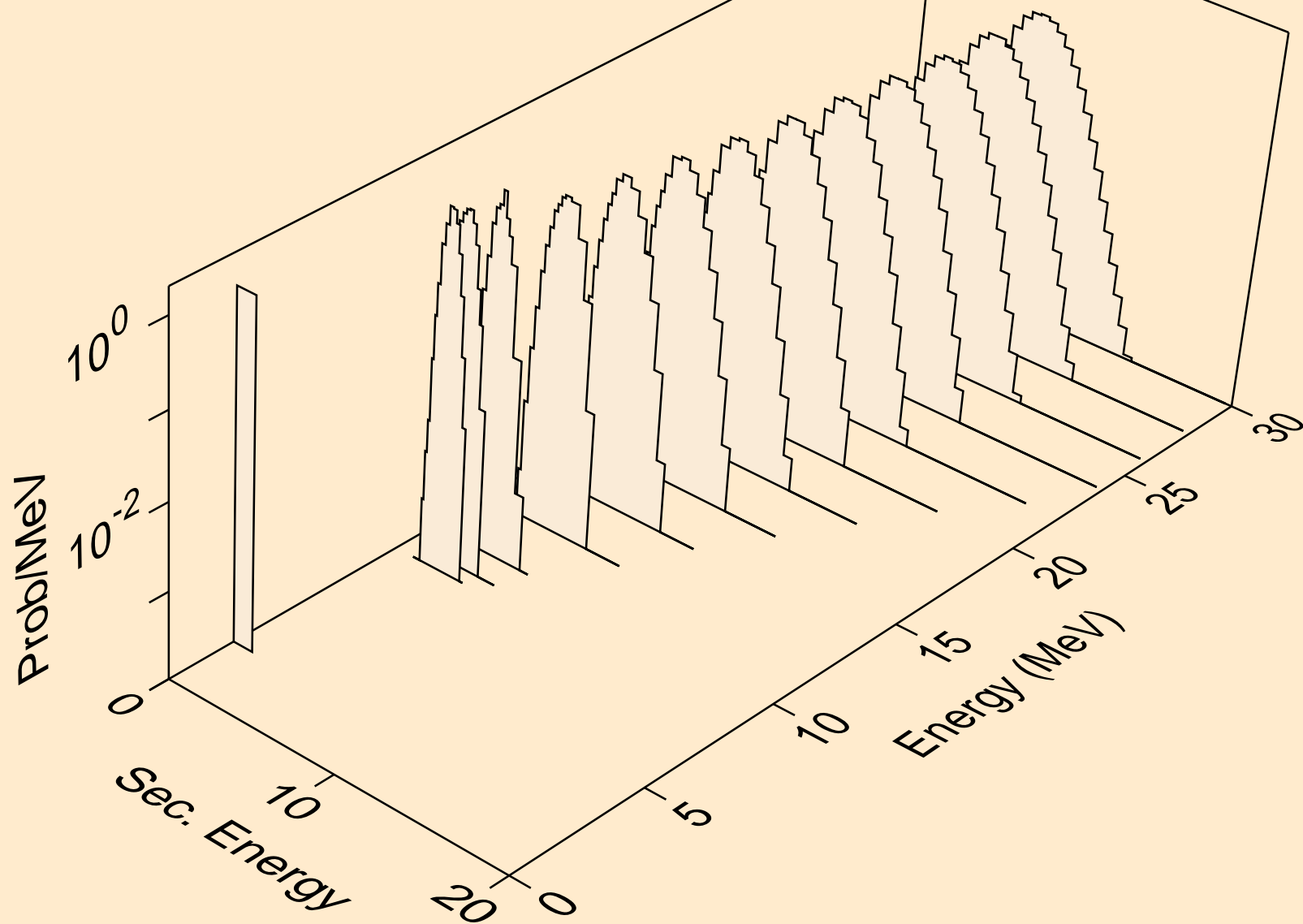

AT201 NEUTRON ACER TENDL-2021 LIBRARY; T=293.6K
protons from (n,pt)

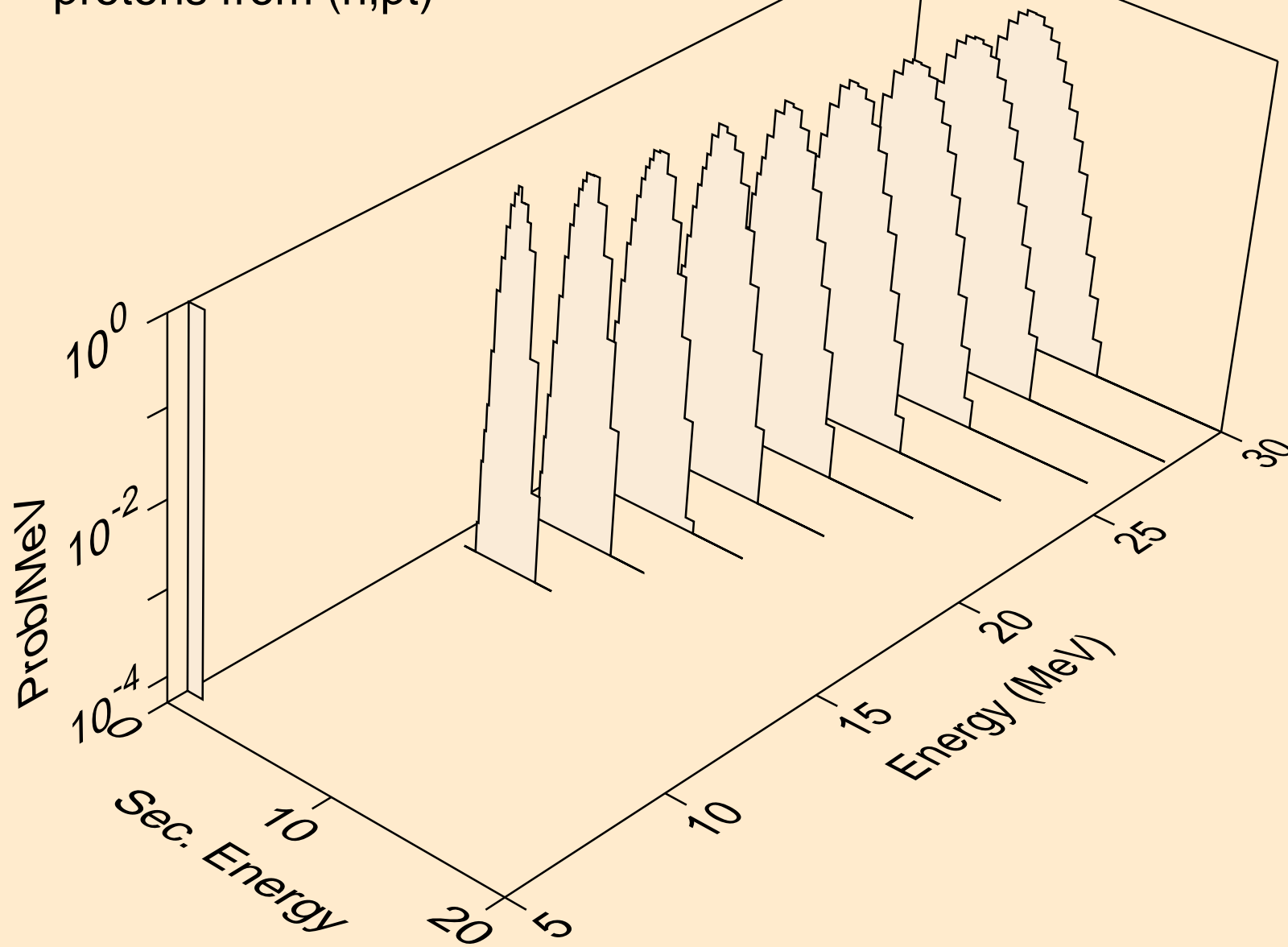

AT201 NEUTRON ACER TENDL-2021 LIBRARY; T=293.6K
deuterons from (n,x)

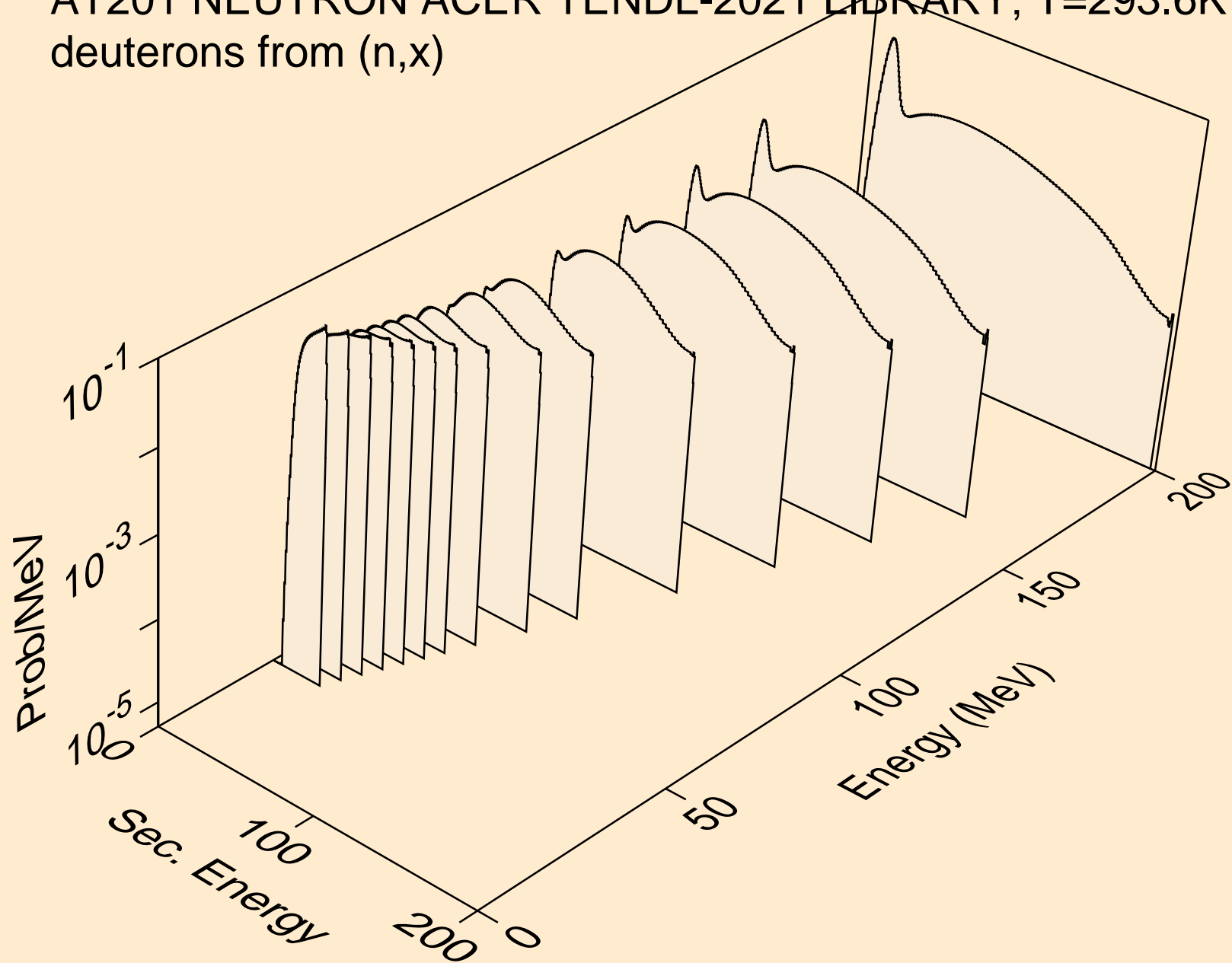

AT201 NEUTRON ACER TENDL-2021 LIBRARY; T=293.6K
deuterons from (n,2nd)

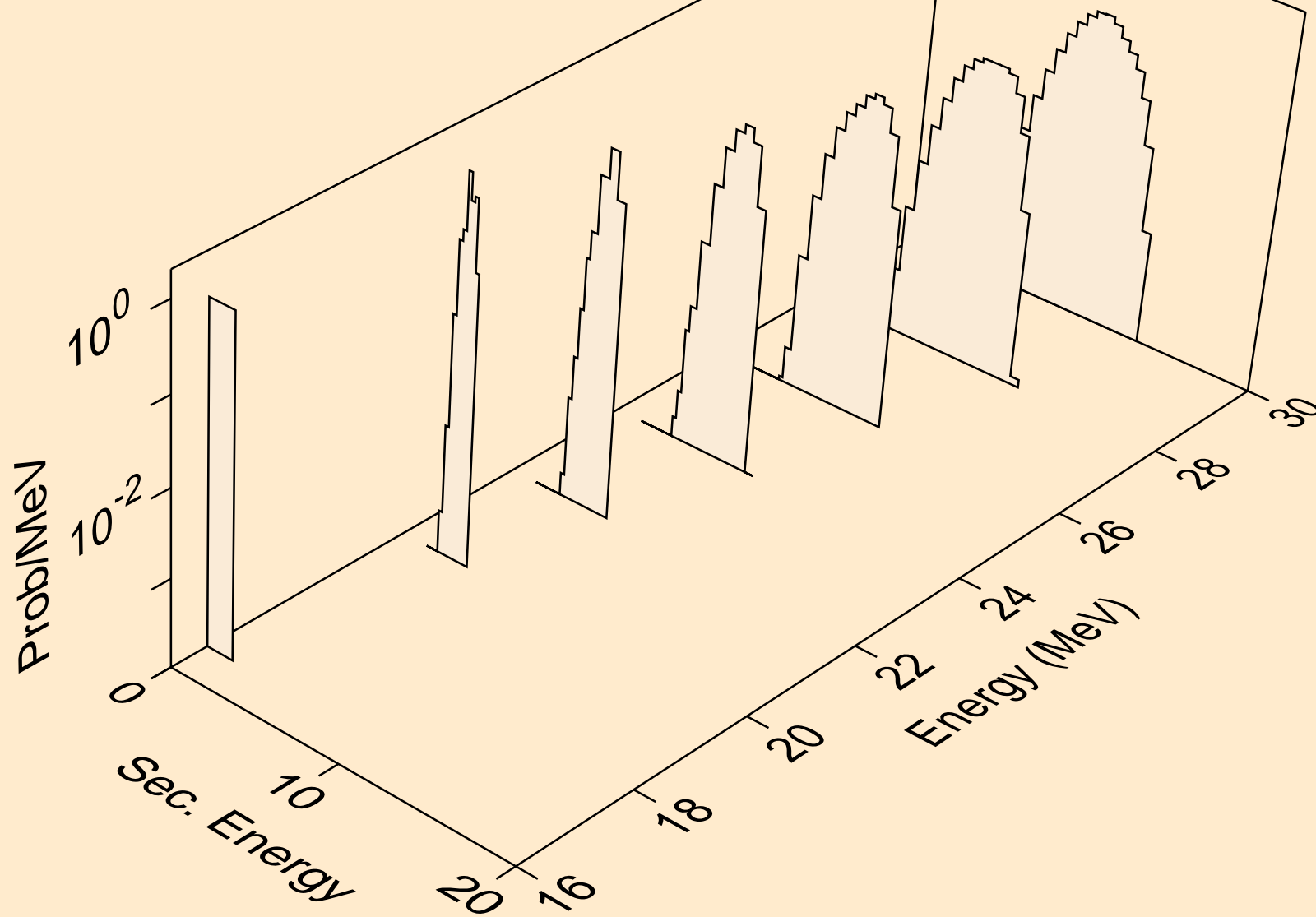

AT201 NEUTRON ACER TENDL-2021 LIBRARY; T=293.6K
deuterons from (n,n*)d

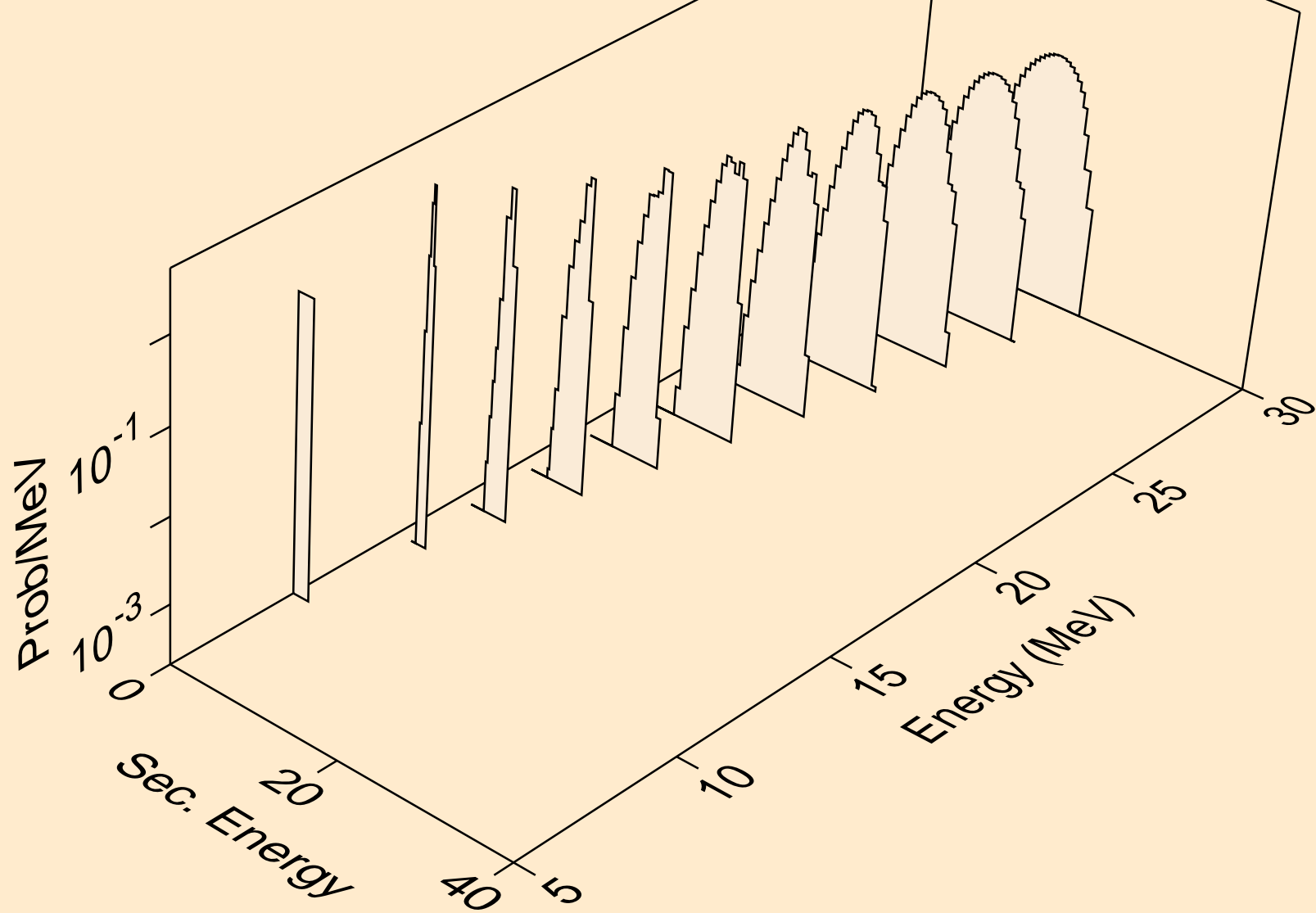

AT201 NEUTRON ACER TENDL-2021 LIBRARY; T=293.6K
deuterons from (n,d)

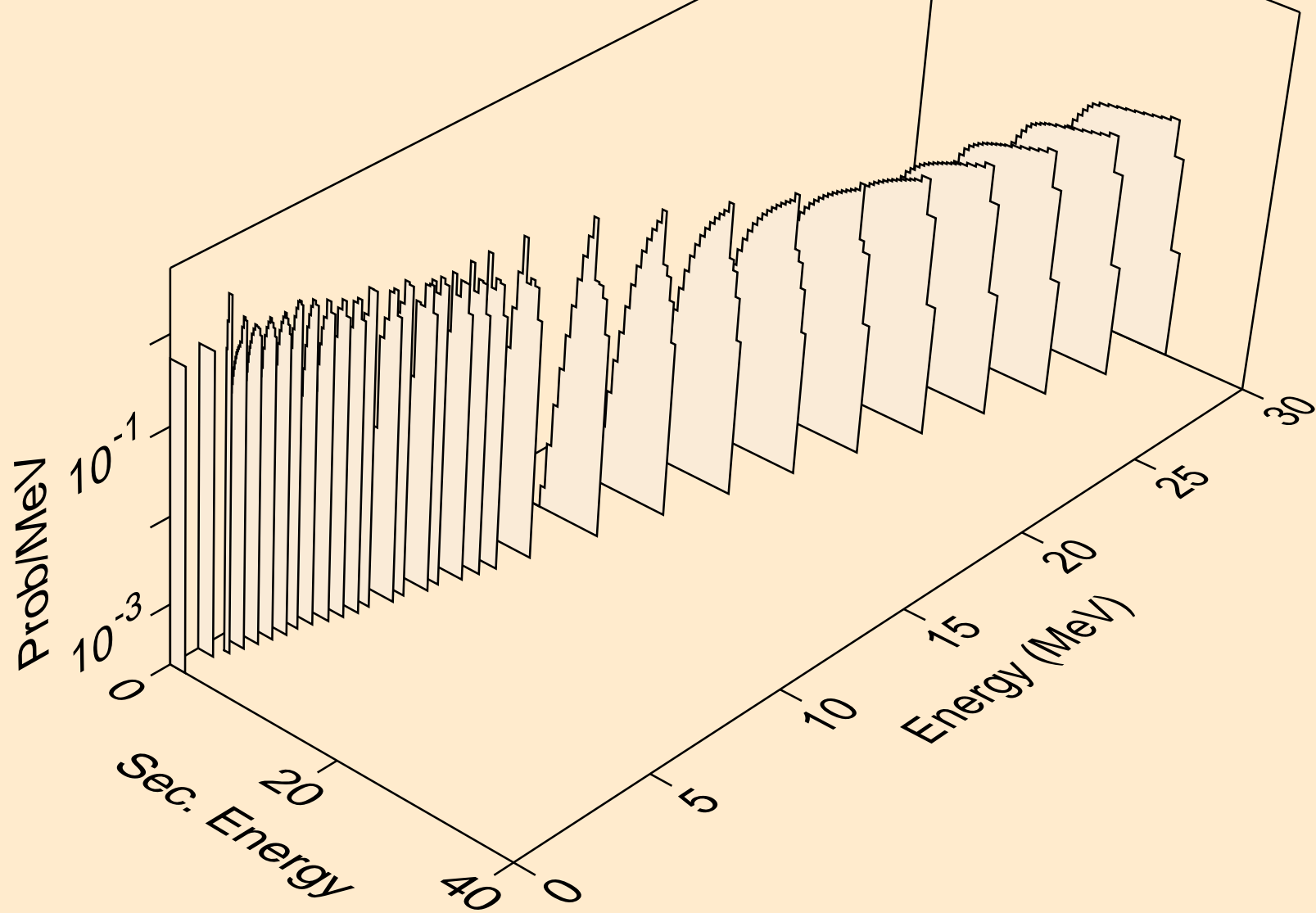

AT201 NEUTRON ACER TENDL-2021 LIBRARY; T=293.6K
deuterons from (n,pd)

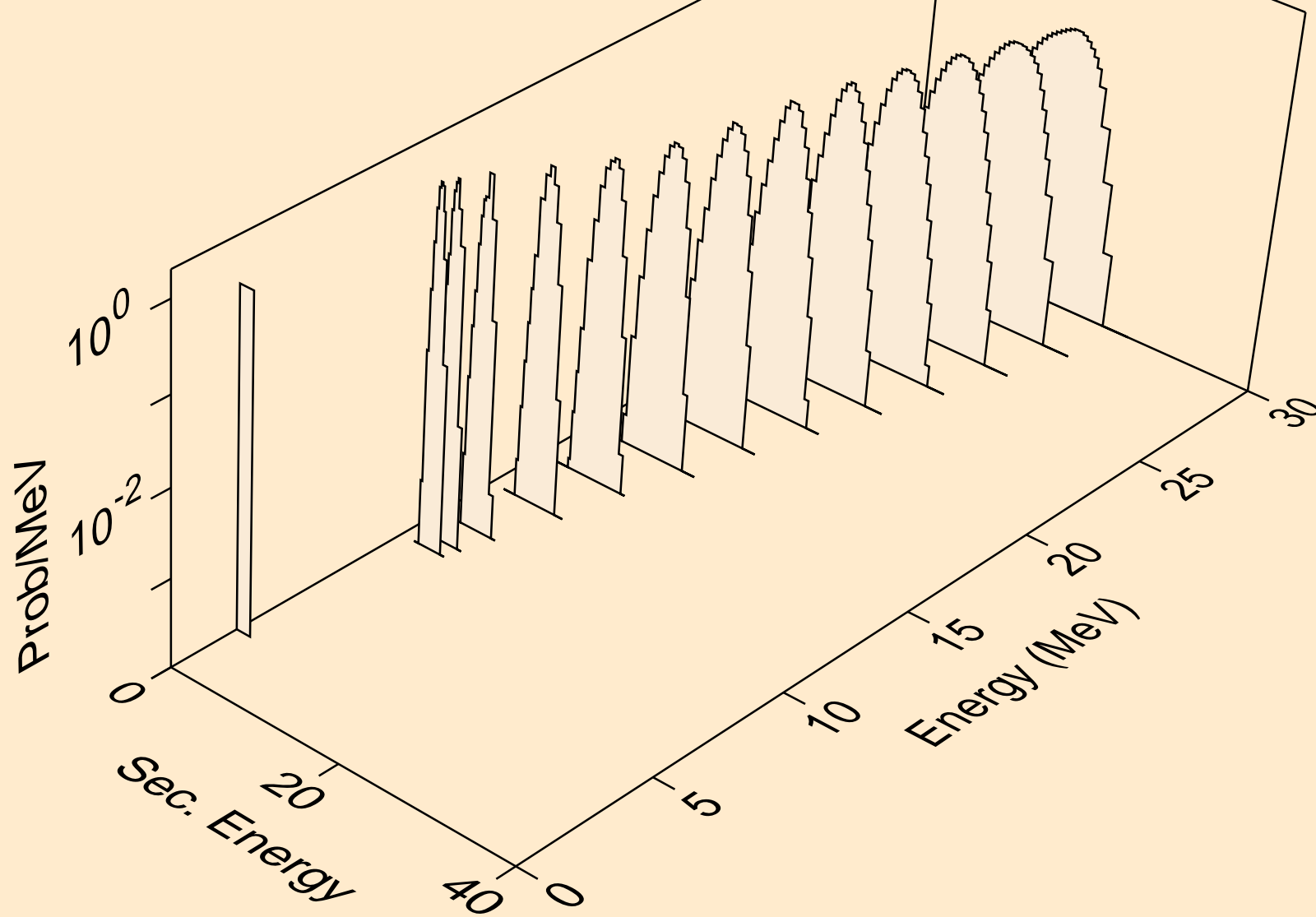

AT201 NEUTRON ACER TENDL-2021 LIBRARY; T=293.6K
deuterons from (n,da)

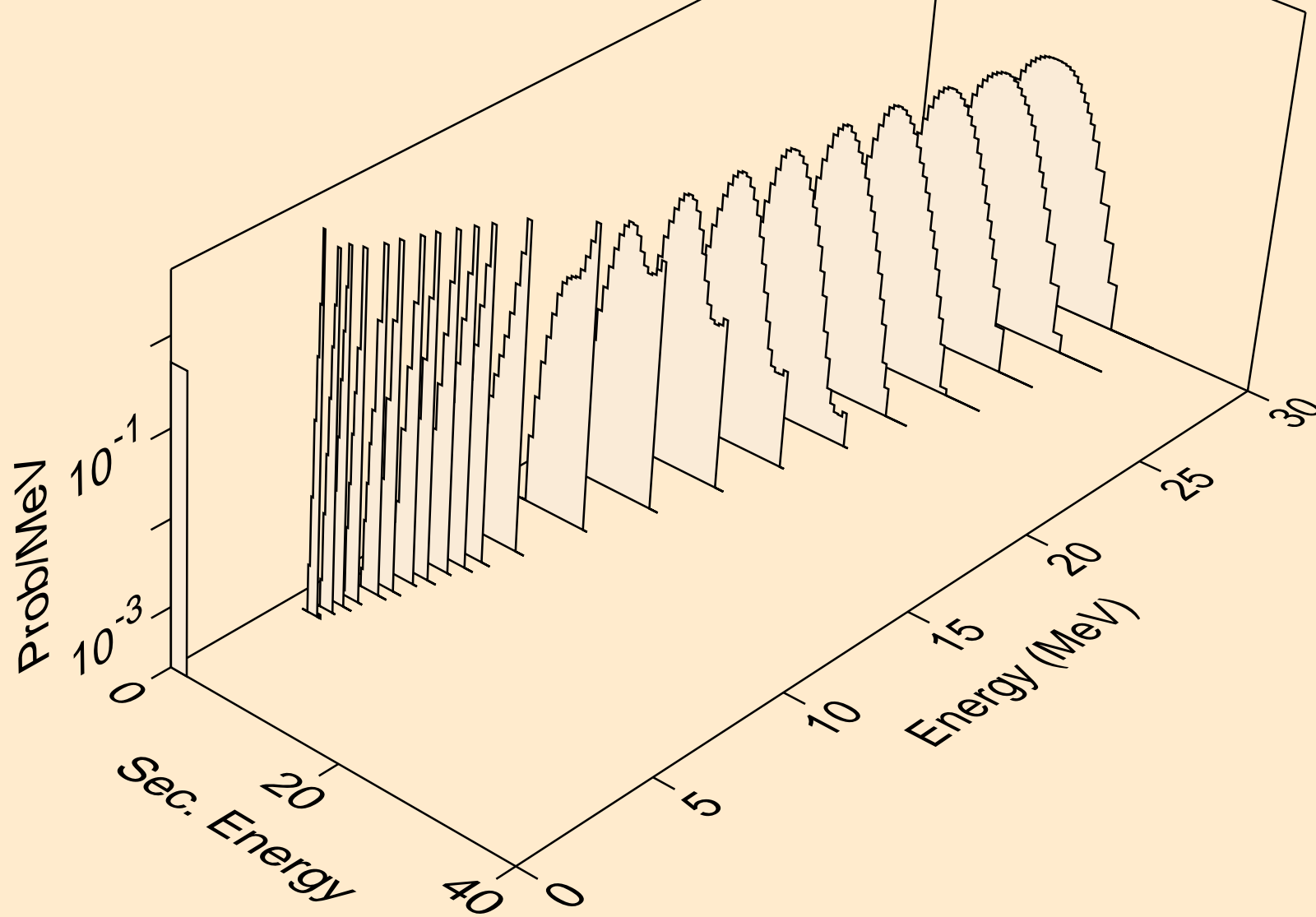

AT201 NEUTRON ACER TENDL-2021 LIBRARY; T=293.6K
tritons from (n,x)

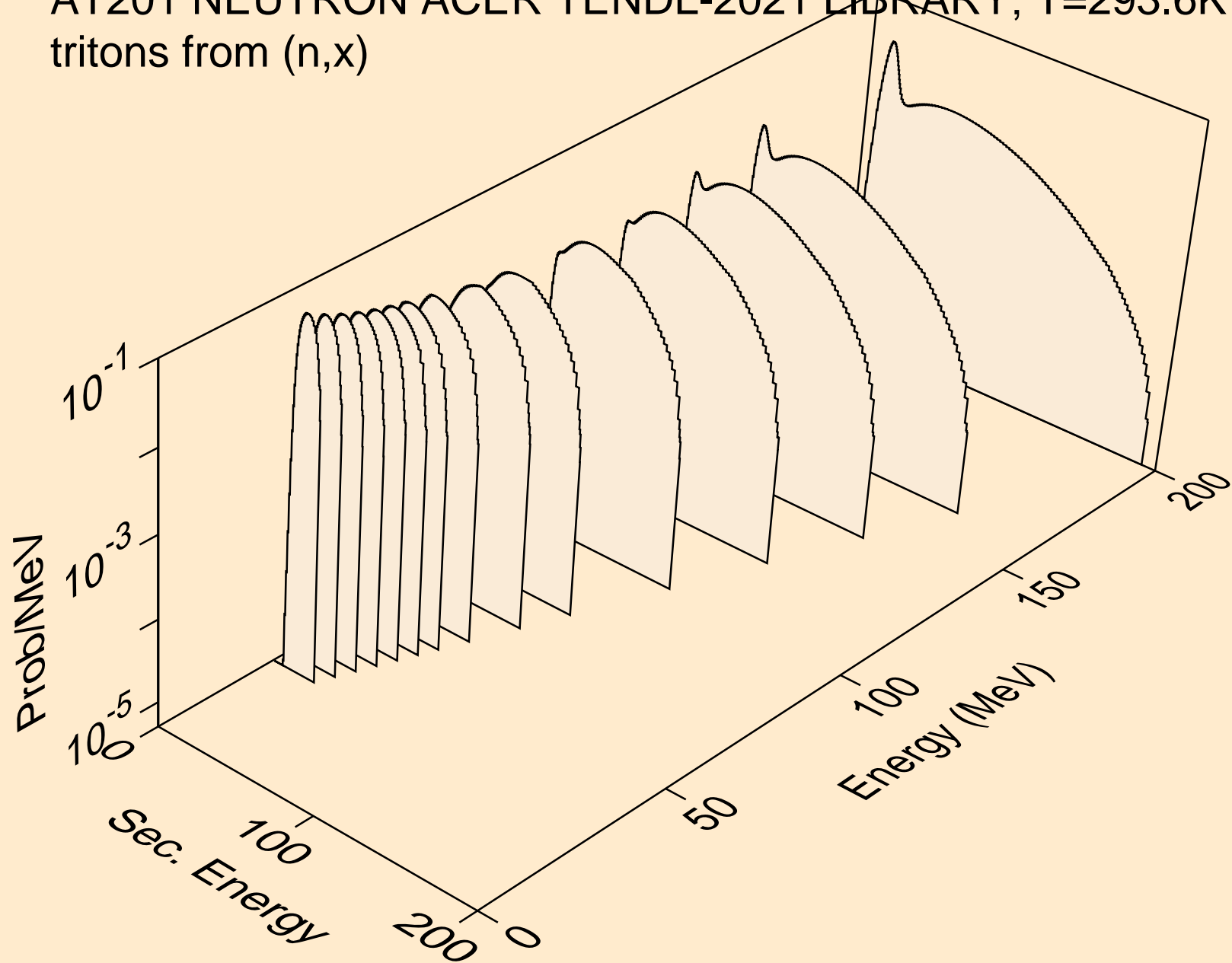

AT201 NEUTRON ACER TENDL-2021 LIBRARY; T=293.6K
tritons from (n,n*)t

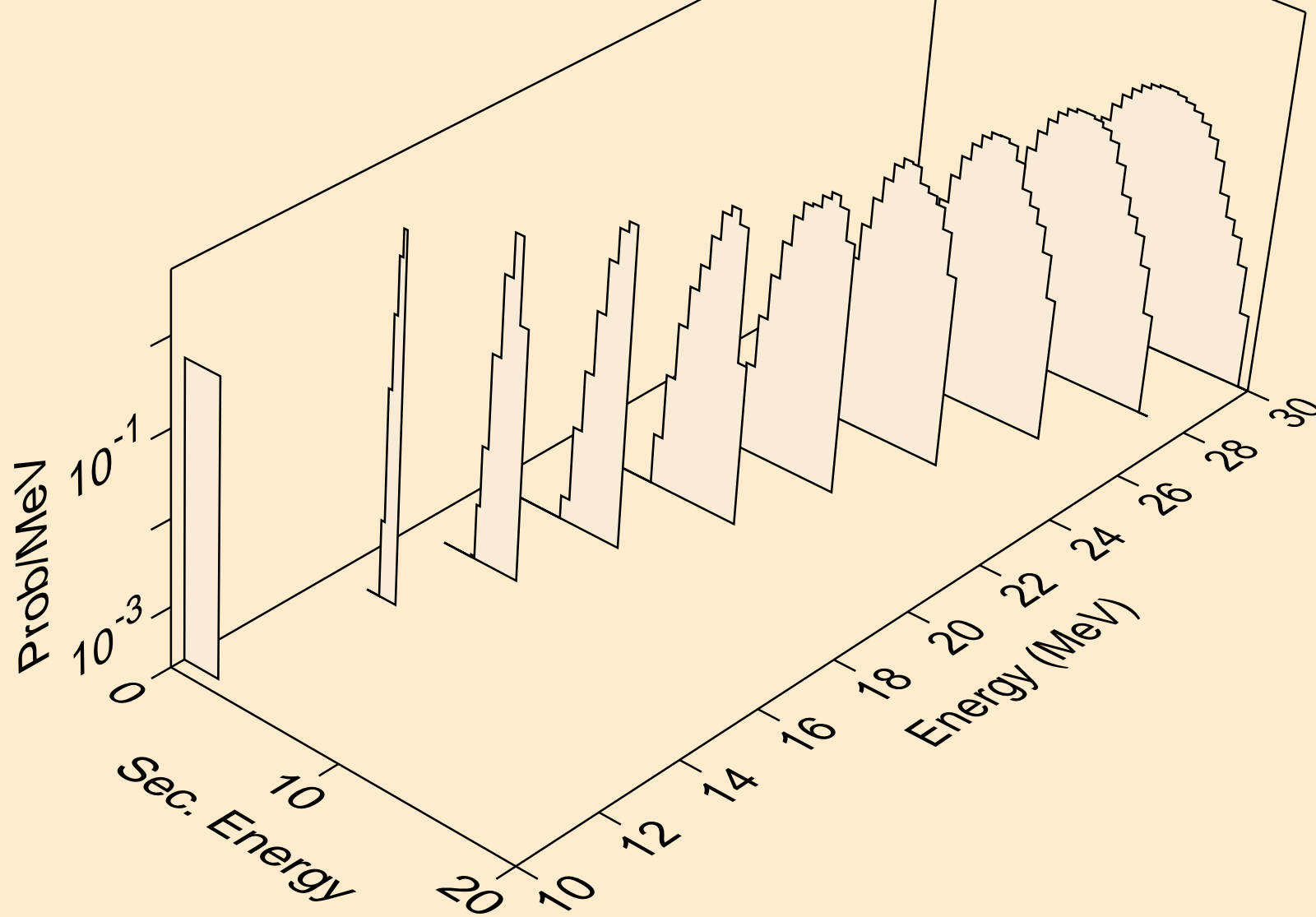

AT201 NEUTRON ACER TENDL-2021 LIBRARY; T=293.6K
tritons from (n,t)

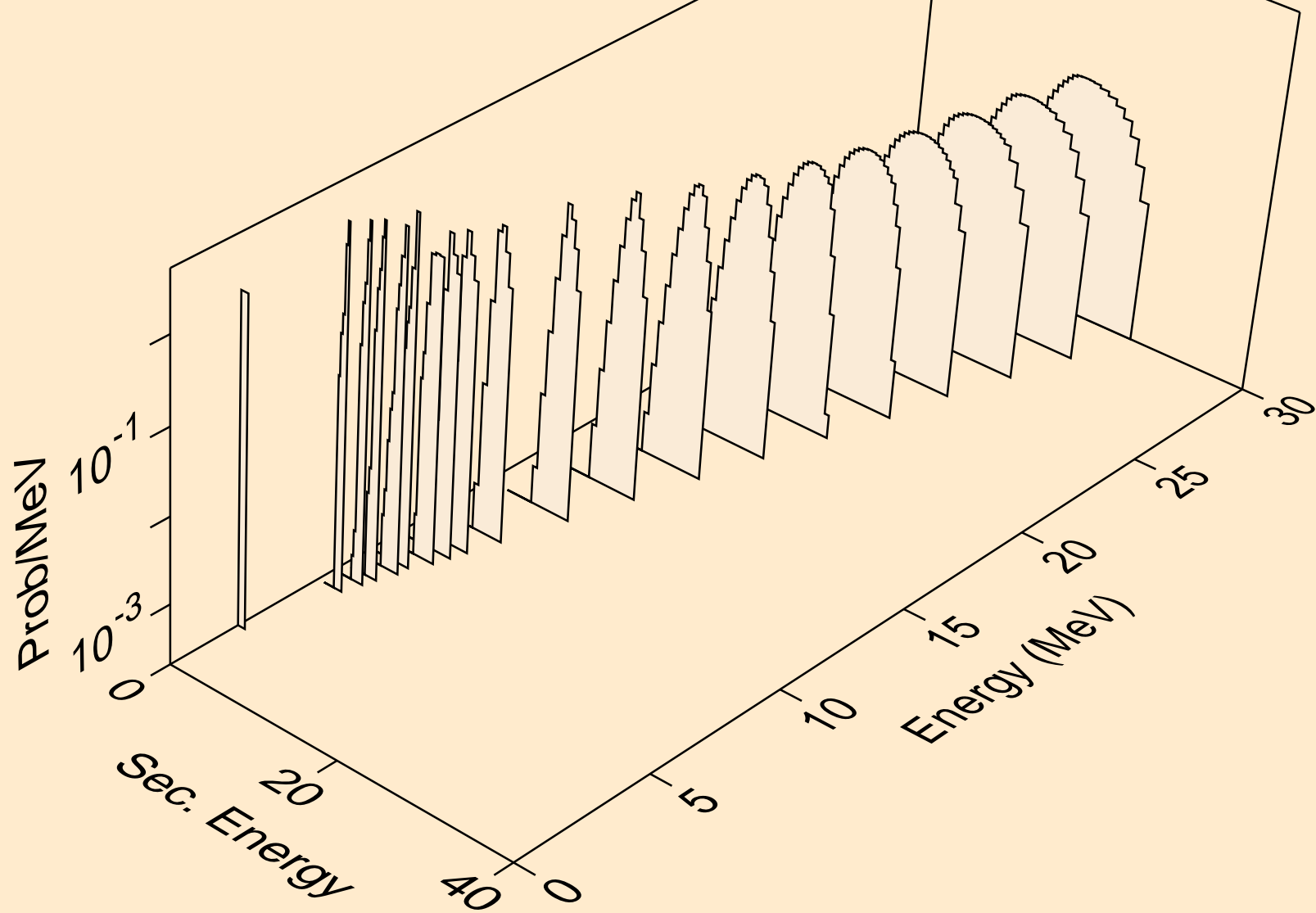

AT201 NEUTRON ACER TENDL-2021 LIBRARY; T=293.6K
tritons from (n,pt)

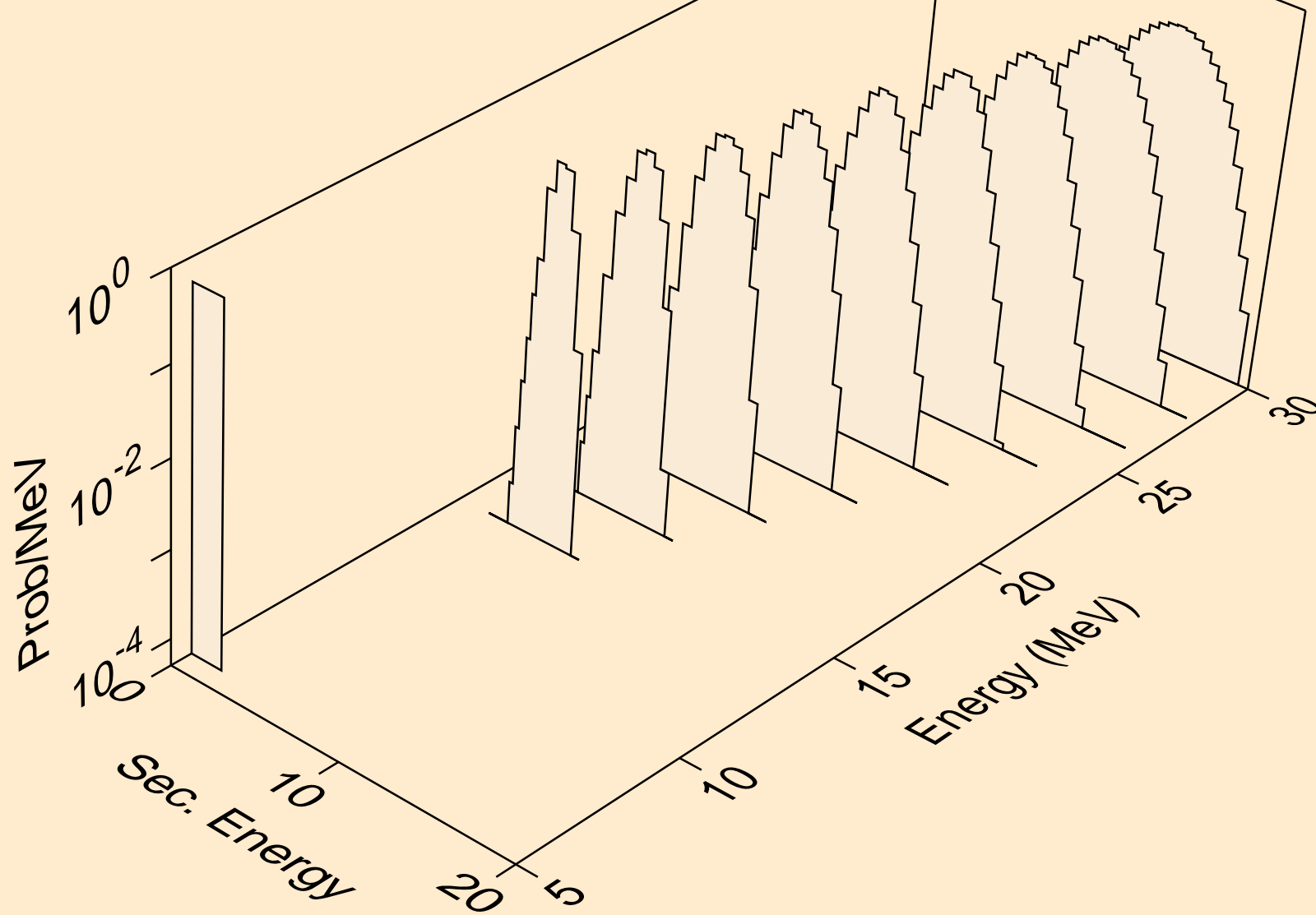

AT201 NEUTRON ACER TENDL-2021 LIBRARY; T=293.6K
he3s from (n,x)

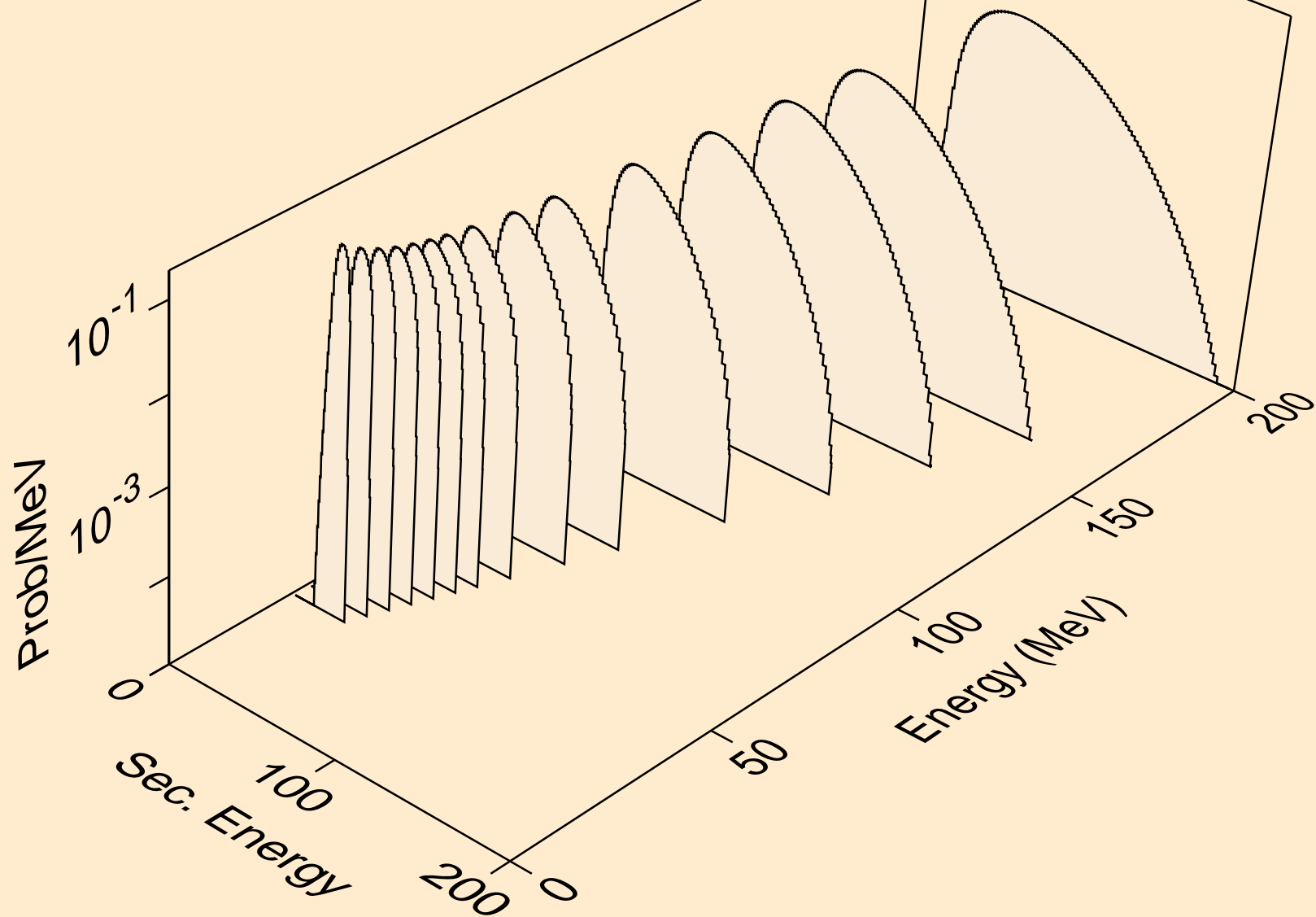

AT201 NEUTRON ACER TENDL-2021 LIBRARY; T=293.6K
he3s from (n,n*)he3

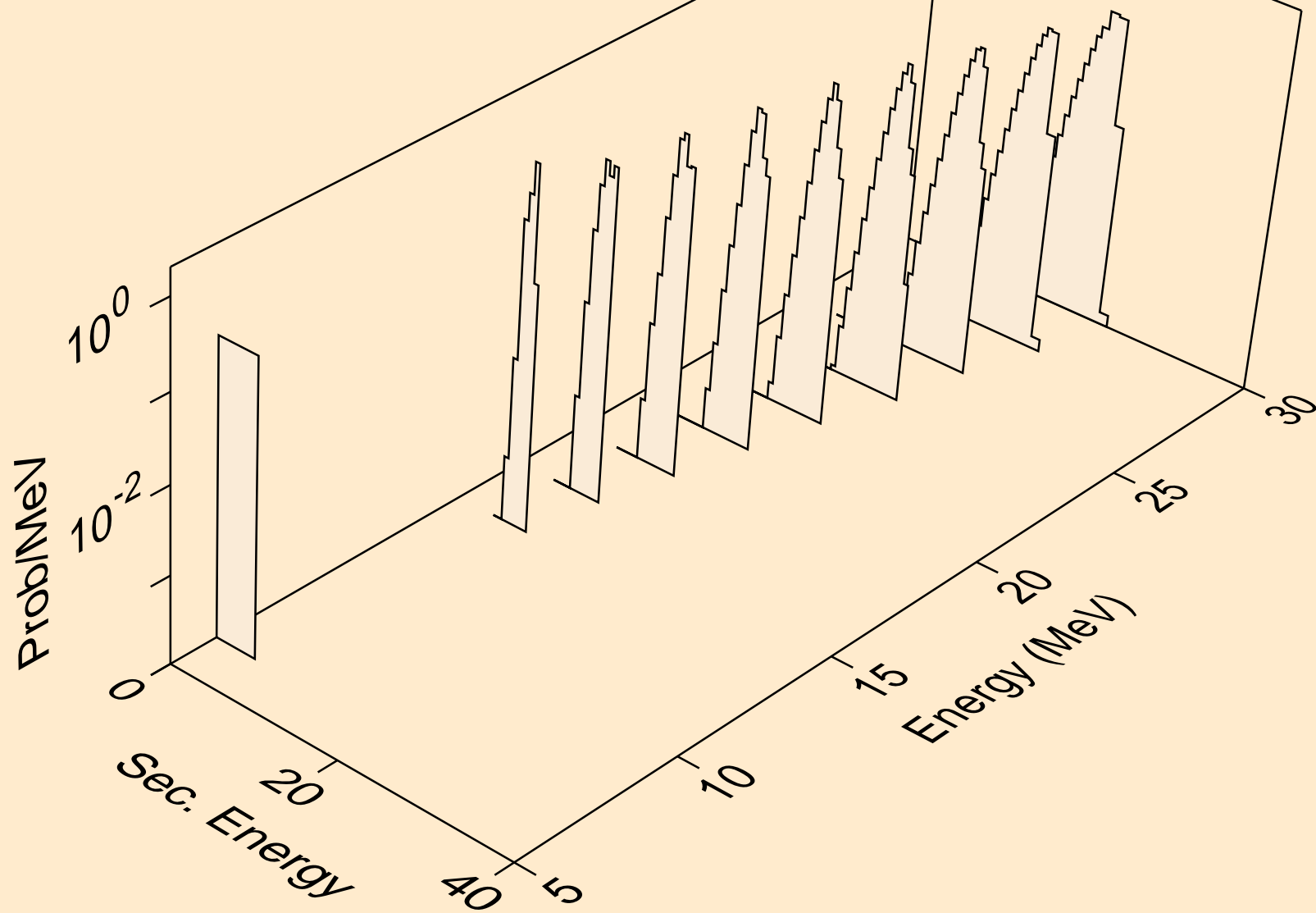

AT201 NEUTRON ACER TENDL-2021 LIBRARY; T=293.6K
he3s from (n,he3)

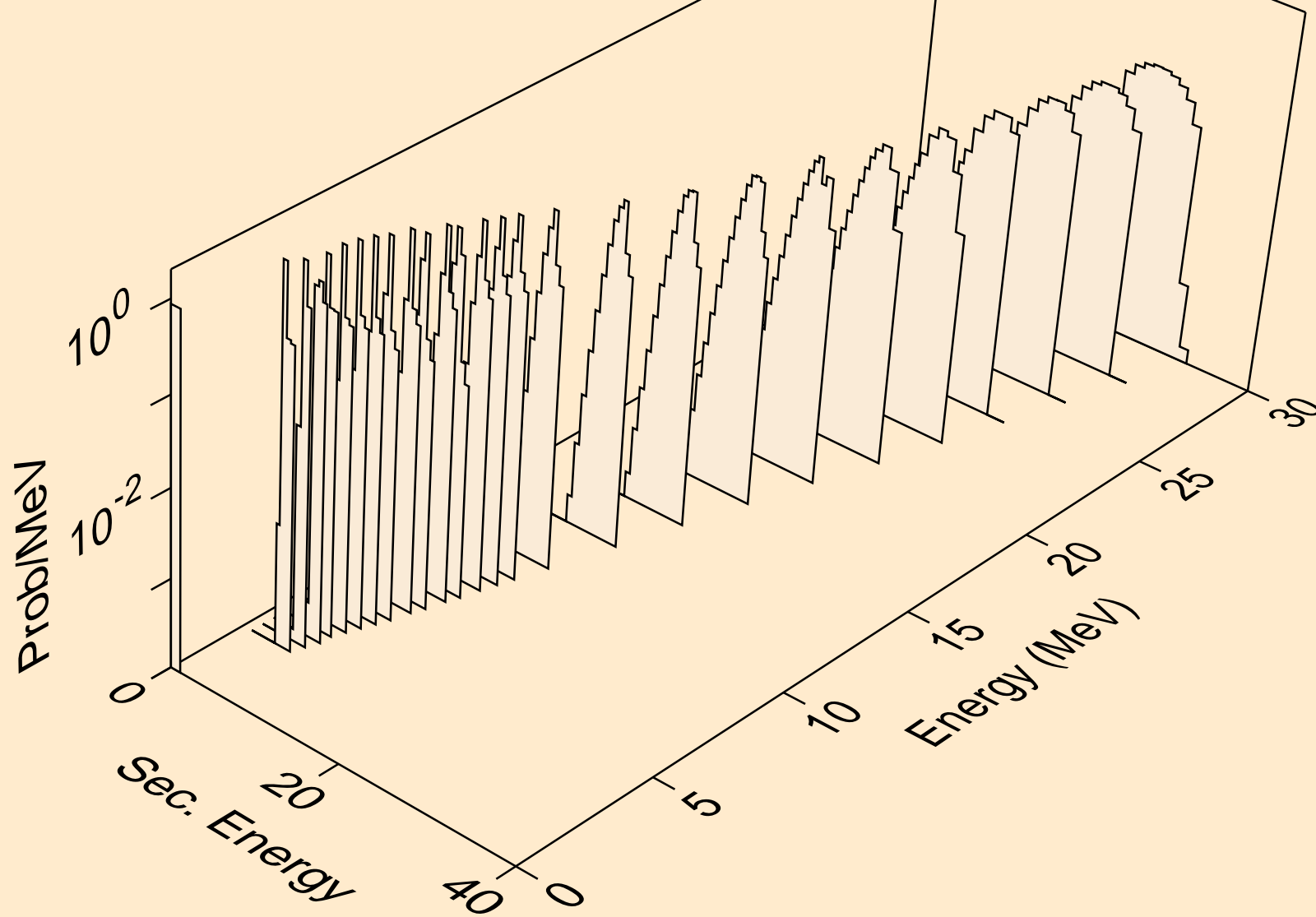

AT201 NEUTRON ACER TENDL-2021 LIBRARY; T=293.6K
alphas from (n,x)

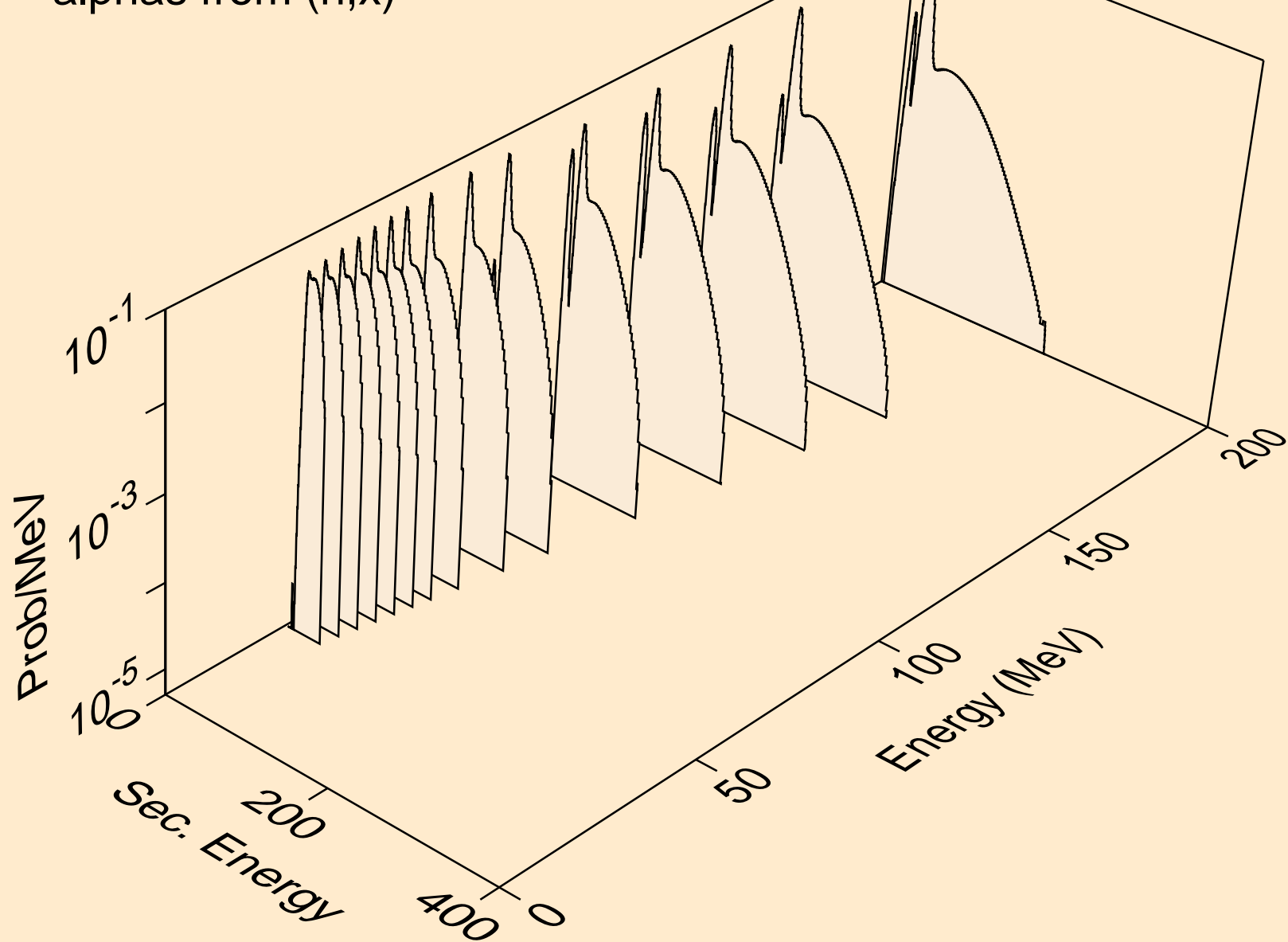

AT201 NEUTRON ACER TENDL-2021 LIBRARY; T=293.6K
alphas from (n,n*)a

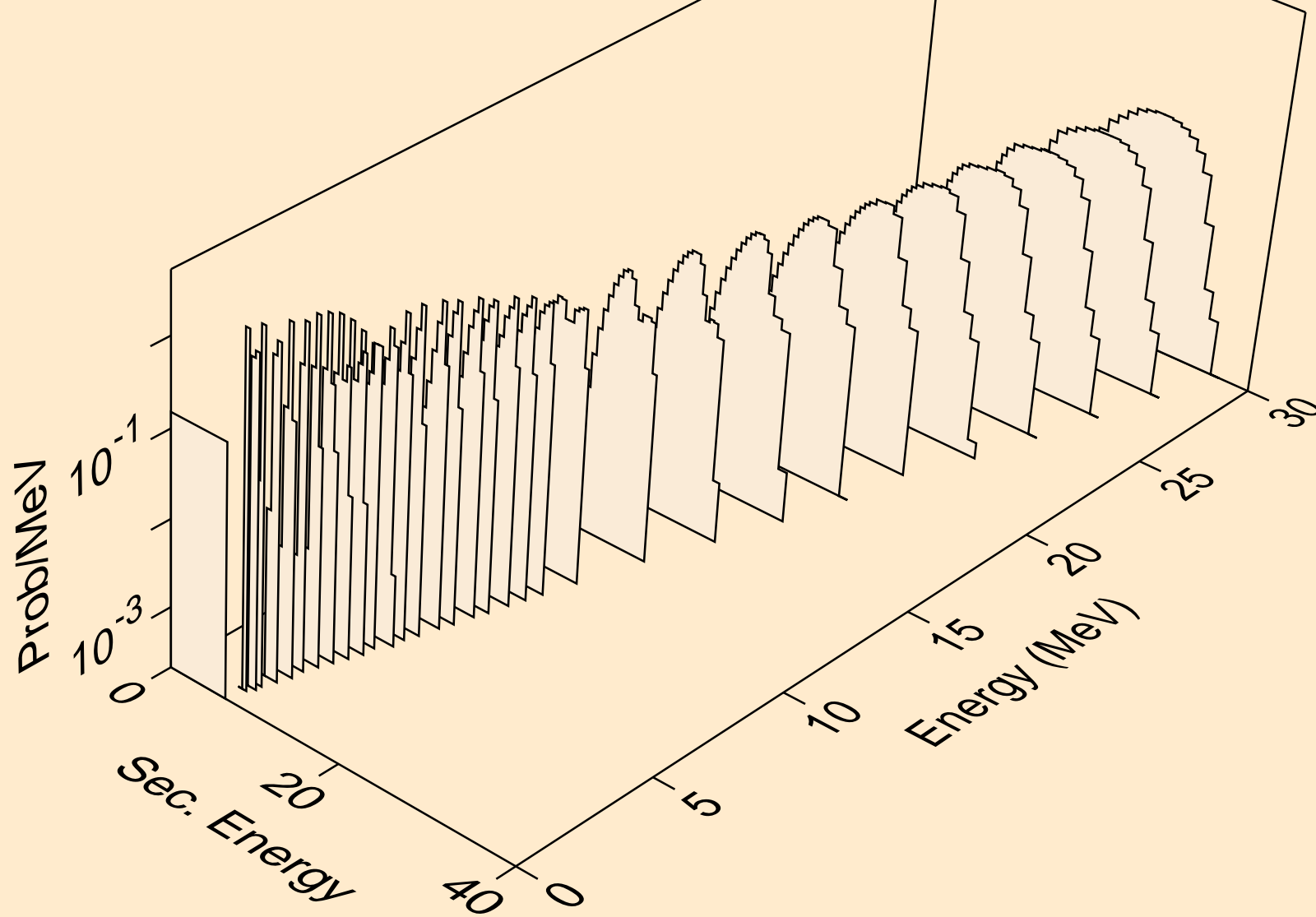

AT201 NEUTRON ACER TENDL-2021 LIBRARY; T=293.6K
alphas from (n,2n)a

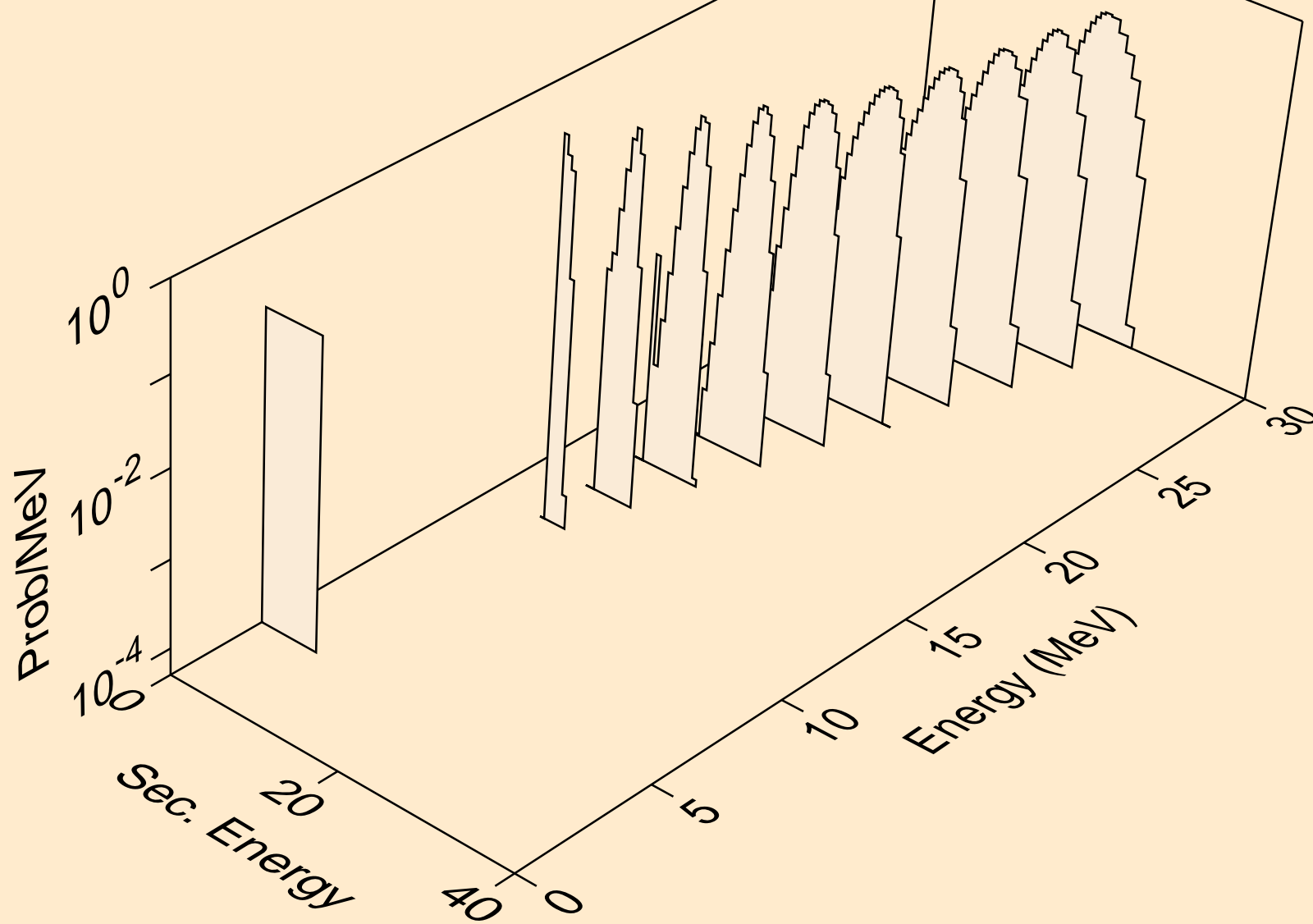

AT201 NEUTRON ACER TENDL-2021 LIBRARY; T=293.6K
alphas from (n,3n)a

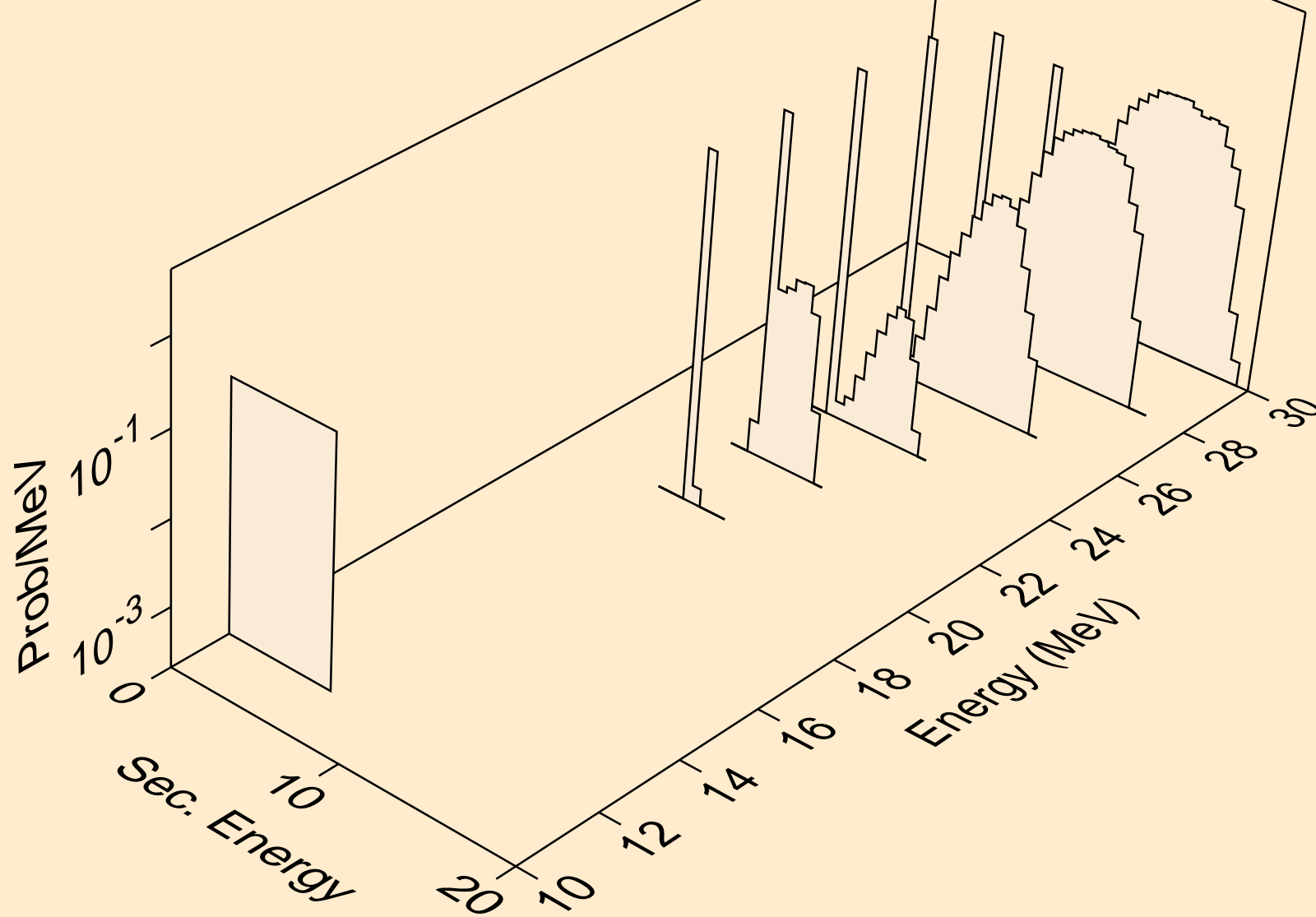

AT201 NEUTRON ACER TENDL-2021 LIBRARY; T=293.6K
alphas from (n,n*)2a

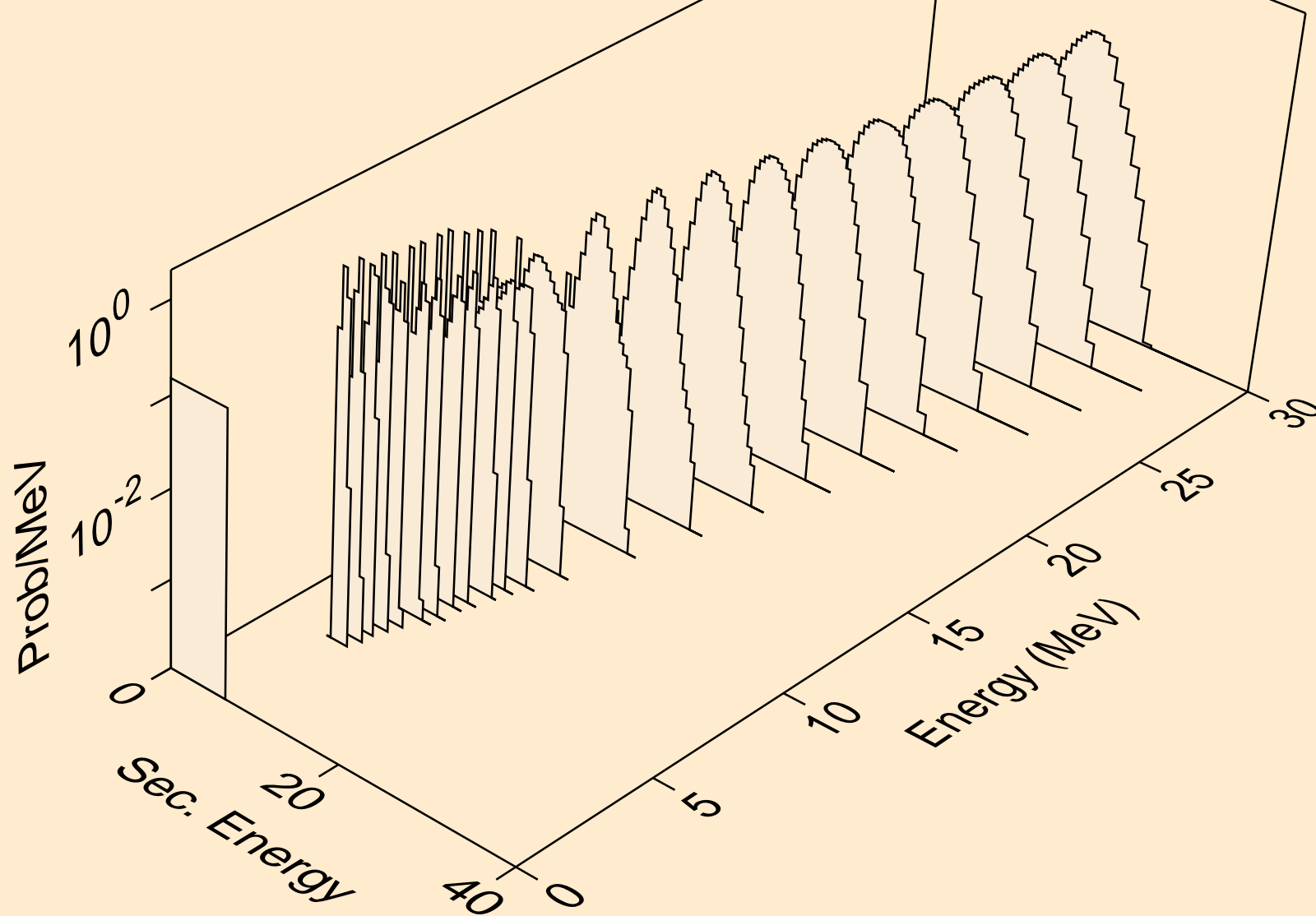

AT201 NEUTRON ACER TENDL-2021 LIBRARY; T=293.6K
alphas from (n,2n)2a

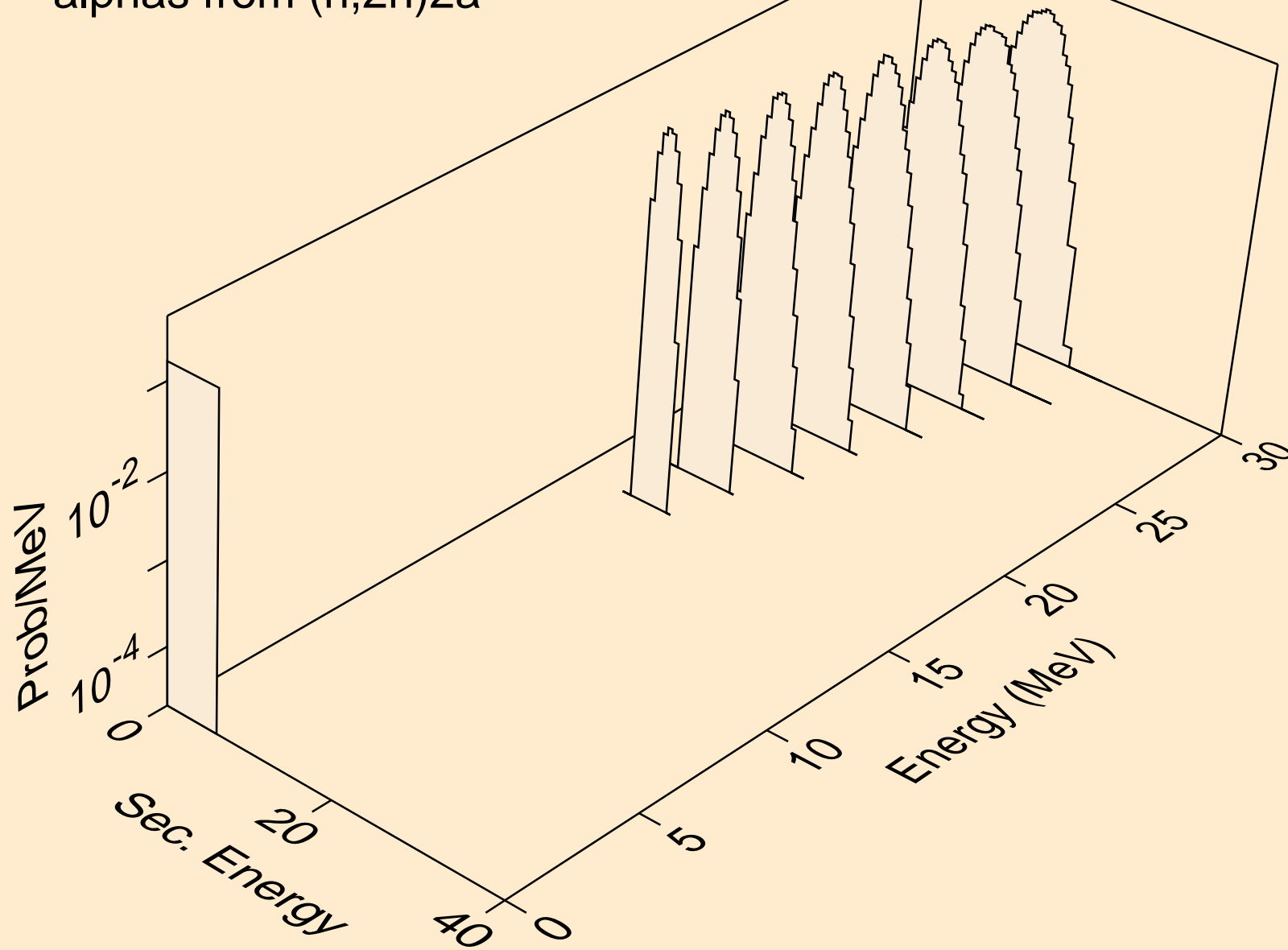

AT201 NEUTRON ACER TENDL-2021 LIBRARY; T=293.6K
alphas from (n,npa)

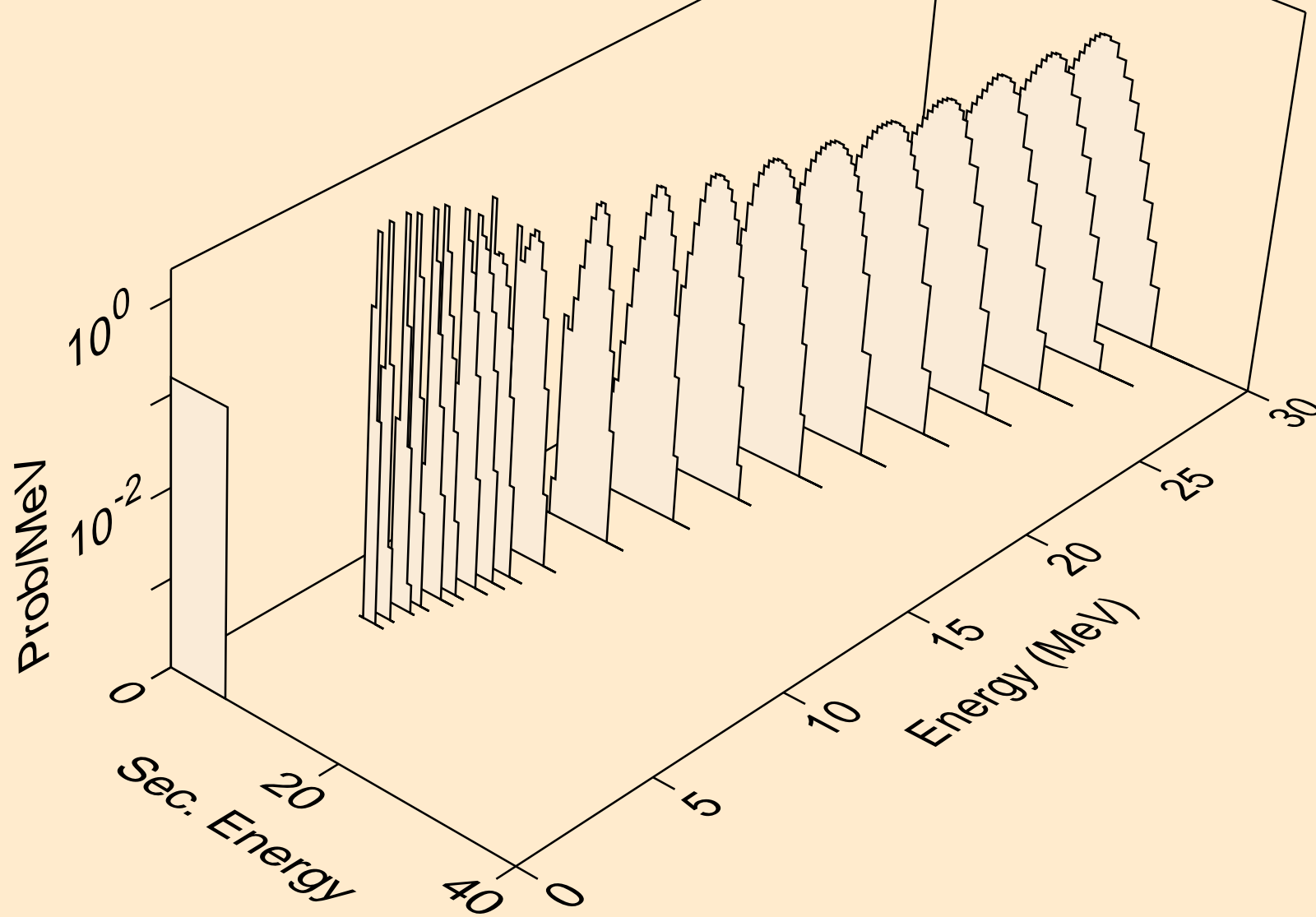

AT201 NEUTRON ACER TENDL-2021 LIBRARY; T=293.6K
alphas from (n,a)

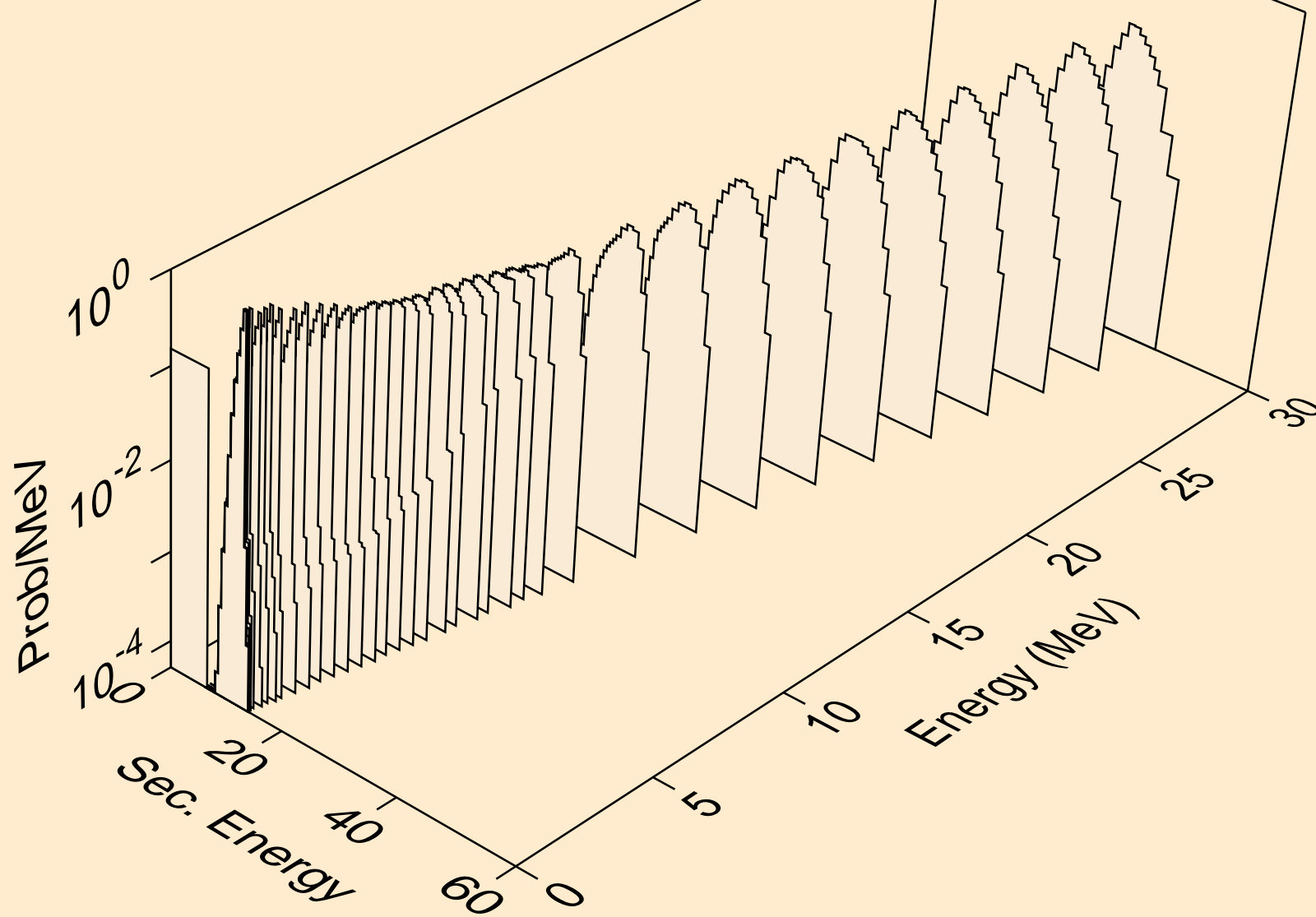

AT201 NEUTRON ACER TENDL-2021 LIBRARY; T=293.6K
alphas from (n,2a)

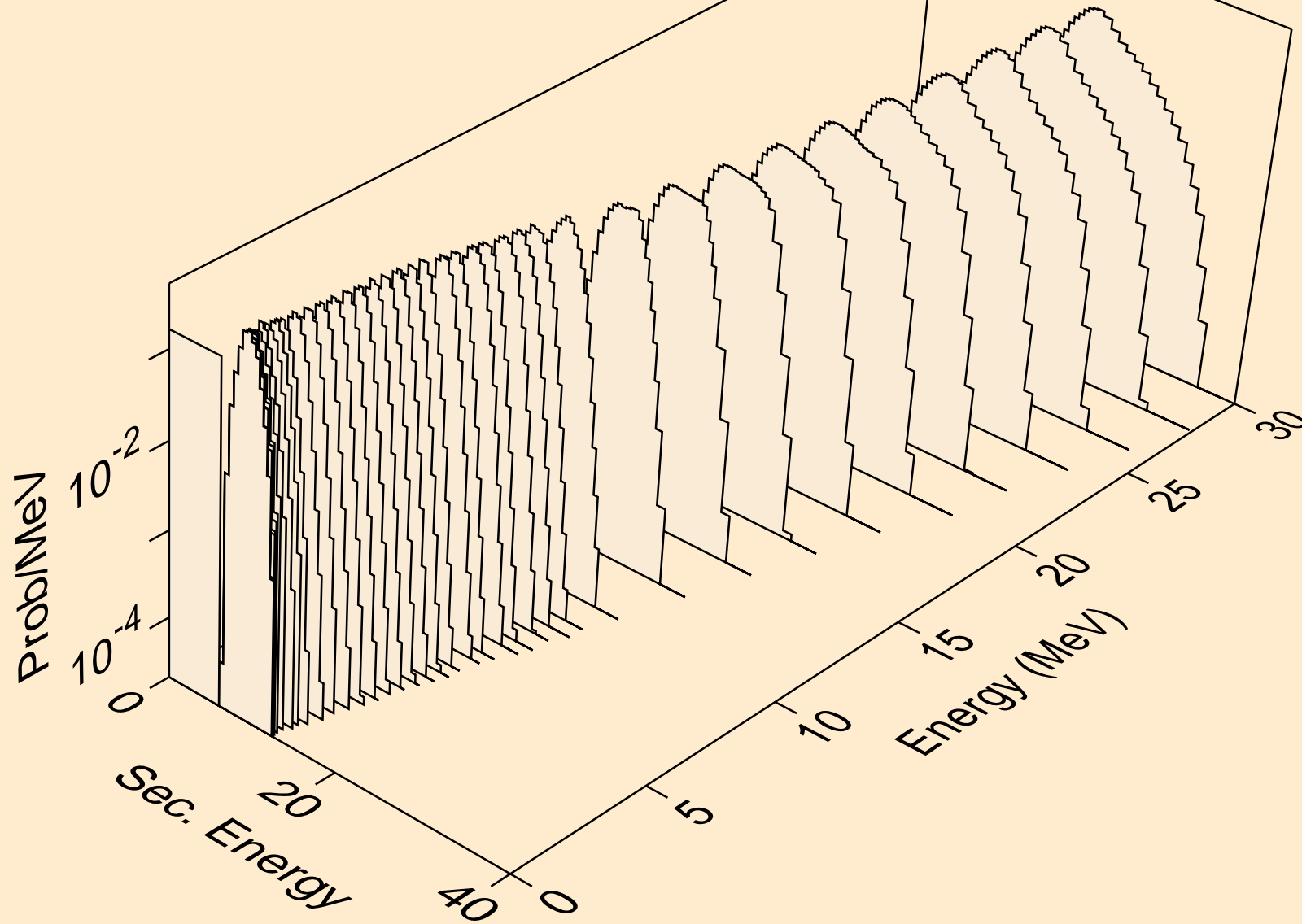

AT201 NEUTRON ACER TENDL-2021 LIBRARY; T=293.6K
alphas from (n,pa)

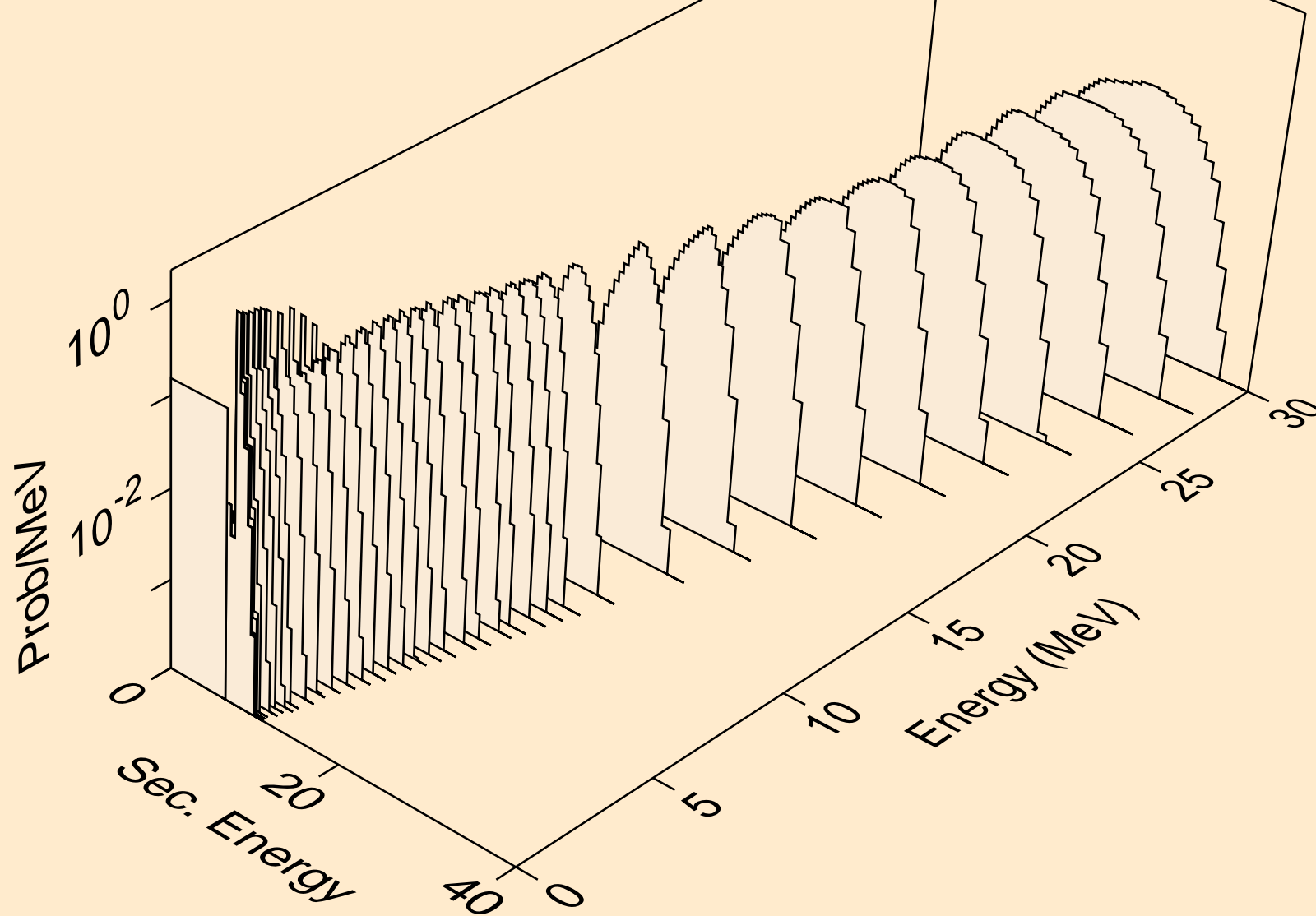

AT201 NEUTRON ACER TENDL-2021 LIBRARY; T=293.6K
alphas from (n,da)

