

AT206 NEUTRON ACER TENDL-2021 LIBRARY; T=293.6K

Principal cross sections

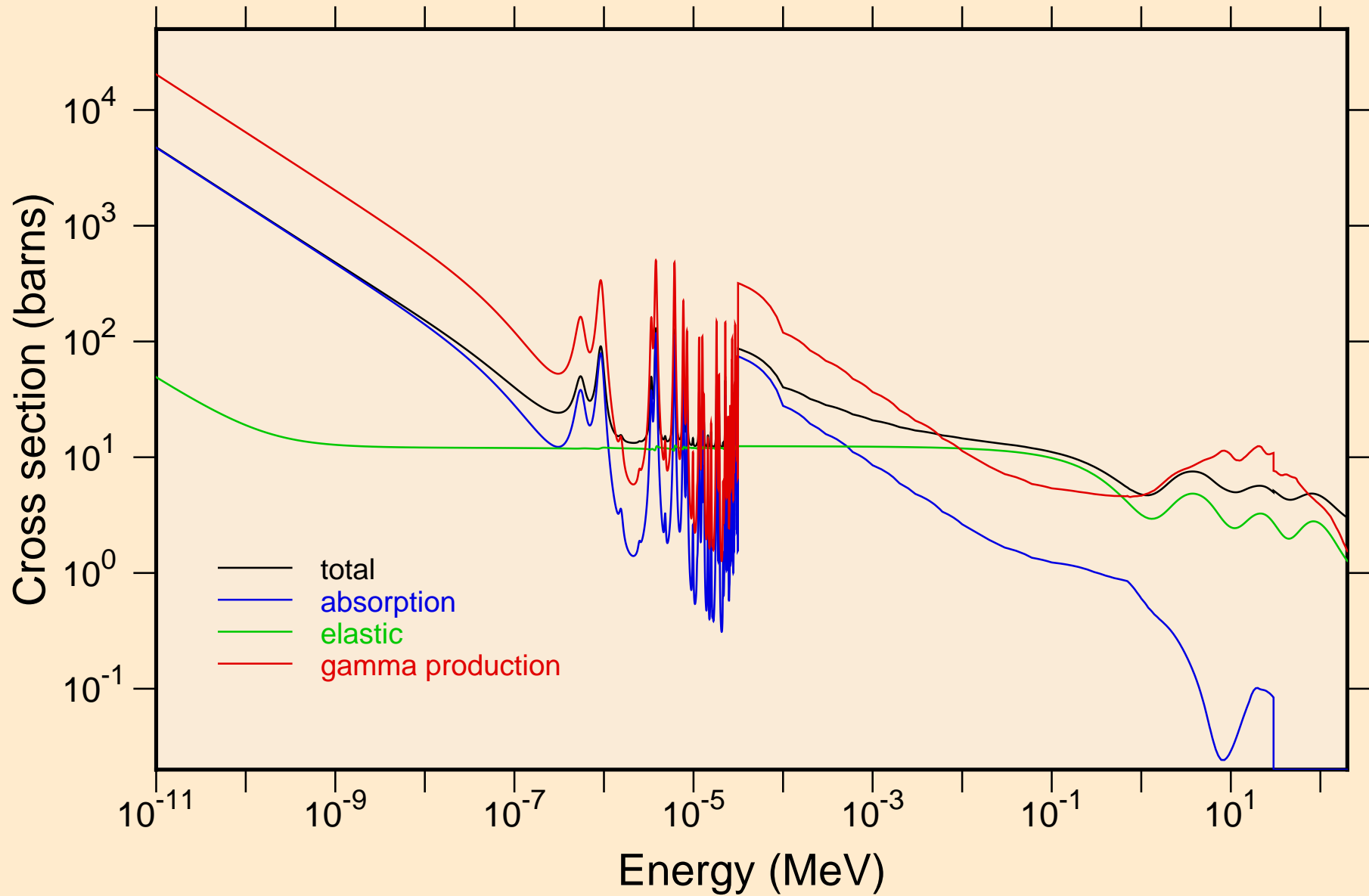

AT206 NEUTRON ACER TENDL-2021 LIBRARY; T=293.6K
resonance total cross section

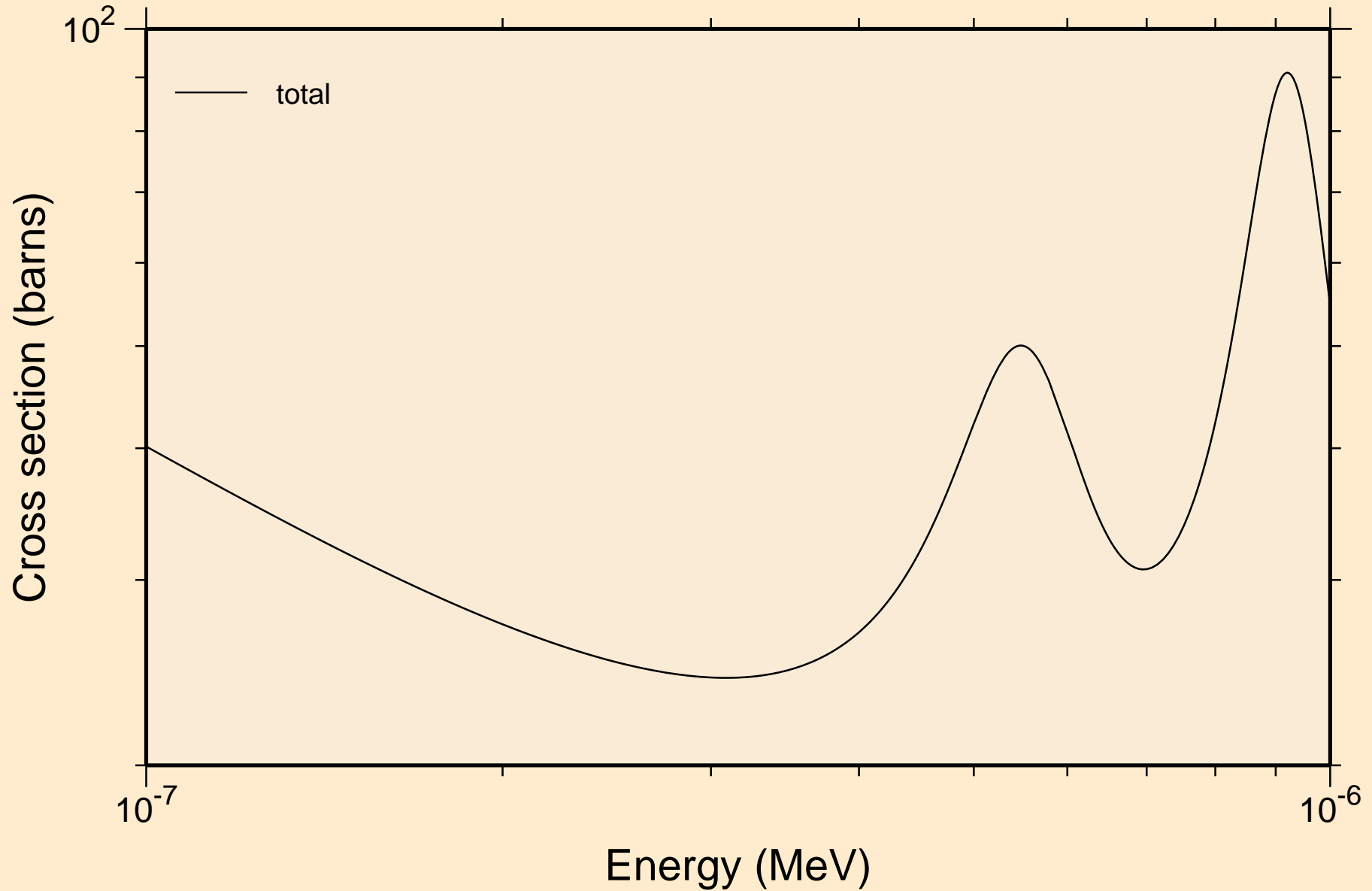

AT206 NEUTRON ACER TENDL-2021 LIBRARY; T=293.6K
resonance total cross section

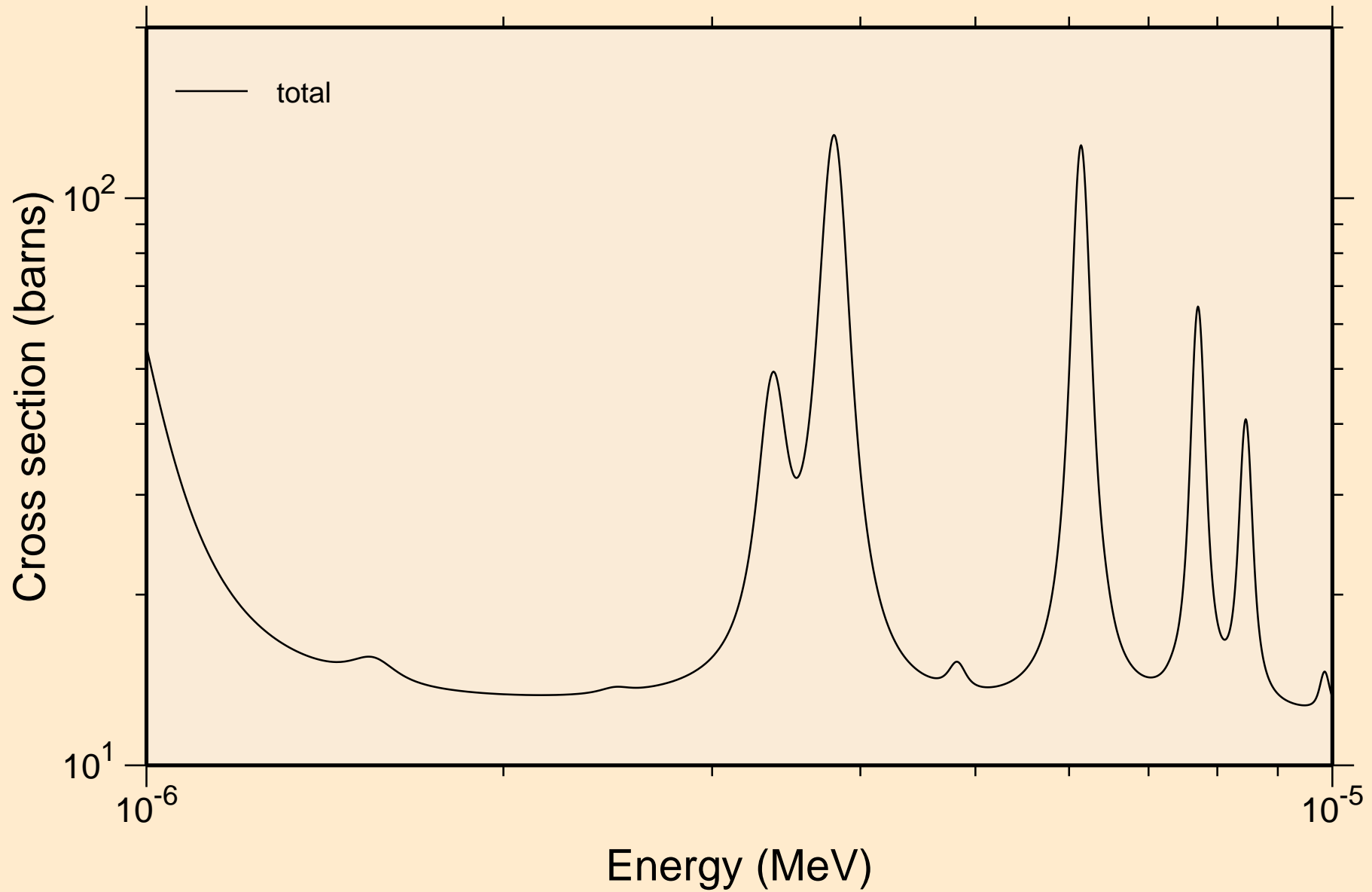

AT206 NEUTRON ACER TENDL-2021 LIBRARY; T=293.6K
resonance total cross section

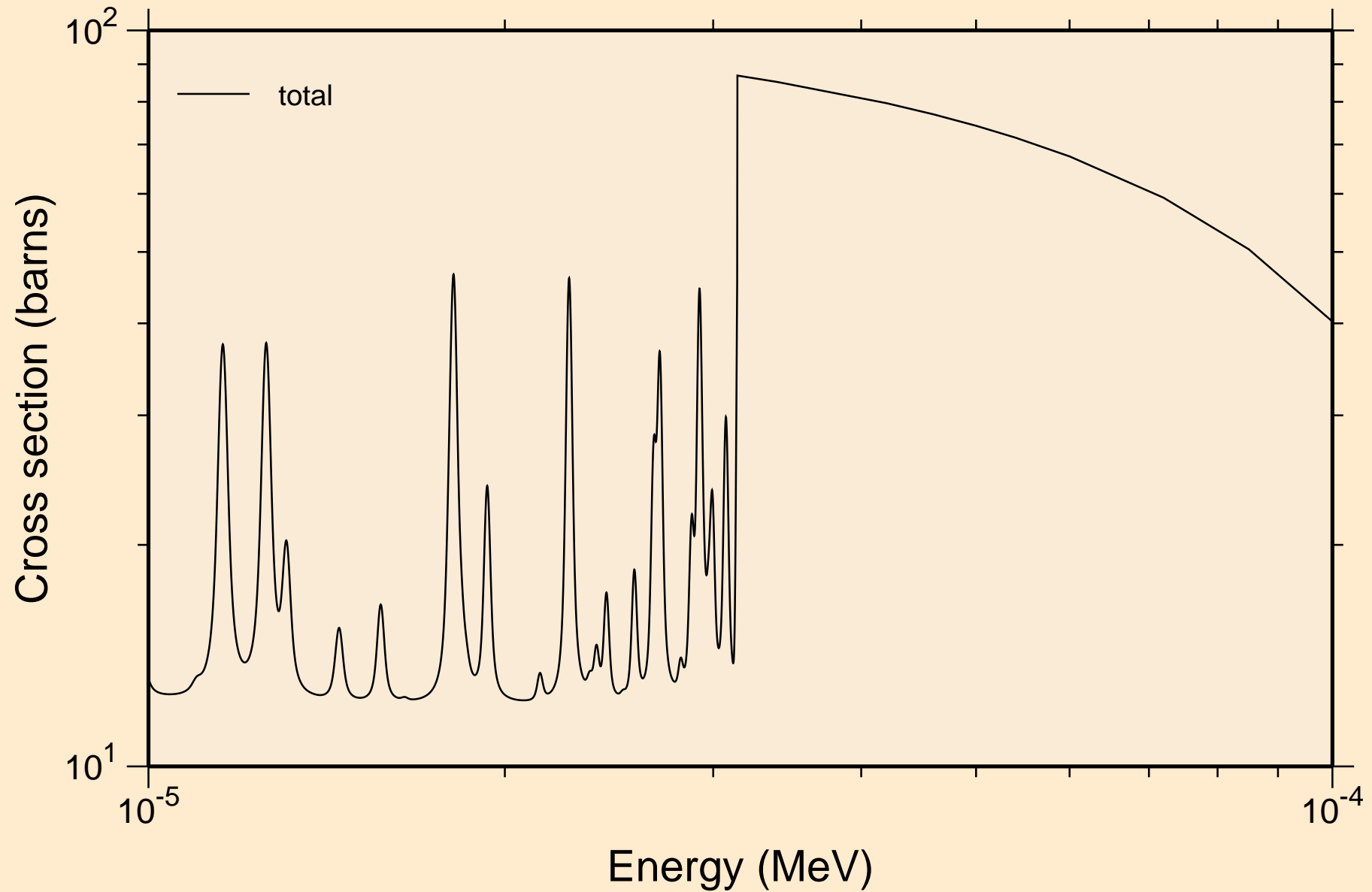

AT206 NEUTRON ACER TENDL-2021 LIBRARY; T=293.6K
resonance total cross section

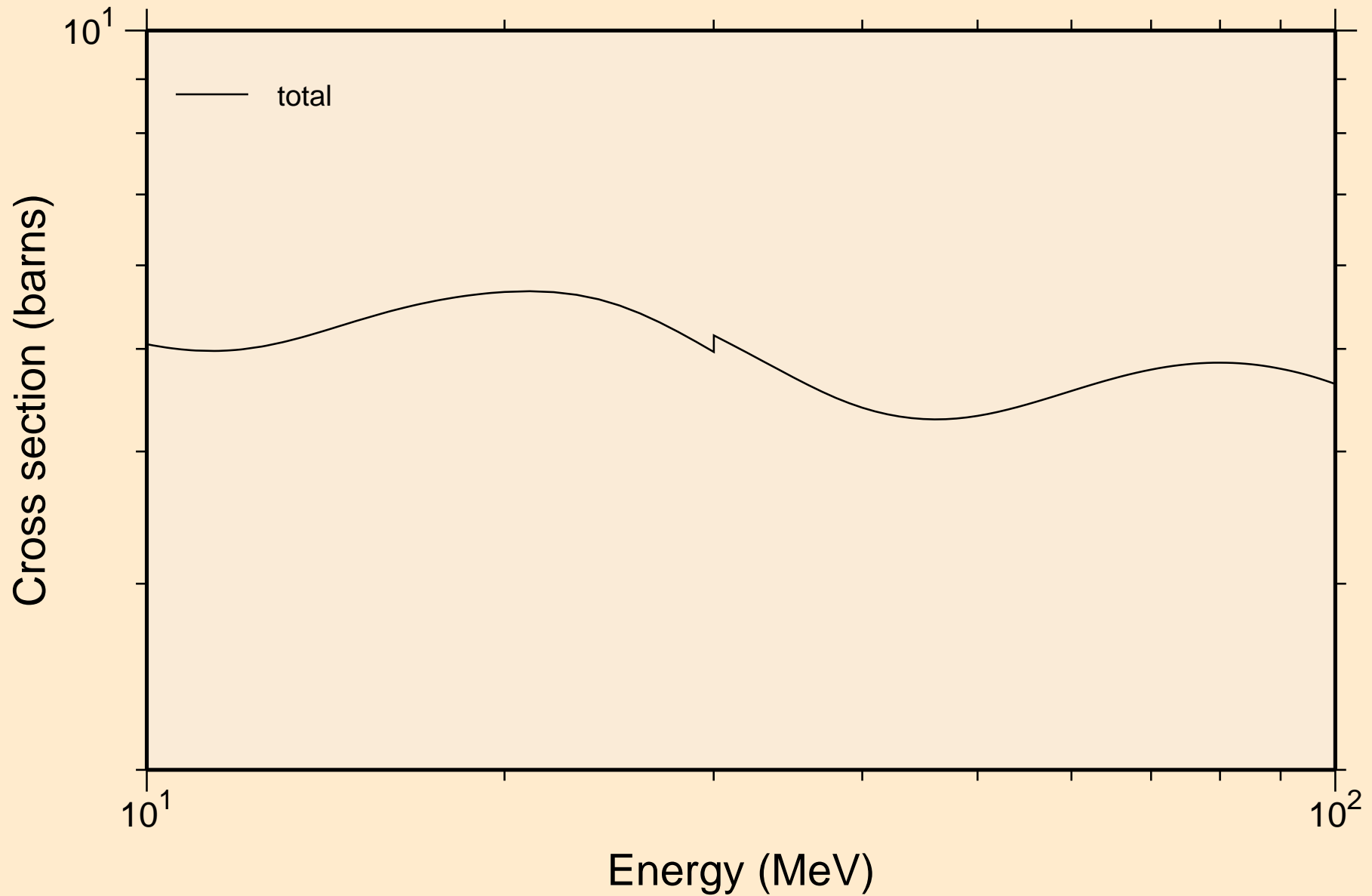

AT206 NEUTRON ACER TENDL-2021 LIBRARY; T=293.6K
resonance absorption cross sections

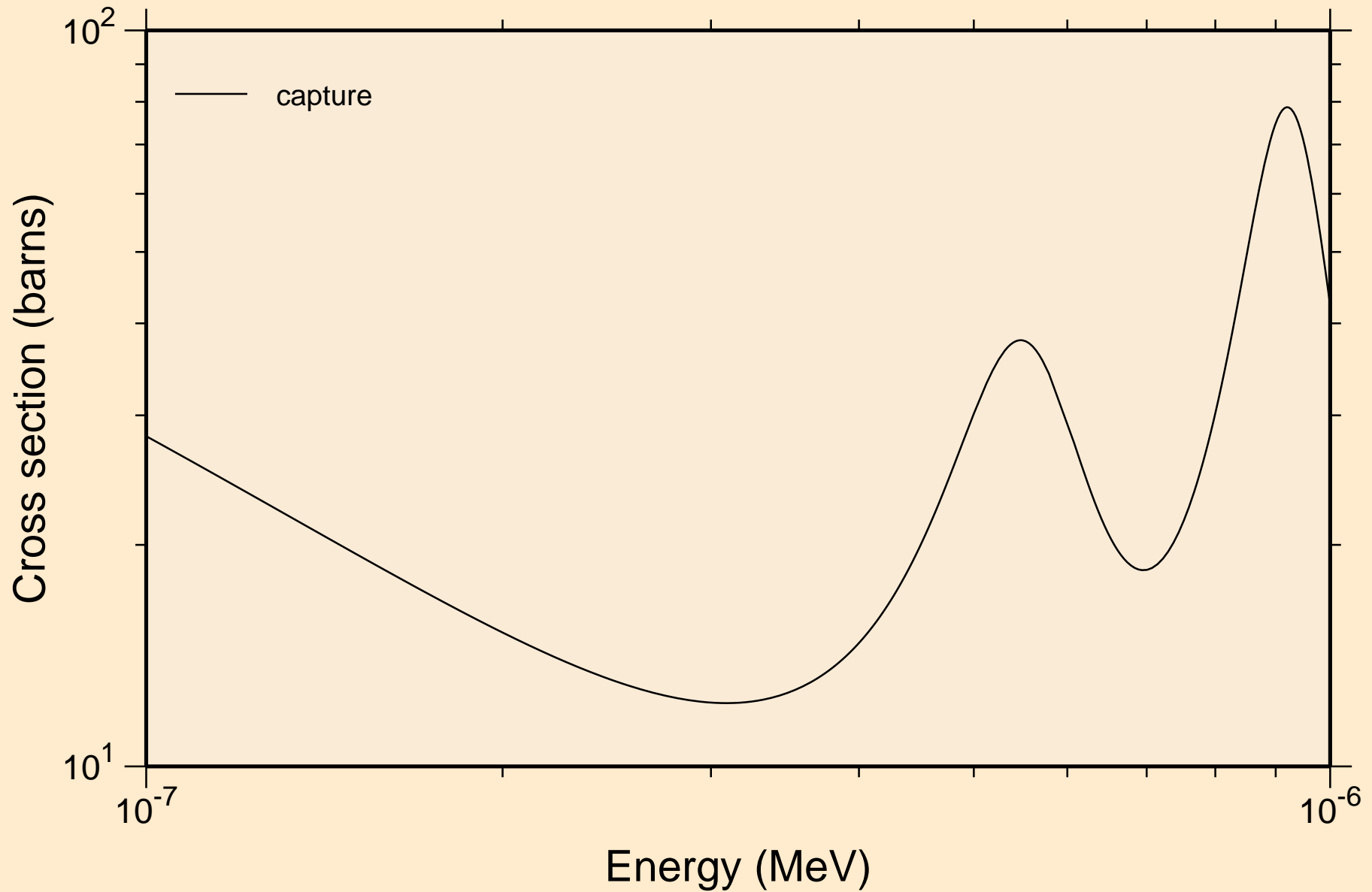

AT206 NEUTRON ACER TENDL-2021 LIBRARY; T=293.6K
resonance absorption cross sections

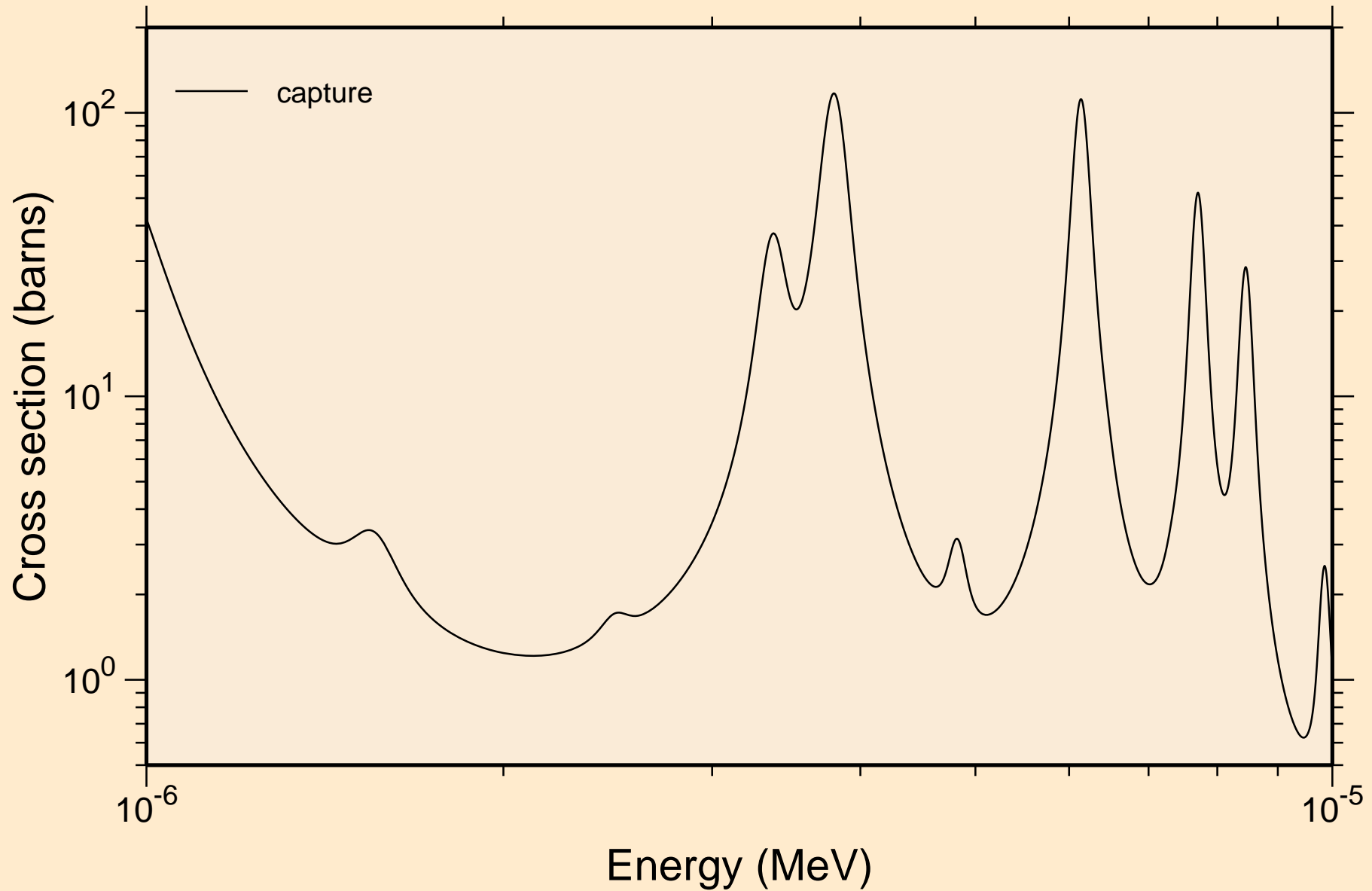

AT206 NEUTRON ACER TENDL-2021 LIBRARY; T=293.6K
resonance absorption cross sections

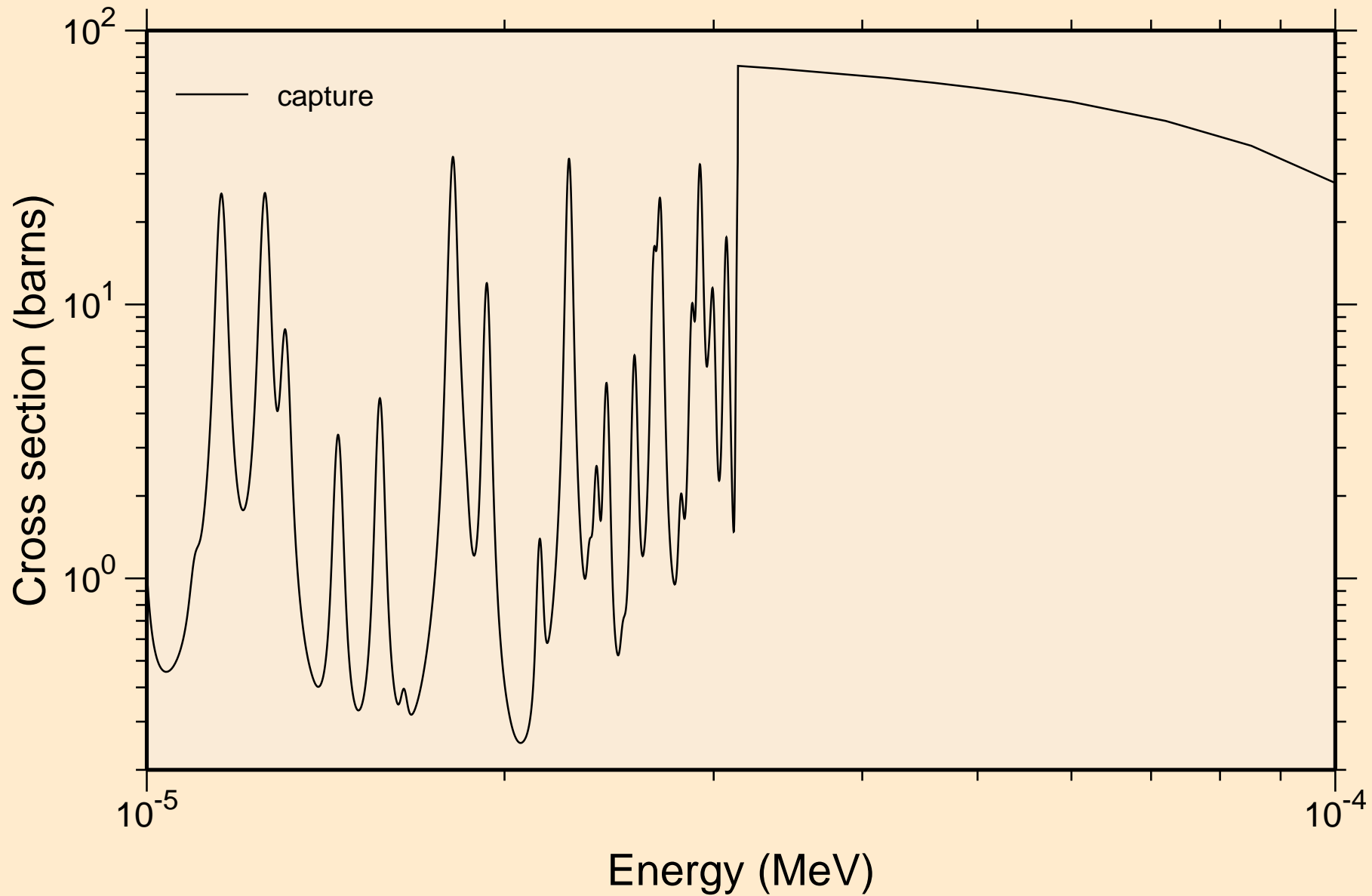

AT206 NEUTRON ACER TENDL-2021 LIBRARY; T=293.6K
resonance absorption cross sections

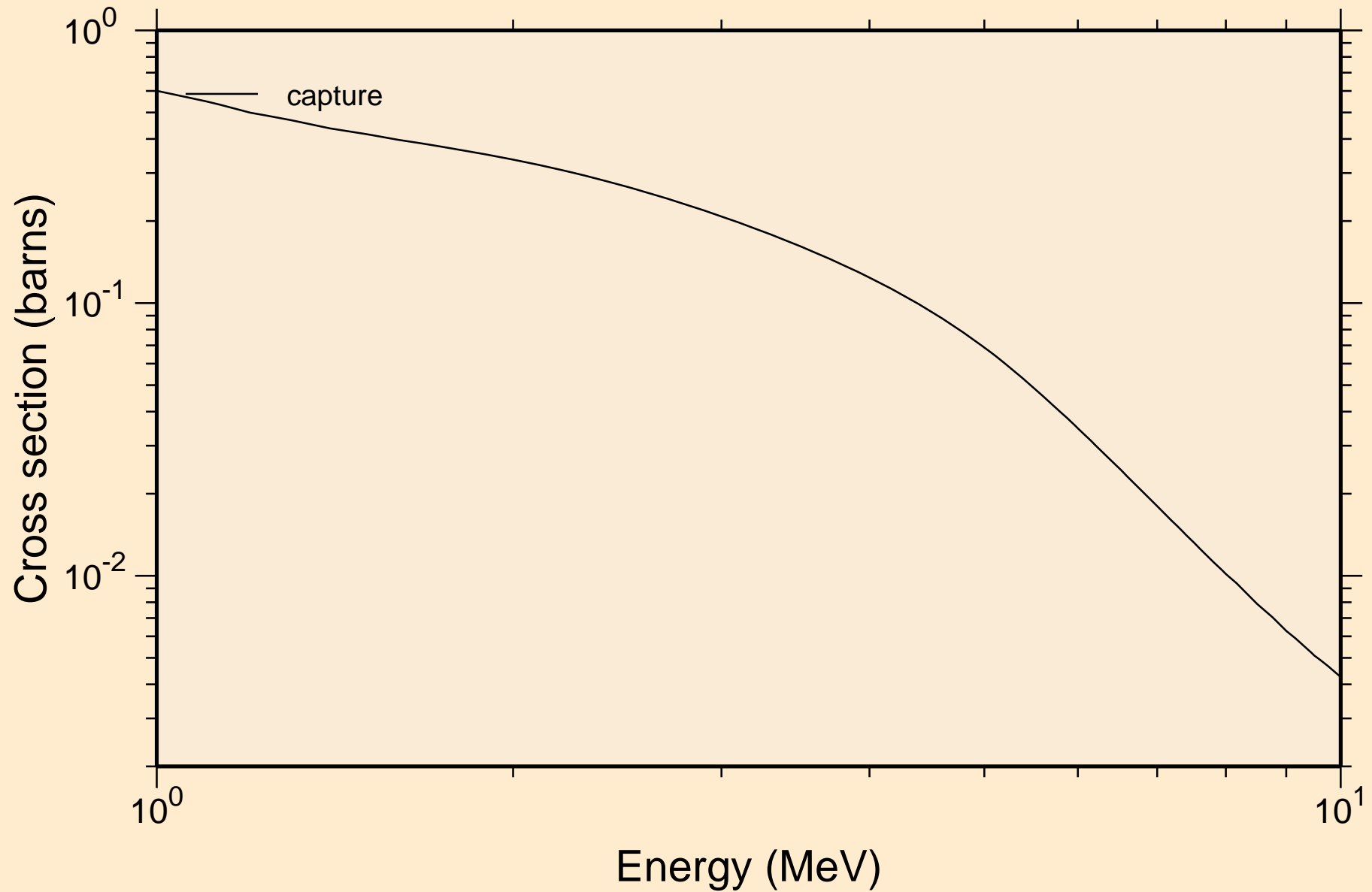

AT206 NEUTRON ACER TENDL-2021 LIBRARY; T=293.6K
Heating

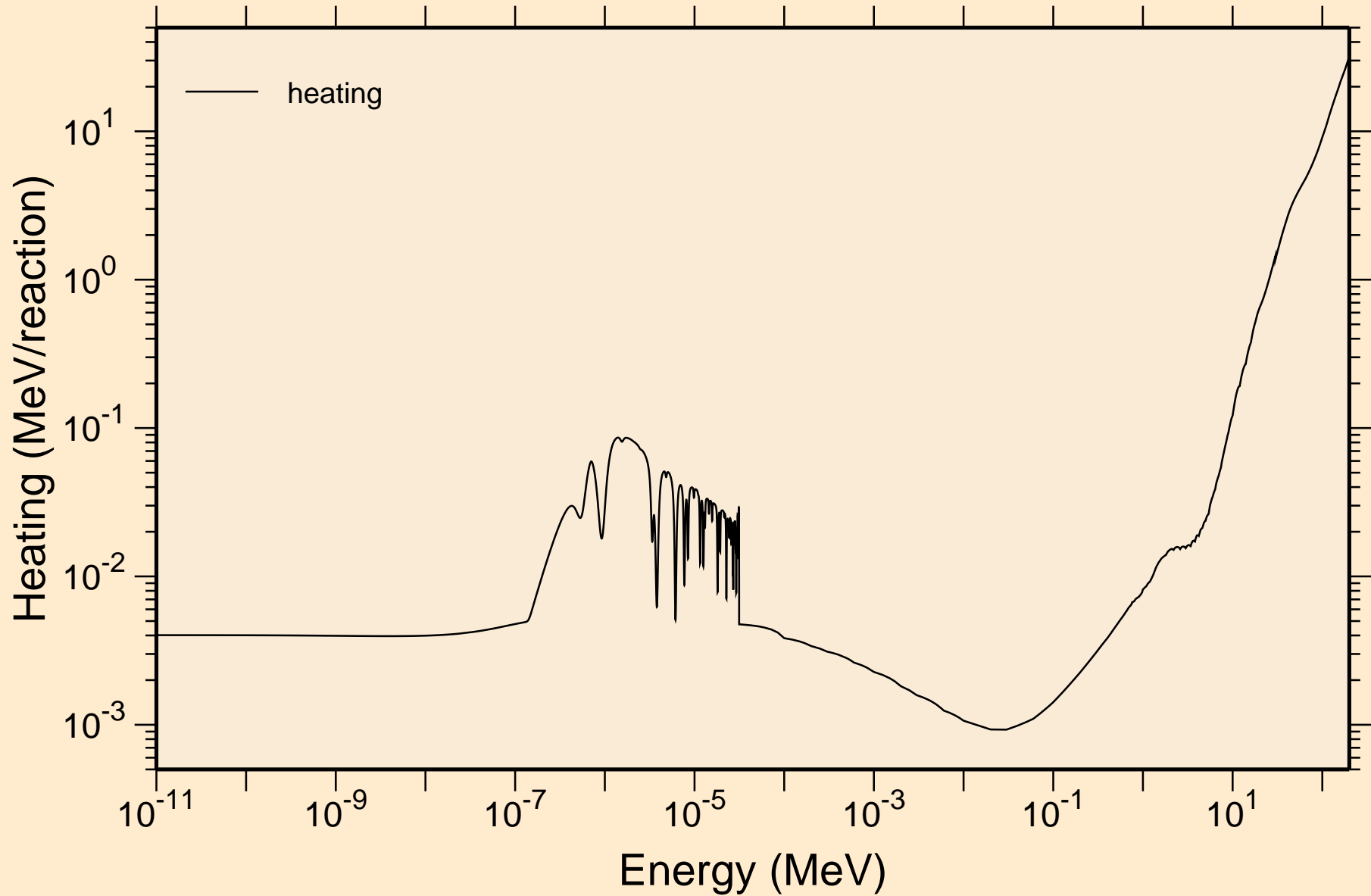

AT206 NEUTRON ACER TENDL-2021 LIBRARY; T=293.6K
Damage

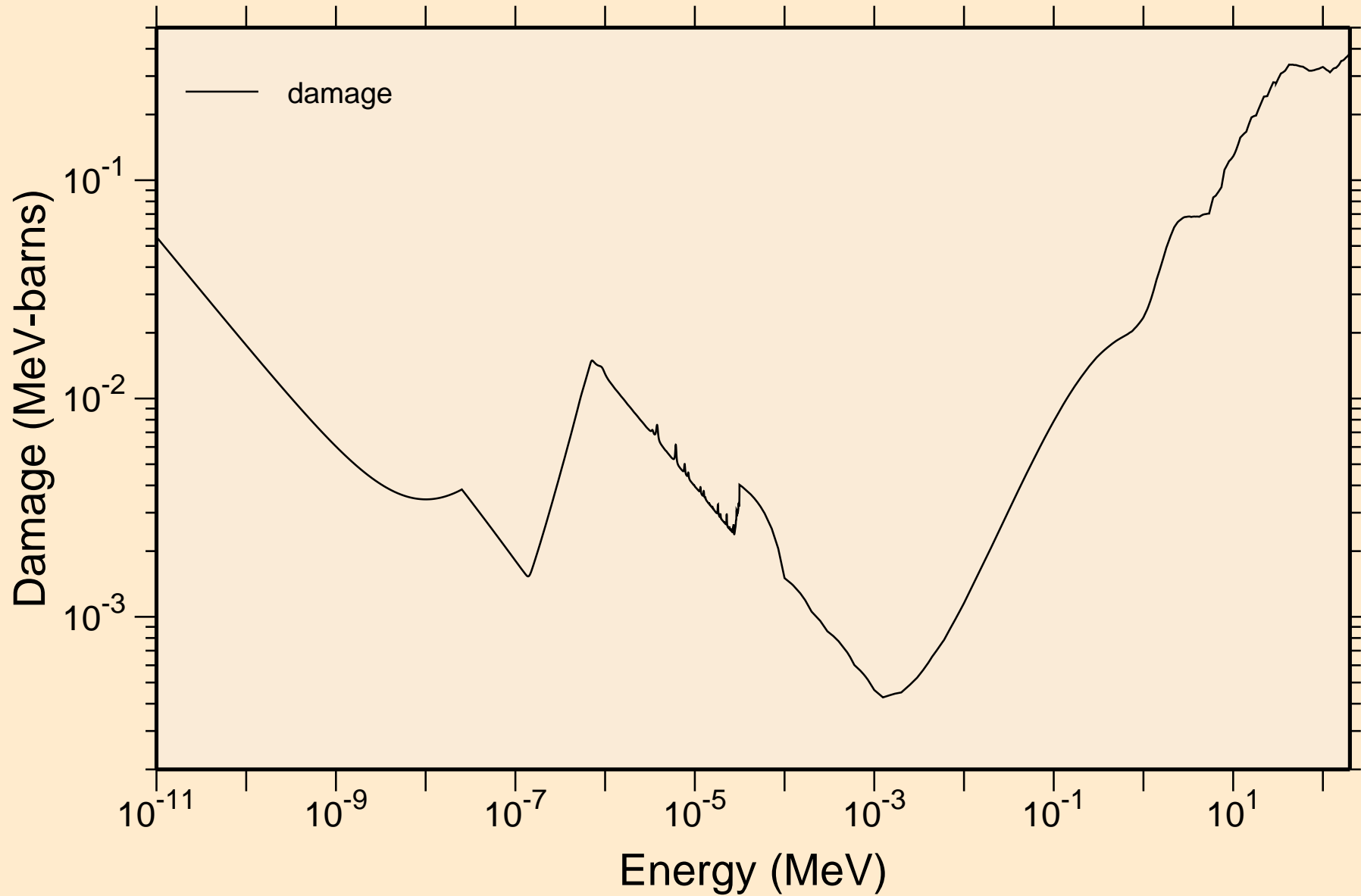

AT206 NEUTRON ACER TENDL-2021 LIBRARY; T=293.6K
Non-threshold reactions

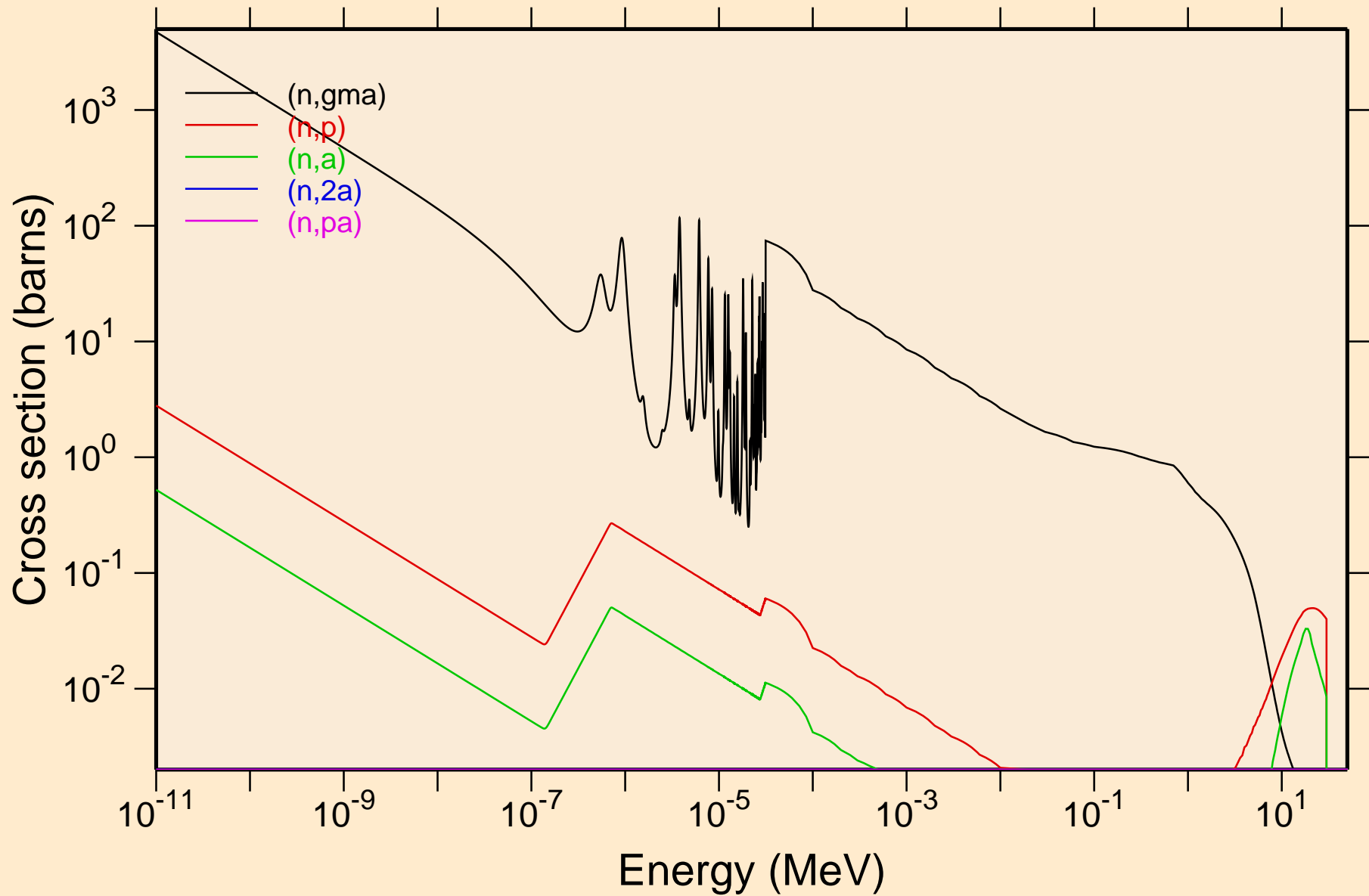

AT206 NEUTRON ACER TENDL-2021 LIBRARY; T=293.6K
Non-threshold reactions

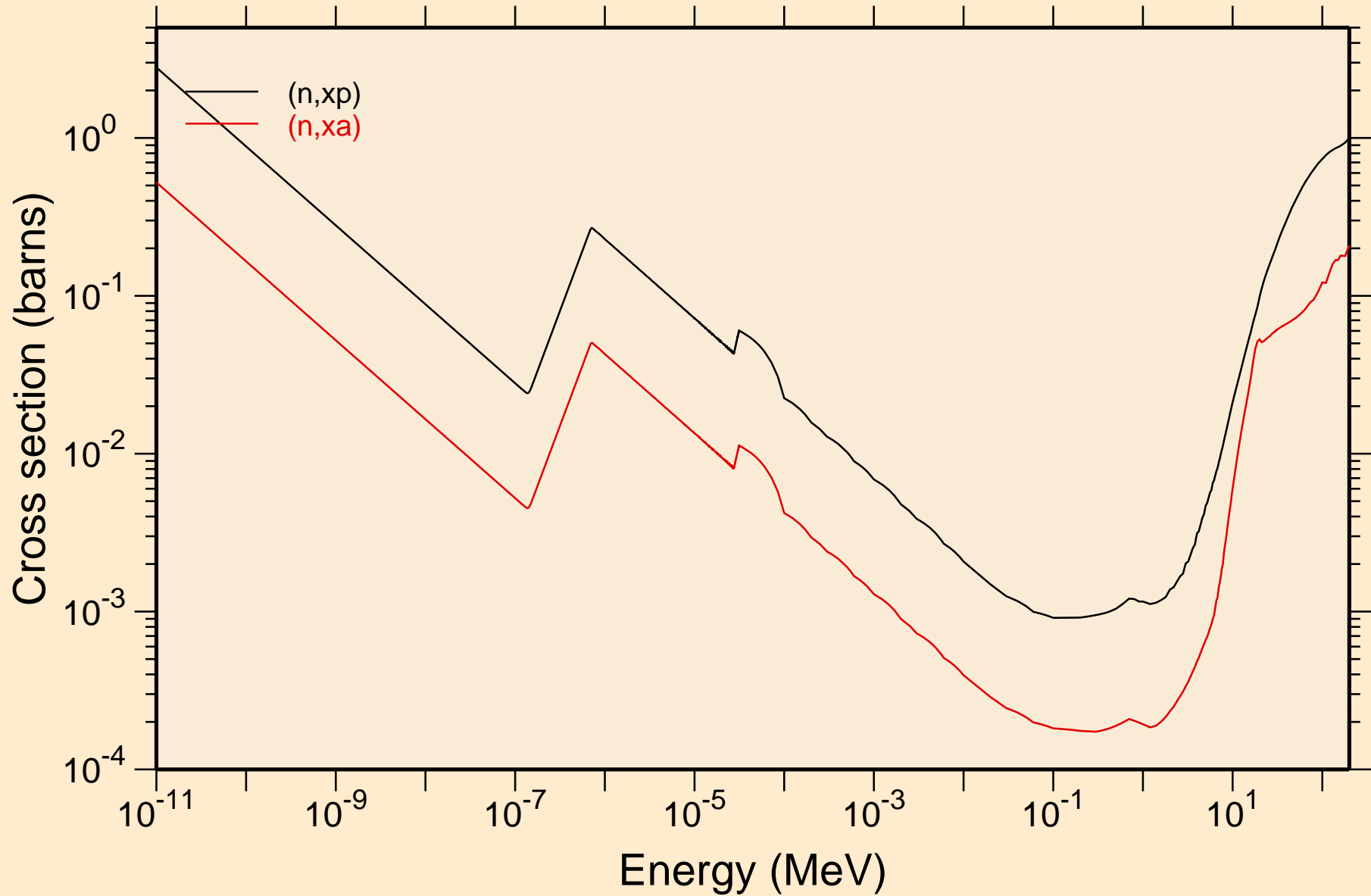

AT206 NEUTRON ACER TENDL-2021 LIBRARY; T=293.6K
Principal cross sections

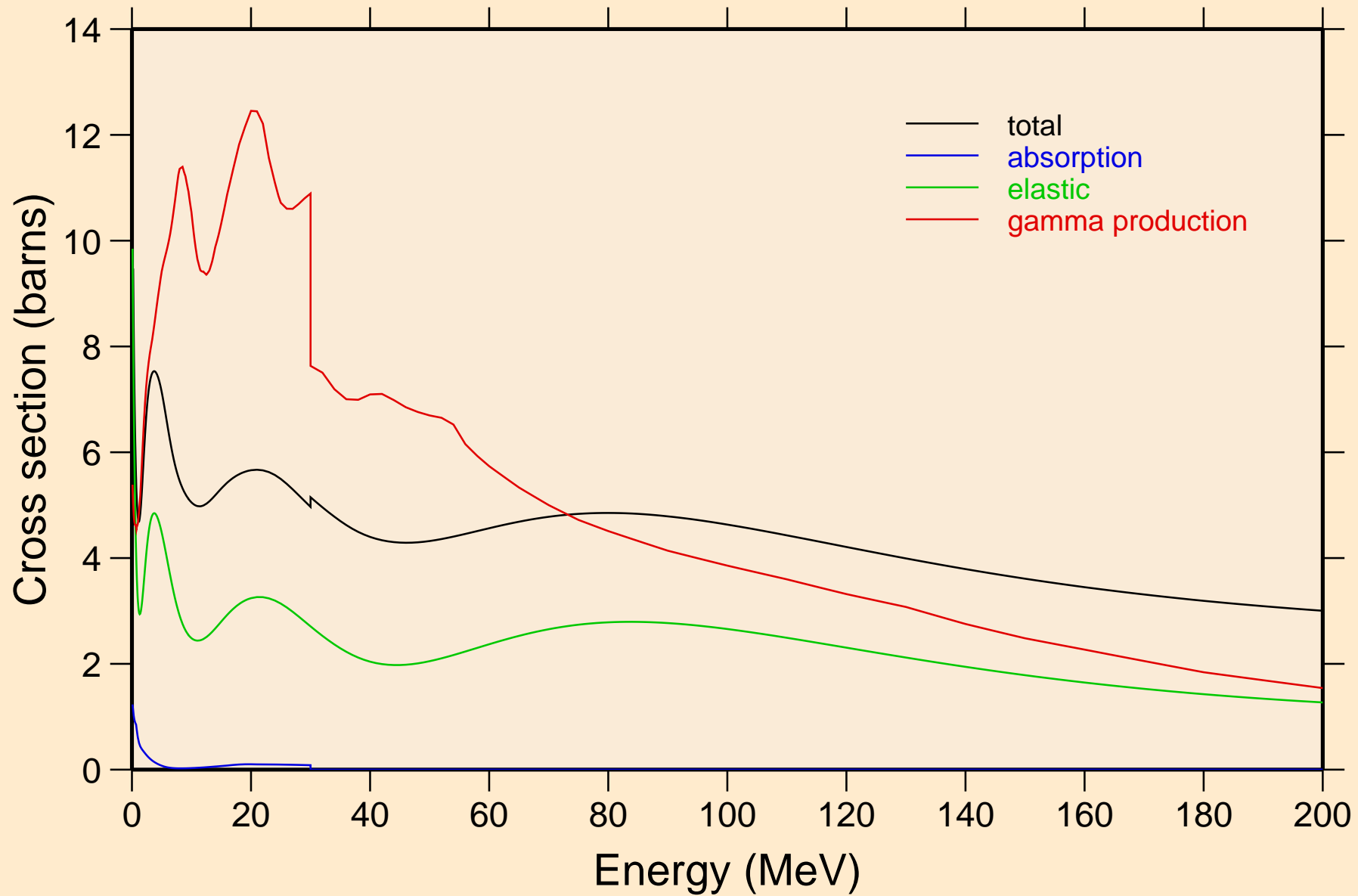

AT206 NEUTRON ACER TENDL-2021 LIBRARY; T=293.6K
Heating

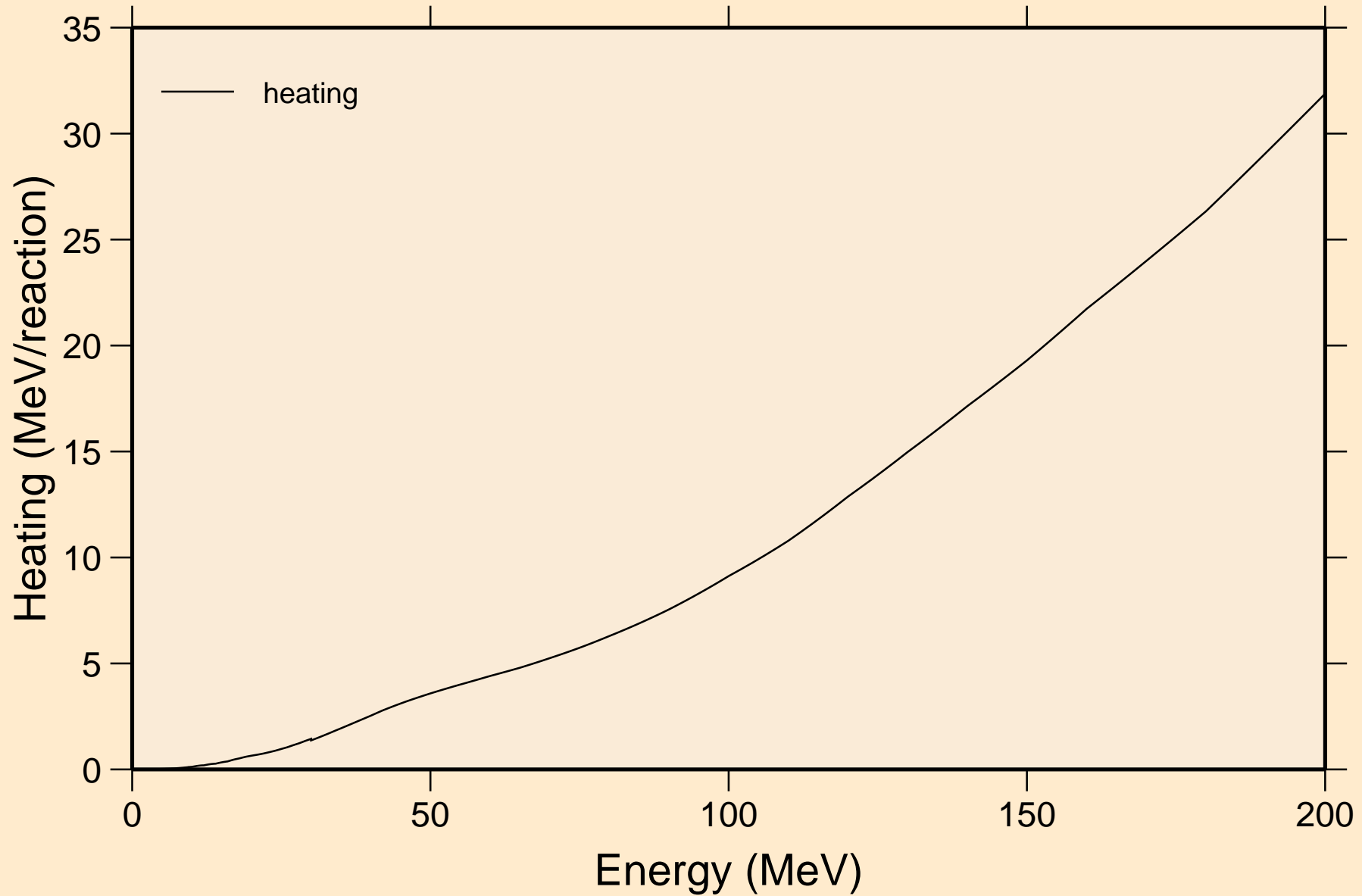

AT206 NEUTRON ACER TENDL-2021 LIBRARY; T=293.6K
Damage

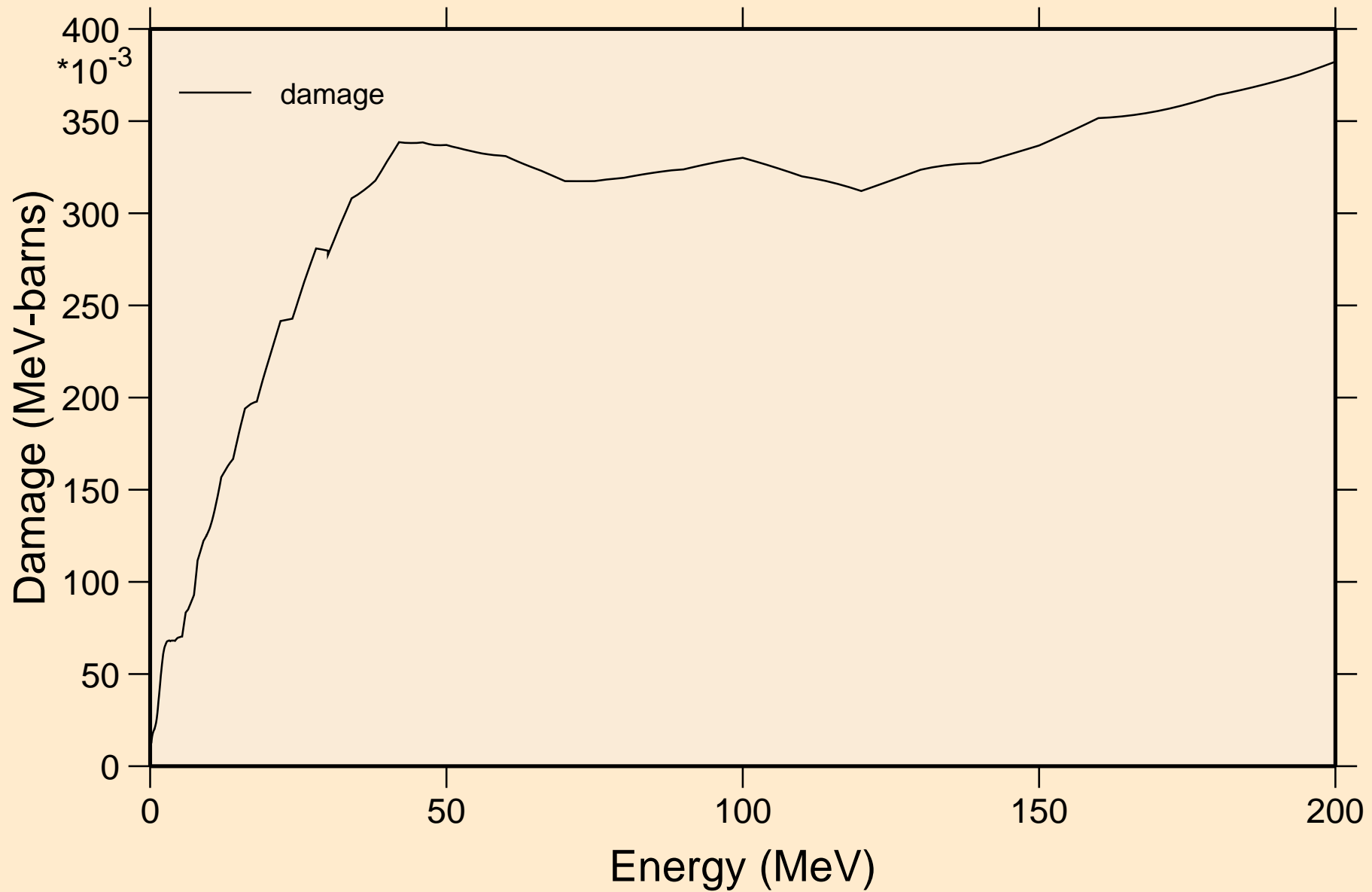

AT206 NEUTRON ACER TENDL-2021 LIBRARY; T=293.6K
Non-threshold reactions

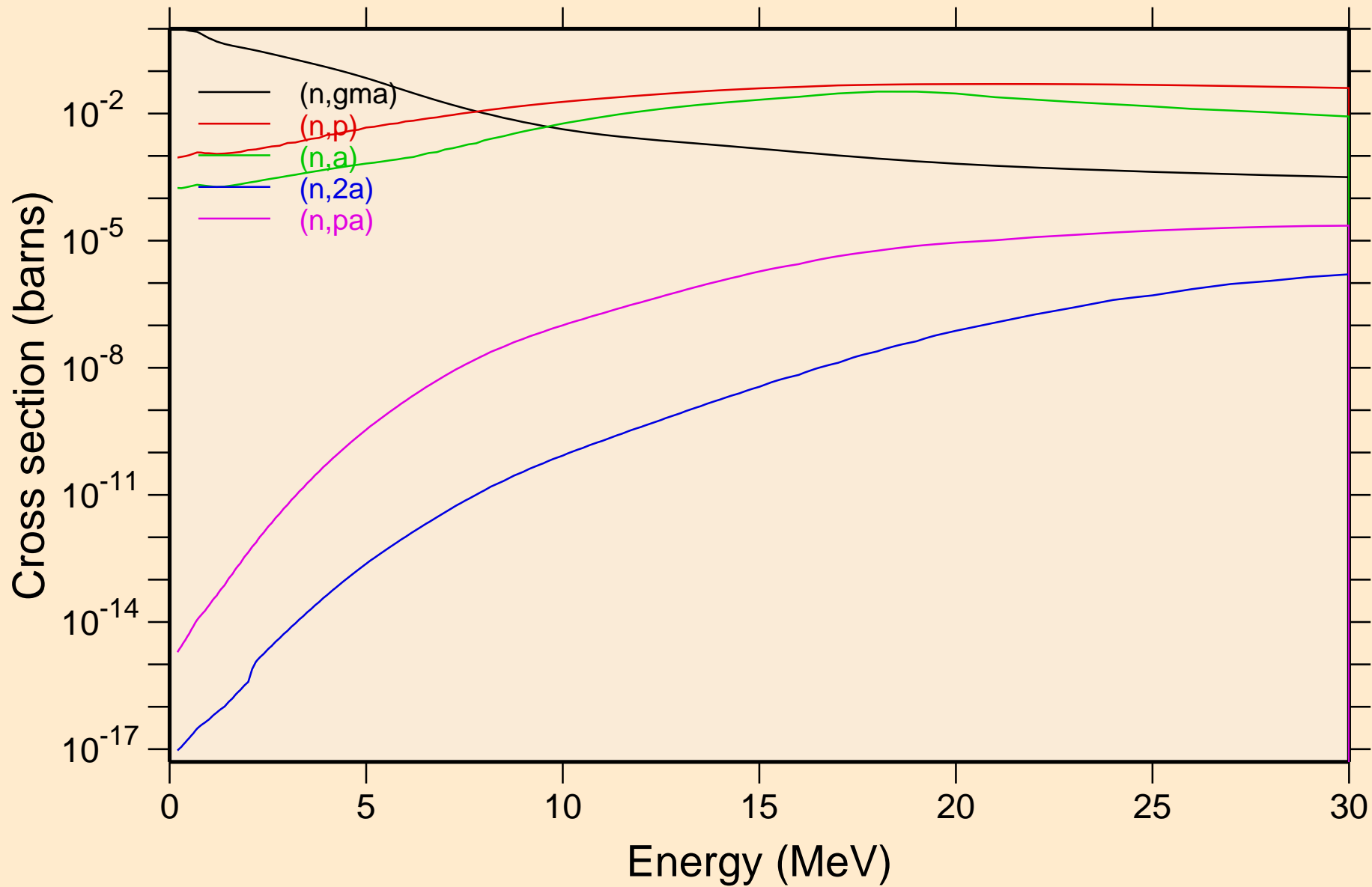

AT206 NEUTRON ACER TENDL-2021 LIBRARY; T=293.6K
Non-threshold reactions

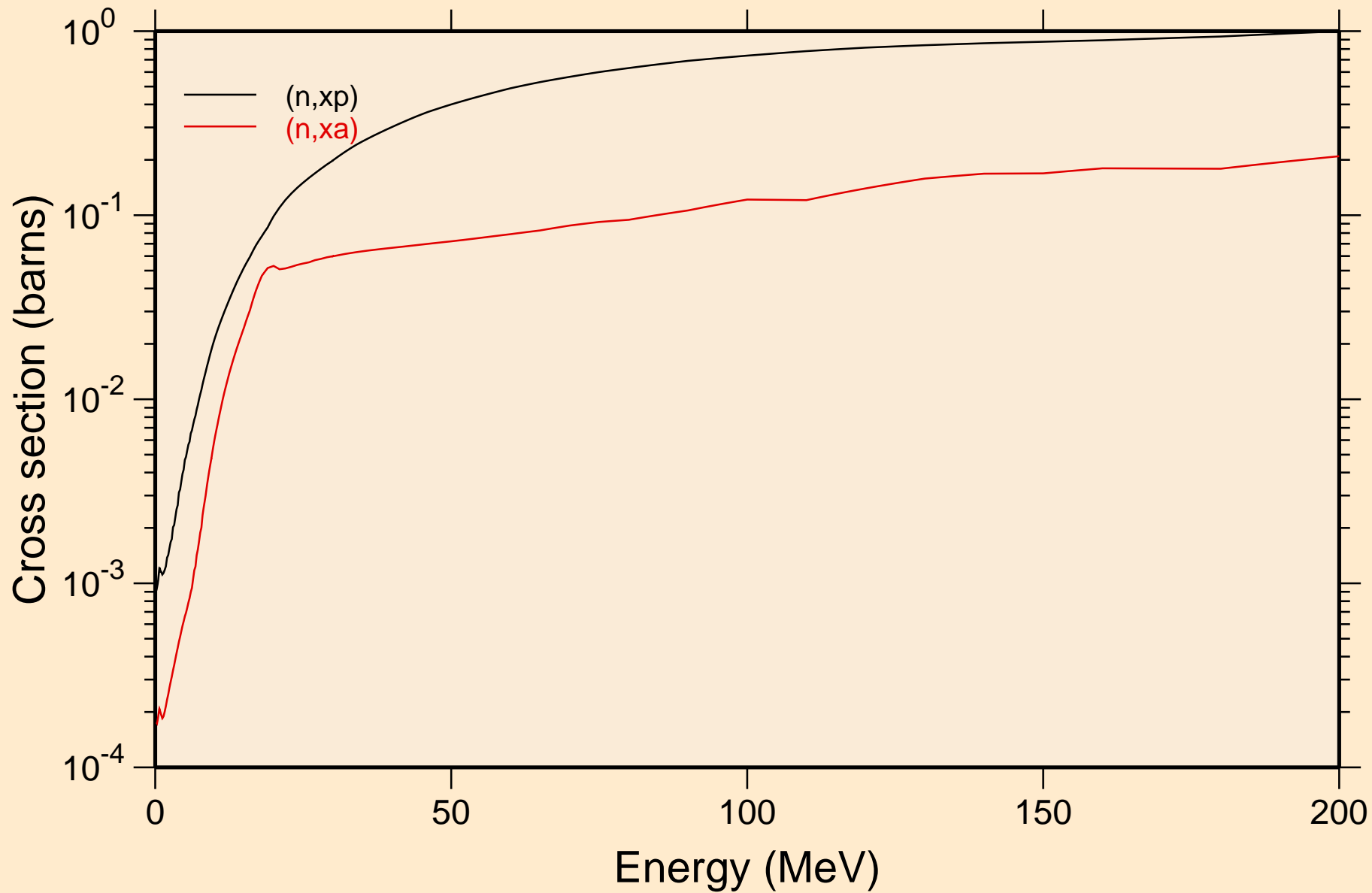

AT206 NEUTRON ACER TENDL-2021 LIBRARY; T=293.6K
Inelastic levels

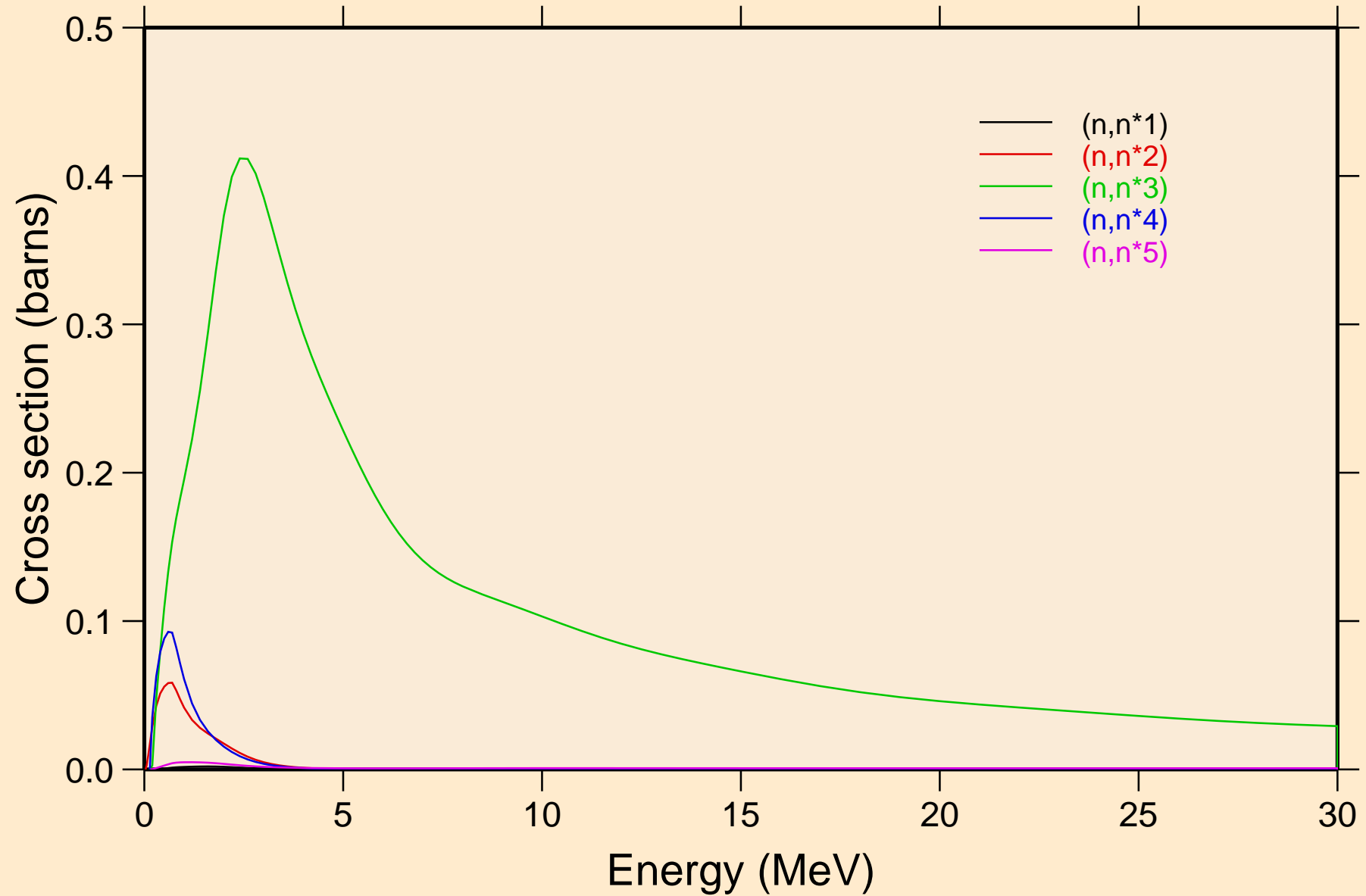

AT206 NEUTRON ACER TENDL-2021 LIBRARY; T=293.6K
Inelastic levels

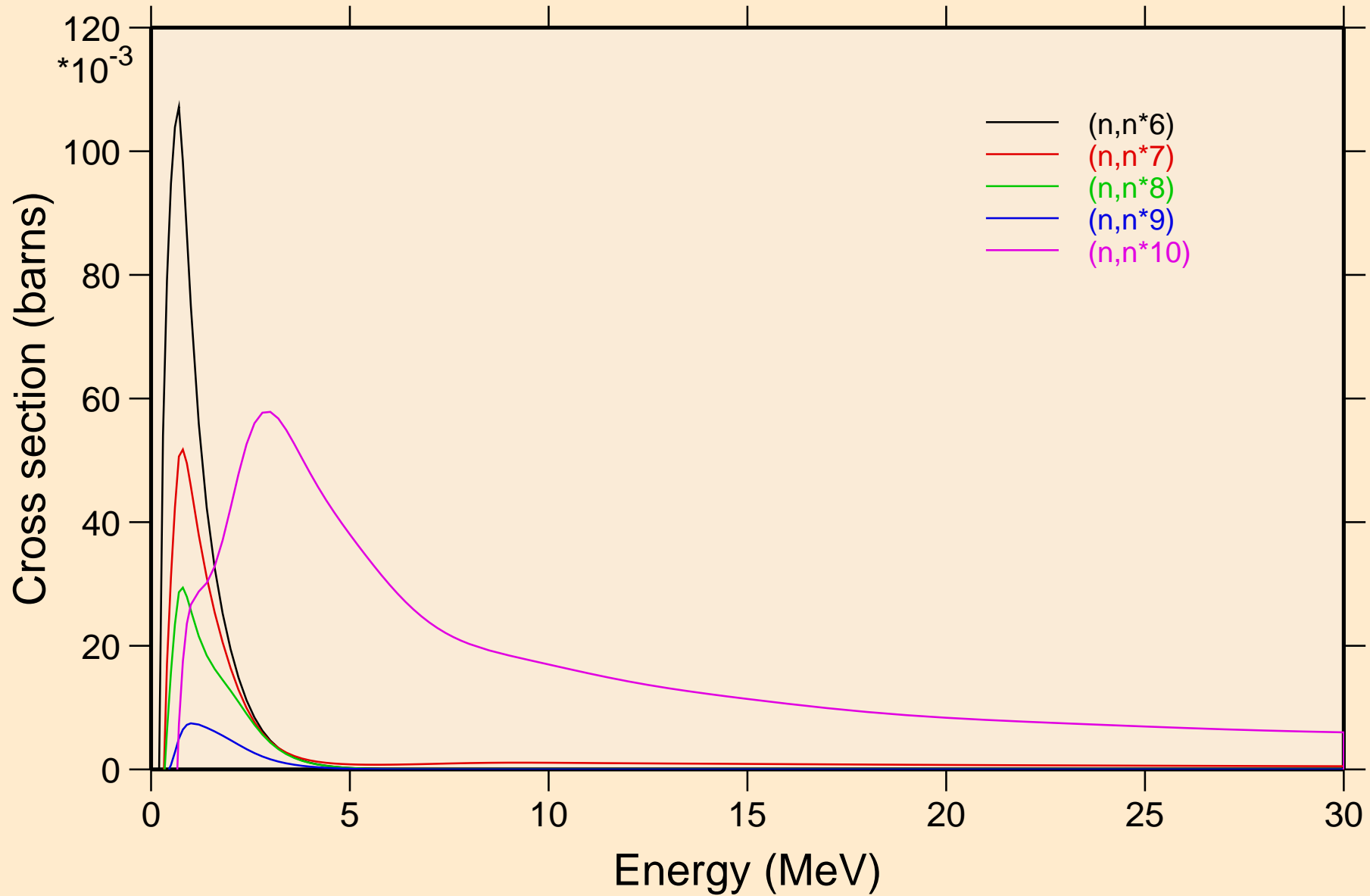

AT206 NEUTRON ACER TENDL-2021 LIBRARY; T=293.6K
Inelastic levels

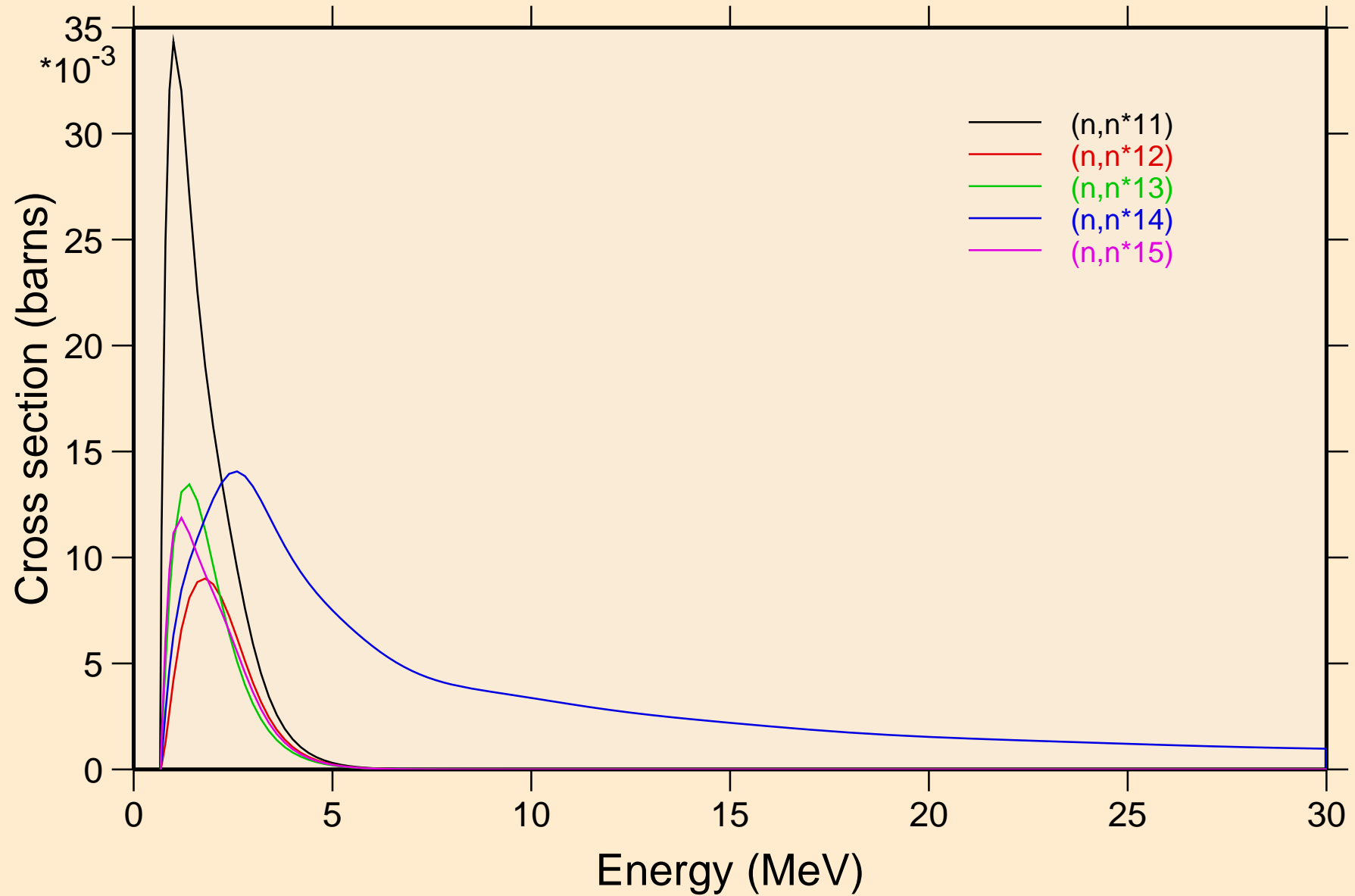

AT206 NEUTRON ACER TENDL-2021 LIBRARY; T=293.6K
Inelastic levels

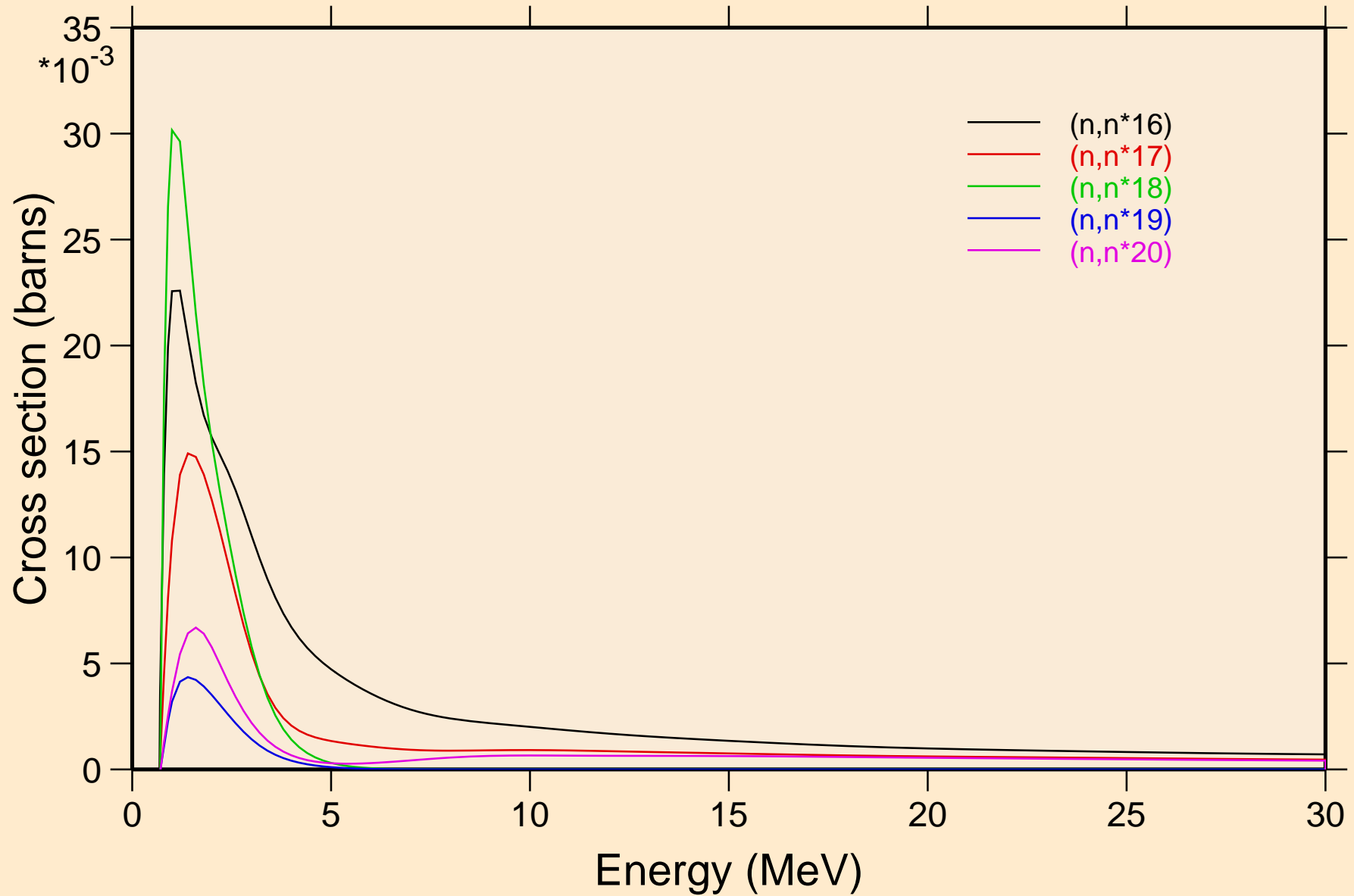

AT206 NEUTRON ACER TENDL-2021 LIBRARY; T=293.6K
Inelastic levels

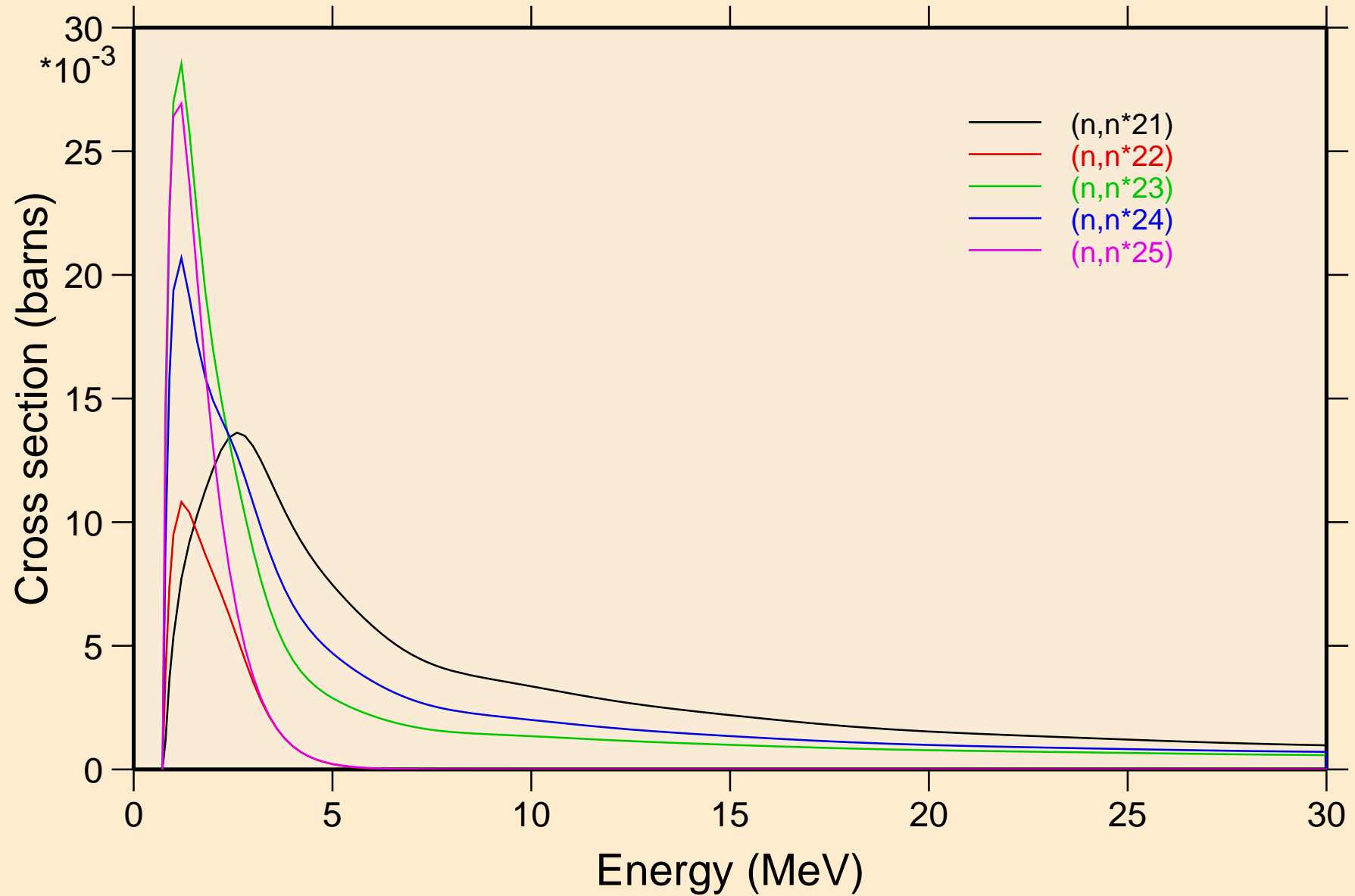

AT206 NEUTRON ACER TENDL-2021 LIBRARY; T=293.6K
Inelastic levels

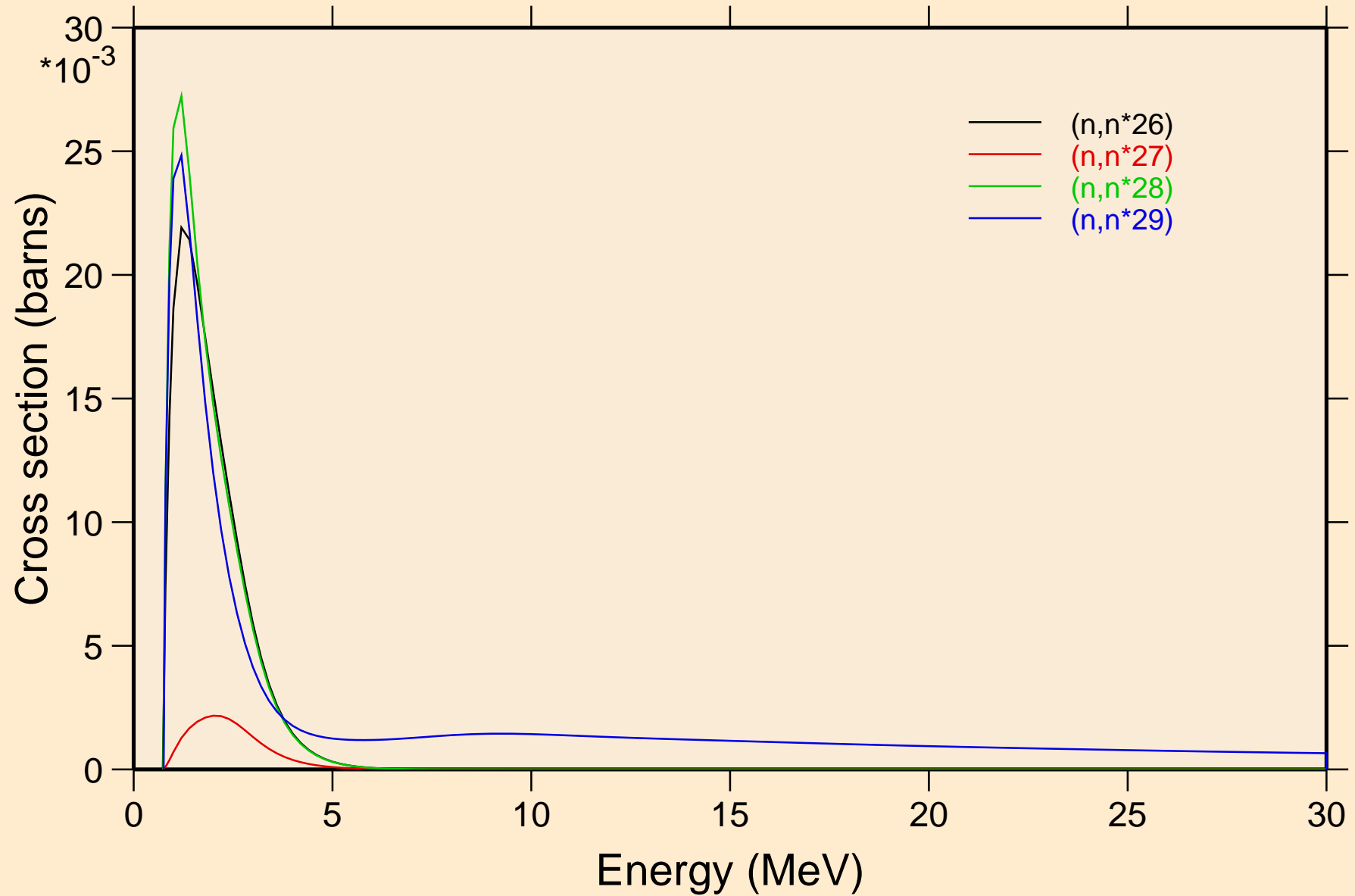

AT206 NEUTRON ACER TENDL-2021 LIBRARY; T=293.6K
Threshold reactions

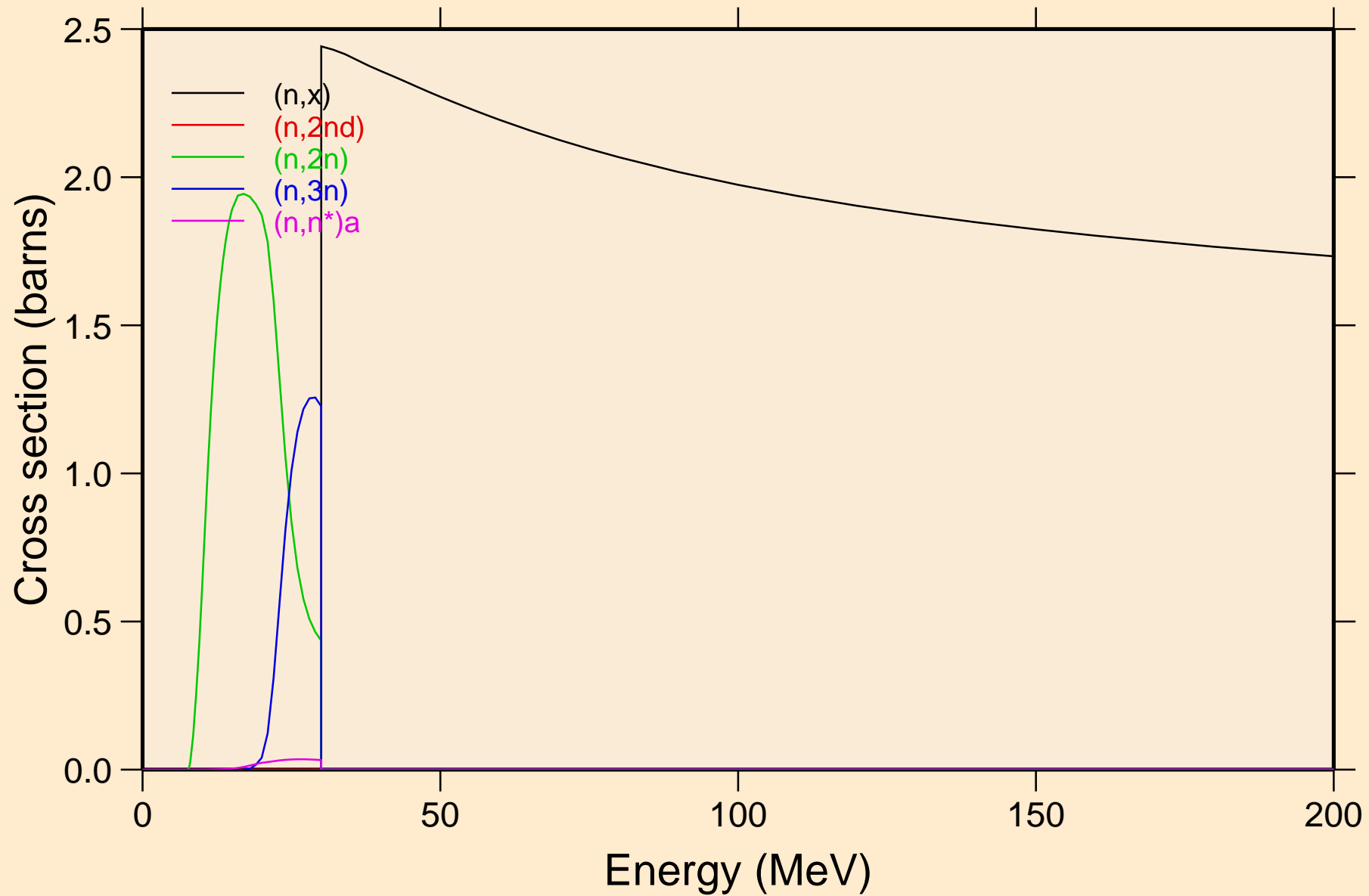

AT206 NEUTRON ACER TENDL-2021 LIBRARY; T=293.6K
Threshold reactions

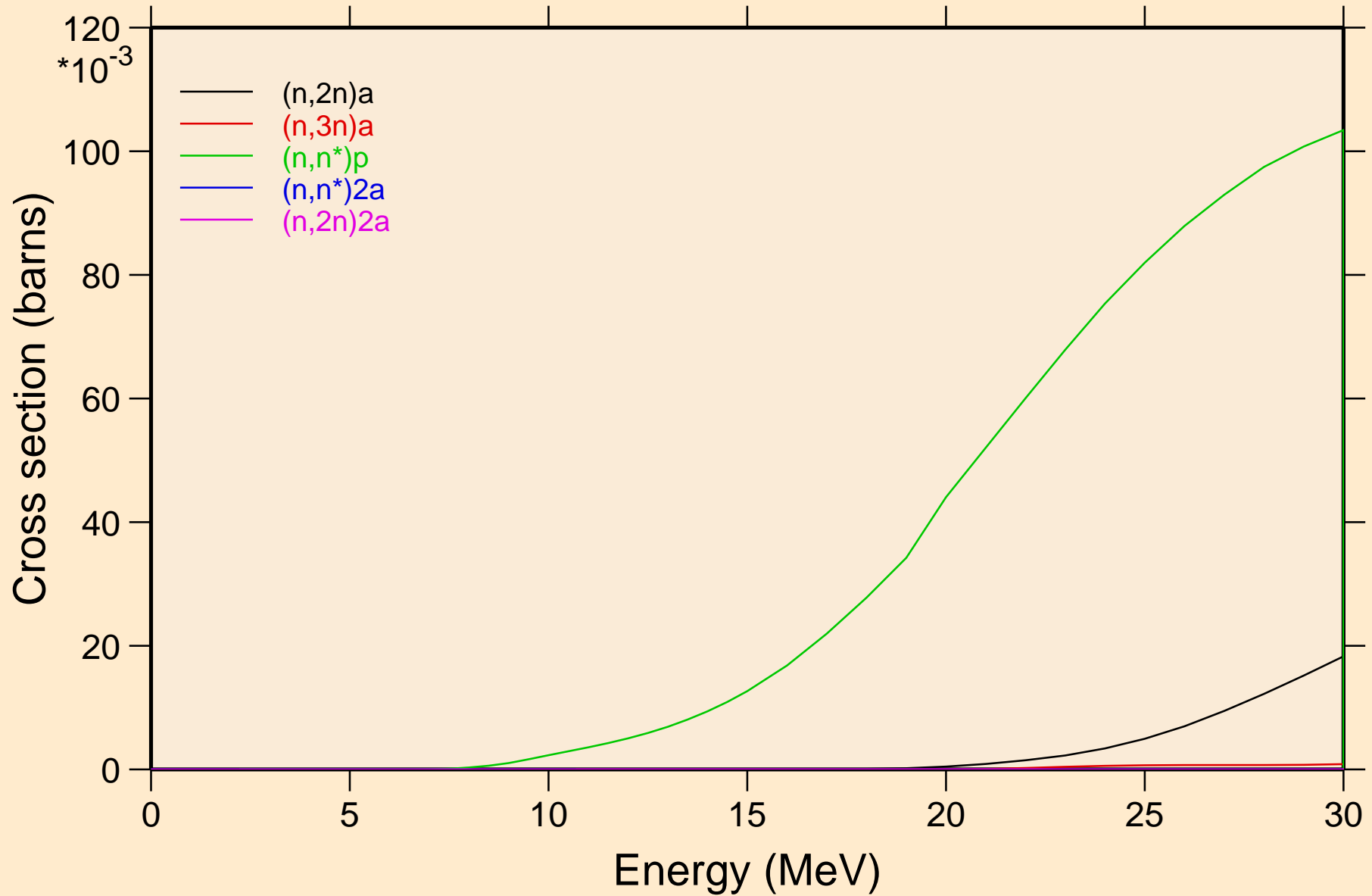

AT206 NEUTRON ACER TENDL-2021 LIBRARY; T=293.6K
Threshold reactions

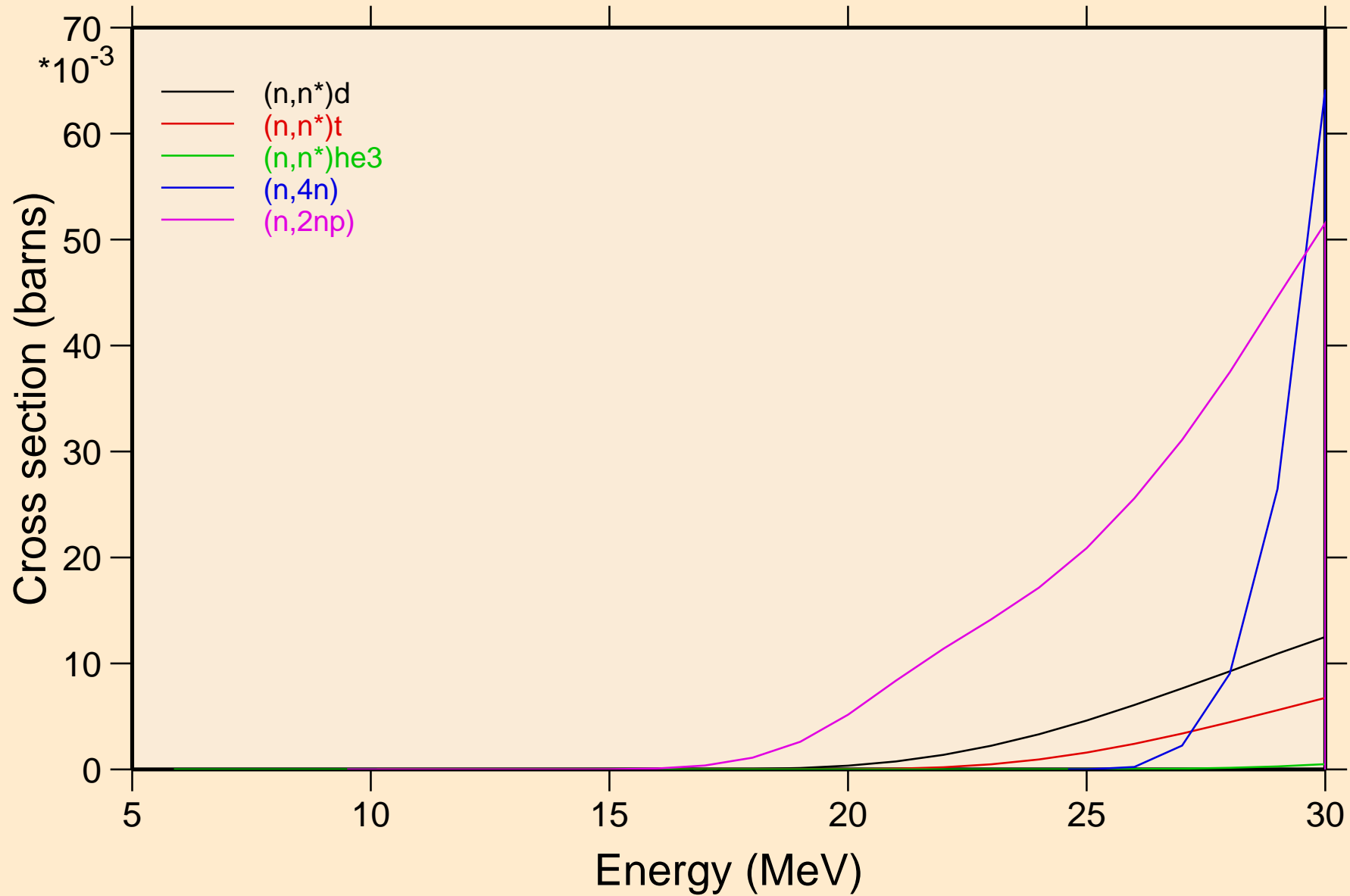

AT206 NEUTRON ACER TENDL-2021 LIBRARY; T=293.6K
Threshold reactions

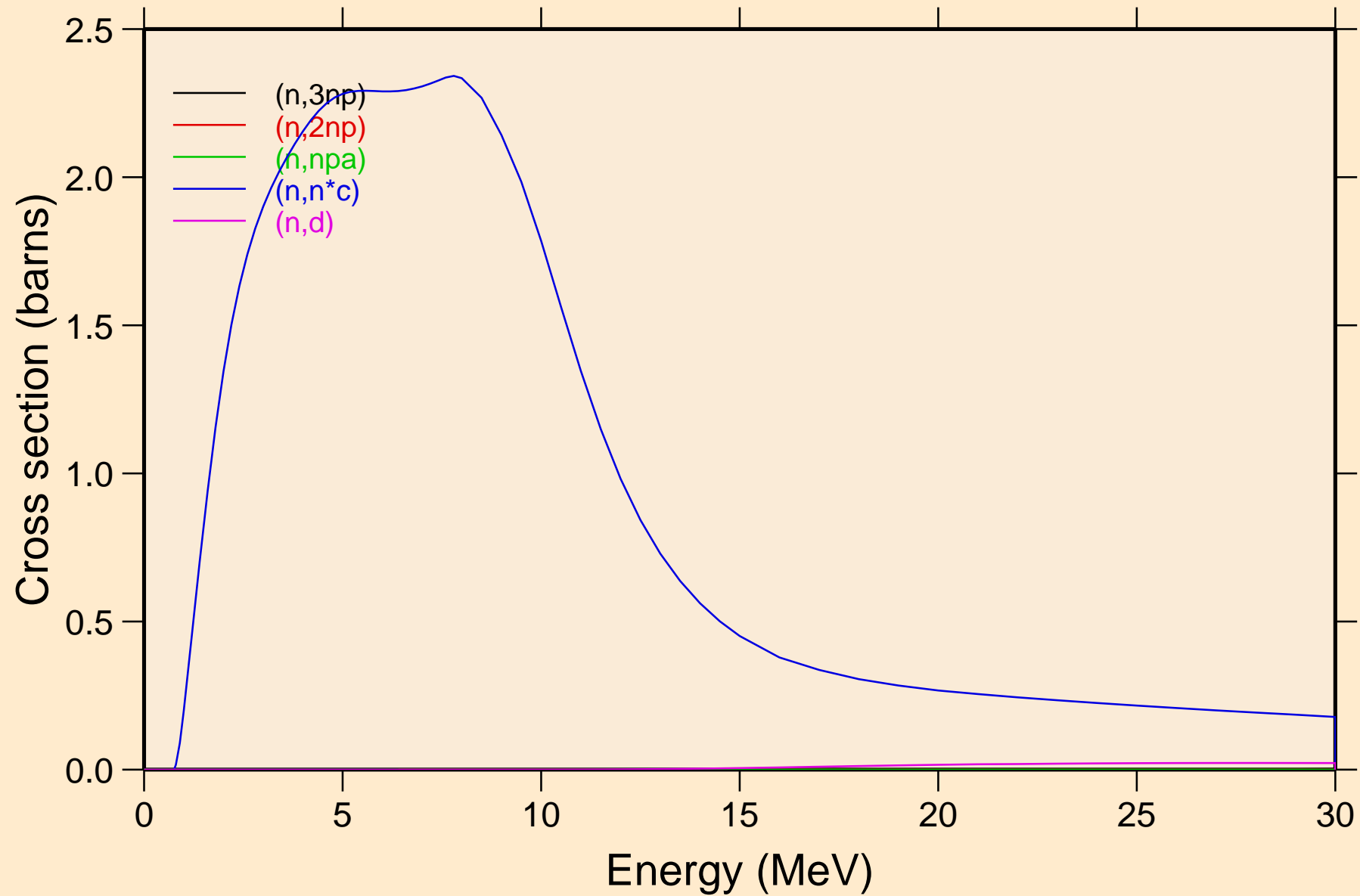

AT206 NEUTRON ACER TENDL-2021 LIBRARY; T=293.6K
Threshold reactions

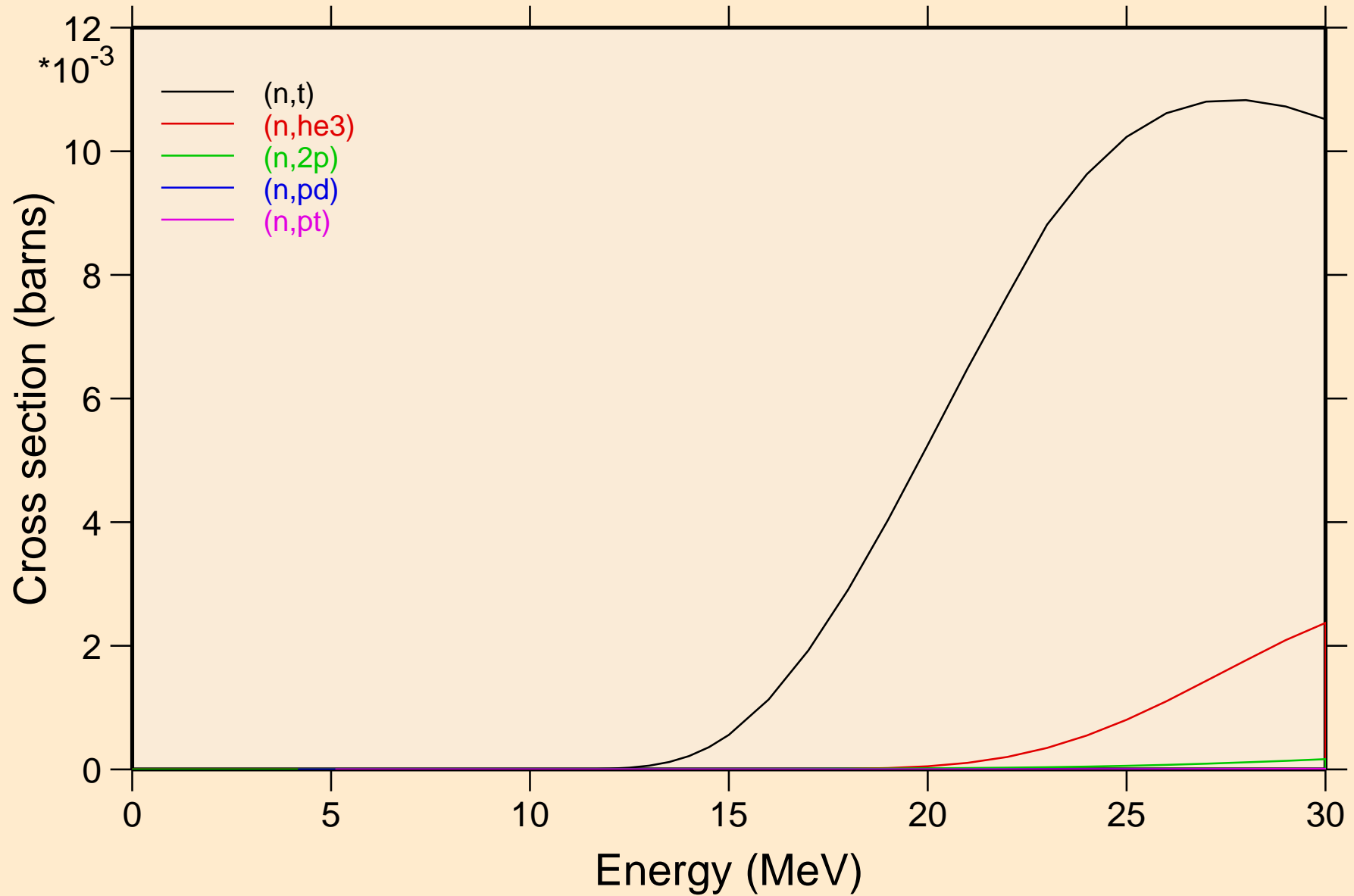

AT206 NEUTRON ACER TENDL-2021 LIBRARY; T=293.6K
Threshold reactions

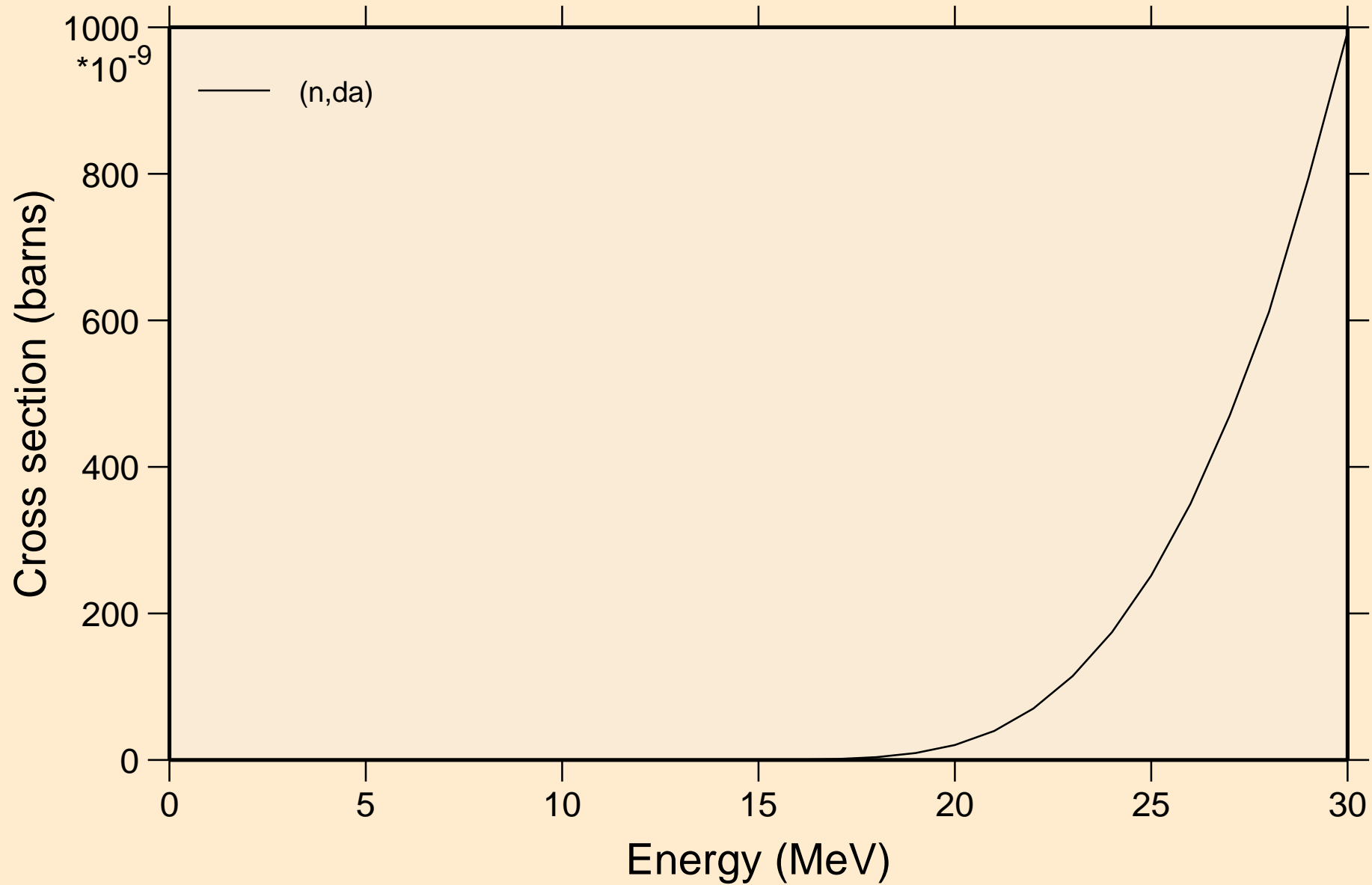

AT206 NEUTRON ACER TENDL-2021 LIBRARY; T=293.6K
Threshold reactions

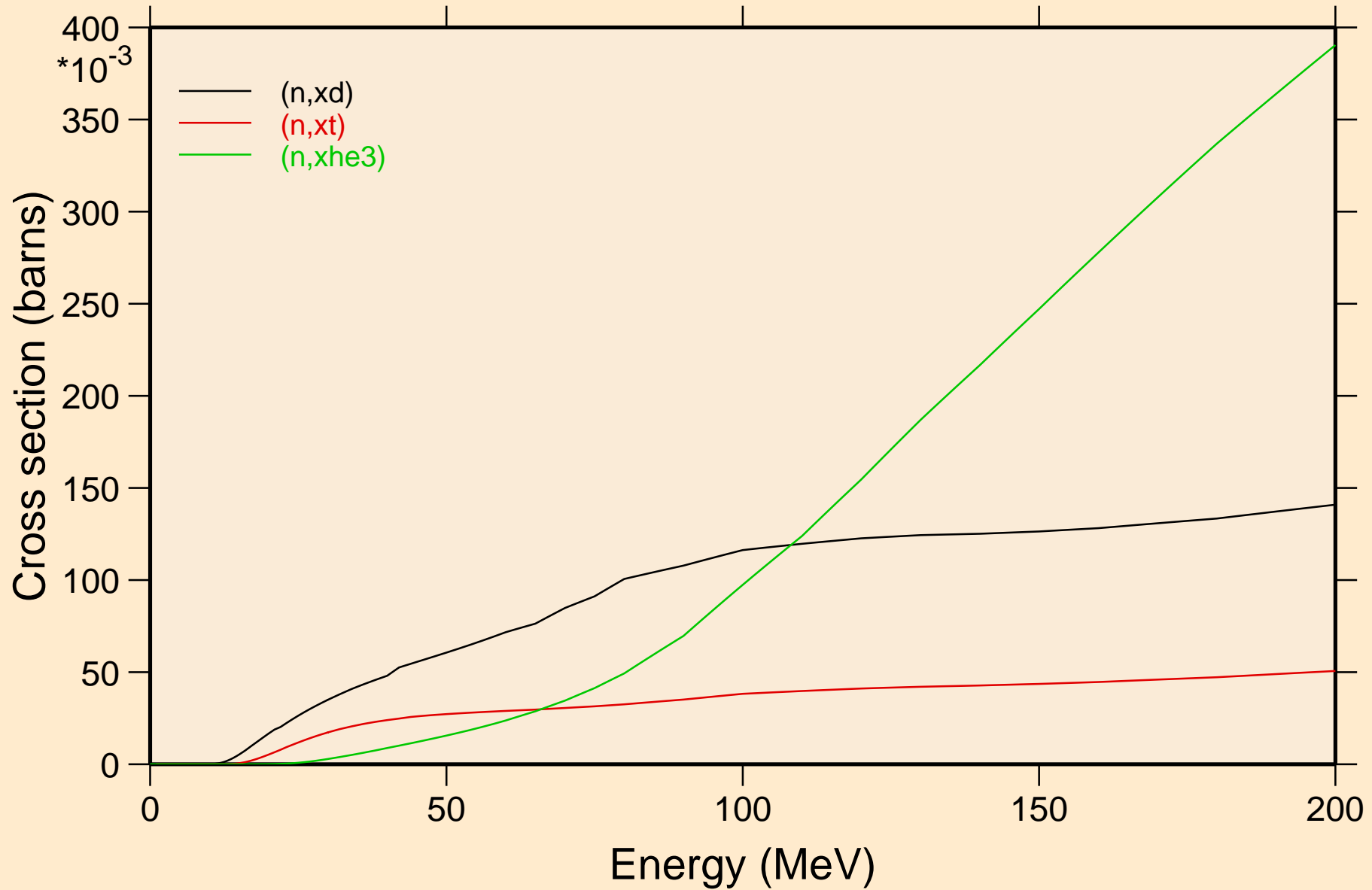

AT206 NEUTRON ACER TENDL-2021 LIBRARY; T=293.6K
angular distribution for elastic

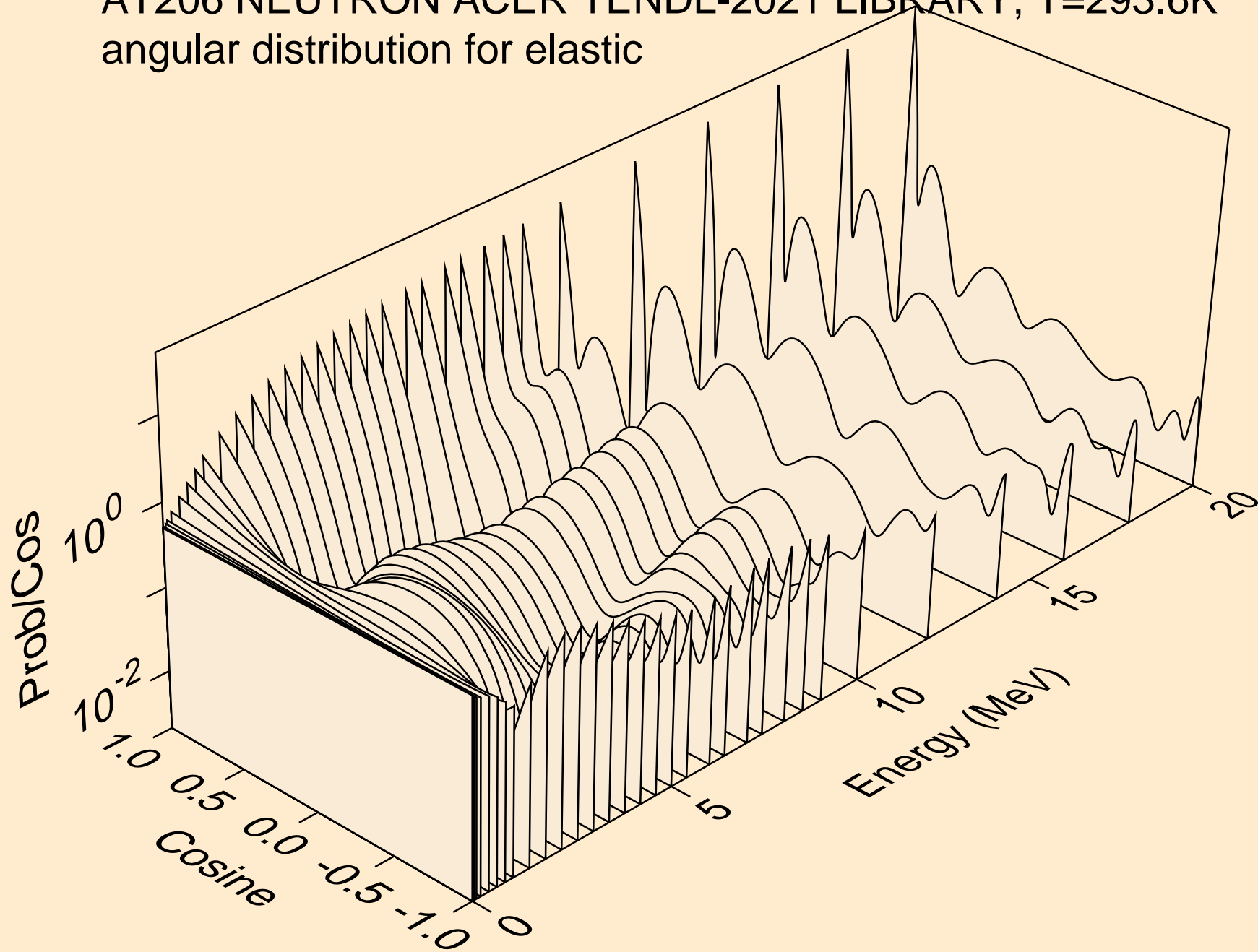

AT206 NEUTRON ACER TENDL-2021 LIBRARY; T=293.6K
angular distribution for elastic

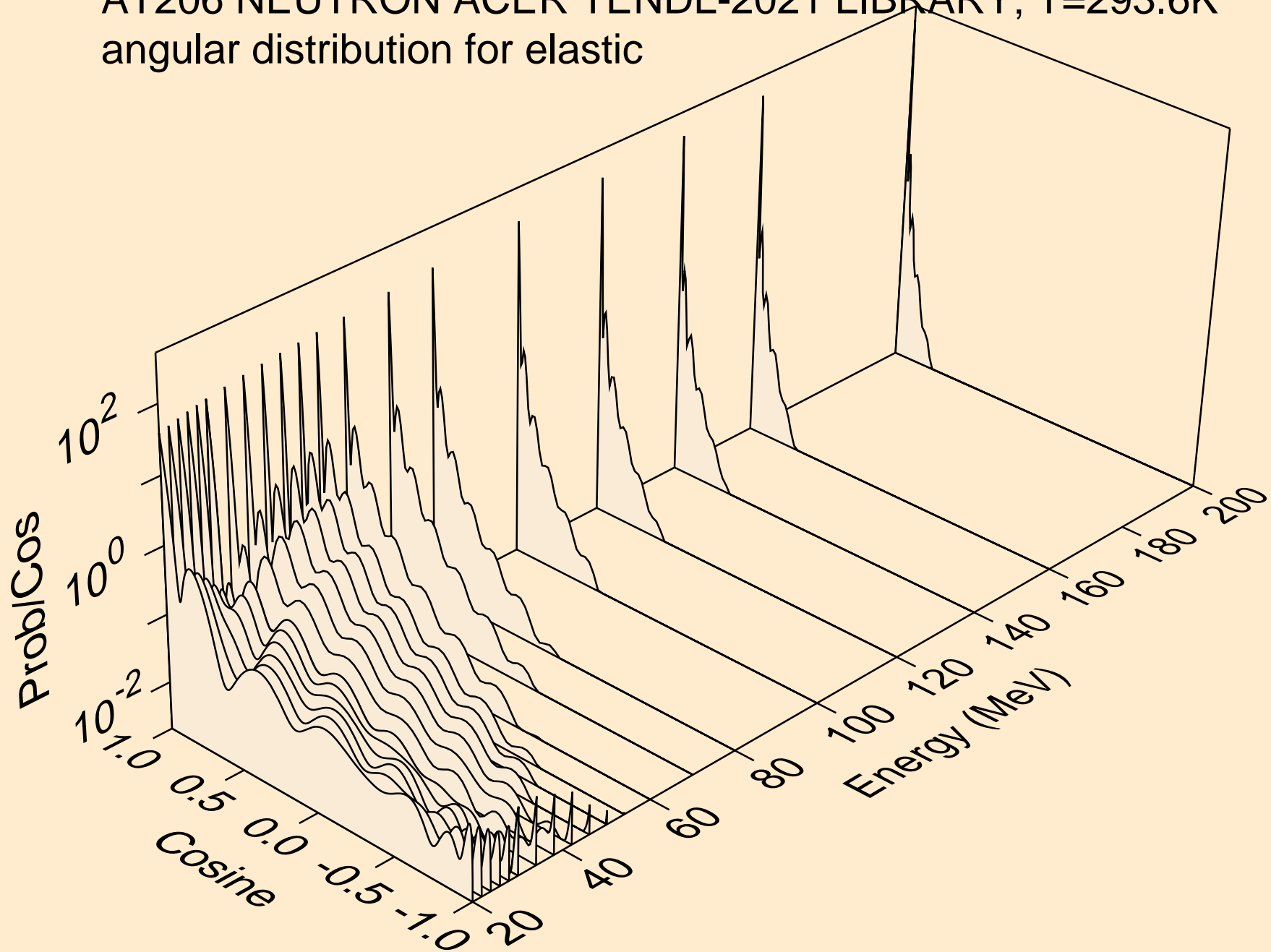

AT206 NEUTRON ACER TENDL-2021 LIBRARY; T=293.6K
angular distribution for (n,n*1)

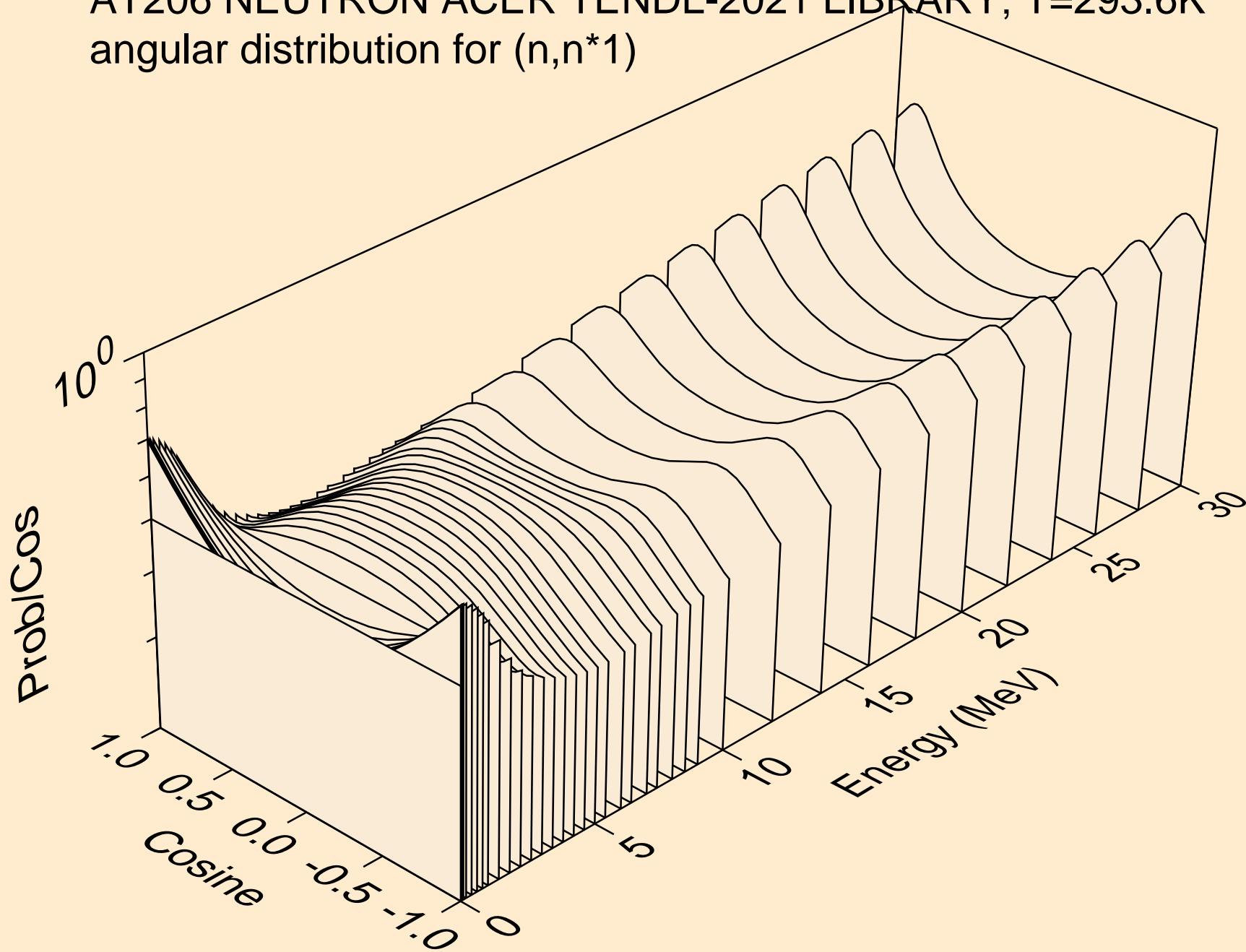

AT206 NEUTRON ACER TENDL-2021 LIBRARY; T=293.6K
angular distribution for (n,n*2)

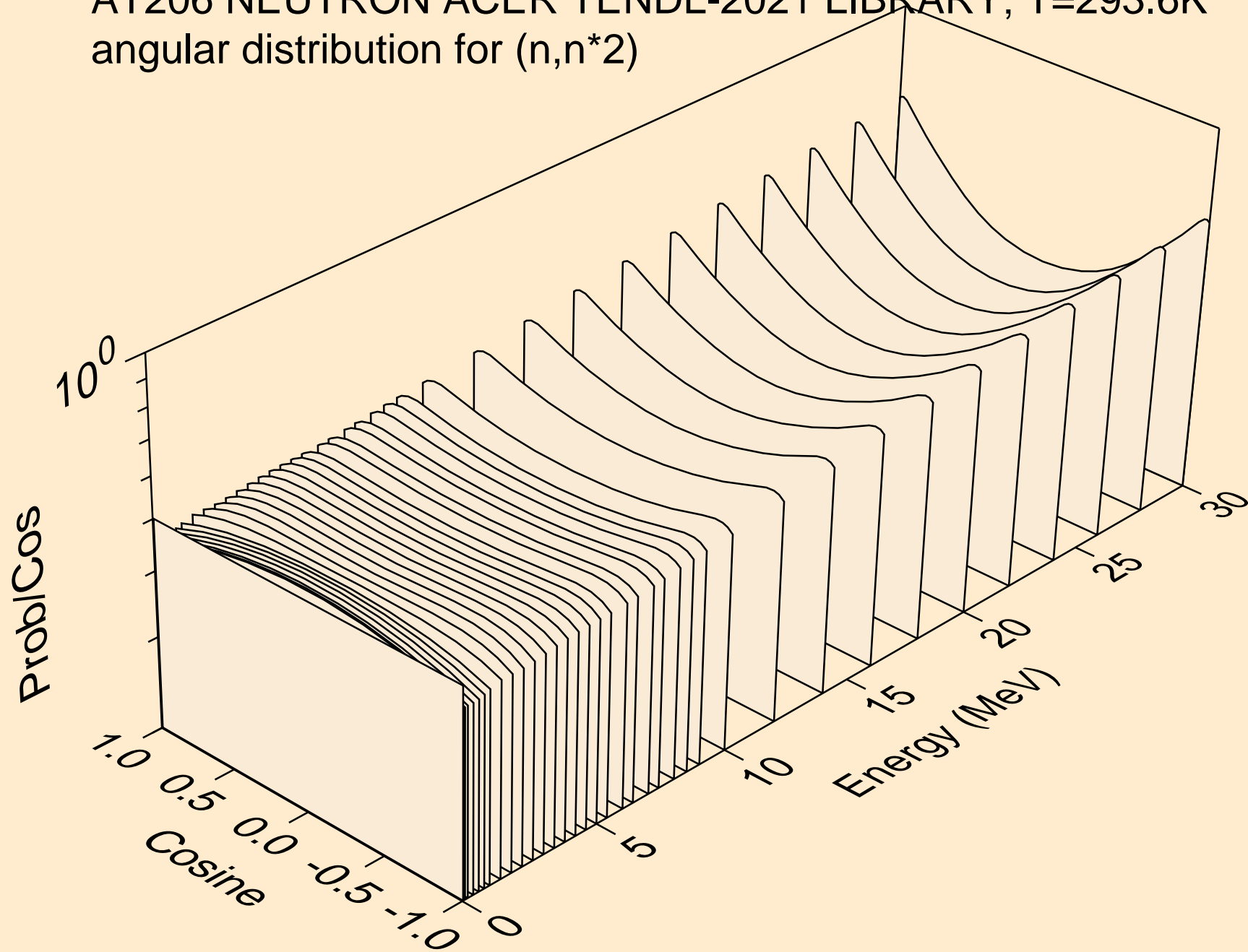

AT206 NEUTRON ACER TENDL-2021 LIBRARY; T=293.6K
angular distribution for (n,n*3)

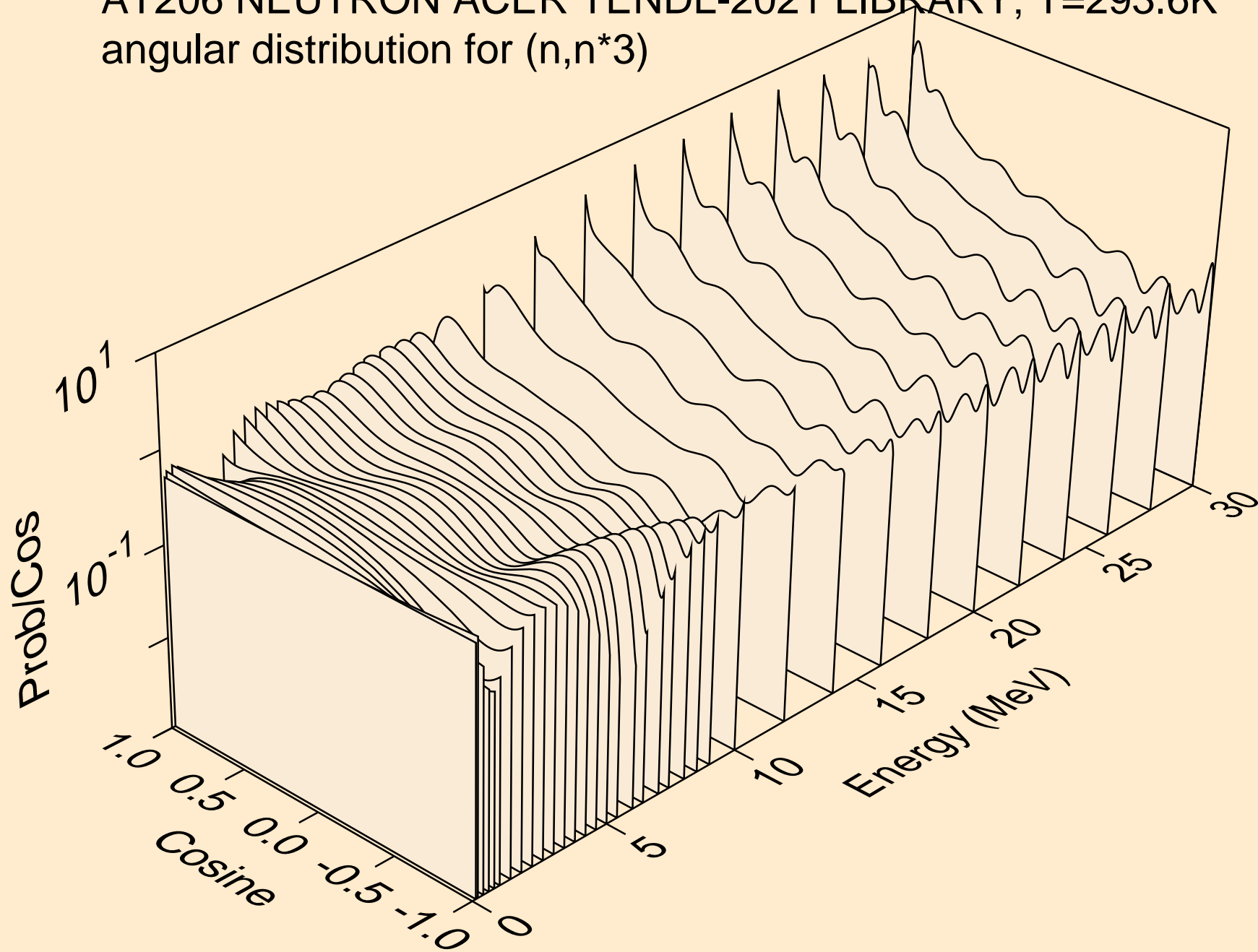

AT206 NEUTRON ACER TENDL-2021 LIBRARY; T=293.6K
angular distribution for (n,n*4)

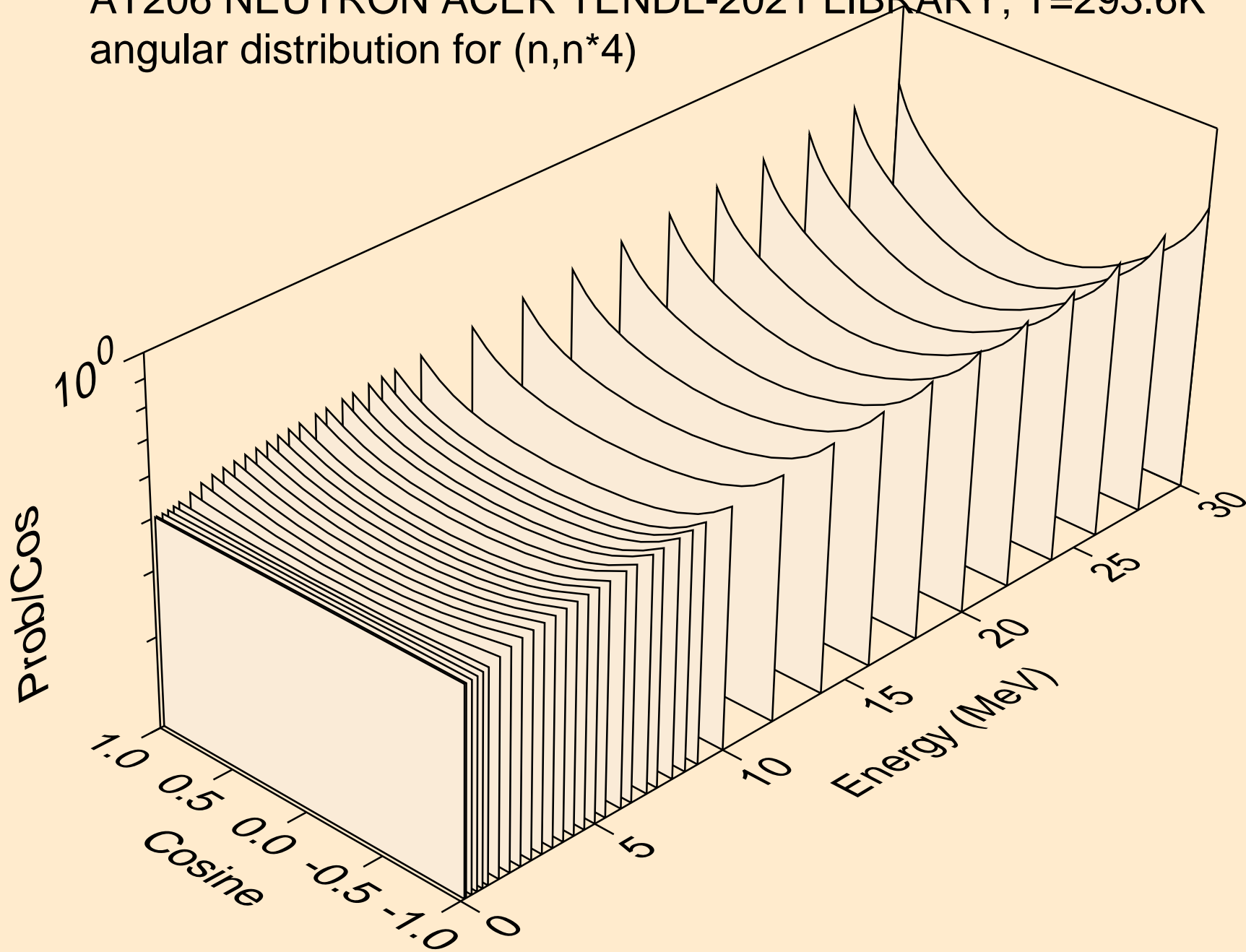

AT206 NEUTRON ACER TENDL-2021 LIBRARY; T=293.6K
angular distribution for (n,n*5)

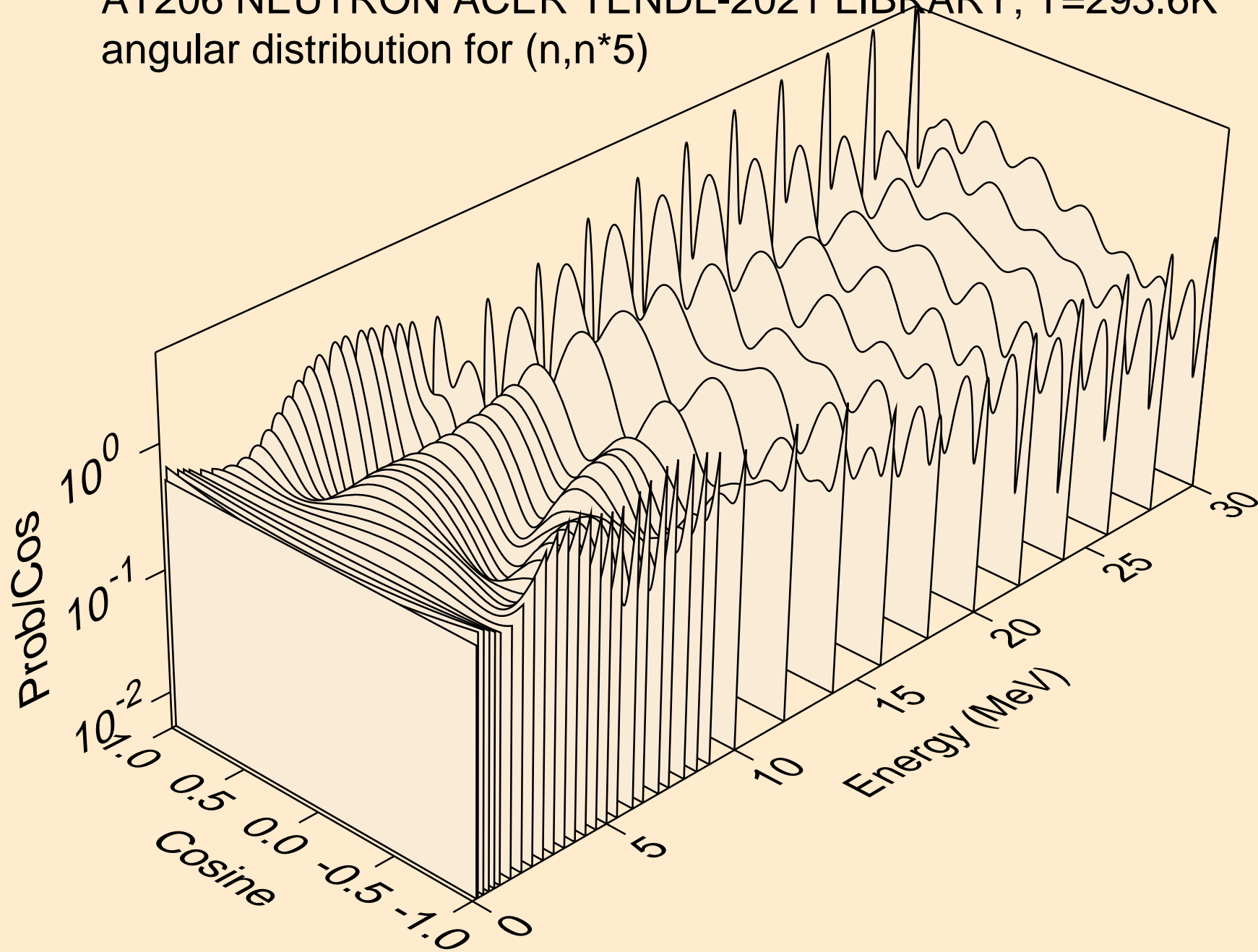

AT206 NEUTRON ACER TENDL-2021 LIBRARY; T=293.6K
angular distribution for (n,n*6)

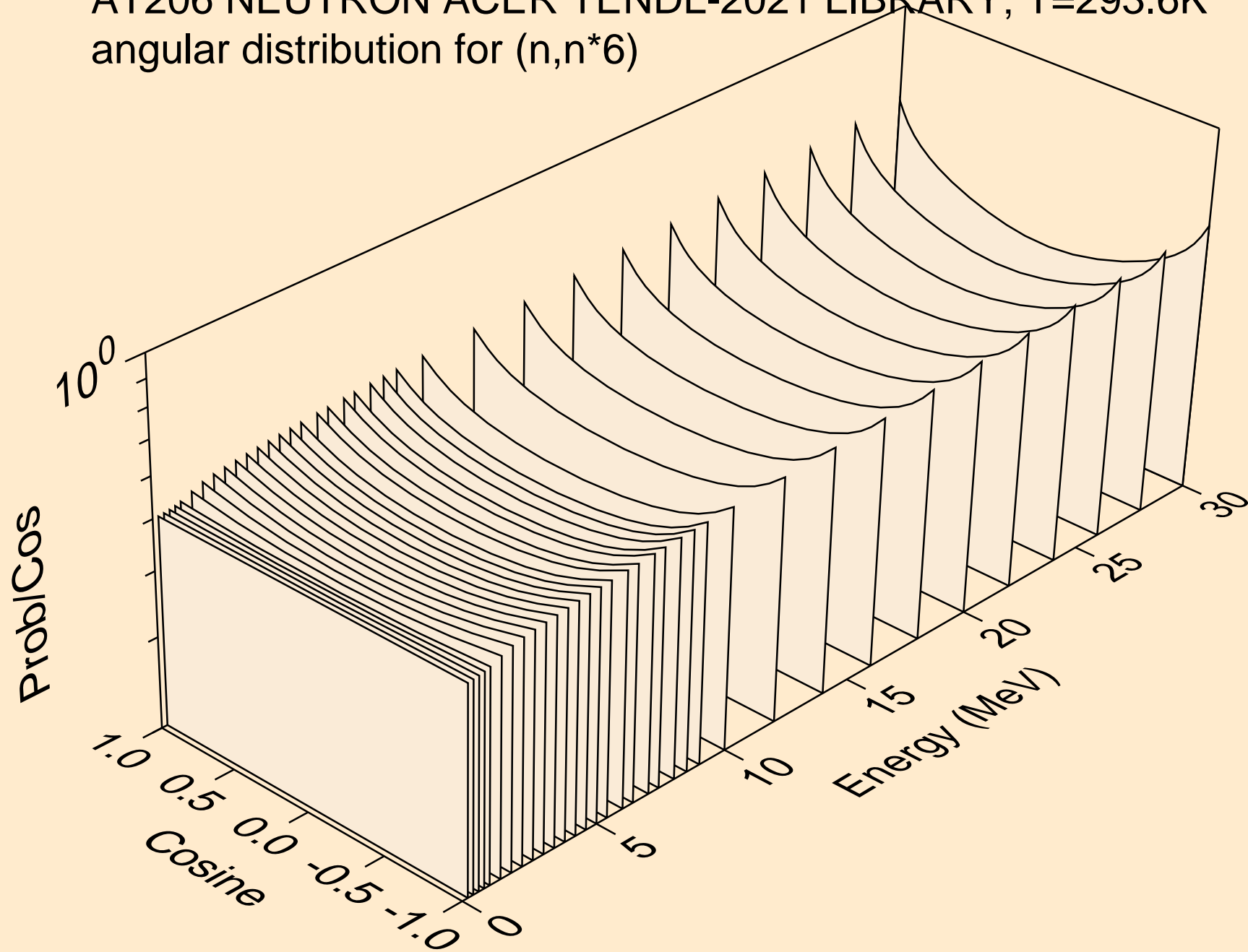

AT206 NEUTRON ACER TENDL-2021 LIBRARY; T=293.6K
angular distribution for (n,n*7)

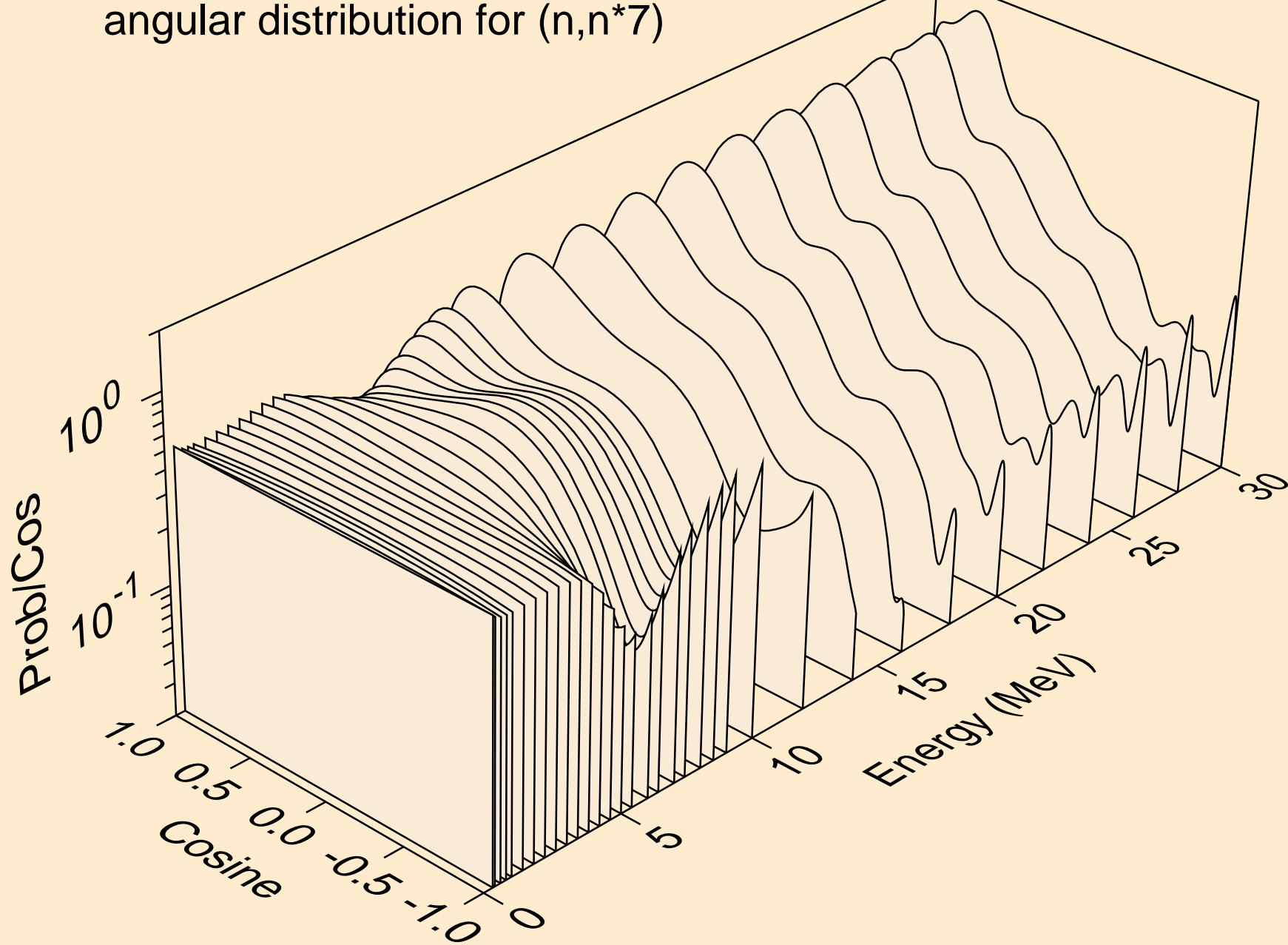

AT206 NEUTRON ACER TENDL-2021 LIBRARY; T=293.6K
angular distribution for (n,n*8)

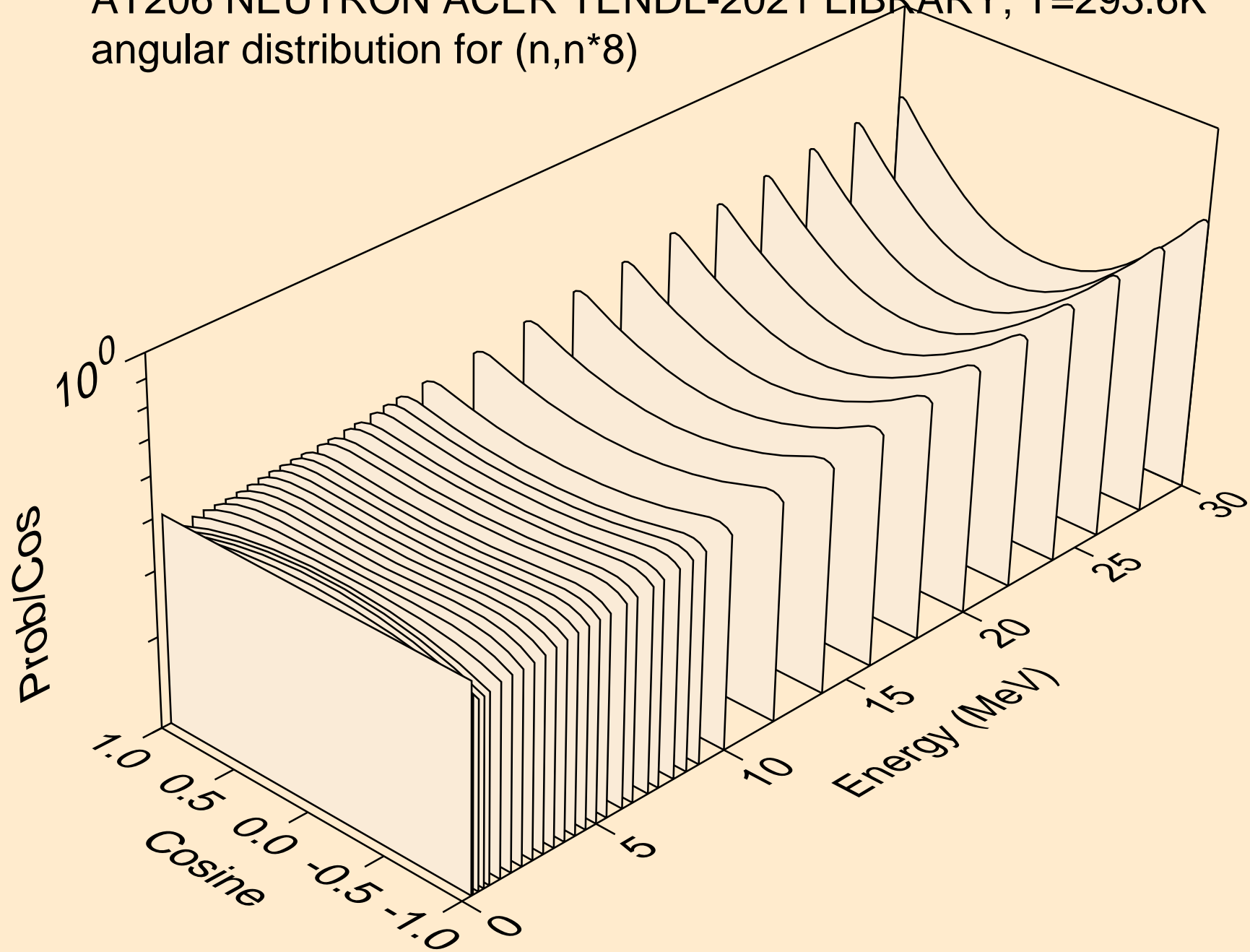

AT206 NEUTRON ACER TENDL-2021 LIBRARY; T=293.6K
angular distribution for (n,n*9)

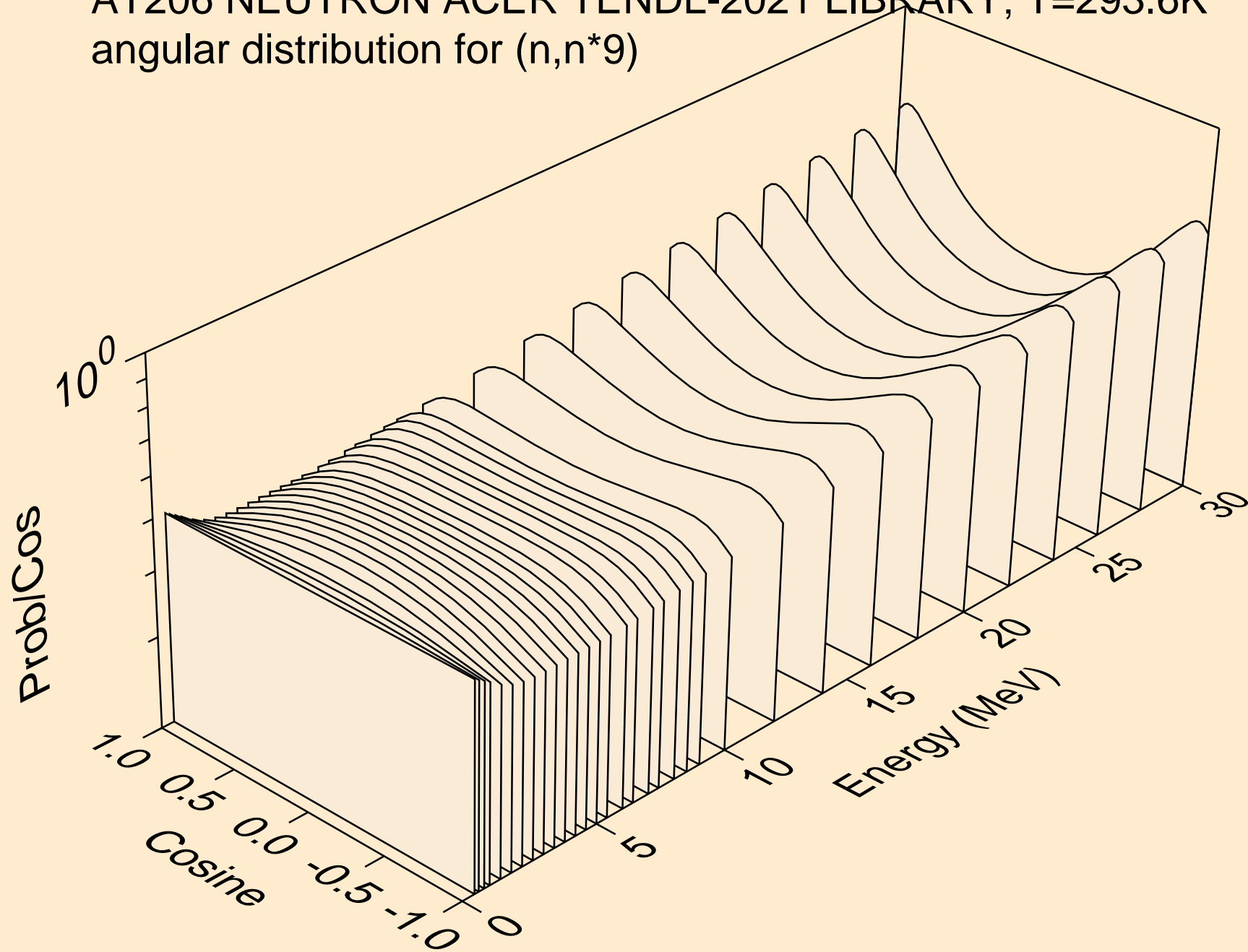

AT206 NEUTRON ACER TENDL-2021 LIBRARY; T=293.6K
angular distribution for (n,n*10)

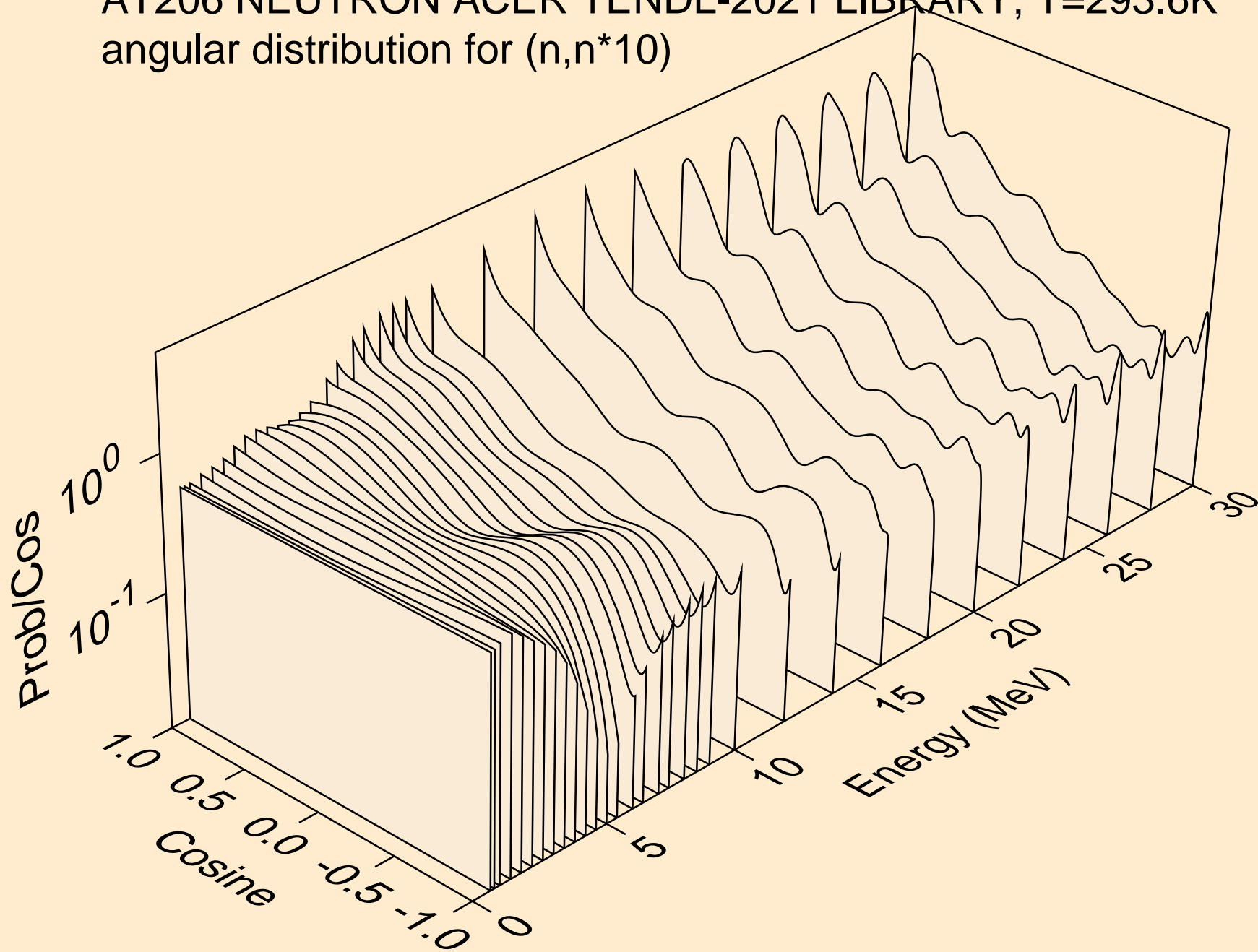

AT206 NEUTRON ACER TENDL-2021 LIBRARY; T=293.6K
angular distribution for (n,n*11)

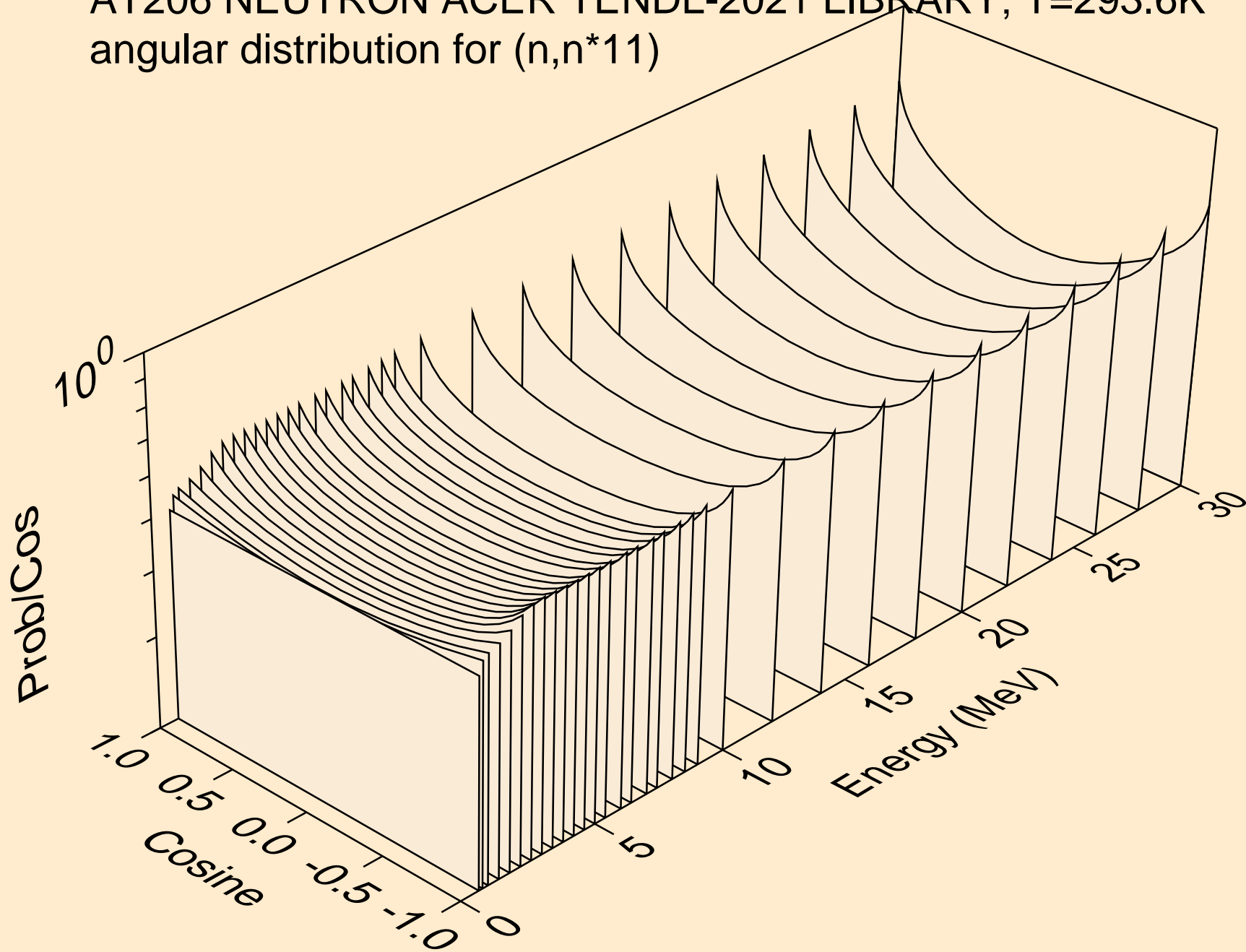

AT206 NEUTRON ACER TENDL-2021 LIBRARY; T=293.6K
angular distribution for (n,n*12)

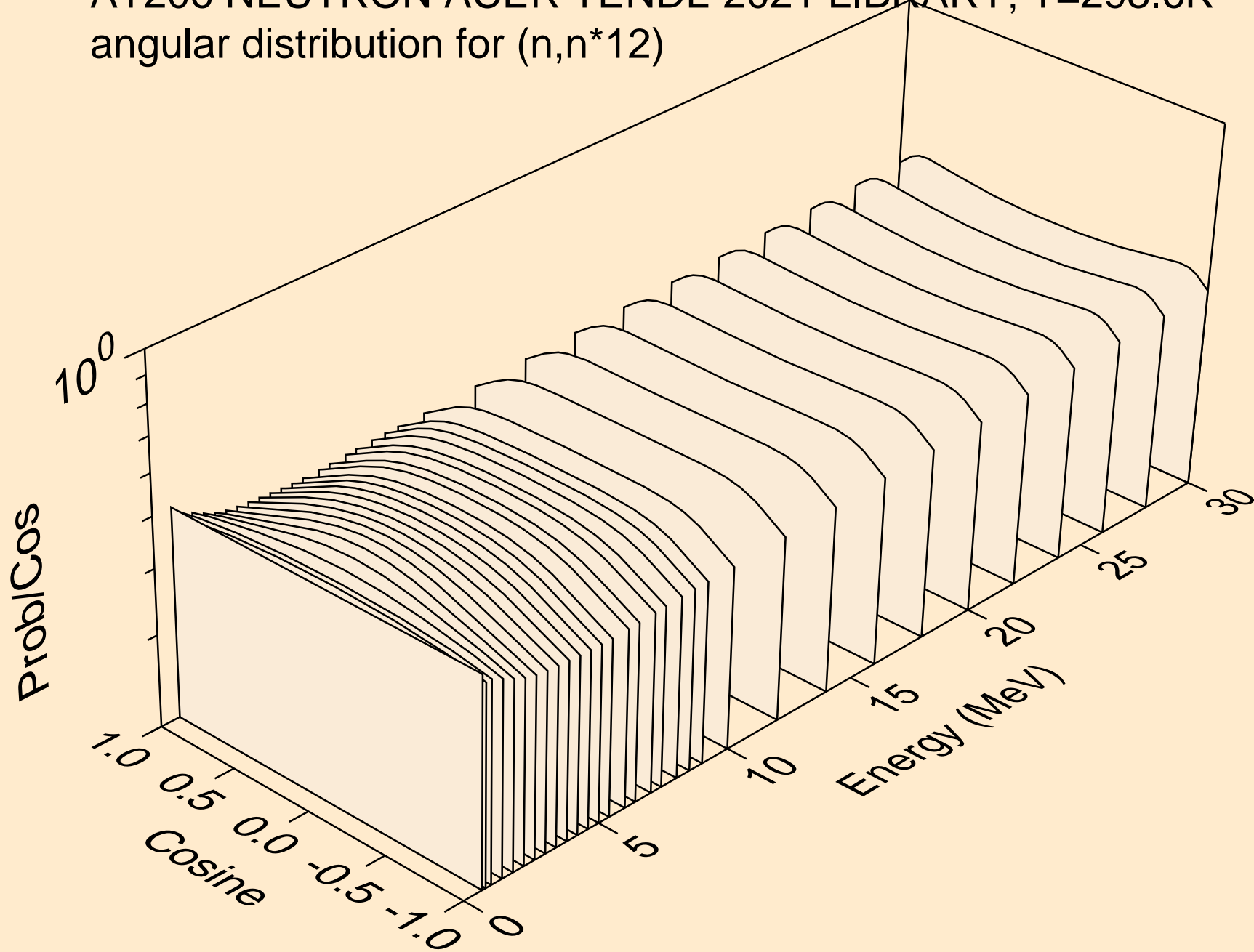

AT206 NEUTRON ACER TENDL-2021 LIBRARY; T=293.6K
angular distribution for (n,n*13)

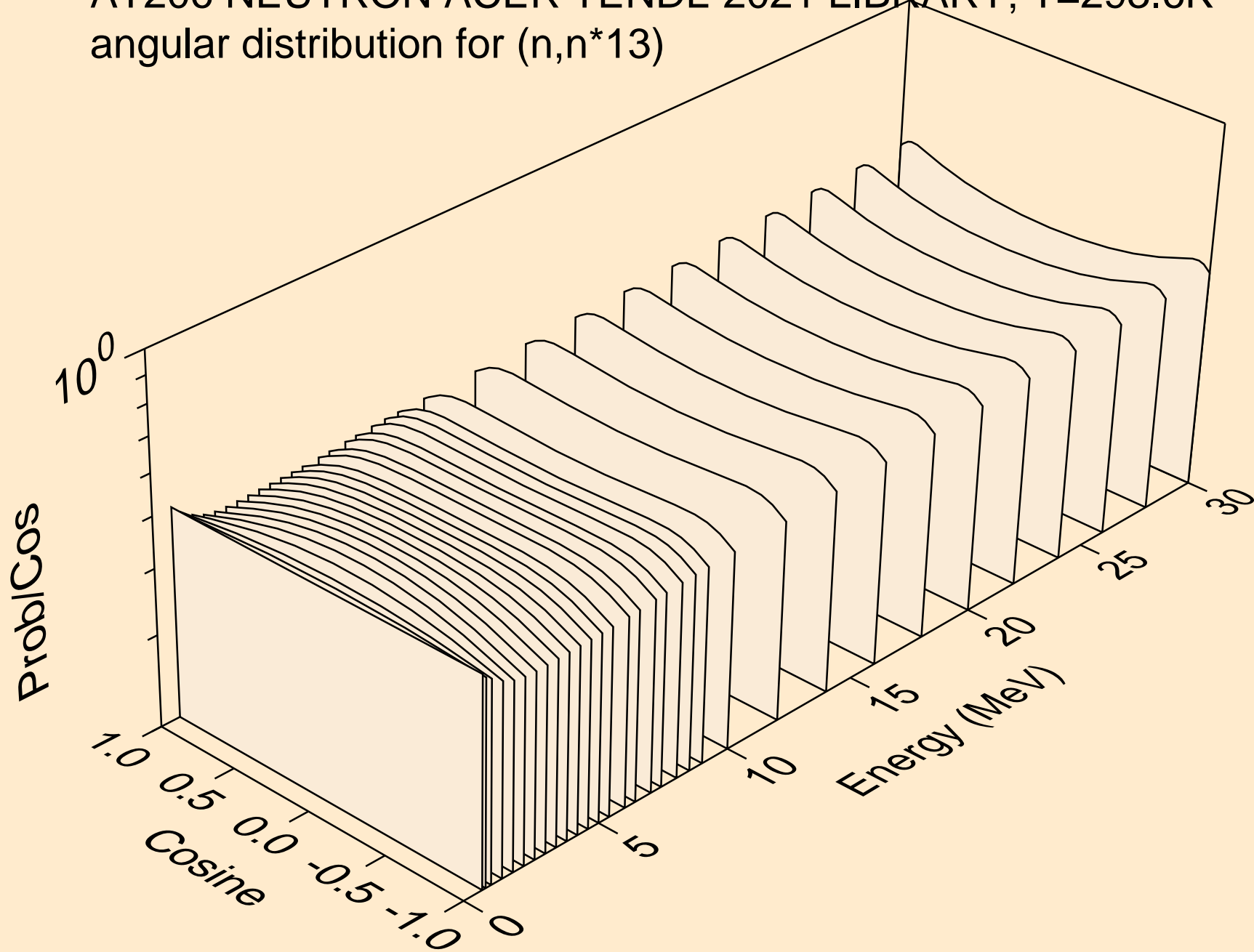

AT206 NEUTRON ACER TENDL-2021 LIBRARY; T=293.6K
angular distribution for (n,n*14)

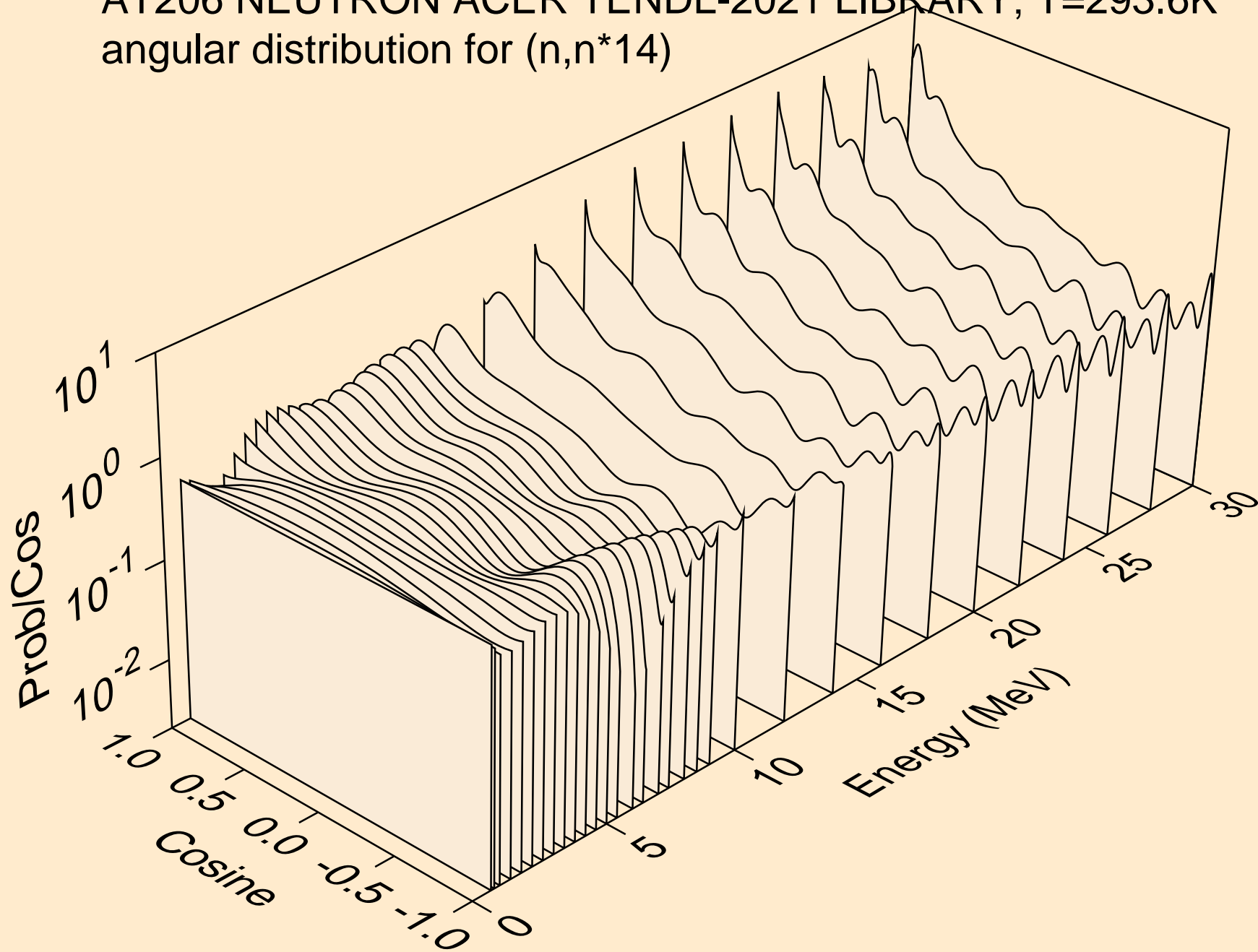

AT206 NEUTRON ACER TENDL-2021 LIBRARY; T=293.6K
angular distribution for (n,n*15)

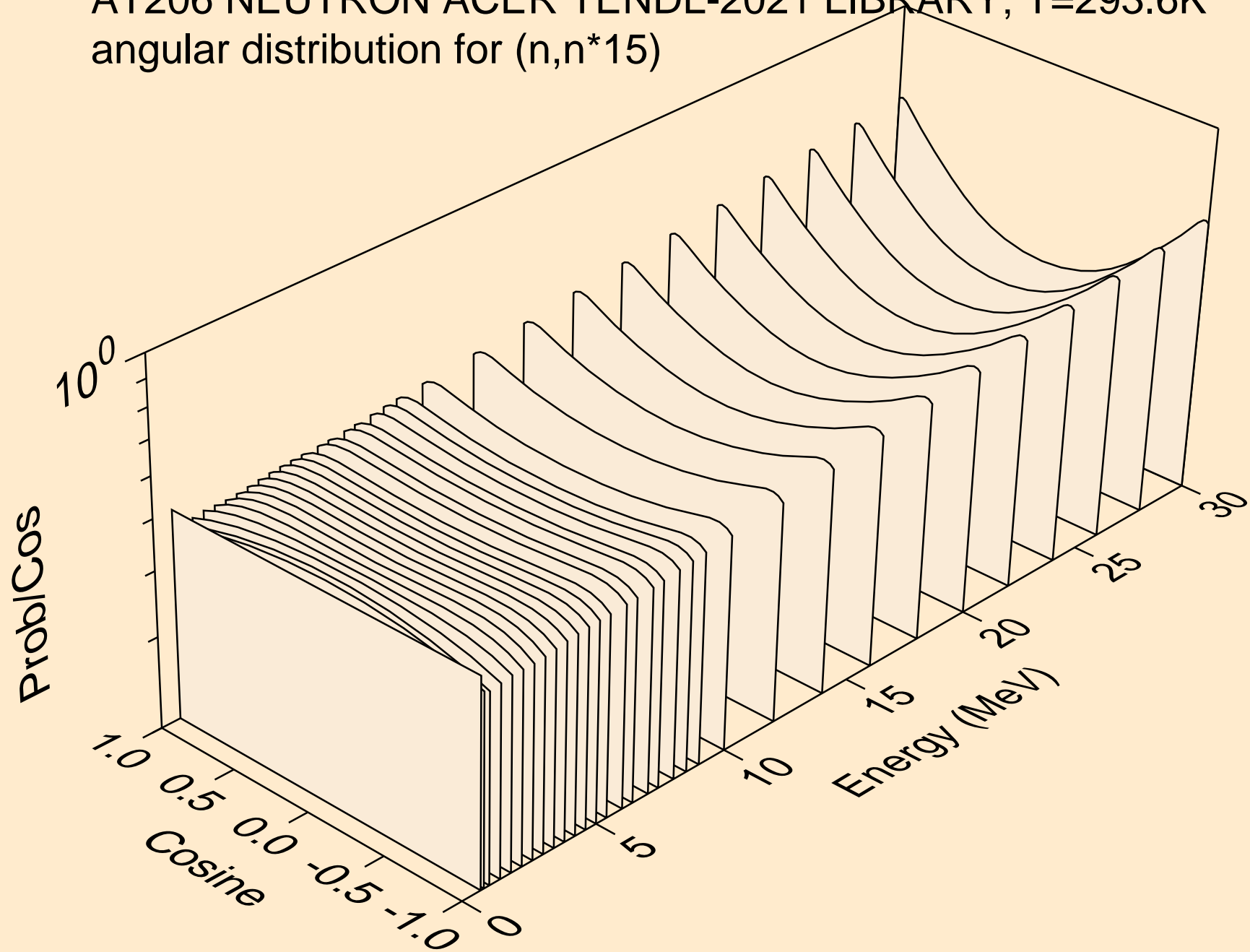

AT206 NEUTRON ACER TENDL-2021 LIBRARY; T=293.6K
angular distribution for (n,n*16)

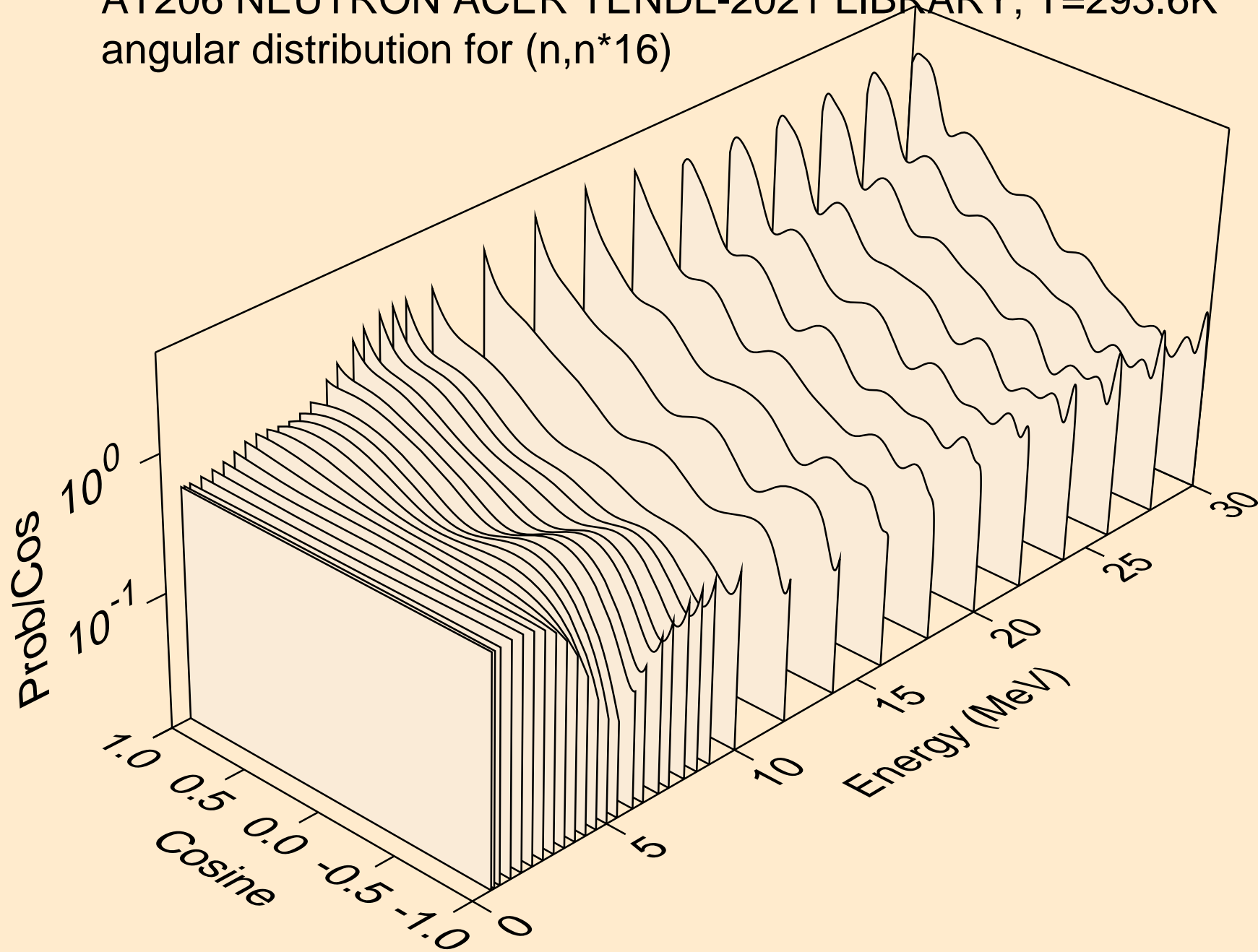

AT206 NEUTRON ACER TENDL-2021 LIBRARY; T=293.6K
angular distribution for (n,n*17)

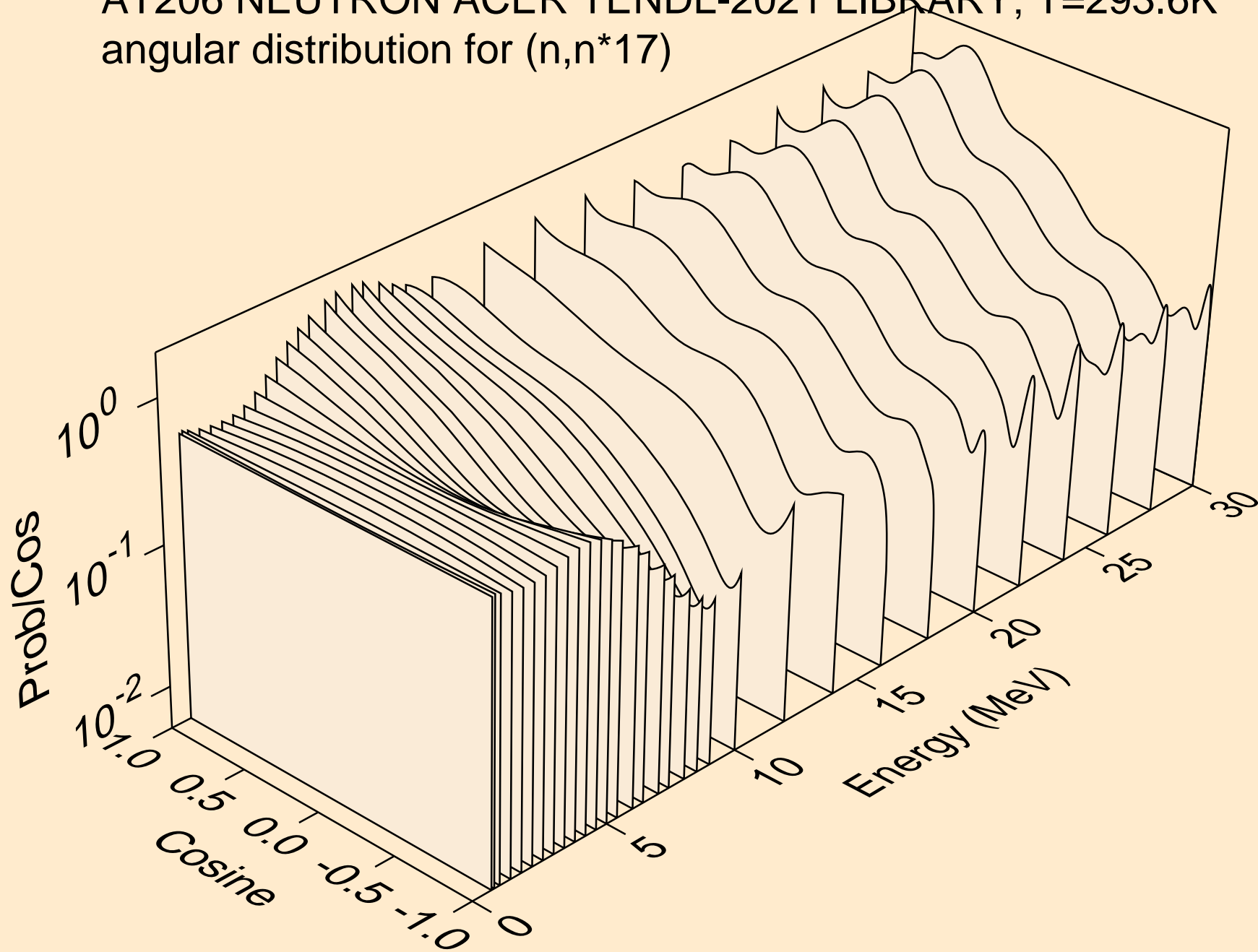

AT206 NEUTRON ACER TENDL-2021 LIBRARY; T=293.6K
angular distribution for (n,n*18)

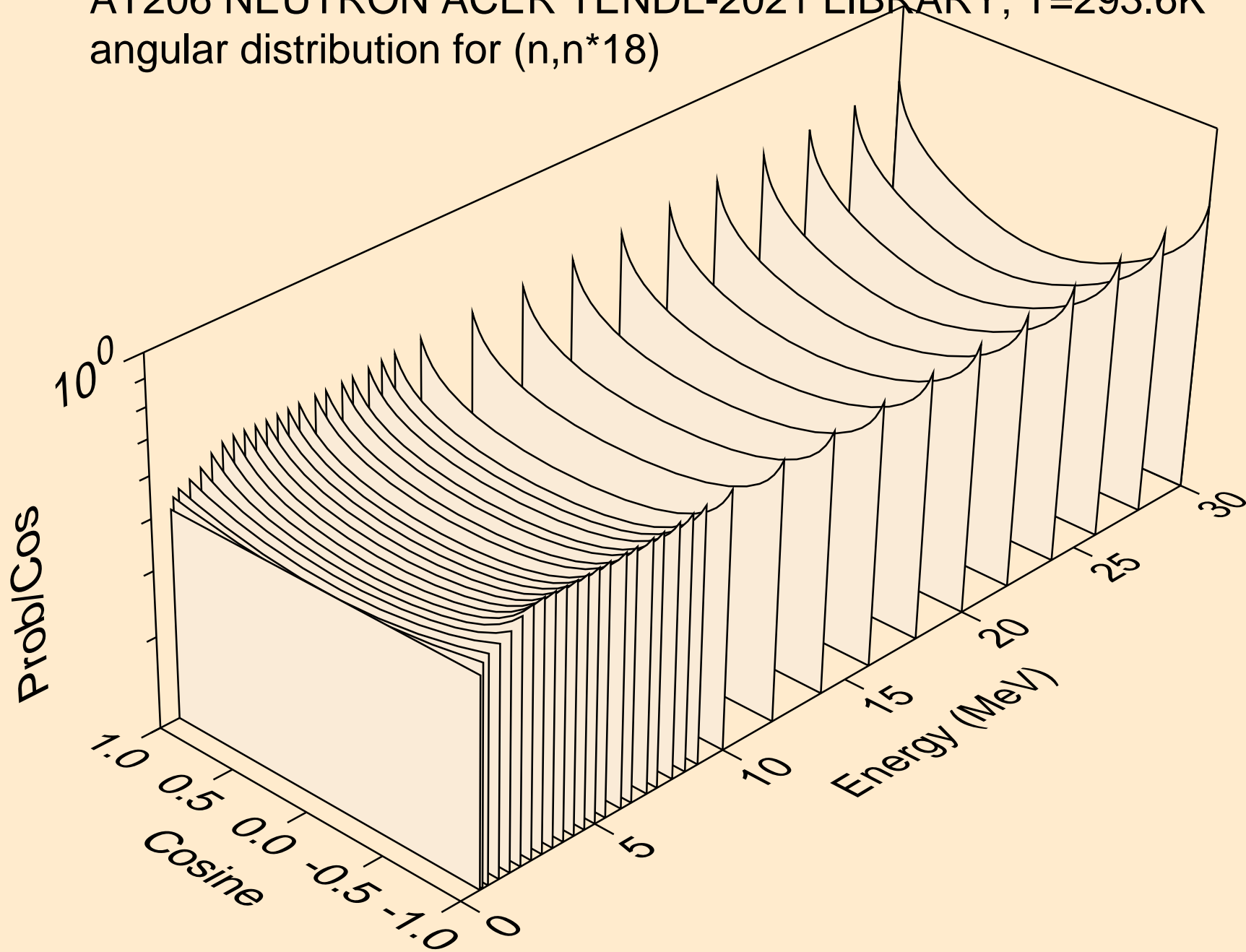

AT206 NEUTRON ACER TENDL-2021 LIBRARY; T=293.6K
angular distribution for (n,n*19)

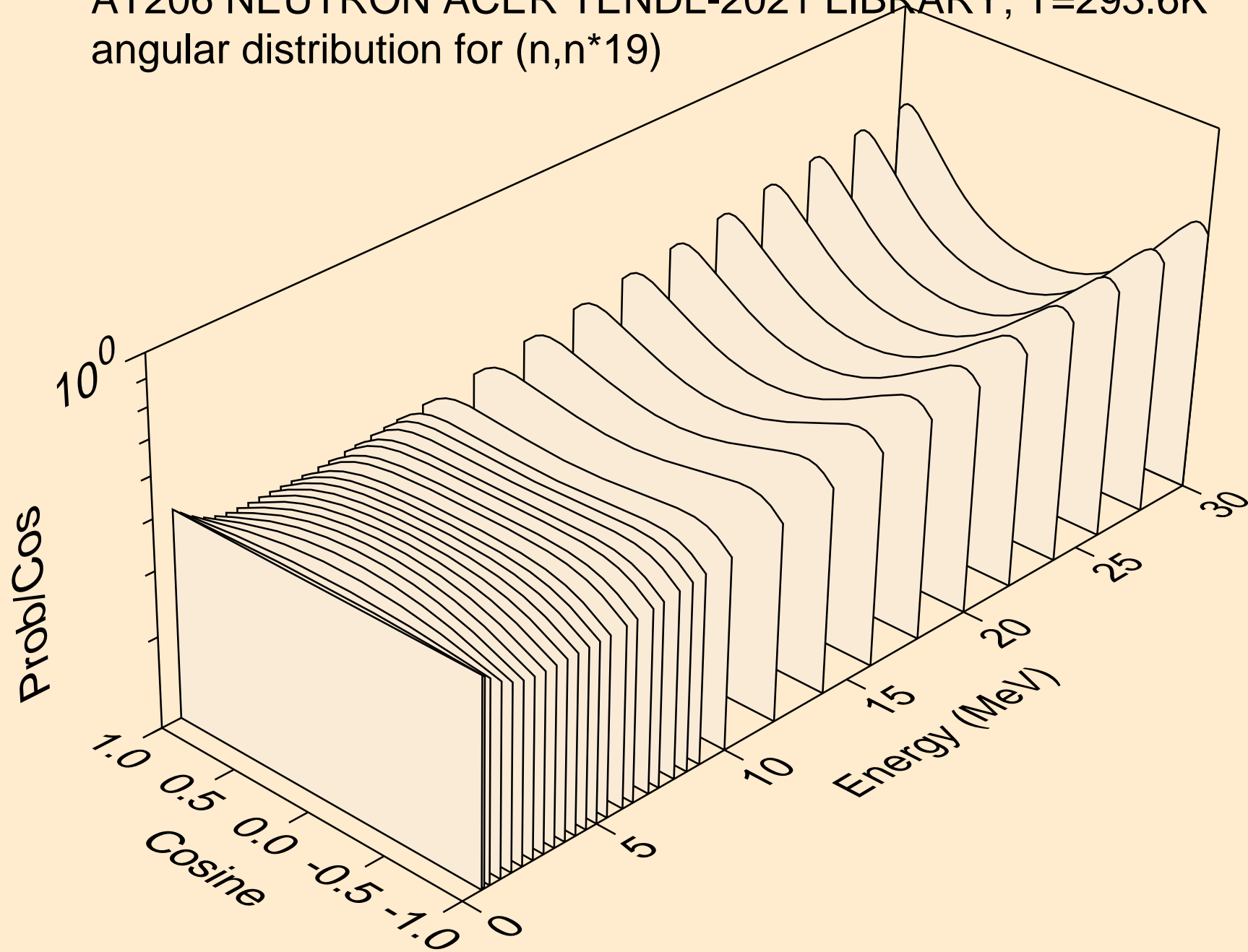

AT206 NEUTRON ACER TENDL-2021 LIBRARY; T=293.6K
angular distribution for (n,n*20)

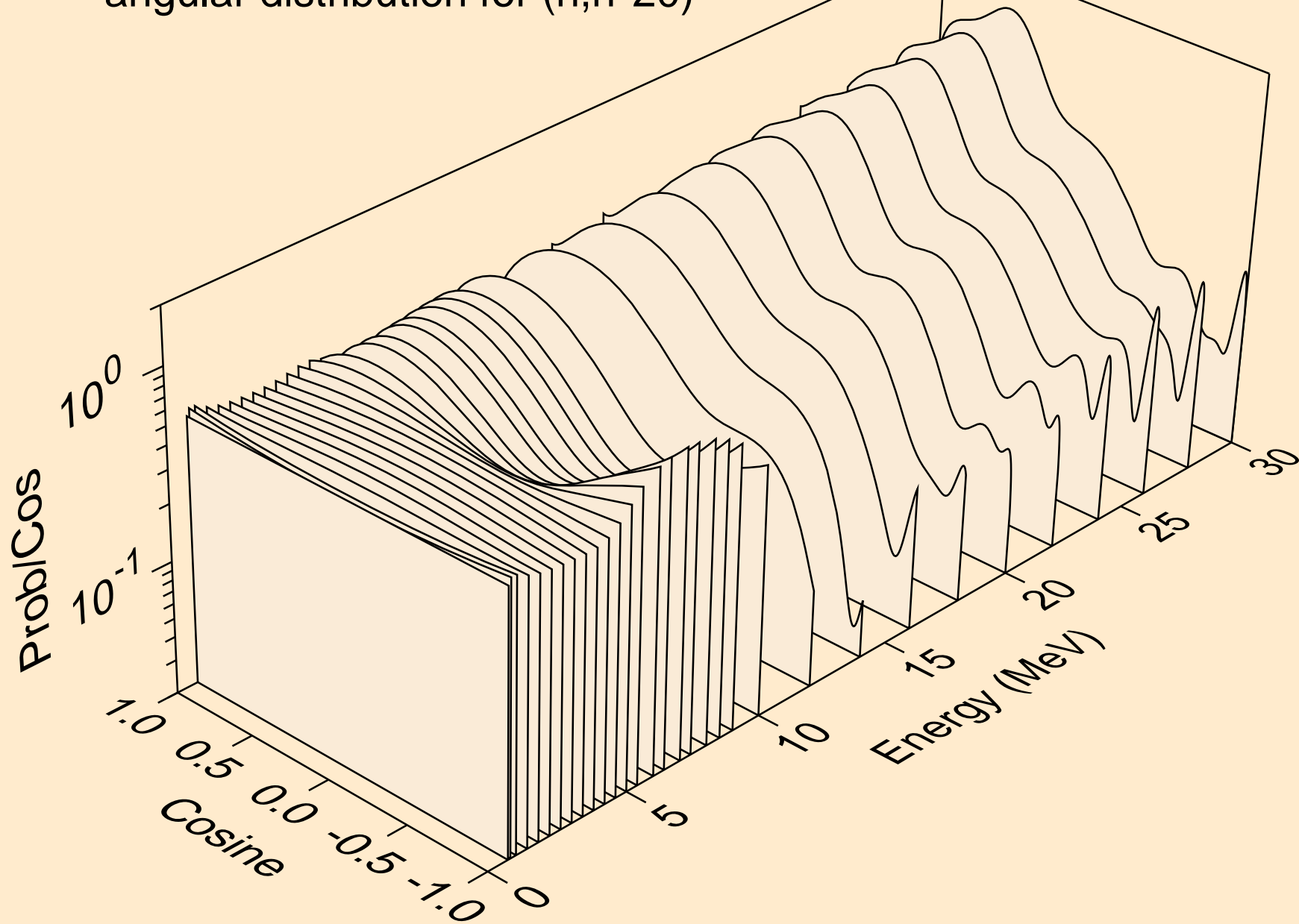

AT206 NEUTRON ACER TENDL-2021 LIBRARY; T=293.6K
angular distribution for (n,n*21)

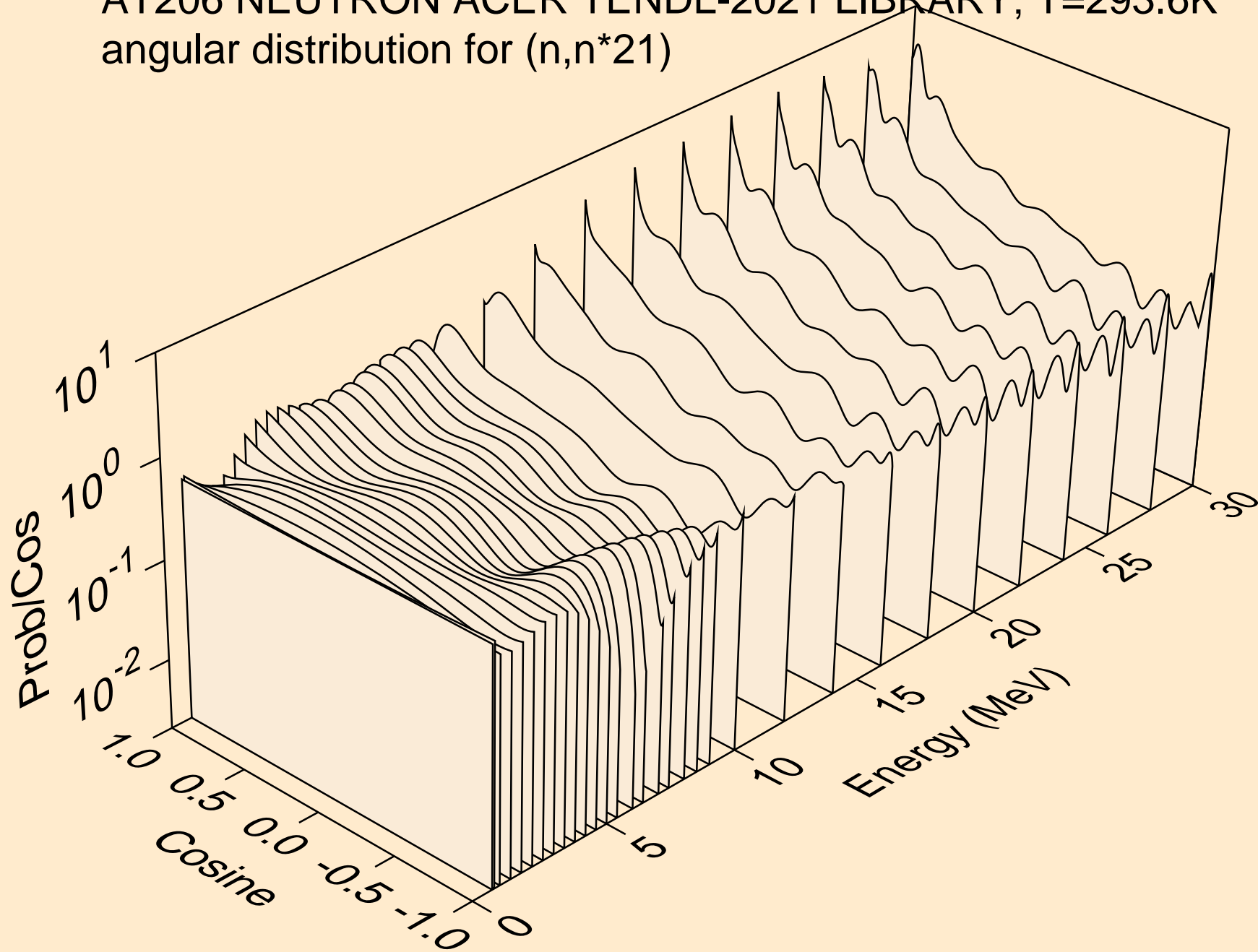

AT206 NEUTRON ACER TENDL-2021 LIBRARY; T=293.6K
angular distribution for (n,n*22)

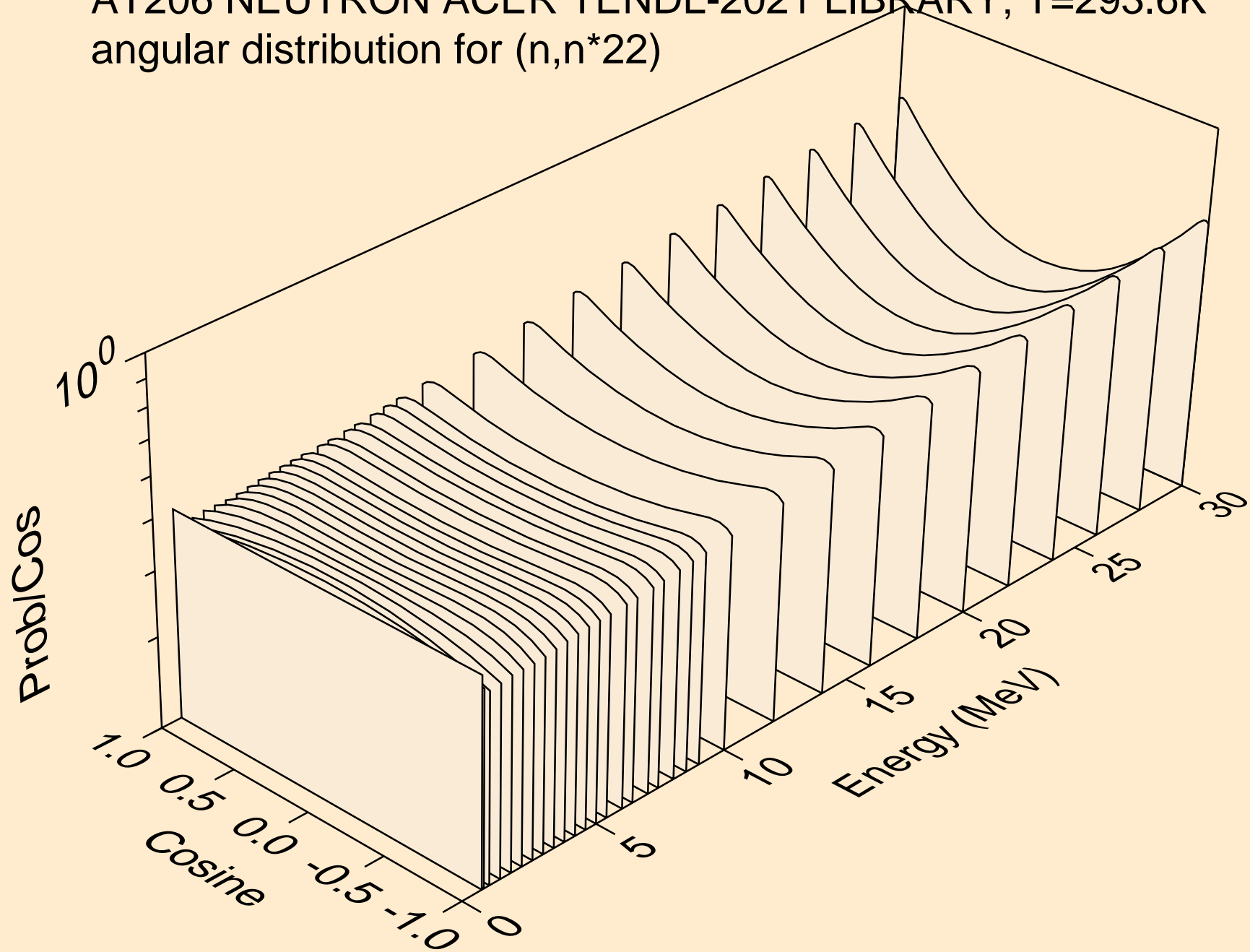

AT206 NEUTRON ACER TENDL-2021 LIBRARY; T=293.6K
angular distribution for (n,n*23)

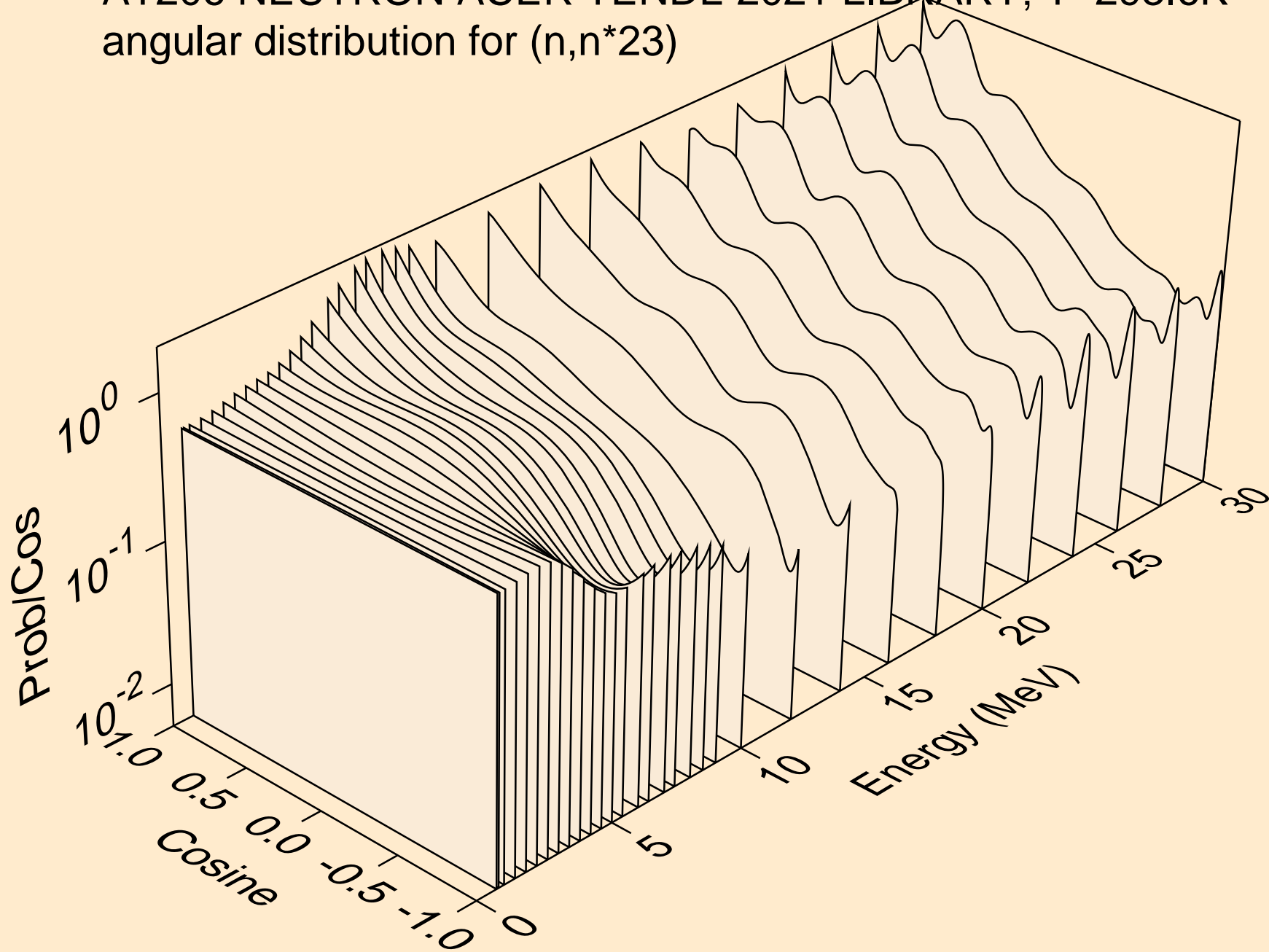

AT206 NEUTRON ACER TENDL-2021 LIBRARY; T=293.6K
angular distribution for (n,n*24)

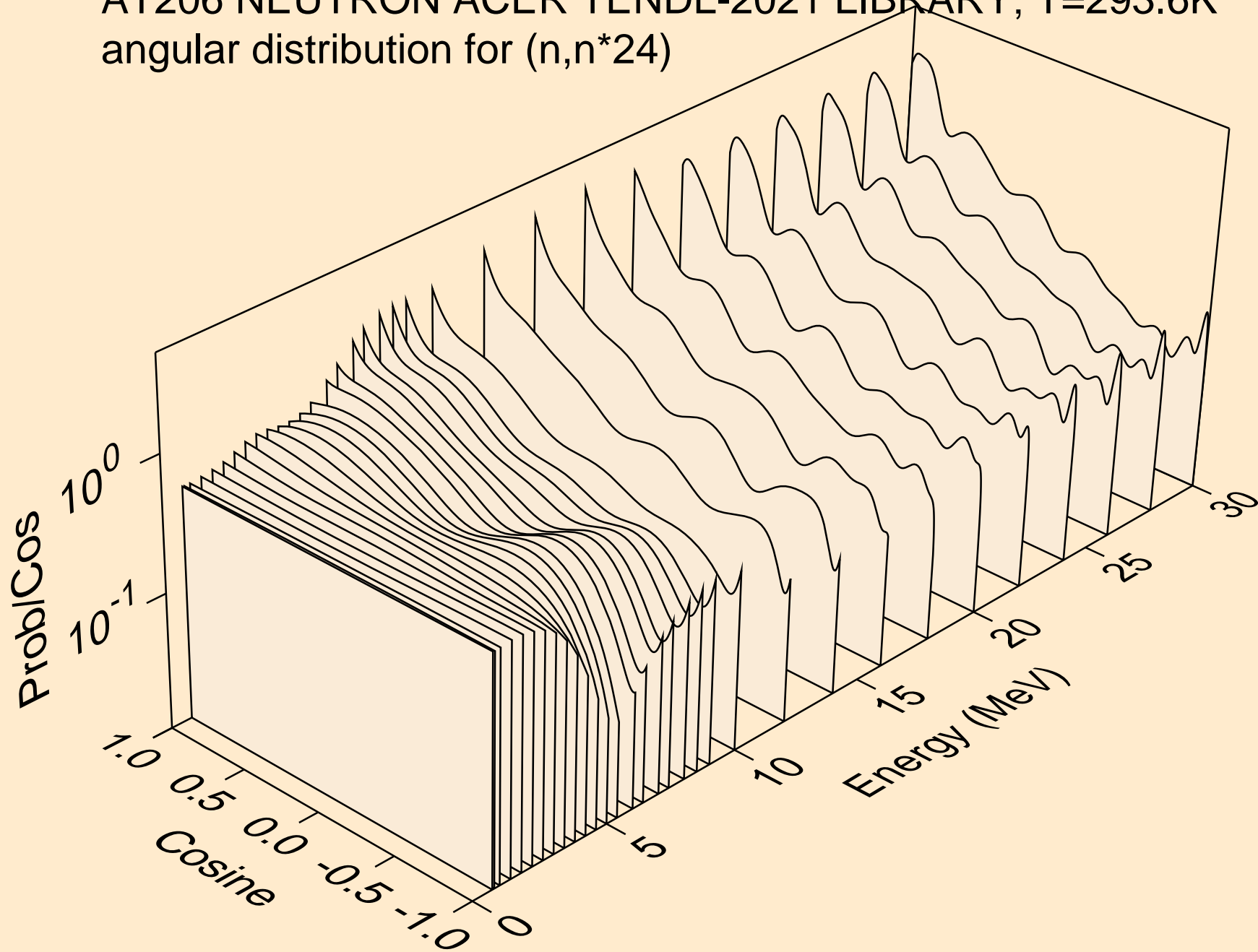

AT206 NEUTRON ACER TENDL-2021 LIBRARY; T=293.6K
angular distribution for (n,n*25)

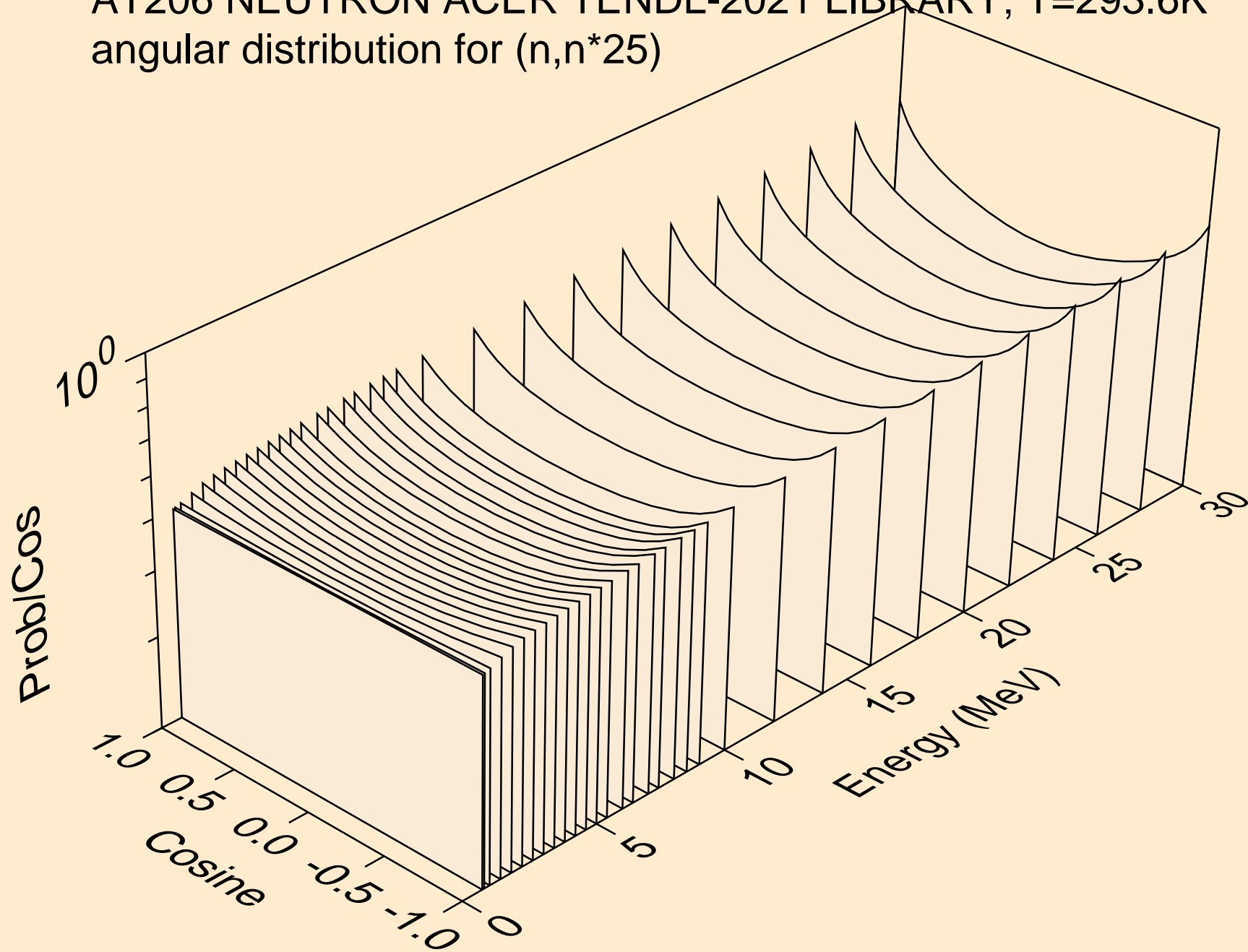

AT206 NEUTRON ACER TENDL-2021 LIBRARY; T=293.6K
angular distribution for (n,n*26)

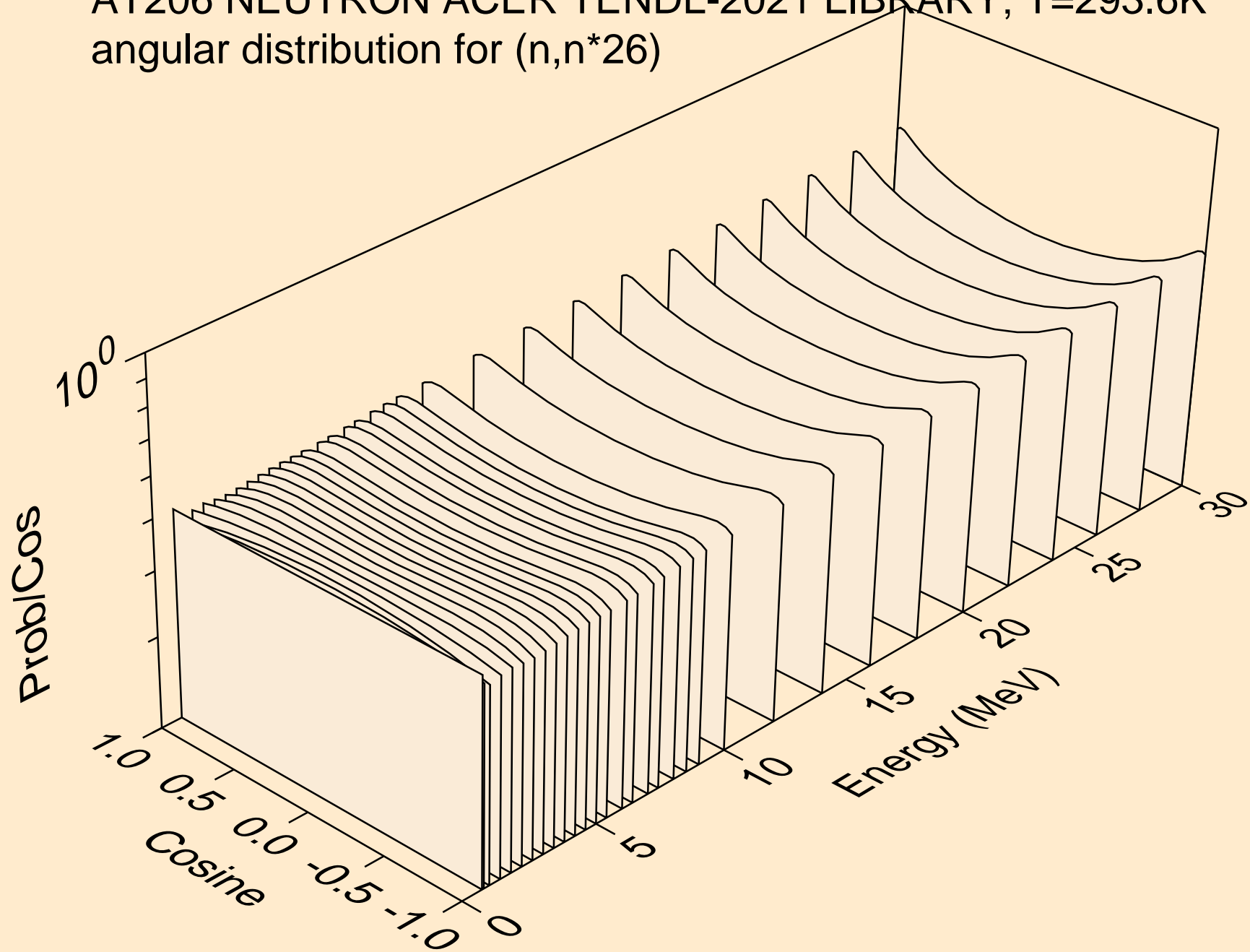

AT206 NEUTRON ACER TENDL-2021 LIBRARY; T=293.6K
angular distribution for (n,n*27)

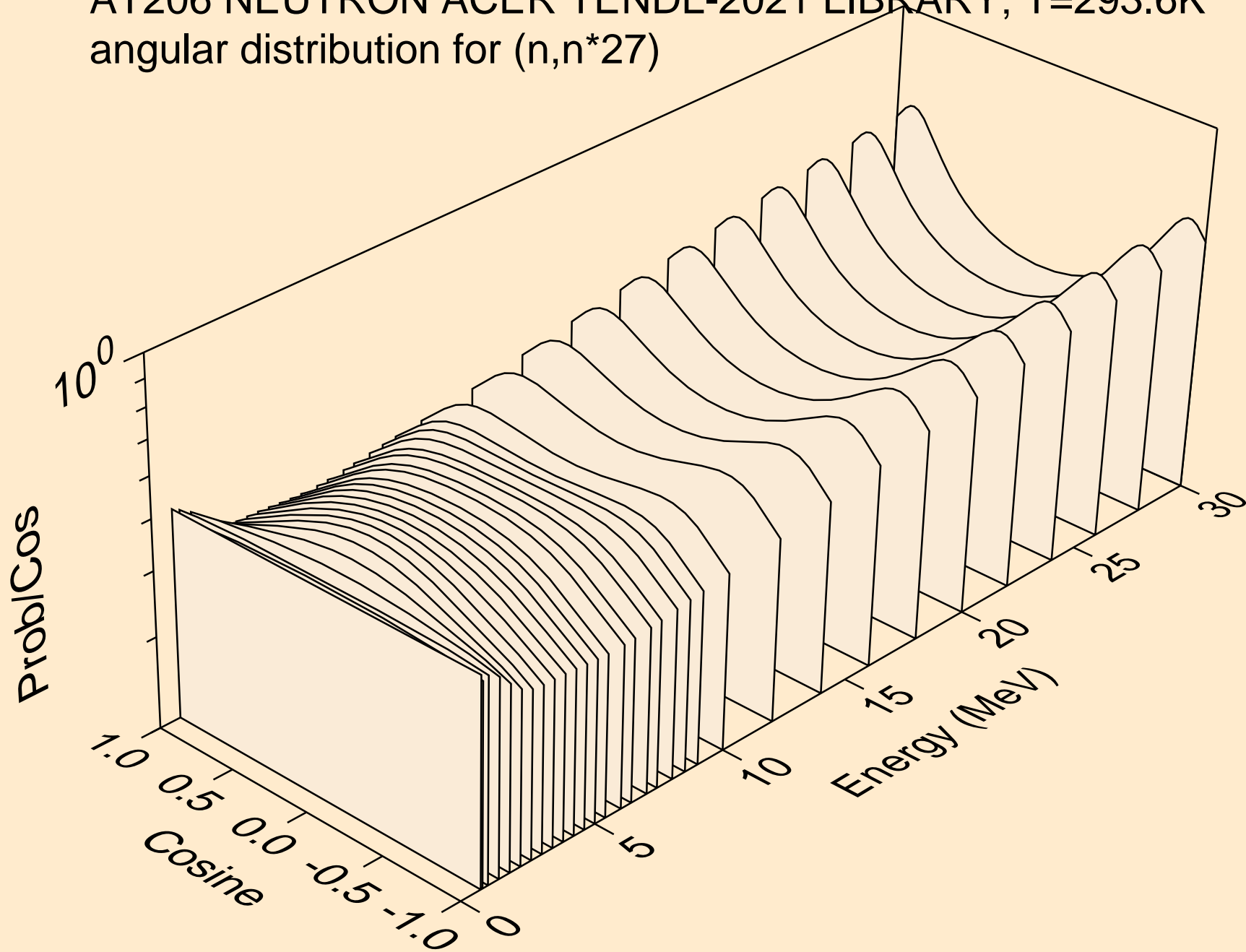

AT206 NEUTRON ACER TENDL-2021 LIBRARY; T=293.6K
angular distribution for (n,n*28)

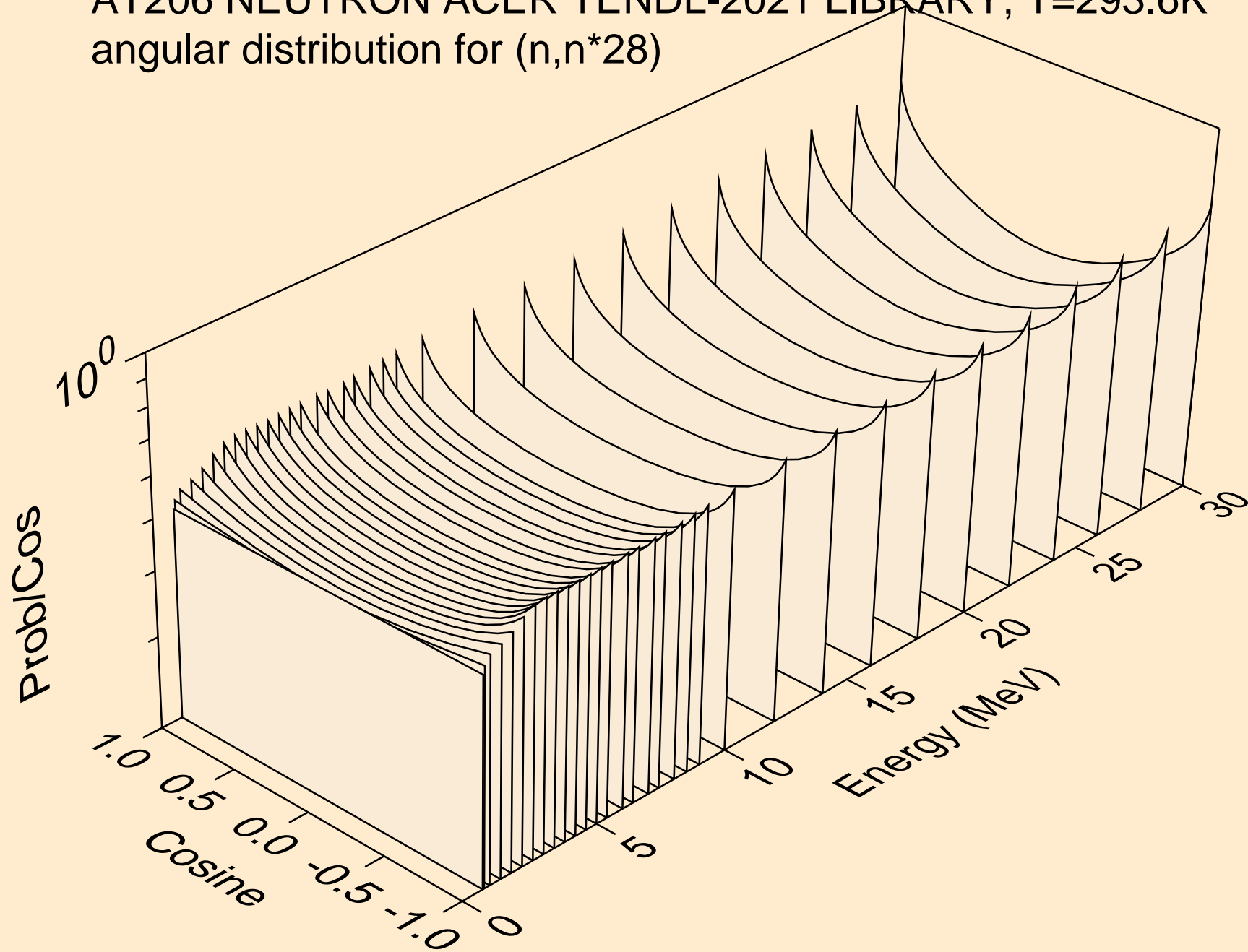

AT206 NEUTRON ACER TENDL-2021 LIBRARY; T=293.6K
angular distribution for (n,n*29)

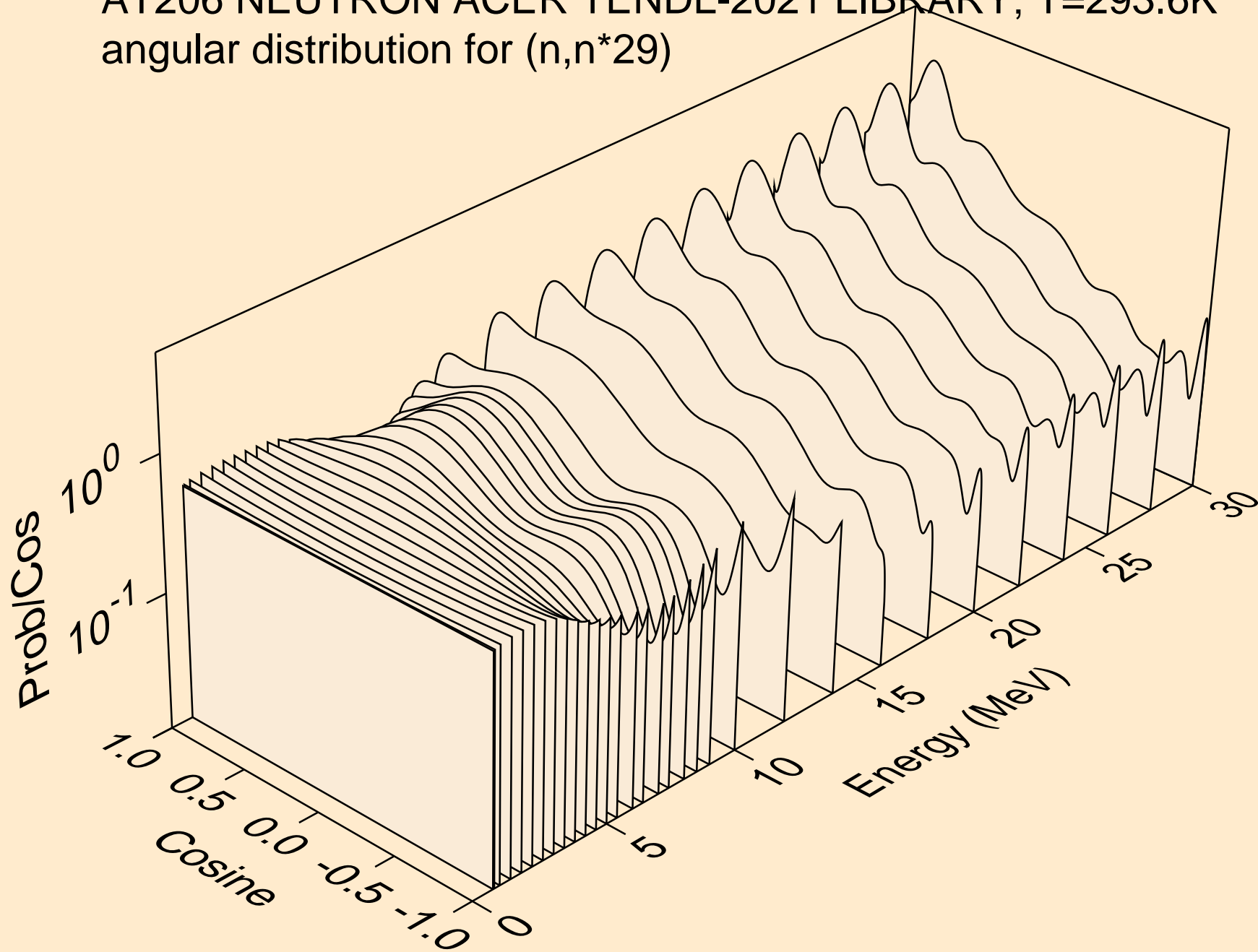

AT206 NEUTRON ACER TENDL-2021 LIBRARY; T=293.6K
Neutron emission for (n,x)

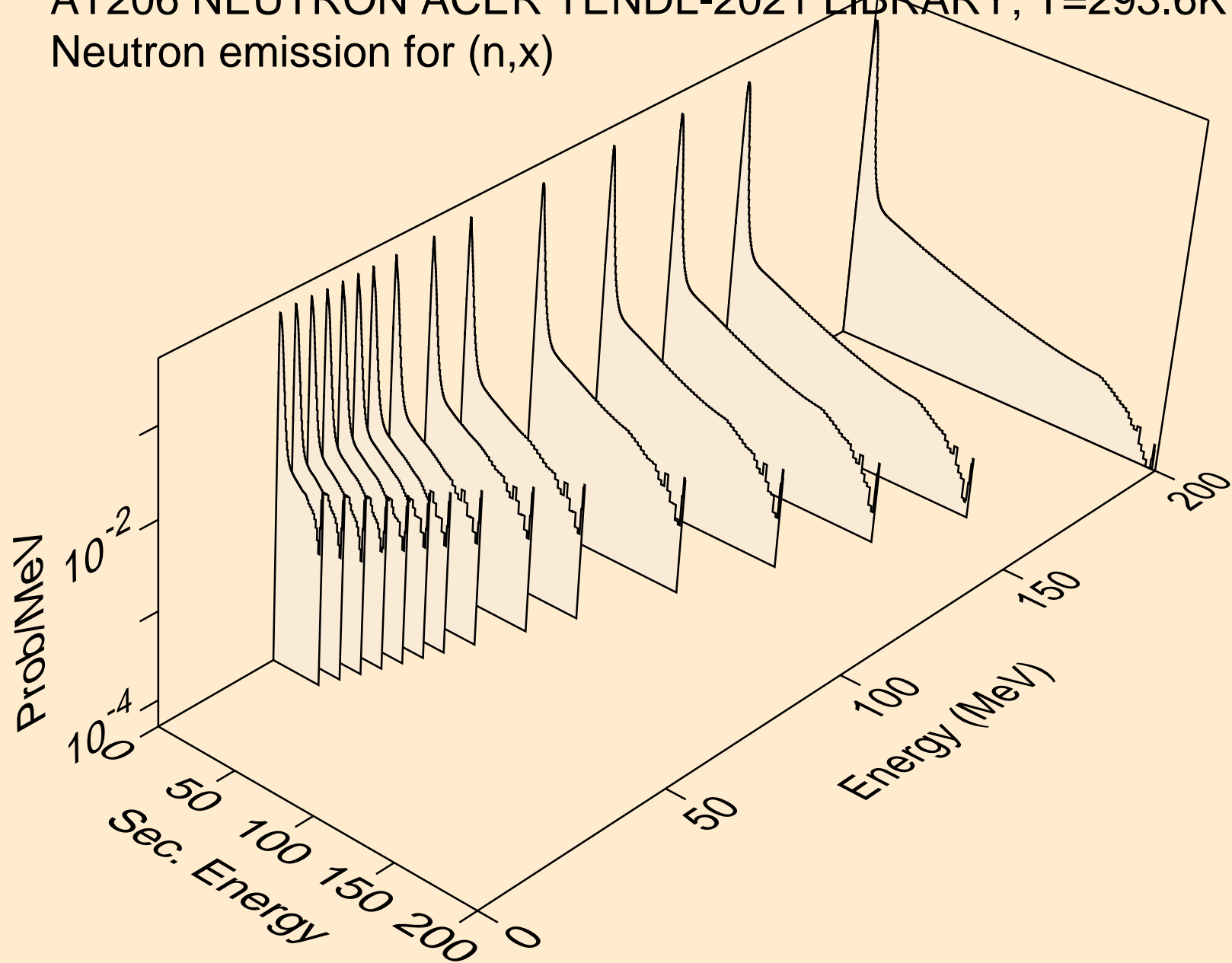

AT206 NEUTRON ACER TENDL-2021 LIBRARY; T=293.6K
Neutron emission for (n,2nd)

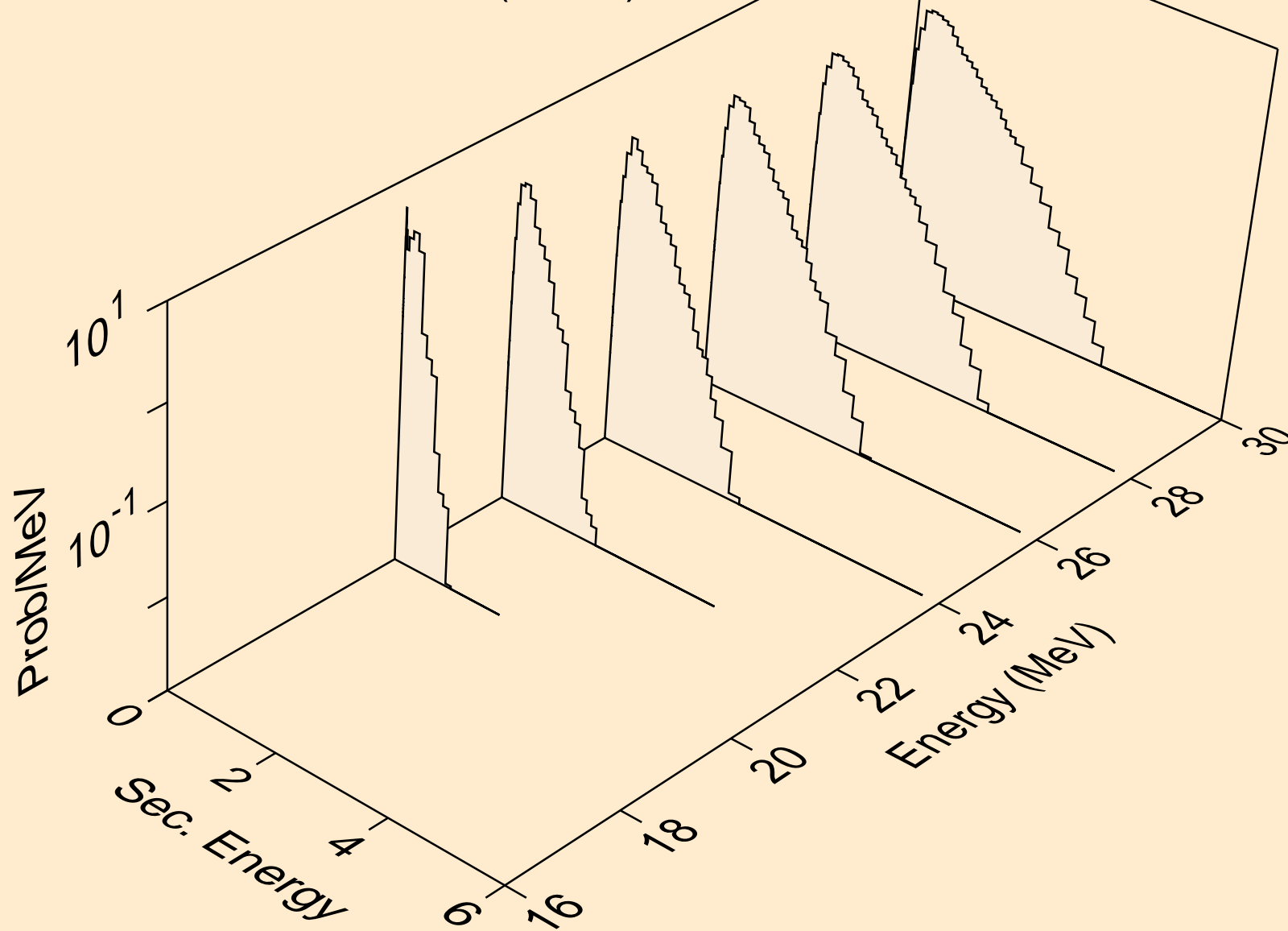

AT206 NEUTRON ACER TENDL-2021 LIBRARY; T=293.6K
Neutron emission for (n,2n)

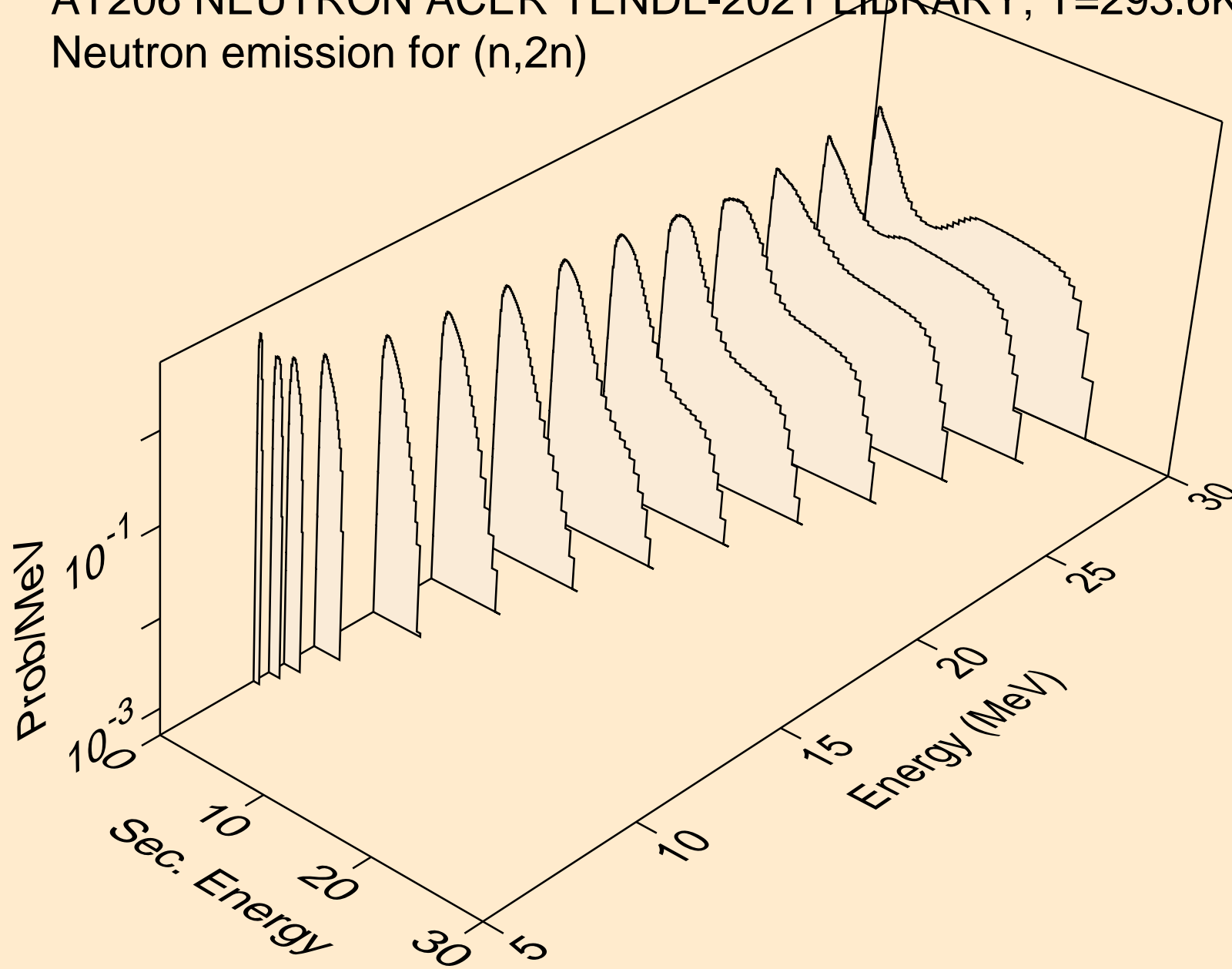

AT206 NEUTRON ACER TENDL-2021 LIBRARY; T=293.6K
Neutron emission for (n,3n)

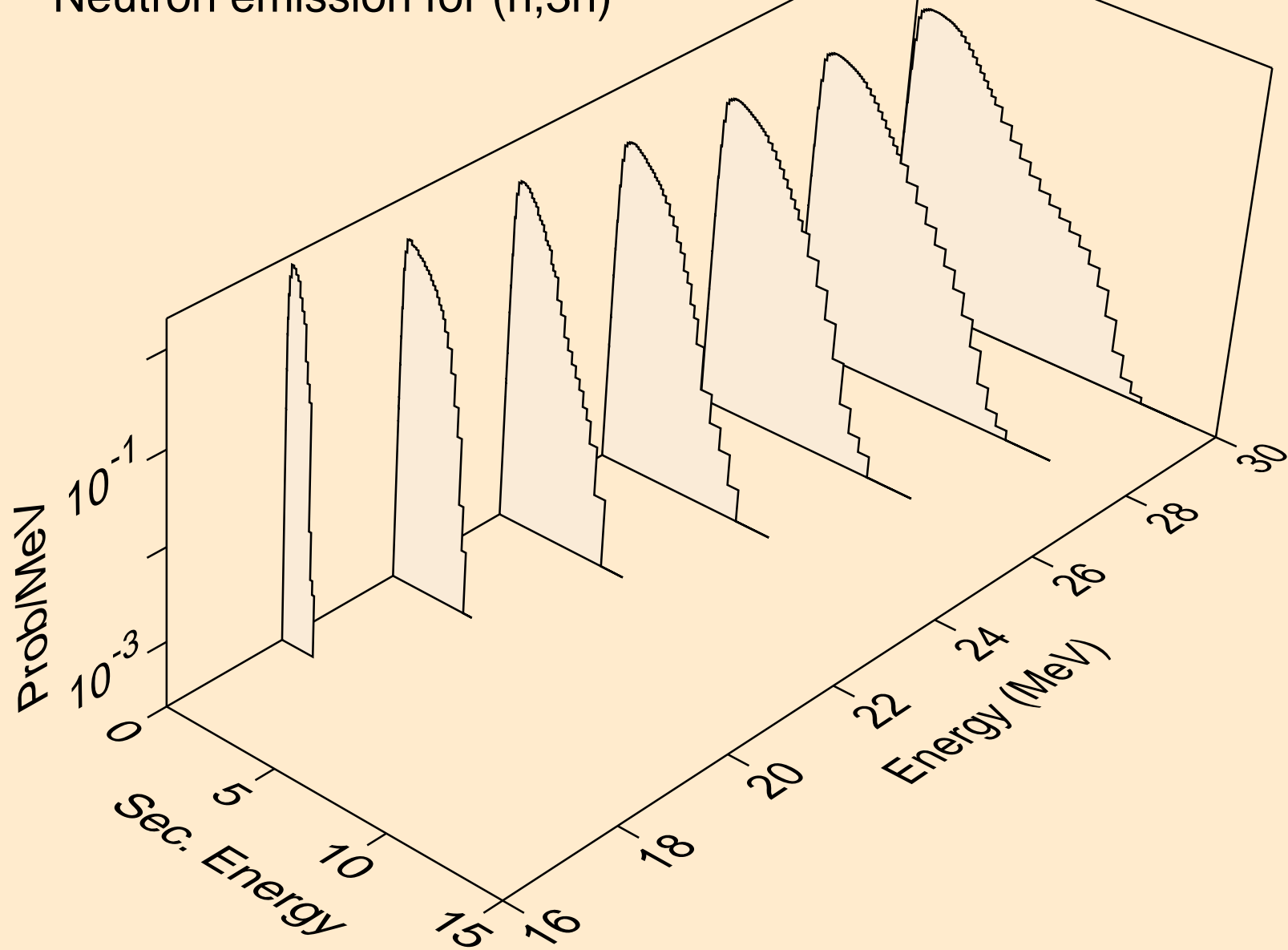

AT206 NEUTRON ACER TENDL-2021 LIBRARY; T=293.6K
Neutron emission for (n,n*)a

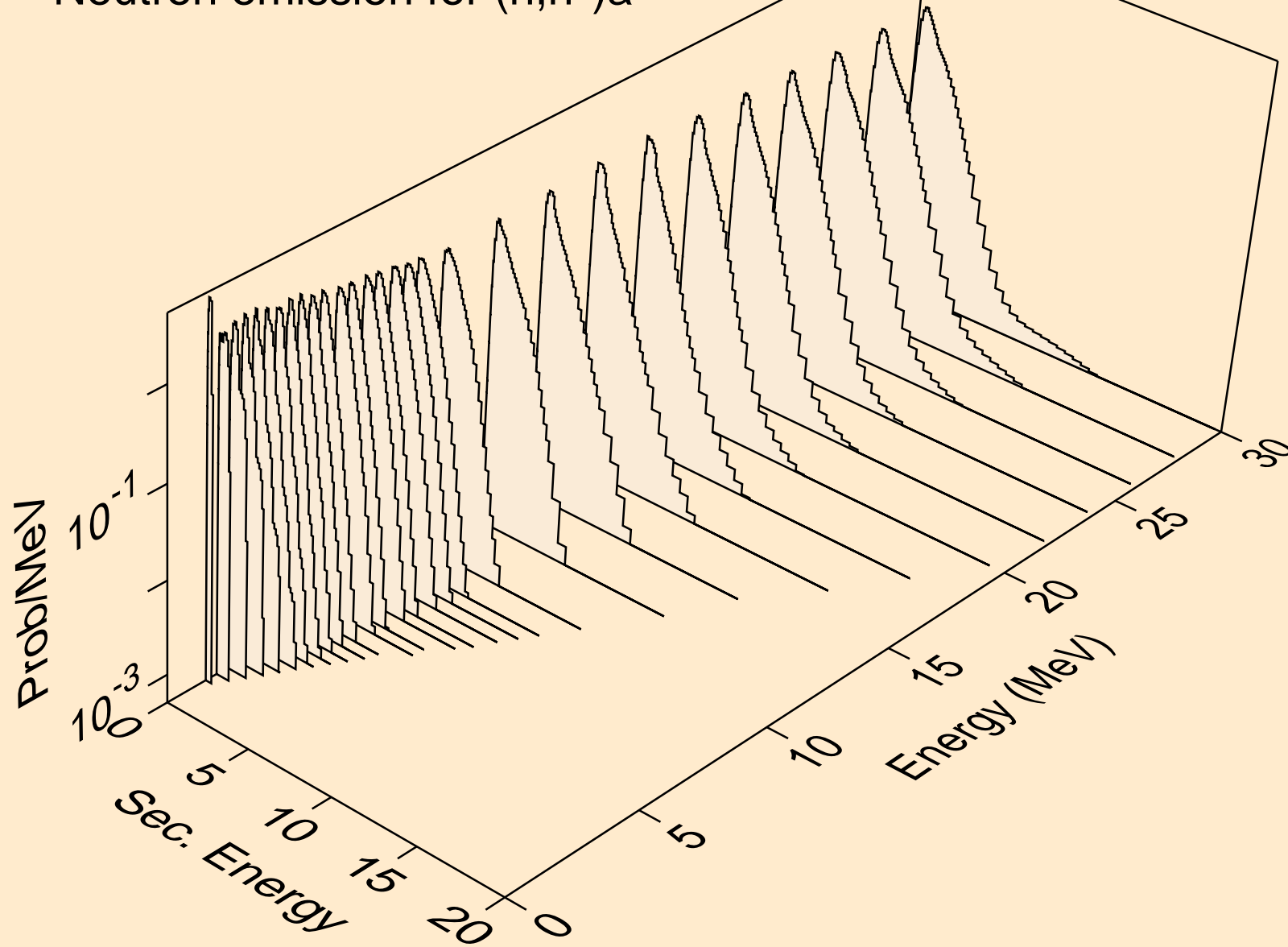

AT206 NEUTRON ACER TENDL-2021 LIBRARY; T=293.6K
Neutron emission for (n,2n)a

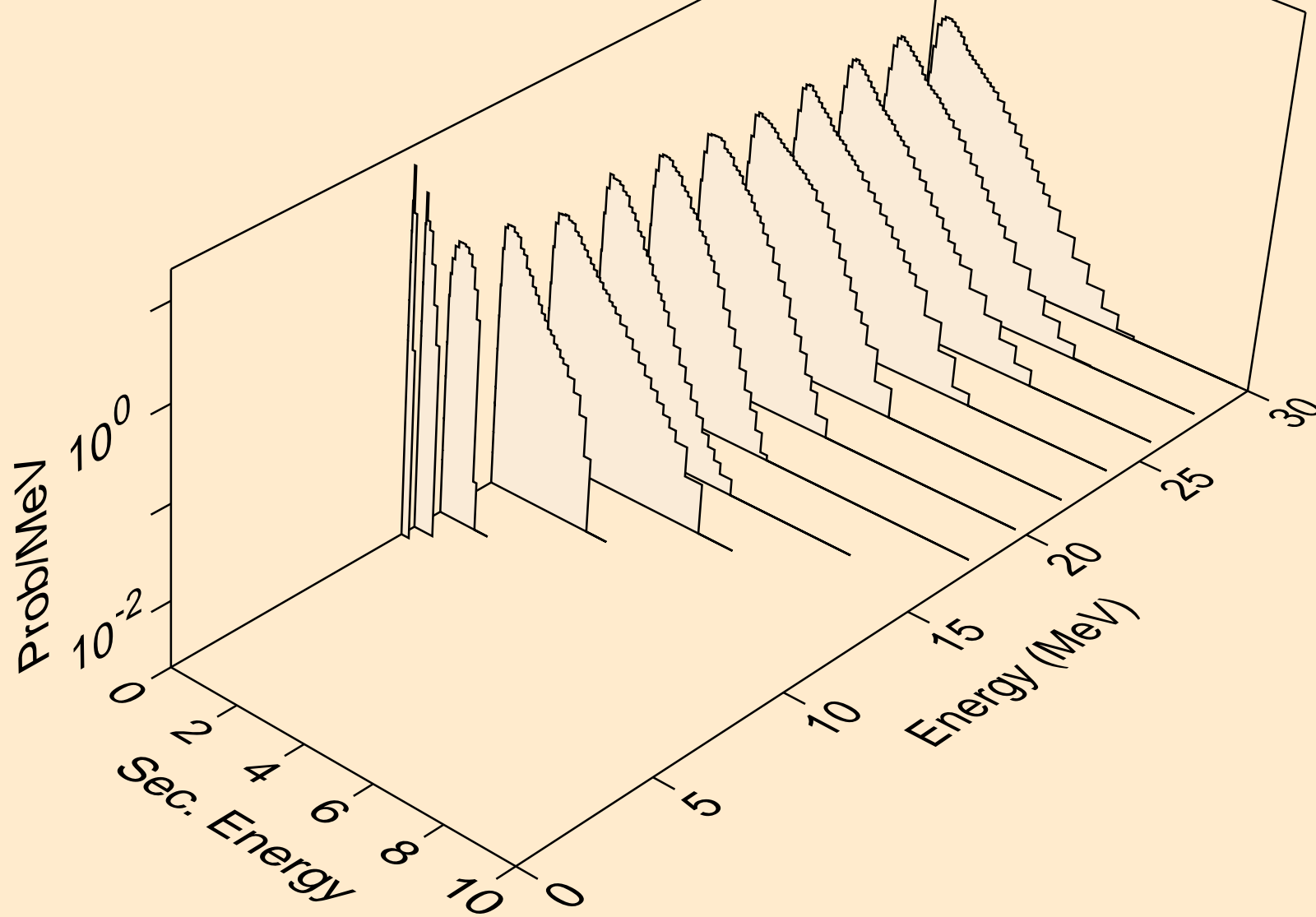

AT206 NEUTRON ACER TENDL-2021 LIBRARY; T=293.6K
Neutron emission for (n,3n)_a

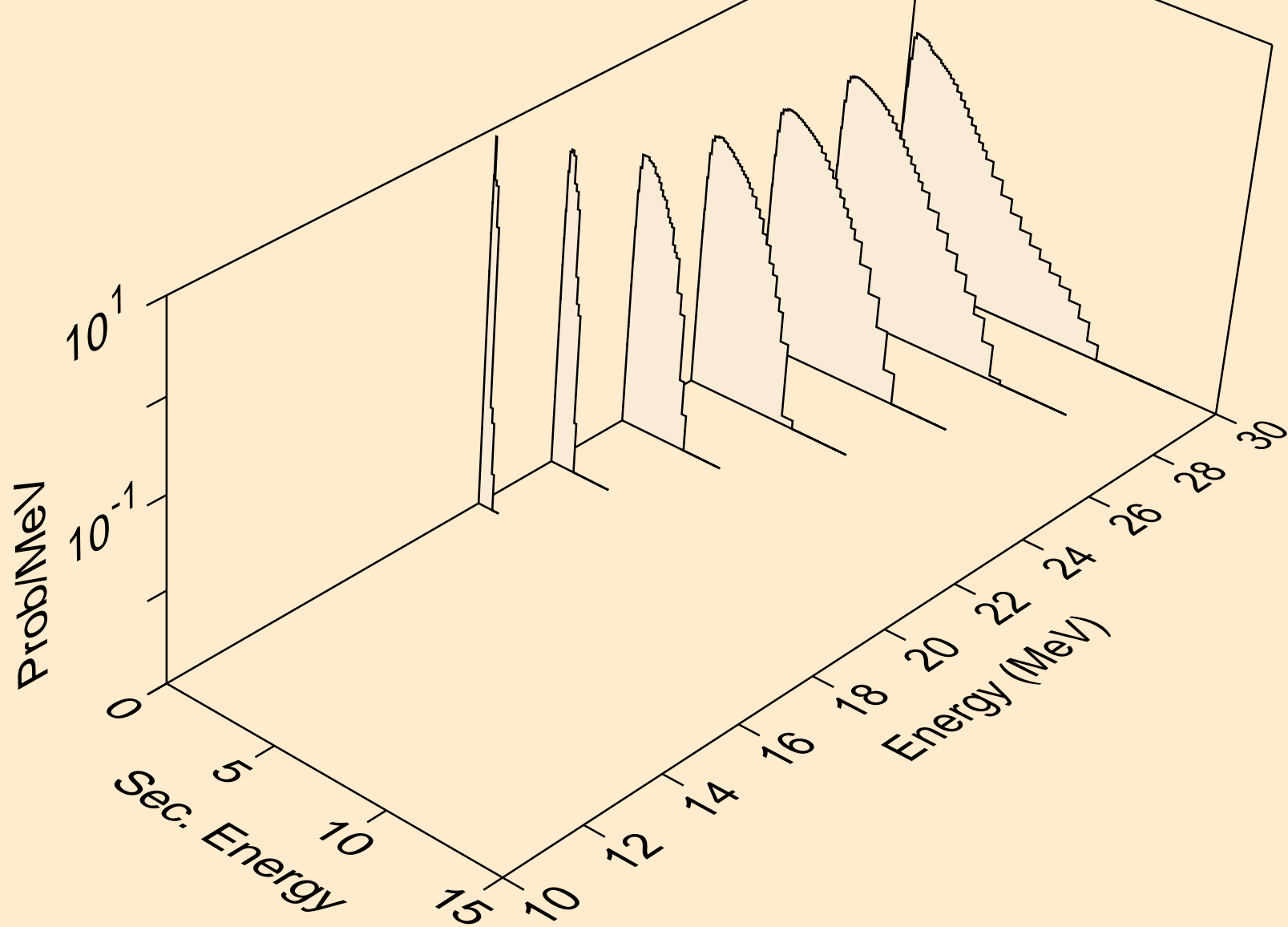

AT206 NEUTRON ACER TENDL-2021 LIBRARY; T=293.6K
Neutron emission for (n,n*)p

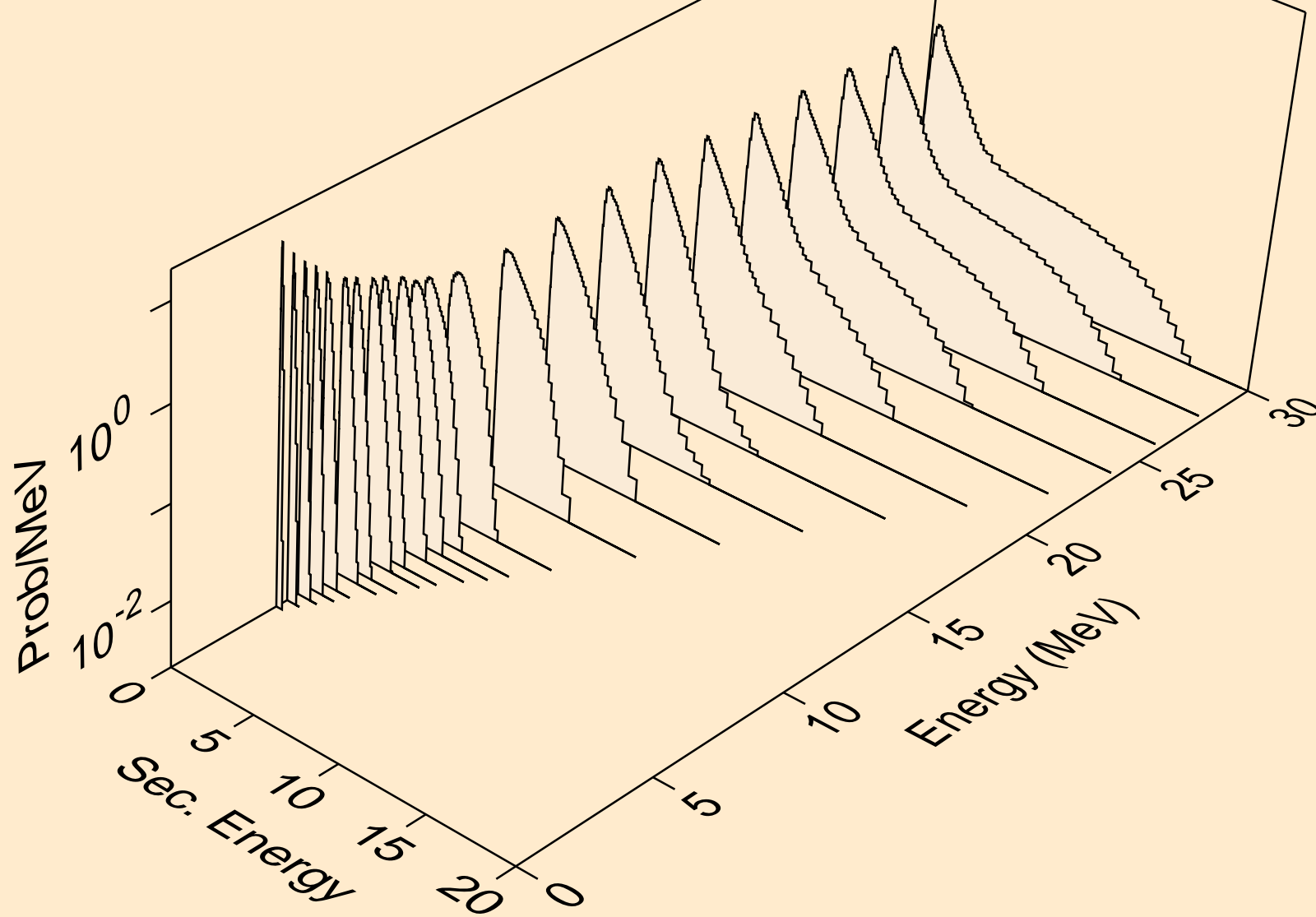

AT206 NEUTRON ACER TENDL-2021 LIBRARY; T=293.6K
Neutron emission for (n,n*)2a

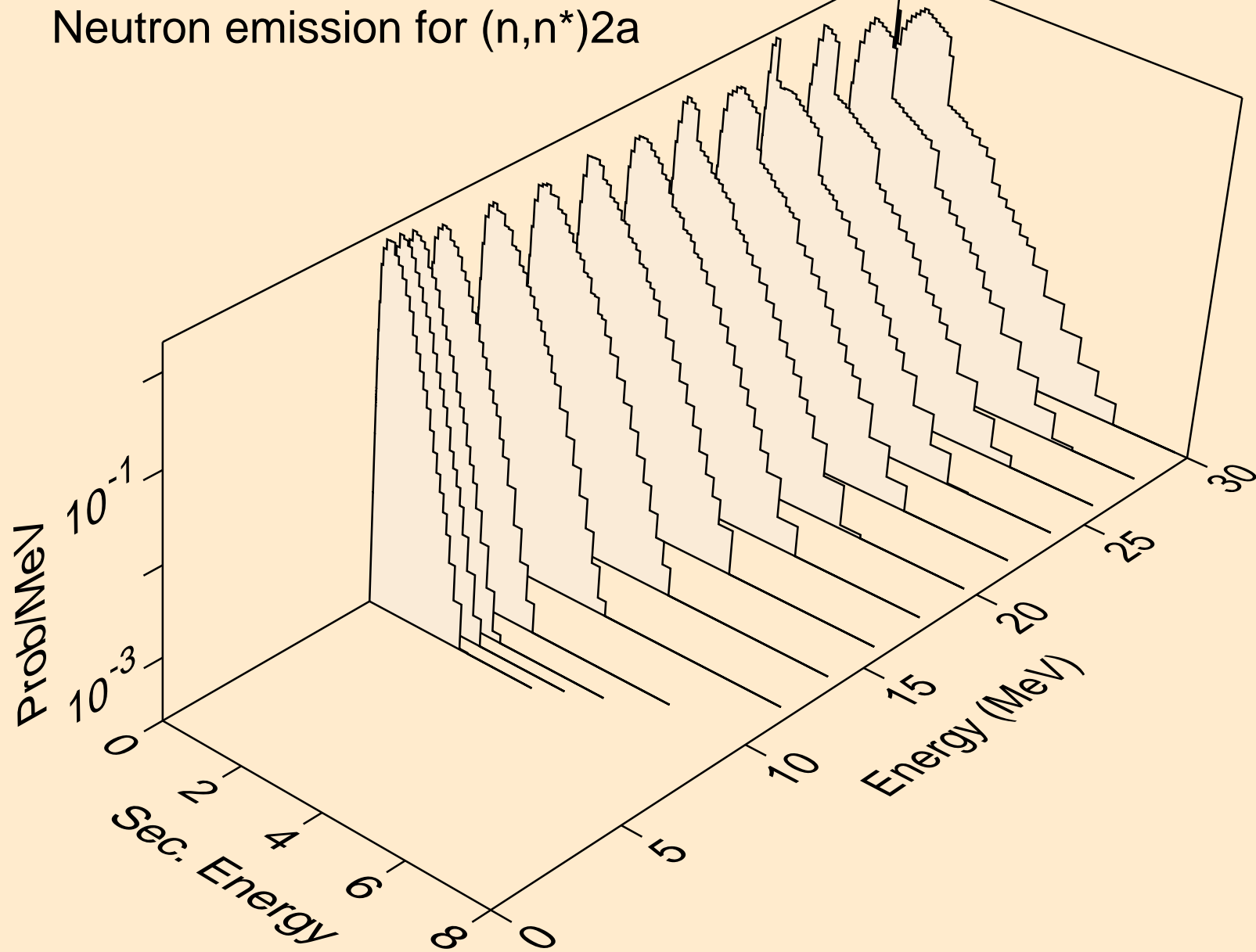

AT206 NEUTRON ACER TENDL-2021 LIBRARY; T=293.6K
Neutron emission for (n,2n)2a

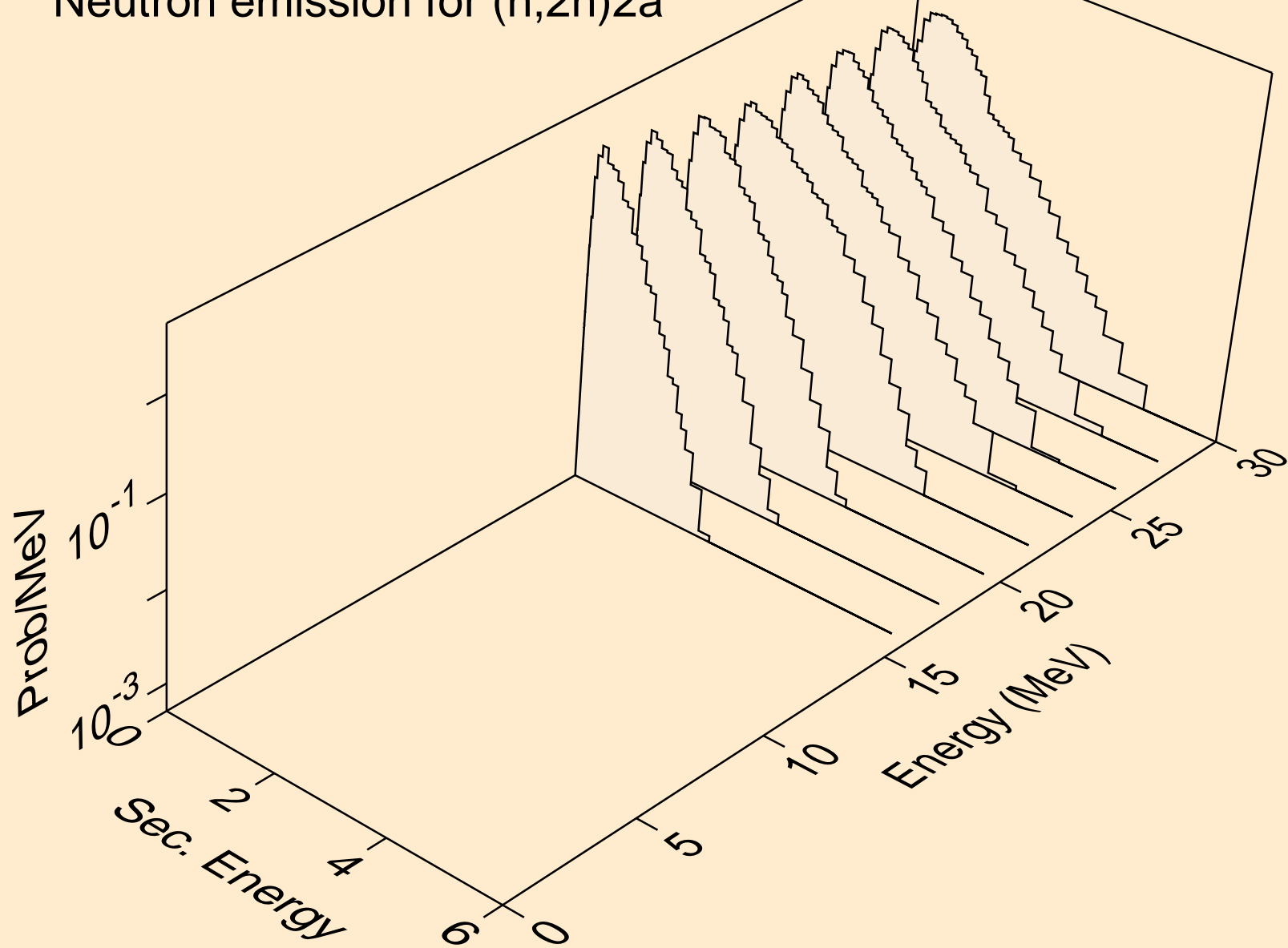

AT206 NEUTRON ACER TENDL-2021 LIBRARY; T=293.6K
Neutron emission for (n,n*)d

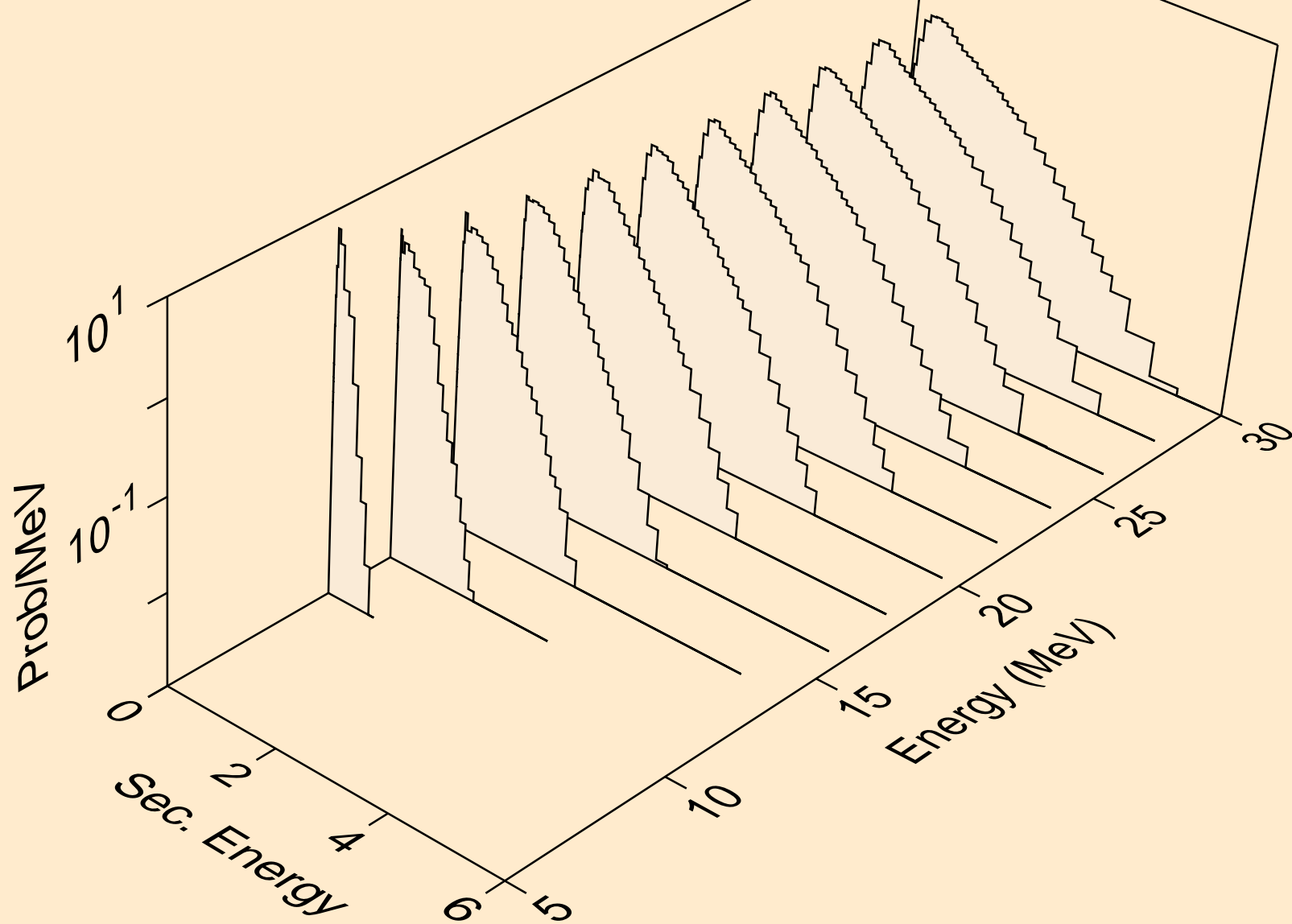

AT206 NEUTRON ACER TENDL-2021 LIBRARY; T=293.6K
Neutron emission for (n,n*)t

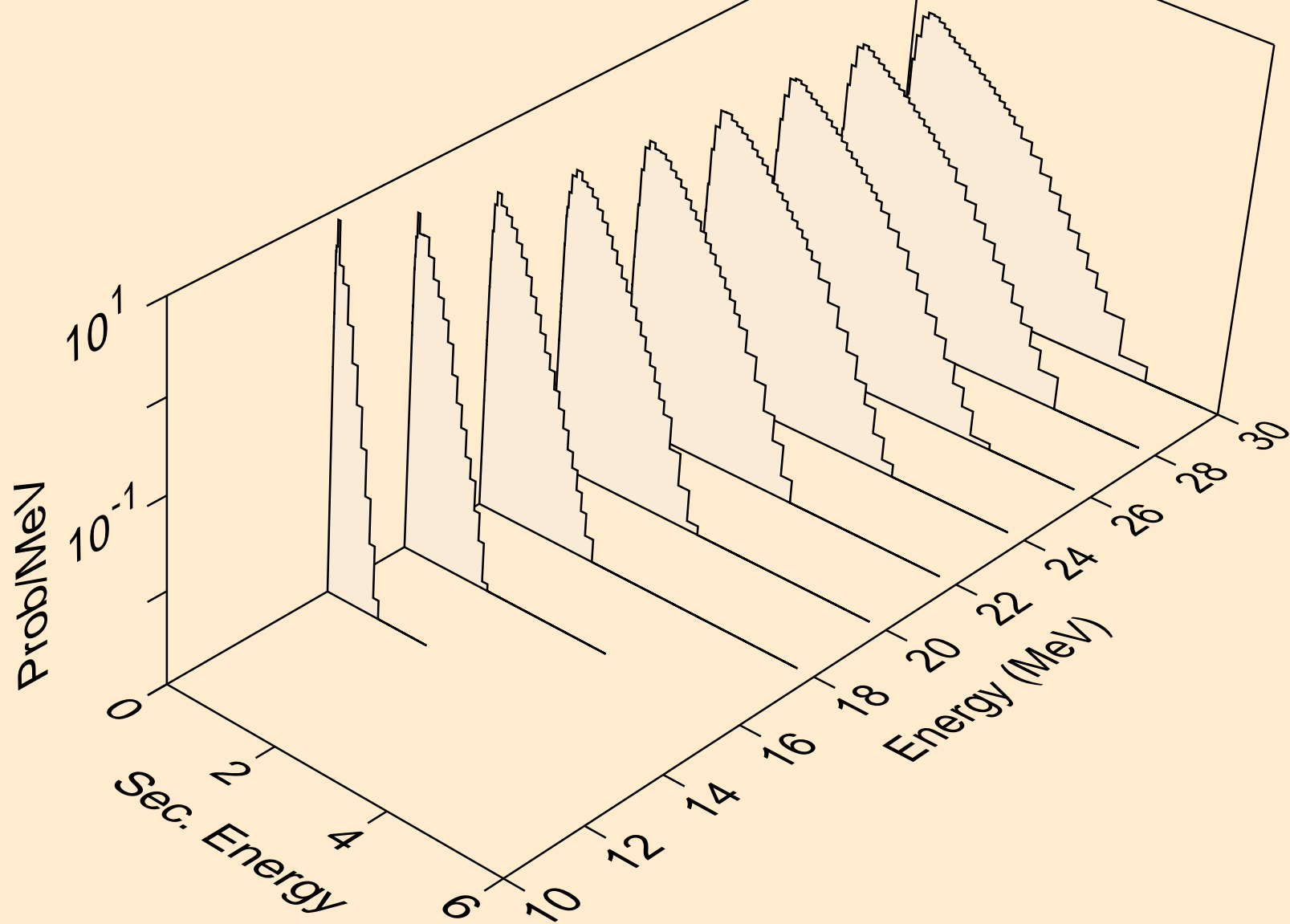

AT206 NEUTRON ACER TENDL-2021 LIBRARY; T=293.6K
Neutron emission for (n,n*)he3

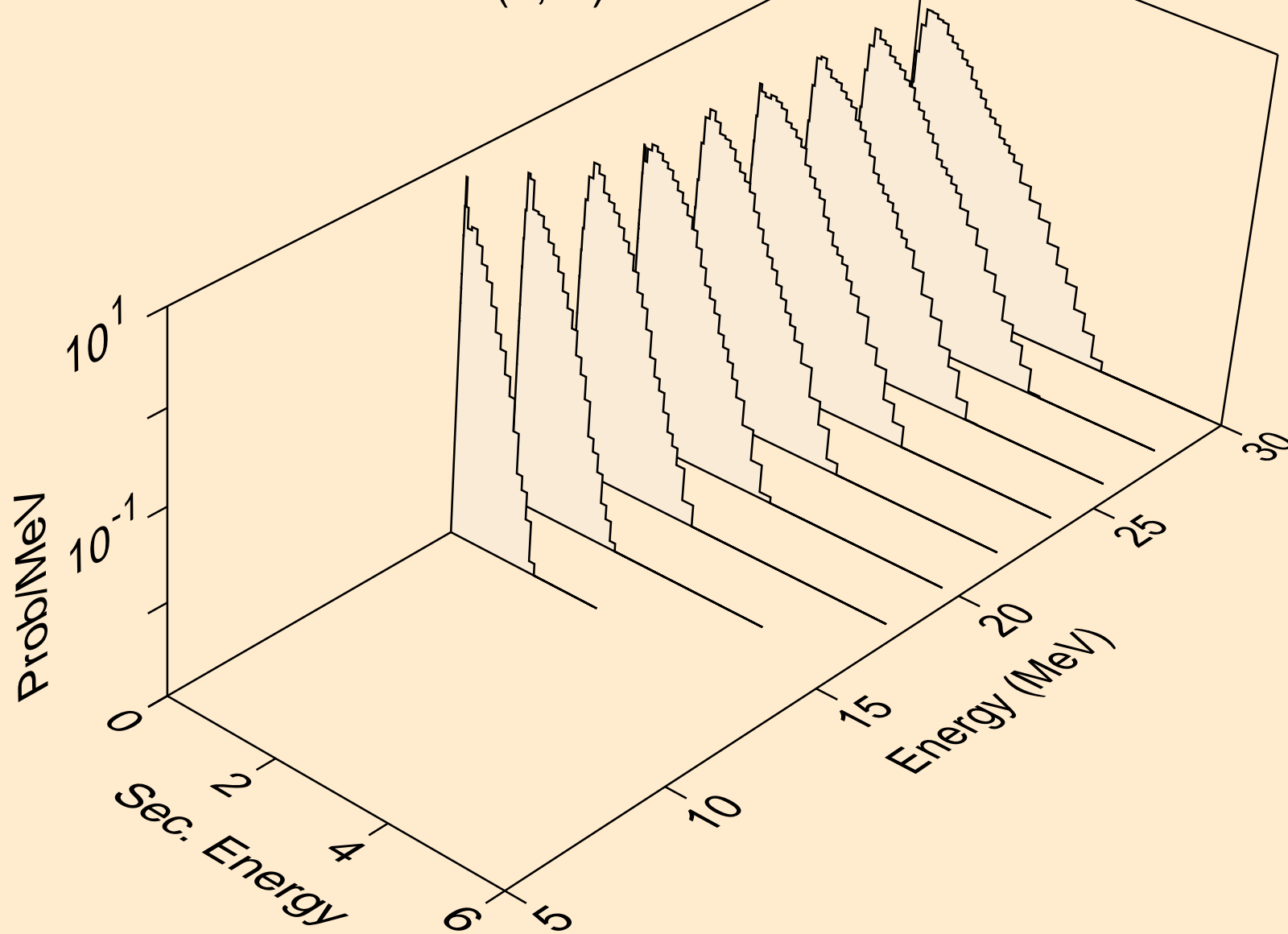

AT206 NEUTRON ACER TENDL-2021 LIBRARY; T=293.6K
Neutron emission for (n,4n)

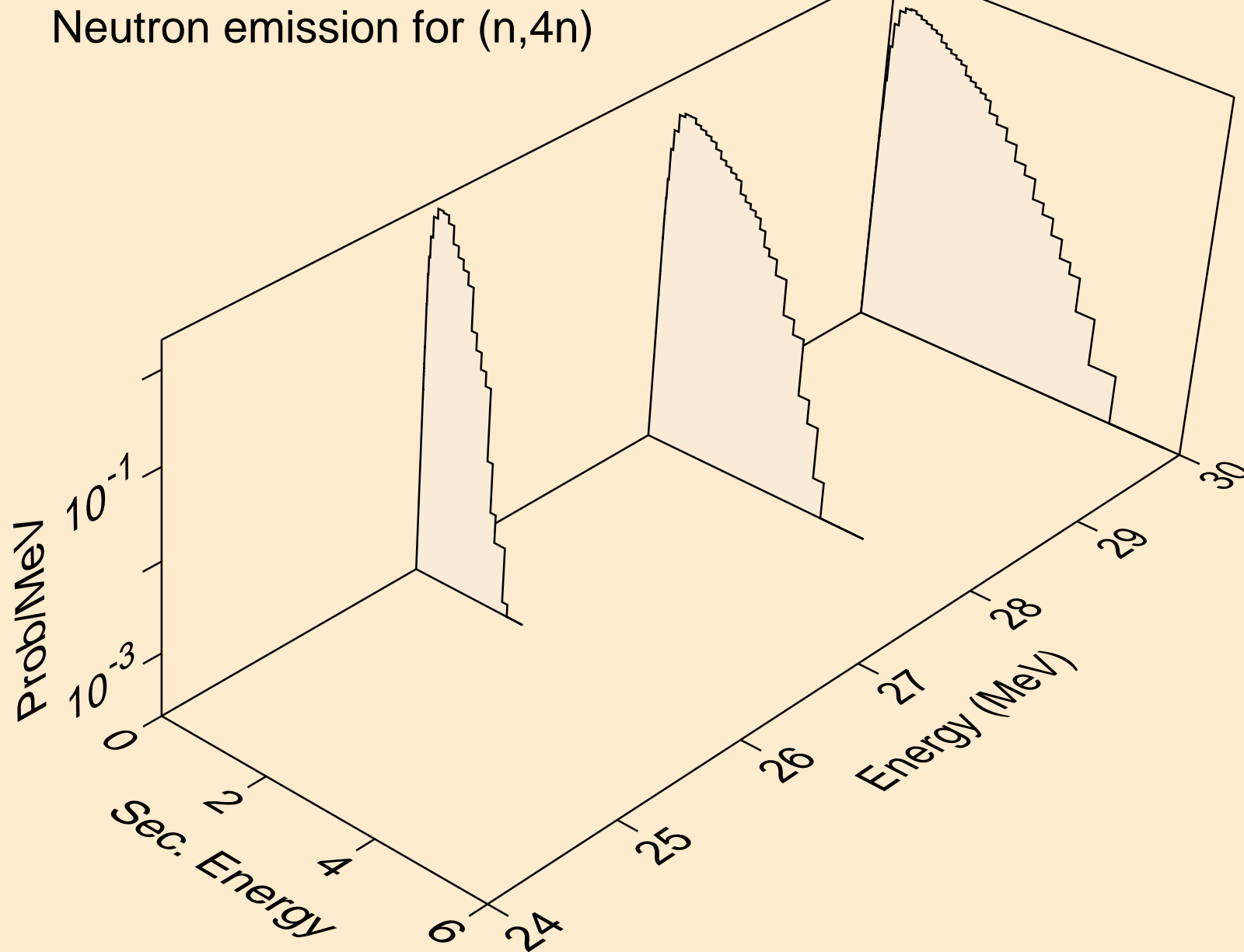

AT206 NEUTRON ACER TENDL-2021 LIBRARY; T=293.6K
Neutron emission for (n,2np)

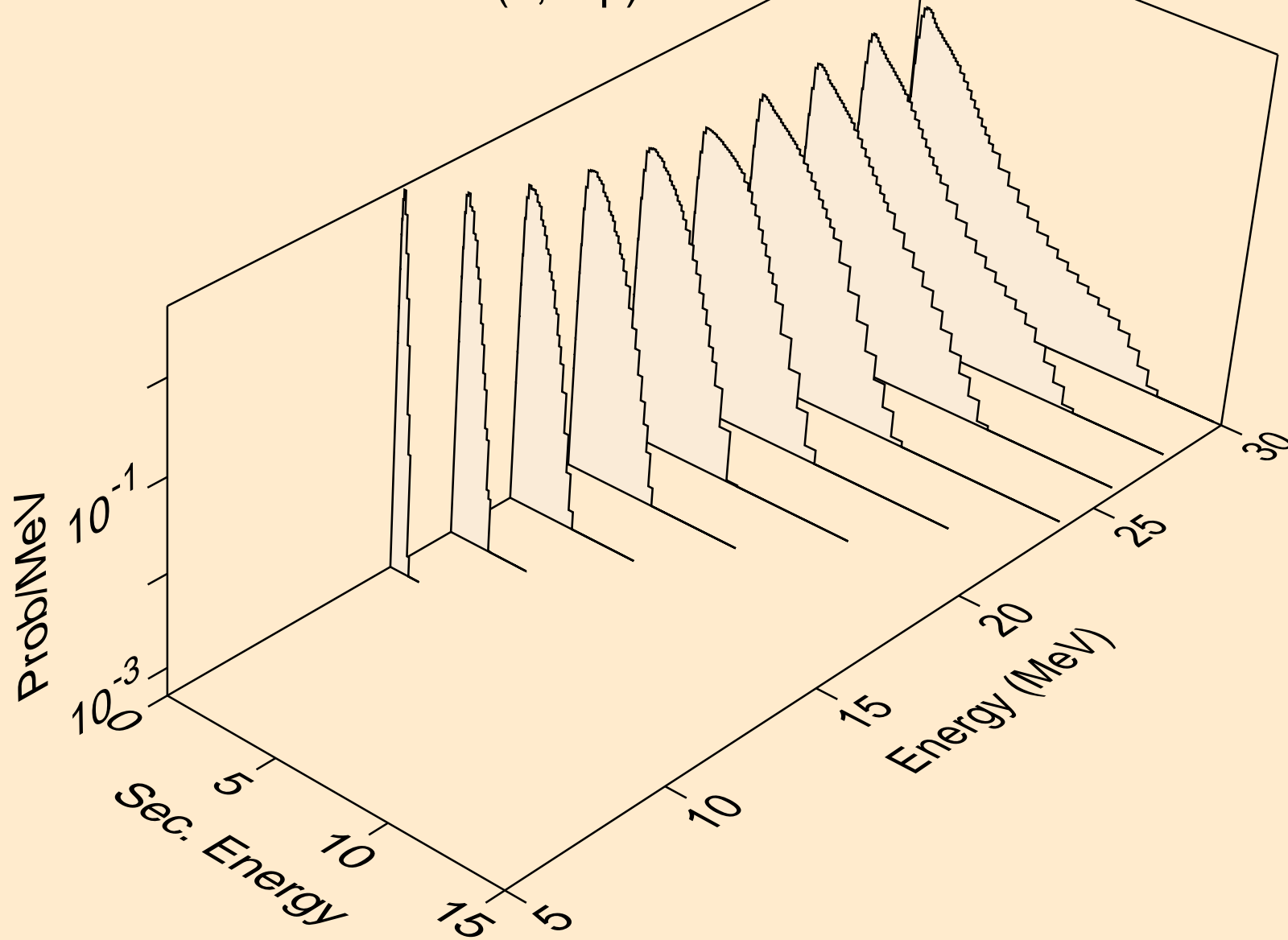

AT206 NEUTRON ACER TENDL-2021 LIBRARY; T=293.6K
Neutron emission for (n,3np)

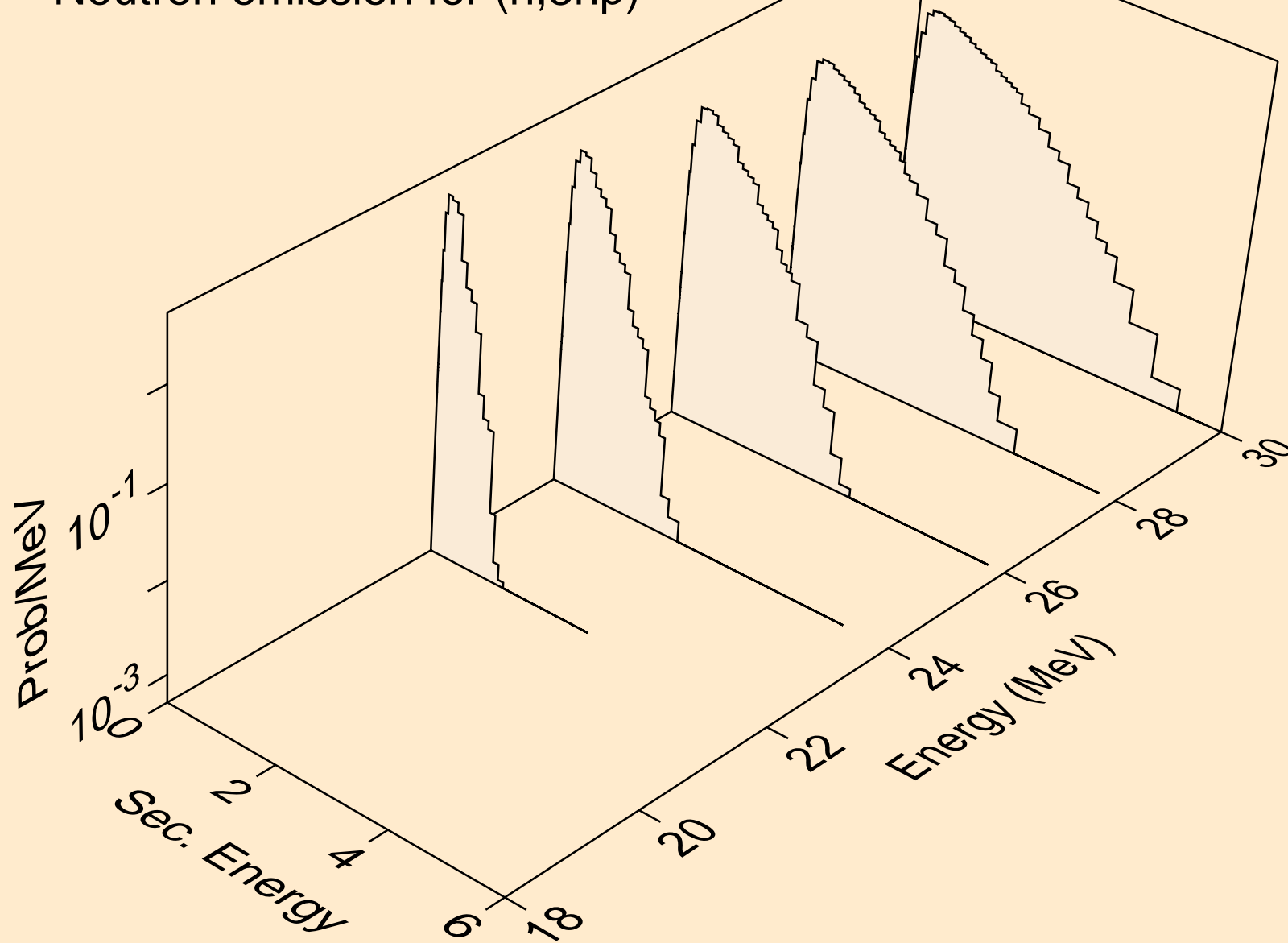

AT206 NEUTRON ACER TENDL-2021 LIBRARY; T=293.6K
Neutron emission for (n,2np)

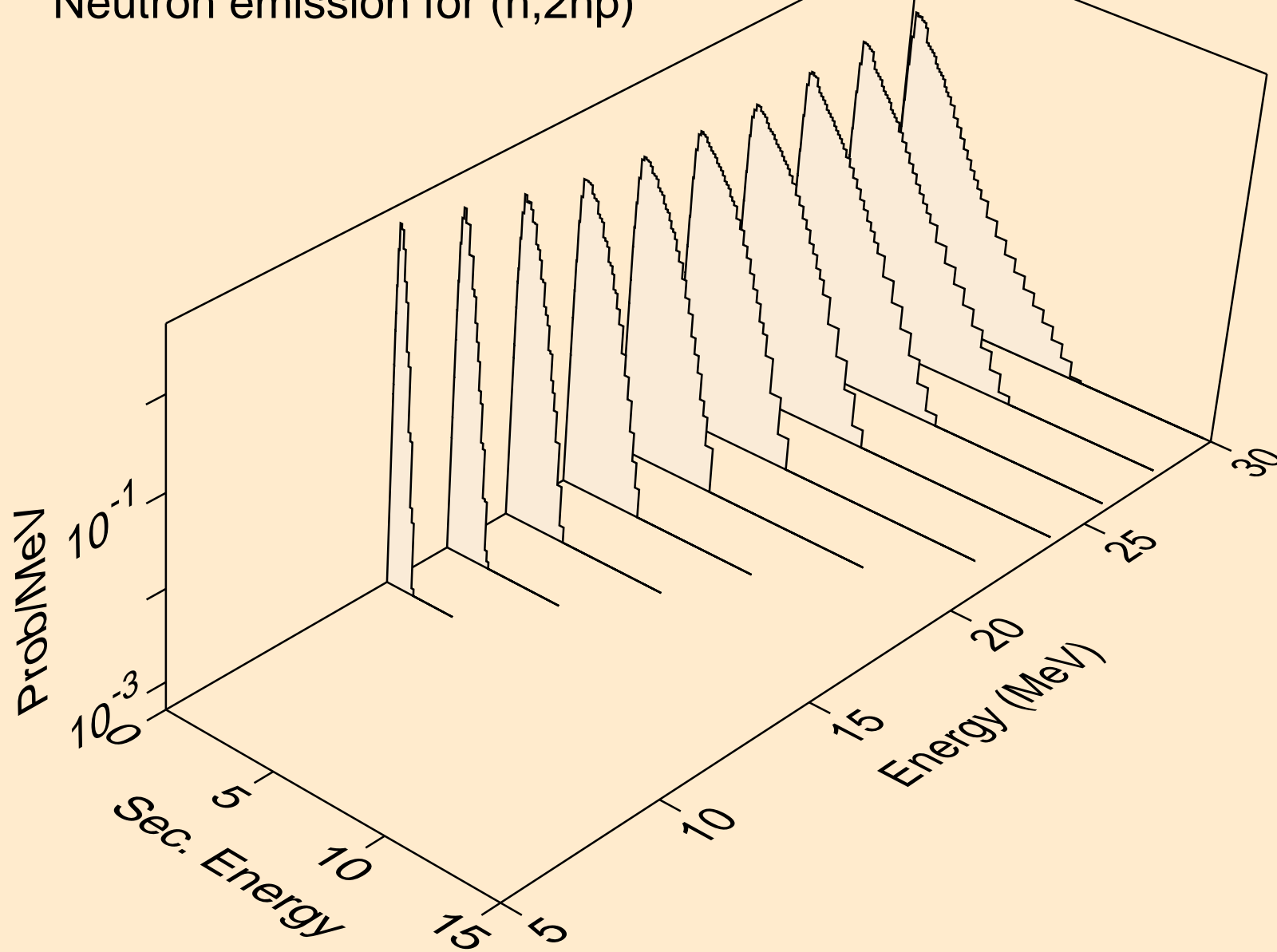

AT206 NEUTRON ACER TENDL-2021 LIBRARY; T=293.6K
Neutron emission for (n,npa)

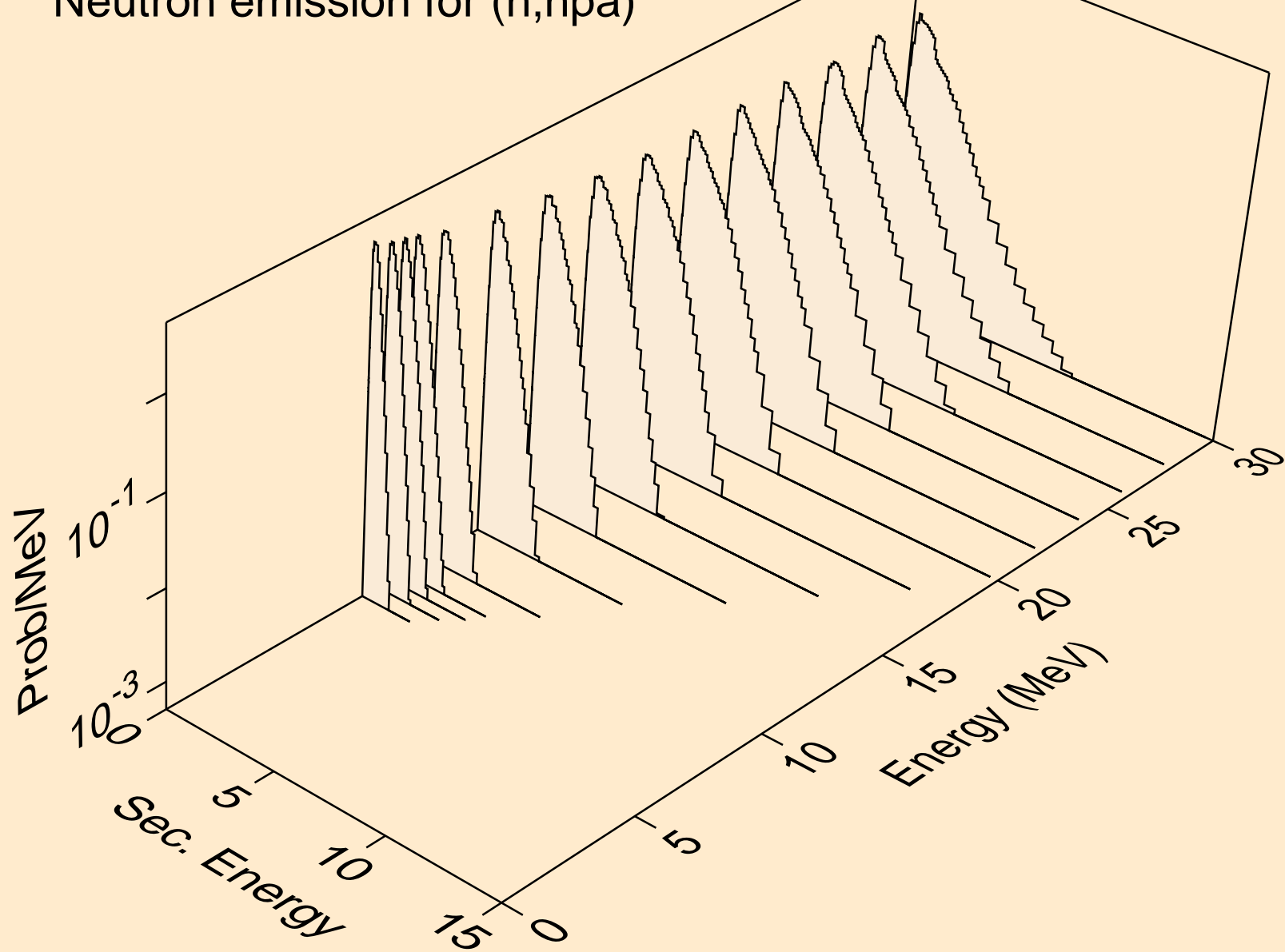

AT206 NEUTRON ACER TENDL-2021 LIBRARY; T=293.6K
Neutron emission for (n,n*c)

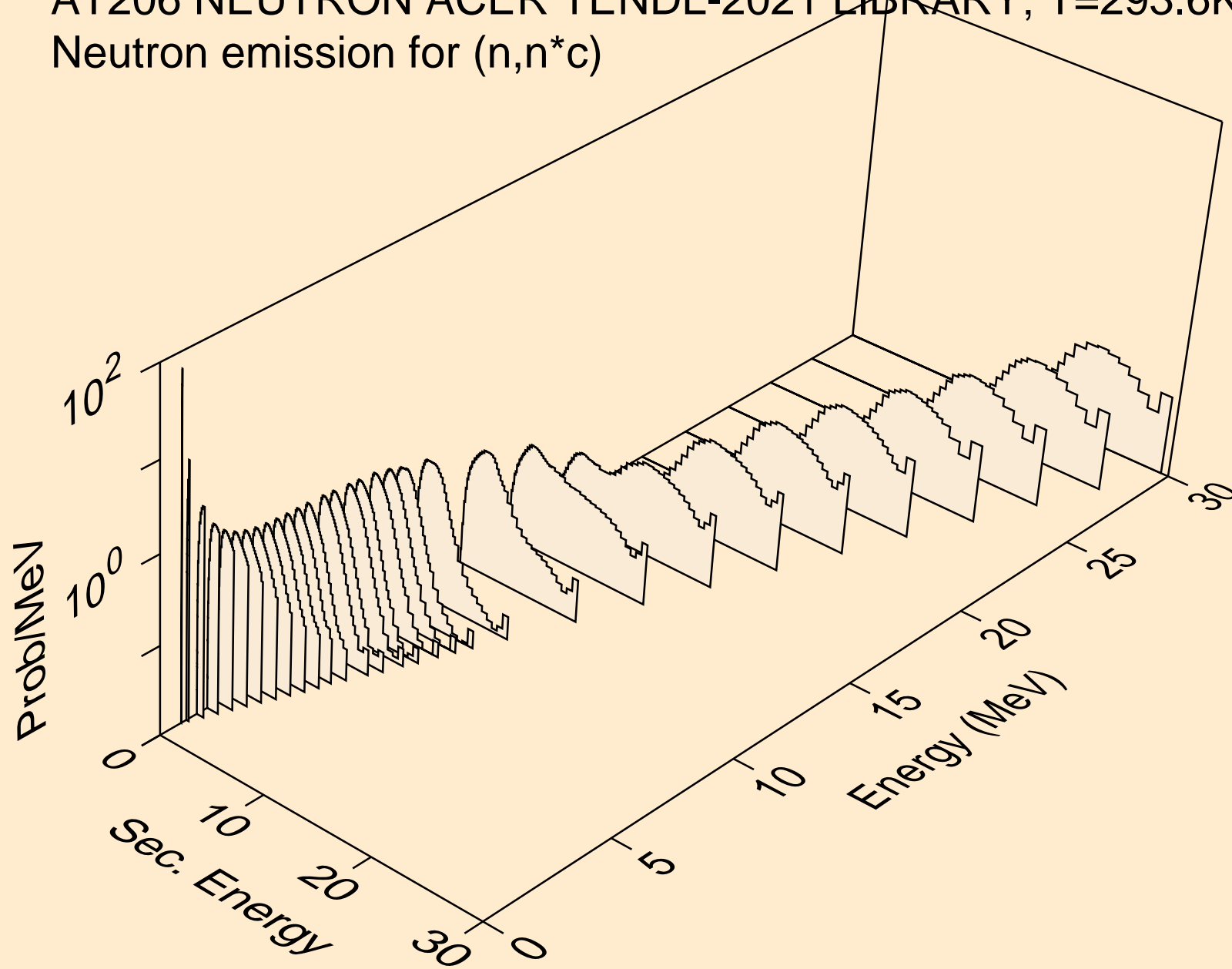

AT206 NEUTRON ACER TENDL-2021 LIBRARY; T=293.6K
Photon emission for (n,x)

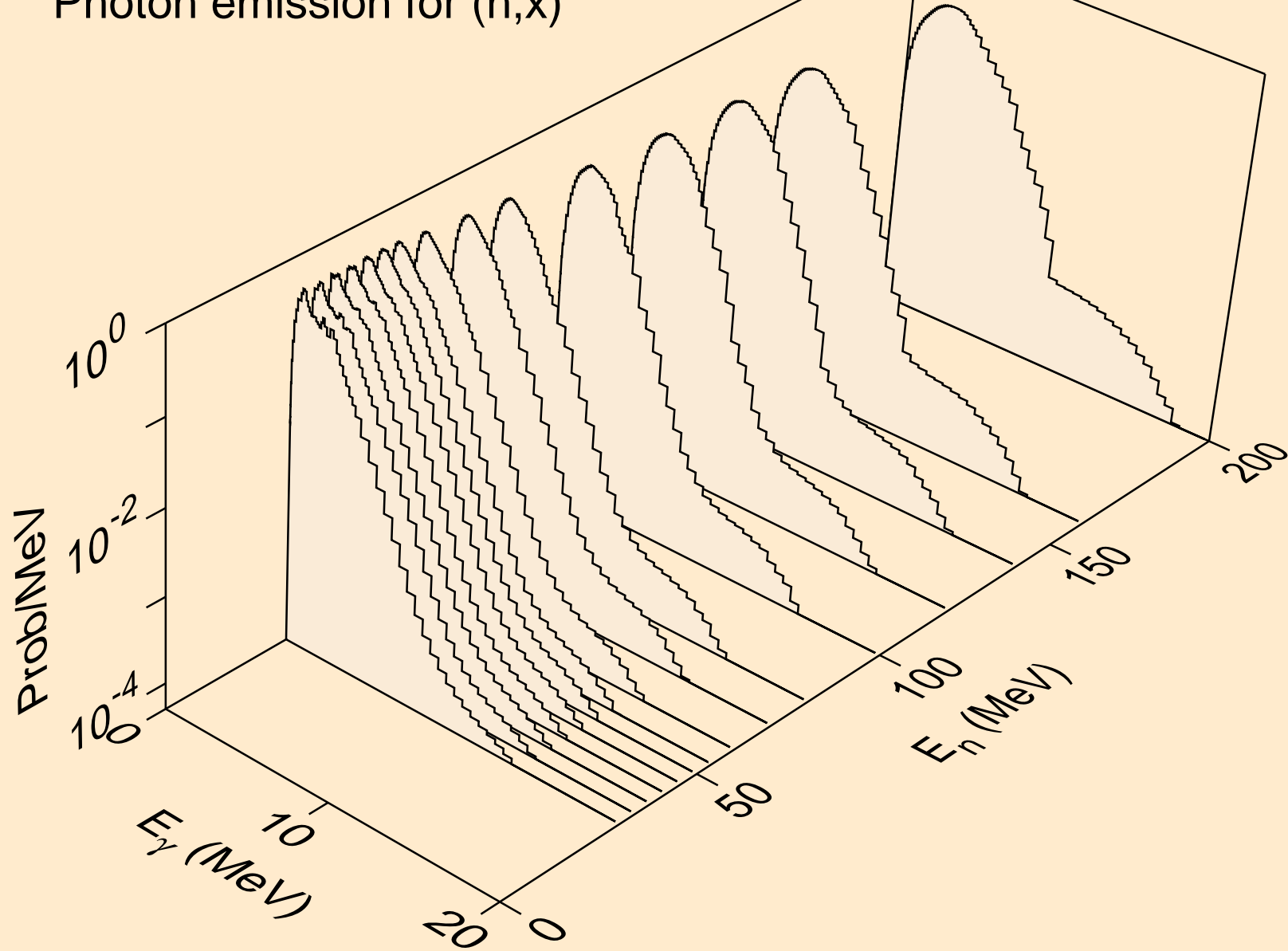

AT206 NEUTRON ACER TENDL-2021 LIBRARY; T=293.6K
Photon emission for (n,2nd)

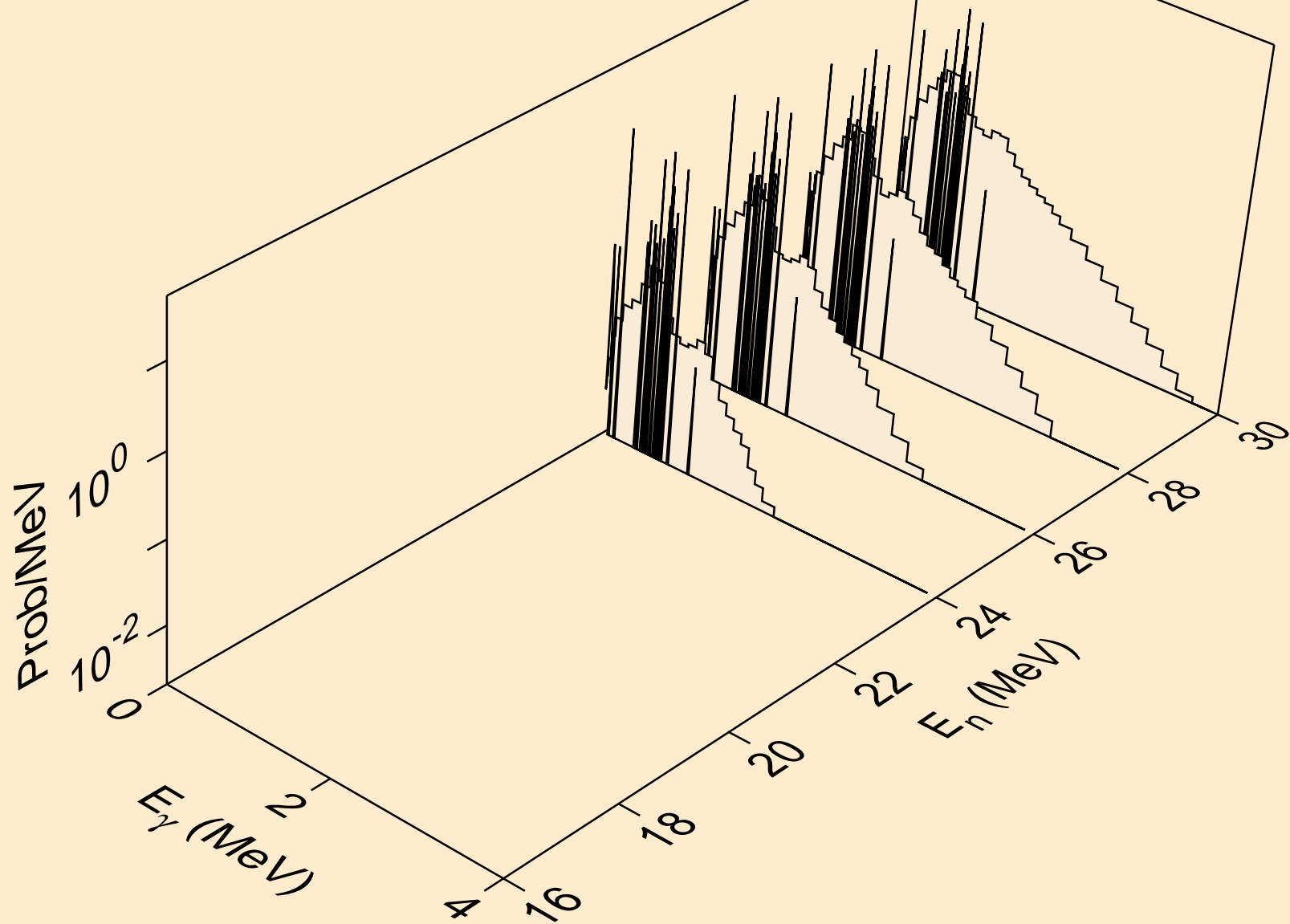

AT206 NEUTRON ACER TENDL-2021 LIBRARY; T=293.6K
Photon emission for (n,2n)

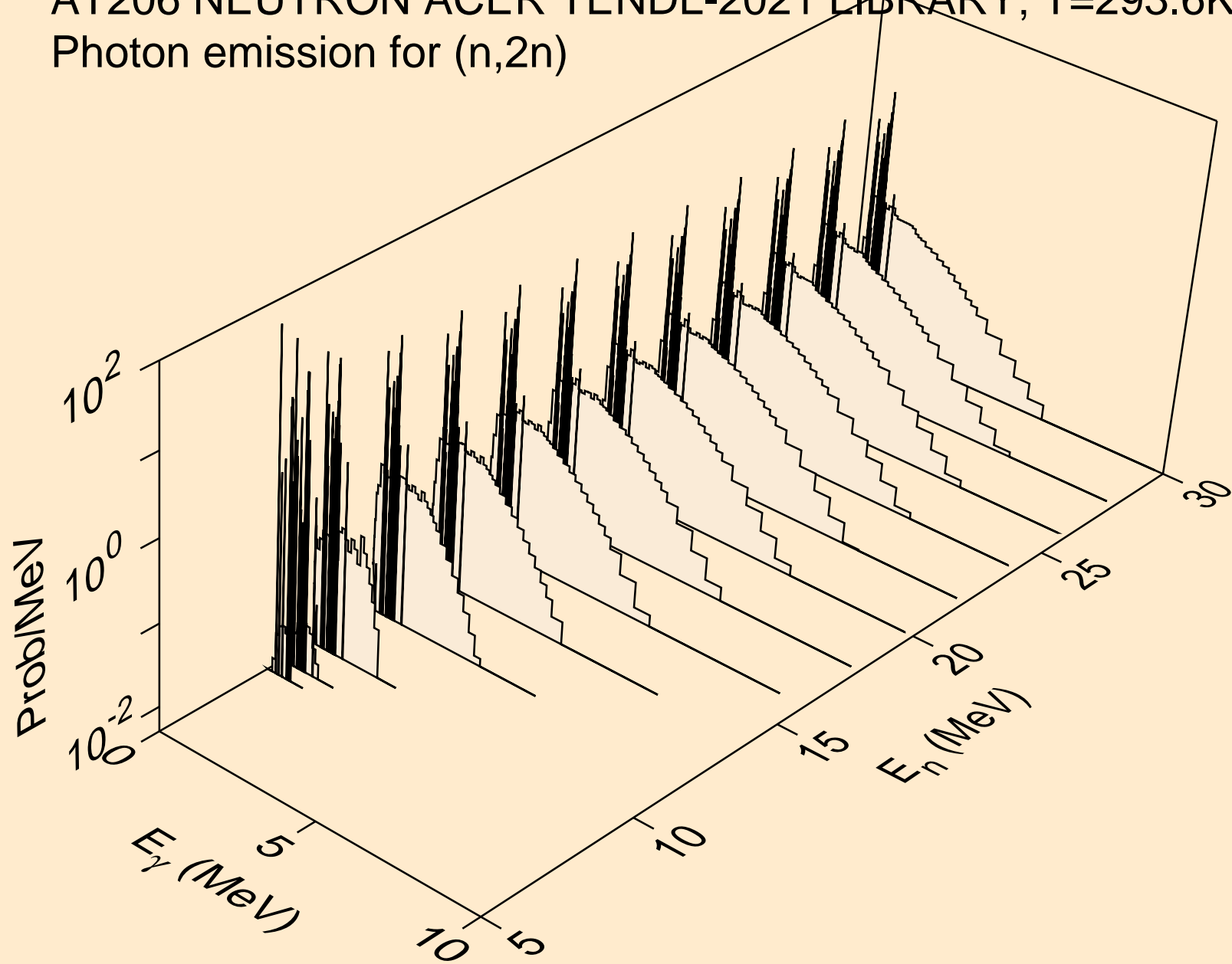

AT206 NEUTRON ACER TENDL-2021 LIBRARY; T=293.6K
Photon emission for (n,3n)

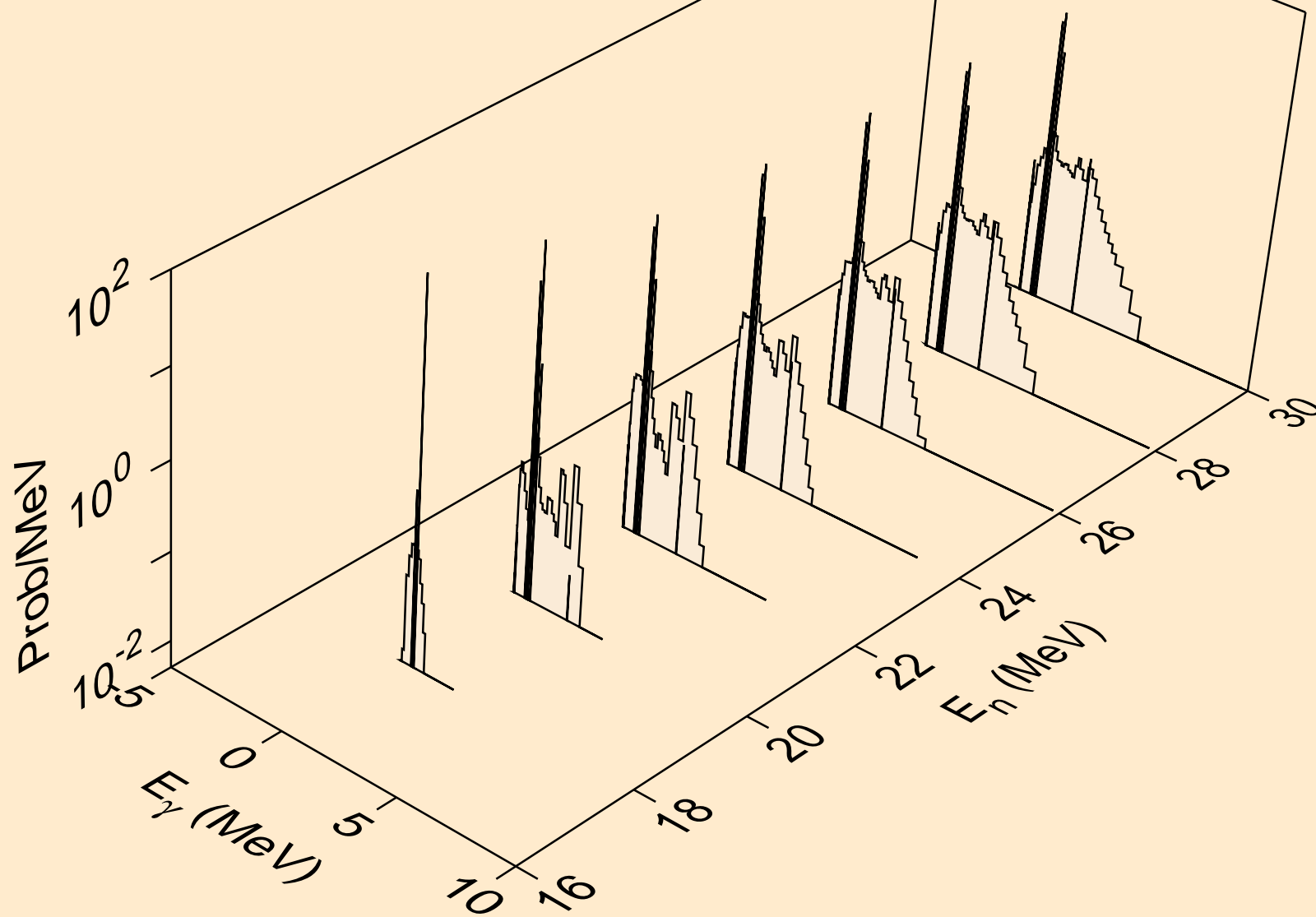

AT206 NEUTRON ACER TENDL-2021 LIBRARY; T=293.6K
Photon emission for (n,n*)a

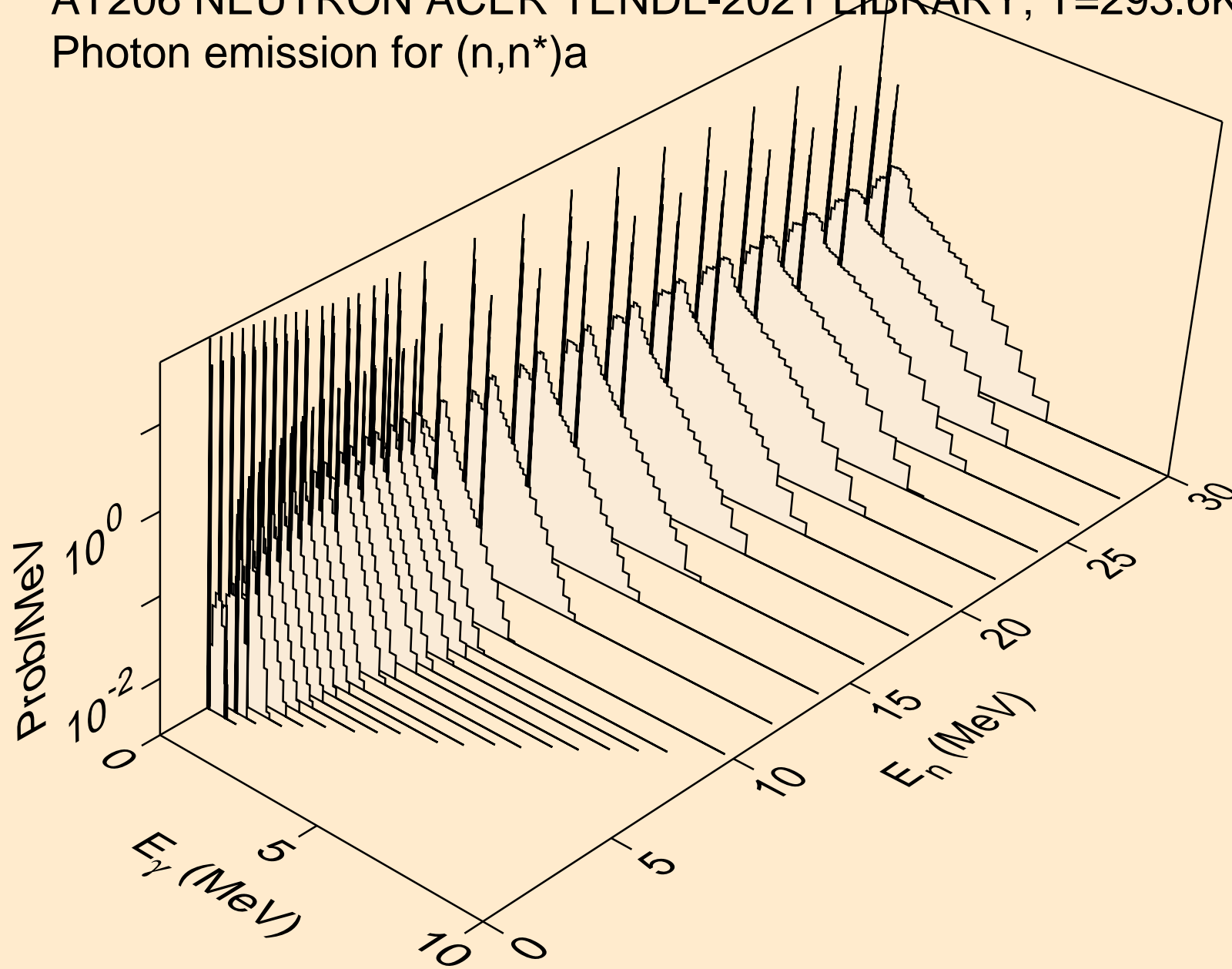

AT206 NEUTRON ACER TENDL-2021 LIBRARY; T=293.6K
Photon emission for (n,2n)a

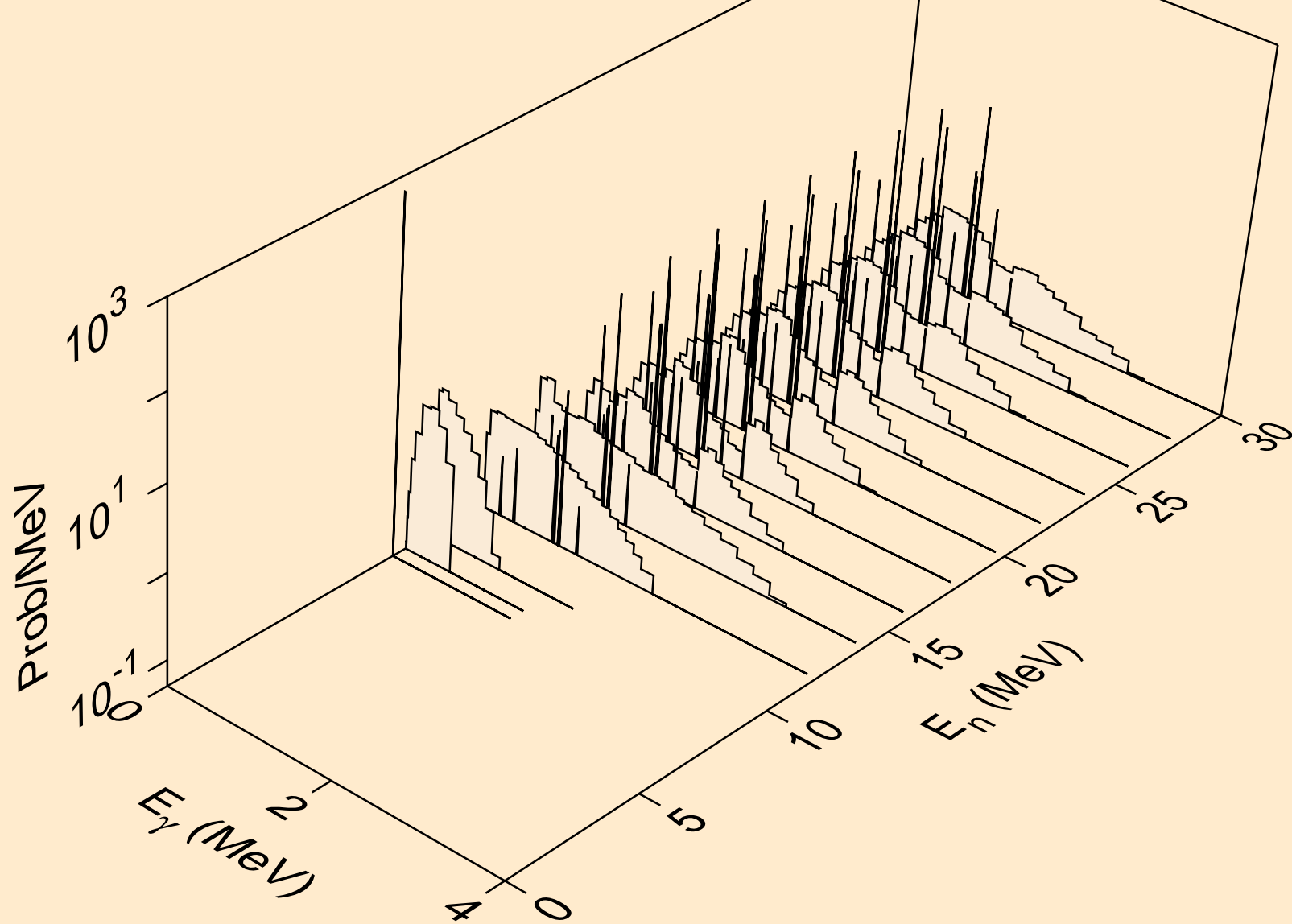

AT206 NEUTRON ACER TENDL-2021 LIBRARY; T=293.6K
Photon emission for (n,3n)a

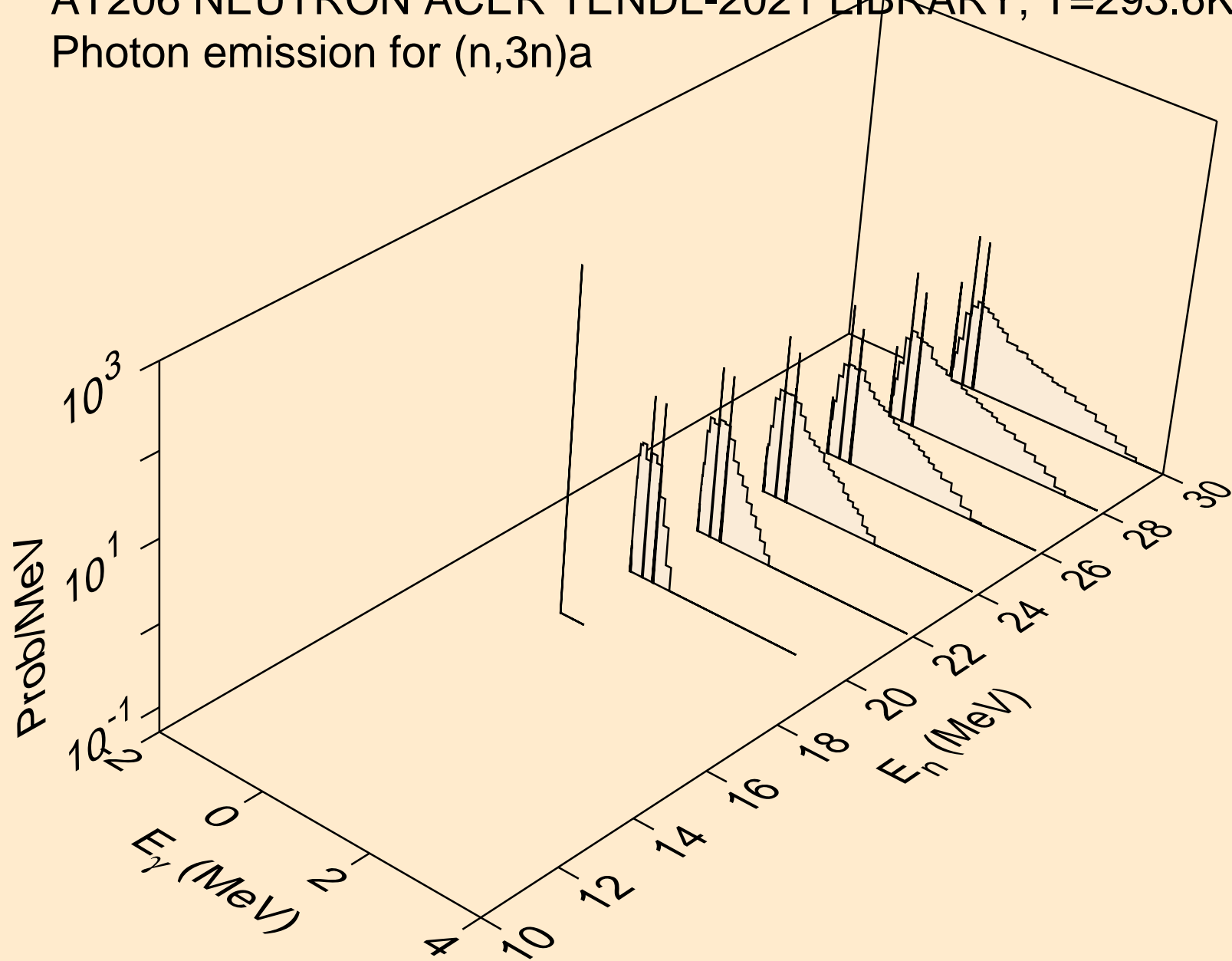

AT206 NEUTRON ACER TENDL-2021 LIBRARY; T=293.6K
Photon emission for (n,n*)p

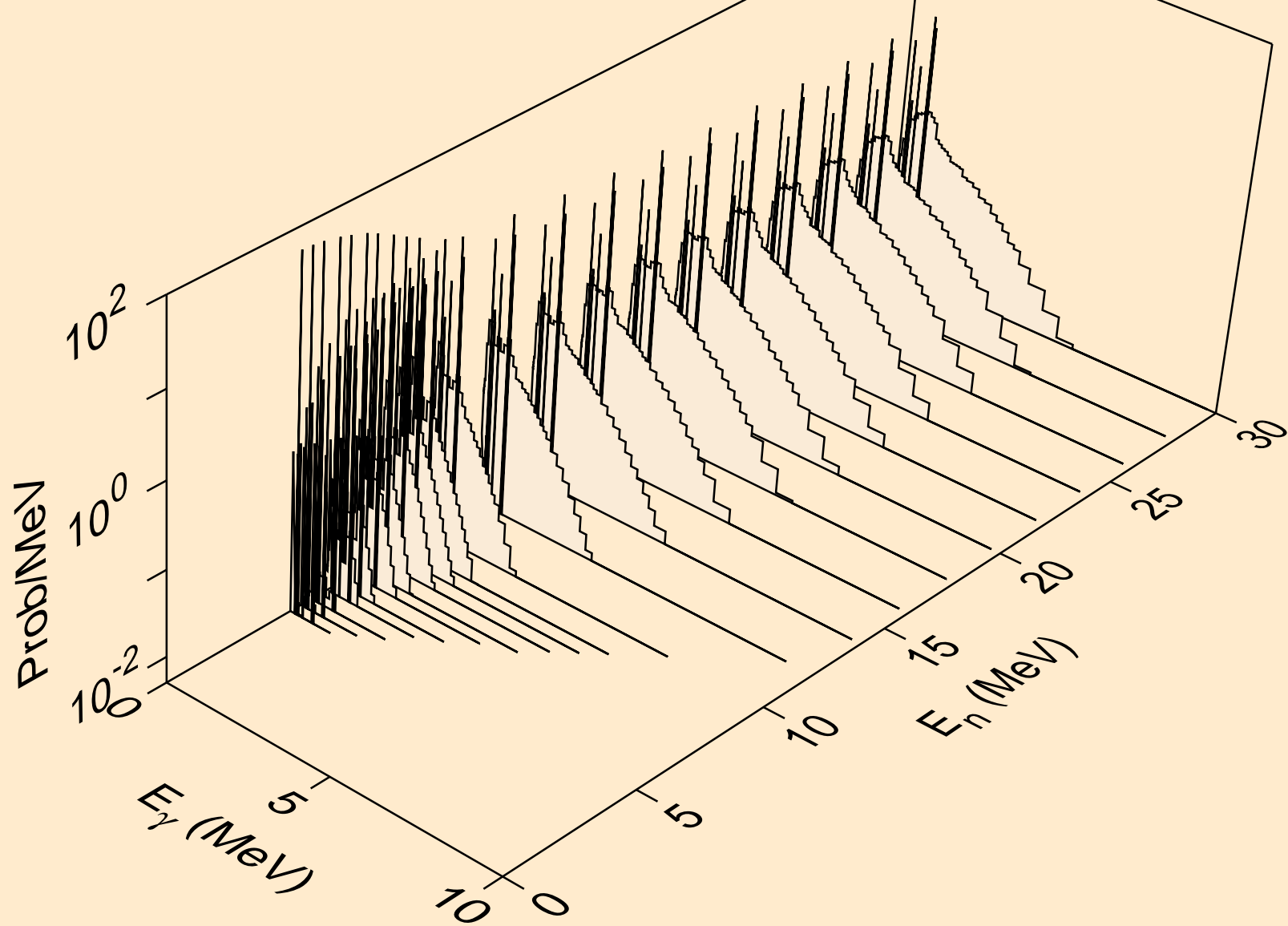

AT206 NEUTRON ACER TENDL-2021 LIBRARY; T=293.6K
Photon emission for (n,n*)2a

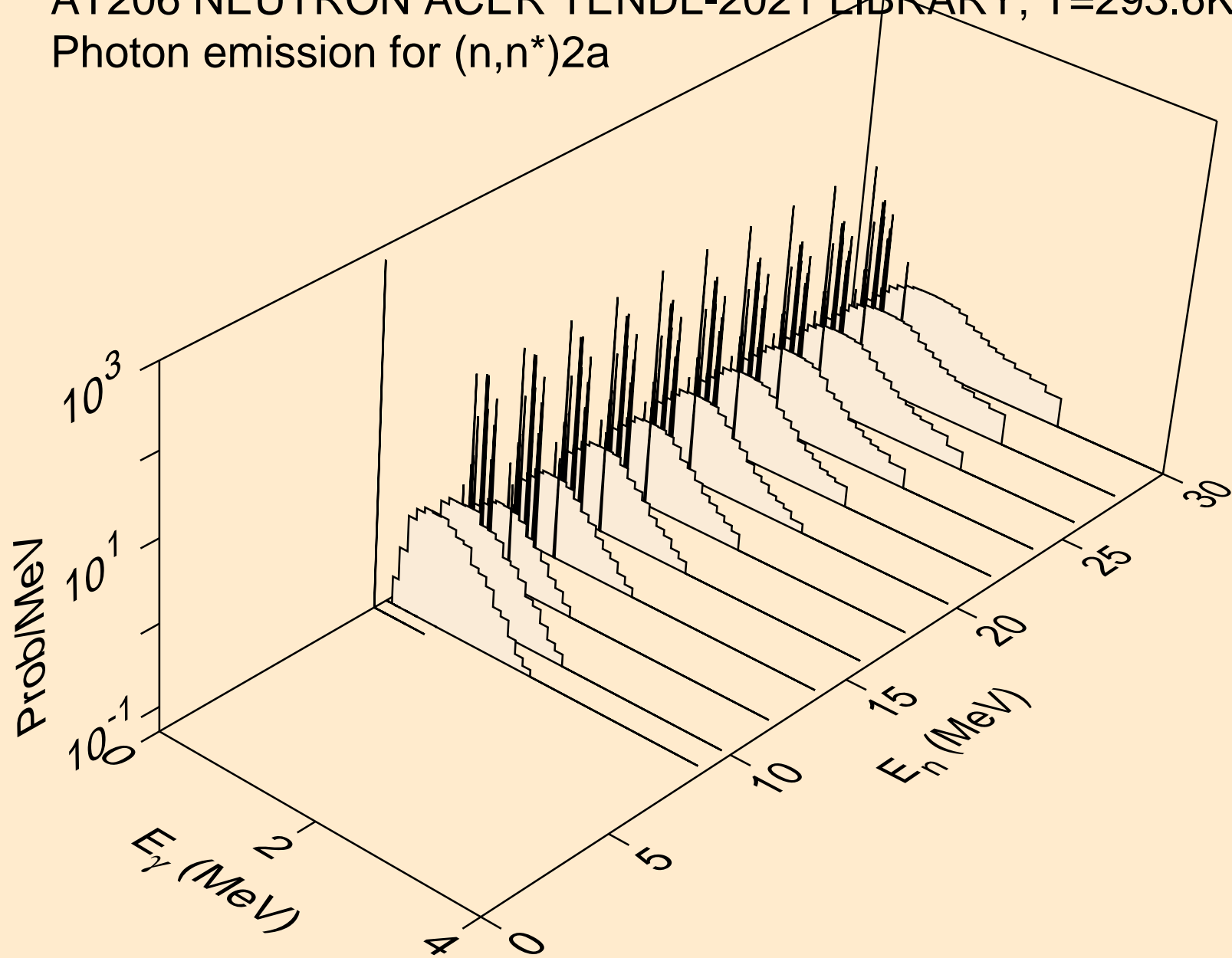

AT206 NEUTRON ACER TENDL-2021 LIBRARY; T=293.6K
Photon emission for (n,2n)2a

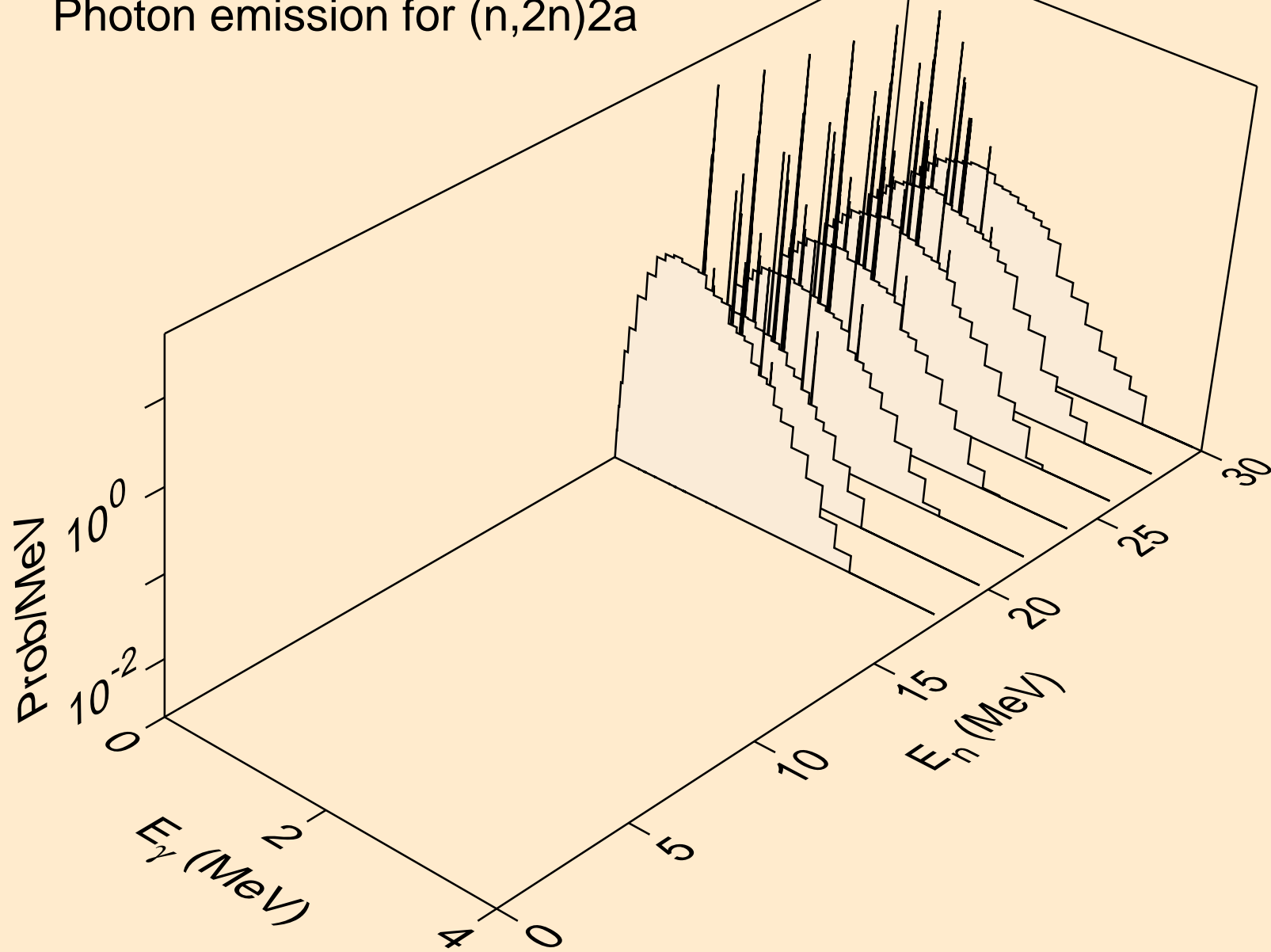

AT206 NEUTRON ACER TENDL-2021 LIBRARY; T=293.6K
Photon emission for (n,n*)d

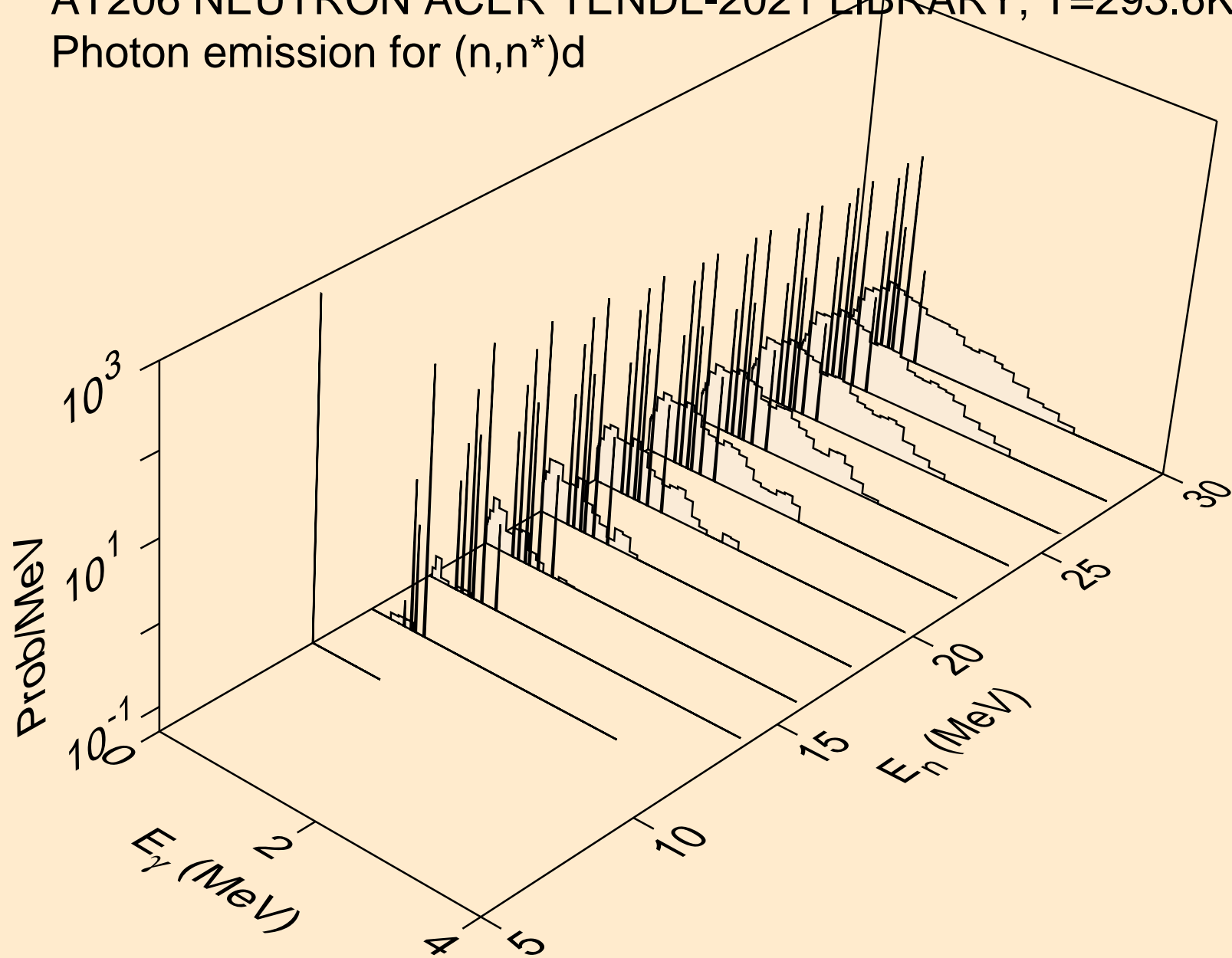

AT206 NEUTRON ACER TENDL-2021 LIBRARY; T=293.6K
Photon emission for (n,n*)t

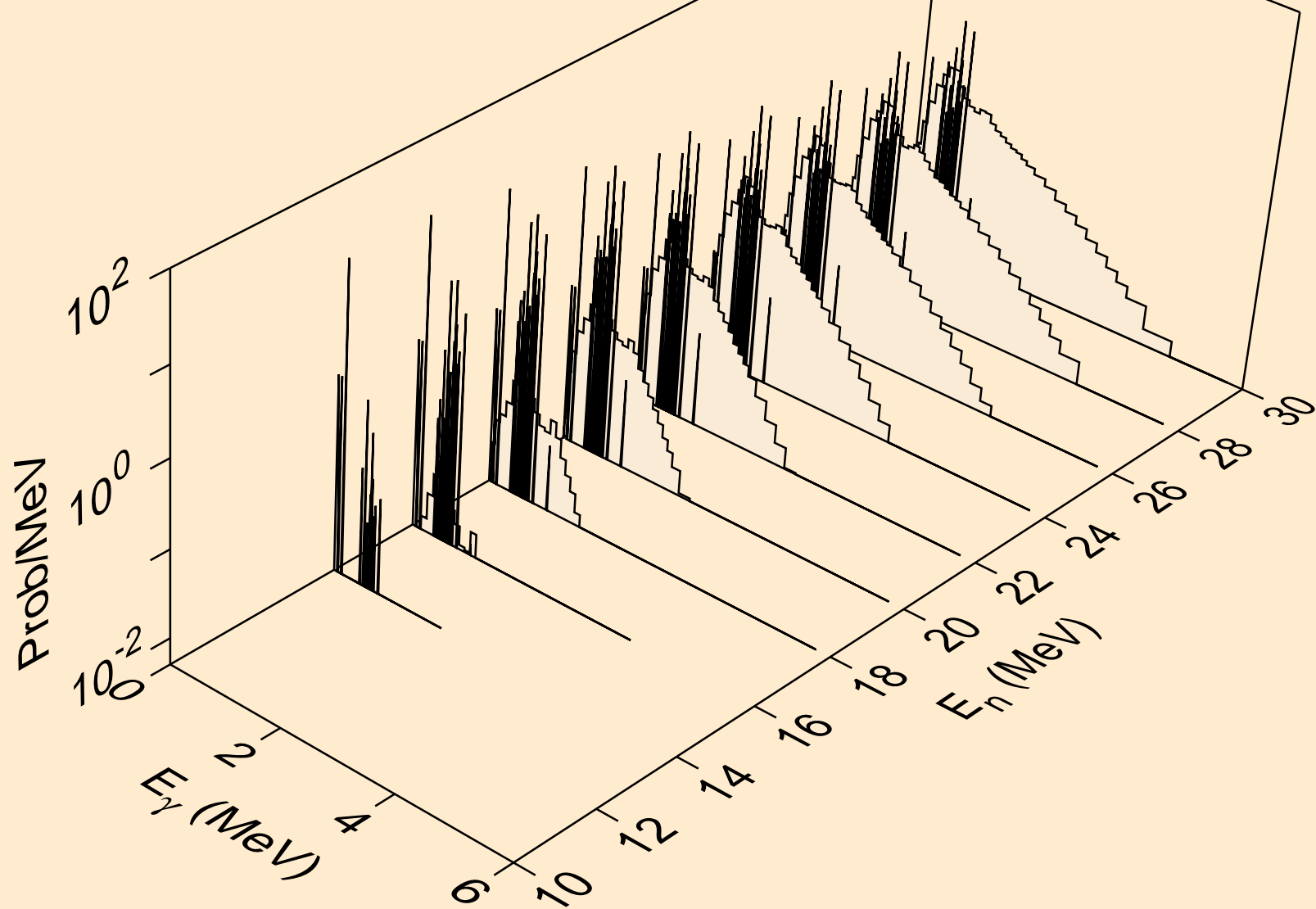

AT206 NEUTRON ACER TENDL-2021 LIBRARY; T=293.6K
Photon emission for (n,n*)he3

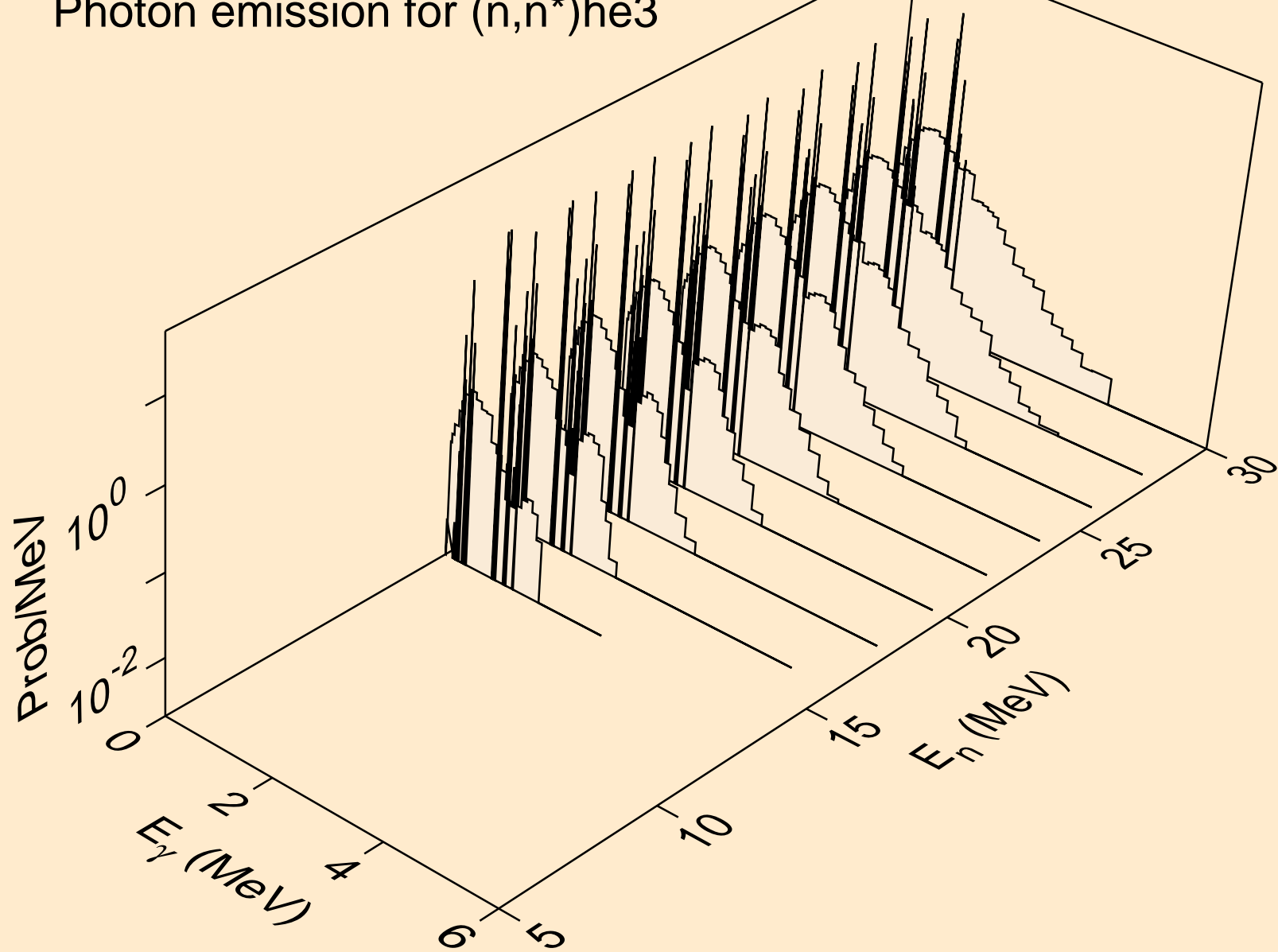

AT206 NEUTRON ACER TENDL-2021 LIBRARY; T=293.6K
Photon emission for (n,4n)

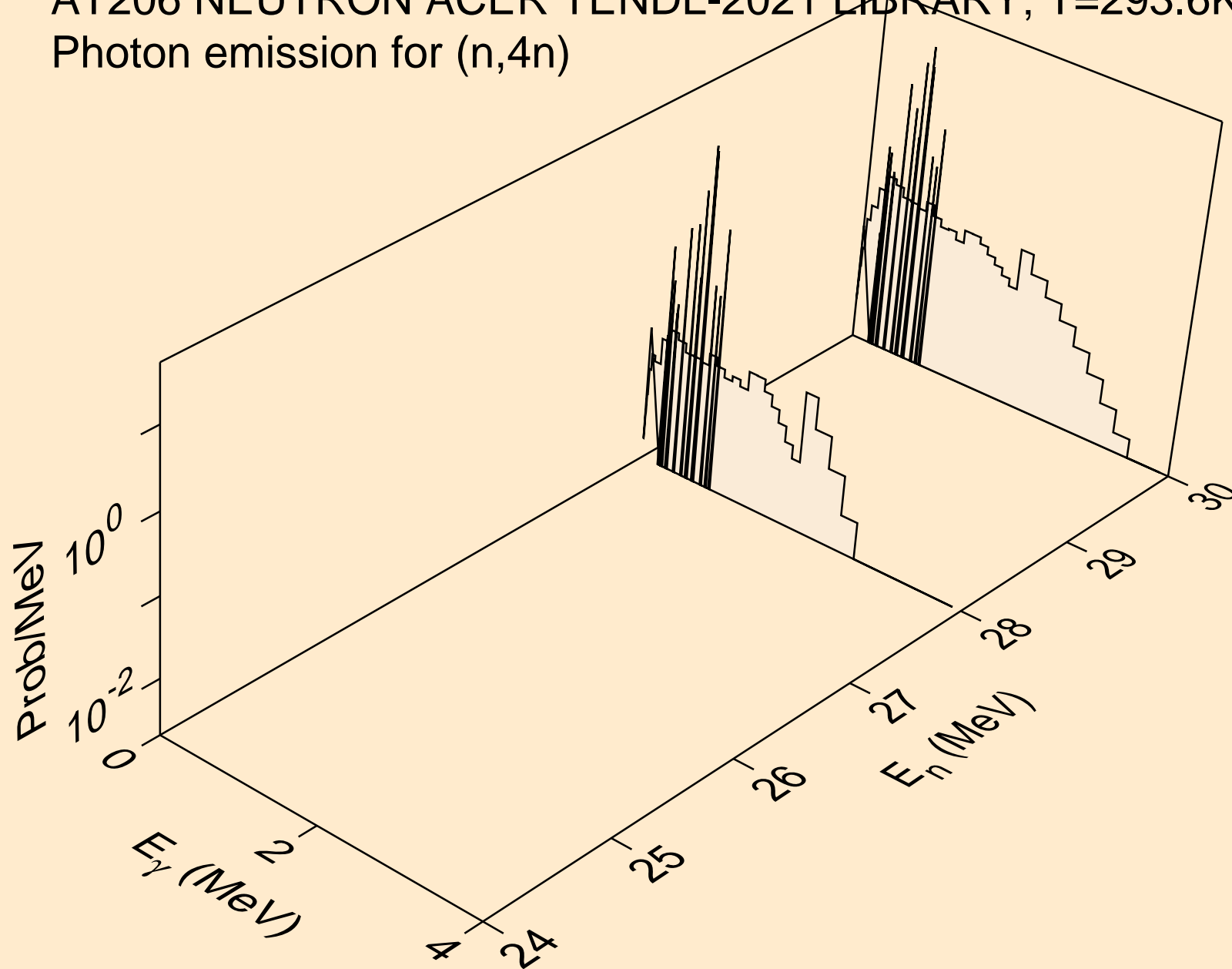

AT206 NEUTRON ACER TENDL-2021 LIBRARY; T=293.6K
Photon emission for (n,2np)

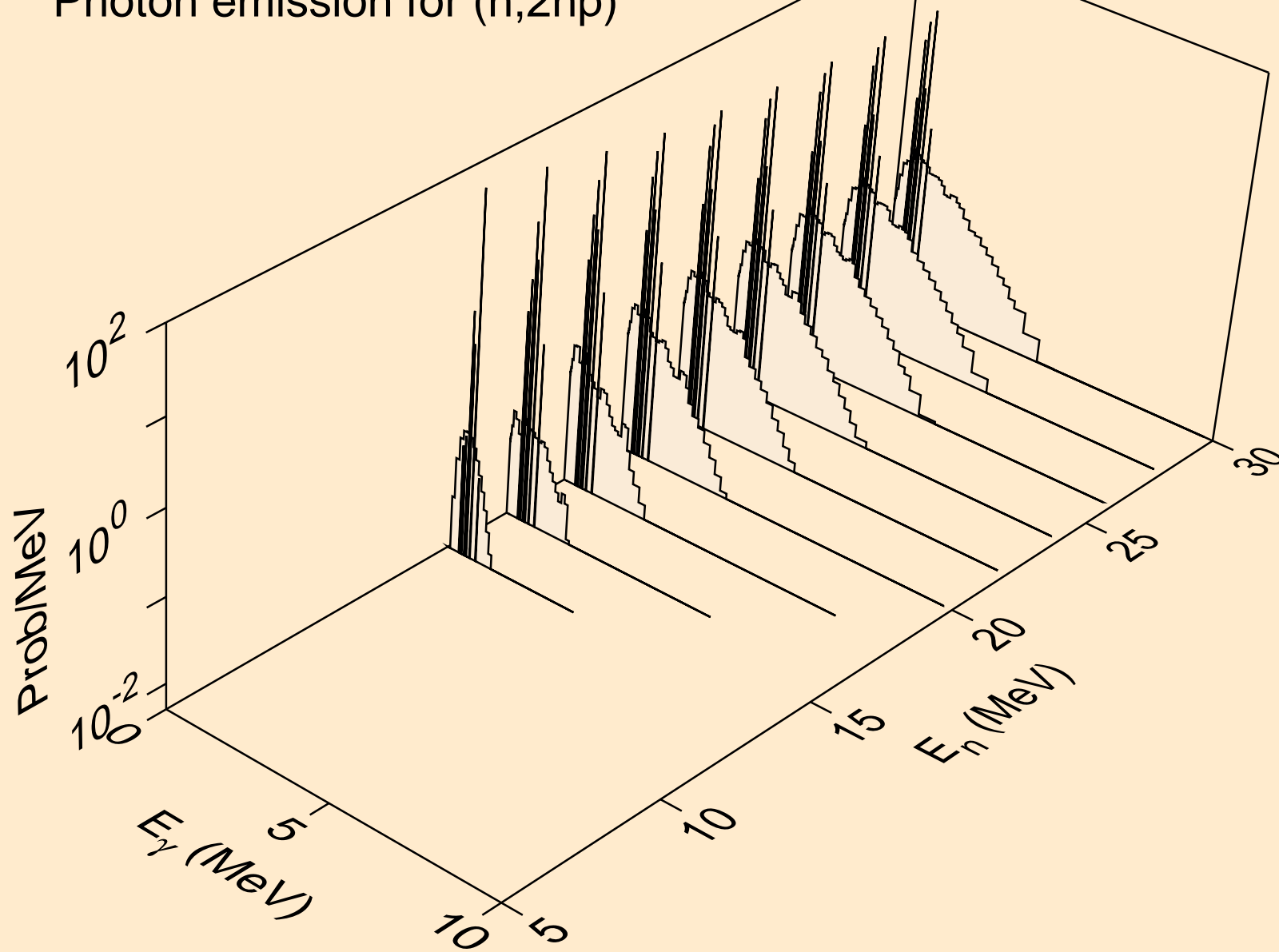

AT206 NEUTRON ACER TENDL-2021 LIBRARY; T=293.6K
Photon emission for (n,3np)

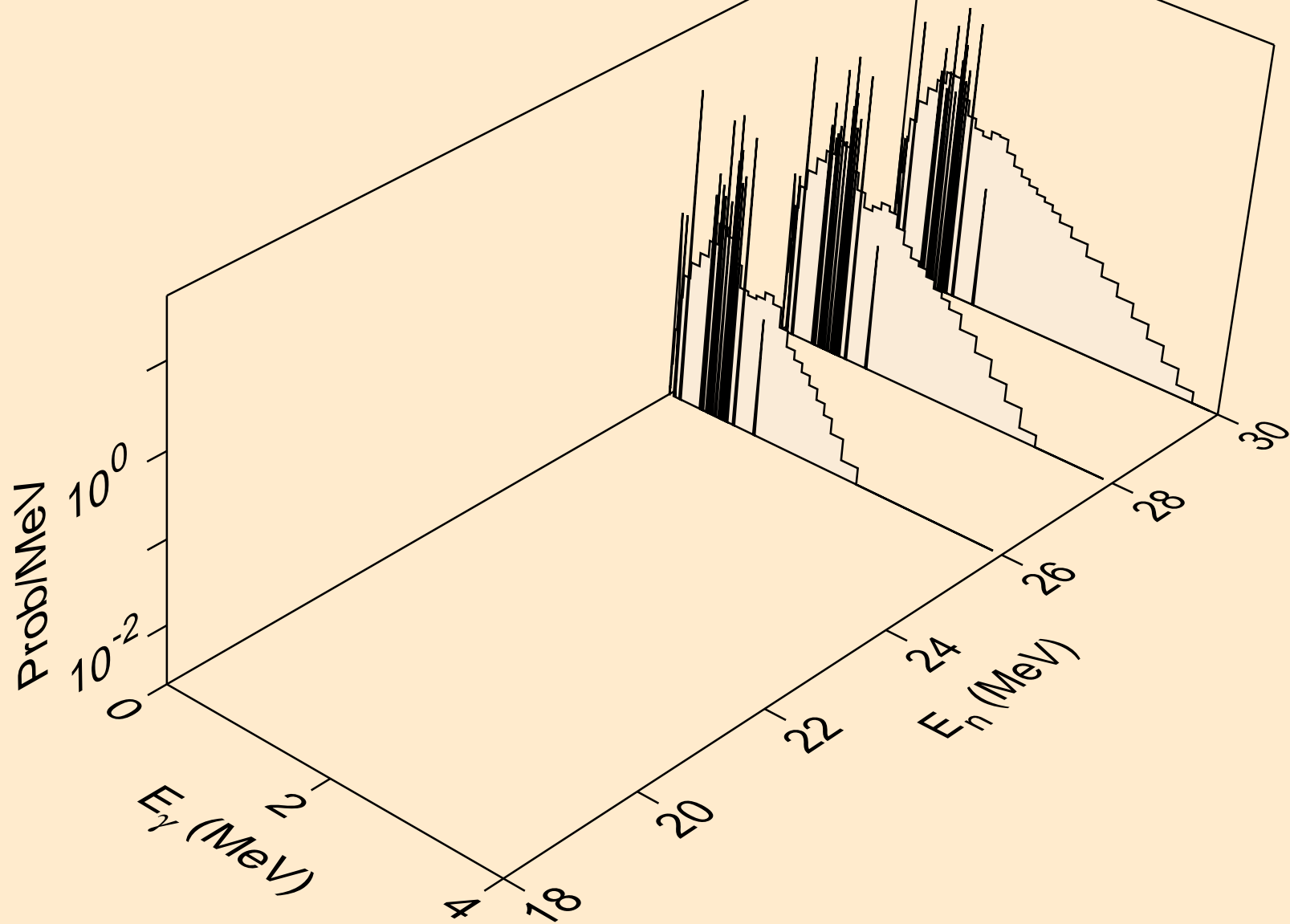

AT206 NEUTRON ACER TENDL-2021 LIBRARY; T=293.6K
Photon emission for (n,2np)

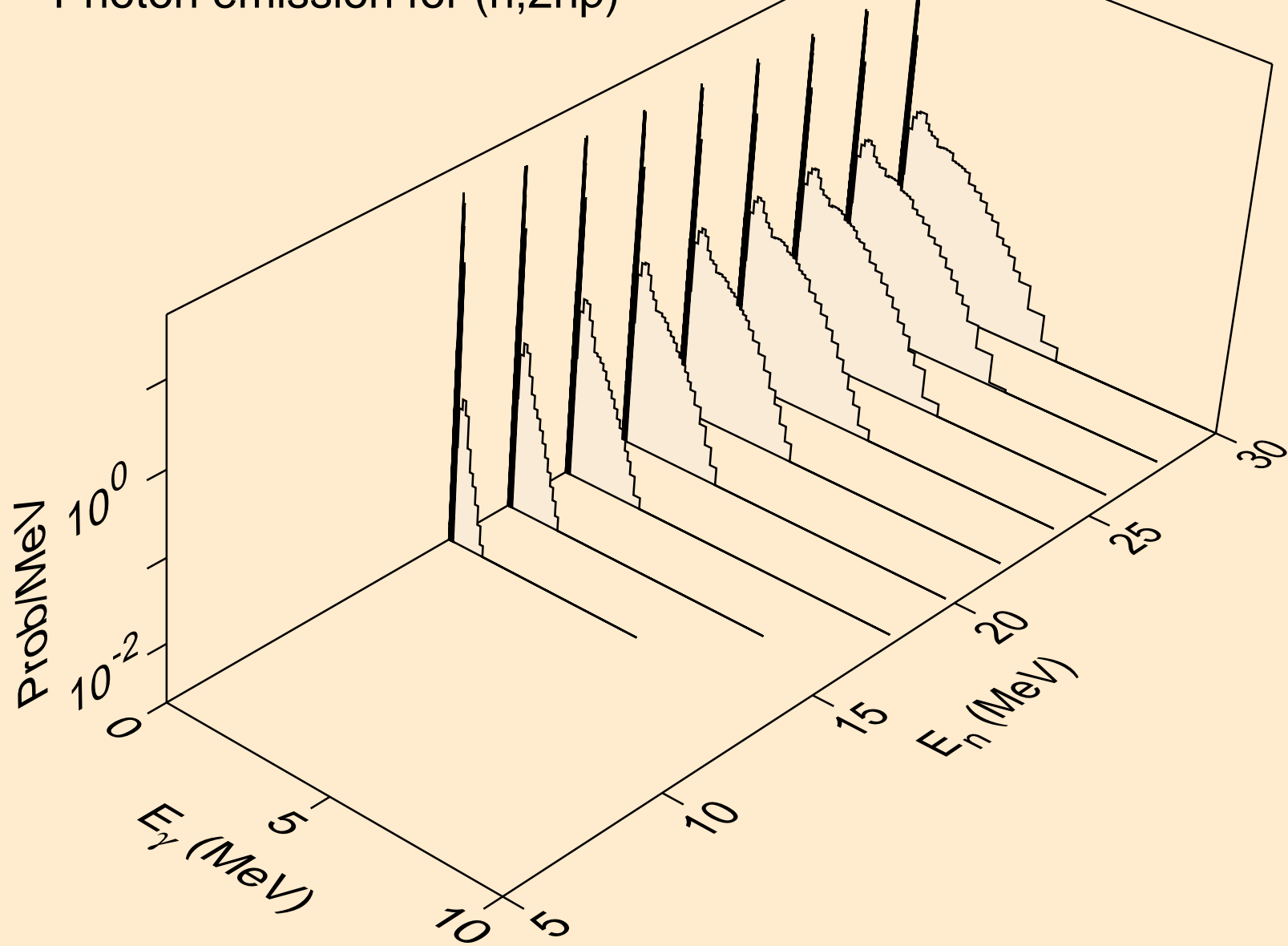

AT206 NEUTRON ACER TENDL-2021 LIBRARY; T=293.6K
Photon emission for (n,npa)

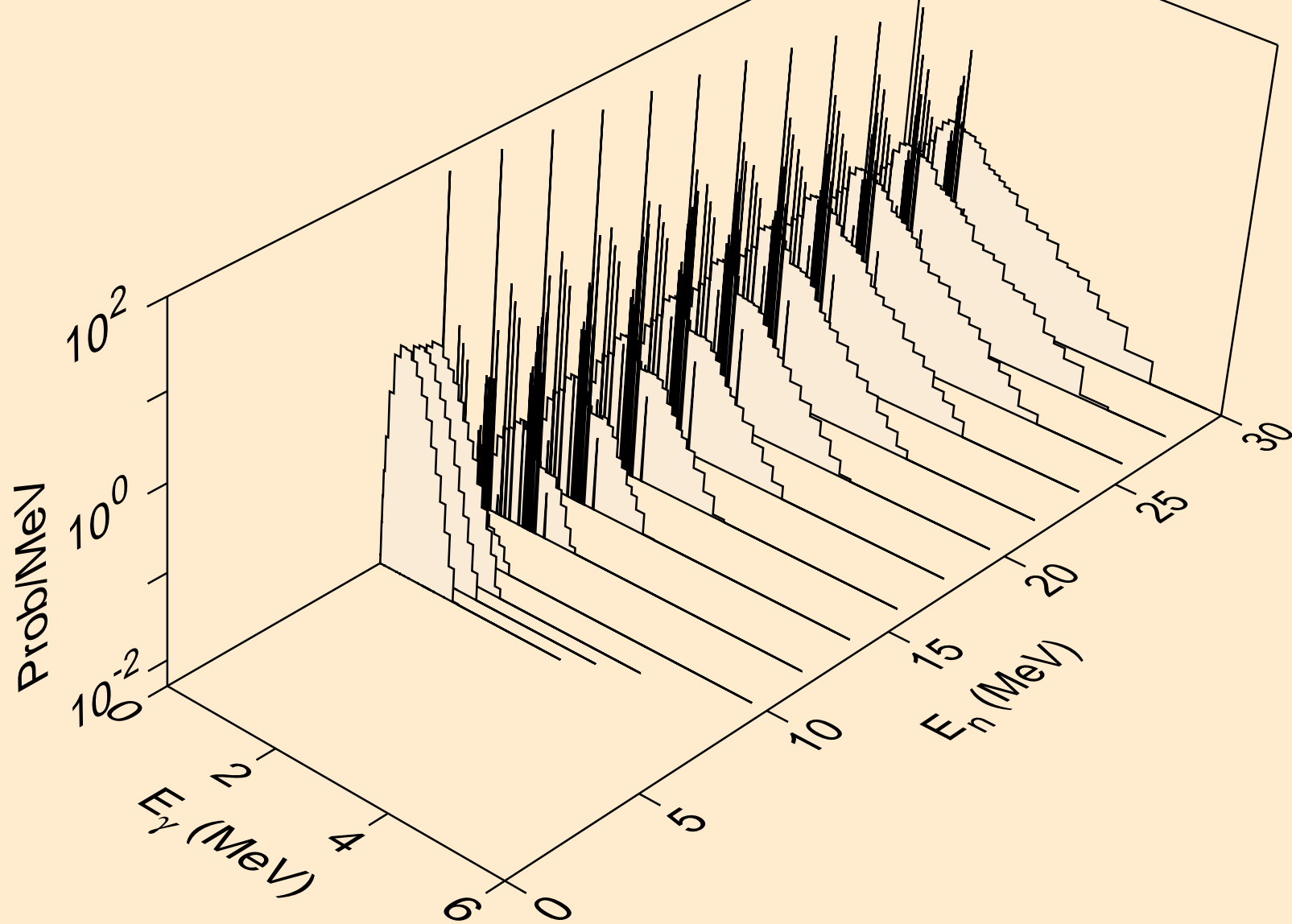

AT206 NEUTRON ACER TENDL-2021 LIBRARY; T=293.6K
Photon emission for (n,n*c)

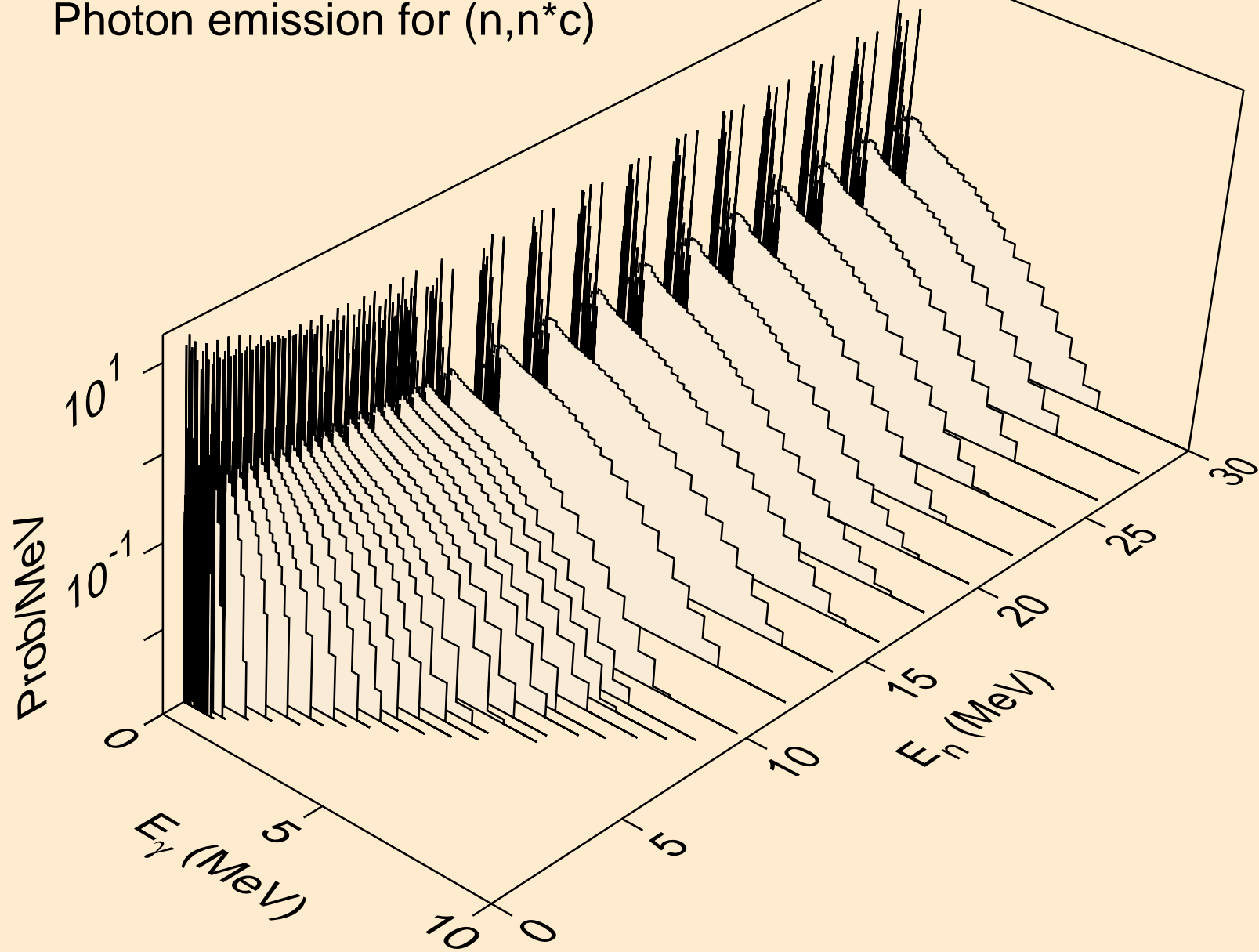

AT206 NEUTRON ACER TENDL-2021 LIBRARY; T=293.6K
Photon emission for (n,gma)

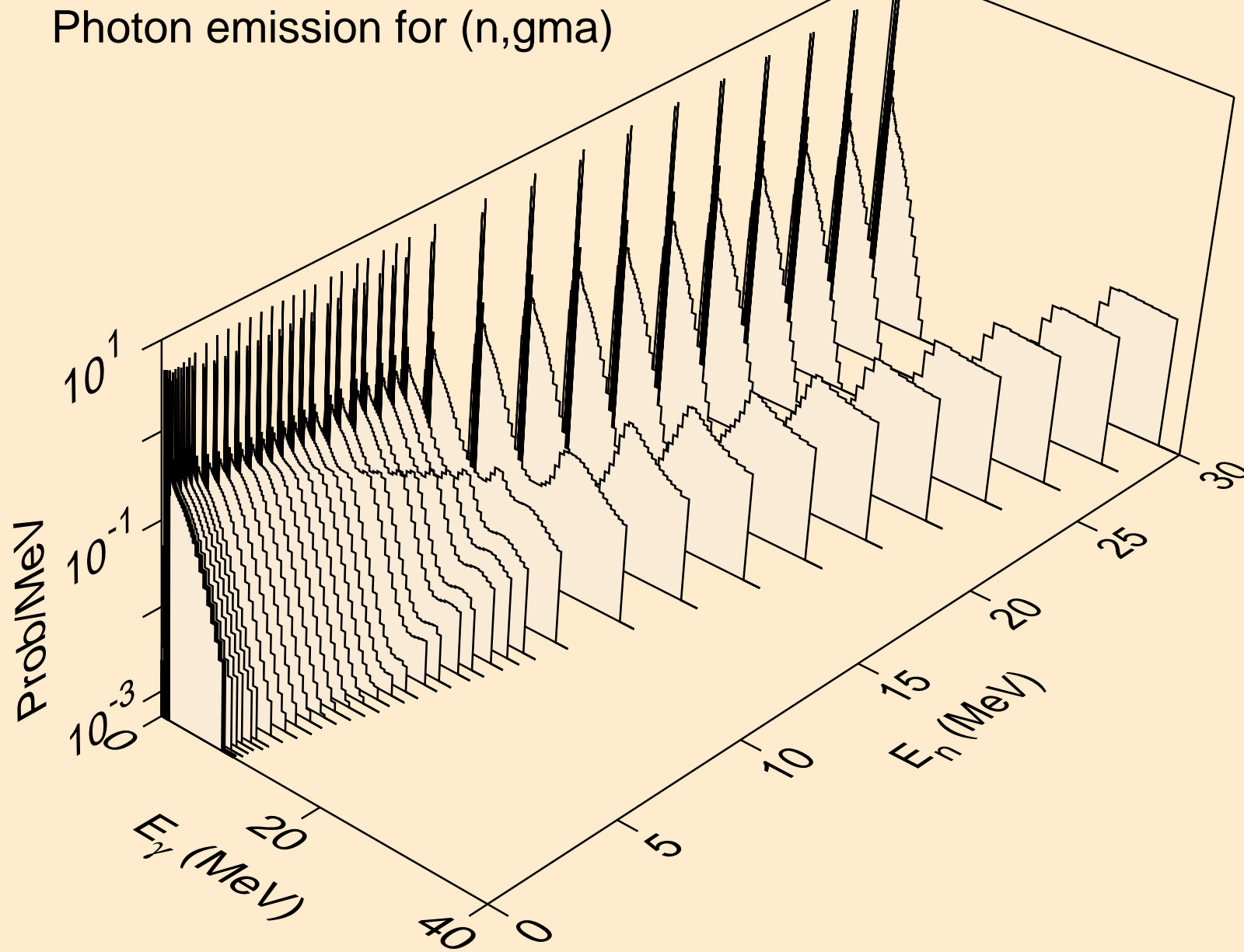

AT206 NEUTRON ACER TENDL-2021 LIBRARY; T=293.6K
Photon emission for (n,p)

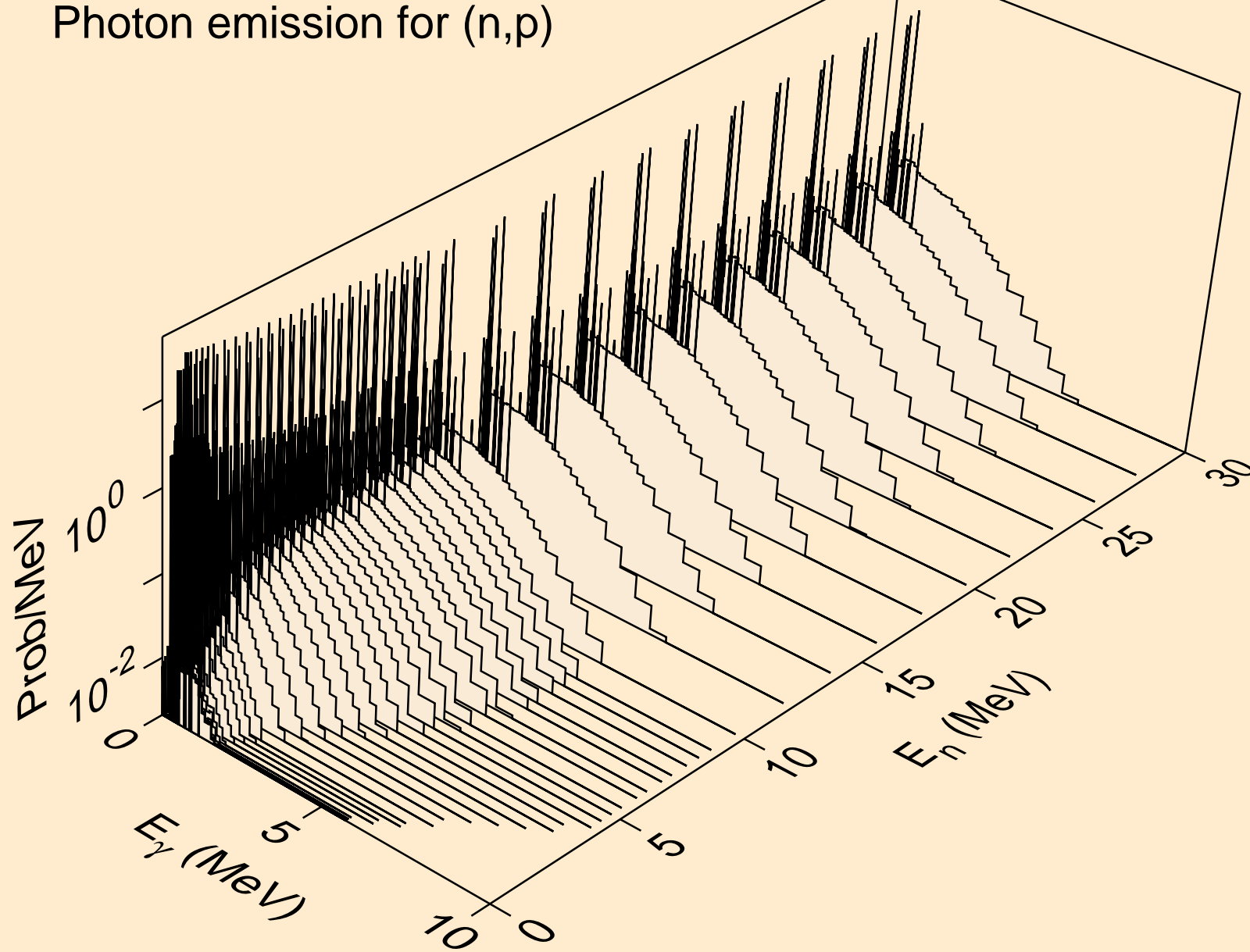

AT206 NEUTRON ACER TENDL-2021 LIBRARY; T=293.6K
Photon emission for (n,d)

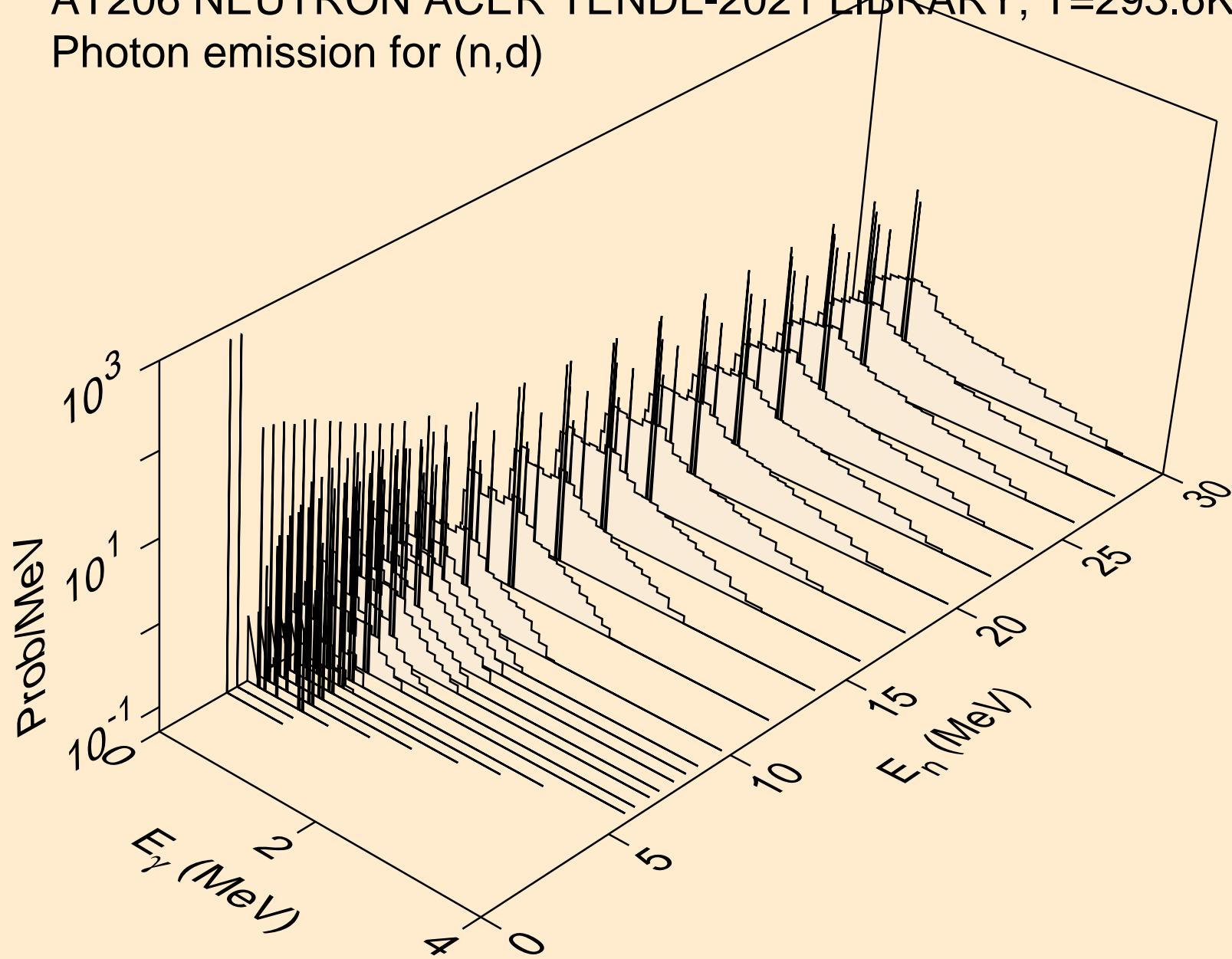

AT206 NEUTRON ACER TENDL-2021 LIBRARY; T=293.6K
Photon emission for (n,t)

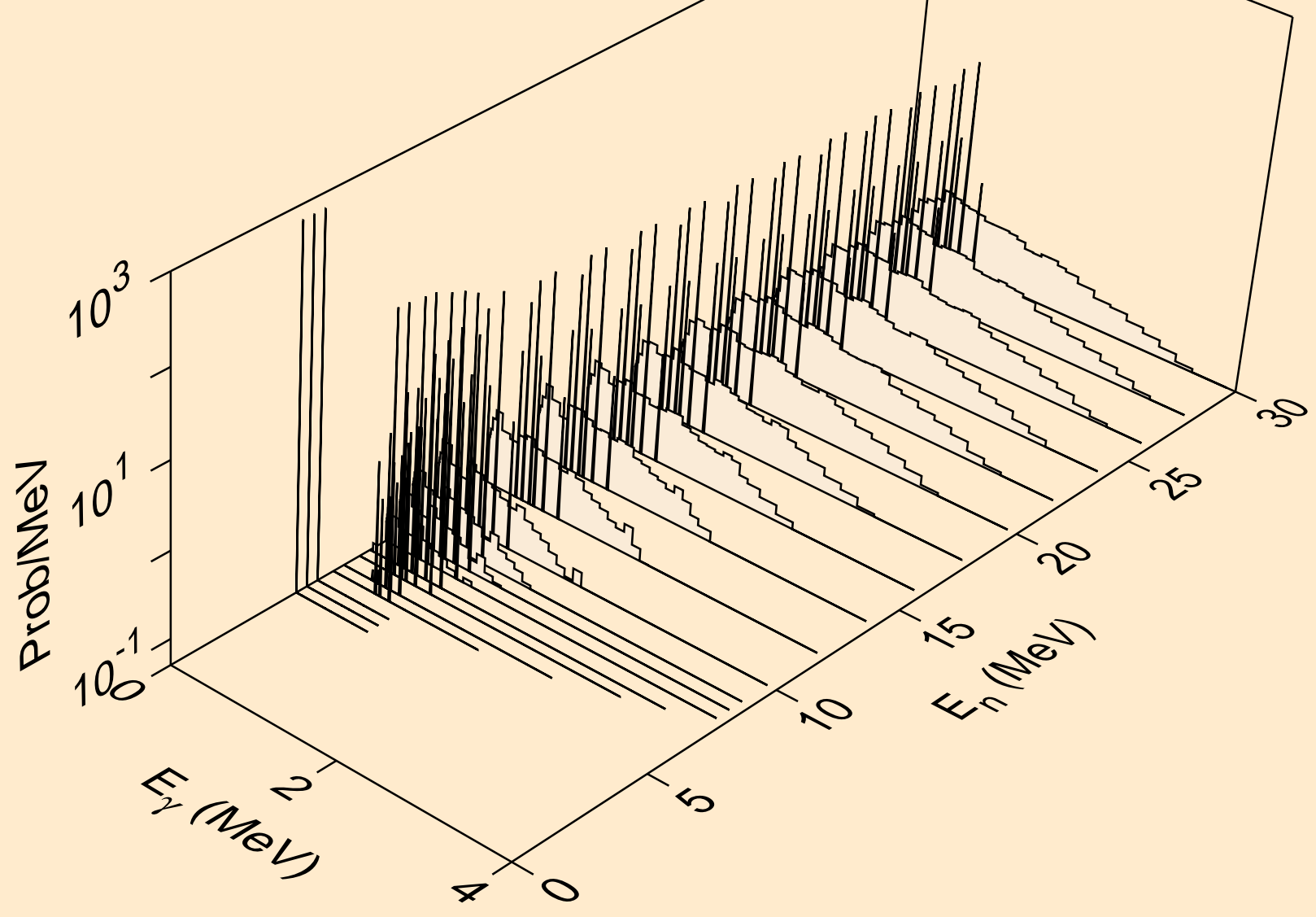

AT206 NEUTRON ACER TENDL-2021 LIBRARY; T=293.6K
Photon emission for (n,he3)

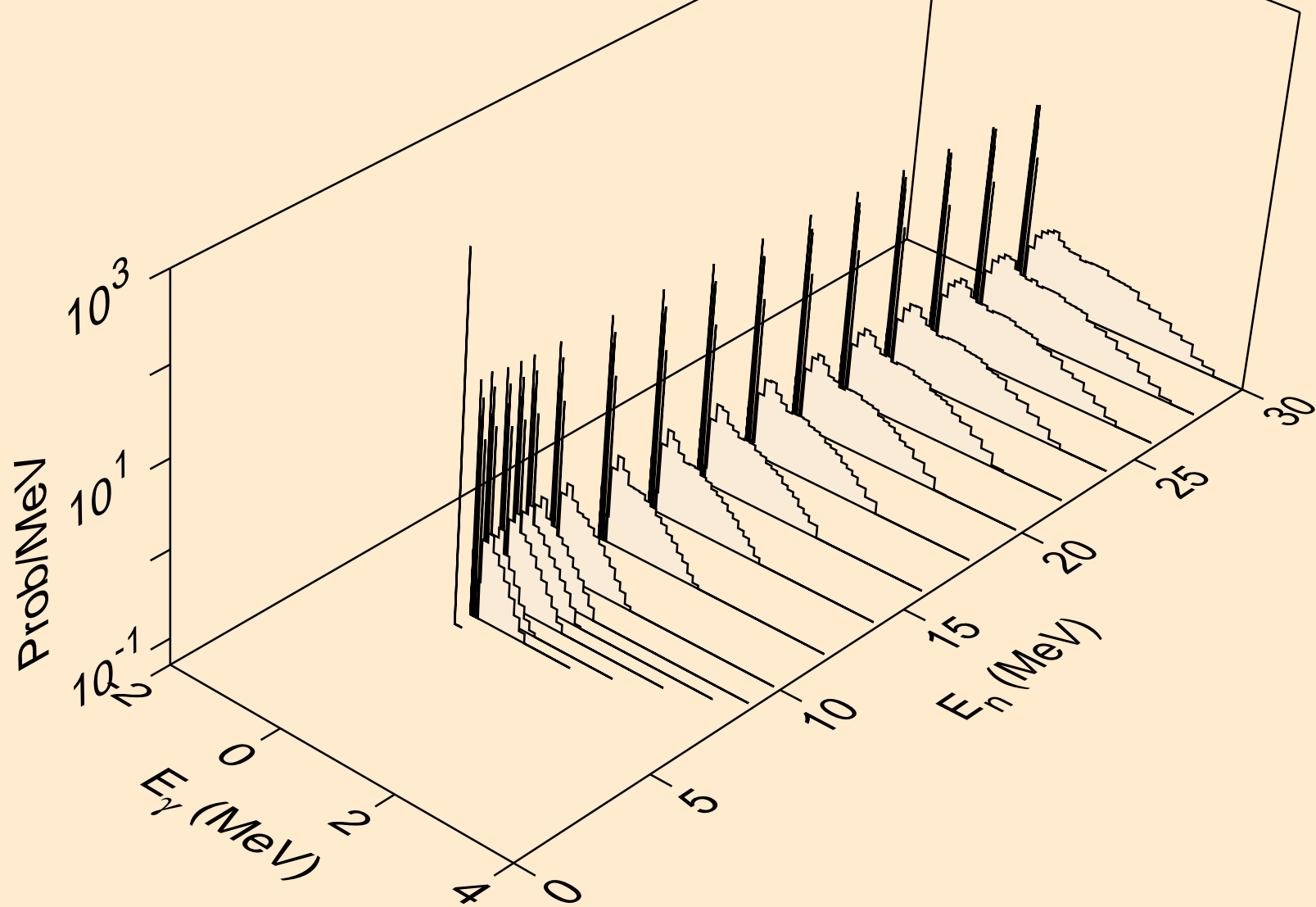

AT206 NEUTRON ACER TENDL-2021 LIBRARY; T=293.6K
Photon emission for (n,a)

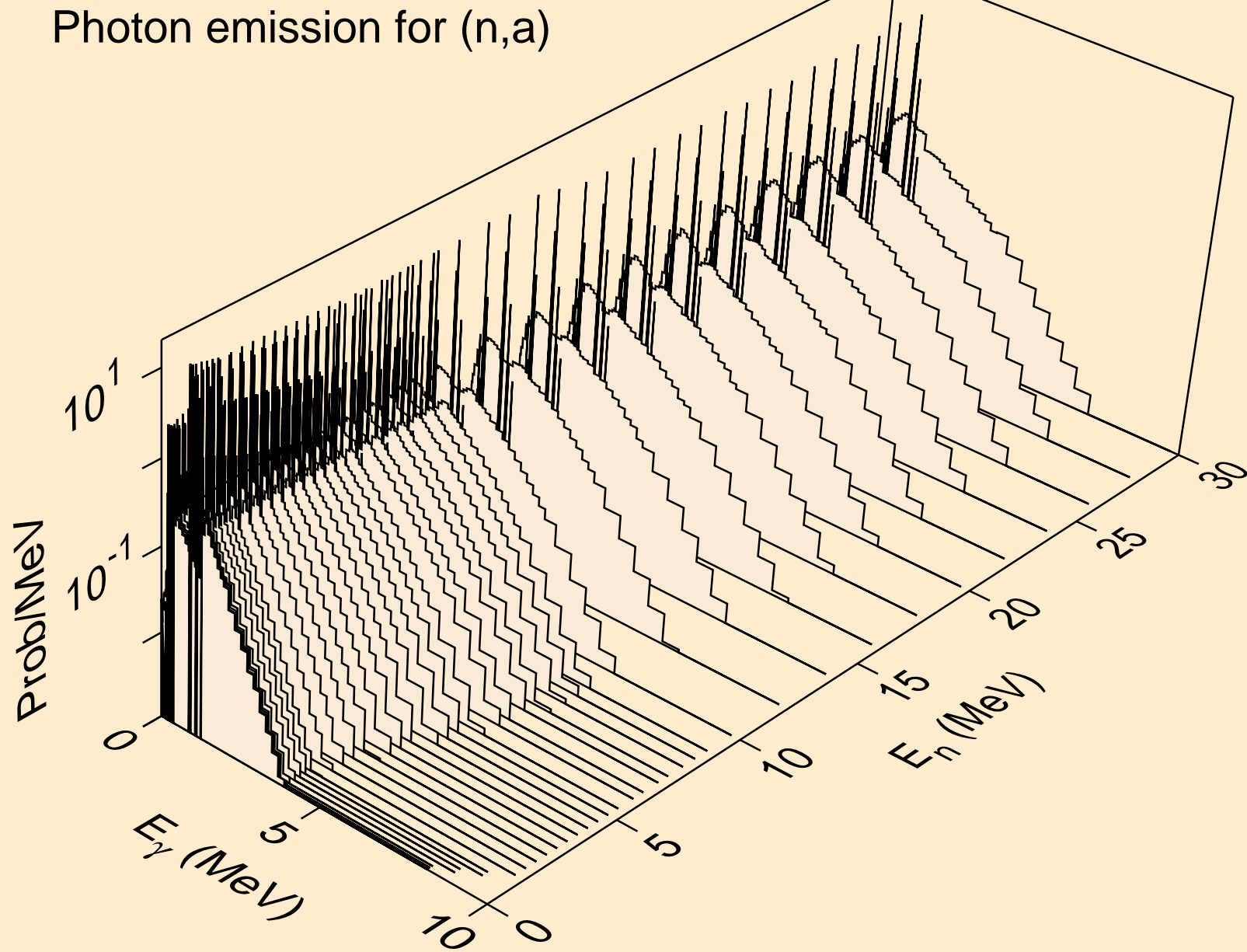

AT206 NEUTRON ACER TENDL-2021 LIBRARY; T=293.6K
Photon emission for (n,2a)

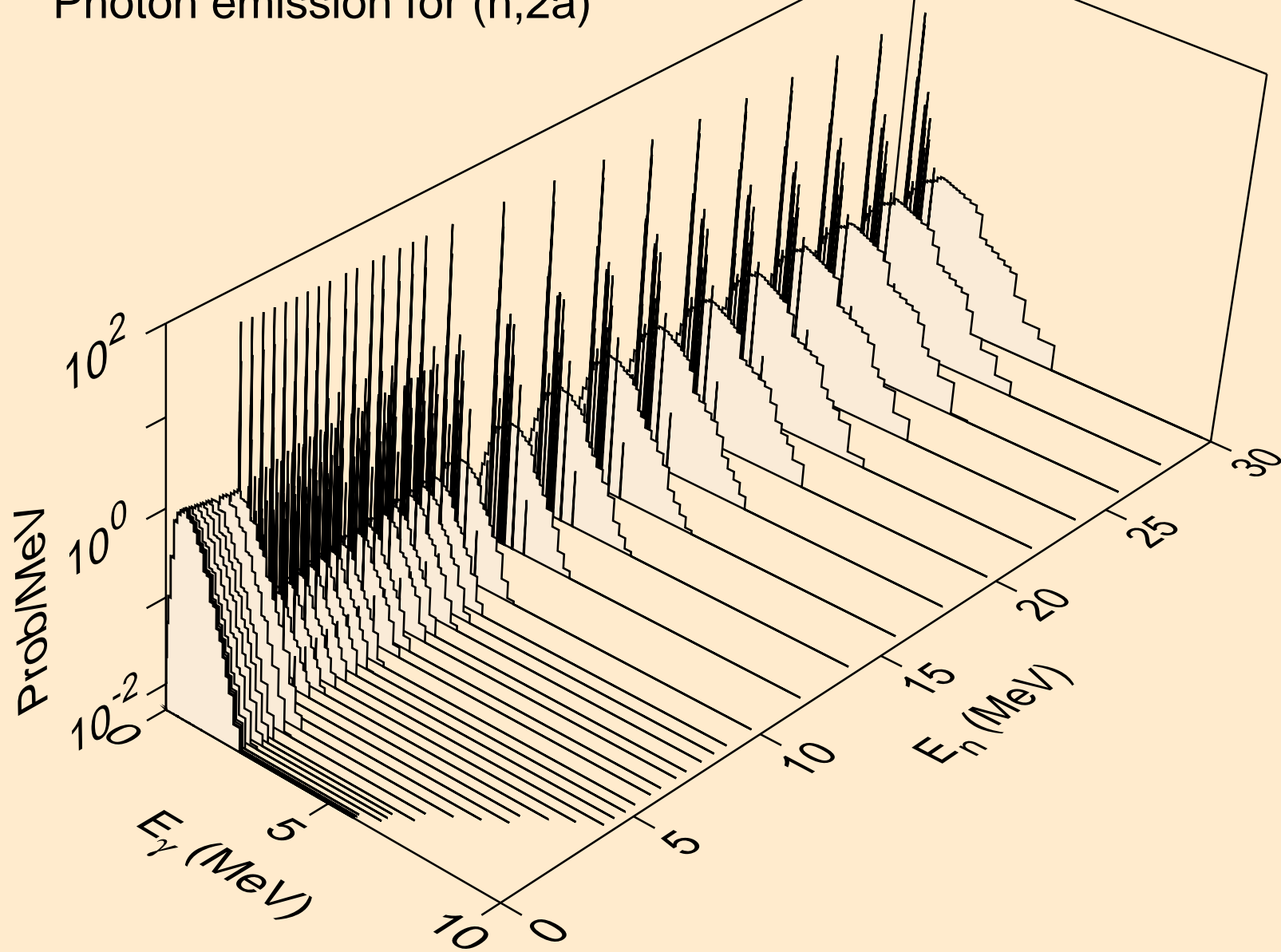

AT206 NEUTRON ACER TENDL-2021 LIBRARY; T=293.6K
Photon emission for (n,2p)

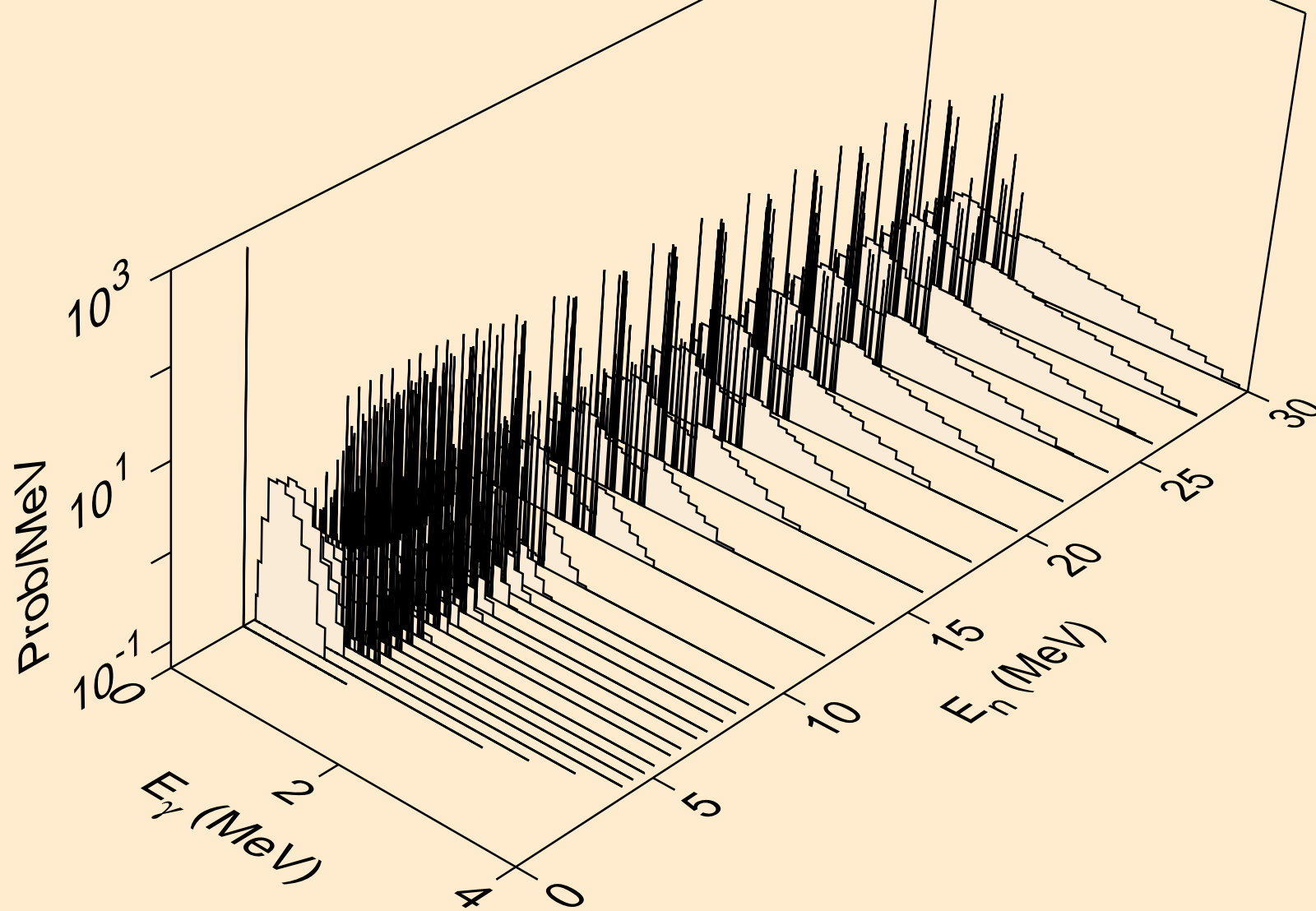

AT206 NEUTRON ACER TENDL-2021 LIBRARY; T=293.6K
Photon emission for (n,p α)

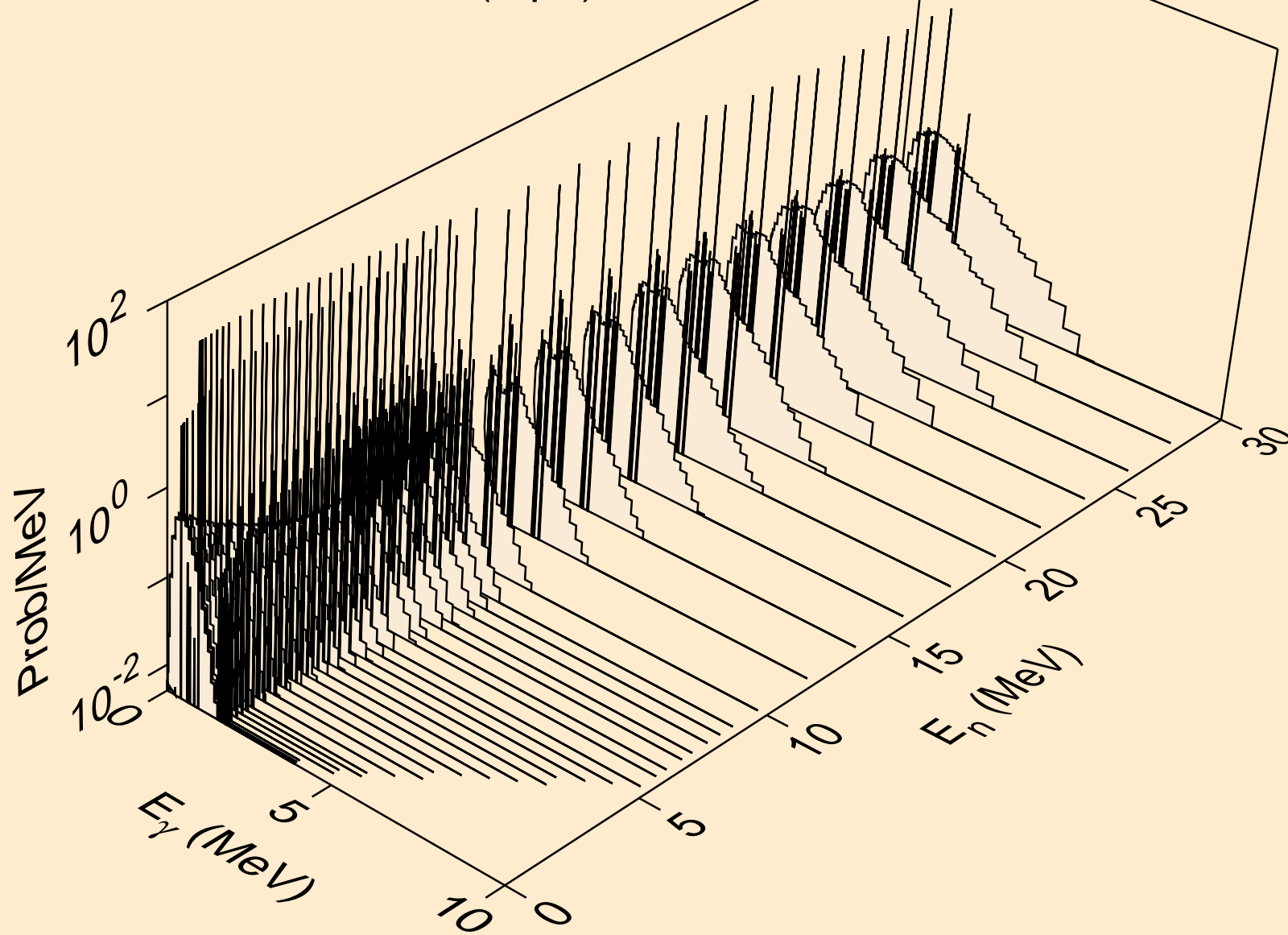

AT206 NEUTRON ACER TENDL-2021 LIBRARY; T=293.6K
Photon emission for (n,pd)

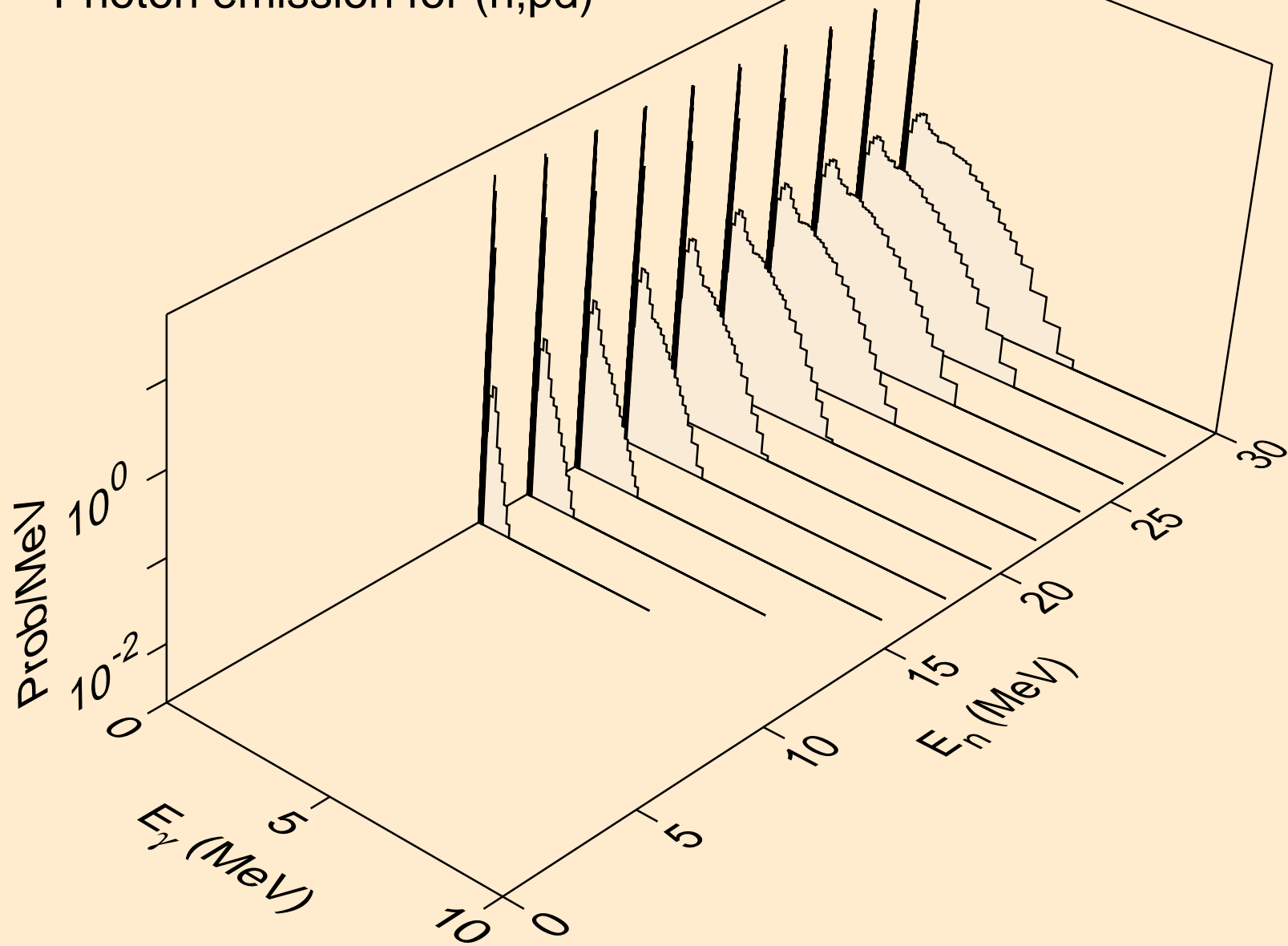

AT206 NEUTRON ACER TENDL-2021 LIBRARY; T=293.6K
Photon emission for (n,pt)

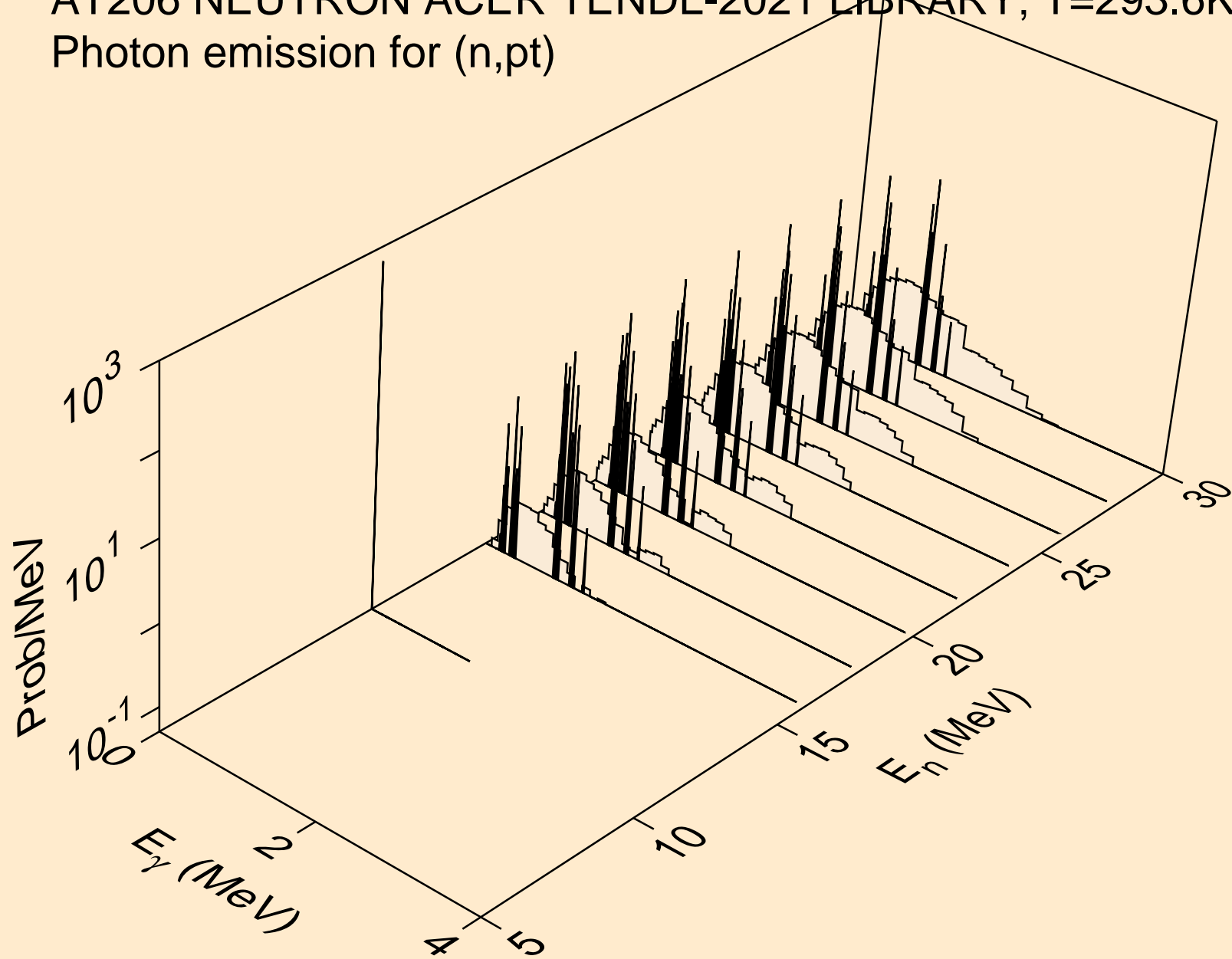

AT206 NEUTRON ACER TENDL-2021 LIBRARY; T=293.6K
Photon emission for (n,da)

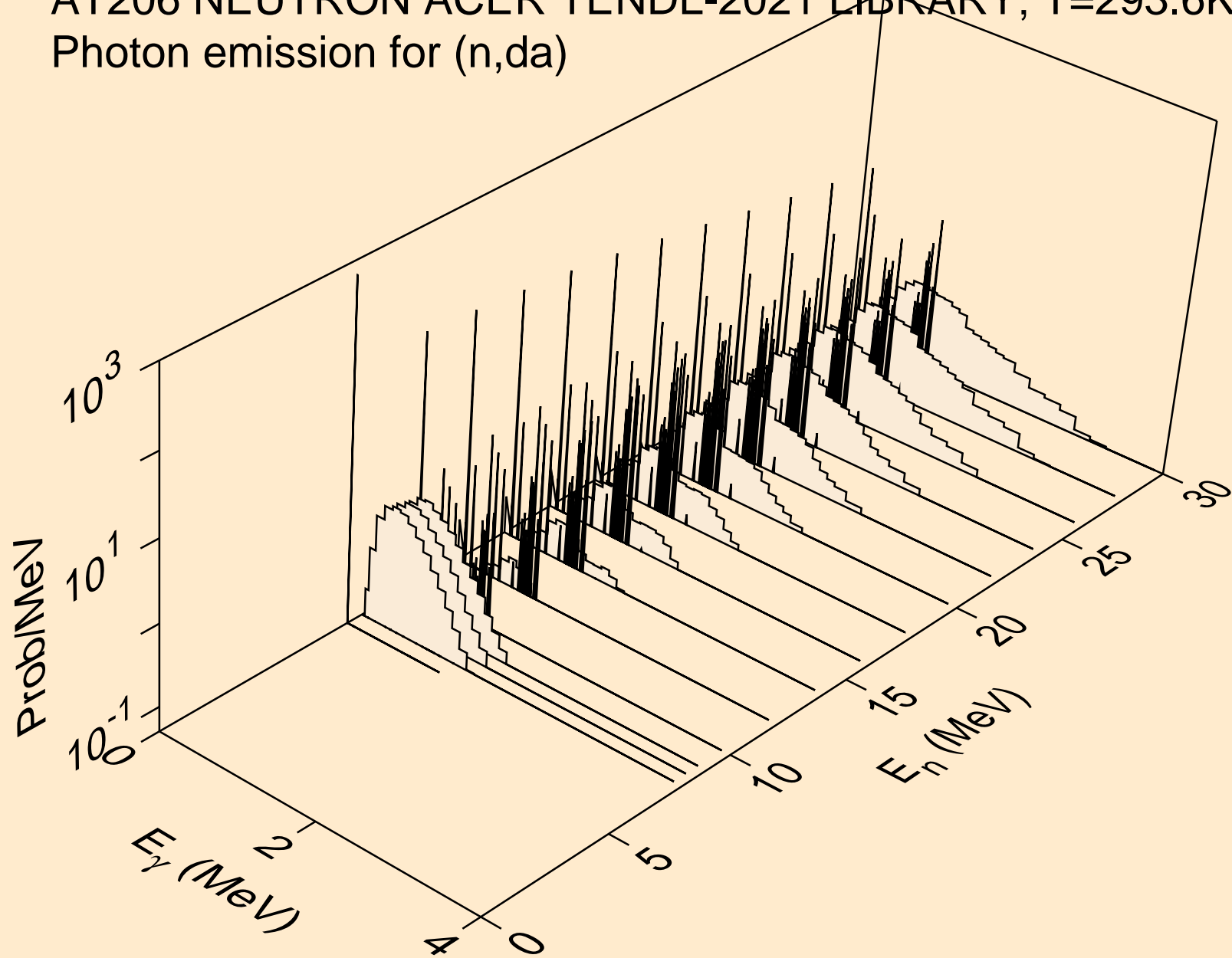

AT206 NEUTRON ACER TENDL-2021 LIBRARY; T=293.6K
thermal capture photon spectrum

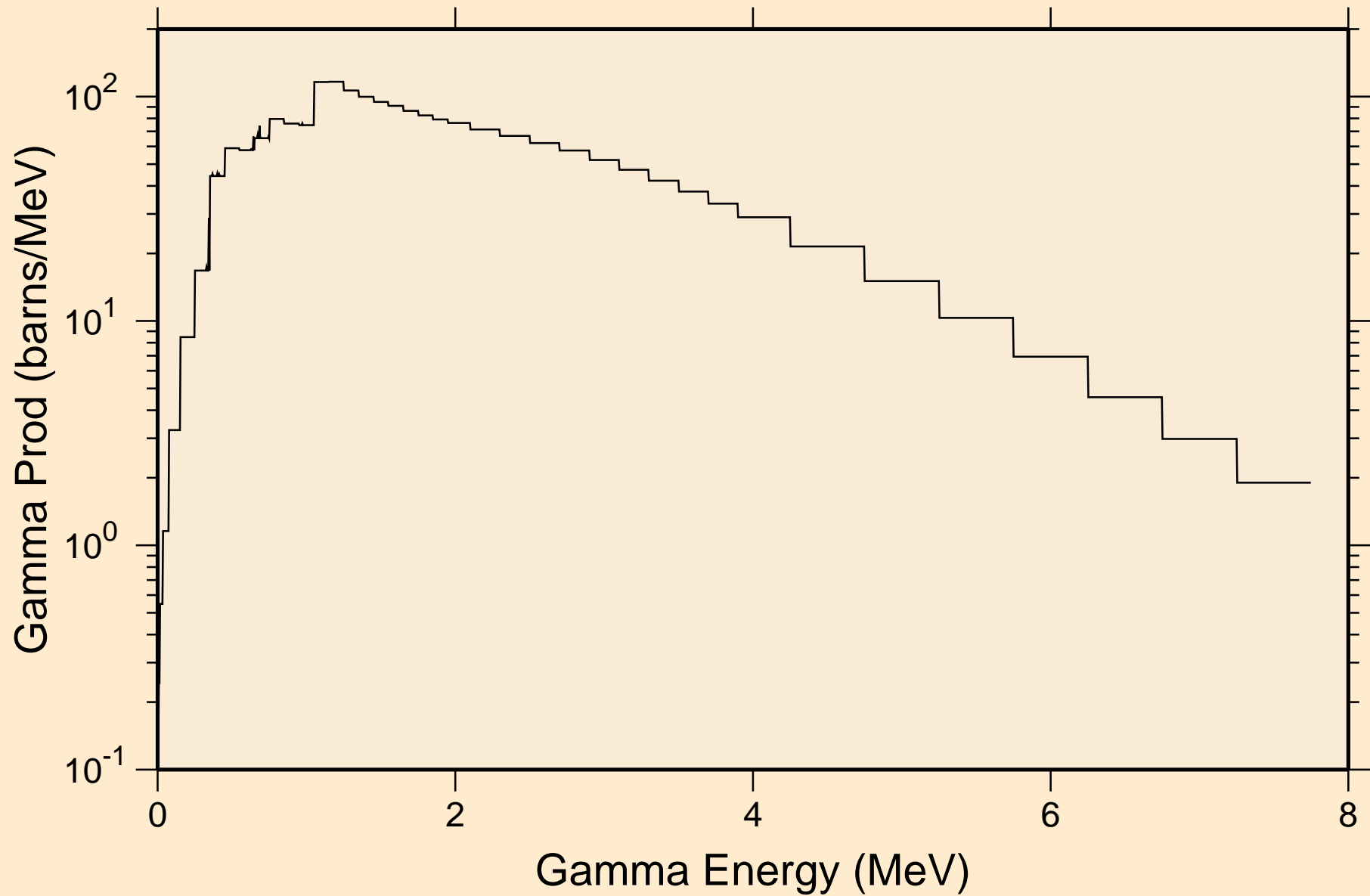

AT206 NEUTRON ACER TENDL-2021 LIBRARY; T=293.6K
14 MeV photon spectrum

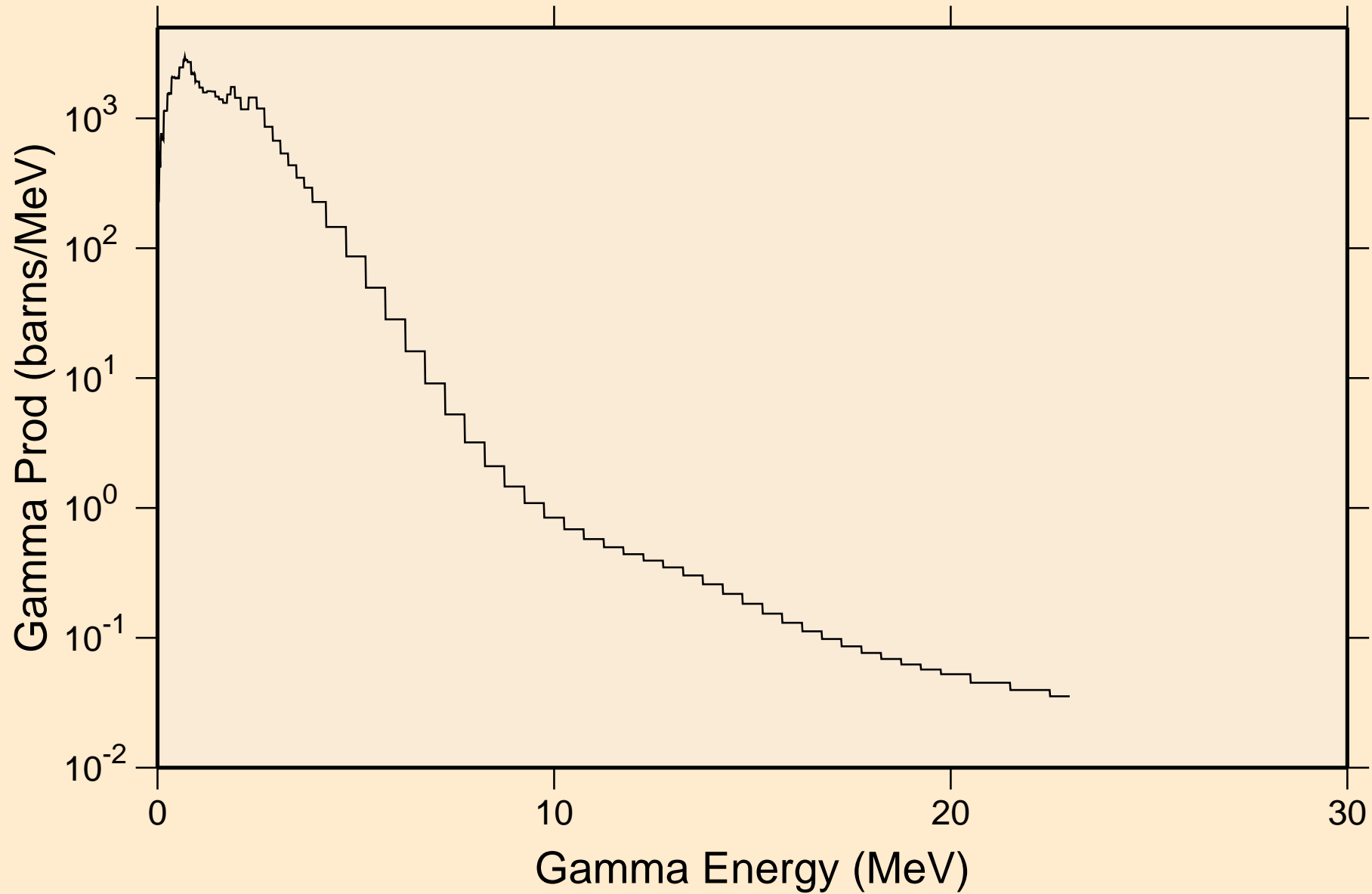

AT206 NEUTRON ACER TENDL-2021 LIBRARY; T=293.6K
Particle heating contributions

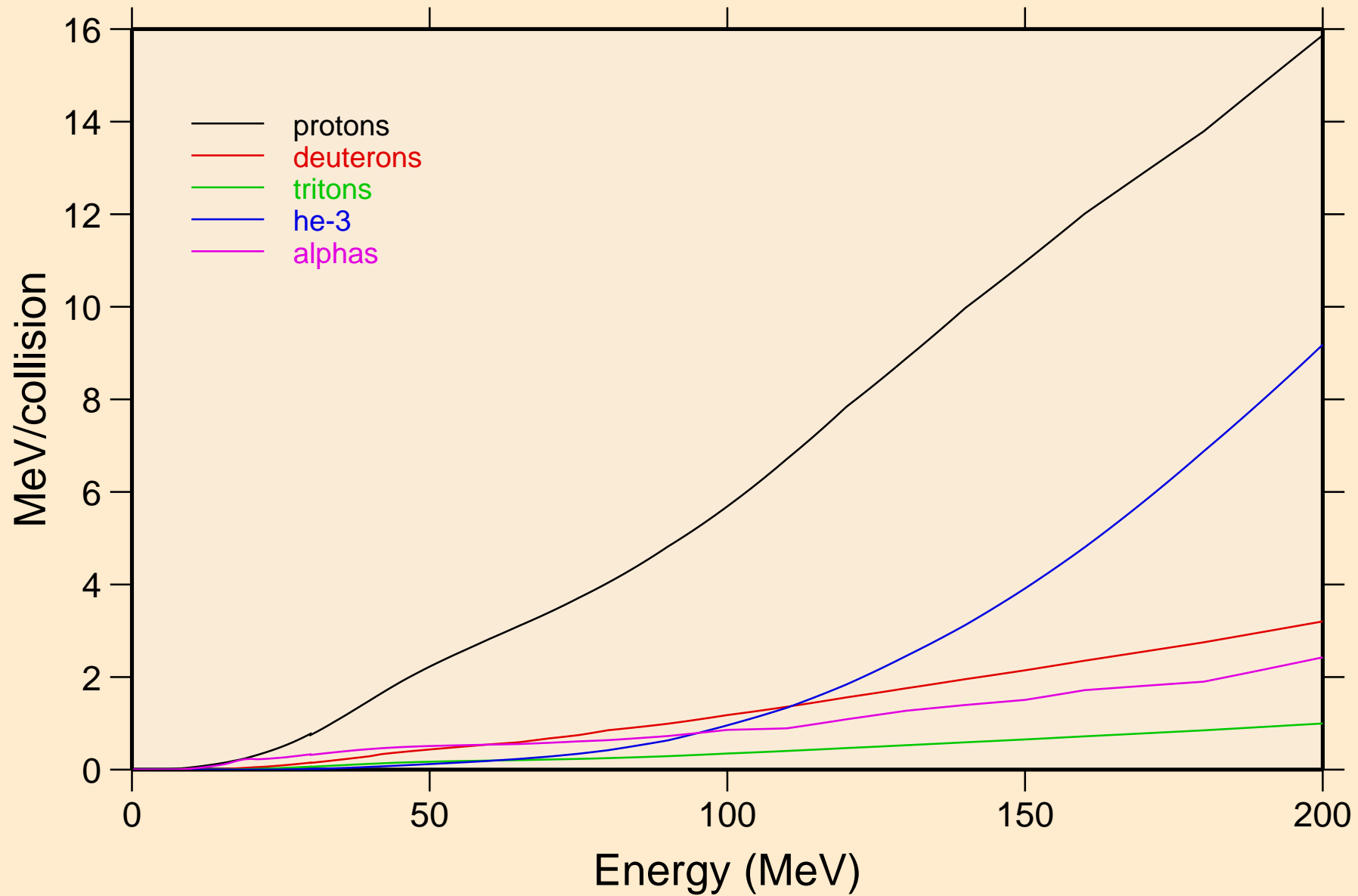

AT206 NEUTRON ACER TENDL-2021 LIBRARY; T=293.6K
Recoil Heating

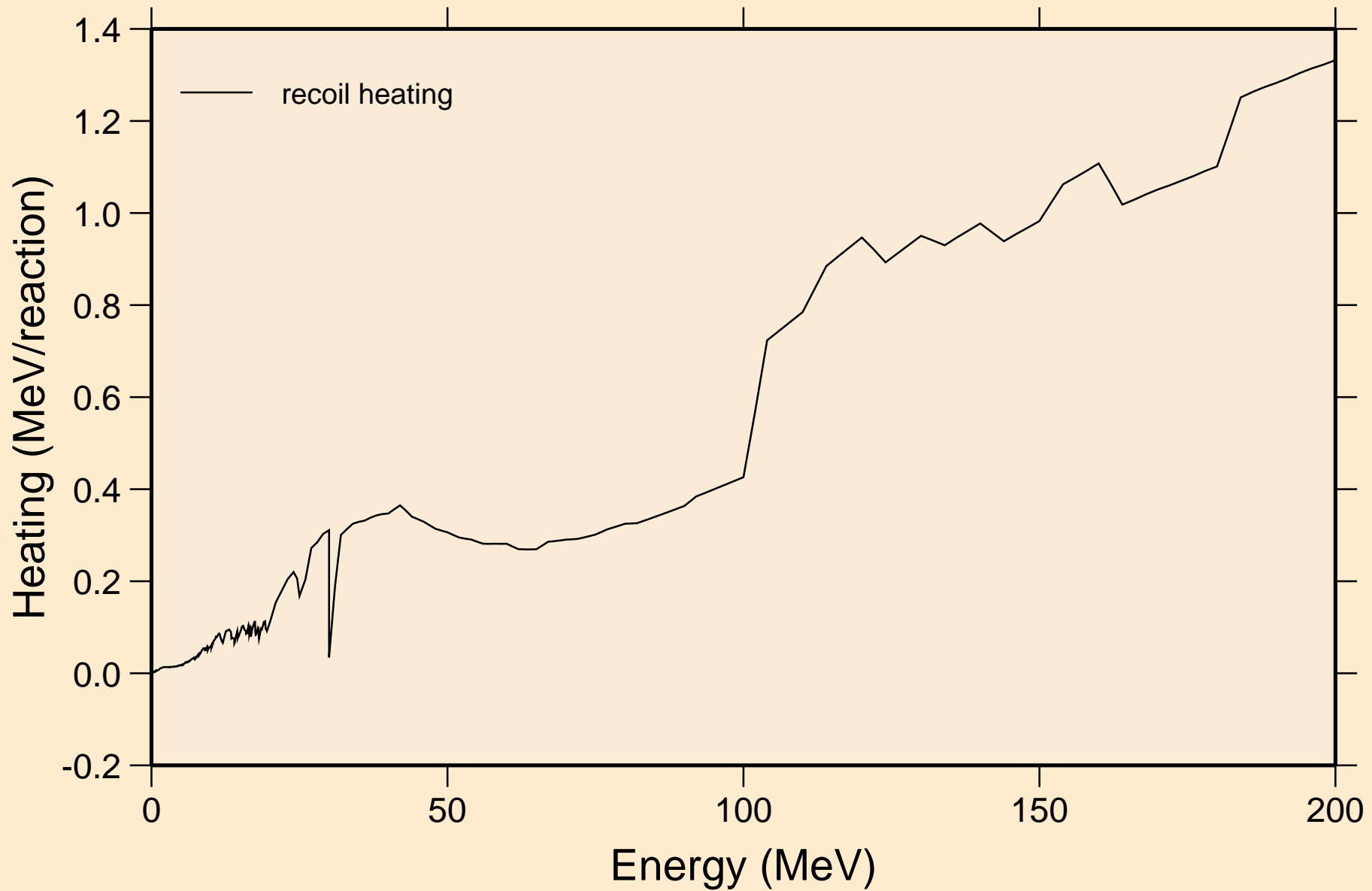

AT206 NEUTRON ACER TENDL-2021 LIBRARY; T=293.6K
Particle production cross sections

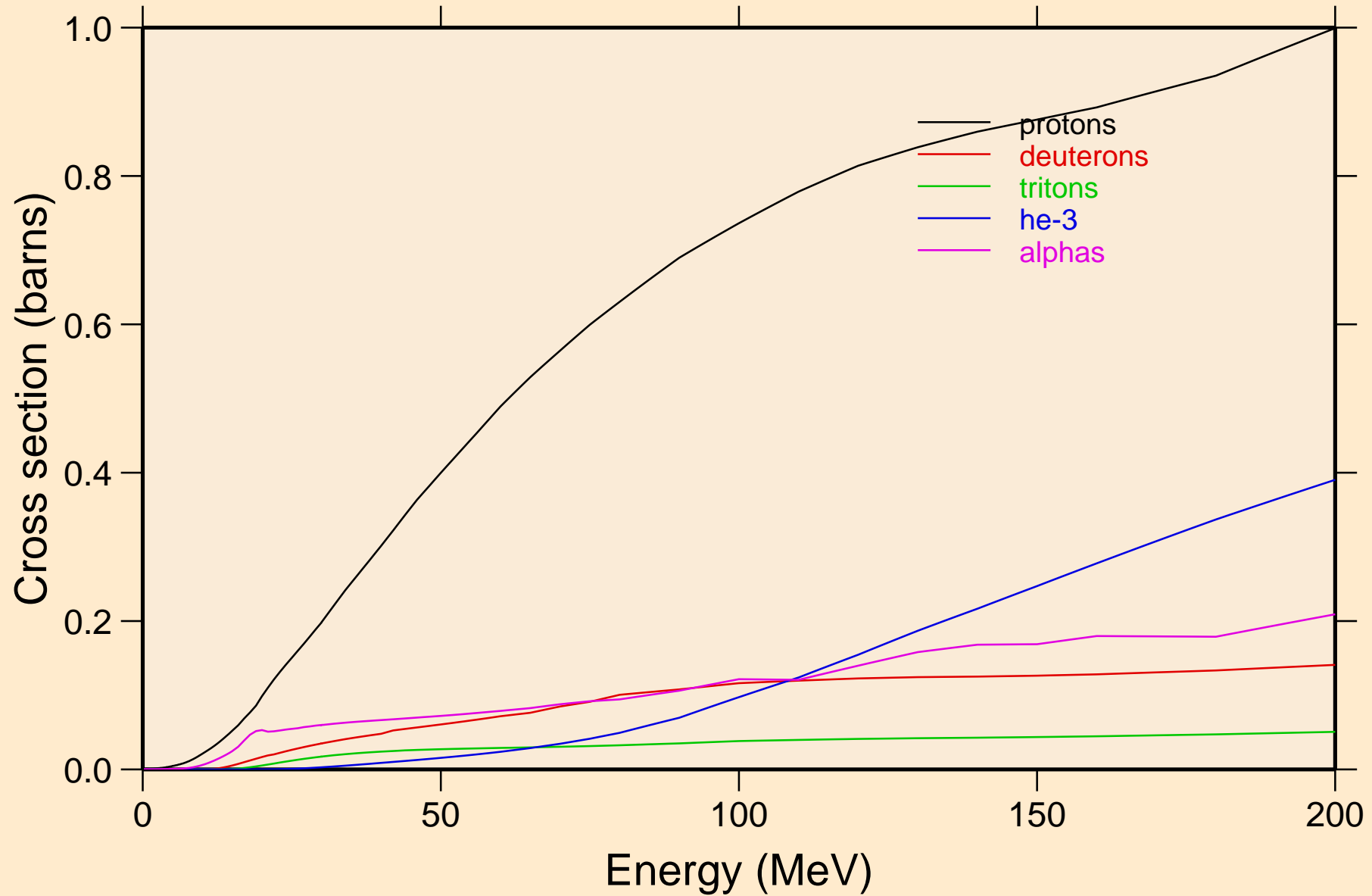

AT206 NEUTRON ACER TENDL-2021 LIBRARY; T=293.6K
protons from (n,x)

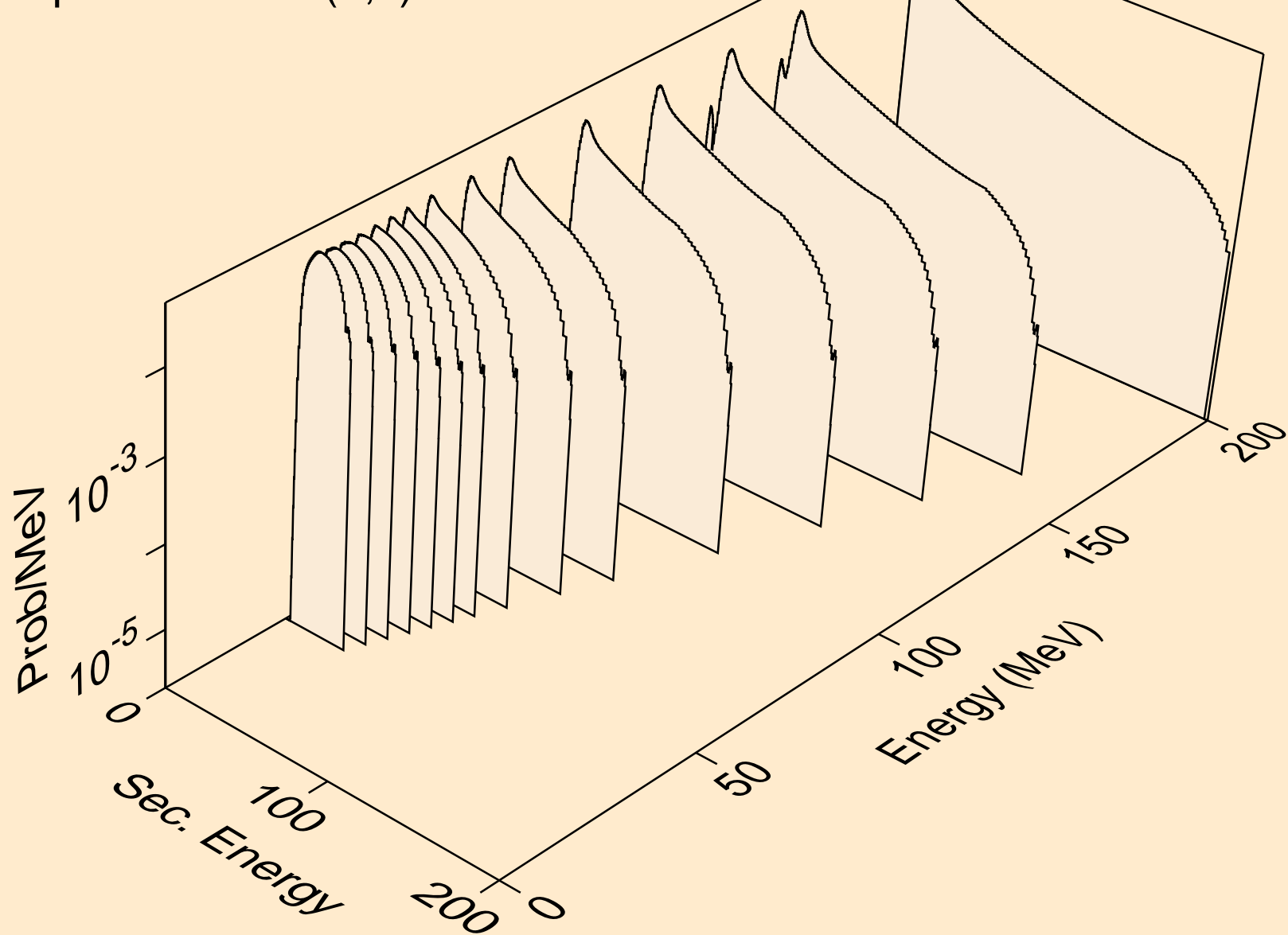

AT206 NEUTRON ACER TENDL-2021 LIBRARY; T=293.6K
protons from (n,n*)p

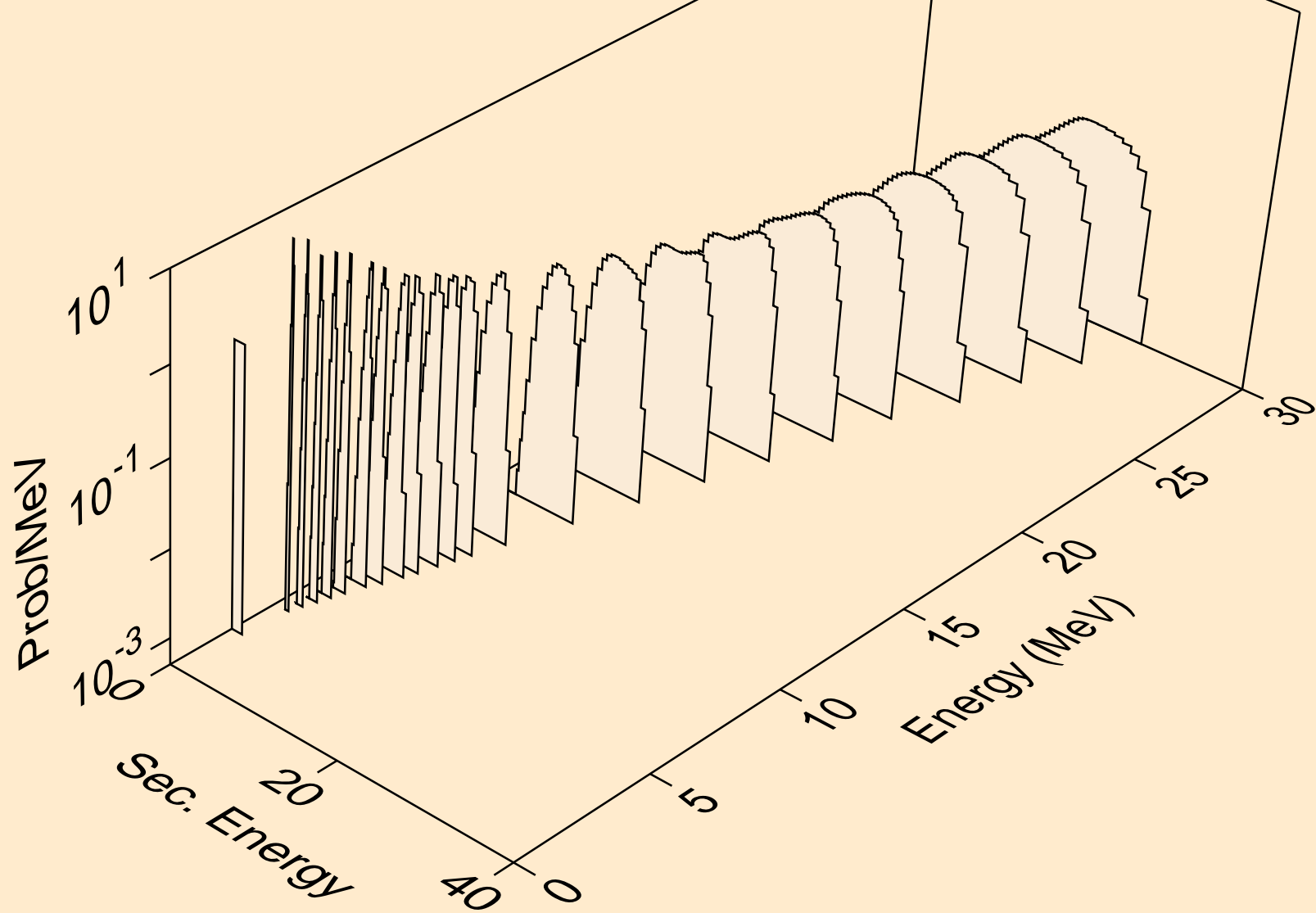

AT206 NEUTRON ACER TENDL-2021 LIBRARY; T=293.6K
protons from (n,2np)

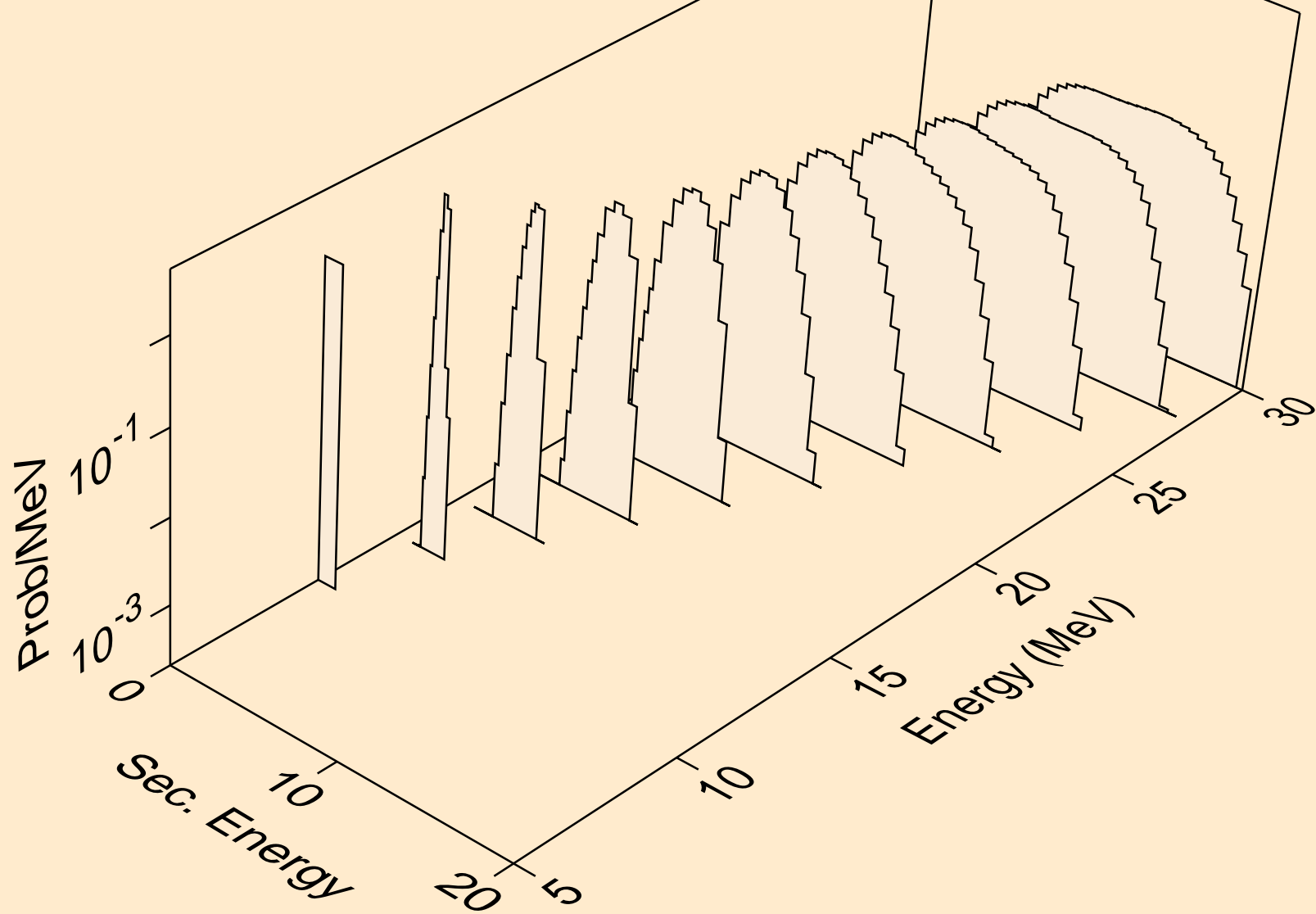

AT206 NEUTRON ACER TENDL-2021 LIBRARY; T=293.6K
protons from (n,3np)

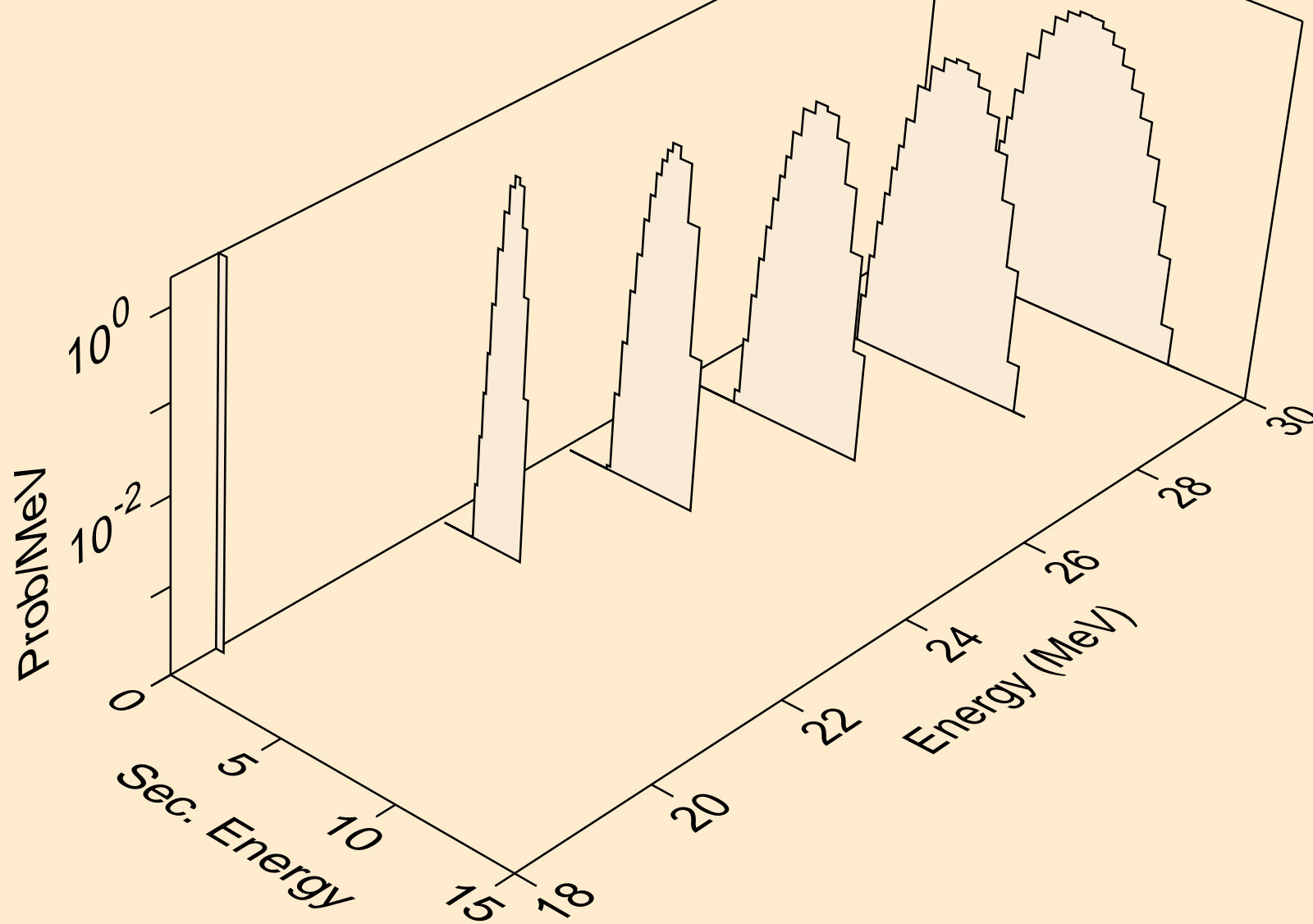

AT206 NEUTRON ACER TENDL-2021 LIBRARY; T=293.6K
protons from (n,2np)

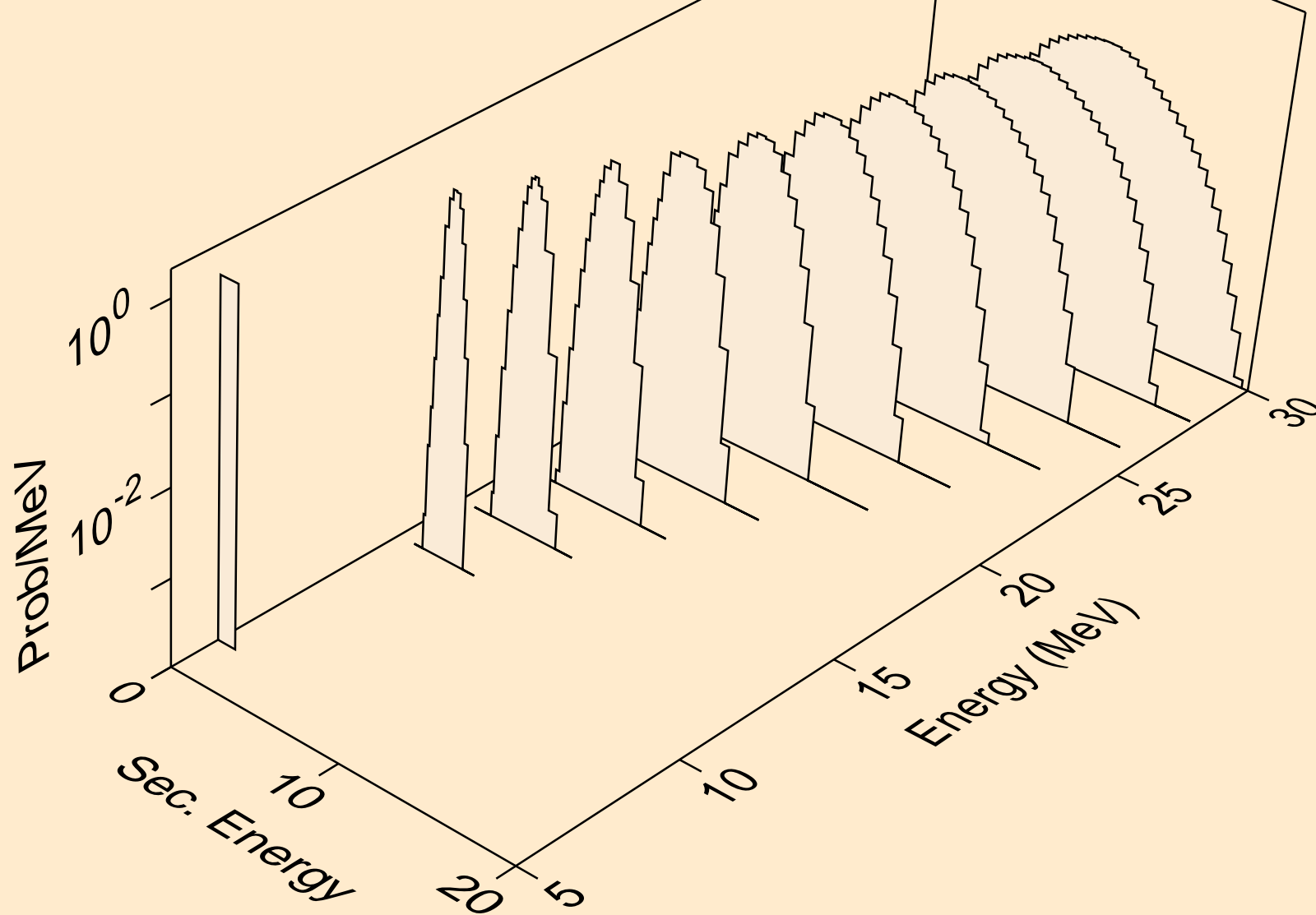

AT206 NEUTRON ACER TENDL-2021 LIBRARY; T=293.6K
protons from (n,npa)

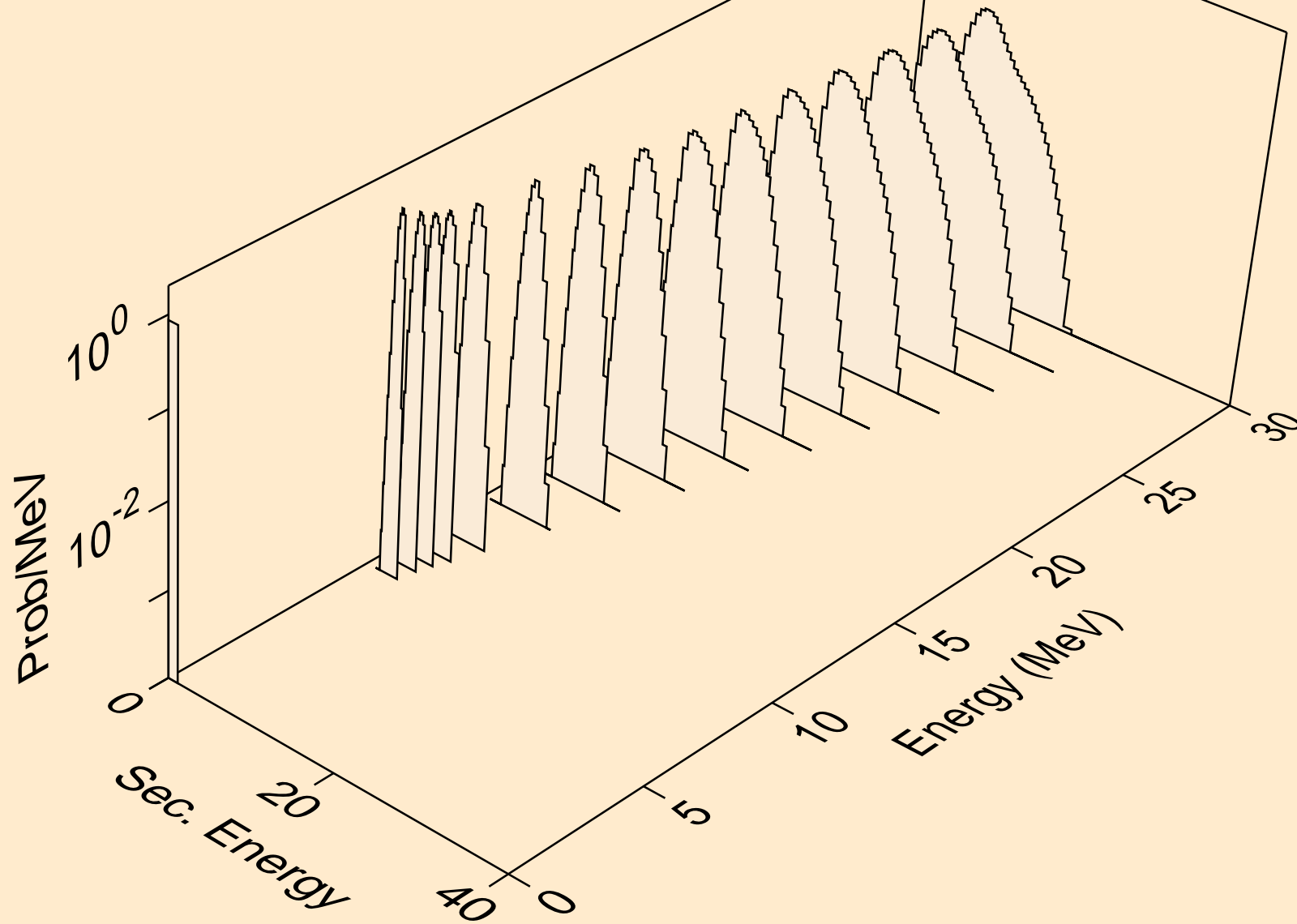

AT206 NEUTRON ACER TENDL-2021 LIBRARY; T=293.6K
protons from (n,p)

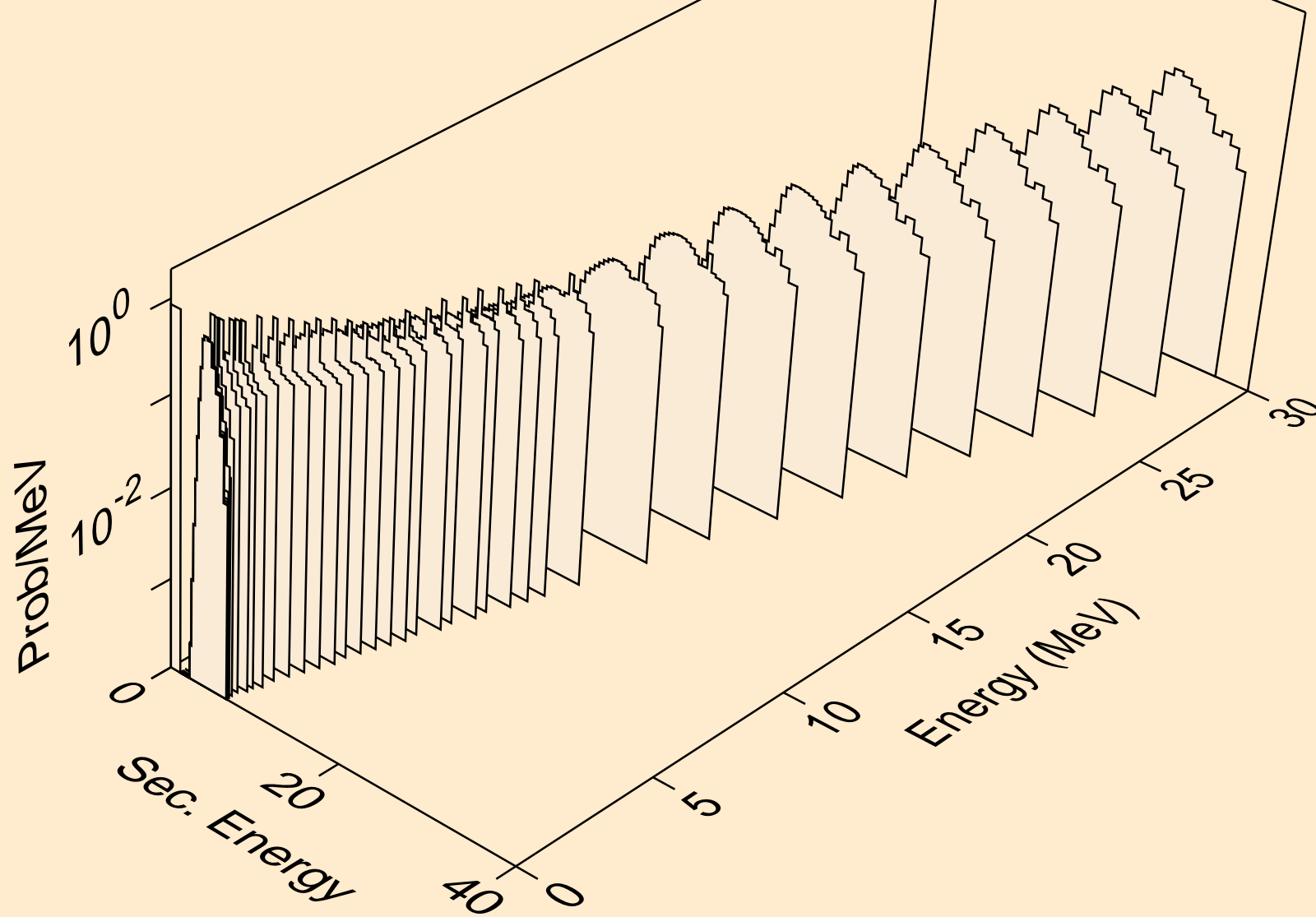

AT206 NEUTRON ACER TENDL-2021 LIBRARY; T=293.6K
protons from (n,2p)

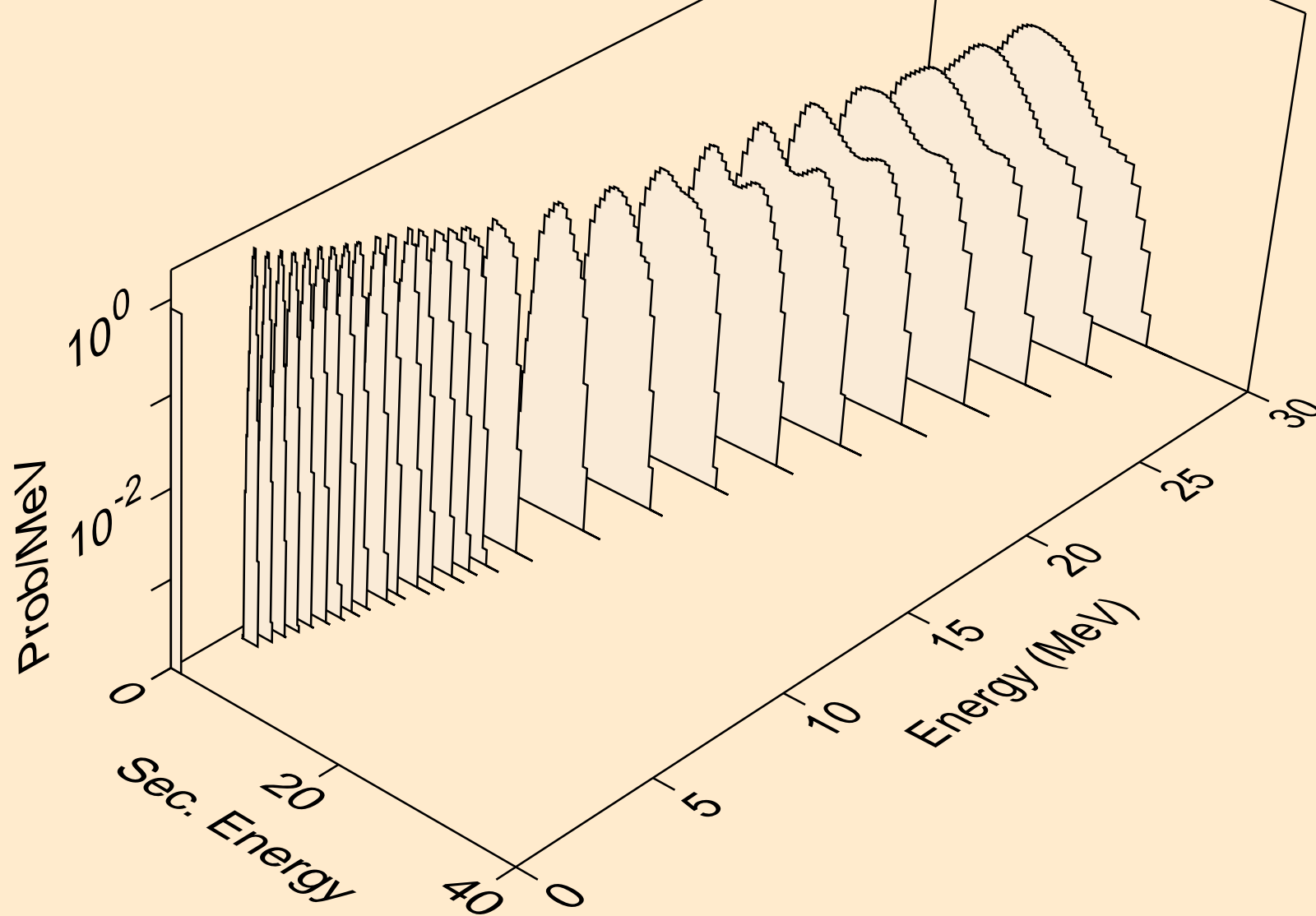

AT206 NEUTRON ACER TENDL-2021 LIBRARY; T=293.6K
protons from (n,p)

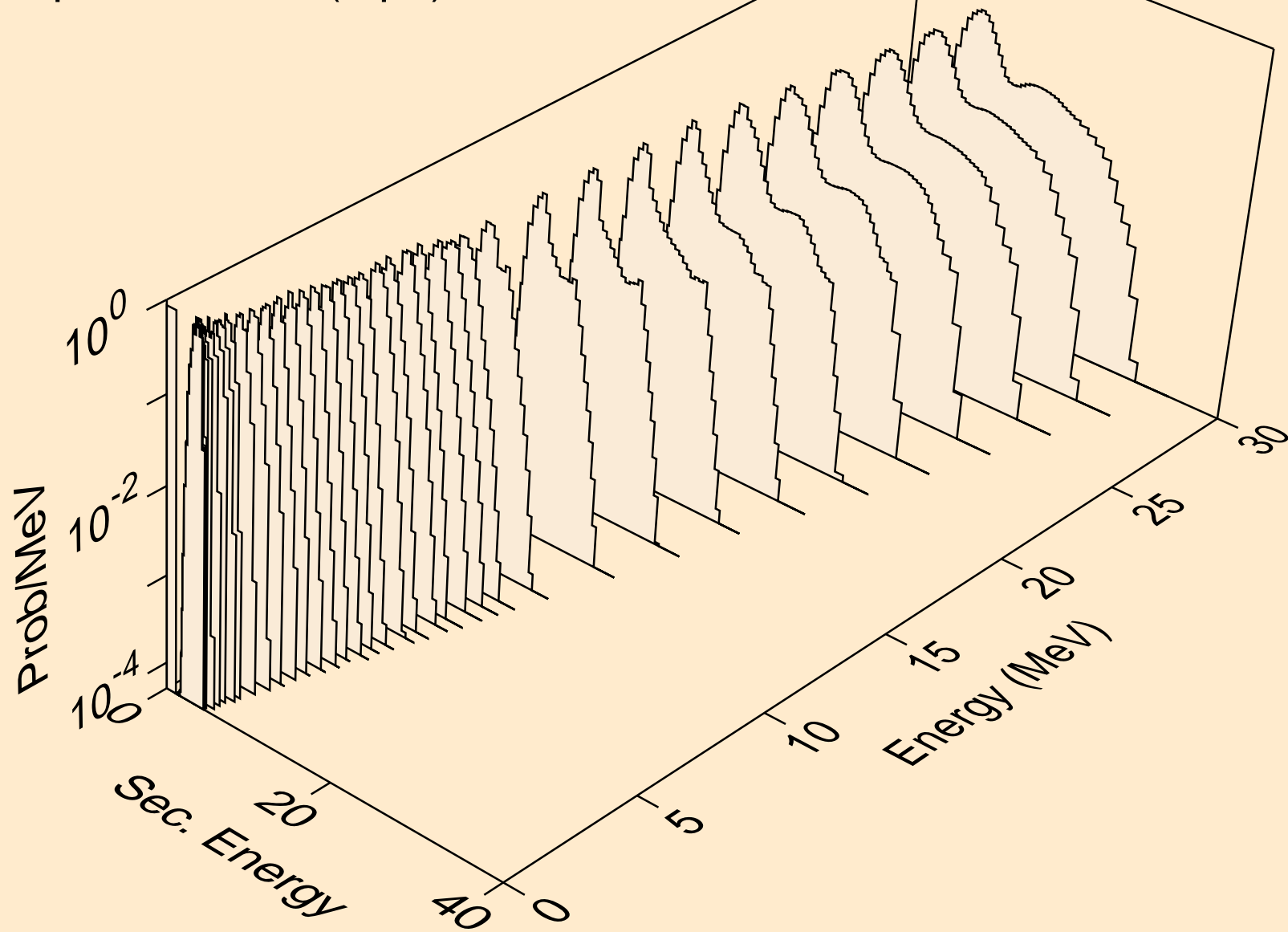

AT206 NEUTRON ACER TENDL-2021 LIBRARY; T=293.6K
protons from (n,pd)

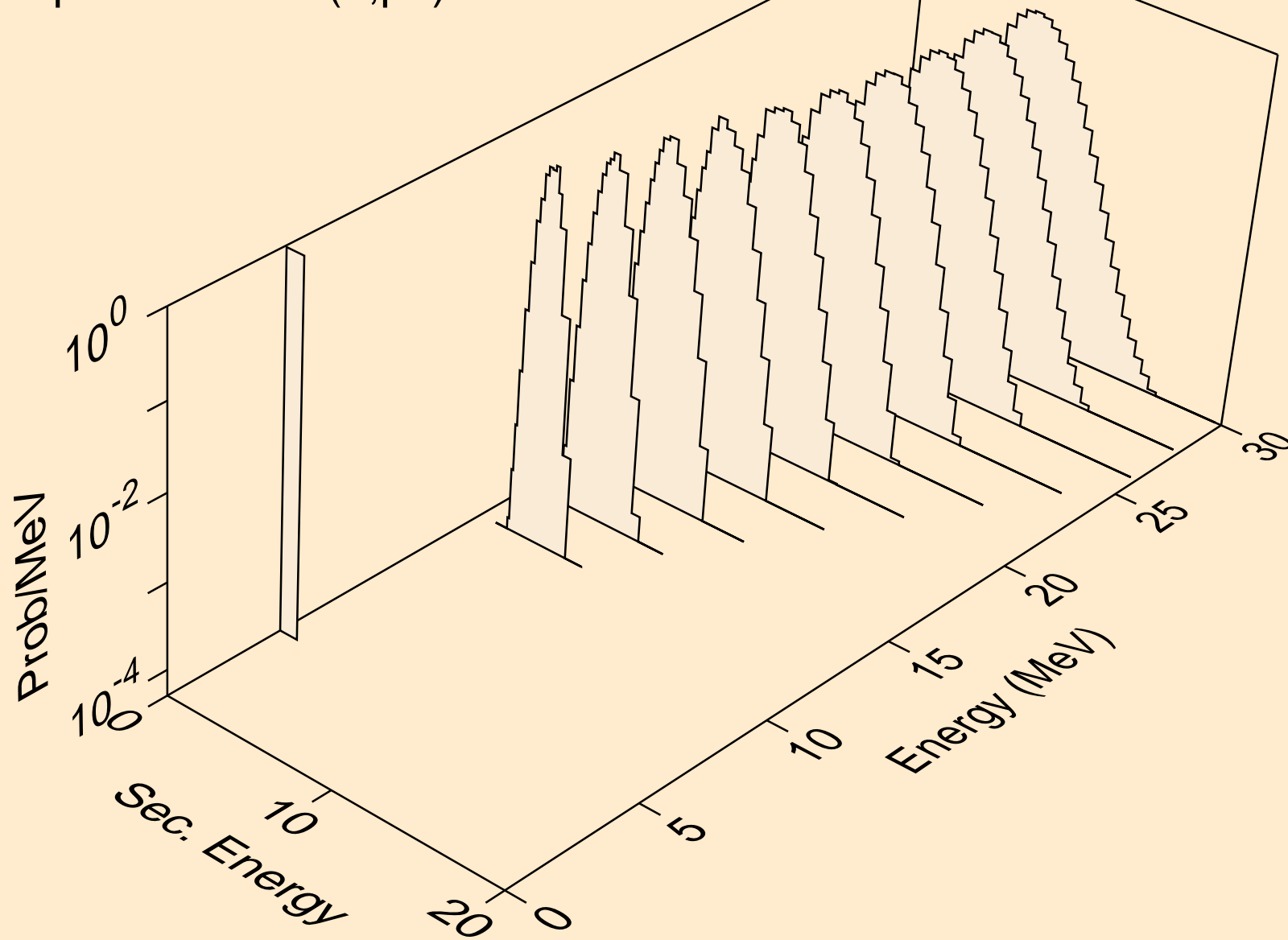

AT206 NEUTRON ACER TENDL-2021 LIBRARY; T=293.6K
protons from (n,pt)

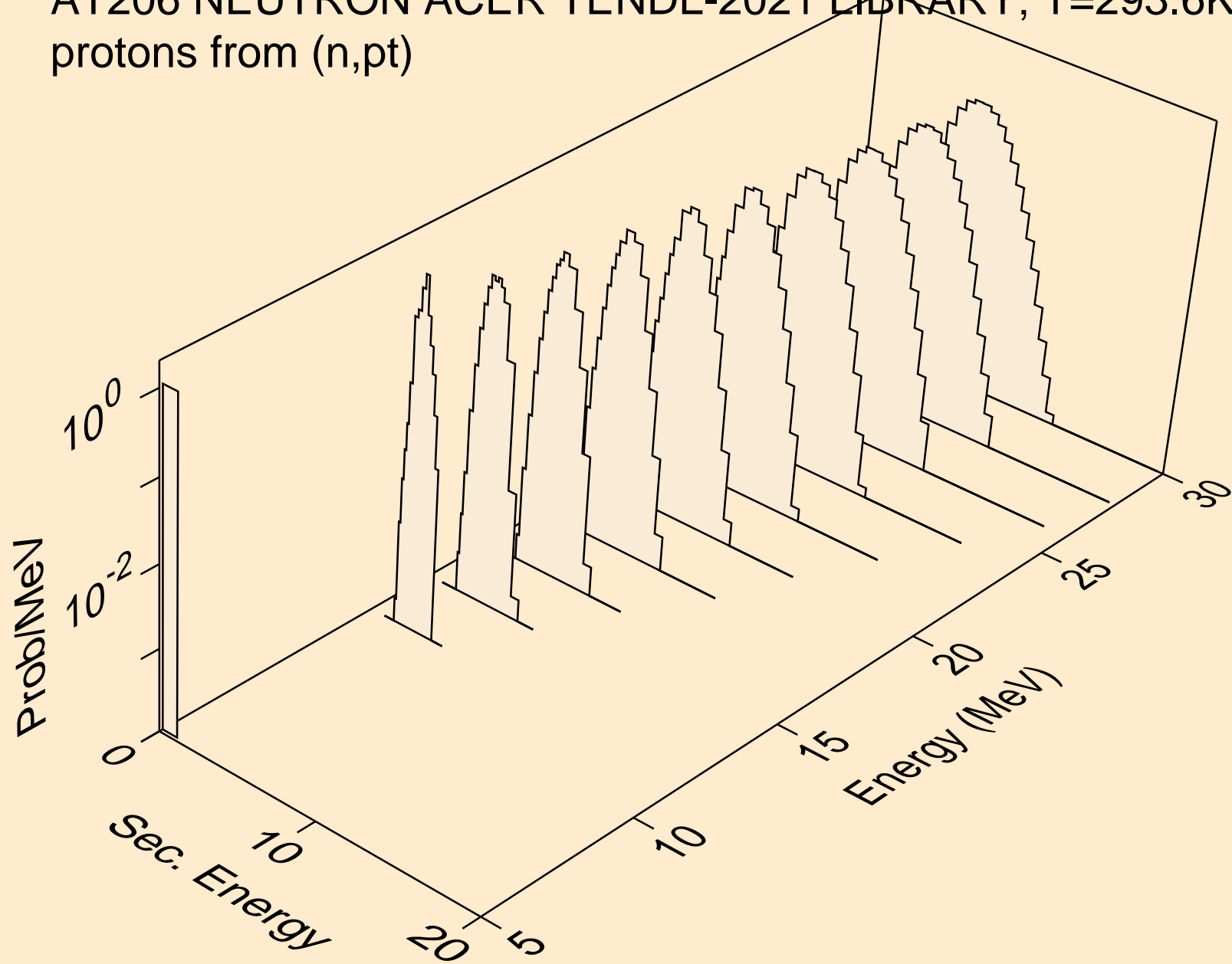

AT206 NEUTRON ACER TENDL-2021 LIBRARY; T=293.6K
deuterons from (n,x)

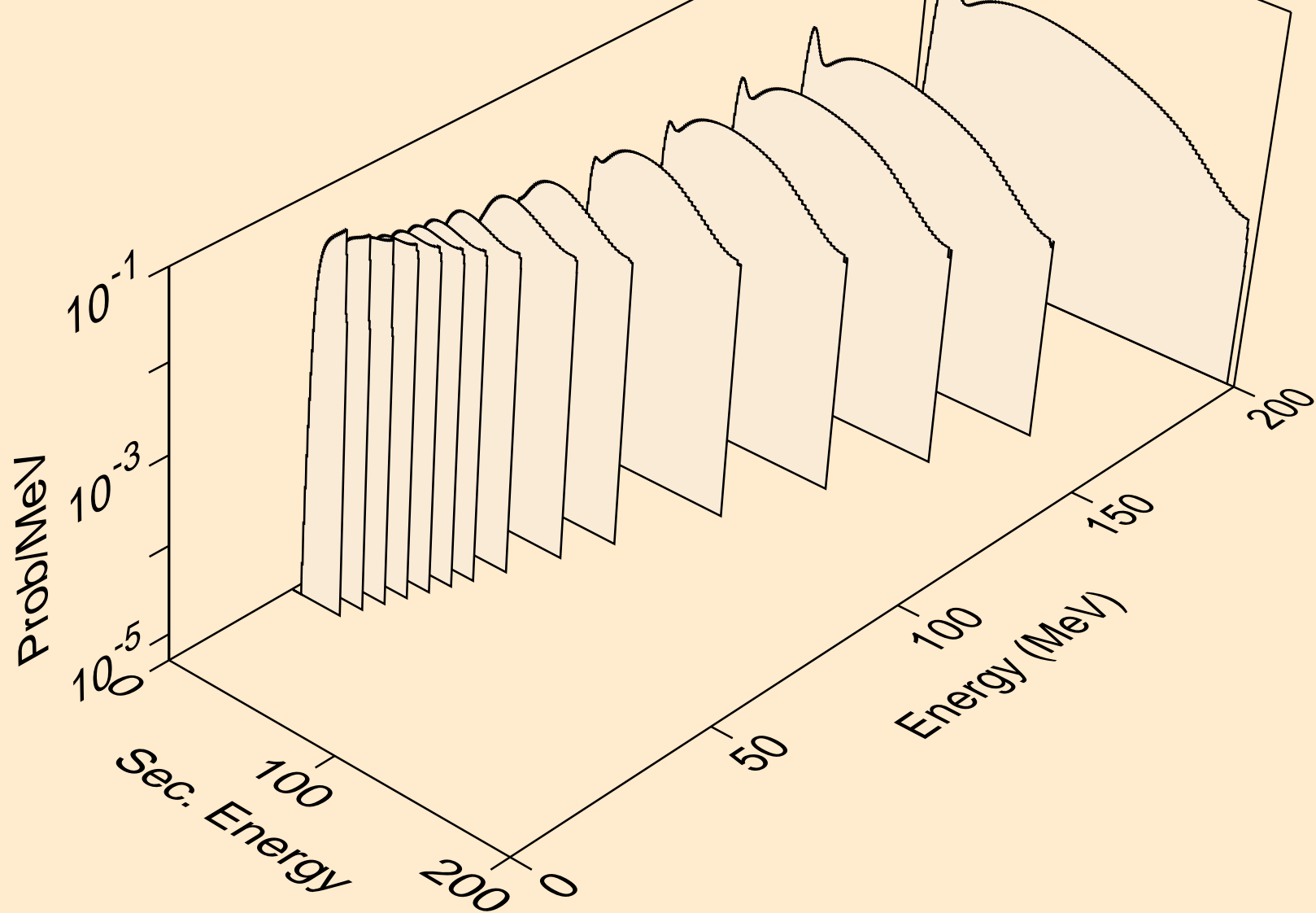

AT206 NEUTRON ACER TENDL-2021 LIBRARY; T=293.6K
deuterons from (n,2nd)

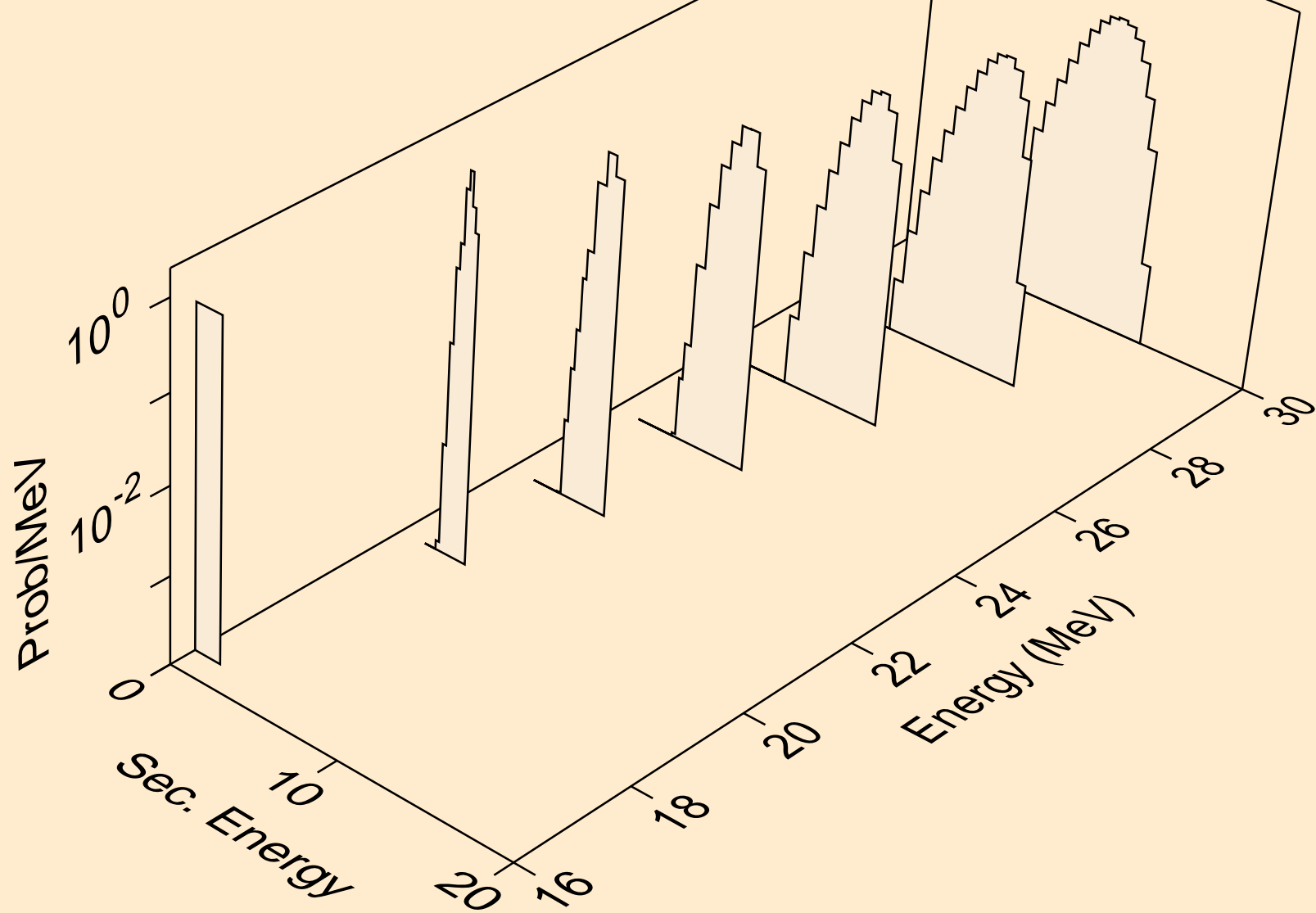

AT206 NEUTRON ACER TENDL-2021 LIBRARY; T=293.6K
deuterons from (n,n*)d

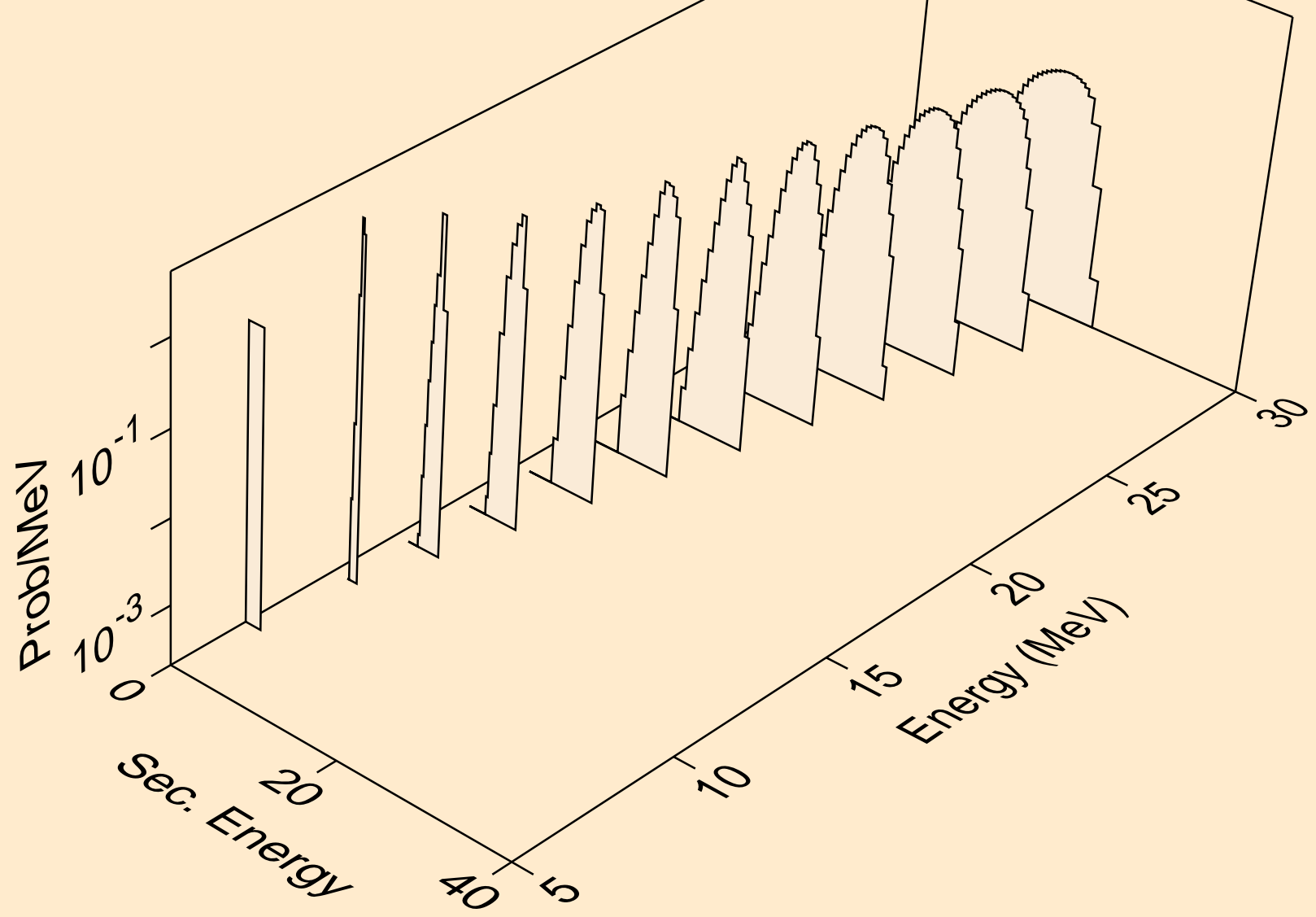

AT206 NEUTRON ACER TENDL-2021 LIBRARY; T=293.6K
deuterons from (n,d)

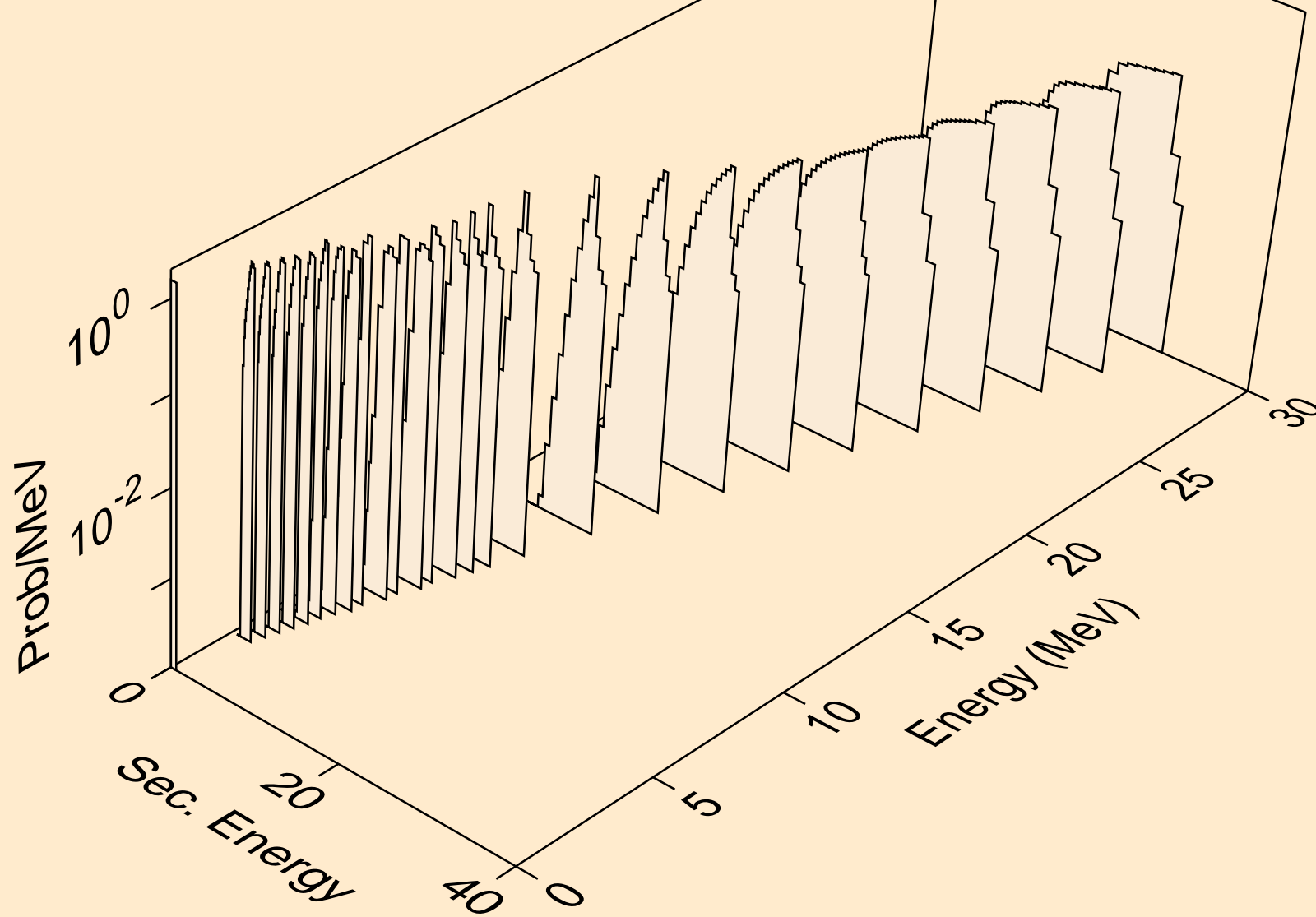

AT206 NEUTRON ACER TENDL-2021 LIBRARY; T=293.6K
deuterons from (n,pd)

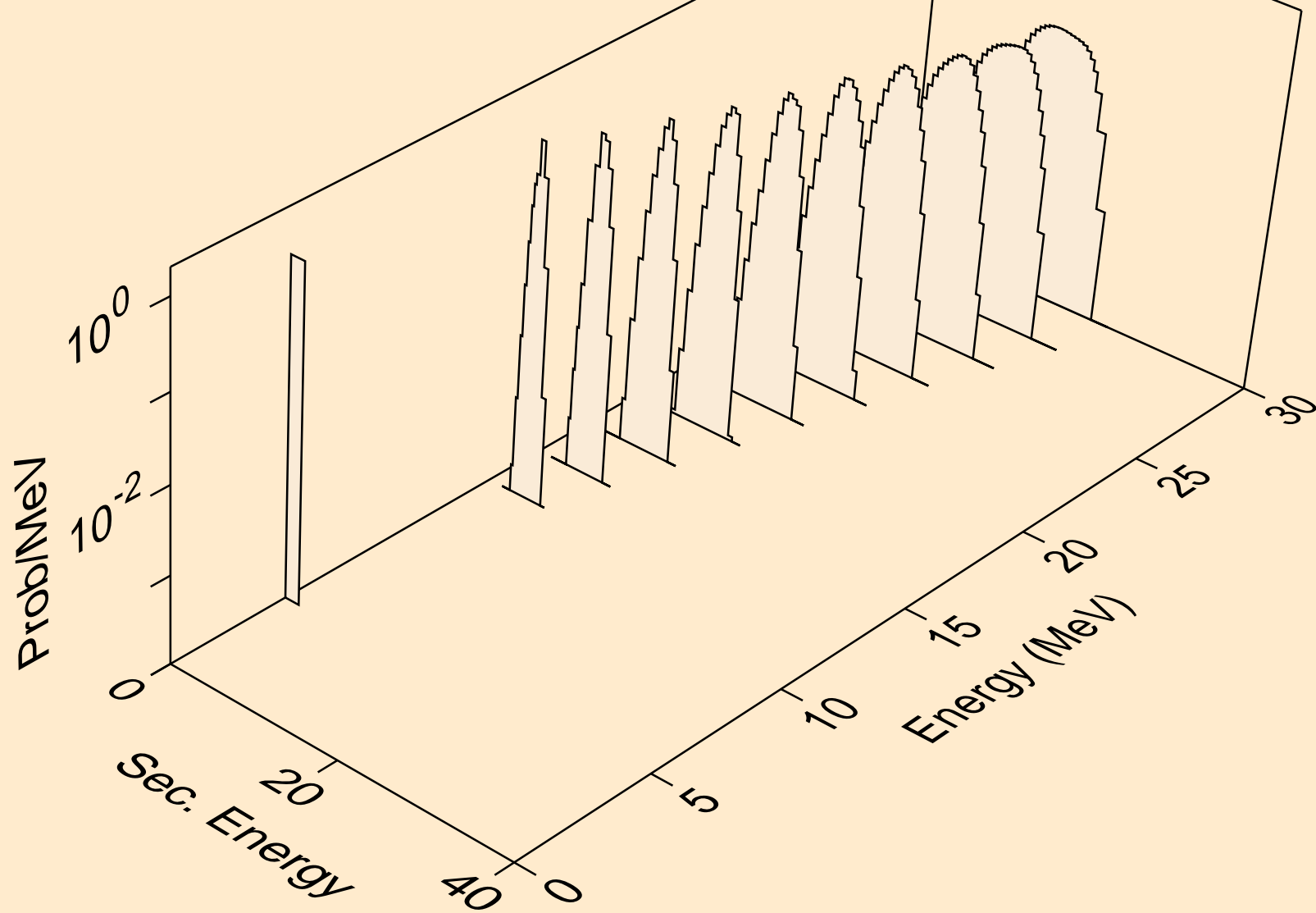

AT206 NEUTRON ACER TENDL-2021 LIBRARY; T=293.6K
deuterons from (n,da)

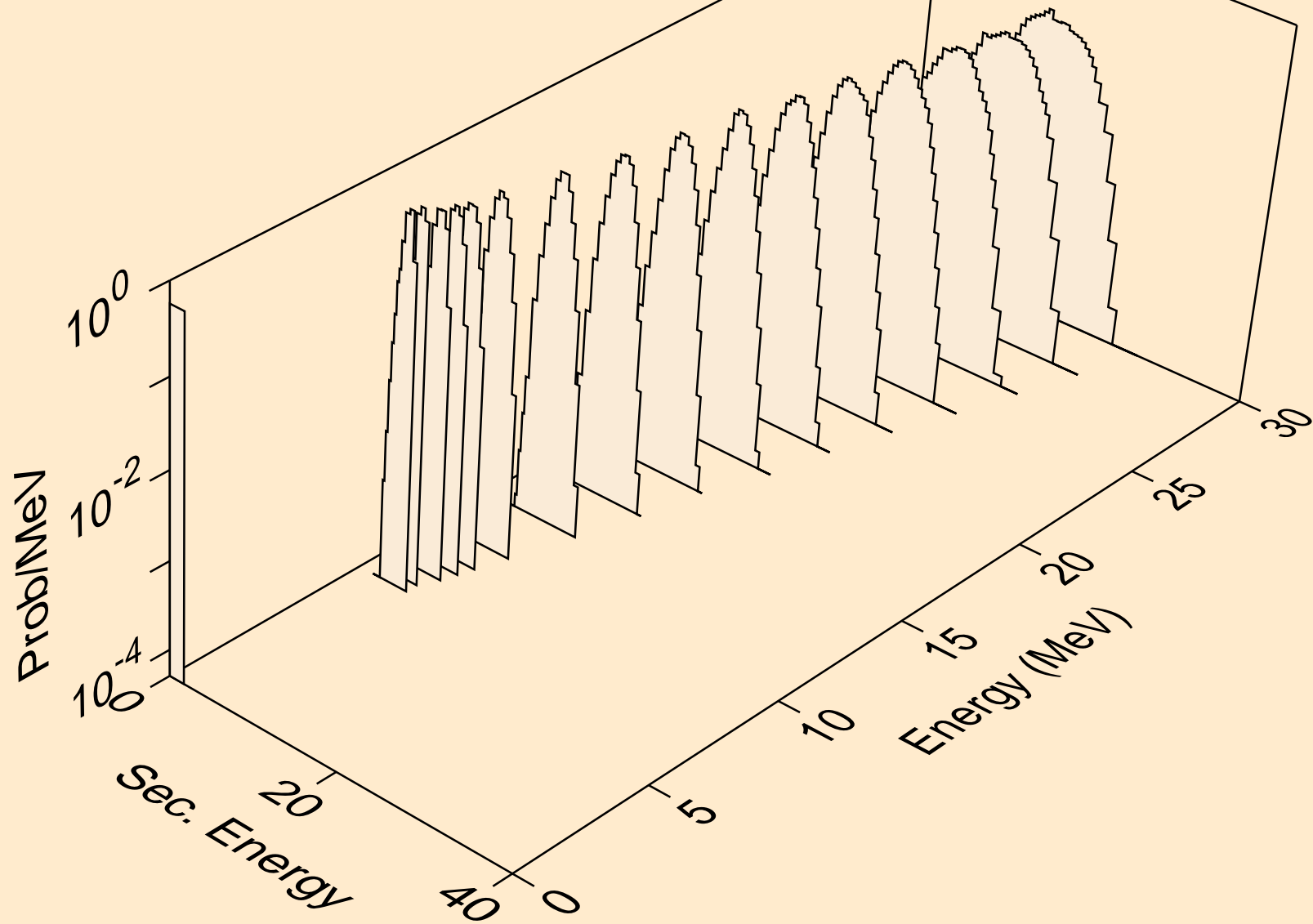

AT206 NEUTRON ACER TENDL-2021 LIBRARY; T=293.6K
tritons from (n,x)

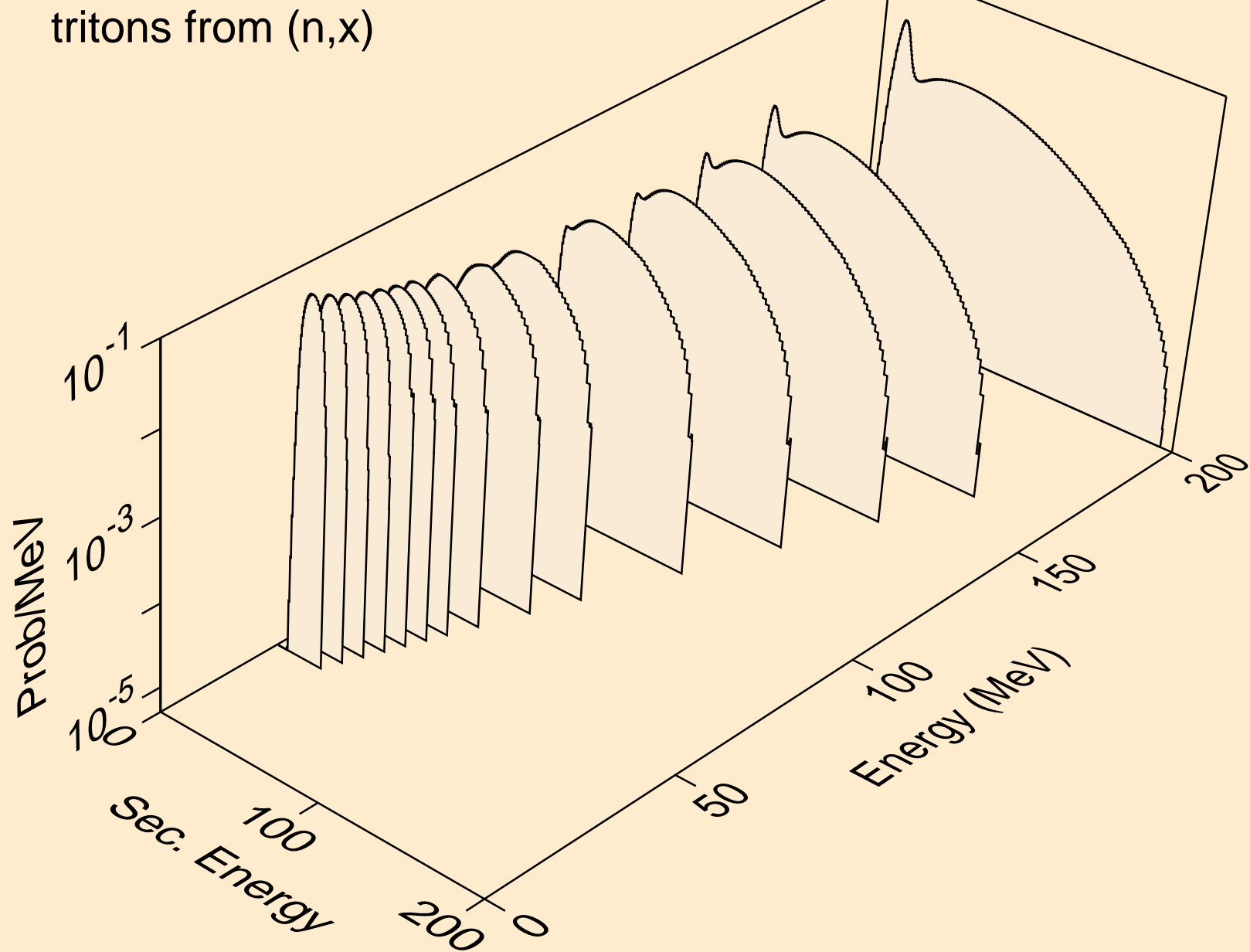

AT206 NEUTRON ACER TENDL-2021 LIBRARY; T=293.6K
tritons from (n,n*)t

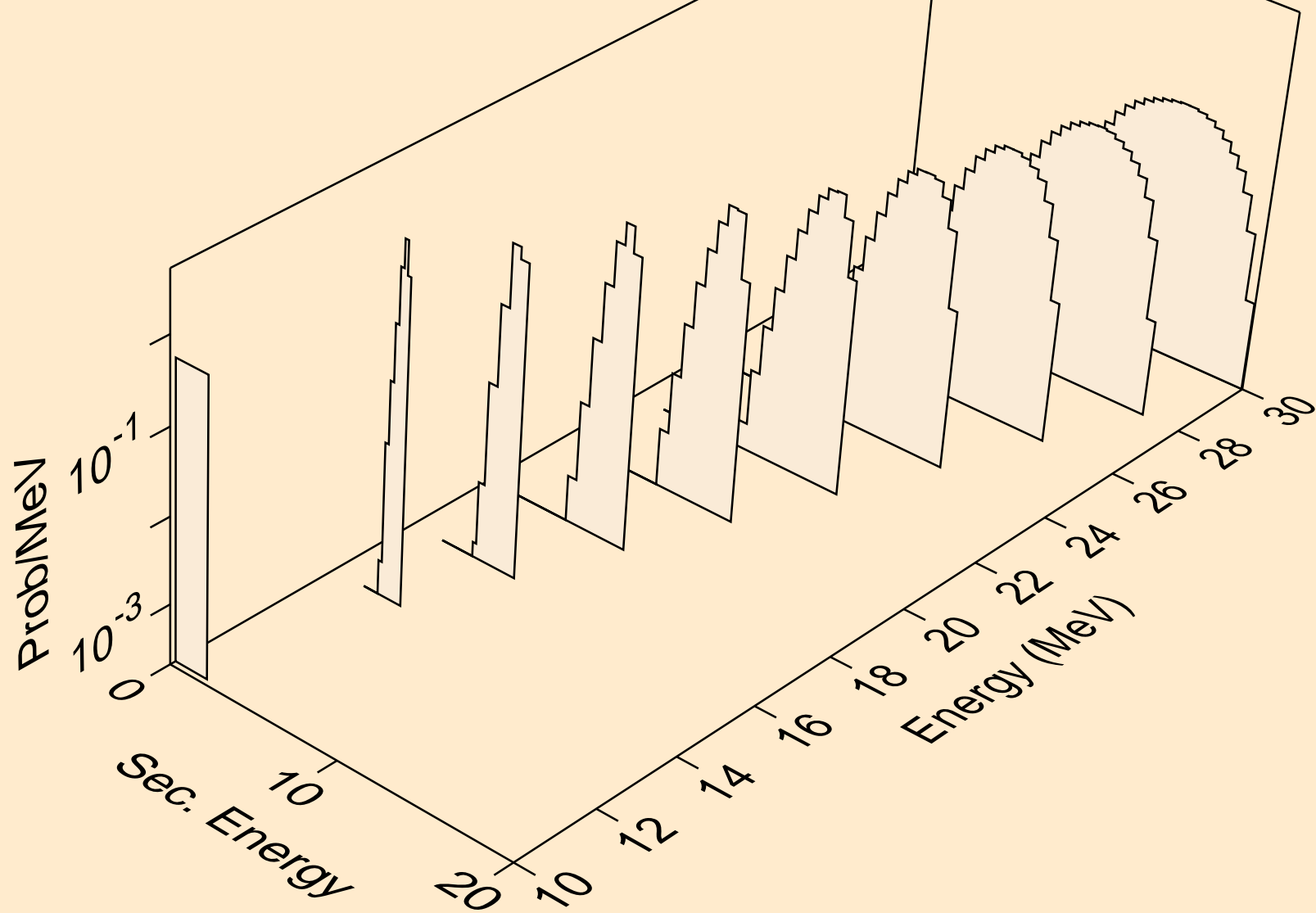

AT206 NEUTRON ACER TENDL-2021 LIBRARY; T=293.6K
tritons from (n,t)

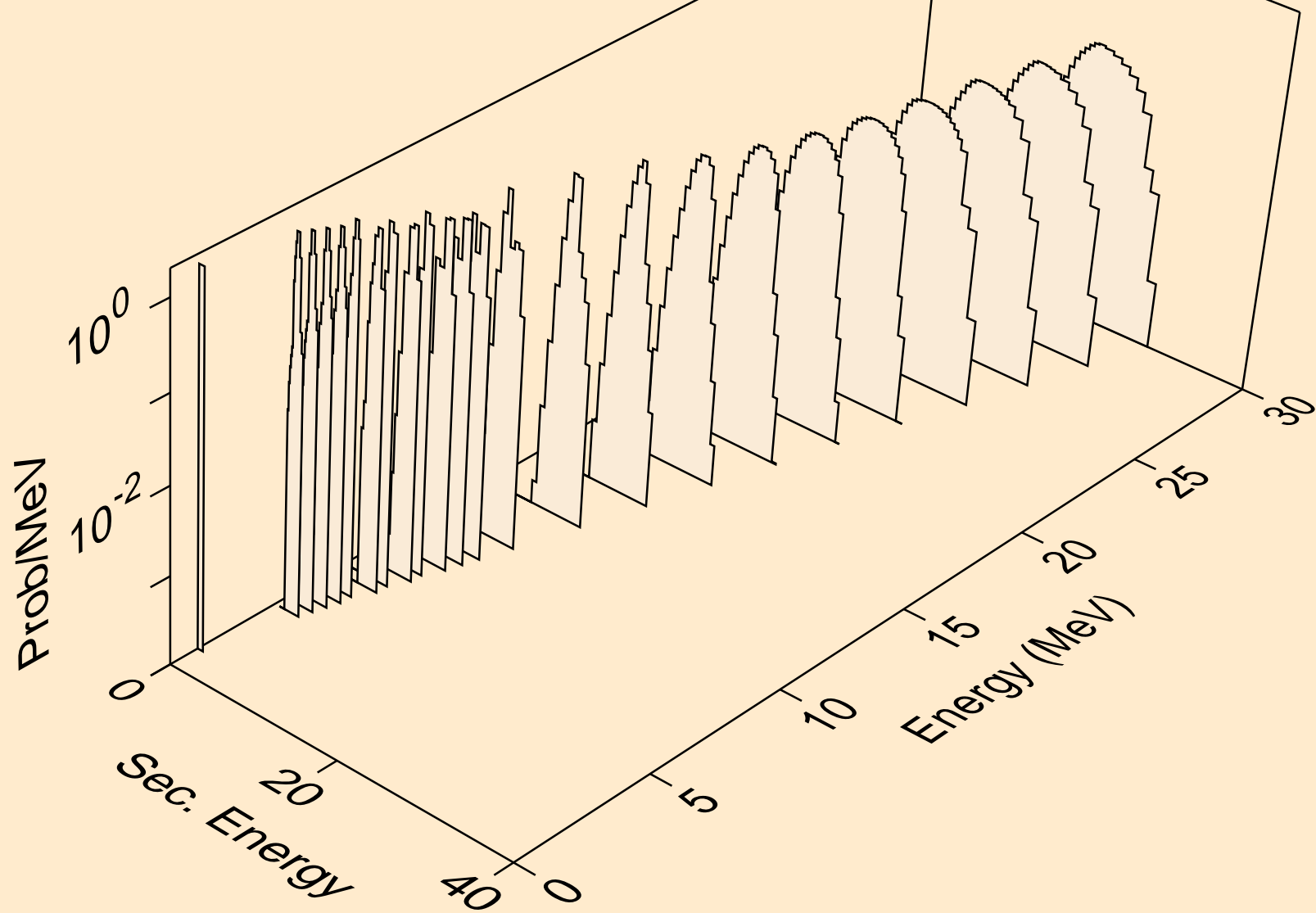

AT206 NEUTRON ACER TENDL-2021 LIBRARY; T=293.6K
tritons from (n,pt)

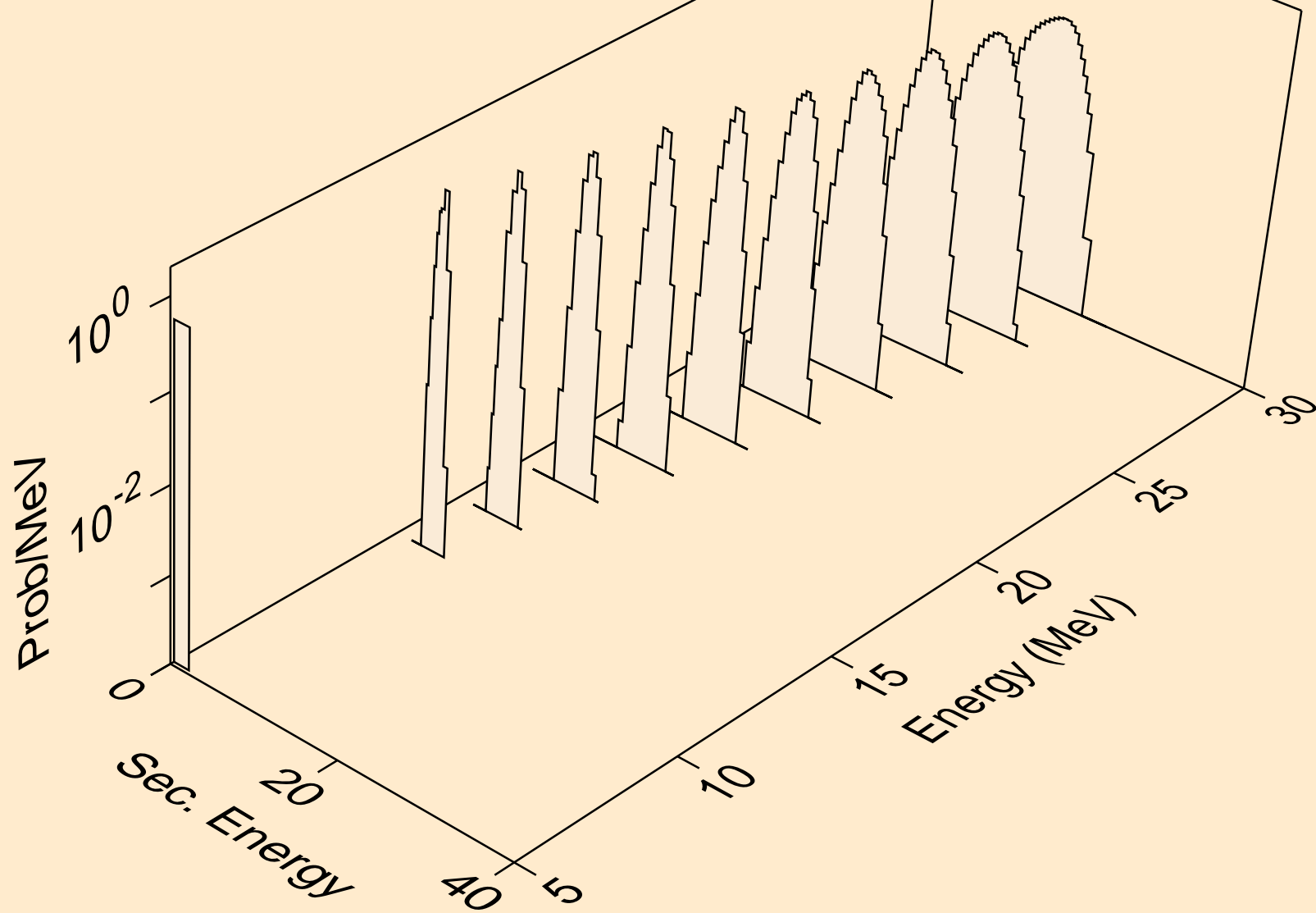

AT206 NEUTRON ACER TENDL-2021 LIBRARY; T=293.6K
he3s from (n,x)

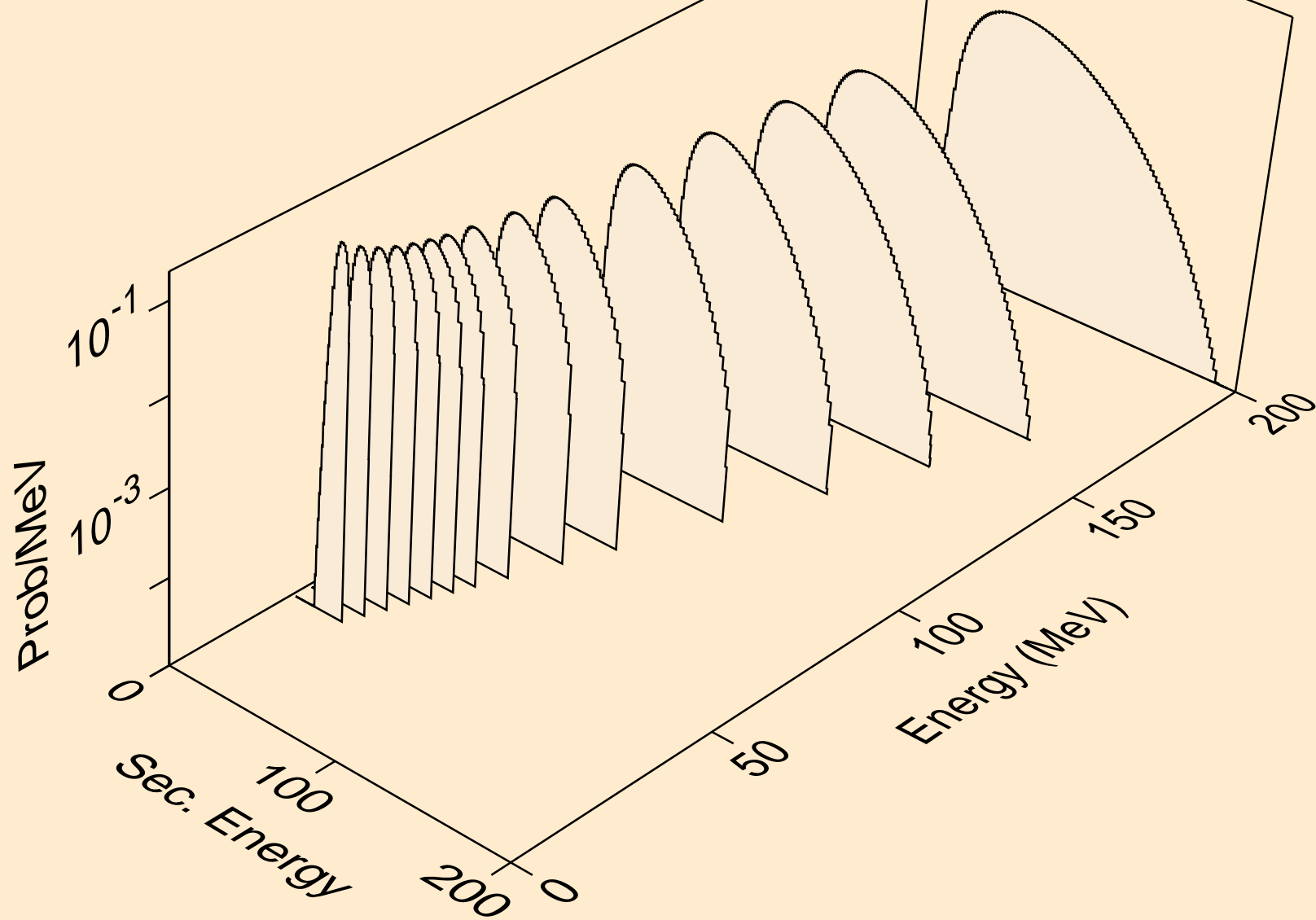

AT206 NEUTRON ACER TENDL-2021 LIBRARY; T=293.6K
he3s from (n,n*)he3

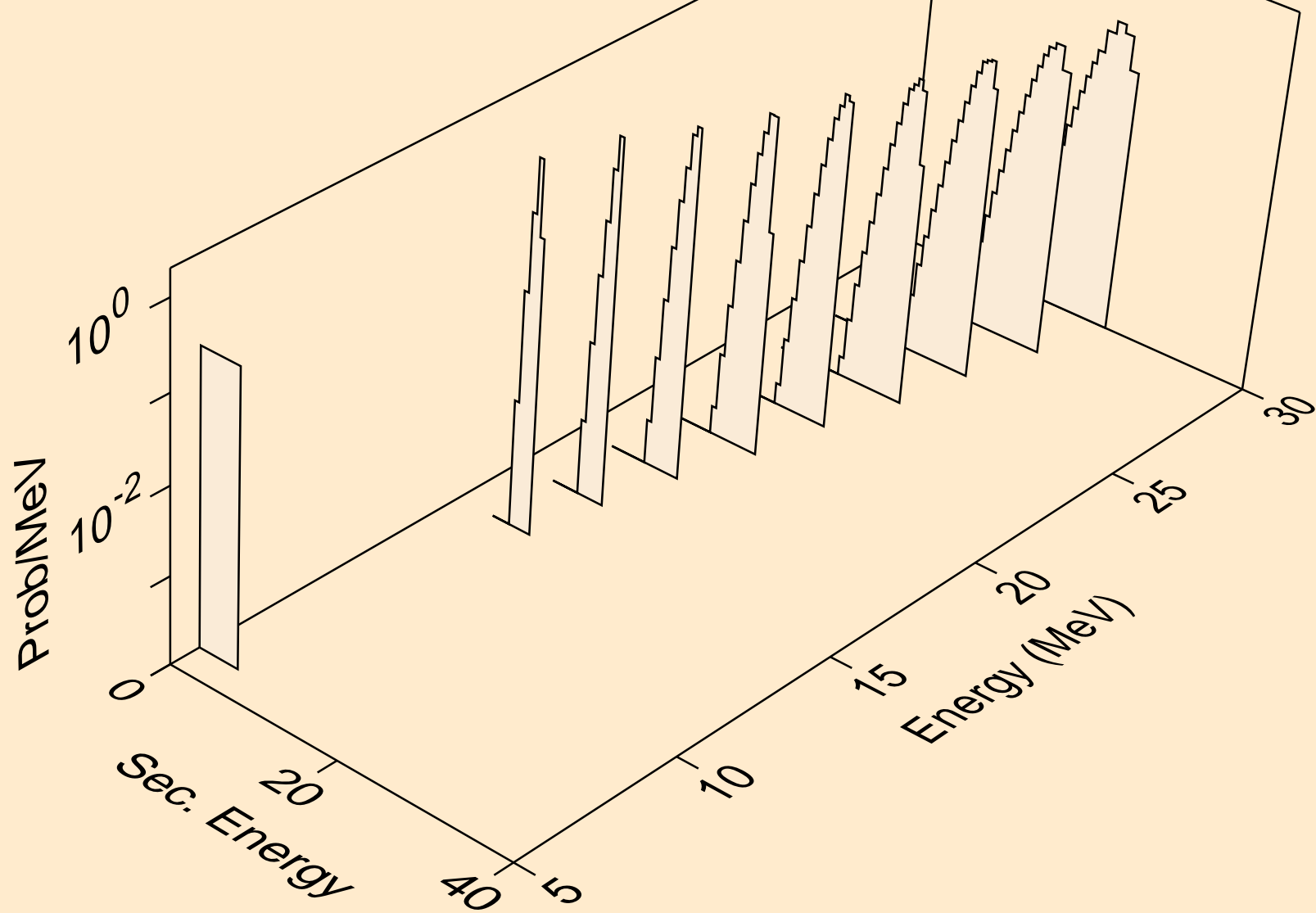

AT206 NEUTRON ACER TENDL-2021 LIBRARY; T=293.6K
he3s from (n,he3)

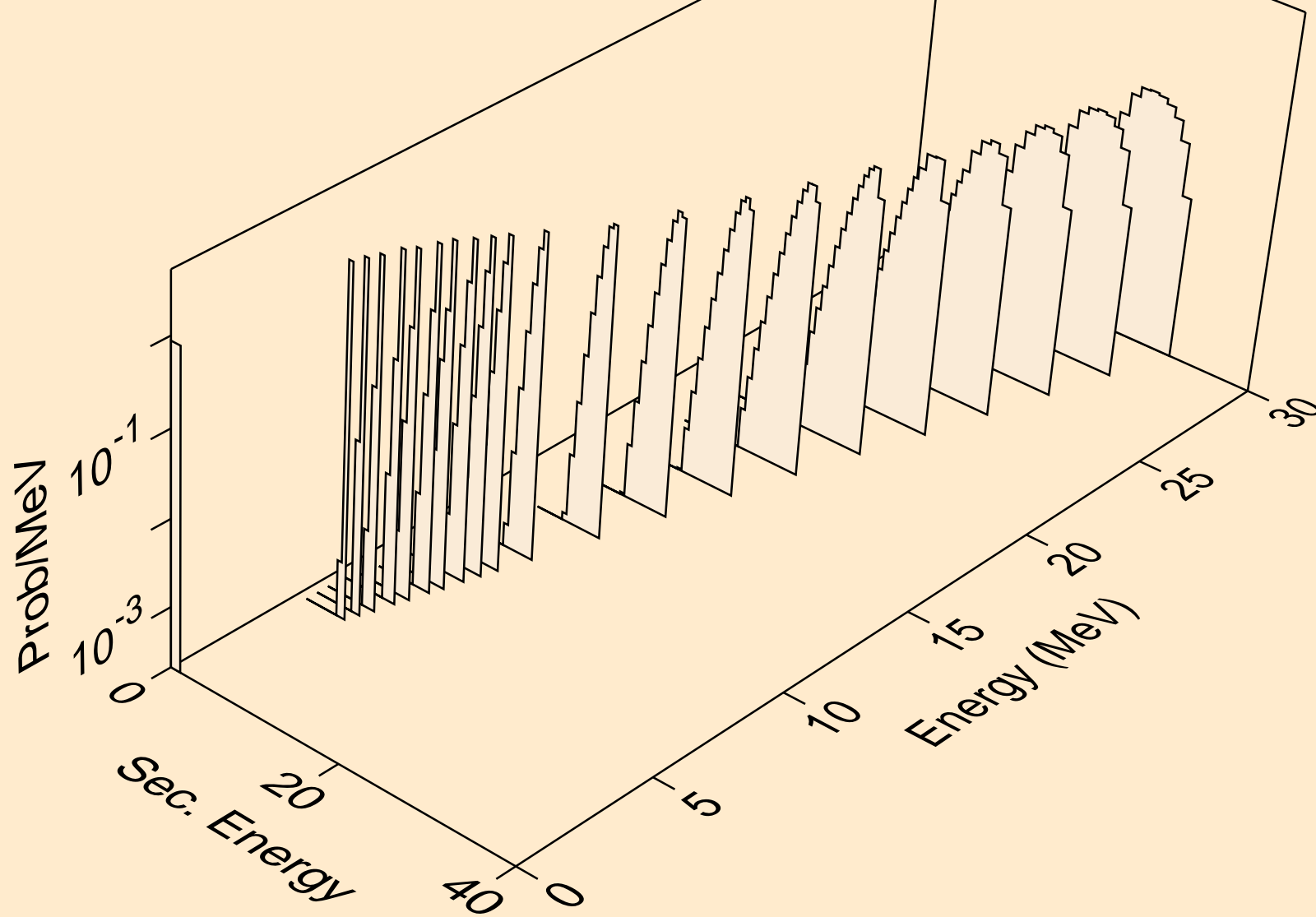

AT206 NEUTRON ACER TENDL-2021 LIBRARY; T=293.6K
alphas from (n,x)

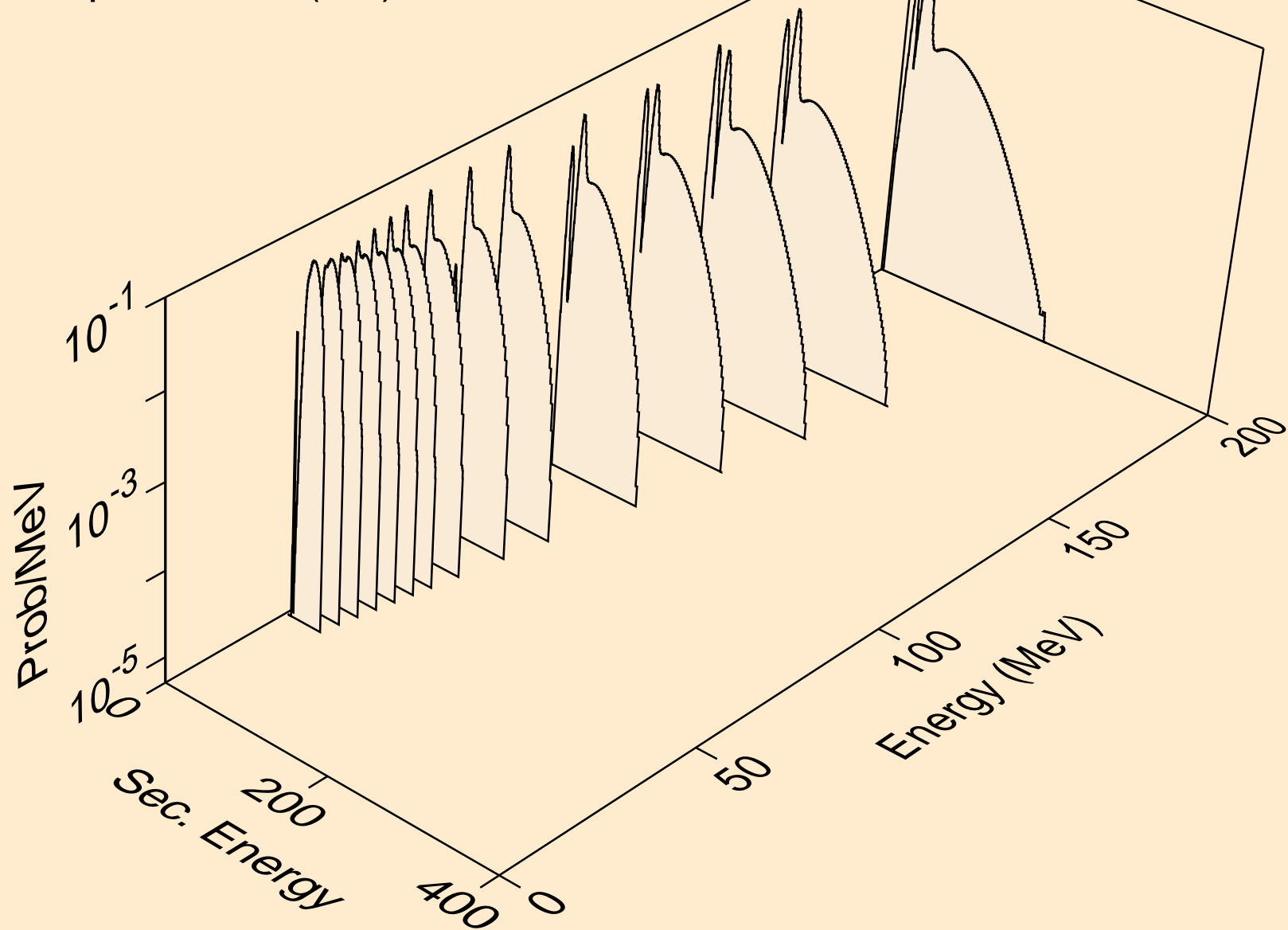

AT206 NEUTRON ACER TENDL-2021 LIBRARY; T=293.6K
alphas from (n,n*)a

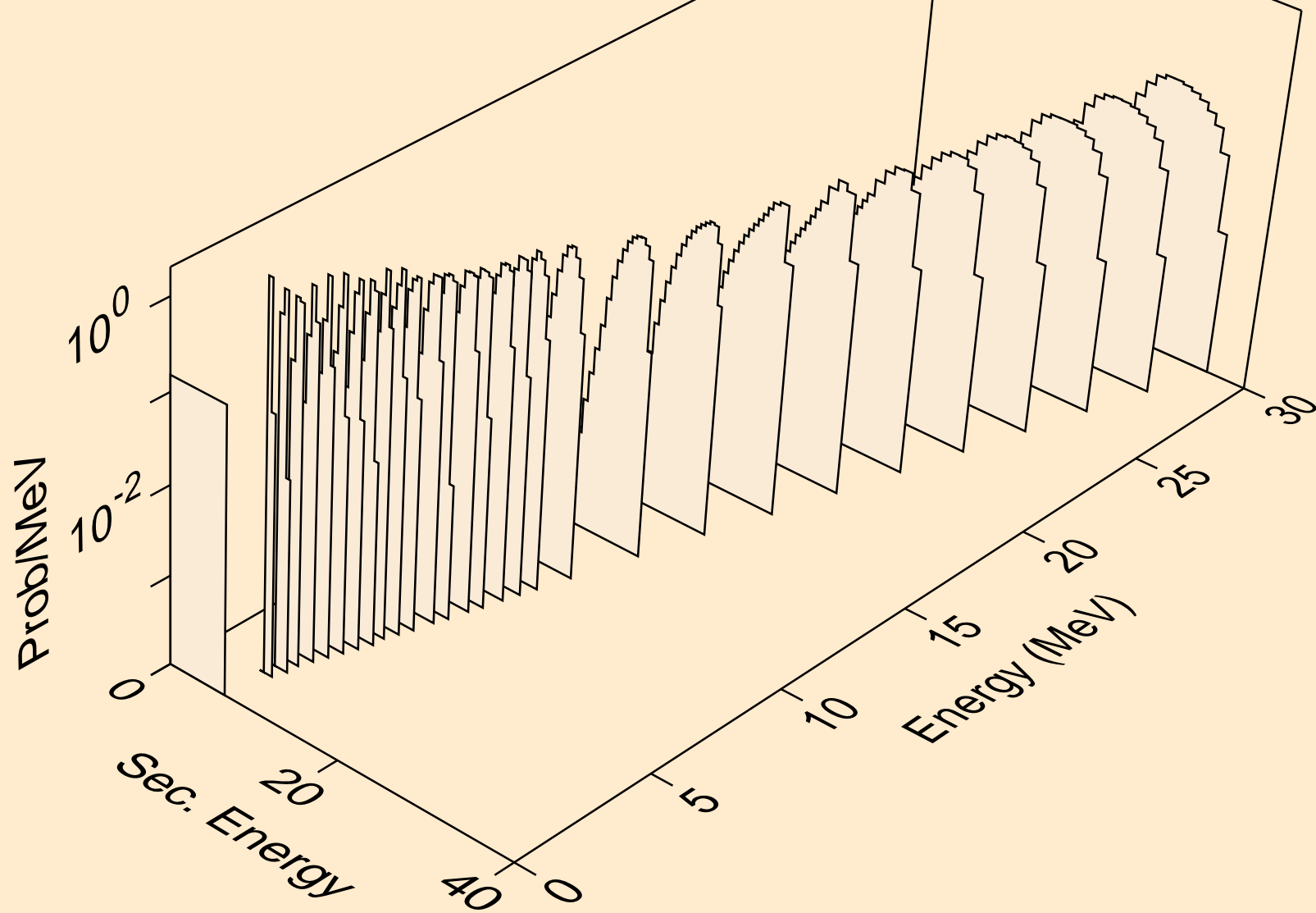

AT206 NEUTRON ACER TENDL-2021 LIBRARY; T=293.6K
alphas from (n,2n)a

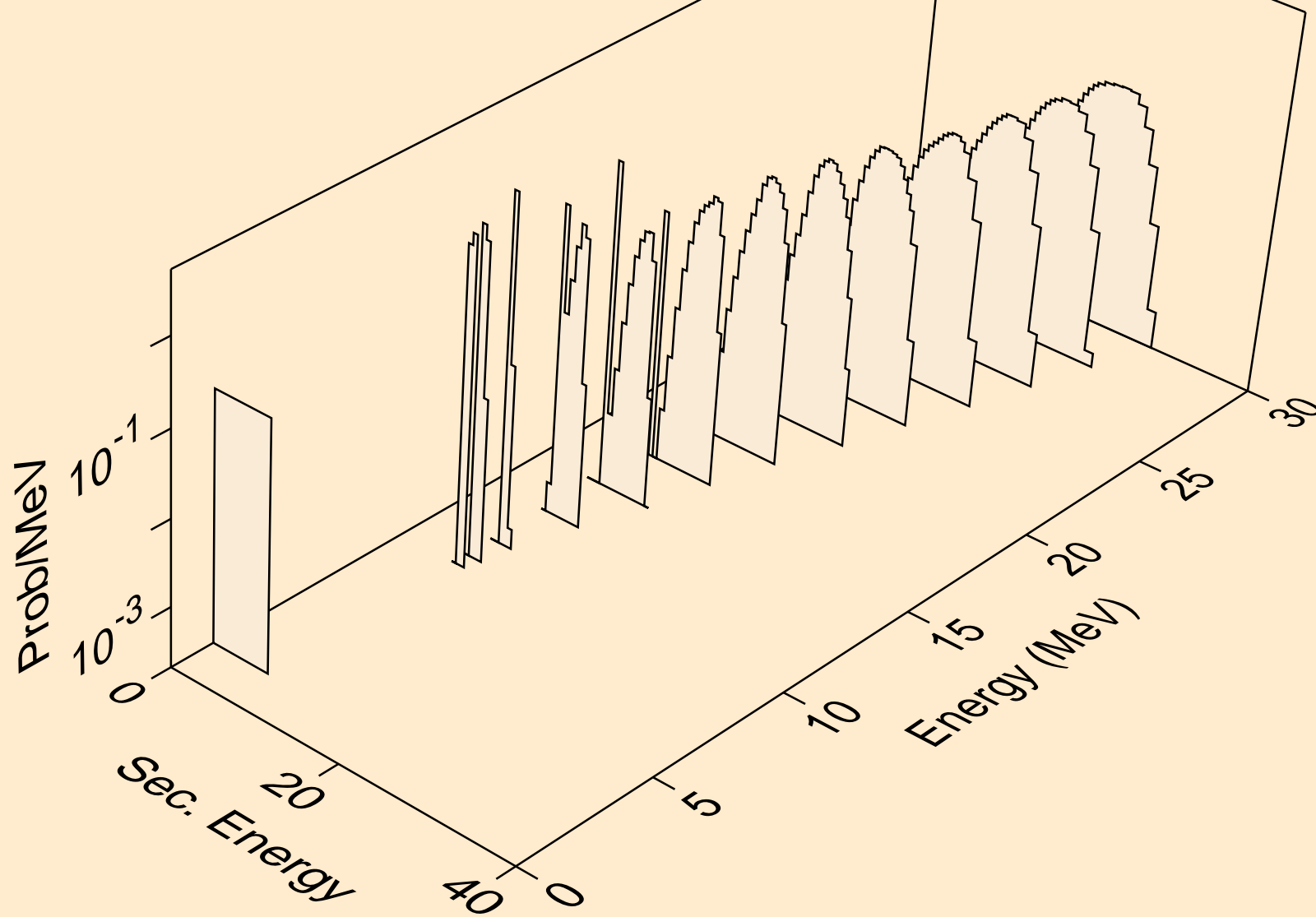

AT206 NEUTRON ACER TENDL-2021 LIBRARY; T=293.6K
alphas from (n,3n)a

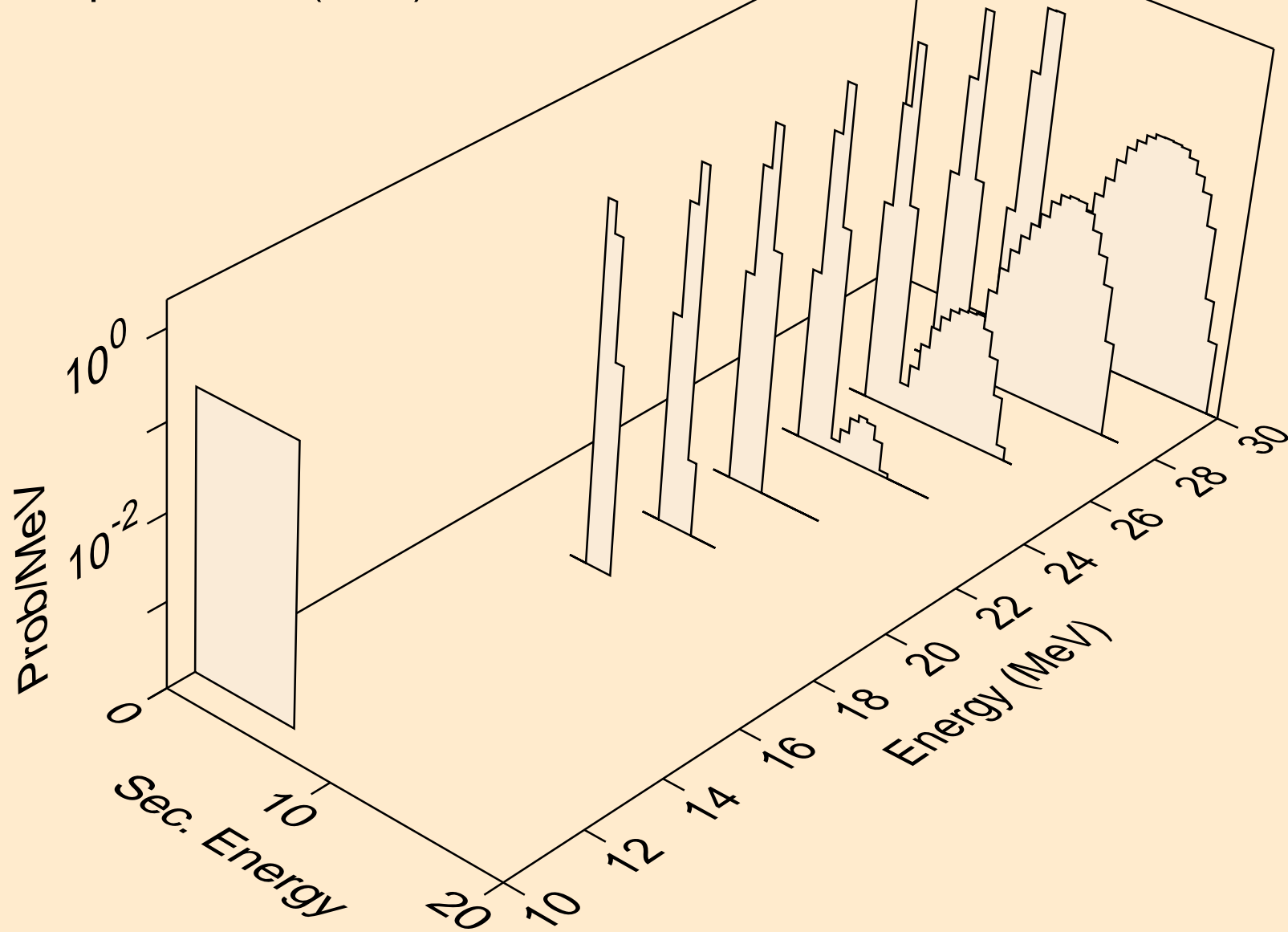

AT206 NEUTRON ACER TENDL-2021 LIBRARY; T=293.6K
alphas from (n,n*)2a

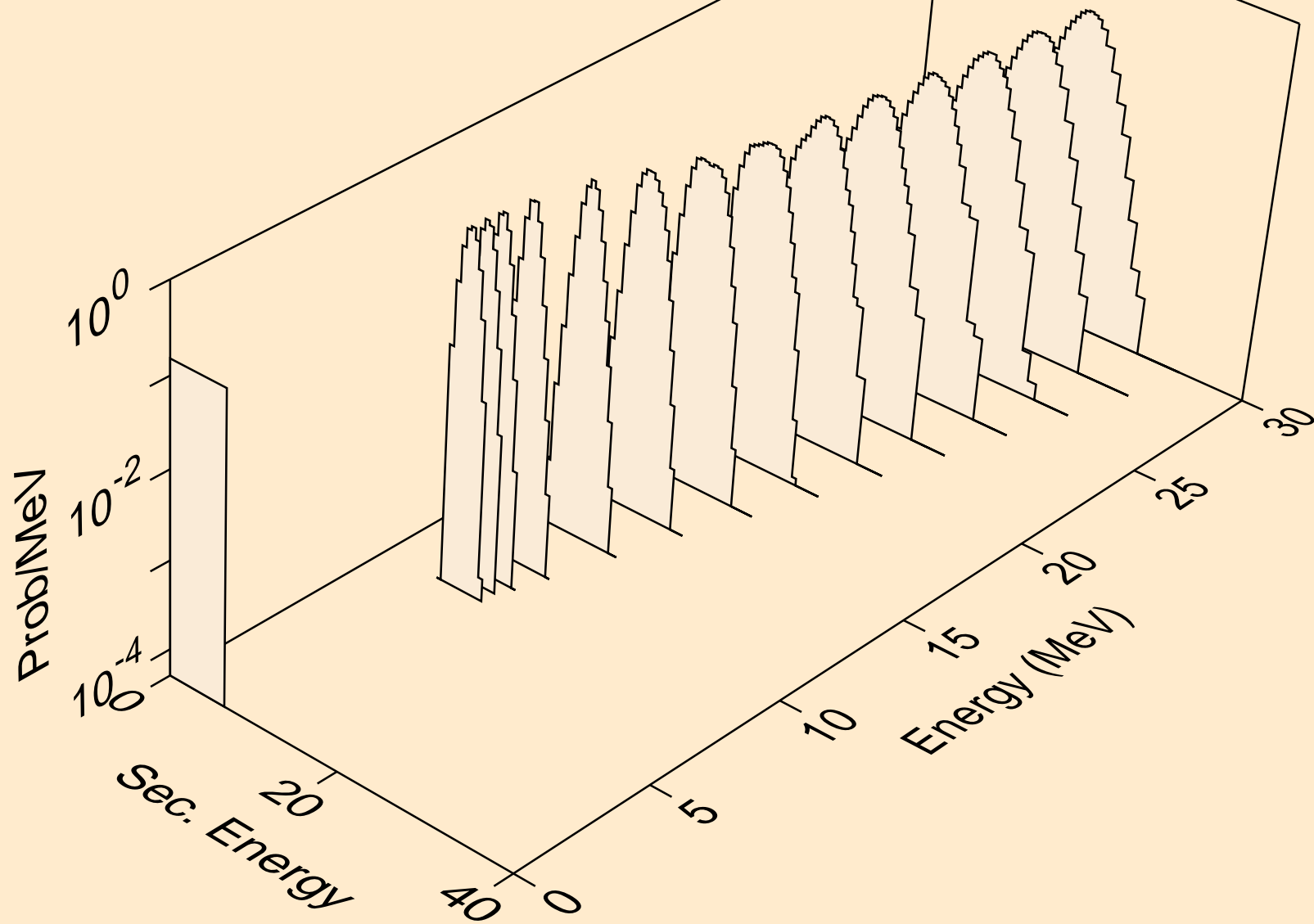

AT206 NEUTRON ACER TENDL-2021 LIBRARY; T=293.6K
alphas from (n,2n)2a

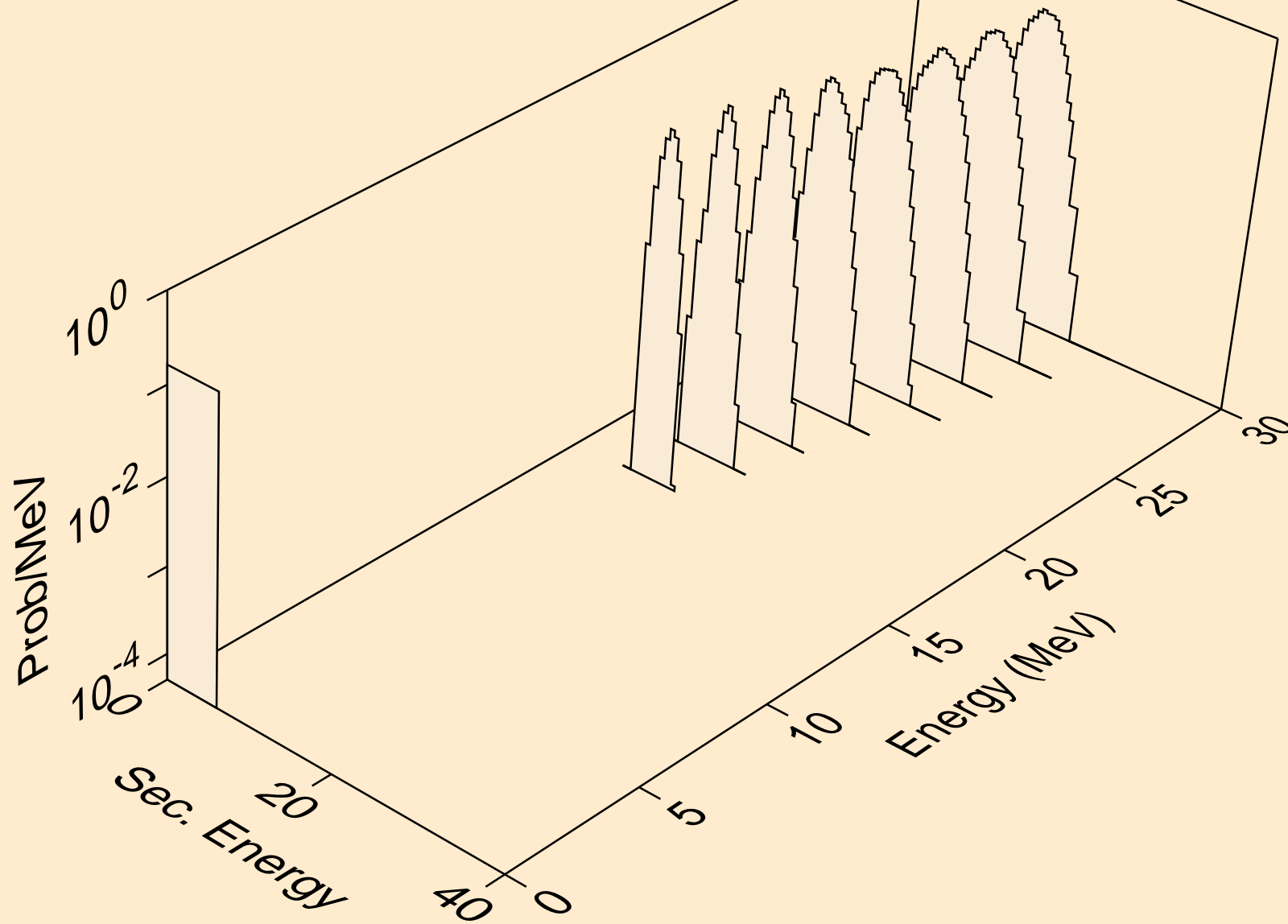

AT206 NEUTRON ACER TENDL-2021 LIBRARY; T=293.6K
alphas from (n,npa)

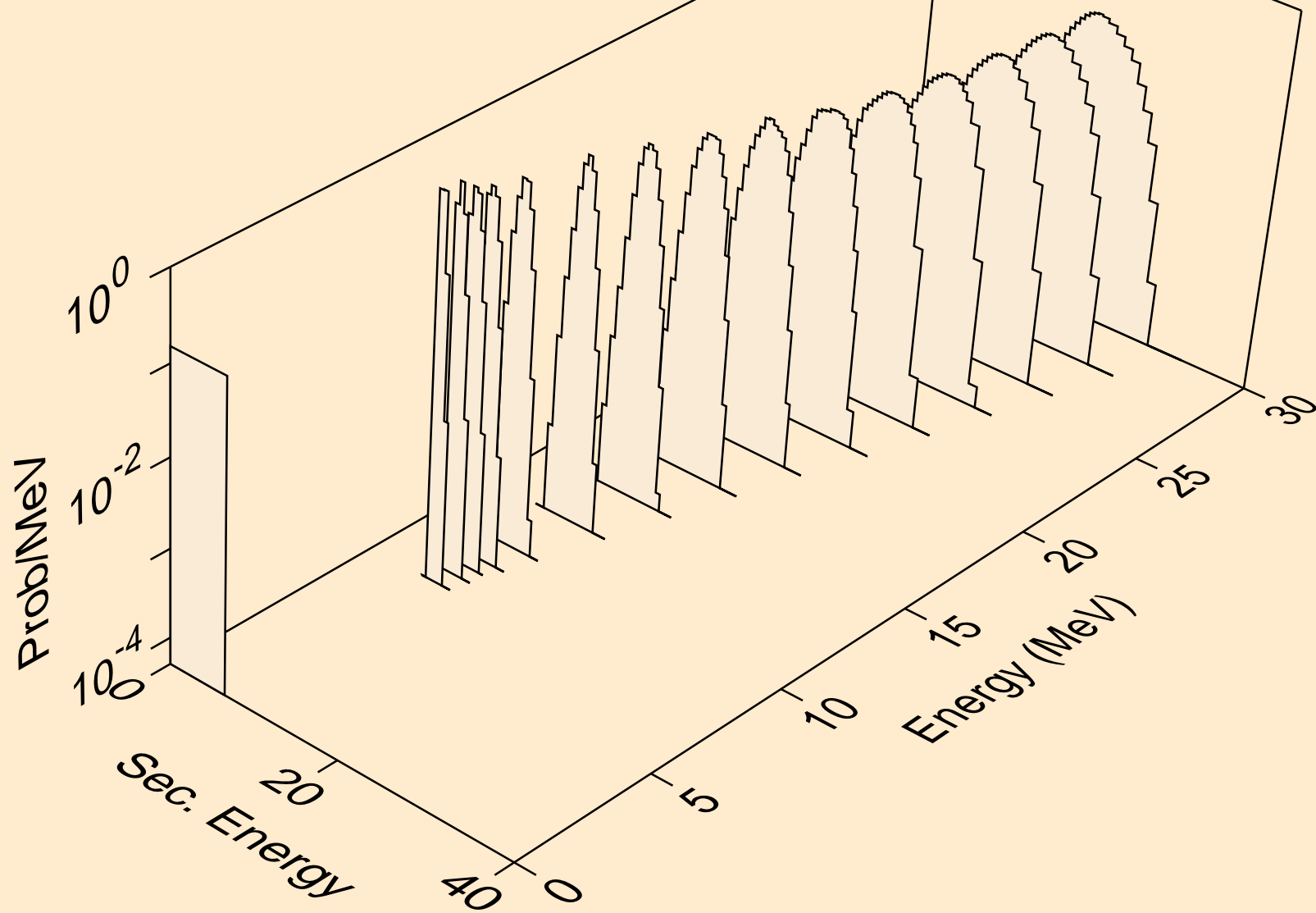

AT206 NEUTRON ACER TENDL-2021 LIBRARY; T=293.6K
alphas from (n,a)

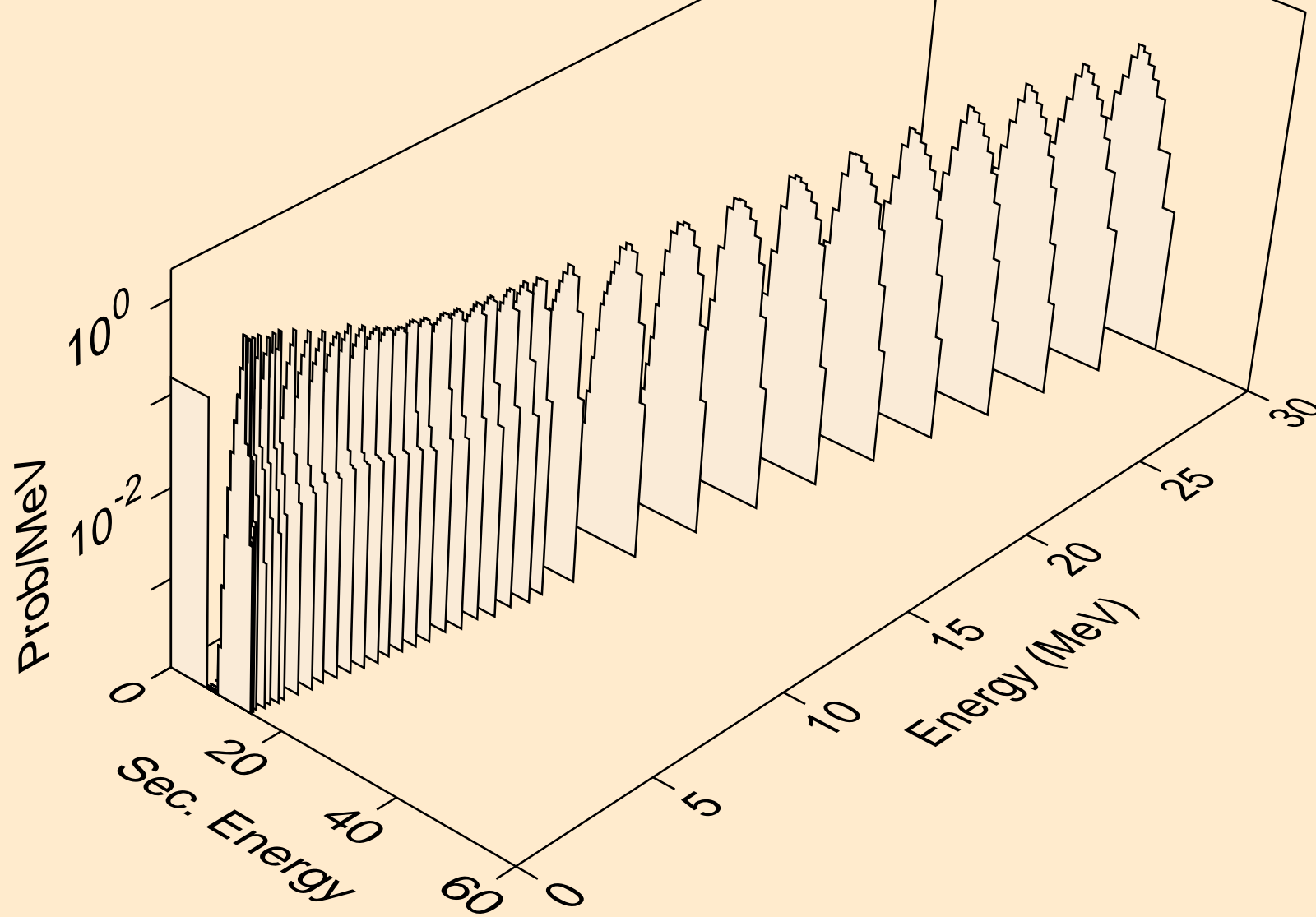

AT206 NEUTRON ACER TENDL-2021 LIBRARY; T=293.6K
alphas from (n,2a)

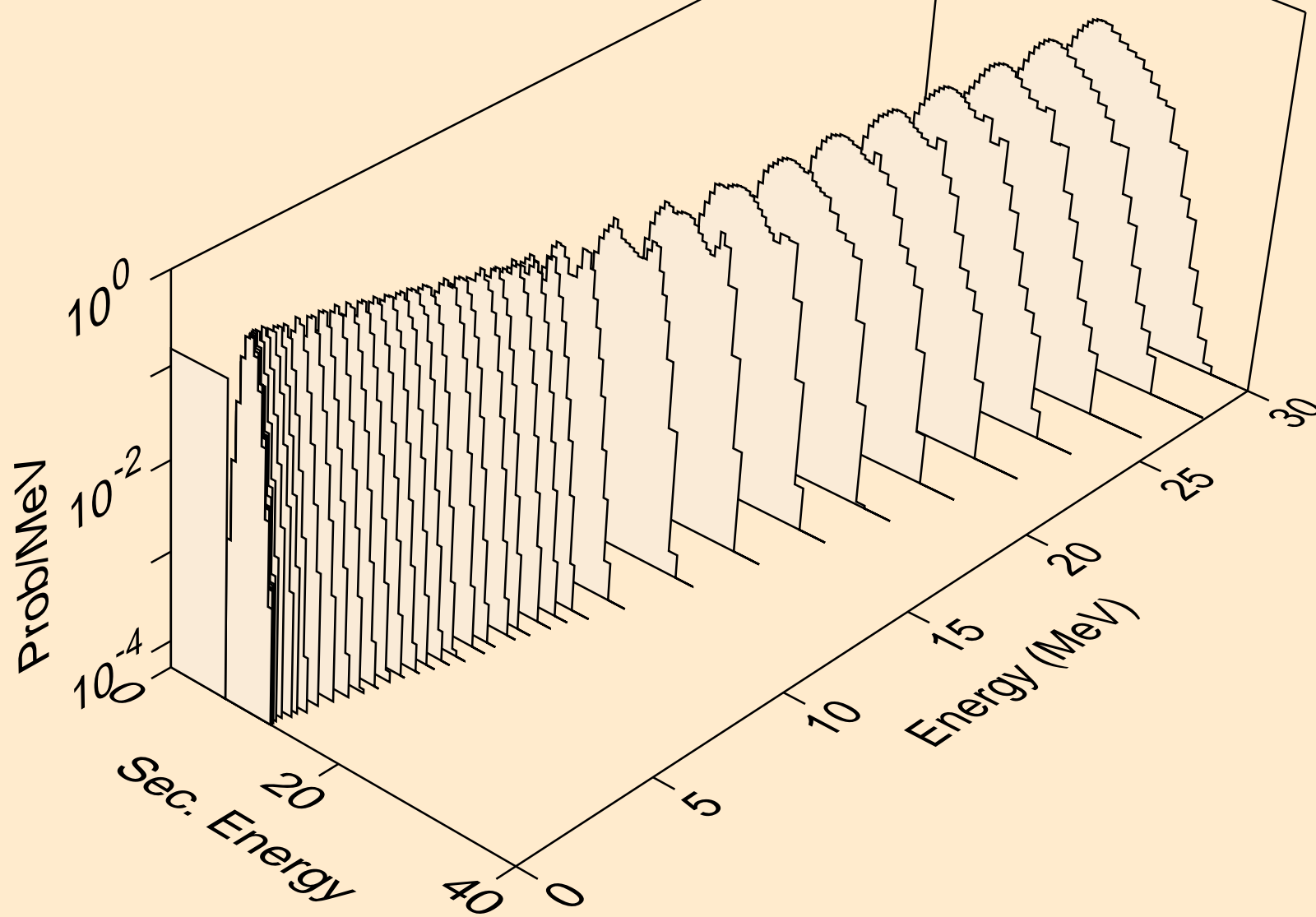

AT206 NEUTRON ACER TENDL-2021 LIBRARY; T=293.6K
alphas from (n,pa)

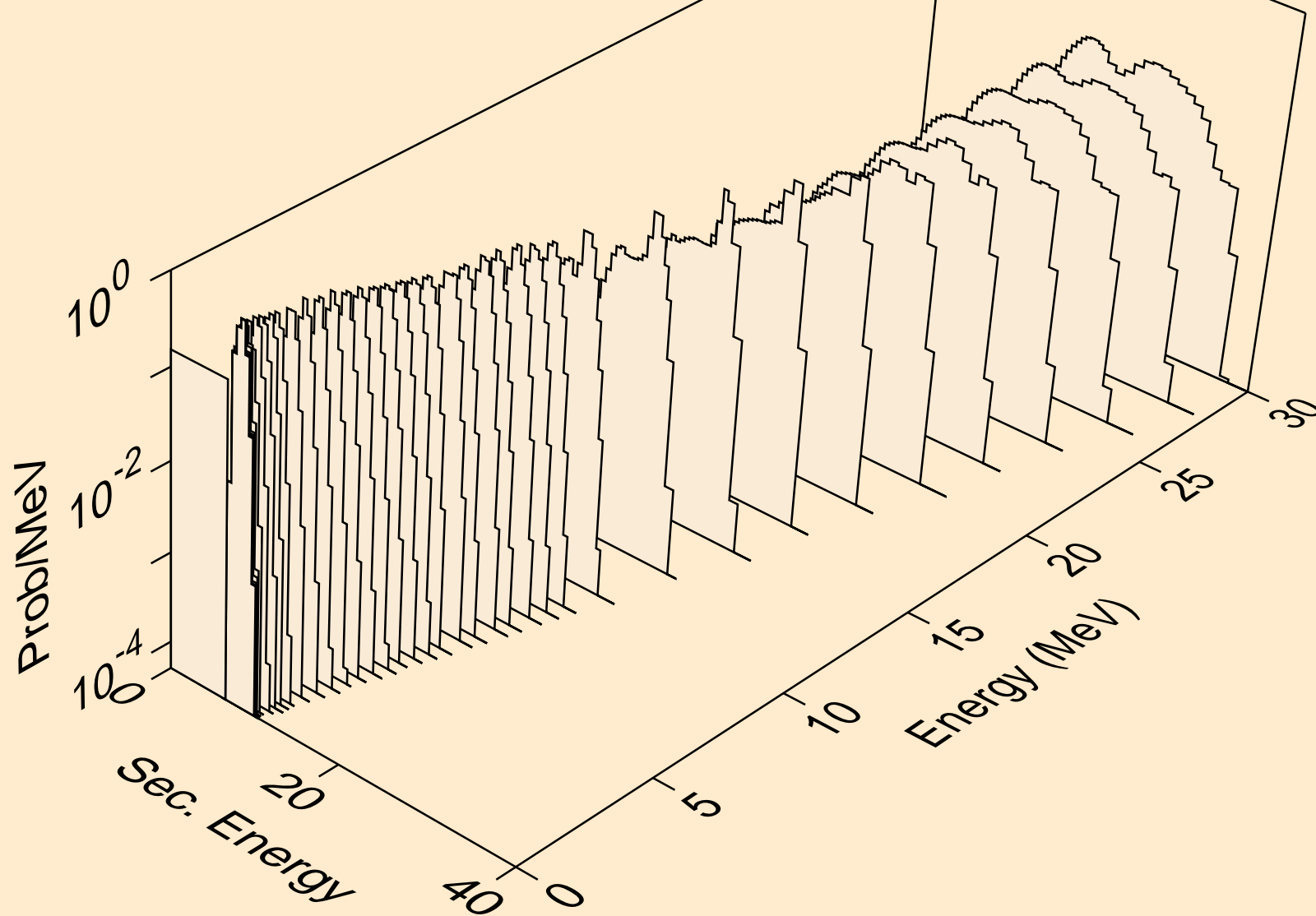

AT206 NEUTRON ACER TENDL-2021 LIBRARY; T=293.6K
alphas from (n,da)

