

AT221 NEUTRON ACER TENDL-2021 LIBRARY; T=293.6K
Principal cross sections

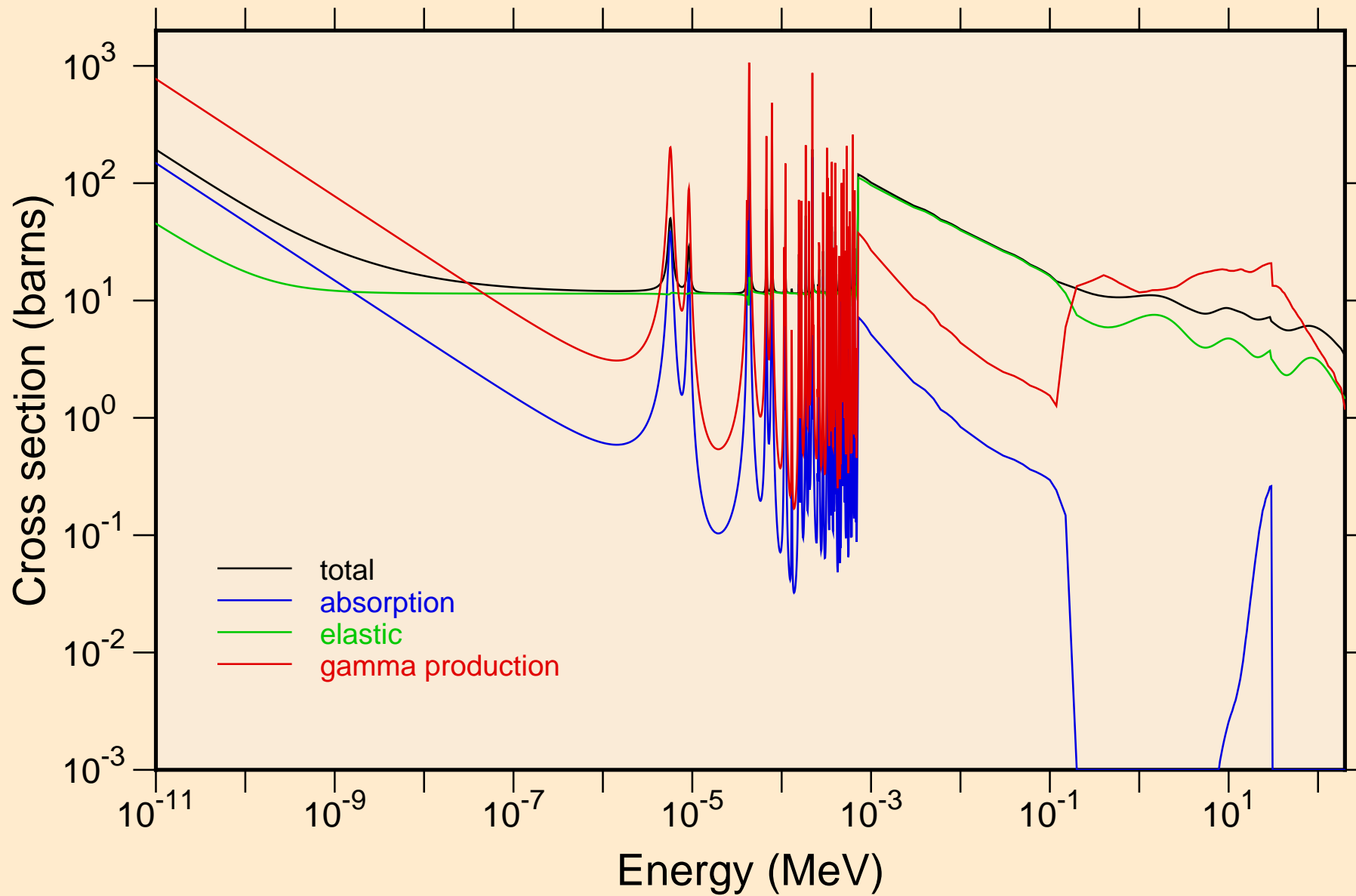

AT221 NEUTRON ACER TENDL-2021 LIBRARY; T=293.6K
resonance total cross section

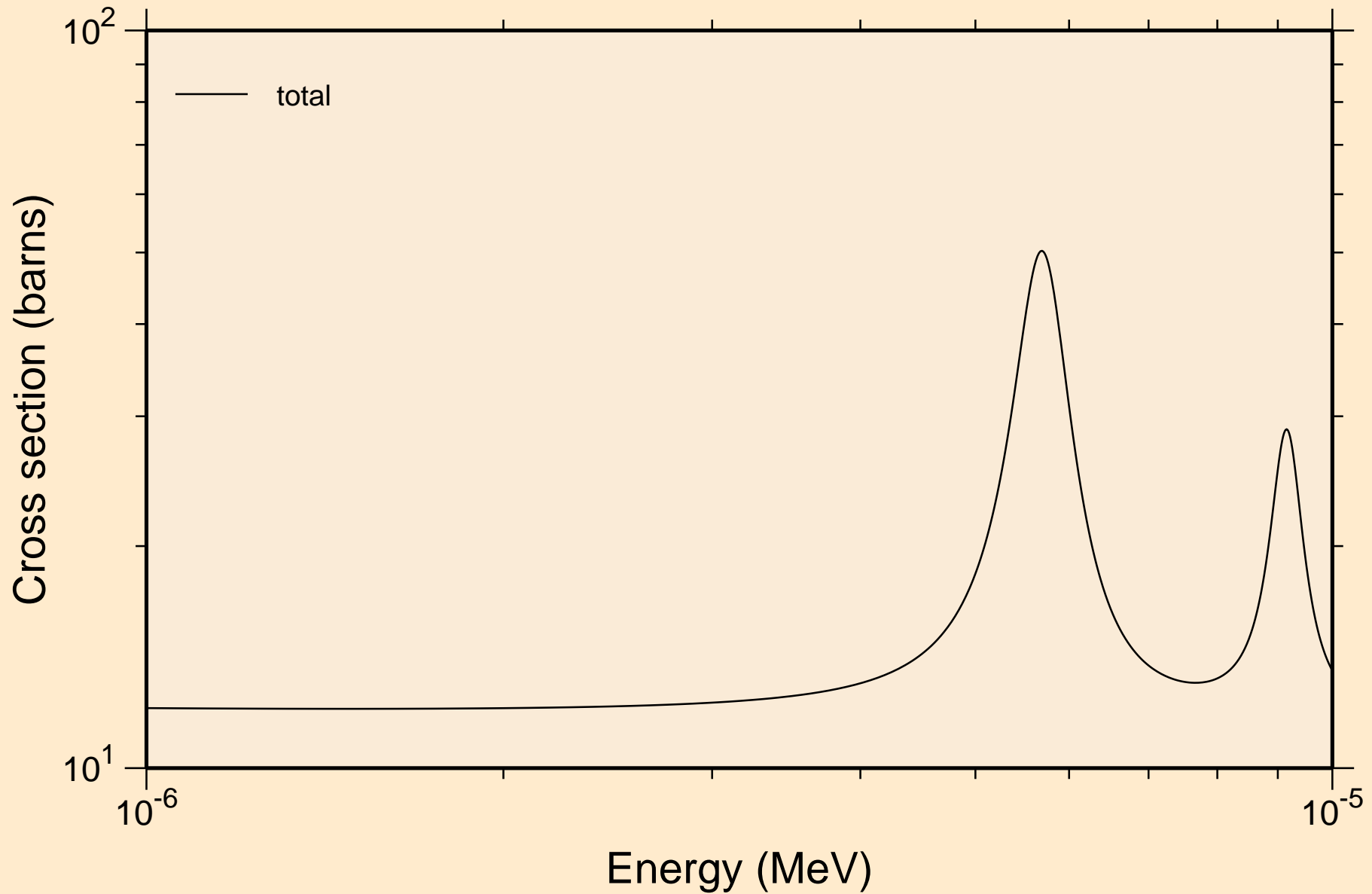

AT221 NEUTRON ACER TENDL-2021 LIBRARY; T=293.6K
resonance total cross section

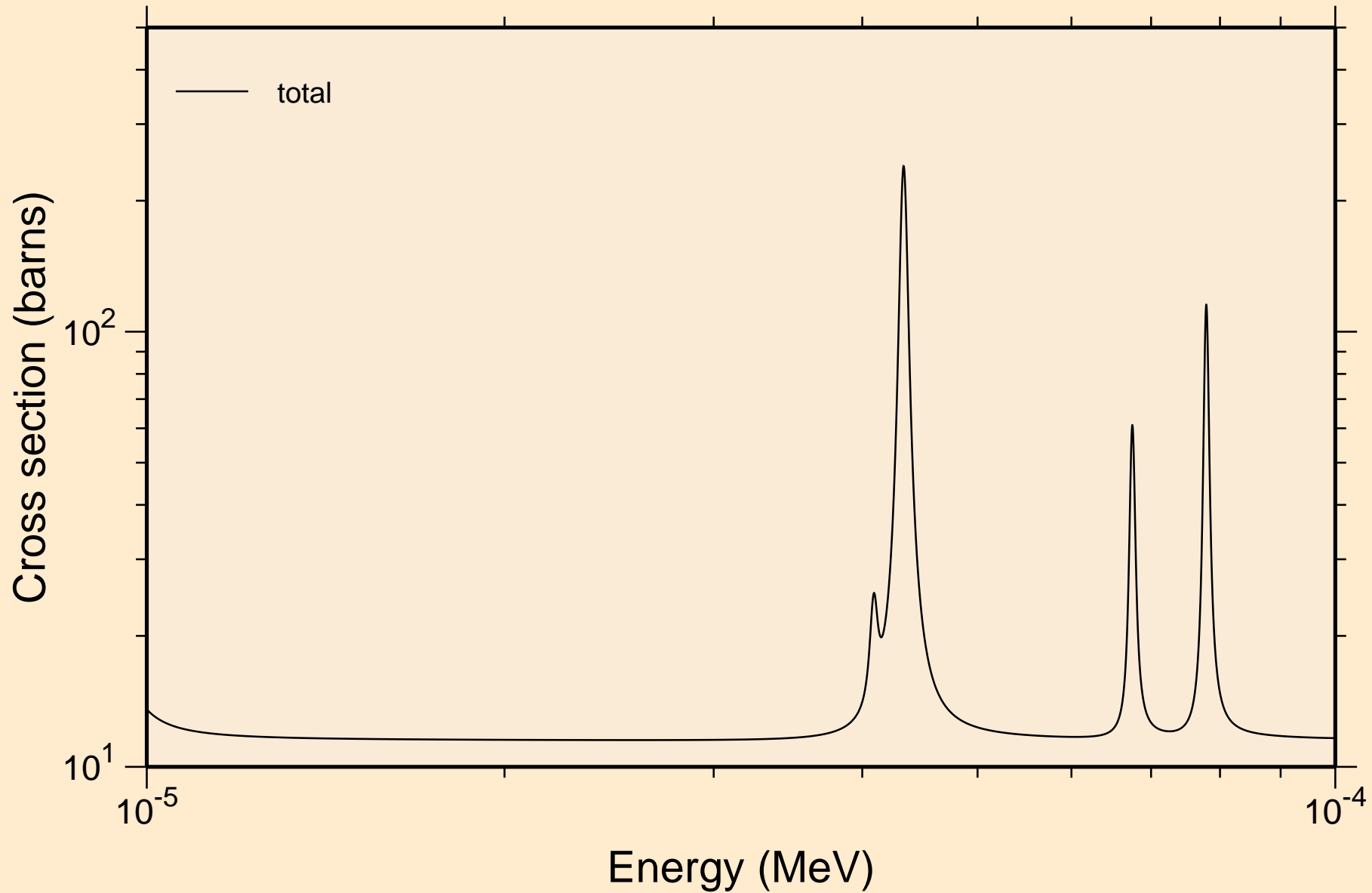

AT221 NEUTRON ACER TENDL-2021 LIBRARY; T=293.6K
resonance total cross section

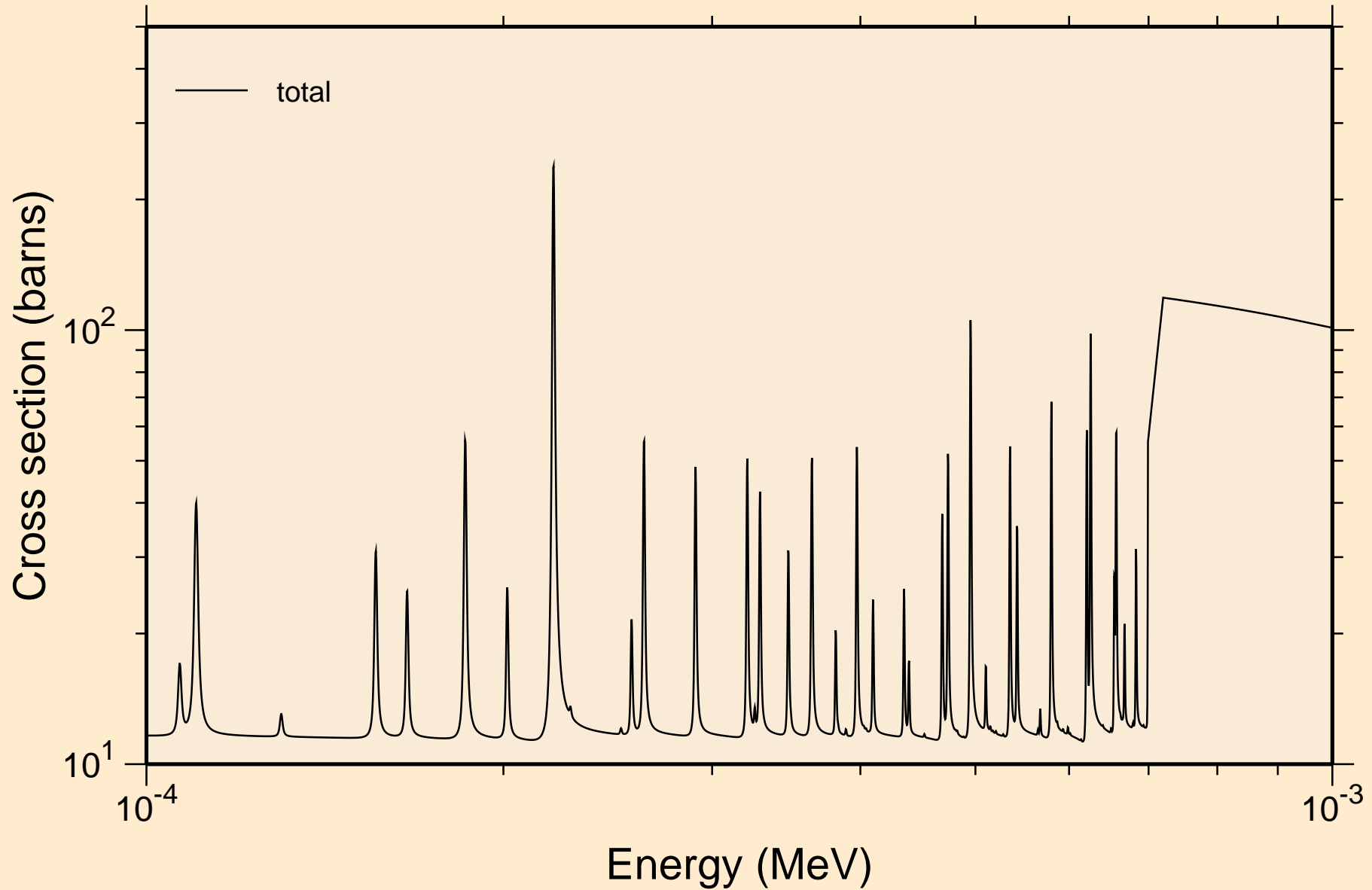

AT221 NEUTRON ACER TENDL-2021 LIBRARY; T=293.6K
resonance total cross section

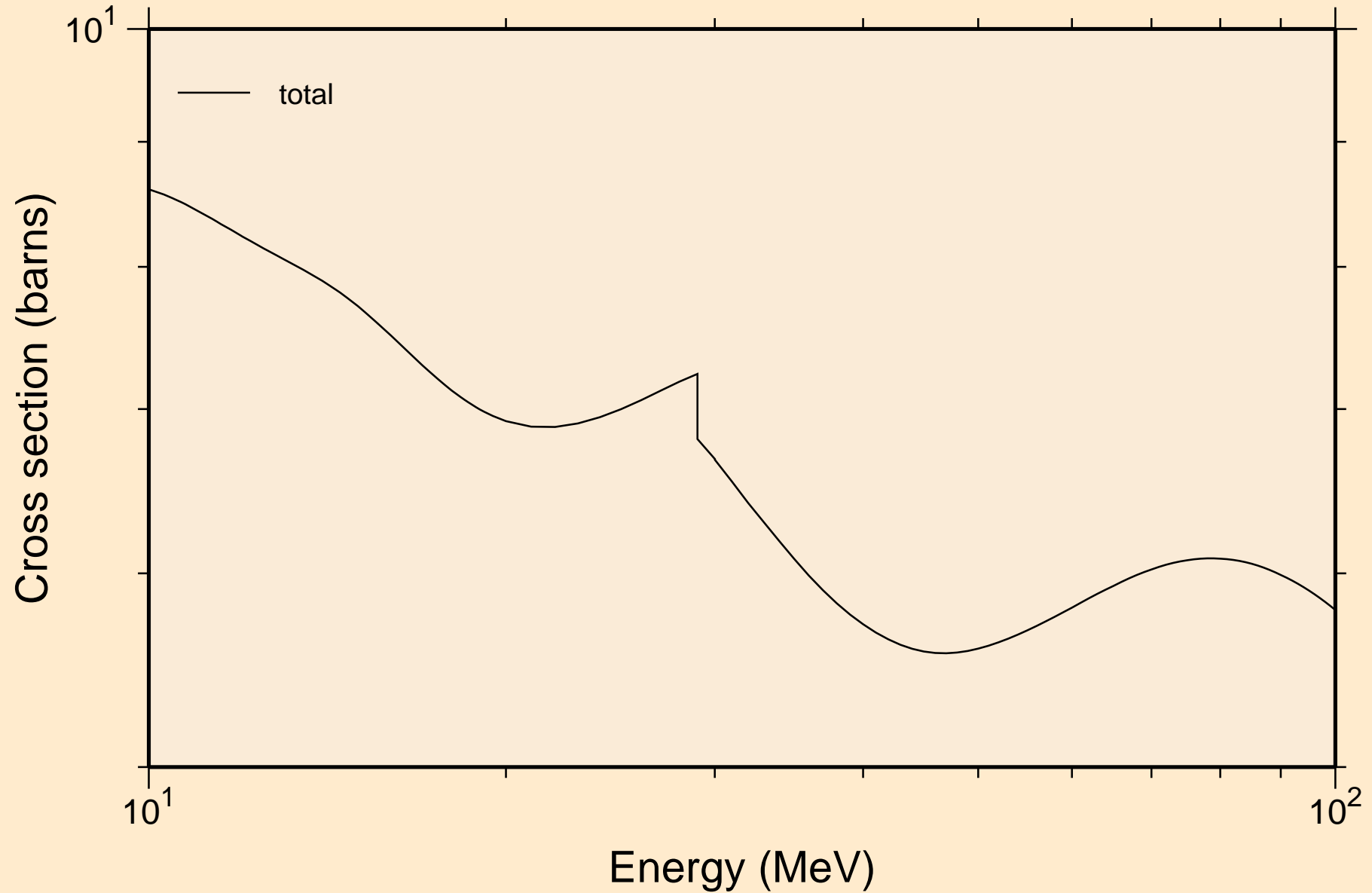

AT221 NEUTRON ACER TENDL-2021 LIBRARY; T=293.6K
resonance absorption cross sections

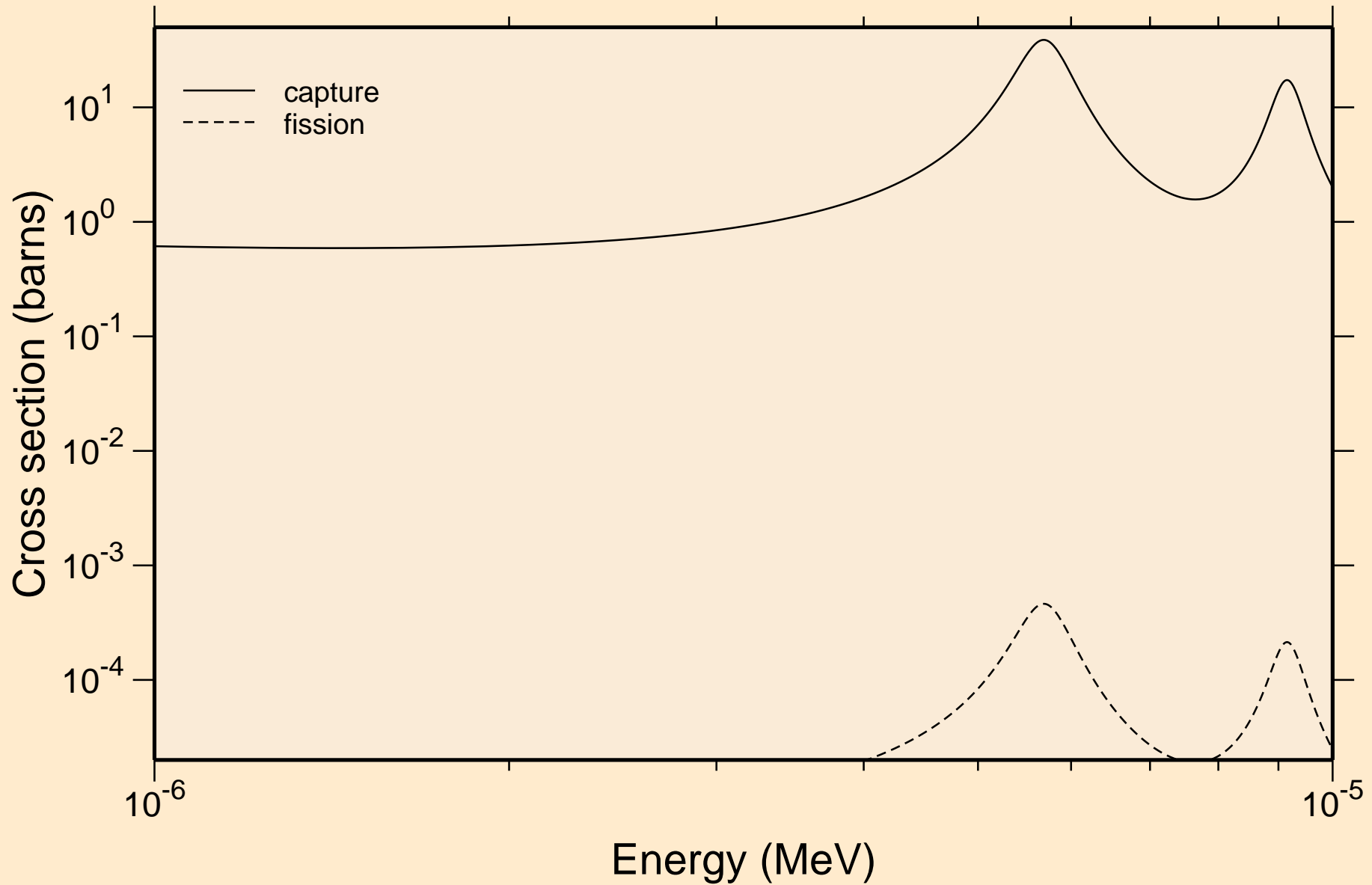

AT221 NEUTRON ACER TENDL-2021 LIBRARY; T=293.6K
resonance absorption cross sections

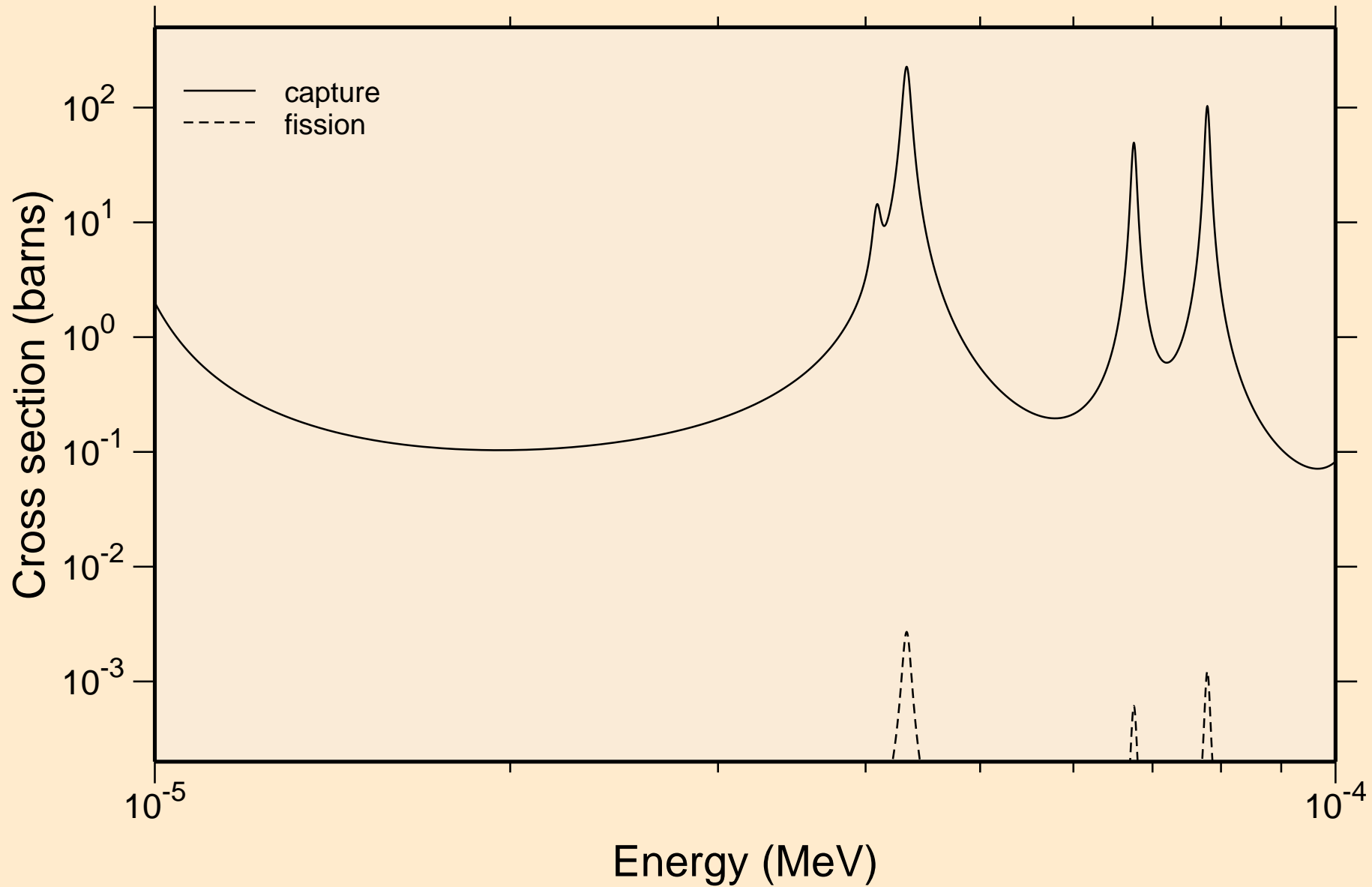

AT221 NEUTRON ACER TENDL-2021 LIBRARY; T=293.6K
resonance absorption cross sections

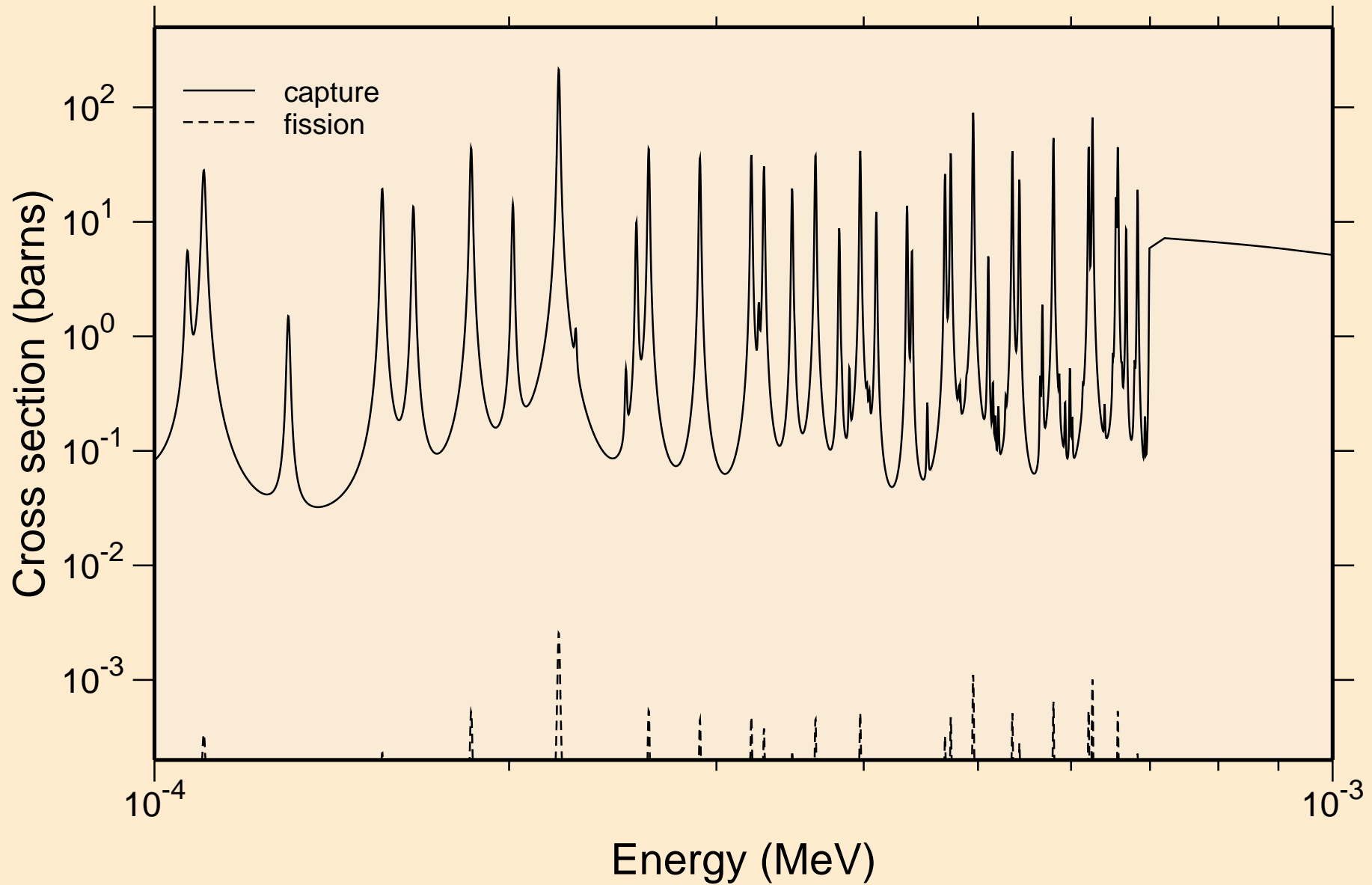

AT221 NEUTRON ACER TENDL-2021 LIBRARY; T=293.6K
resonance absorption cross sections

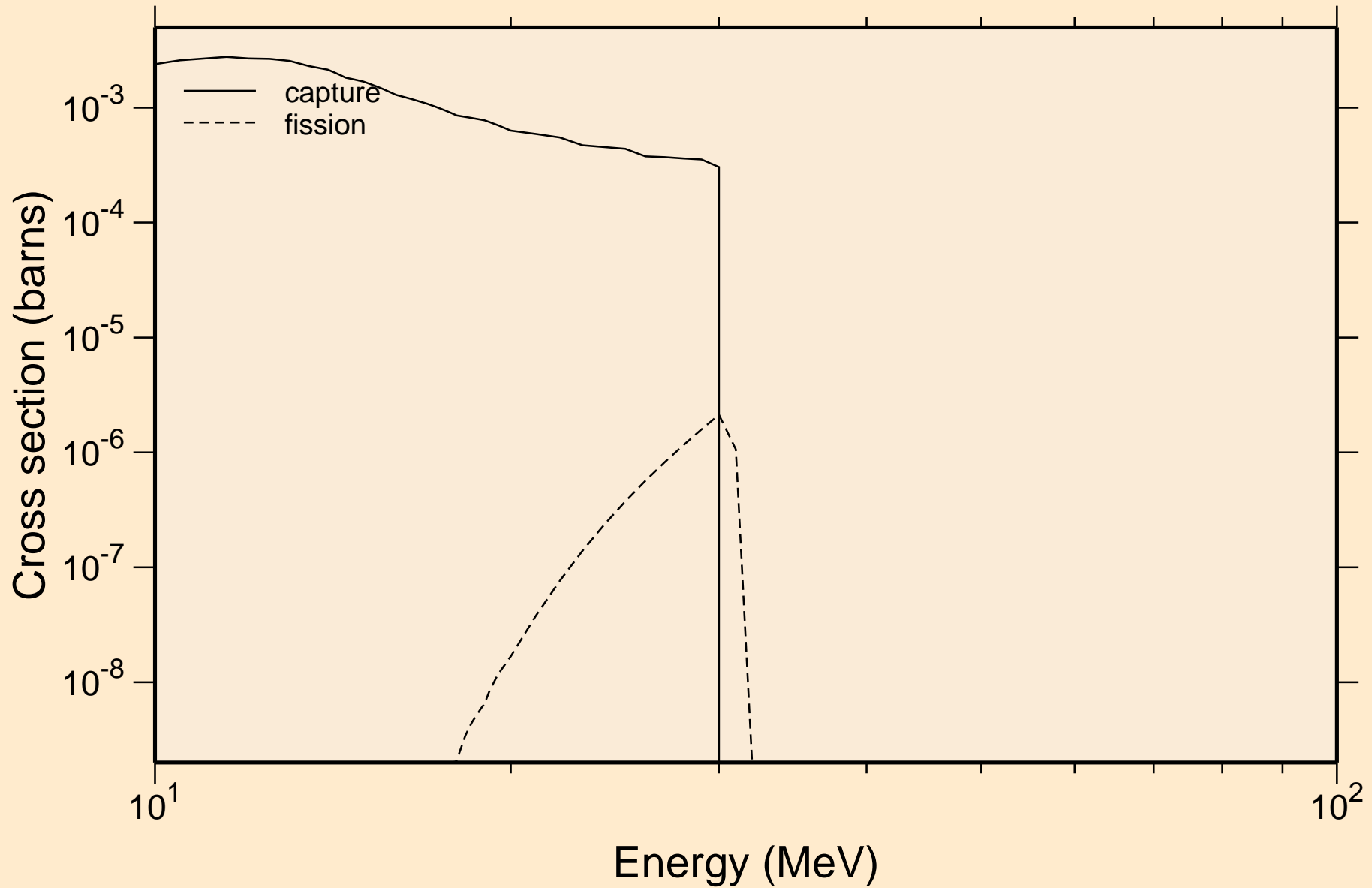

AT221 NEUTRON ACER TENDL-2021 LIBRARY; T=293.6K
Heating

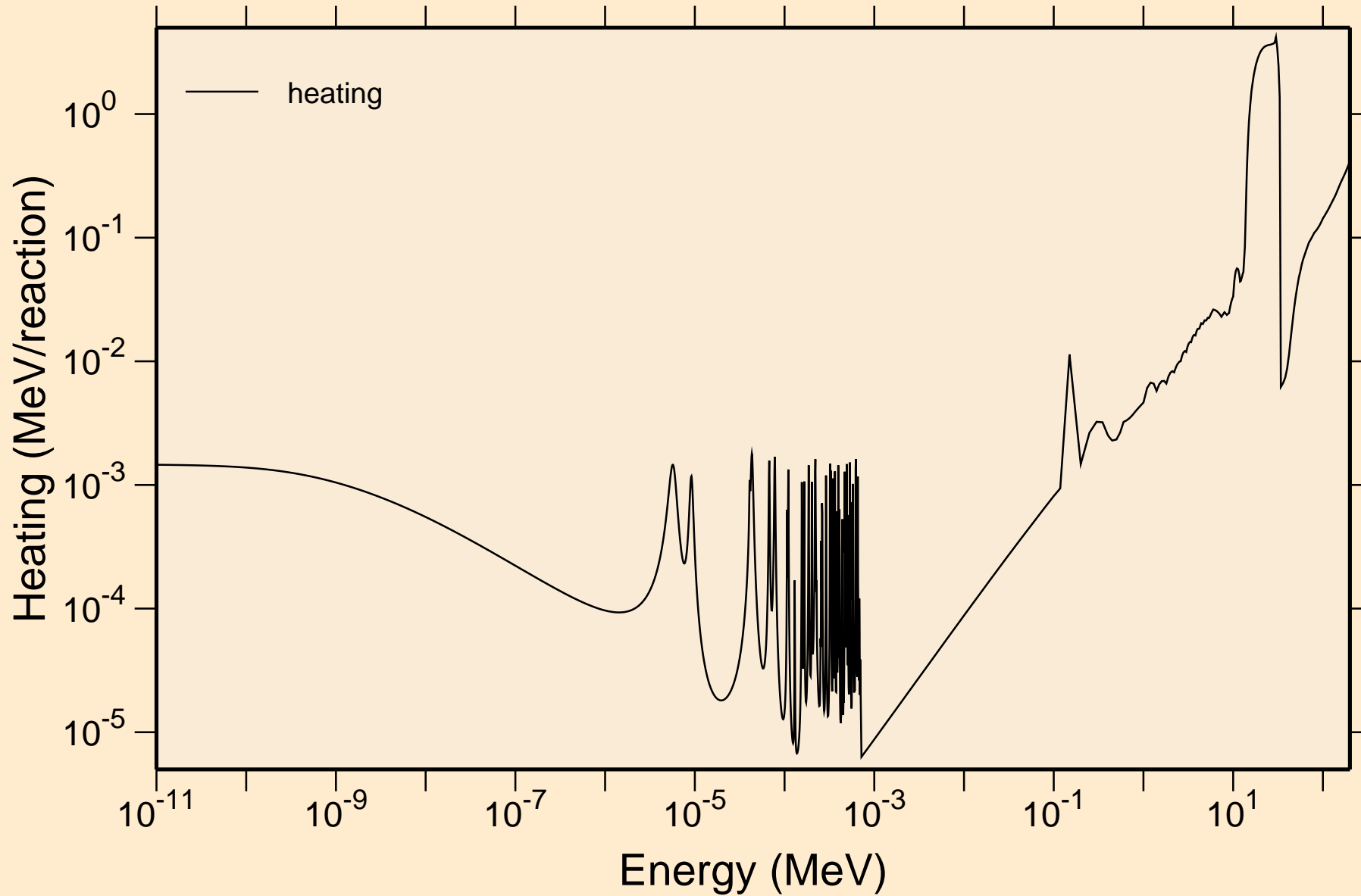

AT221 NEUTRON ACER TENDL-2021 LIBRARY; T=293.6K
Damage

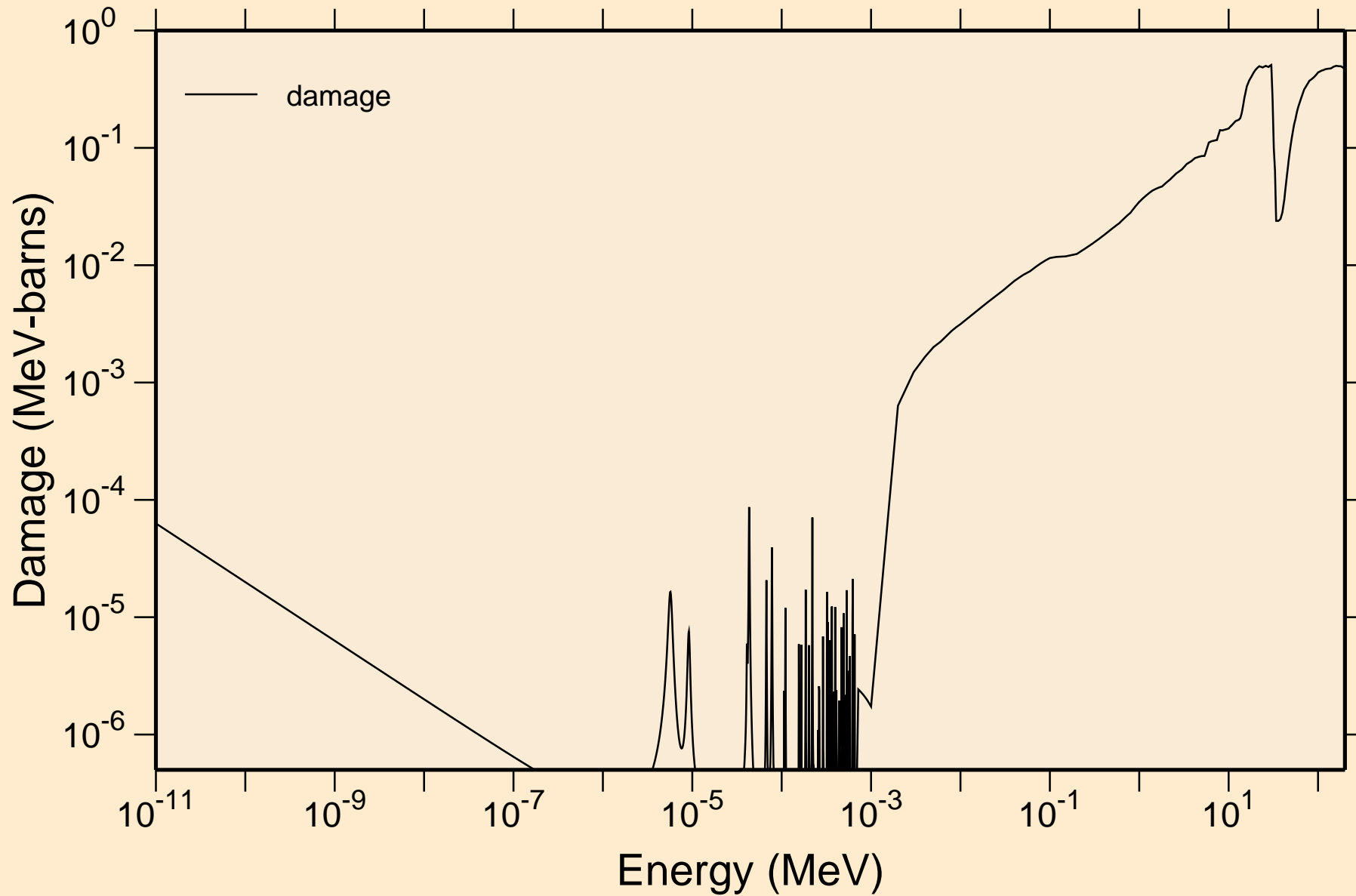

AT221 NEUTRON ACER TENDL-2021 LIBRARY; T=293.6K
Non-threshold reactions

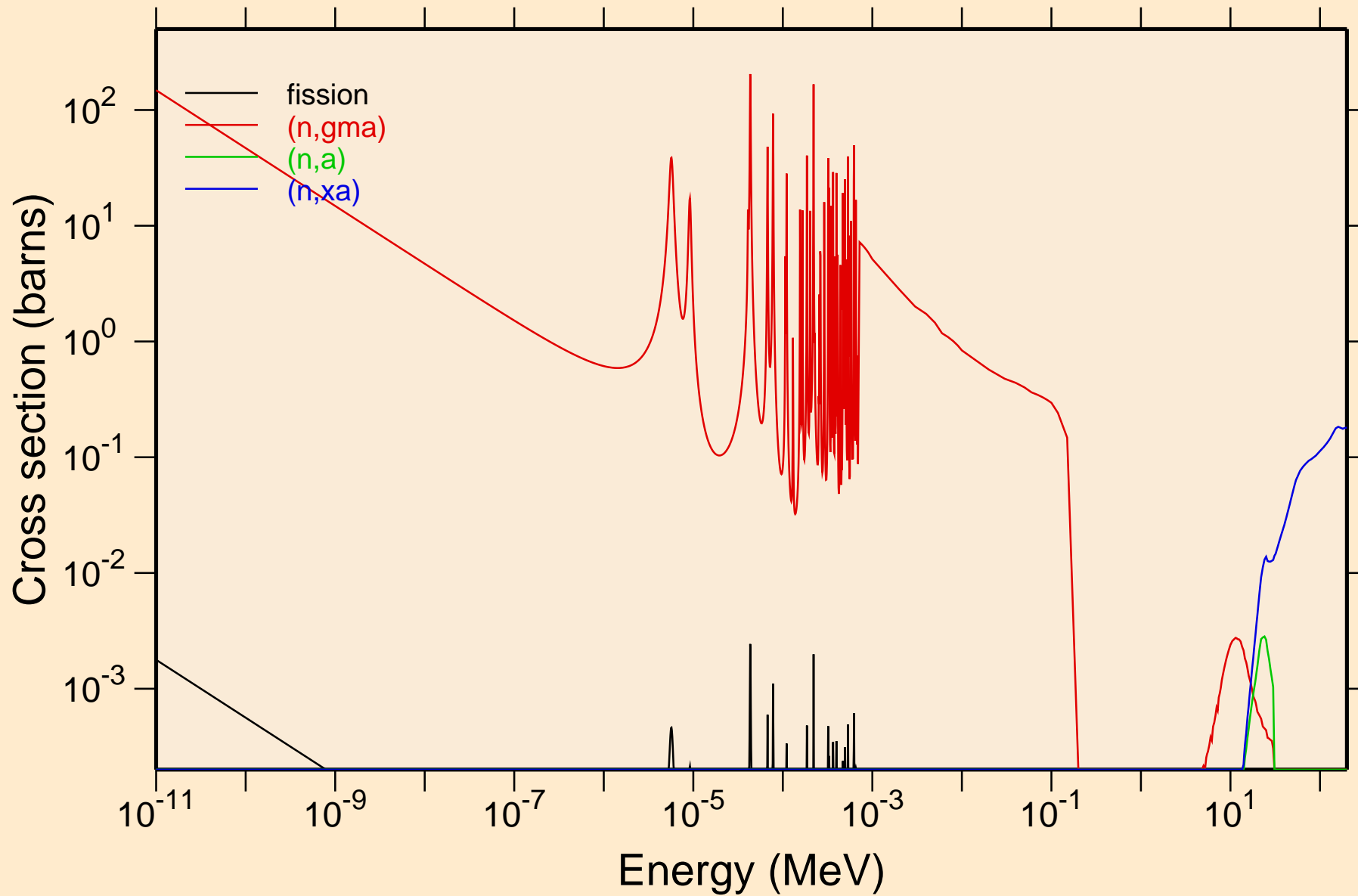

AT221 NEUTRON ACER TENDL-2021 LIBRARY; T=293.6K
Principal cross sections

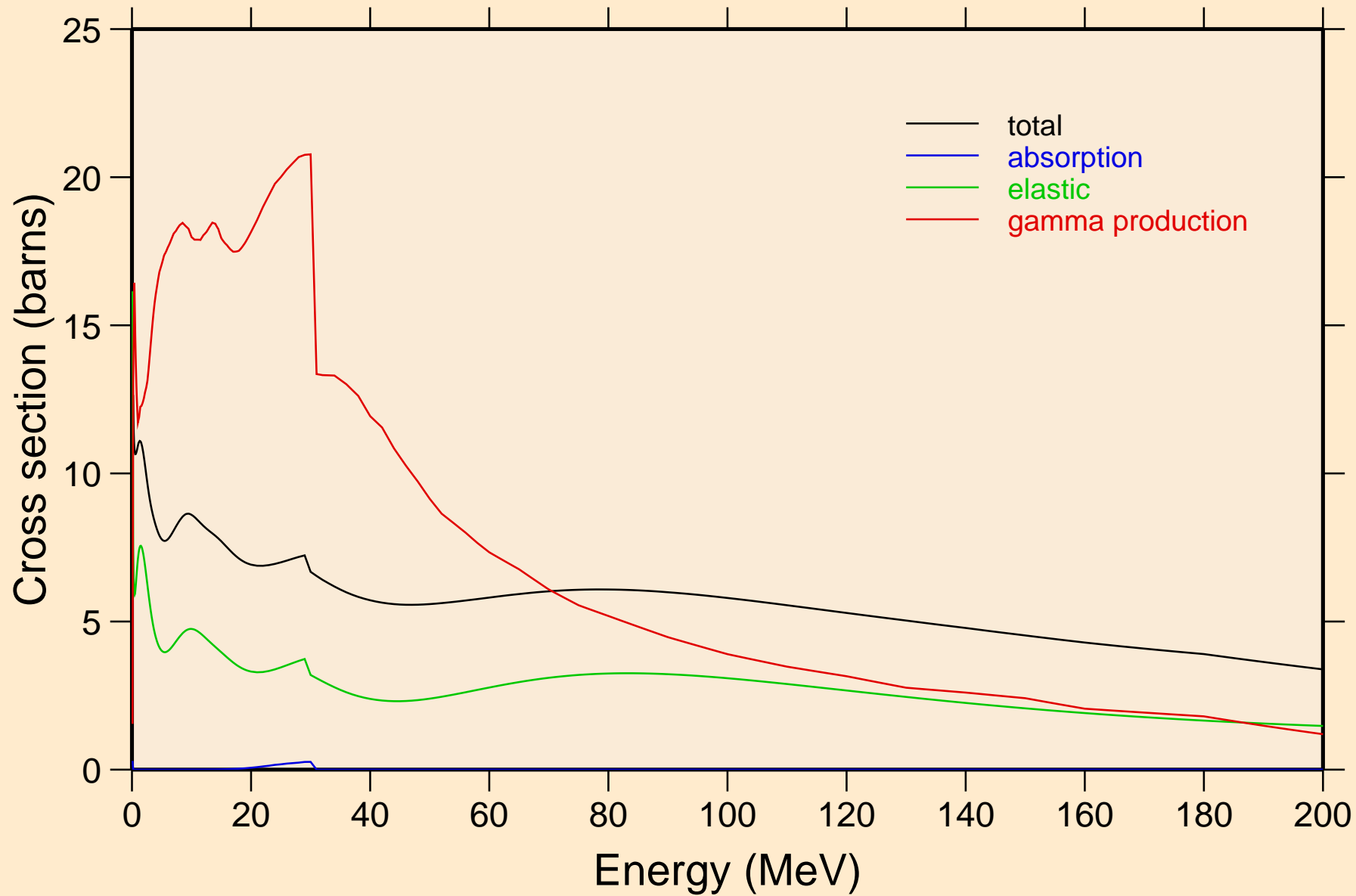

AT221 NEUTRON ACER TENDL-2021 LIBRARY; T=293.6K
Heating

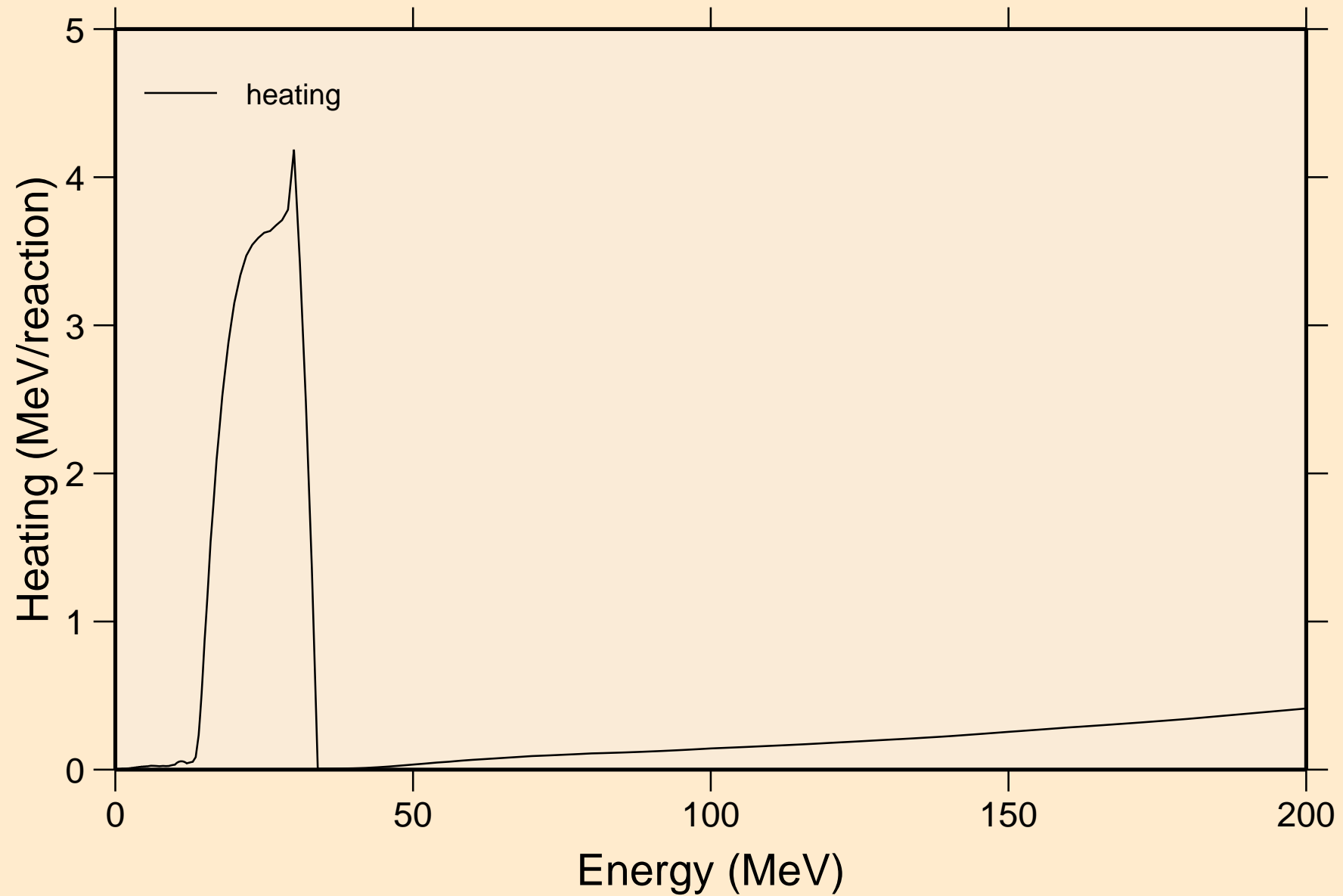

AT221 NEUTRON ACER TENDL-2021 LIBRARY; T=293.6K
Damage

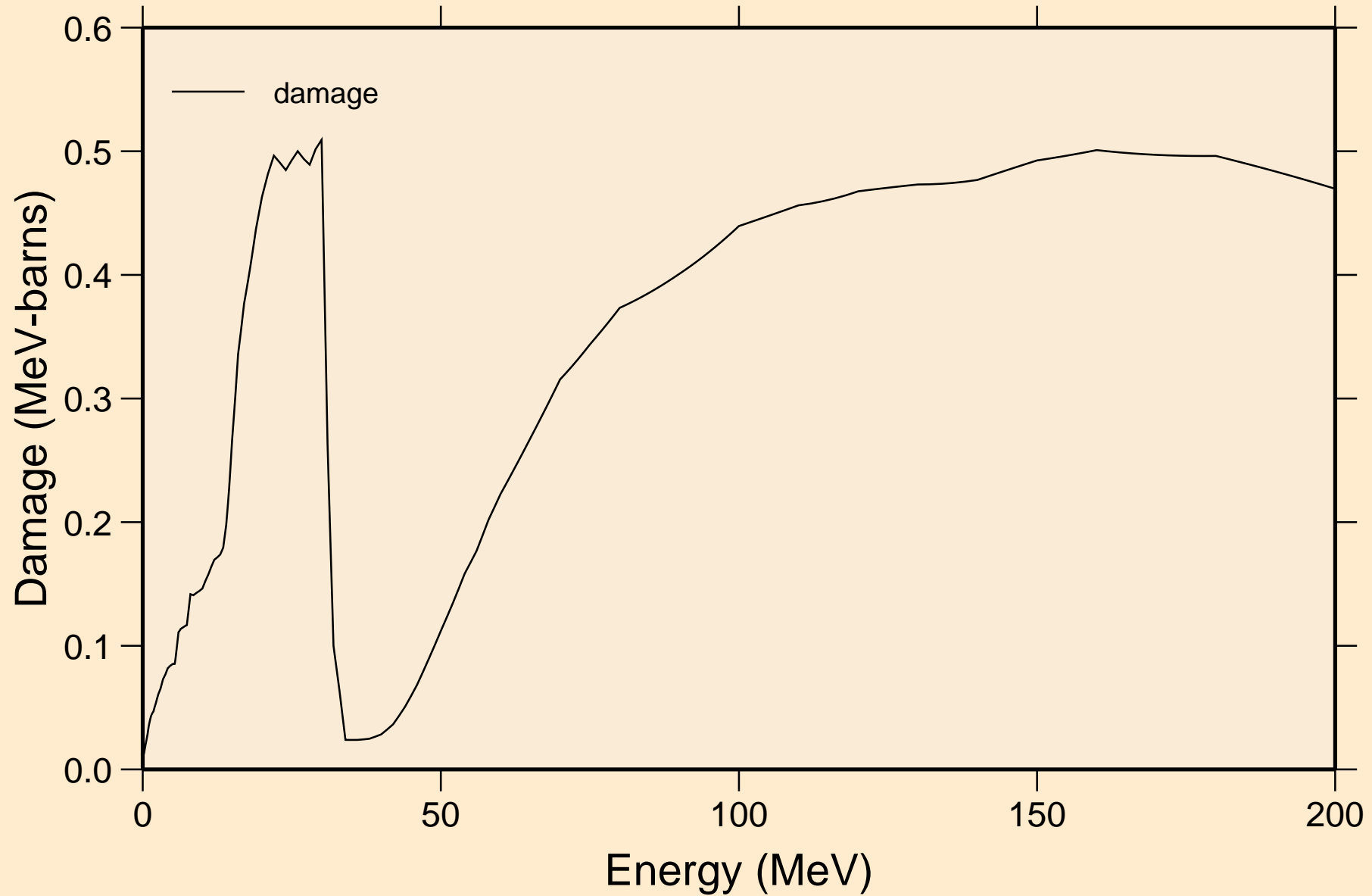

AT221 NEUTRON ACER TENDL-2021 LIBRARY; T=293.6K
Non-threshold reactions

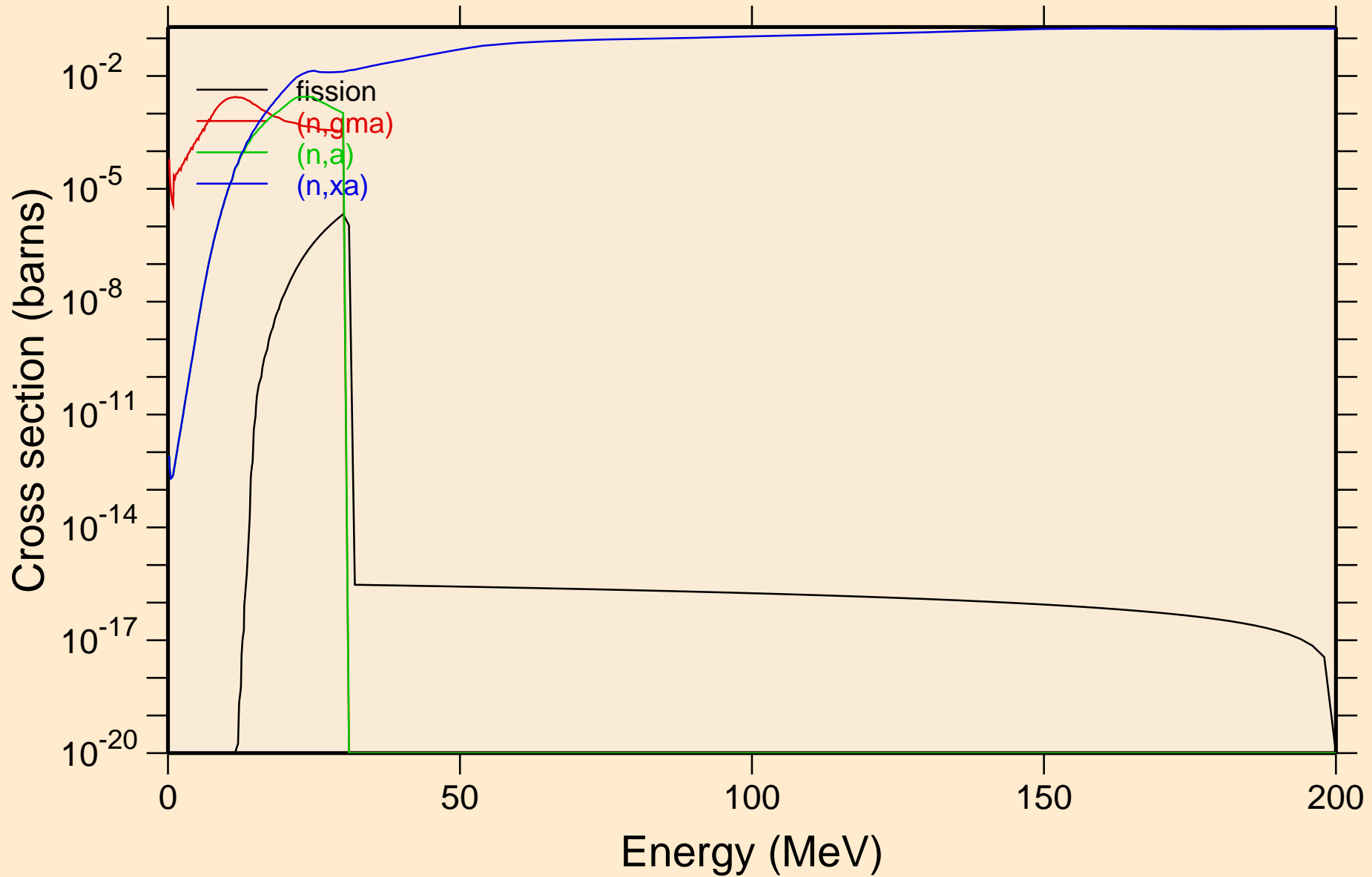

AT221 NEUTRON ACER TENDL-2021 LIBRARY; T=293.6K
Inelastic levels

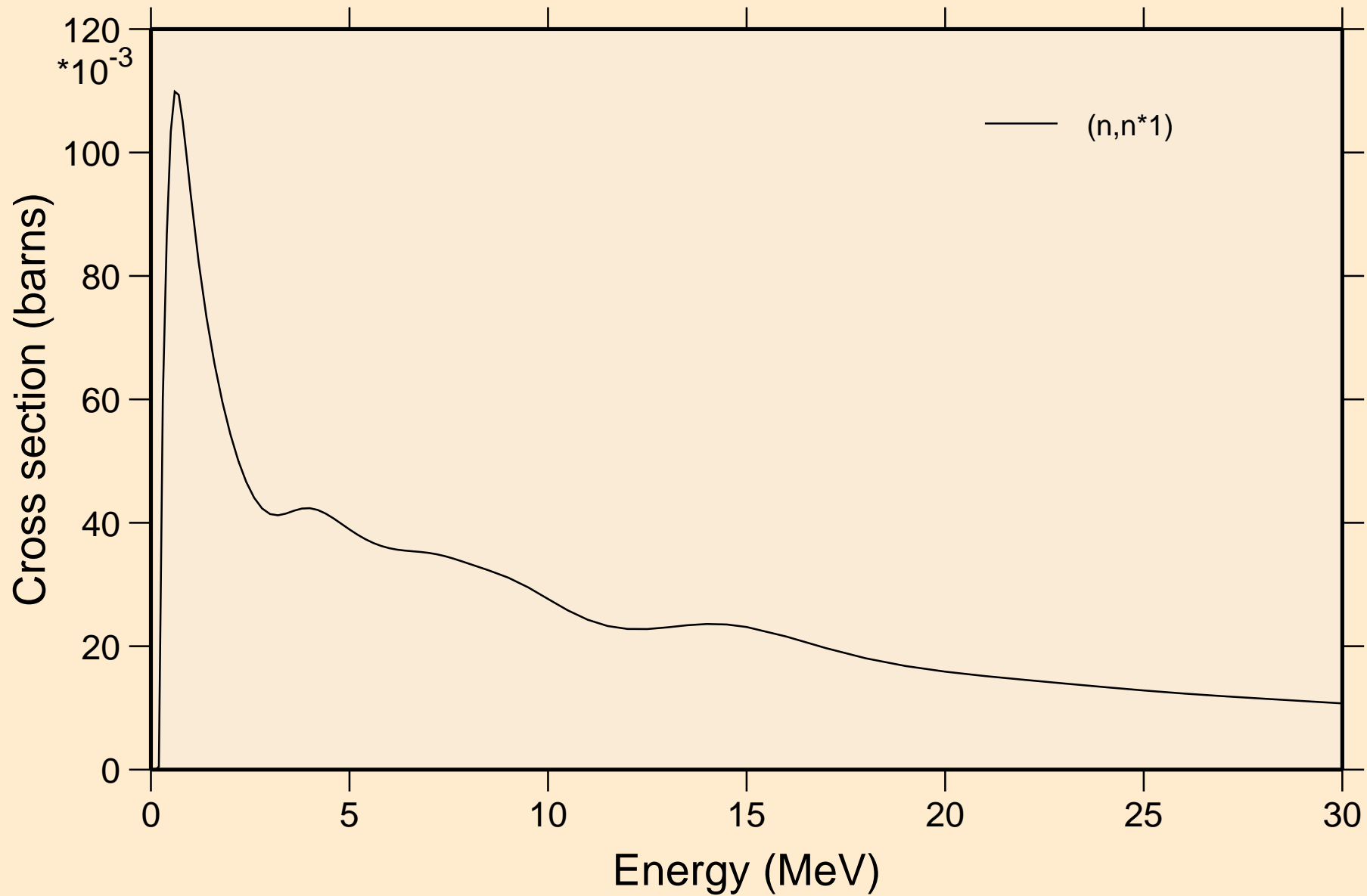

AT221 NEUTRON ACER TENDL-2021 LIBRARY; T=293.6K
Threshold reactions

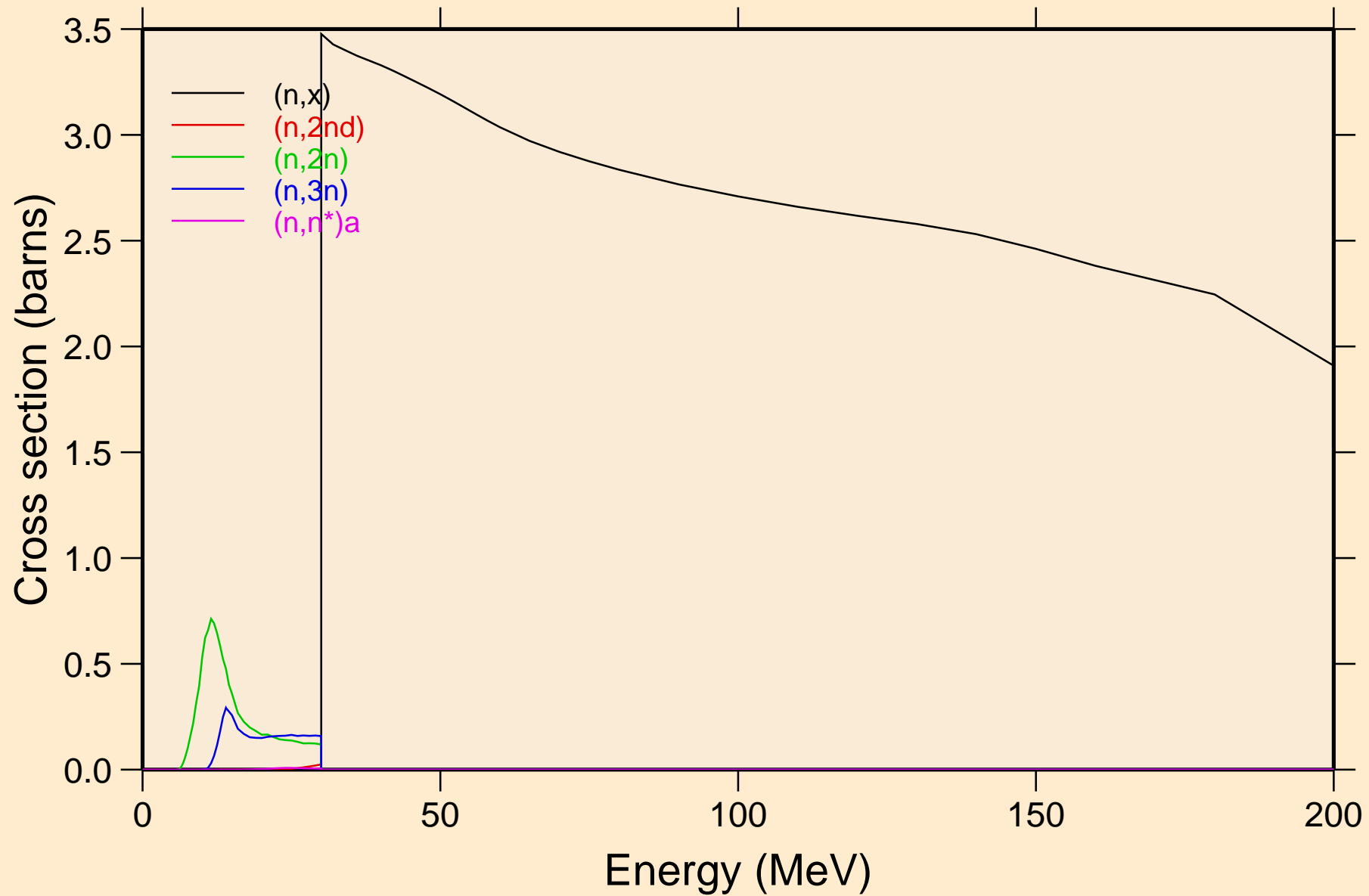

AT221 NEUTRON ACER TENDL-2021 LIBRARY; T=293.6K
Threshold reactions

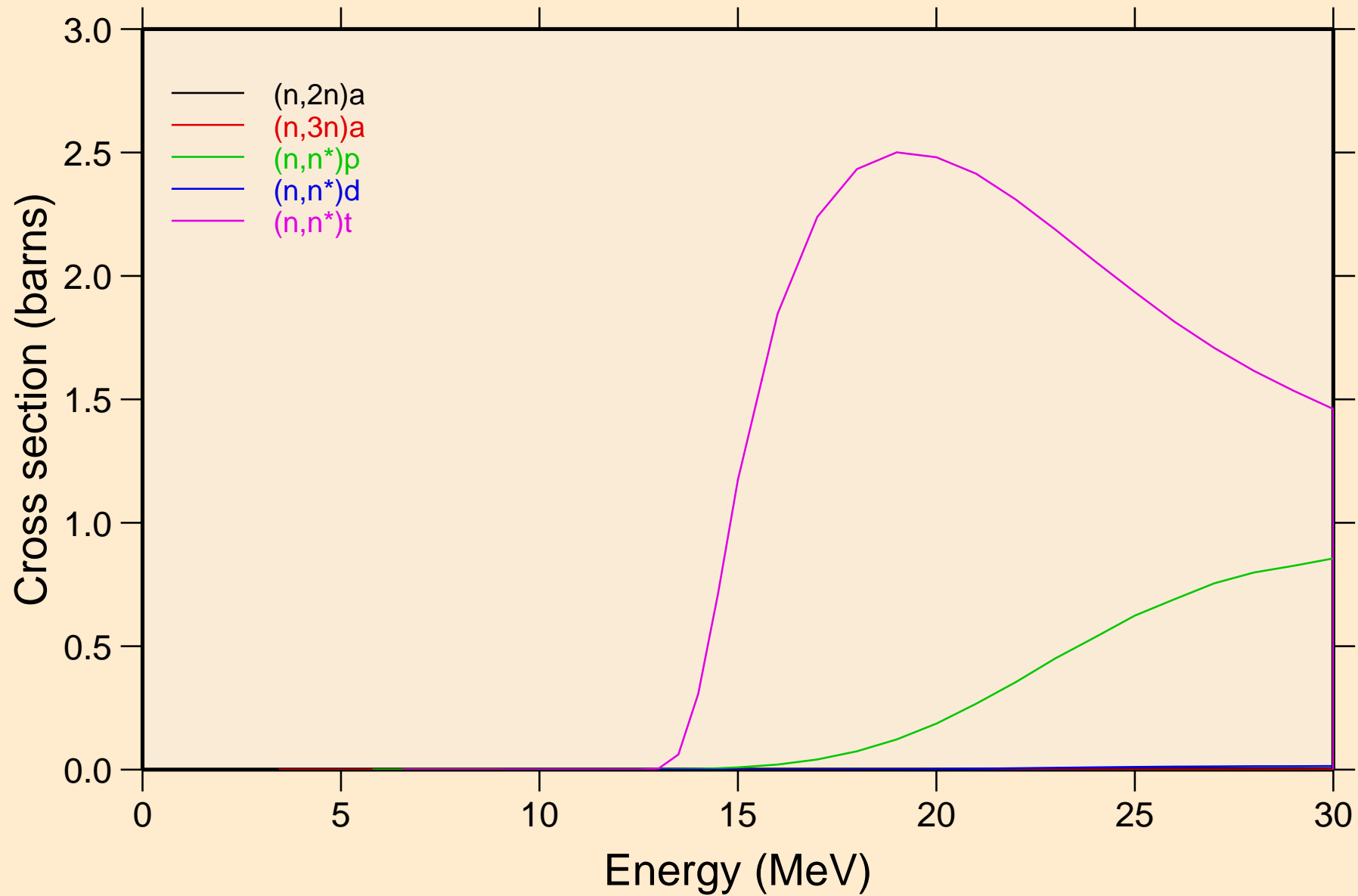

AT221 NEUTRON ACER TENDL-2021 LIBRARY; T=293.6K
Threshold reactions

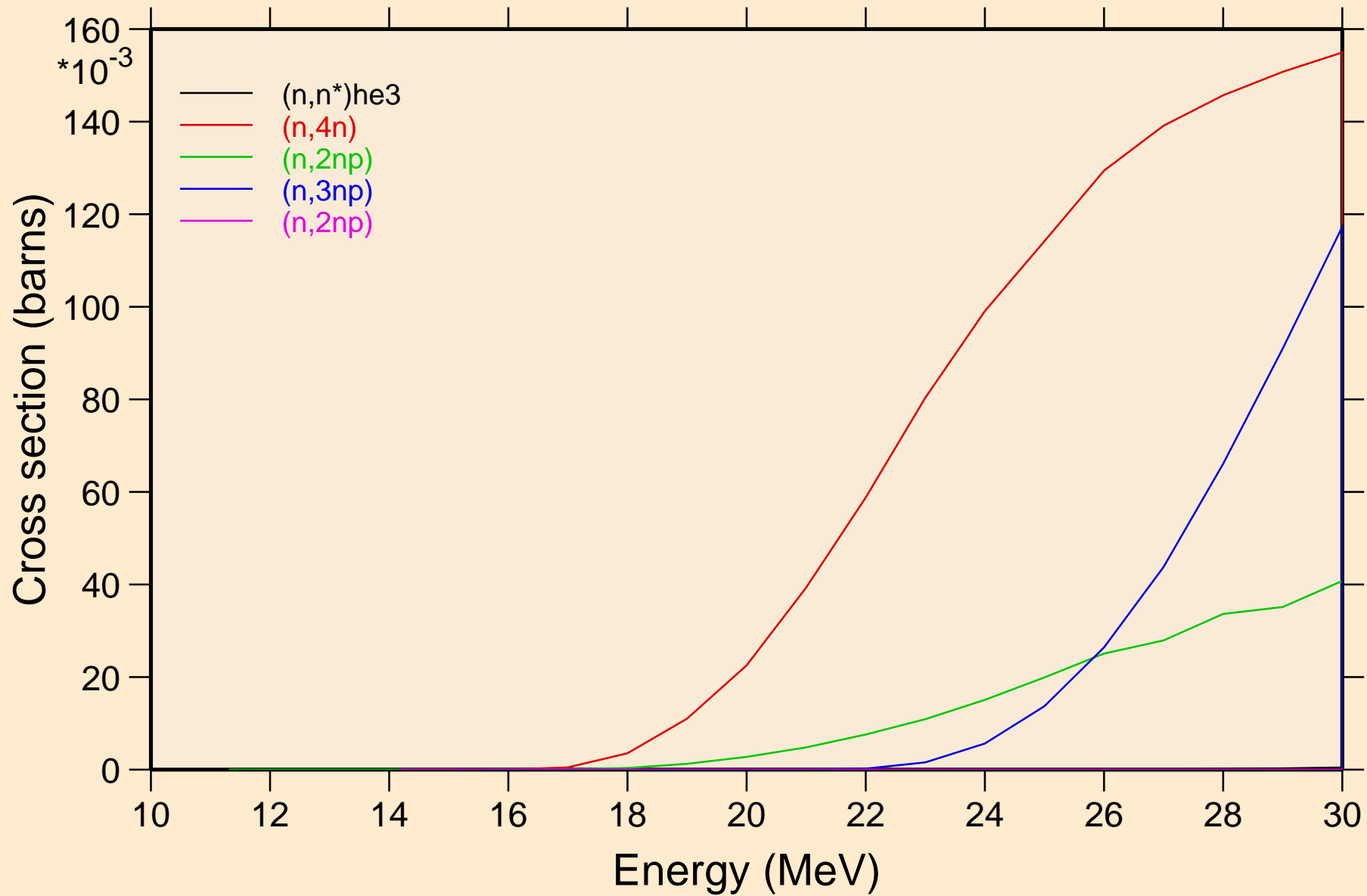

AT221 NEUTRON ACER TENDL-2021 LIBRARY; T=293.6K
Threshold reactions

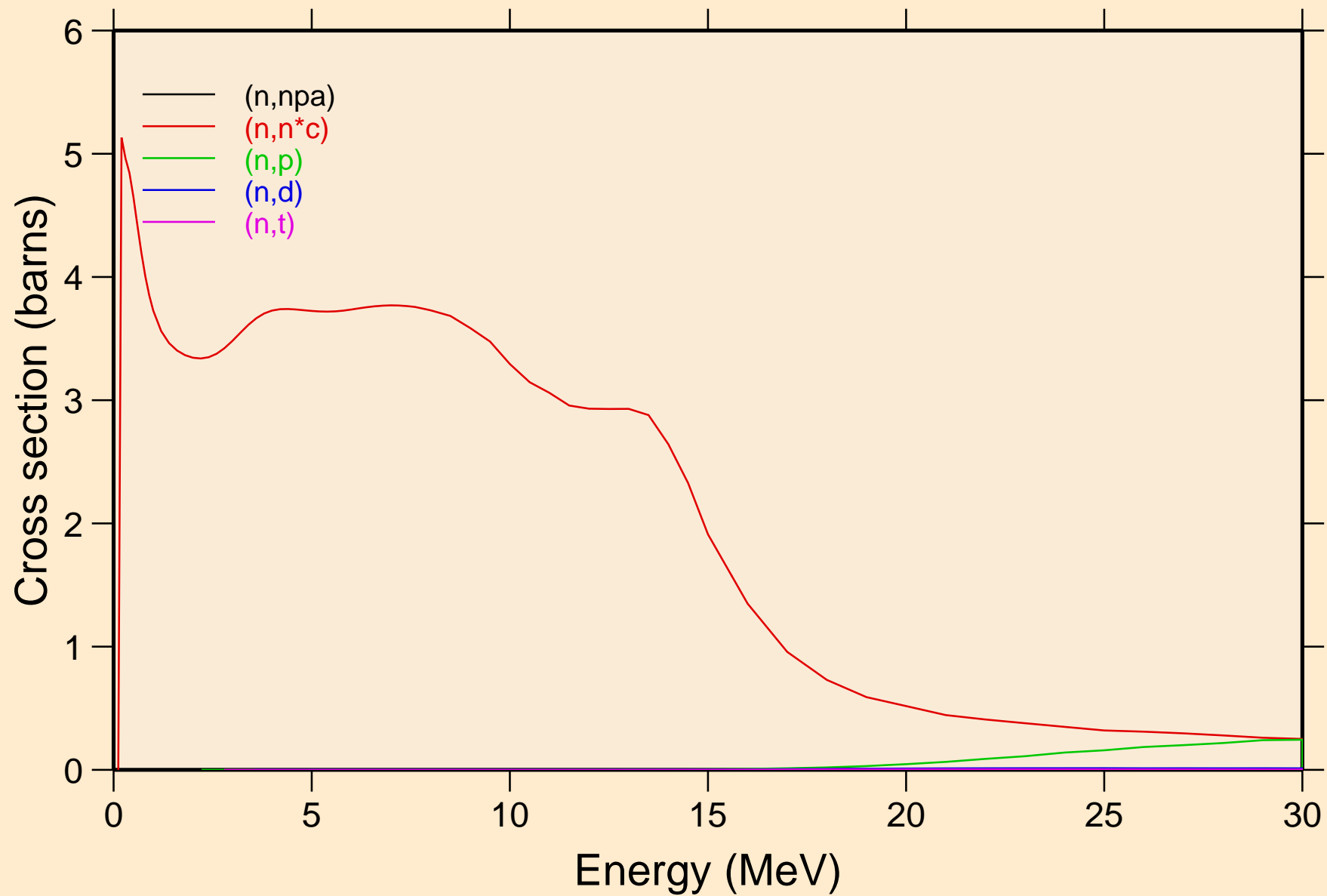

AT221 NEUTRON ACER TENDL-2021 LIBRARY; T=293.6K
Threshold reactions

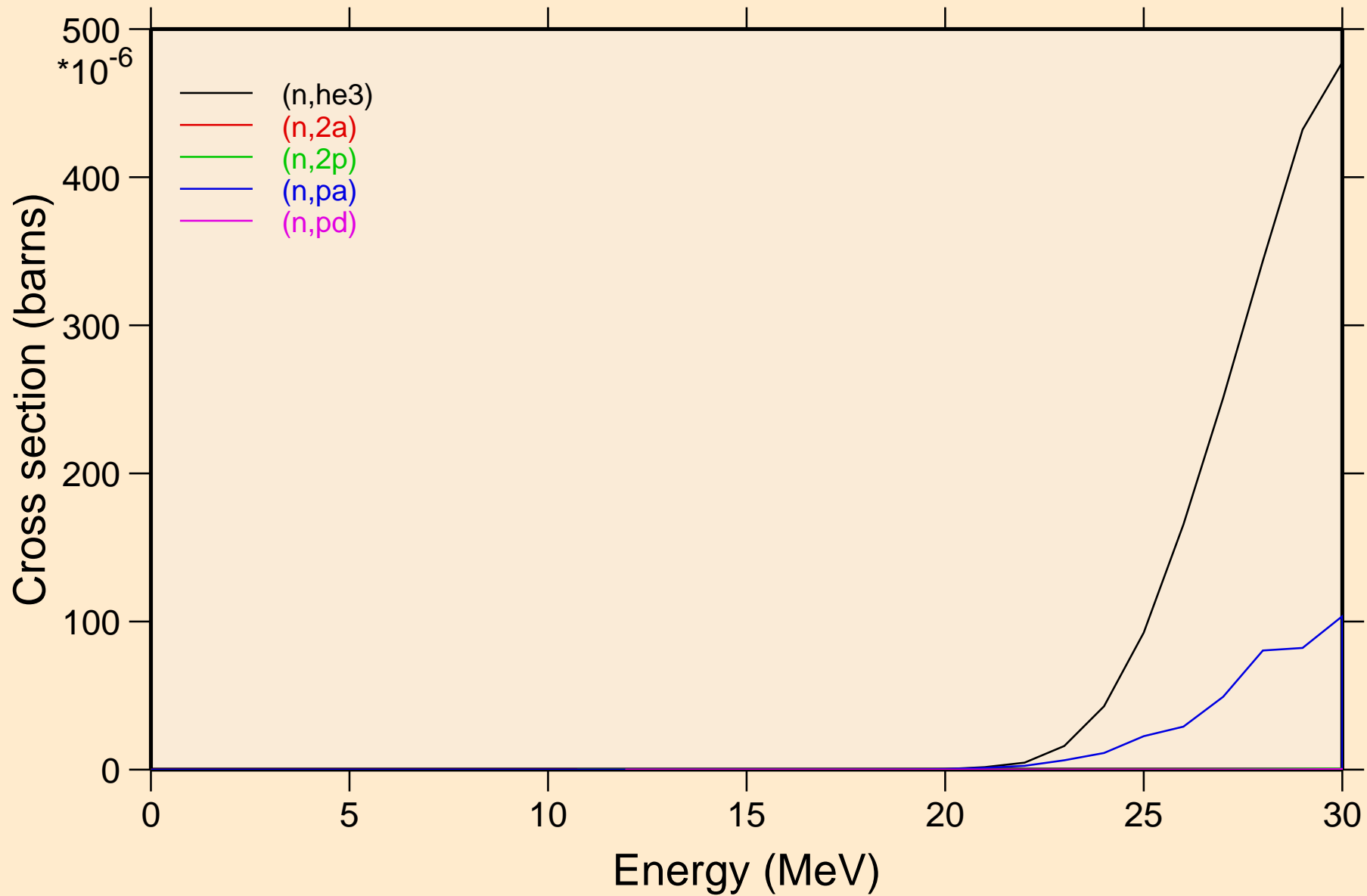

AT221 NEUTRON ACER TENDL-2021 LIBRARY; T=293.6K
Threshold reactions

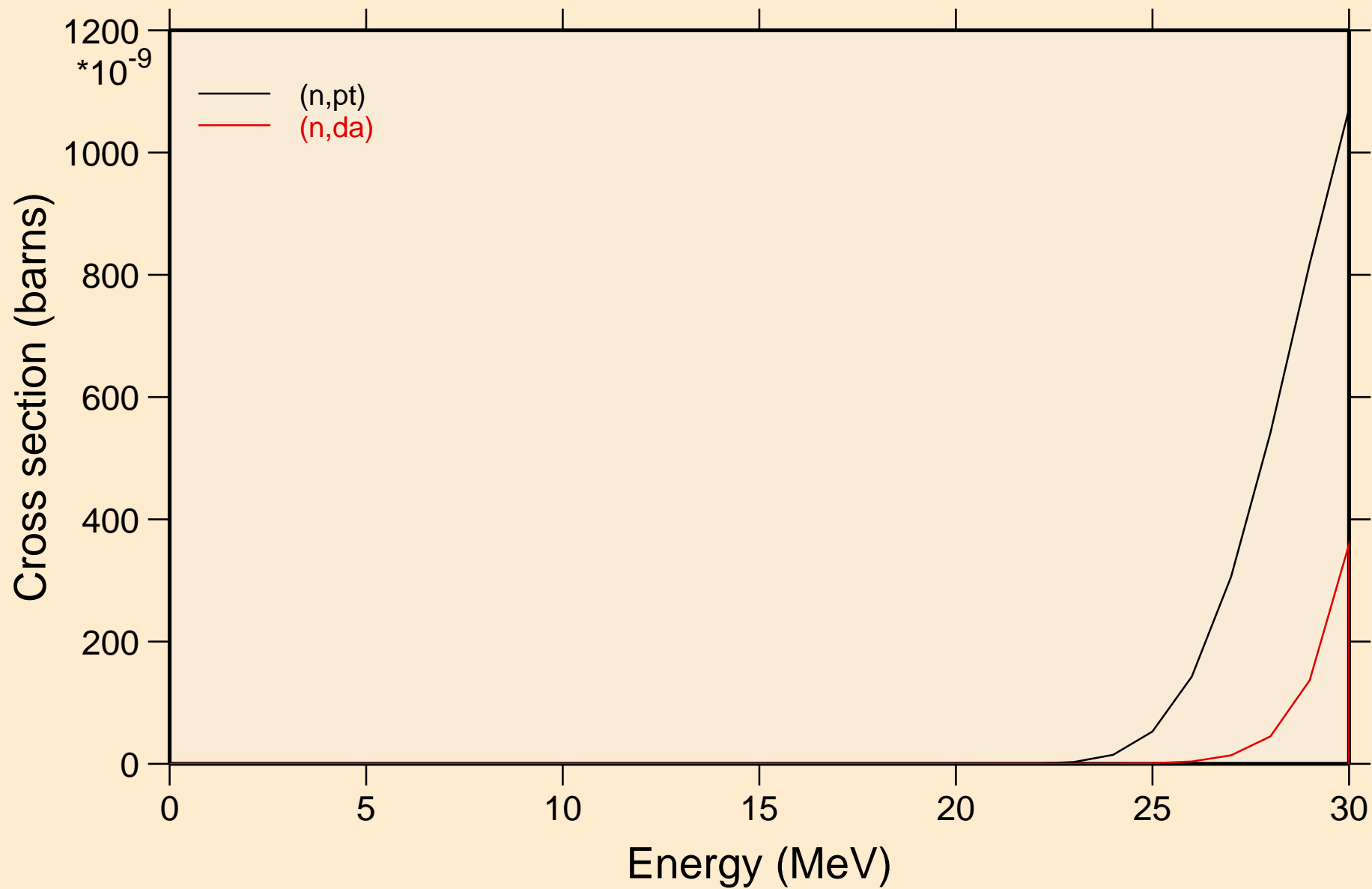

AT221 NEUTRON ACER TENDL-2021 LIBRARY; T=293.6K
Threshold reactions

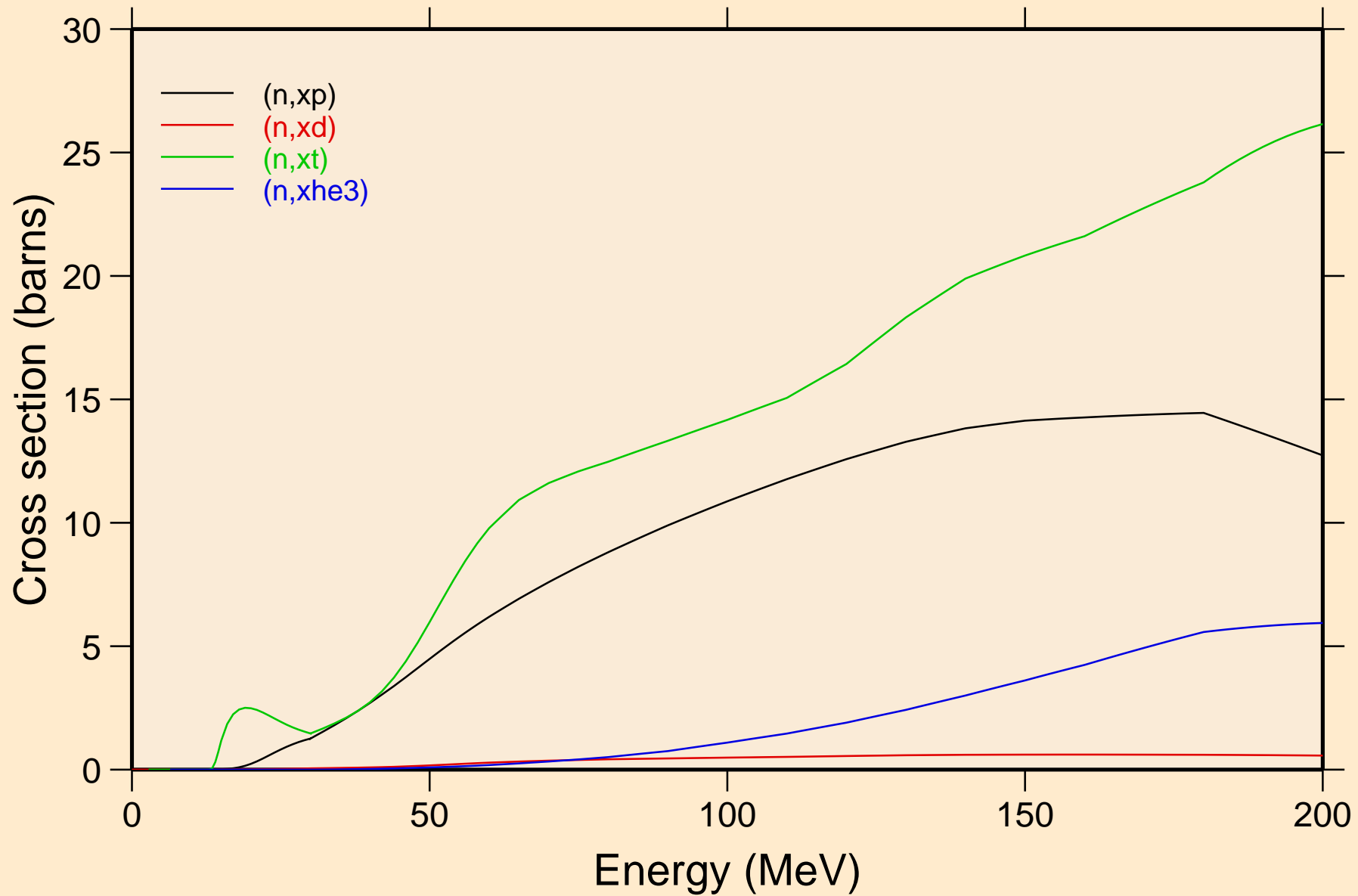

AT221 NEUTRON ACER TENDL-2021 LIBRARY; T=293.6K
angular distribution for elastic

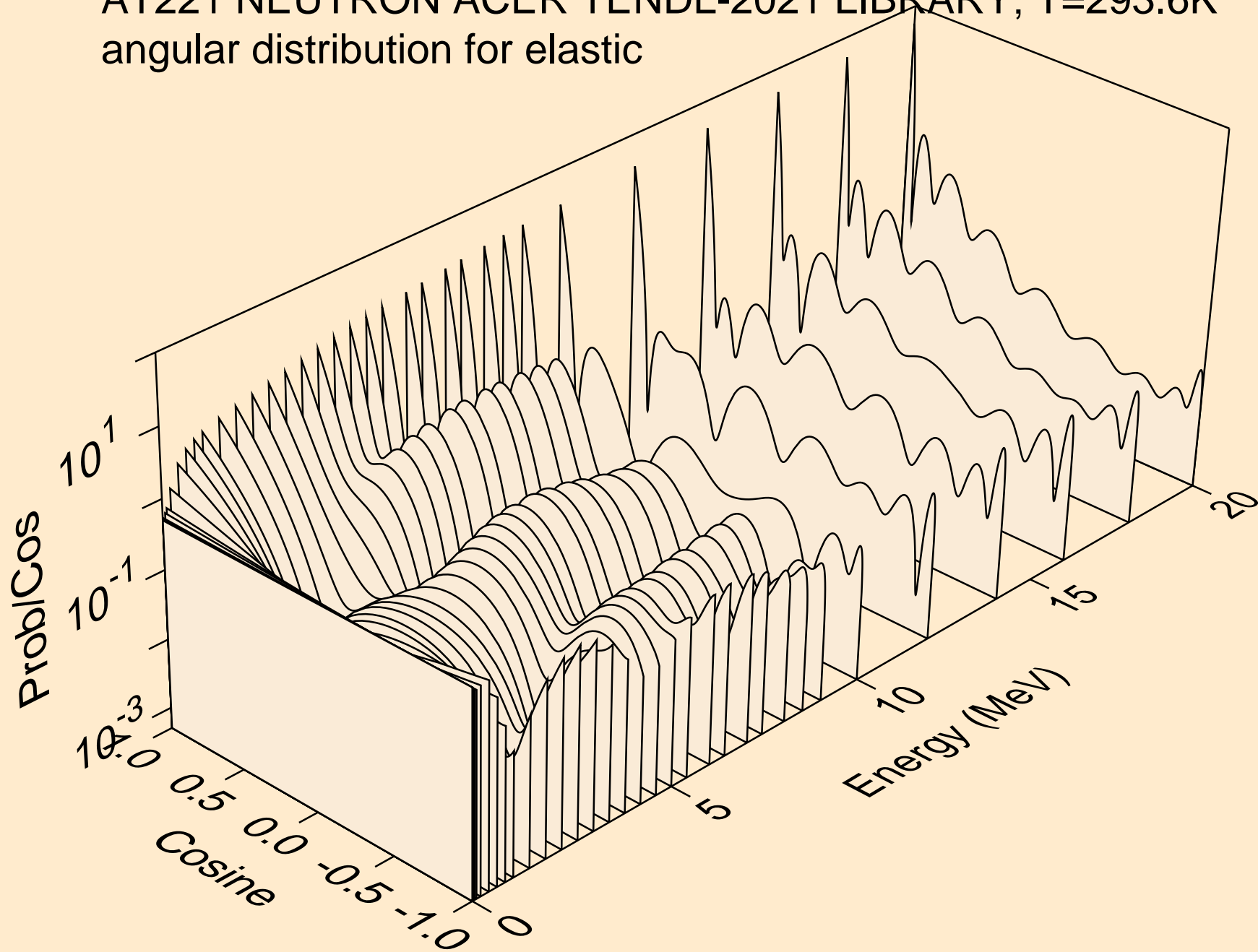

AT221 NEUTRON ACER TENDL-2021 LIBRARY; T=293.6K
angular distribution for elastic

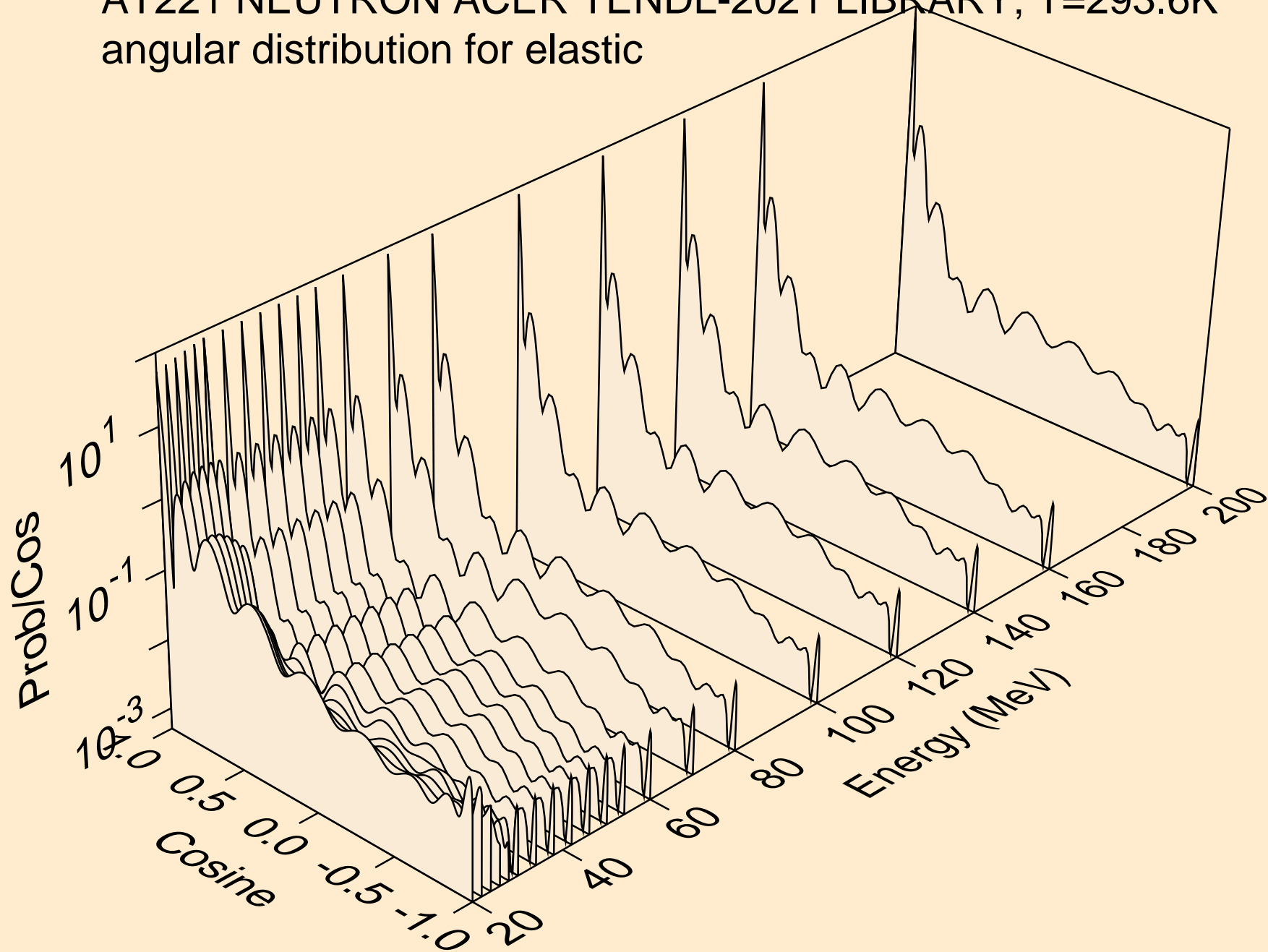

AT221 NEUTRON ACER TENDL-2021 LIBRARY; T=293.6K
angular distribution for (n,n*1)

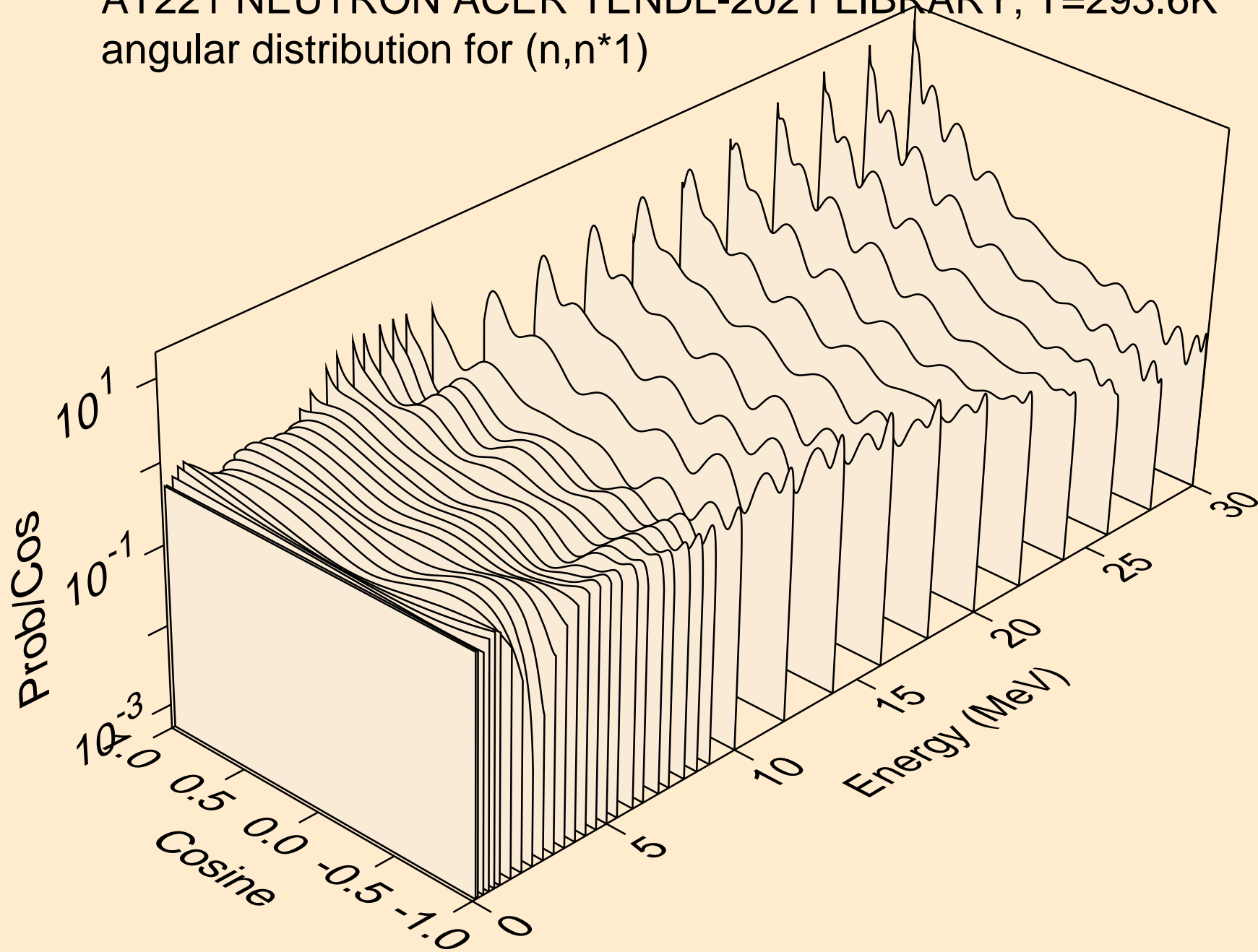

AT221 NEUTRON ACER TENDL-2021 LIBRARY; T=293.6K
Total fission nubar

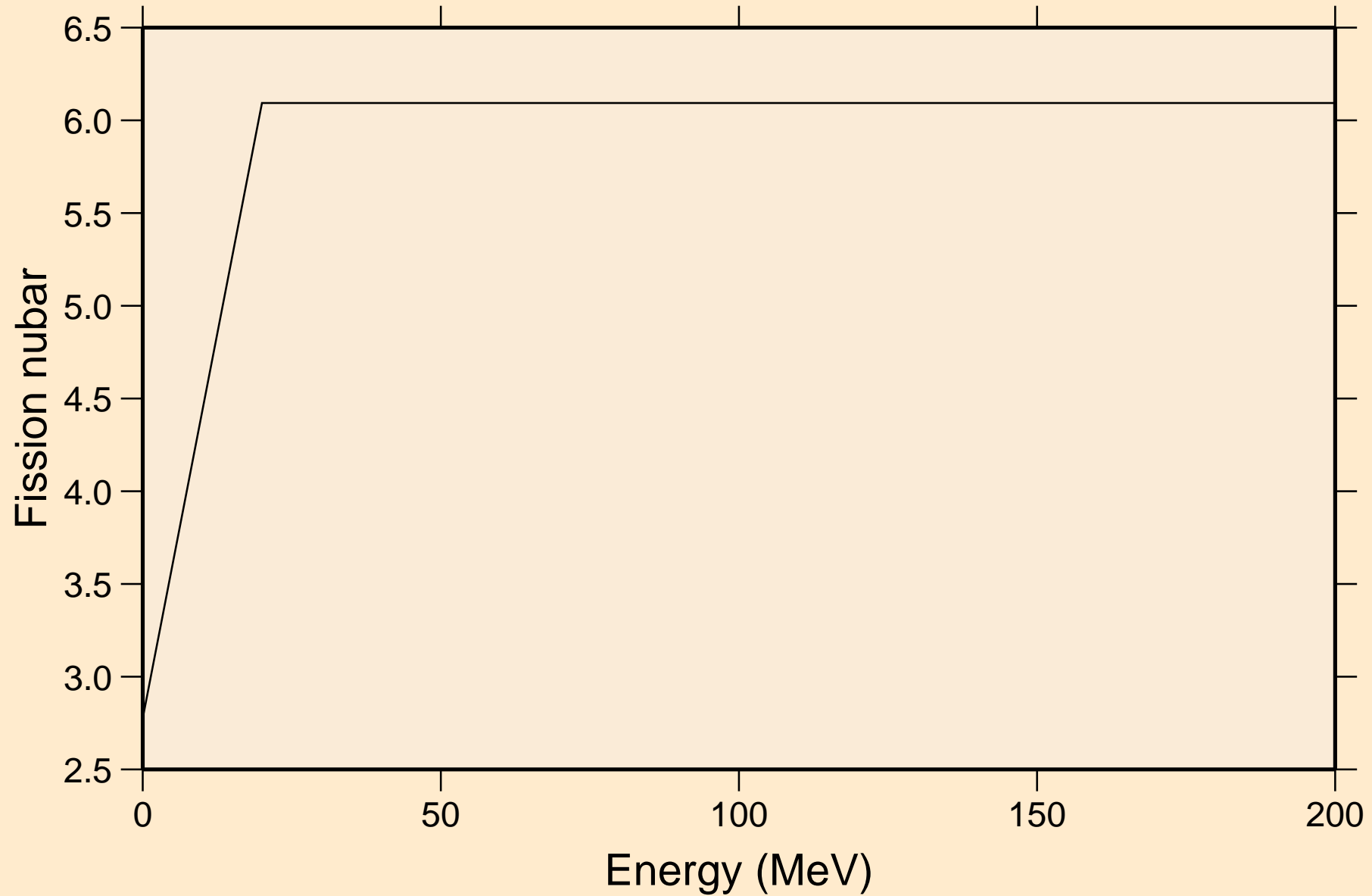

AT221 NEUTRON ACER TENDL-2021 LIBRARY; T=293.6K
Neutron emission for (n,x)

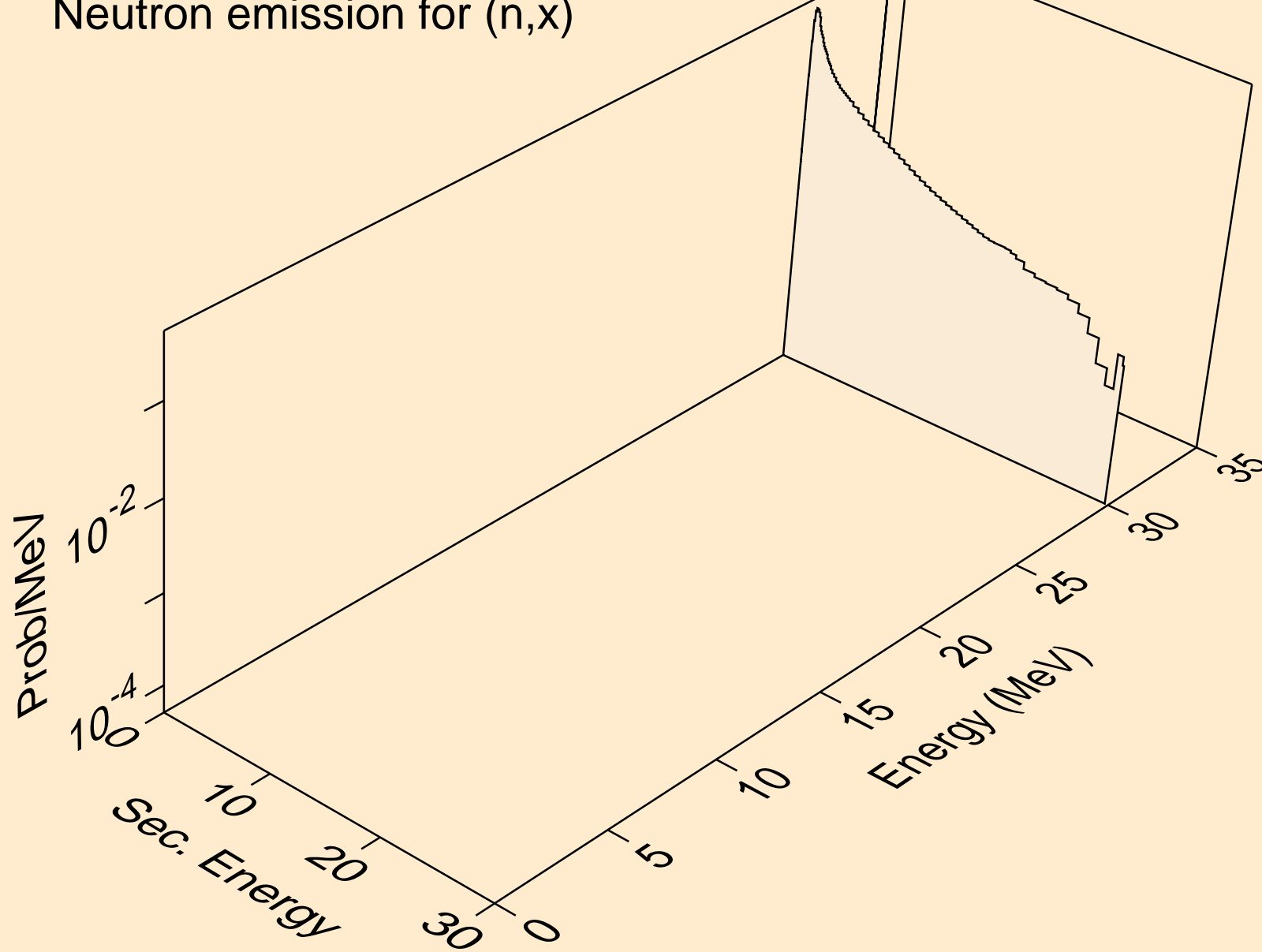

AT221 NEUTRON ACER TENDL-2021 LIBRARY; T=293.6K
Neutron emission for (n,2nd)

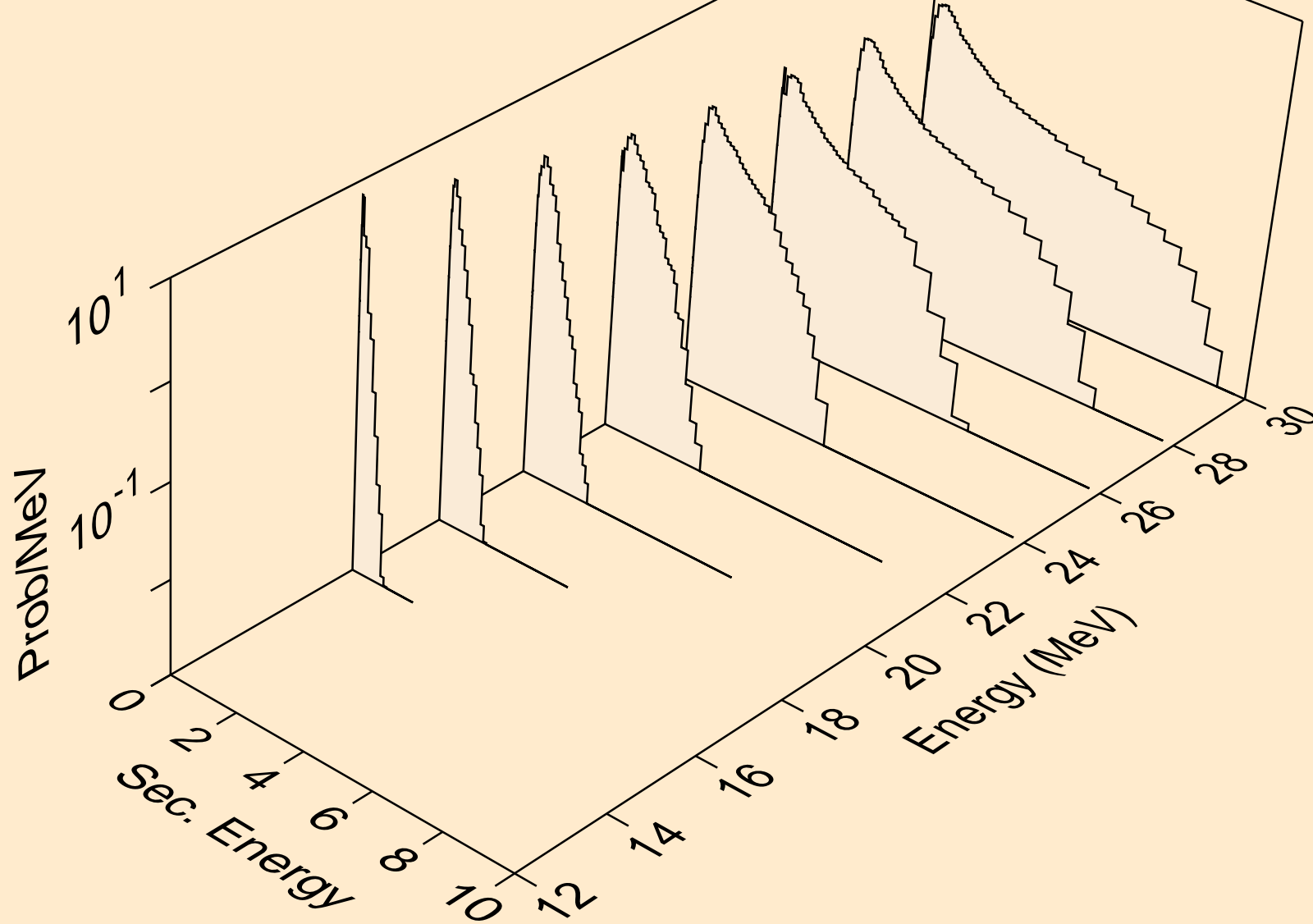

AT221 NEUTRON ACER TENDL-2021 LIBRARY; T=293.6K
Neutron emission for (n,2n)

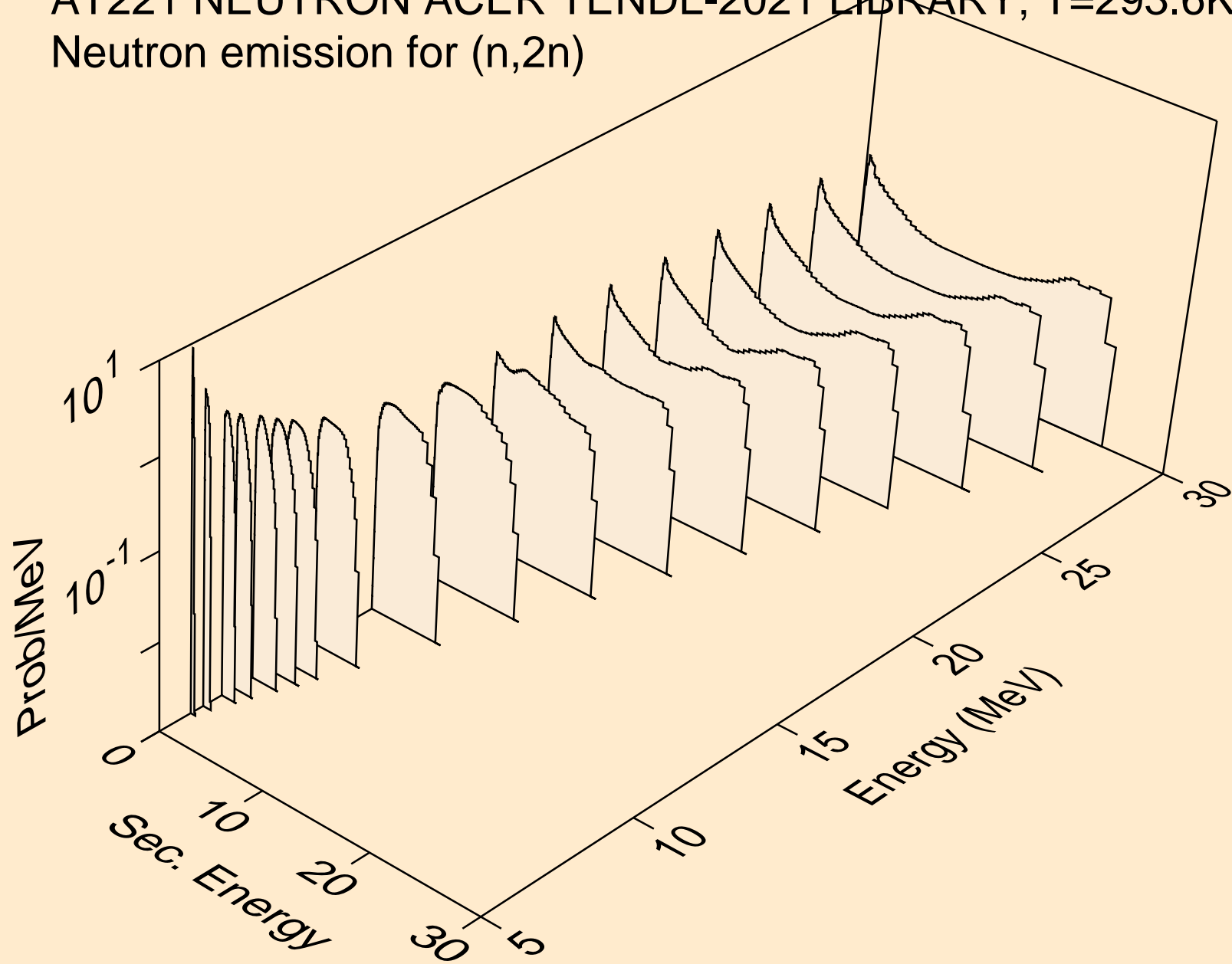

AT221 NEUTRON ACER TENDL-2021 LIBRARY; T=293.6K
Neutron emission for (n,3n)

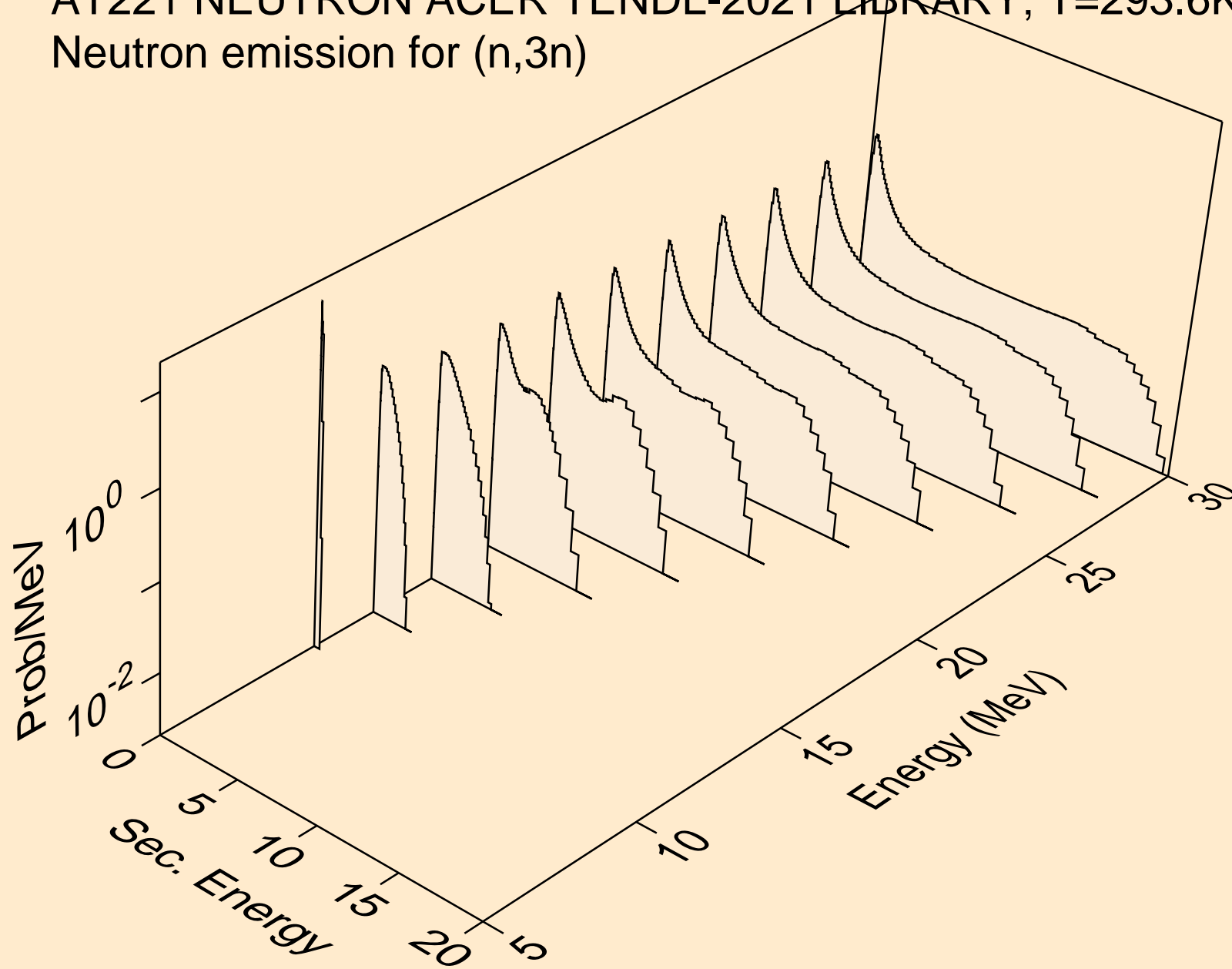

AT221 NEUTRON ACER TENDL-2021 LIBRARY; T=293.6K
Neutron emission for fission

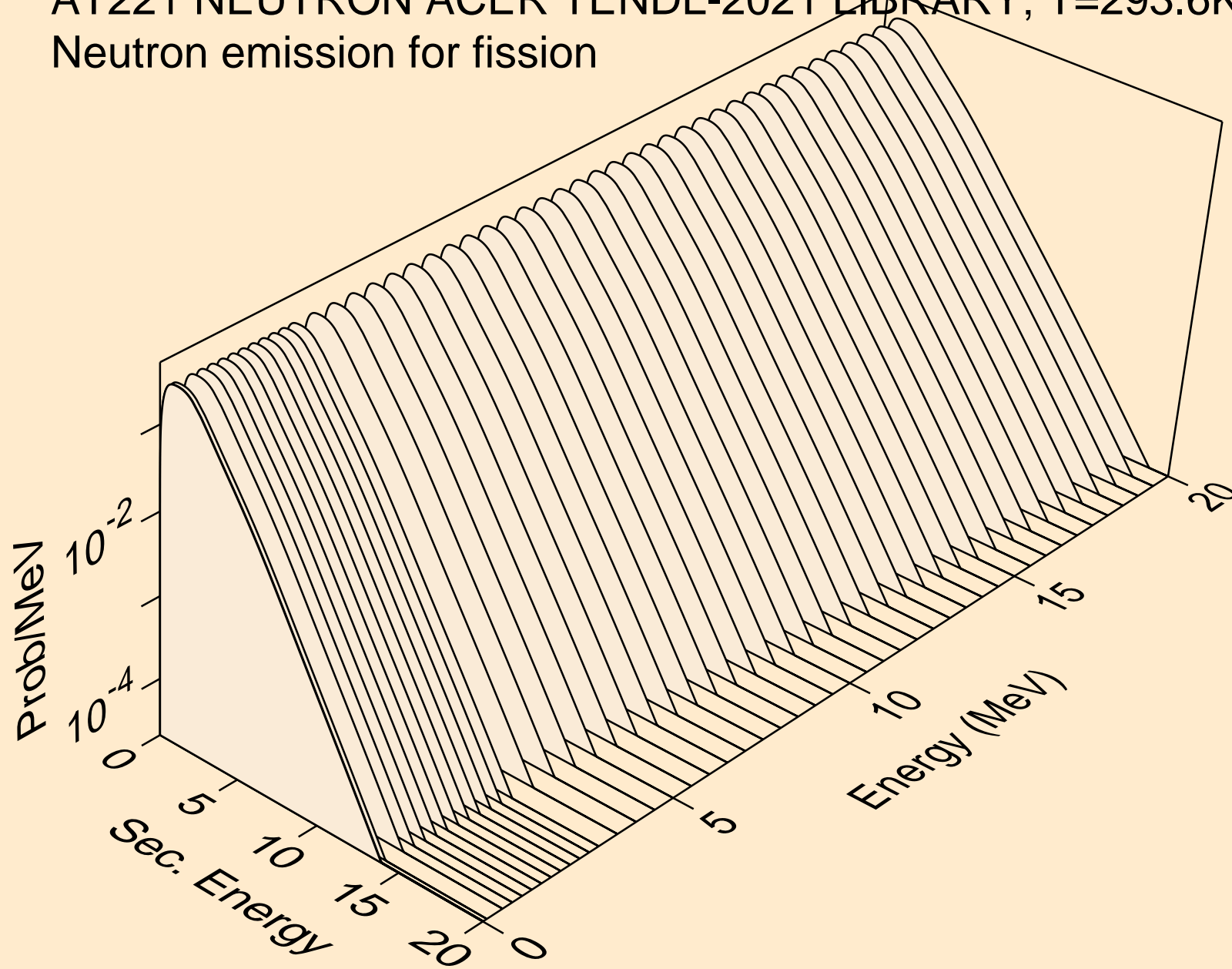

AT221 NEUTRON ACER TENDL-2021 LIBRARY; T=293.6K
Neutron emission for (n,n*)a

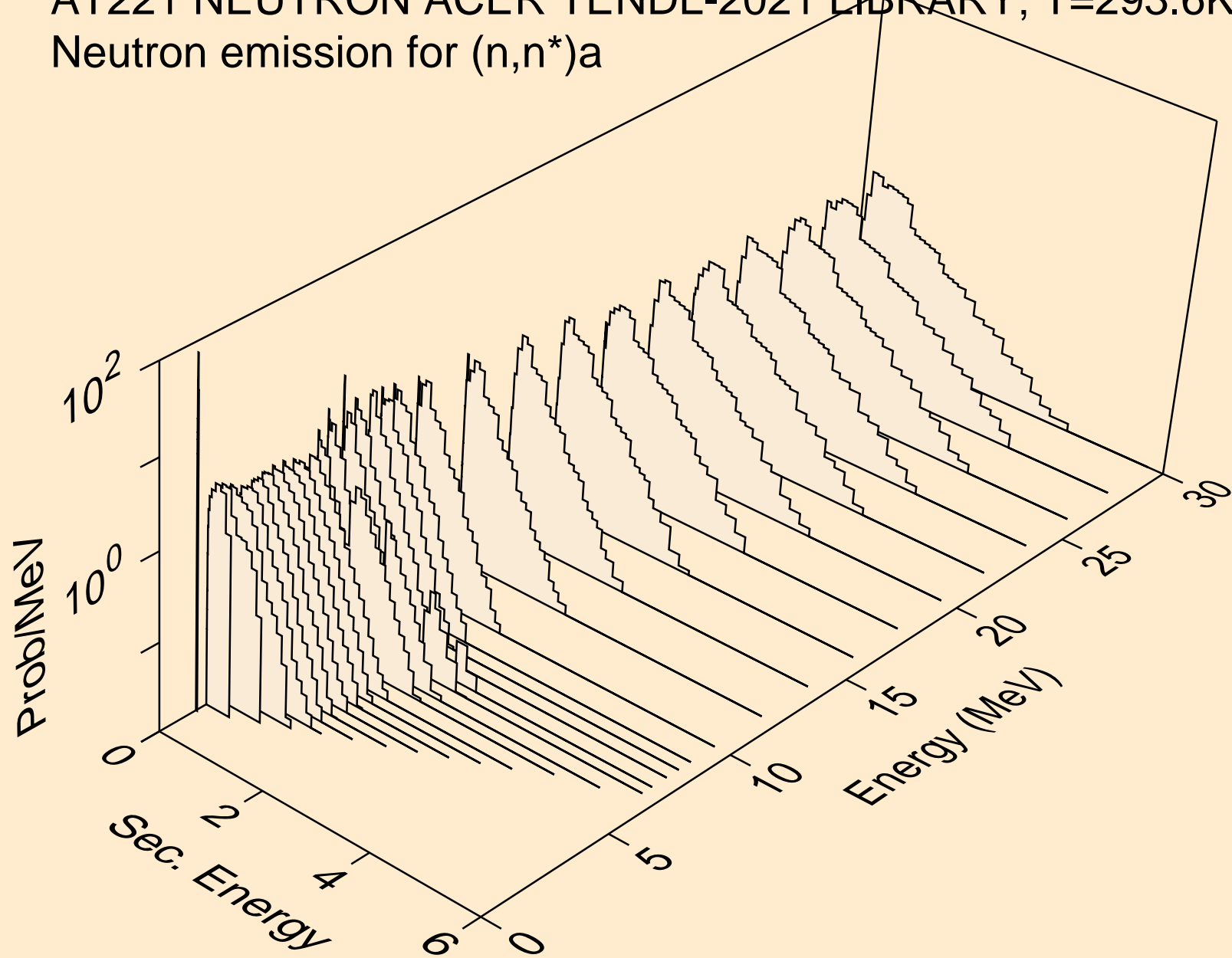

AT221 NEUTRON ACER TENDL-2021 LIBRARY; T=293.6K
Neutron emission for (n,2n)a

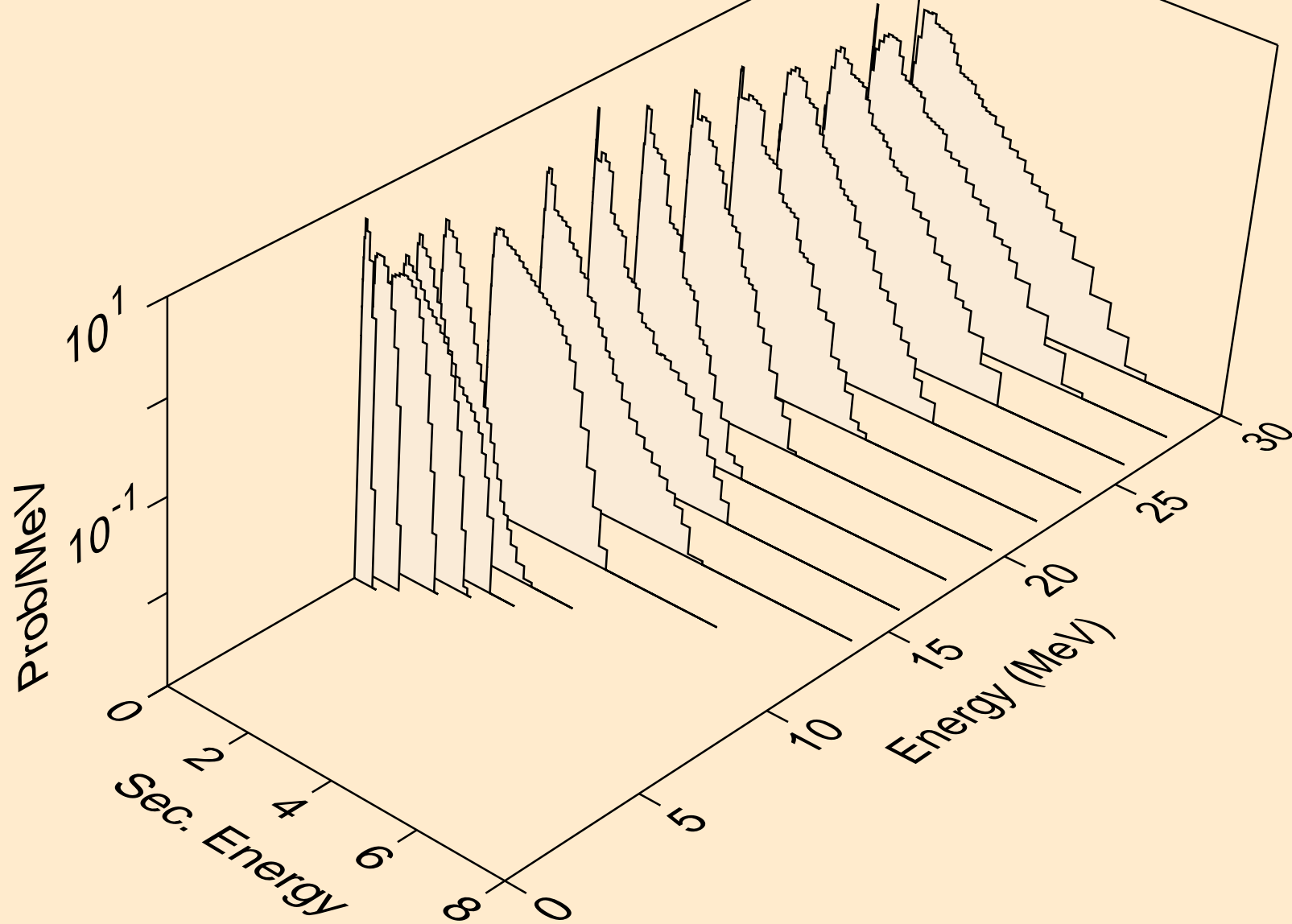

AT221 NEUTRON ACER TENDL-2021 LIBRARY; T=293.6K
Neutron emission for (n,3n)a

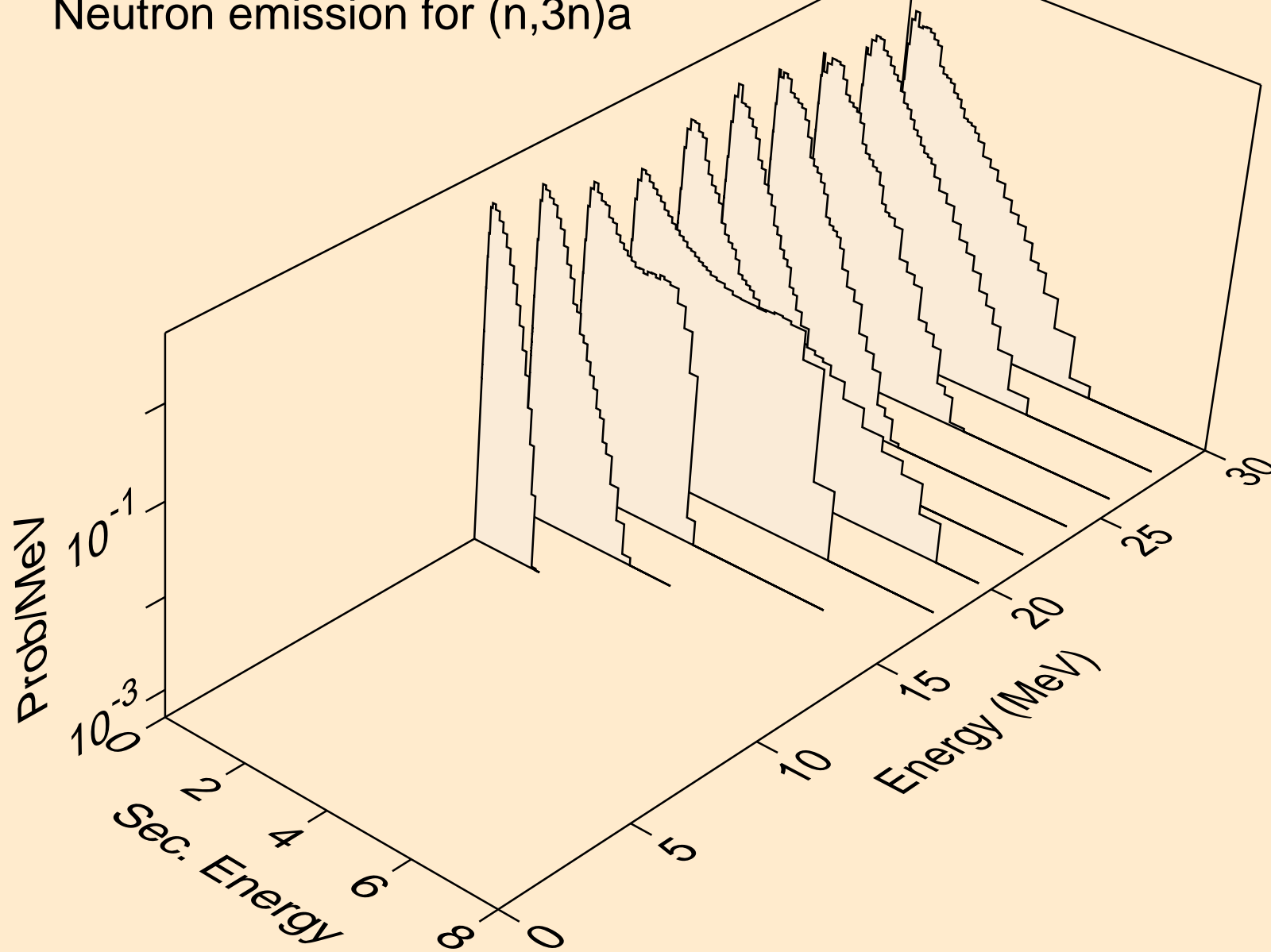

AT221 NEUTRON ACER TENDL-2021 LIBRARY; T=293.6K
Neutron emission for (n,n*)p

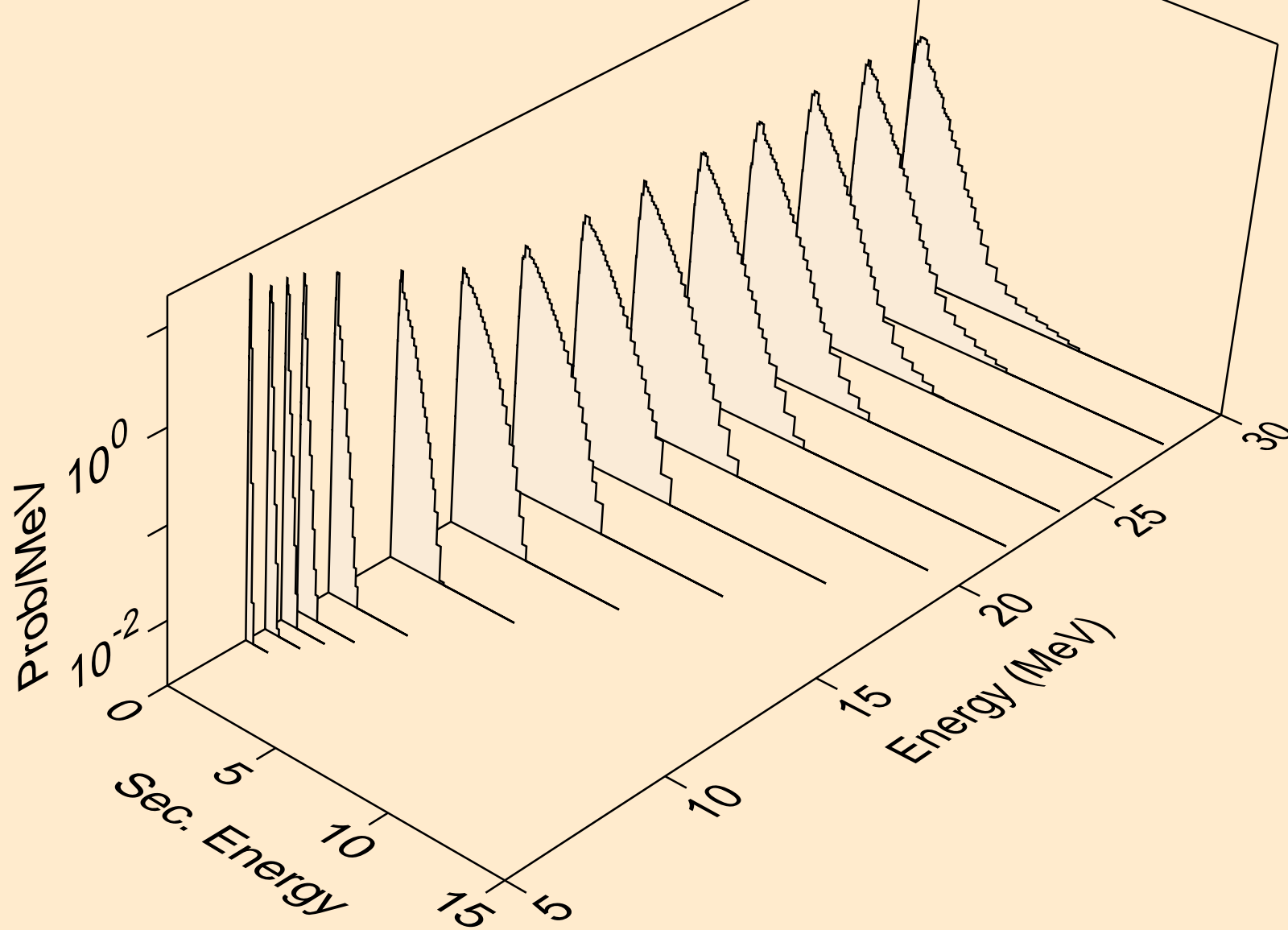

AT221 NEUTRON ACER TENDL-2021 LIBRARY; T=293.6K
Neutron emission for (n,n*)d

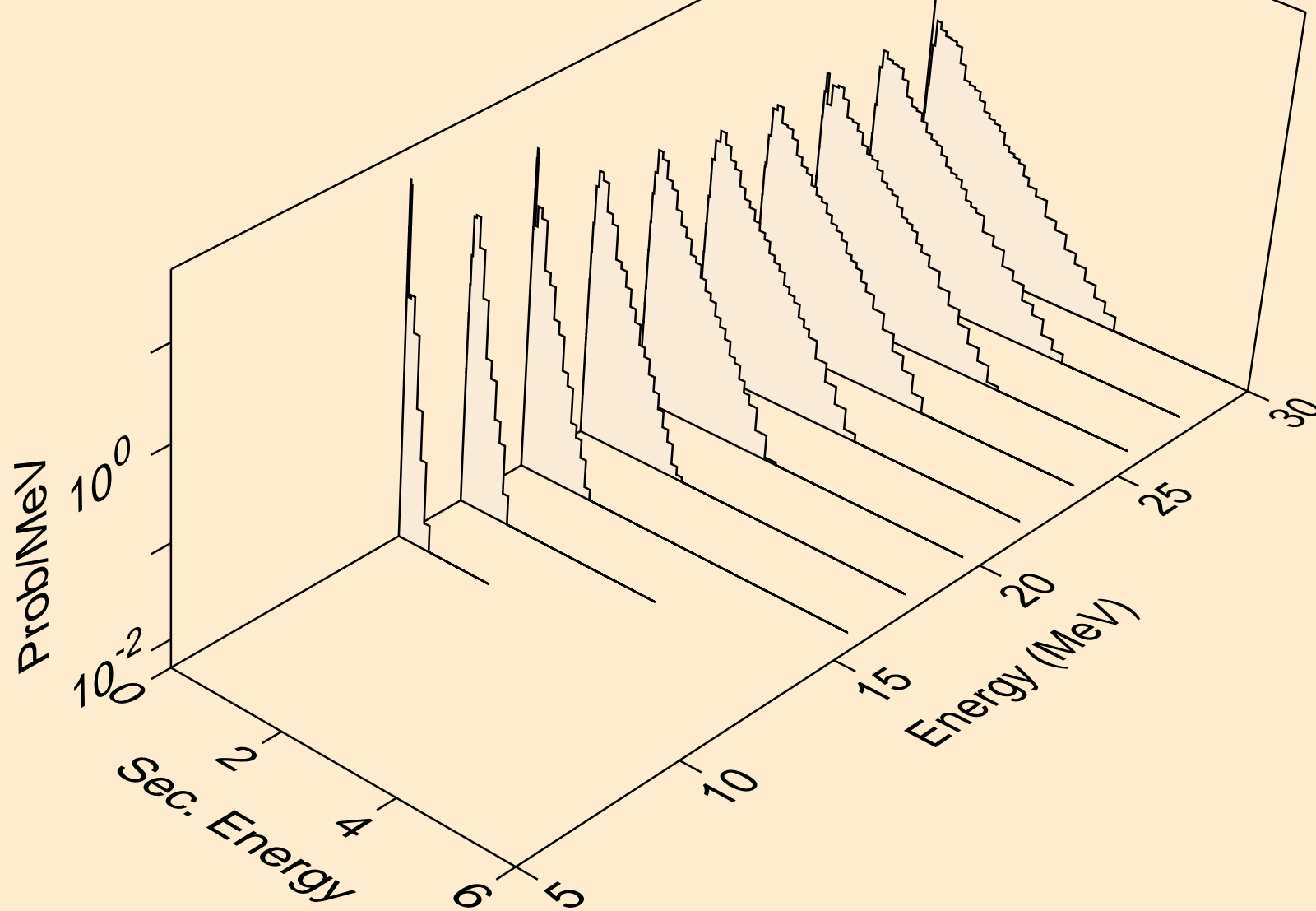

AT221 NEUTRON ACER TENDL-2021 LIBRARY; T=293.6K
Neutron emission for (n,n*)t

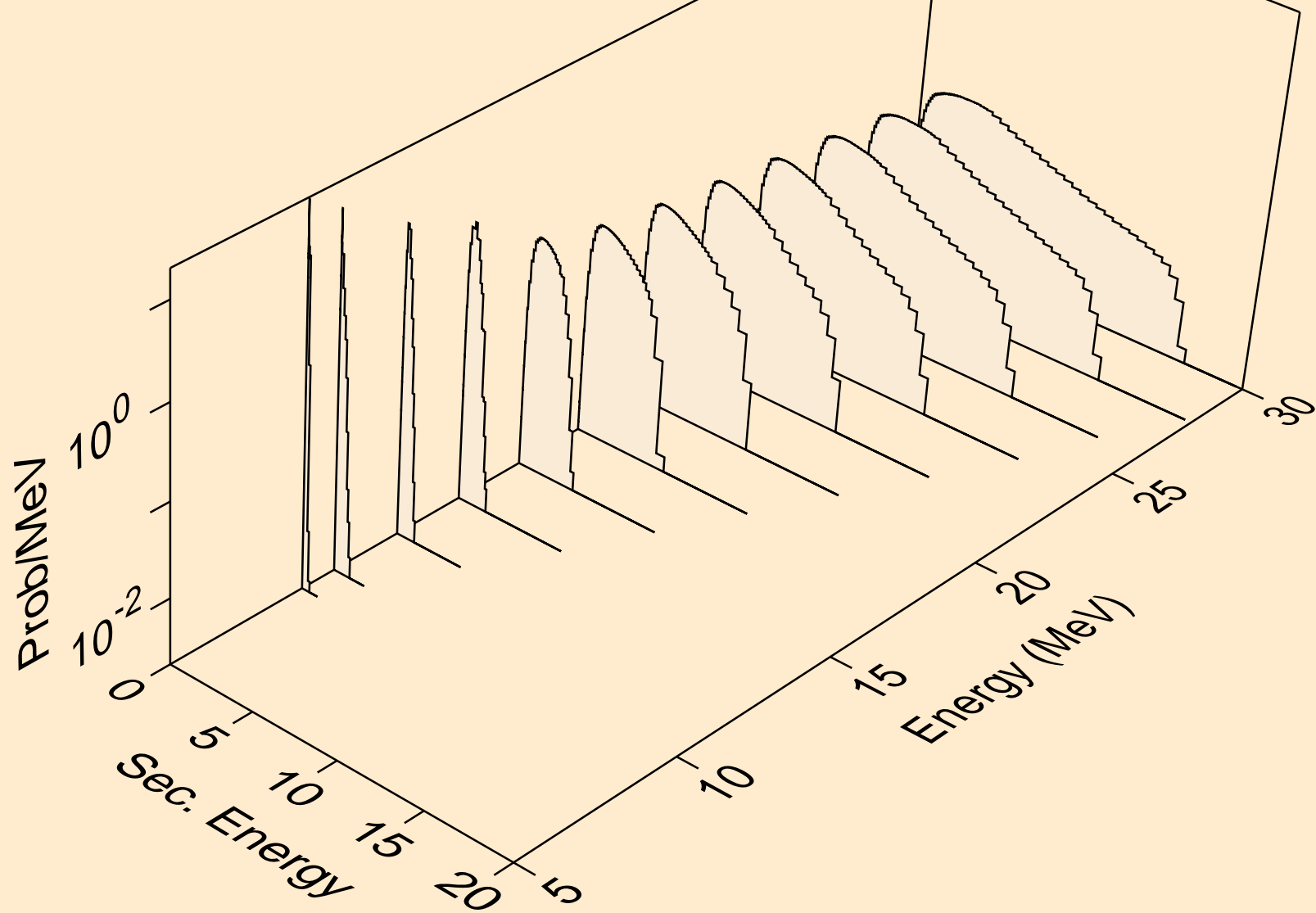

AT221 NEUTRON ACER TENDL-2021 LIBRARY; T=293.6K
Neutron emission for (n,n*)he3

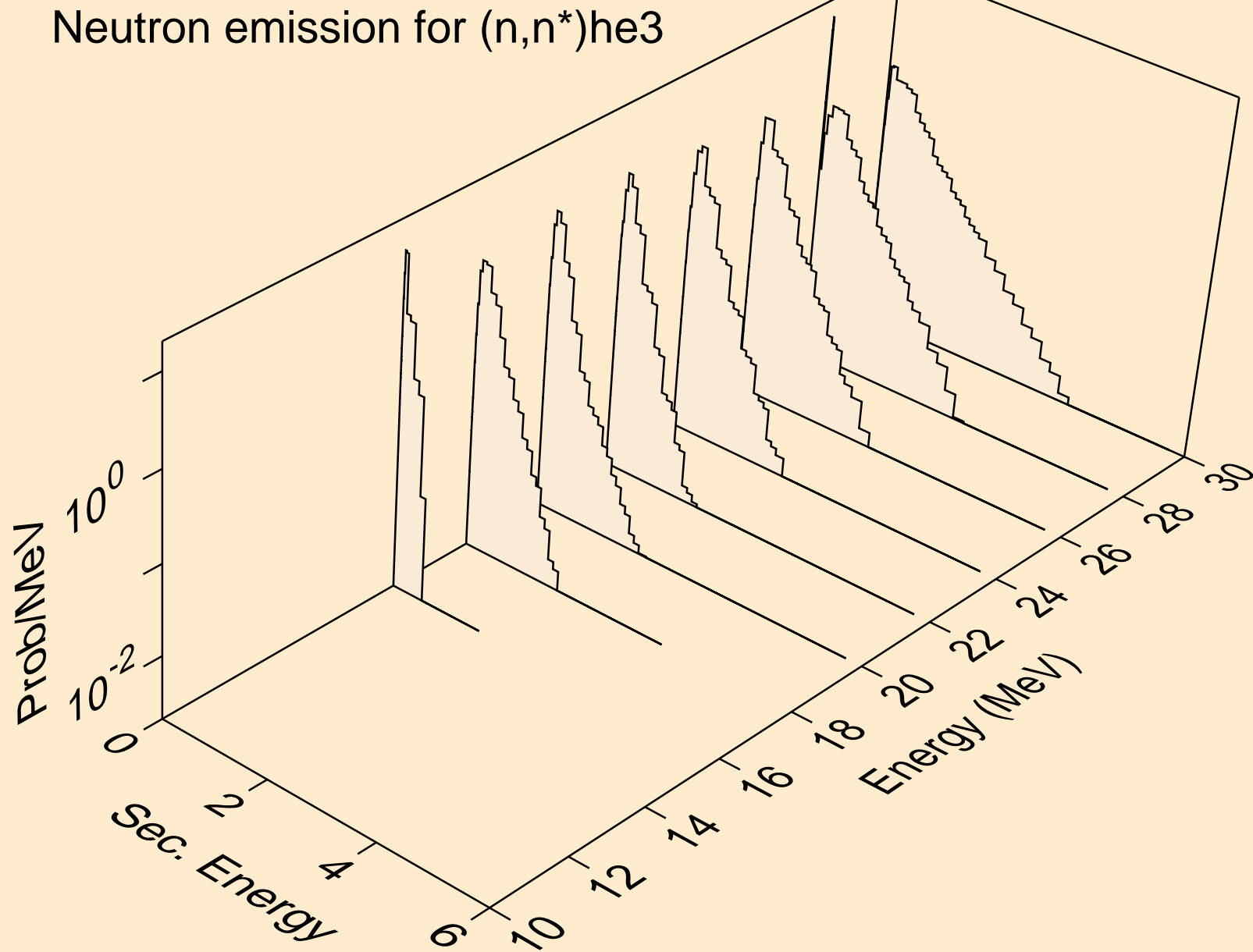

AT221 NEUTRON ACER TENDL-2021 LIBRARY; T=293.6K
Neutron emission for (n,4n)

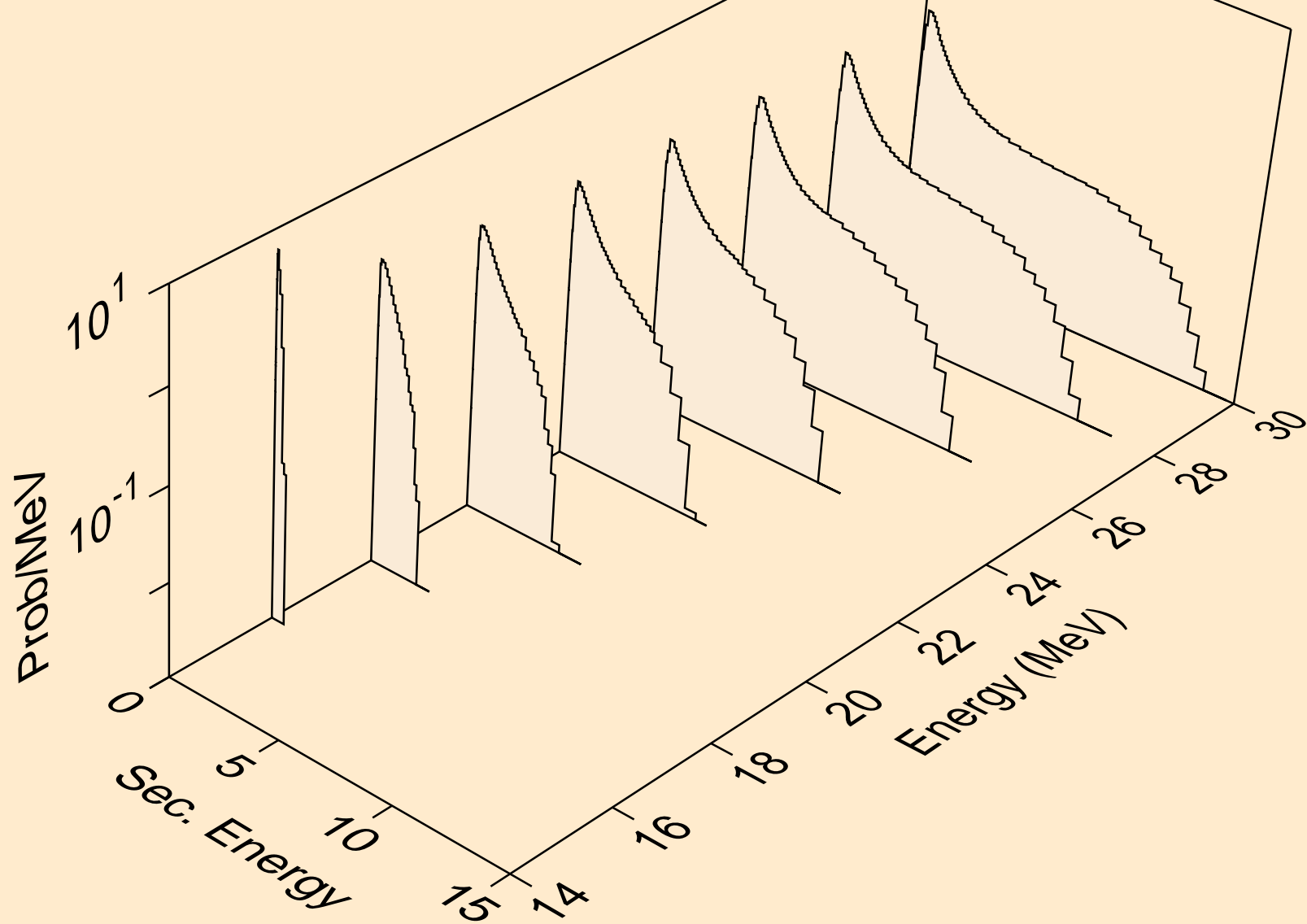

AT221 NEUTRON ACER TENDL-2021 LIBRARY; T=293.6K
Neutron emission for (n,2np)

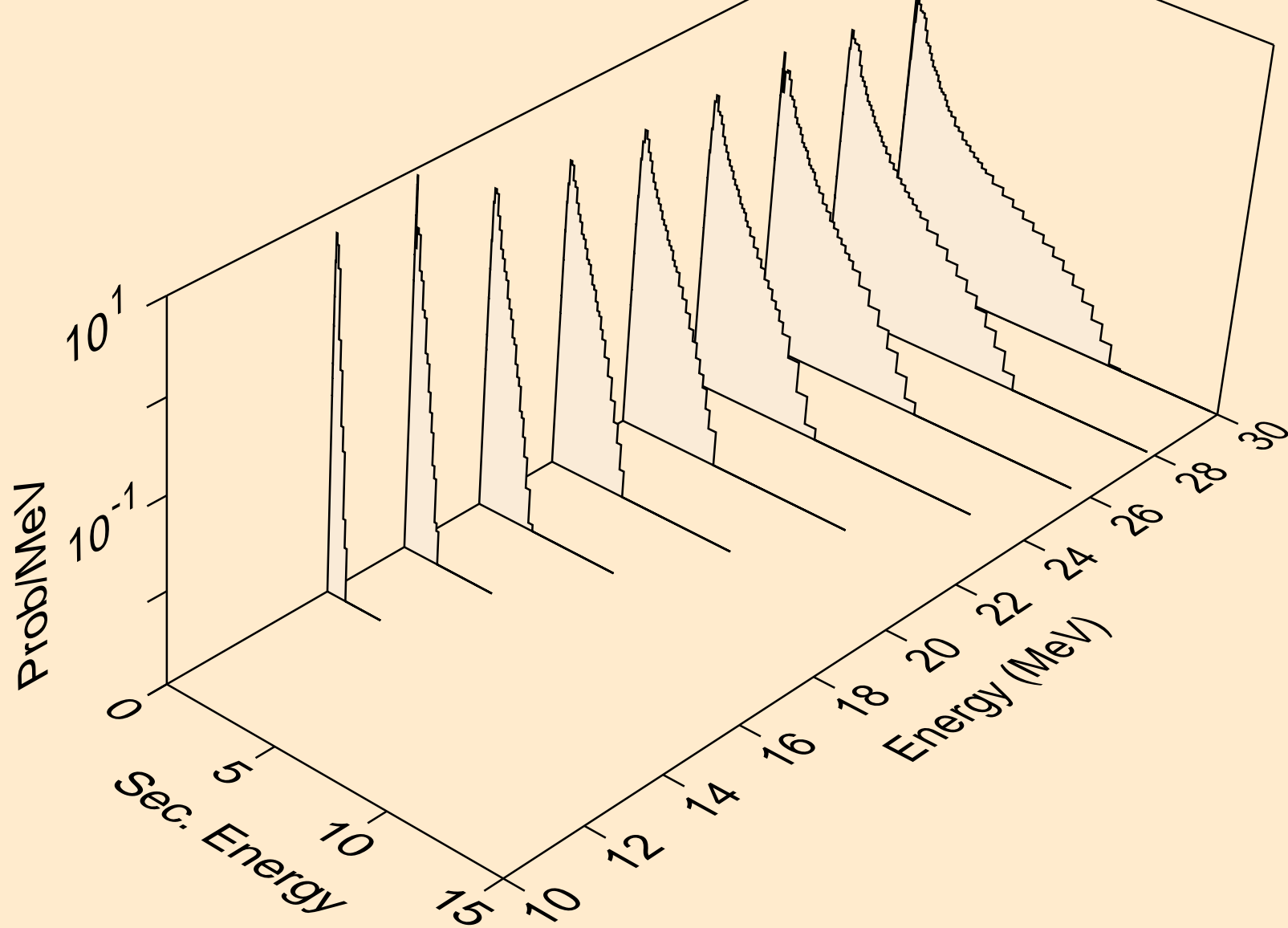

AT221 NEUTRON ACER TENDL-2021 LIBRARY; T=293.6K
Neutron emission for (n,3np)

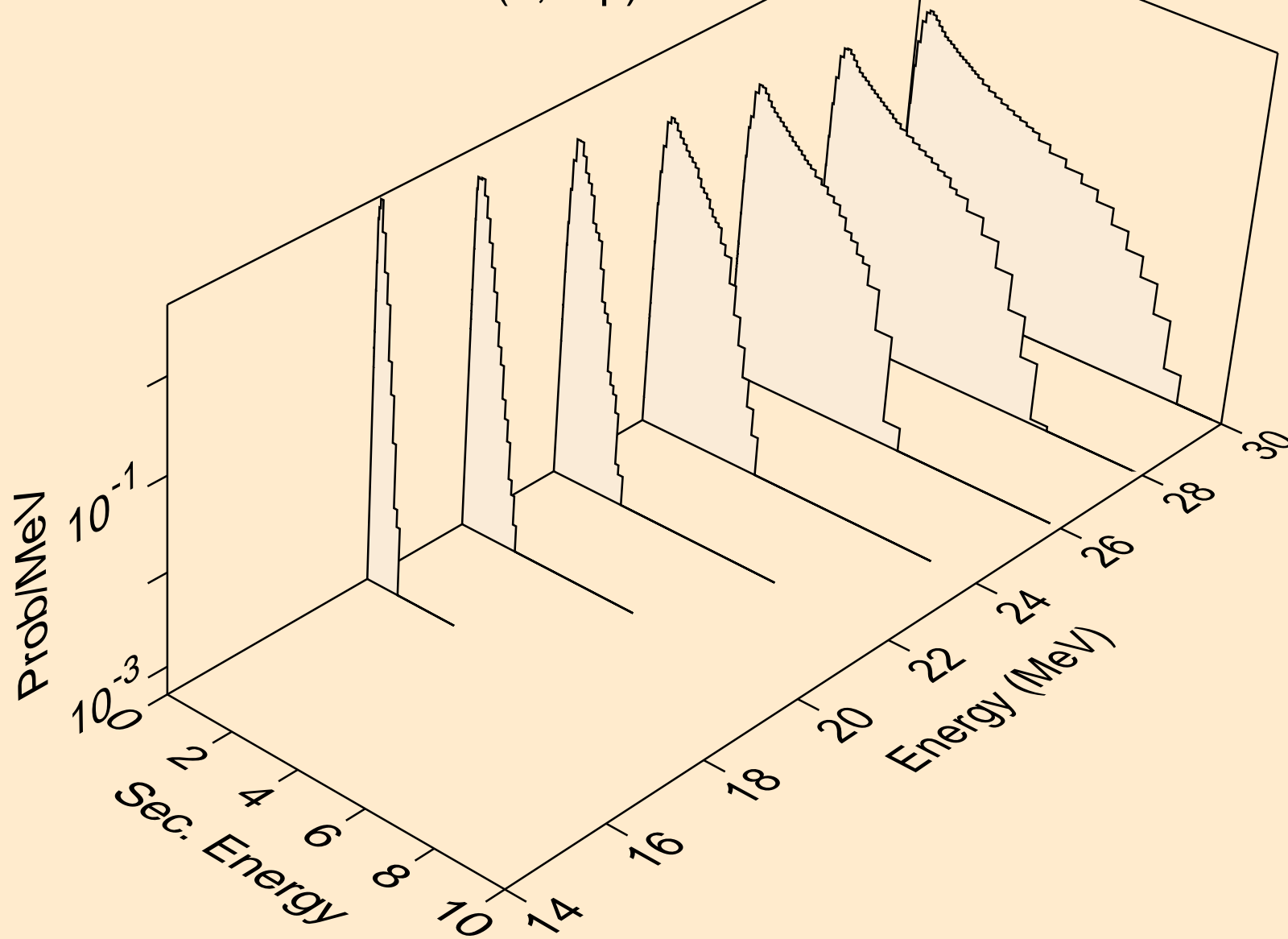

AT221 NEUTRON ACER TENDL-2021 LIBRARY; T=293.6K
Neutron emission for (n,2np)

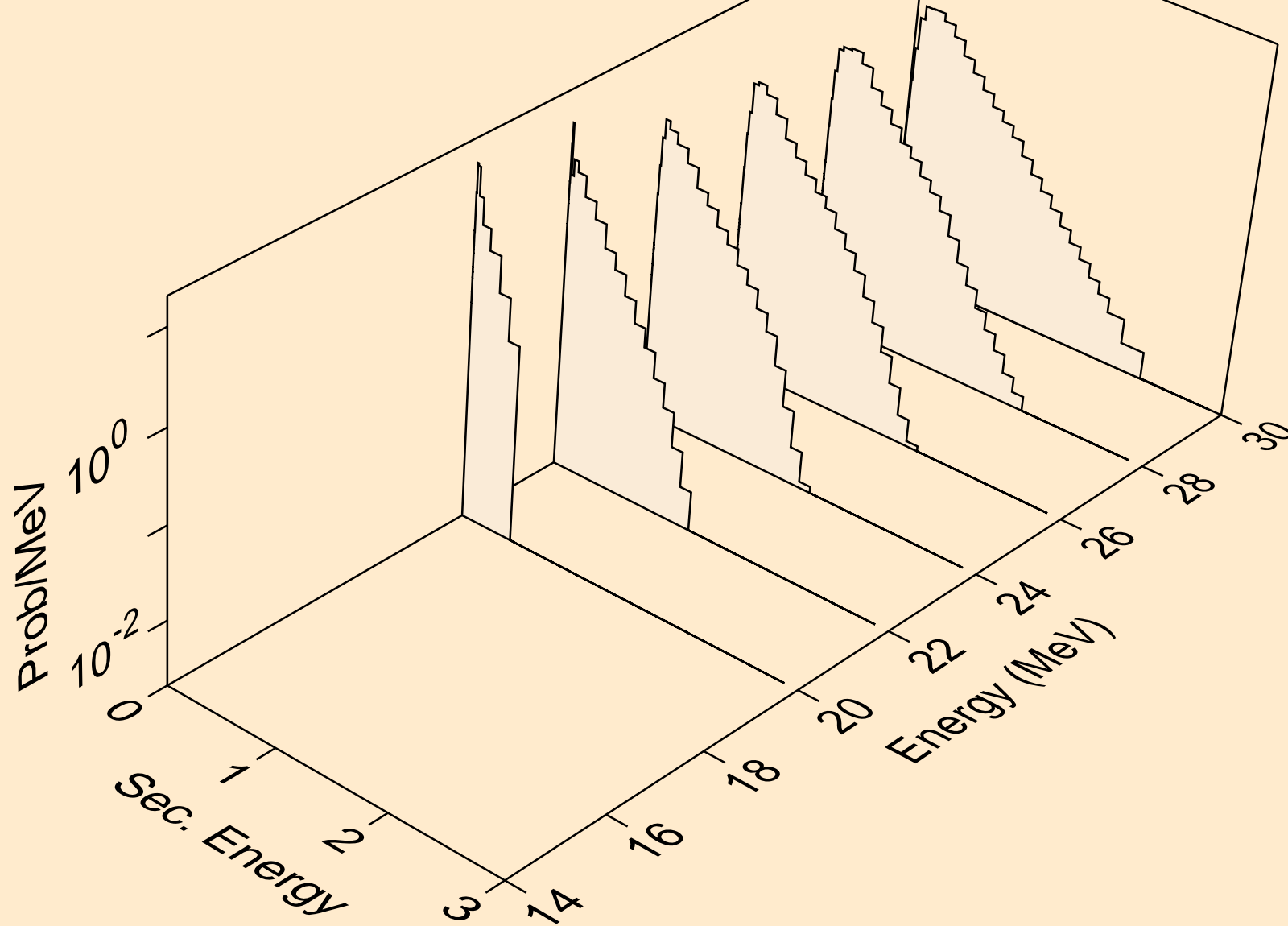

AT221 NEUTRON ACER TENDL-2021 LIBRARY; T=293.6K
Neutron emission for (n,npa)

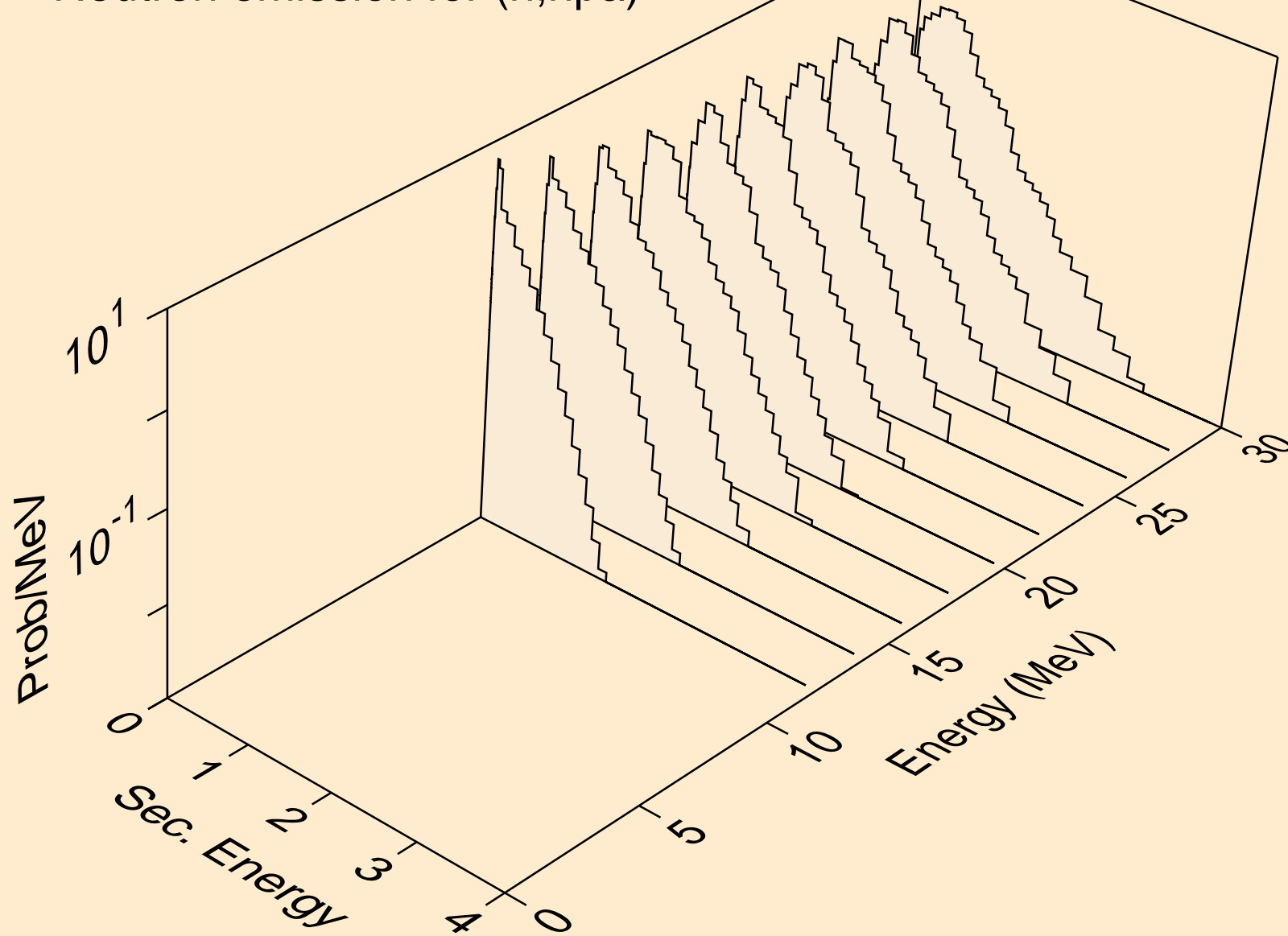

AT221 NEUTRON ACER TENDL-2021 LIBRARY; T=293.6K
Neutron emission for (n,n*c)

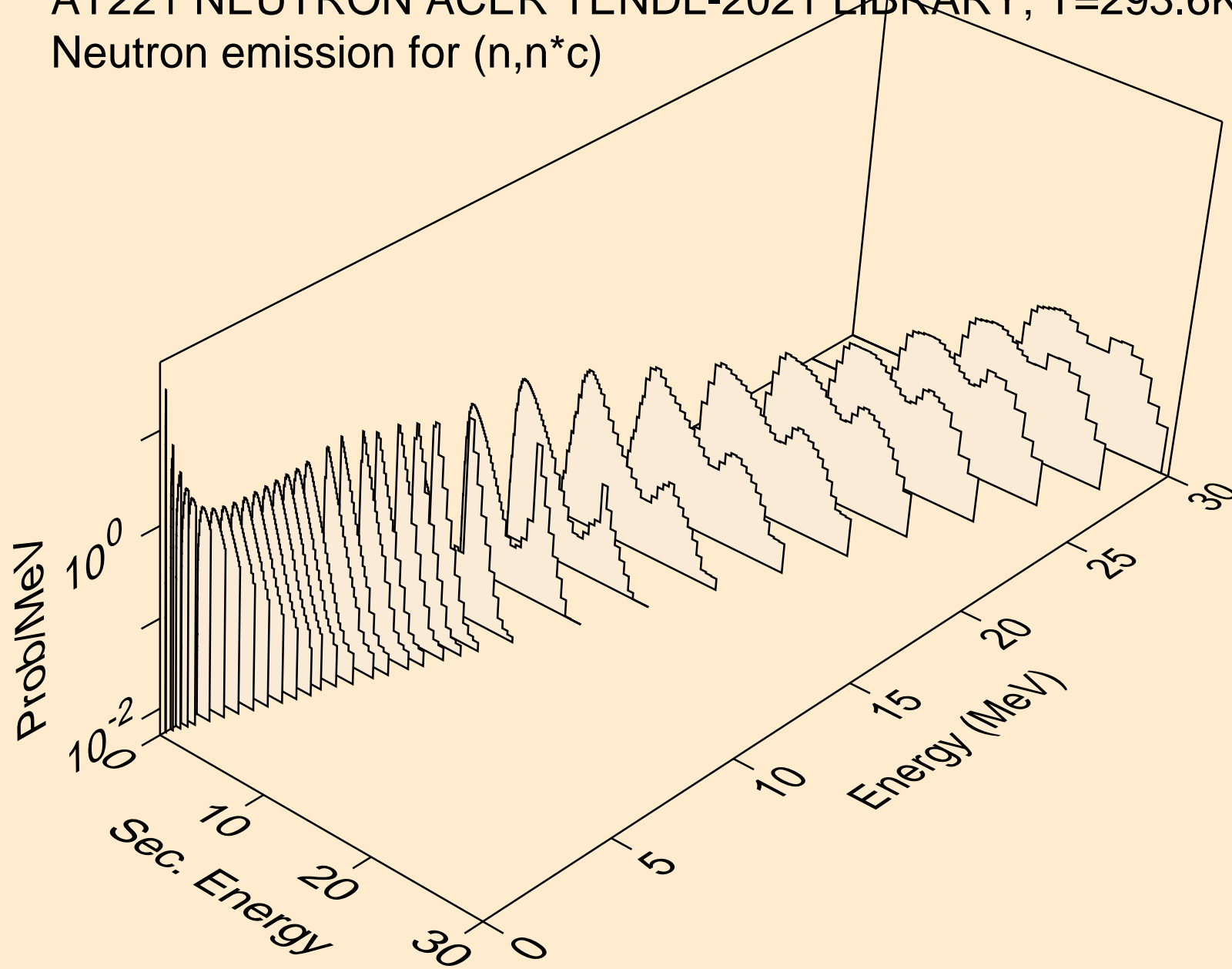

AT221 NEUTRON ACER TENDL-2021 LIBRARY; T=293.6K

Delayed nubar

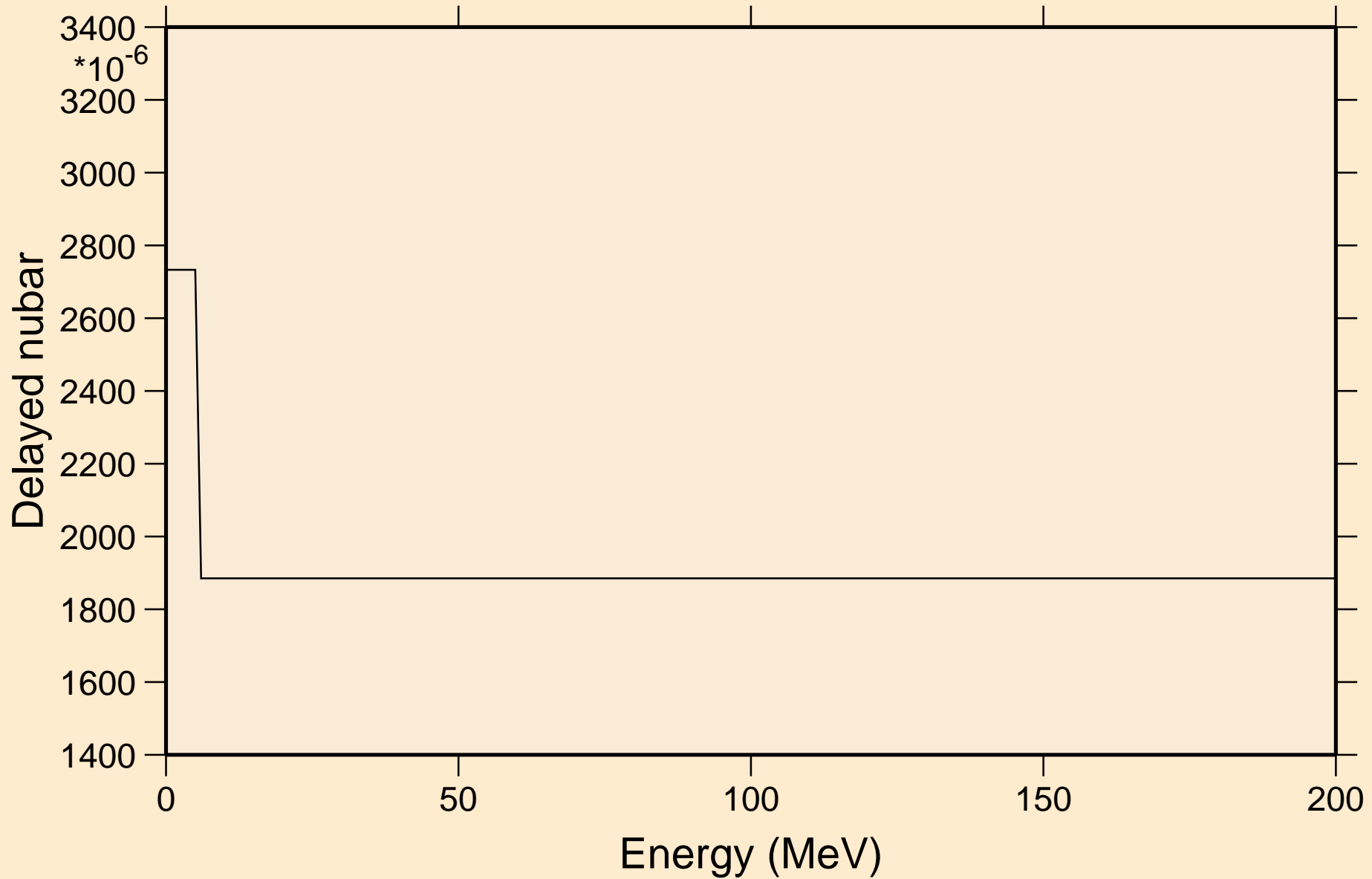

AT221 NEUTRON ACER TENDL-2021 LIBRARY; T=293.6K

Delayed neutron spectra

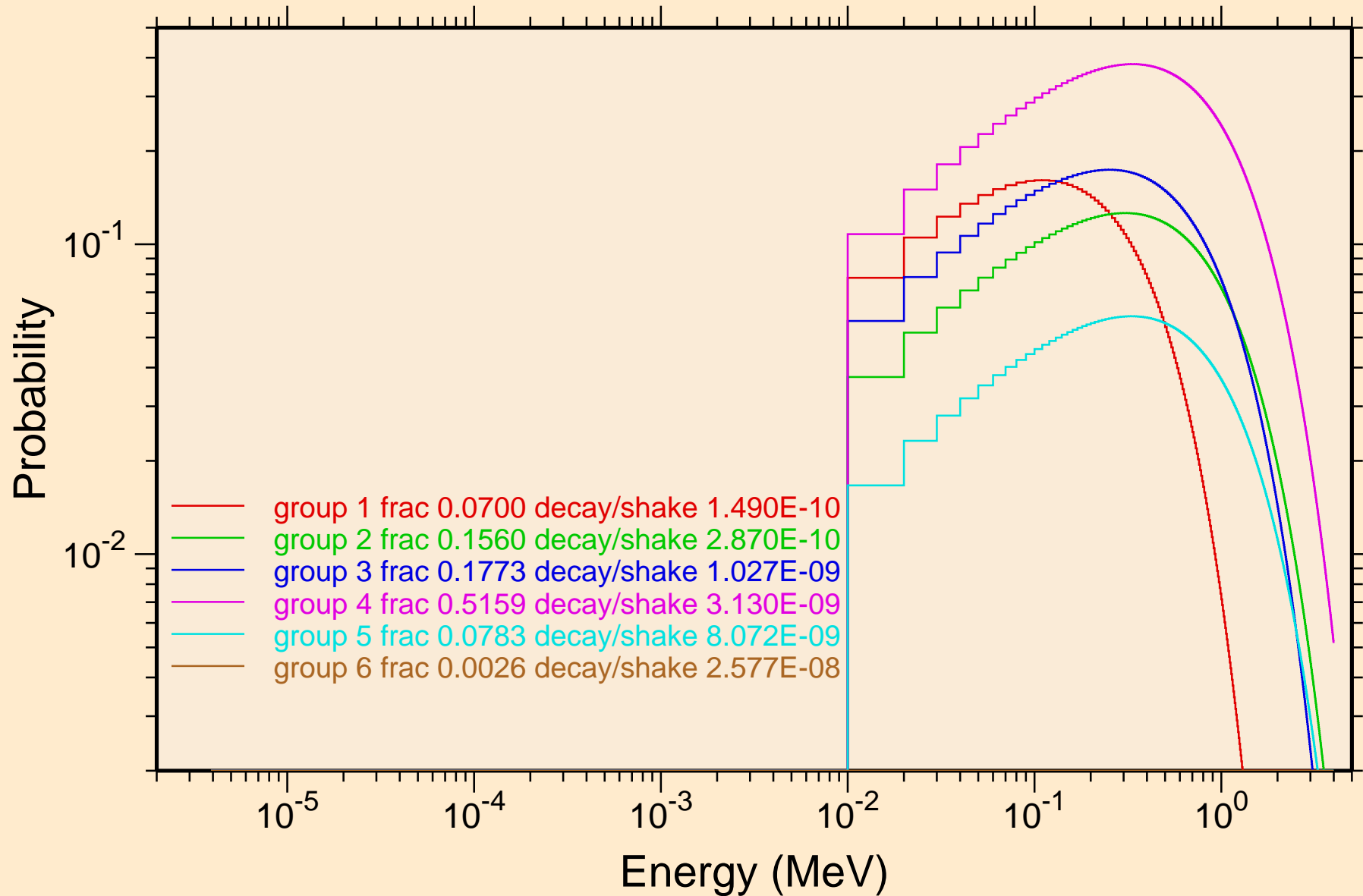

AT221 NEUTRON ACER TENDL-2021 LIBRARY; T=293.6K
Photon emission for (n,x)

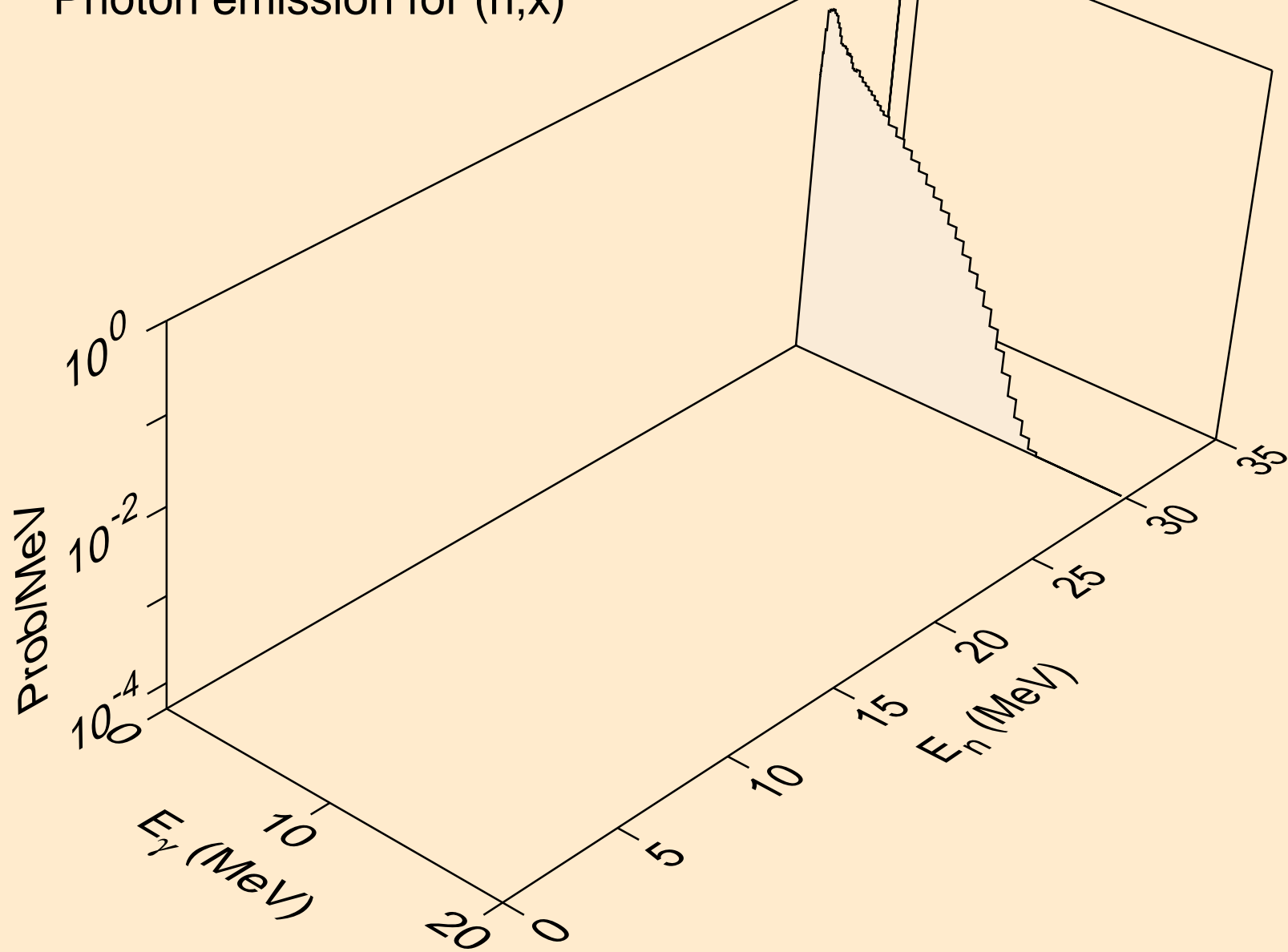

AT221 NEUTRON ACER TENDL-2021 LIBRARY; T=293.6K
Photon emission for (n,2nd)

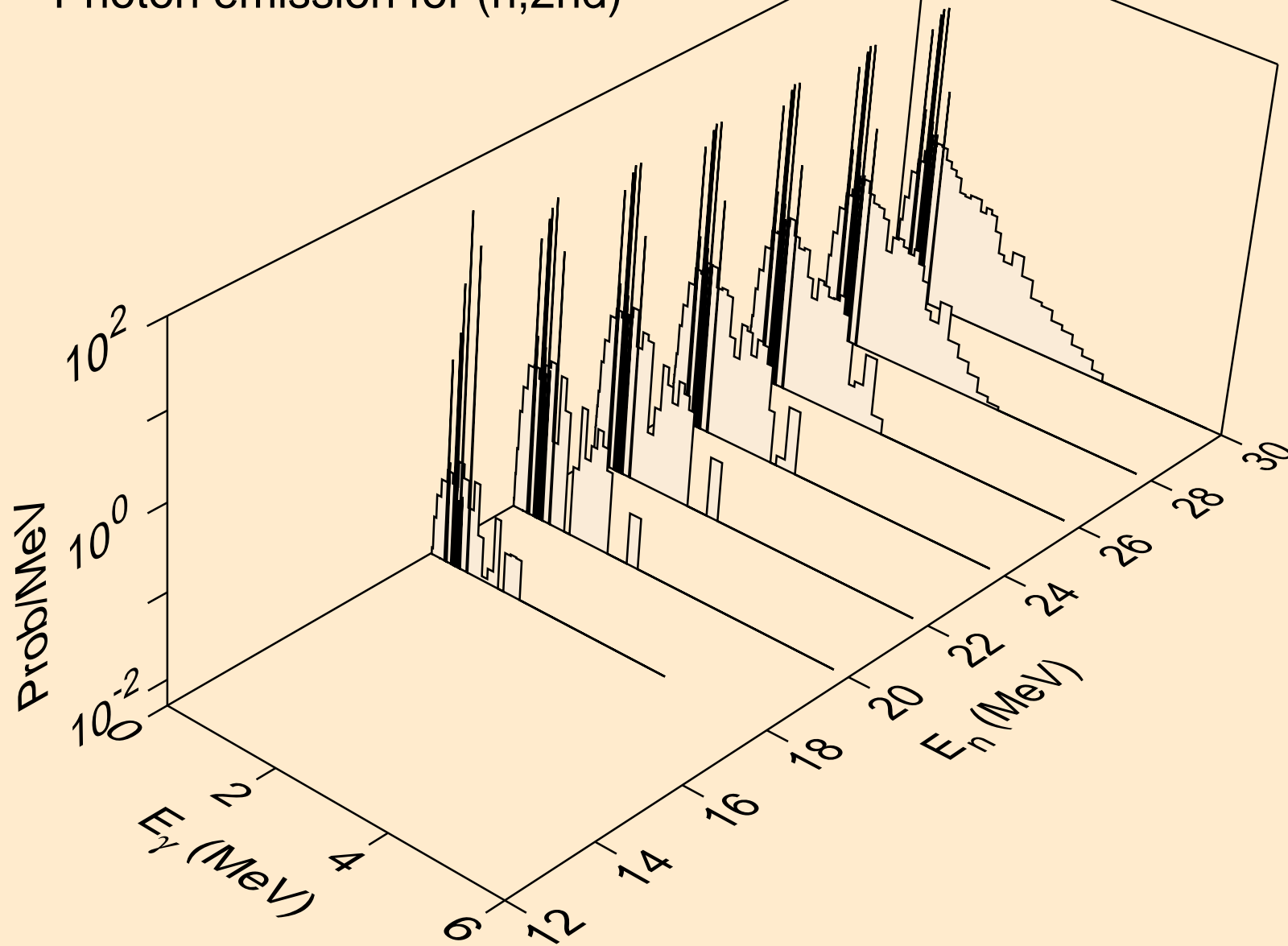

AT221 NEUTRON ACER TENDL-2021 LIBRARY; T=293.6K
Photon emission for (n,2n)

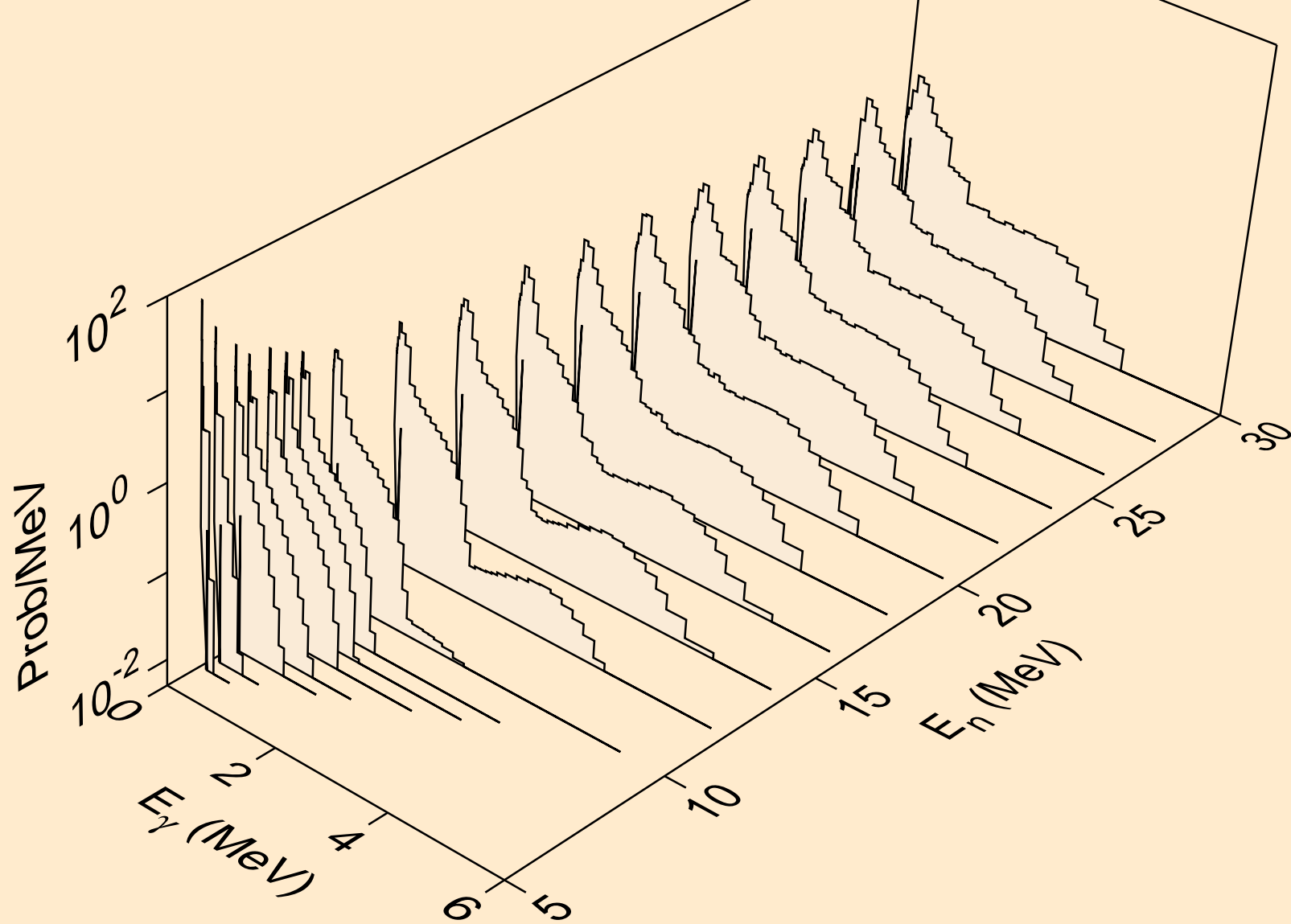

AT221 NEUTRON ACER TENDL-2021 LIBRARY; T=293.6K
Photon emission for (n,3n)

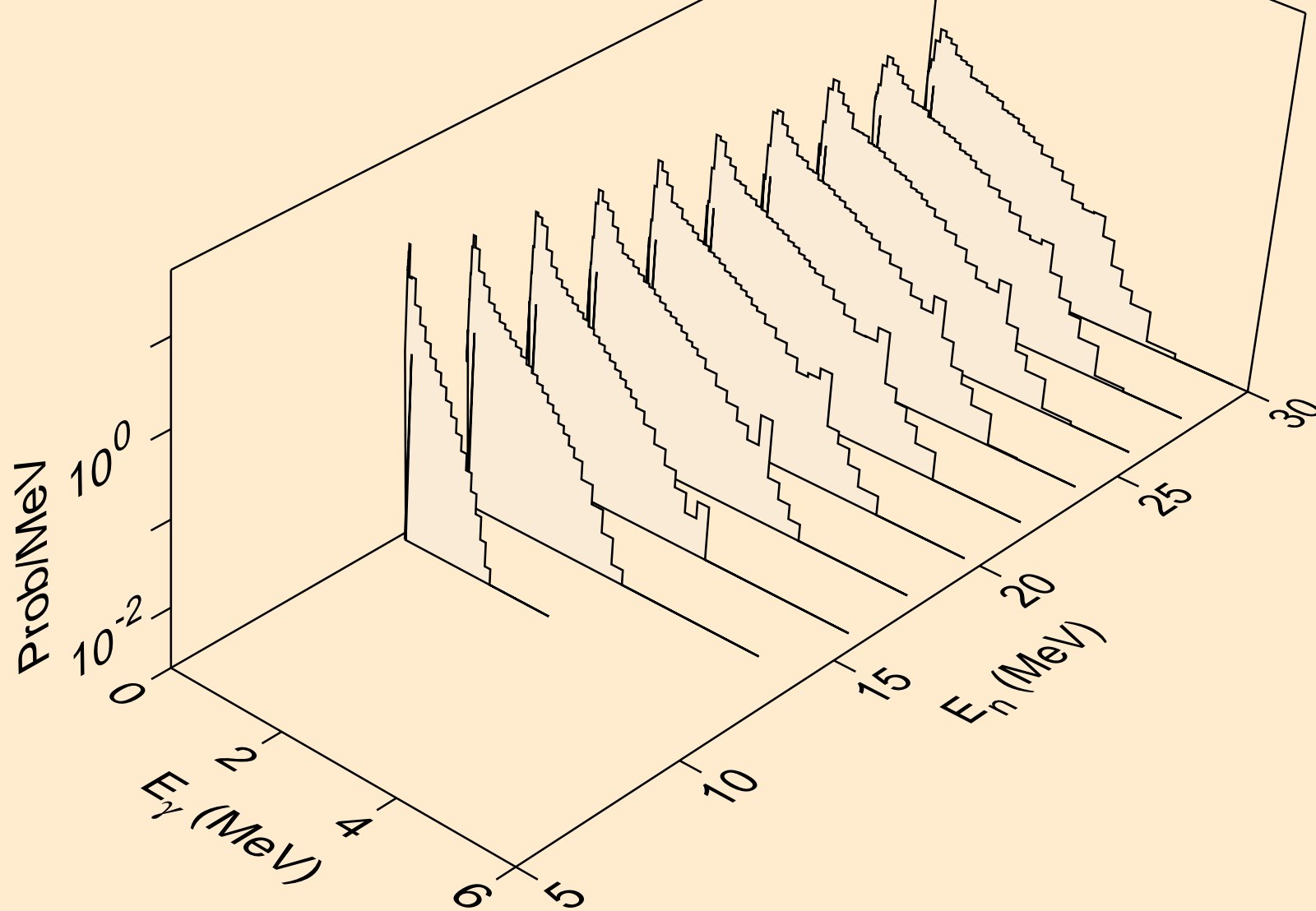

AT221 NEUTRON ACER TENDL-2021 LIBRARY; T=293.6K
Photon emission for (n,n*)a

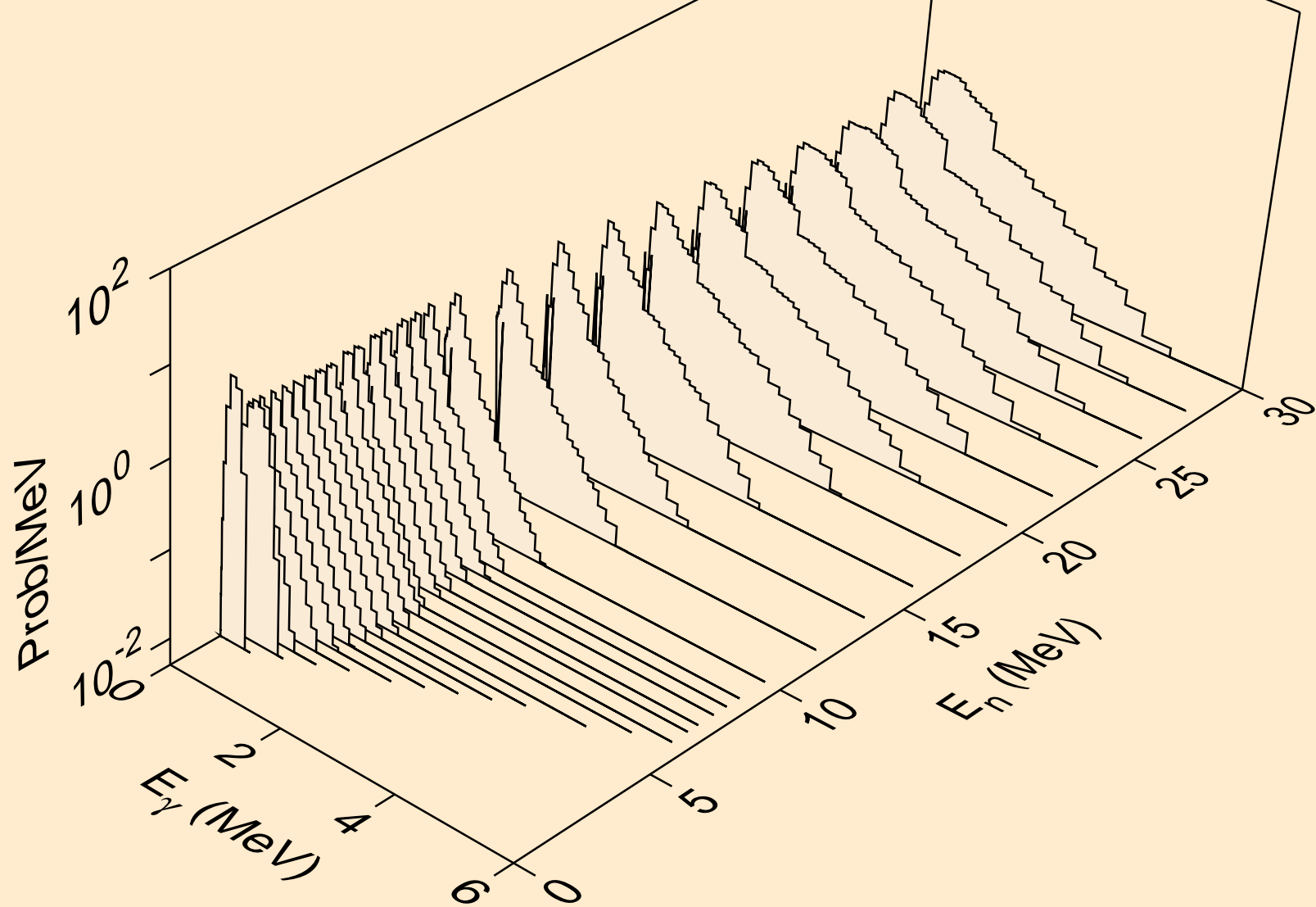

AT221 NEUTRON ACER TENDL-2021 LIBRARY; T=293.6K
Photon emission for (n,2n)a

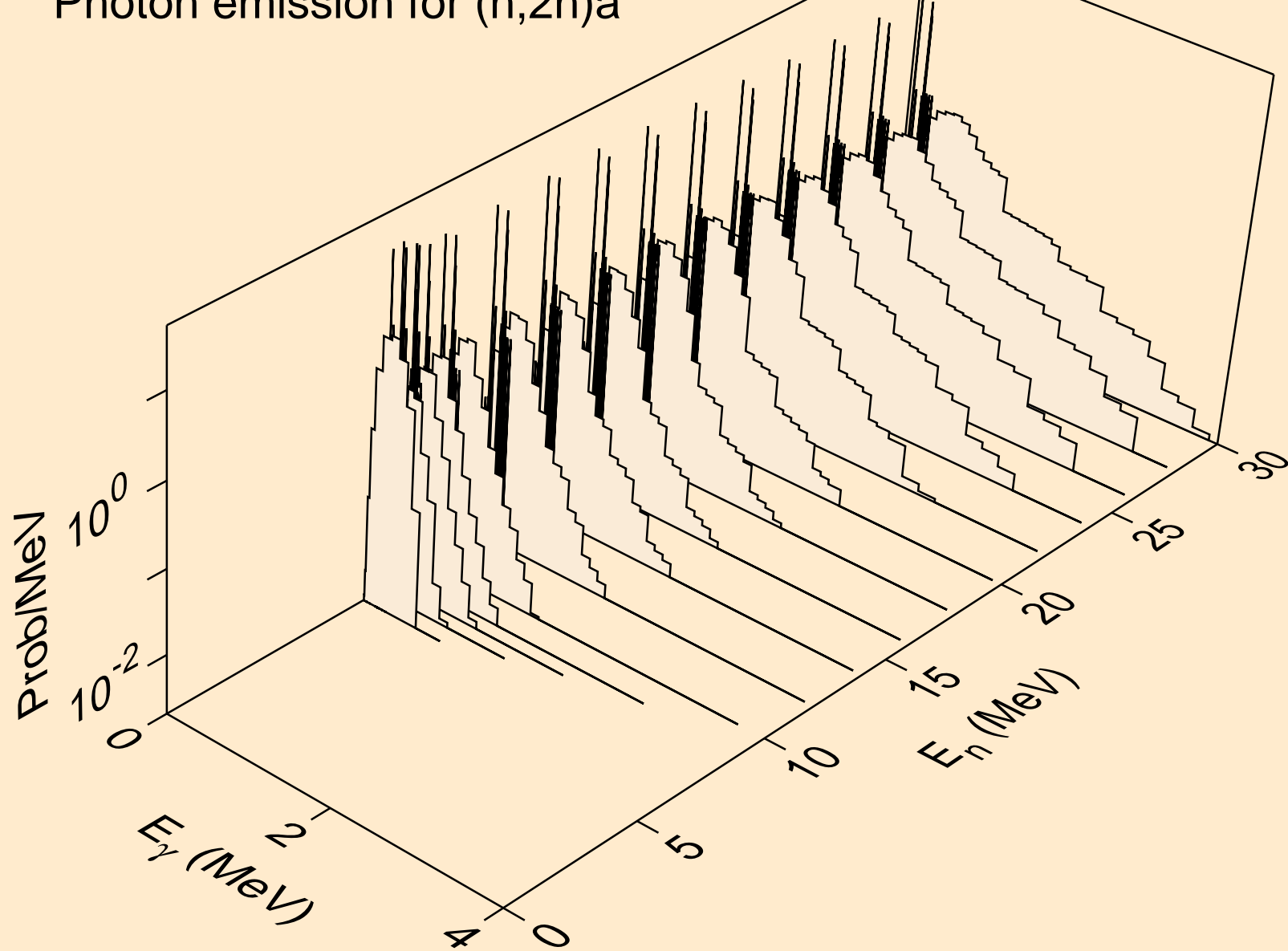

AT221 NEUTRON ACER TENDL-2021 LIBRARY; T=293.6K
Photon emission for (n,3n)a

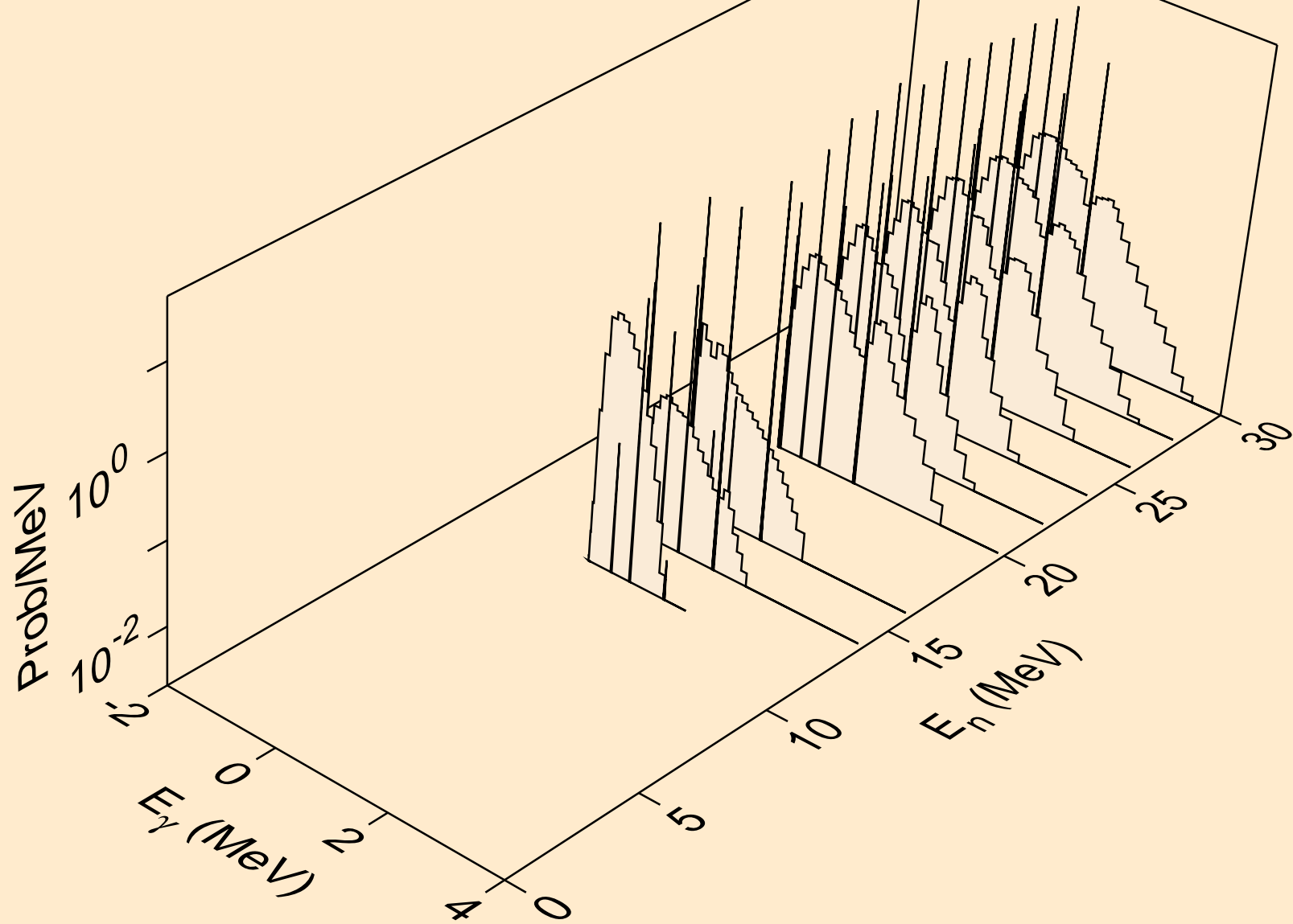

AT221 NEUTRON ACER TENDL-2021 LIBRARY; T=293.6K
Photon emission for (n,n*)p

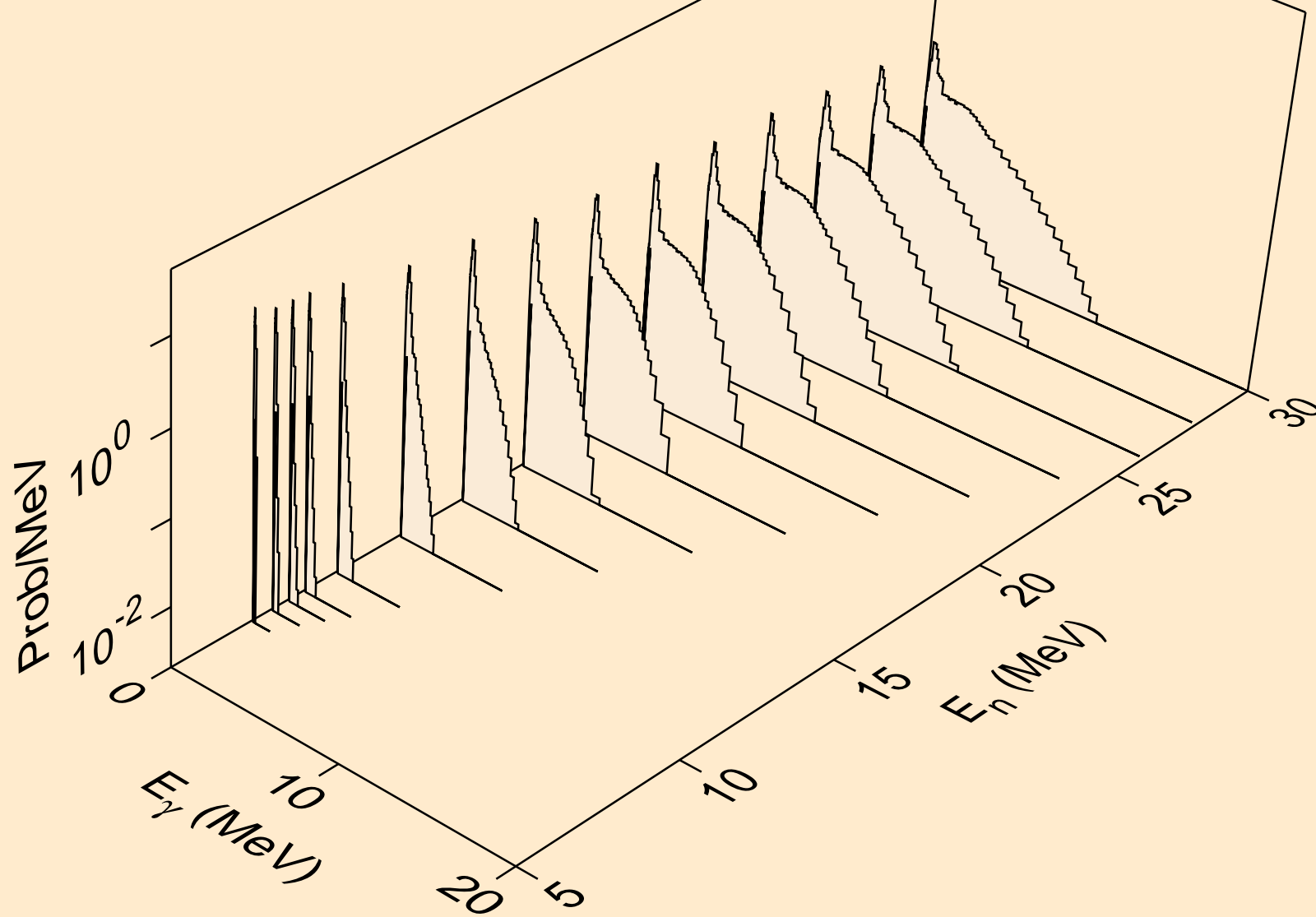

AT221 NEUTRON ACER TENDL-2021 LIBRARY; T=293.6K
Photon emission for (n,n*)d

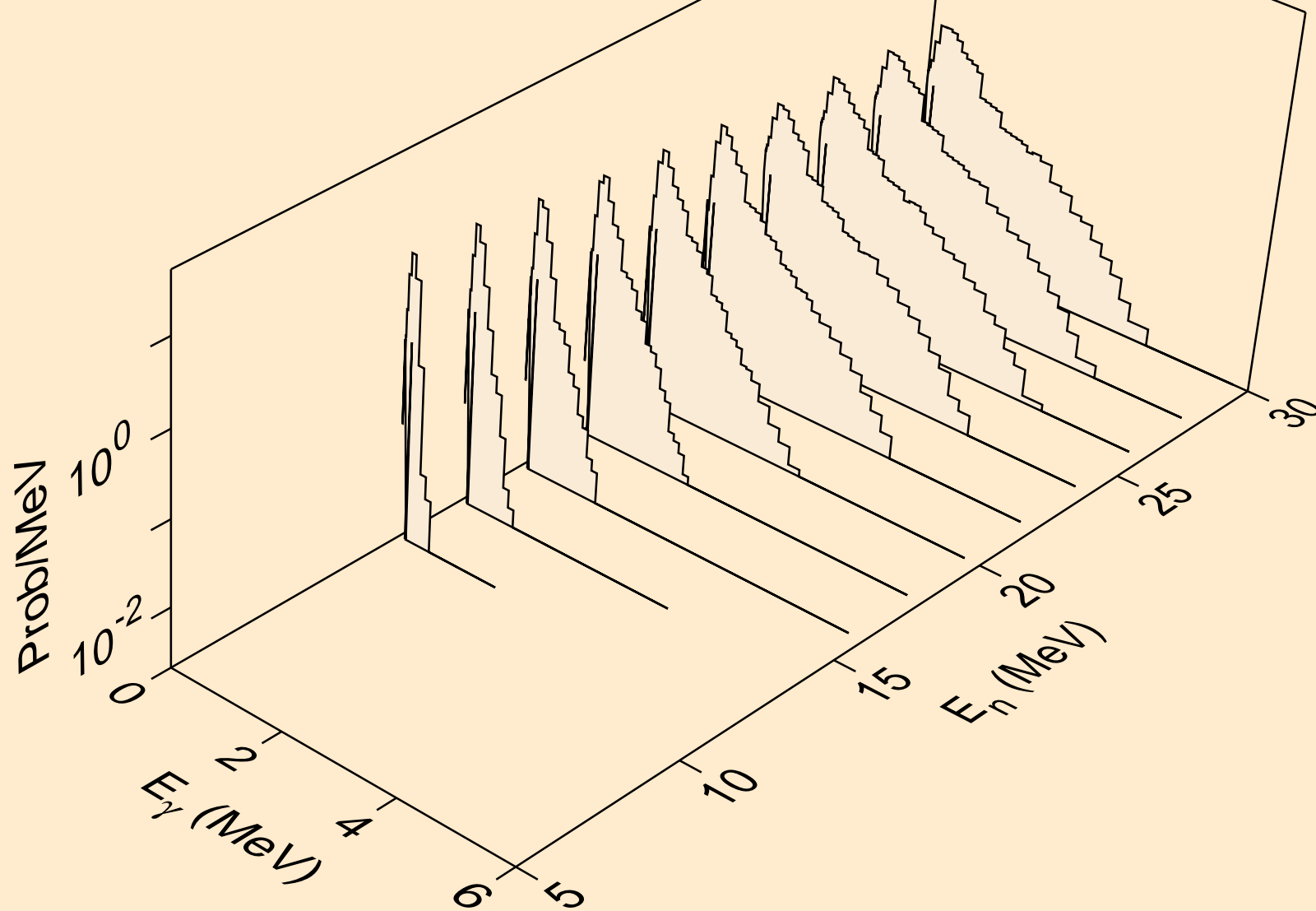

AT221 NEUTRON ACER TENDL-2021 LIBRARY; T=293.6K
Photon emission for (n,n*)t

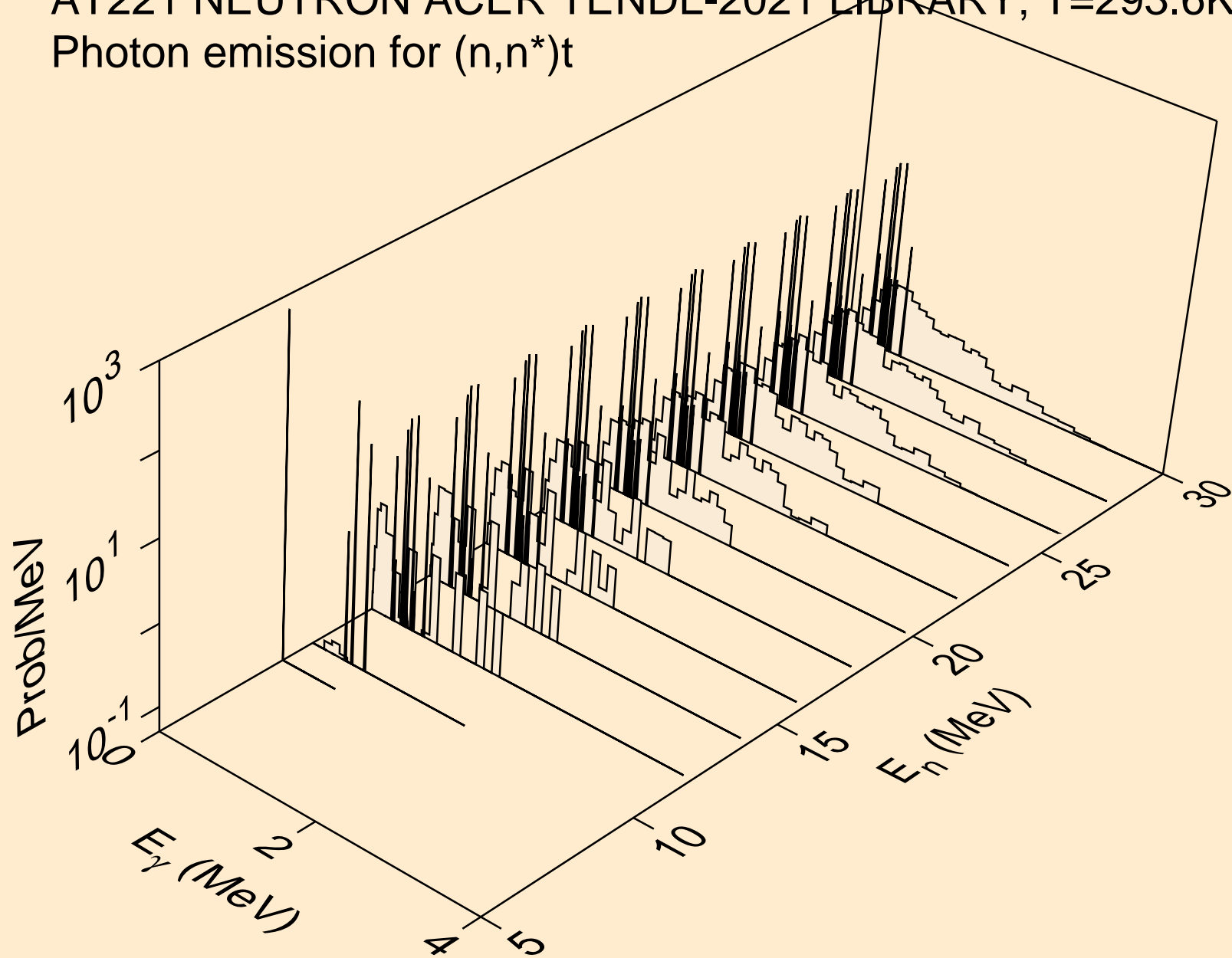

AT221 NEUTRON ACER TENDL-2021 LIBRARY; T=293.6K
Photon emission for (n,n*)he3

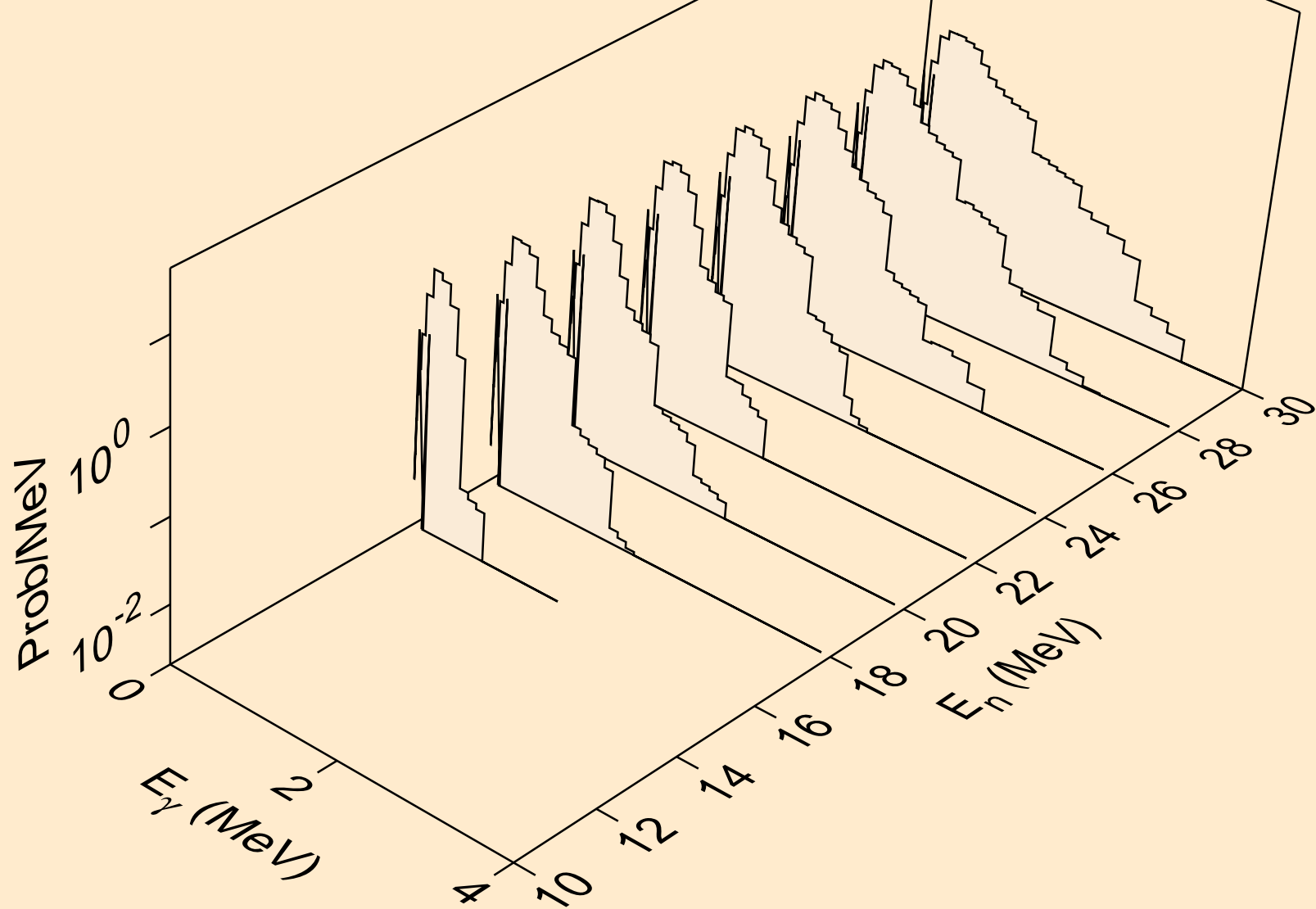

AT221 NEUTRON ACER TENDL-2021 LIBRARY; T=293.6K
Photon emission for (n,4n)

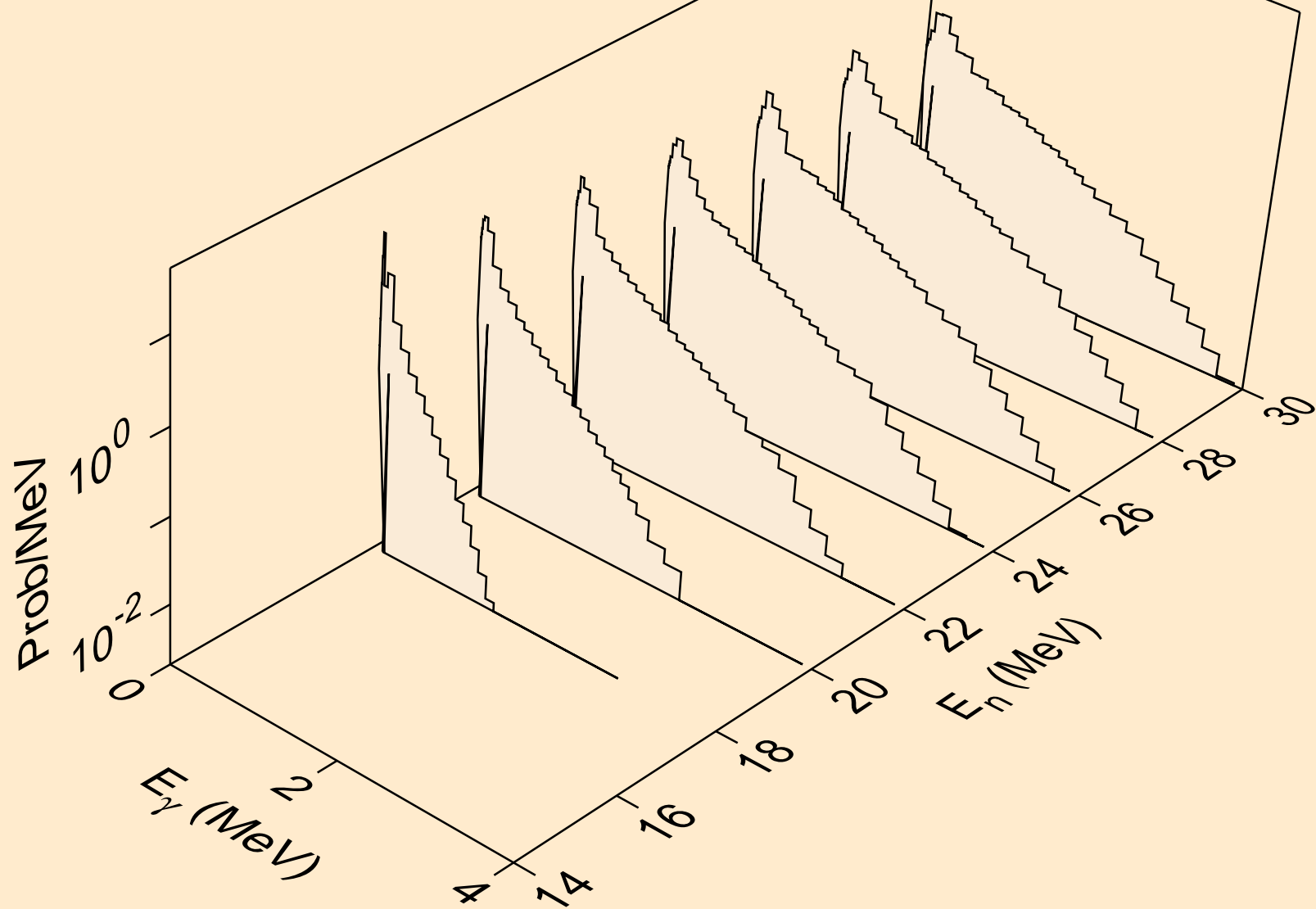

AT221 NEUTRON ACER TENDL-2021 LIBRARY; T=293.6K
Photon emission for (n,2np)

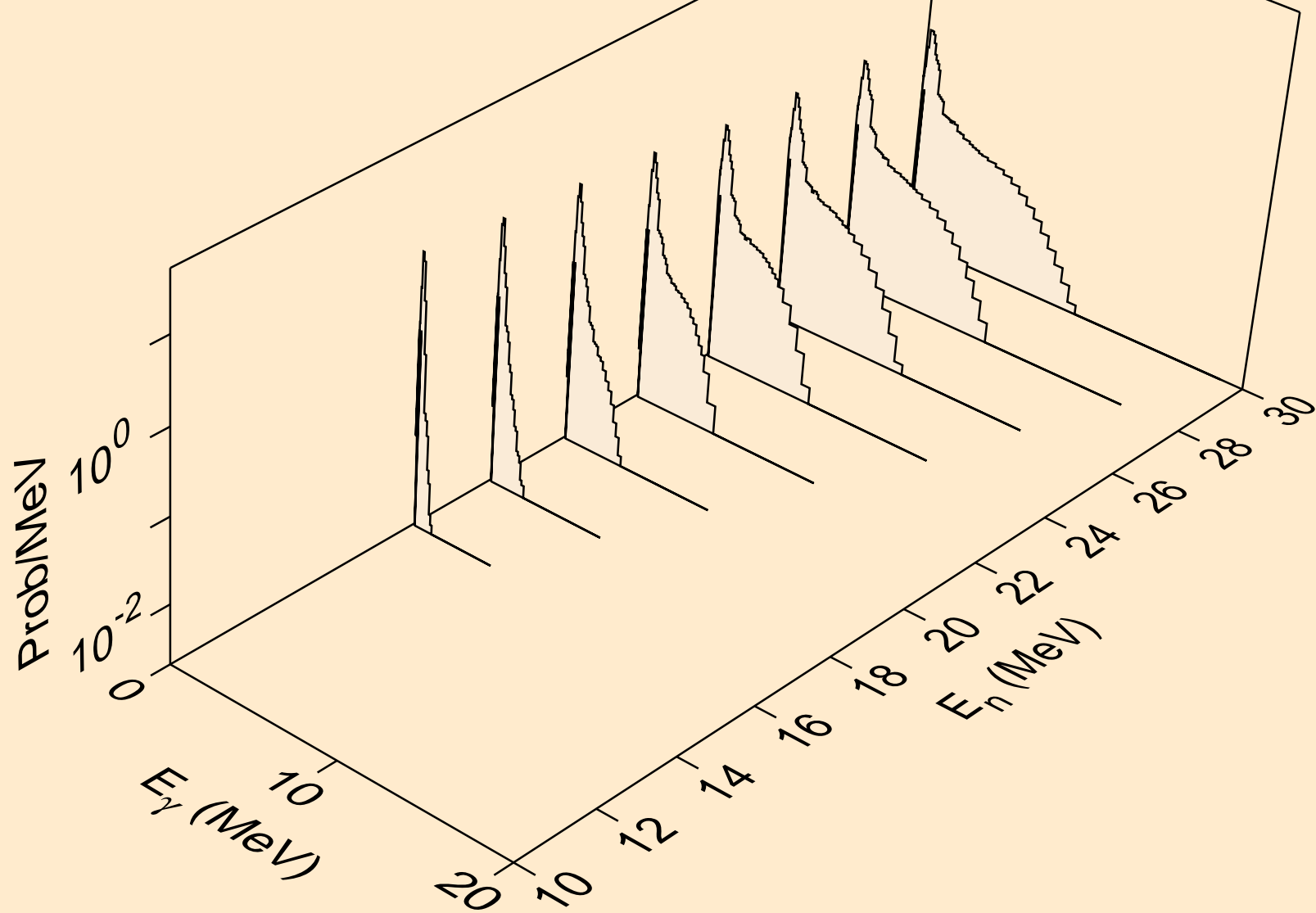

AT221 NEUTRON ACER TENDL-2021 LIBRARY; T=293.6K
Photon emission for (n,3np)

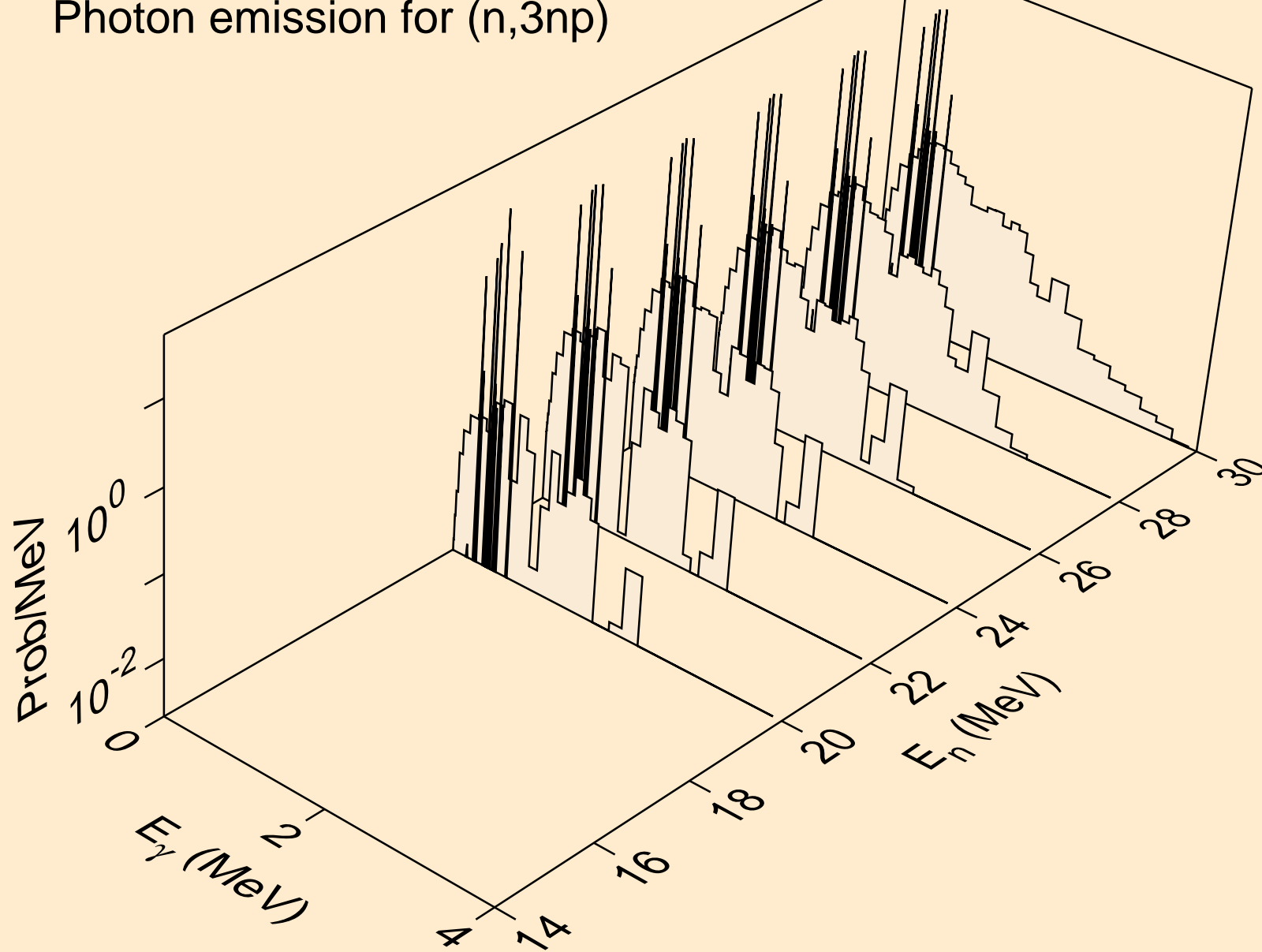

AT221 NEUTRON ACER TENDL-2021 LIBRARY; T=293.6K
Photon emission for (n,2np)

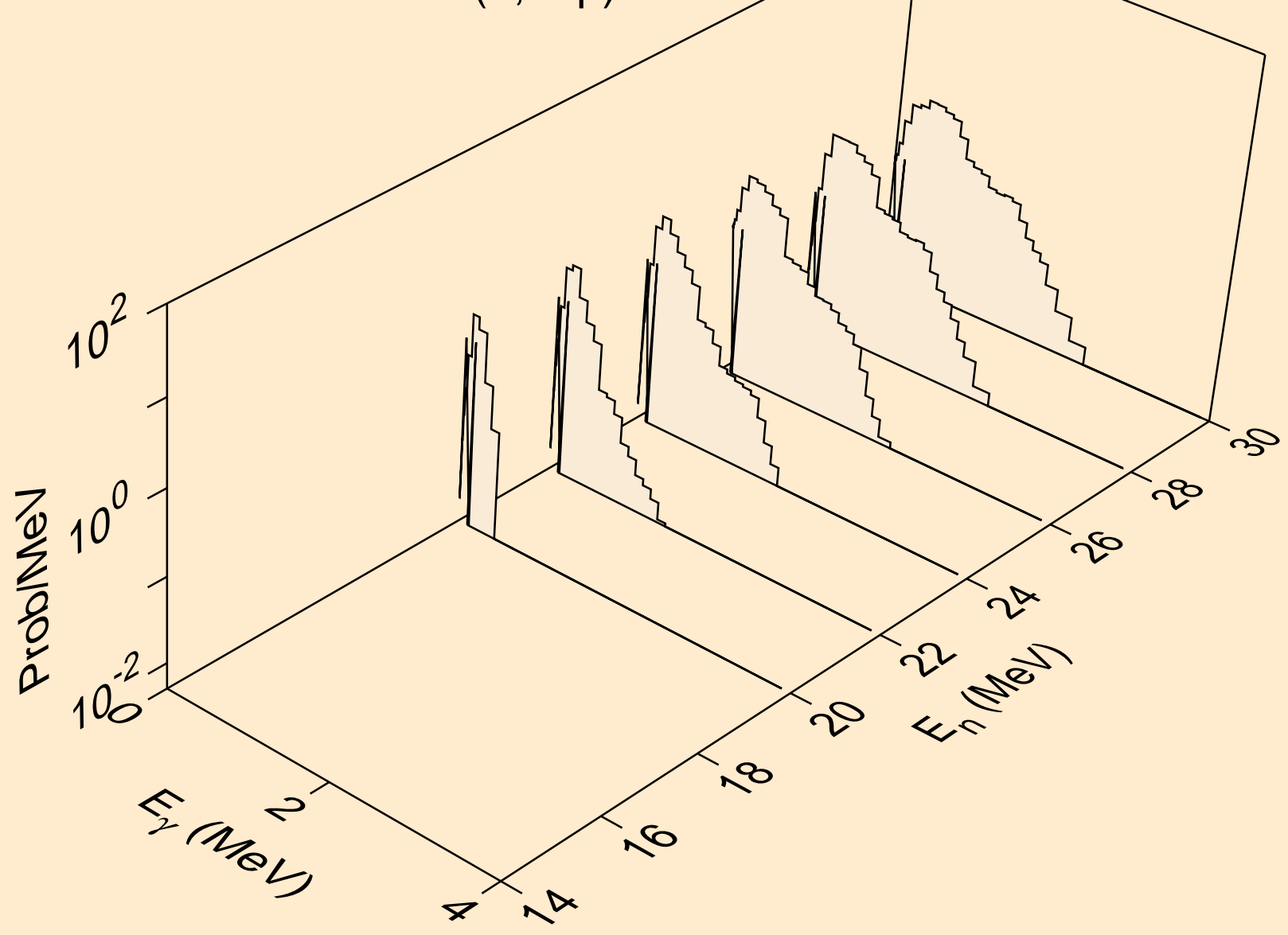

AT221 NEUTRON ACER TENDL-2021 LIBRARY; T=293.6K
Photon emission for (n,npa)

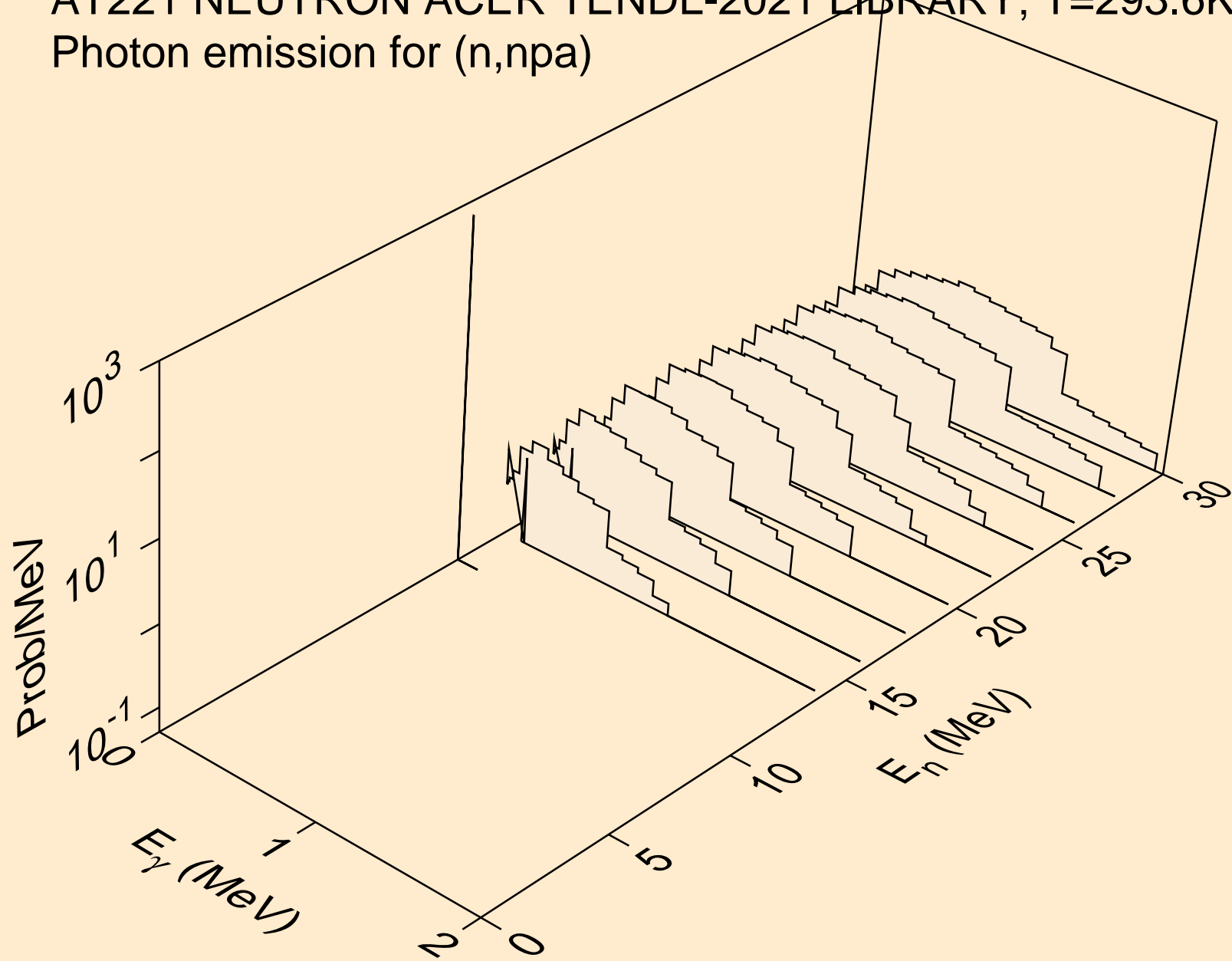

AT221 NEUTRON ACER TENDL-2021 LIBRARY; T=293.6K
Photon emission for (n,n*c)

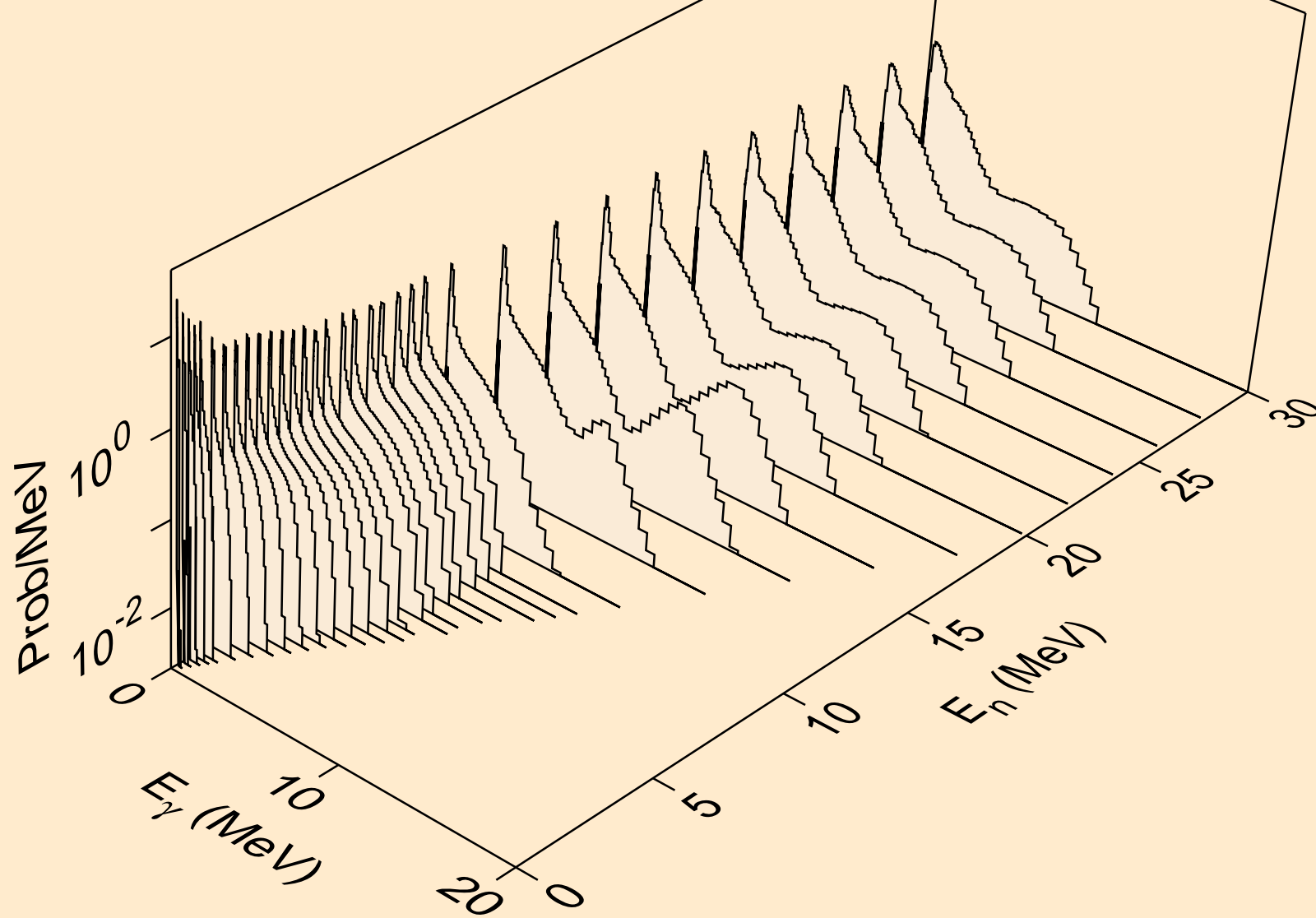

AT221 NEUTRON ACER TENDL-2021 LIBRARY; T=293.6K
Photon emission for (n,gma)

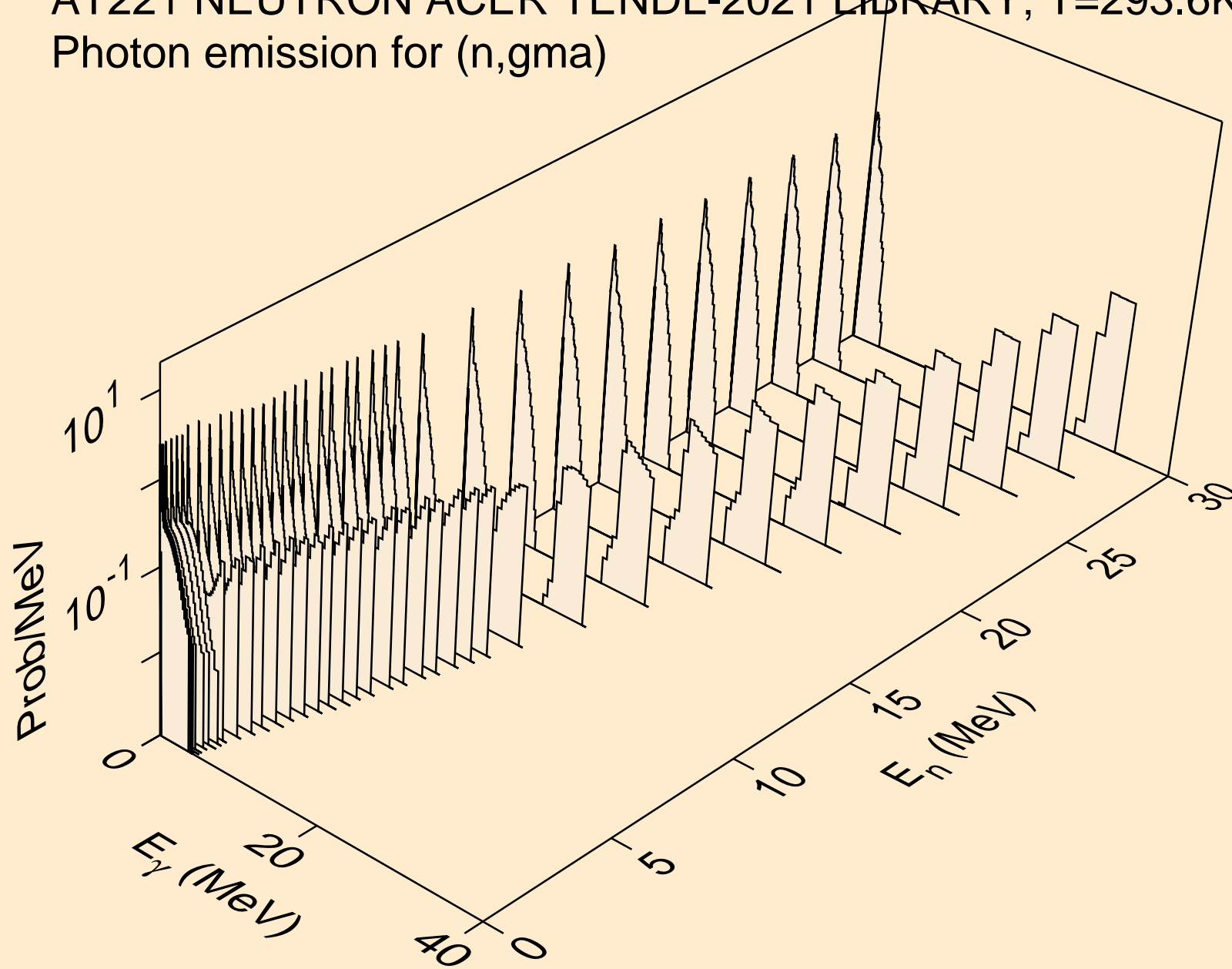

AT221 NEUTRON ACER TENDL-2021 LIBRARY; T=293.6K
Photon emission for (n,p)

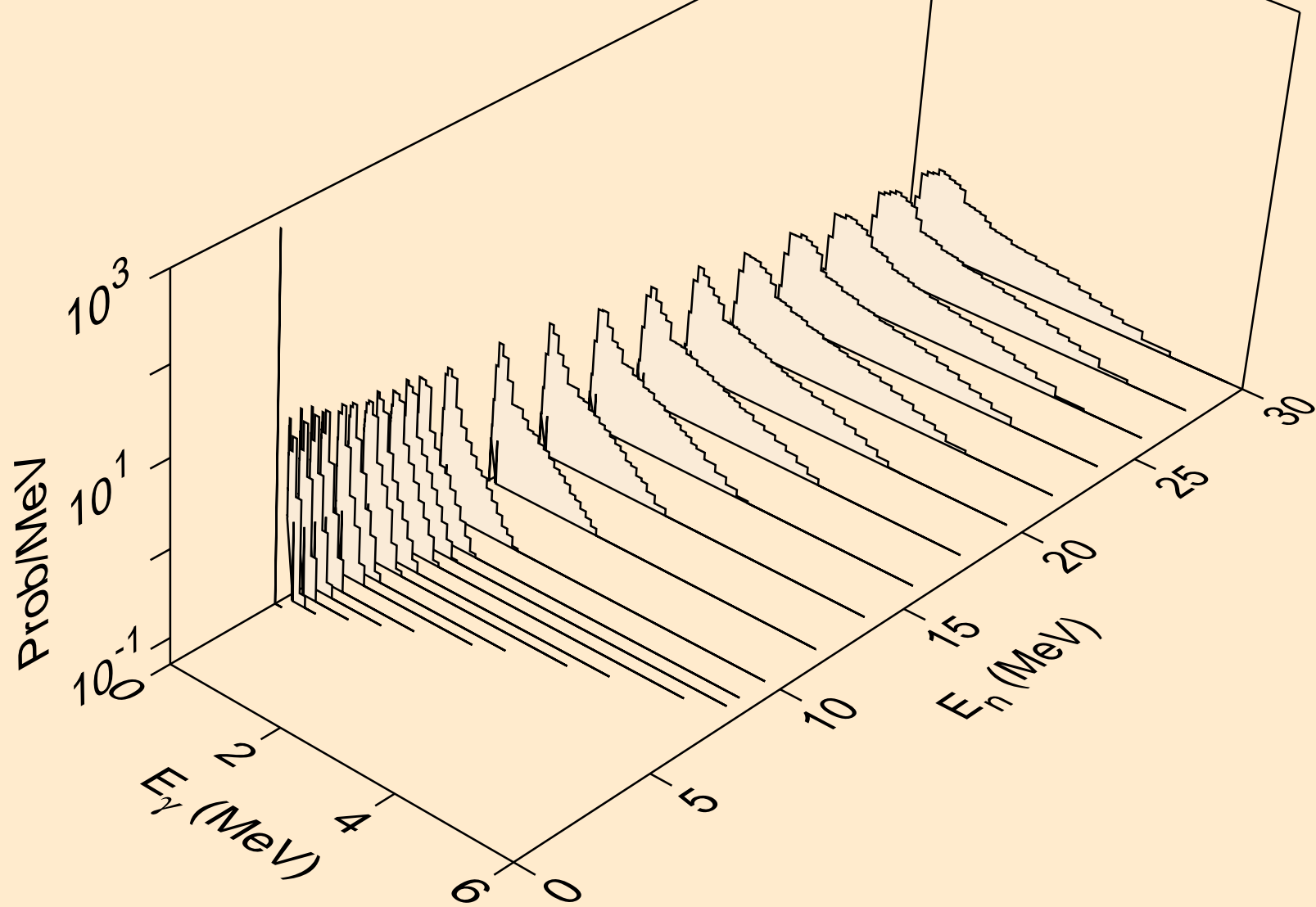

AT221 NEUTRON ACER TENDL-2021 LIBRARY; T=293.6K
Photon emission for (n,d)

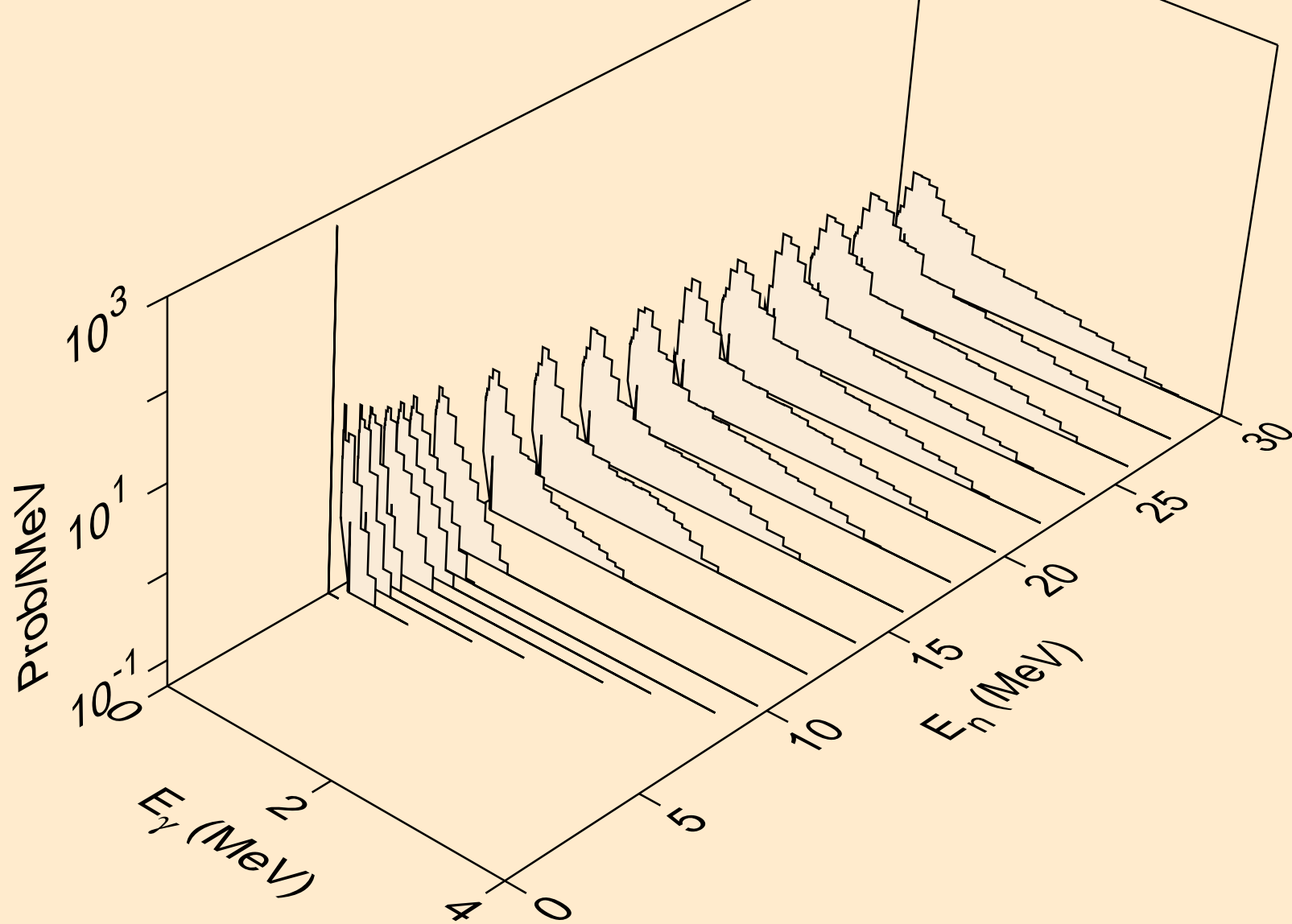

AT221 NEUTRON ACER TENDL-2021 LIBRARY; T=293.6K
Photon emission for (n,t)

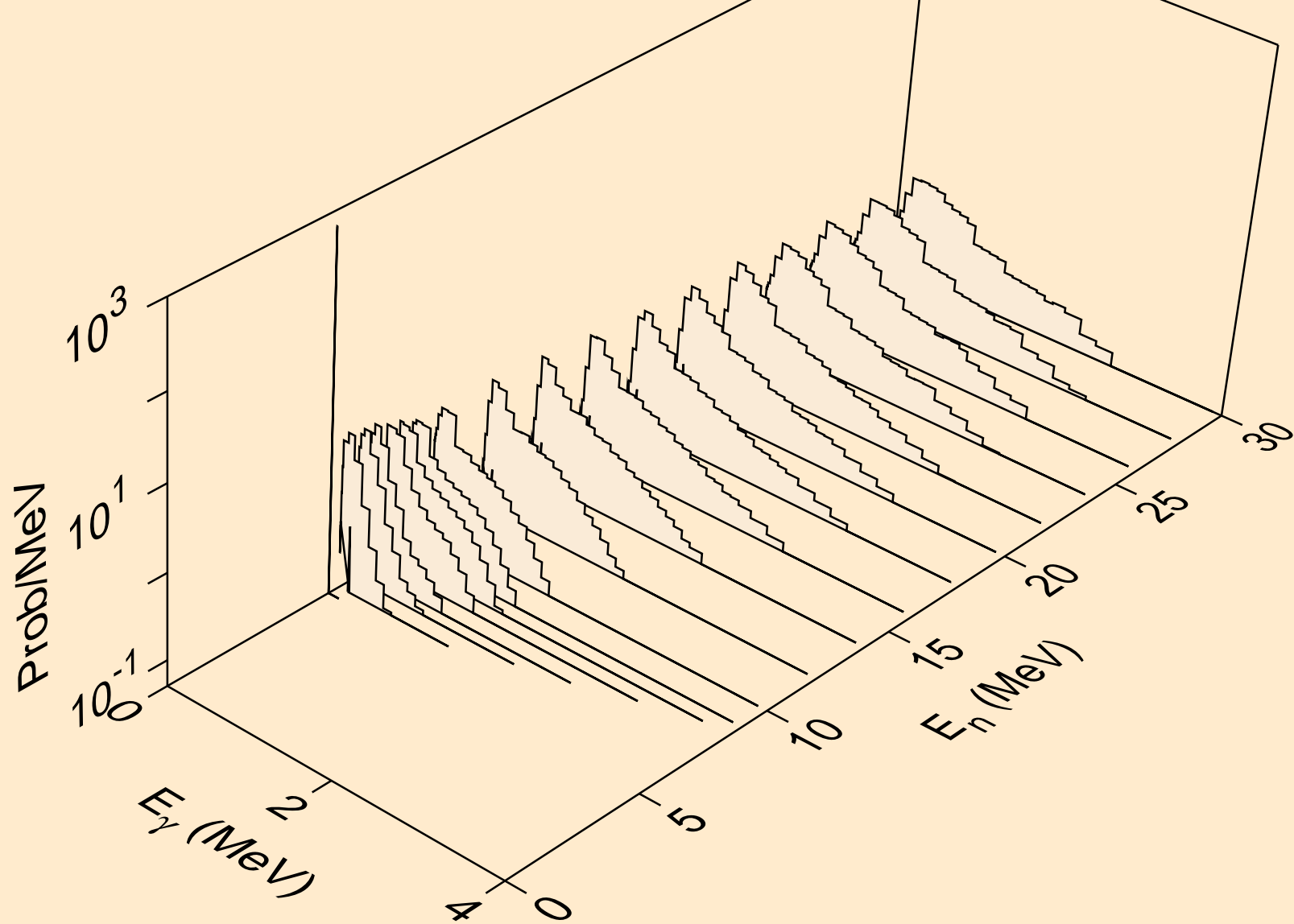

AT221 NEUTRON ACER TENDL-2021 LIBRARY; T=293.6K
Photon emission for (n,he3)

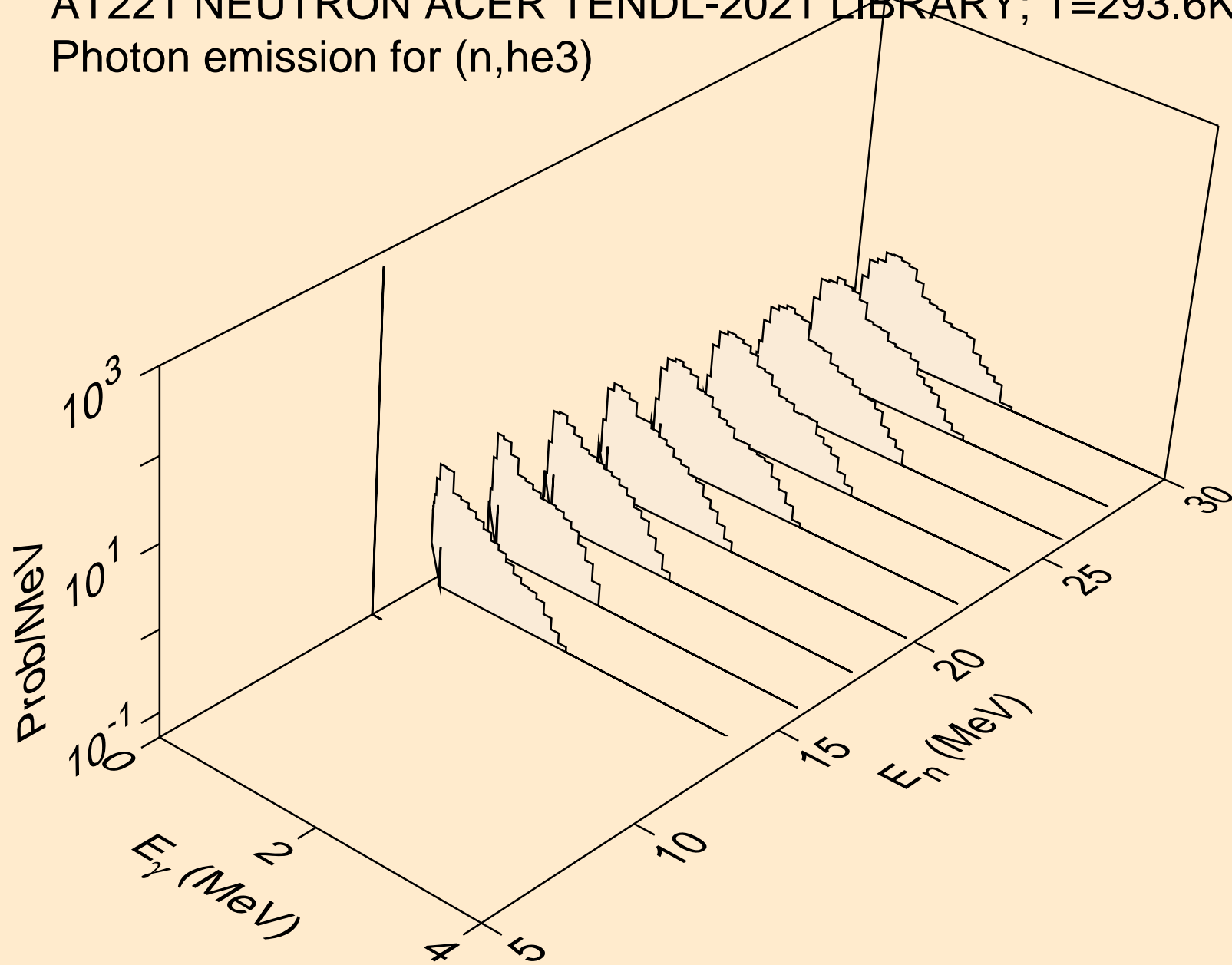

AT221 NEUTRON ACER TENDL-2021 LIBRARY; T=293.6K
Photon emission for (n,a)

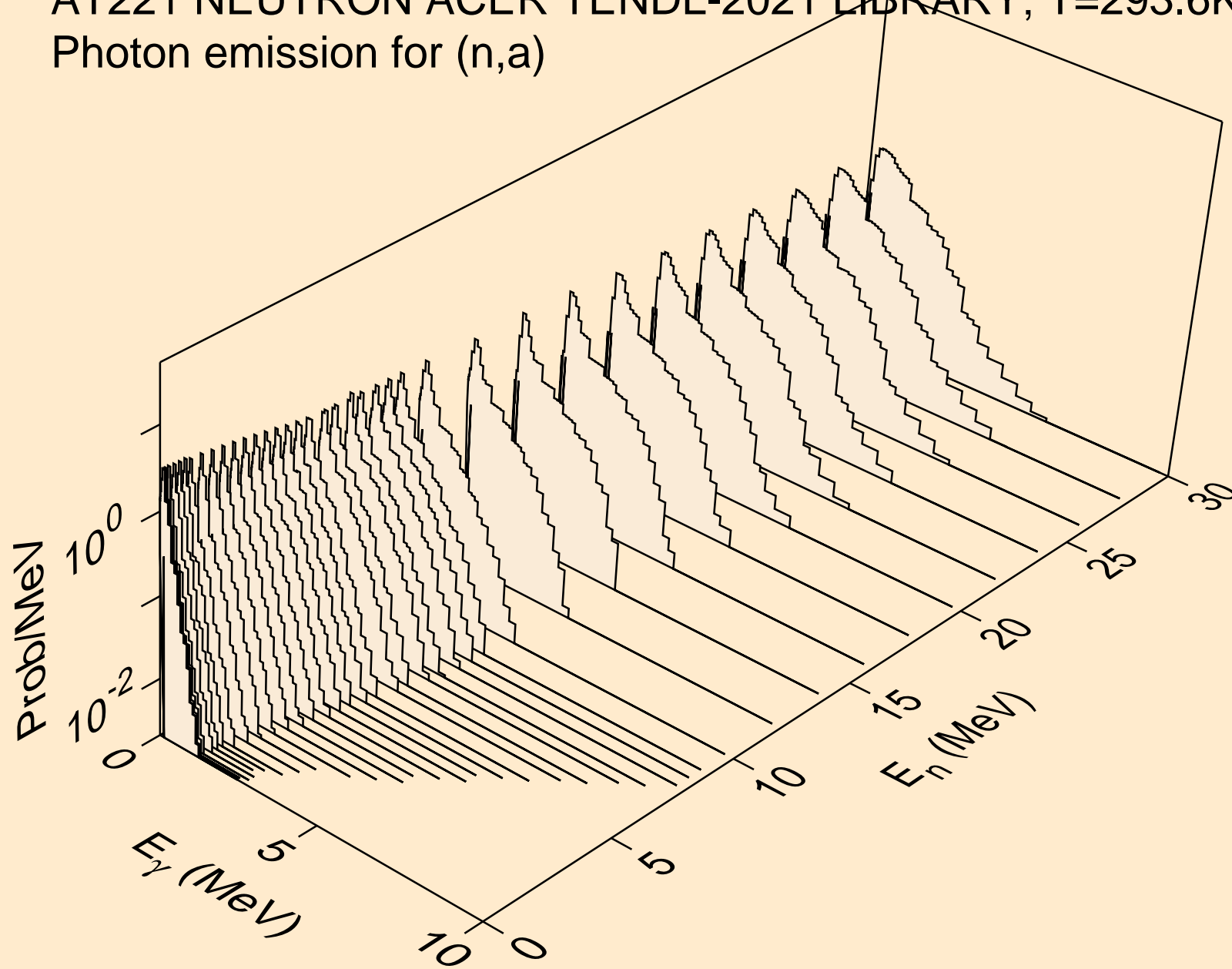

AT221 NEUTRON ACER TENDL-2021 LIBRARY; T=293.6K
Photon emission for (n,2a)

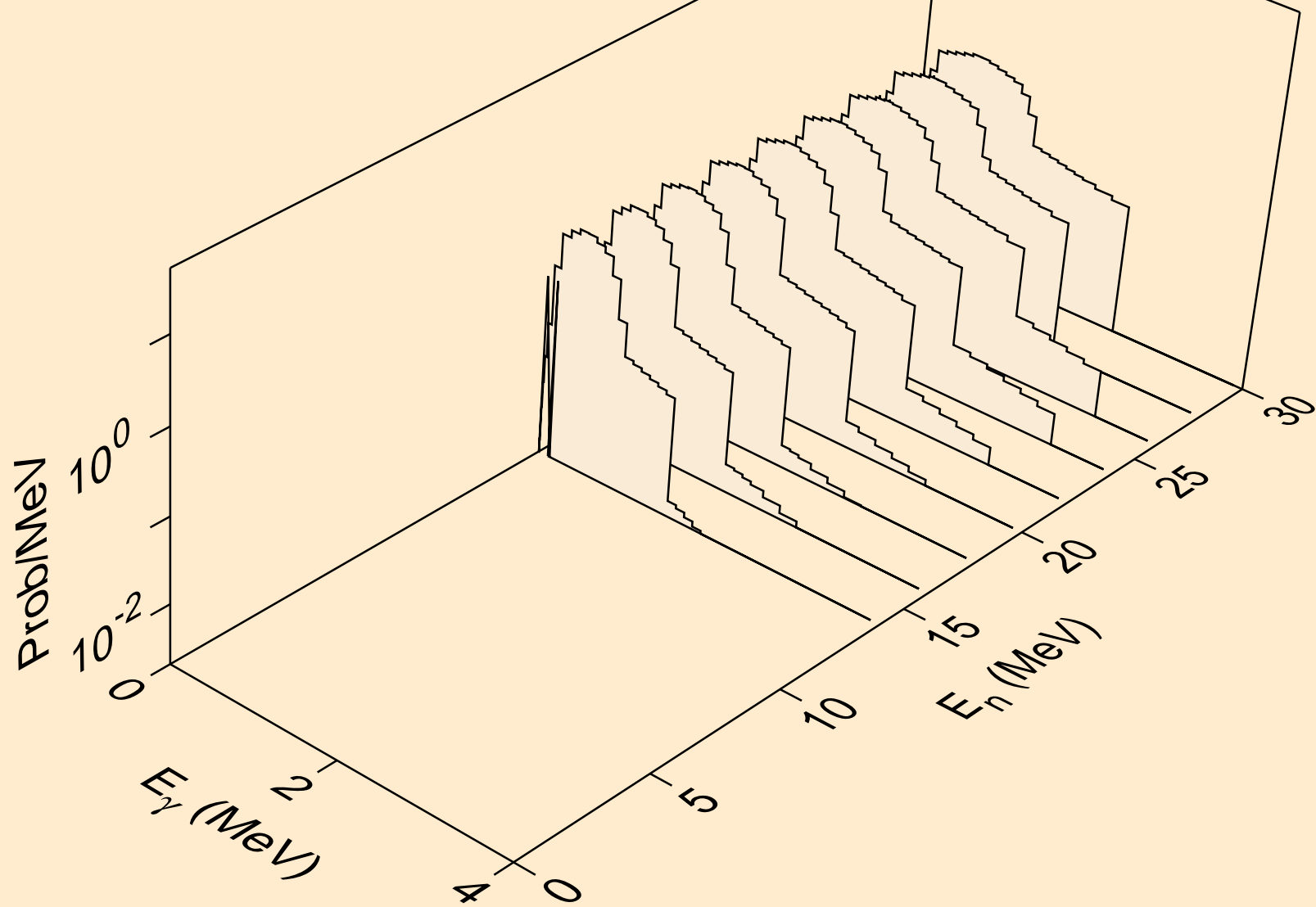

AT221 NEUTRON ACER TENDL-2021 LIBRARY; T=293.6K
Photon emission for (n,2p)

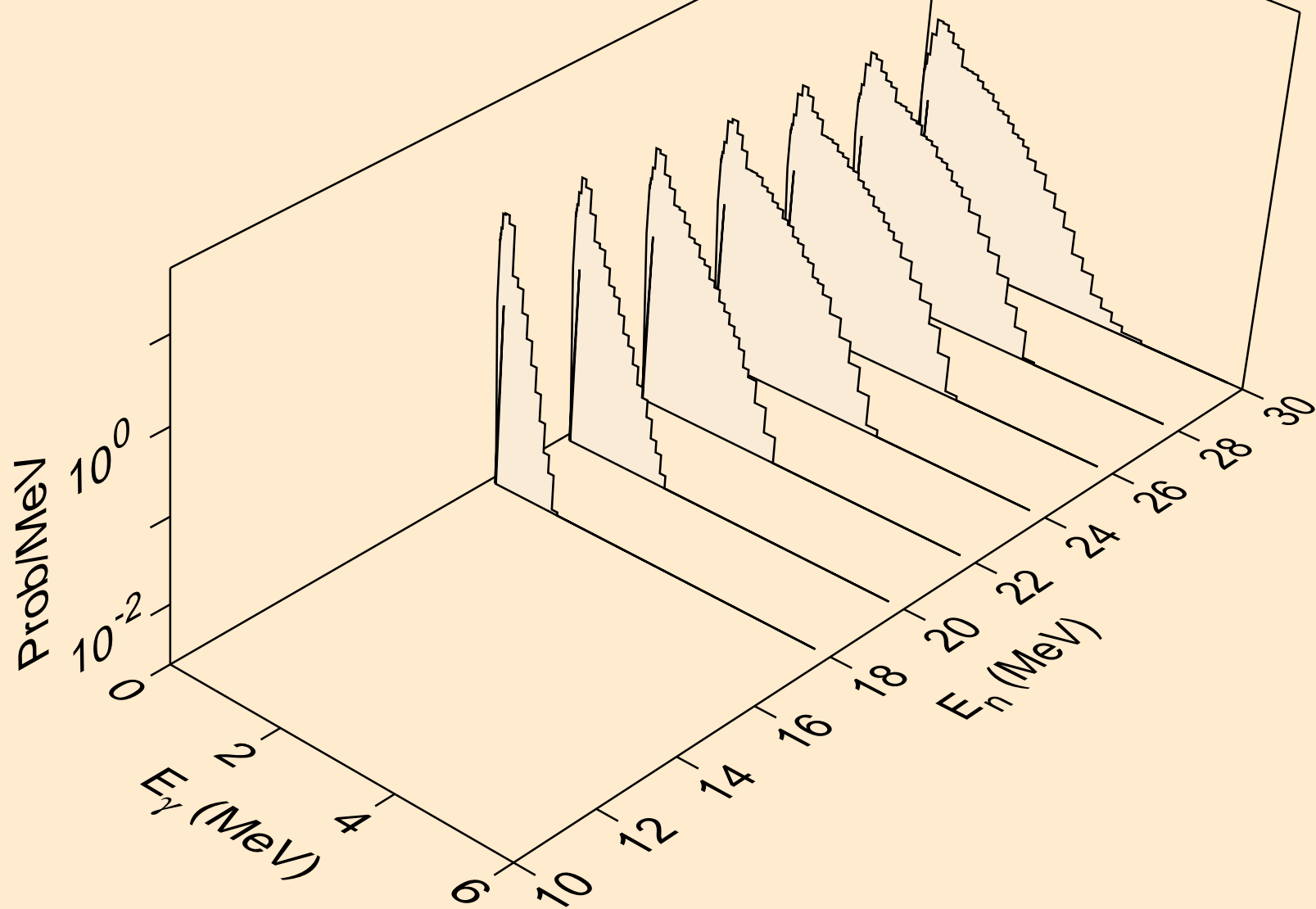

AT221 NEUTRON ACER TENDL-2021 LIBRARY; T=293.6K
Photon emission for (n,p)

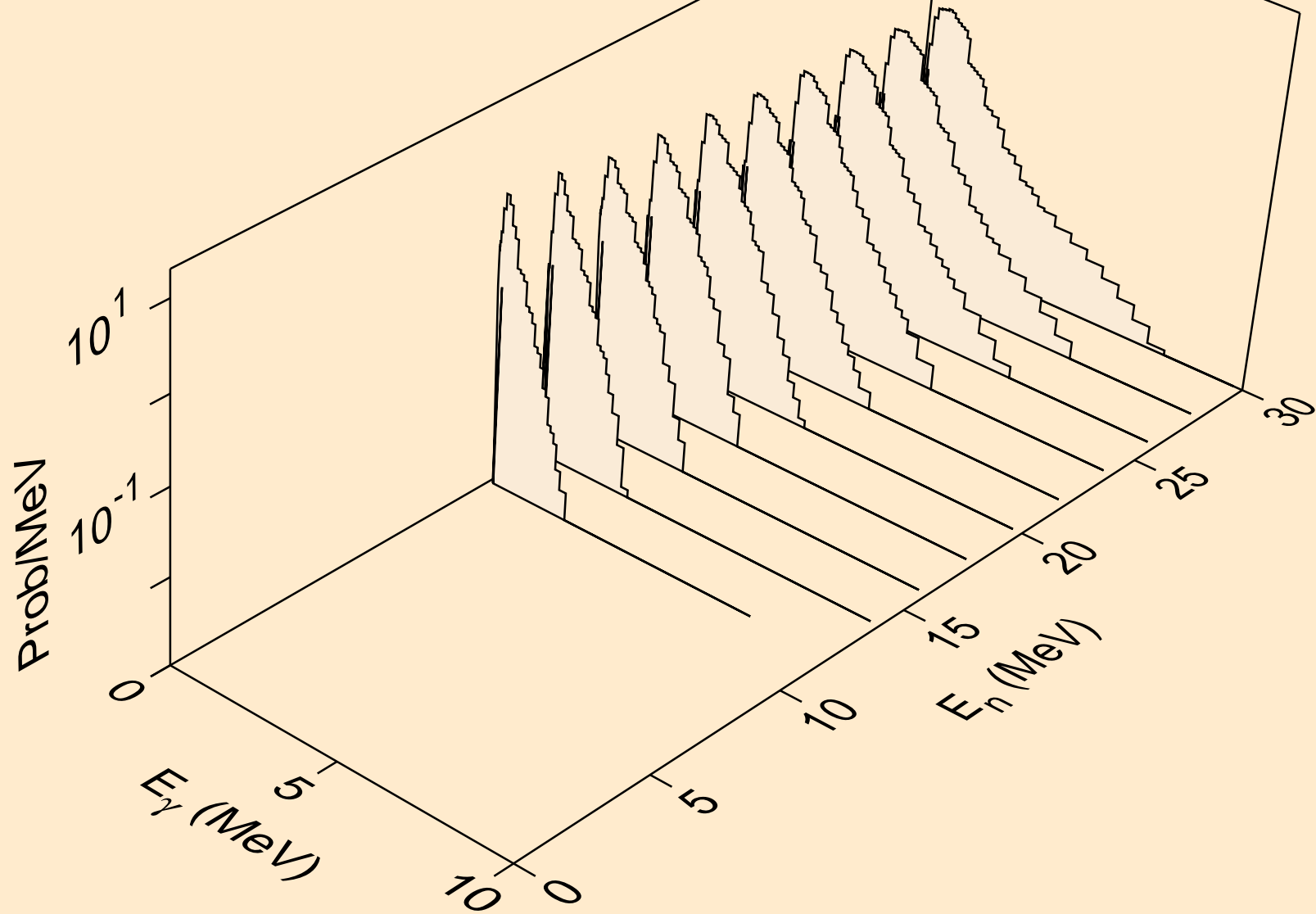

AT221 NEUTRON ACER TENDL-2021 LIBRARY; T=293.6K
Photon emission for (n,pd)

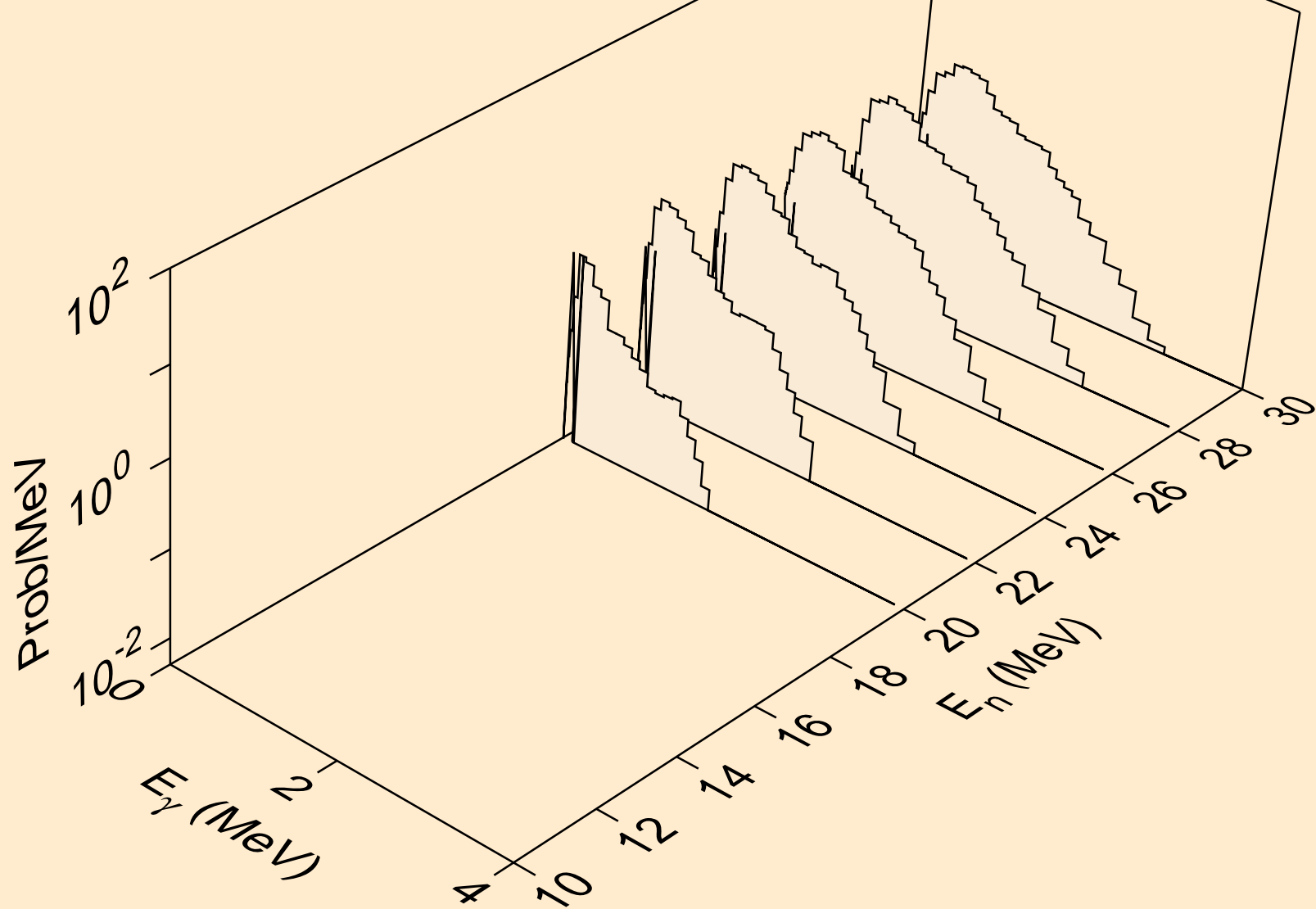

AT221 NEUTRON ACER TENDL-2021 LIBRARY; T=293.6K
Photon emission for (n,pt)

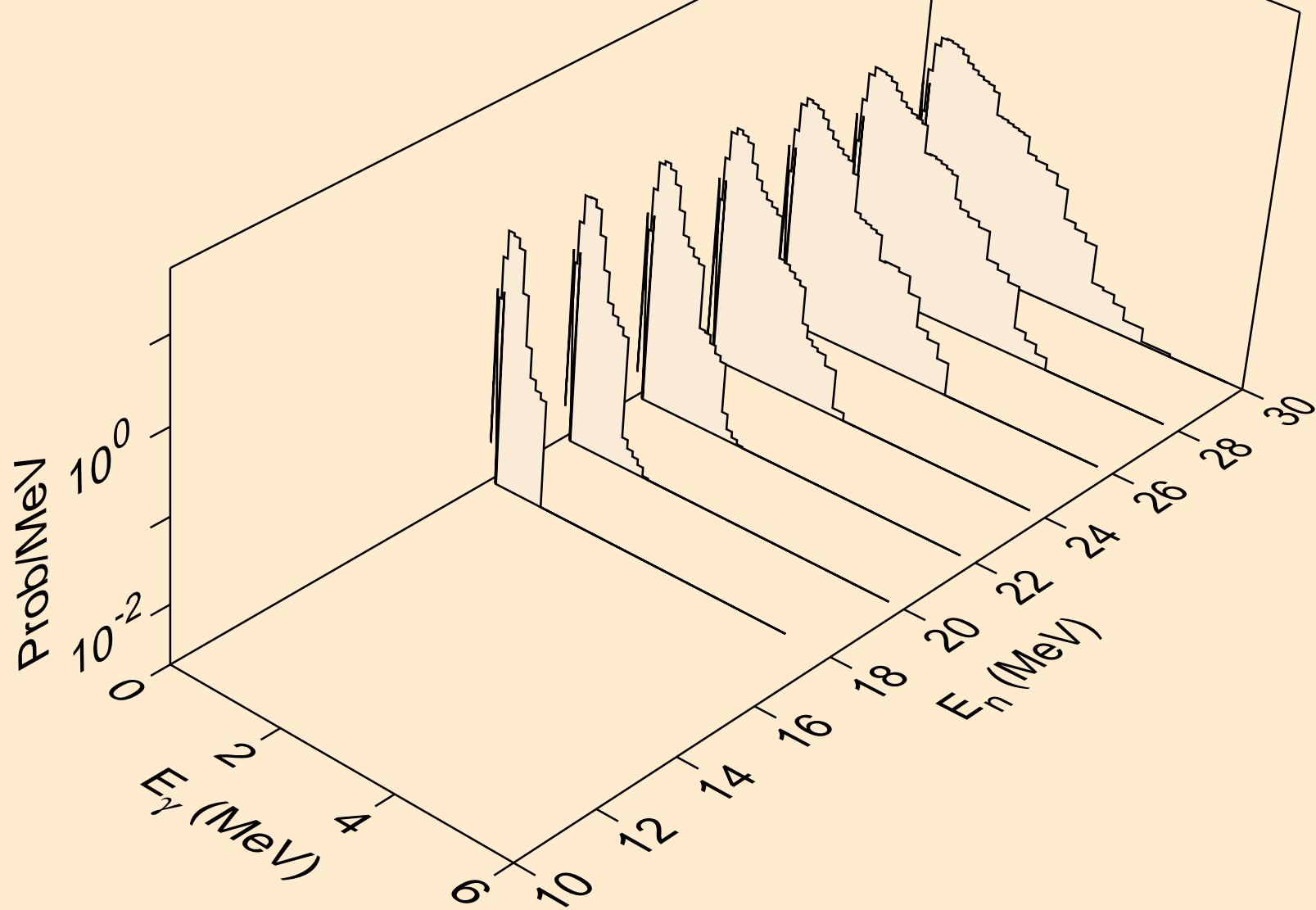

AT221 NEUTRON ACER TENDL-2021 LIBRARY; T=293.6K
Photon emission for (n,da)

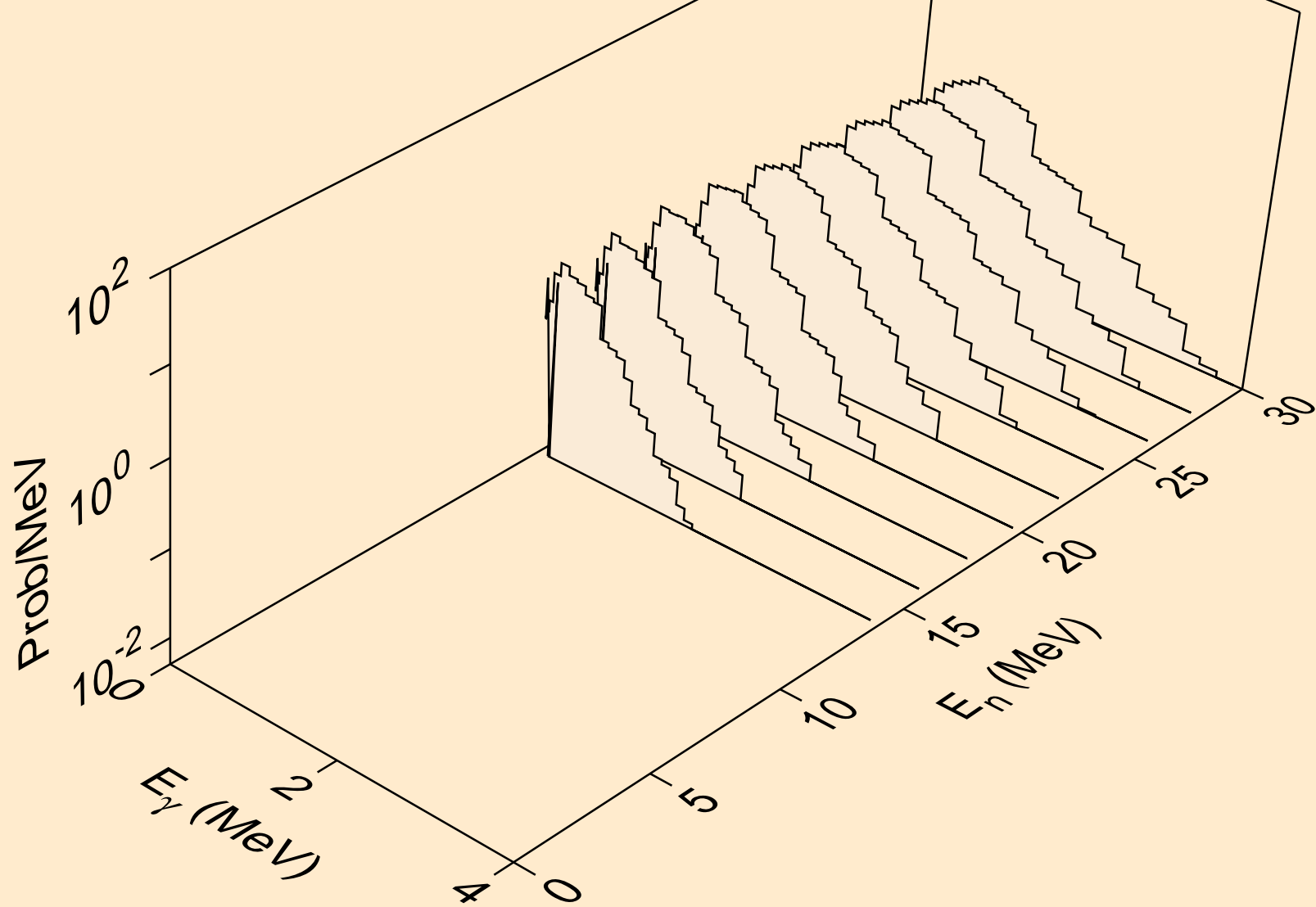

AT221 NEUTRON ACER TENDL-2021 LIBRARY; T=293.6K
thermal capture photon spectrum

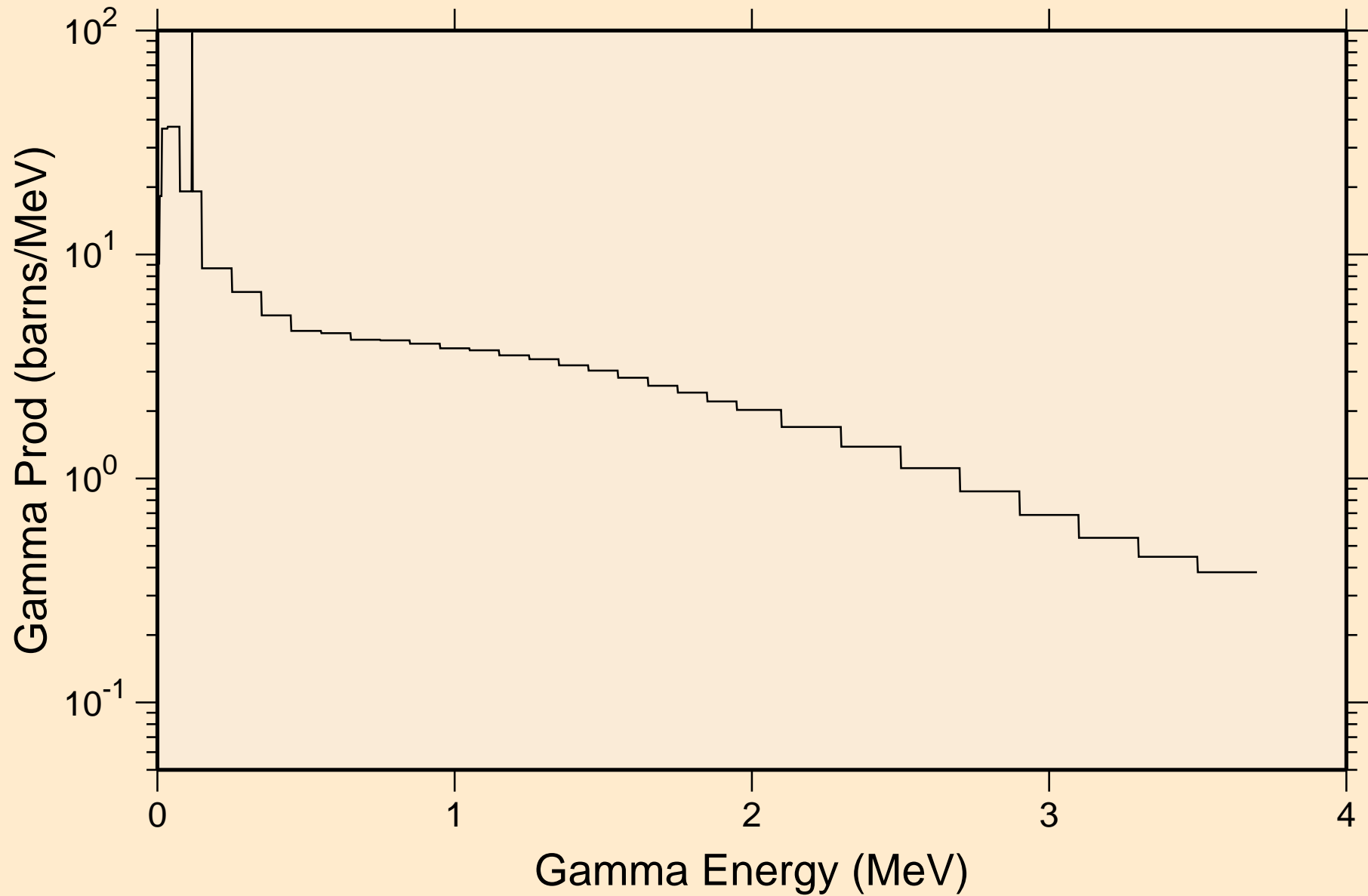

AT221 NEUTRON ACER TENDL-2021 LIBRARY; T=293.6K
14 MeV photon spectrum

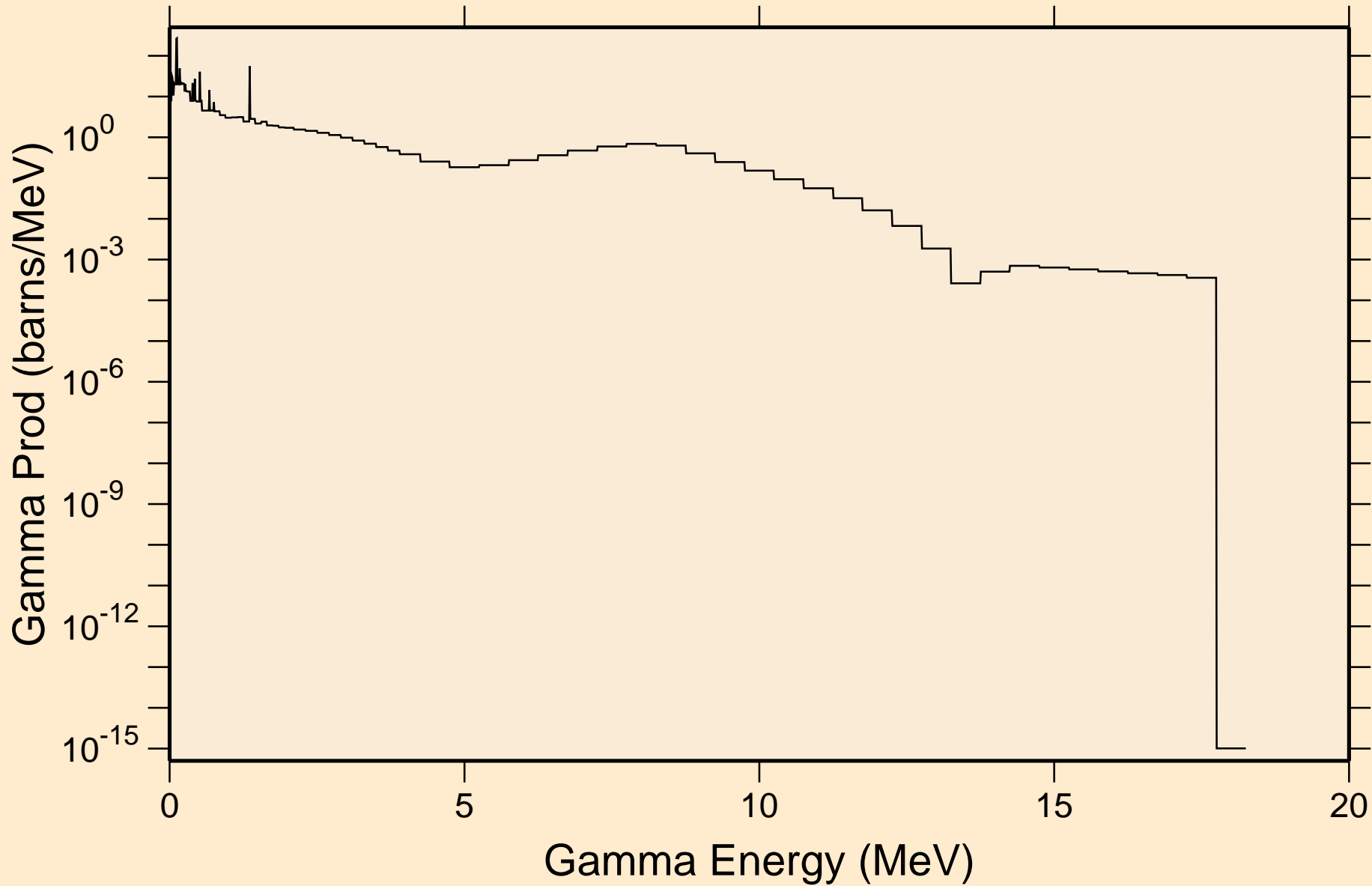

AT221 NEUTRON ACER TENDL-2021 LIBRARY; T=293.6K
Particle heating contributions

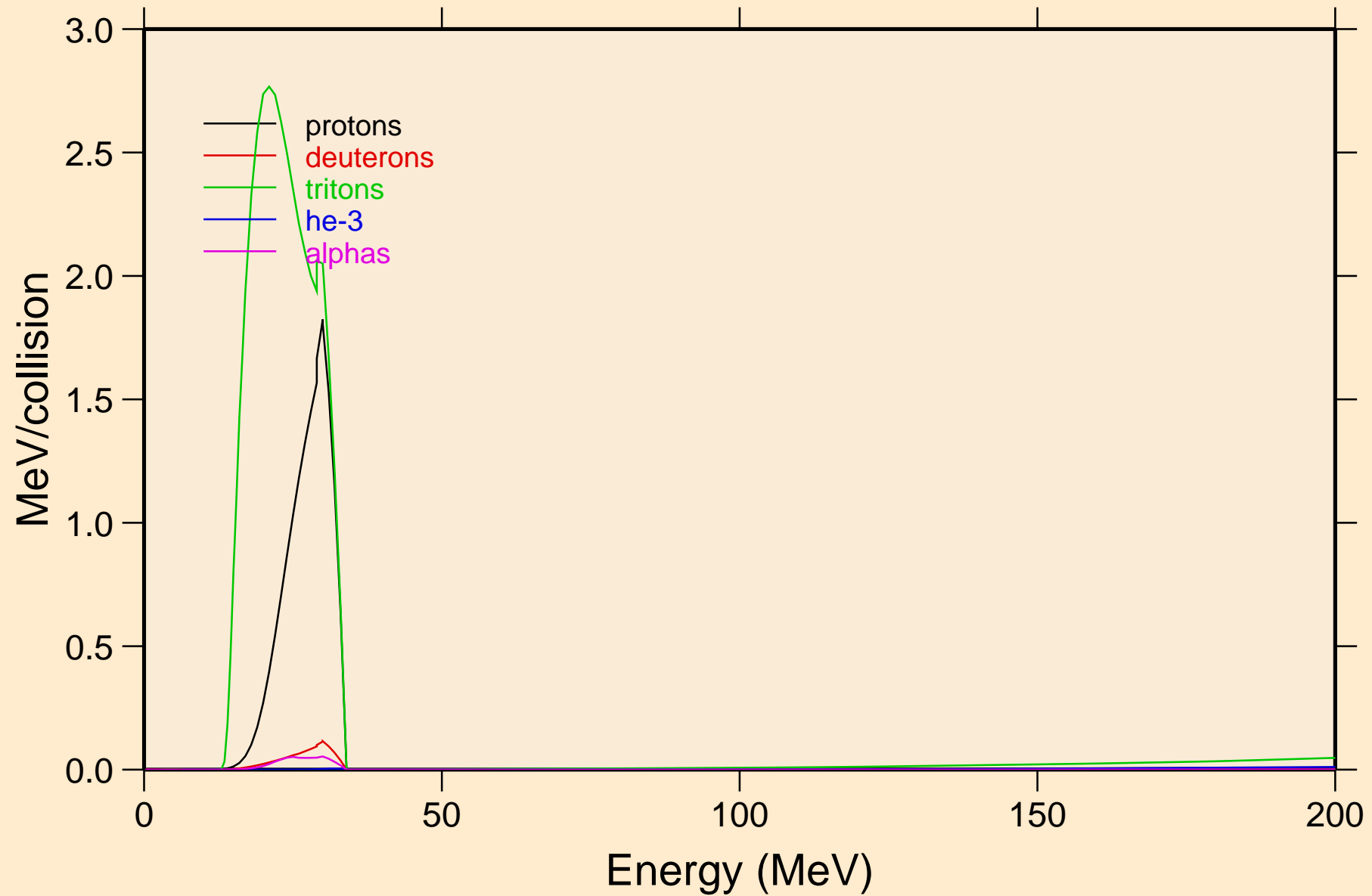

AT221 NEUTRON ACER TENDL-2021 LIBRARY; T=293.6K
Recoil Heating

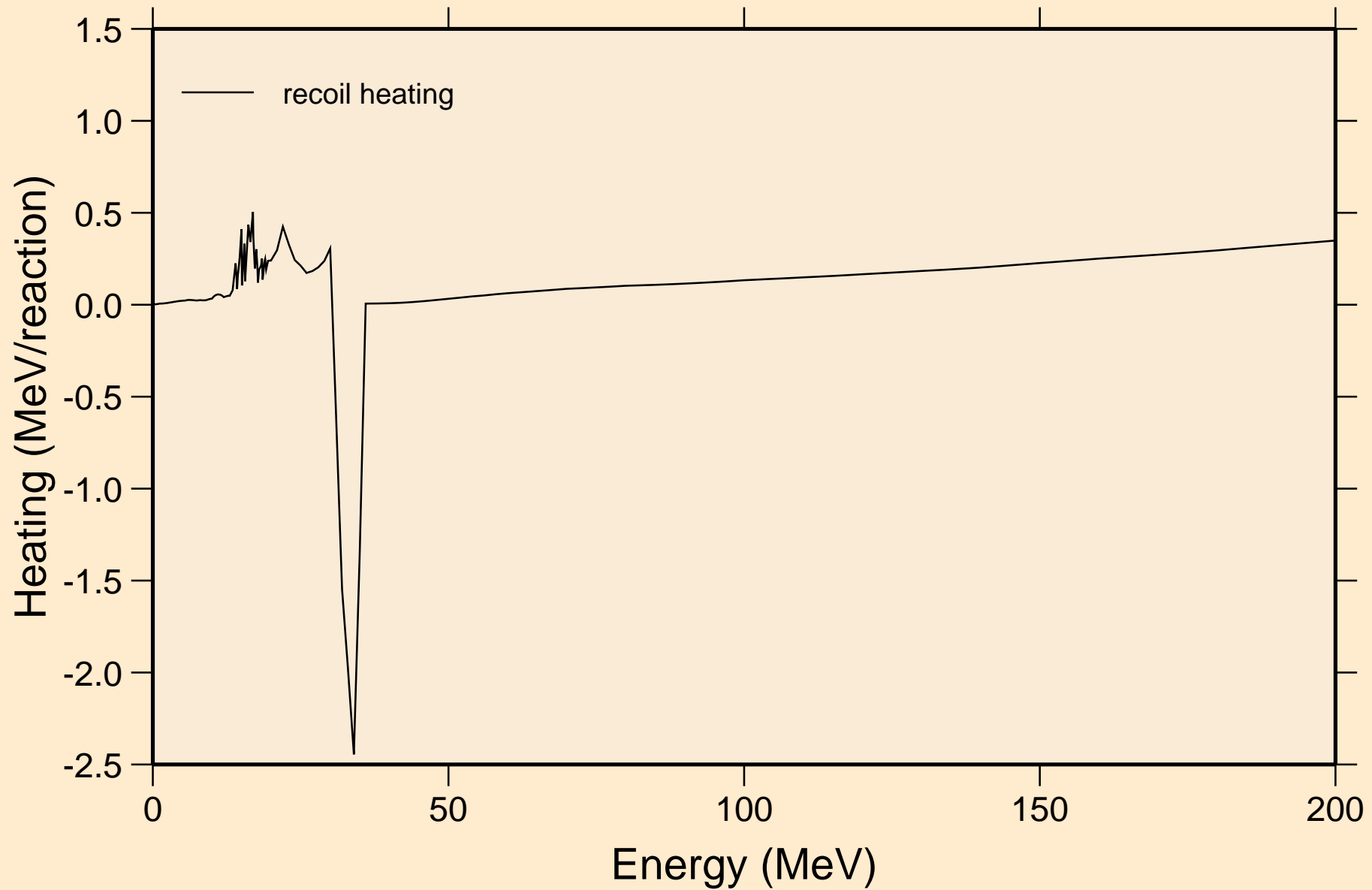

AT221 NEUTRON ACER TENDL-2021 LIBRARY; T=293.6K
Particle production cross sections

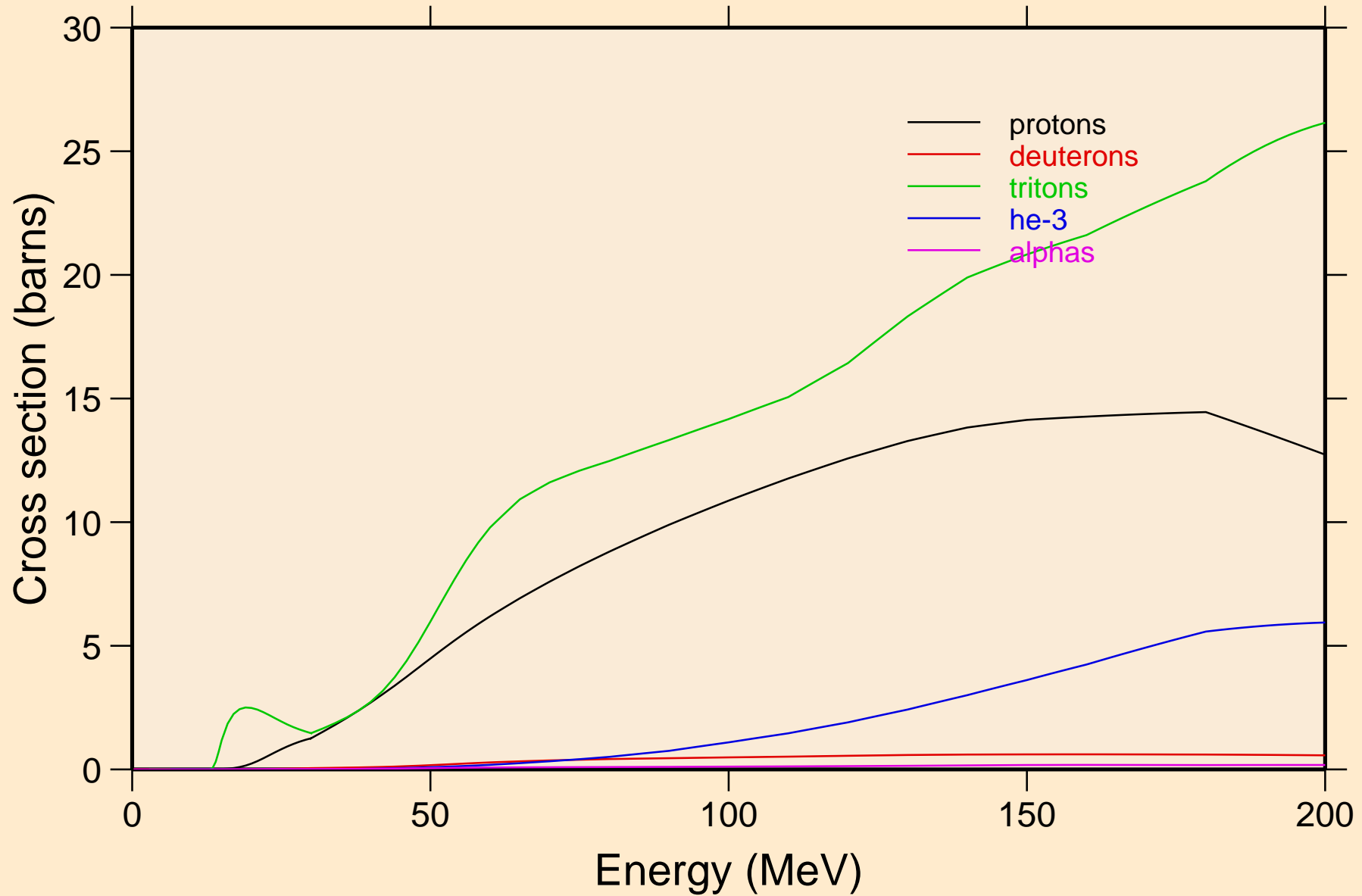

AT221 NEUTRON ACER TENDL-2021 LIBRARY; T=293.6K
protons from (n,x)

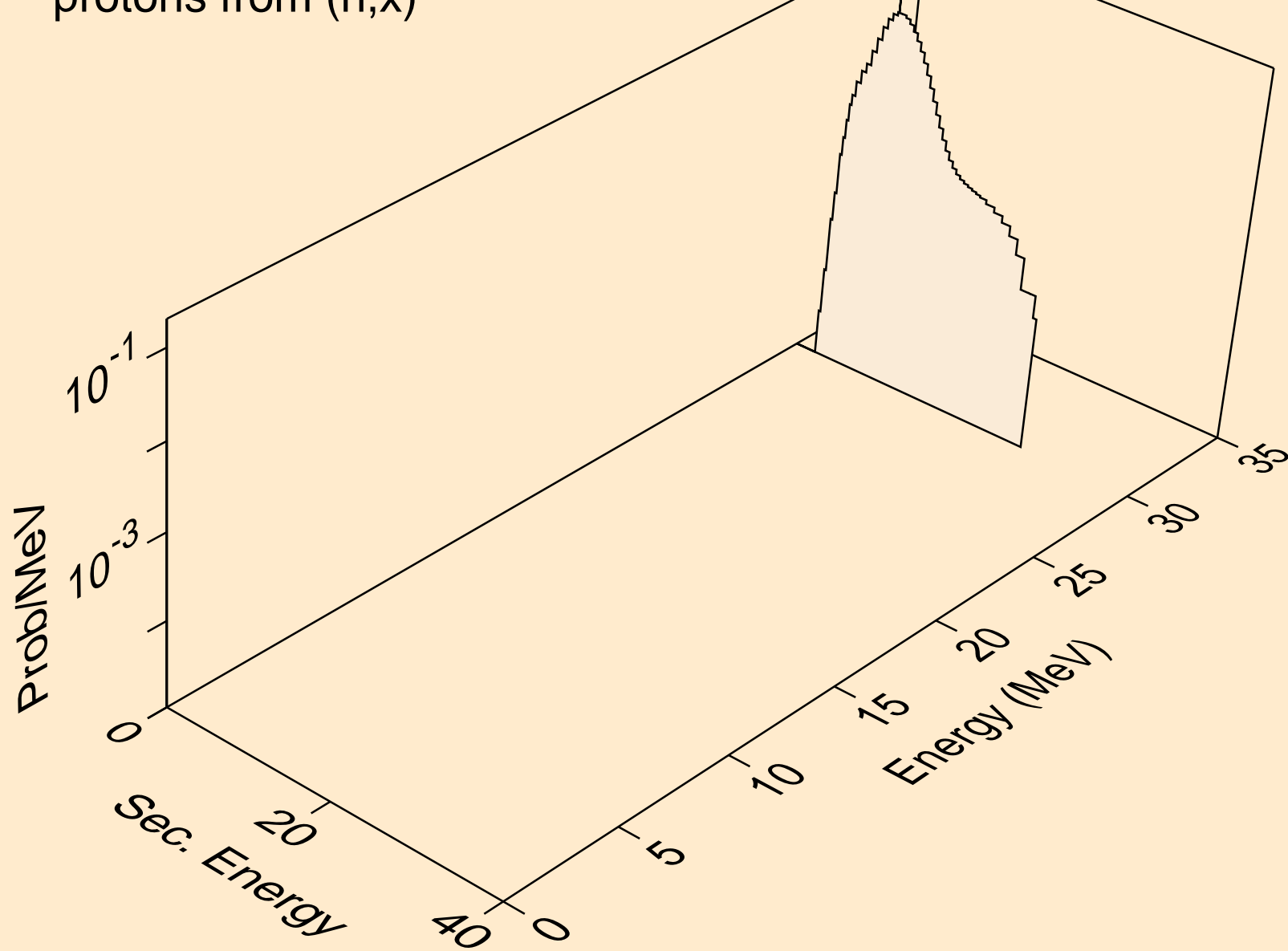

AT221 NEUTRON ACER TENDL-2021 LIBRARY; T=293.6K
protons from (n,n*)p

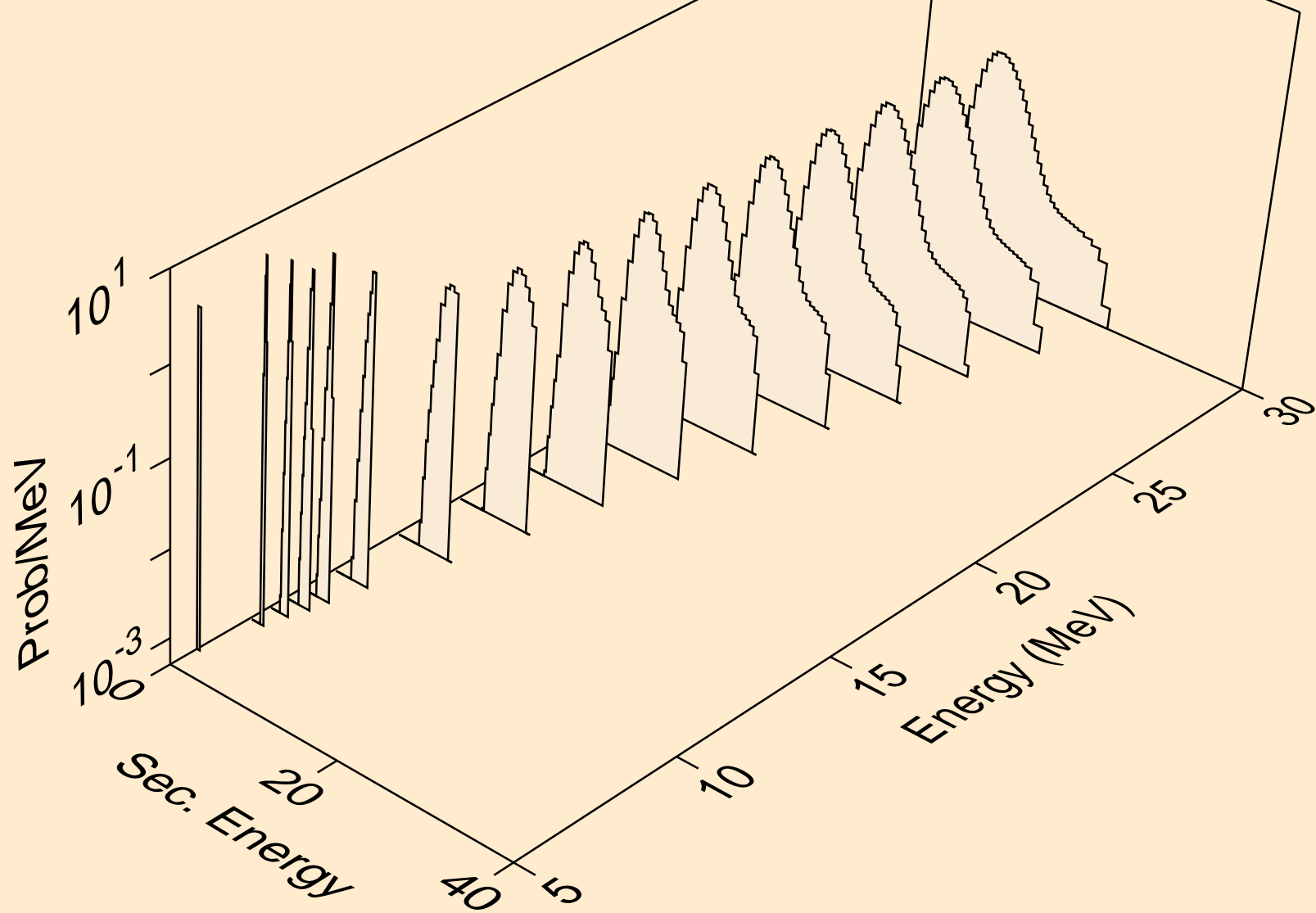

AT221 NEUTRON ACER TENDL-2021 LIBRARY; T=293.6K
protons from (n,2np)

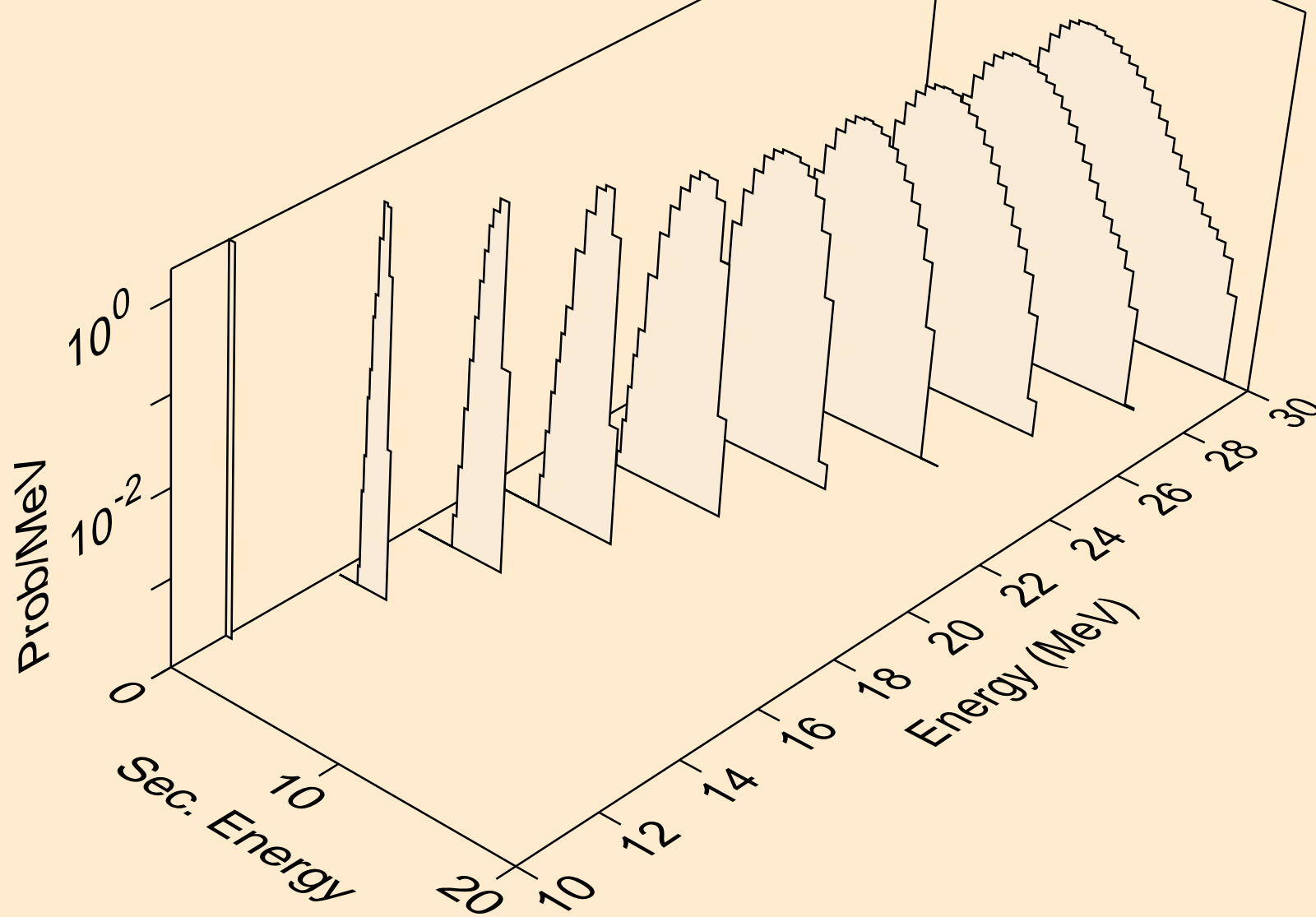

AT221 NEUTRON ACER TENDL-2021 LIBRARY; T=293.6K
protons from (n,3np)

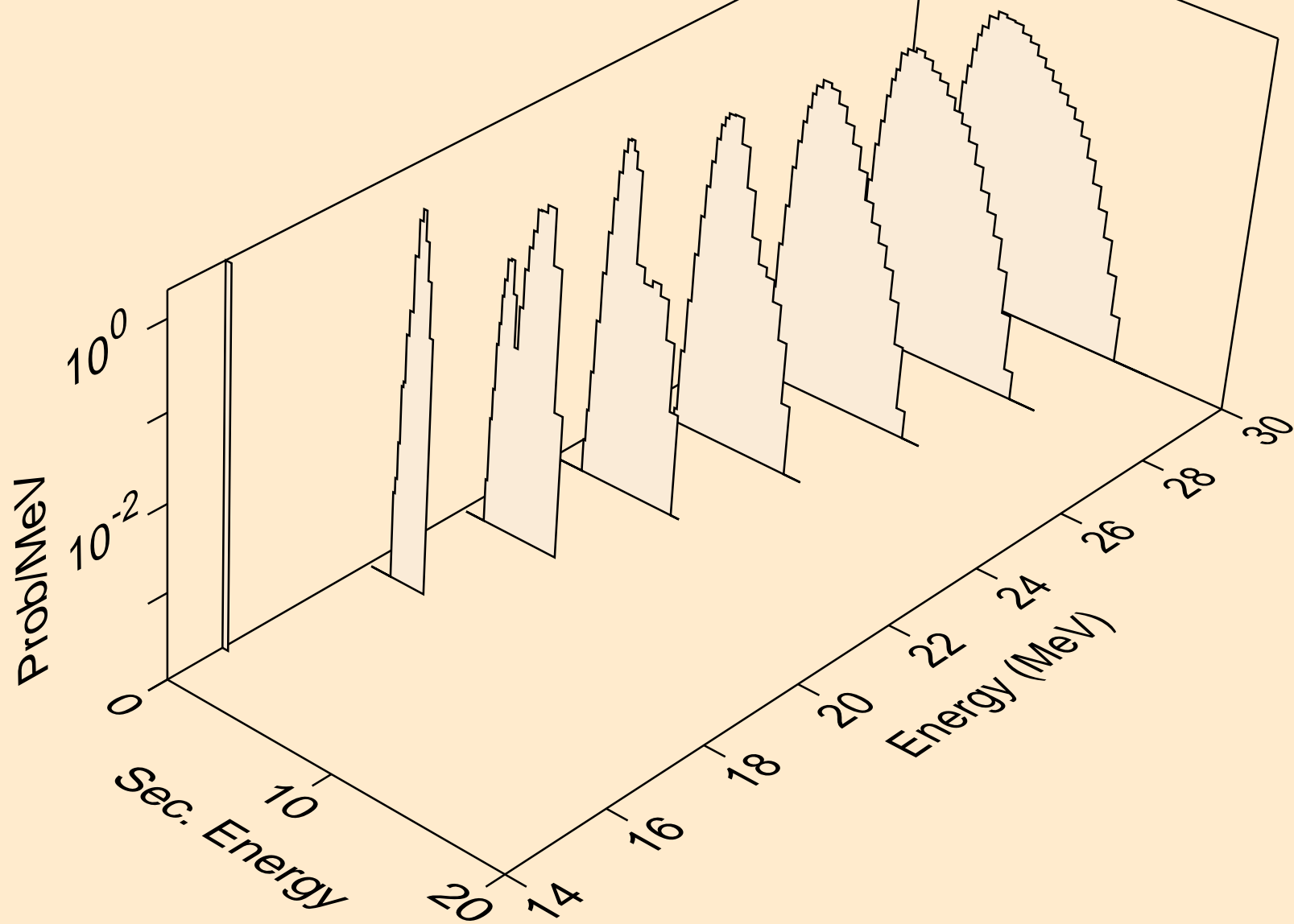

AT221 NEUTRON ACER TENDL-2021 LIBRARY; T=293.6K
protons from (n,2np)

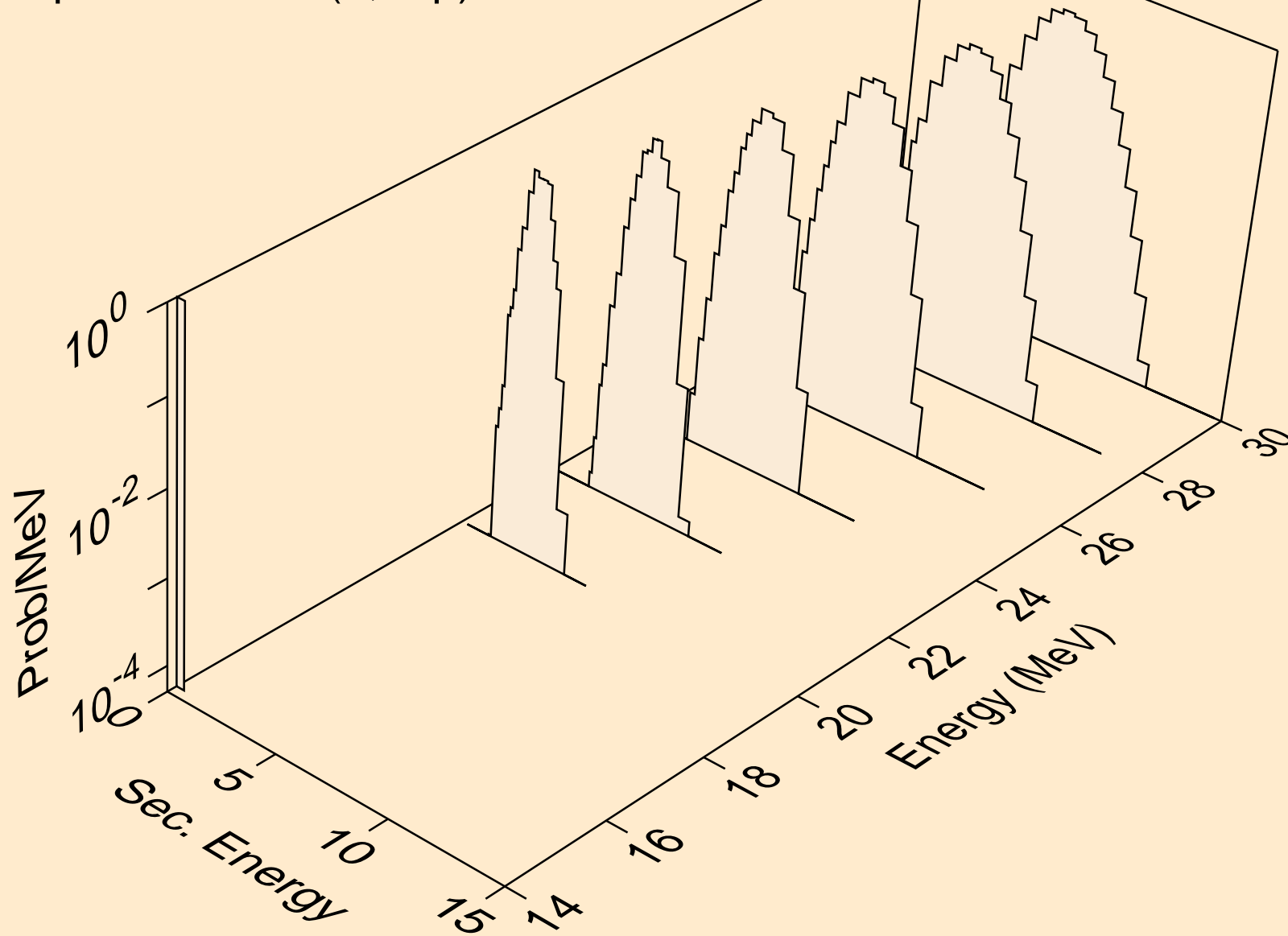

AT221 NEUTRON ACER TENDL-2021 LIBRARY; T=293.6K
protons from (n,npa)

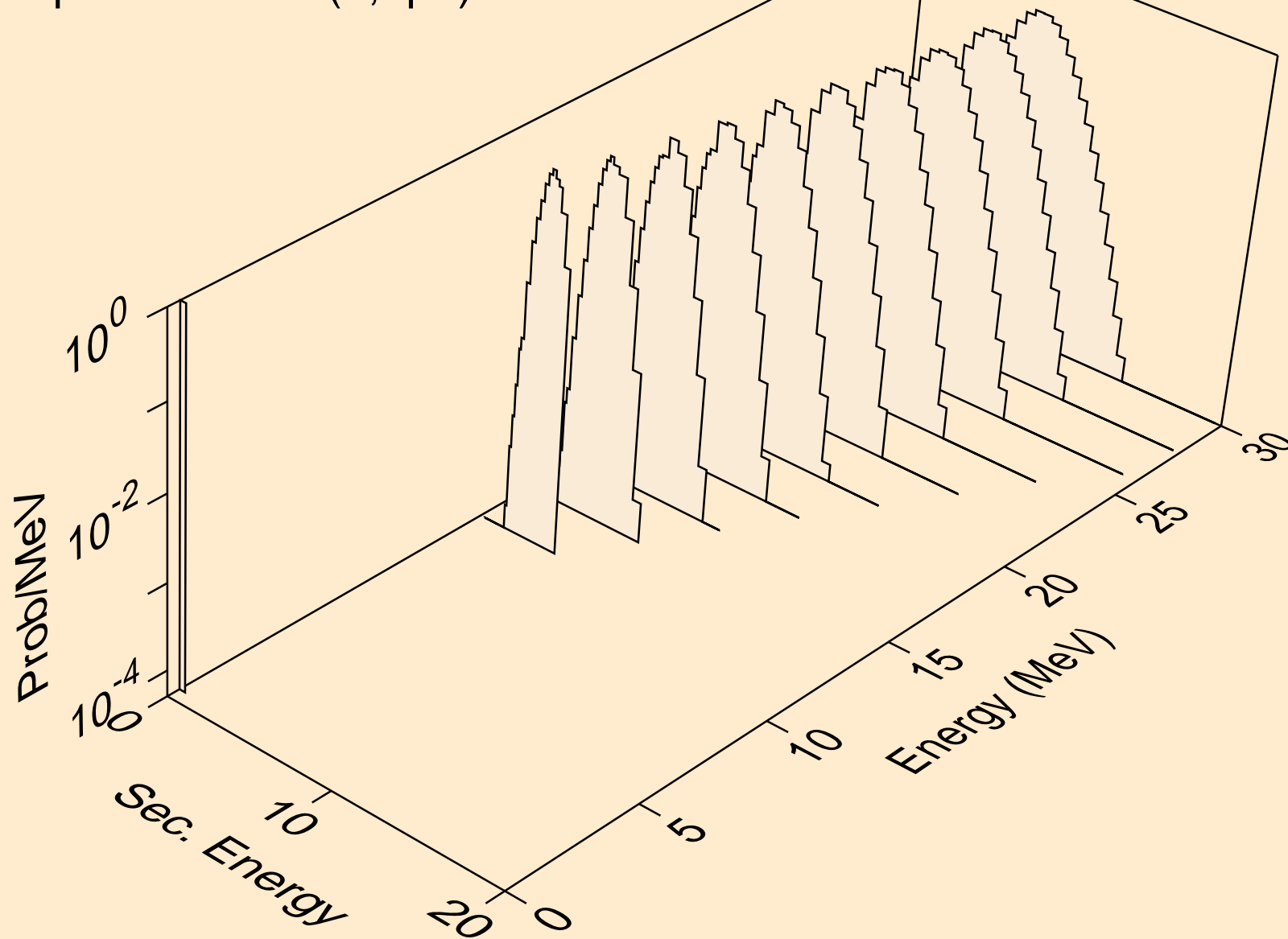

AT221 NEUTRON ACER TENDL-2021 LIBRARY; T=293.6K
protons from (n,p)

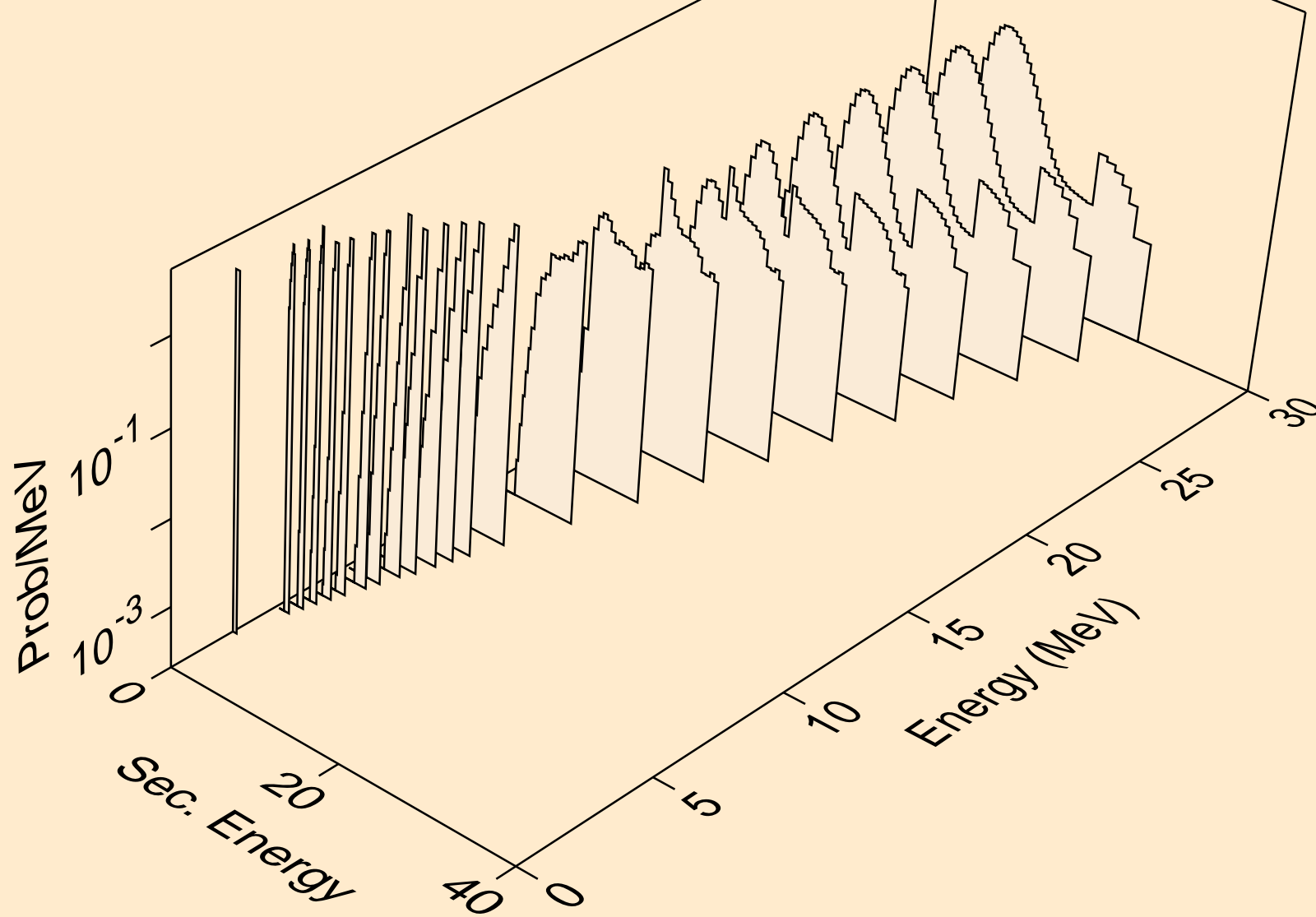

AT221 NEUTRON ACER TENDL-2021 LIBRARY; T=293.6K
protons from (n,2p)

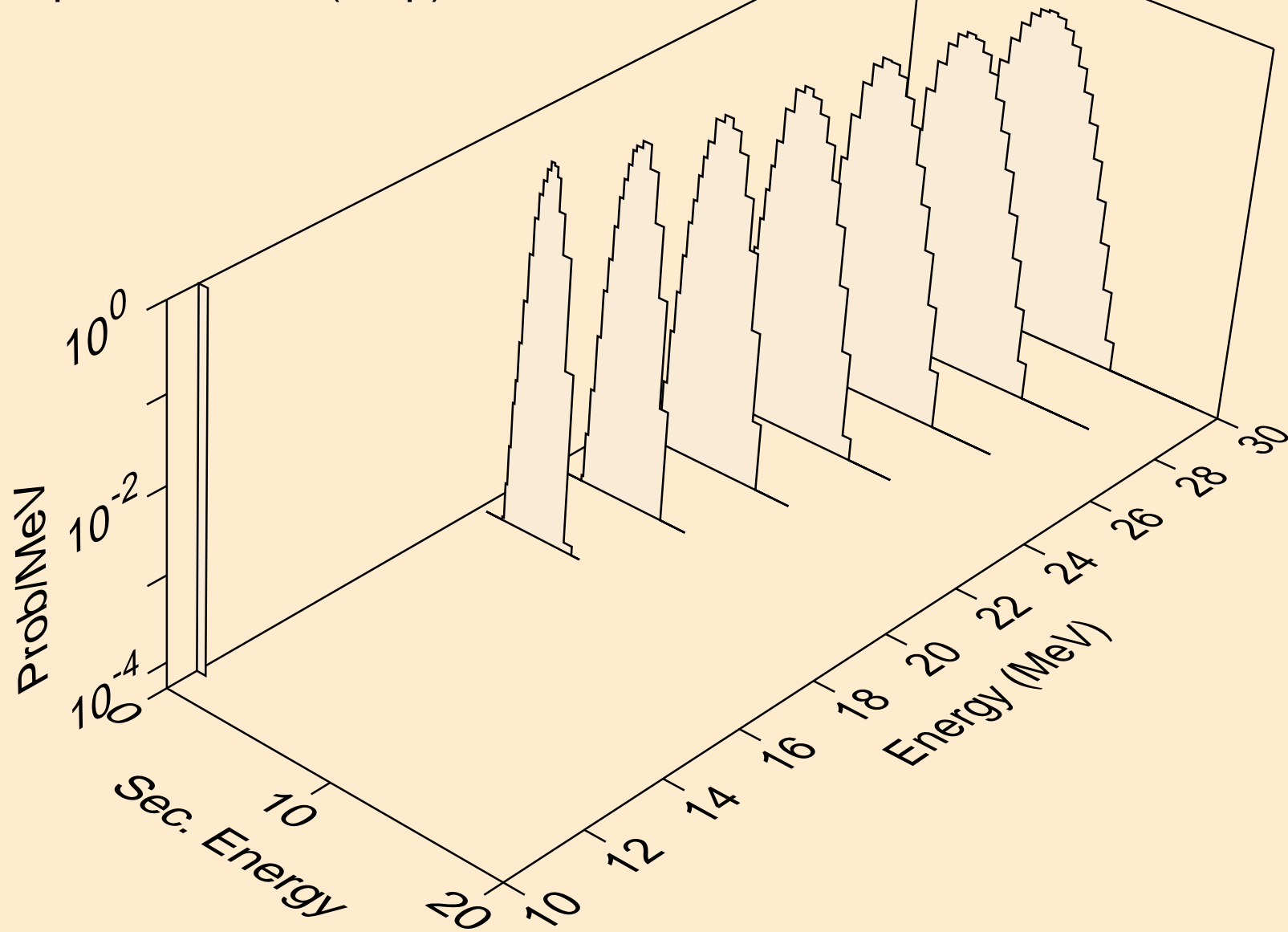

AT221 NEUTRON ACER TENDL-2021 LIBRARY; T=293.6K
protons from (n,p)

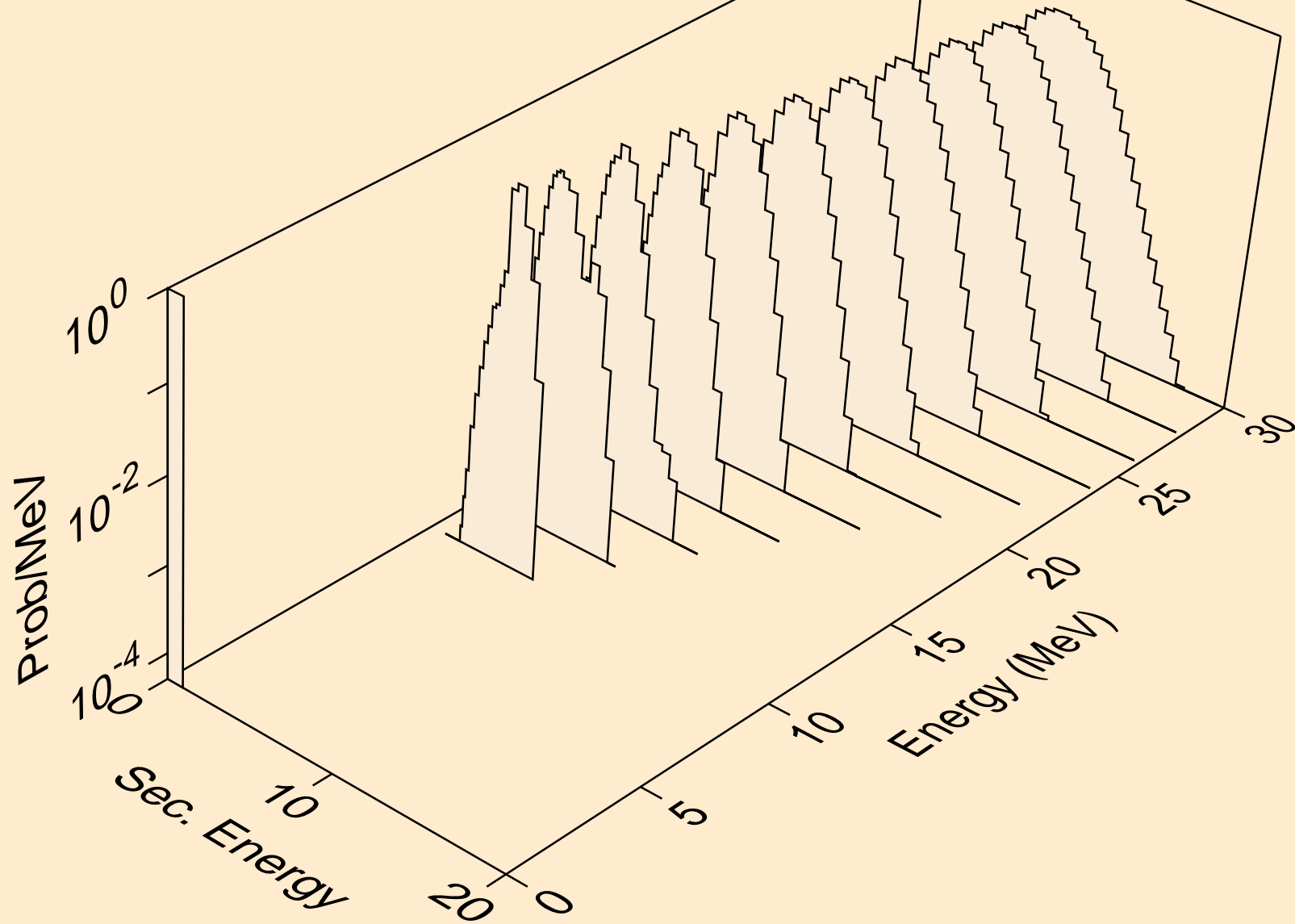

AT221 NEUTRON ACER TENDL-2021 LIBRARY; T=293.6K
protons from (n,pd)

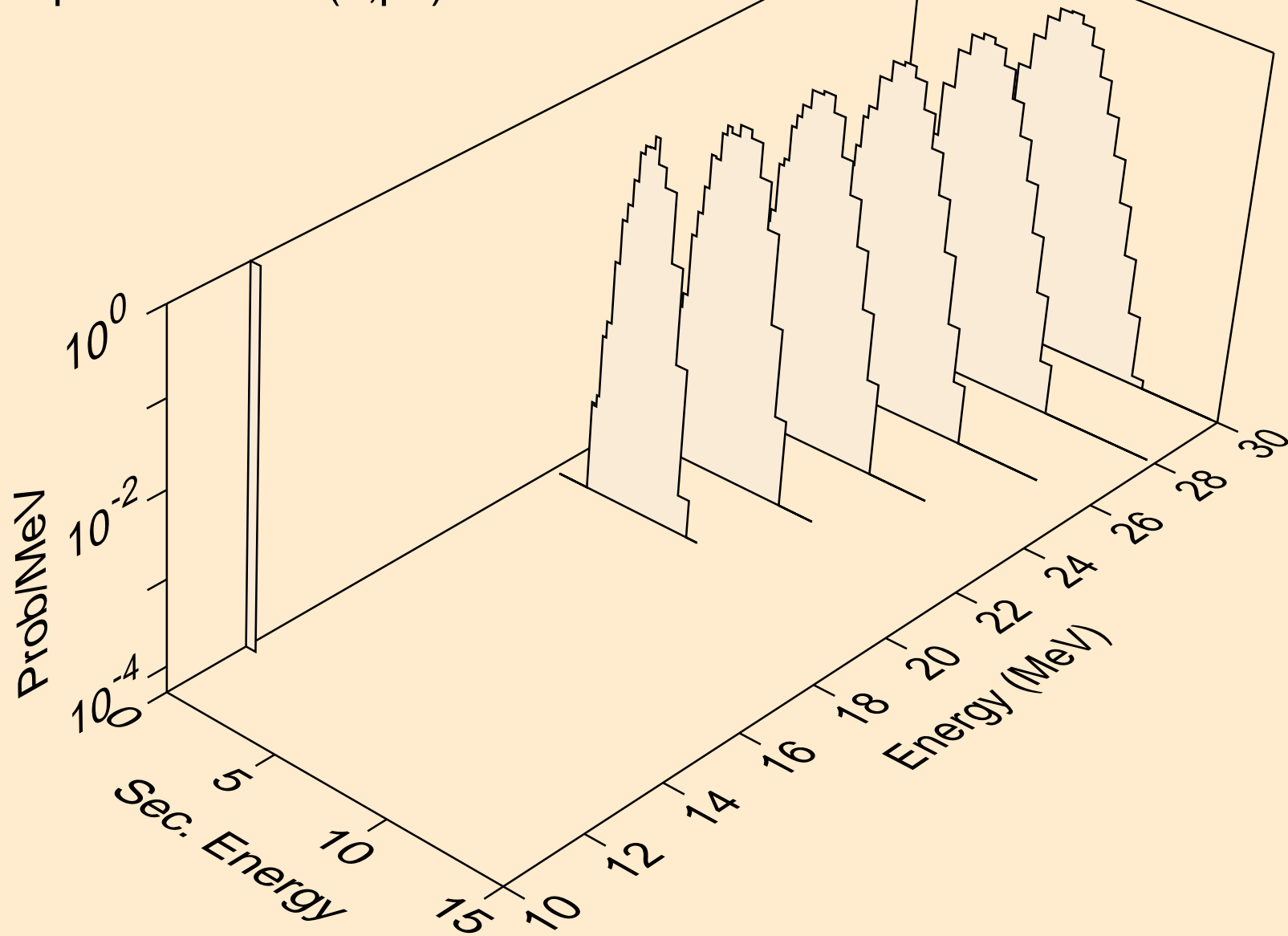

AT221 NEUTRON ACER TENDL-2021 LIBRARY; T=293.6K
protons from (n,pt)

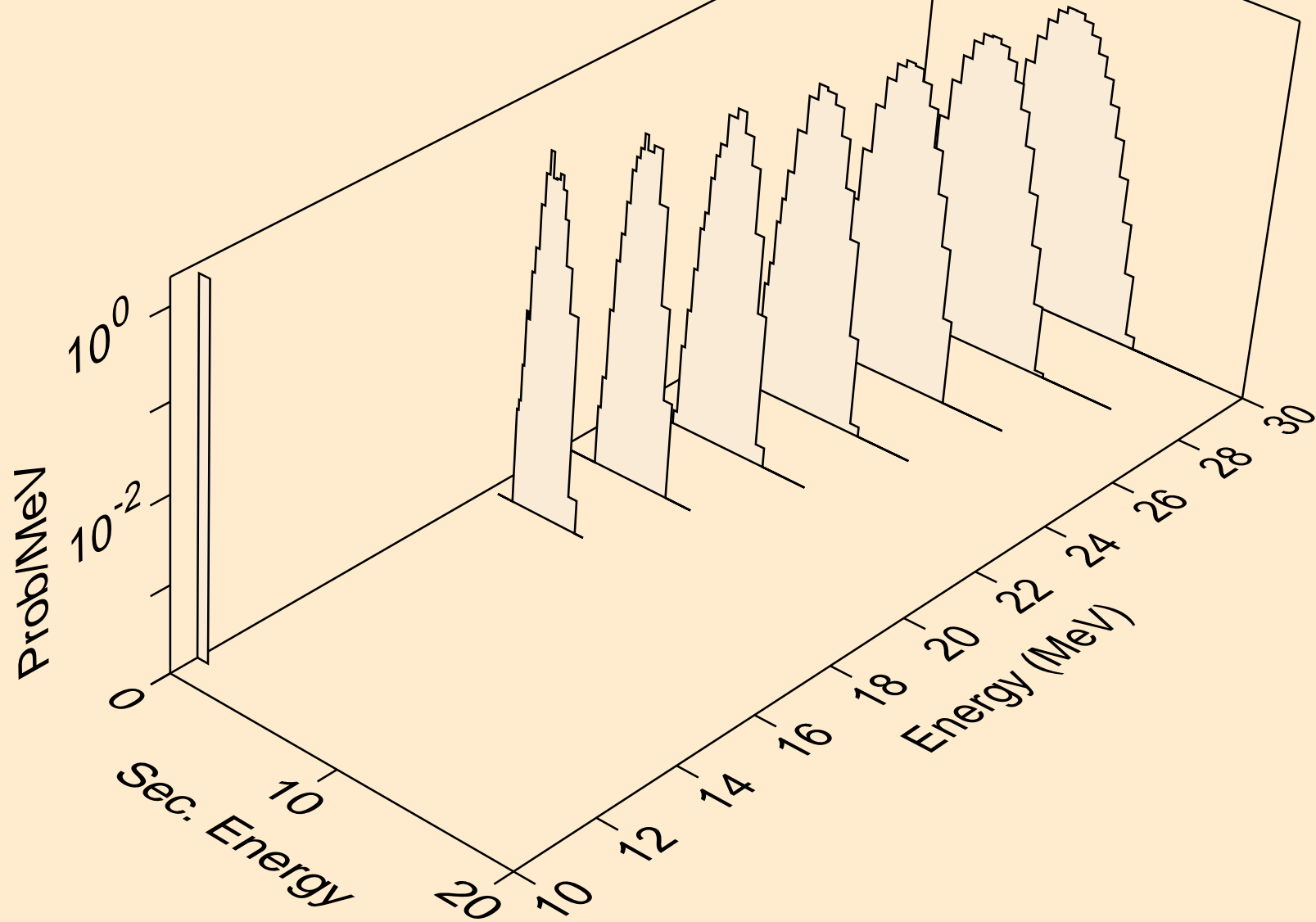

AT221 NEUTRON ACER TENDL-2021 LIBRARY; T=293.6K
deuterons from (n,x)

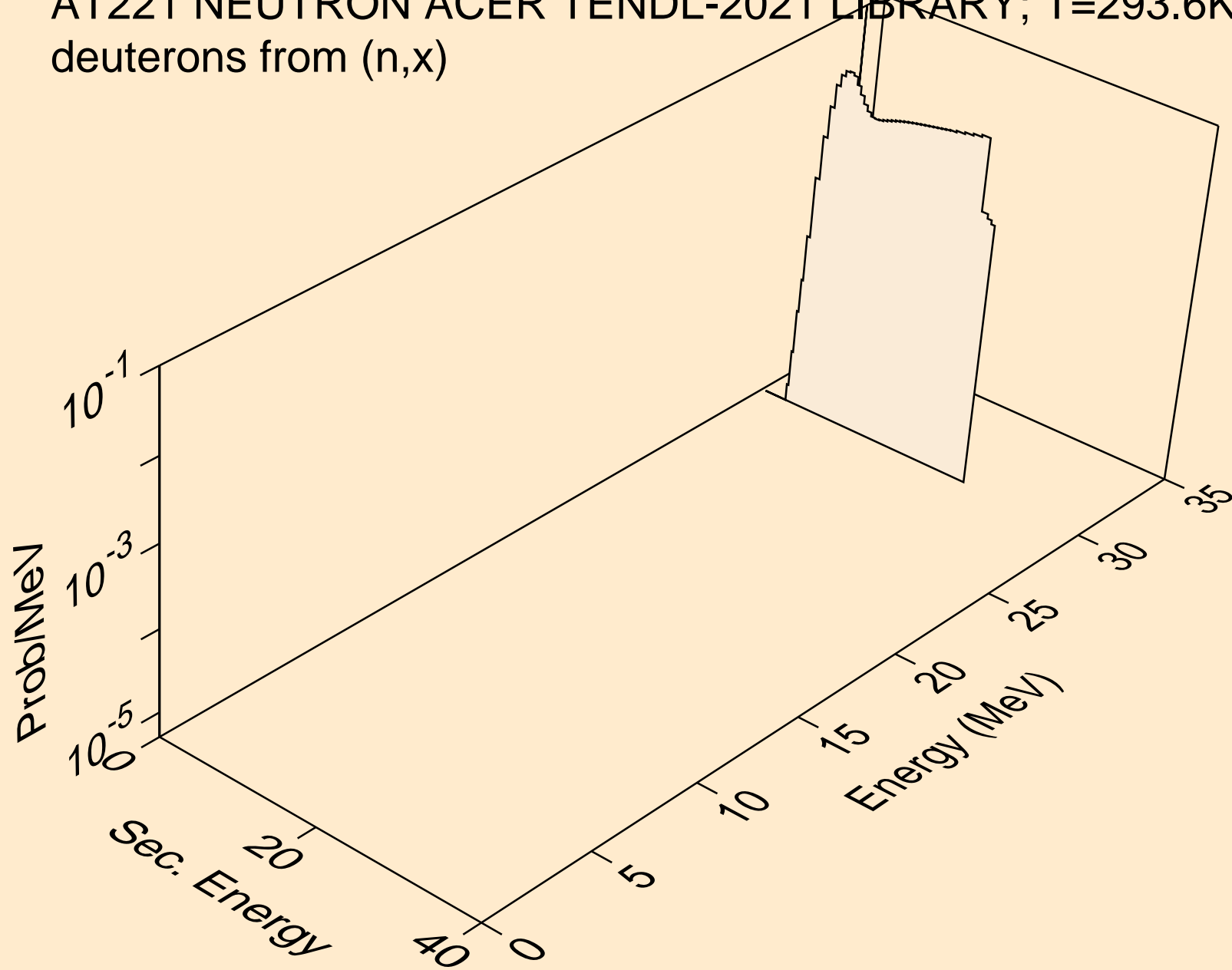

AT221 NEUTRON ACER TENDL-2021 LIBRARY; T=293.6K
deuterons from (n,2nd)

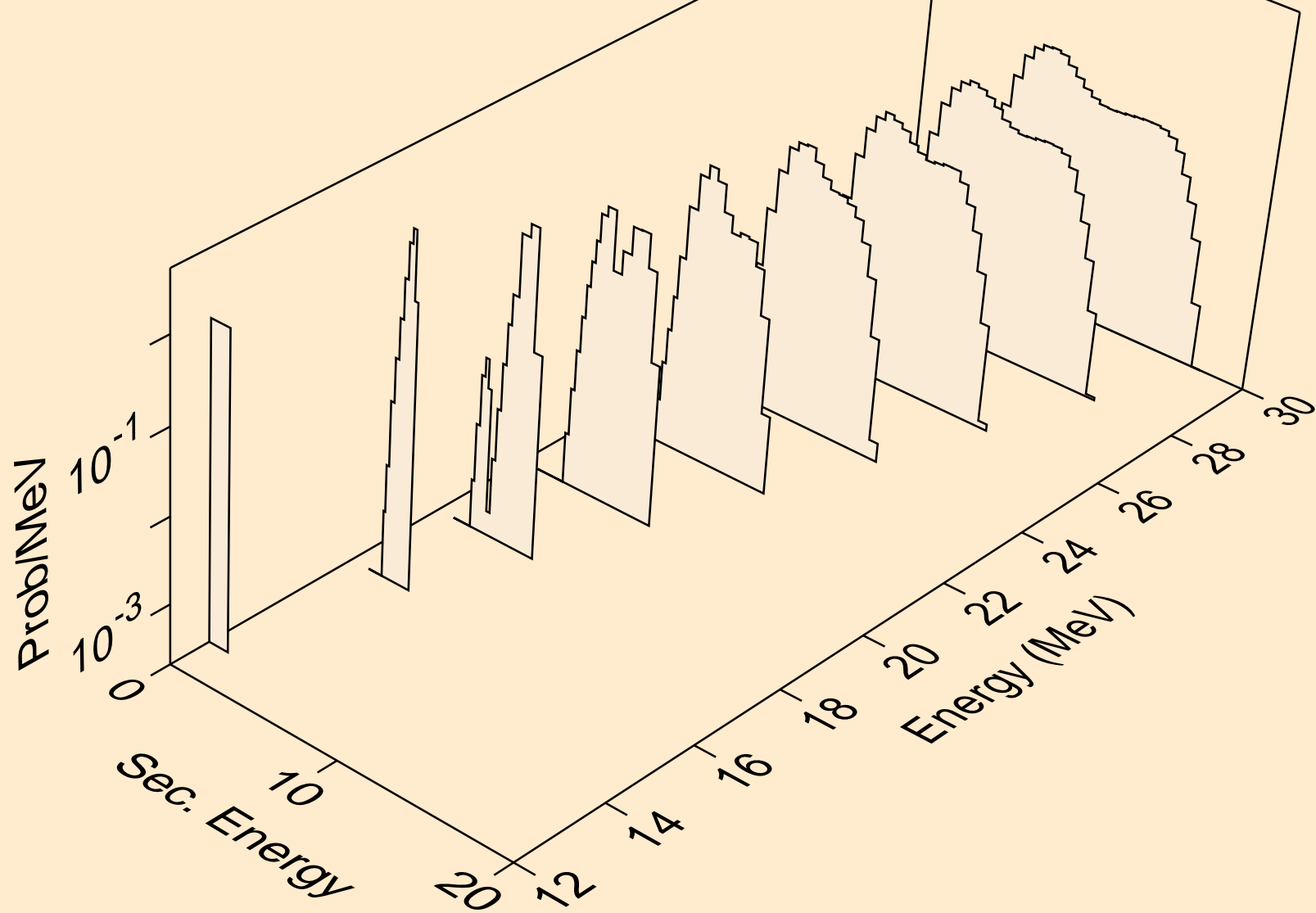

AT221 NEUTRON ACER TENDL-2021 LIBRARY; T=293.6K
deuterons from (n,n*)d

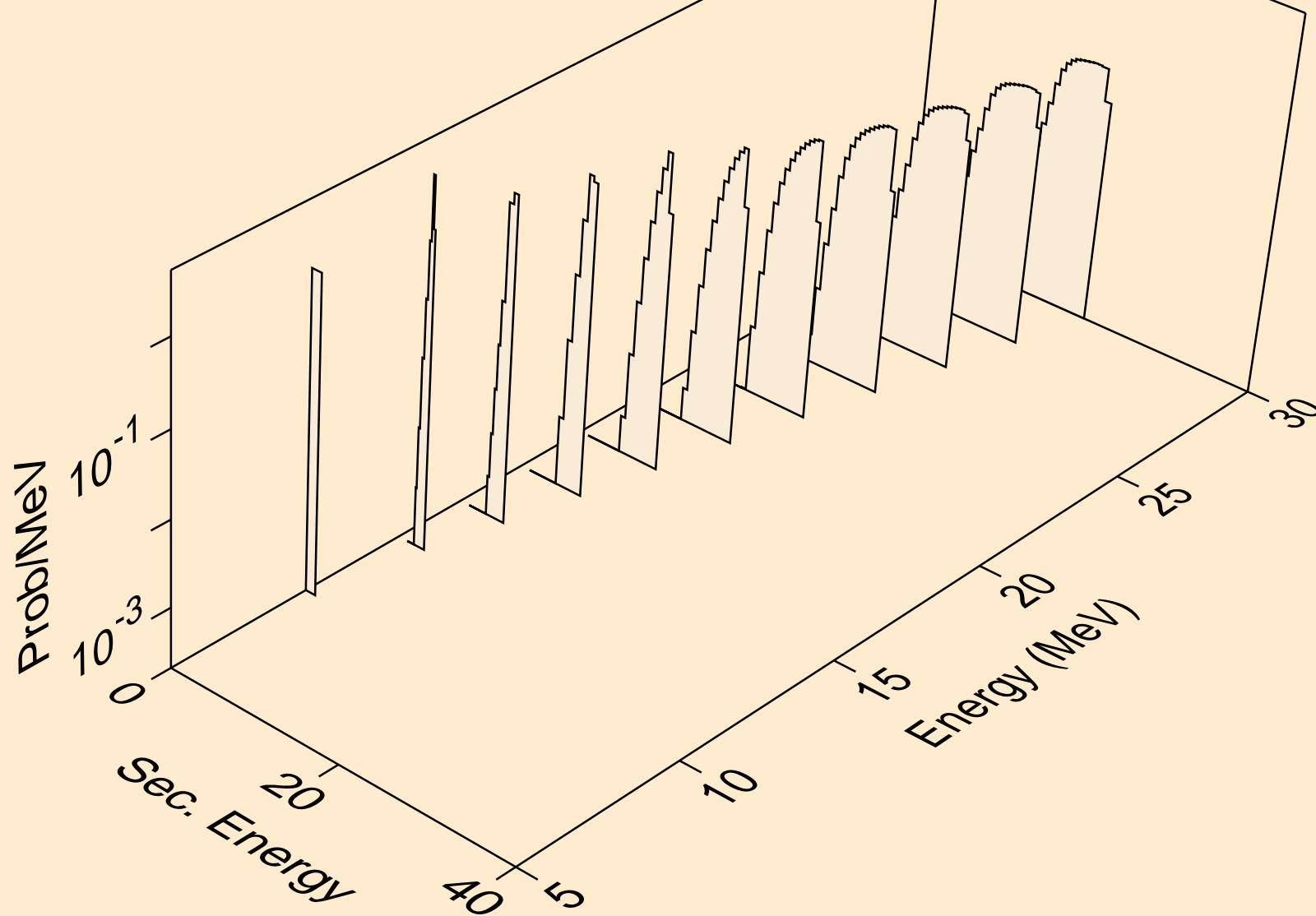

AT221 NEUTRON ACER TENDL-2021 LIBRARY; T=293.6K
deuterons from (n,d)

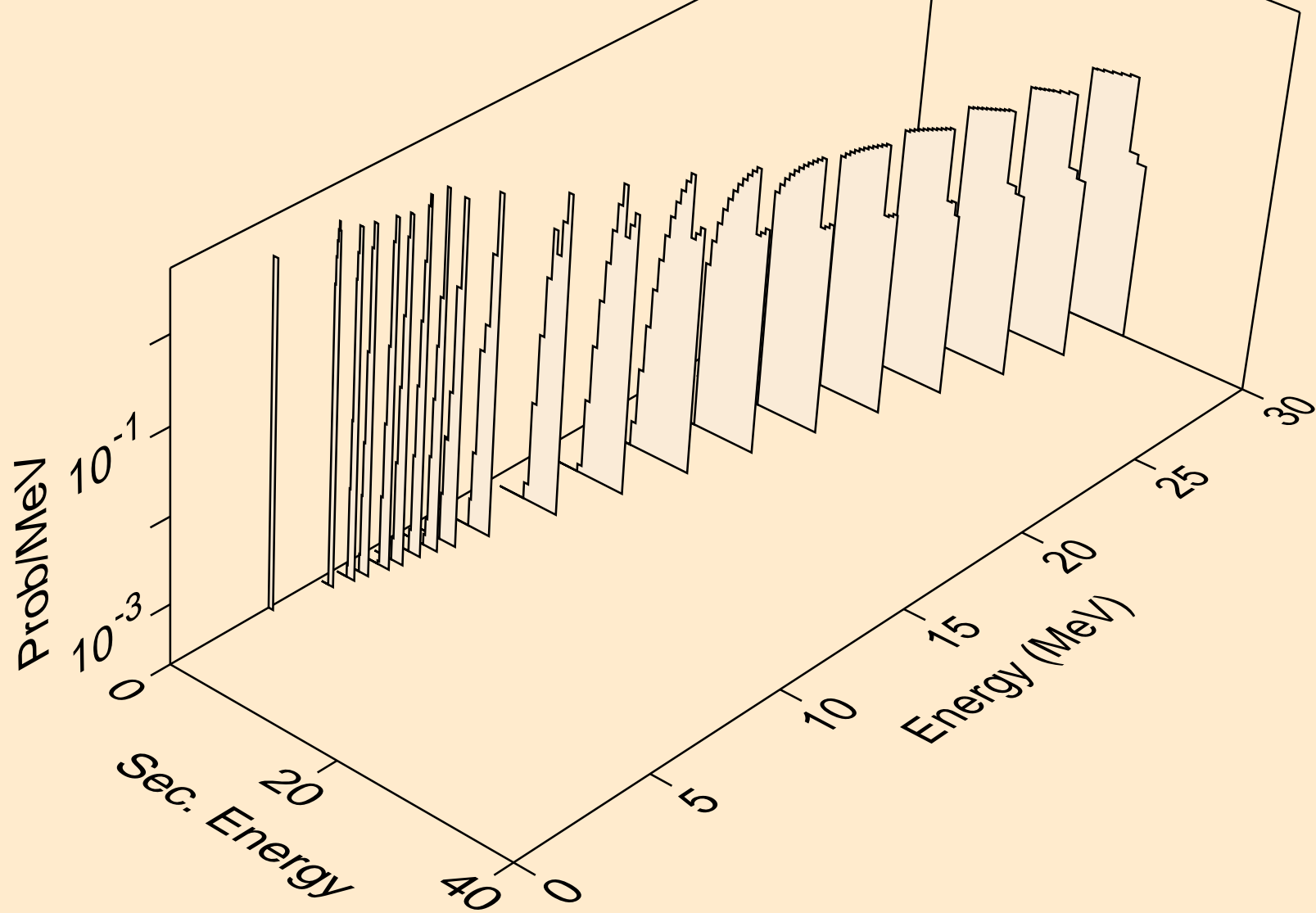

AT221 NEUTRON ACER TENDL-2021 LIBRARY; T=293.6K
deuterons from (n,pd)

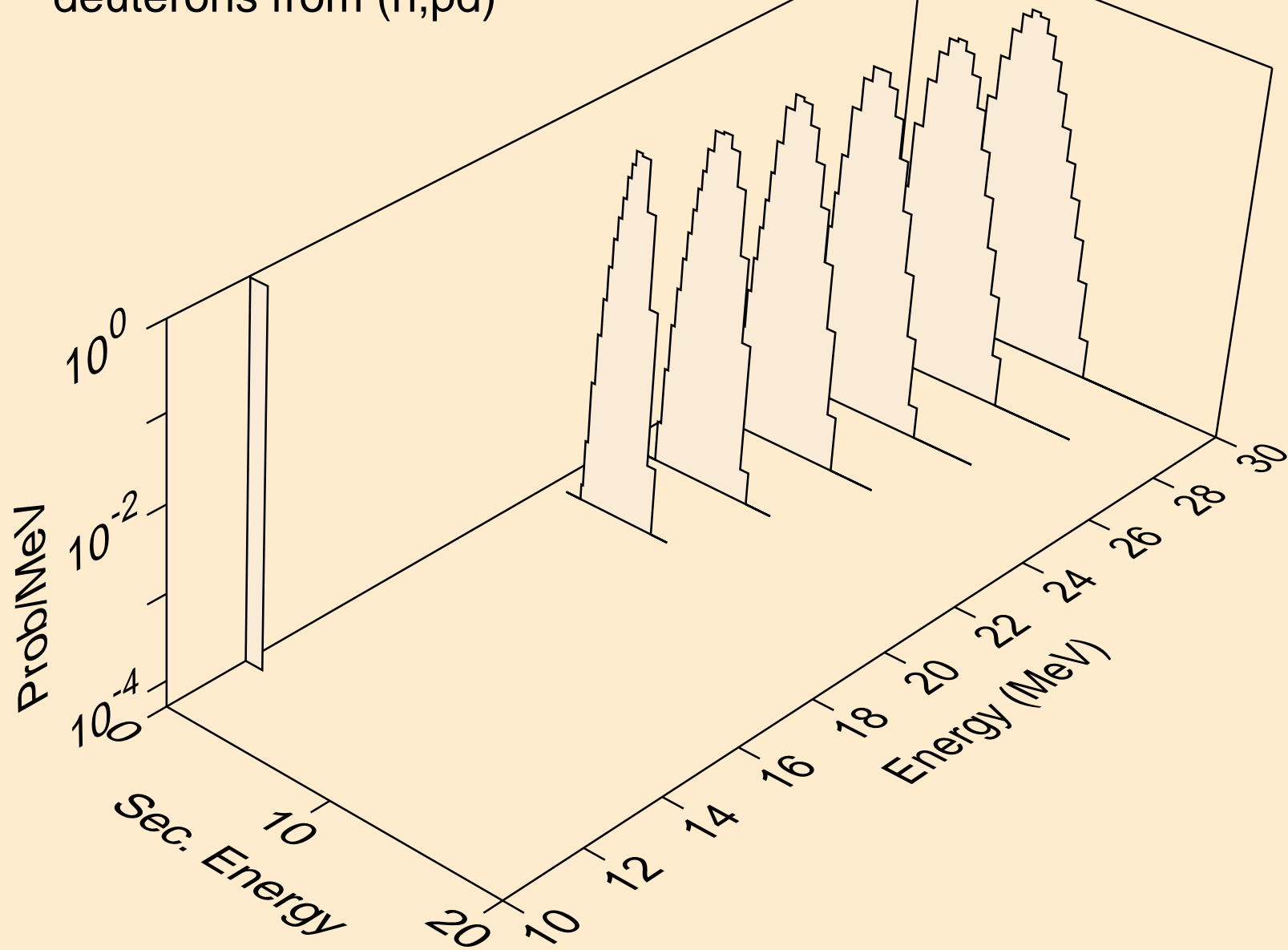

AT221 NEUTRON ACER TENDL-2021 LIBRARY; T=293.6K
deuterons from (n,da)

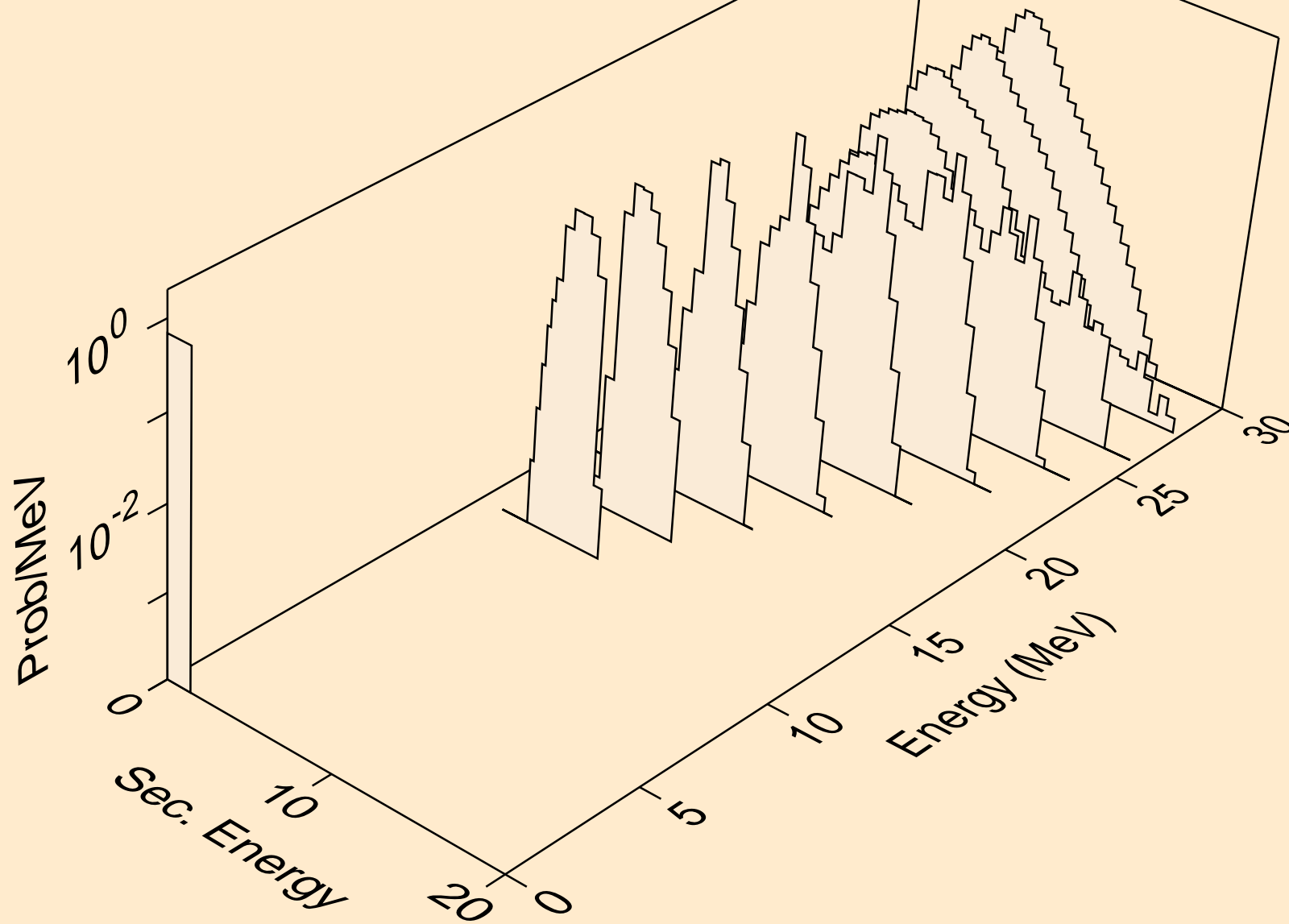

AT221 NEUTRON ACER TENDL-2021 LIBRARY; T=293.6K
tritons from (n,x)

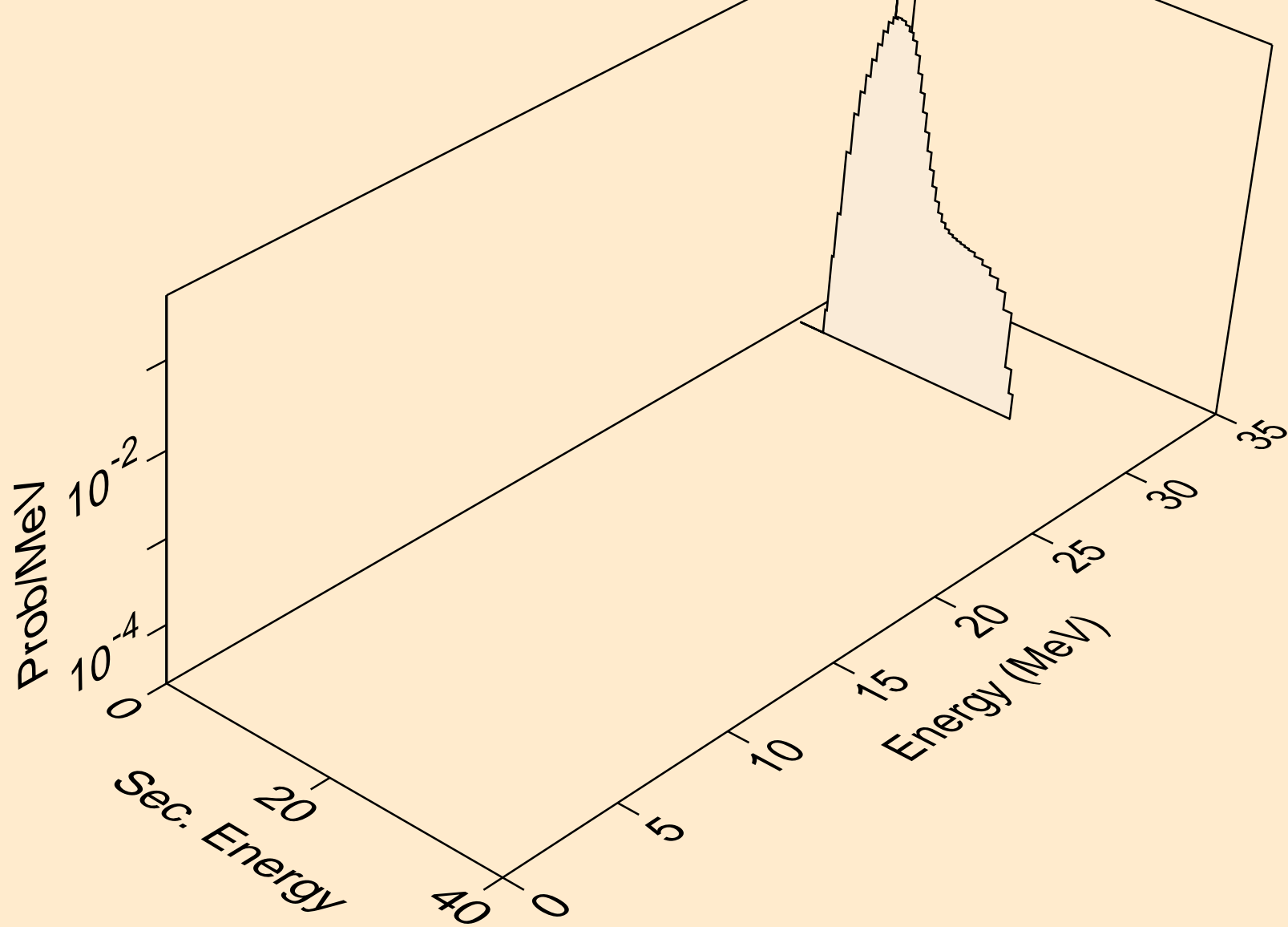

AT221 NEUTRON ACER TENDL-2021 LIBRARY; T=293.6K
tritons from (n,n*)t

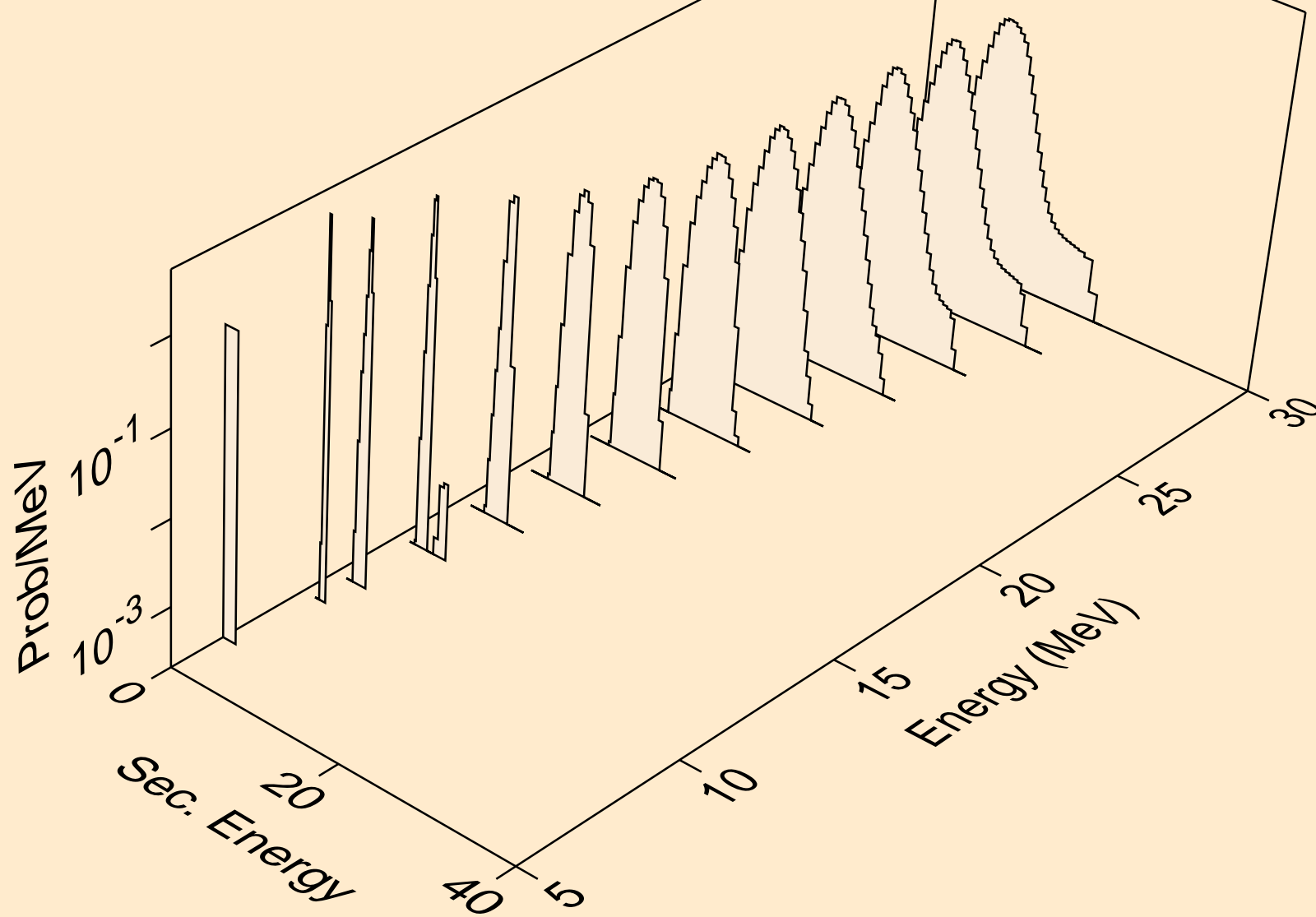

AT221 NEUTRON ACER TENDL-2021 LIBRARY; T=293.6K
tritons from (n,t)

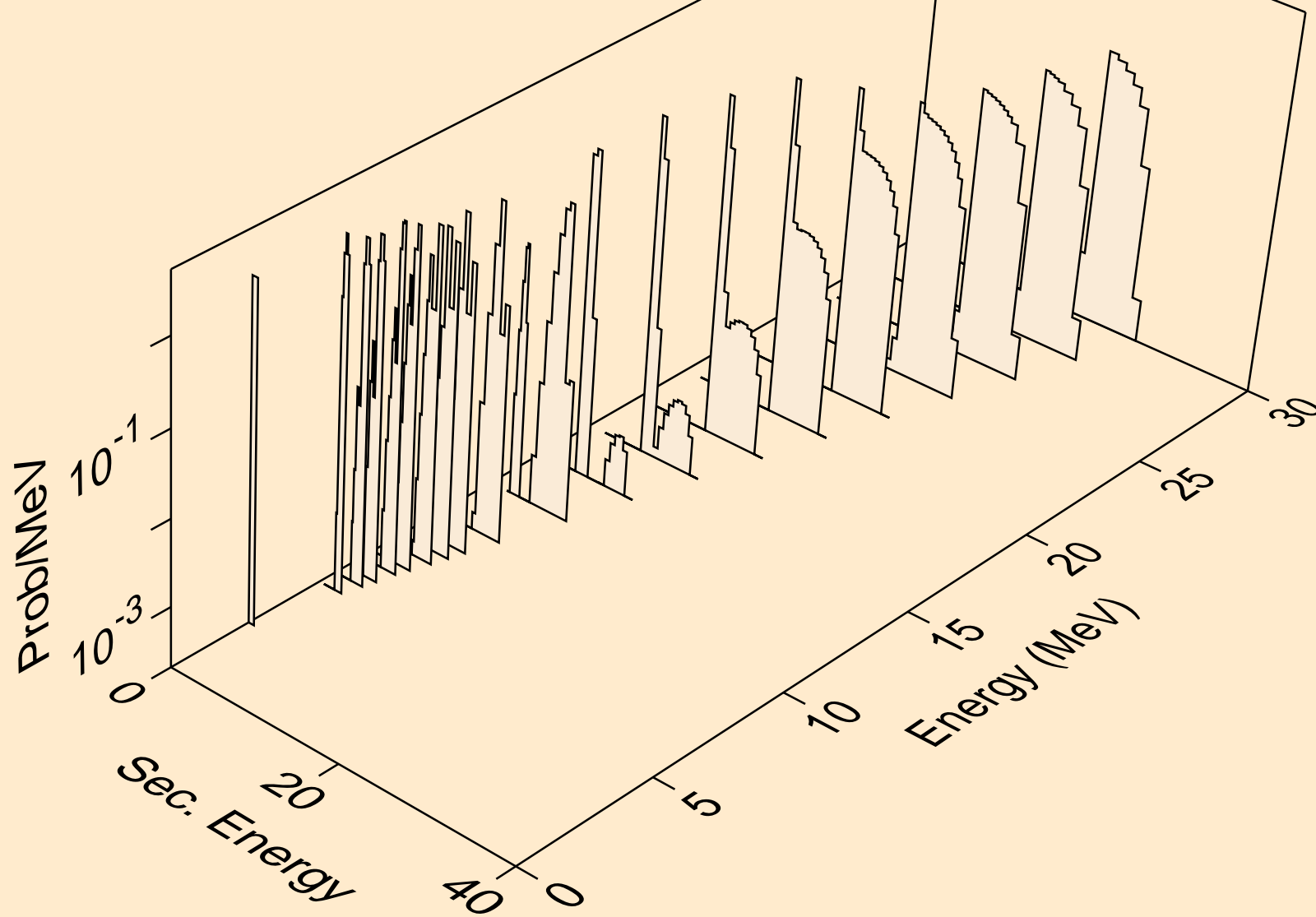

AT221 NEUTRON ACER TENDL-2021 LIBRARY; T=293.6K
tritons from (n,pt)

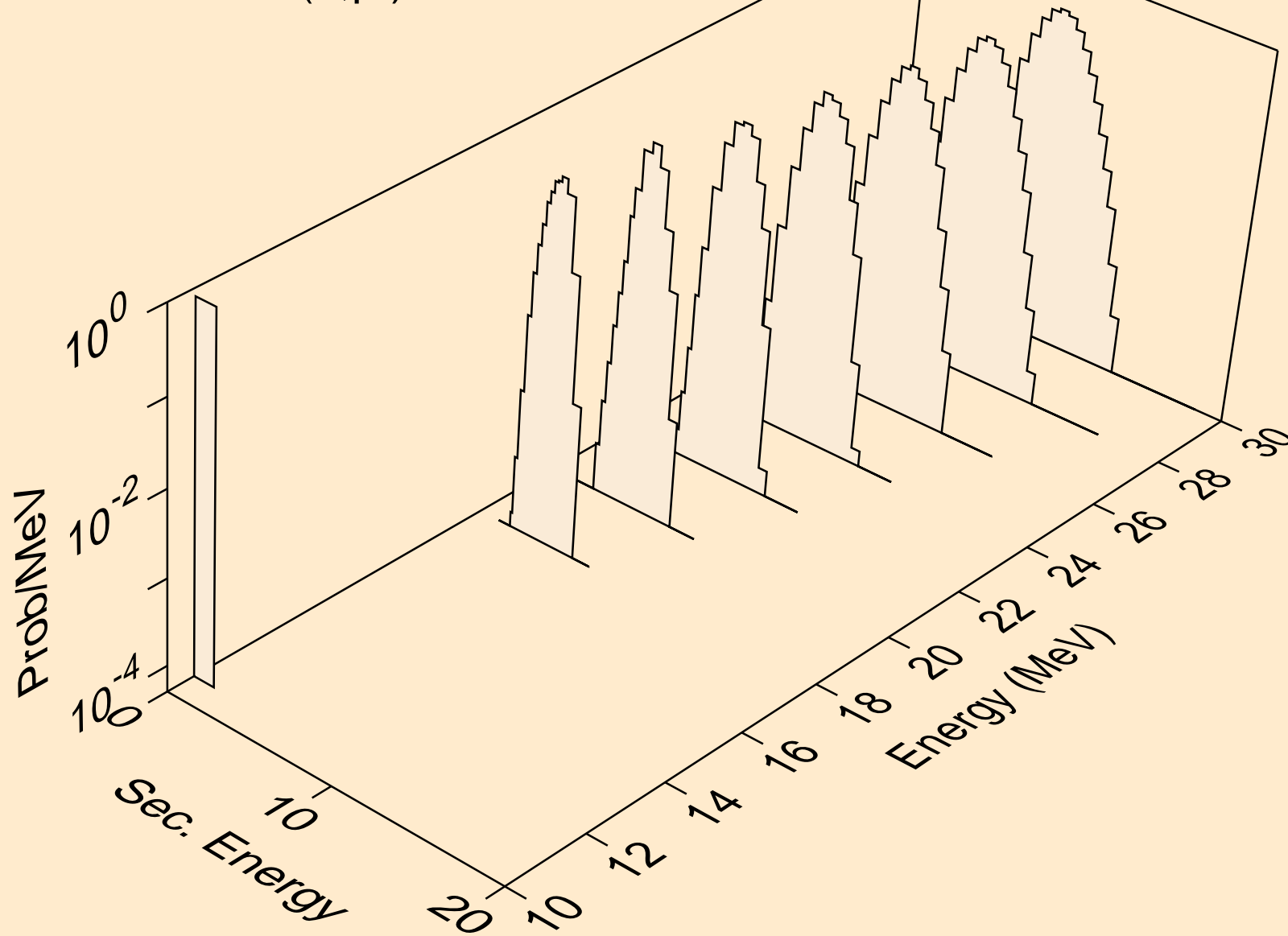

AT221 NEUTRON ACER TENDL-2021 LIBRARY; T=293.6K
he3s from (n,x)

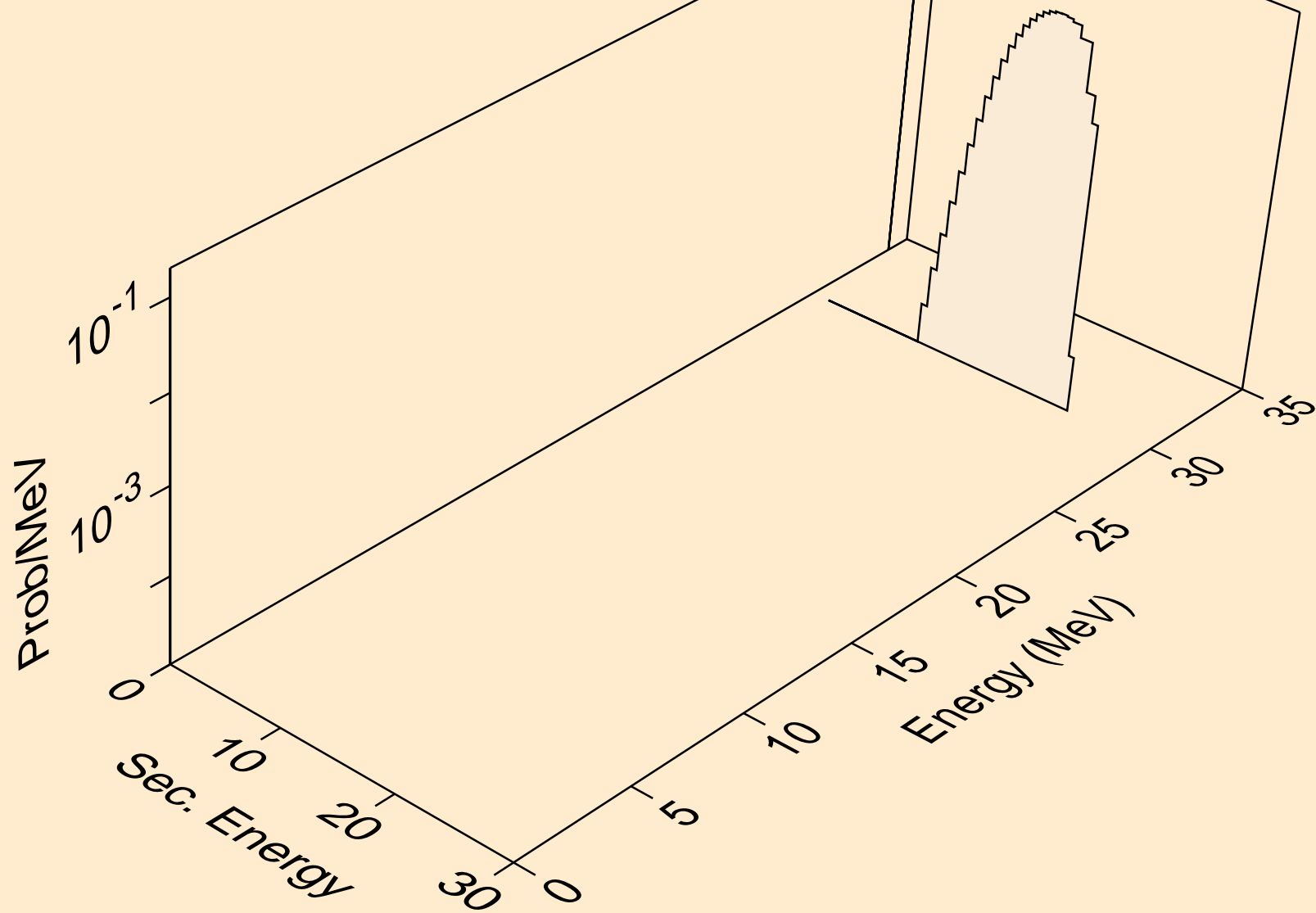

AT221 NEUTRON ACER TENDL-2021 LIBRARY; T=293.6K
he3s from (n,n*)he3

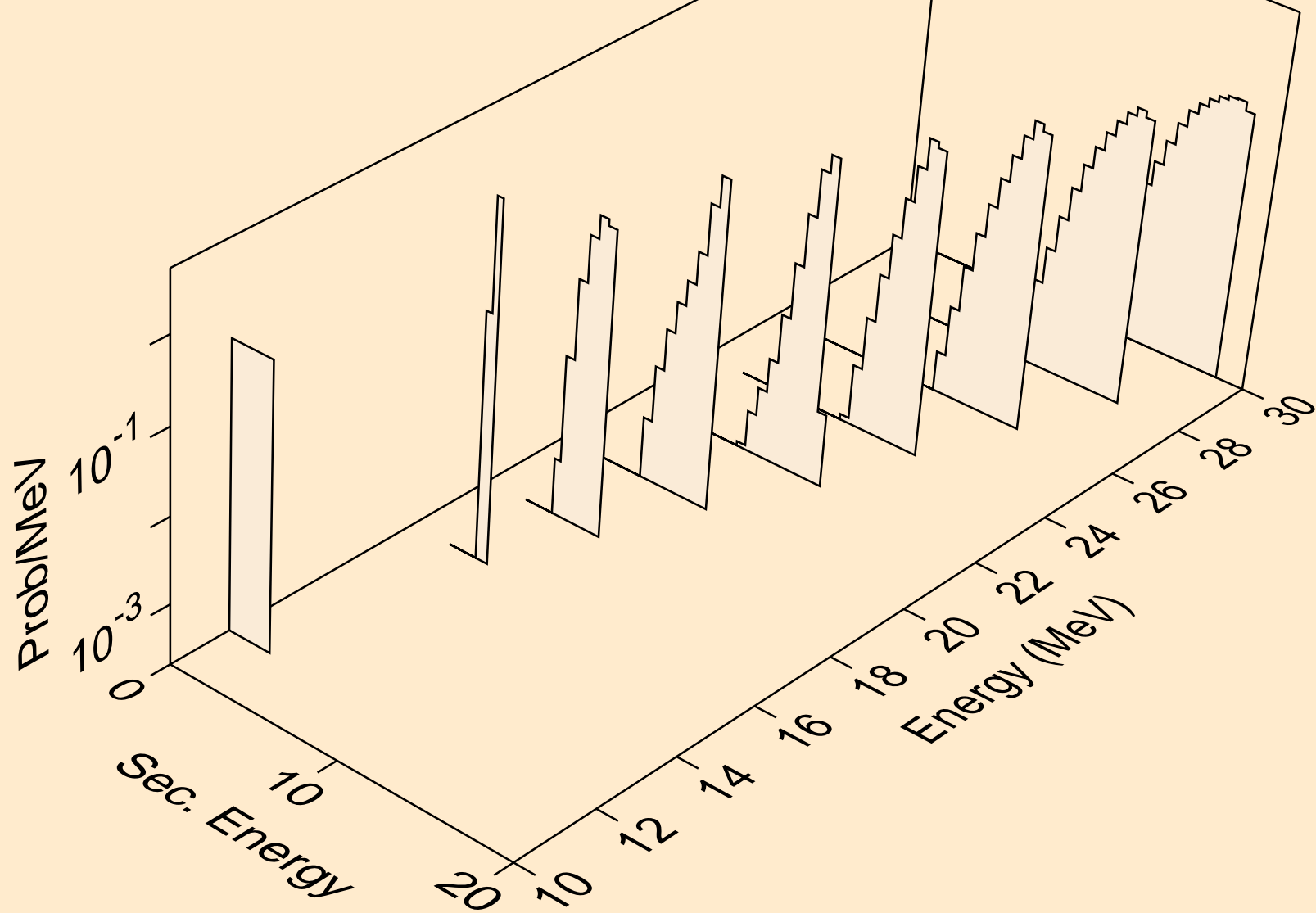

AT221 NEUTRON ACER TENDL-2021 LIBRARY; T=293.6K
he3s from (n,he3)

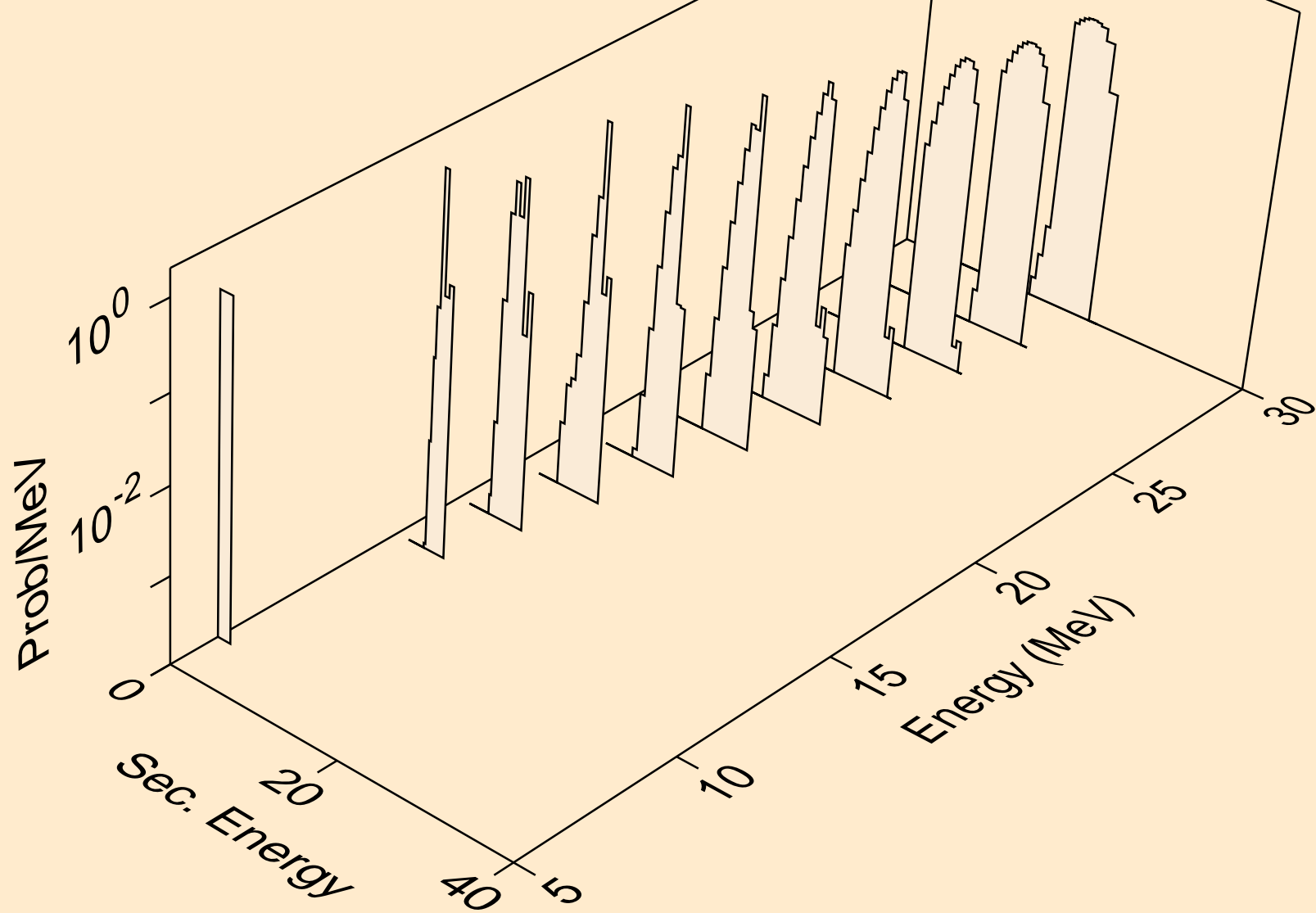

AT221 NEUTRON ACER TENDL-2021 LIBRARY; T=293.6K
alphas from (n,x)

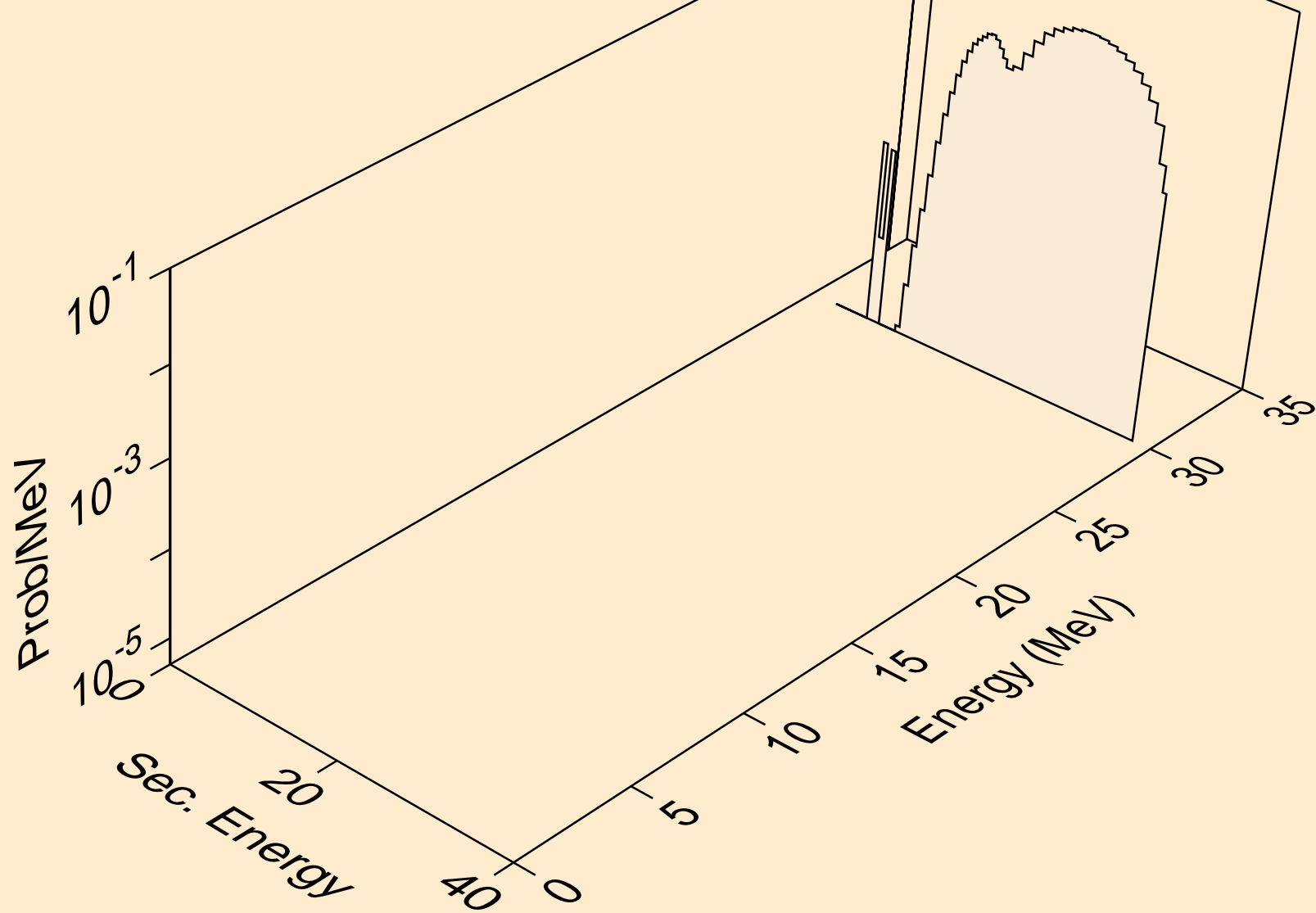

AT221 NEUTRON ACER TENDL-2021 LIBRARY; T=293.6K
alphas from (n,n*)a

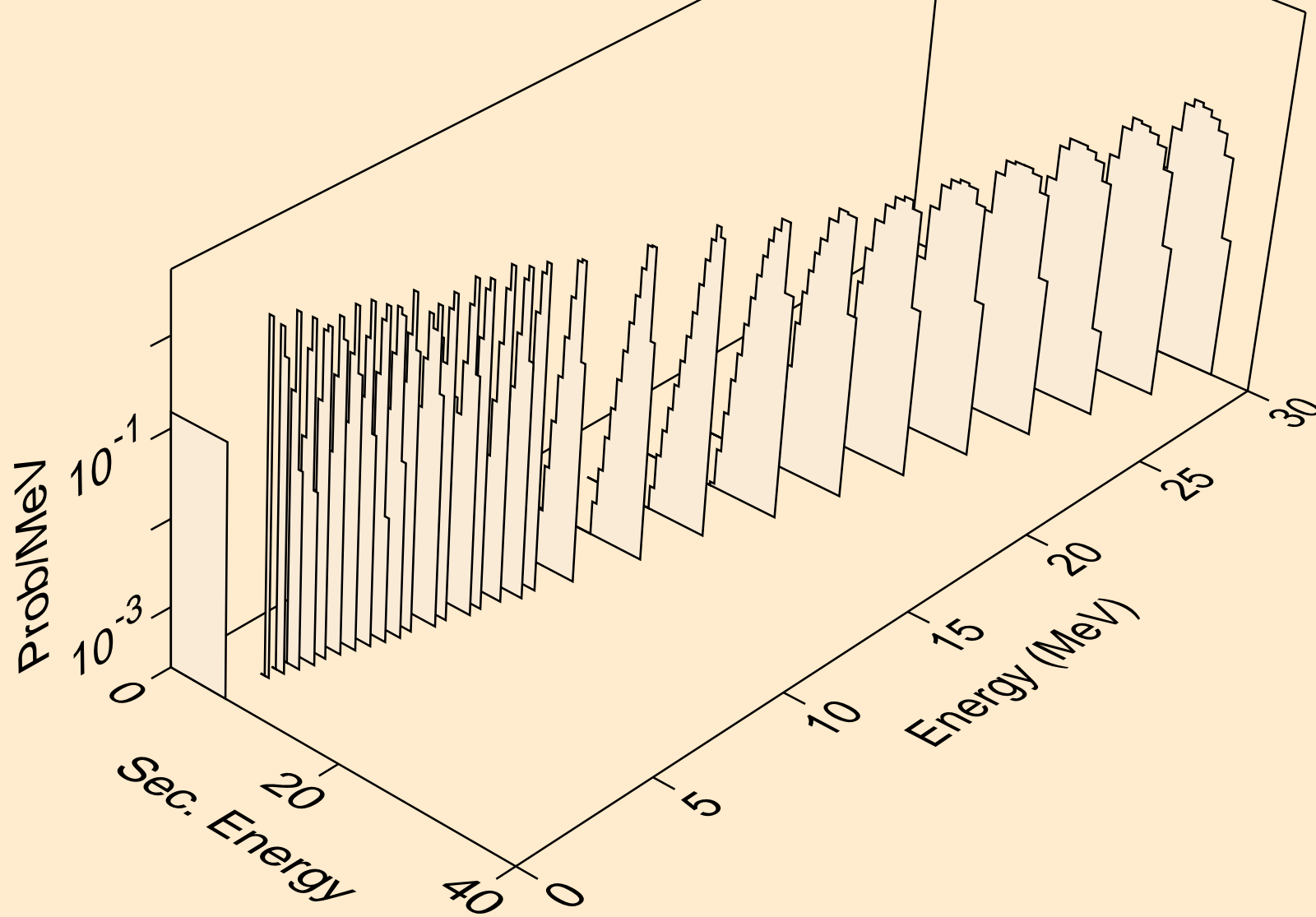

AT221 NEUTRON ACER TENDL-2021 LIBRARY; T=293.6K
alphas from (n,2n)a

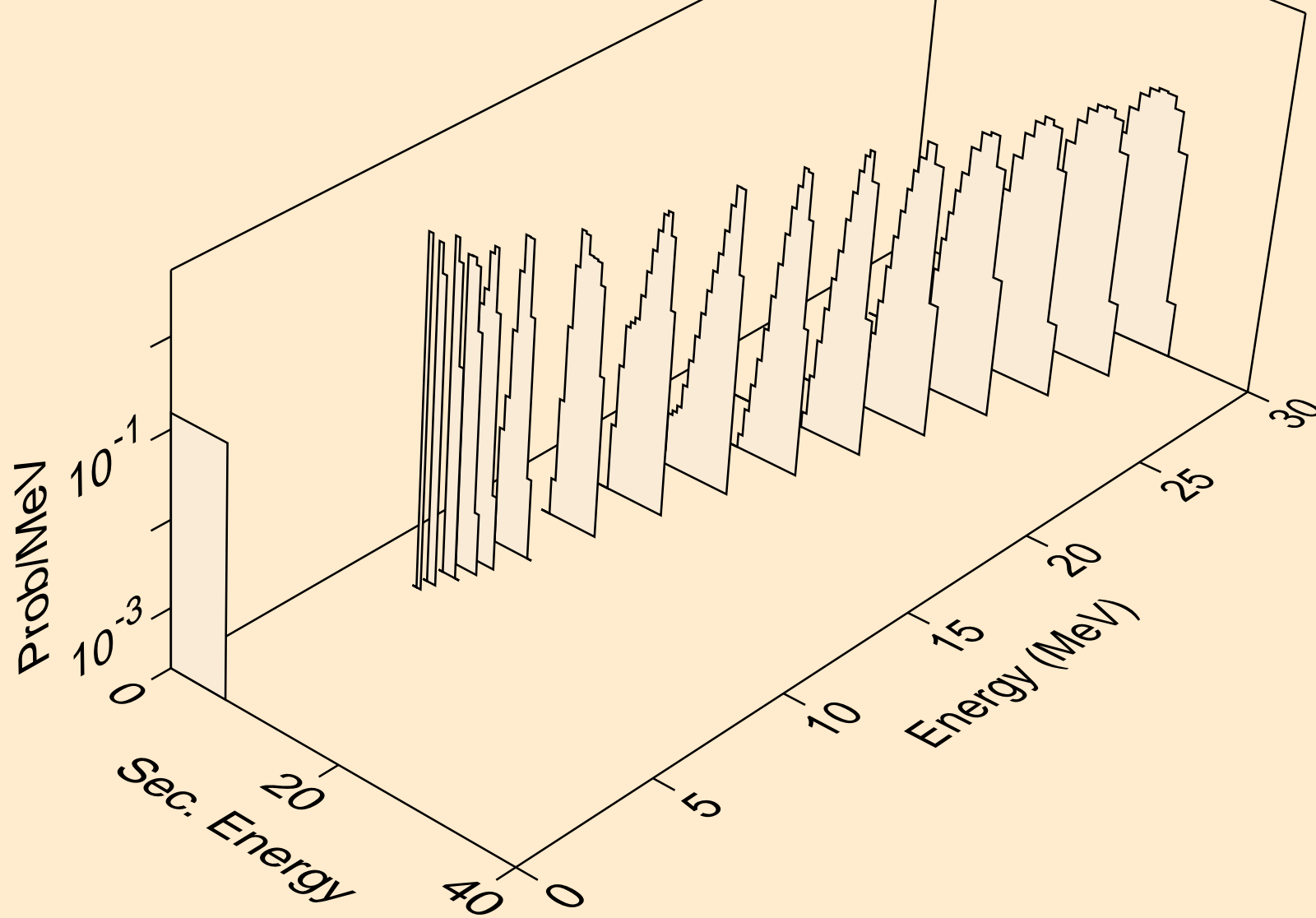

AT221 NEUTRON ACER TENDL-2021 LIBRARY; T=293.6K
alphas from (n,3n)a

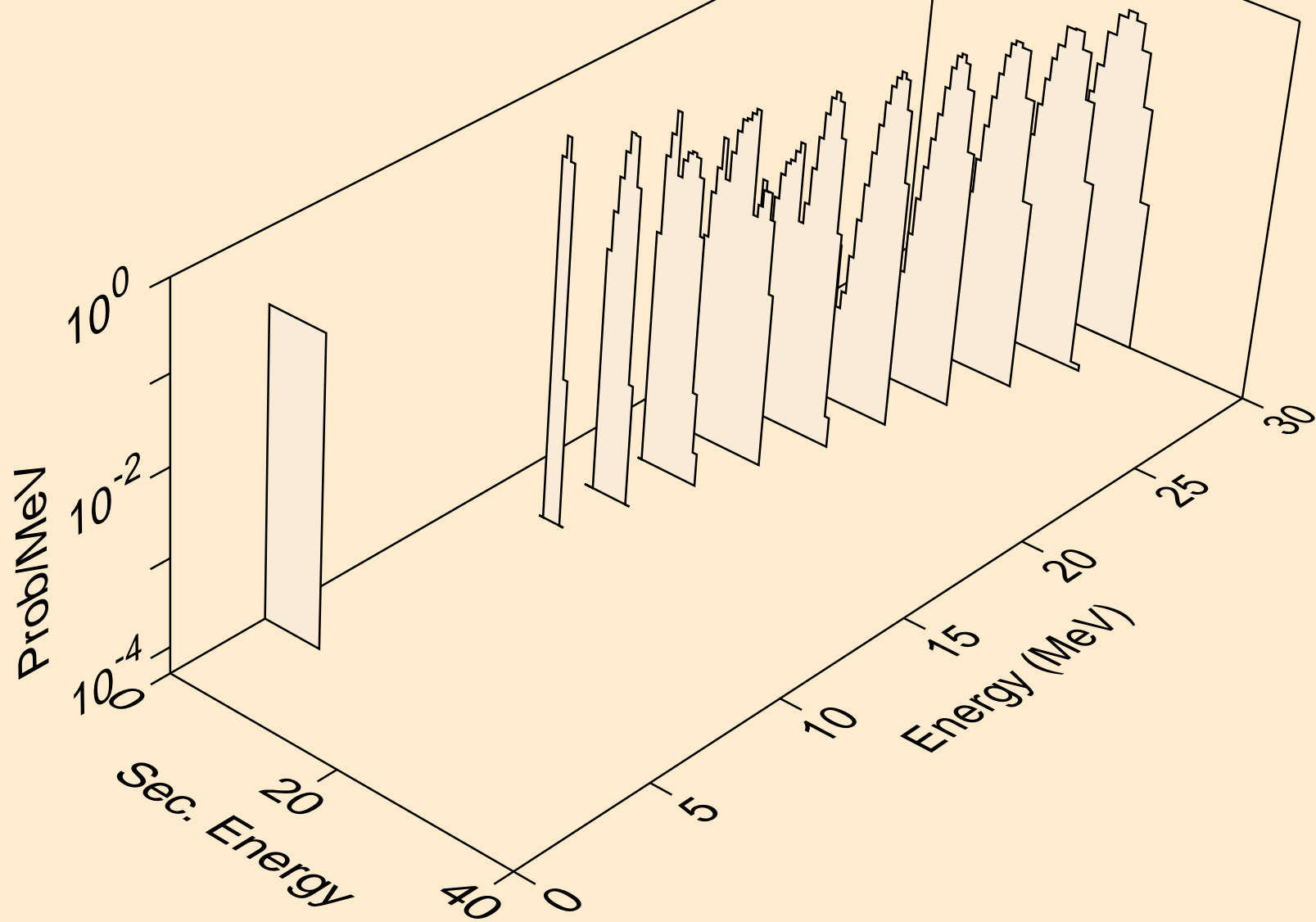

AT221 NEUTRON ACER TENDL-2021 LIBRARY; T=293.6K
alphas from (n,npa)

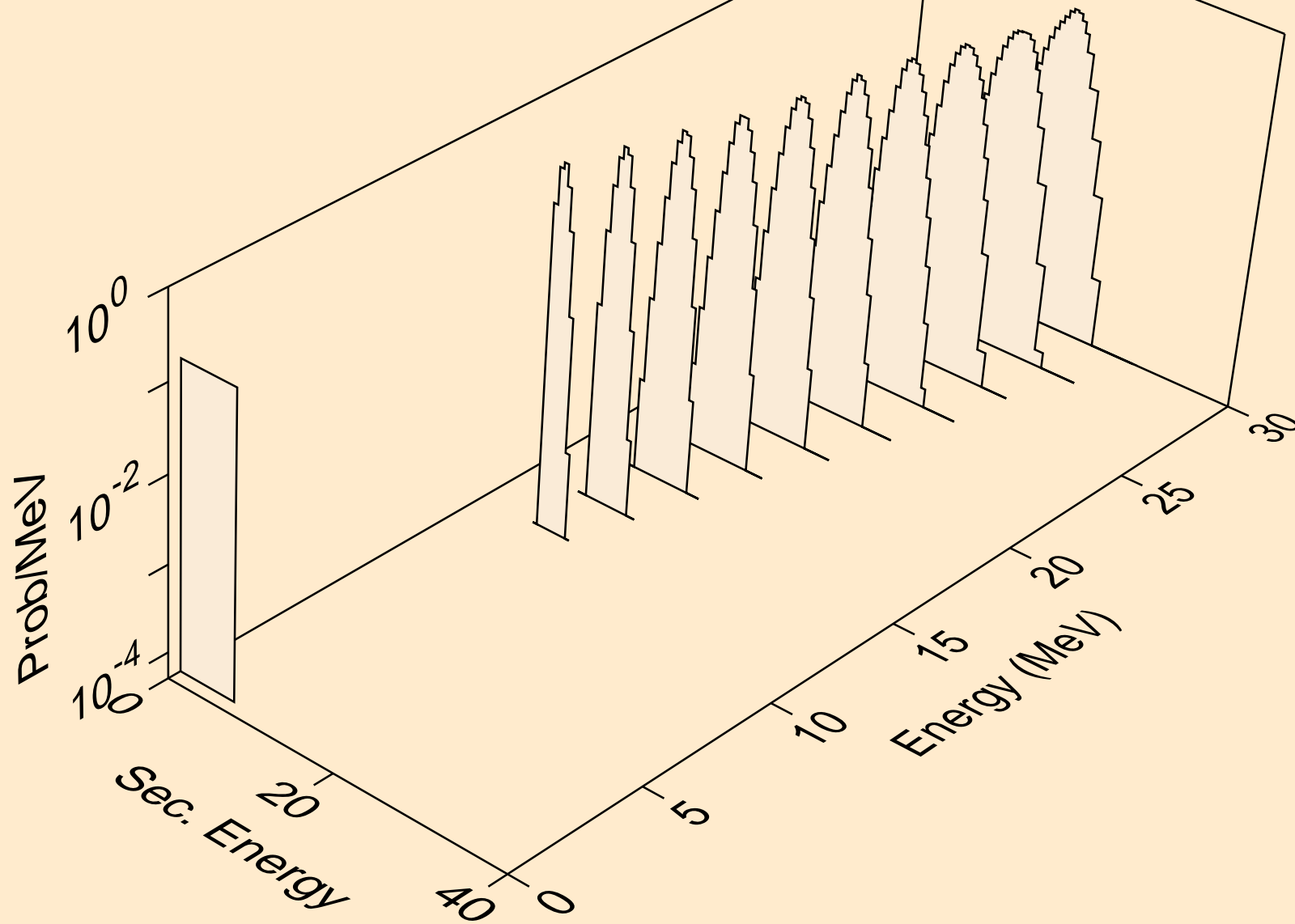

AT221 NEUTRON ACER TENDL-2021 LIBRARY; T=293.6K
alphas from (n,a)

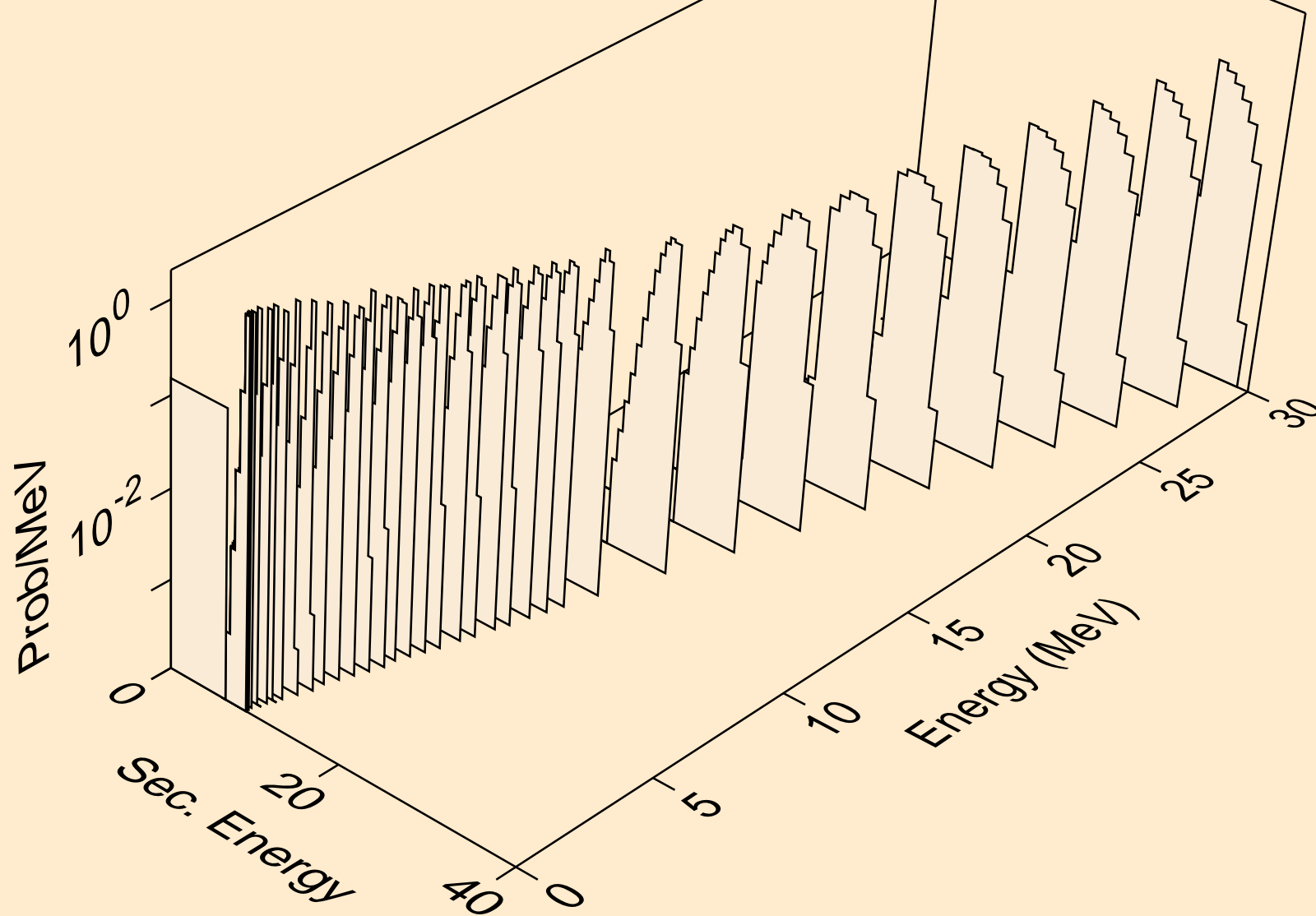

AT221 NEUTRON ACER TENDL-2021 LIBRARY; T=293.6K
alphas from (n,2a)

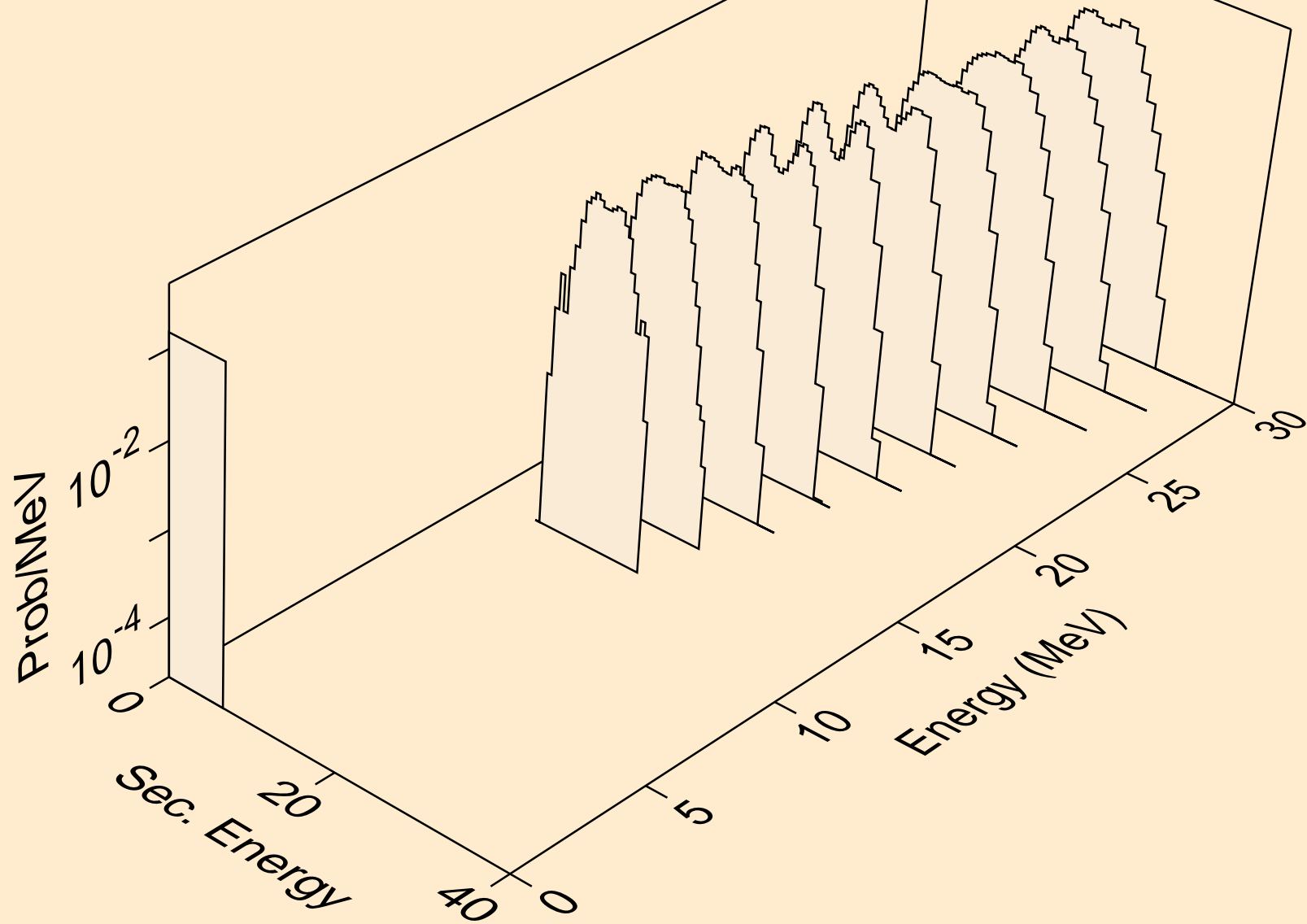

AT221 NEUTRON ACER TENDL-2021 LIBRARY; T=293.6K
alphas from (n,p)

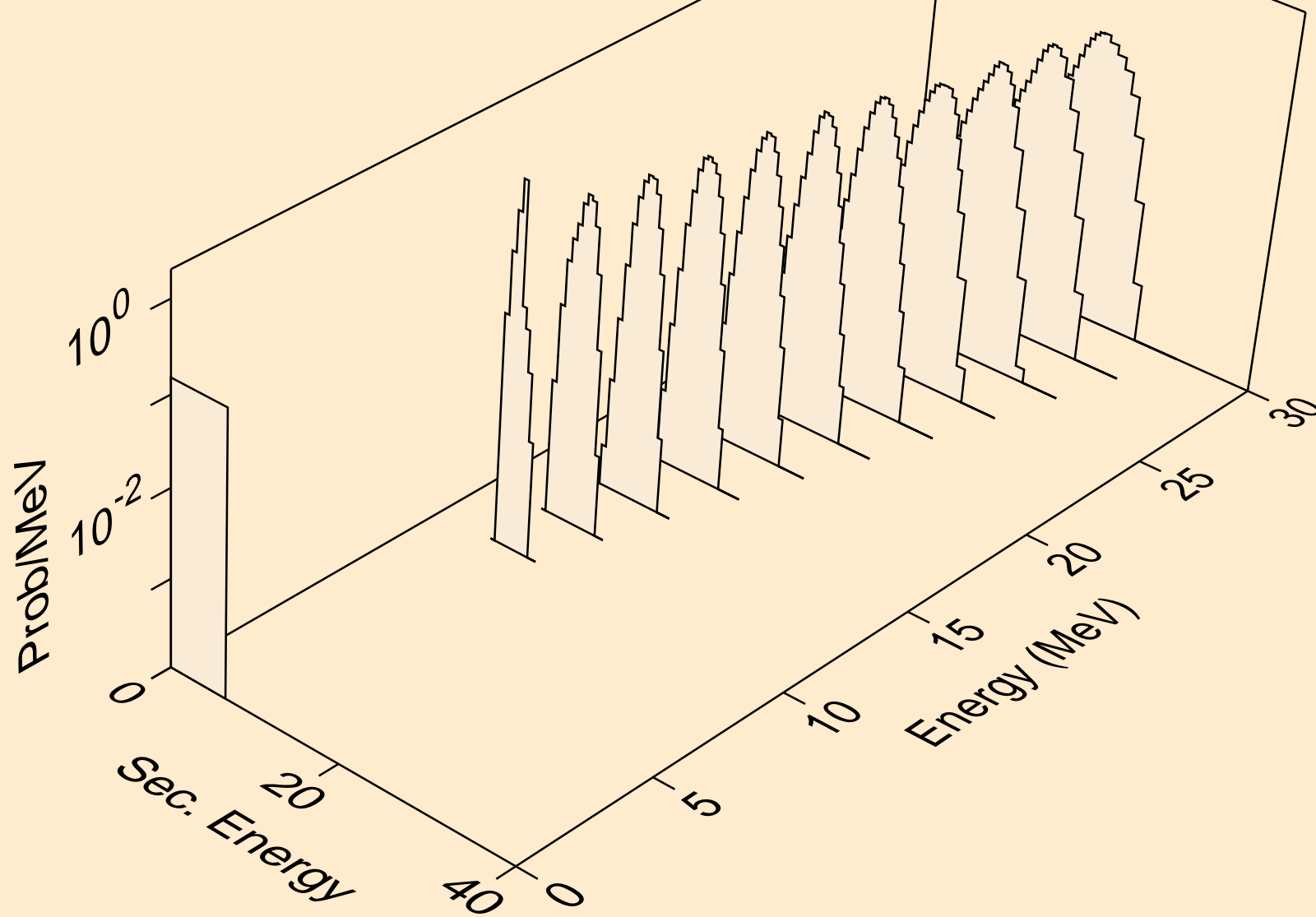

AT221 NEUTRON ACER TENDL-2021 LIBRARY; T=293.6K
alphas from (n,da)

