

AU177M NEUTRON ACER TENDL-2021 LIBRARY; T=293.6K
Principal cross sections

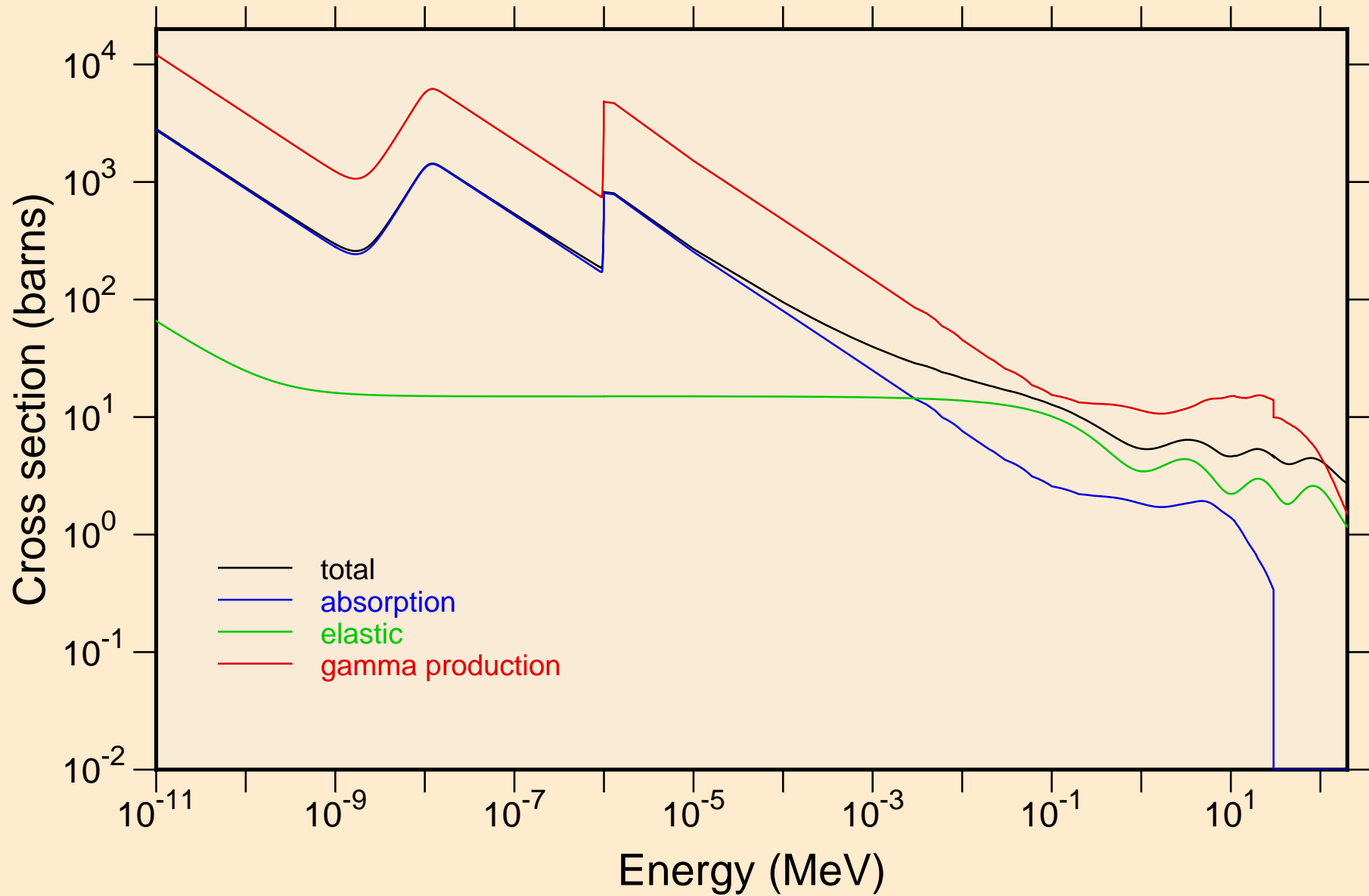

AU177M NEUTRON ACER TENDL-2021 LIBRARY; T=293.6K
Heating

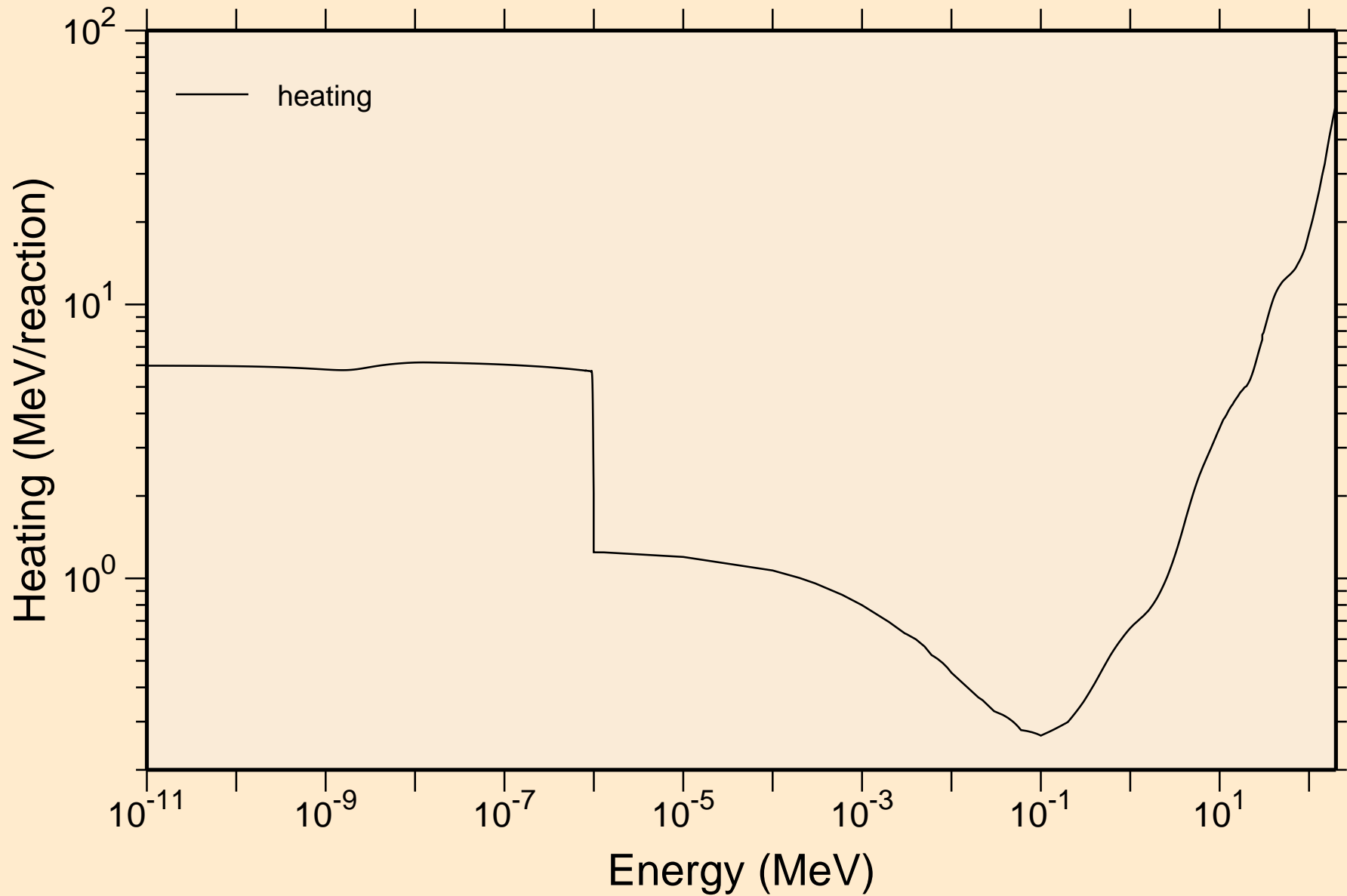

AU177M NEUTRON ACER TENDL-2021 LIBRARY; T=293.6K
Damage

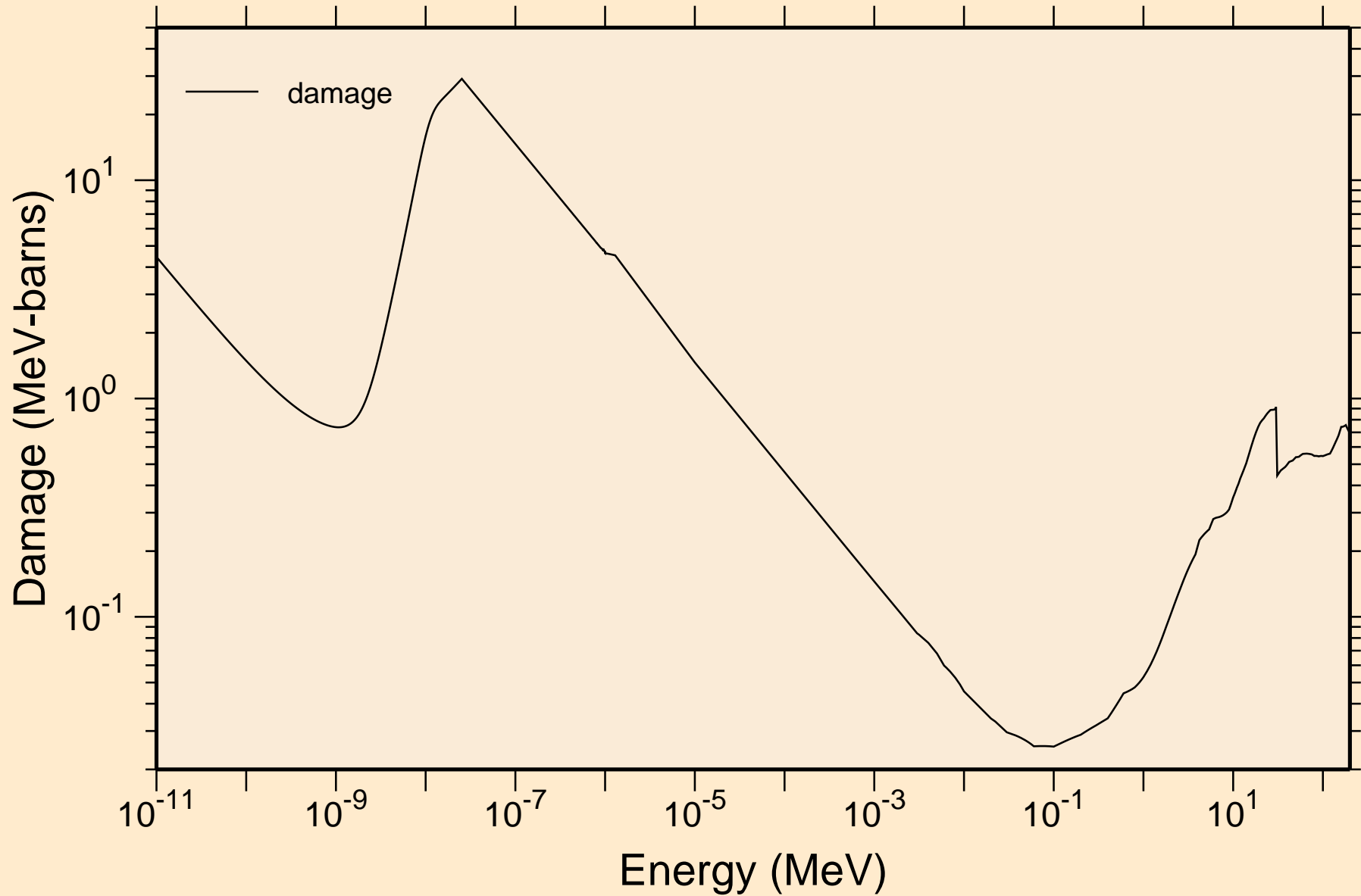

AU177M NEUTRON ACER TENDL-2021 LIBRARY; T=293.6K
Non-threshold reactions

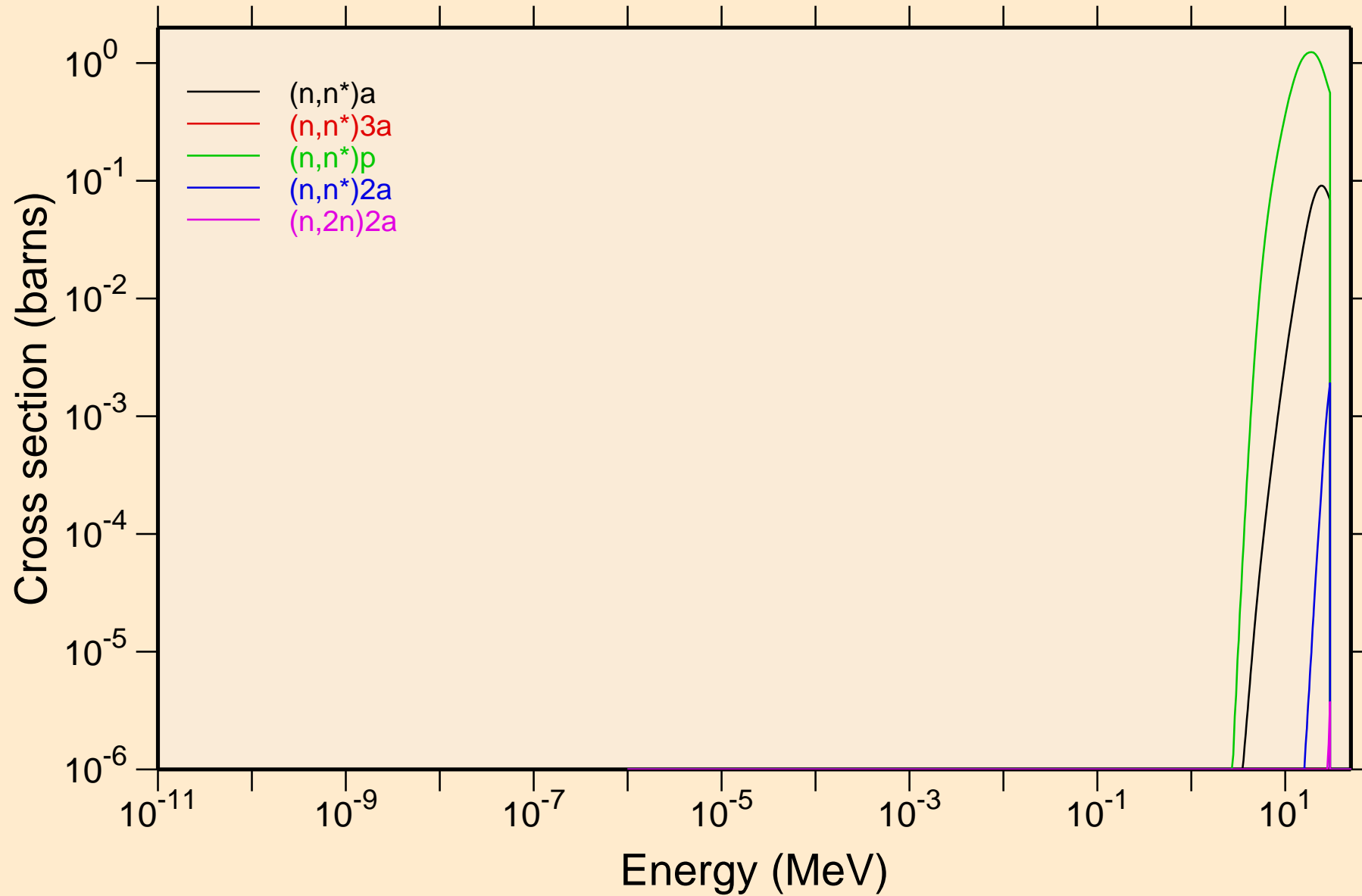

AU177M NEUTRON ACER TENDL-2021 LIBRARY; T=293.6K
Non-threshold reactions

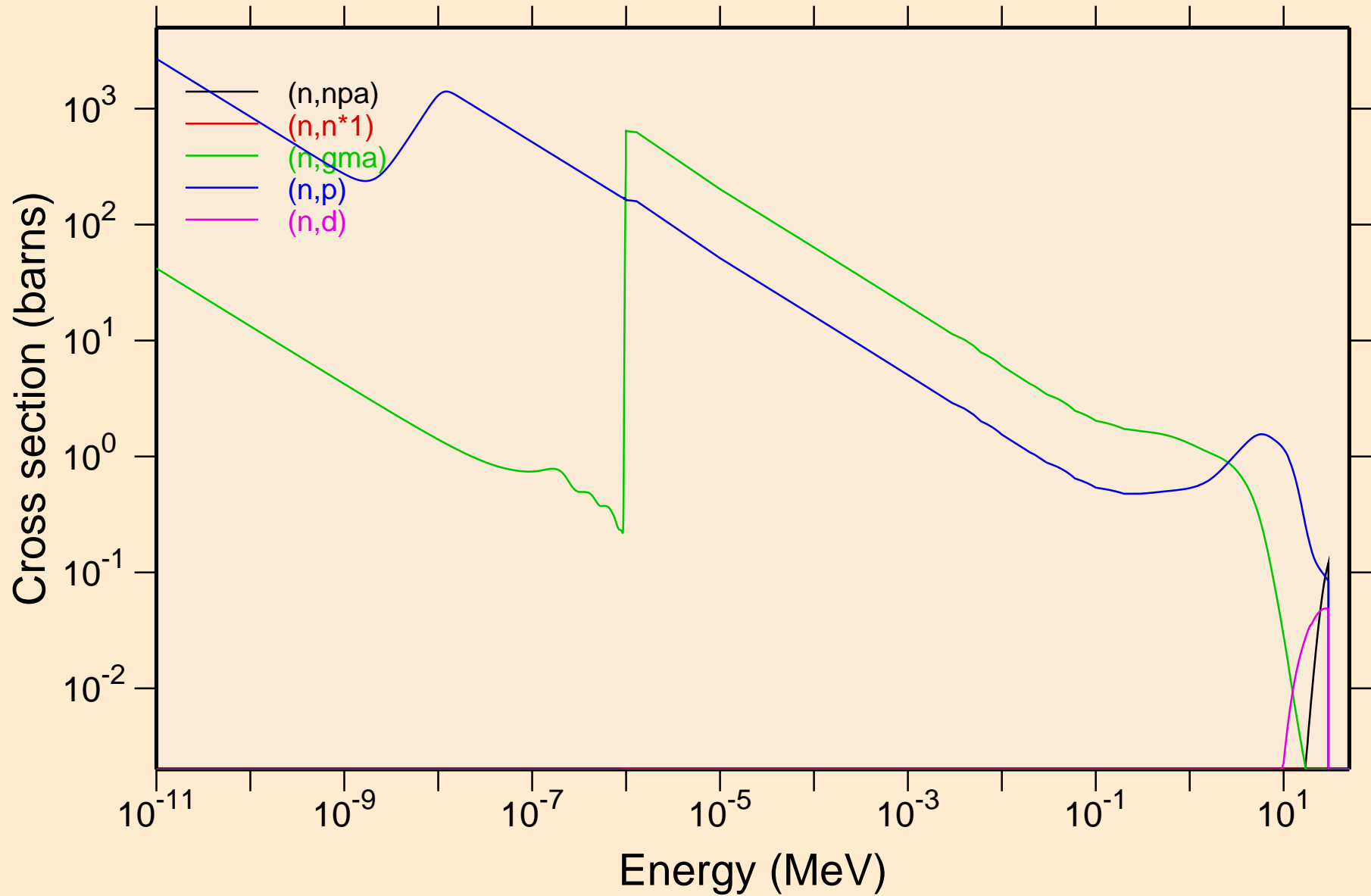

AU177M NEUTRON ACER TENDL-2021 LIBRARY; T=293.6K
Non-threshold reactions

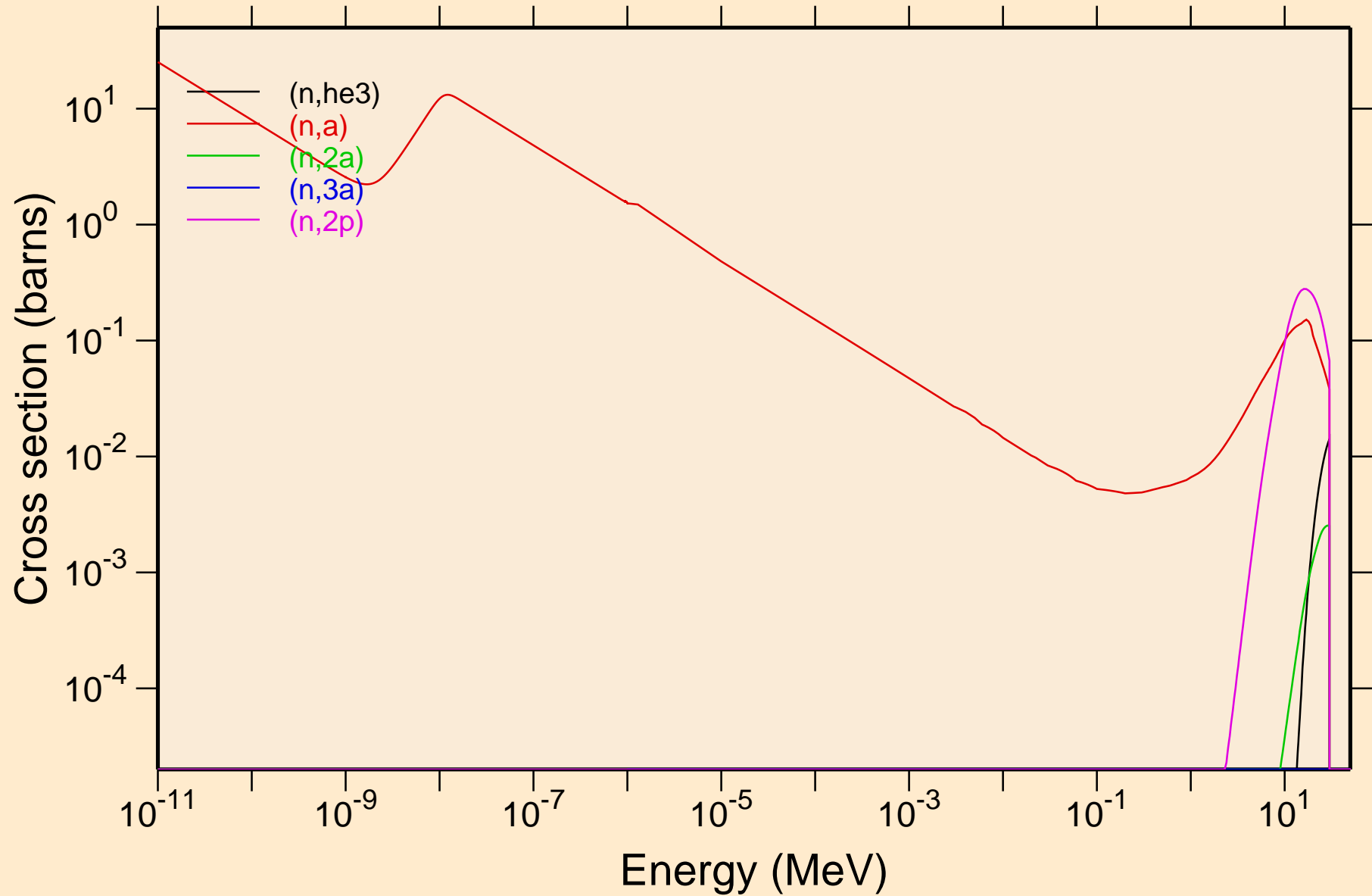

AU177M NEUTRON ACER TENDL-2021 LIBRARY; T=293.6K
Non-threshold reactions

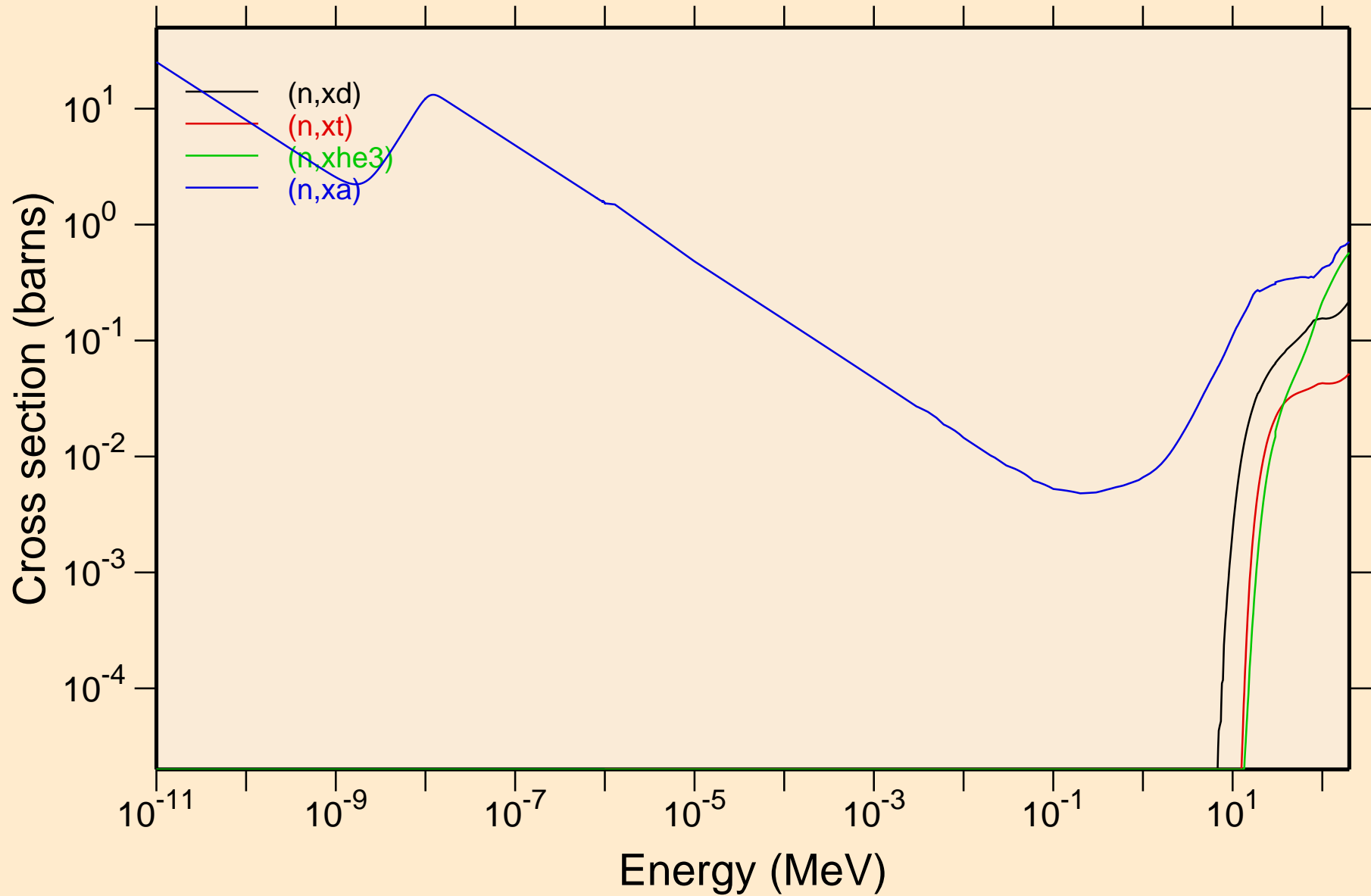

AU177M NEUTRON ACER TENDL-2021 LIBRARY; T=293.6K
Principal cross sections

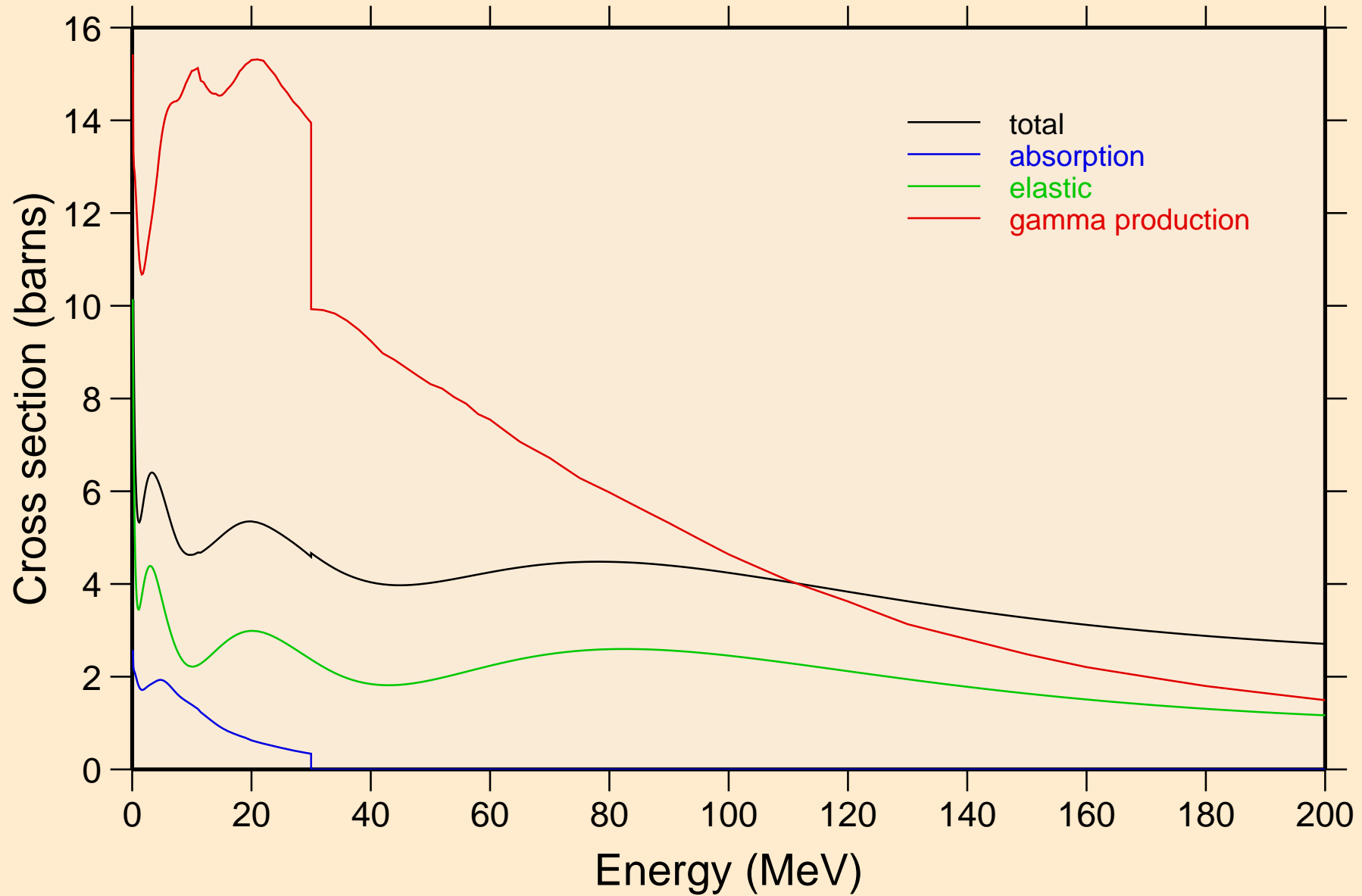

AU177M NEUTRON ACER TENDL-2021 LIBRARY; T=293.6K
Heating

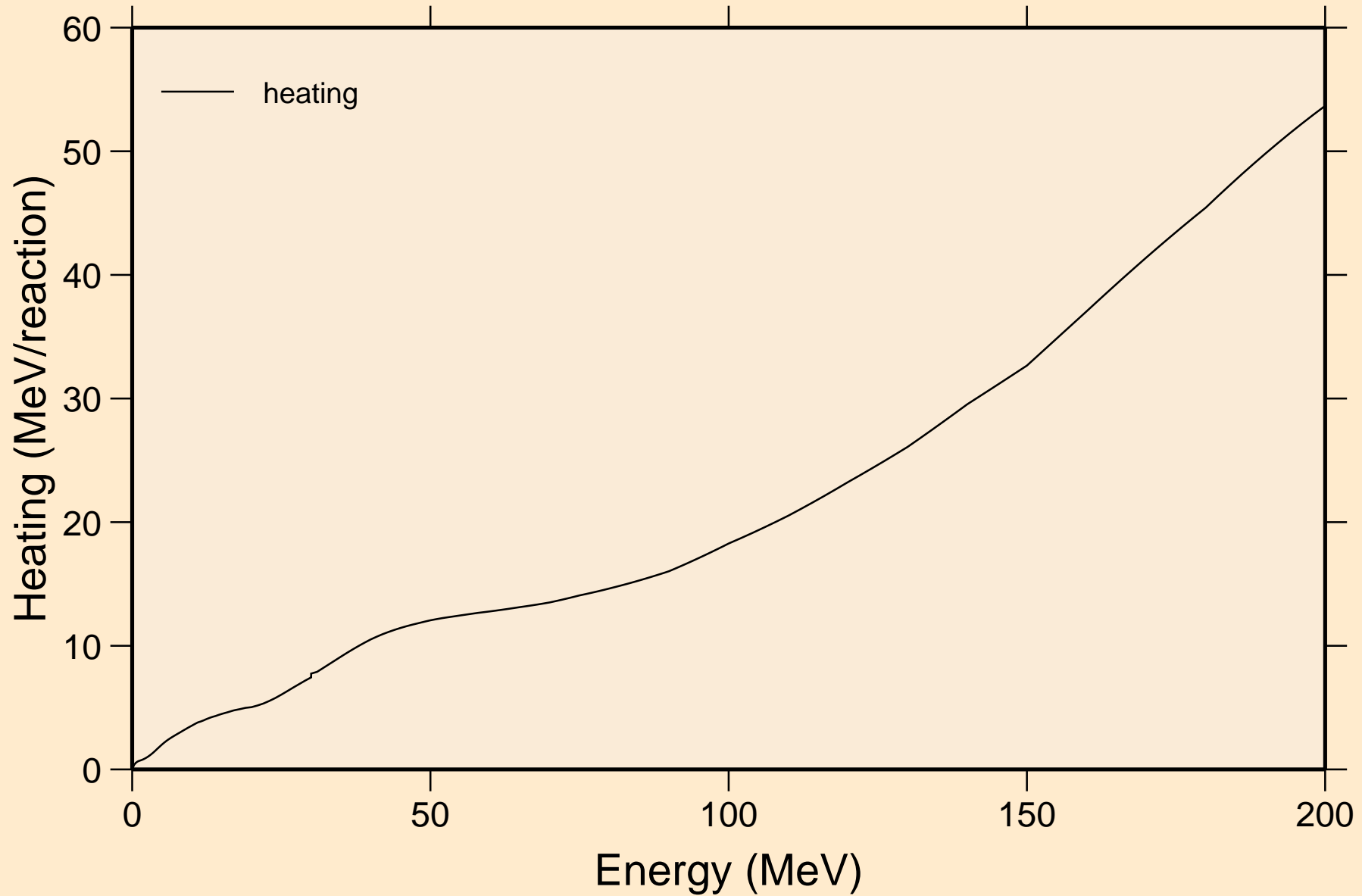

AU177M NEUTRON ACER TENDL-2021 LIBRARY; T=293.6K
Damage

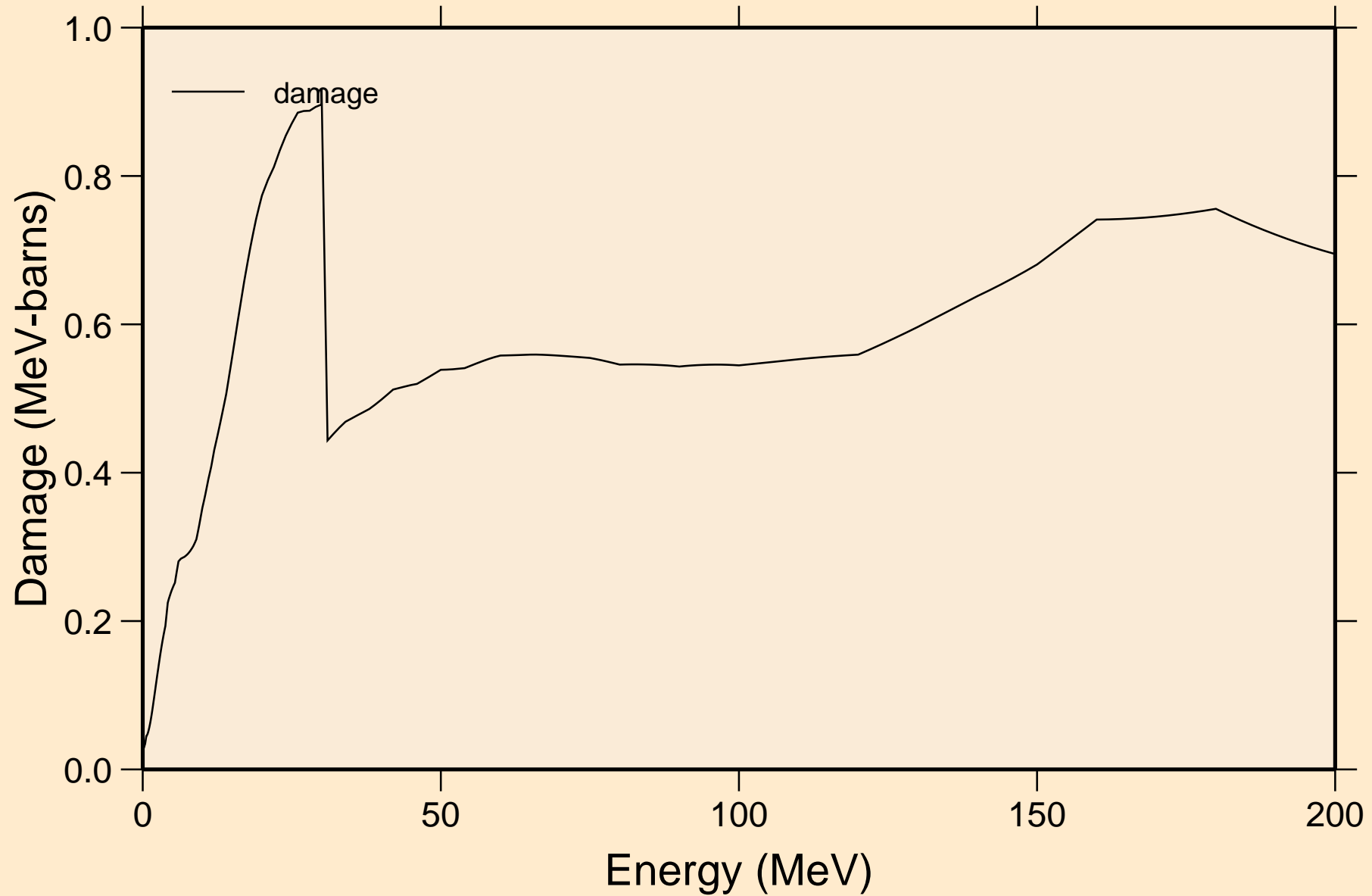

AU177M NEUTRON ACER TENDL-2021 LIBRARY; T=293.6K
Non-threshold reactions

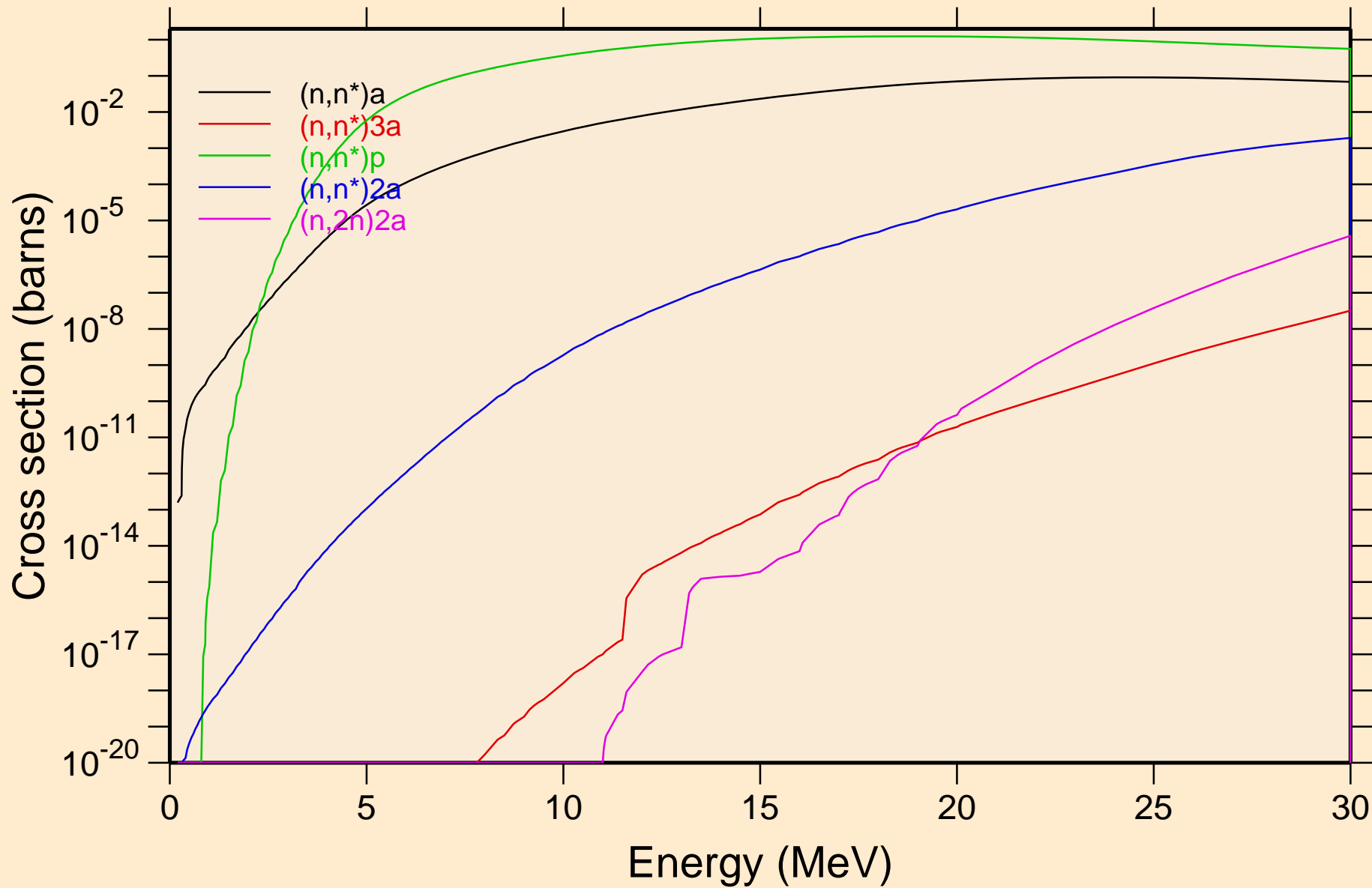

AU177M NEUTRON ACER TENDL-2021 LIBRARY; T=293.6K
Non-threshold reactions

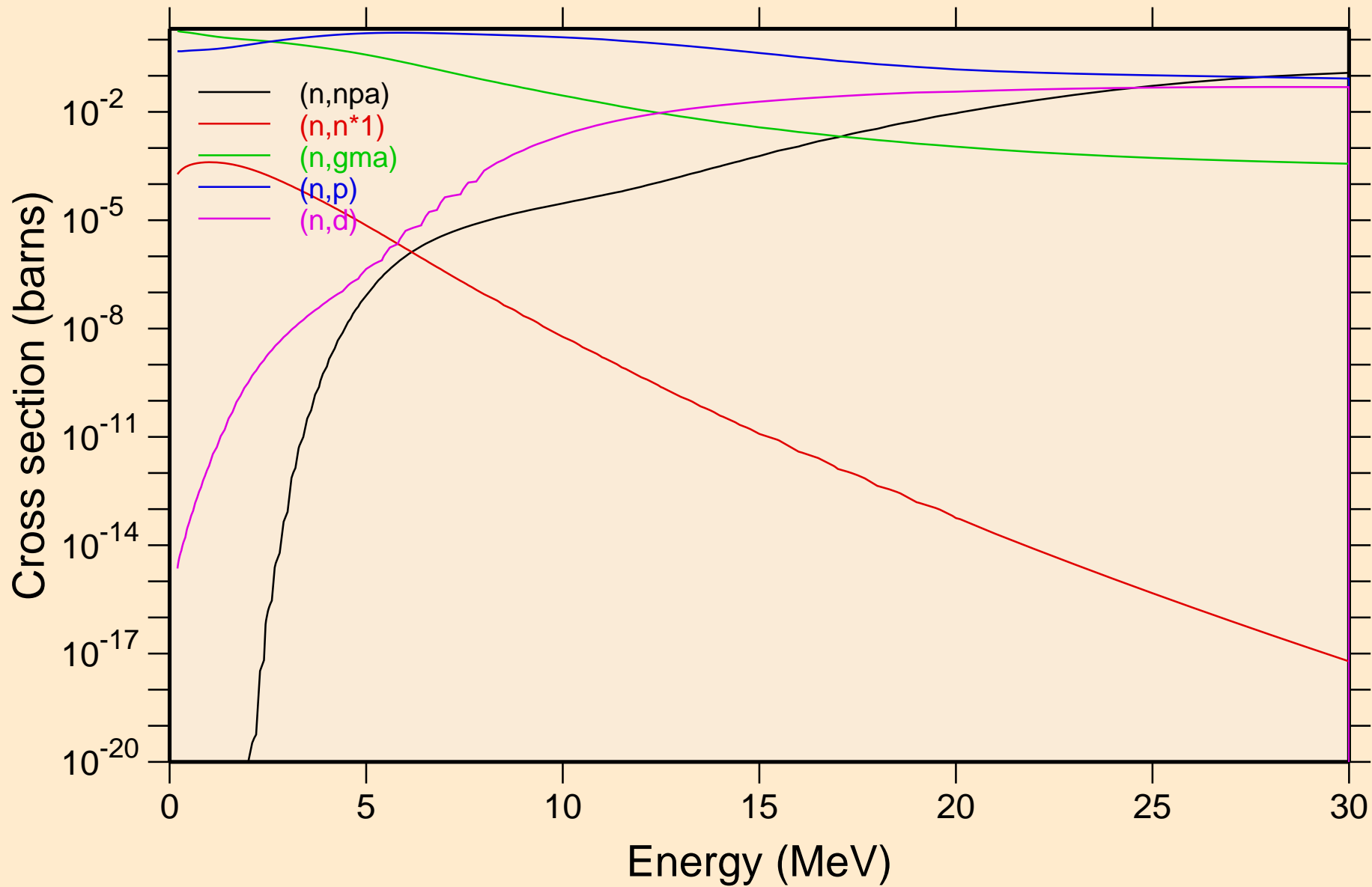

AU177M NEUTRON ACER TENDL-2021 LIBRARY; T=293.6K
Non-threshold reactions

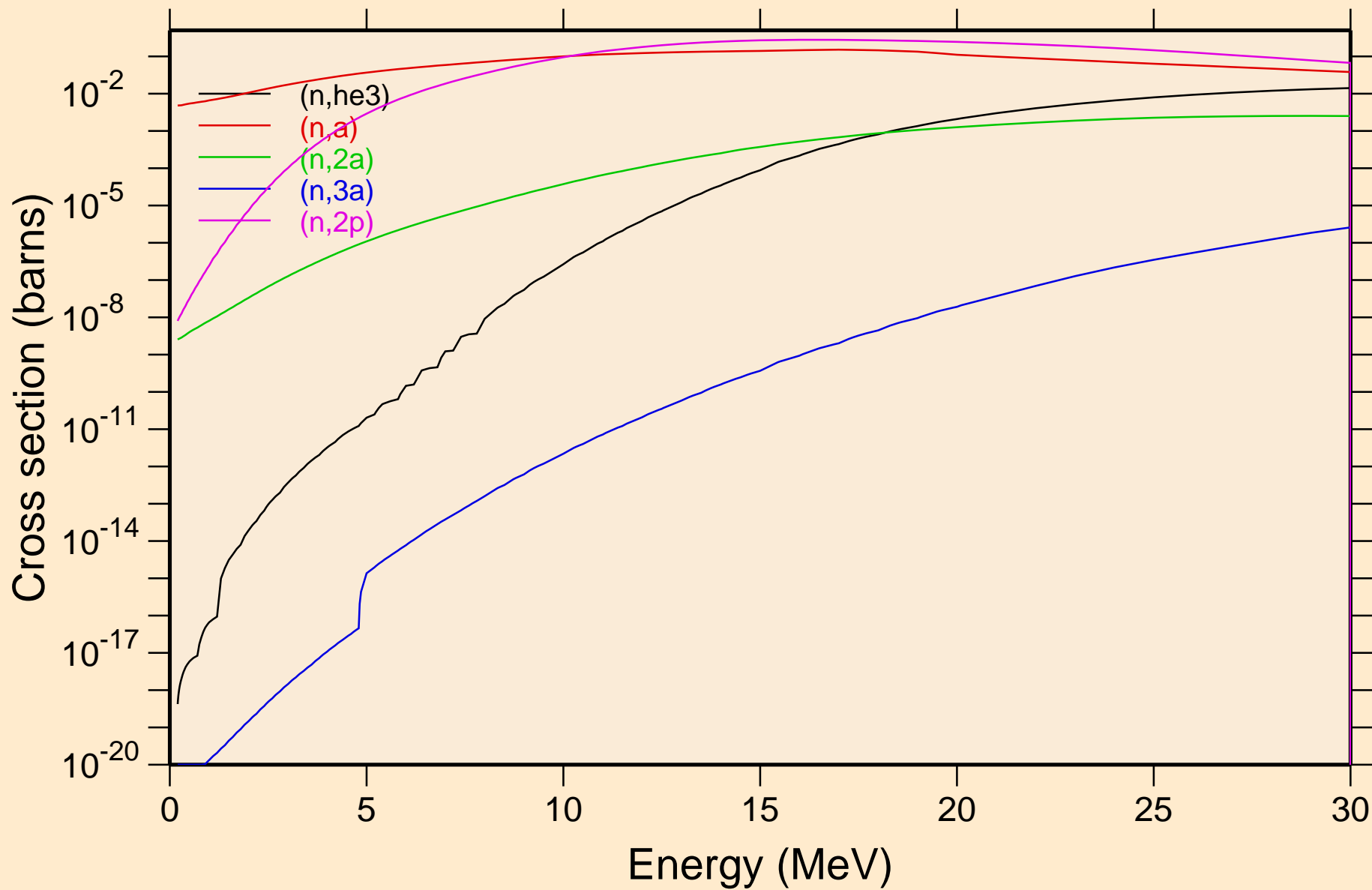

AU177M NEUTRON ACER TENDL-2021 LIBRARY; T=293.6K
Non-threshold reactions

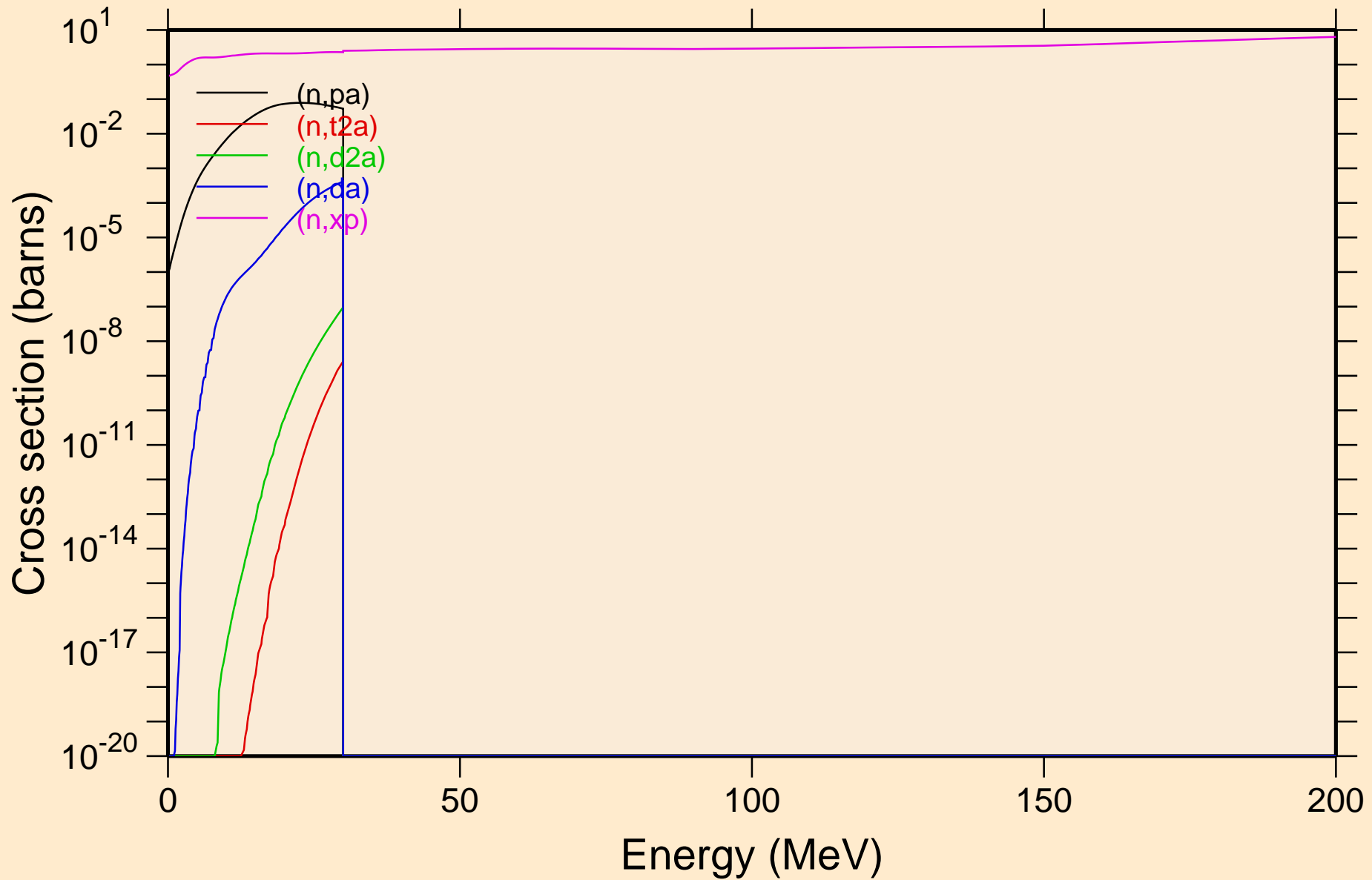

AU177M NEUTRON ACER TENDL-2021 LIBRARY; T=293.6K
Non-threshold reactions

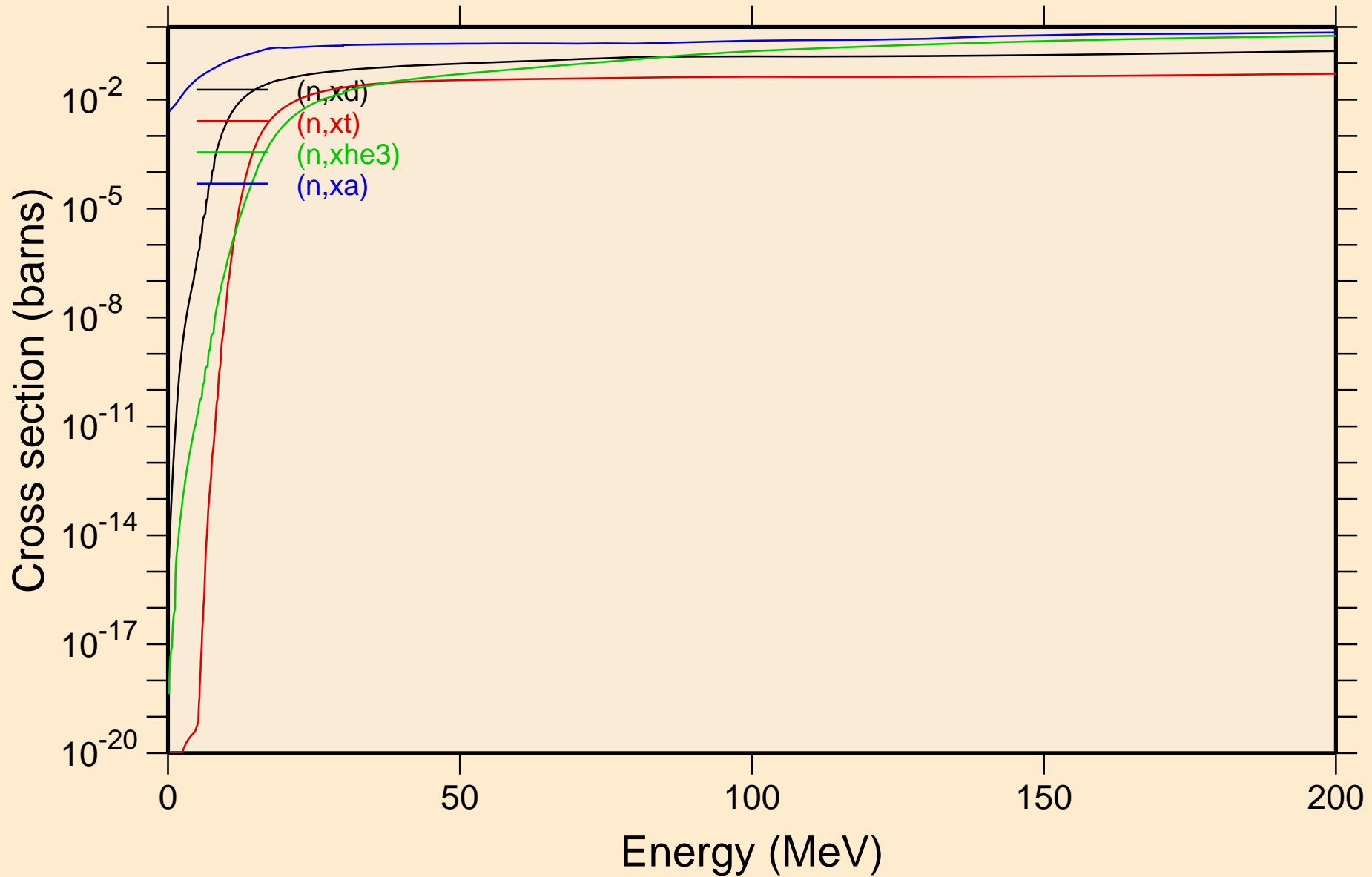

AU177M NEUTRON ACER TENDL-2021 LIBRARY; T=293.6K
Inelastic levels

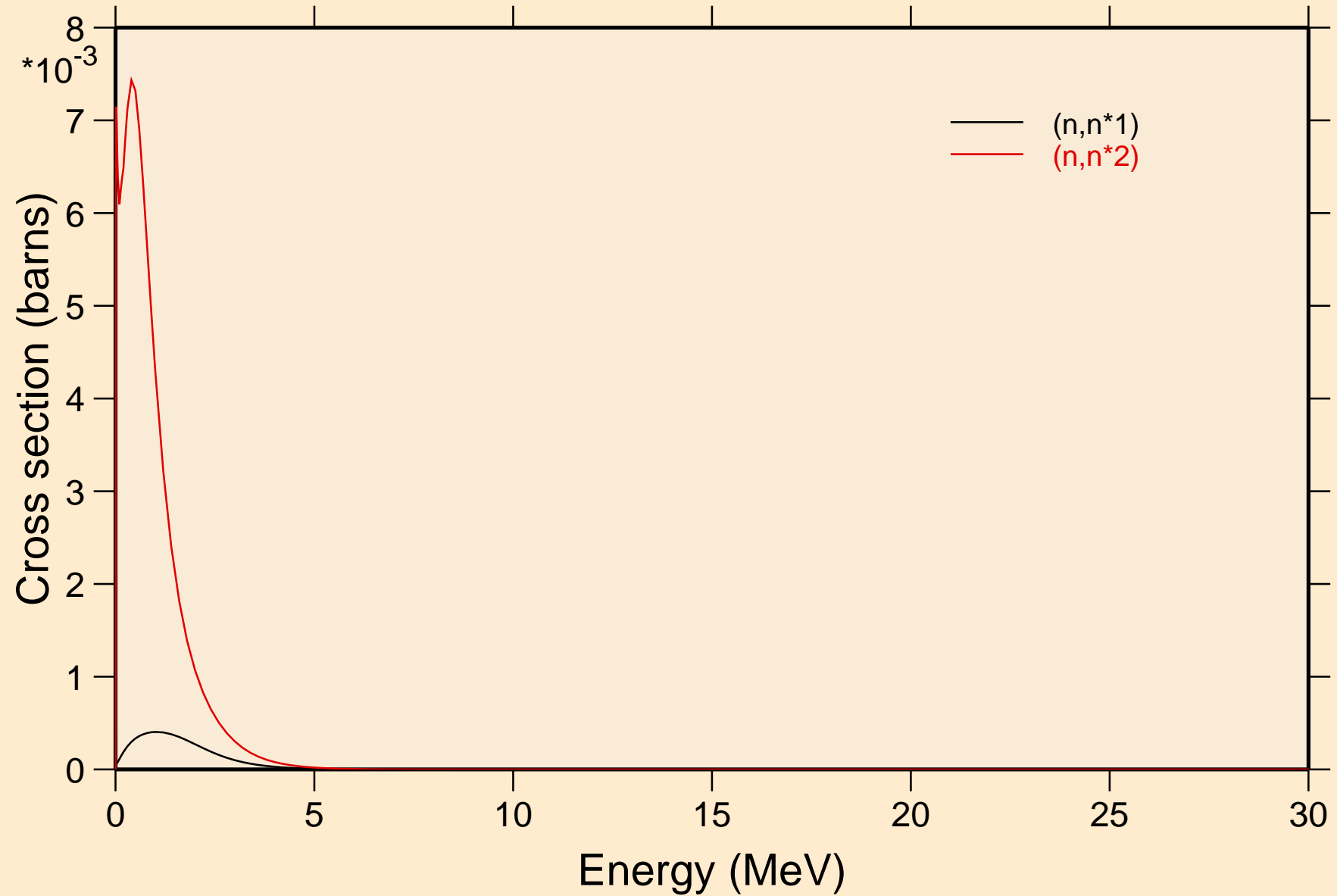

AU177M NEUTRON ACER TENDL-2021 LIBRARY; T=293.6K
Threshold reactions

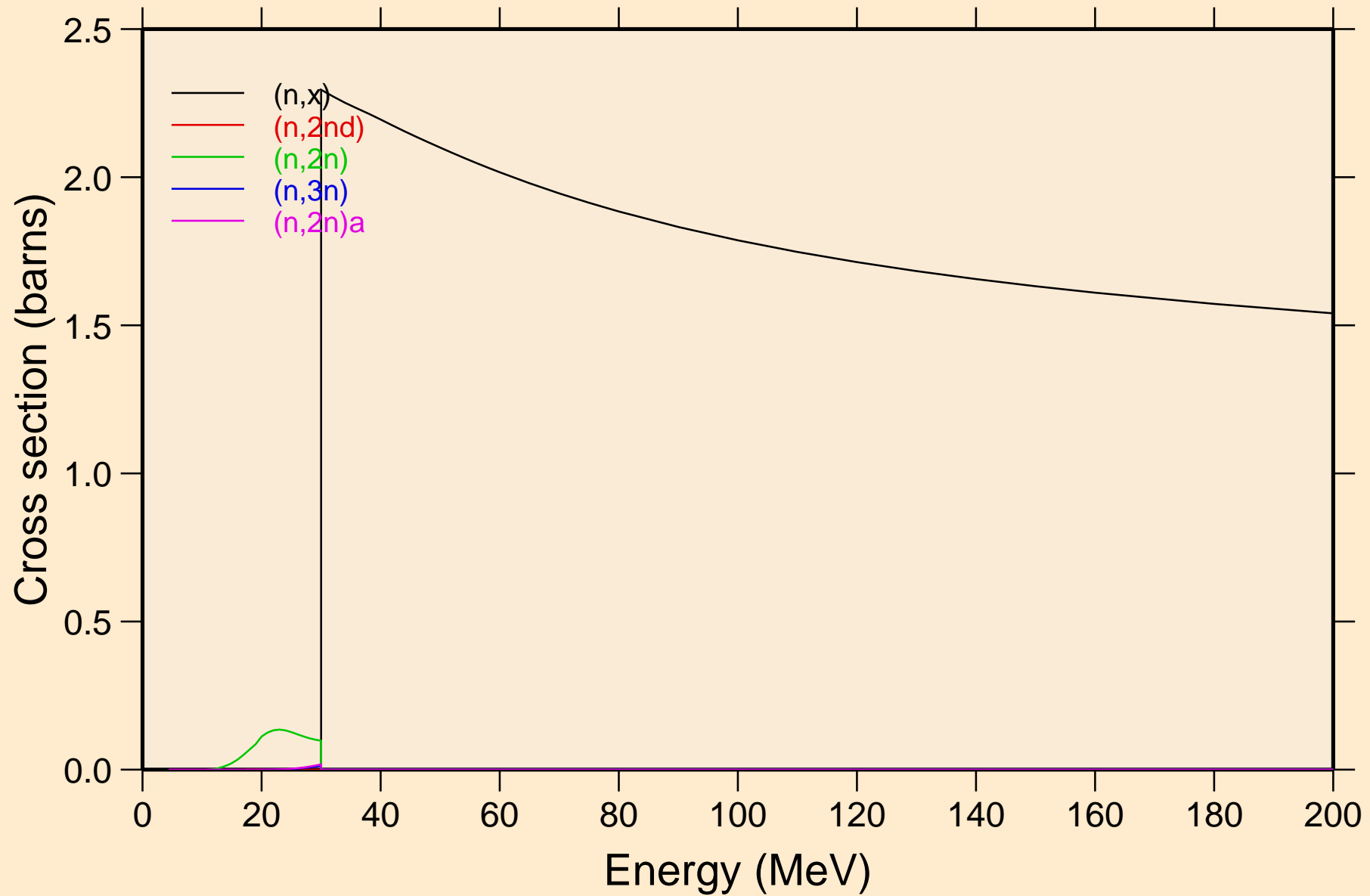

AU177M NEUTRON ACER TENDL-2021 LIBRARY; T=293.6K
Threshold reactions

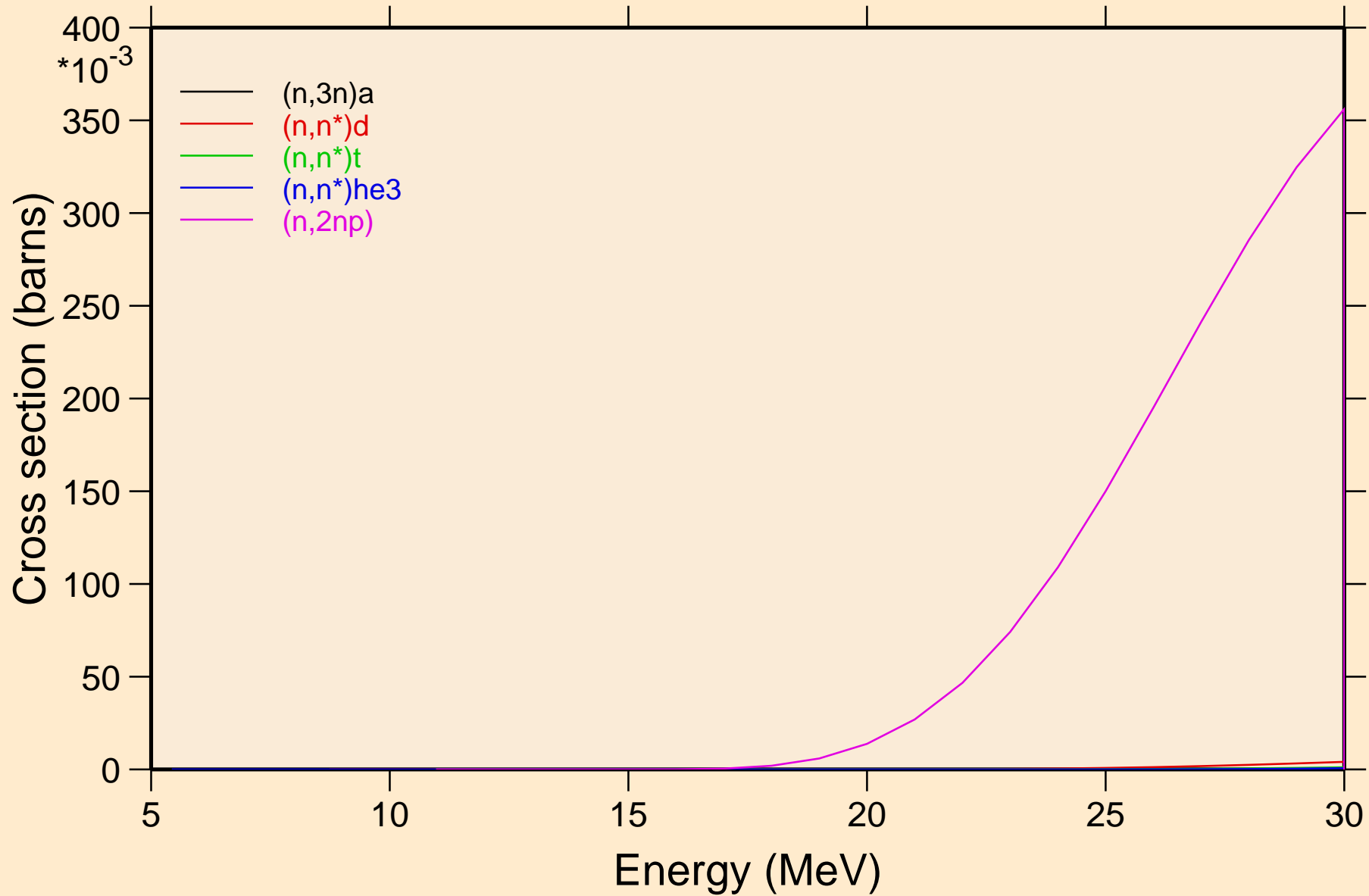

AU177M NEUTRON ACER TENDL-2021 LIBRARY; T=293.6K
Threshold reactions

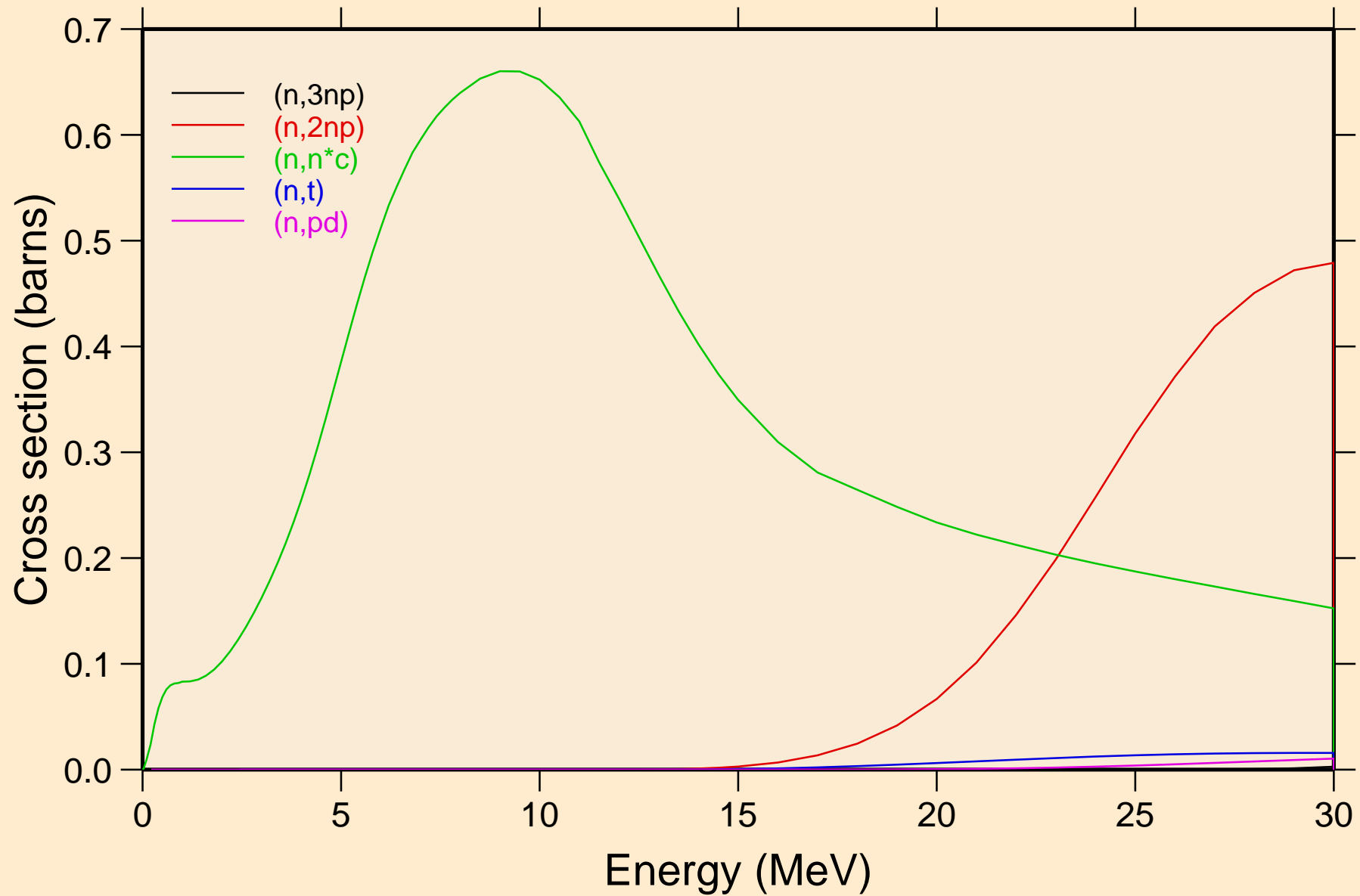

AU177M NEUTRON ACER TENDL-2021 LIBRARY; T=293.6K
Threshold reactions

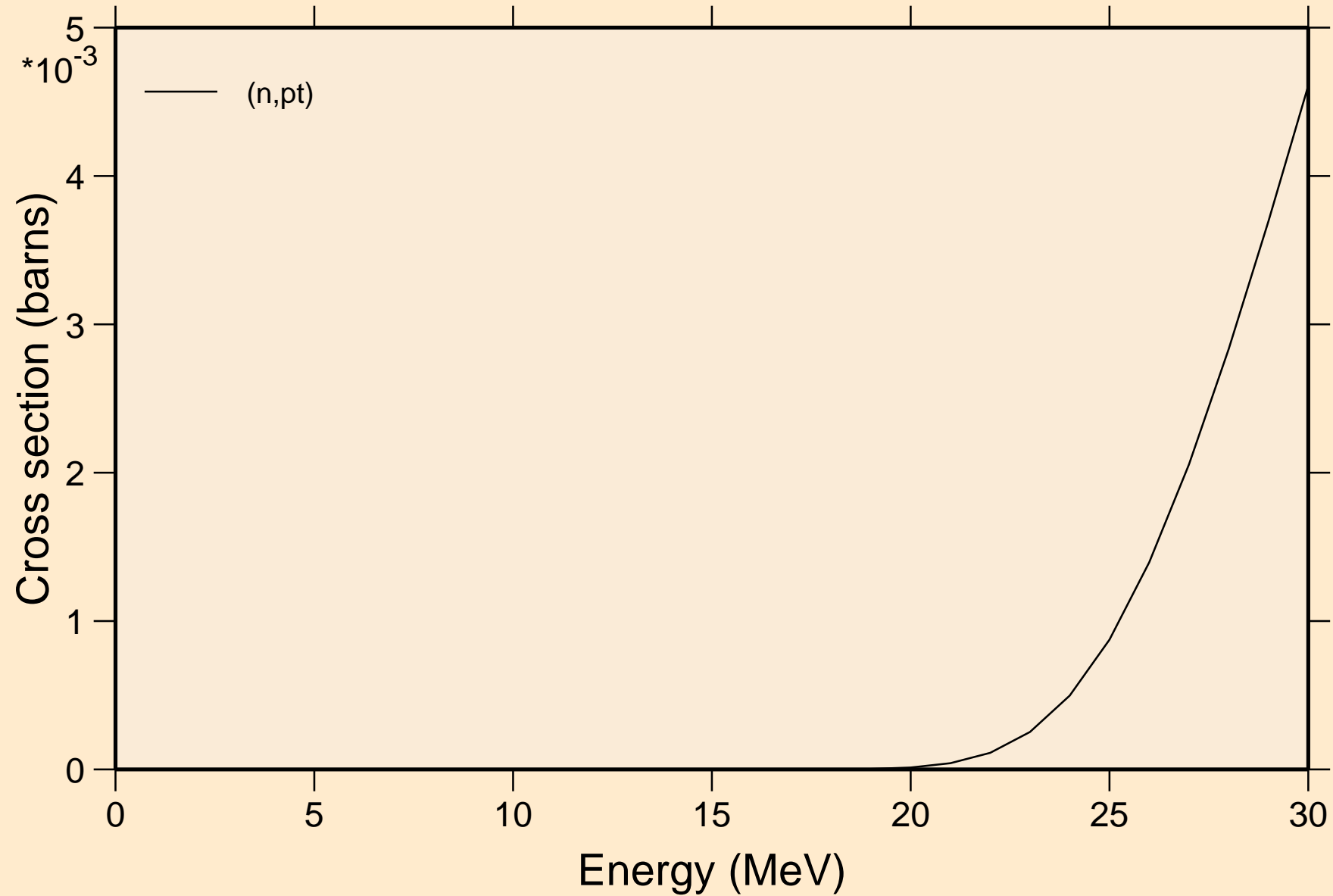

AU177M NEUTRON ACER TENDL-2021 LIBRARY; T=293.6K
angular distribution for elastic

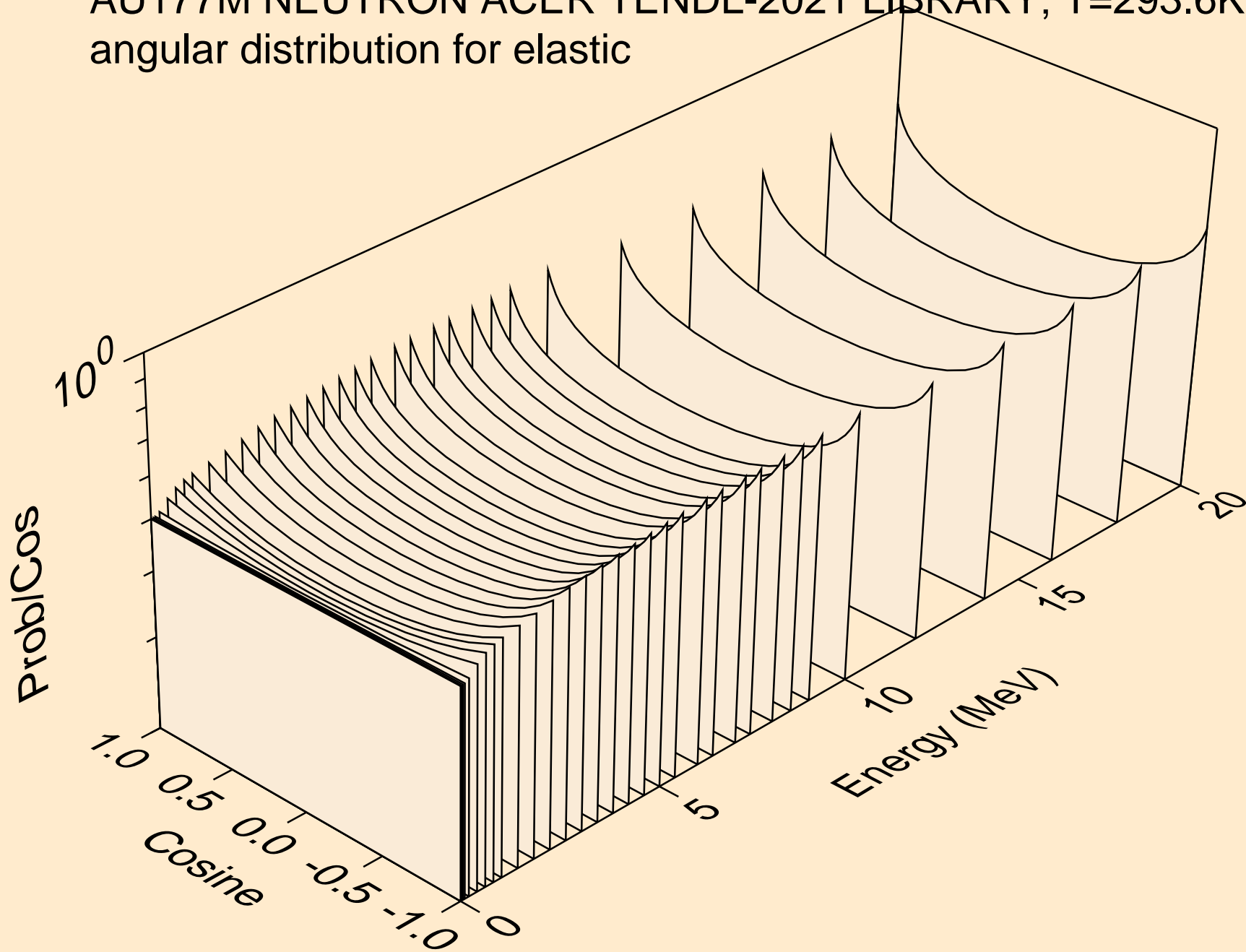

AU177M NEUTRON ACER TENDL-2021 LIBRARY; T=293.6K
angular distribution for elastic

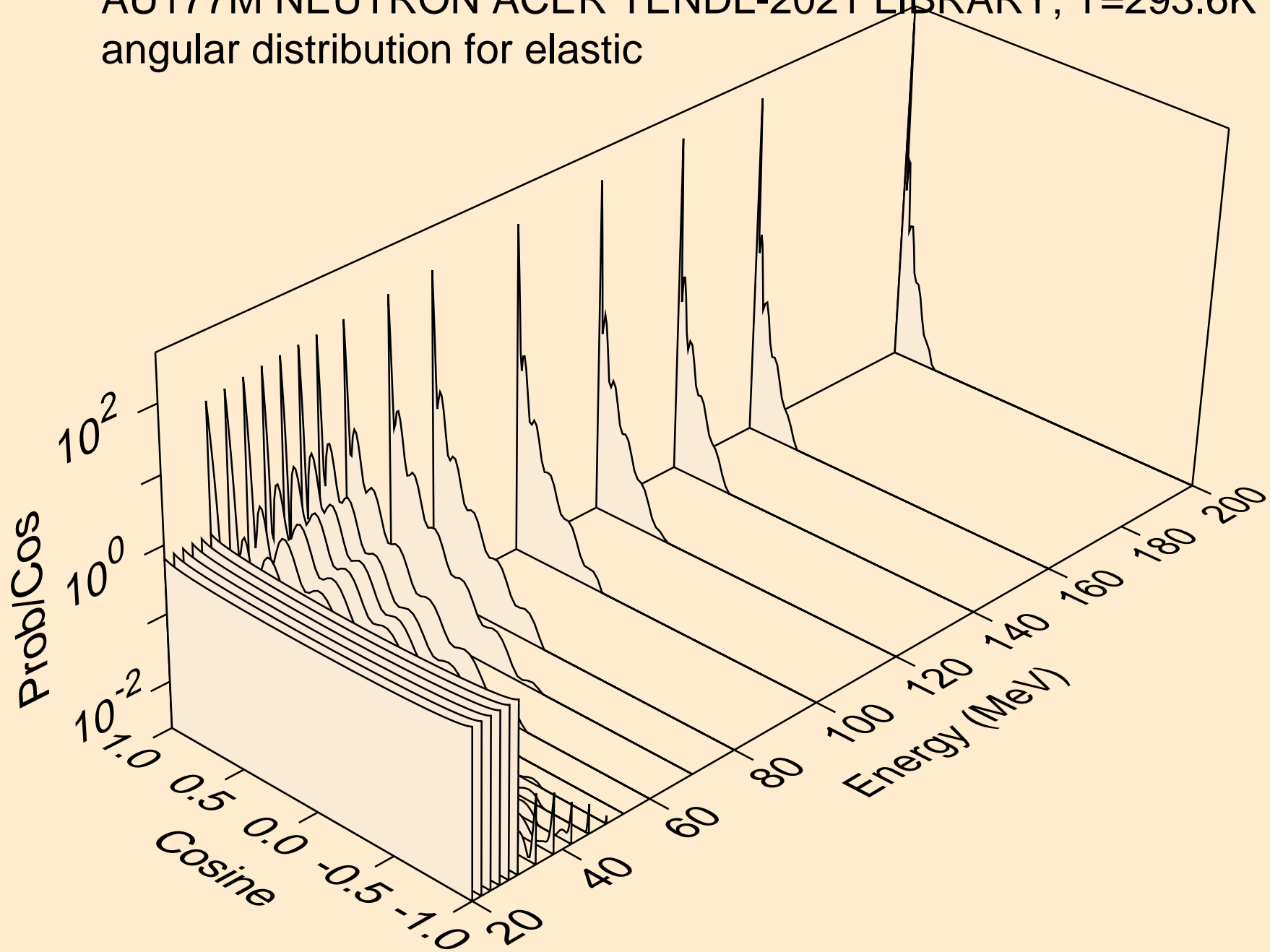

AU177M NEUTRON ACER TENDL-2021 LIBRARY; T=293.6K
angular distribution for (n,n*1)

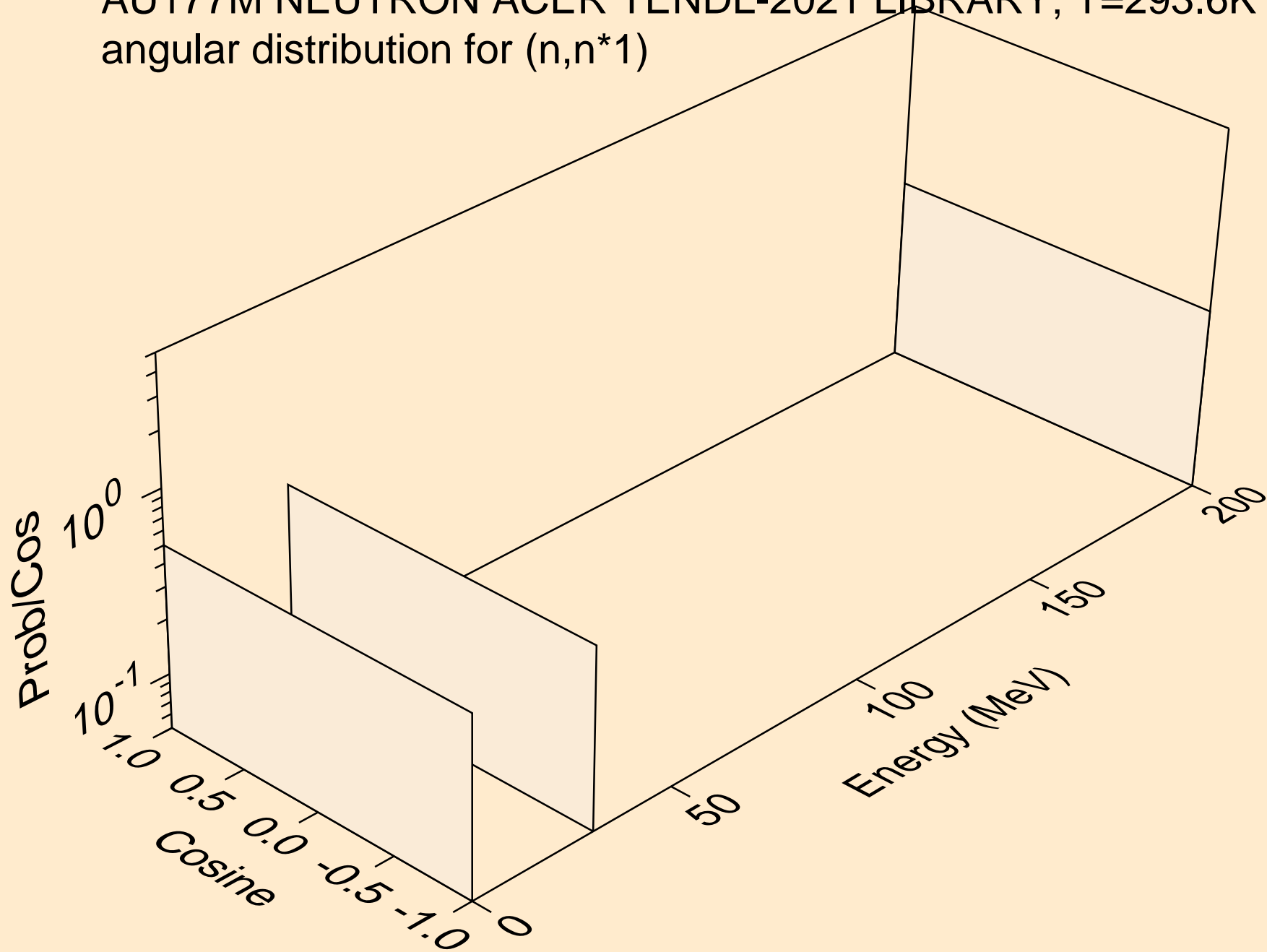

AU177M NEUTRON ACER TENDL-2021 LIBRARY; T=293.6K
angular distribution for (n,n*2)

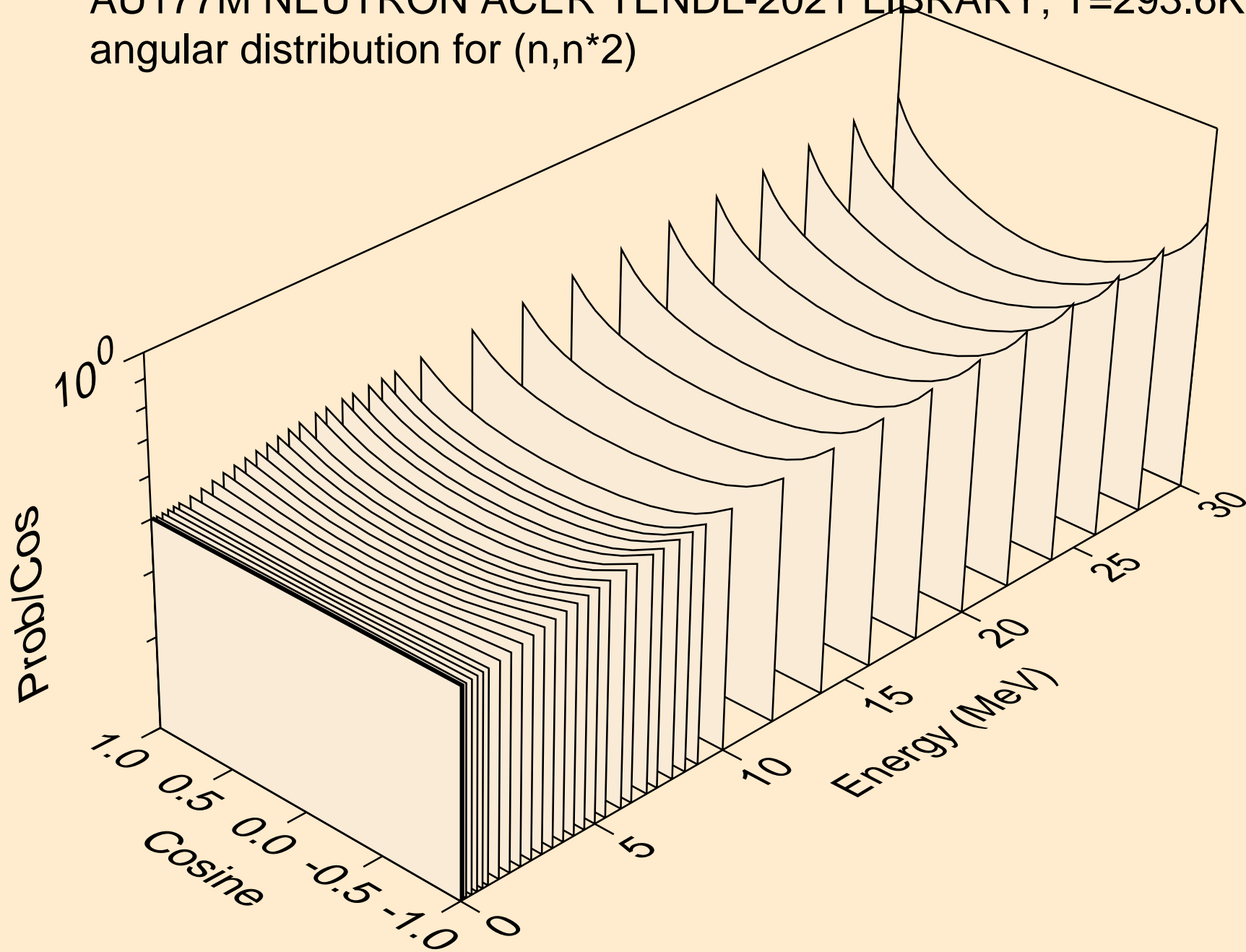

AU177M NEUTRON ACER TENDL-2021 LIBRARY; T=293.6K
Neutron emission for (n,x)

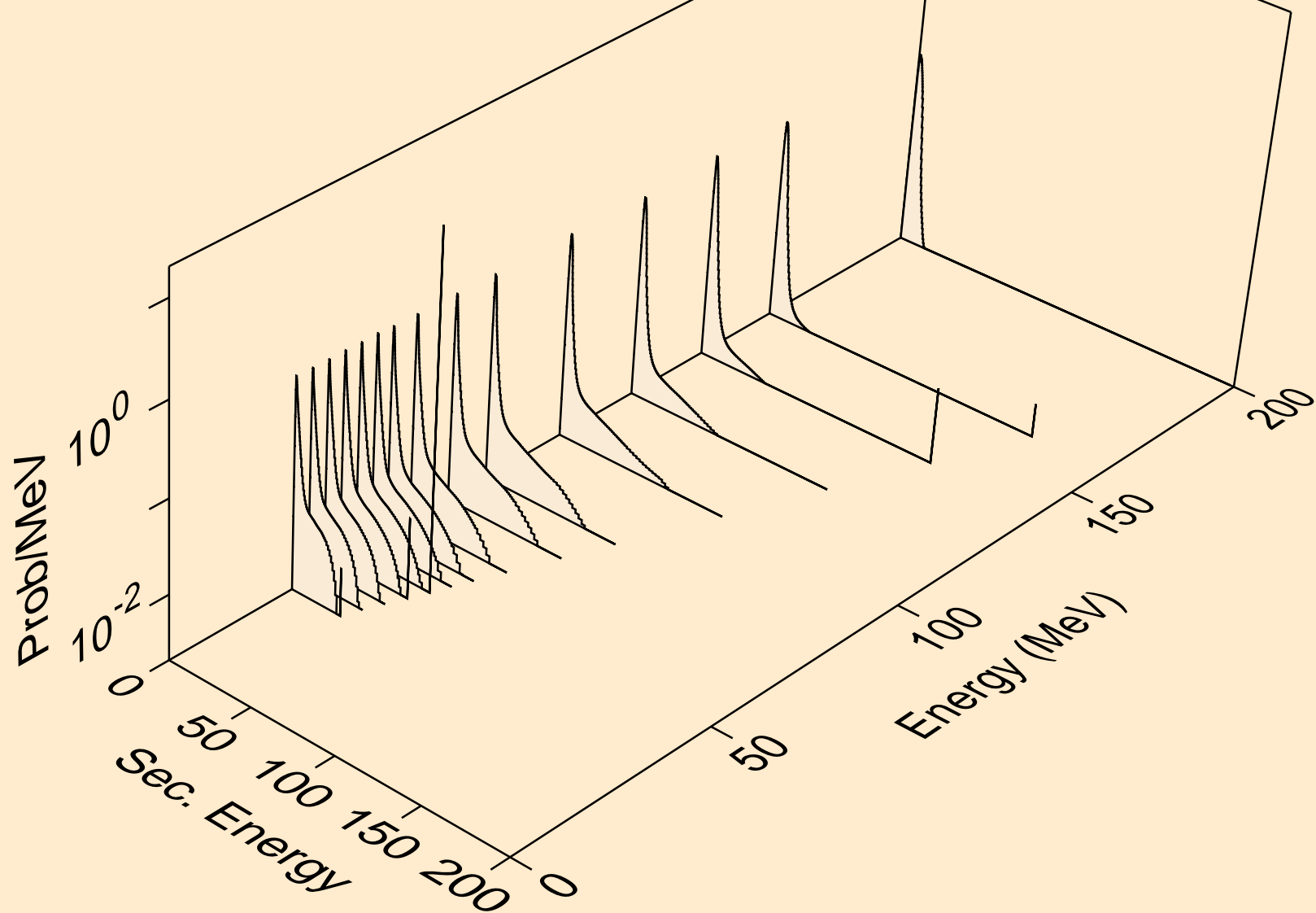

AU177M NEUTRON ACER TENDL-2021 LIBRARY; T=293.6K
Neutron emission for (n,2nd)

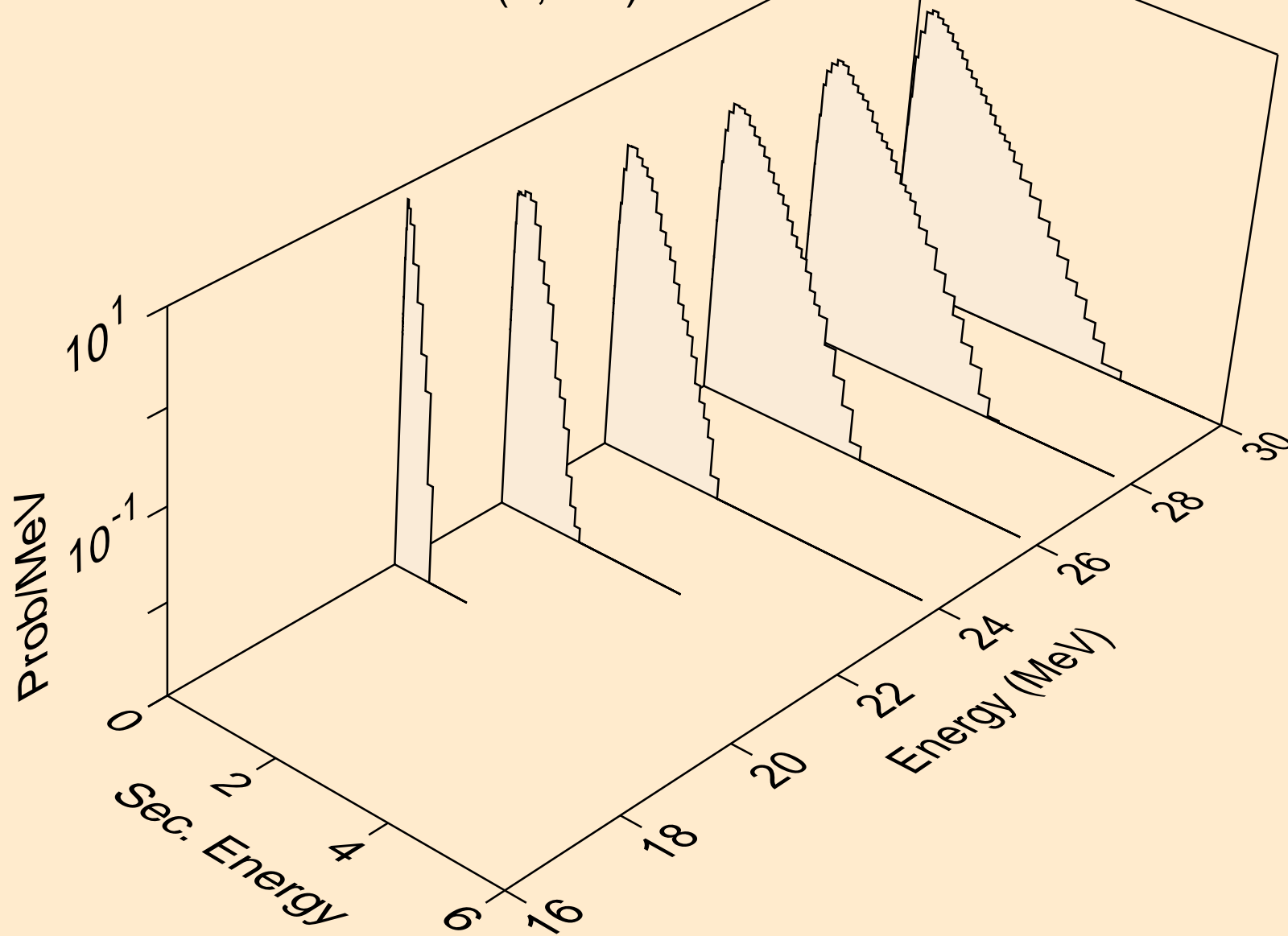

AU177M NEUTRON ACER TENDL-2021 LIBRARY; T=293.6K
Neutron emission for (n,2n)

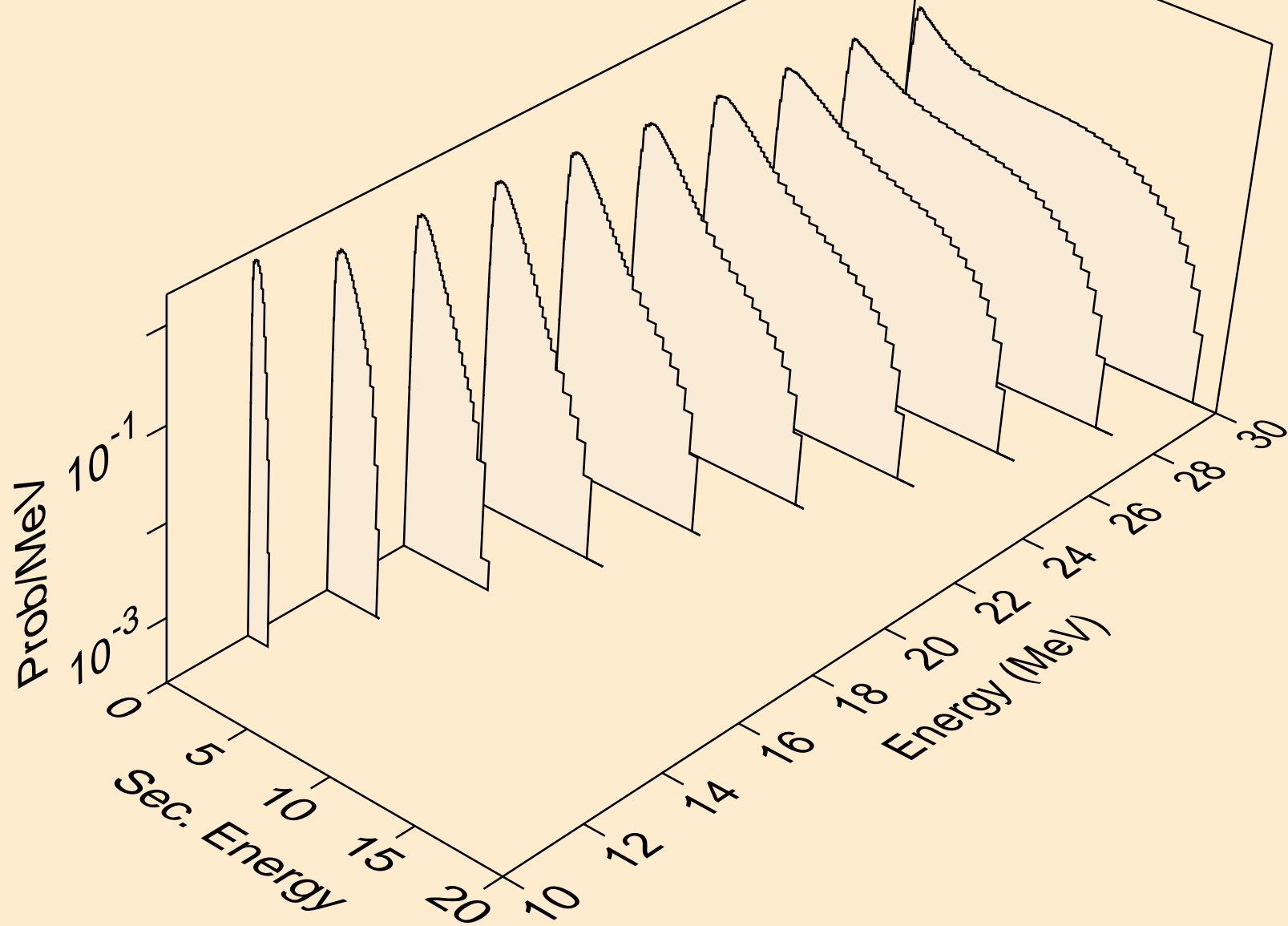

AU177M NEUTRON ACER TENDL-2021 LIBRARY; T=293.6K
Neutron emission for (n,3n)

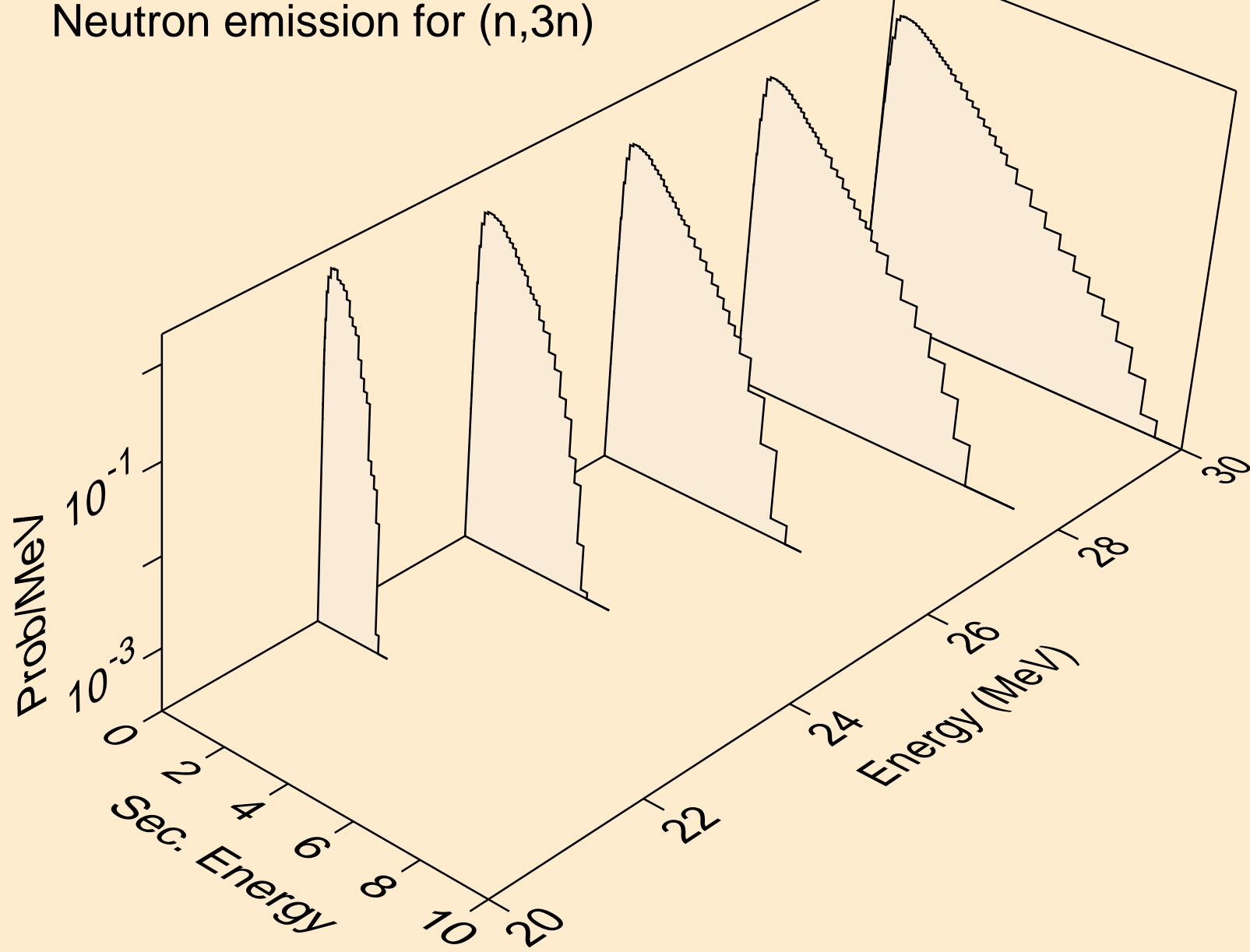

AU177M NEUTRON ACER TENDL-2021 LIBRARY; T=293.6K
Neutron emission for (n,n*)a

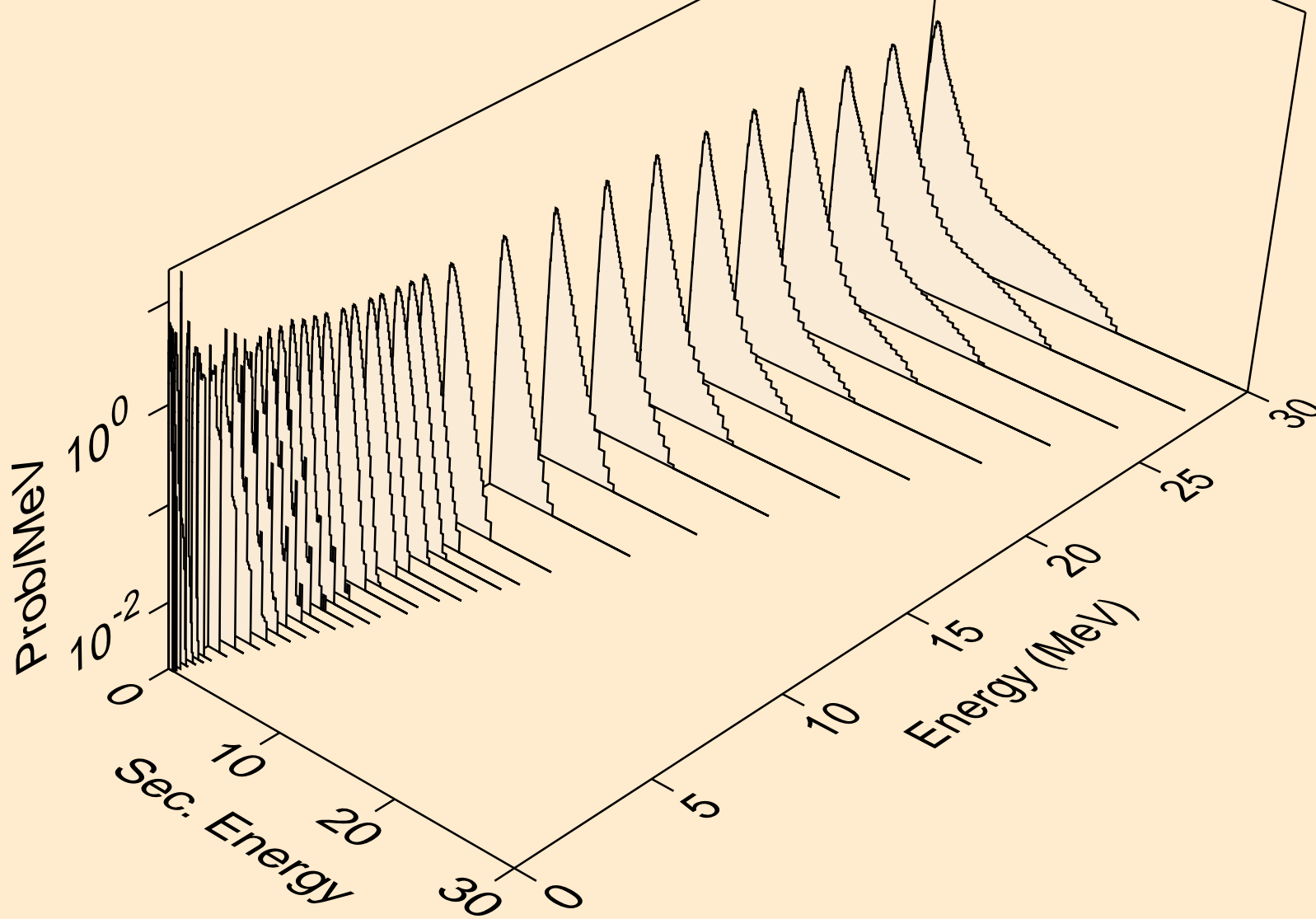

AU177M NEUTRON ACER TENDL-2021 LIBRARY; T=293.6K
Neutron emission for (n,n*)3a

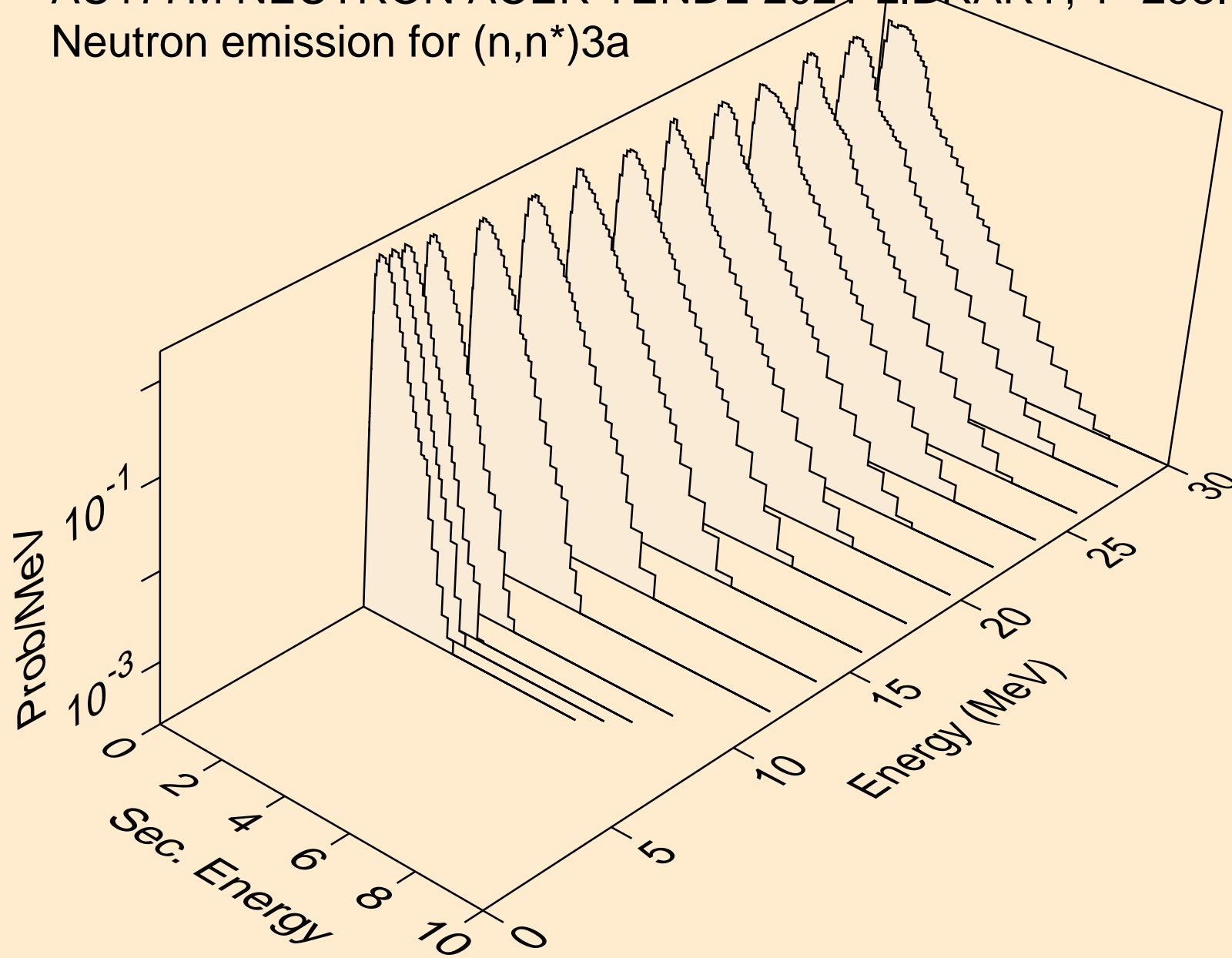

AU177M NEUTRON ACER TENDL-2021 LIBRARY; T=293.6K
Neutron emission for (n,2n)a

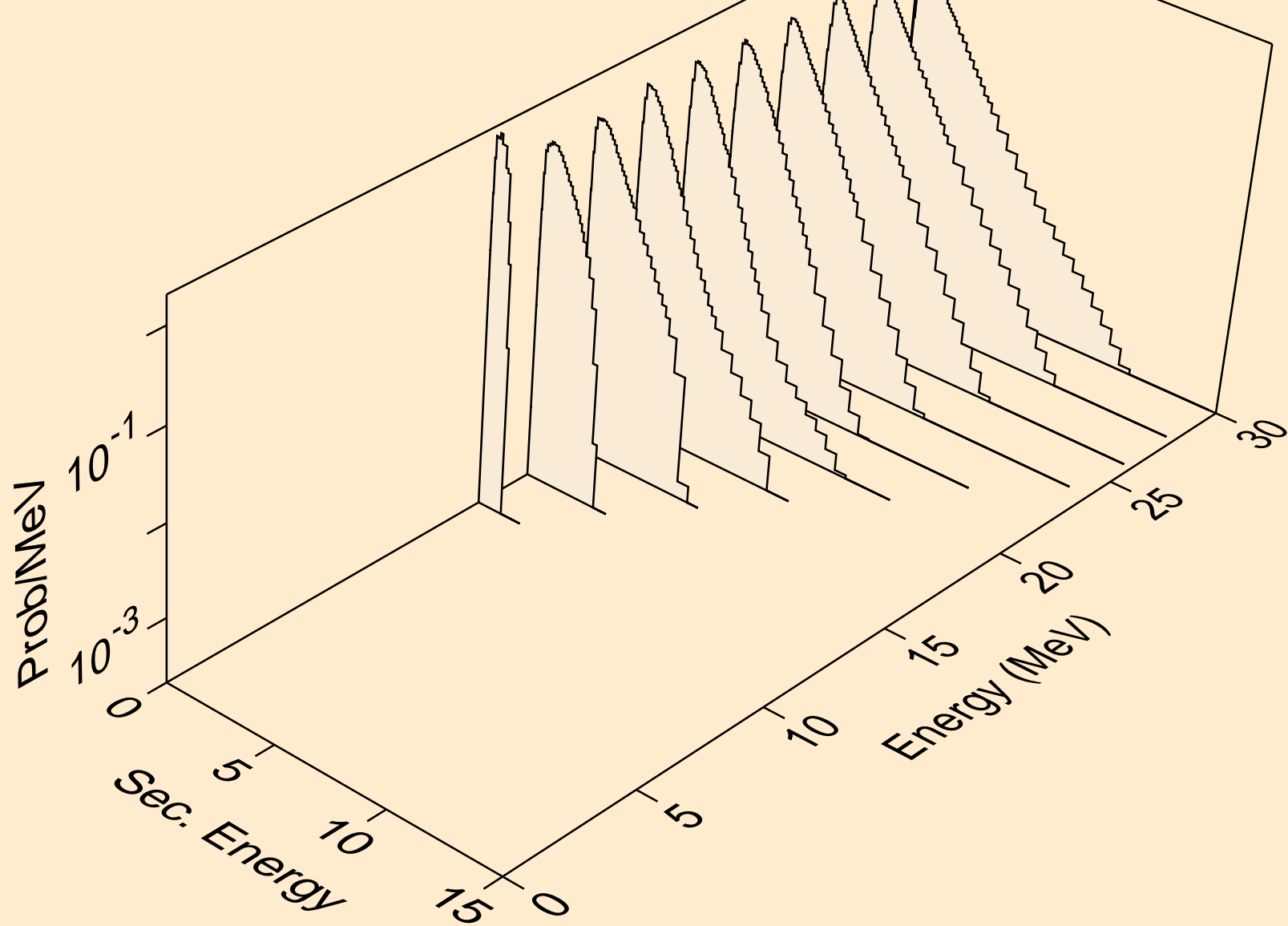

AU177M NEUTRON ACER TENDL-2021 LIBRARY; T=293.6K
Neutron emission for (n,3n)a

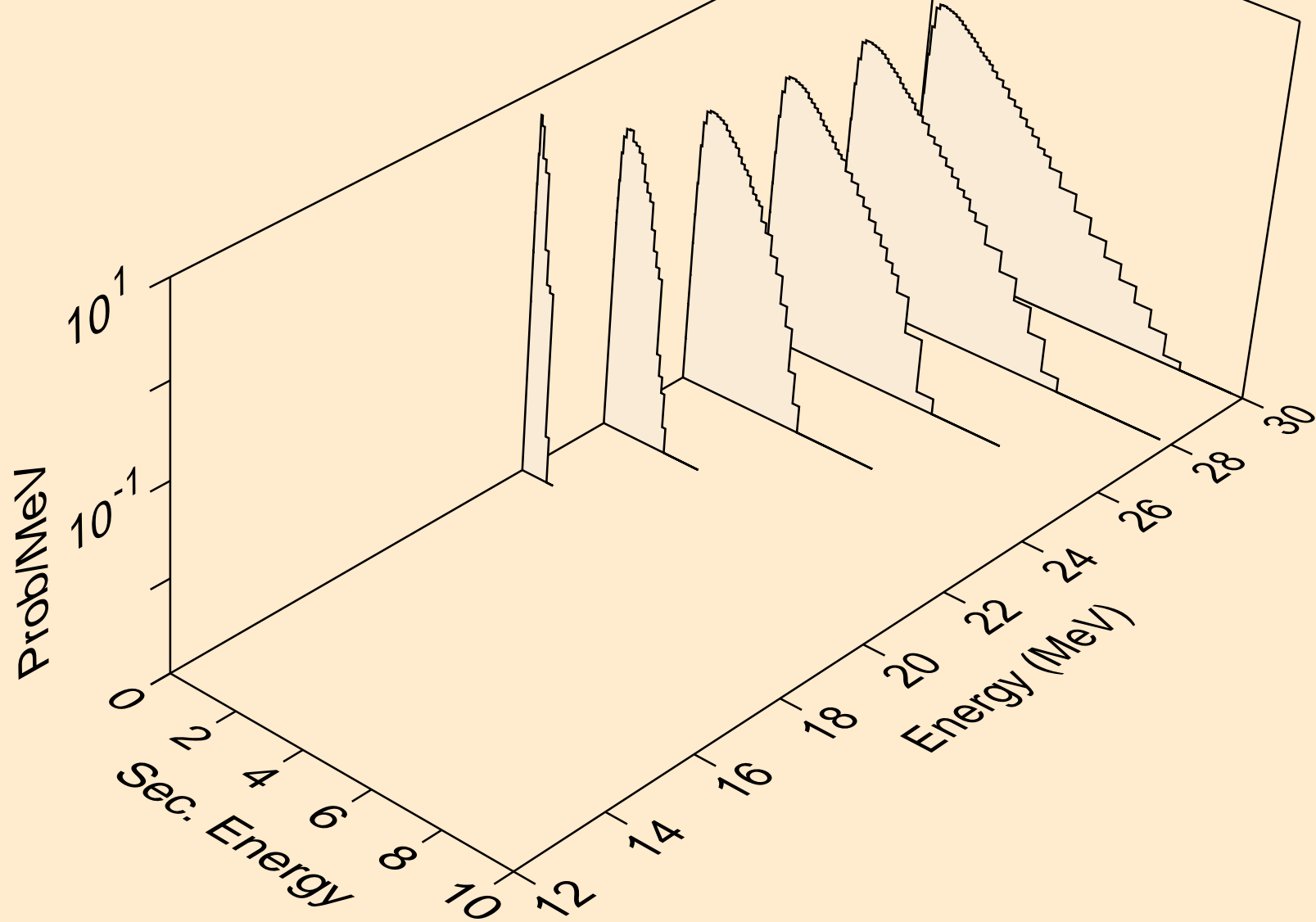

AU177M NEUTRON ACER TENDL-2021 LIBRARY; T=293.6K
Neutron emission for (n,n*)p

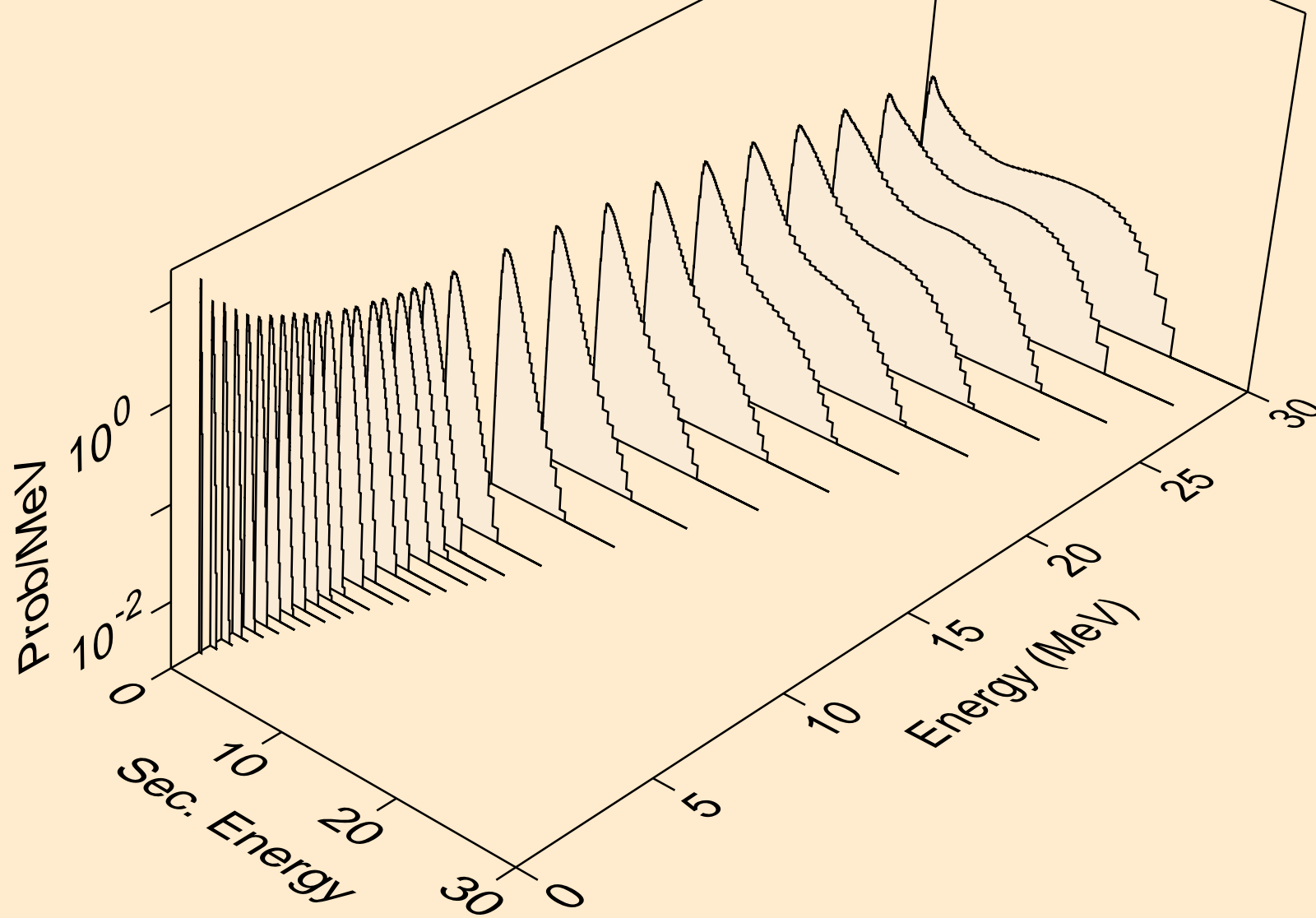

AU177M NEUTRON ACER TENDL-2021 LIBRARY; T=293.6K
Neutron emission for (n,n*)2a

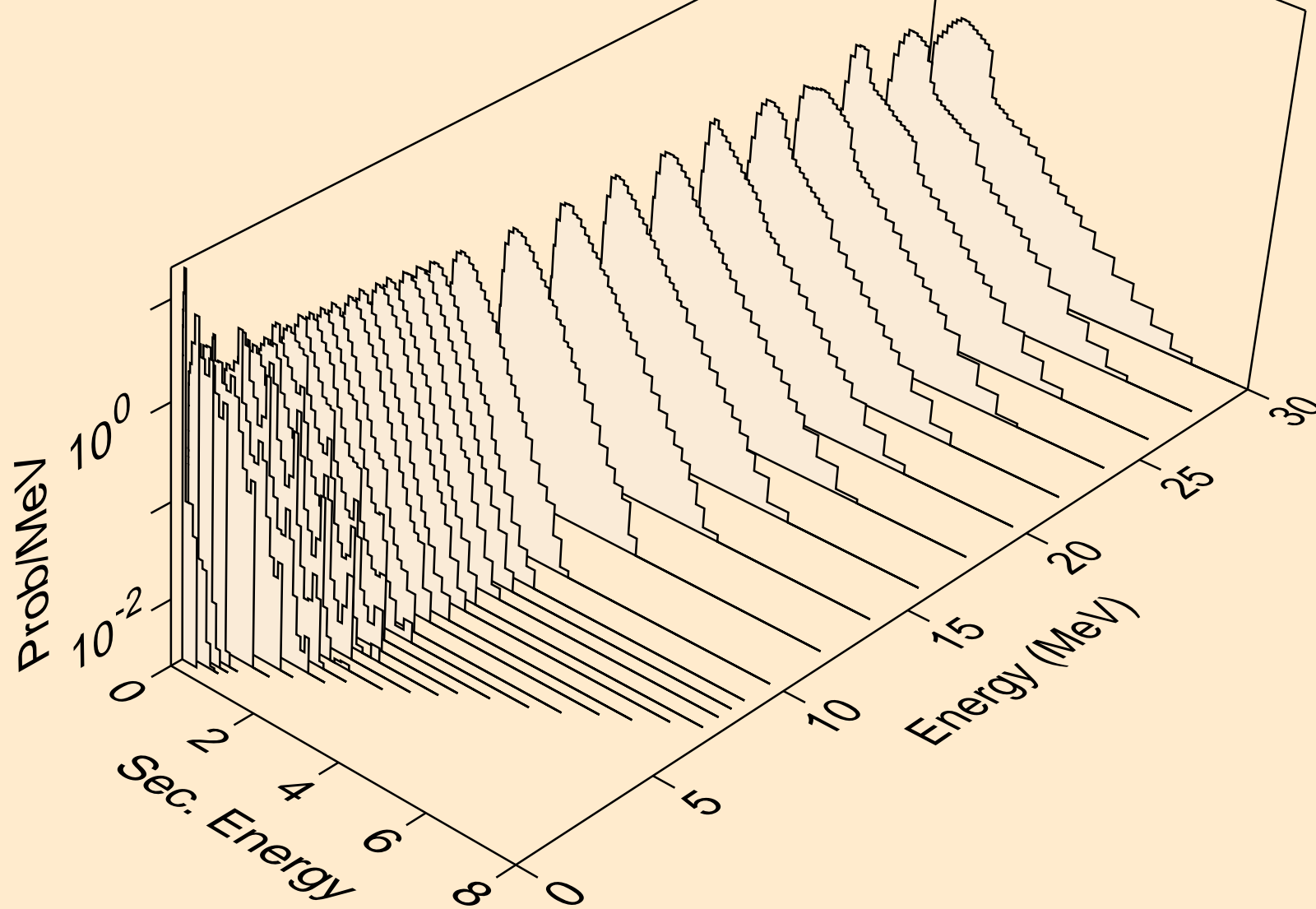

AU177M NEUTRON ACER TENDL-2021 LIBRARY; T=293.6K
Neutron emission for (n,2n)2a

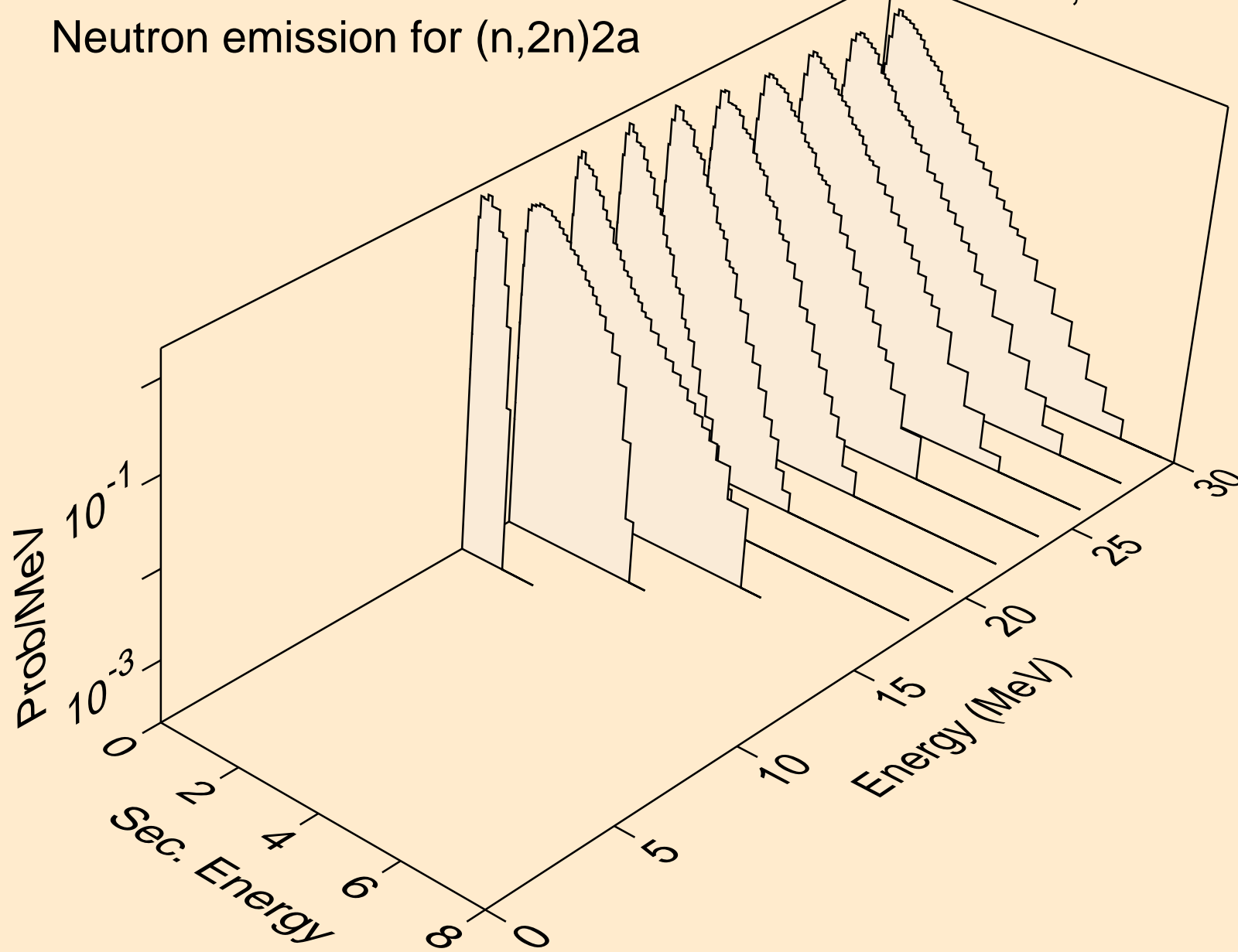

AU177M NEUTRON ACER TENDL-2021 LIBRARY; T=293.6K
Neutron emission for (n,n*)d

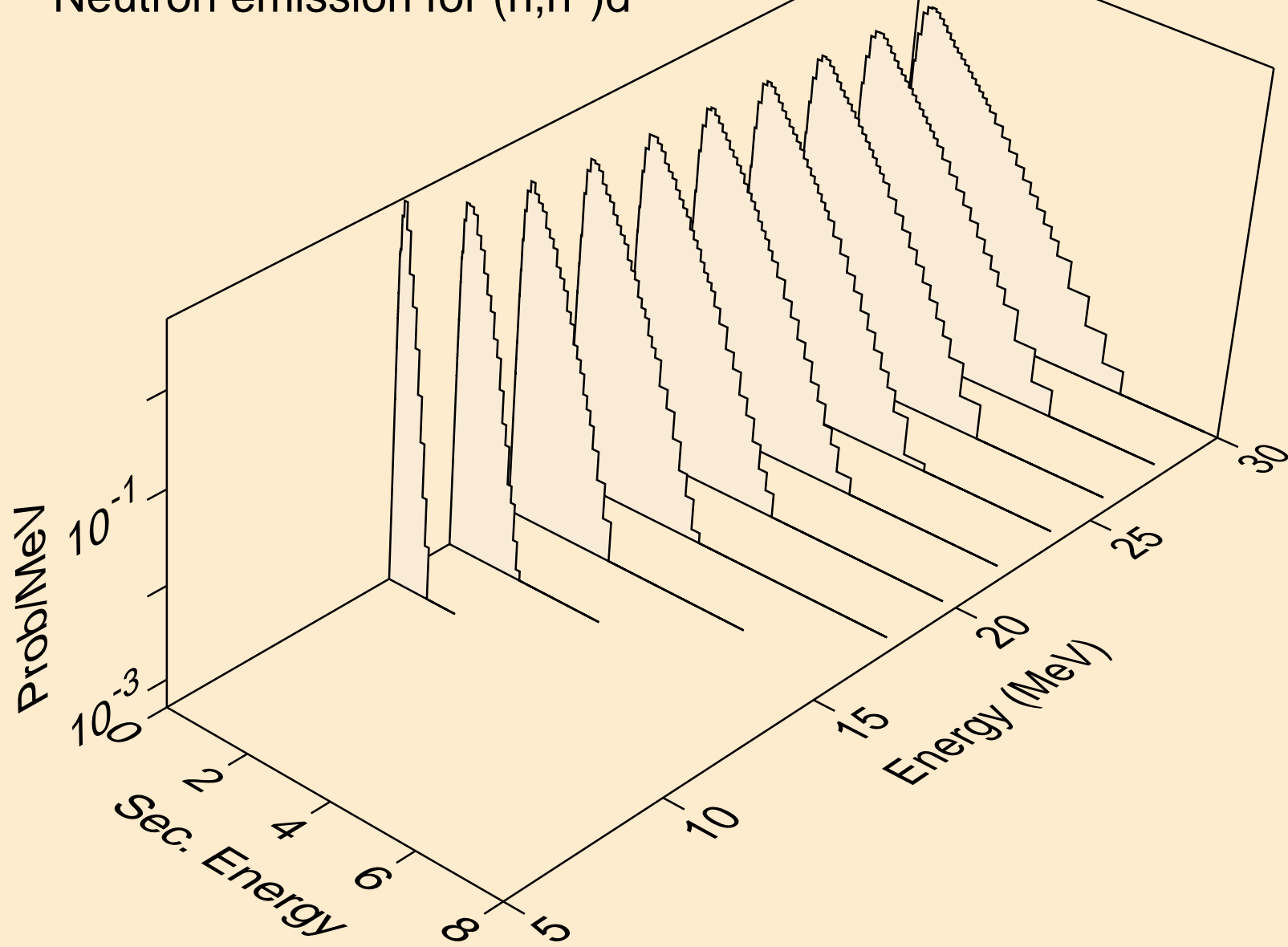

AU177M NEUTRON ACER TENDL-2021 LIBRARY; T=293.6K
Neutron emission for (n,n*)t

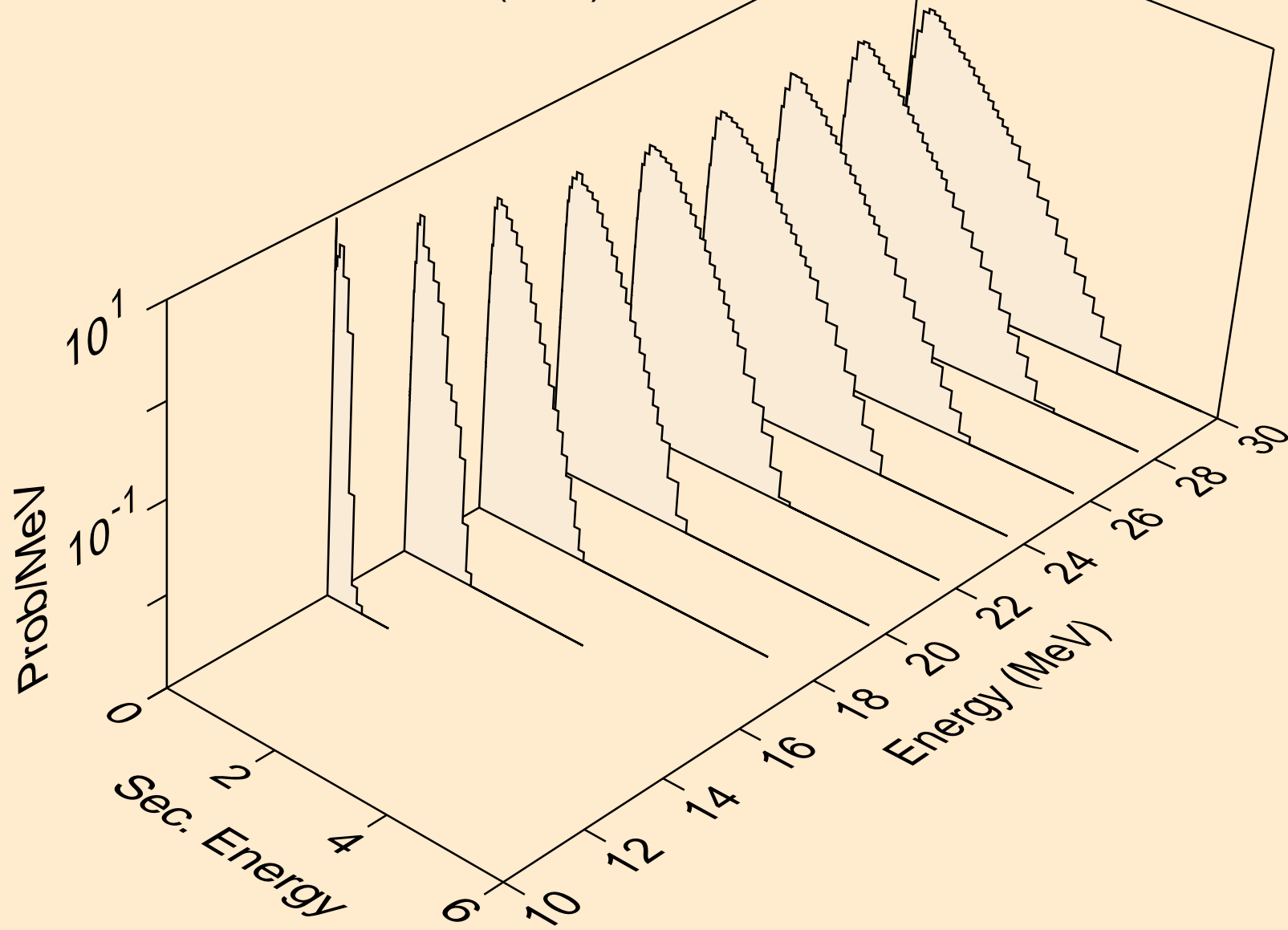

AU177M NEUTRON ACER TENDL-2021 LIBRARY; T=293.6K
Neutron emission for (n,n*)he3

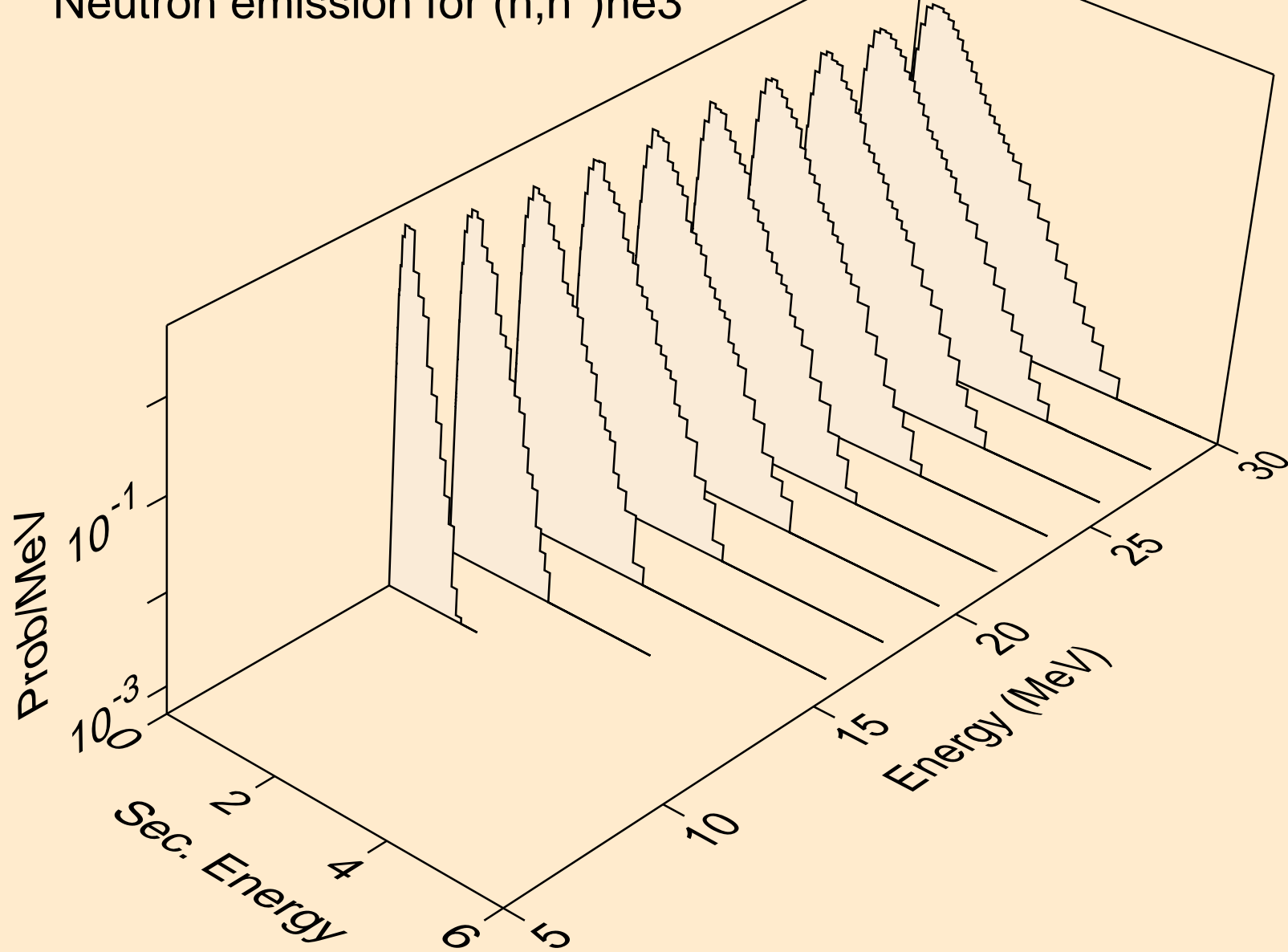

AU177M NEUTRON ACER TENDL-2021 LIBRARY; T=293.6K
Neutron emission for (n,2np)

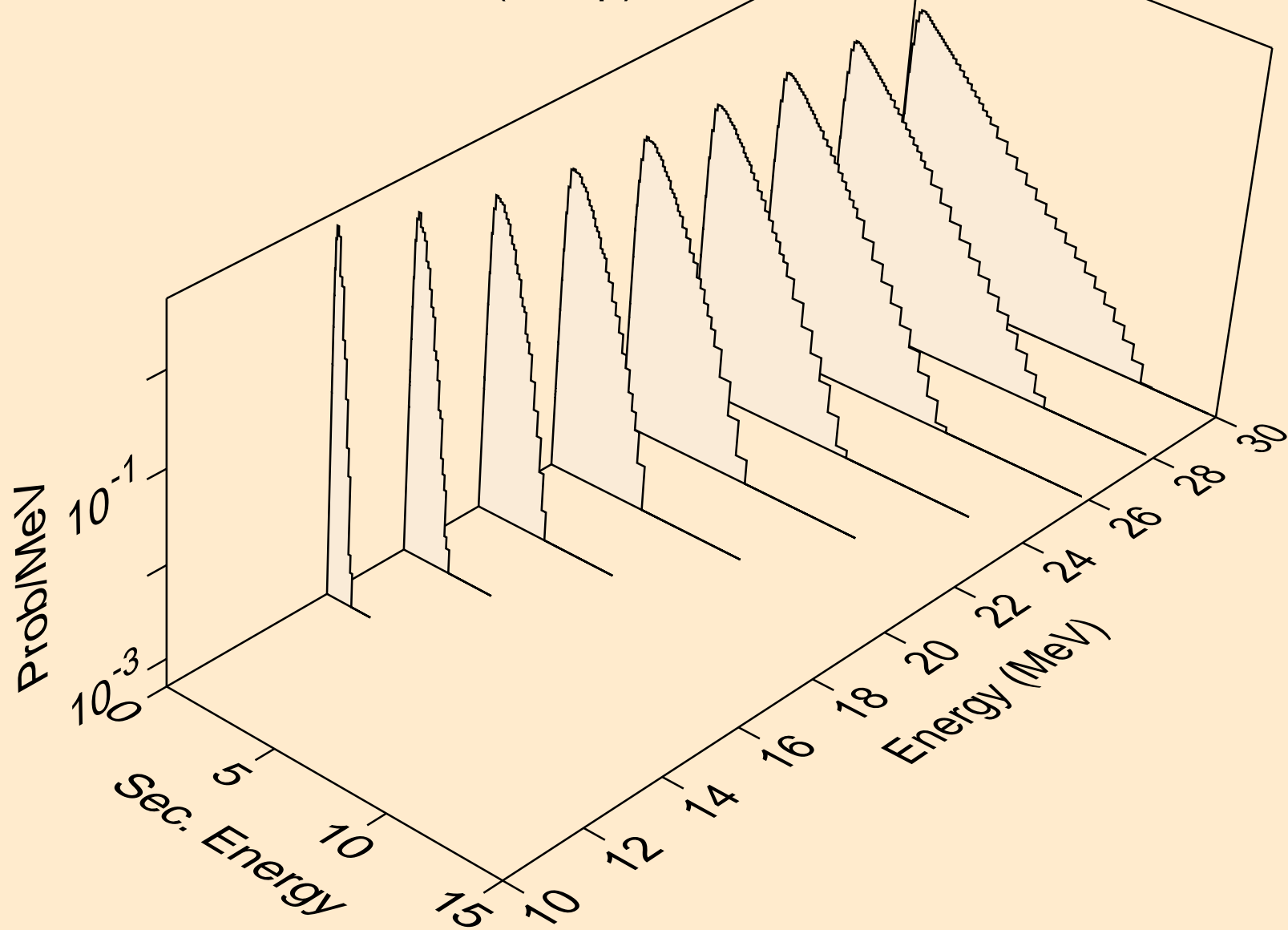

AU177M NEUTRON ACER TENDL-2021 LIBRARY; T=293.6K
Neutron emission for (n,3np)

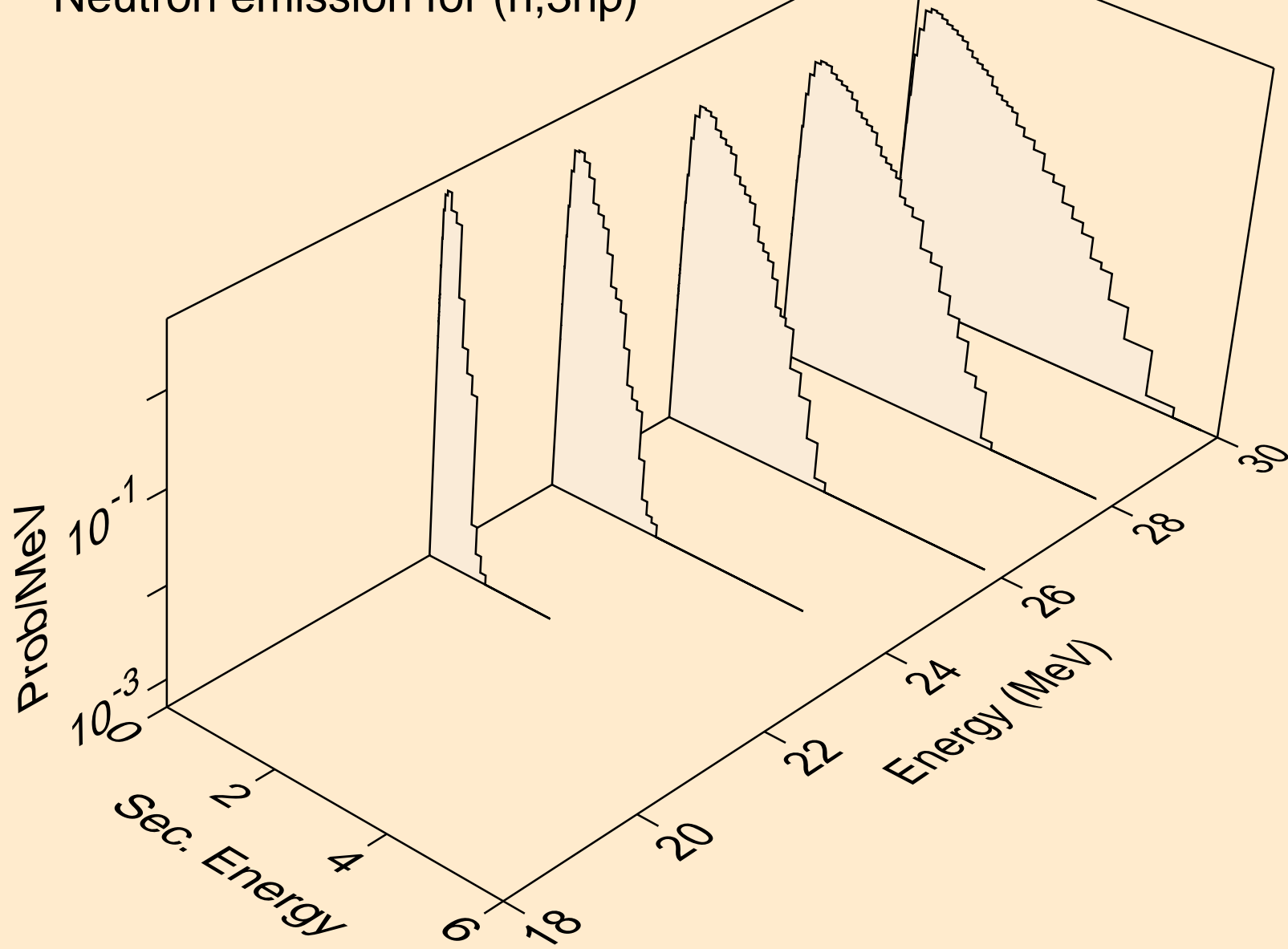

AU177M NEUTRON ACER TENDL-2021 LIBRARY; T=293.6K
Neutron emission for (n,2np)

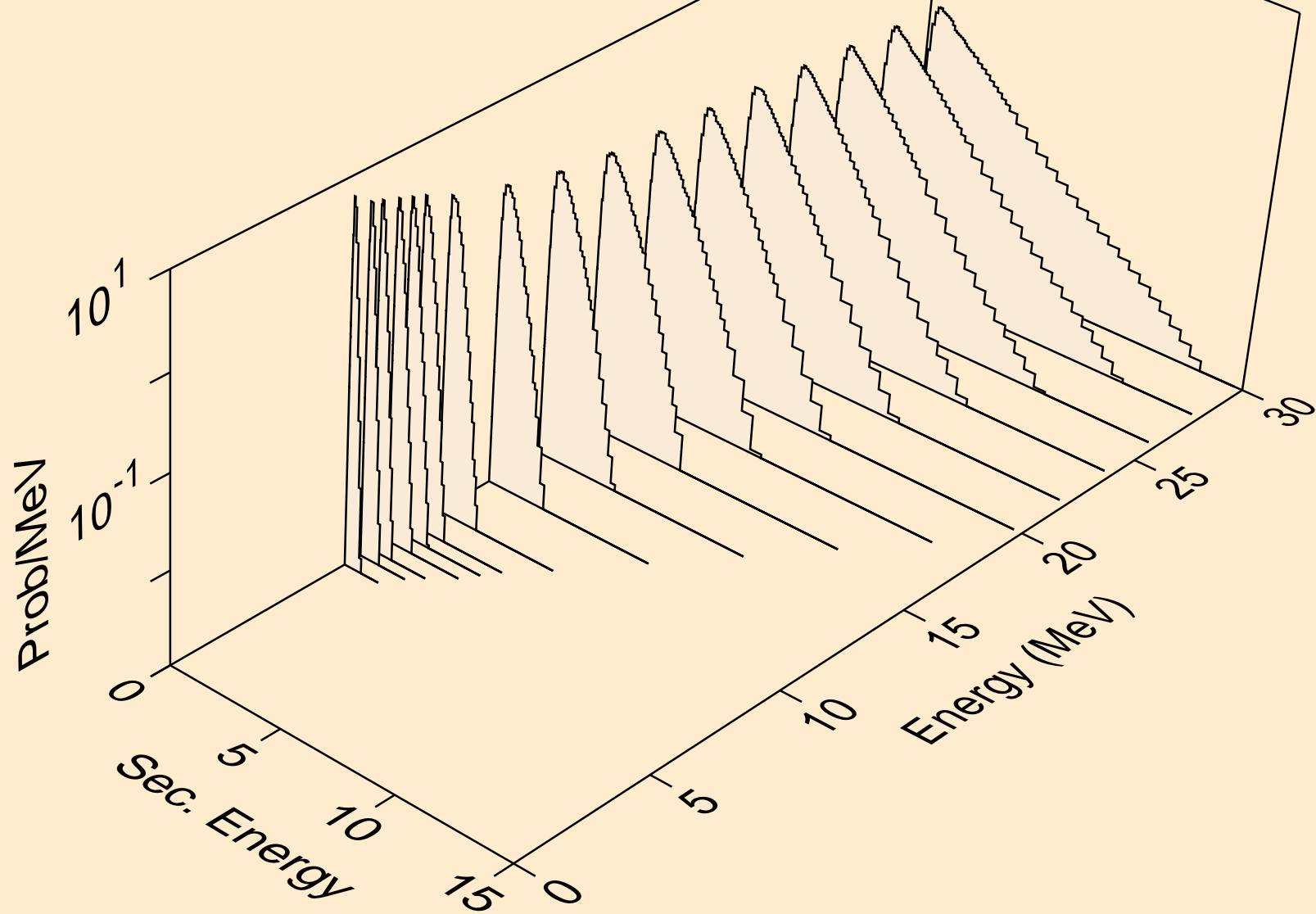

AU177M NEUTRON ACER TENDL-2021 LIBRARY; T=293.6K
Neutron emission for (n,npa)

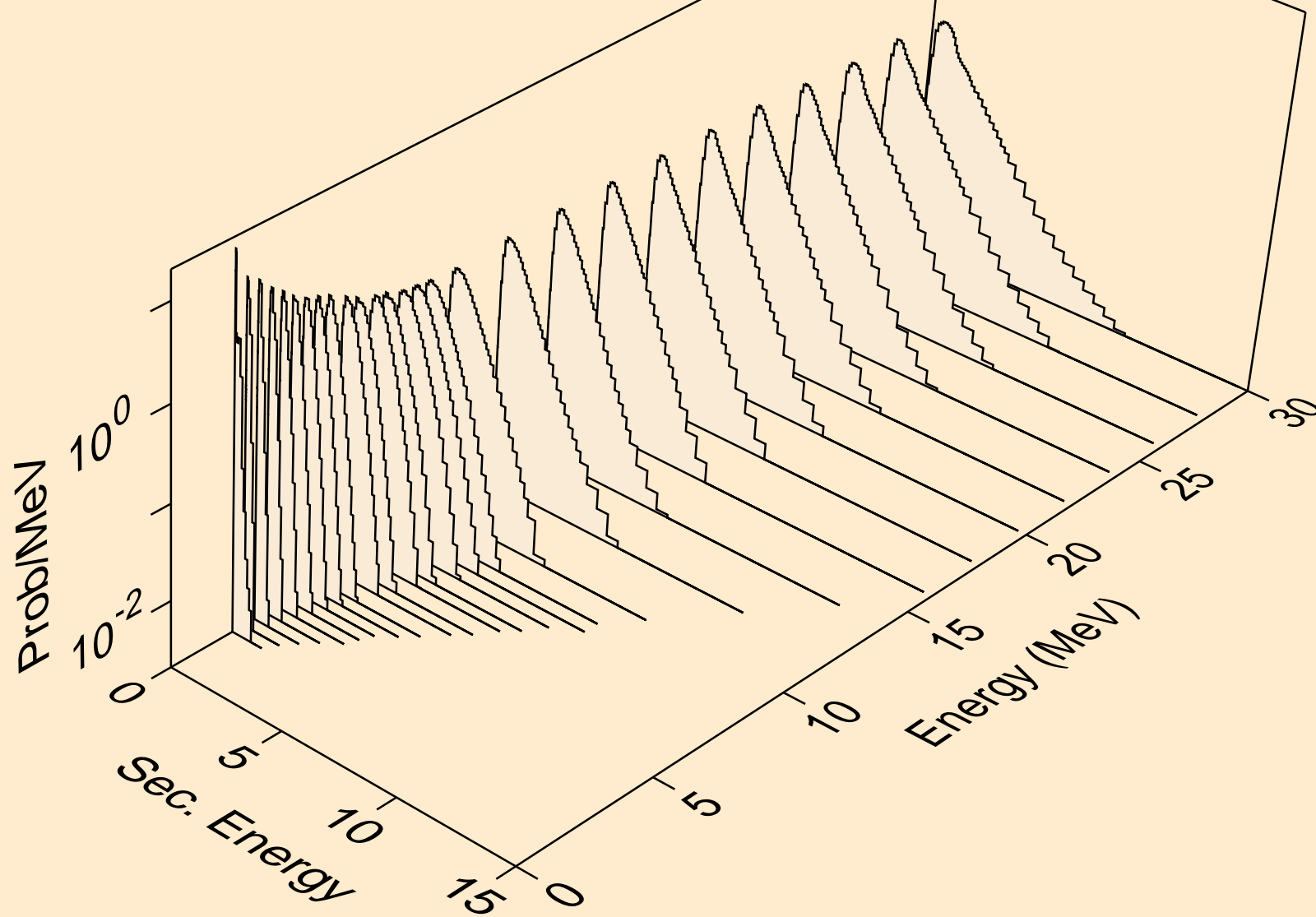

AU177M NEUTRON ACER TENDL-2021 LIBRARY; T=293.6K
Neutron emission for (n,n*c)

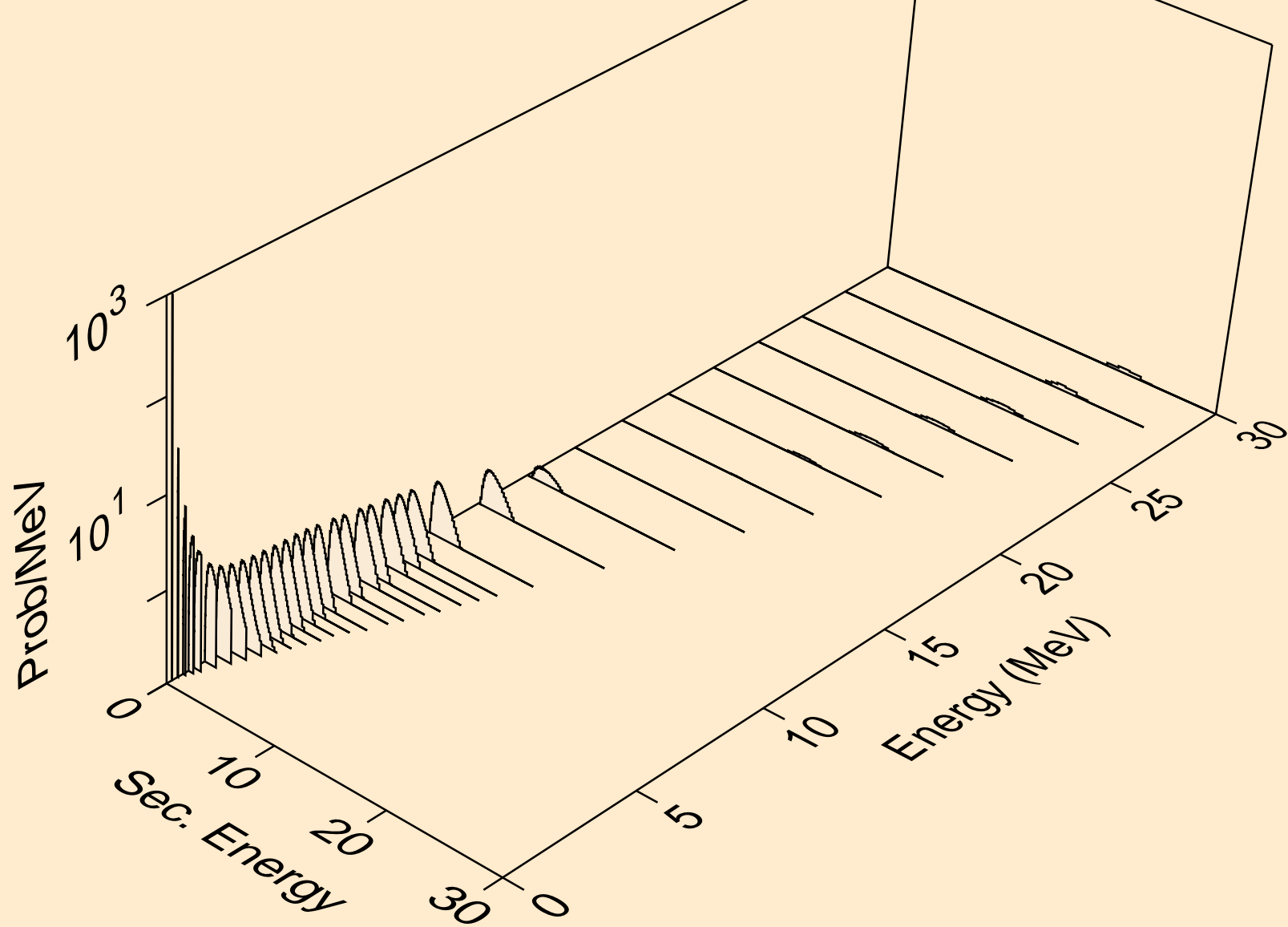

AU177M NEUTRON ACER TENDL-2021 LIBRARY; T=293.6K
Photon emission for (n,x)

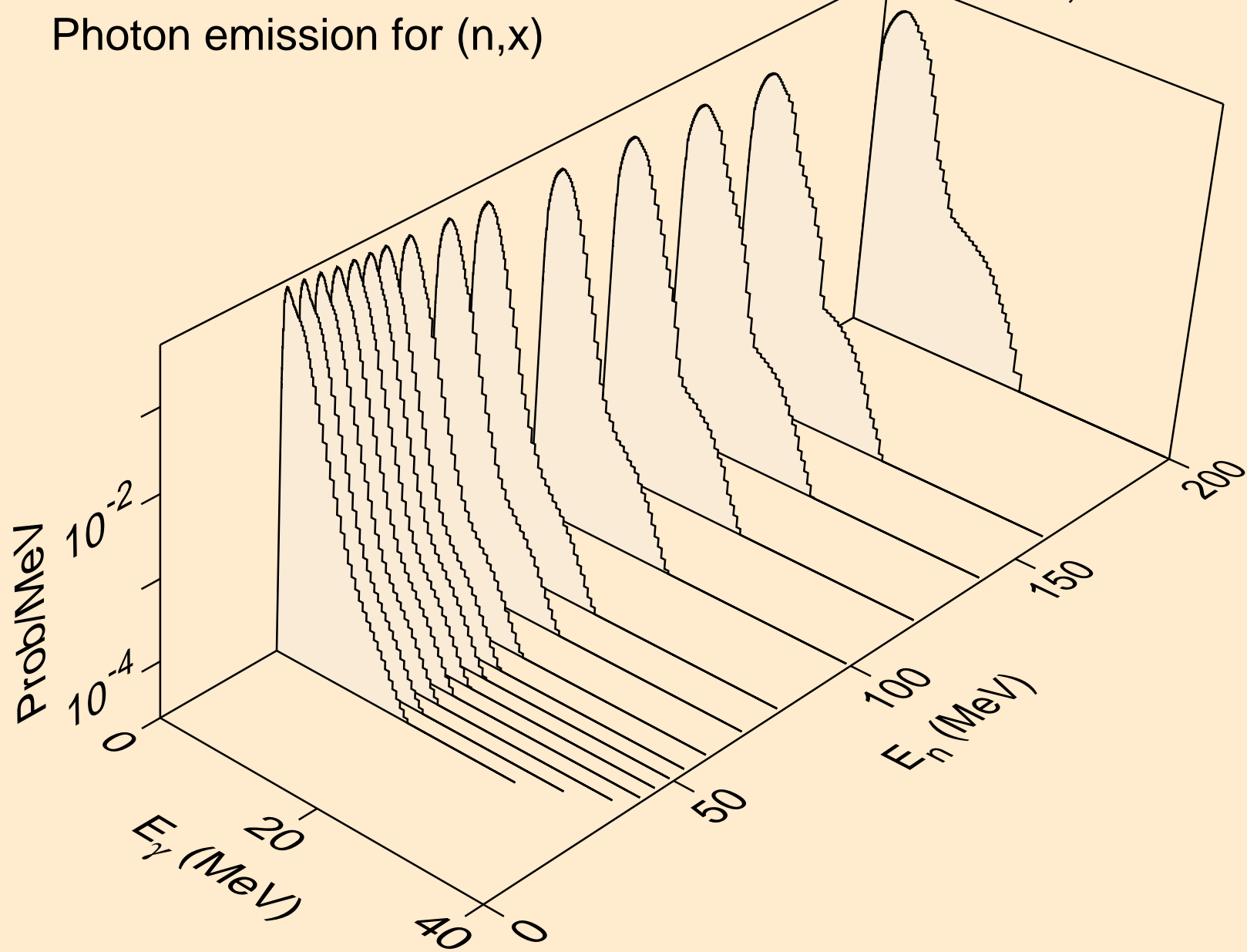

AU177M NEUTRON ACER TENDL-2021 LIBRARY; T=293.6K
Photon emission for (n,2nd)

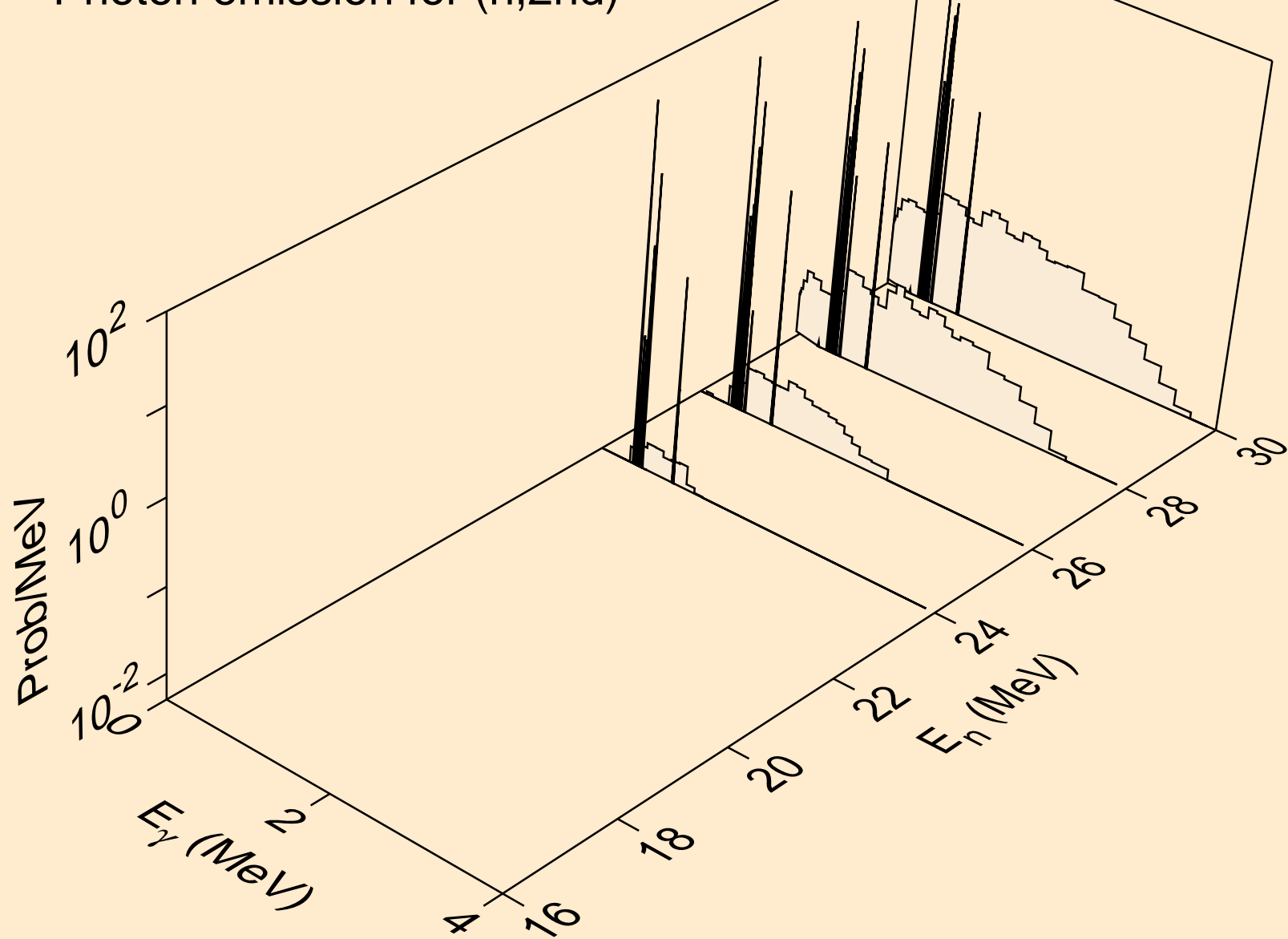

AU177M NEUTRON ACER TENDL-2021 LIBRARY; T=293.6K
Photon emission for (n,2n)

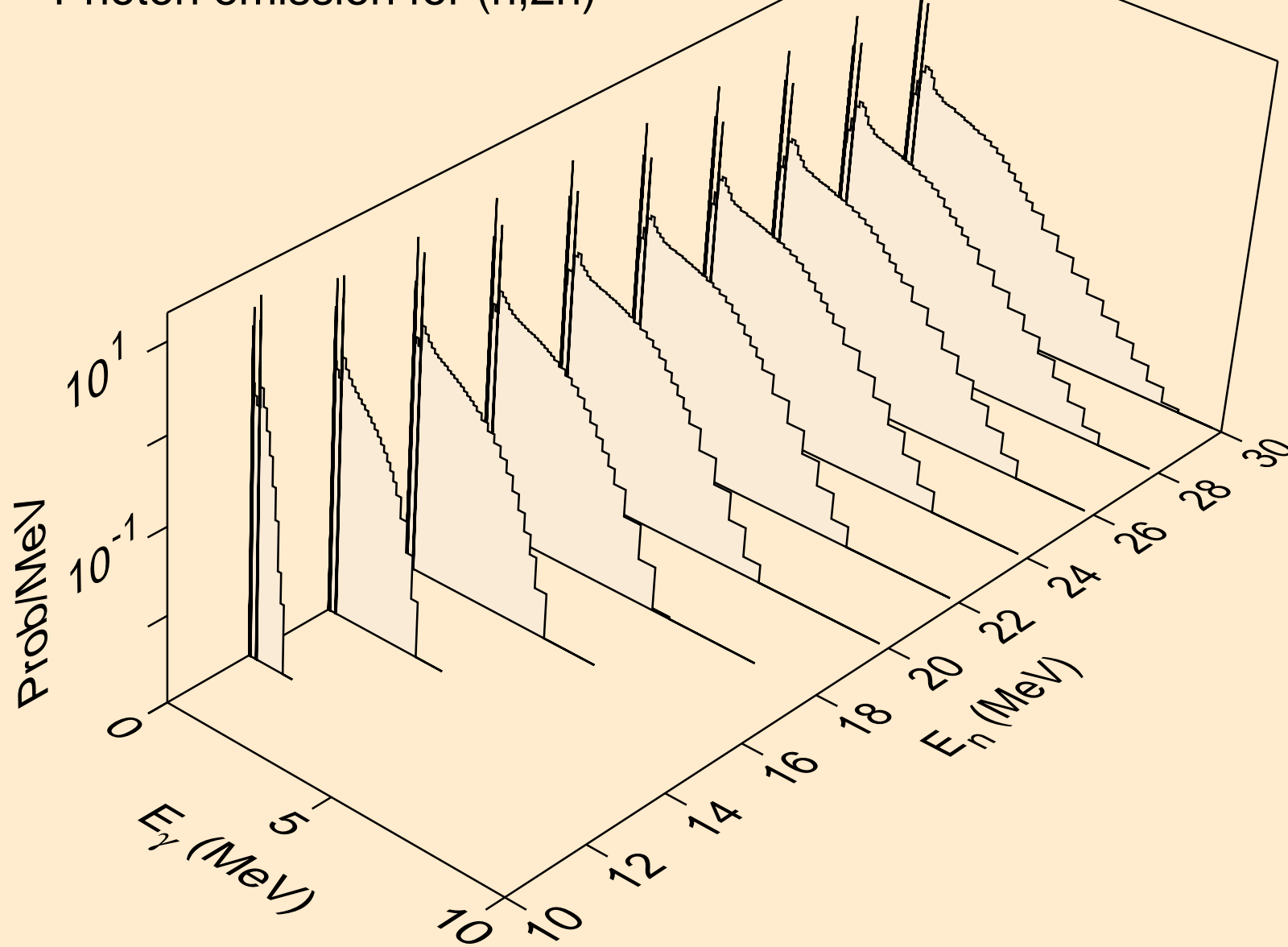

AU177M NEUTRON ACER TENDL-2021 LIBRARY; T=293.6K
Photon emission for (n,3n)

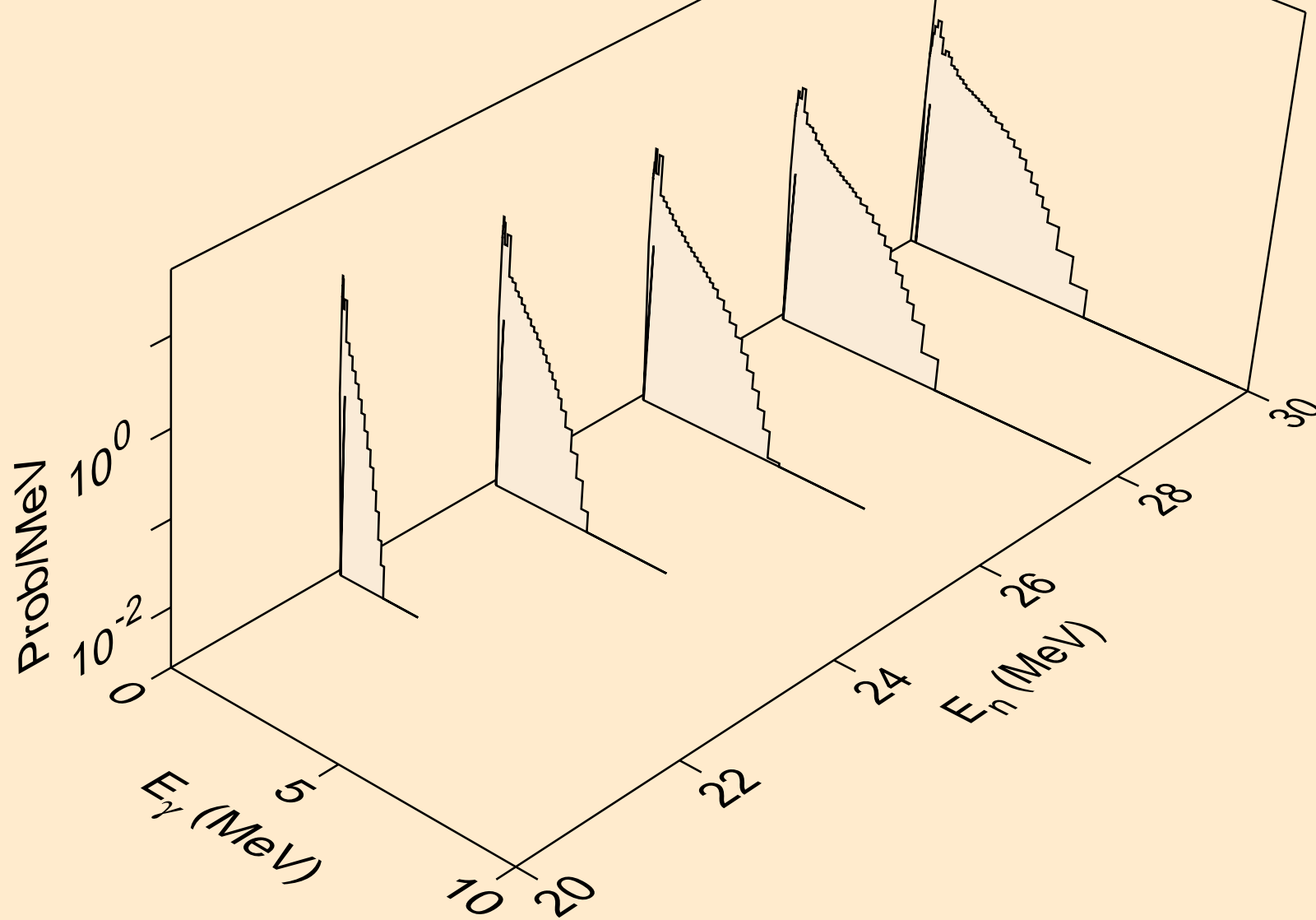

AU177M NEUTRON ACER TENDL-2021 LIBRARY; T=293.6K
Photon emission for (n,n*)a

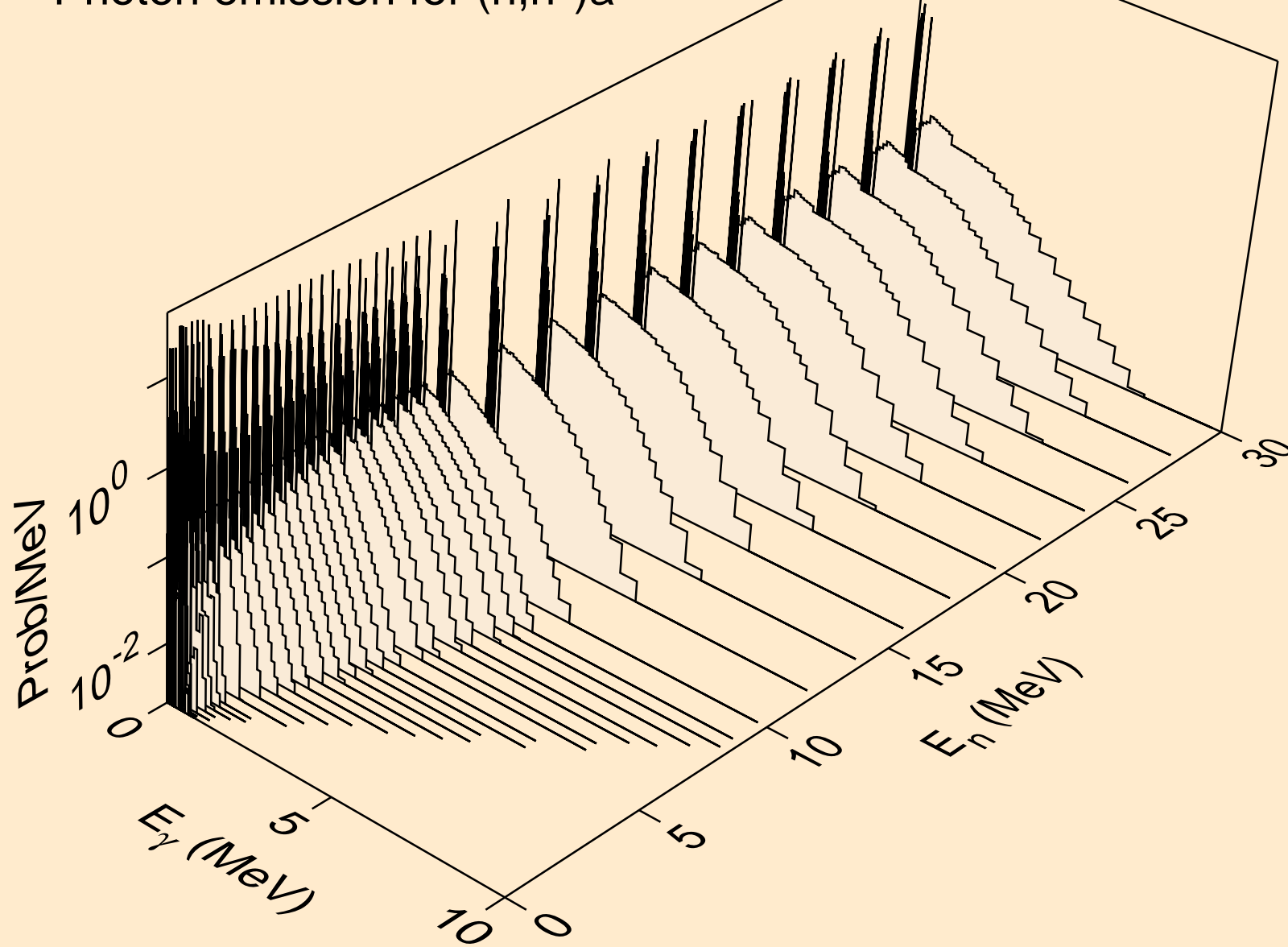

AU177M NEUTRON ACER TENDL-2021 LIBRARY; T=293.6K
Photon emission for (n,n*)3a

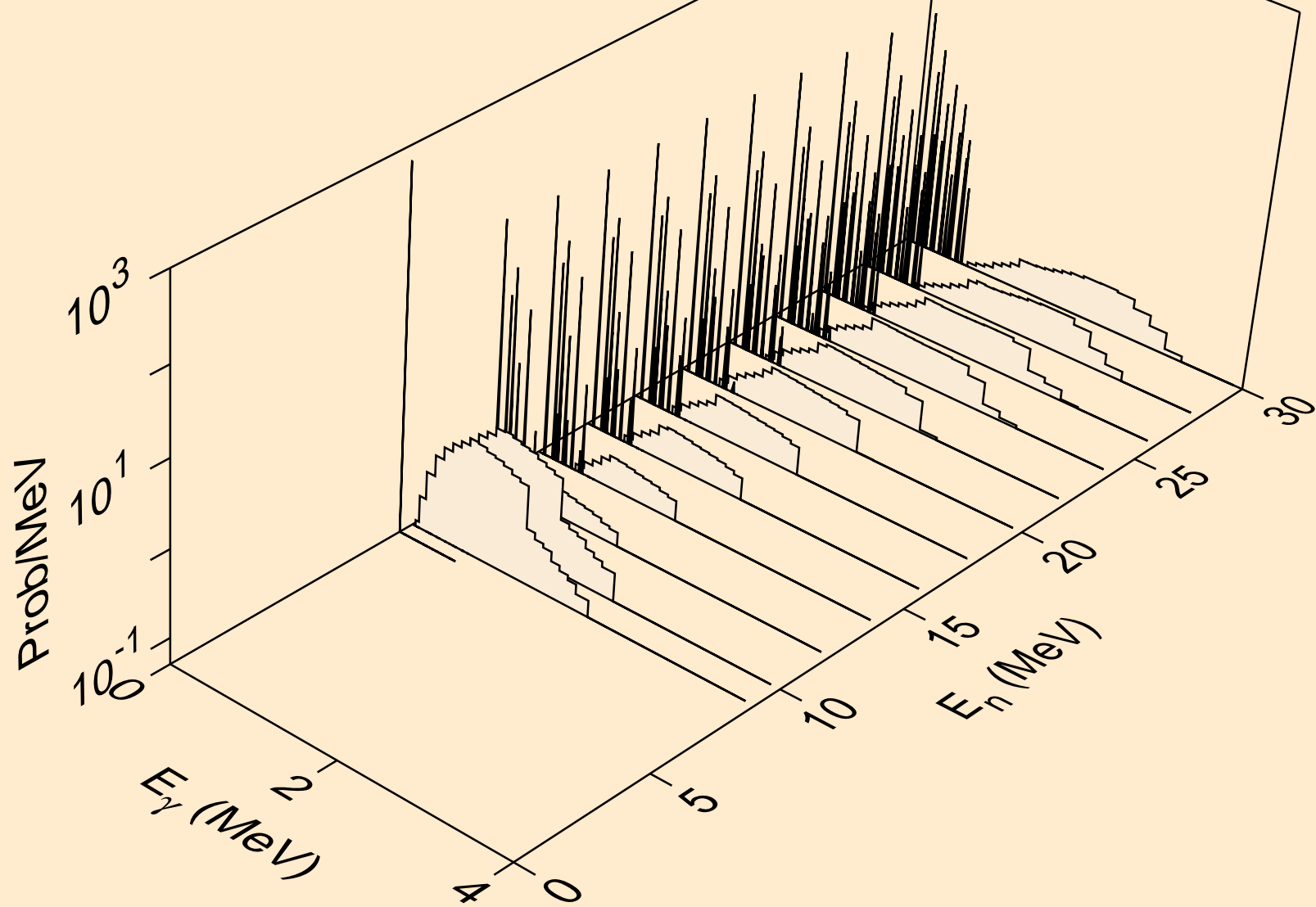

AU177M NEUTRON ACER TENDL-2021 LIBRARY; T=293.6K
Photon emission for (n,2n)a

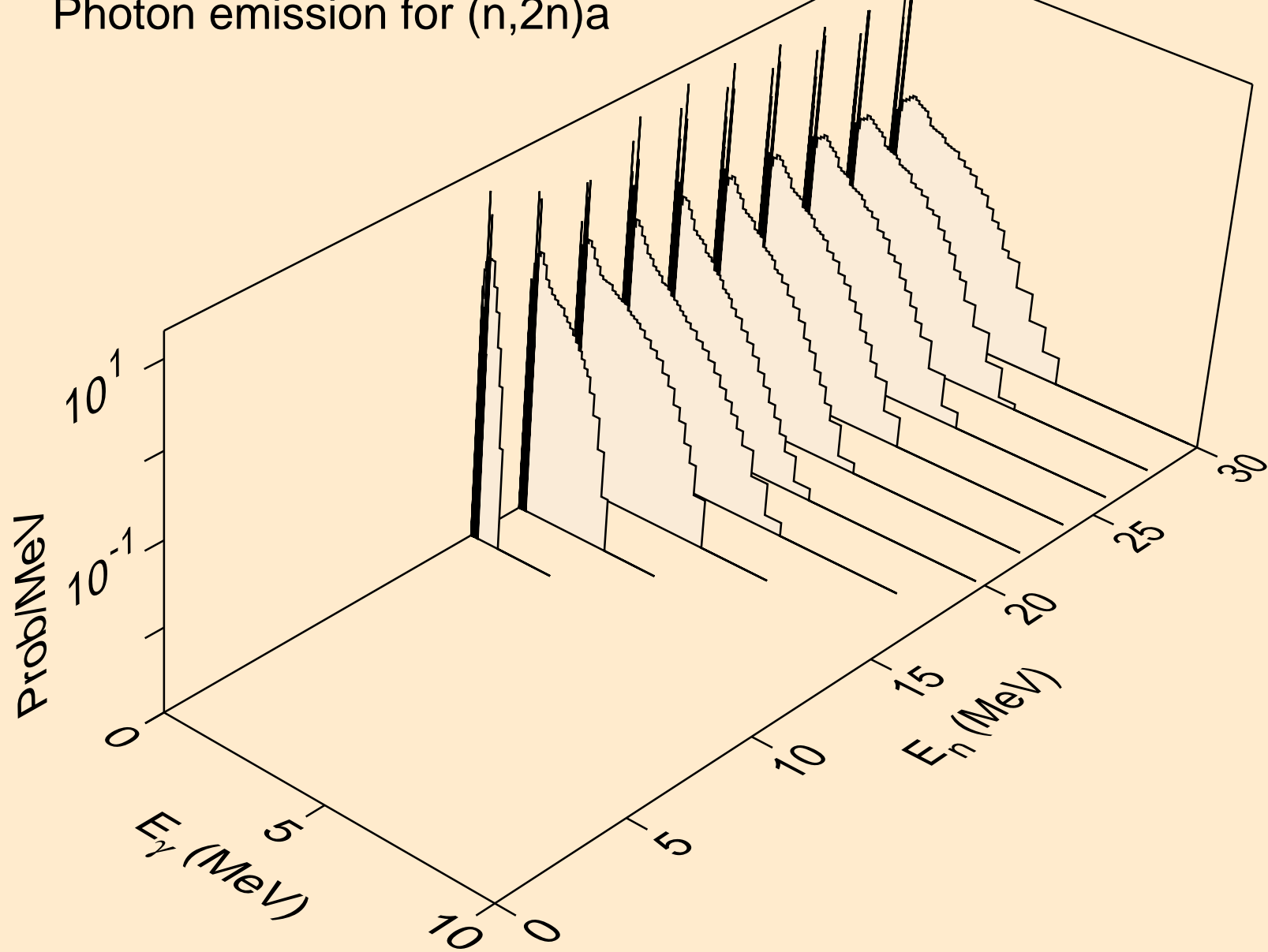

AU177M NEUTRON ACER TENDL-2021 LIBRARY; T=293.6K
Photon emission for (n,3n)a

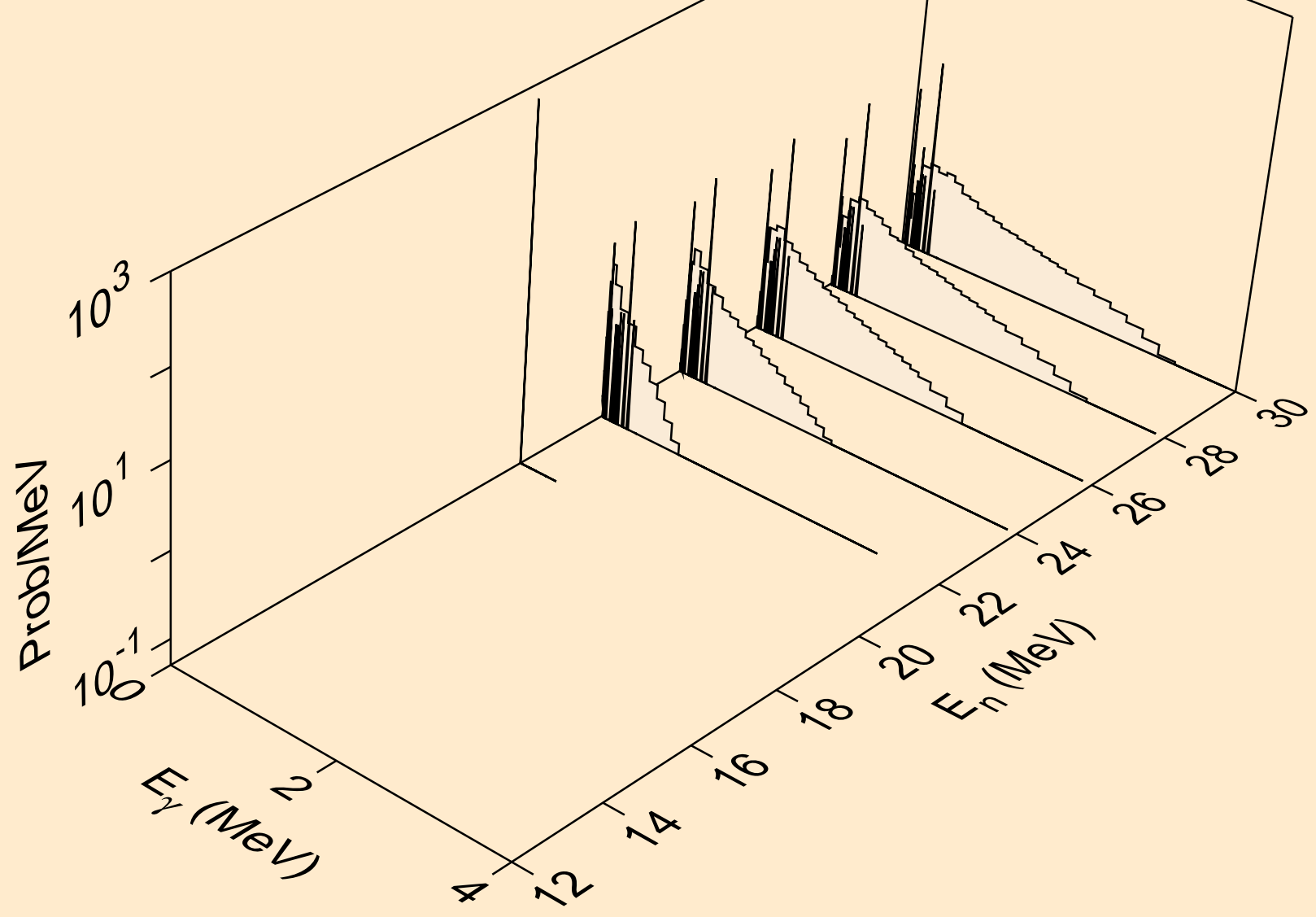

AU177M NEUTRON ACER TENDL-2021 LIBRARY; T=293.6K
Photon emission for (n,n*)p

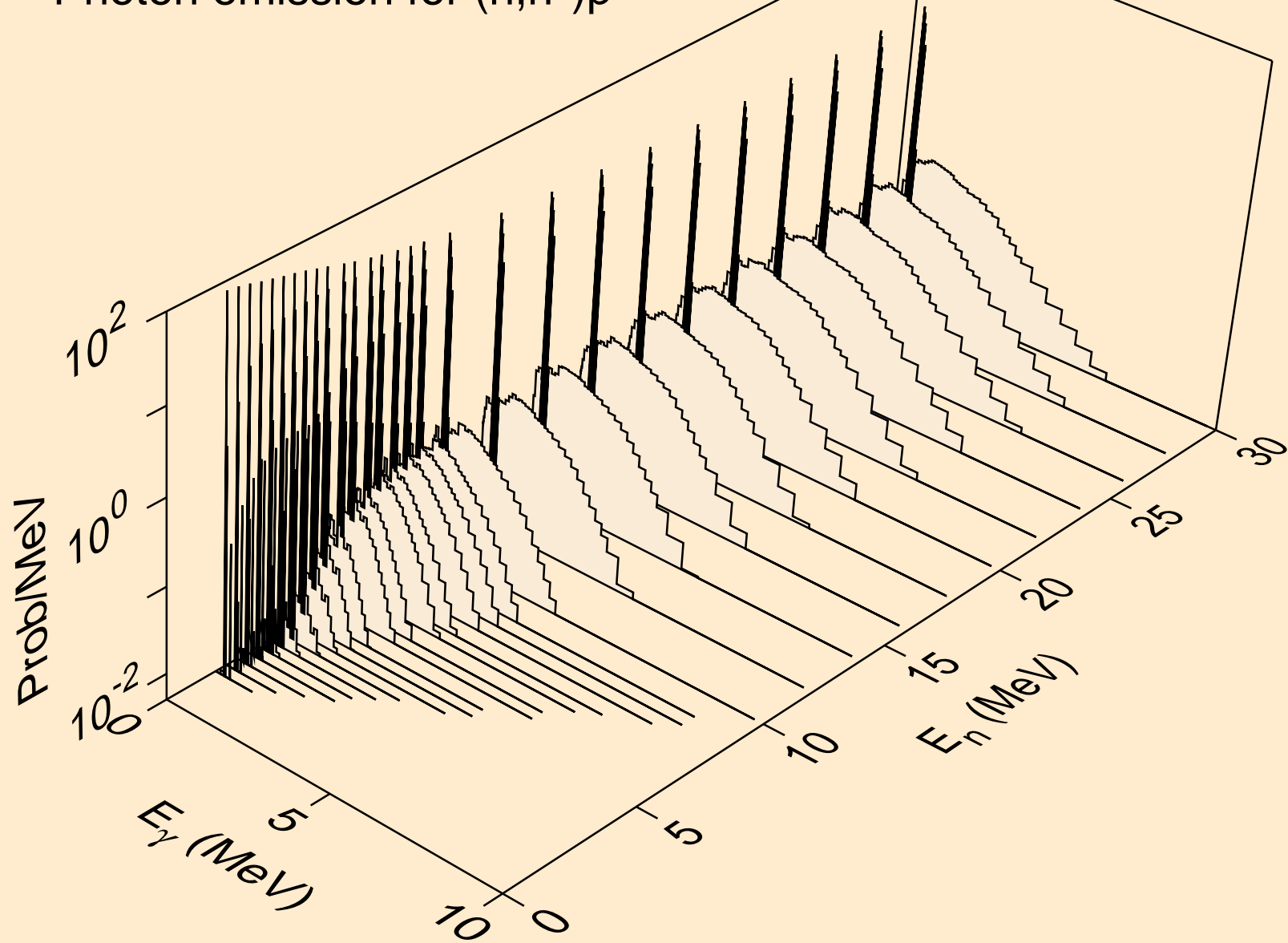

AU177M NEUTRON ACER TENDL-2021 LIBRARY; T=293.6K
Photon emission for (n,n*)2a

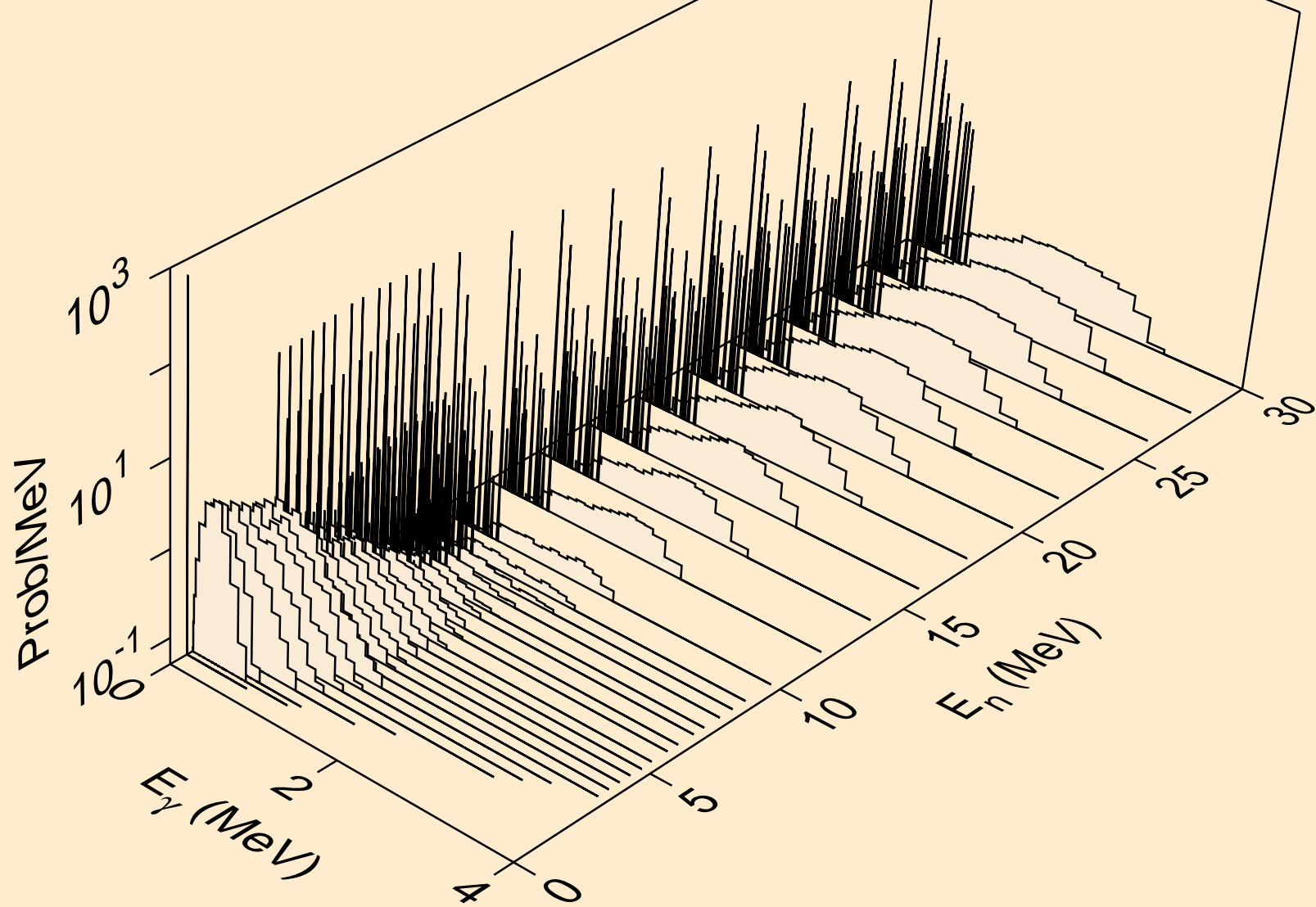

AU177M NEUTRON ACER TENDL-2021 LIBRARY; T=293.6K
Photon emission for (n,2n)2a

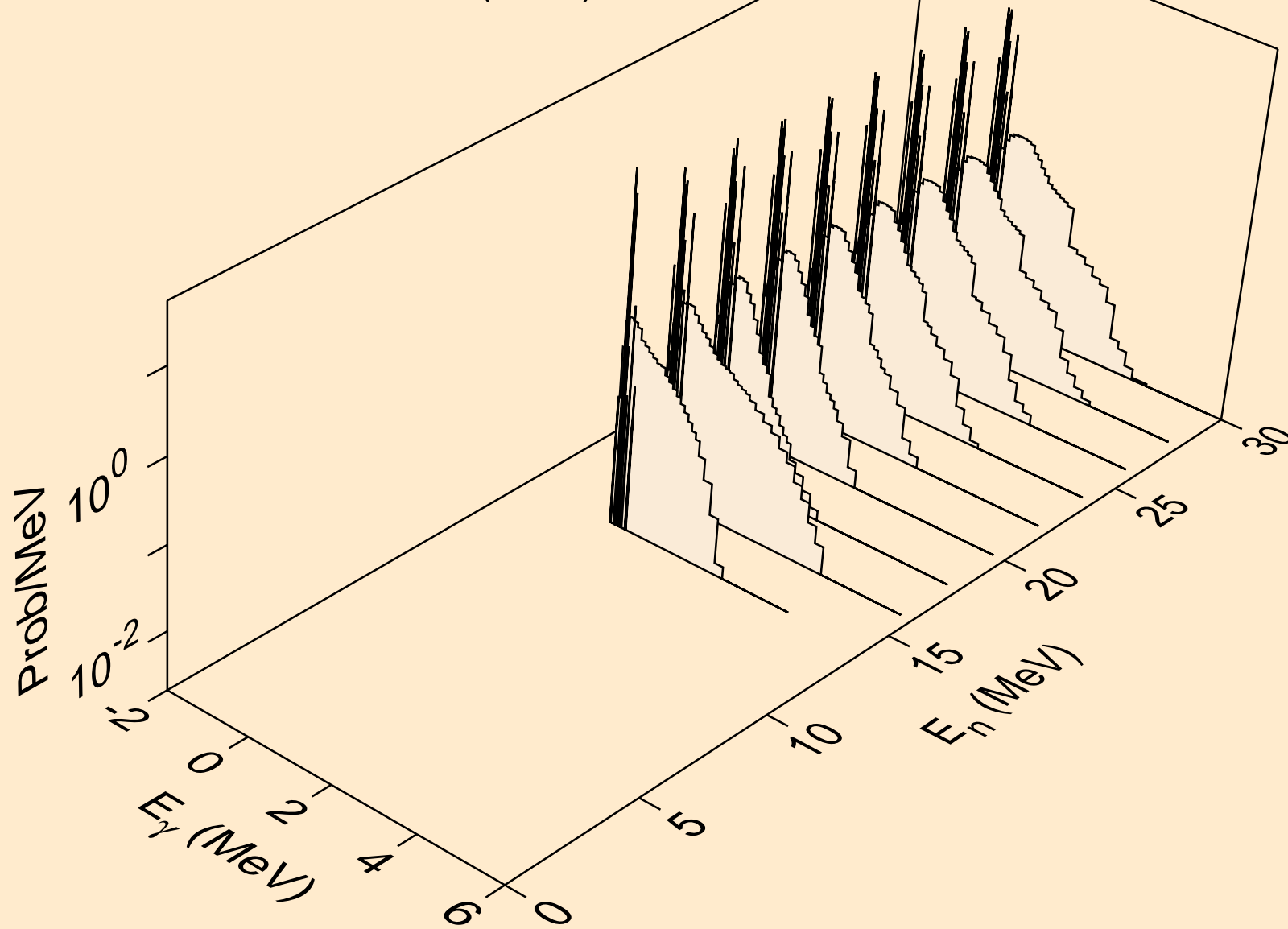

AU177M NEUTRON ACER TENDL-2021 LIBRARY; T=293.6K
Photon emission for (n,n*)d

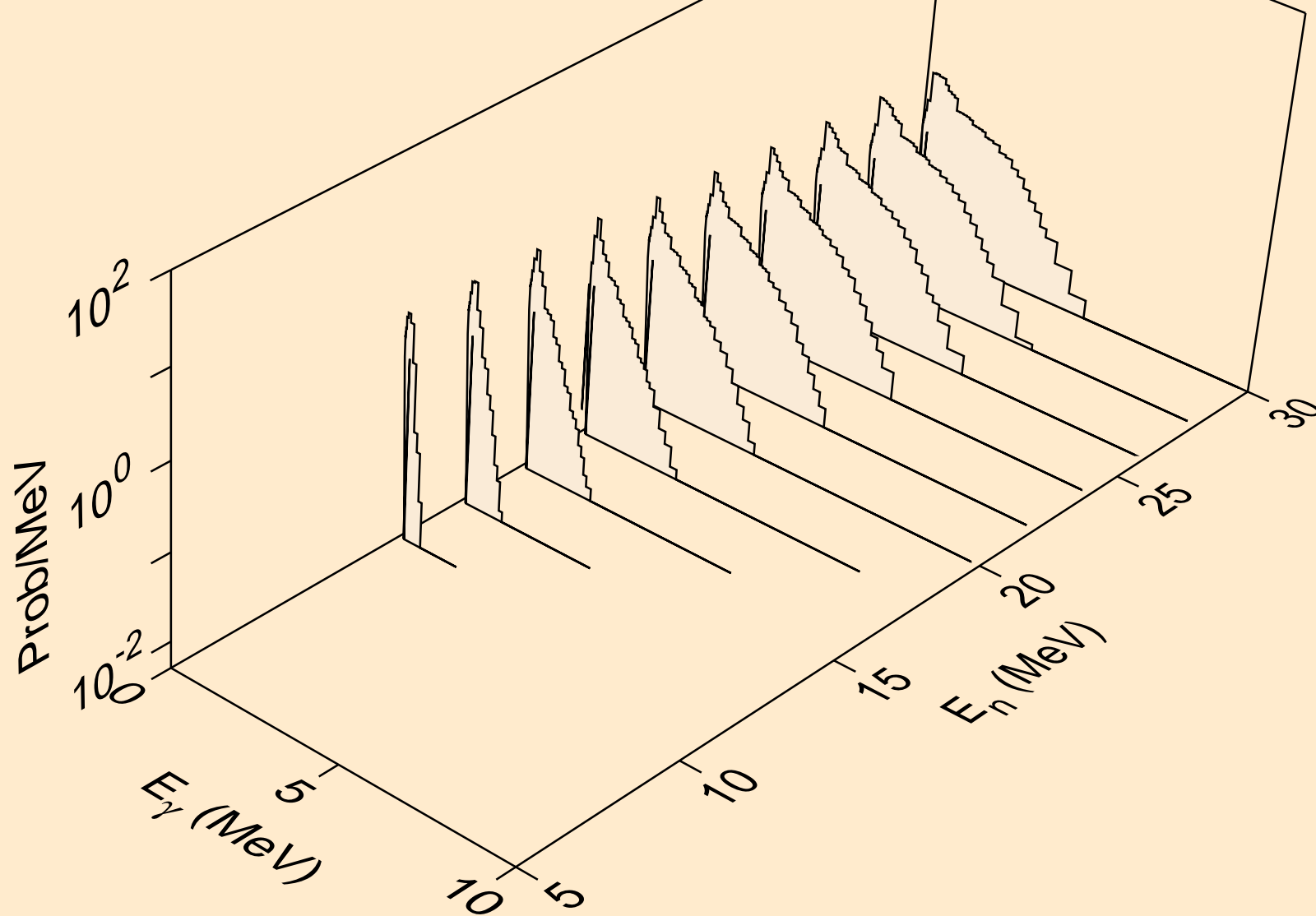

AU177M NEUTRON ACER TENDL-2021 LIBRARY; T=293.6K
Photon emission for (n,n*)t

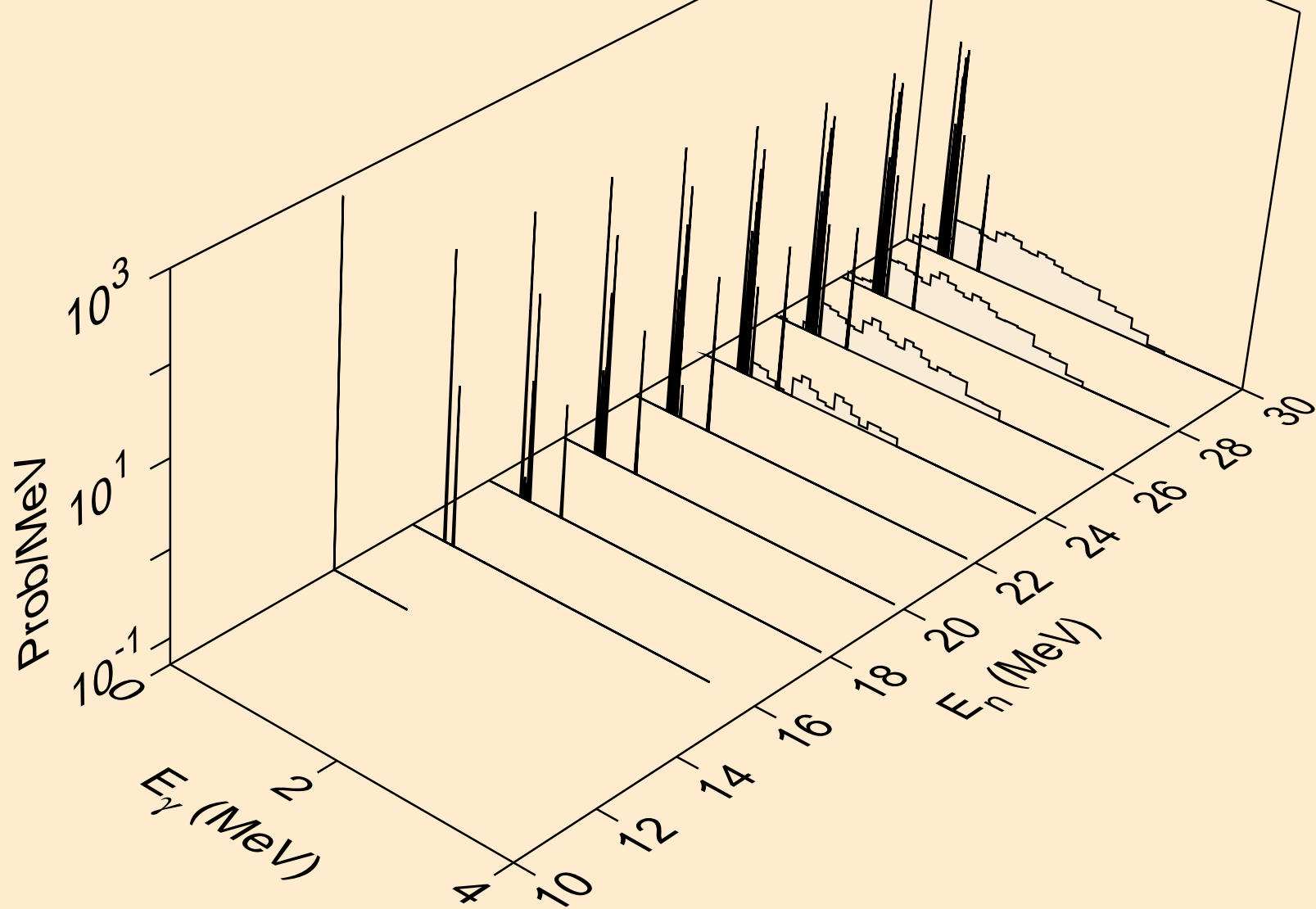

AU177M NEUTRON ACER TENDL-2021 LIBRARY; T=293.6K
Photon emission for (n,n*)he3

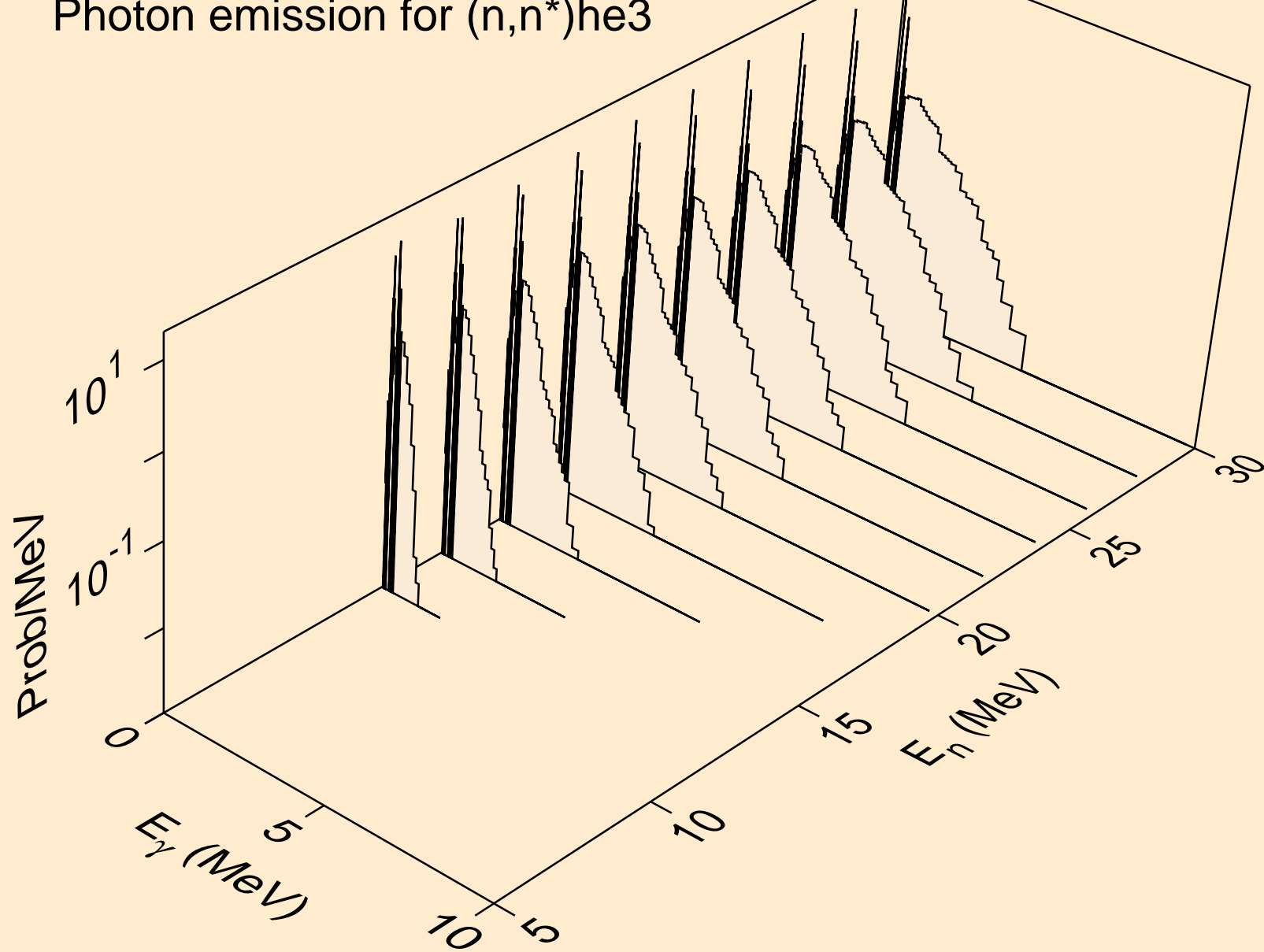

AU177M NEUTRON ACER TENDL-2021 LIBRARY; T=293.6K
Photon emission for (n,2np)

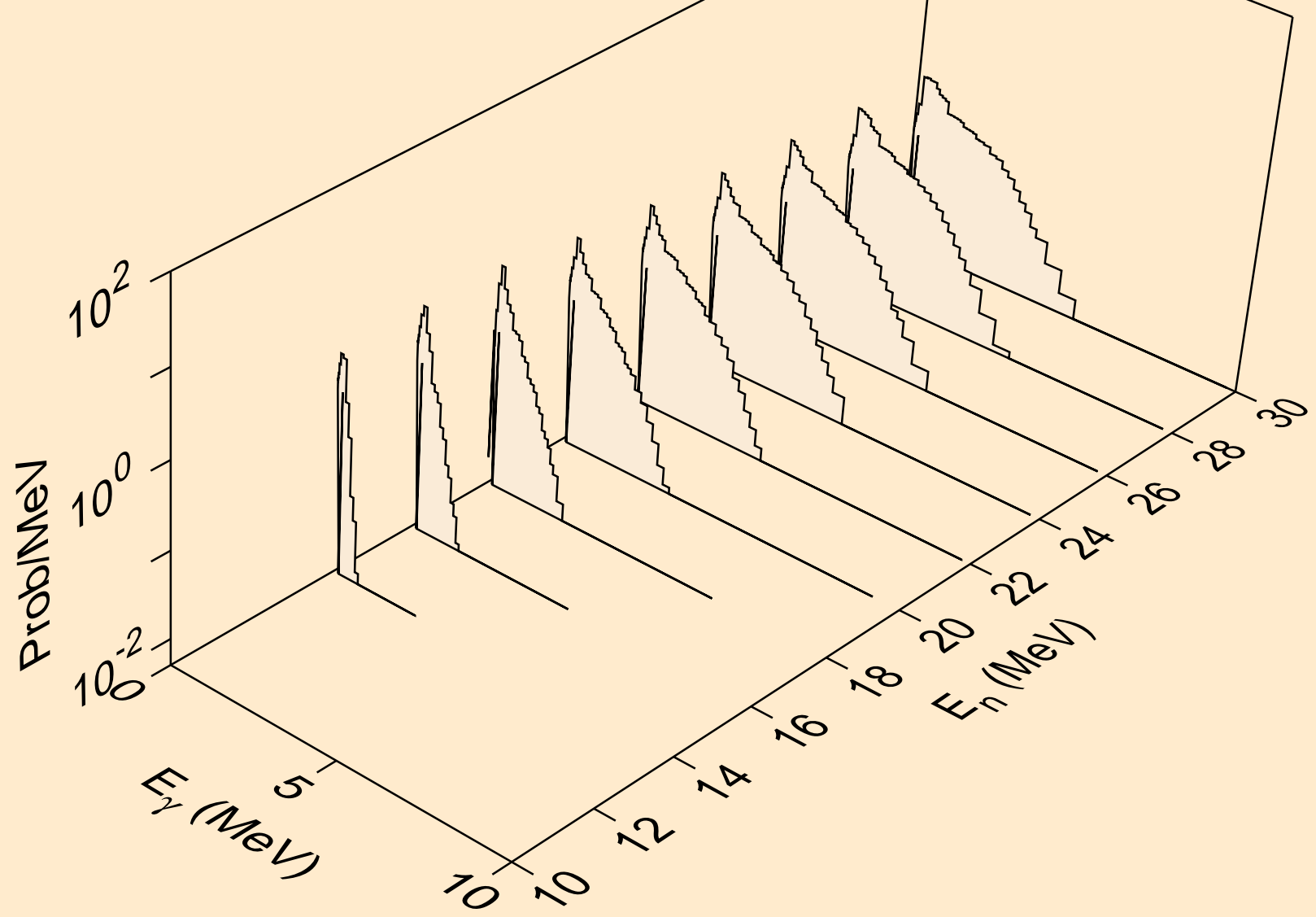

AU177M NEUTRON ACER TENDL-2021 LIBRARY; T=293.6K
Photon emission for (n,3np)

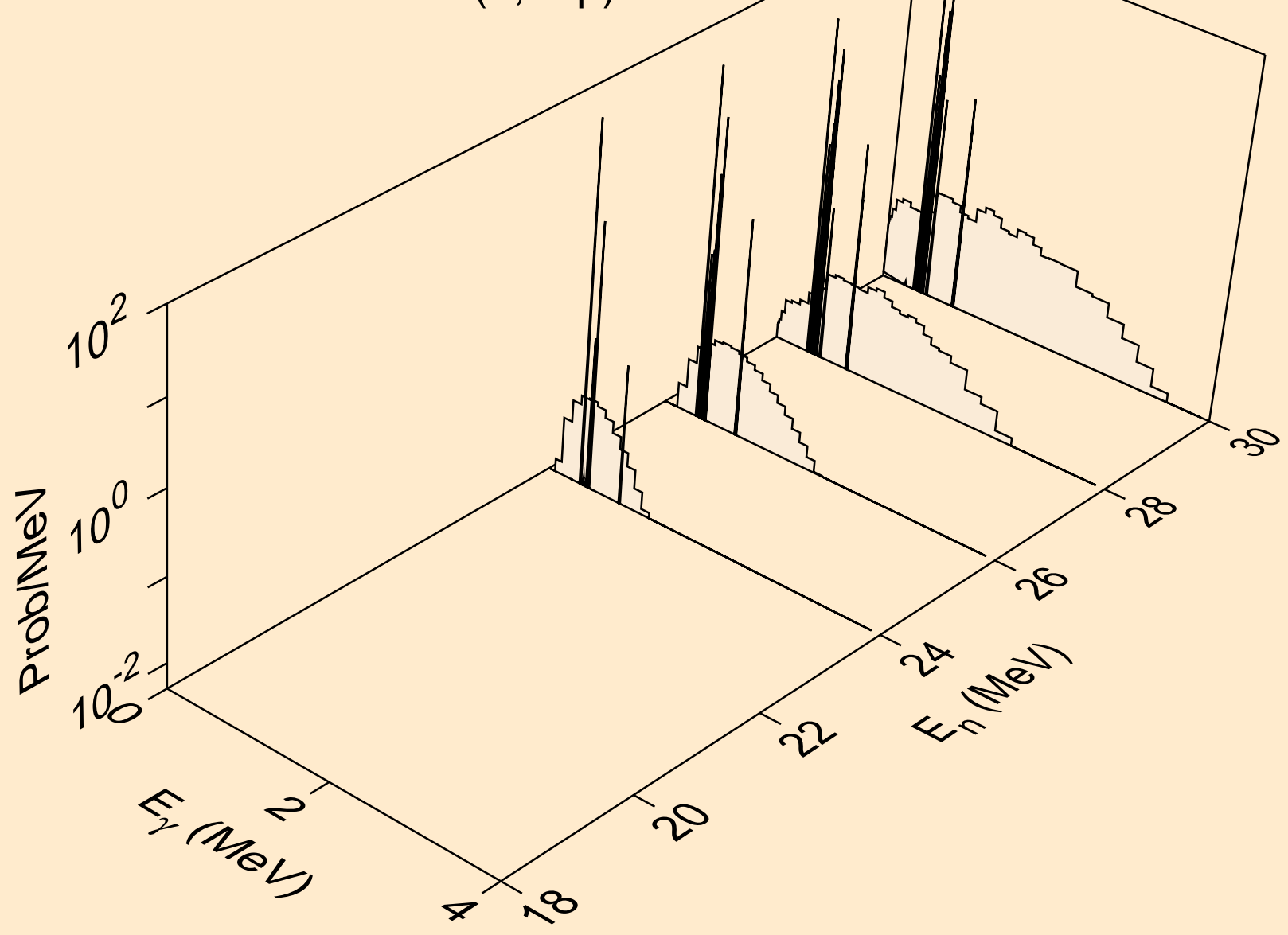

AU177M NEUTRON ACER TENDL-2021 LIBRARY; T=293.6K
Photon emission for (n,2np)

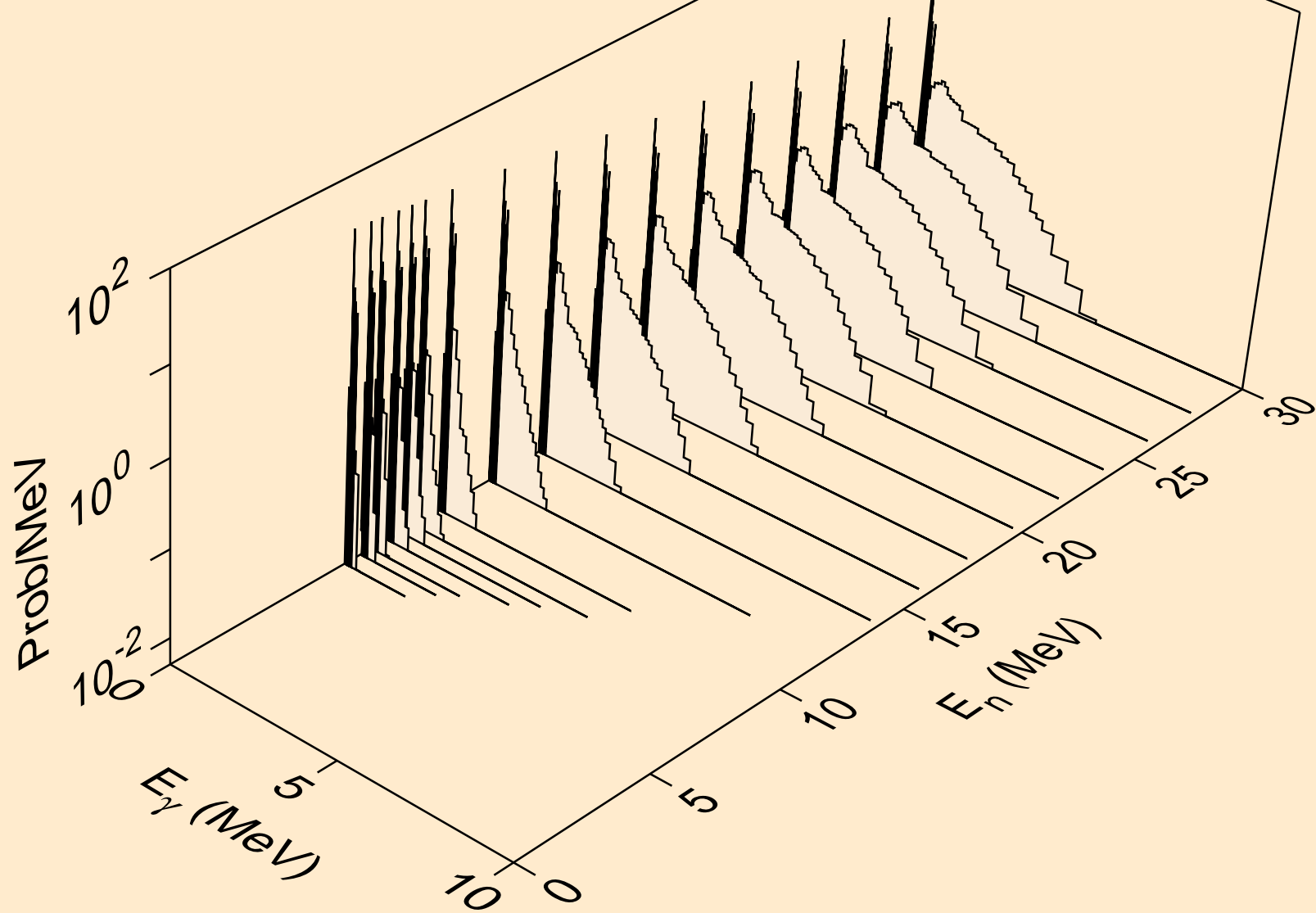

AU177M NEUTRON ACER TENDL-2021 LIBRARY; T=293.6K
Photon emission for (n,npa)

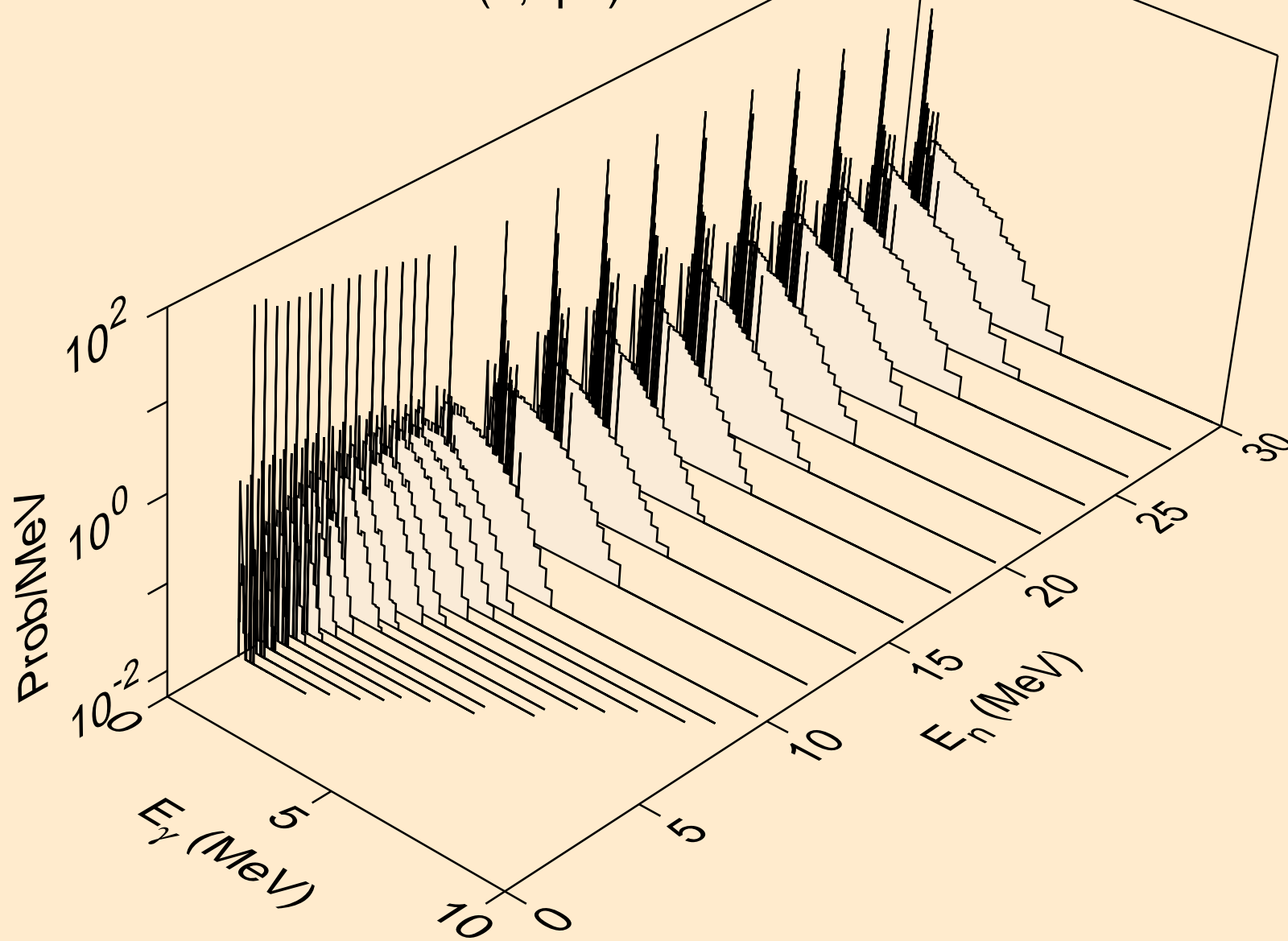

AU177M NEUTRON ACER TENDL-2021 LIBRARY; T=293.6K
Photon emission for (n,n*2)

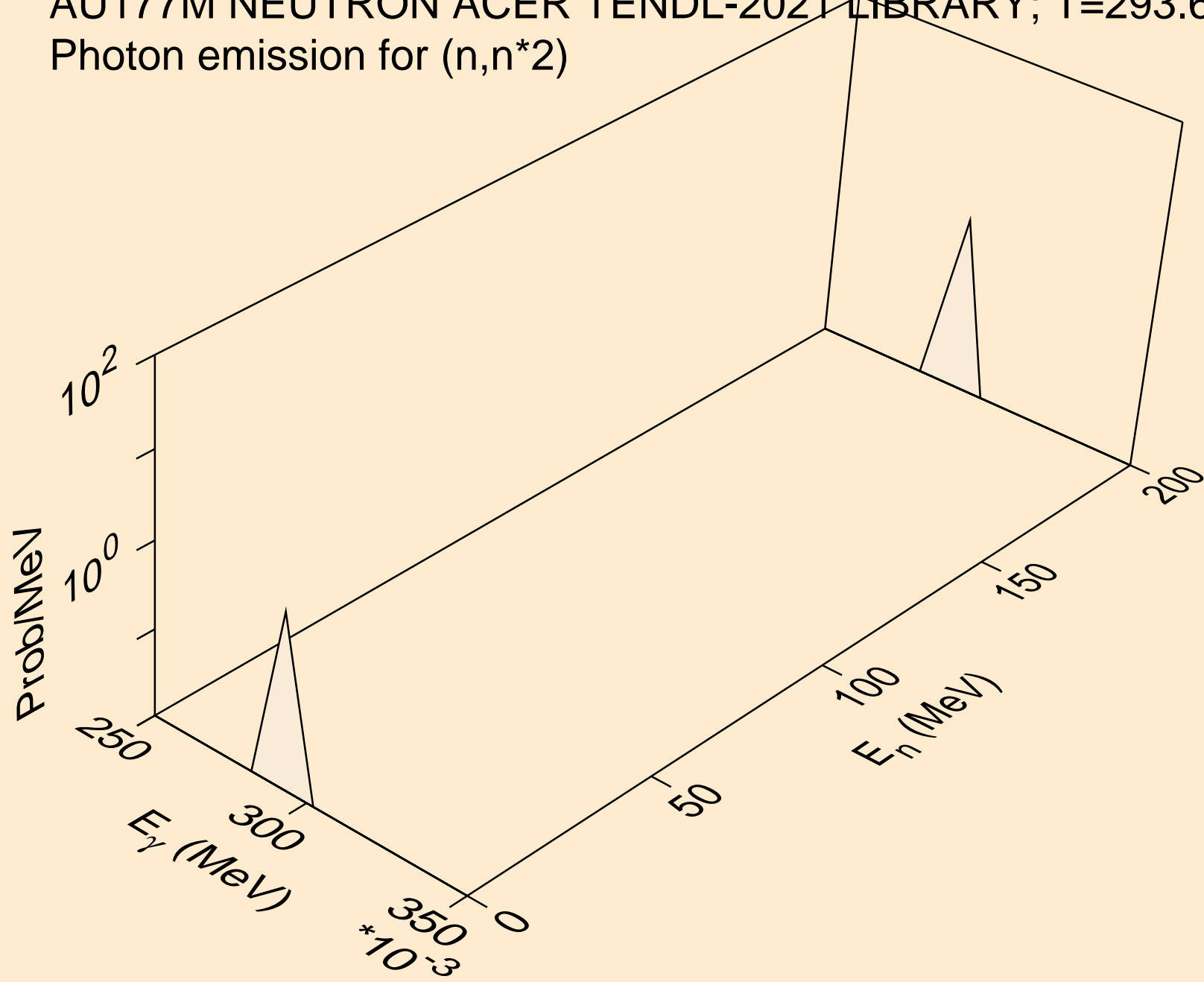

AU177M NEUTRON ACER TENDL-2021 LIBRARY; T=293.6K
Photon emission for (n,n*c)

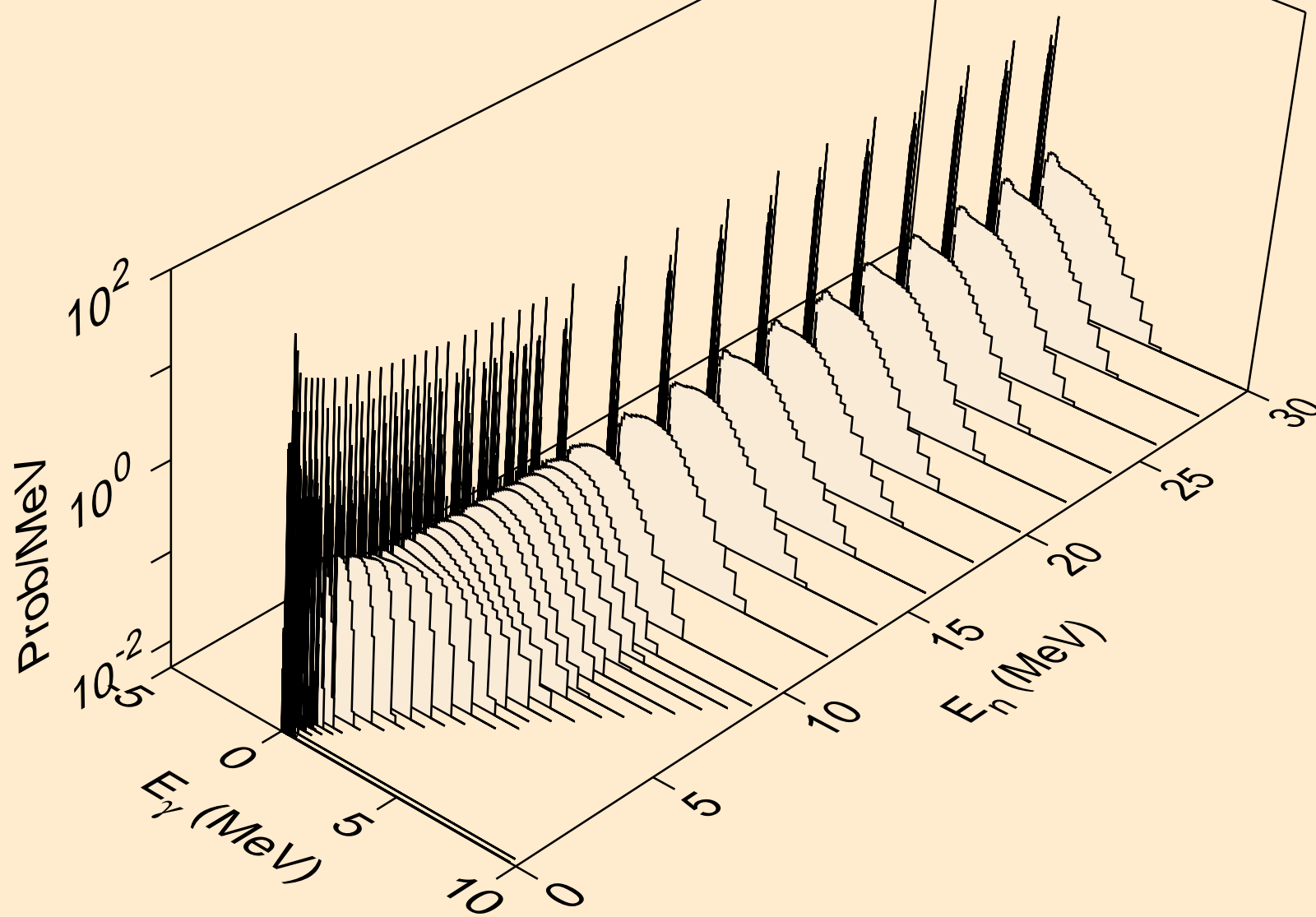

AU177M NEUTRON ACER TENDL-2021 LIBRARY; T=293.6K
Photon emission for (n,gma)

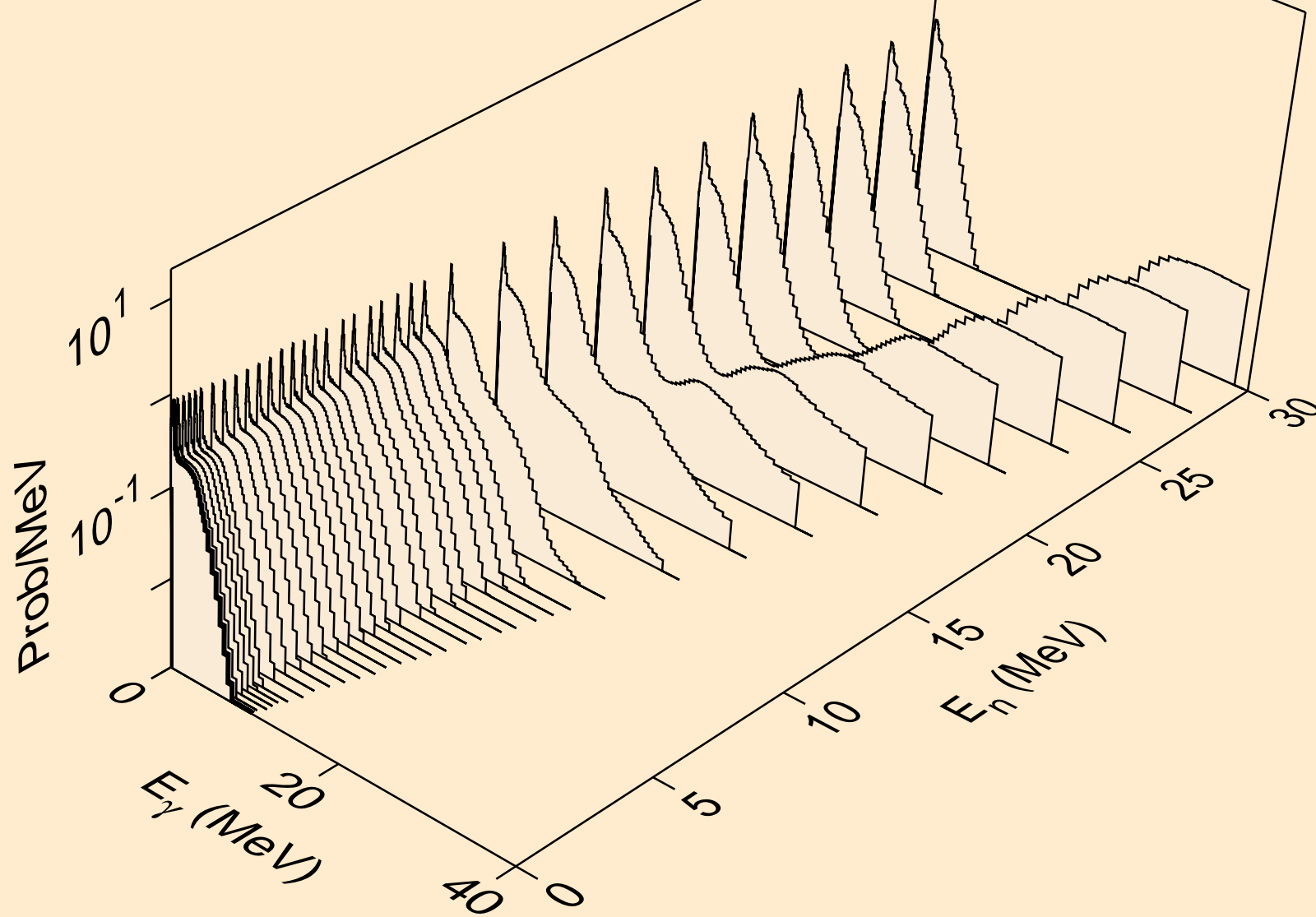

AU177M NEUTRON ACER TENDL-2021 LIBRARY; T=293.6K
Photon emission for (n,p)

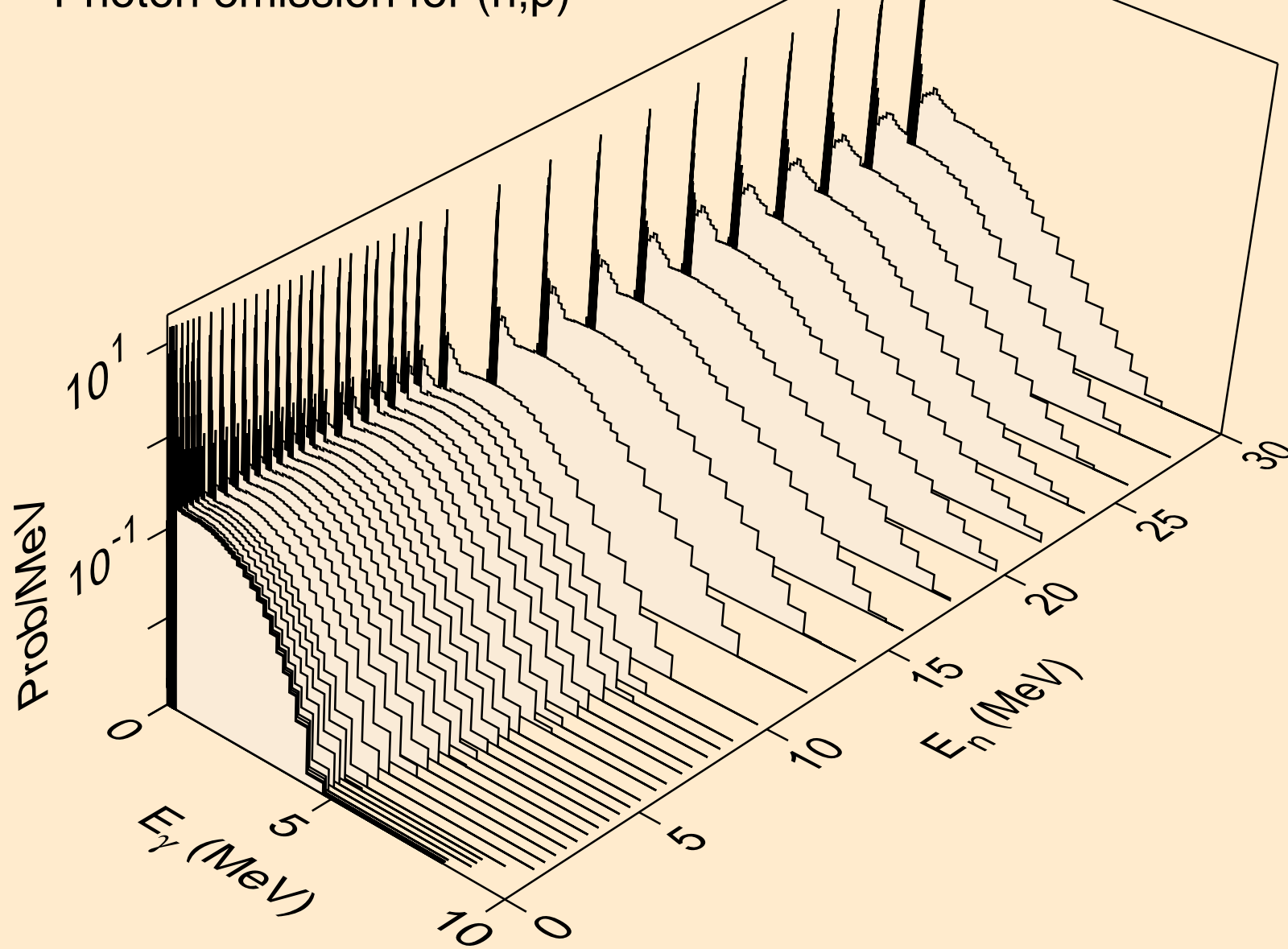

AU177M NEUTRON ACER TENDL-2021 LIBRARY; T=293.6K
Photon emission for (n,d)

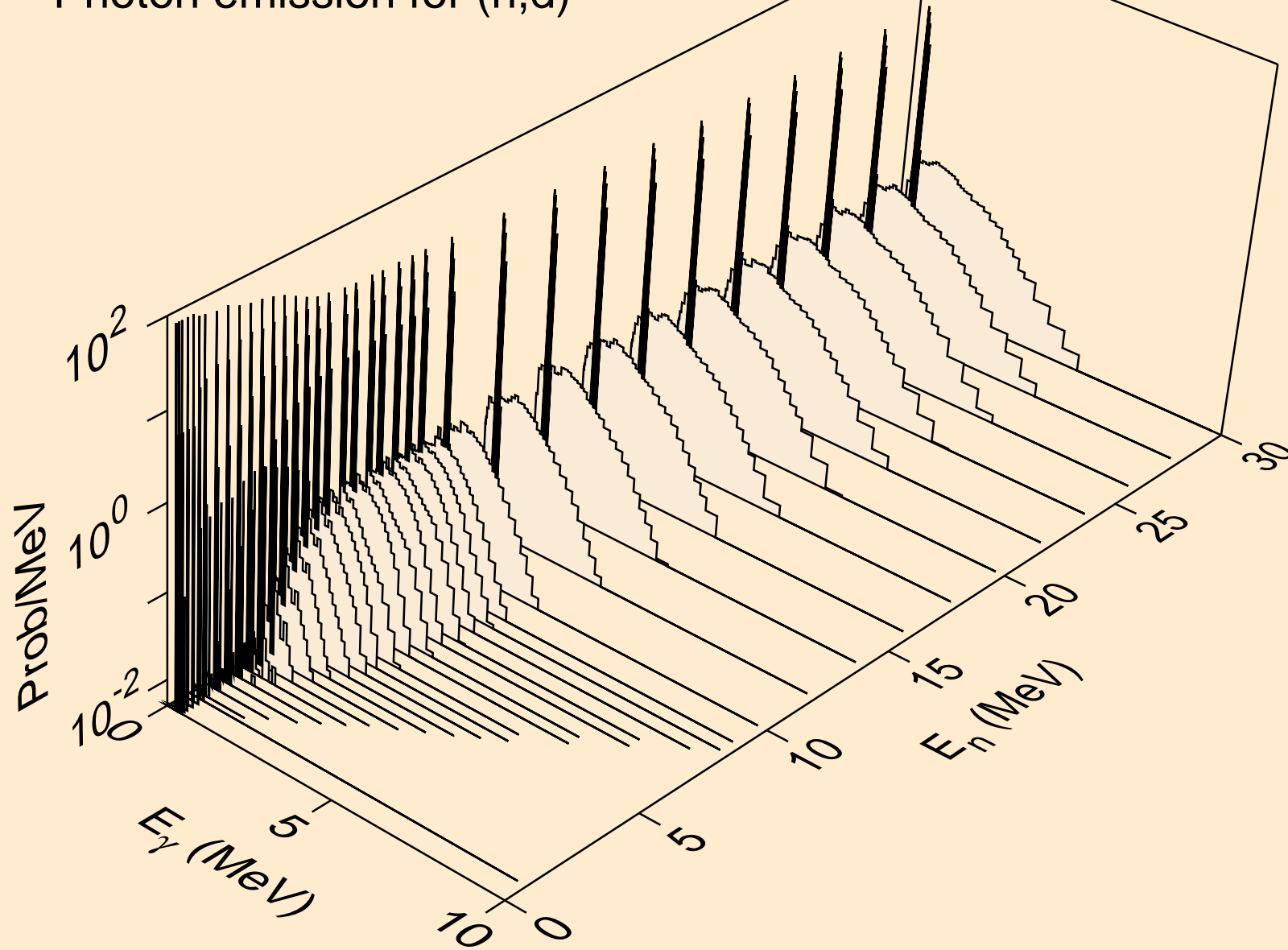

AU177M NEUTRON ACER TENDL-2021 LIBRARY; T=293.6K
Photon emission for (n,t)

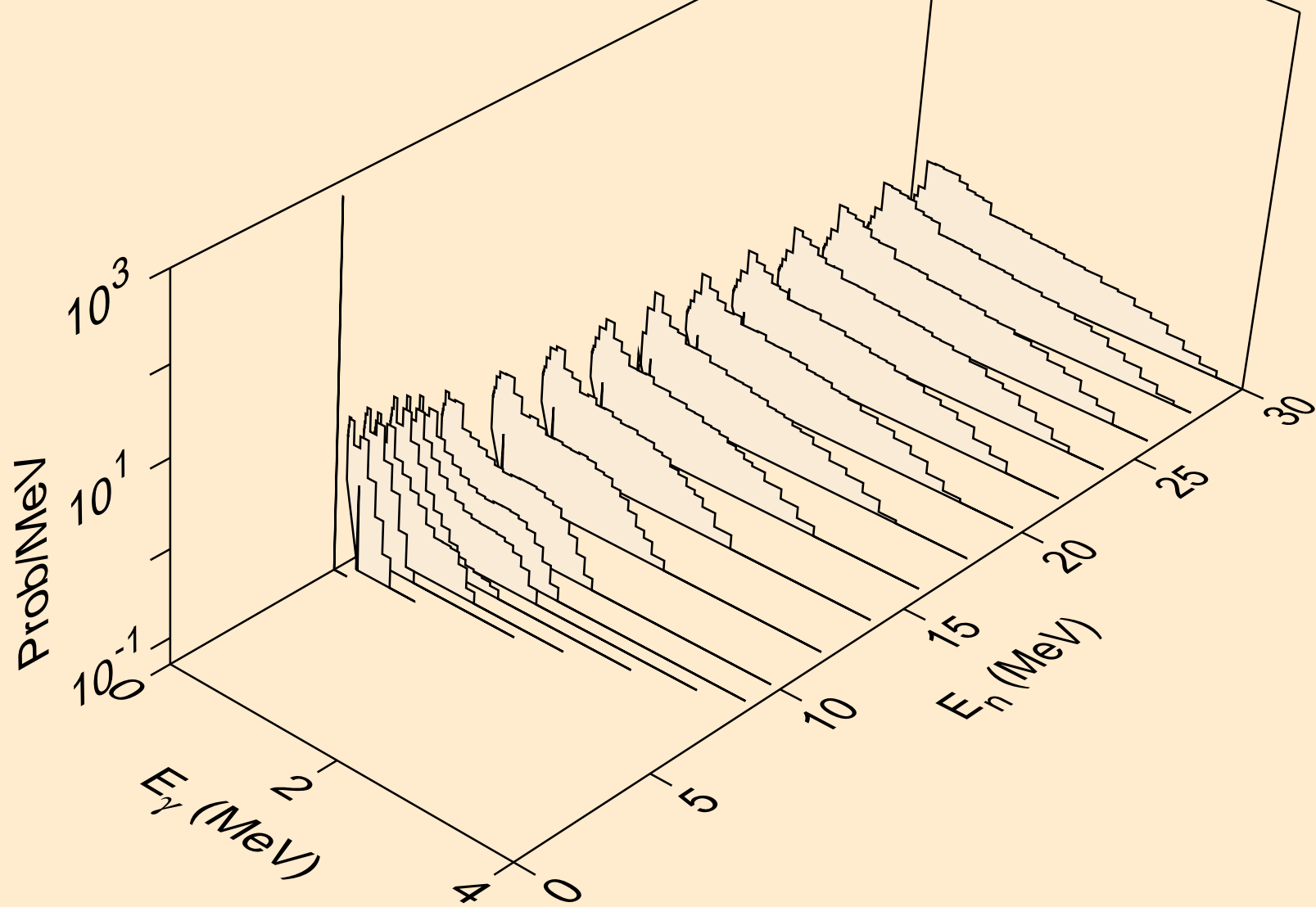

AU177M NEUTRON ACER TENDL-2021 LIBRARY; T=293.6K
Photon emission for (n,he3)

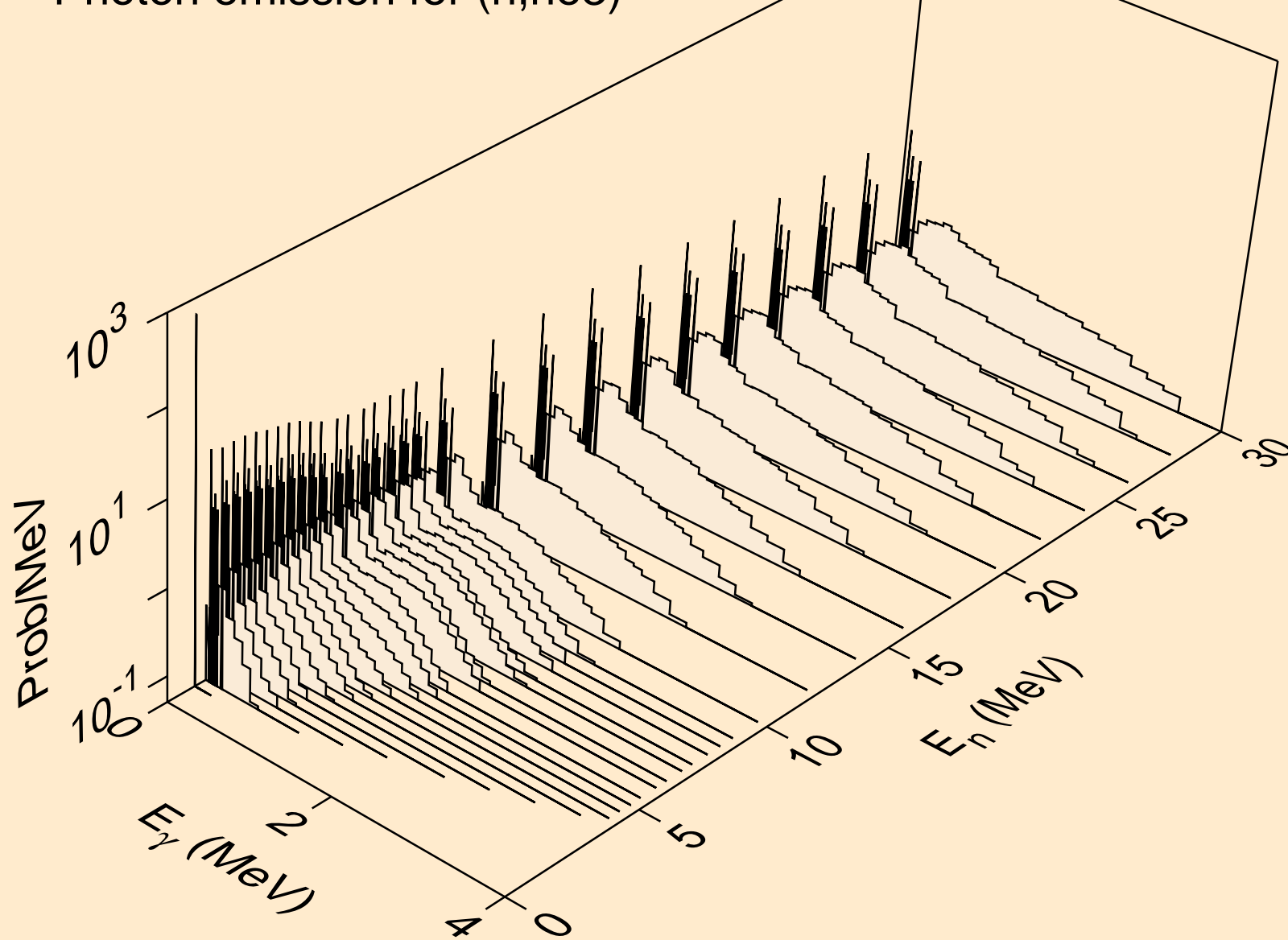

AU177M NEUTRON ACER TENDL-2021 LIBRARY; T=293.6K
Photon emission for (n,a)

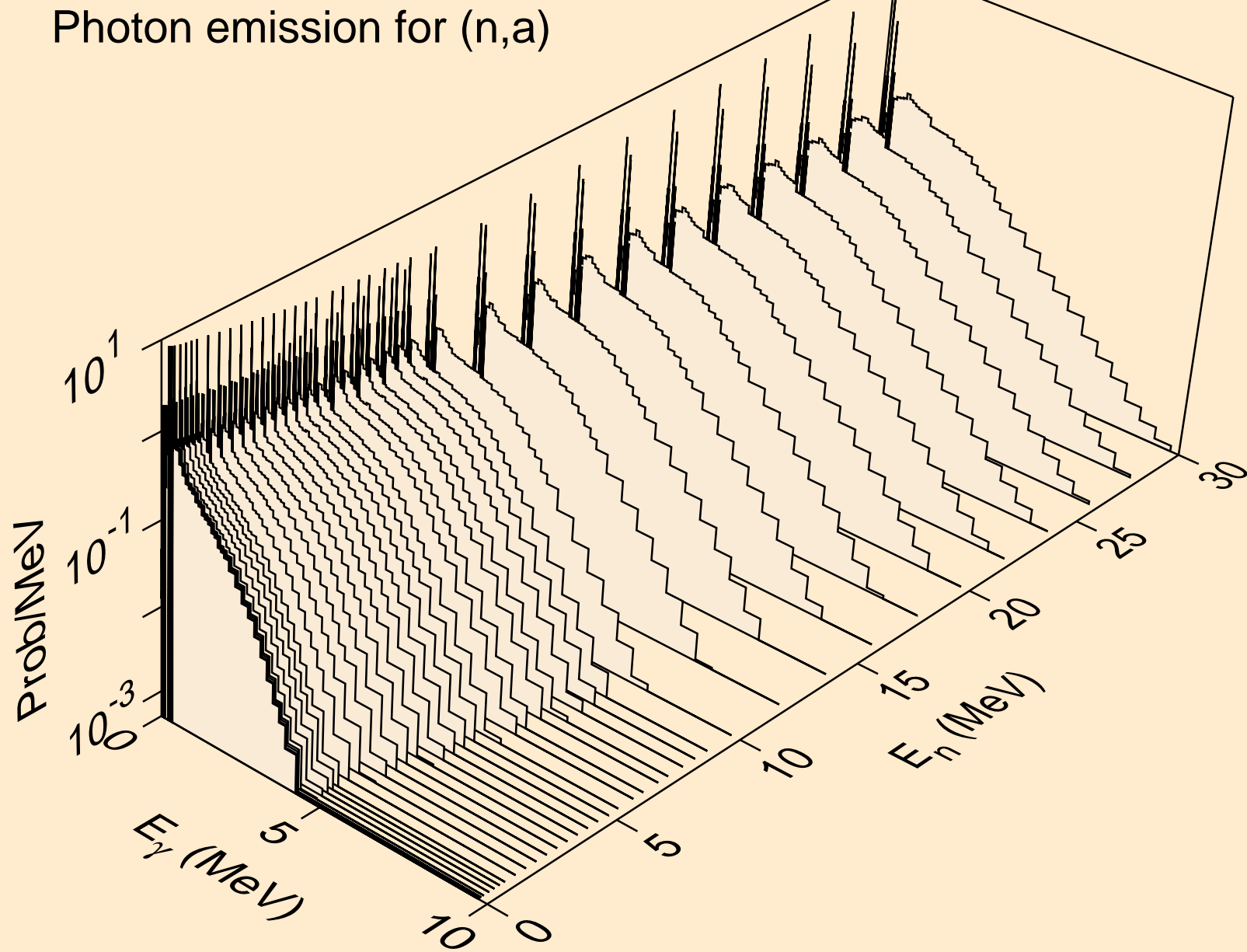

AU177M NEUTRON ACER TENDL-2021 LIBRARY; T=293.6K
Photon emission for (n,2a)

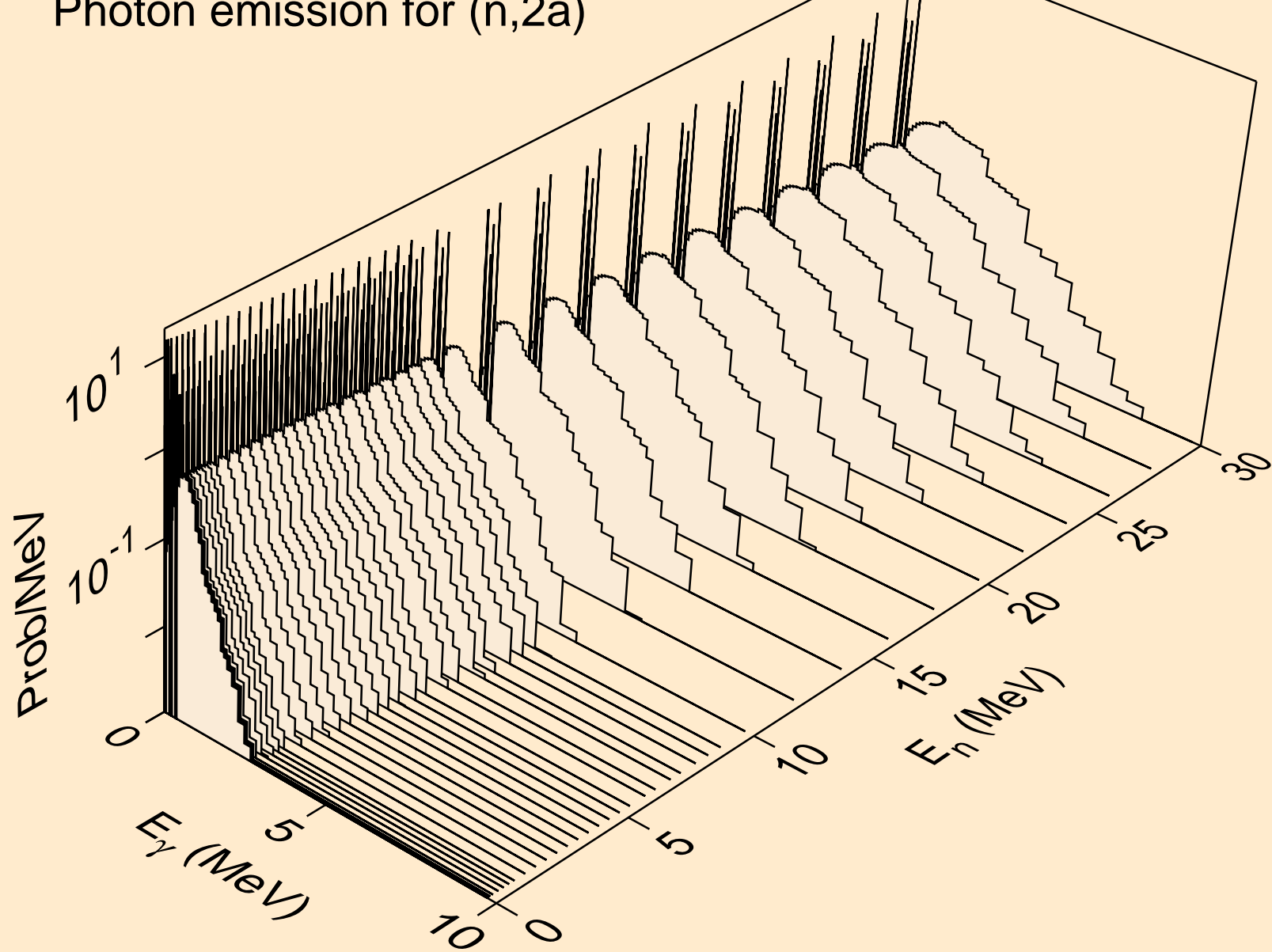

AU177M NEUTRON ACER TENDL-2021 LIBRARY; T=293.6K
Photon emission for (n,3a)

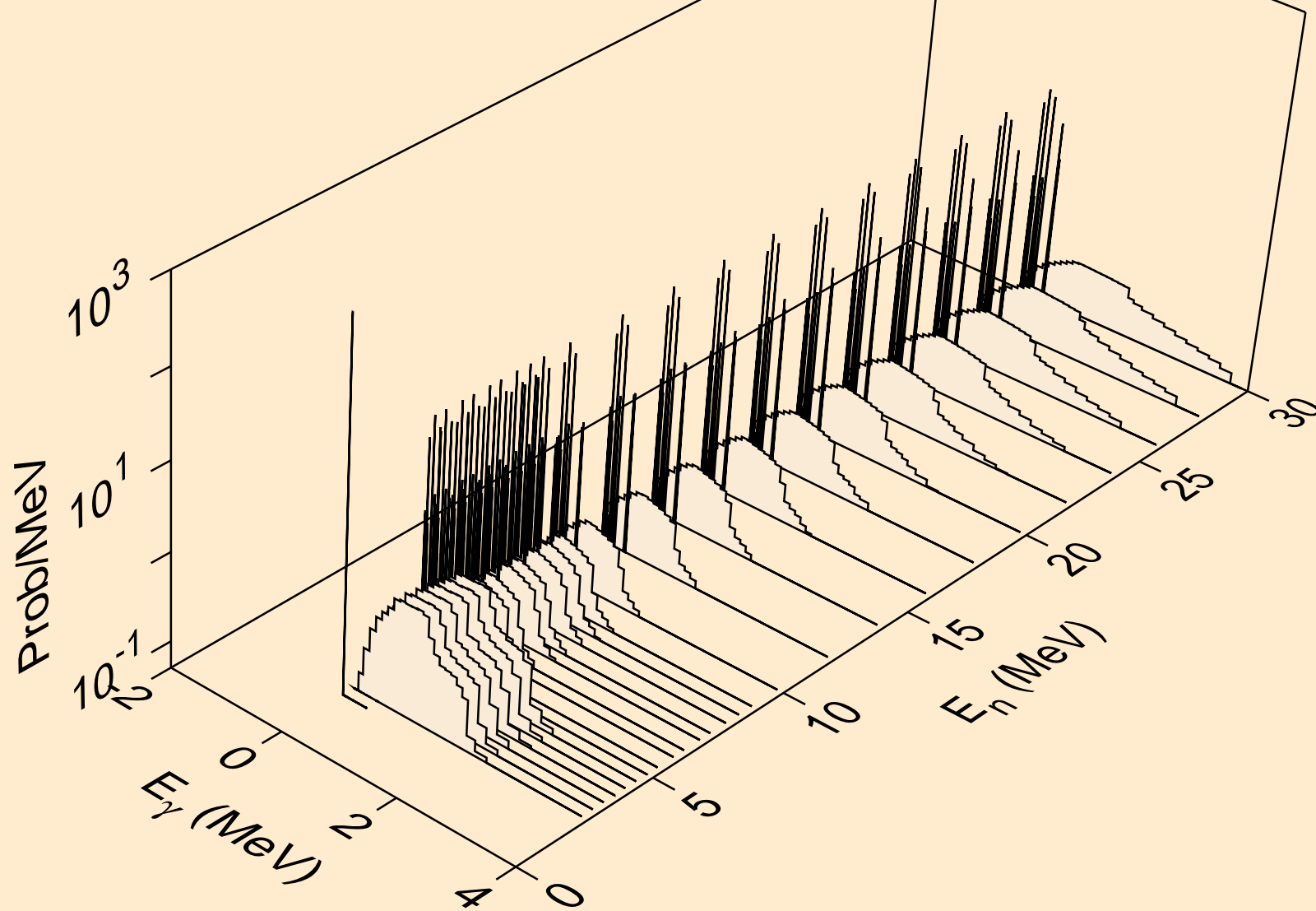

AU177M NEUTRON ACER TENDL-2021 LIBRARY; T=293.6K
Photon emission for (n,2p)

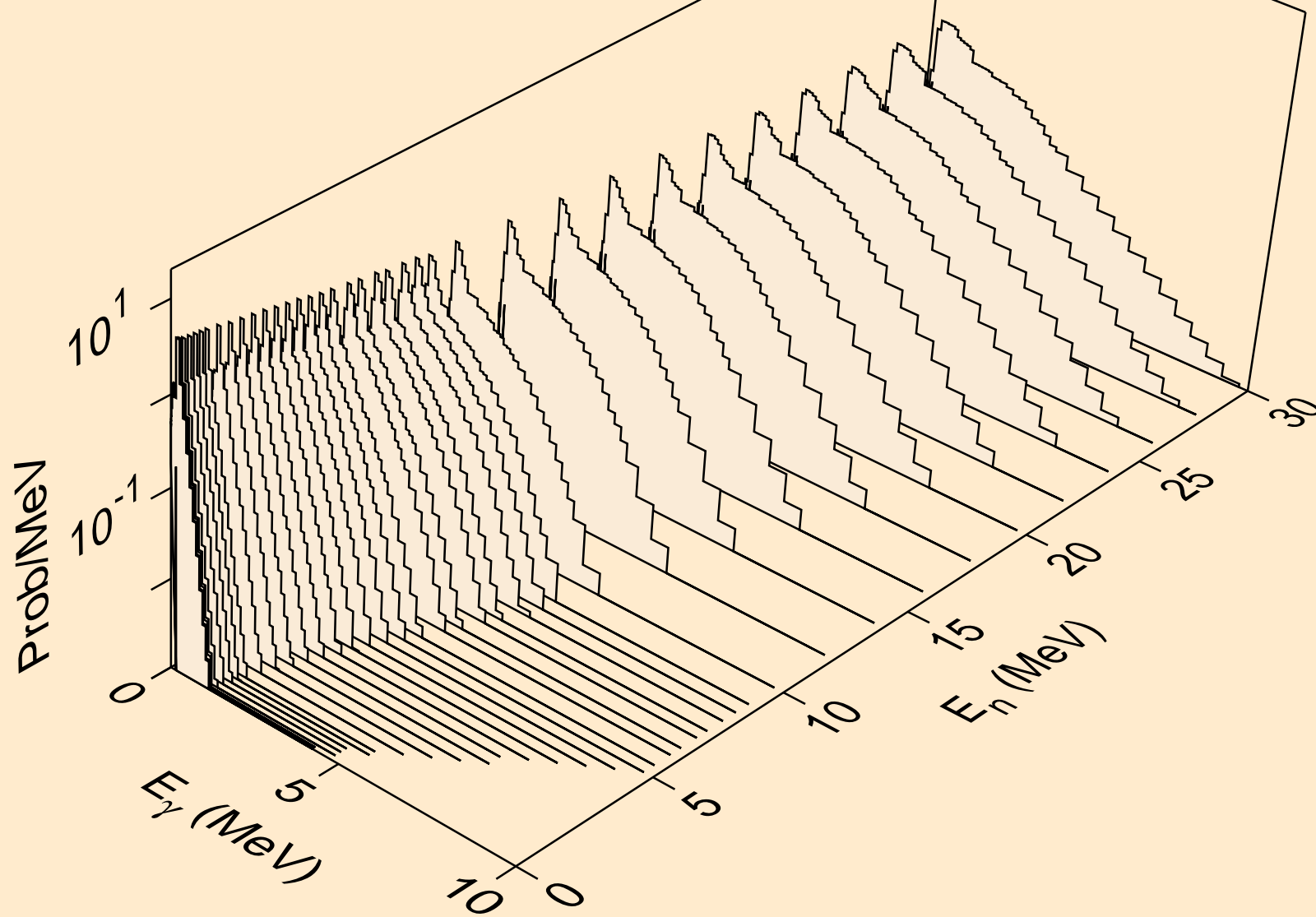

AU177M NEUTRON ACER TENDL-2021 LIBRARY; T=293.6K
Photon emission for (n,p α)

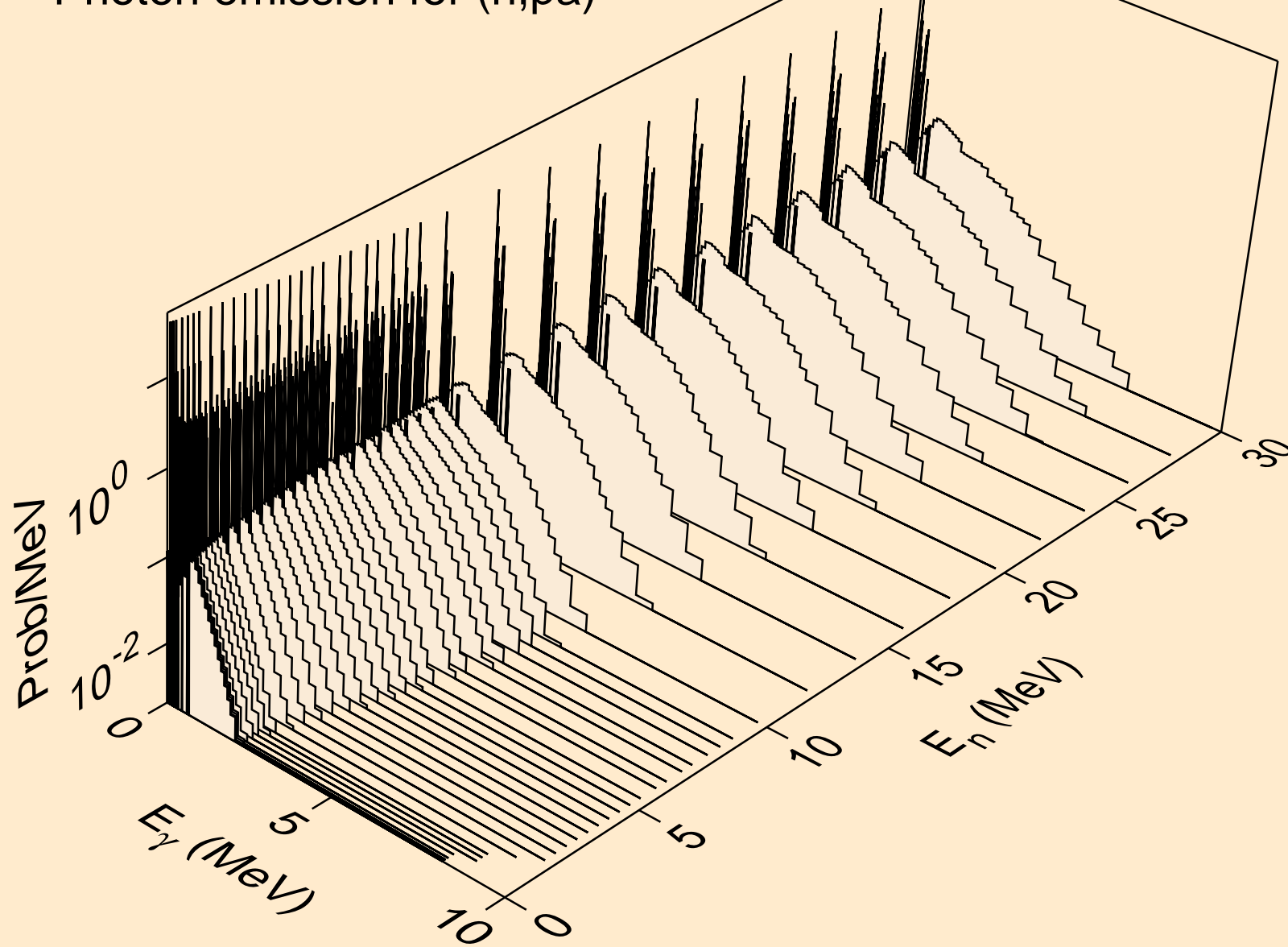

AU177M NEUTRON ACER TENDL-2021 LIBRARY; T=293.6K
Photon emission for (n,t2a)

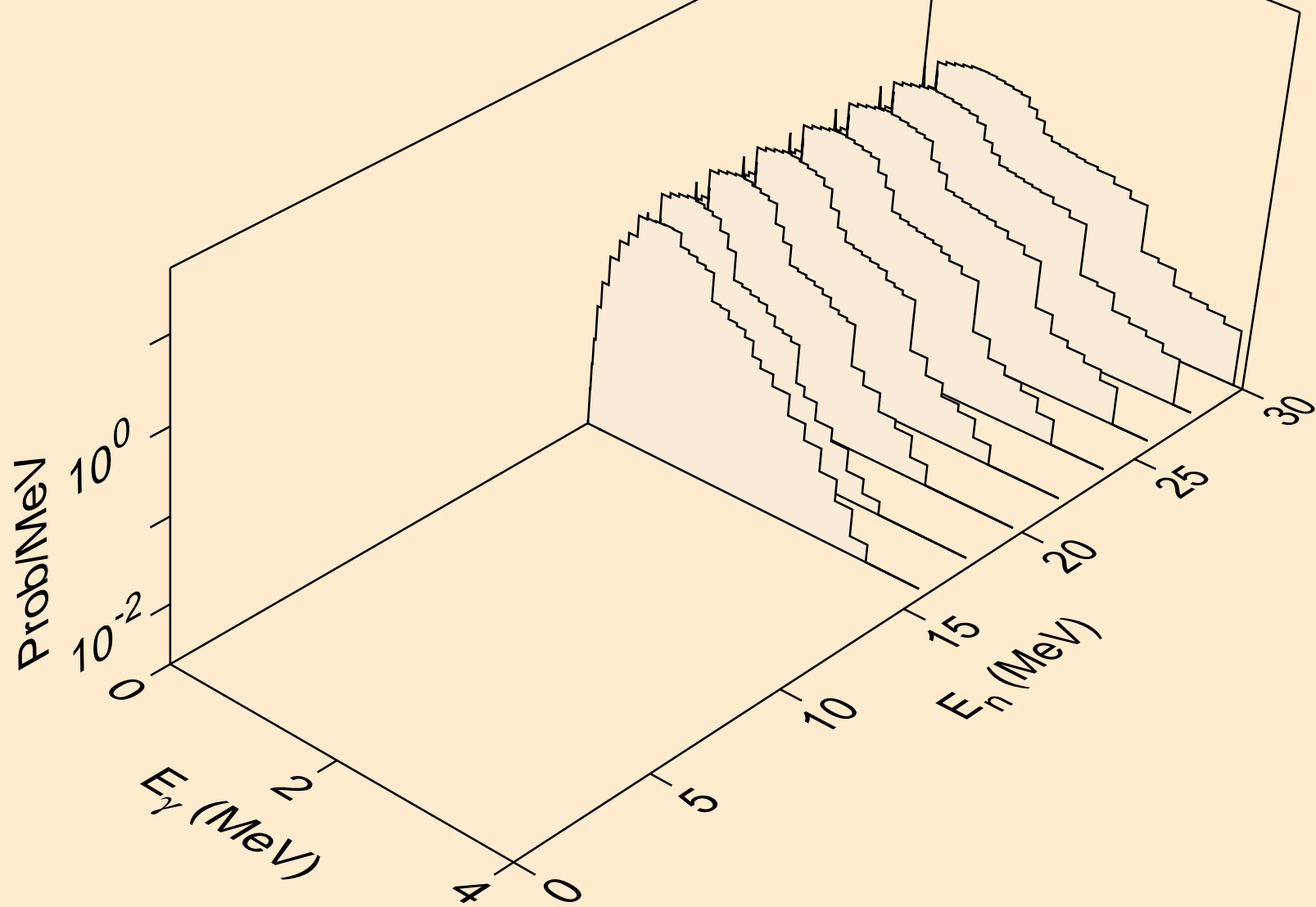

AU177M NEUTRON ACER TENDL-2021 LIBRARY; T=293.6K
Photon emission for (n,d2a)

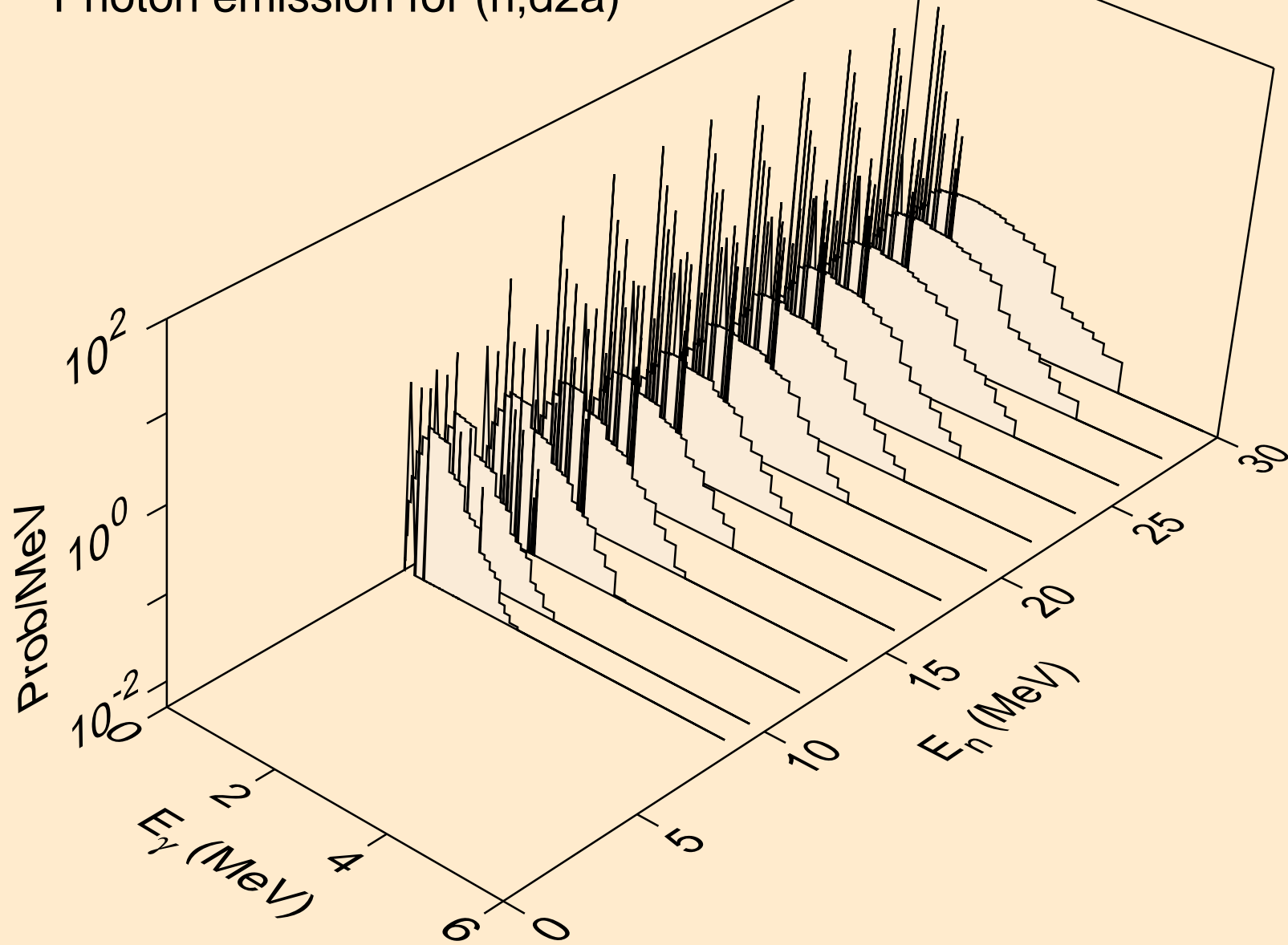

AU177M NEUTRON ACER TENDL-2021 LIBRARY; T=293.6K
Photon emission for (n,pd)

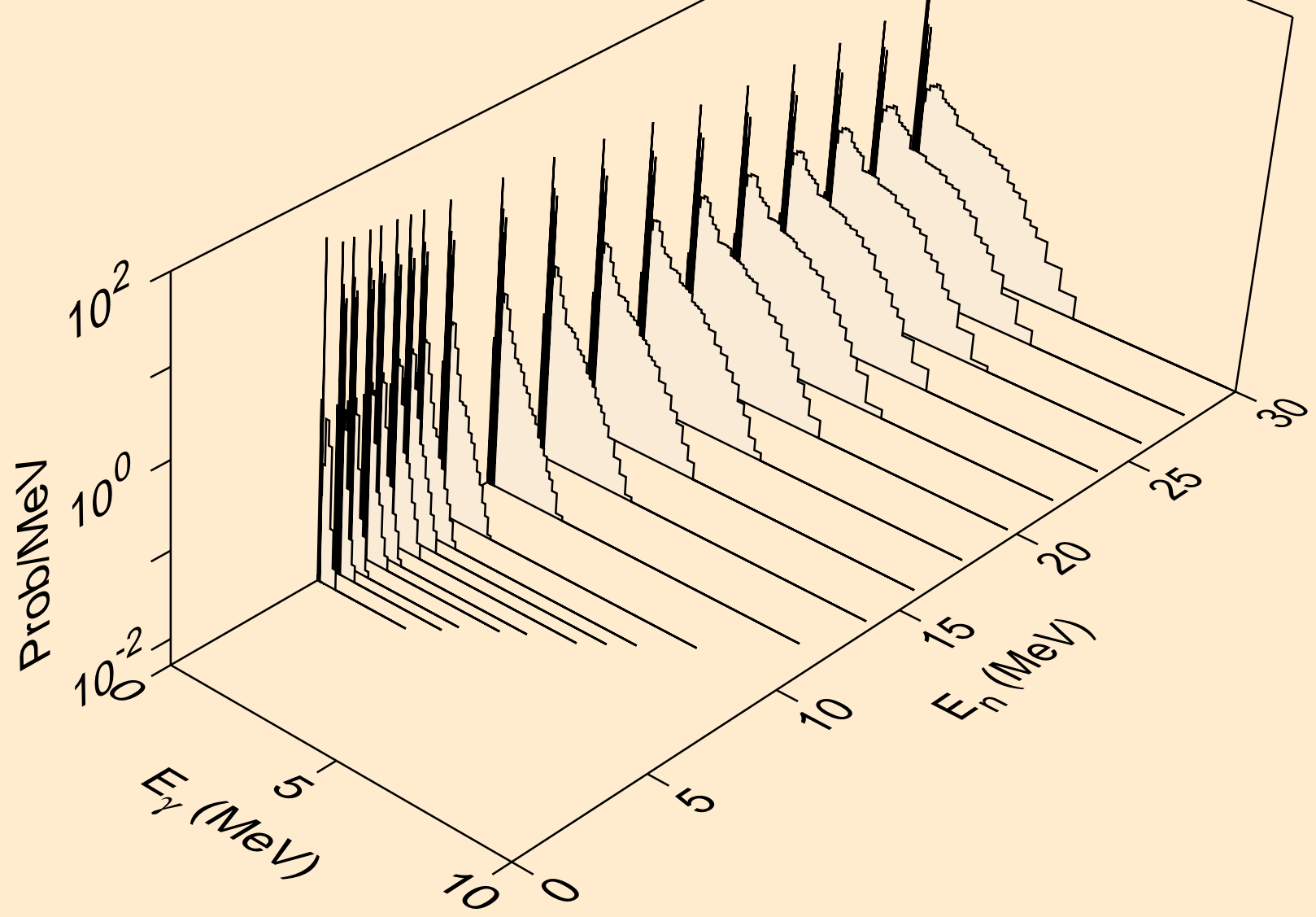

AU177M NEUTRON ACER TENDL-2021 LIBRARY; T=293.6K
Photon emission for (n,pt)

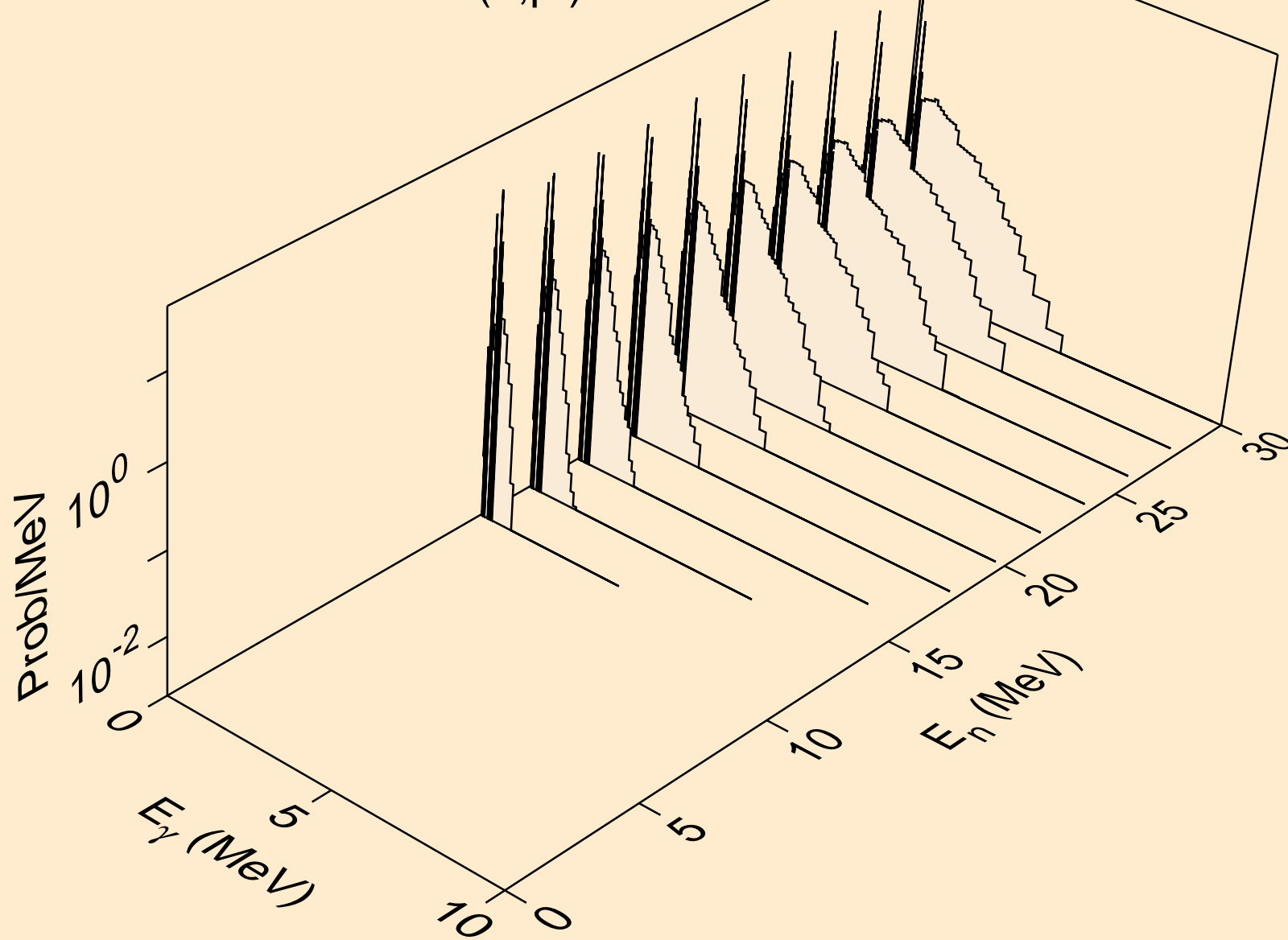

AU177M NEUTRON ACER TENDL-2021 LIBRARY; T=293.6K
Photon emission for (n,da)

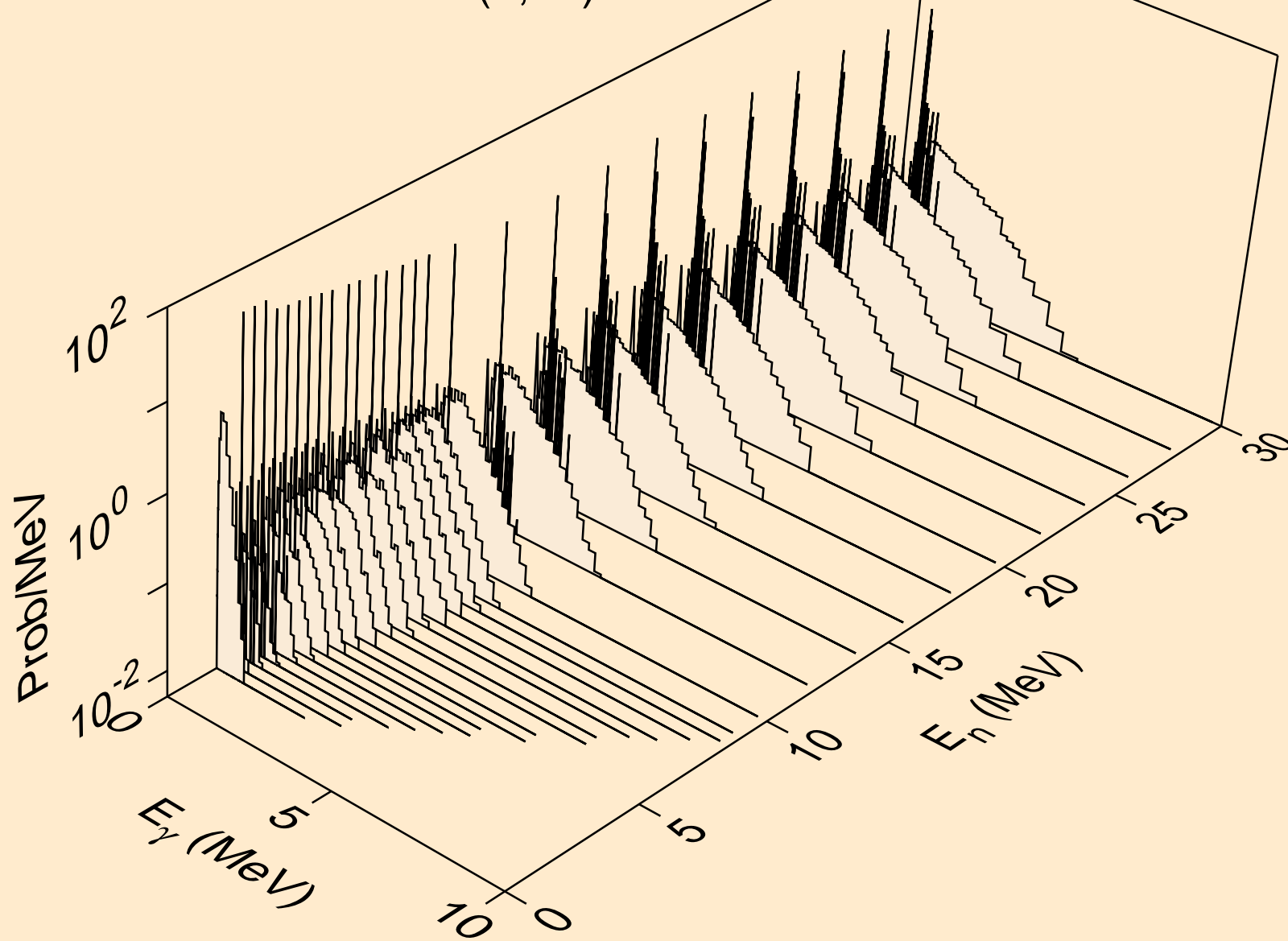

AU177M NEUTRON ACER TENDL-2021 LIBRARY; T=293.6K
thermal capture photon spectrum

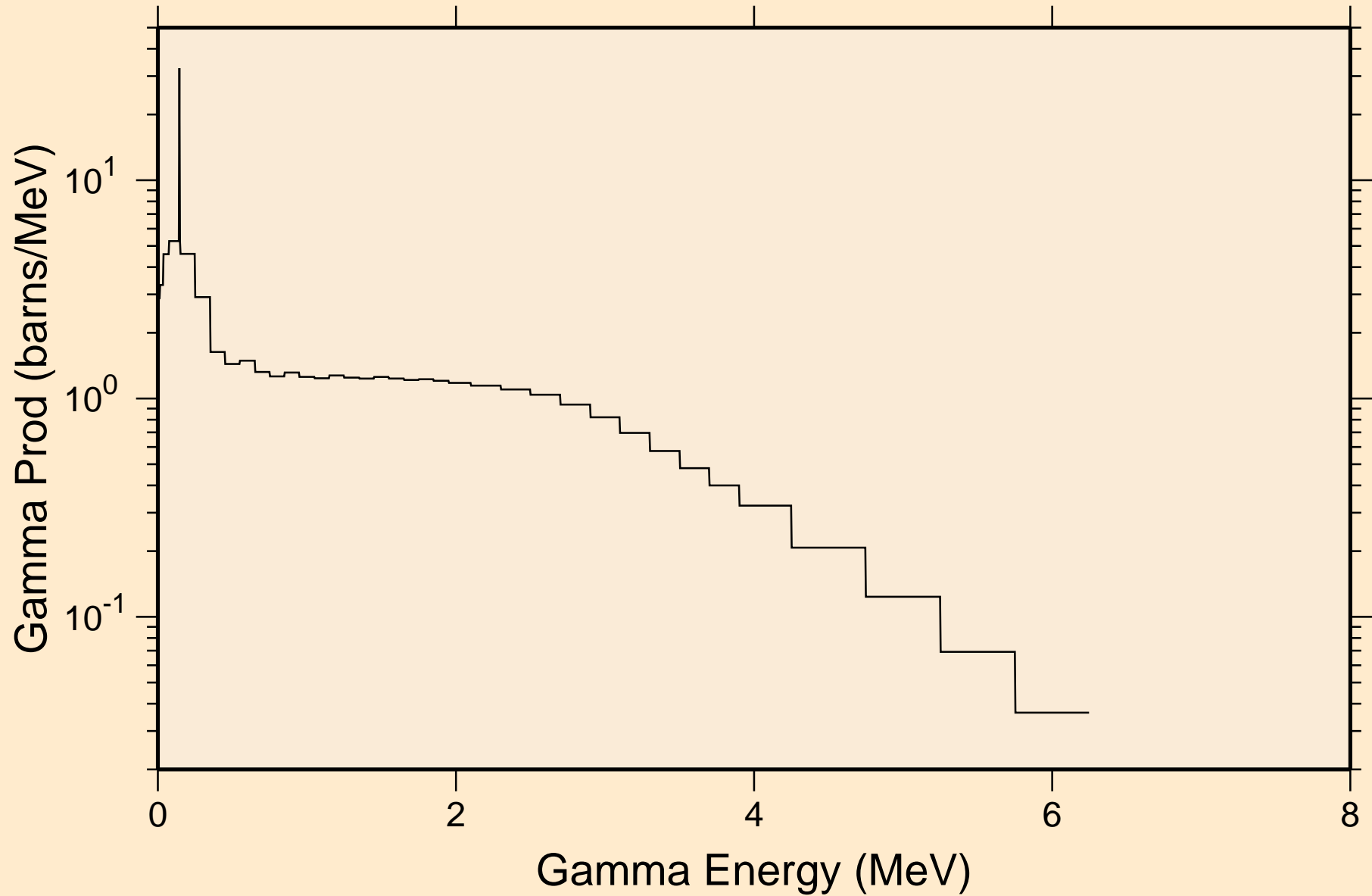

AU177M NEUTRON ACER TENDL-2021 LIBRARY; T=293.6K
14 MeV photon spectrum

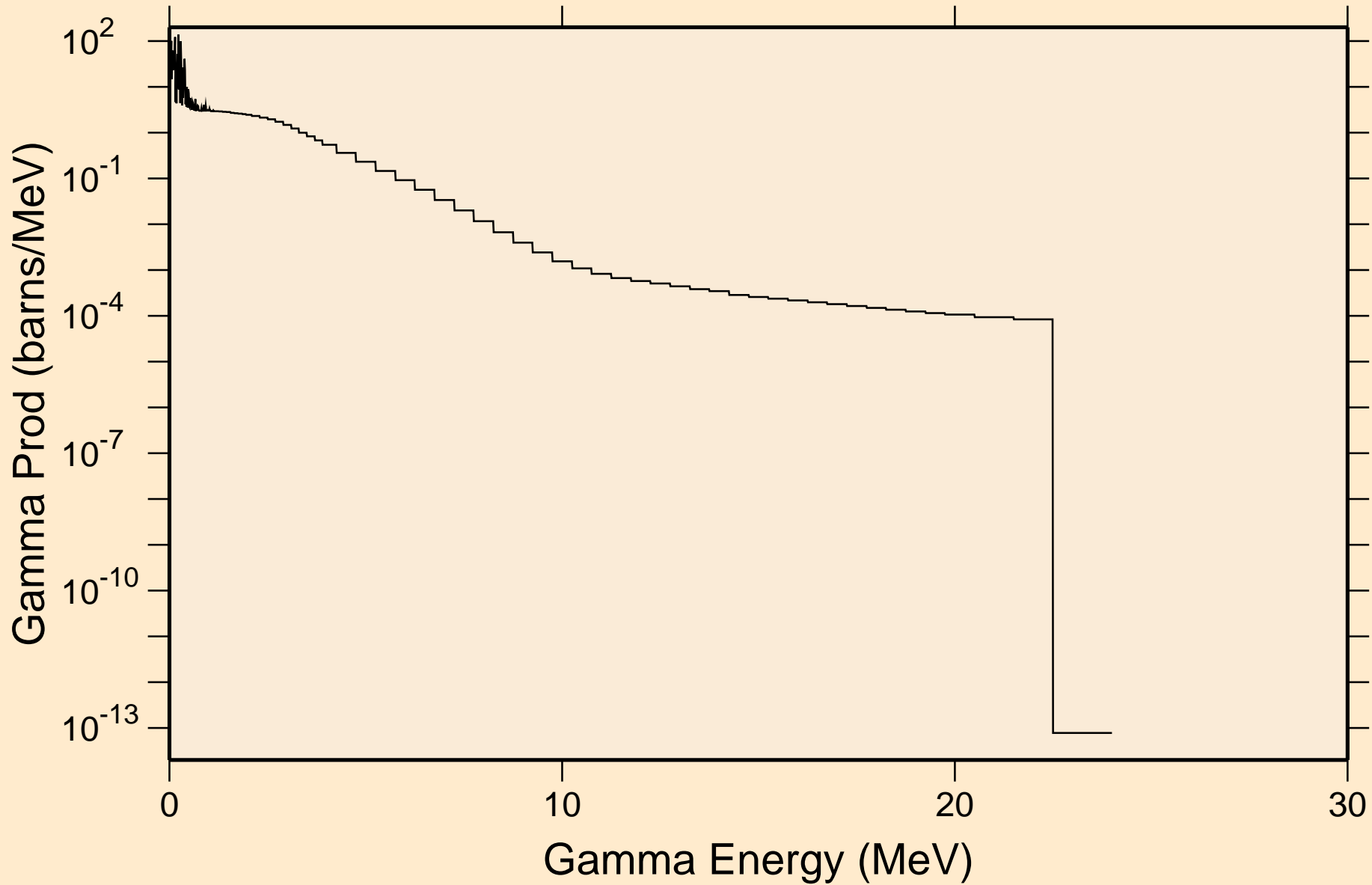

AU177M NEUTRON ACER TENDL-2021 LIBRARY; T=293.6K
Particle heating contributions

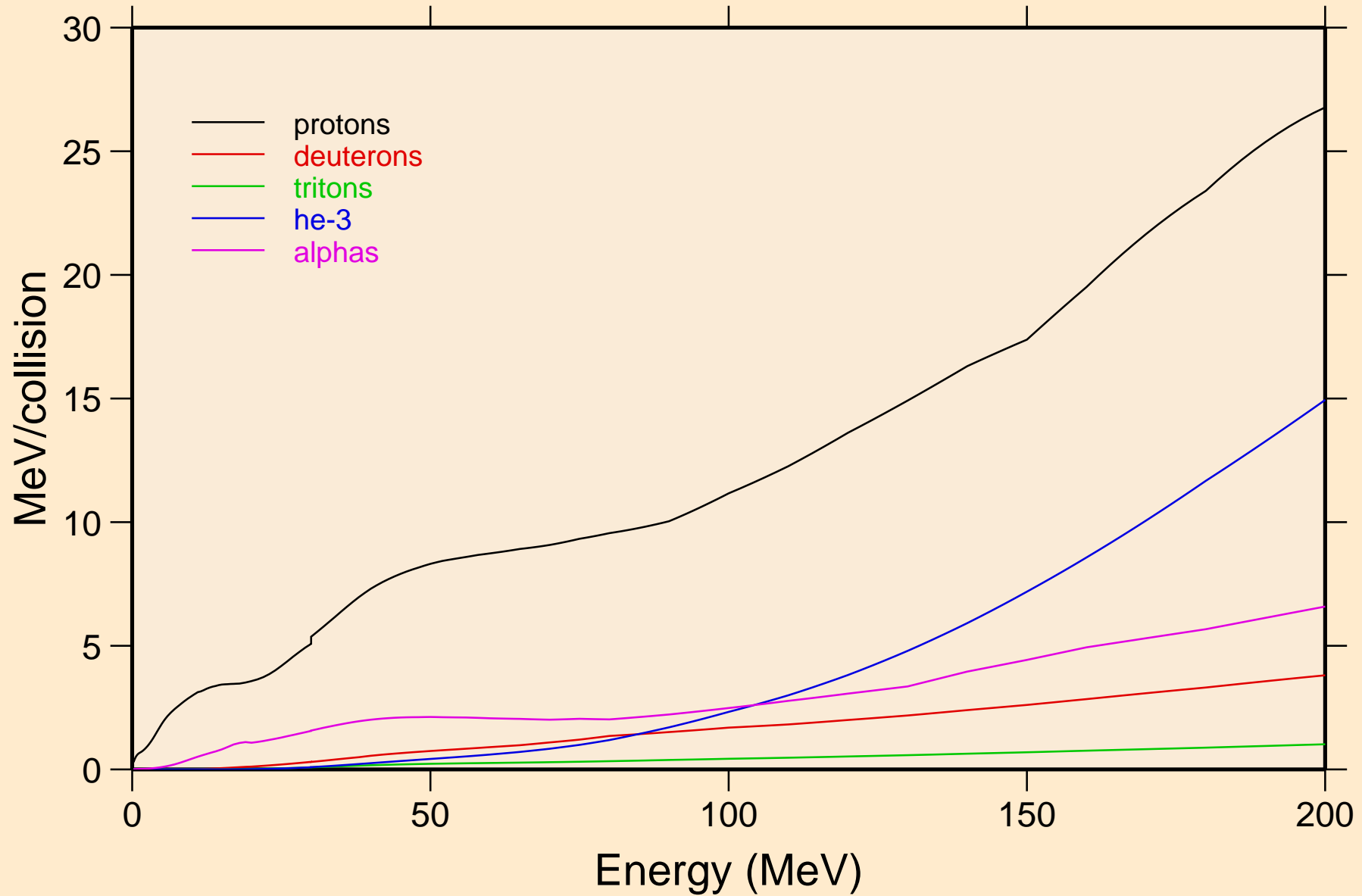

AU177M NEUTRON ACER TENDL-2021 LIBRARY; T=293.6K
Recoil Heating

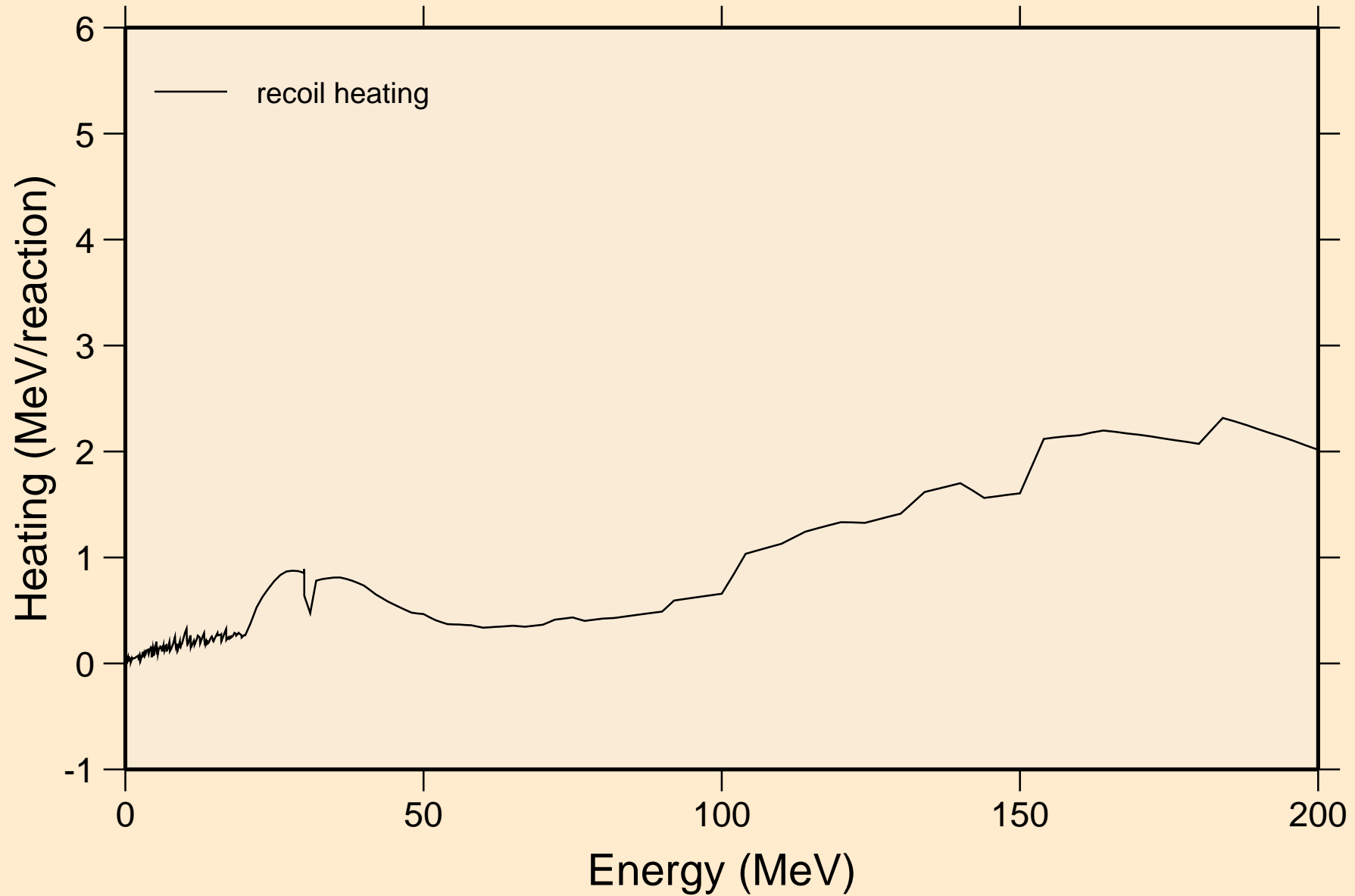

AU177M NEUTRON ACER TENDL-2021 LIBRARY; T=293.6K
Particle production cross sections

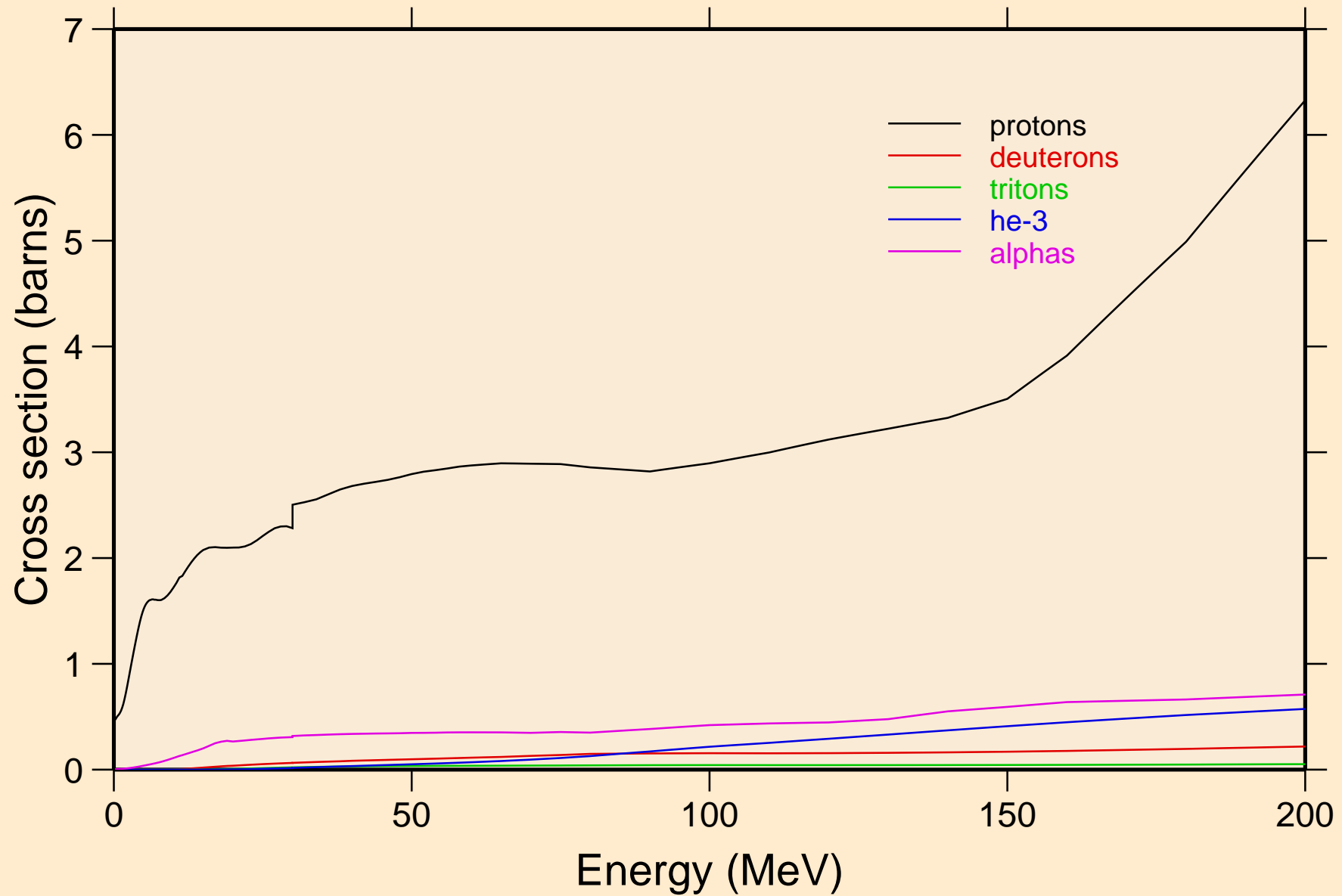

AU177M NEUTRON ACER TENDL-2021 LIBRARY; T=293.6K
protons from (n,x)

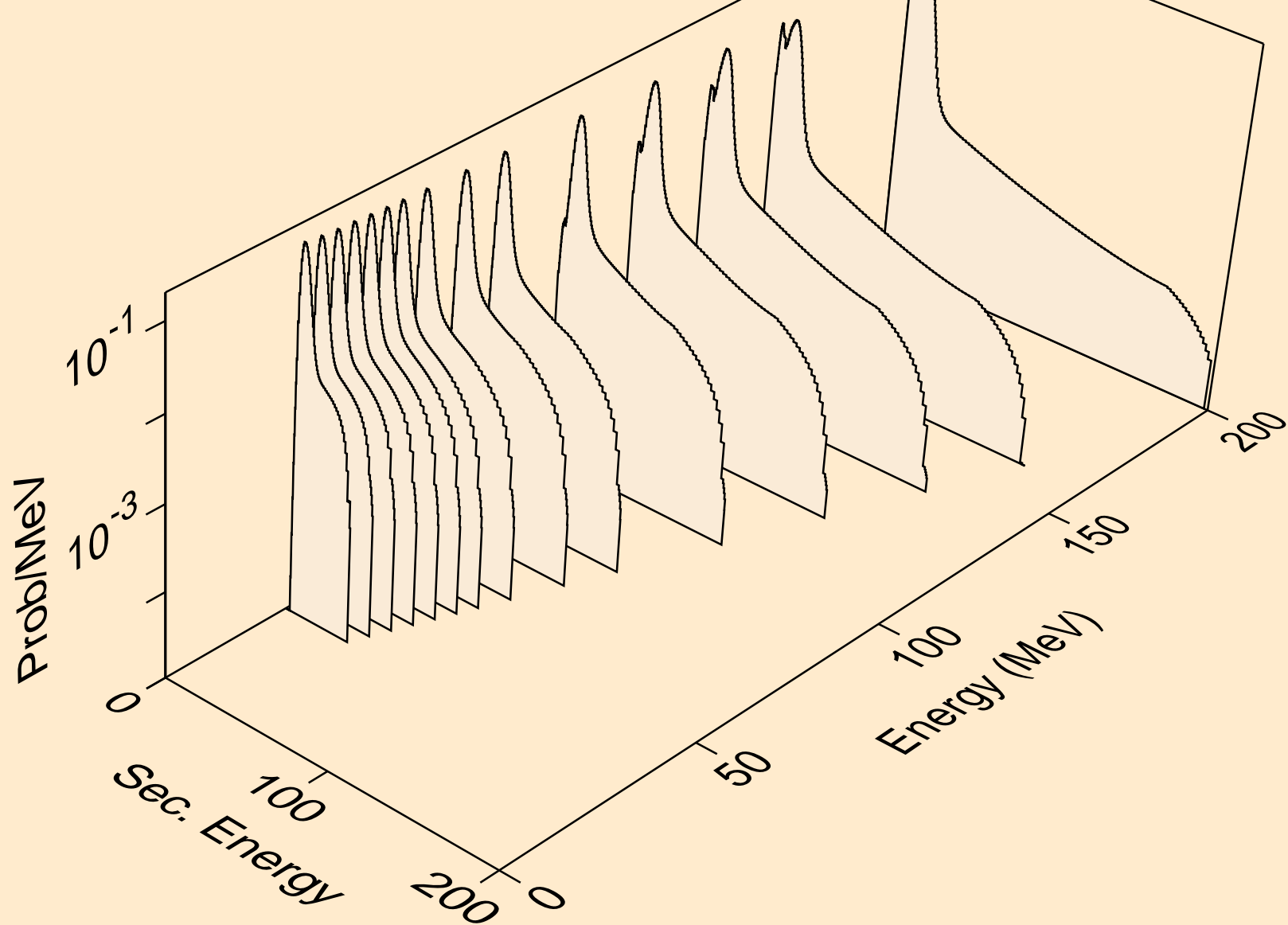

AU177M NEUTRON ACER TENDL-2021 LIBRARY; T=293.6K
protons from (n,n*)p

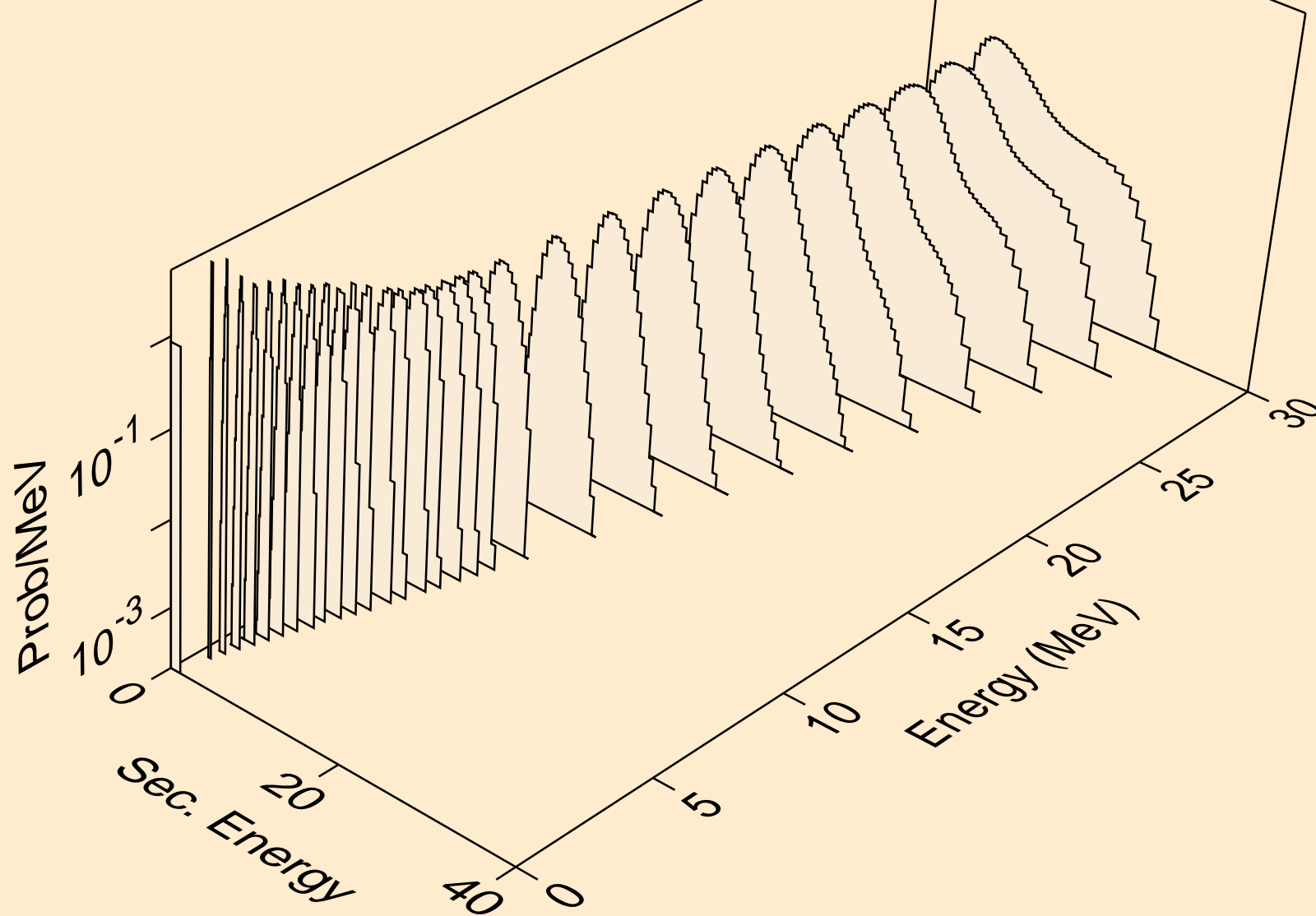

AU177M NEUTRON ACER TENDL-2021 LIBRARY; T=293.6K
protons from (n,2np)

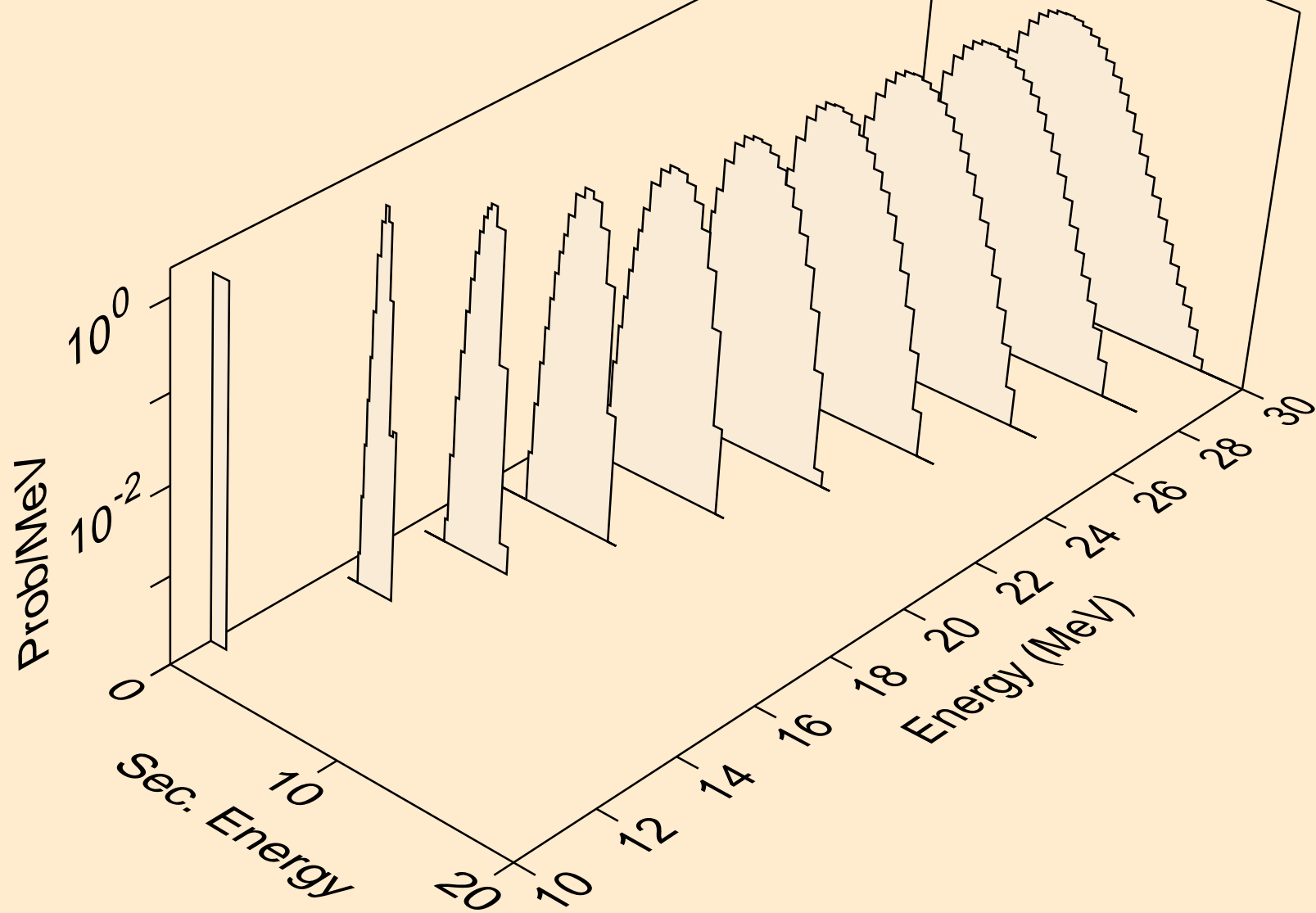

AU177M NEUTRON ACER TENDL-2021 LIBRARY; T=293.6K
protons from (n,3np)

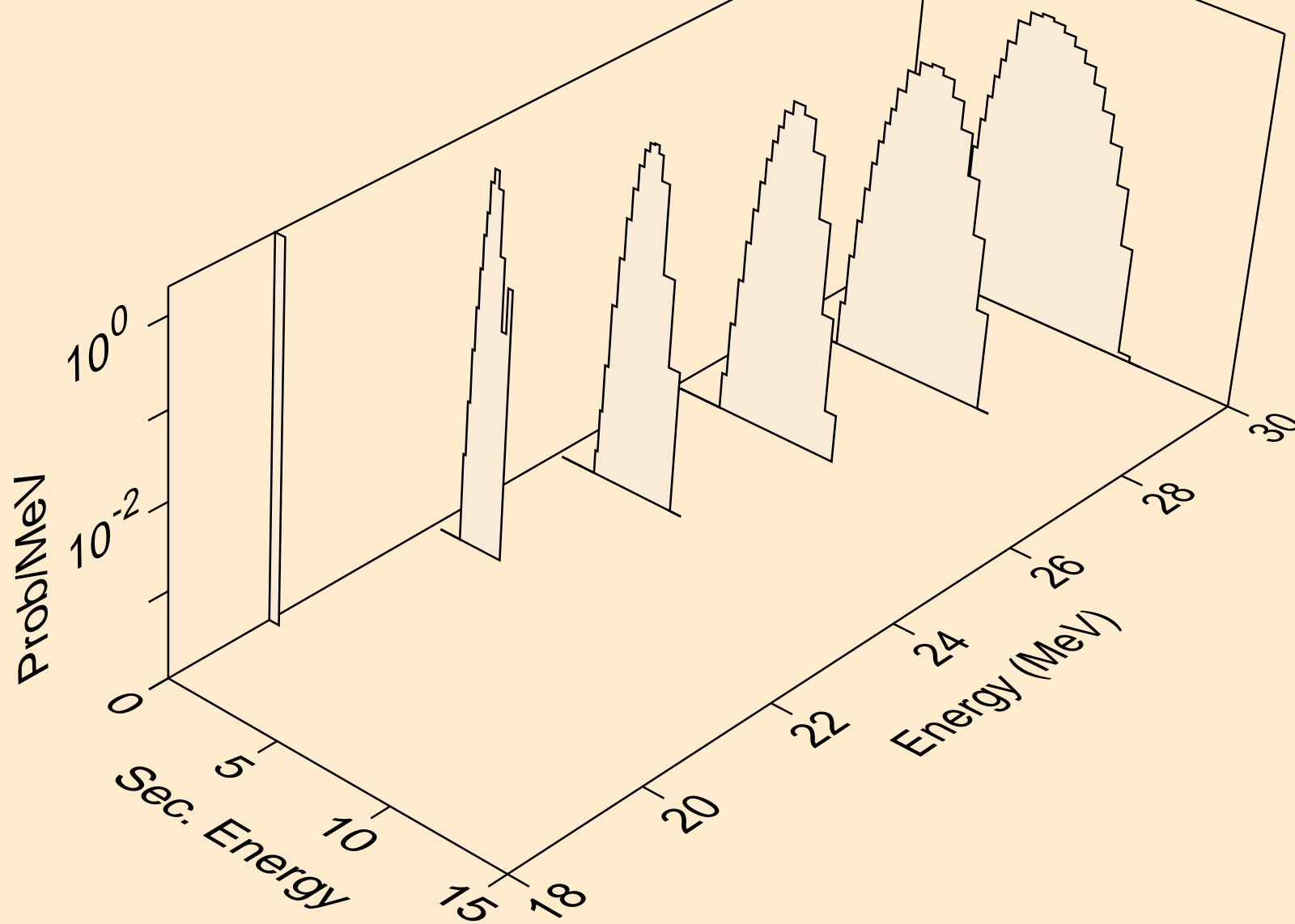

AU177M NEUTRON ACER TENDL-2021 LIBRARY; T=293.6K
protons from (n,2np)

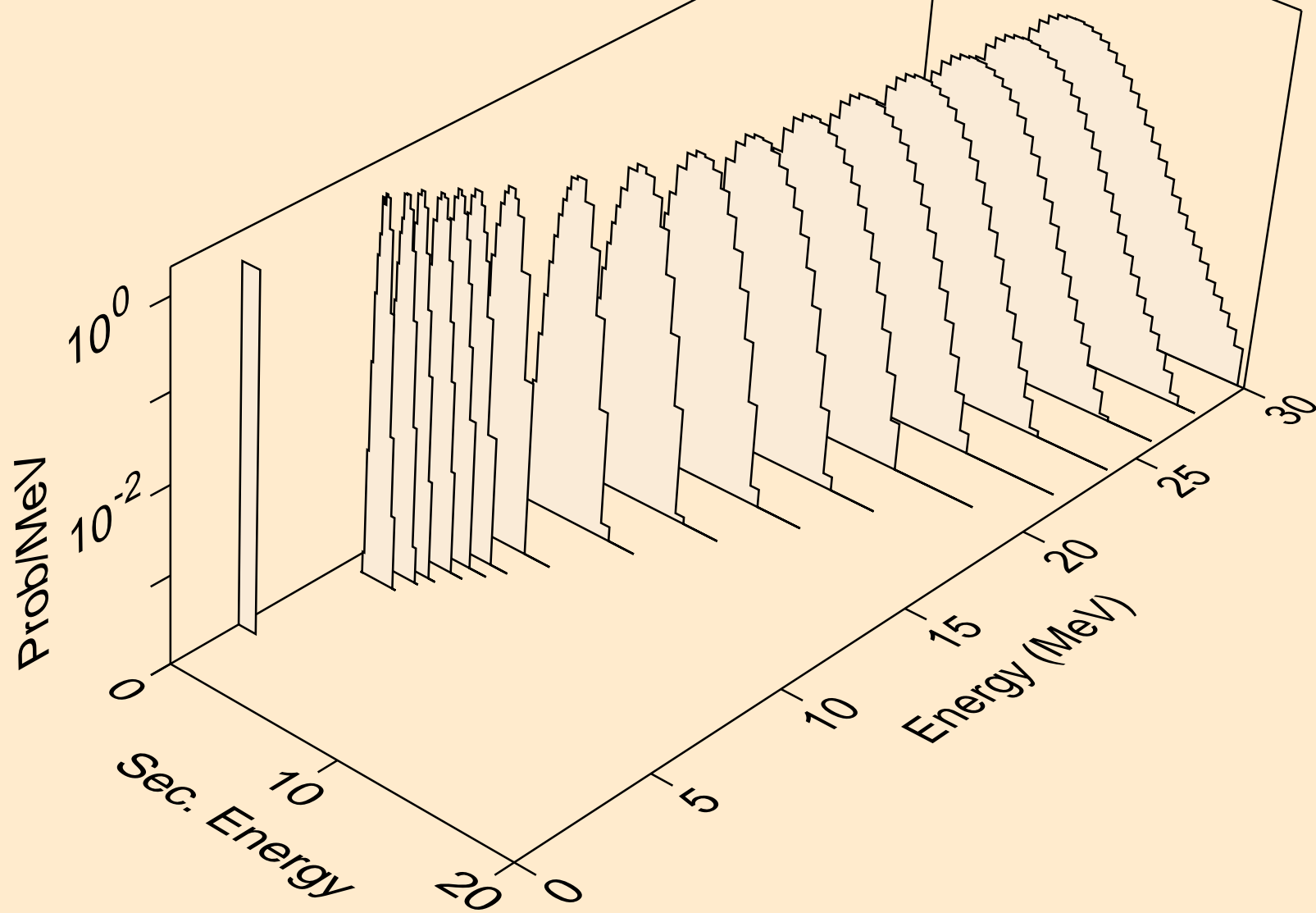

AU177M NEUTRON ACER TENDL-2021 LIBRARY; T=293.6K
protons from (n,npa)

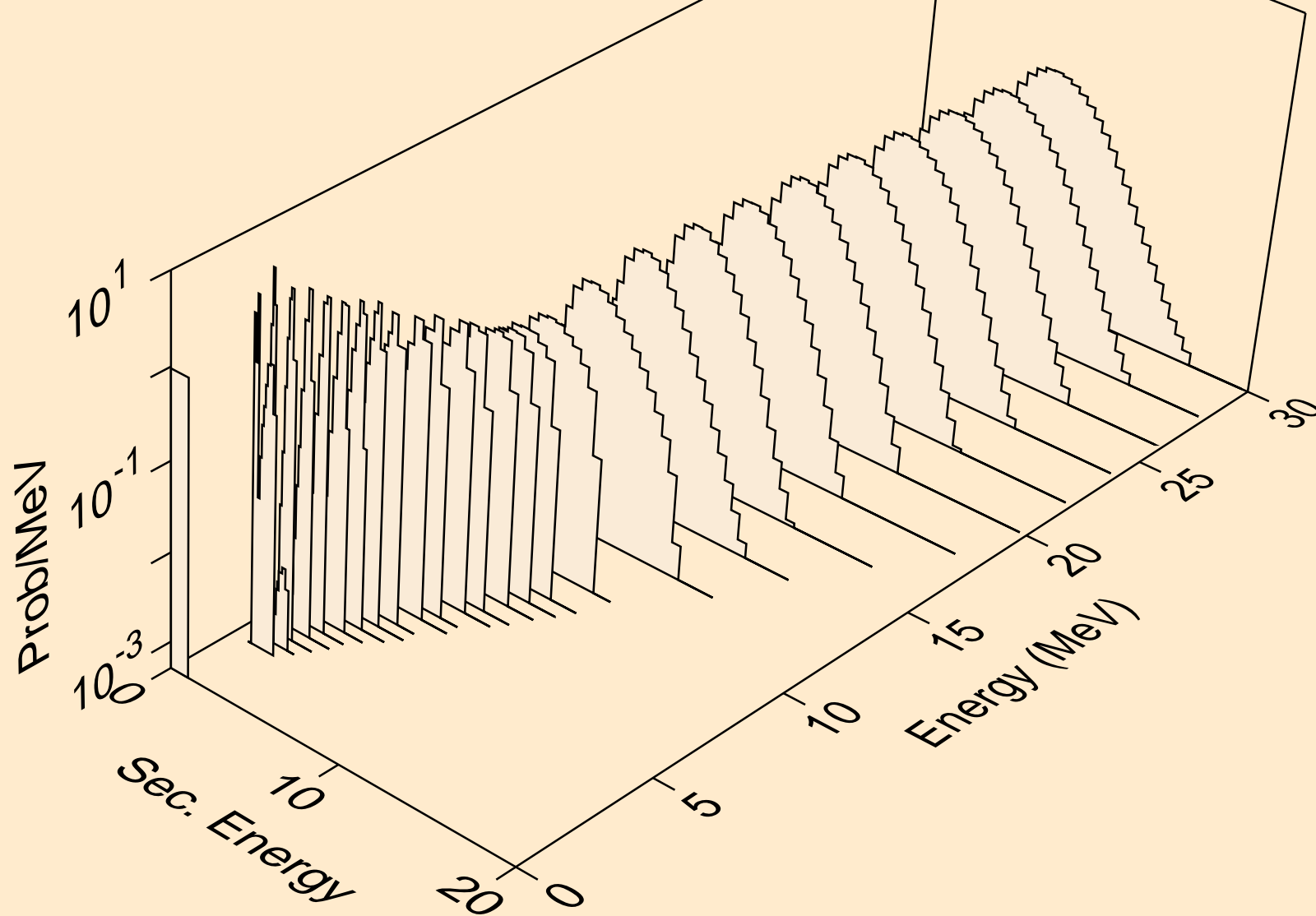

AU177M NEUTRON ACER TENDL-2021 LIBRARY; T=293.6K
protons from (n,p)

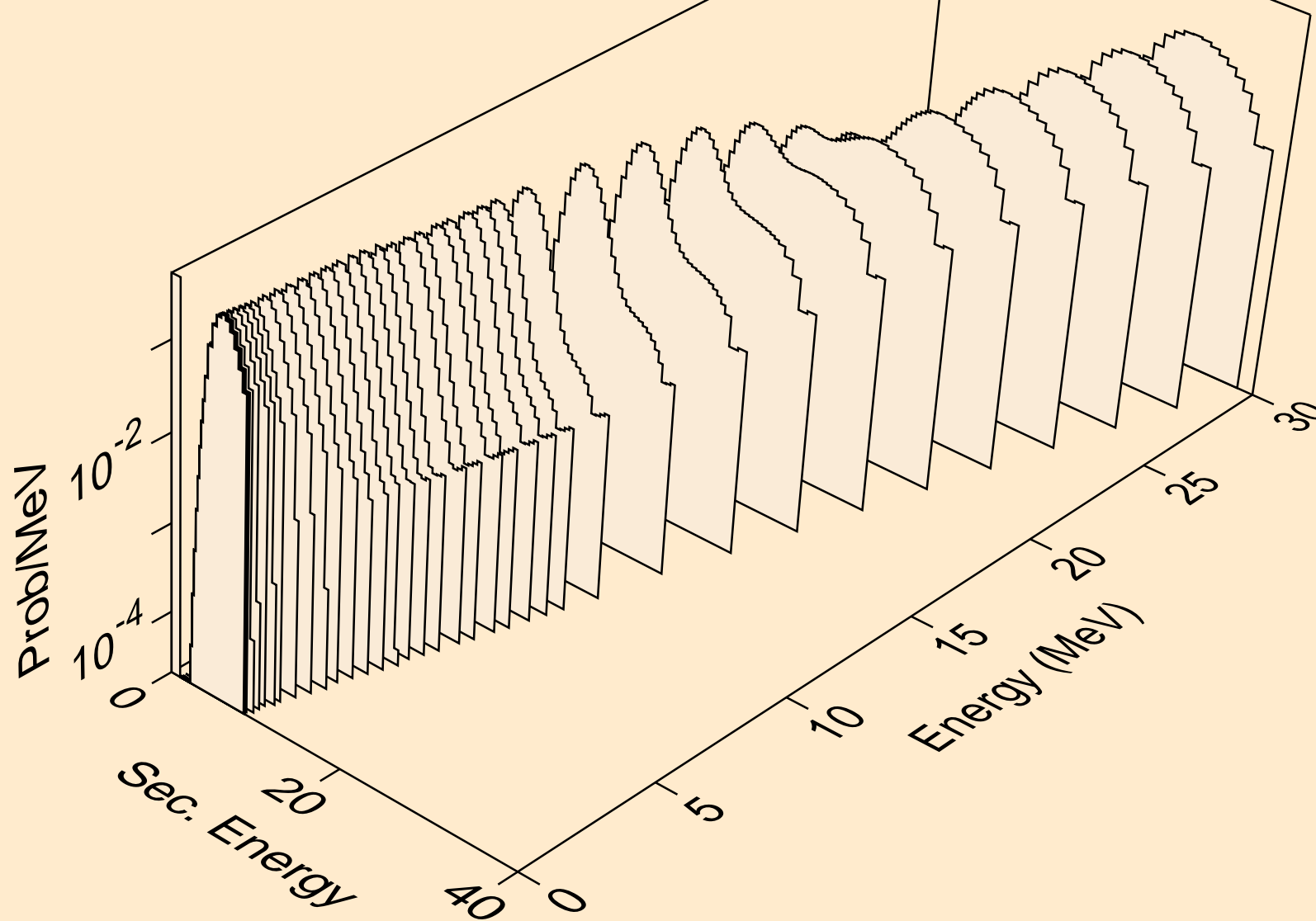

AU177M NEUTRON ACER TENDL-2021 LIBRARY; T=293.6K
protons from (n,2p)

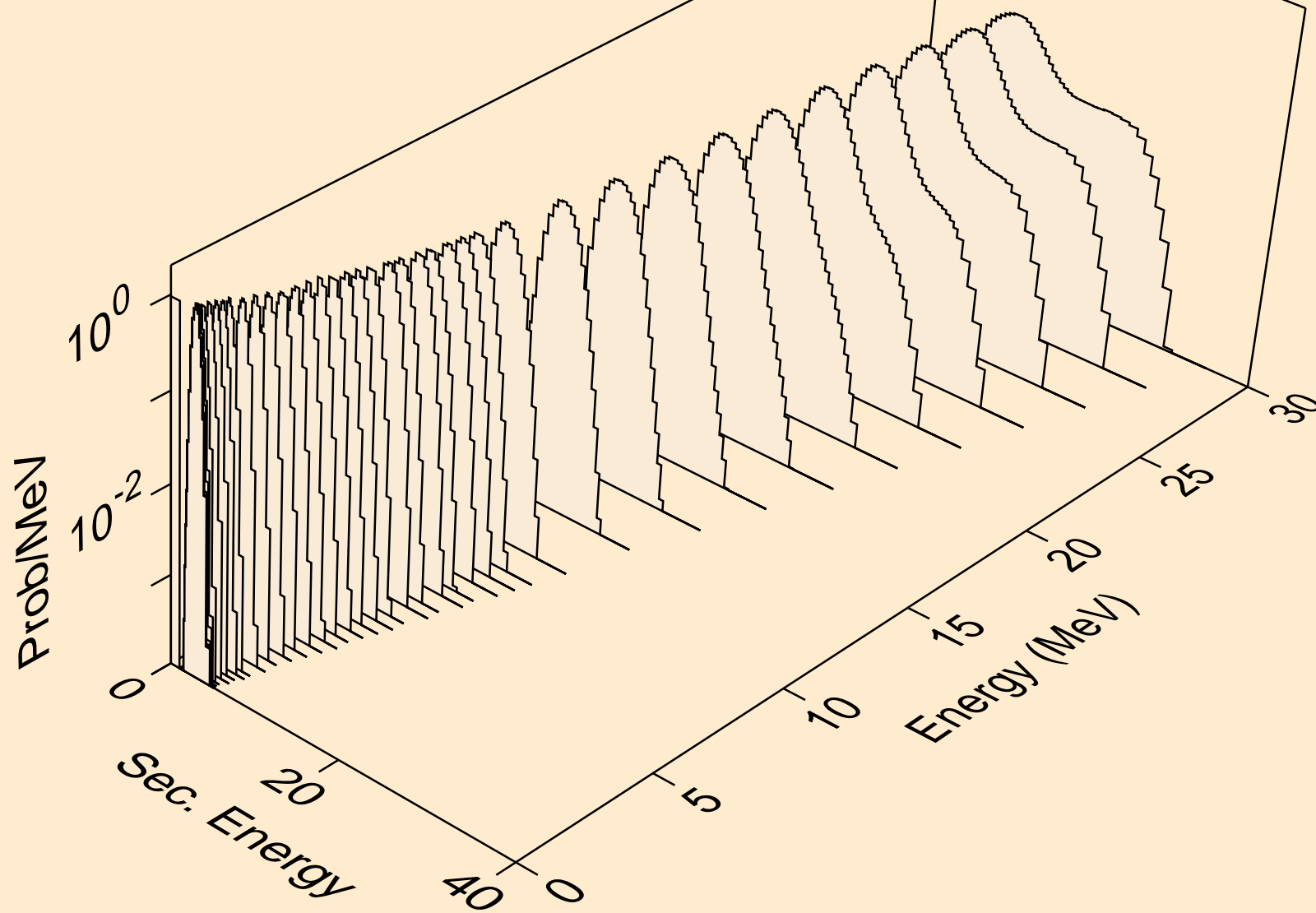

AU177M NEUTRON ACER TENDL-2021 LIBRARY; T=293.6K
protons from (n,p)

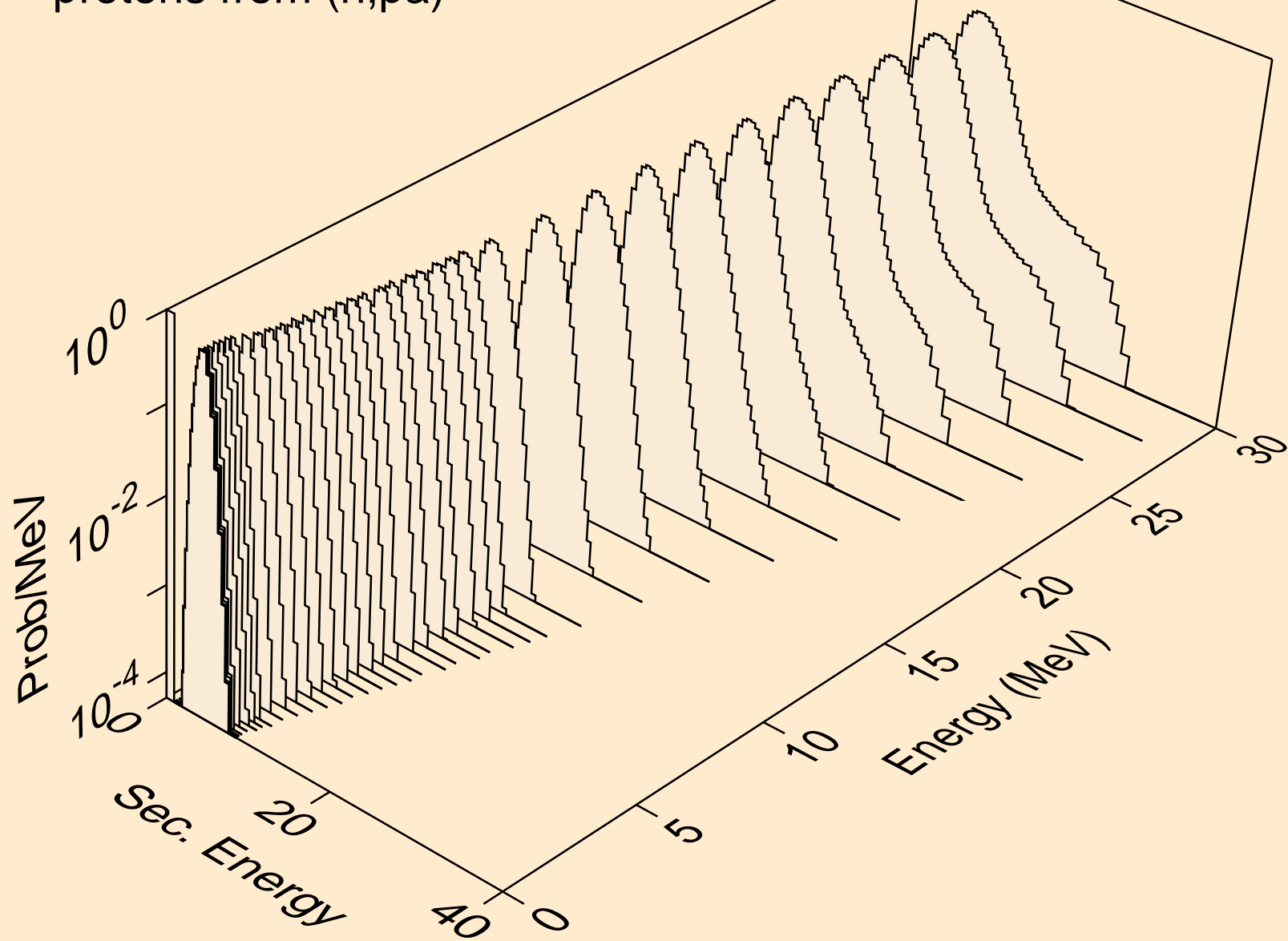

AU177M NEUTRON ACER TENDL-2021 LIBRARY; T=293.6K
protons from (n,pd)

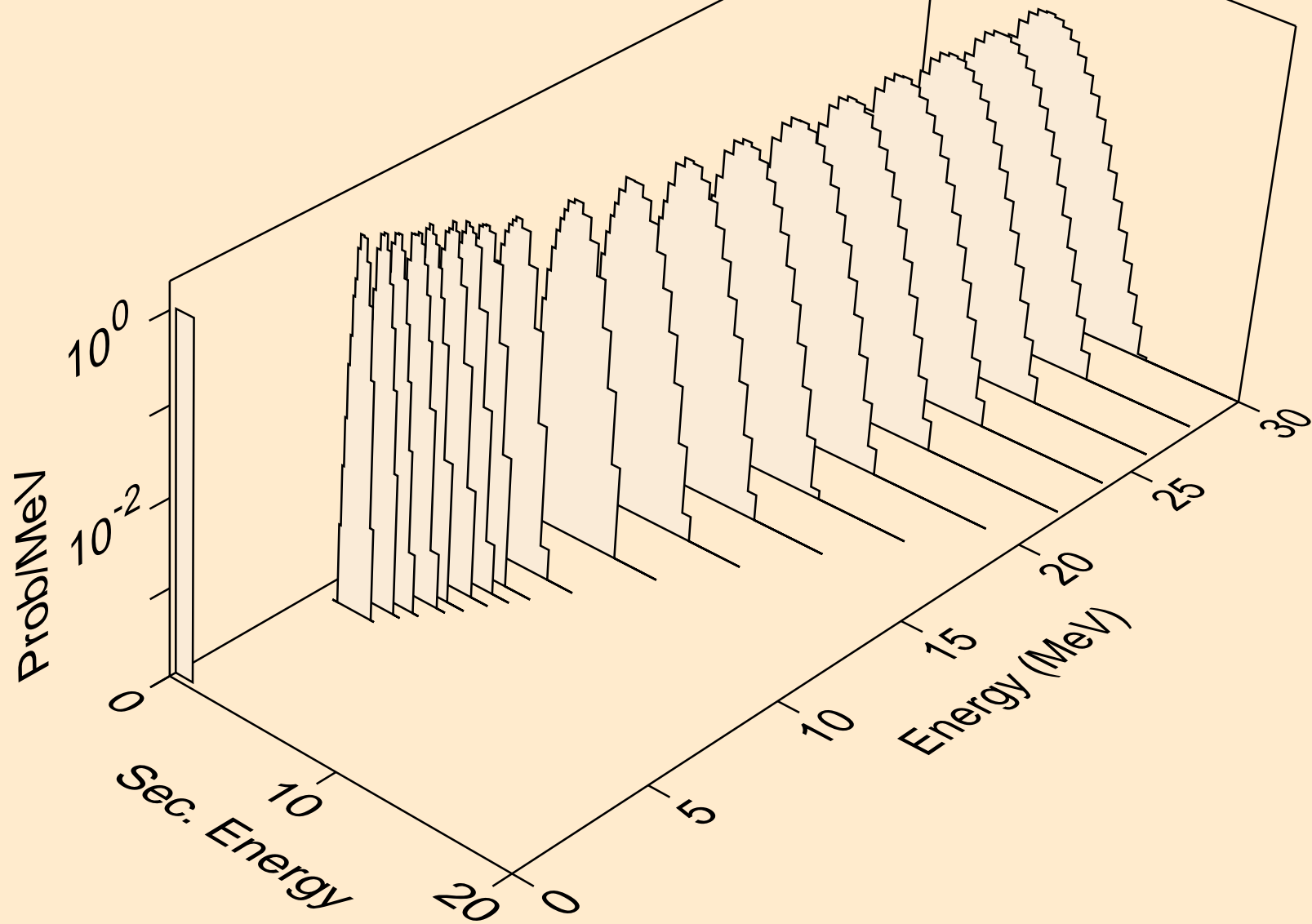

AU177M NEUTRON ACER TENDL-2021 LIBRARY; T=293.6K
protons from (n,pt)

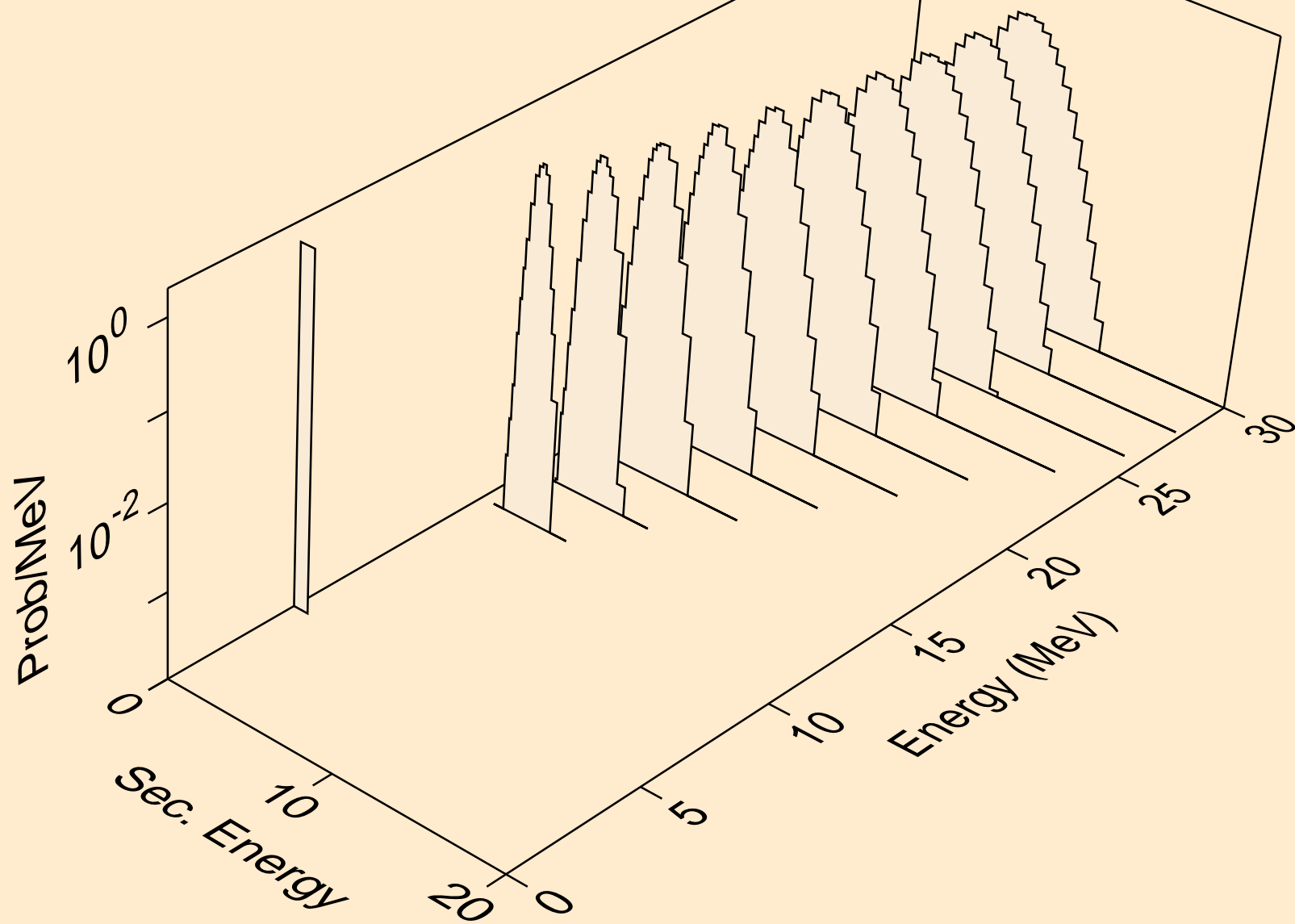

AU177M NEUTRON ACER TENDL-2021 LIBRARY; T=293.6K
deuterons from (n,x)

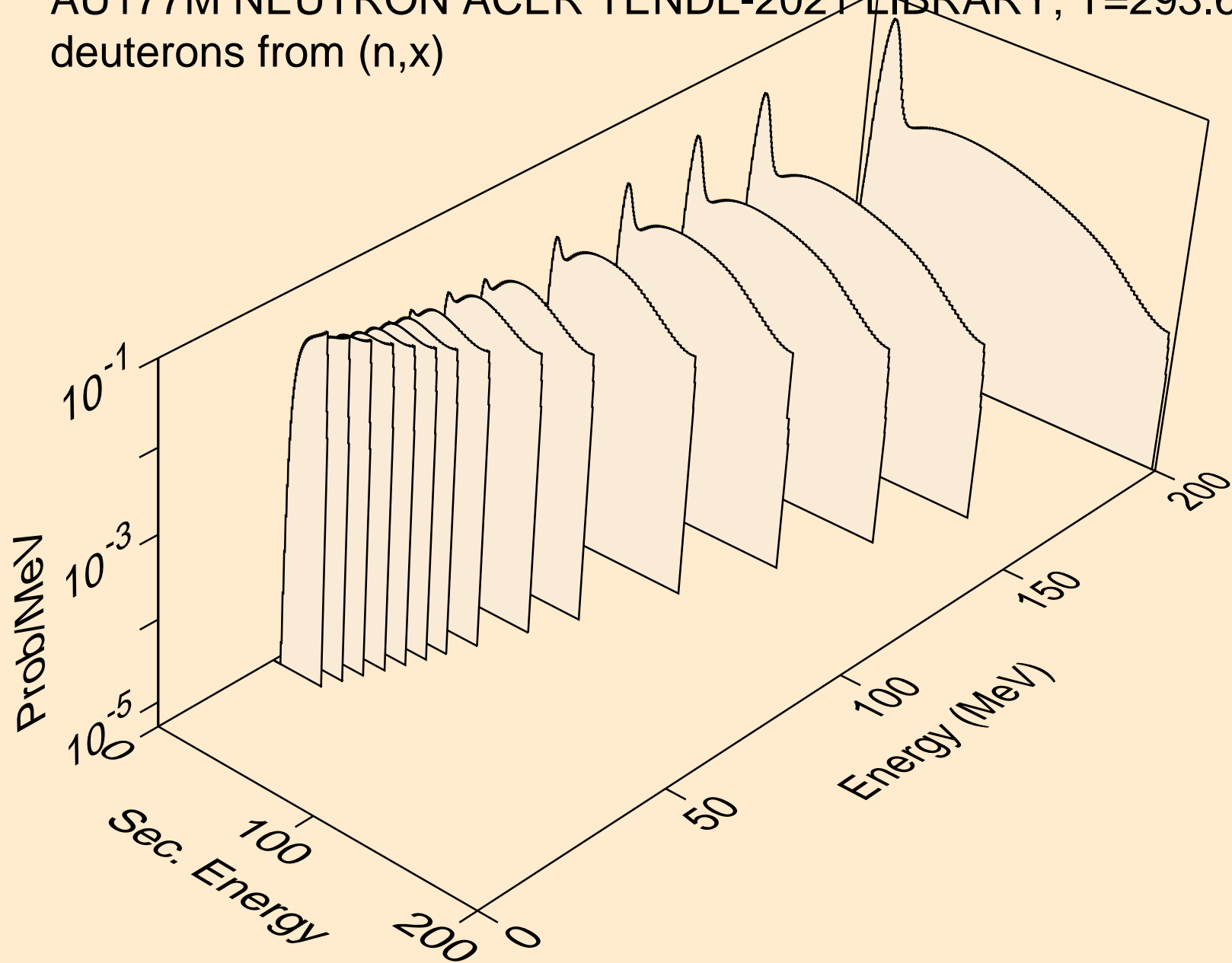

AU177M NEUTRON ACER TENDL-2021 LIBRARY; T=293.6K
deuterons from (n,2nd)

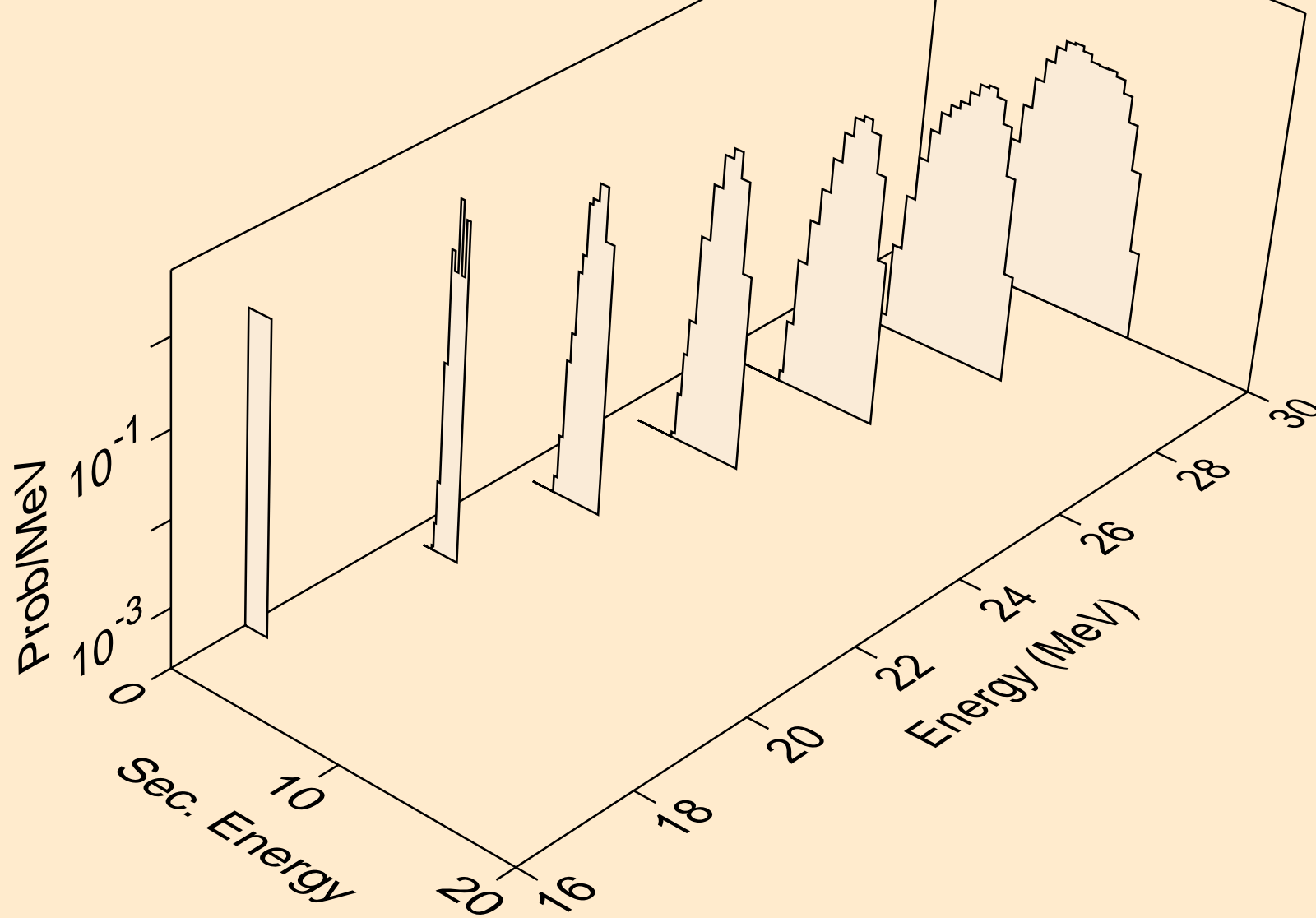

AU177M NEUTRON ACER TENDL-2021 LIBRARY; T=293.6K
deuterons from (n,n*)d

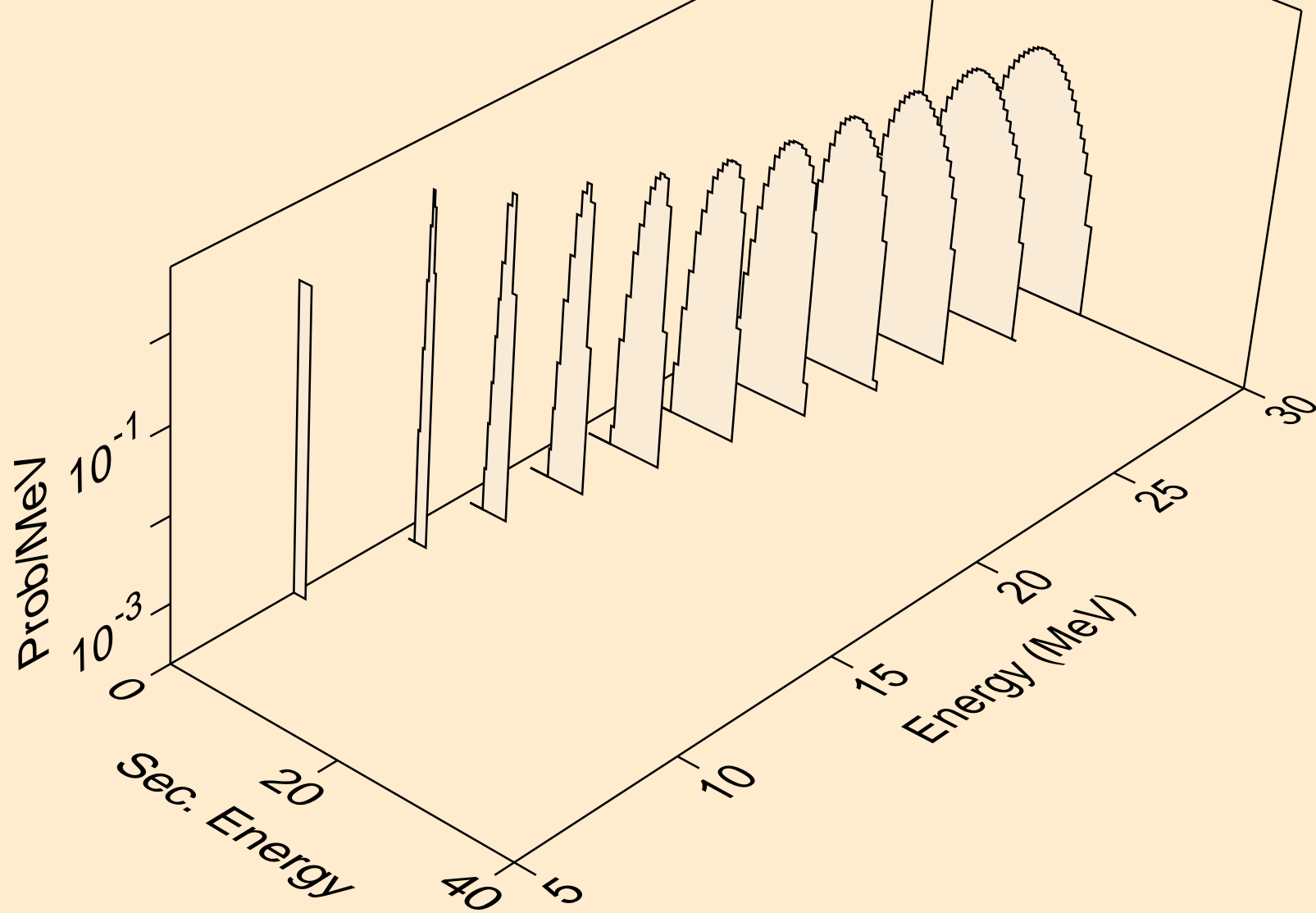

AU177M NEUTRON ACER TENDL-2021 LIBRARY; T=293.6K
deuterons from (n,d)

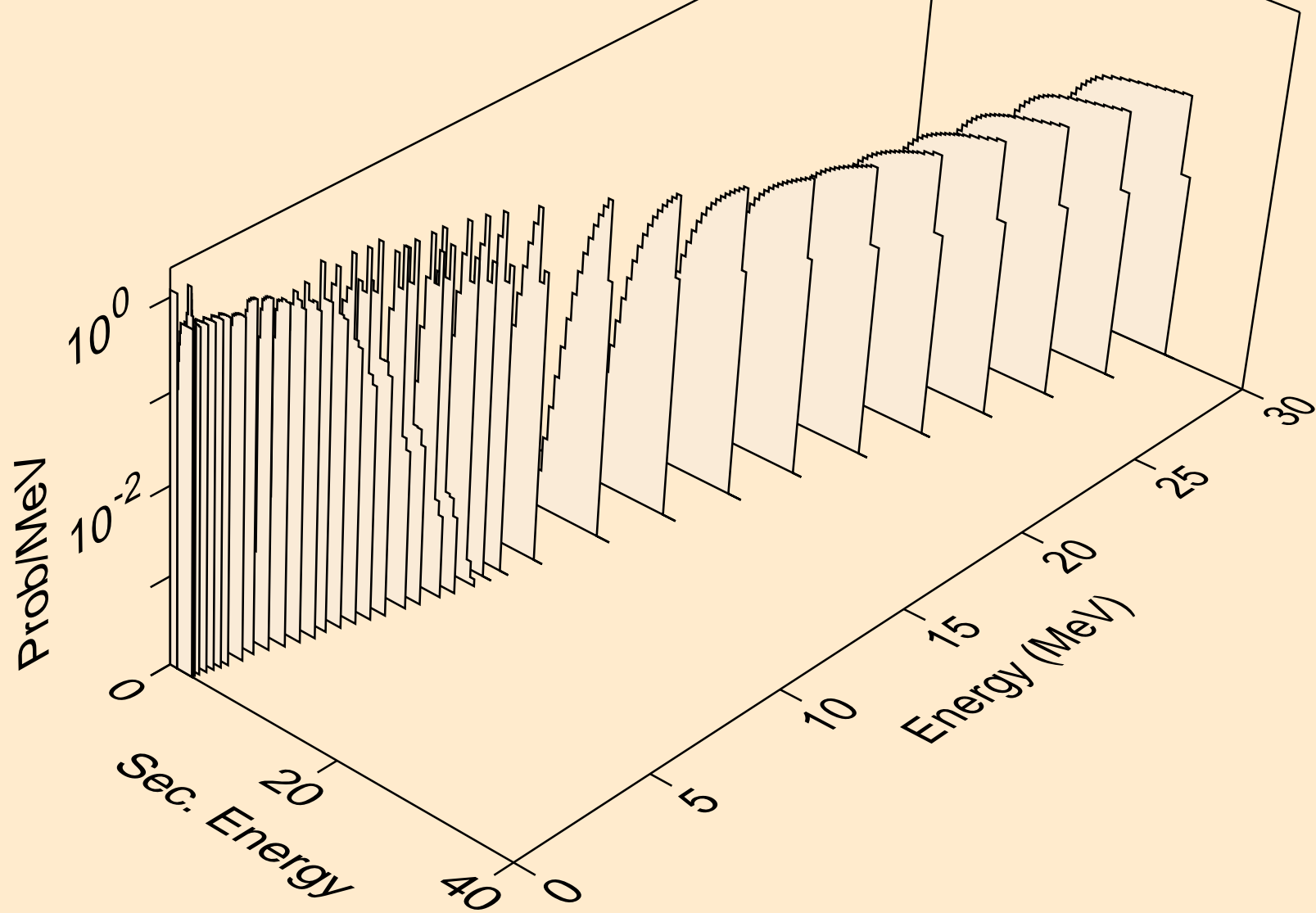

AU177M NEUTRON ACER TENDL-2021 LIBRARY; T=293.6K
deuterons from (n,d2a)

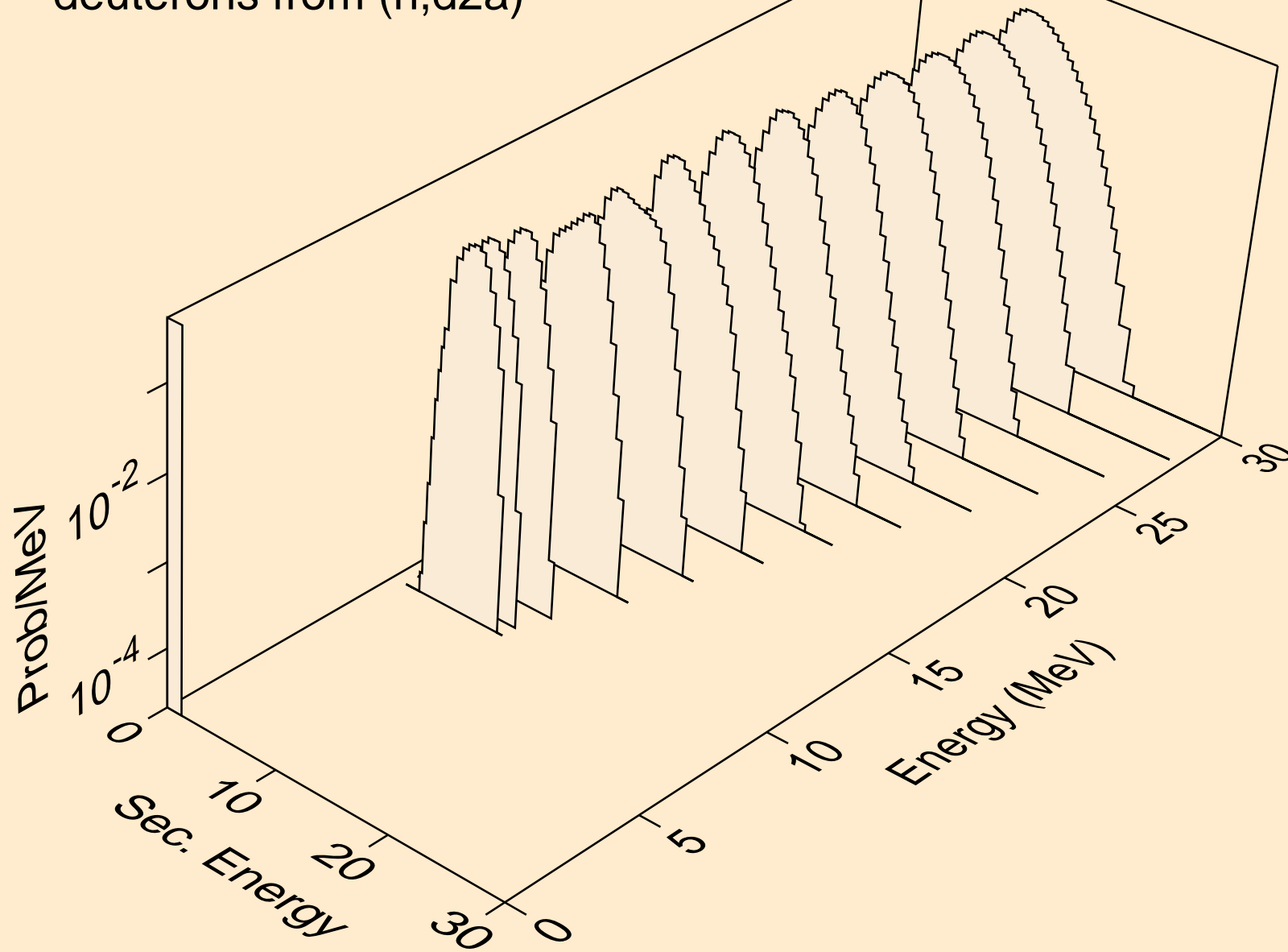

AU177M NEUTRON ACER TENDL-2021 LIBRARY; T=293.6K
deuterons from (n,pd)

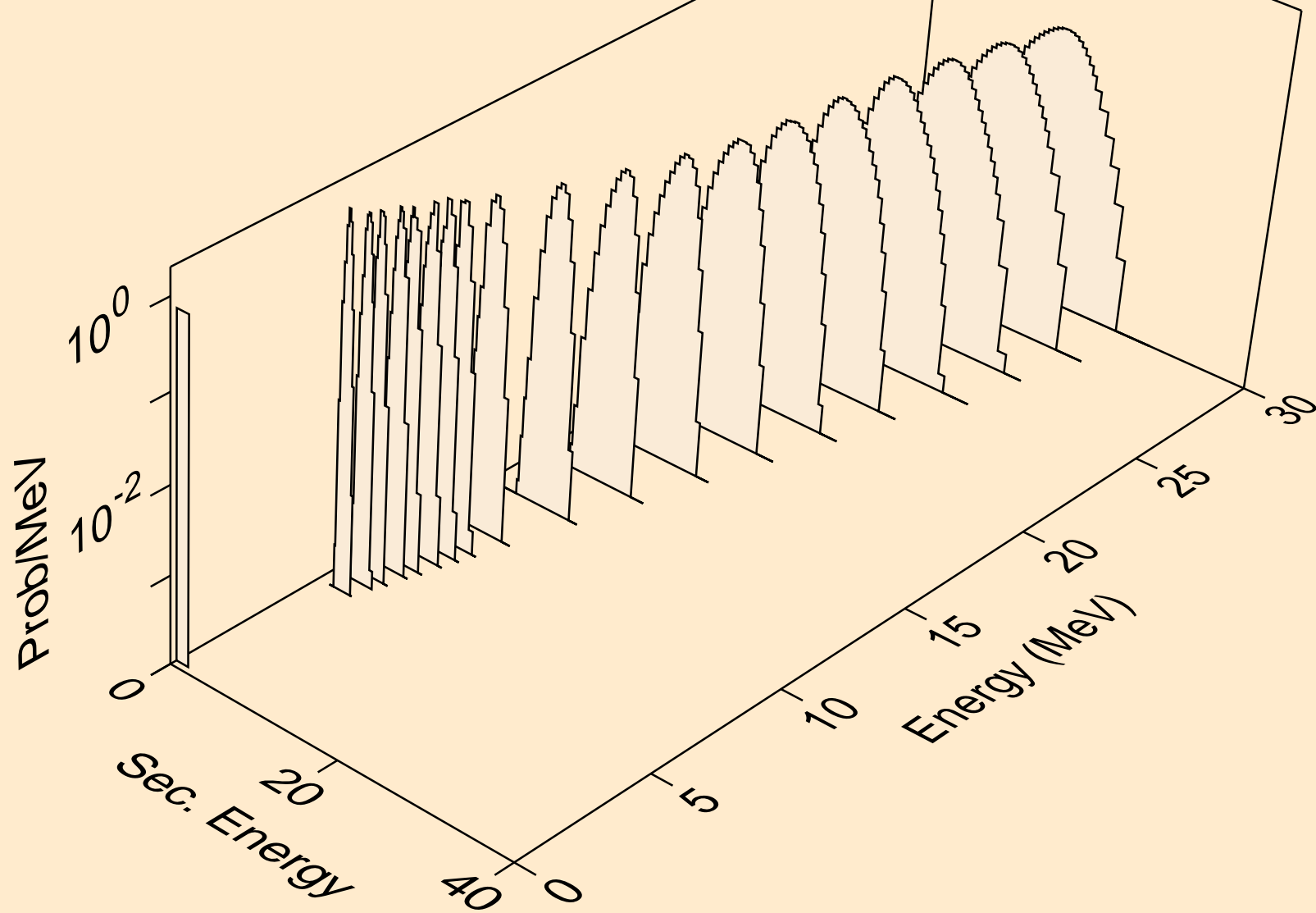

AU177M NEUTRON ACER TENDL-2021 LIBRARY; T=293.6K
deuterons from (n,da)

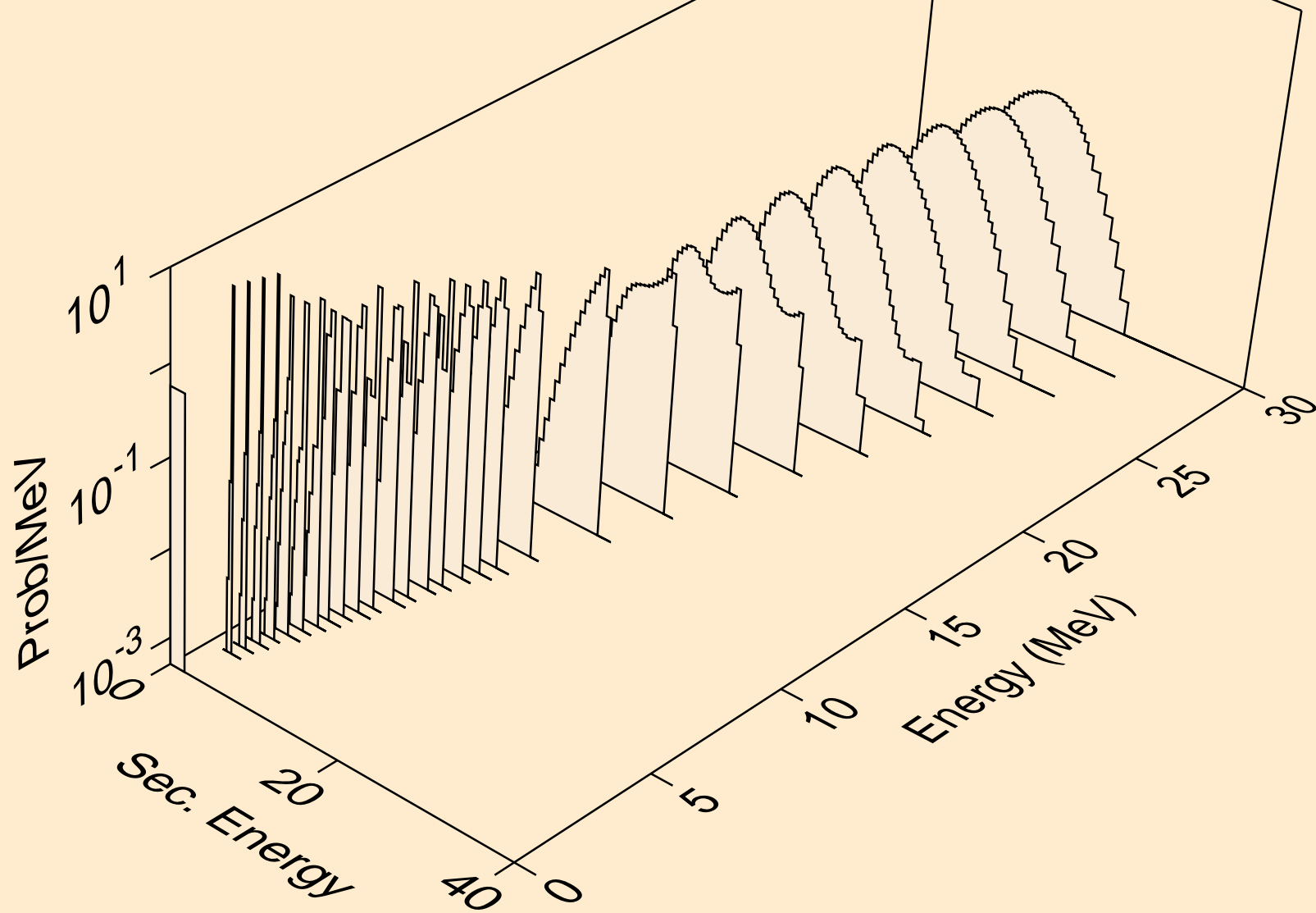

AU177M NEUTRON ACER TENDL-2021 LIBRARY; T=293.6K
tritons from (n,x)

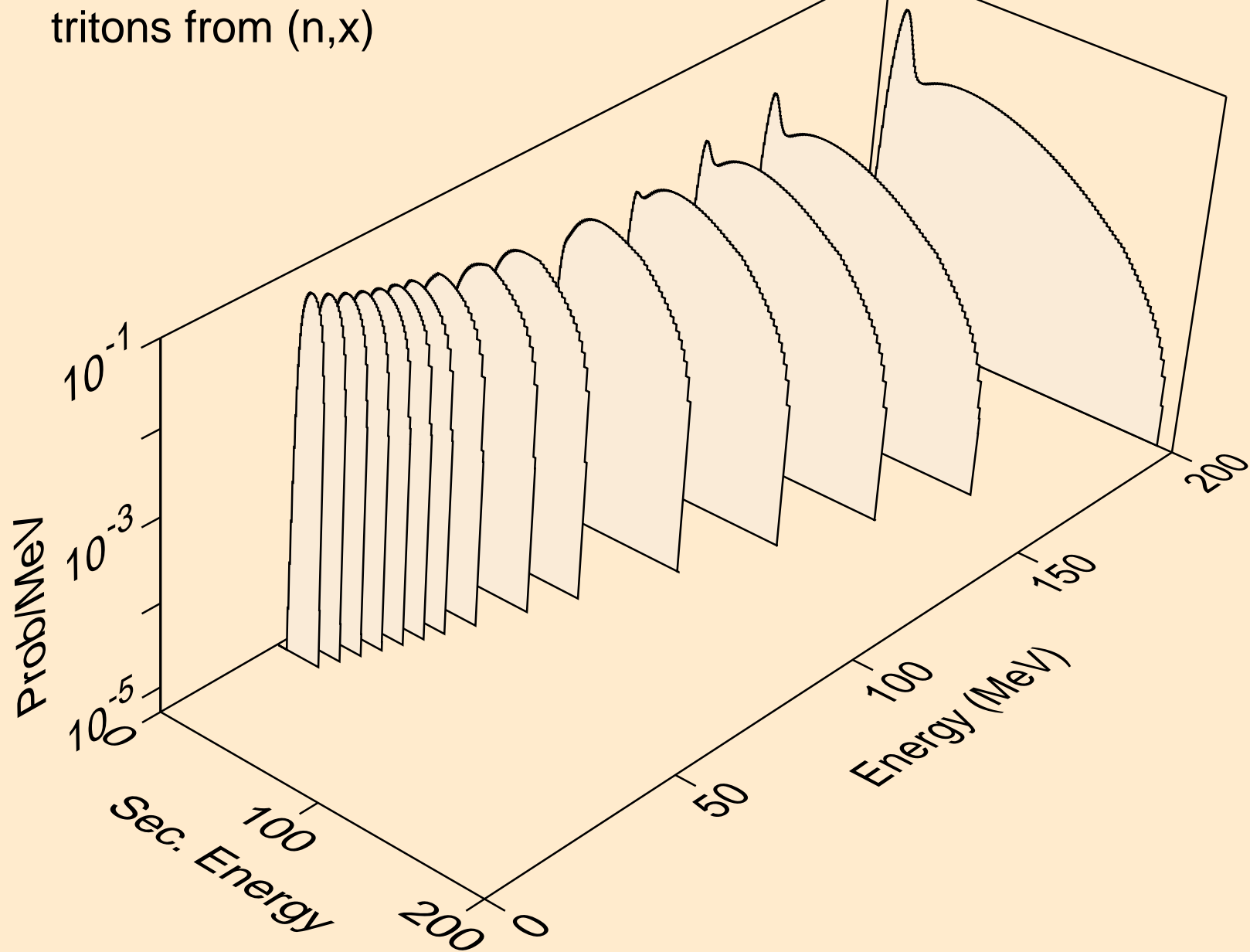

AU177M NEUTRON ACER TENDL-2021 LIBRARY; T=293.6K
tritons from (n,n*)t

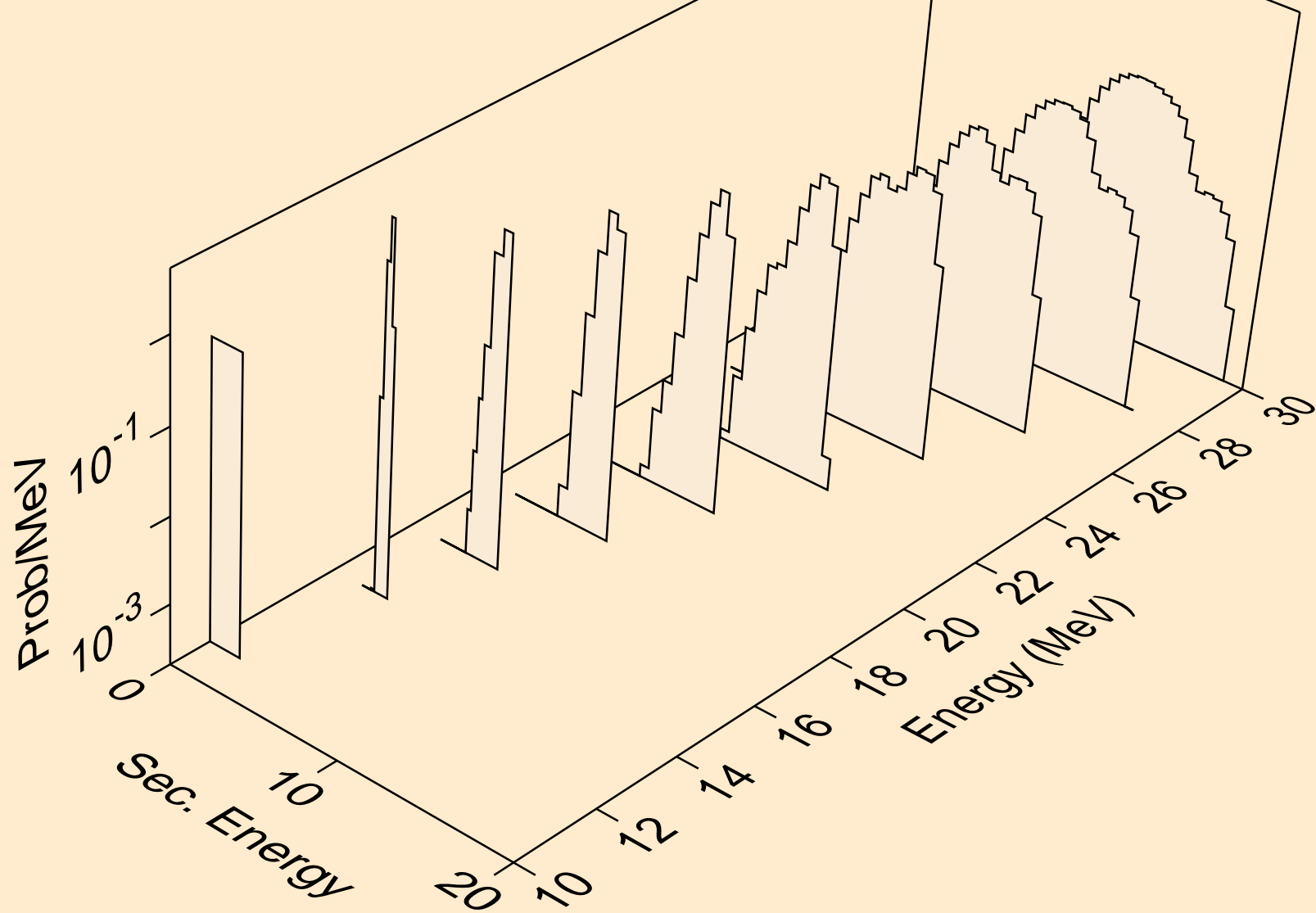

AU177M NEUTRON ACER TENDL-2021 LIBRARY; T=293.6K
tritons from (n,t)

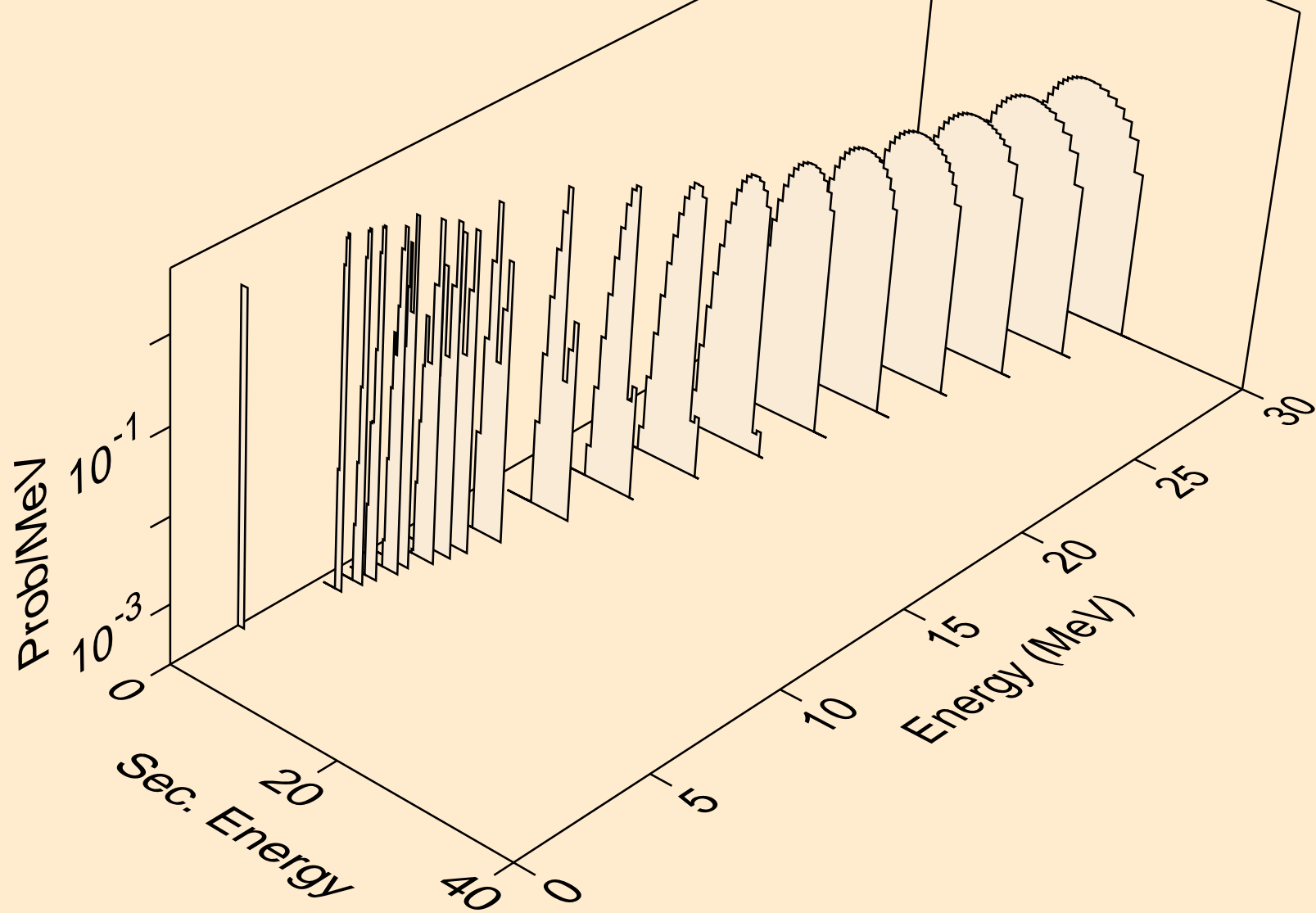

AU177M NEUTRON ACER TENDL-2021 LIBRARY; T=293.6K
tritons from (n,t2a)

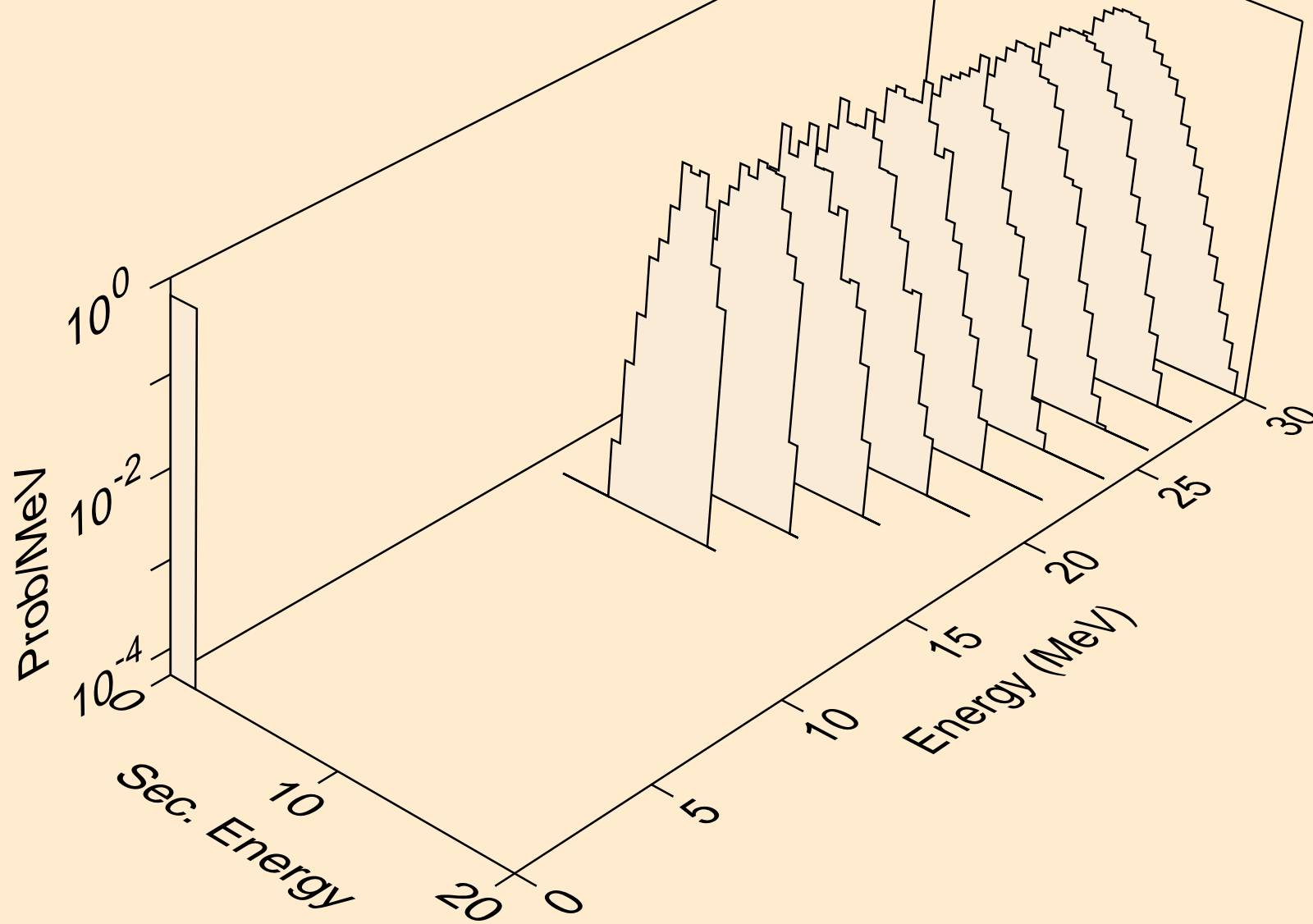

AU177M NEUTRON ACER TENDL-2021 LIBRARY; T=293.6K
tritons from (n,pt)

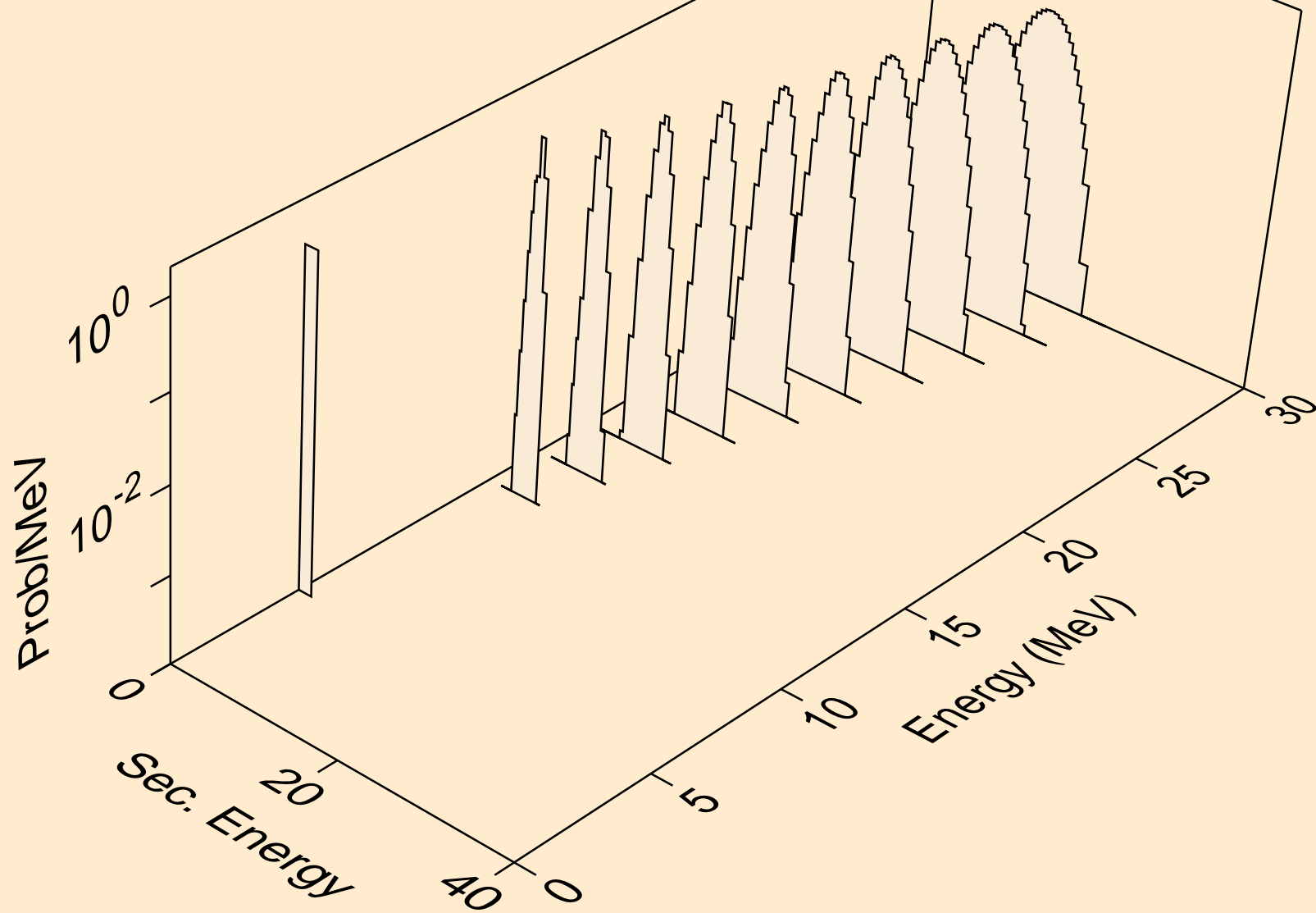

AU177M NEUTRON ACER TENDL-2021 LIBRARY; T=293.6K
he3s from (n,x)

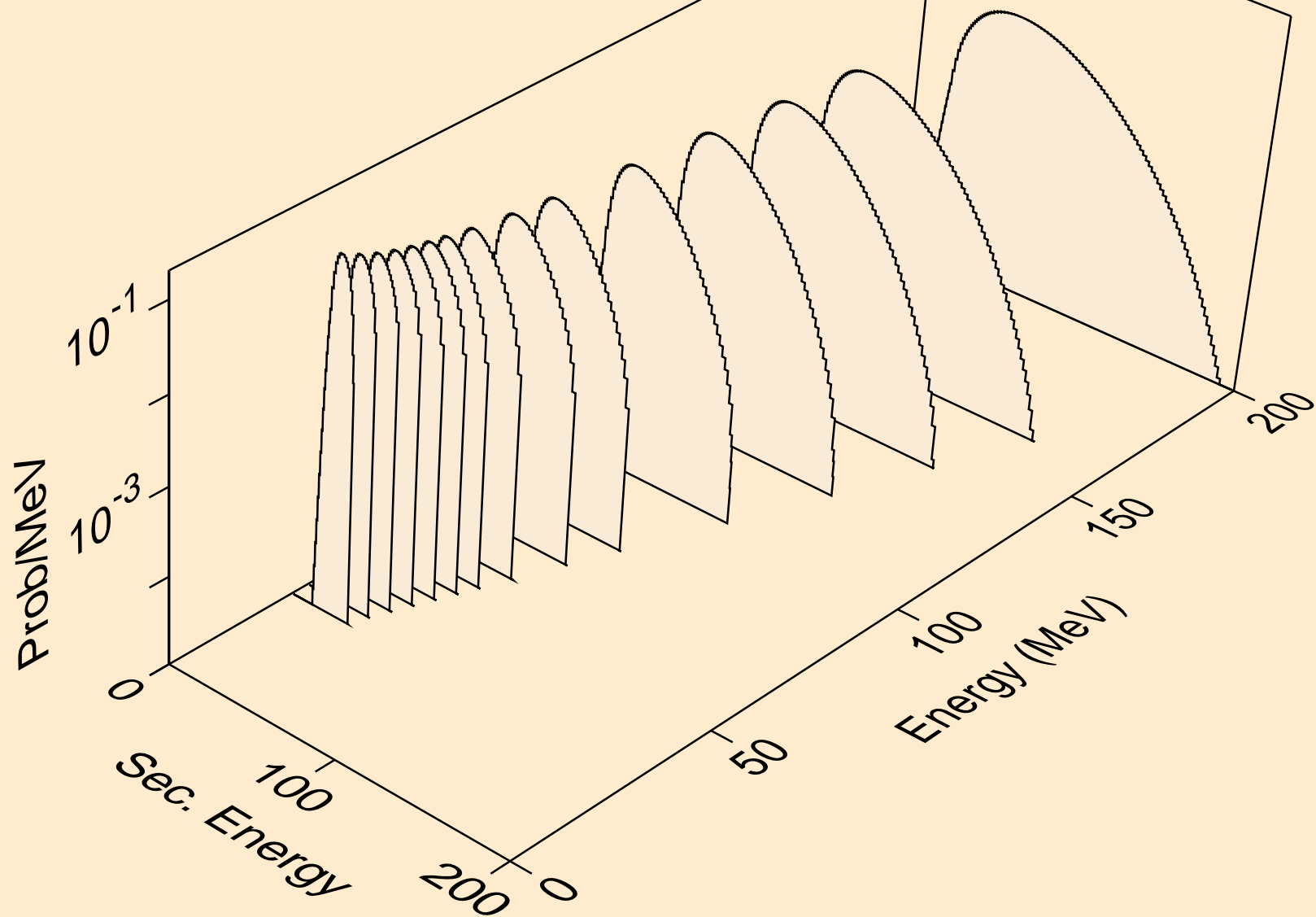

AU177M NEUTRON ACER TENDL-2021 LIBRARY; T=293.6K
he3s from (n,n*)he3

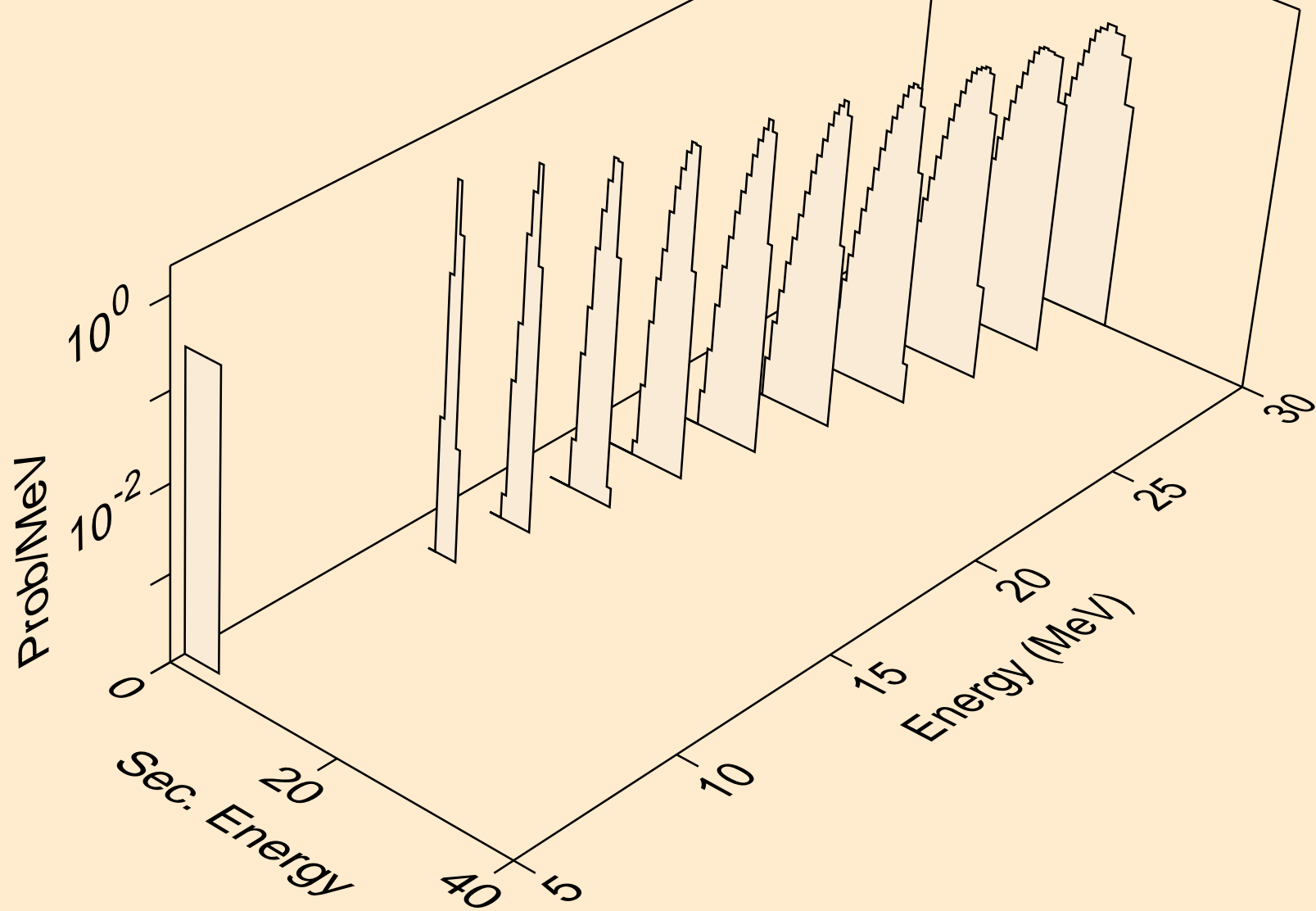

AU177M NEUTRON ACER TENDL-2021 LIBRARY; T=293.6K
he3s from (n,he3)

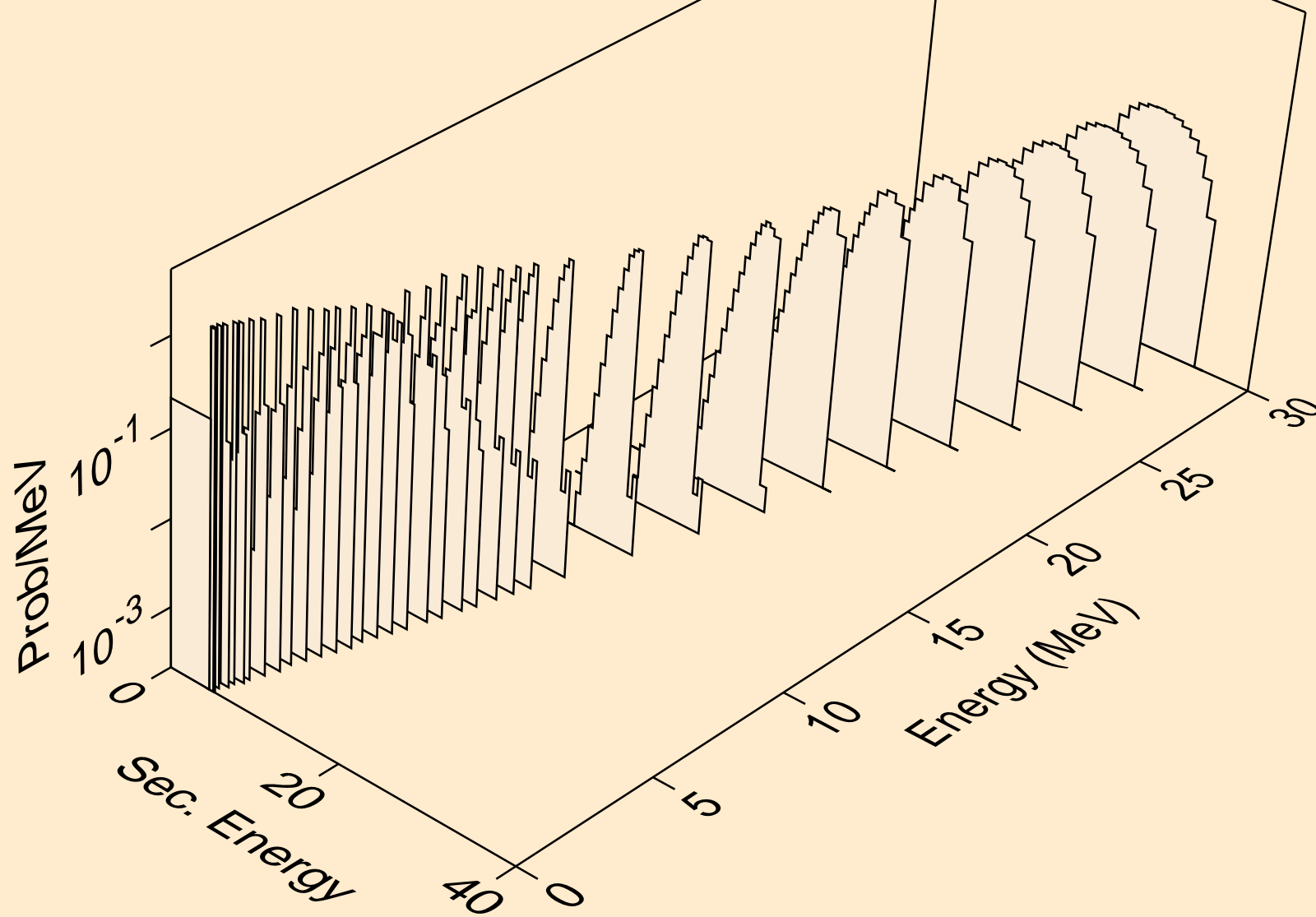

AU177M NEUTRON ACER TENDL-2021 LIBRARY; T=293.6K
alphas from (n,x)

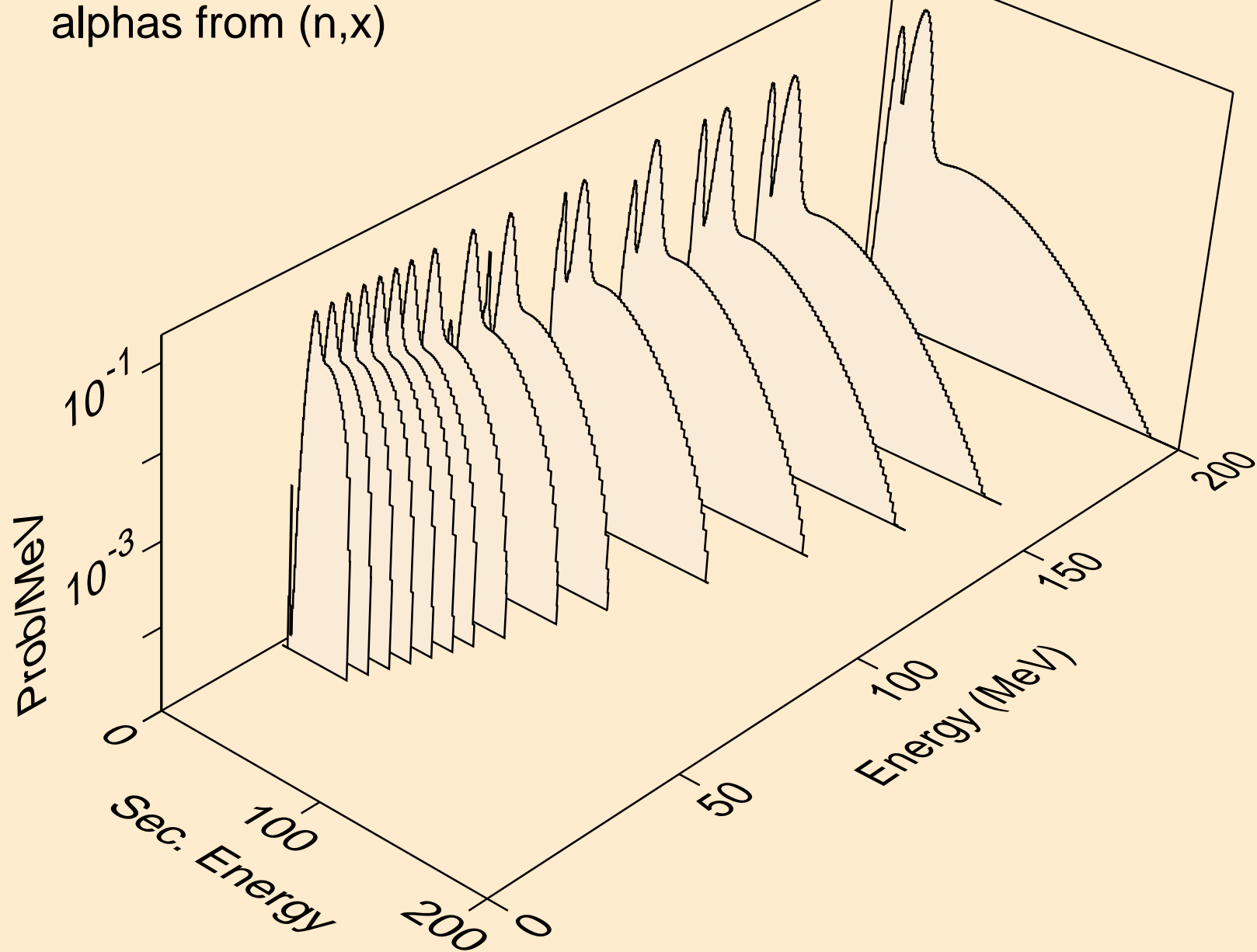

AU177M NEUTRON ACER TENDL-2021 LIBRARY; T=293.6K
alphas from (n,n*)a

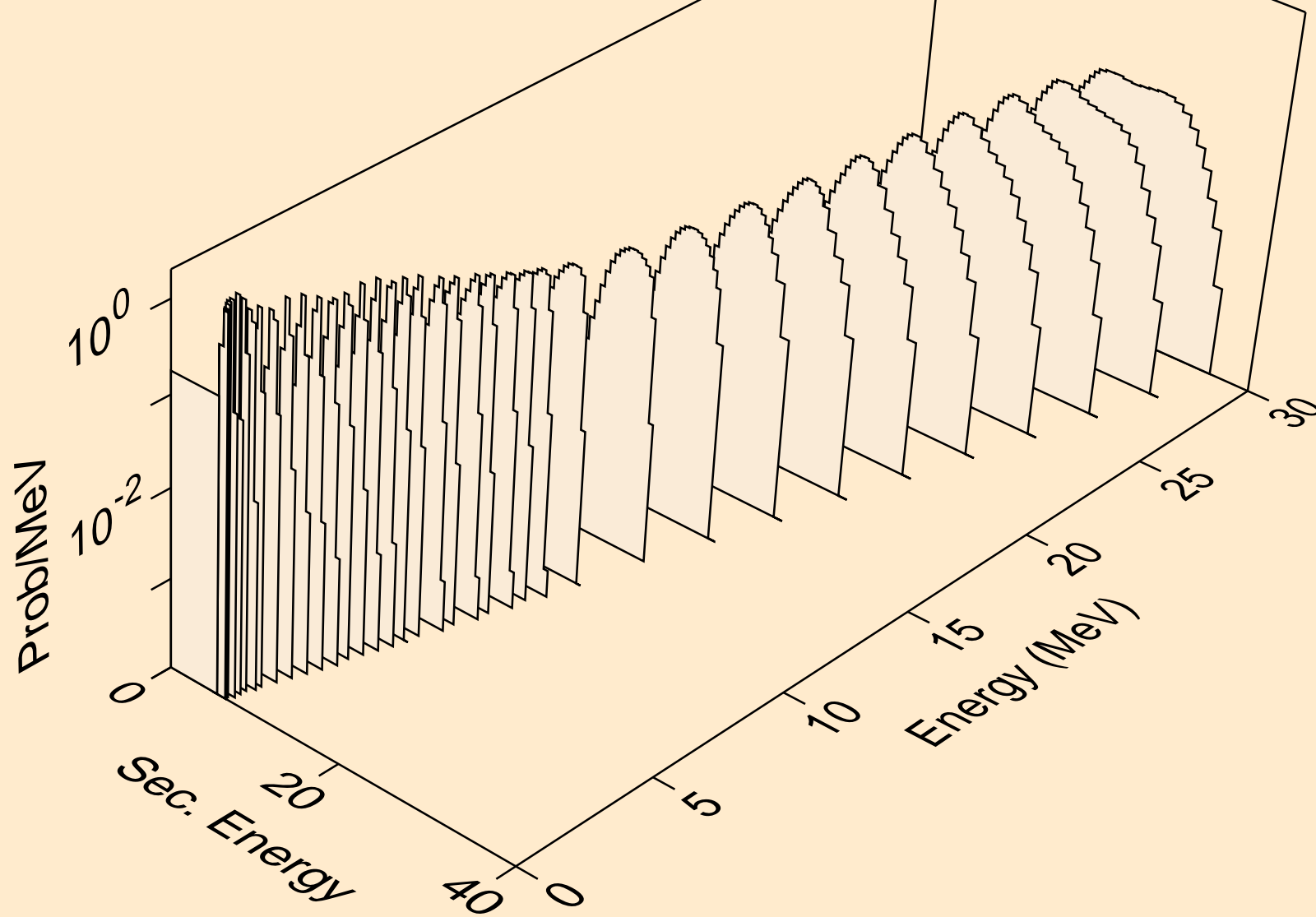

AU177M NEUTRON ACER TENDL-2021 LIBRARY; T=293.6K
alphas from (n,n*)3a

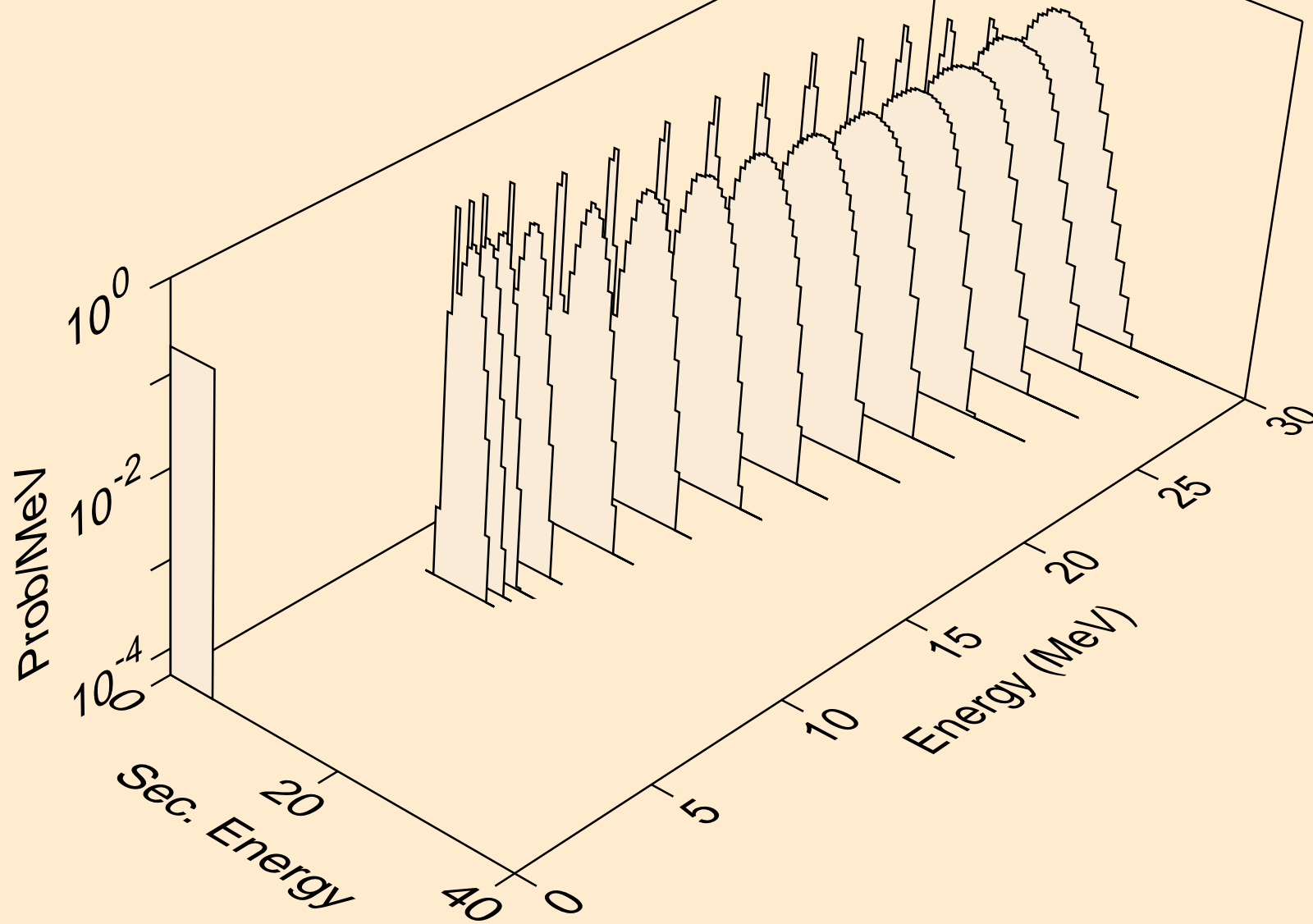

AU177M NEUTRON ACER TENDL-2021 LIBRARY; T=293.6K
alphas from (n,2n)a

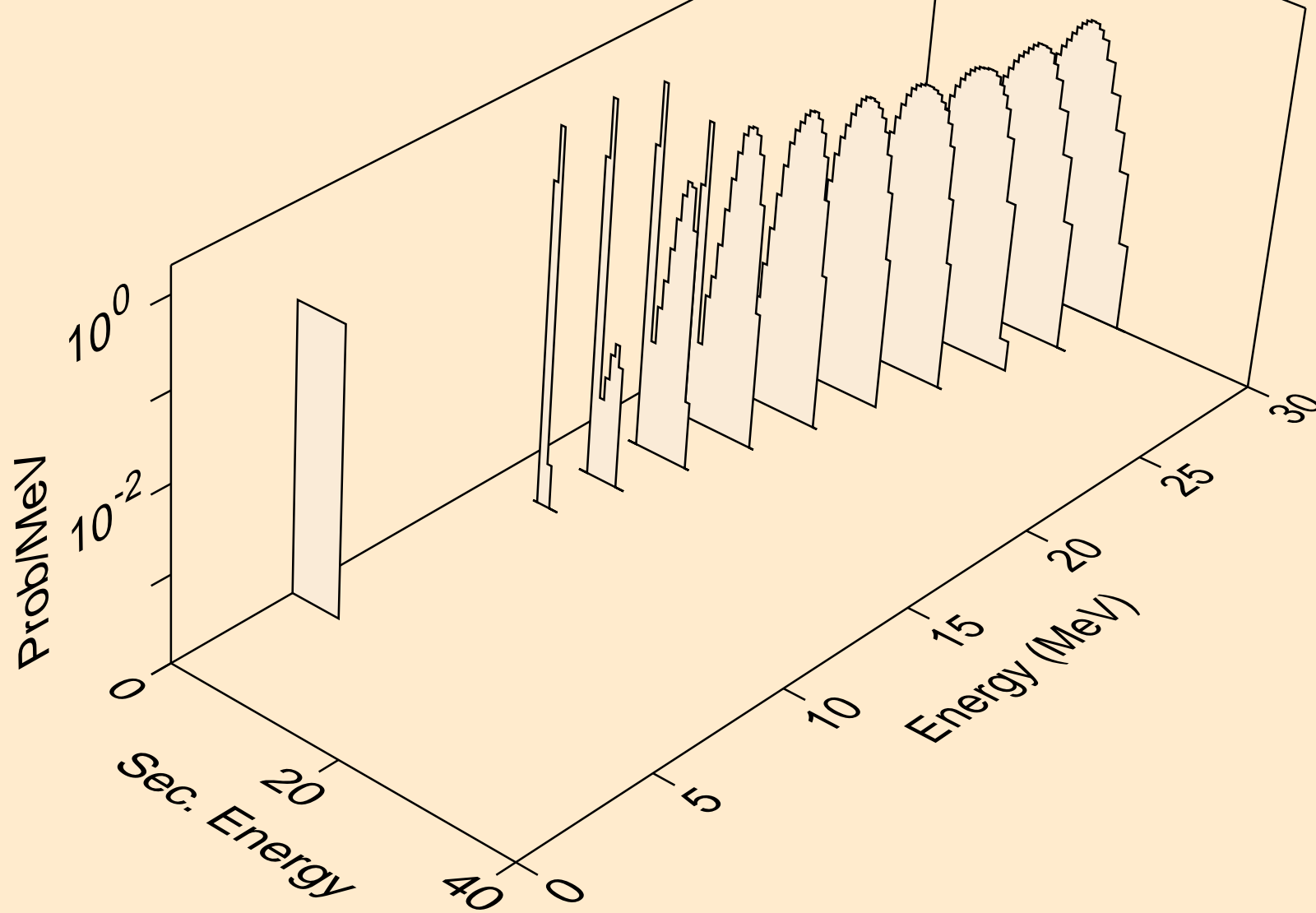

AU177M NEUTRON ACER TENDL-2021 LIBRARY; T=293.6K
alphas from (n,3n)a

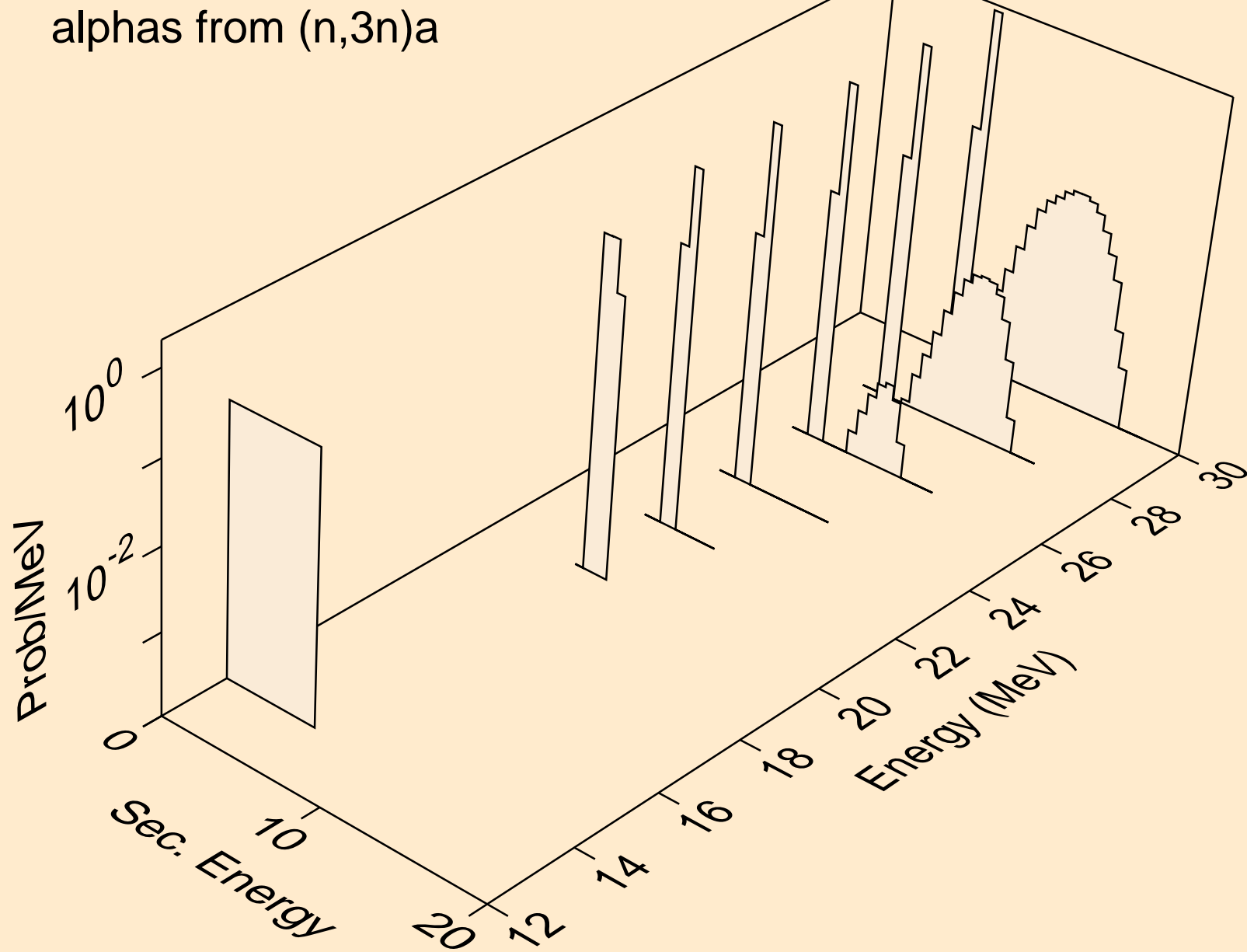

AU177M NEUTRON ACER TENDL-2021 LIBRARY; T=293.6K
alphas from (n,n*)2a

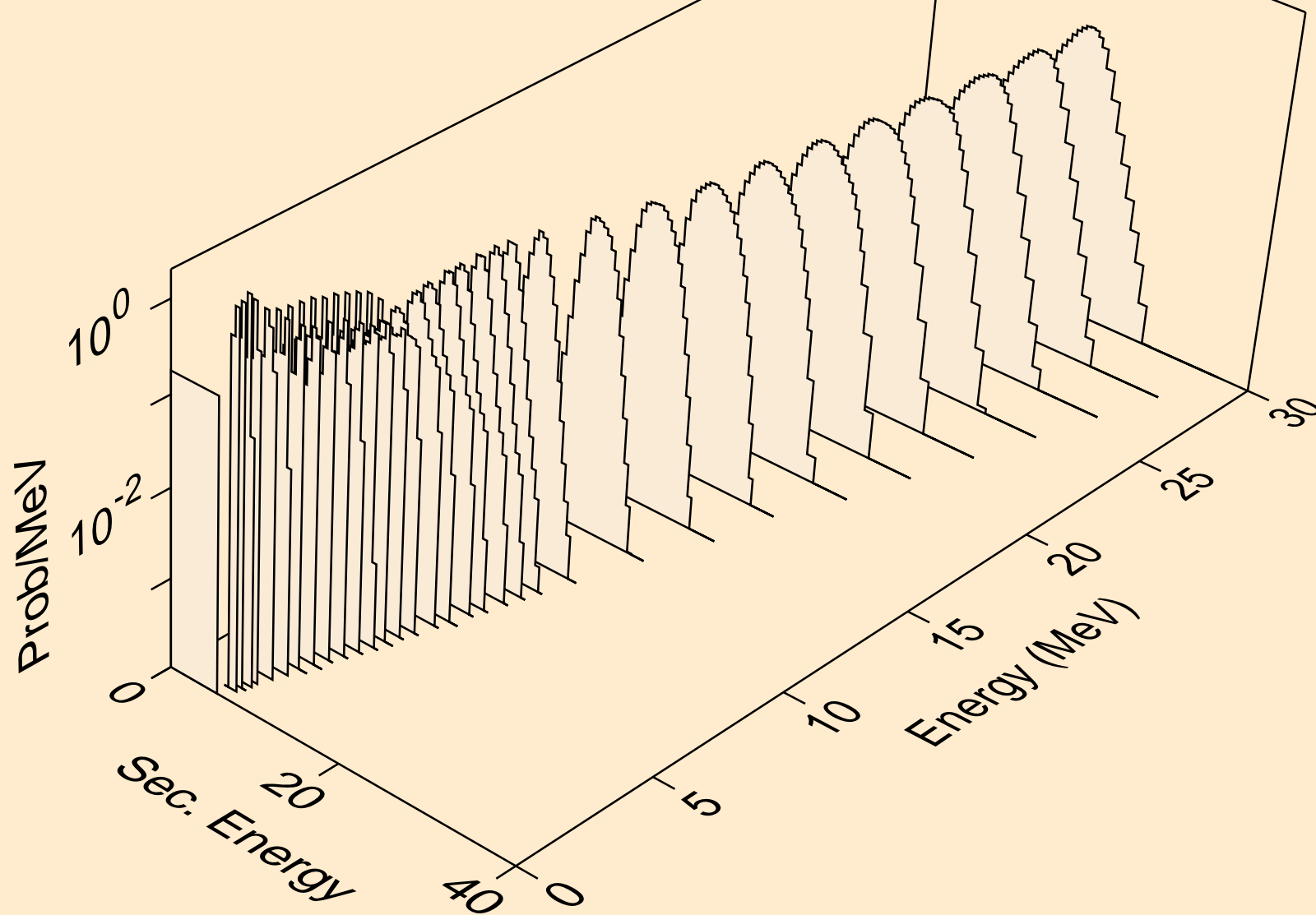

AU177M NEUTRON ACER TENDL-2021 LIBRARY; T=293.6K
alphas from (n,2n)2a

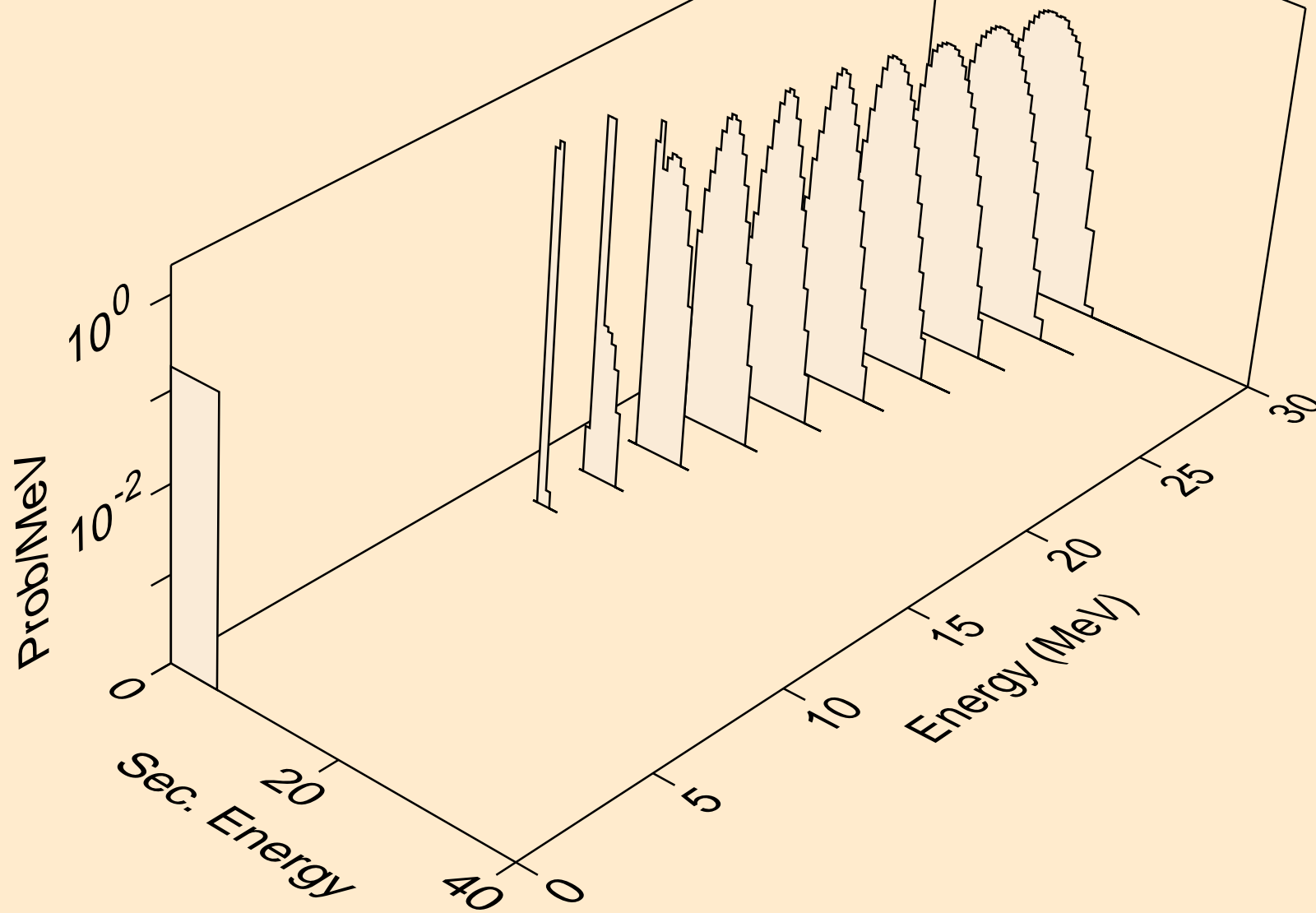

AU177M NEUTRON ACER TENDL-2021 LIBRARY; T=293.6K
alphas from (n,npa)

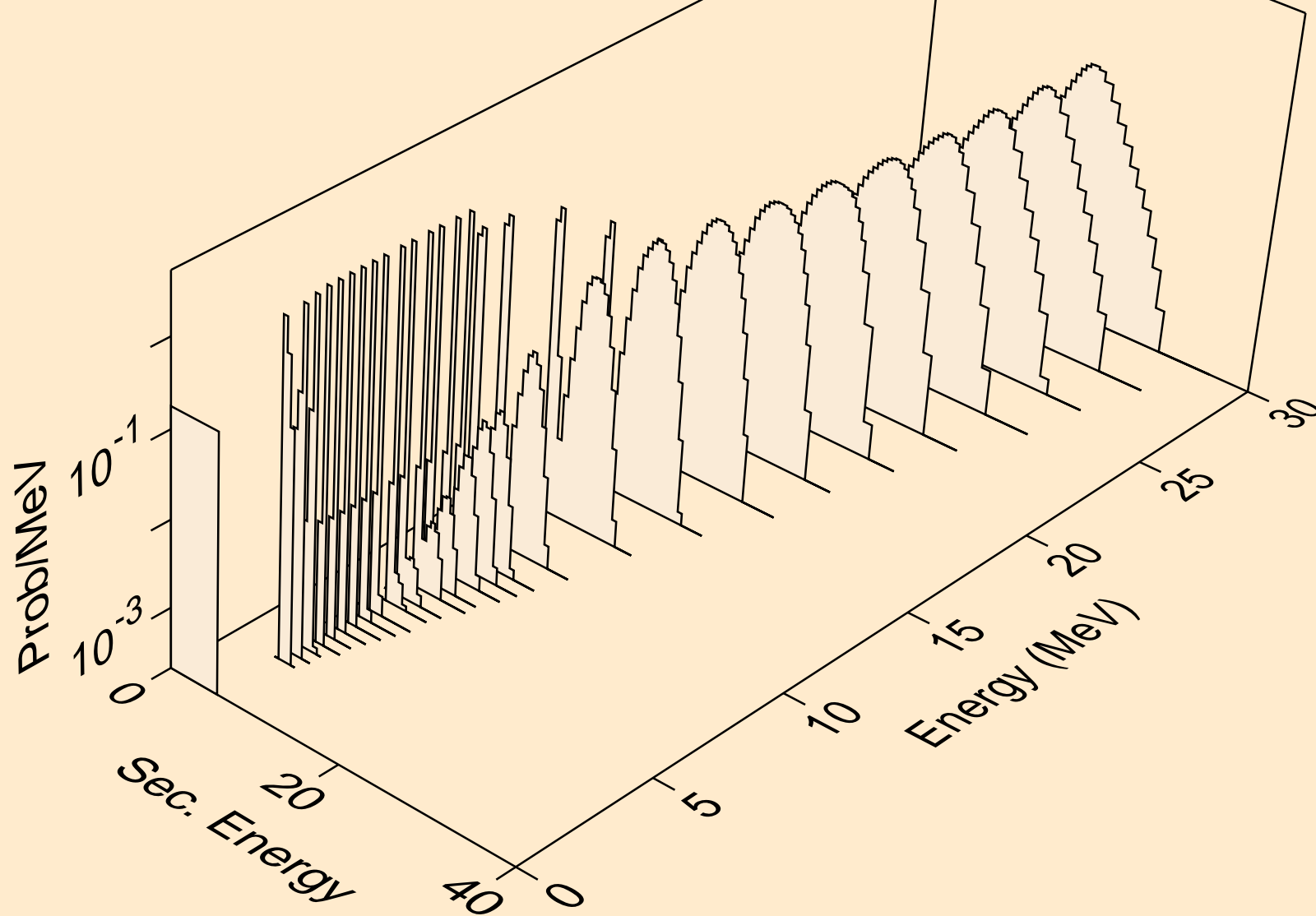

AU177M NEUTRON ACER TENDL-2021 LIBRARY; T=293.6K
alphas from (n,a)

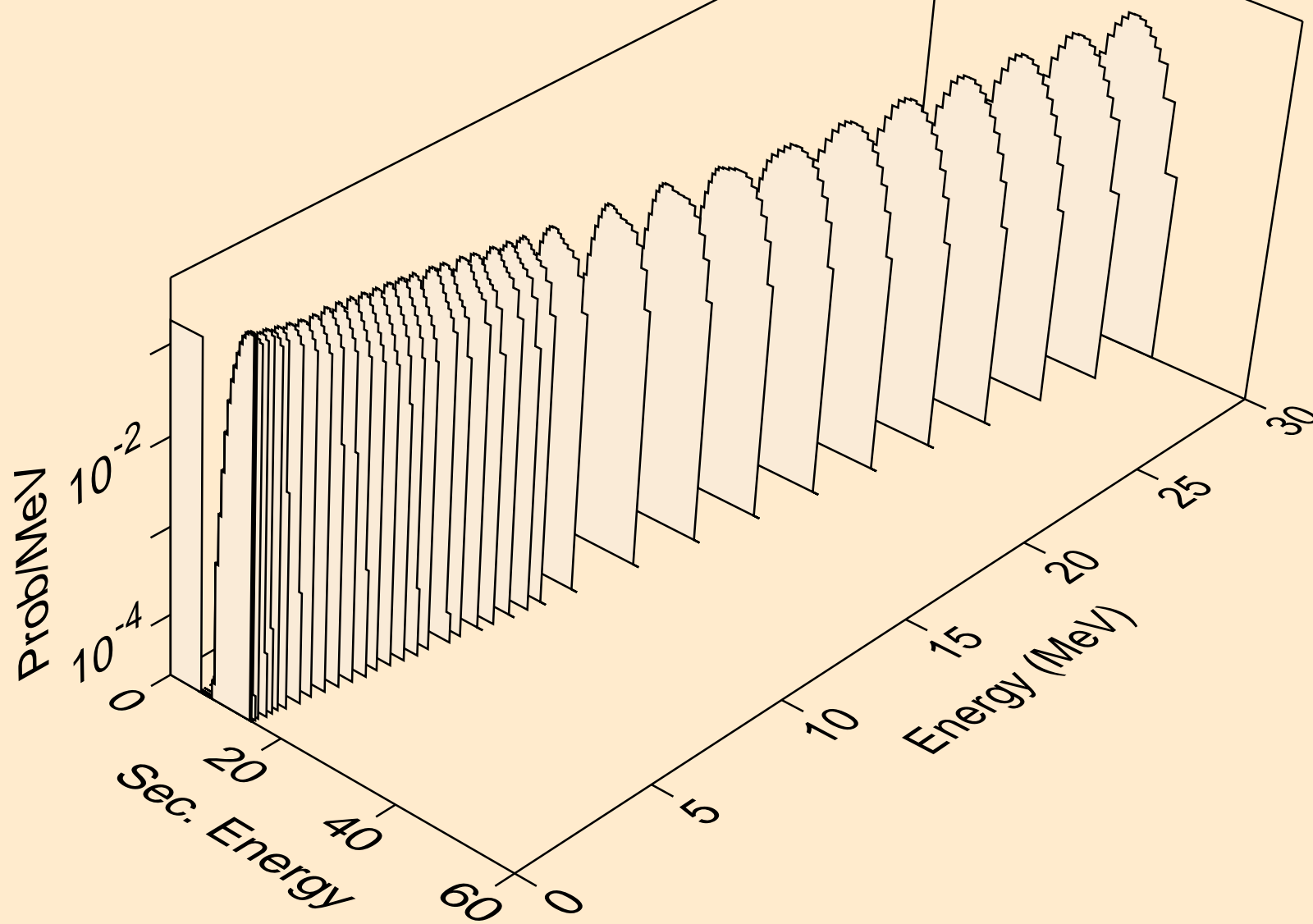

AU177M NEUTRON ACER TENDL-2021 LIBRARY; T=293.6K
alphas from (n,2a)

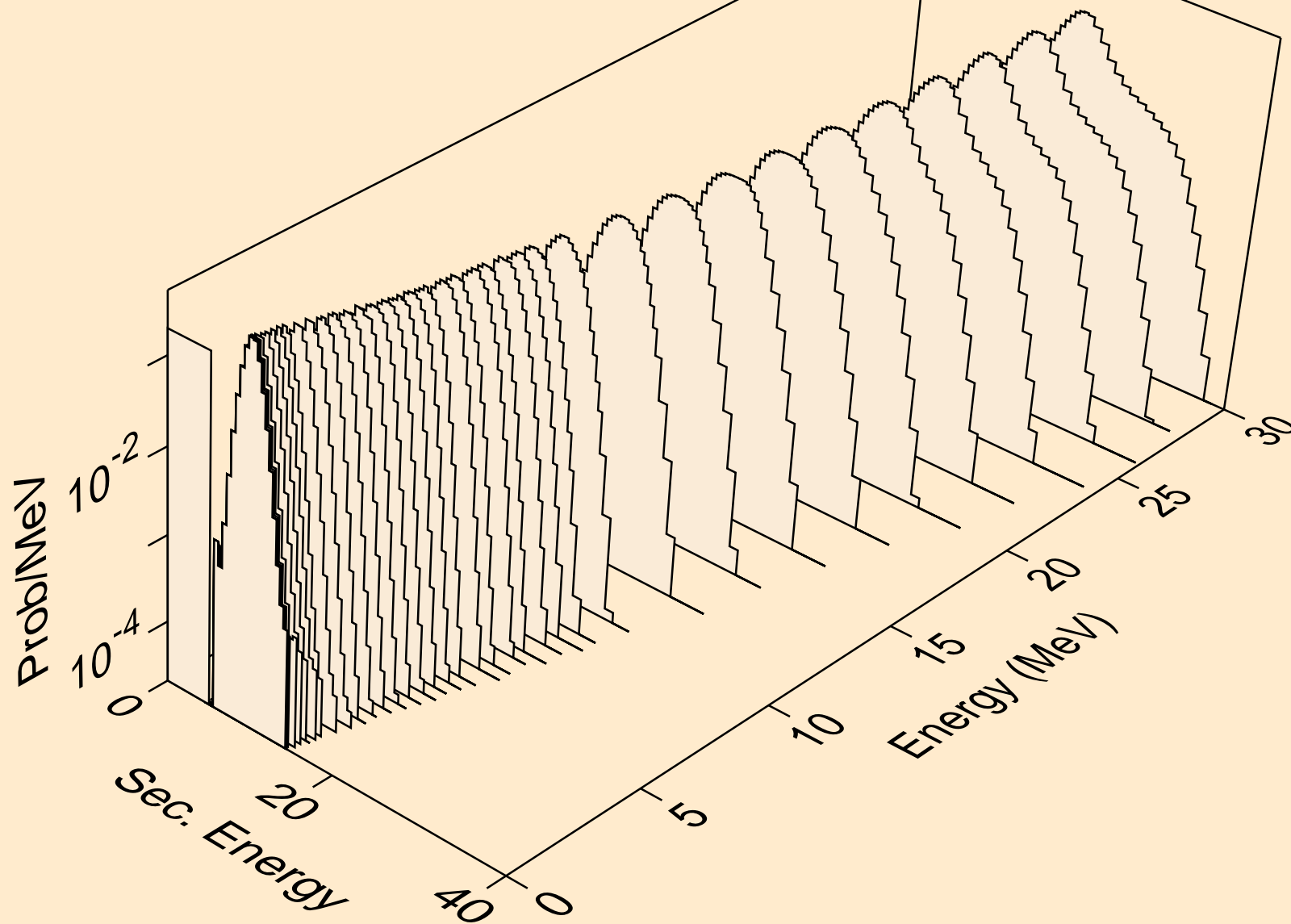

AU177M NEUTRON ACER TENDL-2021 LIBRARY; T=293.6K
alphas from (n,3a)

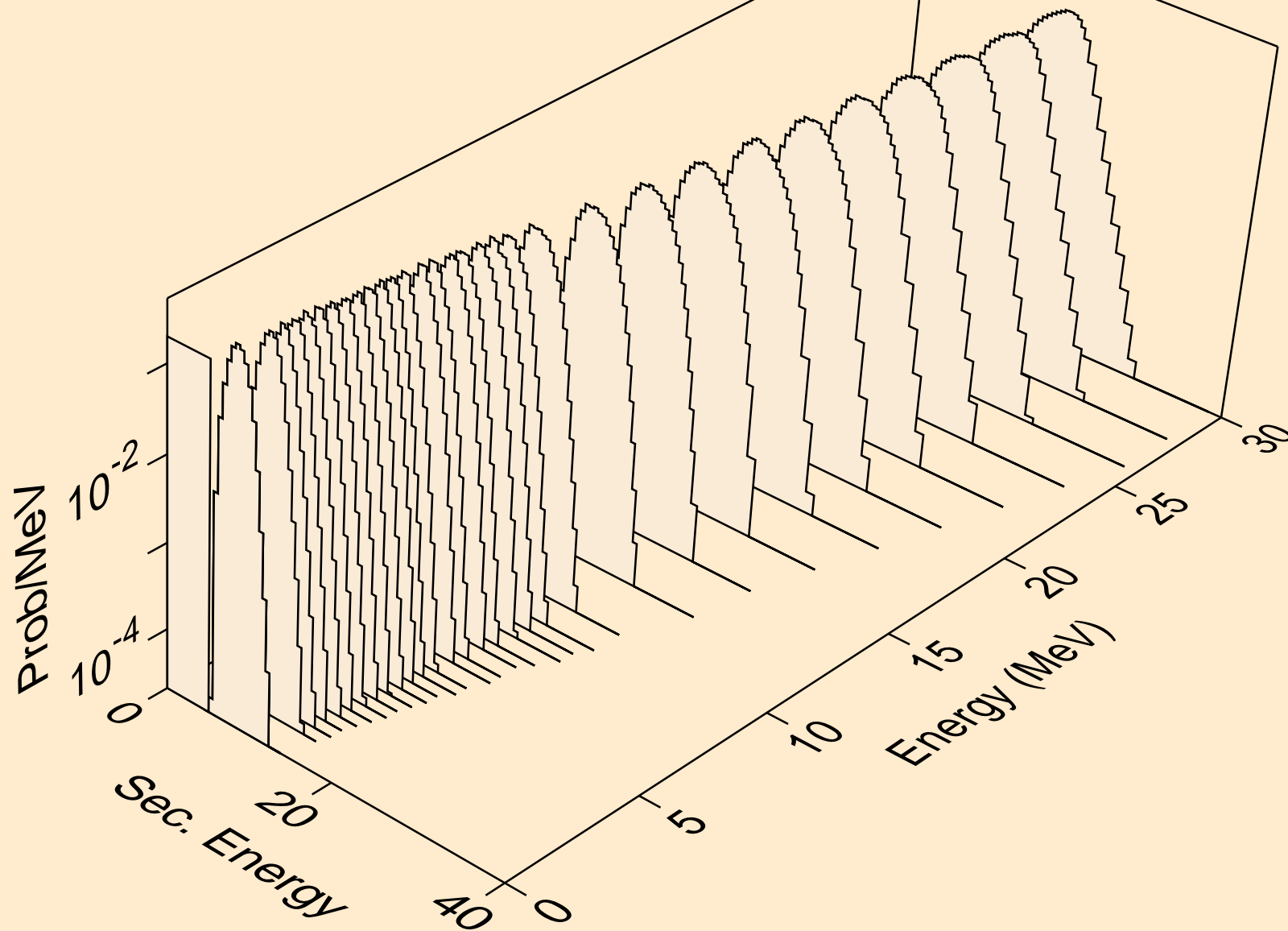

AU177M NEUTRON ACER TENDL-2021 LIBRARY; T=293.6K
alphas from (n,pa)

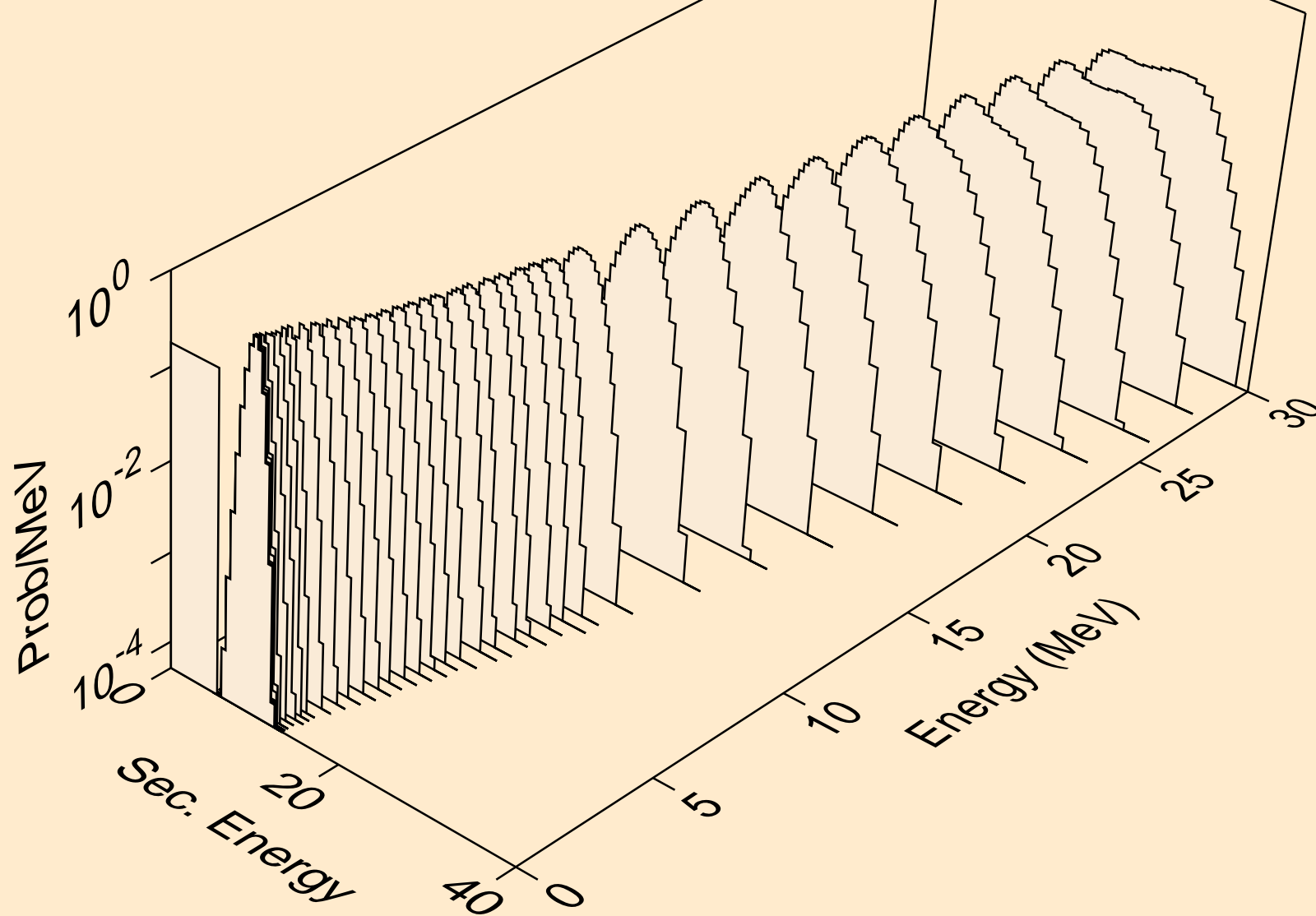

AU177M NEUTRON ACER TENDL-2021 LIBRARY; T=293.6K
alphas from (n,t2a)

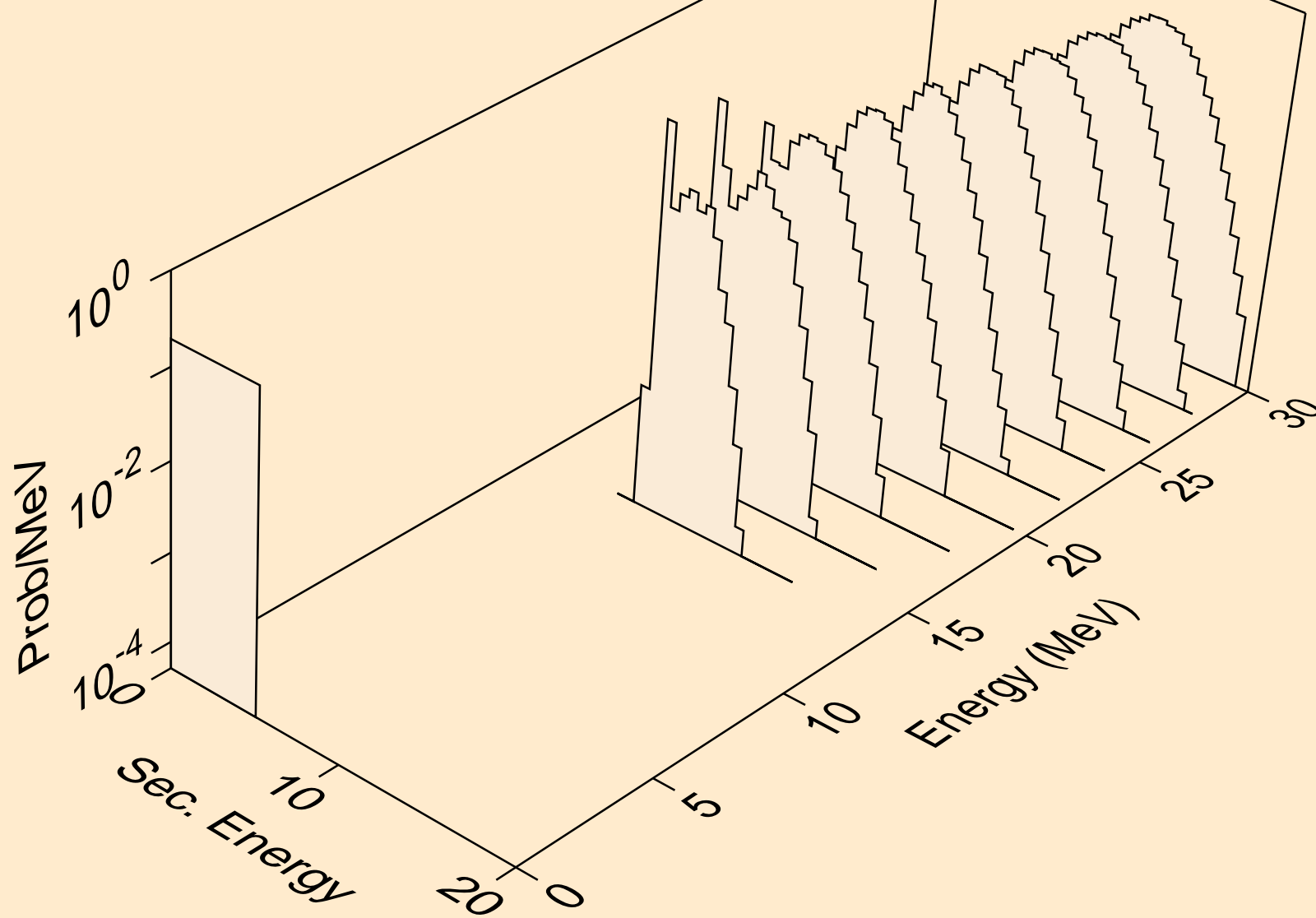

AU177M NEUTRON ACER TENDL-2021 LIBRARY; T=293.6K
alphas from (n,d2a)

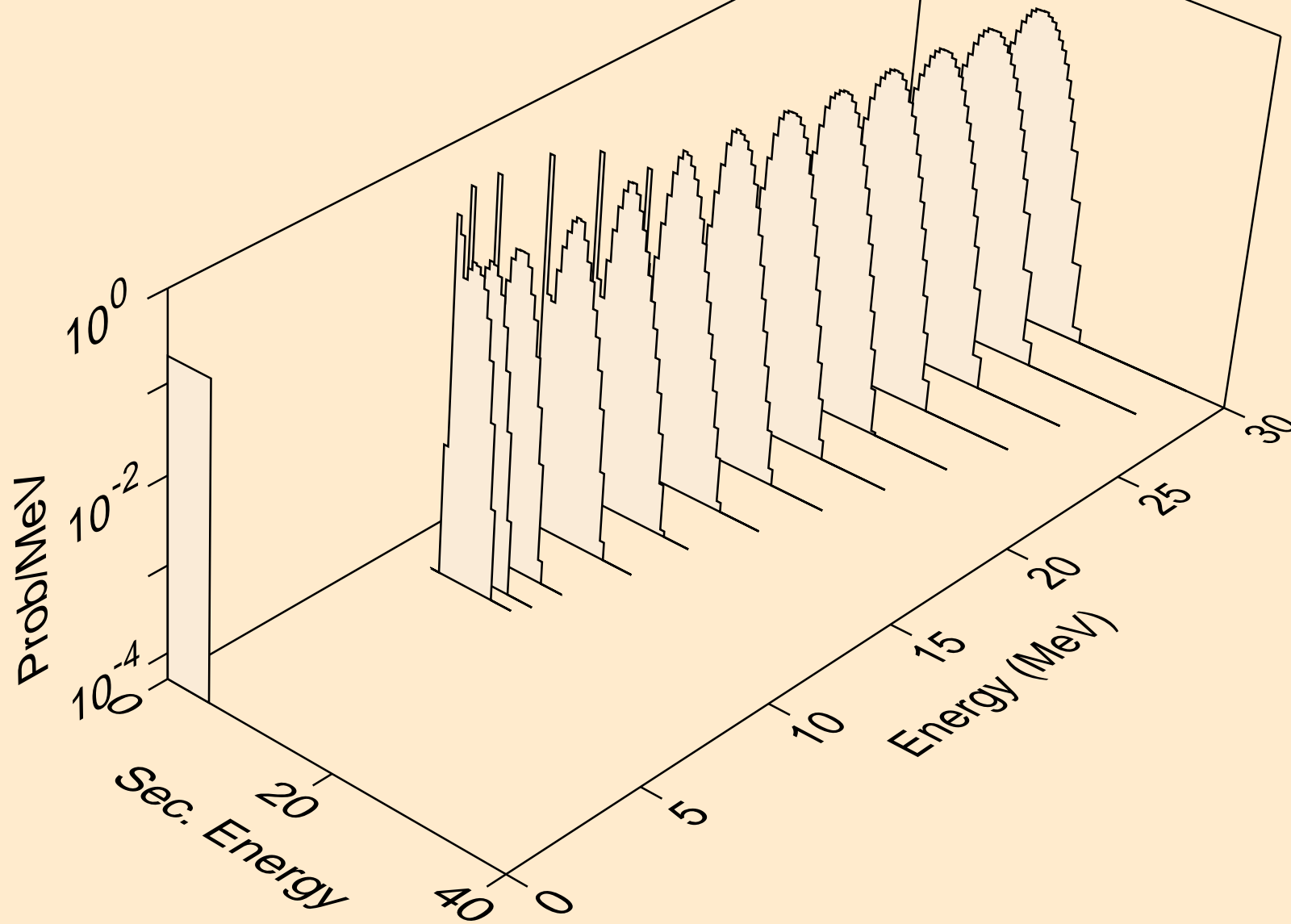

AU177M NEUTRON ACER TENDL-2021 LIBRARY; T=293.6K
alphas from (n,da)

