

AU183 NEUTRON ACER TENDL-2021 LIBRARY; T=293.6K
Principal cross sections

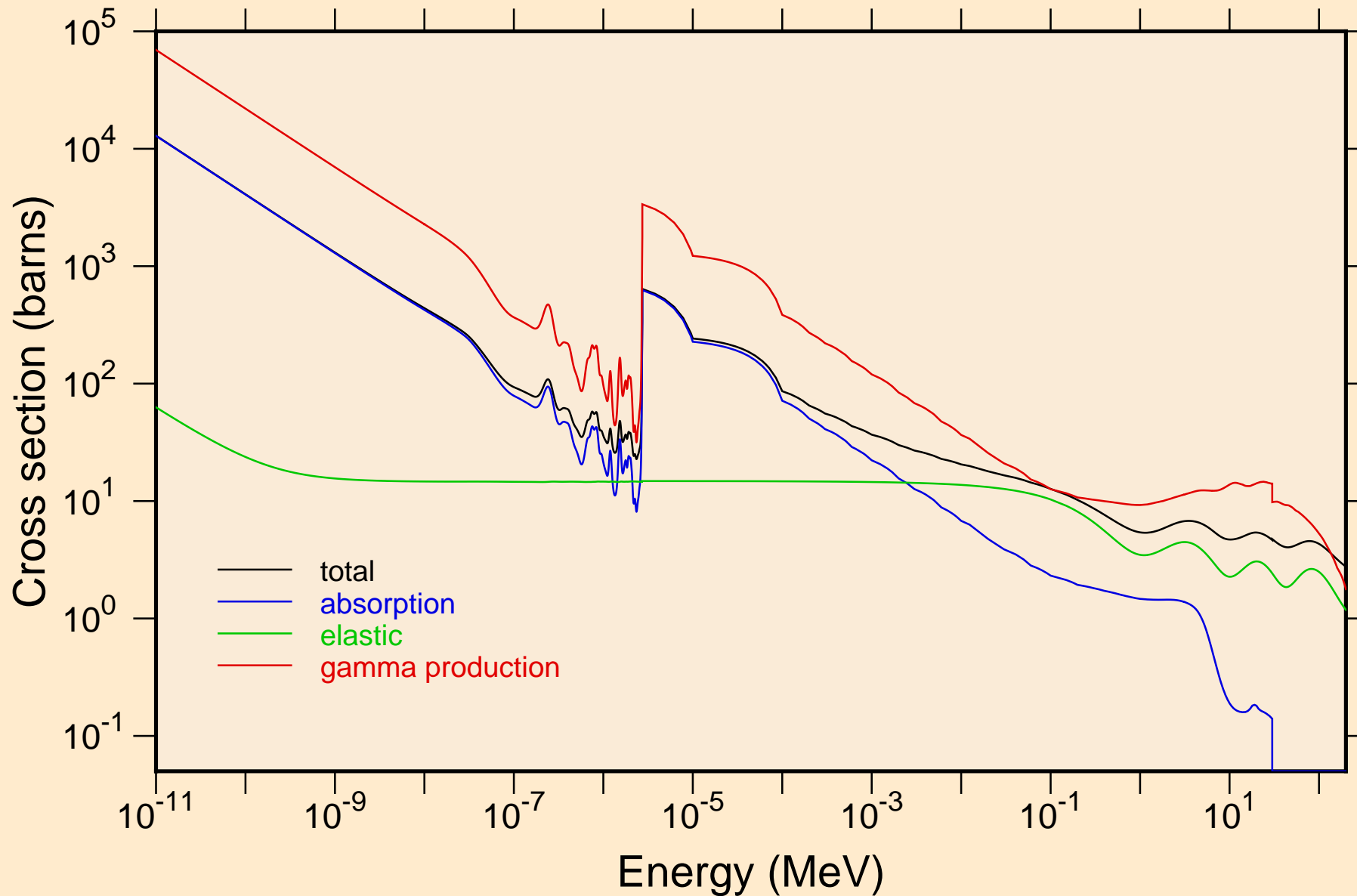

AU183 NEUTRON ACER TENDL-2021 LIBRARY; T=293.6K
Heating

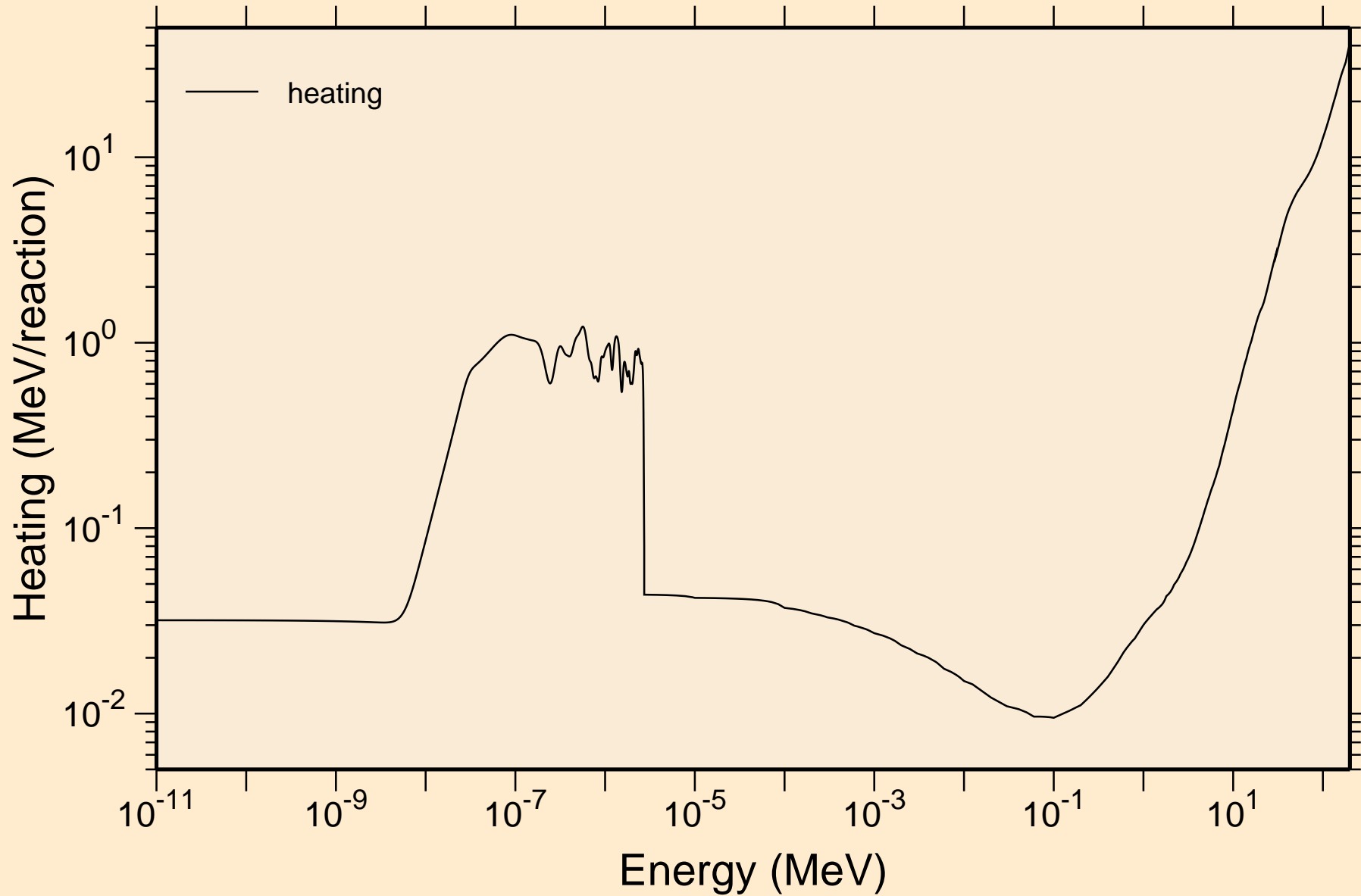

AU183 NEUTRON ACER TENDL-2021 LIBRARY; T=293.6K
Damage

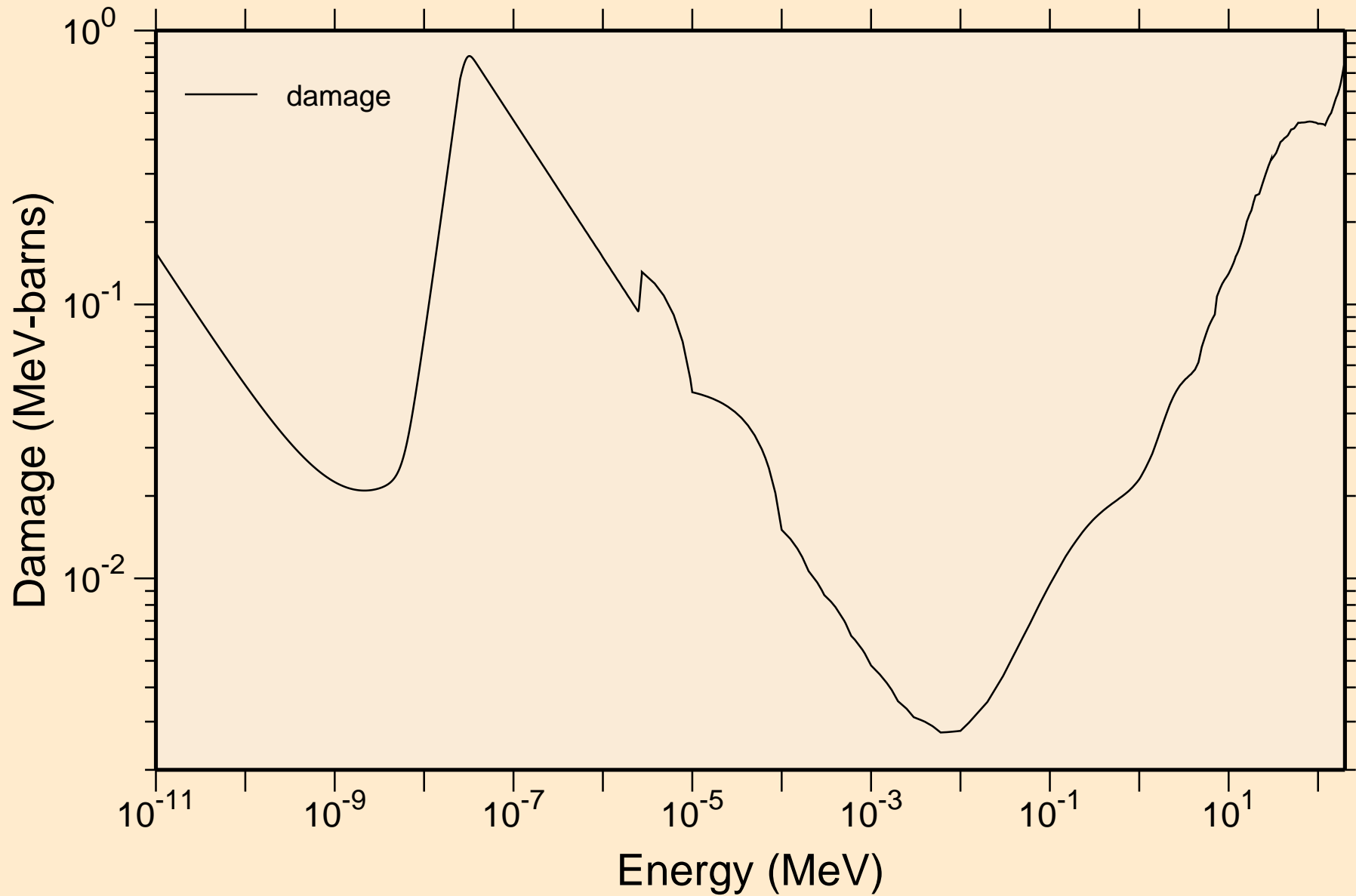

AU183 NEUTRON ACER TENDL-2021 LIBRARY; T=293.6K
Non-threshold reactions

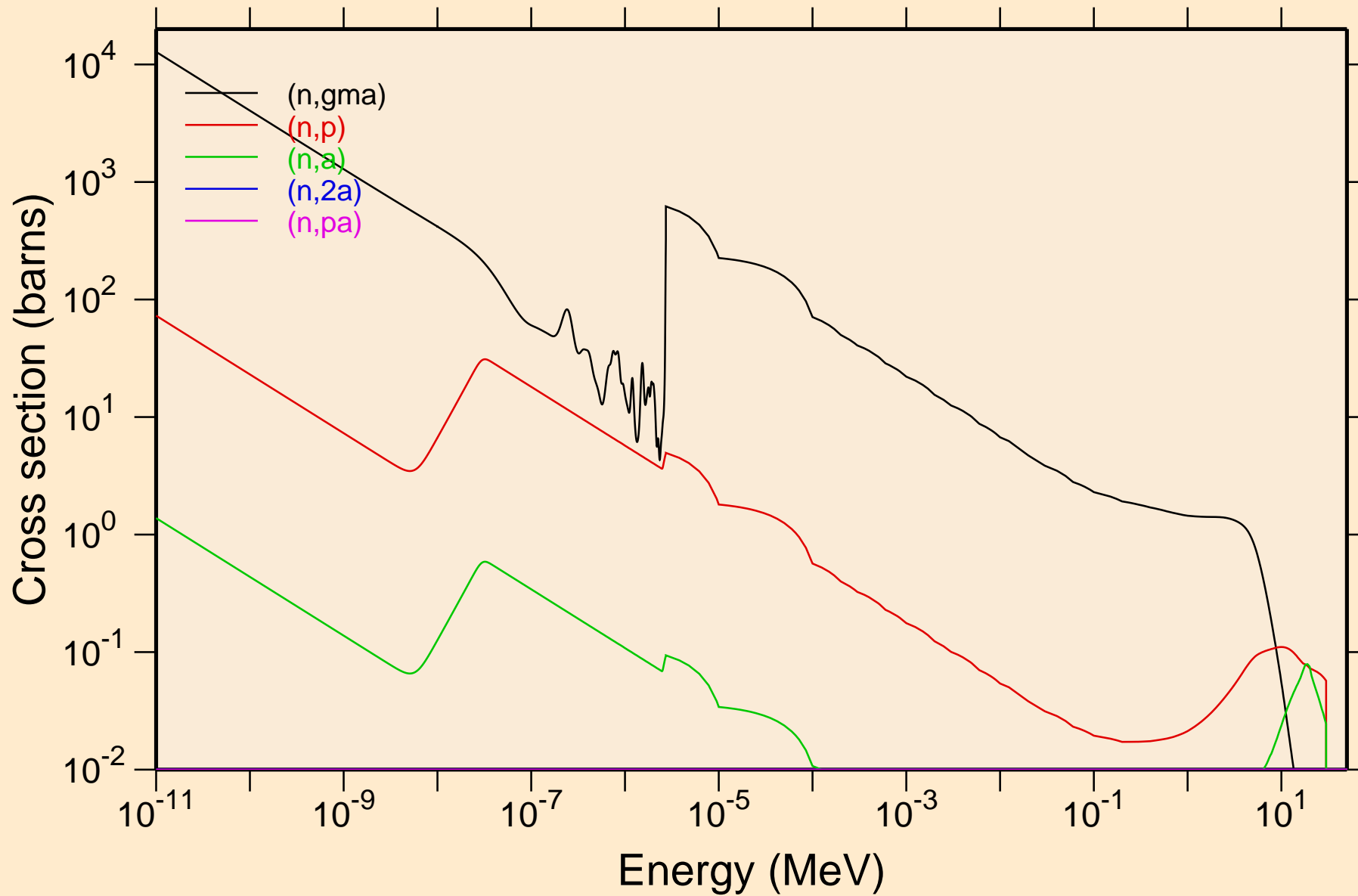

AU183 NEUTRON ACER TENDL-2021 LIBRARY; T=293.6K
Non-threshold reactions

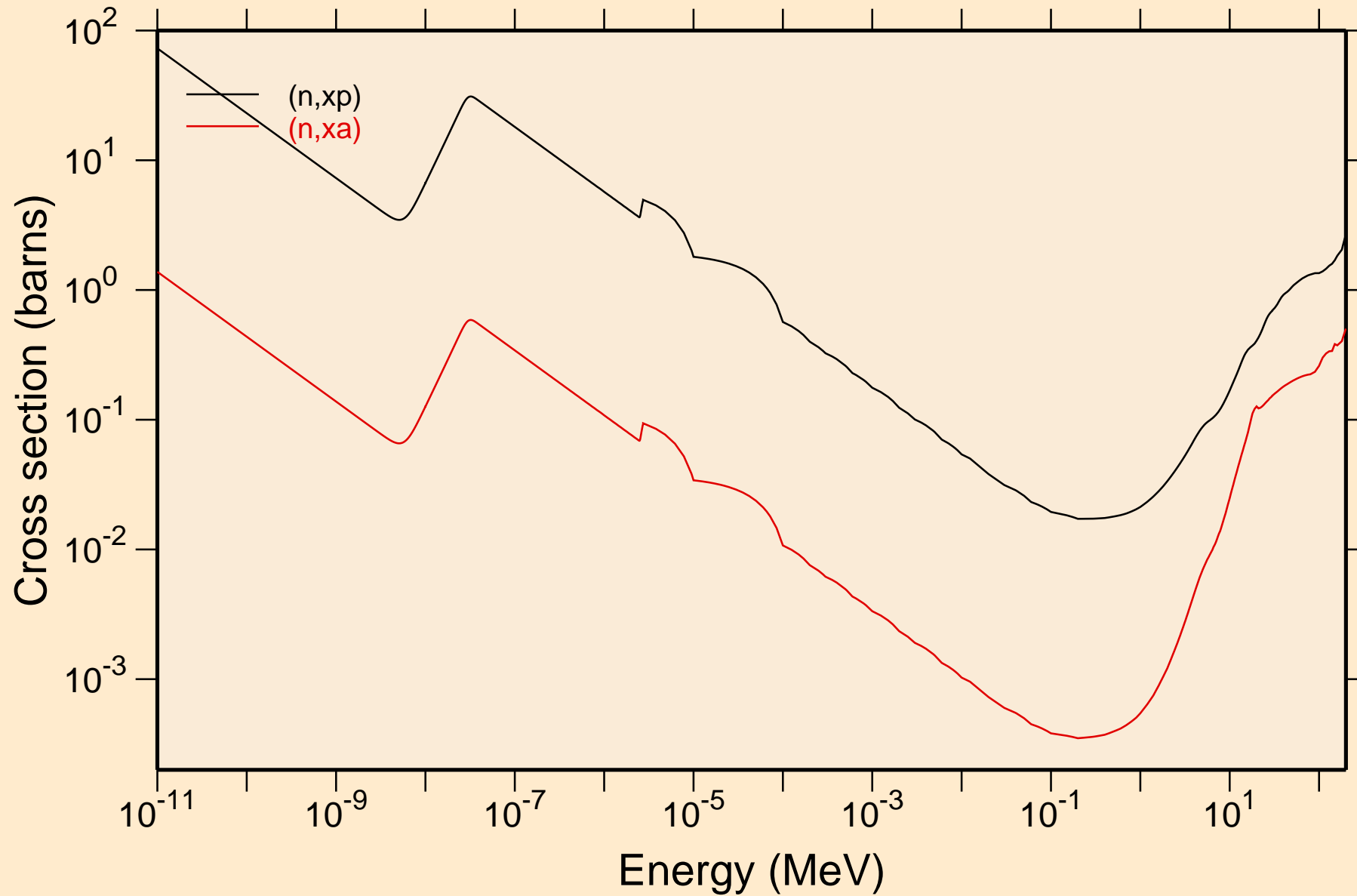

AU183 NEUTRON ACER TENDL-2021 LIBRARY; T=293.6K

Principal cross sections

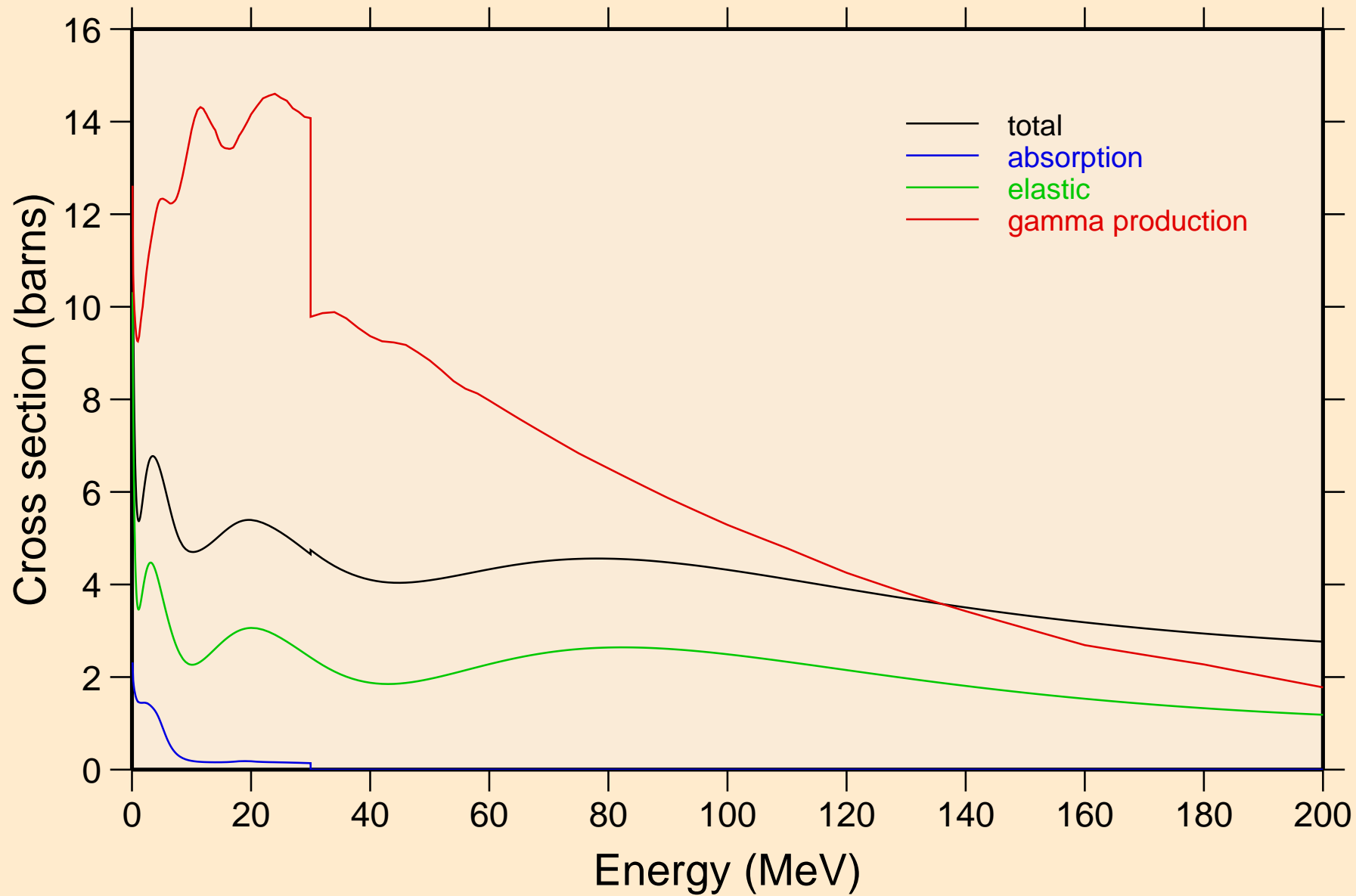

AU183 NEUTRON ACER TENDL-2021 LIBRARY; T=293.6K
Heating

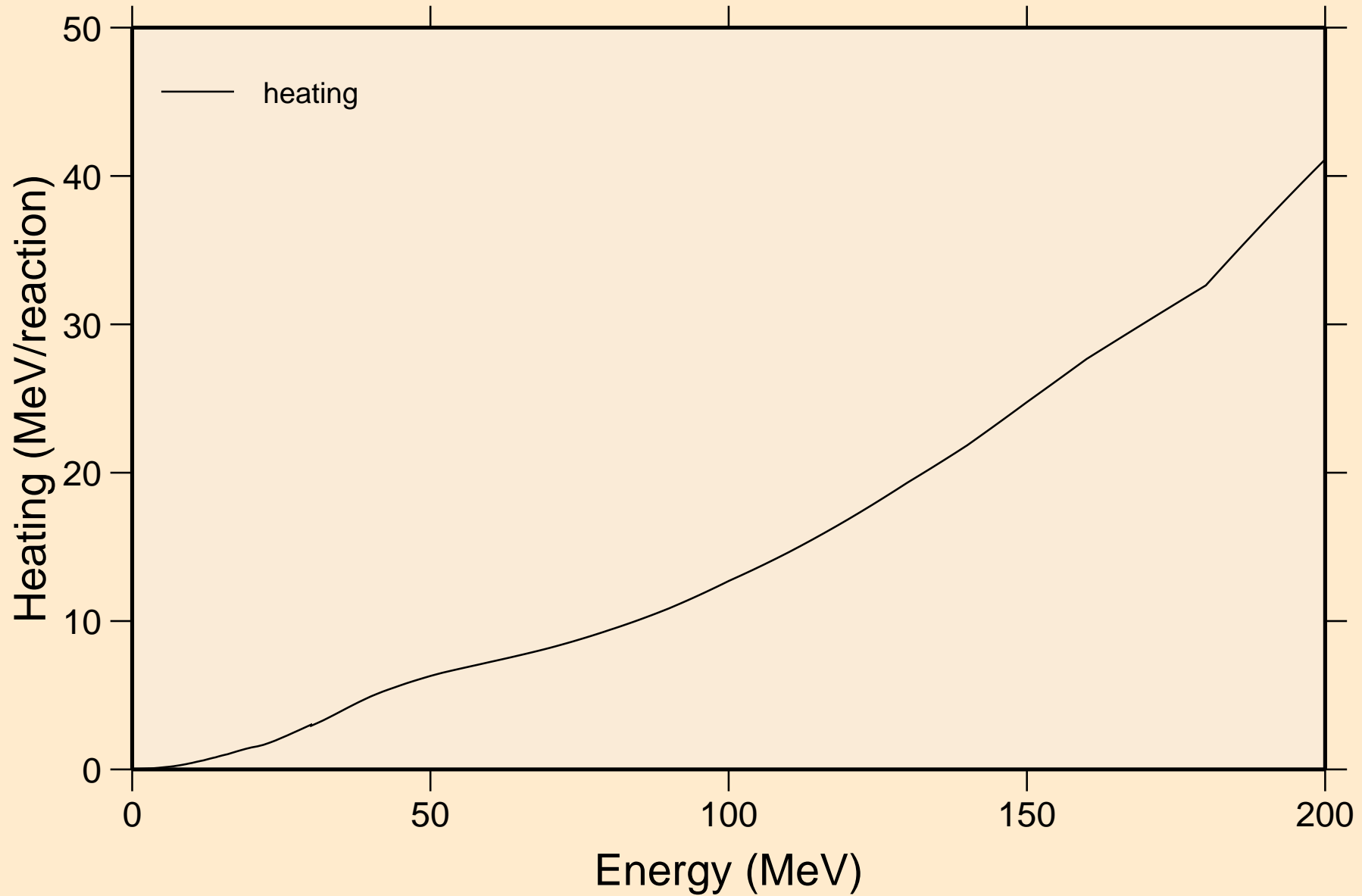

AU183 NEUTRON ACER TENDL-2021 LIBRARY; T=293.6K
Damage

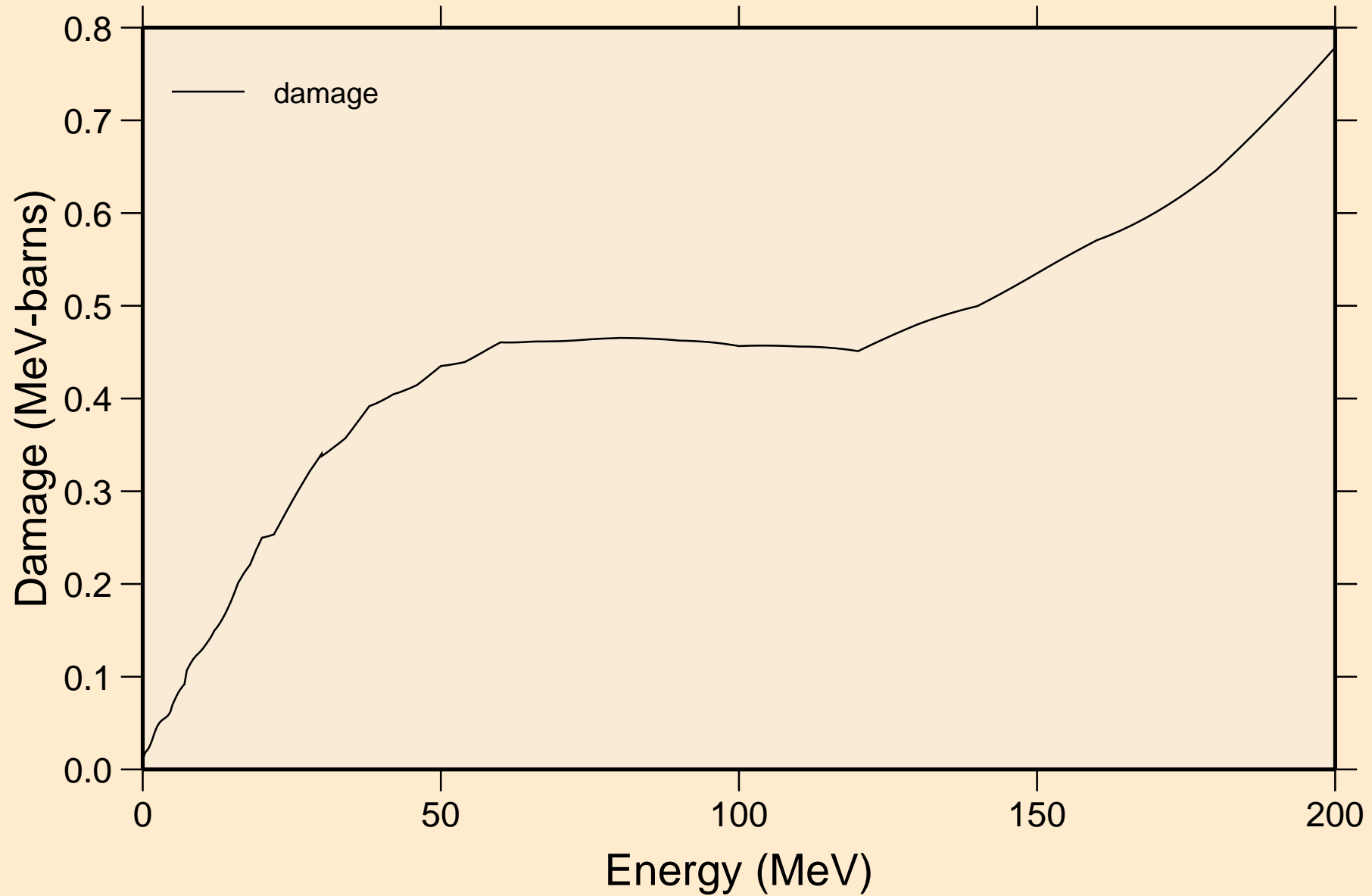

AU183 NEUTRON ACER TENDL-2021 LIBRARY; T=293.6K
Non-threshold reactions

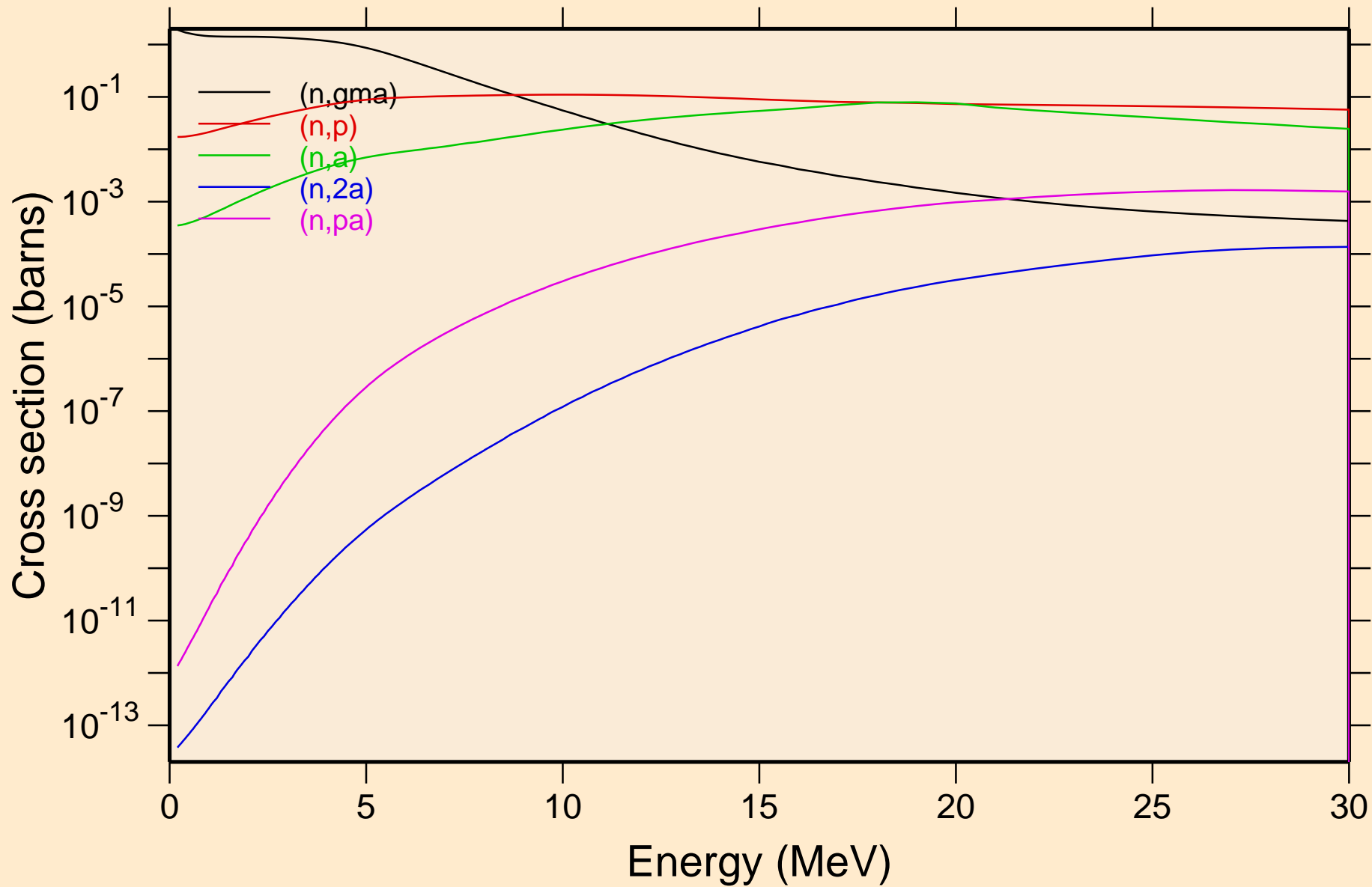

AU183 NEUTRON ACER TENDL-2021 LIBRARY; T=293.6K
Non-threshold reactions

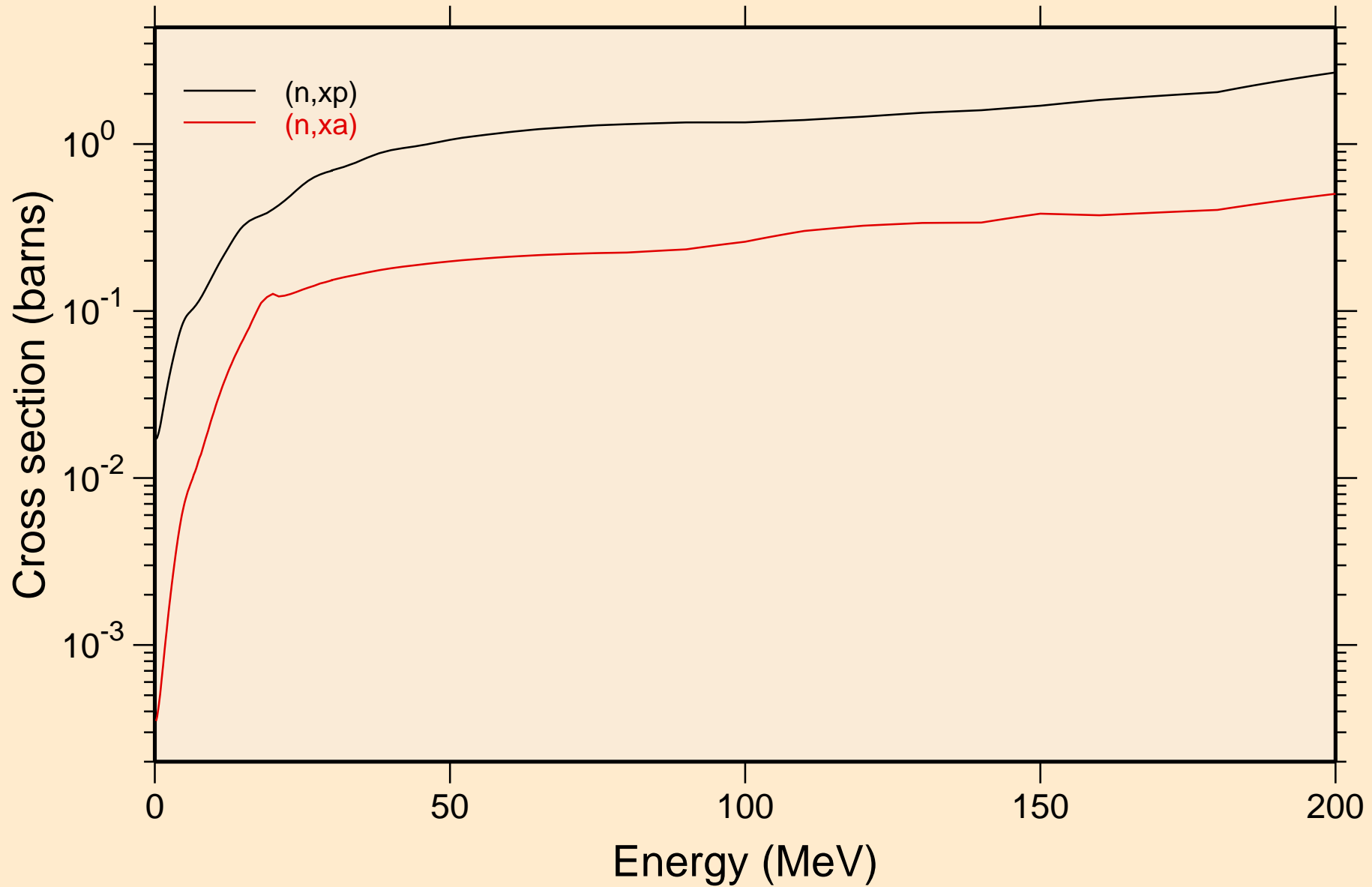

AU183 NEUTRON ACER TENDL-2021 LIBRARY; T=293.6K
Inelastic levels

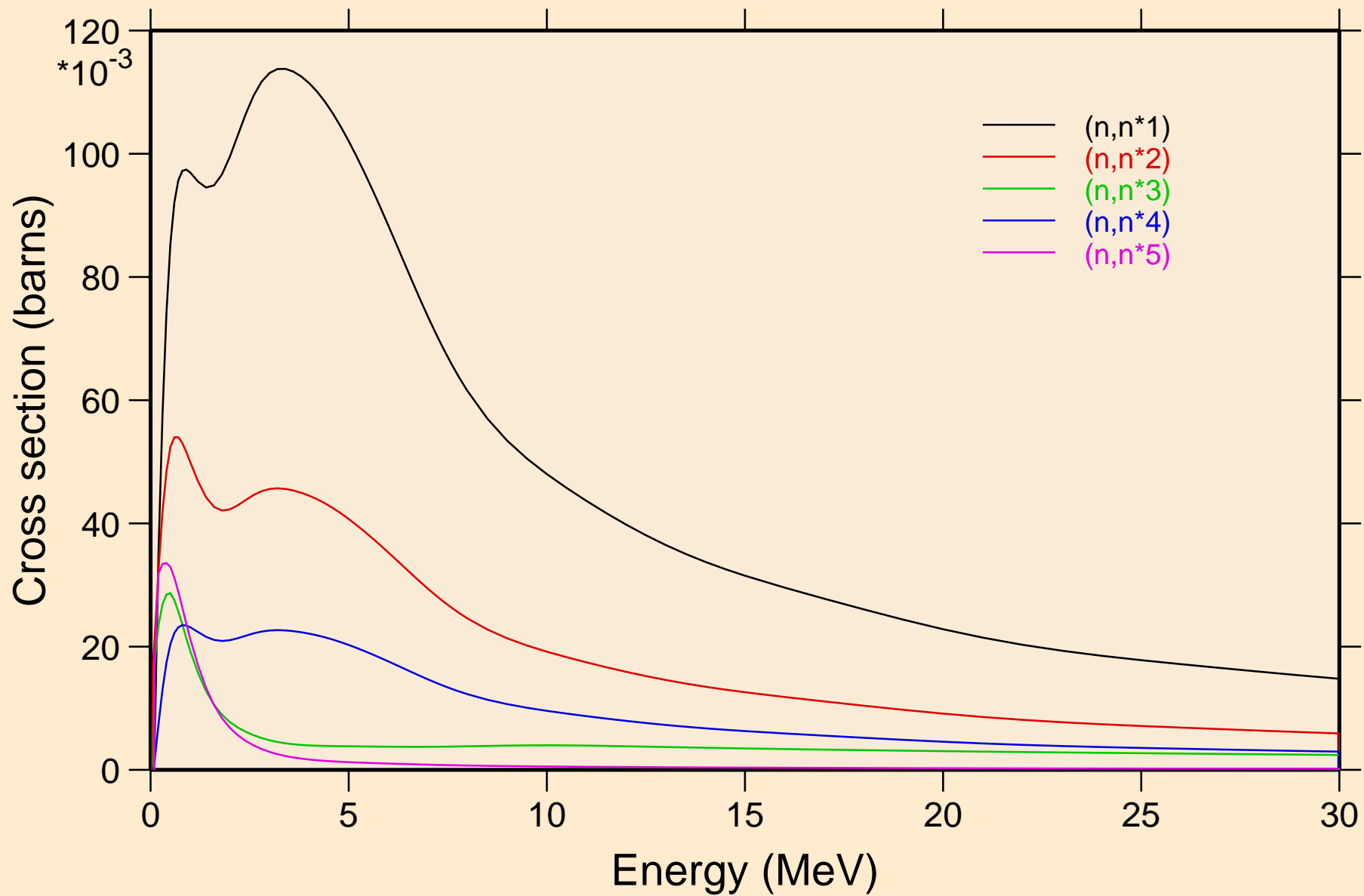

AU183 NEUTRON ACER TENDL-2021 LIBRARY; T=293.6K
Inelastic levels

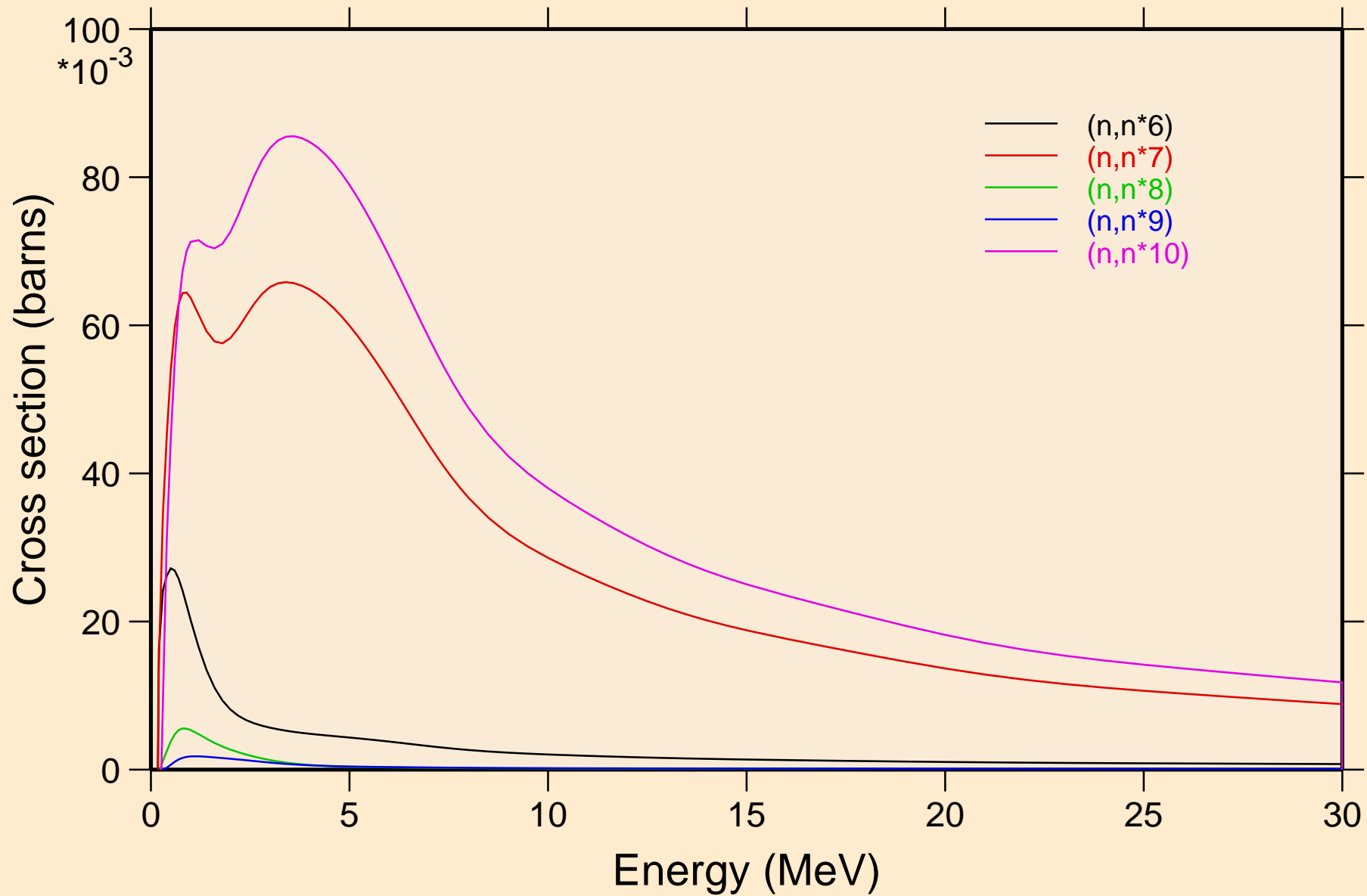

AU183 NEUTRON ACER TENDL-2021 LIBRARY; T=293.6K
Inelastic levels

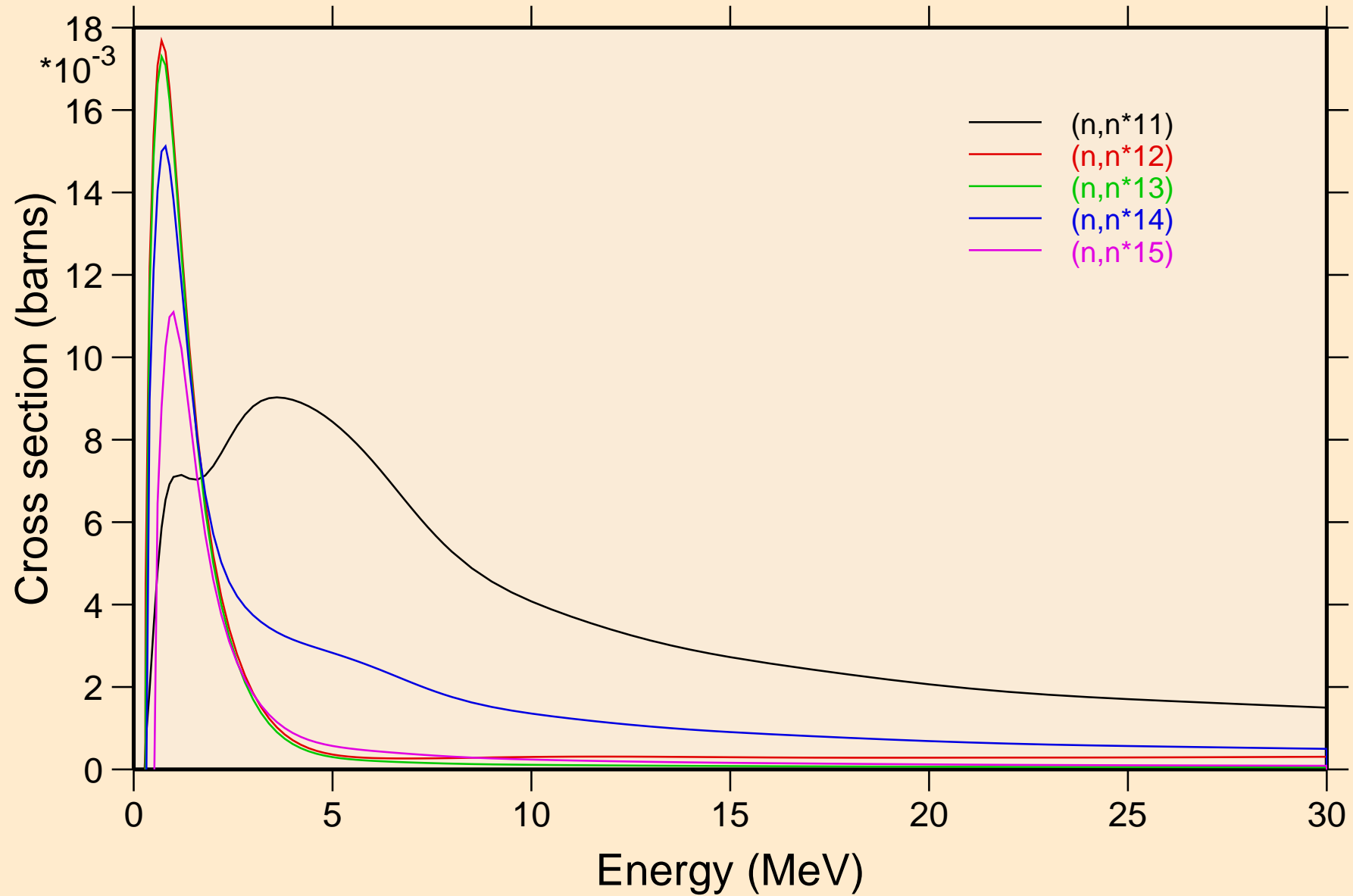

AU183 NEUTRON ACER TENDL-2021 LIBRARY; T=293.6K
Threshold reactions

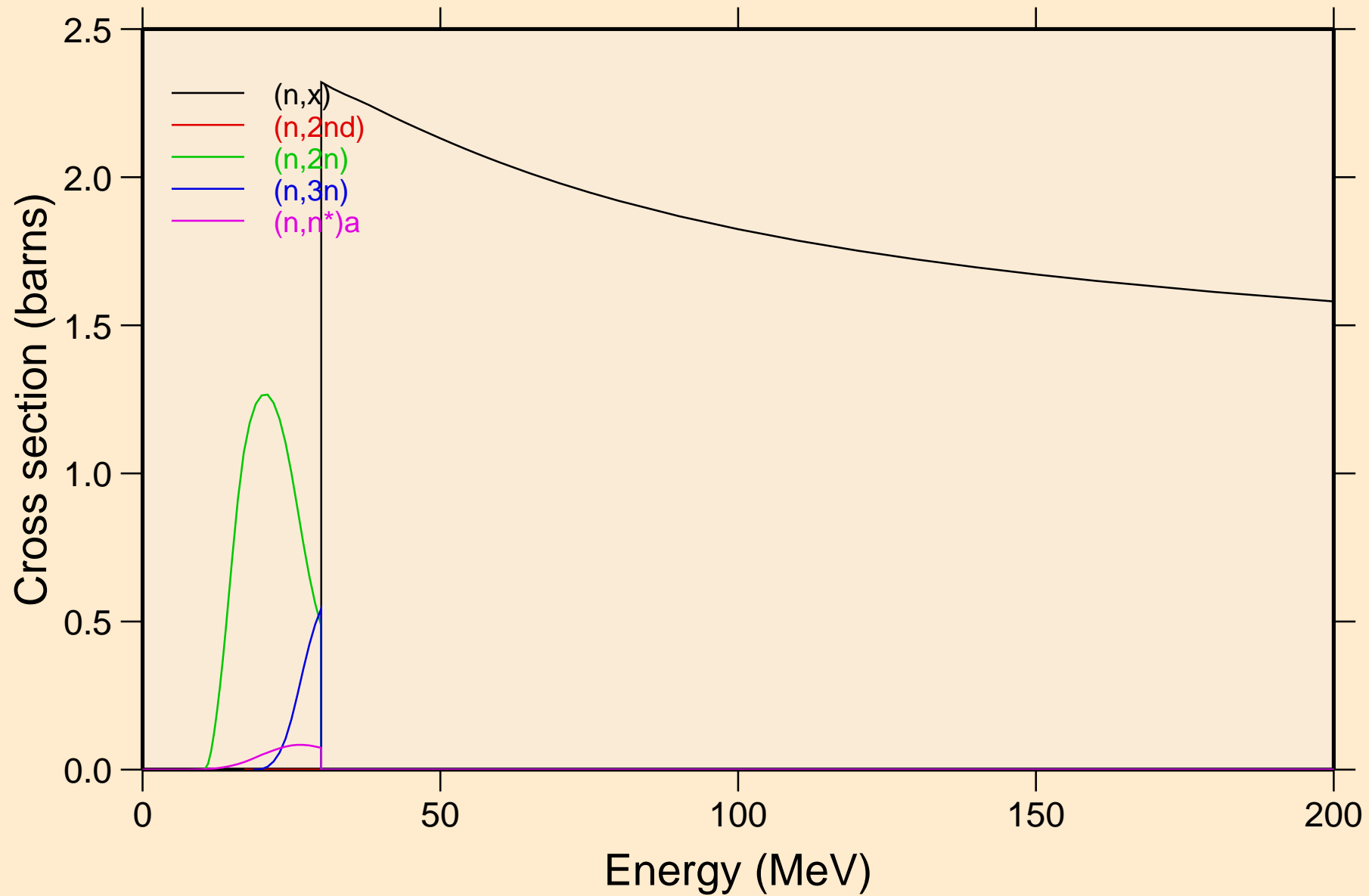

AU183 NEUTRON ACER TENDL-2021 LIBRARY; T=293.6K
Threshold reactions

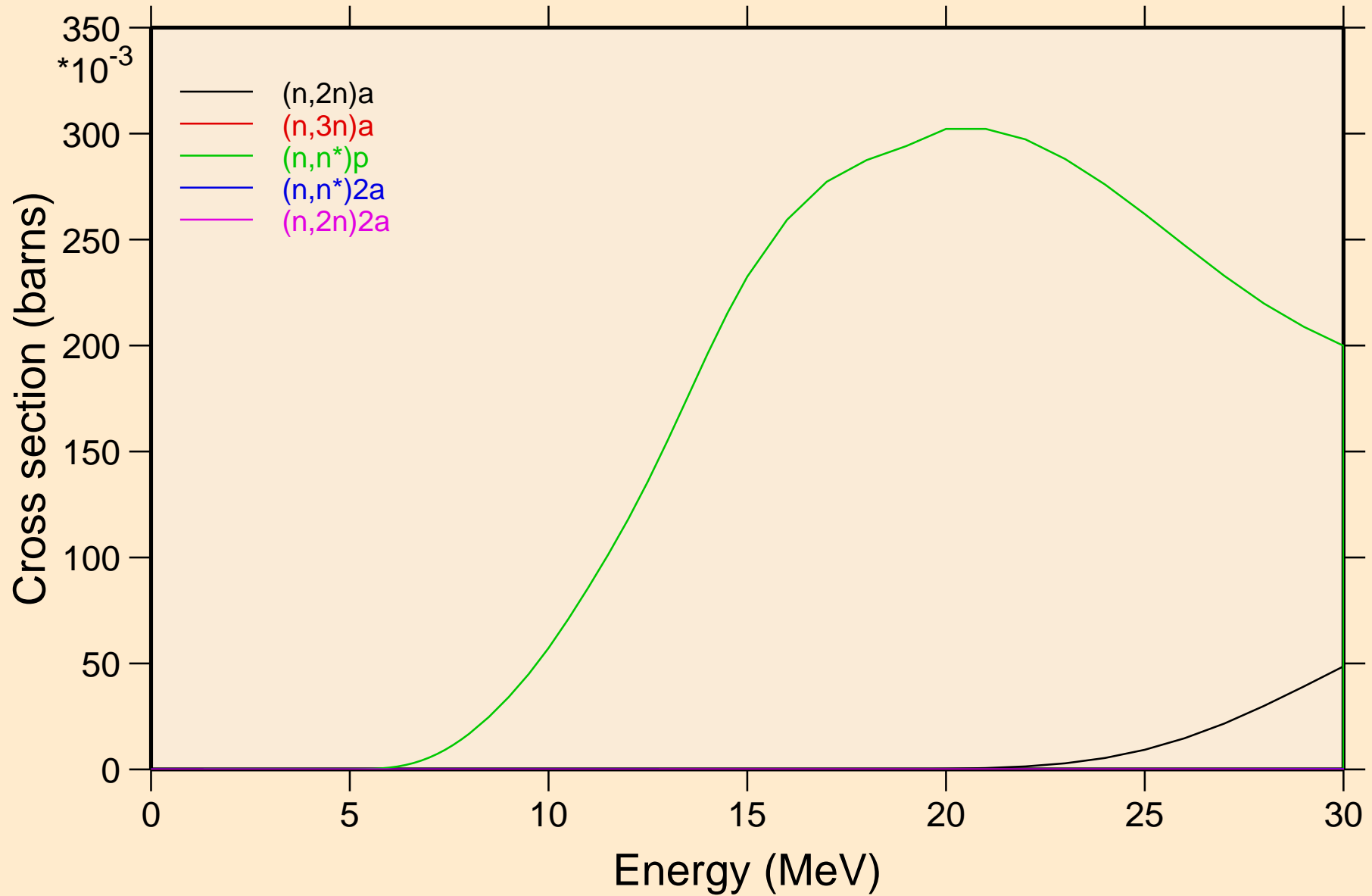

AU183 NEUTRON ACER TENDL-2021 LIBRARY; T=293.6K

Threshold reactions

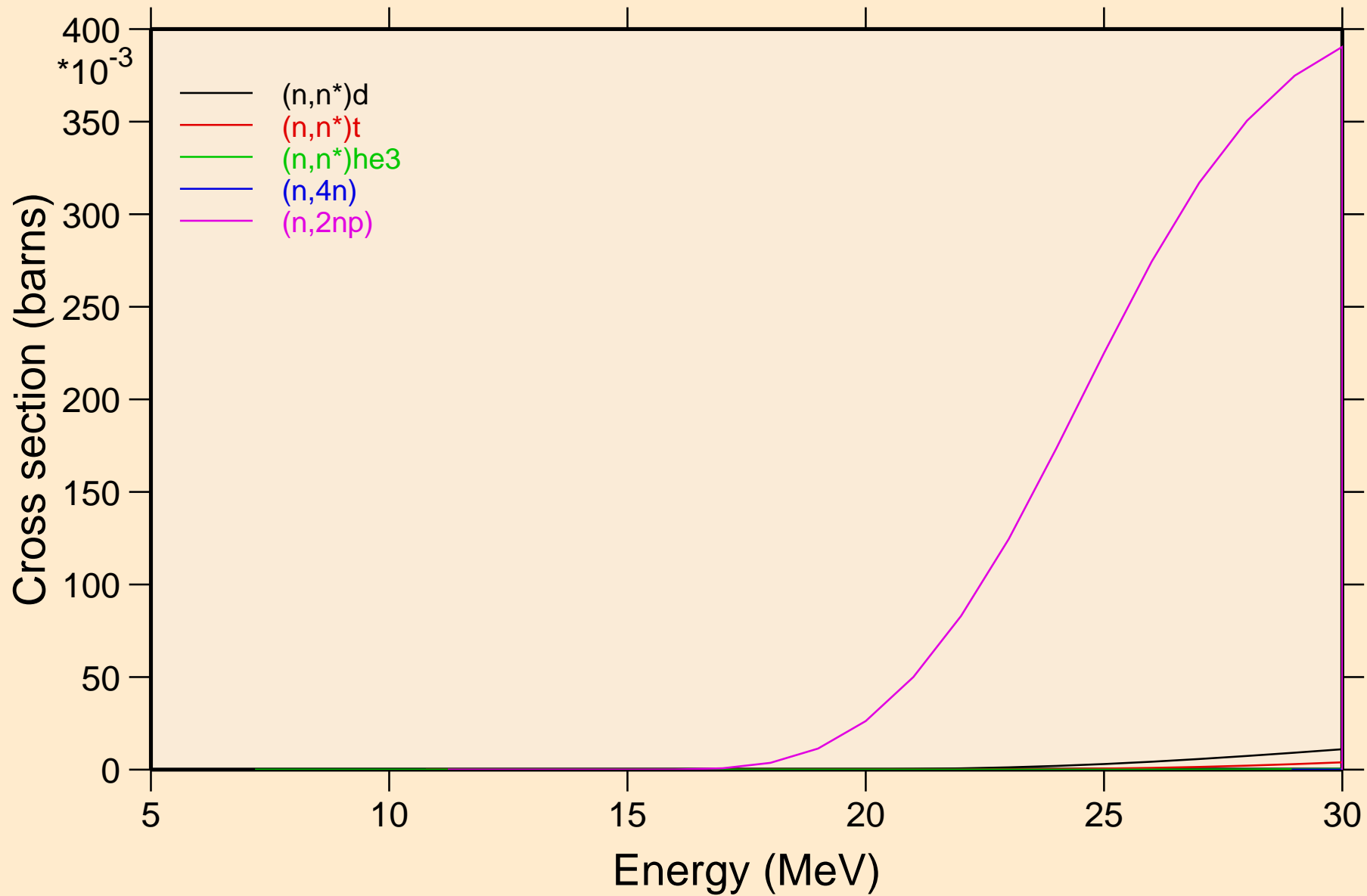

AU183 NEUTRON ACER TENDL-2021 LIBRARY; T=293.6K
Threshold reactions

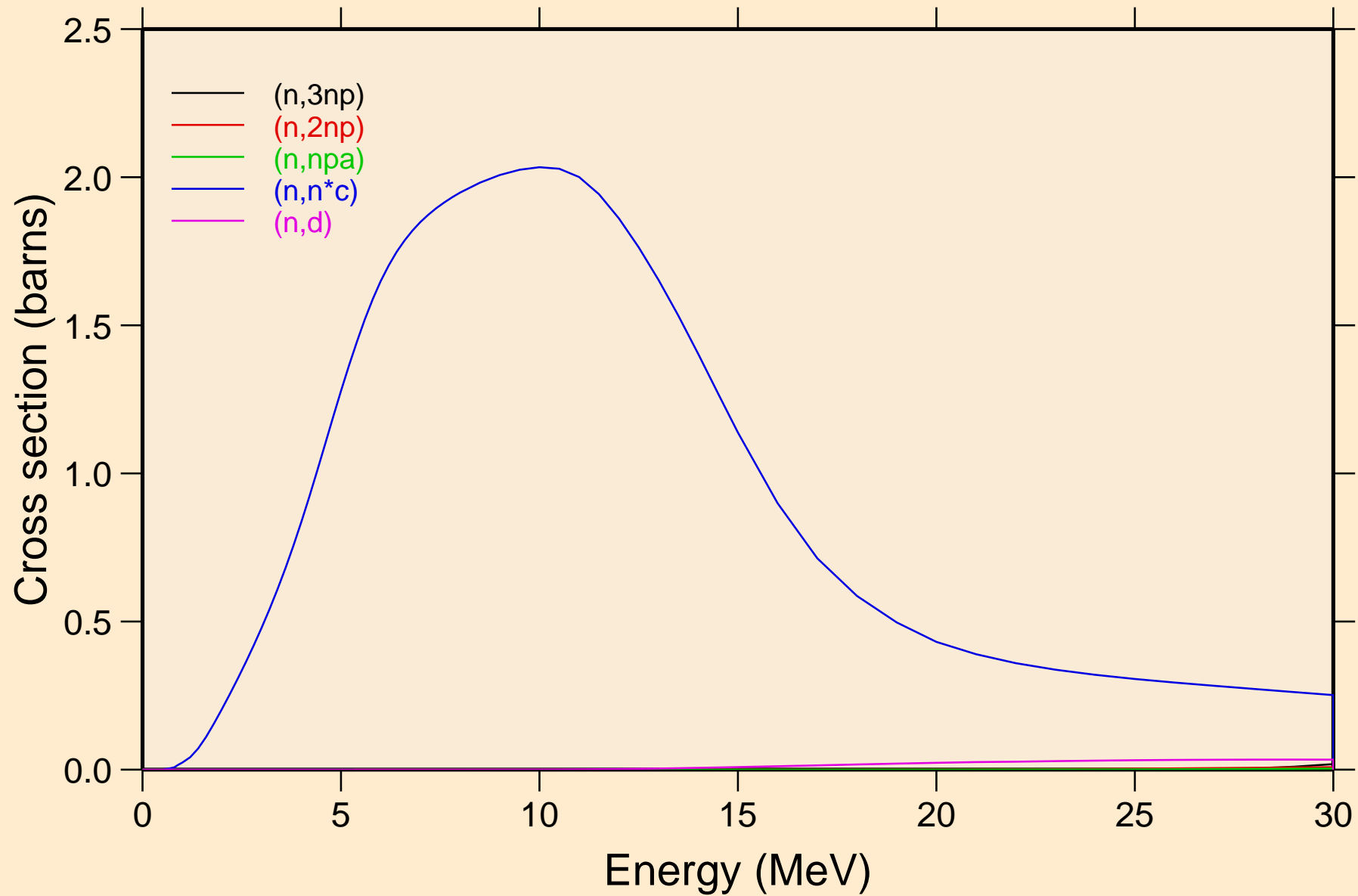

AU183 NEUTRON ACER TENDL-2021 LIBRARY; T=293.6K
Threshold reactions

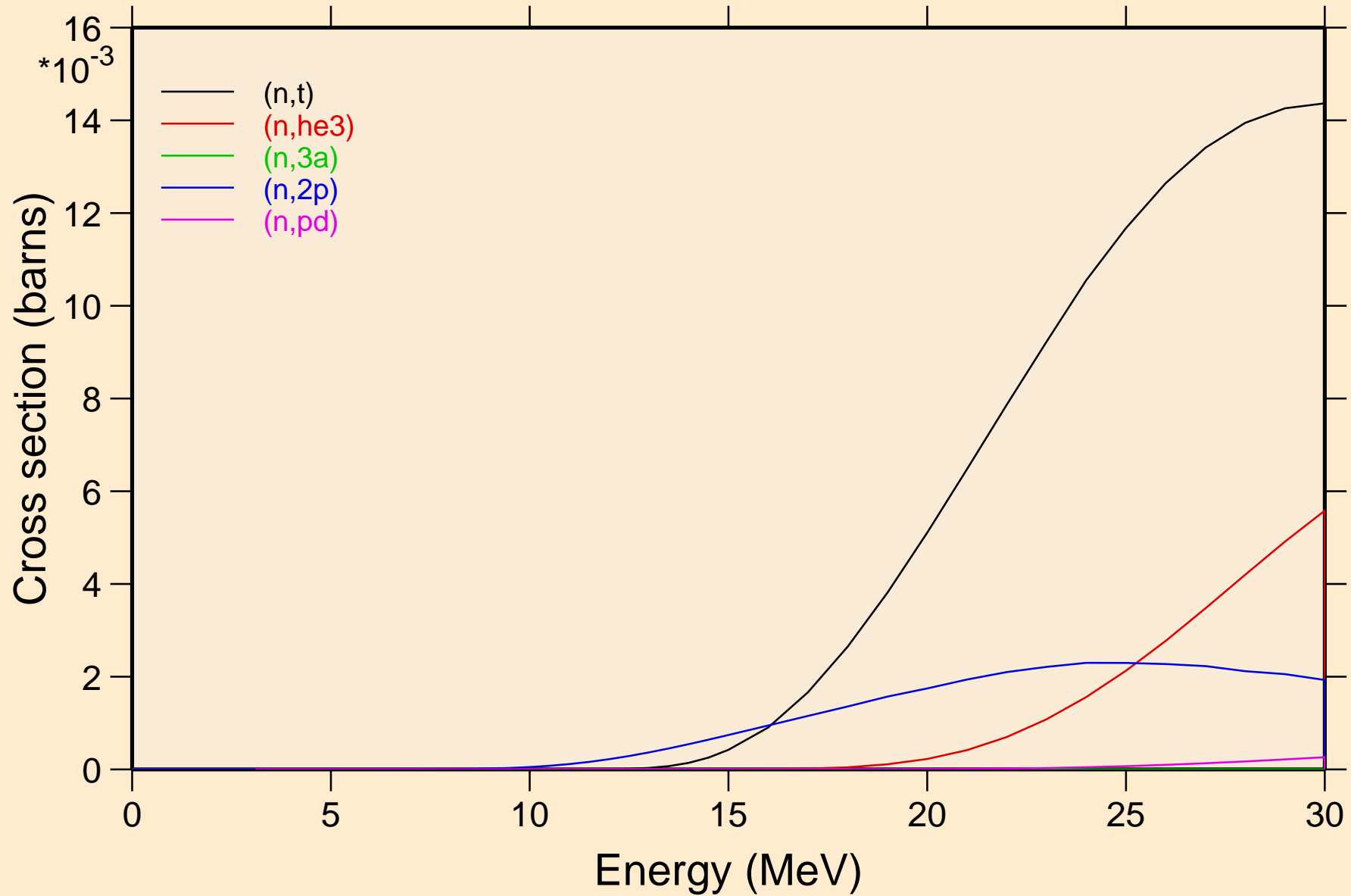

AU183 NEUTRON ACER TENDL-2021 LIBRARY; T=293.6K
Threshold reactions

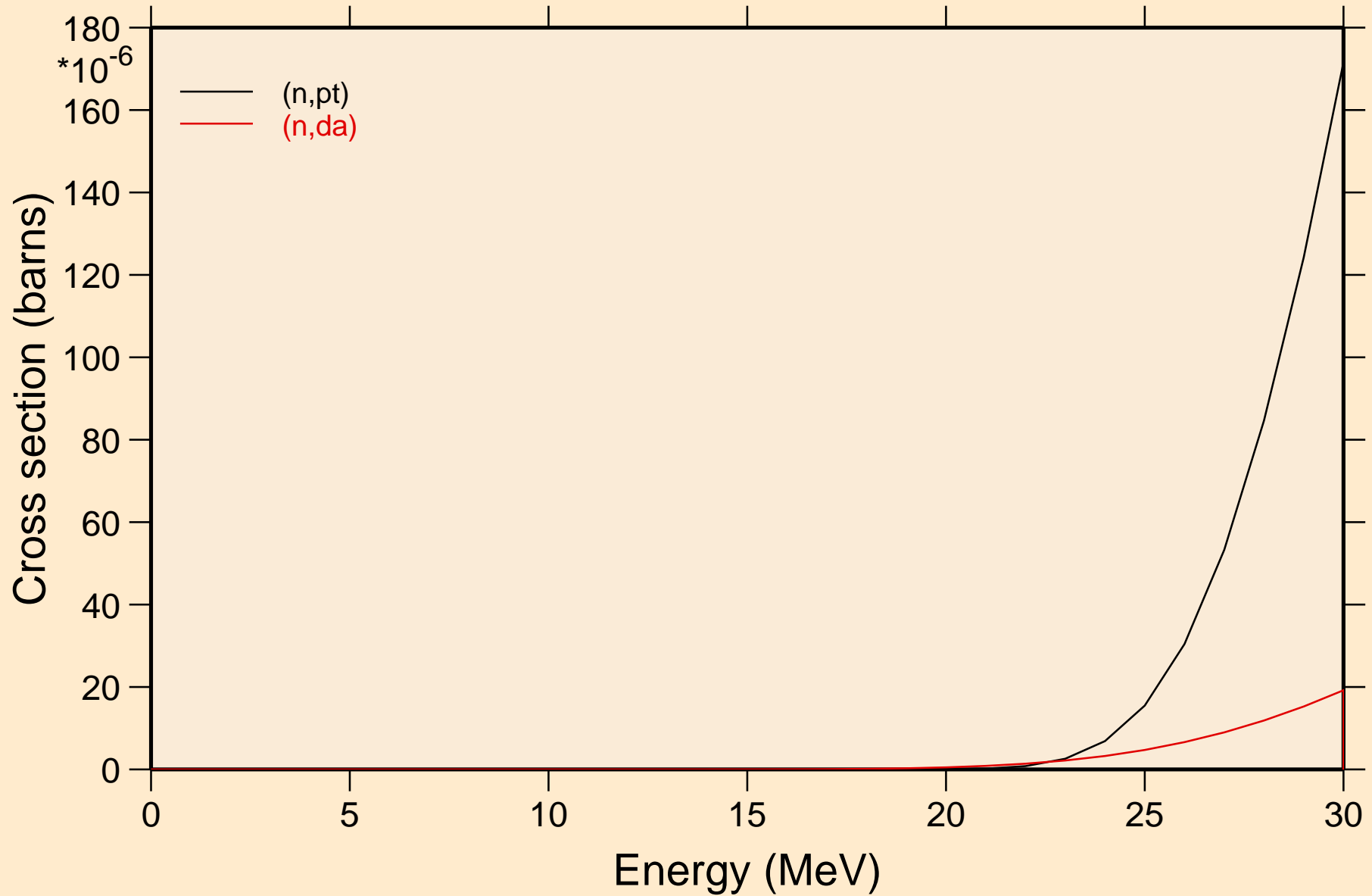

AU183 NEUTRON ACER TENDL-2021 LIBRARY; T=293.6K
Threshold reactions

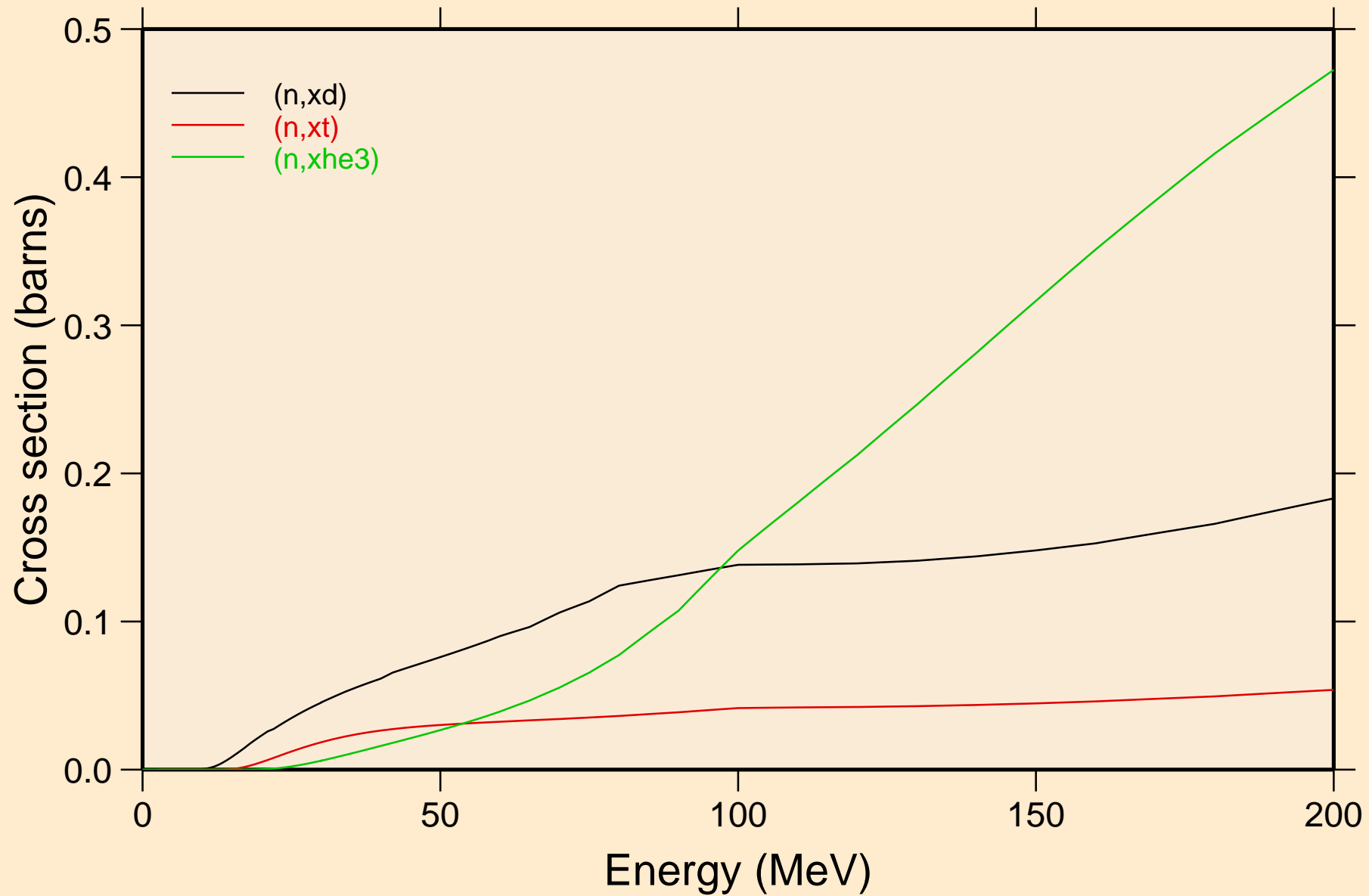

AU183 NEUTRON ACER TENDL-2021 LIBRARY; T=293.6K
angular distribution for elastic

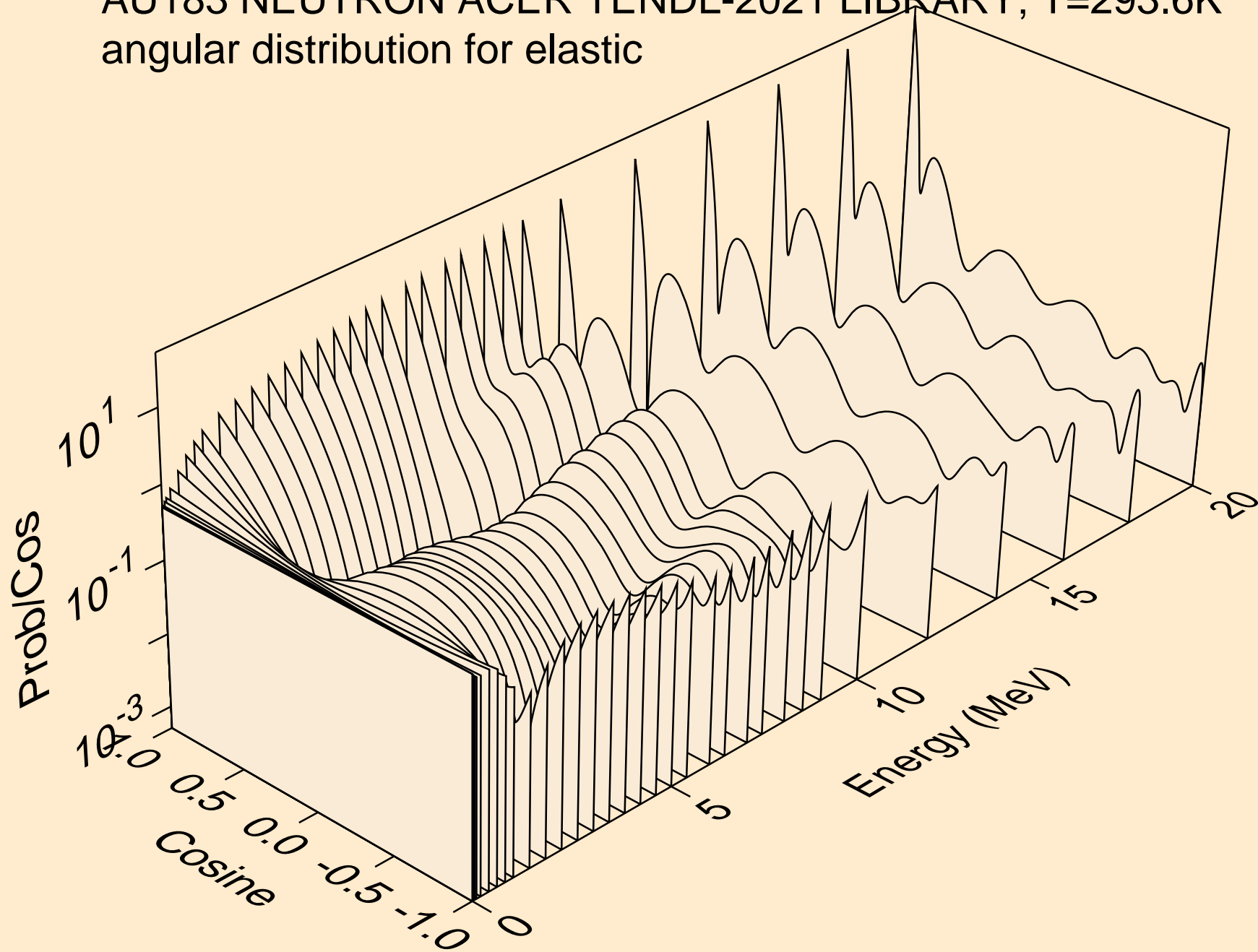

AU183 NEUTRON ACER TENDL-2021 LIBRARY; T=293.6K
angular distribution for elastic

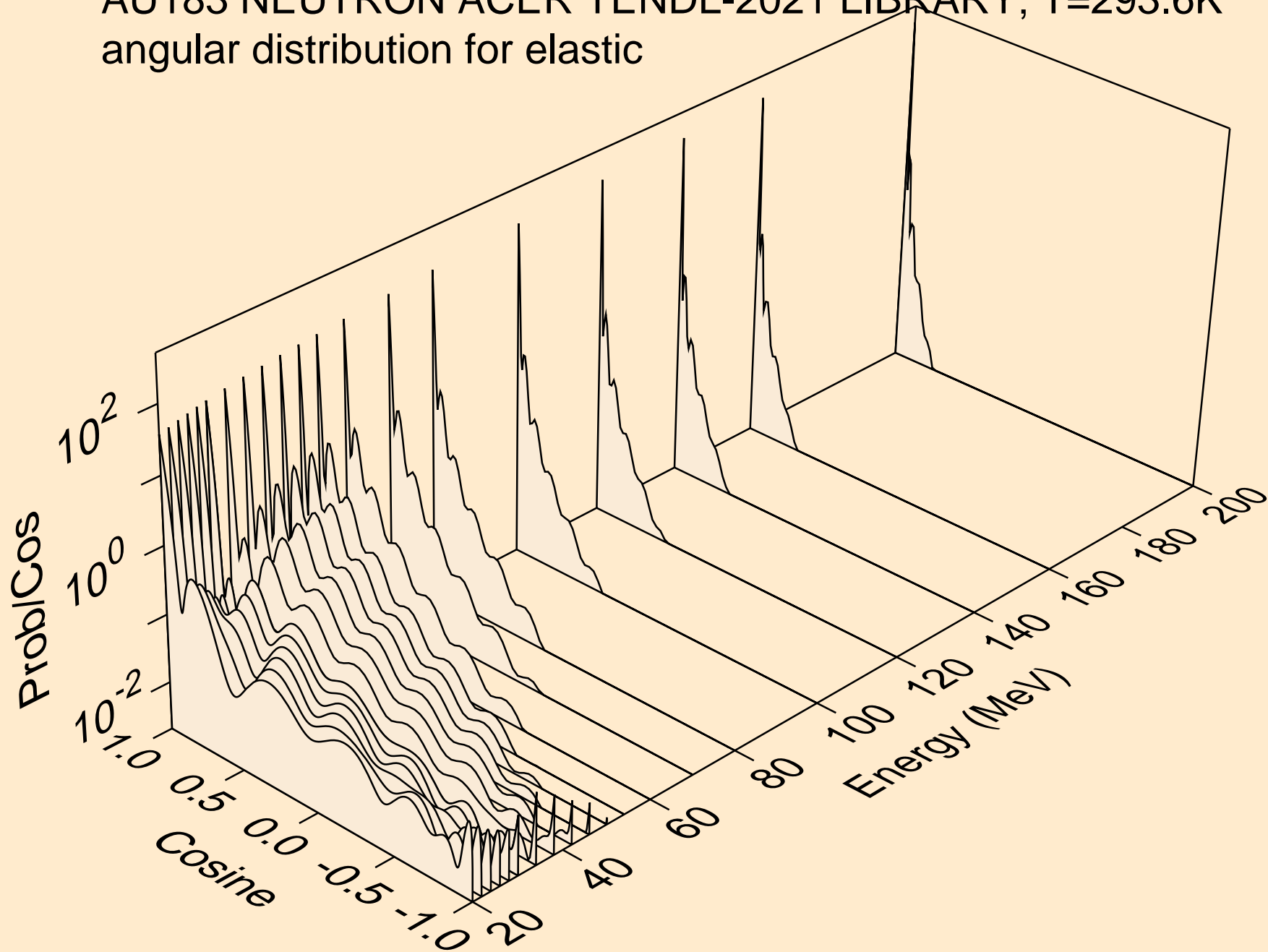

AU183 NEUTRON ACER TENDL-2021 LIBRARY; T=293.6K
angular distribution for (n,n*1)

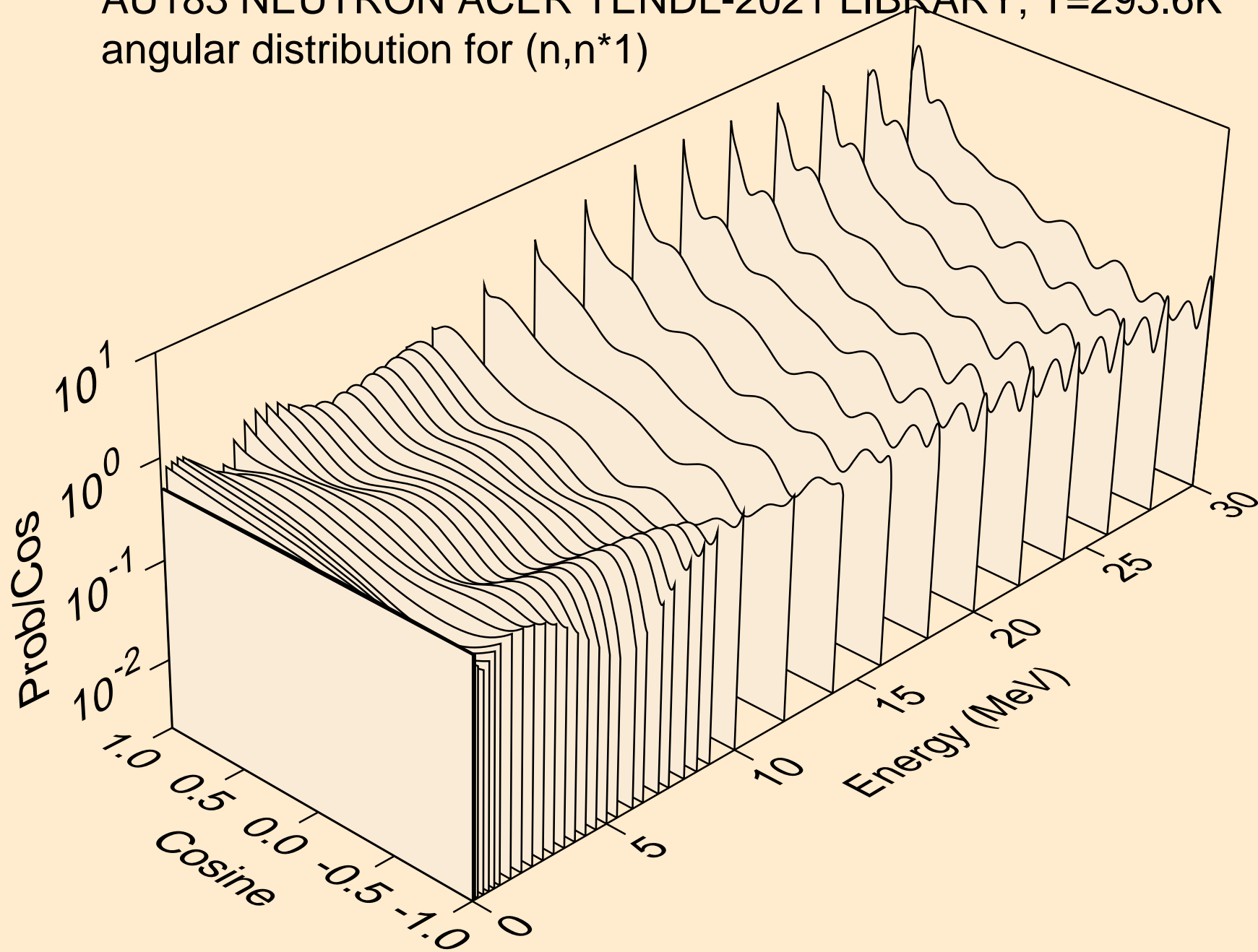

AU183 NEUTRON ACER TENDL-2021 LIBRARY; T=293.6K
angular distribution for (n,n*2)

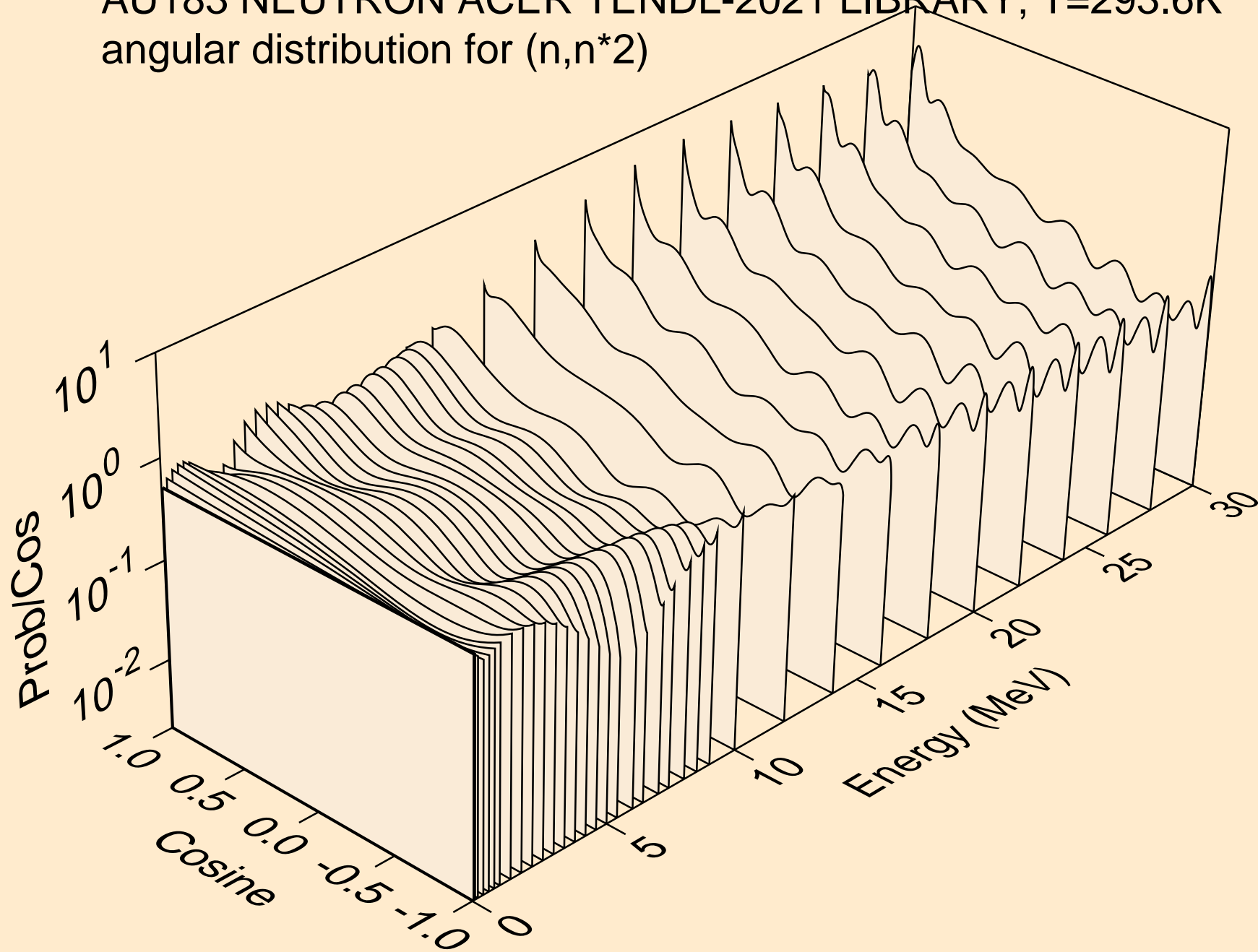

AU183 NEUTRON ACER TENDL-2021 LIBRARY; T=293.6K
angular distribution for (n,n*3)

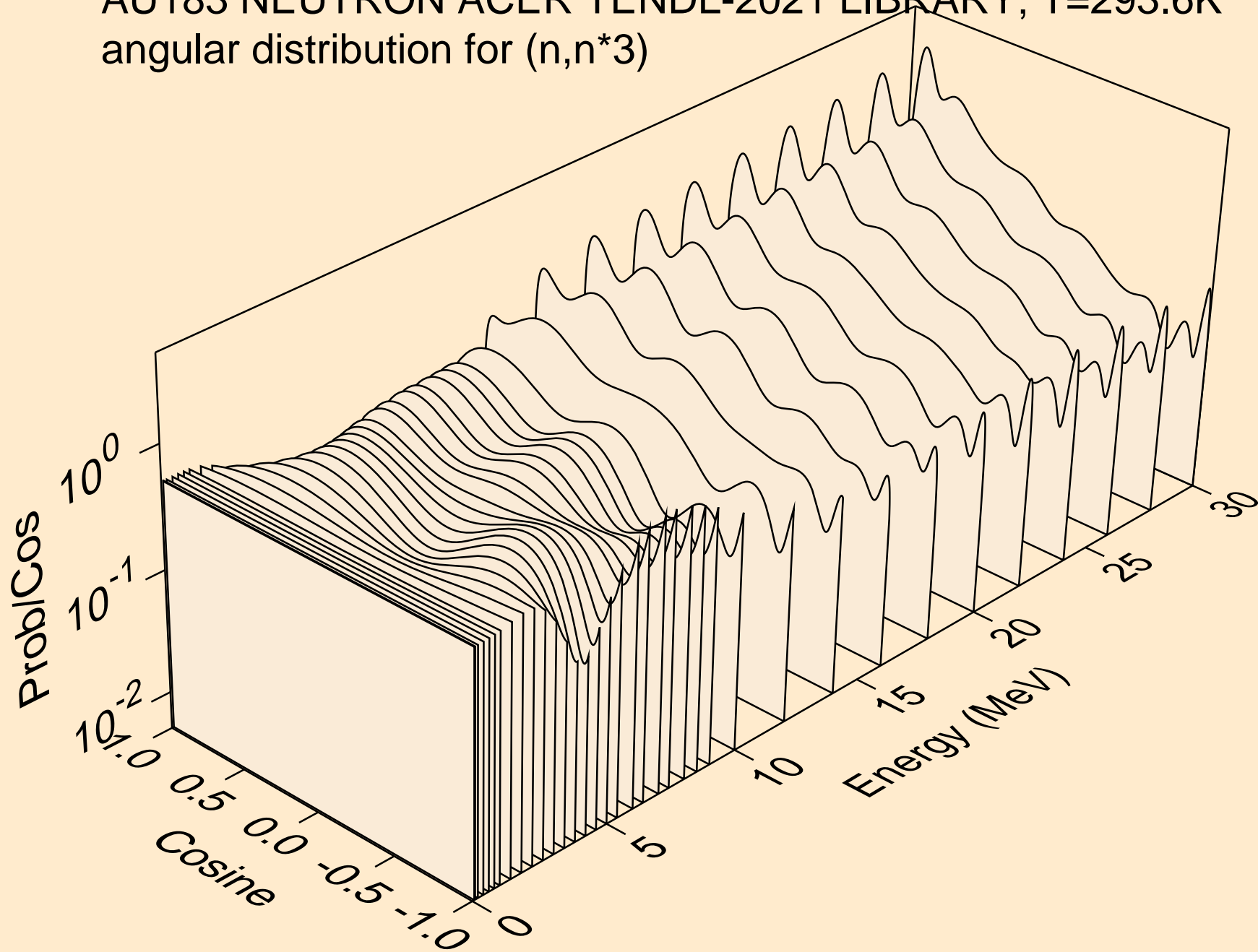

AU183 NEUTRON ACER TENDL-2021 LIBRARY; T=293.6K
angular distribution for (n,n*4)

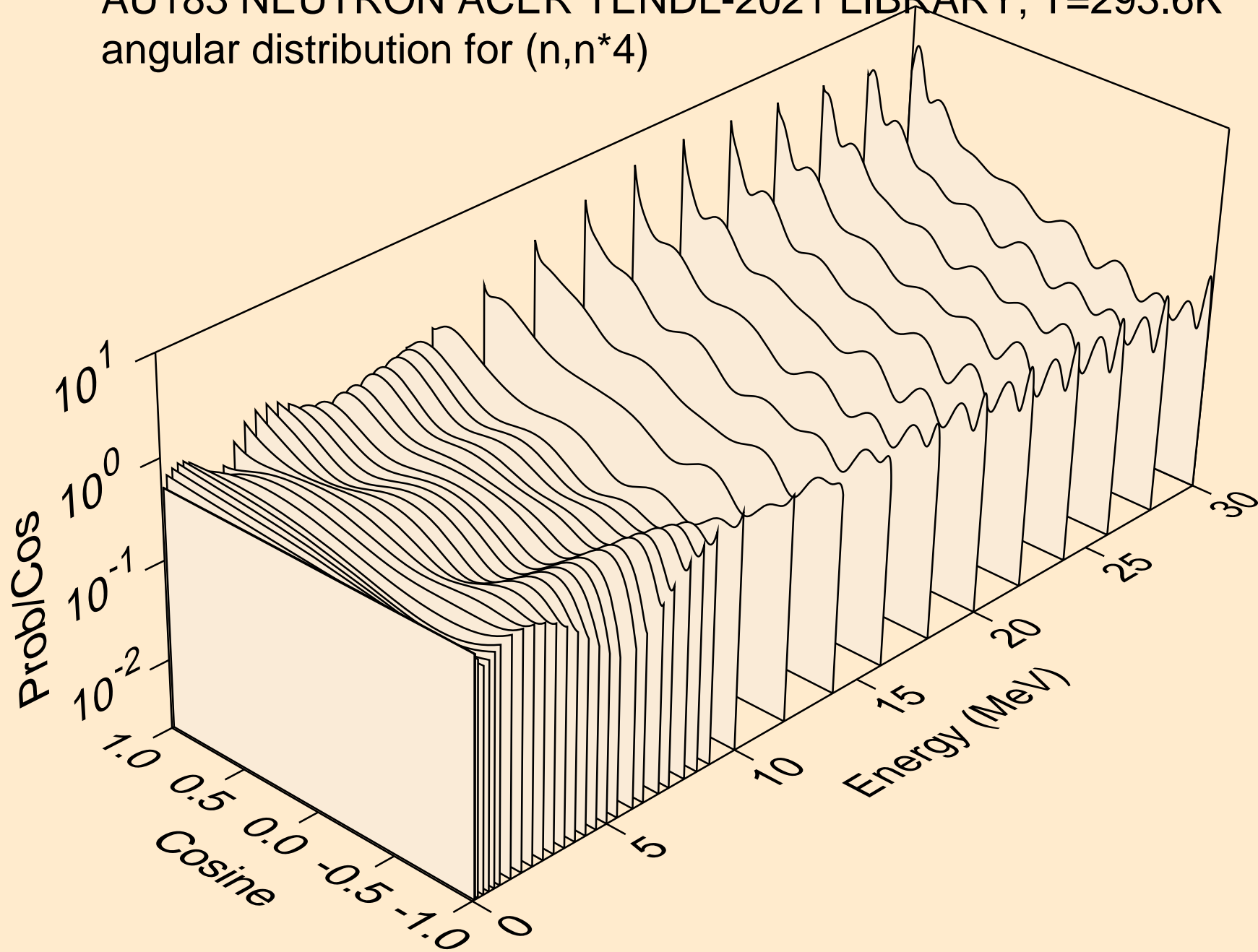

AU183 NEUTRON ACER TENDL-2021 LIBRARY; T=293.6K
angular distribution for (n,n*5)

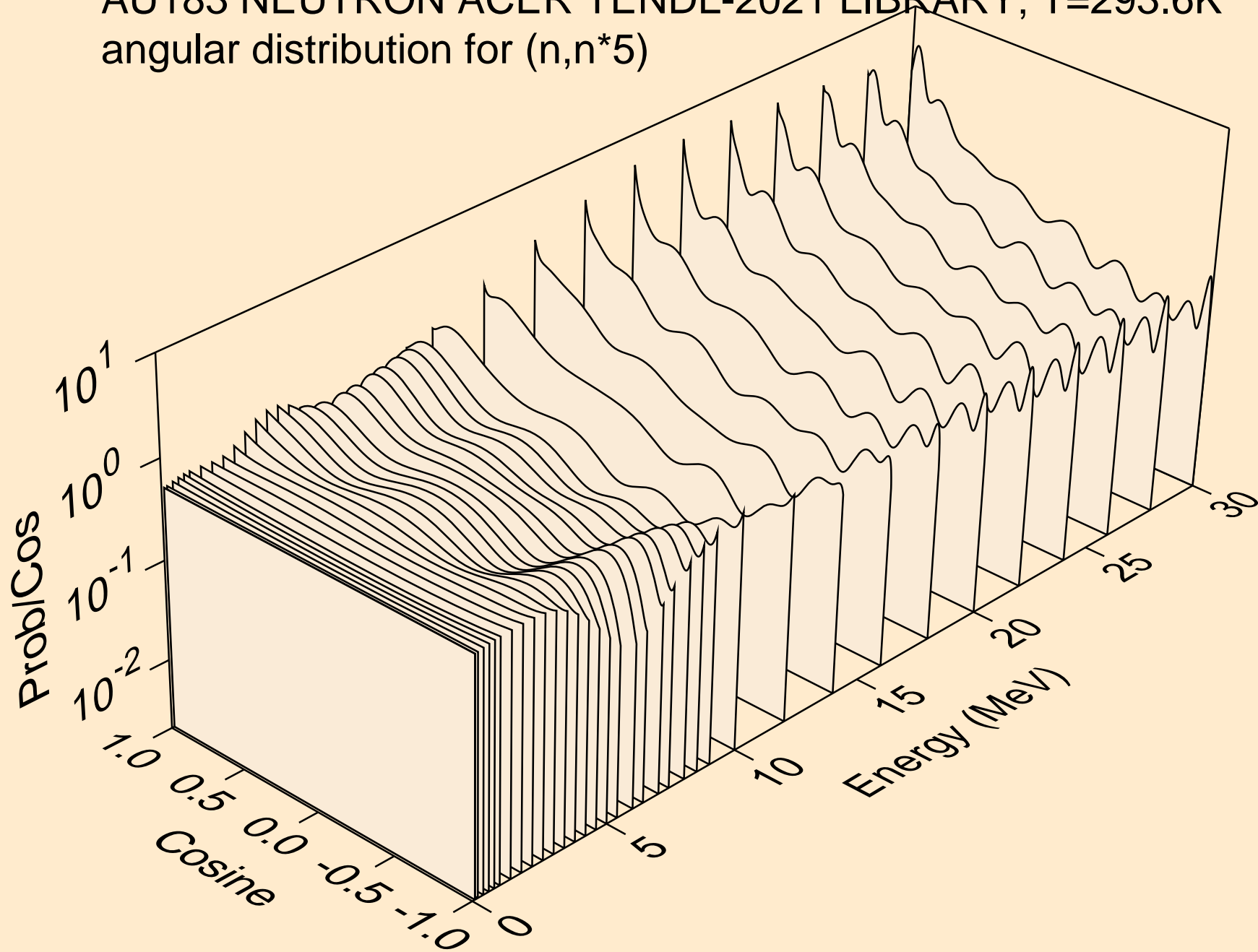

AU183 NEUTRON ACER TENDL-2021 LIBRARY; T=293.6K
angular distribution for (n,n*6)

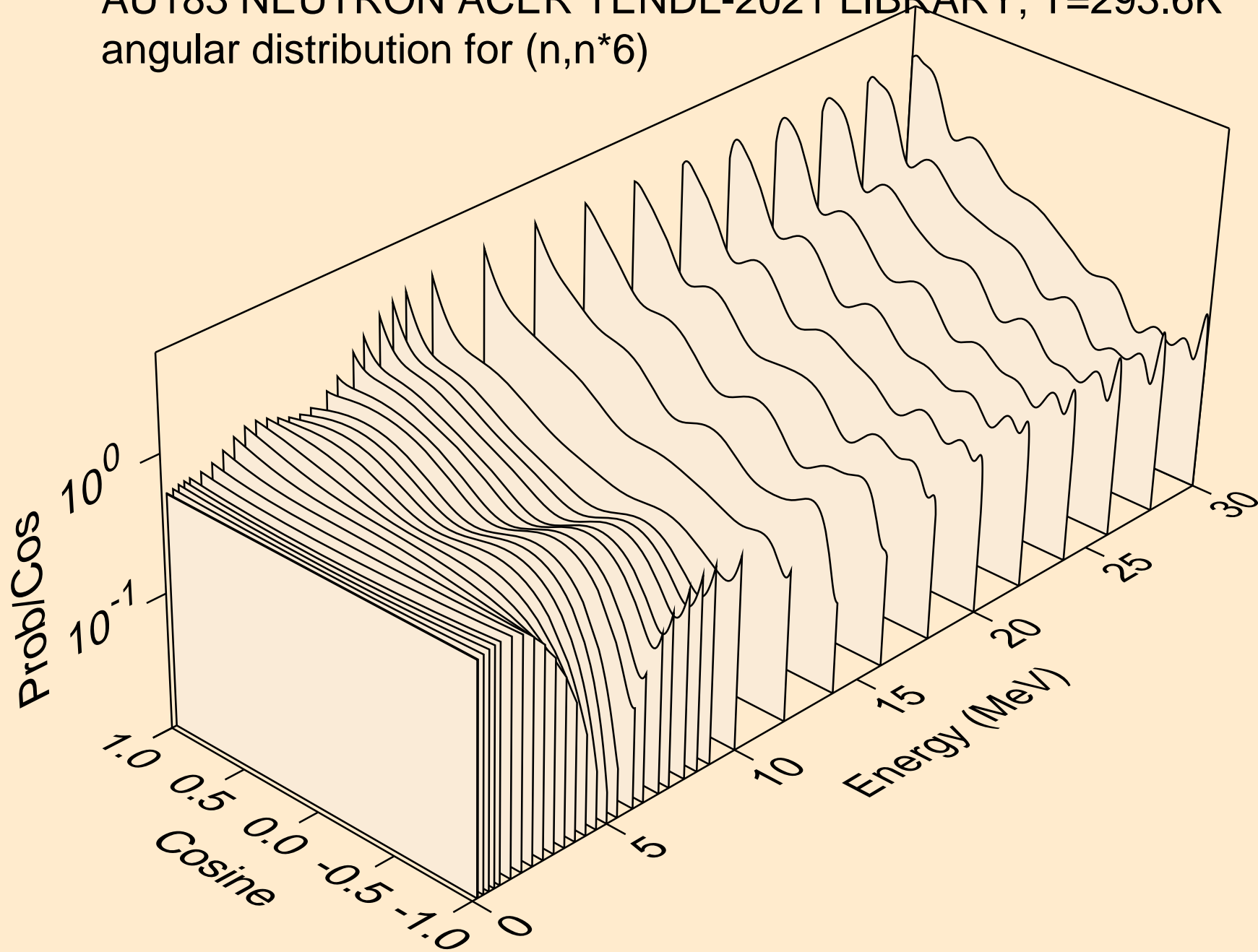

AU183 NEUTRON ACER TENDL-2021 LIBRARY; T=293.6K
angular distribution for (n,n*7)

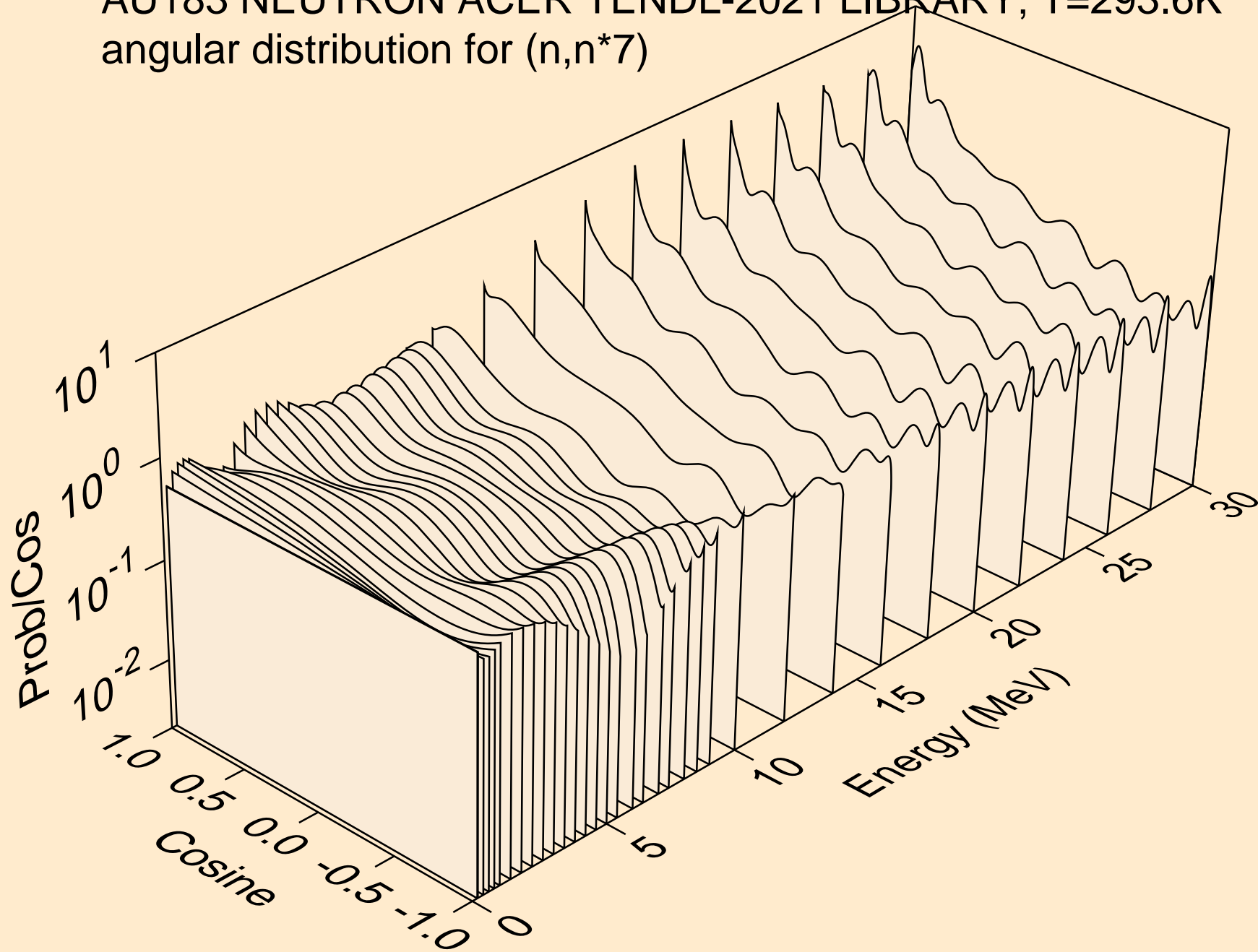

AU183 NEUTRON ACER TENDL-2021 LIBRARY; T=293.6K
angular distribution for (n,n*8)

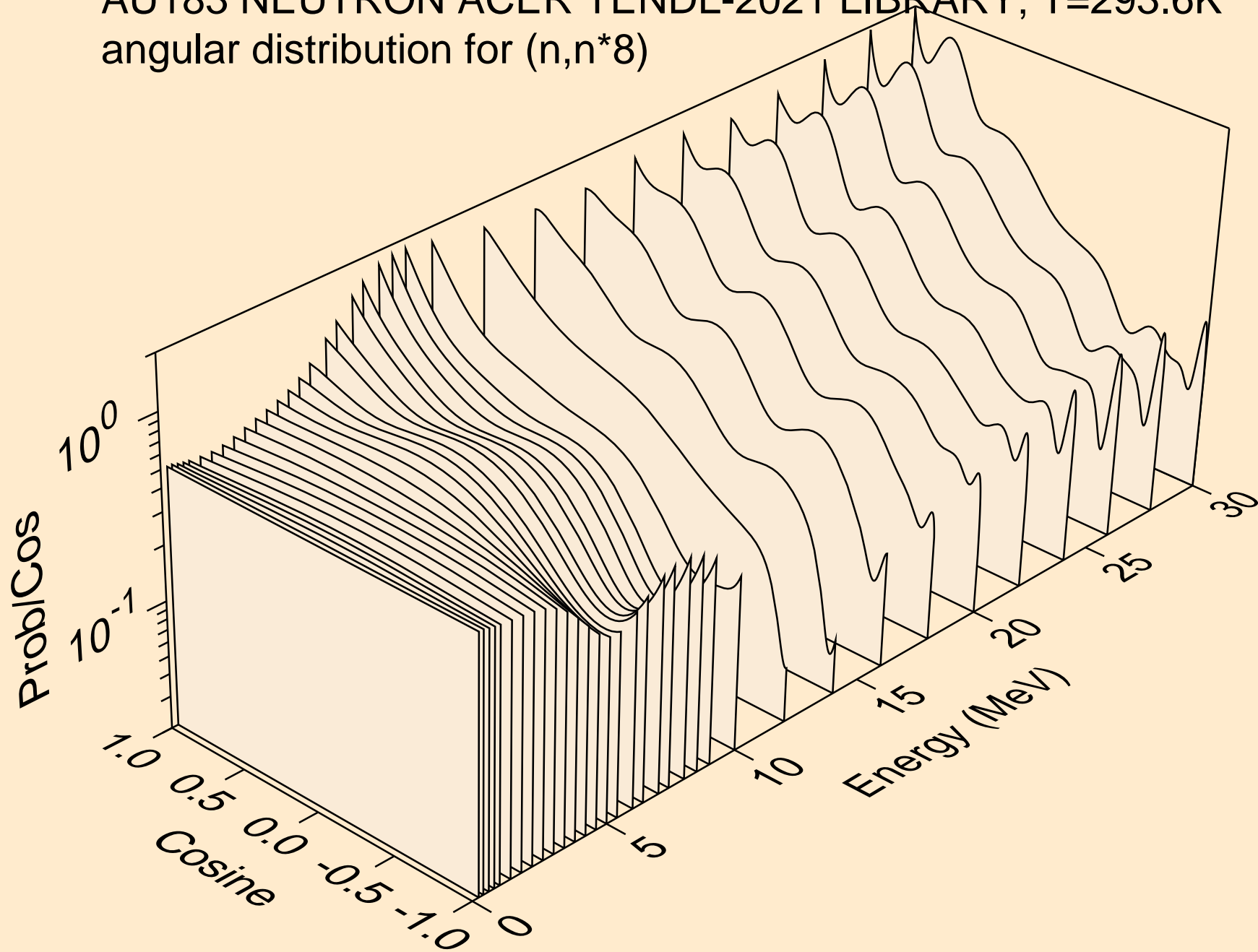

AU183 NEUTRON ACER TENDL-2021 LIBRARY; T=293.6K
angular distribution for (n,n*9)

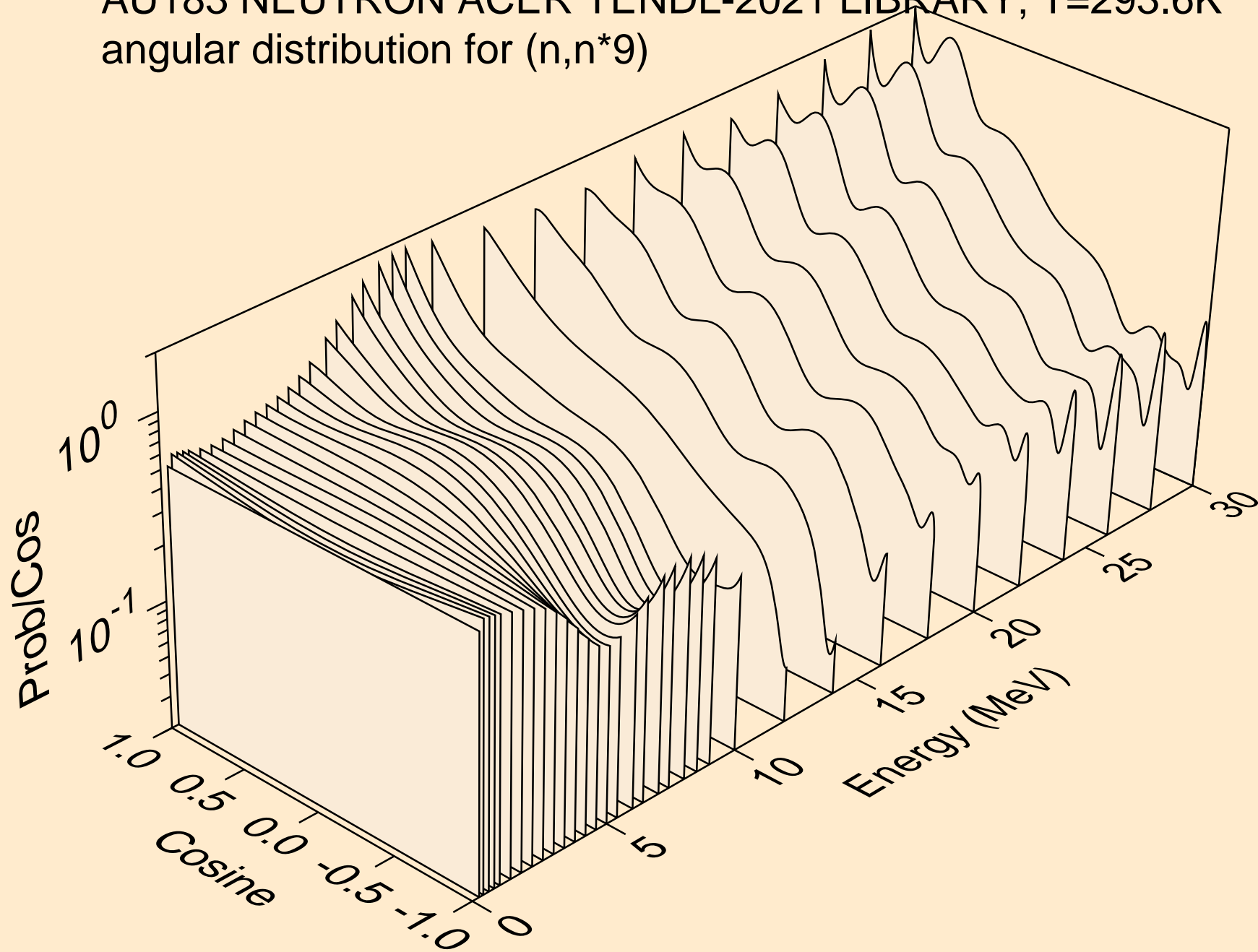

AU183 NEUTRON ACER TENDL-2021 LIBRARY; T=293.6K
angular distribution for (n,n*10)

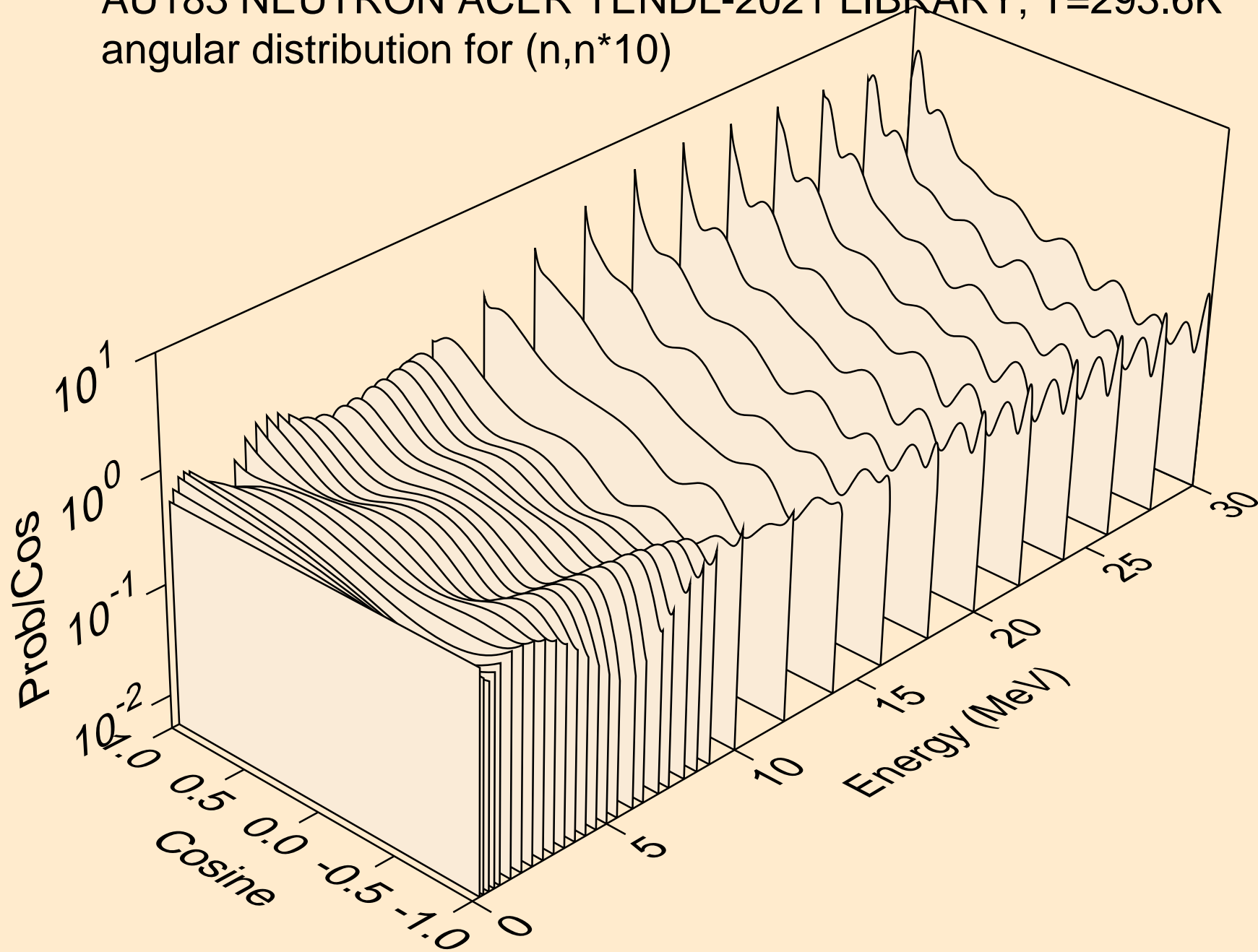

AU183 NEUTRON ACER TENDL-2021 LIBRARY; T=293.6K
angular distribution for (n,n*11)

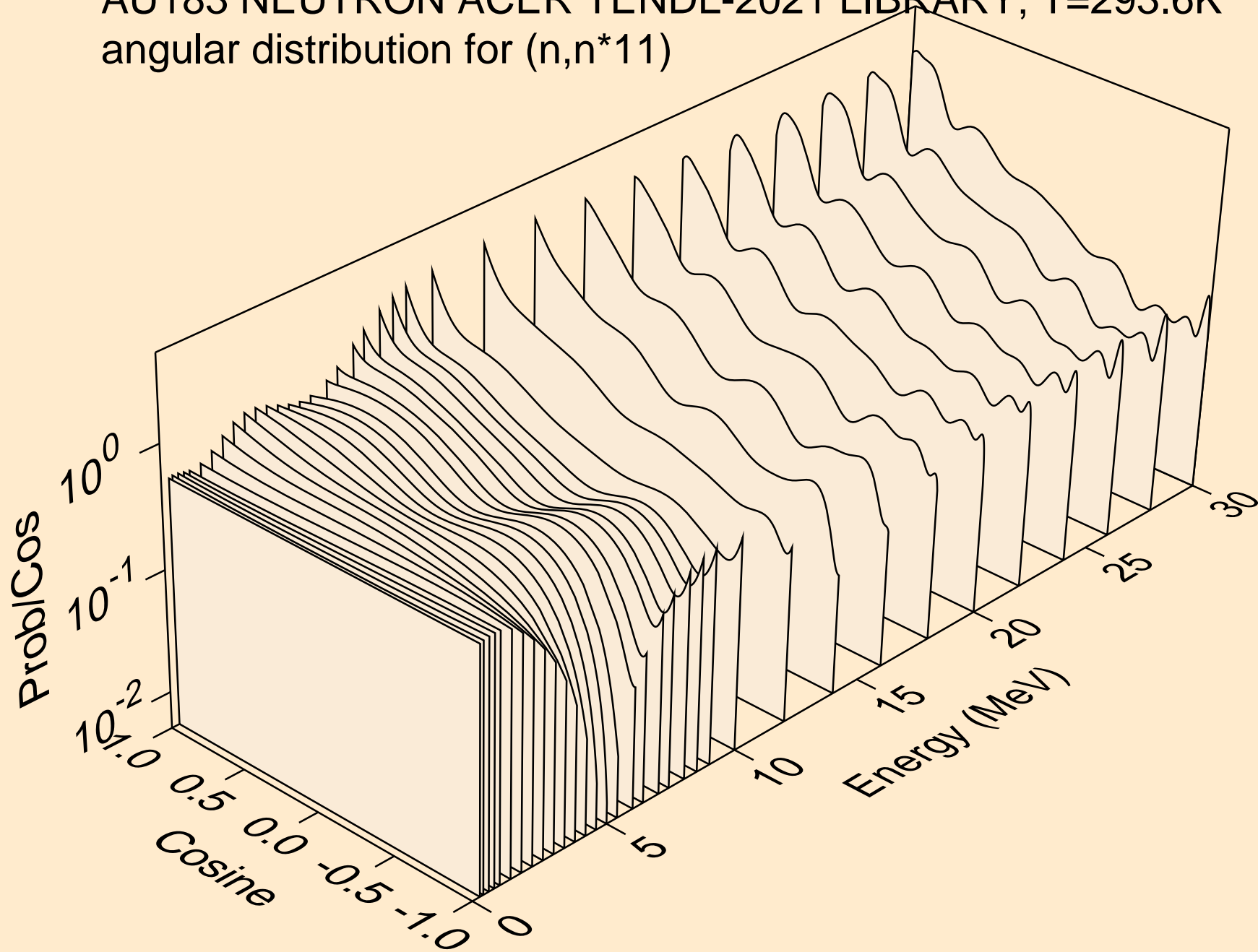

AU183 NEUTRON ACER TENDL-2021 LIBRARY; T=293.6K
angular distribution for (n,n*12)

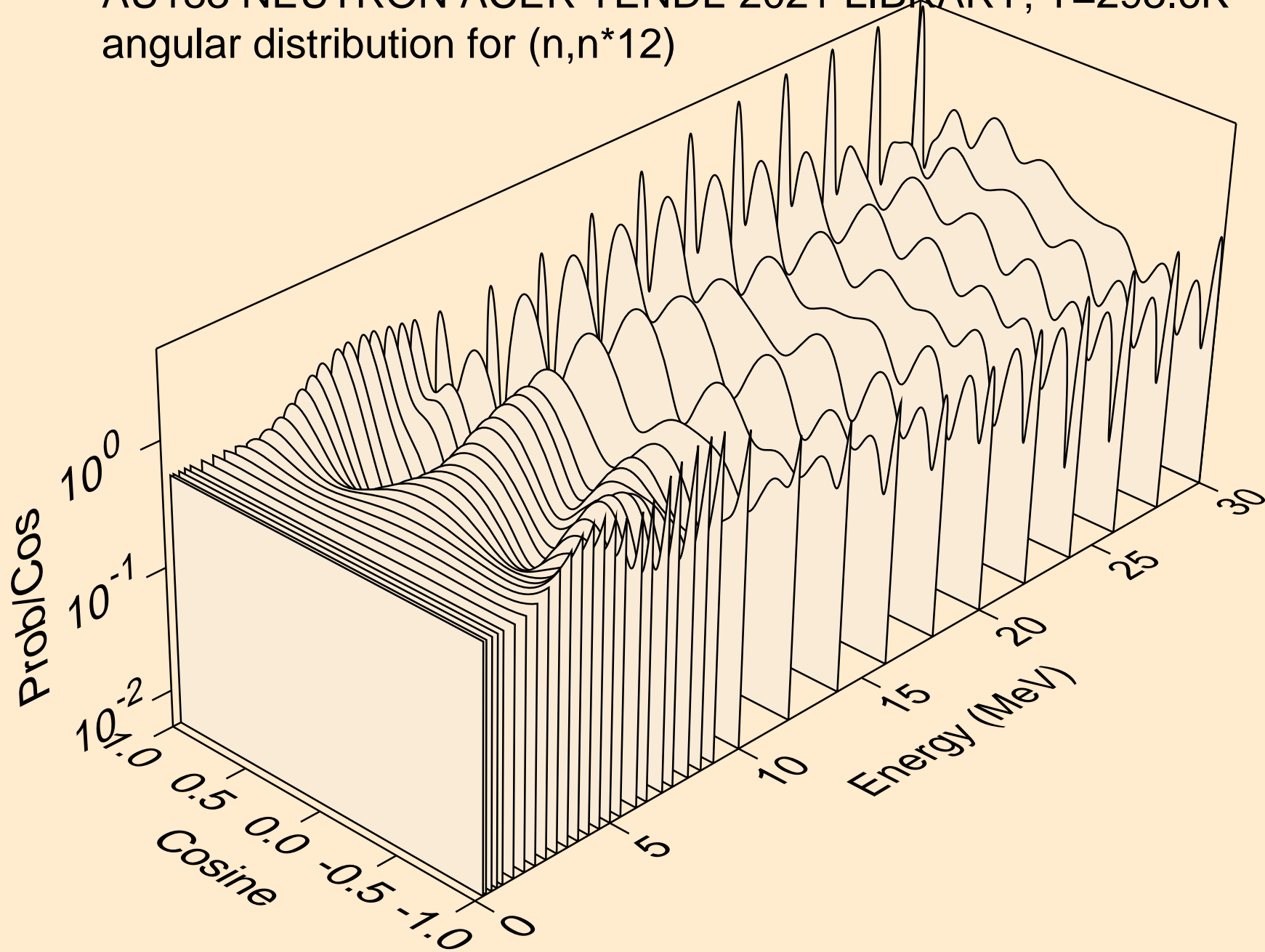

AU183 NEUTRON ACER TENDL-2021 LIBRARY; T=293.6K
angular distribution for (n,n*13)

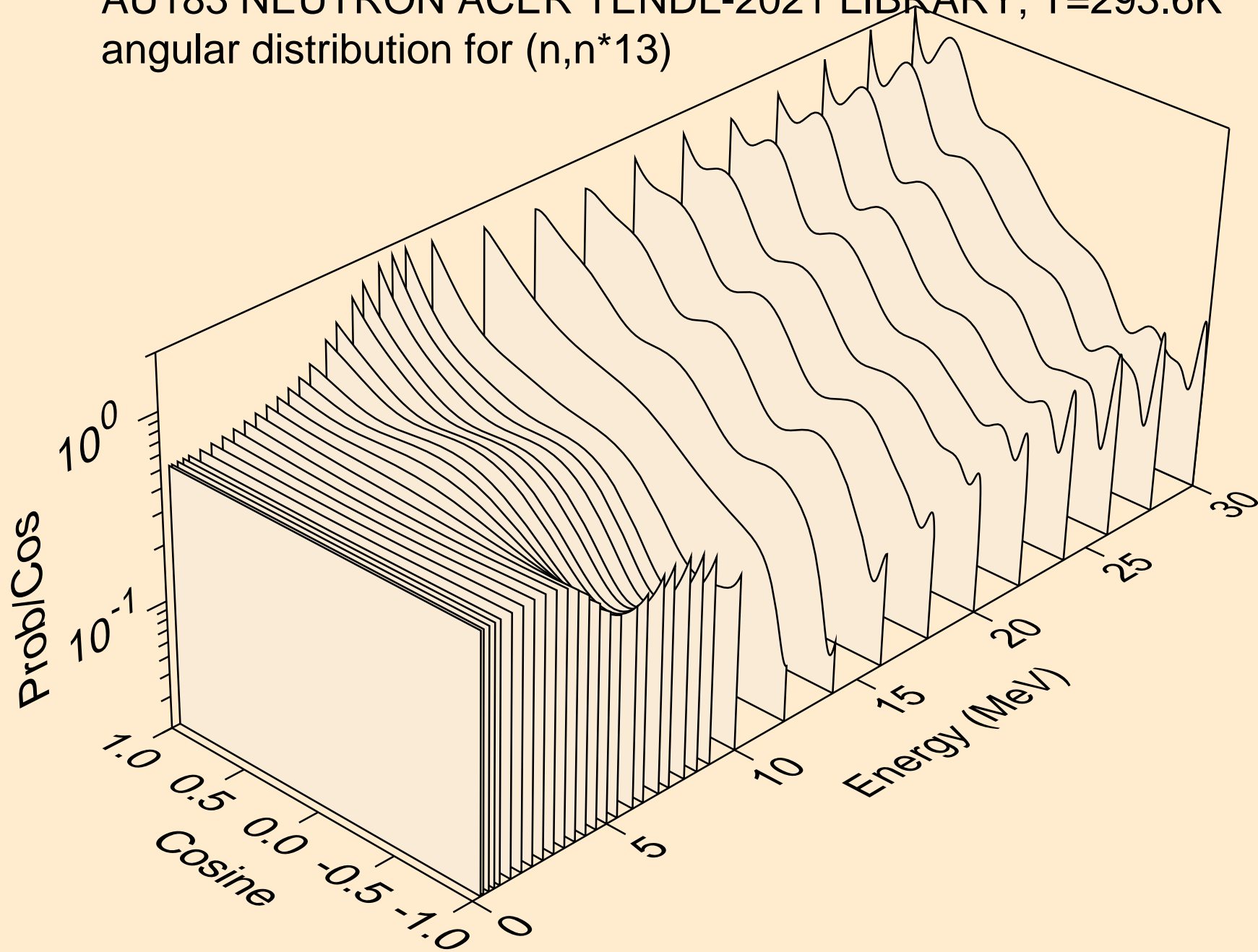

AU183 NEUTRON ACER TENDL-2021 LIBRARY; T=293.6K
angular distribution for (n,n*14)

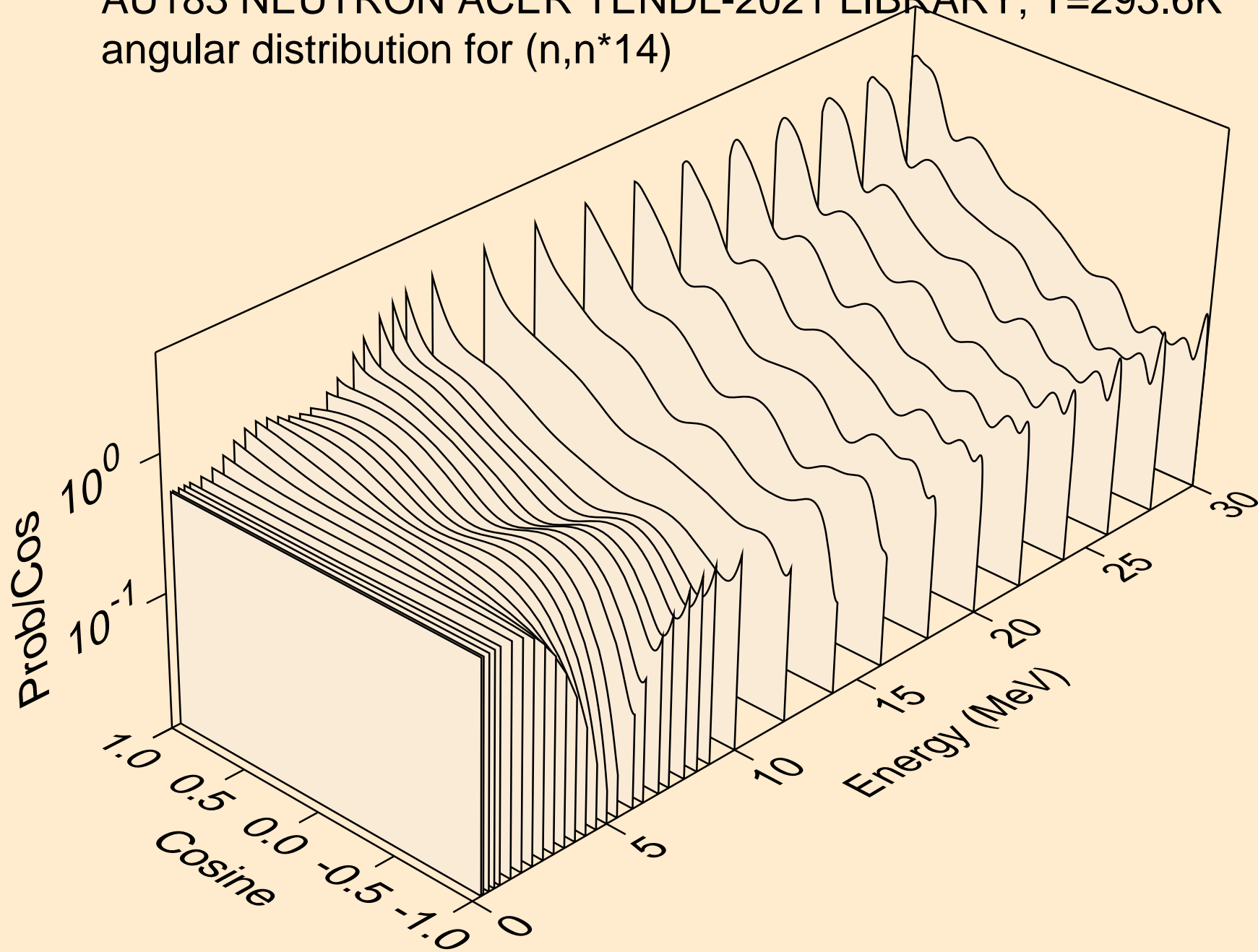

AU183 NEUTRON ACER TENDL-2021 LIBRARY; T=293.6K
angular distribution for (n,n*15)

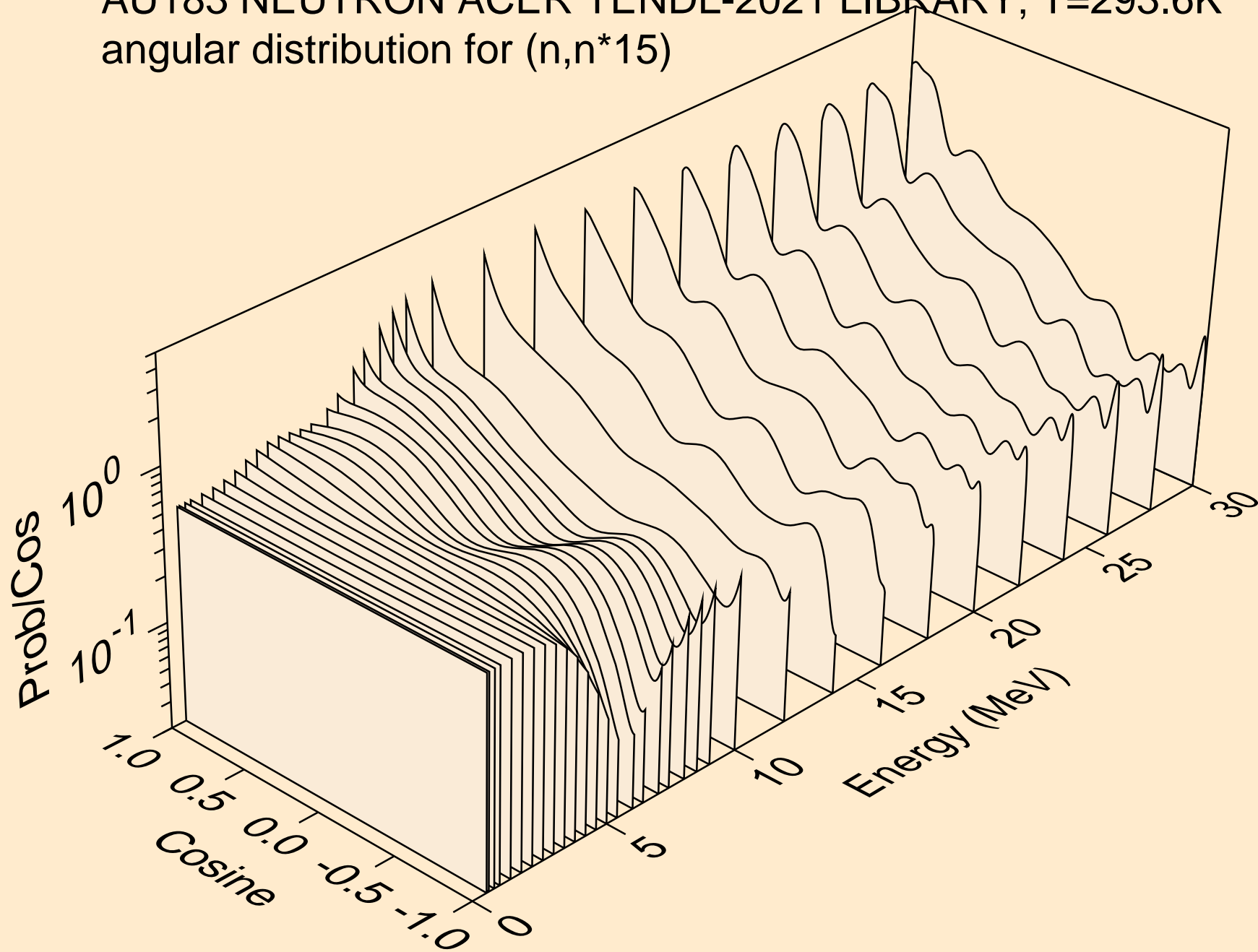

AU183 NEUTRON ACER TENDL-2021 LIBRARY; T=293.6K
Neutron emission for (n,x)

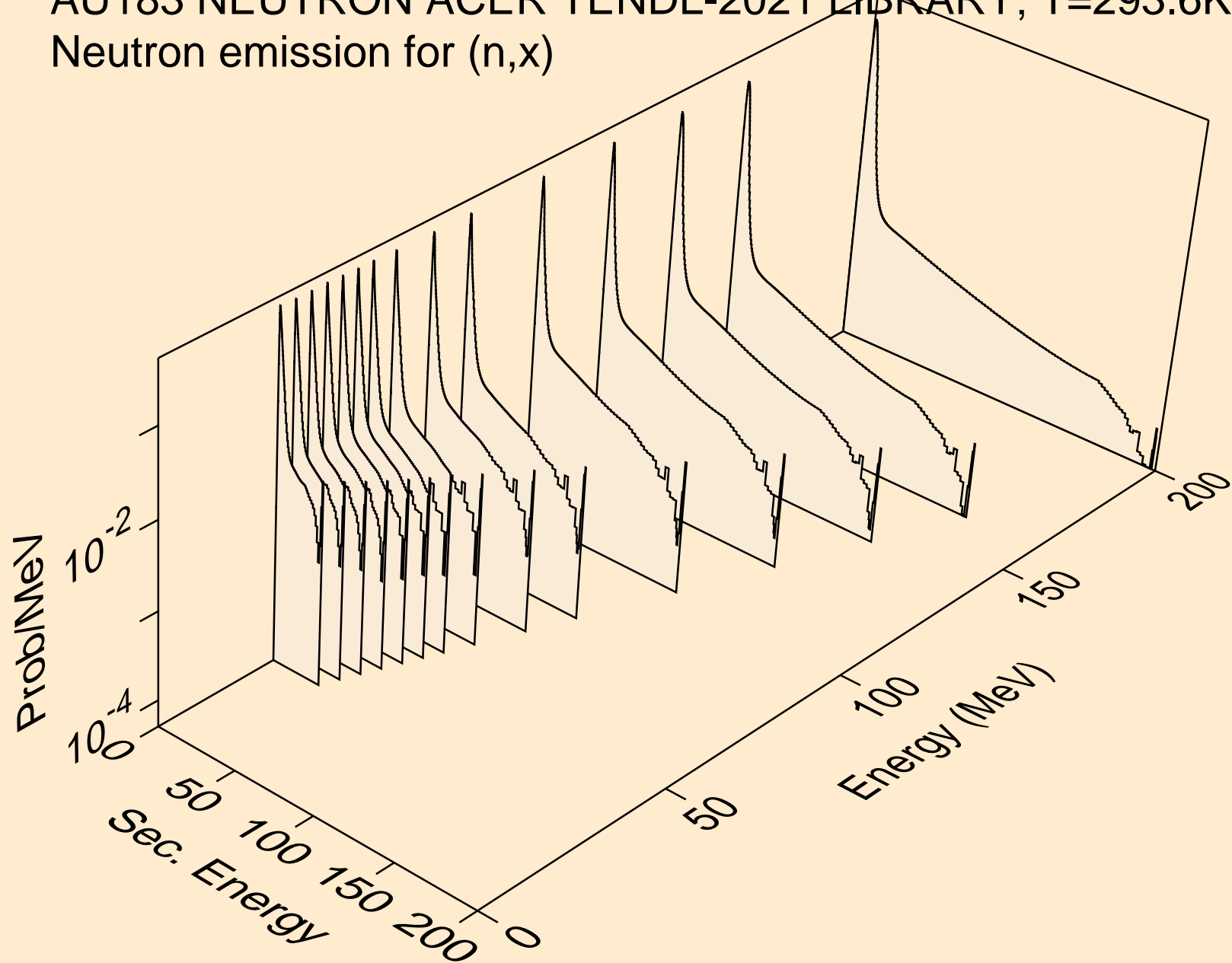

AU183 NEUTRON ACER TENDL-2021 LIBRARY; T=293.6K
Neutron emission for (n,2nd)

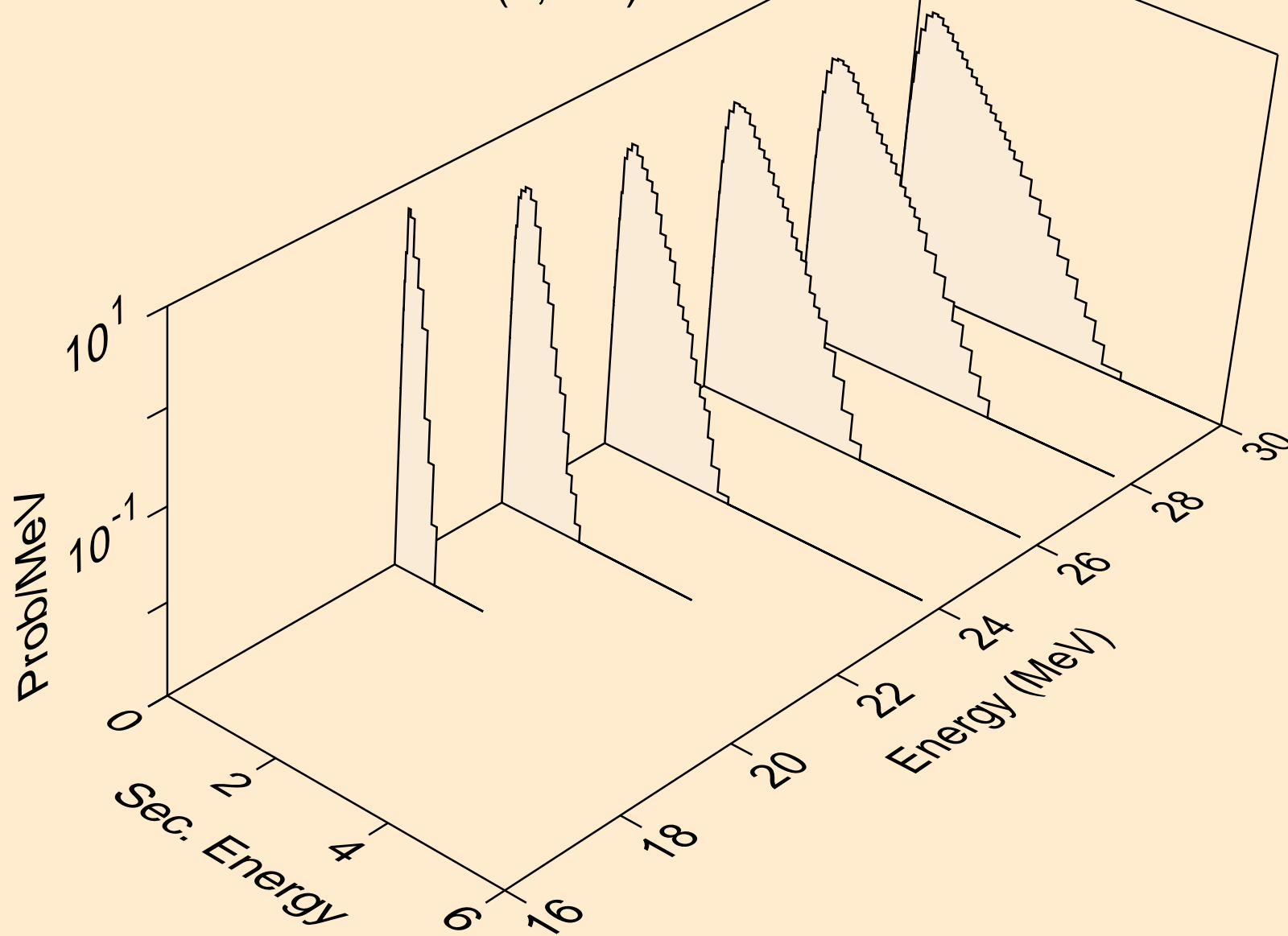

AU183 NEUTRON ACER TENDL-2021 LIBRARY; T=293.6K
Neutron emission for (n,2n)

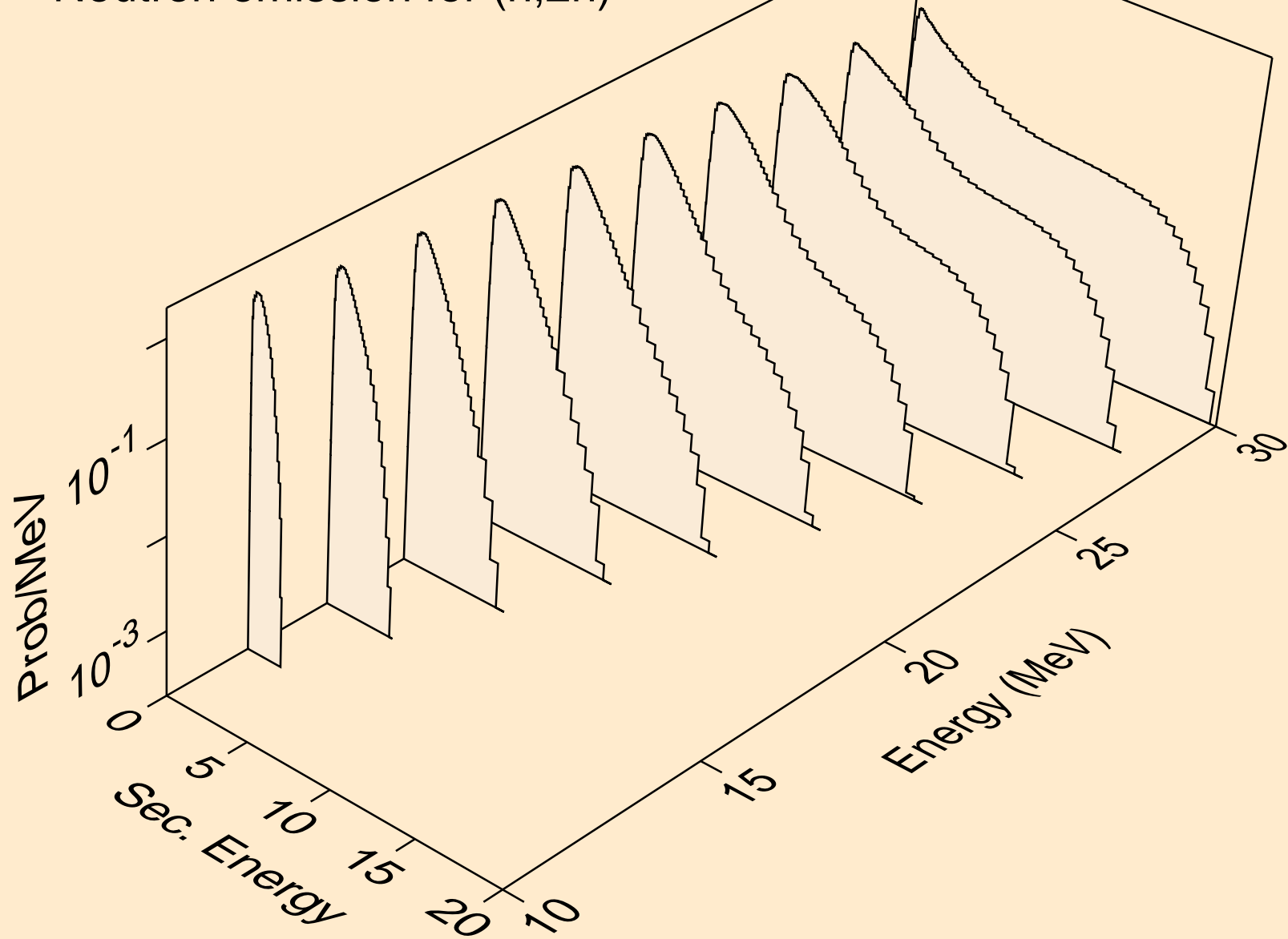

AU183 NEUTRON ACER TENDL-2021 LIBRARY; T=293.6K
Neutron emission for (n,3n)

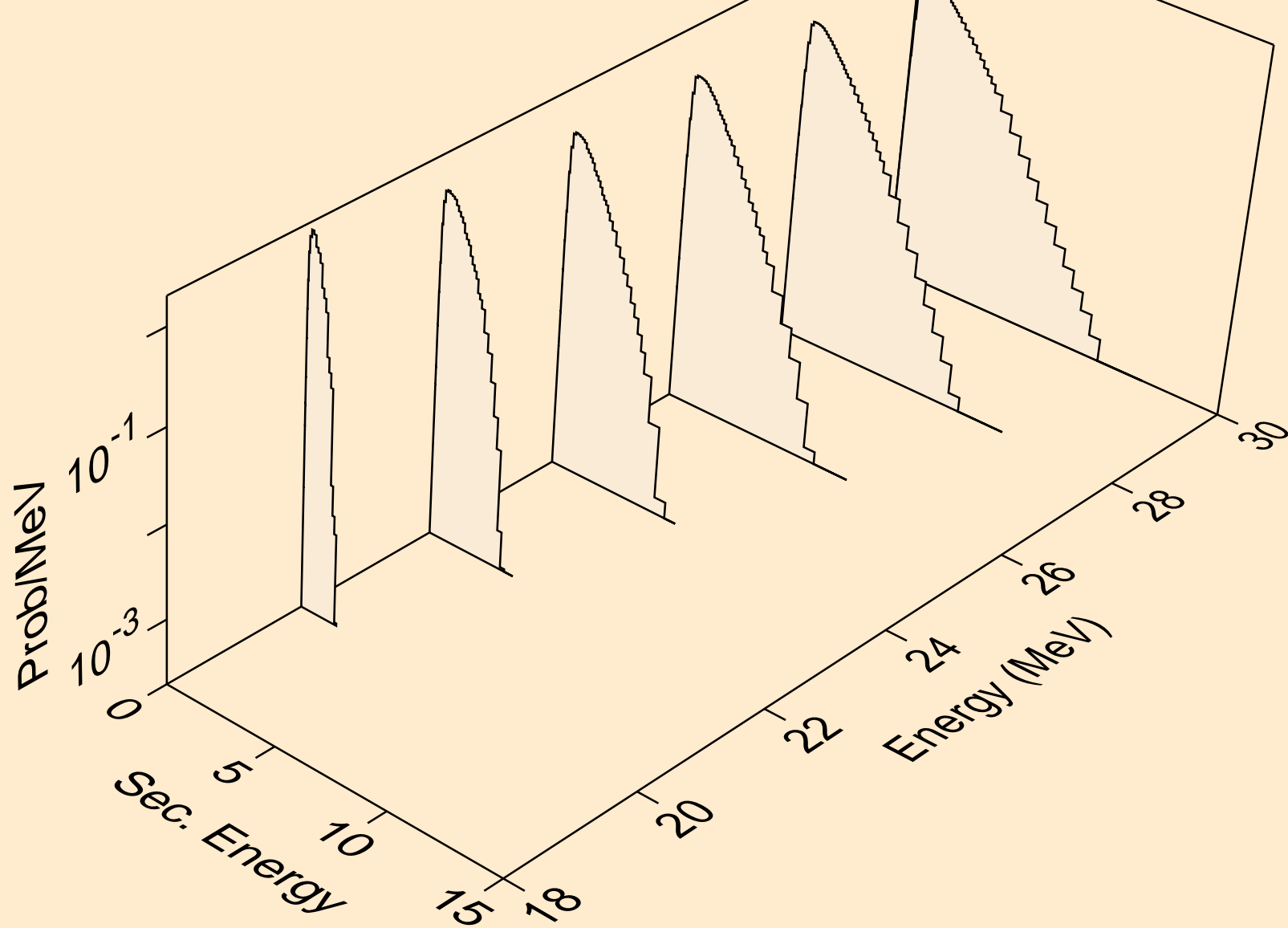

AU183 NEUTRON ACER TENDL-2021 LIBRARY; T=293.6K
Neutron emission for (n,n*)a

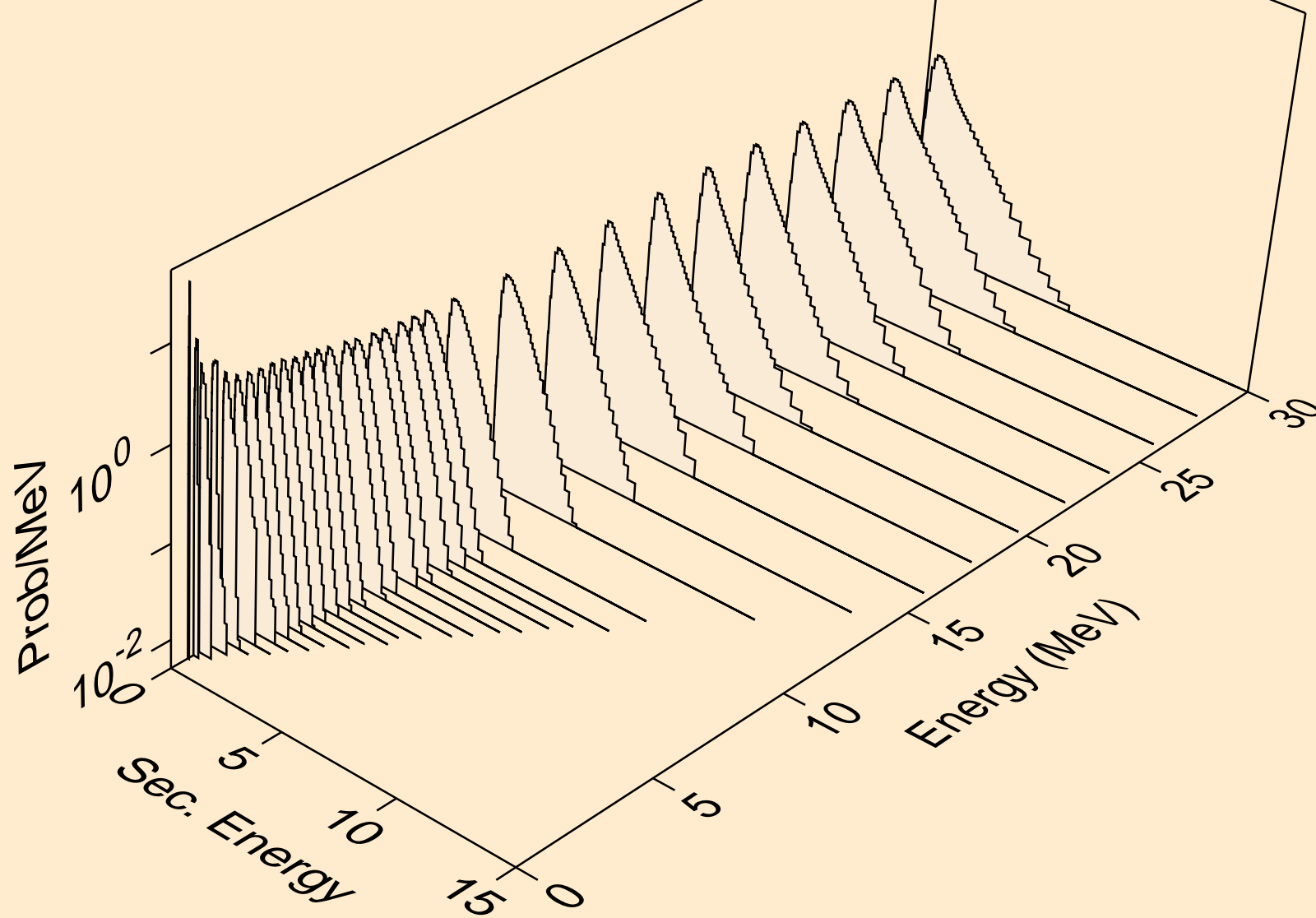

AU183 NEUTRON ACER TENDL-2021 LIBRARY; T=293.6K
Neutron emission for (n,2n)_a

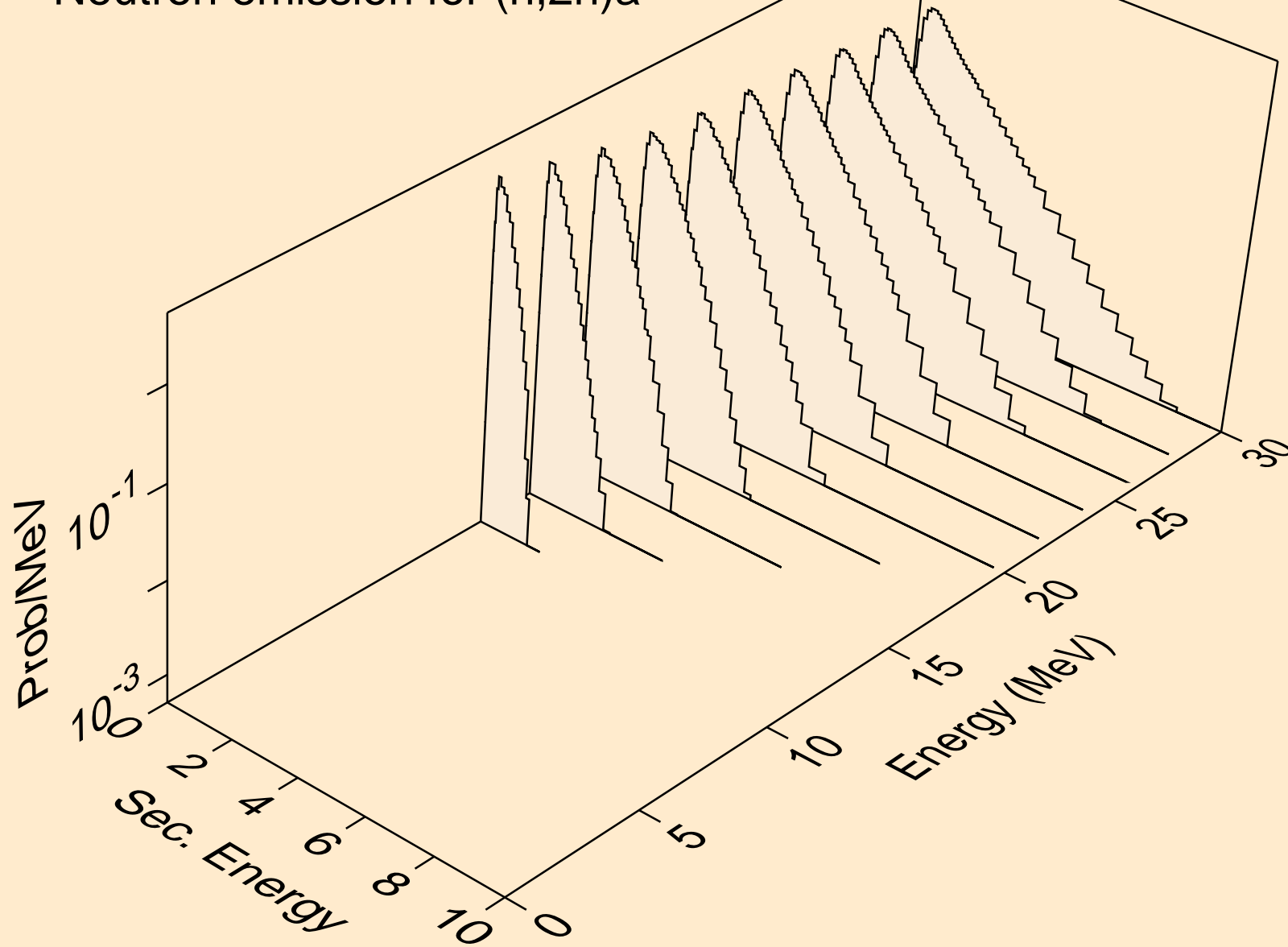

AU183 NEUTRON ACER TENDL-2021 LIBRARY; T=293.6K
Neutron emission for (n,3n)a

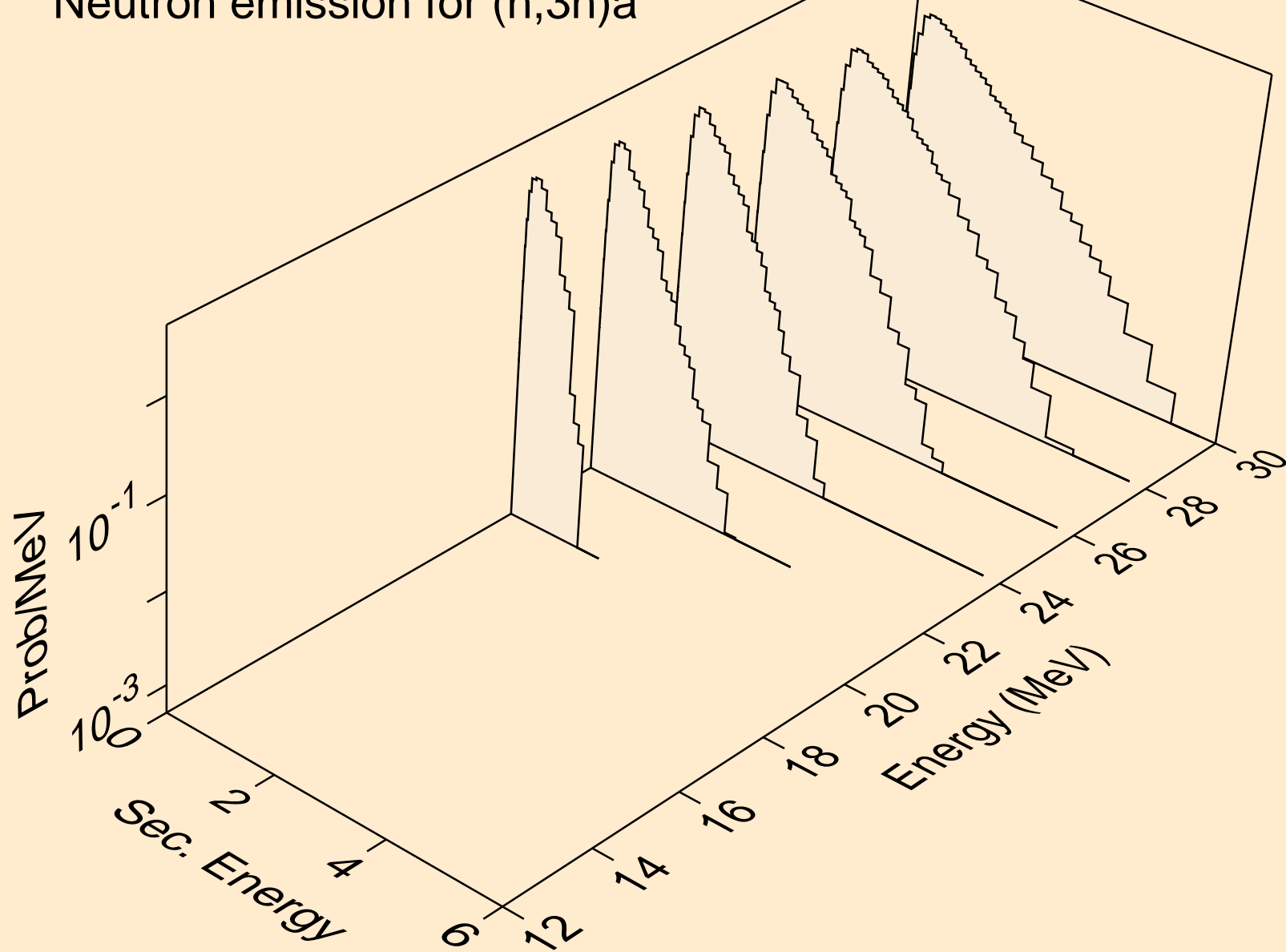

AU183 NEUTRON ACER TENDL-2021 LIBRARY; T=293.6K
Neutron emission for (n,n*)p

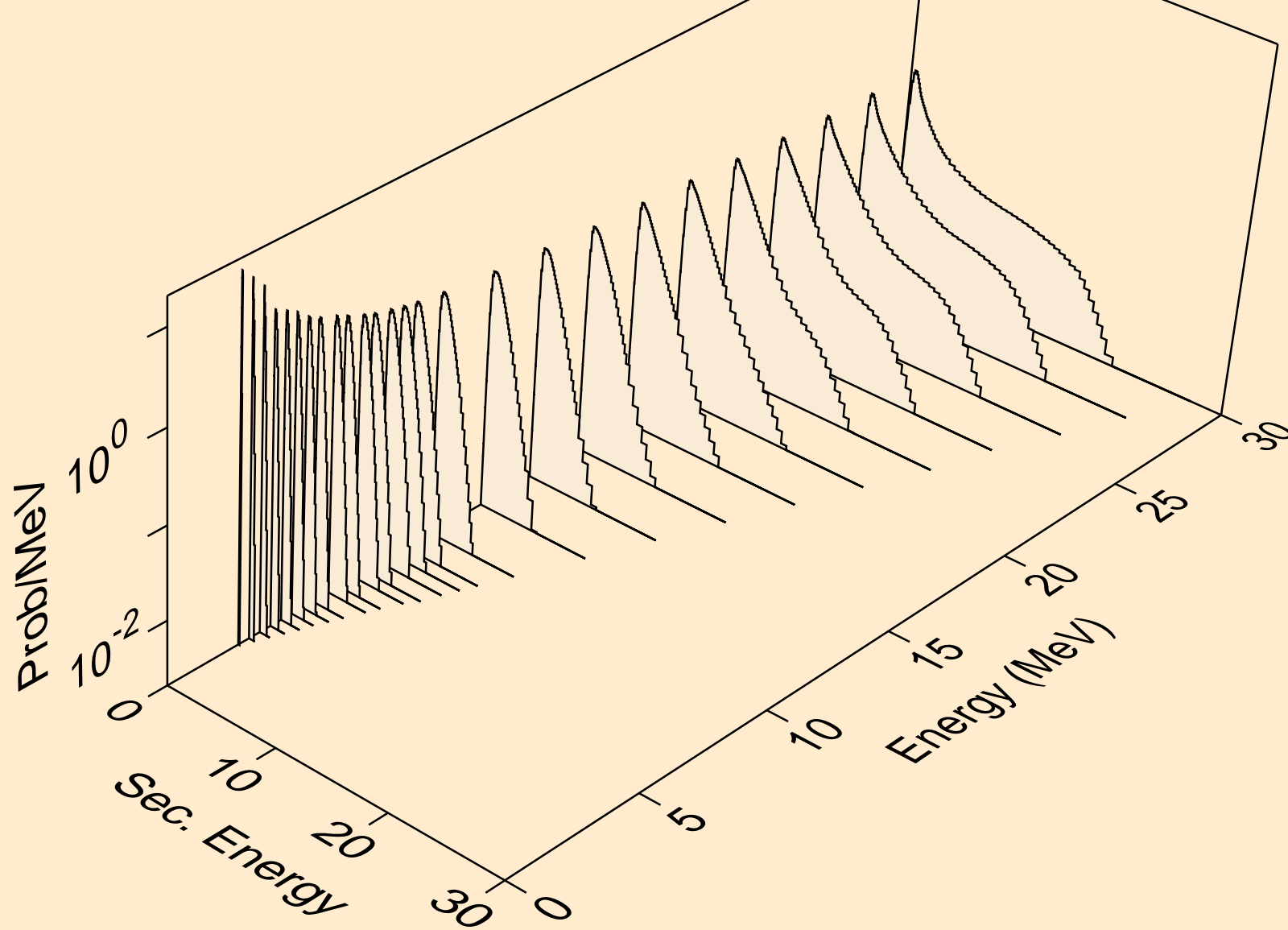

AU183 NEUTRON ACER TENDL-2021 LIBRARY; T=293.6K
Neutron emission for (n,n*)2a

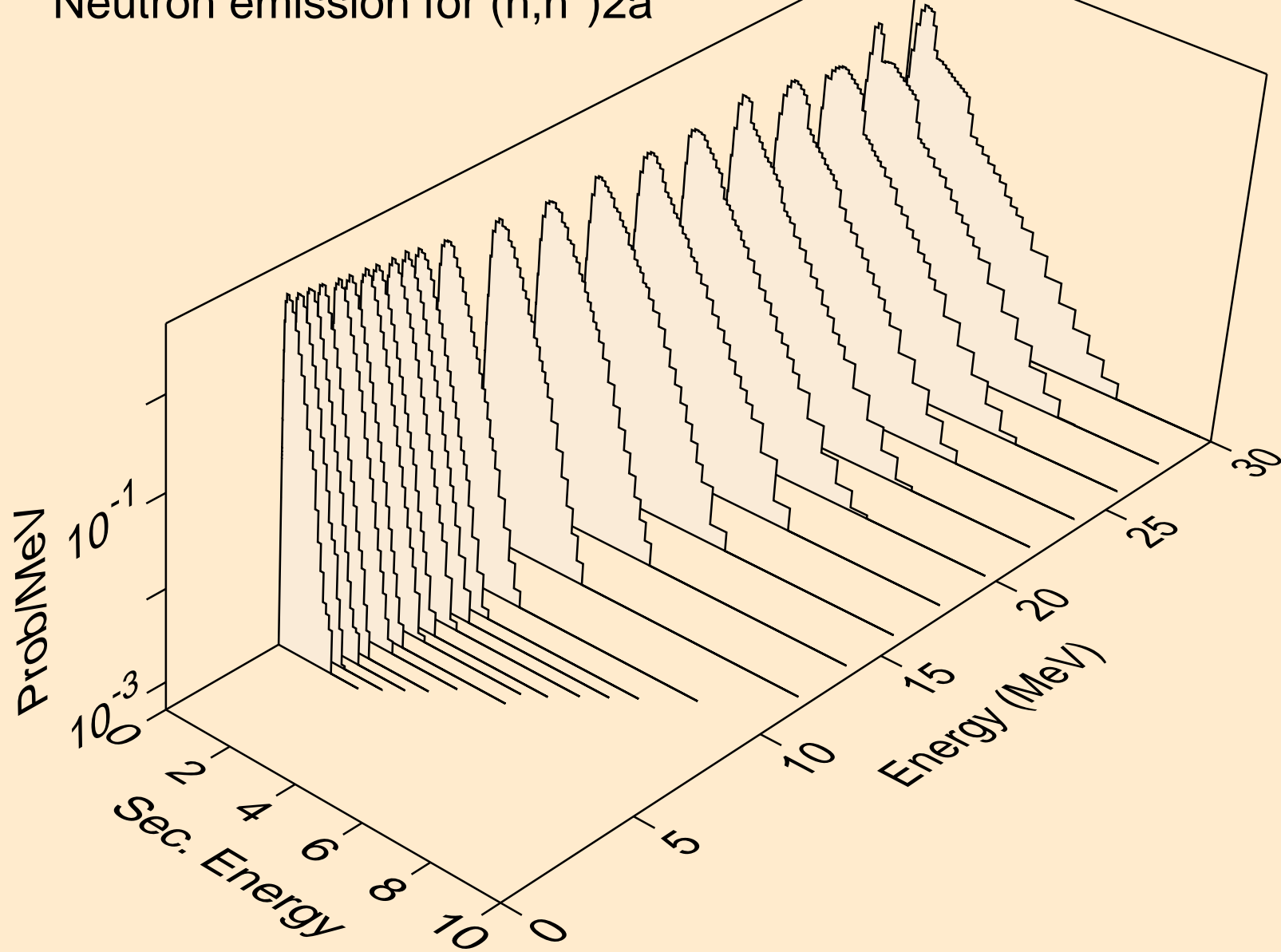

AU183 NEUTRON ACER TENDL-2021 LIBRARY; T=293.6K
Neutron emission for (n,2n)2a

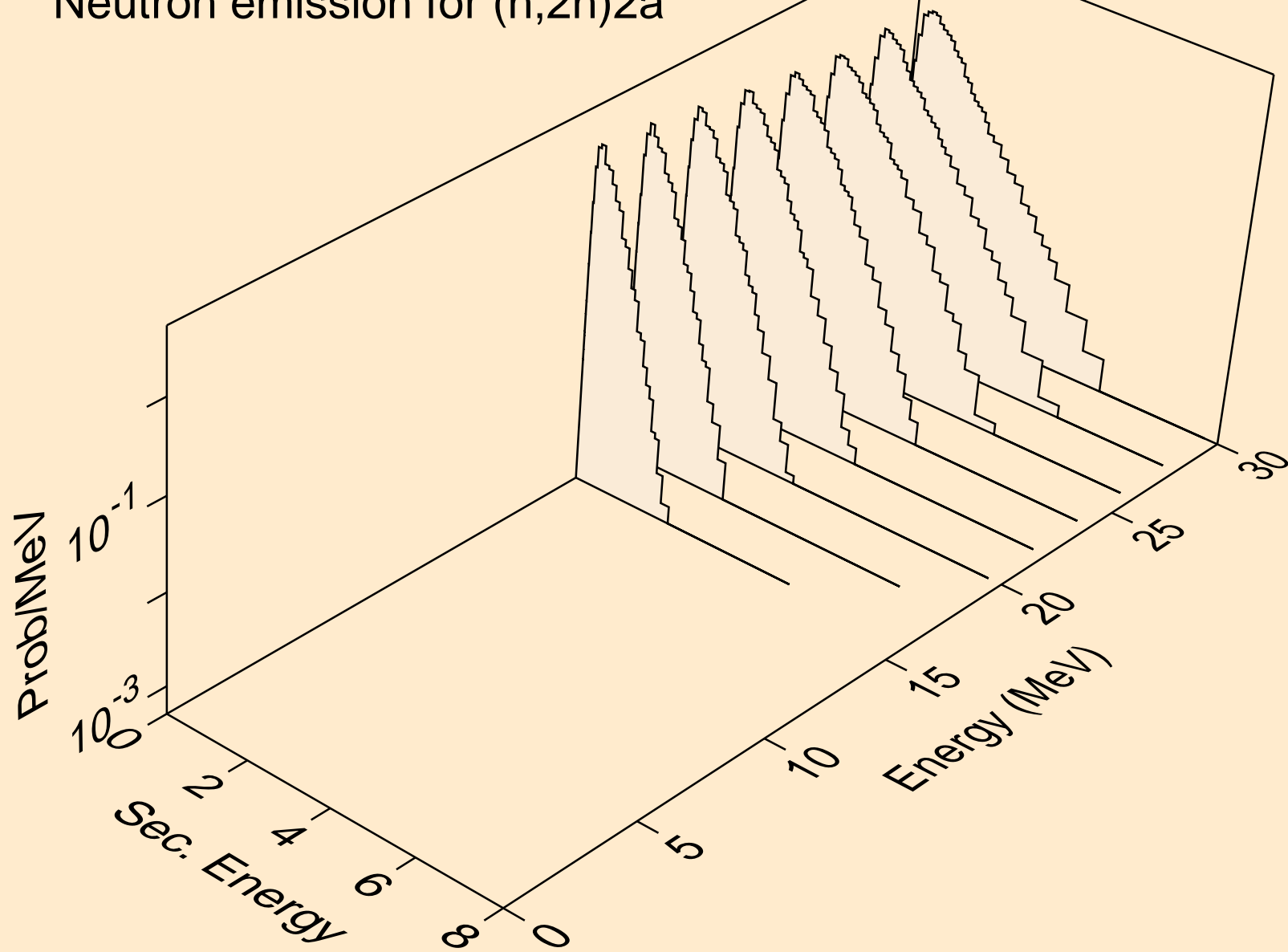

AU183 NEUTRON ACER TENDL-2021 LIBRARY; T=293.6K
Neutron emission for (n,n*)d

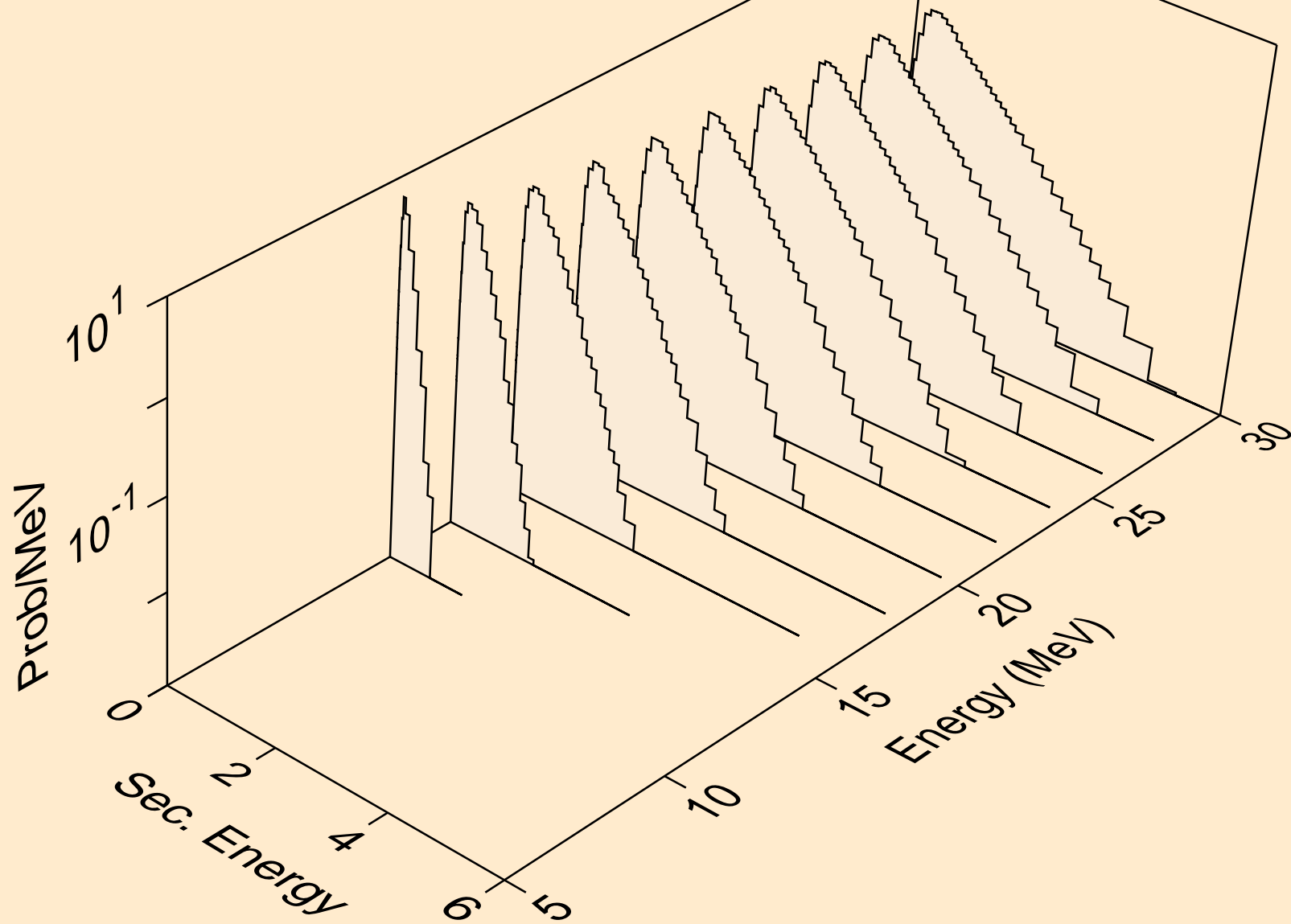

AU183 NEUTRON ACER TENDL-2021 LIBRARY; T=293.6K
Neutron emission for (n,n*)t

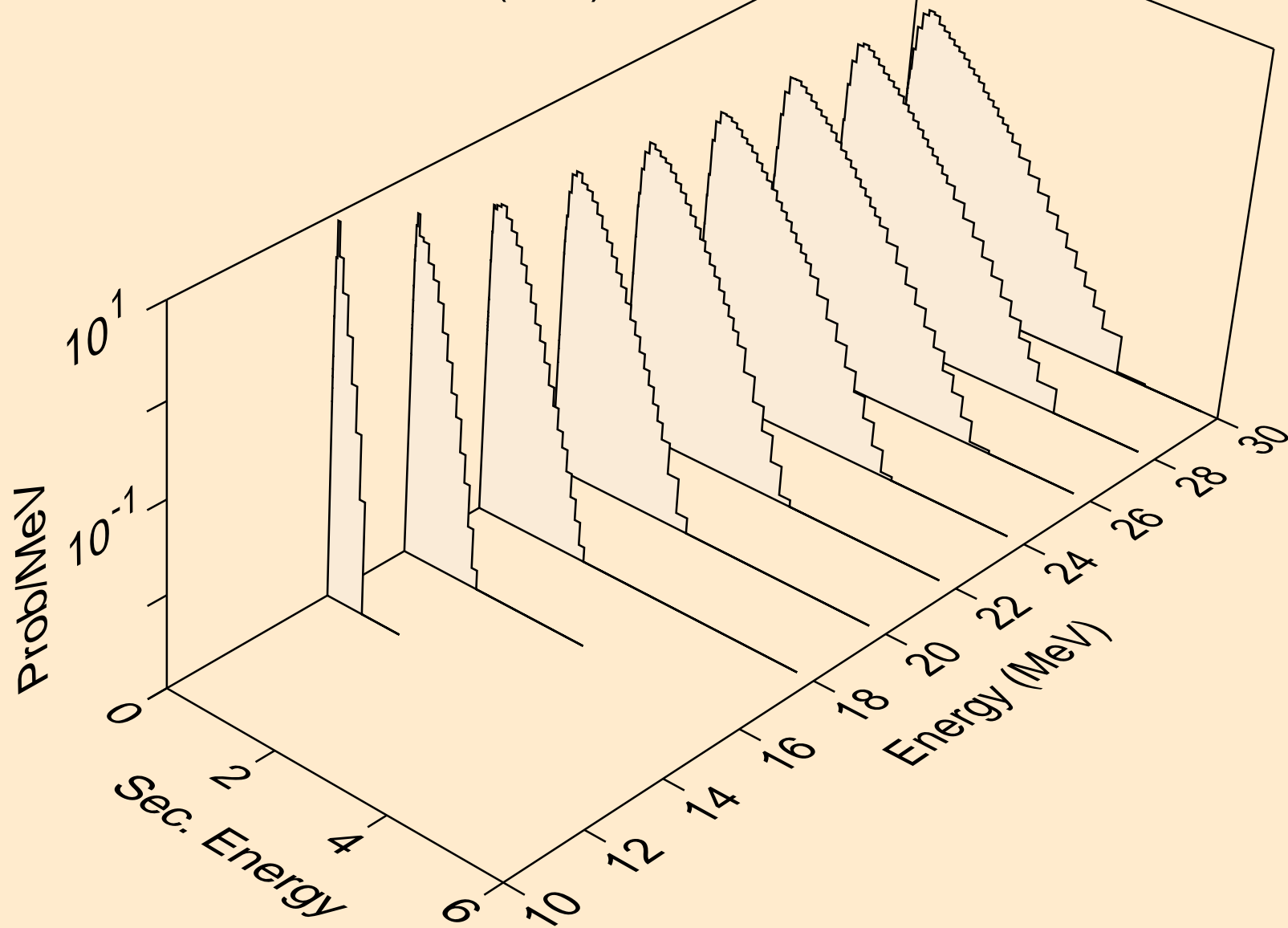

AU183 NEUTRON ACER TENDL-2021 LIBRARY; T=293.6K
Neutron emission for (n,n*)he3

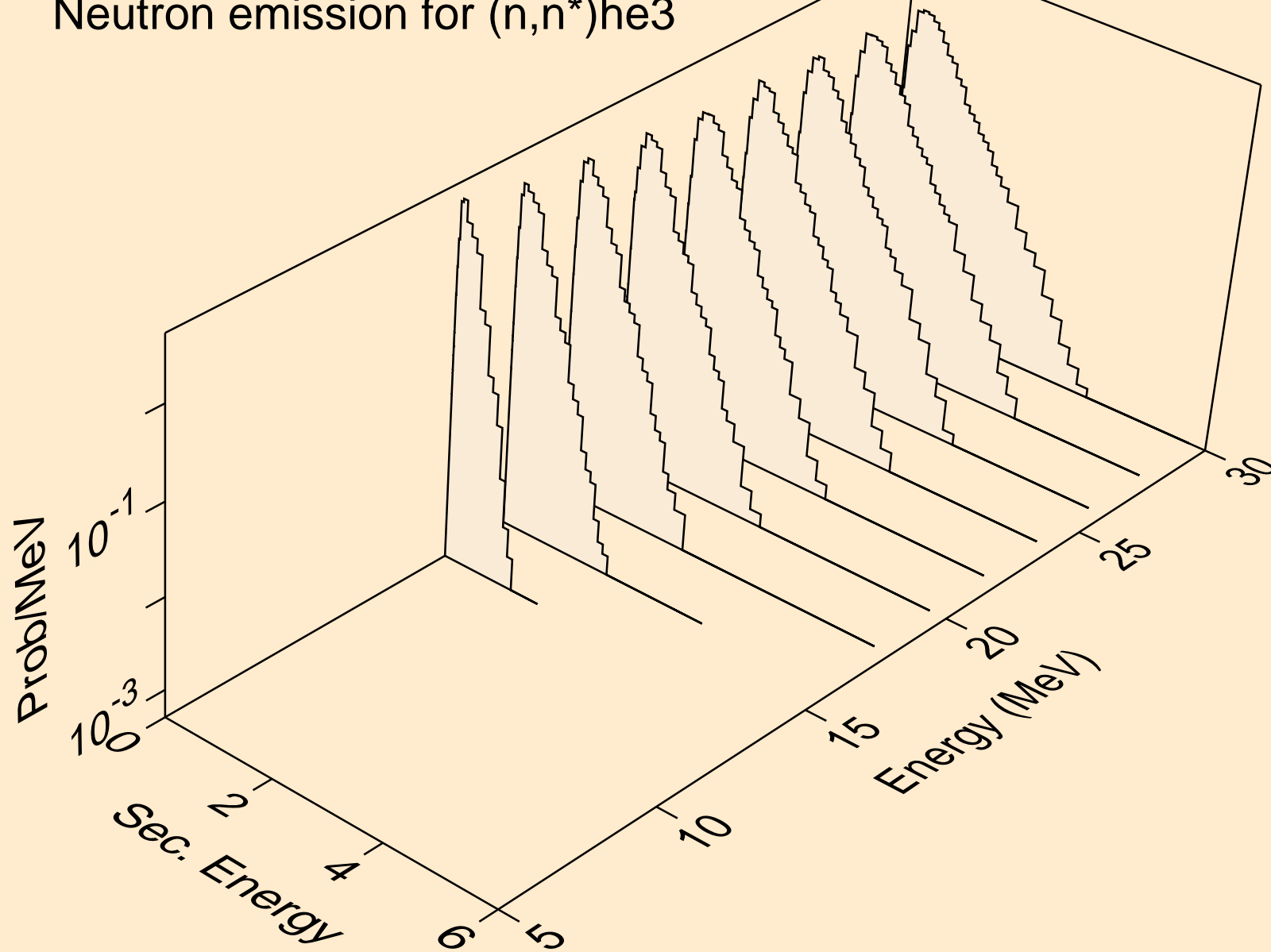

AU183 NEUTRON ACER TENDL-2021 LIBRARY; T=293.6K
Neutron emission for (n,4n)

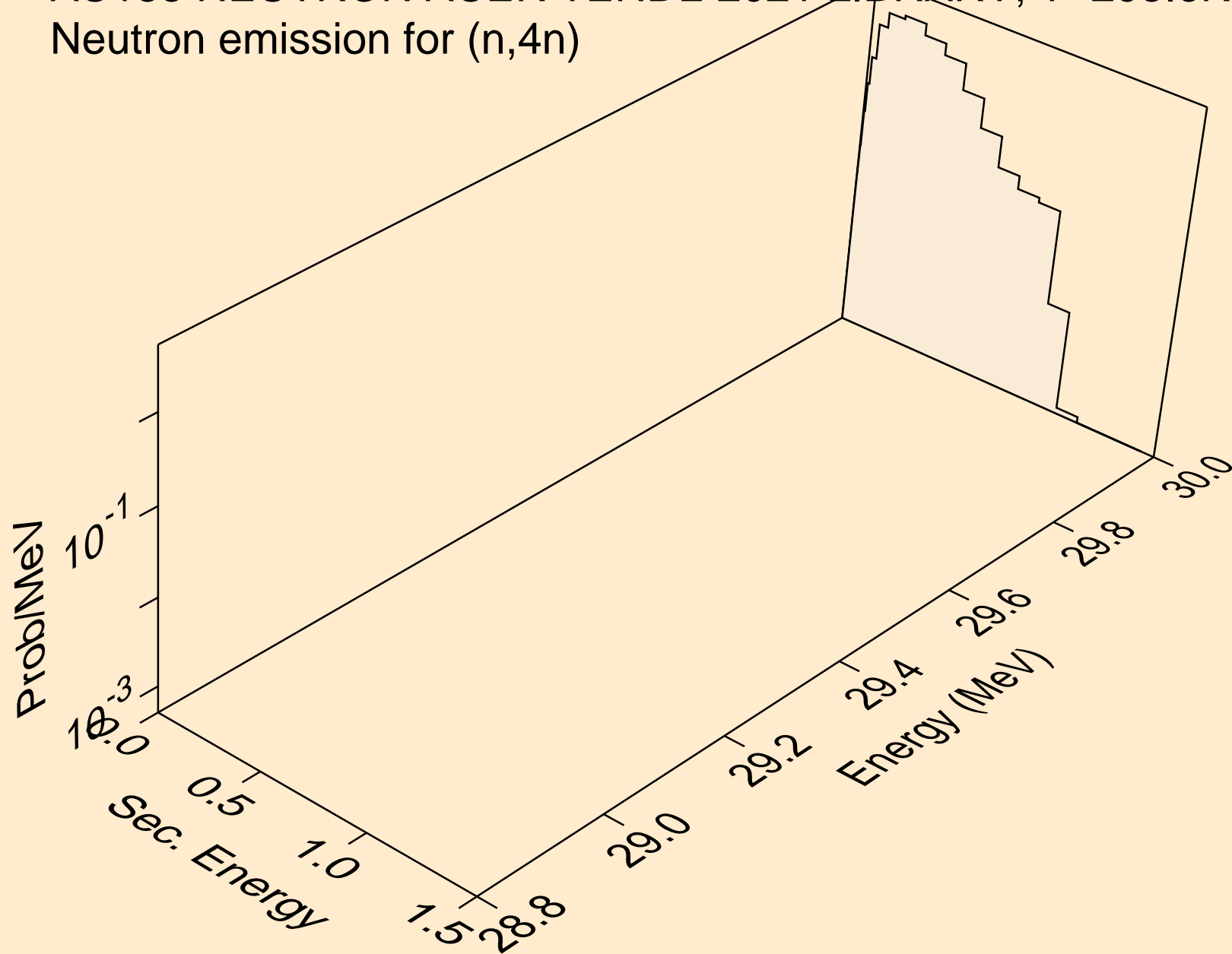

AU183 NEUTRON ACER TENDL-2021 LIBRARY; T=293.6K
Neutron emission for (n,2np)

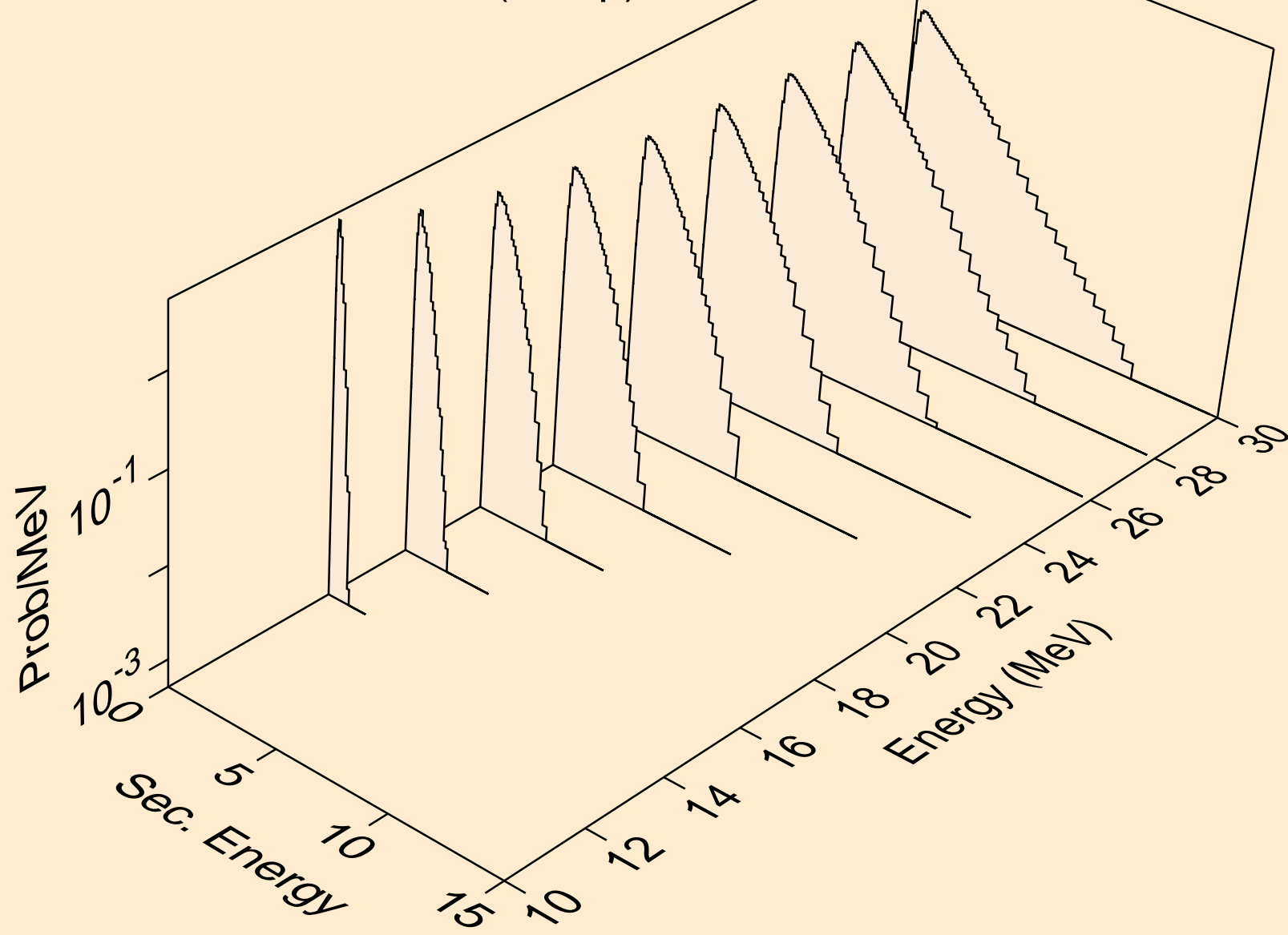

AU183 NEUTRON ACER TENDL-2021 LIBRARY; T=293.6K
Neutron emission for (n,3np)

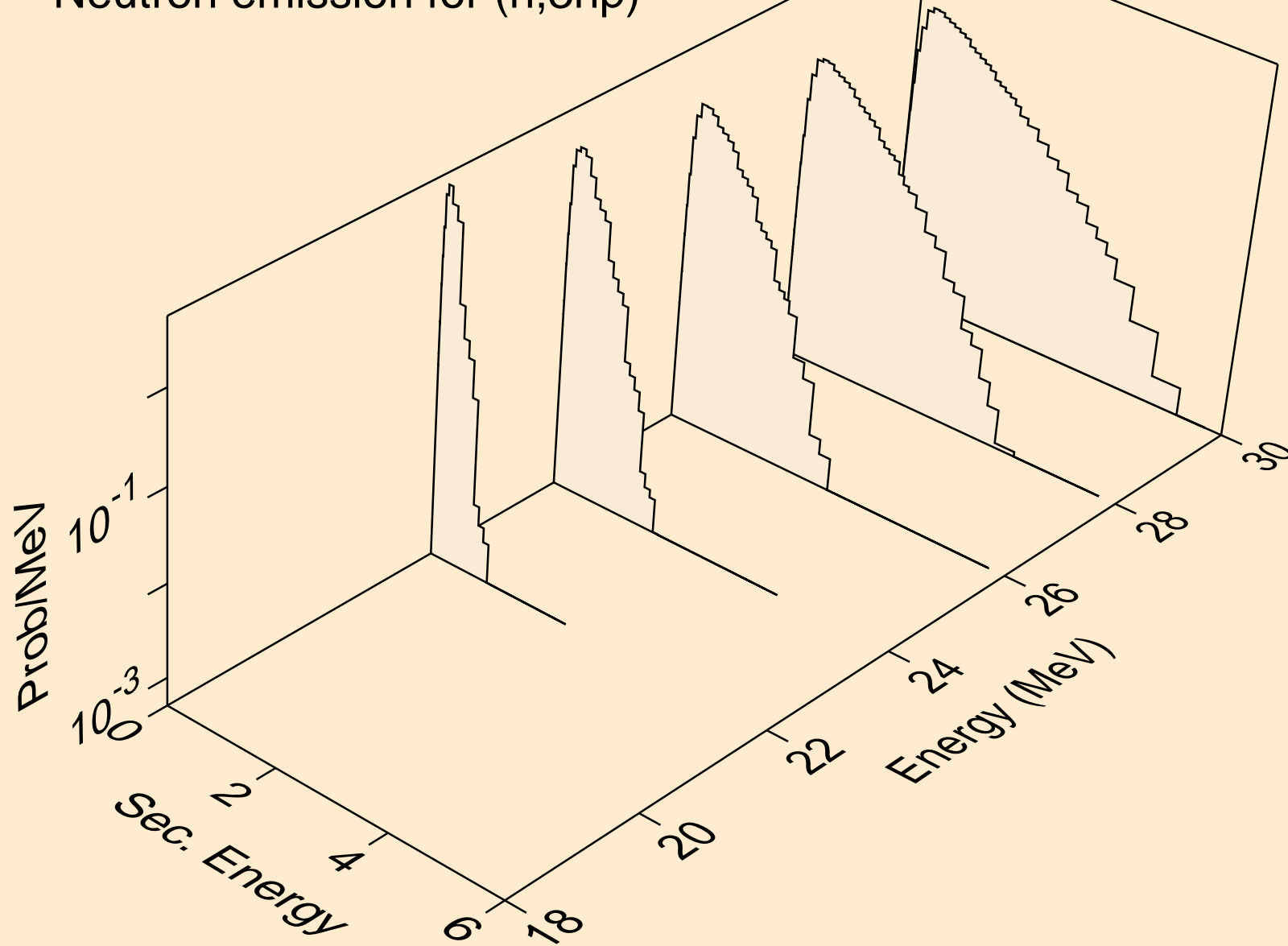

AU183 NEUTRON ACER TENDL-2021 LIBRARY; T=293.6K
Neutron emission for (n,2np)

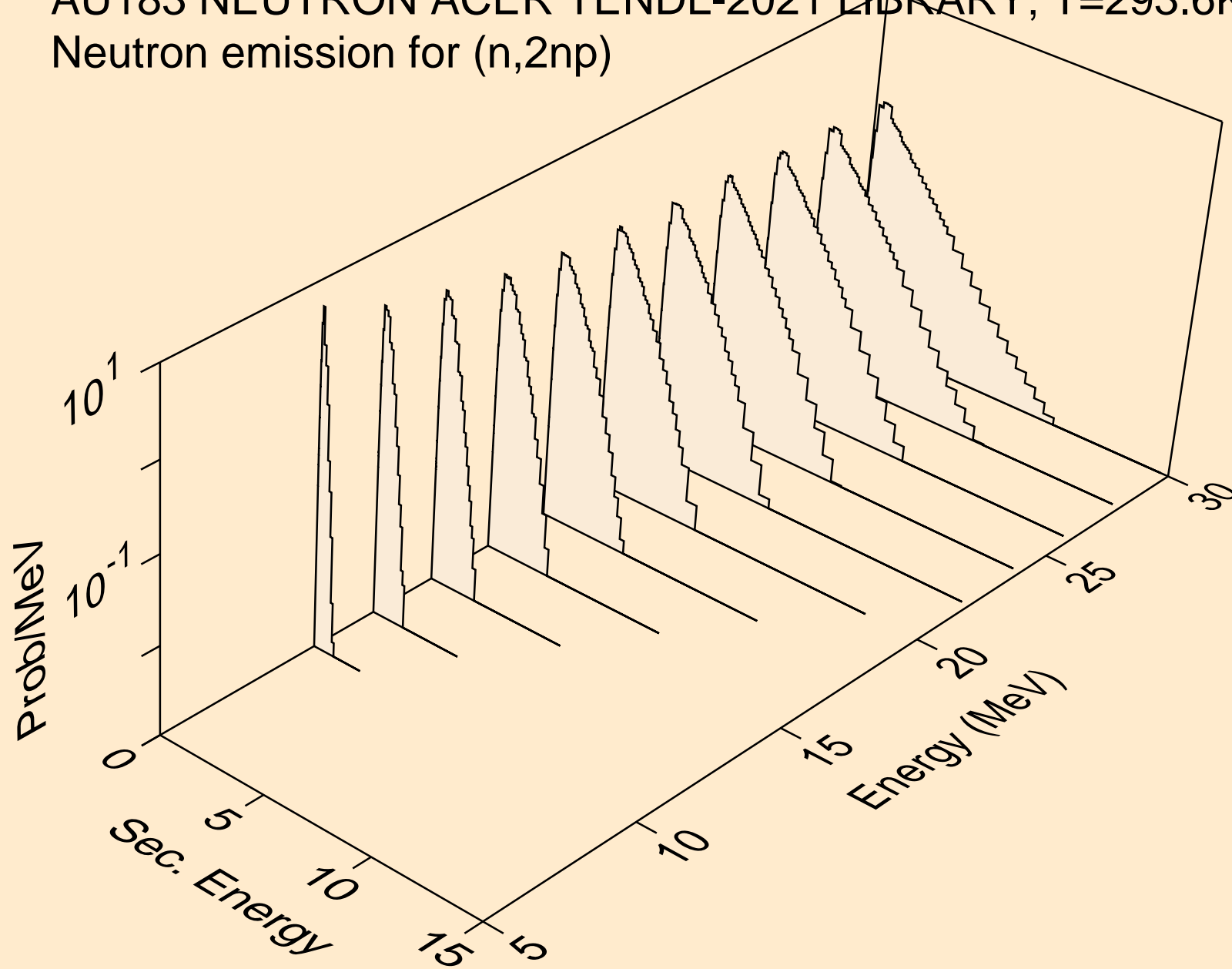

AU183 NEUTRON ACER TENDL-2021 LIBRARY; T=293.6K
Neutron emission for (n,npa)

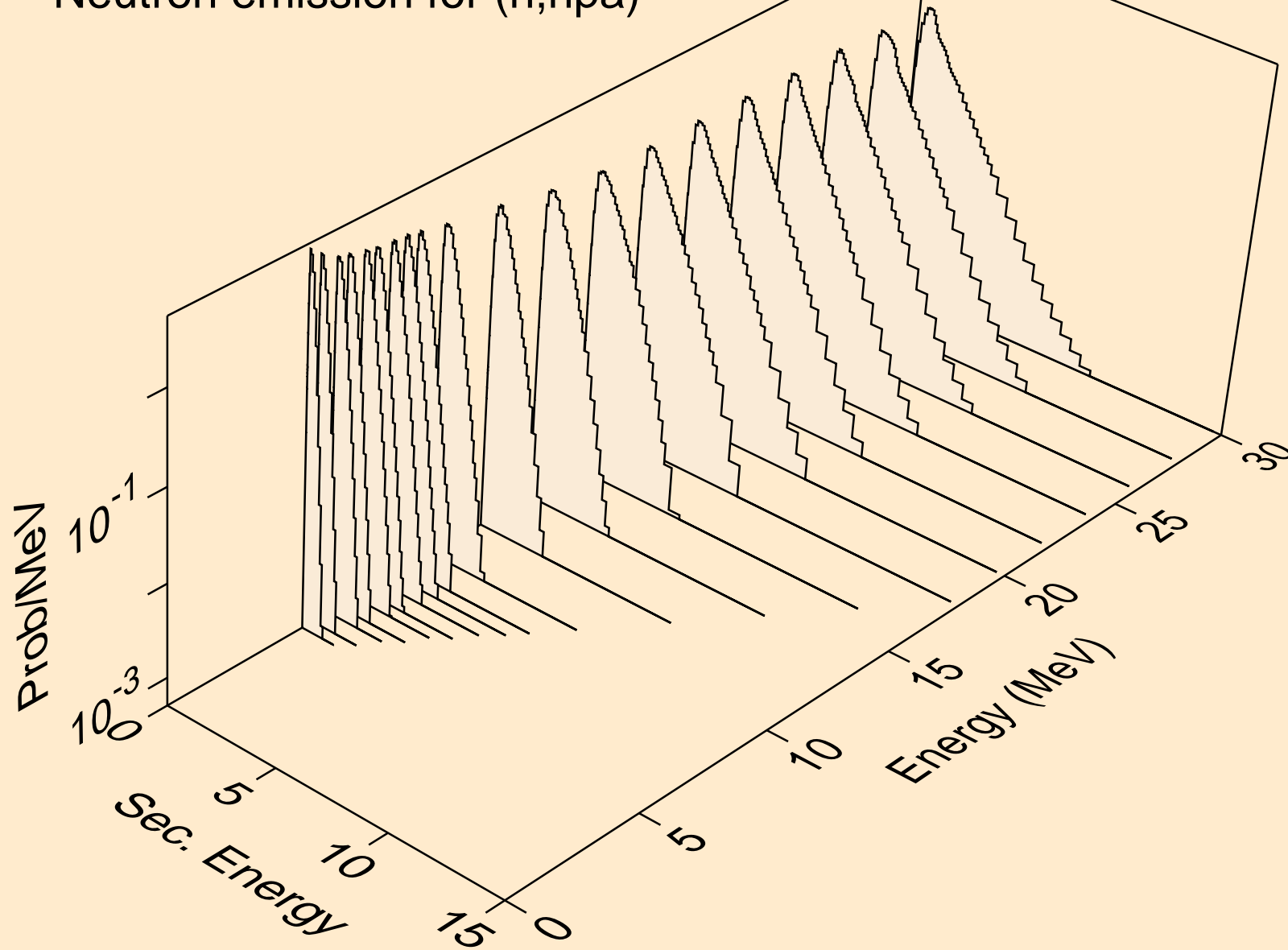

AU183 NEUTRON ACER TENDL-2021 LIBRARY; T=293.6K
Neutron emission for (n,n*c)

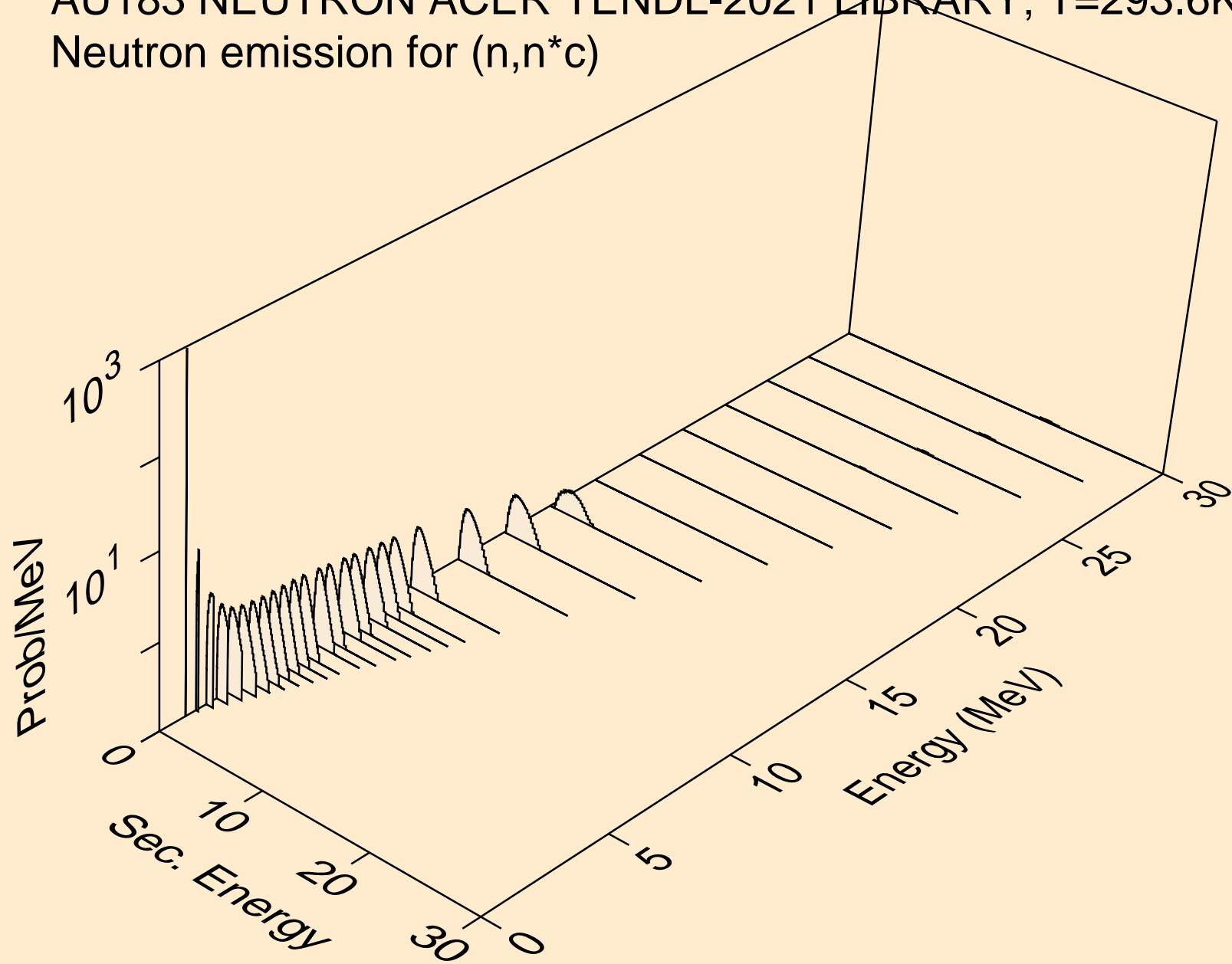

AU183 NEUTRON ACER TENDL-2021 LIBRARY; T=293.6K
Photon emission for (n,x)

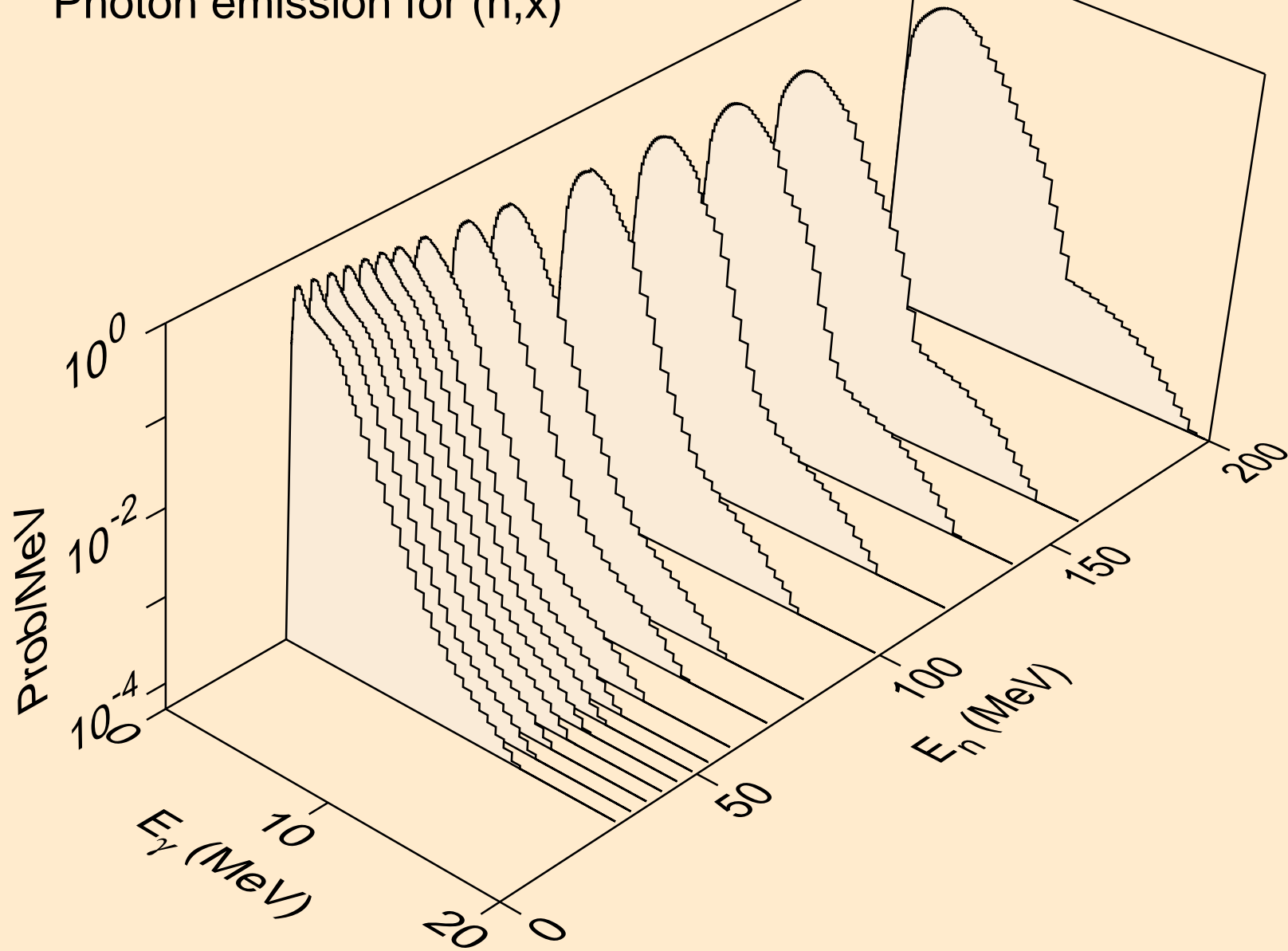

AU183 NEUTRON ACER TENDL-2021 LIBRARY; T=293.6K
Photon emission for (n,2nd)

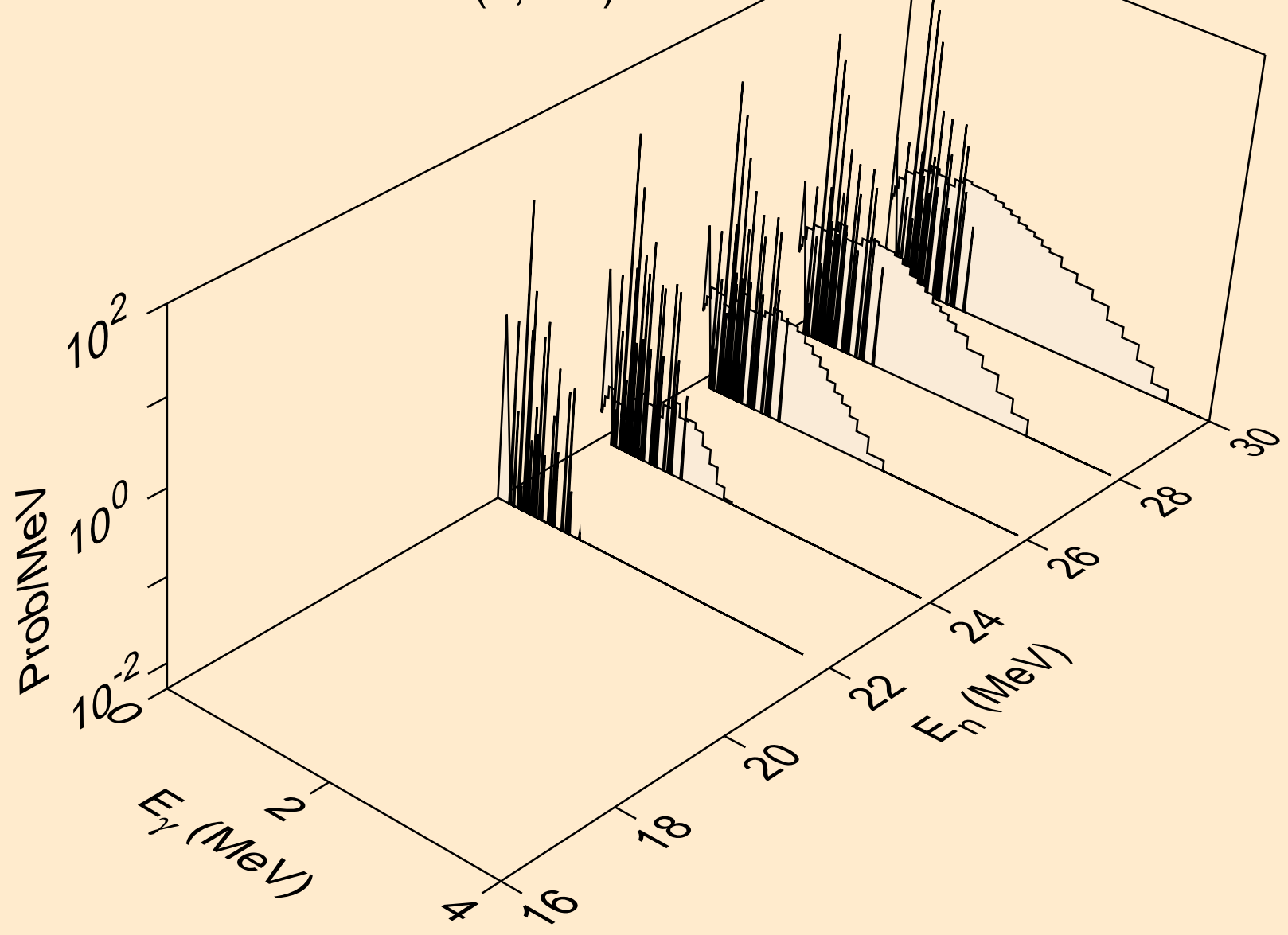

AU183 NEUTRON ACER TENDL-2021 LIBRARY; T=293.6K
Photon emission for (n,2n)

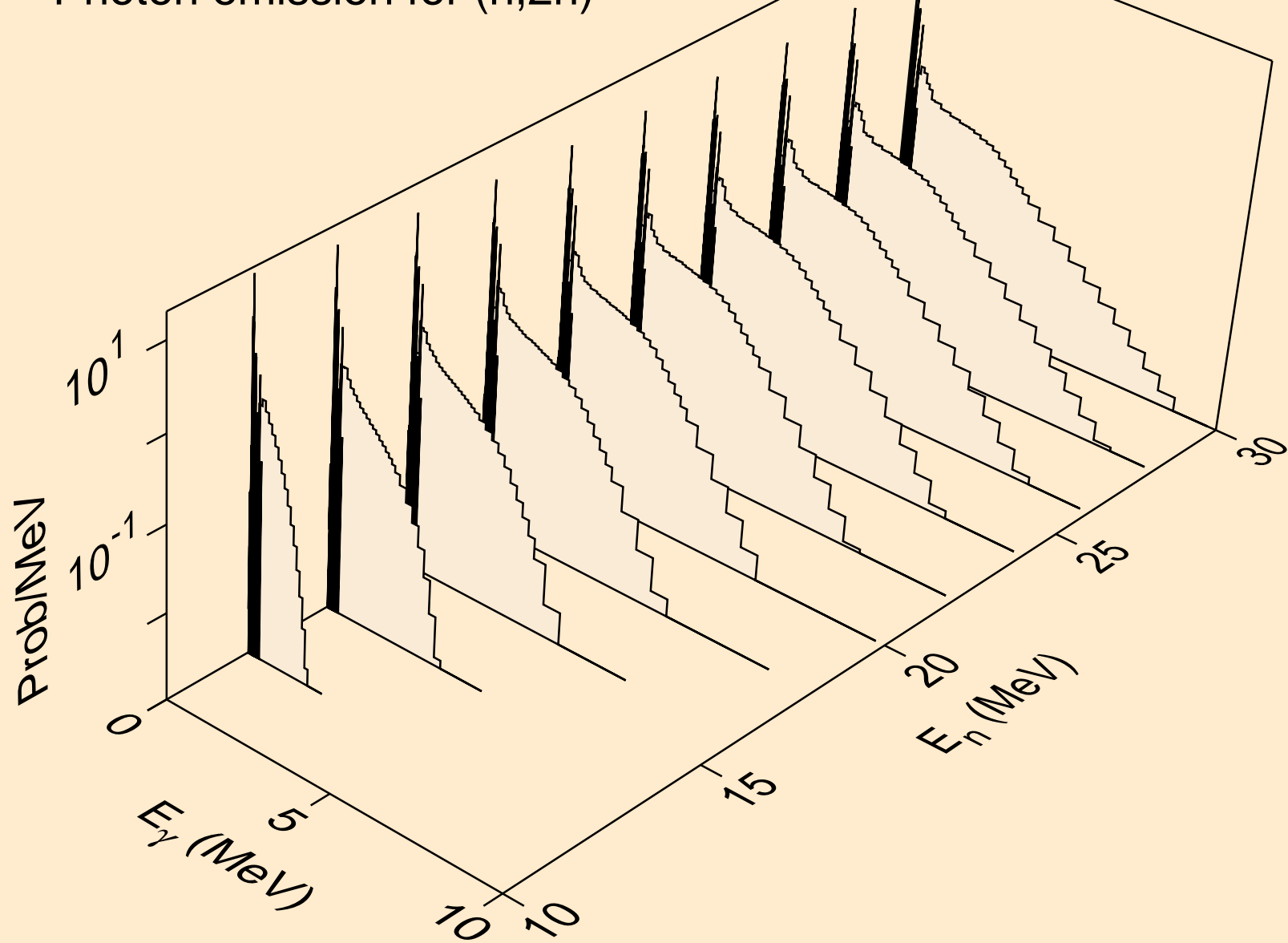

AU183 NEUTRON ACER TENDL-2021 LIBRARY; T=293.6K
Photon emission for (n,3n)

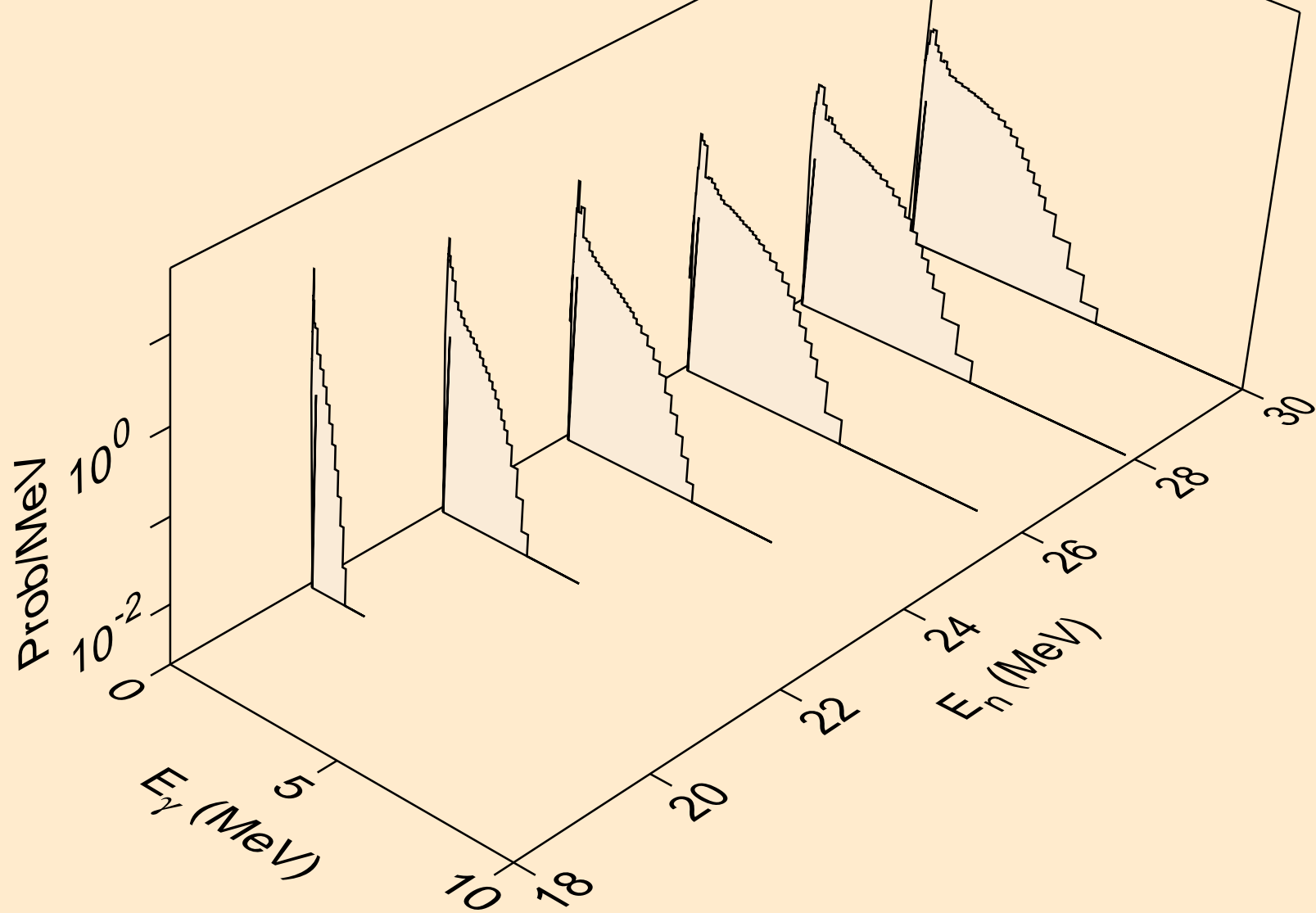

AU183 NEUTRON ACER TENDL-2021 LIBRARY; T=293.6K
Photon emission for (n,n*)a

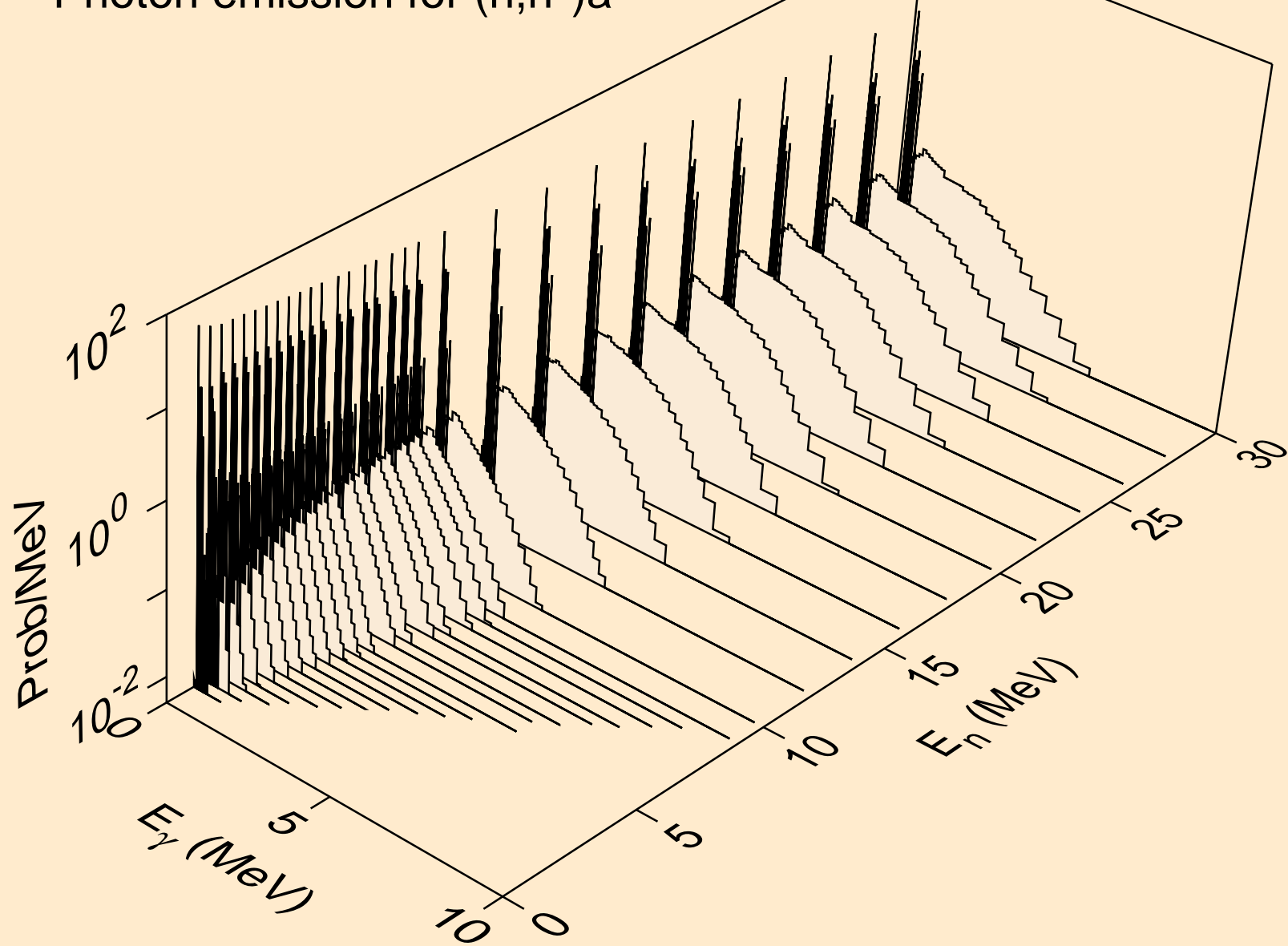

AU183 NEUTRON ACER TENDL-2021 LIBRARY; T=293.6K
Photon emission for (n,2n)a

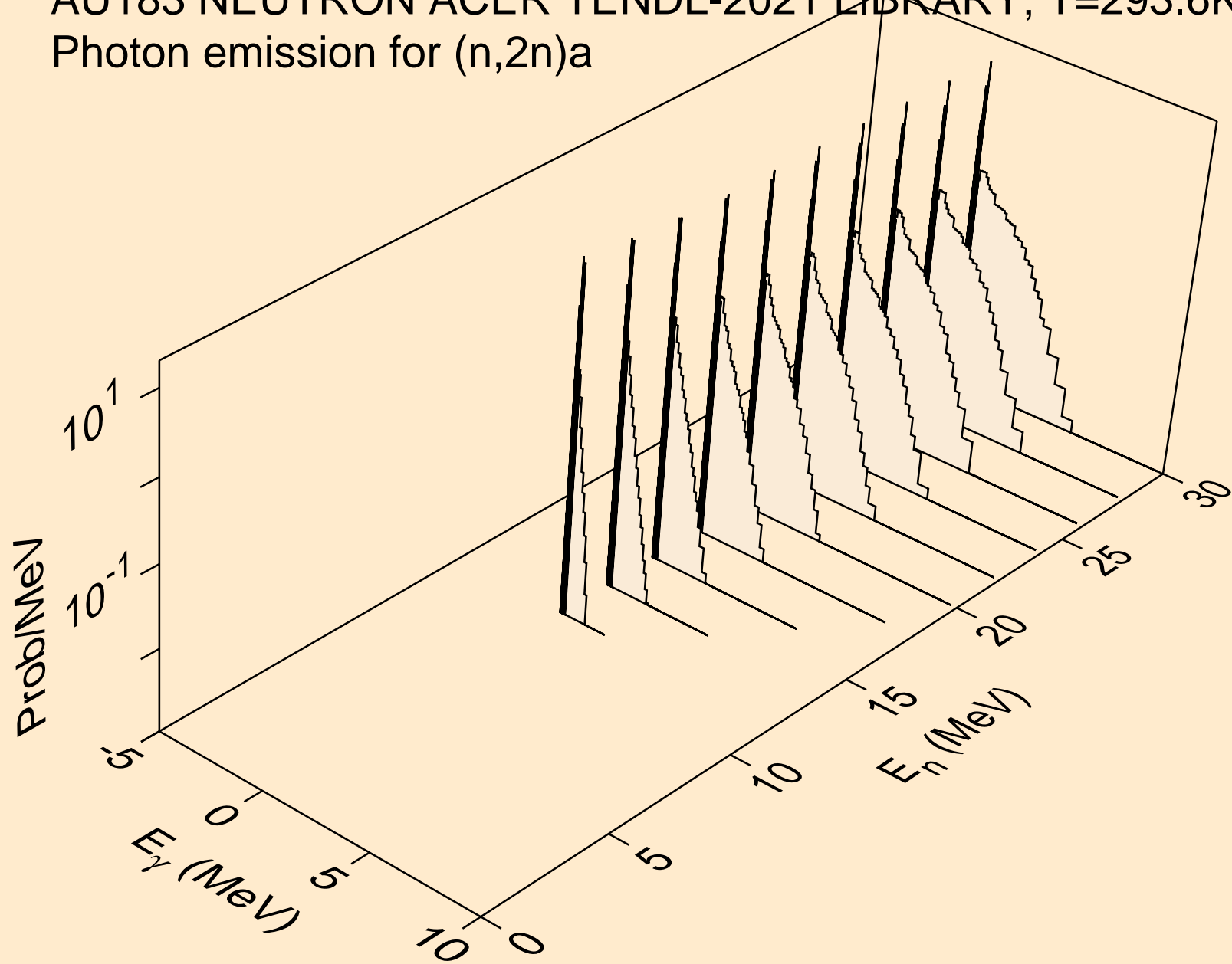

AU183 NEUTRON ACER TENDL-2021 LIBRARY; T=293.6K
Photon emission for (n,3n)a

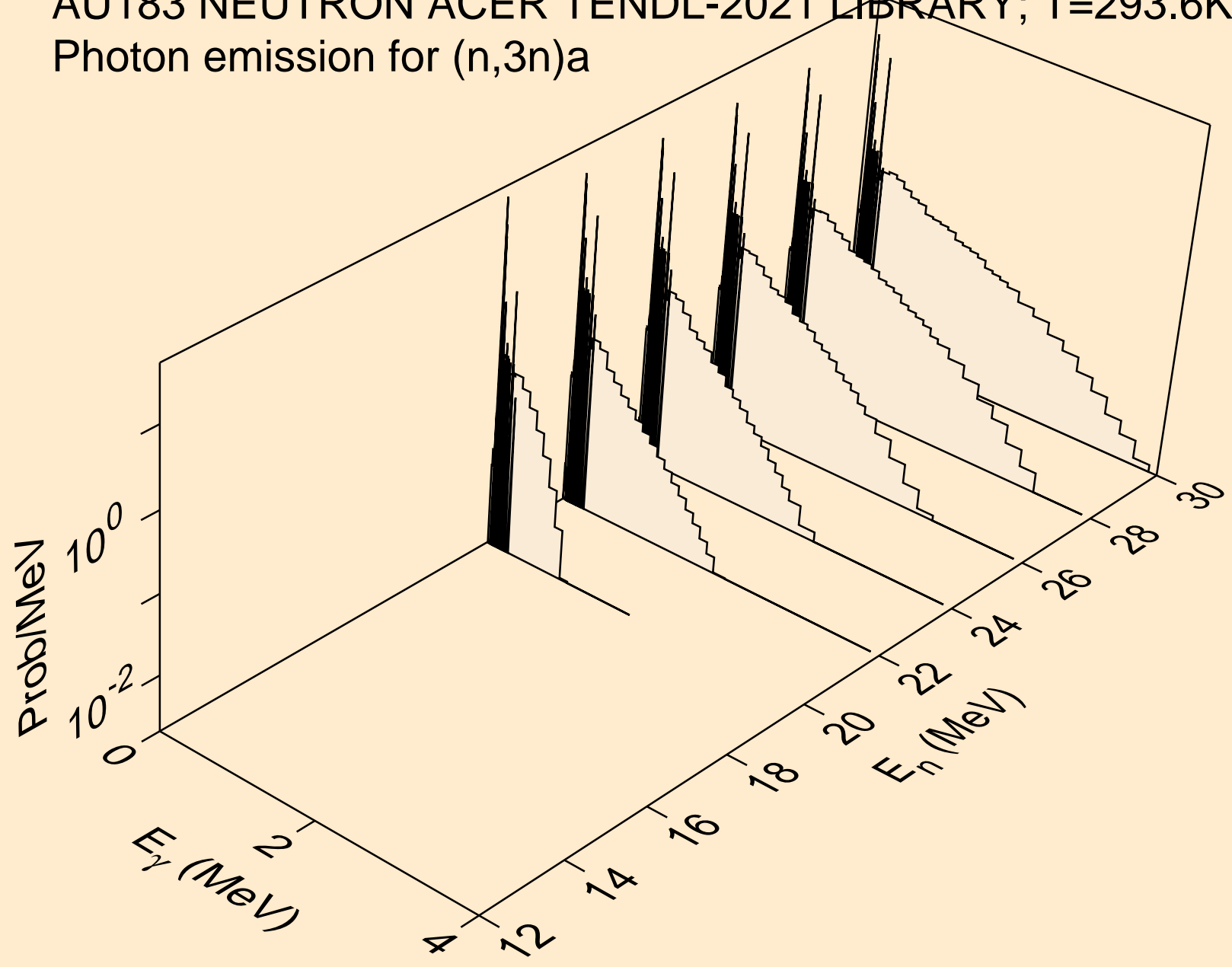

AU183 NEUTRON ACER TENDL-2021 LIBRARY; T=293.6K
Photon emission for (n,n*)p

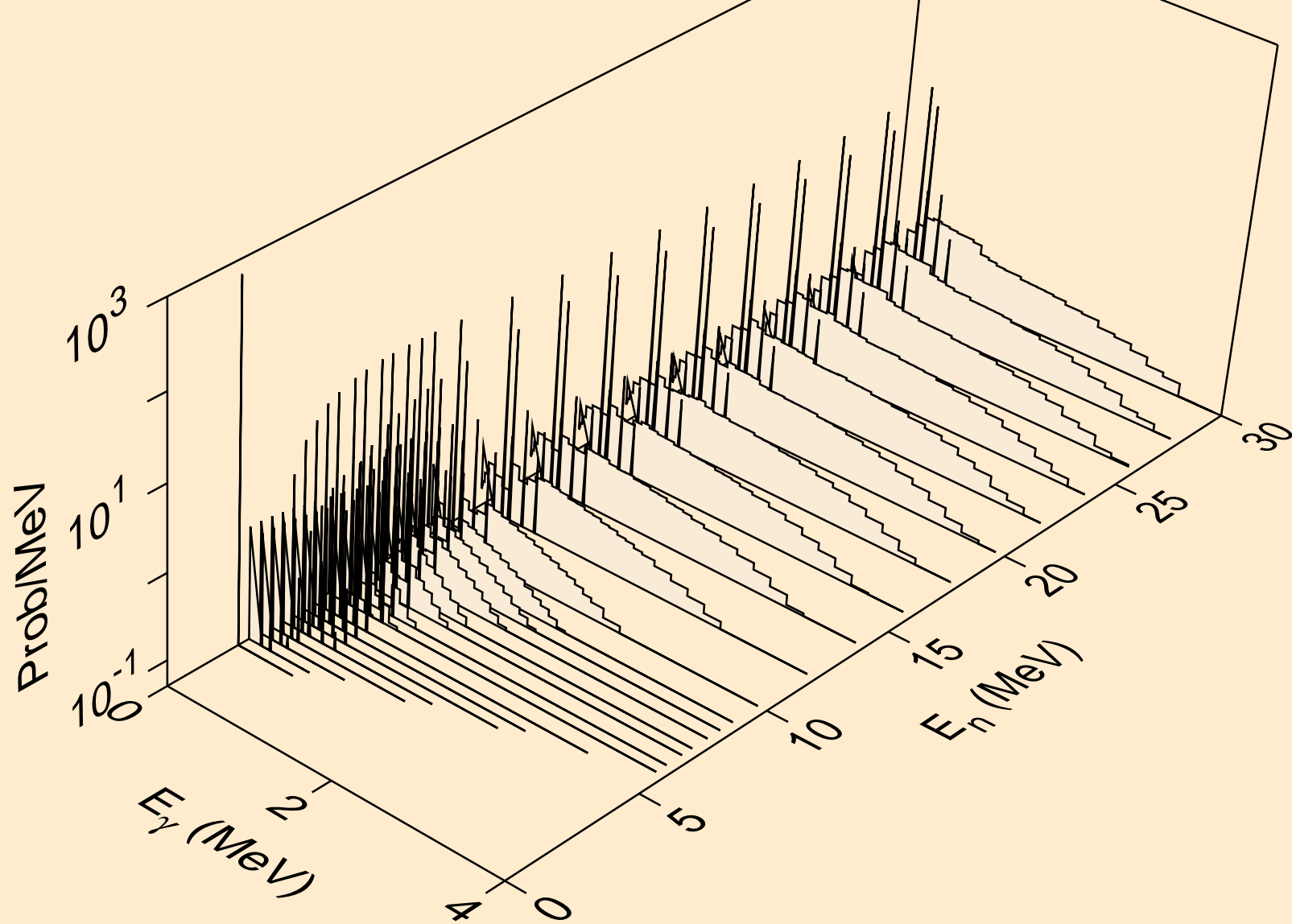

AU183 NEUTRON ACER TENDL-2021 LIBRARY; T=293.6K
Photon emission for (n,n*)2a

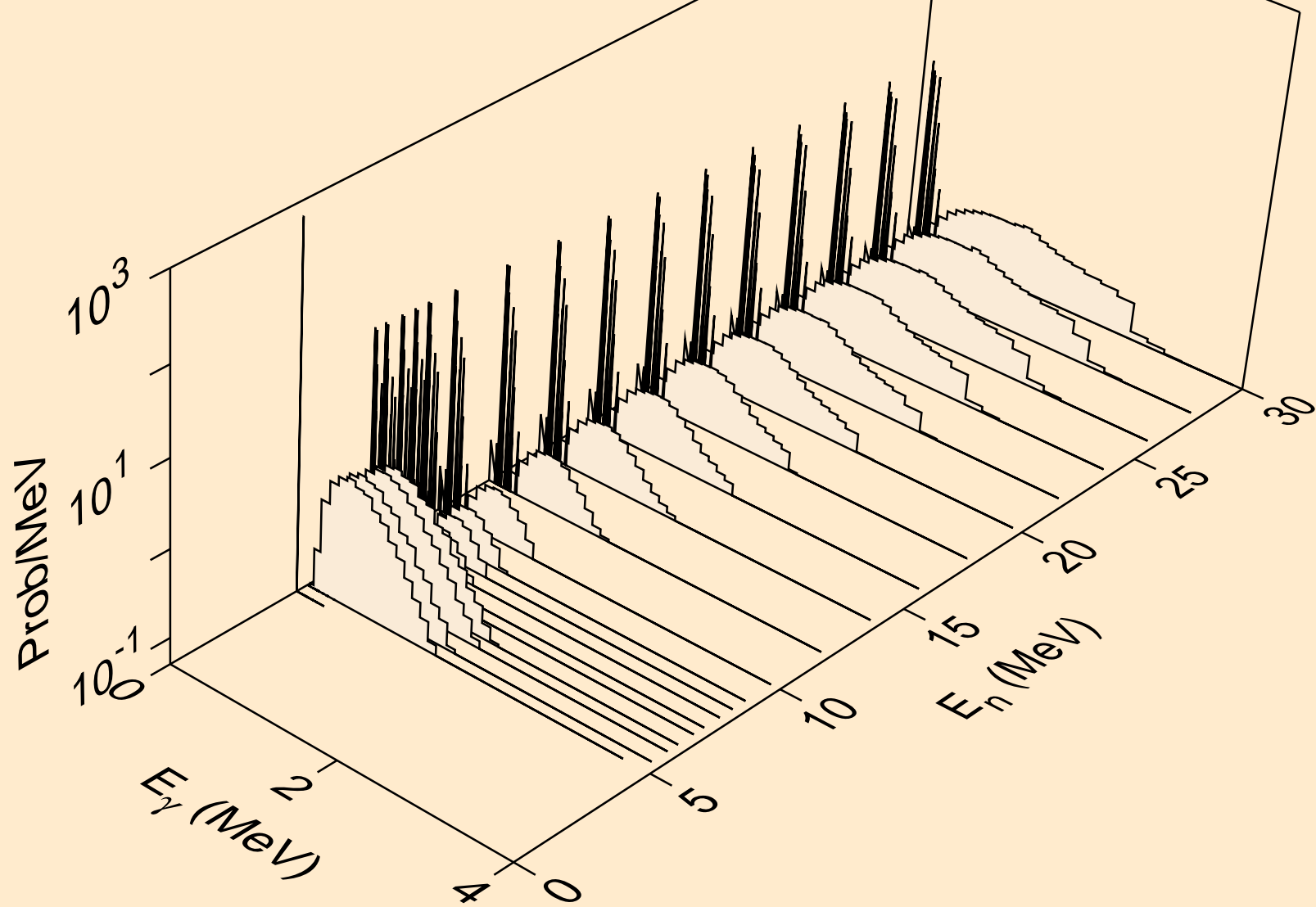

AU183 NEUTRON ACER TENDL-2021 LIBRARY; T=293.6K
Photon emission for (n,2n)2a

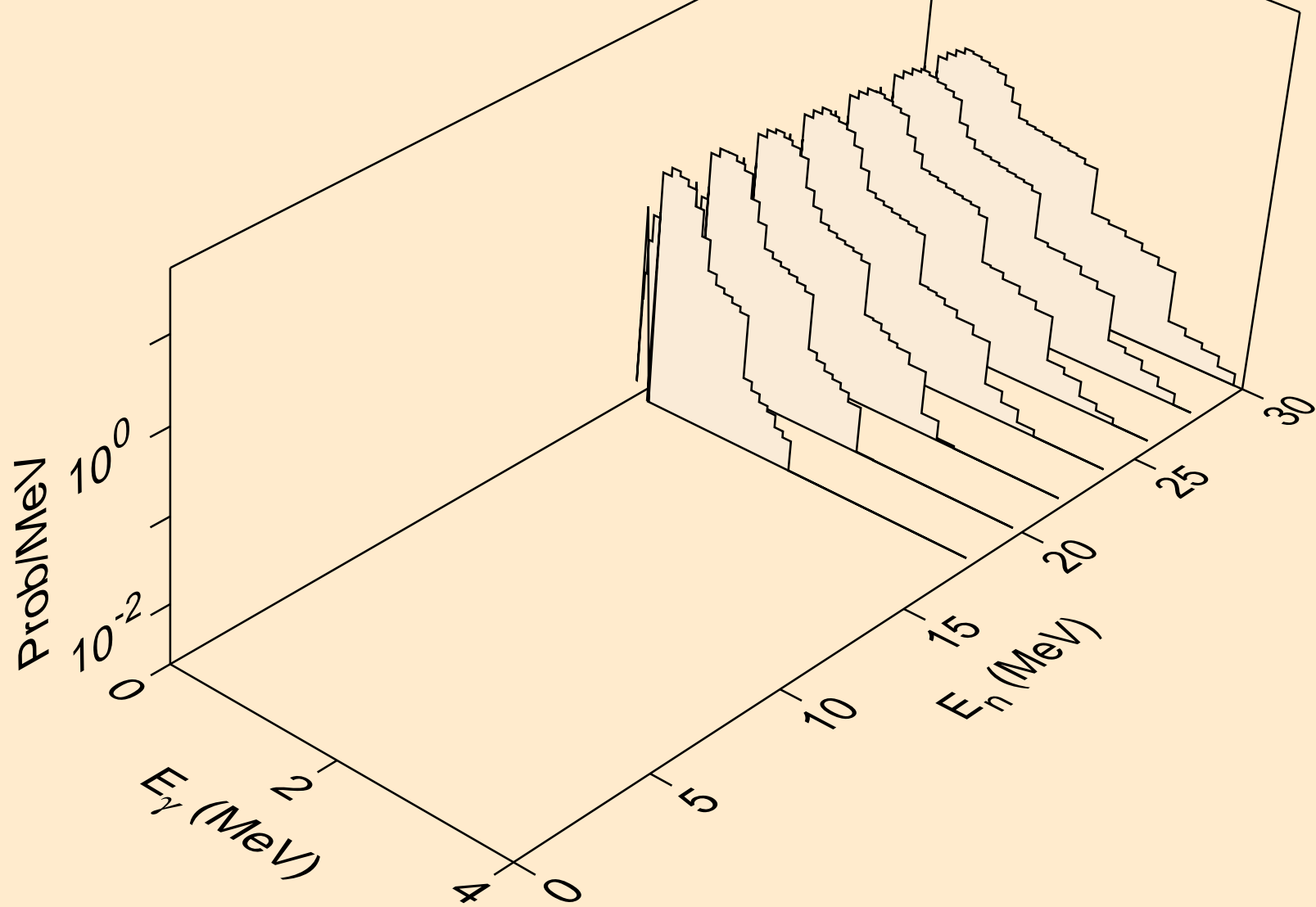

AU183 NEUTRON ACER TENDL-2021 LIBRARY; T=293.6K
Photon emission for (n,n*)d

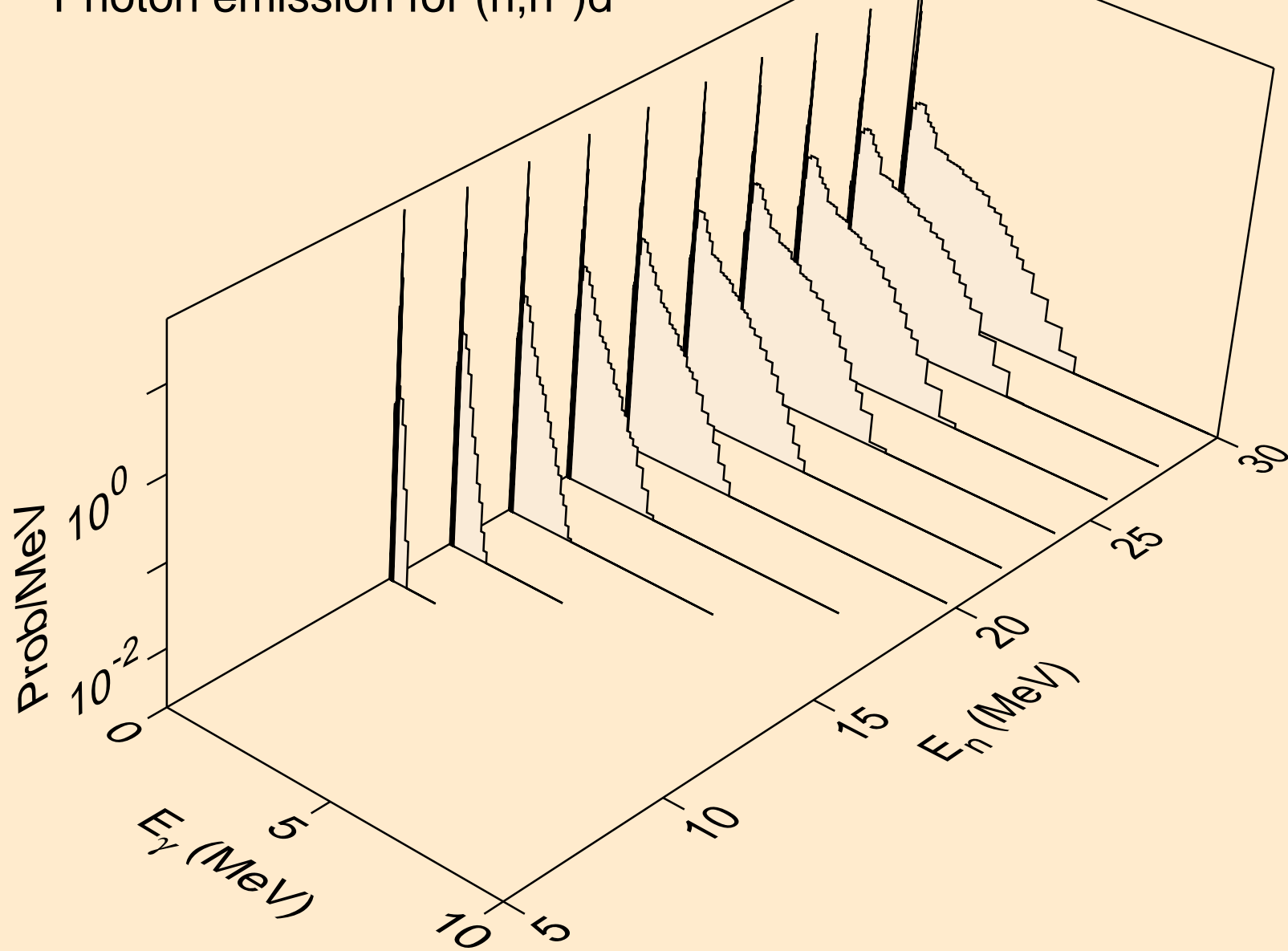

AU183 NEUTRON ACER TENDL-2021 LIBRARY; T=293.6K
Photon emission for (n,n*)t

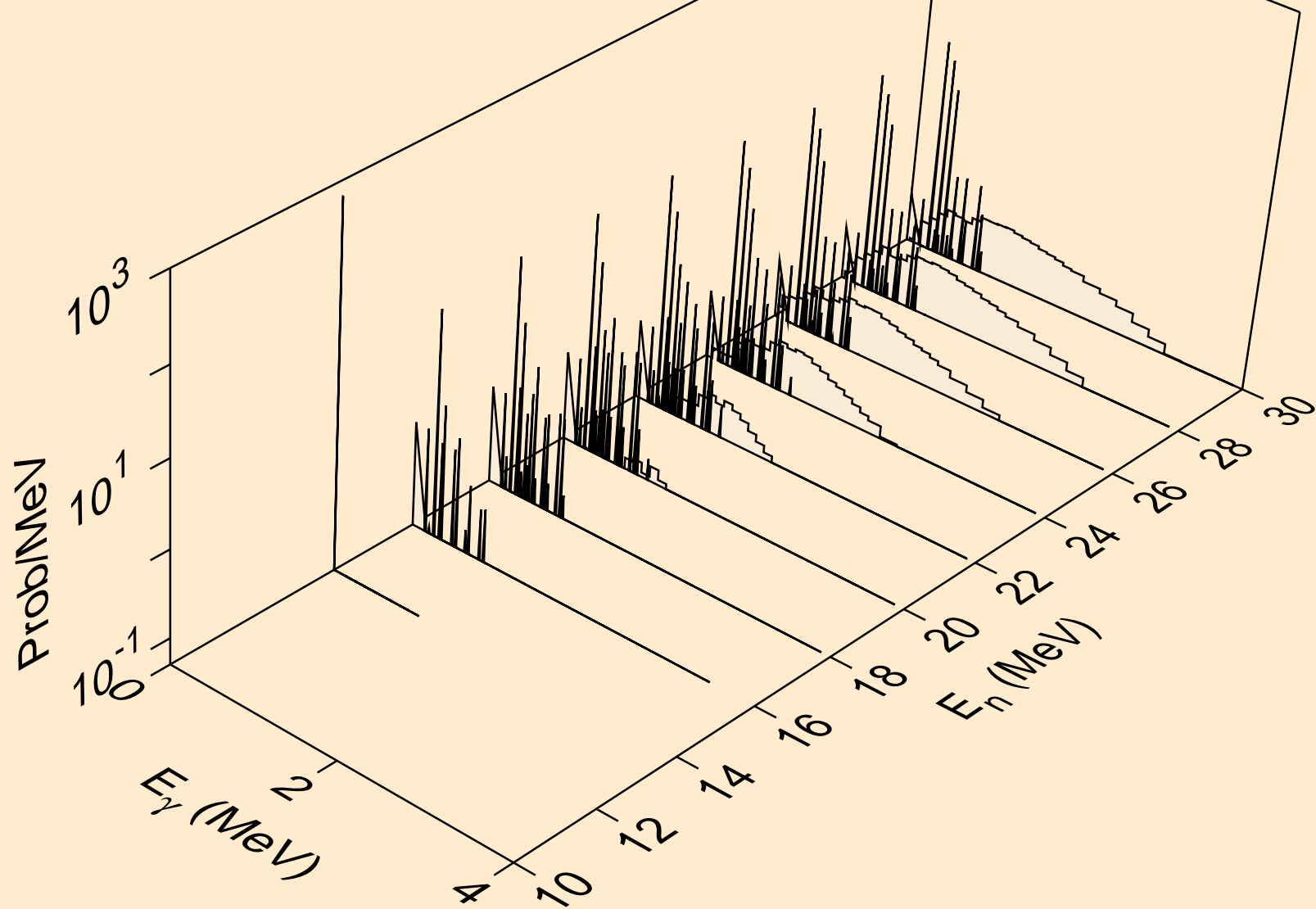

AU183 NEUTRON ACER TENDL-2021 LIBRARY; T=293.6K
Photon emission for (n,n*)he3

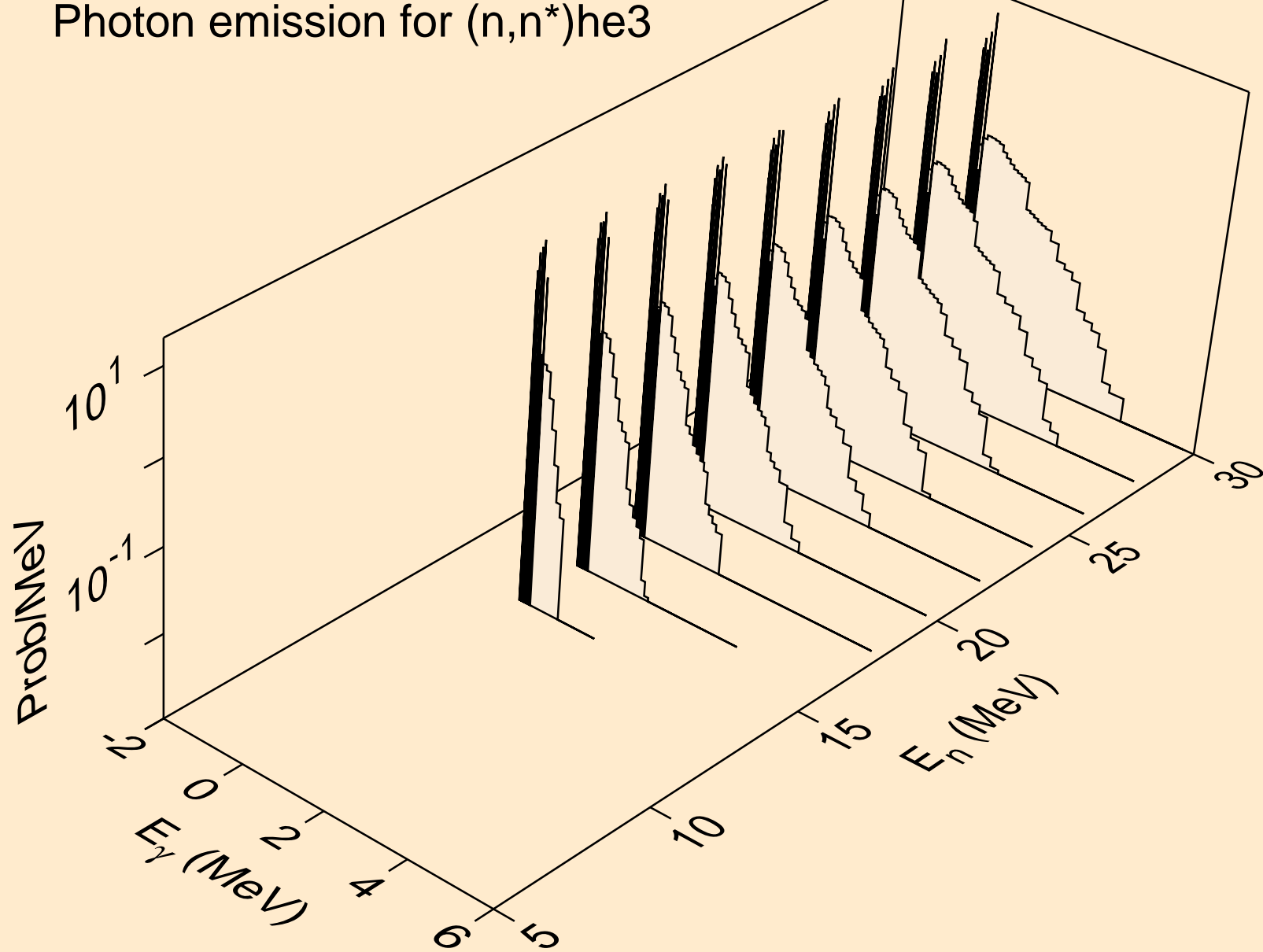

AU183 NEUTRON ACER TENDL-2021 LIBRARY; T=293.6K
Photon emission for (n,4n)

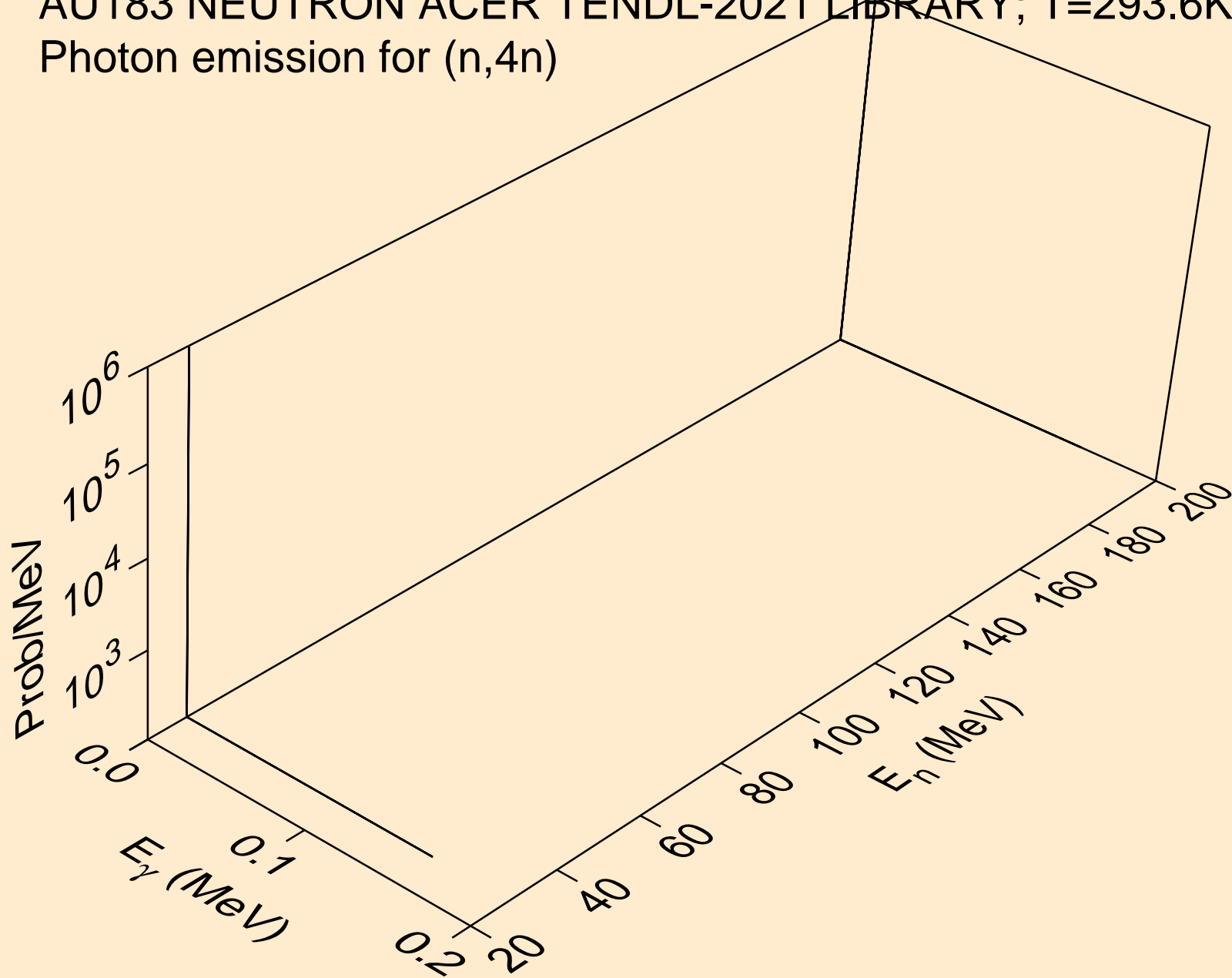

AU183 NEUTRON ACER TENDL-2021 LIBRARY; T=293.6K
Photon emission for (n,2np)

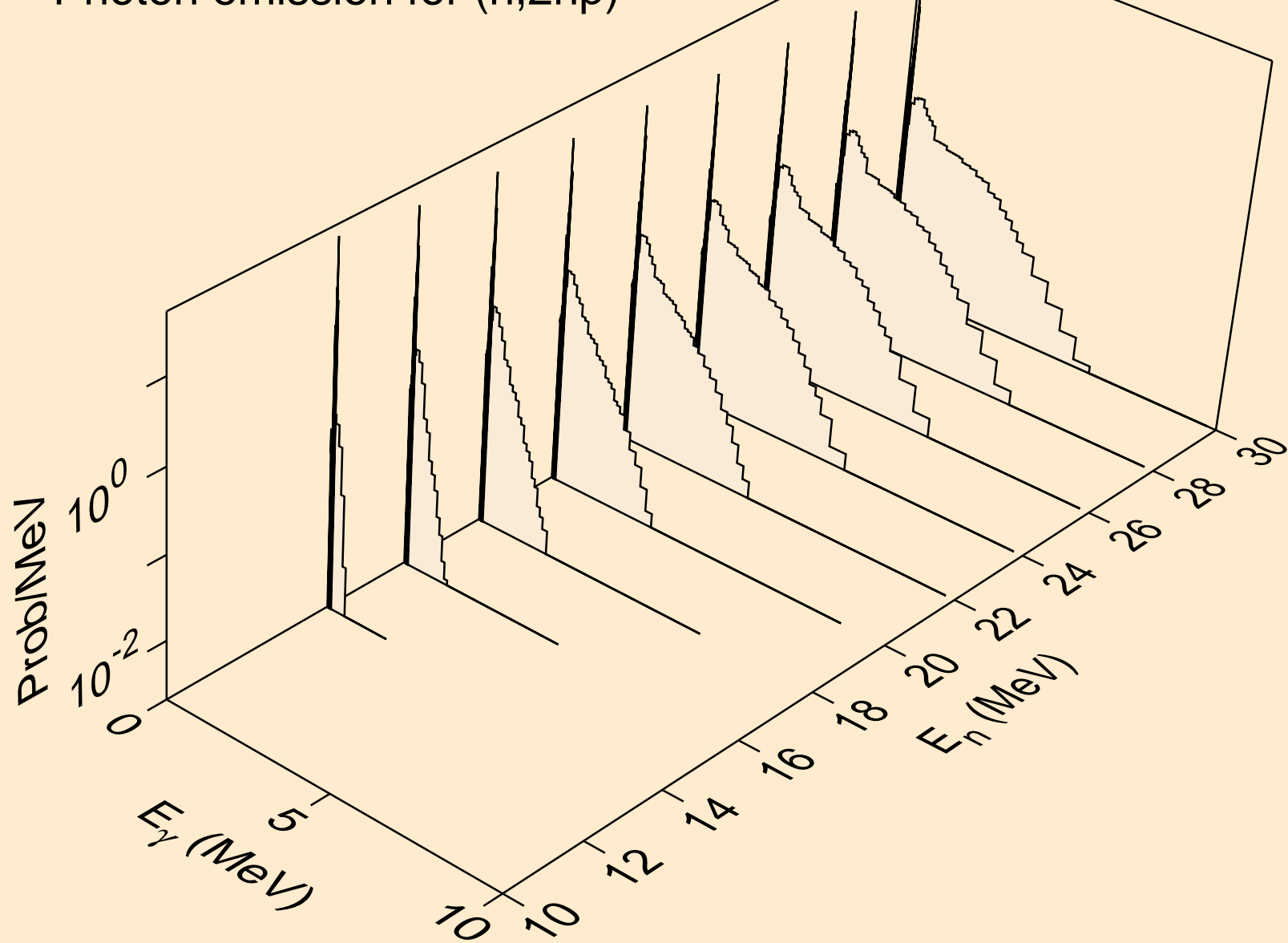

AU183 NEUTRON ACER TENDL-2021 LIBRARY; T=293.6K
Photon emission for (n,3np)

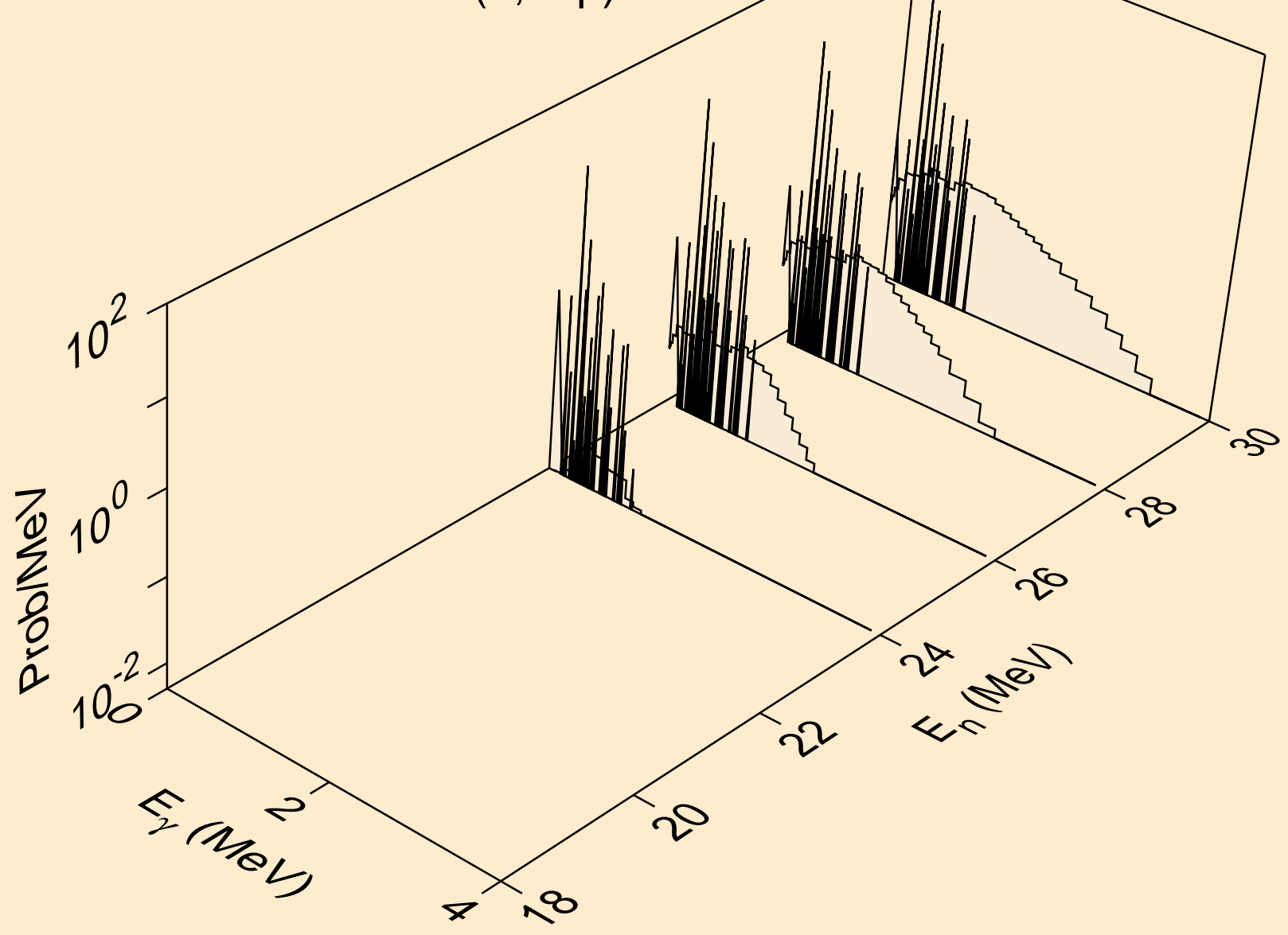

AU183 NEUTRON ACER TENDL-2021 LIBRARY; T=293.6K
Photon emission for (n,2np)

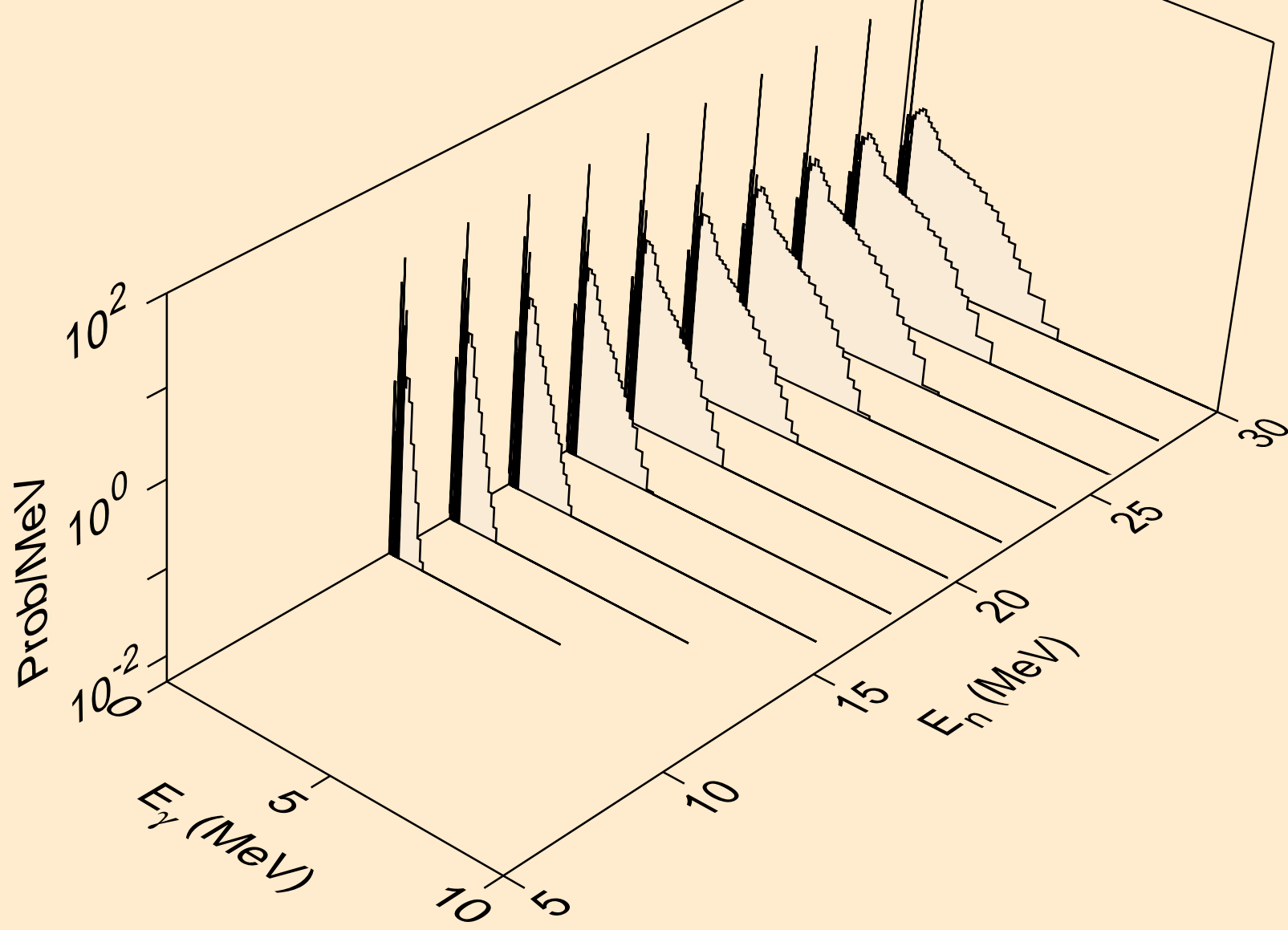

AU183 NEUTRON ACER TENDL-2021 LIBRARY; T=293.6K
Photon emission for (n,npa)

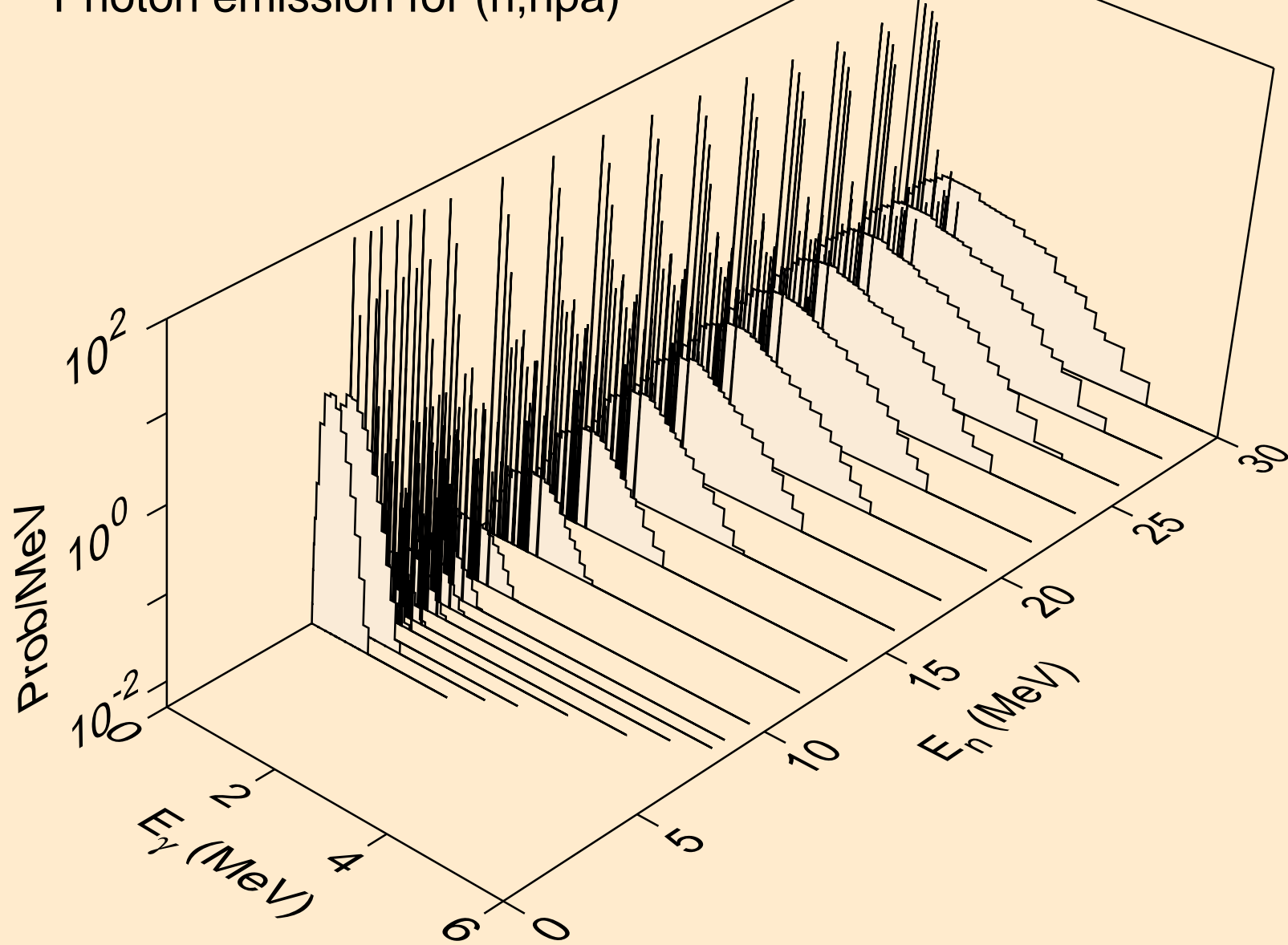

AU183 NEUTRON ACER TENDL-2021 LIBRARY; T=293.6K
Photon emission for (n,n*c)

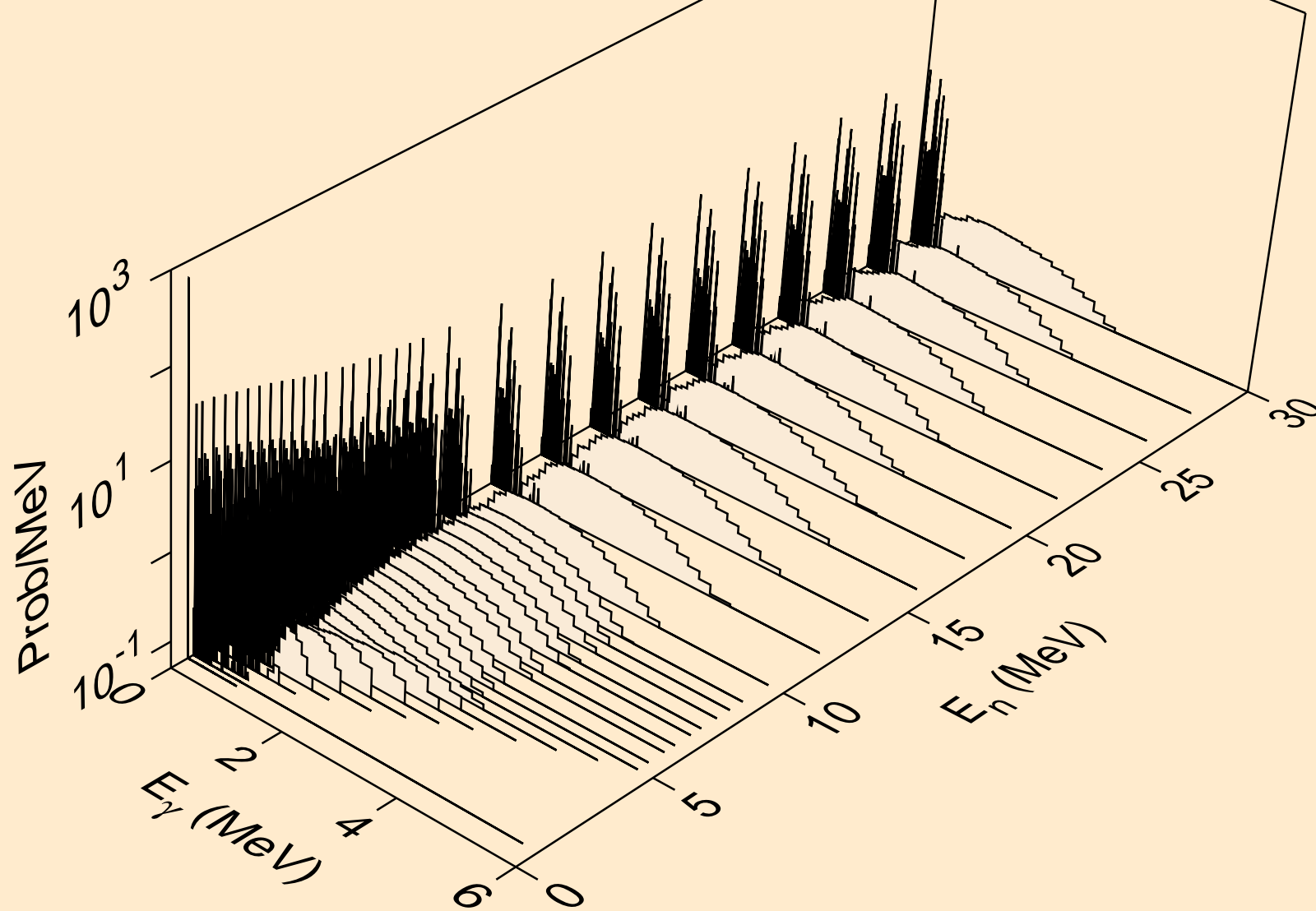

AU183 NEUTRON ACER TENDL-2021 LIBRARY; T=293.6K
Photon emission for (n,gma)

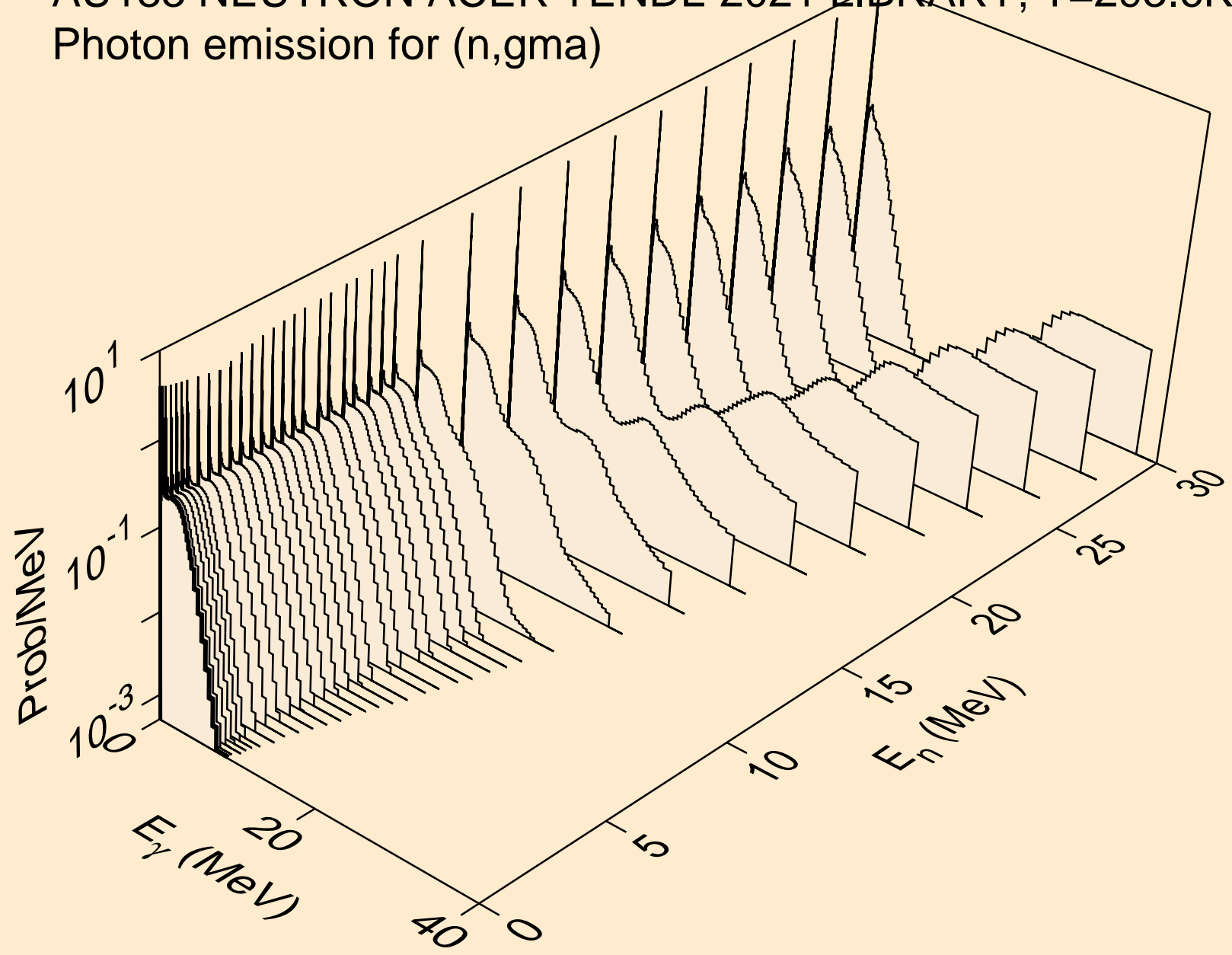

AU183 NEUTRON ACER TENDL-2021 LIBRARY; T=293.6K
Photon emission for (n,p)

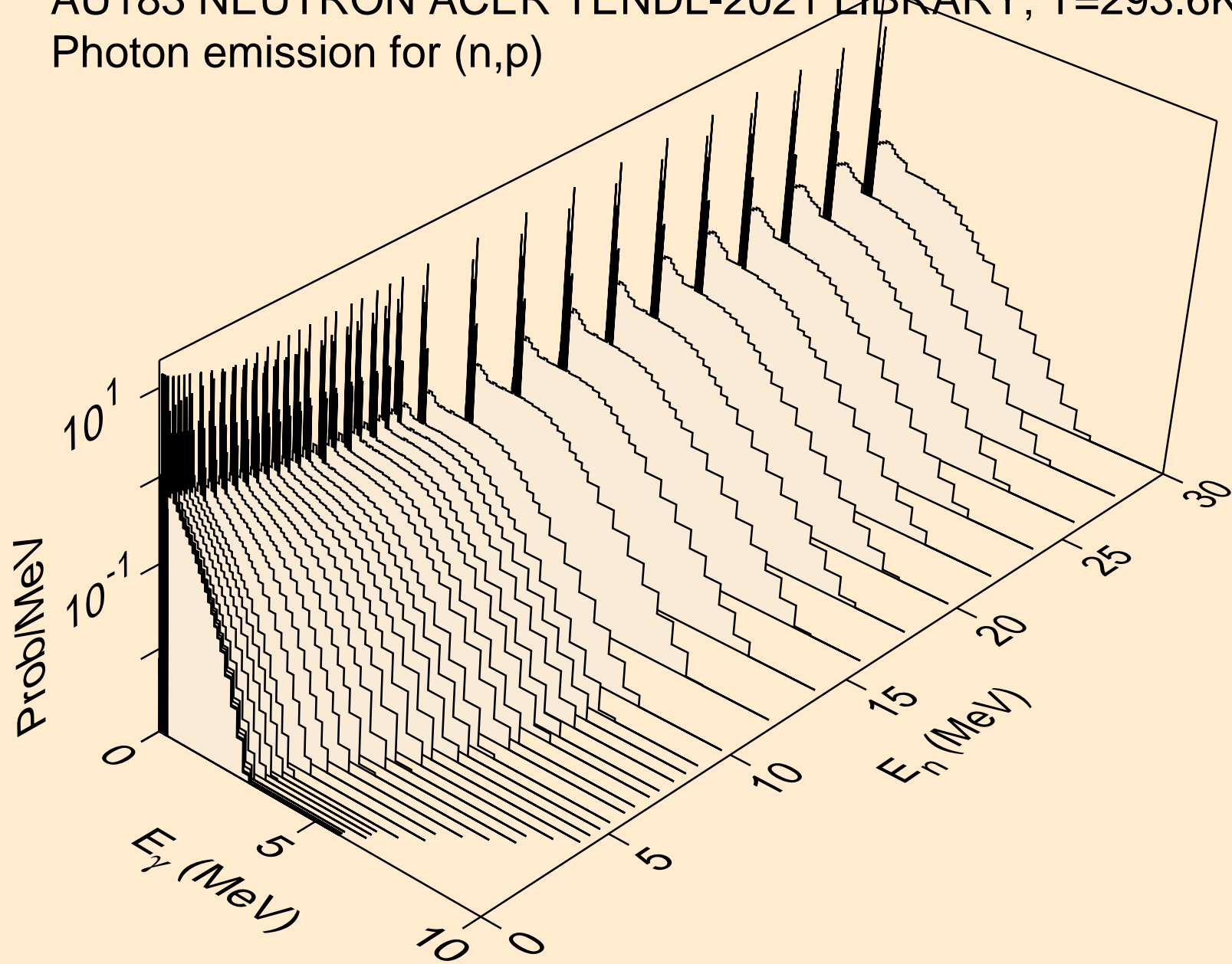

AU183 NEUTRON ACER TENDL-2021 LIBRARY; T=293.6K
Photon emission for (n,d)

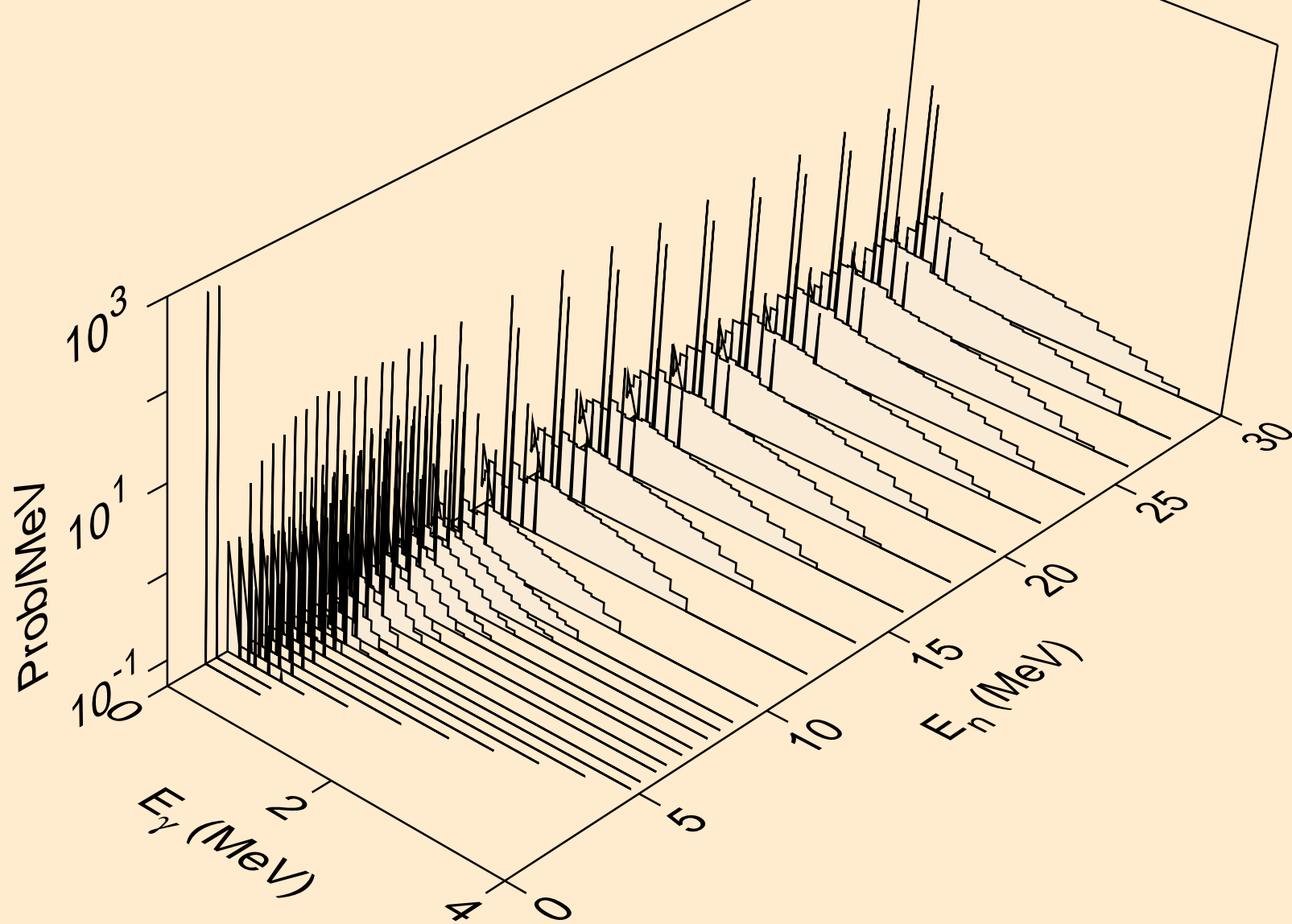

AU183 NEUTRON ACER TENDL-2021 LIBRARY; T=293.6K
Photon emission for (n,t)

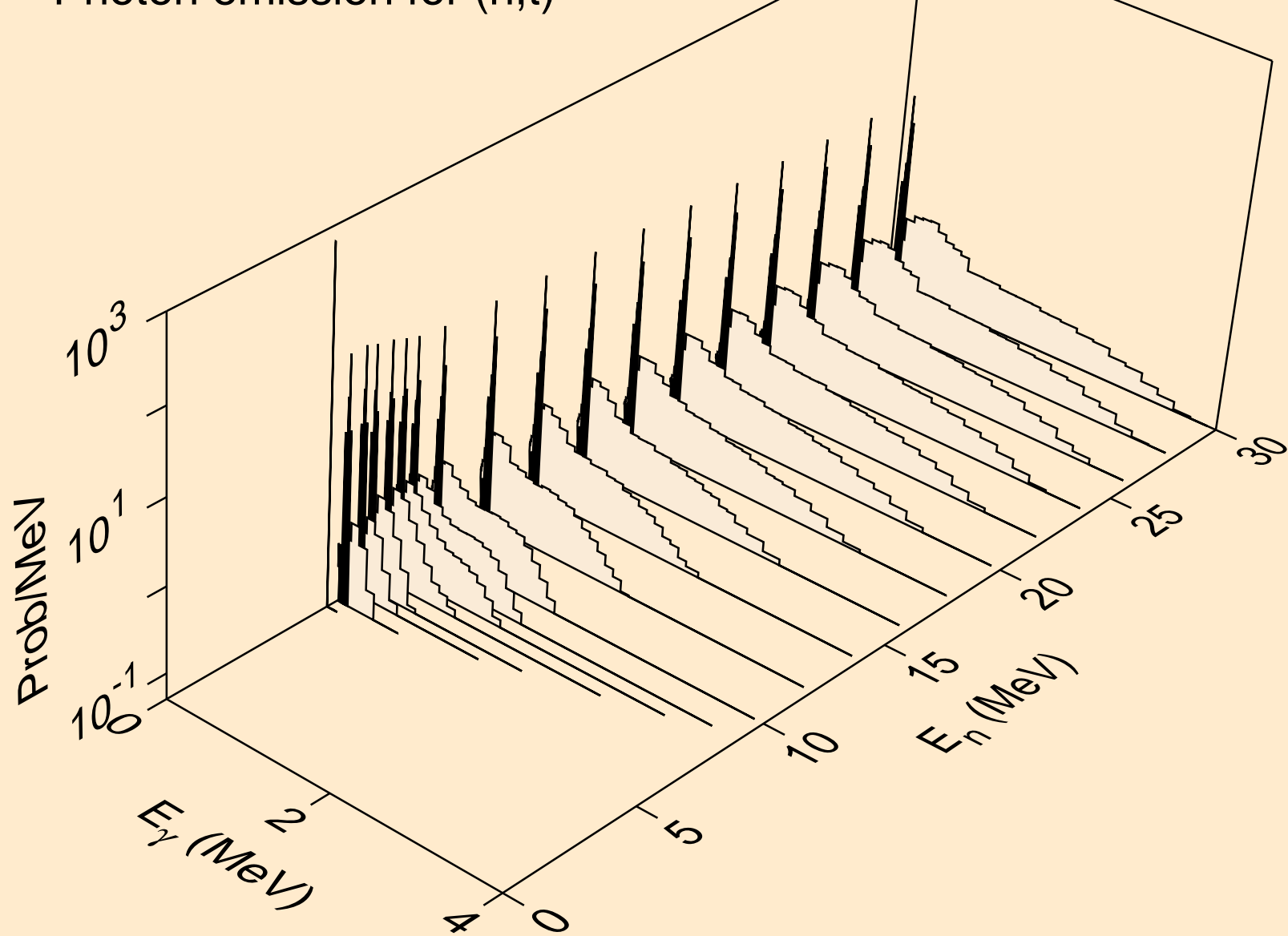

AU183 NEUTRON ACER TENDL-2021 LIBRARY; T=293.6K
Photon emission for (n,he3)

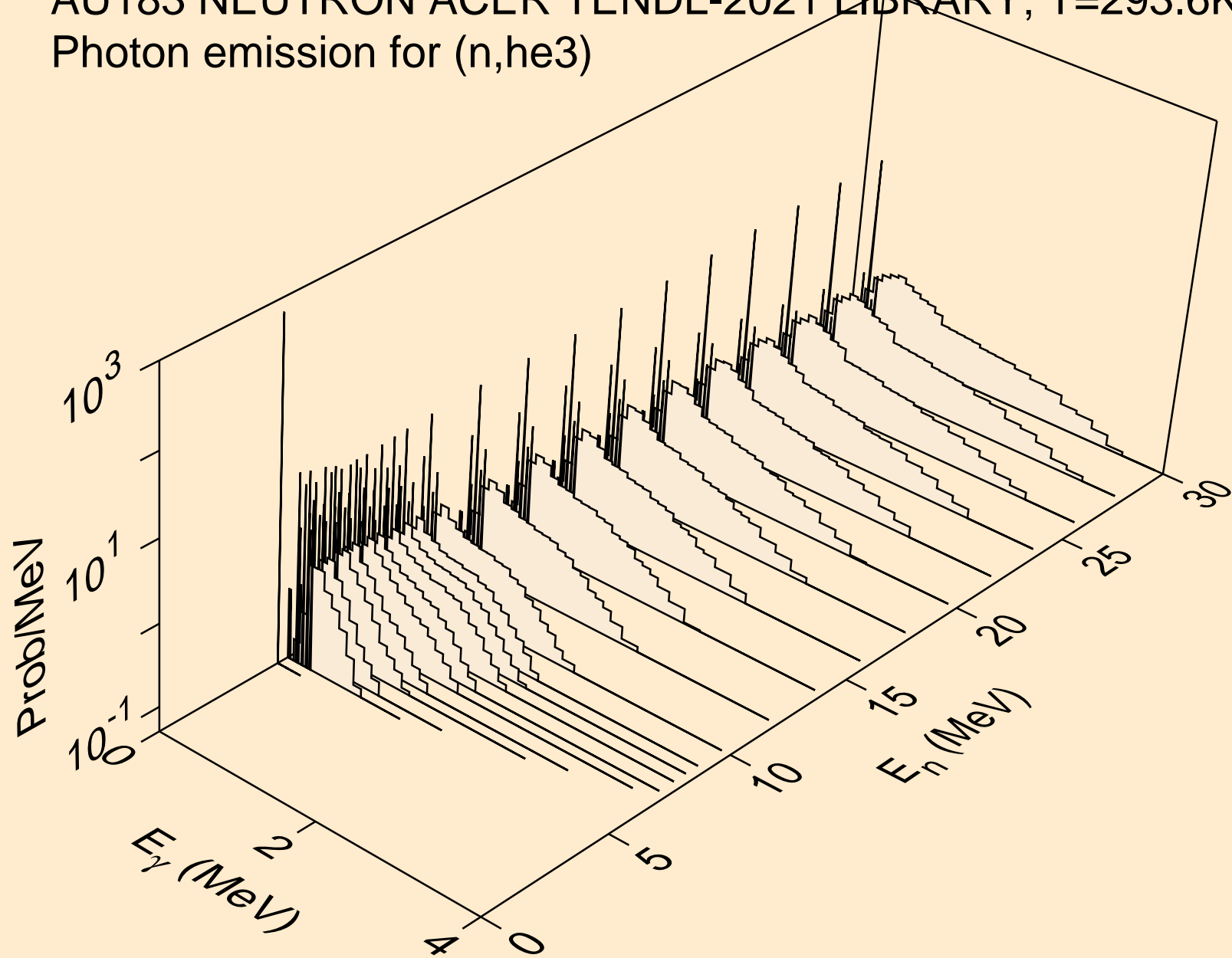

AU183 NEUTRON ACER TENDL-2021 LIBRARY; T=293.6K
Photon emission for (n,a)

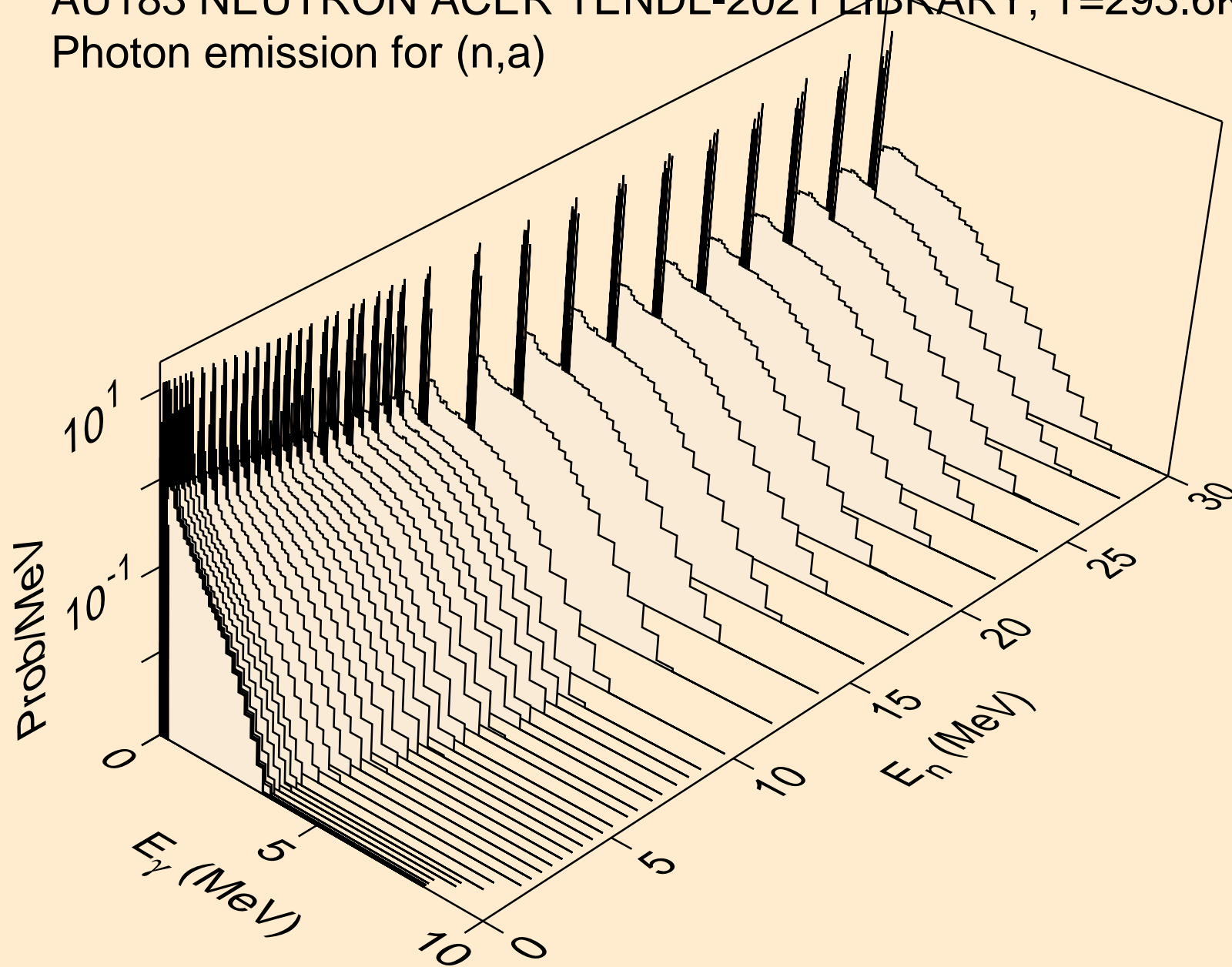

AU183 NEUTRON ACER TENDL-2021 LIBRARY; T=293.6K
Photon emission for (n,2a)

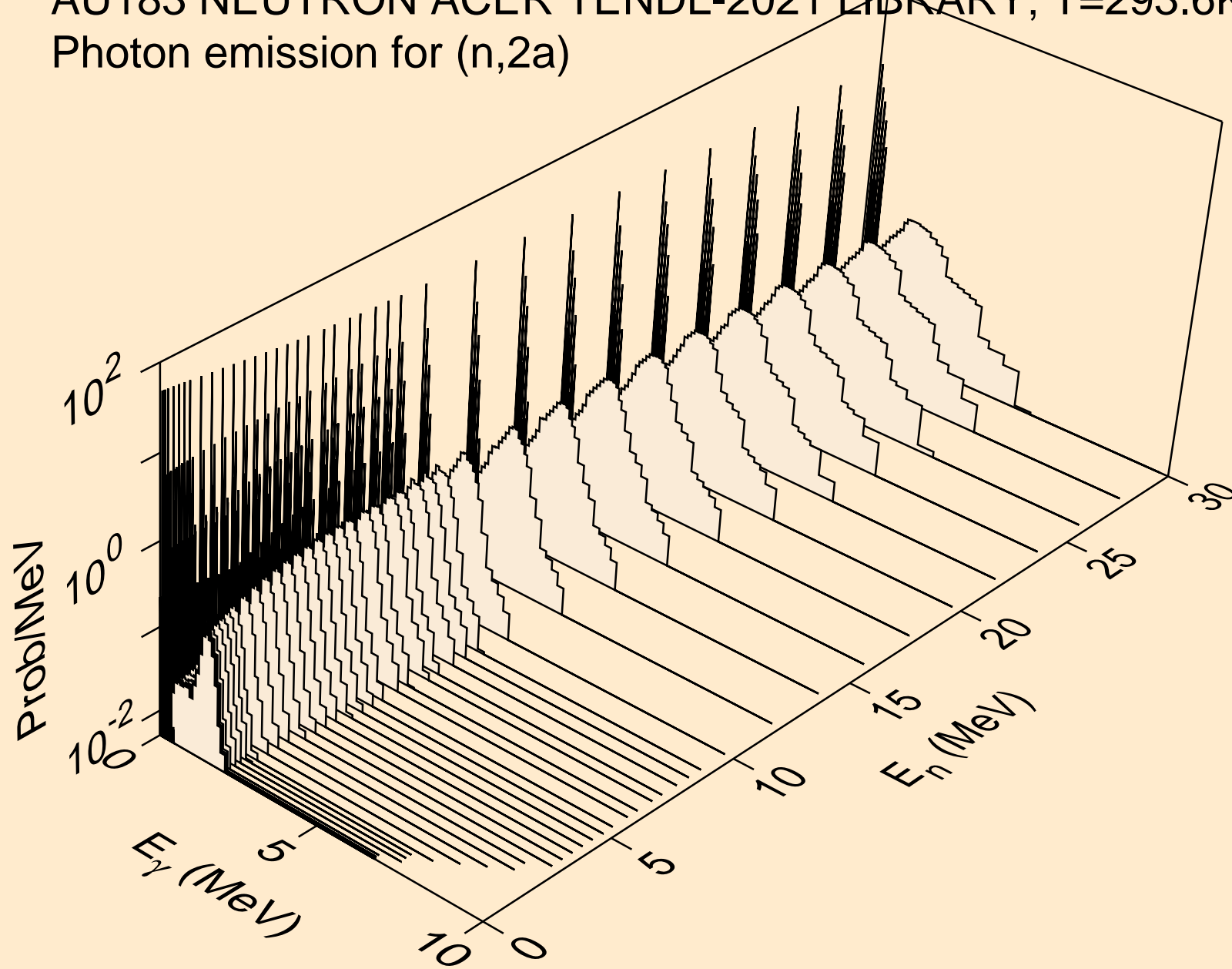

AU183 NEUTRON ACER TENDL-2021 LIBRARY; T=293.6K
Photon emission for (n,3a)

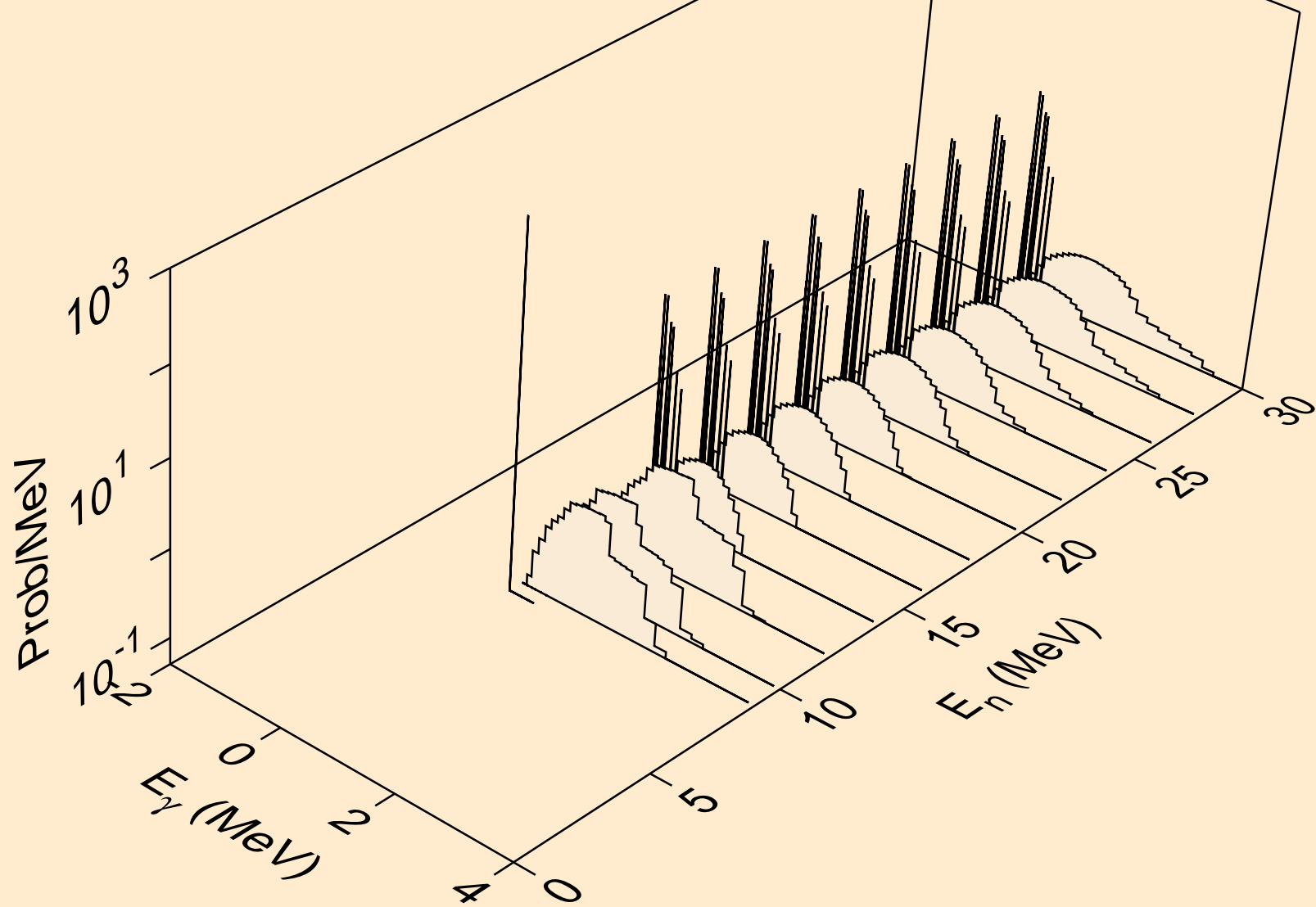

AU183 NEUTRON ACER TENDL-2021 LIBRARY; T=293.6K
Photon emission for (n,2p)

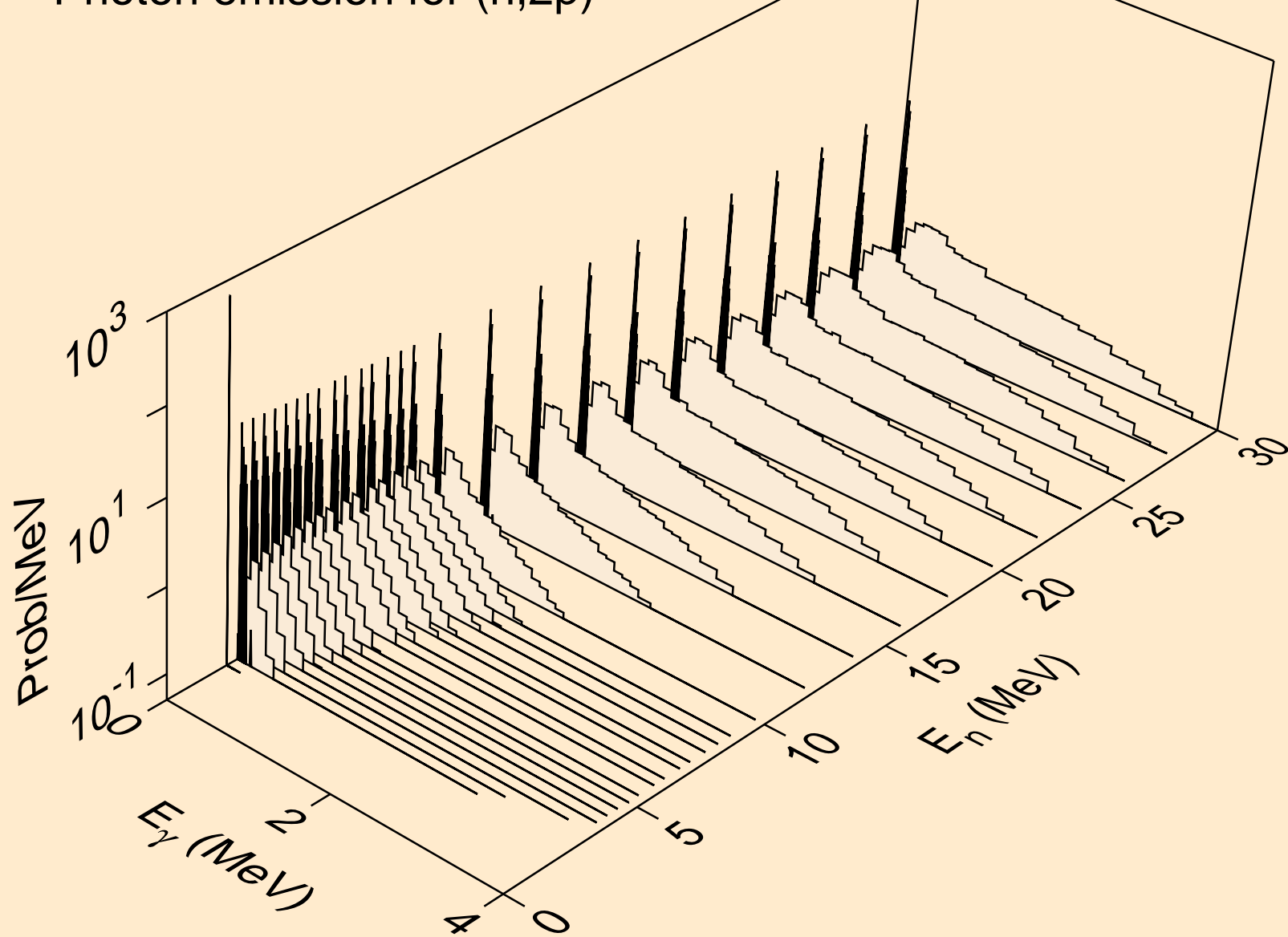

AU183 NEUTRON ACER TENDL-2021 LIBRARY; T=293.6K
Photon emission for (n,p α)

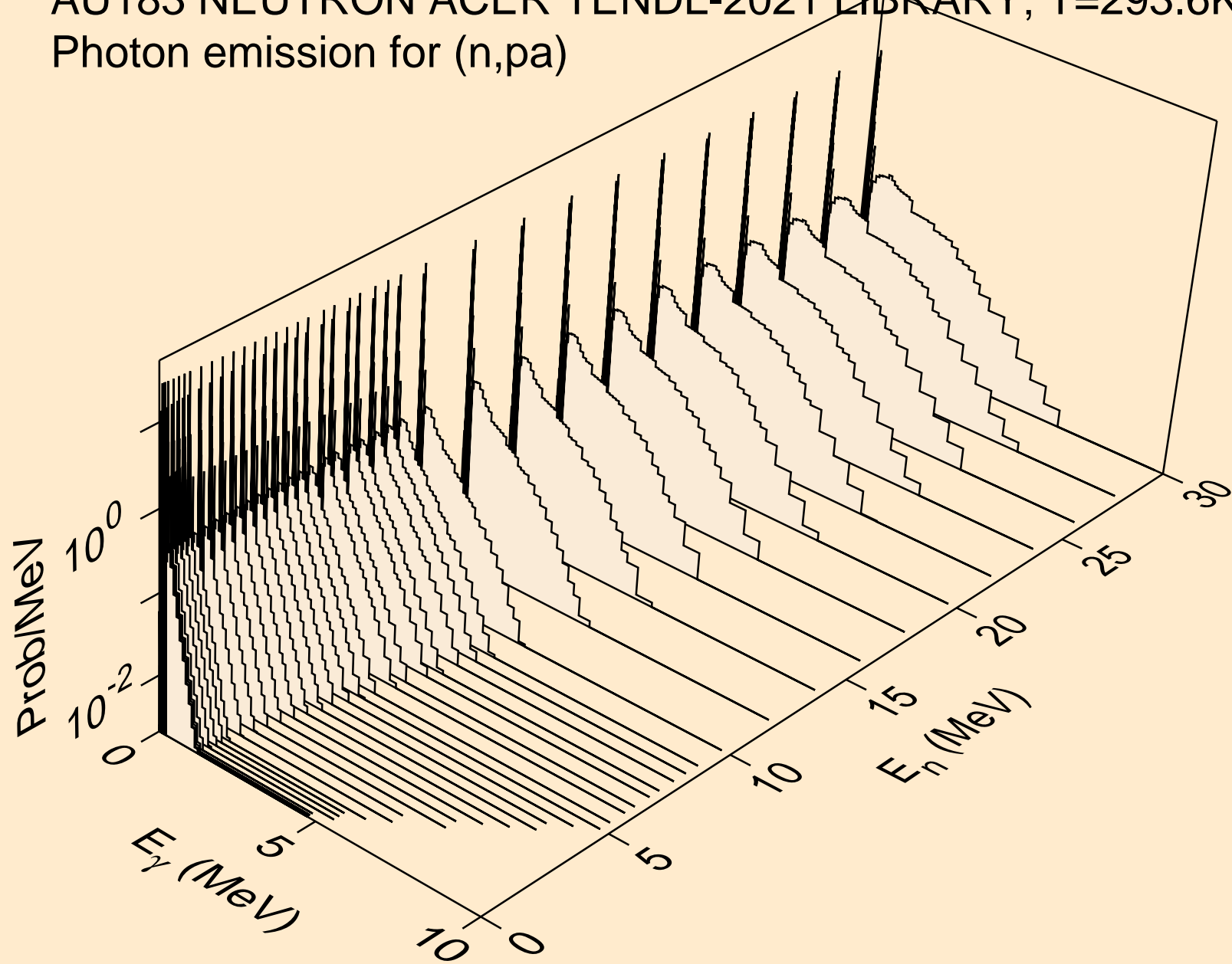

AU183 NEUTRON ACER TENDL-2021 LIBRARY; T=293.6K
Photon emission for (n,pd)

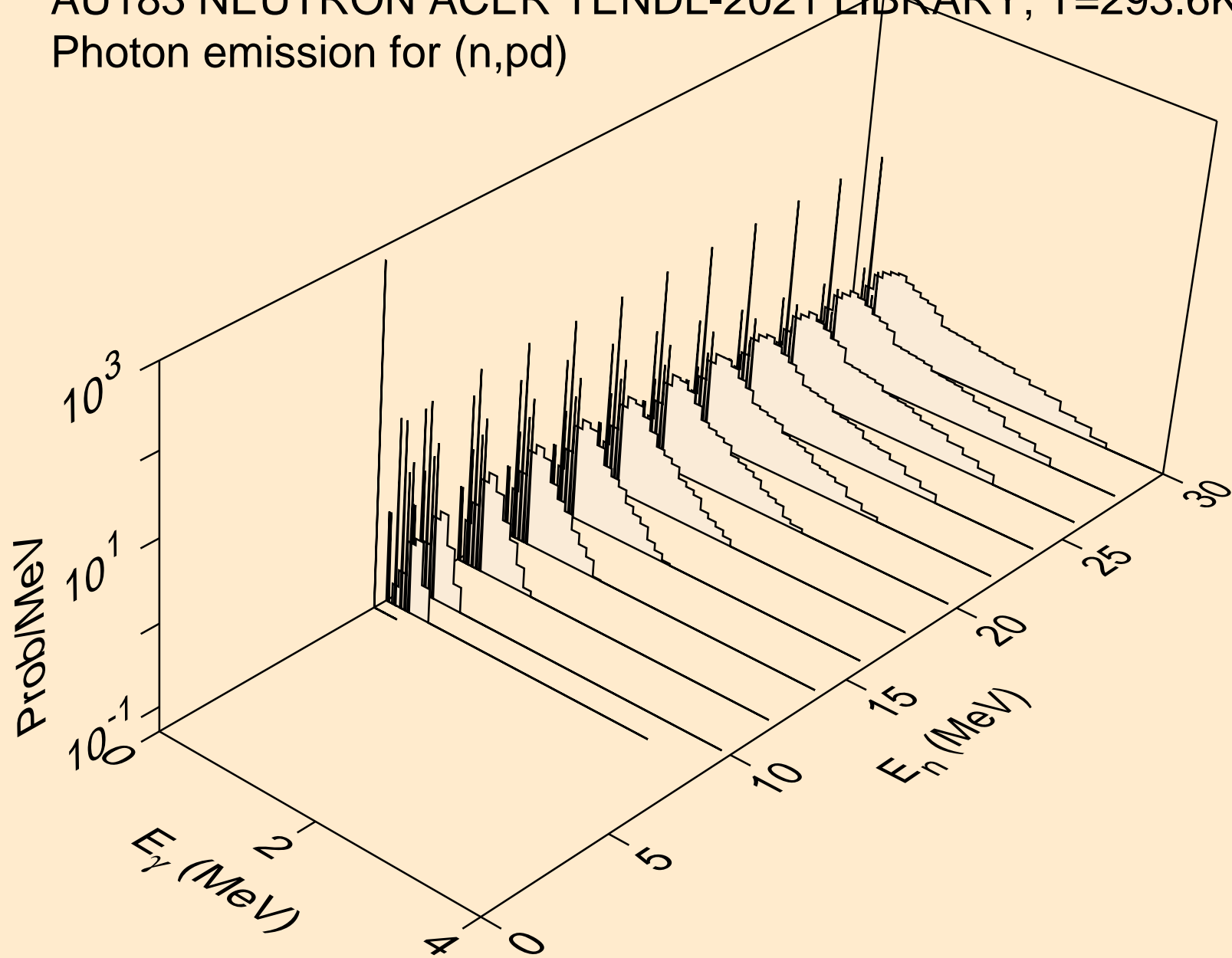

AU183 NEUTRON ACER TENDL-2021 LIBRARY; T=293.6K
Photon emission for (n,pt)

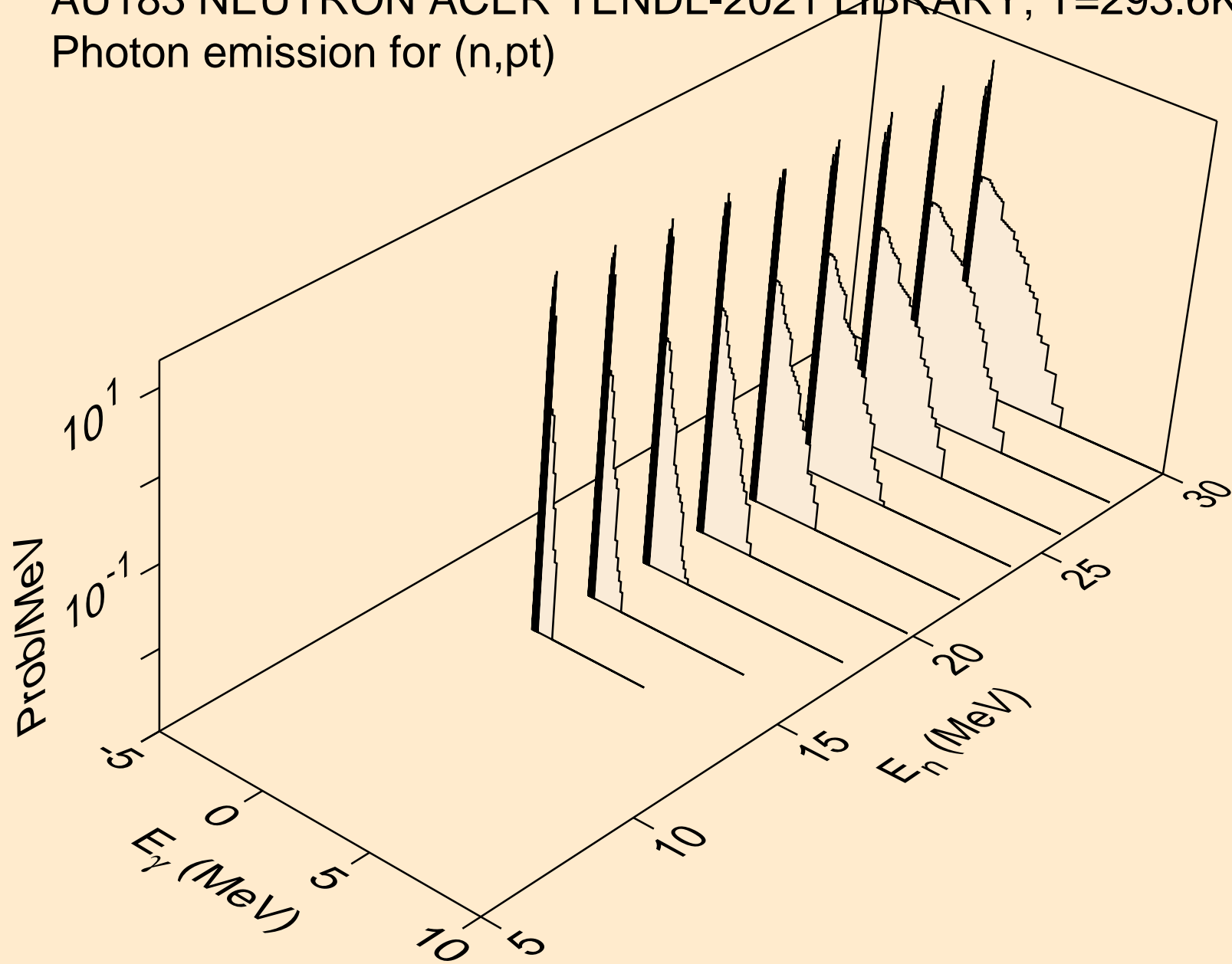

AU183 NEUTRON ACER TENDL-2021 LIBRARY; T=293.6K
Photon emission for (n,da)

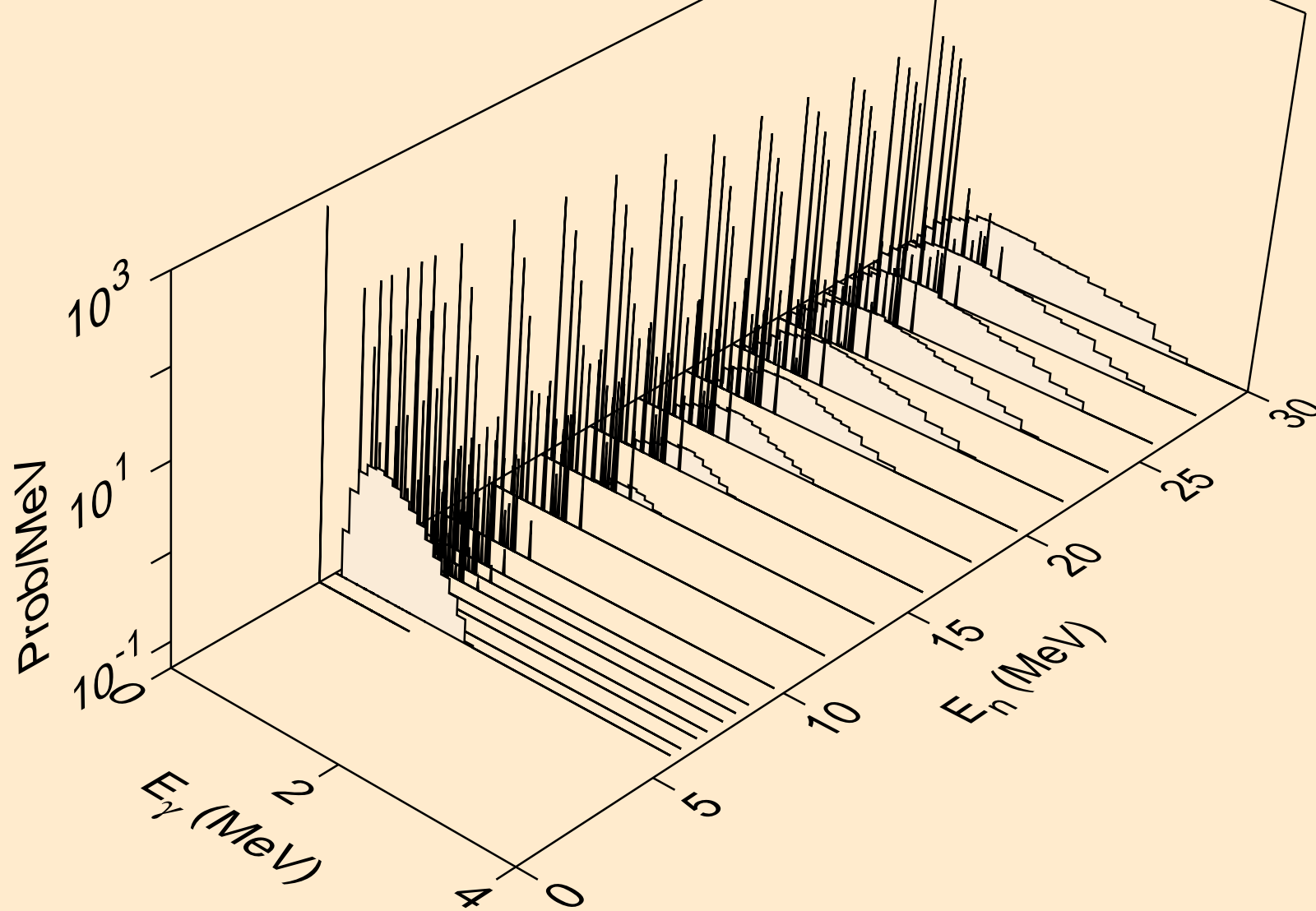

AU183 NEUTRON ACER TENDL-2021 LIBRARY; T=293.6K
thermal capture photon spectrum

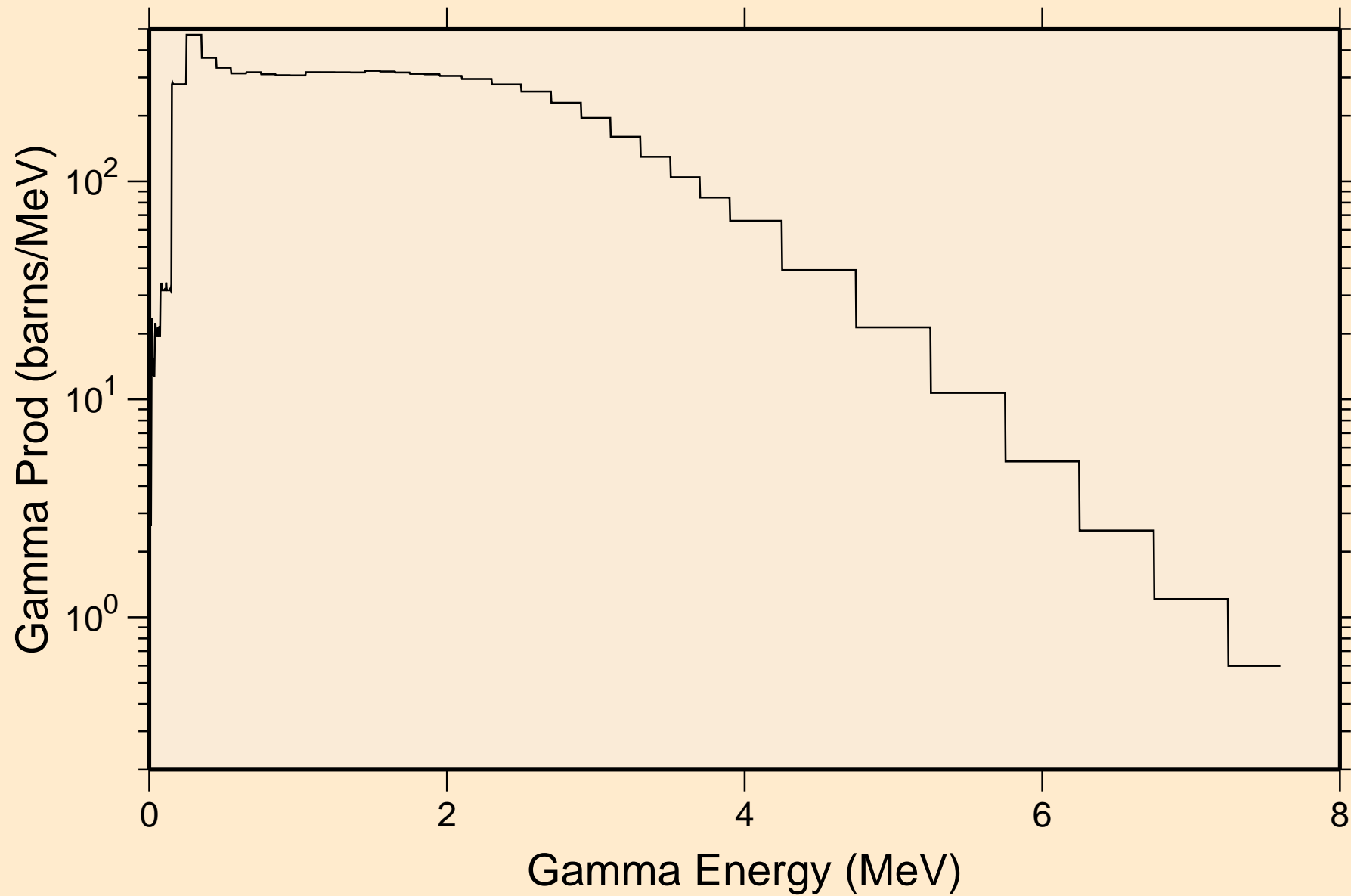

AU183 NEUTRON ACER TENDL-2021 LIBRARY; T=293.6K
14 MeV photon spectrum

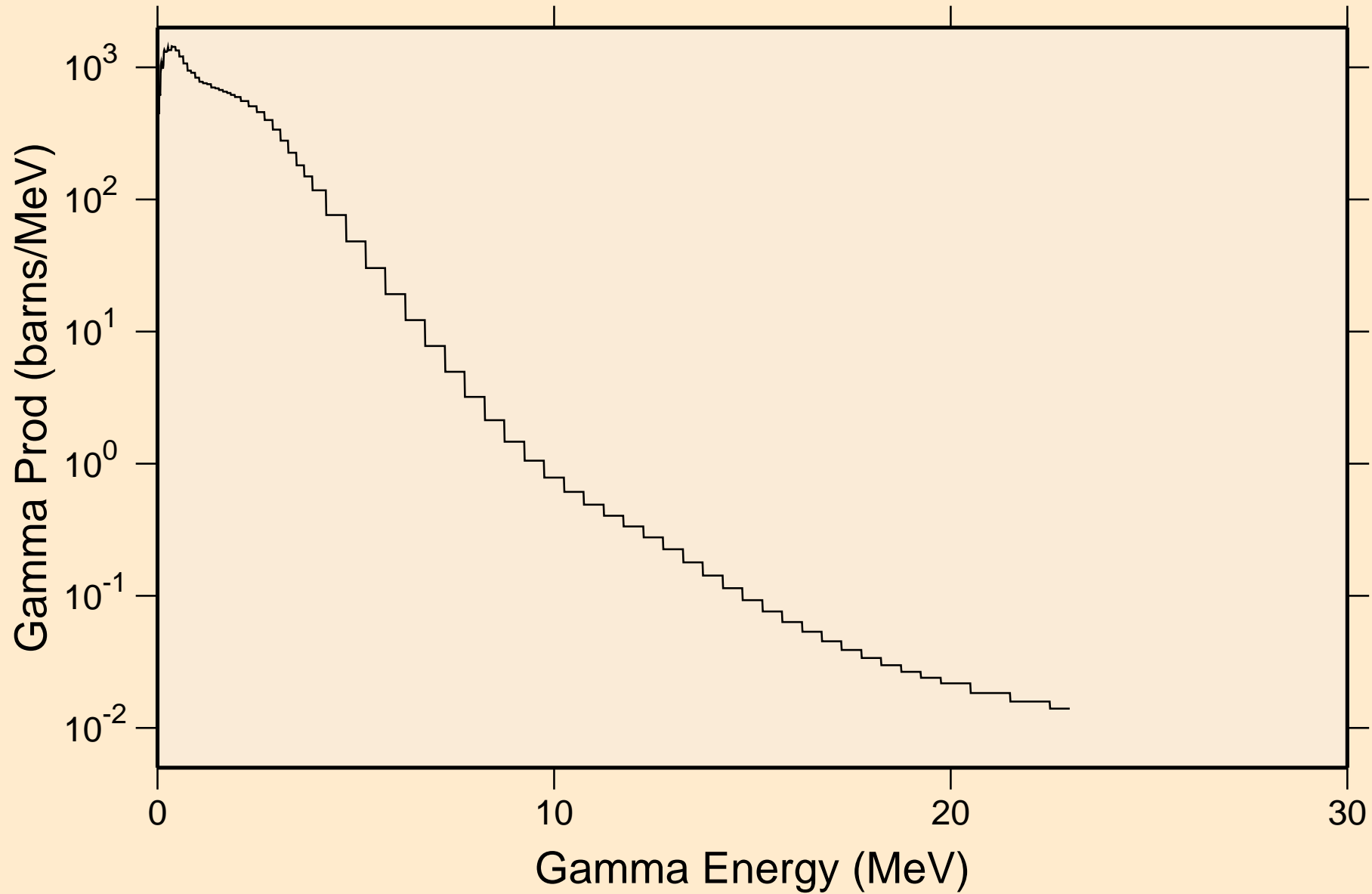

AU183 NEUTRON ACER TENDL-2021 LIBRARY; T=293.6K
Particle heating contributions

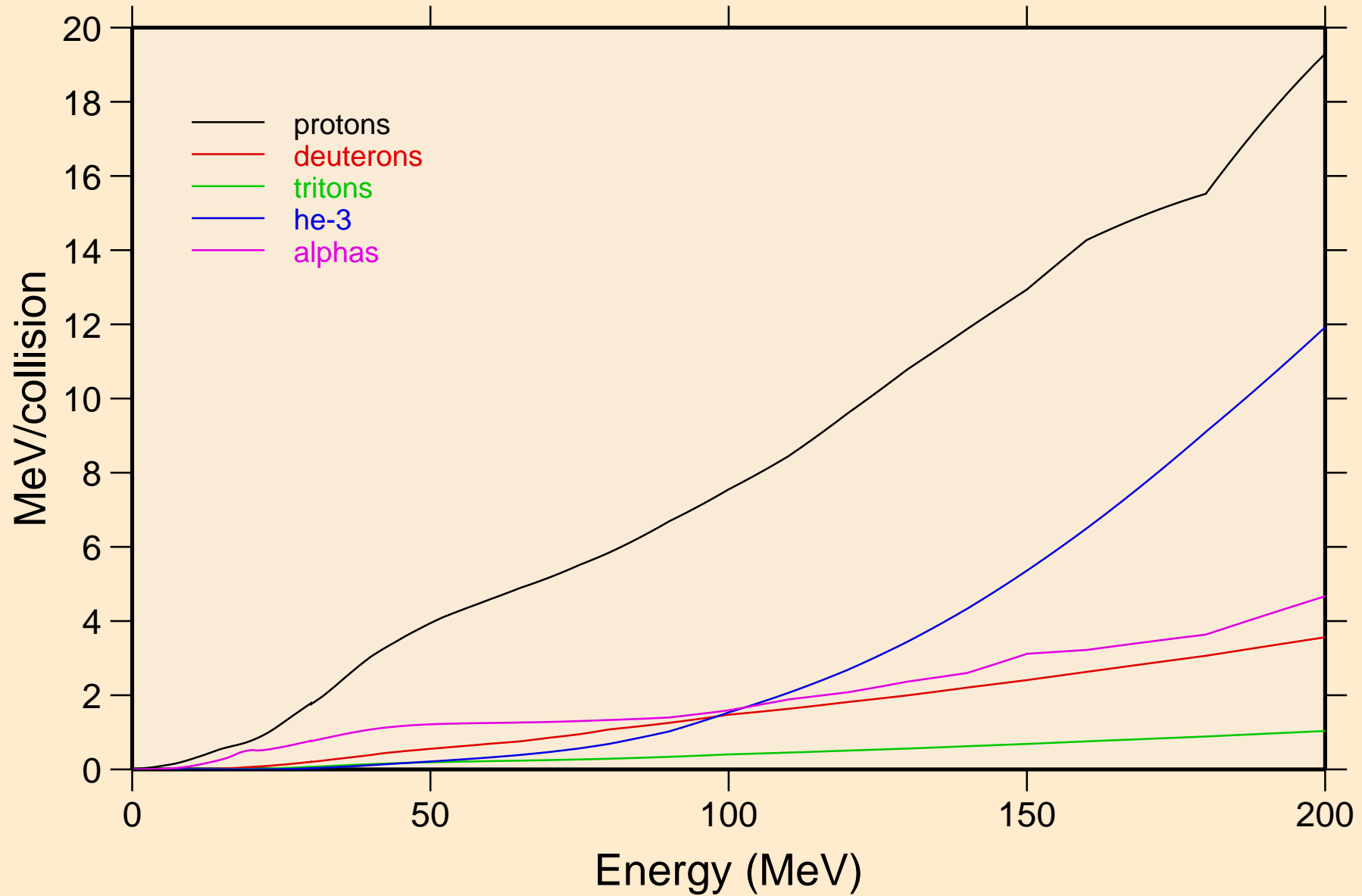

AU183 NEUTRON ACER TENDL-2021 LIBRARY; T=293.6K
Recoil Heating

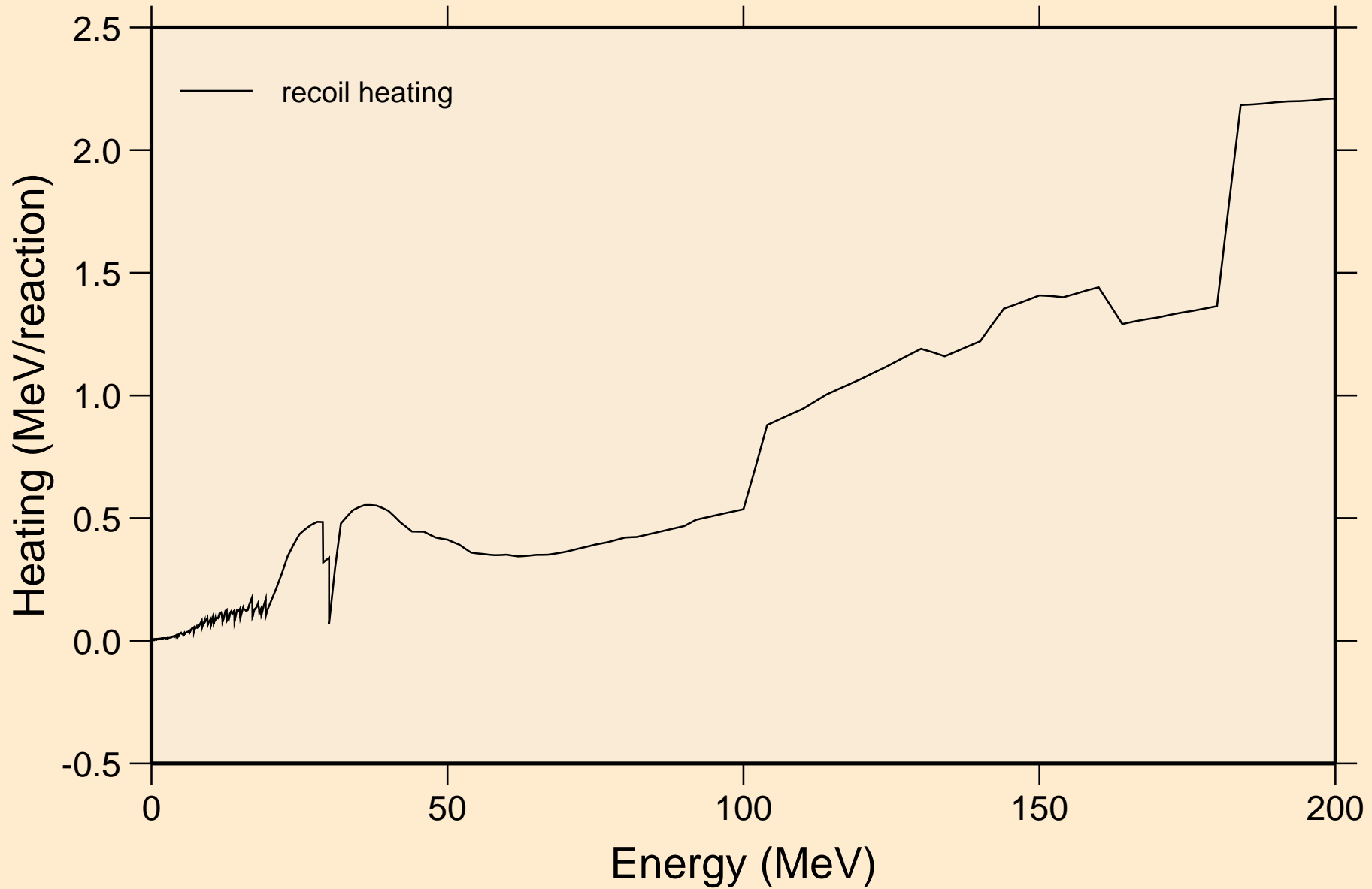

AU183 NEUTRON ACER TENDL-2021 LIBRARY; T=293.6K
Particle production cross sections

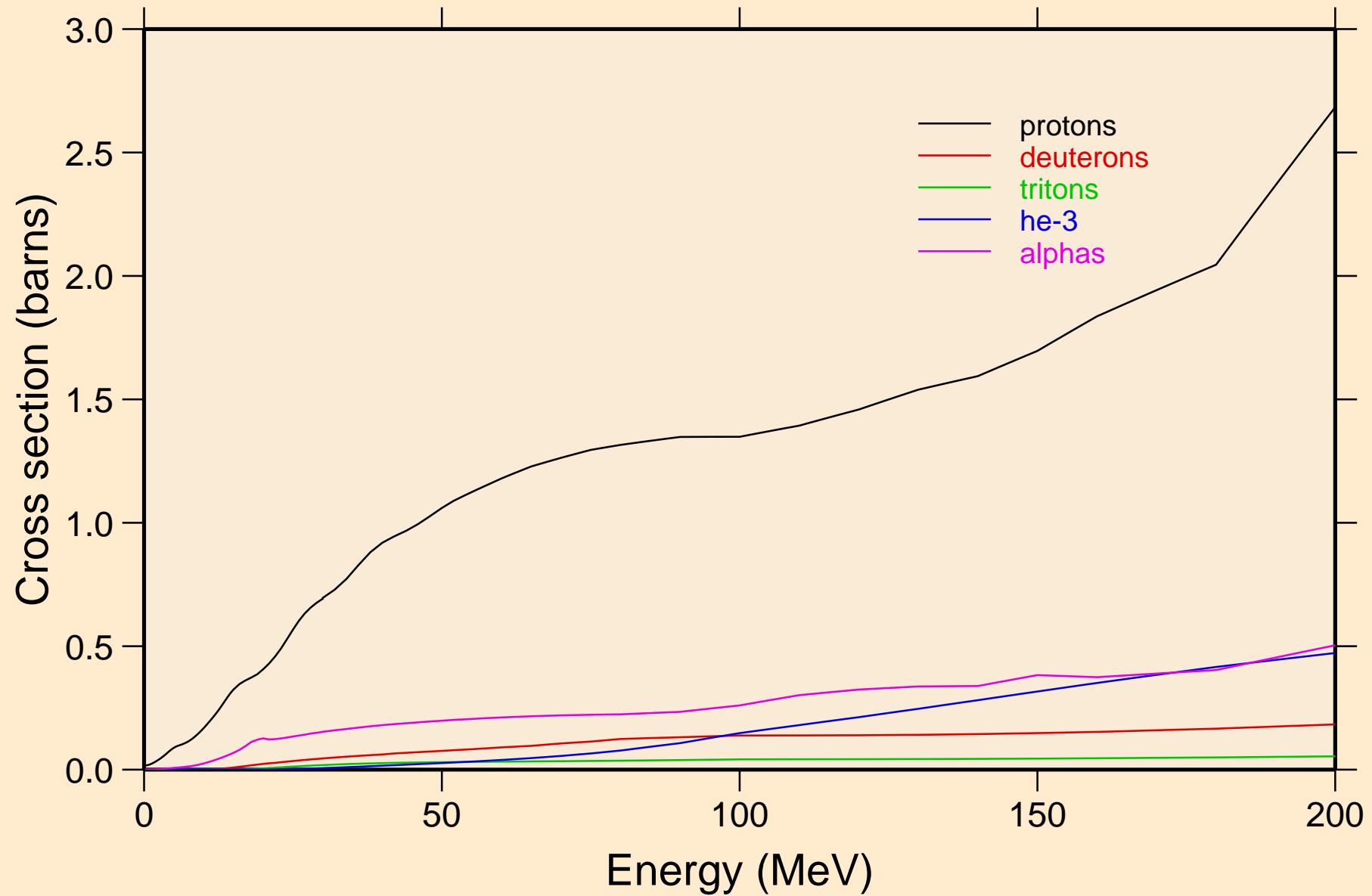

AU183 NEUTRON ACER TENDL-2021 LIBRARY; T=293.6K
protons from (n,x)

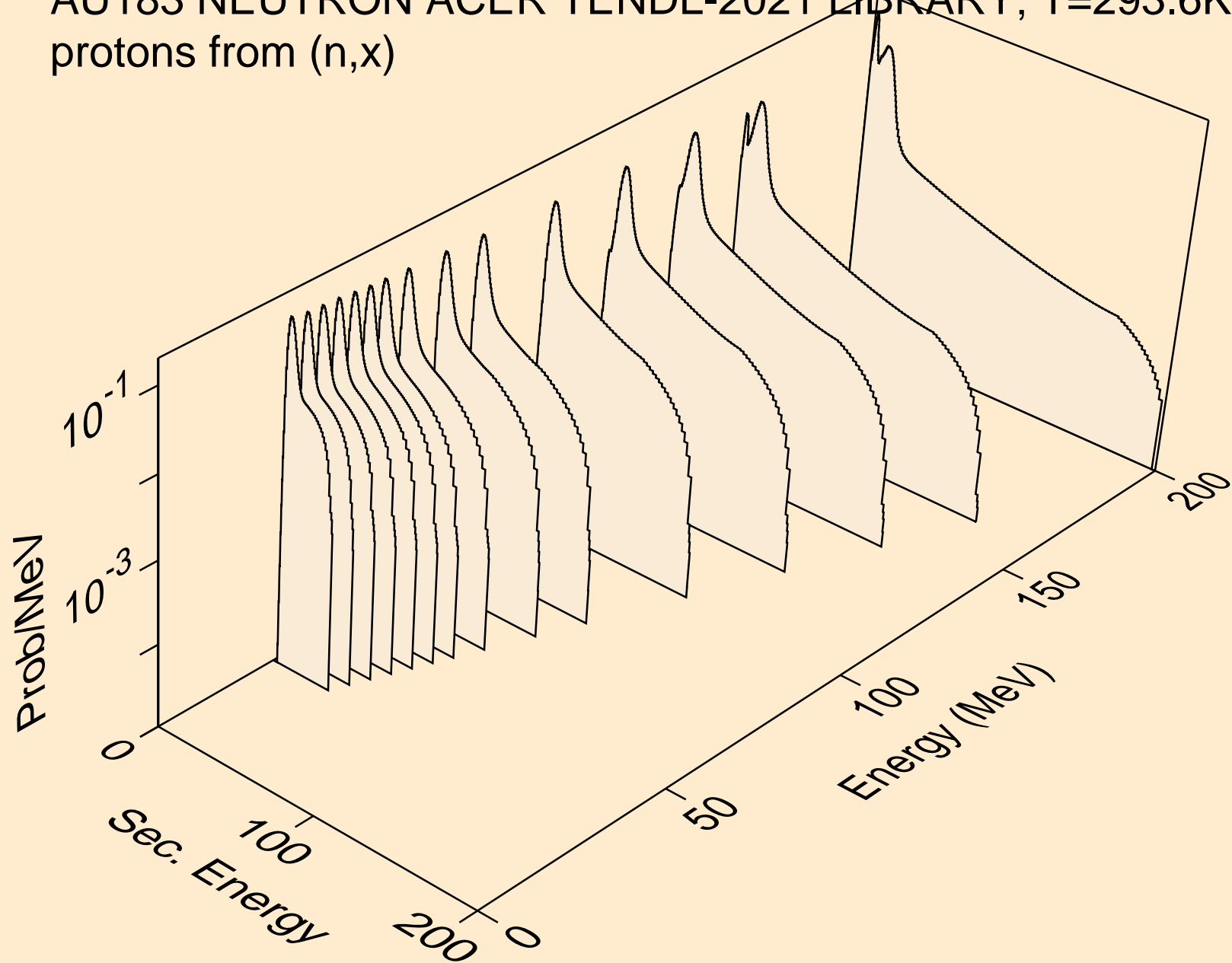

AU183 NEUTRON ACER TENDL-2021 LIBRARY; T=293.6K
protons from (n,n*)p

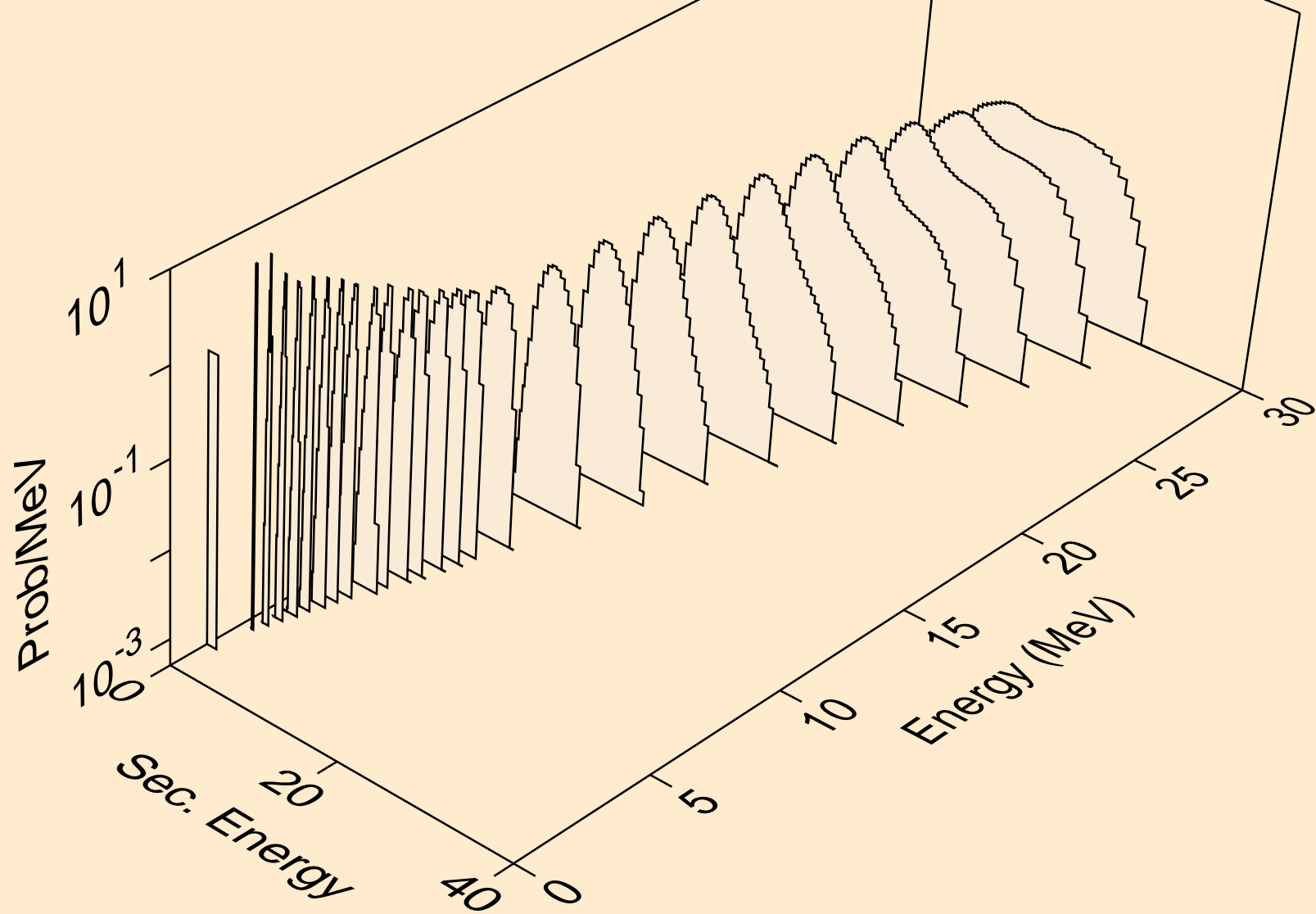

AU183 NEUTRON ACER TENDL-2021 LIBRARY; T=293.6K
protons from (n,2np)

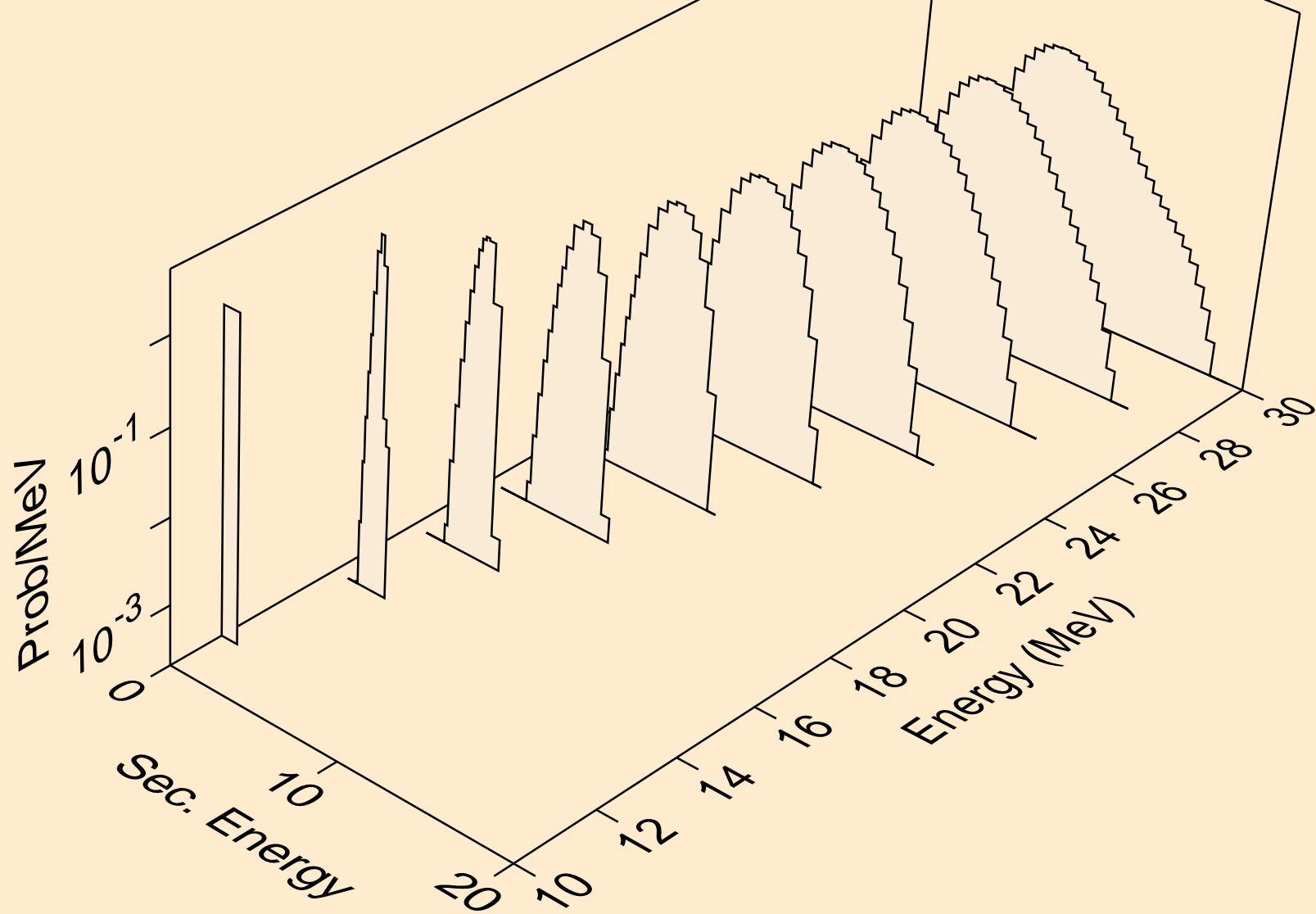

AU183 NEUTRON ACER TENDL-2021 LIBRARY; T=293.6K
protons from (n,3np)

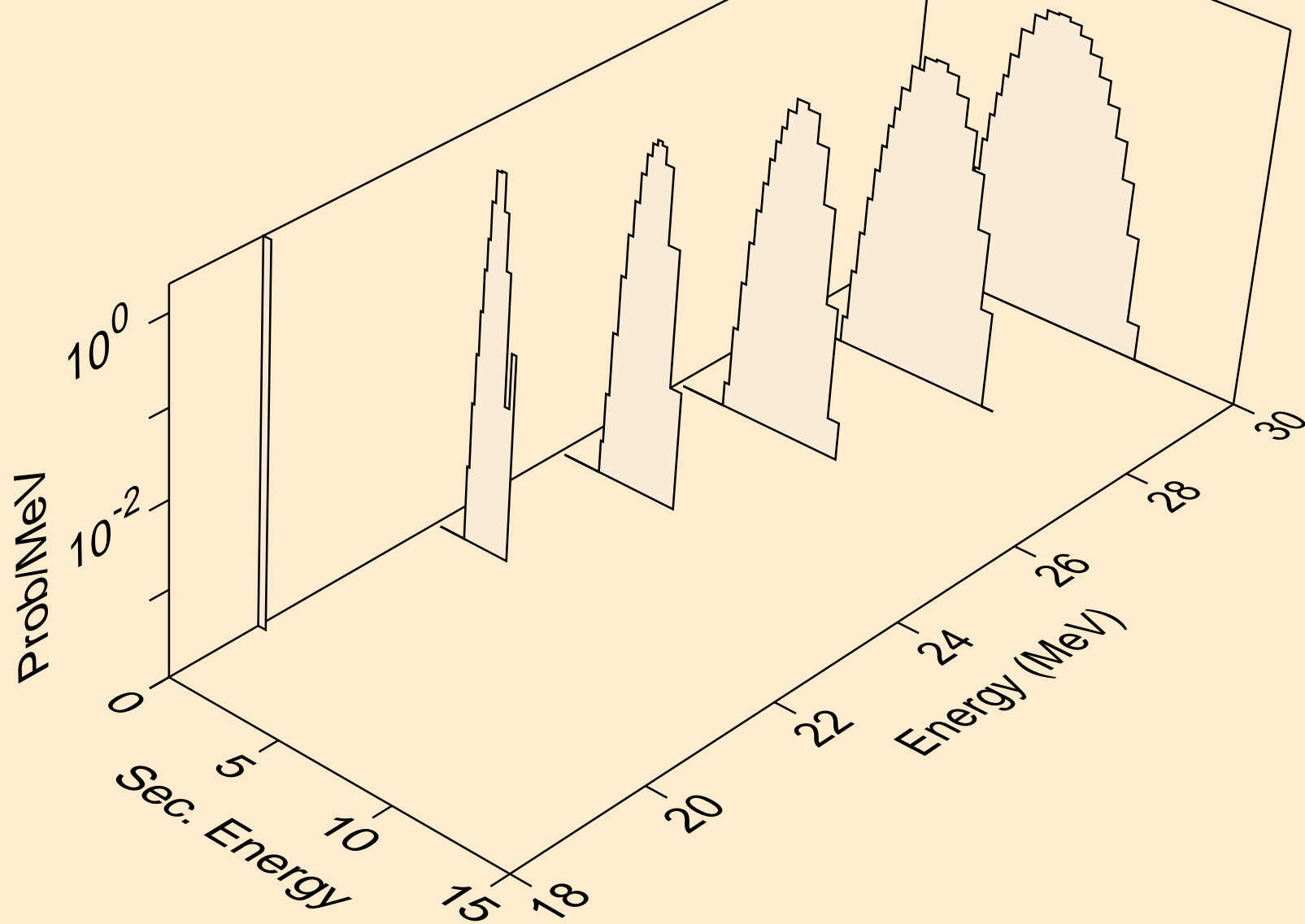

AU183 NEUTRON ACER TENDL-2021 LIBRARY; T=293.6K
protons from (n,2np)

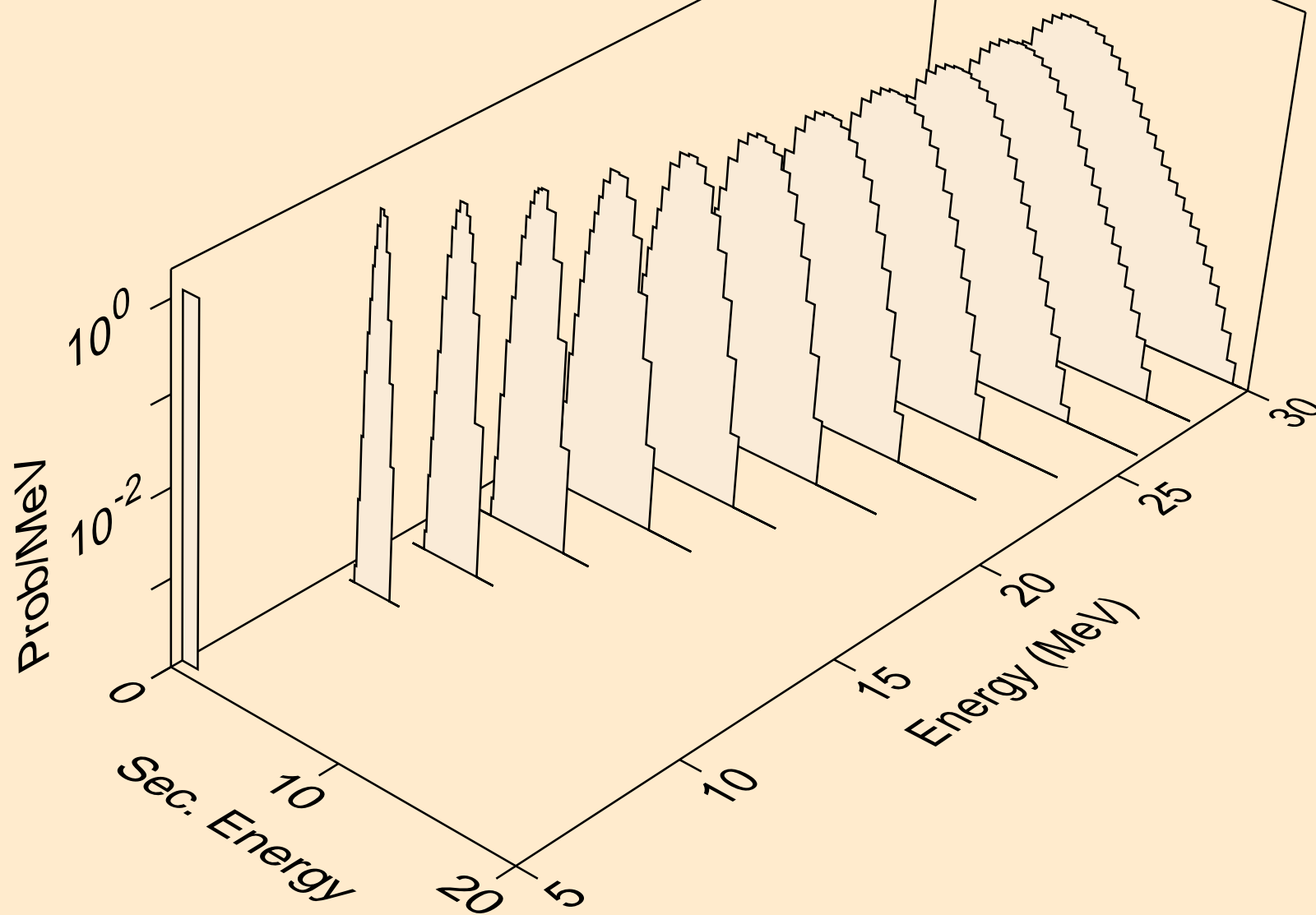

AU183 NEUTRON ACER TENDL-2021 LIBRARY; T=293.6K
protons from (n,npa)

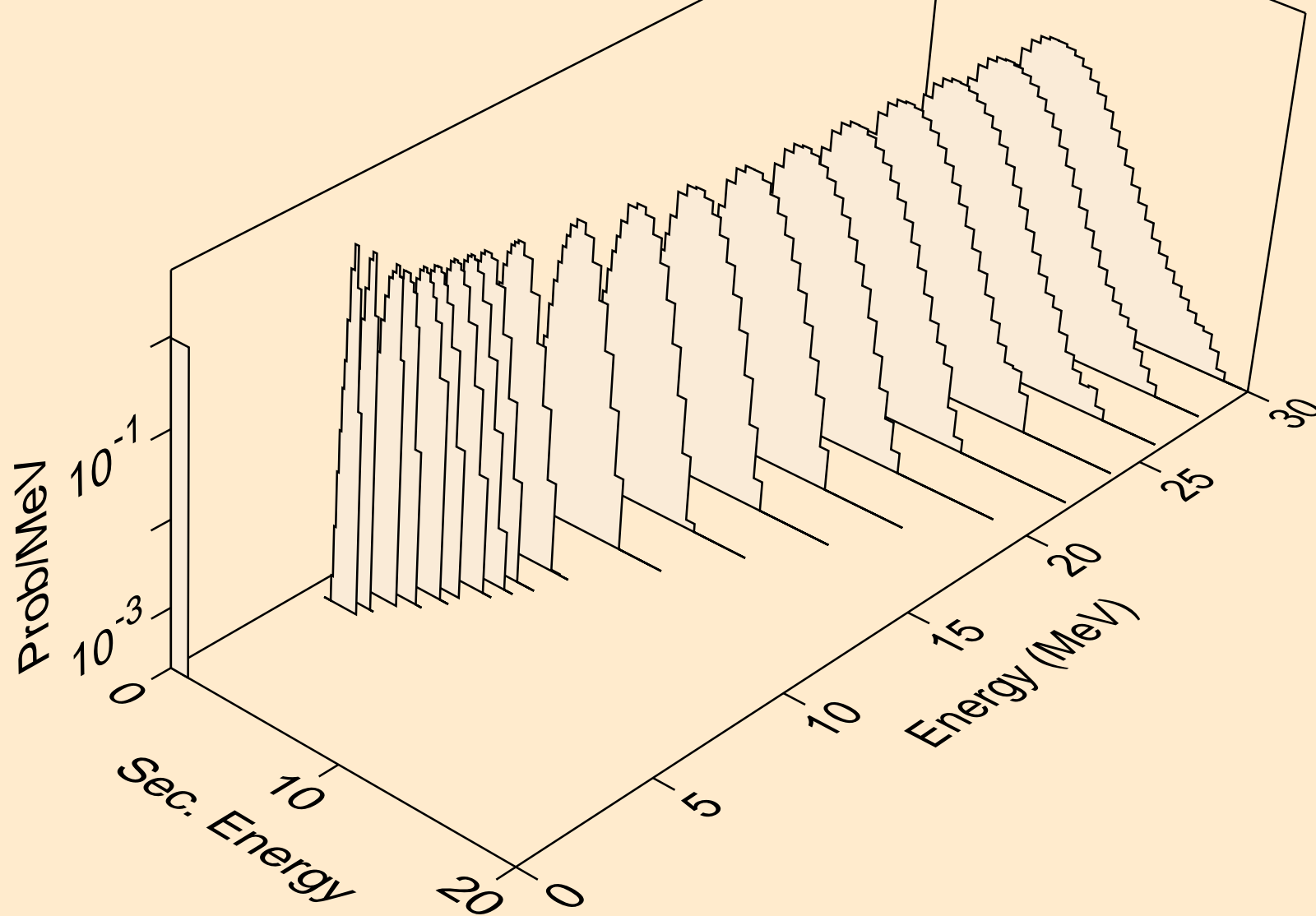

AU183 NEUTRON ACER TENDL-2021 LIBRARY; T=293.6K
protons from (n,p)

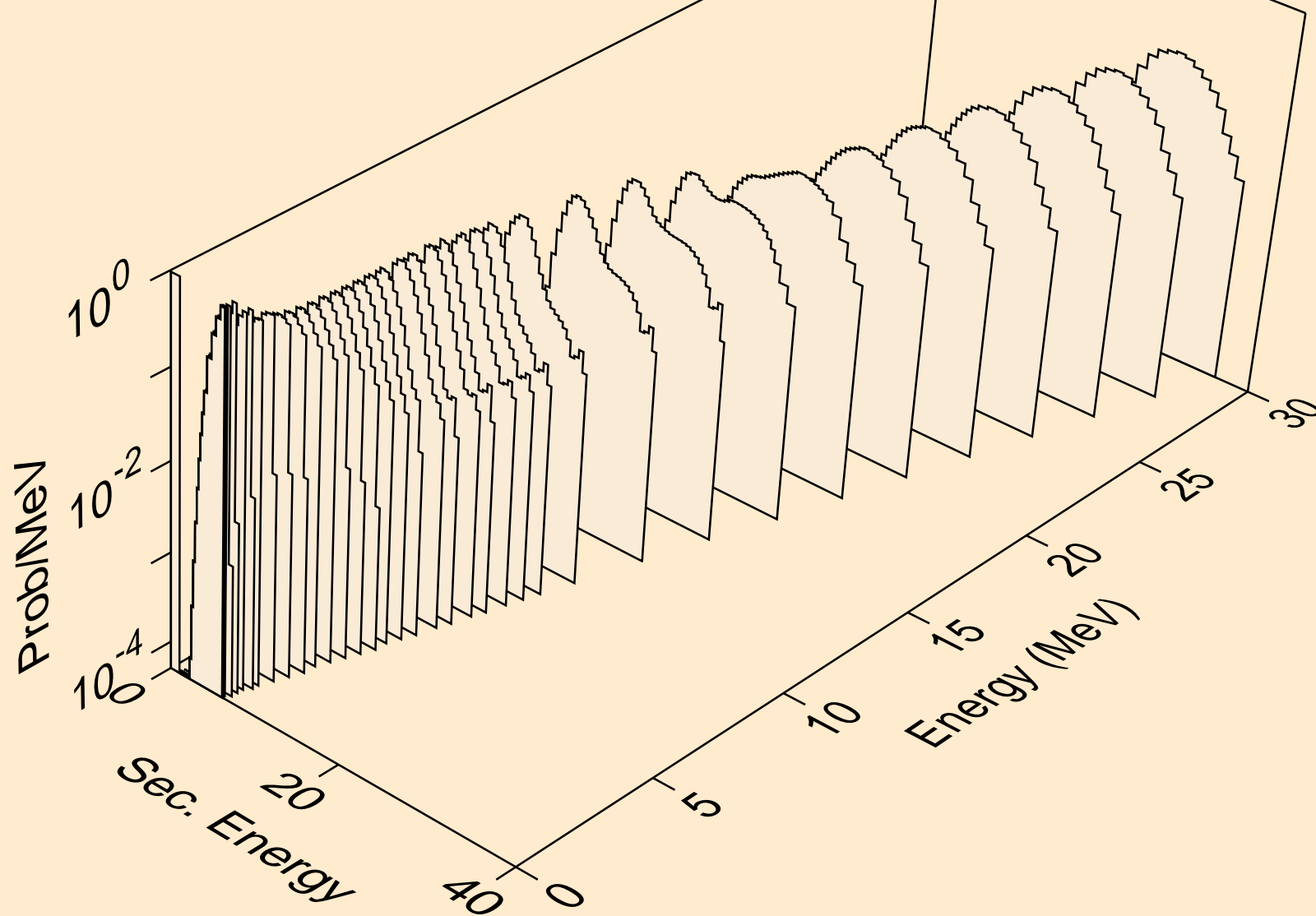

AU183 NEUTRON ACER TENDL-2021 LIBRARY; T=293.6K
protons from (n,2p)

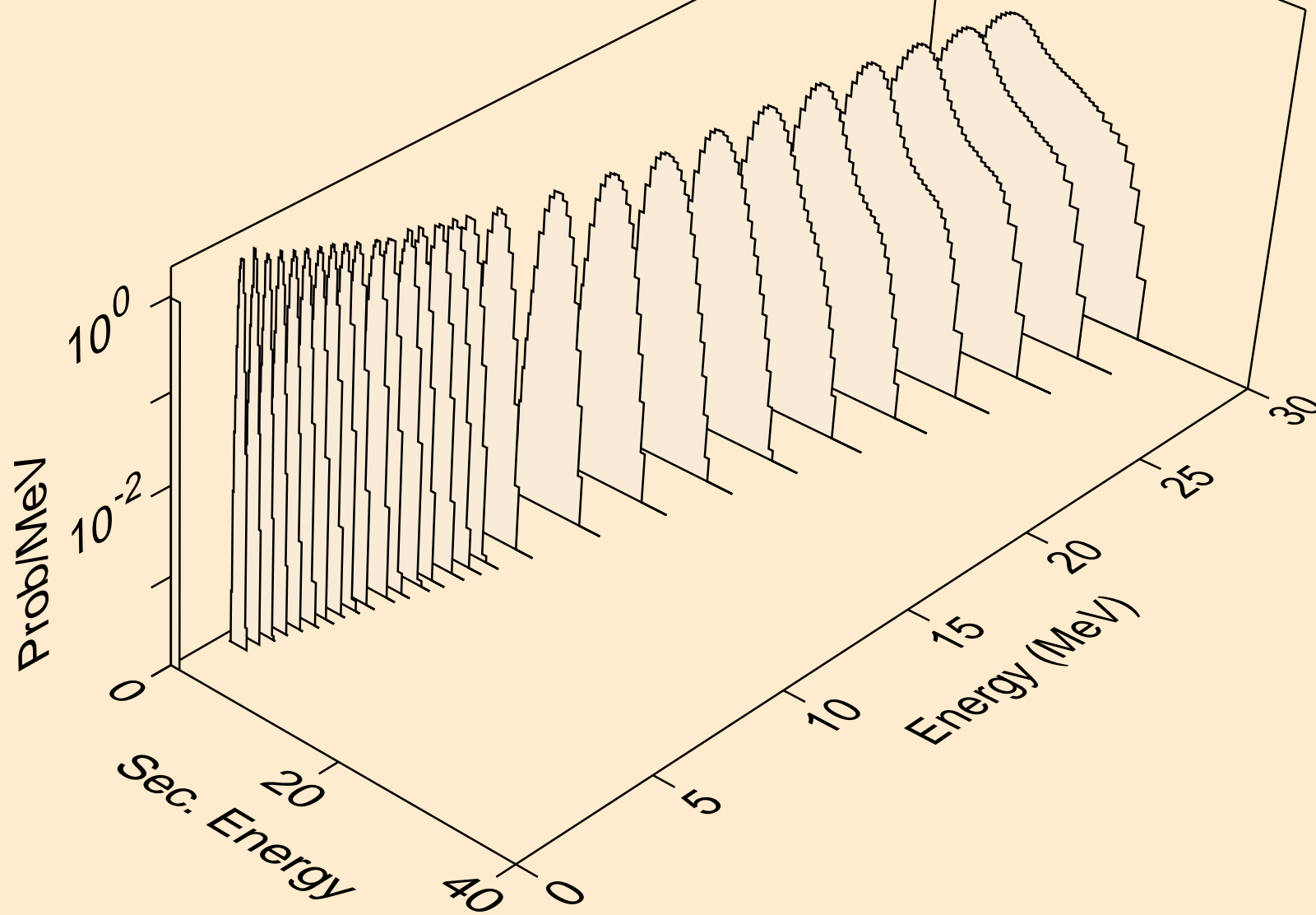

AU183 NEUTRON ACER TENDL-2021 LIBRARY; T=293.6K
protons from (n,p)

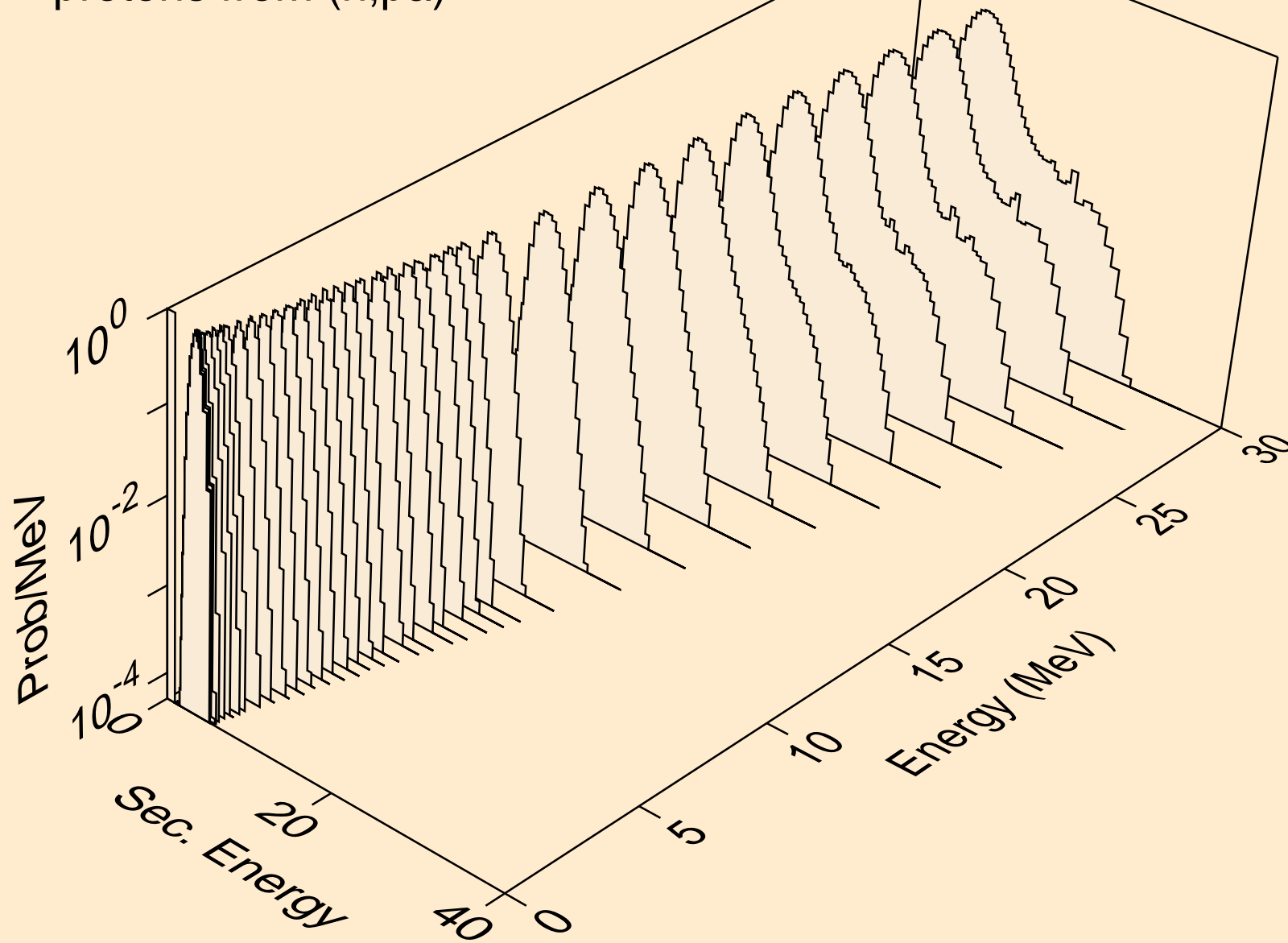

AU183 NEUTRON ACER TENDL-2021 LIBRARY; T=293.6K
protons from (n,pd)

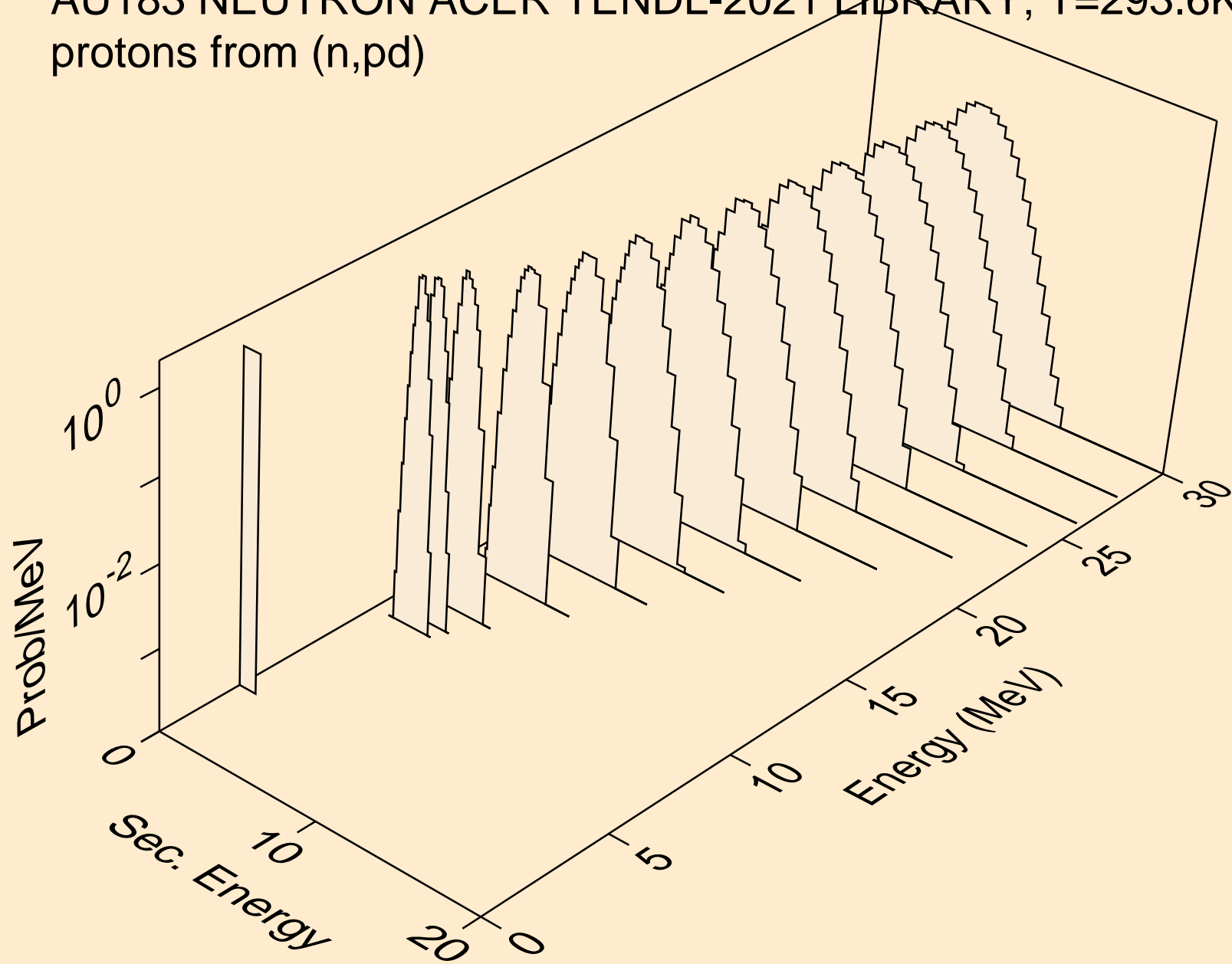

AU183 NEUTRON ACER TENDL-2021 LIBRARY; T=293.6K
protons from (n,pt)

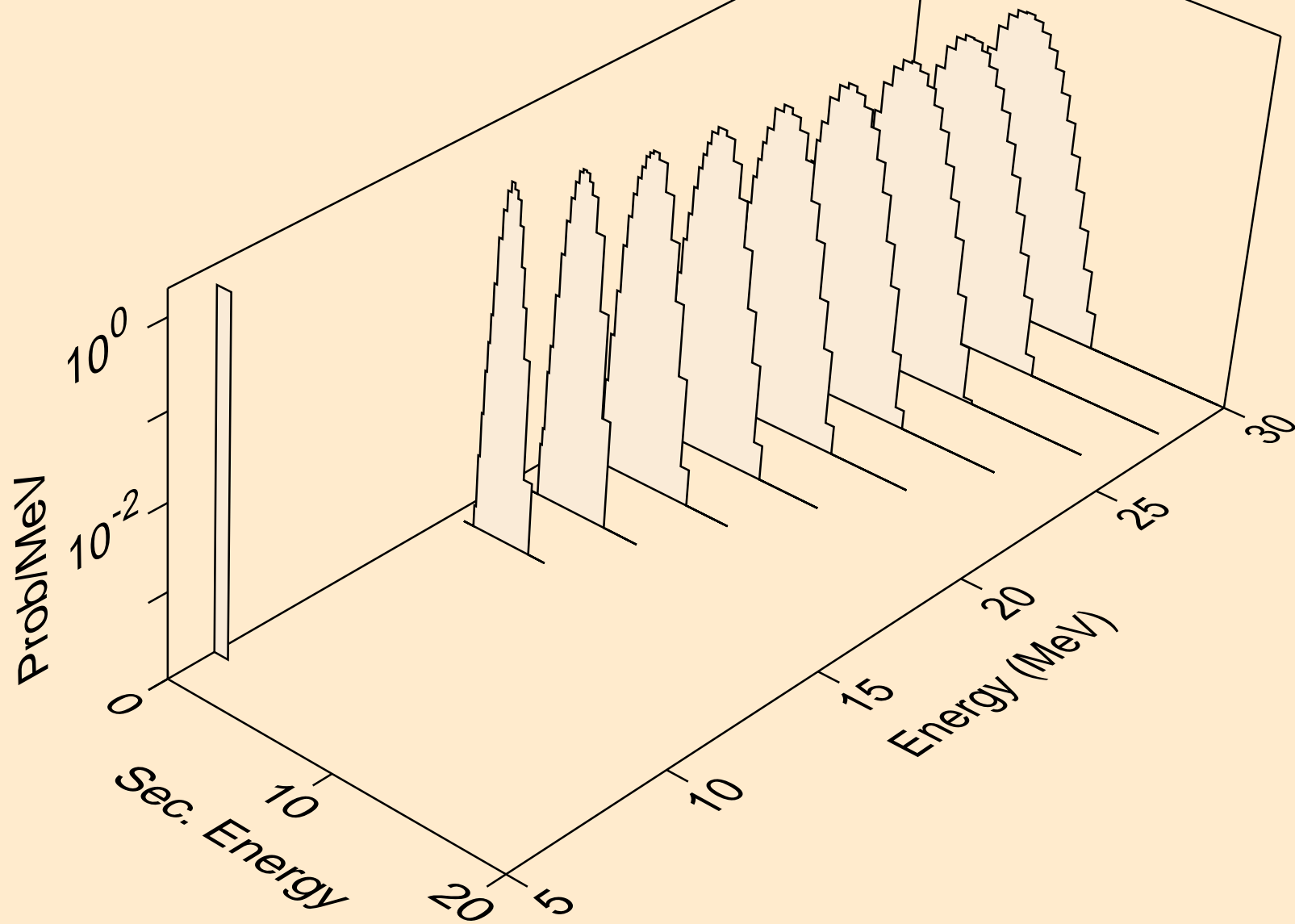

AU183 NEUTRON ACER TENDL-2021 LIBRARY; T=293.6K
deuterons from (n,x)

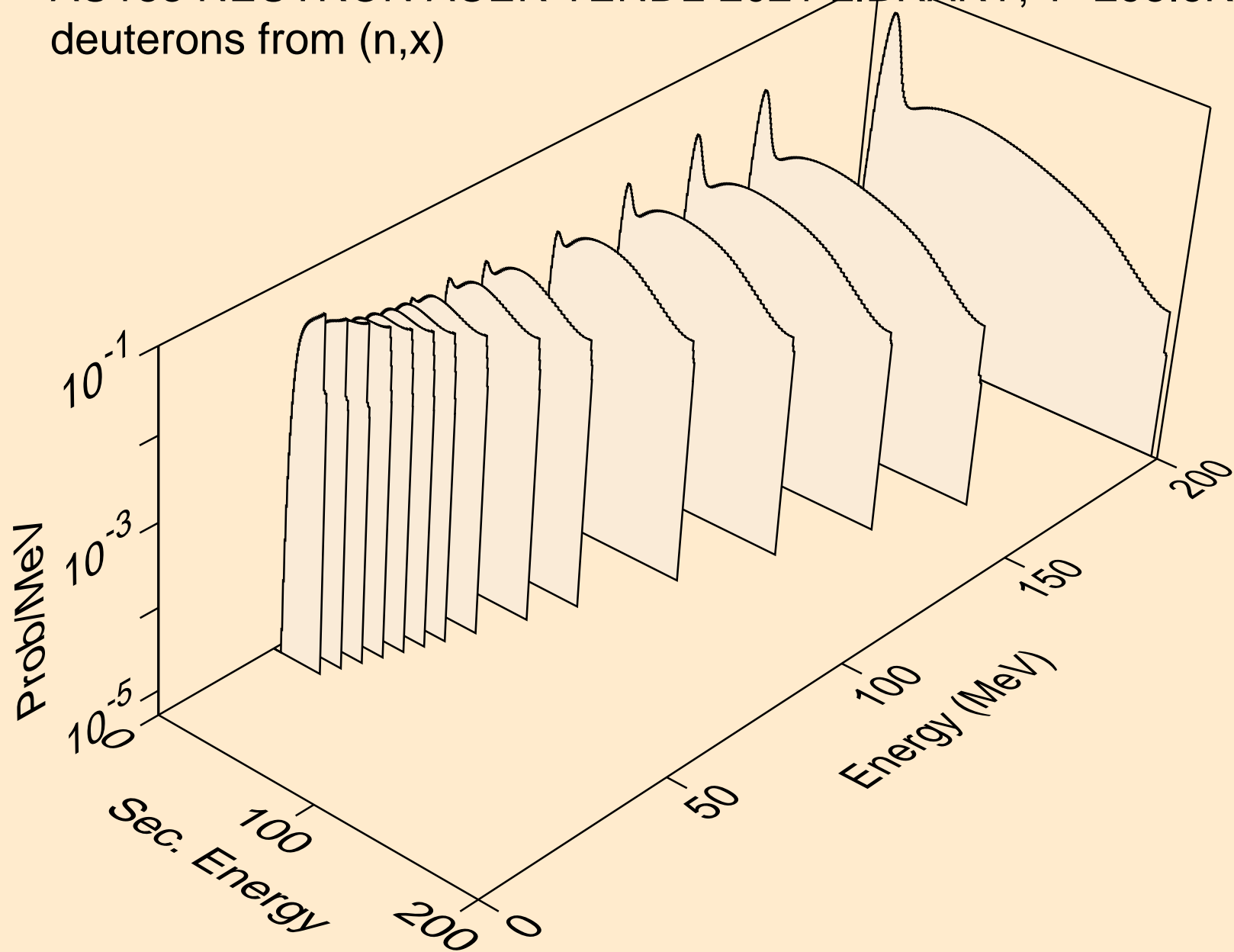

AU183 NEUTRON ACER TENDL-2021 LIBRARY; T=293.6K
deuterons from (n,2nd)

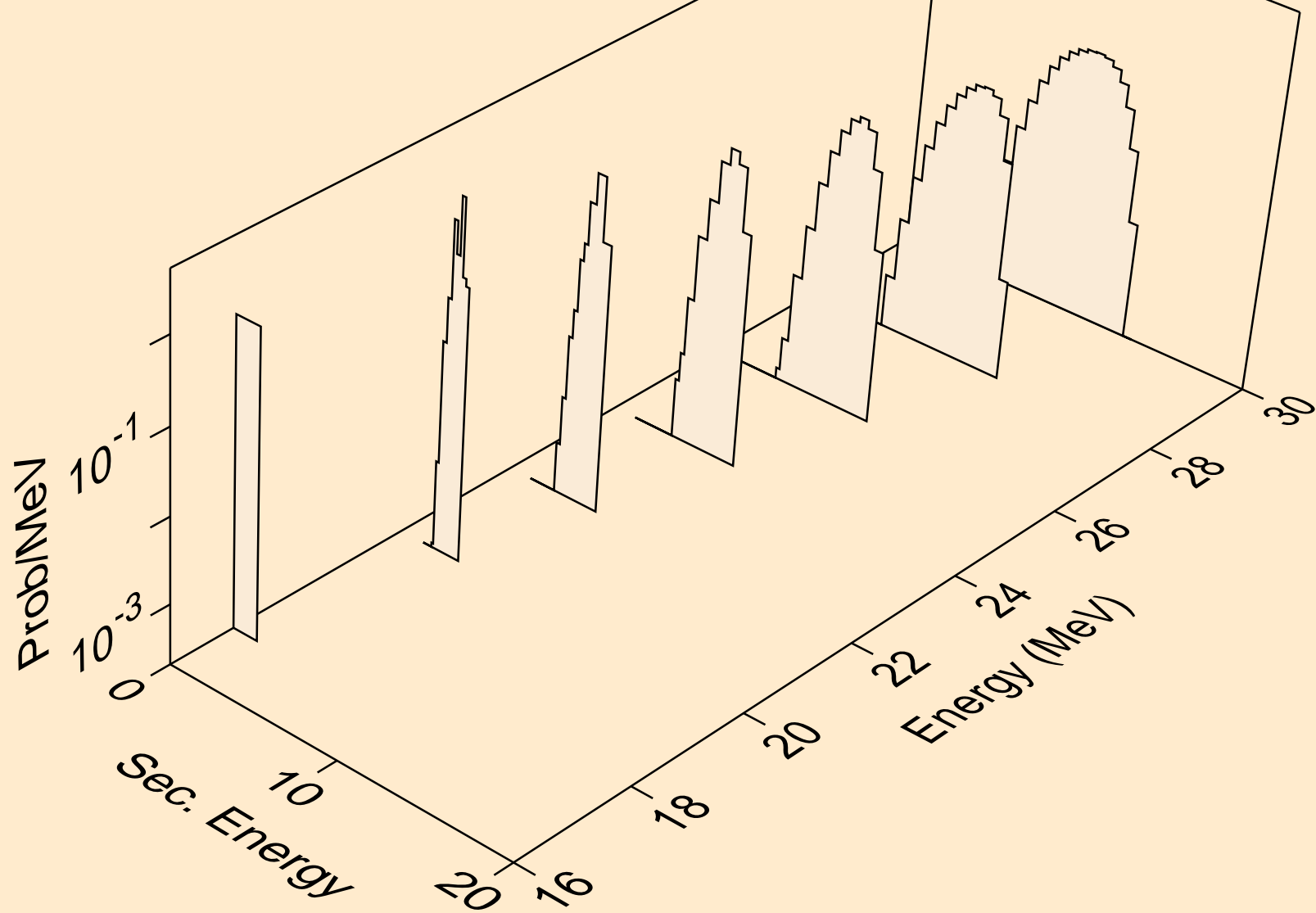

AU183 NEUTRON ACER TENDL-2021 LIBRARY; T=293.6K
deuterons from (n,n*)d

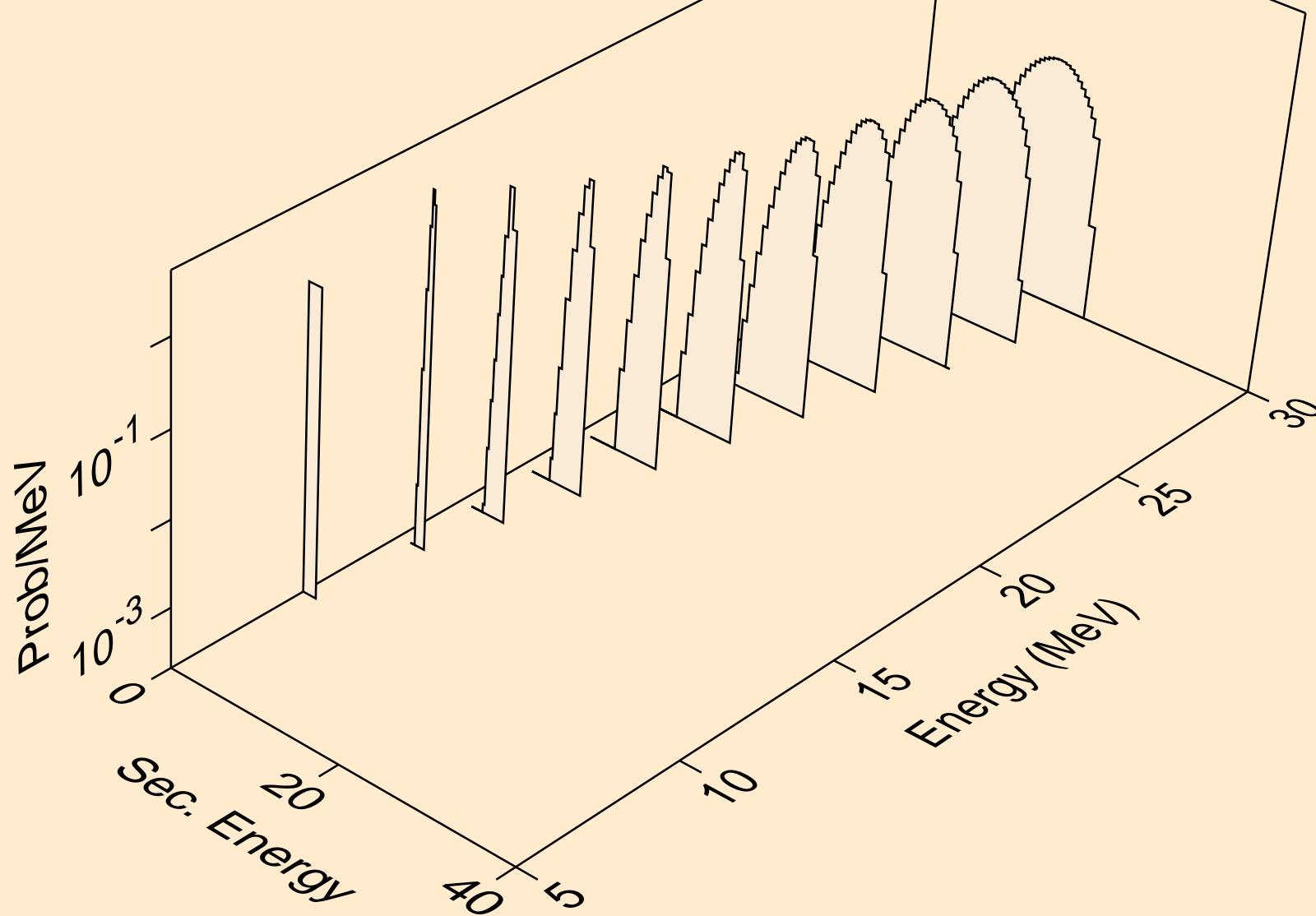

AU183 NEUTRON ACER TENDL-2021 LIBRARY; T=293.6K
deuterons from (n,d)

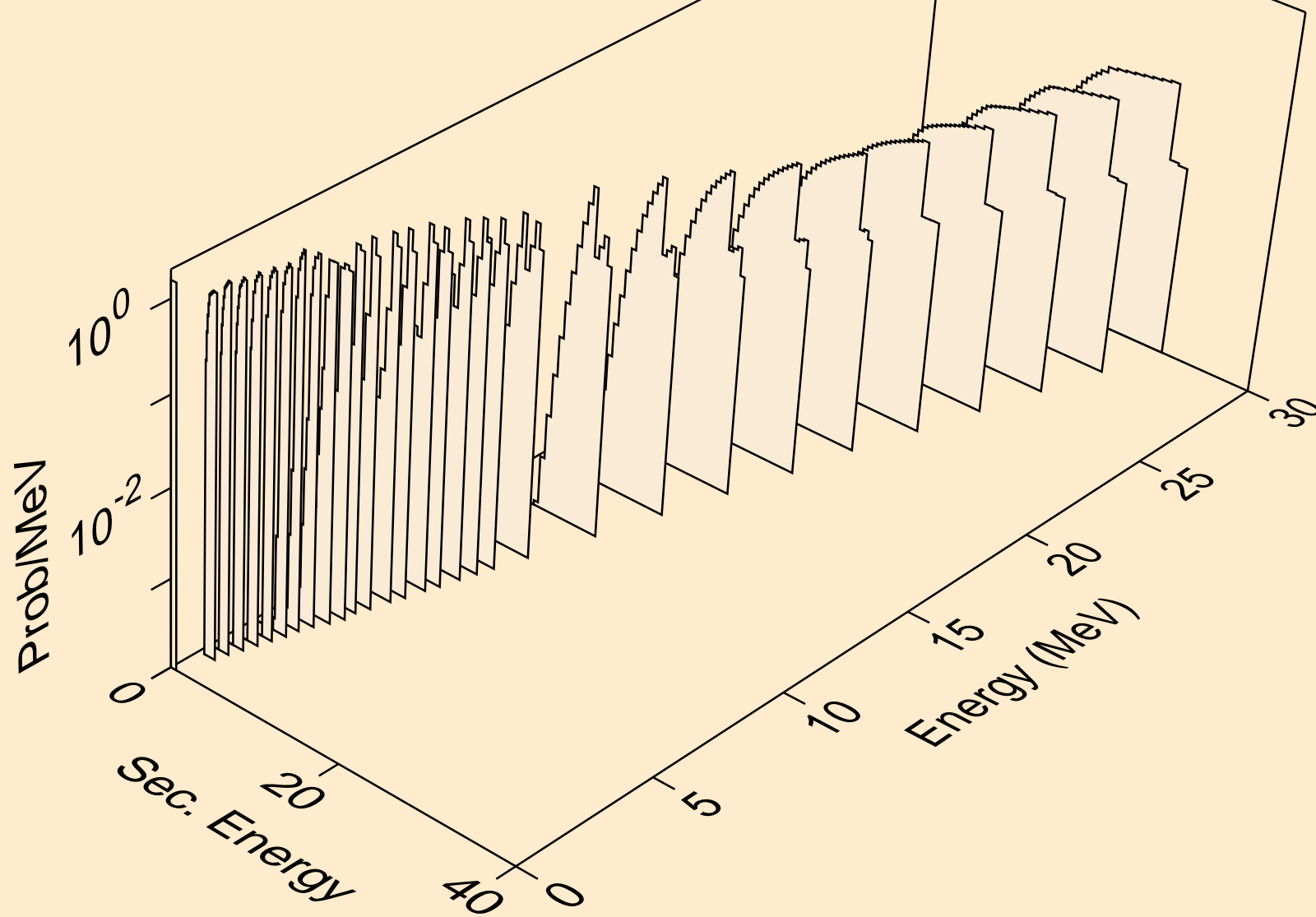

AU183 NEUTRON ACER TENDL-2021 LIBRARY; T=293.6K
deuterons from (n,pd)

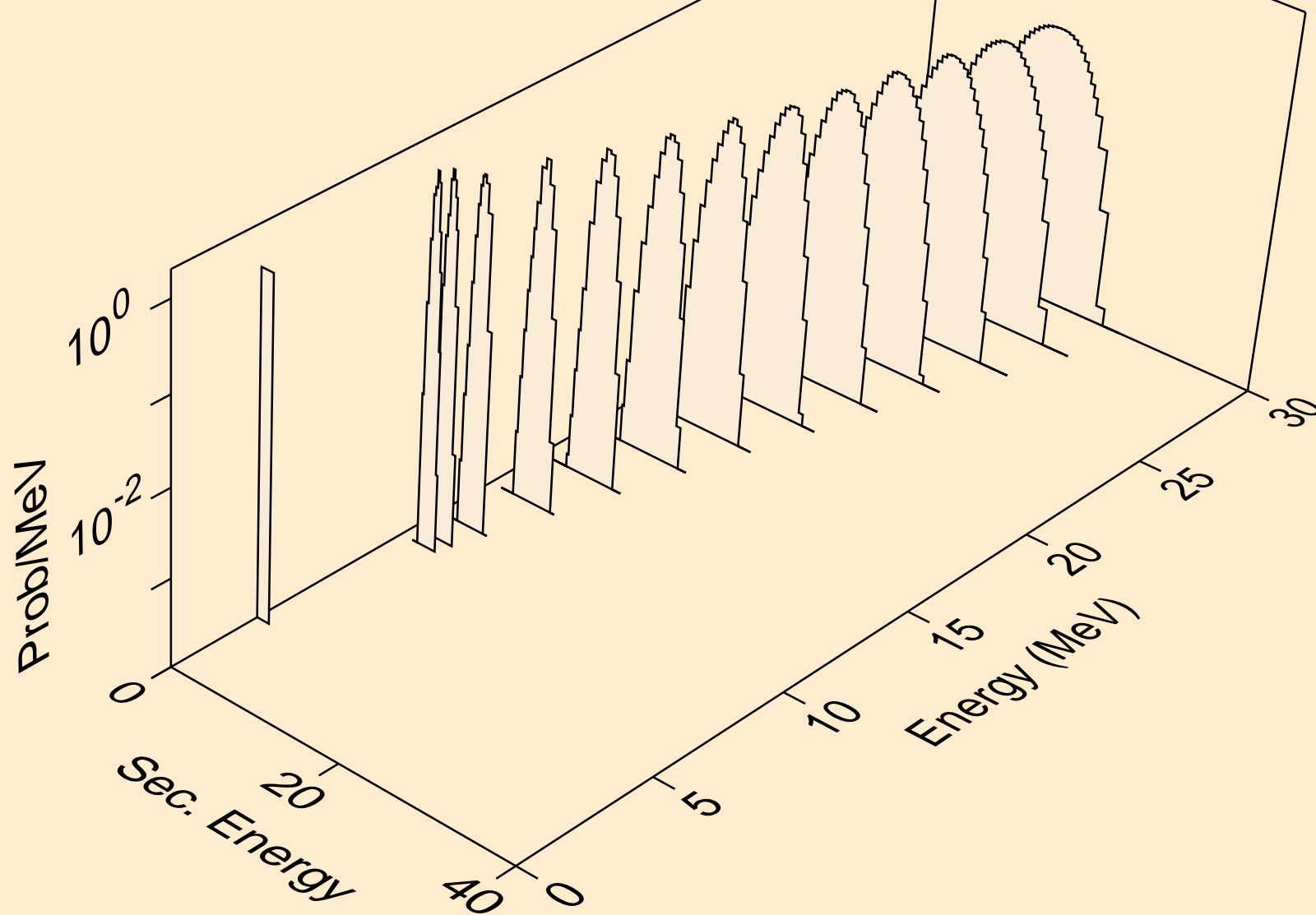

AU183 NEUTRON ACER TENDL-2021 LIBRARY; T=293.6K
deuterons from (n,da)

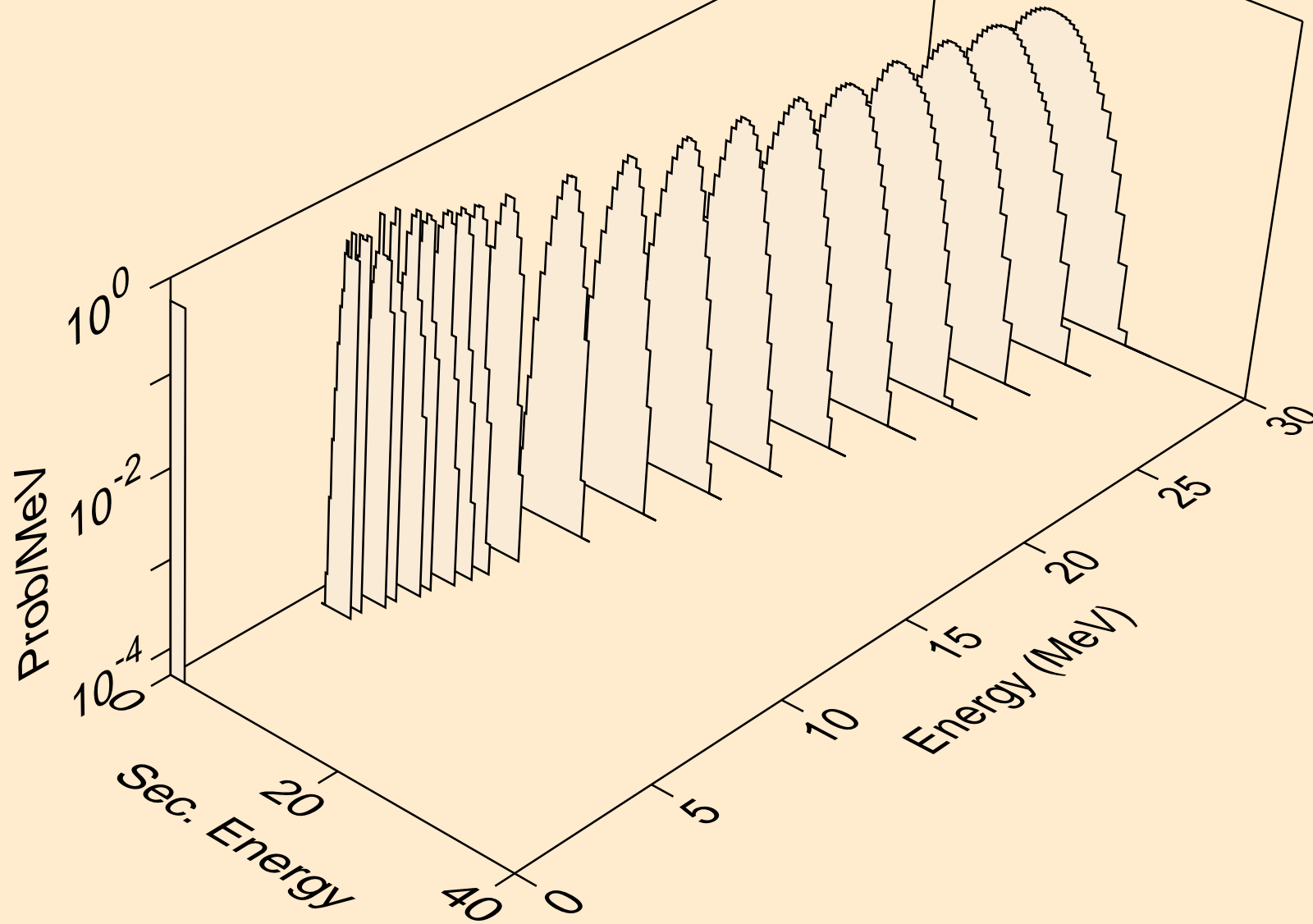

AU183 NEUTRON ACER TENDL-2021 LIBRARY; T=293.6K
tritons from (n,x)

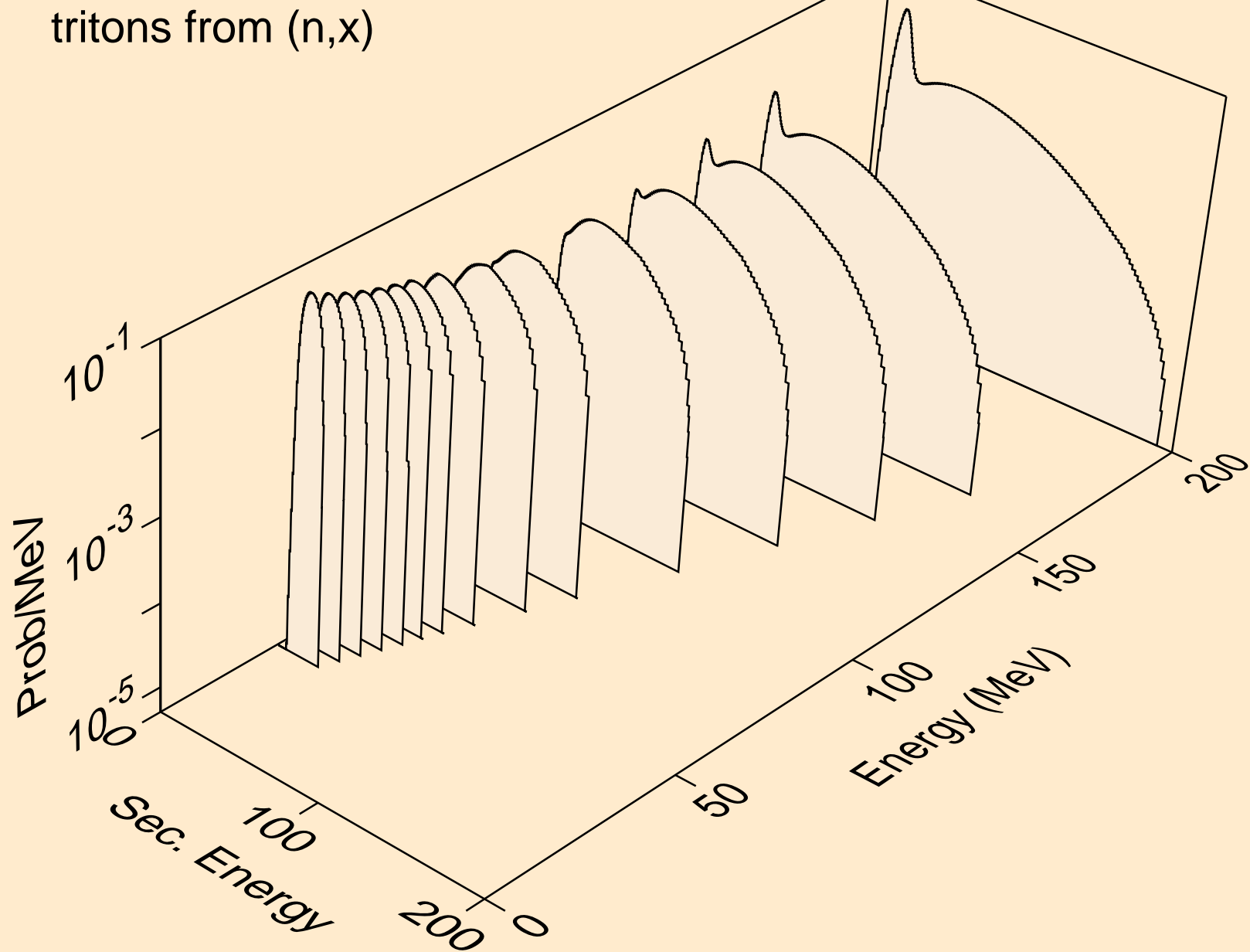

AU183 NEUTRON ACER TENDL-2021 LIBRARY; T=293.6K
tritons from (n,n*)t

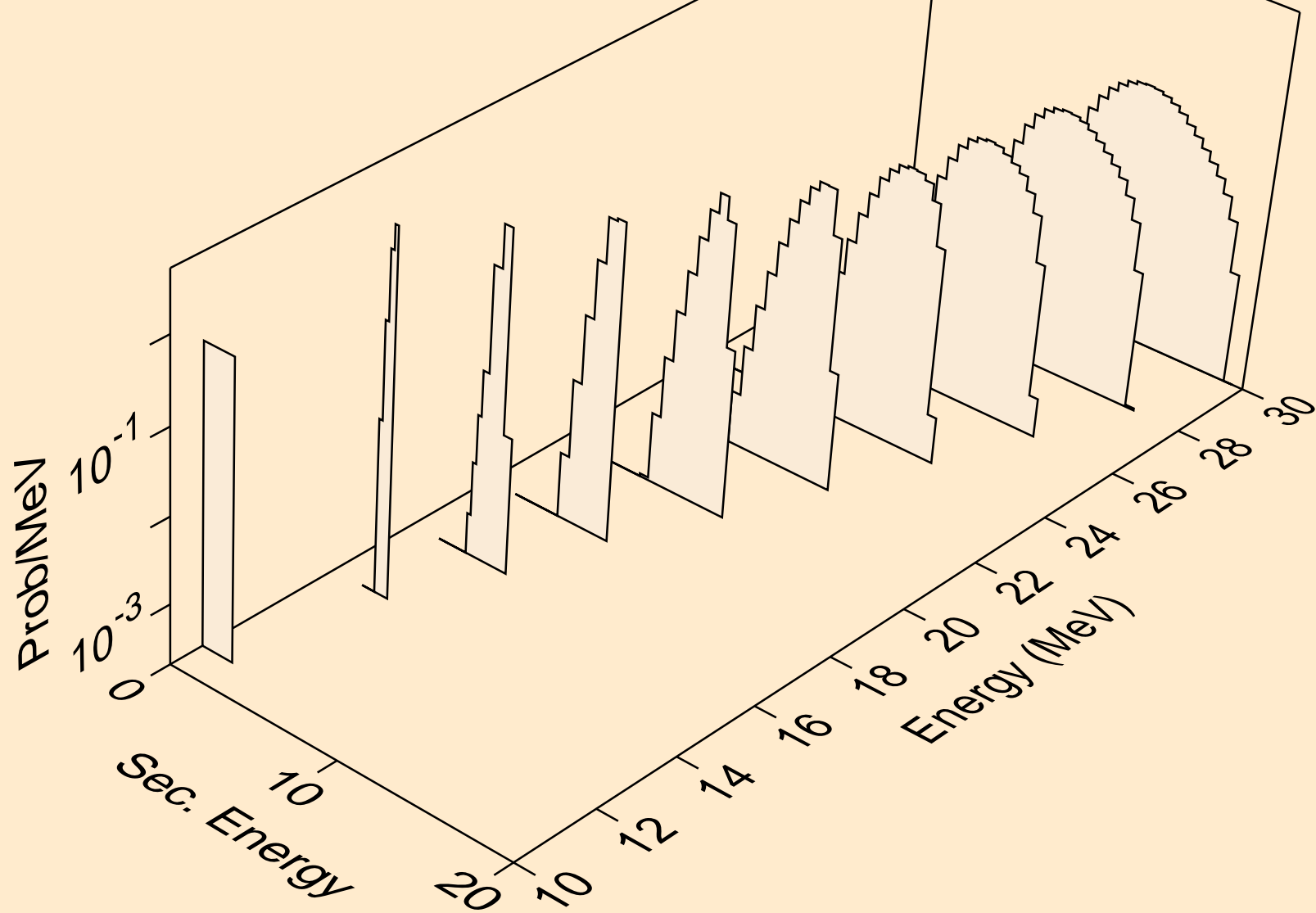

AU183 NEUTRON ACER TENDL-2021 LIBRARY; T=293.6K
tritons from (n,t)

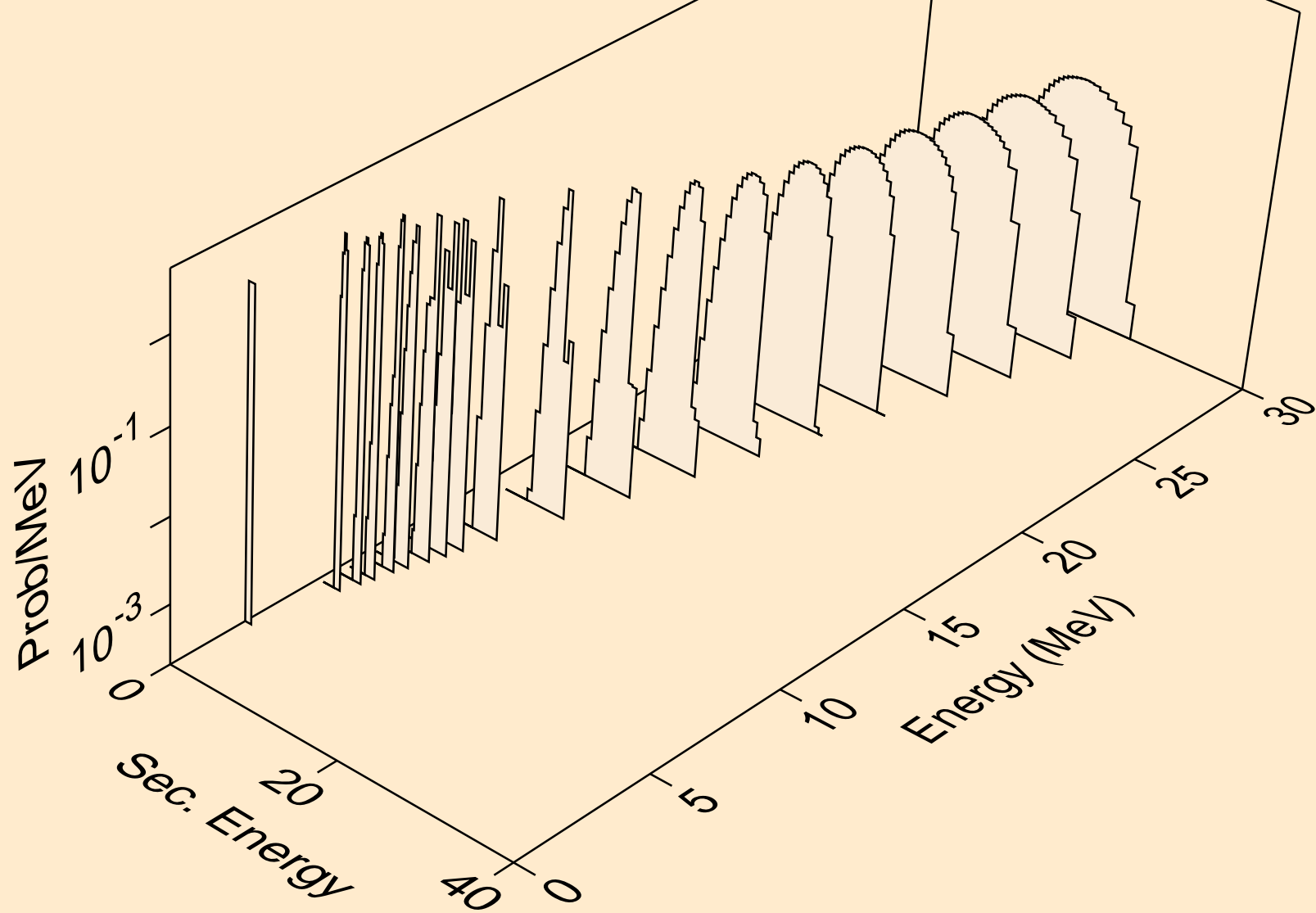

AU183 NEUTRON ACER TENDL-2021 LIBRARY; T=293.6K
tritons from (n,pt)

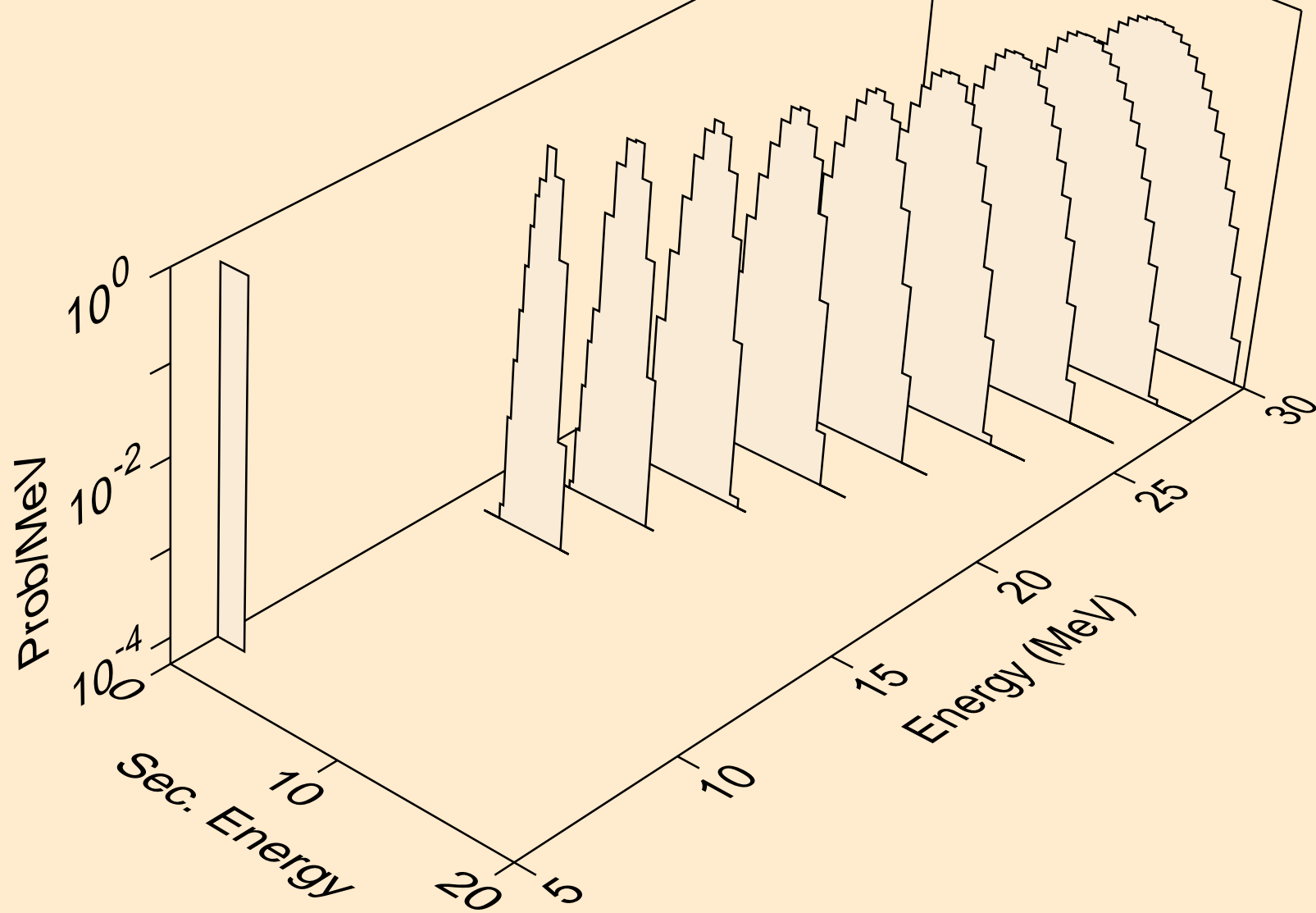

AU183 NEUTRON ACER TENDL-2021 LIBRARY; T=293.6K
he3s from (n,x)

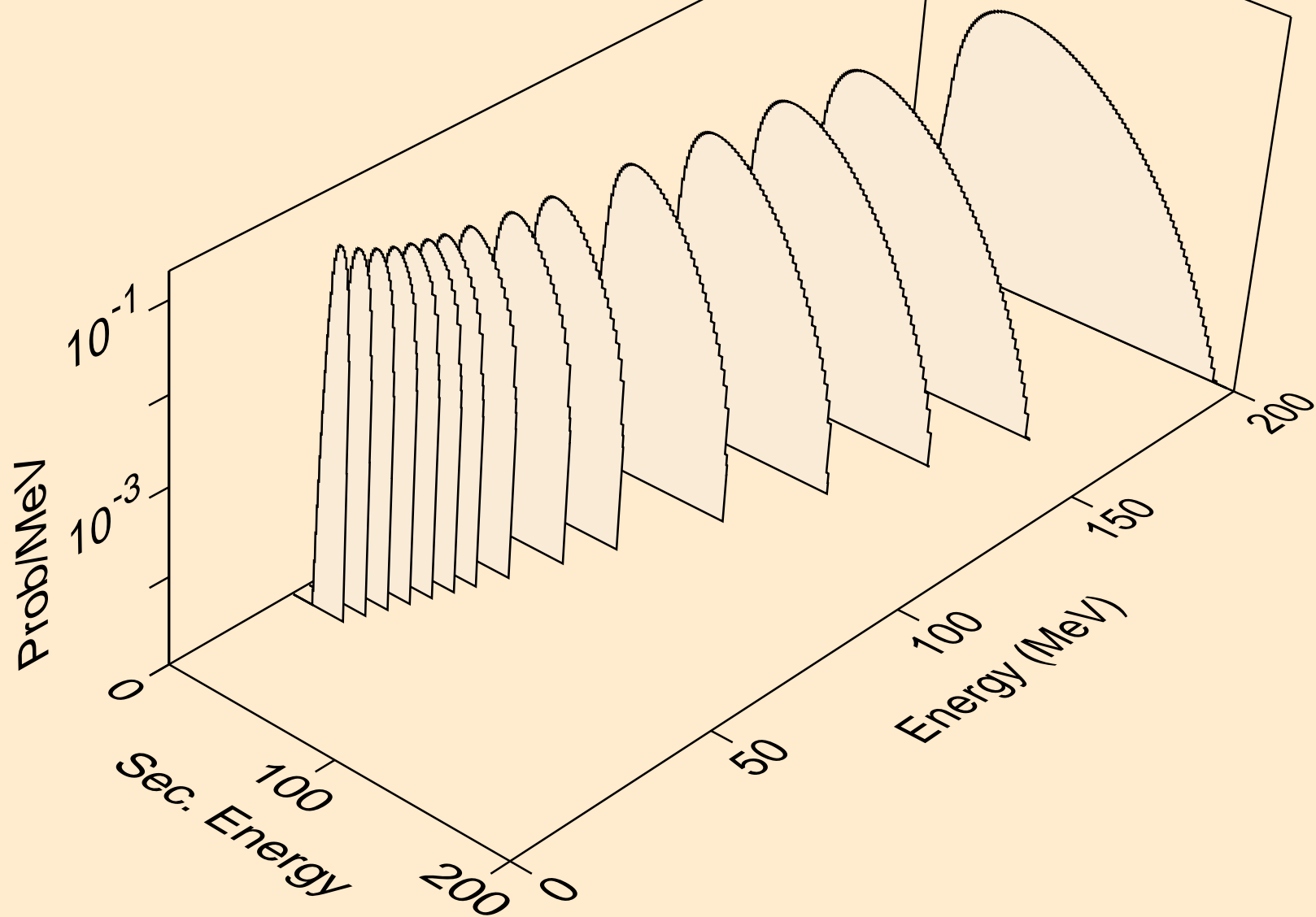

AU183 NEUTRON ACER TENDL-2021 LIBRARY; T=293.6K
he3s from (n,n*)he3

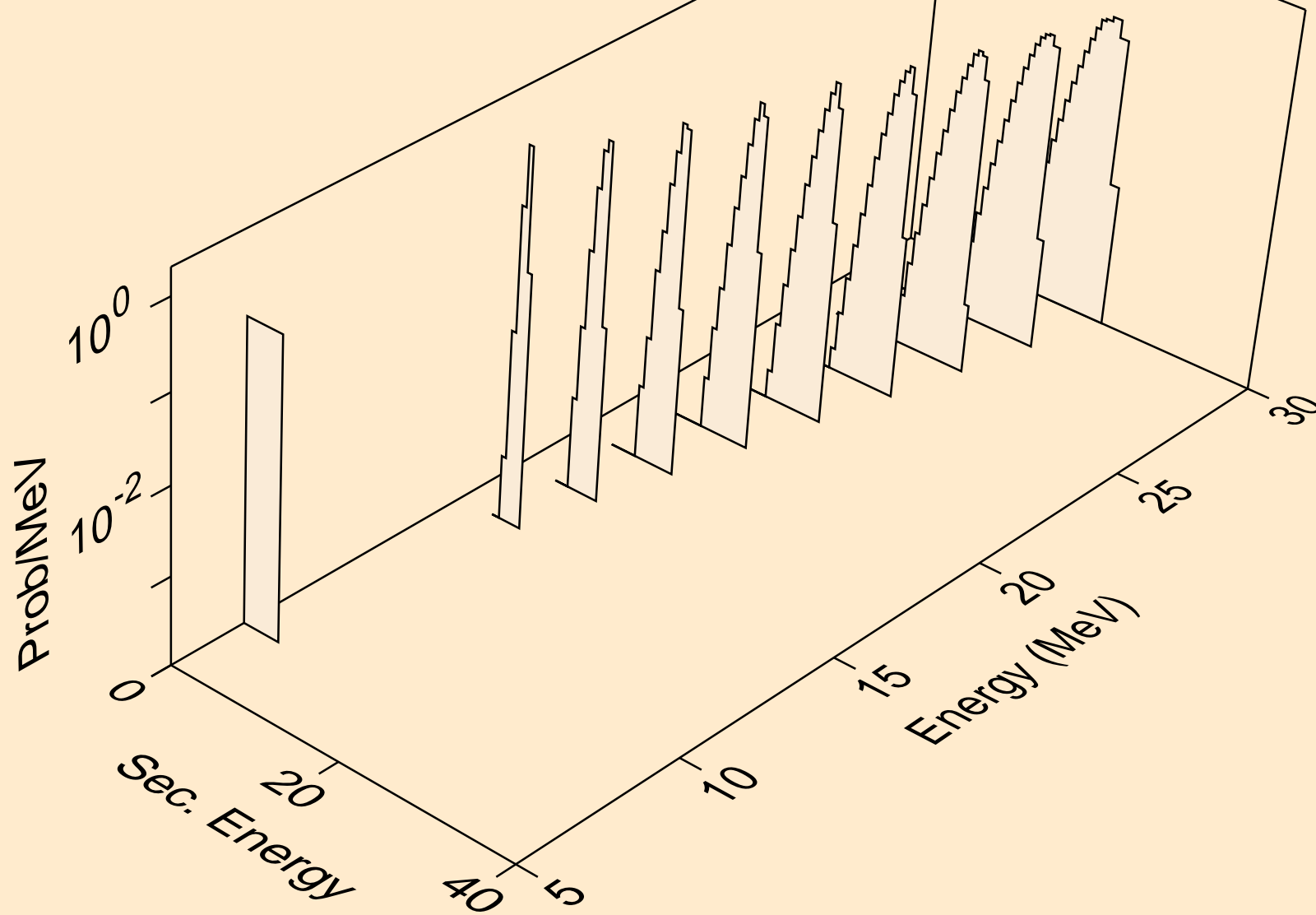

AU183 NEUTRON ACER TENDL-2021 LIBRARY; T=293.6K
he3s from (n,he3)

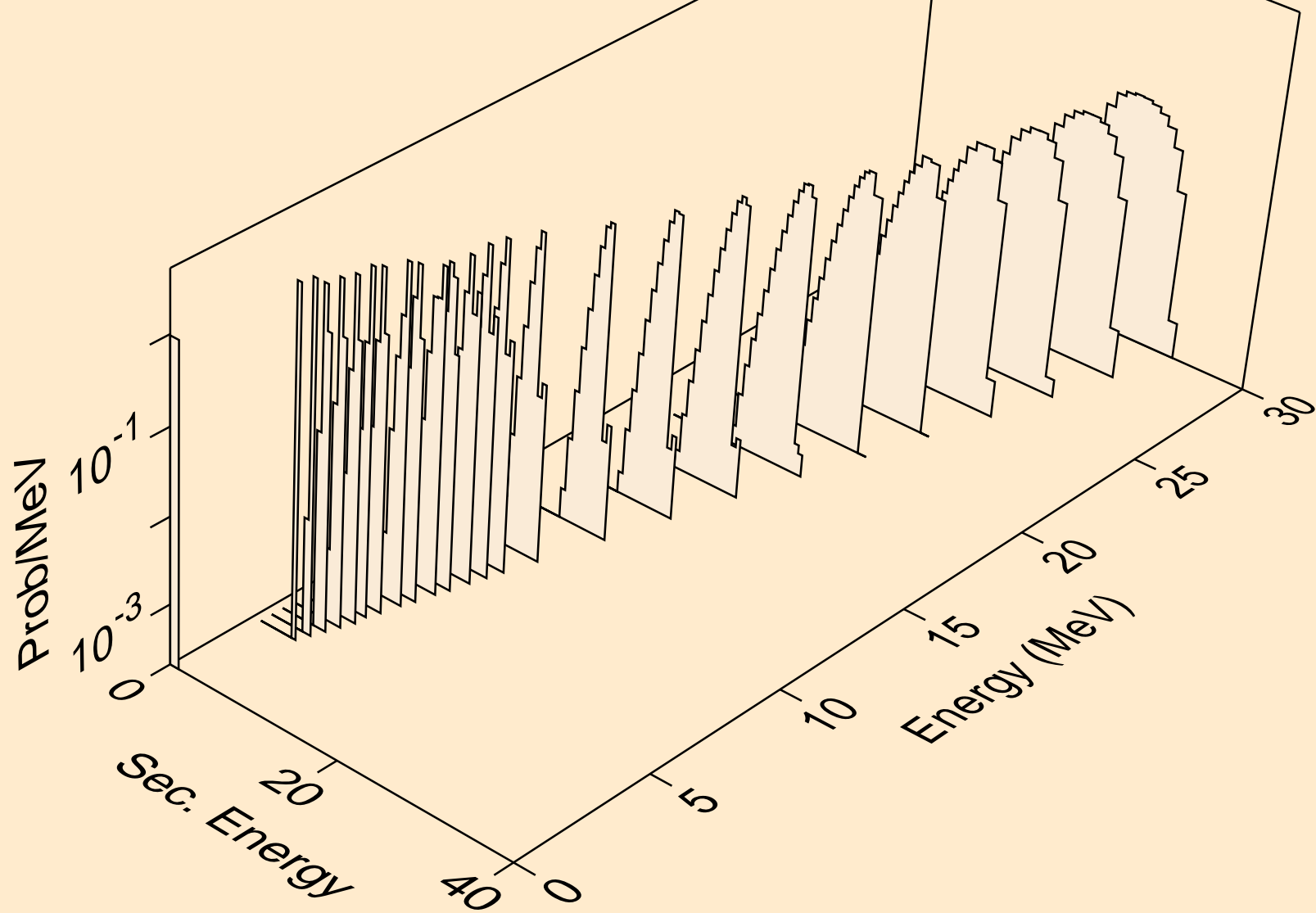

AU183 NEUTRON ACER TENDL-2021 LIBRARY; T=293.6K
alphas from (n,x)

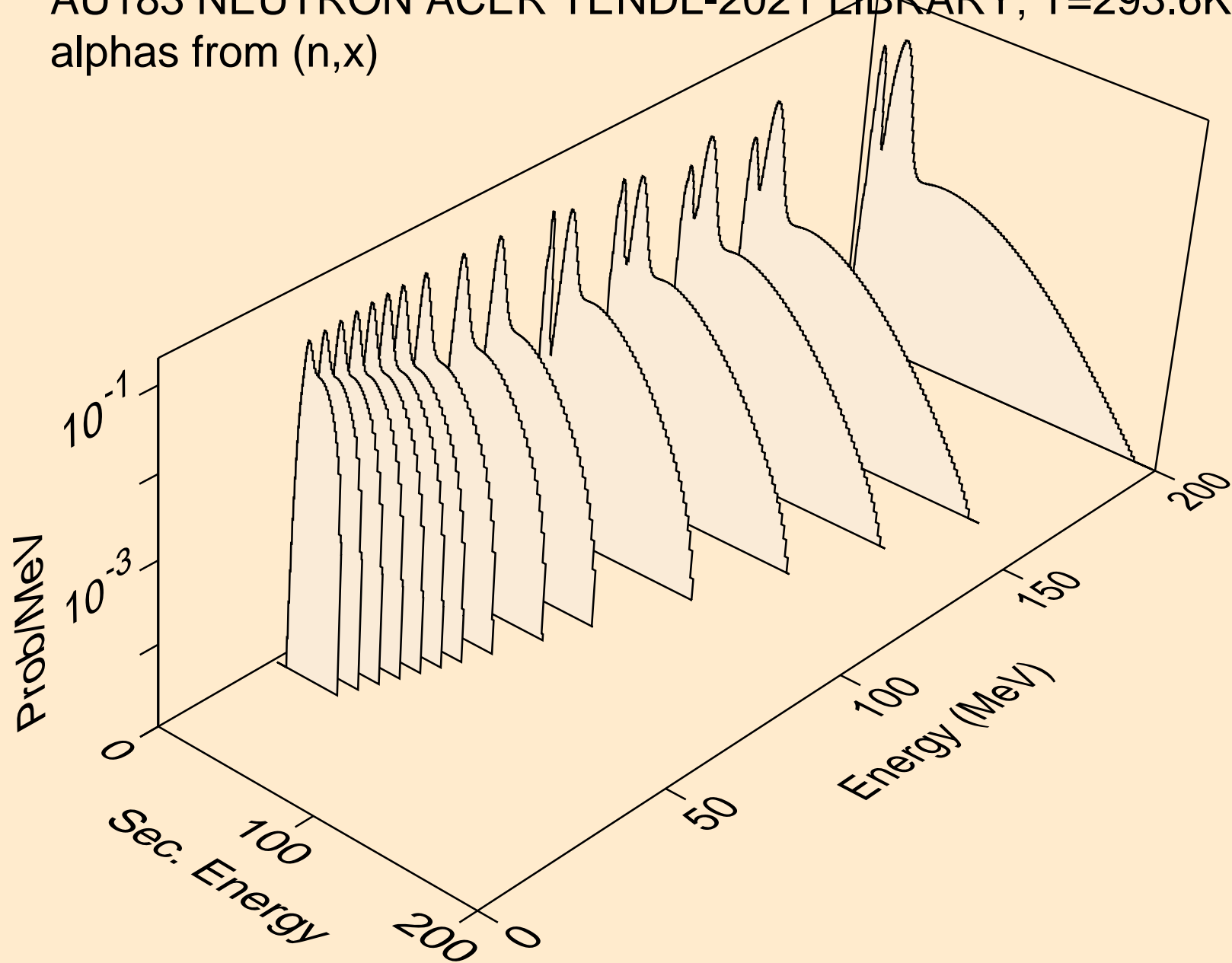

AU183 NEUTRON ACER TENDL-2021 LIBRARY; T=293.6K
alphas from (n,n*)a

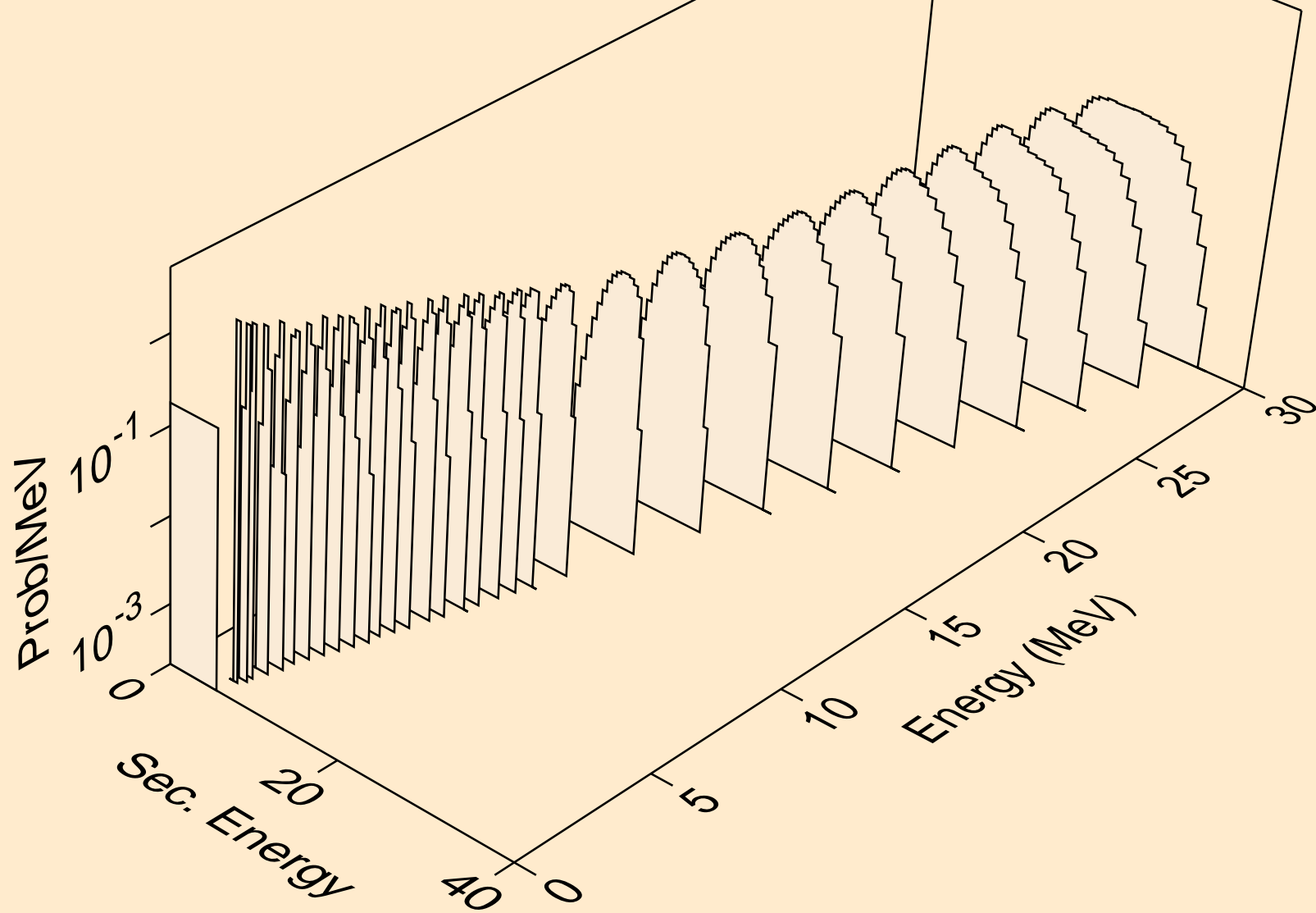

AU183 NEUTRON ACER TENDL-2021 LIBRARY; T=293.6K
alphas from (n,2n)a

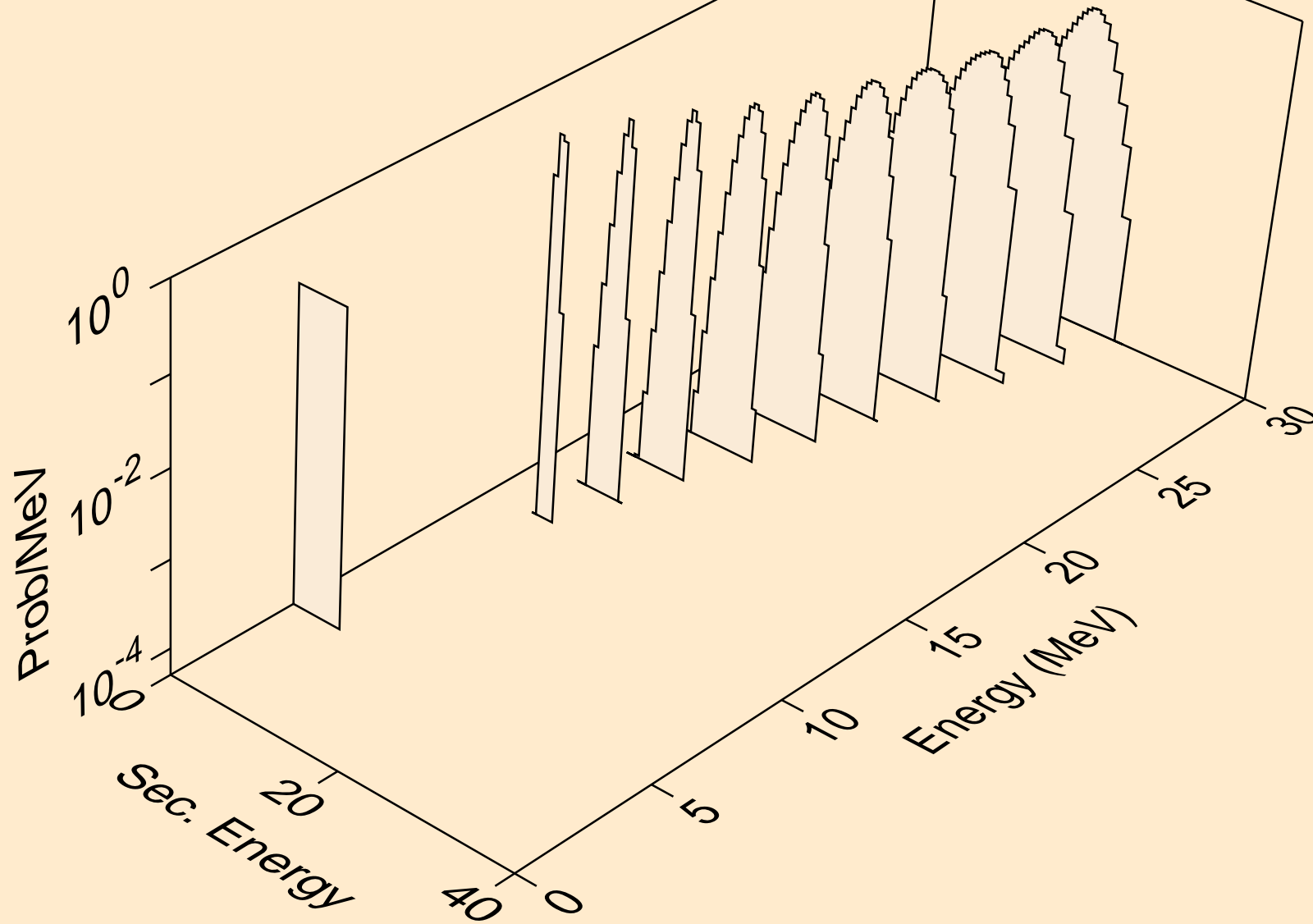

AU183 NEUTRON ACER TENDL-2021 LIBRARY; T=293.6K
alphas from (n,3n)a

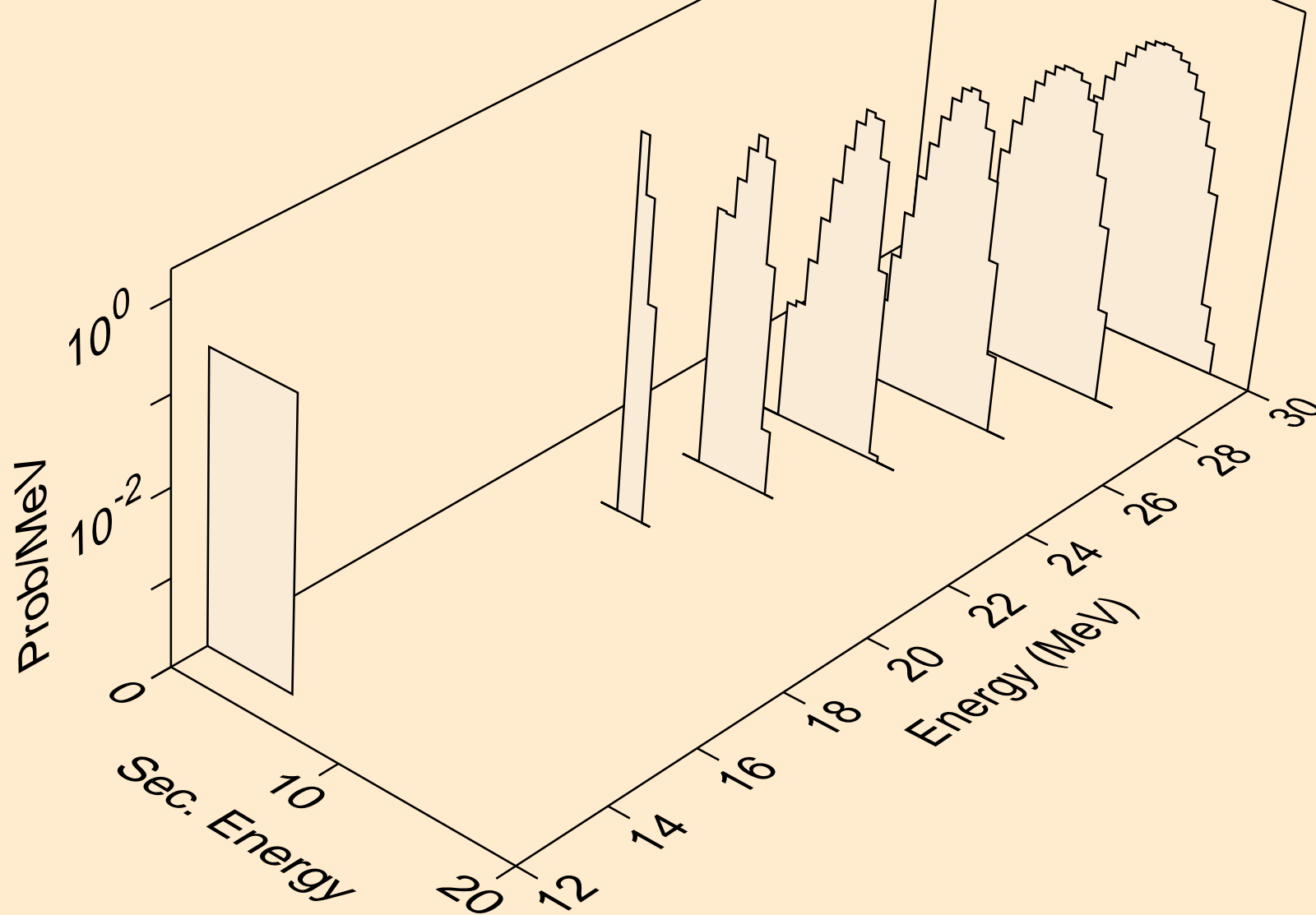

AU183 NEUTRON ACER TENDL-2021 LIBRARY; T=293.6K
alphas from (n,n*)2a

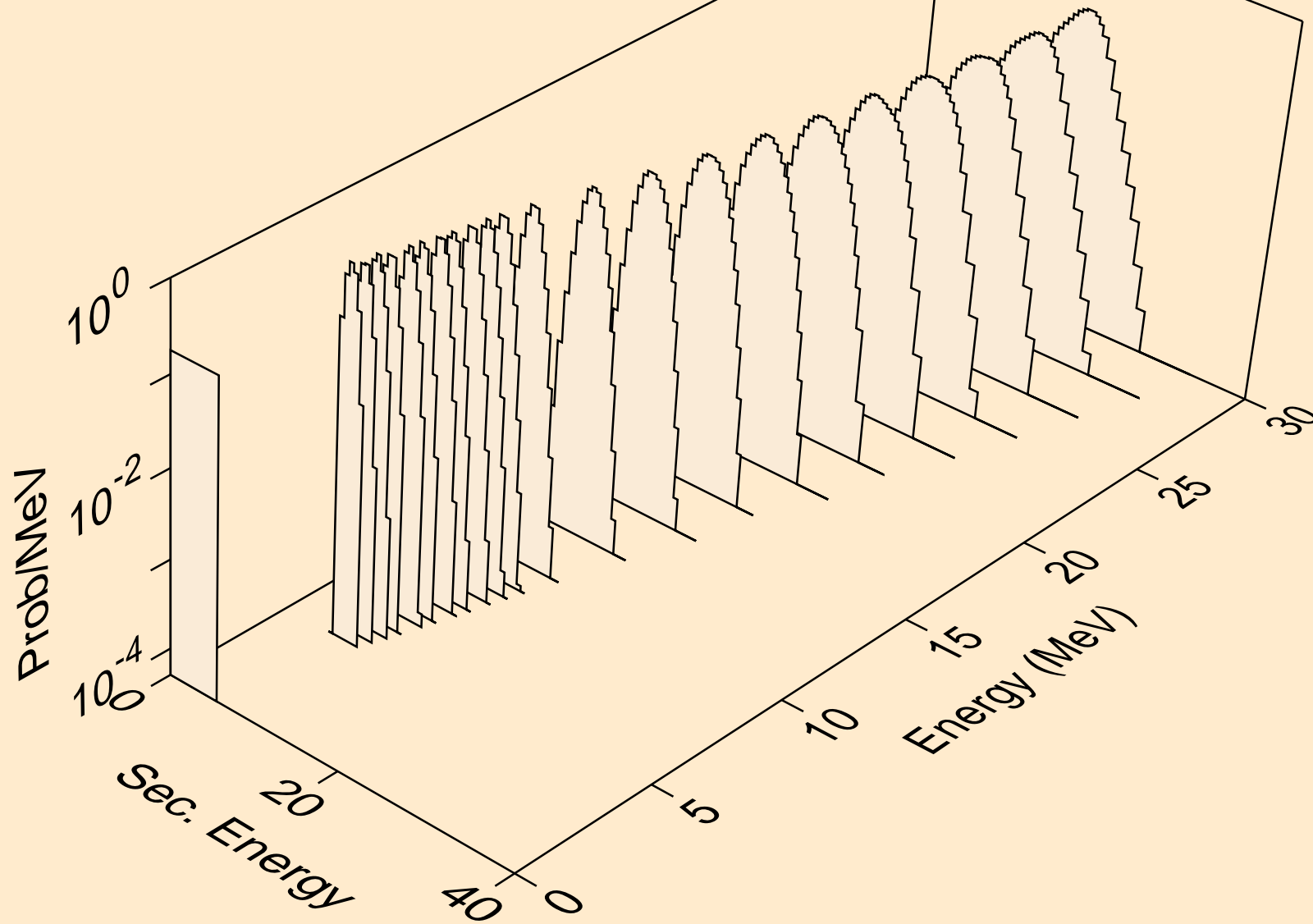

AU183 NEUTRON ACER TENDL-2021 LIBRARY; T=293.6K
alphas from (n,2n)2a

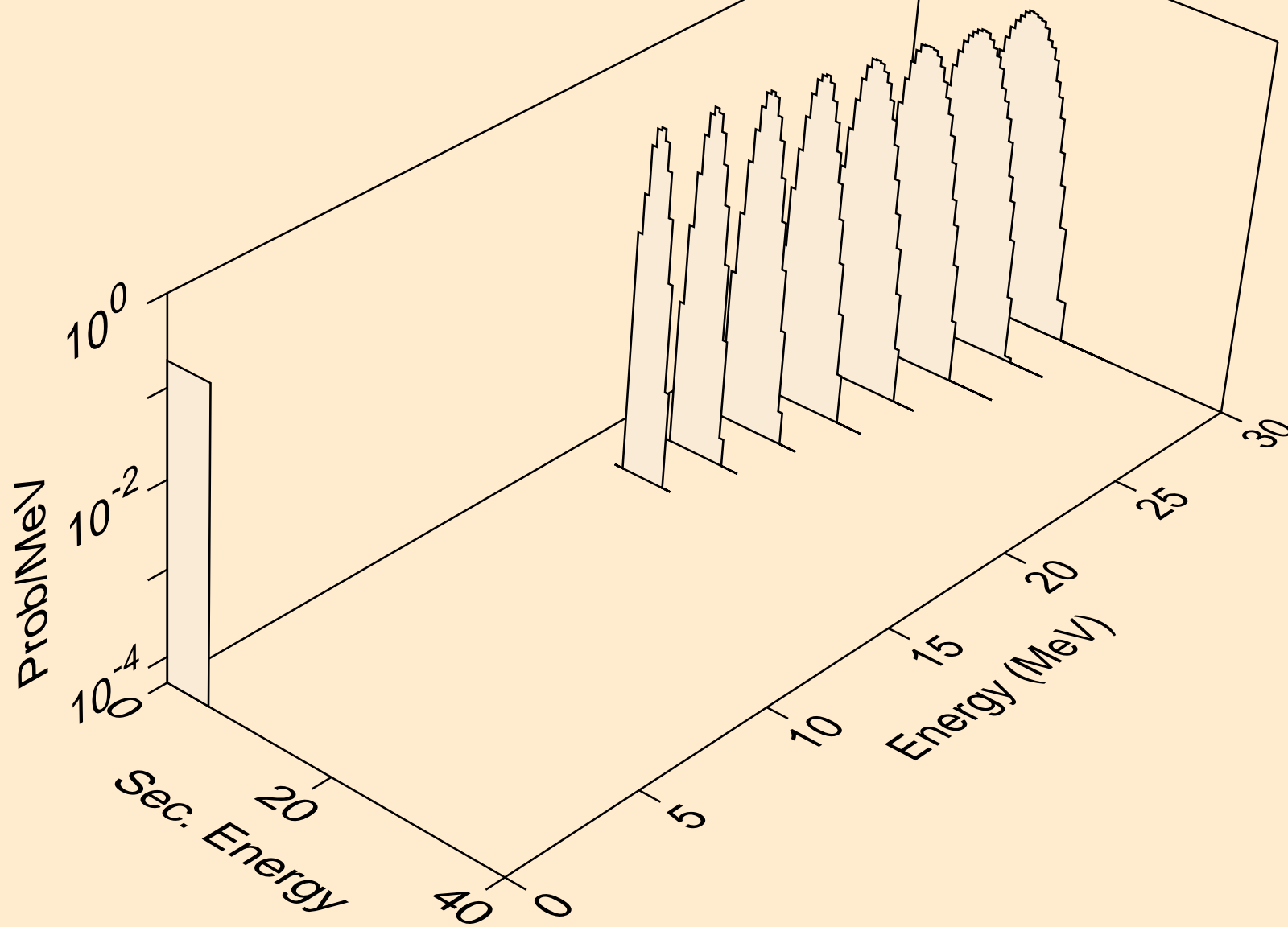

AU183 NEUTRON ACER TENDL-2021 LIBRARY; T=293.6K
alphas from (n,npa)

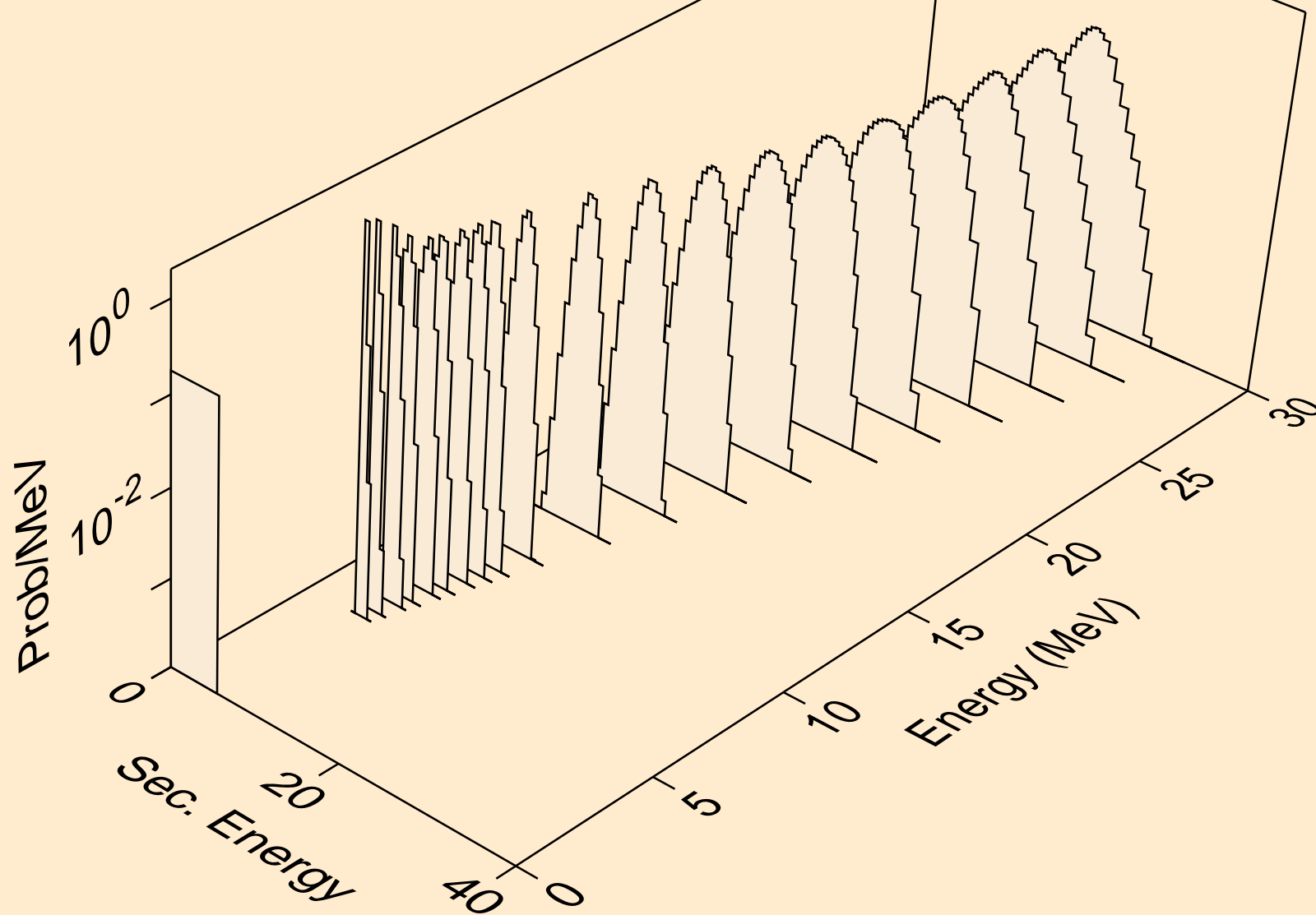

AU183 NEUTRON ACER TENDL-2021 LIBRARY; T=293.6K
alphas from (n,a)

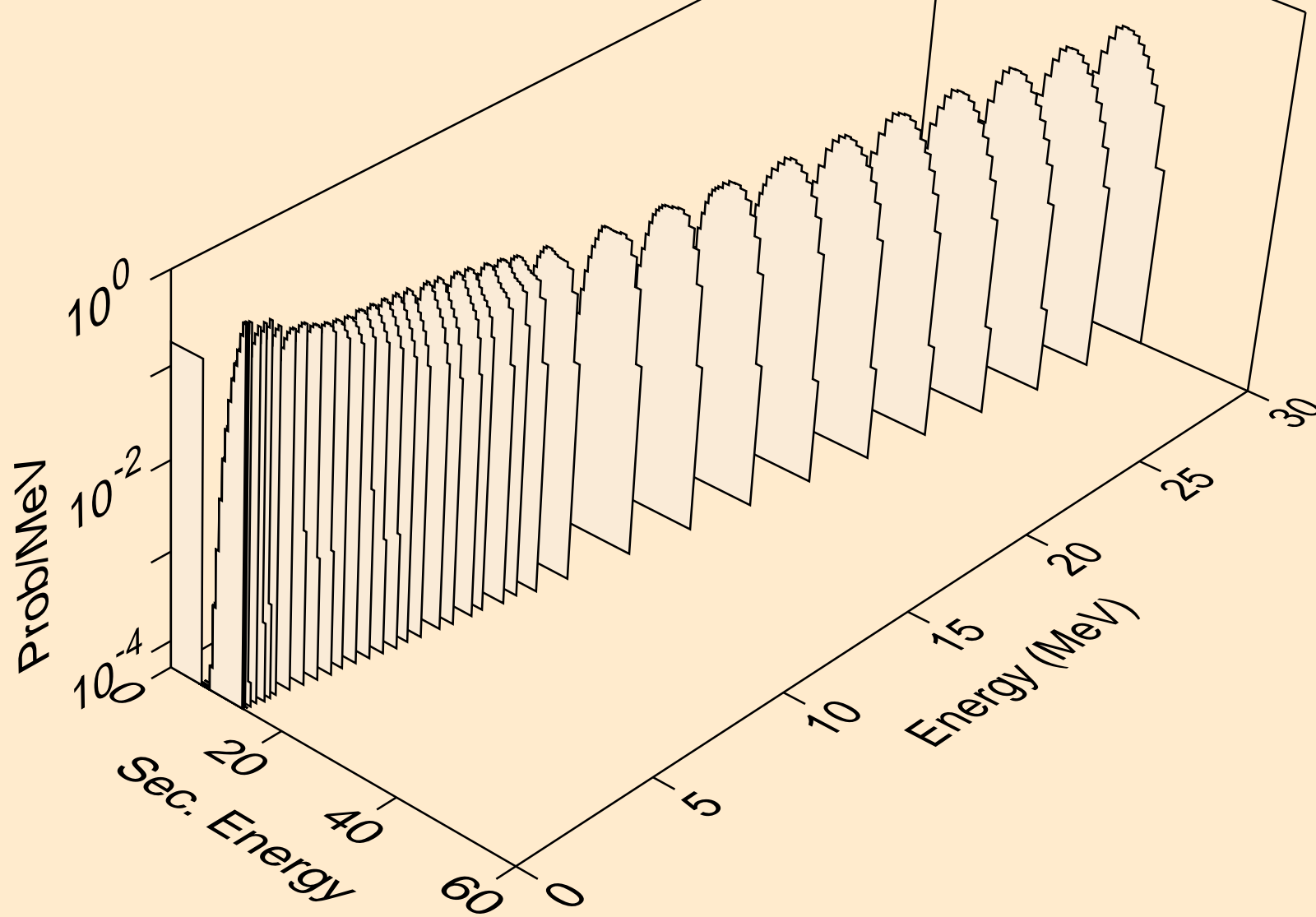

AU183 NEUTRON ACER TENDL-2021 LIBRARY; T=293.6K
alphas from (n,2a)

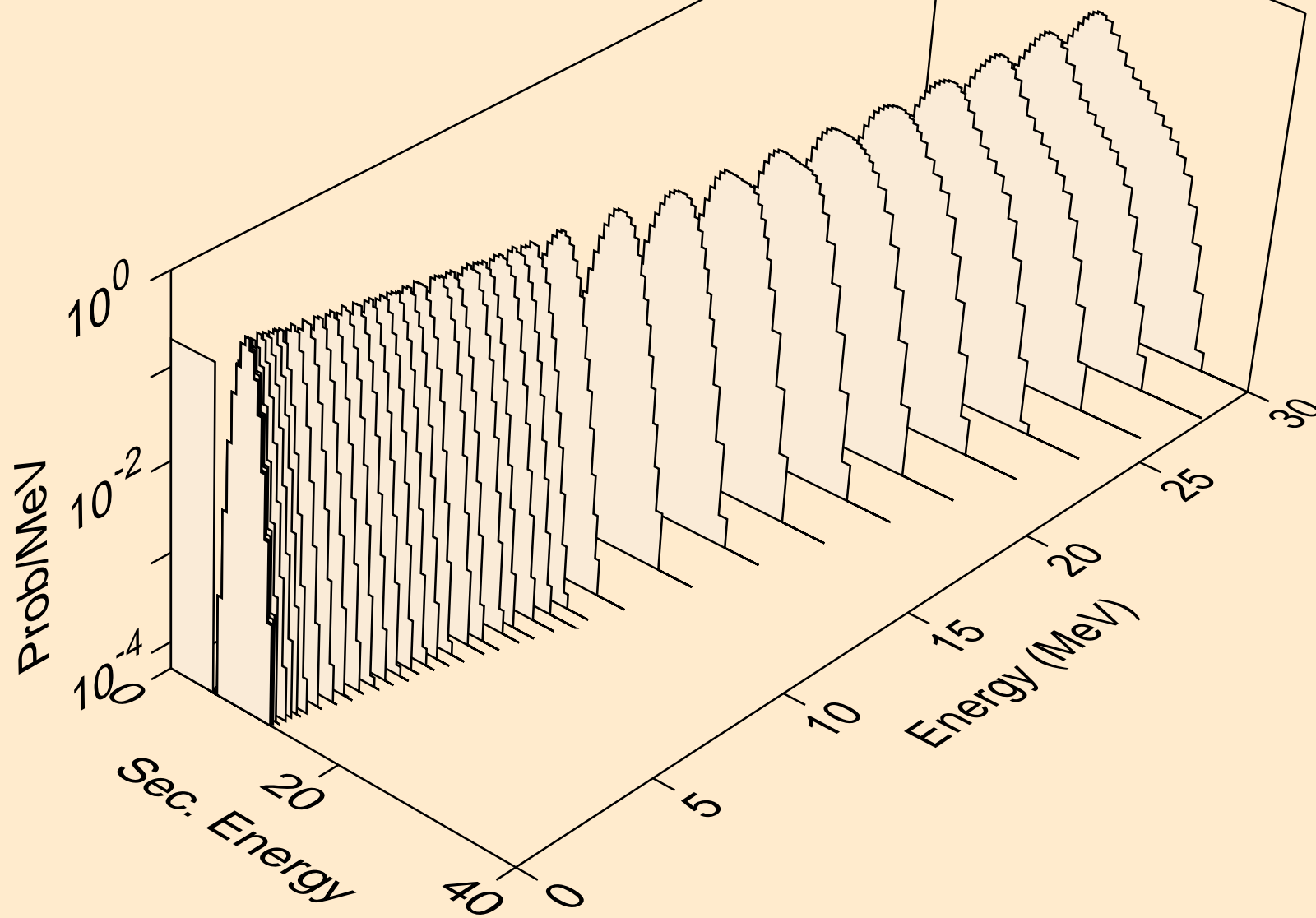

AU183 NEUTRON ACER TENDL-2021 LIBRARY; T=293.6K
alphas from (n,3a)

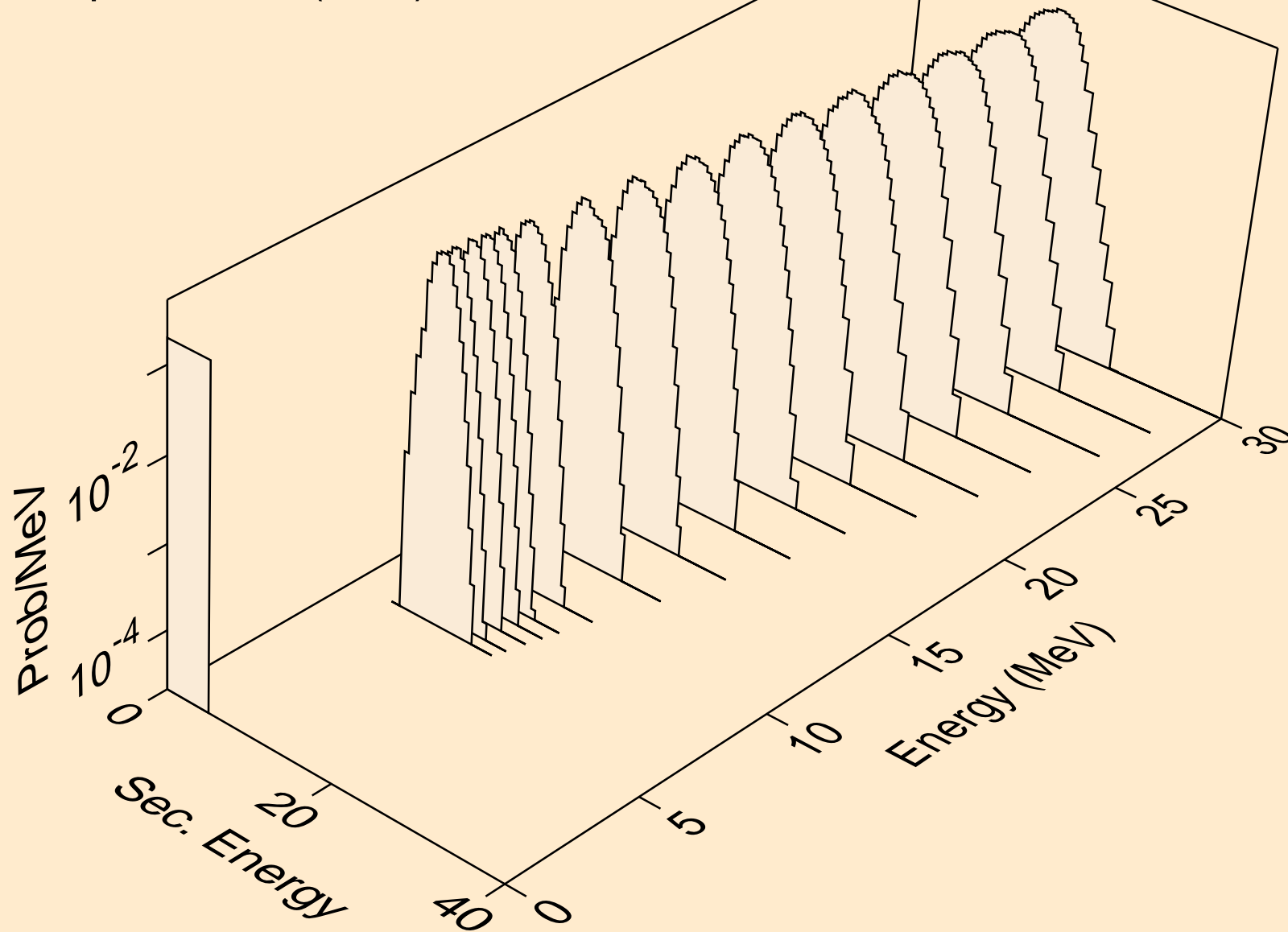

AU183 NEUTRON ACER TENDL-2021 LIBRARY; T=293.6K
alphas from (n,p)

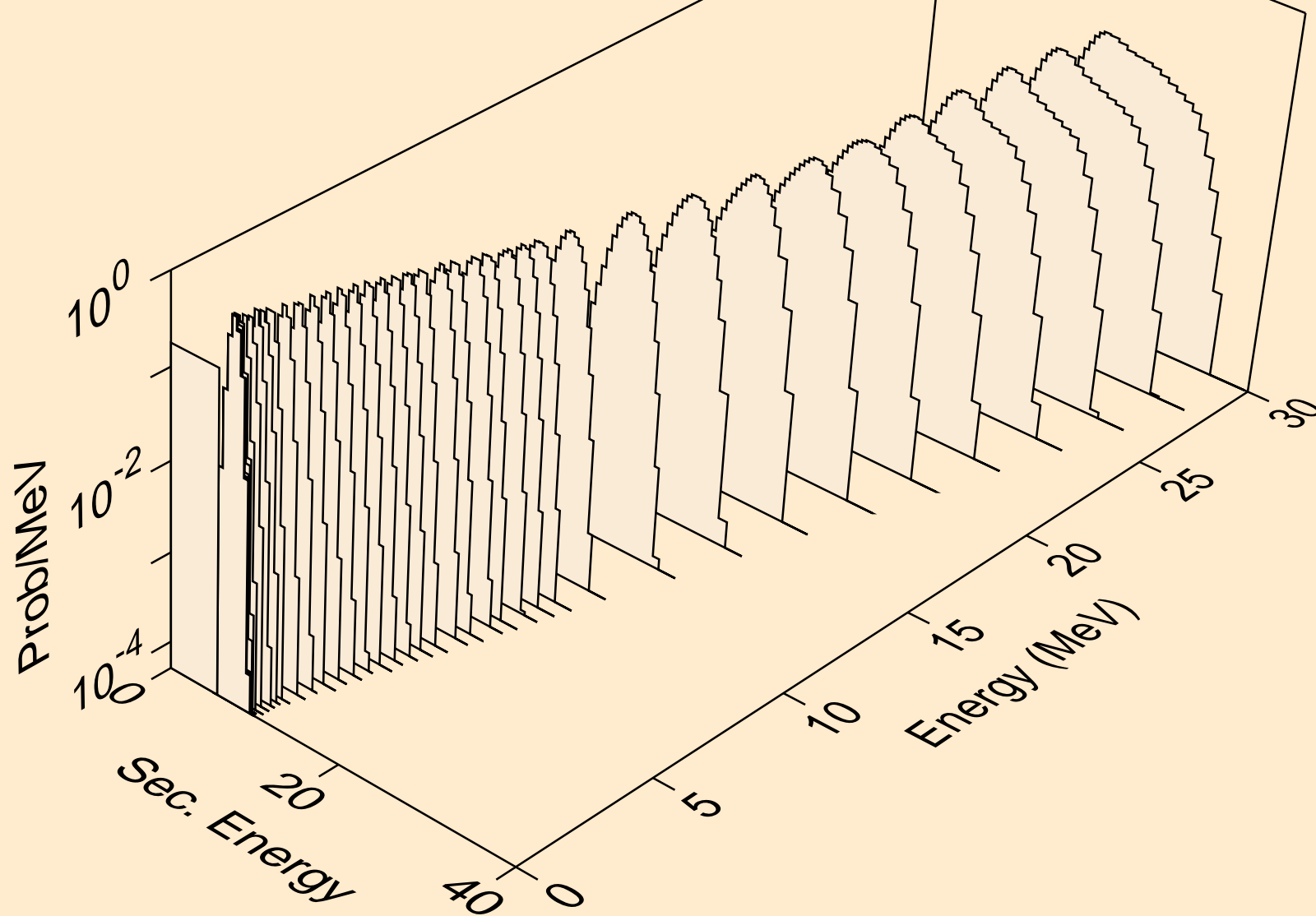

AU183 NEUTRON ACER TENDL-2021 LIBRARY; T=293.6K
alphas from (n,da)

