

AU186 NEUTRON ACER TENDL-2021 LIBRARY; T=293.6K

Principal cross sections

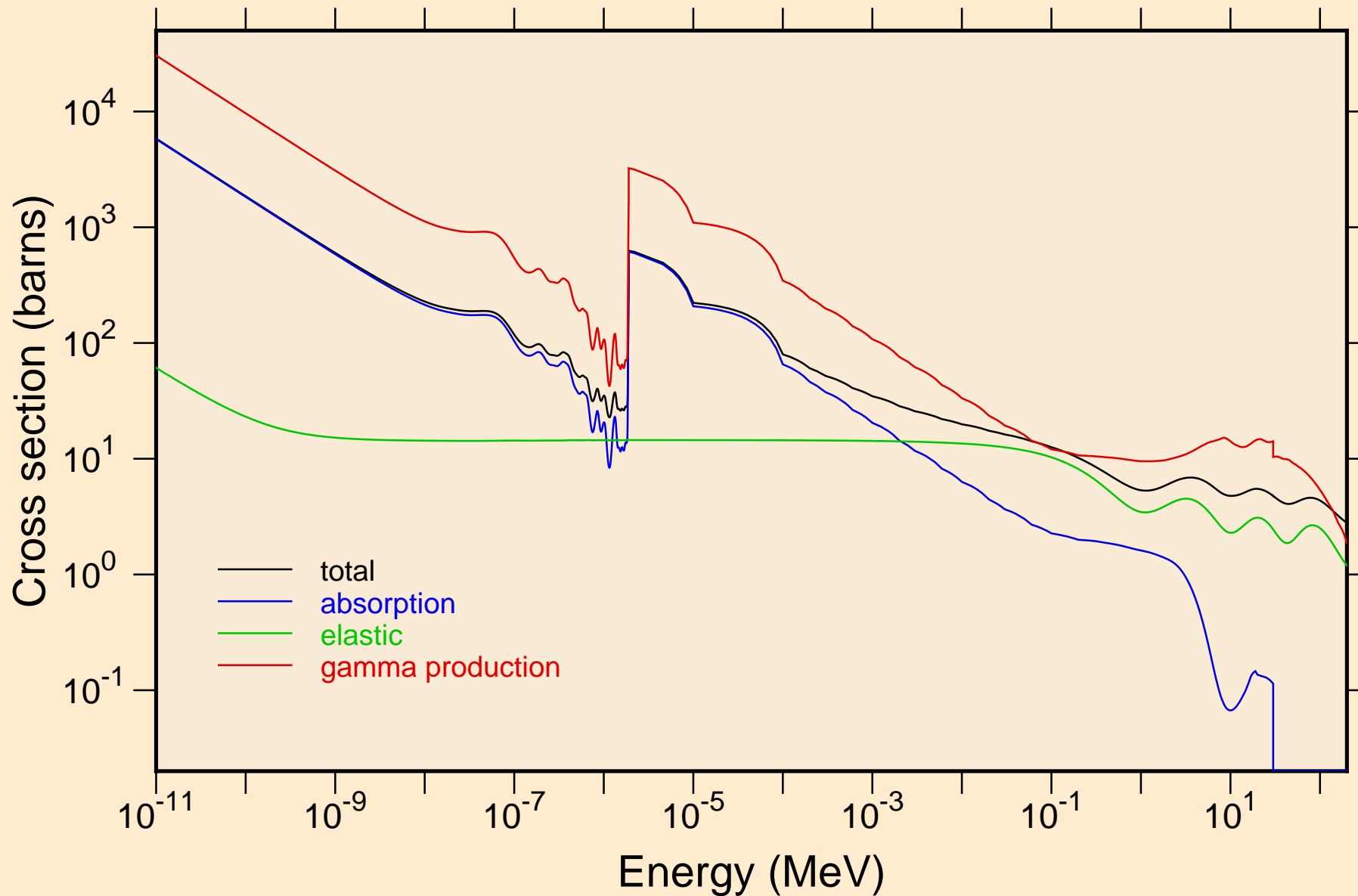

AU186 NEUTRON ACER TENDL-2021 LIBRARY; T=293.6K
Heating

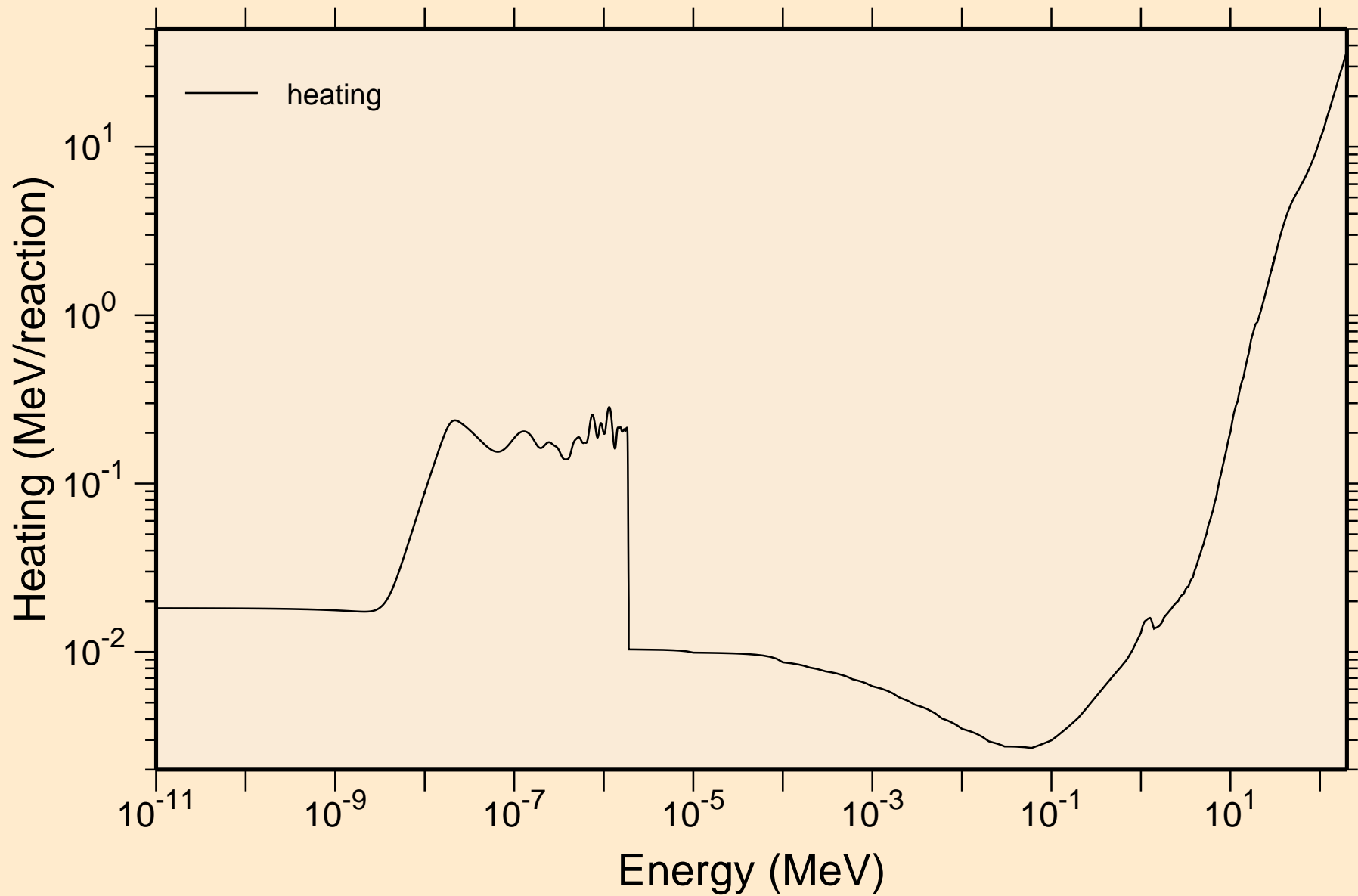

AU186 NEUTRON ACER TENDL-2021 LIBRARY; T=293.6K
Damage

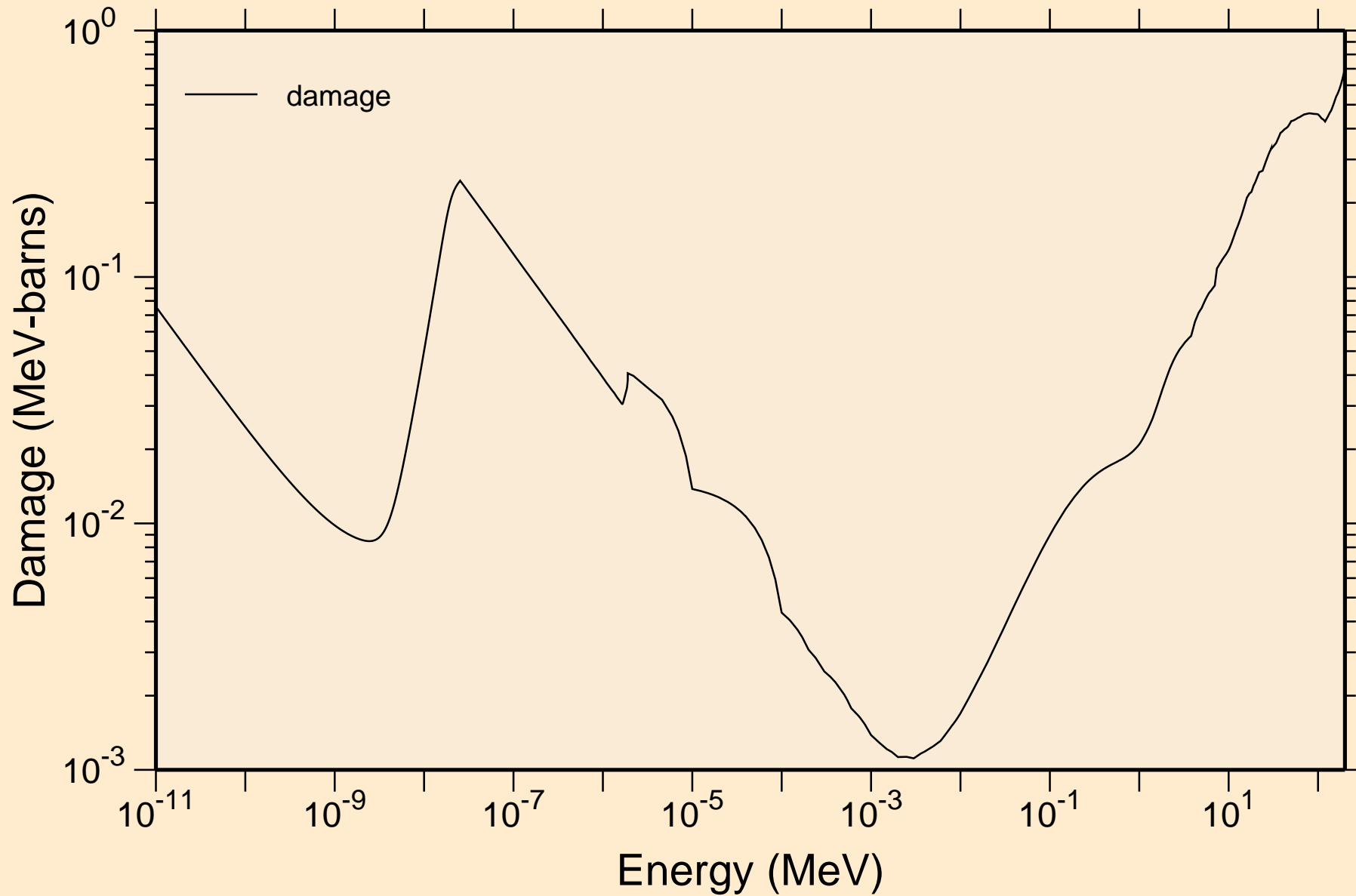

AU186 NEUTRON ACER TENDL-2021 LIBRARY; T=293.6K
Non-threshold reactions

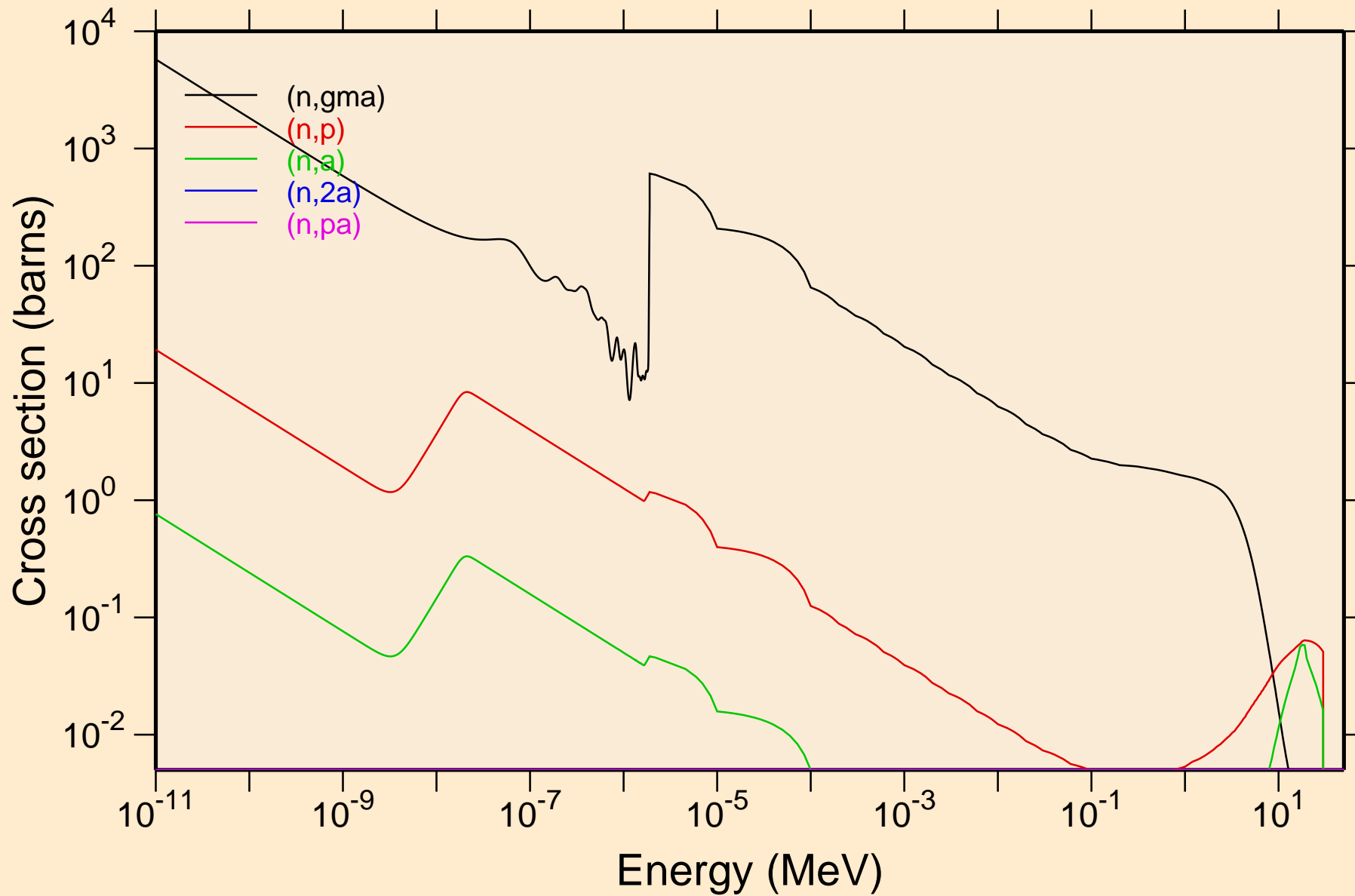

AU186 NEUTRON ACER TENDL-2021 LIBRARY; T=293.6K
Non-threshold reactions

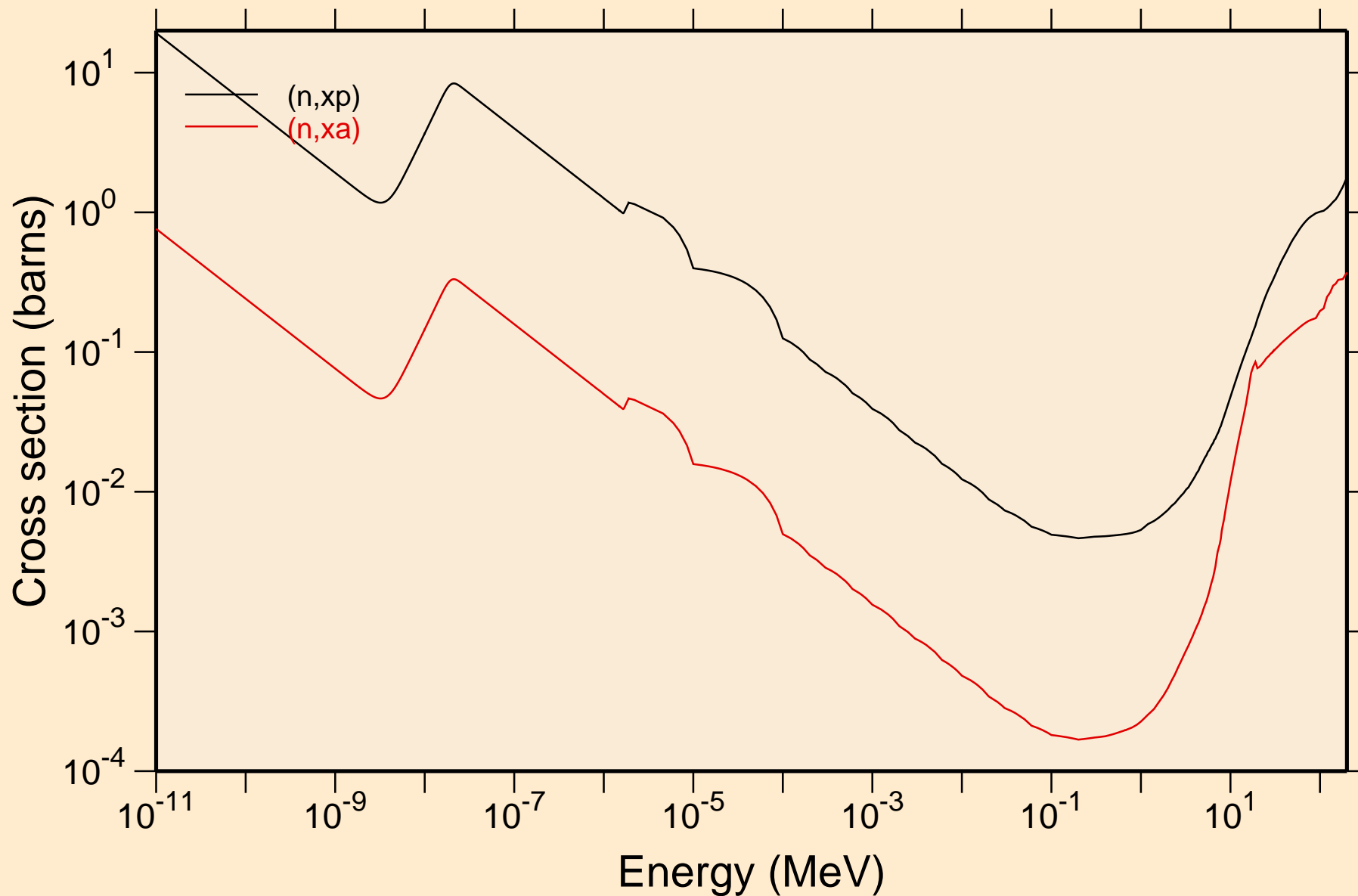

AU186 NEUTRON ACER TENDL-2021 LIBRARY; T=293.6K

Principal cross sections

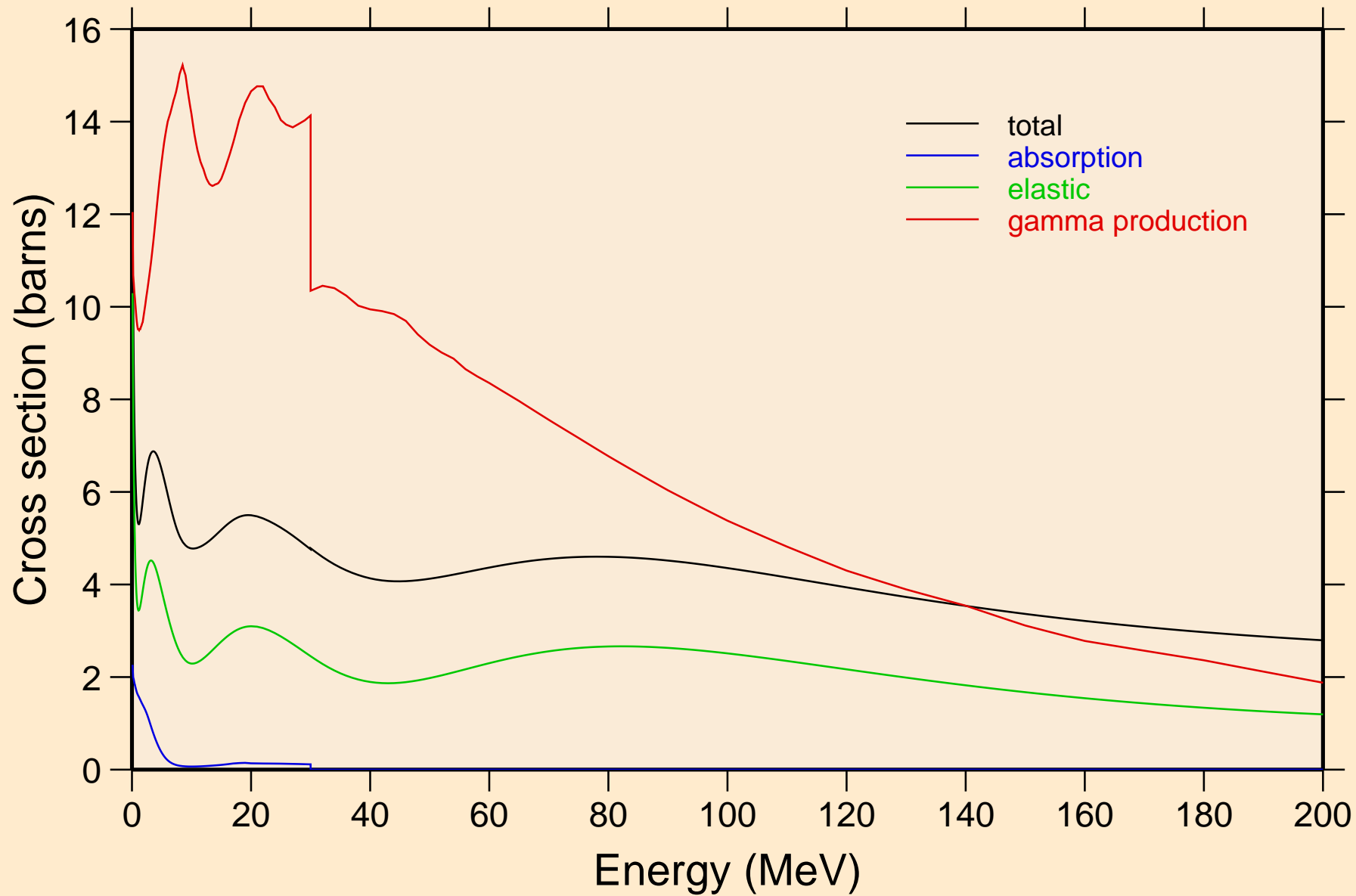

AU186 NEUTRON ACER TENDL-2021 LIBRARY; T=293.6K
Heating

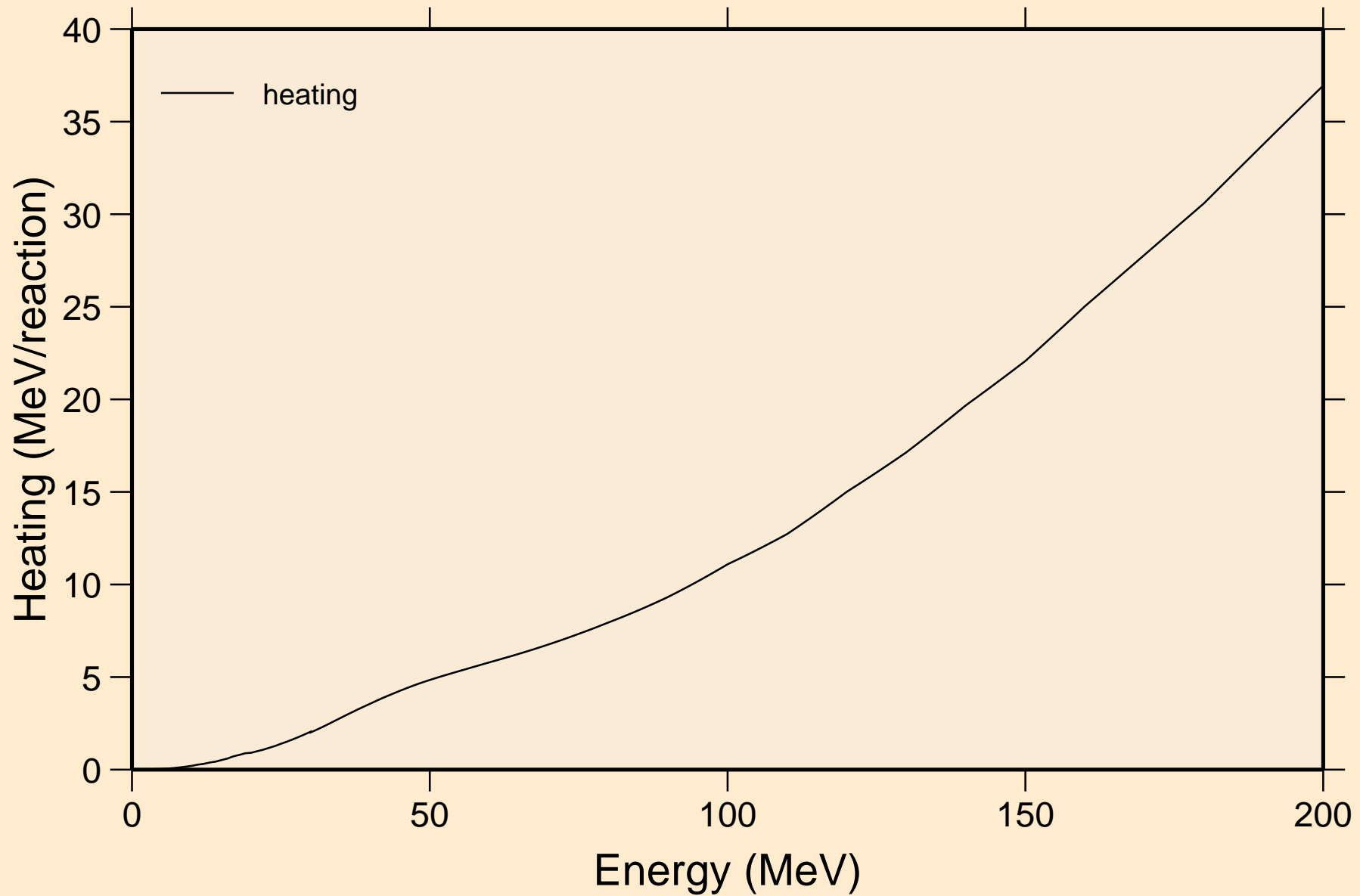

AU186 NEUTRON ACER TENDL-2021 LIBRARY; T=293.6K
Damage

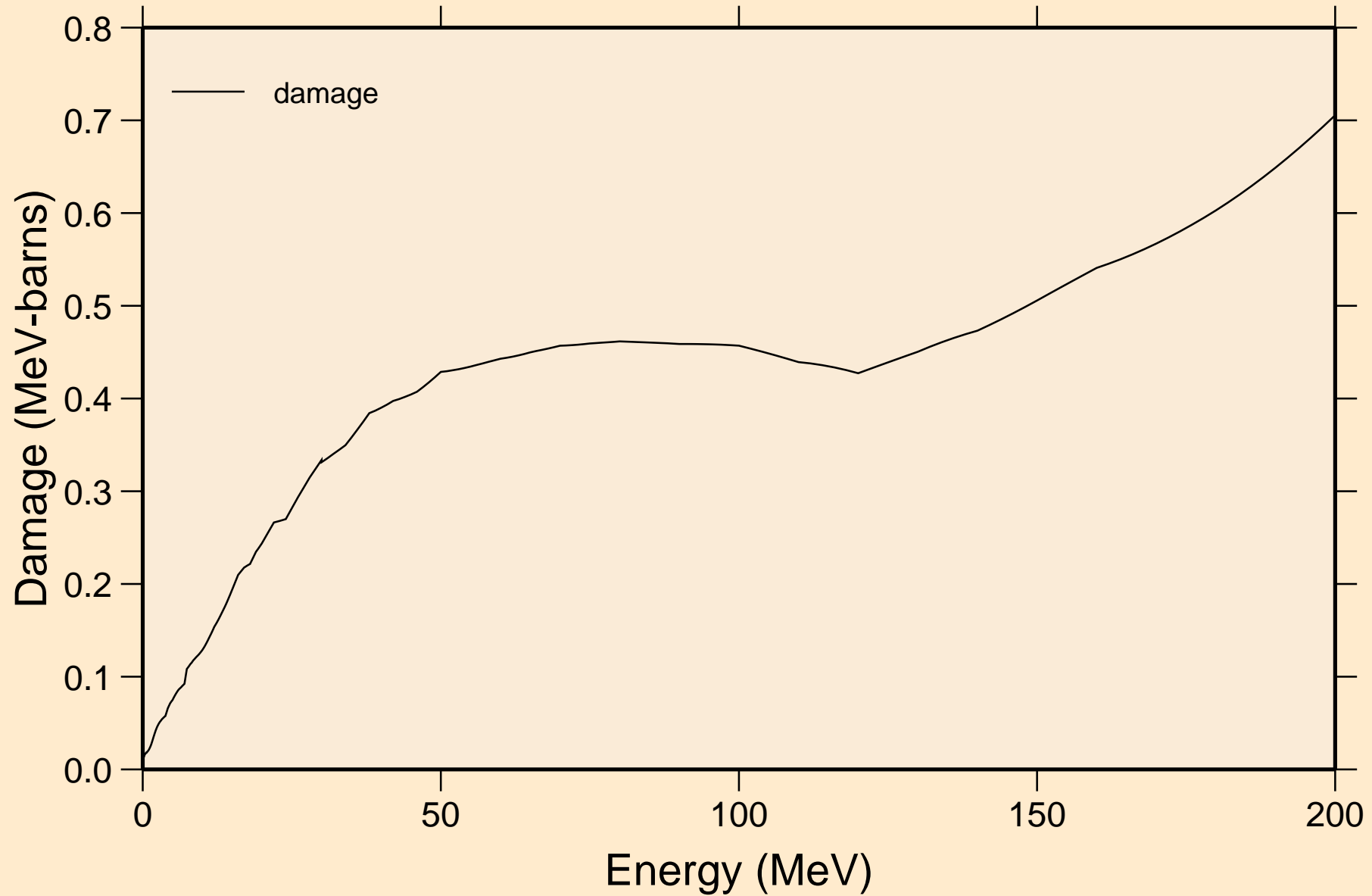

AU186 NEUTRON ACER TENDL-2021 LIBRARY; T=293.6K
Non-threshold reactions

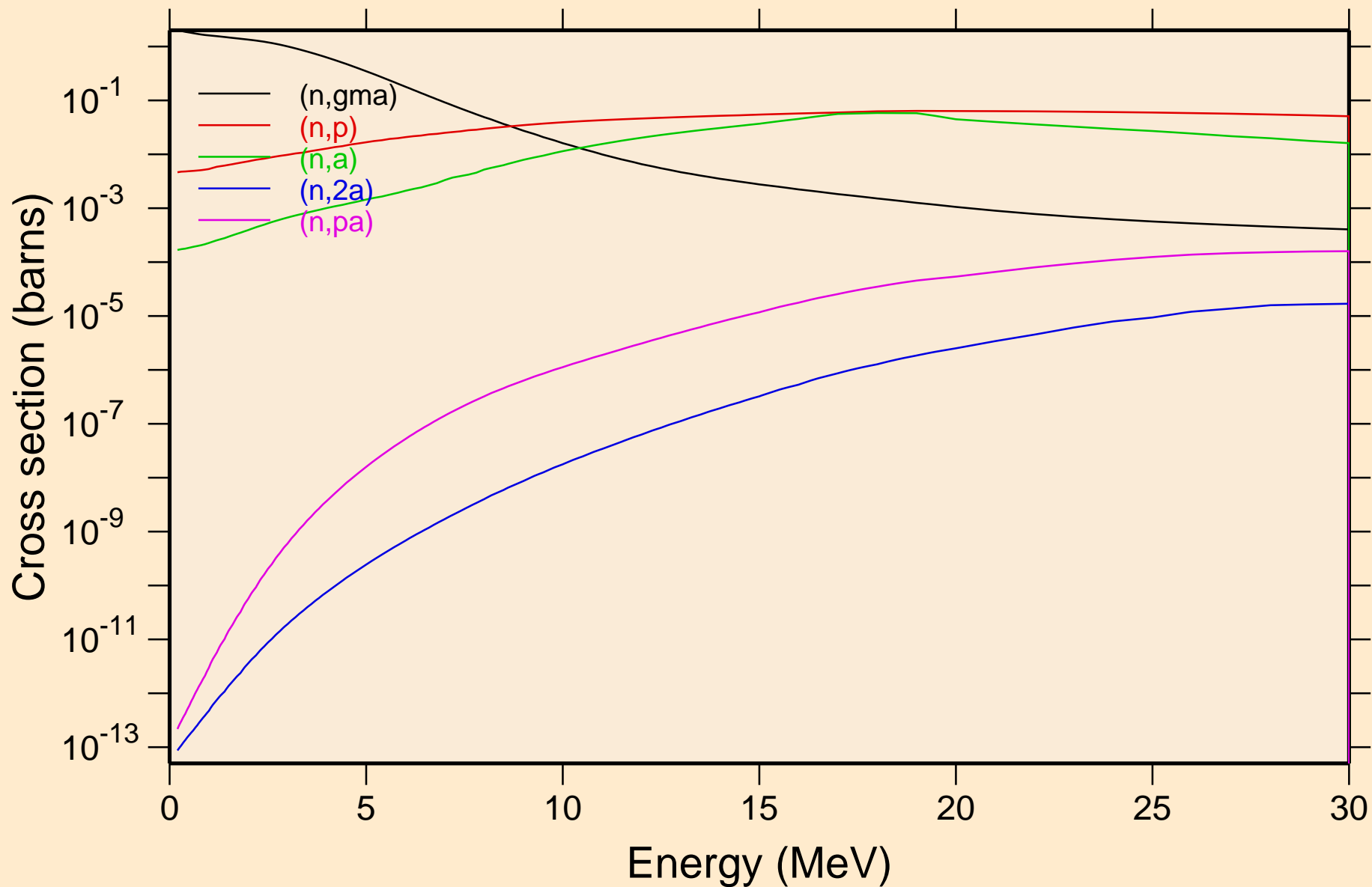

AU186 NEUTRON ACER TENDL-2021 LIBRARY; T=293.6K
Non-threshold reactions

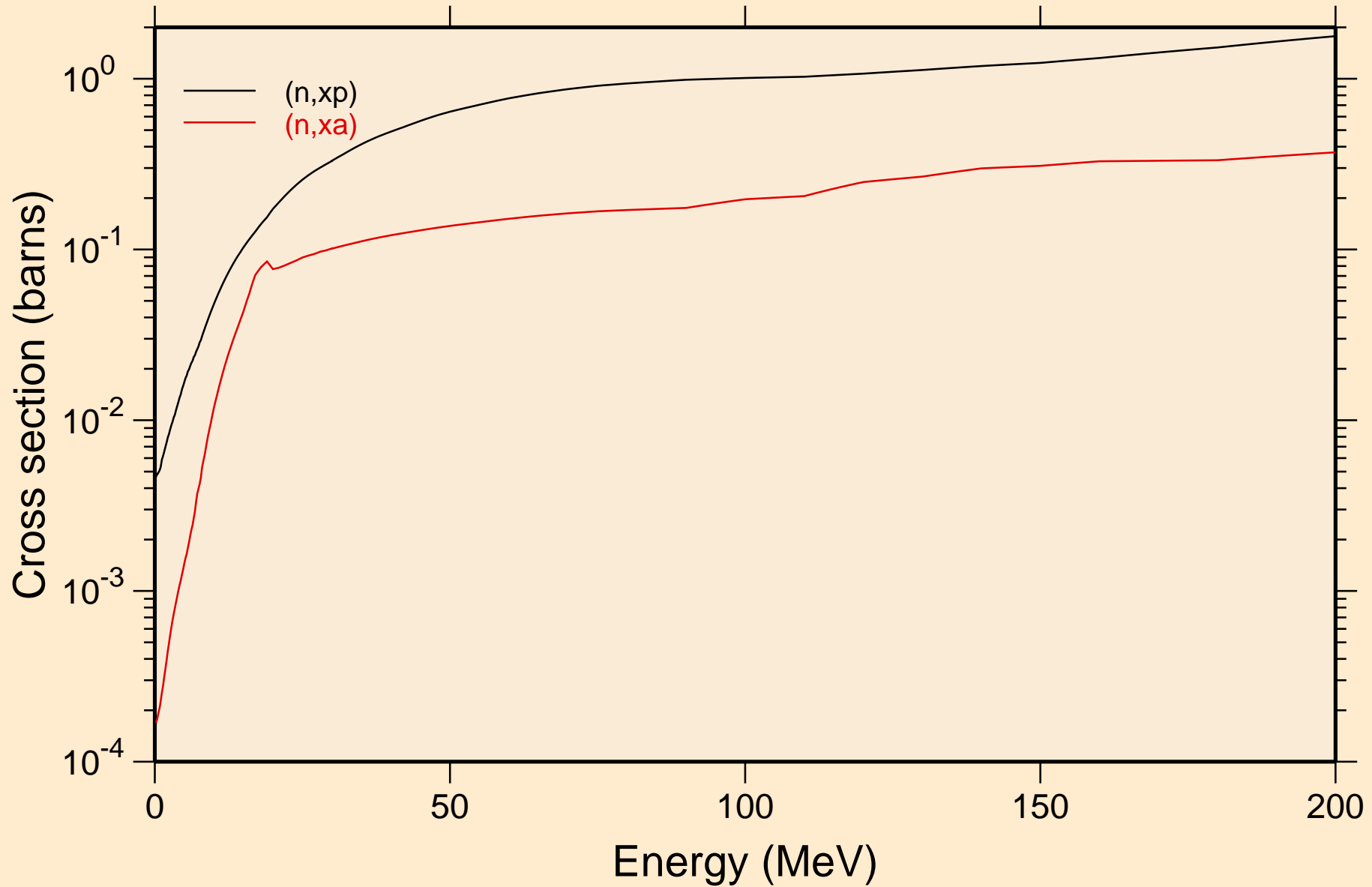

AU186 NEUTRON ACER TENDL-2021 LIBRARY; T=293.6K
Inelastic levels

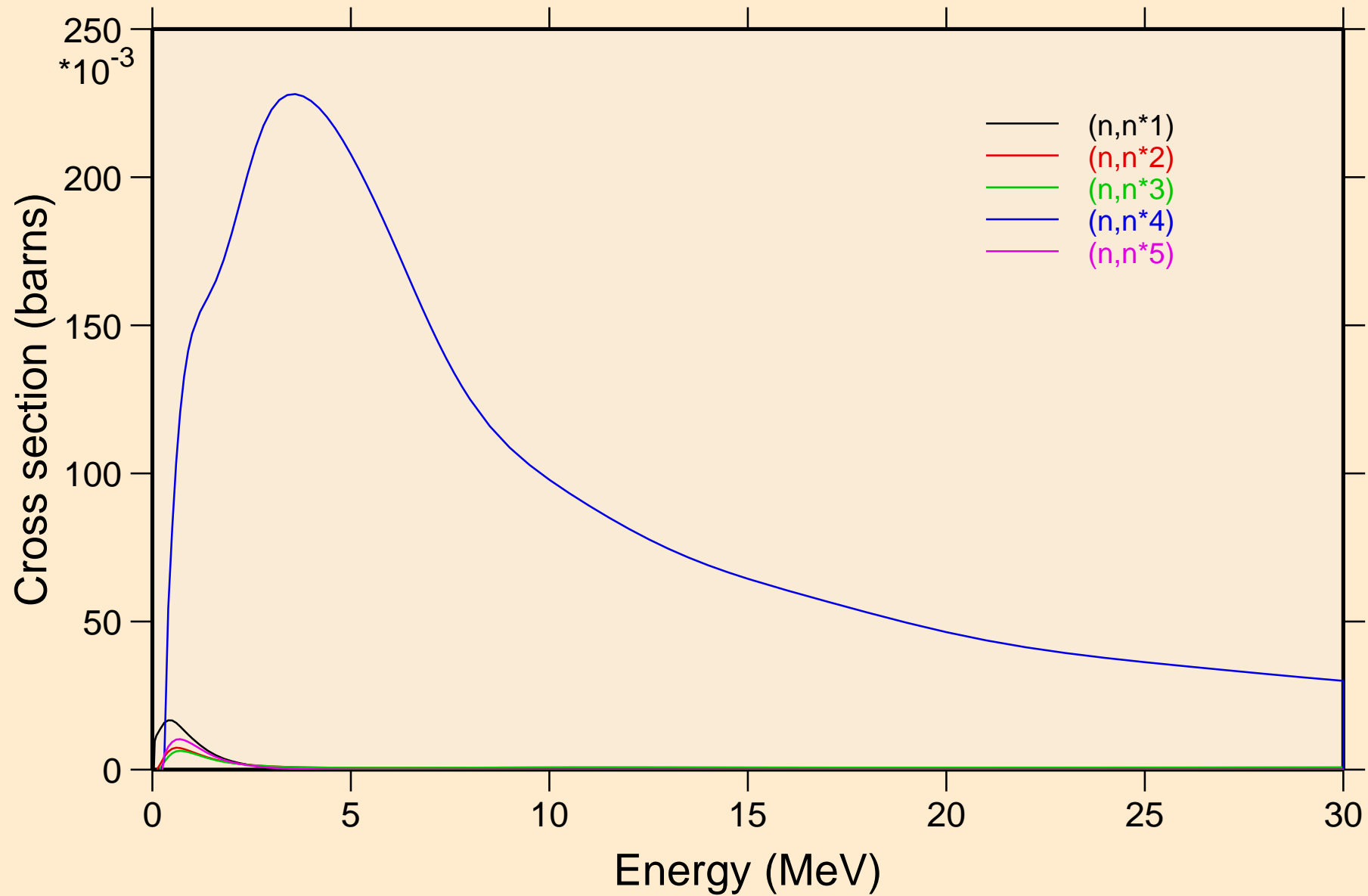

AU186 NEUTRON ACER TENDL-2021 LIBRARY; T=293.6K
Inelastic levels

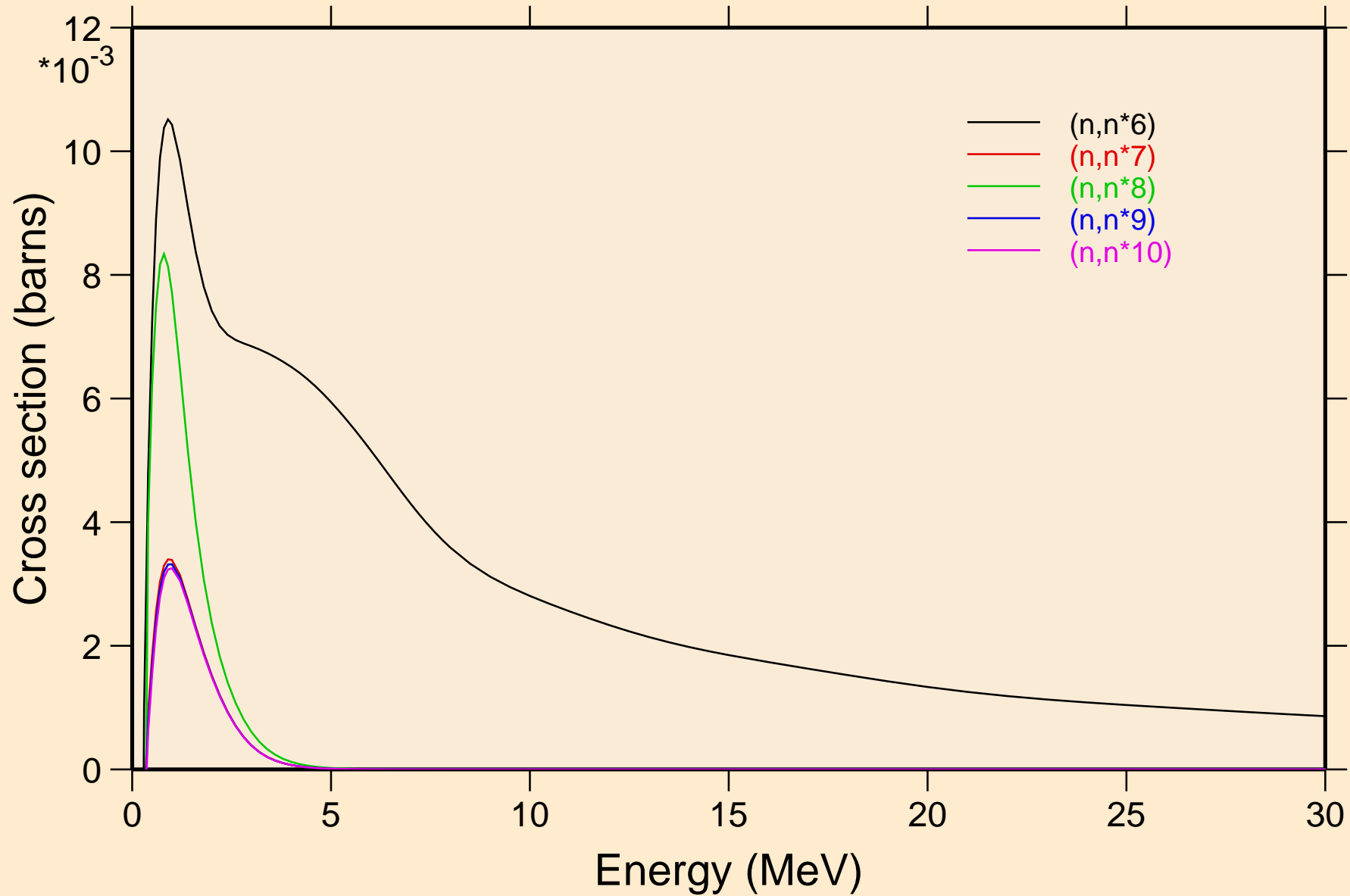

AU186 NEUTRON ACER TENDL-2021 LIBRARY; T=293.6K
Inelastic levels

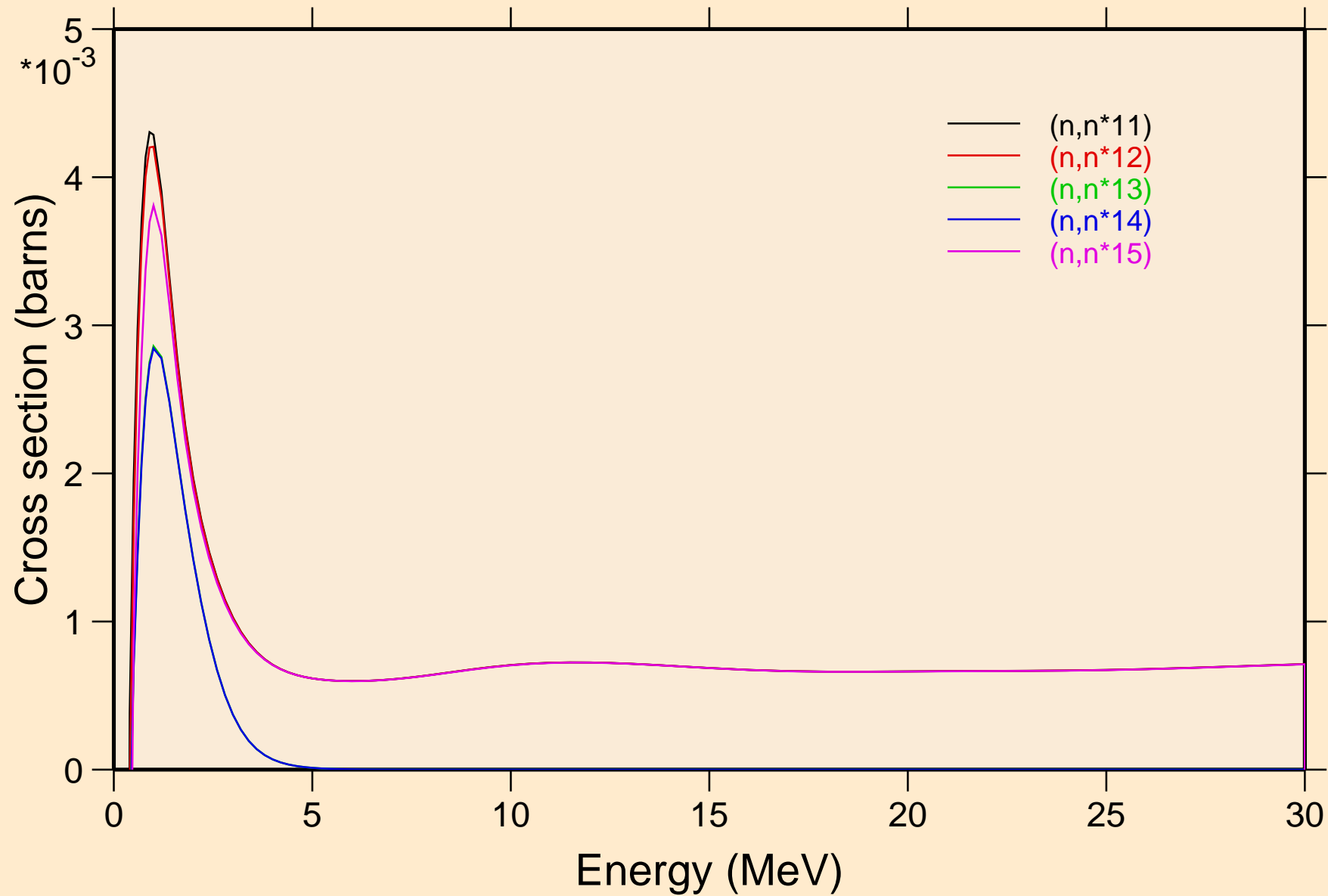

AU186 NEUTRON ACER TENDL-2021 LIBRARY; T=293.6K
Inelastic levels

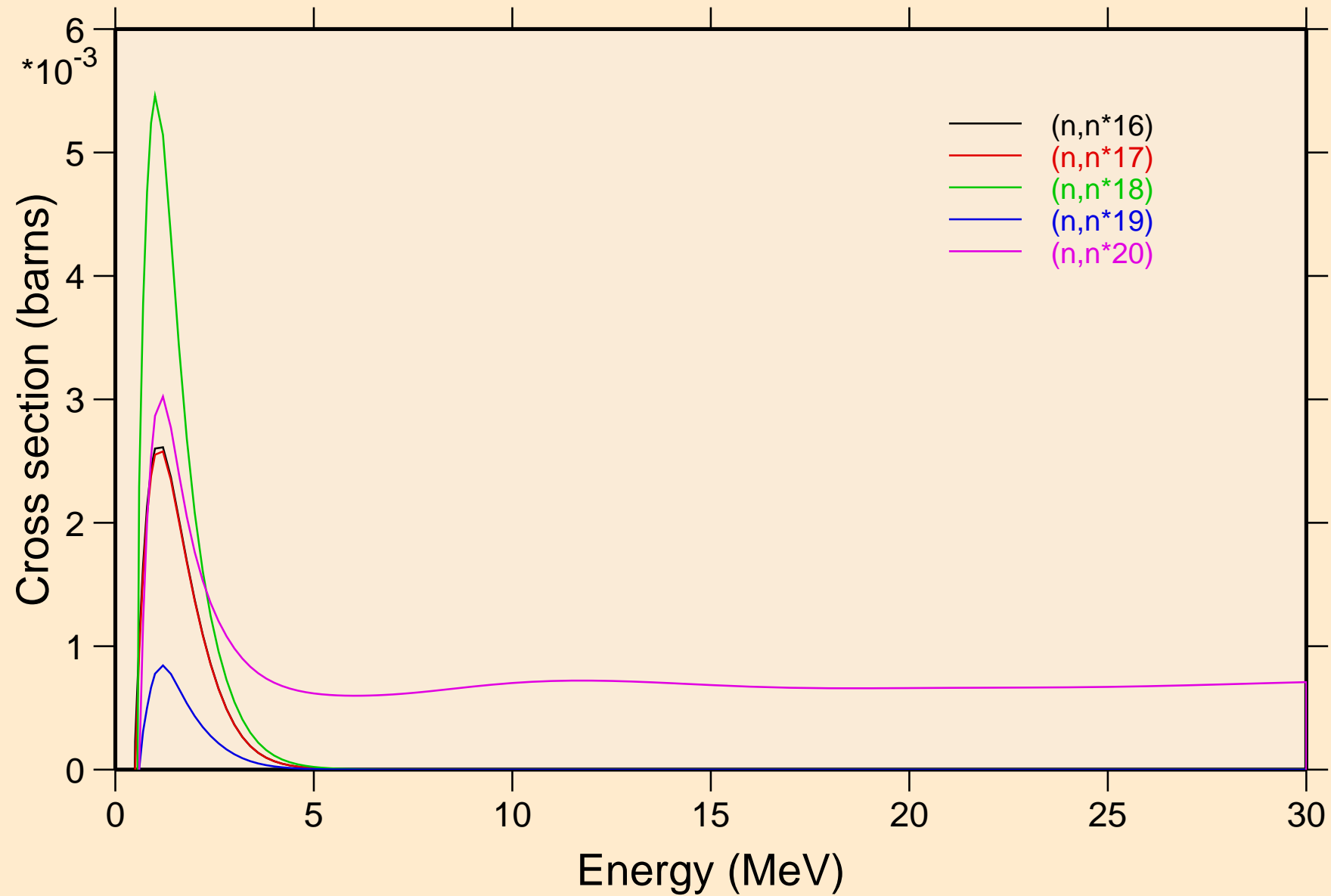

AU186 NEUTRON ACER TENDL-2021 LIBRARY; T=293.6K
Inelastic levels

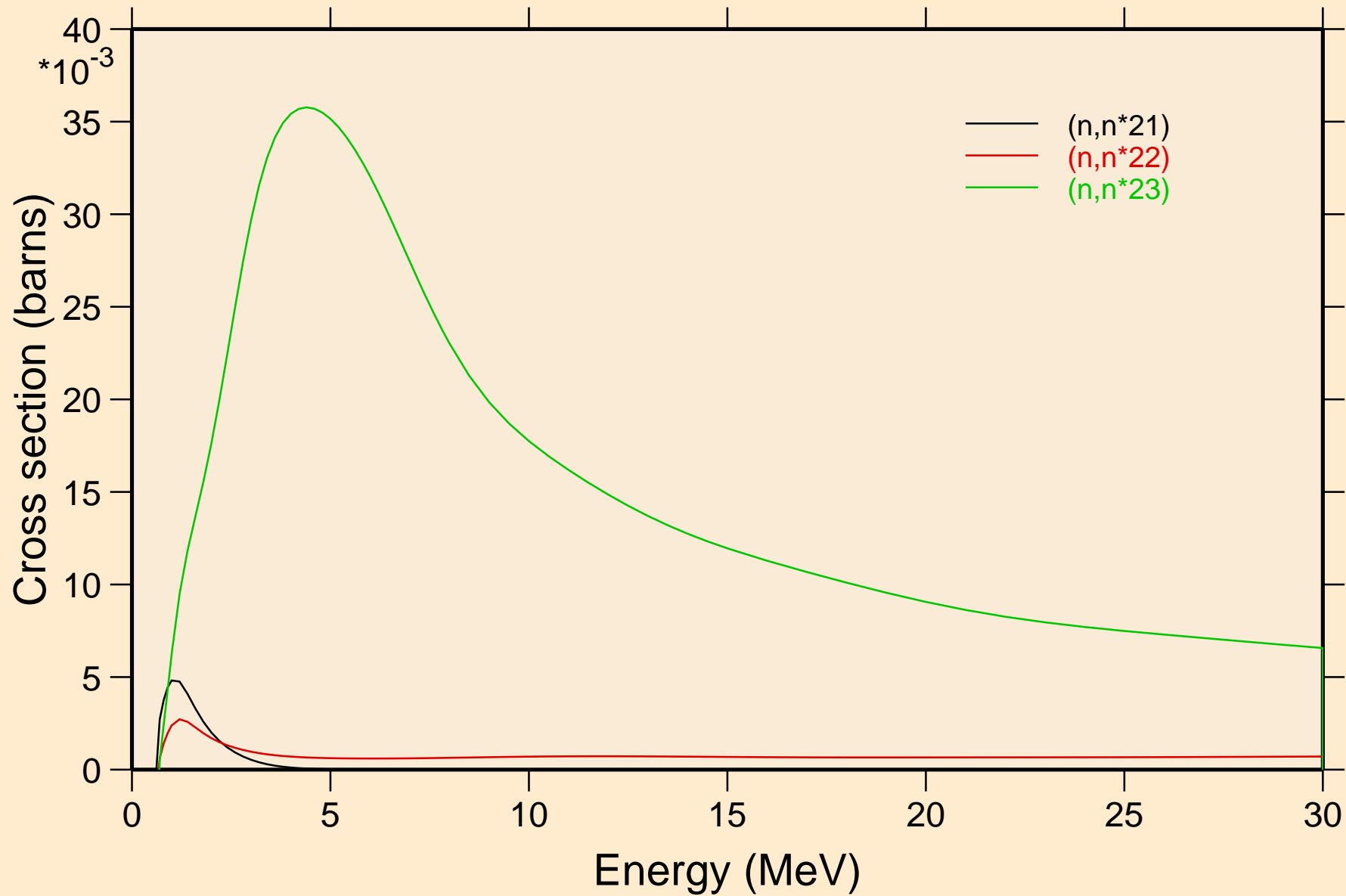

AU186 NEUTRON ACER TENDL-2021 LIBRARY; T=293.6K
Threshold reactions

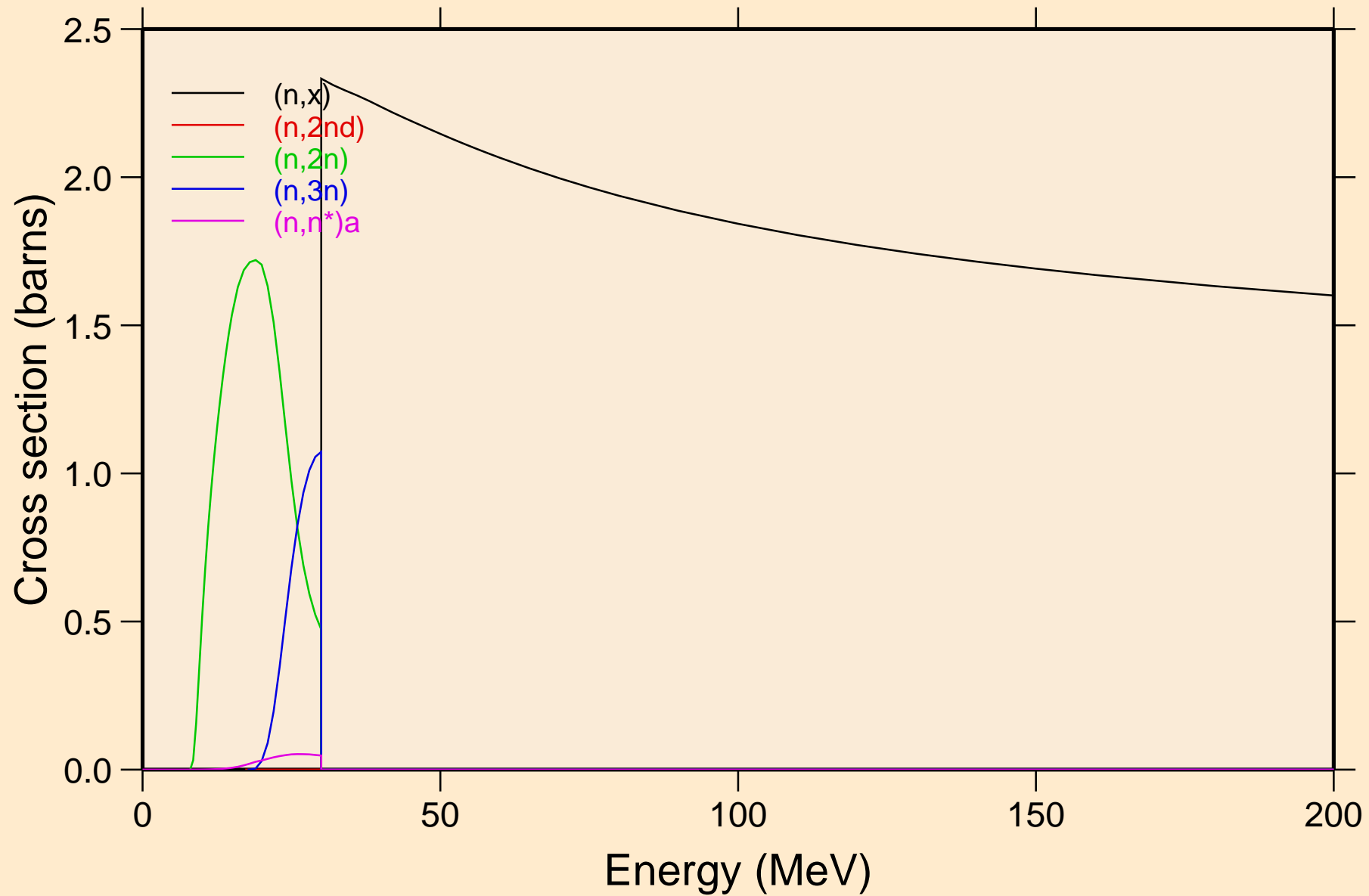

AU186 NEUTRON ACER TENDL-2021 LIBRARY; T=293.6K
Threshold reactions

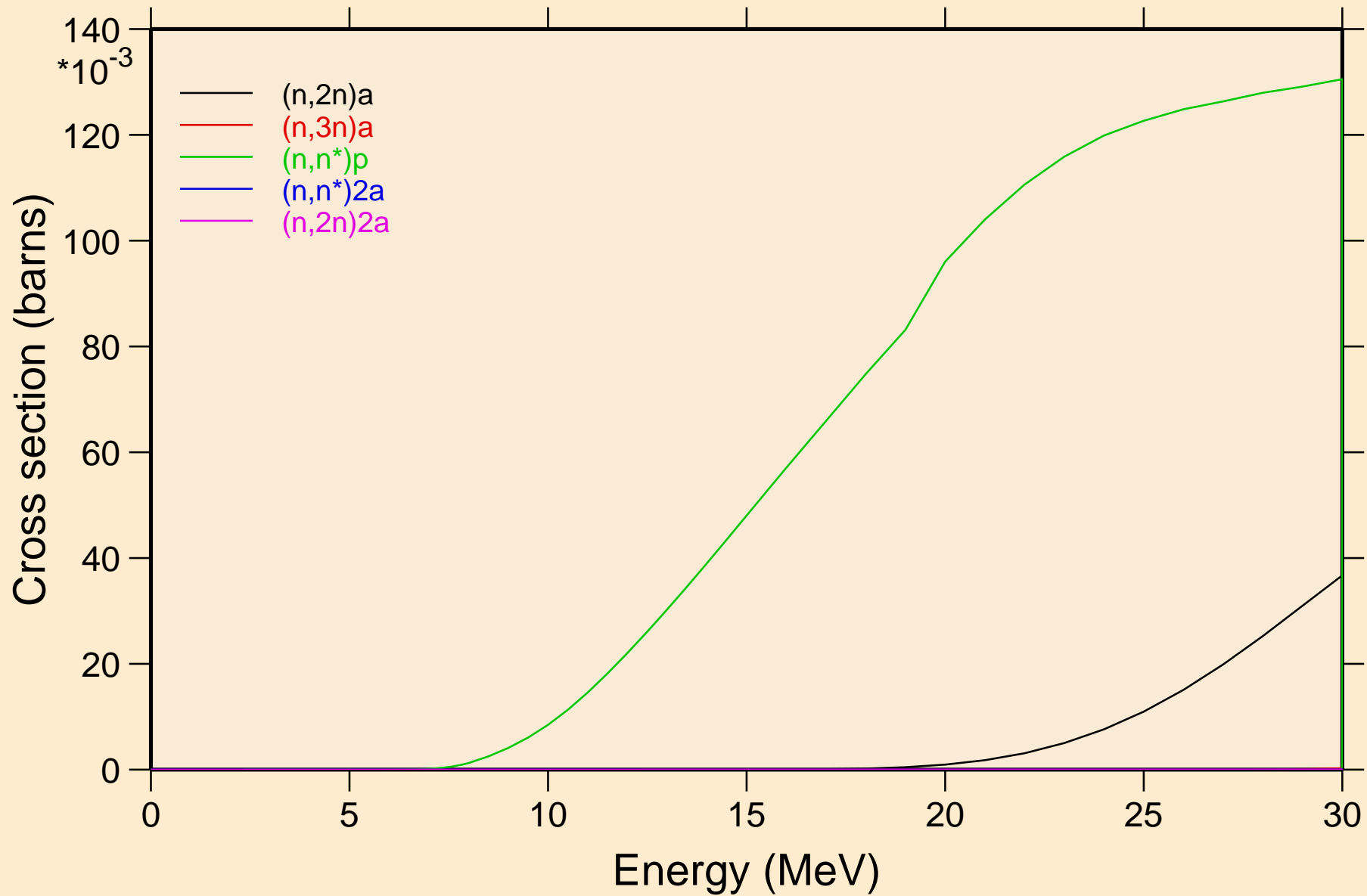

AU186 NEUTRON ACER TENDL-2021 LIBRARY; T=293.6K
Threshold reactions

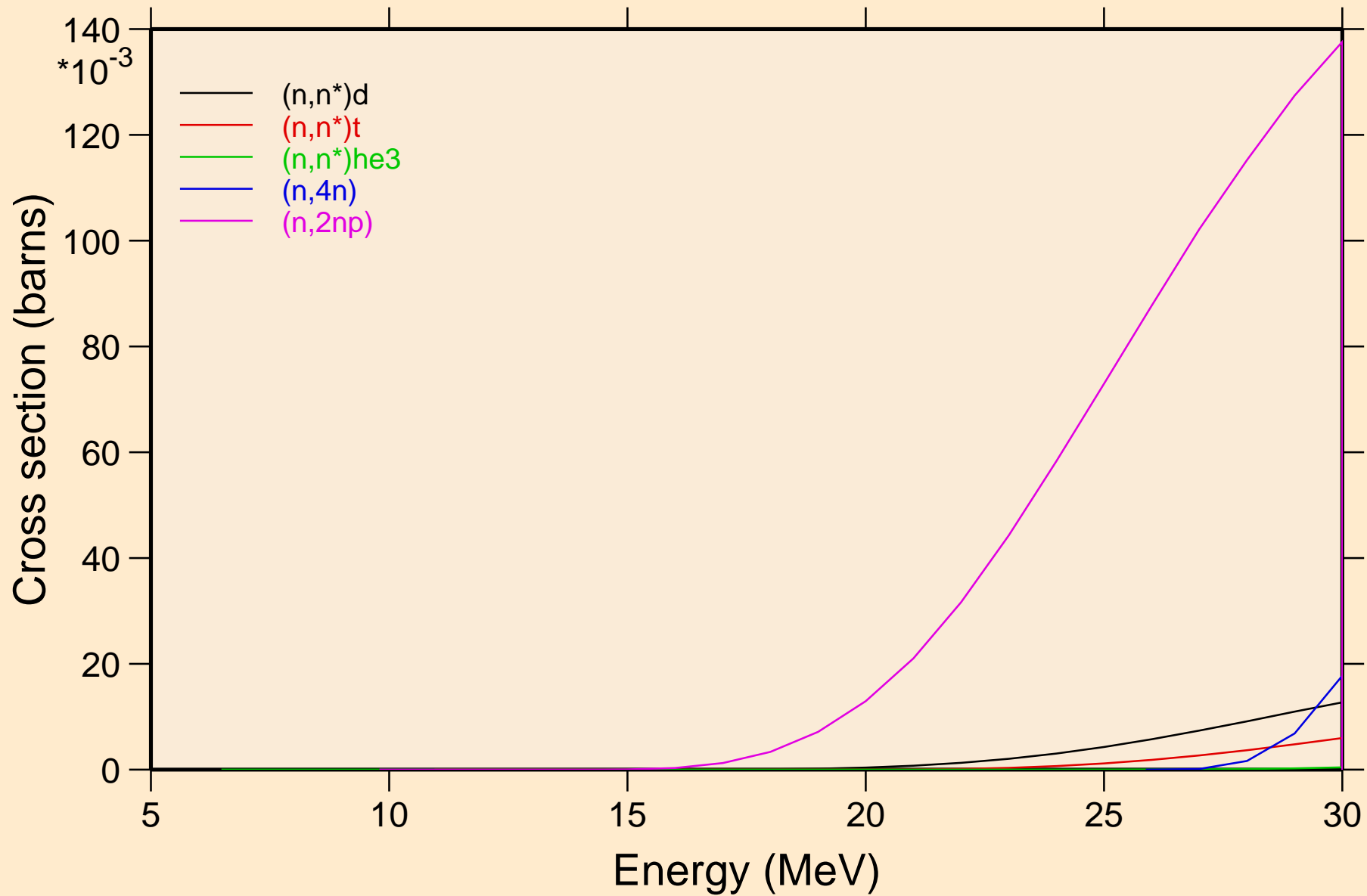

AU186 NEUTRON ACER TENDL-2021 LIBRARY; T=293.6K
Threshold reactions

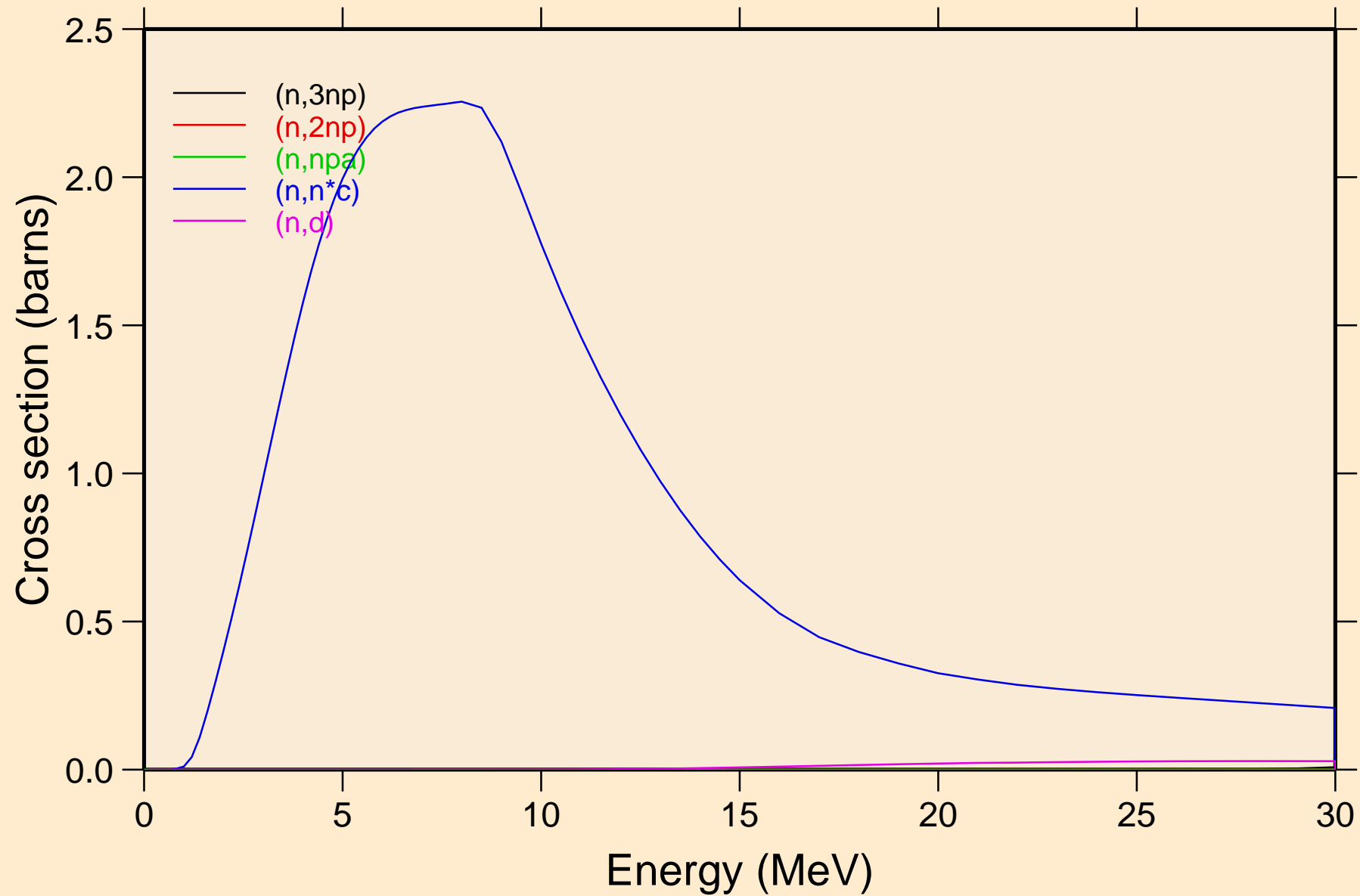

AU186 NEUTRON ACER TENDL-2021 LIBRARY; T=293.6K
Threshold reactions

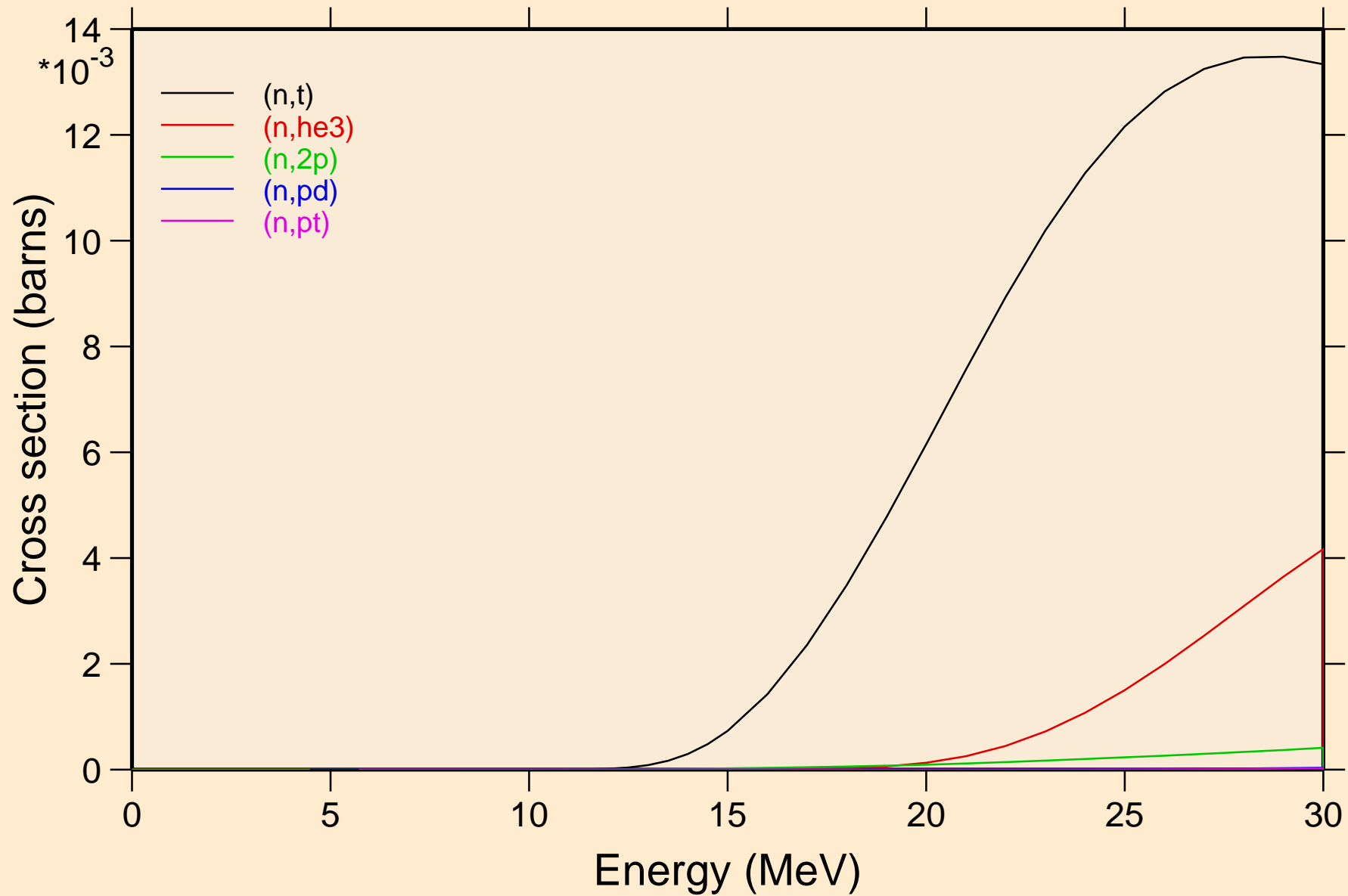

AU186 NEUTRON ACER TENDL-2021 LIBRARY; T=293.6K
Threshold reactions

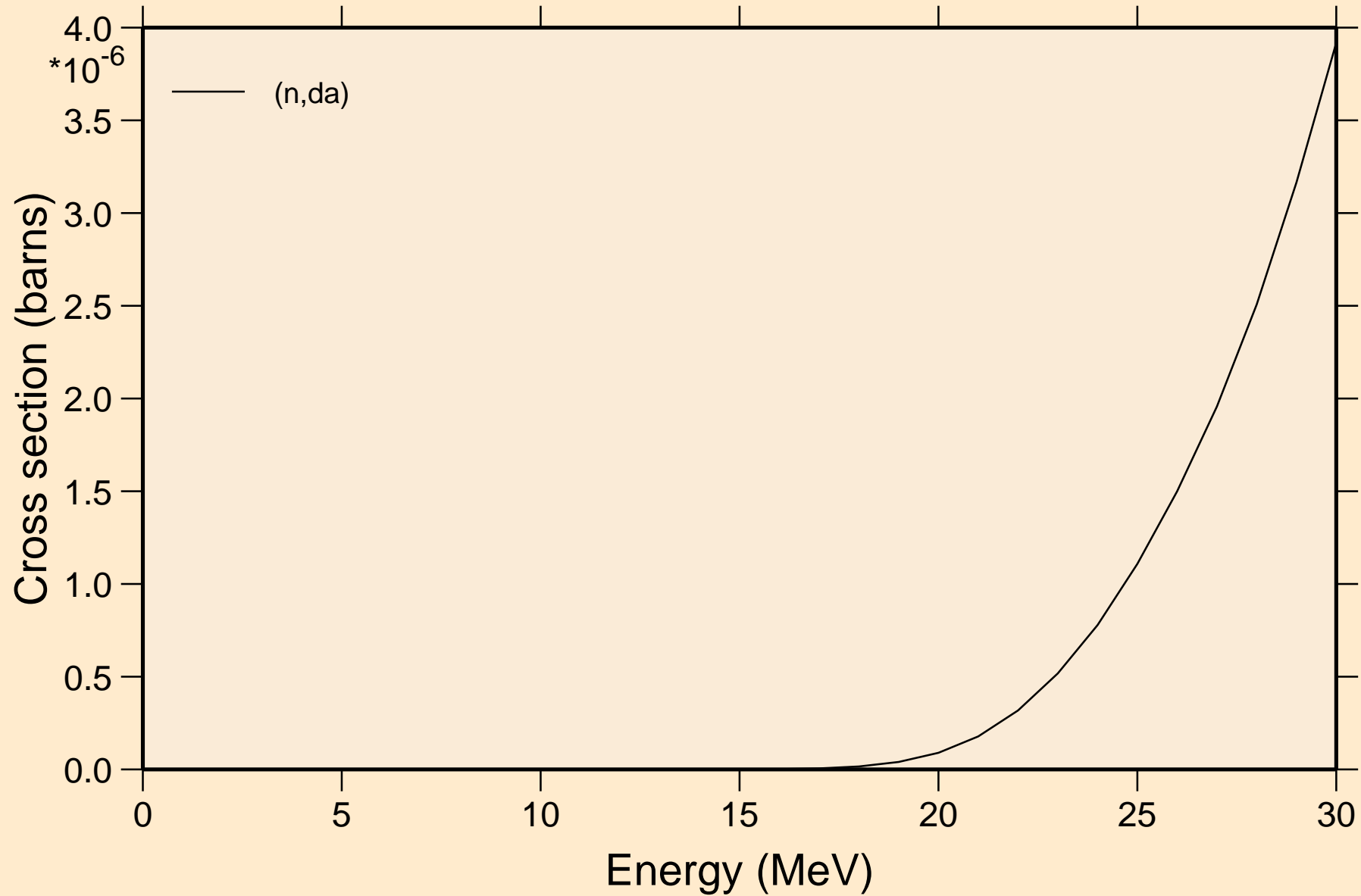

AU186 NEUTRON ACER TENDL-2021 LIBRARY; T=293.6K
Threshold reactions

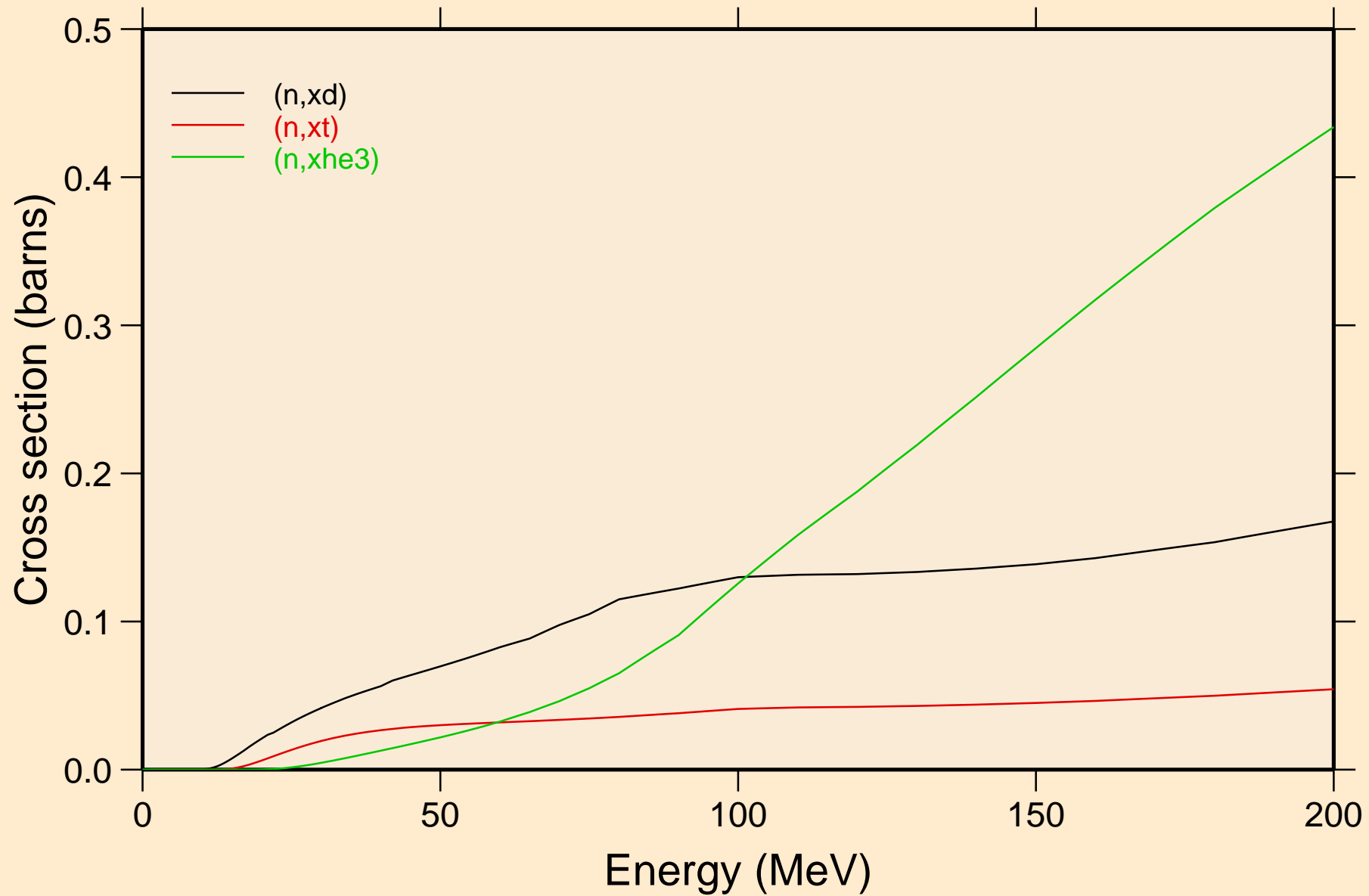

AU186 NEUTRON ACER TENDL-2021 LIBRARY; T=293.6K
angular distribution for elastic

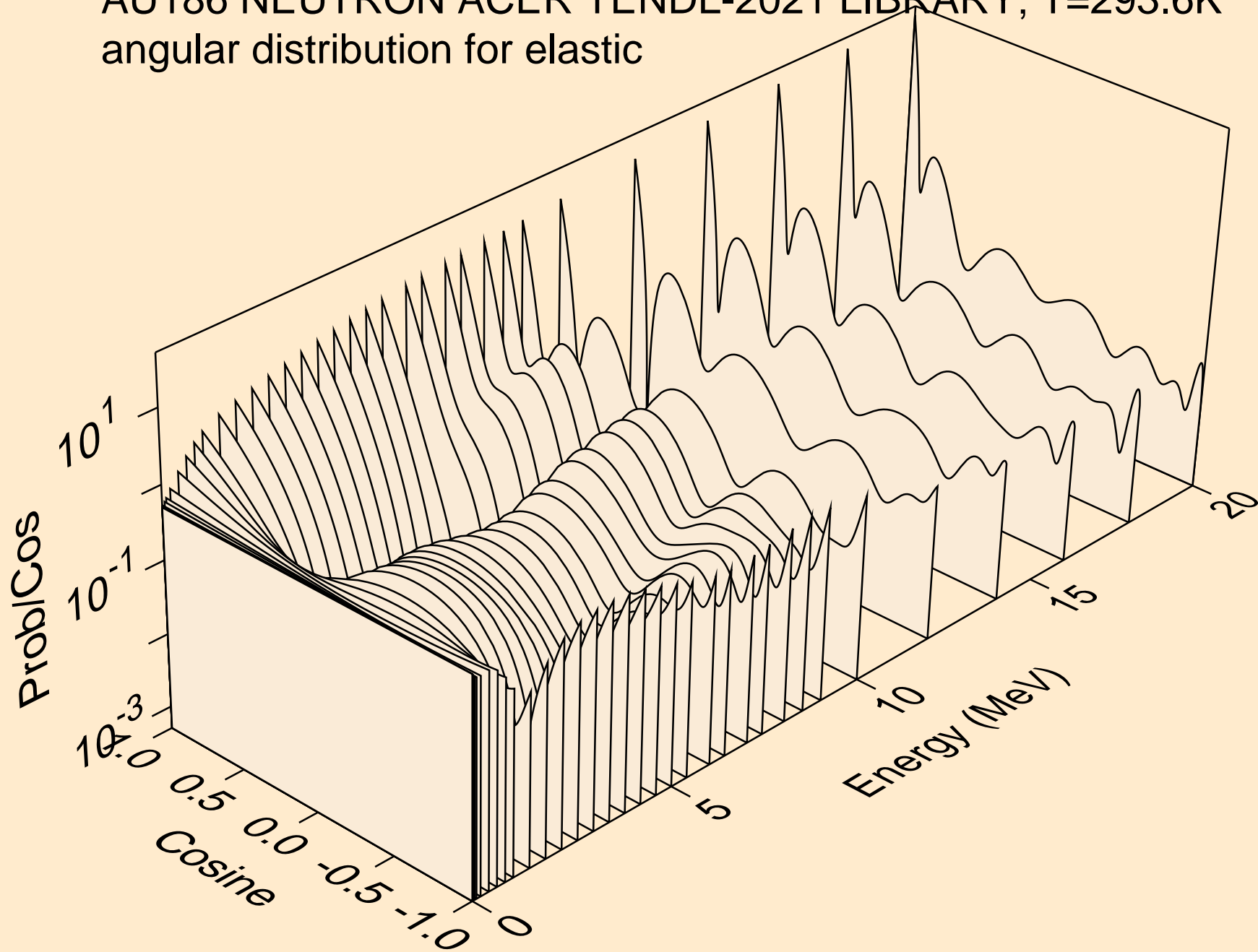

AU186 NEUTRON ACER TENDL-2021 LIBRARY; T=293.6K
angular distribution for elastic

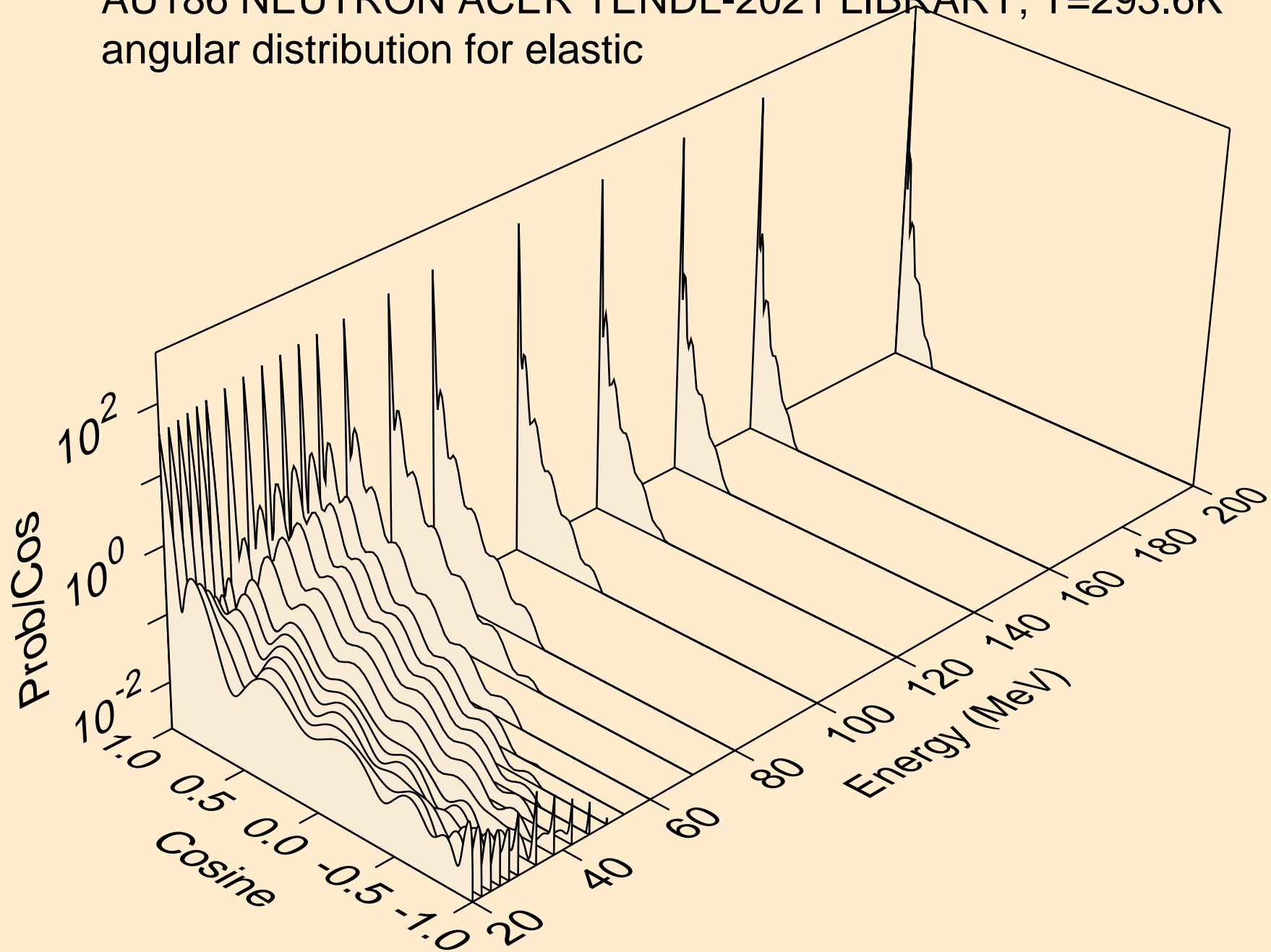

AU186 NEUTRON ACER TENDL-2021 LIBRARY; T=293.6K
angular distribution for (n,n*1)

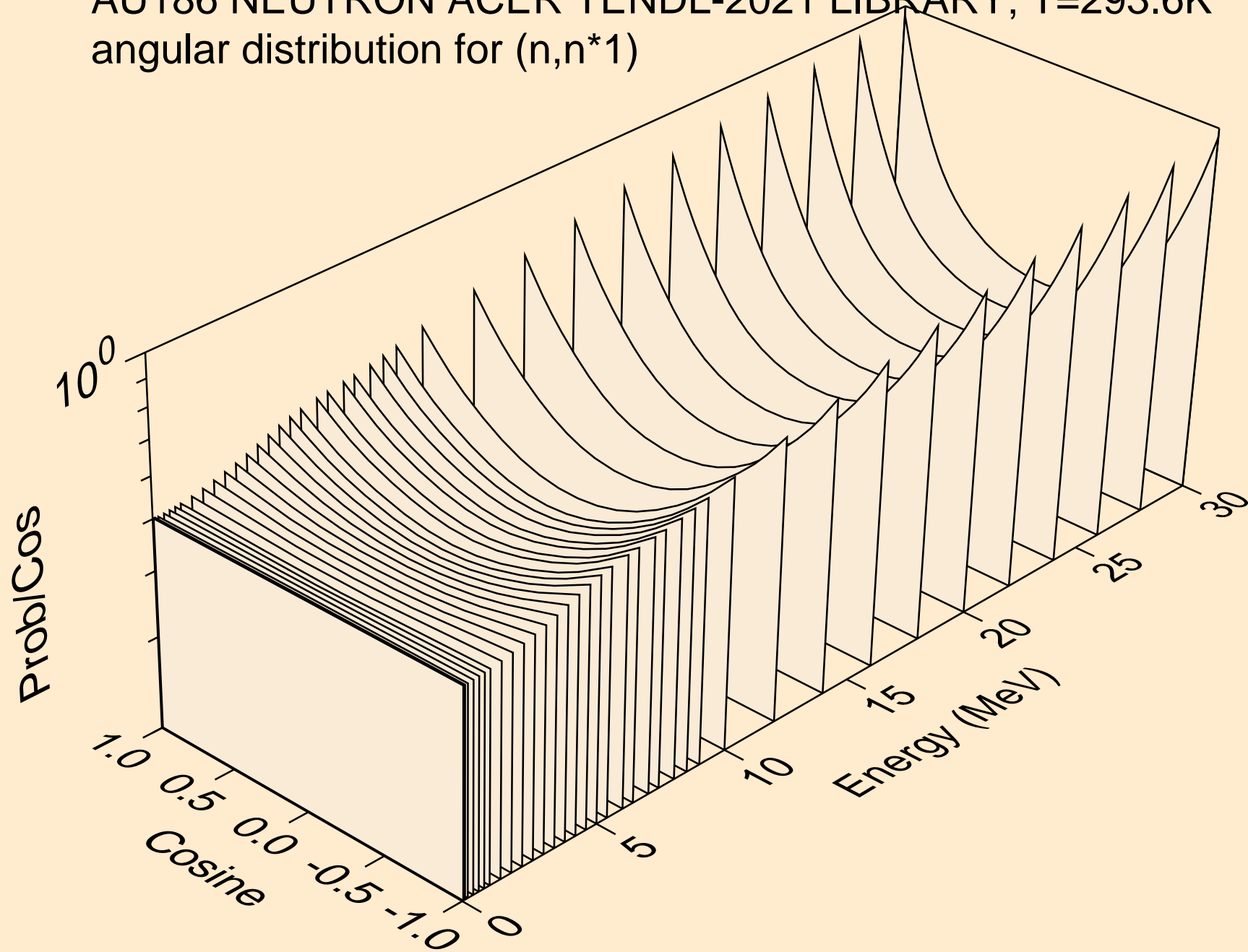

AU186 NEUTRON ACER TENDL-2021 LIBRARY; T=293.6K
angular distribution for (n,n*2)

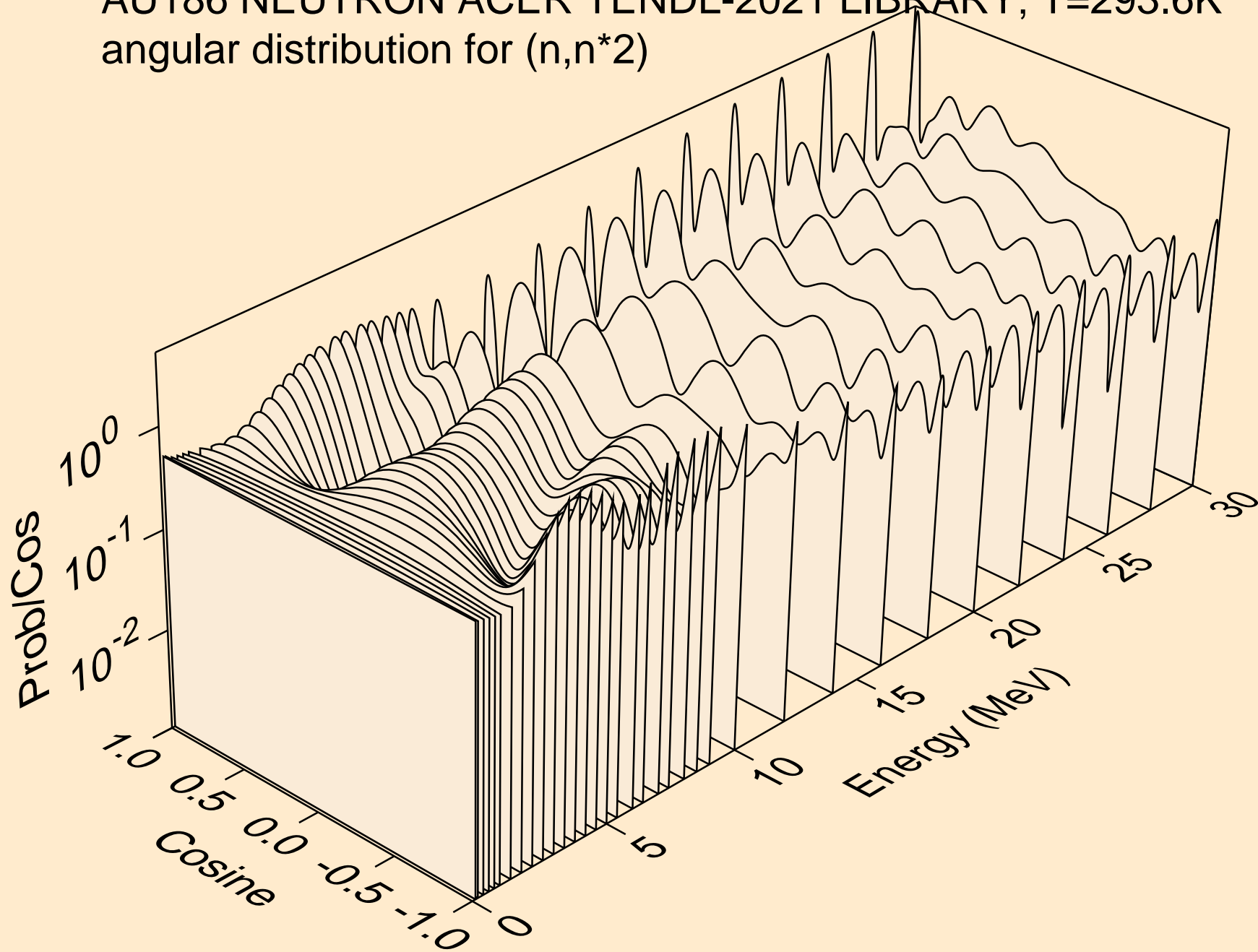

AU186 NEUTRON ACER TENDL-2021 LIBRARY; T=293.6K
angular distribution for (n,n*3)

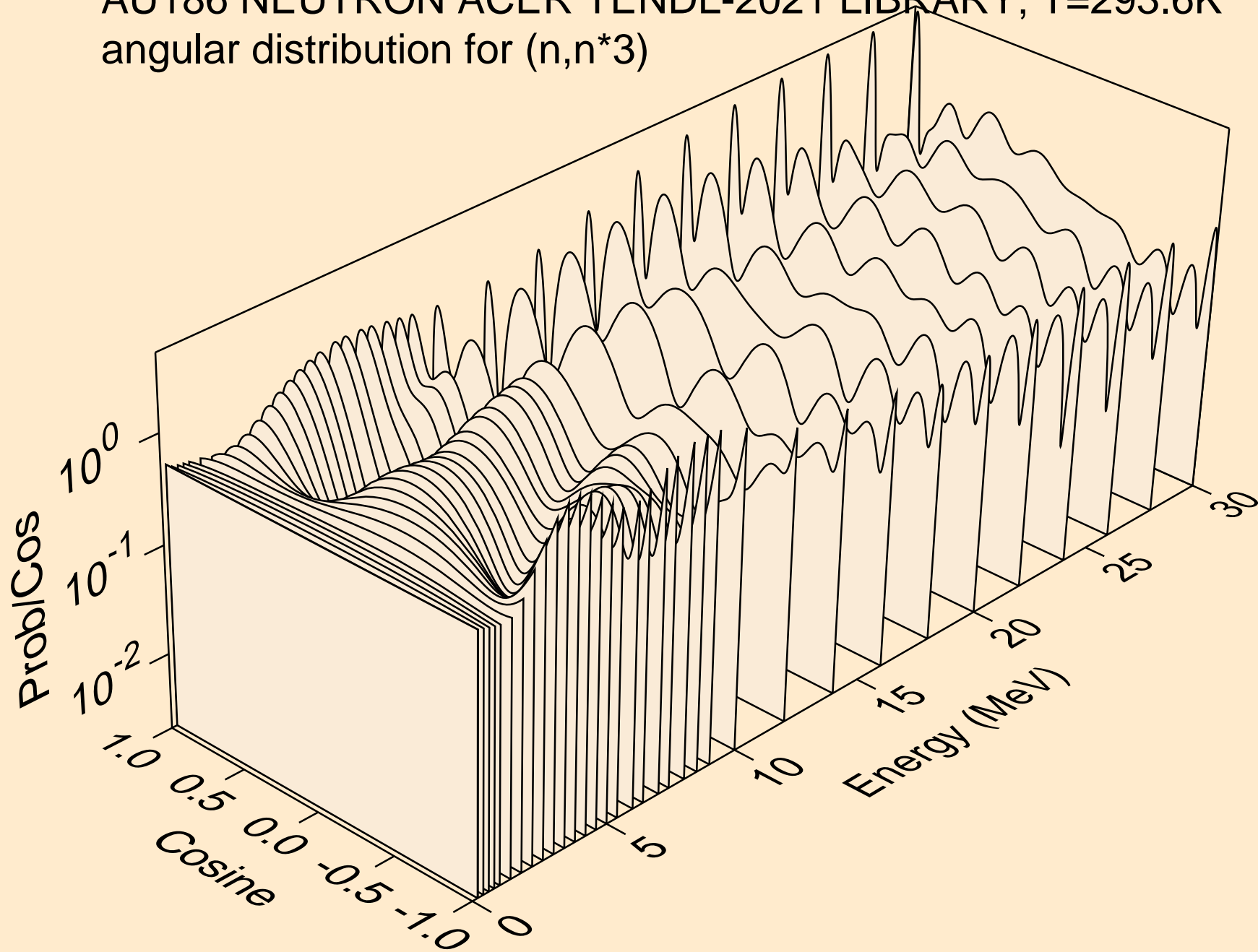

AU186 NEUTRON ACER TENDL-2021 LIBRARY; T=293.6K
angular distribution for (n,n*4)

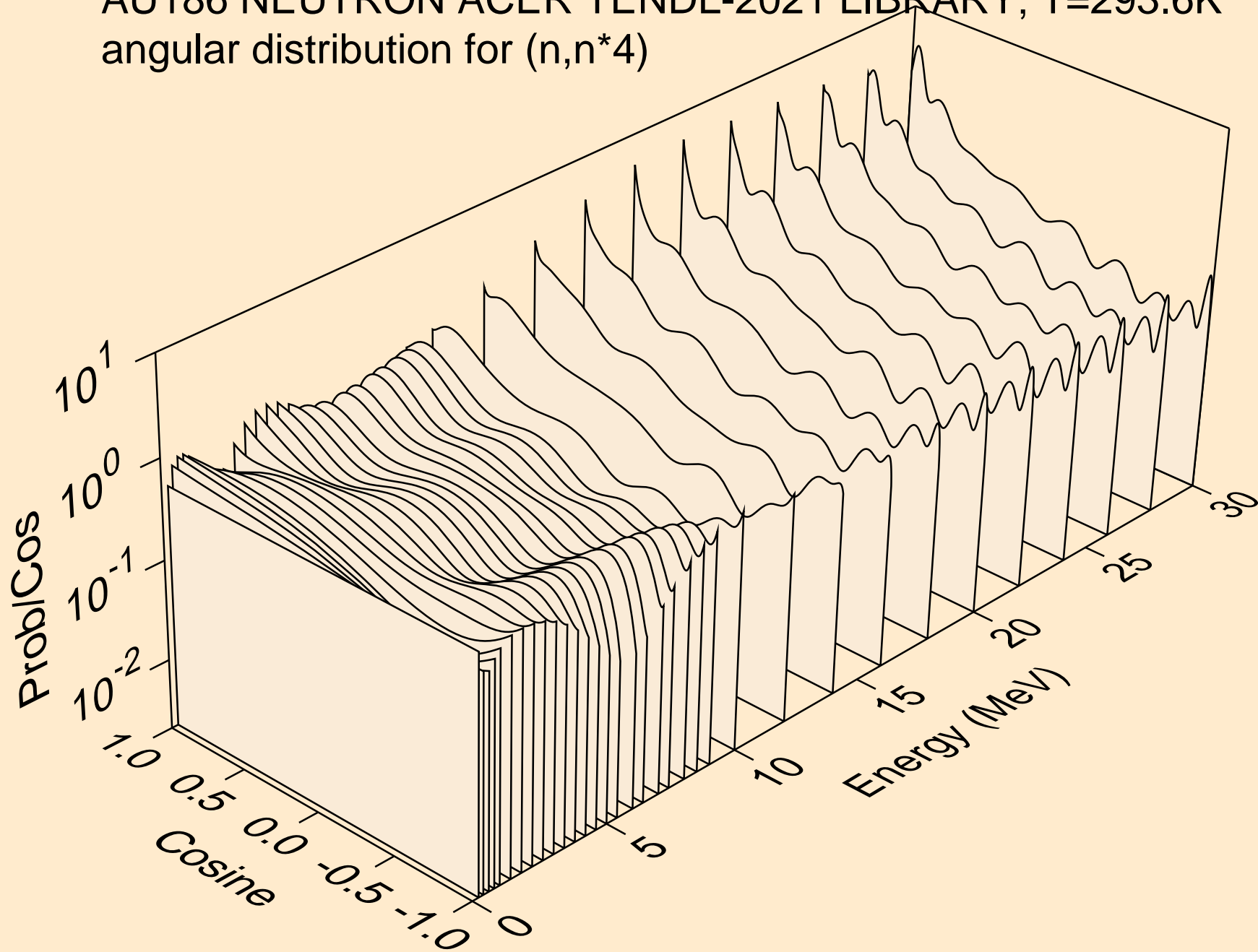

AU186 NEUTRON ACER TENDL-2021 LIBRARY; T=293.6K
angular distribution for (n,n*5)

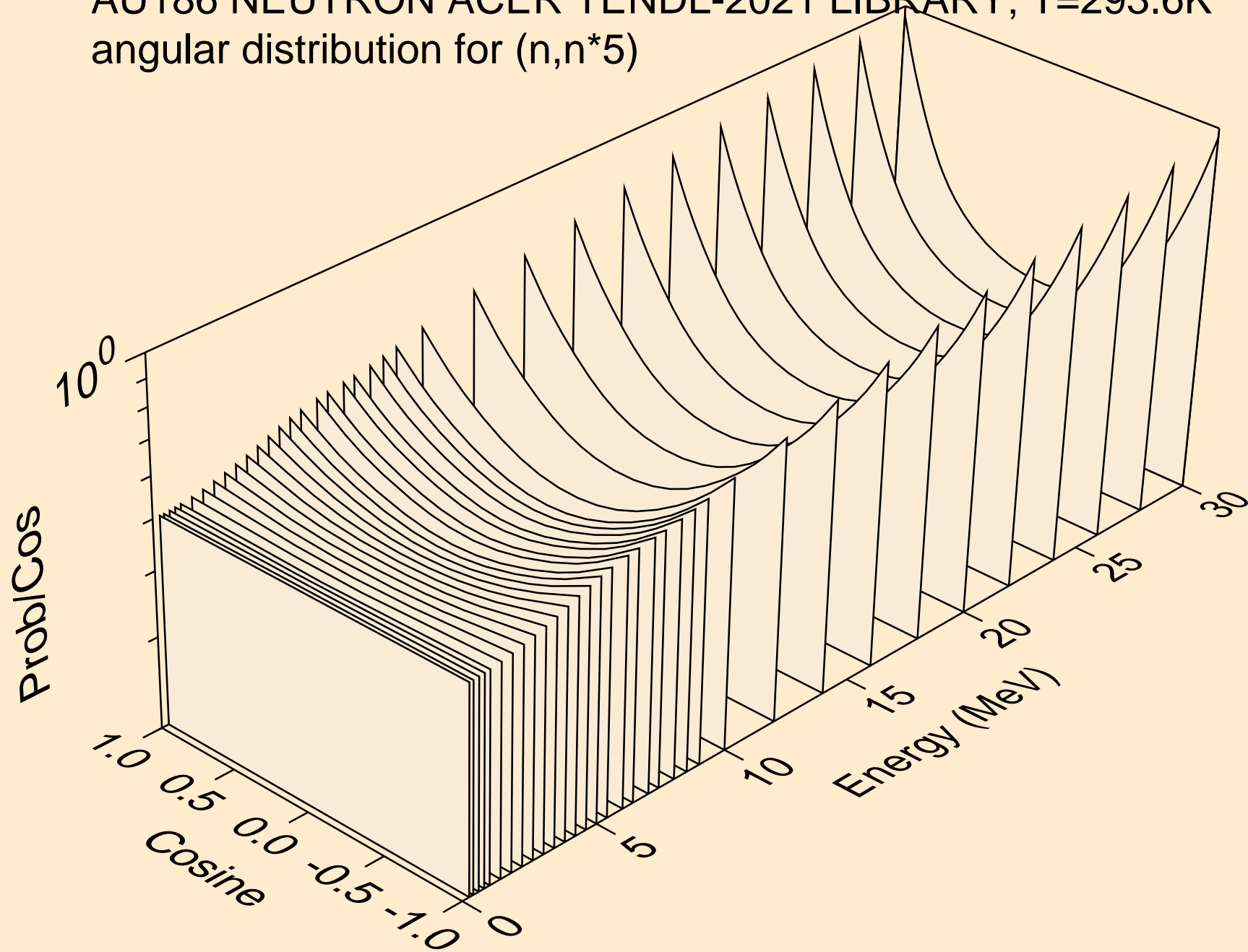

AU186 NEUTRON ACER TENDL-2021 LIBRARY; T=293.6K
angular distribution for (n,n*6)

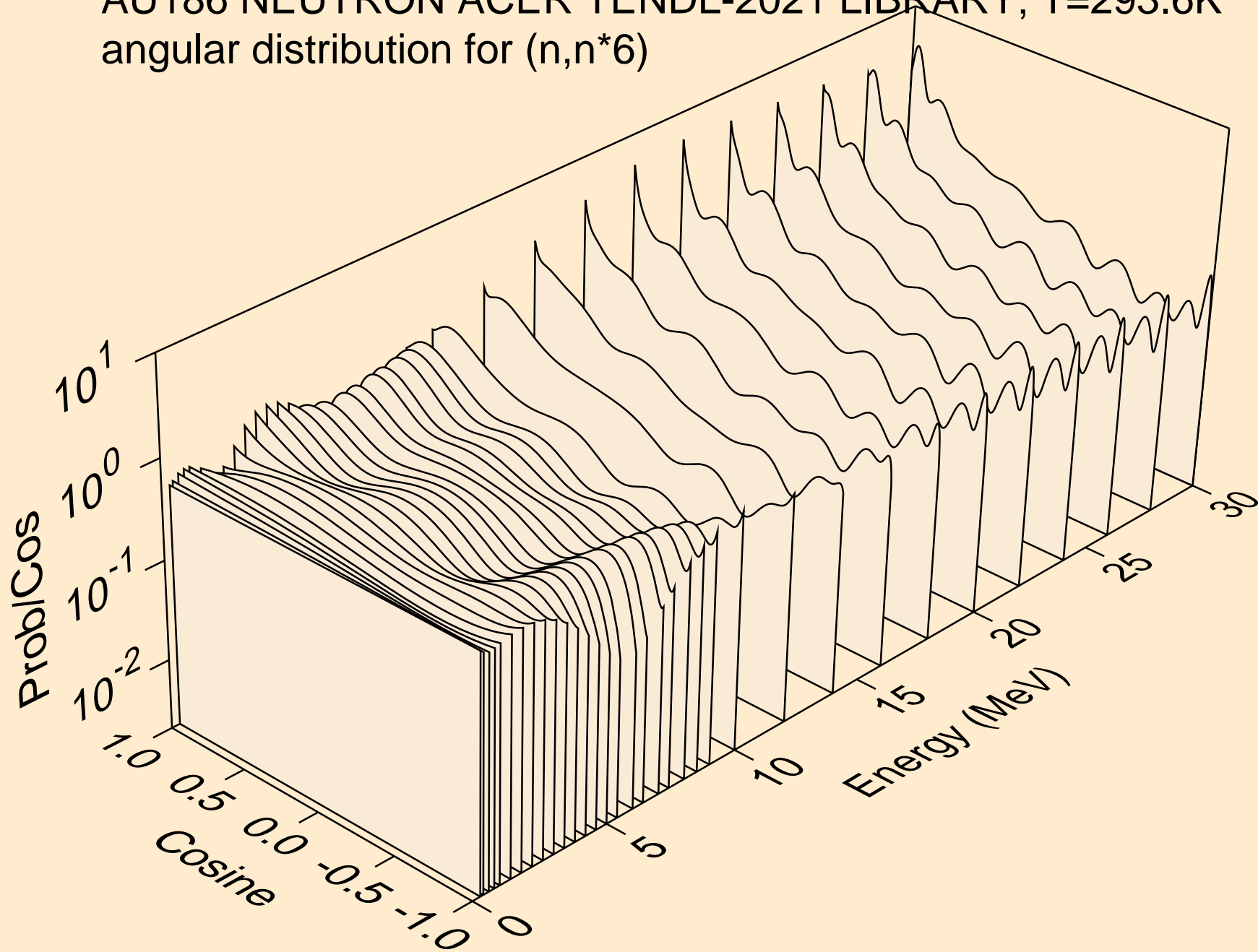

AU186 NEUTRON ACER TENDL-2021 LIBRARY; T=293.6K
angular distribution for (n,n*7)

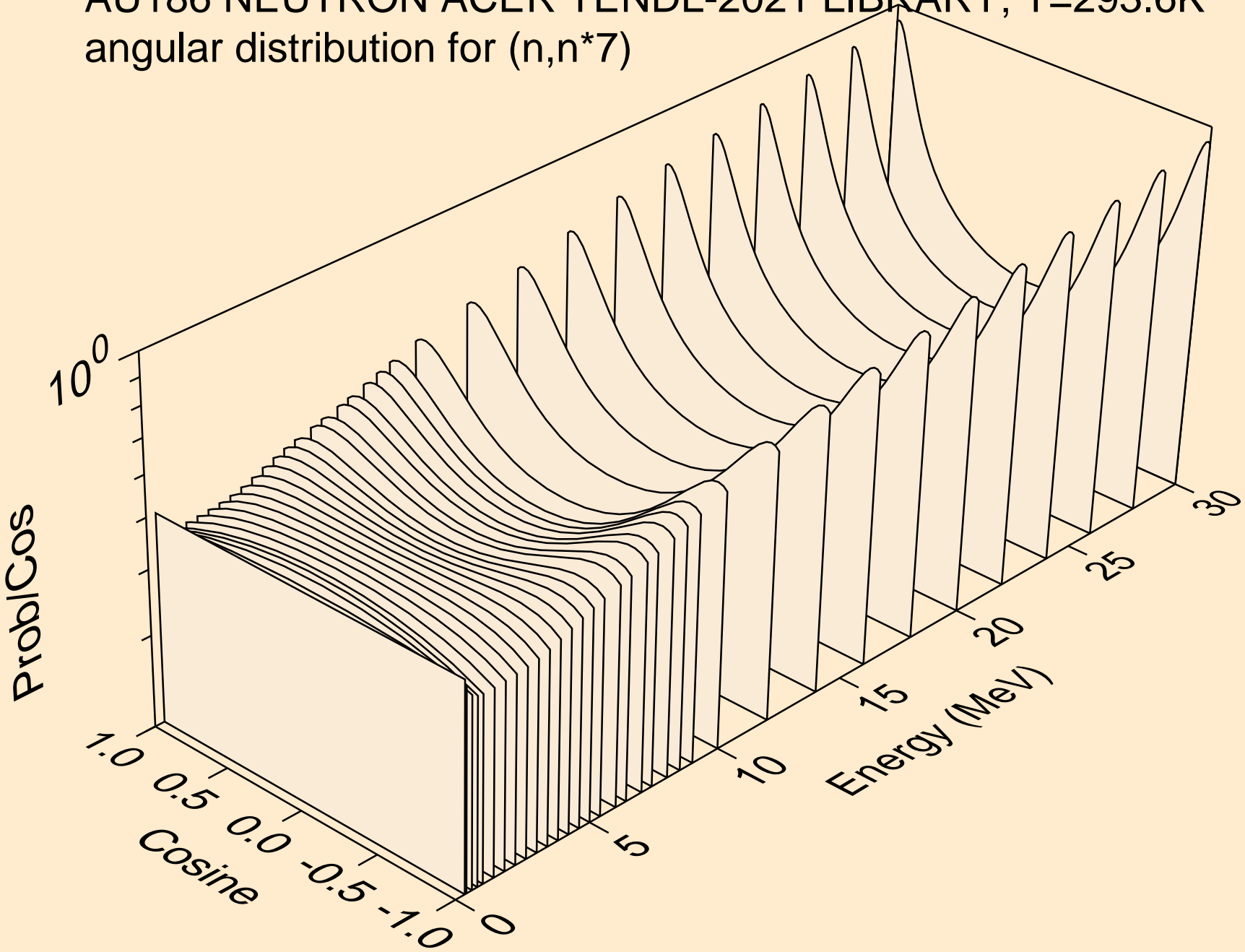

AU186 NEUTRON ACER TENDL-2021 LIBRARY; T=293.6K
angular distribution for (n,n*8)

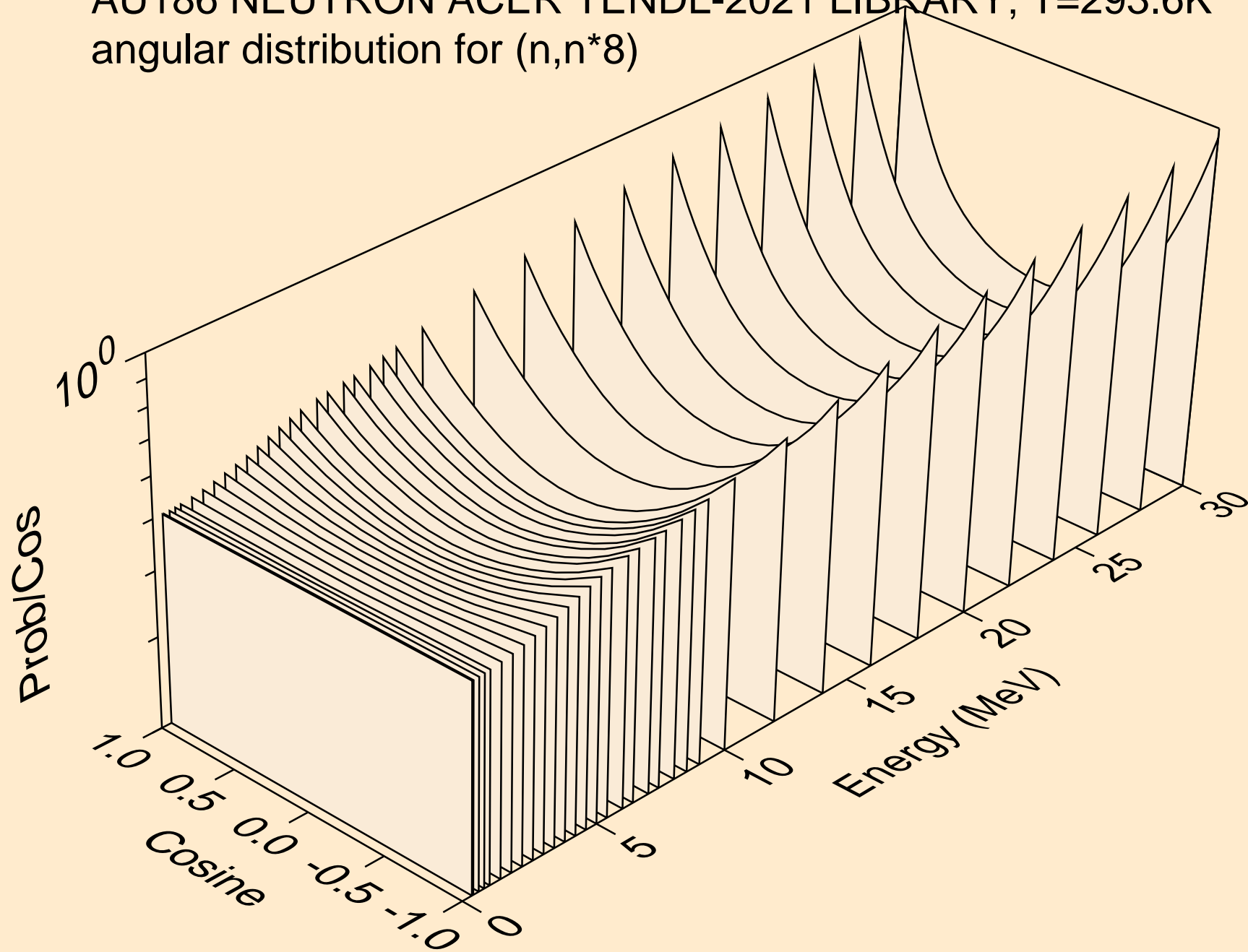

AU186 NEUTRON ACER TENDL-2021 LIBRARY; T=293.6K
angular distribution for (n,n*9)

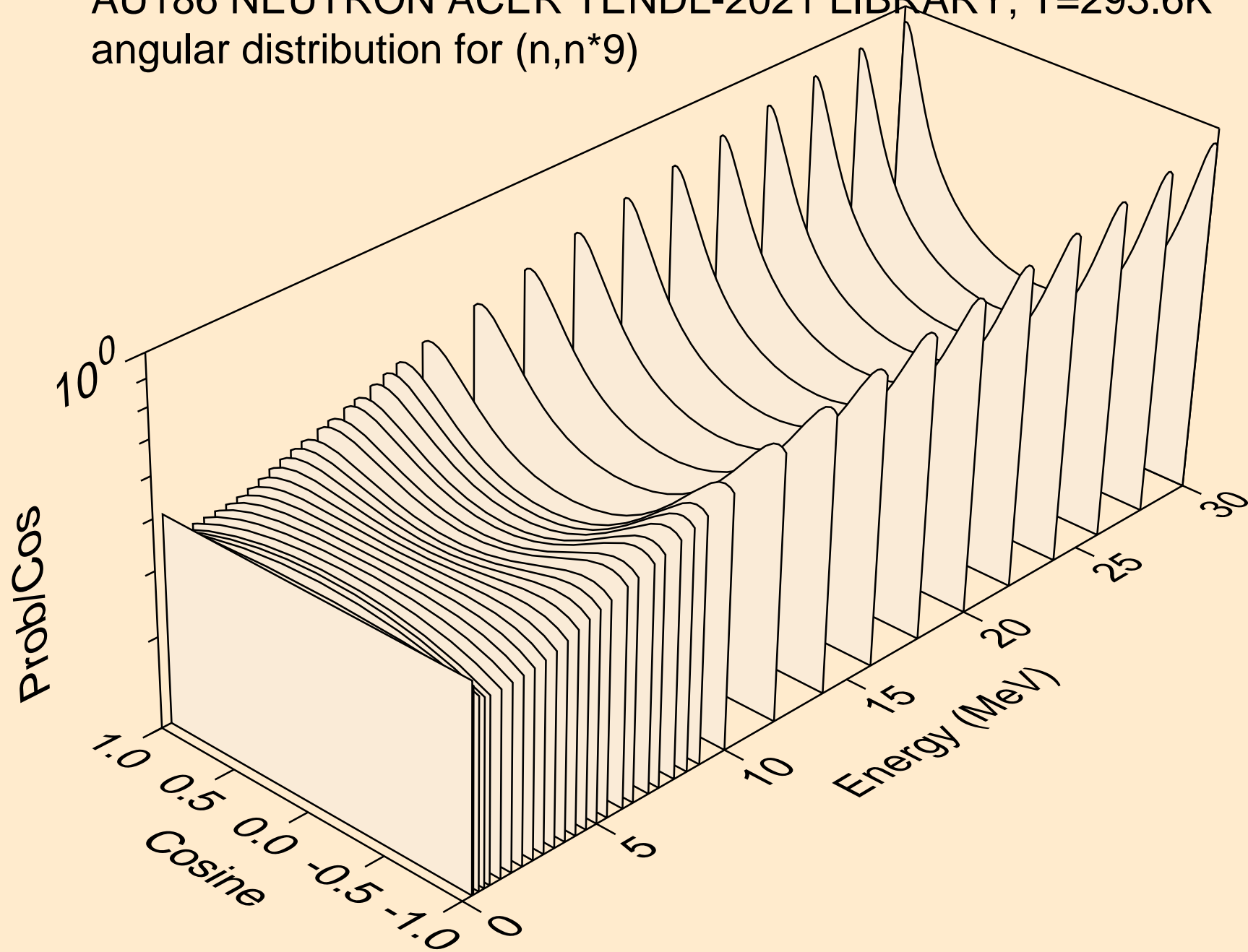

AU186 NEUTRON ACER TENDL-2021 LIBRARY; T=293.6K
angular distribution for (n,n*10)

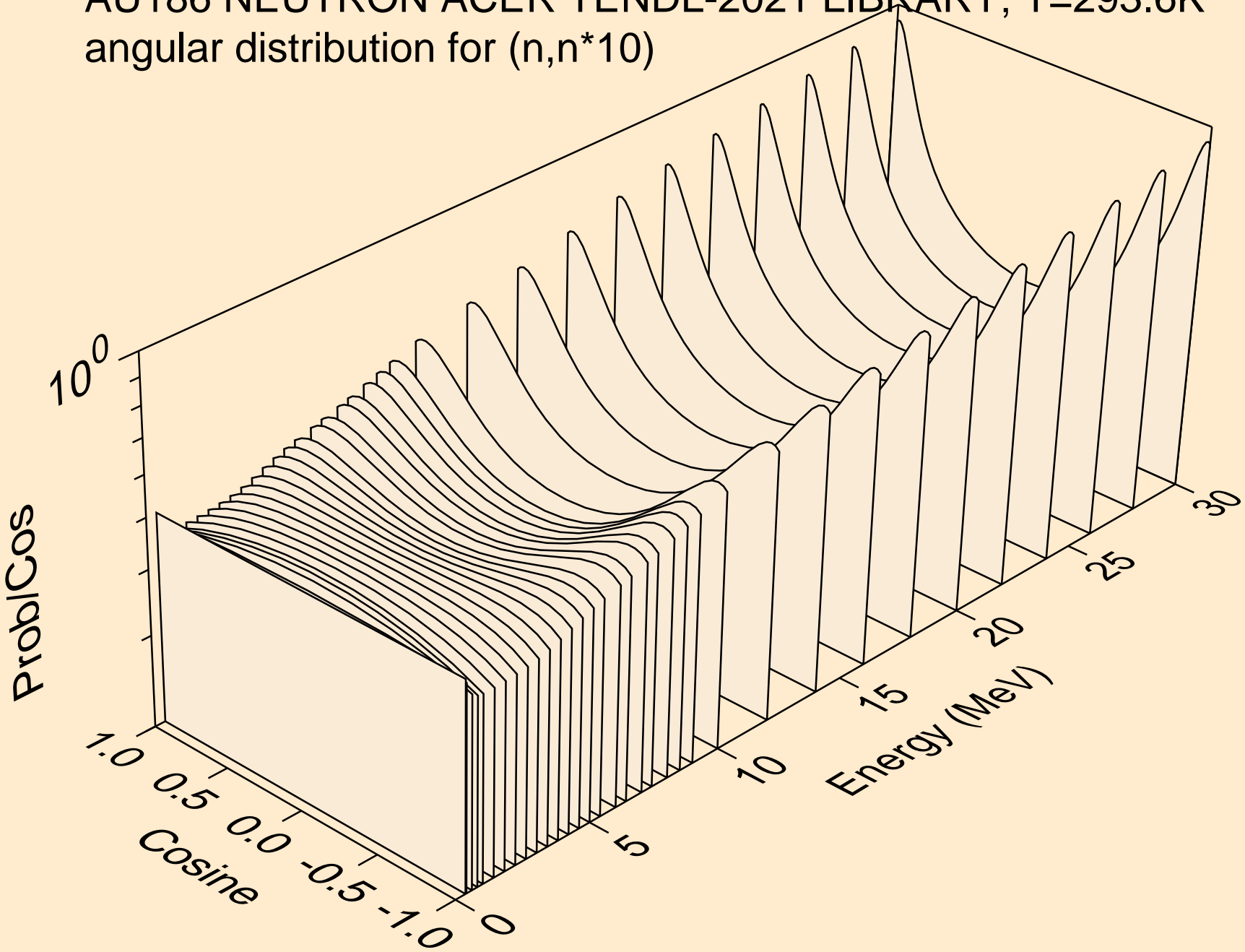

AU186 NEUTRON ACER TENDL-2021 LIBRARY; T=293.6K
angular distribution for (n,n*11)

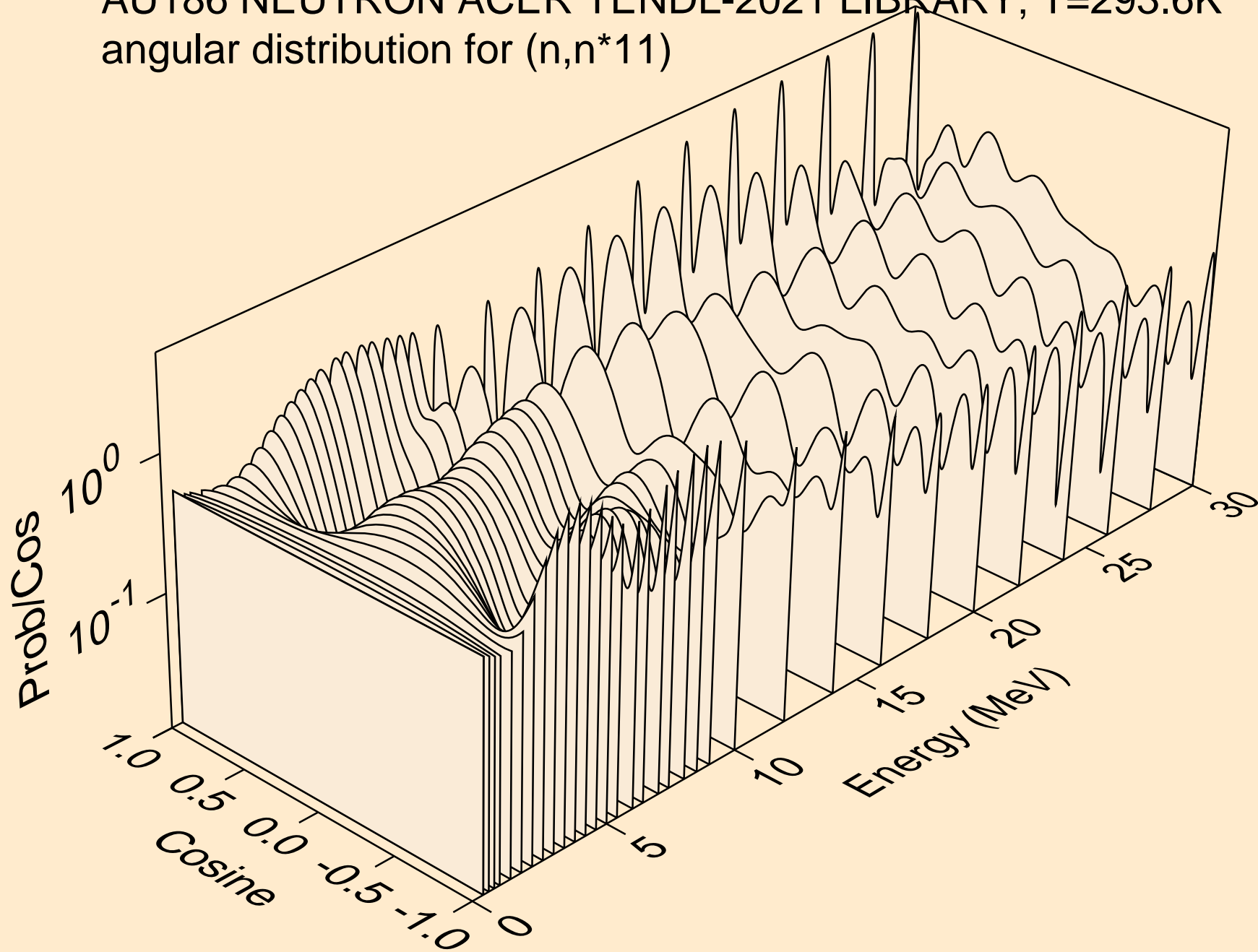

AU186 NEUTRON ACER TENDL-2021 LIBRARY; T=293.6K
angular distribution for (n,n*12)

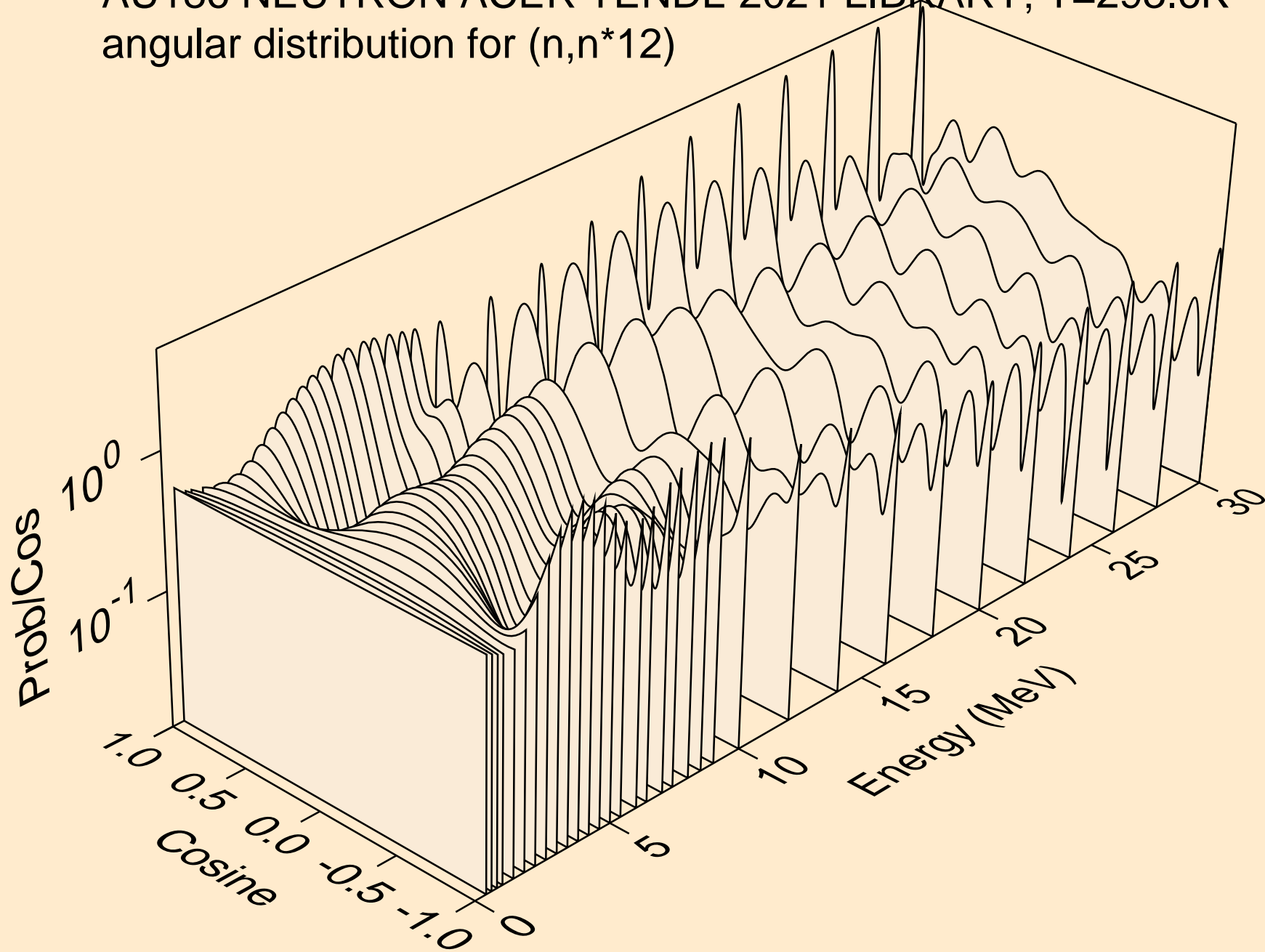

AU186 NEUTRON ACER TENDL-2021 LIBRARY; T=293.6K
angular distribution for (n,n*13)

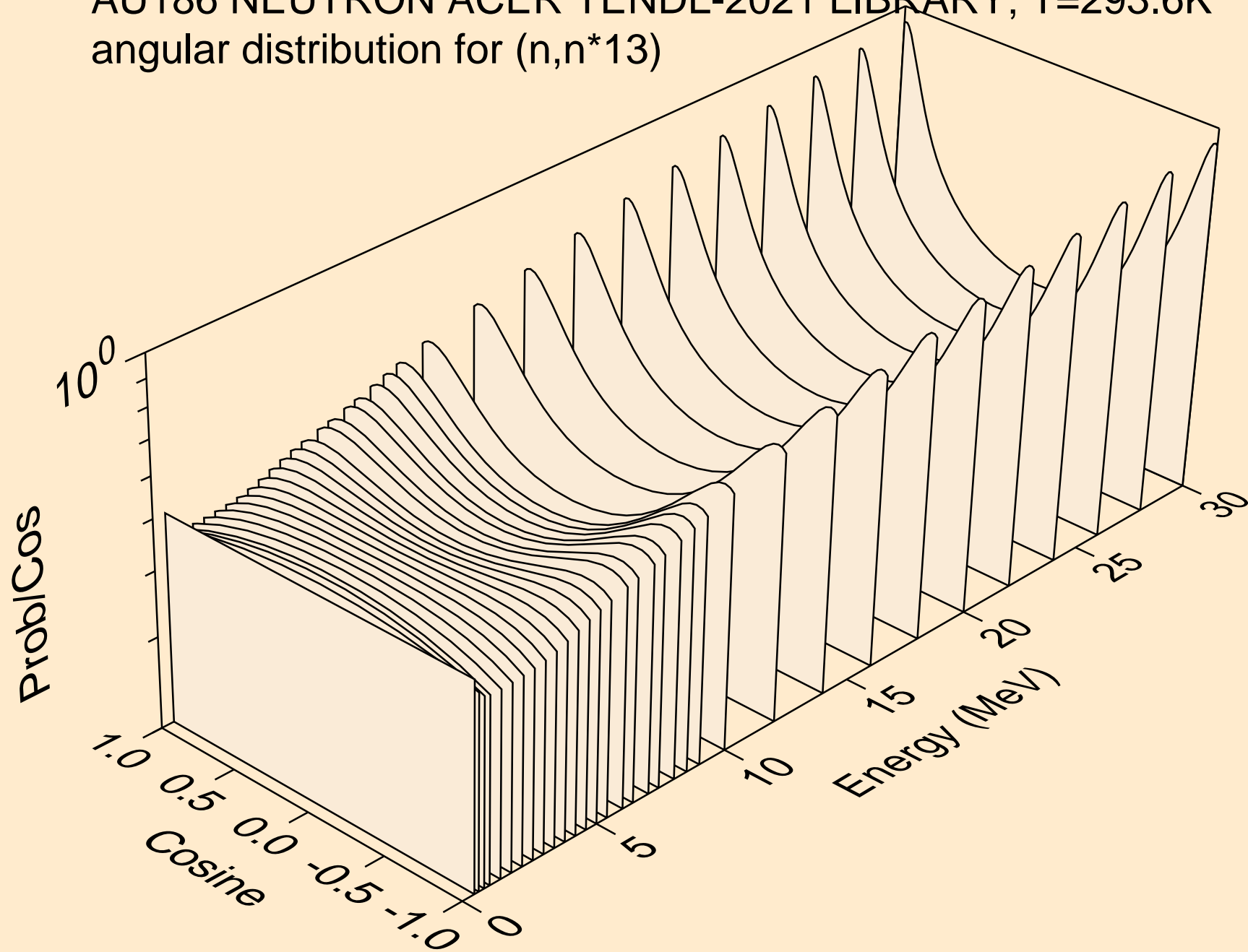

AU186 NEUTRON ACER TENDL-2021 LIBRARY; T=293.6K
angular distribution for (n,n*14)

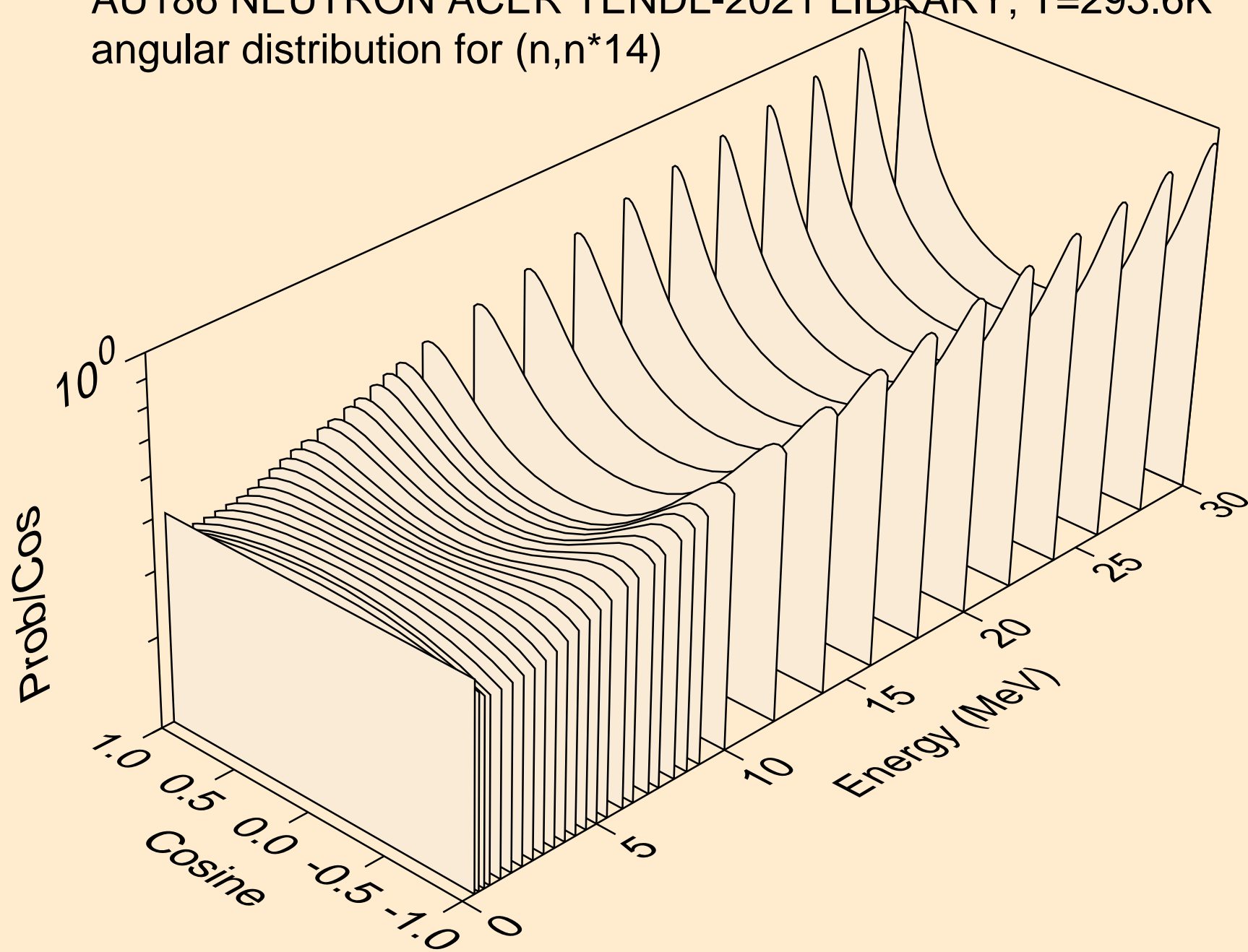

AU186 NEUTRON ACER TENDL-2021 LIBRARY; T=293.6K
angular distribution for (n,n*15)

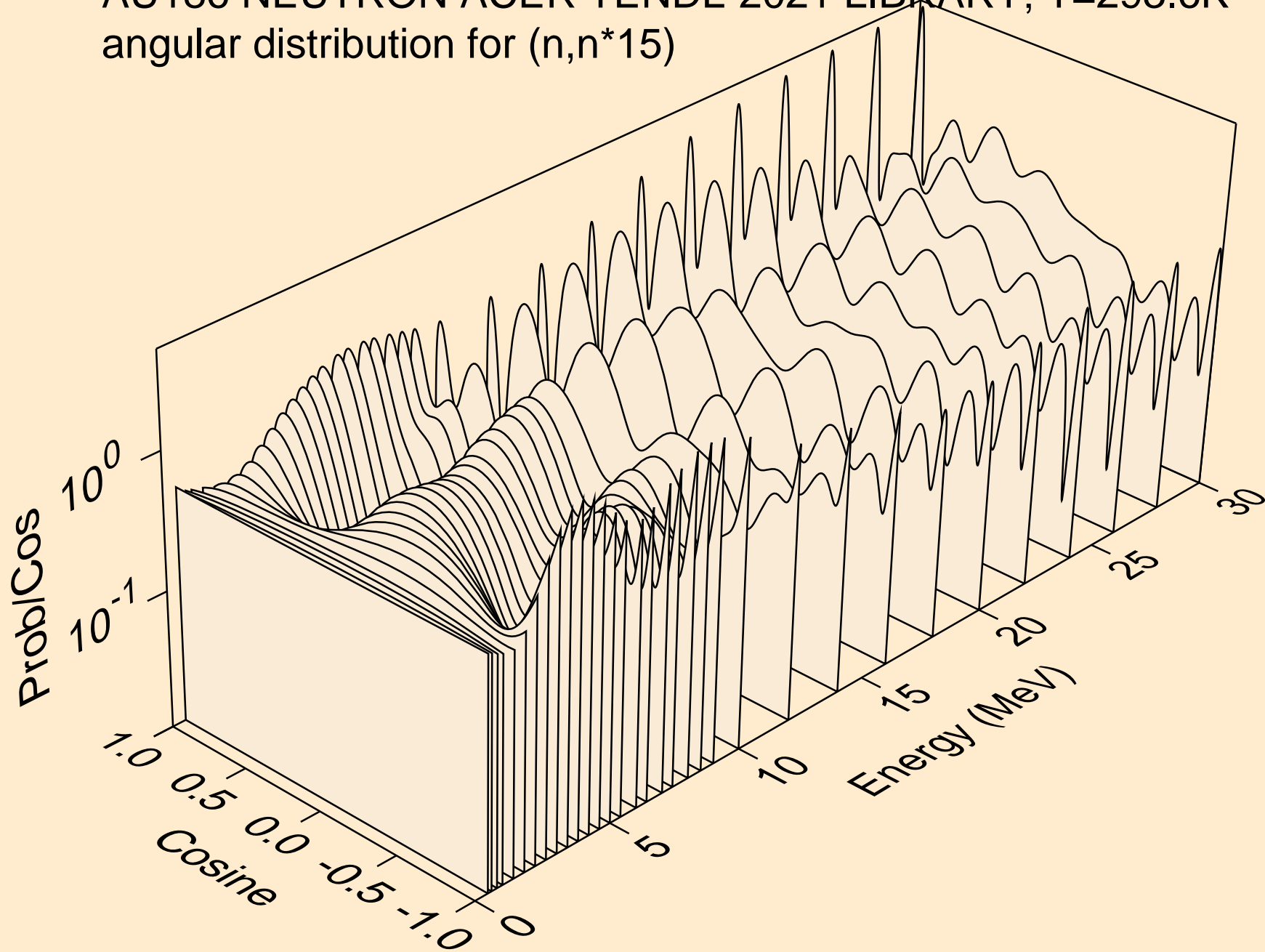

AU186 NEUTRON ACER TENDL-2021 LIBRARY; T=293.6K
angular distribution for (n,n*16)

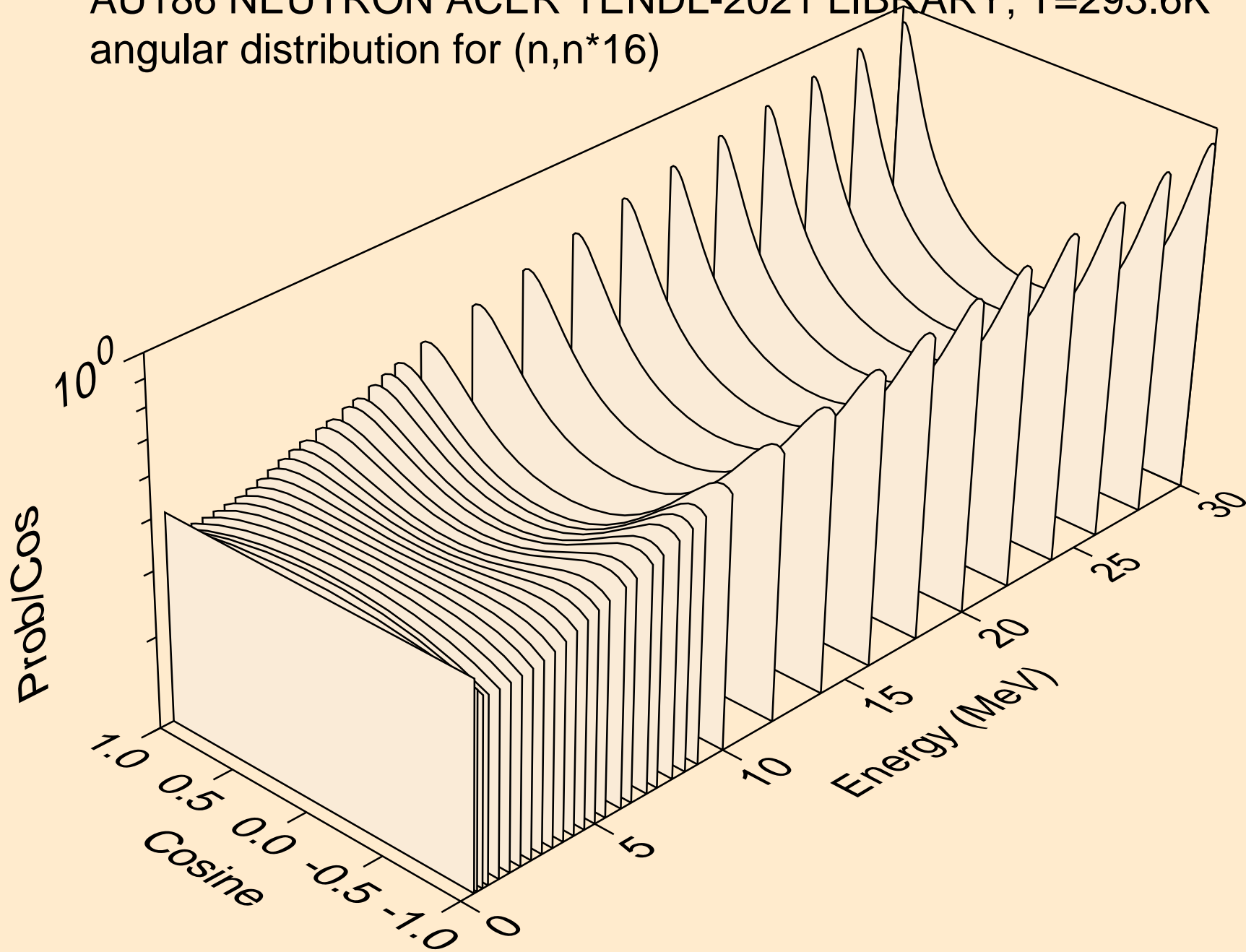

AU186 NEUTRON ACER TENDL-2021 LIBRARY; T=293.6K
angular distribution for (n,n*17)

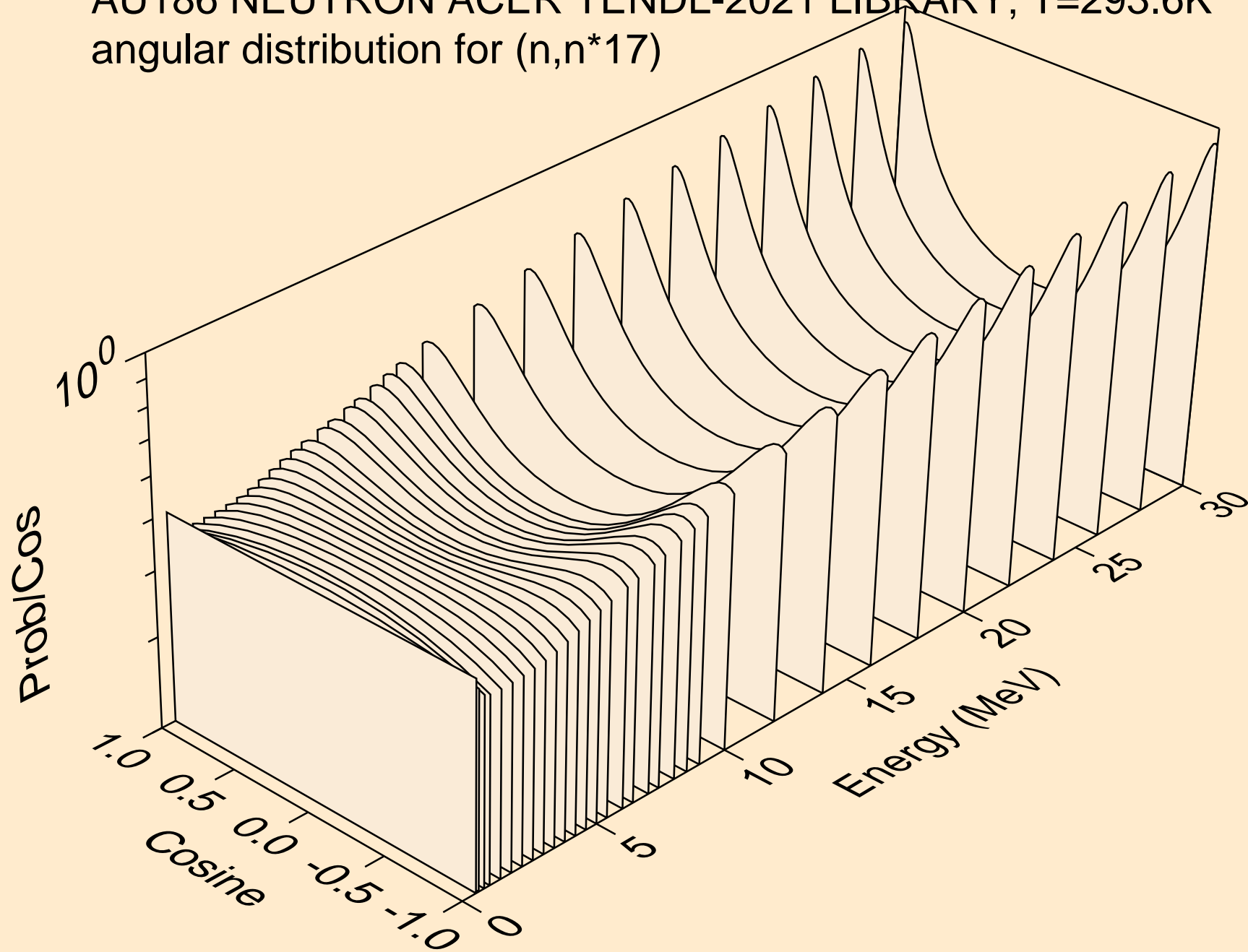

AU186 NEUTRON ACER TENDL-2021 LIBRARY; T=293.6K
angular distribution for (n,n*18)

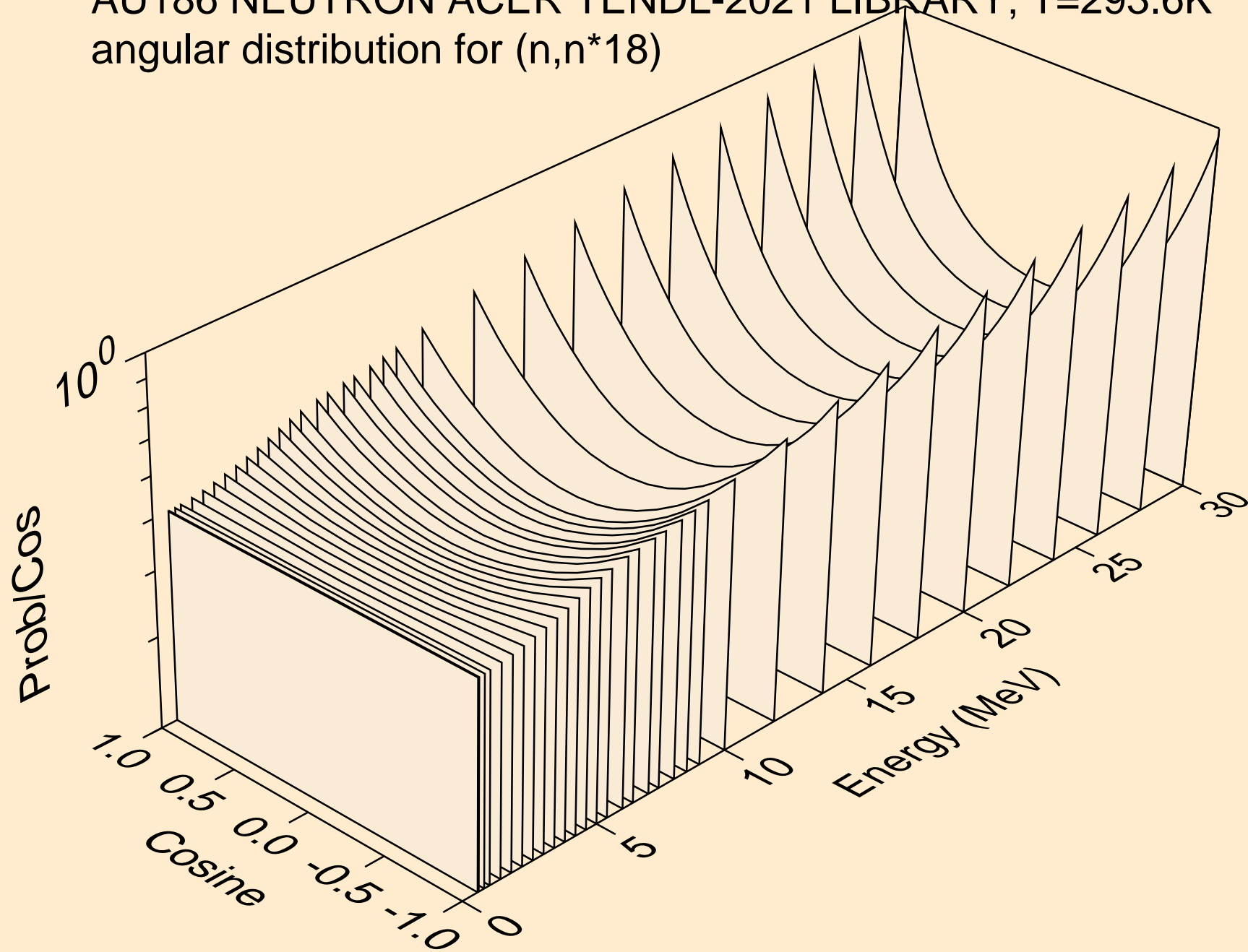

AU186 NEUTRON ACER TENDL-2021 LIBRARY; T=293.6K
angular distribution for (n,n*19)

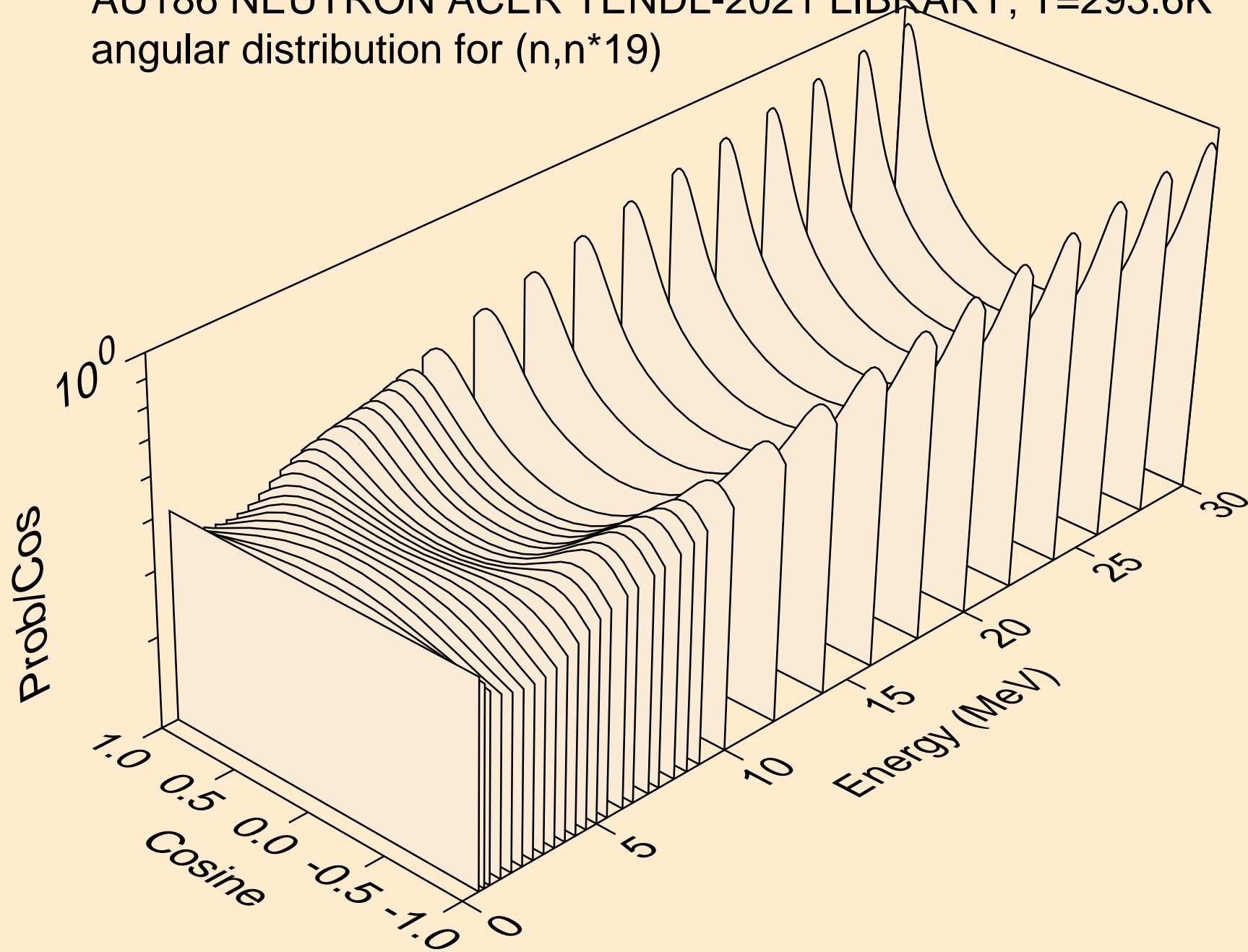

AU186 NEUTRON ACER TENDL-2021 LIBRARY; T=293.6K
angular distribution for (n,n*20)

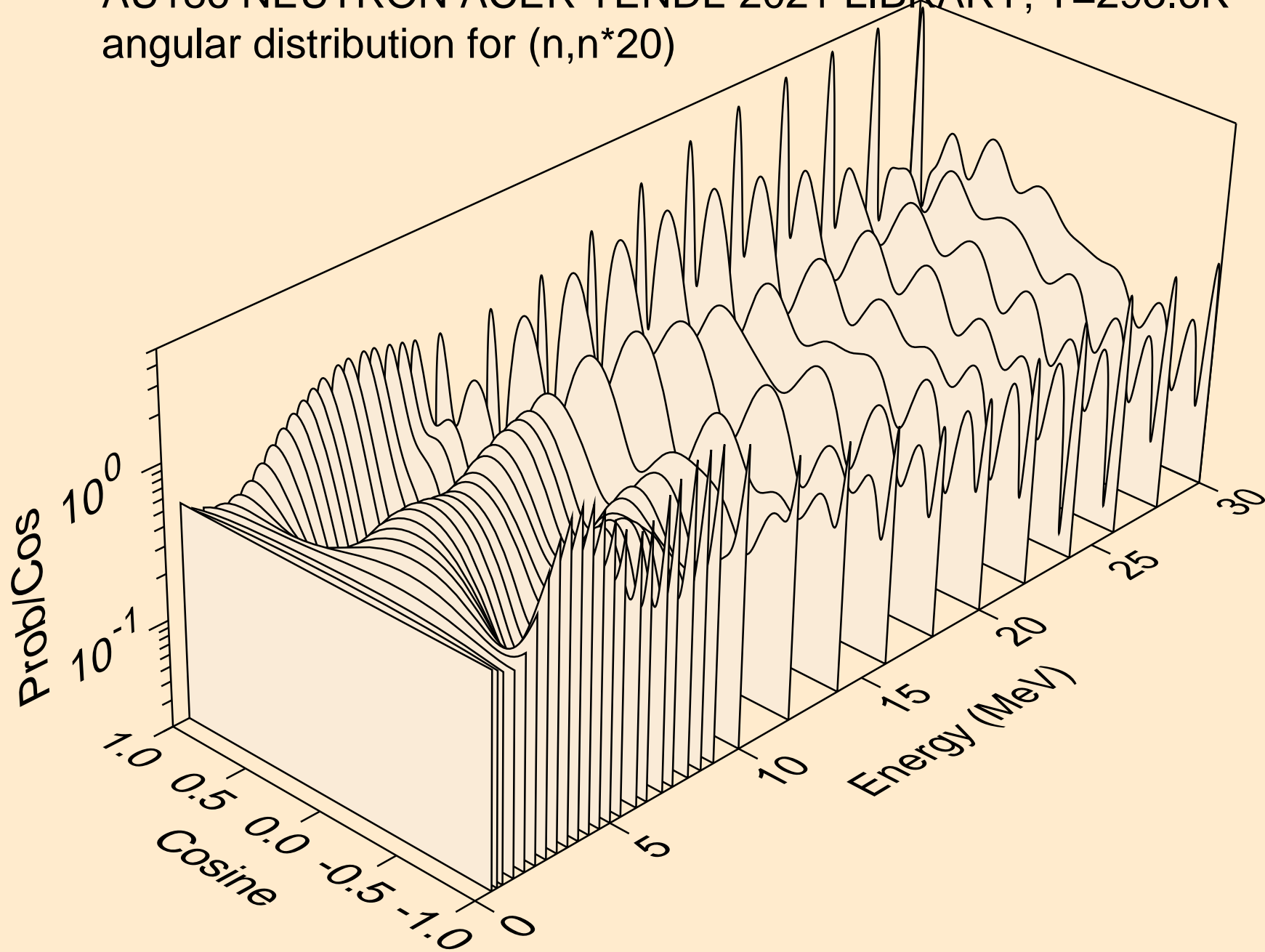

AU186 NEUTRON ACER TENDL-2021 LIBRARY; T=293.6K
angular distribution for (n,n*21)

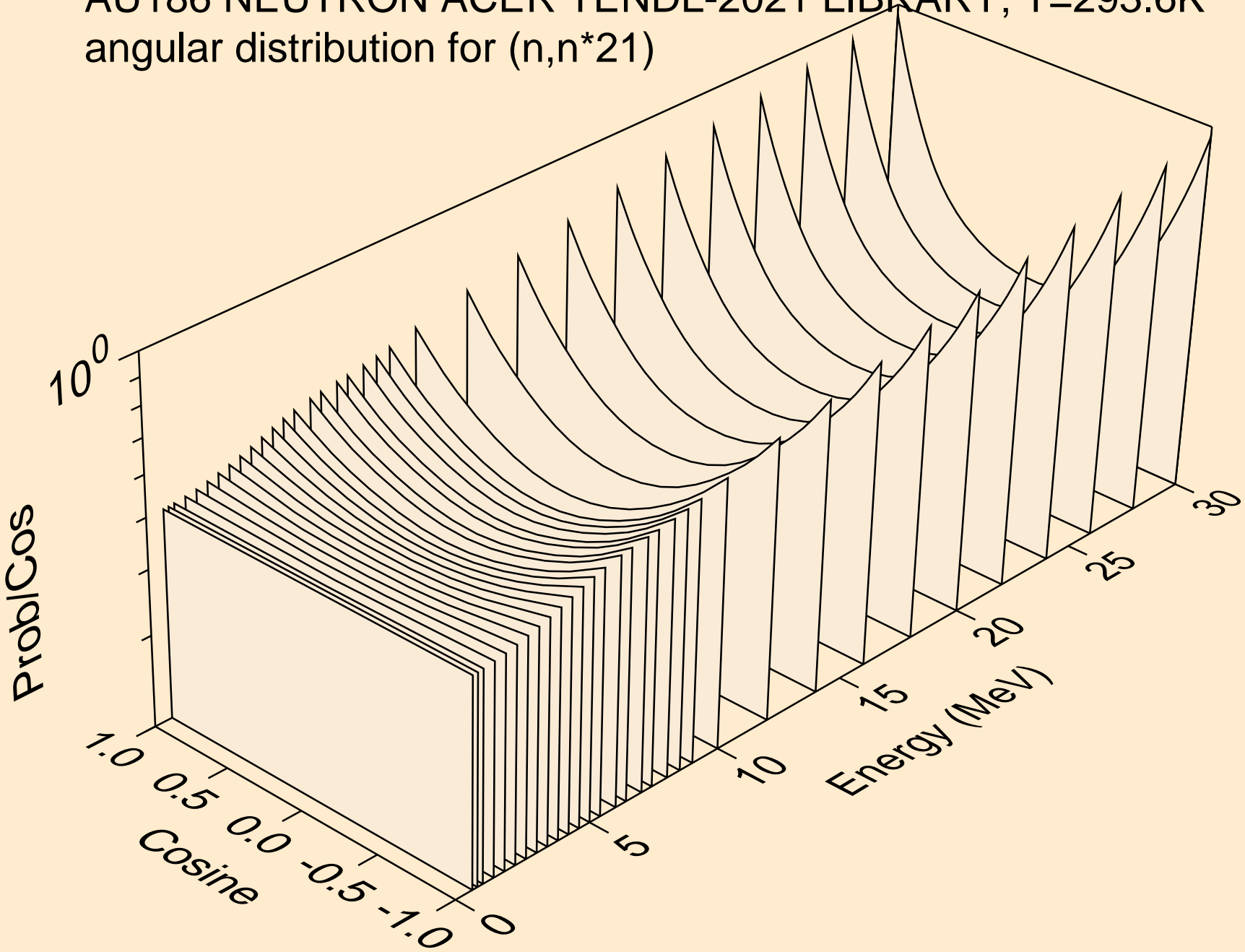

AU186 NEUTRON ACER TENDL-2021 LIBRARY; T=293.6K
angular distribution for (n,n*22)

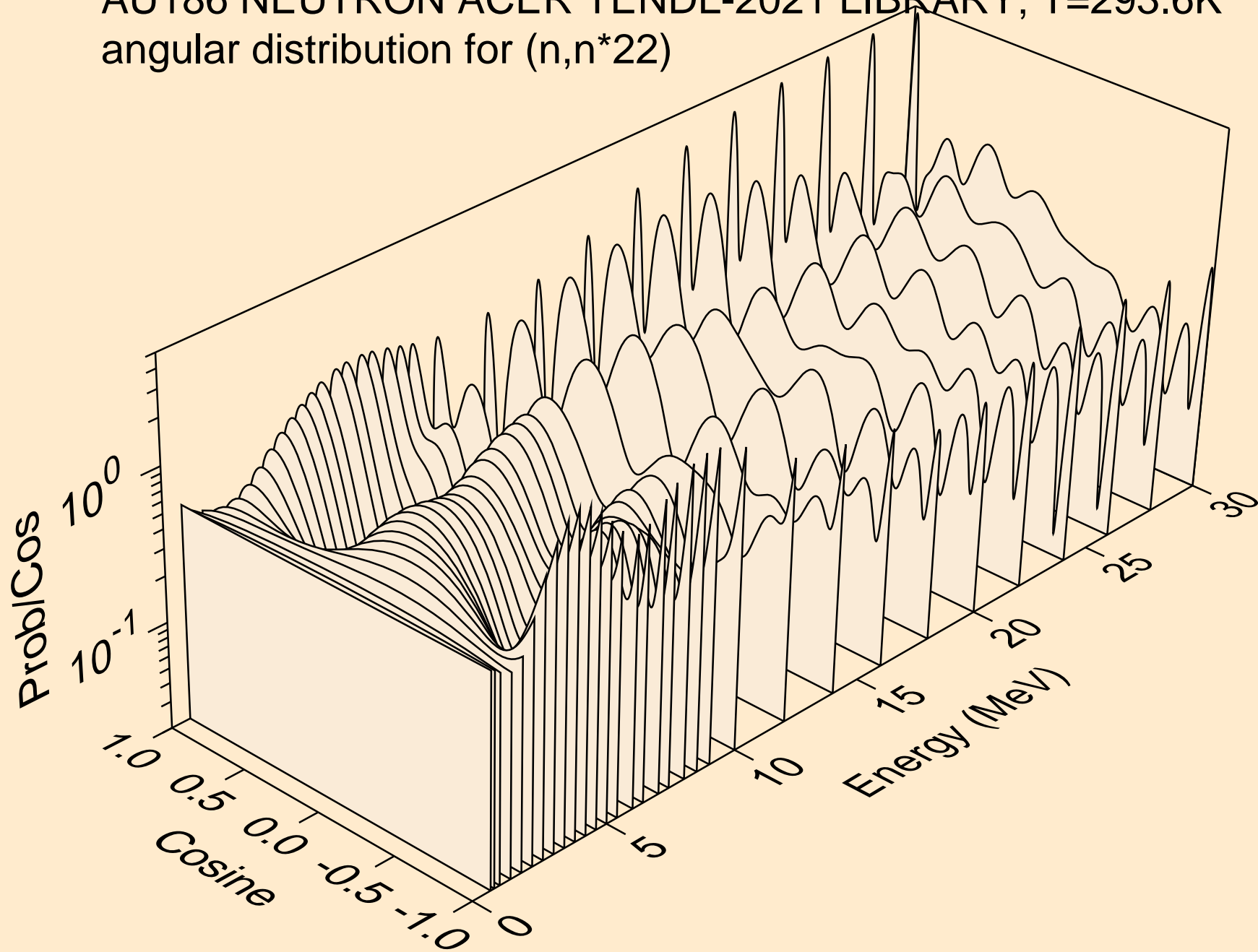

AU186 NEUTRON ACER TENDL-2021 LIBRARY; T=293.6K
angular distribution for (n,n*23)

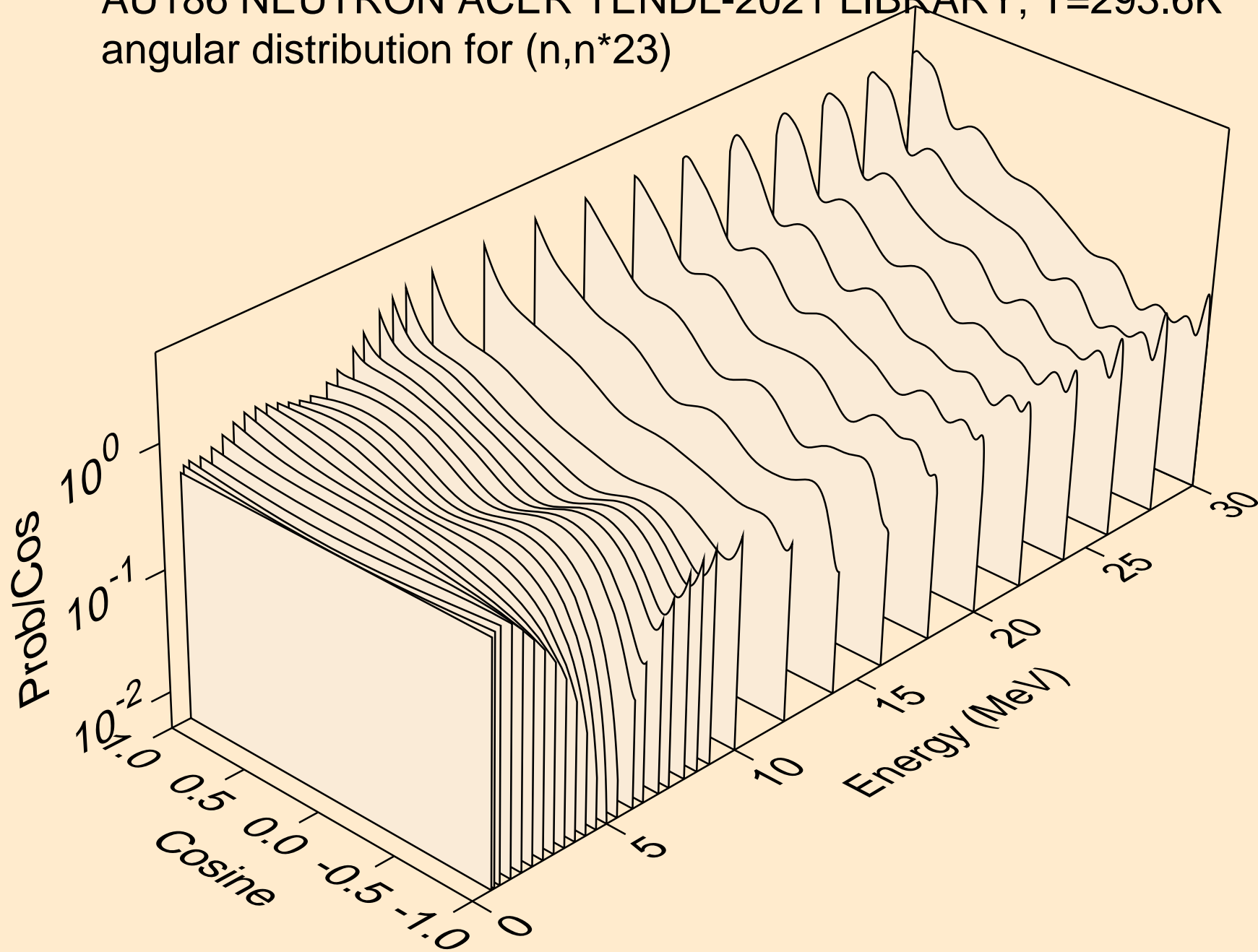

AU186 NEUTRON ACER TENDL-2021 LIBRARY; T=293.6K
Neutron emission for (n,x)

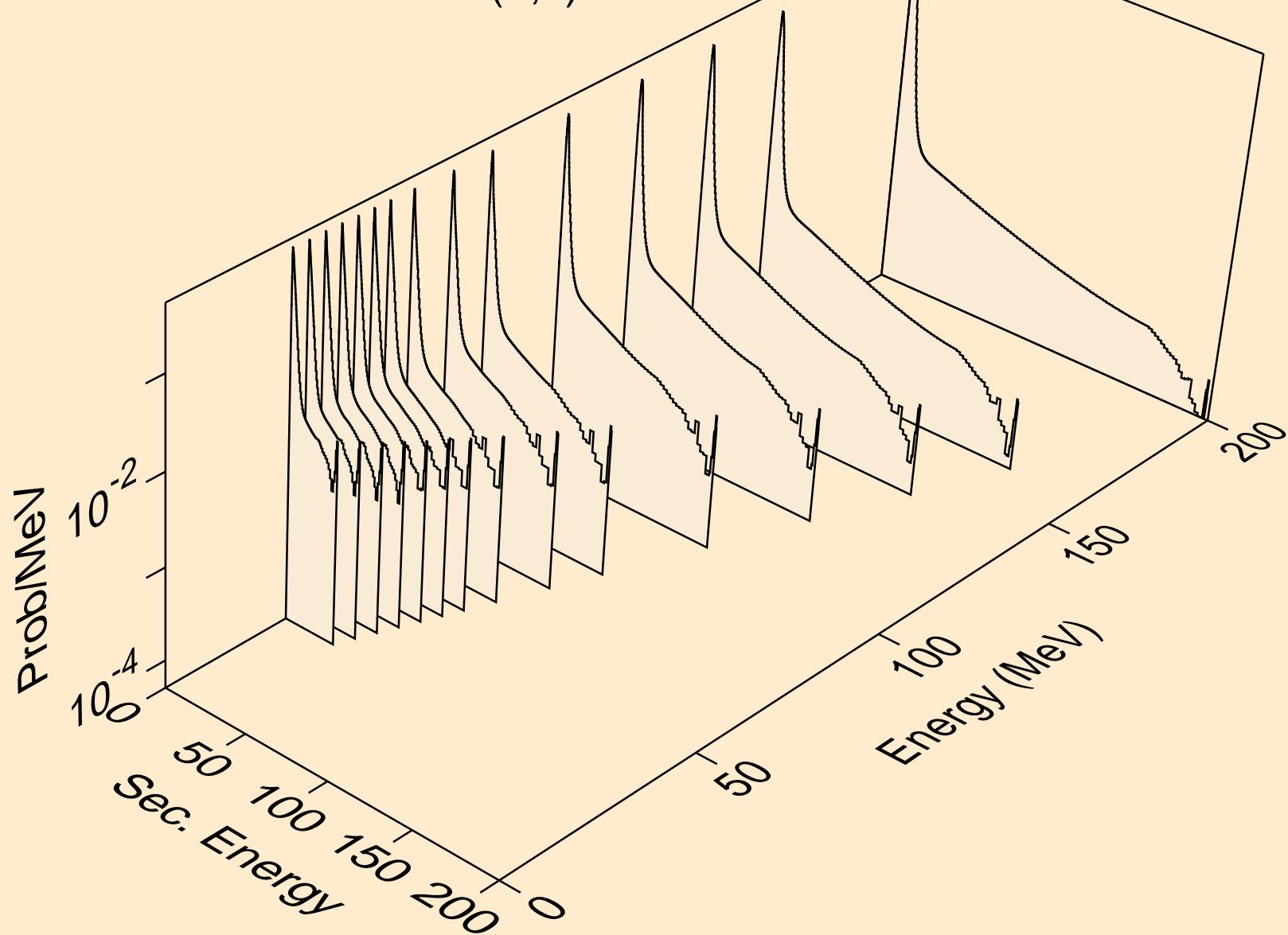

AU186 NEUTRON ACER TENDL-2021 LIBRARY; T=293.6K
Neutron emission for (n,2nd)

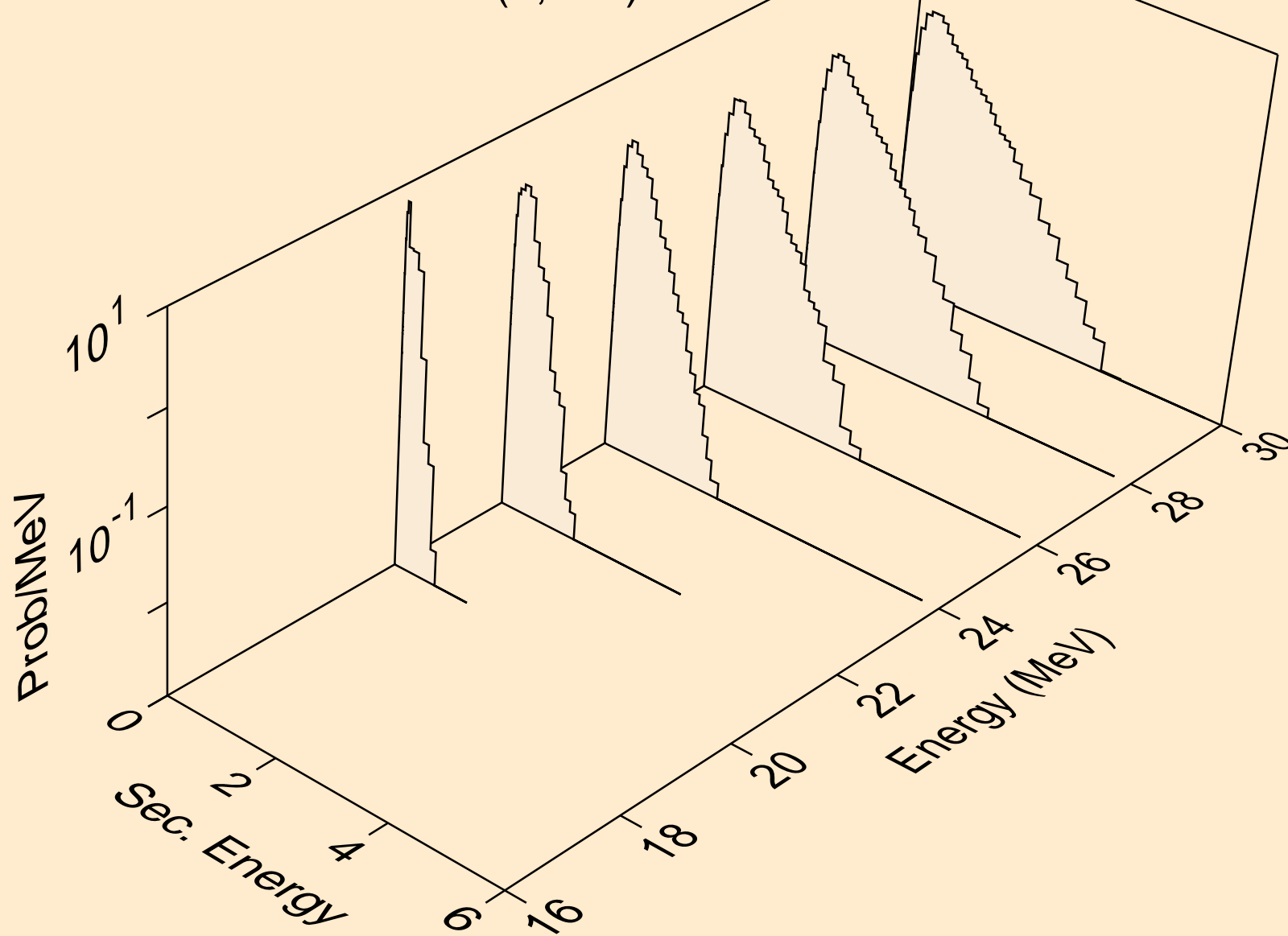

AU186 NEUTRON ACER TENDL-2021 LIBRARY; T=293.6K
Neutron emission for (n,2n)

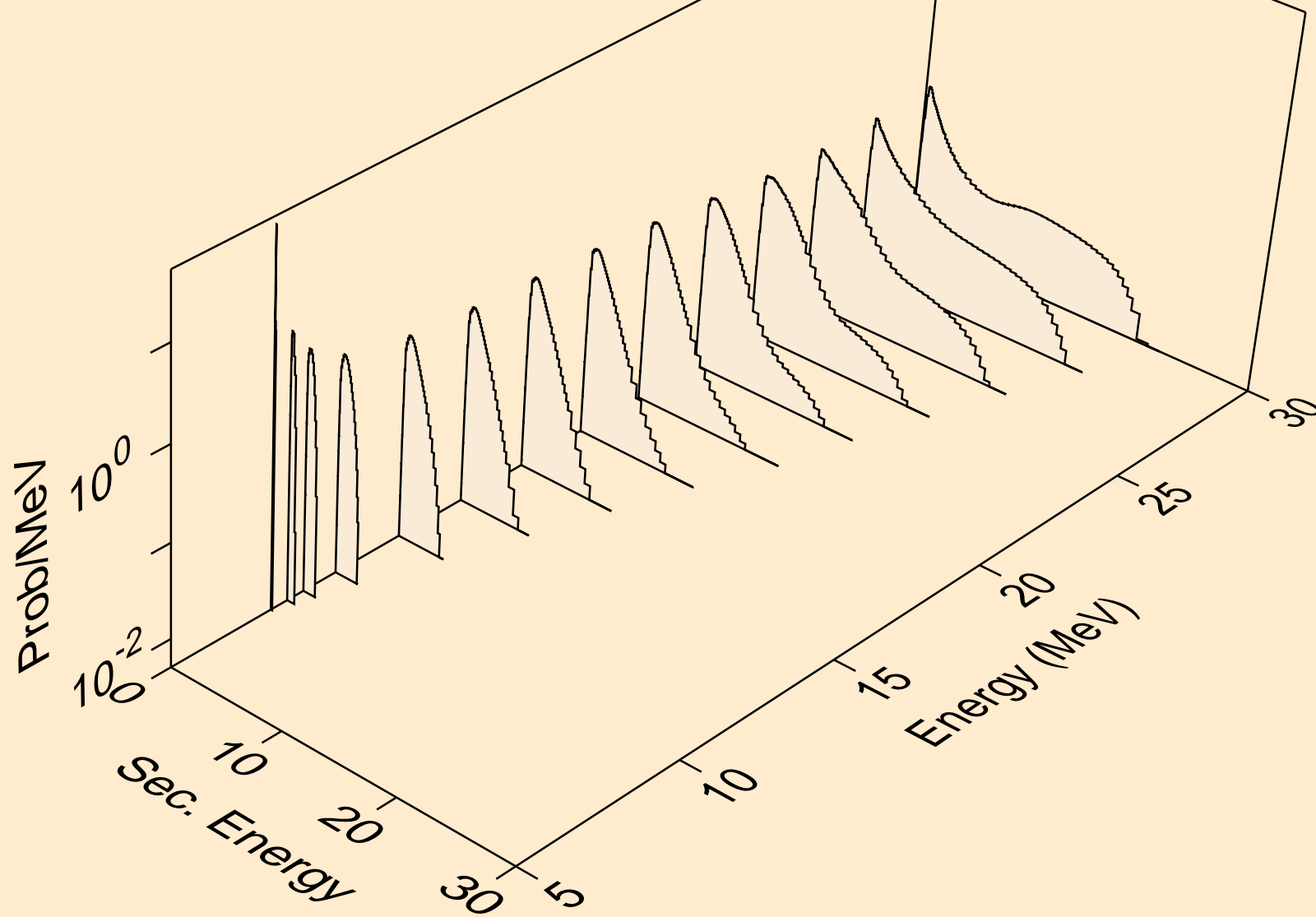

AU186 NEUTRON ACER TENDL-2021 LIBRARY; T=293.6K
Neutron emission for (n,3n)

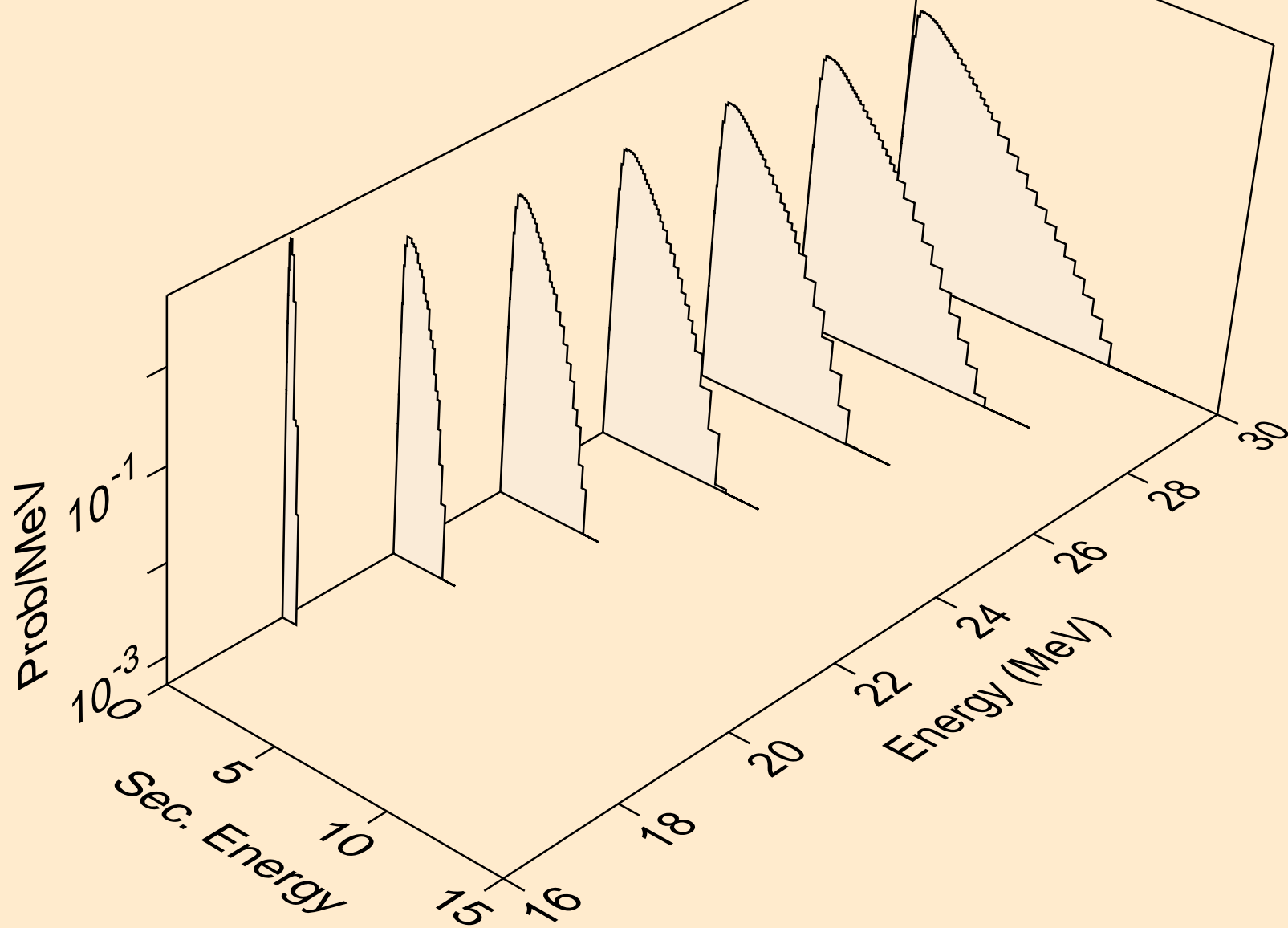

AU186 NEUTRON ACER TENDL-2021 LIBRARY; T=293.6K
Neutron emission for (n,n*)a

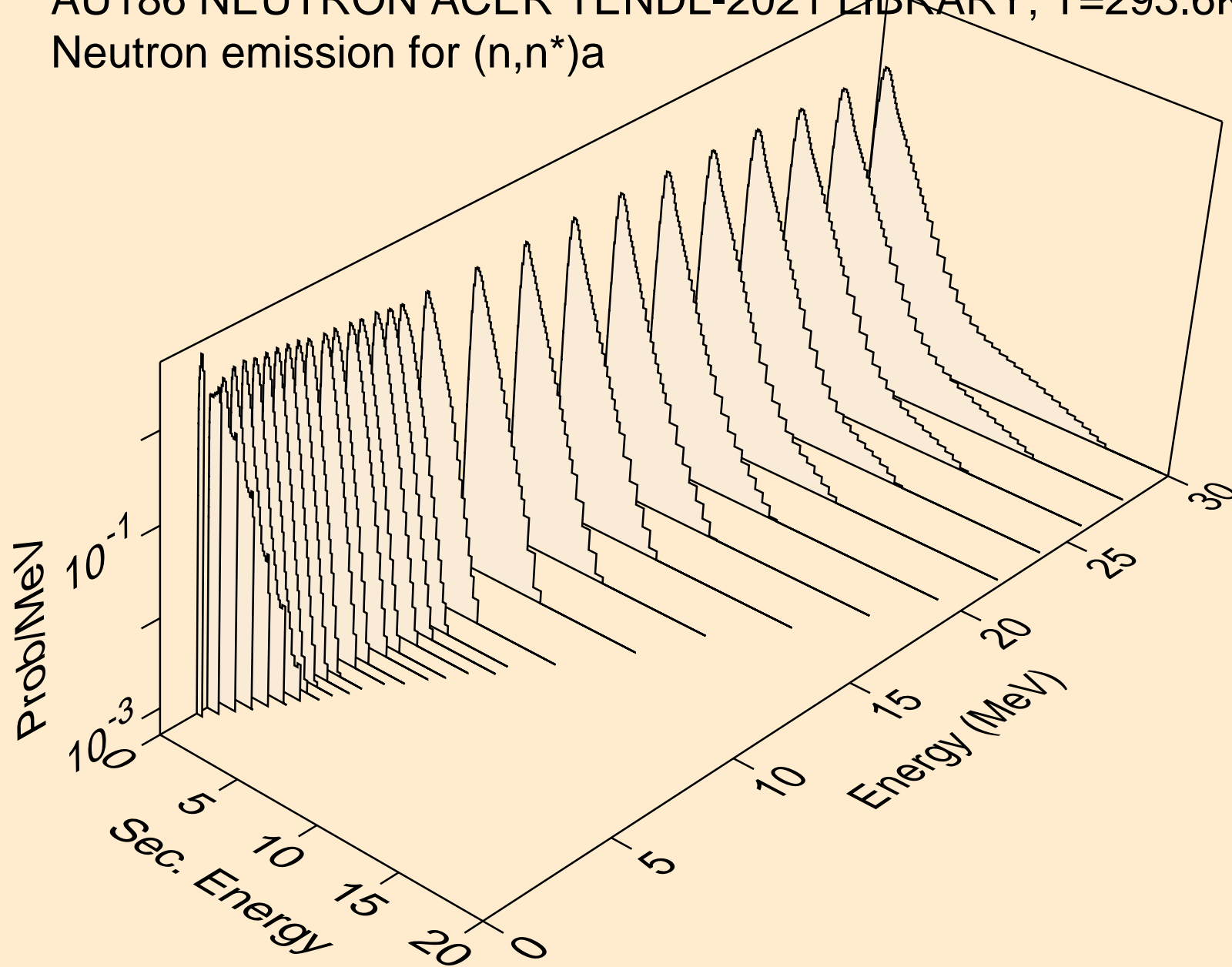

AU186 NEUTRON ACER TENDL-2021 LIBRARY; T=293.6K
Neutron emission for (n,2n)a

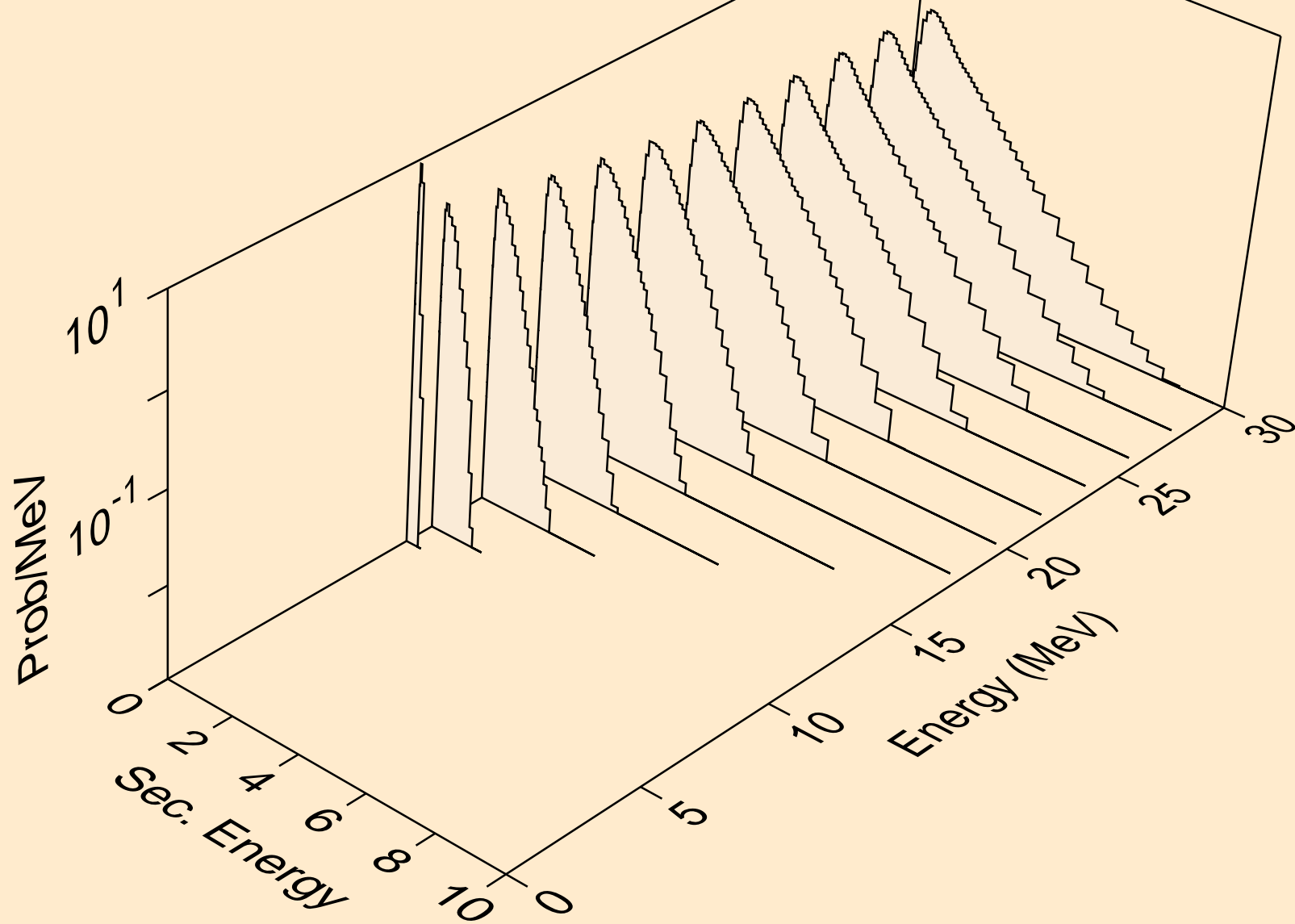

AU186 NEUTRON ACER TENDL-2021 LIBRARY; T=293.6K
Neutron emission for (n,3n)a

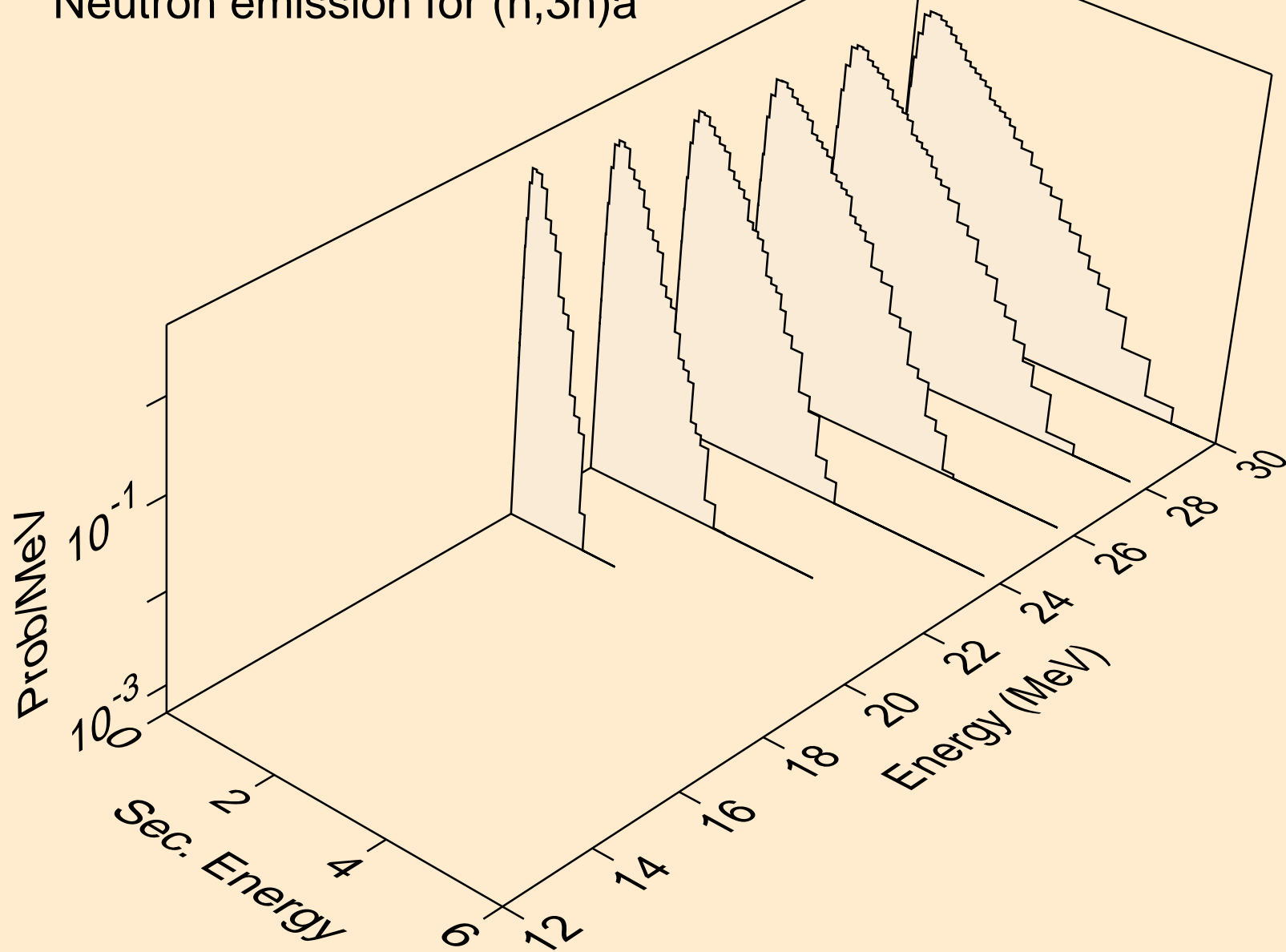

AU186 NEUTRON ACER TENDL-2021 LIBRARY; T=293.6K
Neutron emission for (n,n*)p

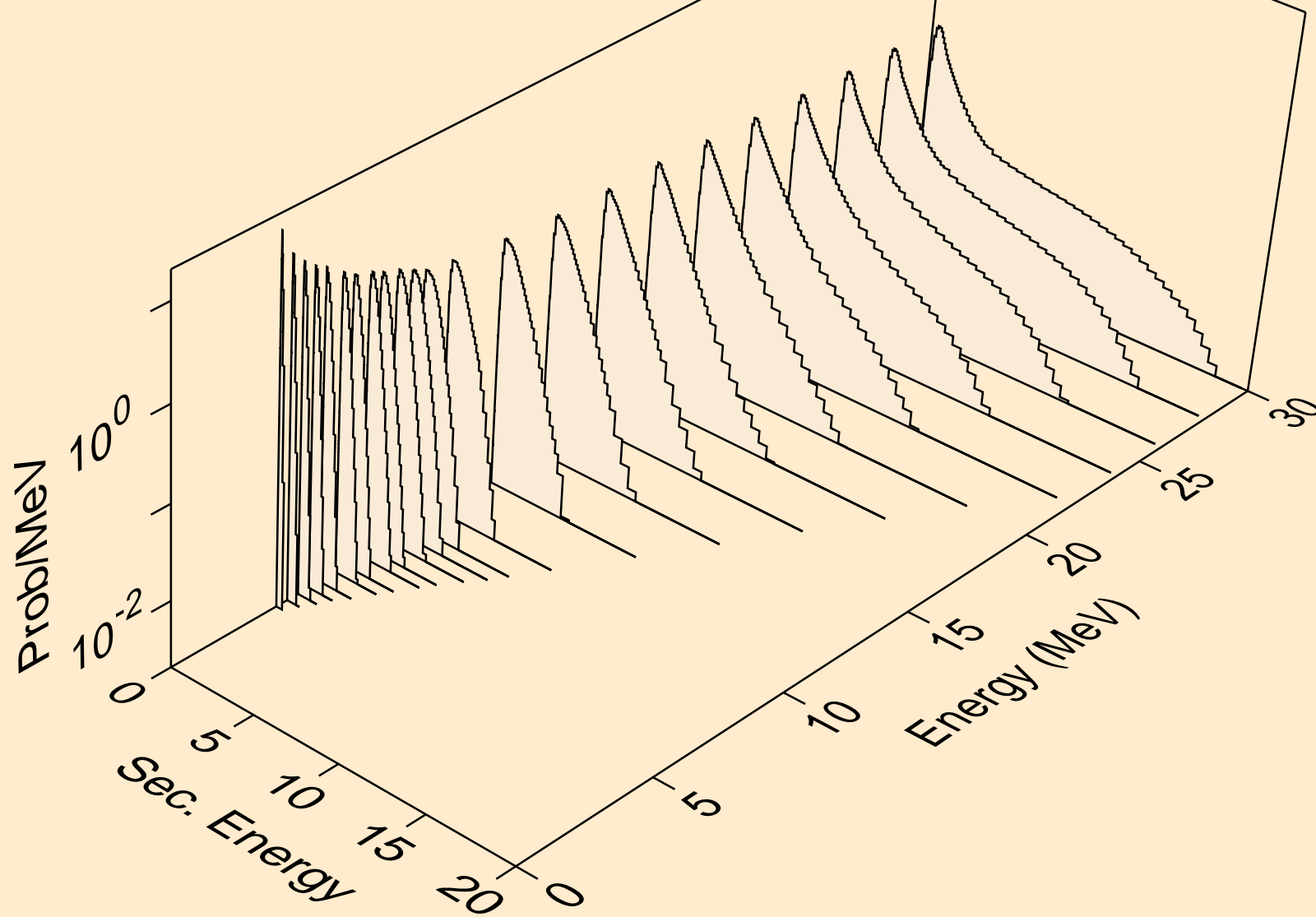

AU186 NEUTRON ACER TENDL-2021 LIBRARY; T=293.6K
Neutron emission for (n,n*)2a

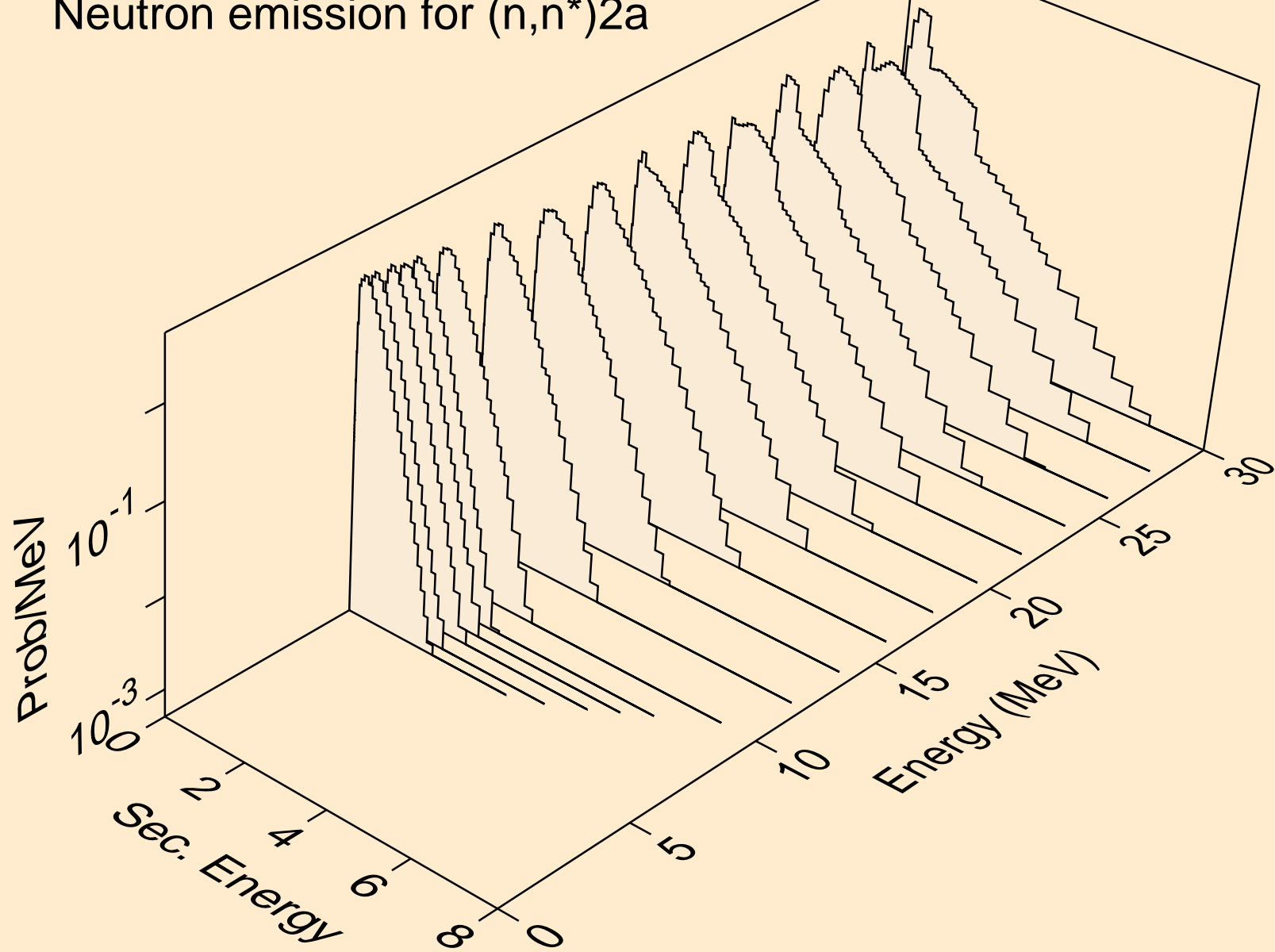

AU186 NEUTRON ACER TENDL-2021 LIBRARY; T=293.6K
Neutron emission for (n,2n)2a

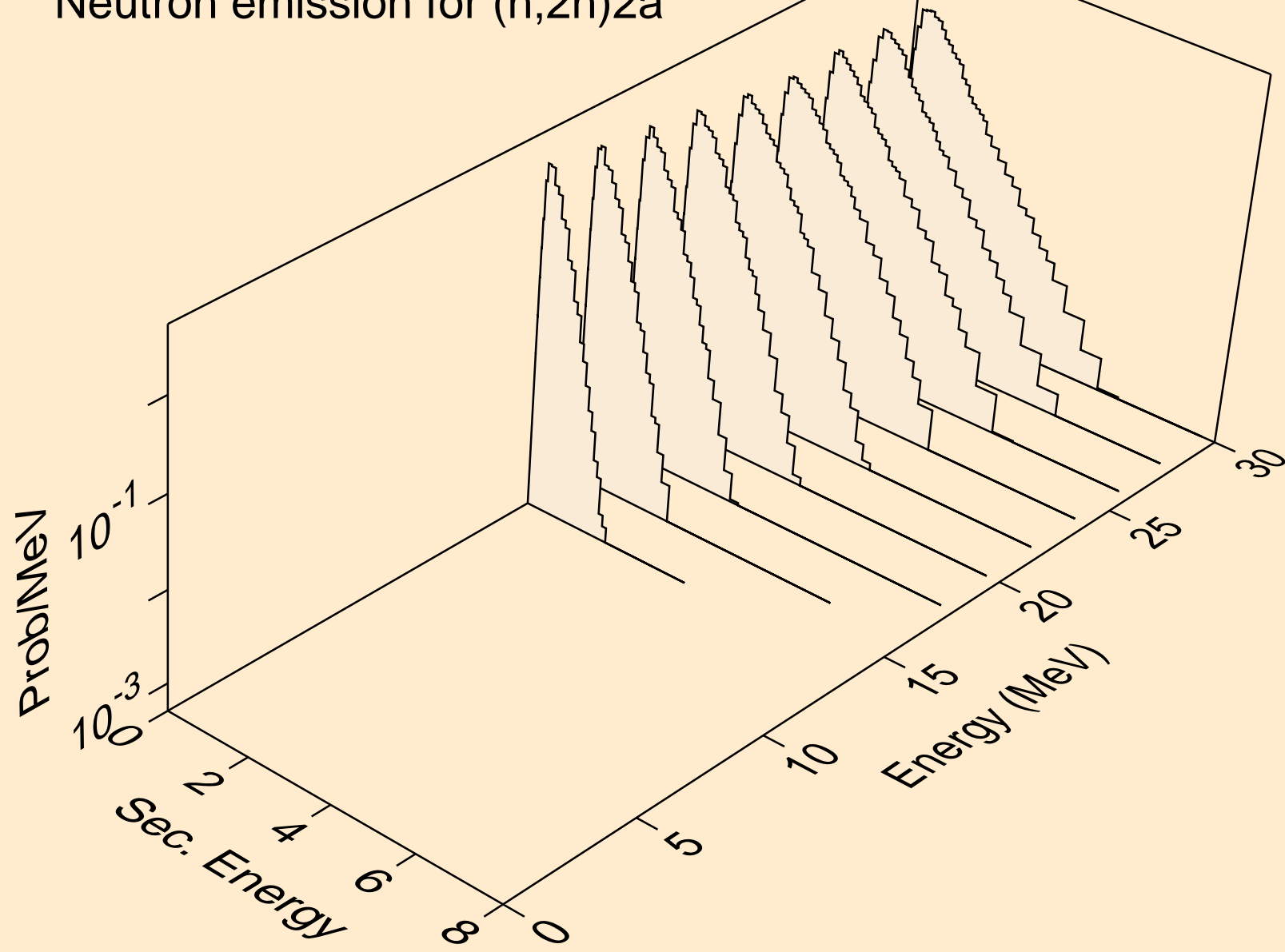

AU186 NEUTRON ACER TENDL-2021 LIBRARY; T=293.6K
Neutron emission for (n,n*)d

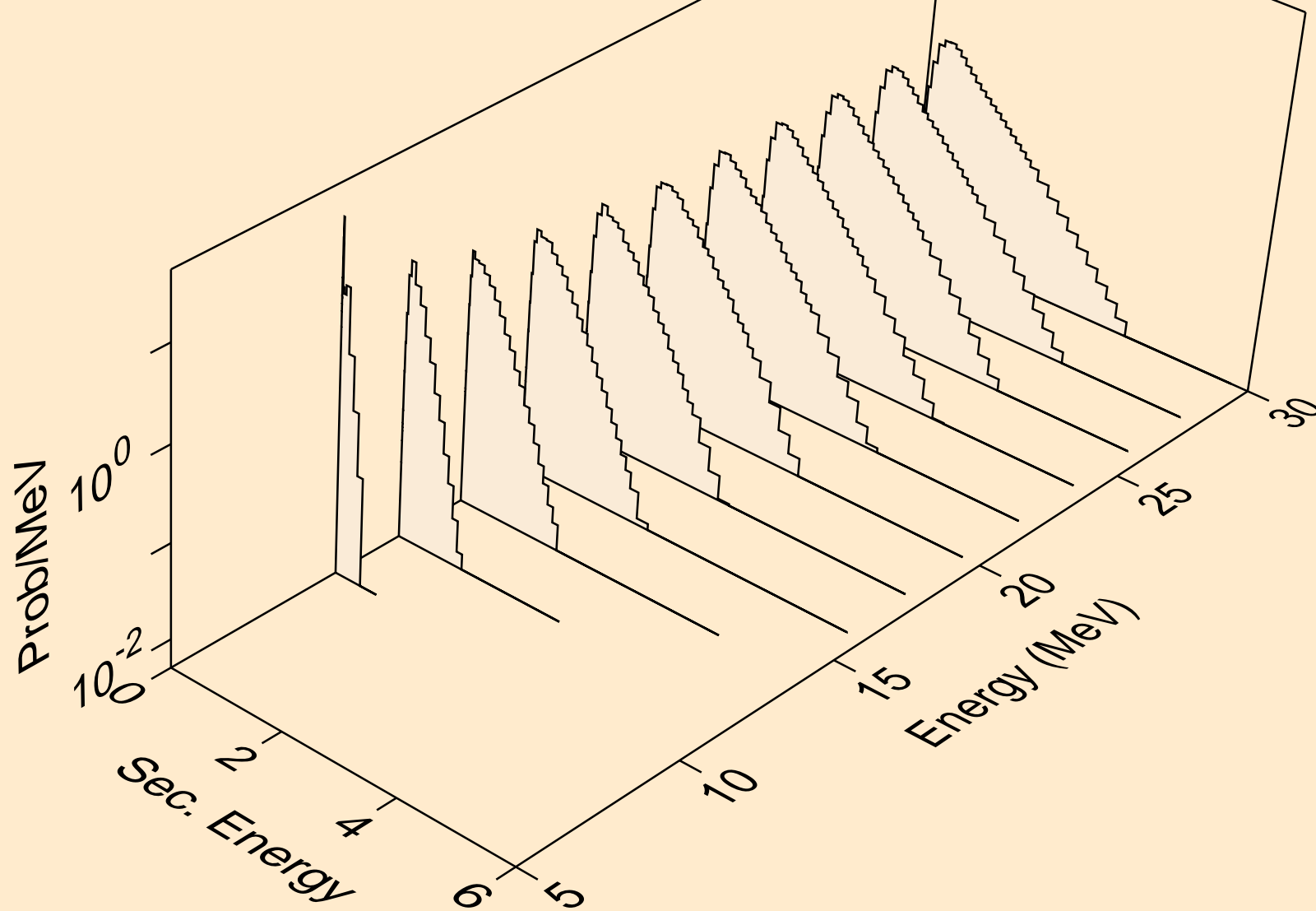

AU186 NEUTRON ACER TENDL-2021 LIBRARY; T=293.6K
Neutron emission for (n,n*)t

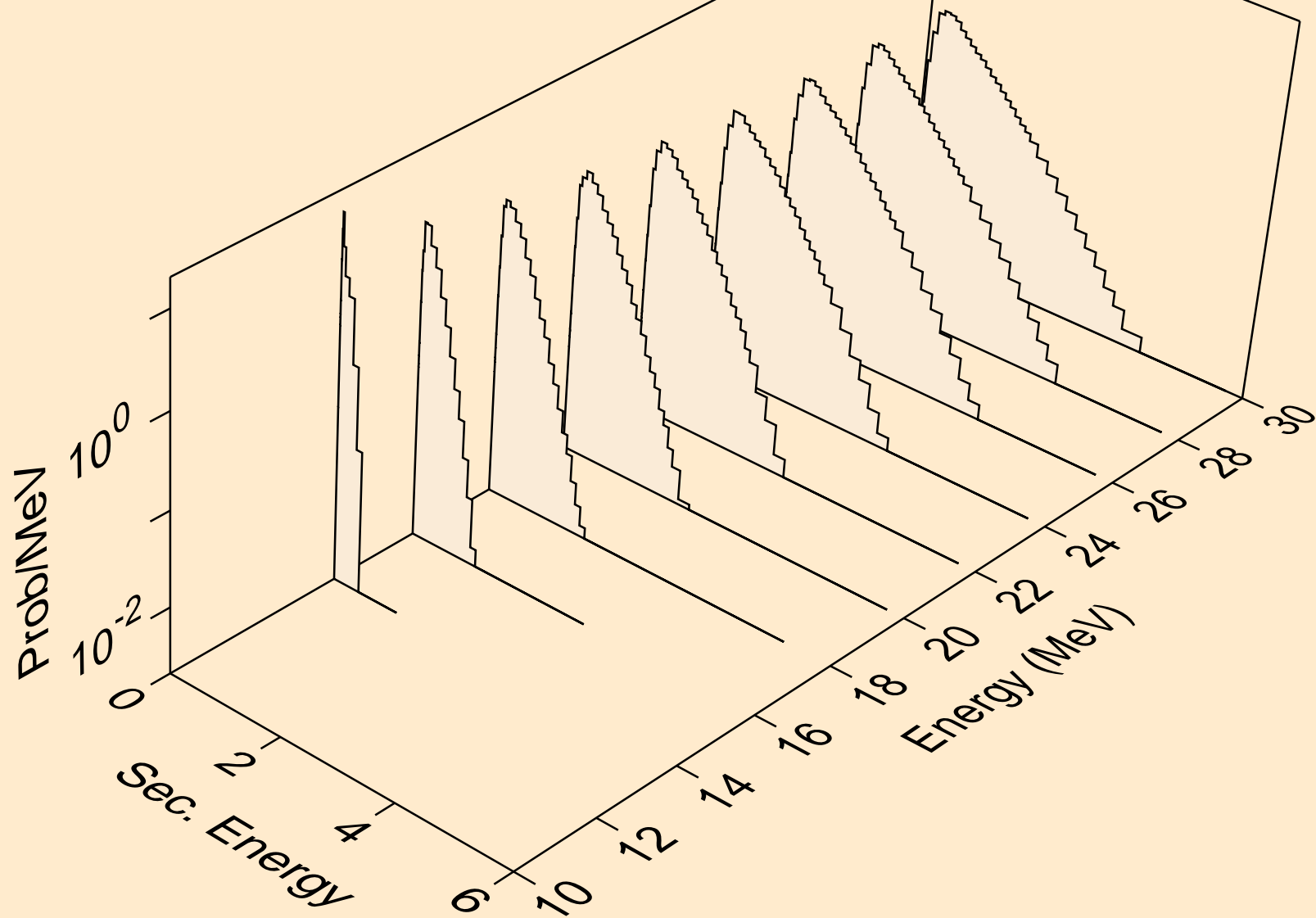

AU186 NEUTRON ACER TENDL-2021 LIBRARY; T=293.6K
Neutron emission for (n,n*)he3

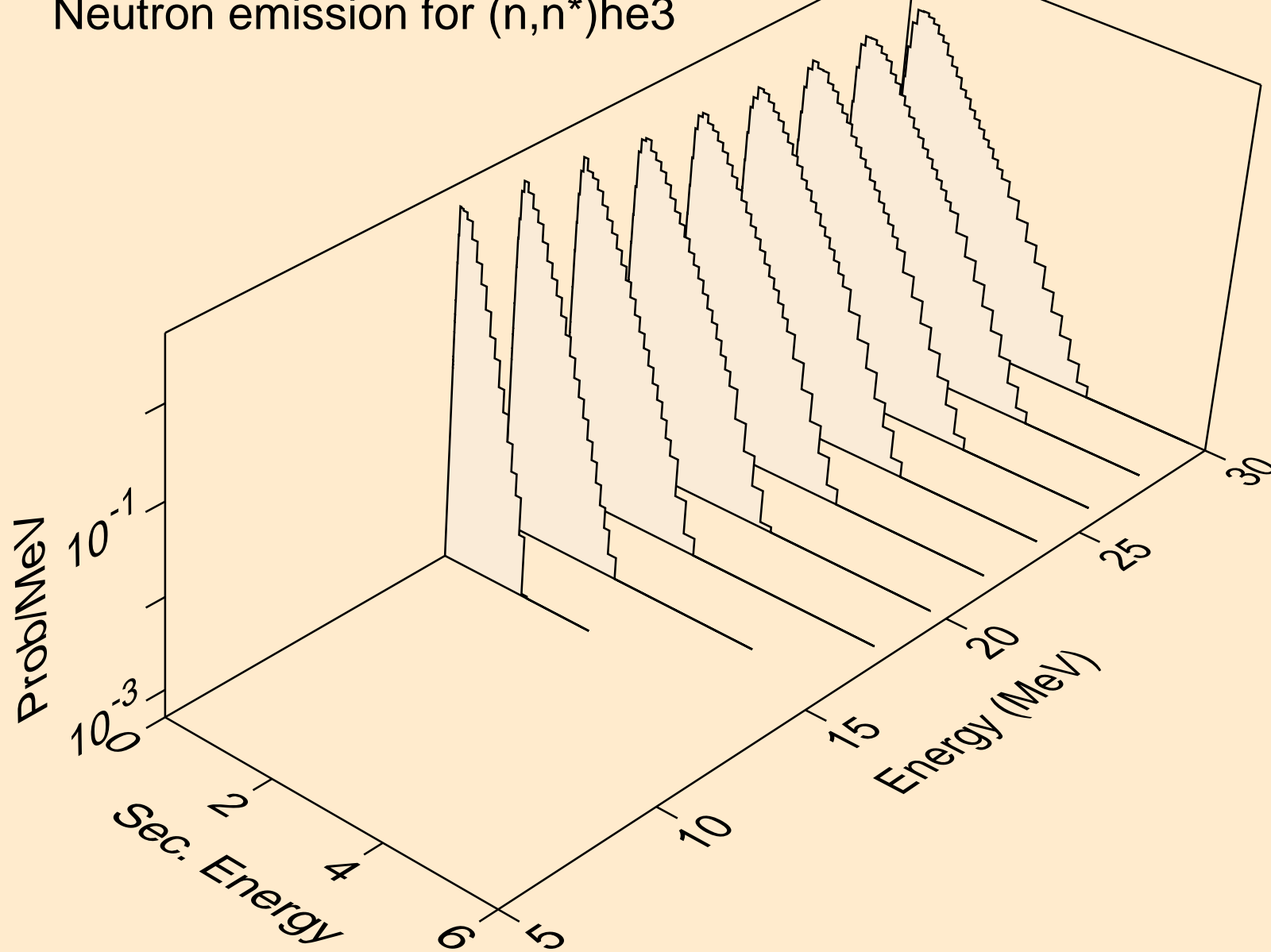

AU186 NEUTRON ACER TENDL-2021 LIBRARY; T=293.6K
Neutron emission for (n,4n)

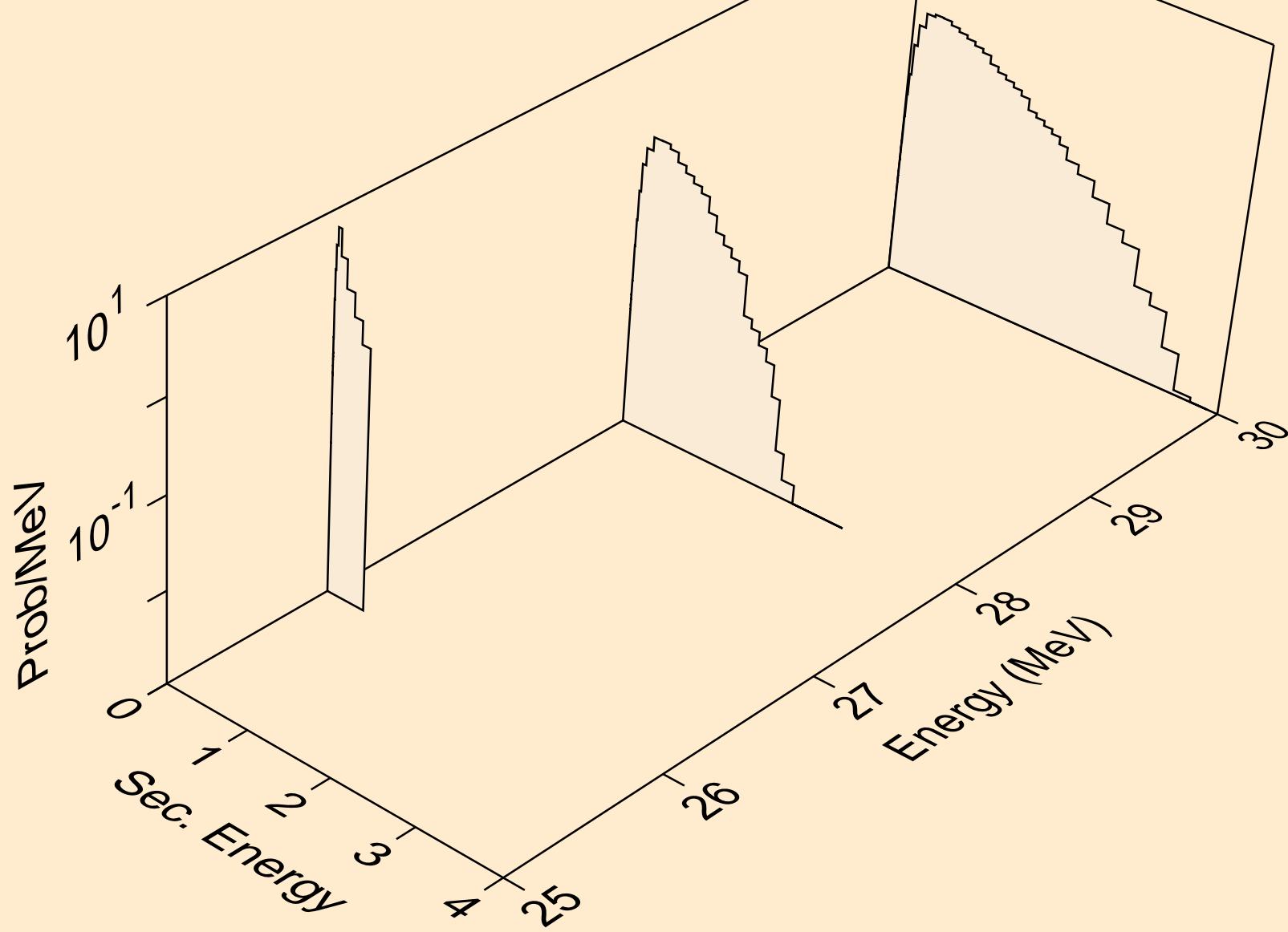

AU186 NEUTRON ACER TENDL-2021 LIBRARY; T=293.6K
Neutron emission for (n,2np)

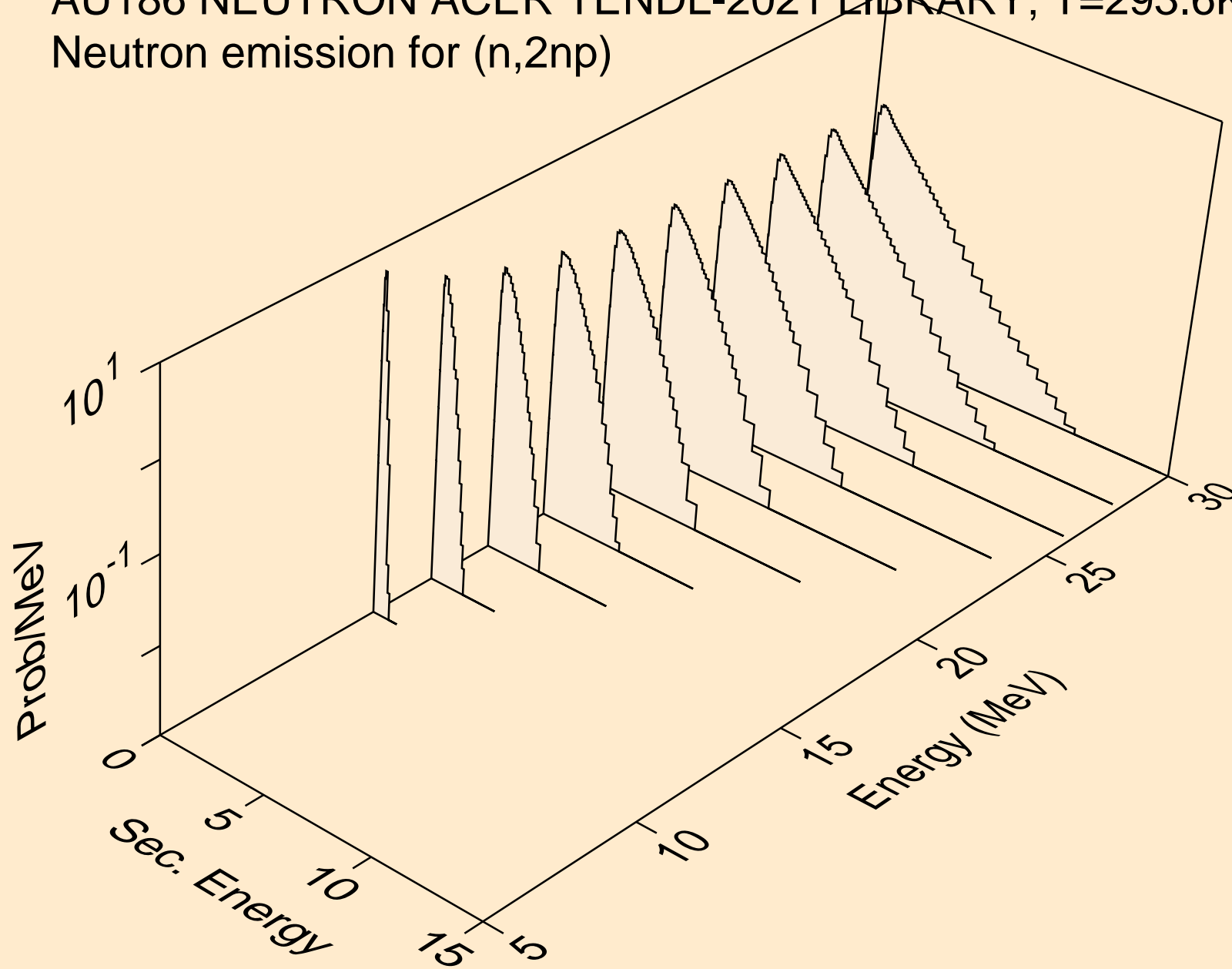

AU186 NEUTRON ACER TENDL-2021 LIBRARY; T=293.6K
Neutron emission for (n,3np)

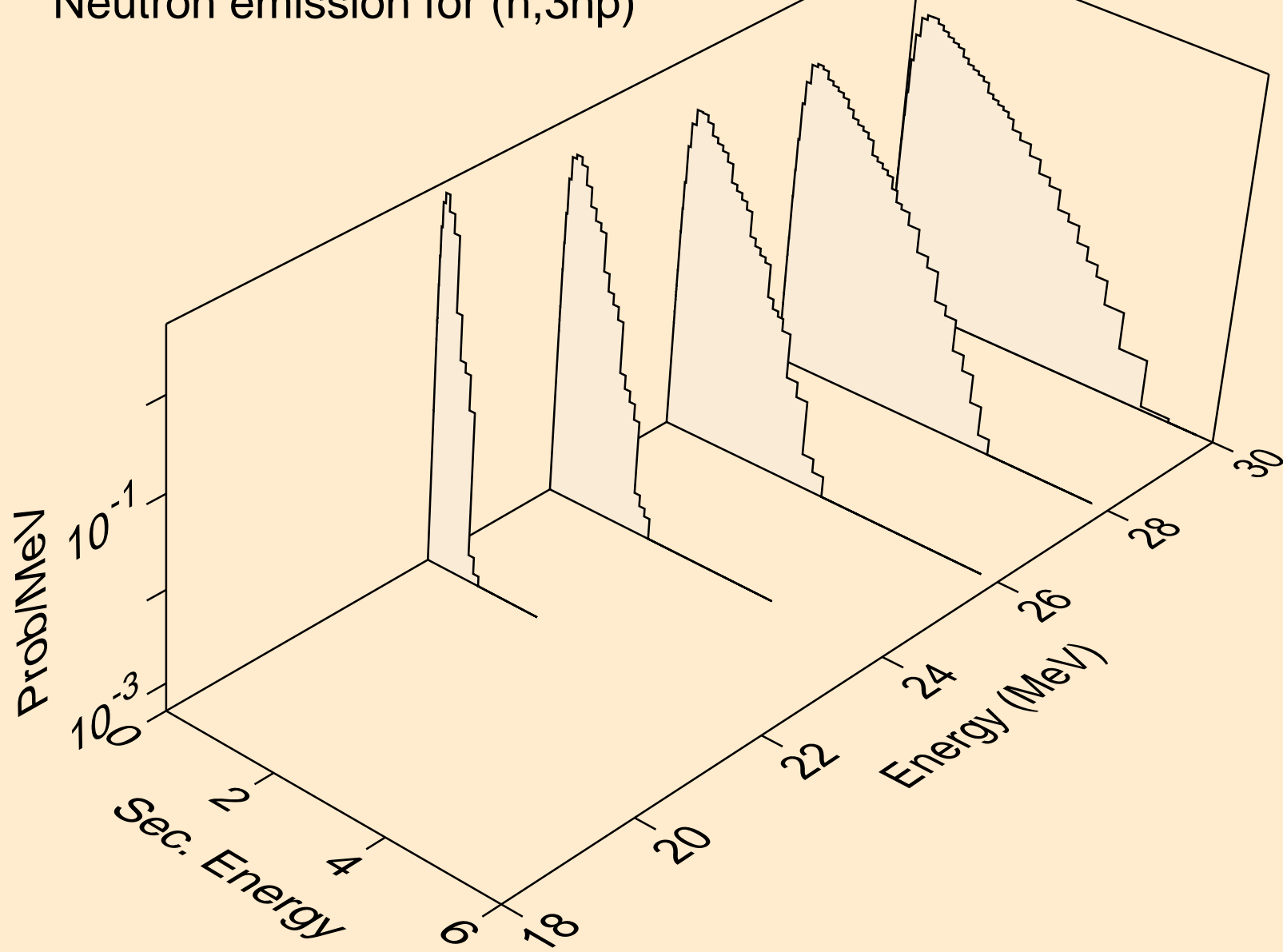

AU186 NEUTRON ACER TENDL-2021 LIBRARY; T=293.6K
Neutron emission for (n,2np)

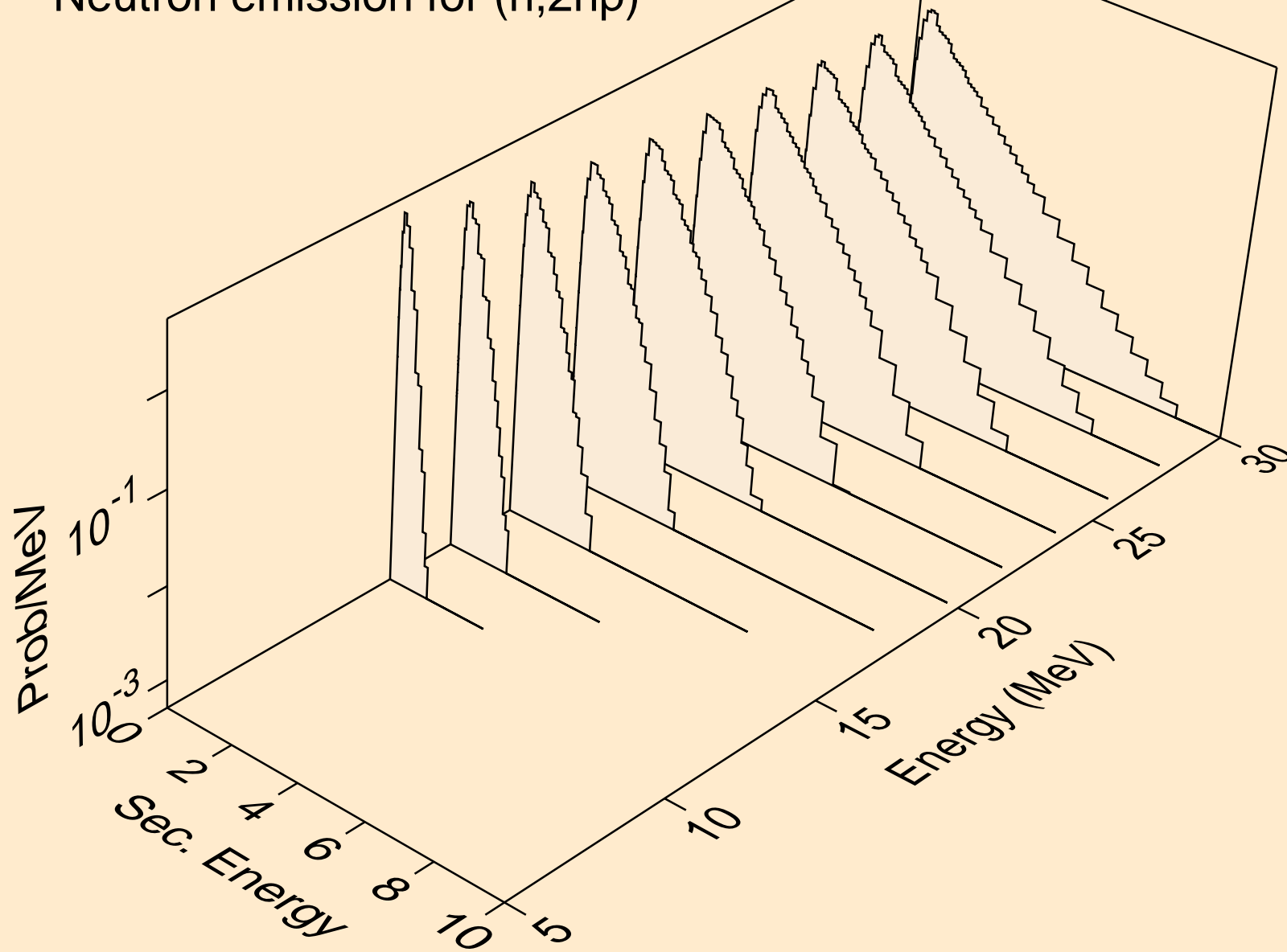

AU186 NEUTRON ACER TENDL-2021 LIBRARY; T=293.6K
Neutron emission for (n,npa)

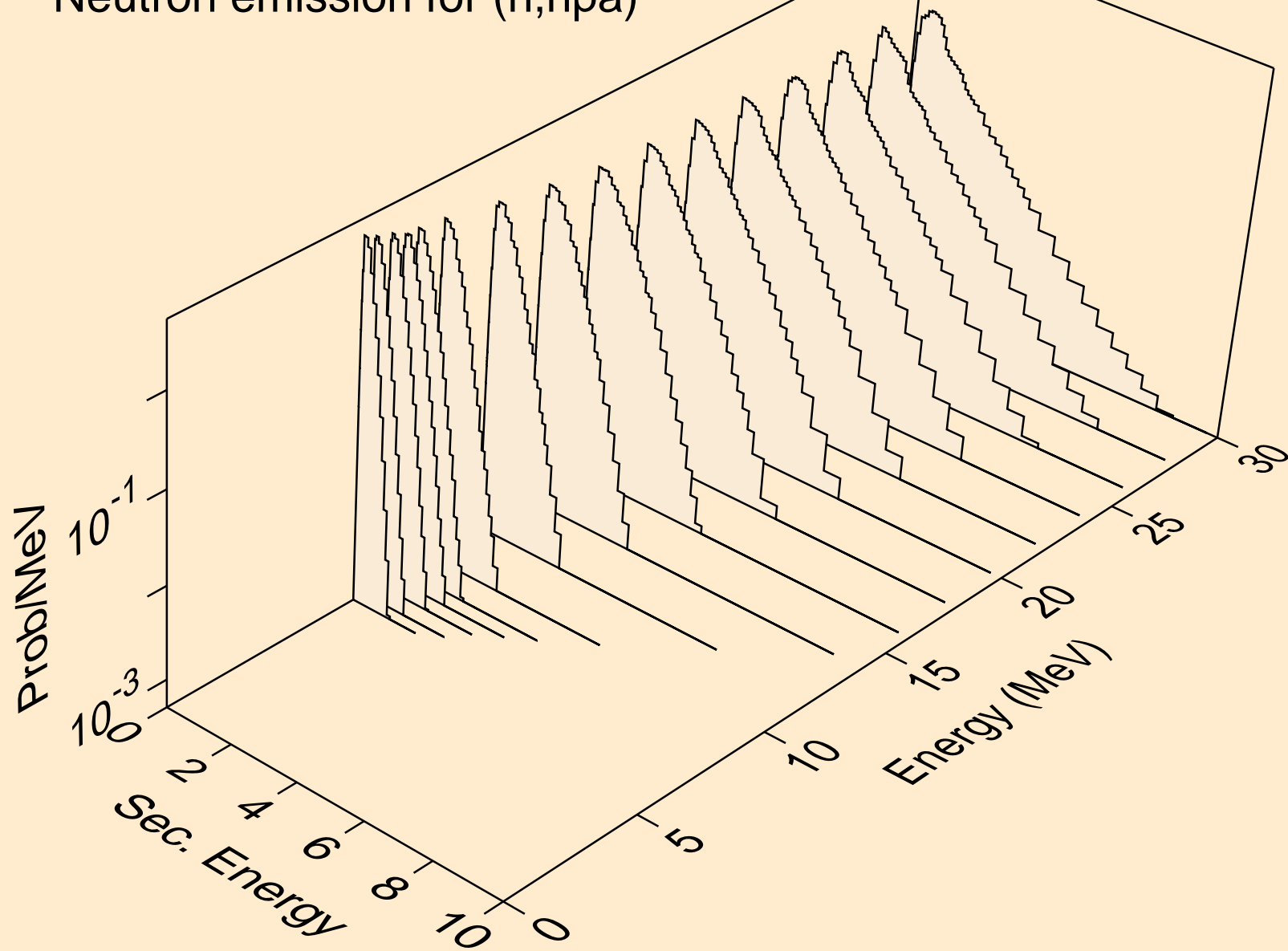

AU186 NEUTRON ACER TENDL-2021 LIBRARY; T=293.6K
Neutron emission for (n,n*c)

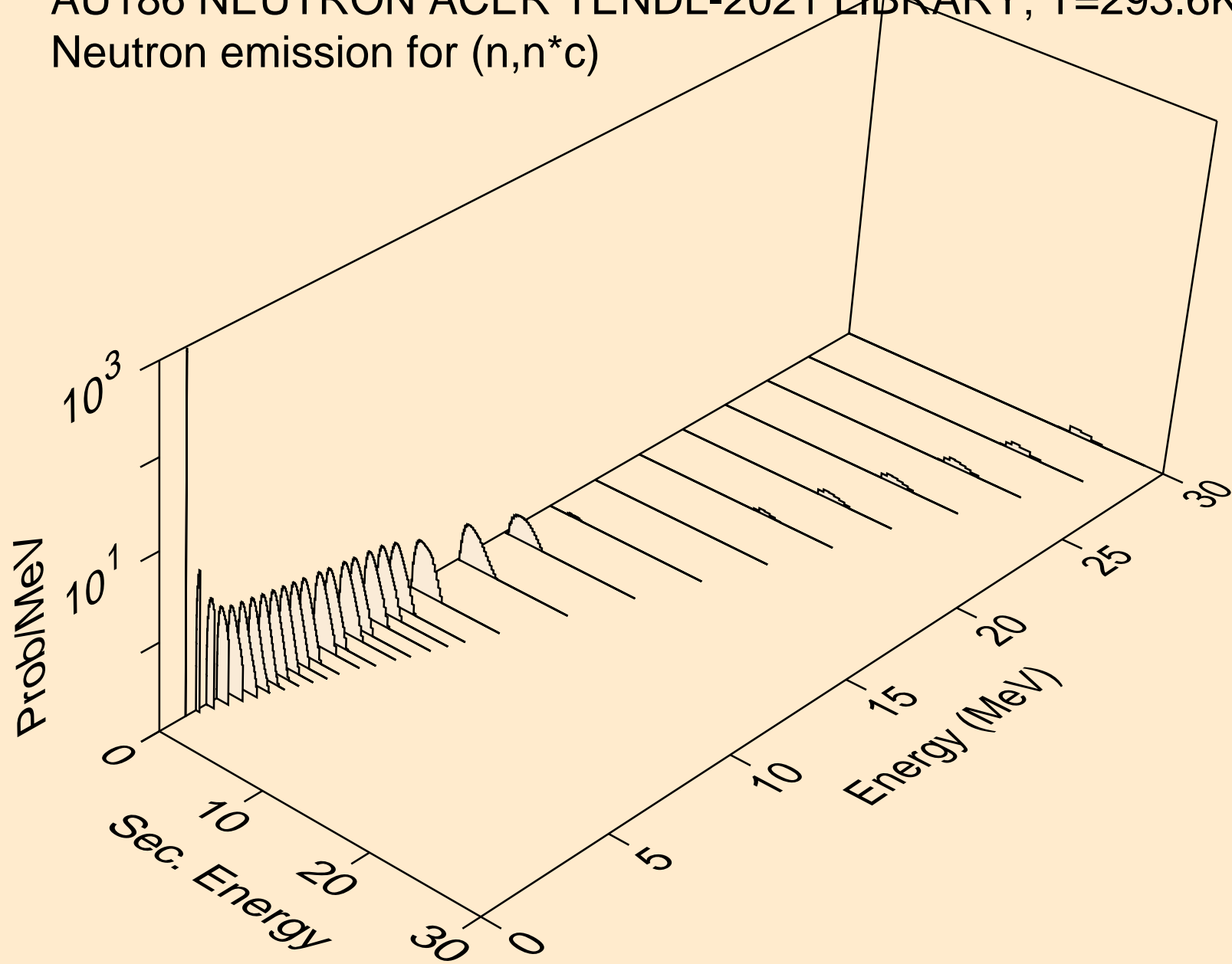

AU186 NEUTRON ACER TENDL-2021 LIBRARY; T=293.6K
Photon emission for (n,x)

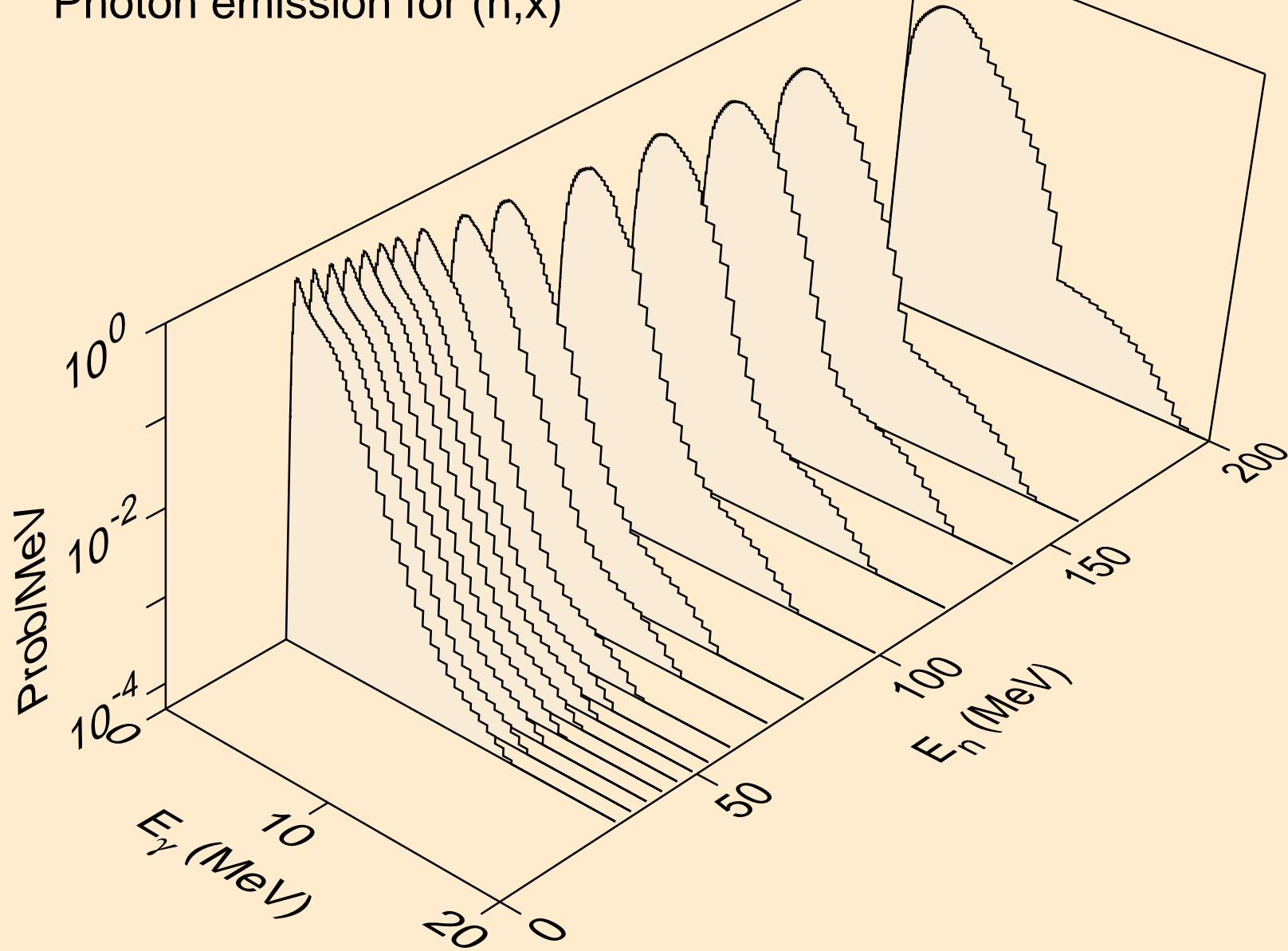

AU186 NEUTRON ACER TENDL-2021 LIBRARY; T=293.6K
Photon emission for (n,2nd)

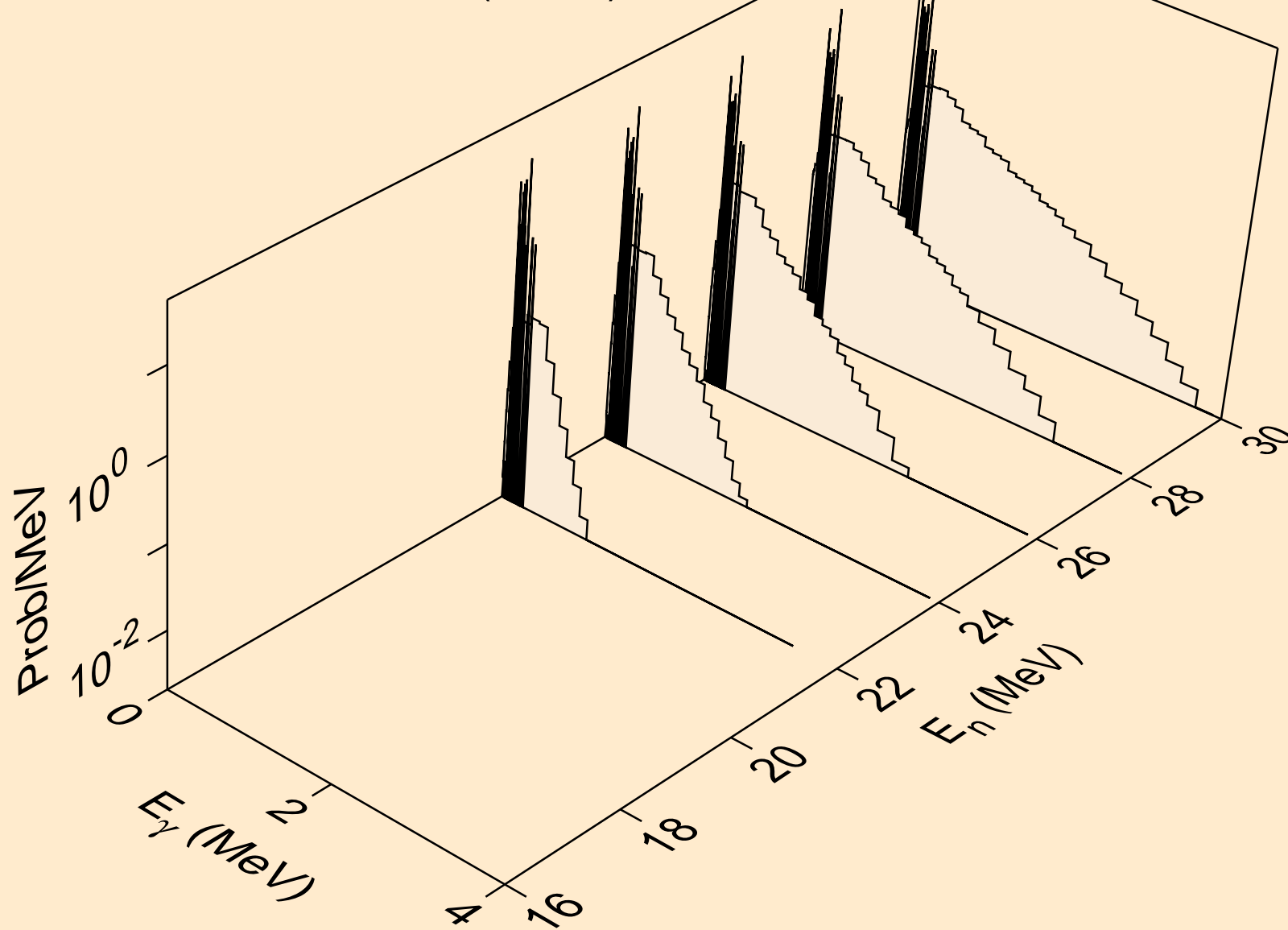

AU186 NEUTRON ACER TENDL-2021 LIBRARY; T=293.6K
Photon emission for (n,2n)

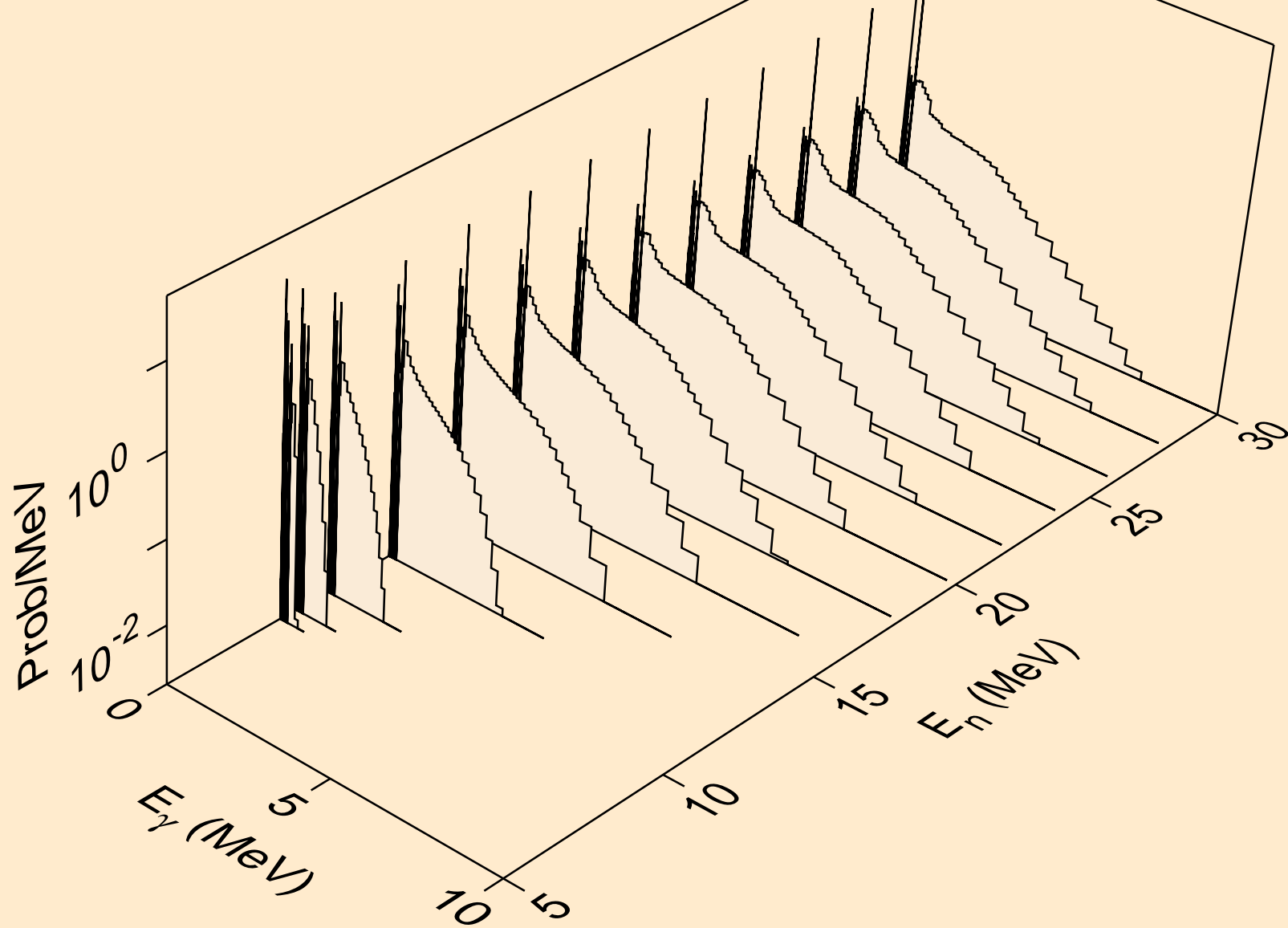

AU186 NEUTRON ACER TENDL-2021 LIBRARY; T=293.6K
Photon emission for (n,3n)

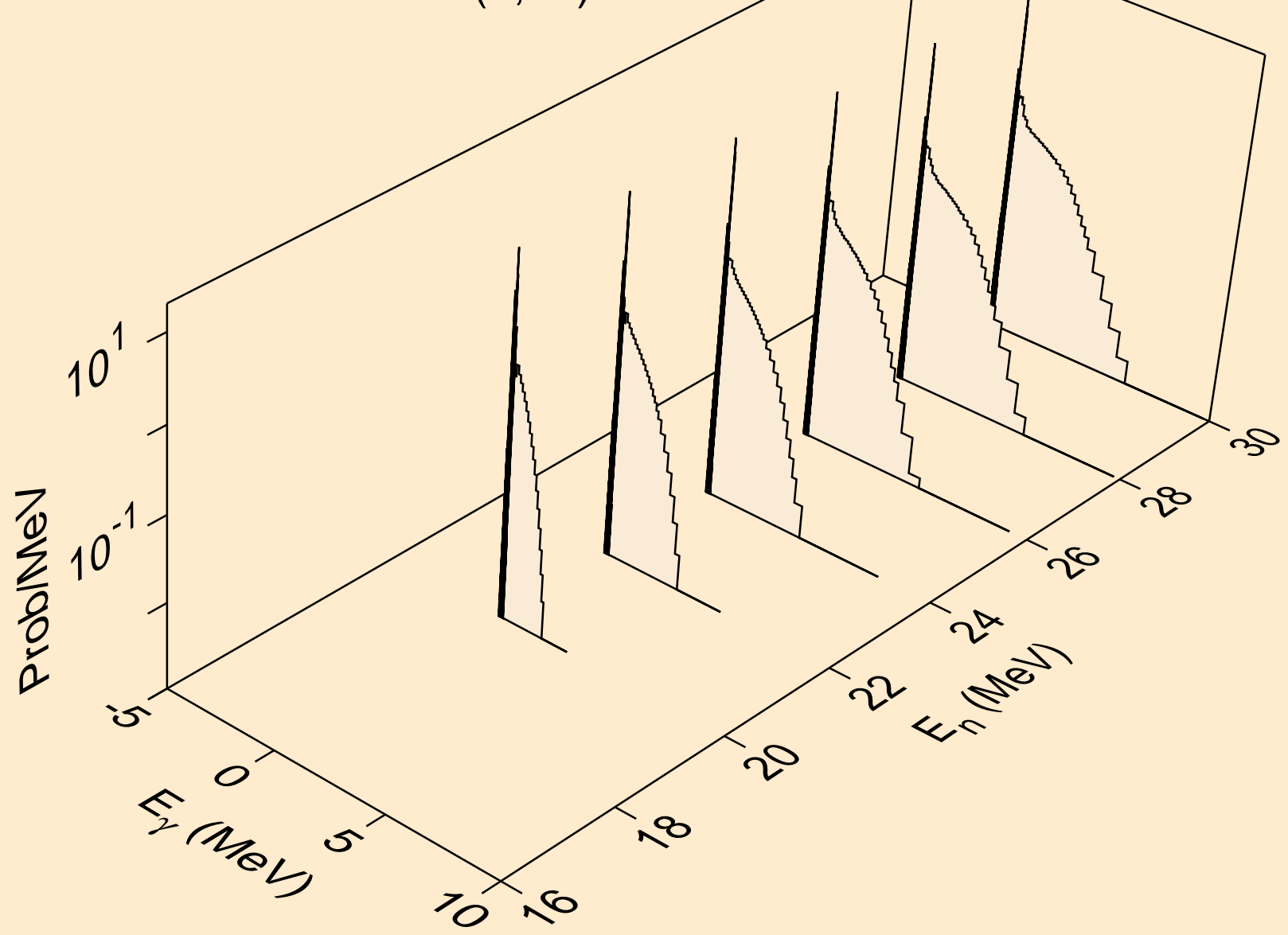

AU186 NEUTRON ACER TENDL-2021 LIBRARY; T=293.6K
Photon emission for (n,n*)a

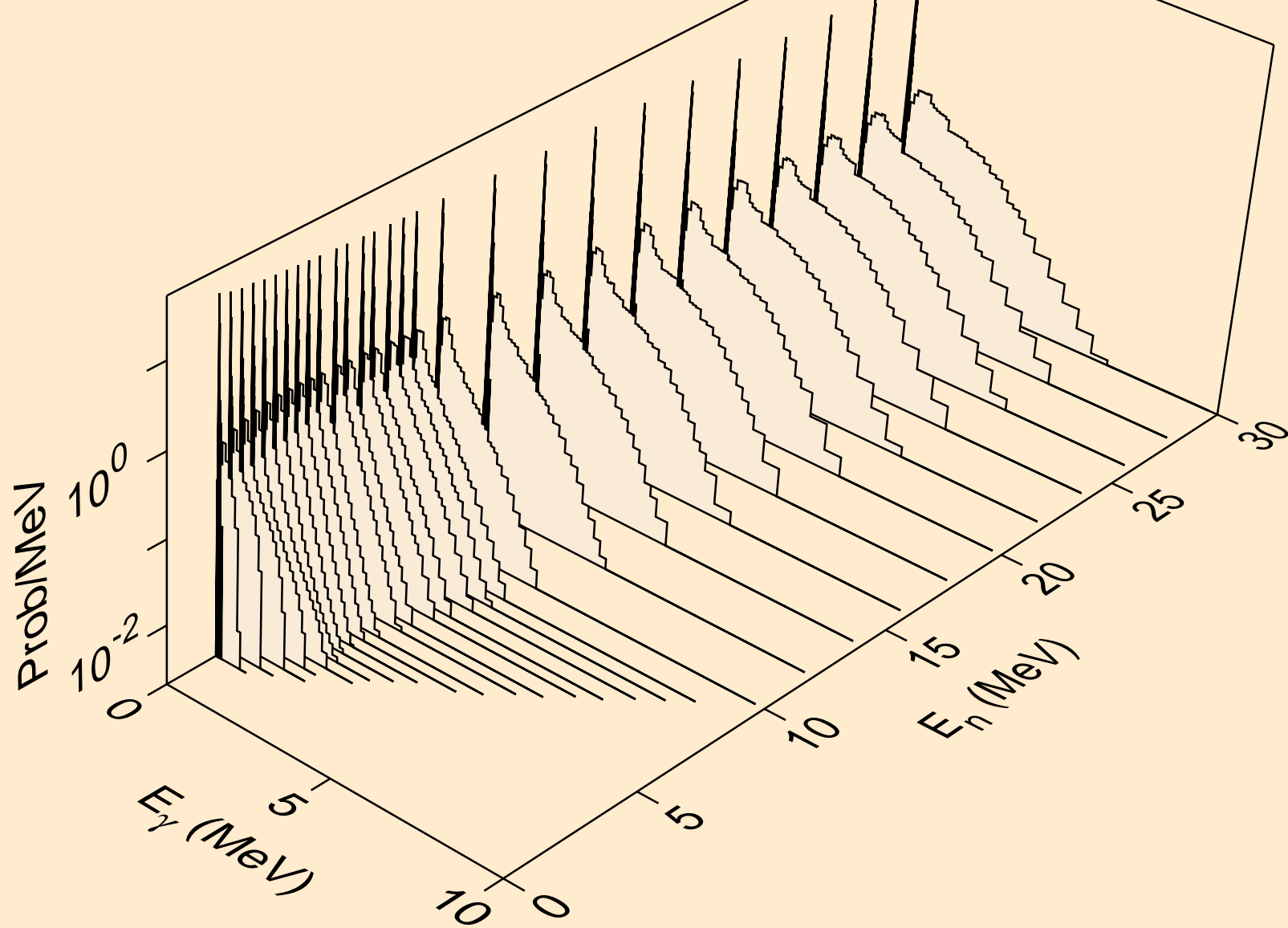

AU186 NEUTRON ACER TENDL-2021 LIBRARY; T=293.6K
Photon emission for (n,2n)a

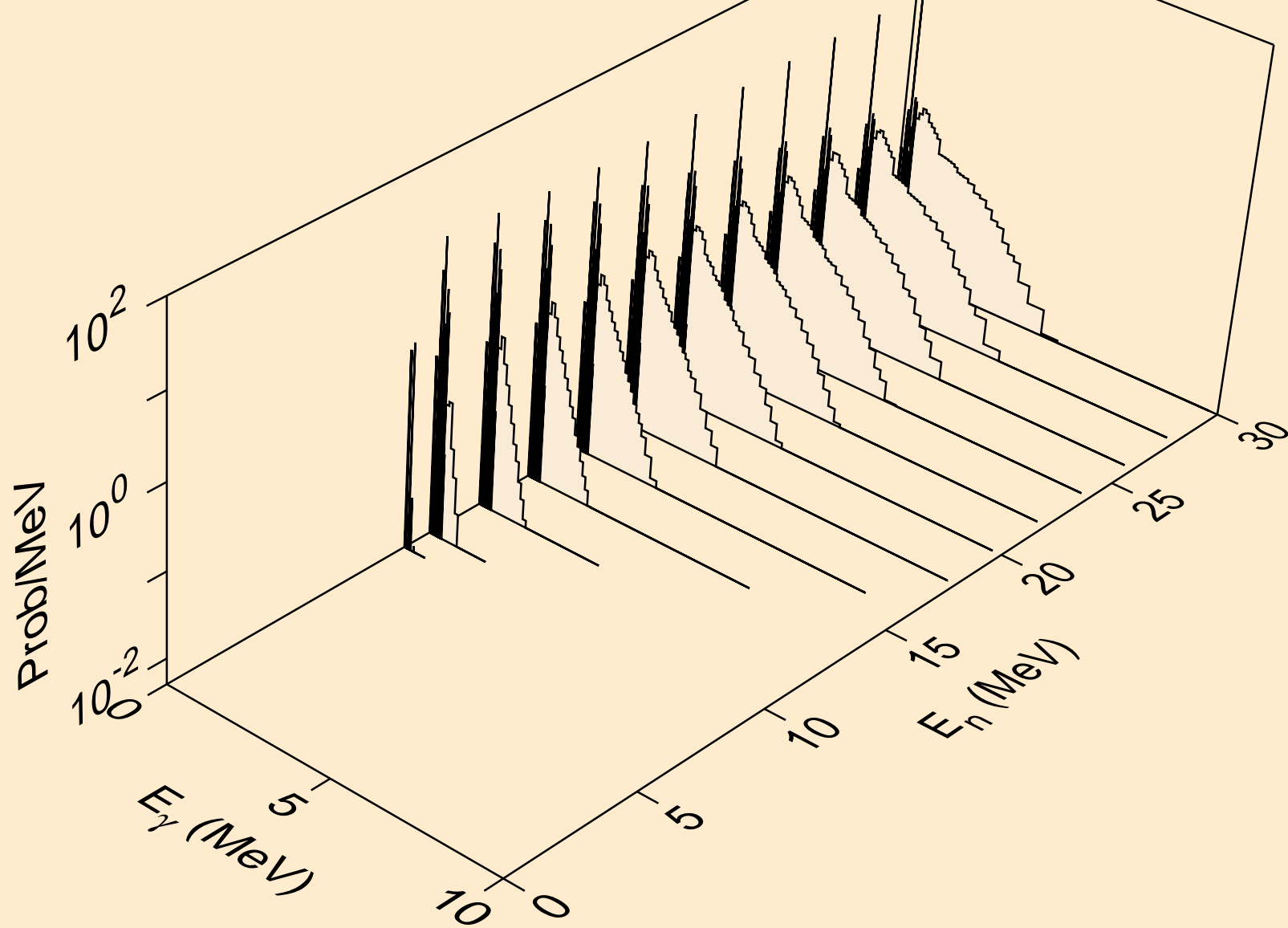

AU186 NEUTRON ACER TENDL-2021 LIBRARY; T=293.6K
Photon emission for (n,3n)a

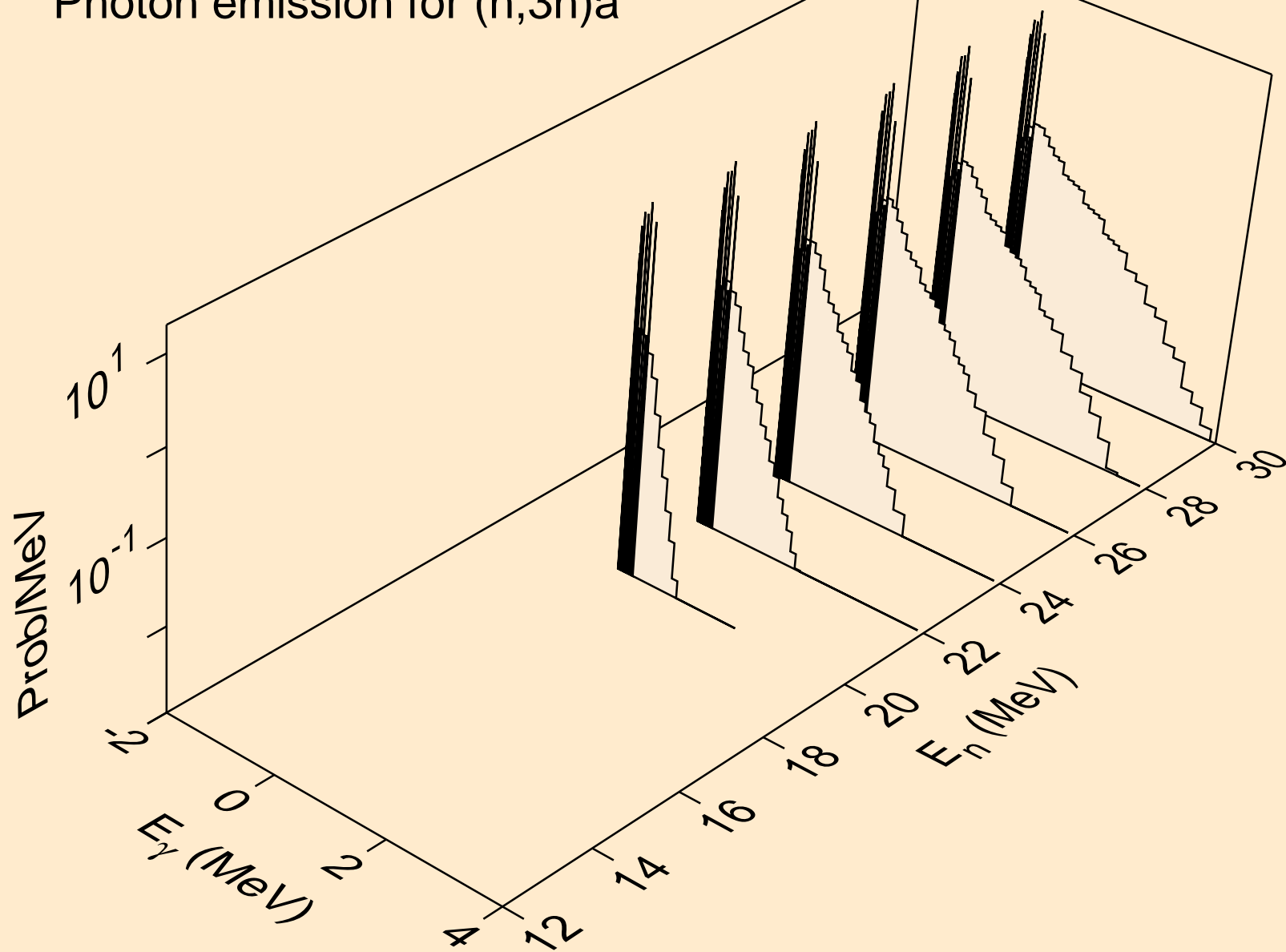

AU186 NEUTRON ACER TENDL-2021 LIBRARY; T=293.6K
Photon emission for (n,n*)p

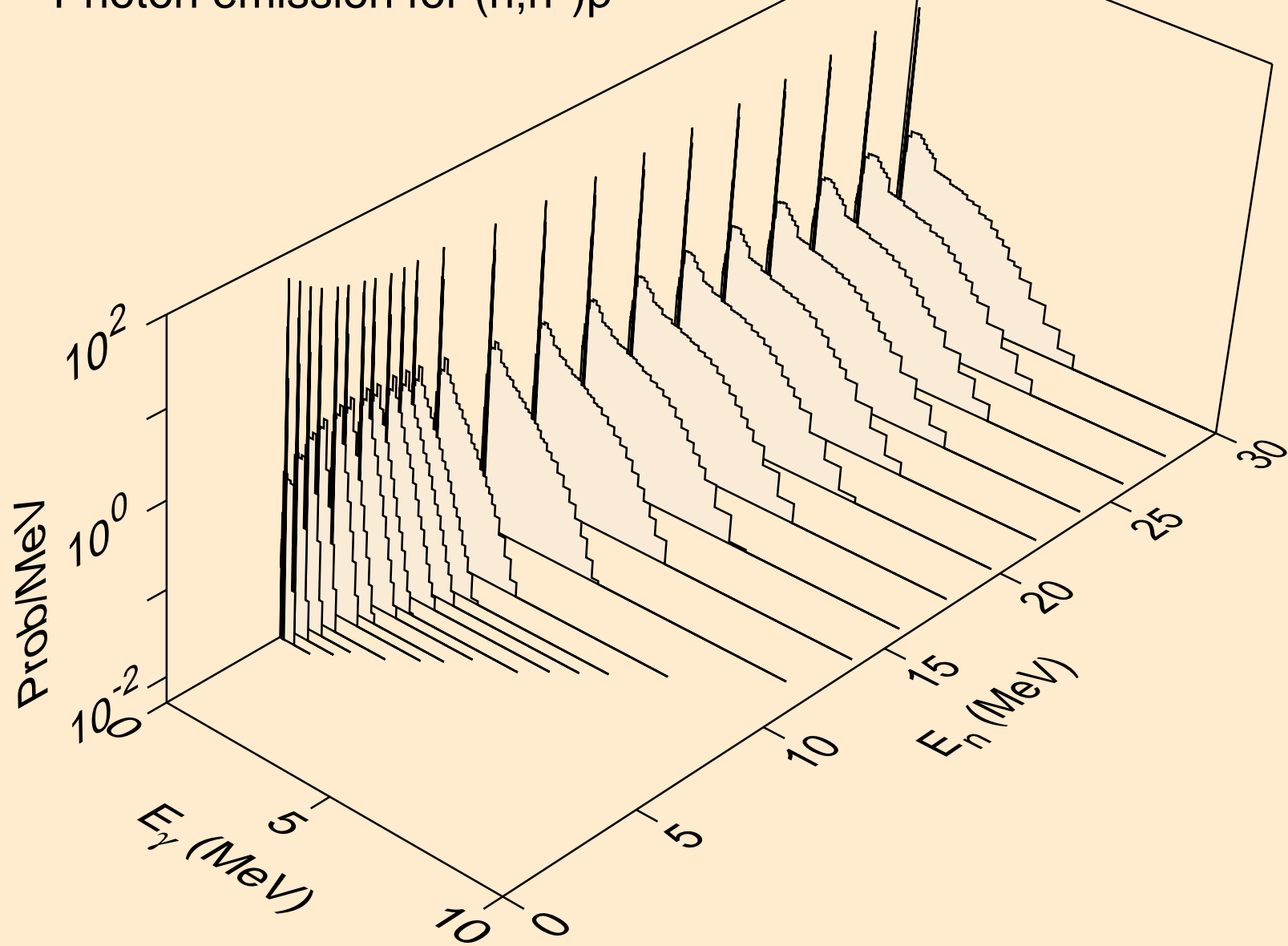

AU186 NEUTRON ACER TENDL-2021 LIBRARY; T=293.6K
Photon emission for (n,n*)2a

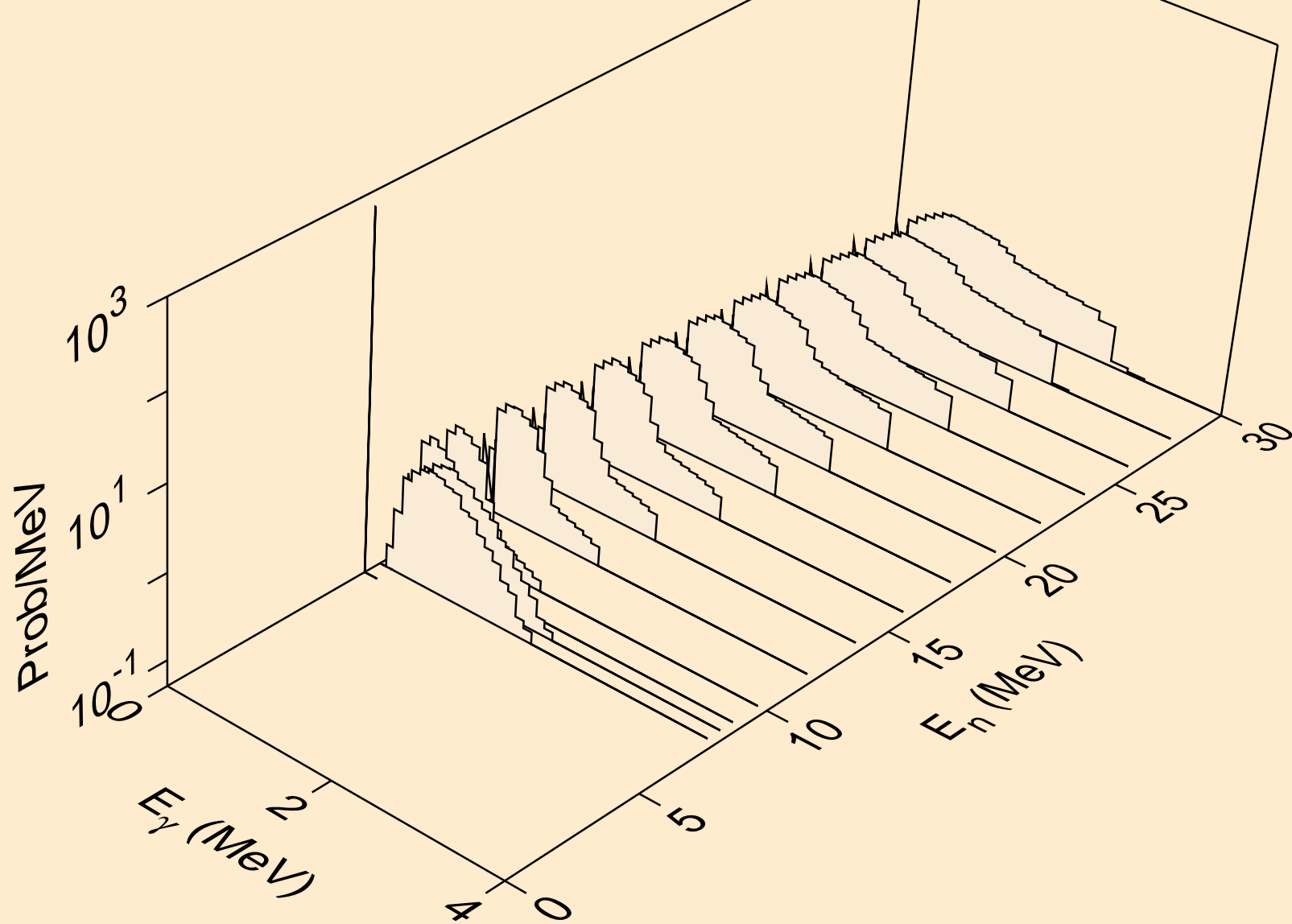

AU186 NEUTRON ACER TENDL-2021 LIBRARY; T=293.6K
Photon emission for (n,2n)2a

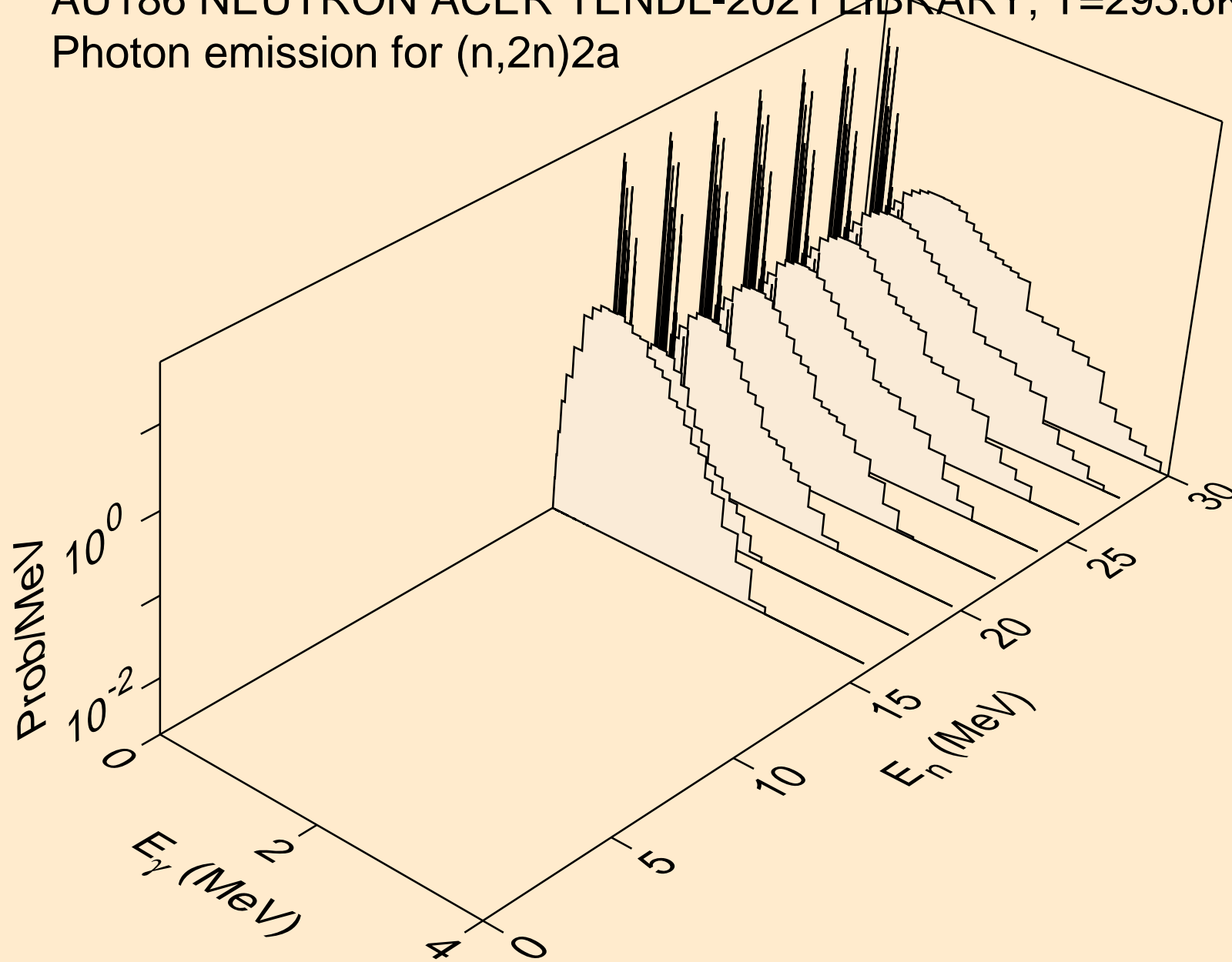

AU186 NEUTRON ACER TENDL-2021 LIBRARY; T=293.6K
Photon emission for (n,n*)d

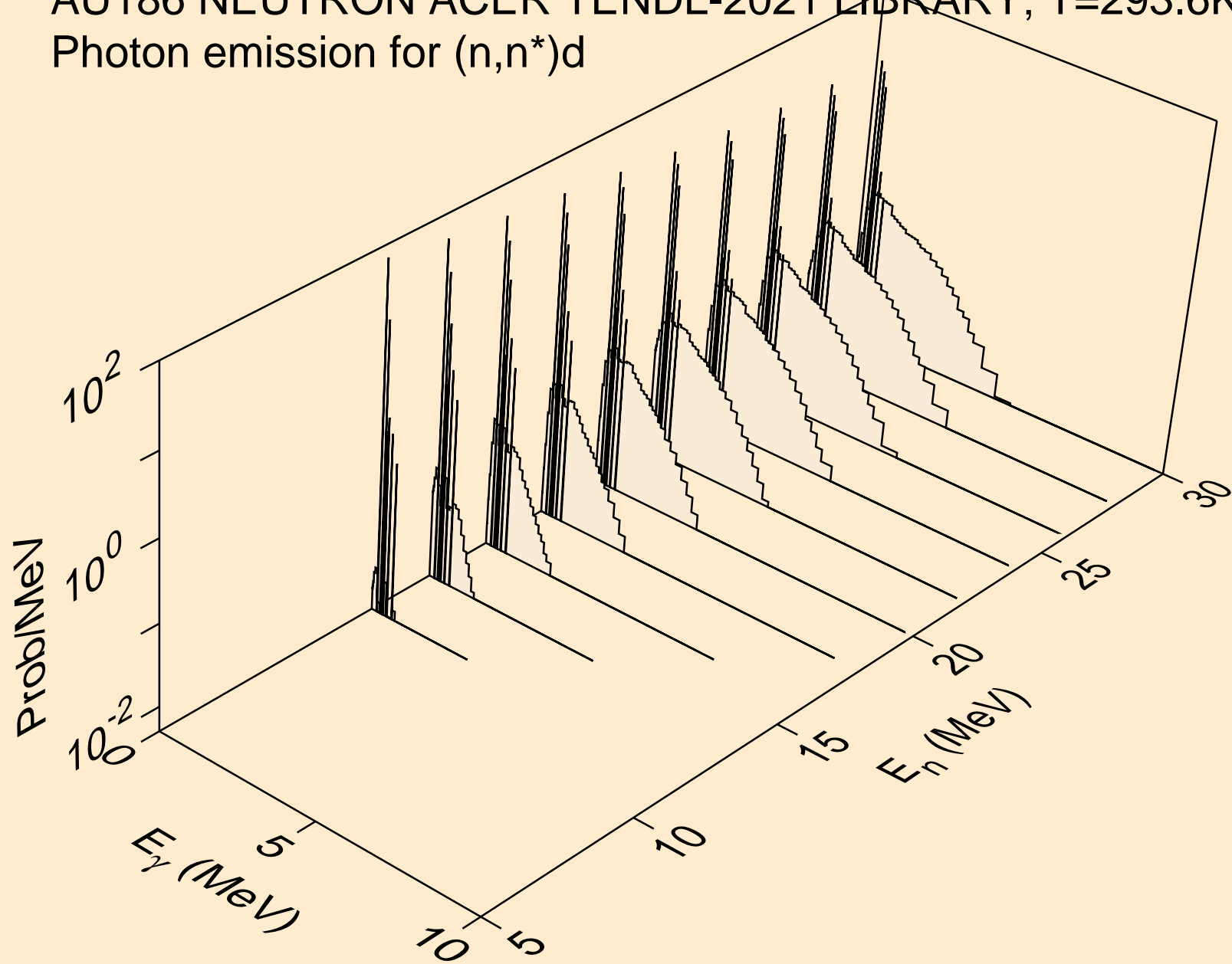

AU186 NEUTRON ACER TENDL-2021 LIBRARY; T=293.6K
Photon emission for (n,n*)t

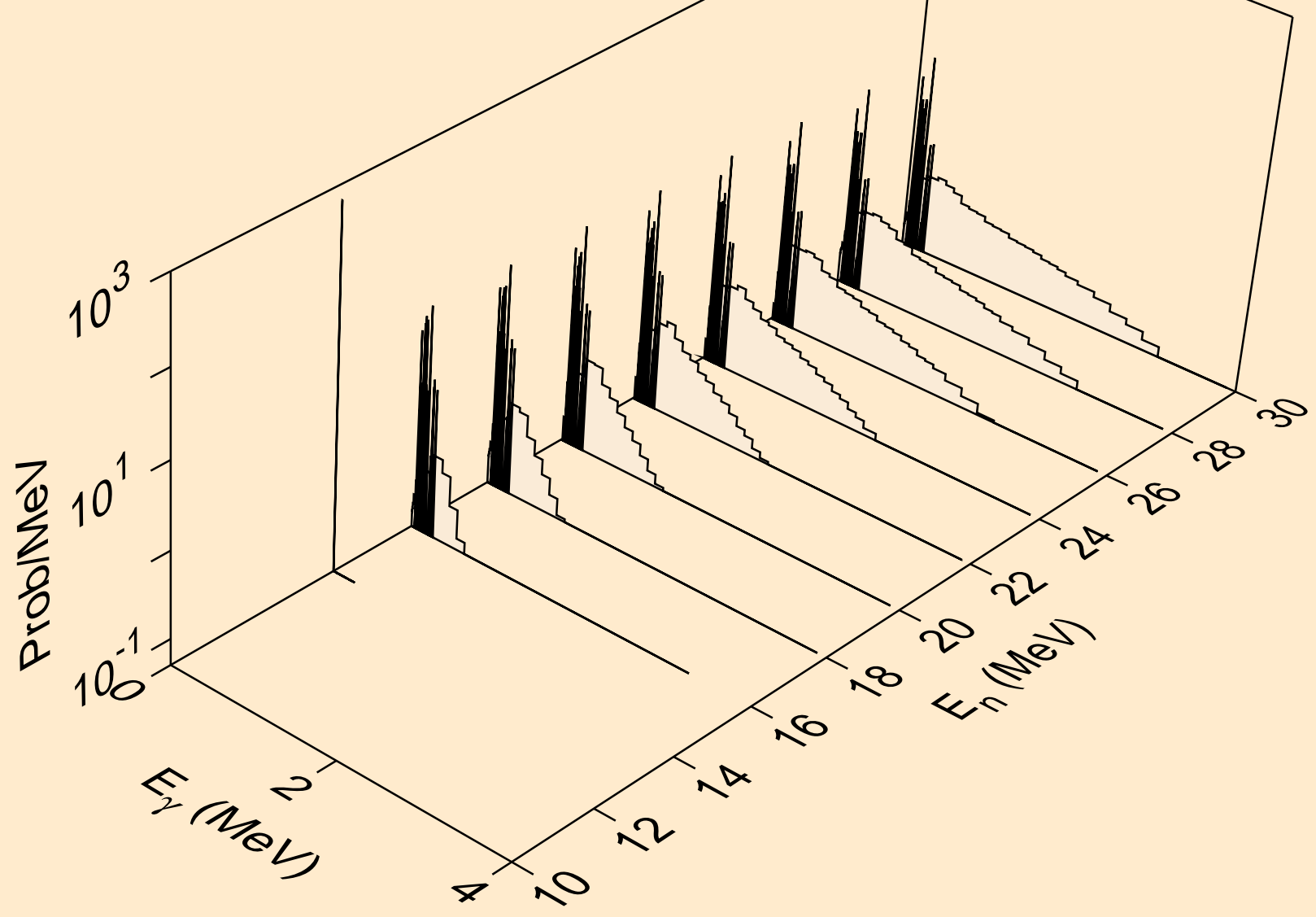

AU186 NEUTRON ACER TENDL-2021 LIBRARY; T=293.6K
Photon emission for (n,n*)he3

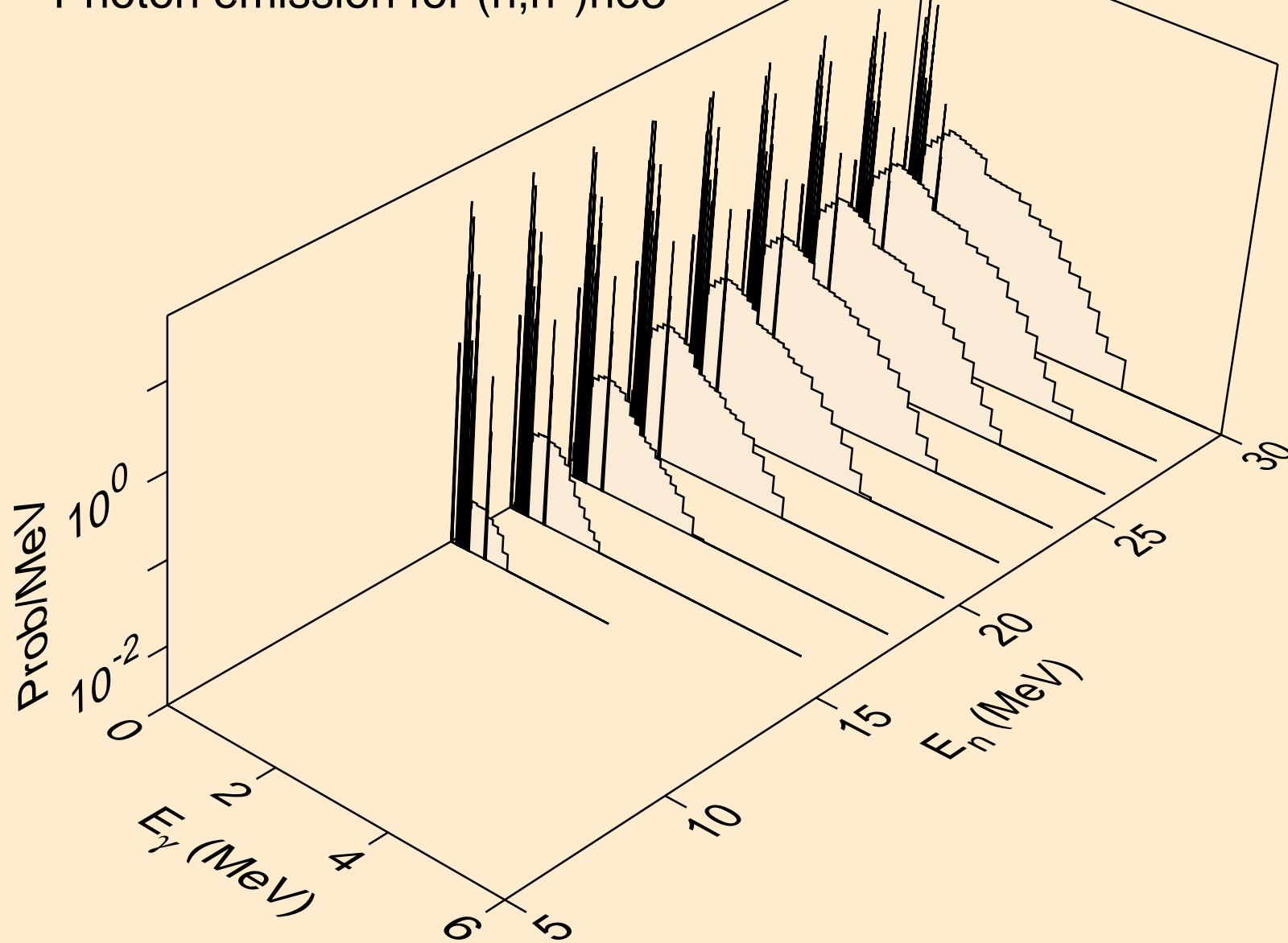

AU186 NEUTRON ACER TENDL-2021 LIBRARY; T=293.6K
Photon emission for (n,4n)

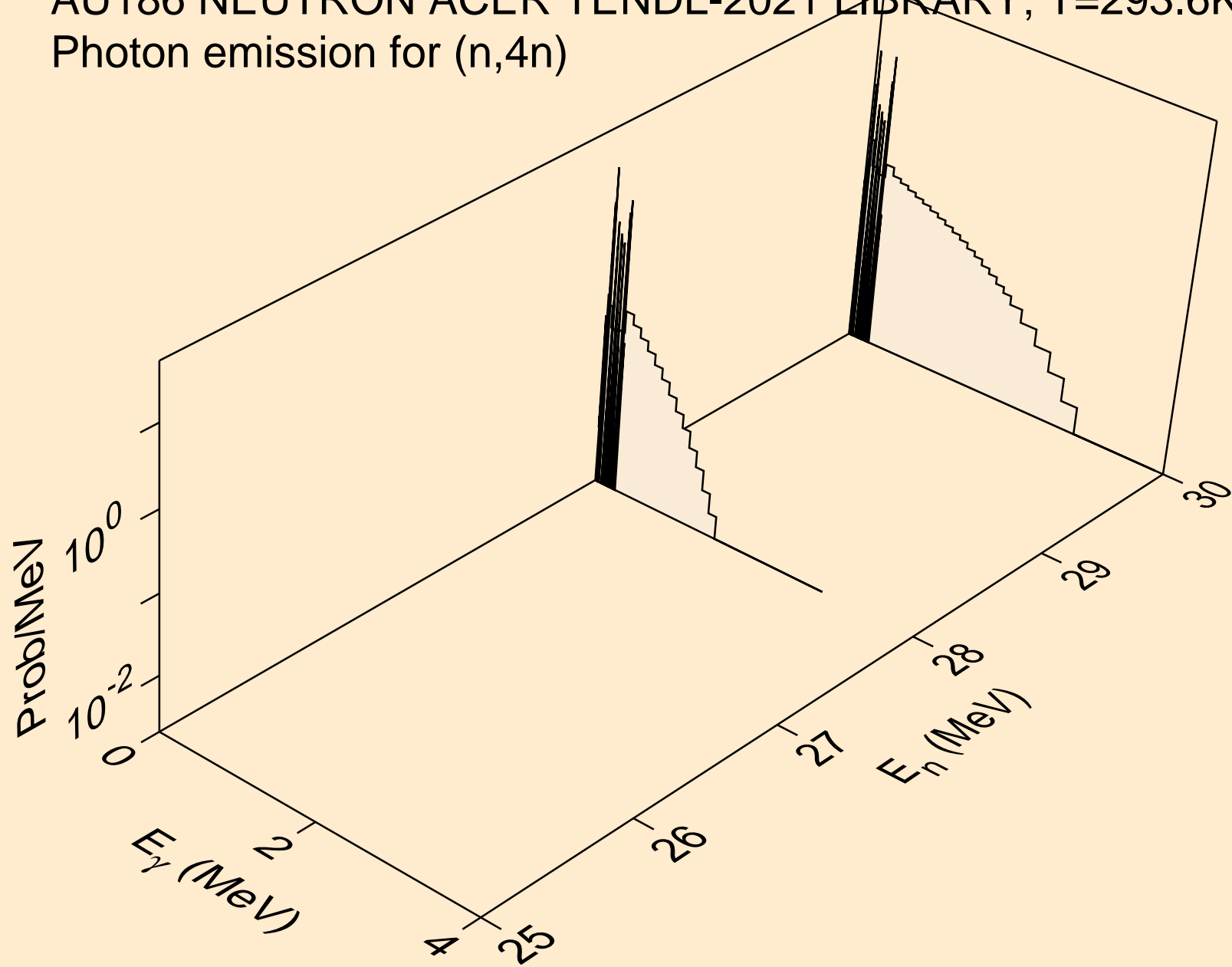

AU186 NEUTRON ACER TENDL-2021 LIBRARY; T=293.6K
Photon emission for (n,2np)

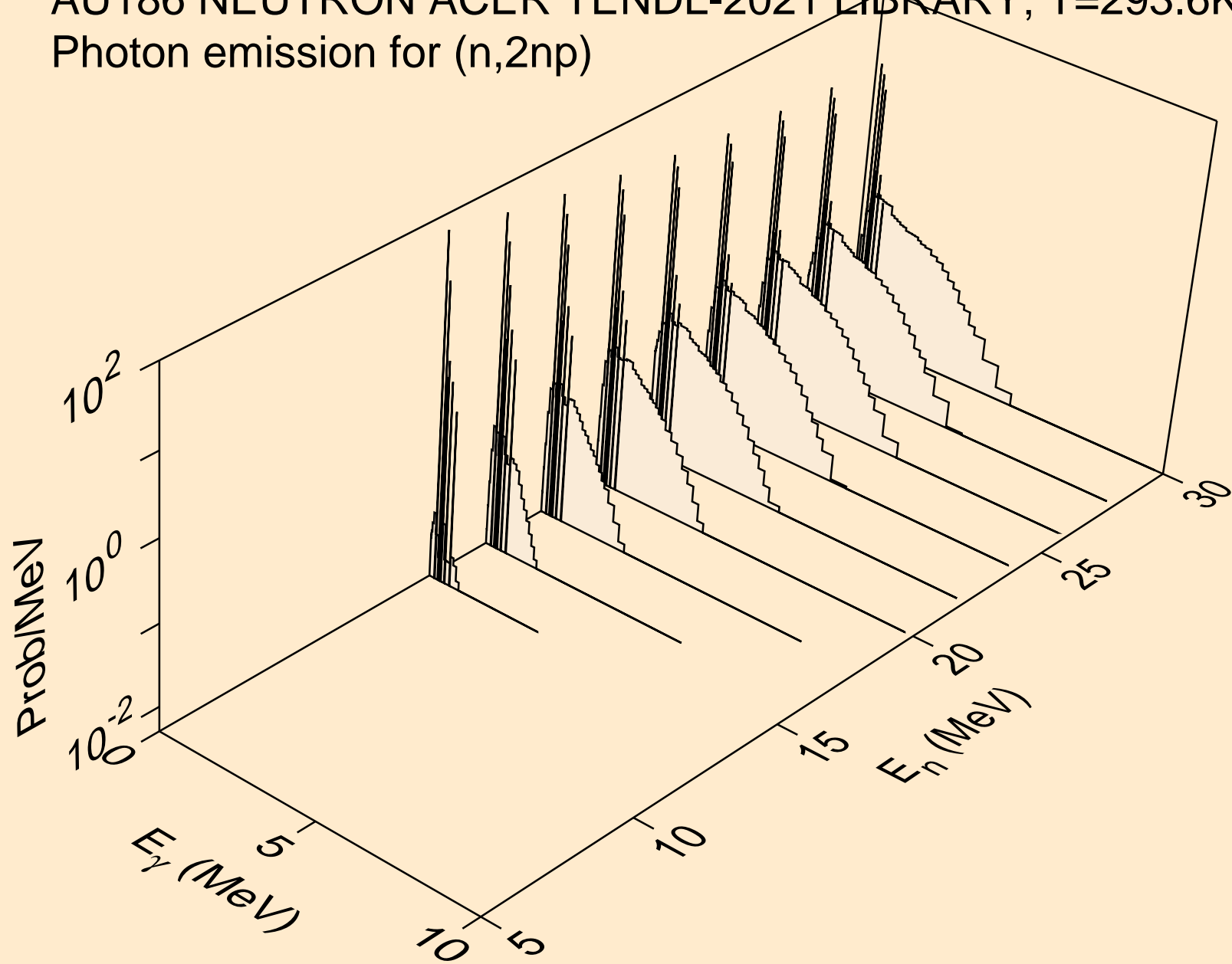

AU186 NEUTRON ACER TENDL-2021 LIBRARY; T=293.6K
Photon emission for (n,3np)

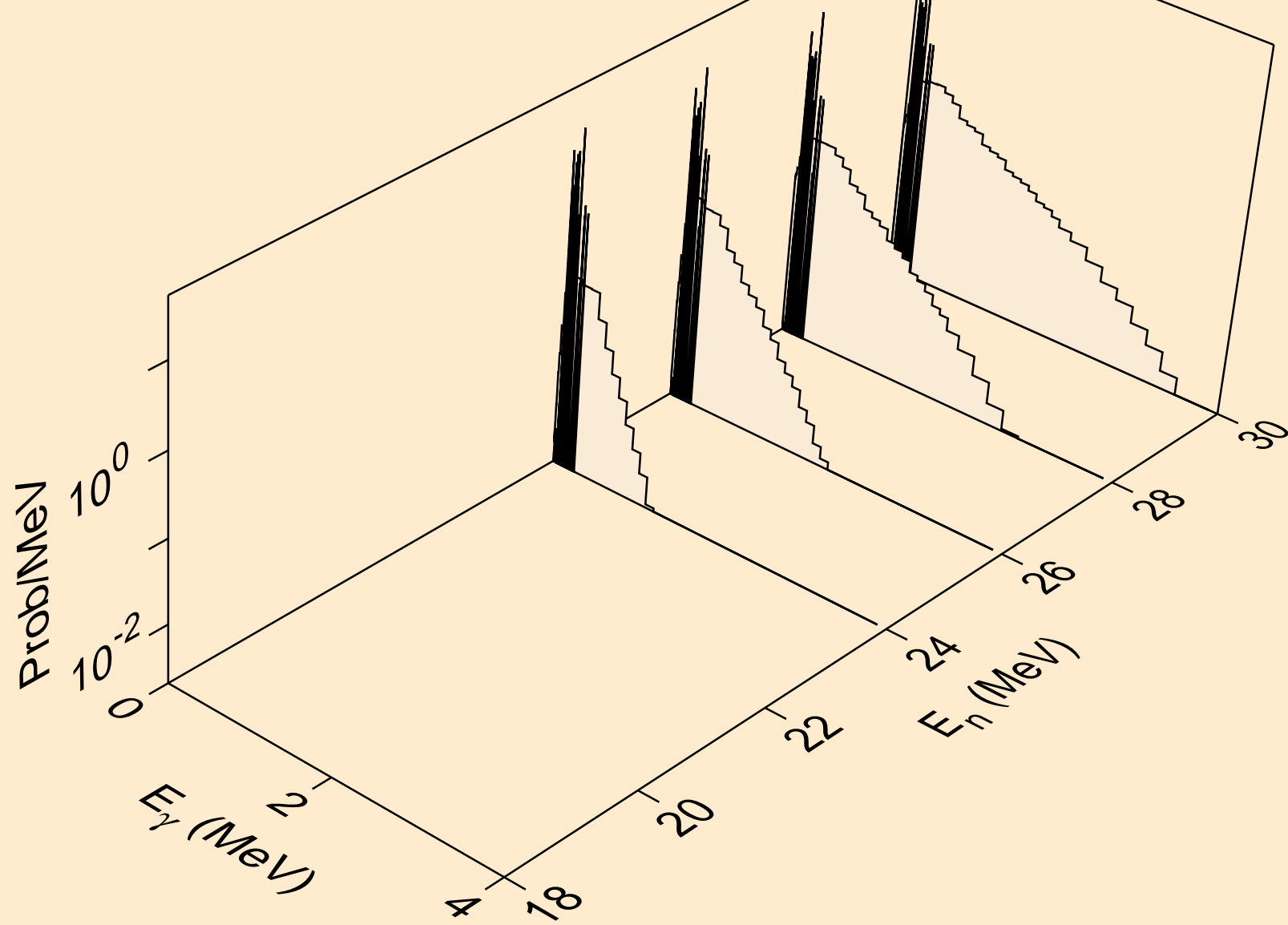

AU186 NEUTRON ACER TENDL-2021 LIBRARY; T=293.6K
Photon emission for (n,2np)

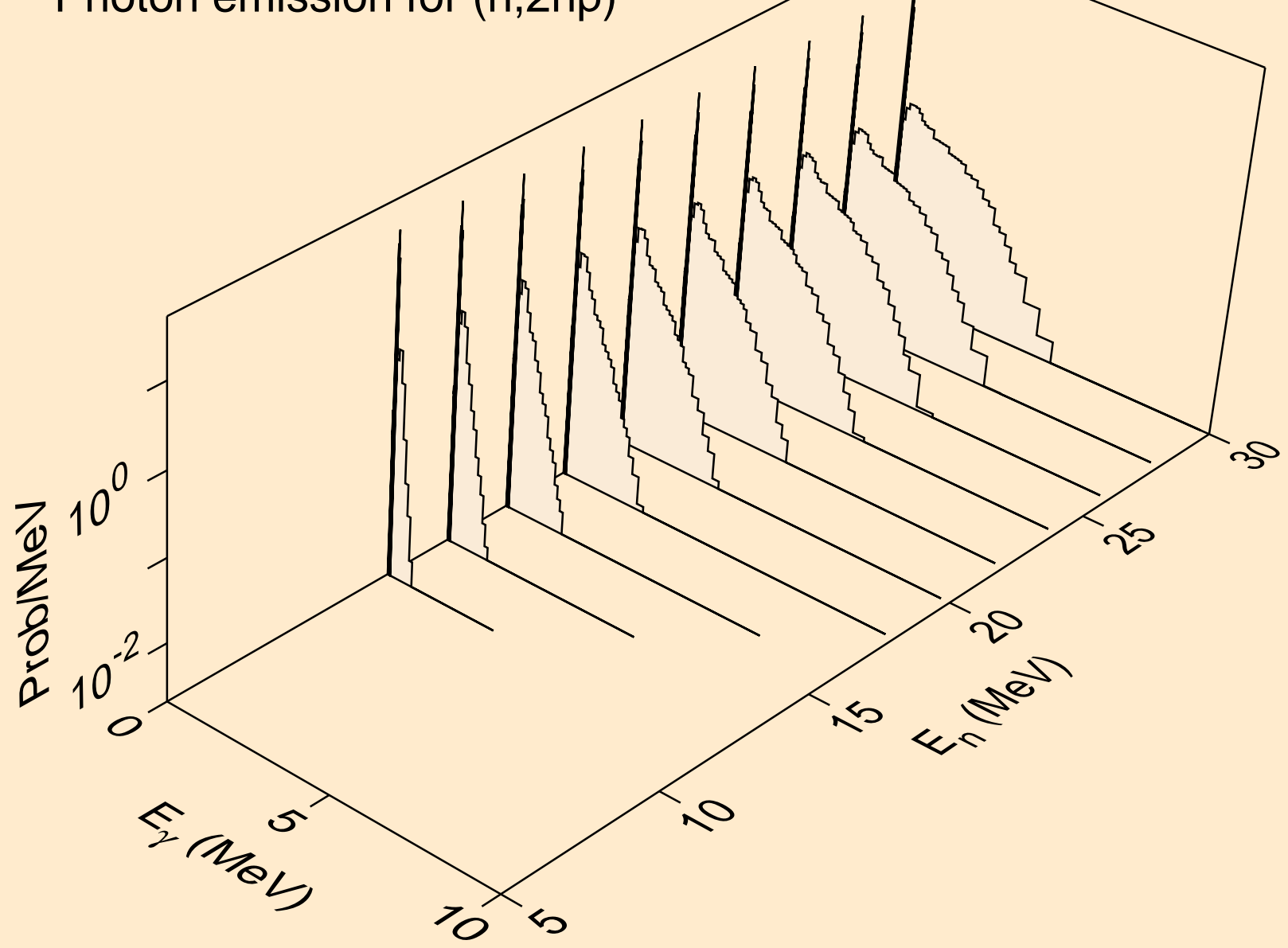

AU186 NEUTRON ACER TENDL-2021 LIBRARY; T=293.6K
Photon emission for (n,npa)

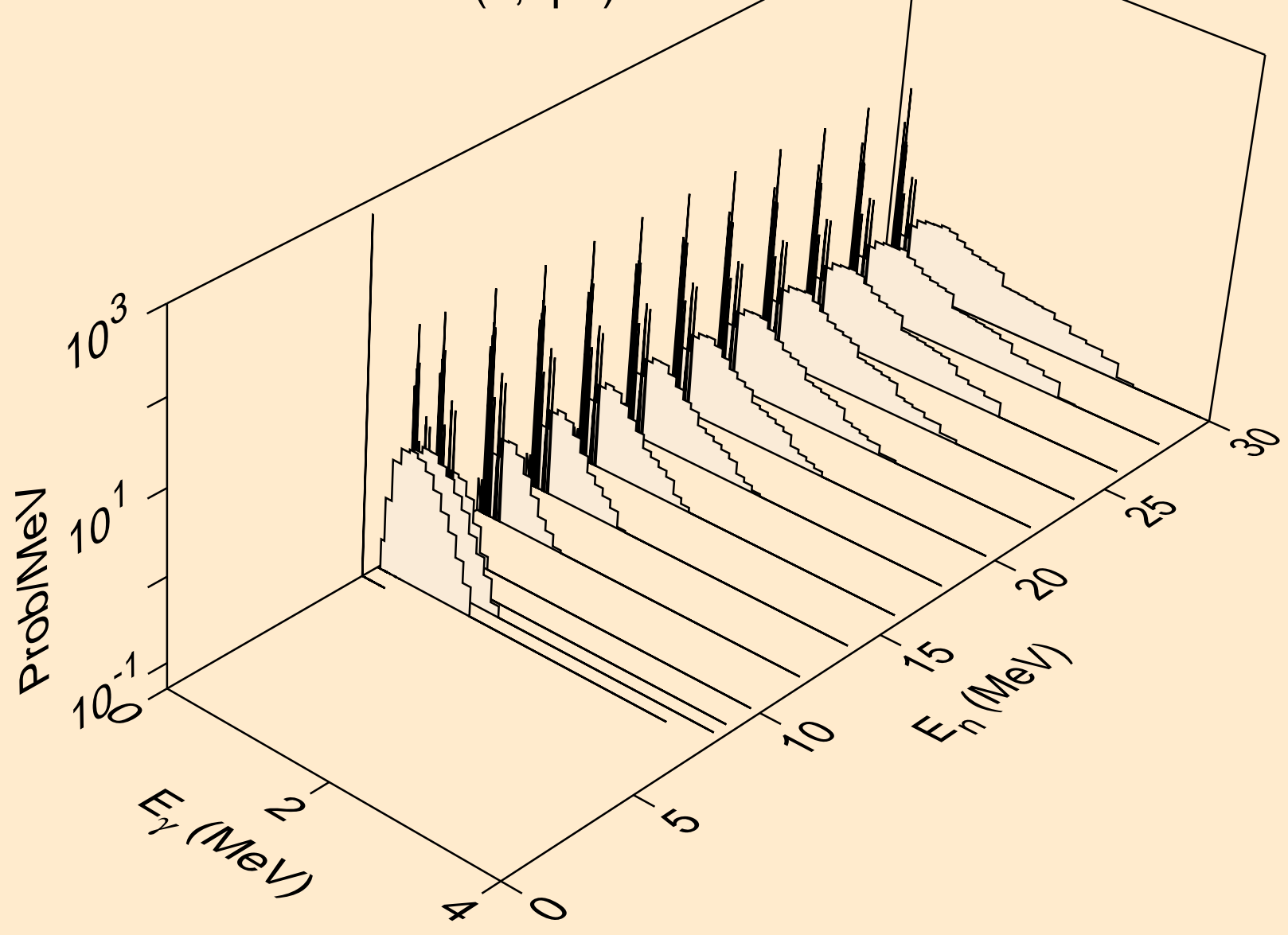

AU186 NEUTRON ACER TENDL-2021 LIBRARY; T=293.6K
Photon emission for (n,n*c)

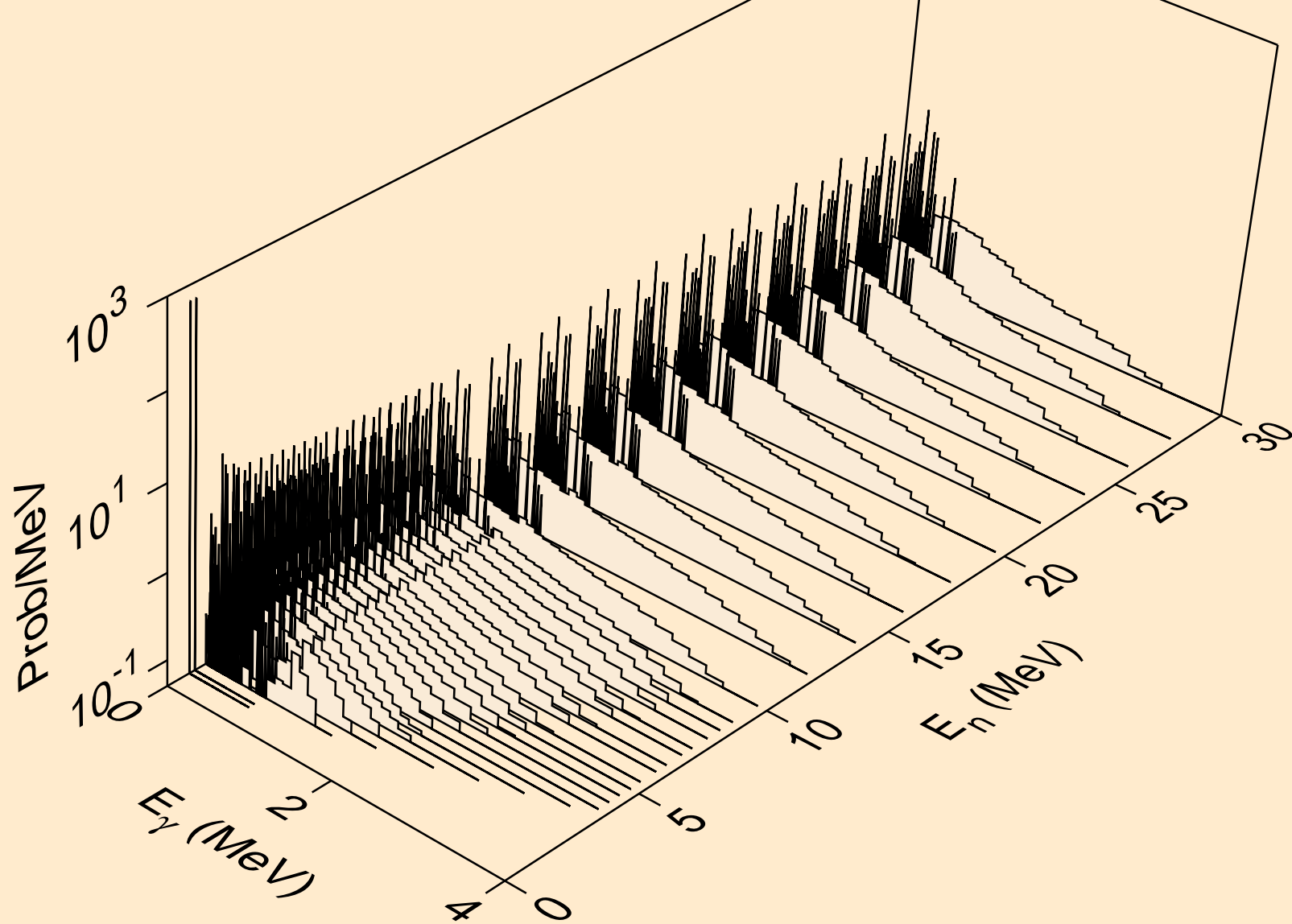

AU186 NEUTRON ACER TENDL-2021 LIBRARY; T=293.6K
Photon emission for (n,gma)

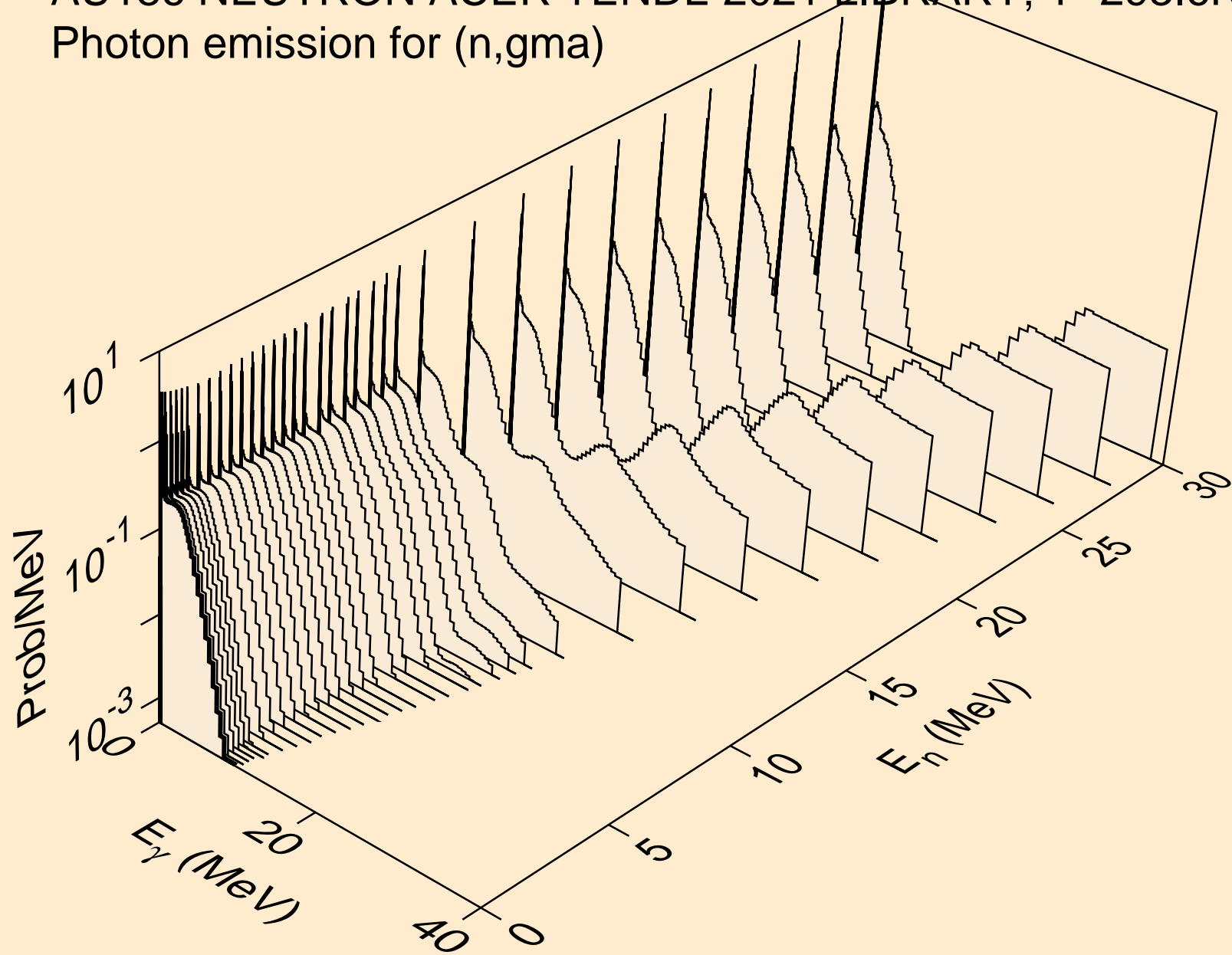

AU186 NEUTRON ACER TENDL-2021 LIBRARY; T=293.6K
Photon emission for (n,p)

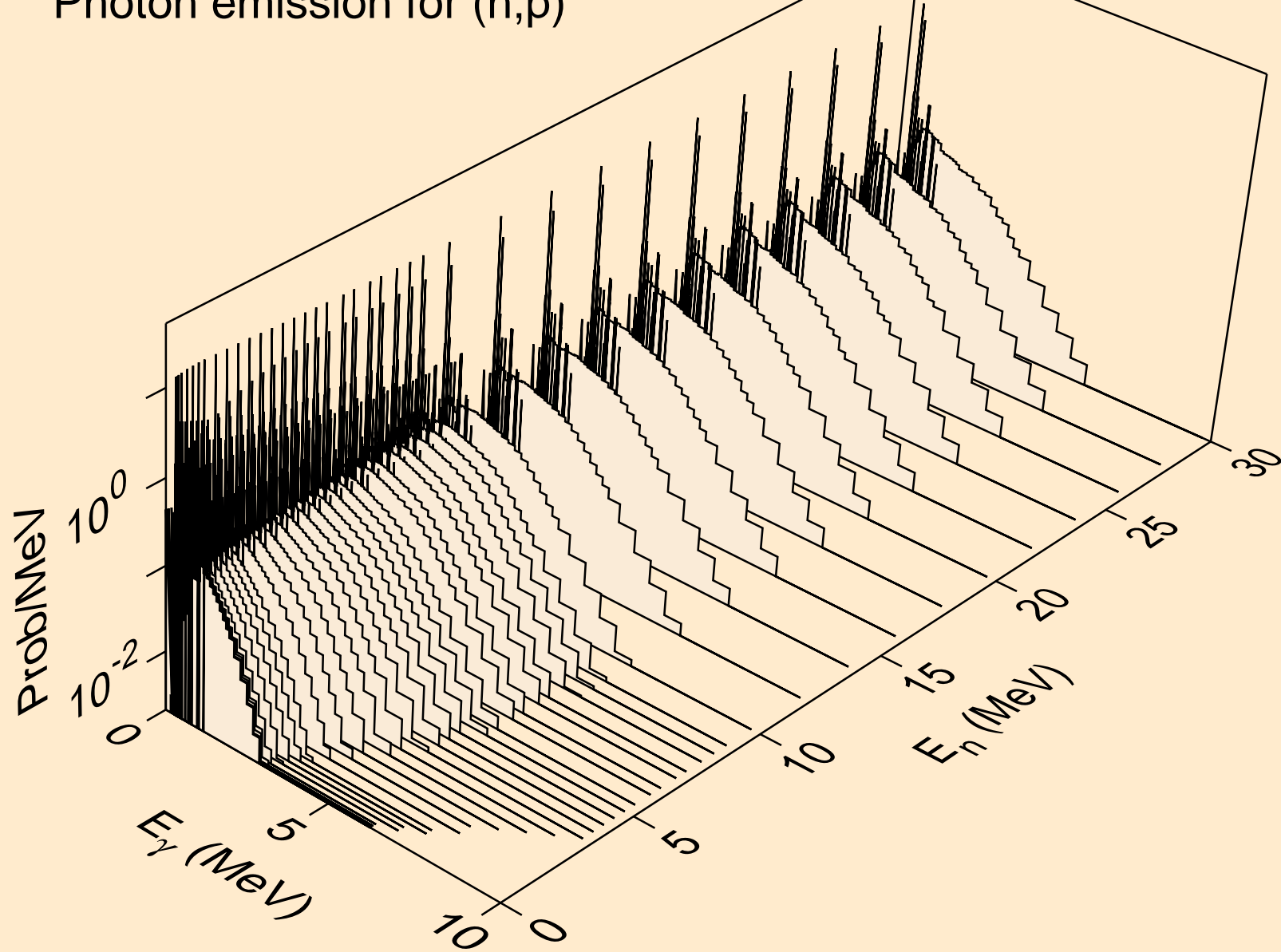

AU186 NEUTRON ACER TENDL-2021 LIBRARY; T=293.6K
Photon emission for (n,d)

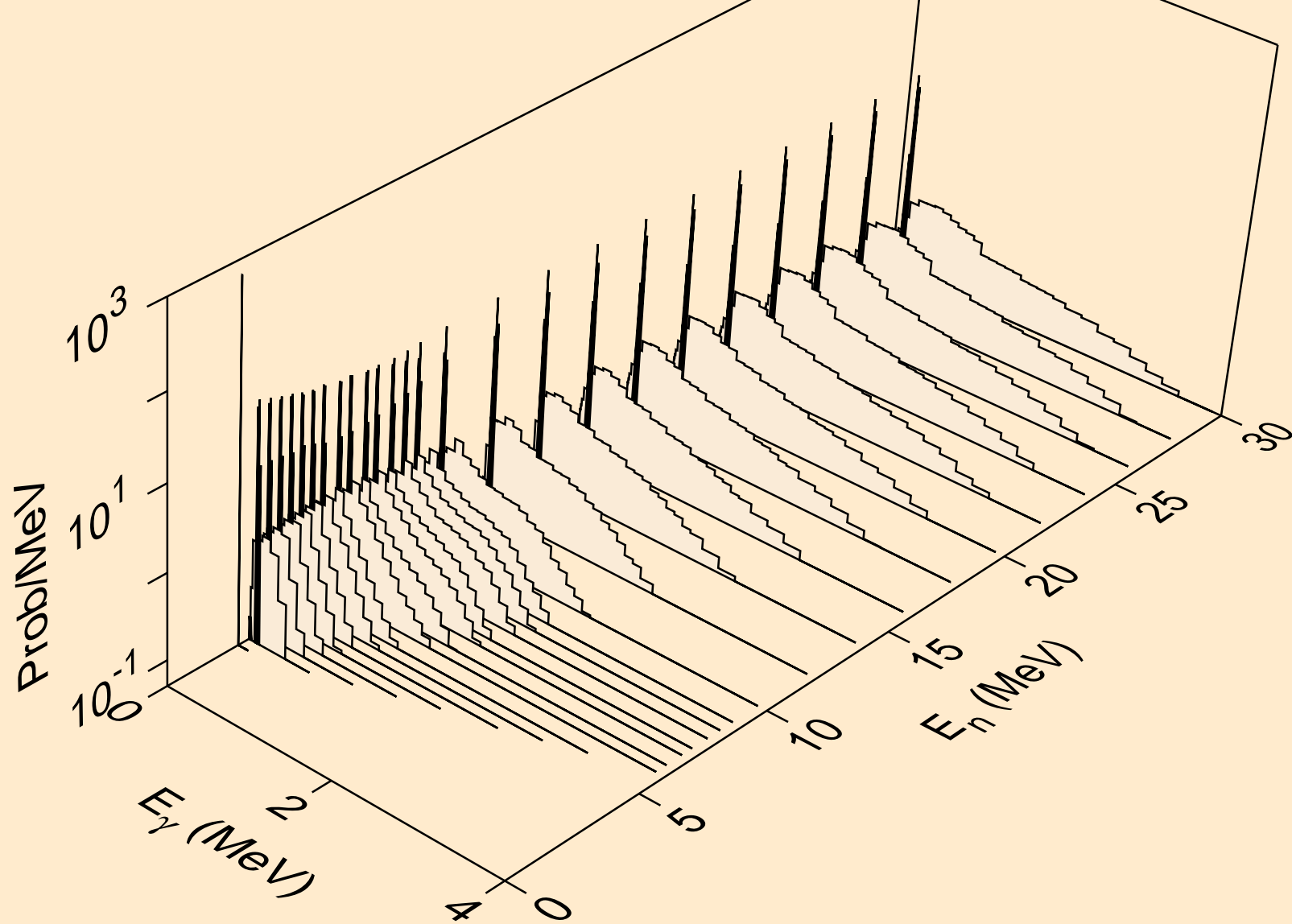

AU186 NEUTRON ACER TENDL-2021 LIBRARY; T=293.6K
Photon emission for (n,t)

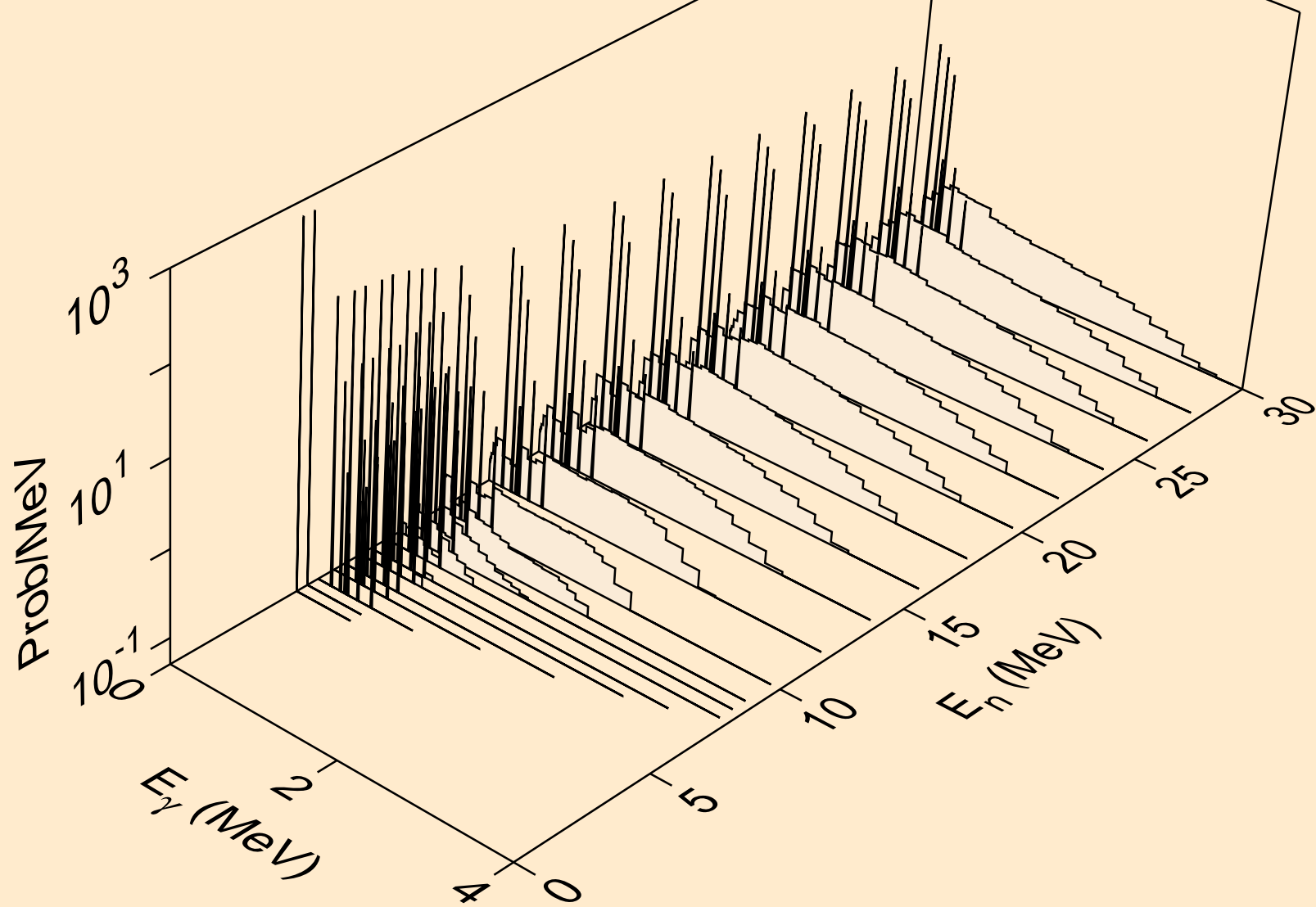

AU186 NEUTRON ACER TENDL-2021 LIBRARY; T=293.6K
Photon emission for (n,he3)

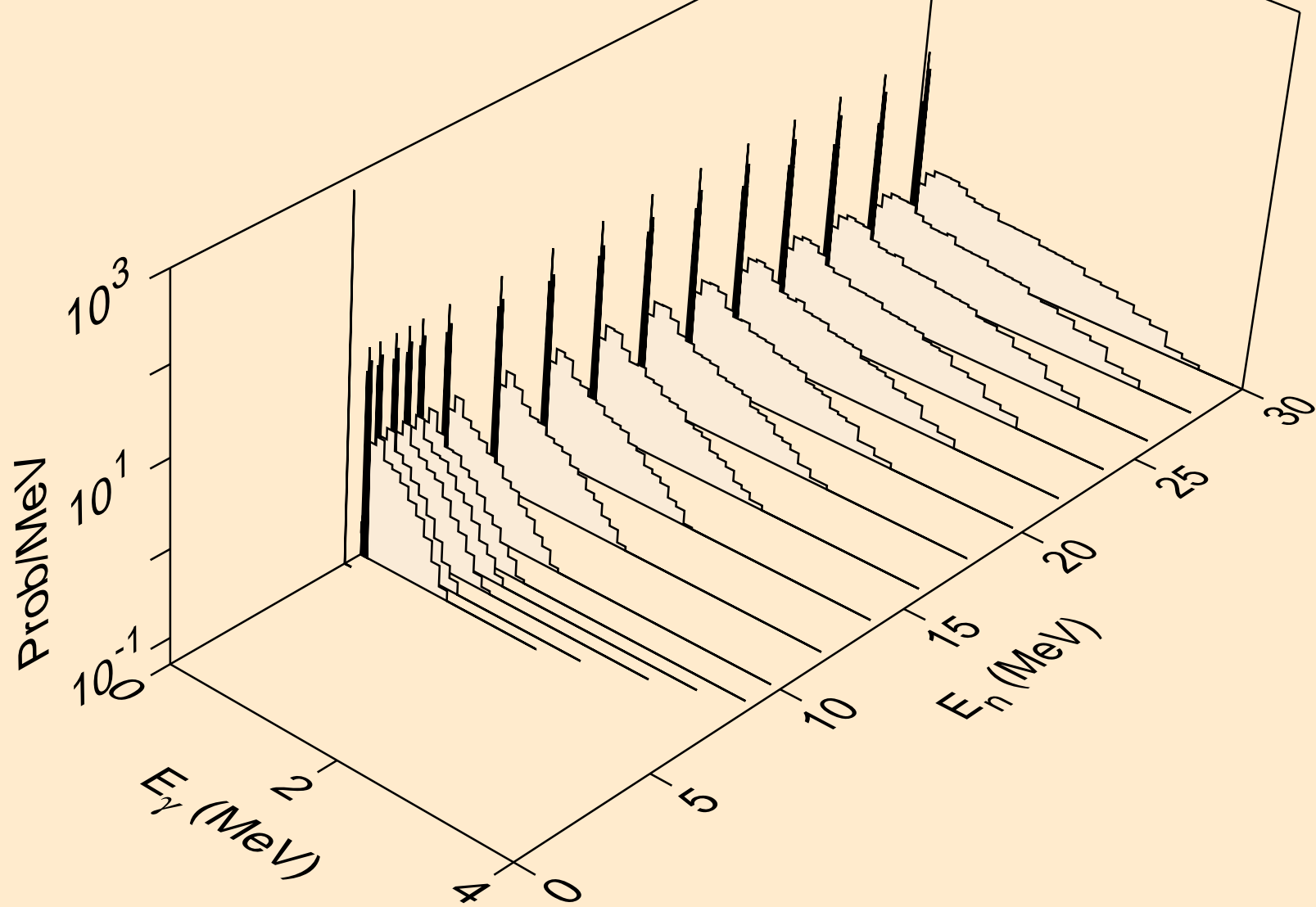

AU186 NEUTRON ACER TENDL-2021 LIBRARY; T=293.6K
Photon emission for (n,a)

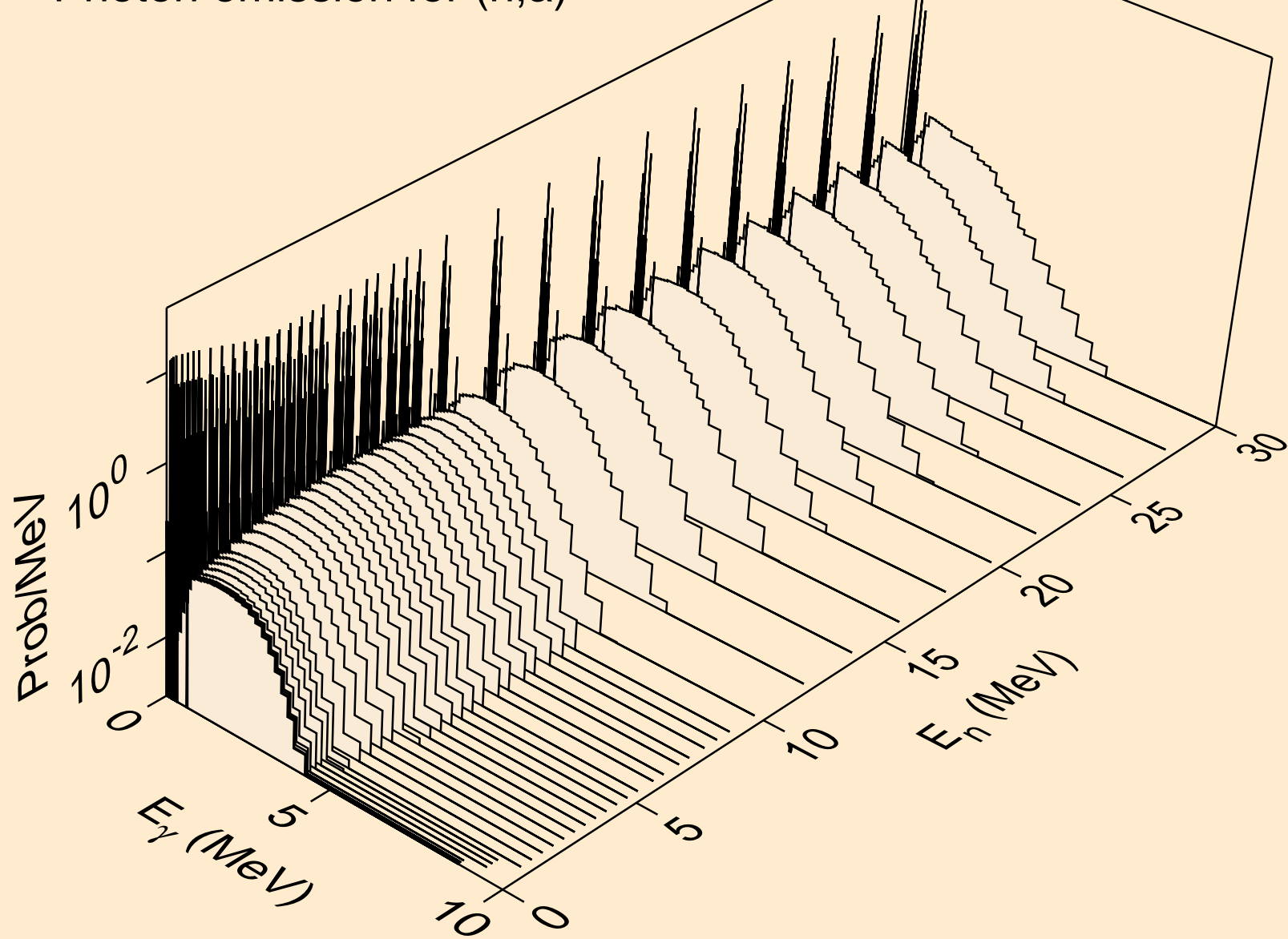

AU186 NEUTRON ACER TENDL-2021 LIBRARY; T=293.6K
Photon emission for (n,2a)

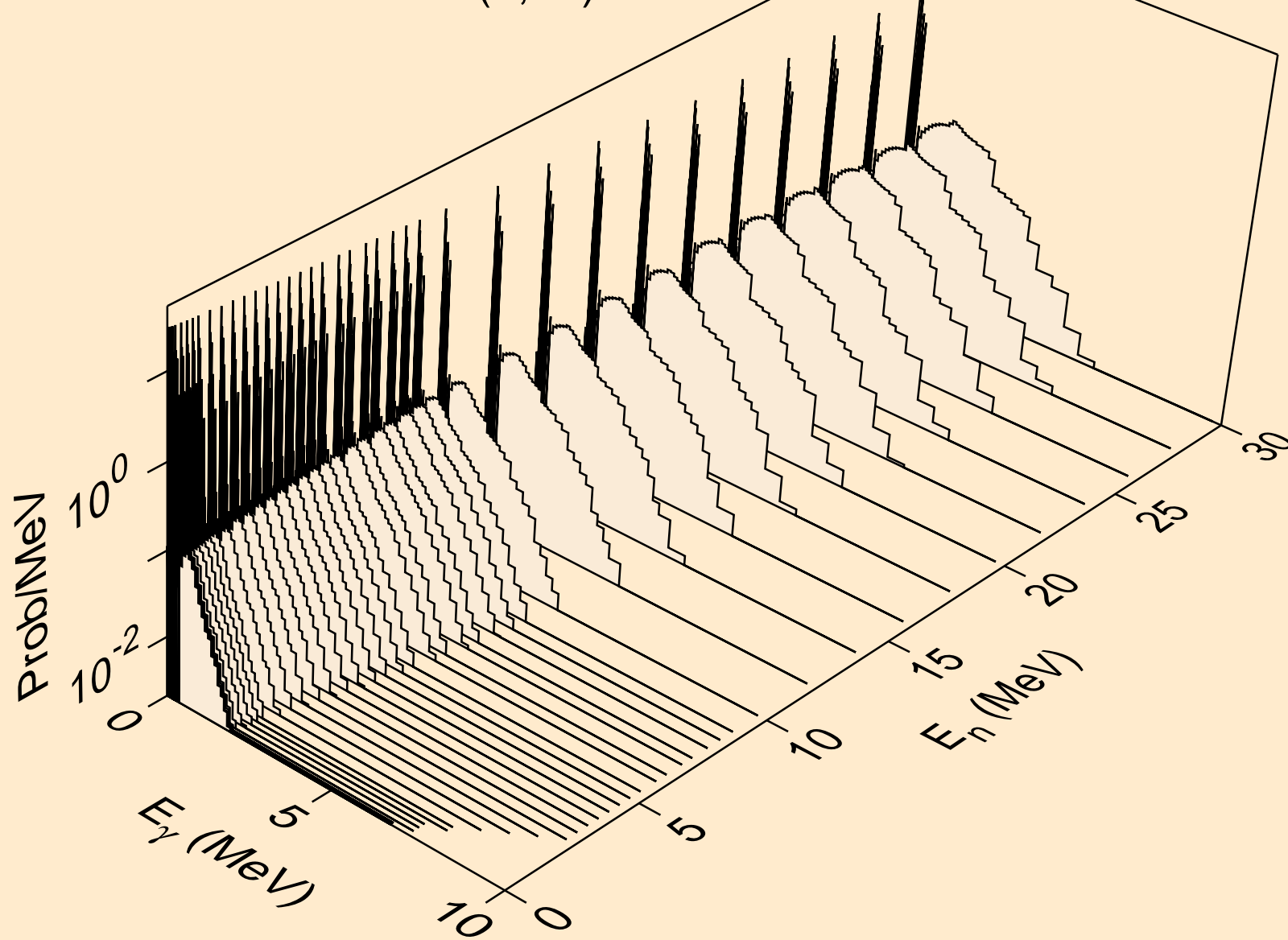

AU186 NEUTRON ACER TENDL-2021 LIBRARY; T=293.6K
Photon emission for (n,2p)

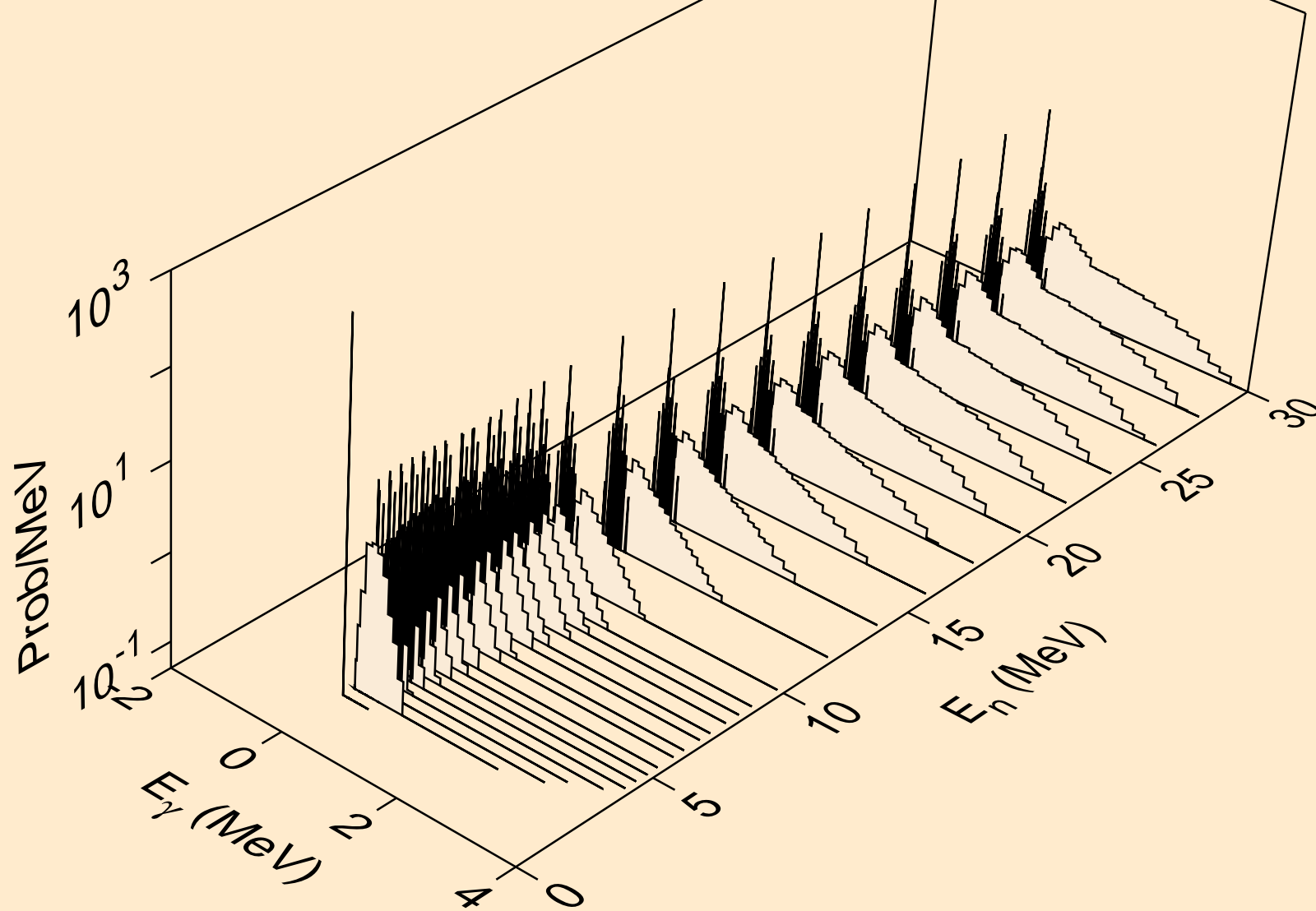

AU186 NEUTRON ACER TENDL-2021 LIBRARY; T=293.6K
Photon emission for (n,p α)

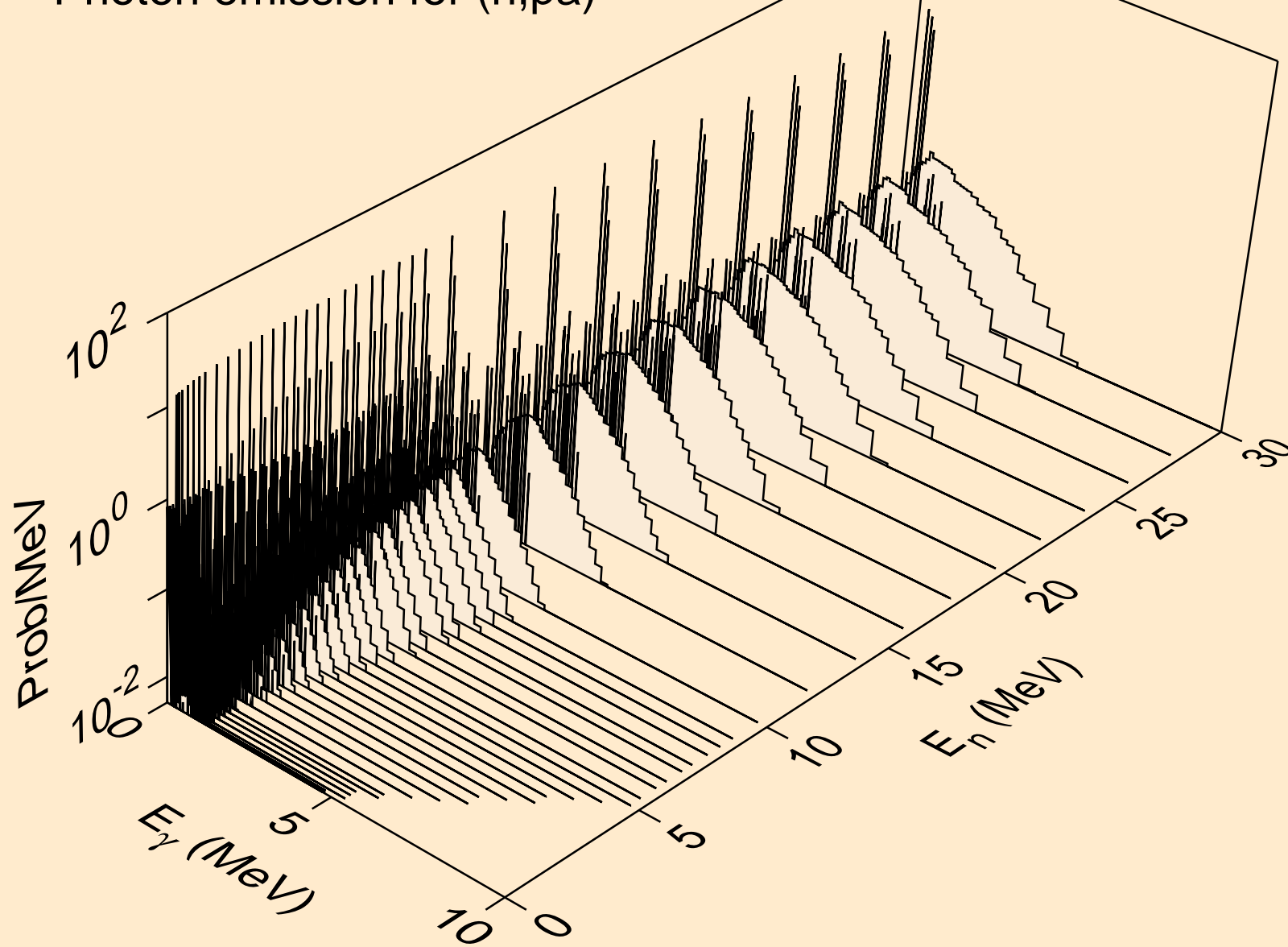

AU186 NEUTRON ACER TENDL-2021 LIBRARY; T=293.6K
Photon emission for (n,pd)

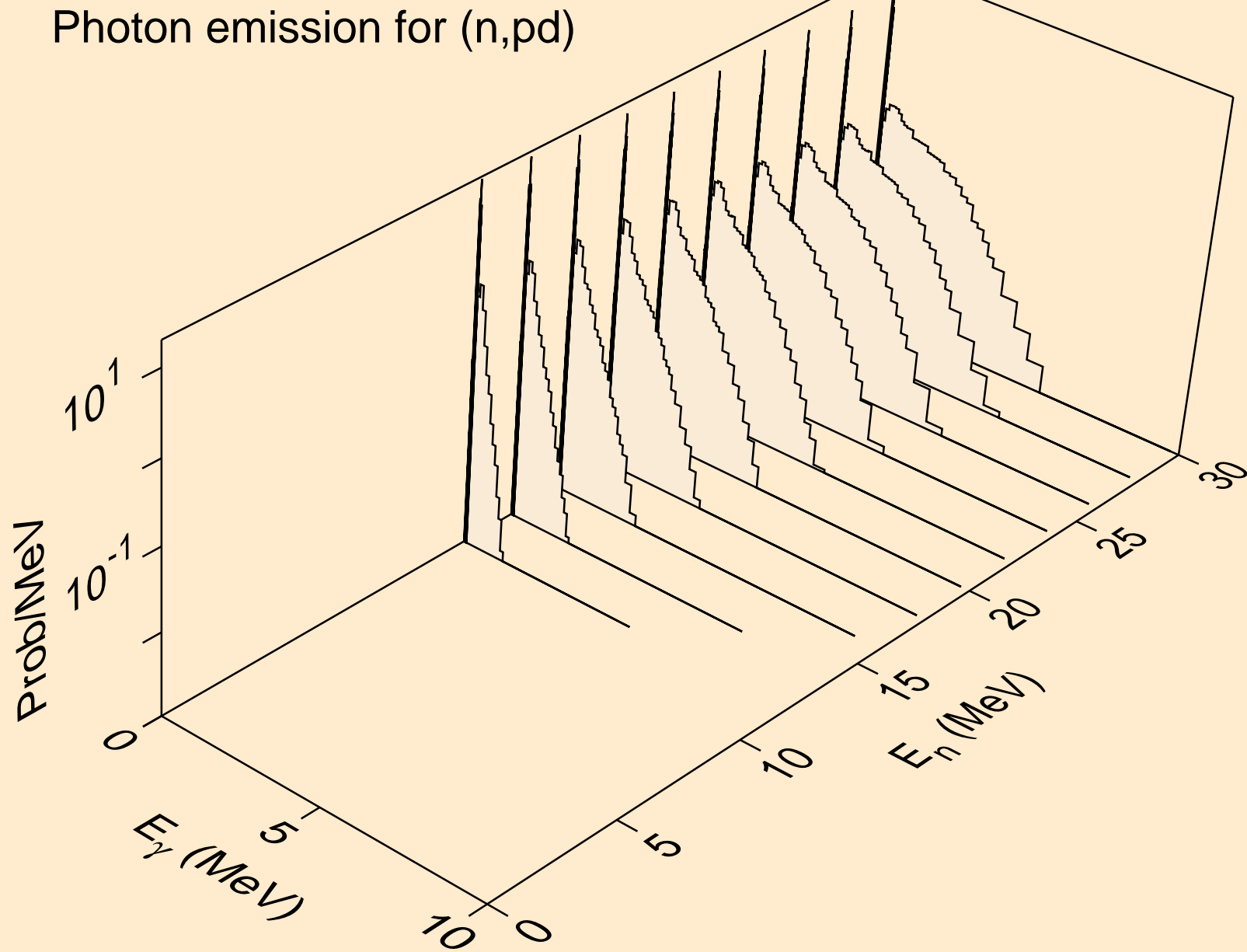

AU186 NEUTRON ACER TENDL-2021 LIBRARY; T=293.6K
Photon emission for (n,pt)

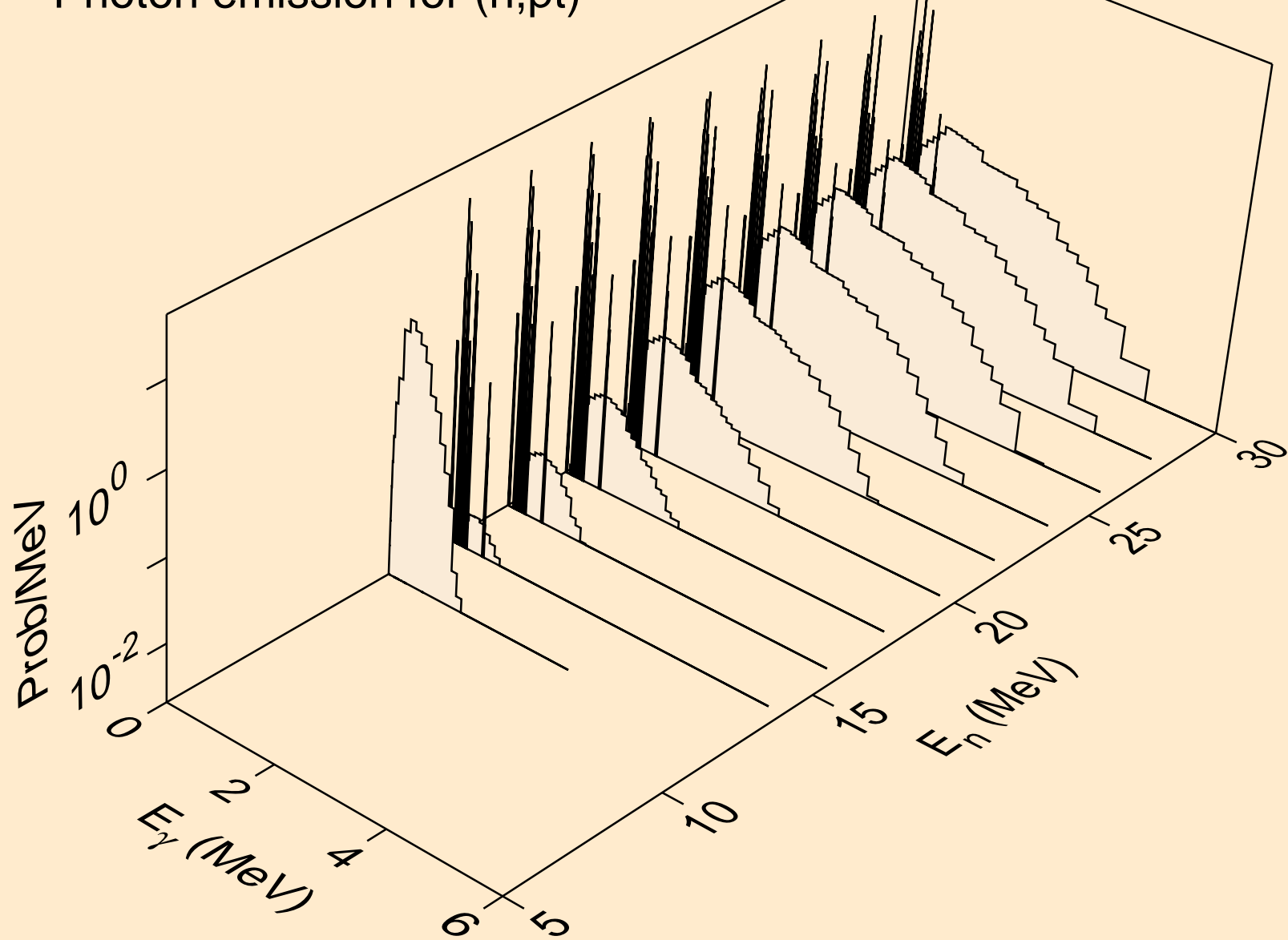

AU186 NEUTRON ACER TENDL-2021 LIBRARY; T=293.6K
Photon emission for (n,da)

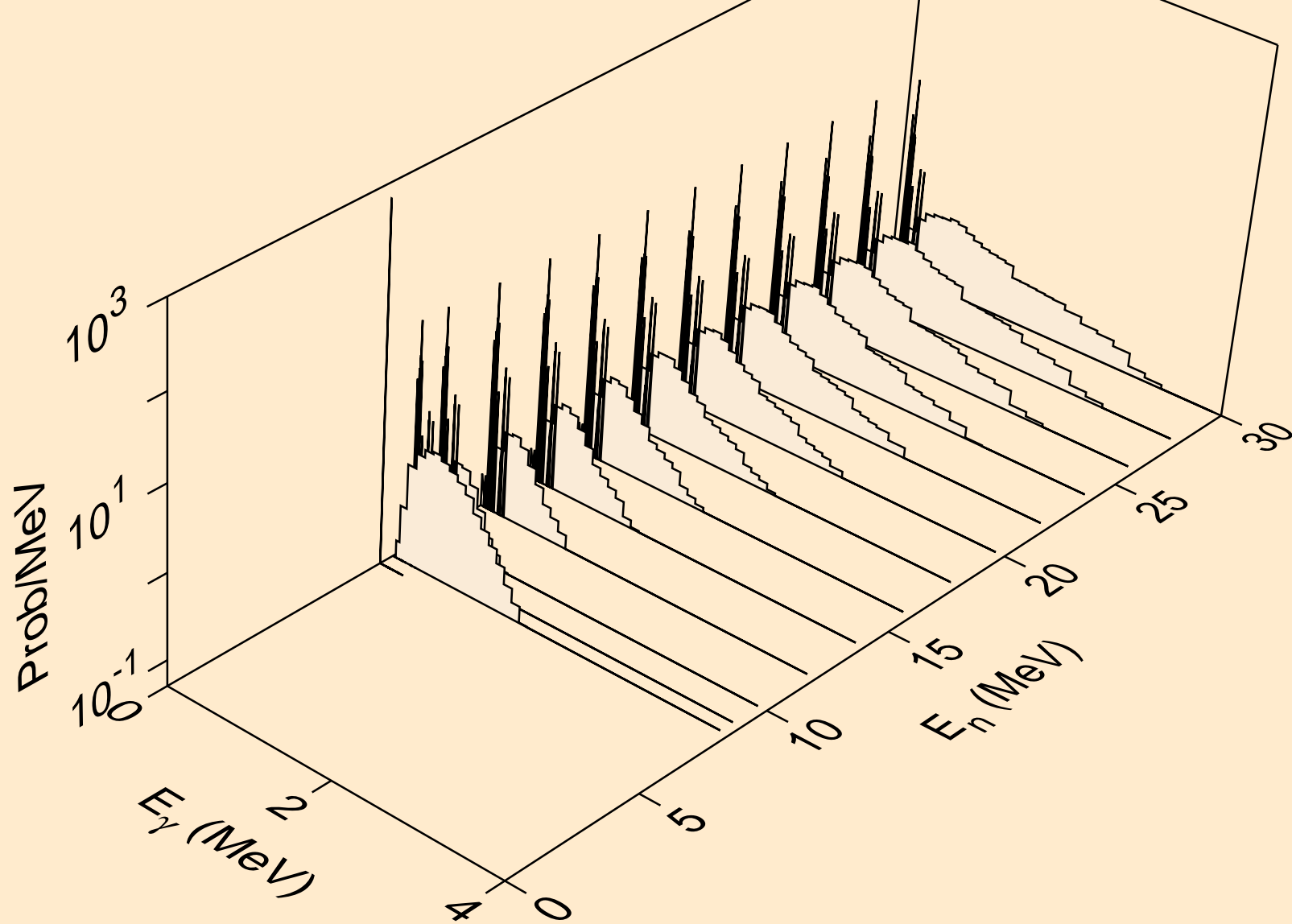

AU186 NEUTRON ACER TENDL-2021 LIBRARY; T=293.6K
thermal capture photon spectrum

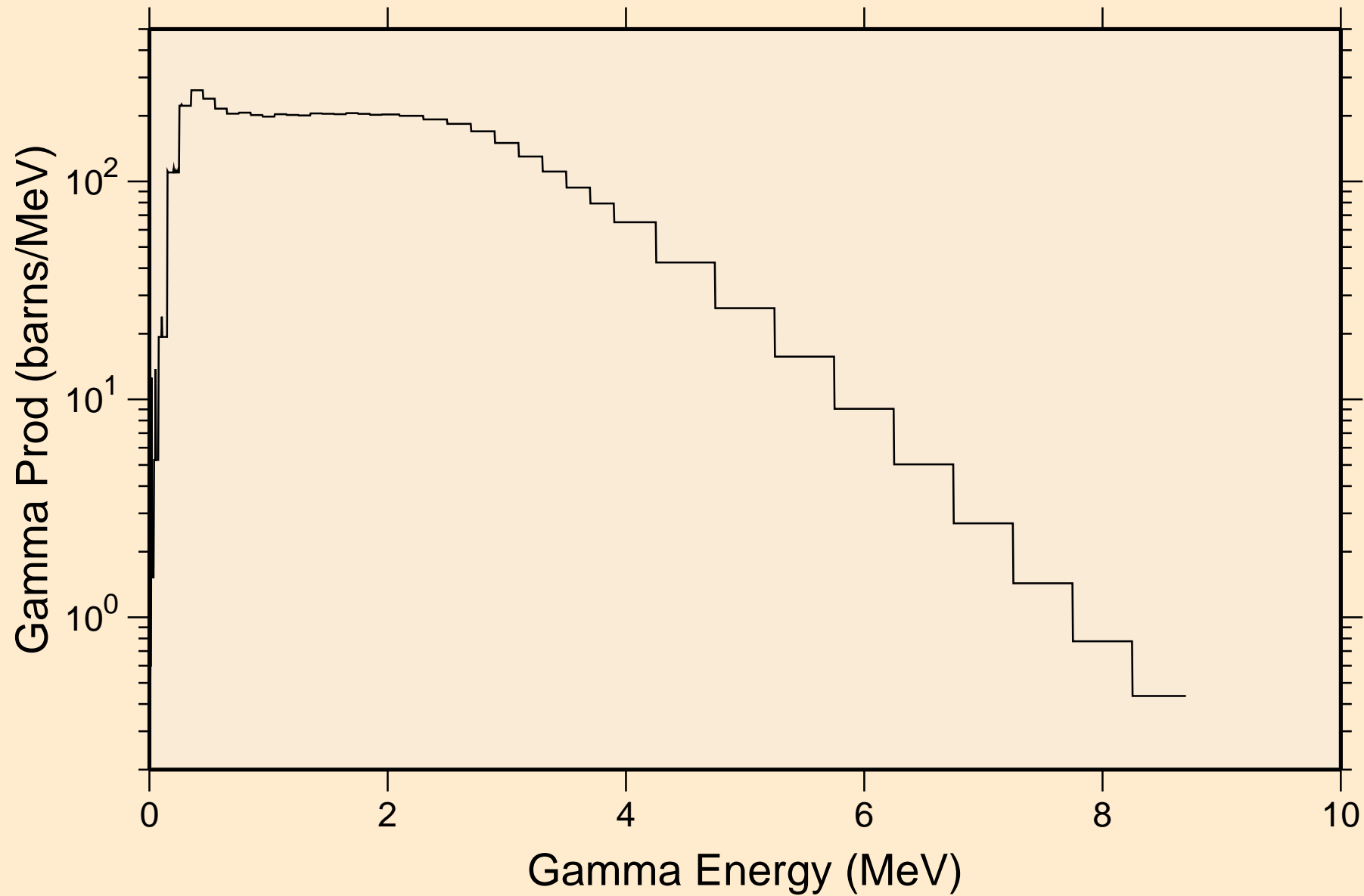

AU186 NEUTRON ACER TENDL-2021 LIBRARY; T=293.6K
14 MeV photon spectrum

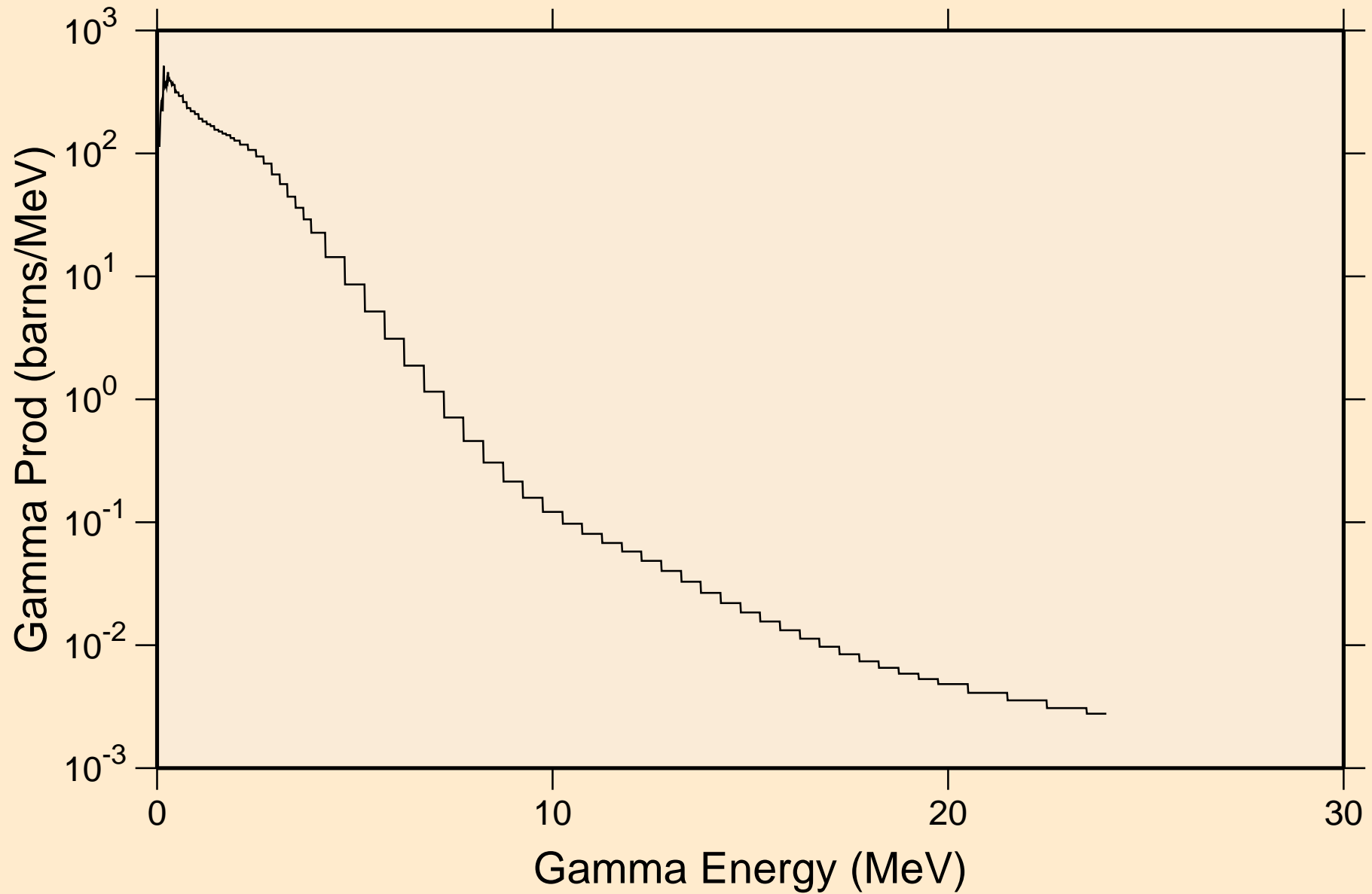

AU186 NEUTRON ACER TENDL-2021 LIBRARY; T=293.6K

Particle heating contributions

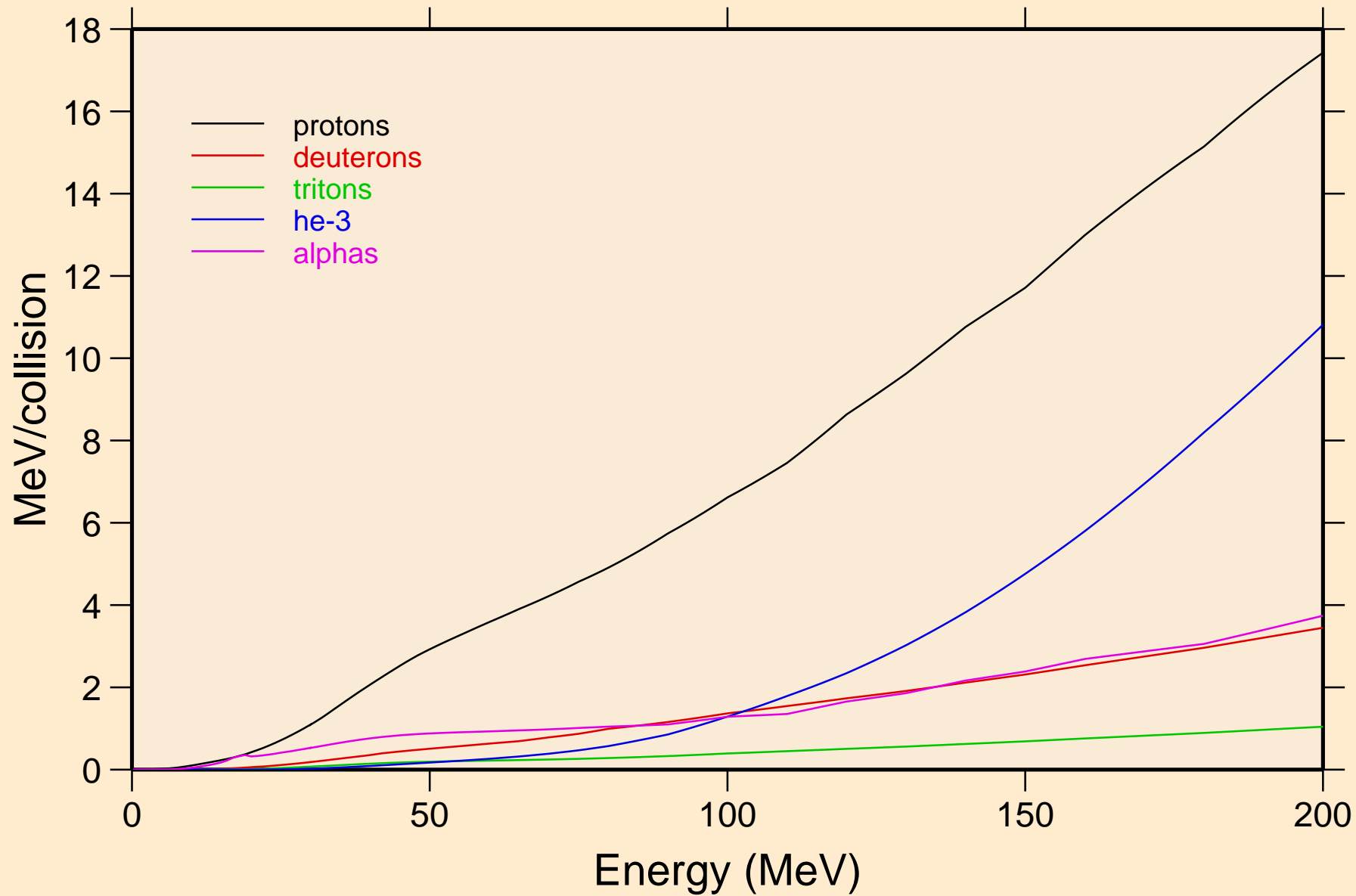

AU186 NEUTRON ACER TENDL-2021 LIBRARY; T=293.6K
Recoil Heating

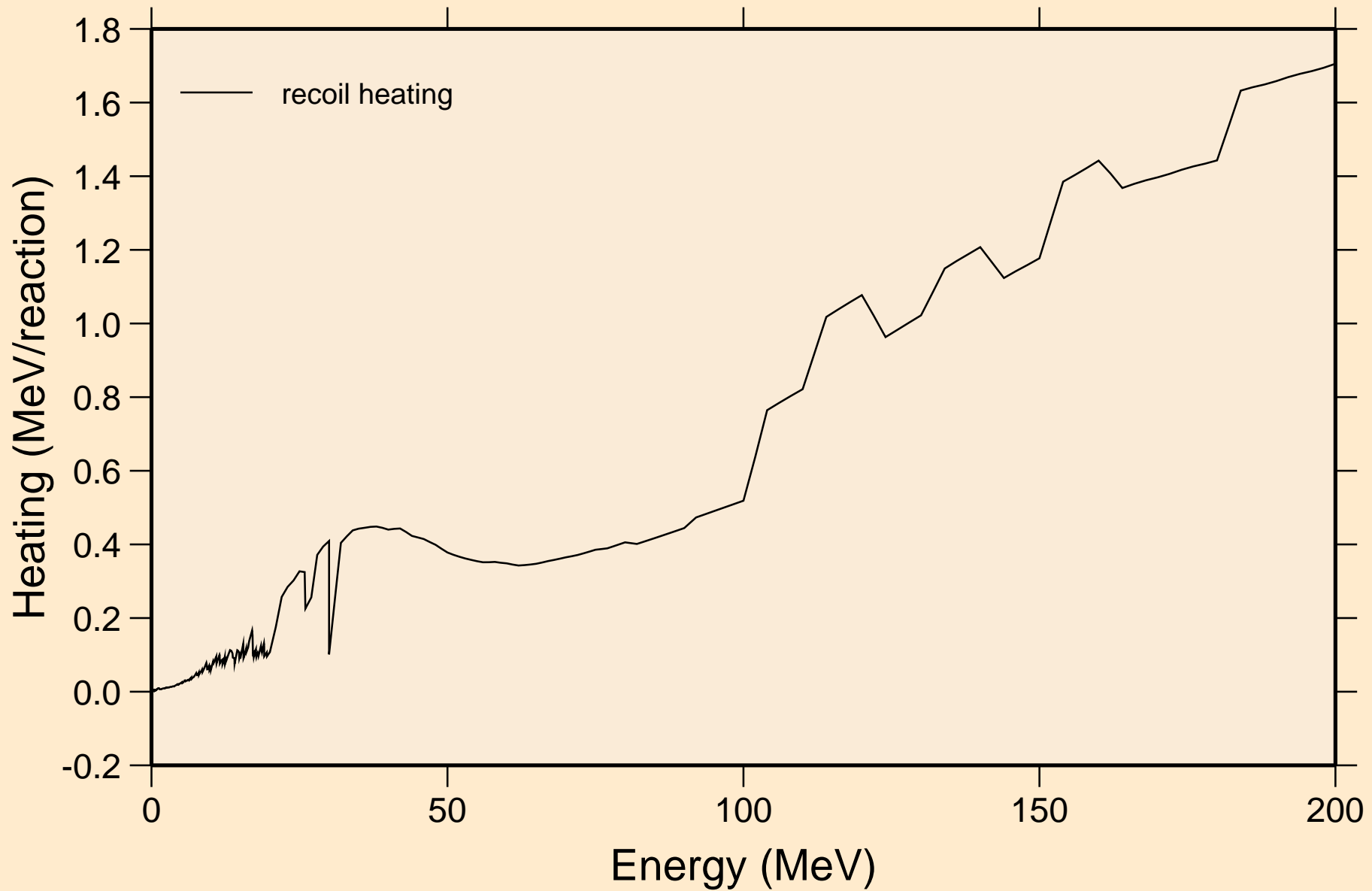

AU186 NEUTRON ACER TENDL-2021 LIBRARY; T=293.6K
Particle production cross sections

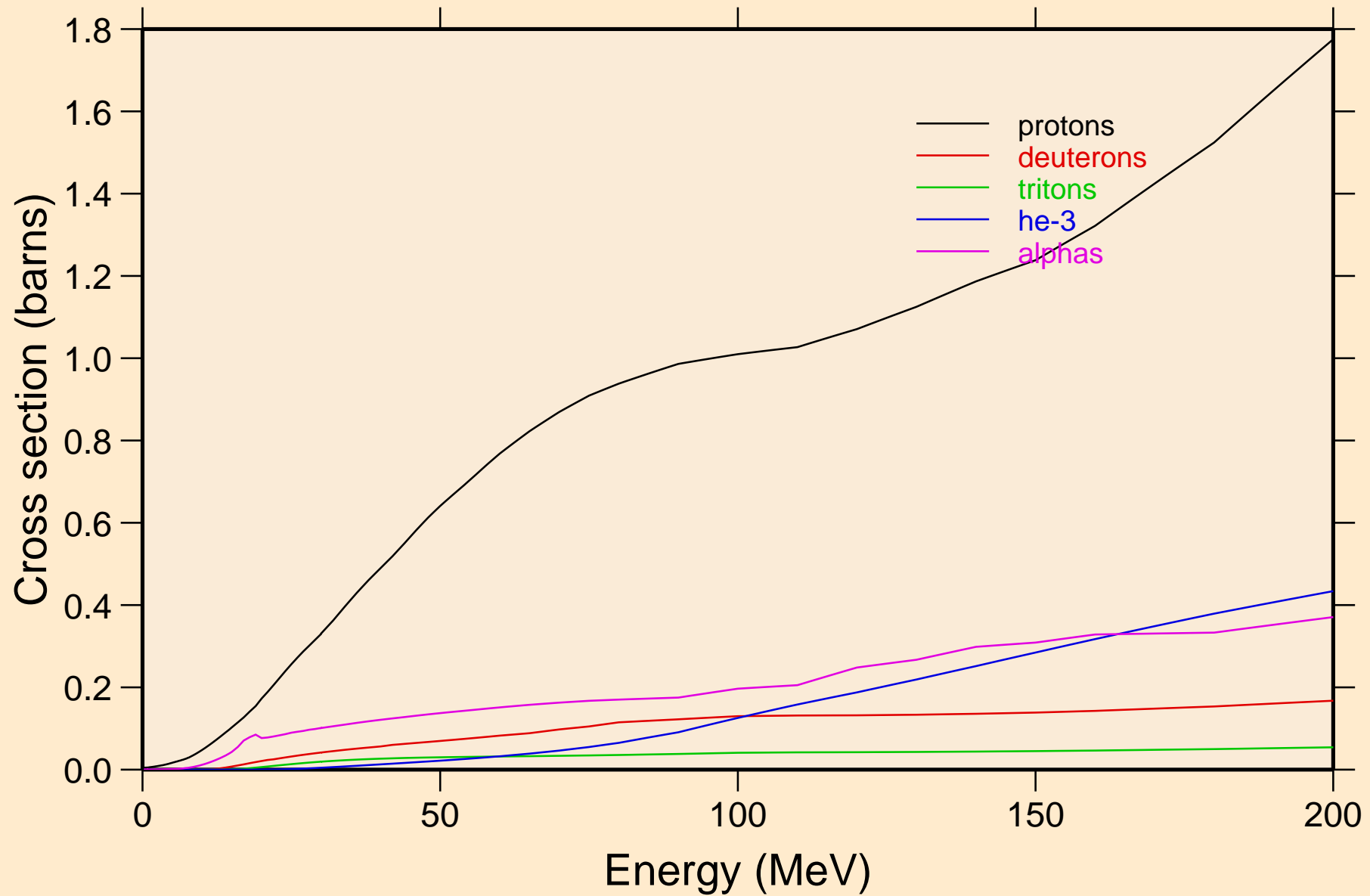

AU186 NEUTRON ACER TENDL-2021 LIBRARY; T=293.6K
protons from (n,x)

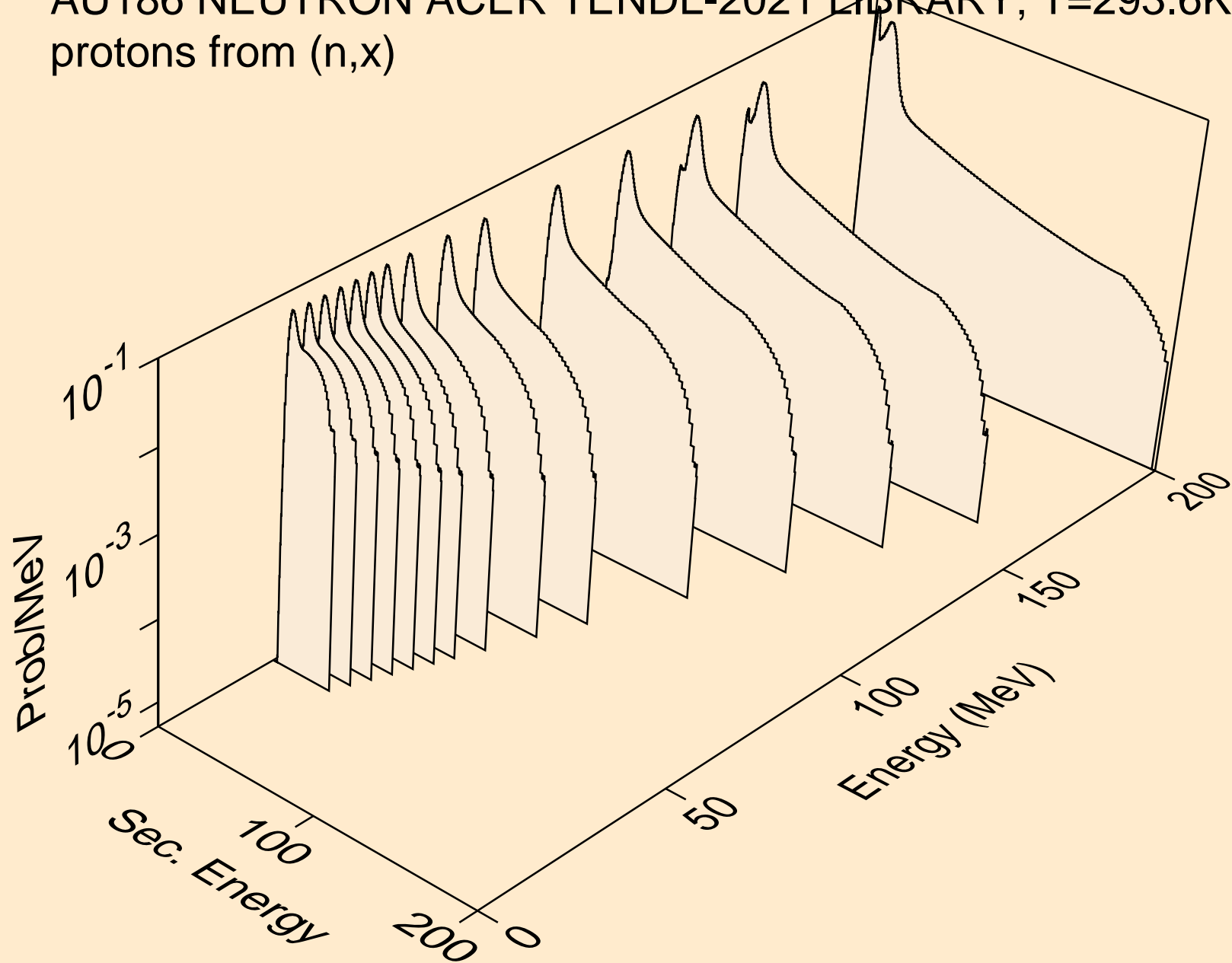

AU186 NEUTRON ACER TENDL-2021 LIBRARY; T=293.6K
protons from (n,n*)p

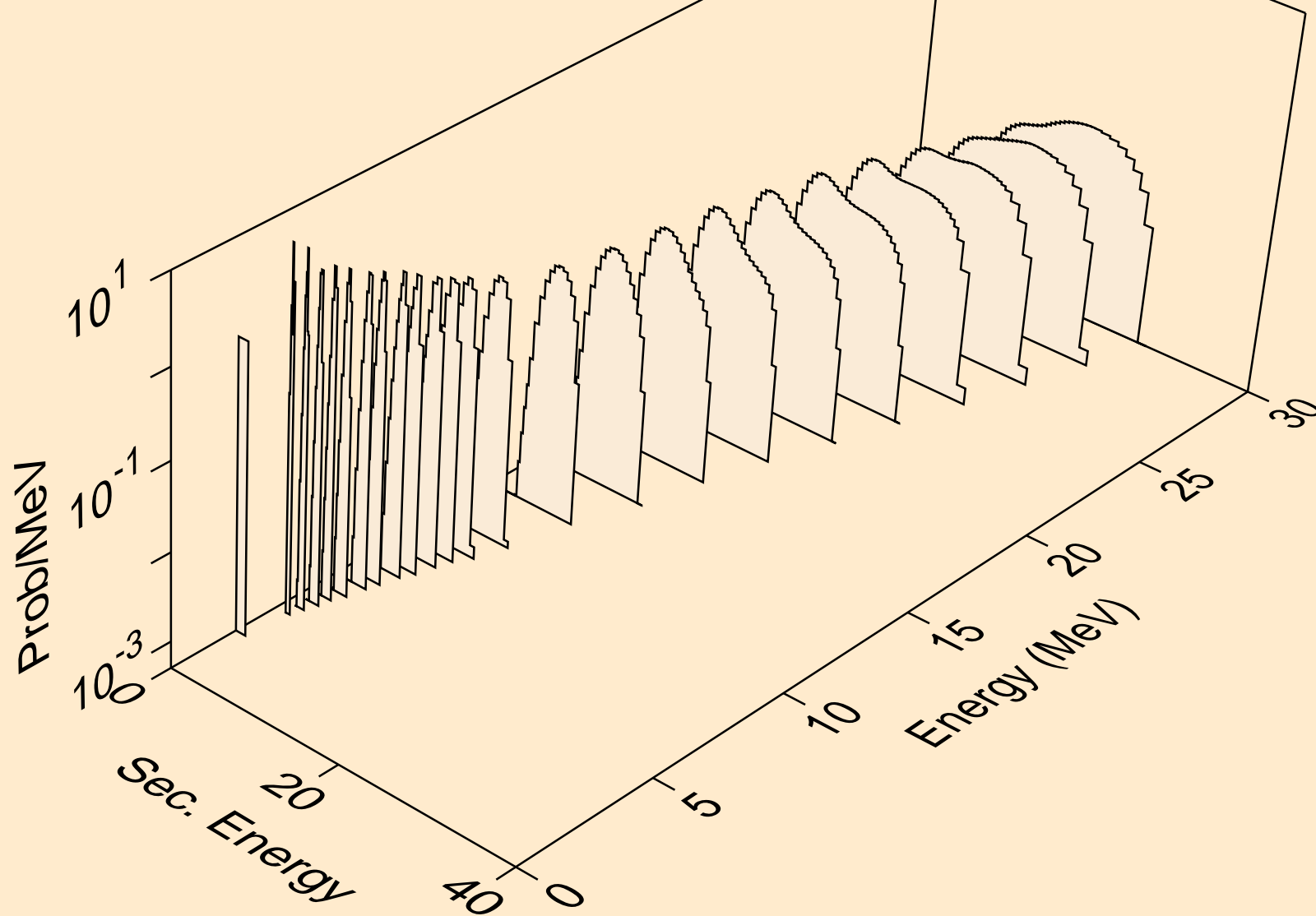

AU186 NEUTRON ACER TENDL-2021 LIBRARY; T=293.6K
protons from (n,2np)

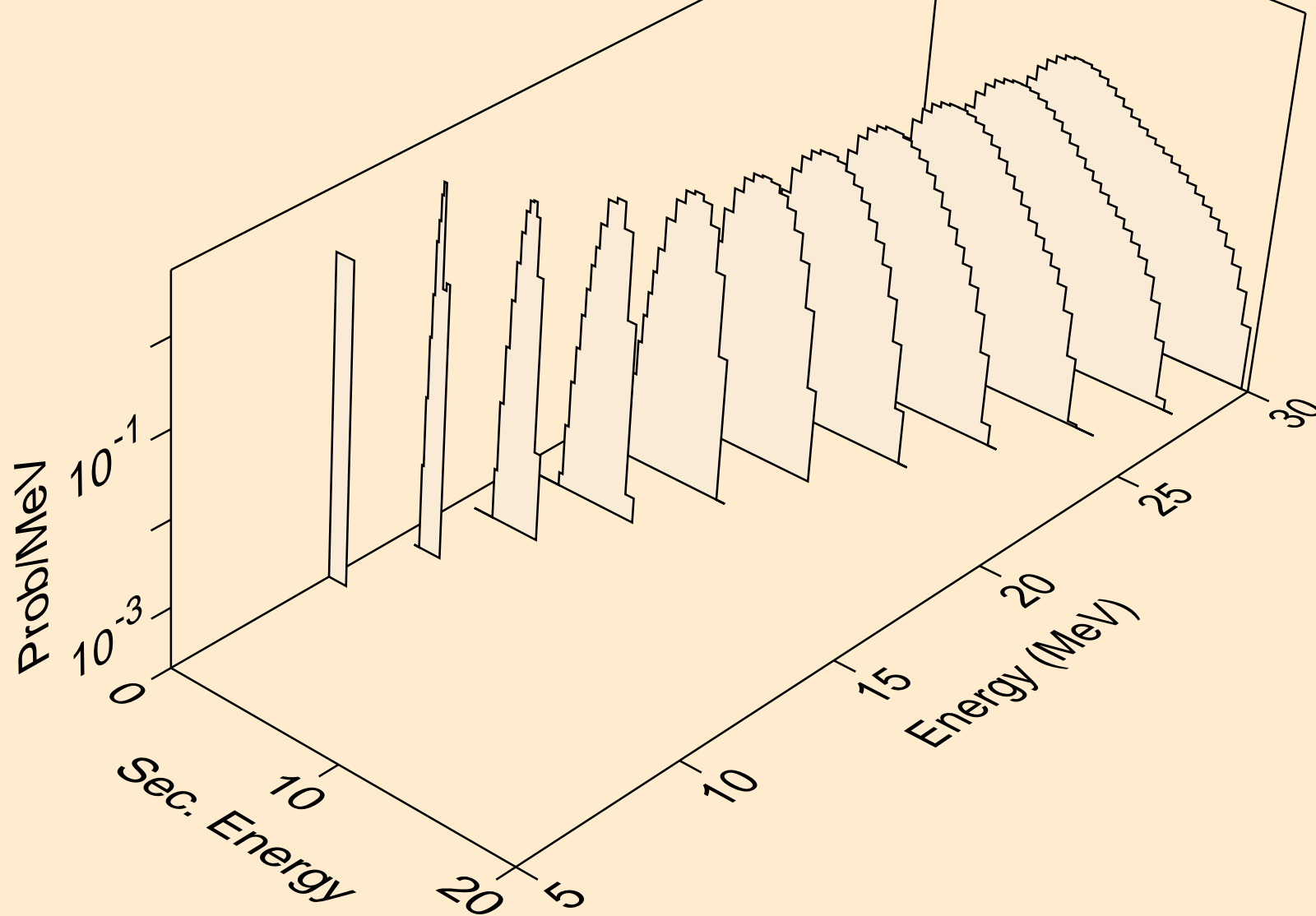

AU186 NEUTRON ACER TENDL-2021 LIBRARY; T=293.6K
protons from (n,3np)

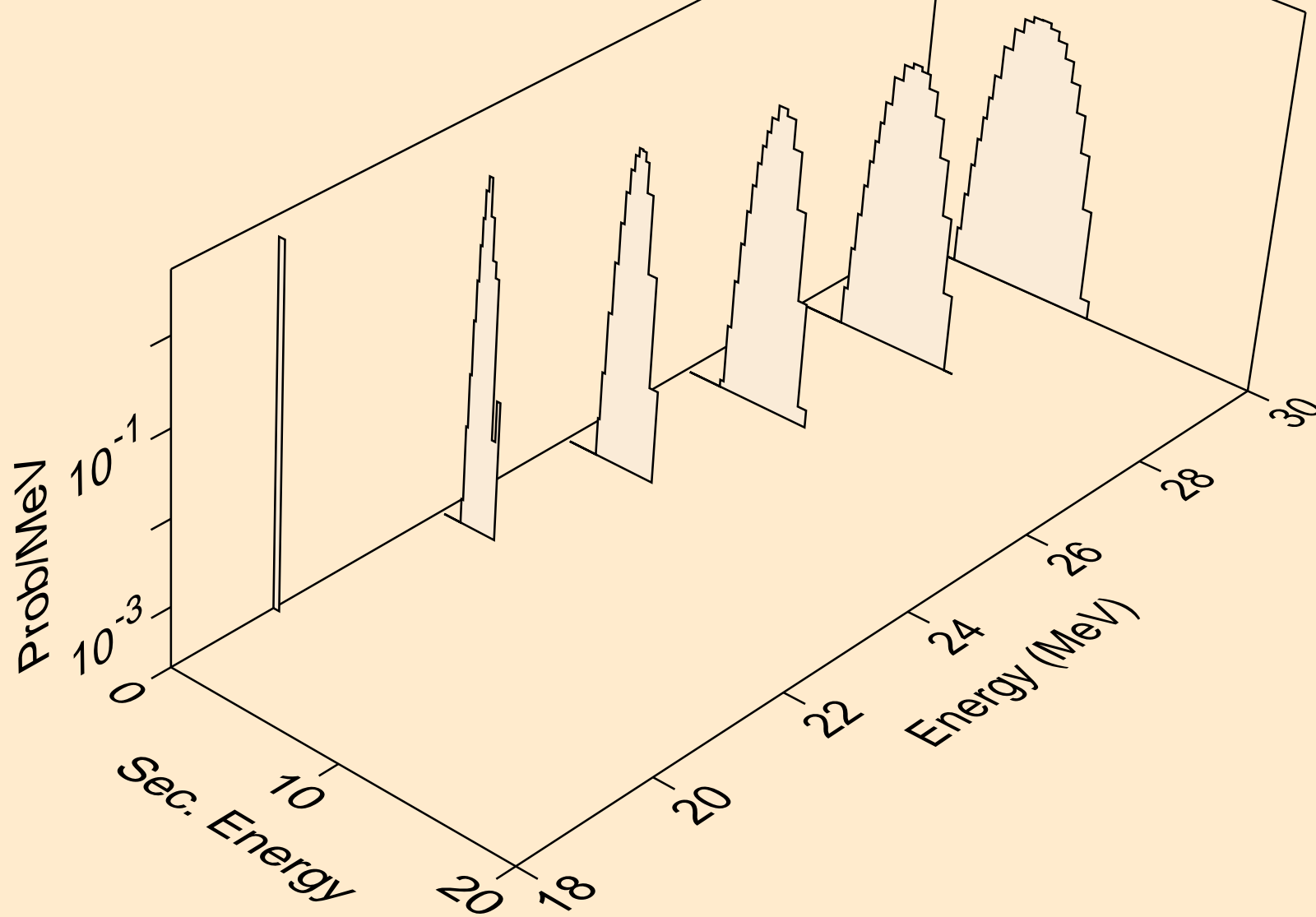

AU186 NEUTRON ACER TENDL-2021 LIBRARY; T=293.6K
protons from (n,2np)

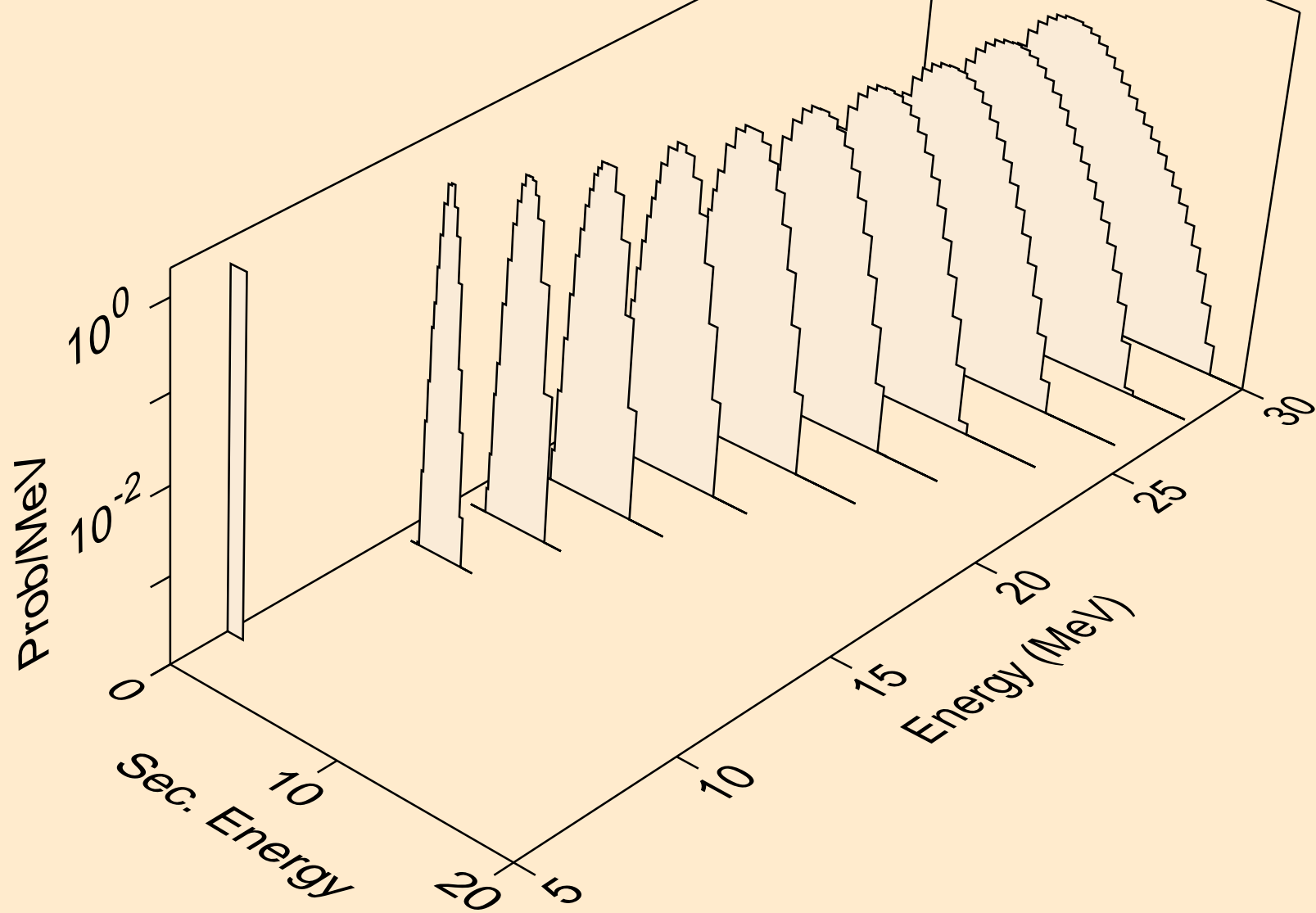

AU186 NEUTRON ACER TENDL-2021 LIBRARY; T=293.6K
protons from (n,npa)

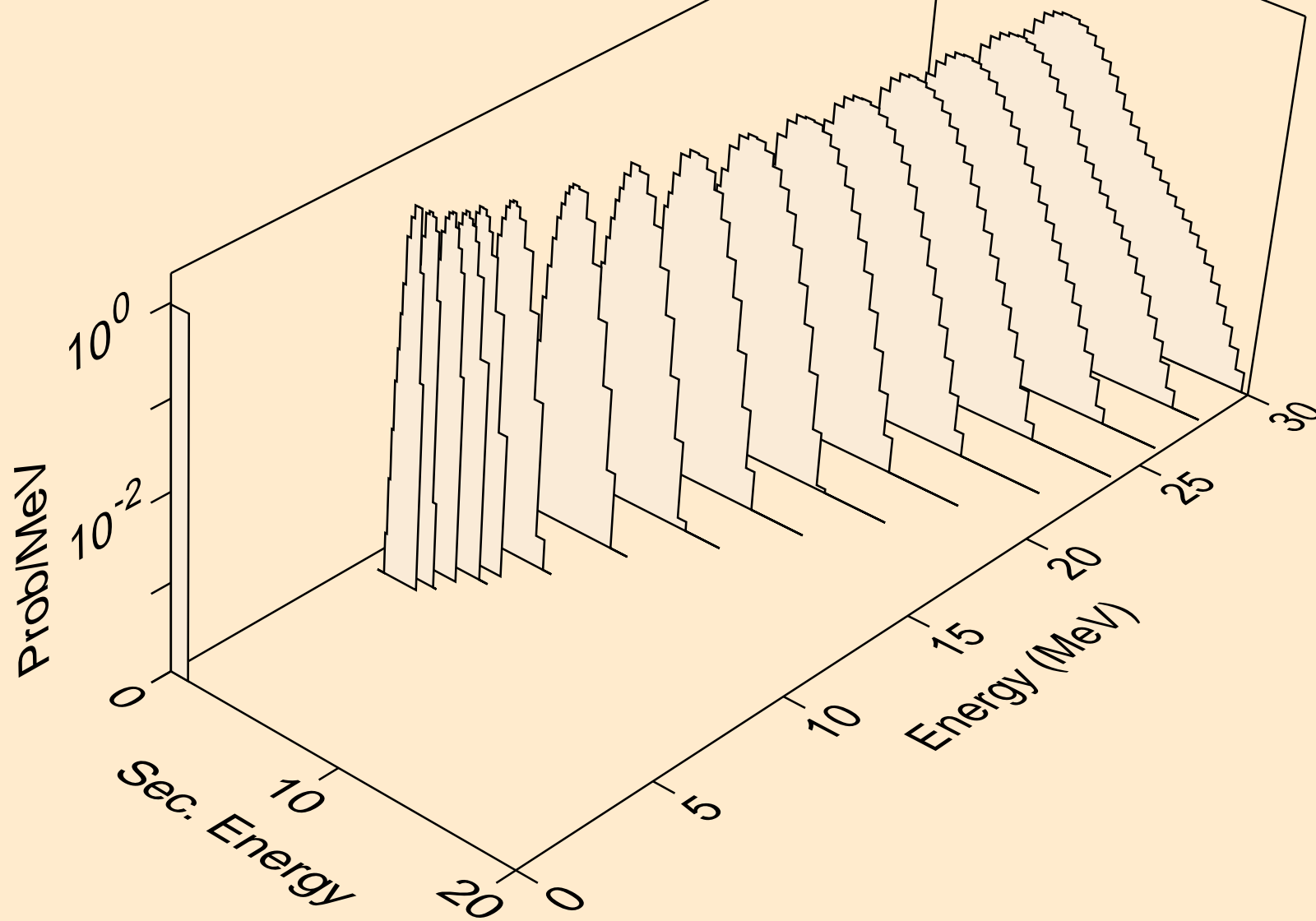

AU186 NEUTRON ACER TENDL-2021 LIBRARY; T=293.6K
protons from (n,p)

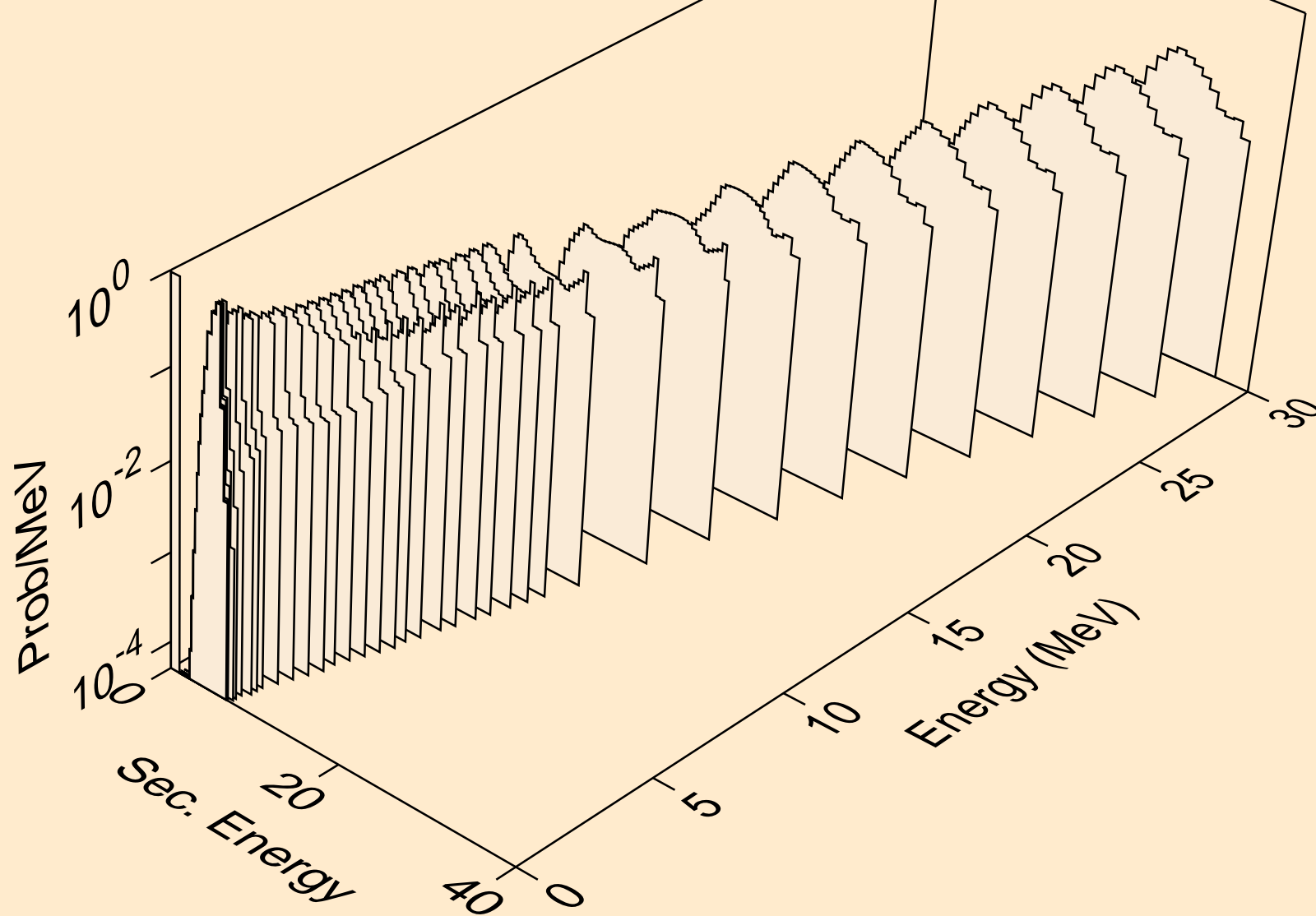

AU186 NEUTRON ACER TENDL-2021 LIBRARY; T=293.6K
protons from (n,2p)

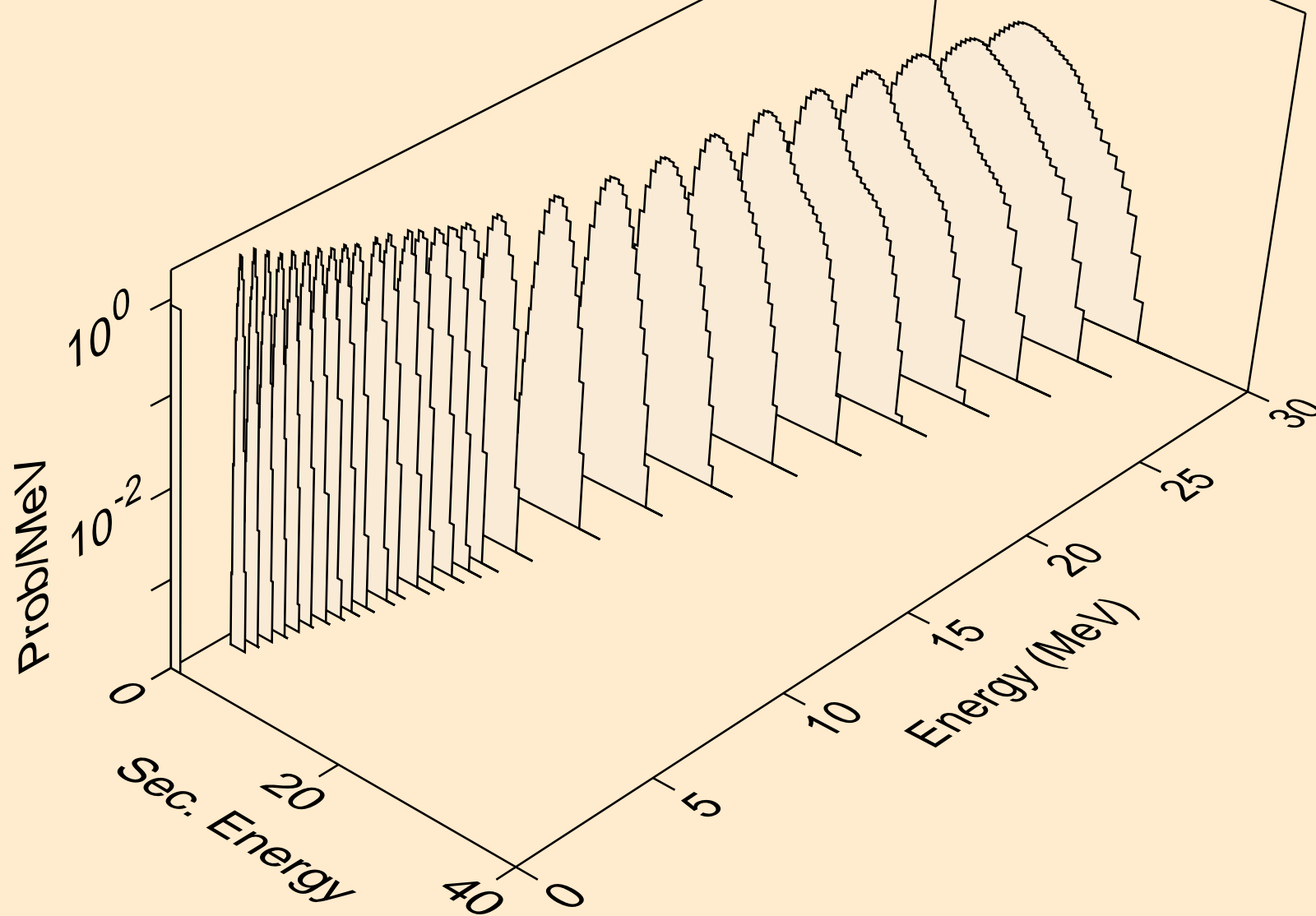

AU186 NEUTRON ACER TENDL-2021 LIBRARY; T=293.6K
protons from (n,p)

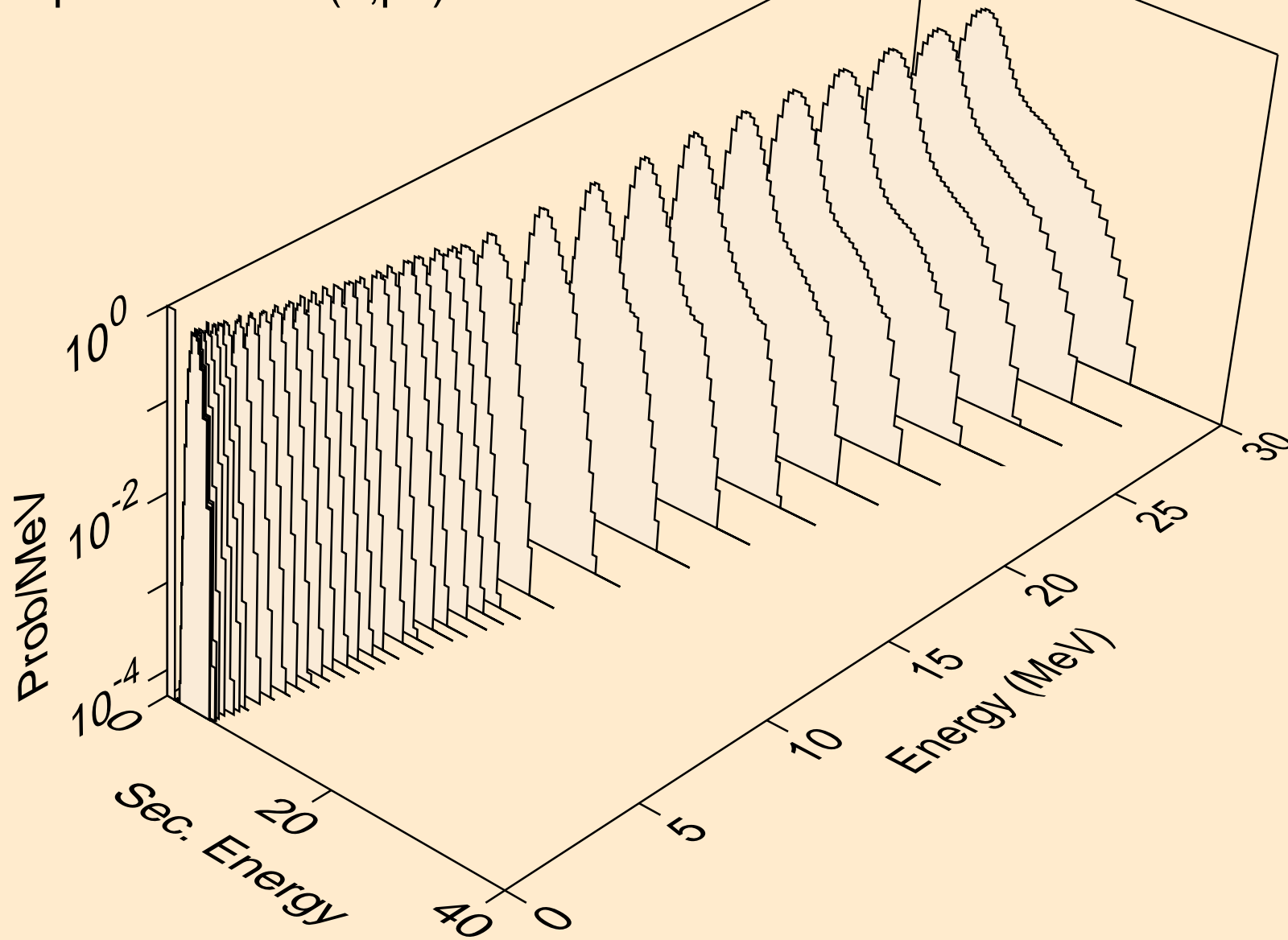

AU186 NEUTRON ACER TENDL-2021 LIBRARY; T=293.6K
protons from (n,pd)

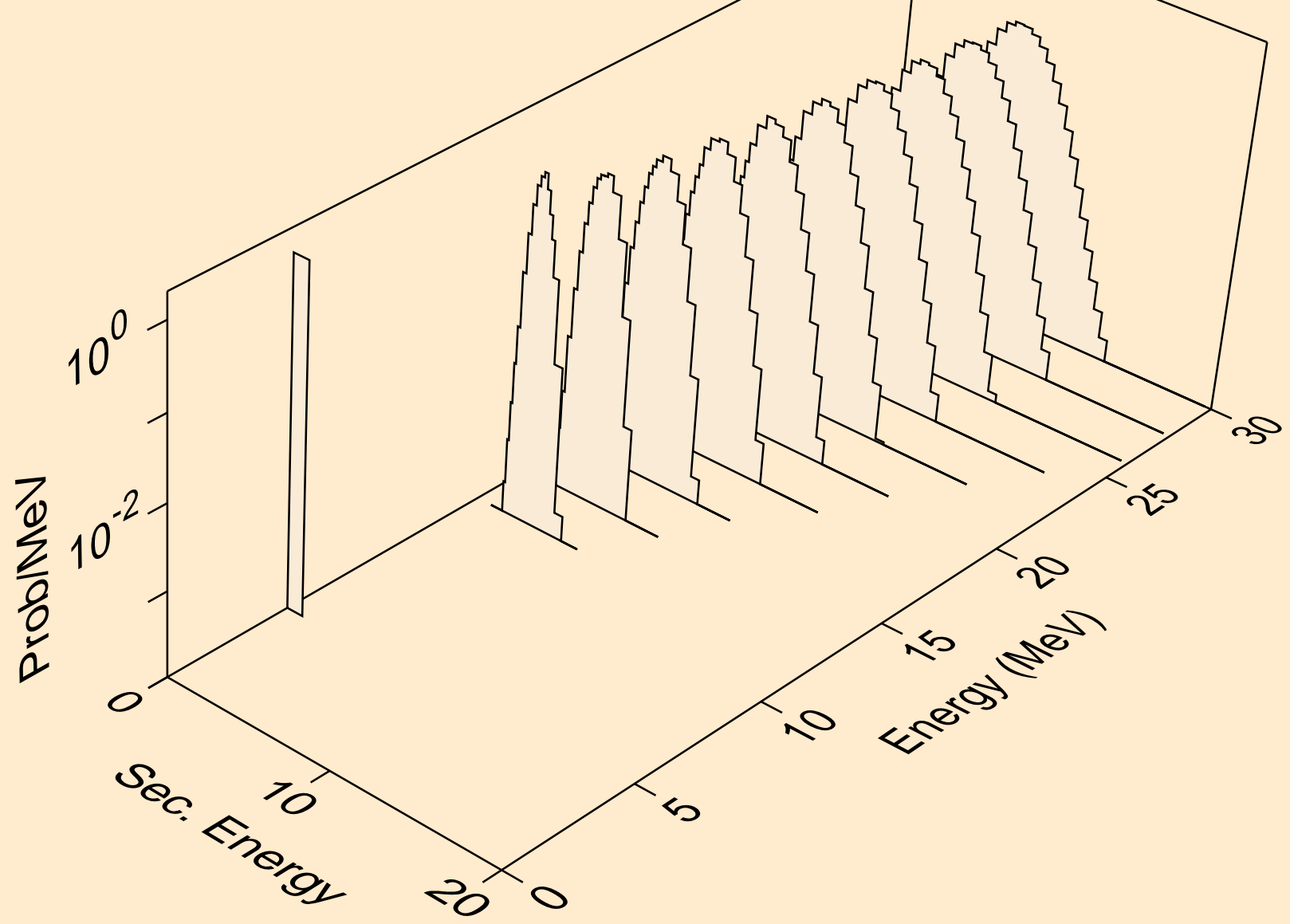

AU186 NEUTRON ACER TENDL-2021 LIBRARY; T=293.6K
protons from (n,pt)

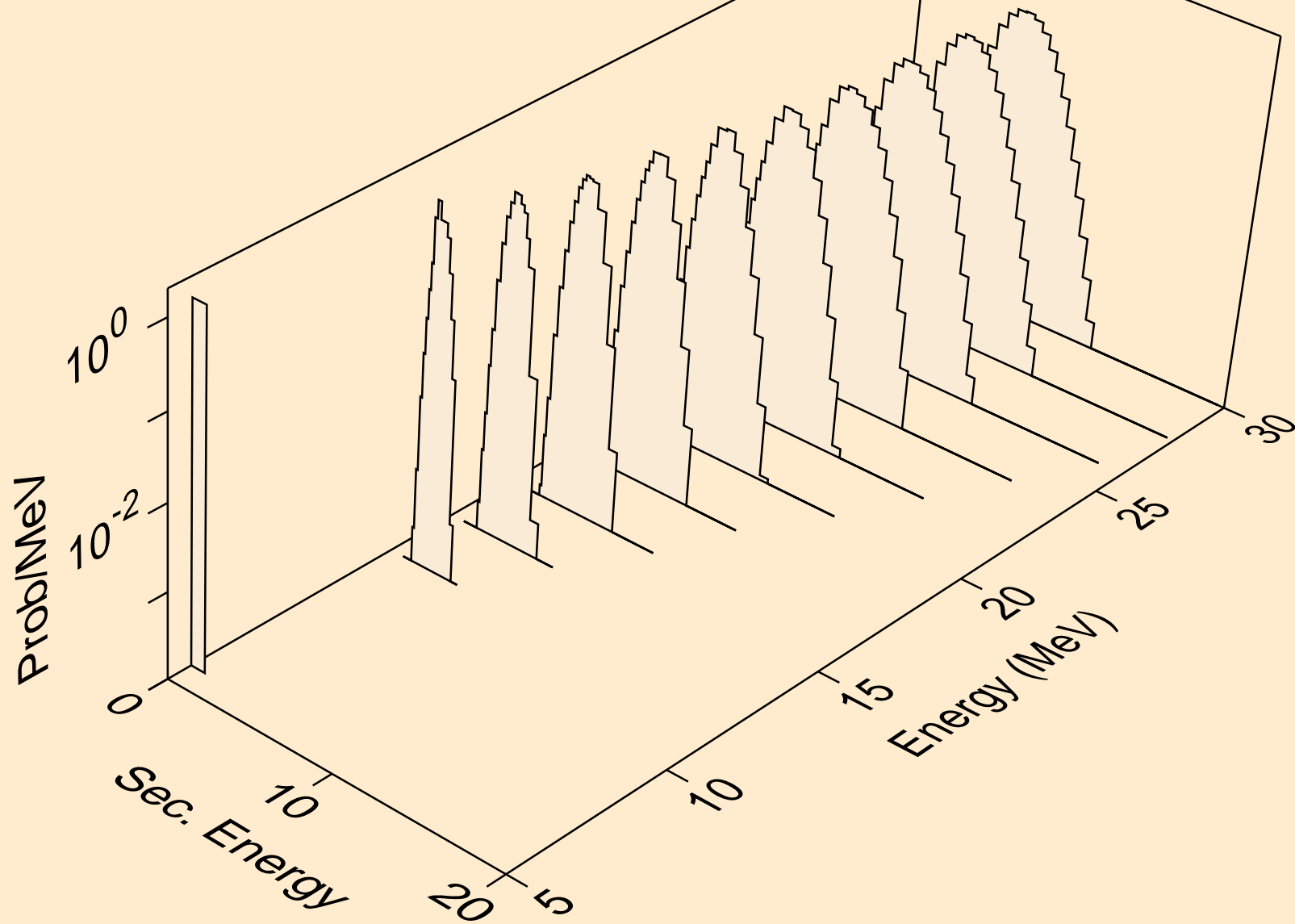

AU186 NEUTRON ACER TENDL-2021 LIBRARY; T=293.6K
deuterons from (n,x)

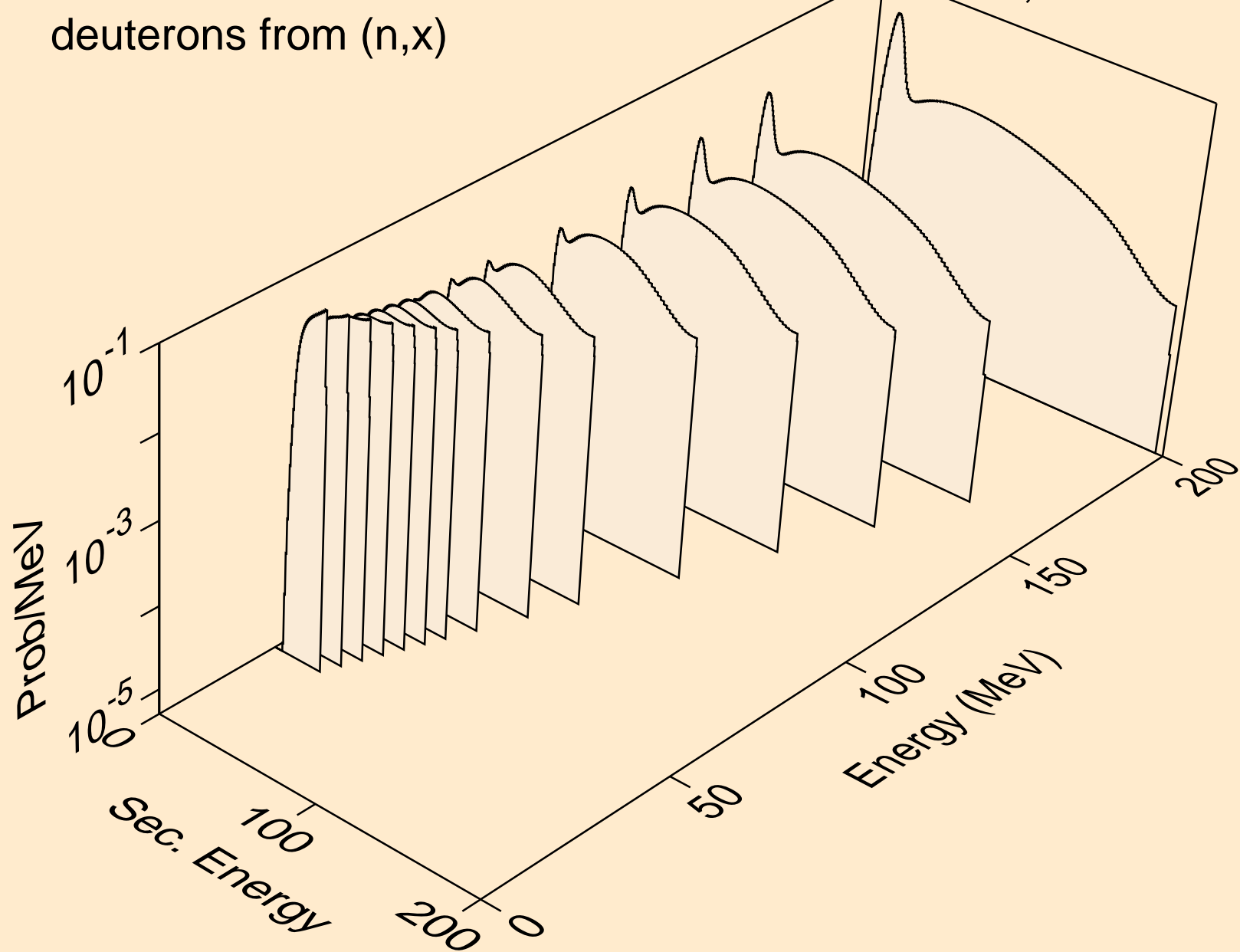

AU186 NEUTRON ACER TENDL-2021 LIBRARY; T=293.6K
deuterons from (n,2nd)

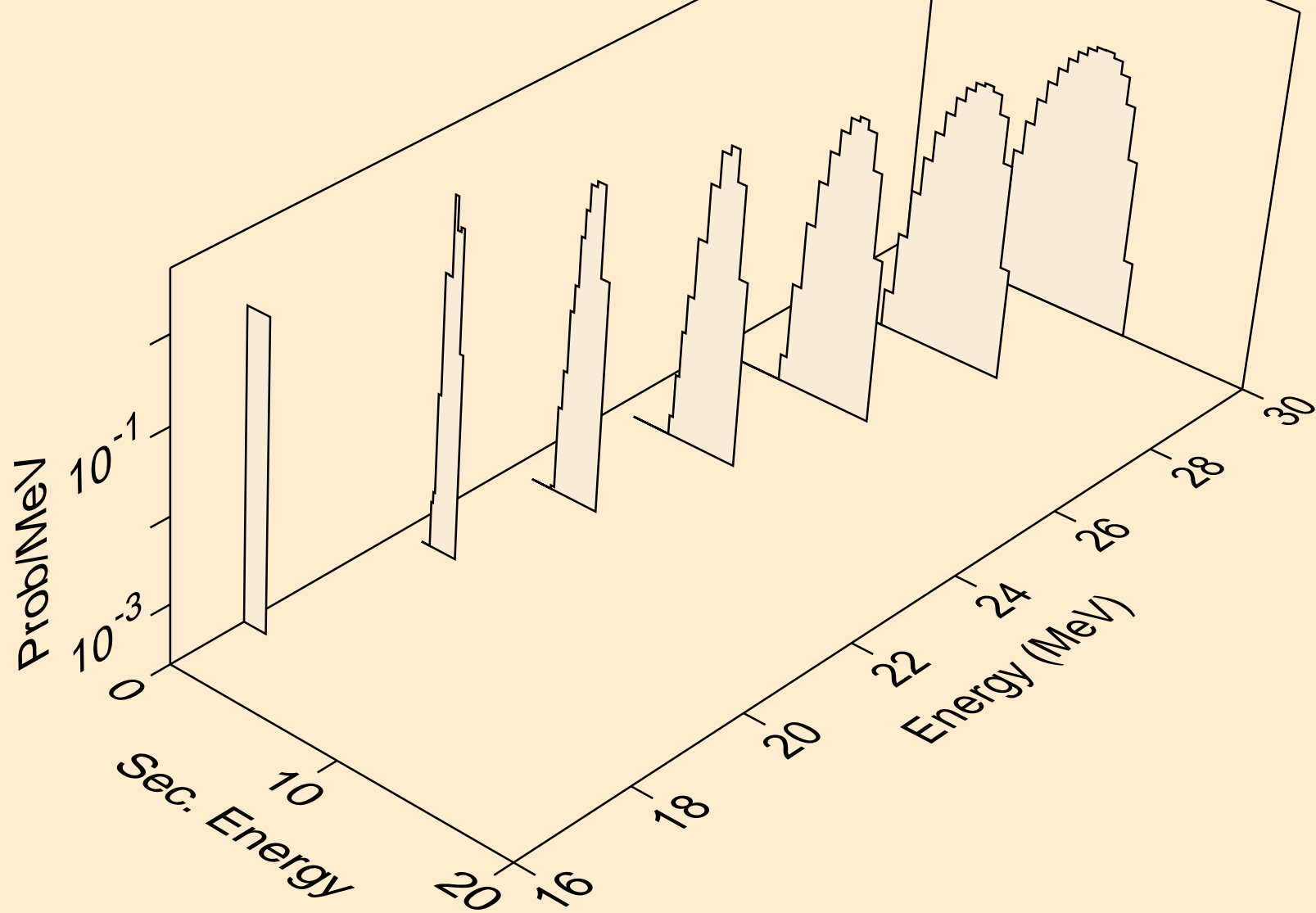

AU186 NEUTRON ACER TENDL-2021 LIBRARY; T=293.6K
deuterons from (n,n*)d

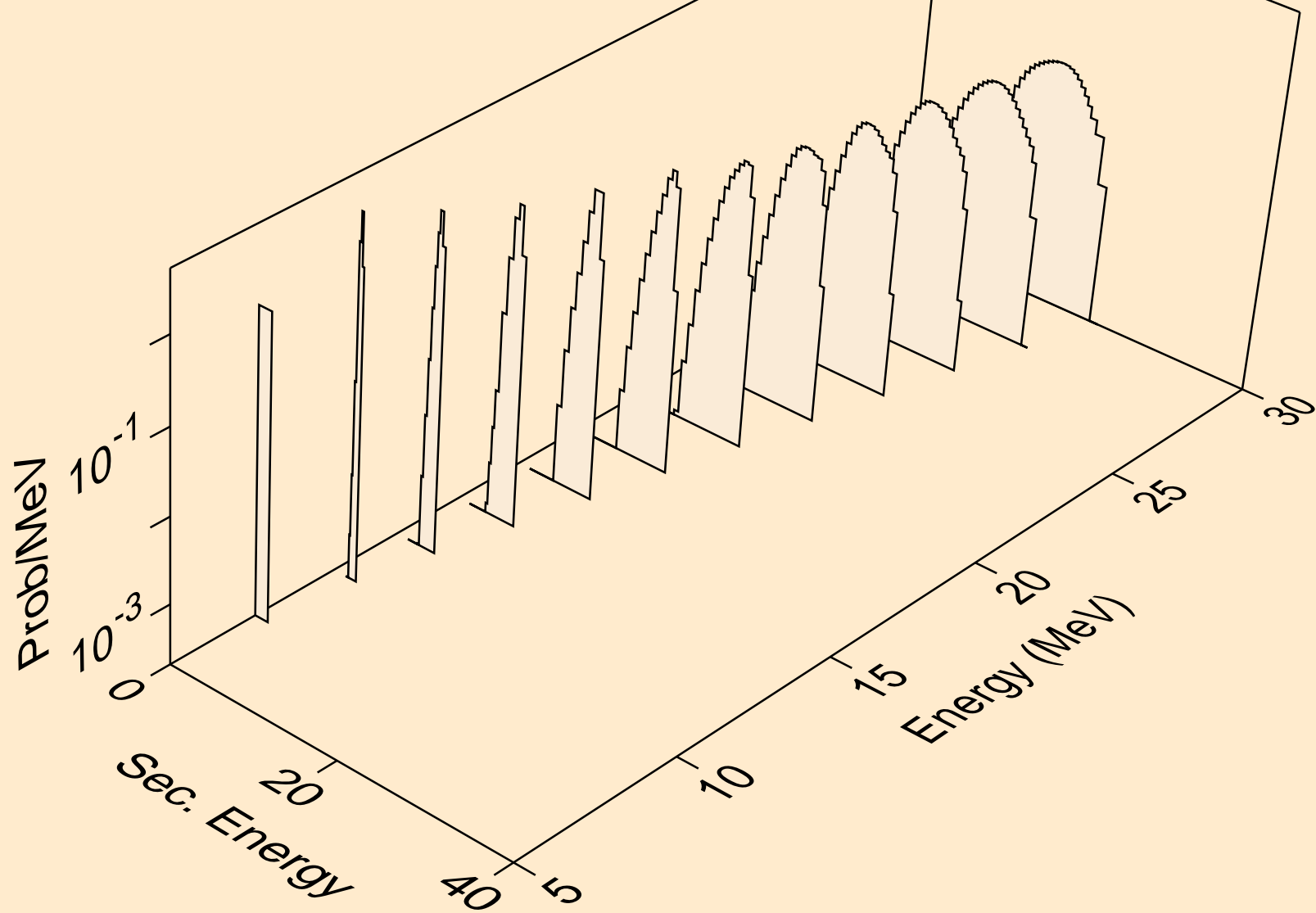

AU186 NEUTRON ACER TENDL-2021 LIBRARY; T=293.6K
deuterons from (n,d)

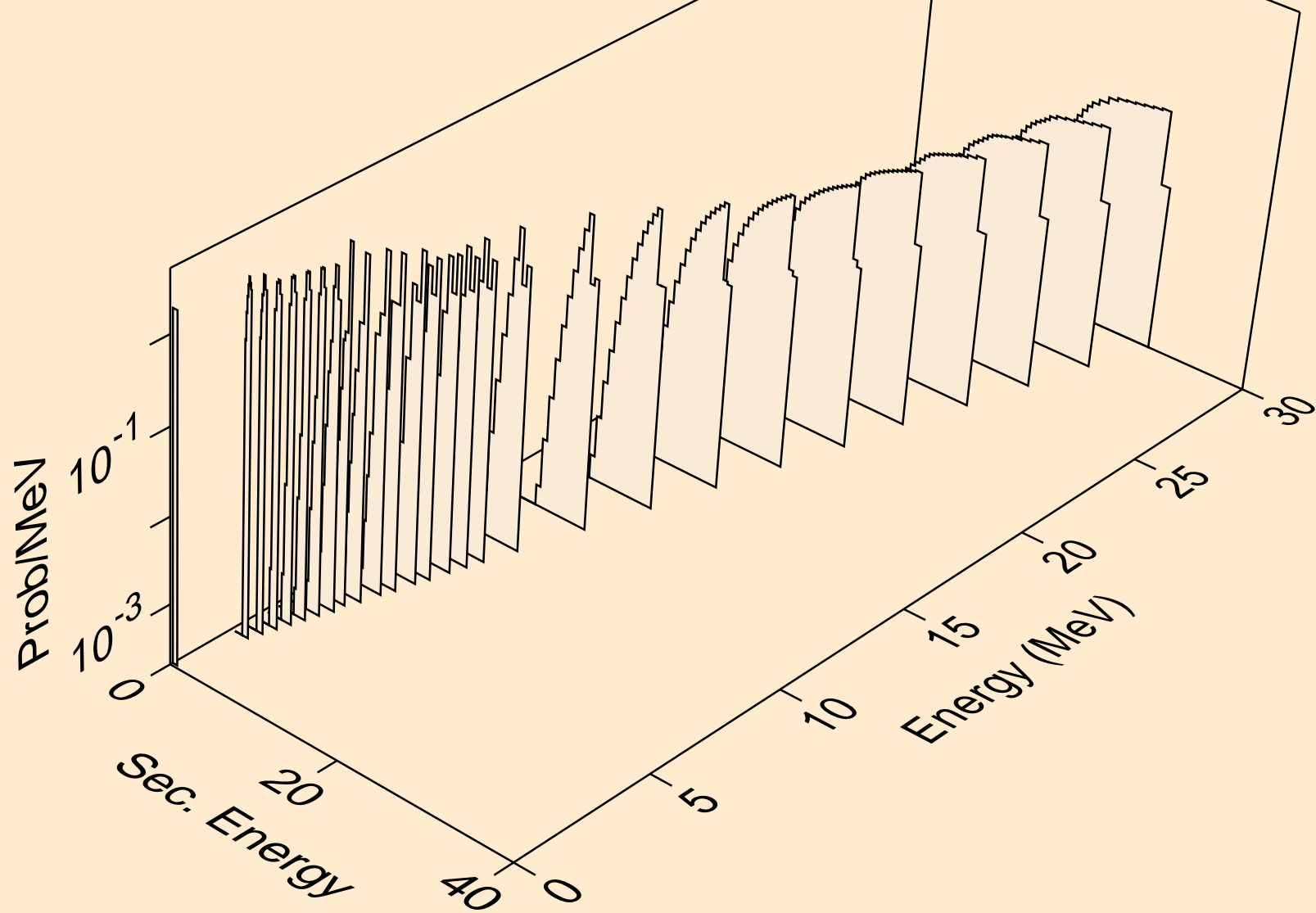

AU186 NEUTRON ACER TENDL-2021 LIBRARY; T=293.6K
deuterons from (n,pd)

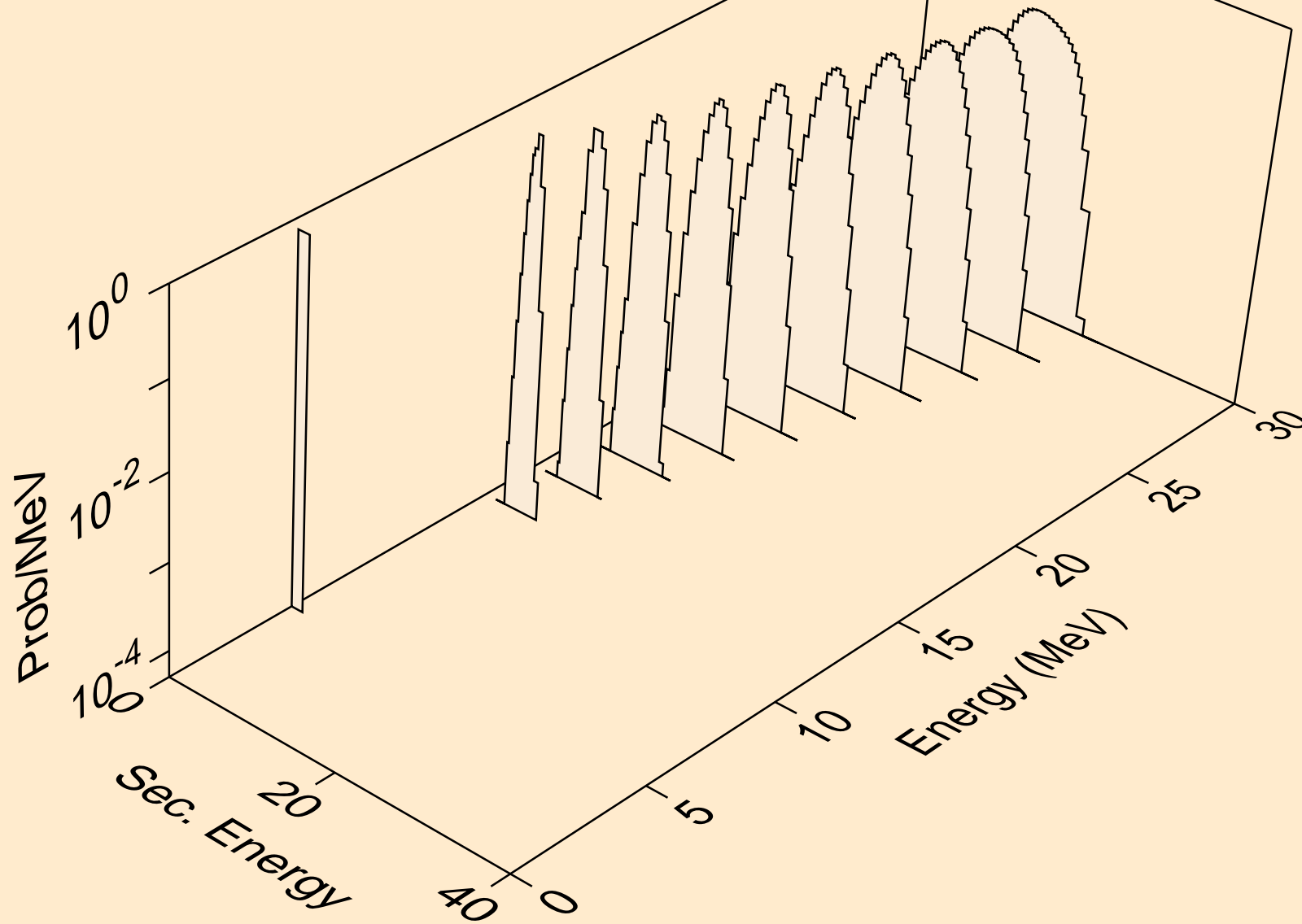

AU186 NEUTRON ACER TENDL-2021 LIBRARY; T=293.6K
deuterons from (n,da)

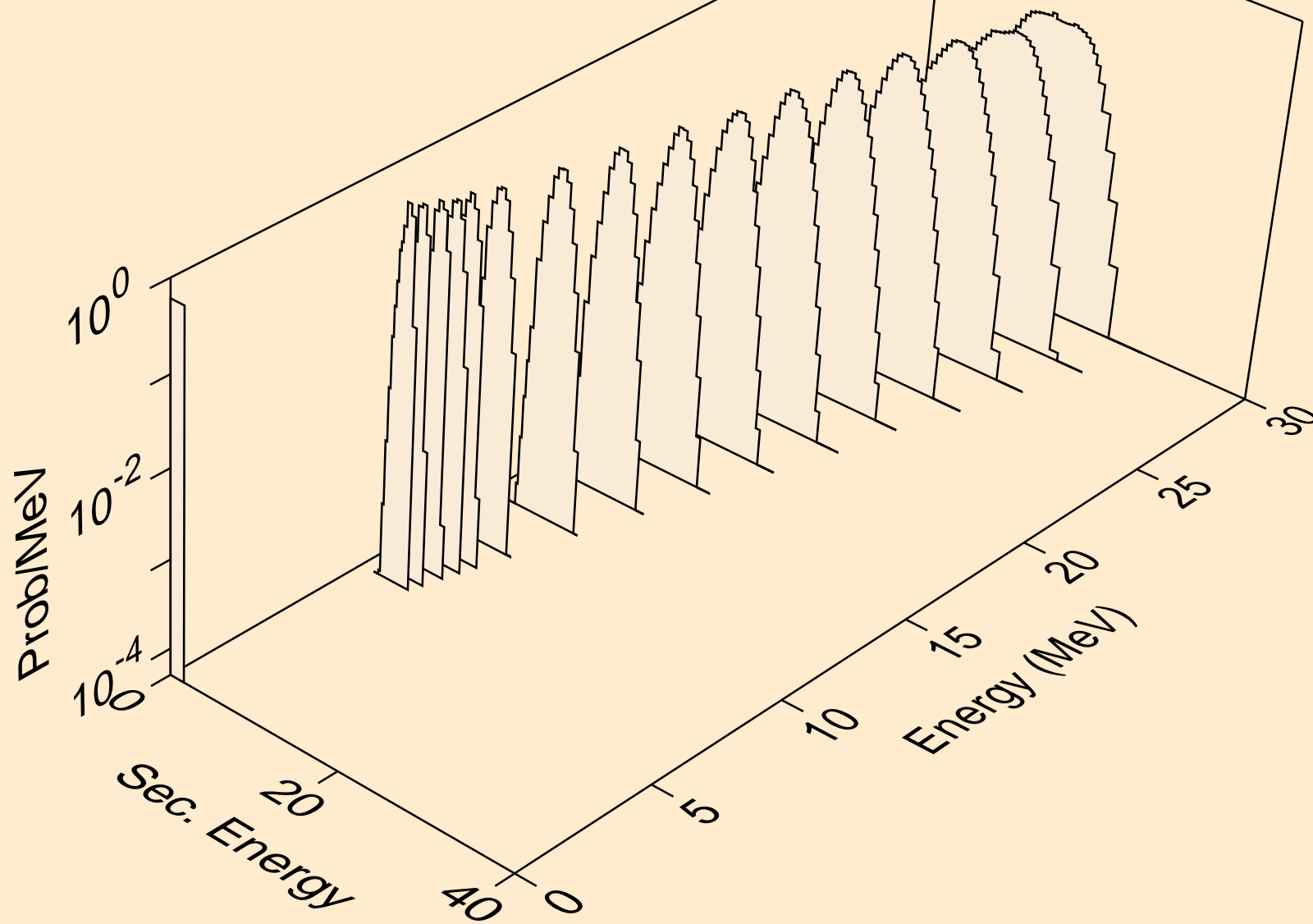

AU186 NEUTRON ACER TENDL-2021 LIBRARY; T=293.6K
tritons from (n,x)

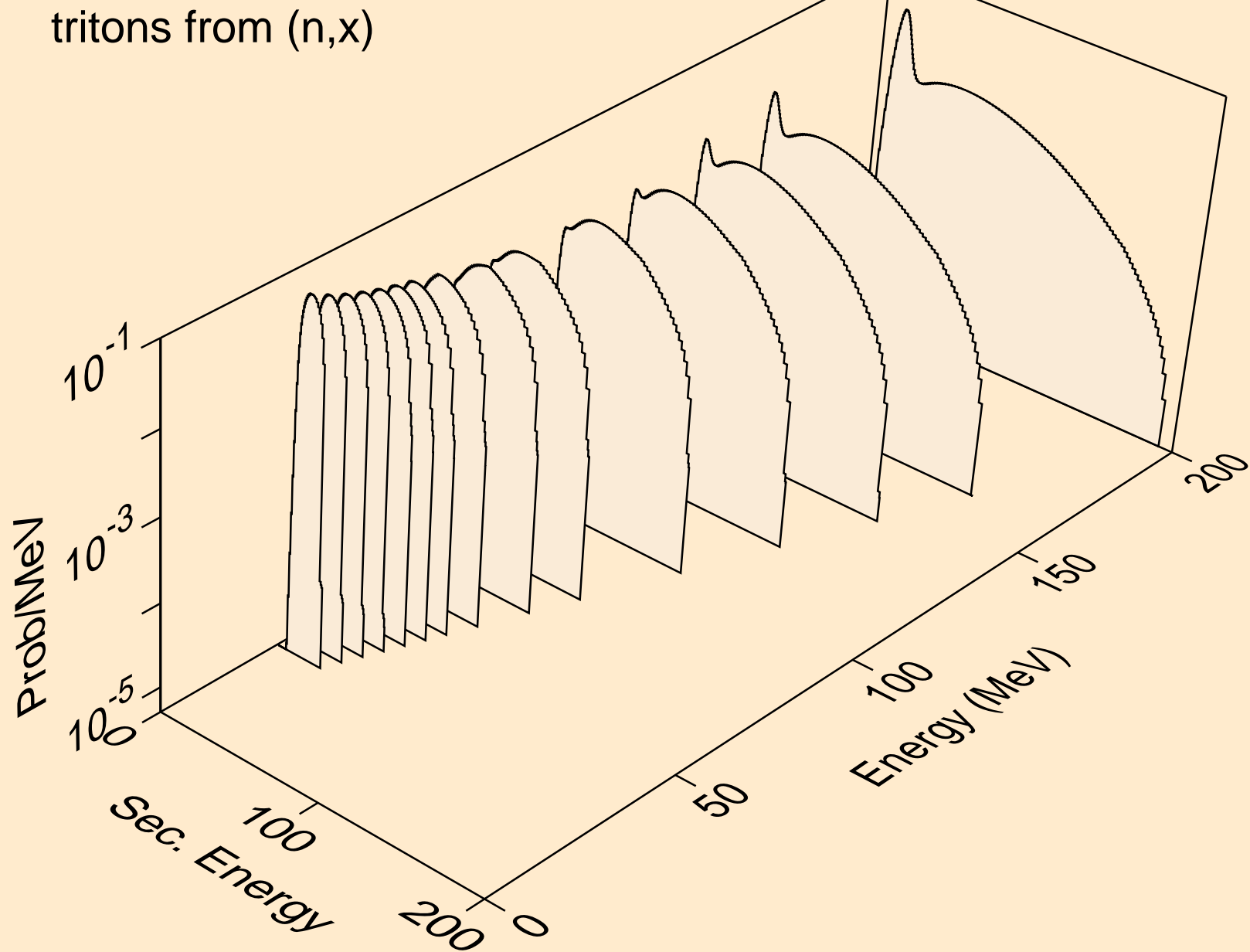

AU186 NEUTRON ACER TENDL-2021 LIBRARY; T=293.6K
tritons from (n,n*)t

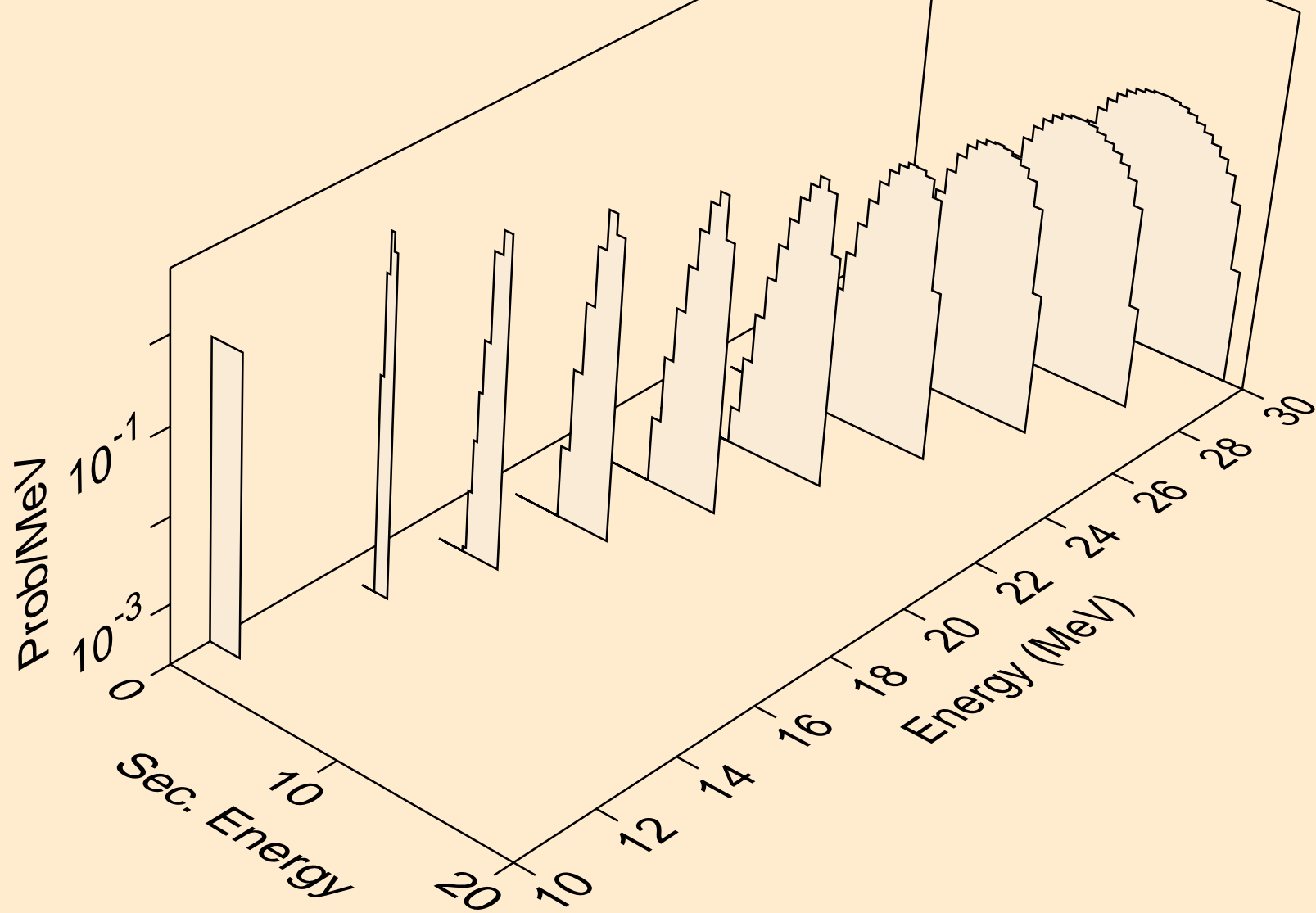

AU186 NEUTRON ACER TENDL-2021 LIBRARY; T=293.6K
tritons from (n,t)

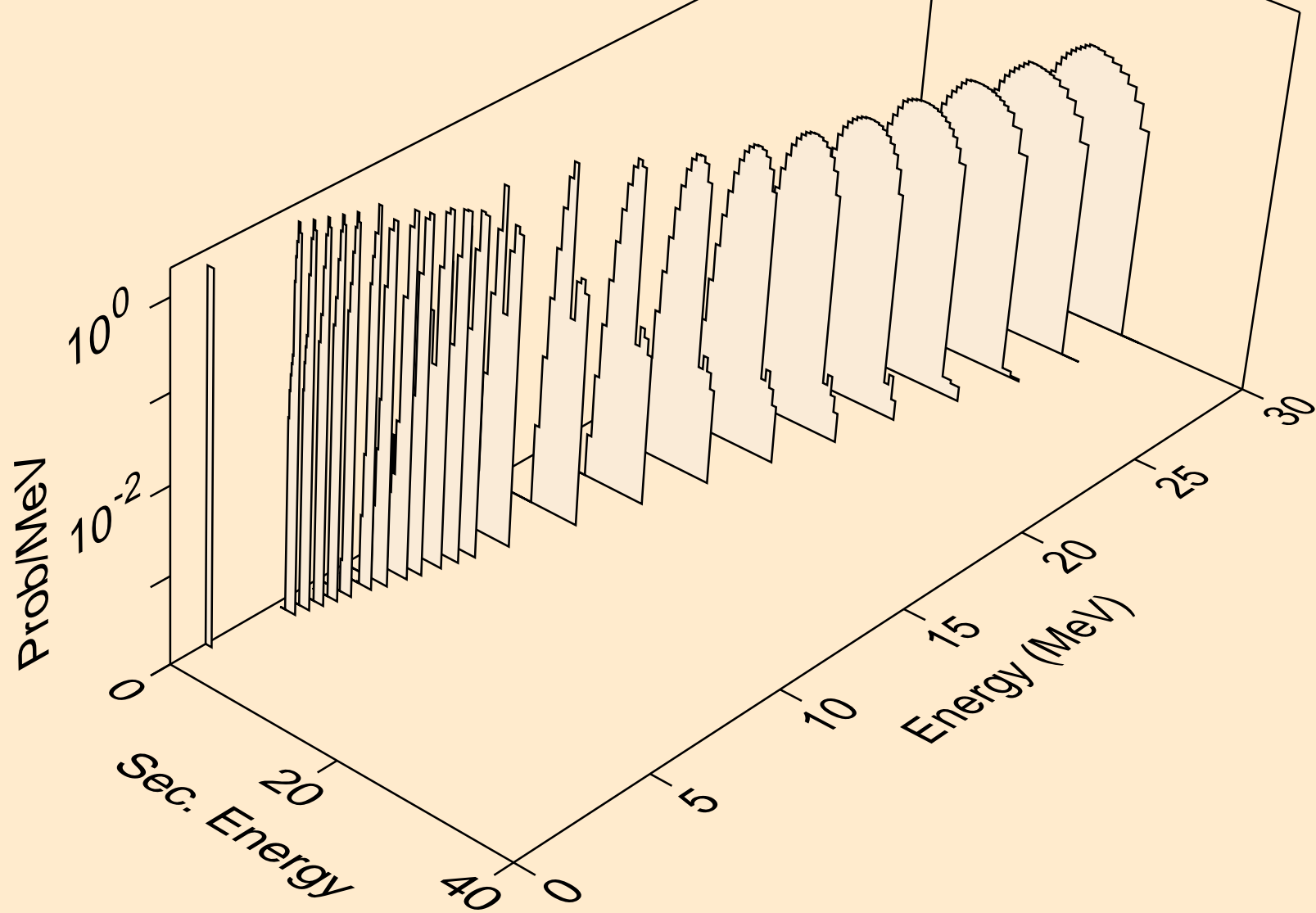

AU186 NEUTRON ACER TENDL-2021 LIBRARY; T=293.6K
tritons from (n,pt)

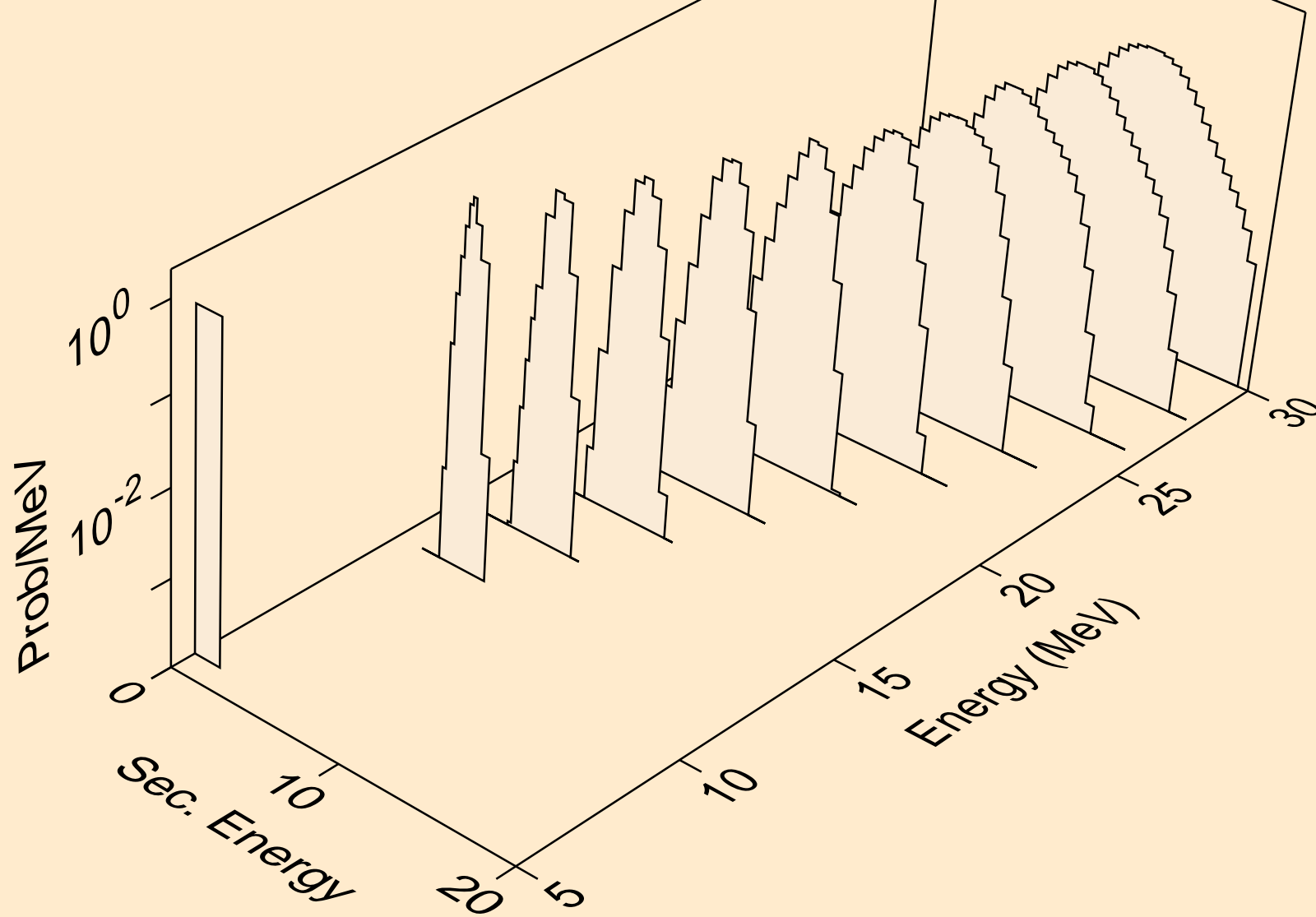

AU186 NEUTRON ACER TENDL-2021 LIBRARY; T=293.6K
he3s from (n,x)

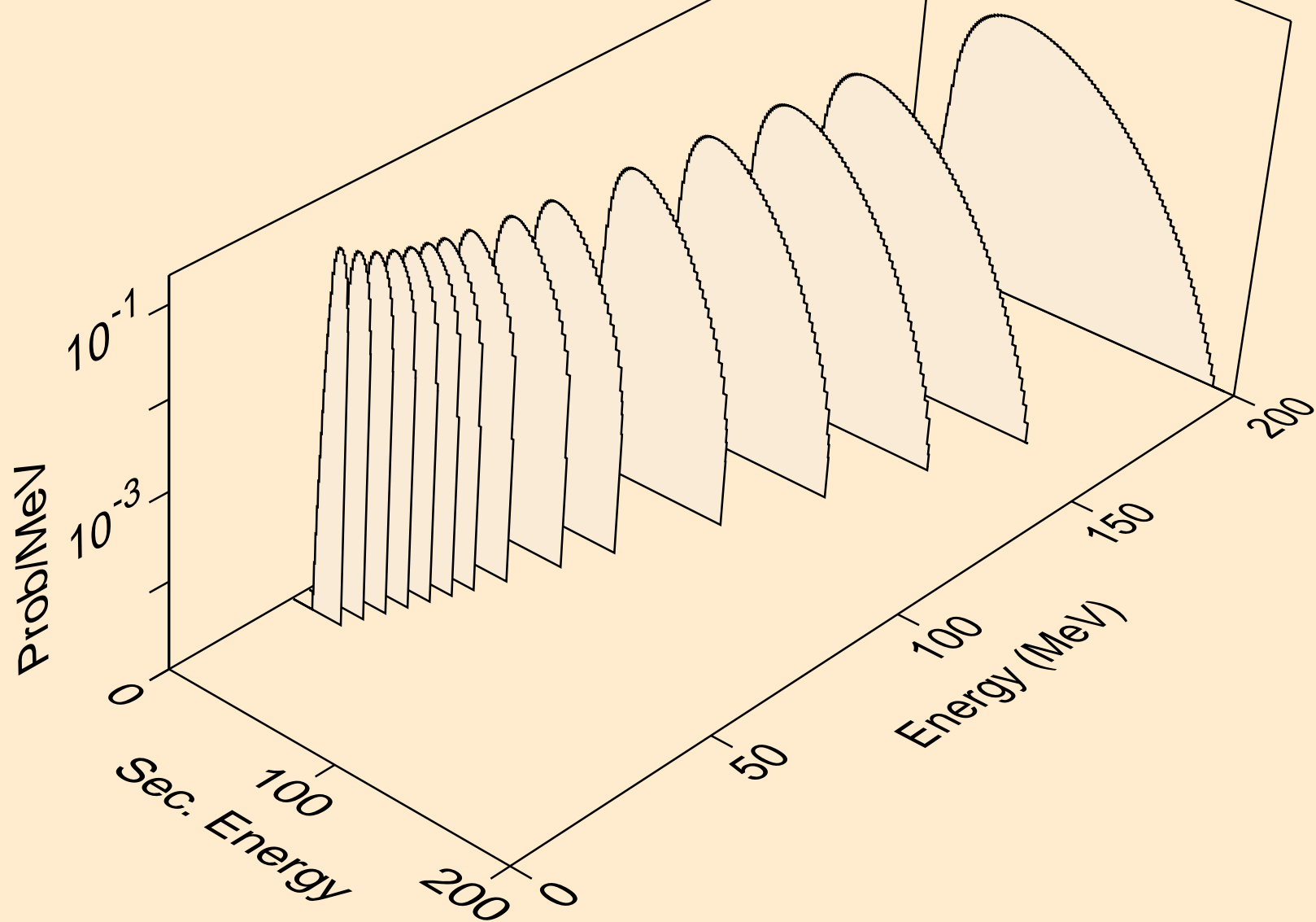

AU186 NEUTRON ACER TENDL-2021 LIBRARY; T=293.6K
he3s from (n,n*)he3

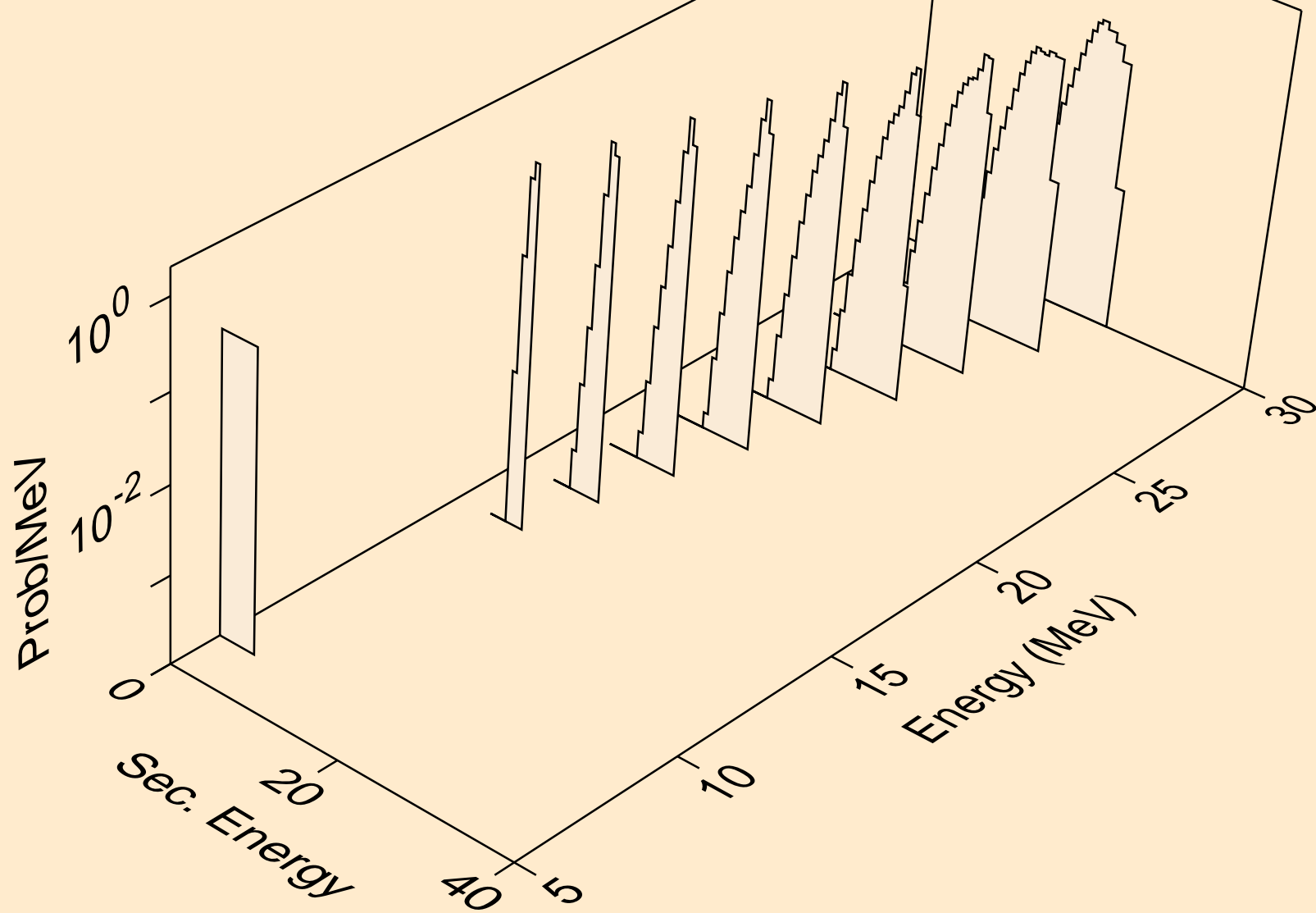

AU186 NEUTRON ACER TENDL-2021 LIBRARY; T=293.6K
he3s from (n,he3)

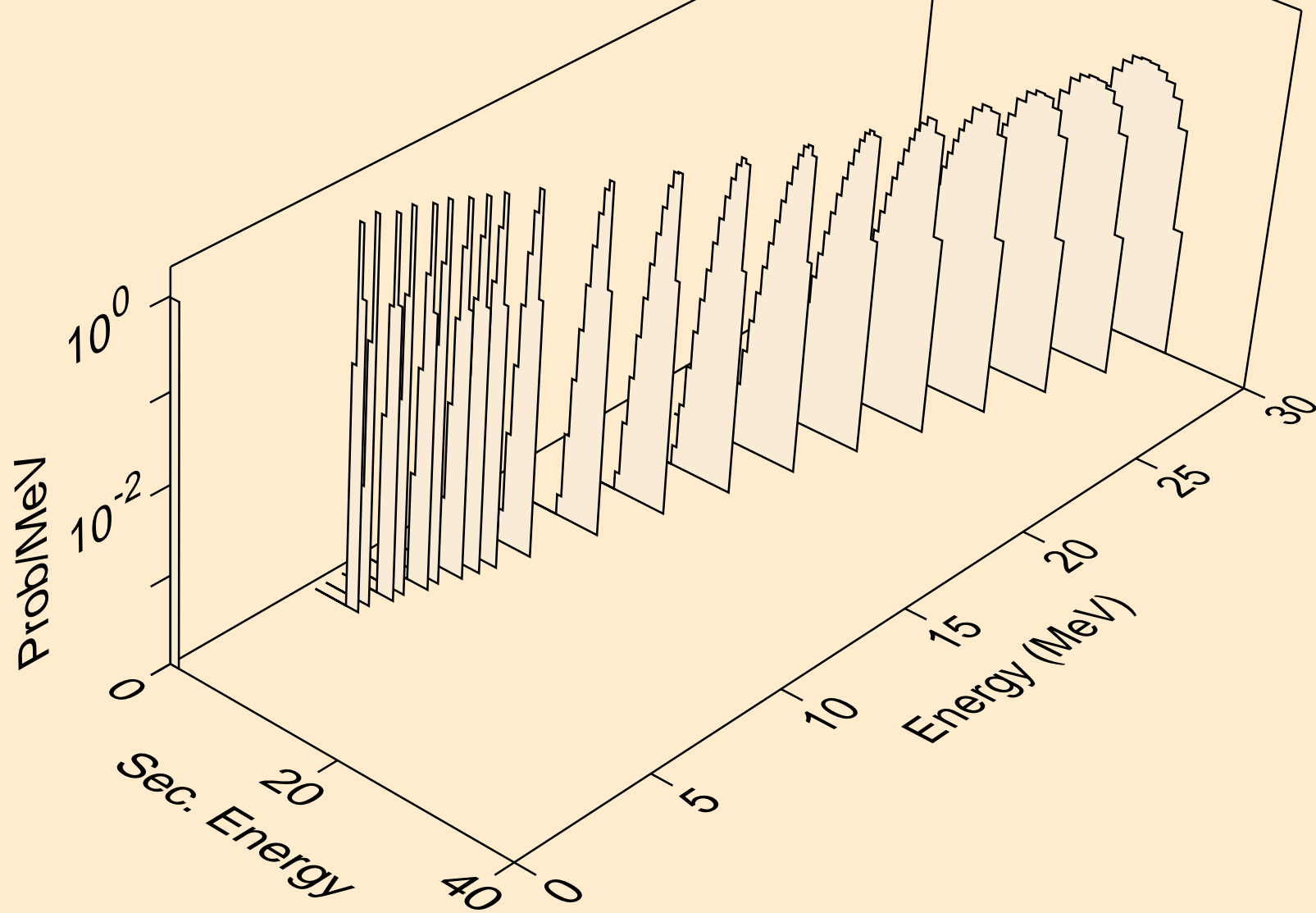

AU186 NEUTRON ACER TENDL-2021 LIBRARY; T=293.6K
alphas from (n,x)

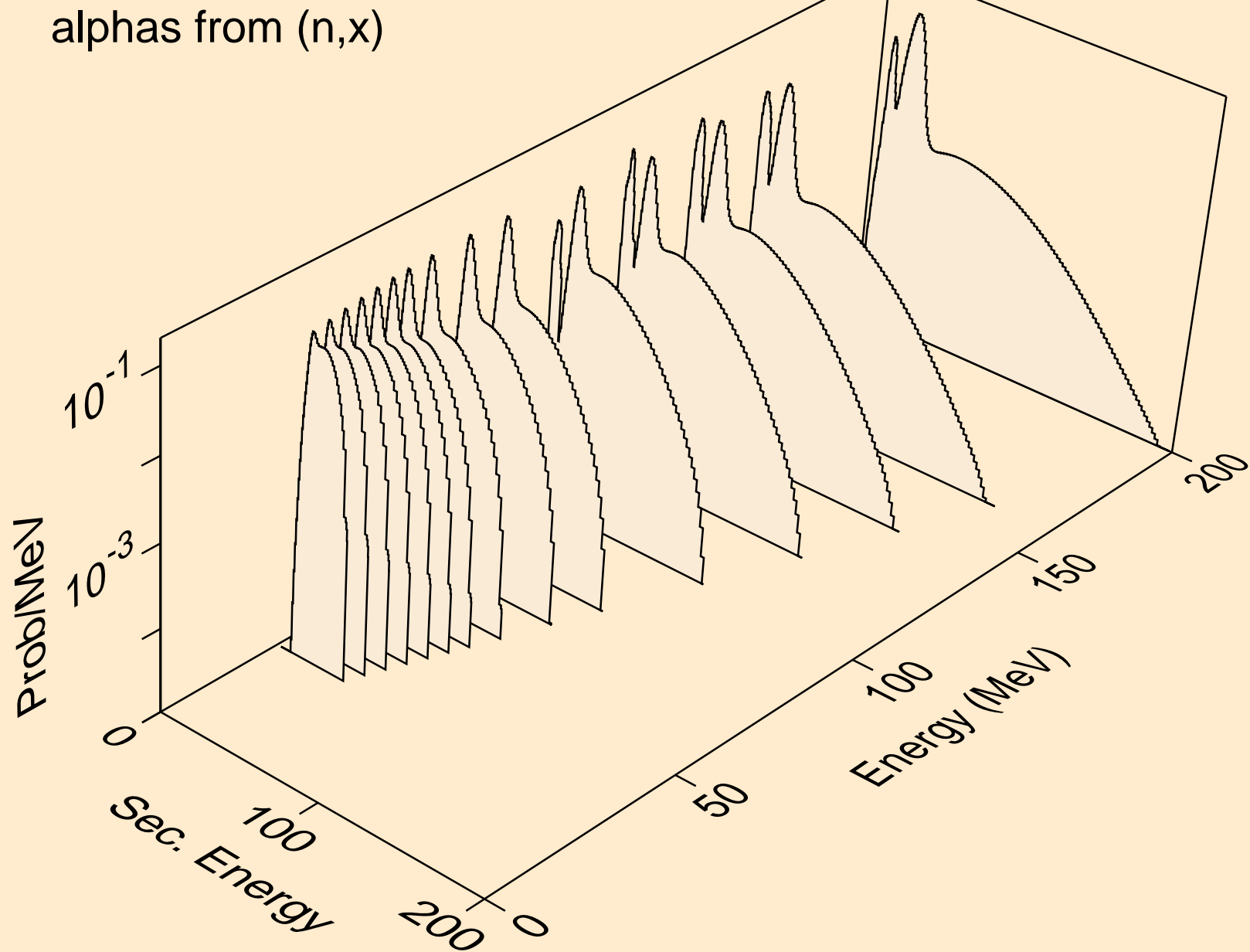

AU186 NEUTRON ACER TENDL-2021 LIBRARY; T=293.6K
alphas from (n,n*)a

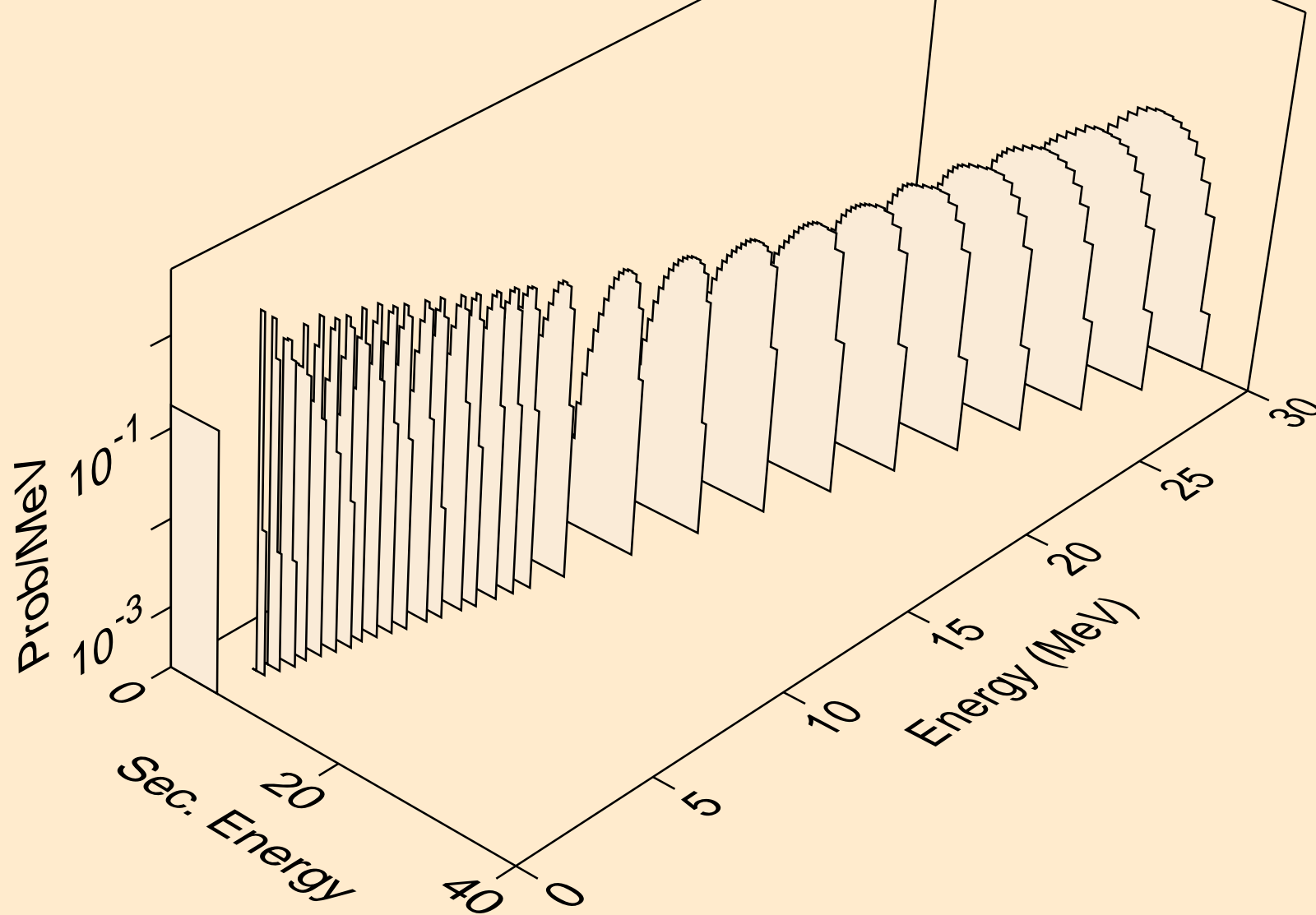

AU186 NEUTRON ACER TENDL-2021 LIBRARY; T=293.6K
alphas from (n,2n)a

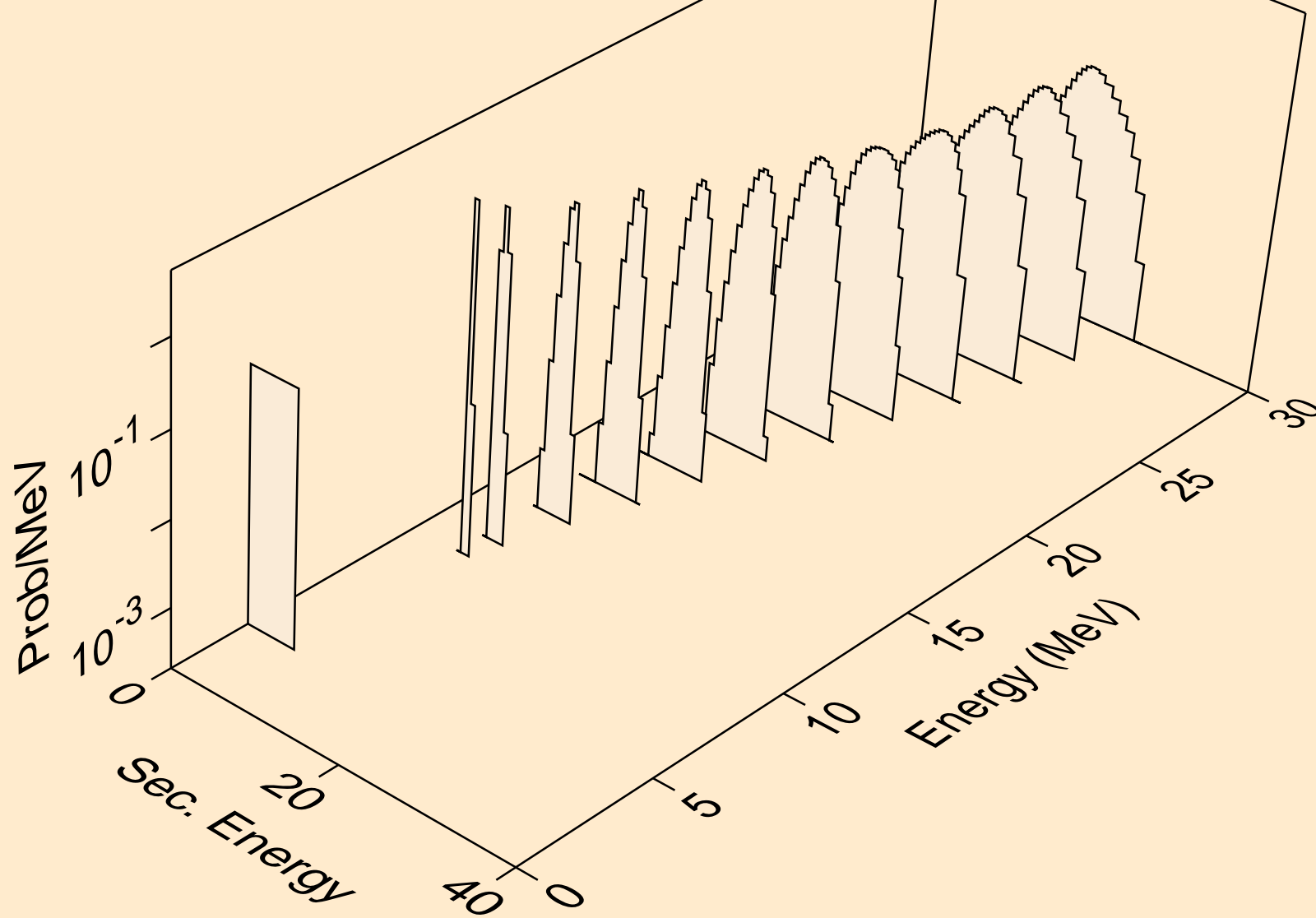

AU186 NEUTRON ACER TENDL-2021 LIBRARY; T=293.6K
alphas from (n,3n)a

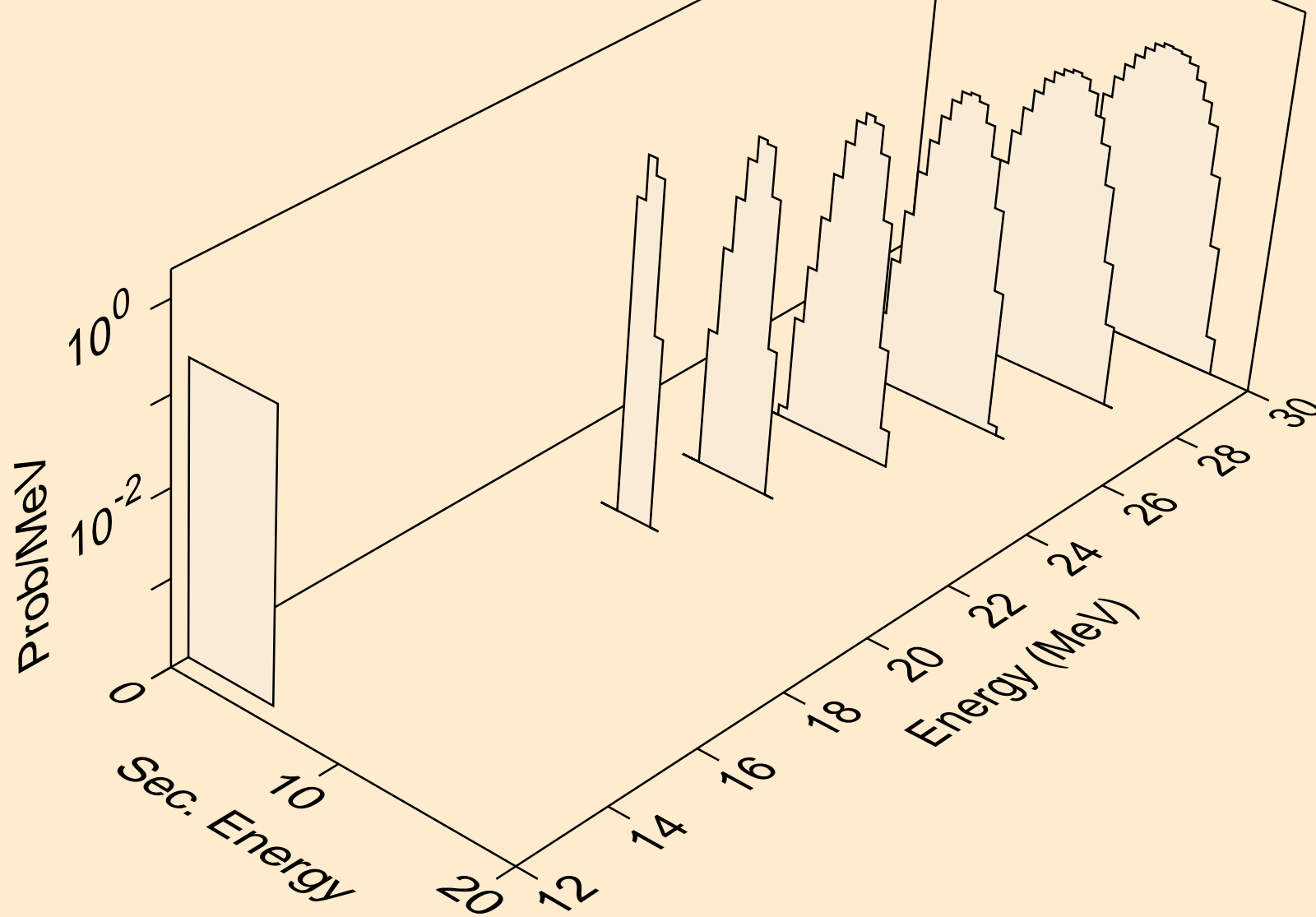

AU186 NEUTRON ACER TENDL-2021 LIBRARY; T=293.6K
alphas from (n,n*)2a

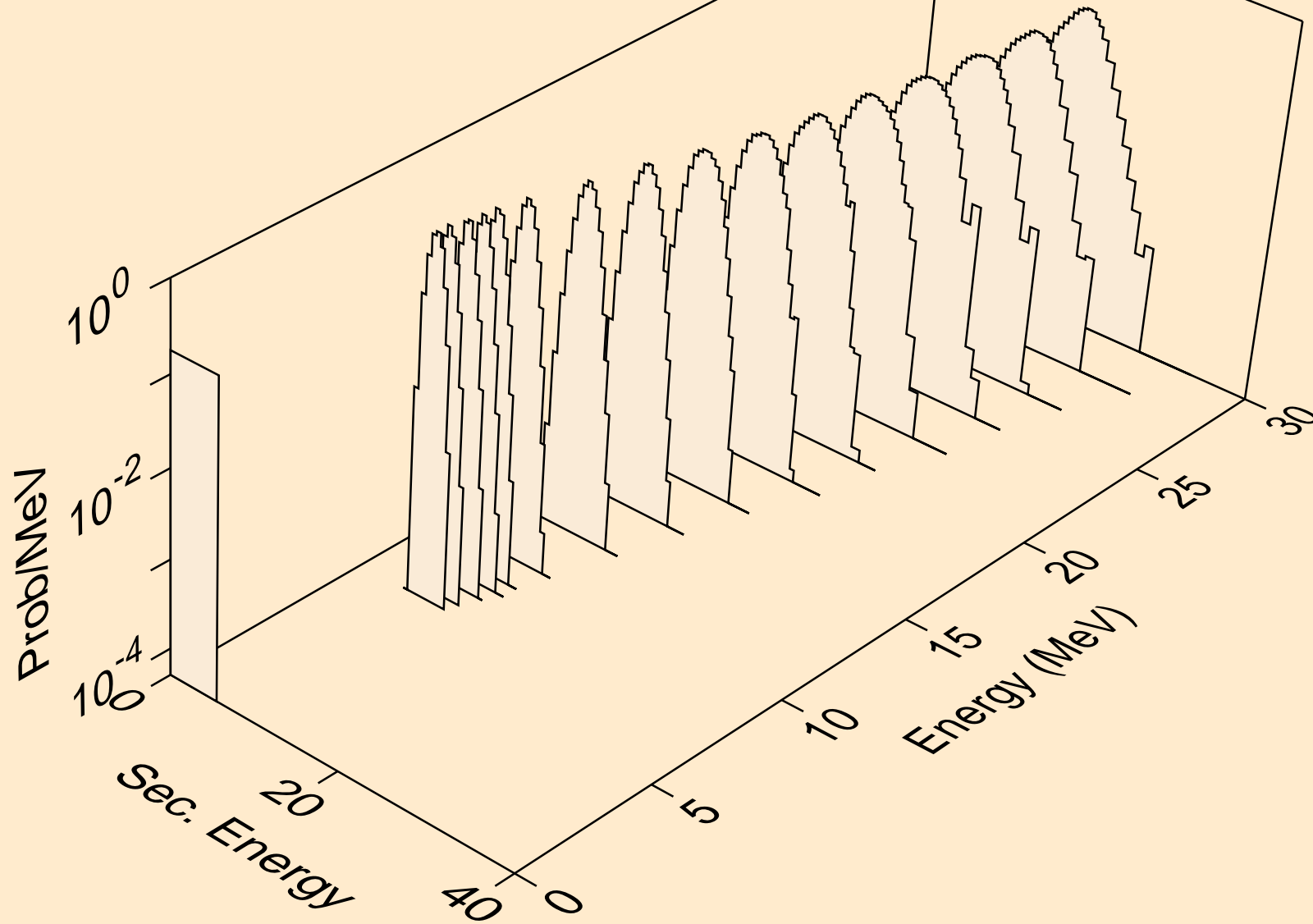

AU186 NEUTRON ACER TENDL-2021 LIBRARY; T=293.6K
alphas from (n,2n)2a

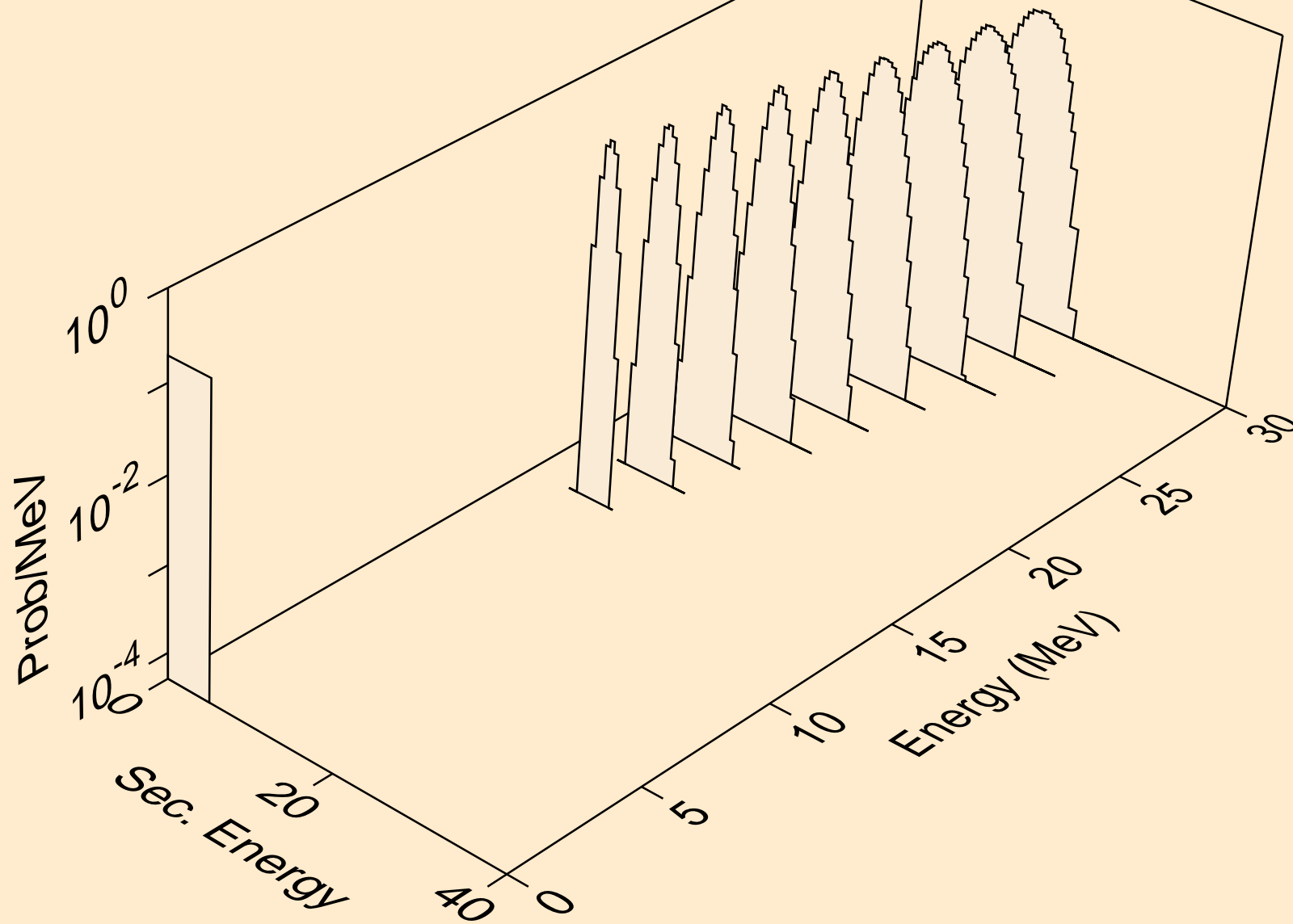

AU186 NEUTRON ACER TENDL-2021 LIBRARY; T=293.6K
alphas from (n,npa)

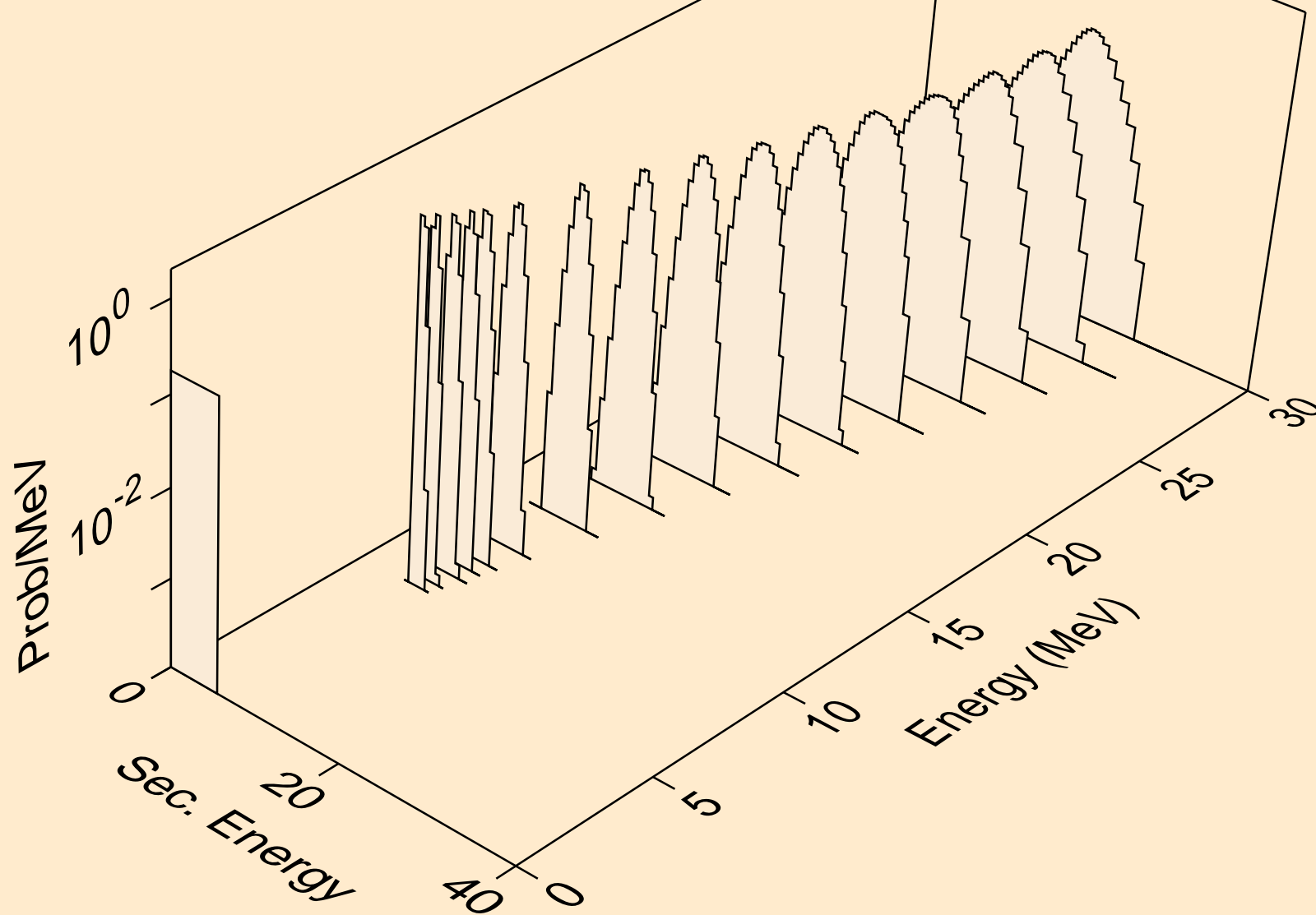

AU186 NEUTRON ACER TENDL-2021 LIBRARY; T=293.6K
alphas from (n,a)

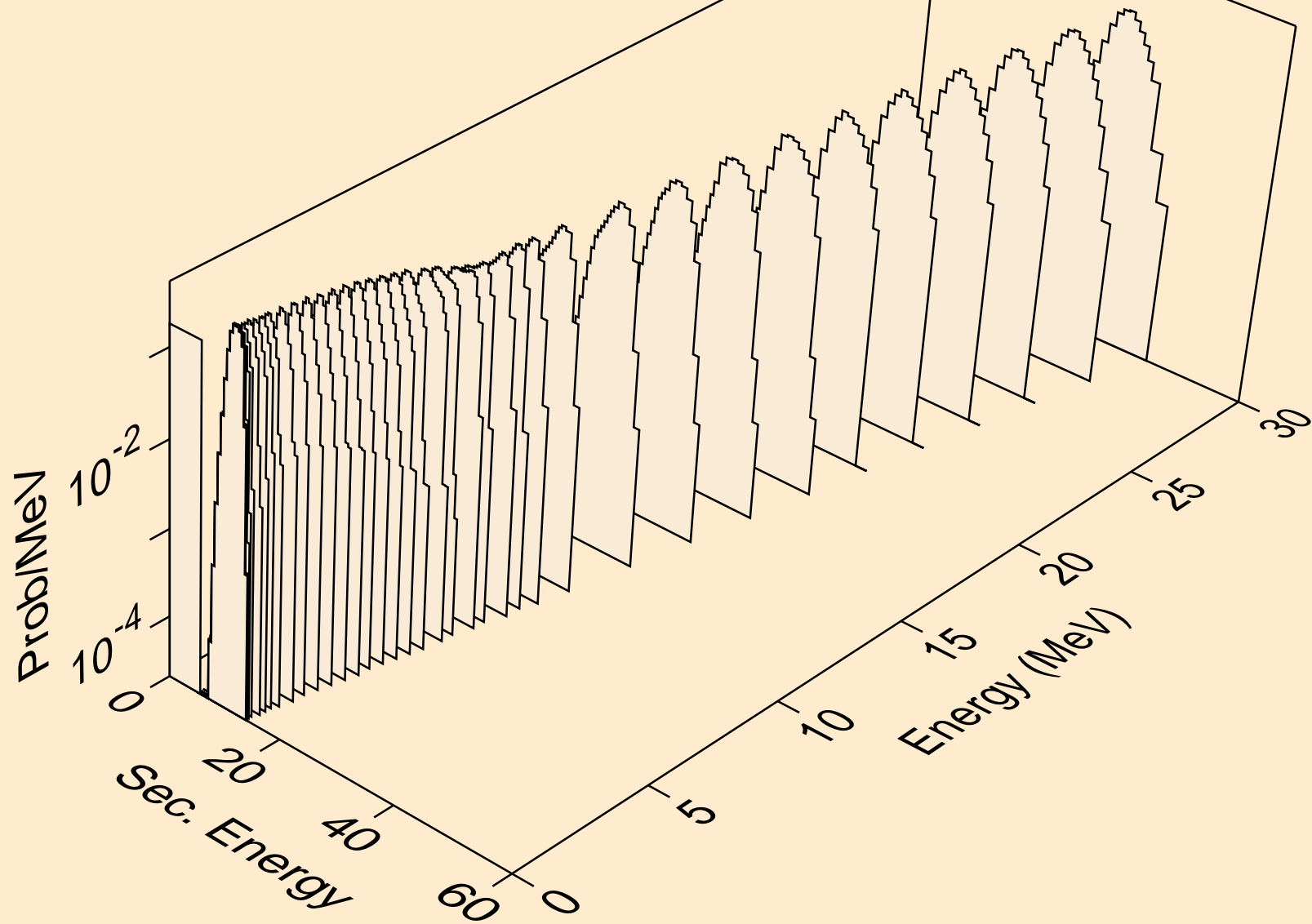

AU186 NEUTRON ACER TENDL-2021 LIBRARY; T=293.6K
alphas from (n,2a)

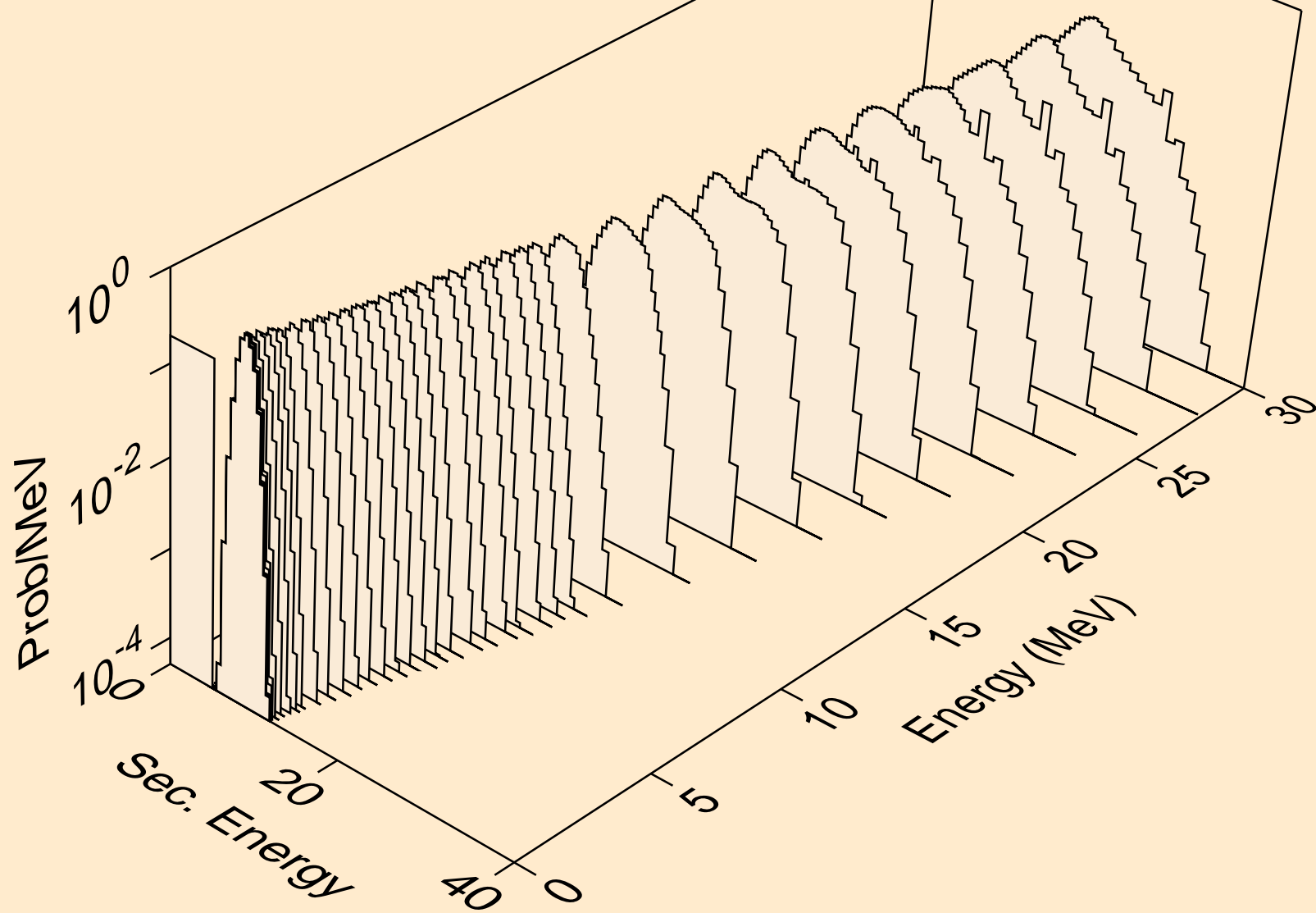

AU186 NEUTRON ACER TENDL-2021 LIBRARY; T=293.6K
alphas from (n,pa)

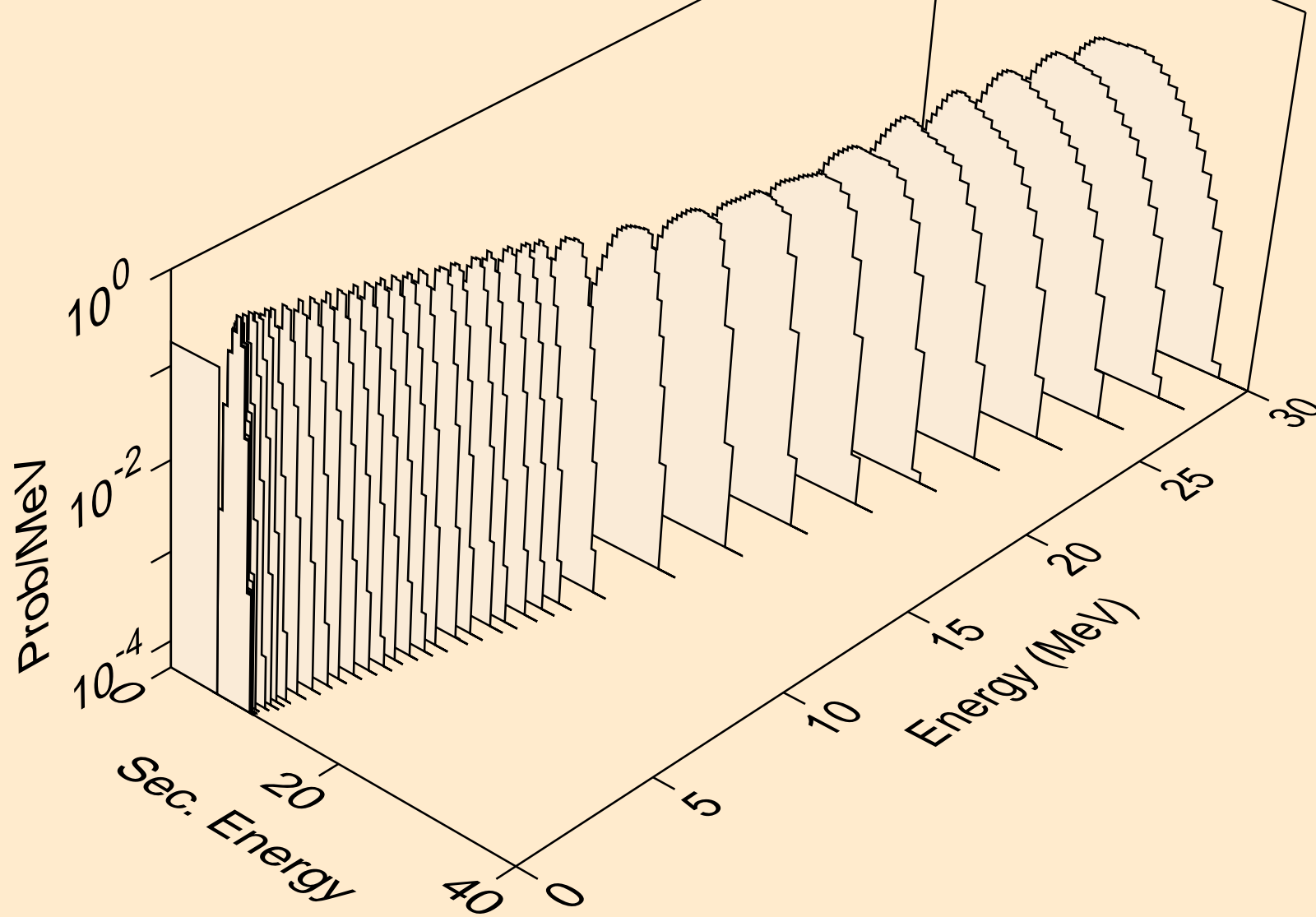

AU186 NEUTRON ACER TENDL-2021 LIBRARY; T=293.6K
alphas from (n,da)

