

AU191 NEUTRON ACER TENDL-2021 LIBRARY; T=293.6K  
Principal cross sections

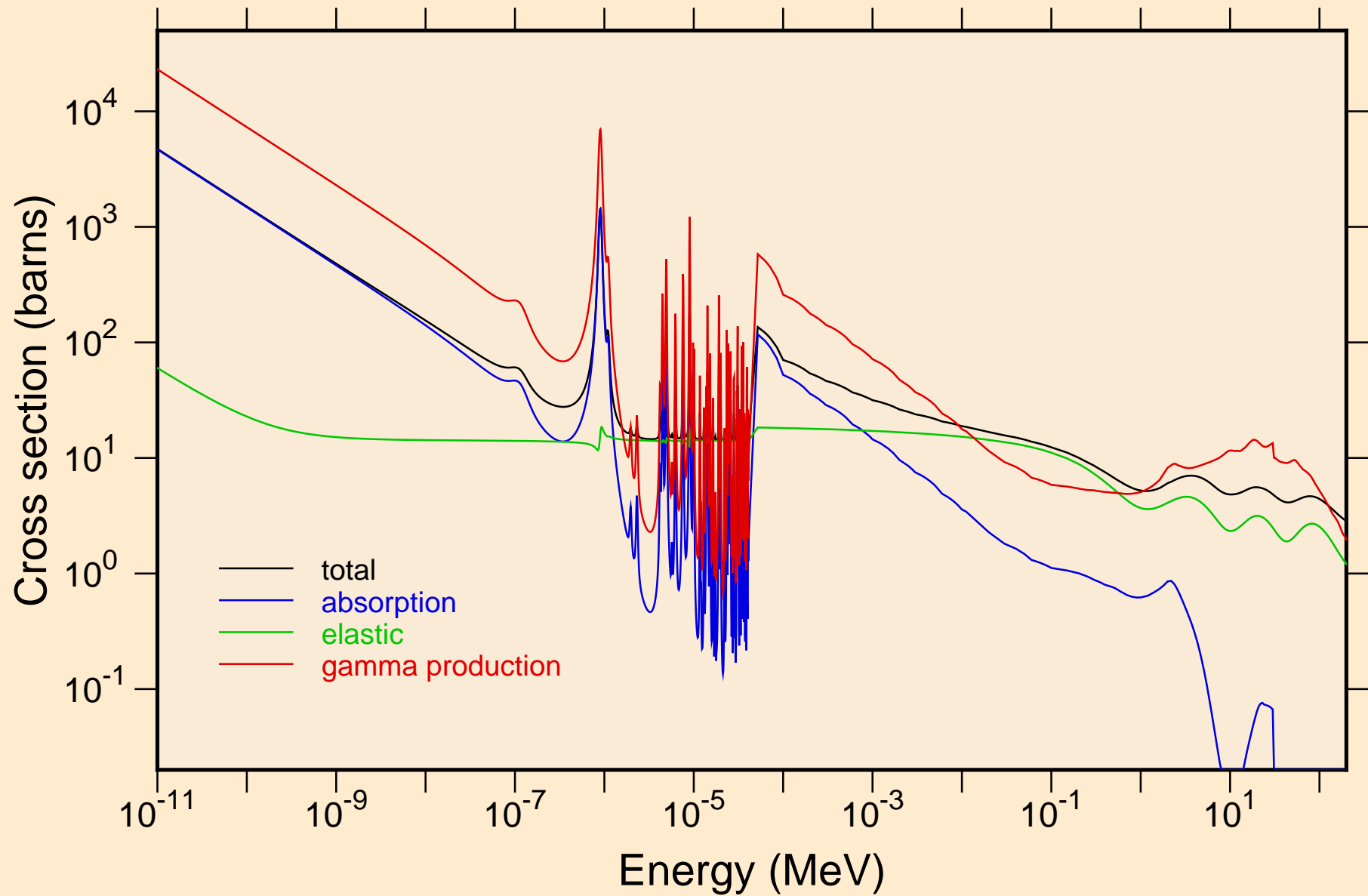

AU191 NEUTRON ACER TENDL-2021 LIBRARY; T=293.6K  
resonance total cross section

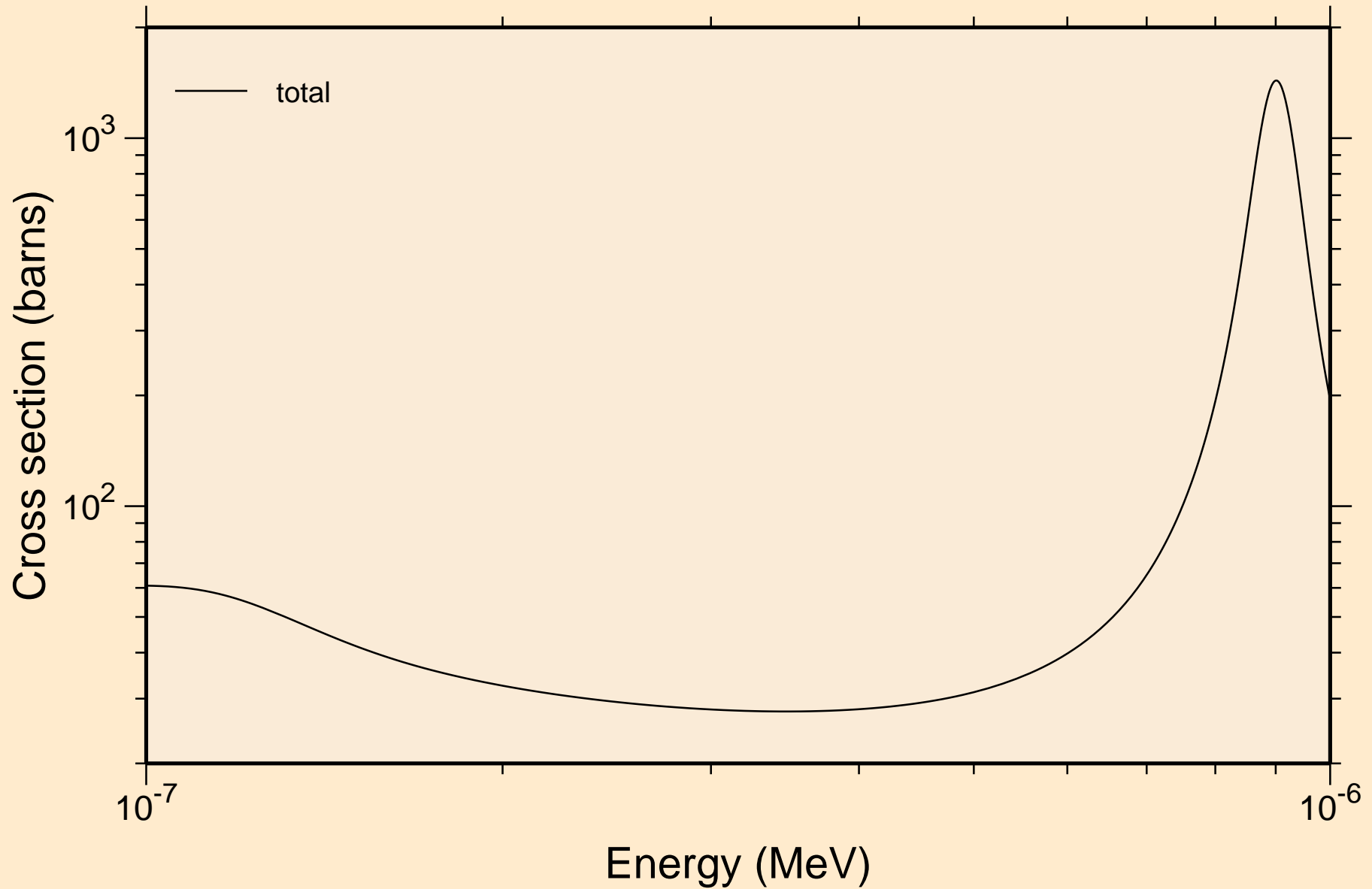

AU191 NEUTRON ACER TENDL-2021 LIBRARY; T=293.6K  
resonance total cross section

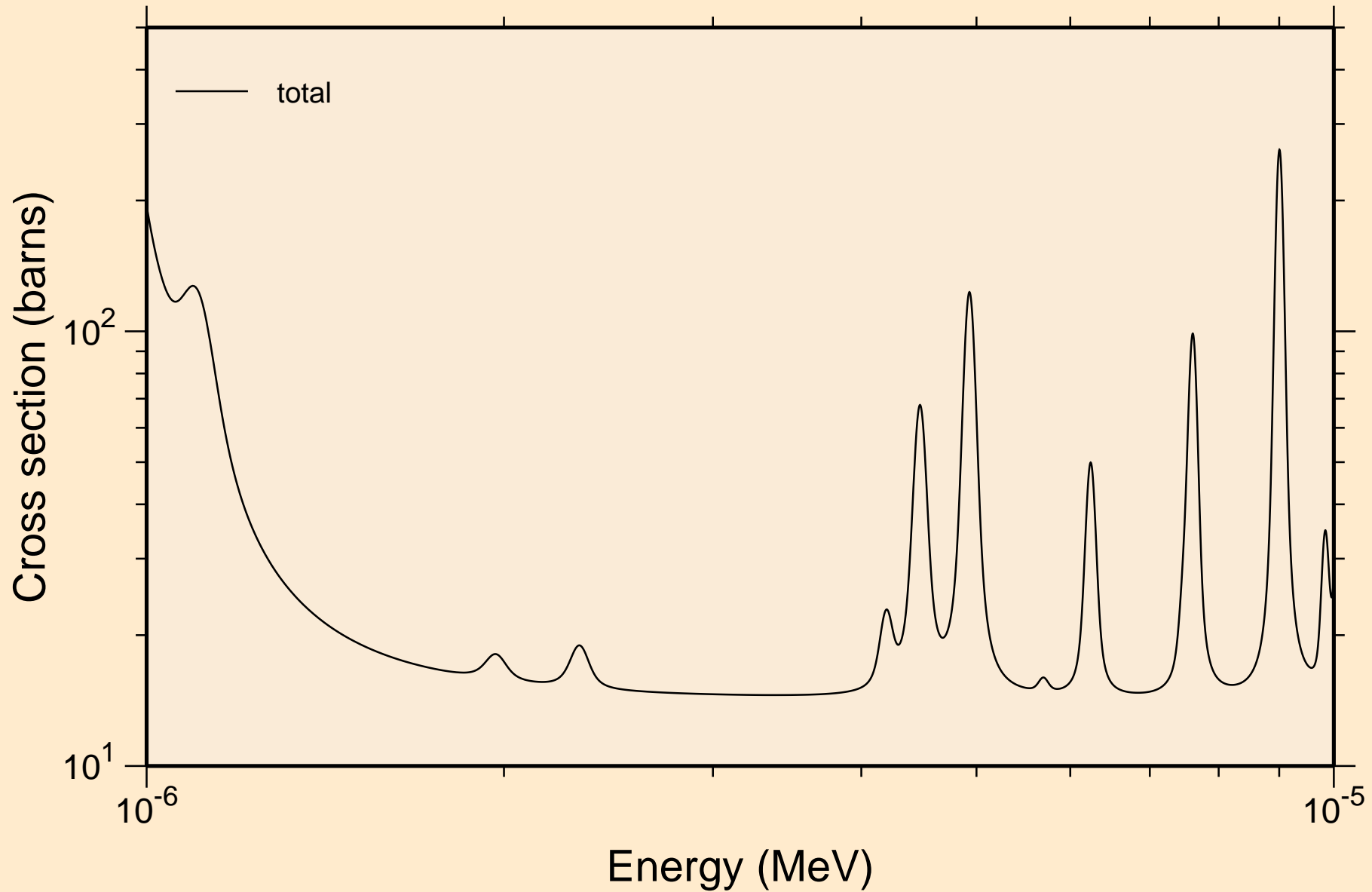

AU191 NEUTRON ACER TENDL-2021 LIBRARY; T=293.6K  
resonance total cross section

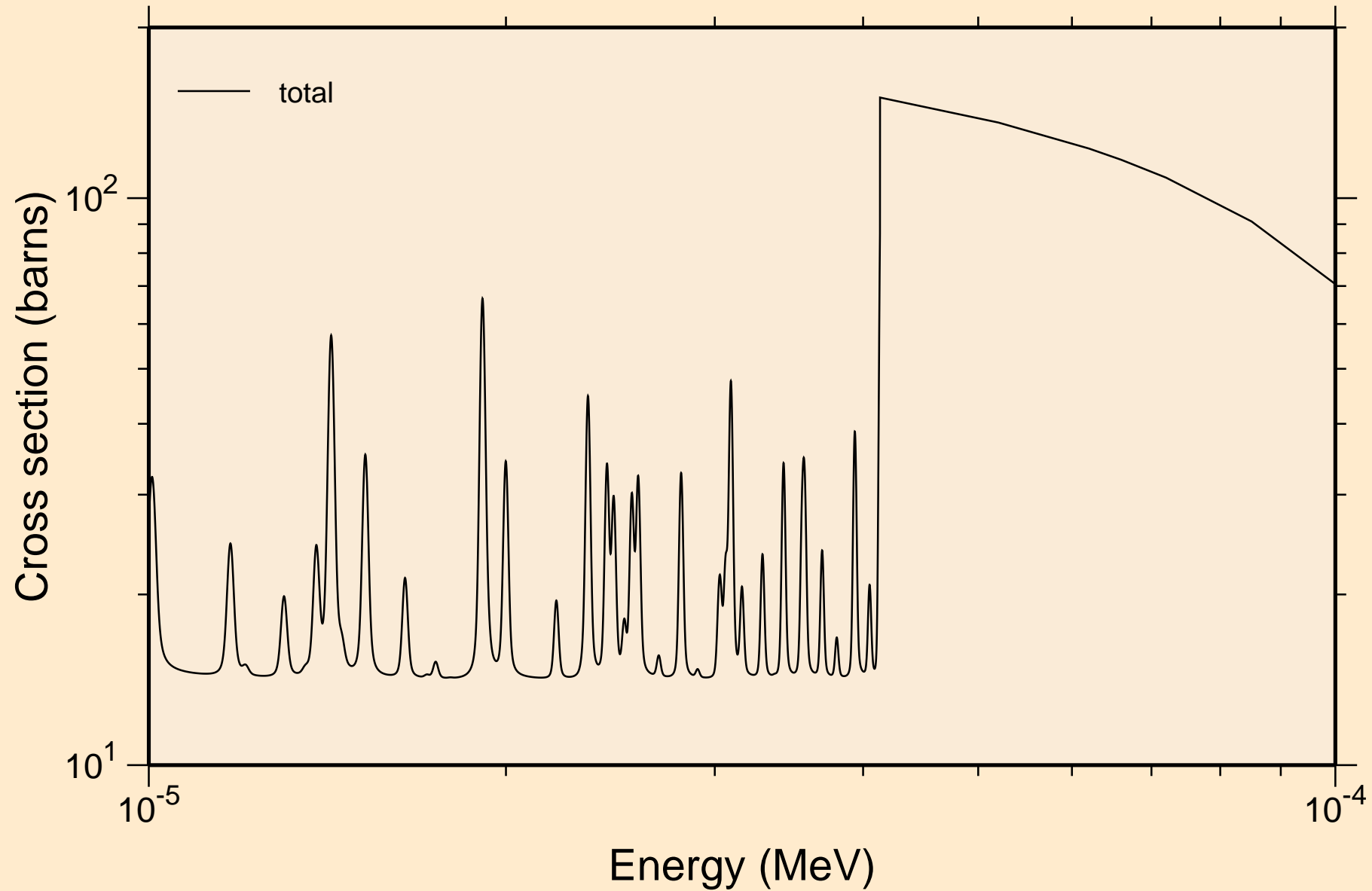

AU191 NEUTRON ACER TENDL-2021 LIBRARY; T=293.6K  
resonance total cross section

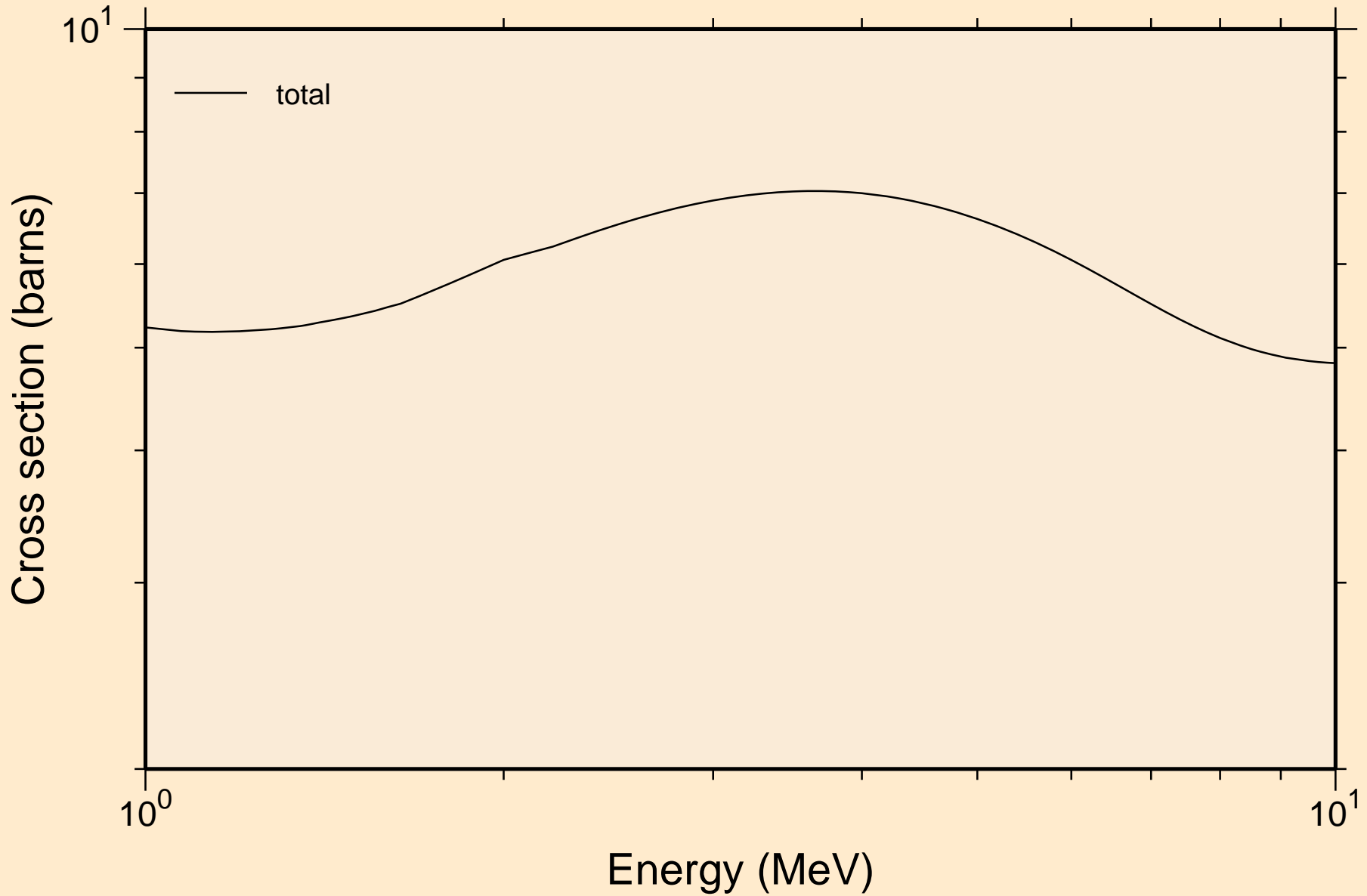

AU191 NEUTRON ACER TENDL-2021 LIBRARY; T=293.6K  
resonance absorption cross sections

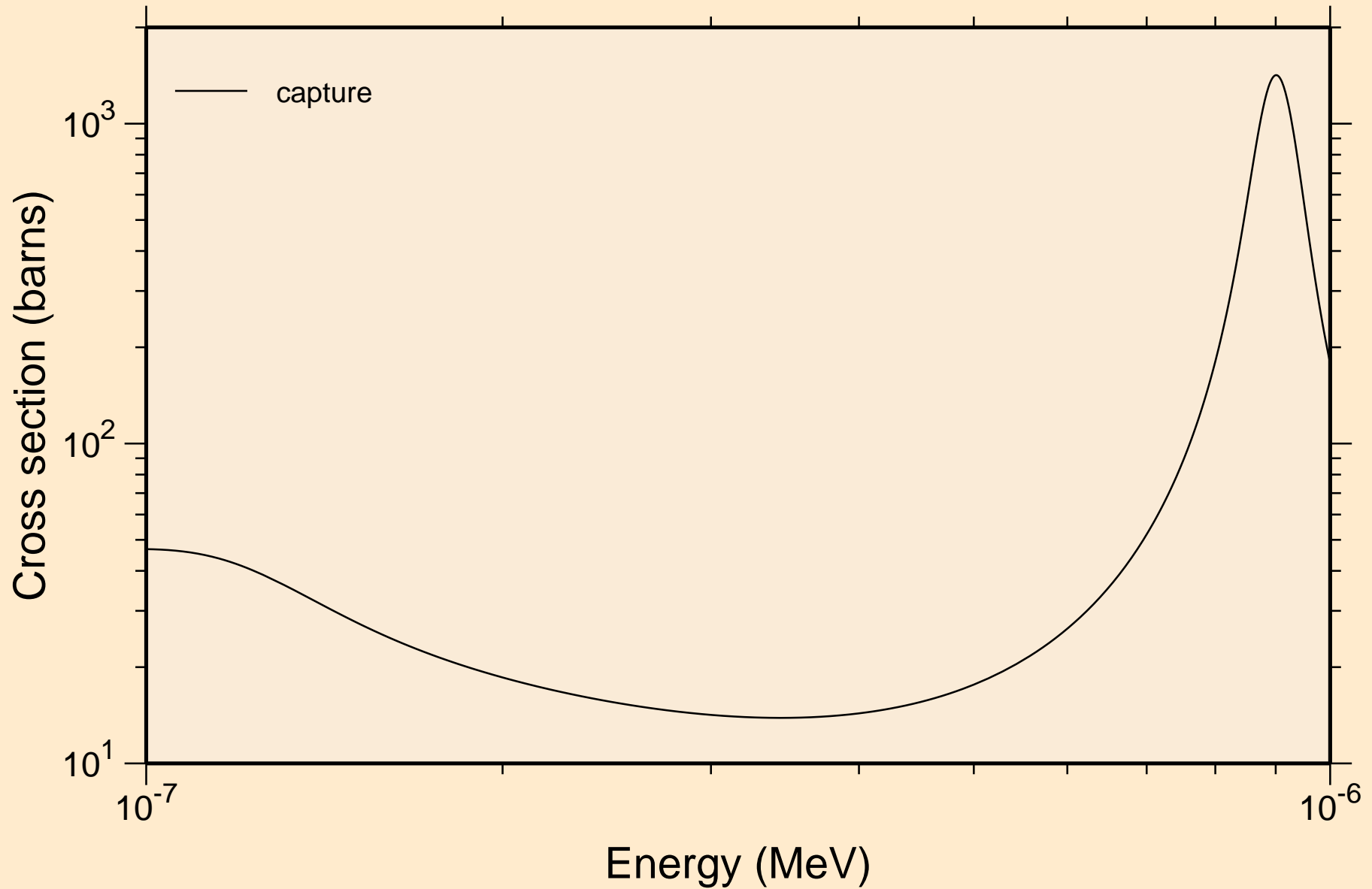

AU191 NEUTRON ACER TENDL-2021 LIBRARY; T=293.6K  
resonance absorption cross sections

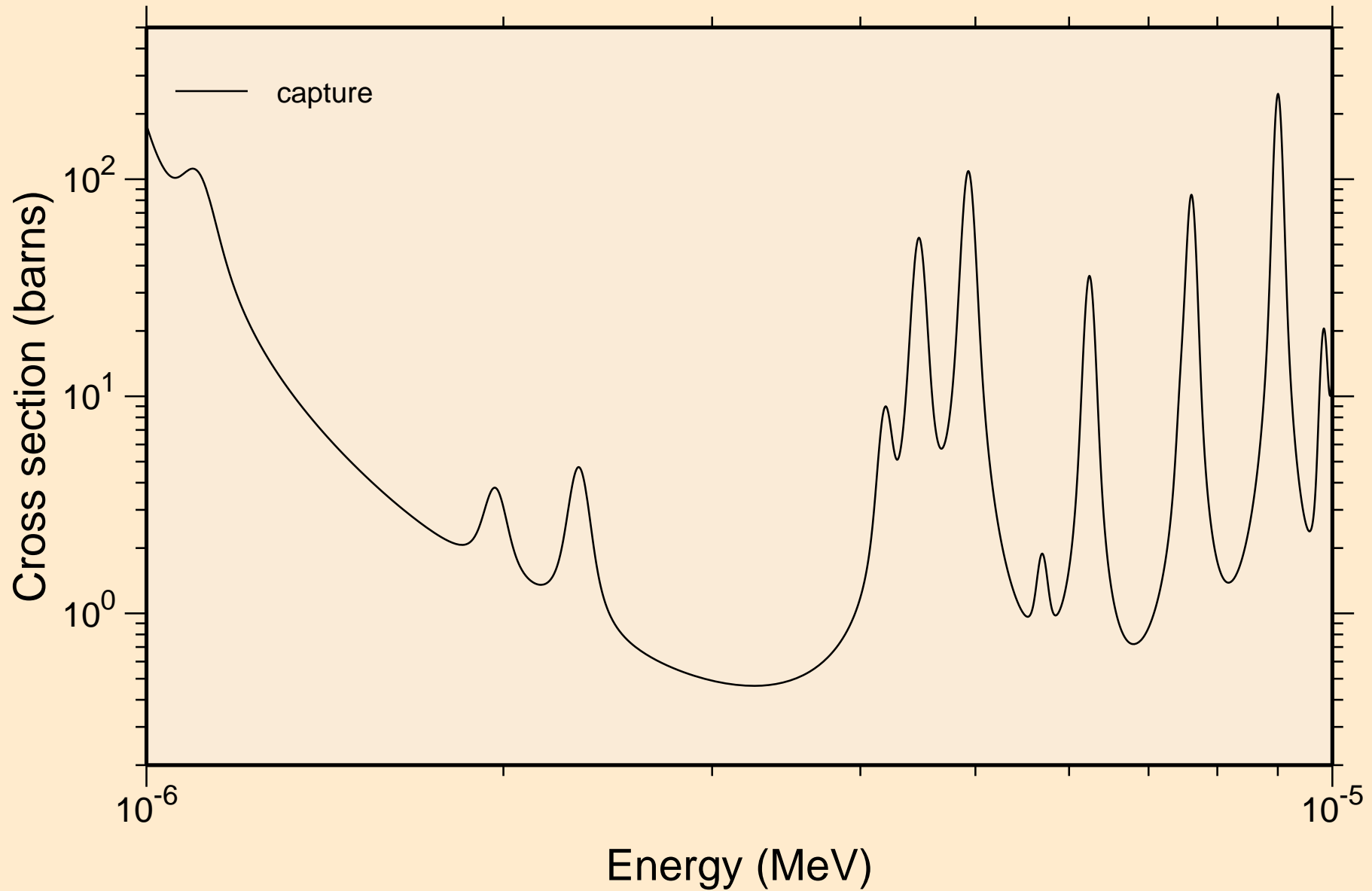

AU191 NEUTRON ACER TENDL-2021 LIBRARY; T=293.6K  
resonance absorption cross sections

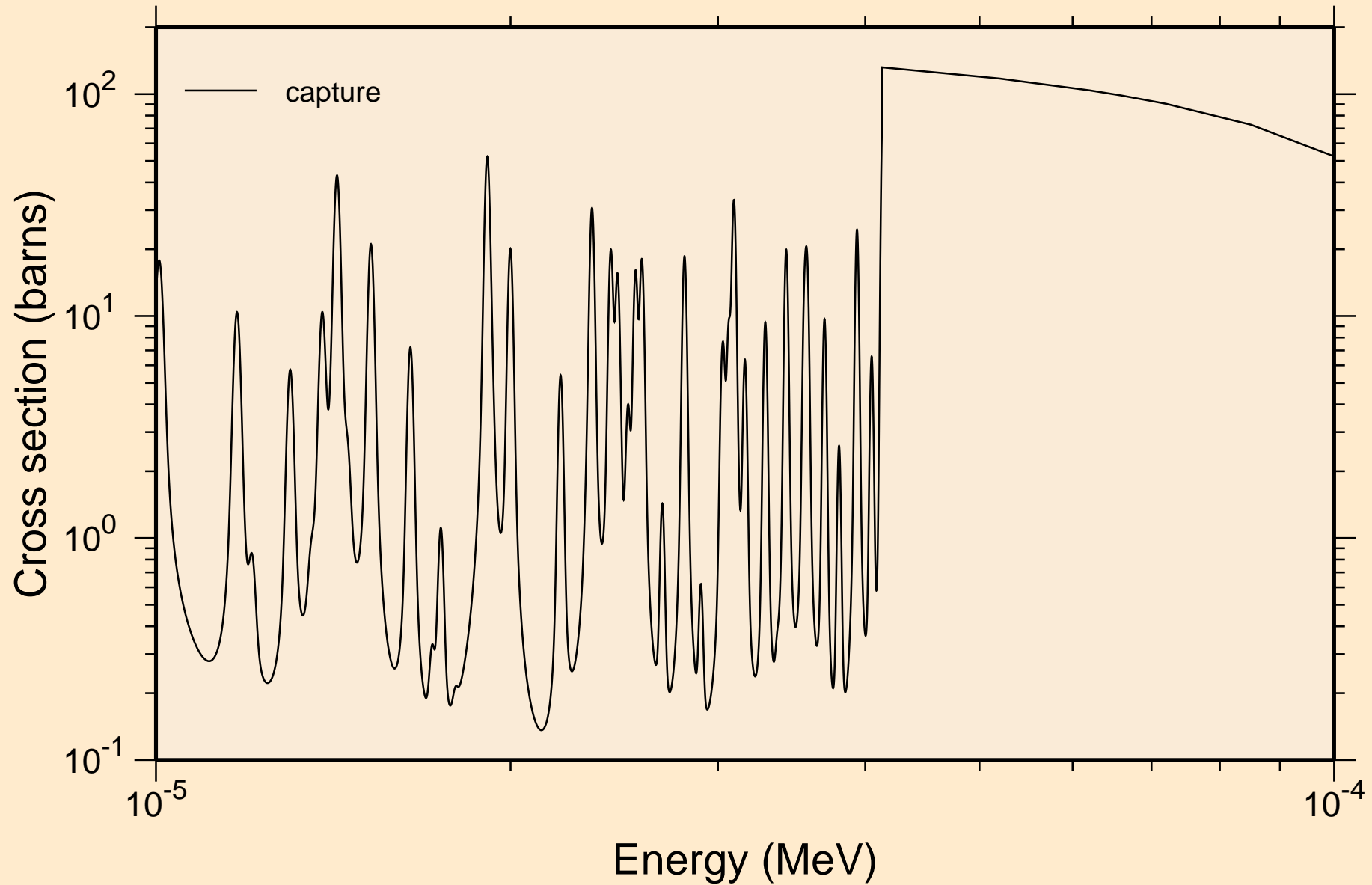



AU191 NEUTRON ACER TENDL-2021 LIBRARY; T=293.6K  
resonance absorption cross sections

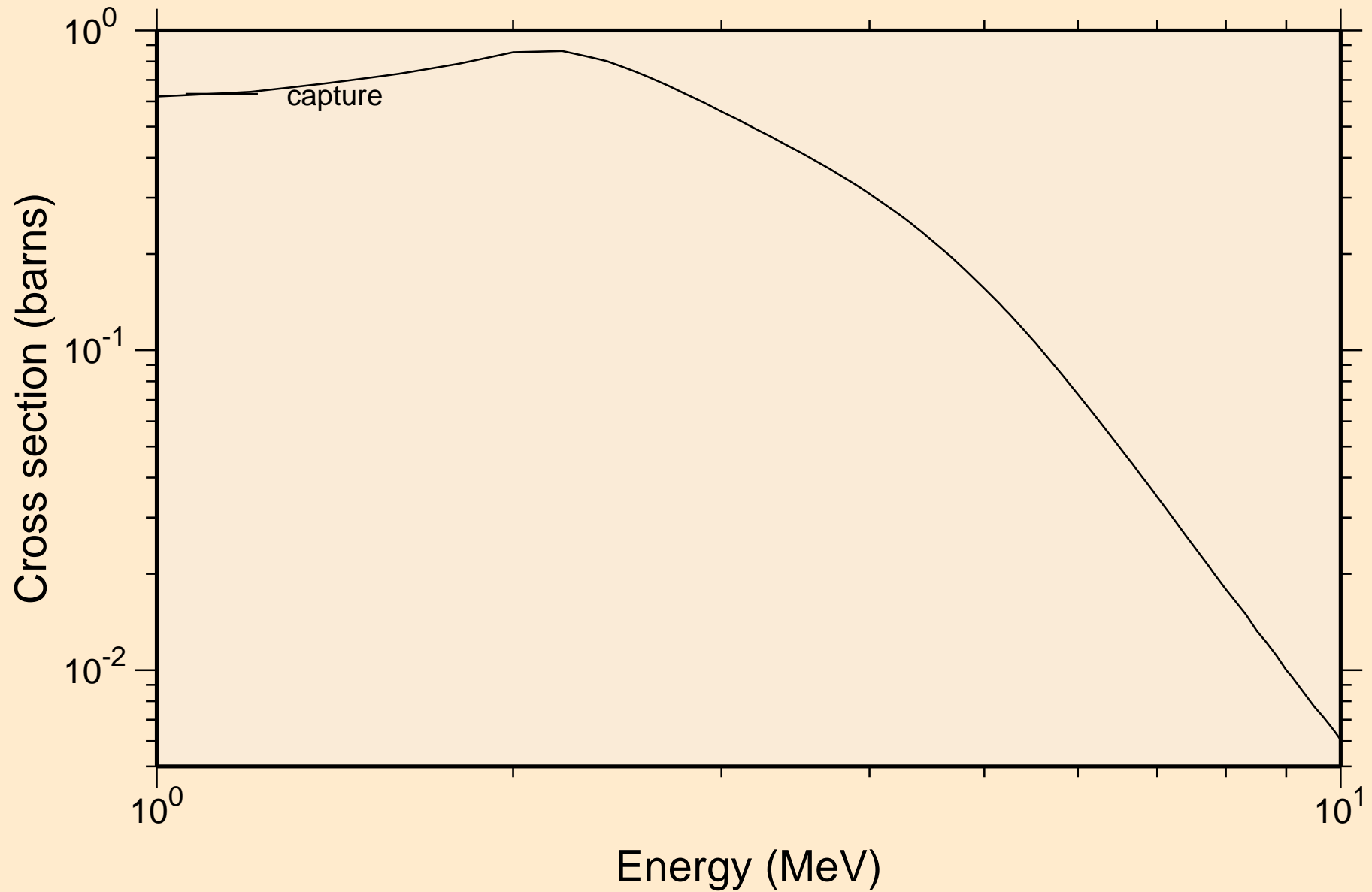

AU191 NEUTRON ACER TENDL-2021 LIBRARY; T=293.6K  
Heating

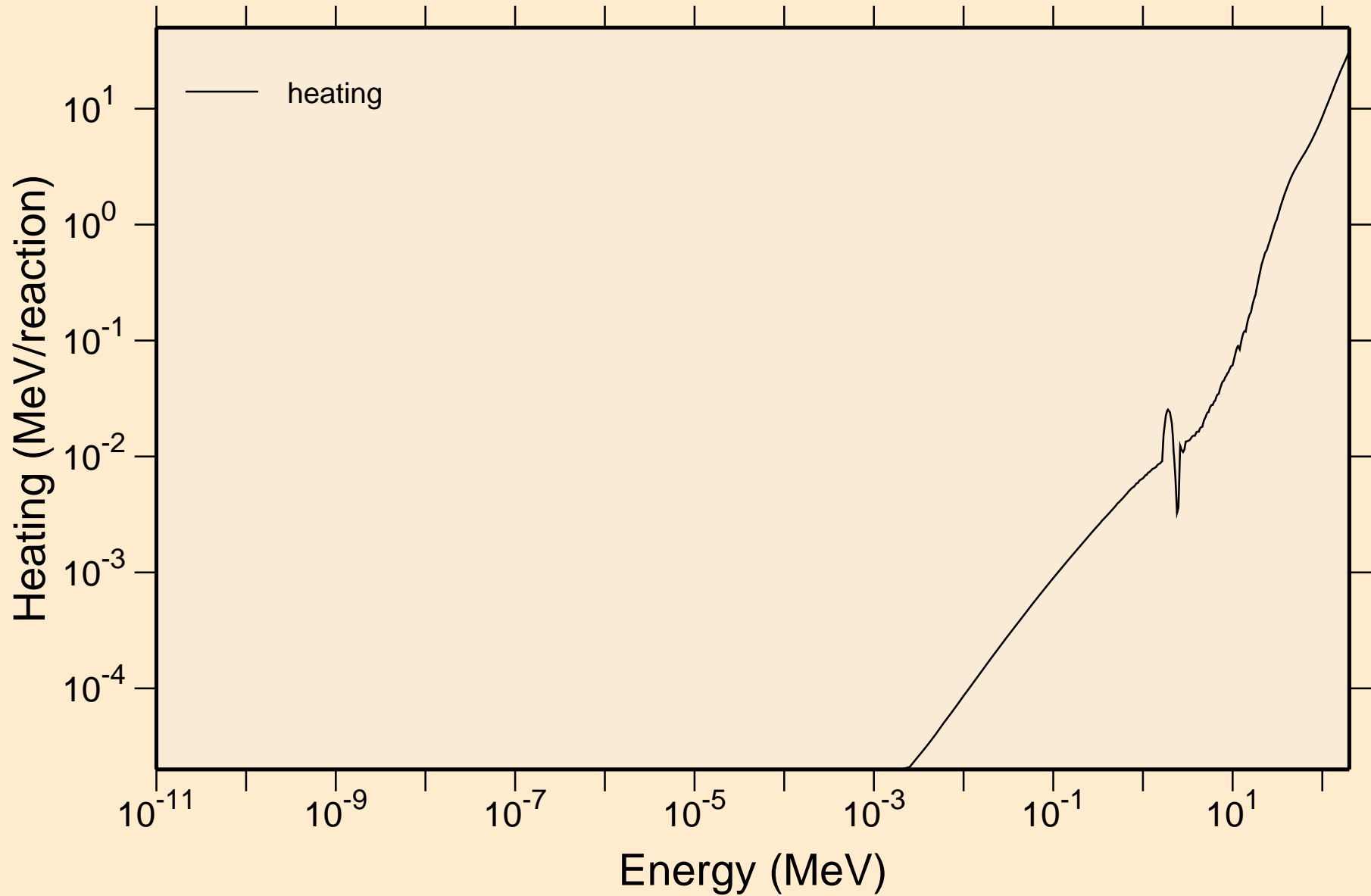

AU191 NEUTRON ACER TENDL-2021 LIBRARY; T=293.6K  
Damage

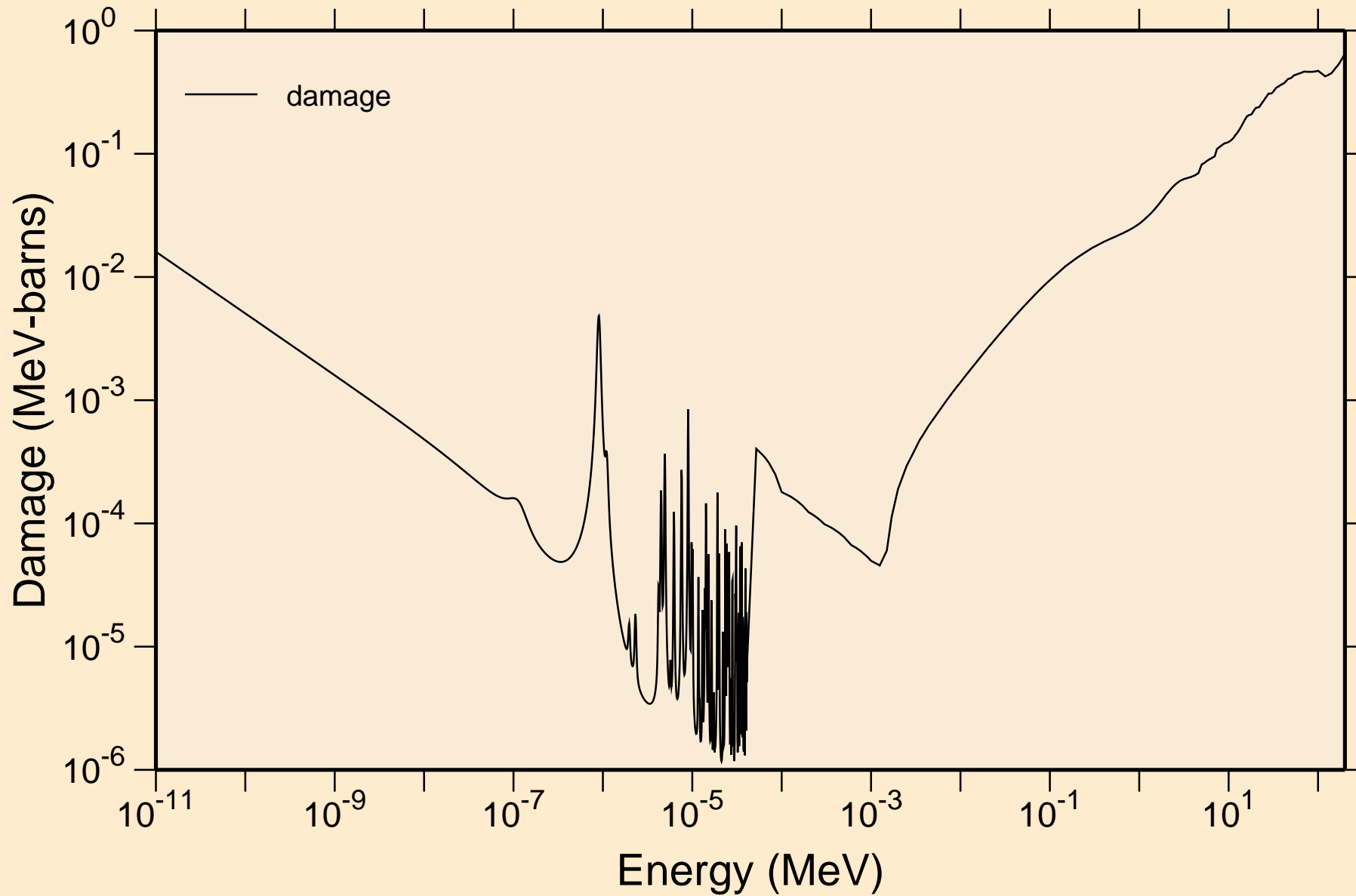

AU191 NEUTRON ACER TENDL-2021 LIBRARY; T=293.6K  
Non-threshold reactions

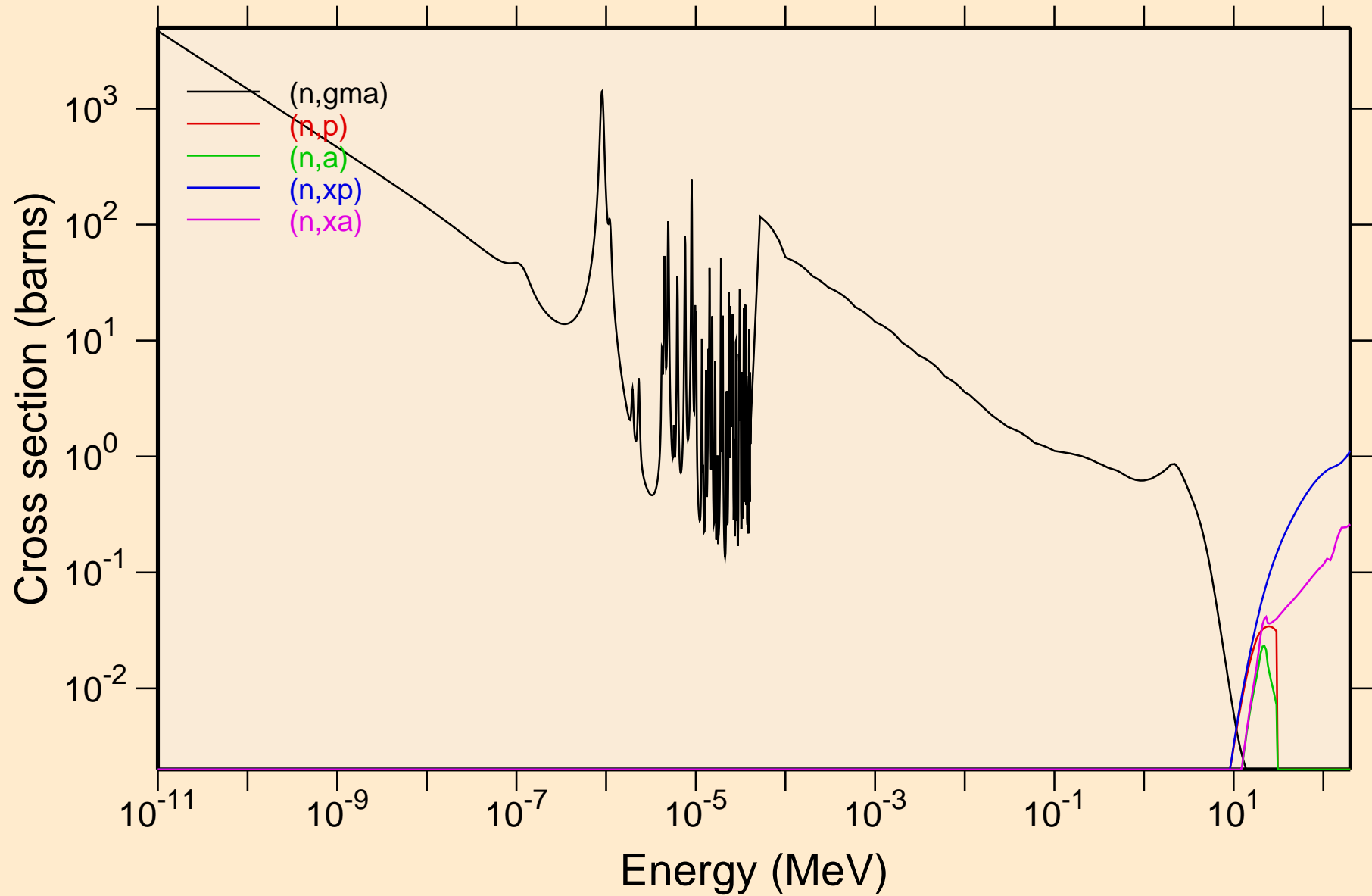

# AU191 NEUTRON ACER TENDL-2021 LIBRARY; T=293.6K

## Principal cross sections

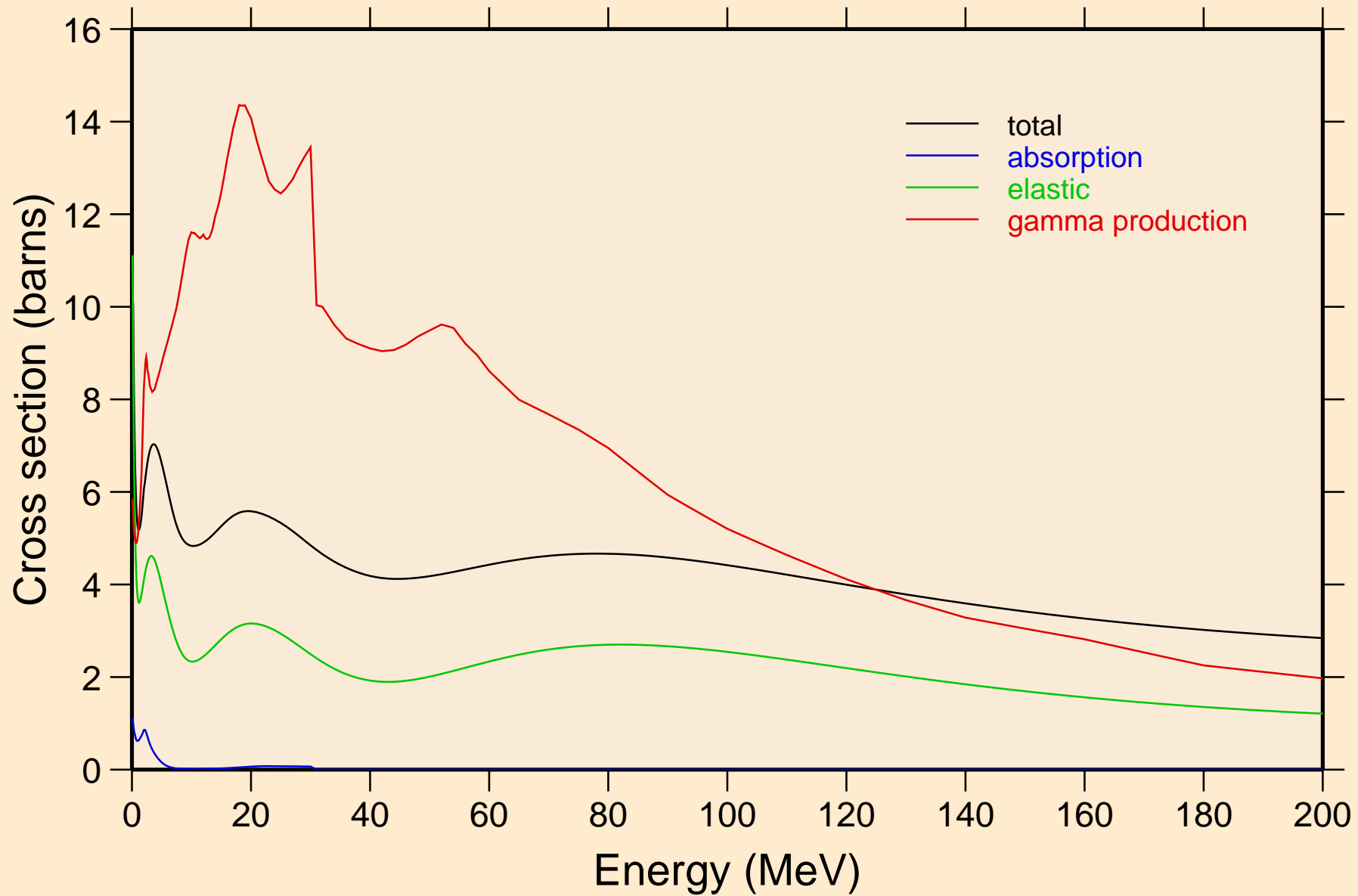

AU191 NEUTRON ACER TENDL-2021 LIBRARY; T=293.6K  
Heating

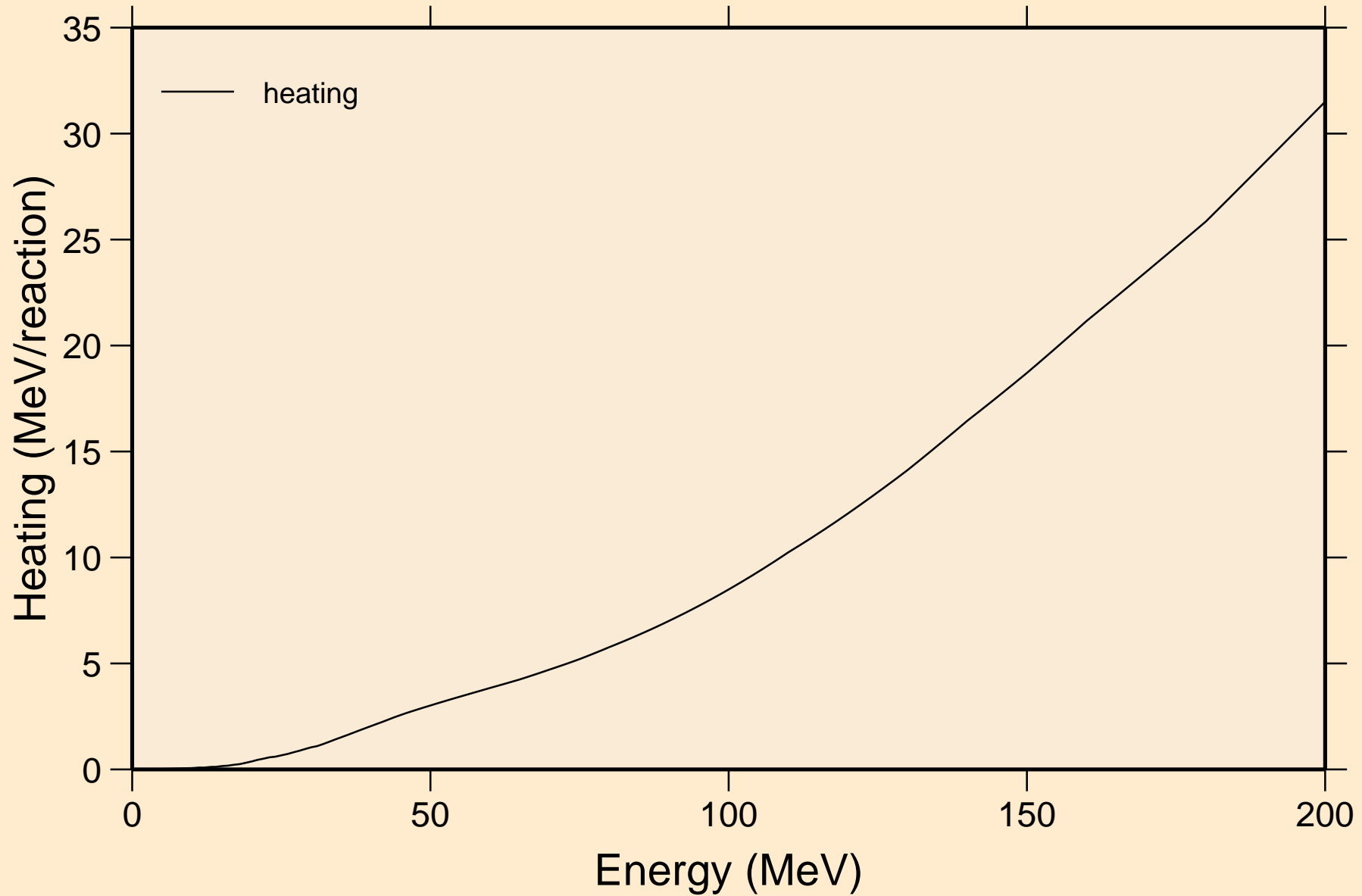

AU191 NEUTRON ACER TENDL-2021 LIBRARY; T=293.6K  
Damage

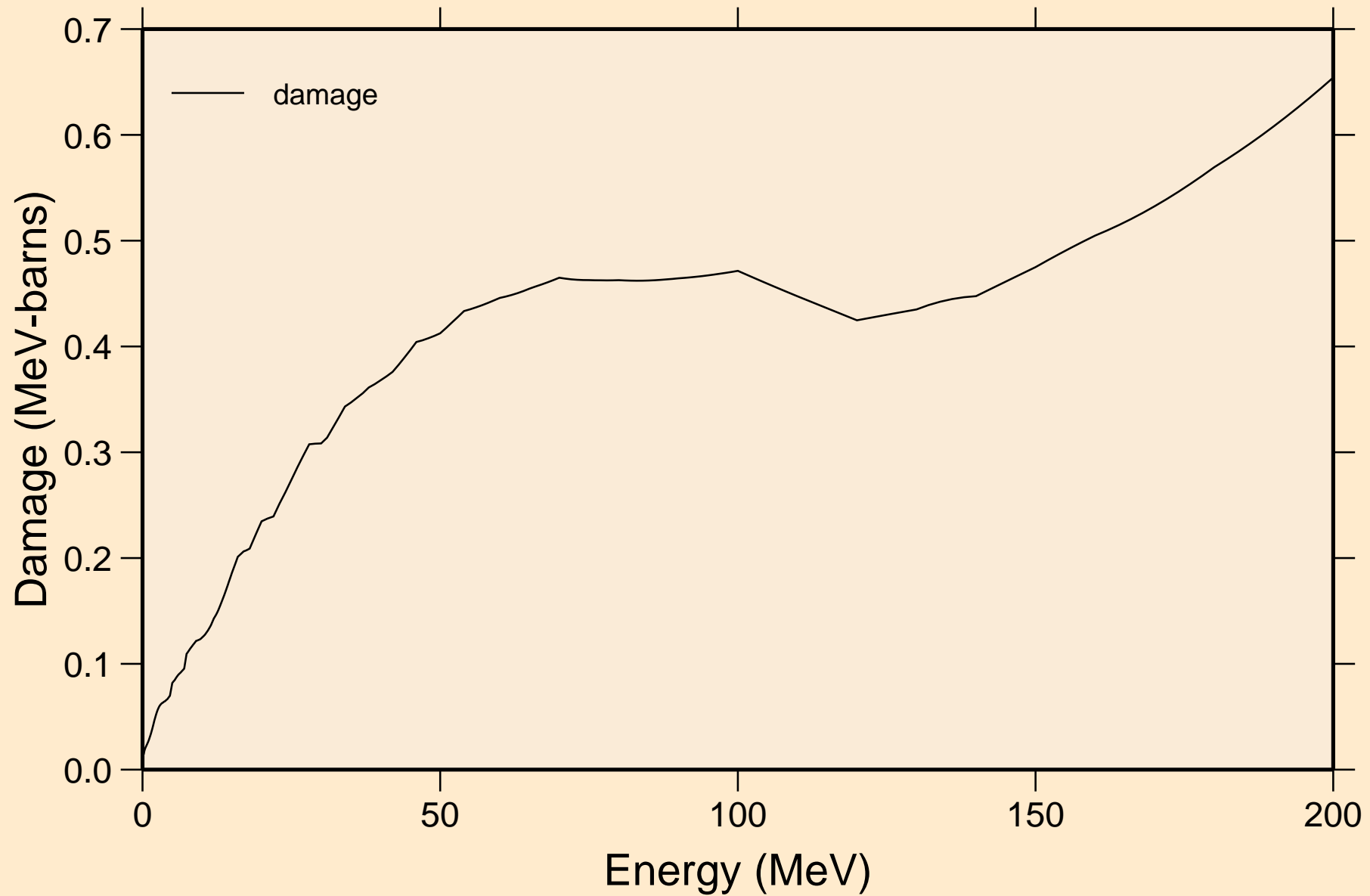

AU191 NEUTRON ACER TENDL-2021 LIBRARY; T=293.6K  
Non-threshold reactions

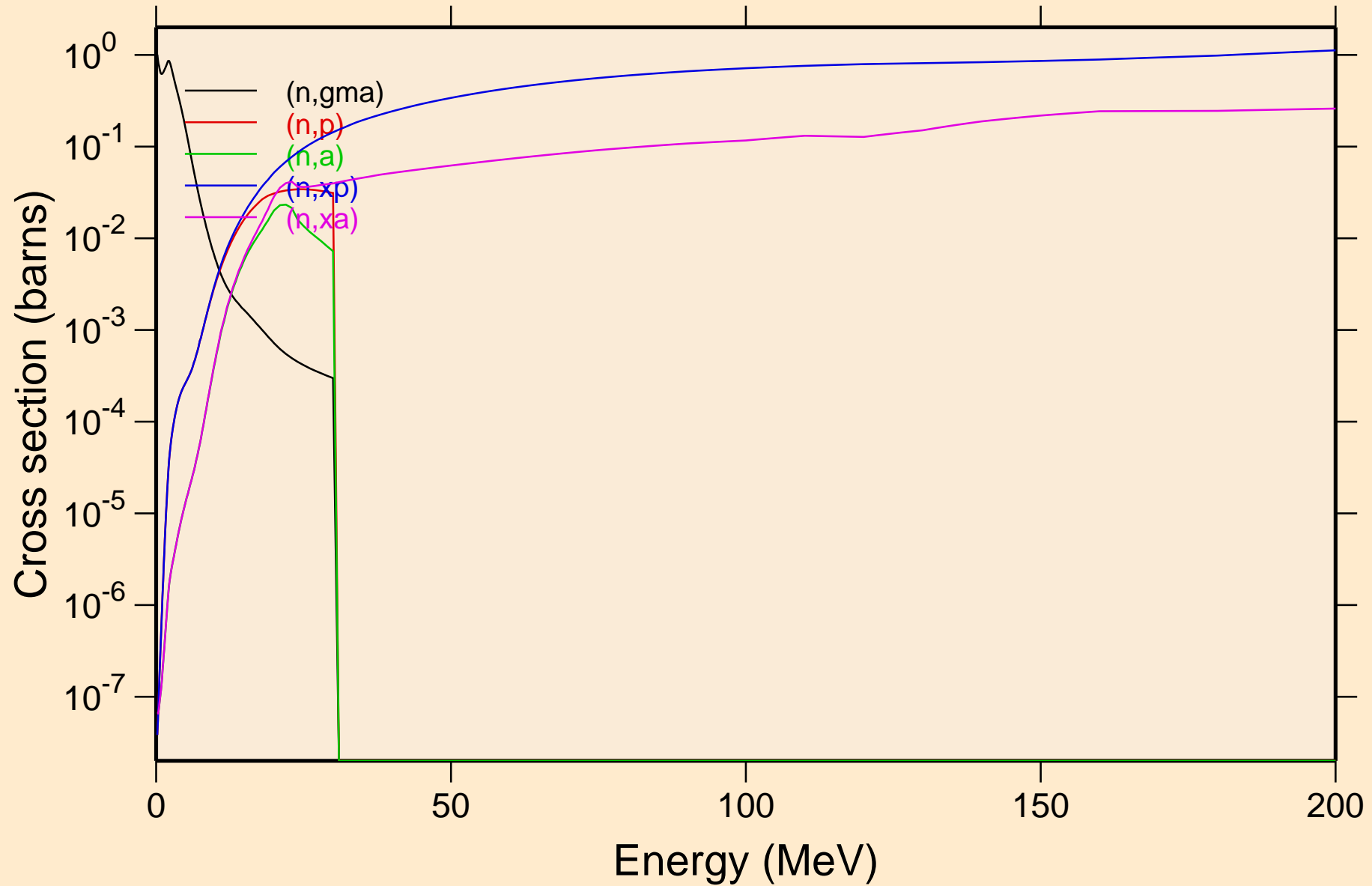



AU191 NEUTRON ACER TENDL-2021 LIBRARY; T=293.6K  
Inelastic levels

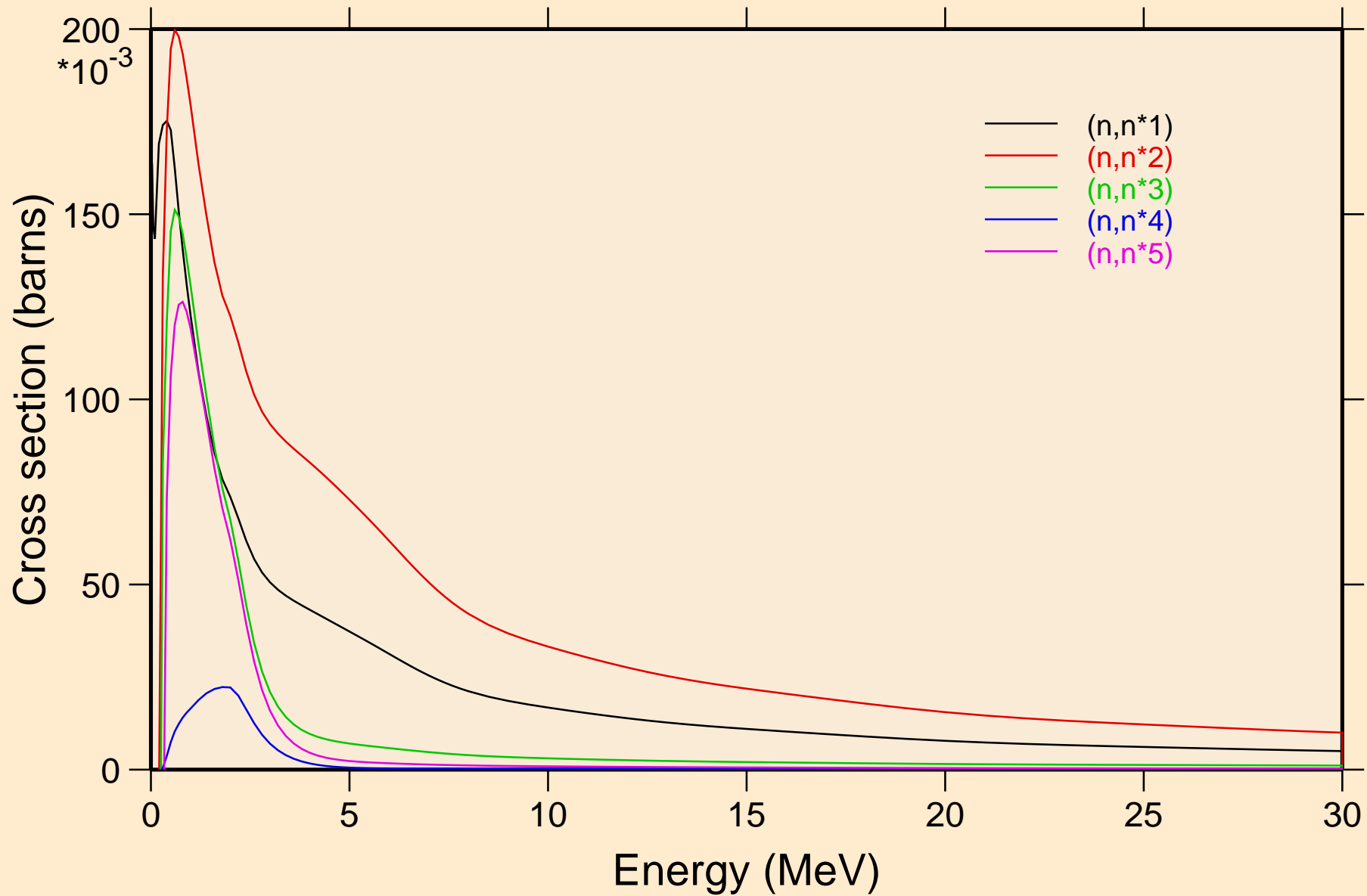

AU191 NEUTRON ACER TENDL-2021 LIBRARY; T=293.6K  
Inelastic levels

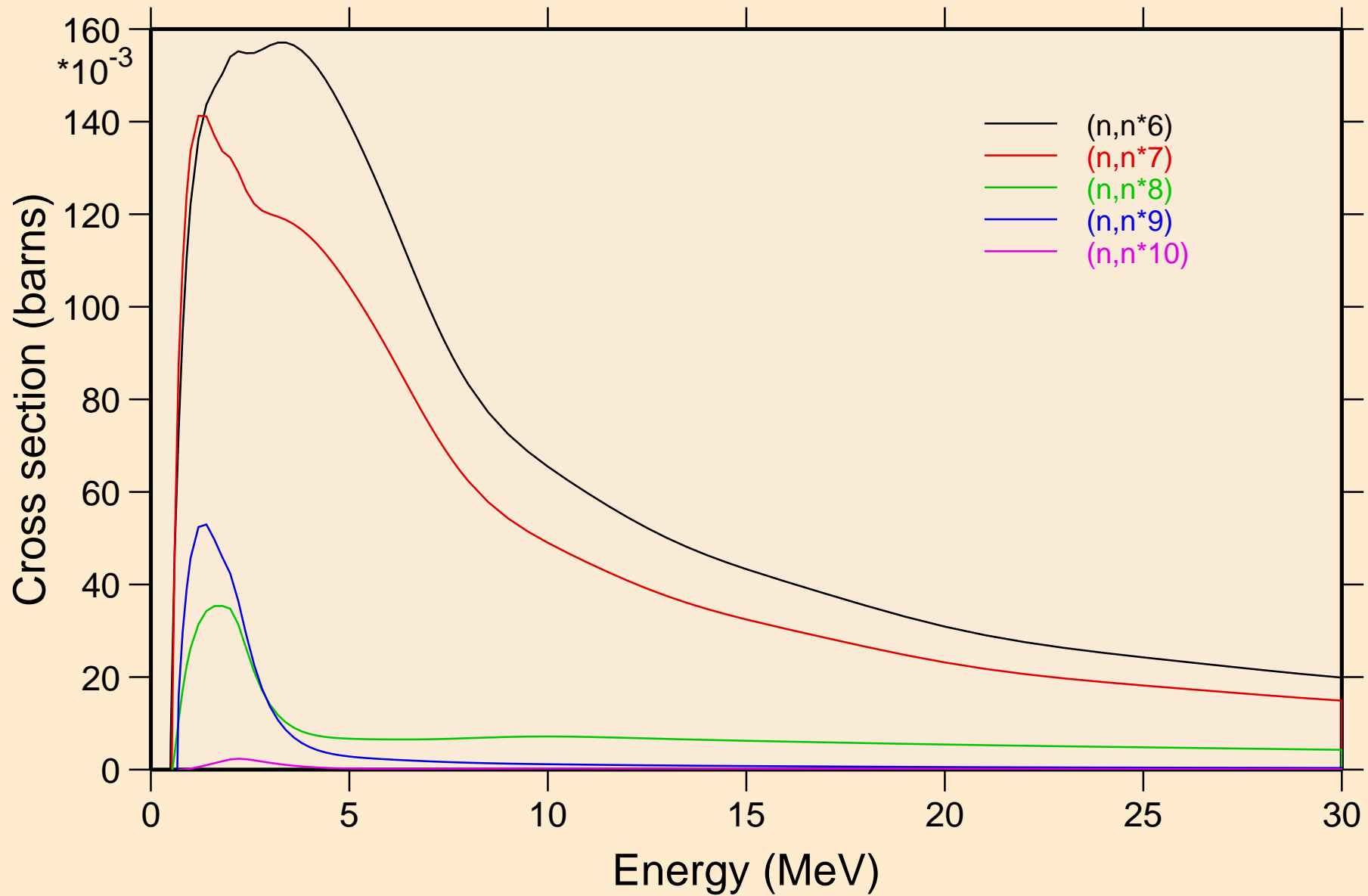

AU191 NEUTRON ACER TENDL-2021 LIBRARY; T=293.6K  
Inelastic levels

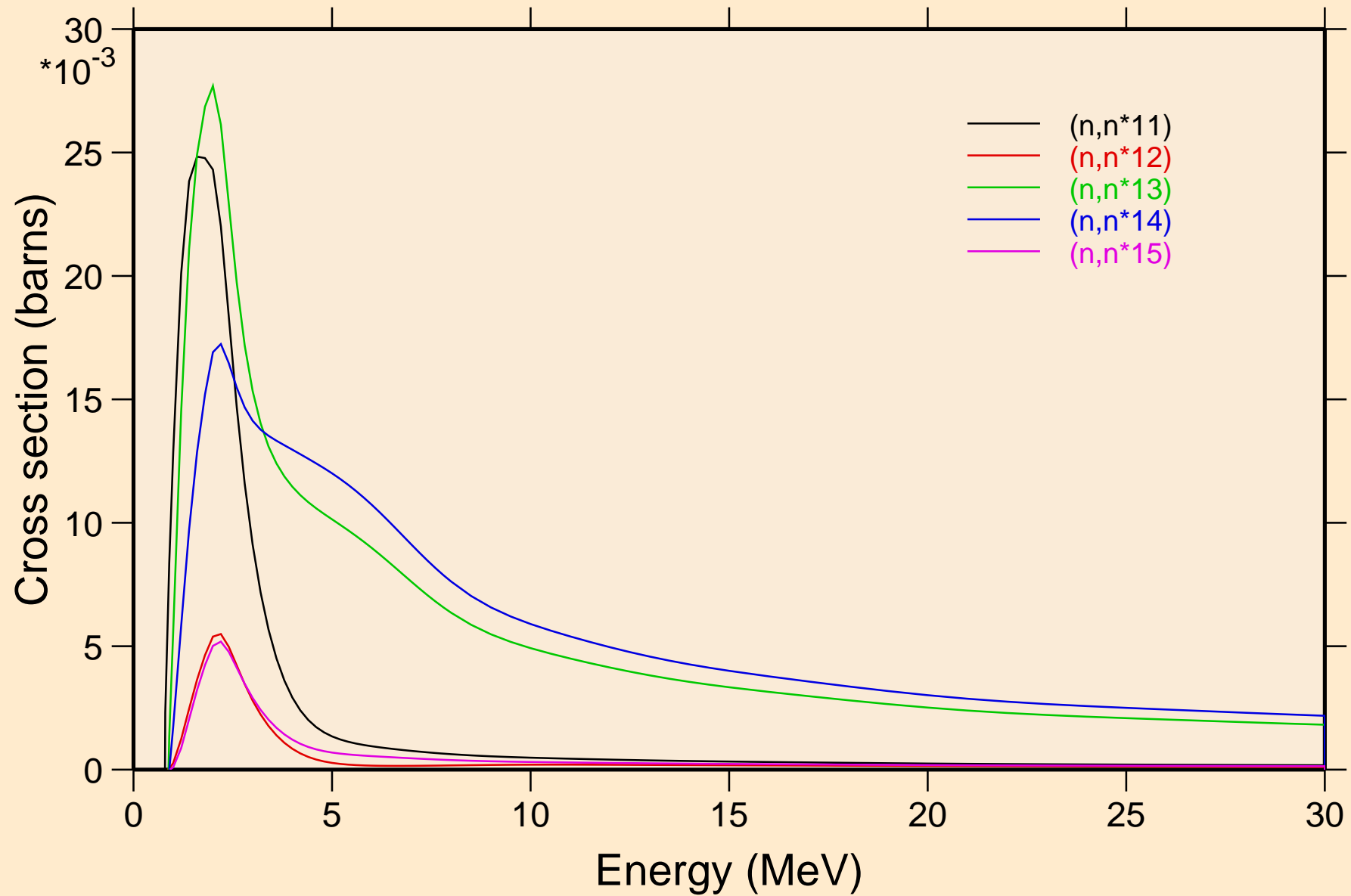

AU191 NEUTRON ACER TENDL-2021 LIBRARY; T=293.6K  
Inelastic levels

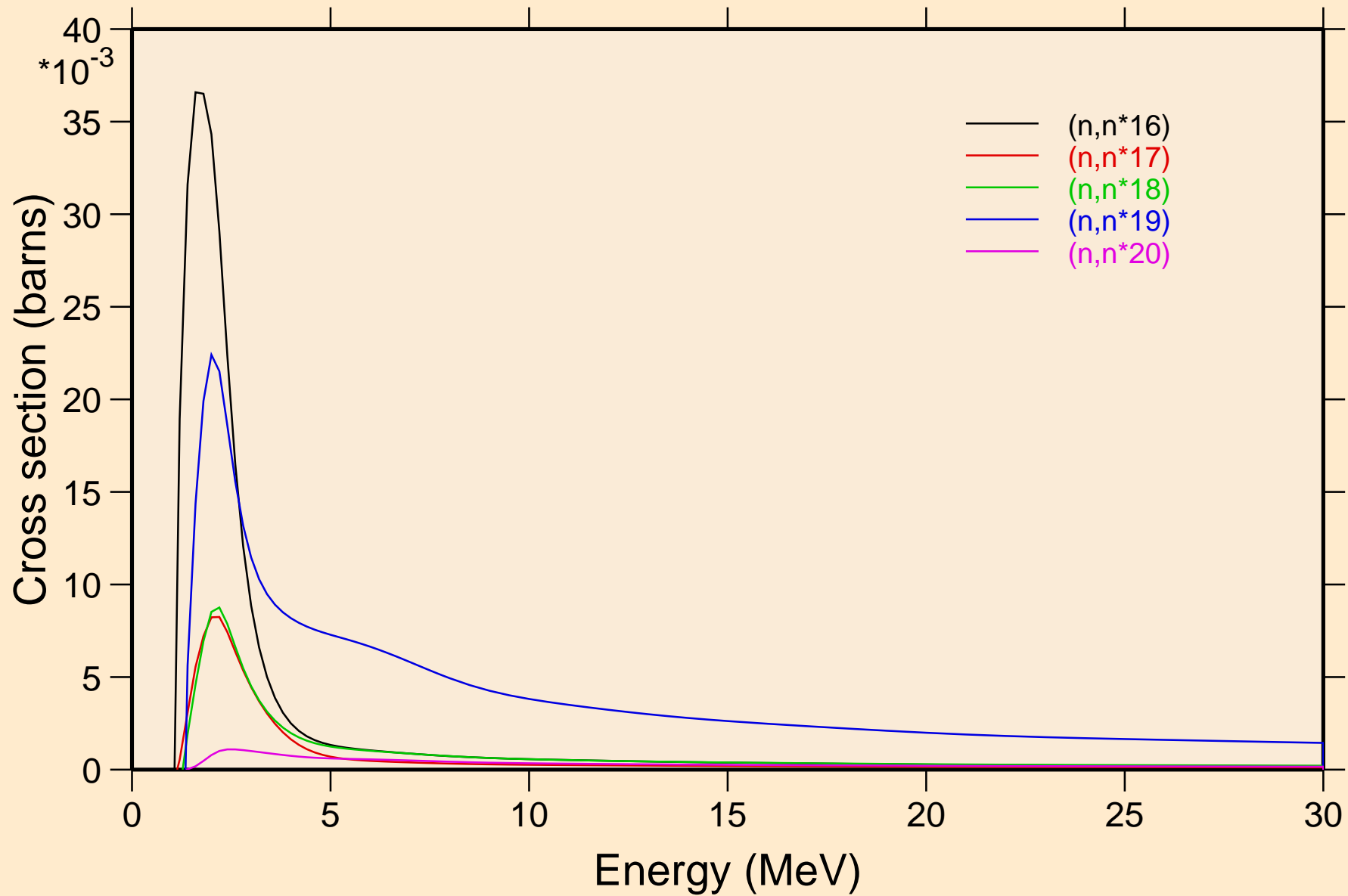

AU191 NEUTRON ACER TENDL-2021 LIBRARY; T=293.6K  
Inelastic levels

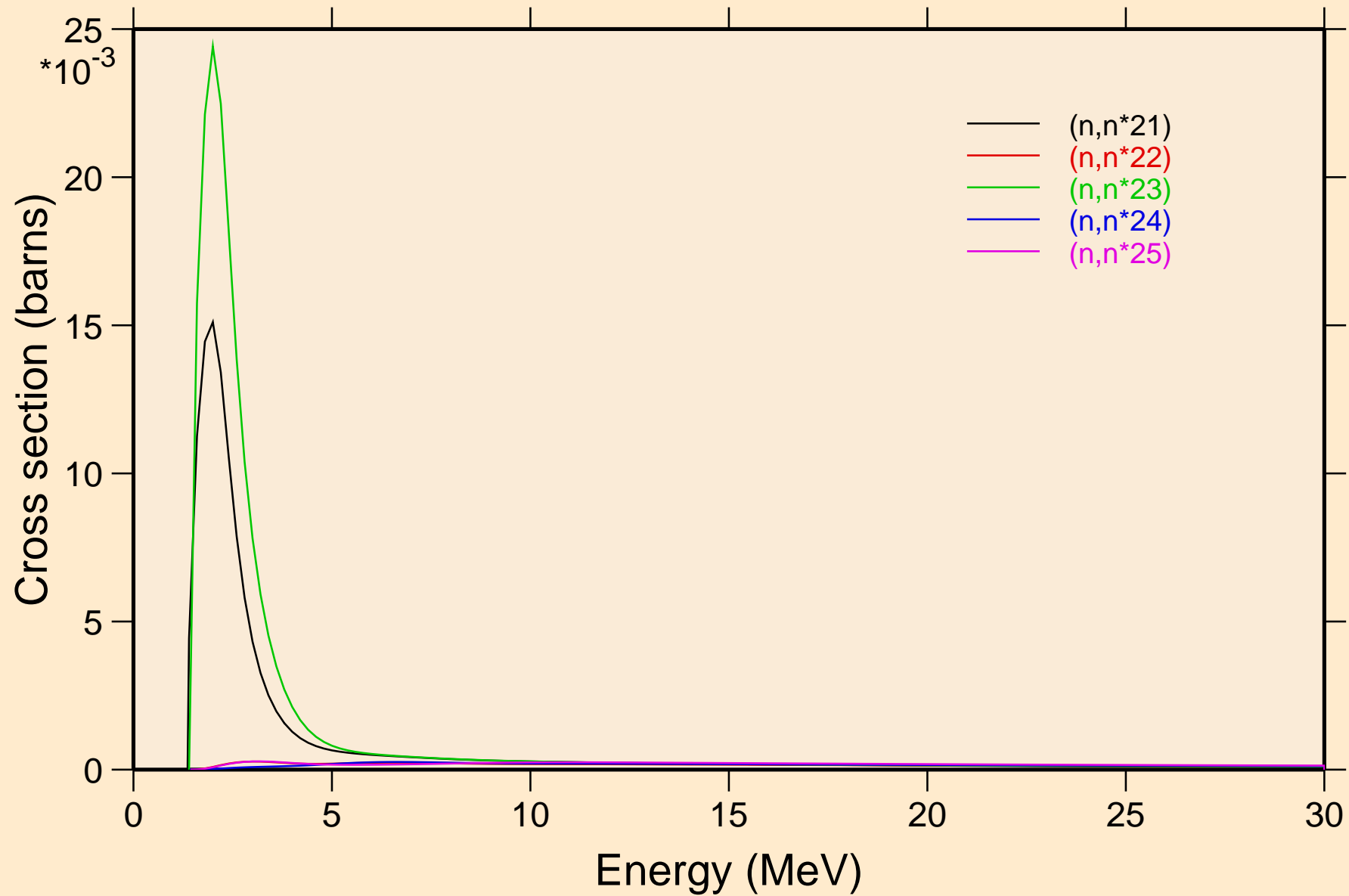

AU191 NEUTRON ACER TENDL-2021 LIBRARY; T=293.6K  
Inelastic levels

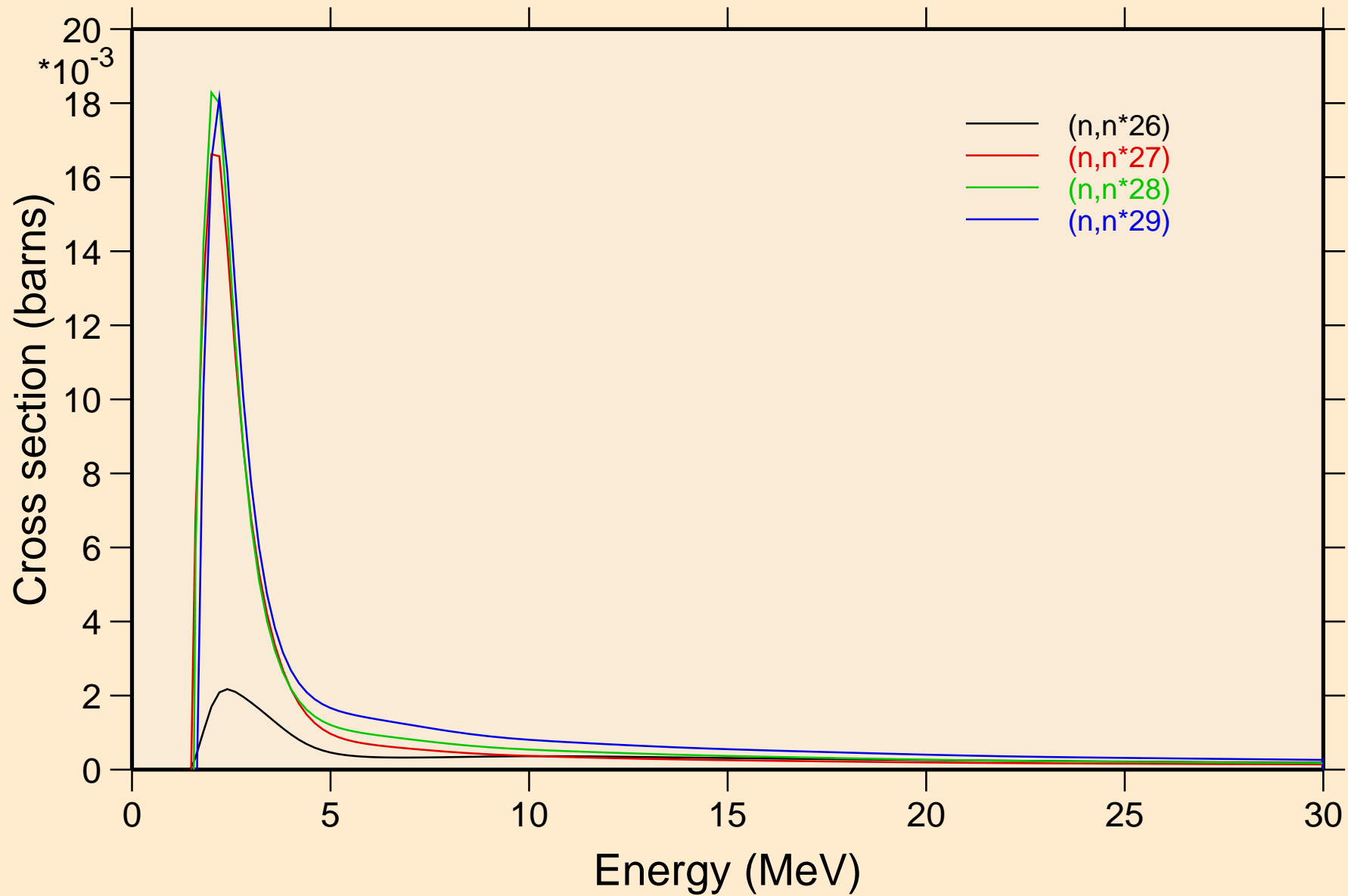

AU191 NEUTRON ACER TENDL-2021 LIBRARY; T=293.6K  
Threshold reactions

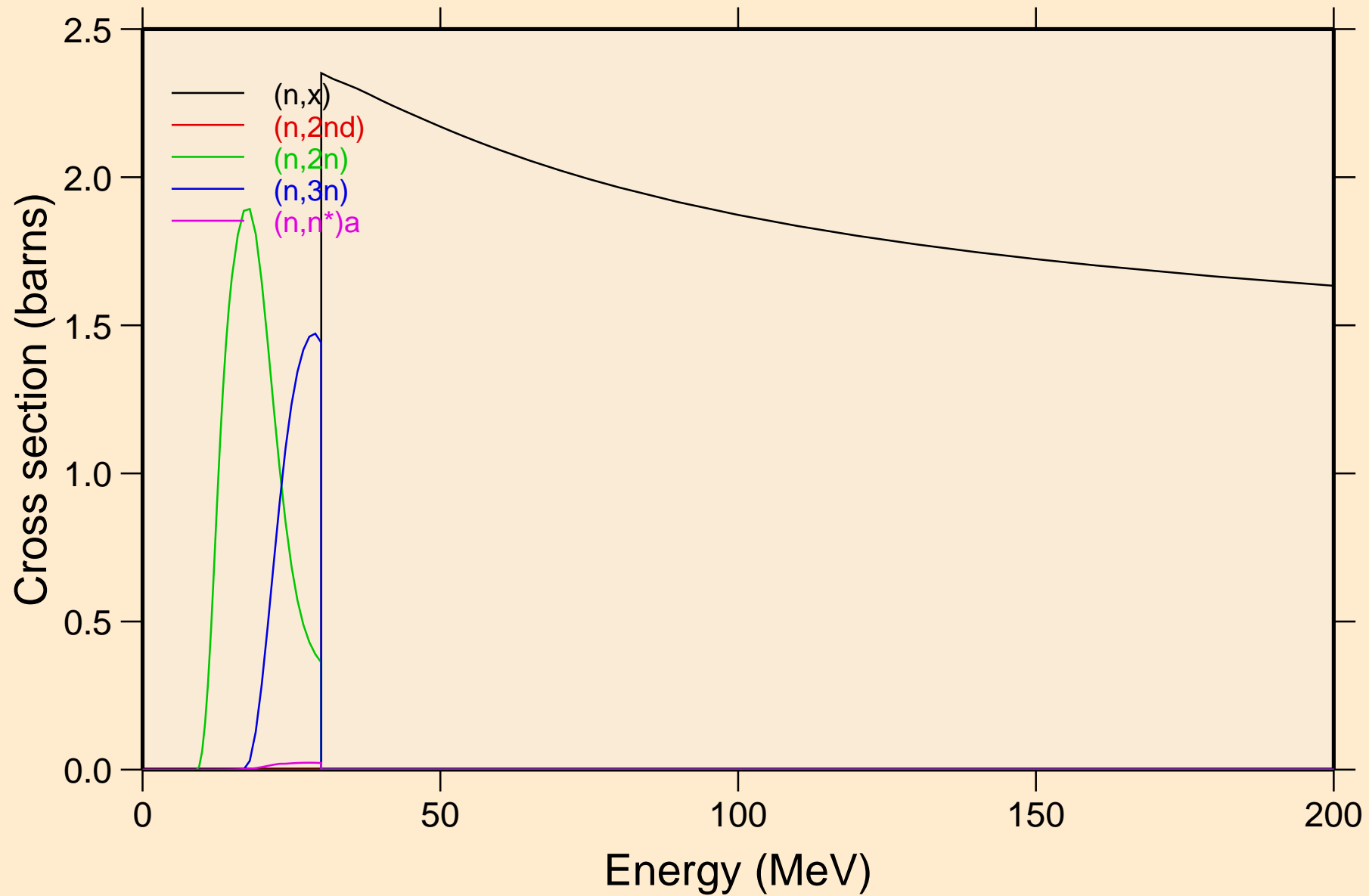

AU191 NEUTRON ACER TENDL-2021 LIBRARY; T=293.6K  
Threshold reactions

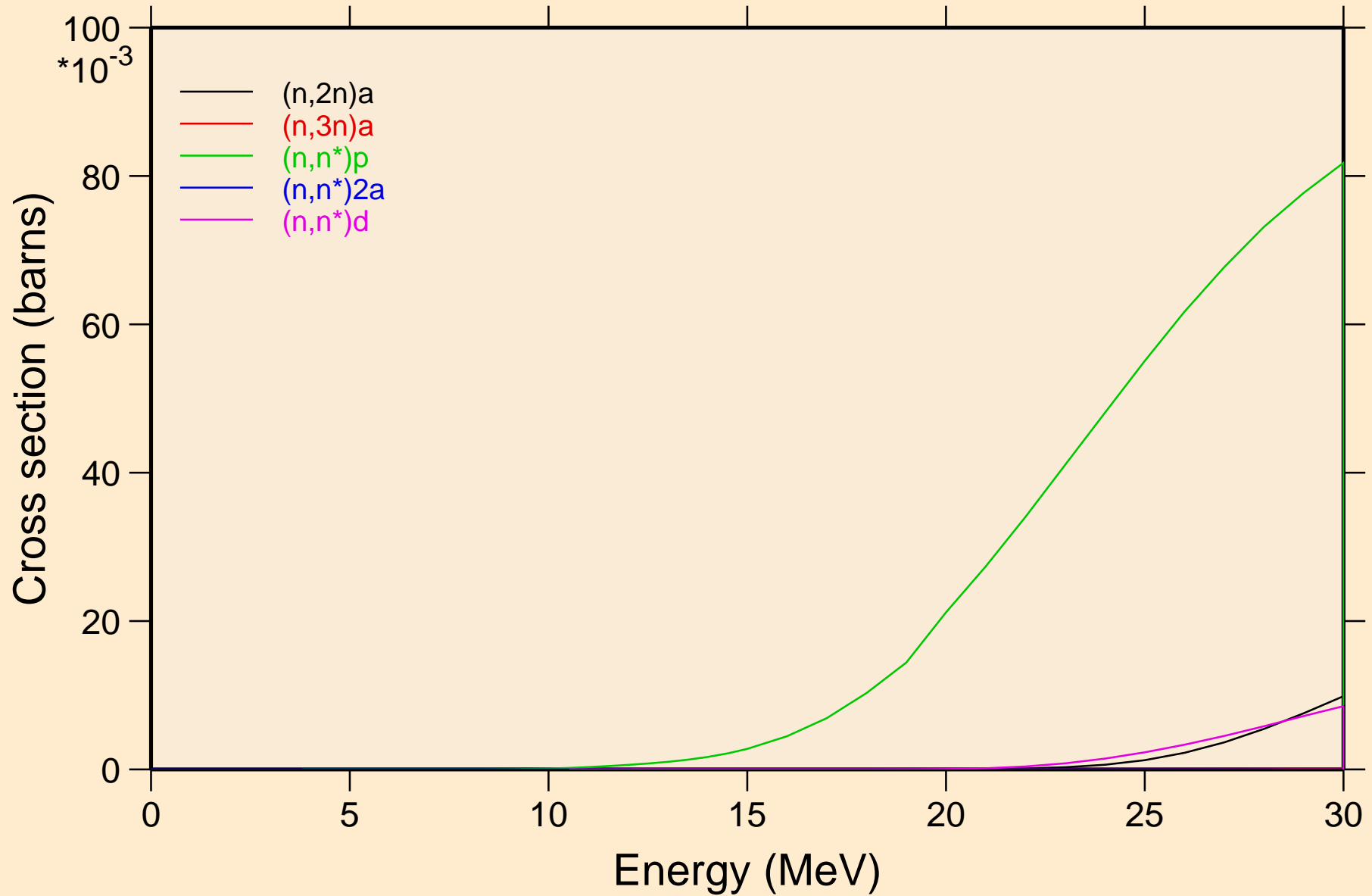



AU191 NEUTRON ACER TENDL-2021 LIBRARY; T=293.6K  
Threshold reactions

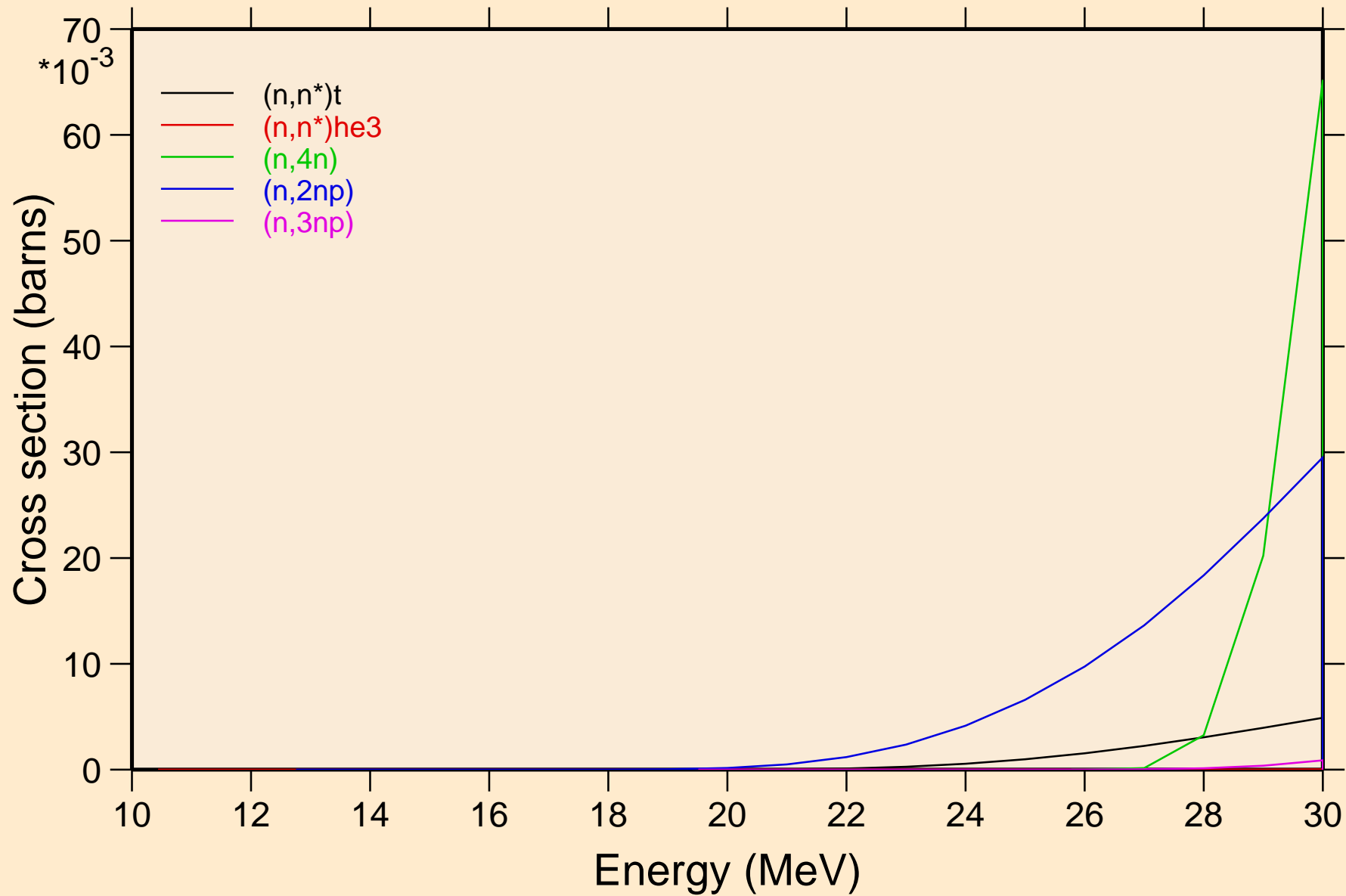

AU191 NEUTRON ACER TENDL-2021 LIBRARY; T=293.6K  
Threshold reactions

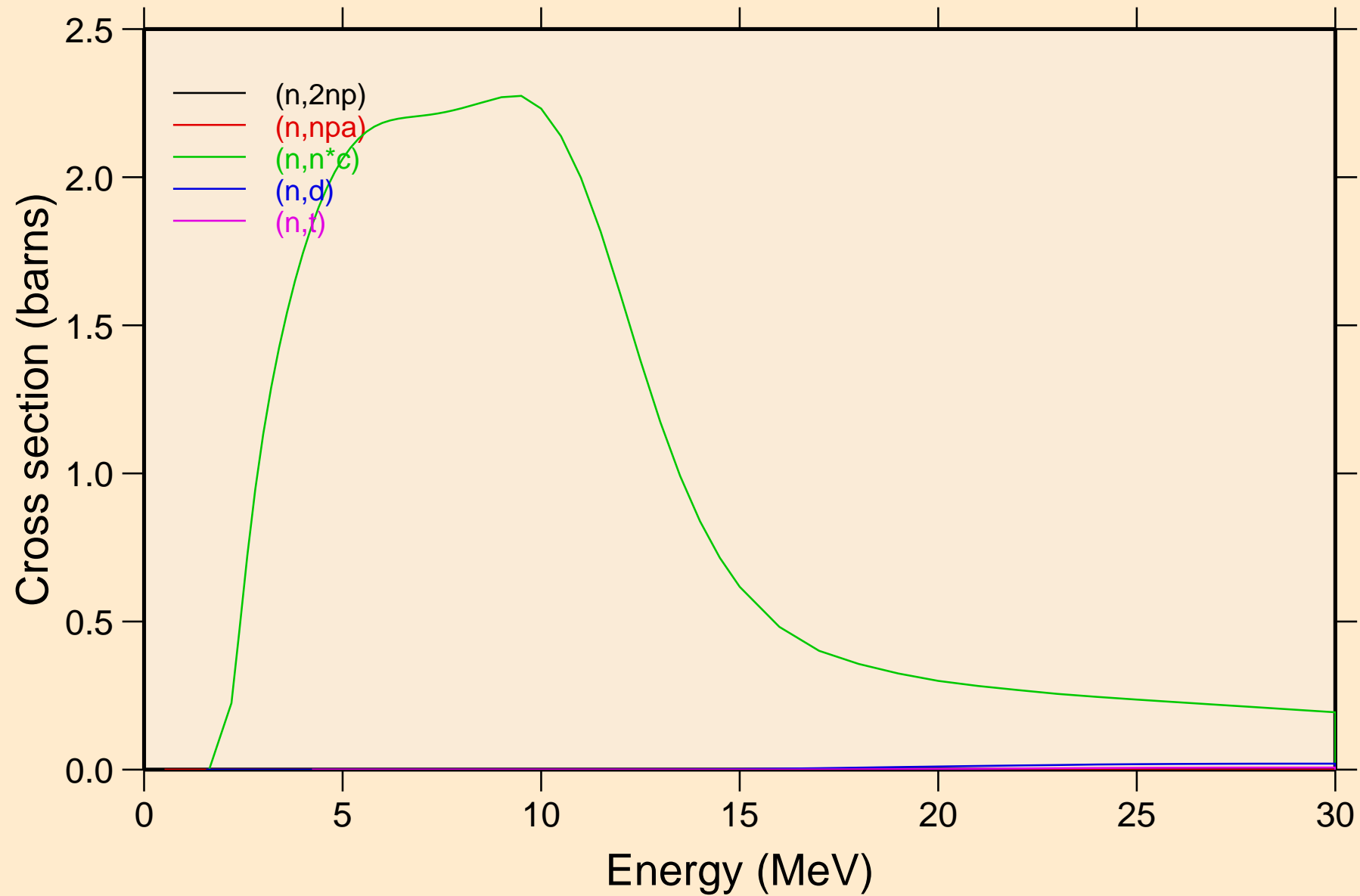

AU191 NEUTRON ACER TENDL-2021 LIBRARY; T=293.6K  
Threshold reactions

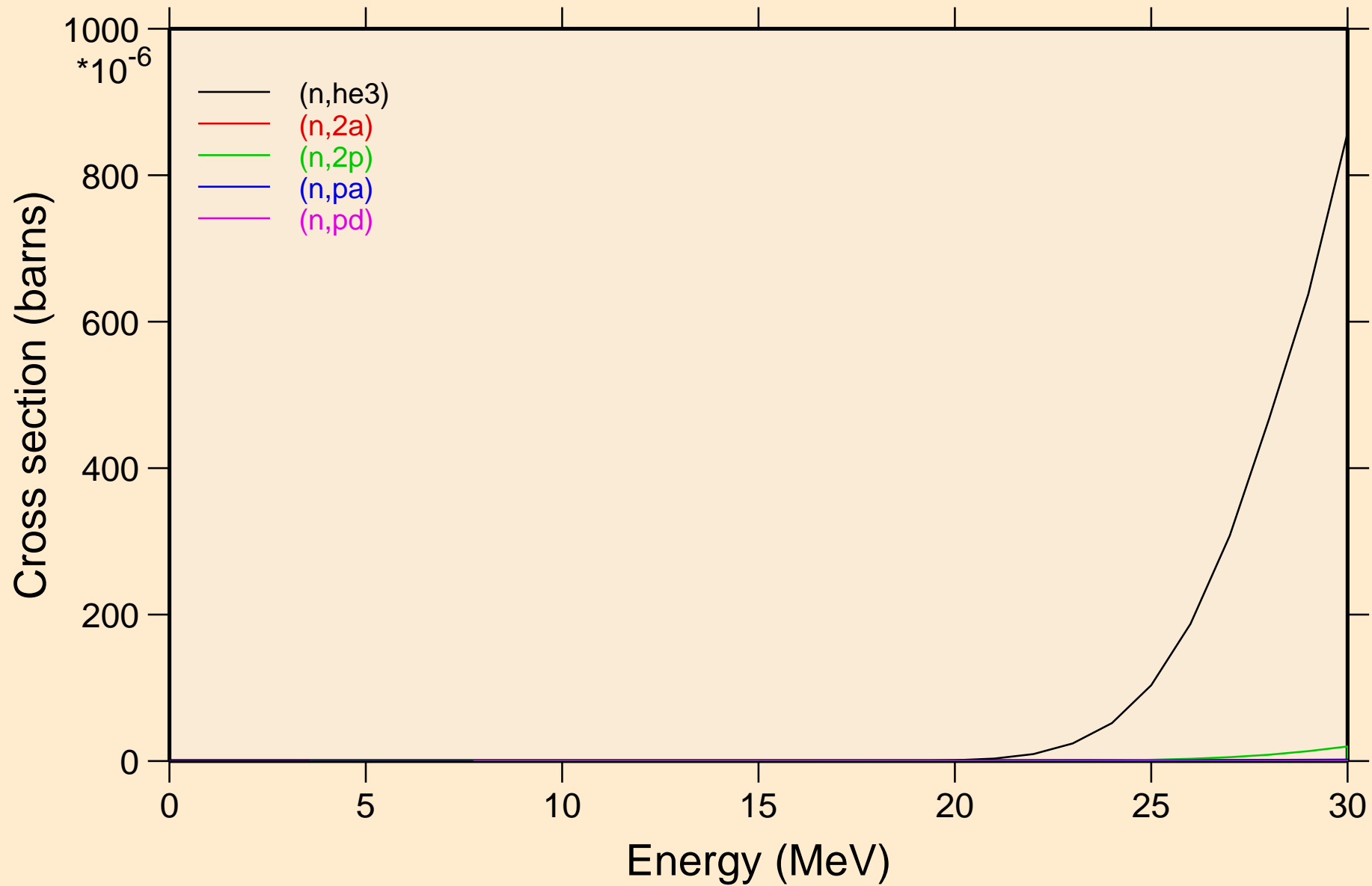

AU191 NEUTRON ACER TENDL-2021 LIBRARY; T=293.6K  
Threshold reactions

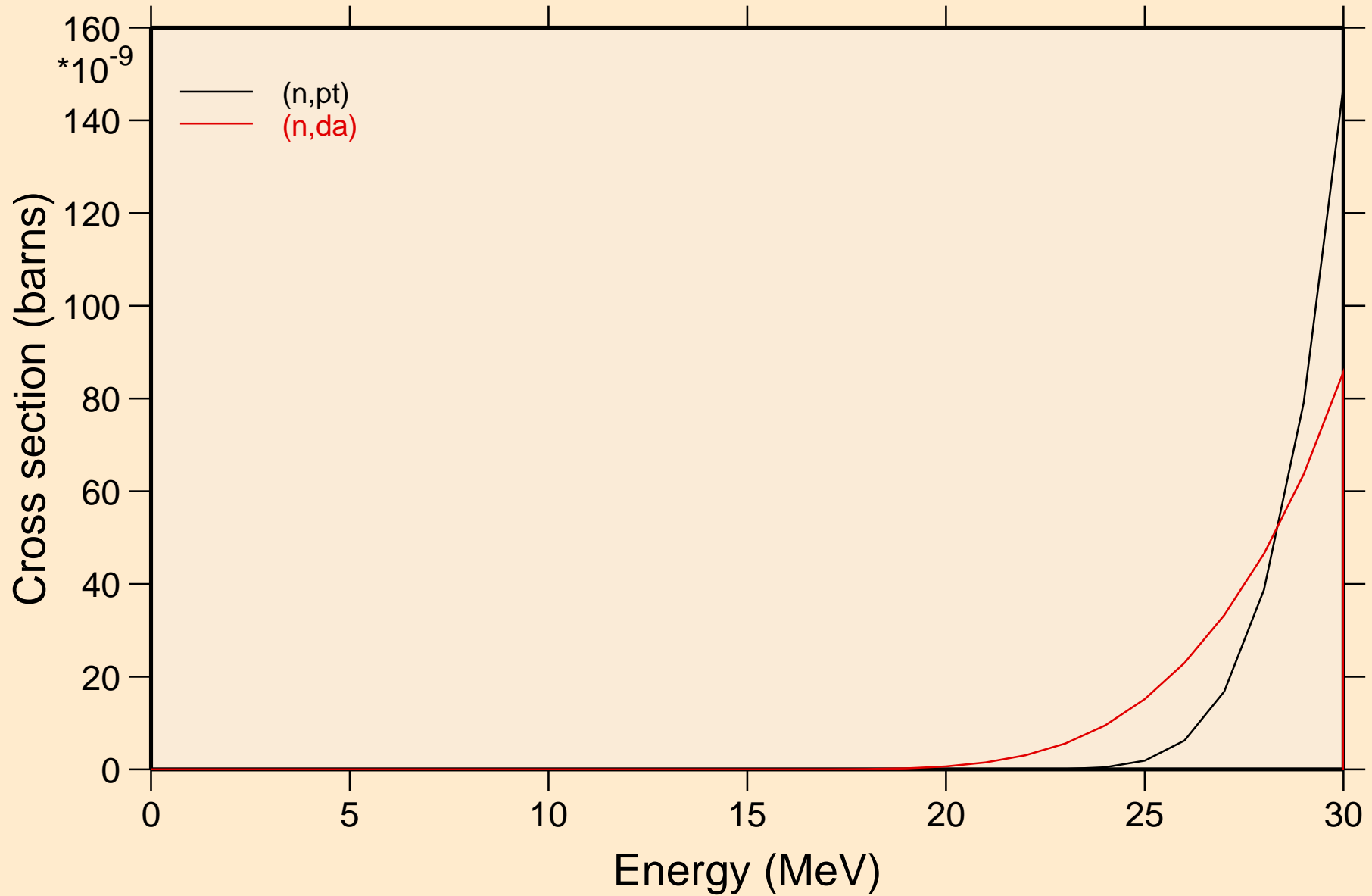

AU191 NEUTRON ACER TENDL-2021 LIBRARY; T=293.6K  
Threshold reactions

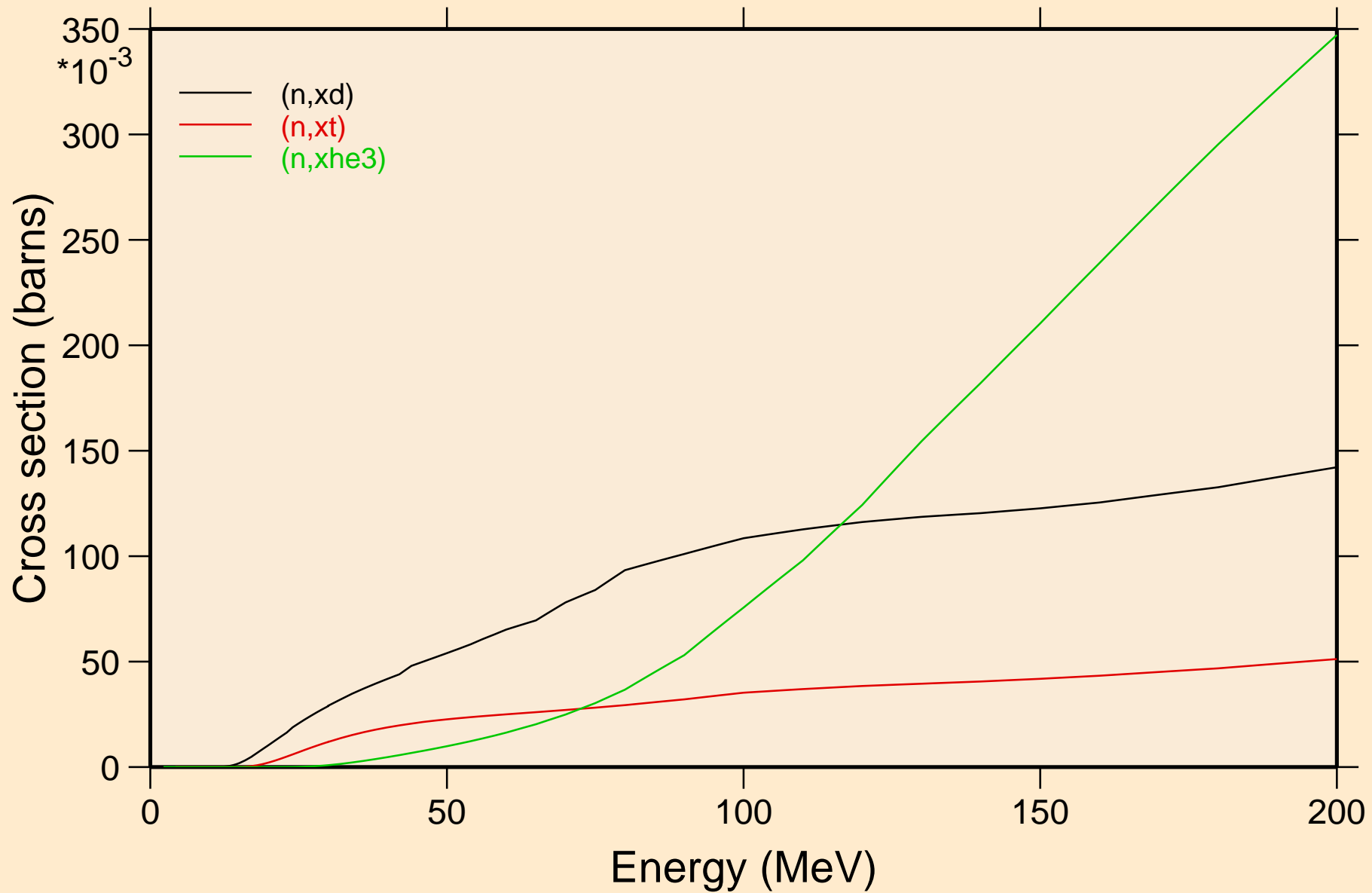

AU191 NEUTRON ACER TENDL-2021 LIBRARY; T=293.6K  
angular distribution for elastic

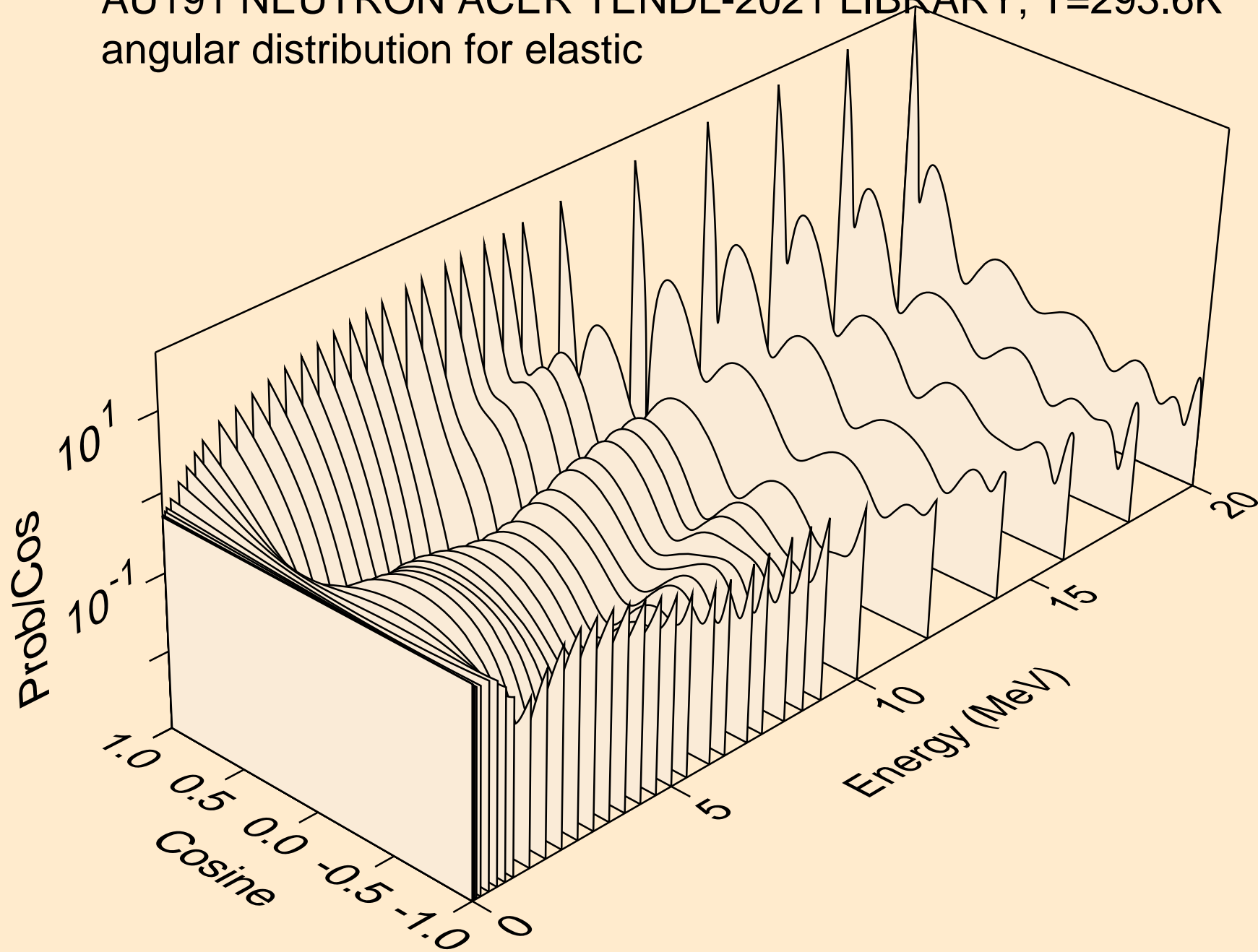

AU191 NEUTRON ACER TENDL-2021 LIBRARY; T=293.6K  
angular distribution for elastic

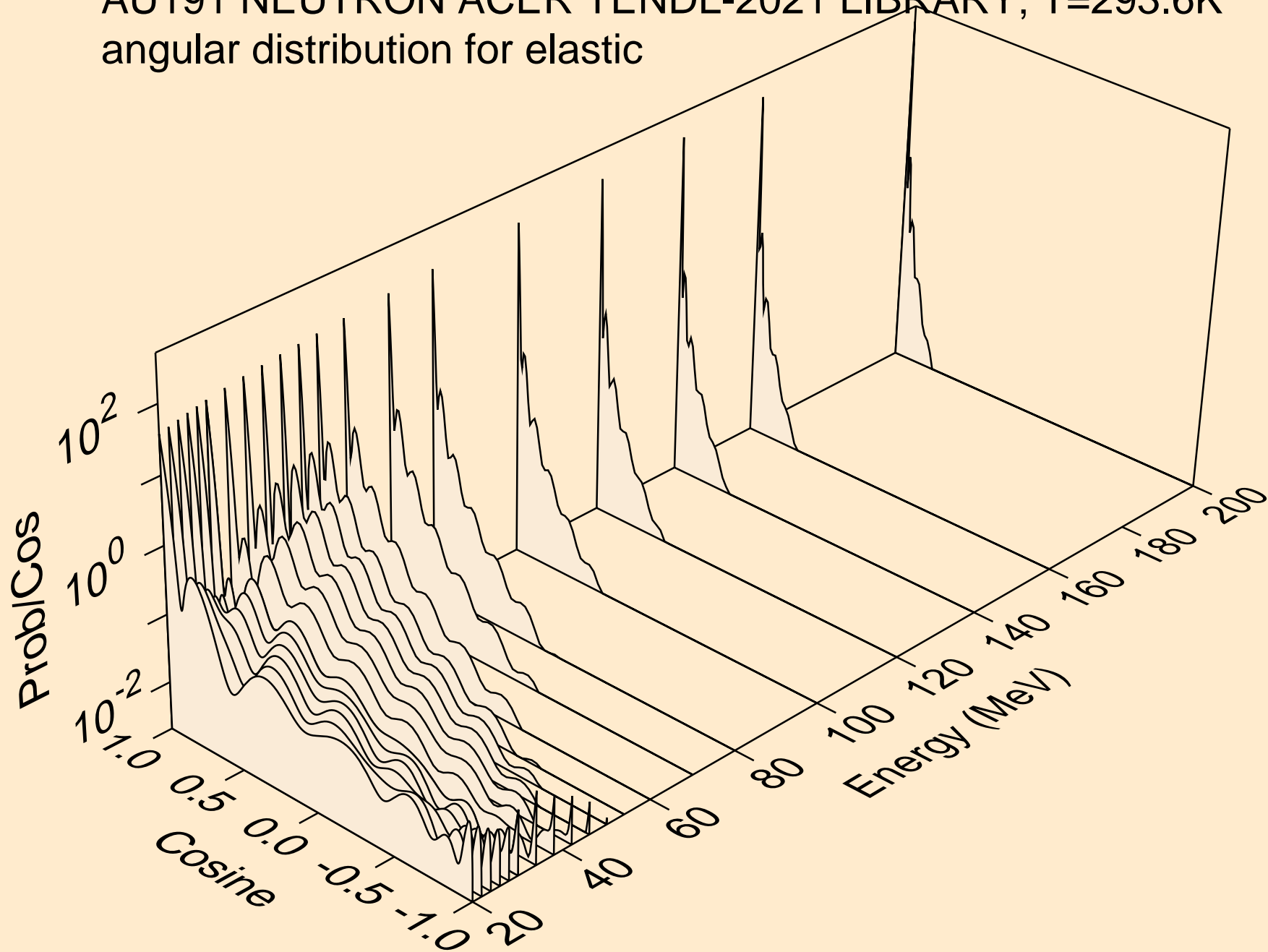

AU191 NEUTRON ACER TENDL-2021 LIBRARY; T=293.6K  
angular distribution for (n,n\*1)

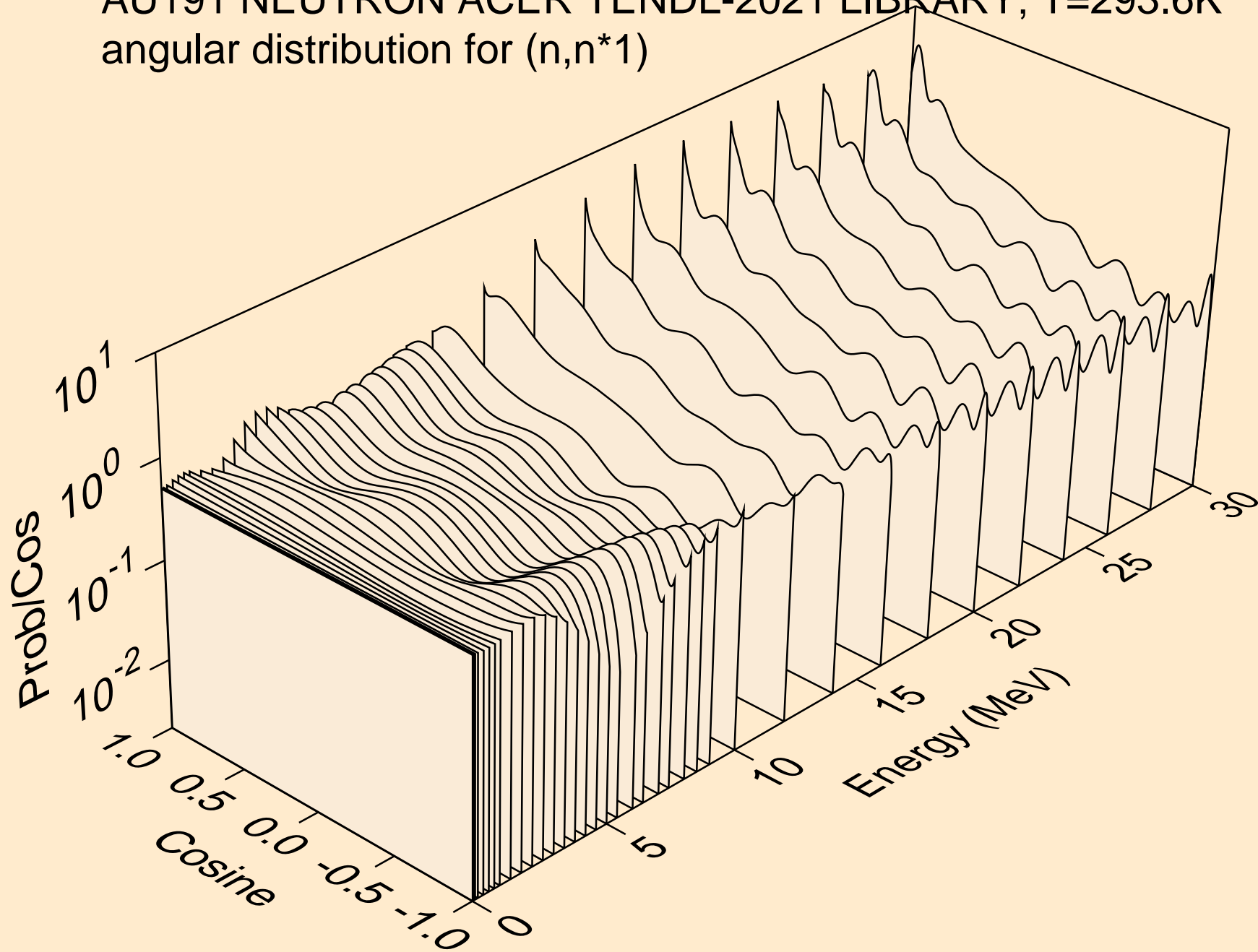



AU191 NEUTRON ACER TENDL-2021 LIBRARY; T=293.6K  
angular distribution for (n,n\*2)

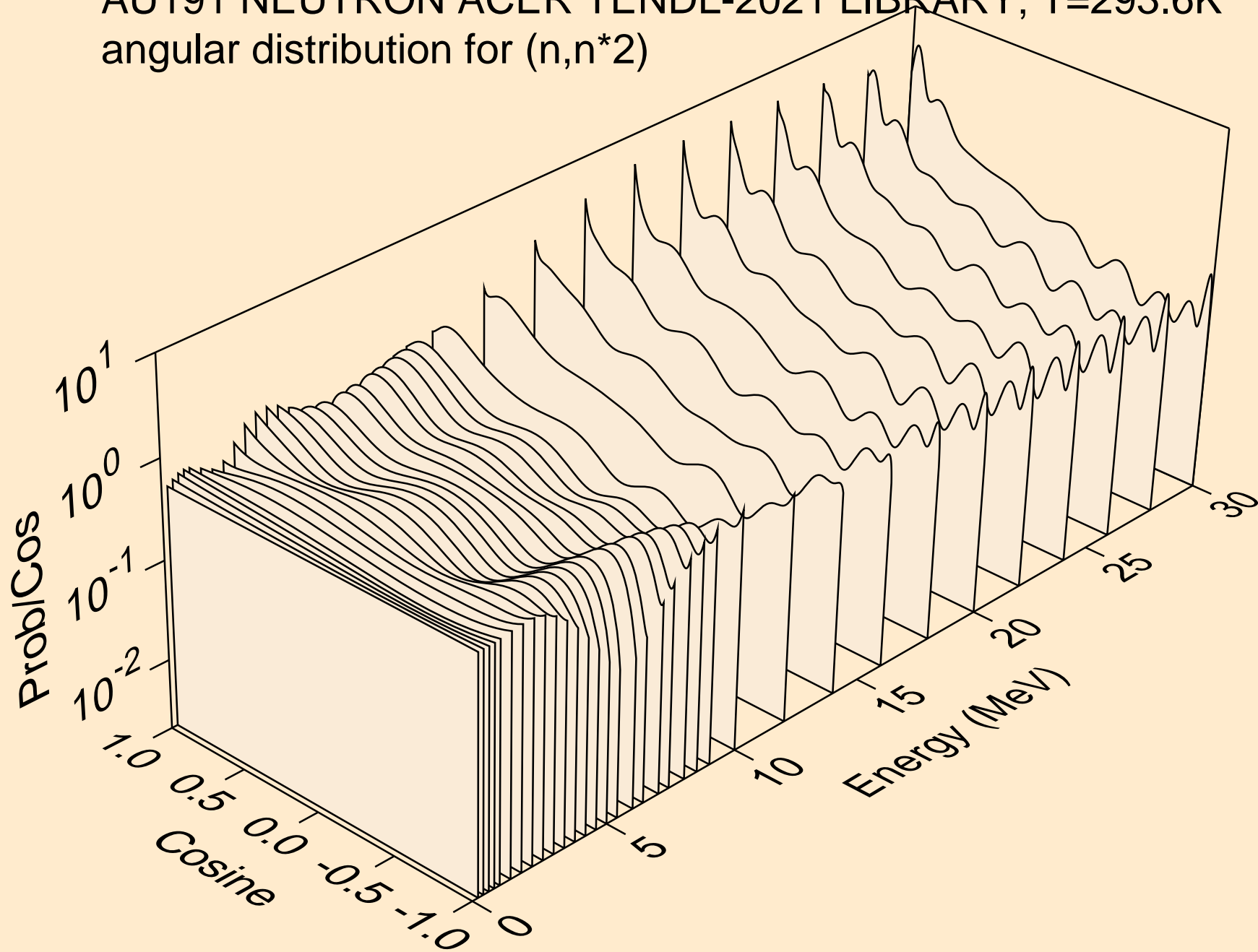

AU191 NEUTRON ACER TENDL-2021 LIBRARY; T=293.6K  
angular distribution for (n,n\*3)

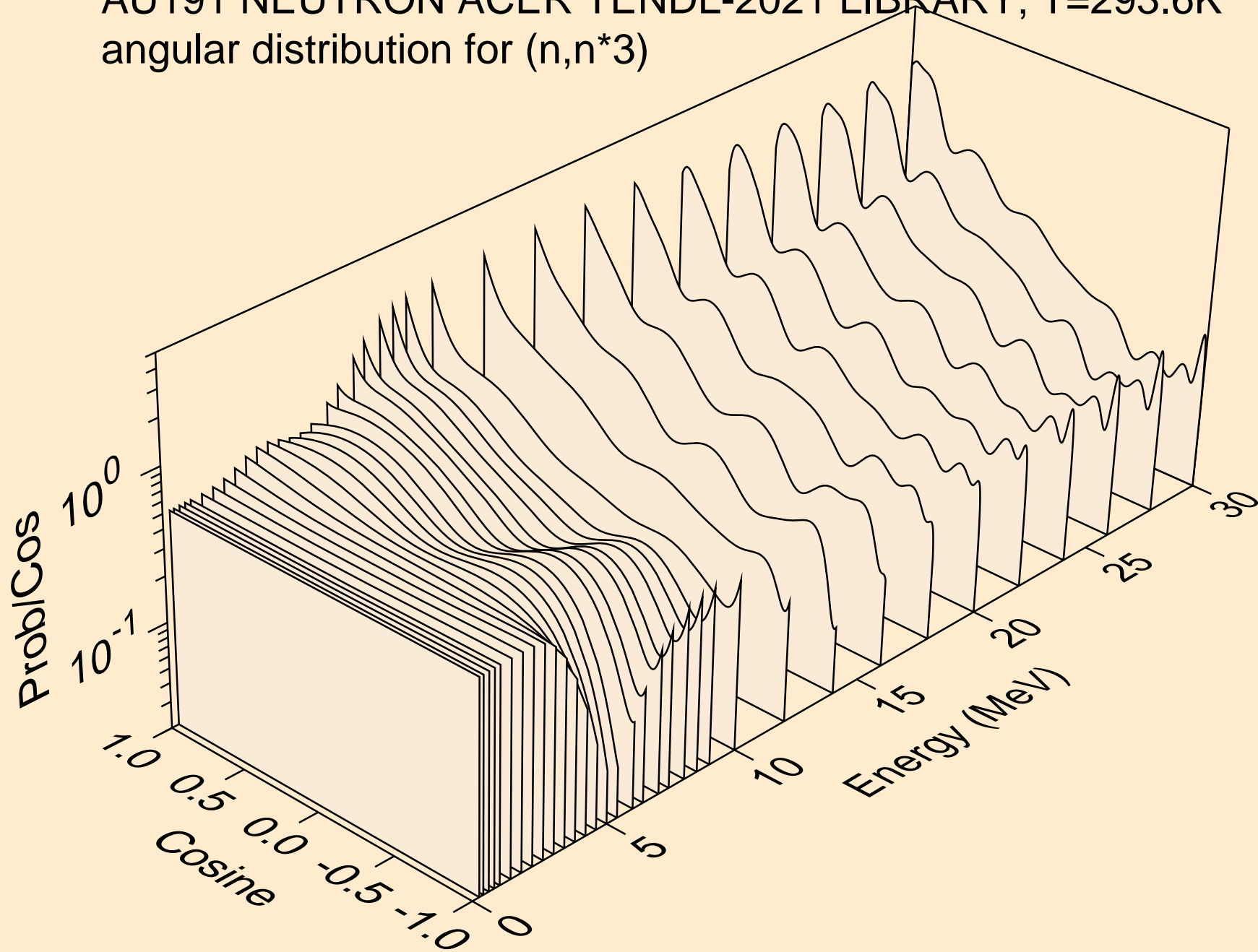

AU191 NEUTRON ACER TENDL-2021 LIBRARY; T=293.6K  
angular distribution for (n,n\*4)

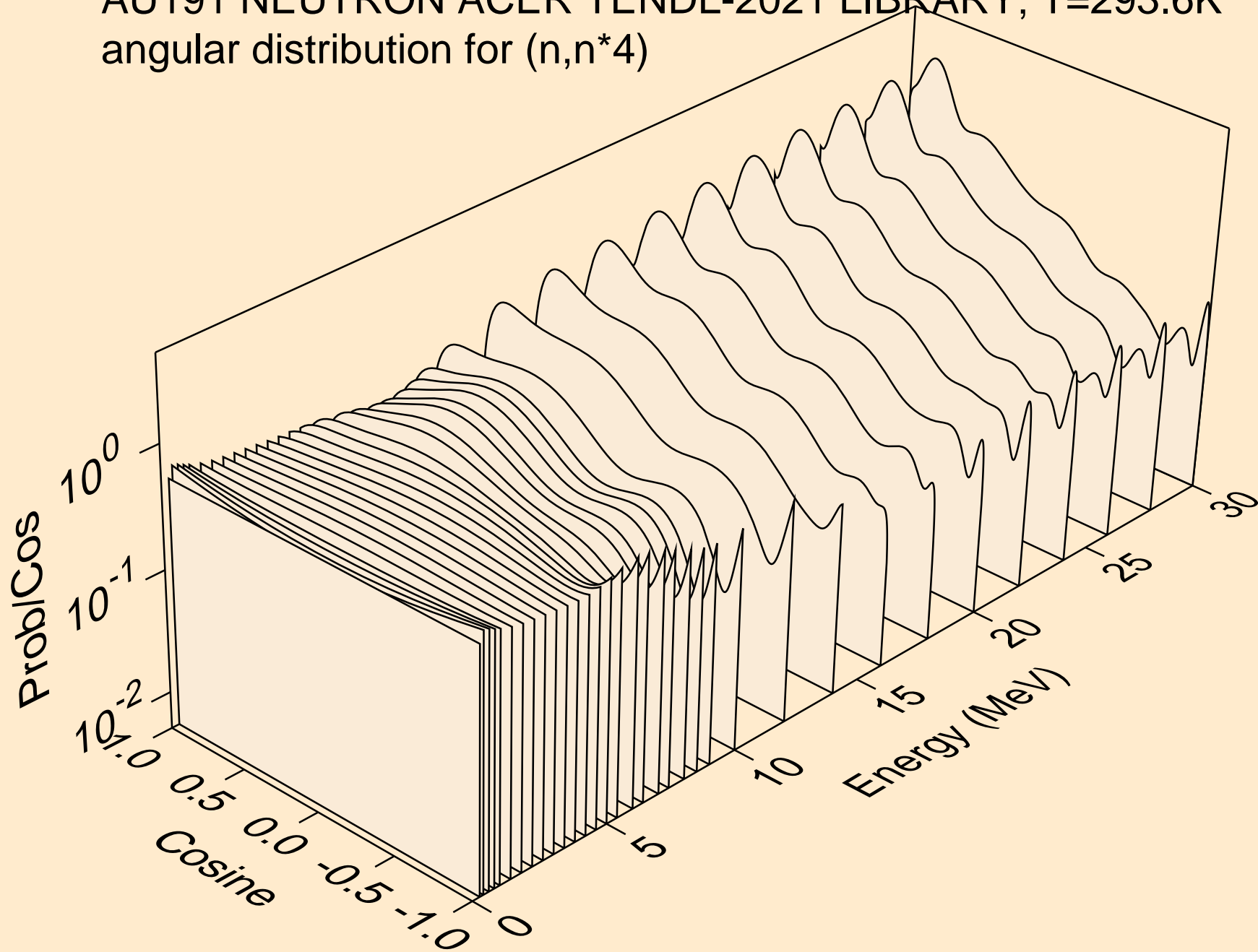

AU191 NEUTRON ACER TENDL-2021 LIBRARY; T=293.6K  
angular distribution for (n,n\*5)

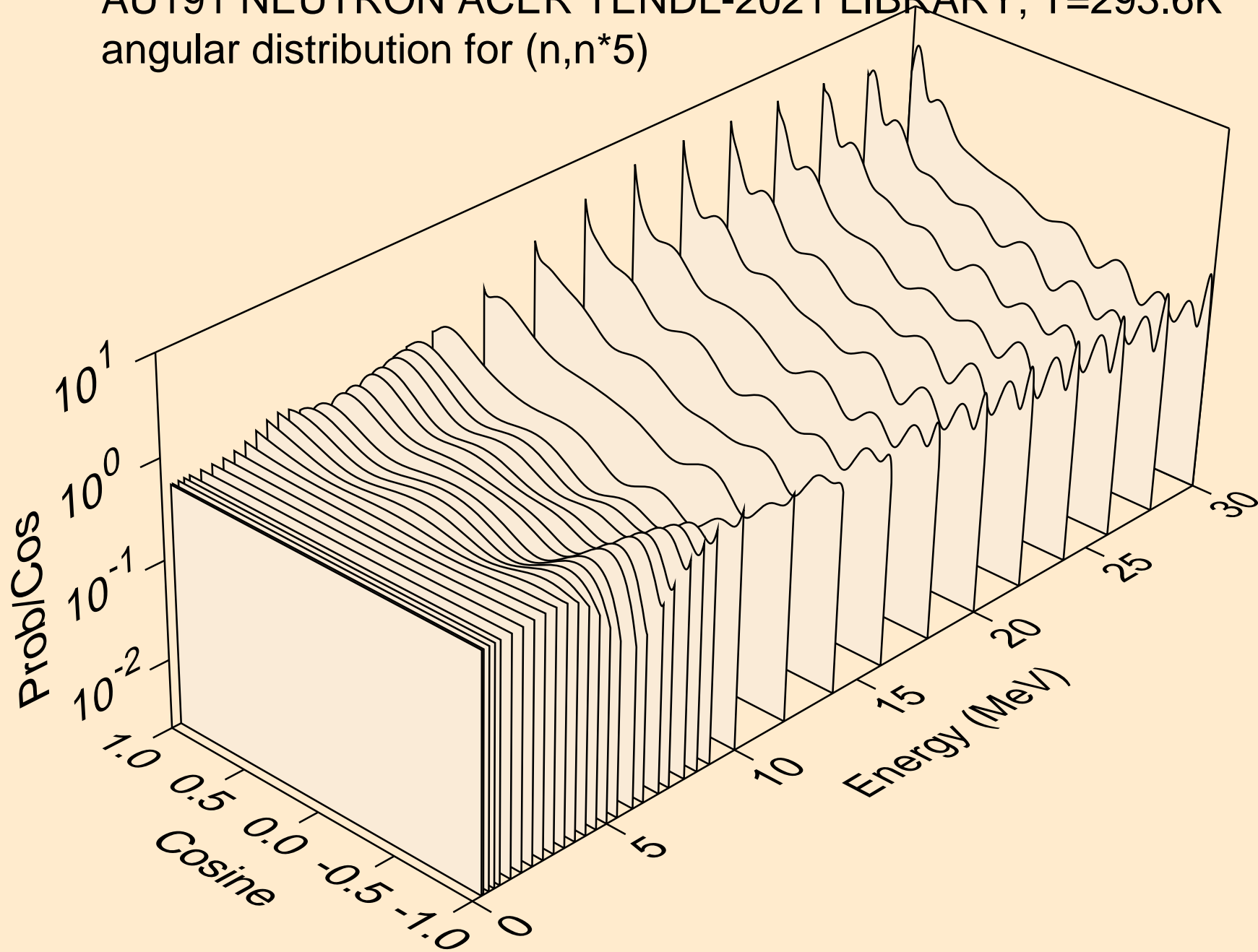

AU191 NEUTRON ACER TENDL-2021 LIBRARY; T=293.6K  
angular distribution for (n,n\*6)

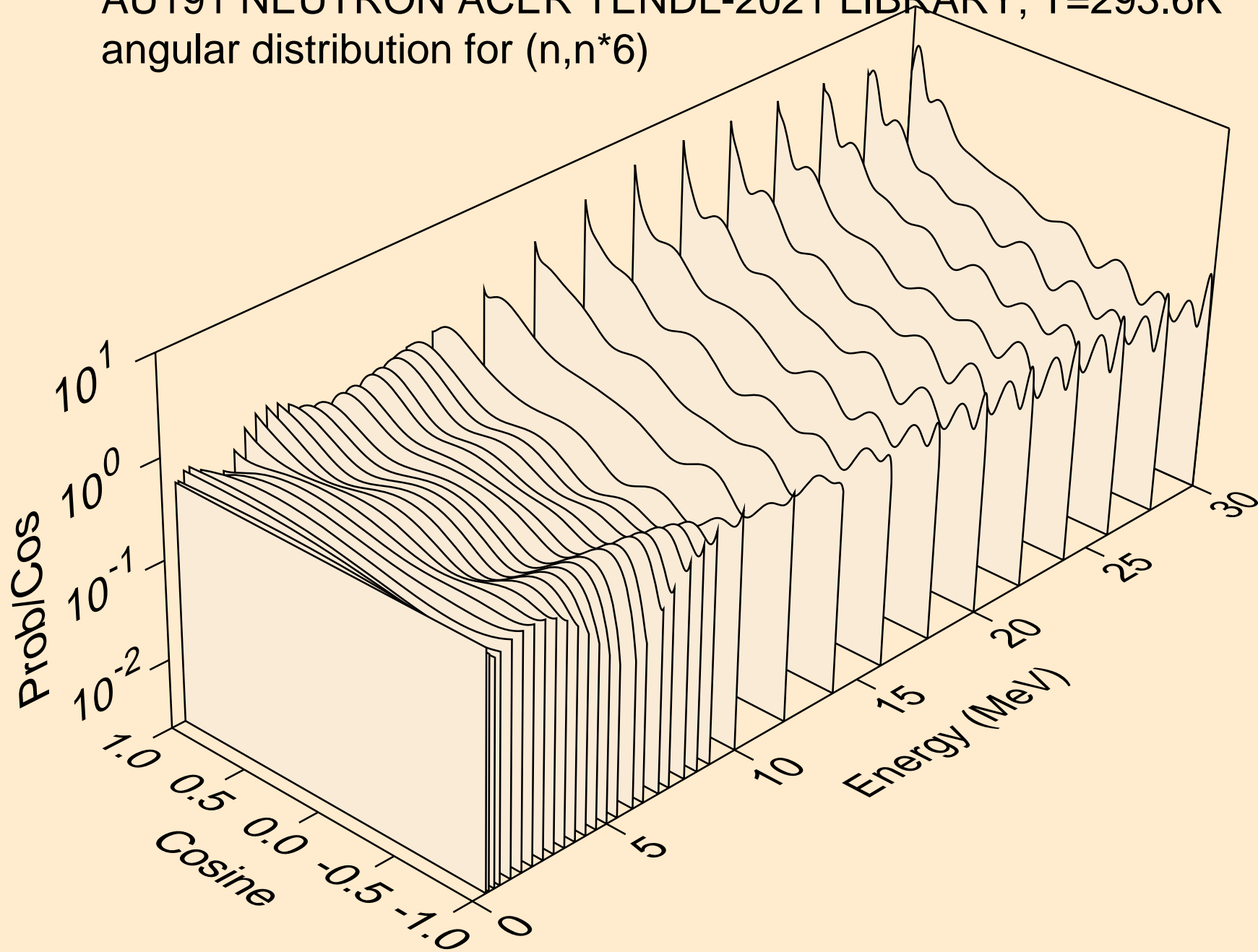

AU191 NEUTRON ACER TENDL-2021 LIBRARY; T=293.6K  
angular distribution for (n,n\*7)

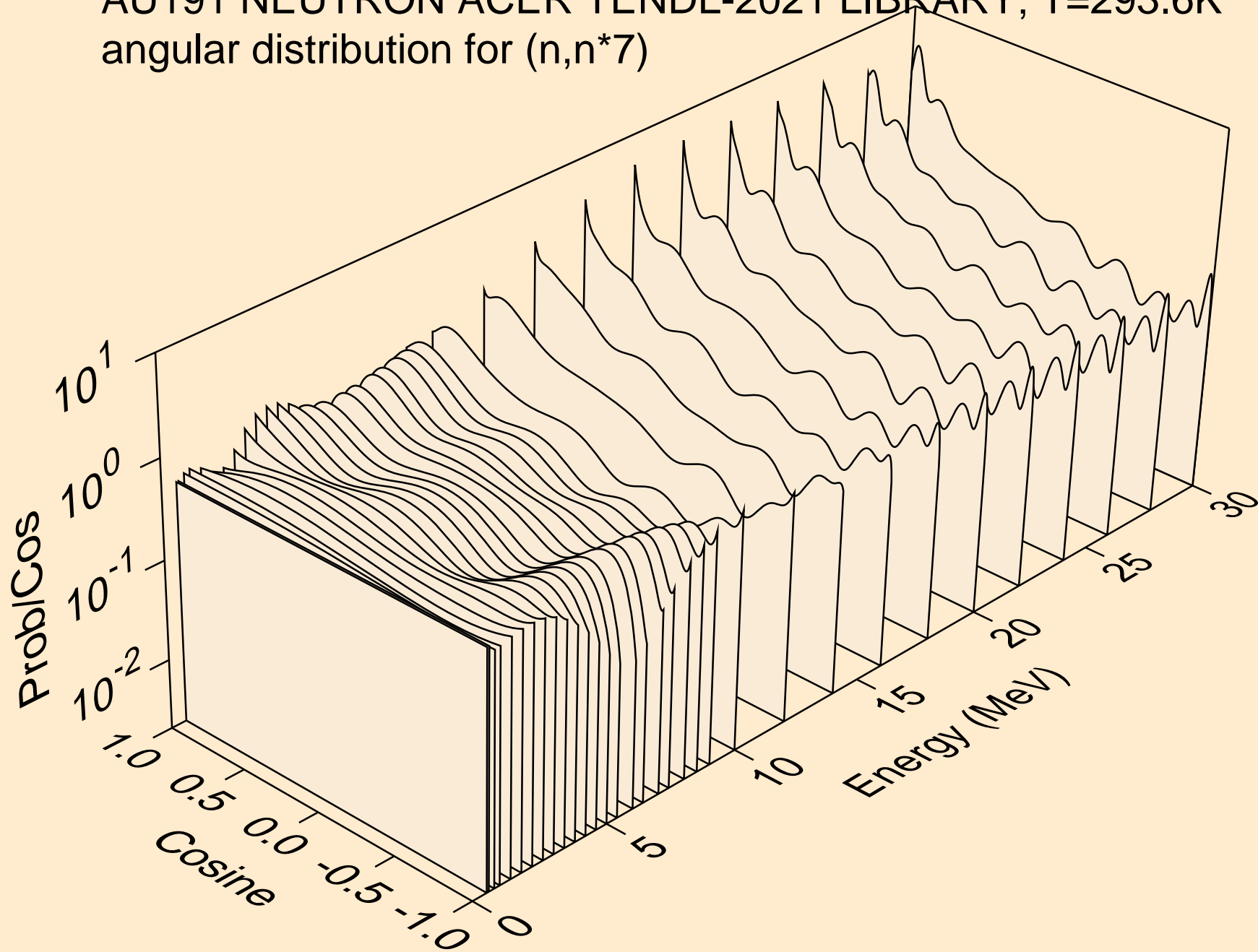

AU191 NEUTRON ACER TENDL-2021 LIBRARY; T=293.6K  
angular distribution for (n,n\*8)

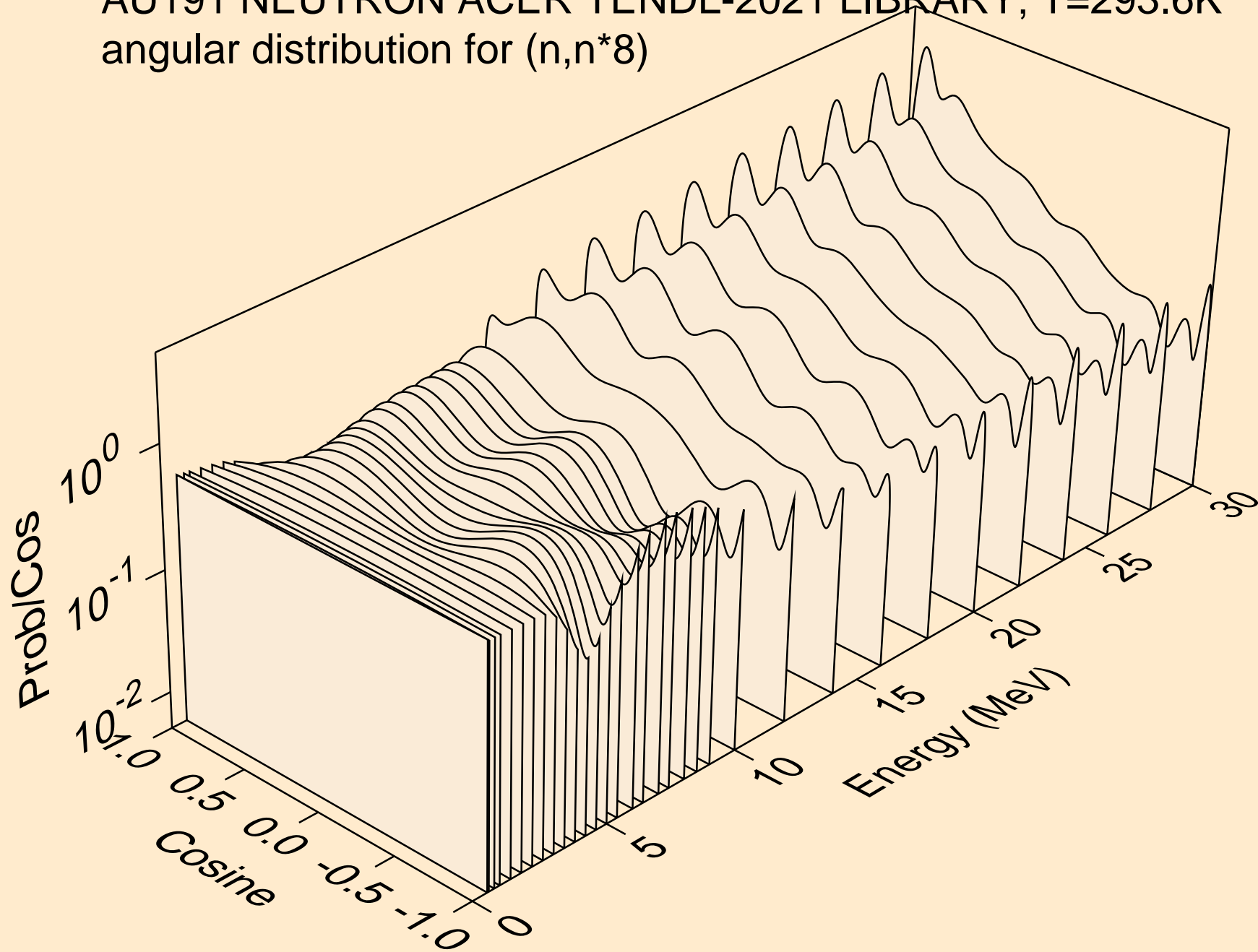

AU191 NEUTRON ACER TENDL-2021 LIBRARY; T=293.6K  
angular distribution for (n,n\*9)

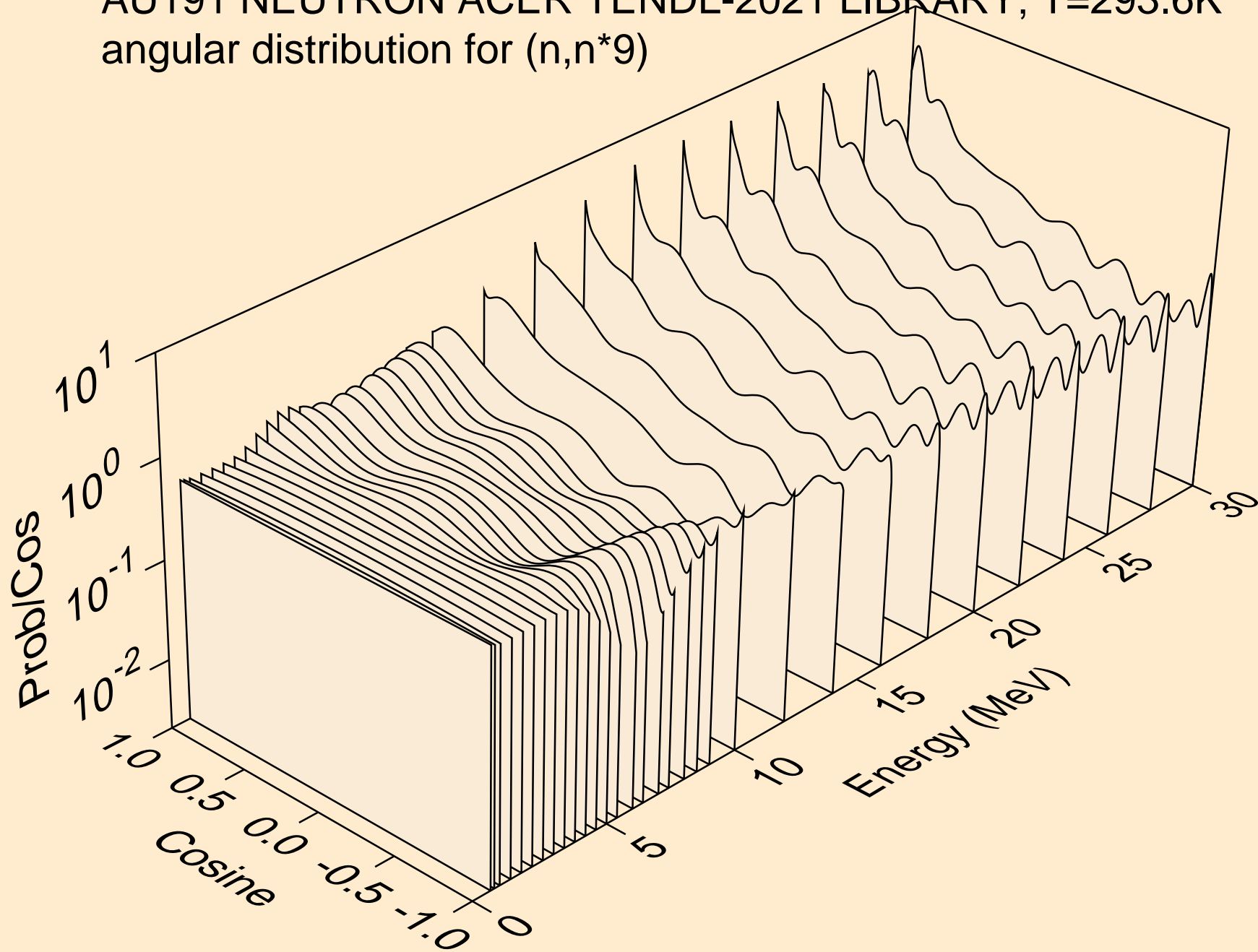



AU191 NEUTRON ACER TENDL-2021 LIBRARY; T=293.6K  
angular distribution for (n,n\*10)

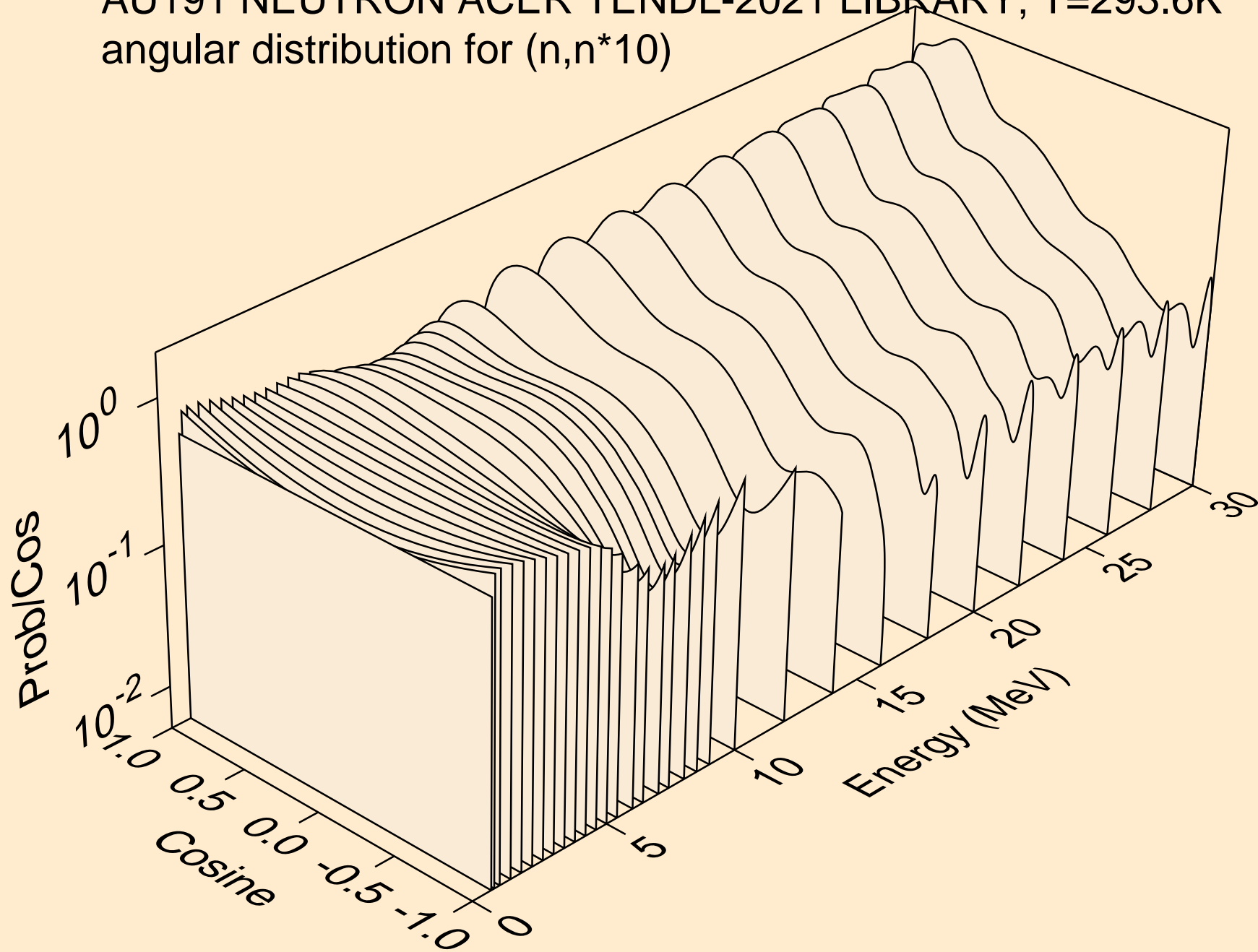

AU191 NEUTRON ACER TENDL-2021 LIBRARY; T=293.6K  
angular distribution for (n,n\*11)

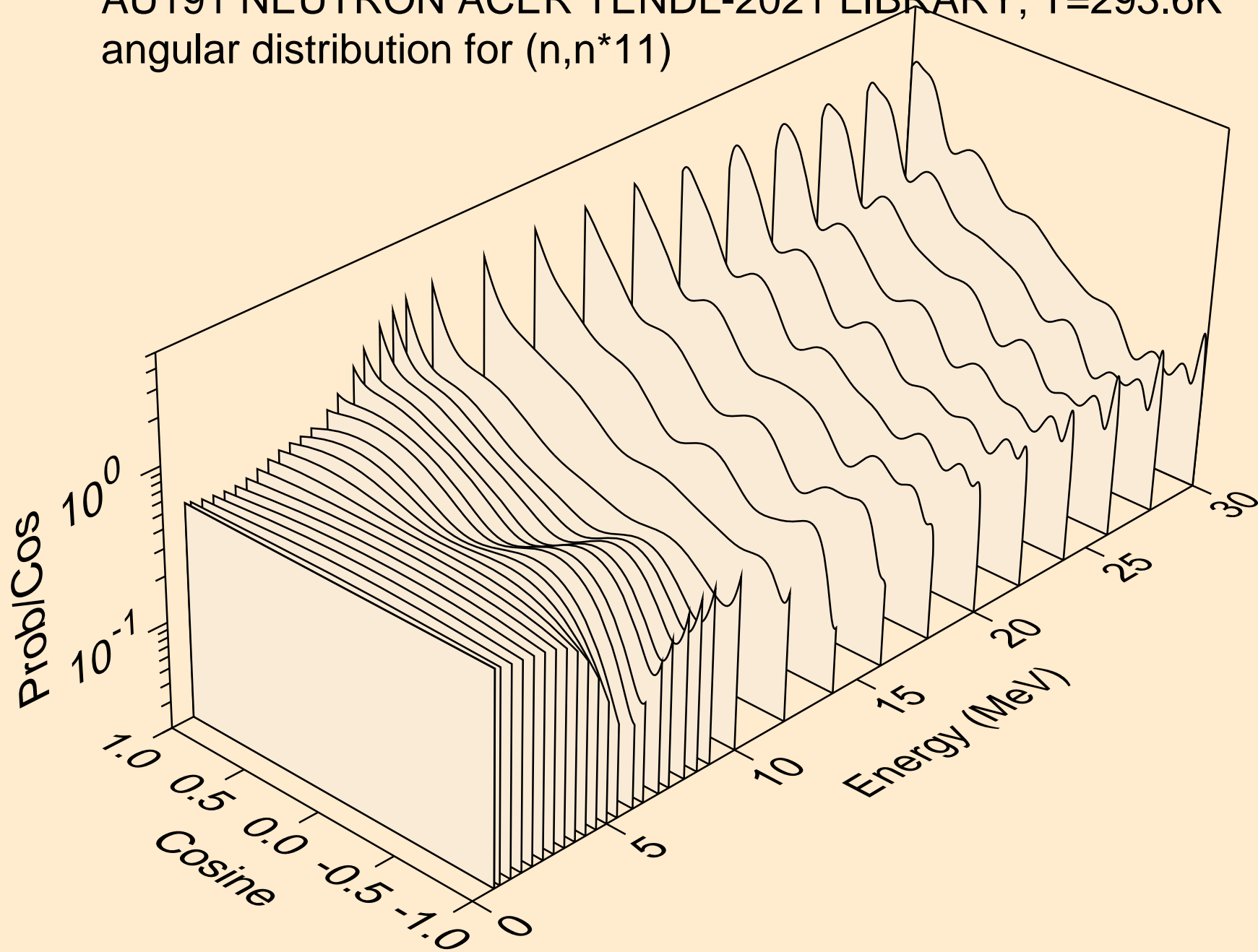

AU191 NEUTRON ACER TENDL-2021 LIBRARY; T=293.6K  
angular distribution for (n,n\*12)

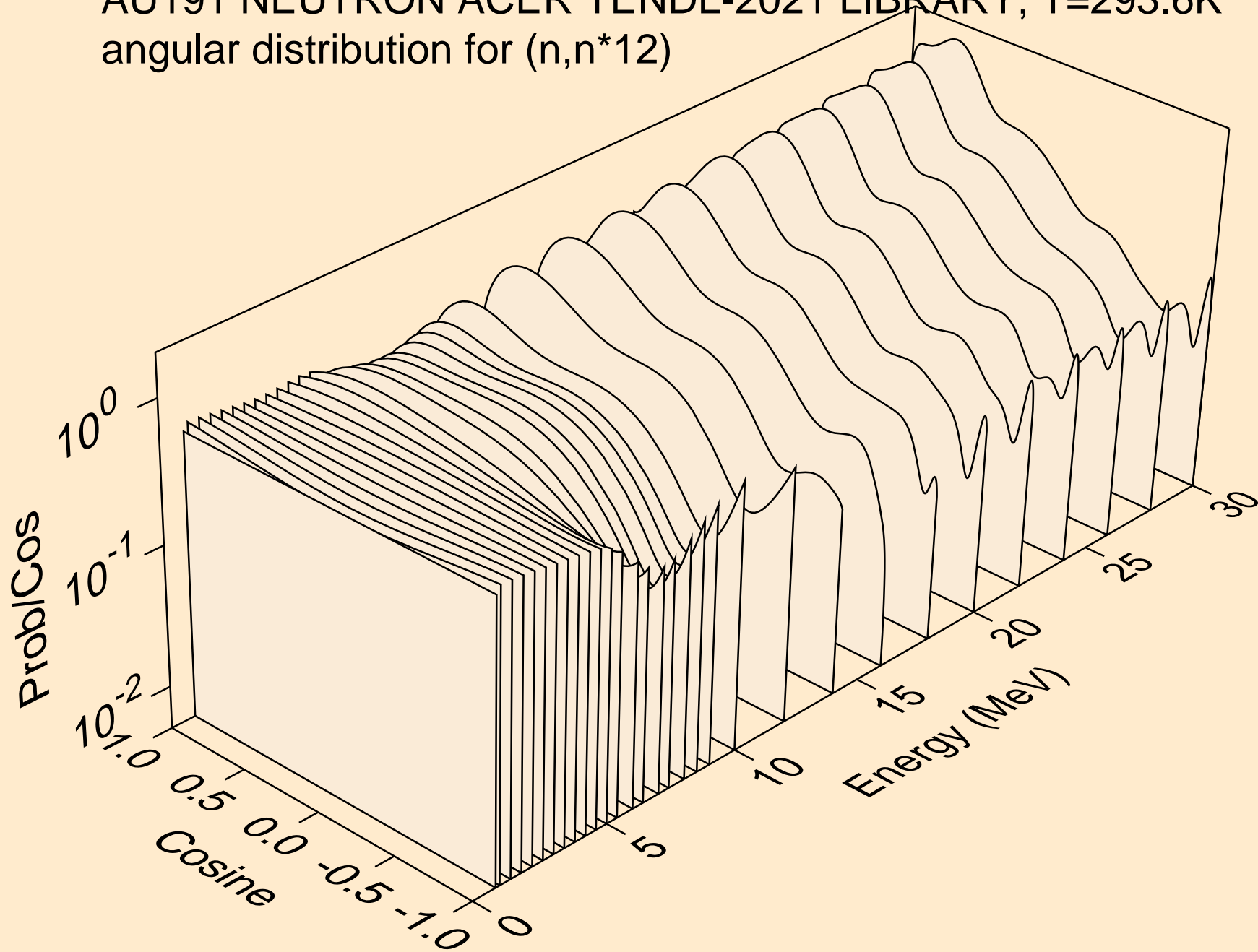

AU191 NEUTRON ACER TENDL-2021 LIBRARY; T=293.6K  
angular distribution for (n,n\*13)

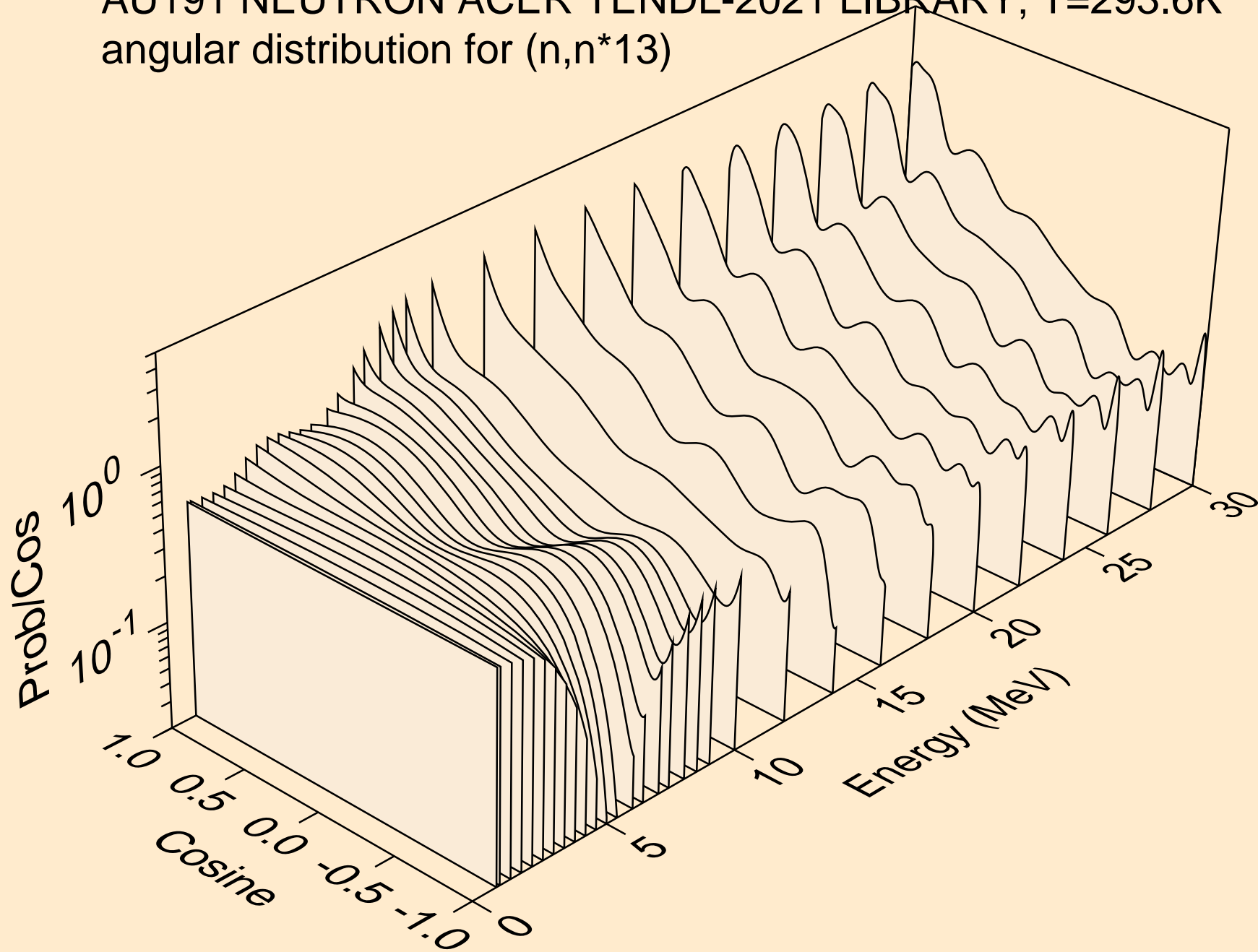

AU191 NEUTRON ACER TENDL-2021 LIBRARY; T=293.6K  
angular distribution for (n,n\*14)

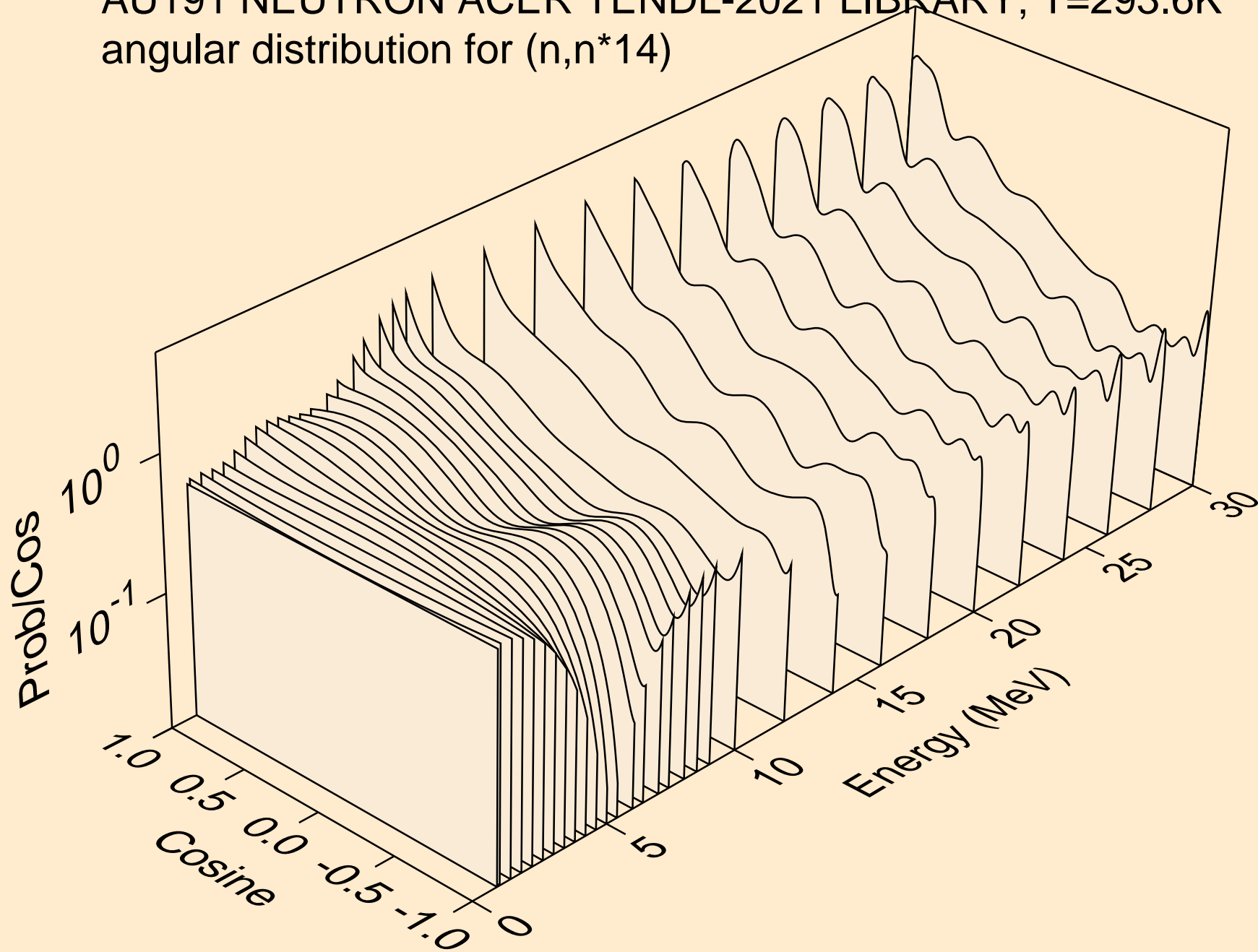

AU191 NEUTRON ACER TENDL-2021 LIBRARY; T=293.6K  
angular distribution for (n,n\*15)

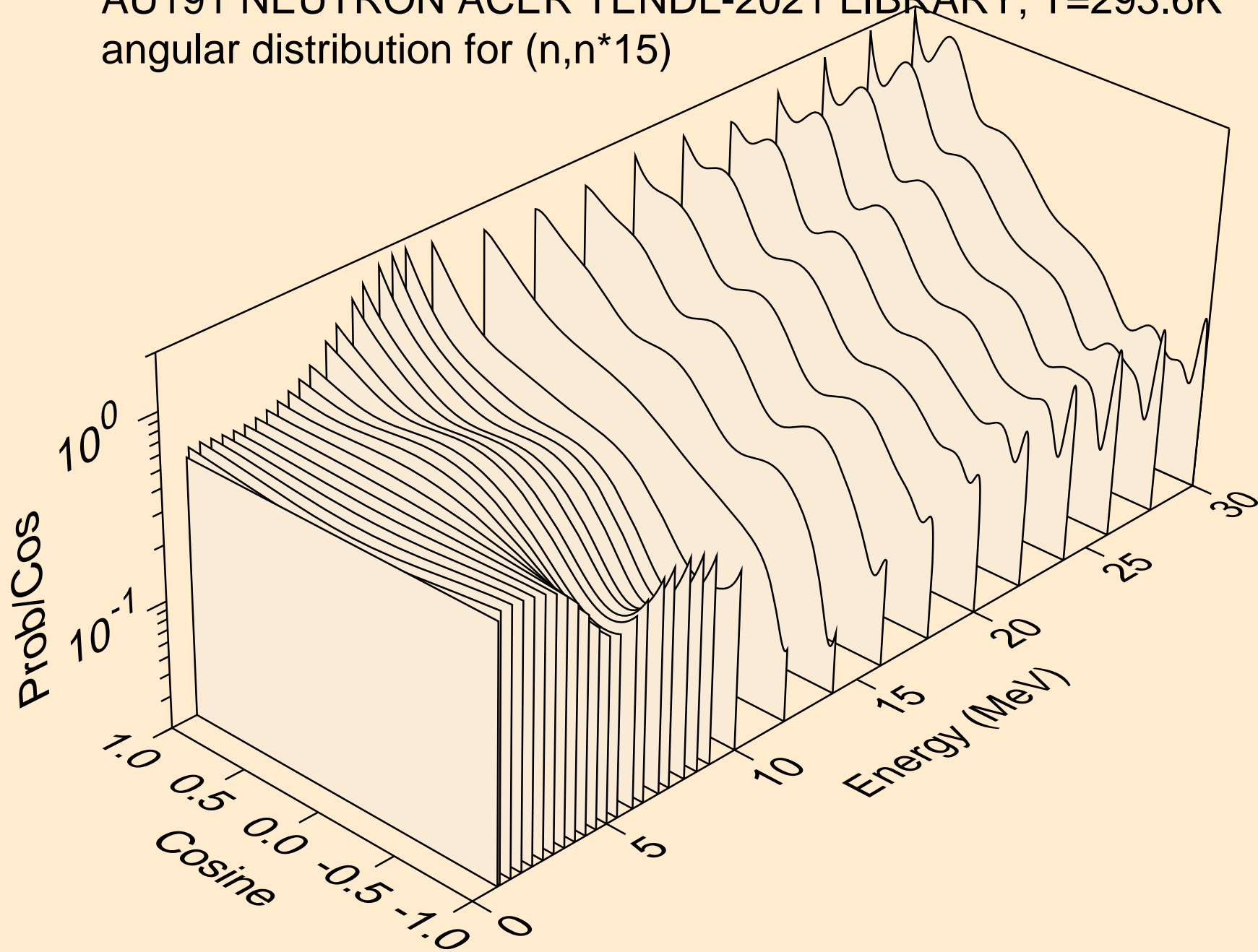

AU191 NEUTRON ACER TENDL-2021 LIBRARY; T=293.6K  
angular distribution for (n,n\*16)

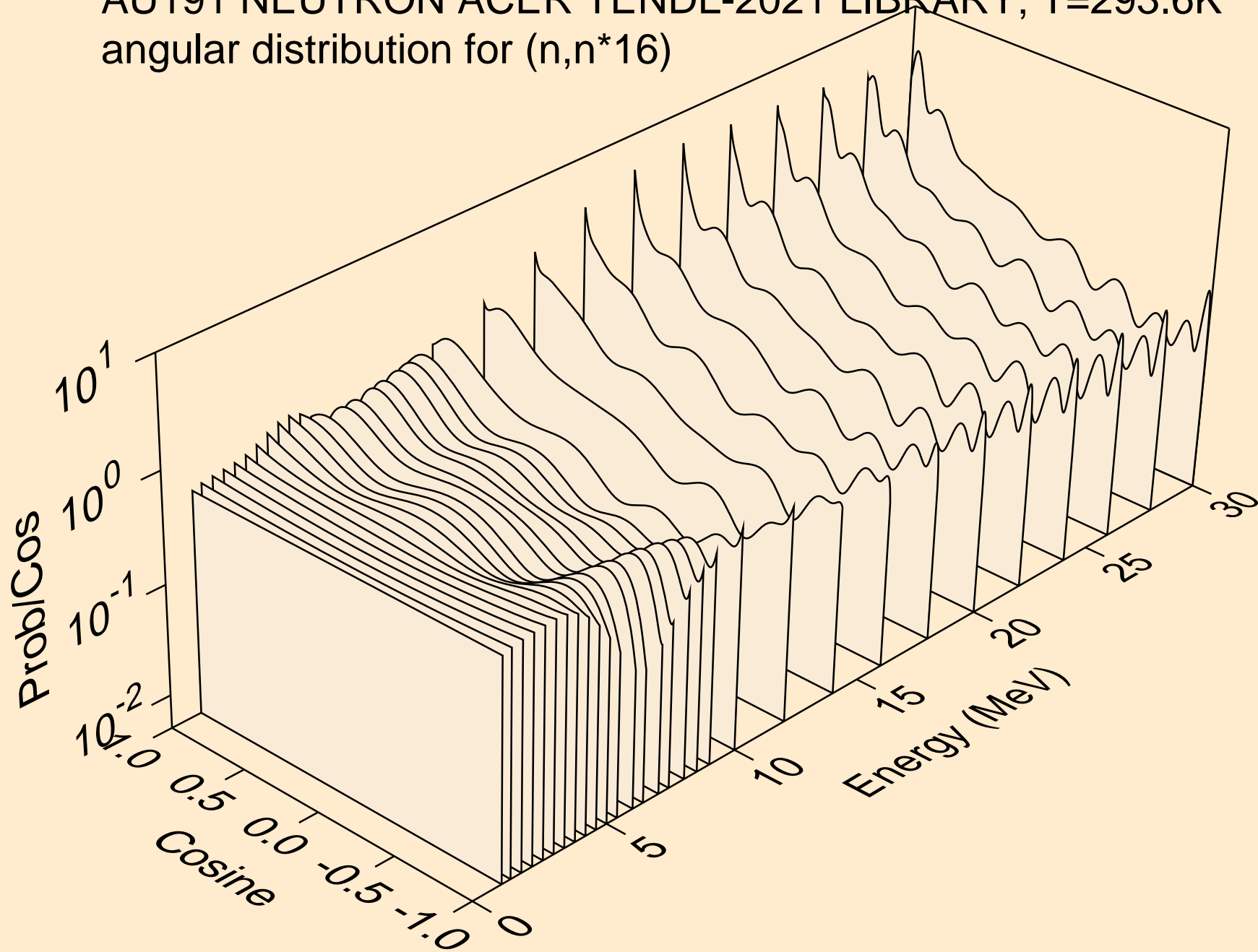

AU191 NEUTRON ACER TENDL-2021 LIBRARY; T=293.6K  
angular distribution for (n,n\*17)

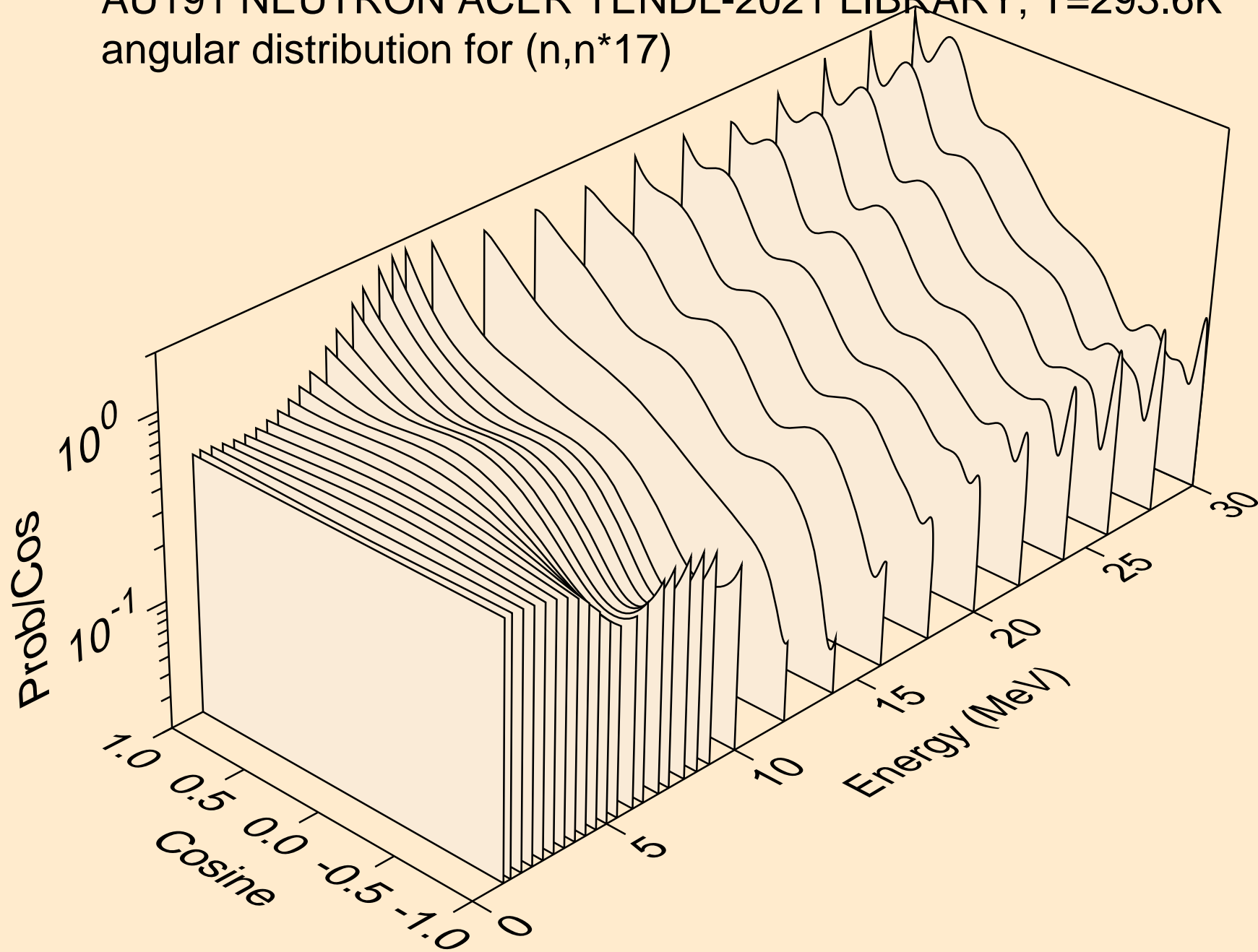



AU191 NEUTRON ACER TENDL-2021 LIBRARY; T=293.6K  
angular distribution for (n,n\*18)

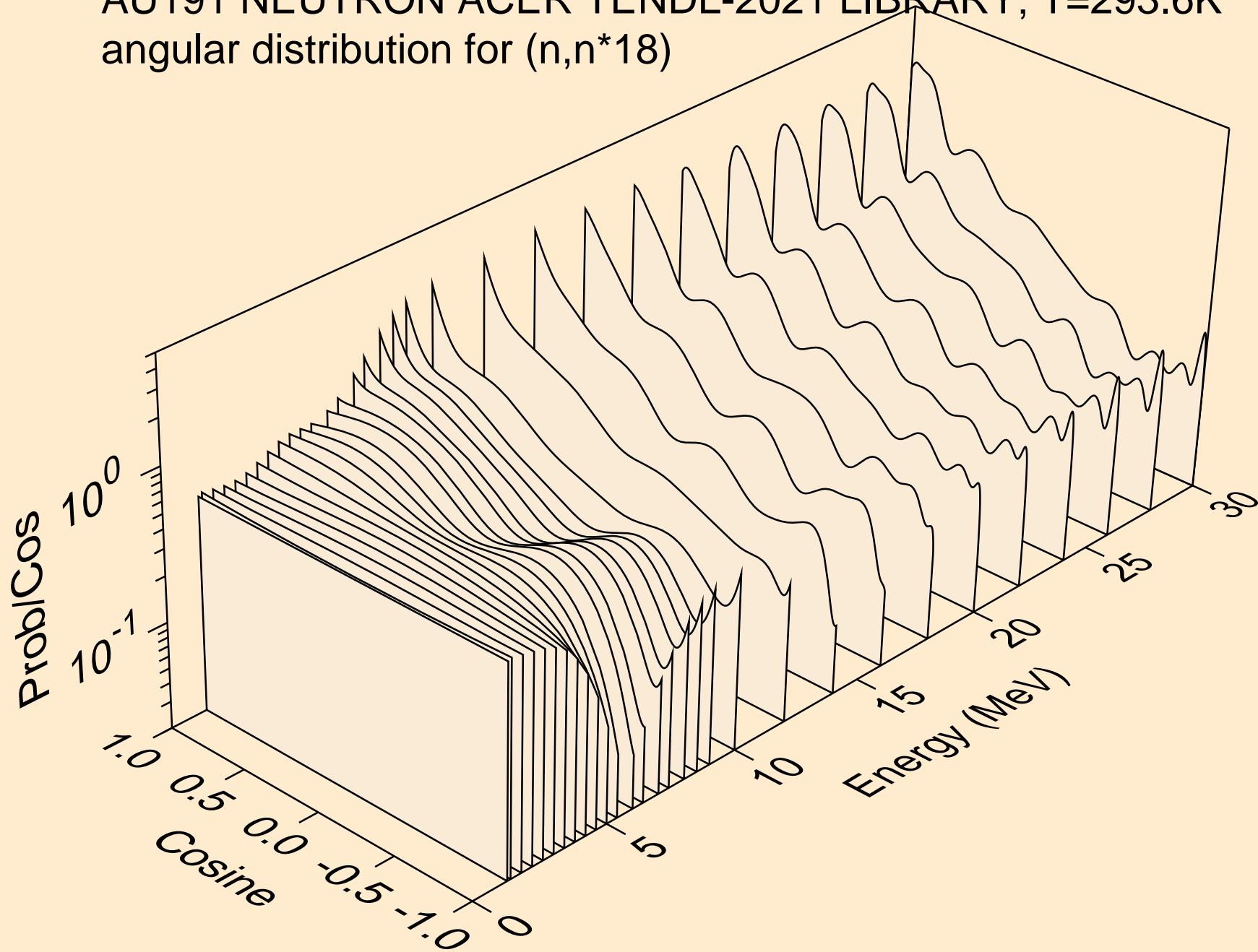

AU191 NEUTRON ACER TENDL-2021 LIBRARY; T=293.6K  
angular distribution for (n,n\*19)

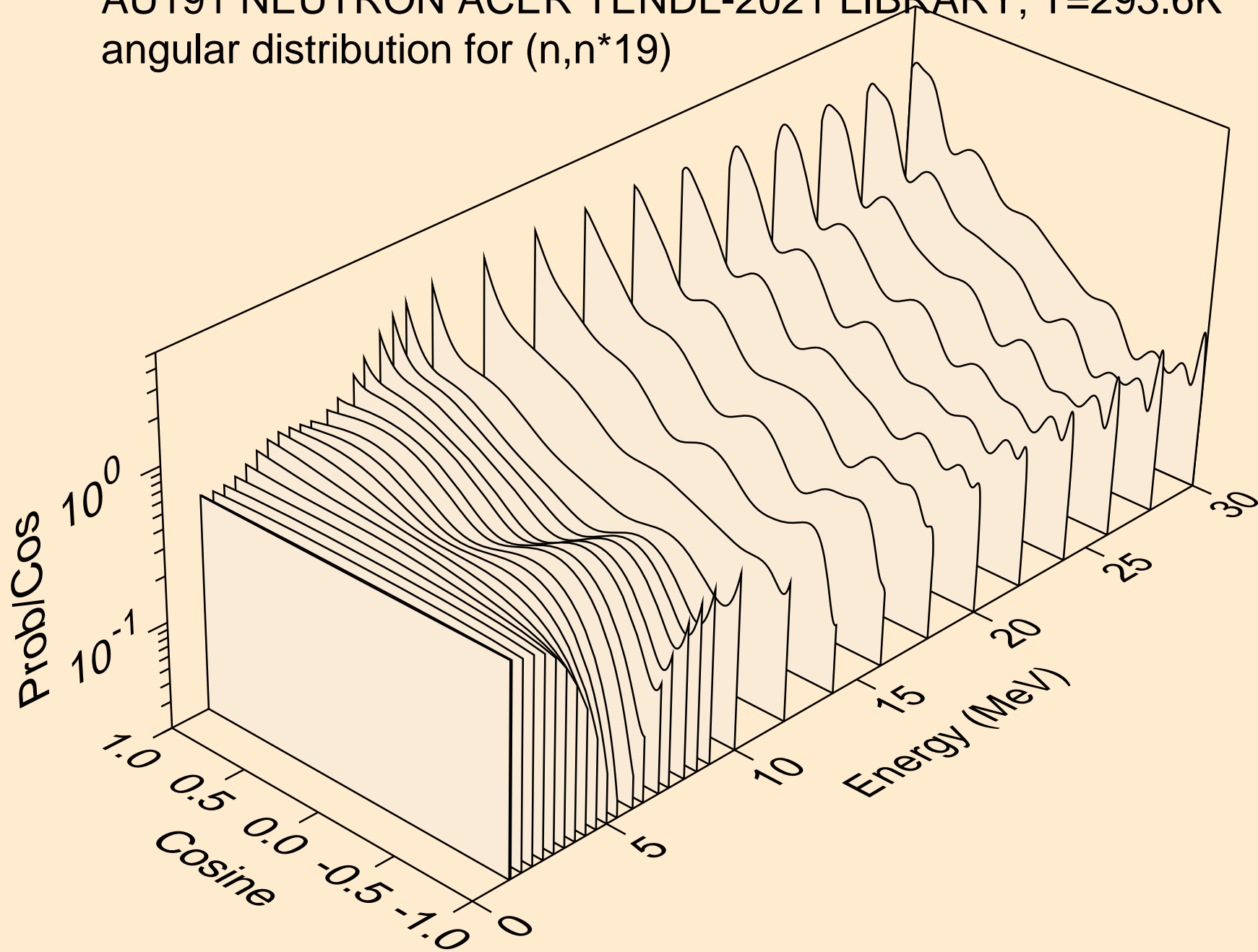

AU191 NEUTRON ACER TENDL-2021 LIBRARY; T=293.6K  
angular distribution for (n,n\*20)

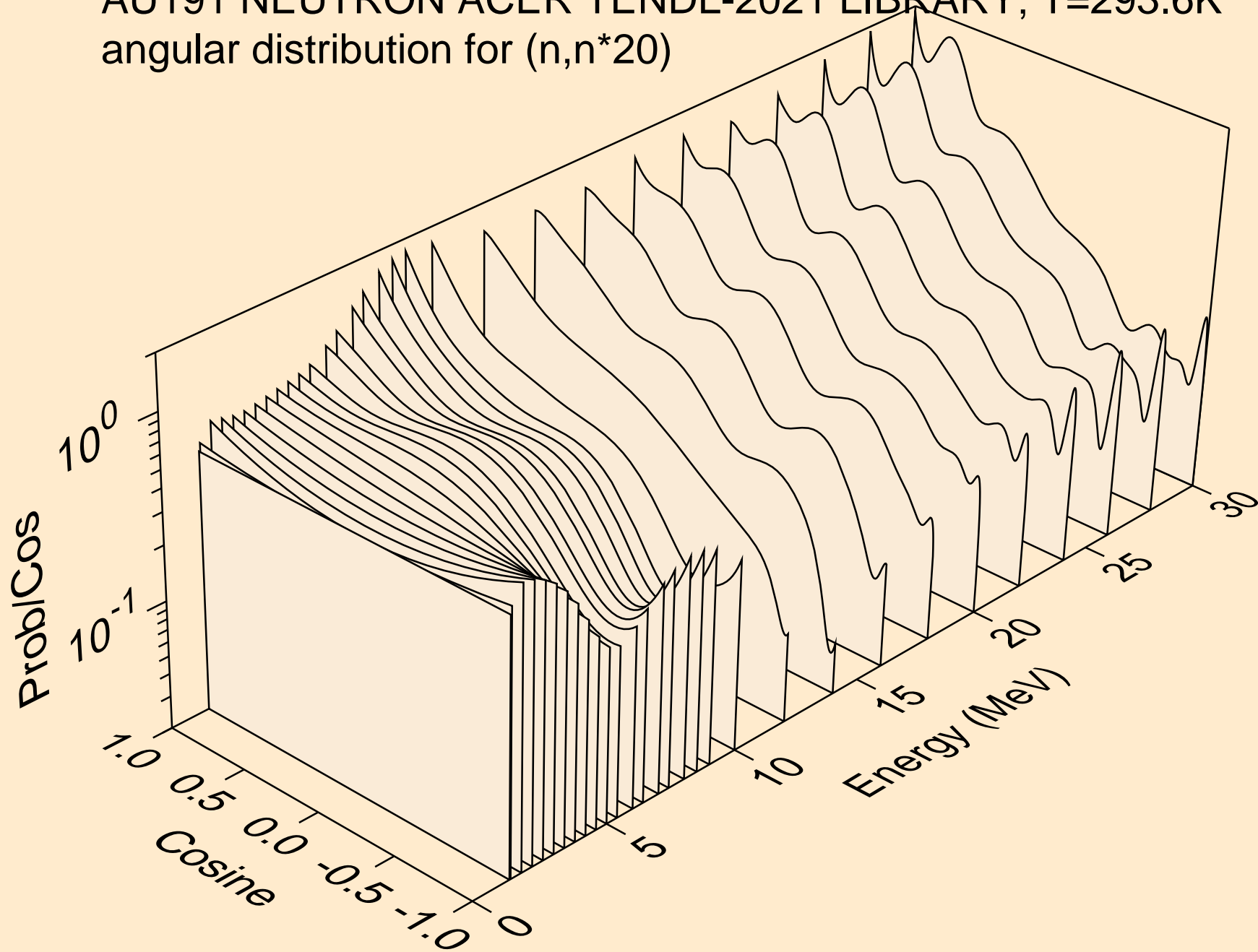

AU191 NEUTRON ACER TENDL-2021 LIBRARY; T=293.6K  
angular distribution for (n,n\*21)

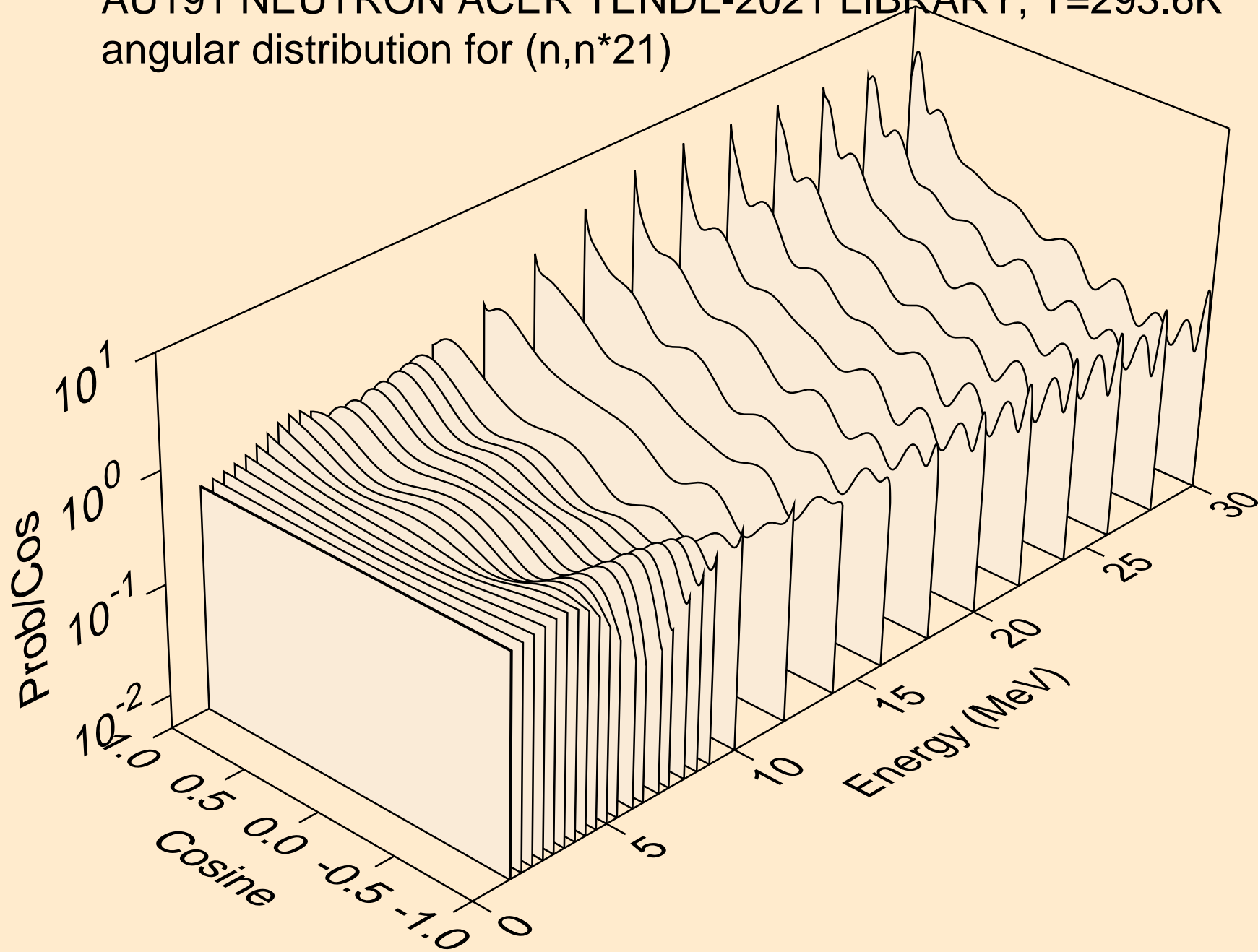

AU191 NEUTRON ACER TENDL-2021 LIBRARY; T=293.6K  
angular distribution for (n,n\*22)

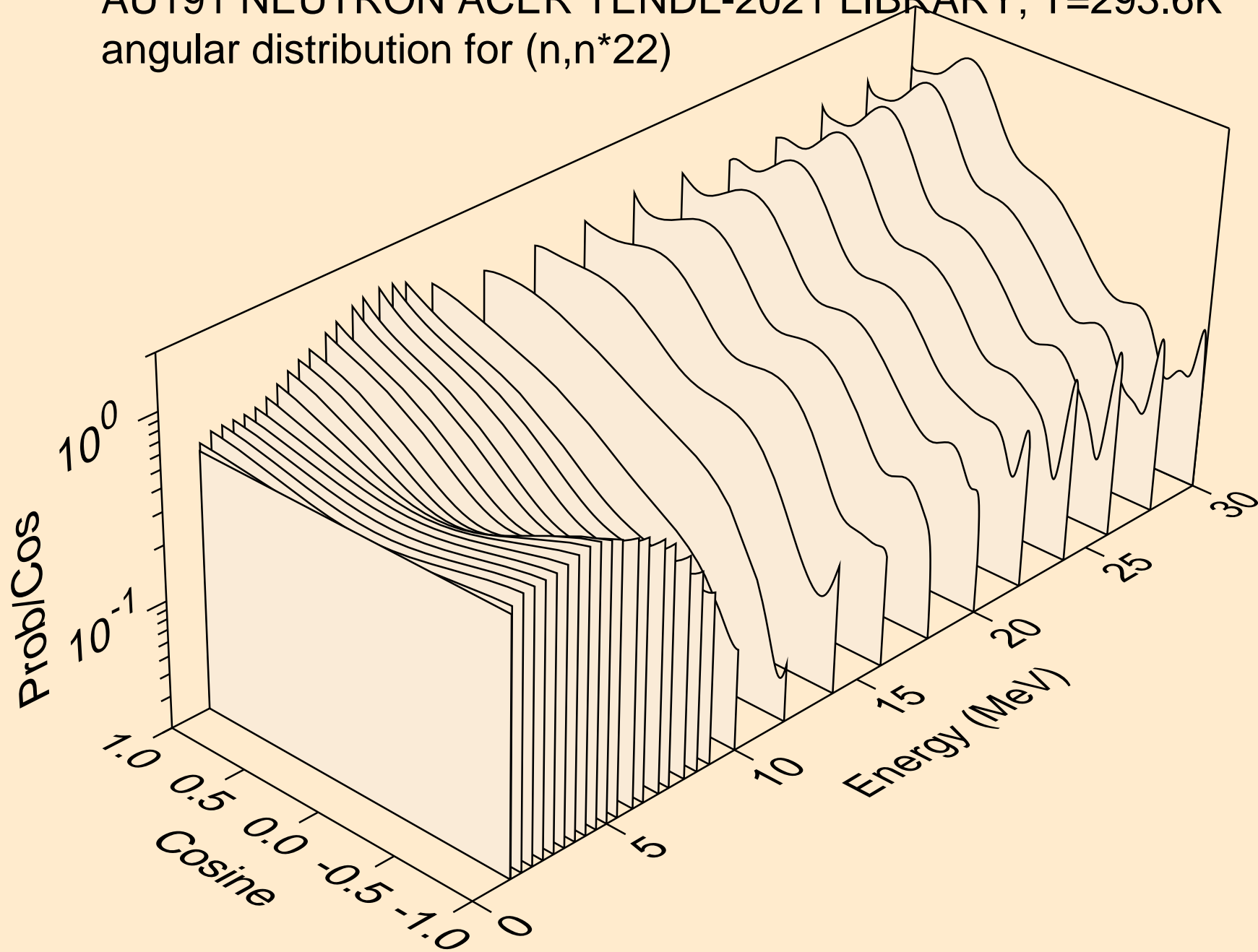

AU191 NEUTRON ACER TENDL-2021 LIBRARY; T=293.6K  
angular distribution for (n,n\*23)

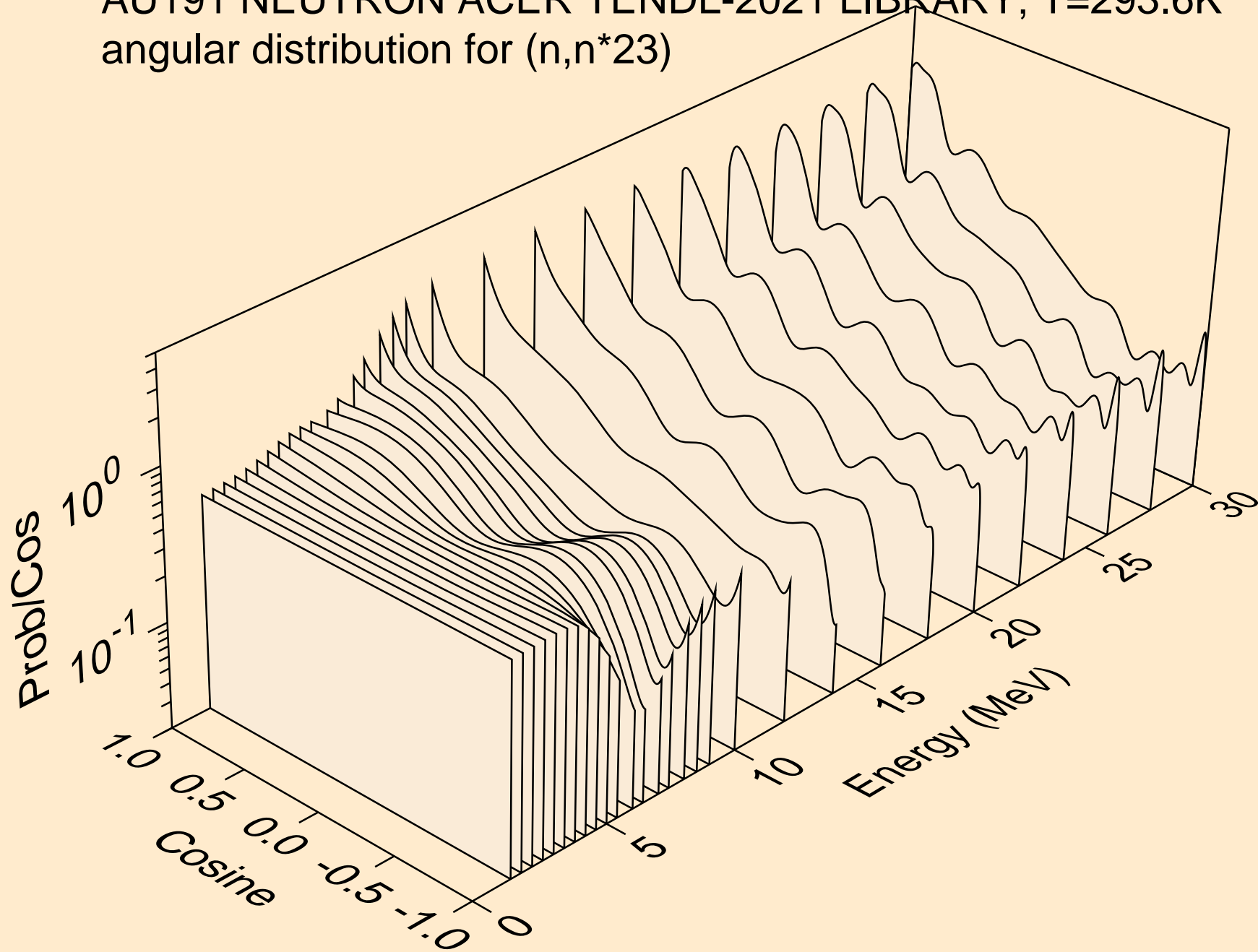

AU191 NEUTRON ACER TENDL-2021 LIBRARY; T=293.6K  
angular distribution for (n,n\*24)

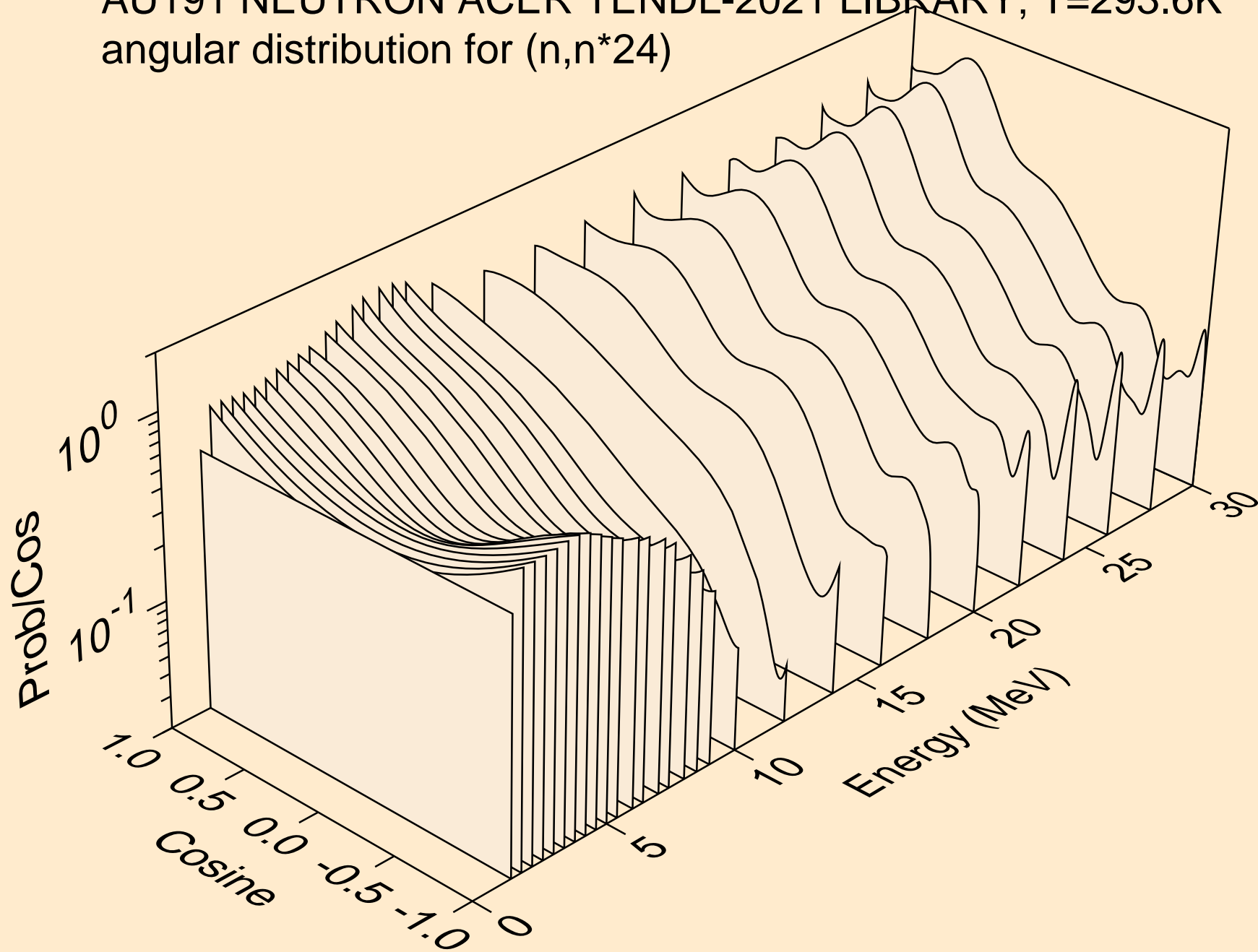

AU191 NEUTRON ACER TENDL-2021 LIBRARY; T=293.6K  
angular distribution for (n,n\*25)

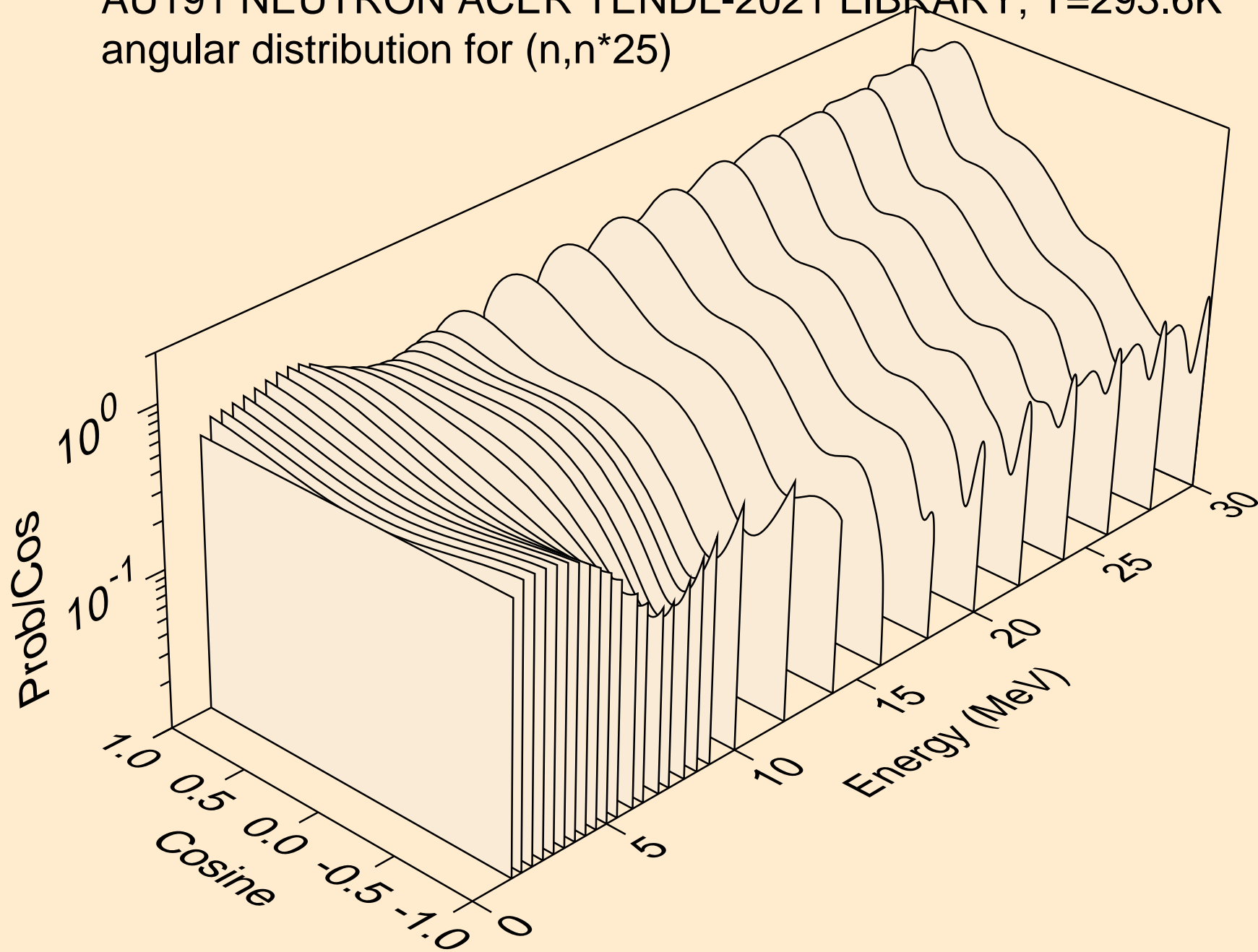



AU191 NEUTRON ACER TENDL-2021 LIBRARY; T=293.6K  
angular distribution for (n,n\*26)

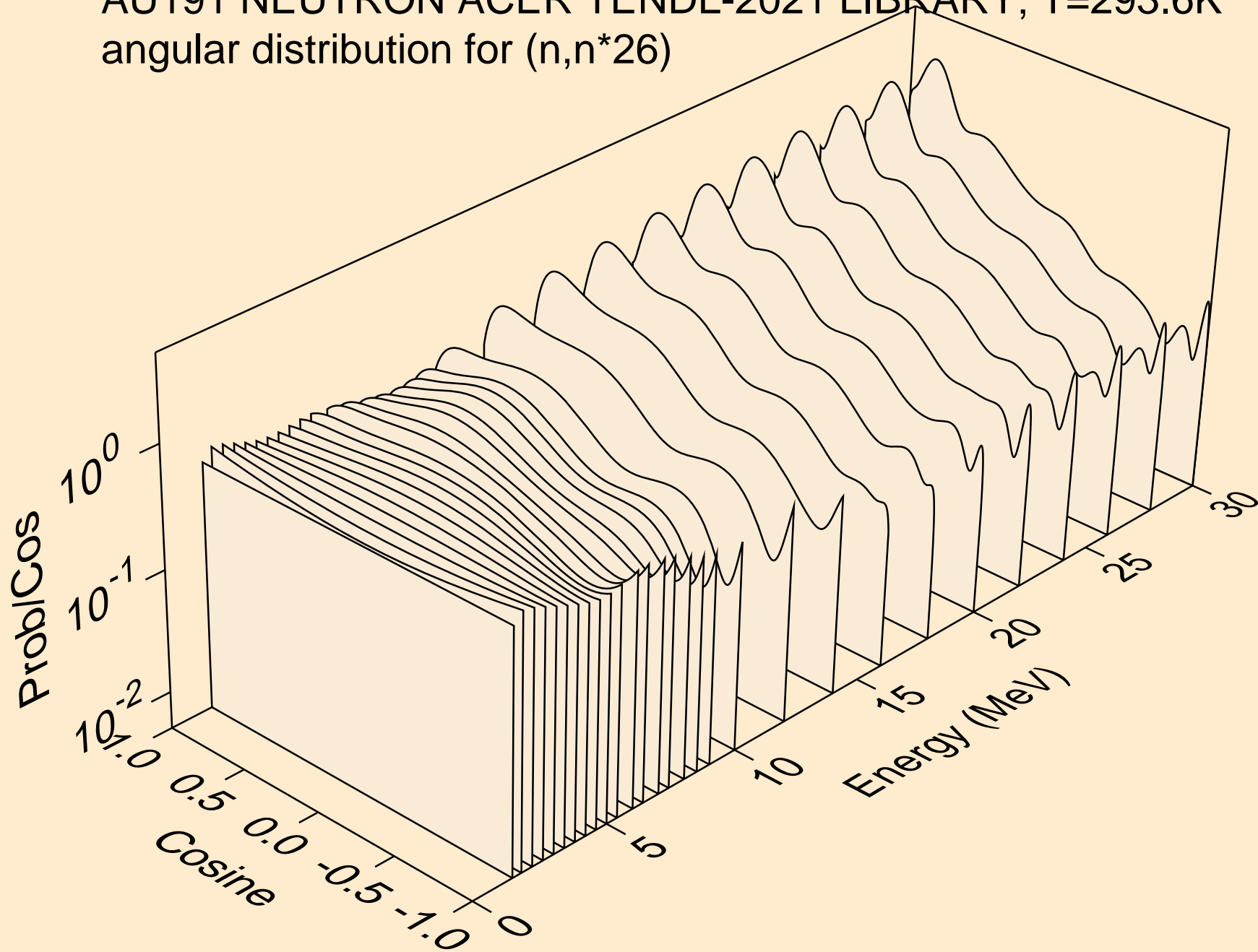

AU191 NEUTRON ACER TENDL-2021 LIBRARY; T=293.6K  
angular distribution for (n,n\*27)

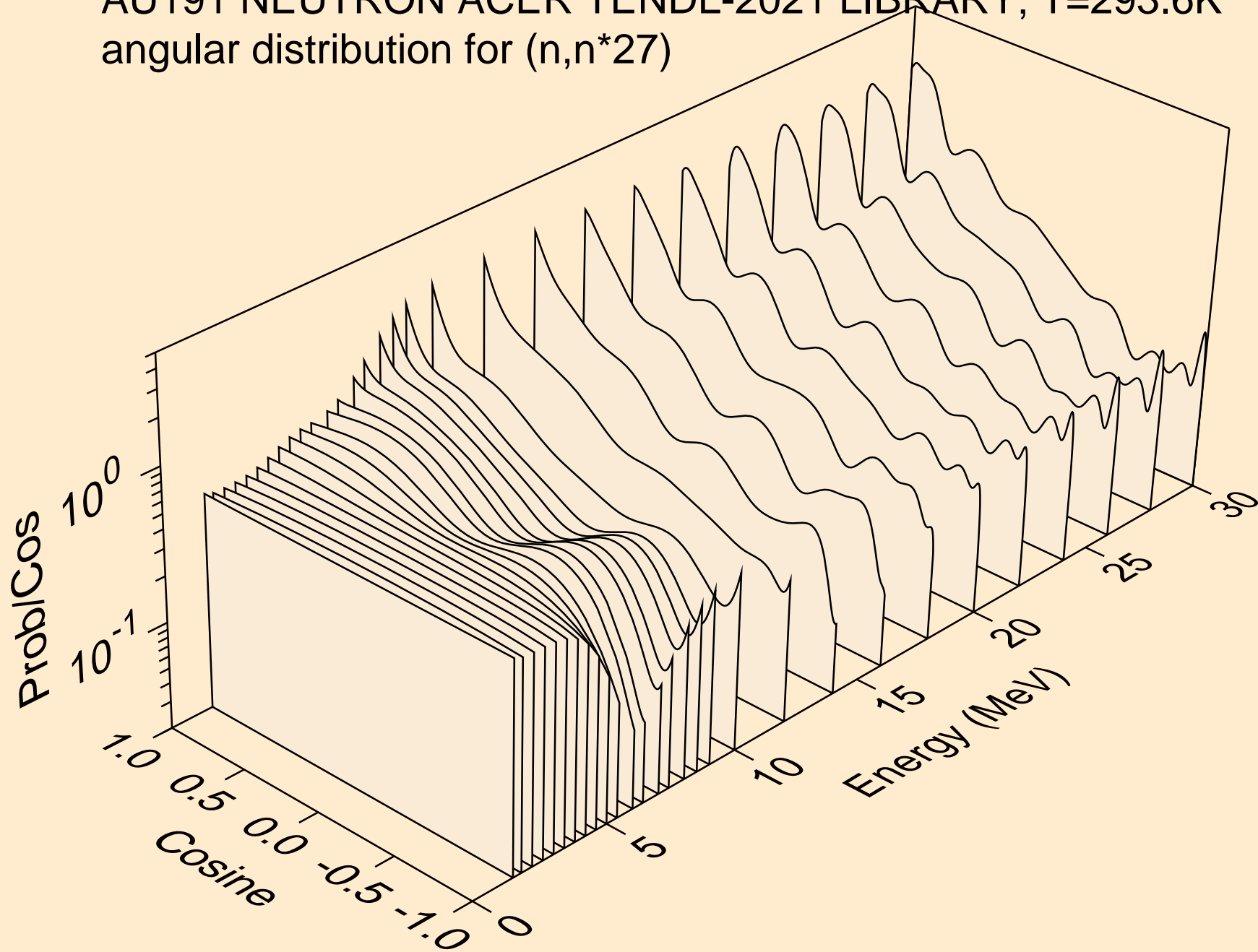

AU191 NEUTRON ACER TENDL-2021 LIBRARY; T=293.6K  
angular distribution for (n,n\*28)

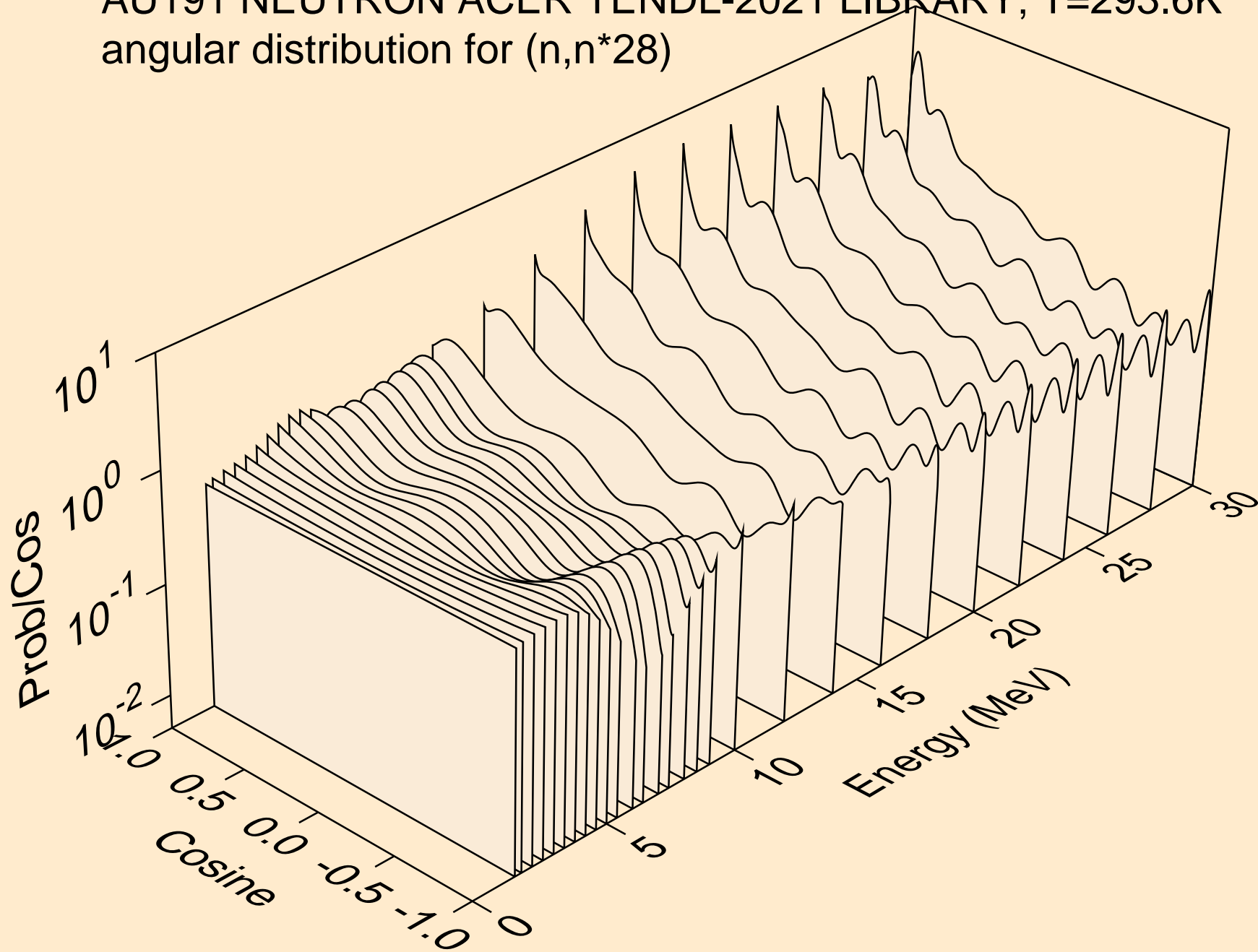

AU191 NEUTRON ACER TENDL-2021 LIBRARY; T=293.6K  
angular distribution for (n,n\*29)

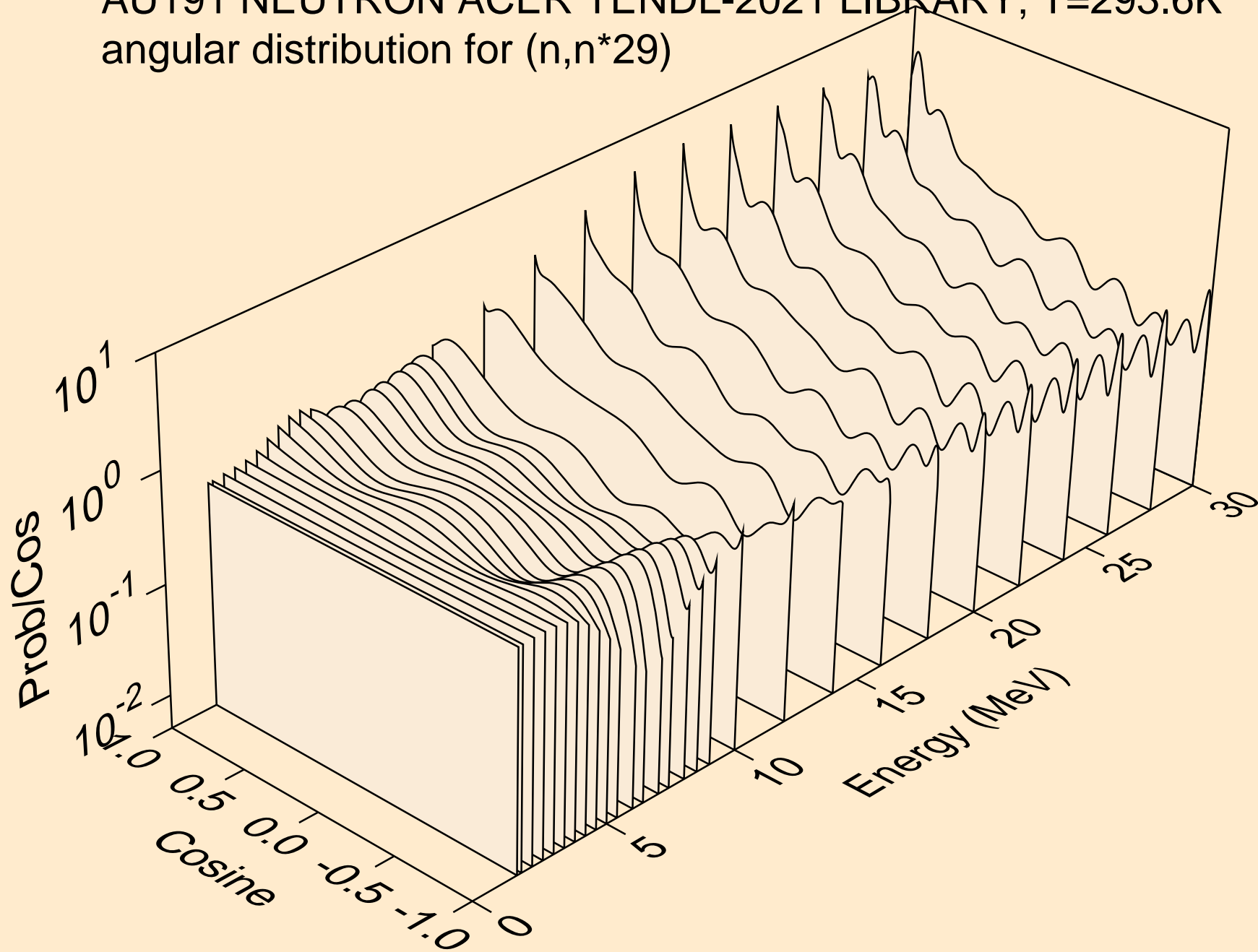

AU191 NEUTRON ACER TENDL-2021 LIBRARY; T=293.6K  
Neutron emission for (n,x)

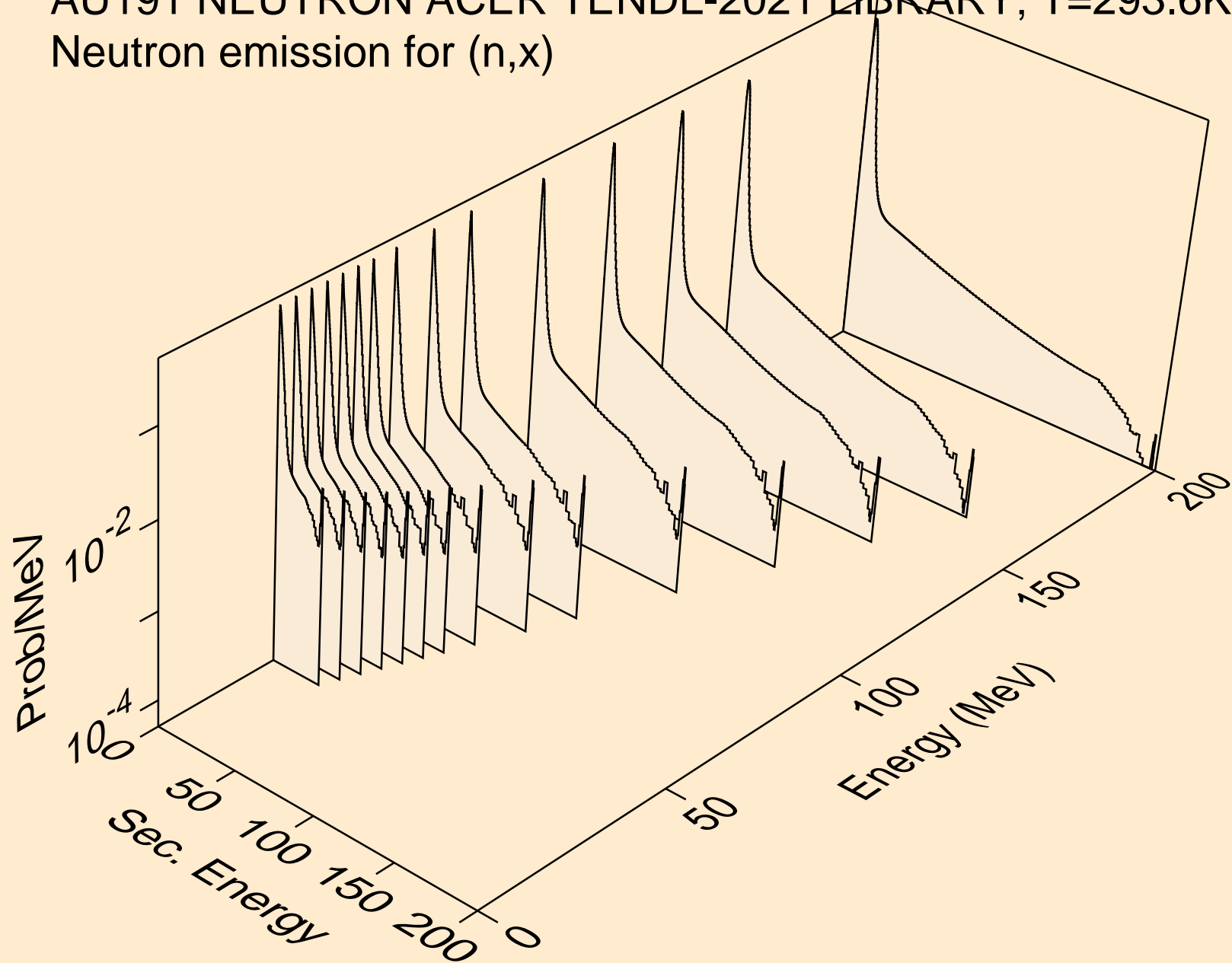

AU191 NEUTRON ACER TENDL-2021 LIBRARY; T=293.6K  
Neutron emission for (n,2nd)

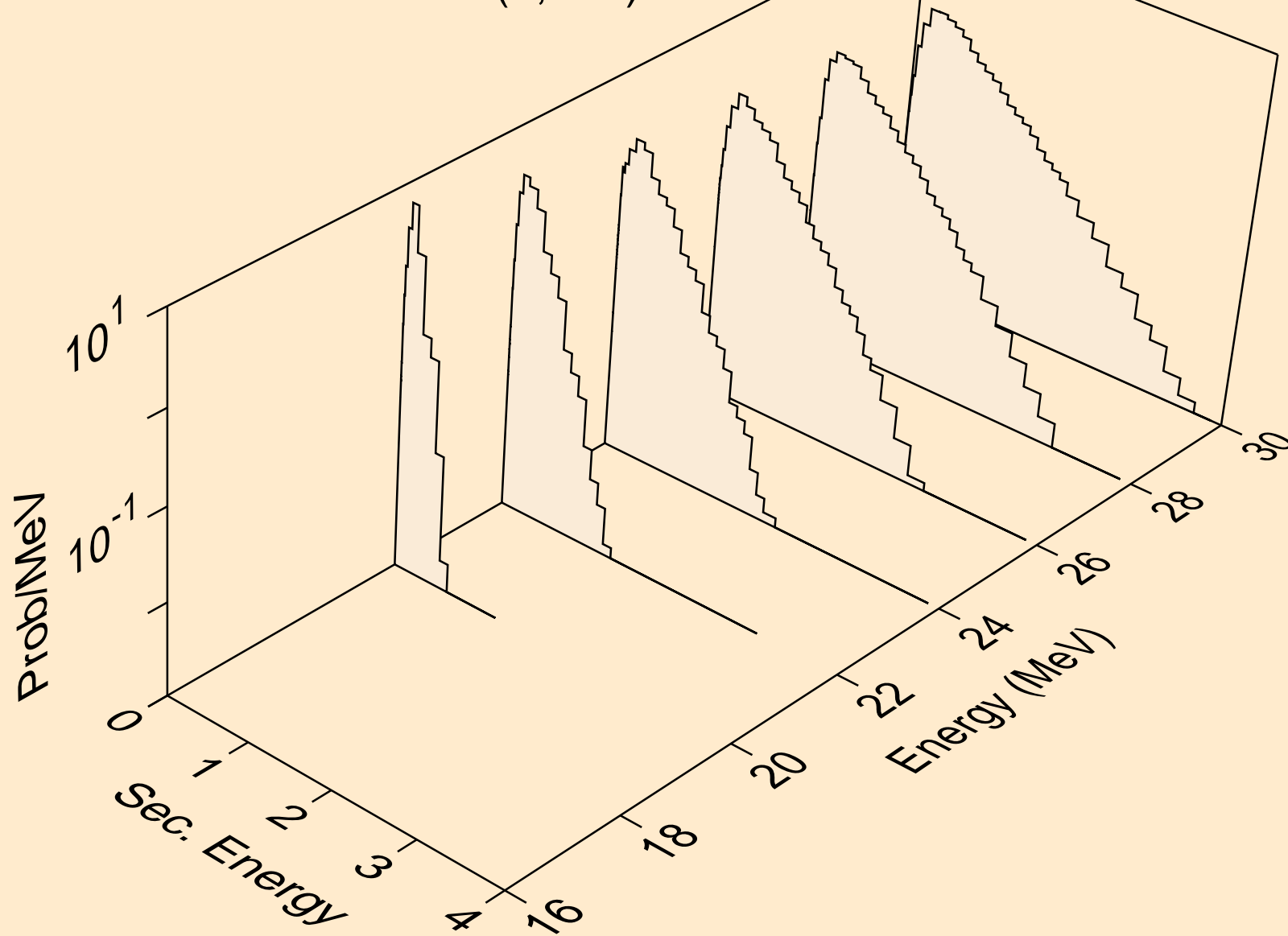

AU191 NEUTRON ACER TENDL-2021 LIBRARY; T=293.6K  
Neutron emission for (n,2n)

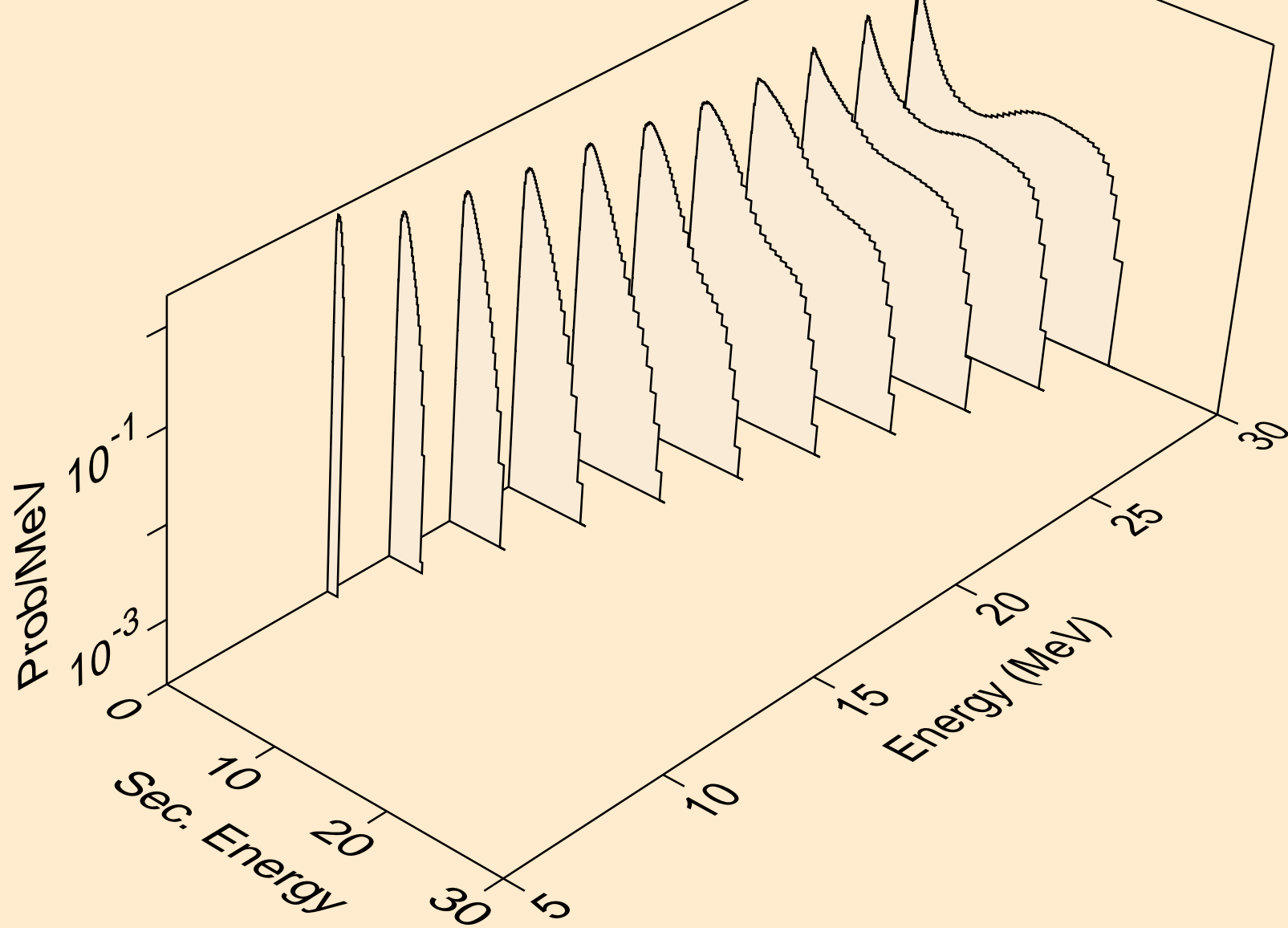

AU191 NEUTRON ACER TENDL-2021 LIBRARY; T=293.6K  
Neutron emission for (n,3n)

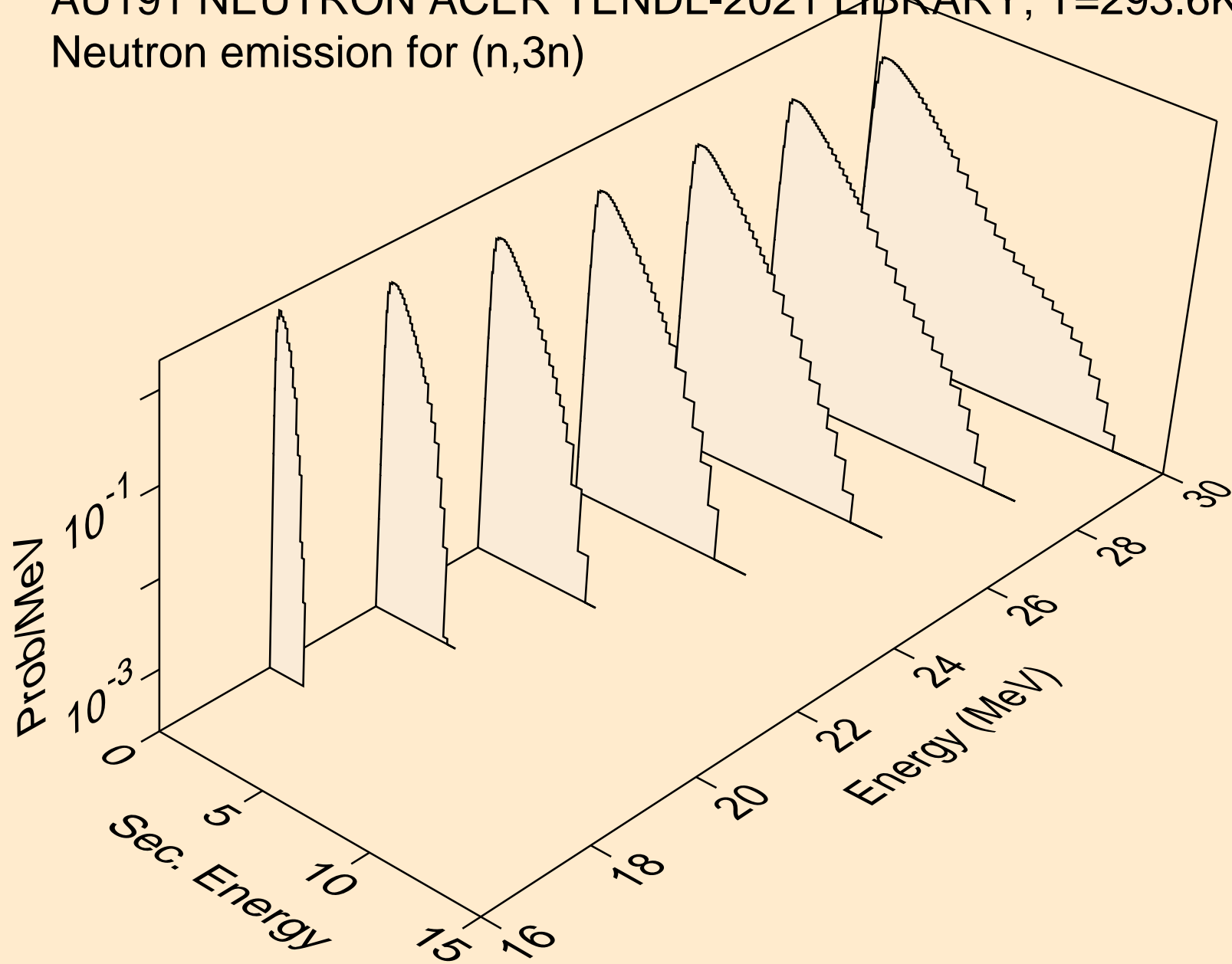



AU191 NEUTRON ACER TENDL-2021 LIBRARY; T=293.6K  
Neutron emission for (n,n\*)a

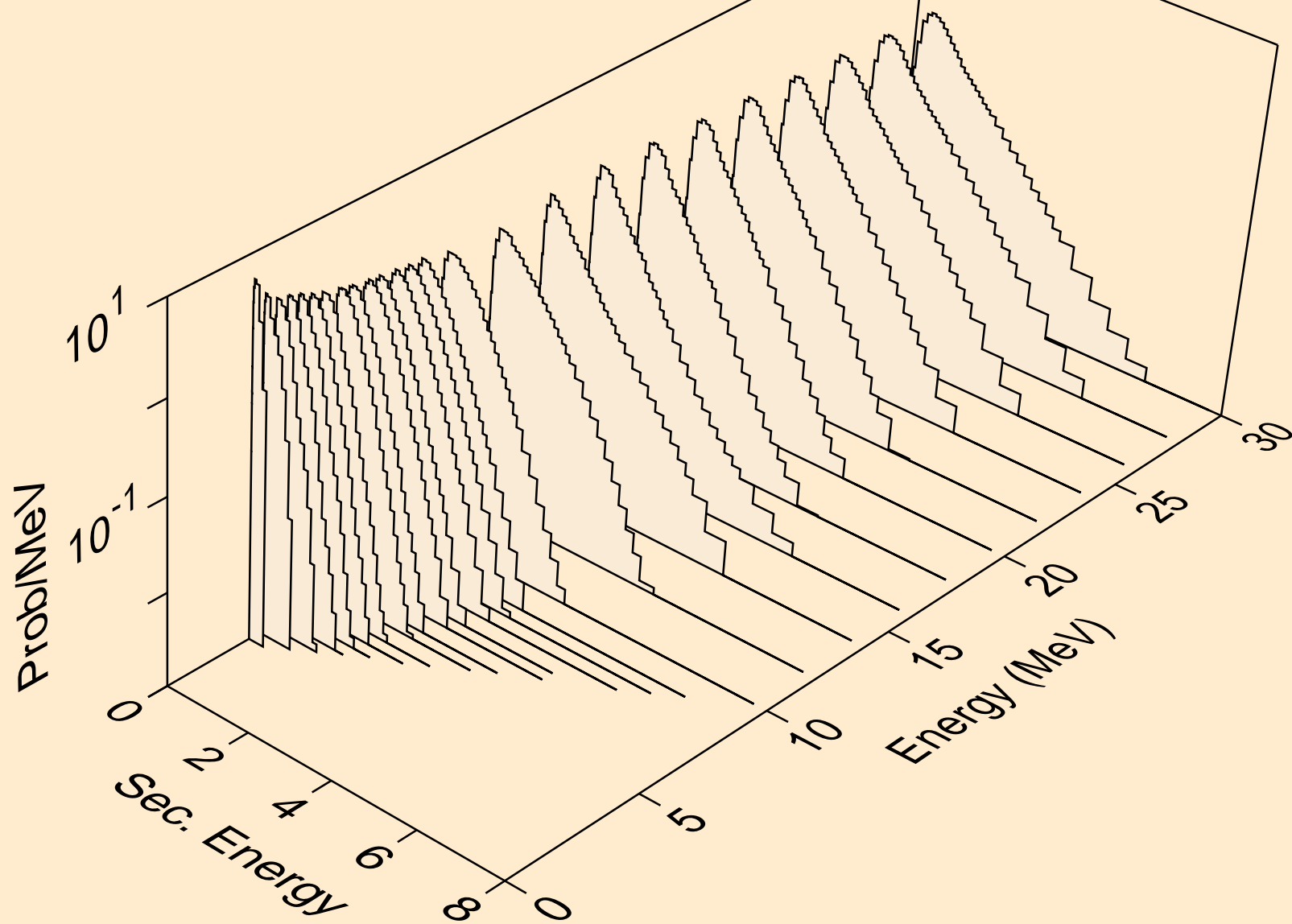

AU191 NEUTRON ACER TENDL-2021 LIBRARY; T=293.6K  
Neutron emission for (n,2n)<sub>a</sub>

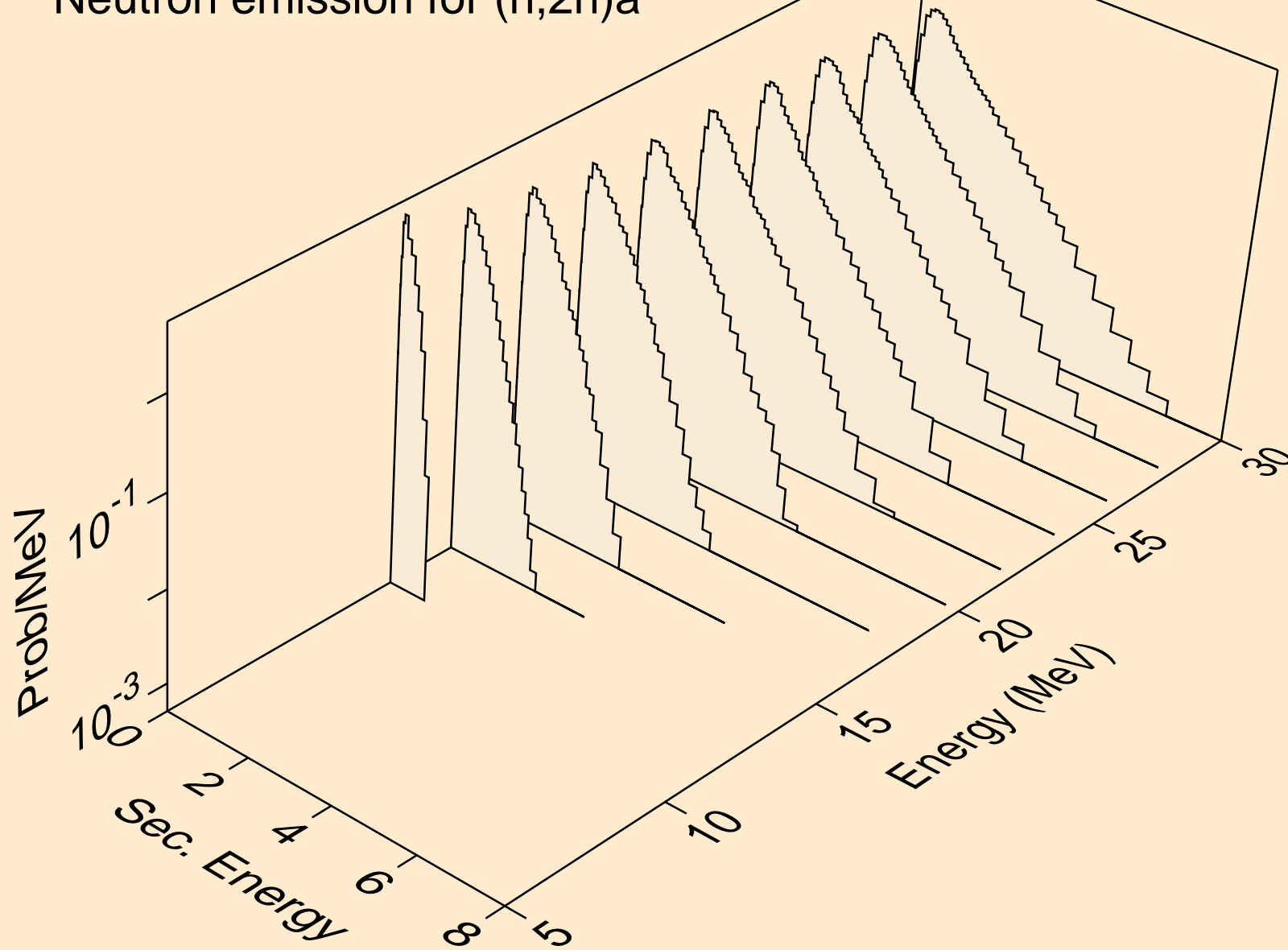

AU191 NEUTRON ACER TENDL-2021 LIBRARY; T=293.6K  
Neutron emission for (n,3n)a

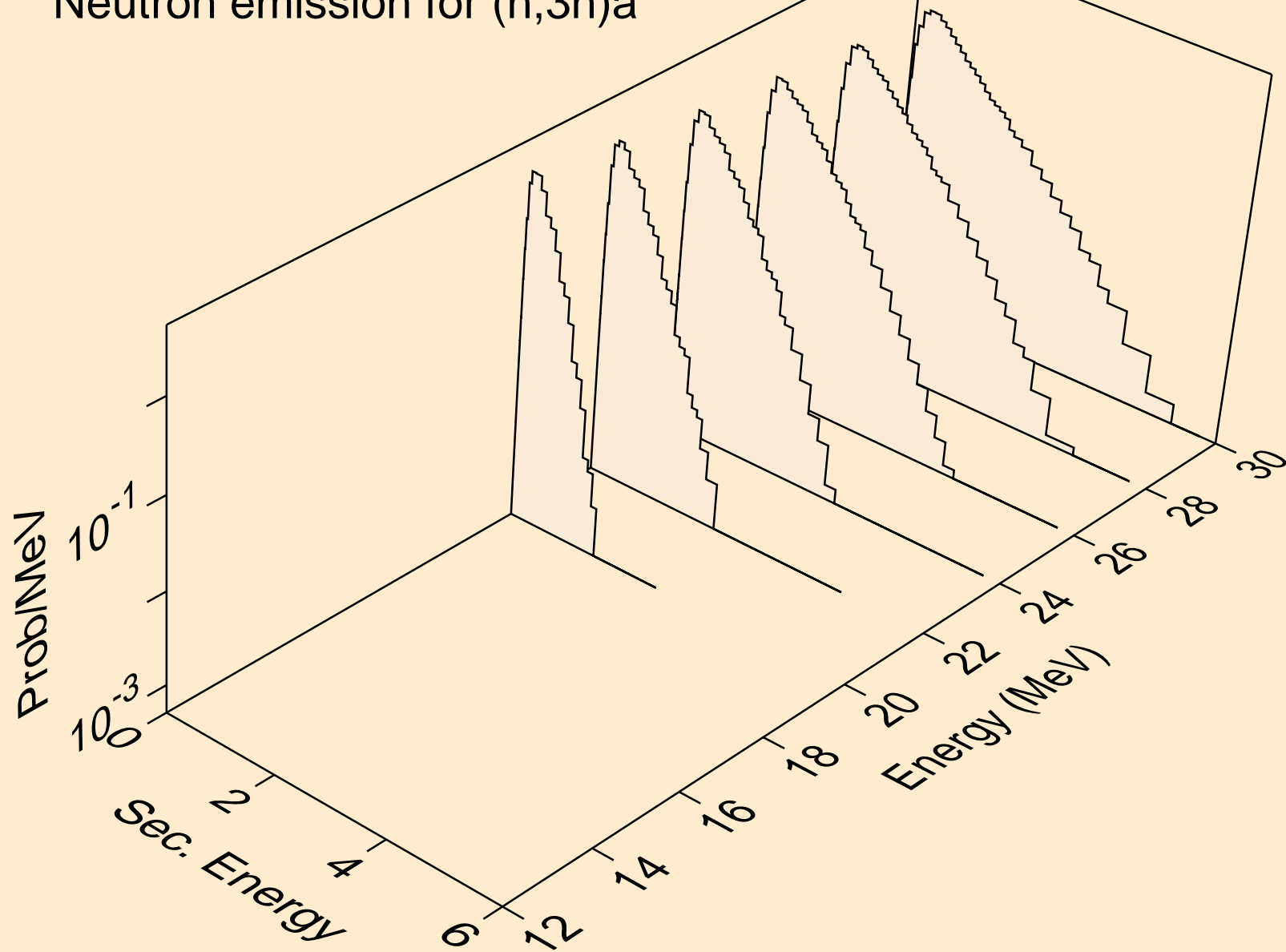

AU191 NEUTRON ACER TENDL-2021 LIBRARY; T=293.6K  
Neutron emission for (n,n\*)p

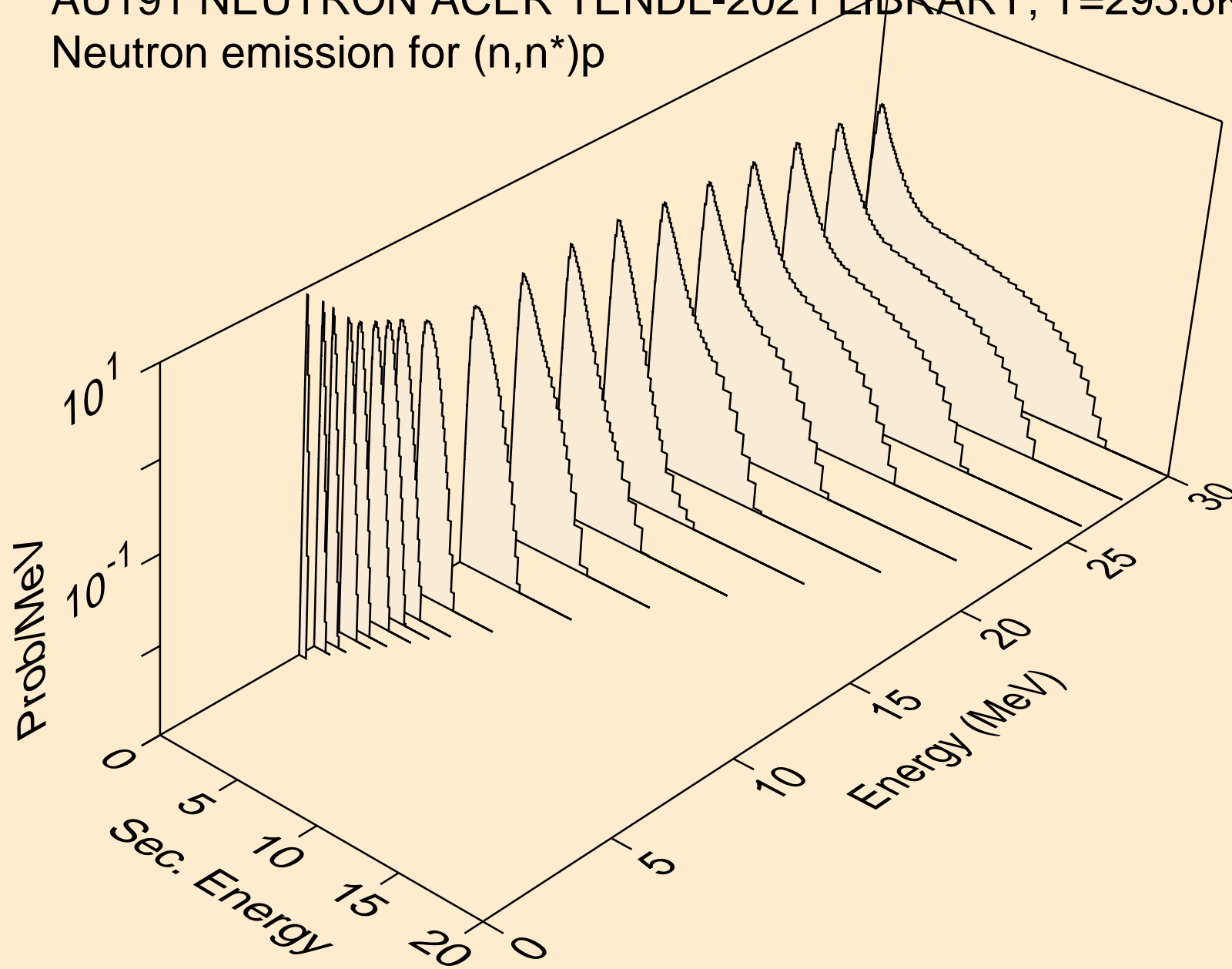

AU191 NEUTRON ACER TENDL-2021 LIBRARY; T=293.6K  
Neutron emission for (n,n\*)2a

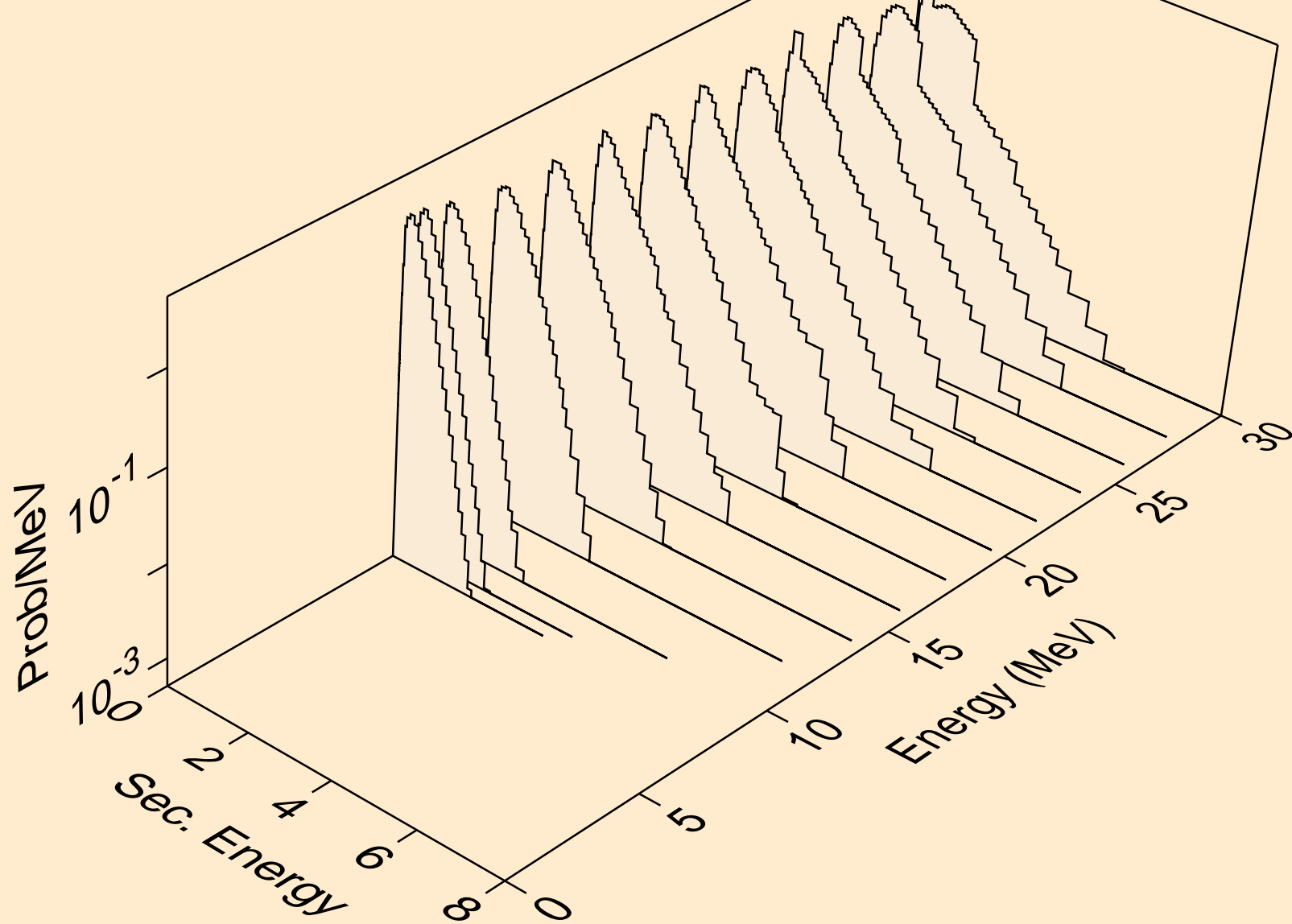

AU191 NEUTRON ACER TENDL-2021 LIBRARY; T=293.6K  
Neutron emission for (n,n\*)d

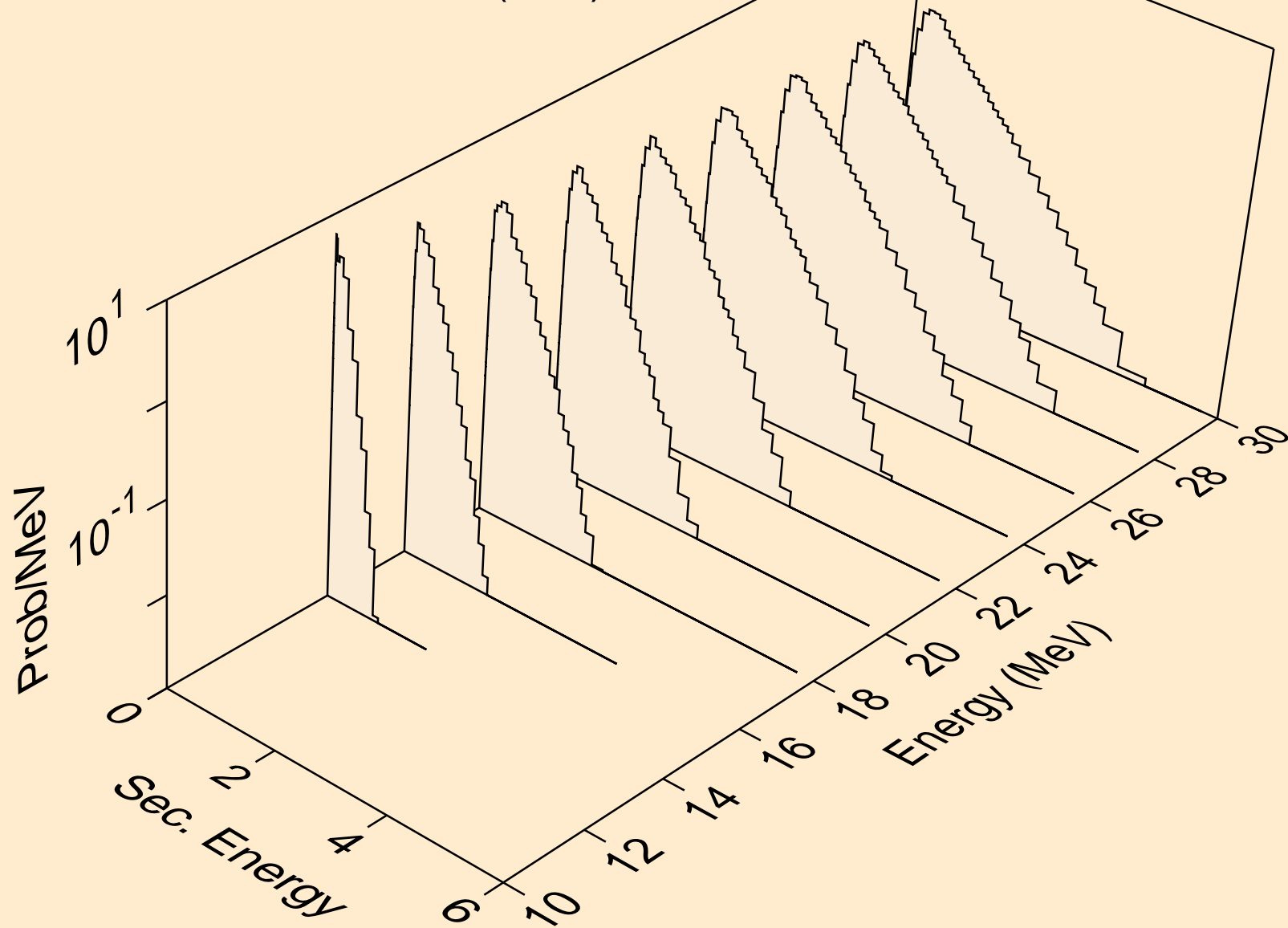

AU191 NEUTRON ACER TENDL-2021 LIBRARY; T=293.6K  
Neutron emission for (n,n\*)t

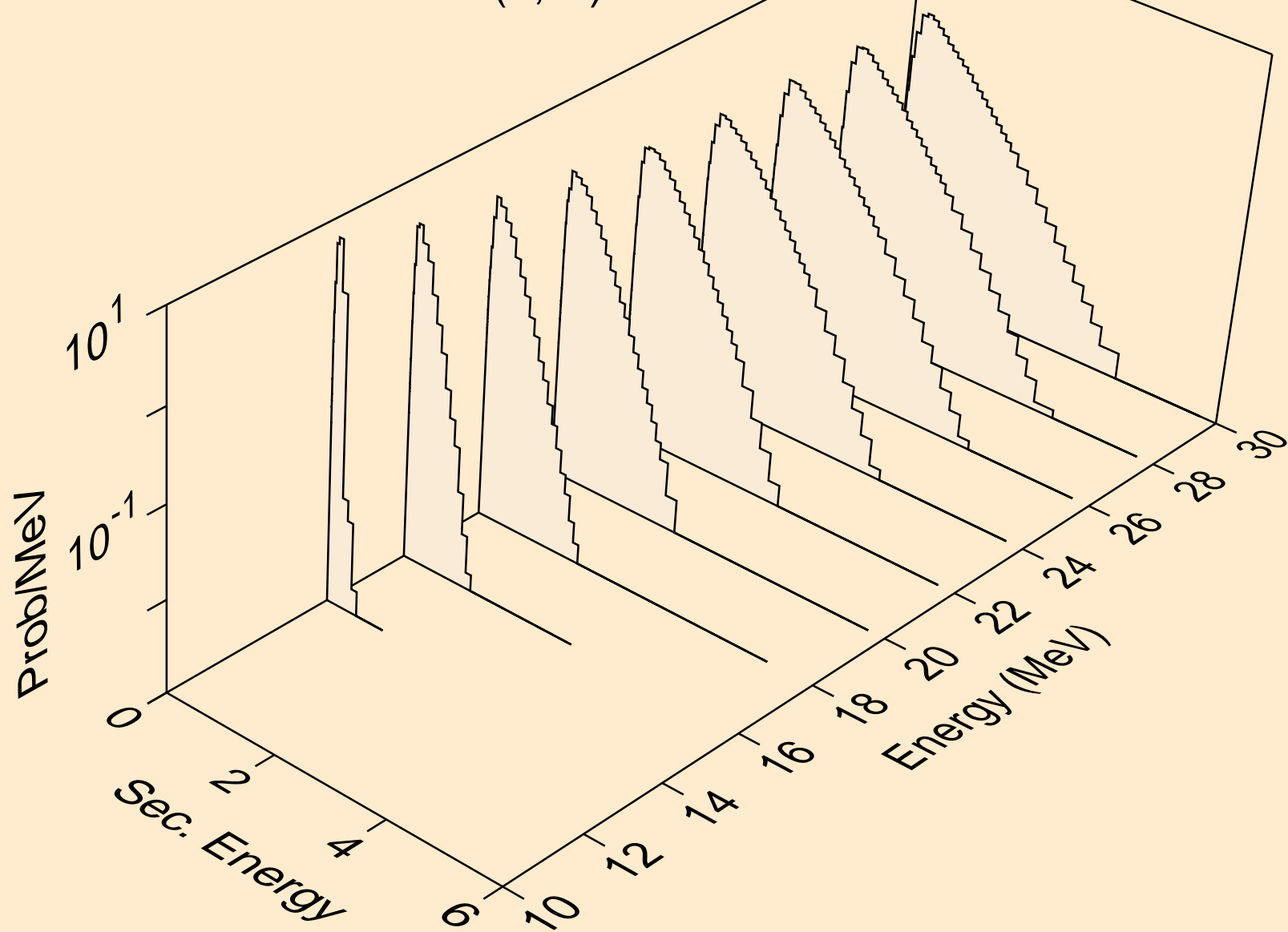

AU191 NEUTRON ACER TENDL-2021 LIBRARY; T=293.6K  
Neutron emission for (n,n\*)he3

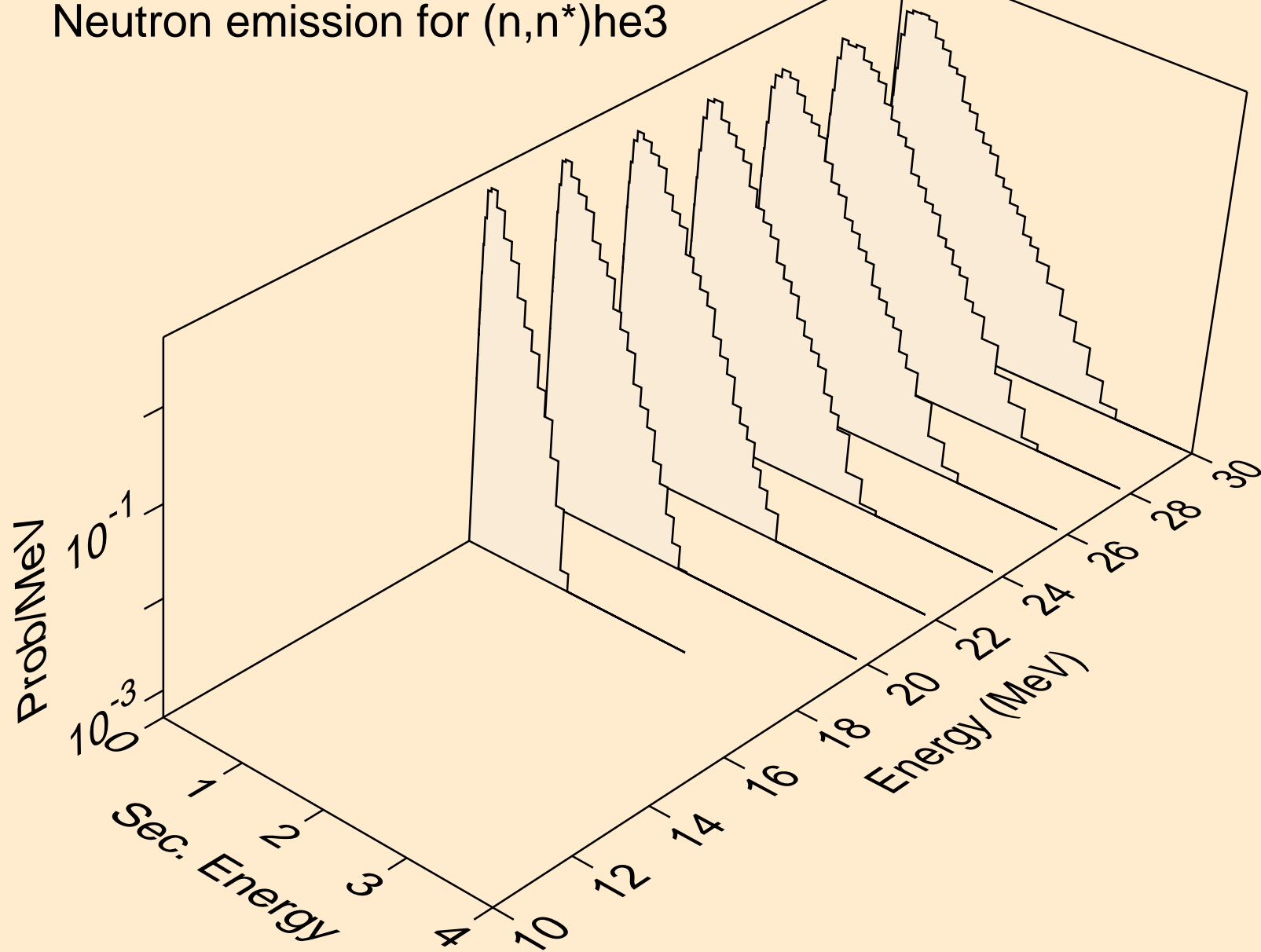



AU191 NEUTRON ACER TENDL-2021 LIBRARY; T=293.6K  
Neutron emission for (n,4n)

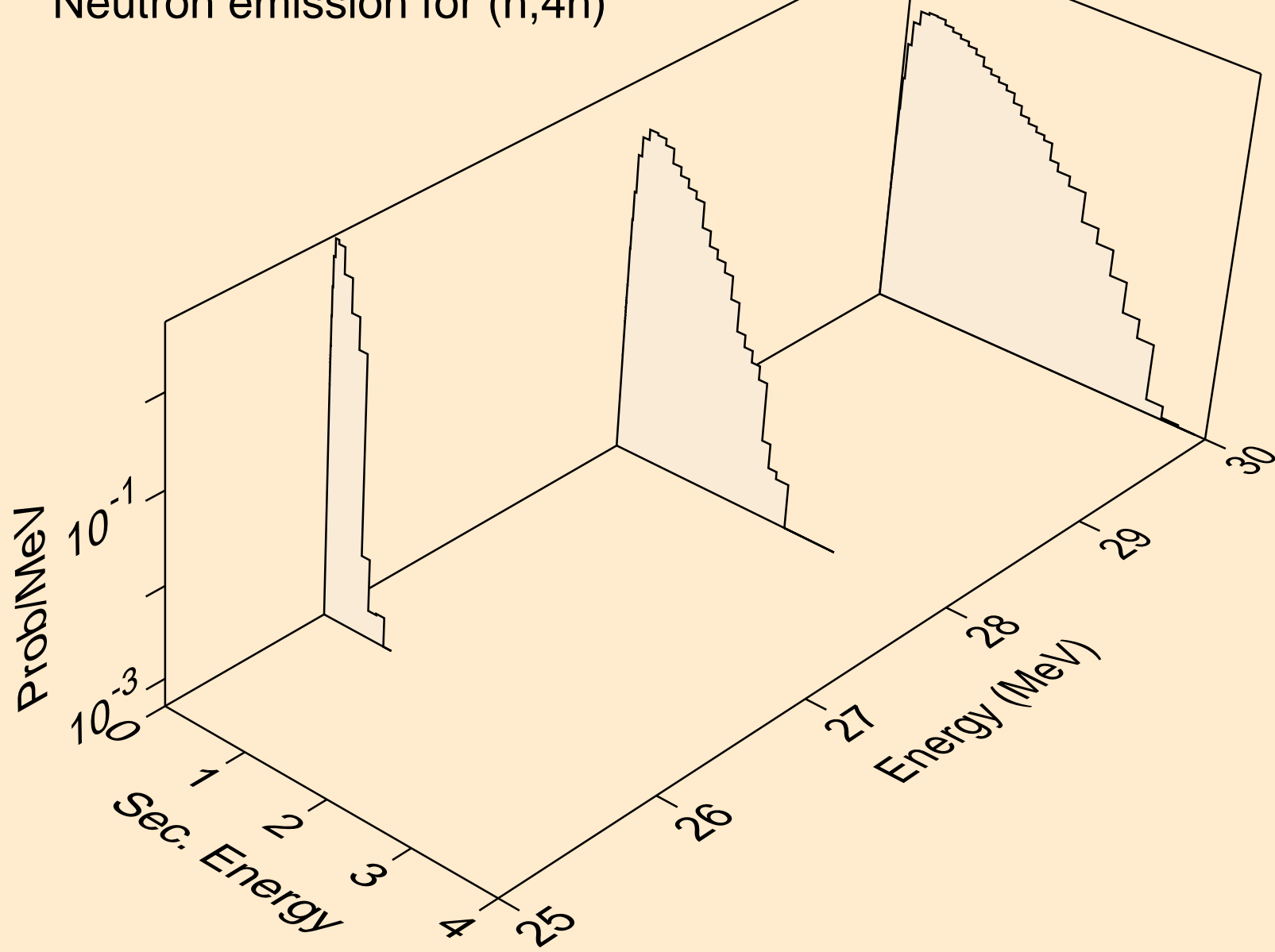

AU191 NEUTRON ACER TENDL-2021 LIBRARY; T=293.6K  
Neutron emission for (n,2np)

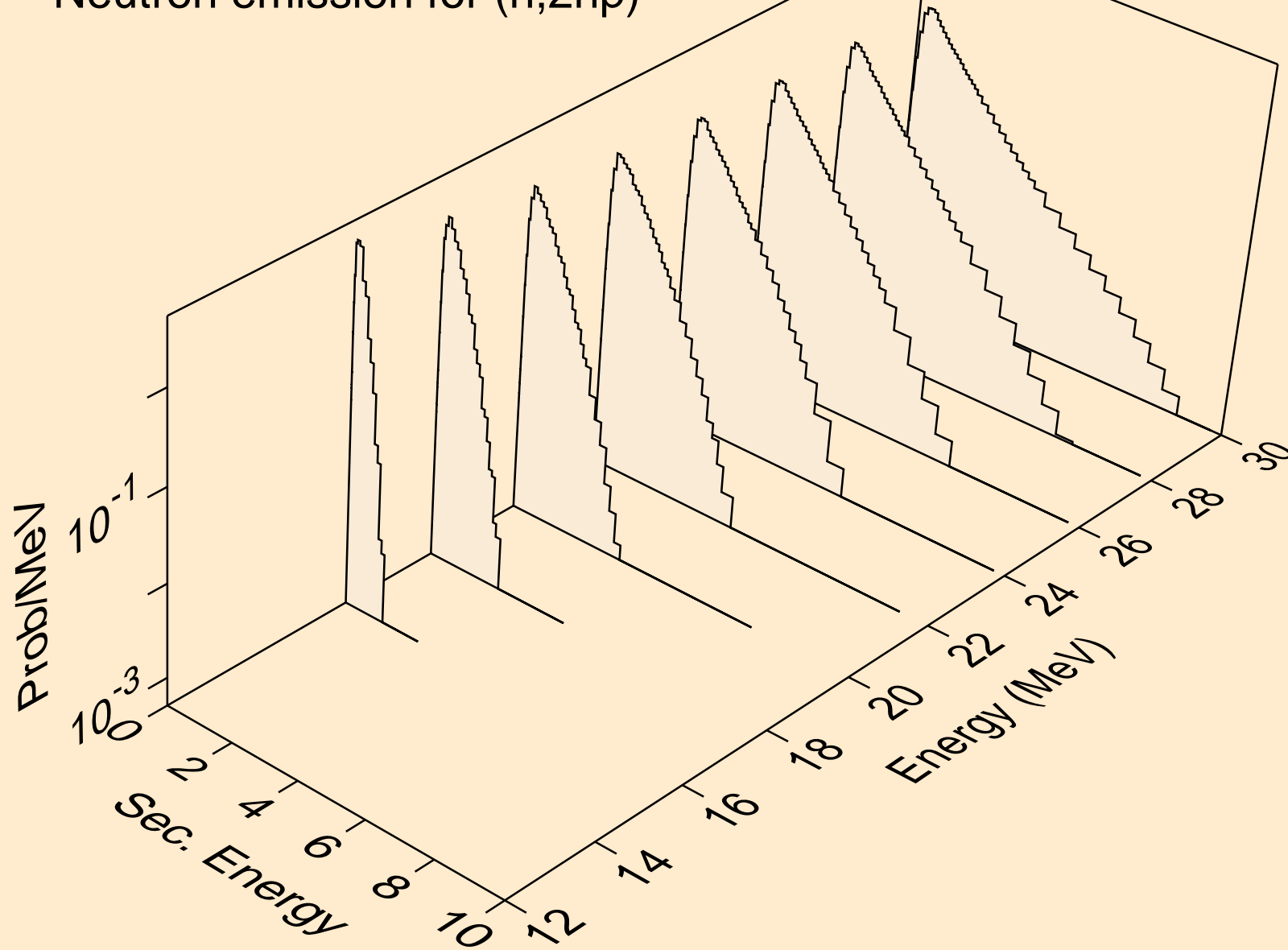

AU191 NEUTRON ACER TENDL-2021 LIBRARY; T=293.6K  
Neutron emission for (n,3np)

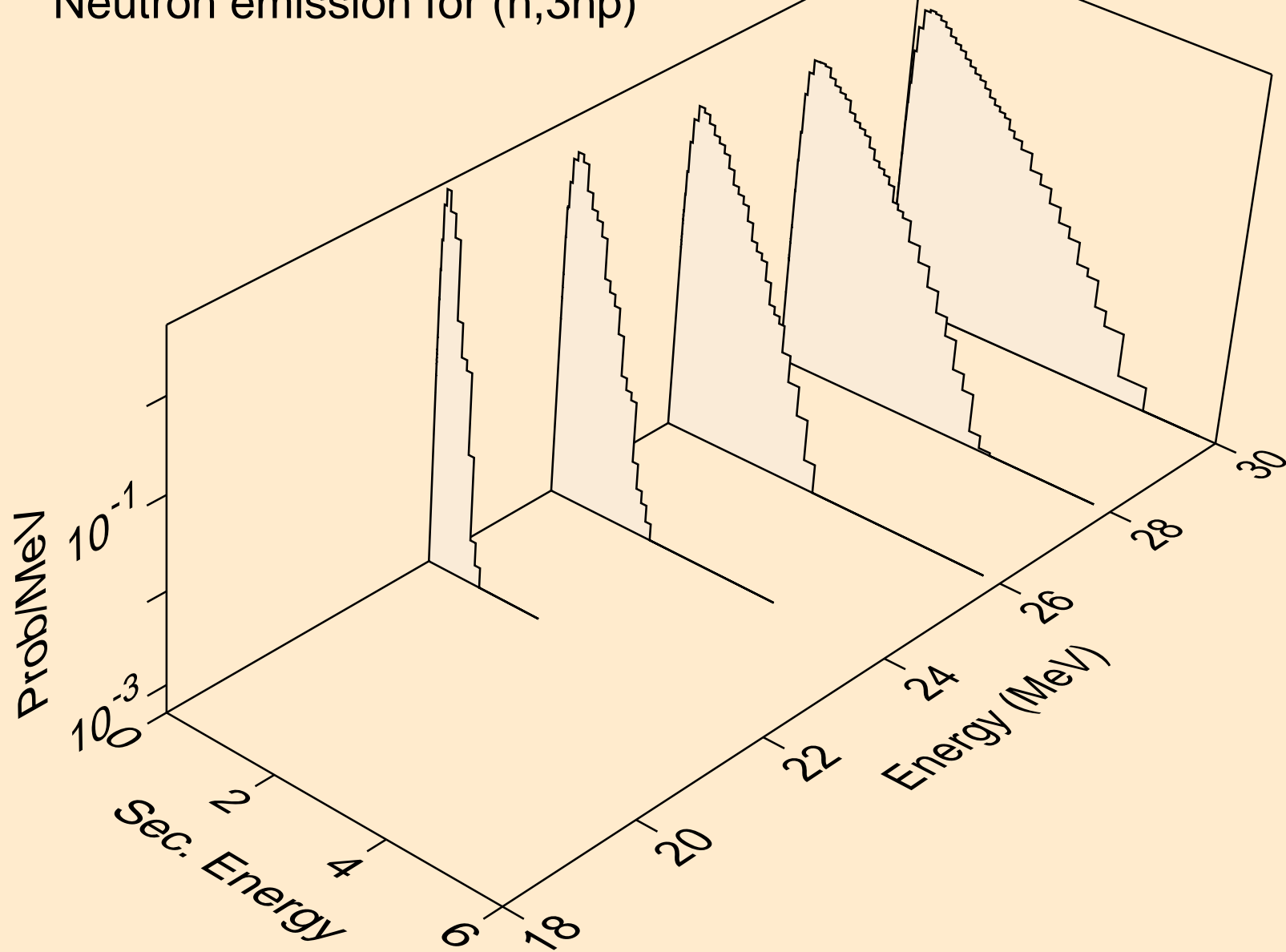

AU191 NEUTRON ACER TENDL-2021 LIBRARY; T=293.6K  
Neutron emission for (n,2np)

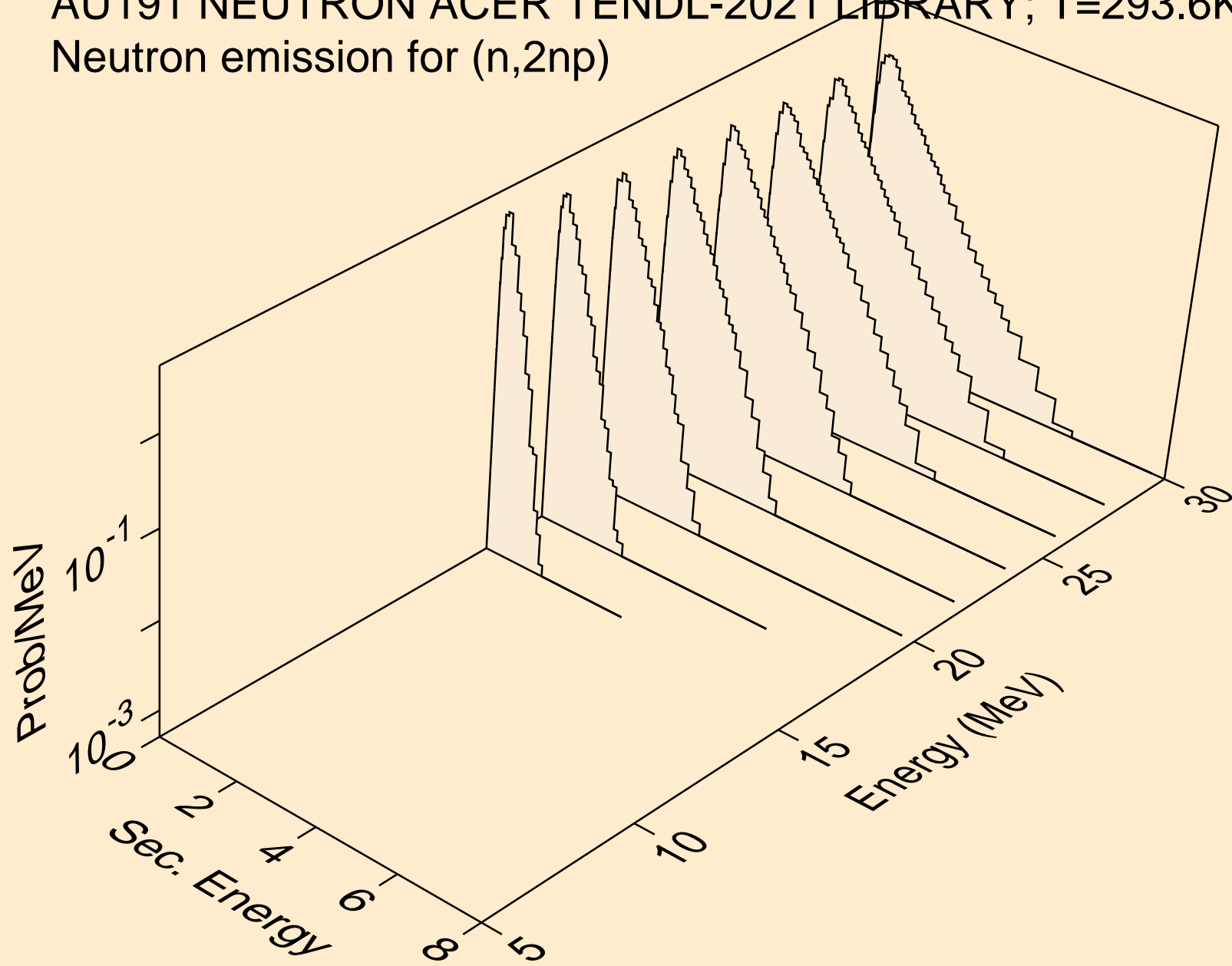

AU191 NEUTRON ACER TENDL-2021 LIBRARY; T=293.6K  
Neutron emission for (n,npa)

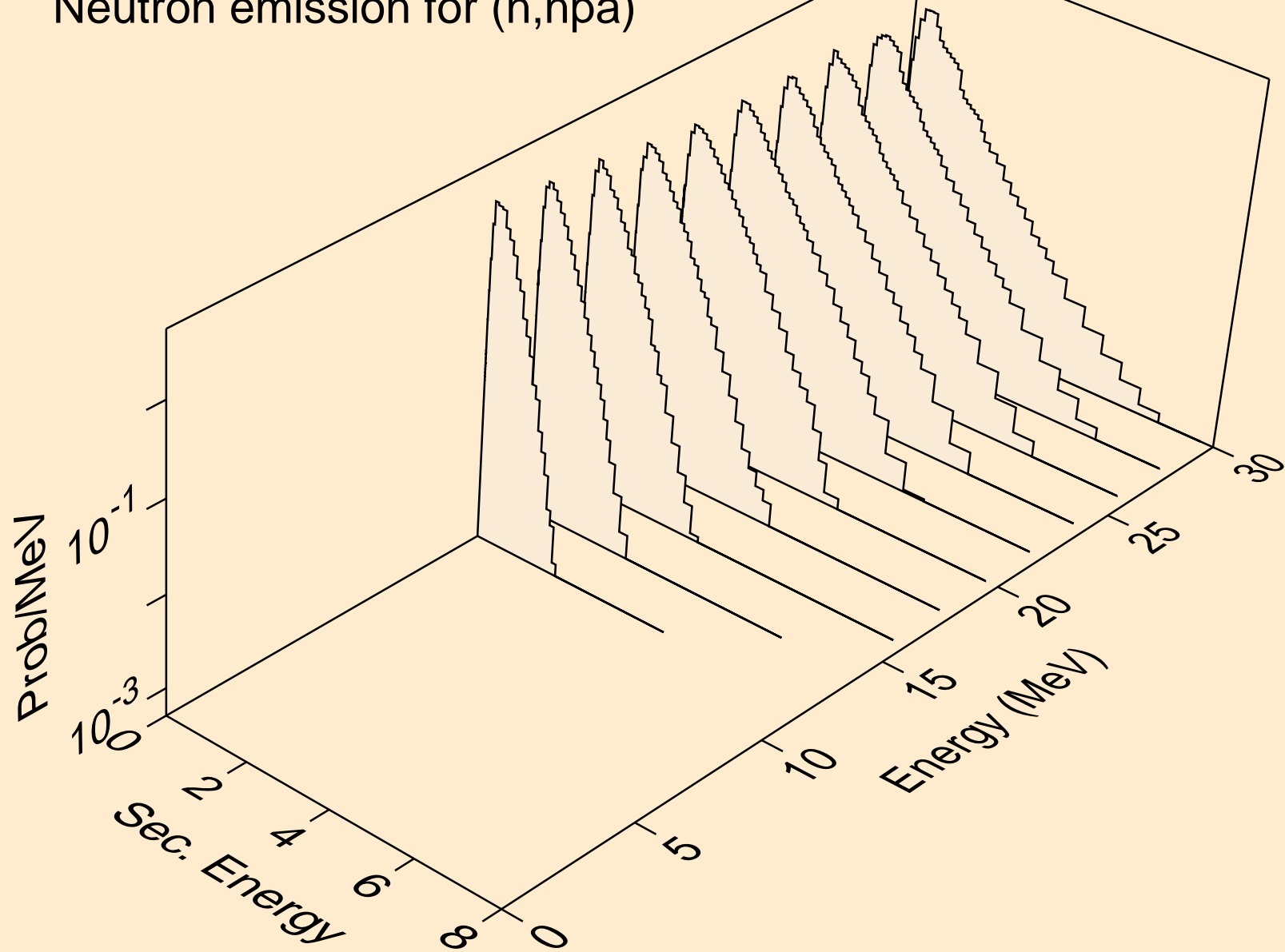

AU191 NEUTRON ACER TENDL-2021 LIBRARY; T=293.6K  
Neutron emission for (n,n\*c)

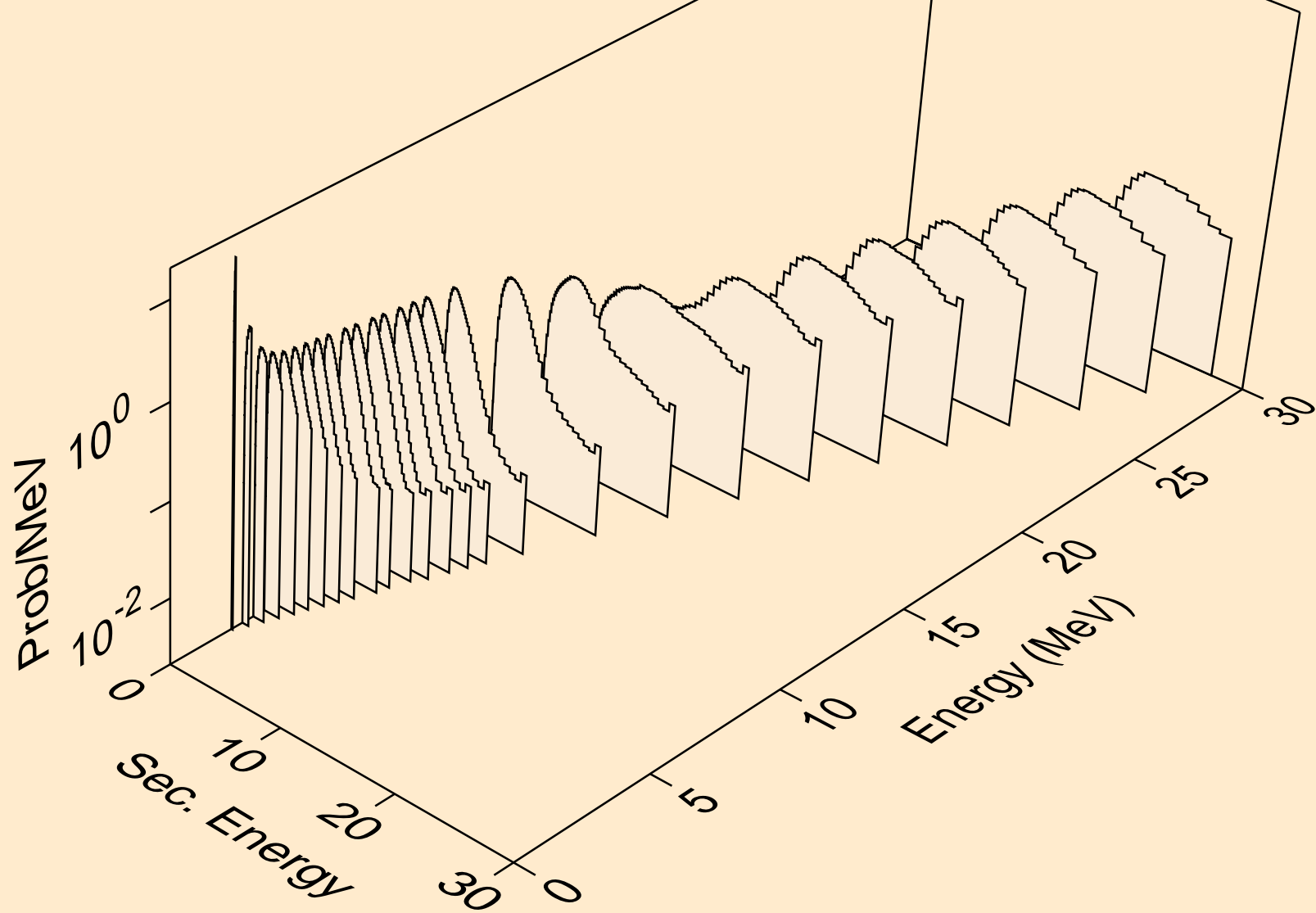

AU191 NEUTRON ACER TENDL-2021 LIBRARY; T=293.6K  
Photon emission for (n,x)

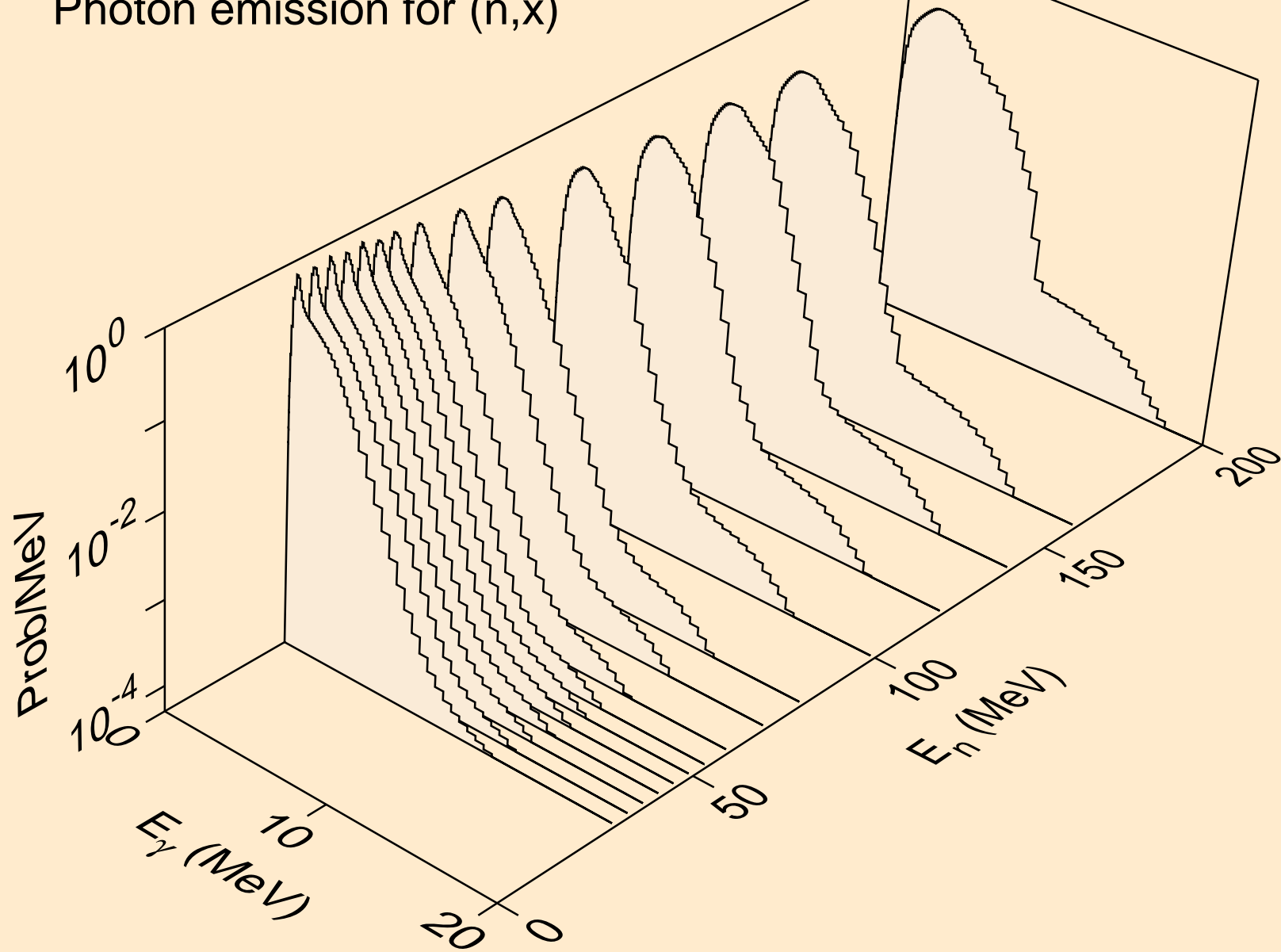

AU191 NEUTRON ACER TENDL-2021 LIBRARY; T=293.6K  
Photon emission for (n,2nd)

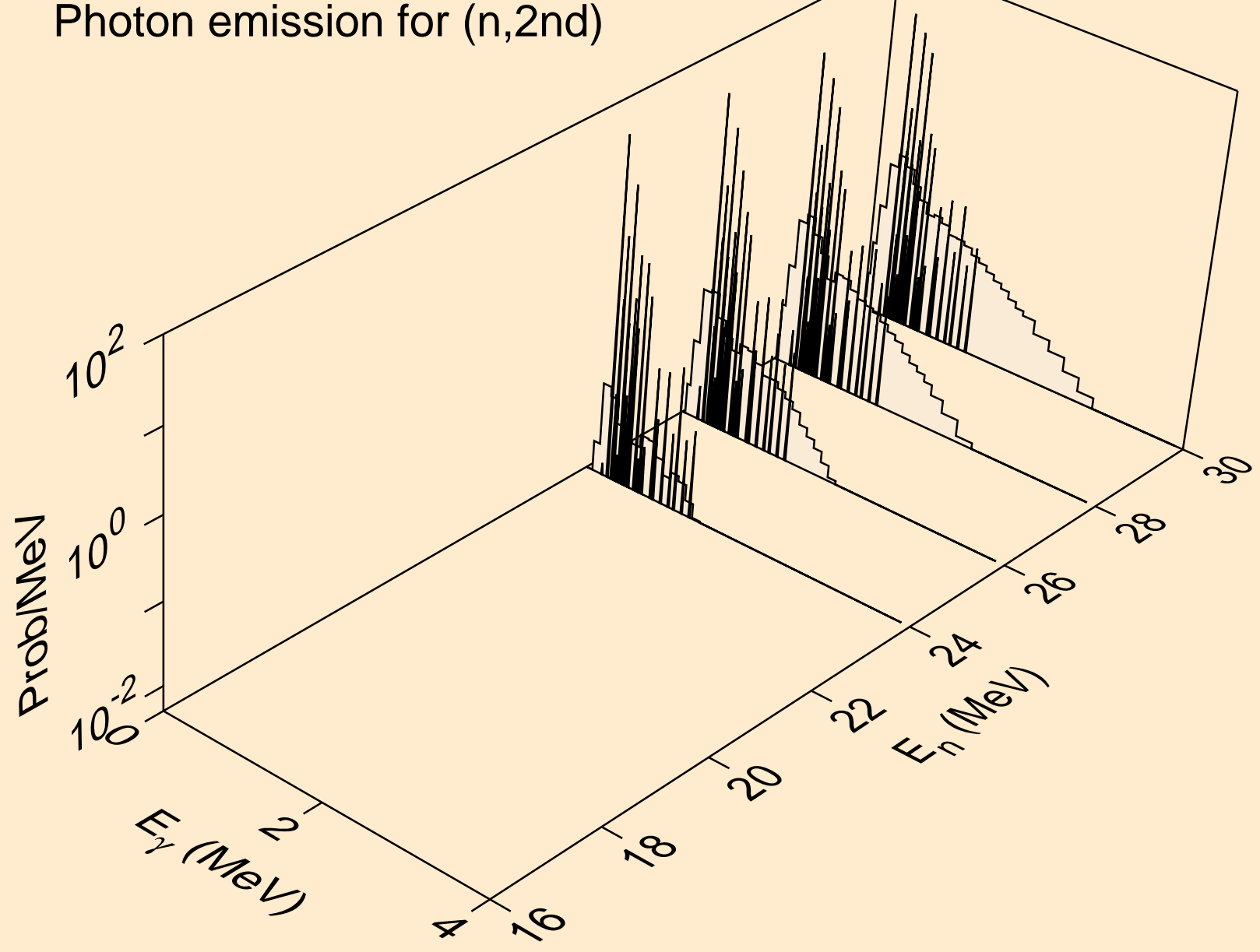



AU191 NEUTRON ACER TENDL-2021 LIBRARY; T=293.6K  
Photon emission for (n,2n)

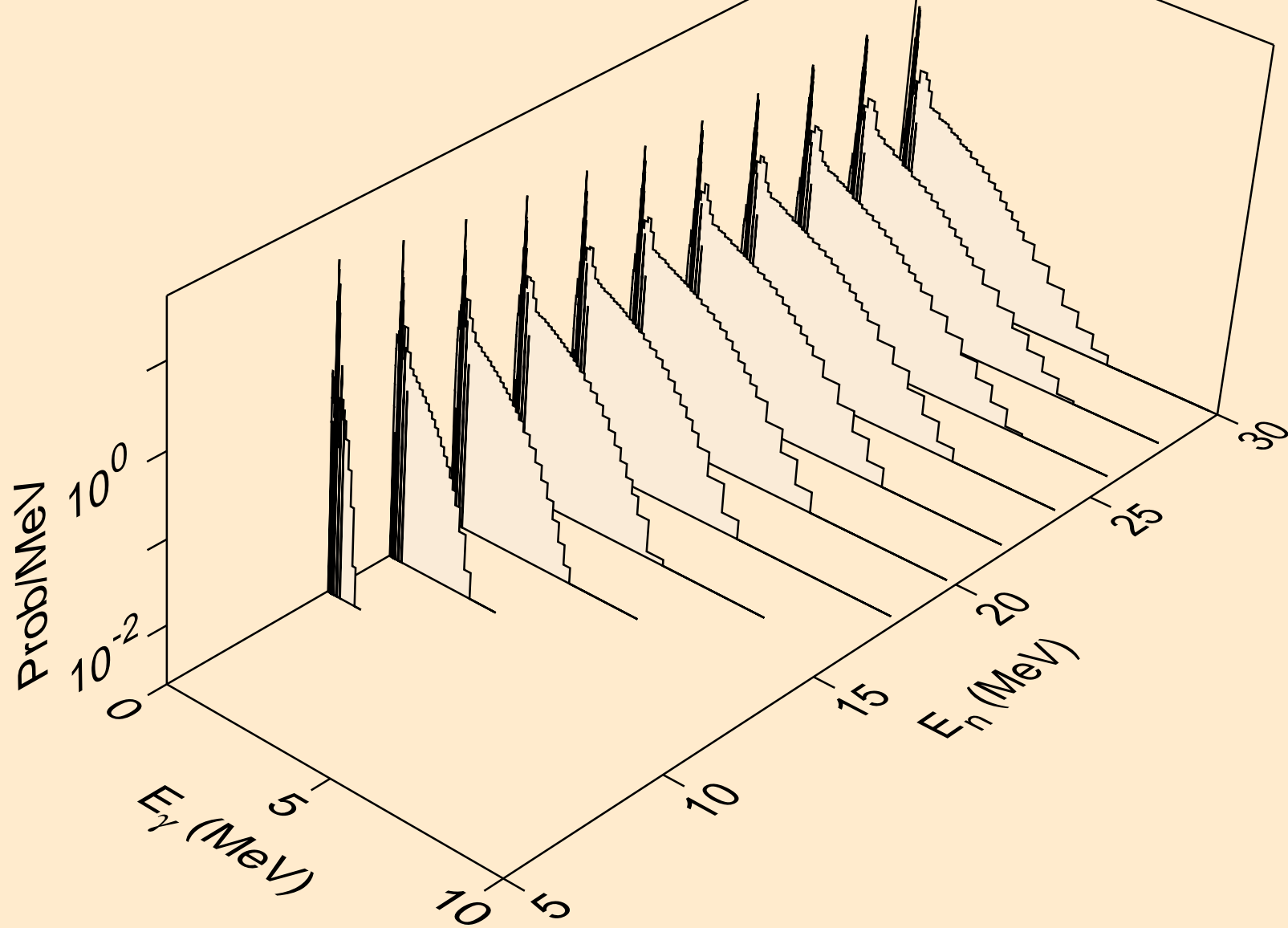

AU191 NEUTRON ACER TENDL-2021 LIBRARY; T=293.6K  
Photon emission for (n,3n)

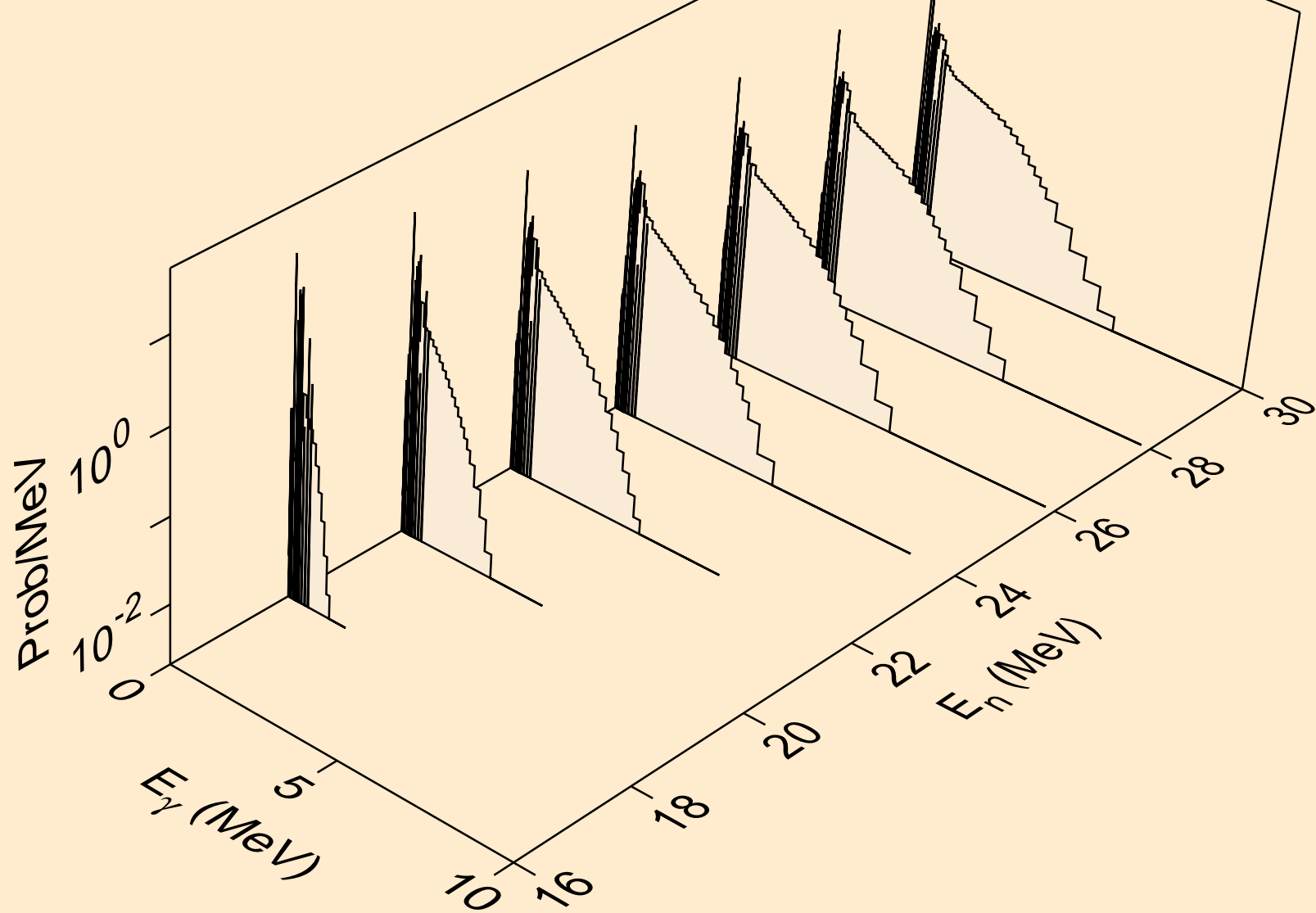

AU191 NEUTRON ACER TENDL-2021 LIBRARY; T=293.6K  
Photon emission for (n,n\*)a

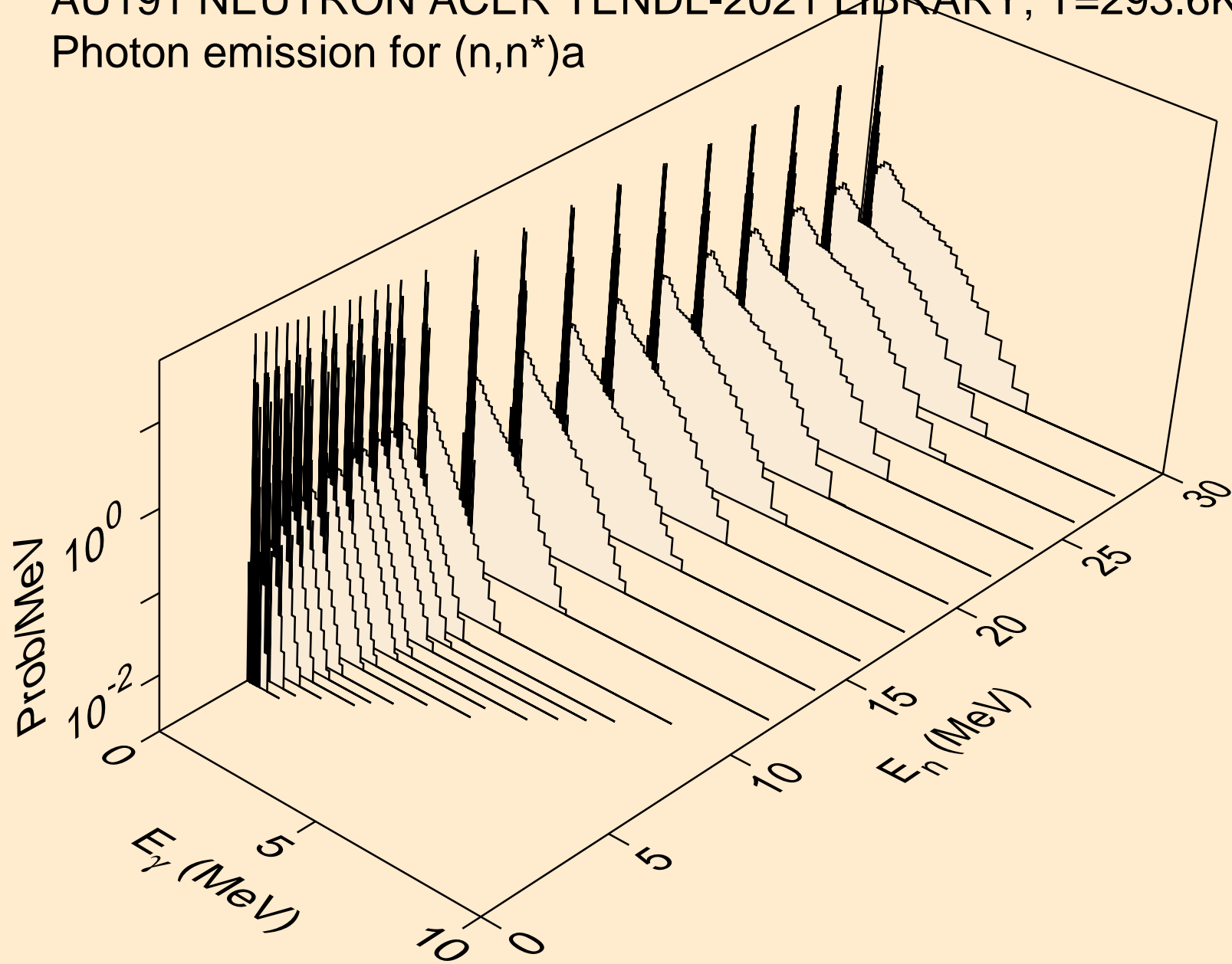

AU191 NEUTRON ACER TENDL-2021 LIBRARY; T=293.6K  
Photon emission for (n,2n)a

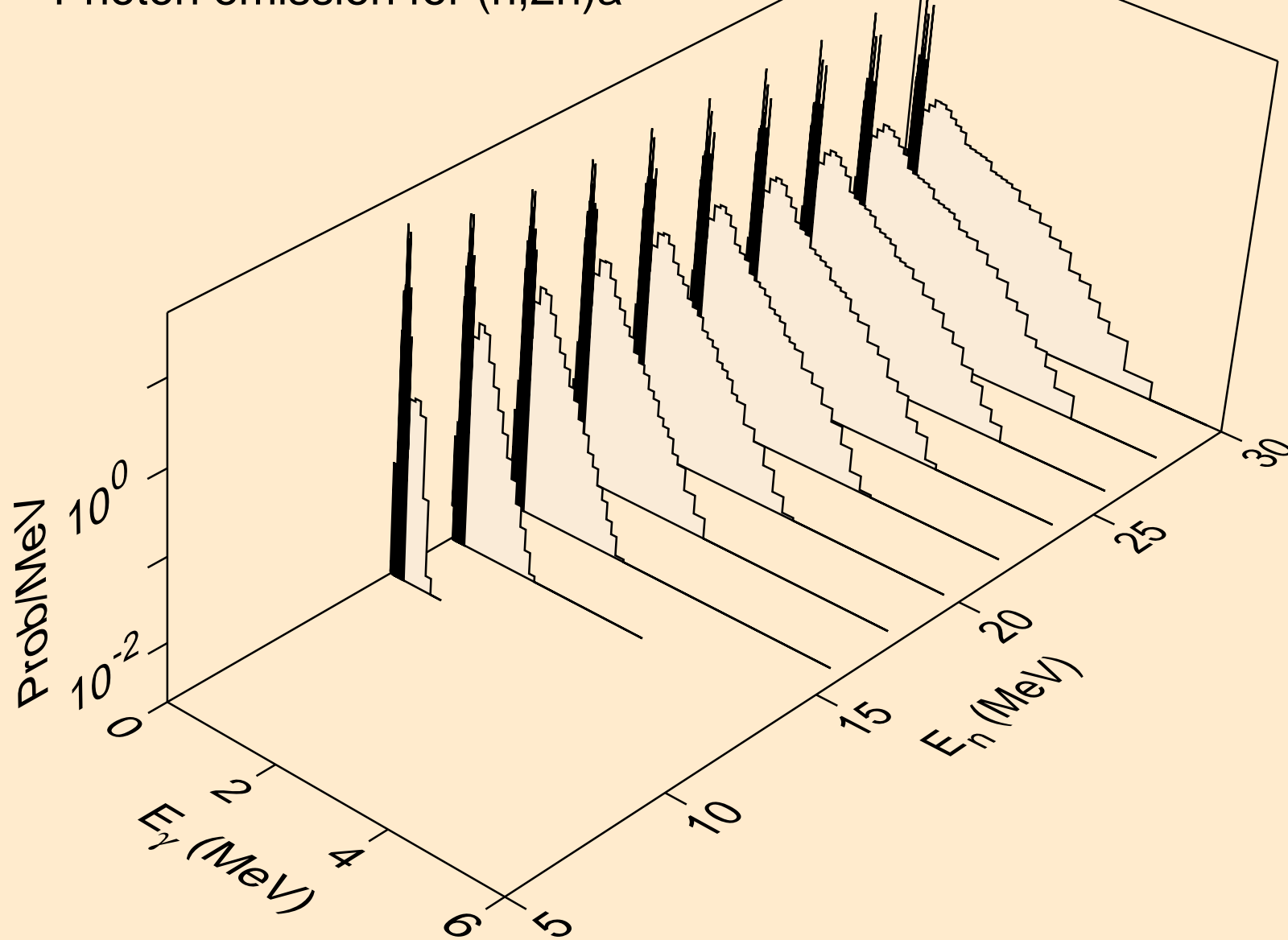

AU191 NEUTRON ACER TENDL-2021 LIBRARY; T=293.6K  
Photon emission for (n,3n)a

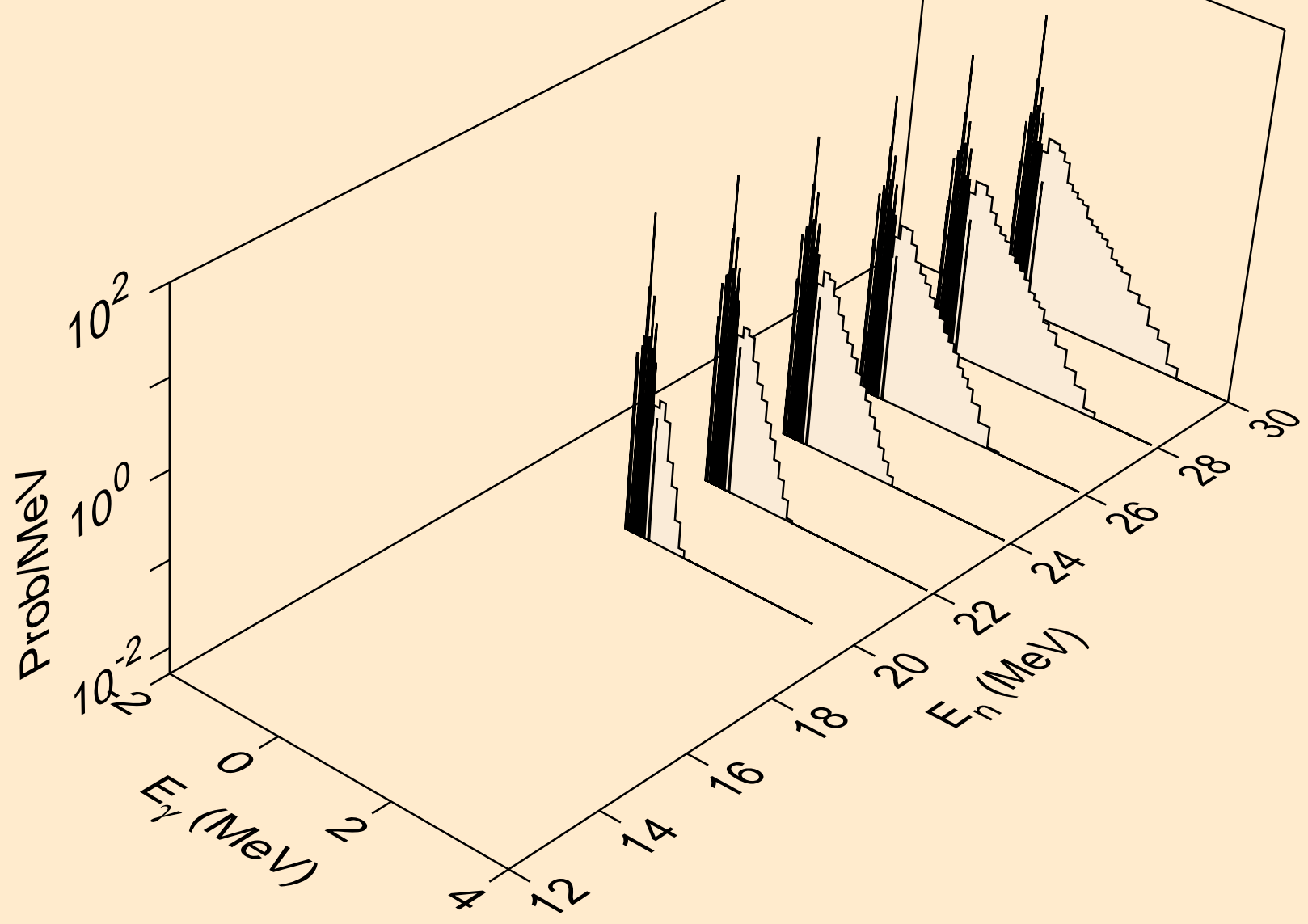

AU191 NEUTRON ACER TENDL-2021 LIBRARY; T=293.6K  
Photon emission for (n,n\*)p

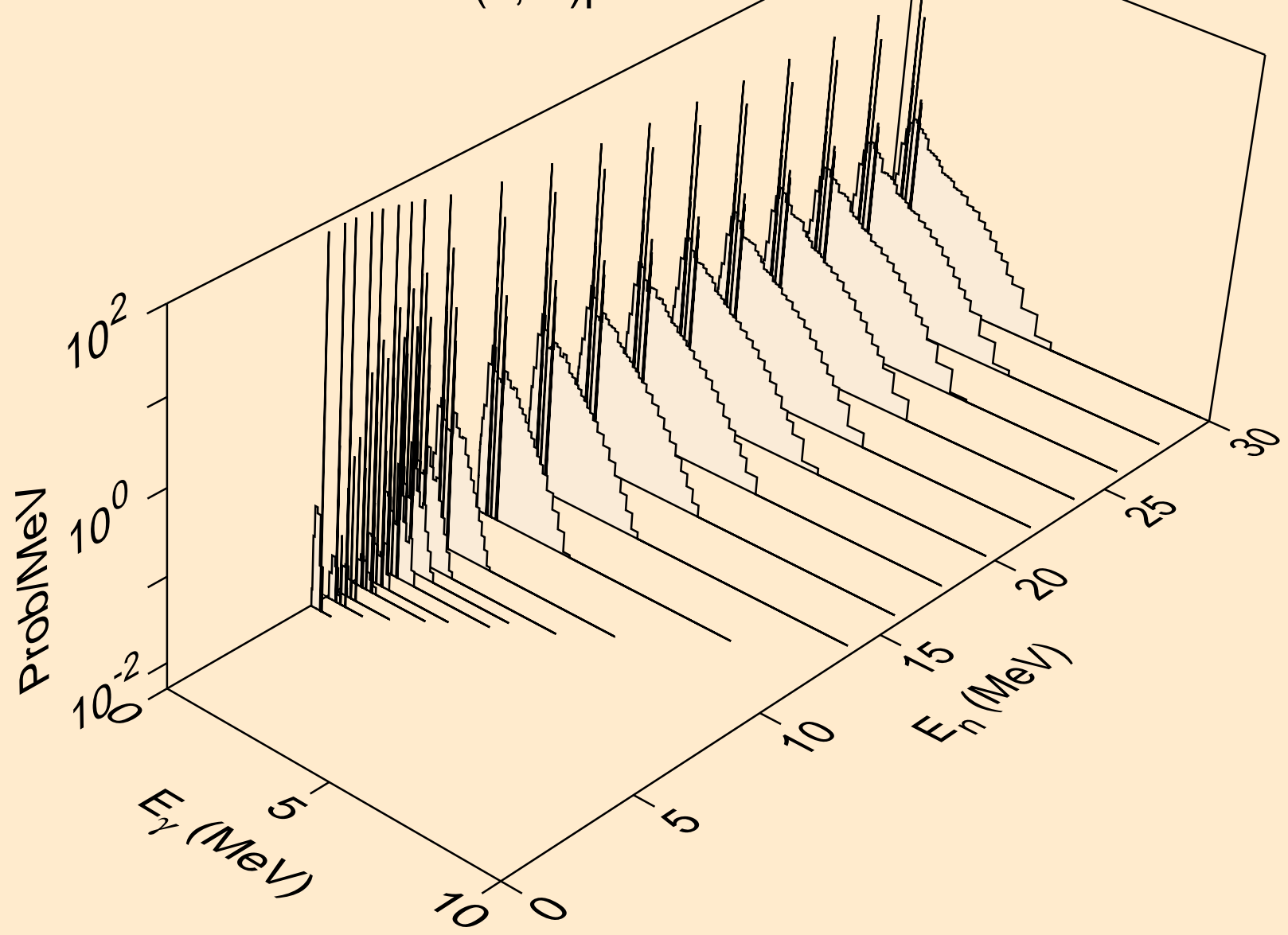

AU191 NEUTRON ACER TENDL-2021 LIBRARY; T=293.6K  
Photon emission for (n,n\*)2a

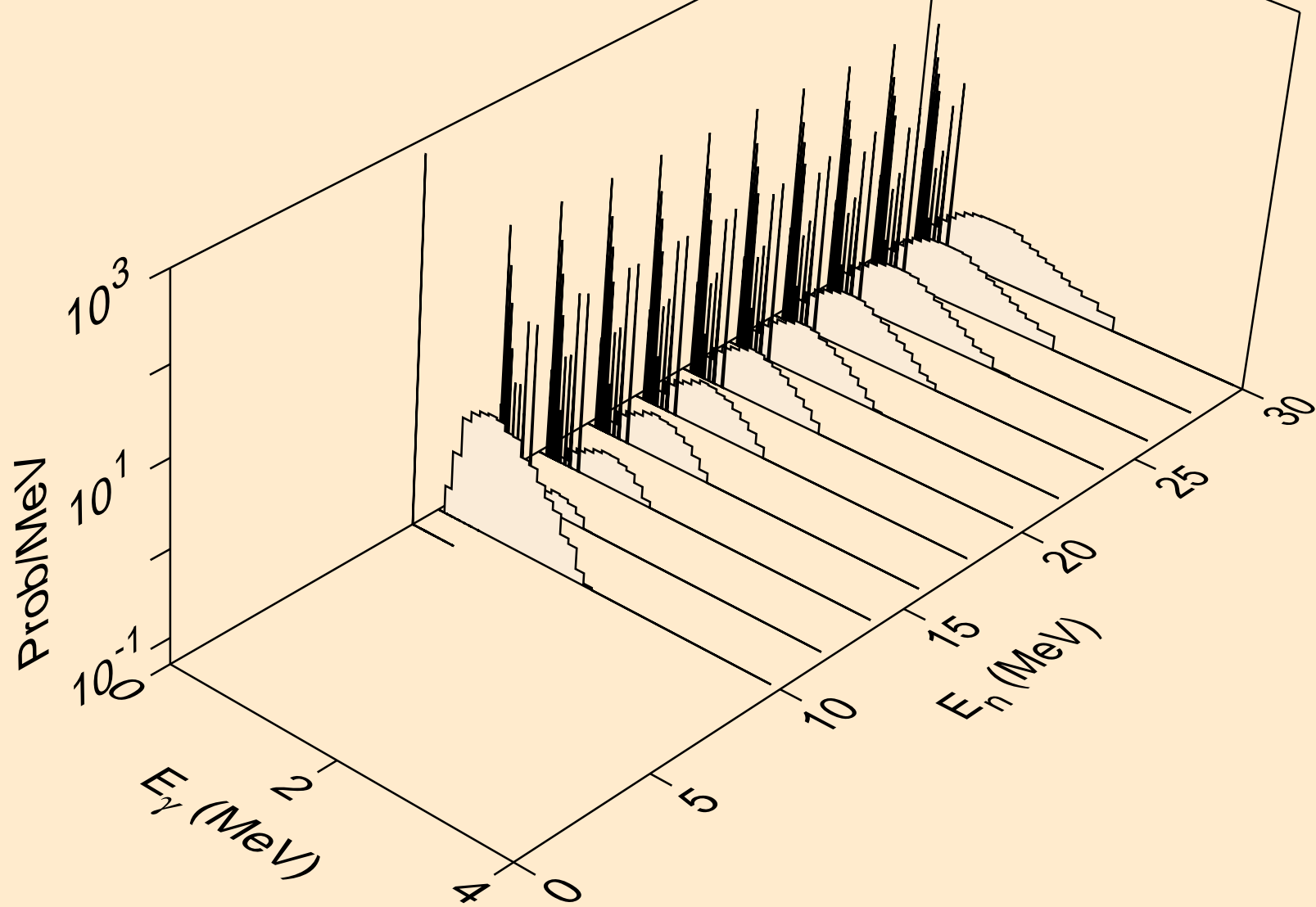

AU191 NEUTRON ACER TENDL-2021 LIBRARY; T=293.6K  
Photon emission for (n,n\*)d

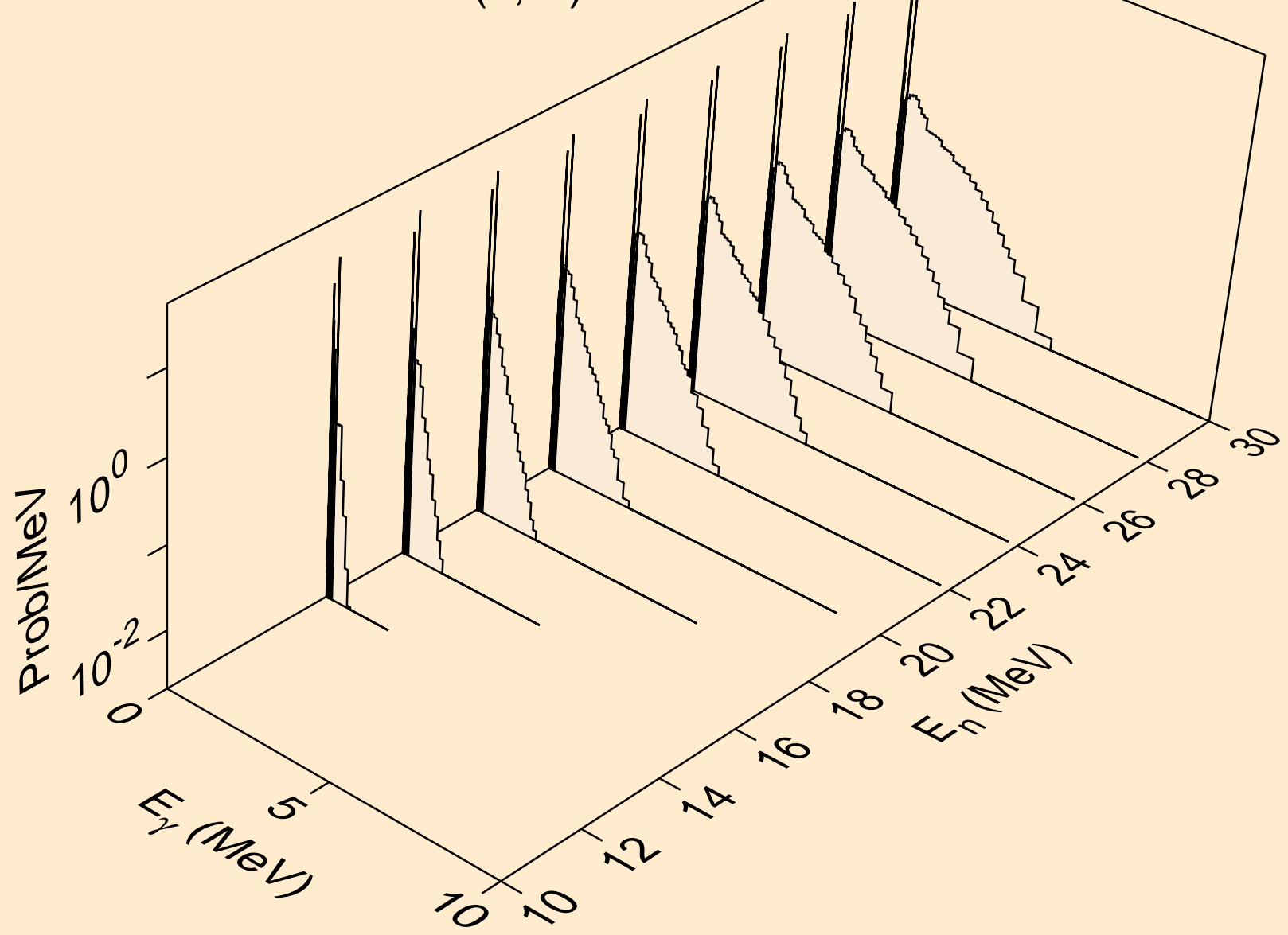



AU191 NEUTRON ACER TENDL-2021 LIBRARY; T=293.6K  
Photon emission for (n,n\*)t

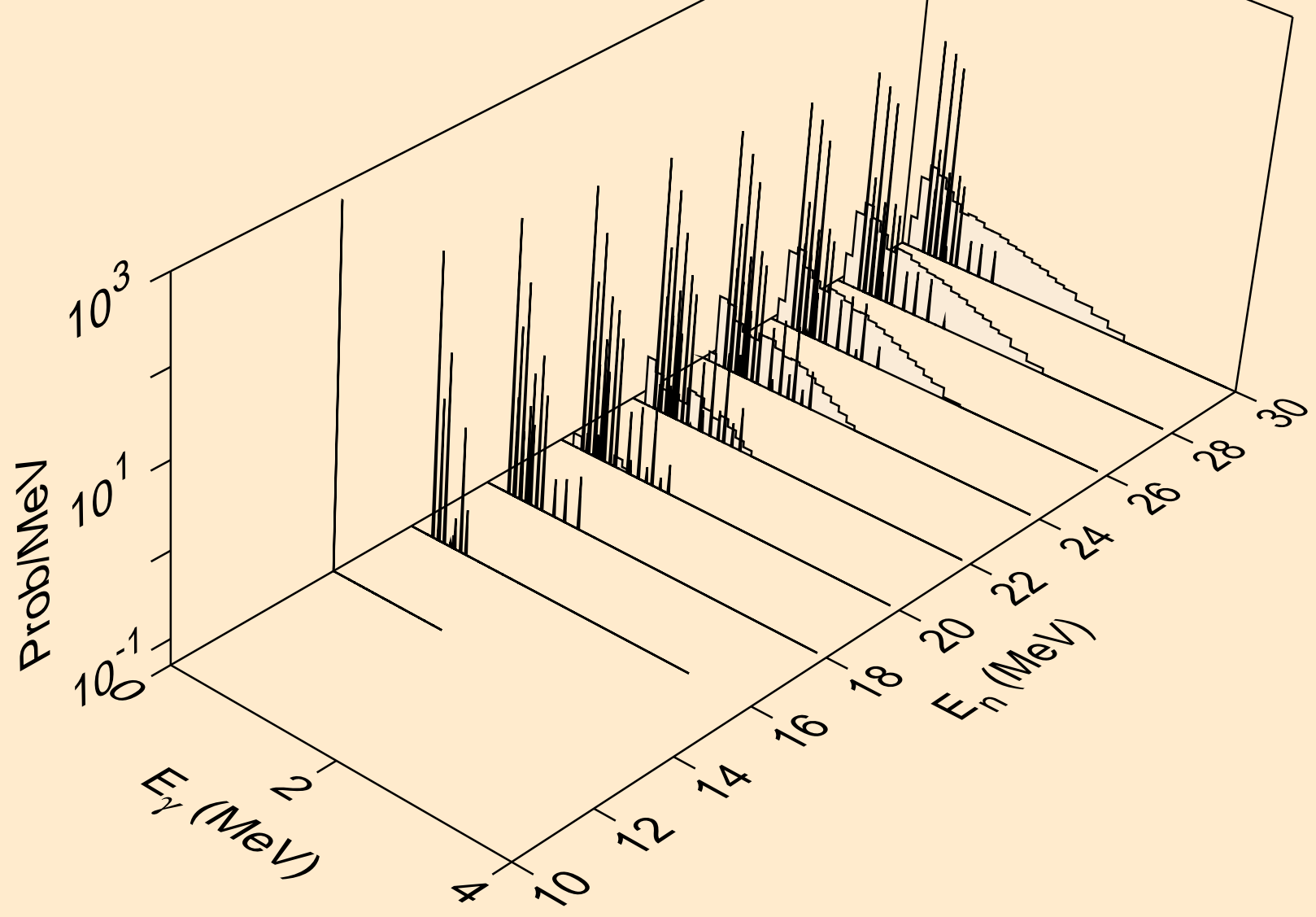

AU191 NEUTRON ACER TENDL-2021 LIBRARY; T=293.6K  
Photon emission for (n,n\*)he3

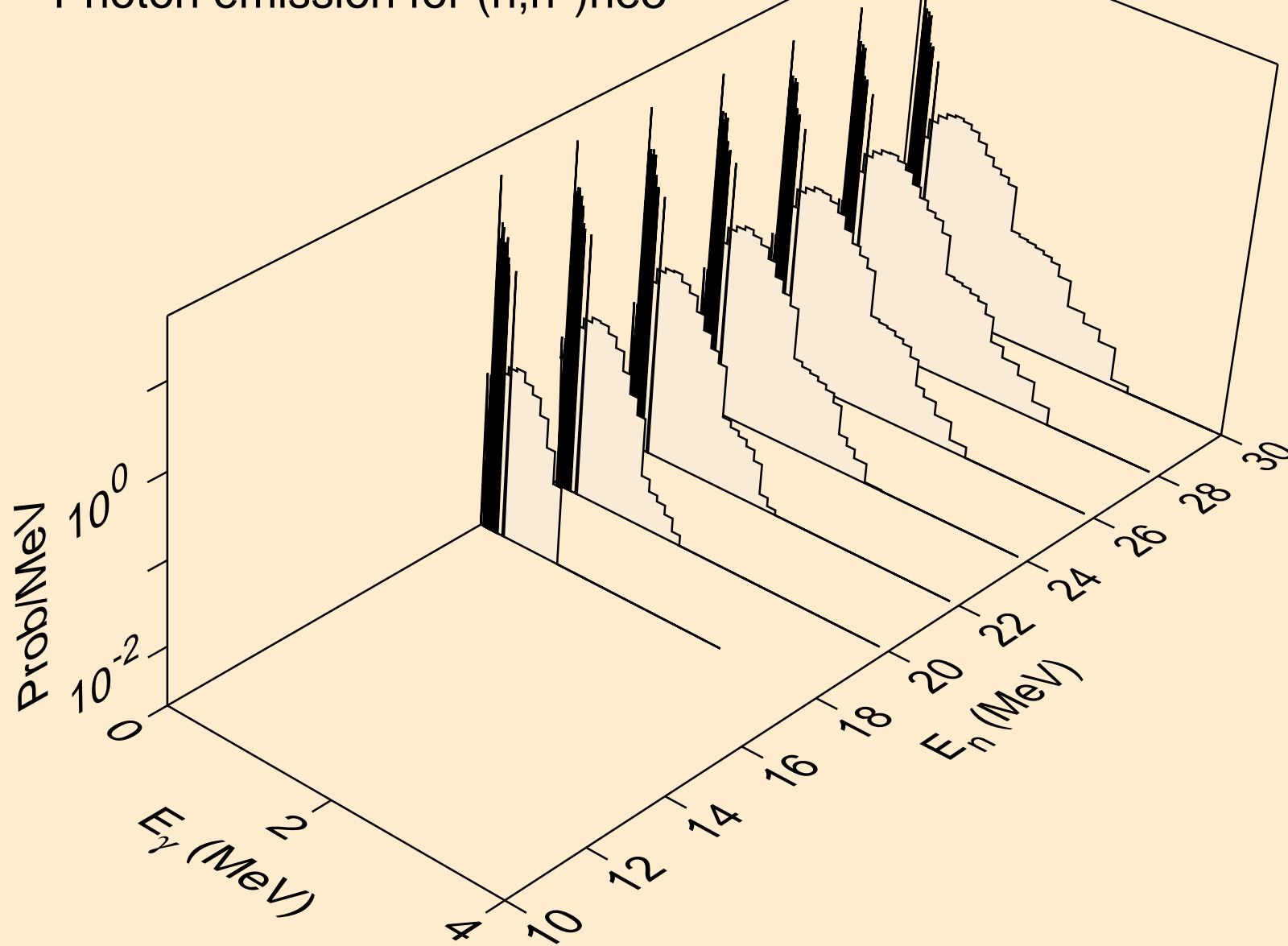

AU191 NEUTRON ACER TENDL-2021 LIBRARY; T=293.6K  
Photon emission for (n,4n)

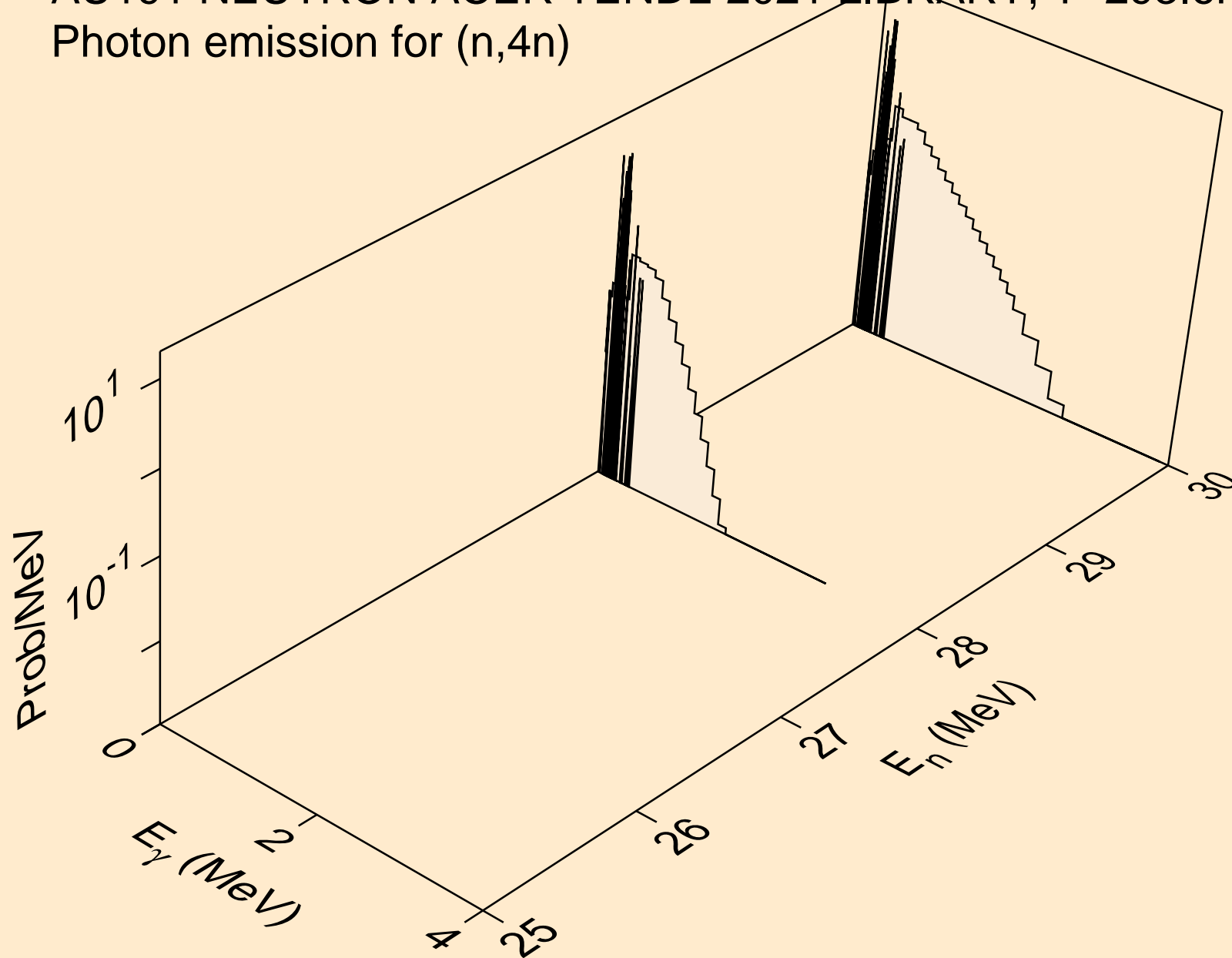

AU191 NEUTRON ACER TENDL-2021 LIBRARY; T=293.6K  
Photon emission for (n,2np)

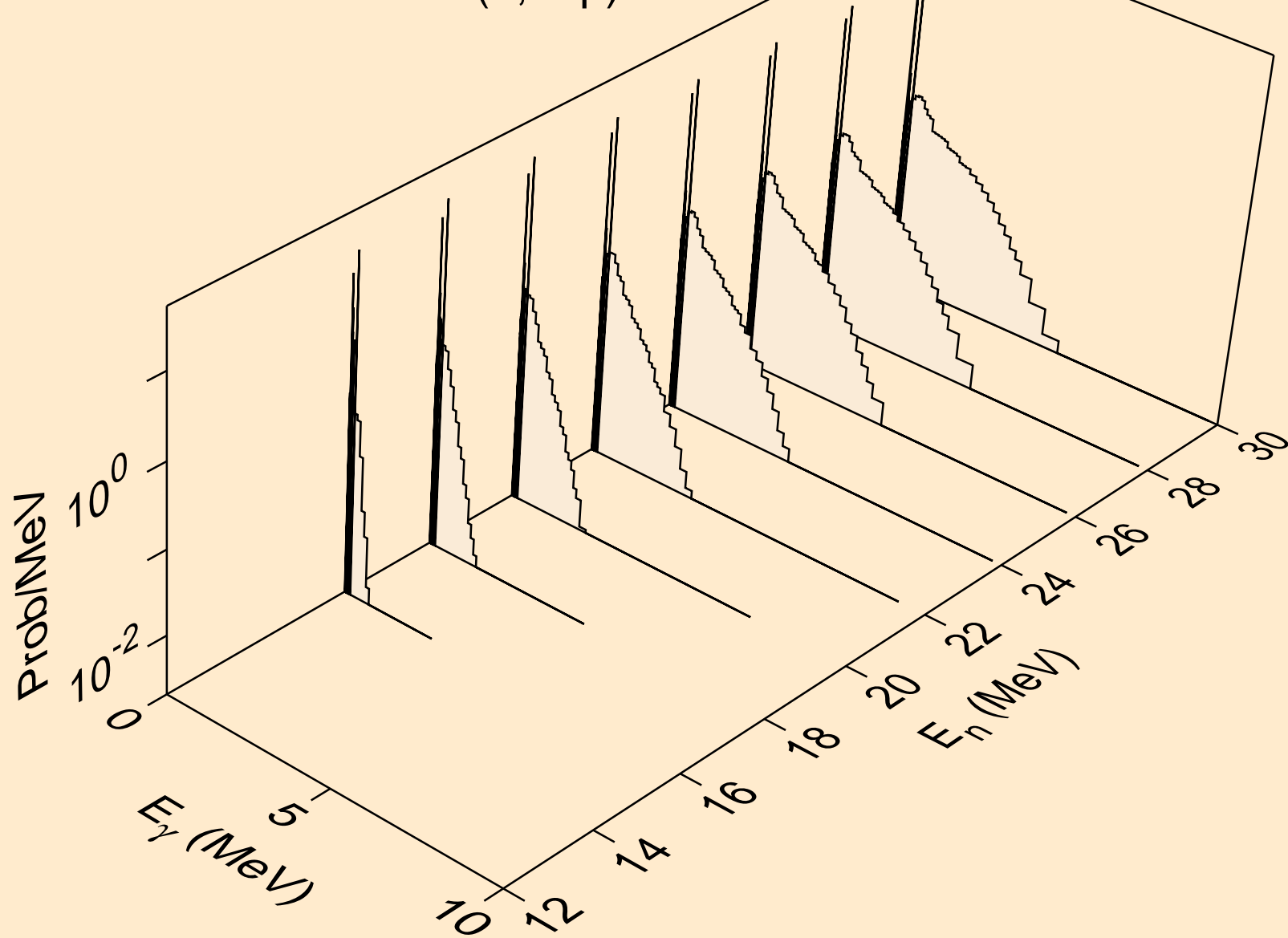

AU191 NEUTRON ACER TENDL-2021 LIBRARY; T=293.6K  
Photon emission for (n,3np)

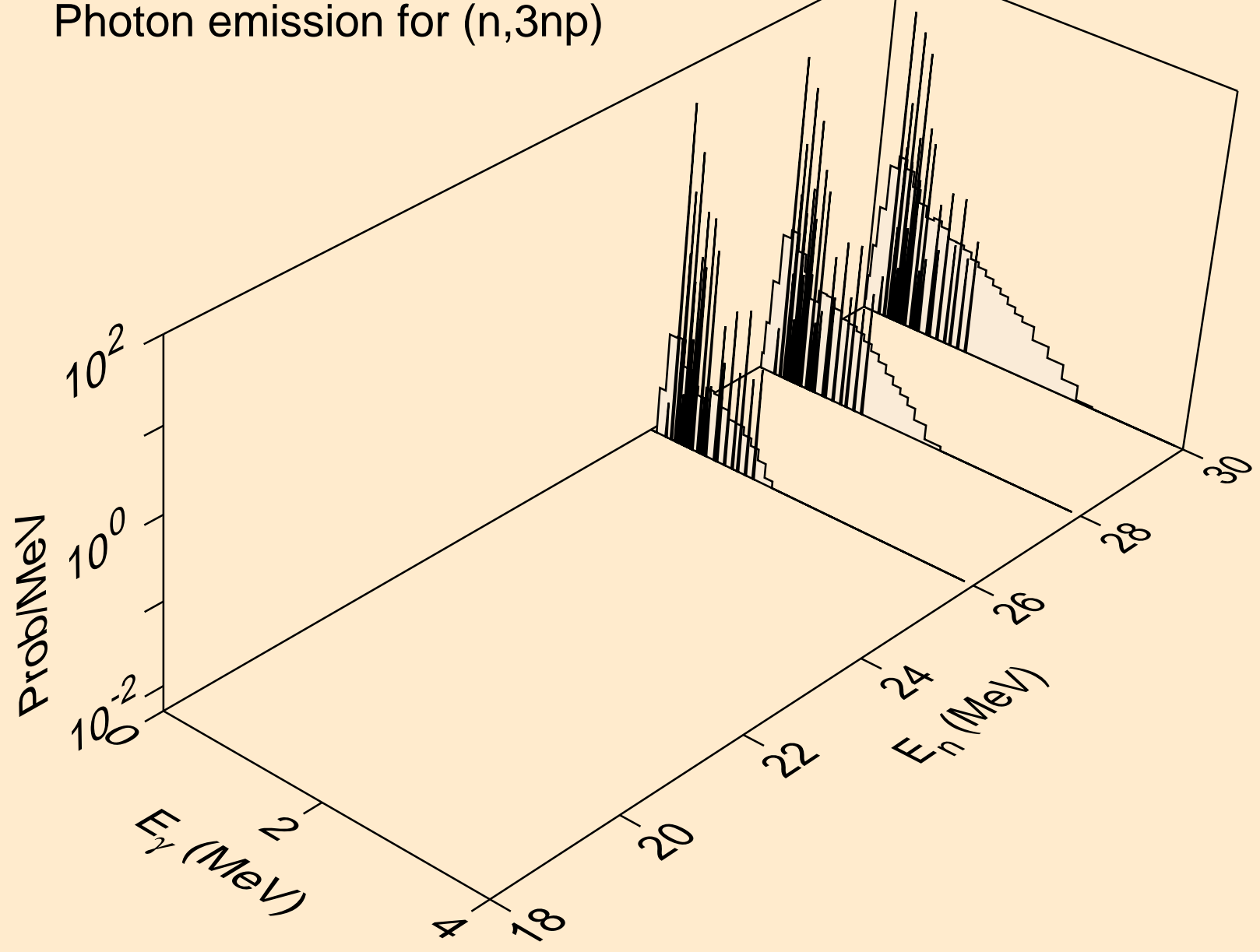

AU191 NEUTRON ACER TENDL-2021 LIBRARY; T=293.6K  
Photon emission for (n,2np)

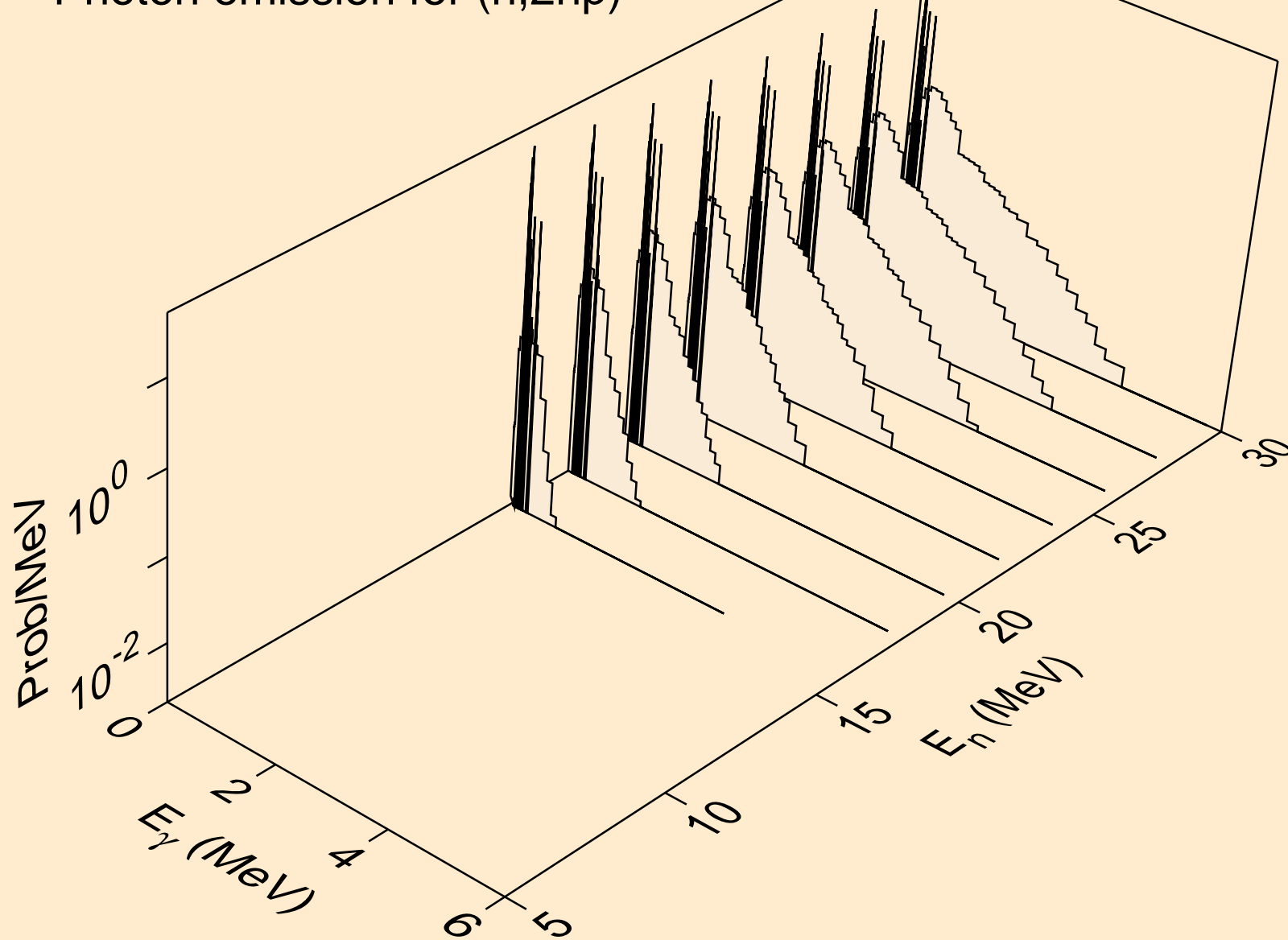

AU191 NEUTRON ACER TENDL-2021 LIBRARY; T=293.6K  
Photon emission for (n,npa)

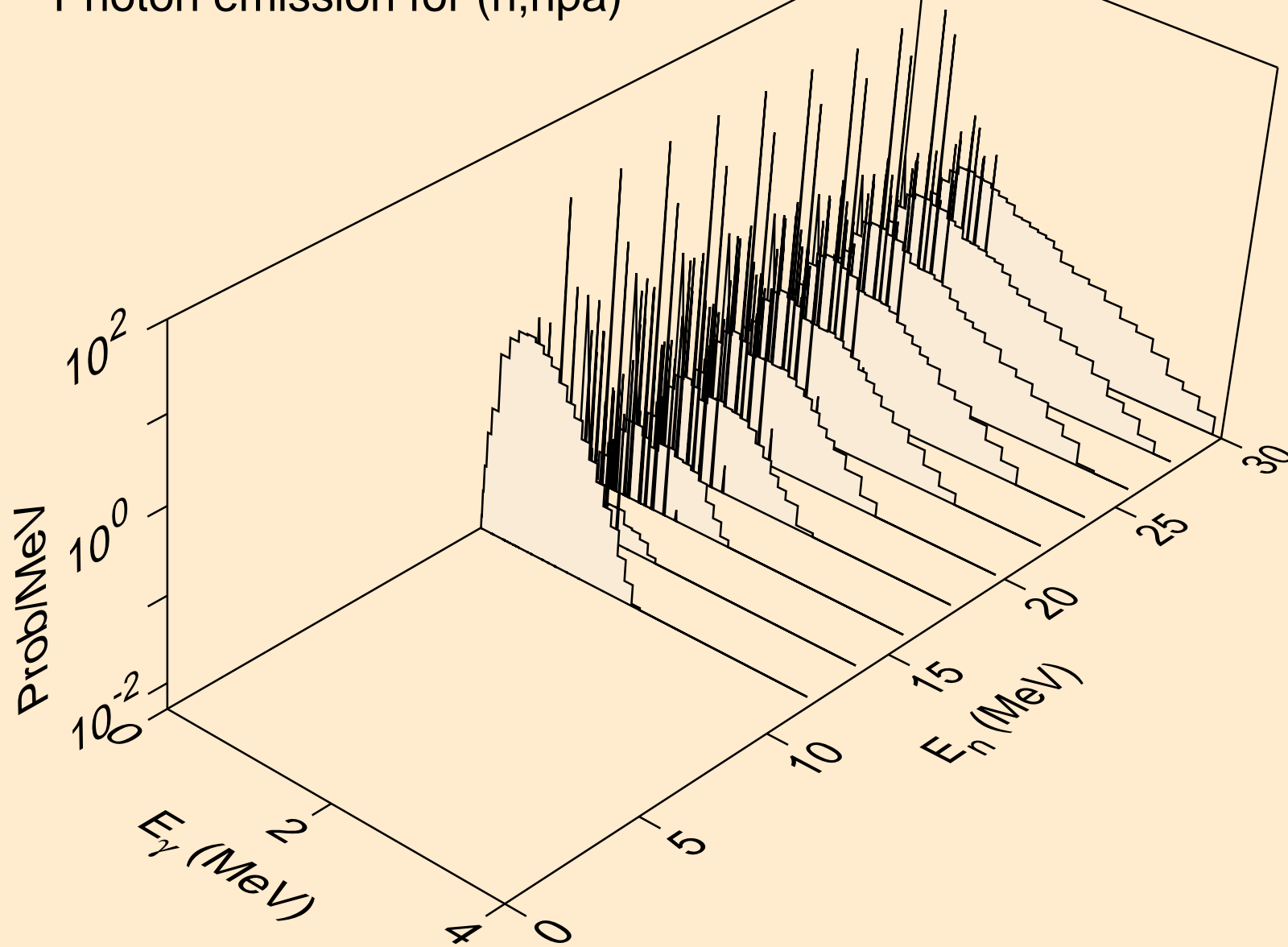

AU191 NEUTRON ACER TENDL-2021 LIBRARY; T=293.6K  
Photon emission for (n,n\*c)

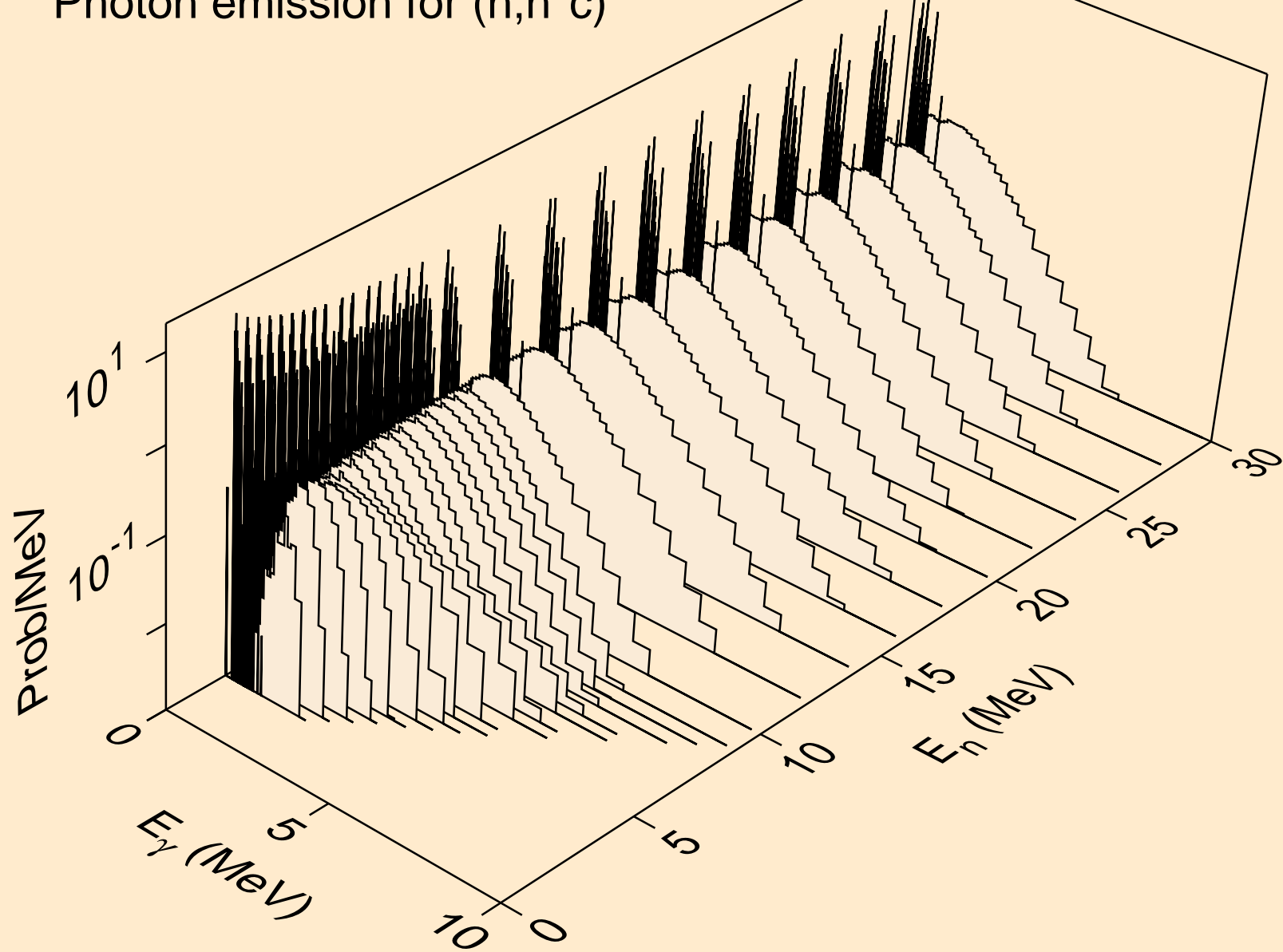



AU191 NEUTRON ACER TENDL-2021 LIBRARY; T=293.6K  
Photon emission for (n,gma)

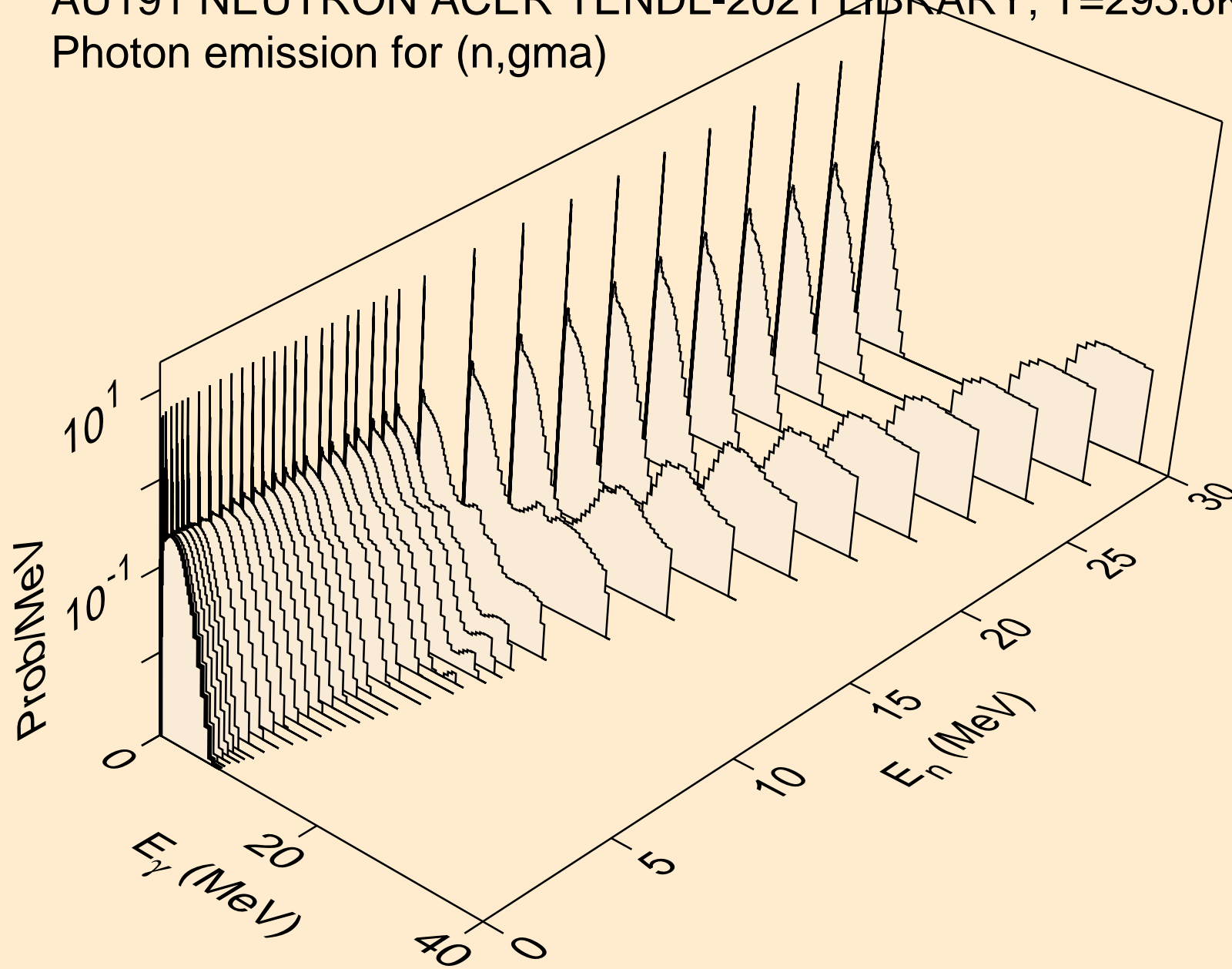

AU191 NEUTRON ACER TENDL-2021 LIBRARY; T=293.6K  
Photon emission for (n,p)

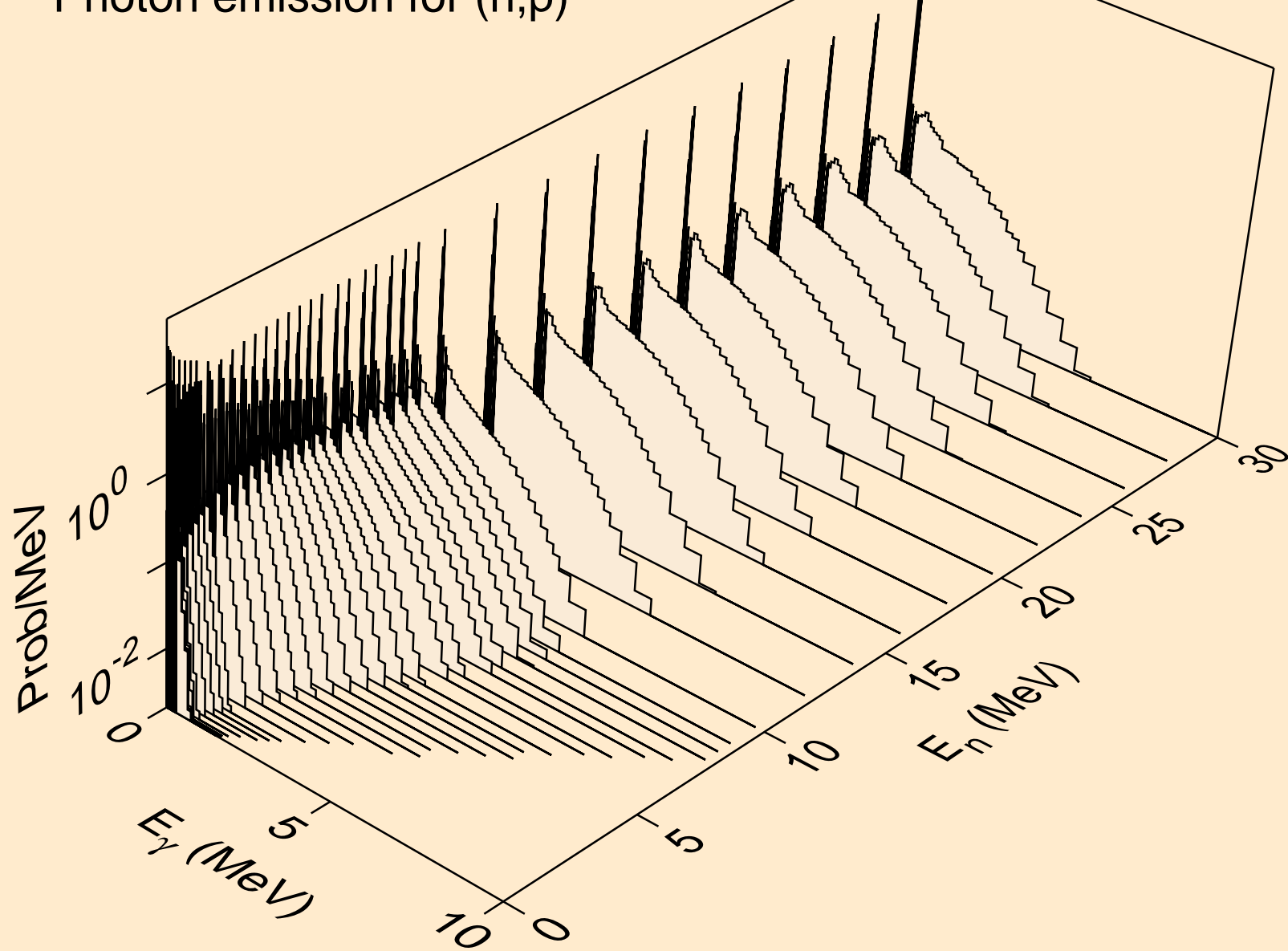

AU191 NEUTRON ACER TENDL-2021 LIBRARY; T=293.6K  
Photon emission for (n,d)

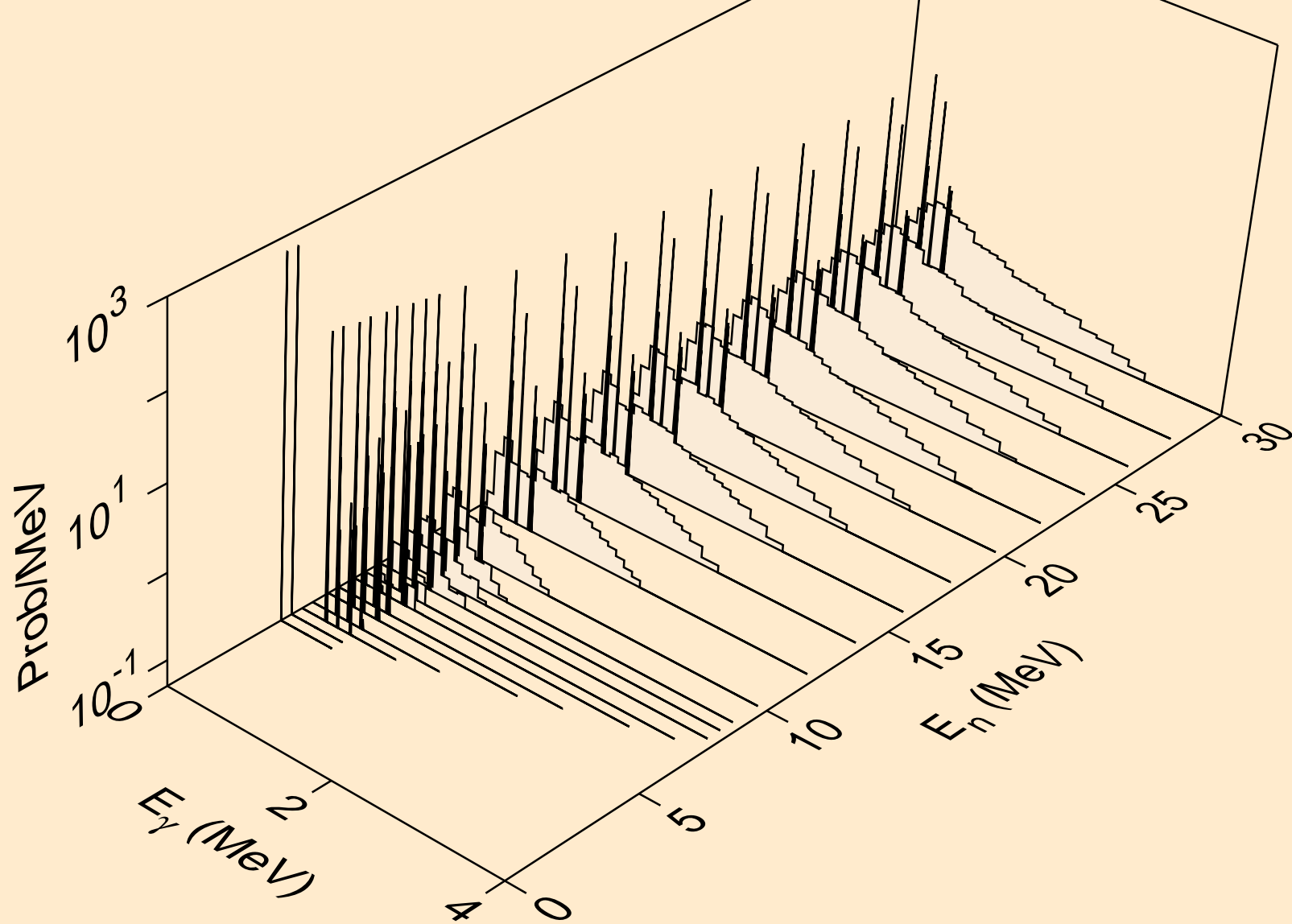

AU191 NEUTRON ACER TENDL-2021 LIBRARY; T=293.6K  
Photon emission for (n,t)

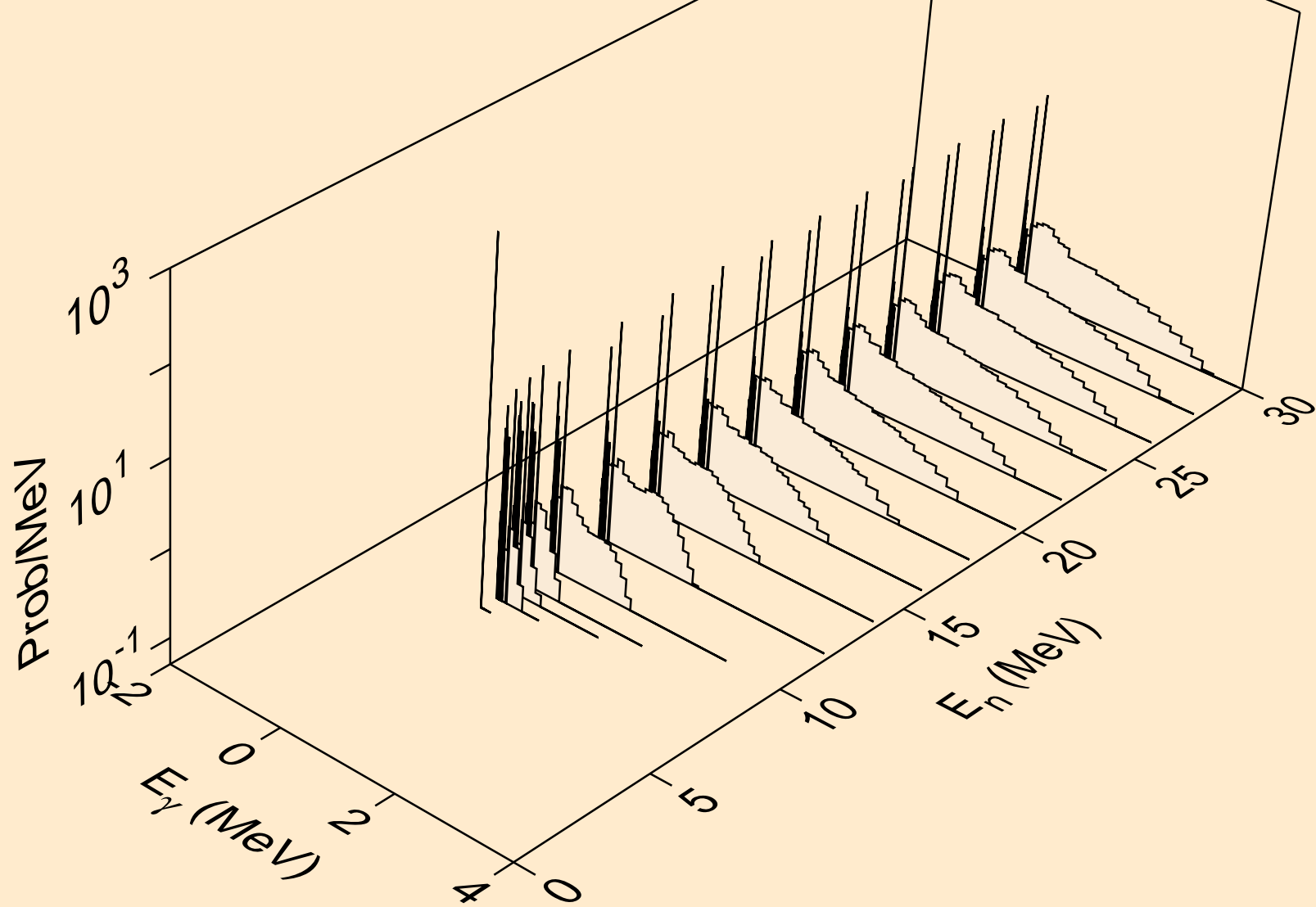

AU191 NEUTRON ACER TENDL-2021 LIBRARY; T=293.6K  
Photon emission for (n,he3)

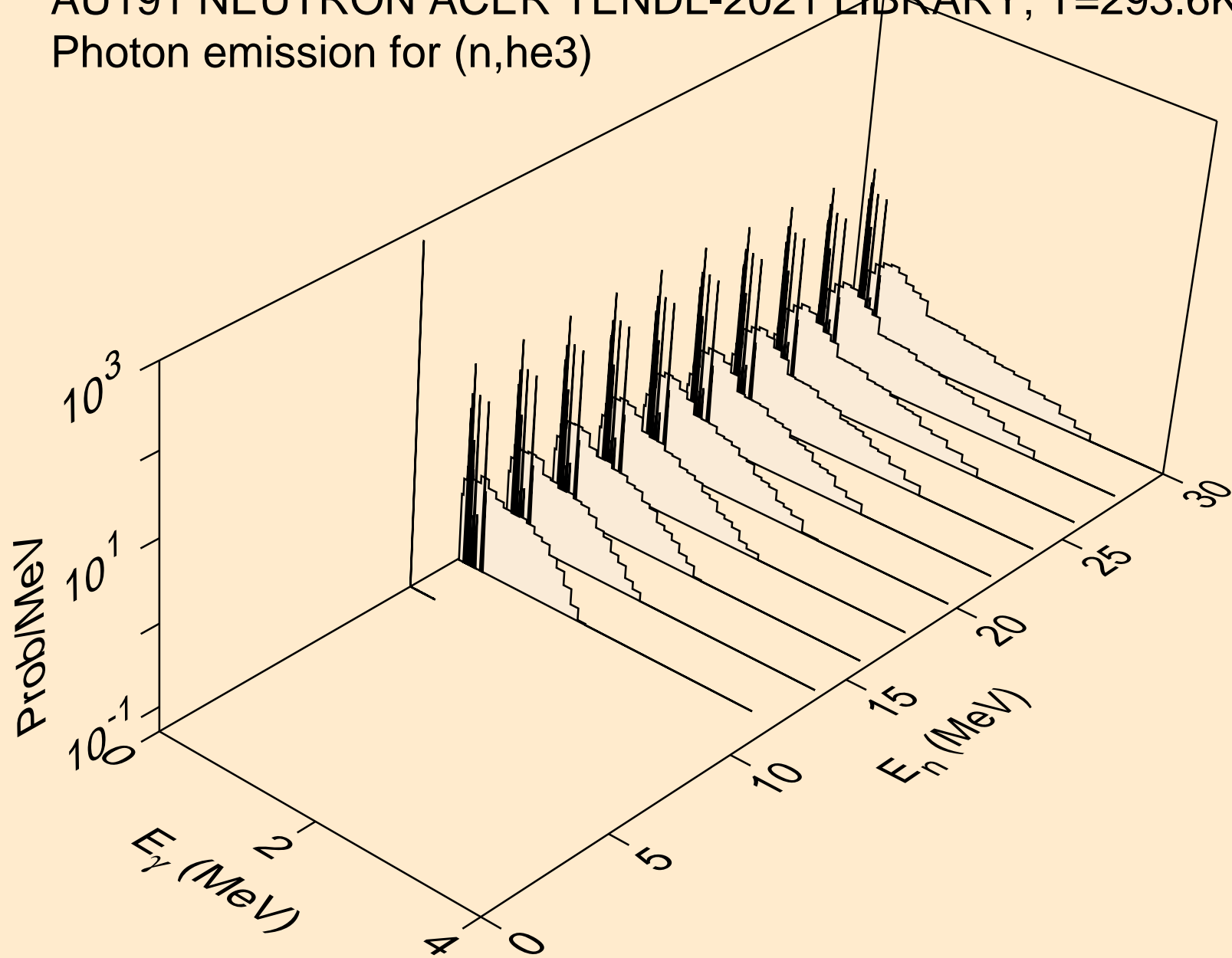

AU191 NEUTRON ACER TENDL-2021 LIBRARY; T=293.6K  
Photon emission for (n,a)

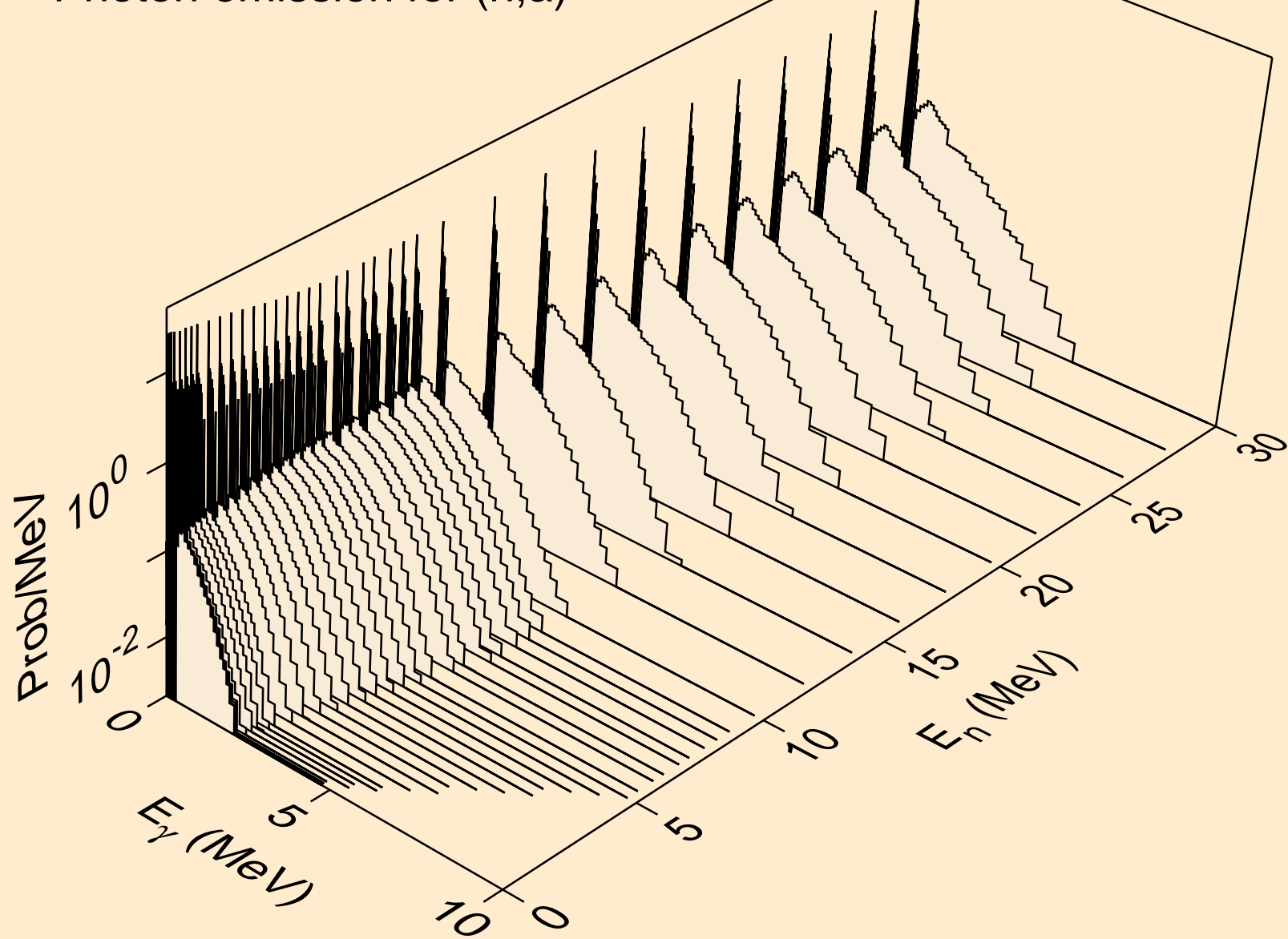

AU191 NEUTRON ACER TENDL-2021 LIBRARY; T=293.6K  
Photon emission for (n,2a)

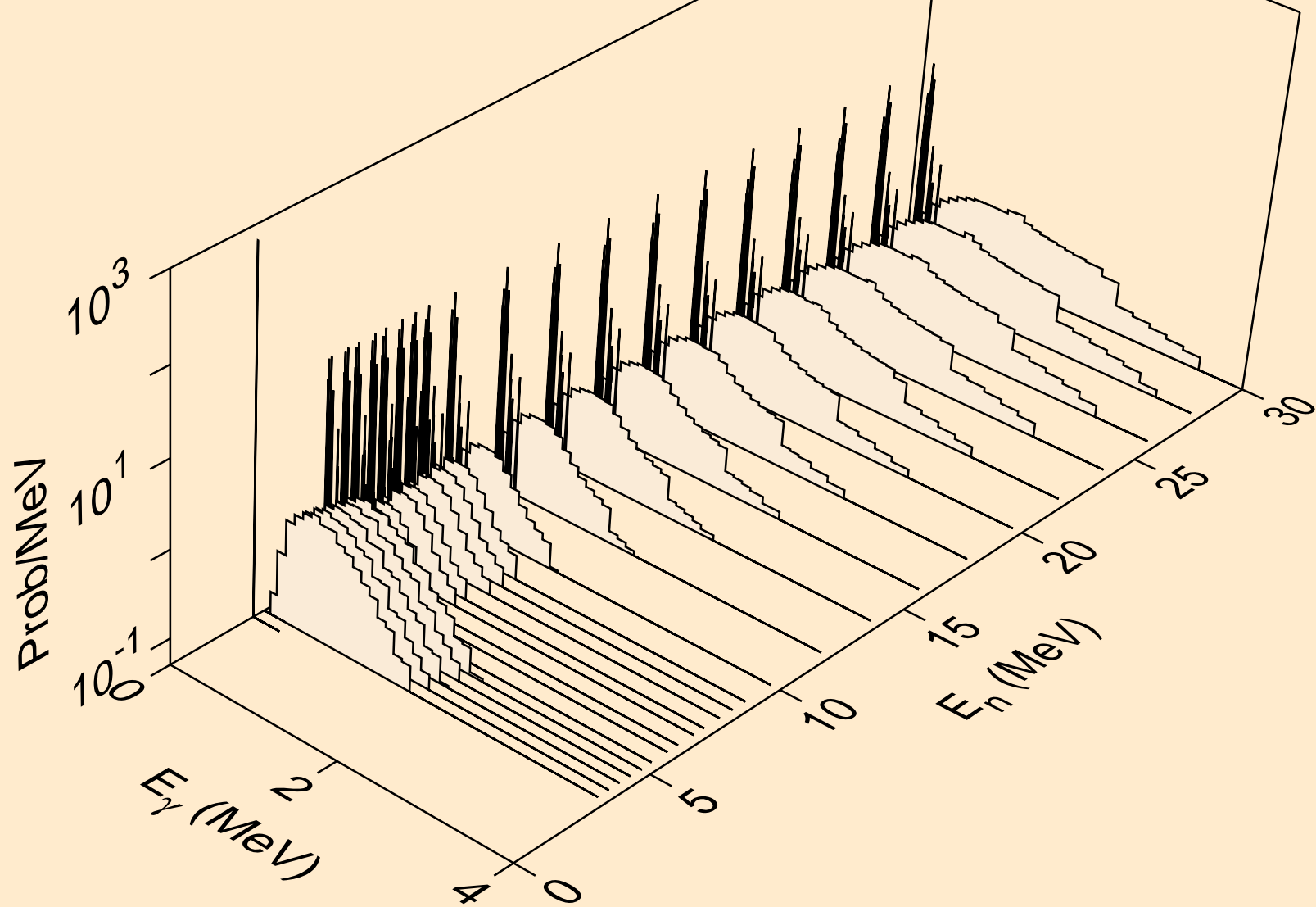

AU191 NEUTRON ACER TENDL-2021 LIBRARY; T=293.6K  
Photon emission for (n,2p)

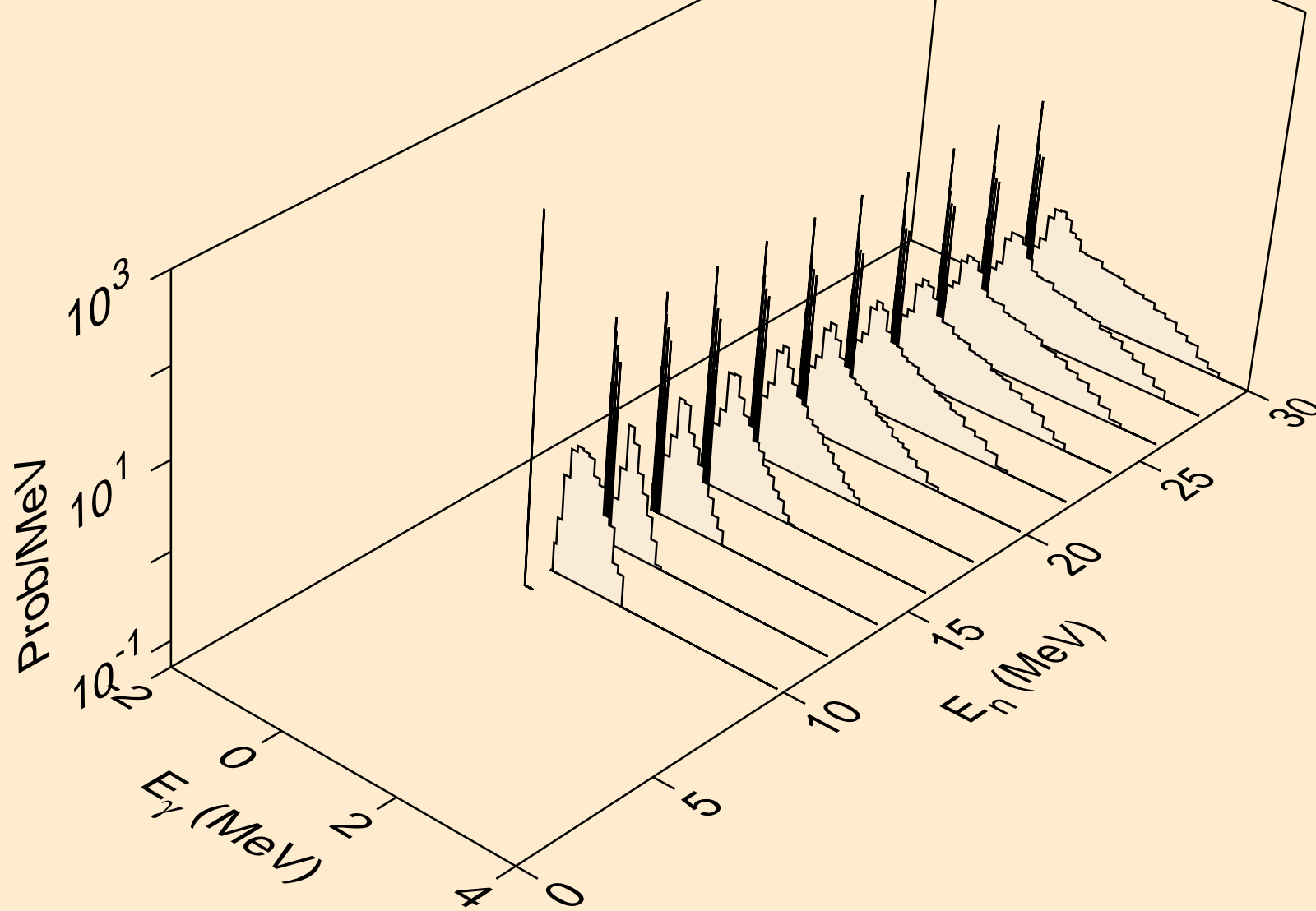



AU191 NEUTRON ACER TENDL-2021 LIBRARY; T=293.6K  
Photon emission for (n,p $\alpha$ )

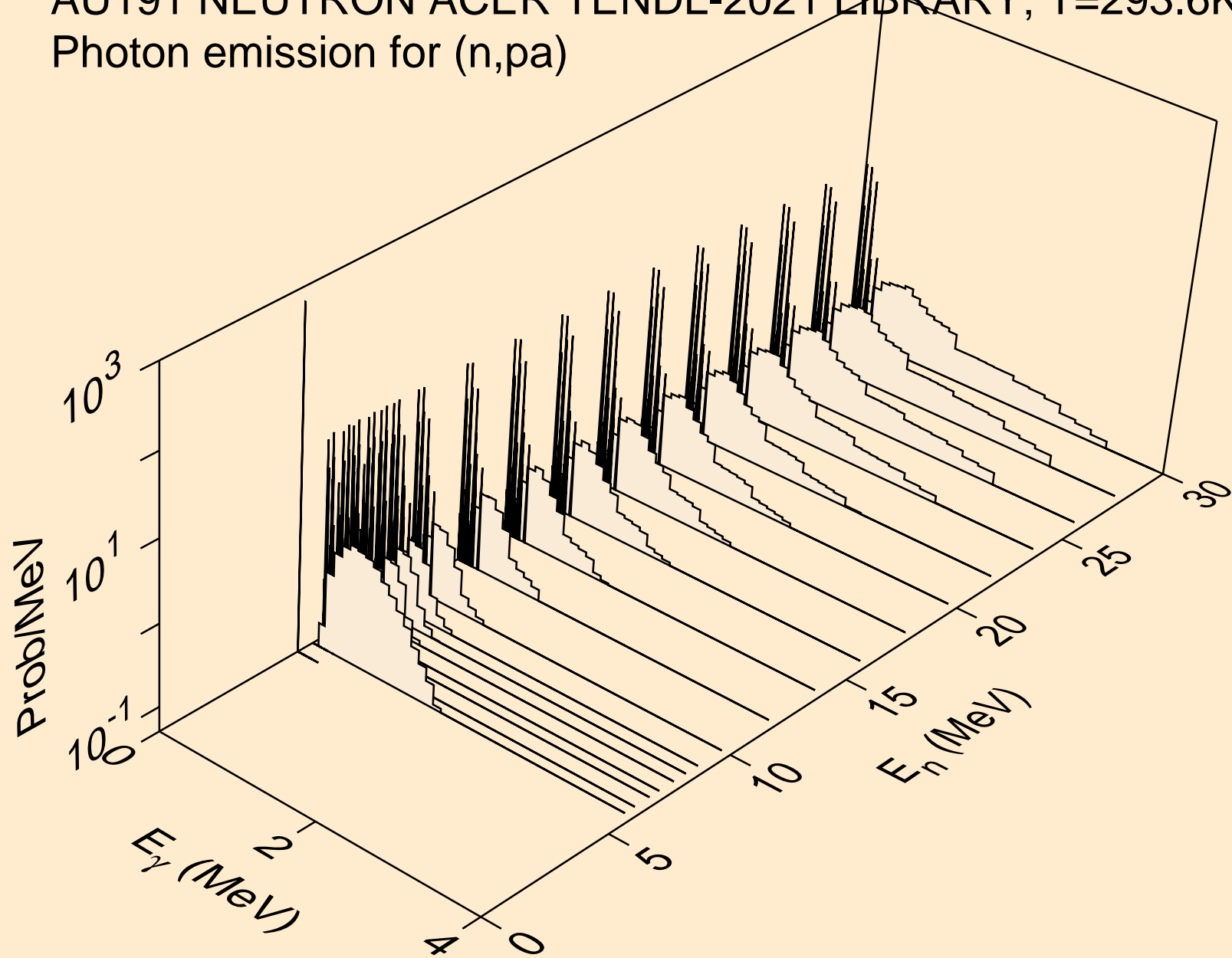

AU191 NEUTRON ACER TENDL-2021 LIBRARY; T=293.6K  
Photon emission for (n,pd)

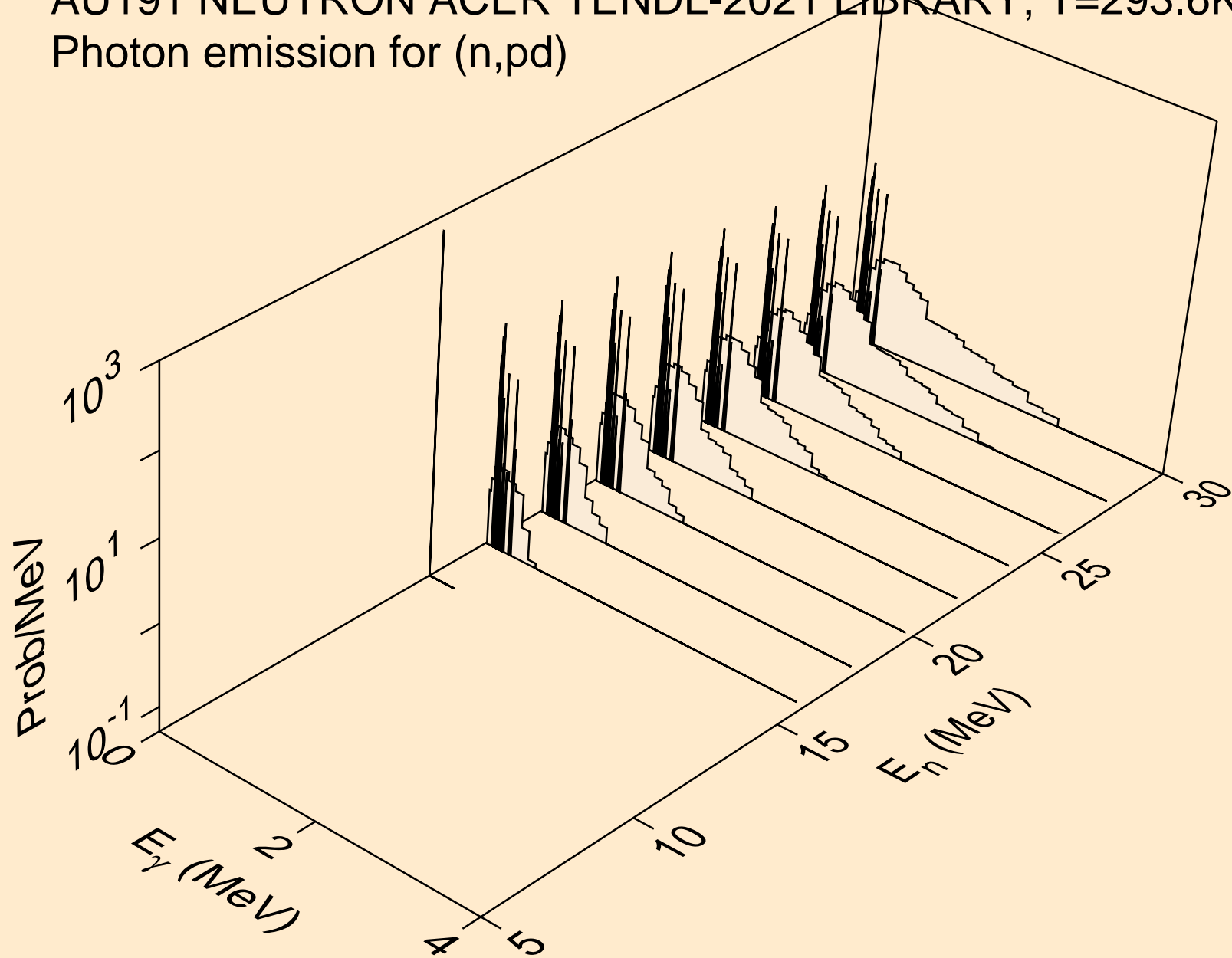

AU191 NEUTRON ACER TENDL-2021 LIBRARY; T=293.6K  
Photon emission for (n,pt)

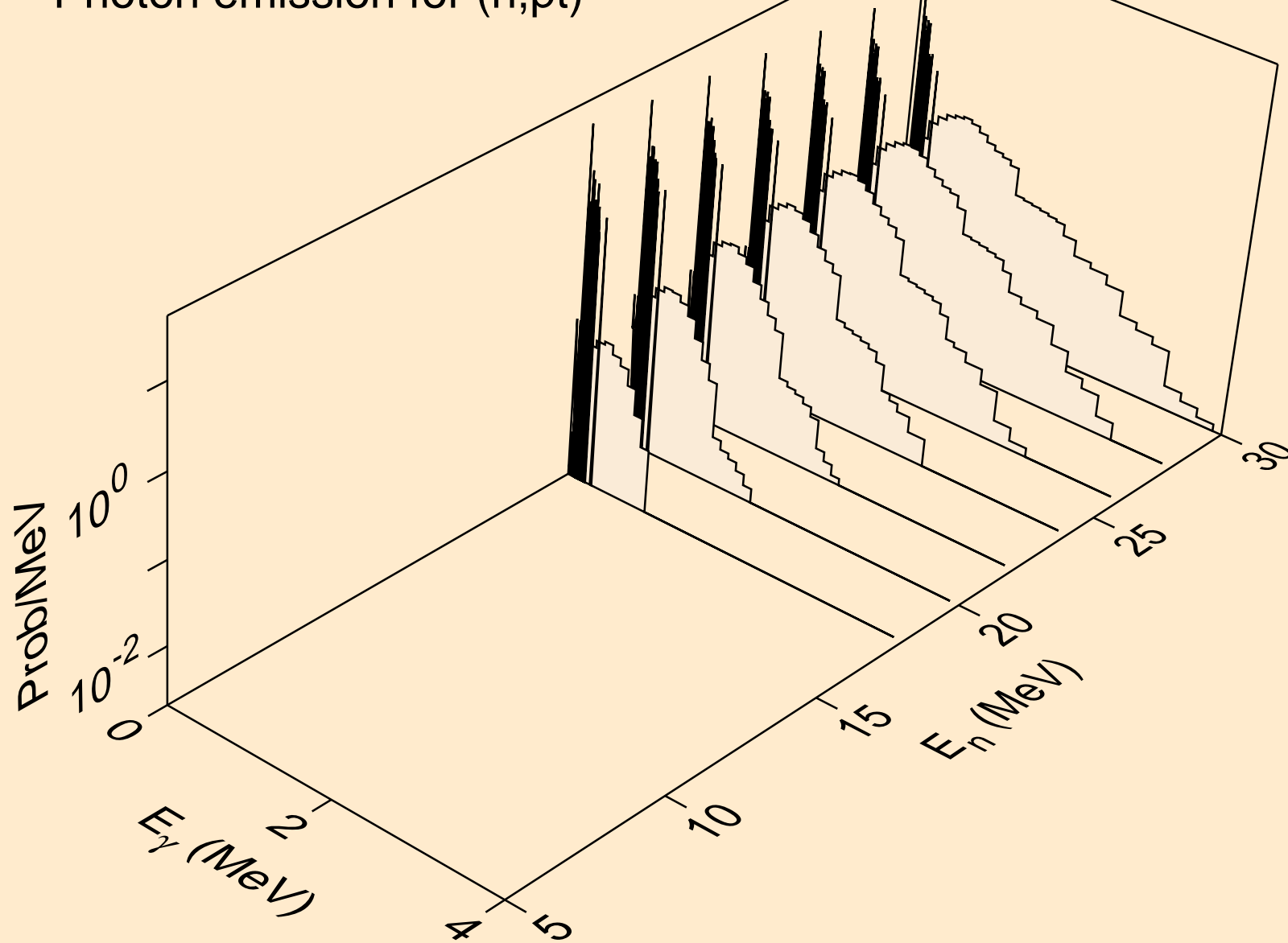

AU191 NEUTRON ACER TENDL-2021 LIBRARY; T=293.6K  
Photon emission for (n,da)

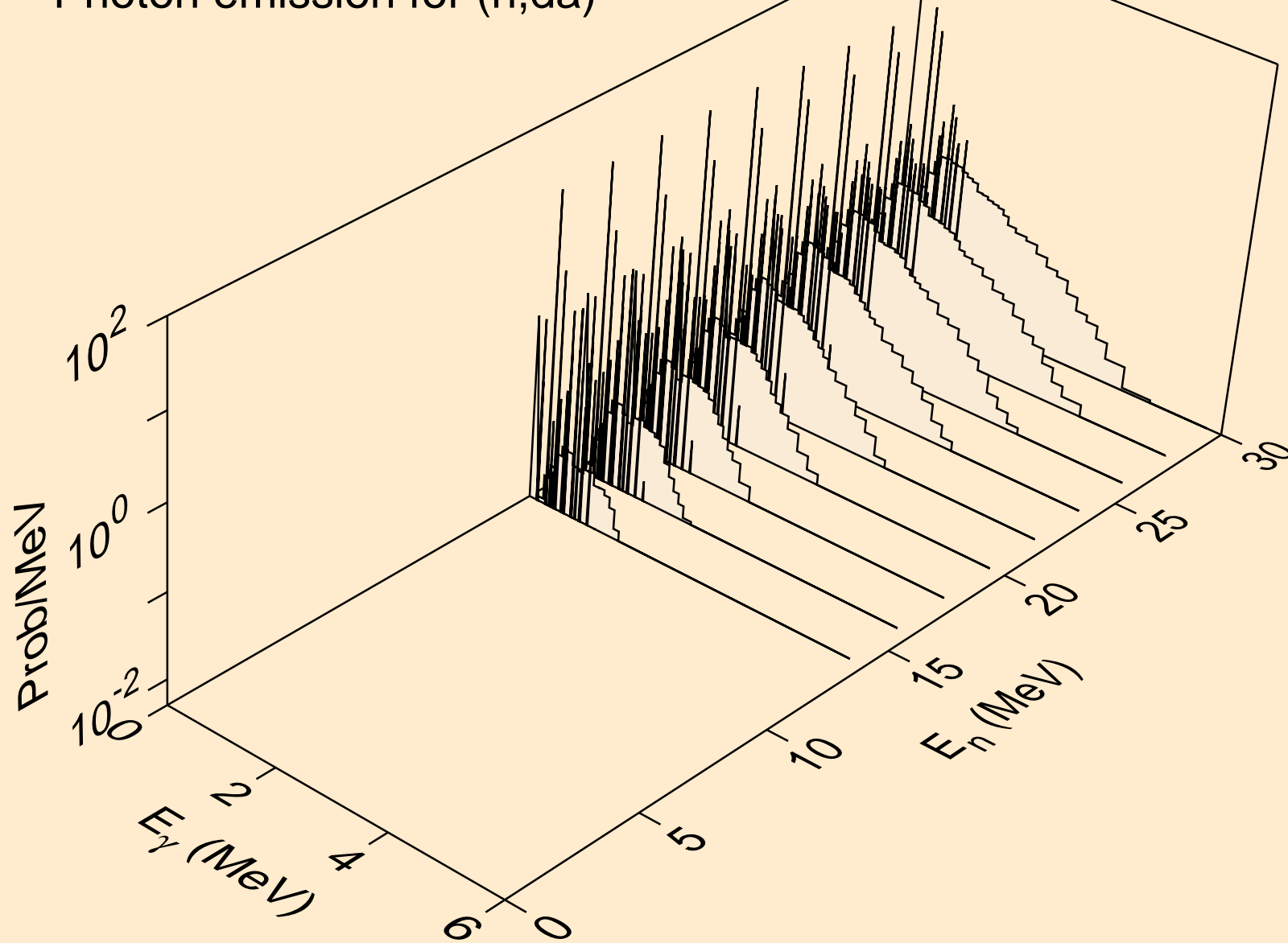

AU191 NEUTRON ACER TENDL-2021 LIBRARY; T=293.6K  
thermal capture photon spectrum

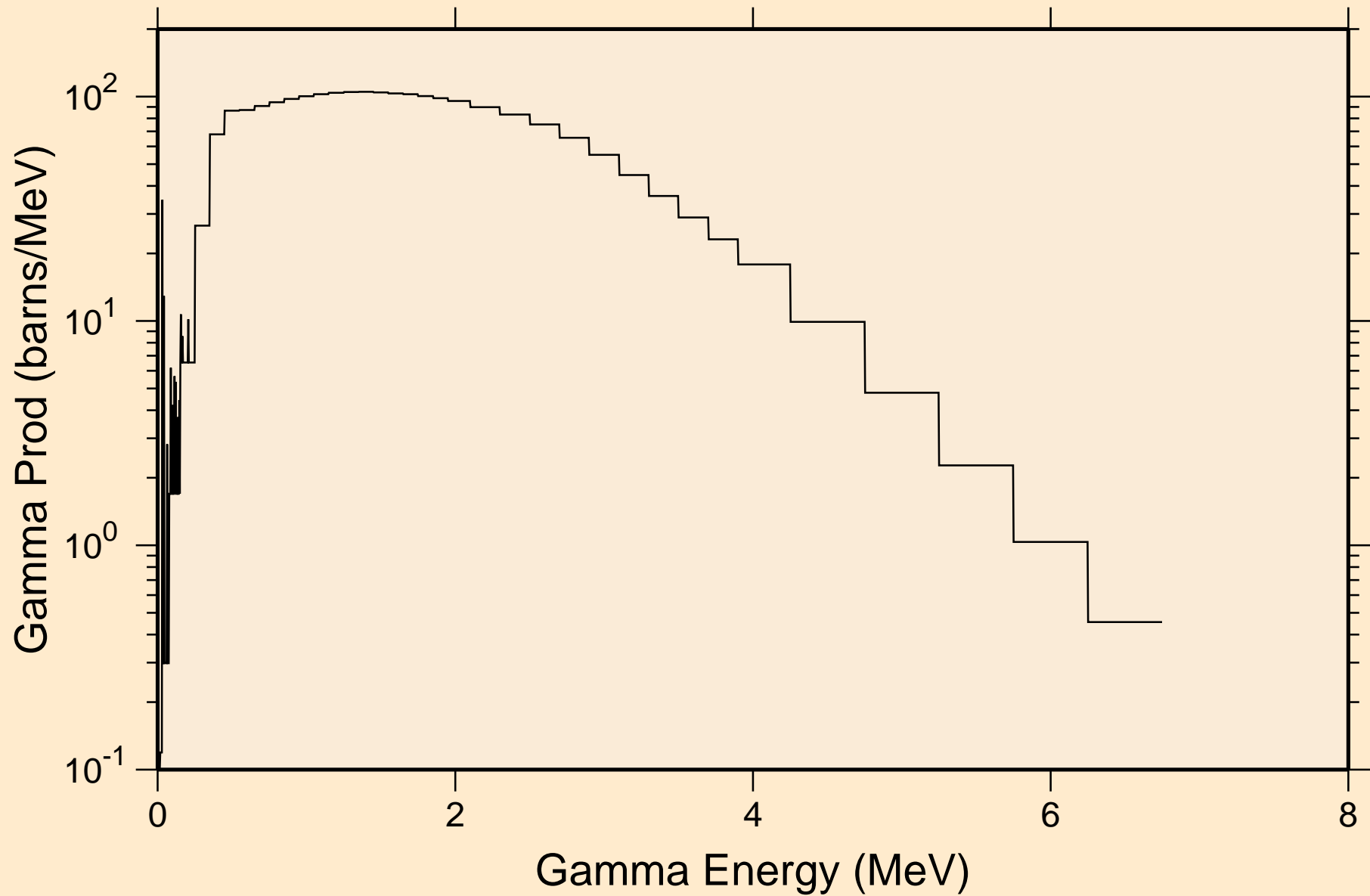

AU191 NEUTRON ACER TENDL-2021 LIBRARY; T=293.6K  
14 MeV photon spectrum

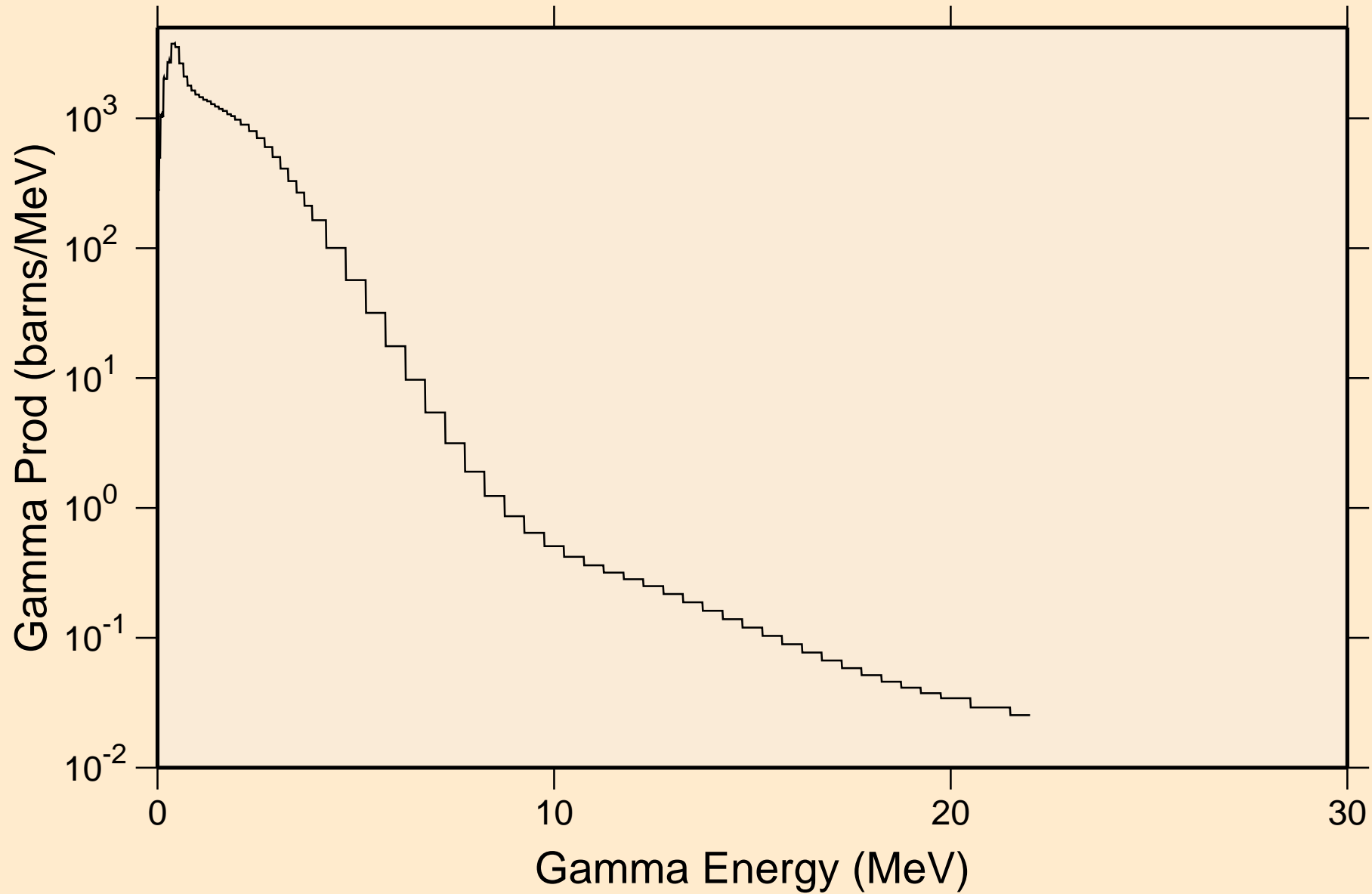

AU191 NEUTRON ACER TENDL-2021 LIBRARY; T=293.6K  
Particle heating contributions

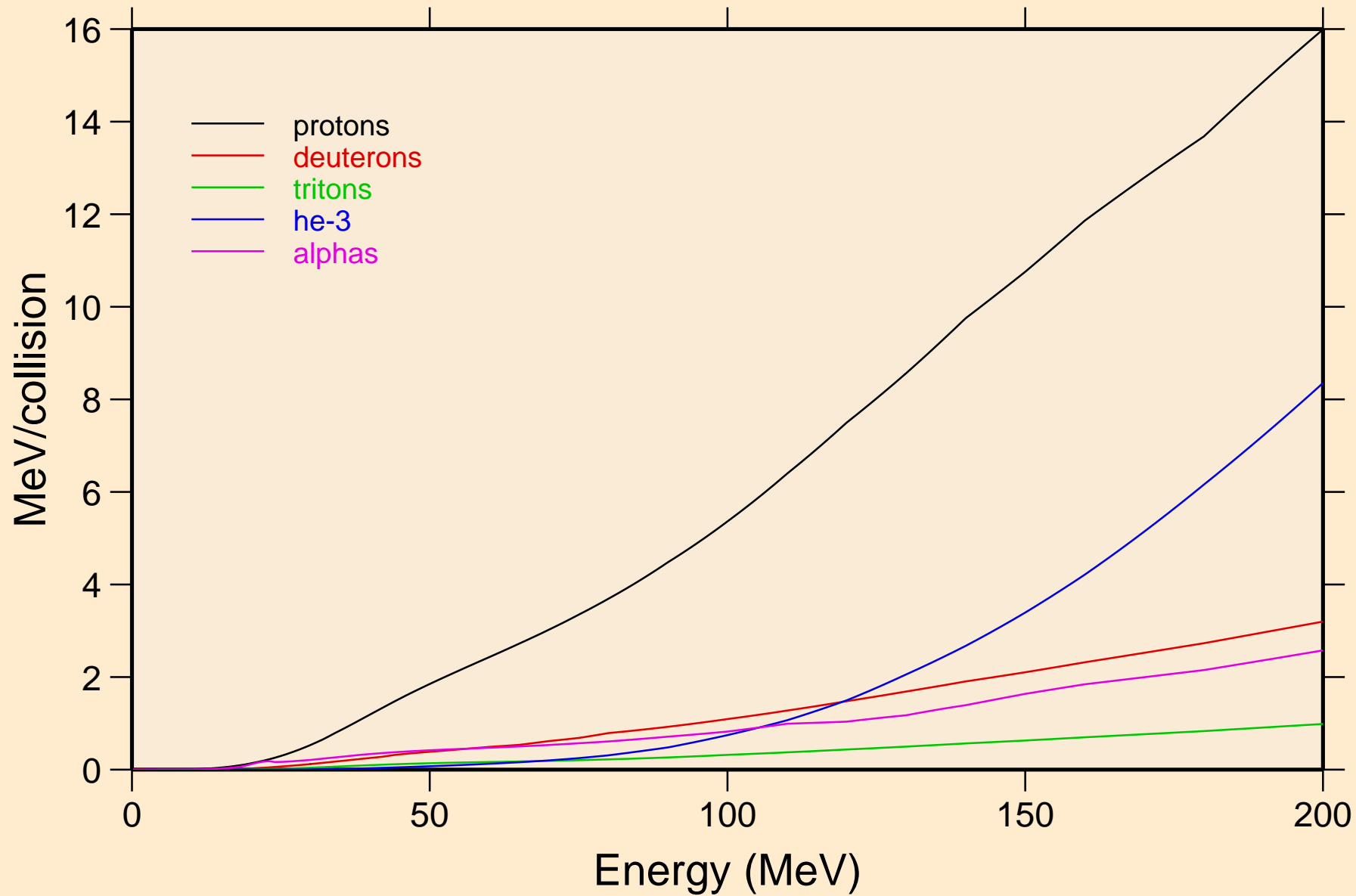

AU191 NEUTRON ACER TENDL-2021 LIBRARY; T=293.6K  
Recoil Heating

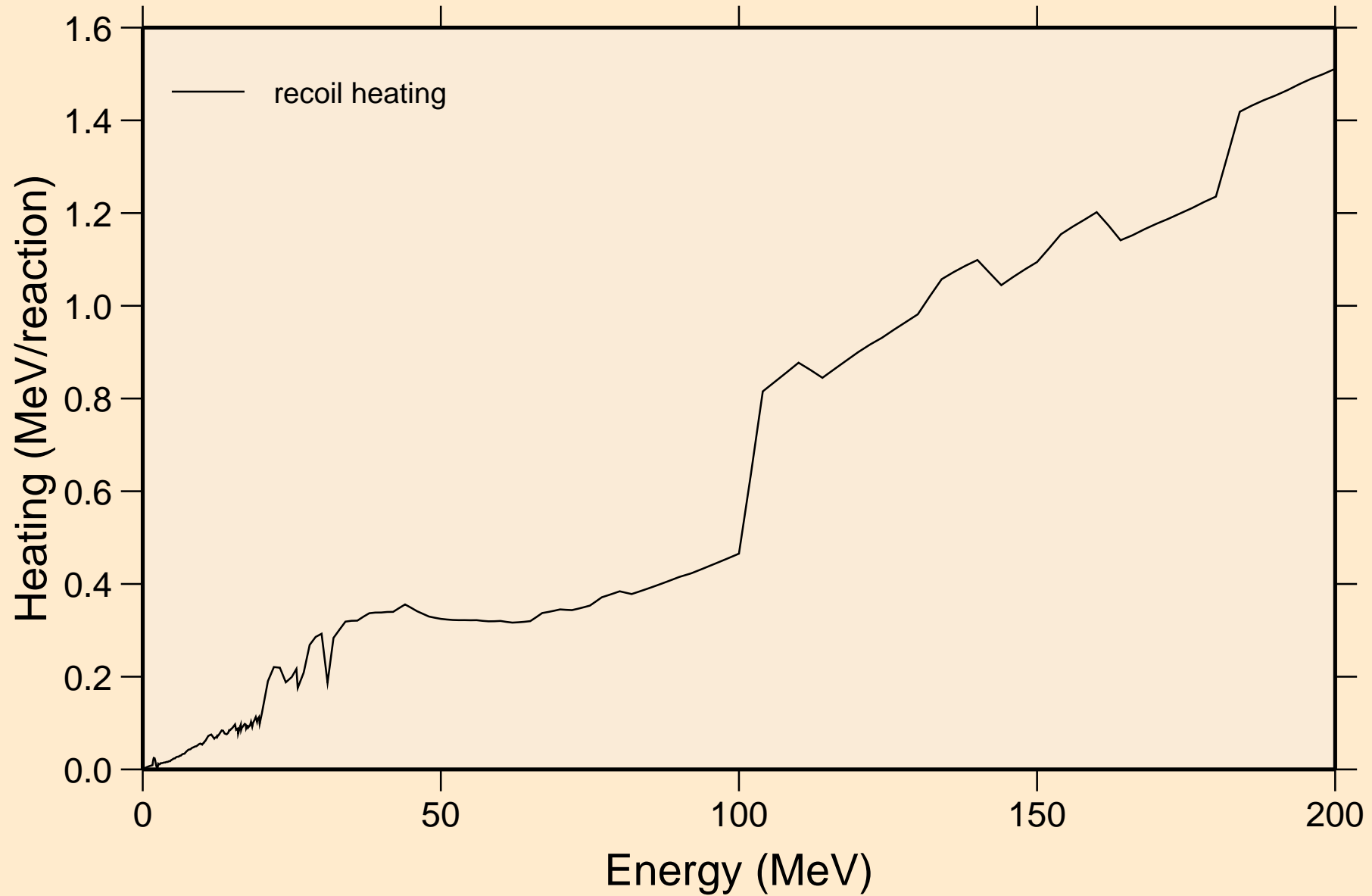



AU191 NEUTRON ACER TENDL-2021 LIBRARY; T=293.6K  
Particle production cross sections

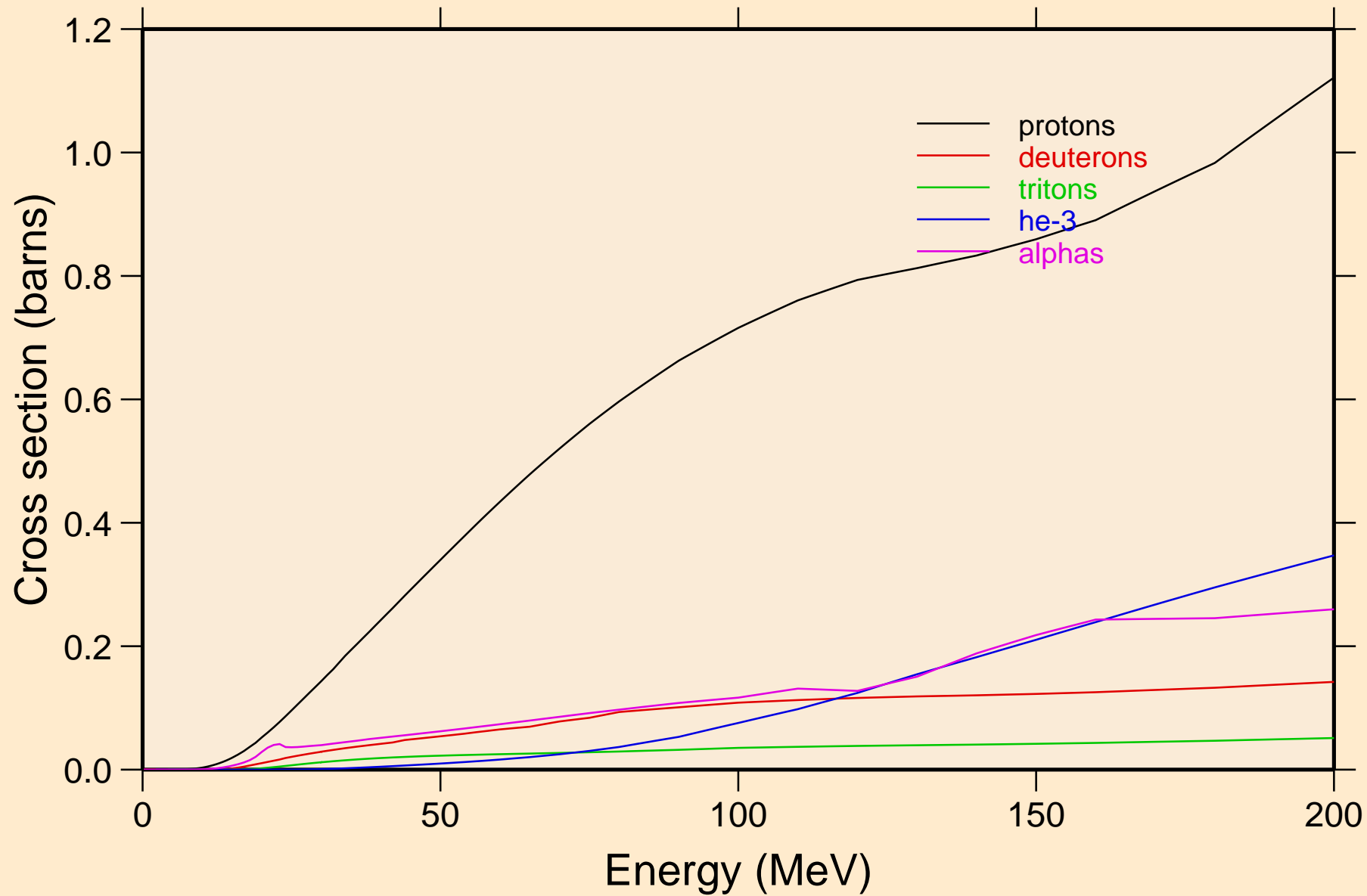

AU191 NEUTRON ACER TENDL-2021 LIBRARY; T=293.6K  
protons from (n,x)

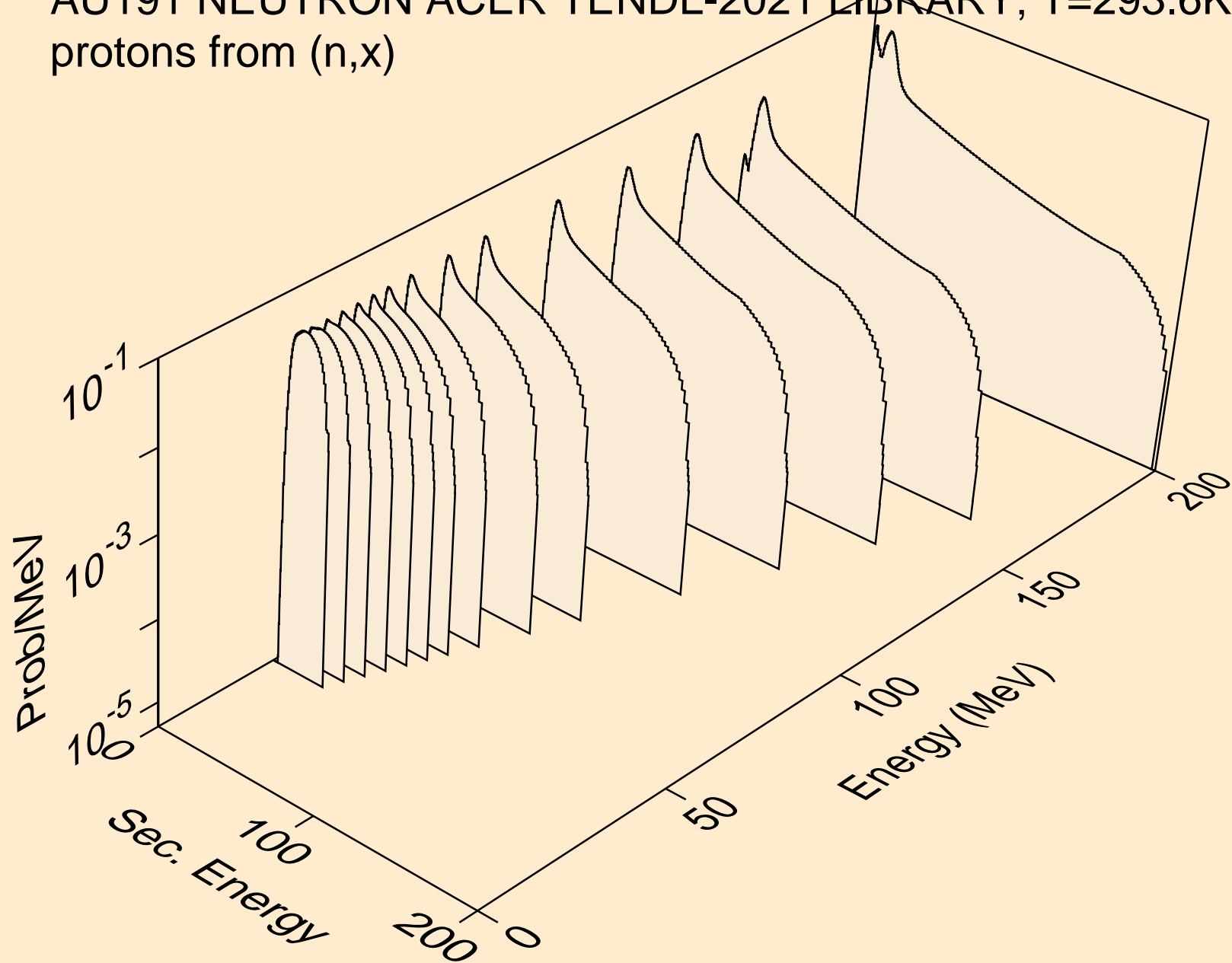

AU191 NEUTRON ACER TENDL-2021 LIBRARY; T=293.6K  
protons from (n,n\*)p

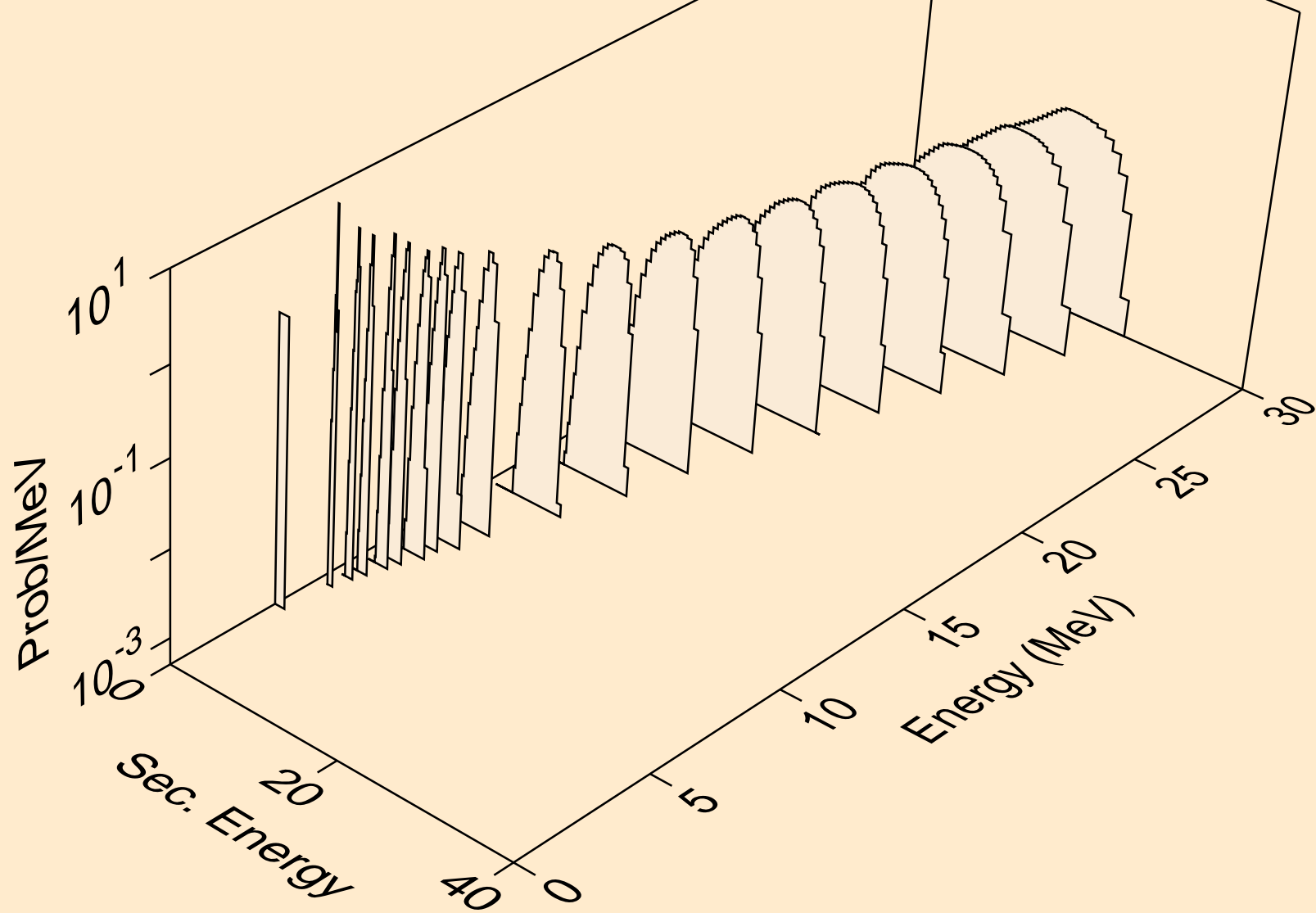

AU191 NEUTRON ACER TENDL-2021 LIBRARY; T=293.6K  
protons from (n,2np)

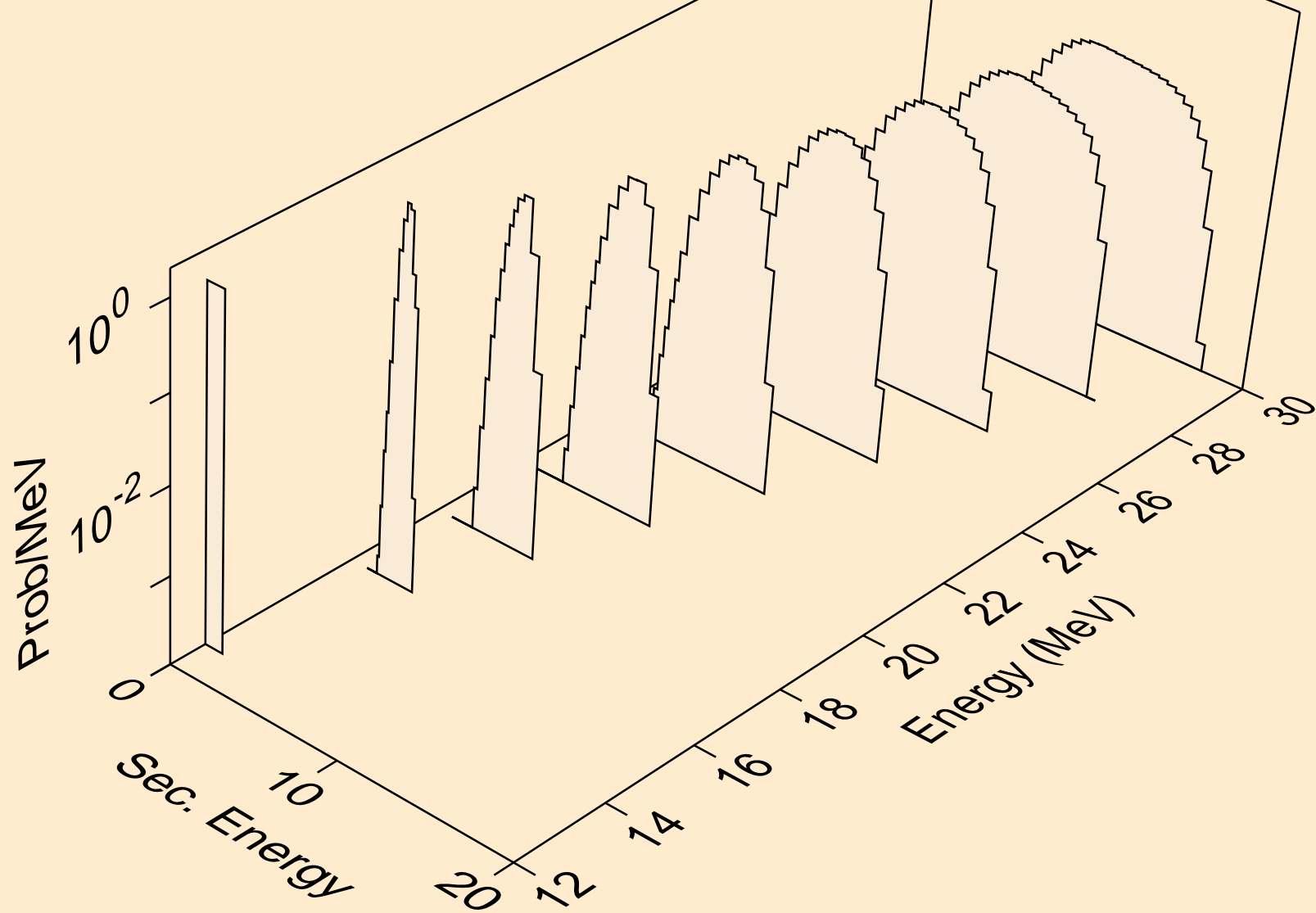

AU191 NEUTRON ACER TENDL-2021 LIBRARY; T=293.6K  
protons from (n,3np)

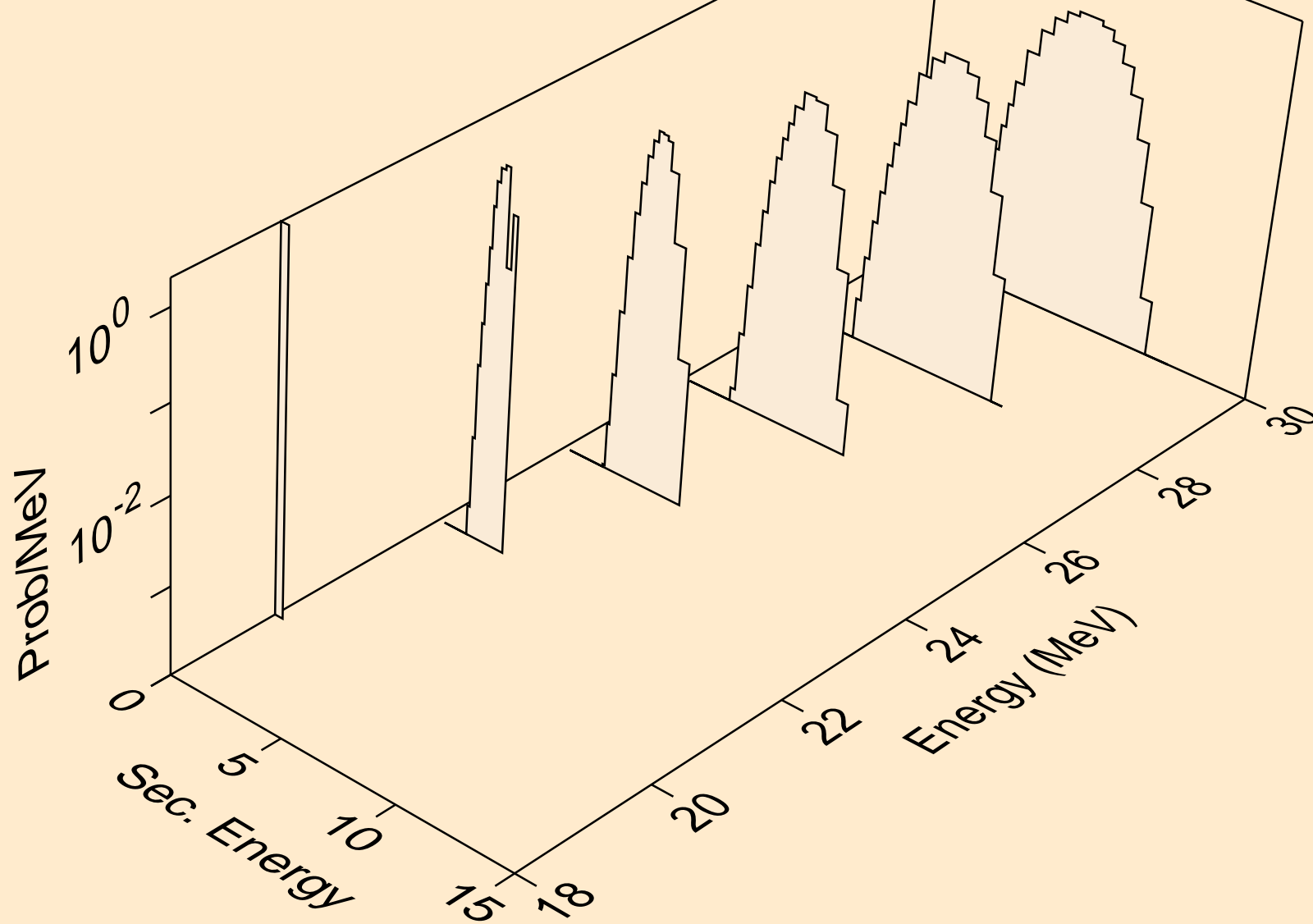

AU191 NEUTRON ACER TENDL-2021 LIBRARY; T=293.6K  
protons from (n,2np)

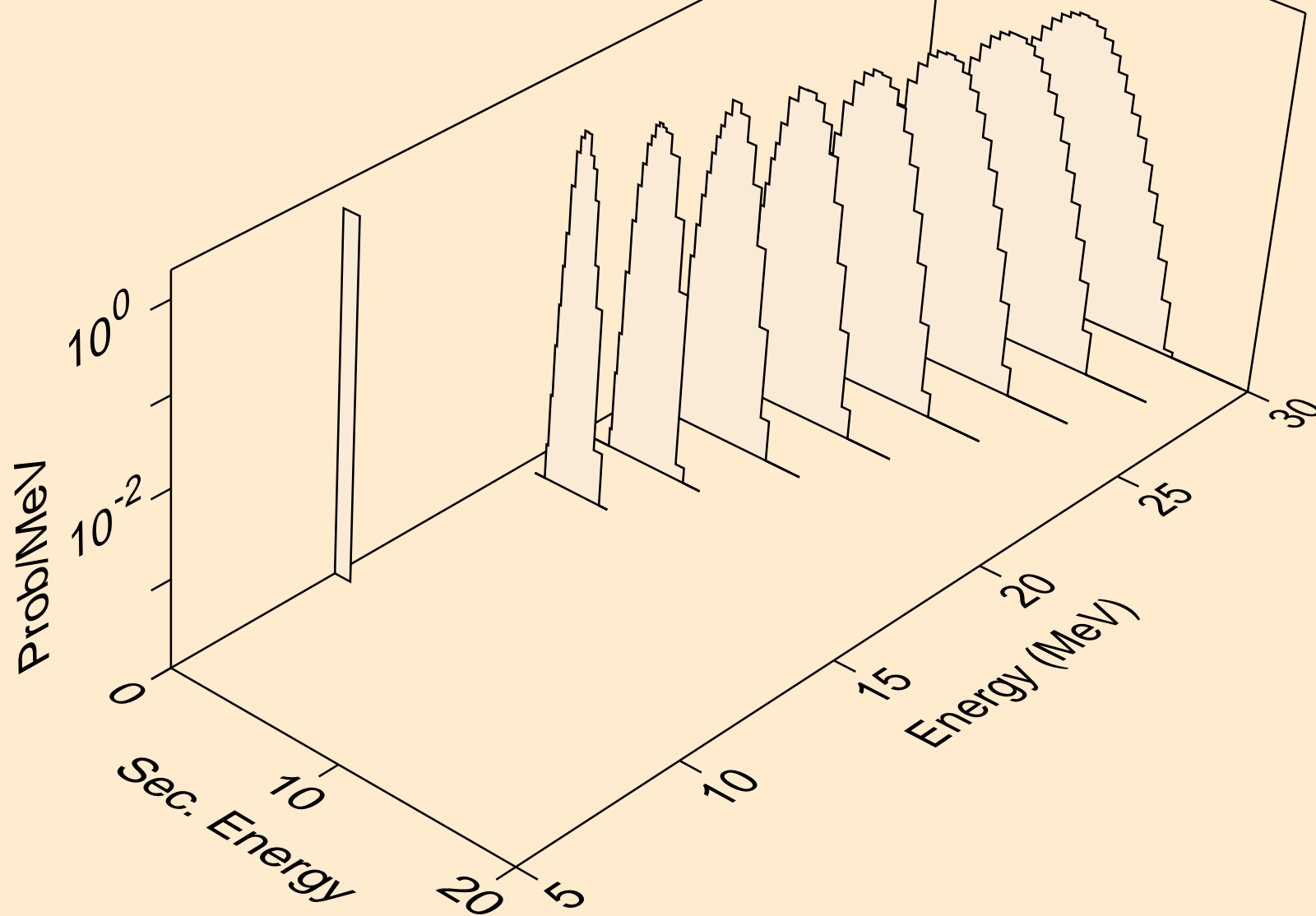

AU191 NEUTRON ACER TENDL-2021 LIBRARY; T=293.6K  
protons from (n,npa)

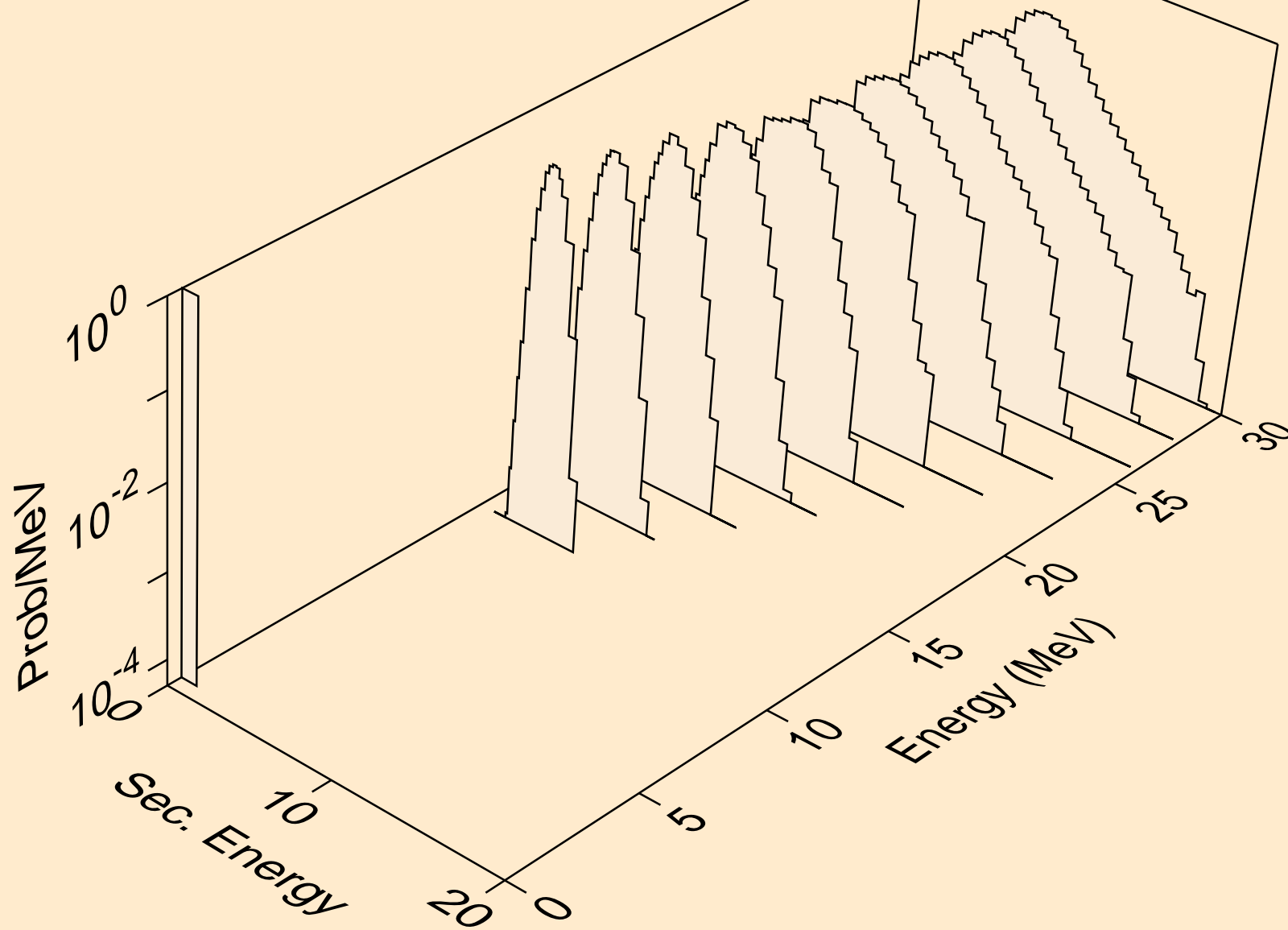

AU191 NEUTRON ACER TENDL-2021 LIBRARY; T=293.6K  
protons from (n,p)

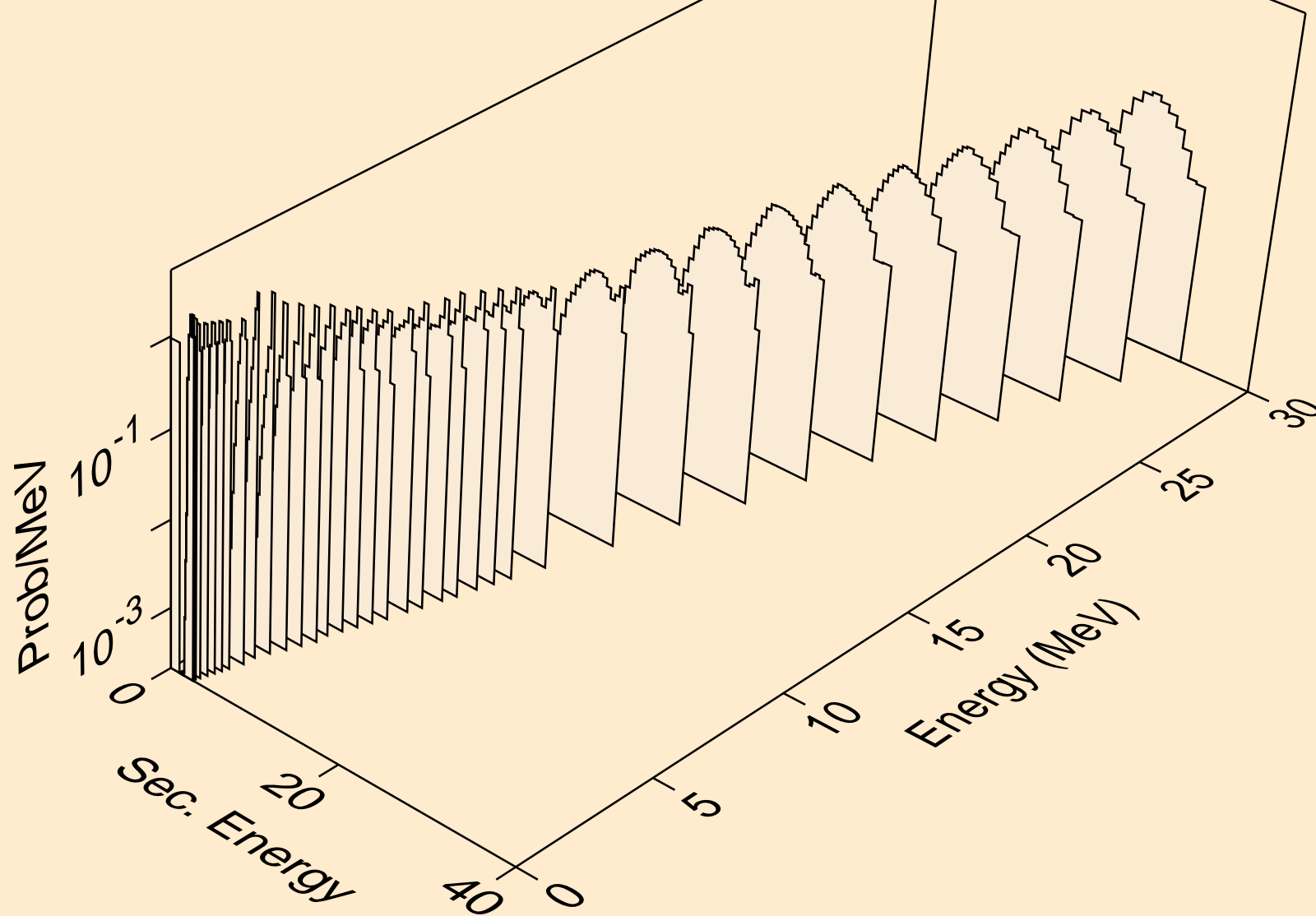



AU191 NEUTRON ACER TENDL-2021 LIBRARY; T=293.6K  
protons from (n,2p)

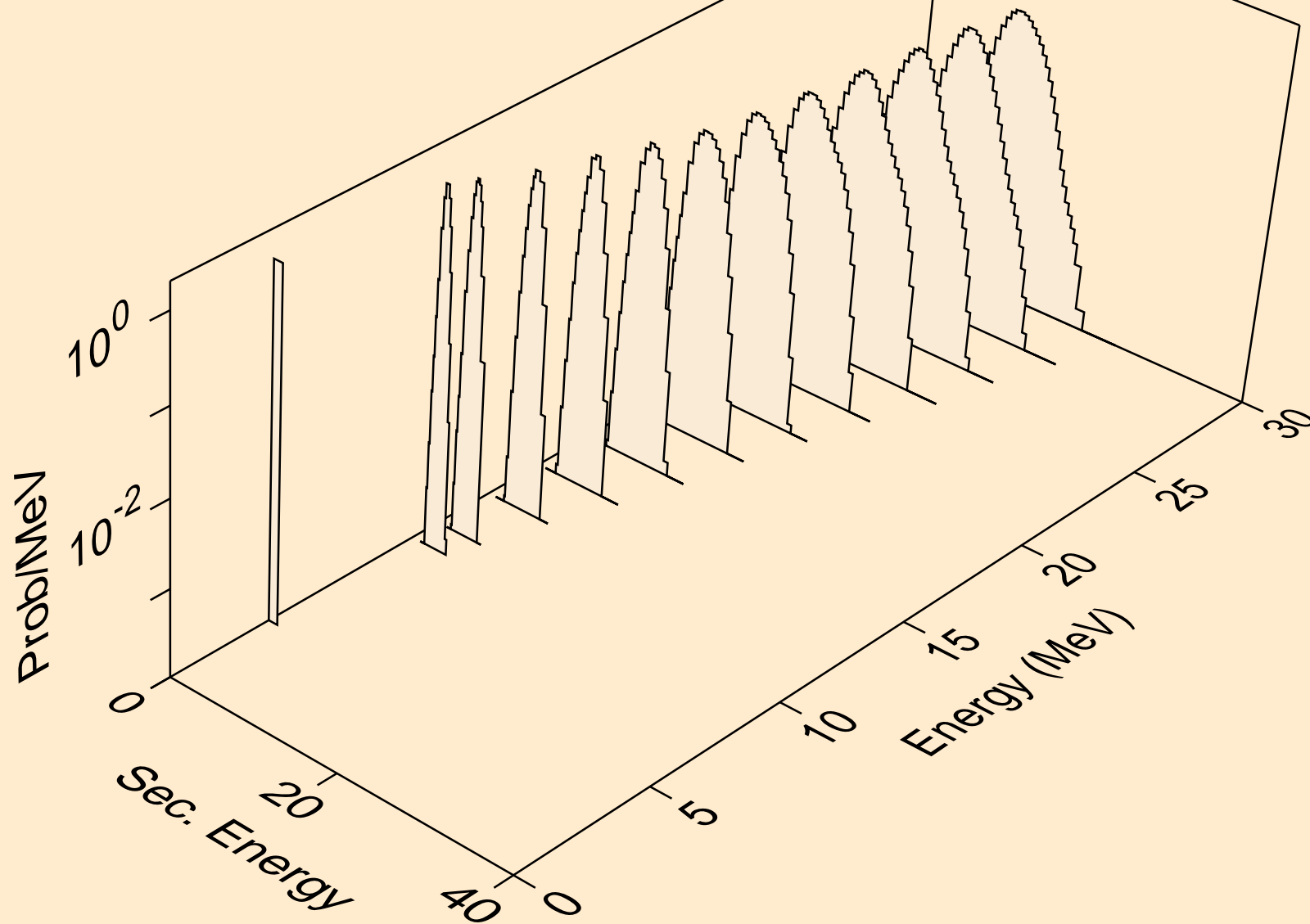

AU191 NEUTRON ACER TENDL-2021 LIBRARY; T=293.6K  
protons from (n,p)

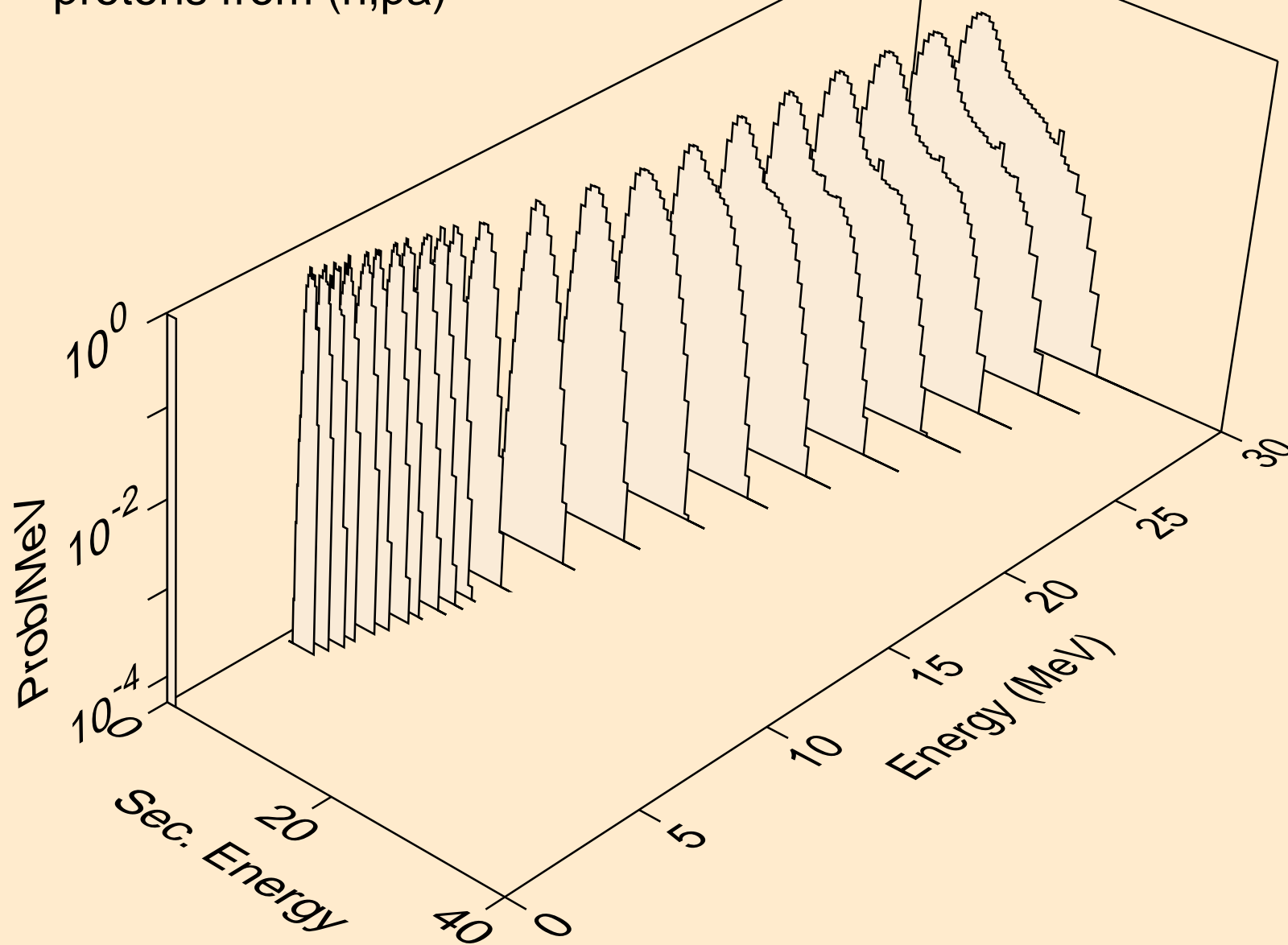

AU191 NEUTRON ACER TENDL-2021 LIBRARY; T=293.6K  
protons from (n,pd)

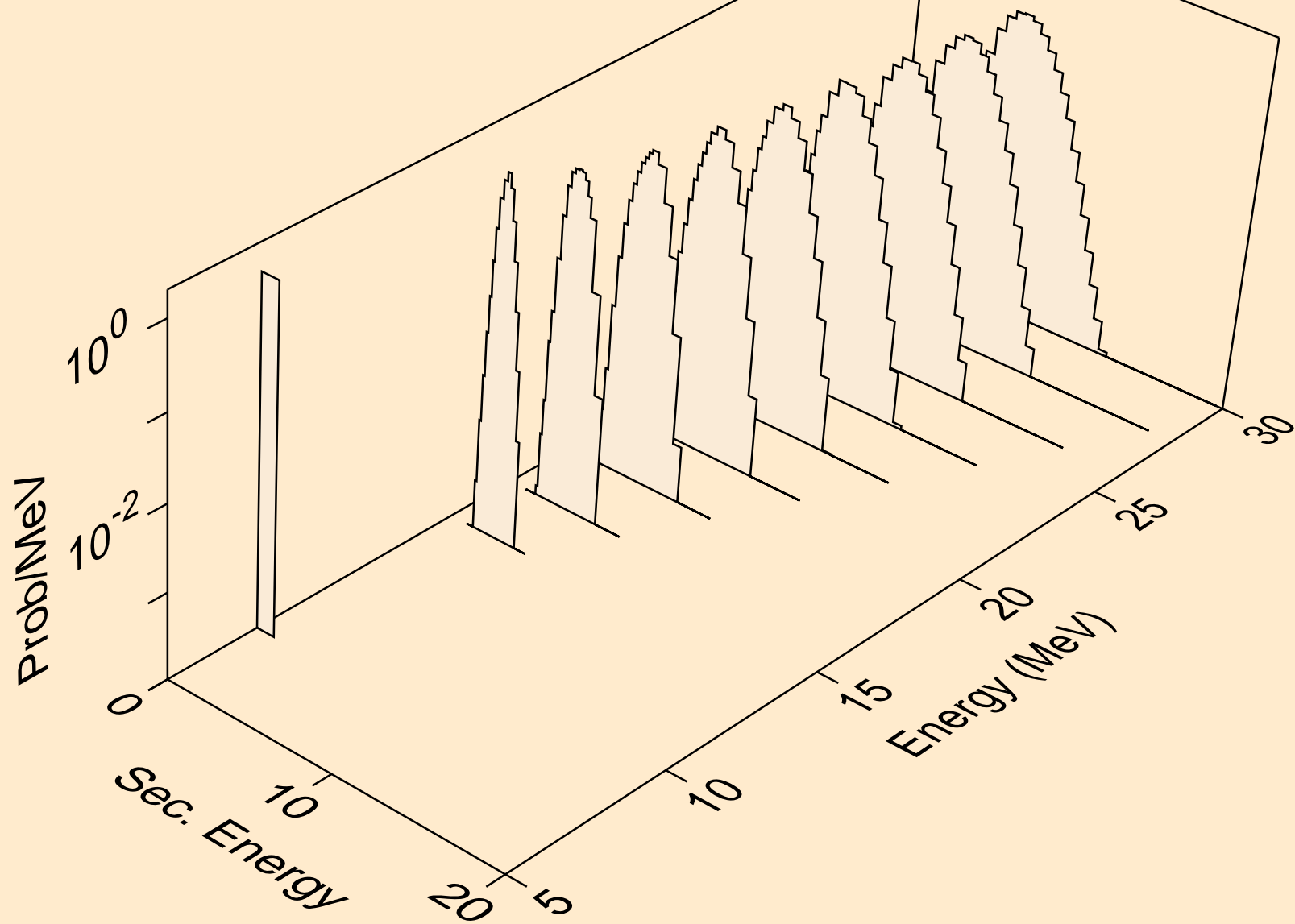

AU191 NEUTRON ACER TENDL-2021 LIBRARY; T=293.6K  
protons from (n,pt)

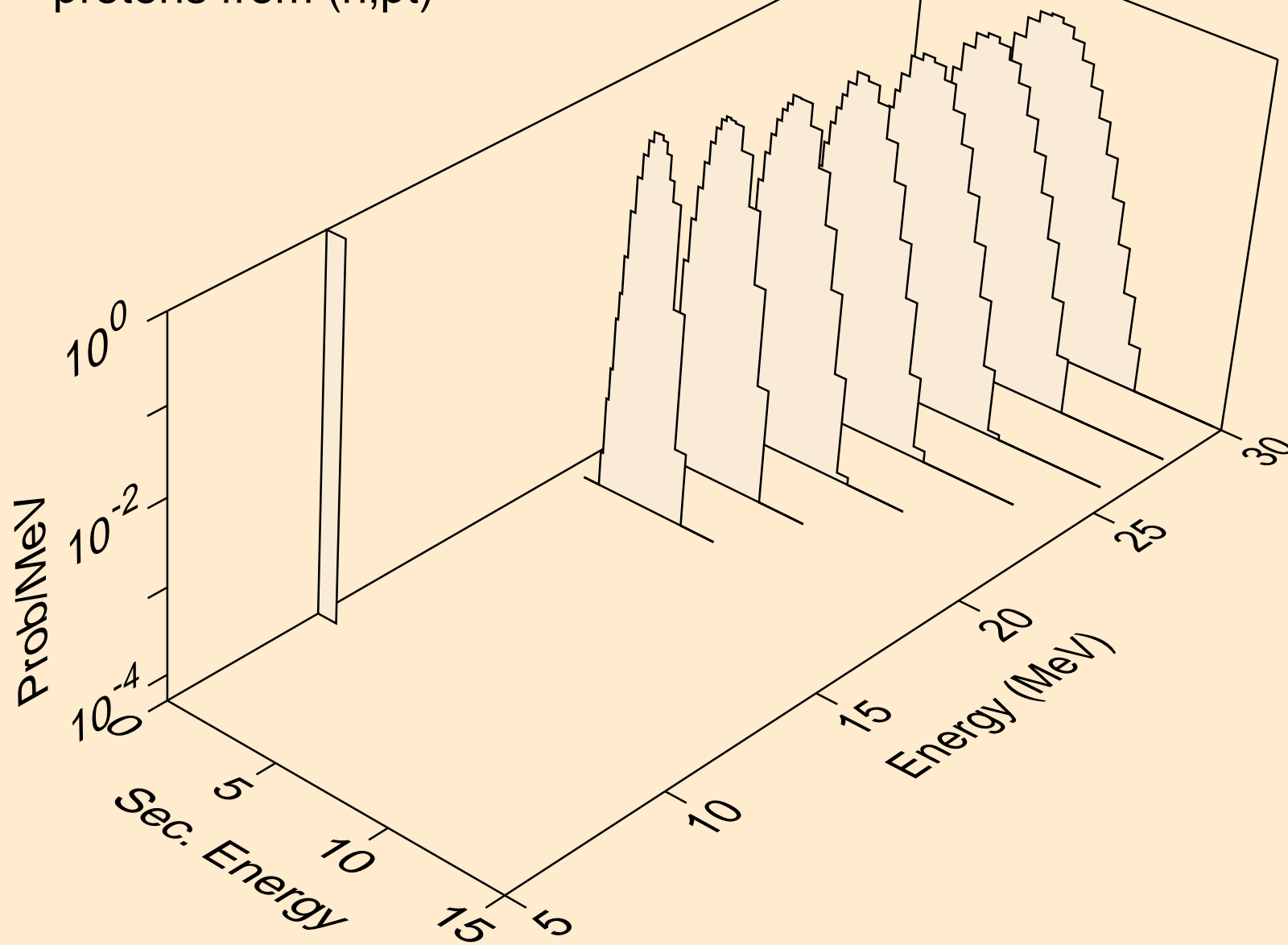

AU191 NEUTRON ACER TENDL-2021 LIBRARY; T=293.6K  
deuterons from (n,x)

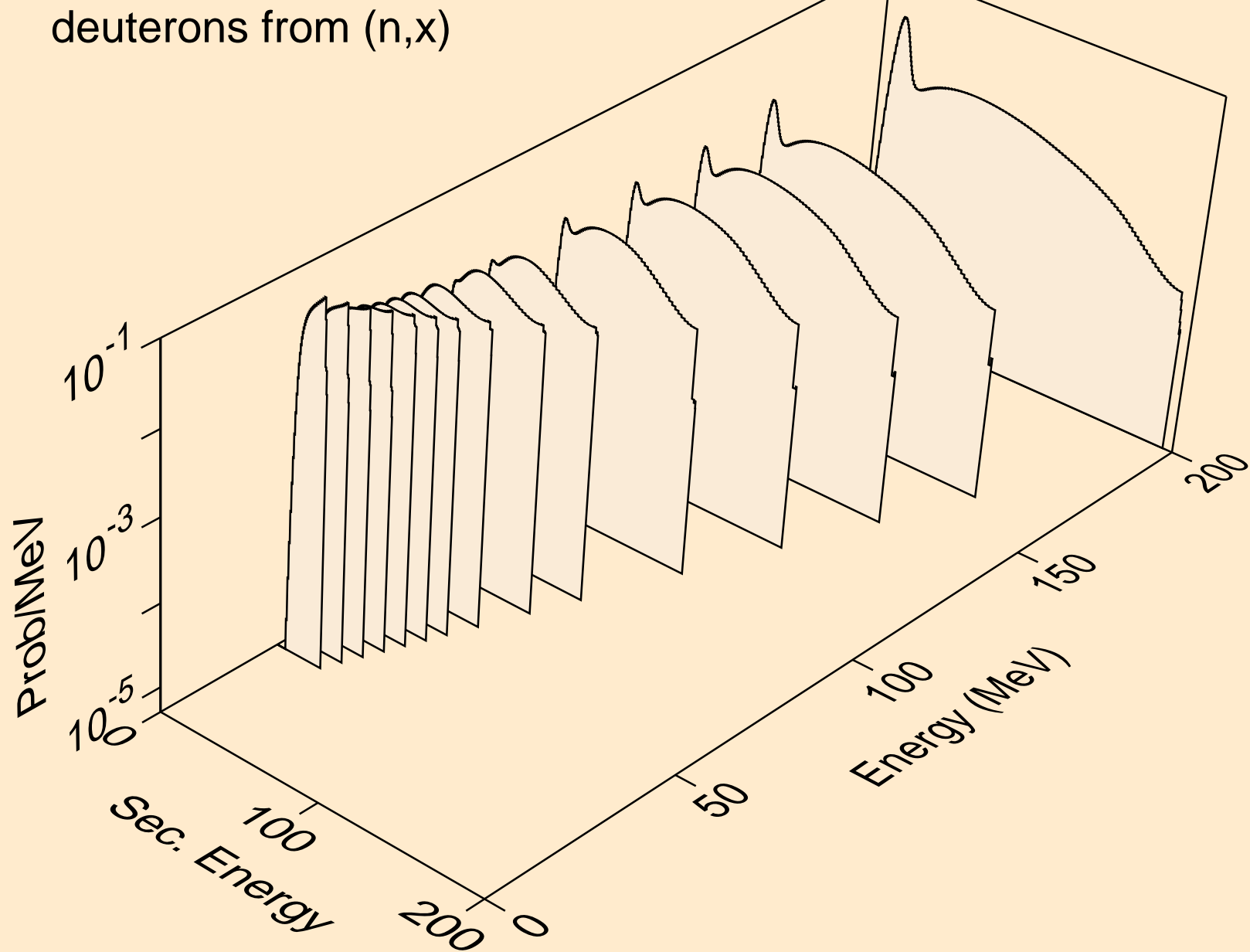

AU191 NEUTRON ACER TENDL-2021 LIBRARY; T=293.6K  
deuterons from (n,2nd)

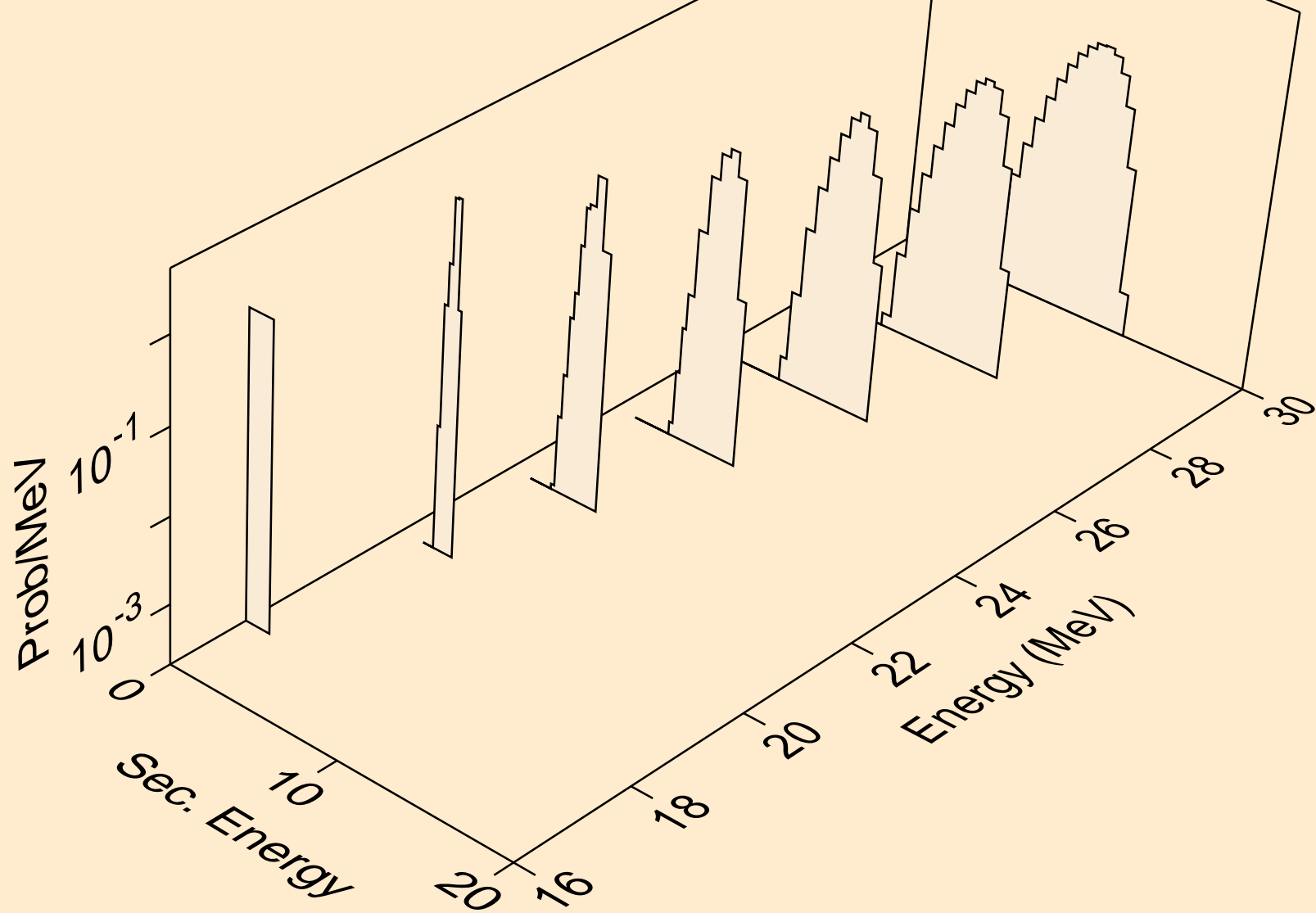

AU191 NEUTRON ACER TENDL-2021 LIBRARY; T=293.6K  
deuterons from (n,n\*)d

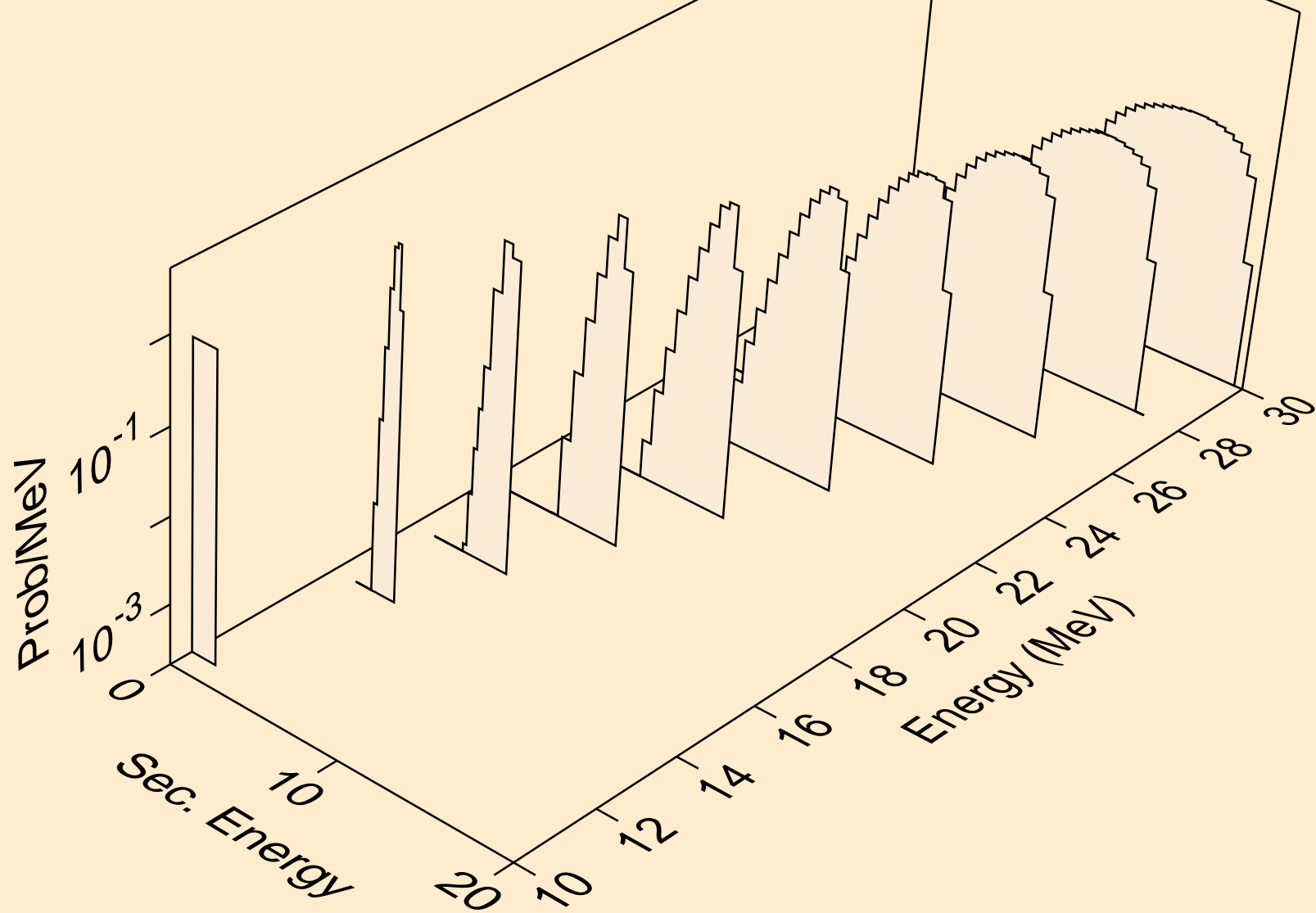

AU191 NEUTRON ACER TENDL-2021 LIBRARY; T=293.6K  
deuterons from (n,d)

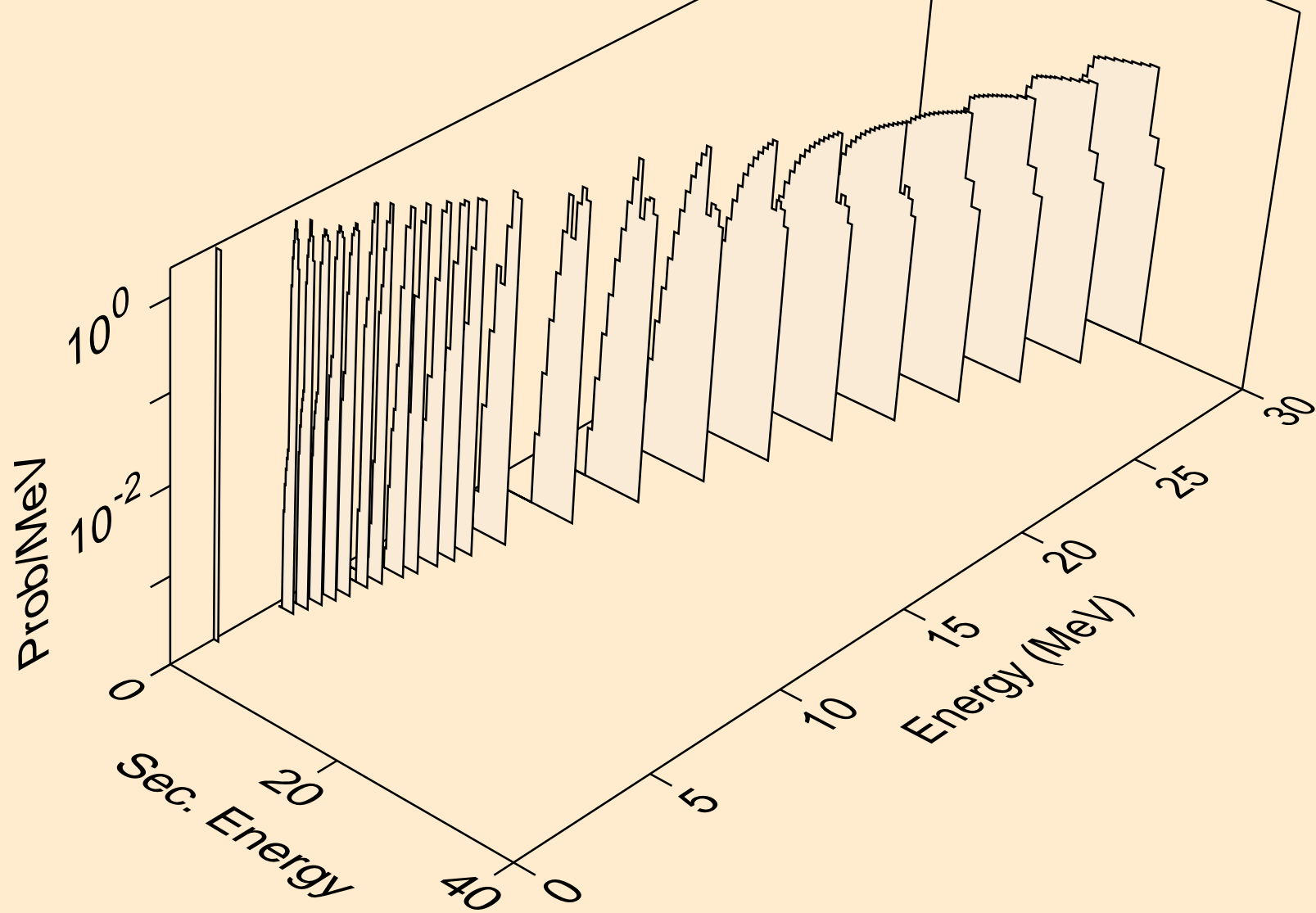



AU191 NEUTRON ACER TENDL-2021 LIBRARY; T=293.6K  
deuterons from (n,pd)

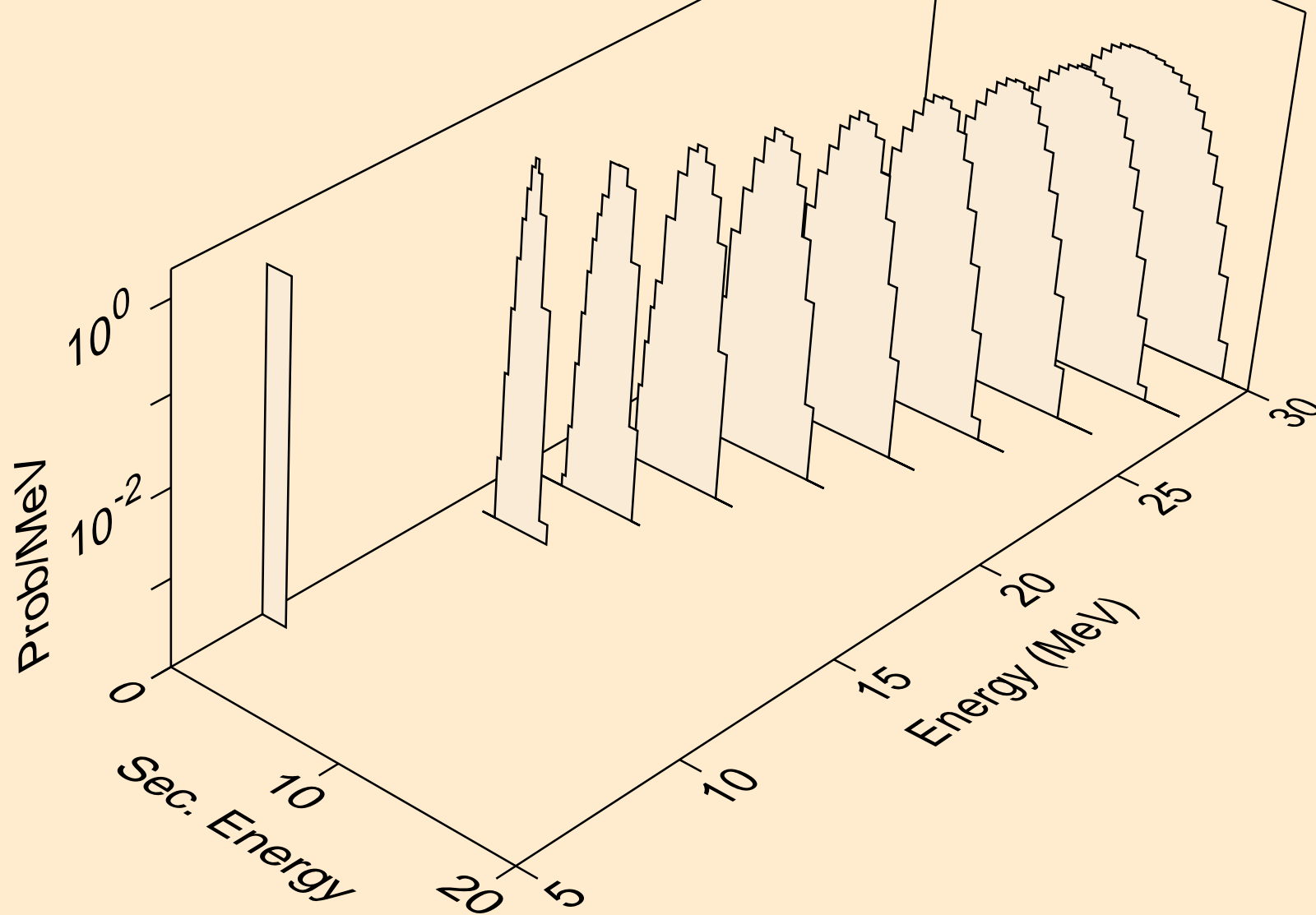

AU191 NEUTRON ACER TENDL-2021 LIBRARY; T=293.6K  
deuterons from (n,da)

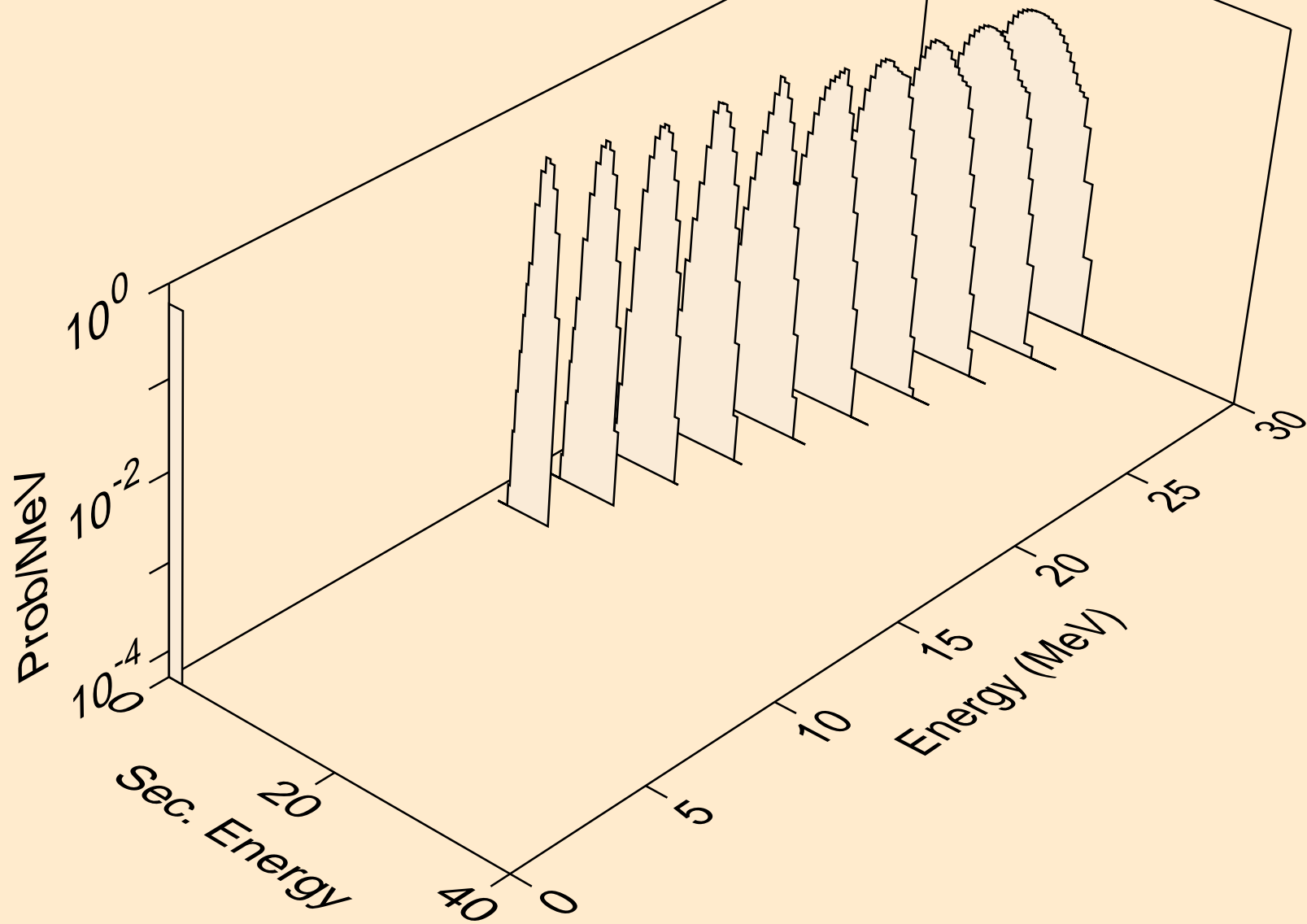

AU191 NEUTRON ACER TENDL-2021 LIBRARY; T=293.6K  
tritons from (n,x)

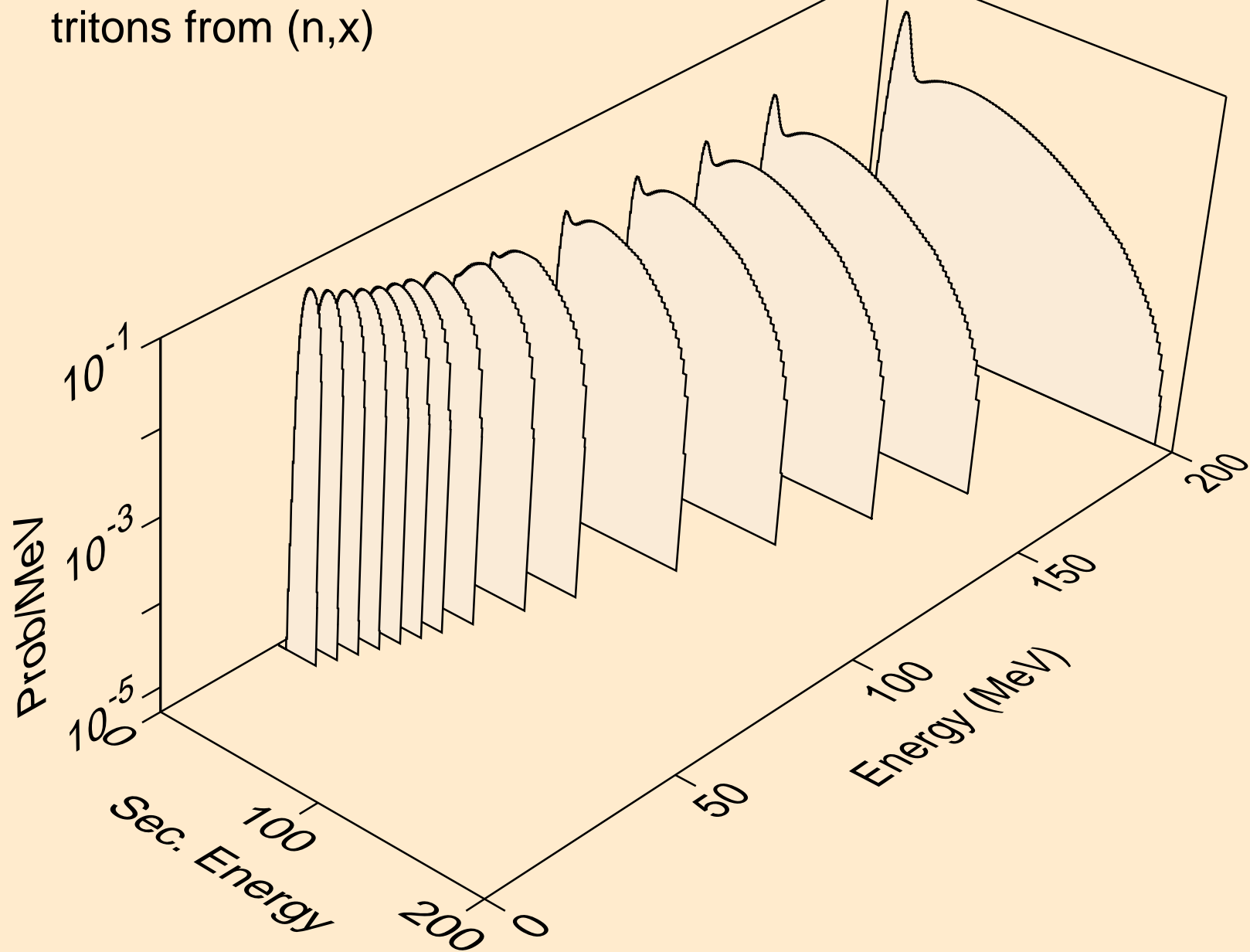

AU191 NEUTRON ACER TENDL-2021 LIBRARY; T=293.6K  
tritons from (n,n\*)t

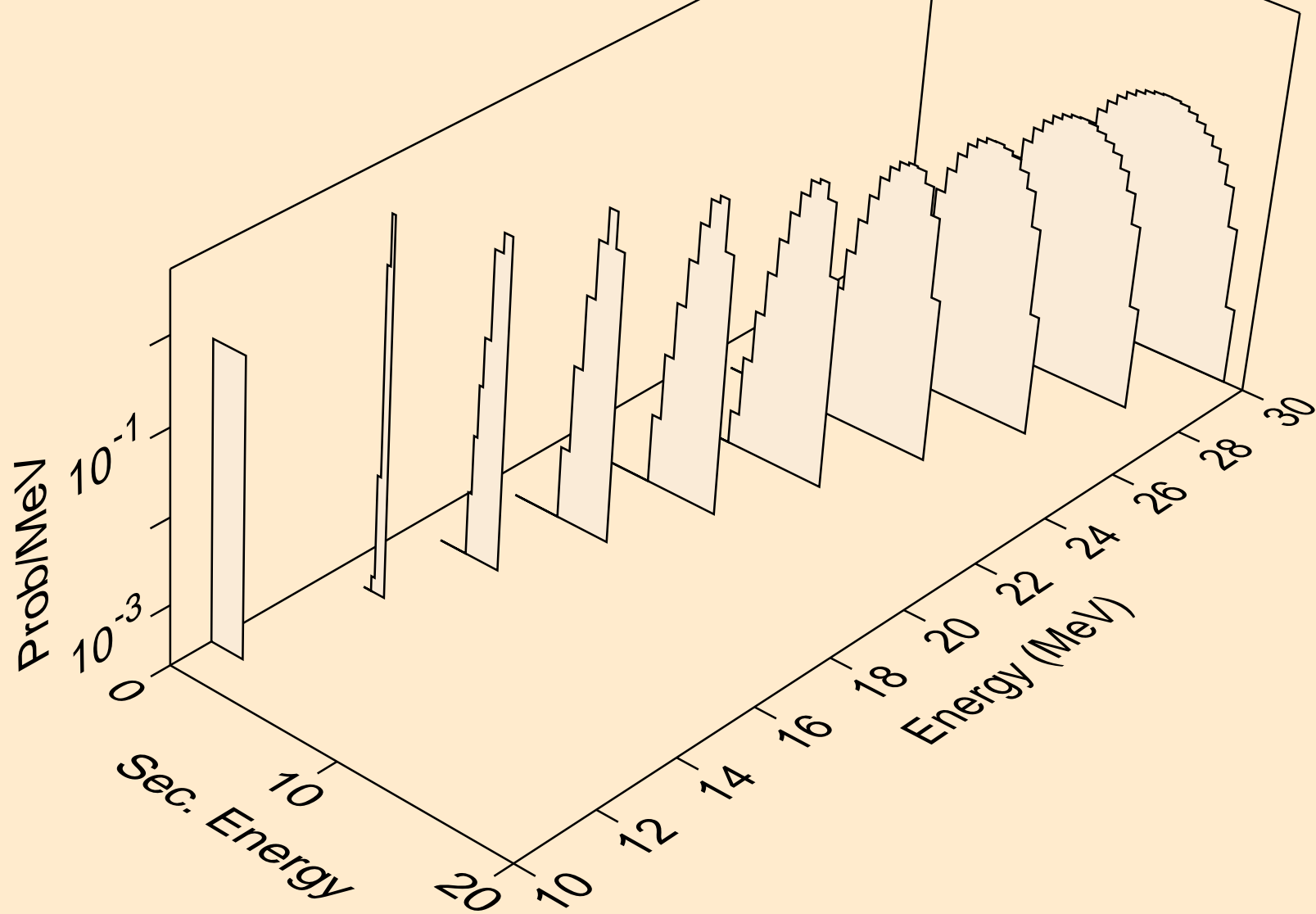

AU191 NEUTRON ACER TENDL-2021 LIBRARY; T=293.6K  
tritons from (n,t)

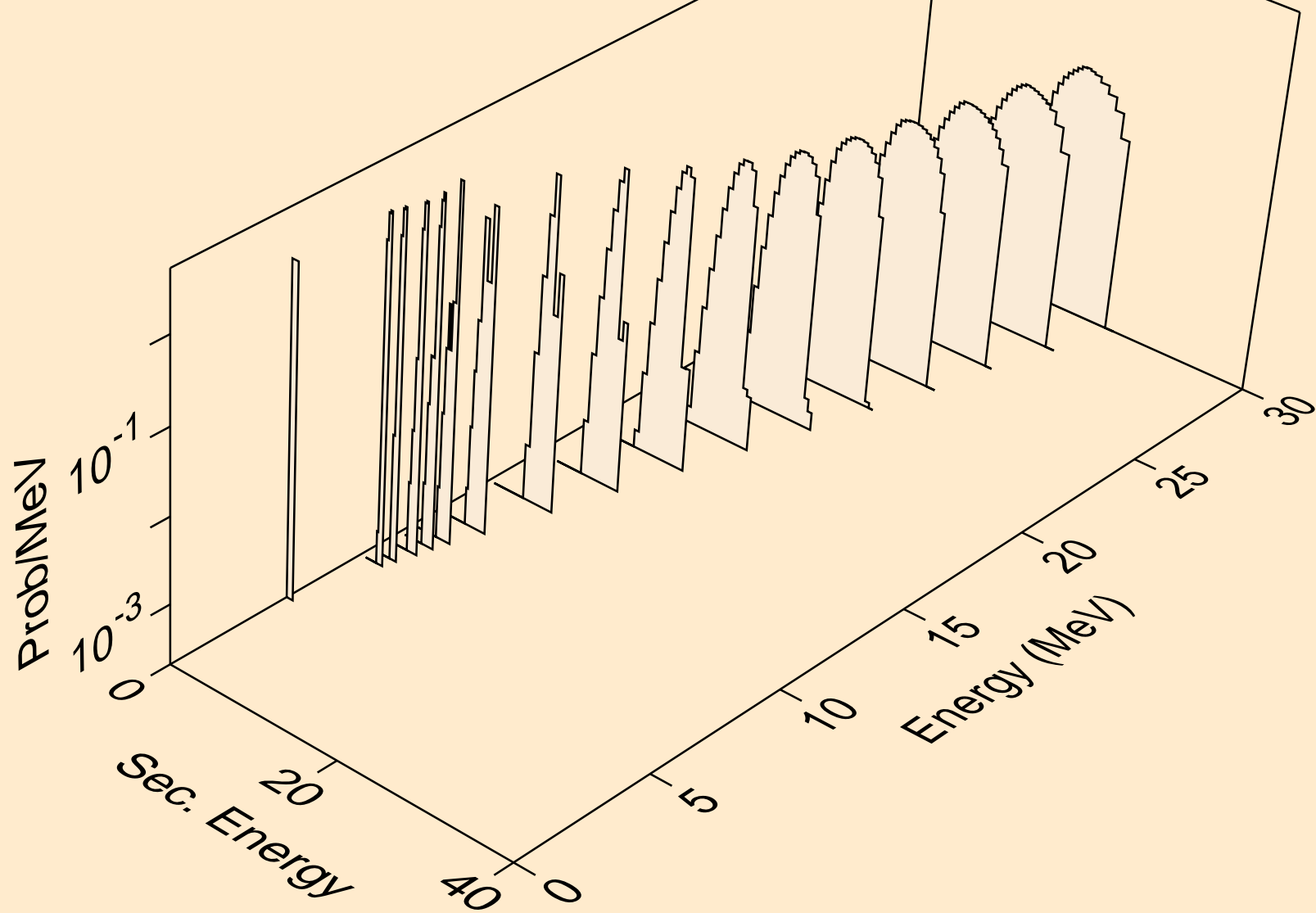

AU191 NEUTRON ACER TENDL-2021 LIBRARY; T=293.6K  
tritons from (n,pt)

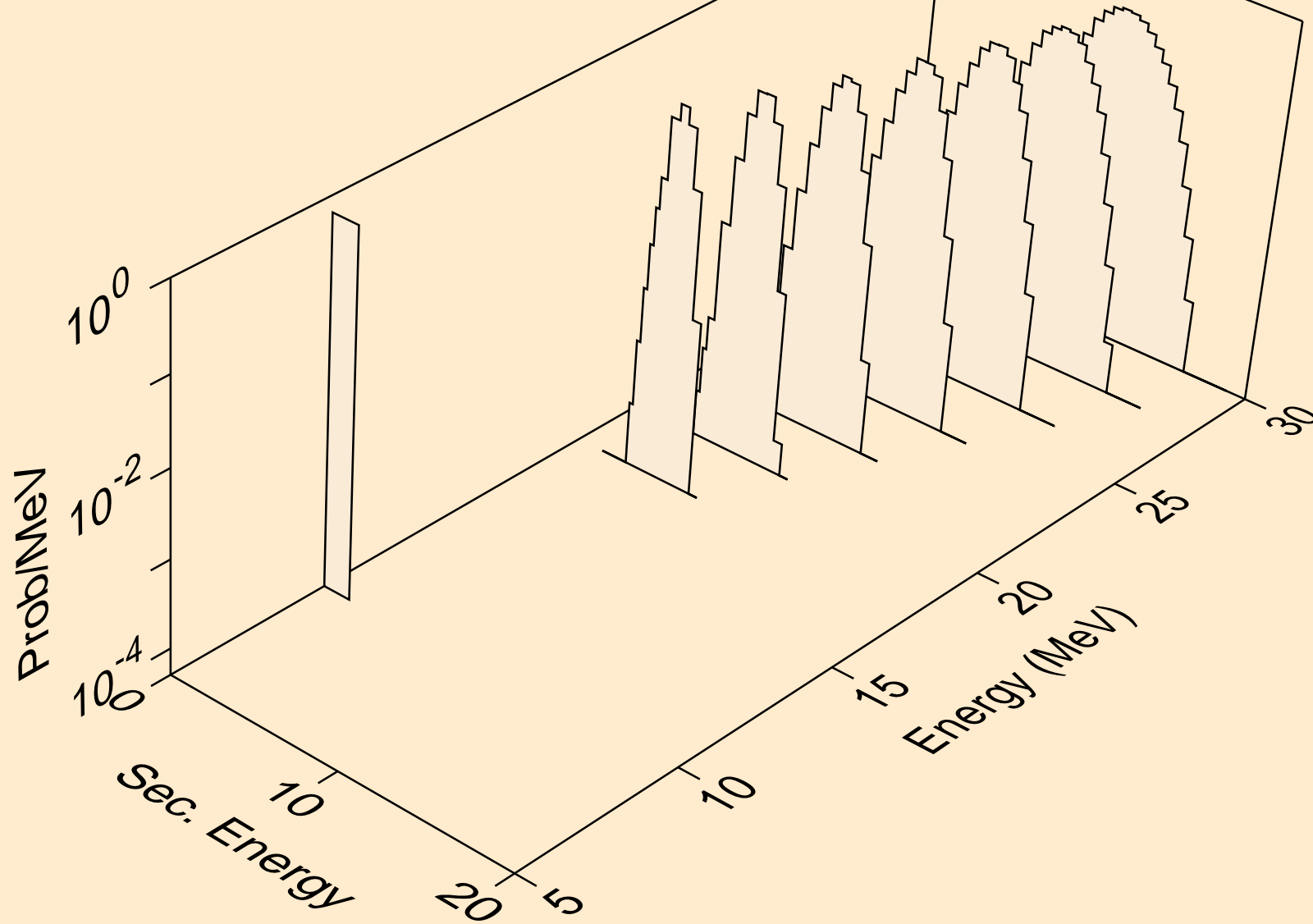

AU191 NEUTRON ACER TENDL-2021 LIBRARY; T=293.6K  
he3s from (n,x)

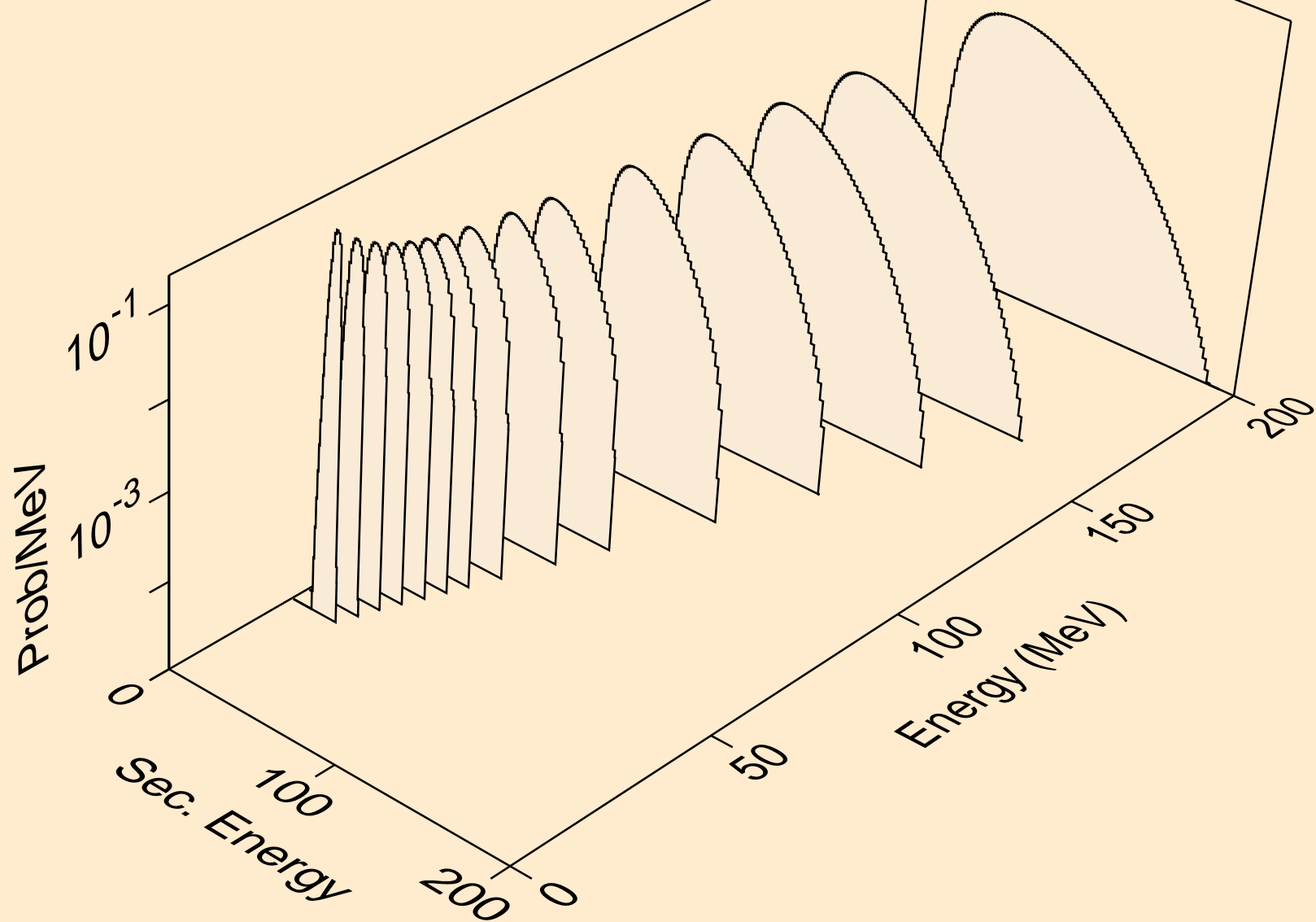

AU191 NEUTRON ACER TENDL-2021 LIBRARY; T=293.6K  
he3s from (n,n\*)he3

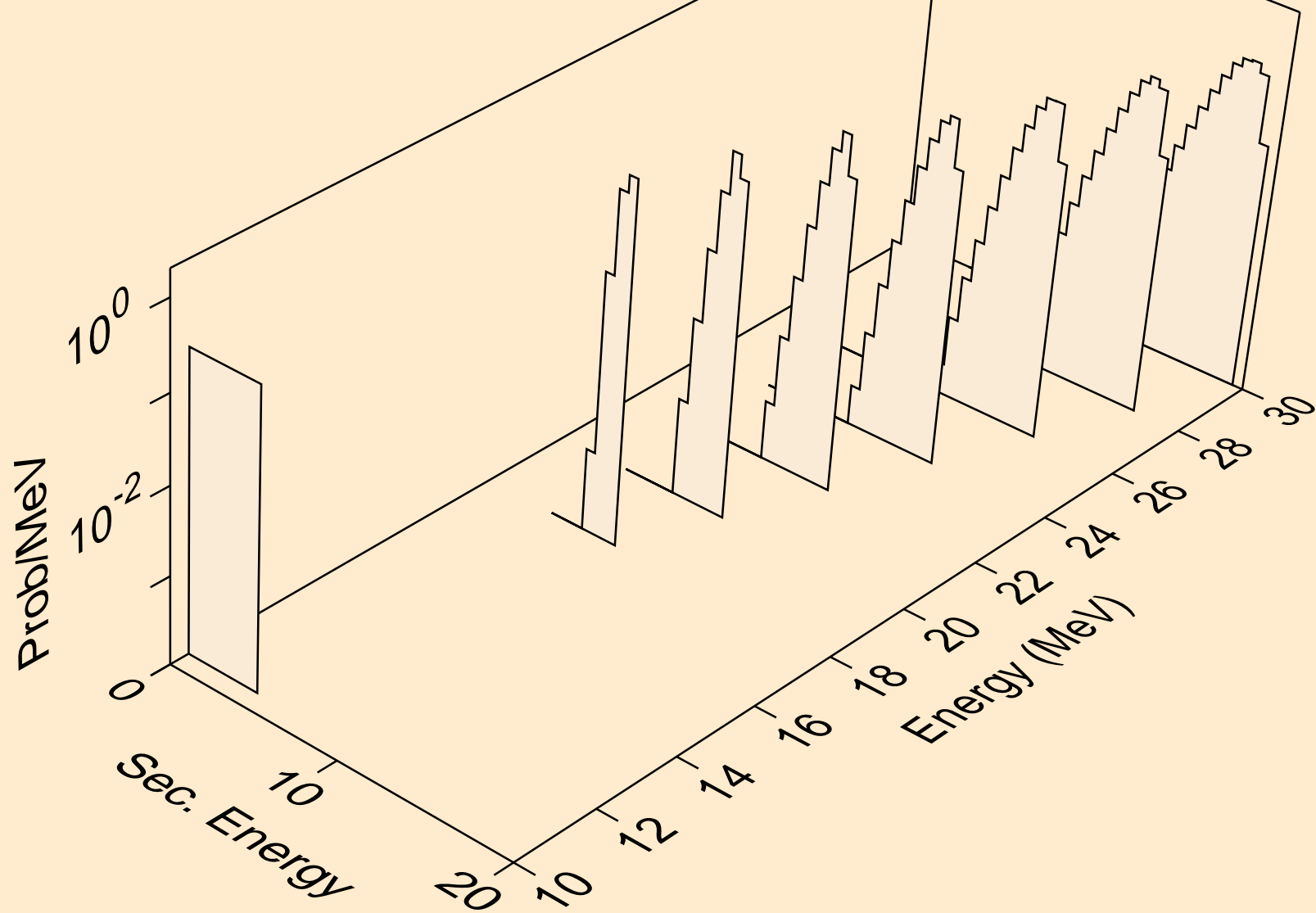



AU191 NEUTRON ACER TENDL-2021 LIBRARY; T=293.6K  
he3s from (n,he3)

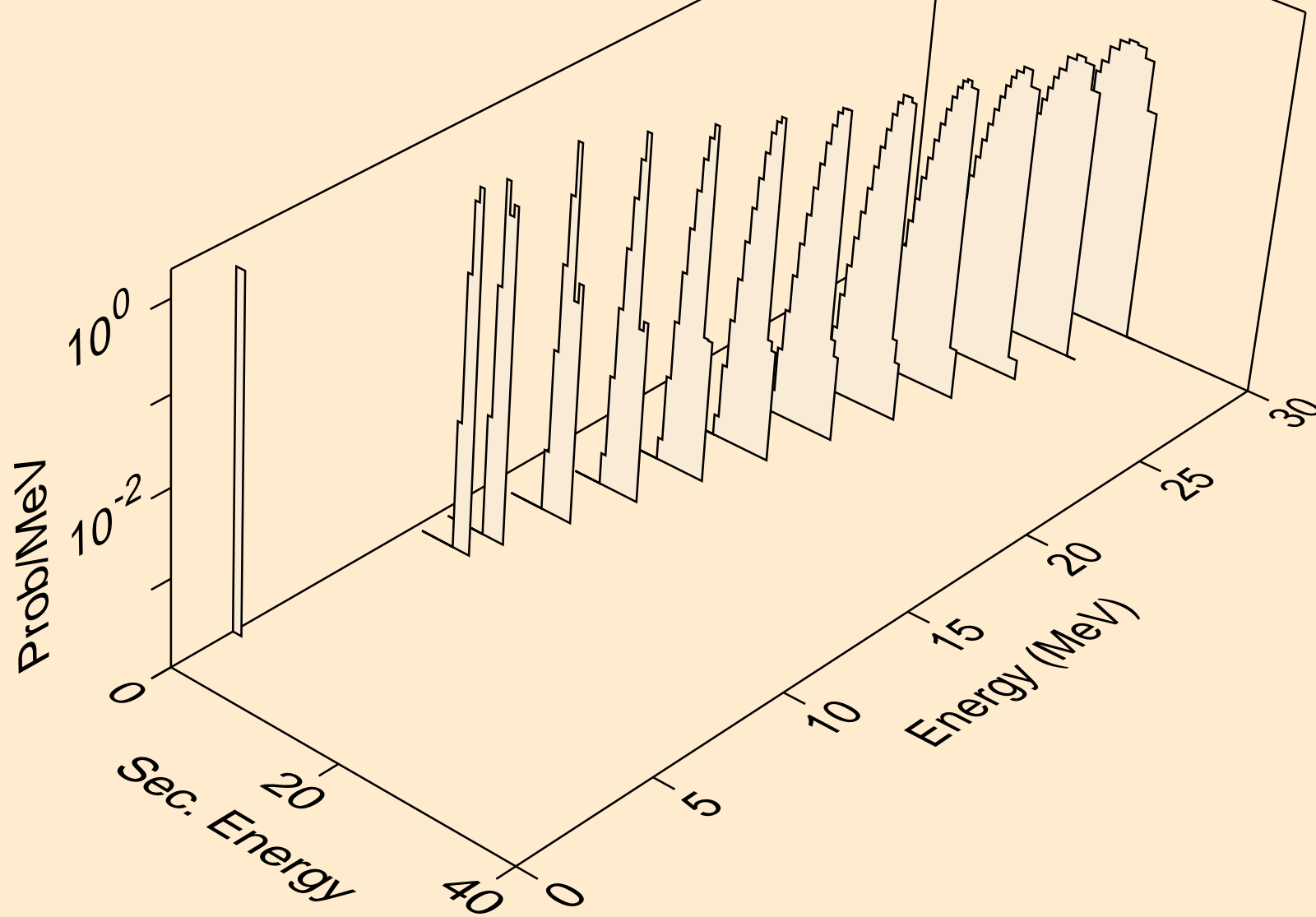

AU191 NEUTRON ACER TENDL-2021 LIBRARY; T=293.6K  
alphas from (n,x)

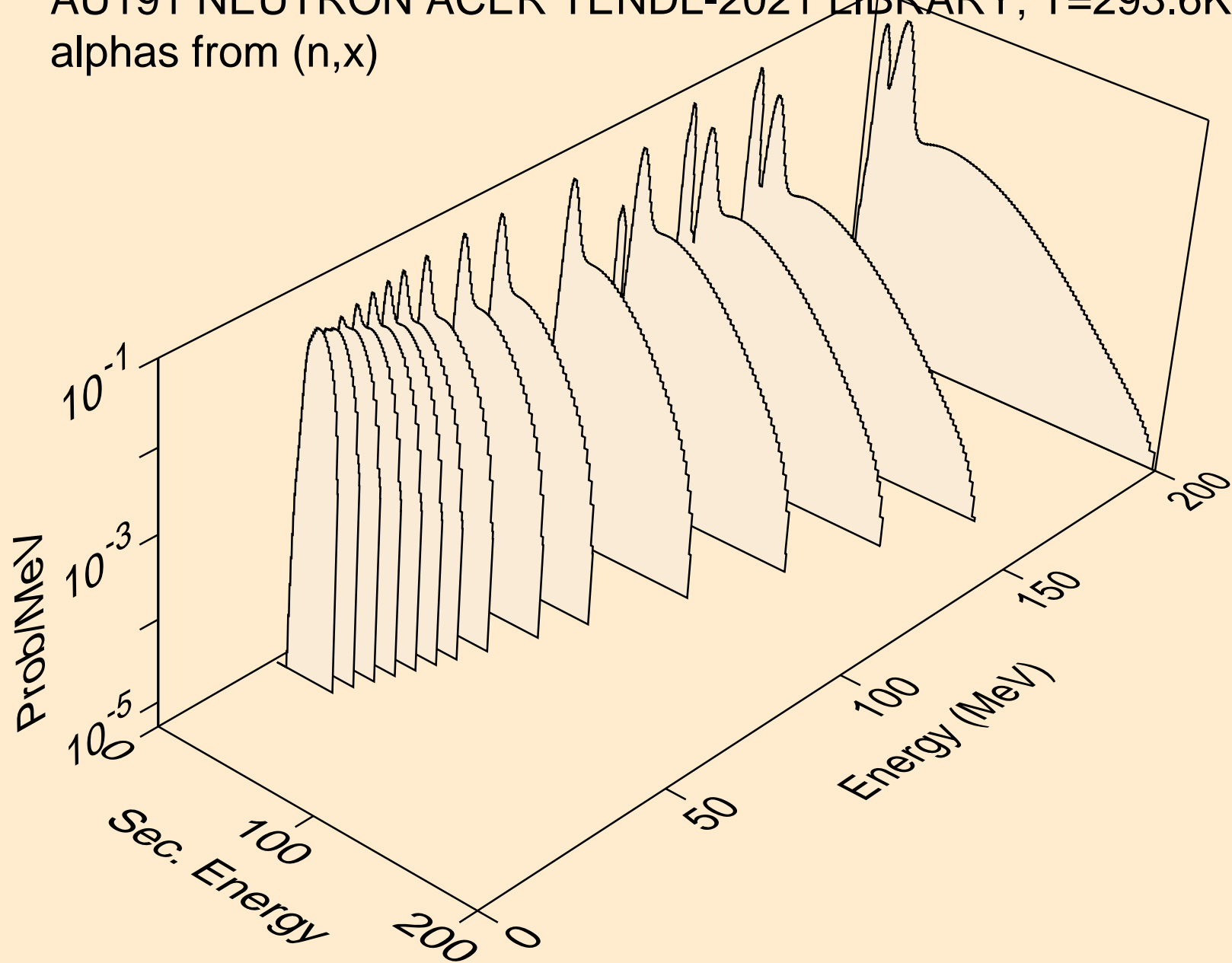

AU191 NEUTRON ACER TENDL-2021 LIBRARY; T=293.6K  
alphas from (n,n\*)a

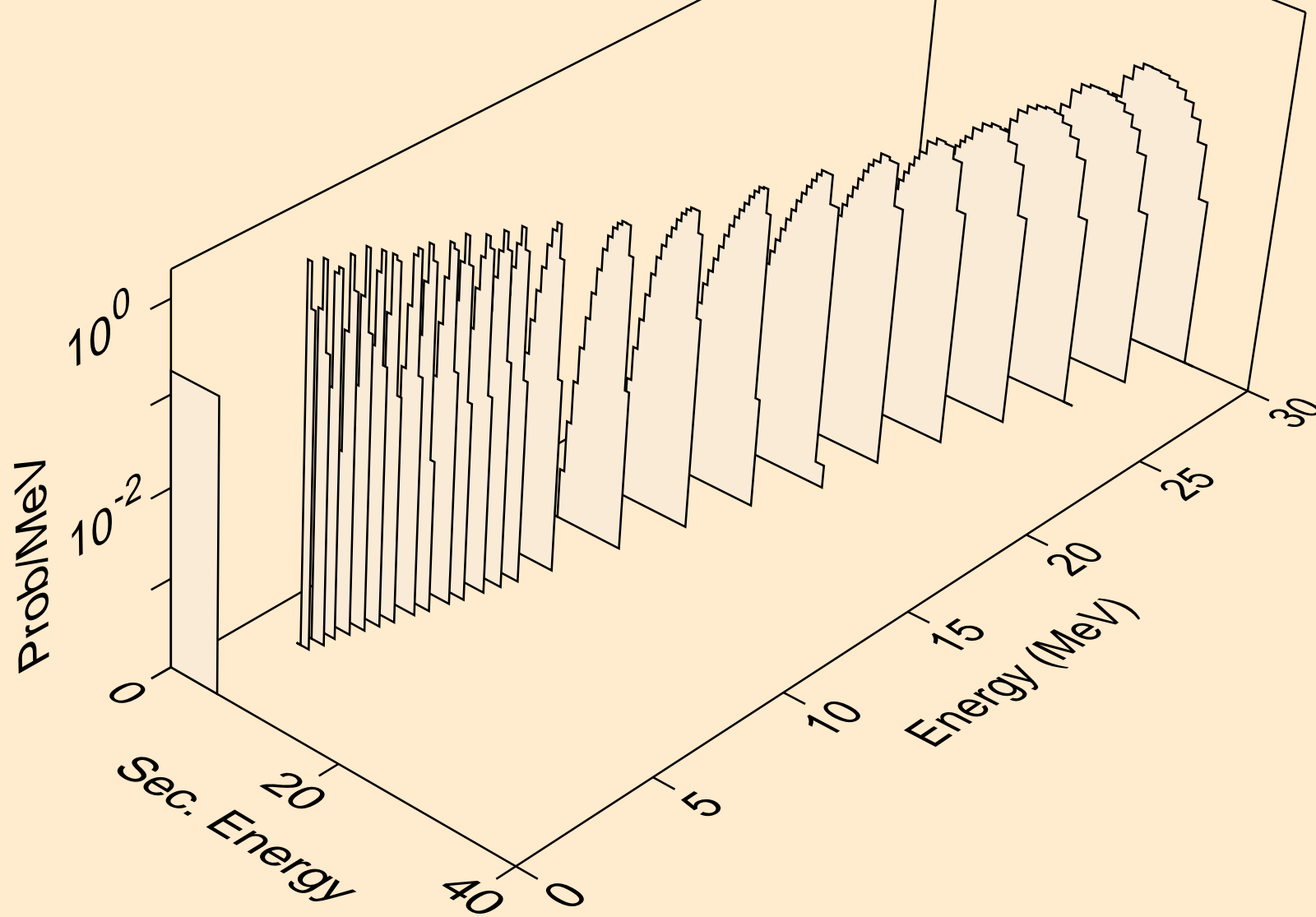

AU191 NEUTRON ACER TENDL-2021 LIBRARY; T=293.6K  
alphas from (n,2n)a

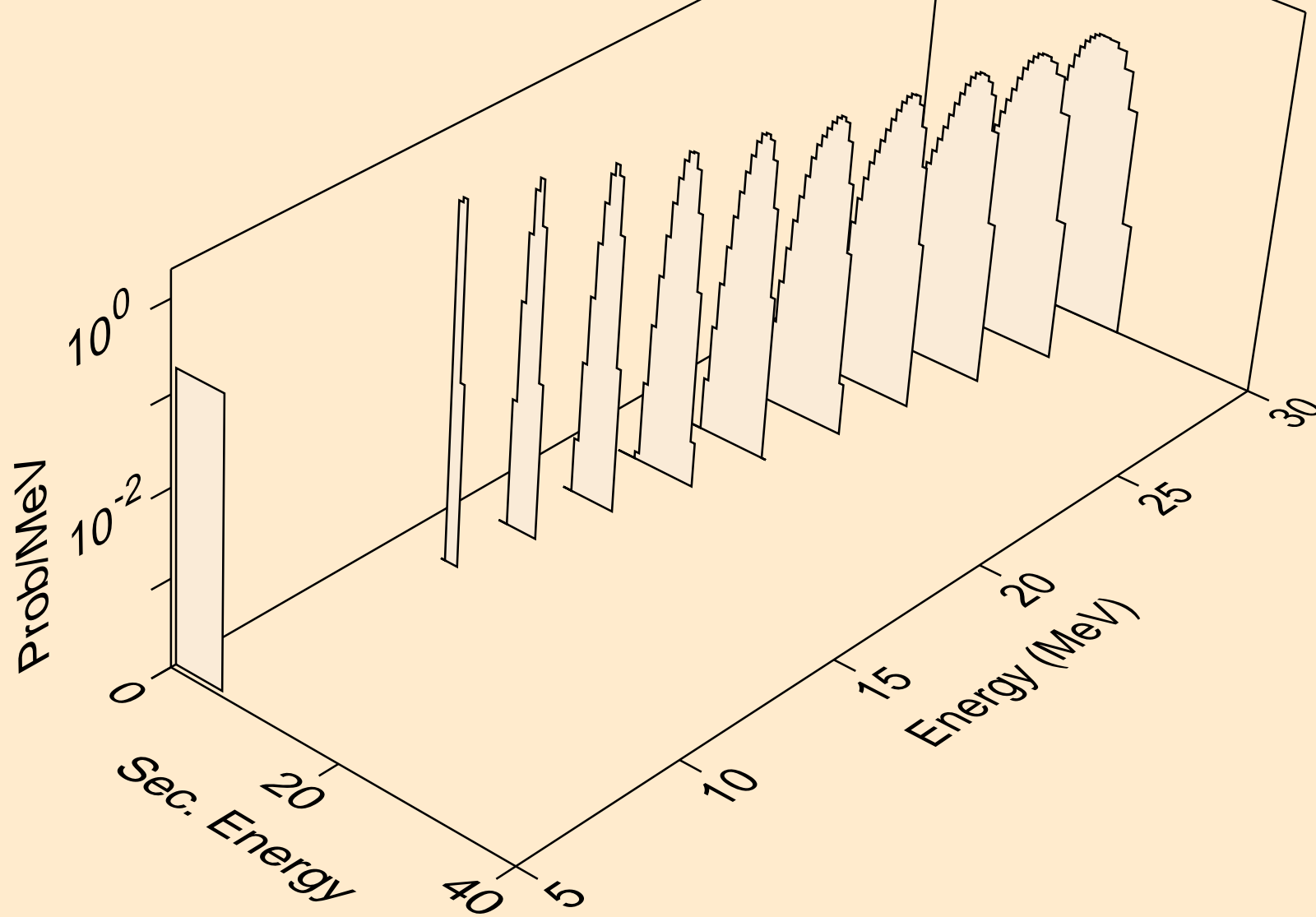

AU191 NEUTRON ACER TENDL-2021 LIBRARY; T=293.6K  
alphas from (n,3n)a

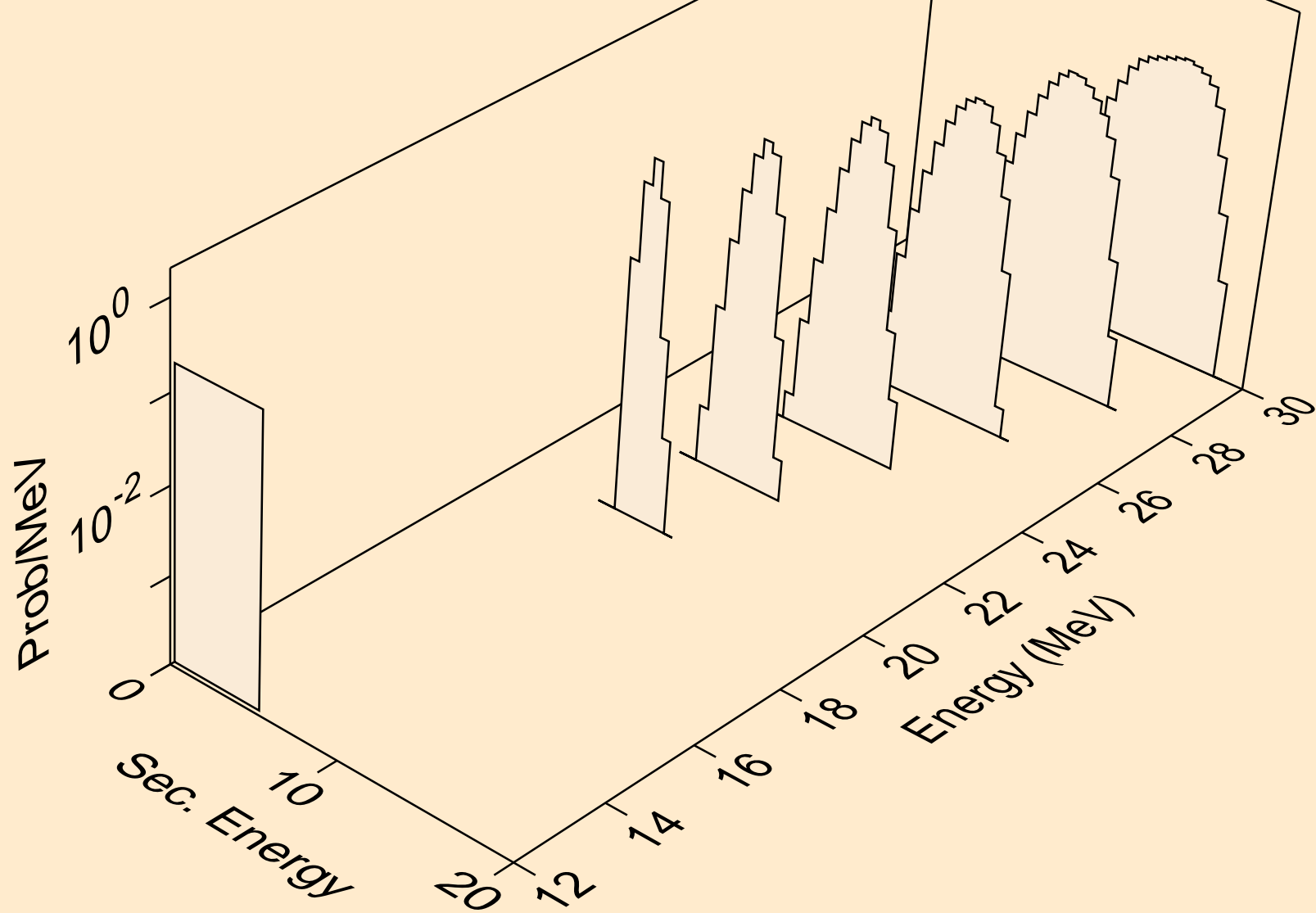

AU191 NEUTRON ACER TENDL-2021 LIBRARY; T=293.6K  
alphas from (n,n\*)2a

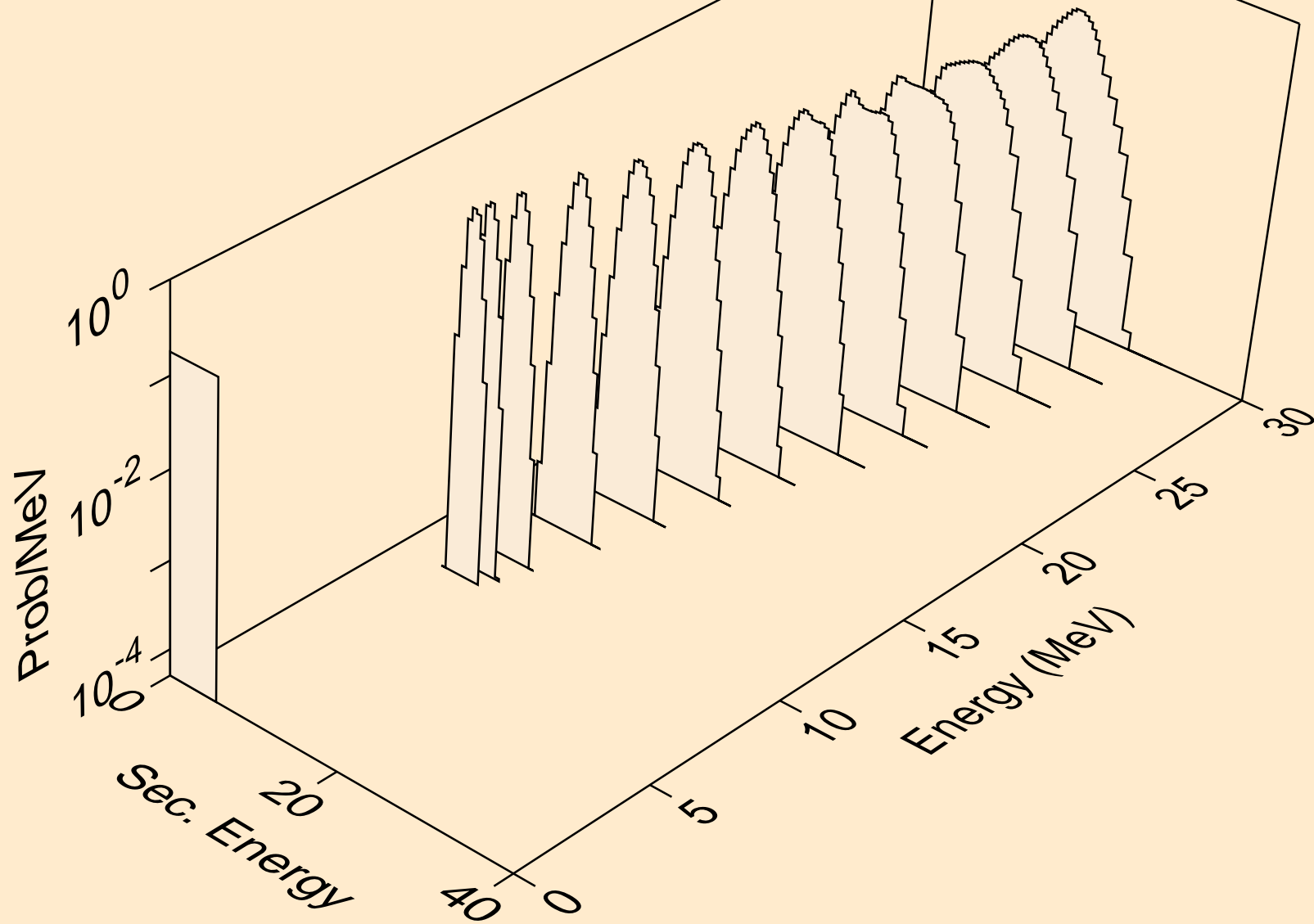

AU191 NEUTRON ACER TENDL-2021 LIBRARY; T=293.6K  
alphas from (n,npa)

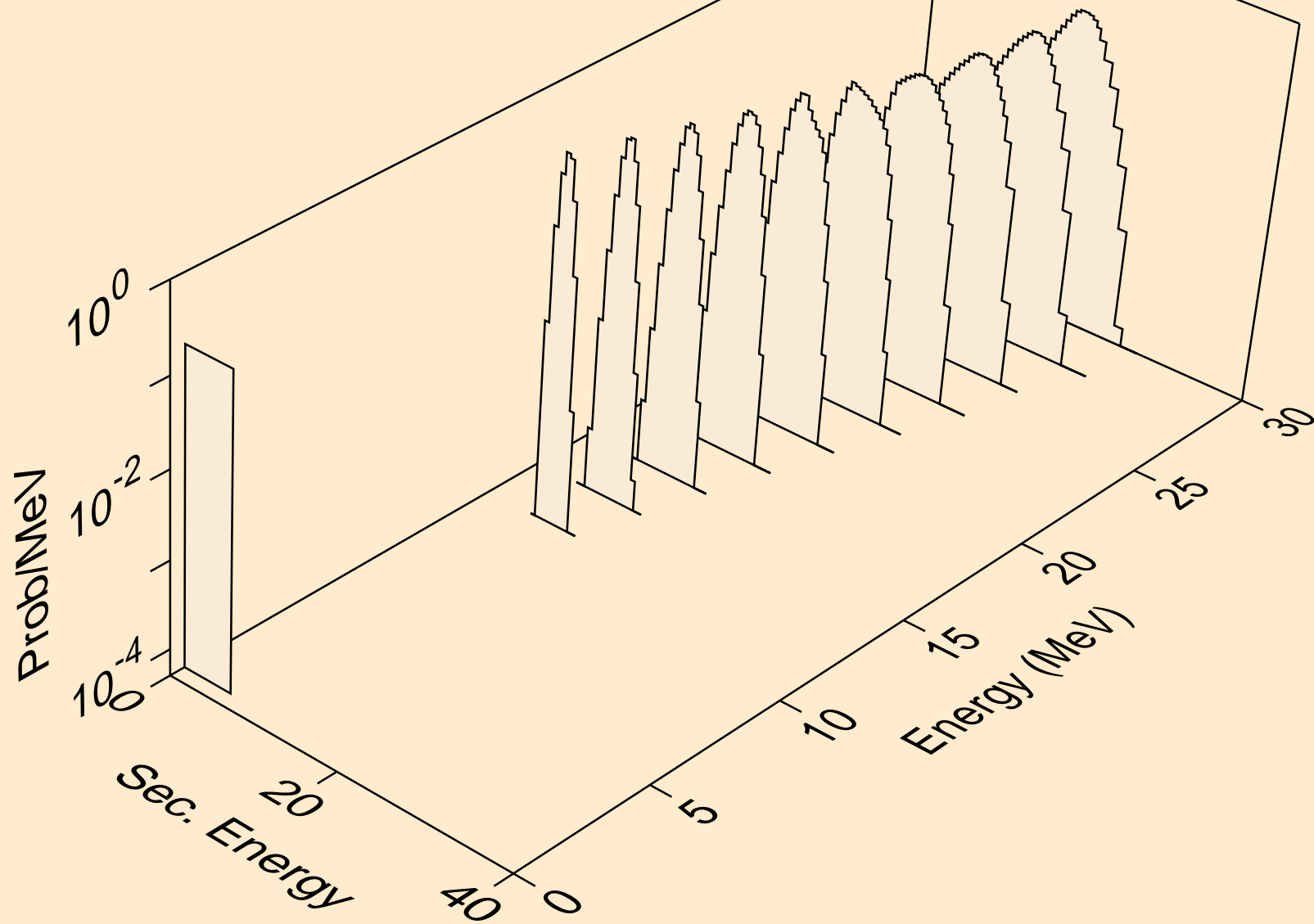

AU191 NEUTRON ACER TENDL-2021 LIBRARY; T=293.6K  
alphas from (n,a)

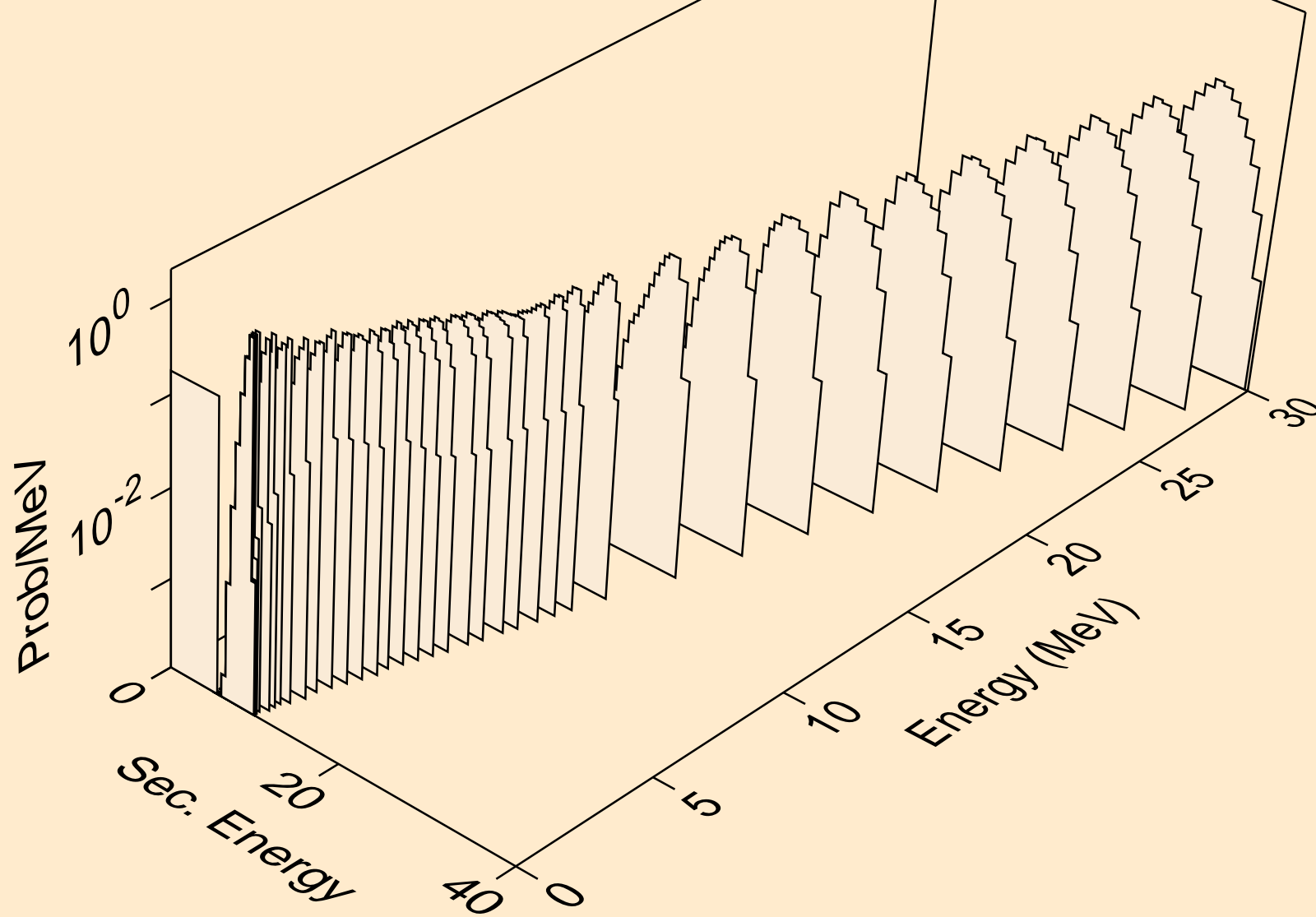



AU191 NEUTRON ACER TENDL-2021 LIBRARY; T=293.6K  
alphas from (n,2a)

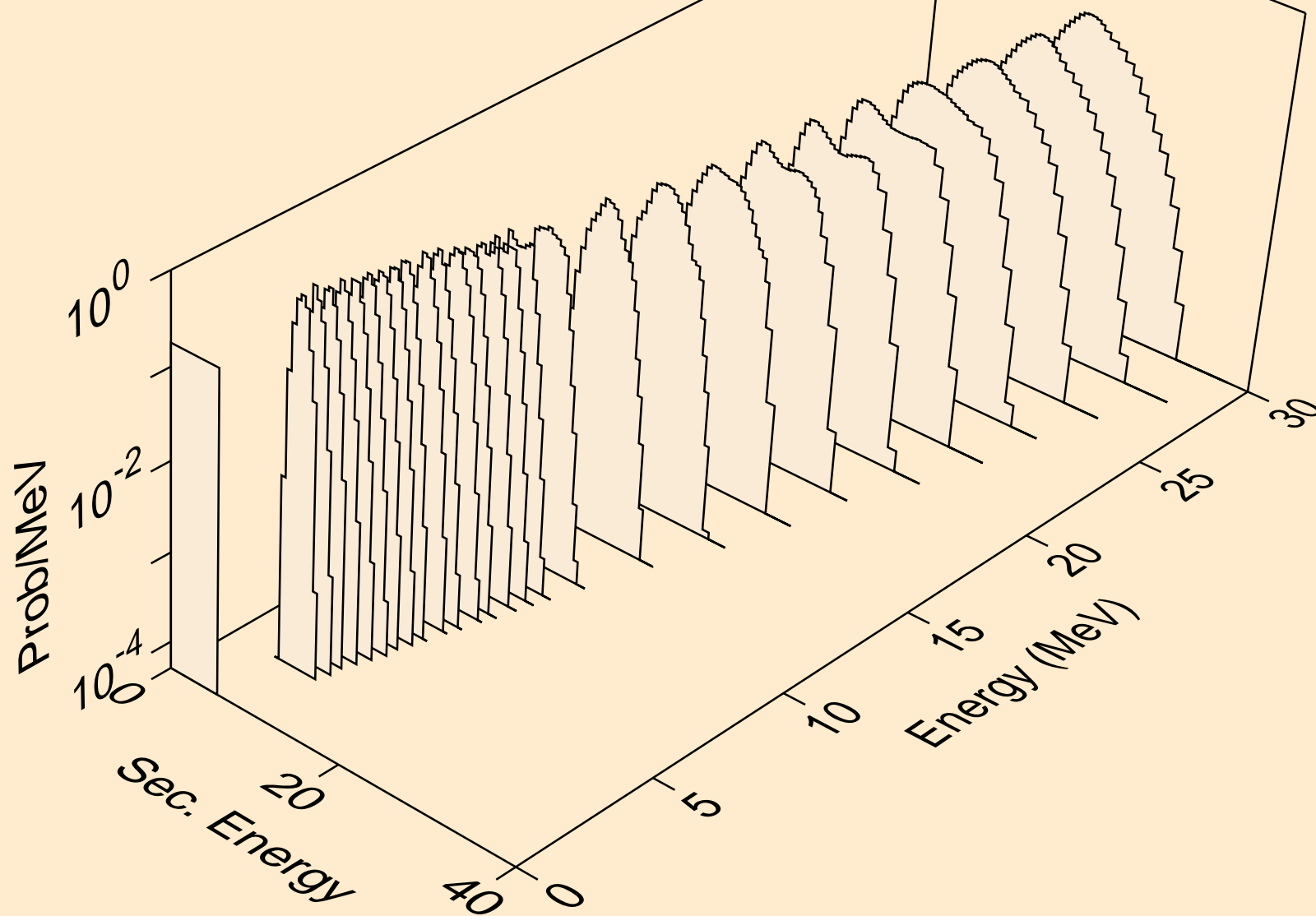

AU191 NEUTRON ACER TENDL-2021 LIBRARY; T=293.6K  
alphas from (n,pa)

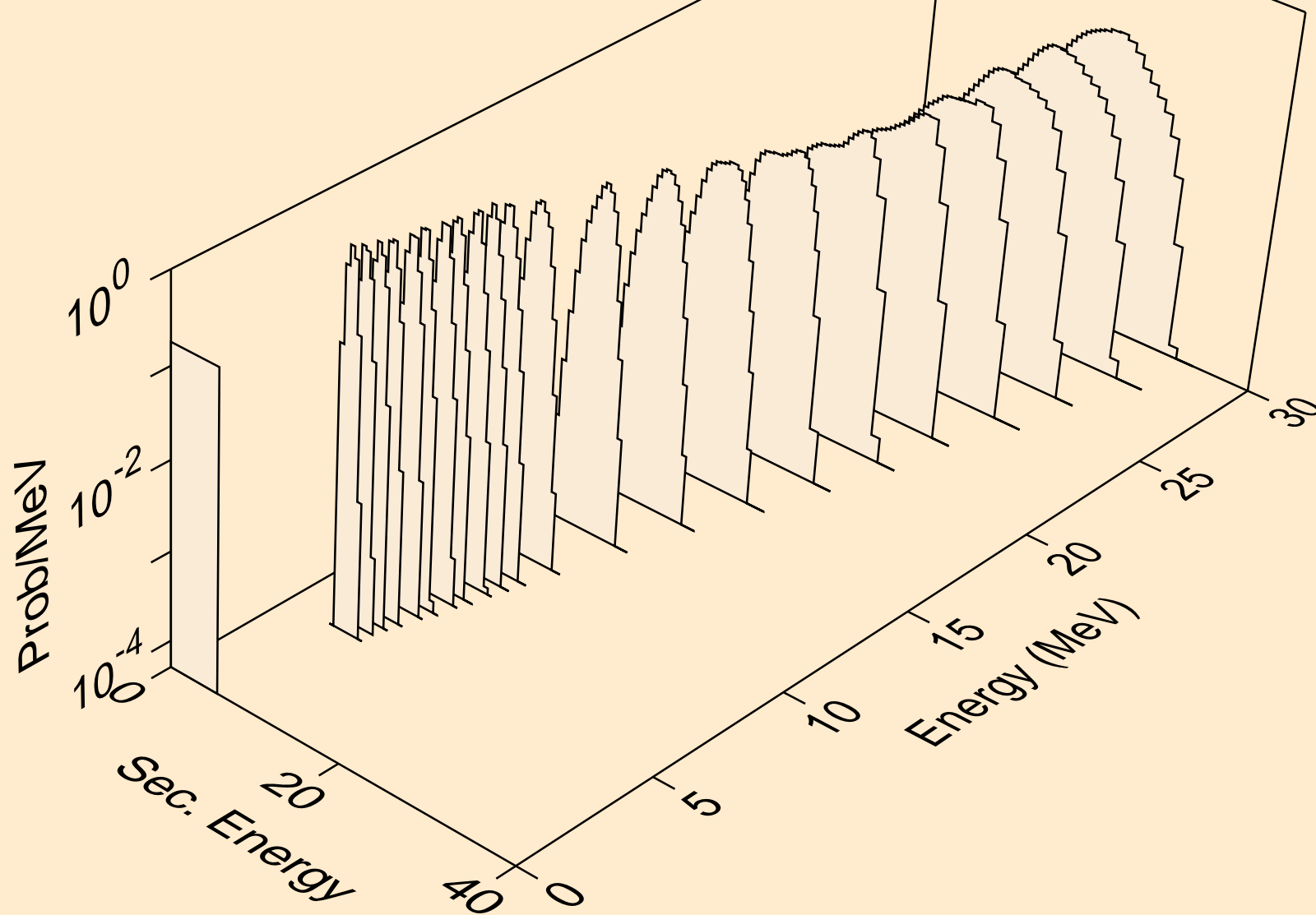

AU191 NEUTRON ACER TENDL-2021 LIBRARY; T=293.6K  
alphas from (n,da)

