

AU197M NEUTRON ACER TENDL-2021 LIBRARY; T=293.6K
Principal cross sections

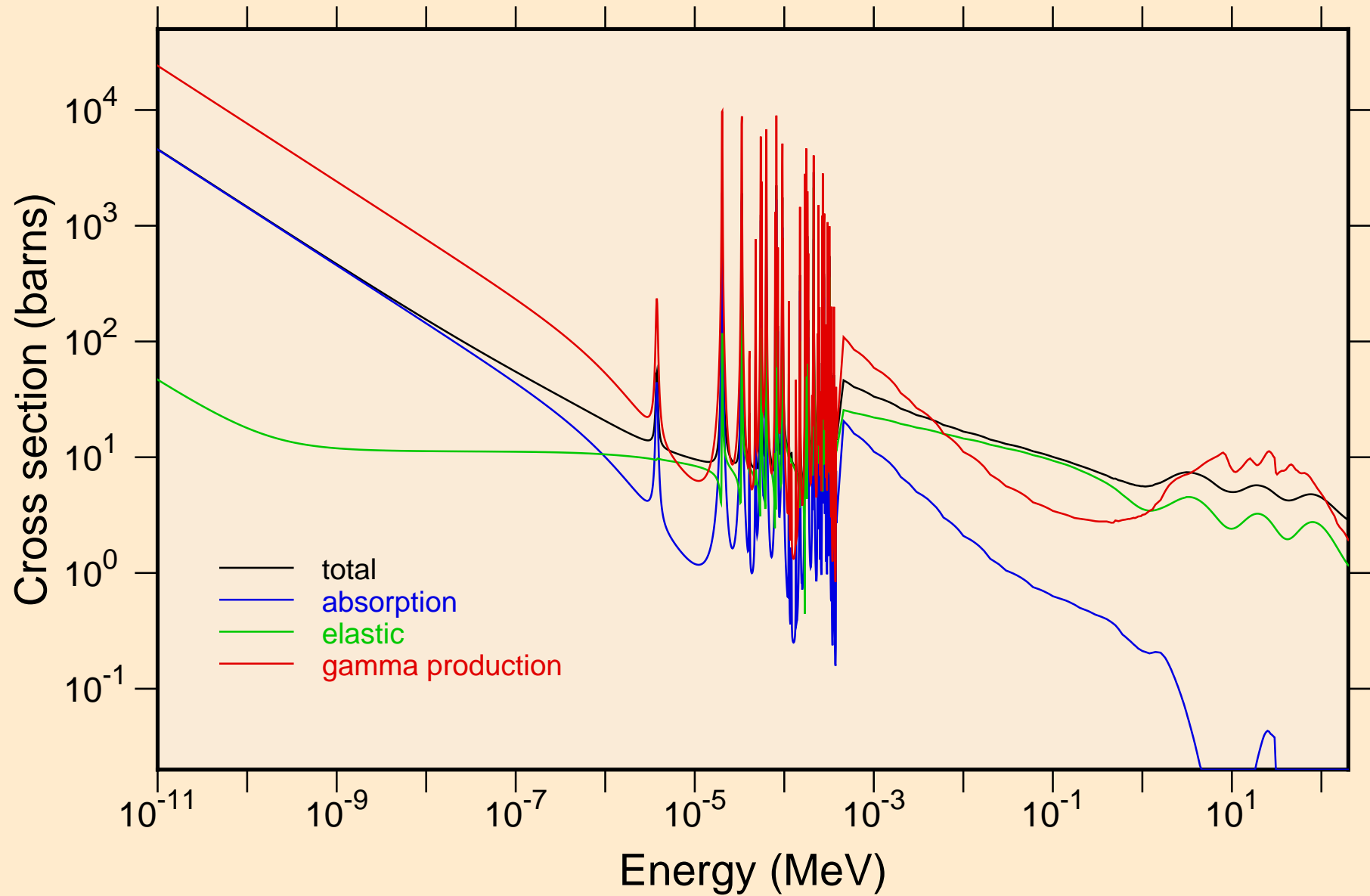

AU197M NEUTRON ACER TENDL-2021 LIBRARY; T=293.6K
resonance total cross section

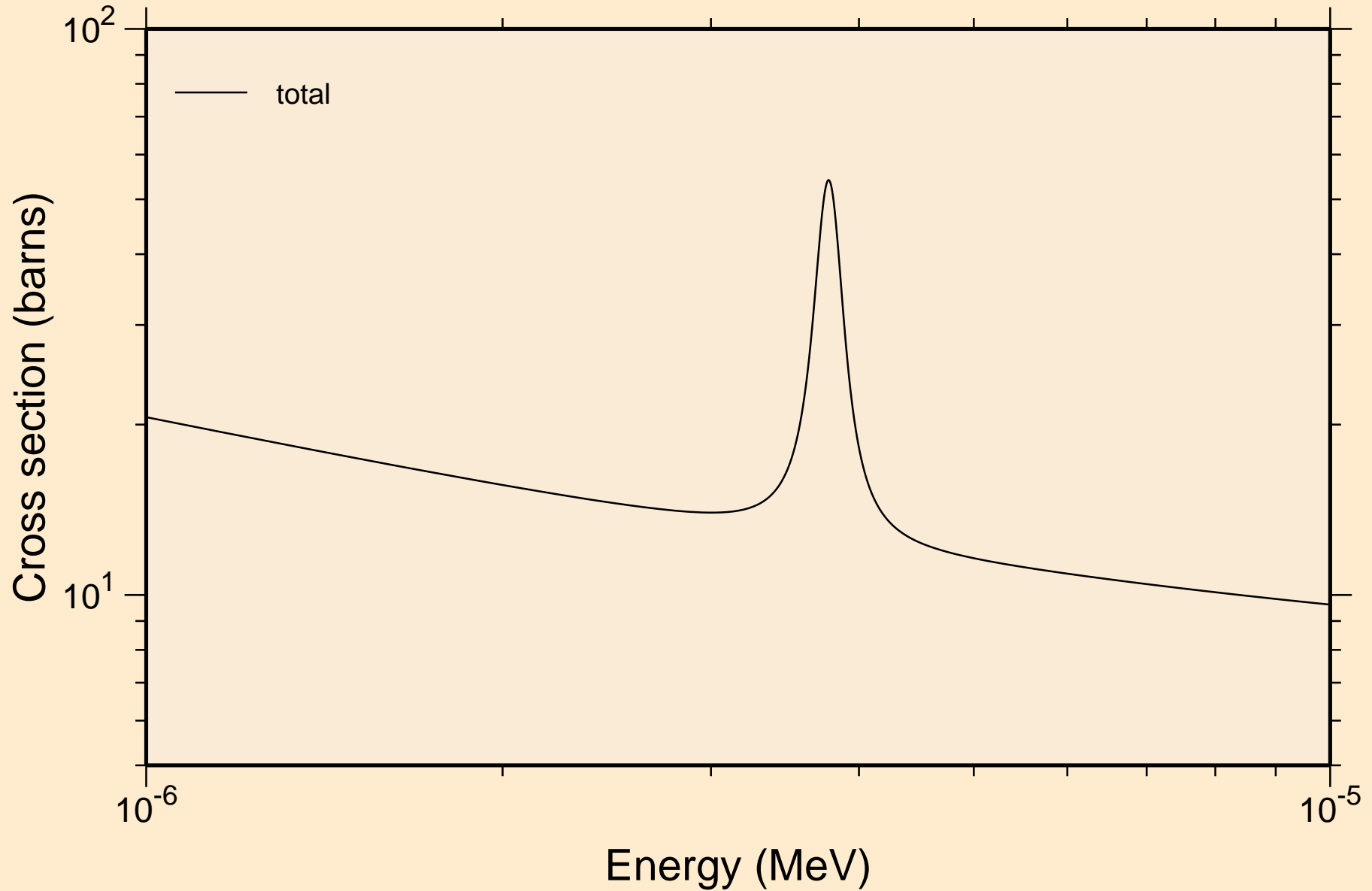

AU197M NEUTRON ACER TENDL-2021 LIBRARY; T=293.6K
resonance total cross section

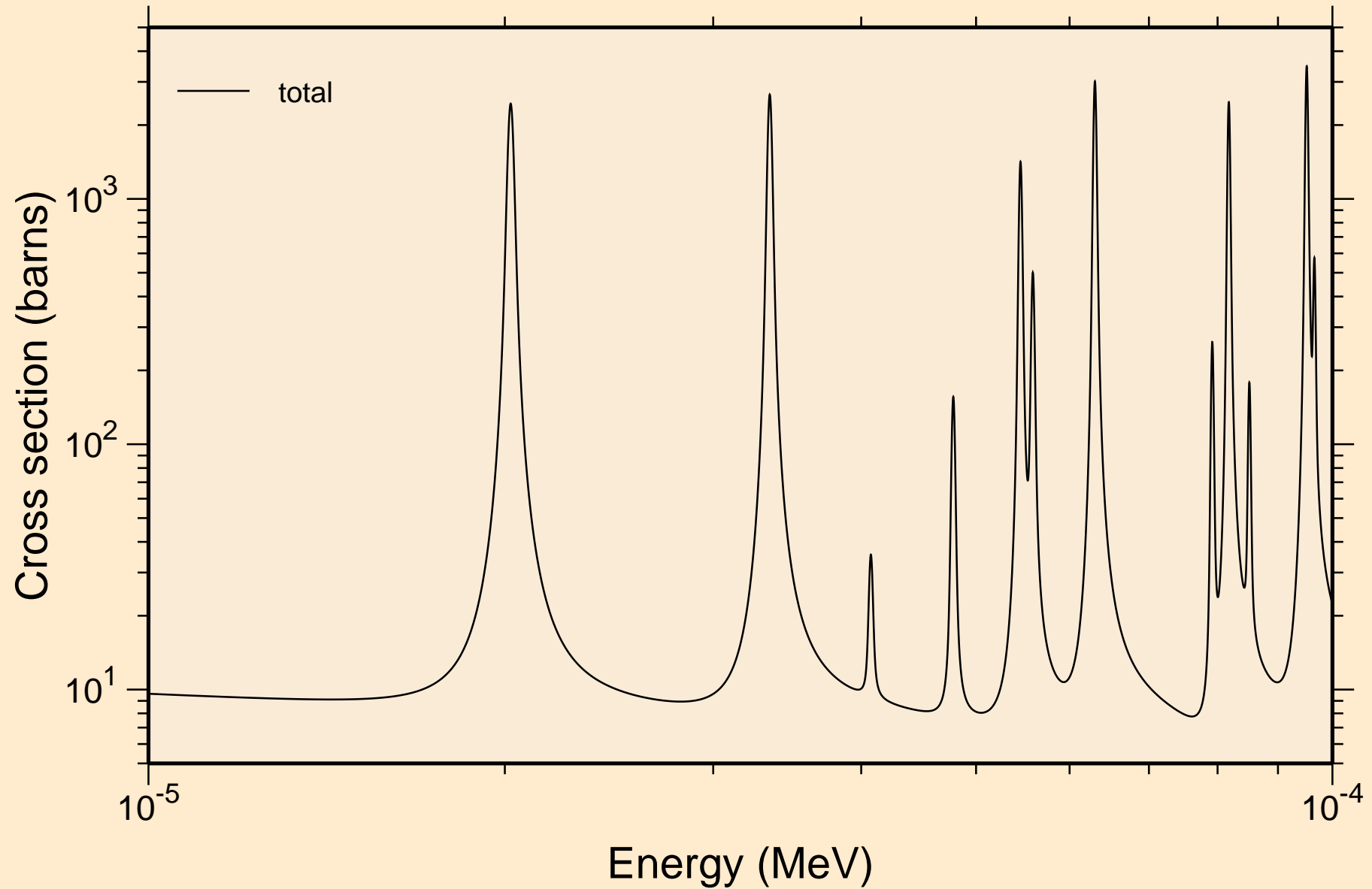

AU197M NEUTRON ACER TENDL-2021 LIBRARY; T=293.6K
resonance total cross section

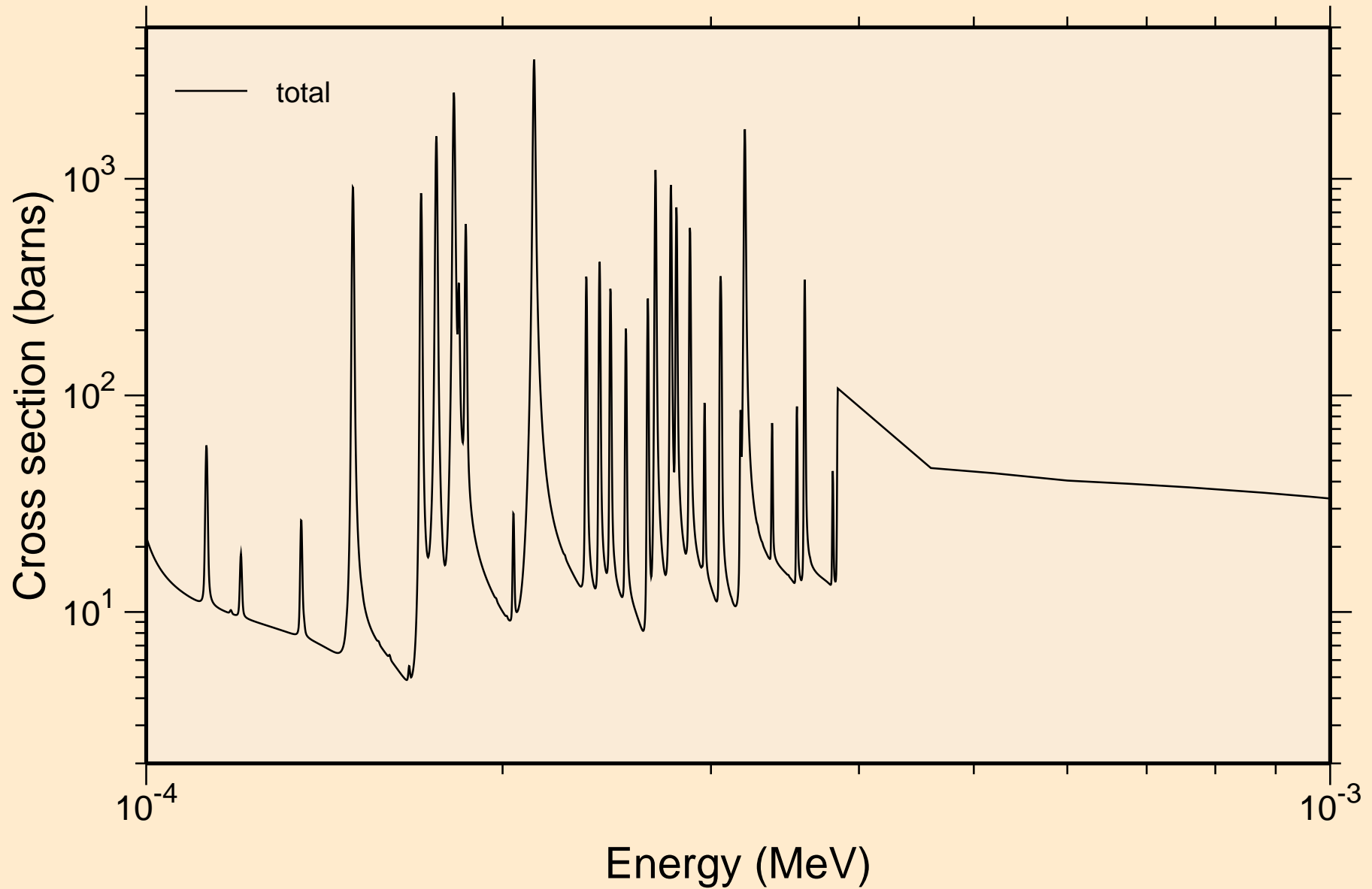

AU197M NEUTRON ACER TENDL-2021 LIBRARY; T=293.6K
resonance total cross section

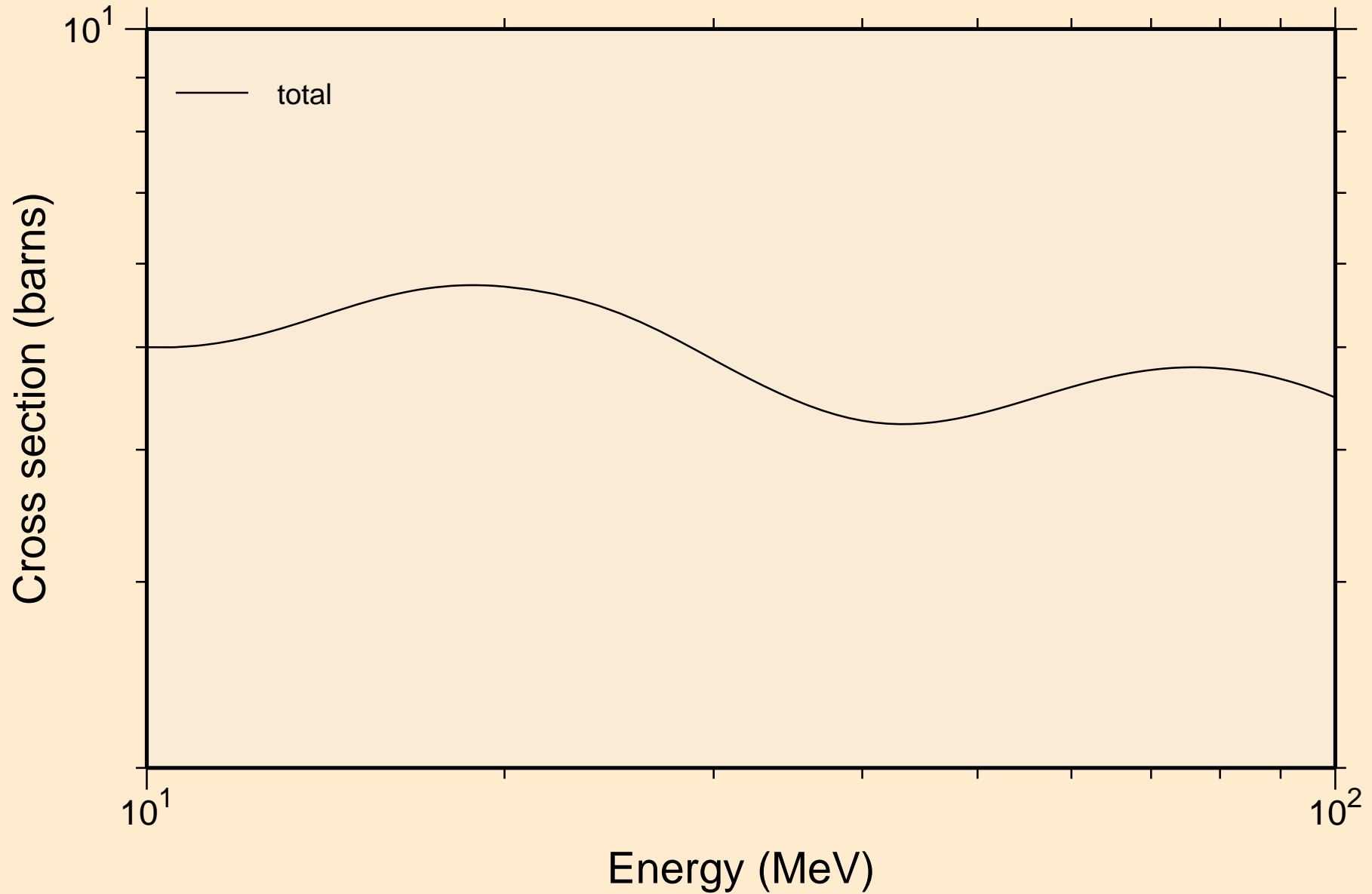

AU197M NEUTRON ACER TENDL-2021 LIBRARY; T=293.6K
resonance absorption cross sections

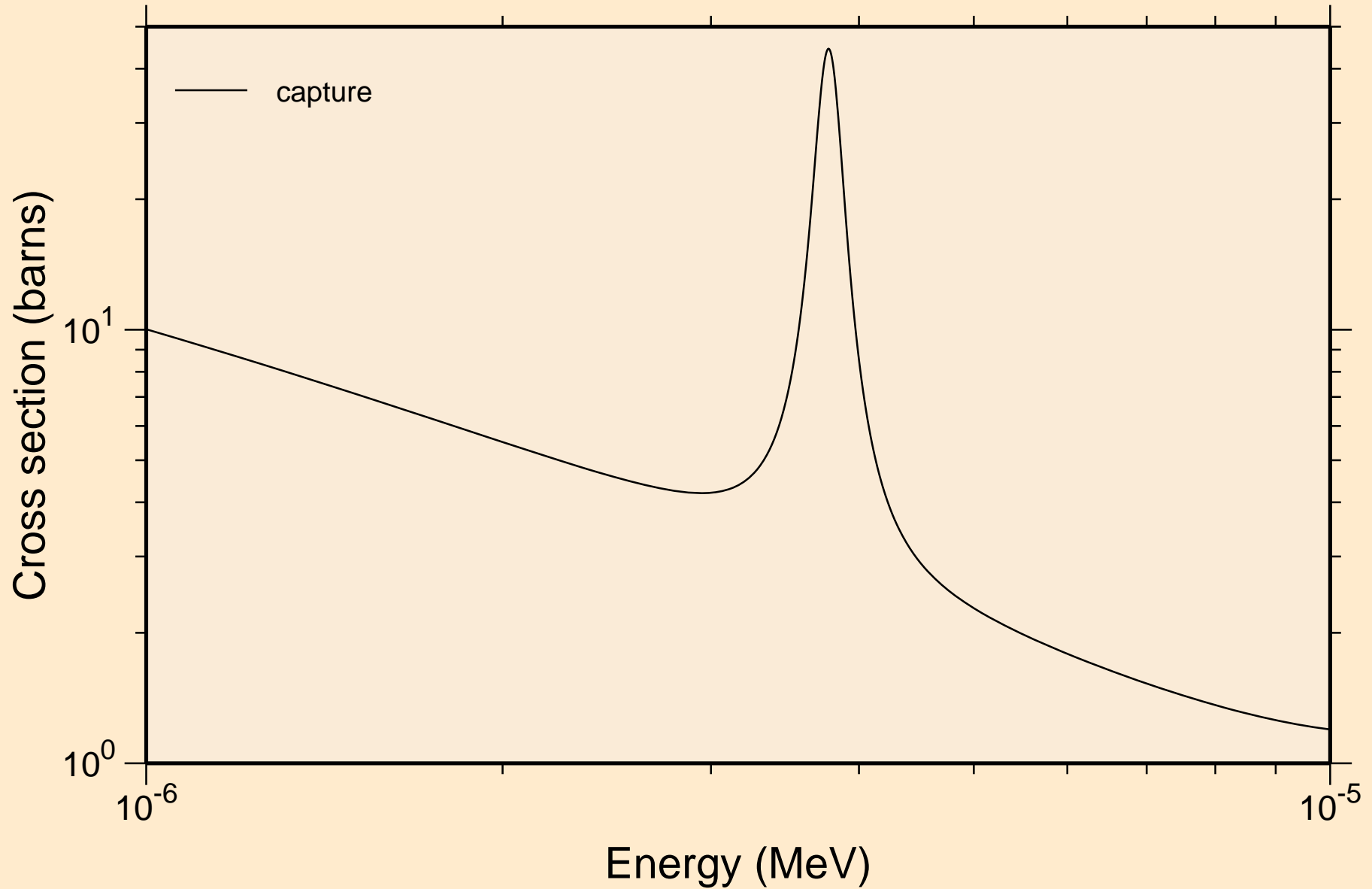

AU197M NEUTRON ACER TENDL-2021 LIBRARY; T=293.6K
resonance absorption cross sections

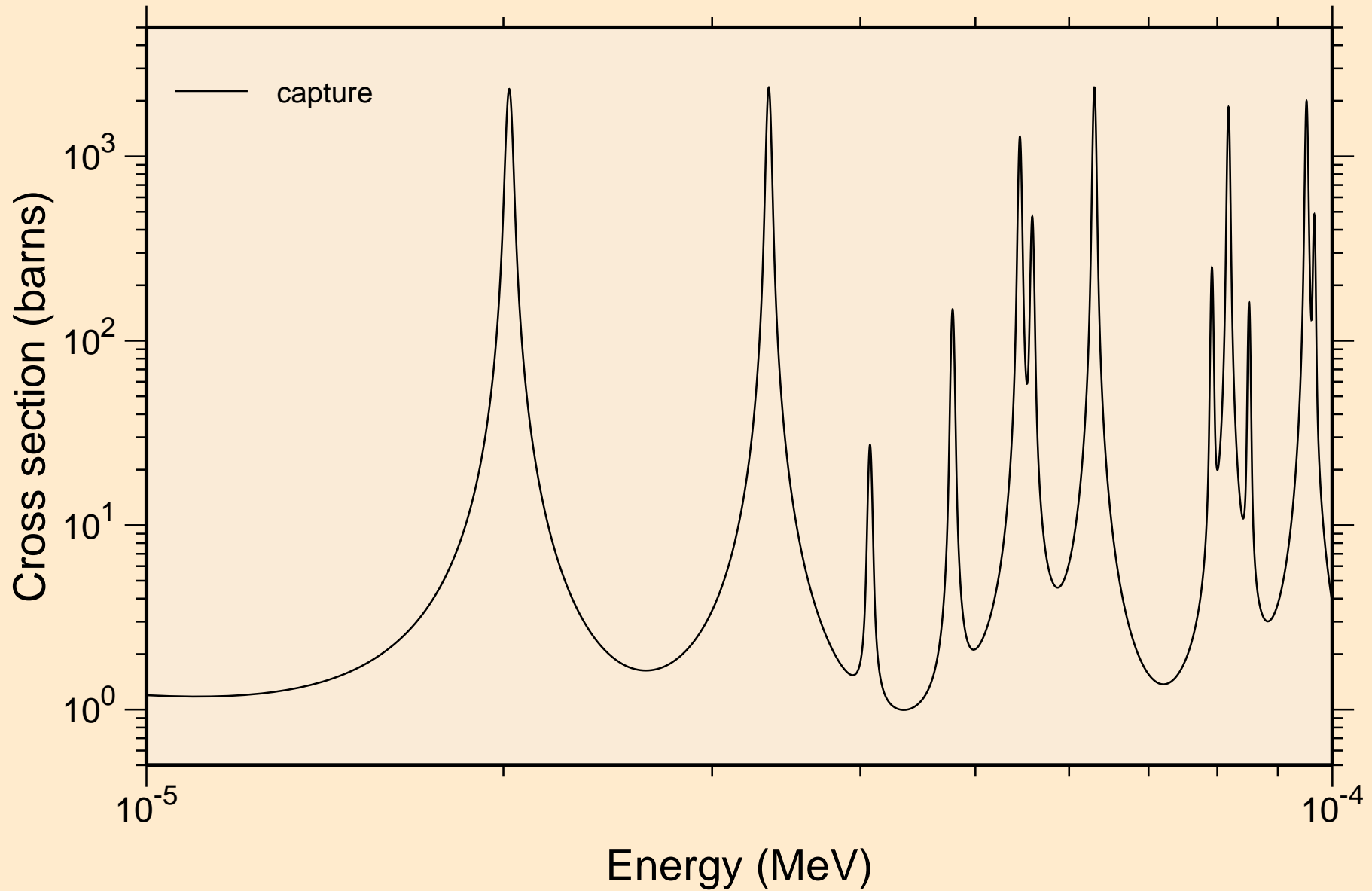

AU197M NEUTRON ACER TENDL-2021 LIBRARY; T=293.6K
resonance absorption cross sections

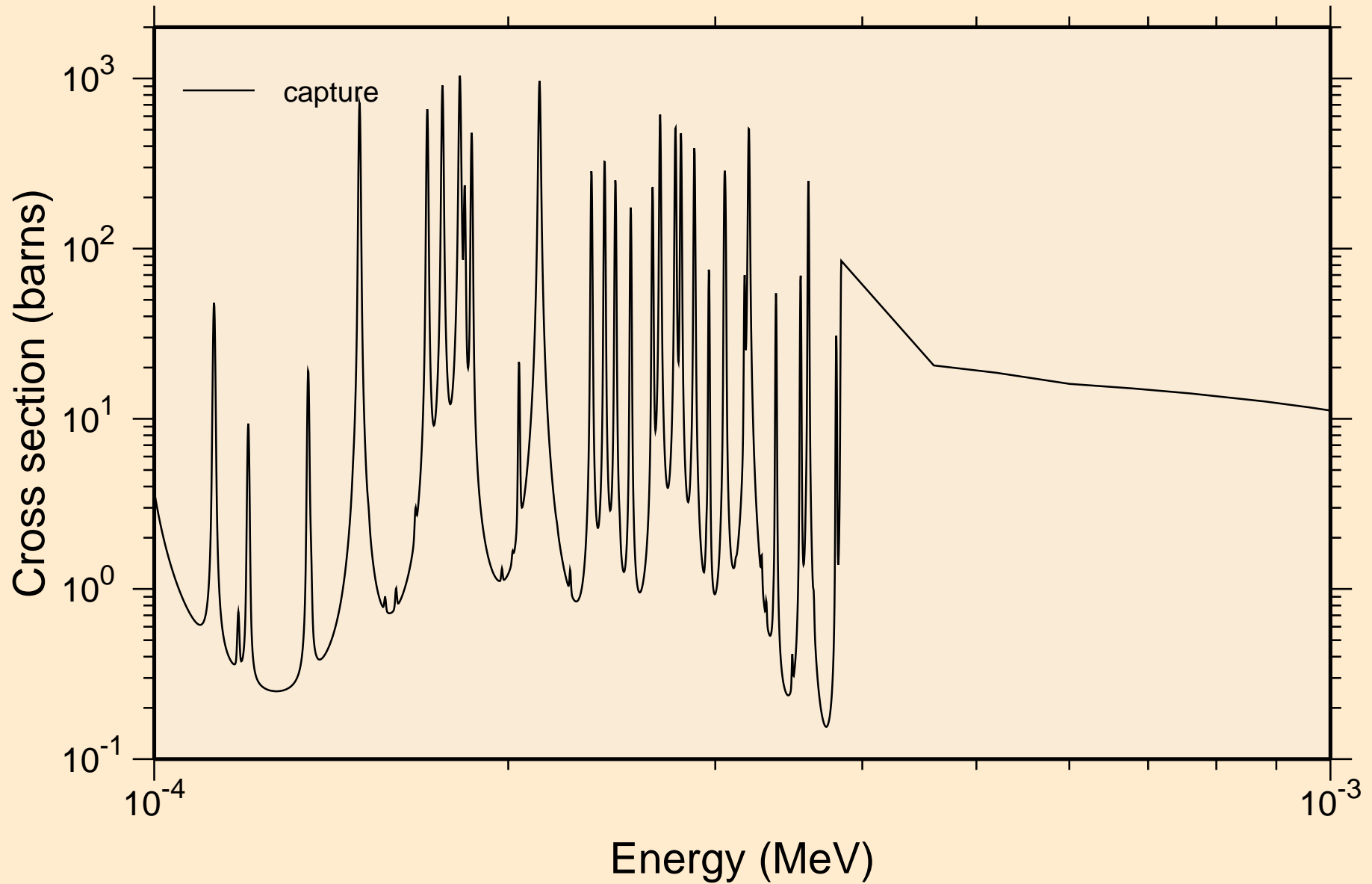

AU197M NEUTRON ACER TENDL-2021 LIBRARY; T=293.6K
resonance absorption cross sections

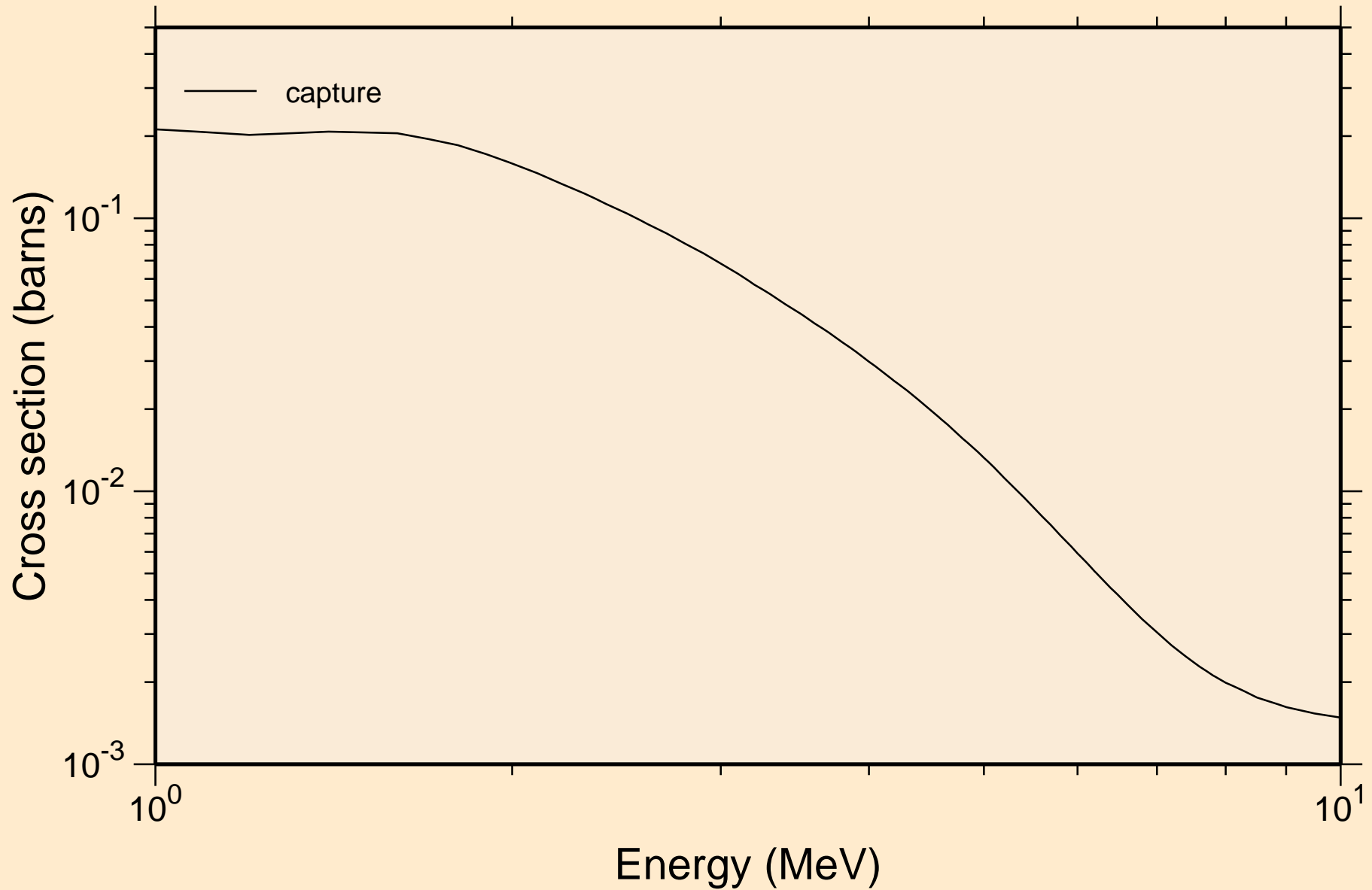

AU197M NEUTRON ACER TENDL-2021 LIBRARY; T=293.6K
Heating

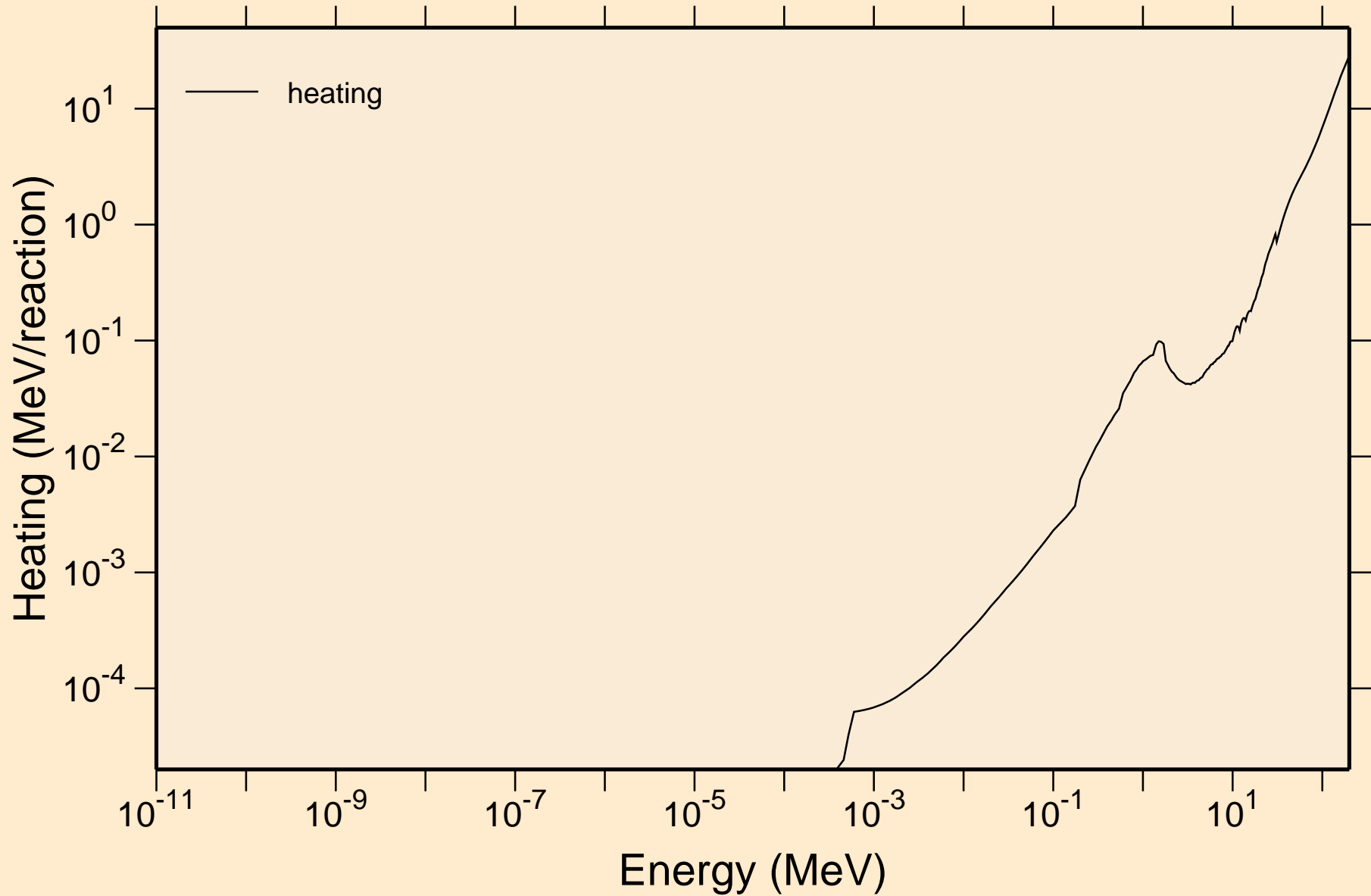

AU197M NEUTRON ACER TENDL-2021 LIBRARY; T=293.6K
Damage

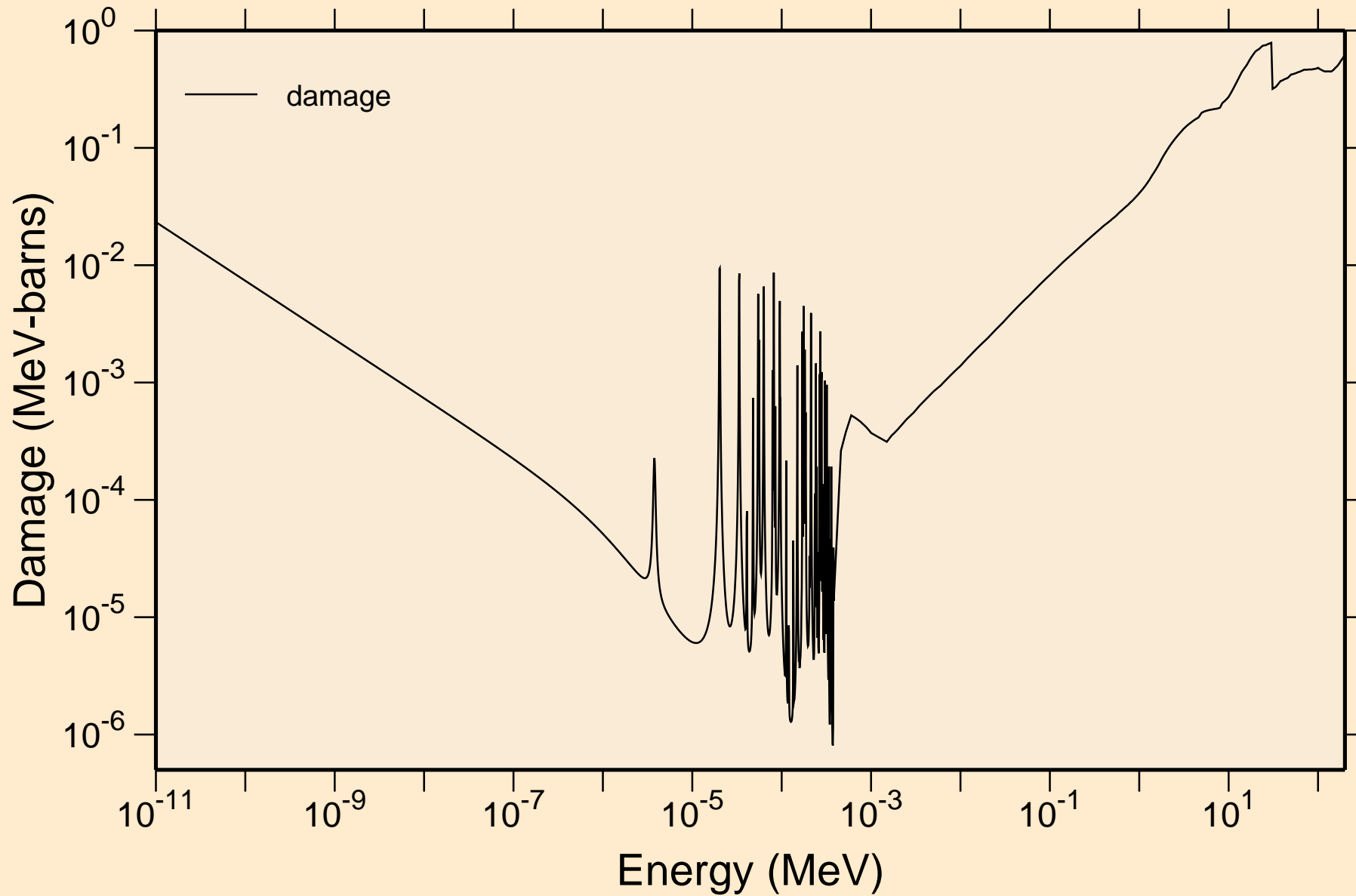

AU197M NEUTRON ACER TENDL-2021 LIBRARY; T=293.6K
Non-threshold reactions

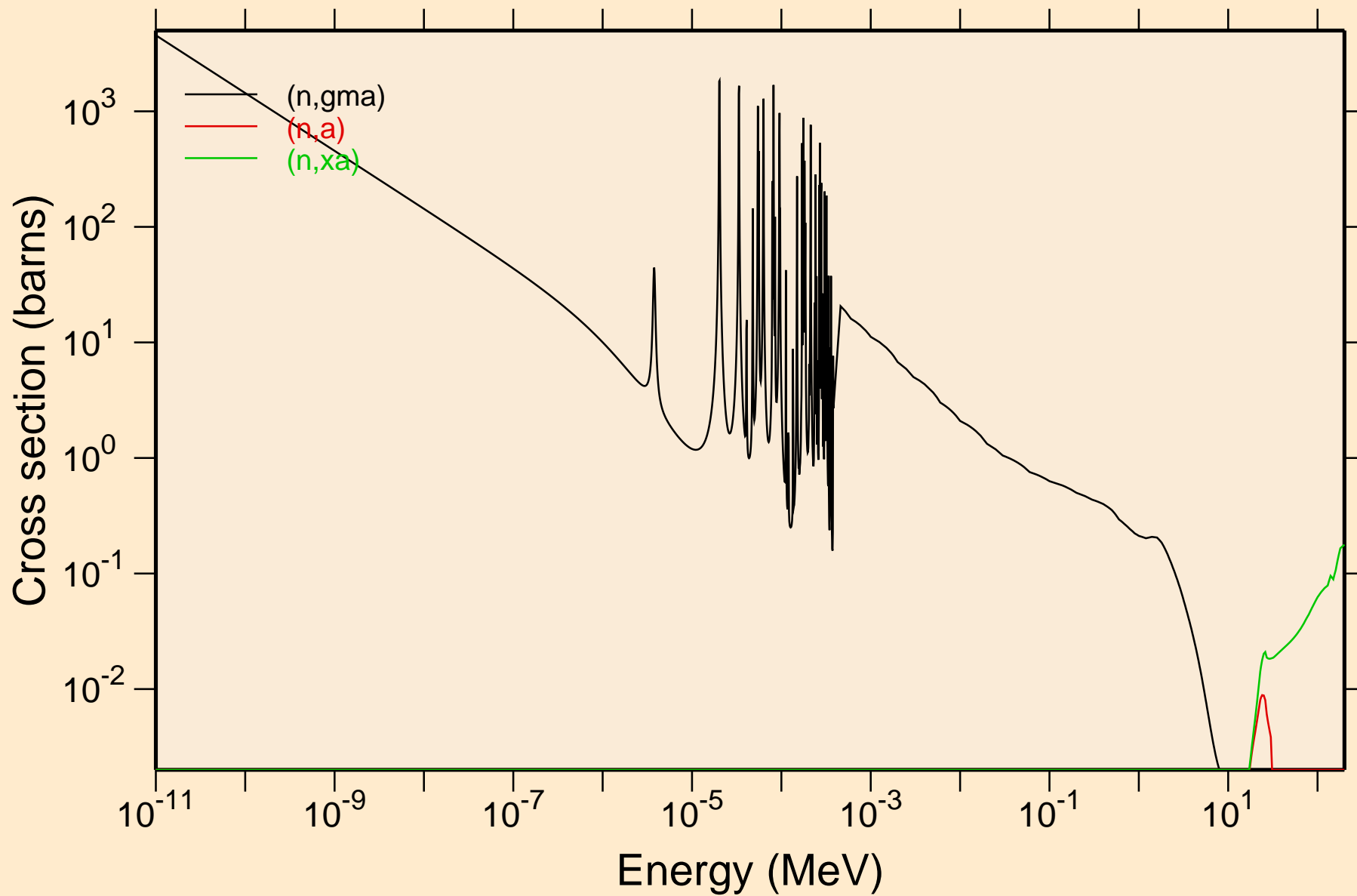

AU197M NEUTRON ACER TENDL-2021 LIBRARY; T=293.6K
Principal cross sections

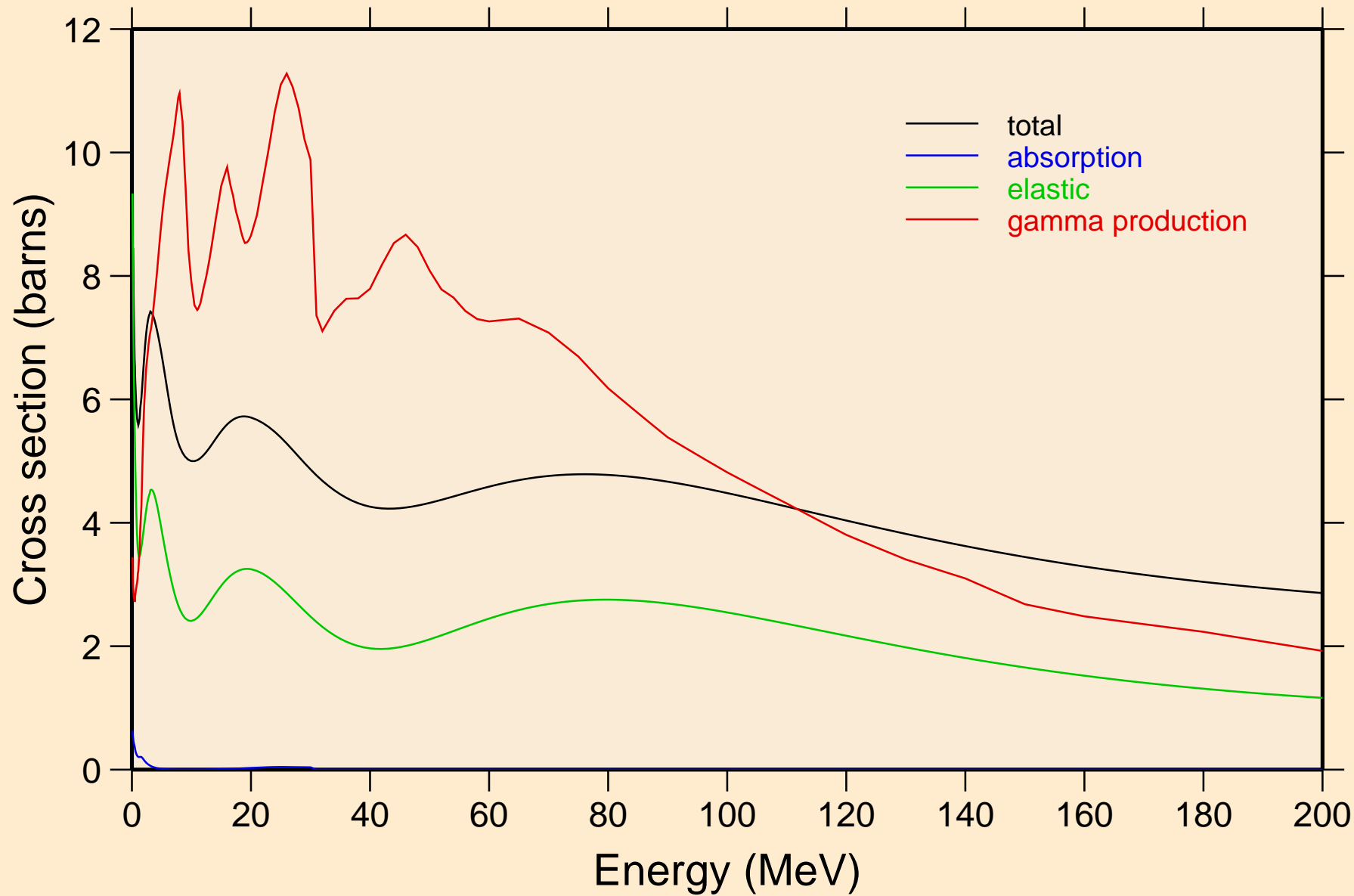

AU197M NEUTRON ACER TENDL-2021 LIBRARY; T=293.6K
Heating

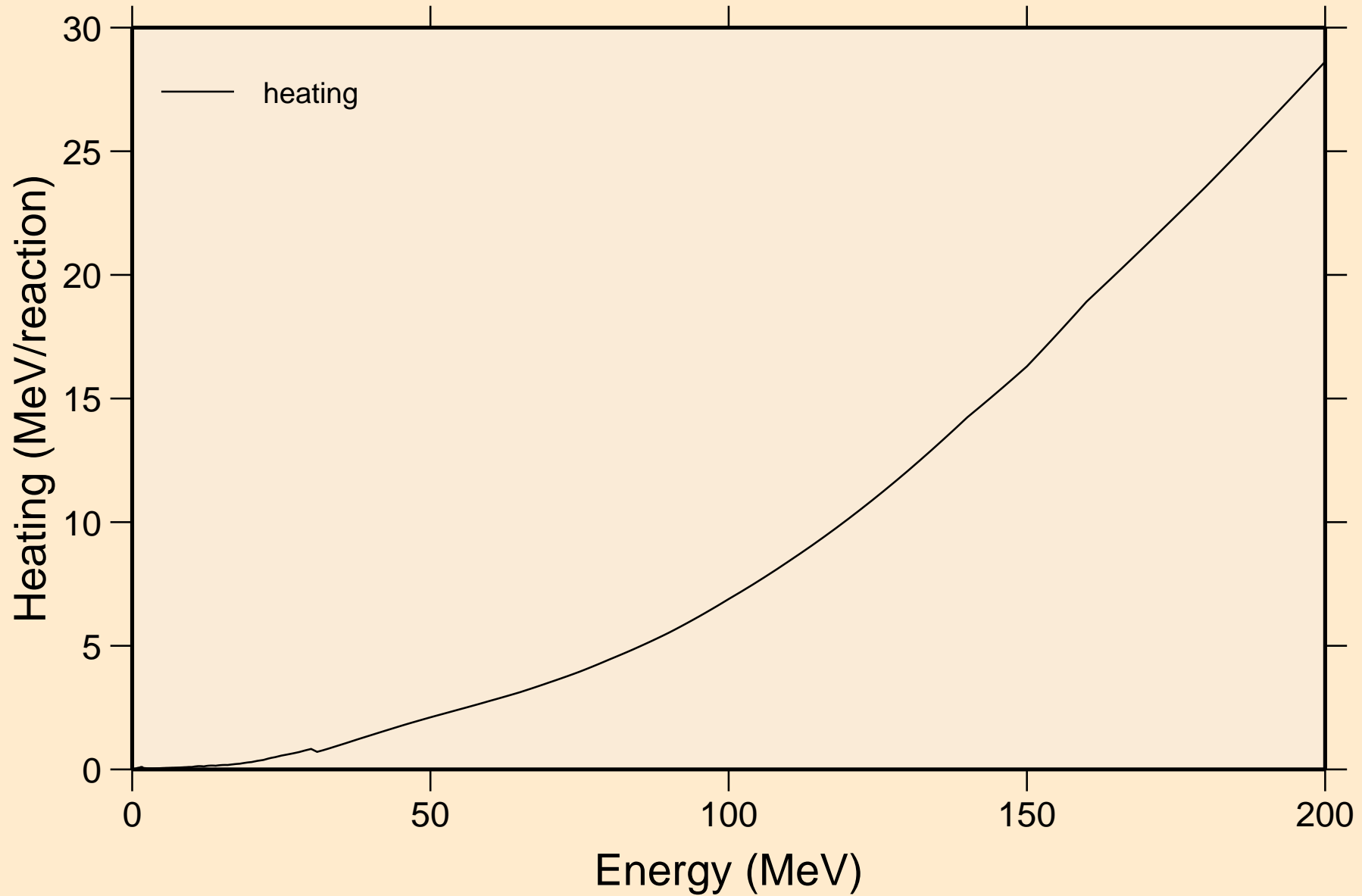

AU197M NEUTRON ACER TENDL-2021 LIBRARY; T=293.6K
Damage

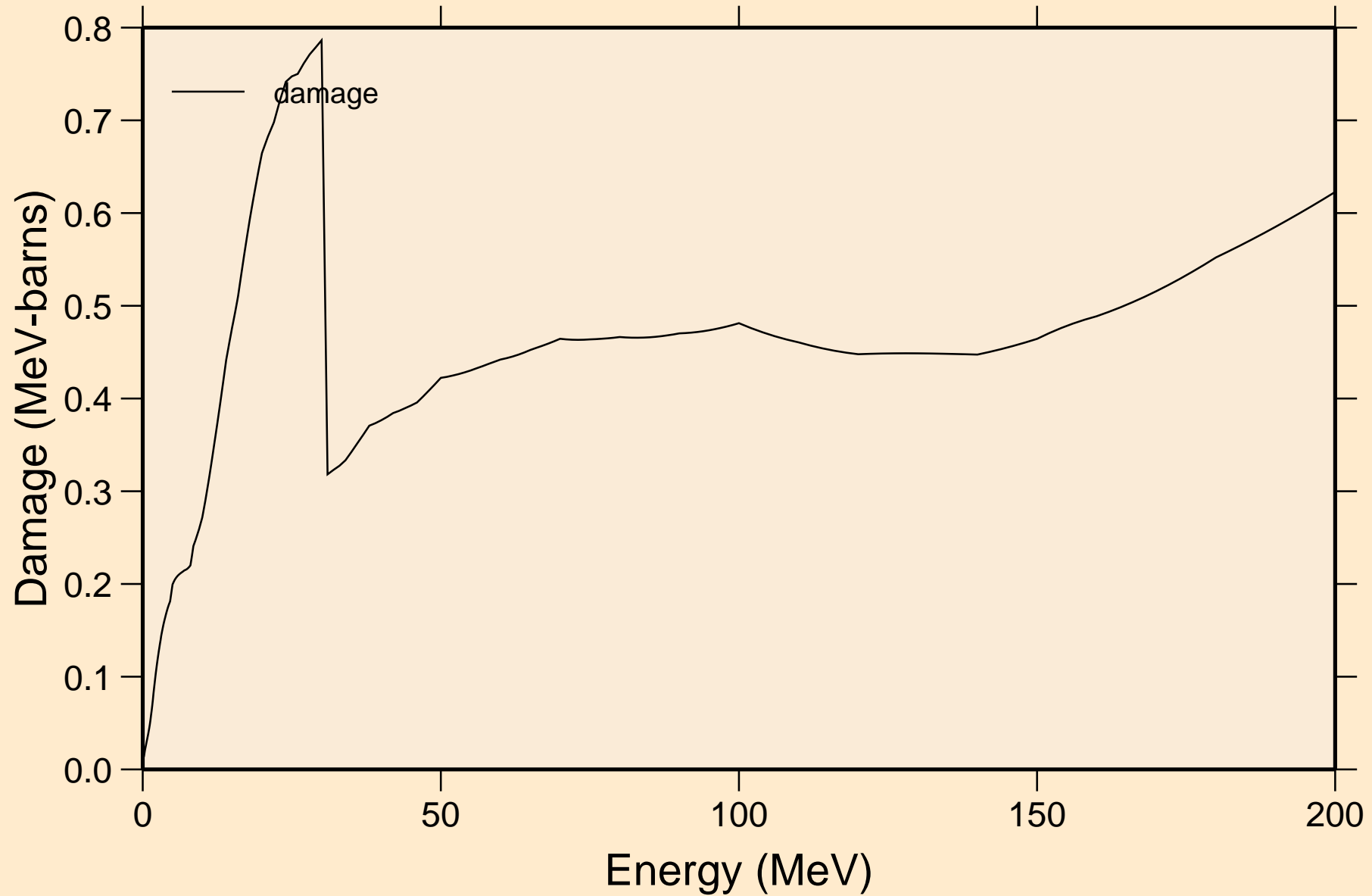

AU197M NEUTRON ACER TENDL-2021 LIBRARY; T=293.6K
Non-threshold reactions

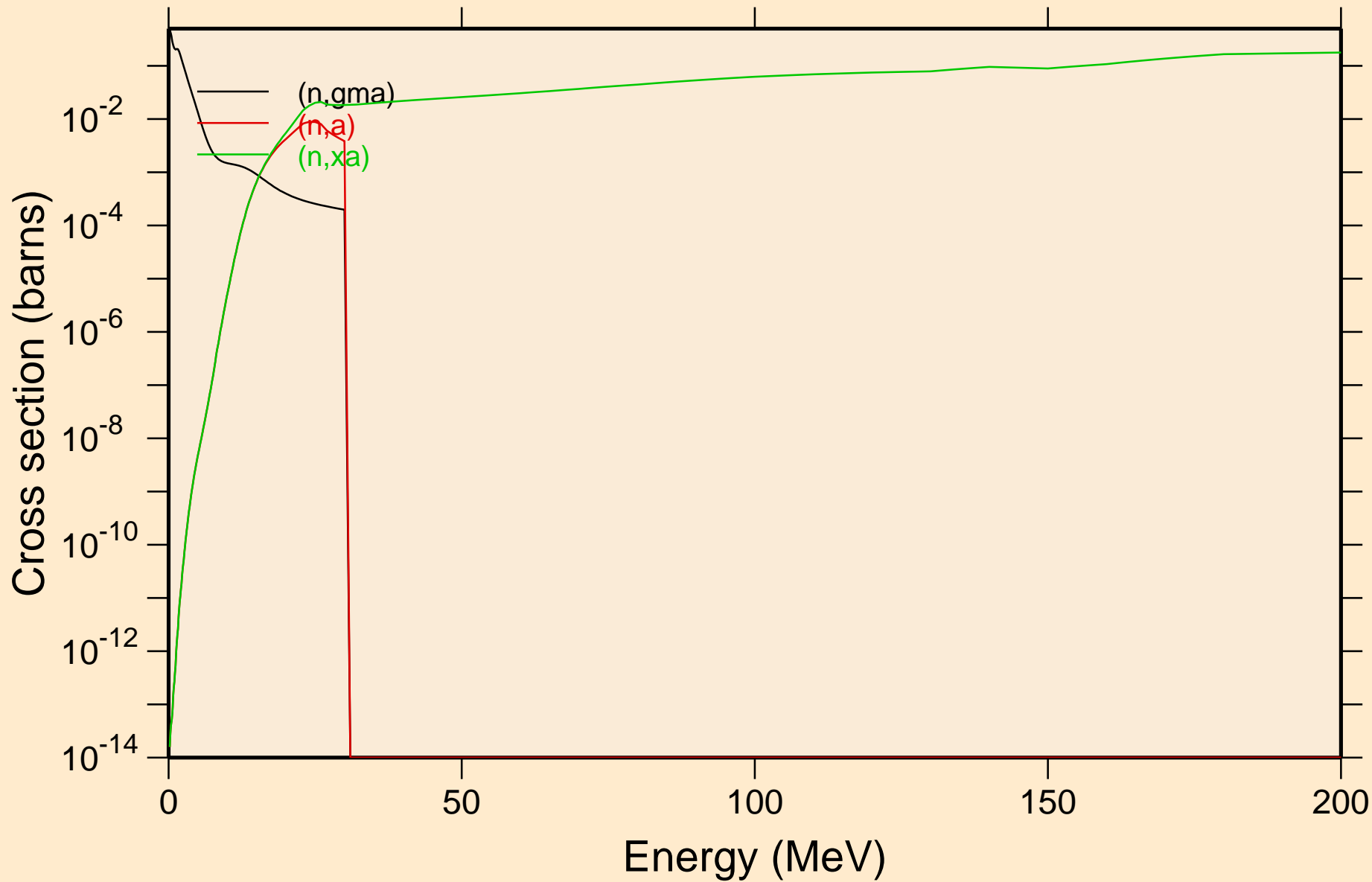

AU197M NEUTRON ACER TENDL-2021 LIBRARY; T=293.6K
Inelastic levels

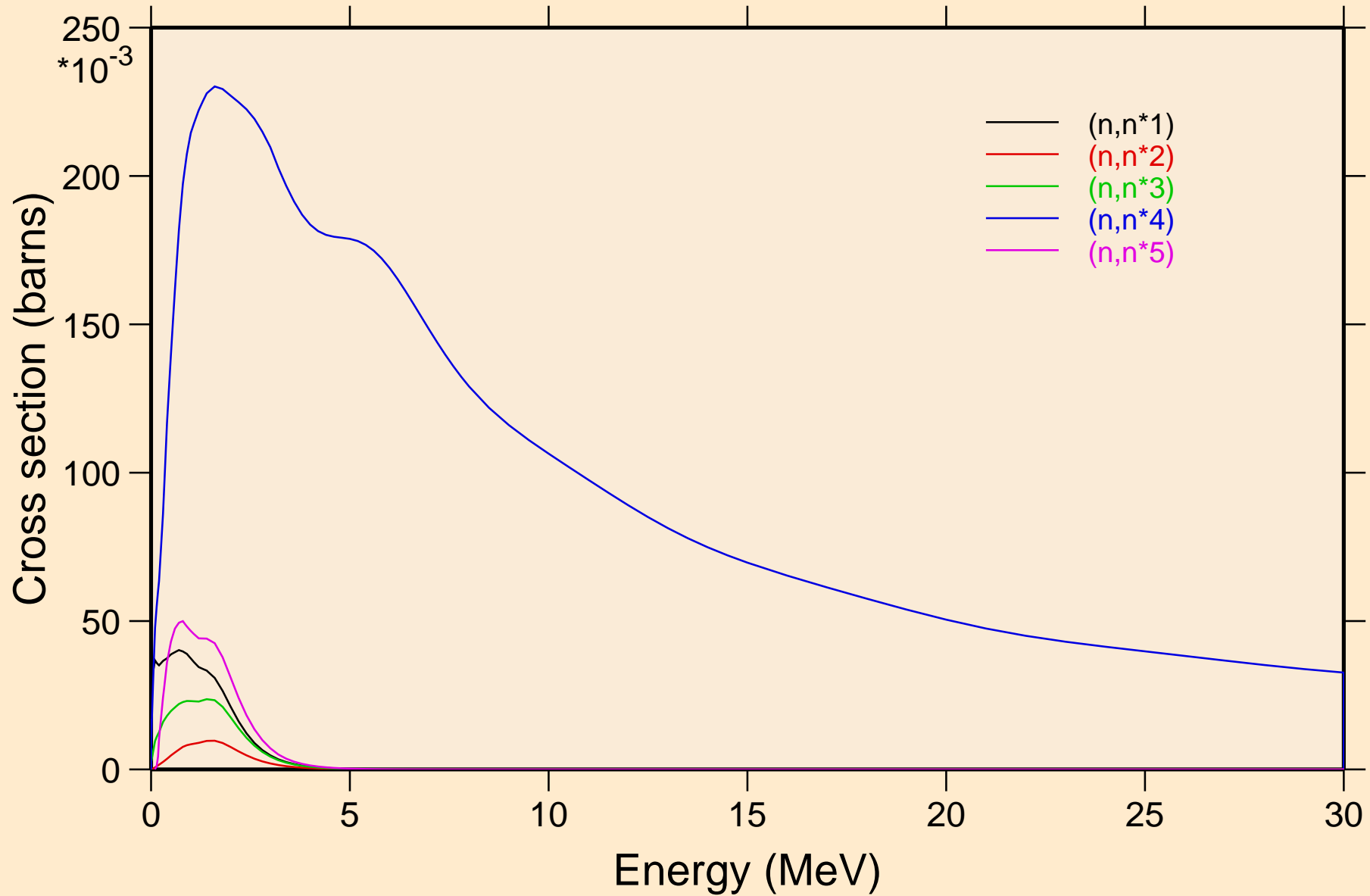

AU197M NEUTRON ACER TENDL-2021 LIBRARY; T=293.6K
Inelastic levels

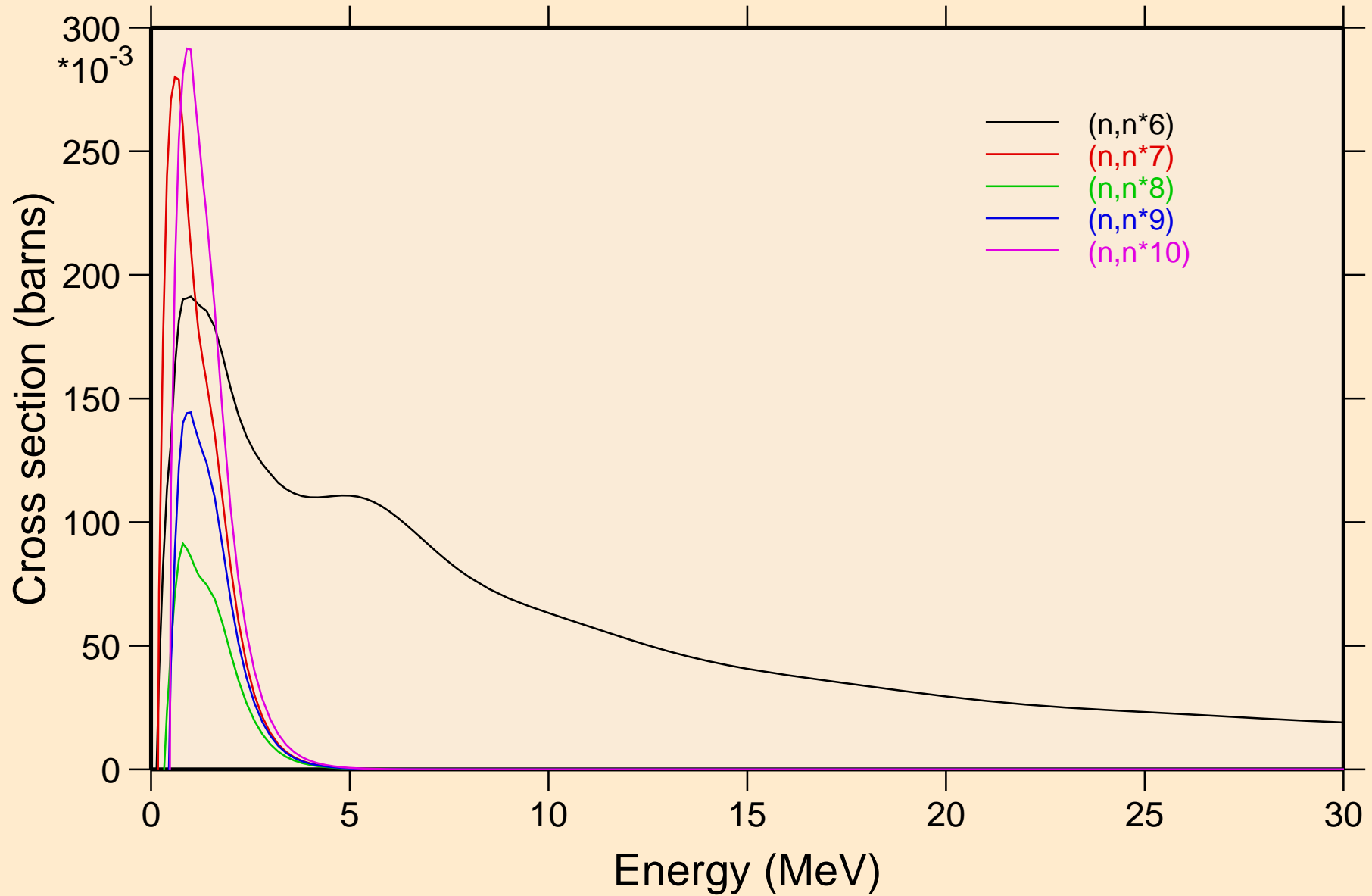

AU197M NEUTRON ACER TENDL-2021 LIBRARY; T=293.6K
Inelastic levels

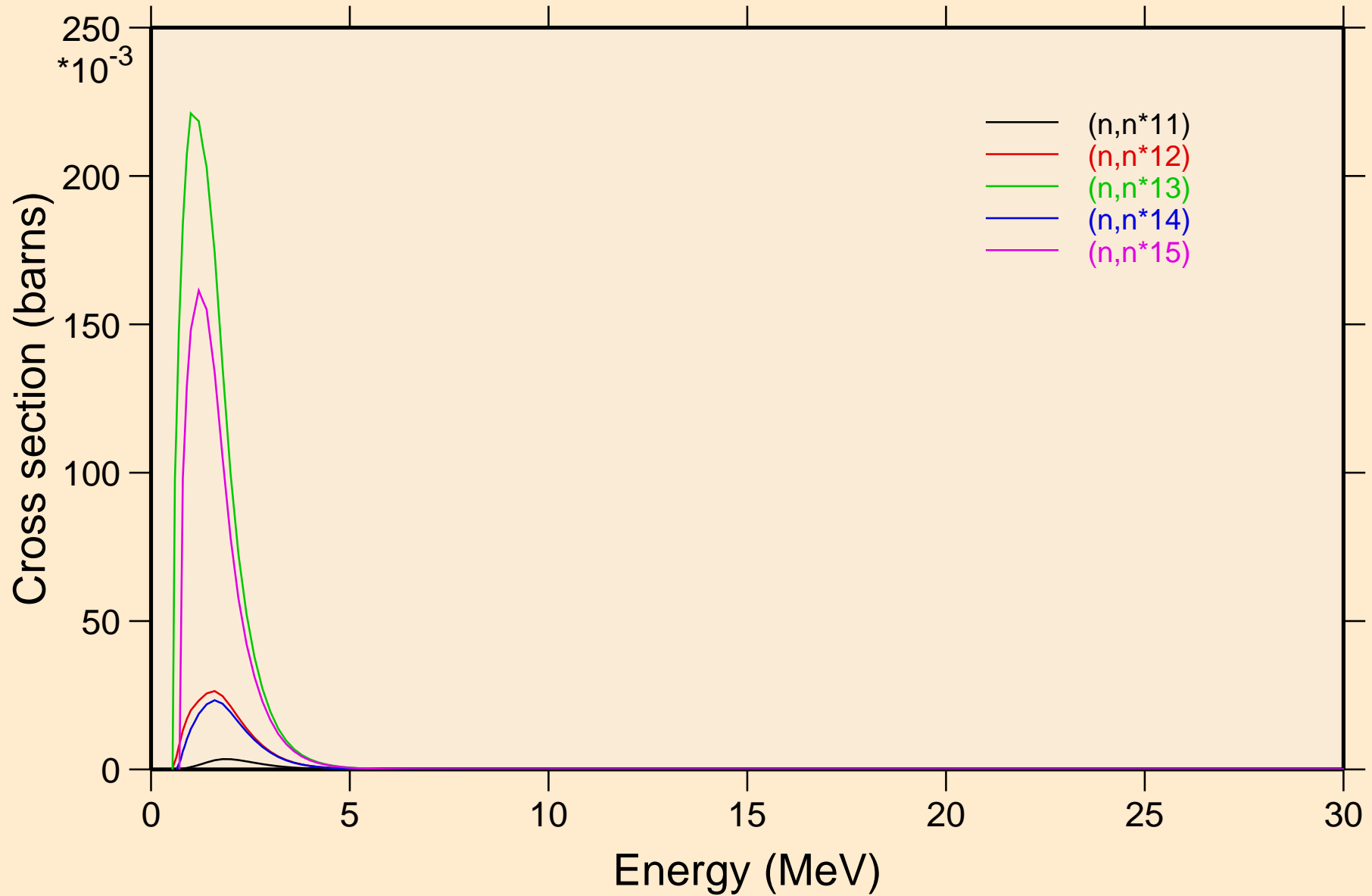

AU197M NEUTRON ACER TENDL-2021 LIBRARY; T=293.6K
Inelastic levels

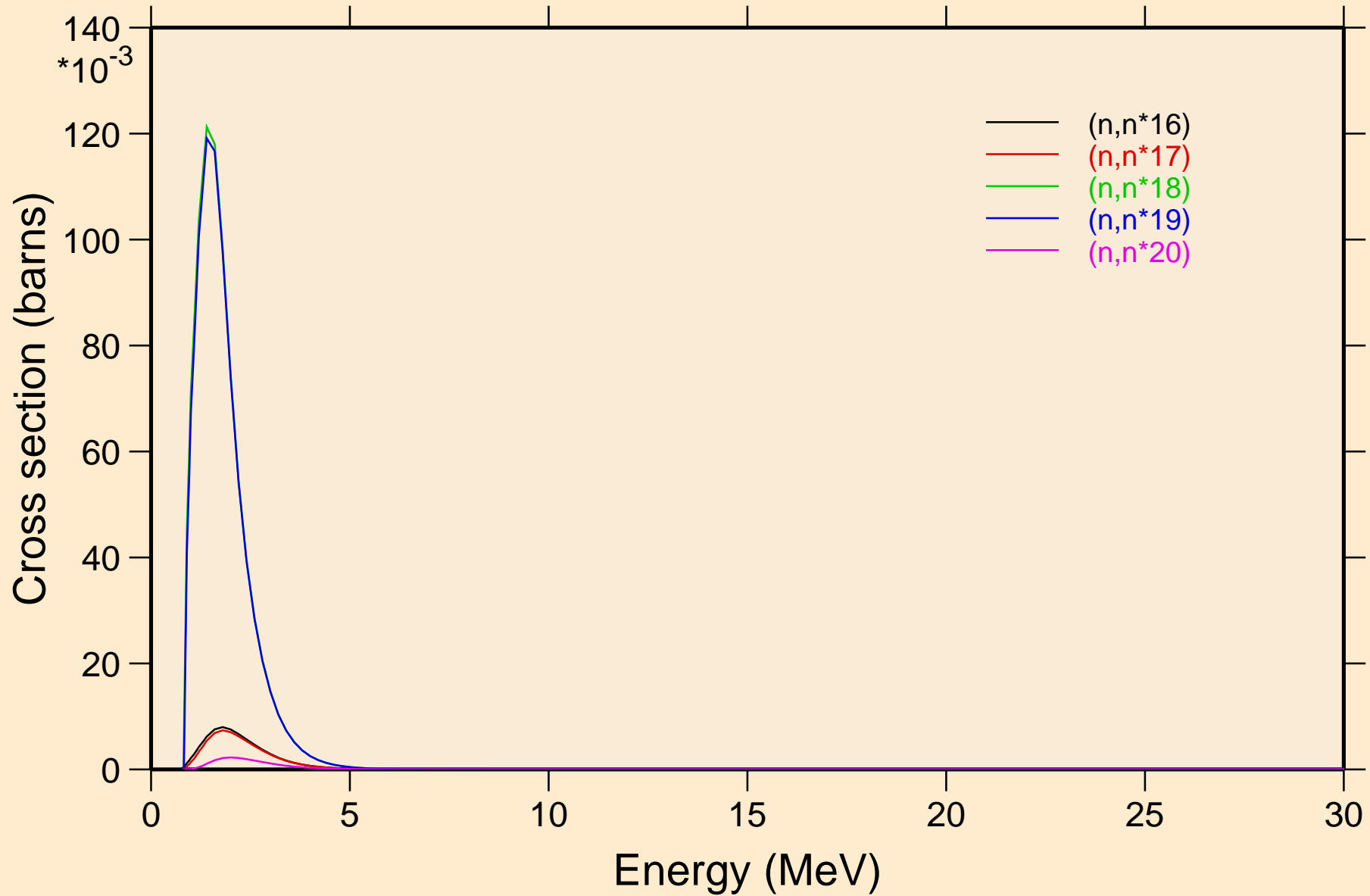

AU197M NEUTRON ACER TENDL-2021 LIBRARY; T=293.6K
Inelastic levels

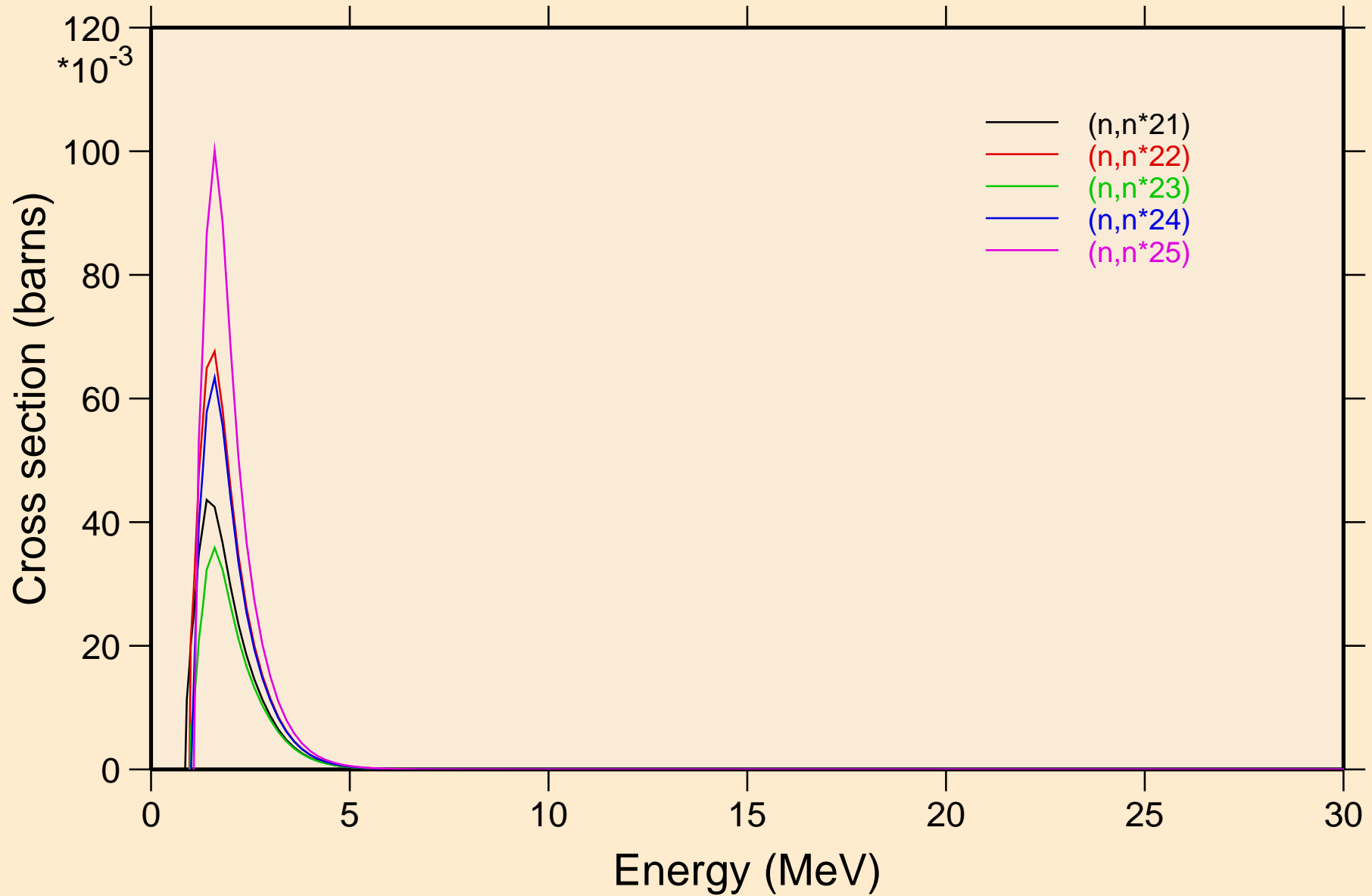

AU197M NEUTRON ACER TENDL-2021 LIBRARY; T=293.6K
Inelastic levels

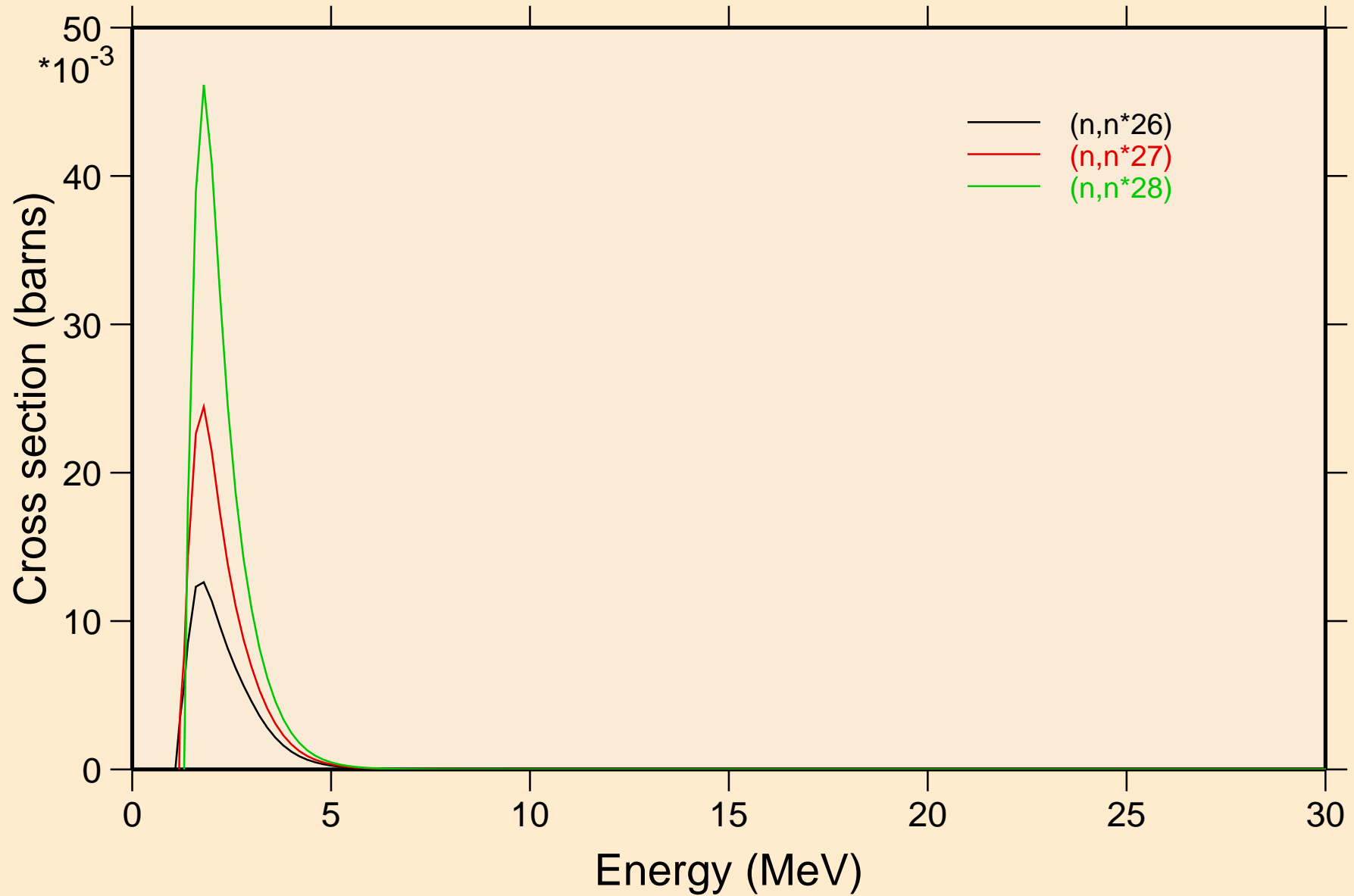

AU197M NEUTRON ACER TENDL-2021 LIBRARY; T=293.6K
Threshold reactions

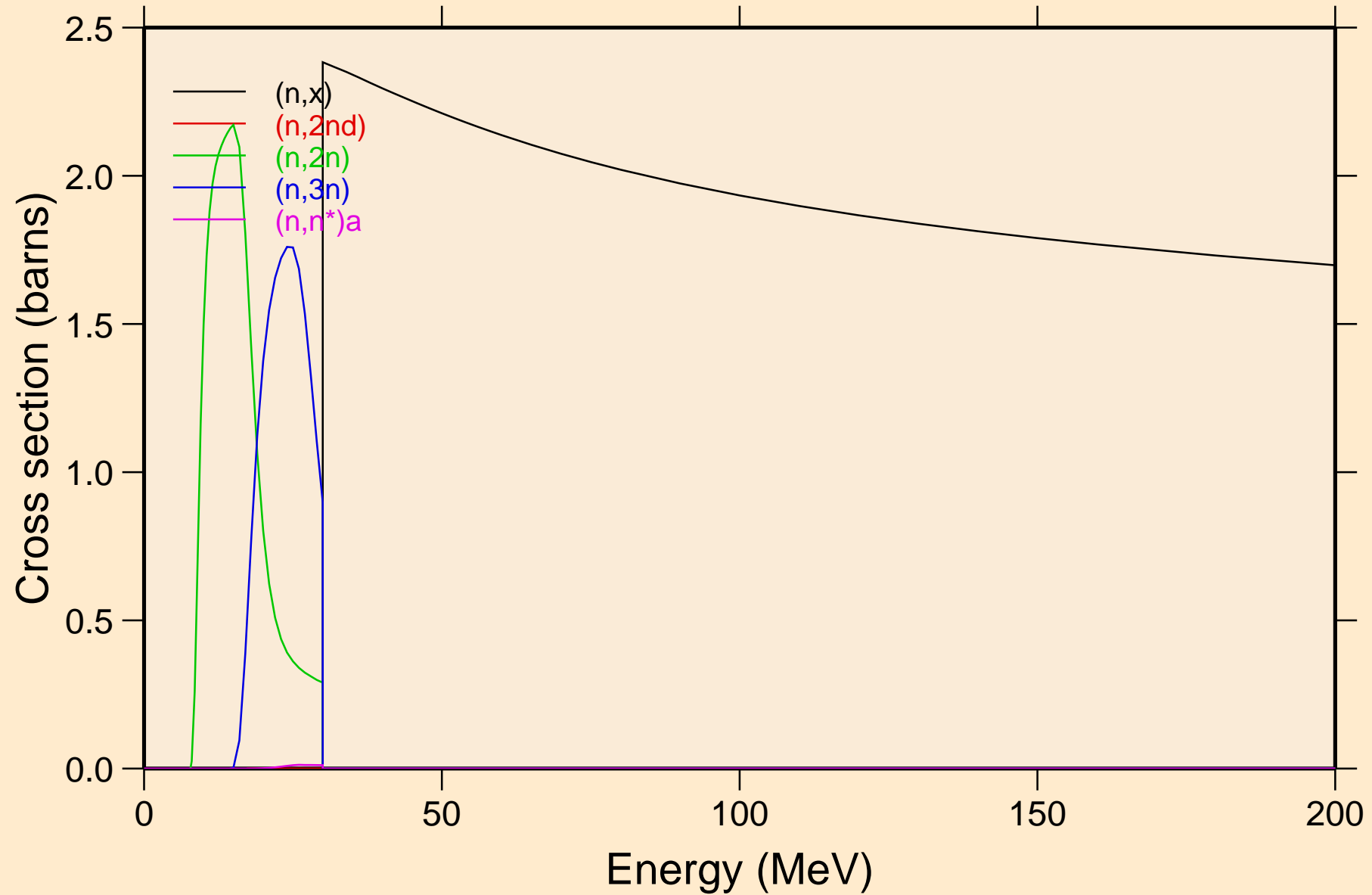

AU197M NEUTRON ACER TENDL-2021 LIBRARY; T=293.6K
Threshold reactions

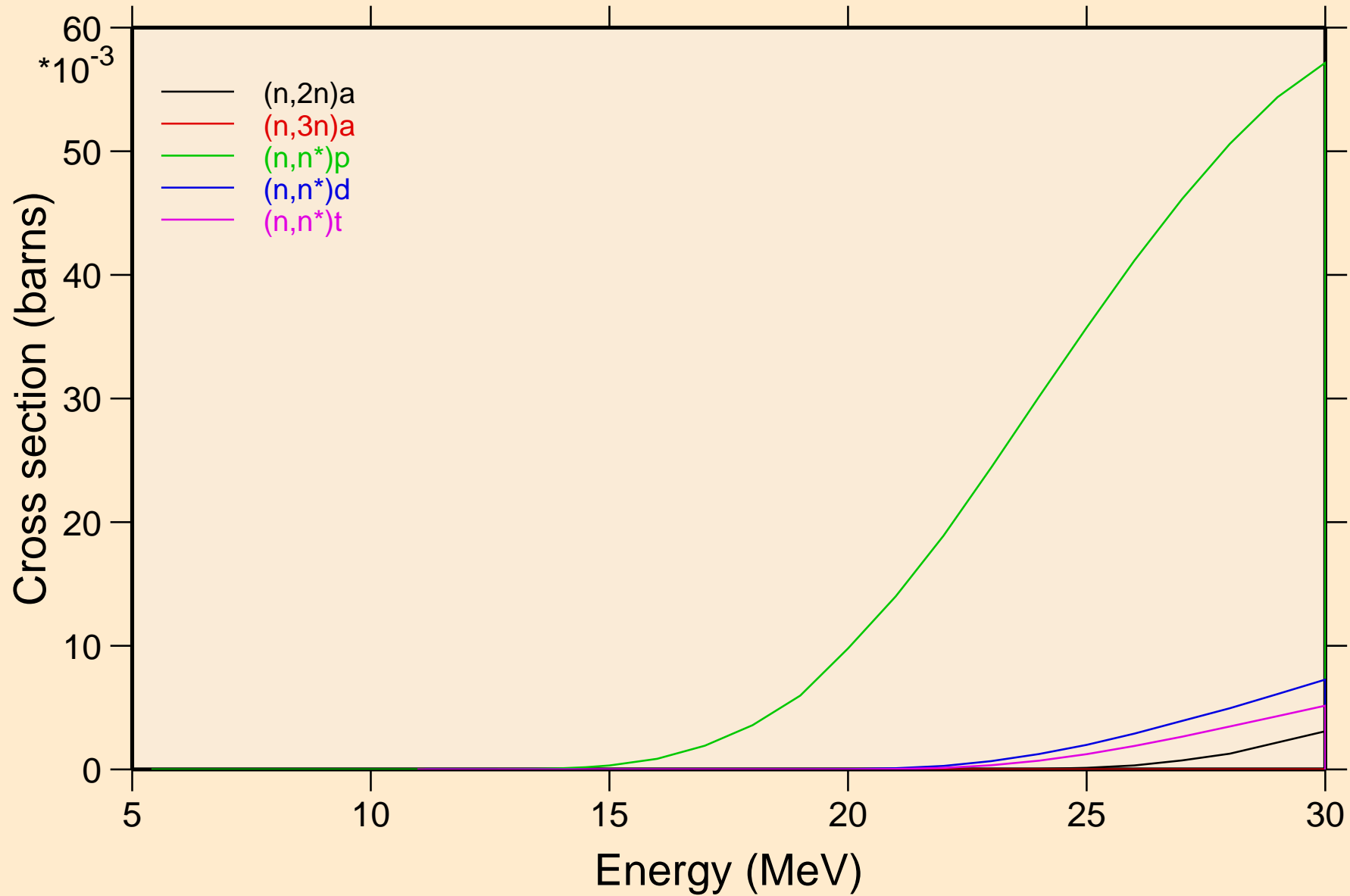

AU197M NEUTRON ACER TENDL-2021 LIBRARY; T=293.6K
Threshold reactions

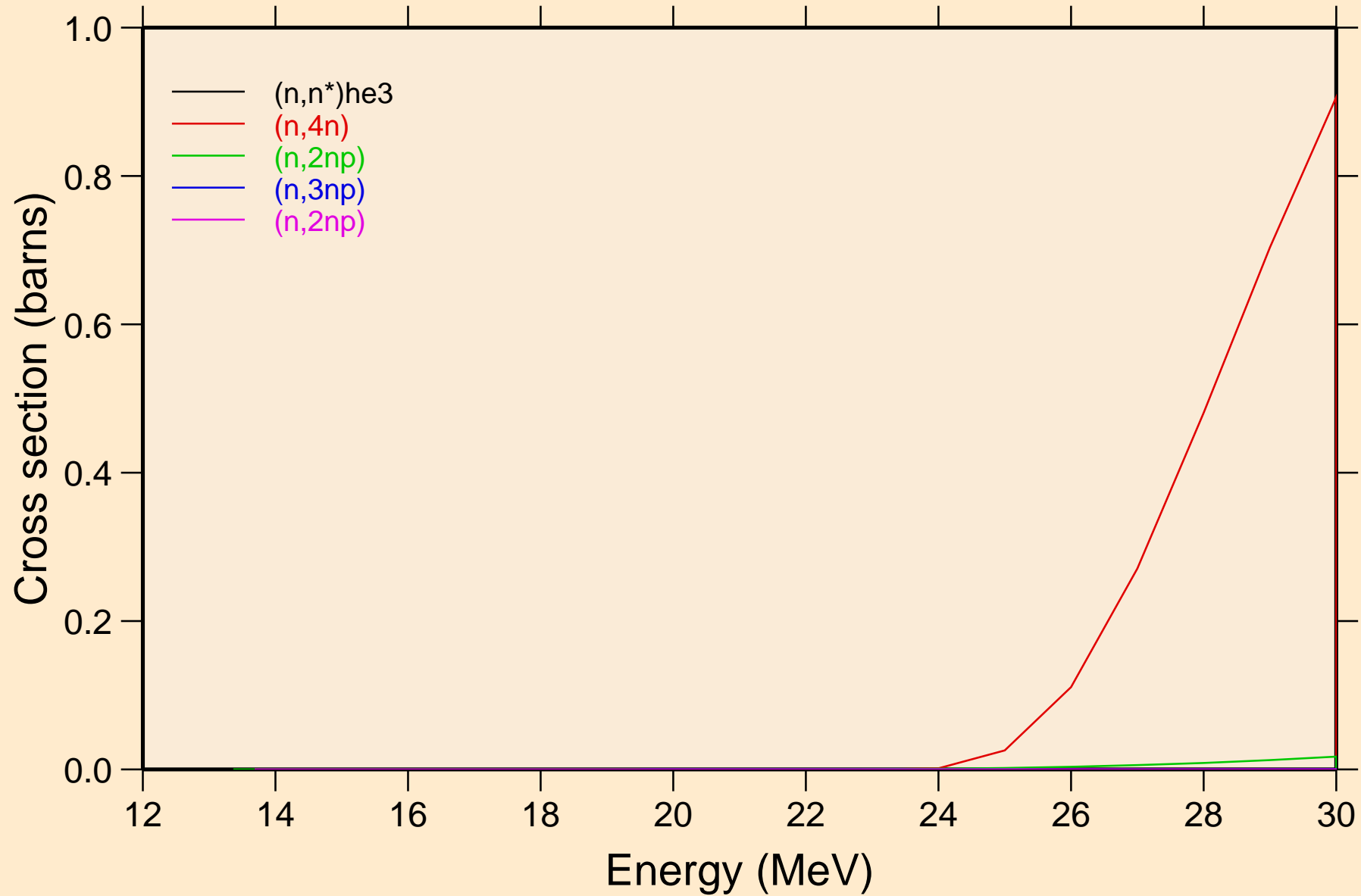

AU197M NEUTRON ACER TENDL-2021 LIBRARY; T=293.6K
Threshold reactions

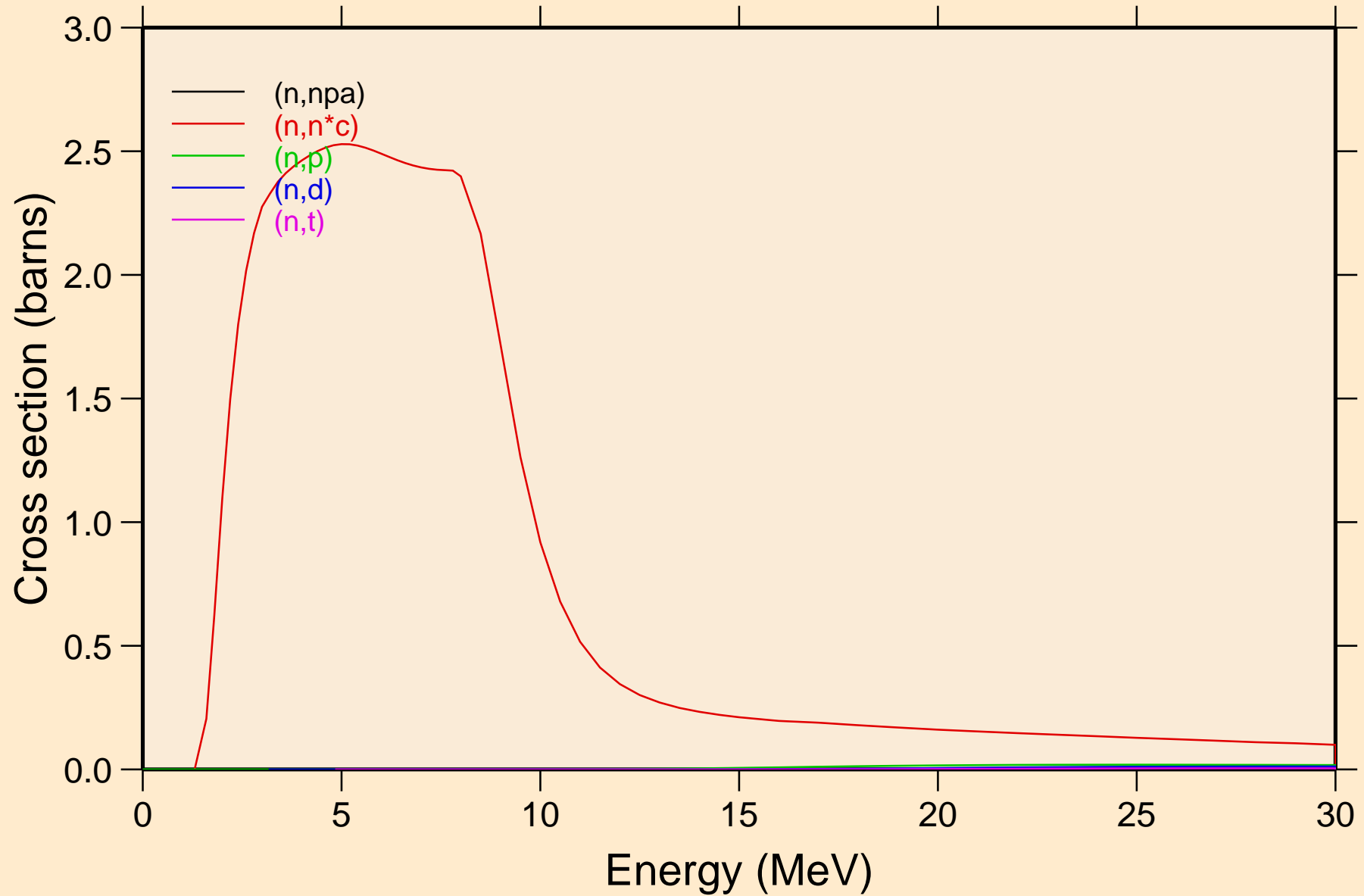

AU197M NEUTRON ACER TENDL-2021 LIBRARY; T=293.6K
Threshold reactions

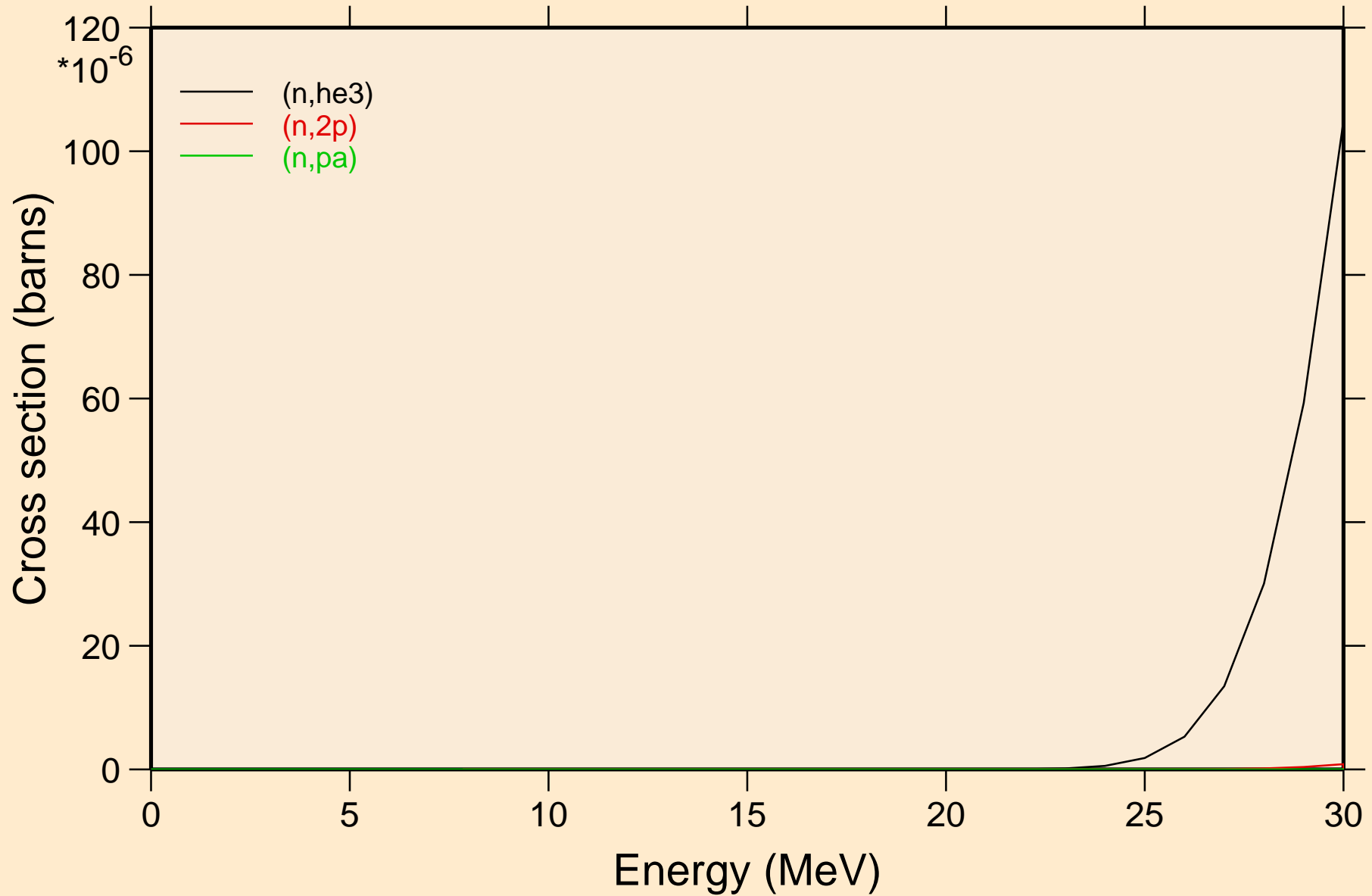

AU197M NEUTRON ACER TENDL-2021 LIBRARY; T=293.6K
Threshold reactions

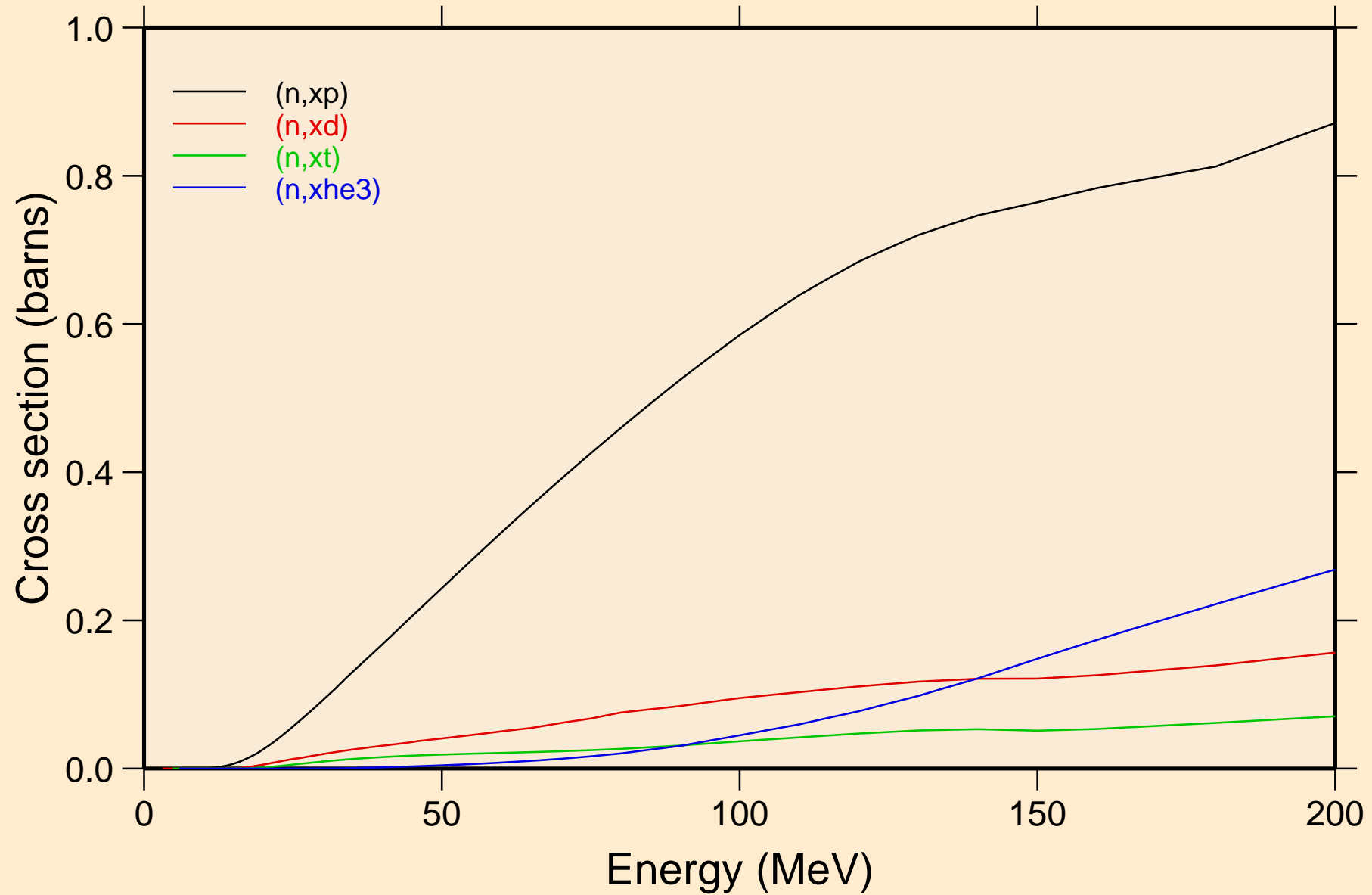

AU197M NEUTRON ACER TENDL-2021 LIBRARY; T=293.6K
angular distribution for elastic

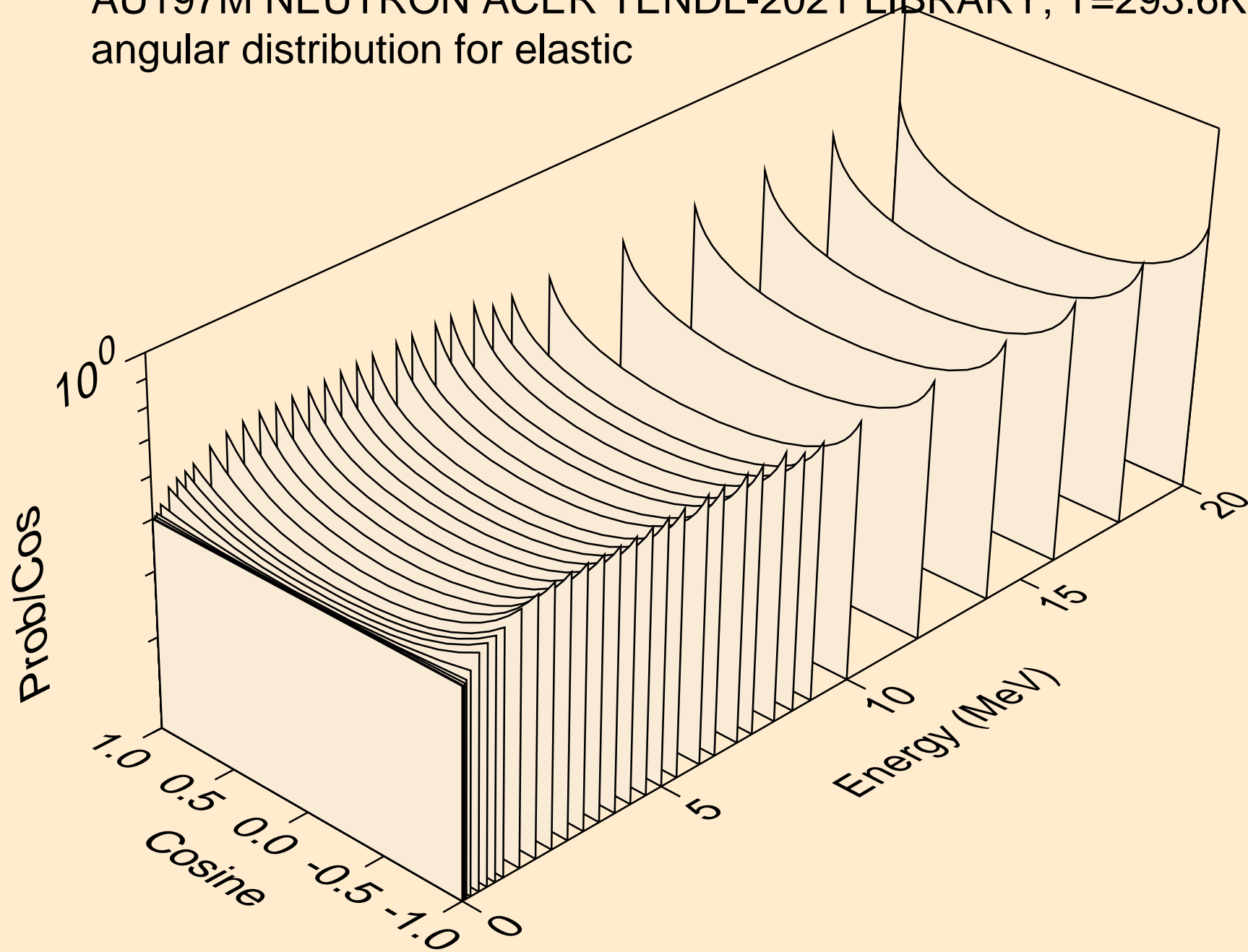

AU197M NEUTRON ACER TENDL-2021 LIBRARY; T=293.6K
angular distribution for elastic

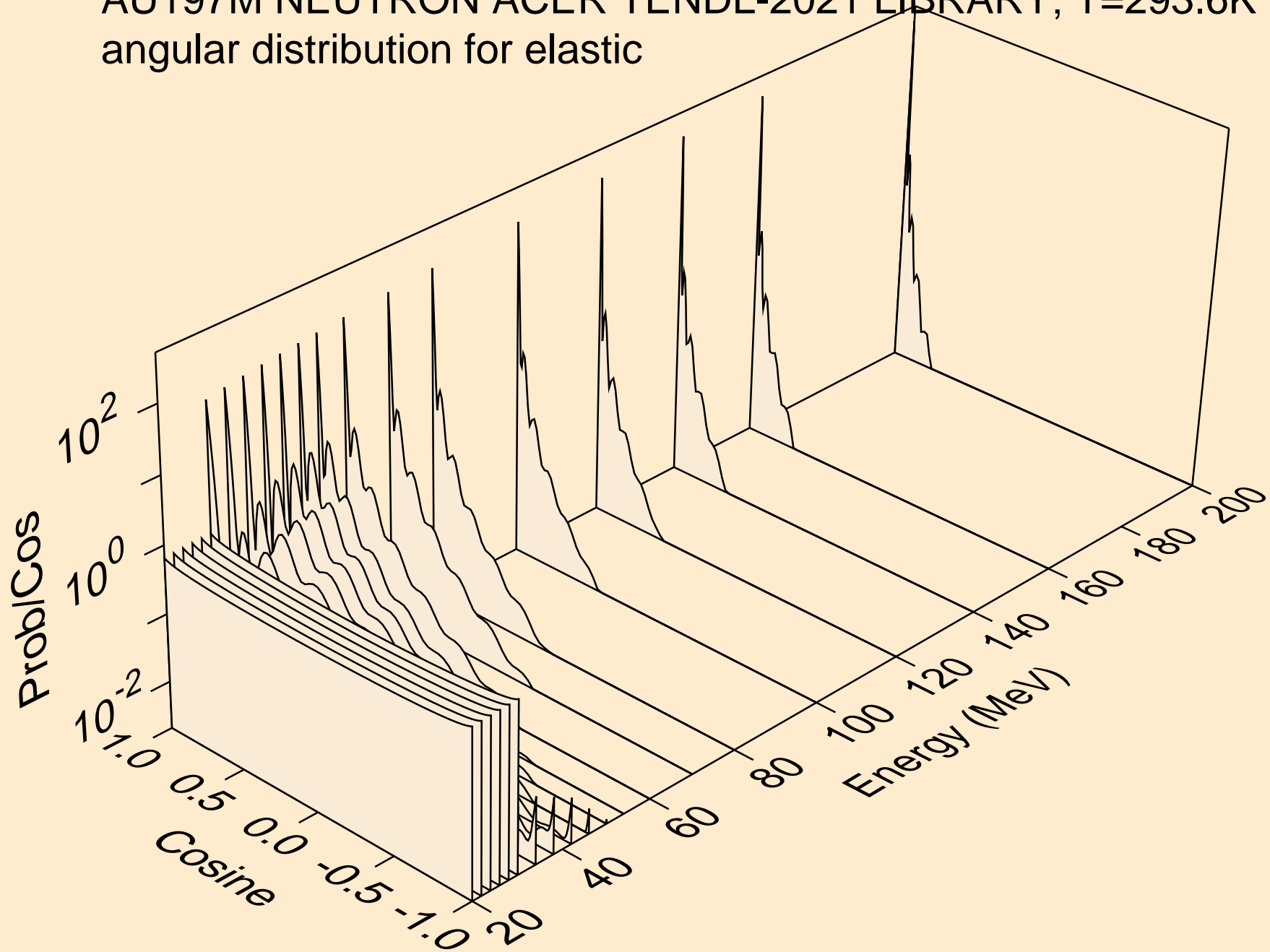

AU197M NEUTRON ACER TENDL-2021 LIBRARY; T=293.6K
angular distribution for (n,n*1)

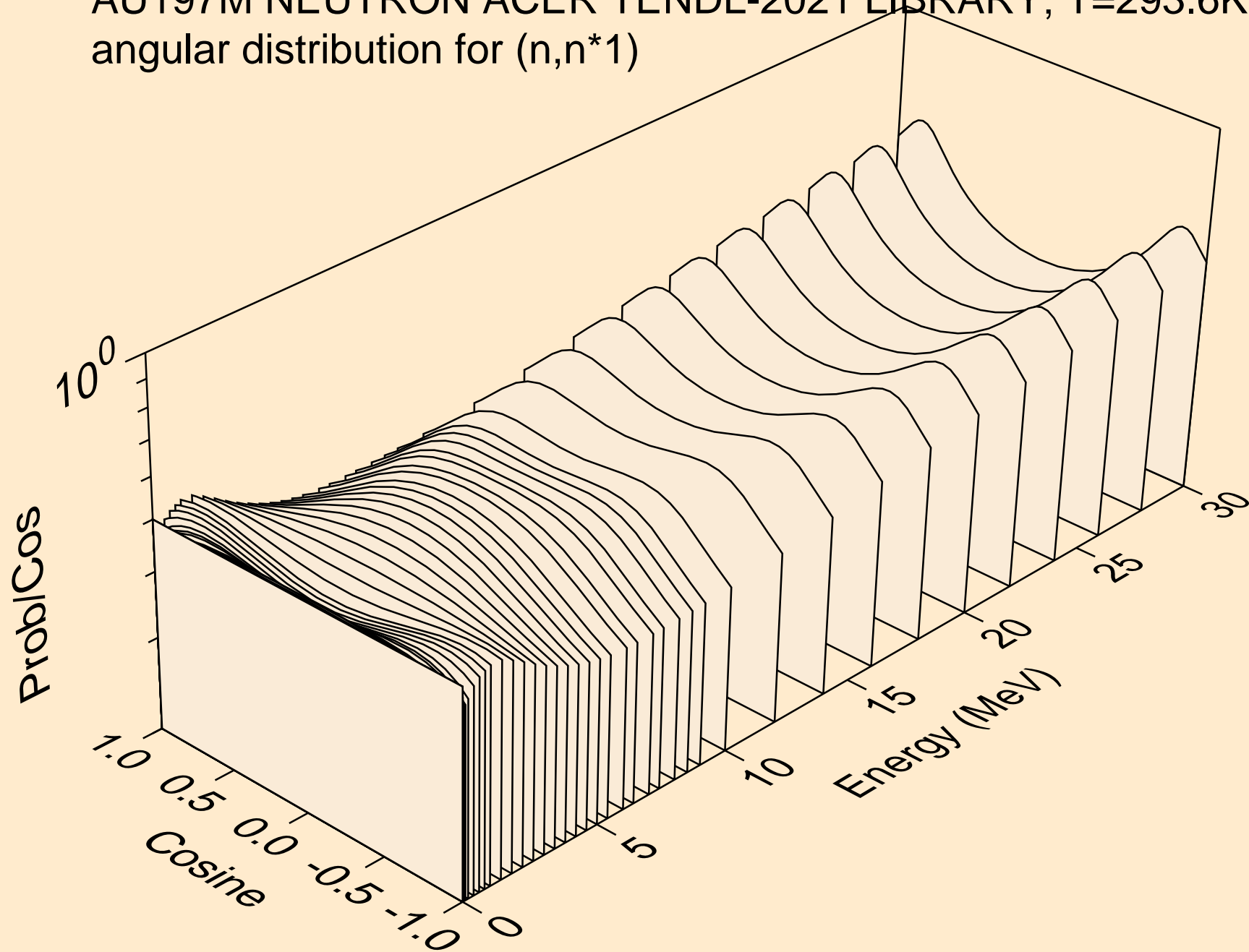

AU197M NEUTRON ACER TENDL-2021 LIBRARY; T=293.6K
angular distribution for (n,n*2)

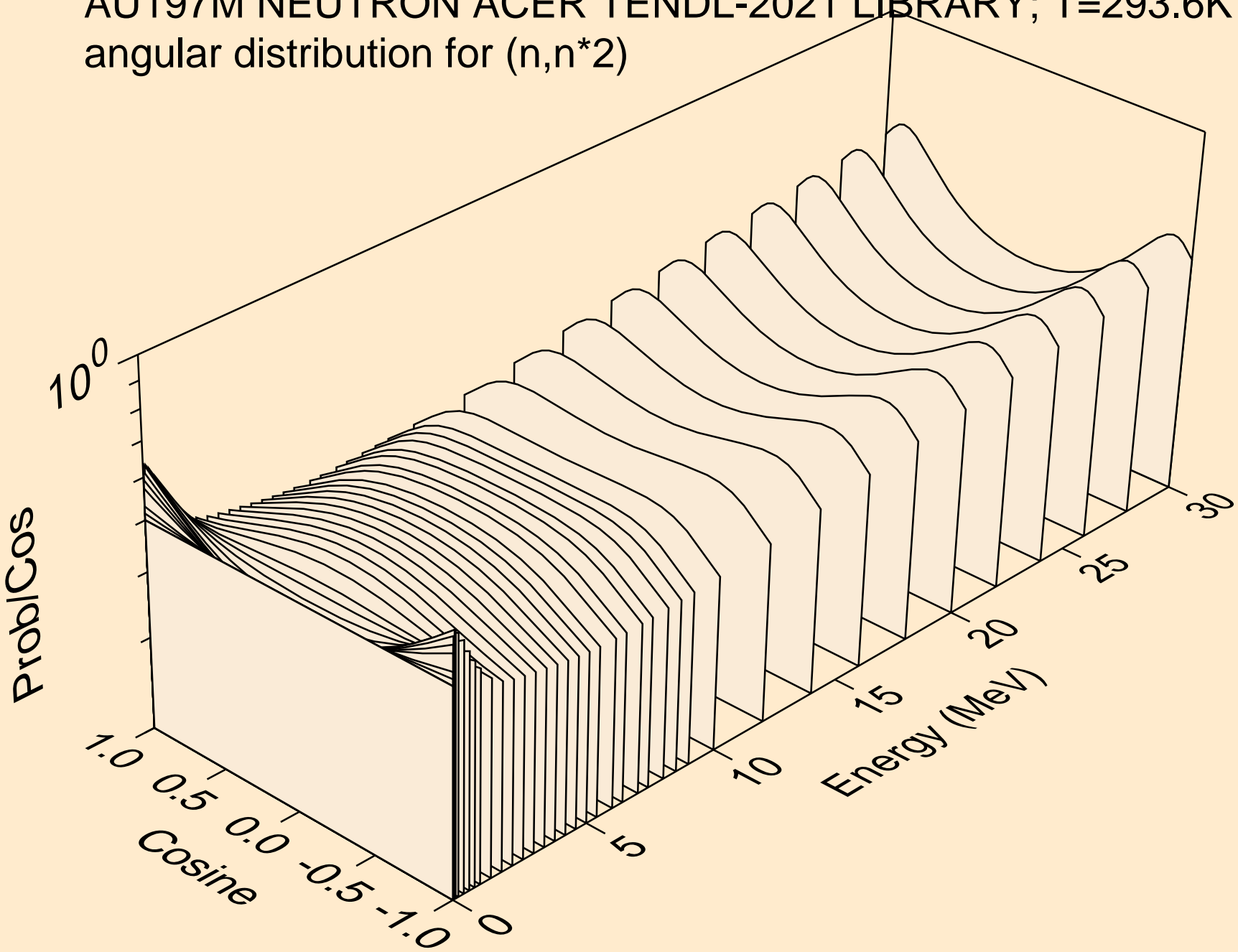

AU197M NEUTRON ACER TENDL-2021 LIBRARY; T=293.6K
angular distribution for (n,n*3)

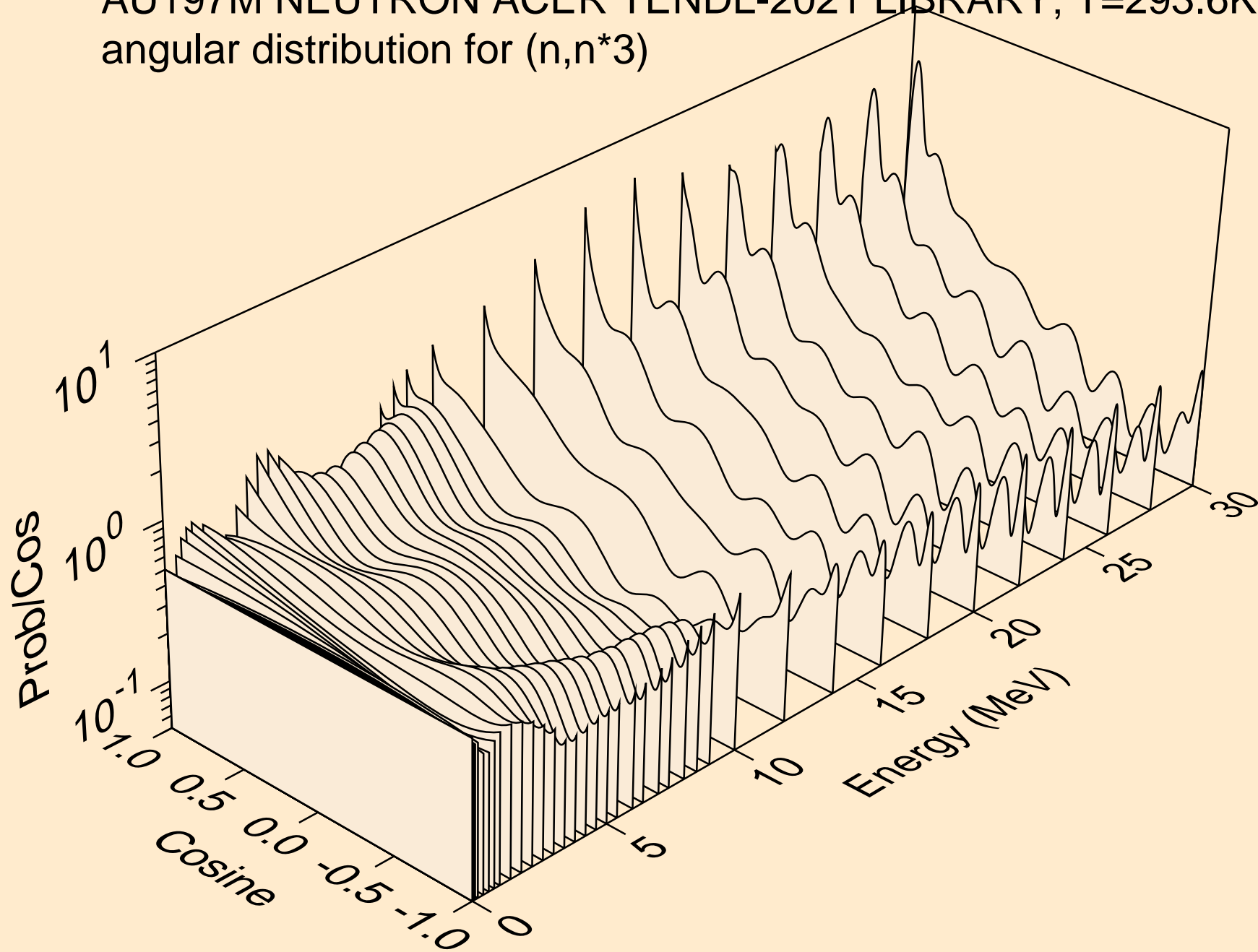

AU197M NEUTRON ACER TENDL-2021 LIBRARY; T=293.6K
angular distribution for (n,n*4)

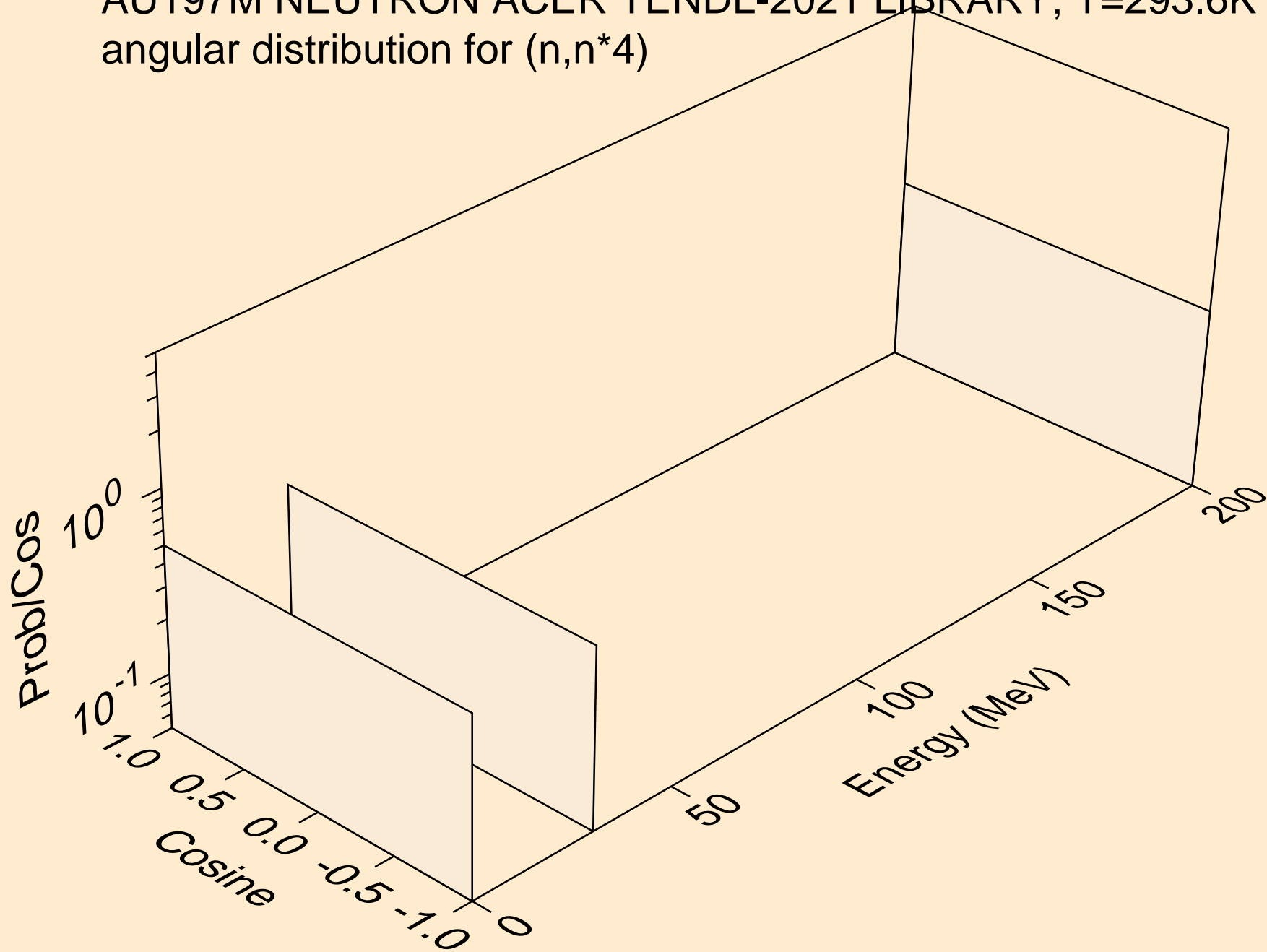

AU197M NEUTRON ACER TENDL-2021 LIBRARY; T=293.6K
angular distribution for (n,n*5)

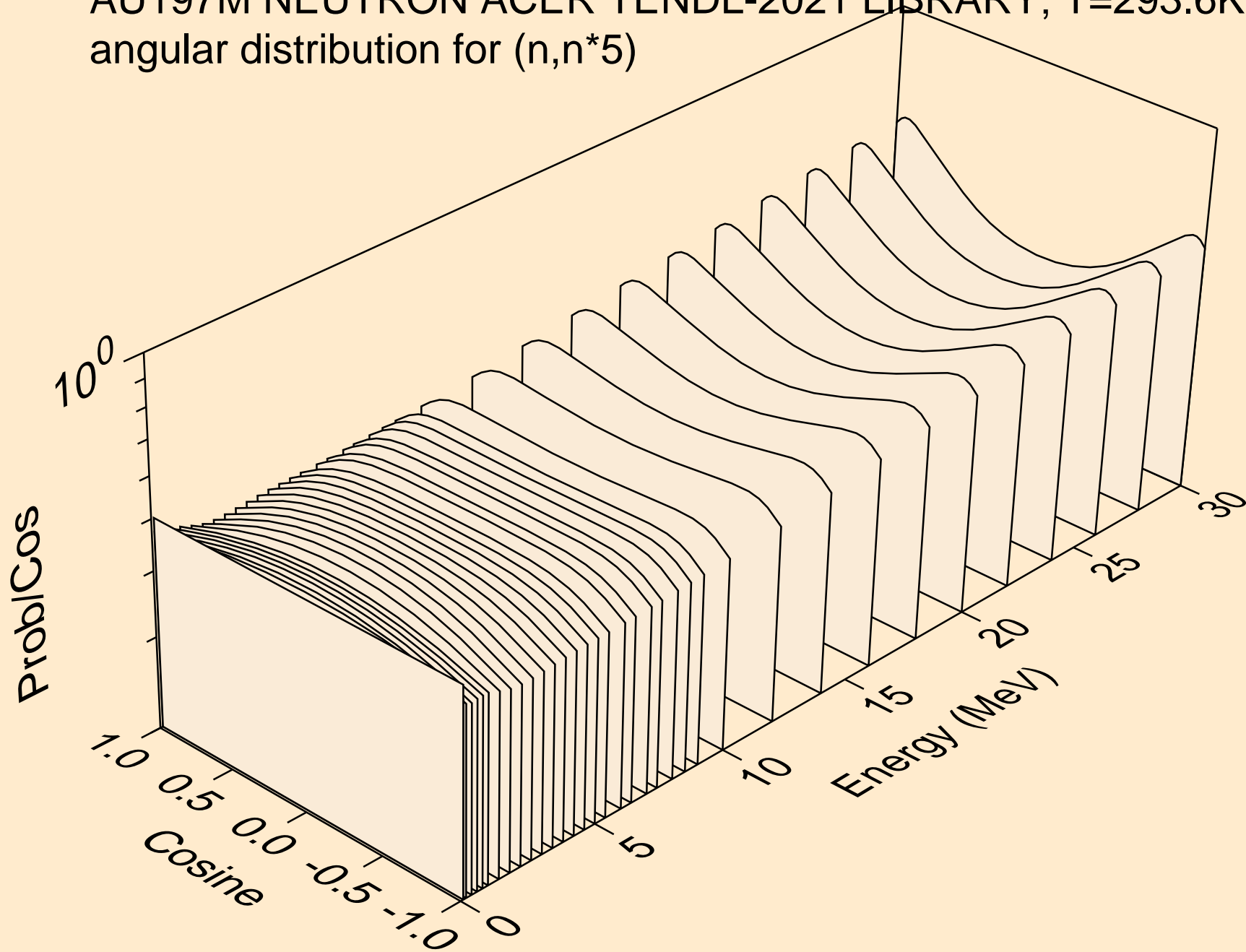

AU197M NEUTRON ACER TENDL-2021 LIBRARY; T=293.6K
angular distribution for (n,n*6)

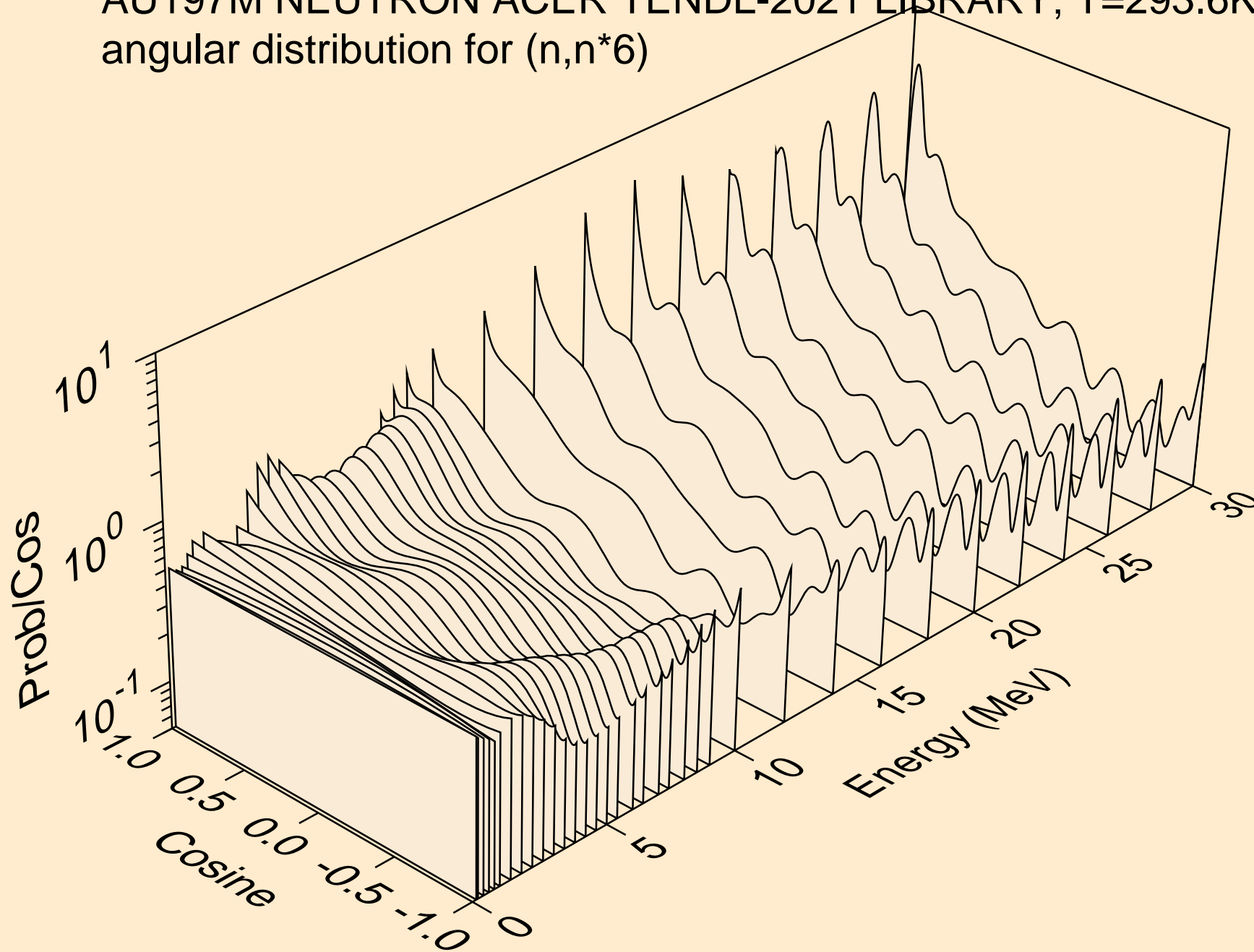

AU197M NEUTRON ACER TENDL-2021 LIBRARY; T=293.6K
angular distribution for (n,n*7)

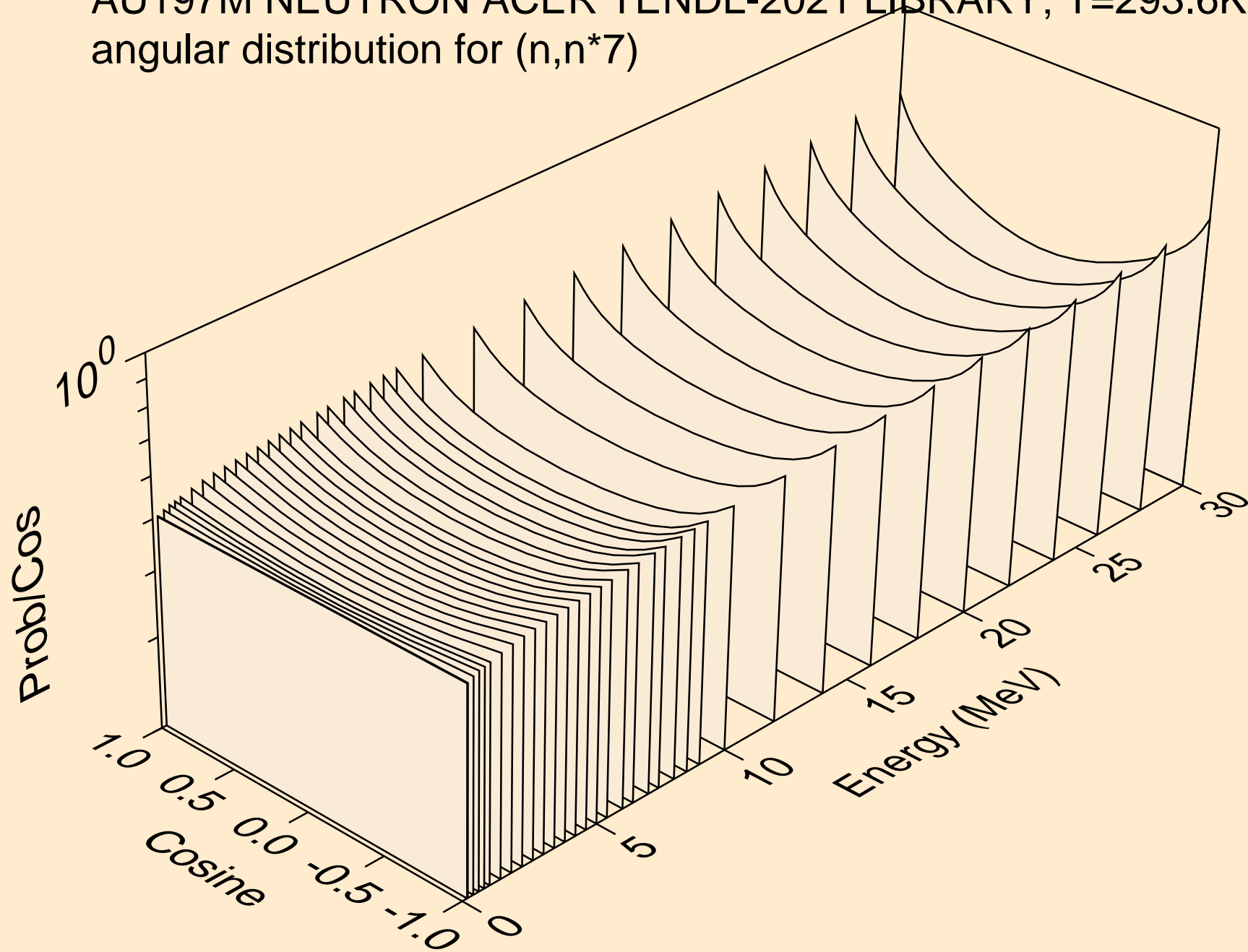

AU197M NEUTRON ACER TENDL-2021 LIBRARY; T=293.6K
angular distribution for (n,n*8)

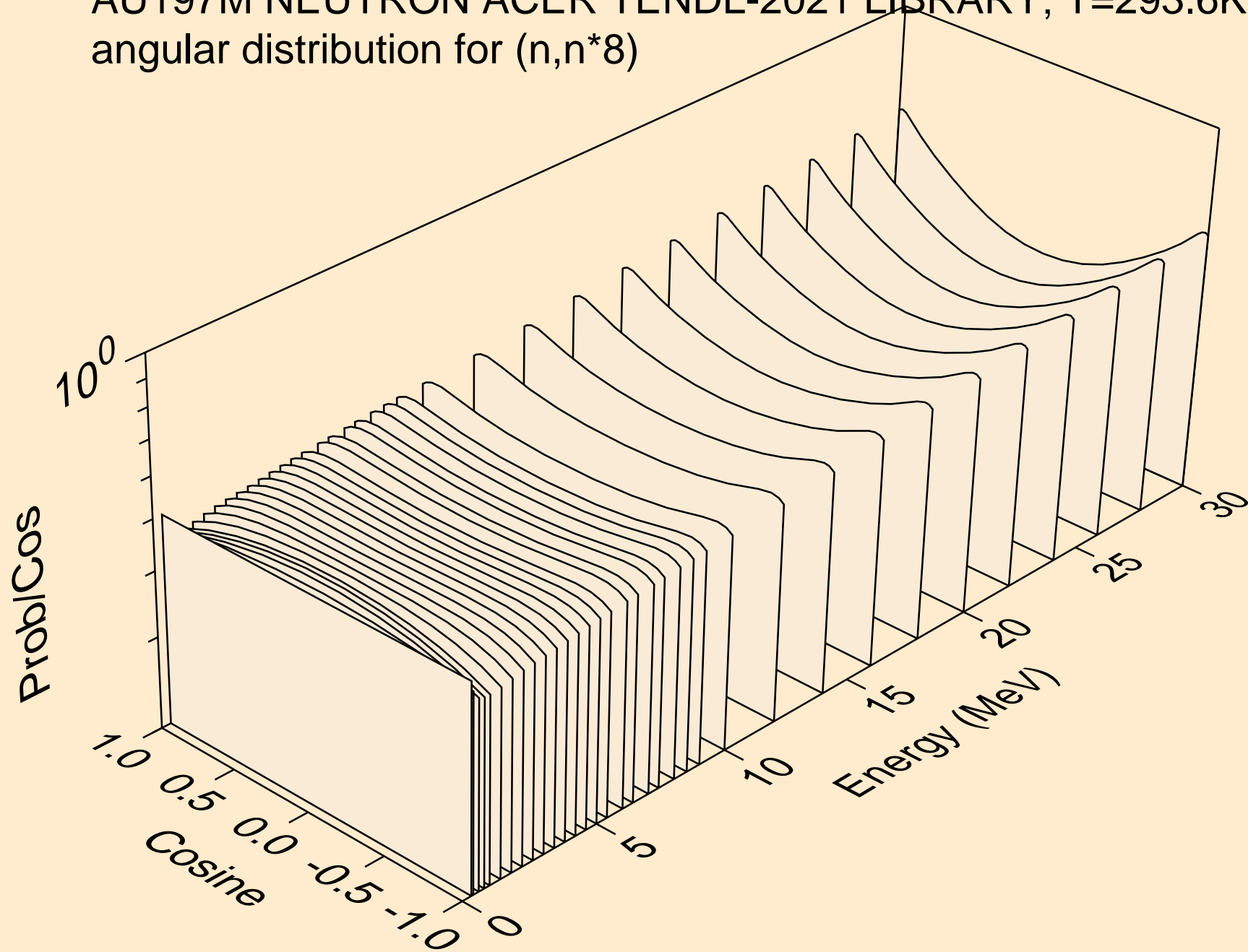

AU197M NEUTRON ACER TENDL-2021 LIBRARY; T=293.6K
angular distribution for (n,n*9)

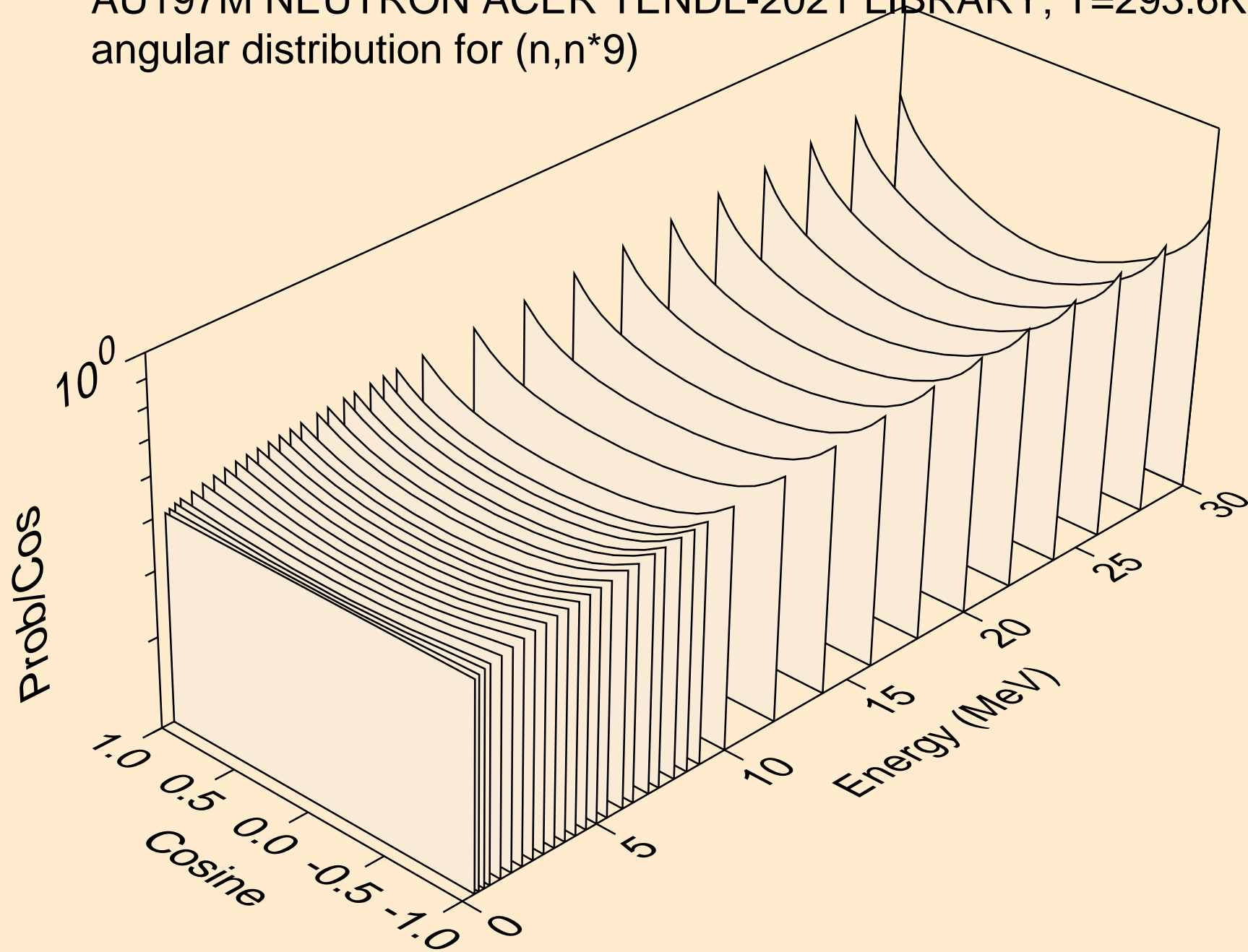

AU197M NEUTRON ACER TENDL-2021 LIBRARY; T=293.6K
angular distribution for (n,n*10)

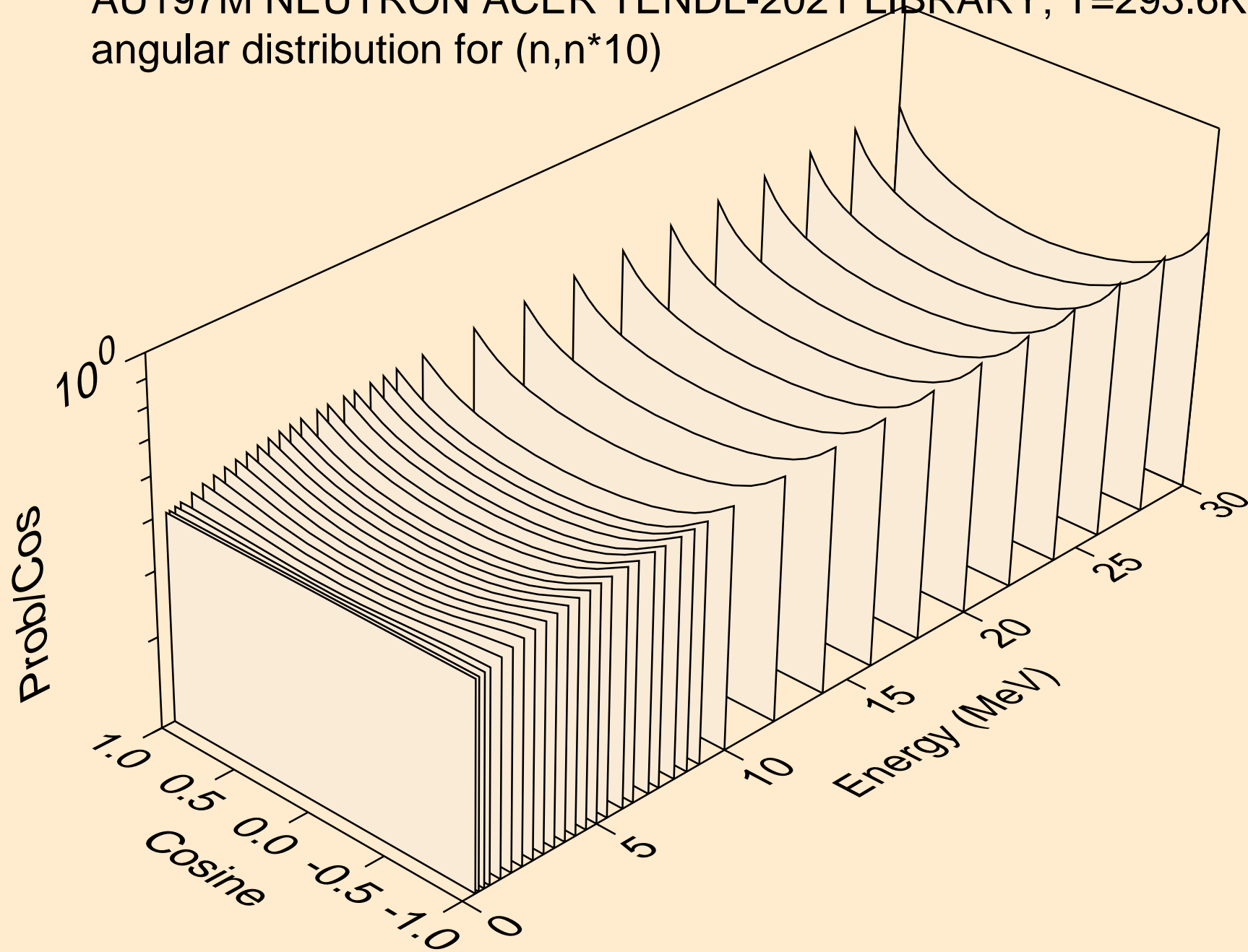

AU197M NEUTRON ACER TENDL-2021 LIBRARY; T=293.6K
angular distribution for (n,n*11)

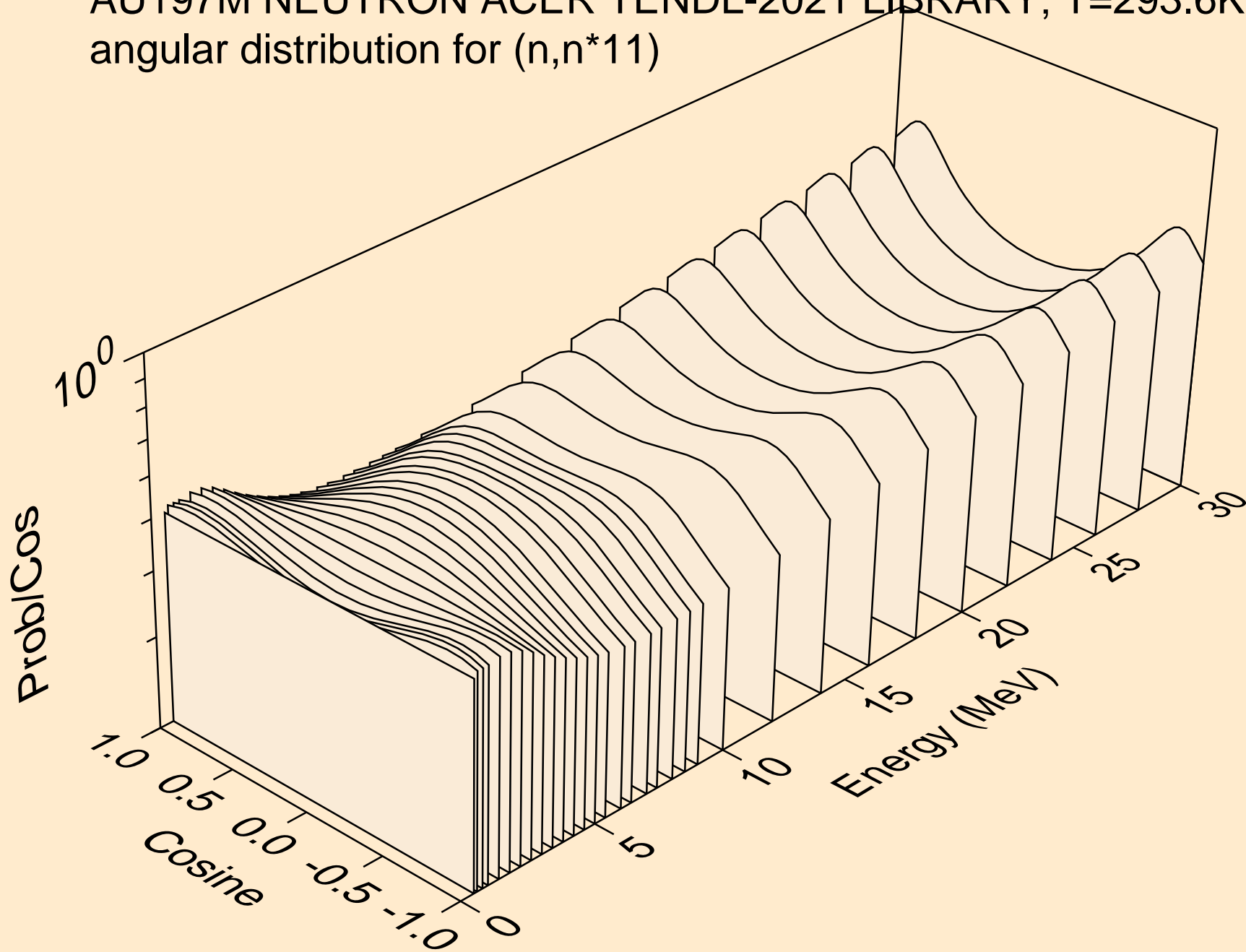

AU197M NEUTRON ACER TENDL-2021 LIBRARY; T=293.6K
angular distribution for (n,n*12)

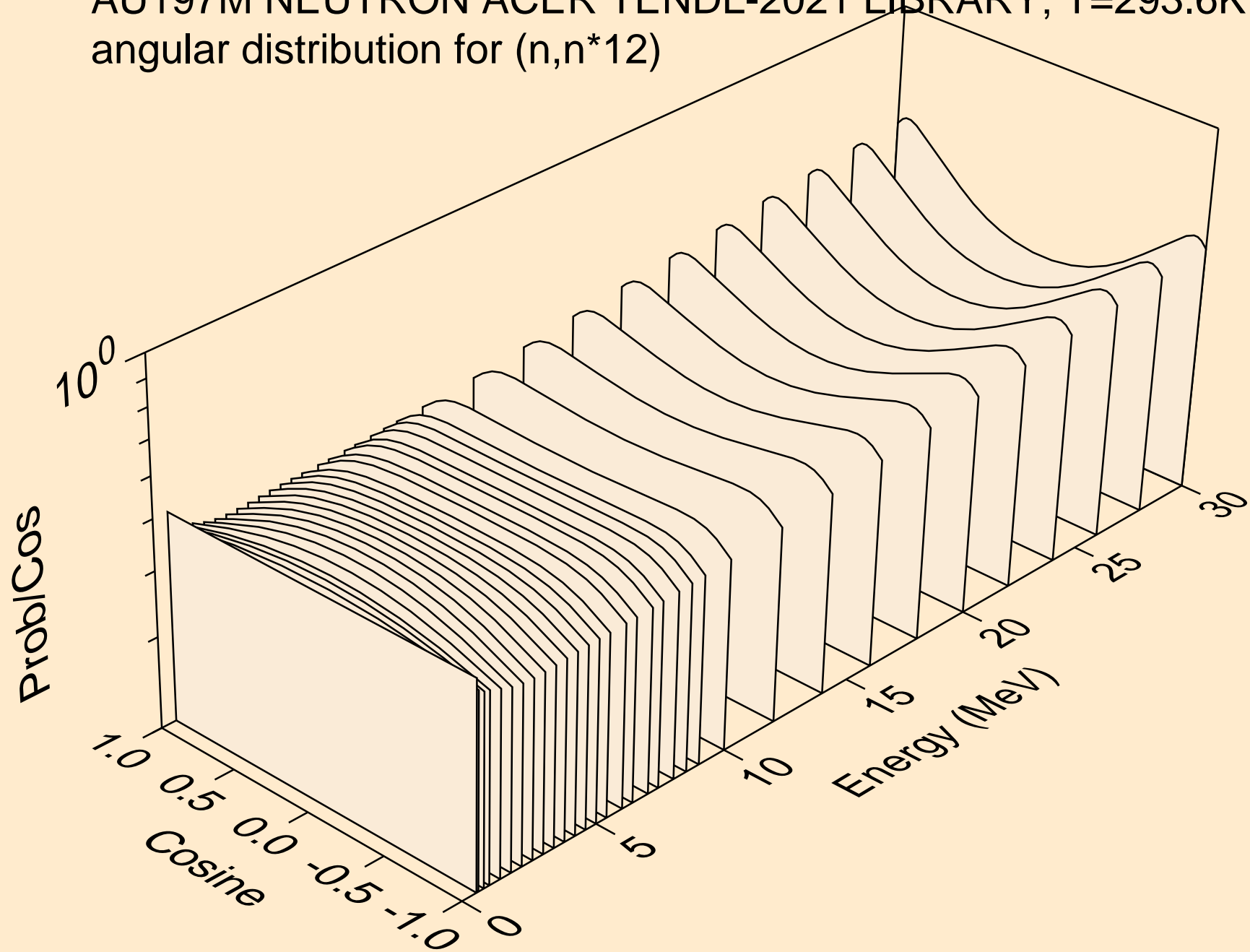

AU197M NEUTRON ACER TENDL-2021 LIBRARY; T=293.6K
angular distribution for (n,n*13)

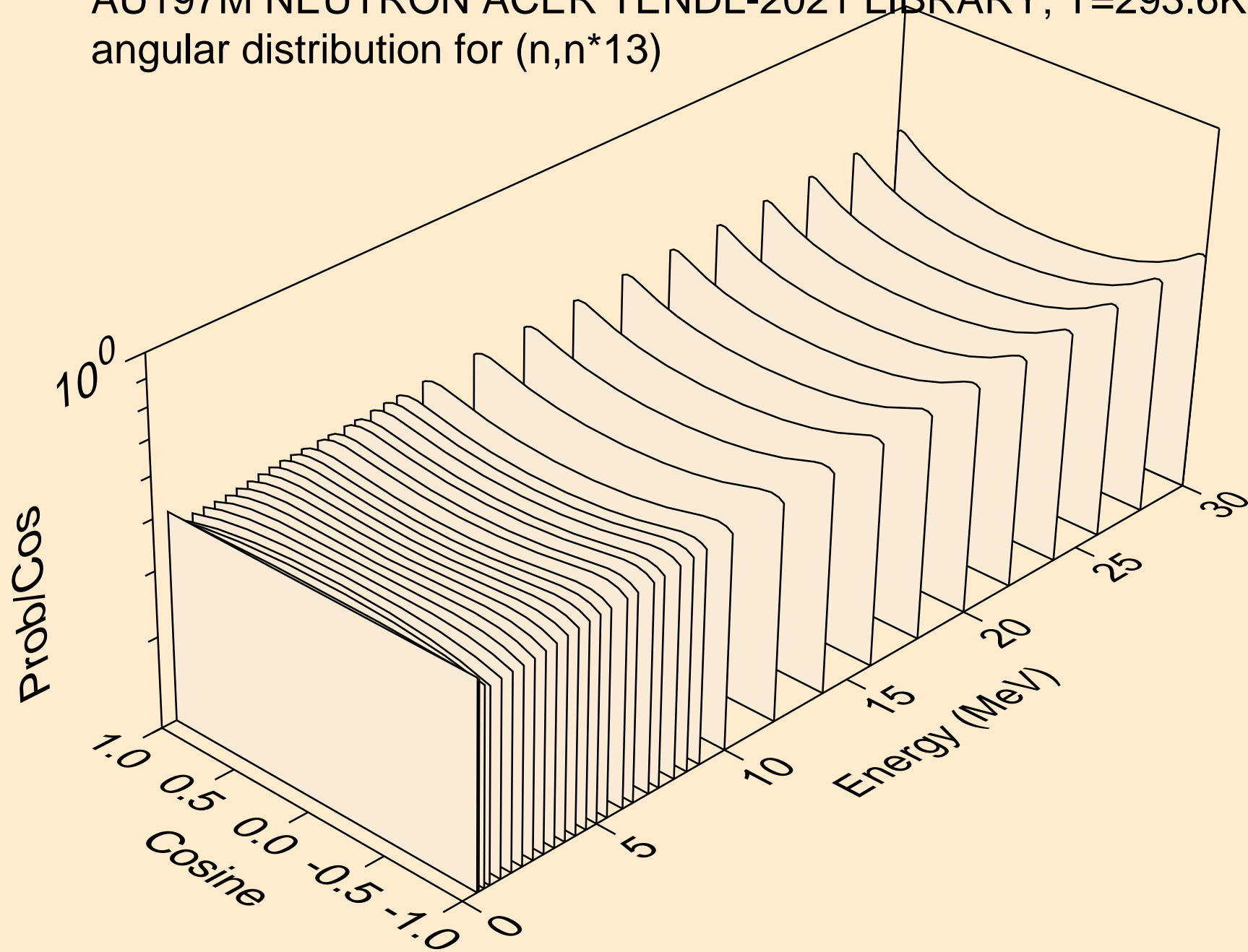

AU197M NEUTRON ACER TENDL-2021 LIBRARY; T=293.6K
angular distribution for (n,n*14)

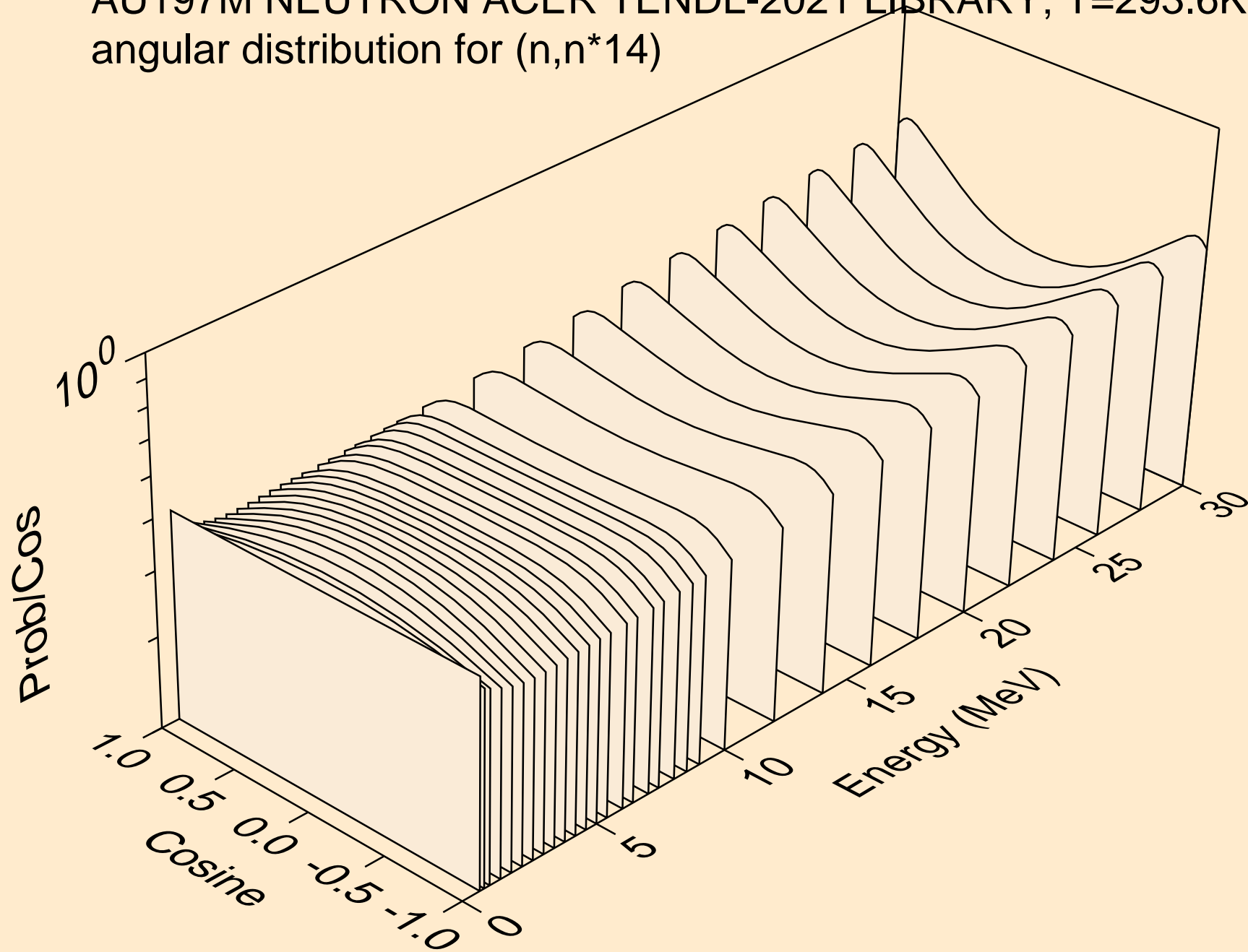

AU197M NEUTRON ACER TENDL-2021 LIBRARY; T=293.6K
angular distribution for (n,n*15)

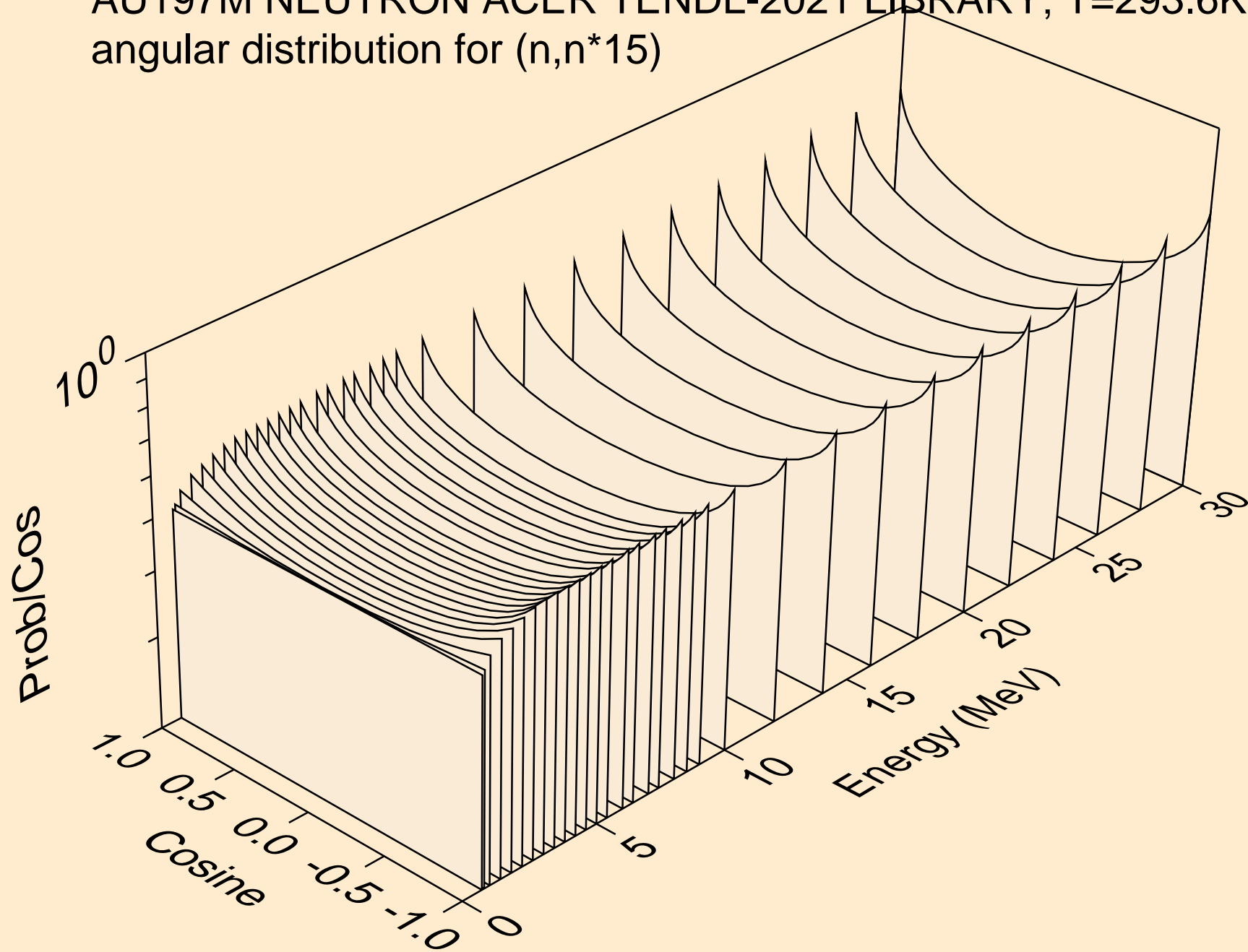

AU197M NEUTRON ACER TENDL-2021 LIBRARY; T=293.6K
angular distribution for (n,n*16)

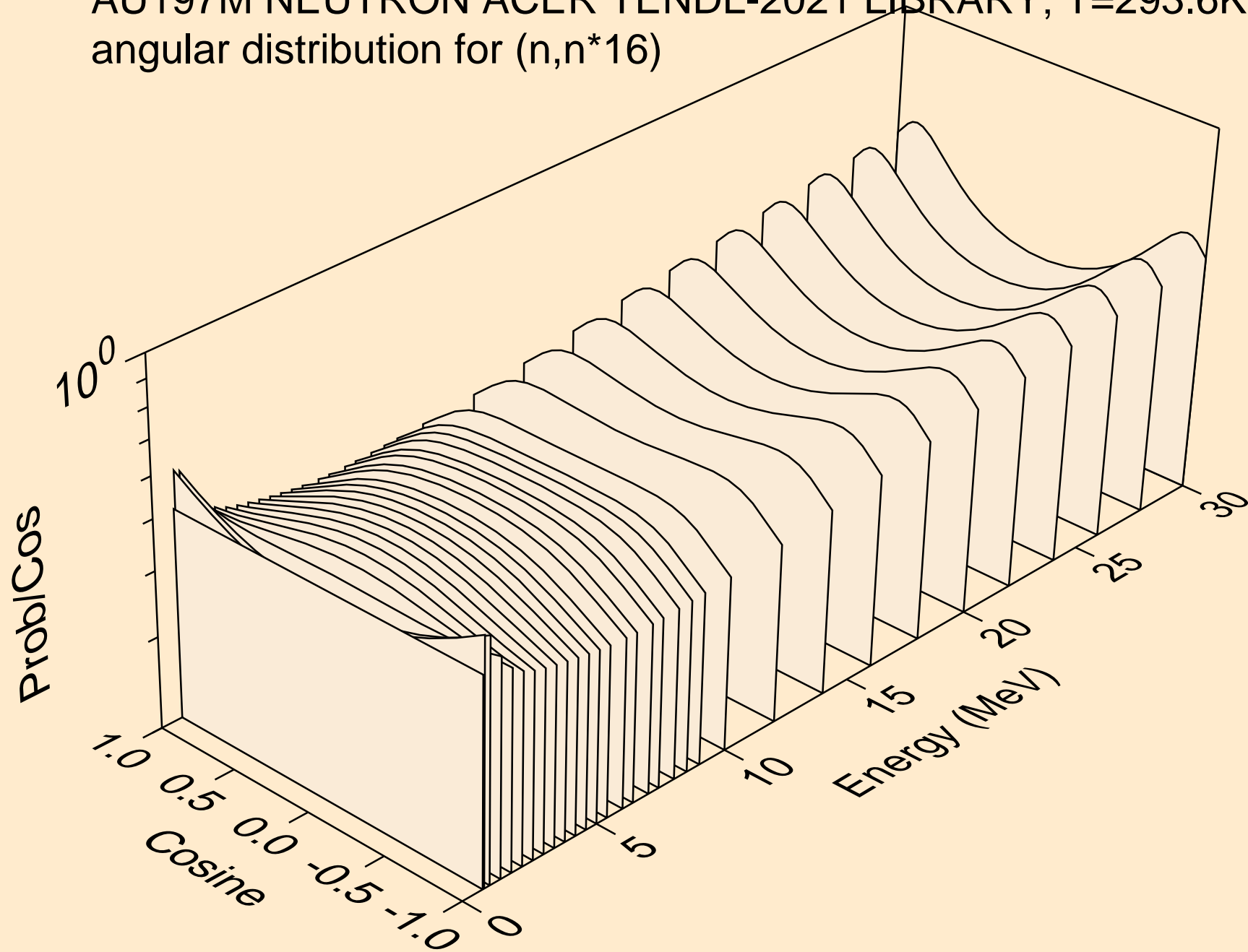

AU197M NEUTRON ACER TENDL-2021 LIBRARY; T=293.6K
angular distribution for (n,n*17)

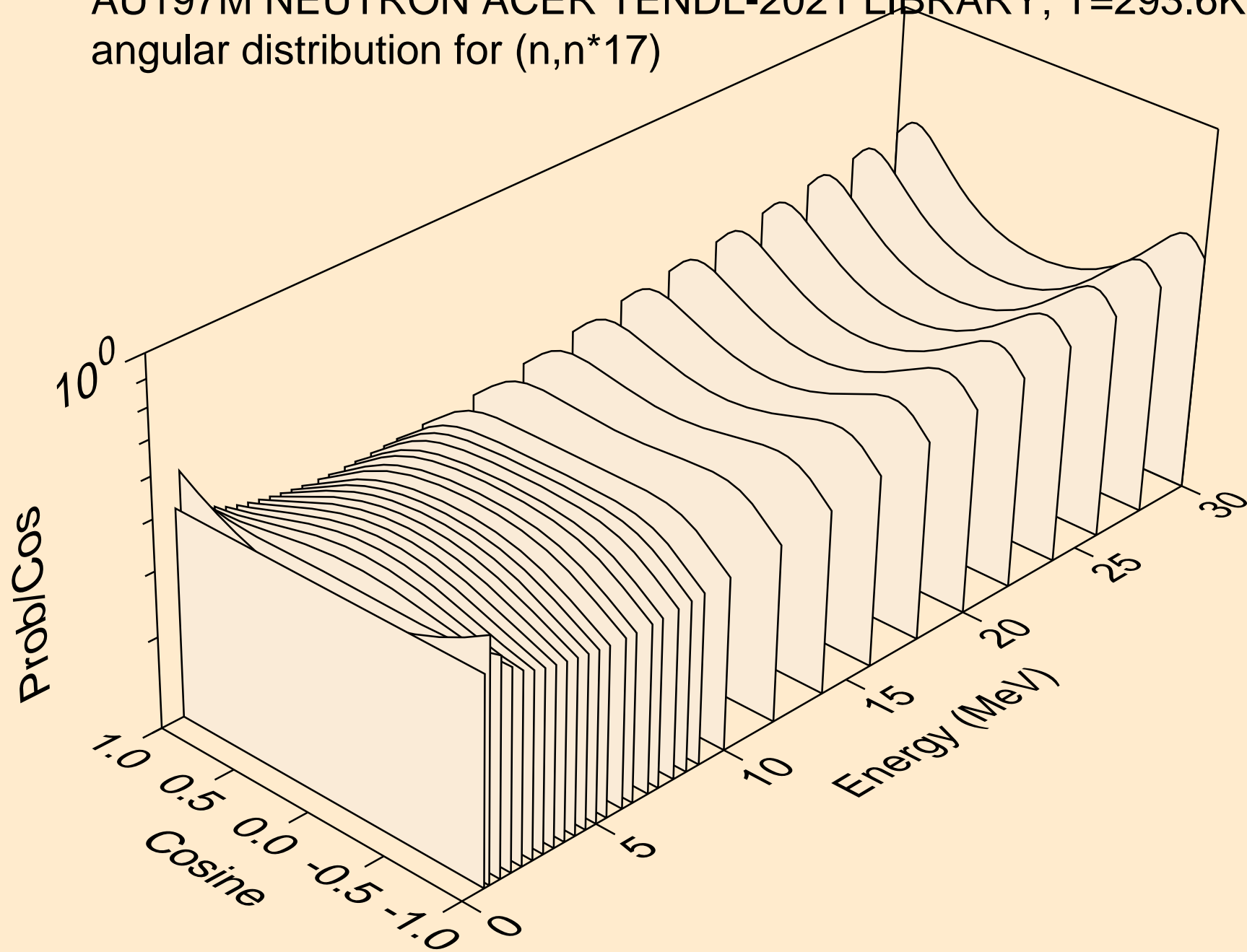

AU197M NEUTRON ACER TENDL-2021 LIBRARY; T=293.6K
angular distribution for (n,n*18)

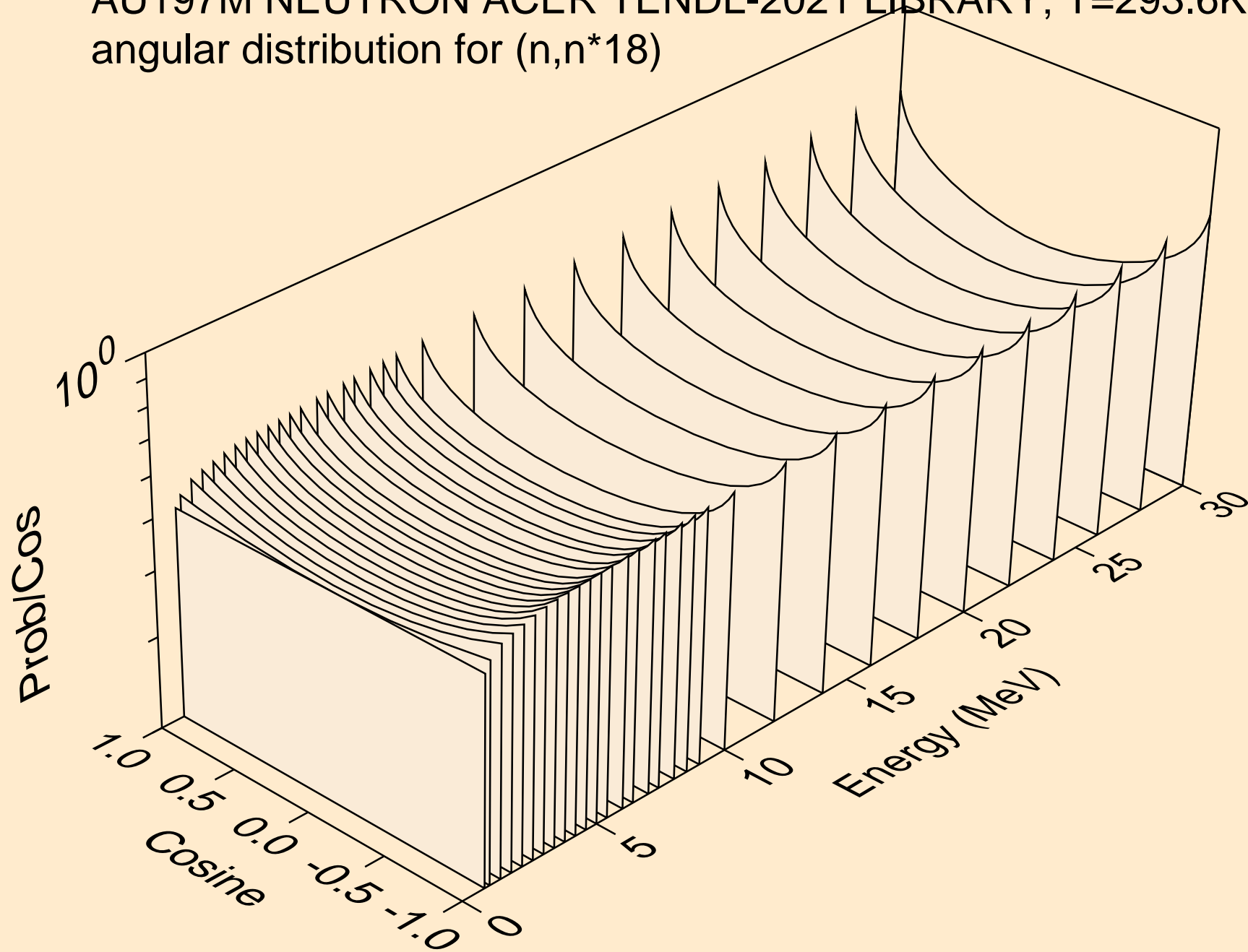

AU197M NEUTRON ACER TENDL-2021 LIBRARY; T=293.6K
angular distribution for (n,n*19)

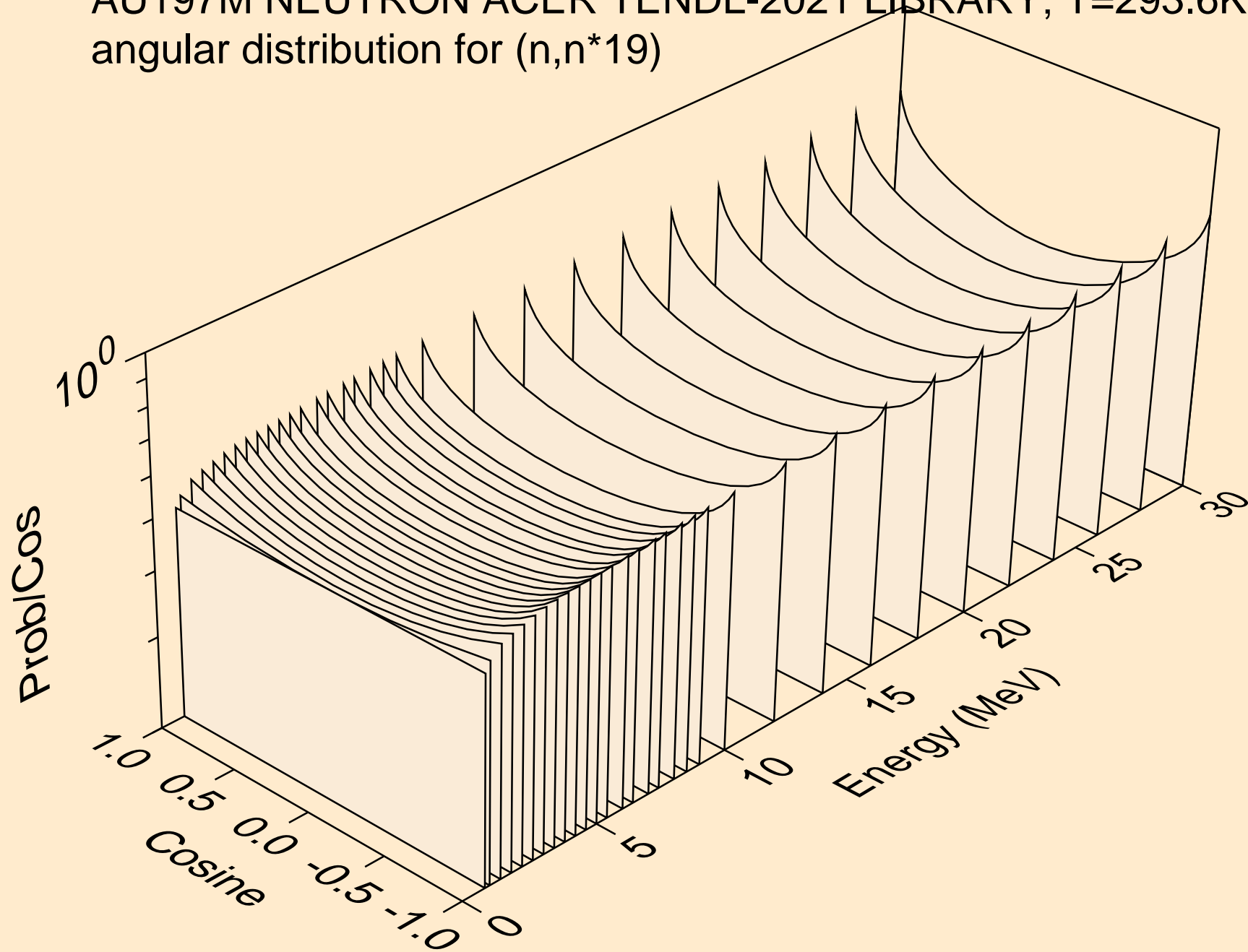

AU197M NEUTRON ACER TENDL-2021 LIBRARY; T=293.6K
angular distribution for (n,n*20)

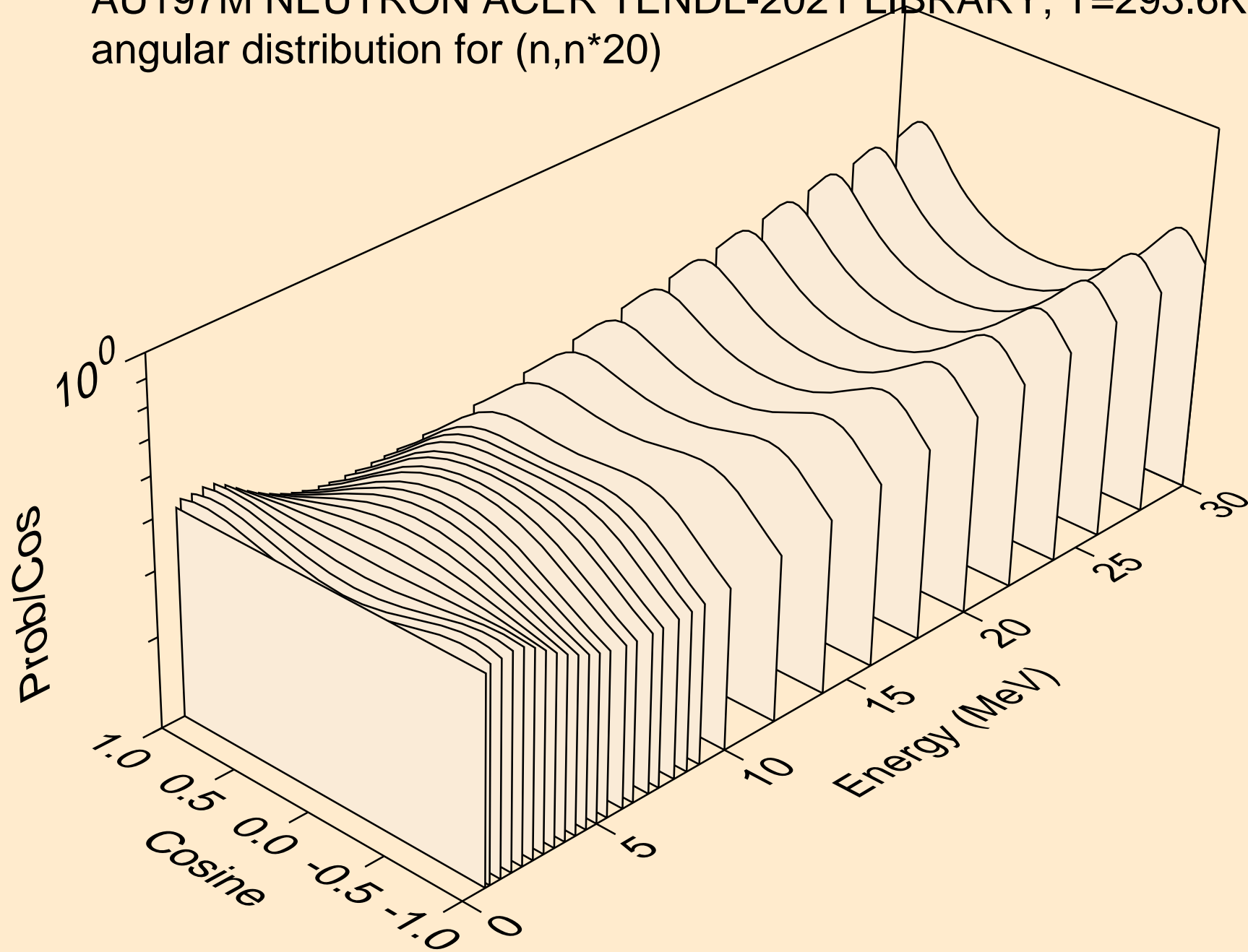

AU197M NEUTRON ACER TENDL-2021 LIBRARY; T=293.6K
angular distribution for (n,n*21)

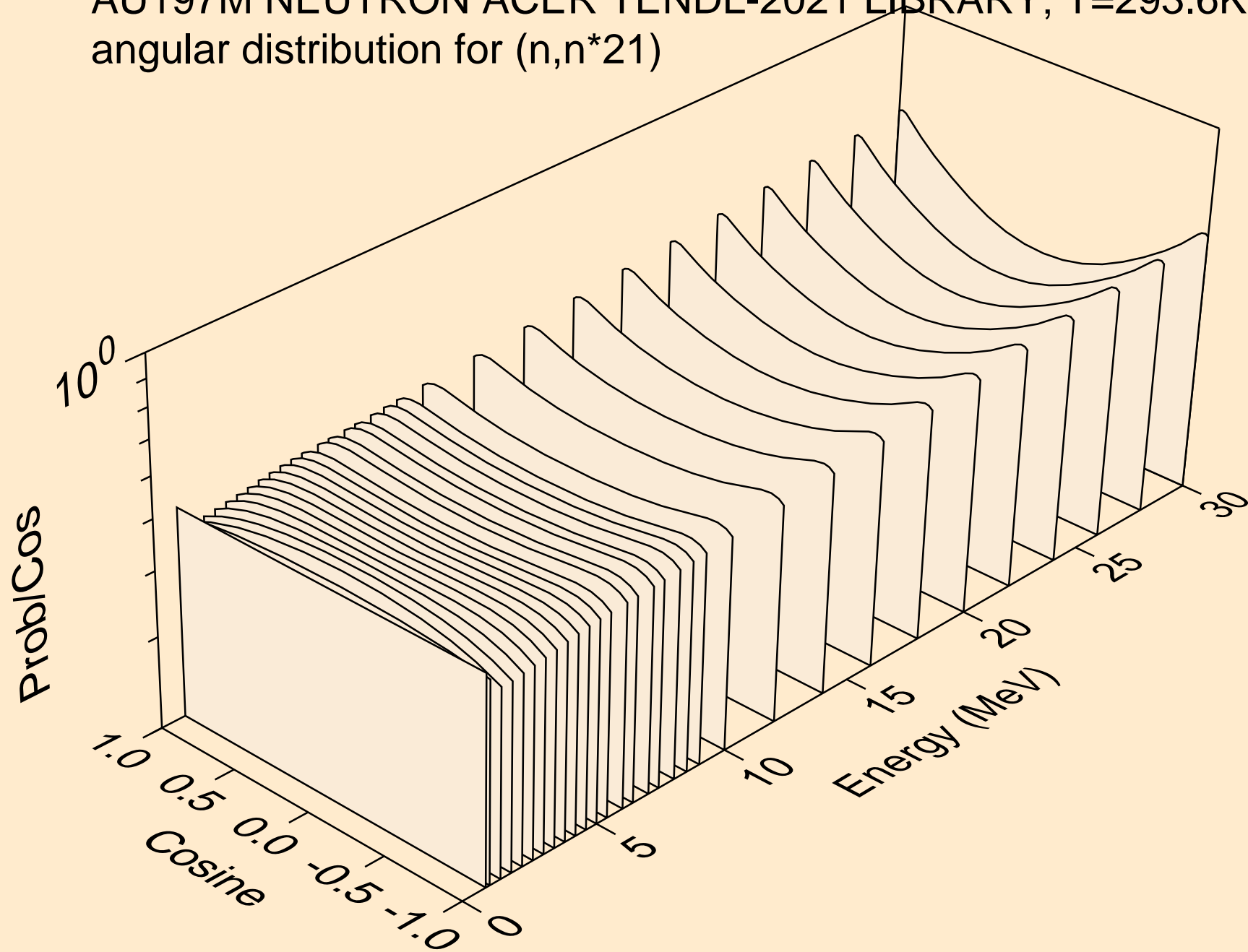

AU197M NEUTRON ACER TENDL-2021 LIBRARY; T=293.6K
angular distribution for (n,n*22)

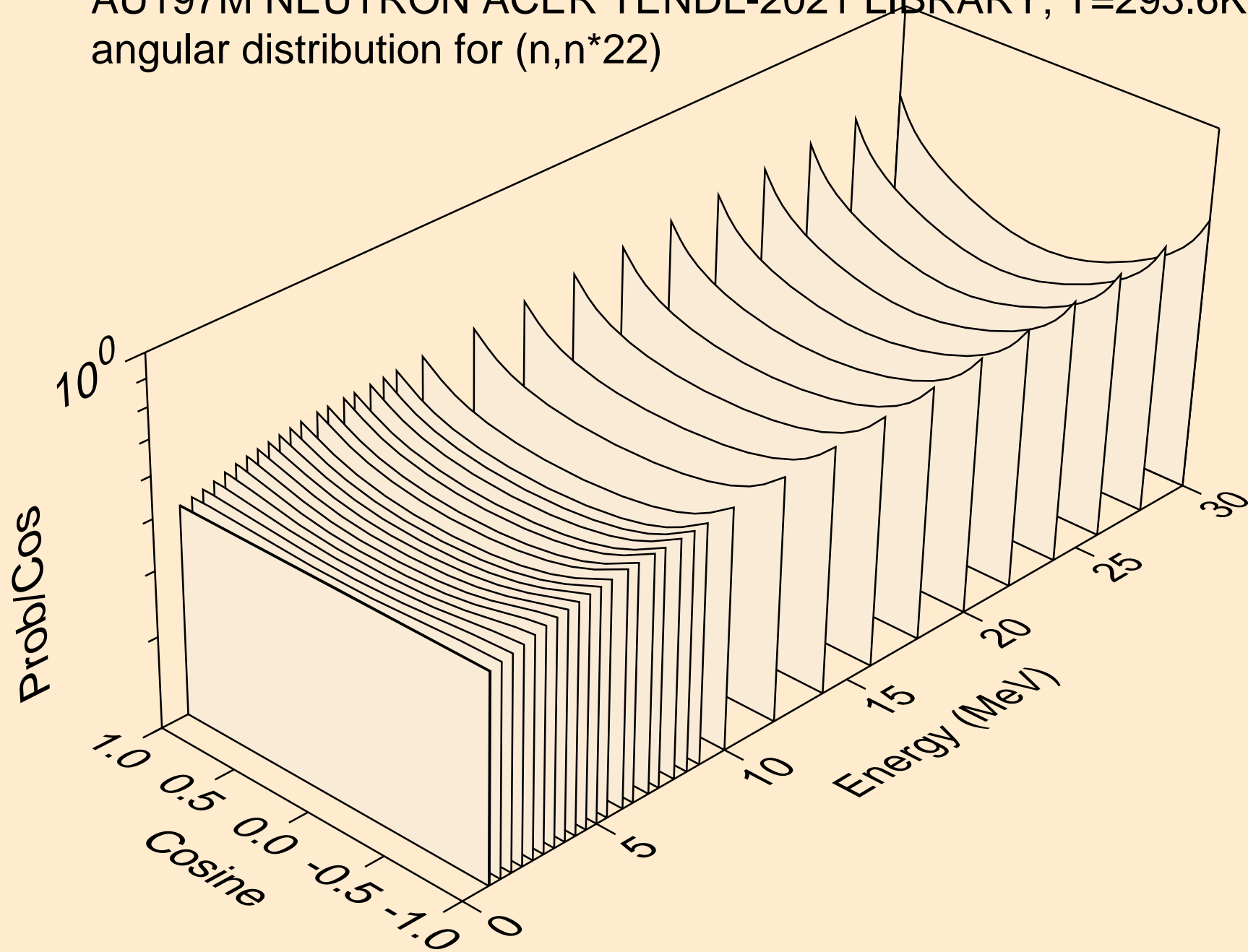

AU197M NEUTRON ACER TENDL-2021 LIBRARY; T=293.6K
angular distribution for (n,n*23)

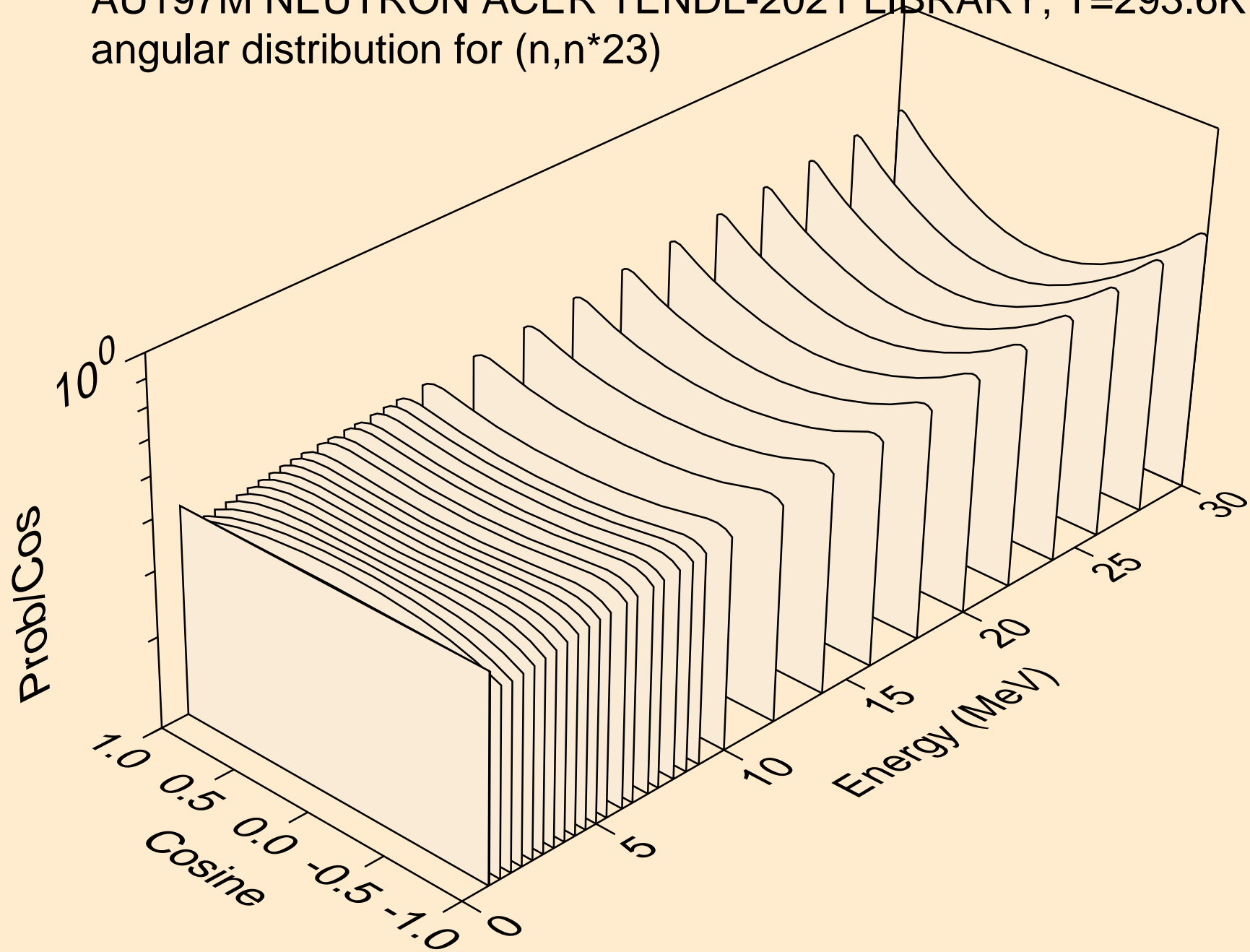

AU197M NEUTRON ACER TENDL-2021 LIBRARY; T=293.6K
angular distribution for (n,n*24)

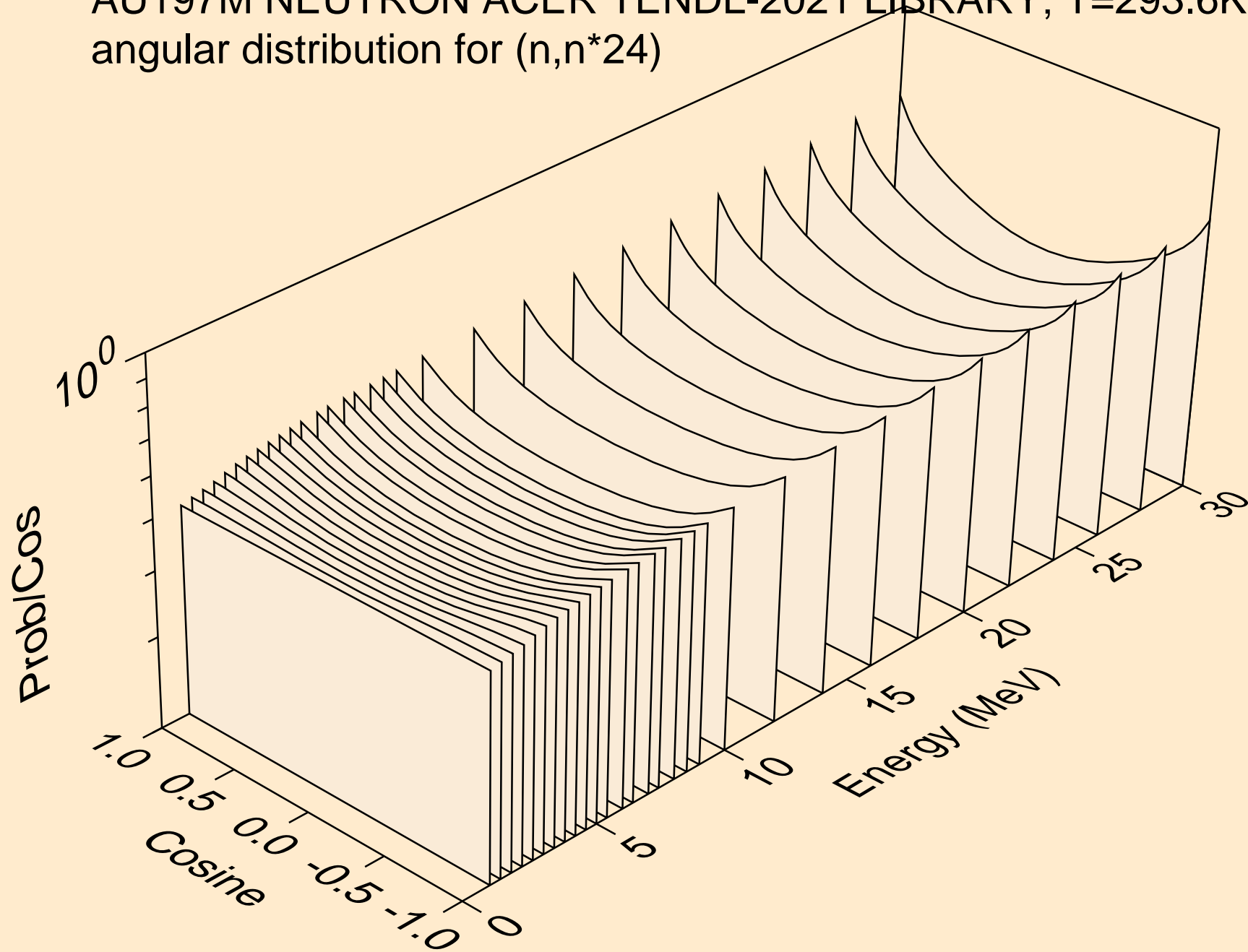

AU197M NEUTRON ACER TENDL-2021 LIBRARY; T=293.6K
angular distribution for (n,n*25)

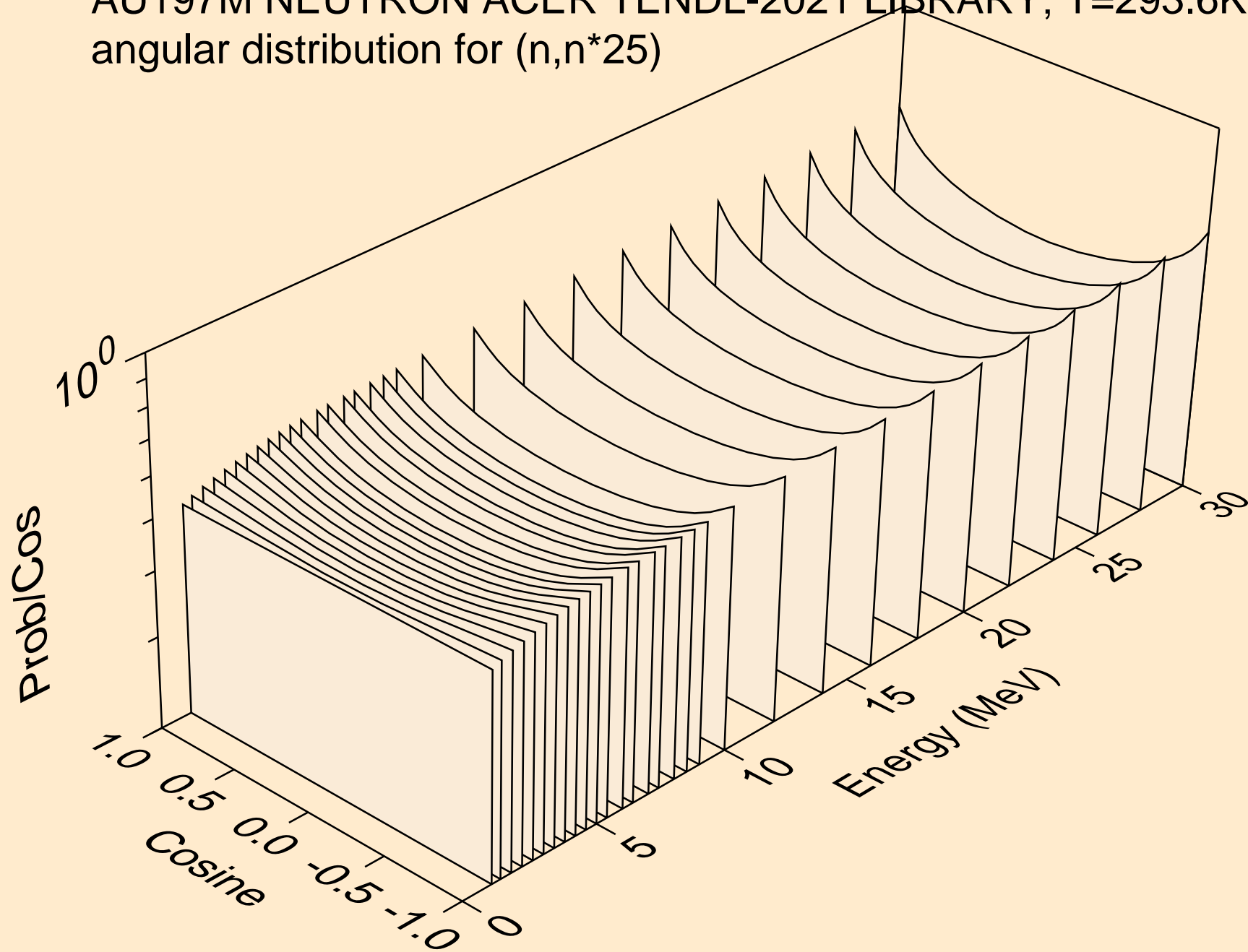

AU197M NEUTRON ACER TENDL-2021 LIBRARY; T=293.6K
angular distribution for (n,n*26)

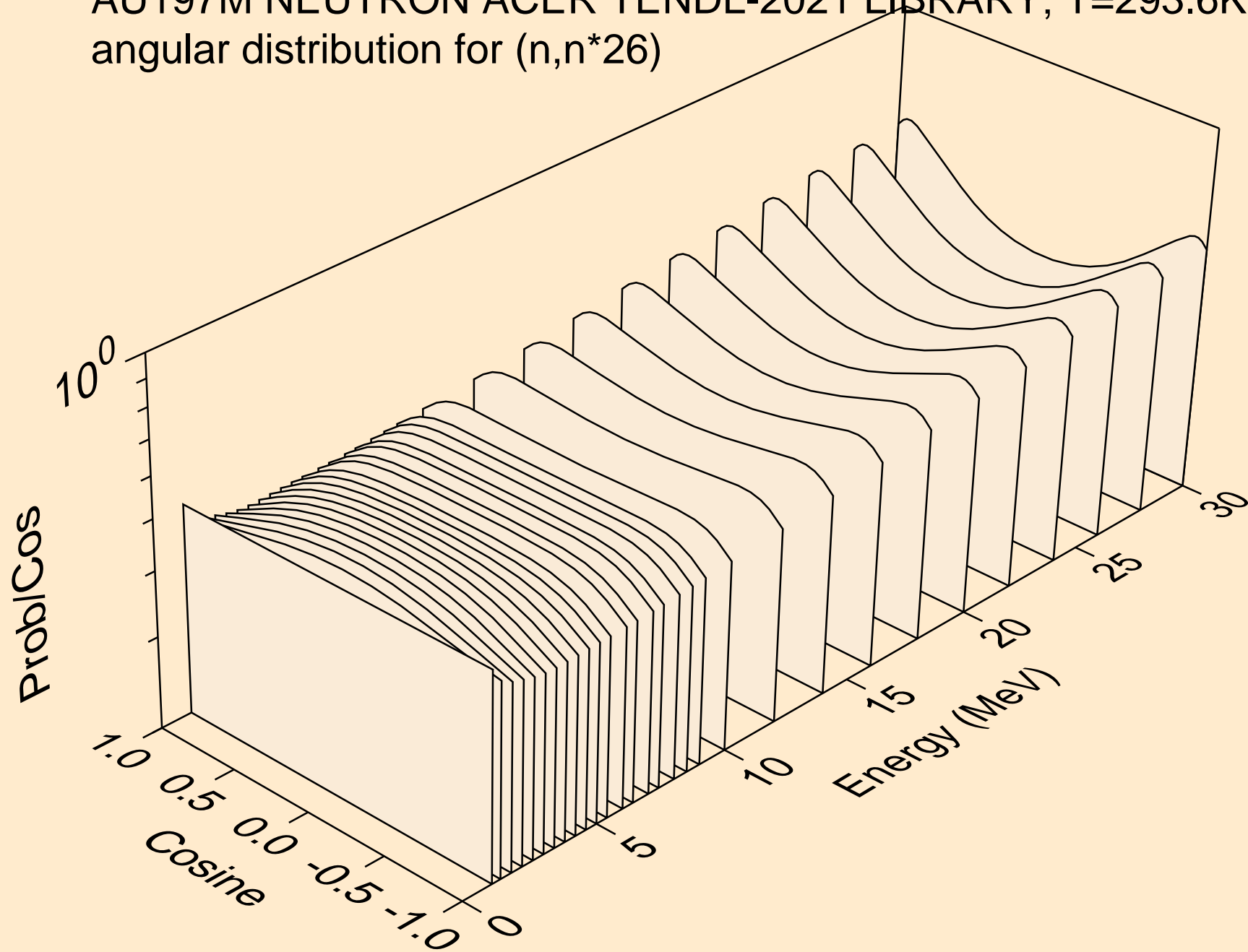

AU197M NEUTRON ACER TENDL-2021 LIBRARY; T=293.6K
angular distribution for (n,n*27)

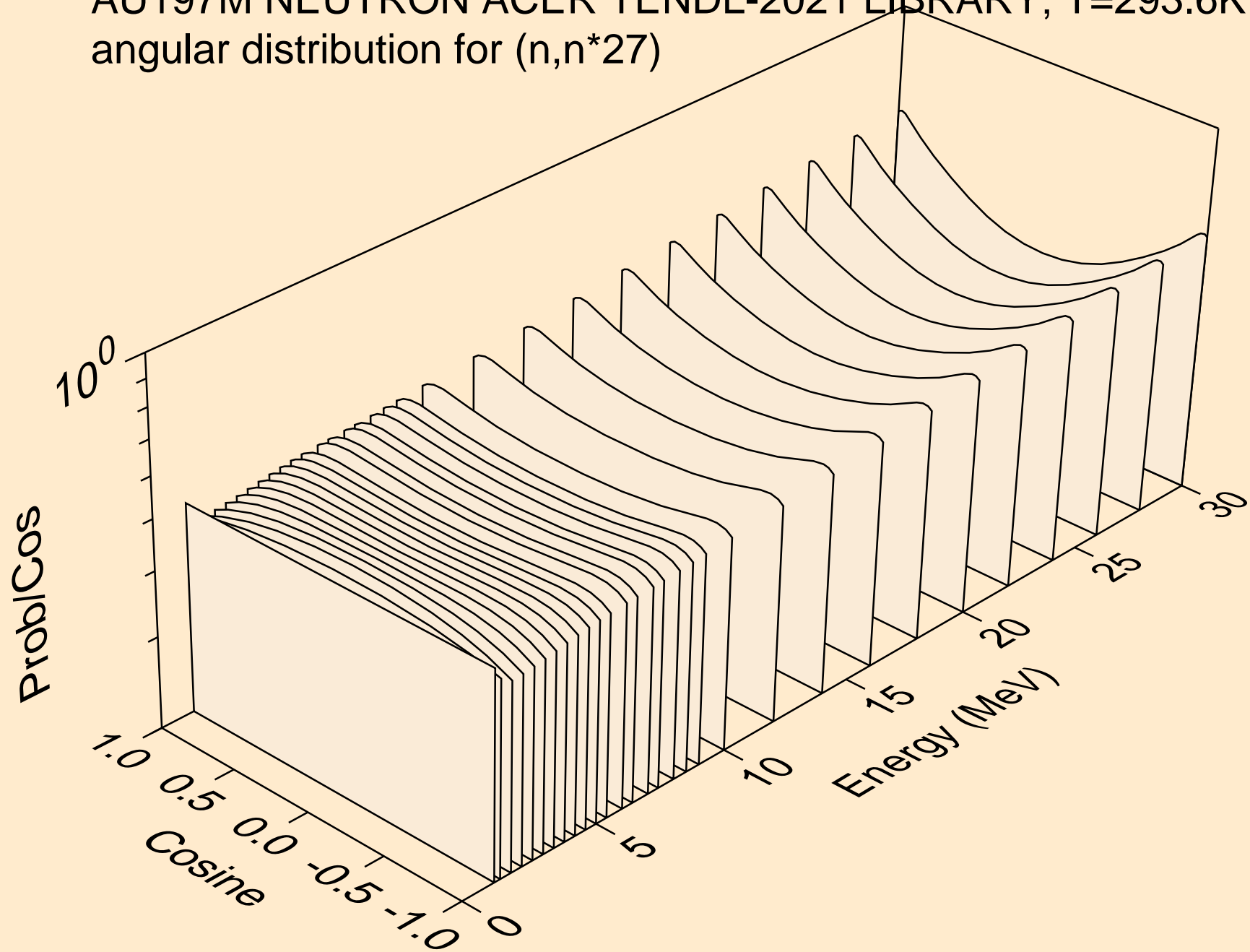

AU197M NEUTRON ACER TENDL-2021 LIBRARY; T=293.6K
angular distribution for (n,n*28)

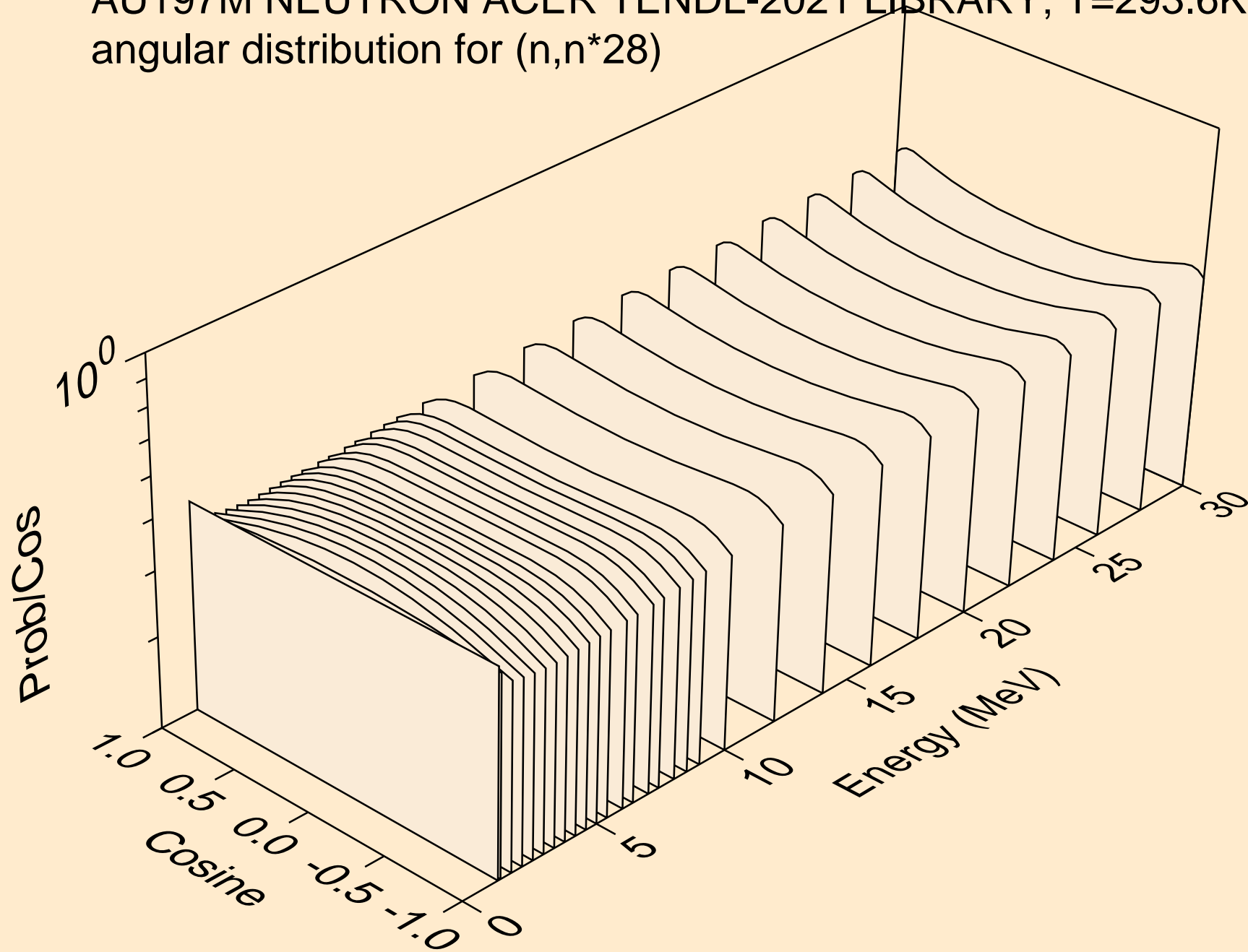

AU197M NEUTRON ACER TENDL-2021 LIBRARY; T=293.6K
Neutron emission for (n,x)

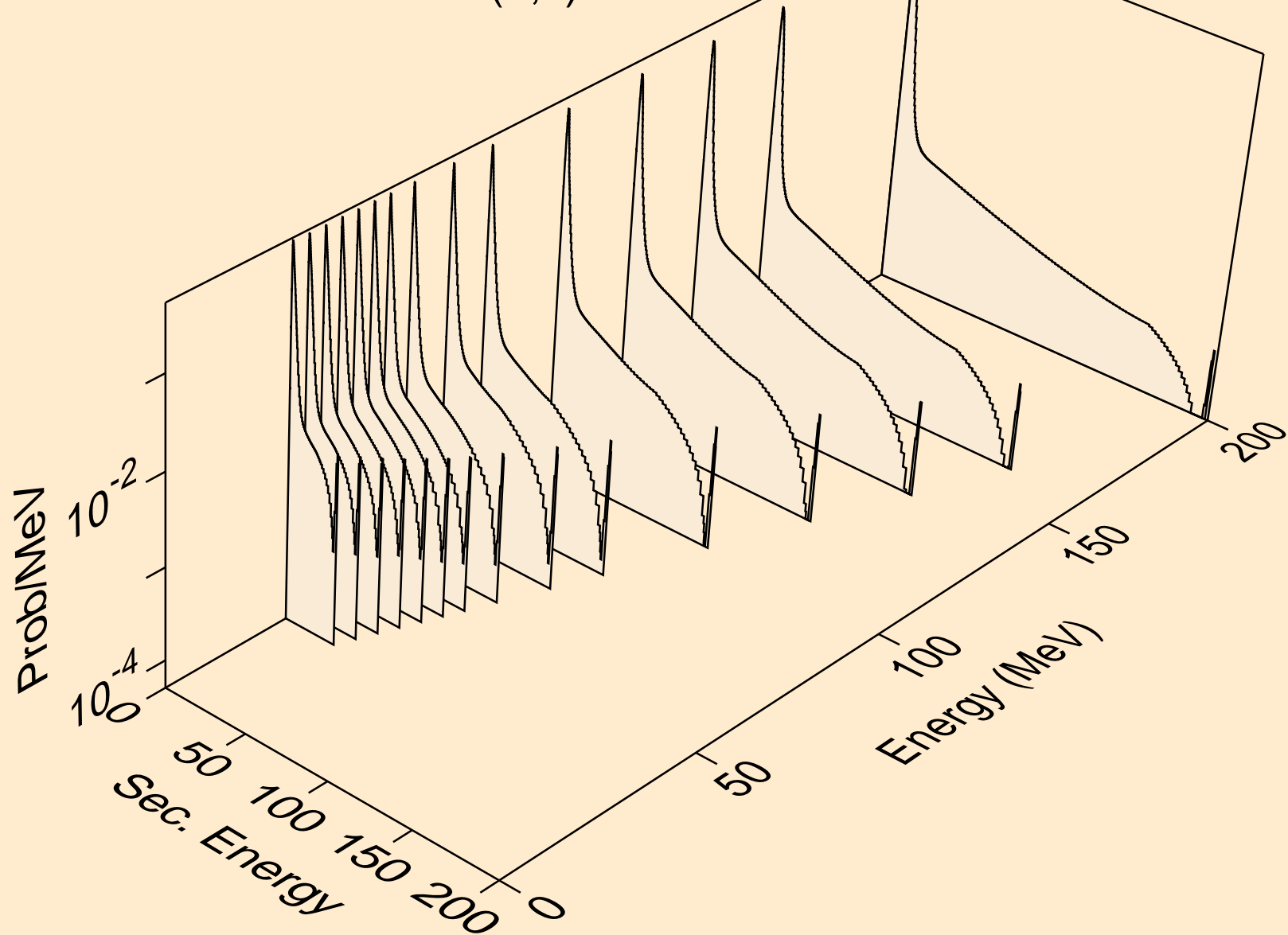

AU197M NEUTRON ACER TENDL-2021 LIBRARY; T=293.6K
Neutron emission for (n,2nd)

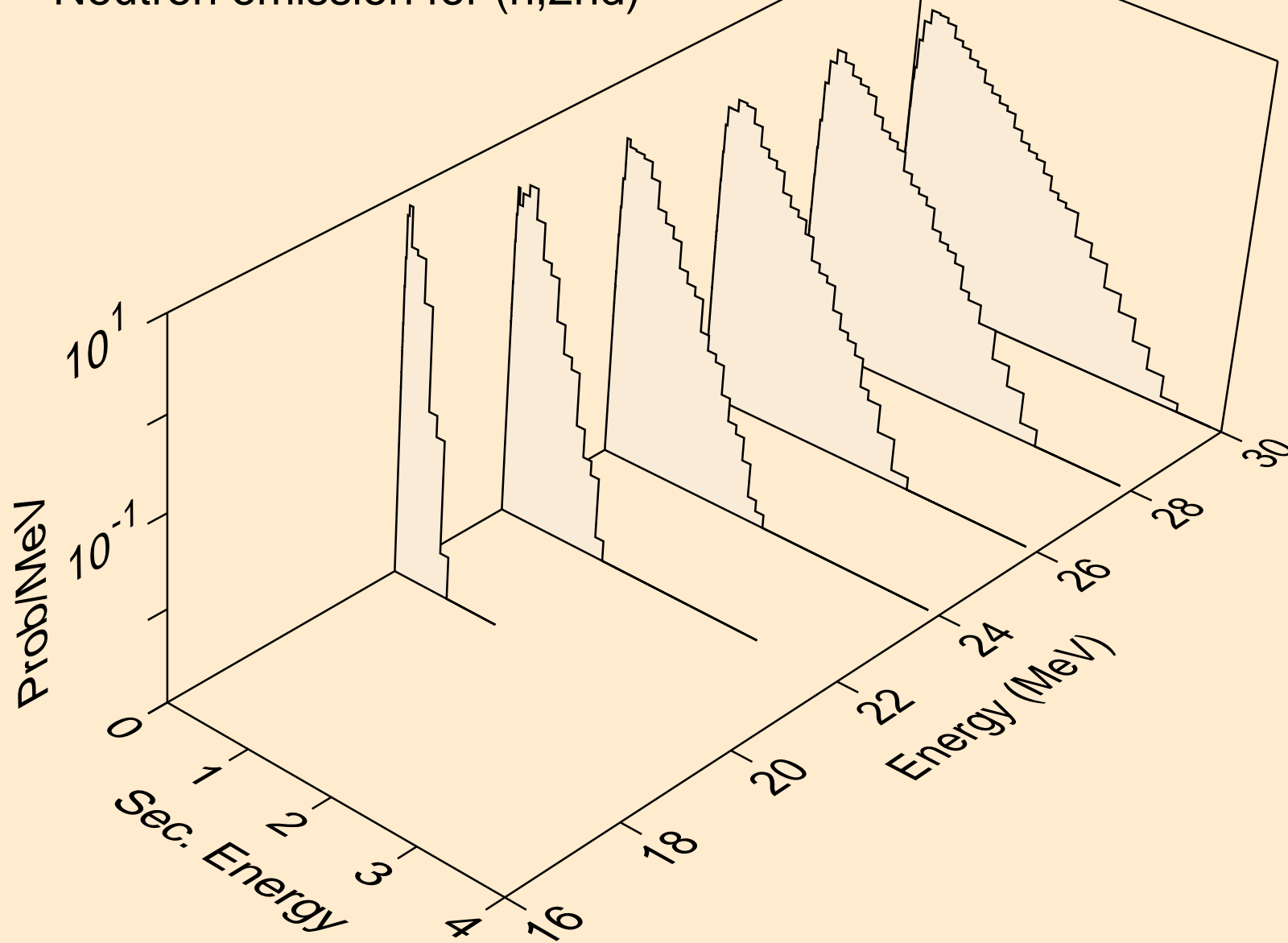

AU197M NEUTRON ACER TENDL-2021 LIBRARY; T=293.6K
Neutron emission for (n,2n)

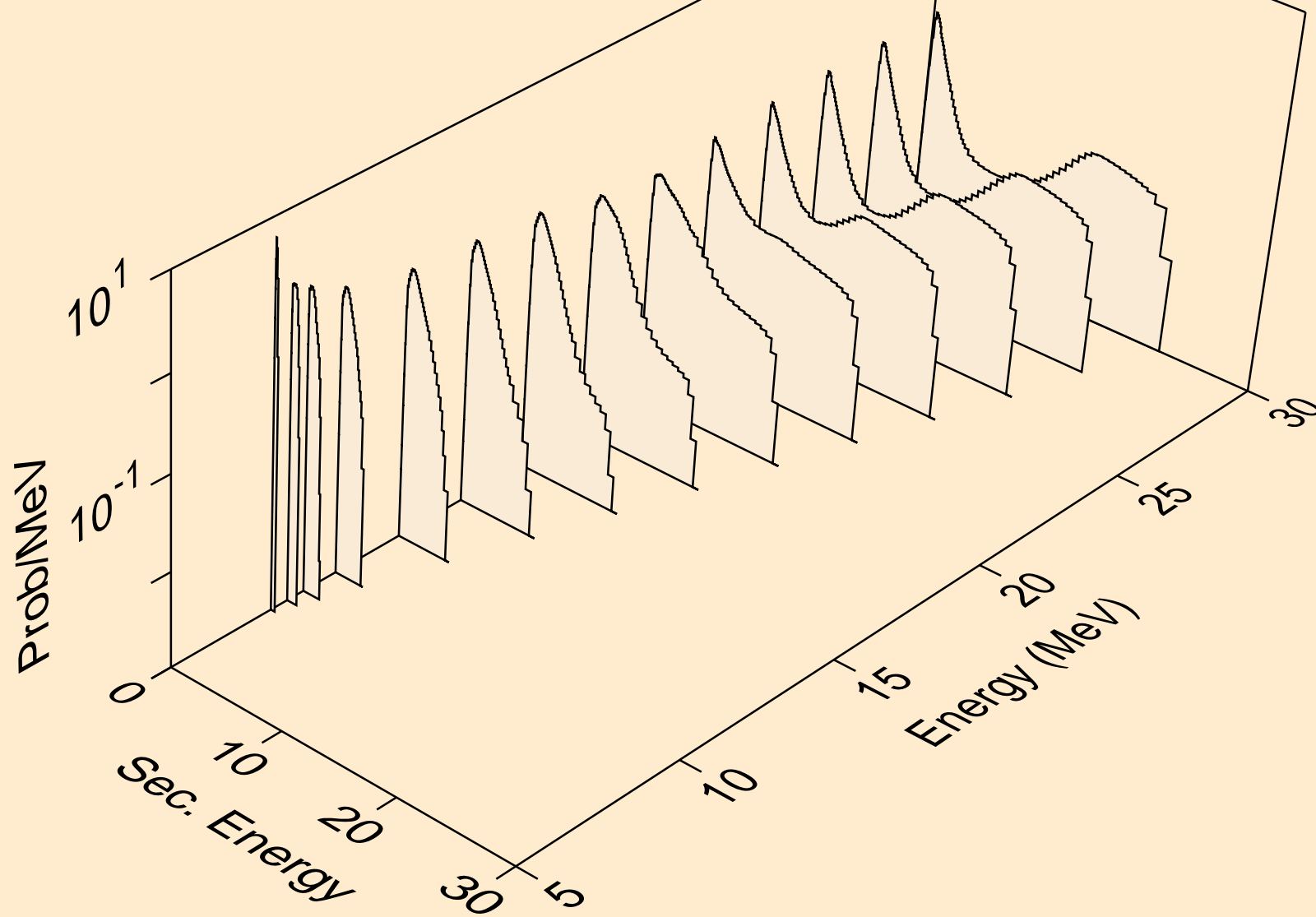

AU197M NEUTRON ACER TENDL-2021 LIBRARY; T=293.6K
Neutron emission for (n,3n)

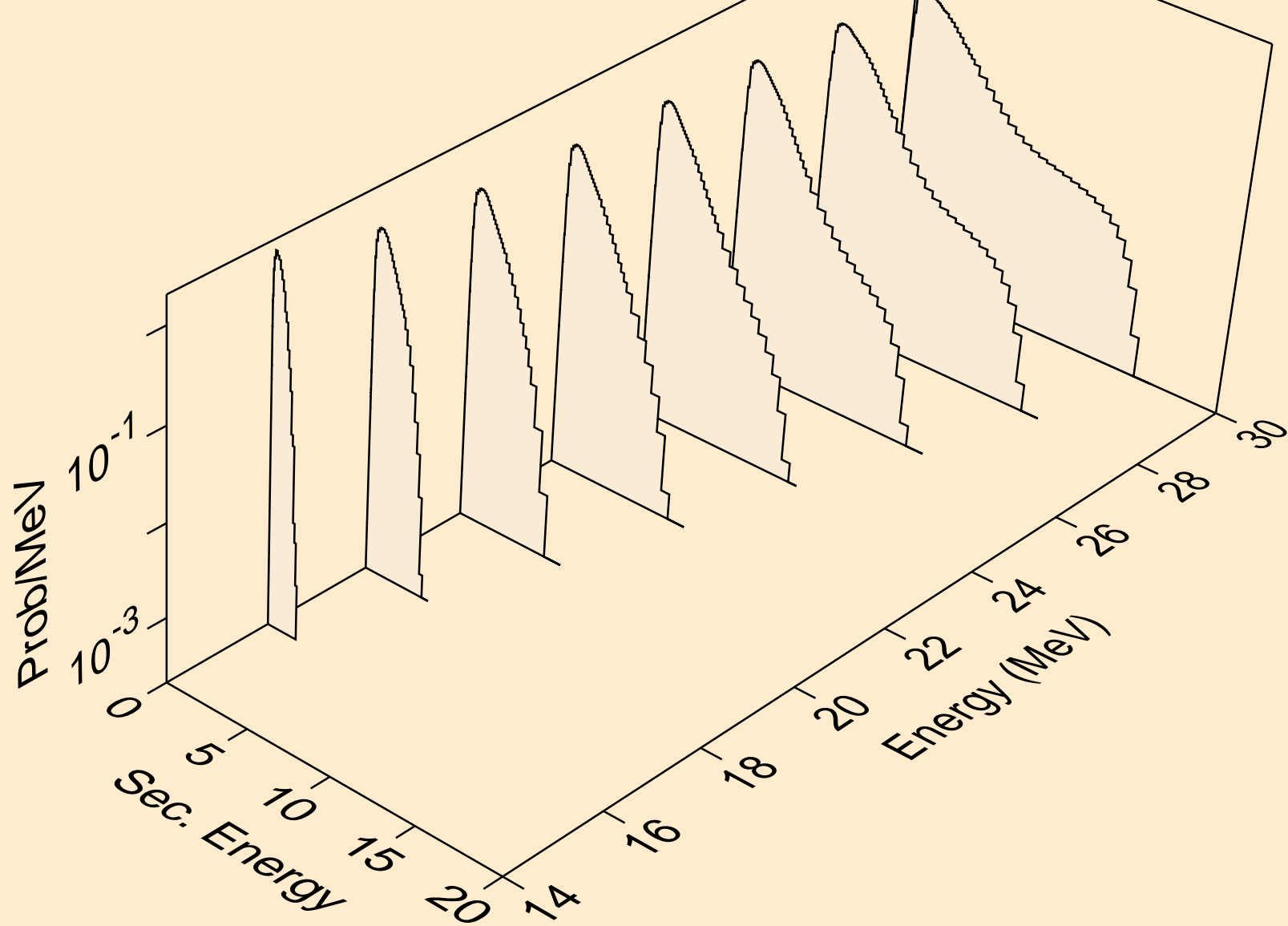

AU197M NEUTRON ACER TENDL-2021 LIBRARY; T=293.6K
Neutron emission for (n,n*)a

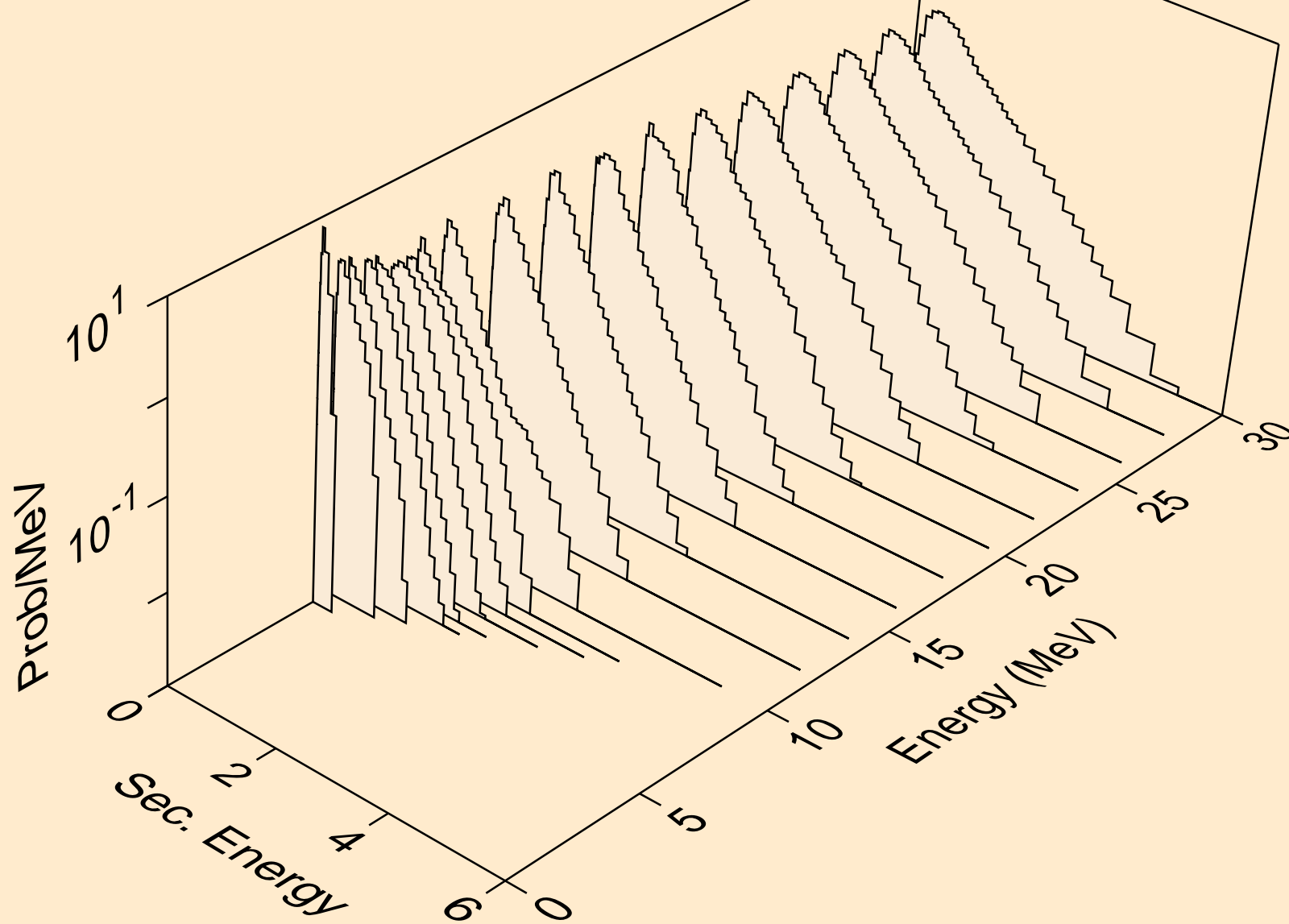

AU197M NEUTRON ACER TENDL-2021 LIBRARY; T=293.6K
Neutron emission for (n,2n)_a

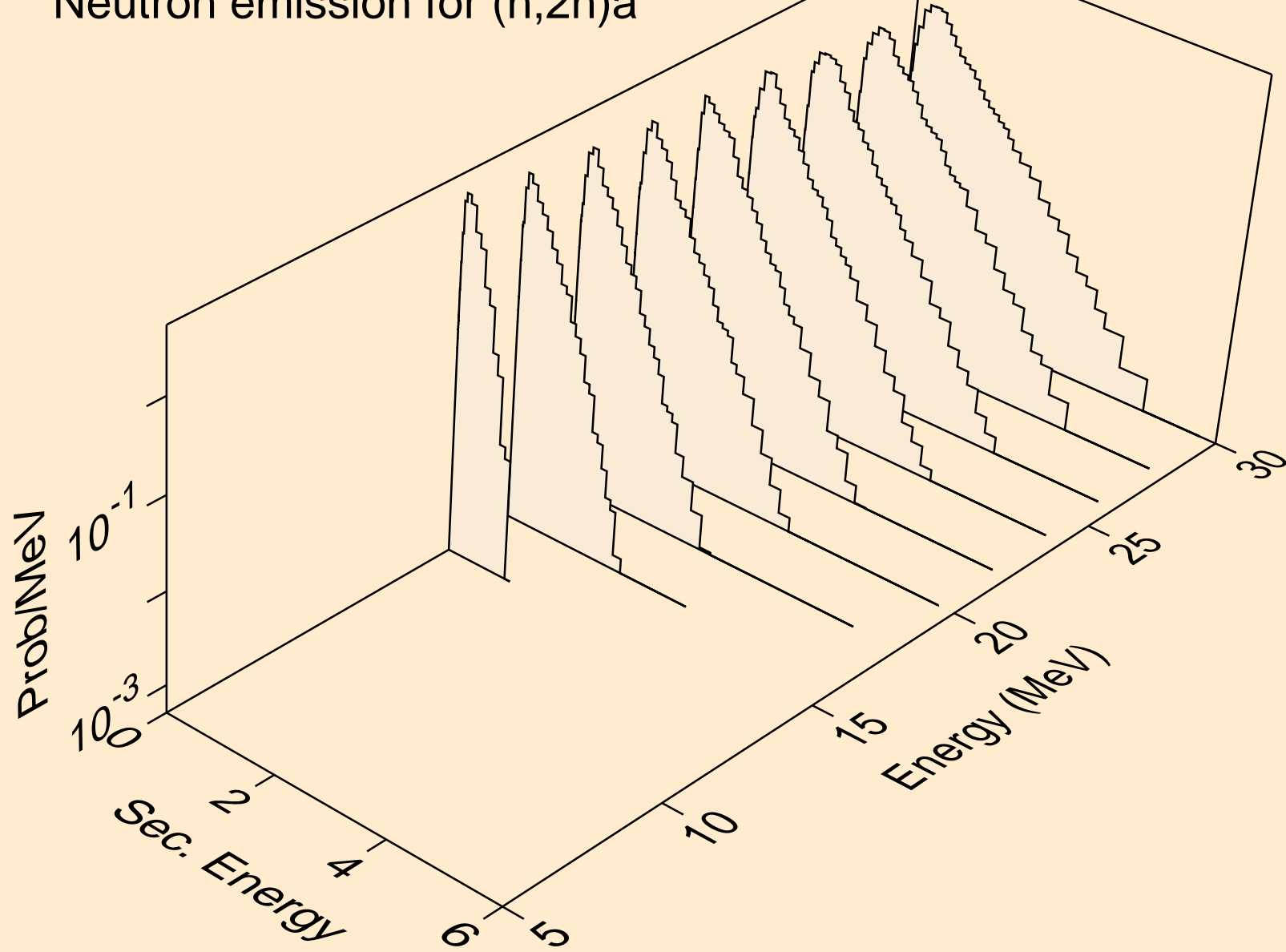

AU197M NEUTRON ACER TENDL-2021 LIBRARY; T=293.6K
Neutron emission for (n,3n)a

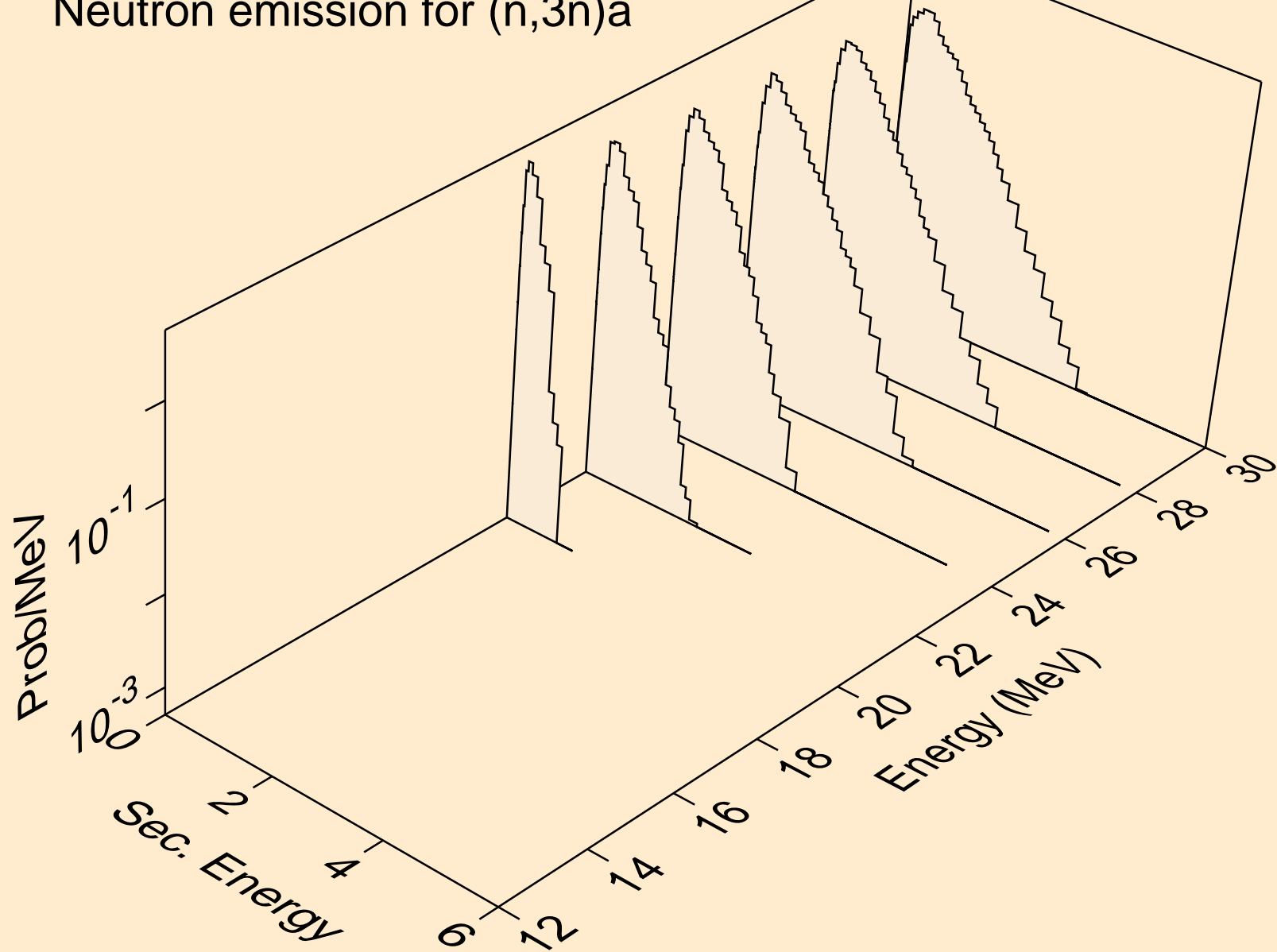

AU197M NEUTRON ACER TENDL-2021 LIBRARY; T=293.6K
Neutron emission for (n,n*)p

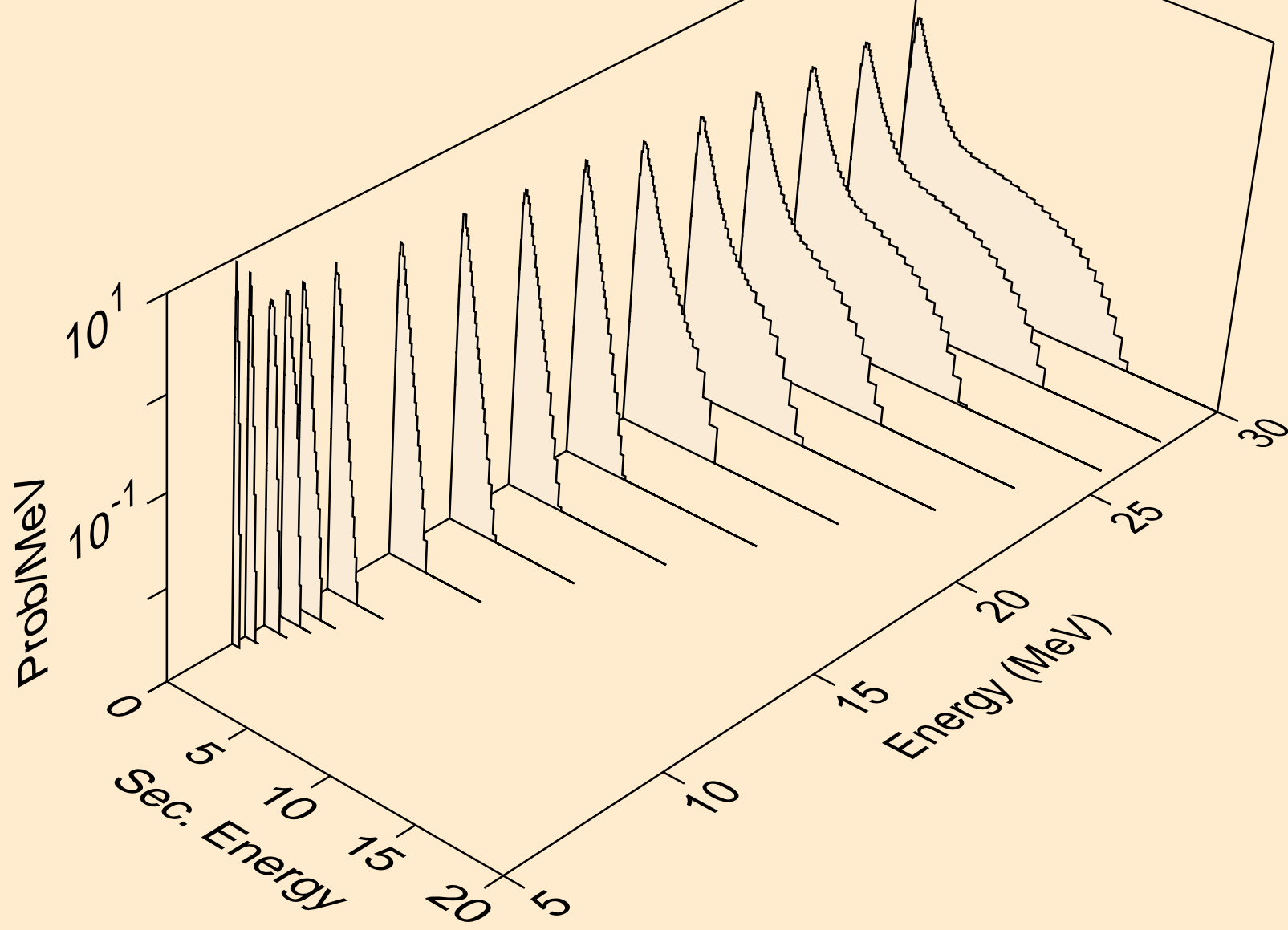

AU197M NEUTRON ACER TENDL-2021 LIBRARY; T=293.6K
Neutron emission for (n,n*)d

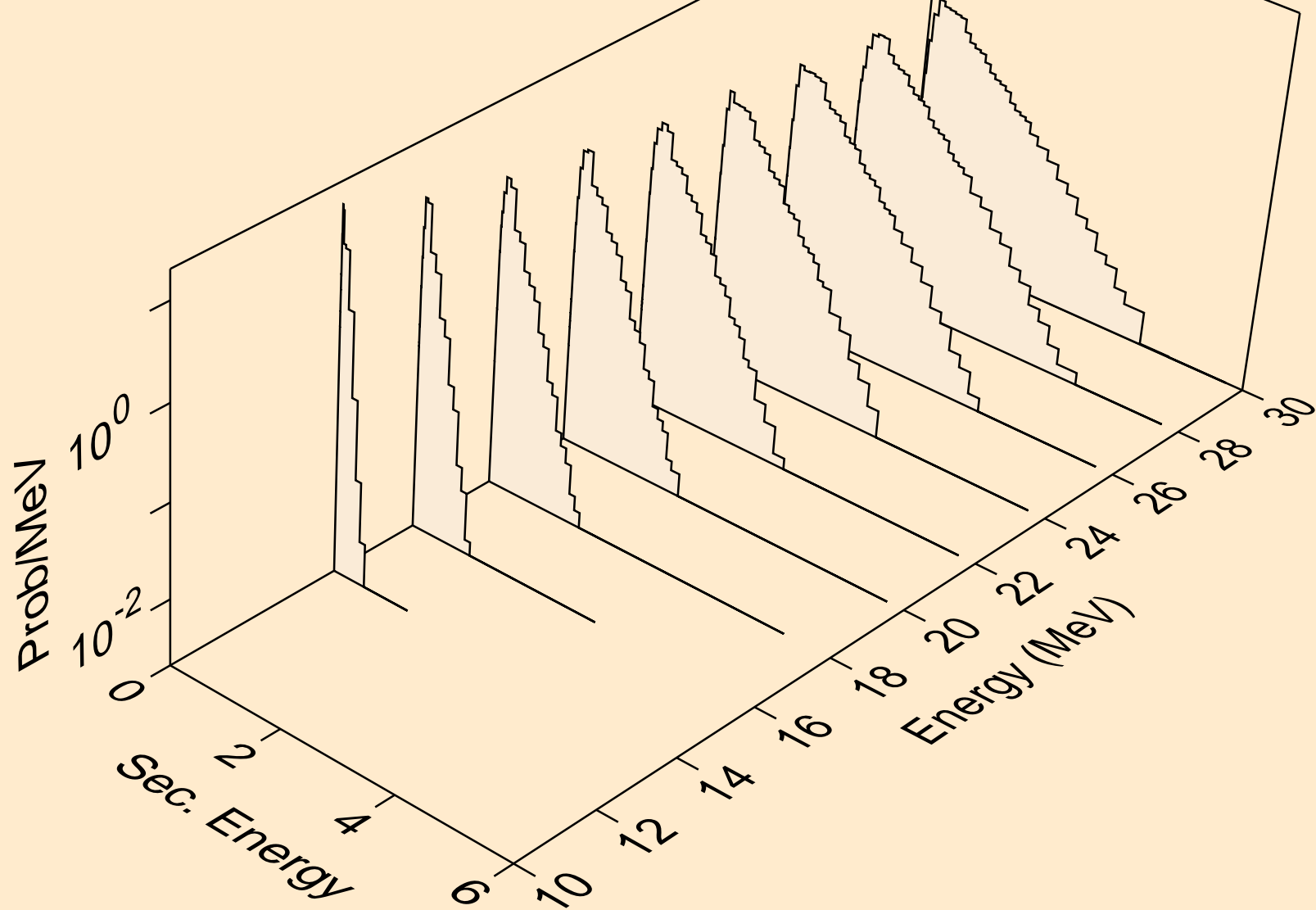

AU197M NEUTRON ACER TENDL-2021 LIBRARY; T=293.6K
Neutron emission for (n,n*)t

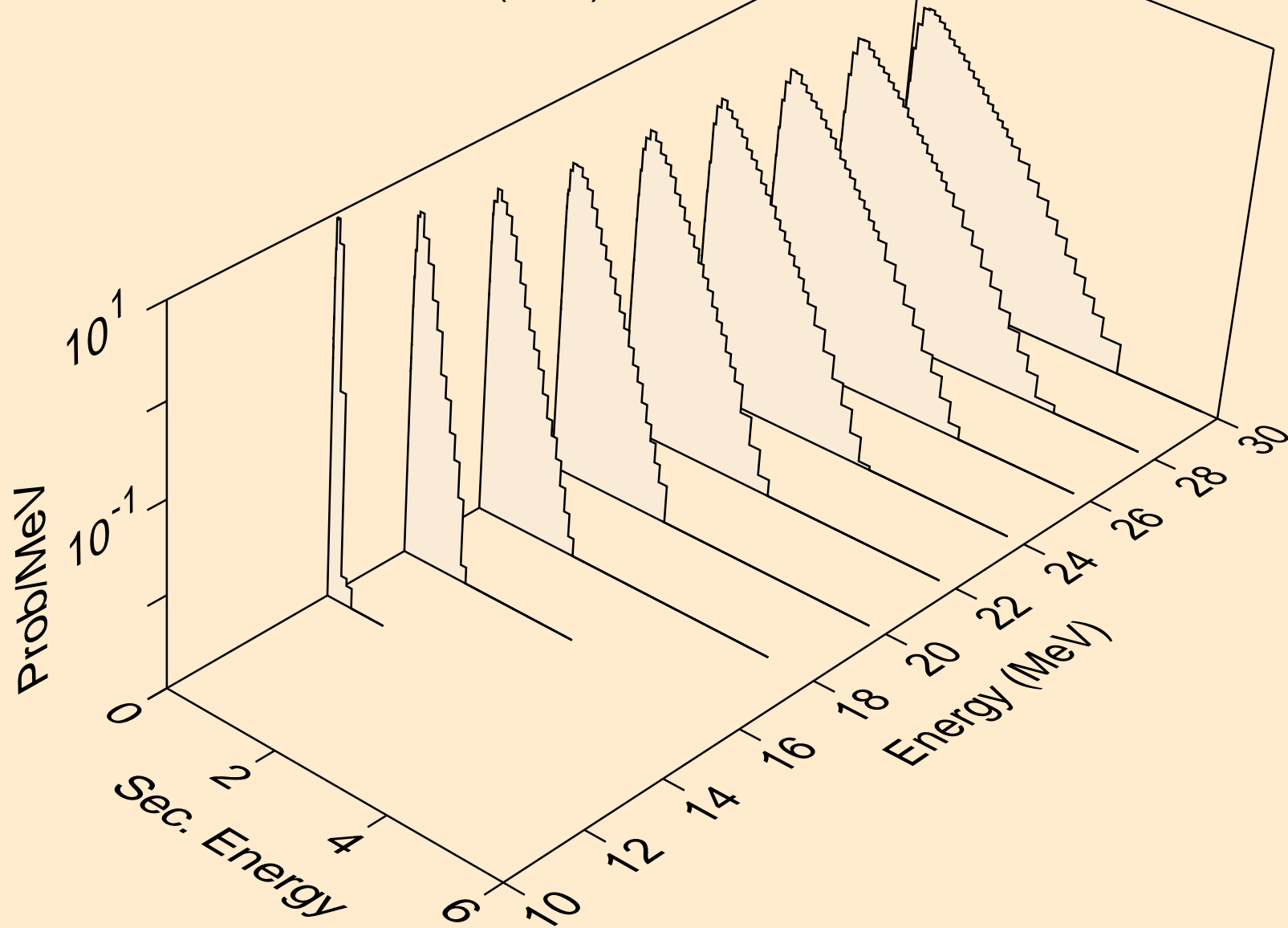

AU197M NEUTRON ACER TENDL-2021 LIBRARY; T=293.6K
Neutron emission for (n,n*)he3

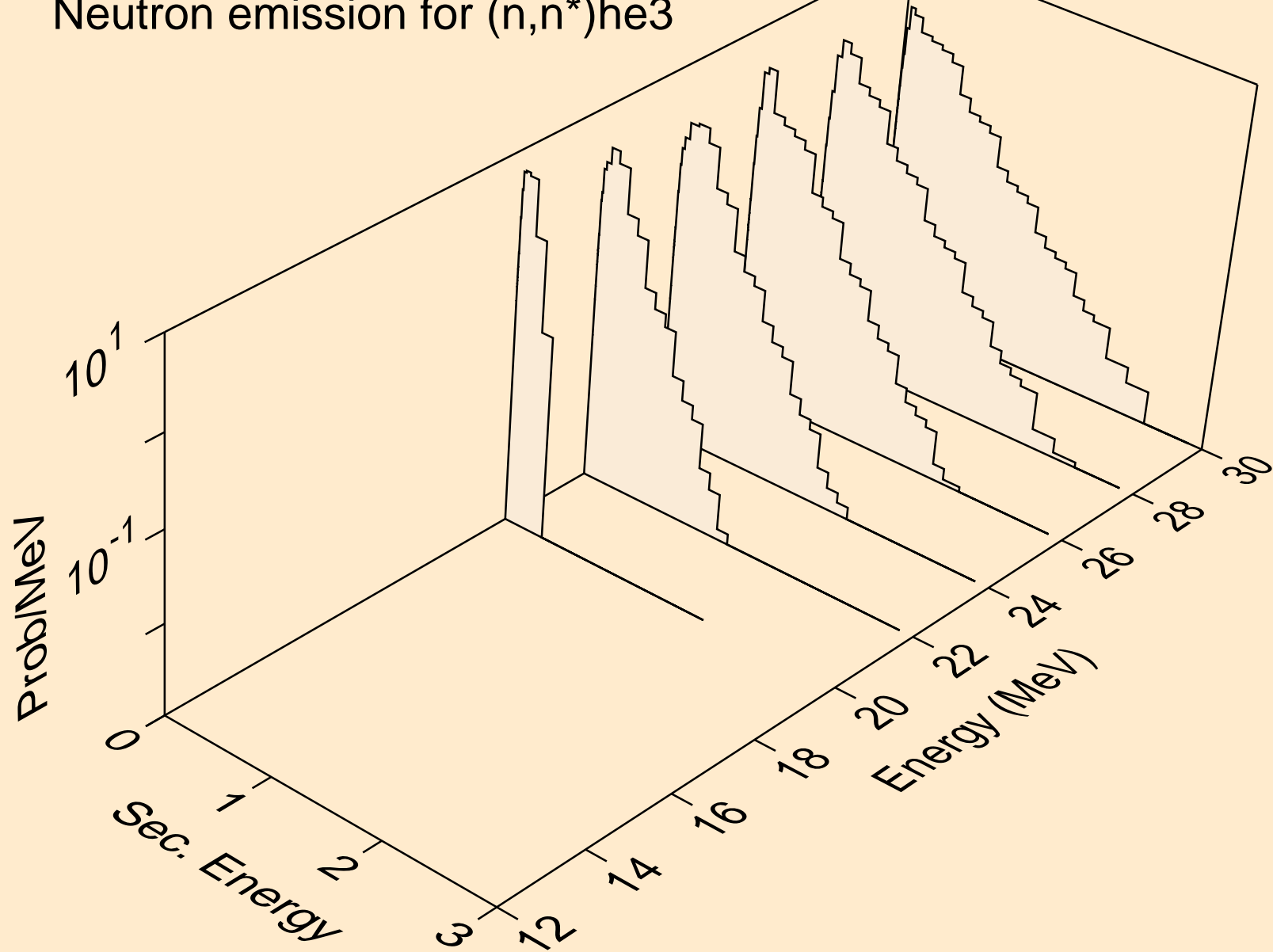

AU197M NEUTRON ACER TENDL-2021 LIBRARY; T=293.6K
Neutron emission for (n,4n)

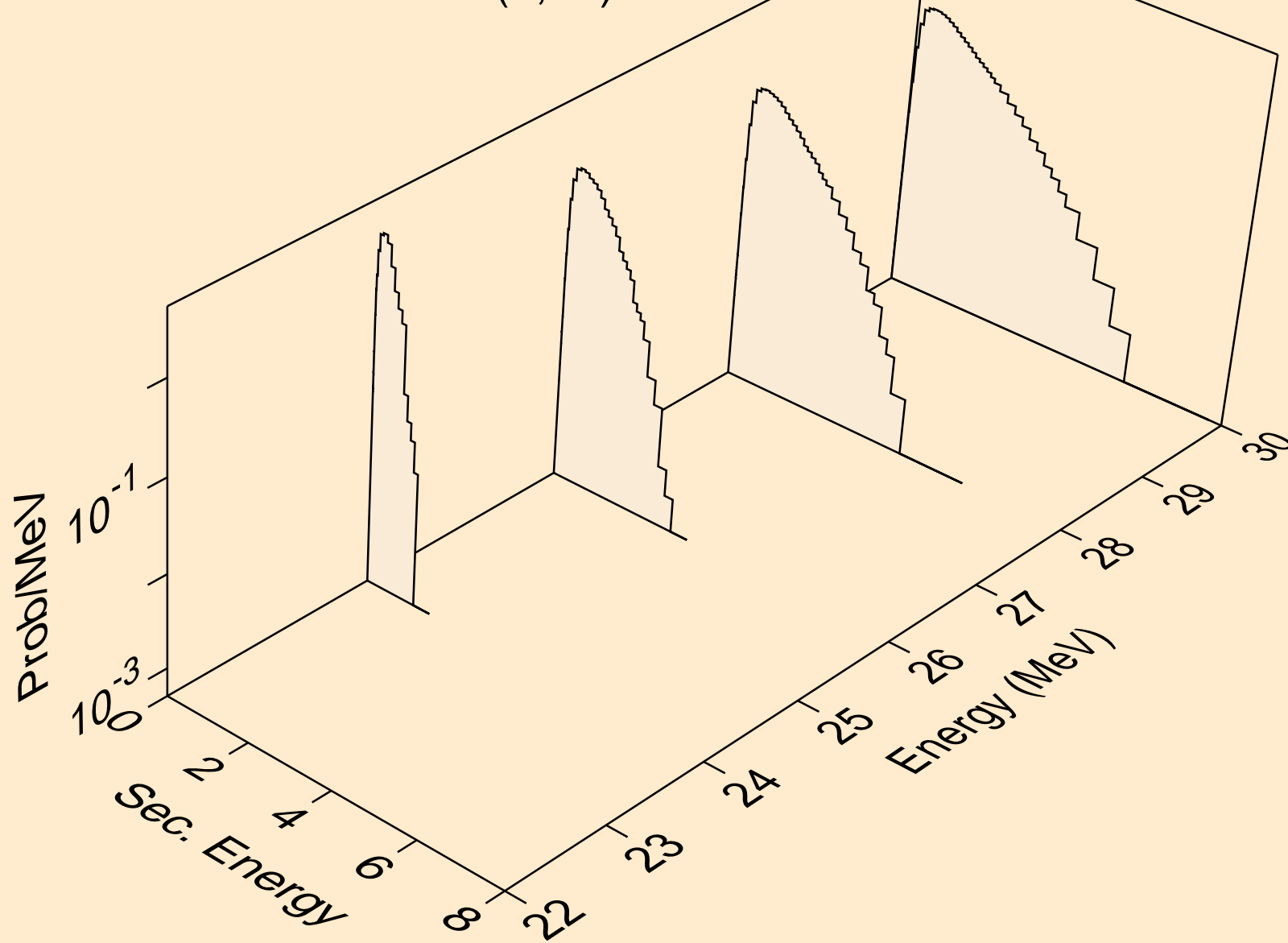

AU197M NEUTRON ACER TENDL-2021 LIBRARY; T=293.6K
Neutron emission for (n,2np)

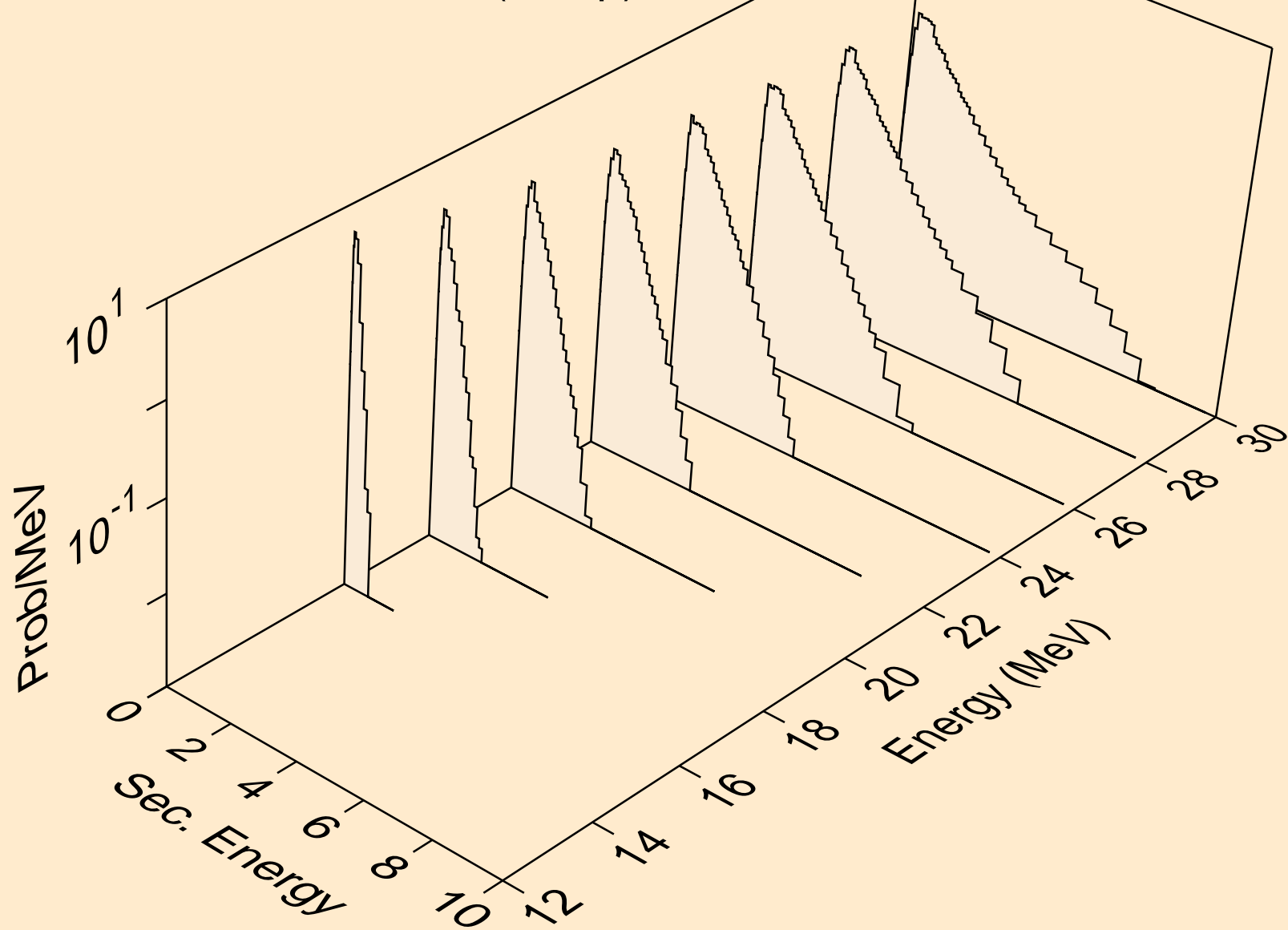

AU197M NEUTRON ACER TENDL-2021 LIBRARY; T=293.6K
Neutron emission for (n,3np)

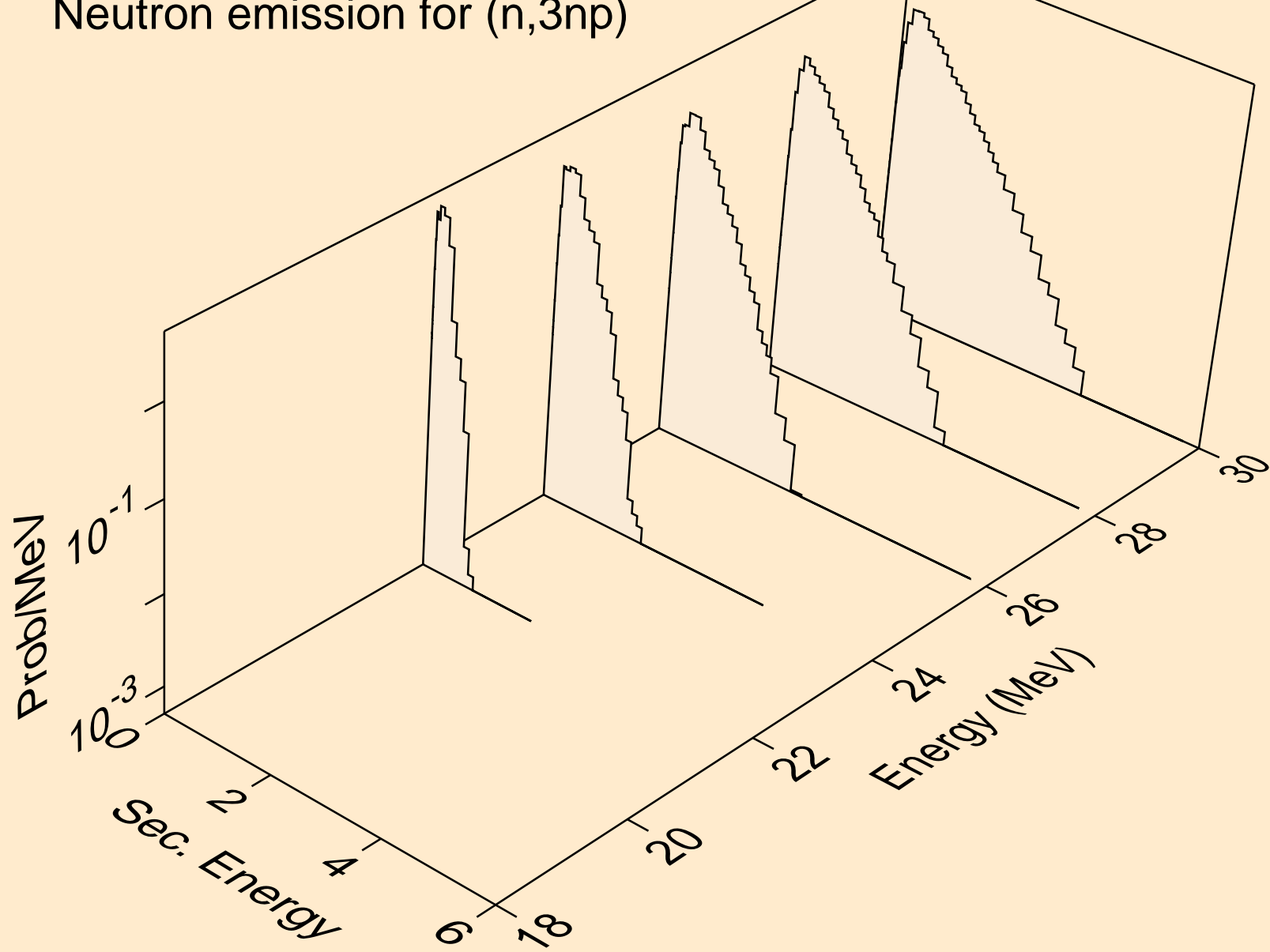

AU197M NEUTRON ACER TENDL-2021 LIBRARY; T=293.6K
Neutron emission for (n,2np)

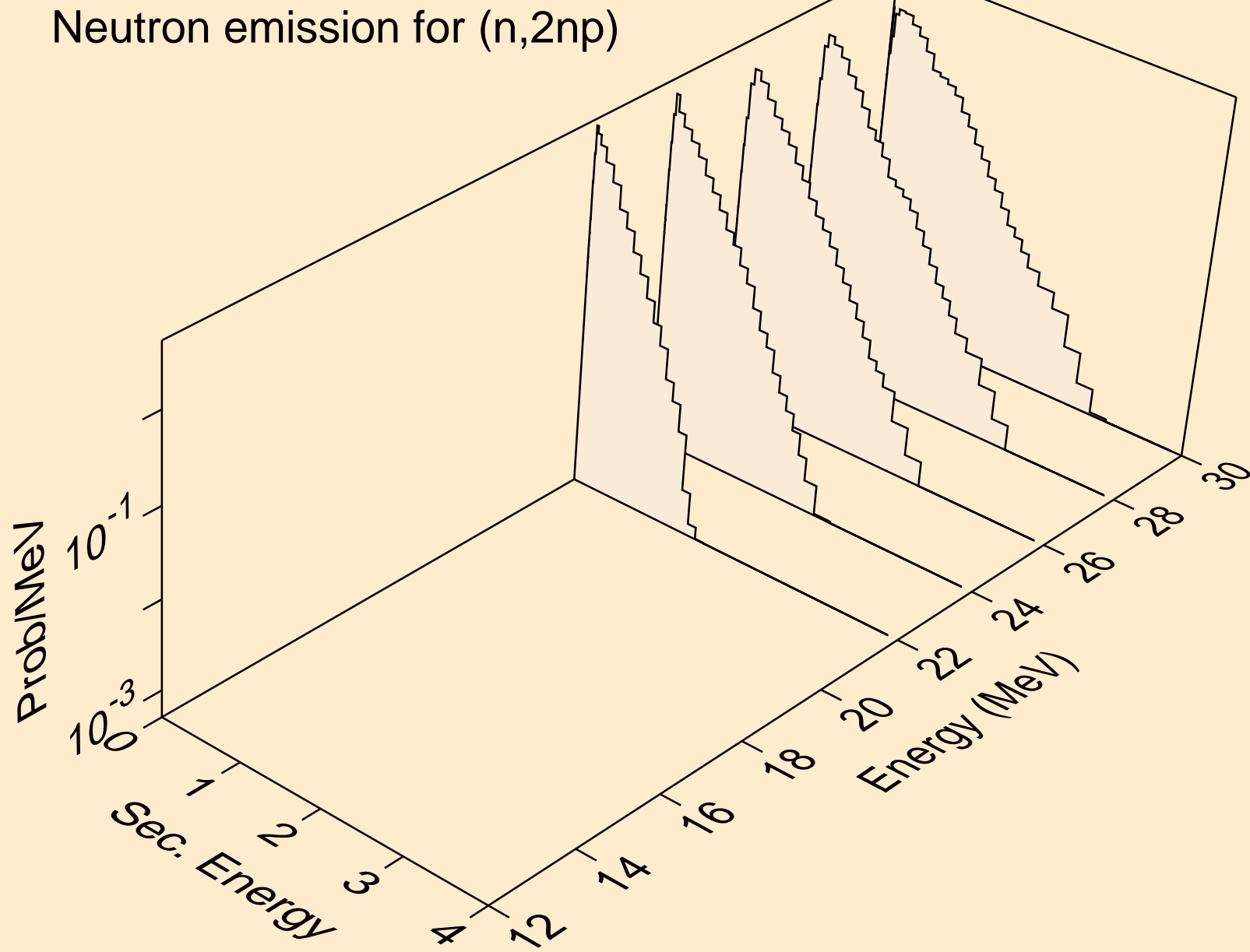

AU197M NEUTRON ACER TENDL-2021 LIBRARY; T=293.6K
Neutron emission for (n,npa)

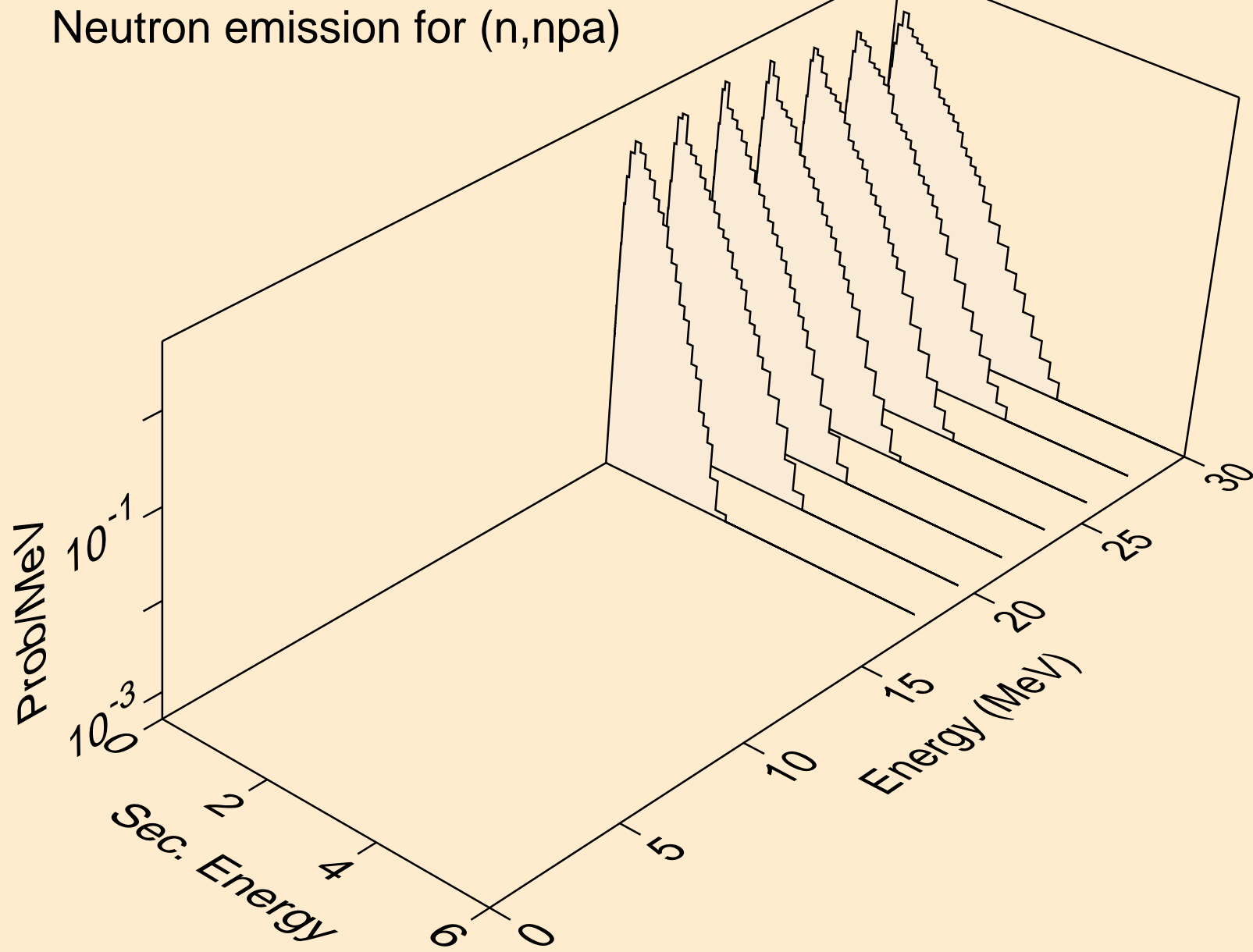

AU197M NEUTRON ACER TENDL-2021 LIBRARY; T=293.6K
Neutron emission for (n,n*c)

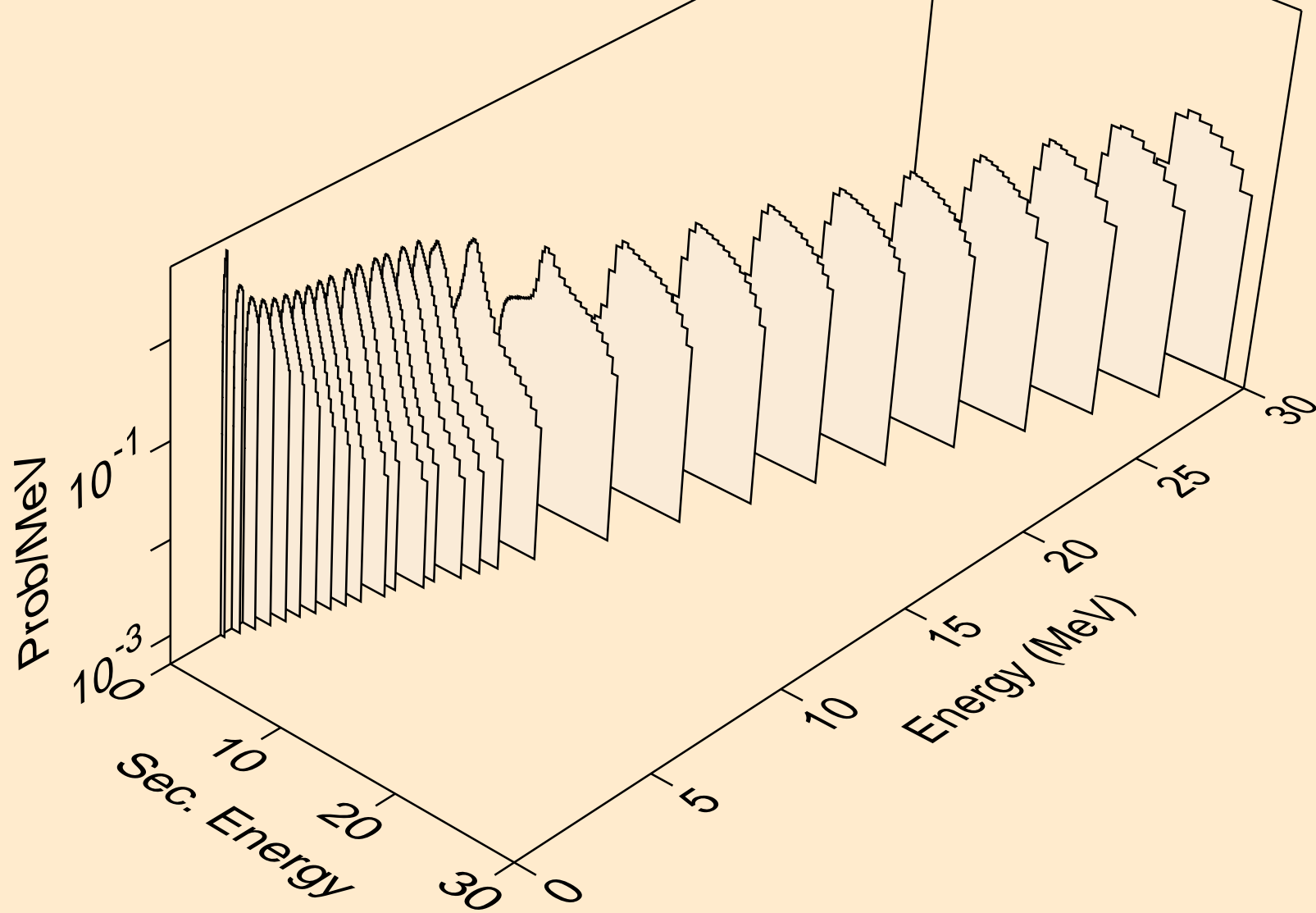

AU197M NEUTRON ACER TENDL-2021 LIBRARY; T=293.6K
Photon emission for (n,x)

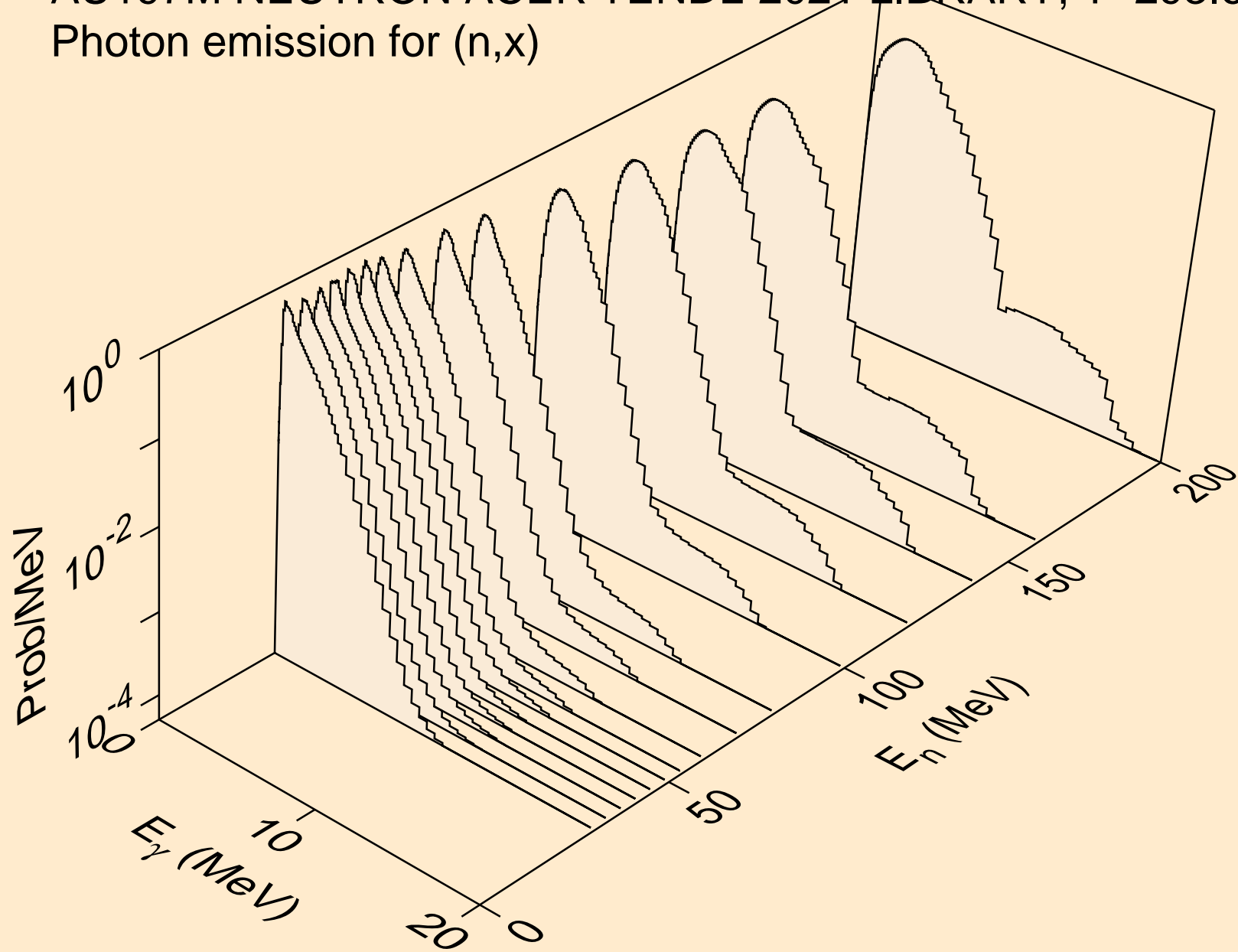

AU197M NEUTRON ACER TENDL-2021 LIBRARY; T=293.6K
Photon emission for (n,2nd)

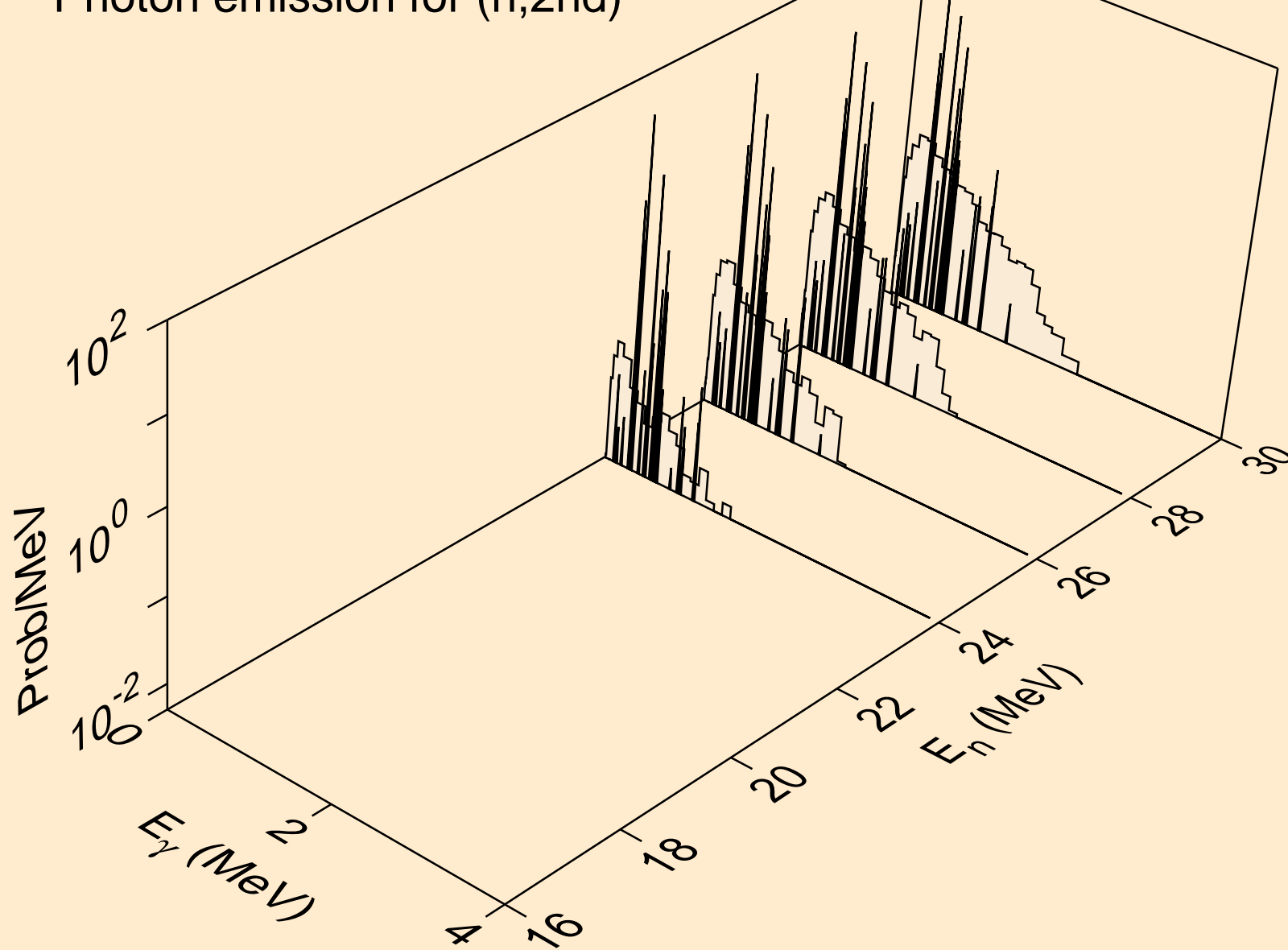

AU197M NEUTRON ACER TENDL-2021 LIBRARY; T=293.6K
Photon emission for (n,2n)

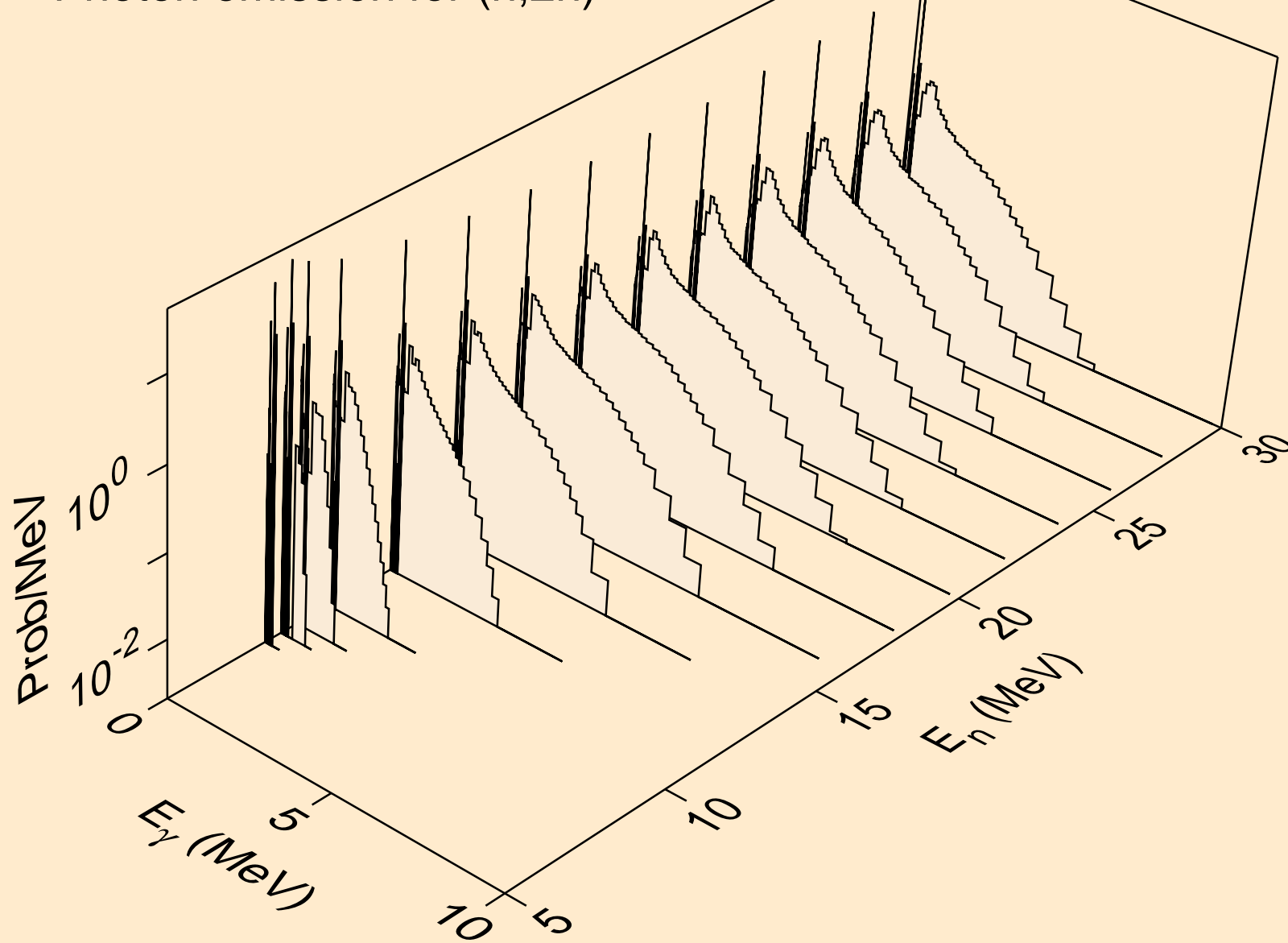

AU197M NEUTRON ACER TENDL-2021 LIBRARY; T=293.6K
Photon emission for (n,3n)

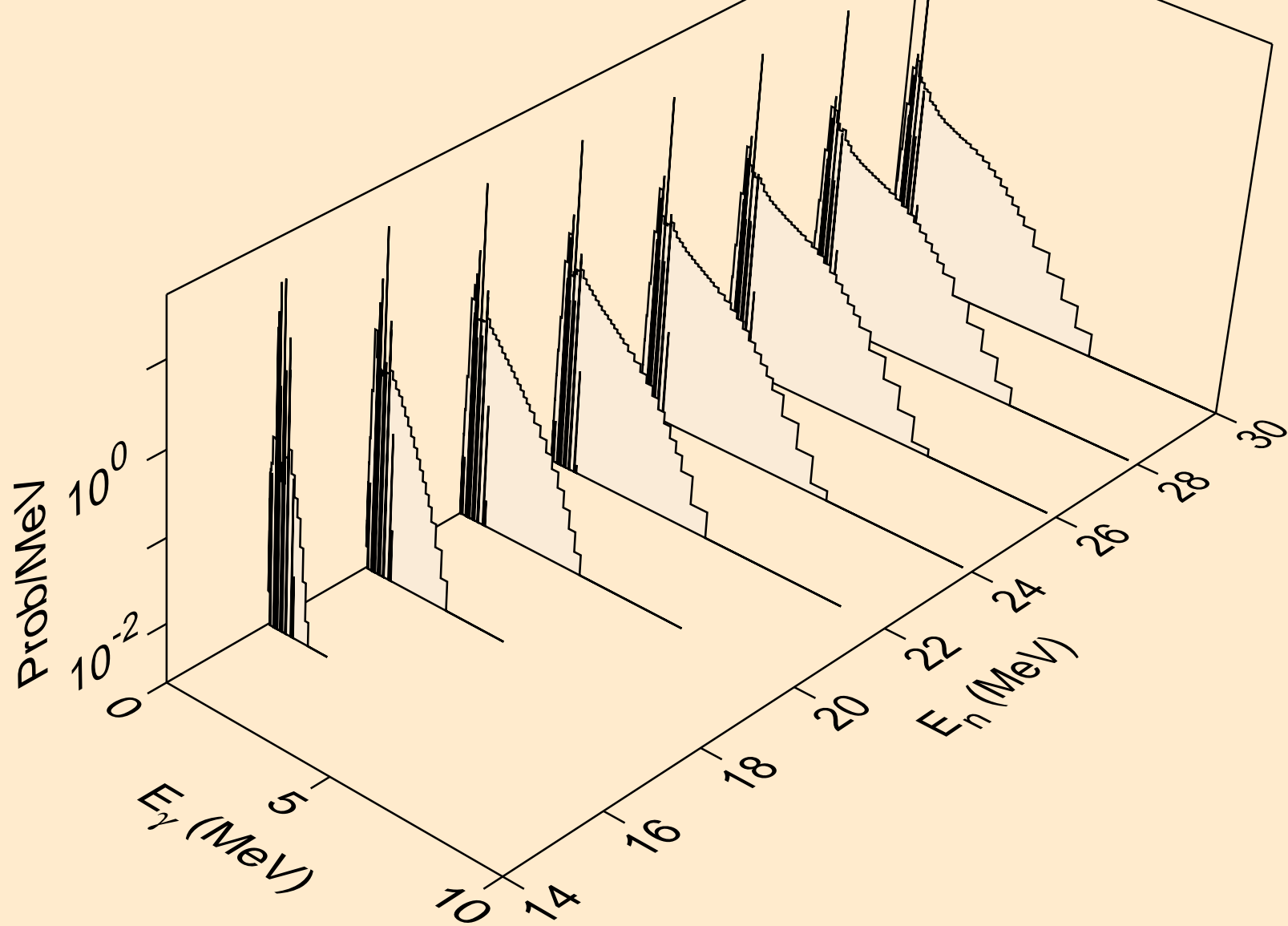

AU197M NEUTRON ACER TENDL-2021 LIBRARY; T=293.6K
Photon emission for (n,n*)a

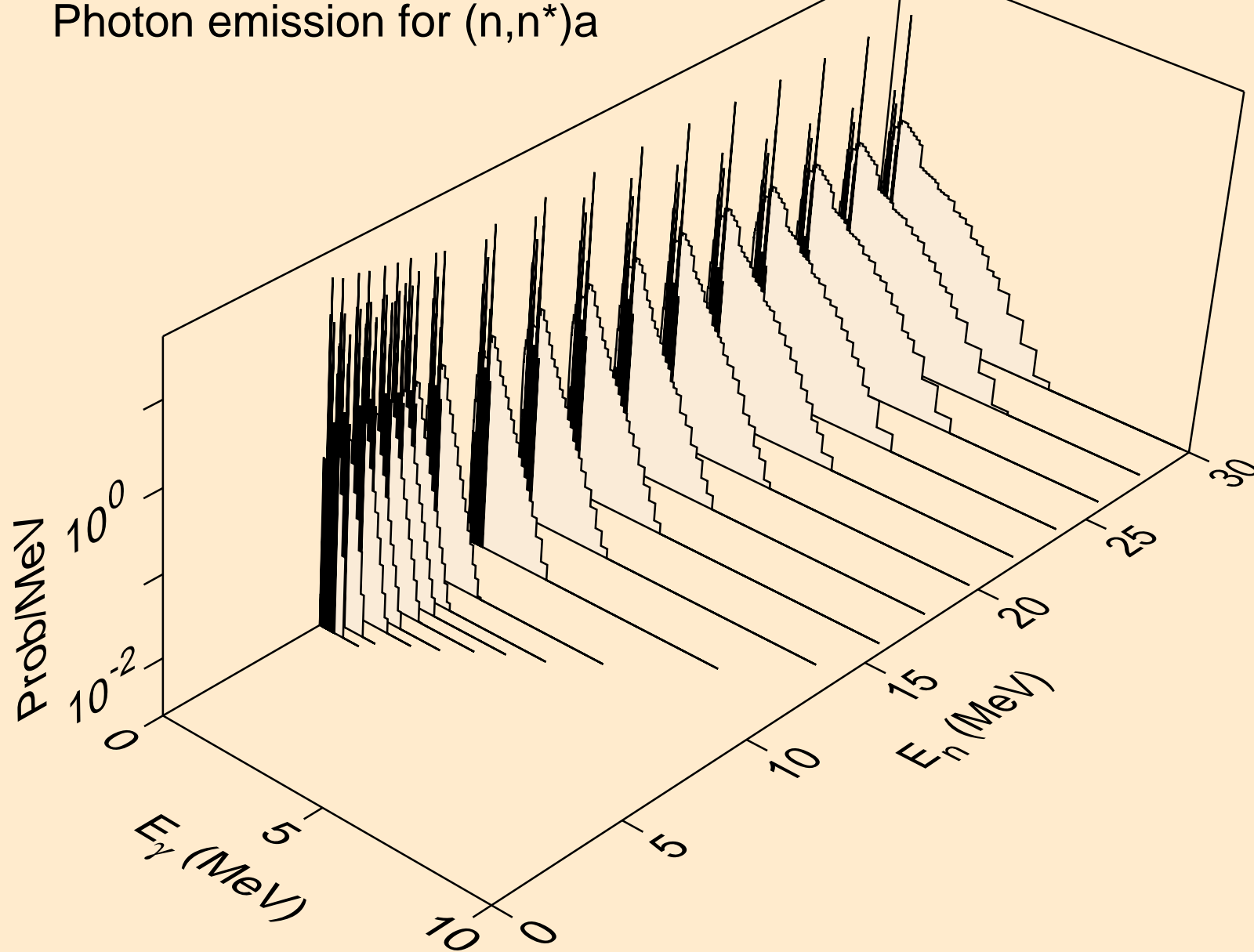

AU197M NEUTRON ACER TENDL-2021 LIBRARY; T=293.6K
Photon emission for (n,2n)a

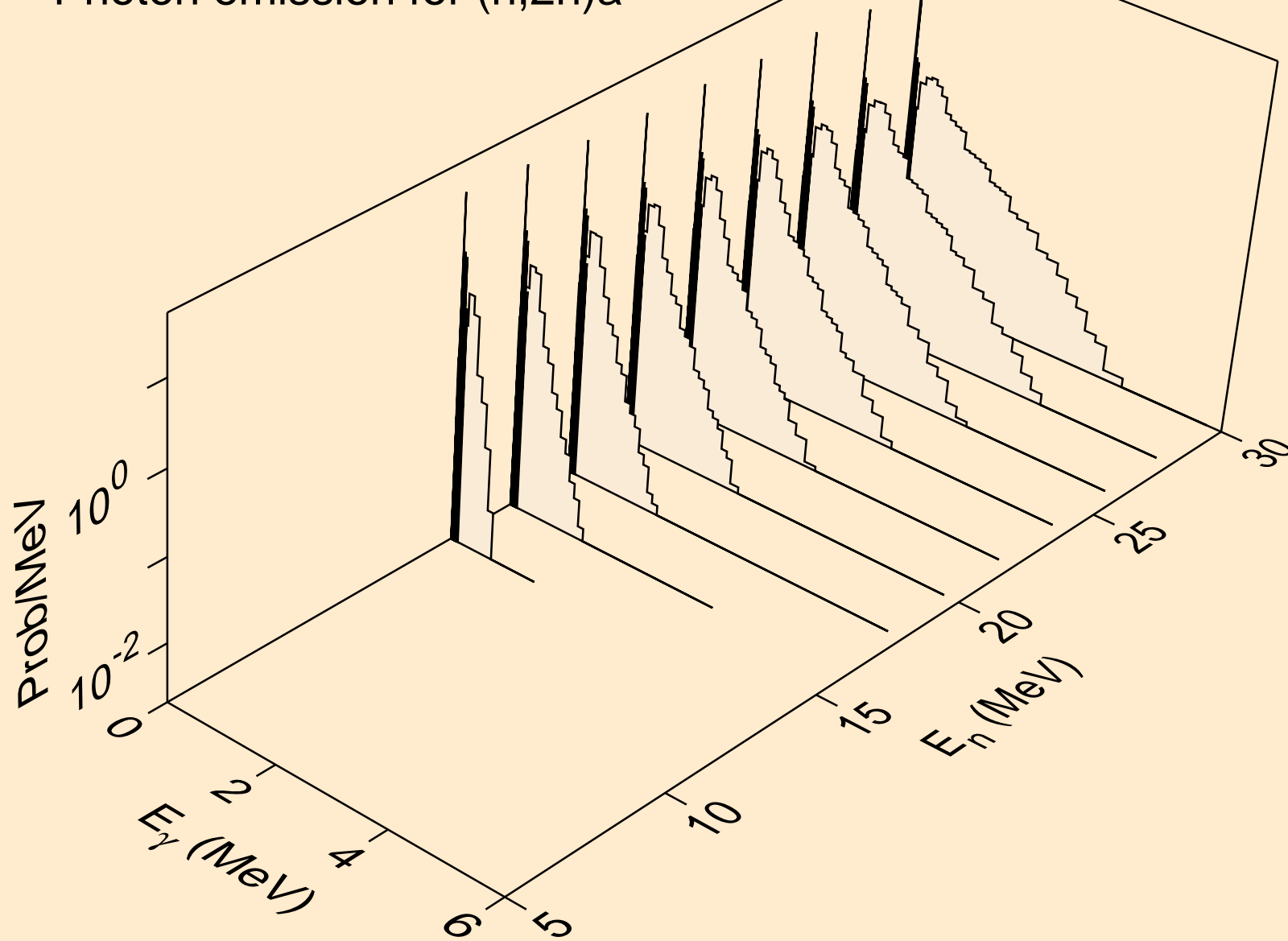

AU197M NEUTRON ACER TENDL-2021 LIBRARY; T=293.6K
Photon emission for (n,3n)a

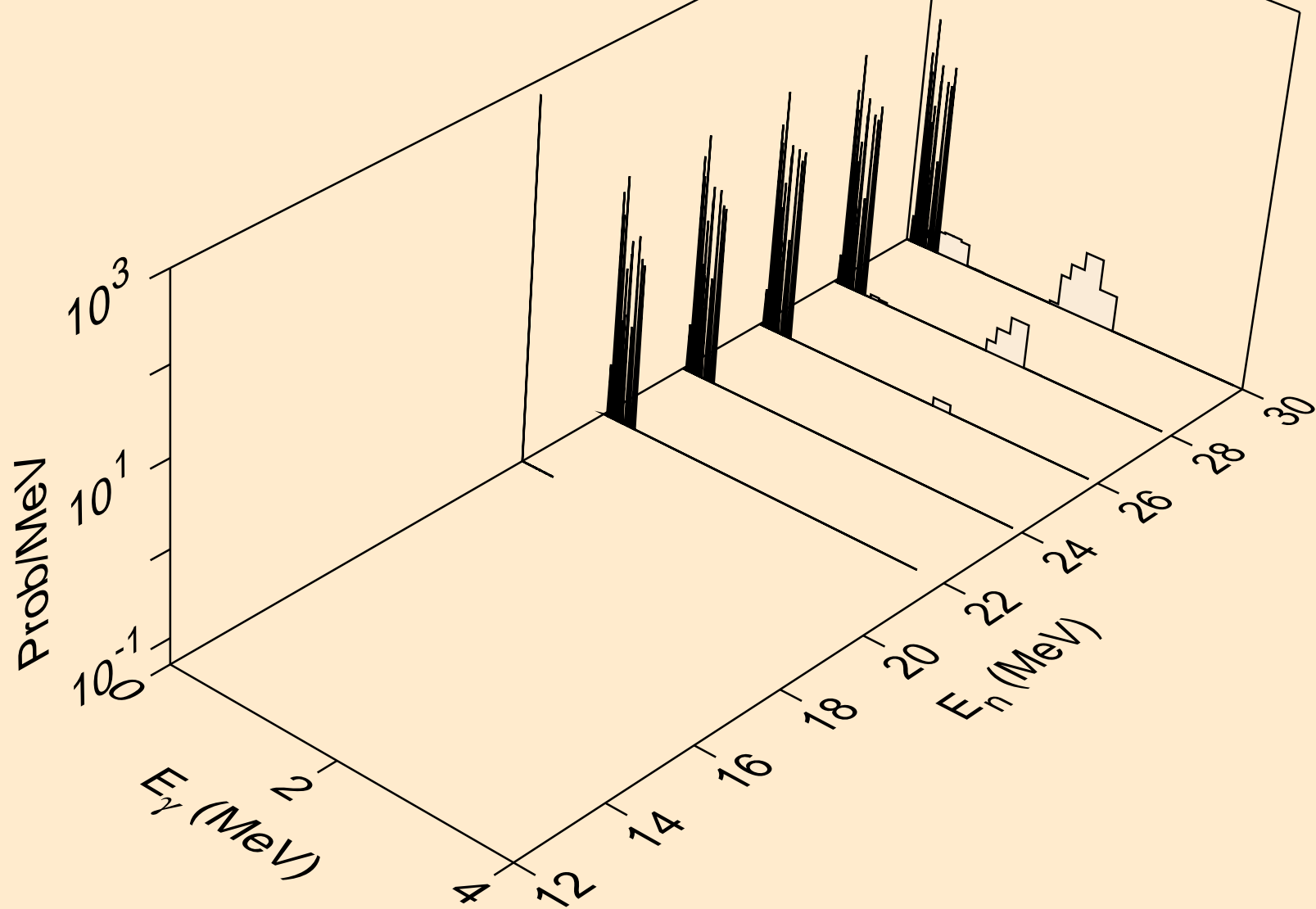

AU197M NEUTRON ACER TENDL-2021 LIBRARY; T=293.6K
Photon emission for (n,n*)p

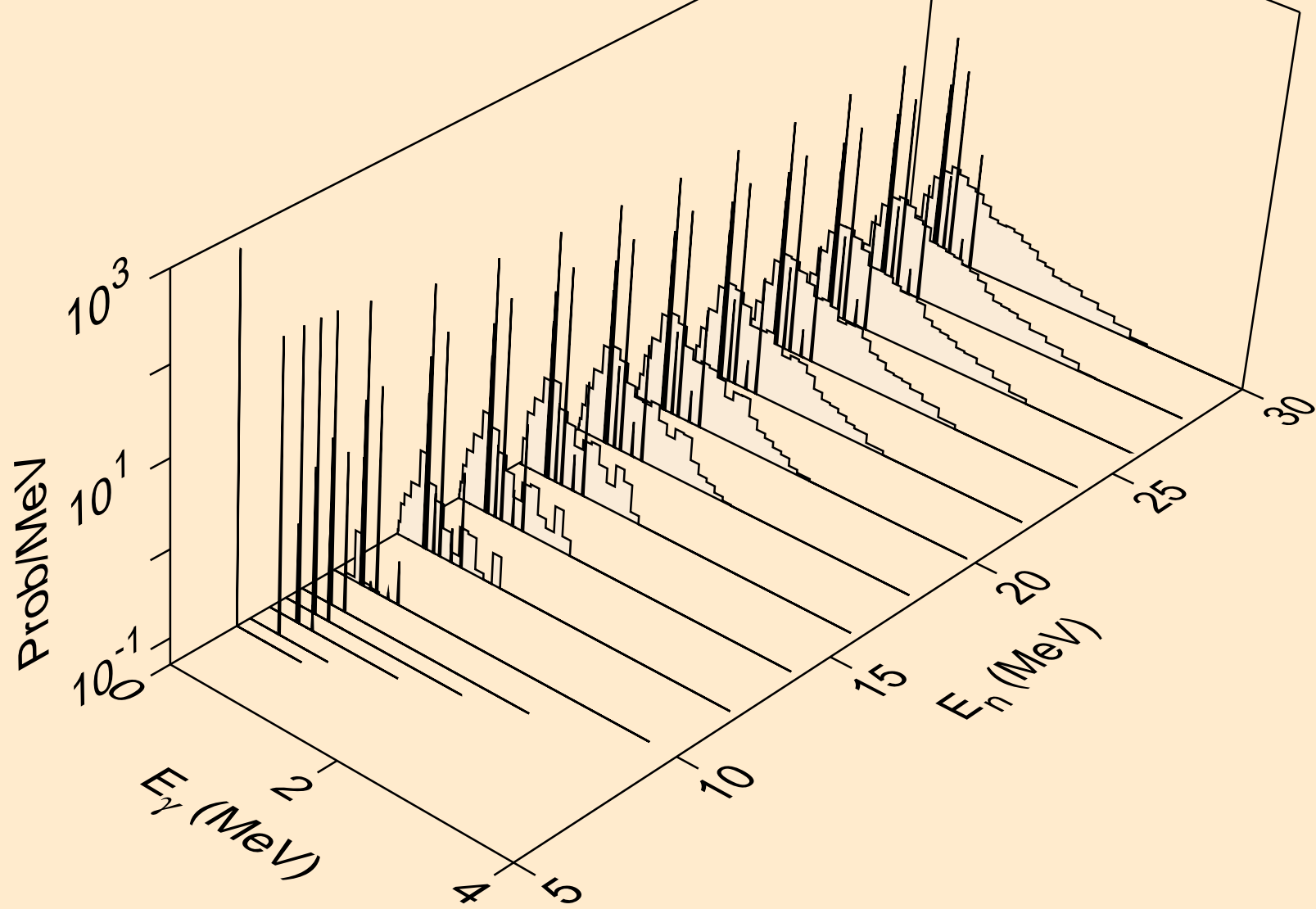

AU197M NEUTRON ACER TENDL-2021 LIBRARY; T=293.6K
Photon emission for (n,n*)d

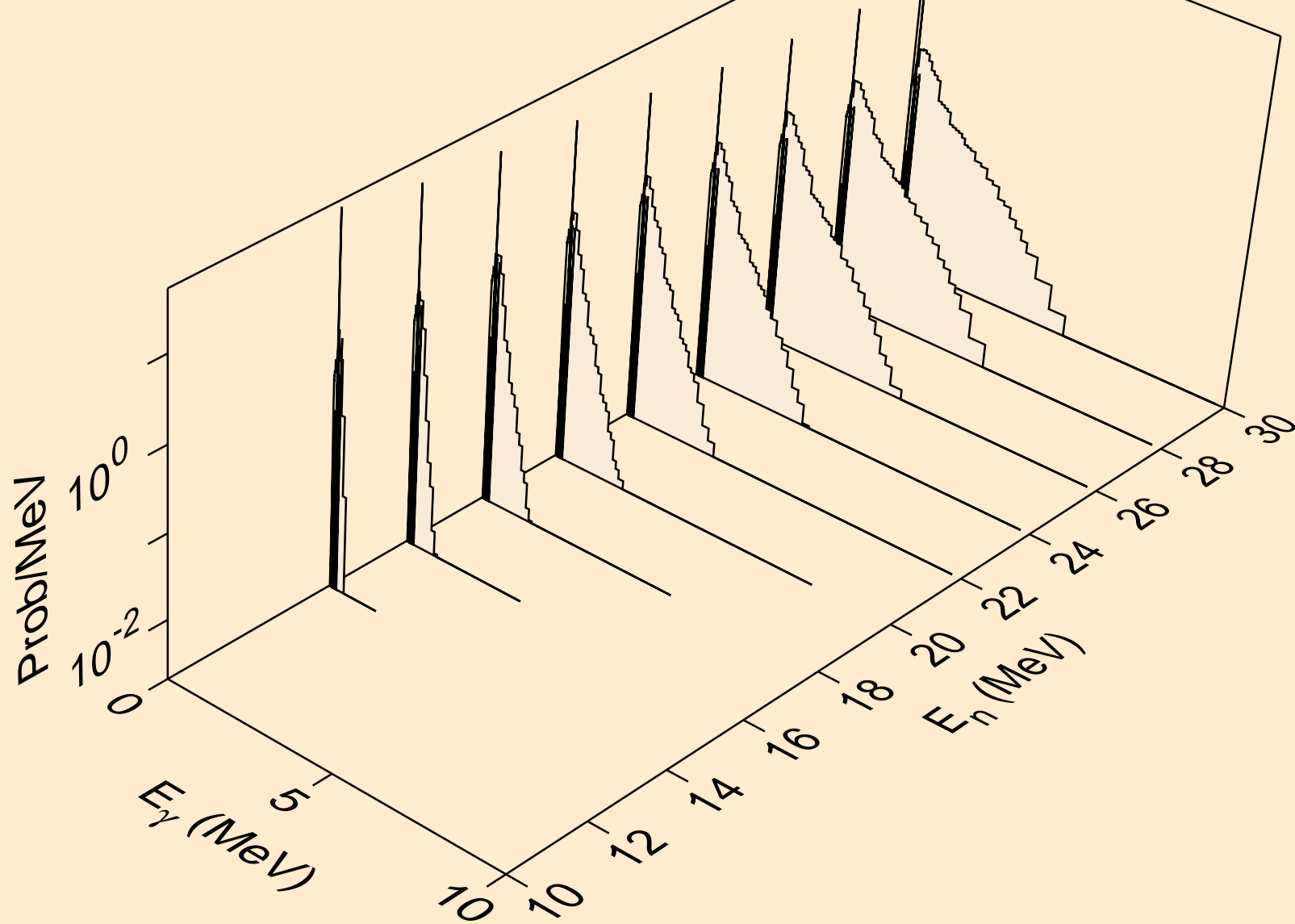

AU197M NEUTRON ACER TENDL-2021 LIBRARY; T=293.6K
Photon emission for (n,n*)t

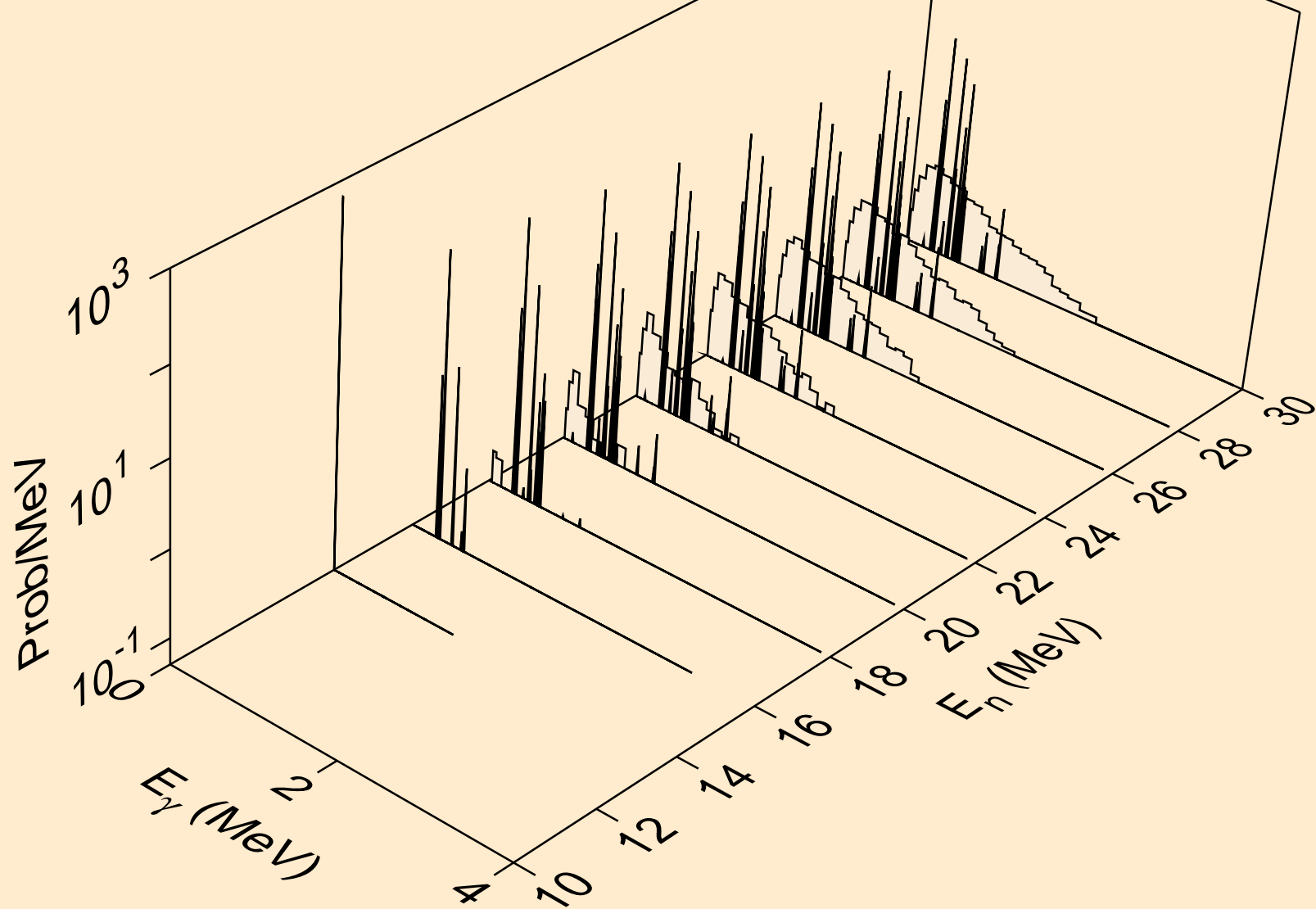

AU197M NEUTRON ACER TENDL-2021 LIBRARY; T=293.6K
Photon emission for (n,n*)he3

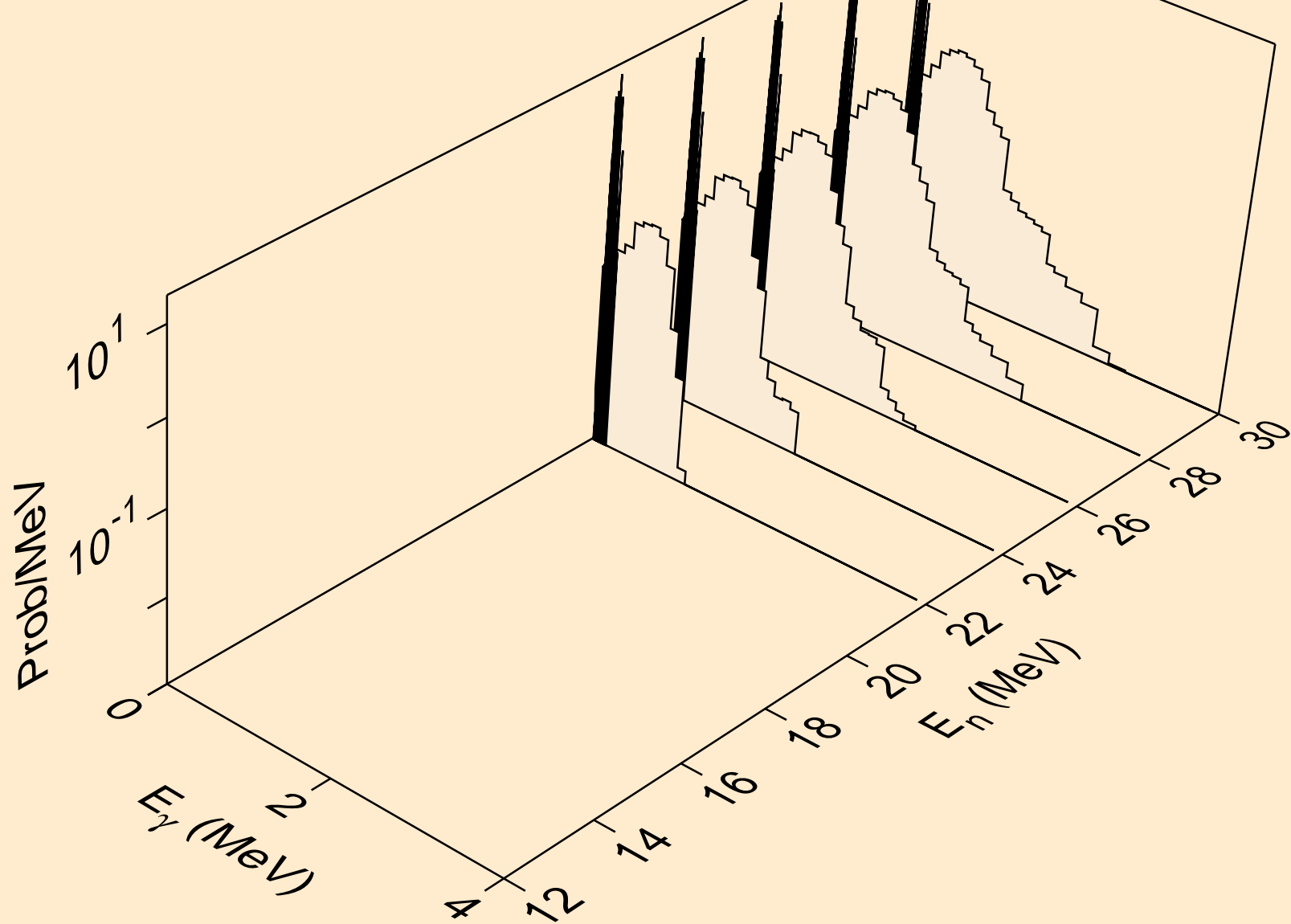

AU197M NEUTRON ACER TENDL-2021 LIBRARY; T=293.6K
Photon emission for (n,4n)

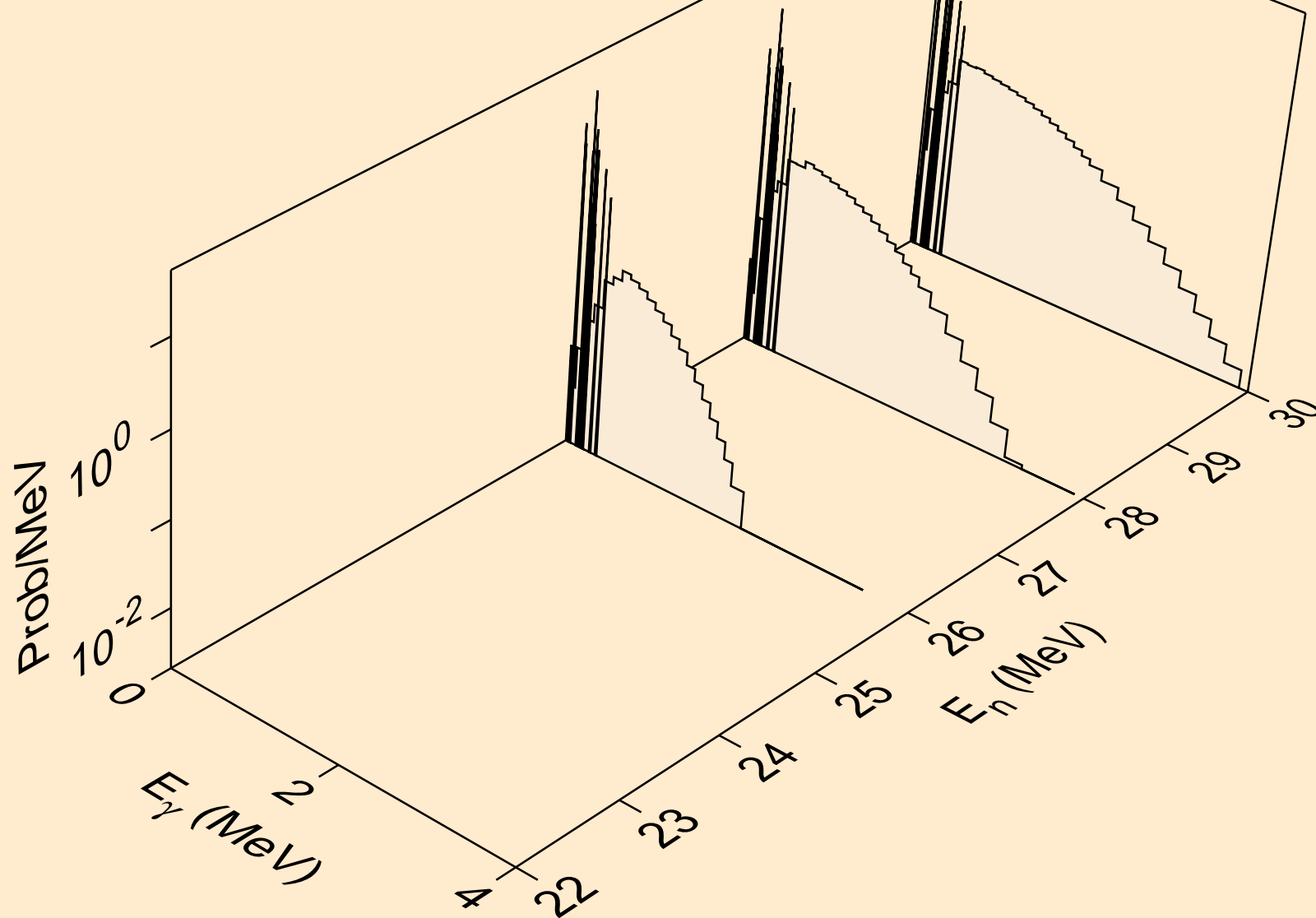

AU197M NEUTRON ACER TENDL-2021 LIBRARY; T=293.6K
Photon emission for (n,2np)

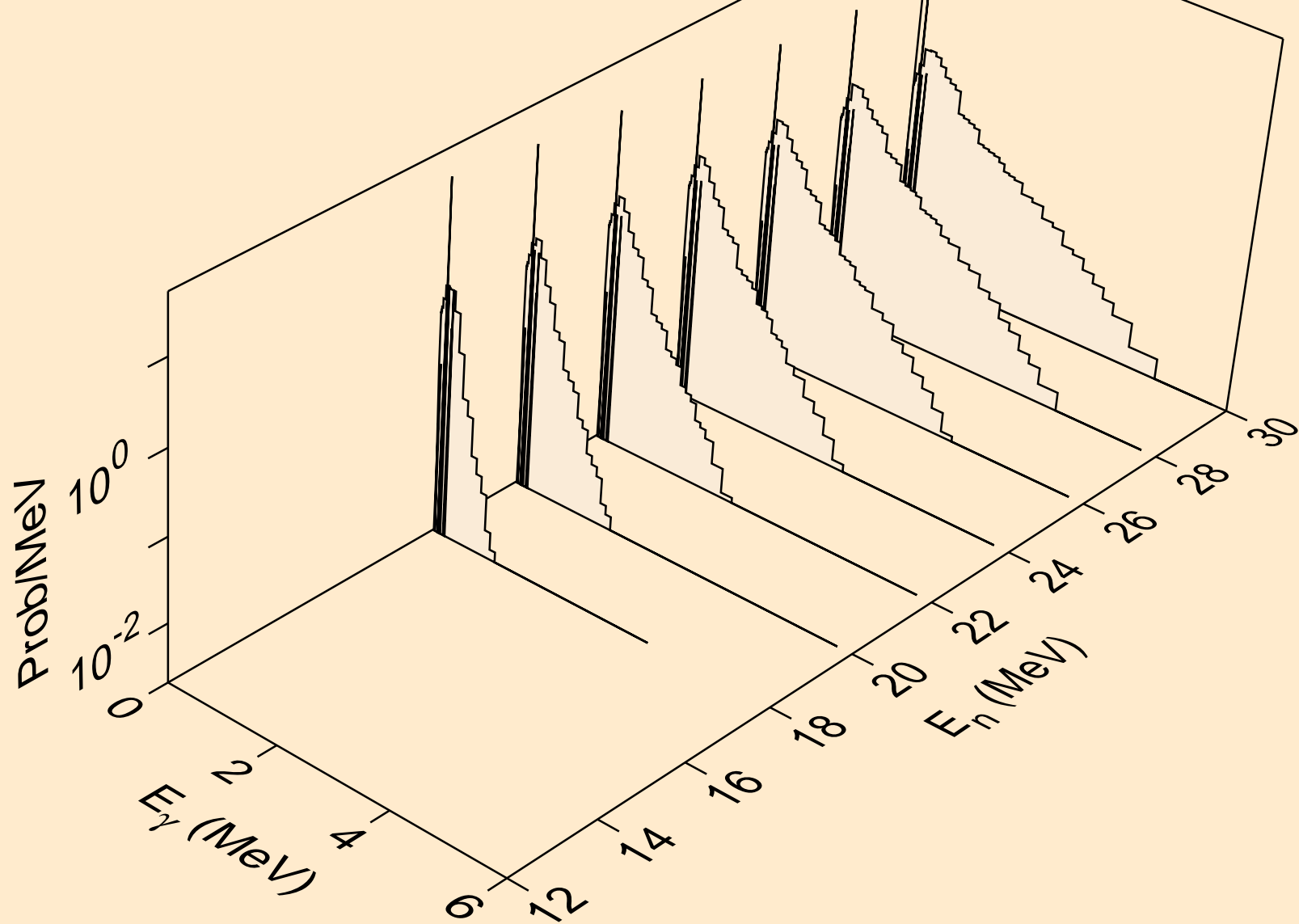

AU197M NEUTRON ACER TENDL-2021 LIBRARY; T=293.6K
Photon emission for (n,3np)

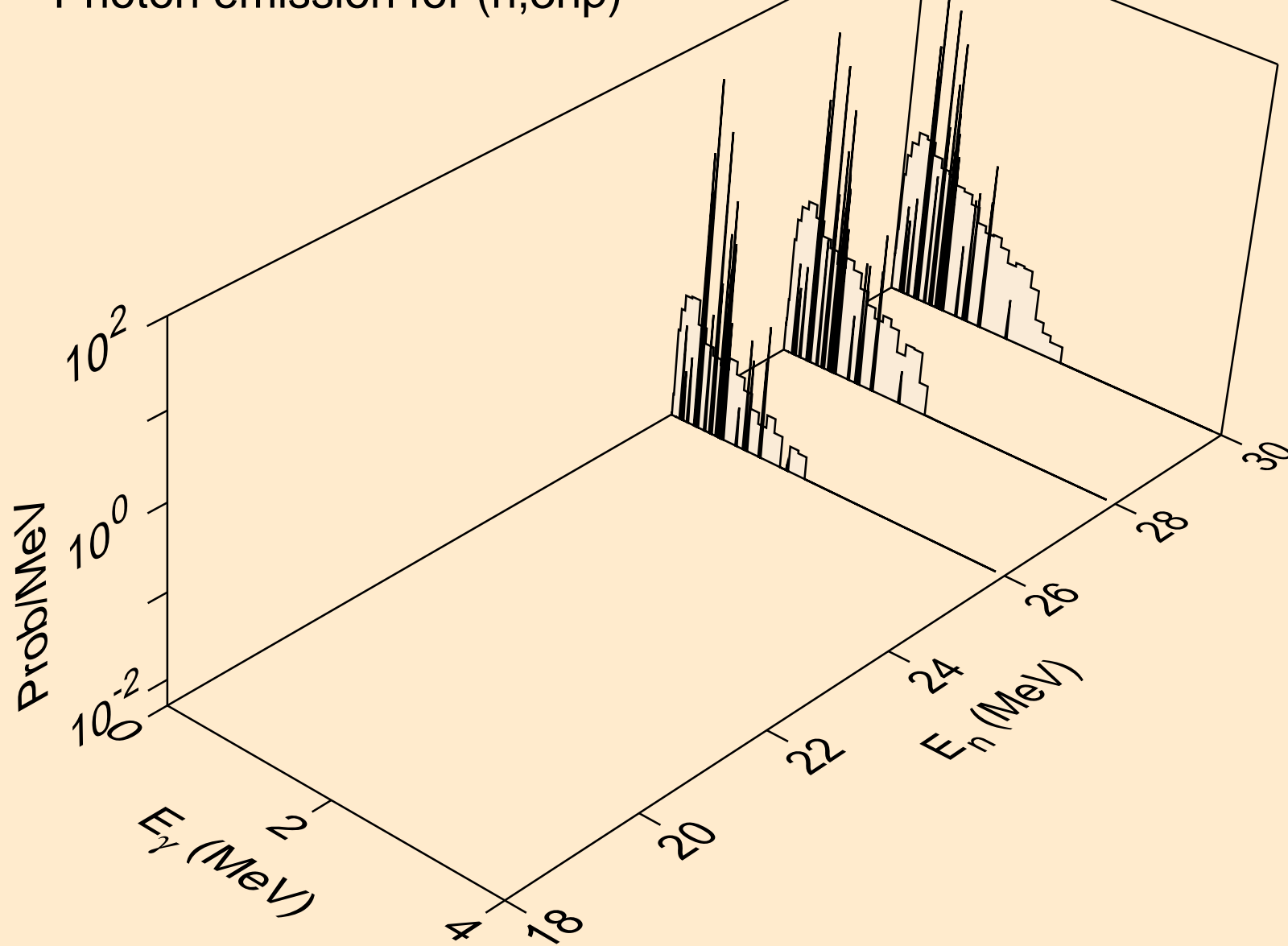

AU197M NEUTRON ACER TENDL-2021 LIBRARY; T=293.6K
Photon emission for (n,2np)

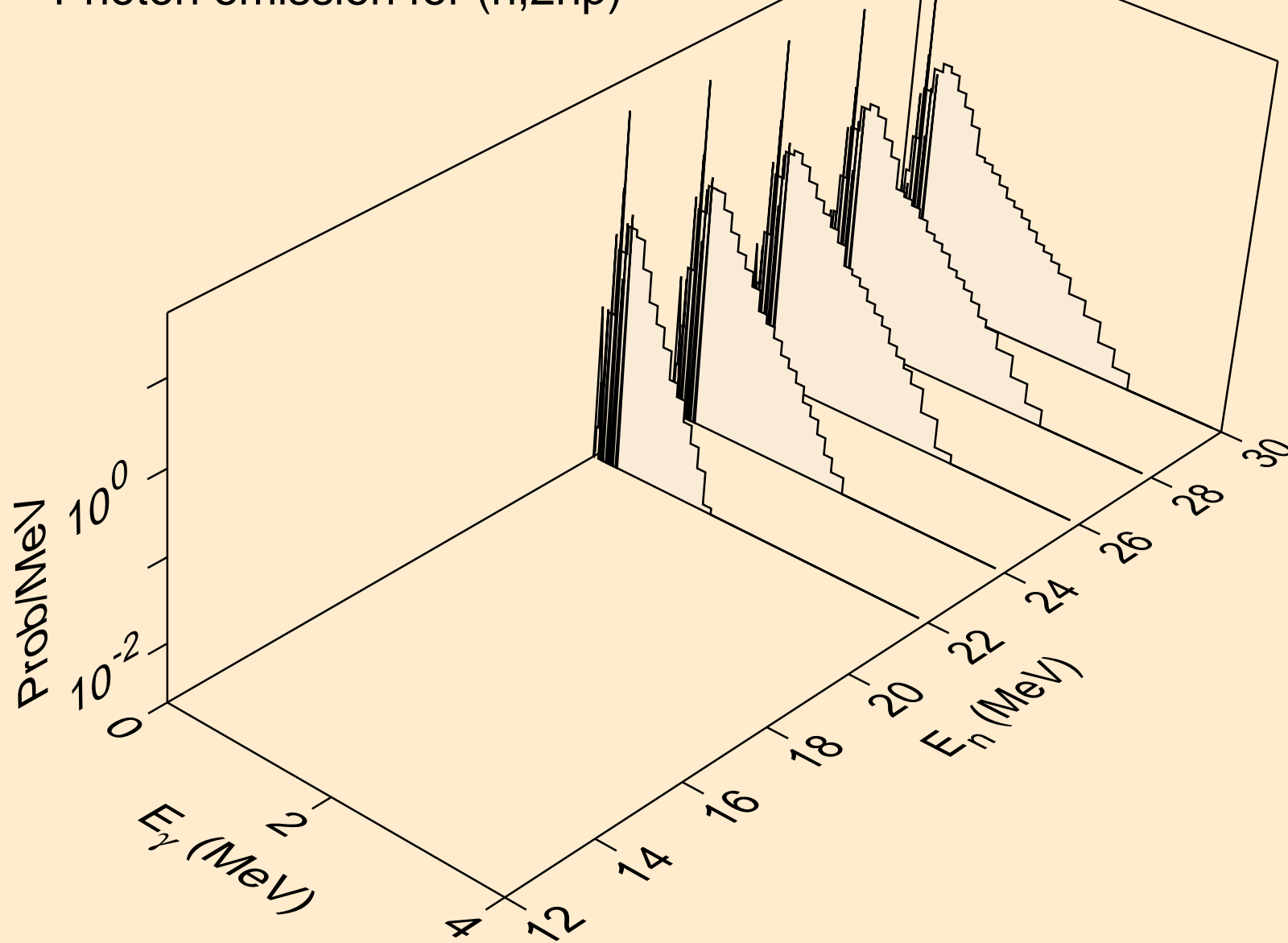

AU197M NEUTRON ACER TENDL-2021 LIBRARY; T=293.6K
Photon emission for (n,npa)

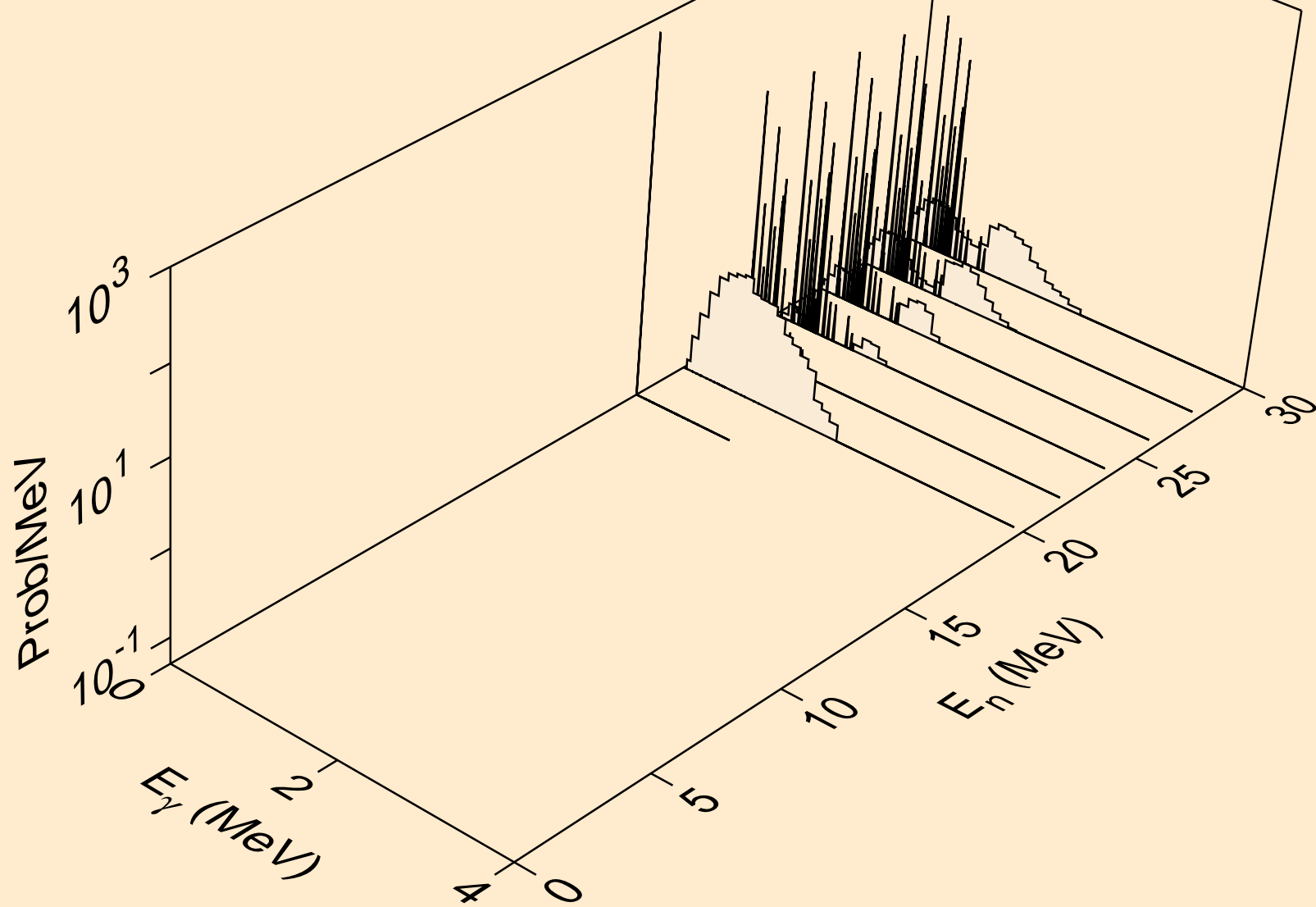

AU197M NEUTRON ACER TENDL-2021 LIBRARY; T=293.6K
Photon emission for (n,n*1)

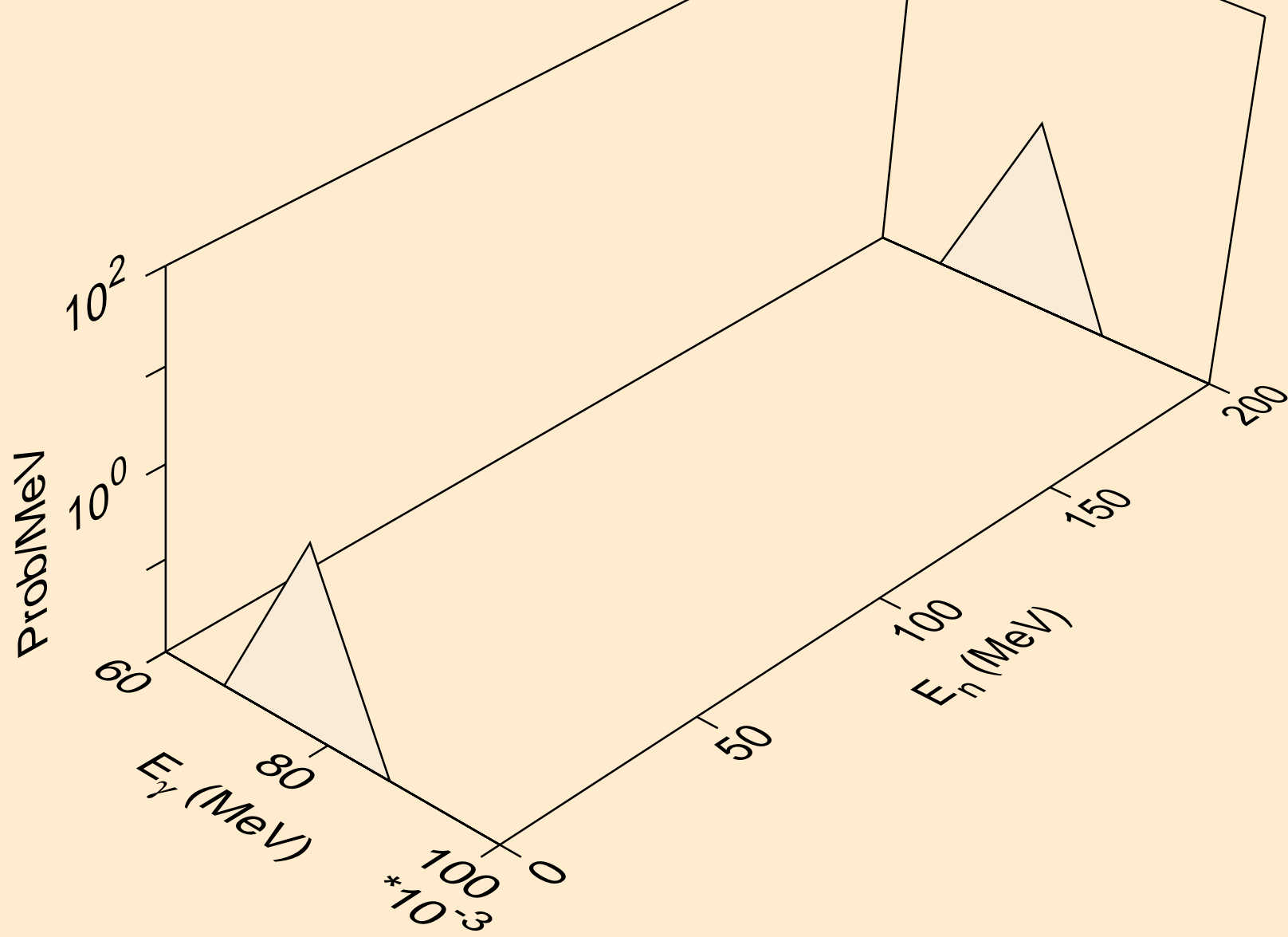

AU197M NEUTRON ACER TENDL-2021 LIBRARY; T=293.6K
Photon emission for (n,n*2)

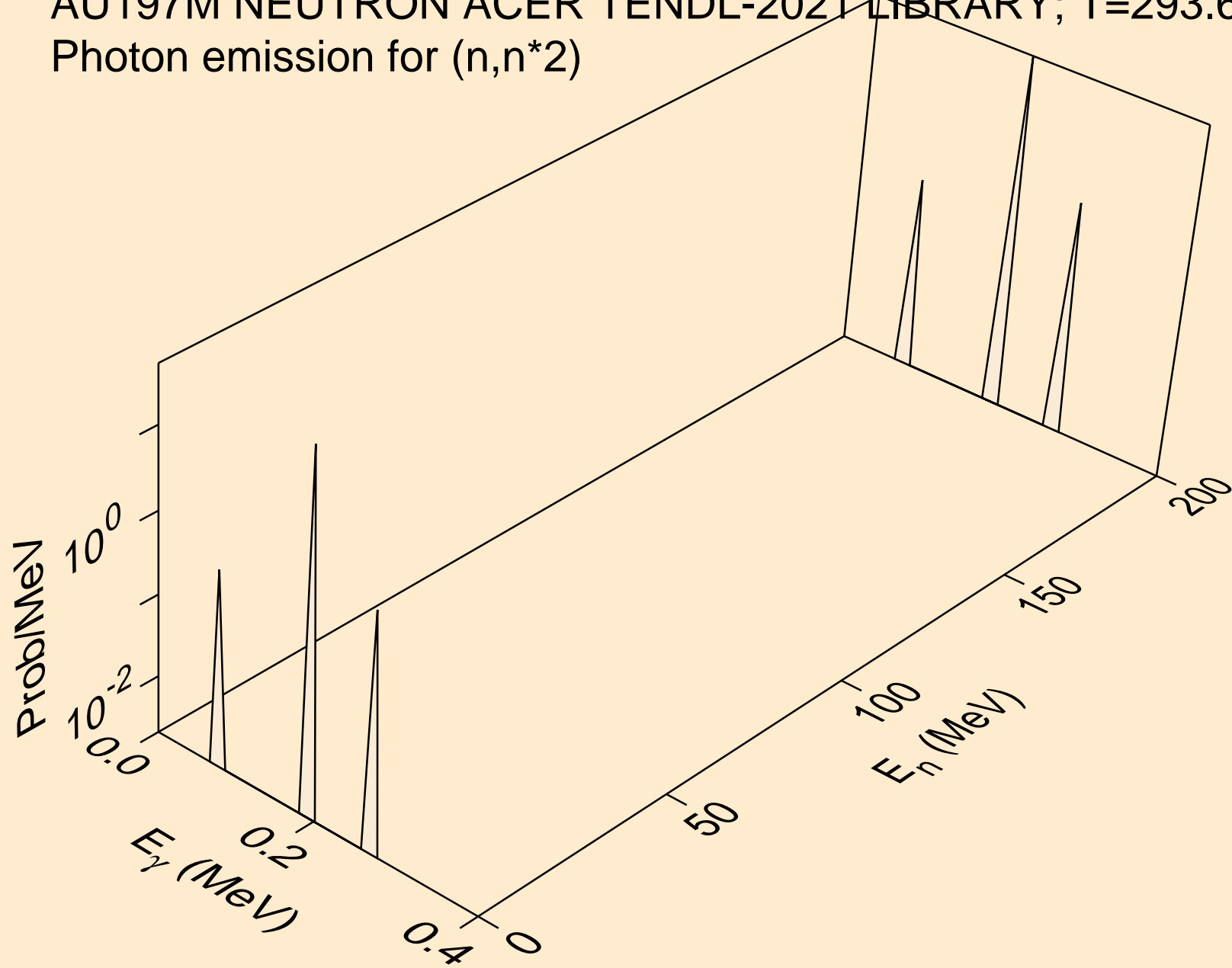

AU197M NEUTRON ACER TENDL-2021 LIBRARY; T=293.6K
Photon emission for (n,n*3)

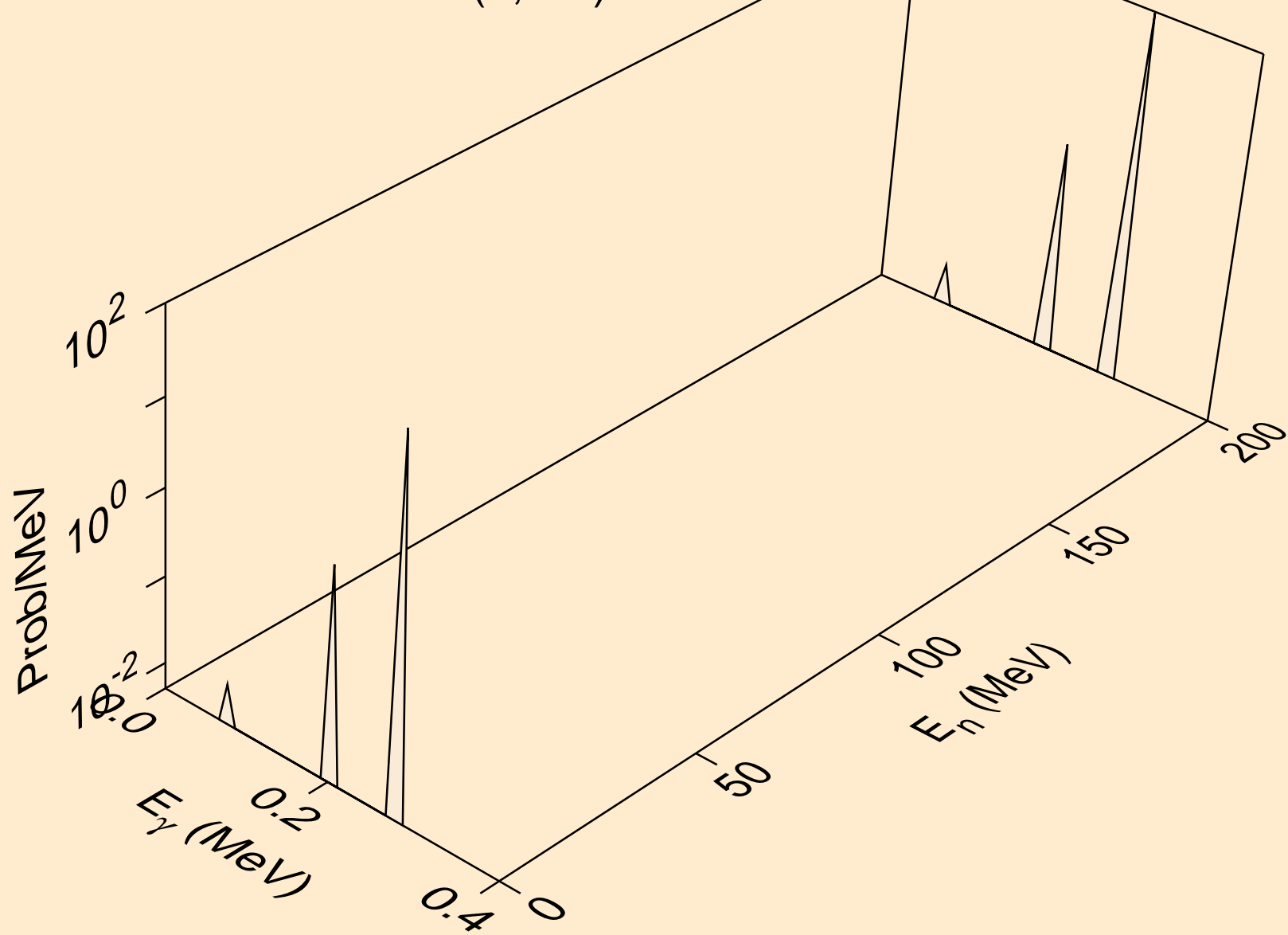

AU197M NEUTRON ACER TENDL-2021 LIBRARY; T=293.6K
Photon emission for (n,n*5)

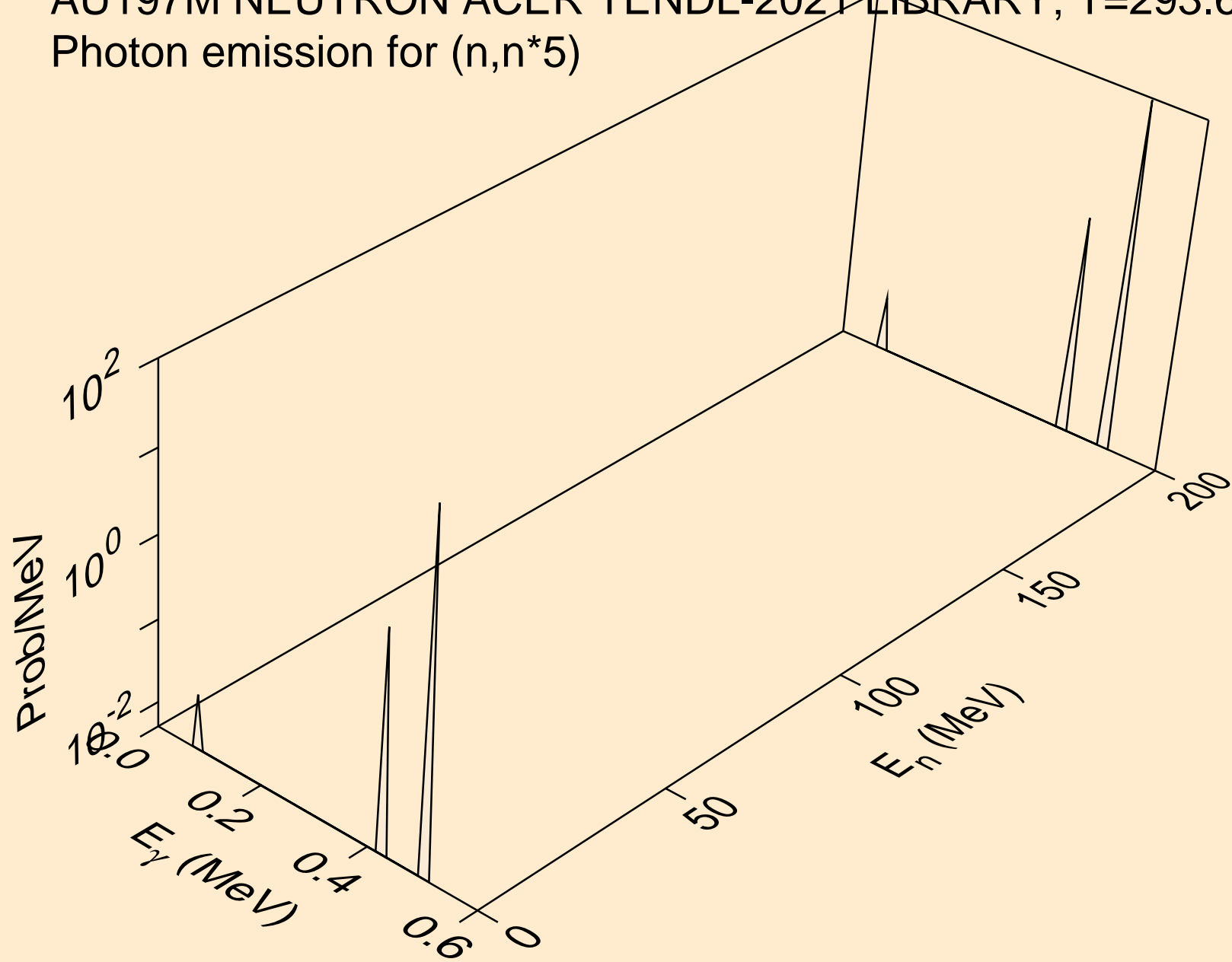

AU197M NEUTRON ACER TENDL-2021 LIBRARY; T=293.6K
Photon emission for (n,n*6)

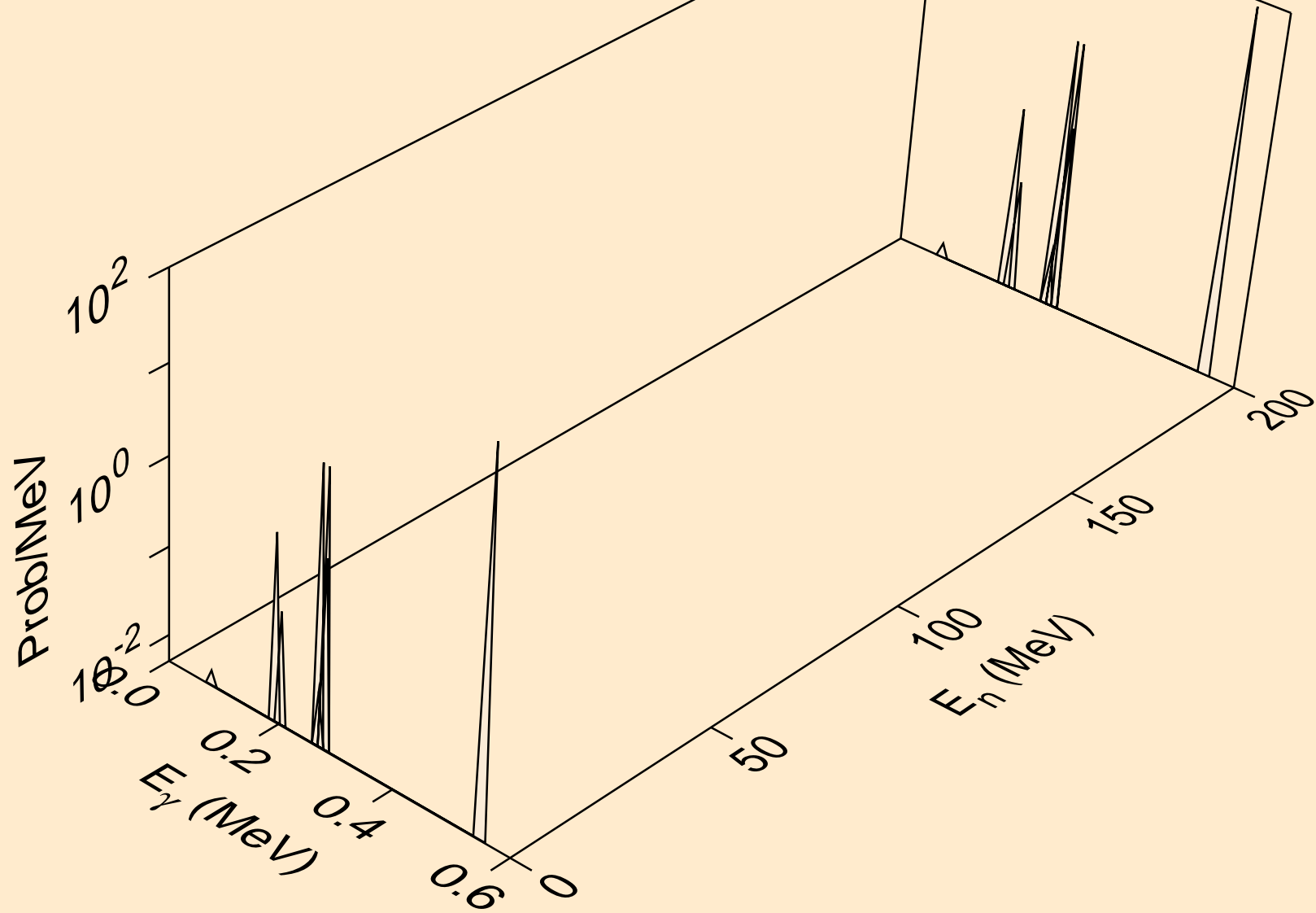

AU197M NEUTRON ACER TENDL-2021 LIBRARY; T=293.6K
Photon emission for (n,n*7)

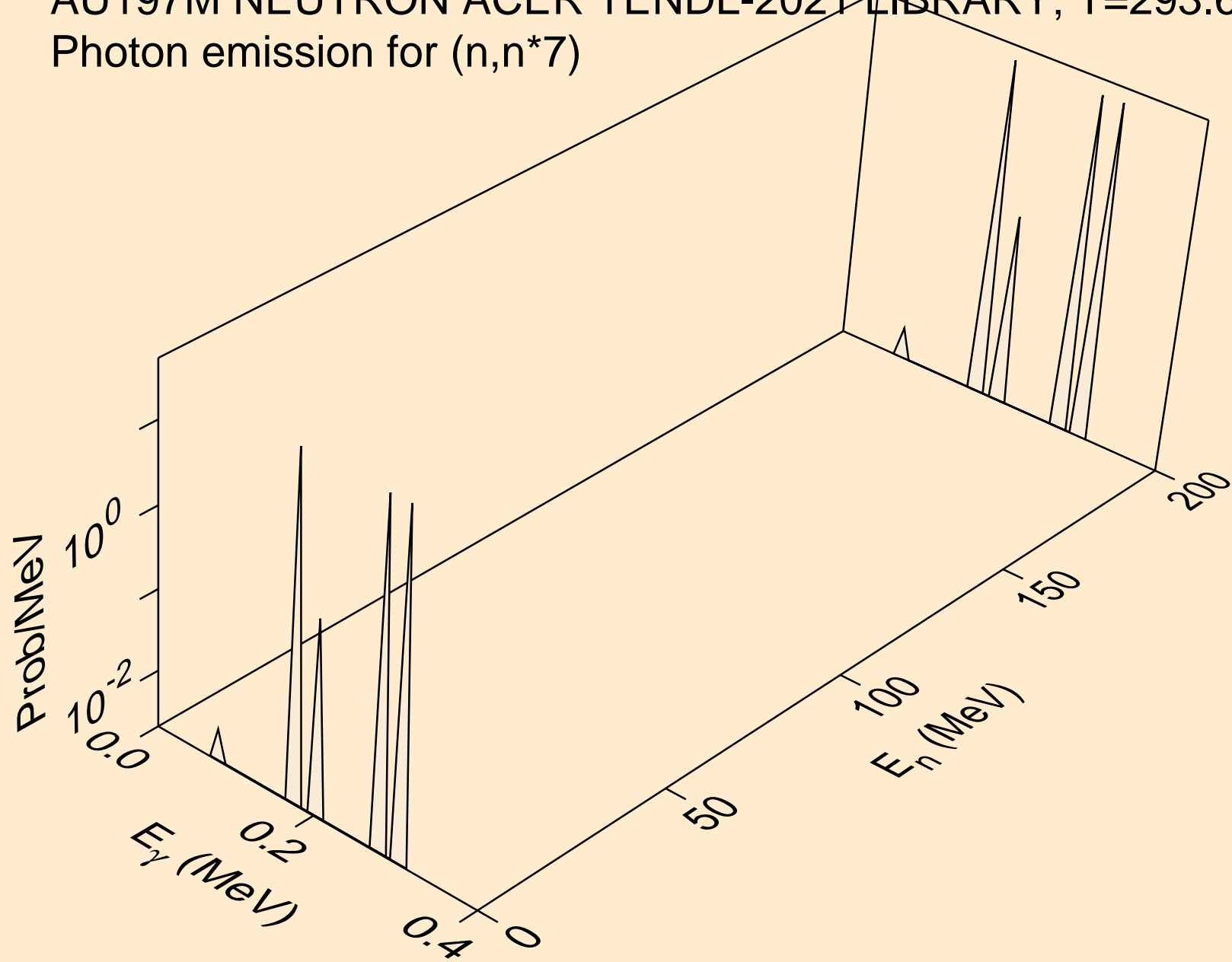

AU197M NEUTRON ACER TENDL-2021 LIBRARY; T=293.6K
Photon emission for (n,n*8)

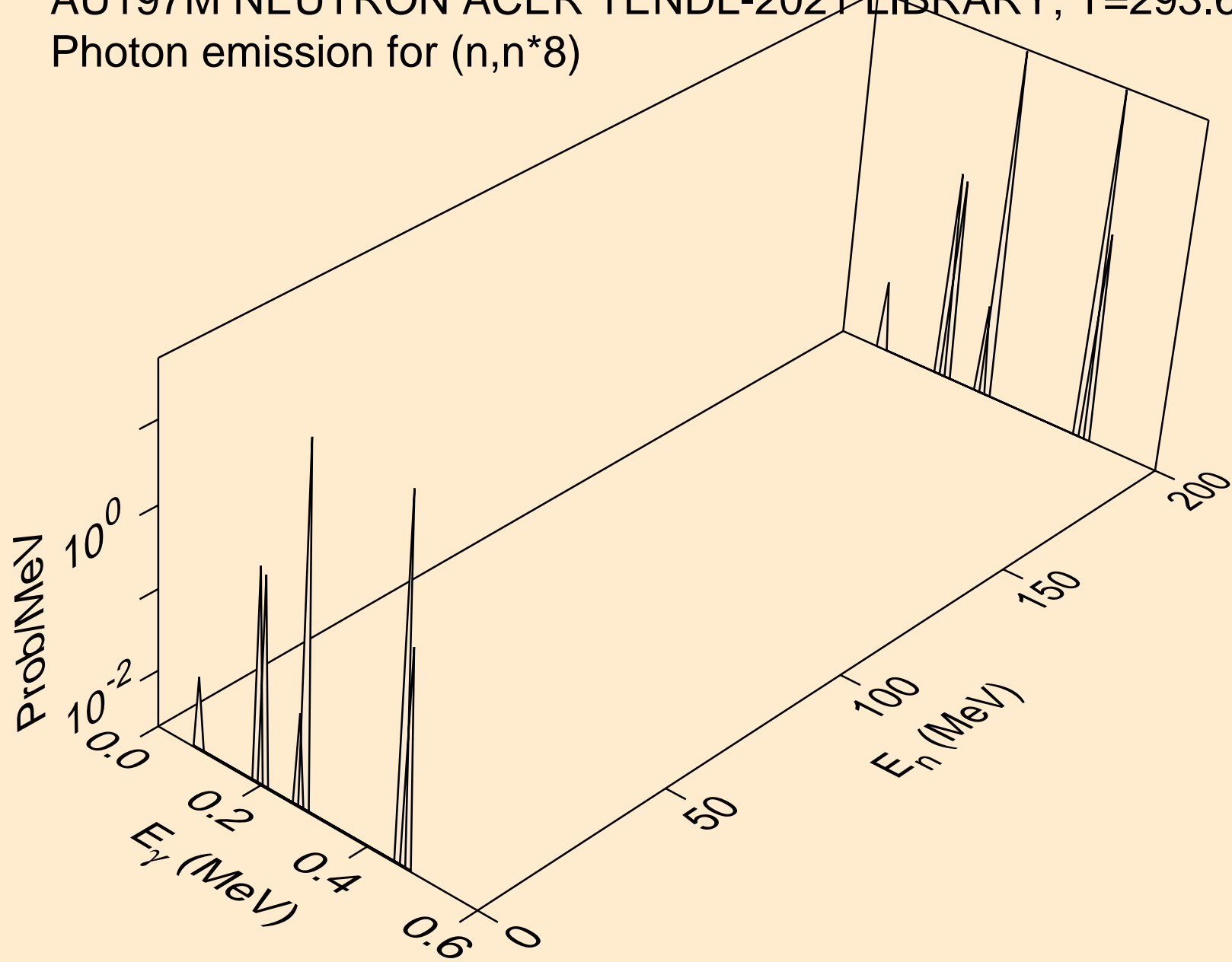

AU197M NEUTRON ACER TENDL-2021 LIBRARY; T=293.6K
Photon emission for (n,n*9)

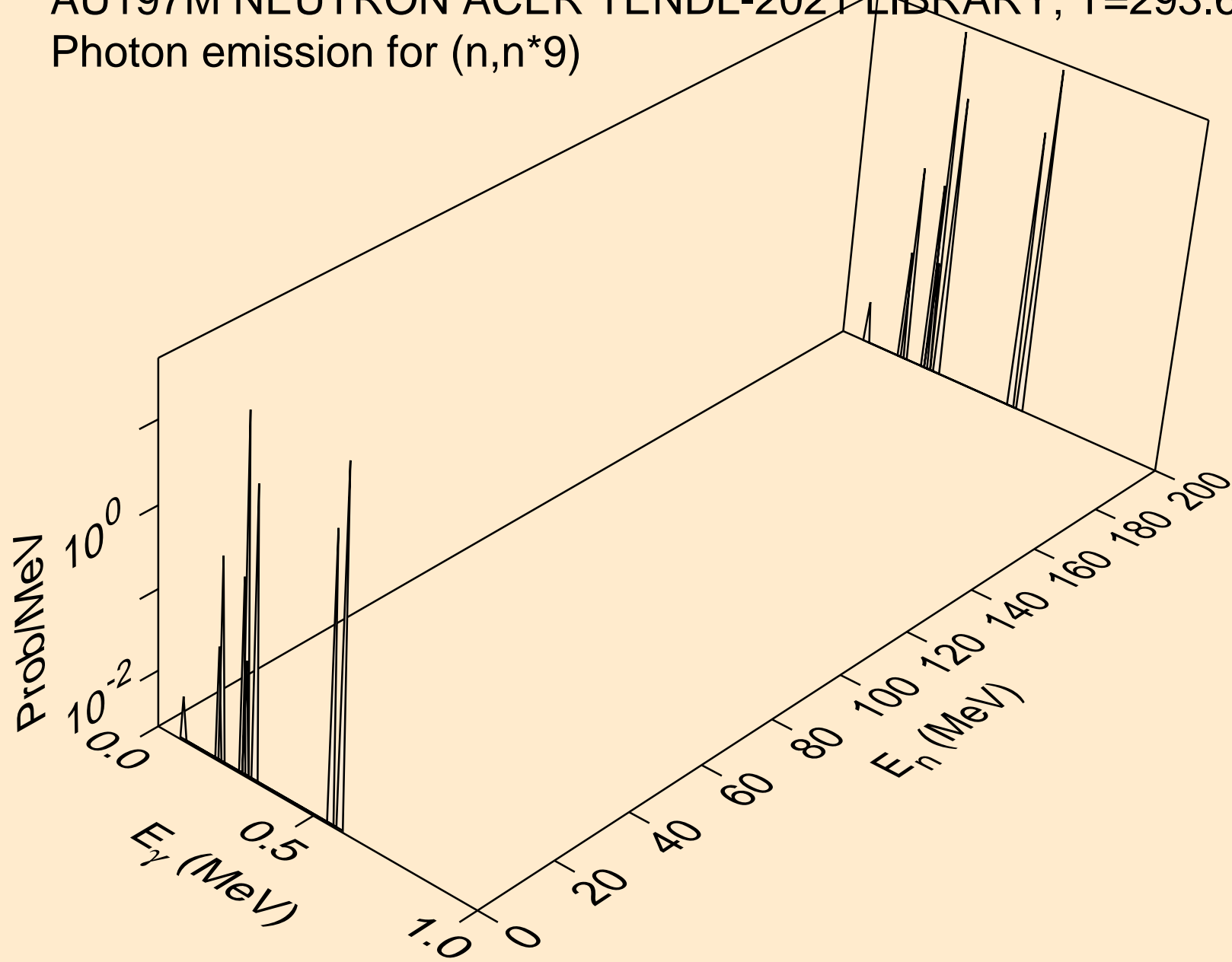

AU197M NEUTRON ACER TENDL-2021 LIBRARY; T=293.6K
Photon emission for (n,n*10)

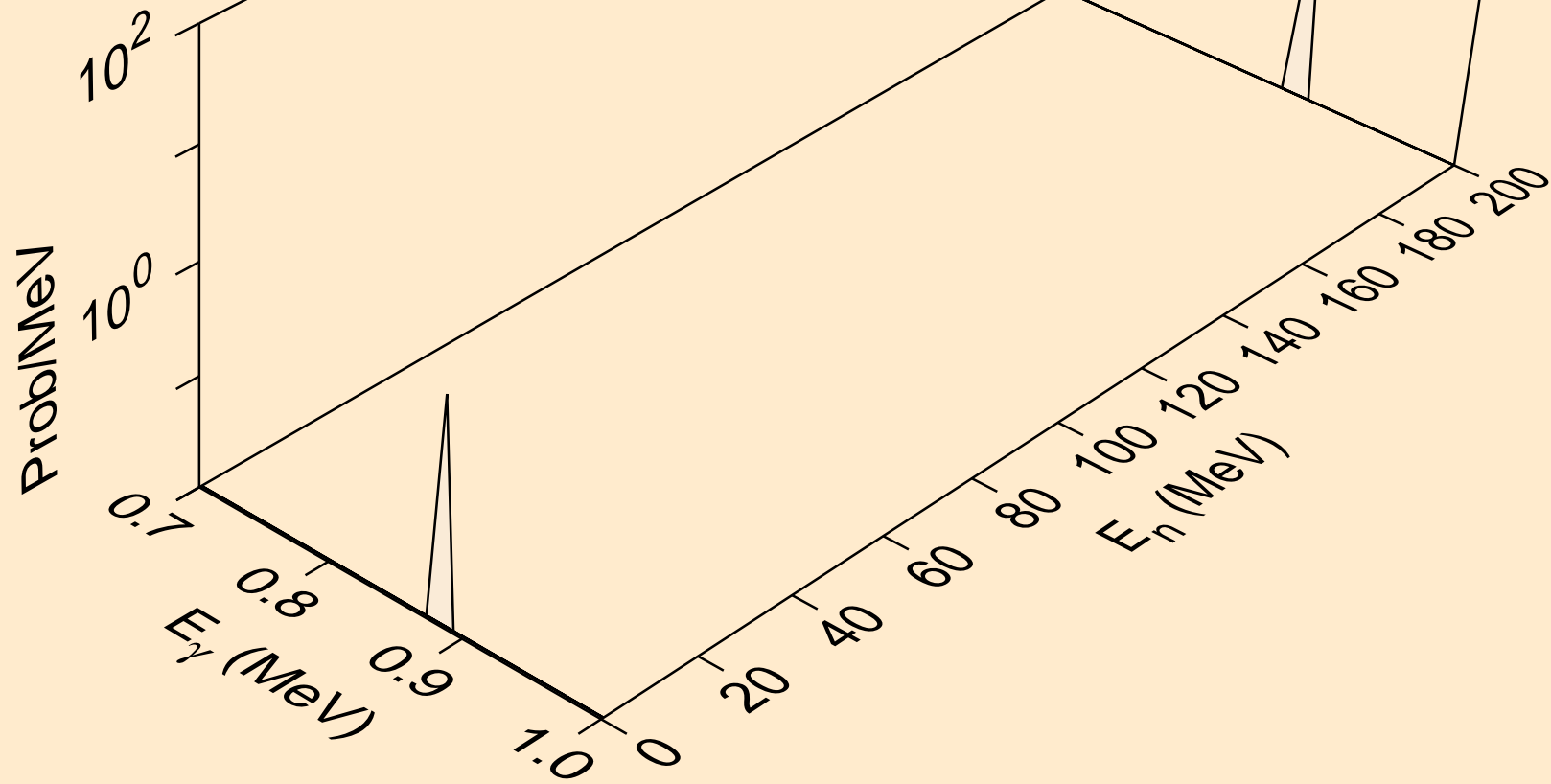

AU197M NEUTRON ACER TENDL-2021 LIBRARY; T=293.6K
Photon emission for (n,n*11)

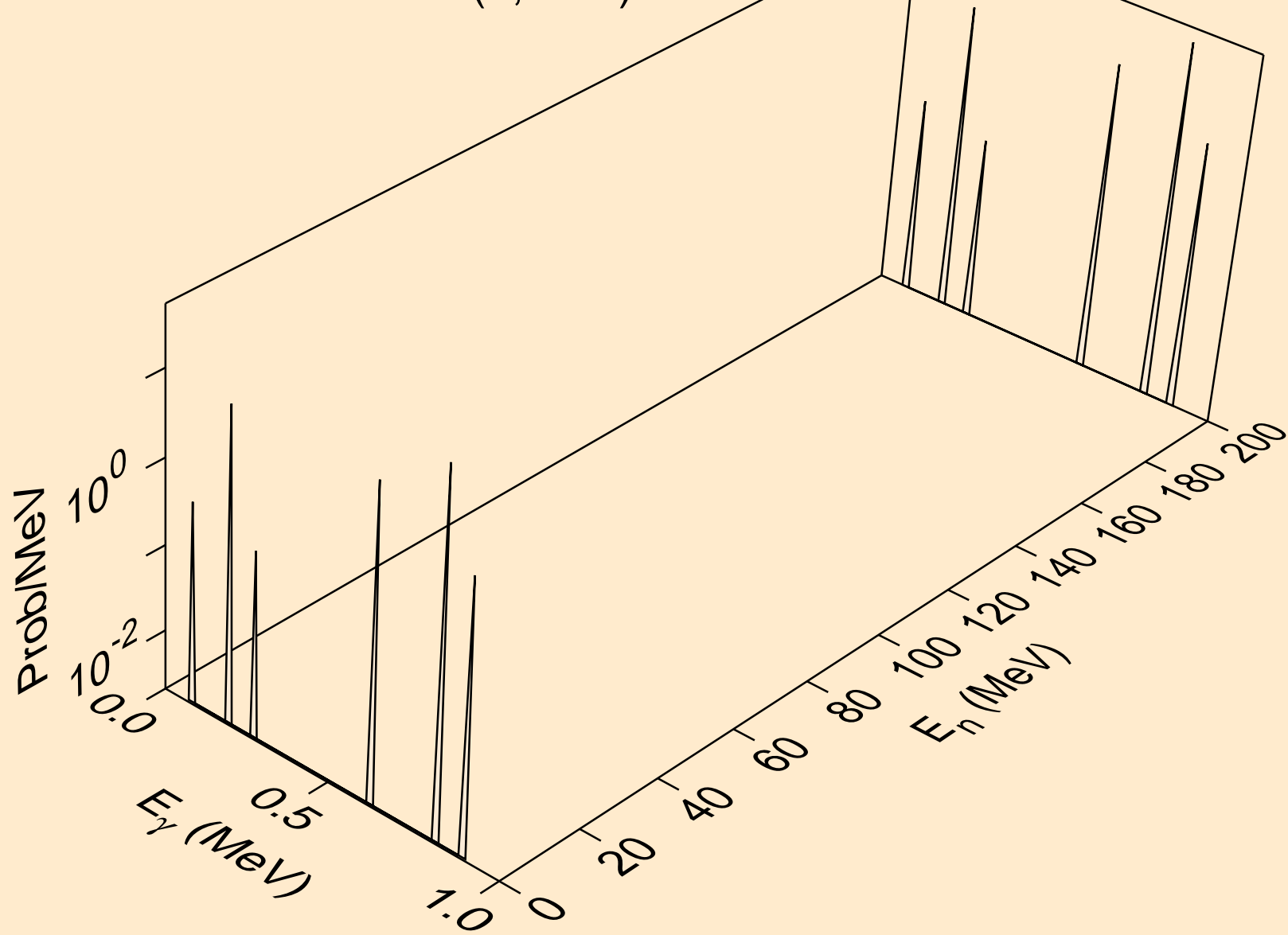

AU197M NEUTRON ACER TENDL-2021 LIBRARY; T=293.6K
Photon emission for (n,n*12)

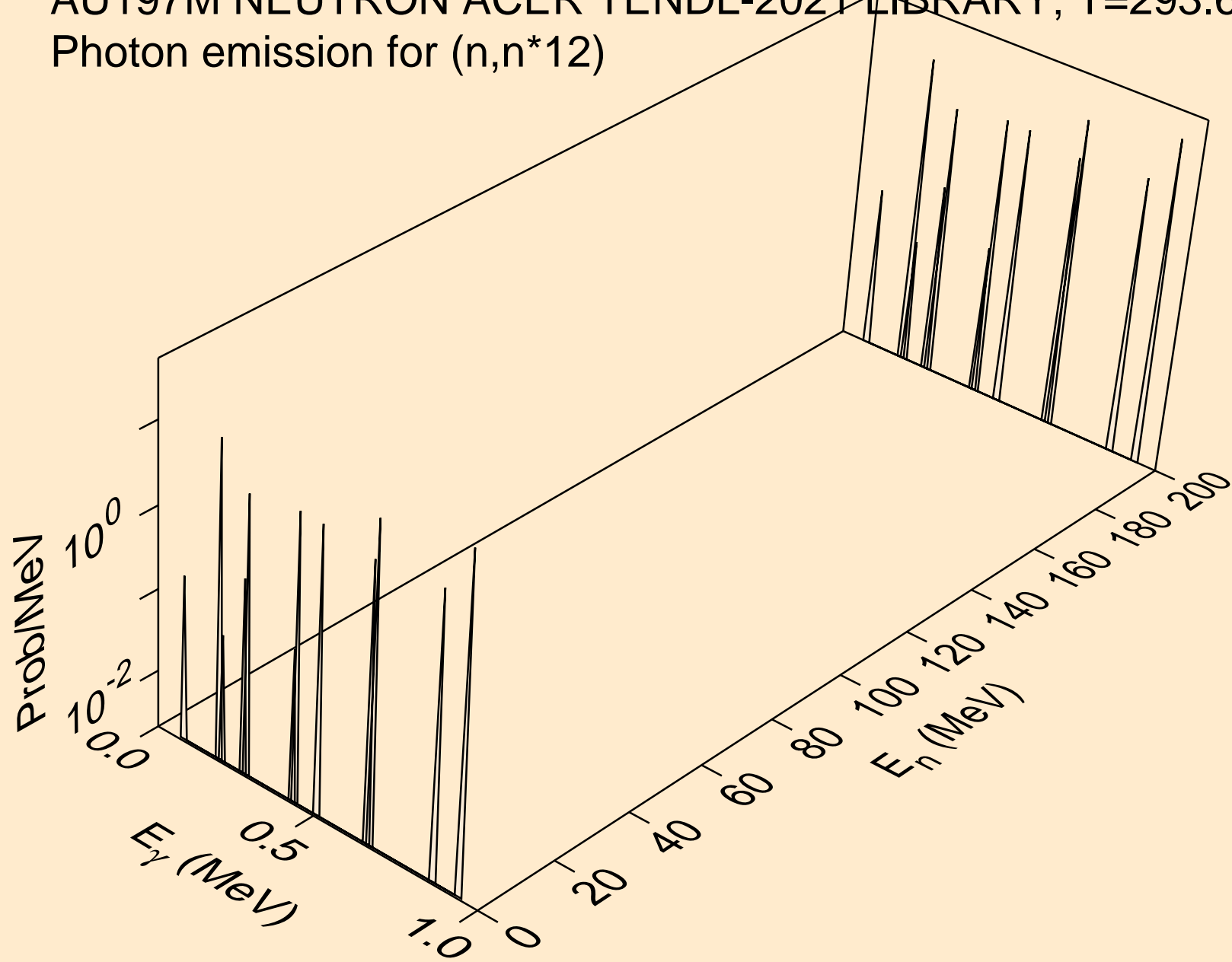

AU197M NEUTRON ACER TENDL-2021 LIBRARY; T=293.6K
Photon emission for (n,n*13)

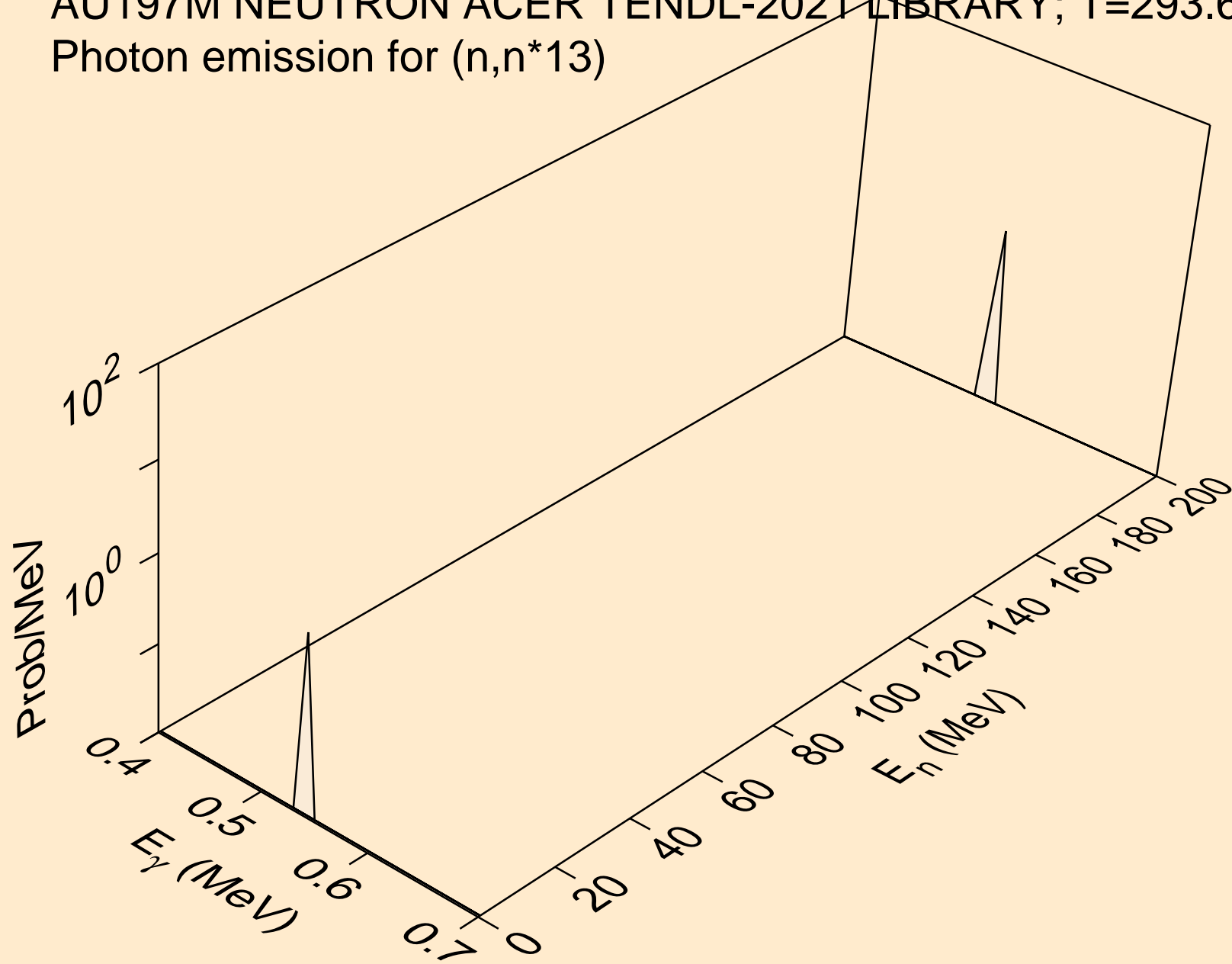

AU197M NEUTRON ACER TENDL-2021 LIBRARY; T=293.6K
Photon emission for (n,n*14)

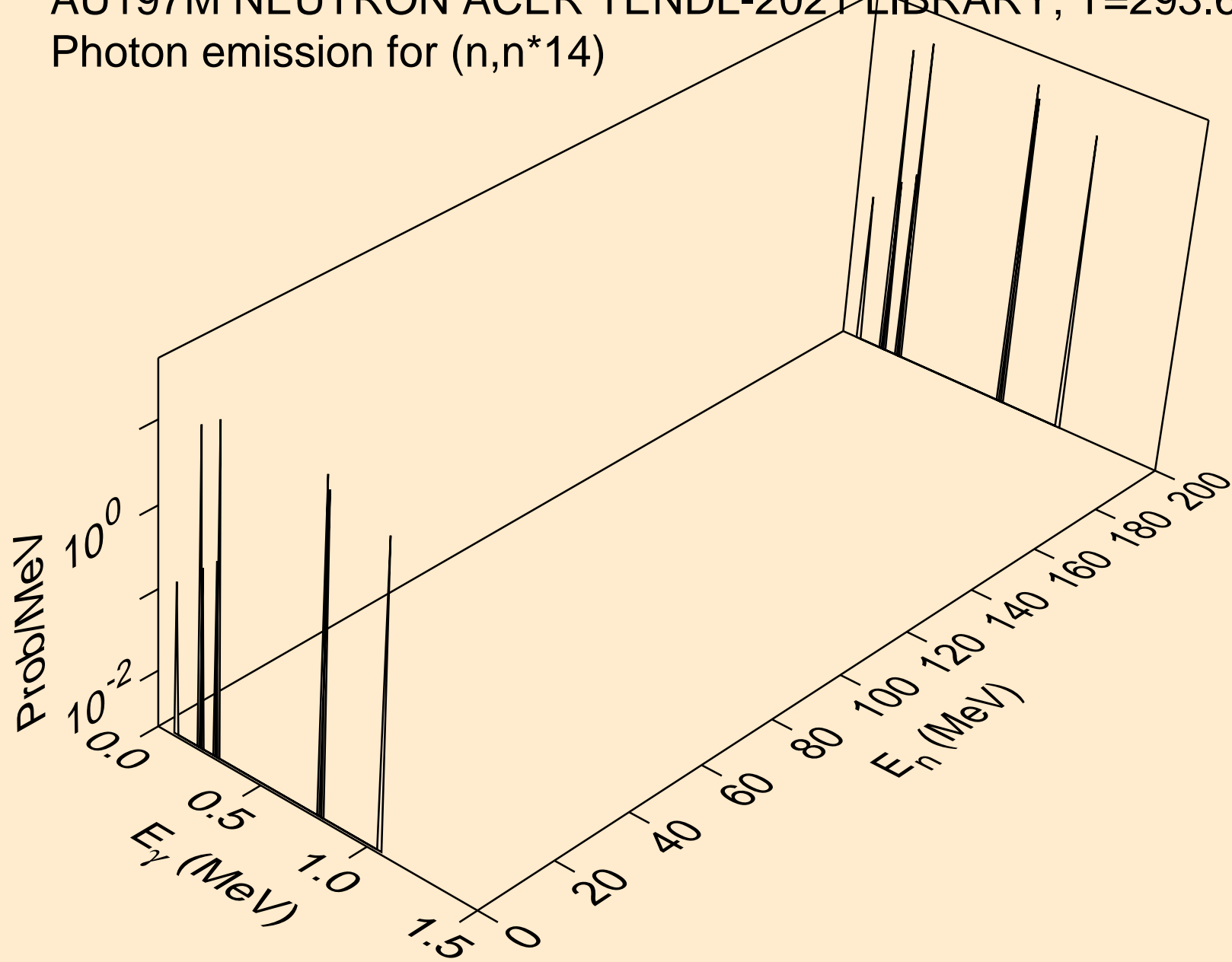

AU197M NEUTRON ACER TENDL-2021 LIBRARY; T=293.6K
Photon emission for (n,n*15)

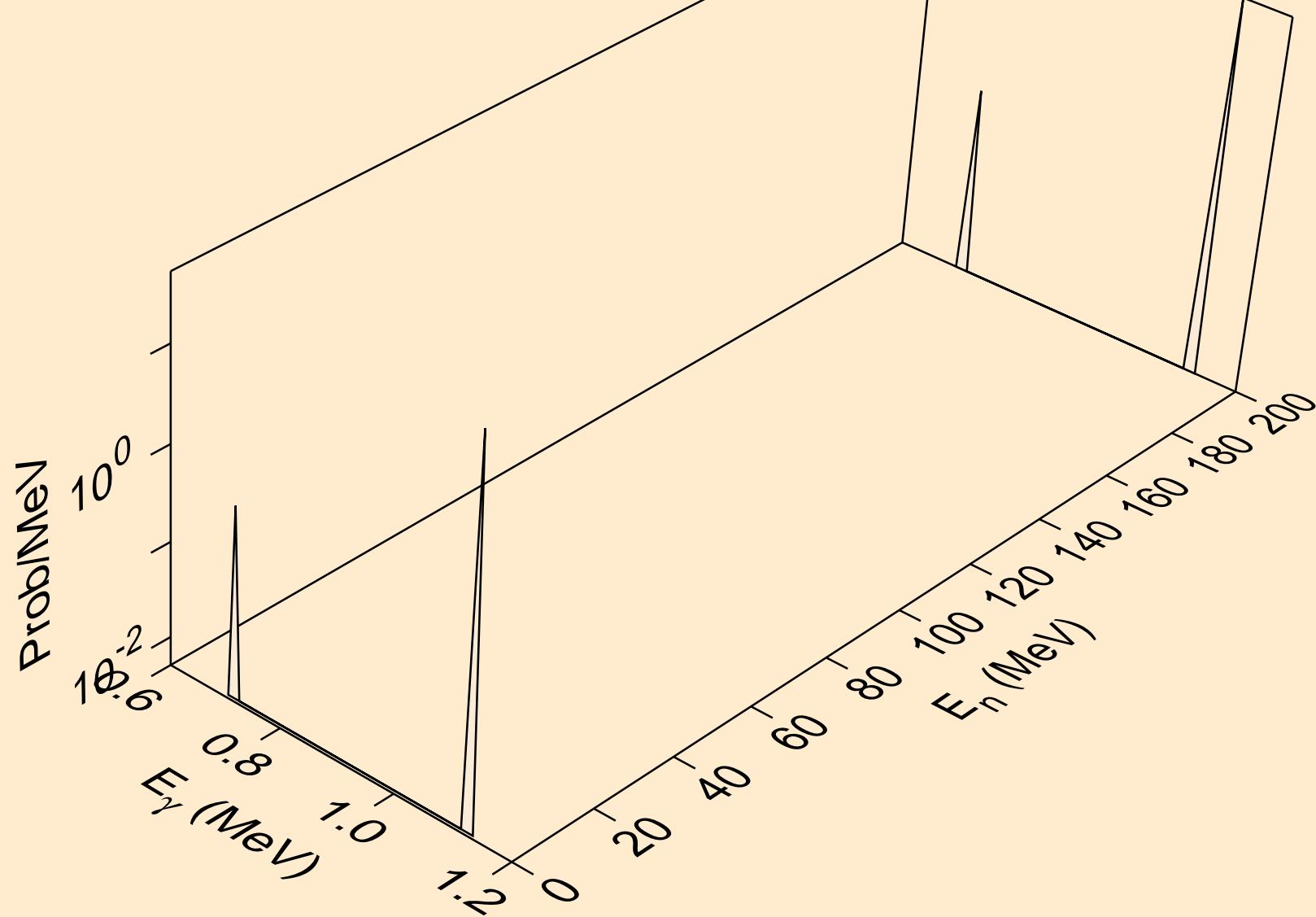

AU197M NEUTRON ACER TENDL-2021 LIBRARY; T=293.6K
Photon emission for (n,n*16)

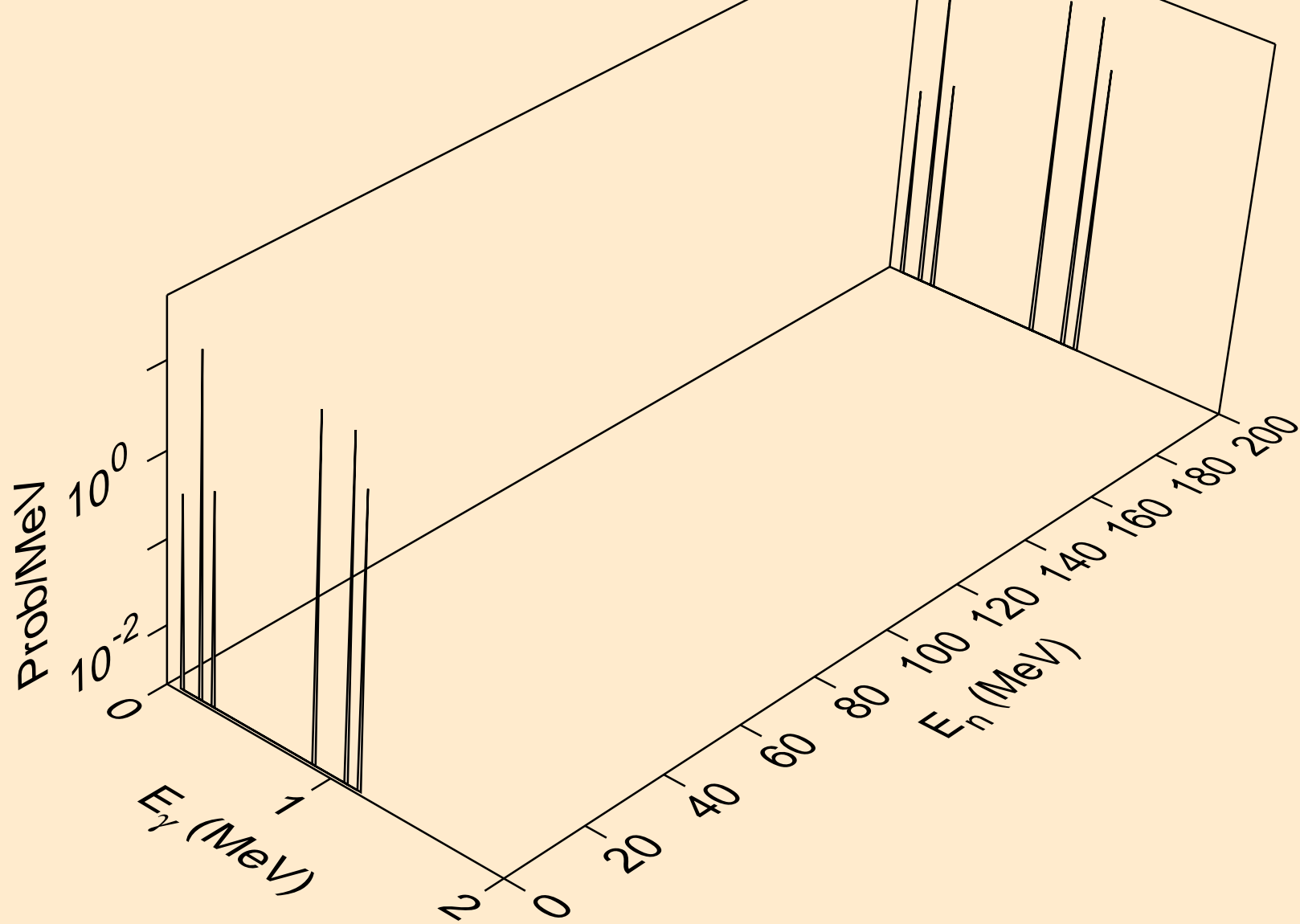

AU197M NEUTRON ACER TENDL-2021 LIBRARY; T=293.6K
Photon emission for (n,n*17)

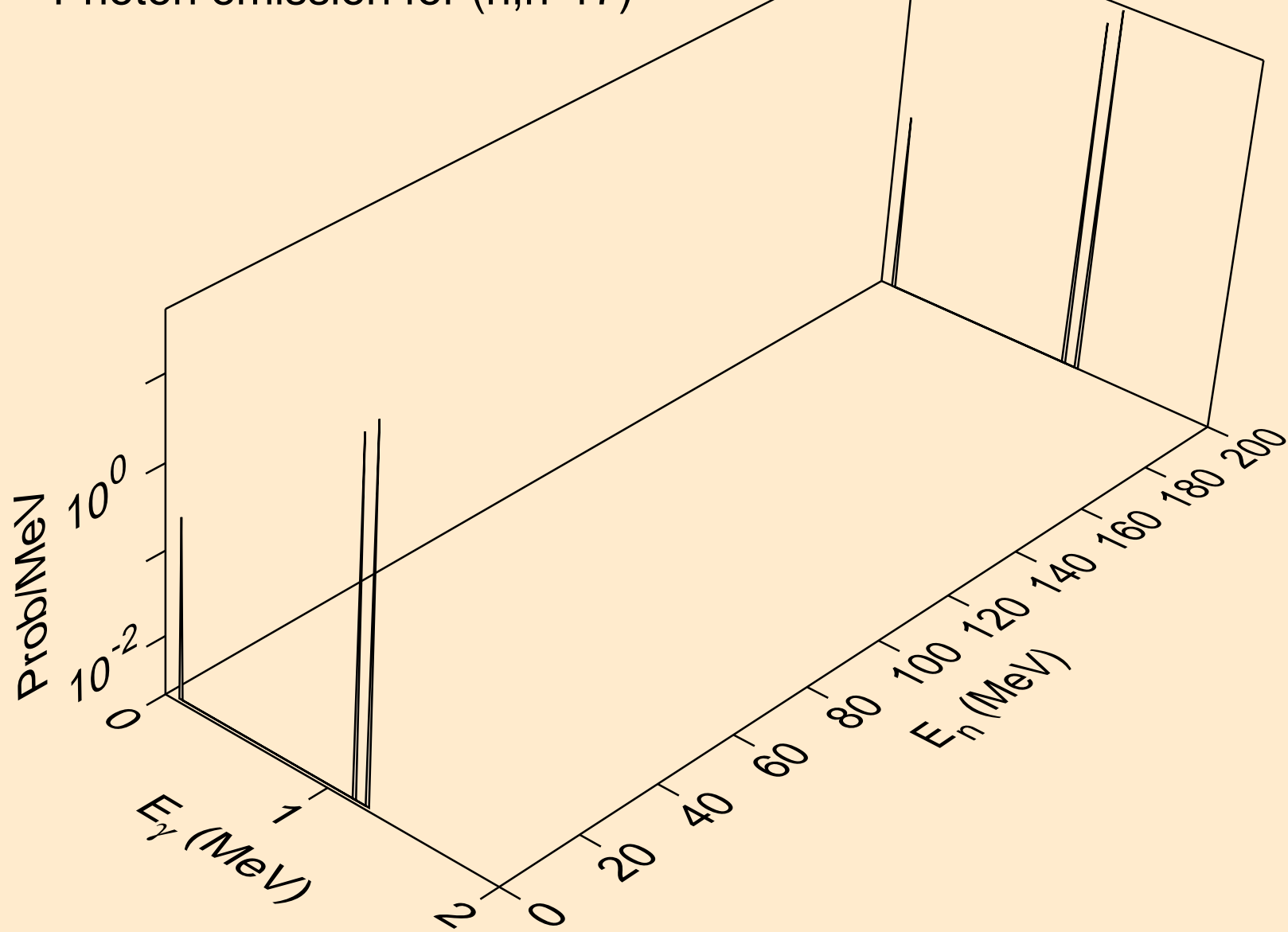

AU197M NEUTRON ACER TENDL-2021 LIBRARY; T=293.6K
Photon emission for (n,n*18)

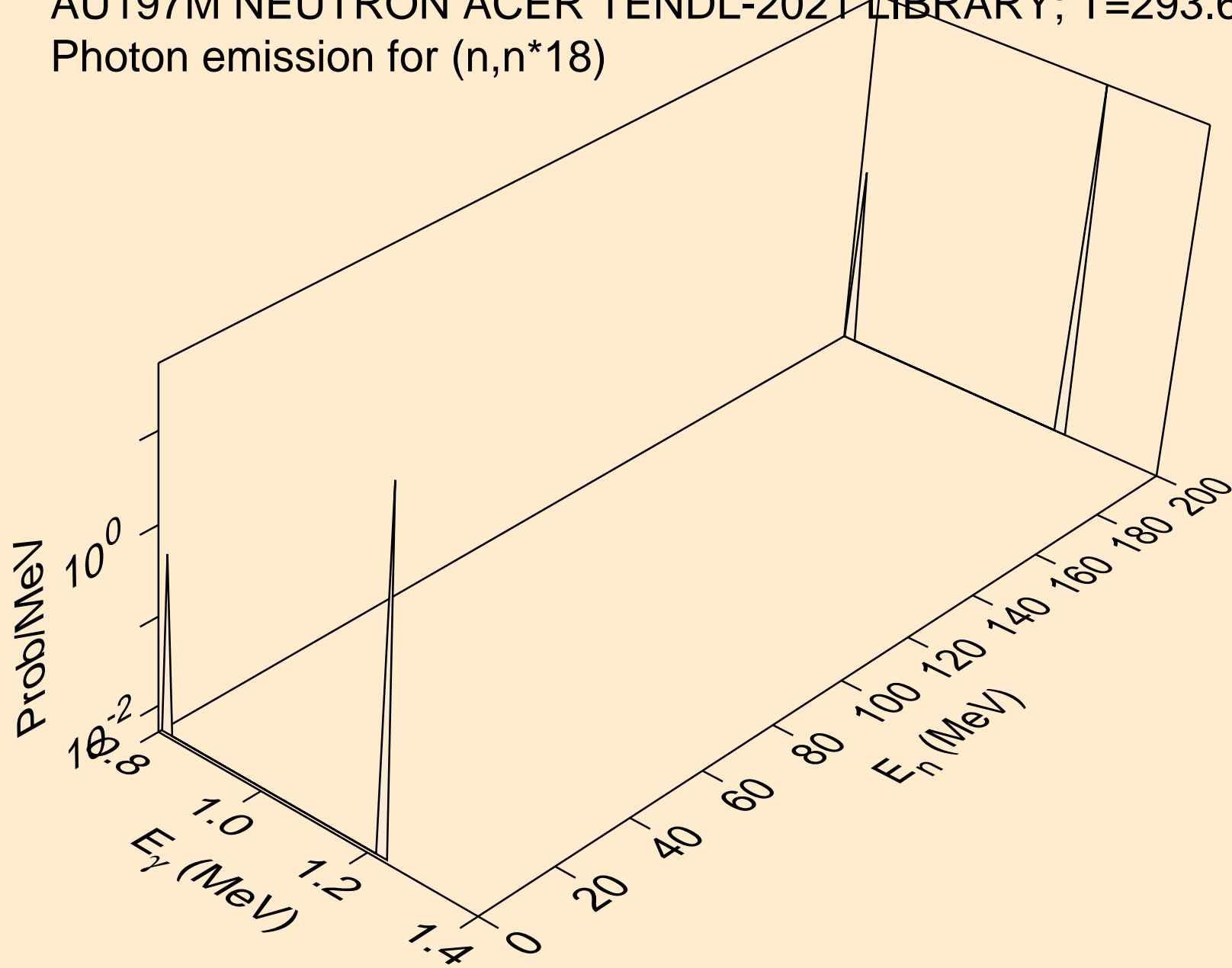

AU197M NEUTRON ACER TENDL-2021 LIBRARY; T=293.6K
Photon emission for (n,n*19)

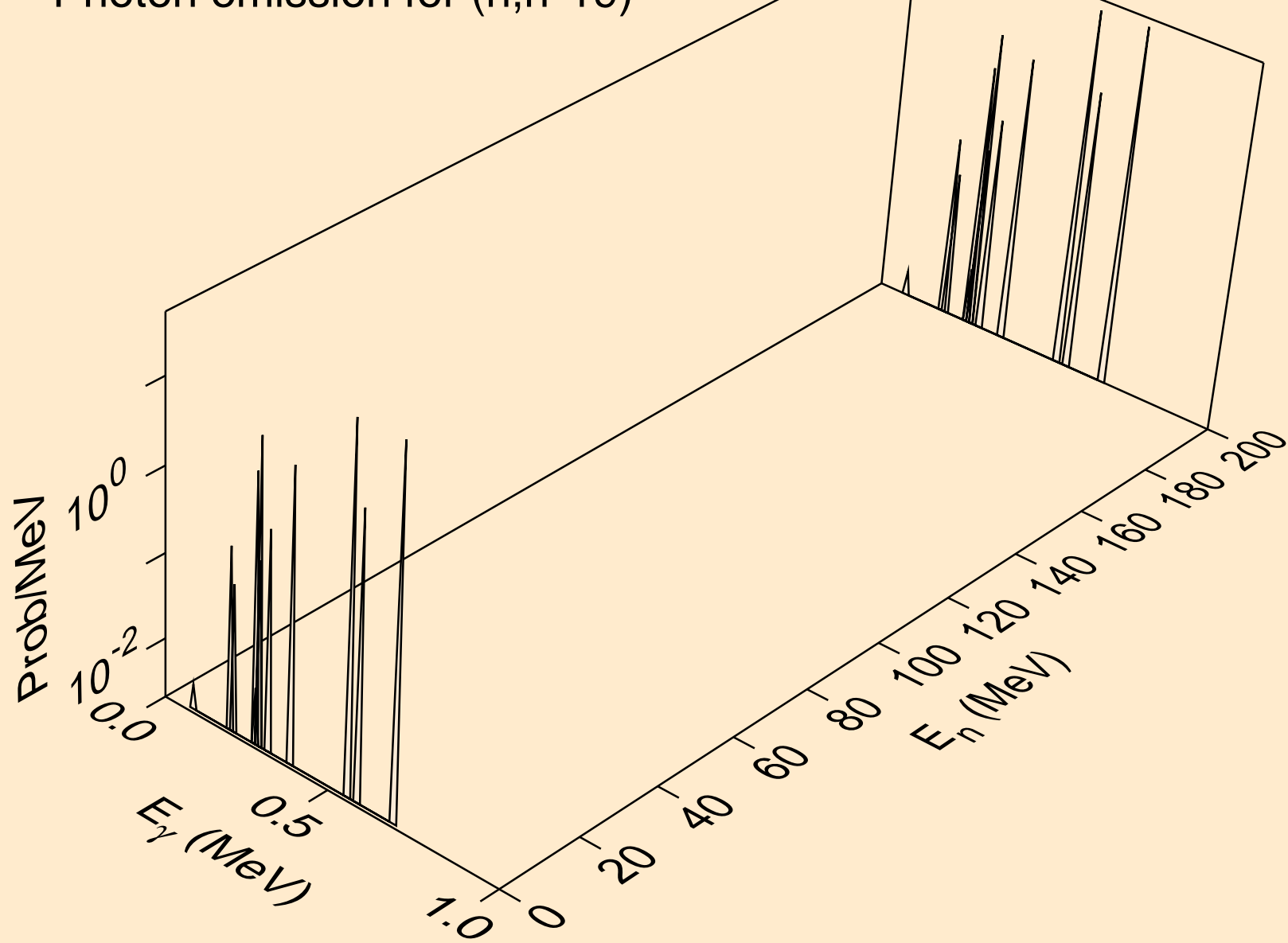

AU197M NEUTRON ACER TENDL-2021 LIBRARY; T=293.6K
Photon emission for (n,n*20)

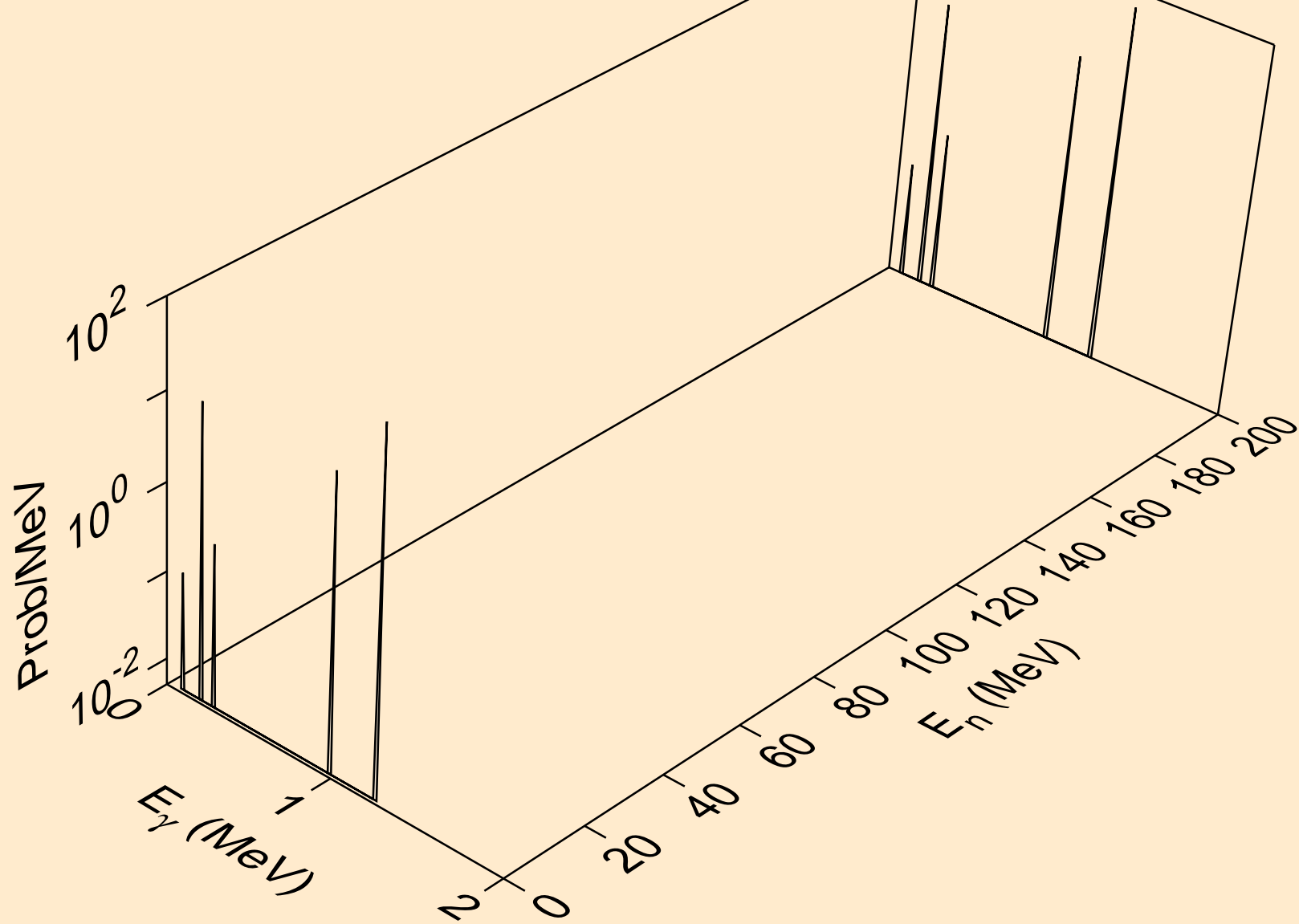

AU197M NEUTRON ACER TENDL-2021 LIBRARY; T=293.6K
Photon emission for (n,n*21)

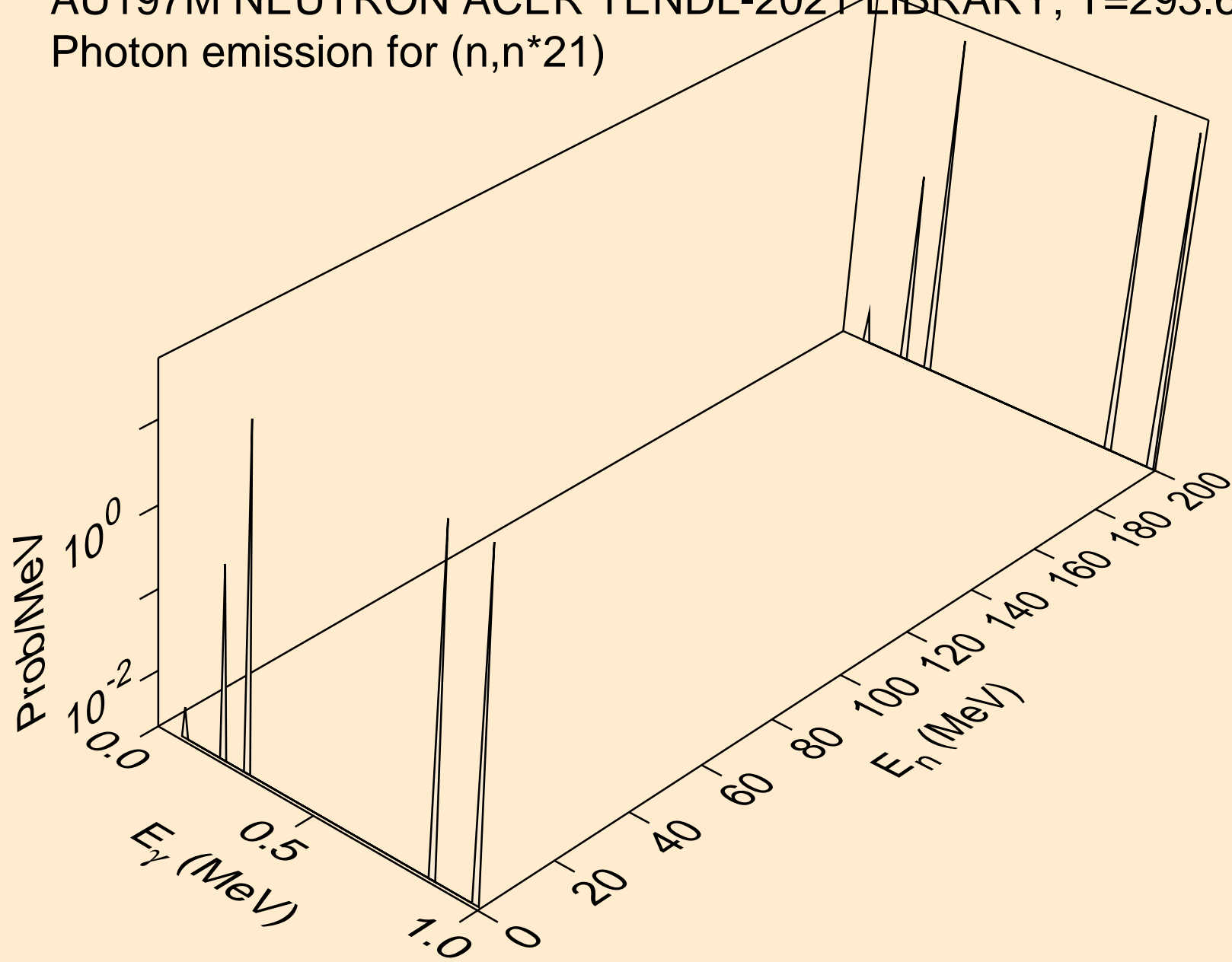

AU197M NEUTRON ACER TENDL-2021 LIBRARY; T=293.6K
Photon emission for (n,n*22)

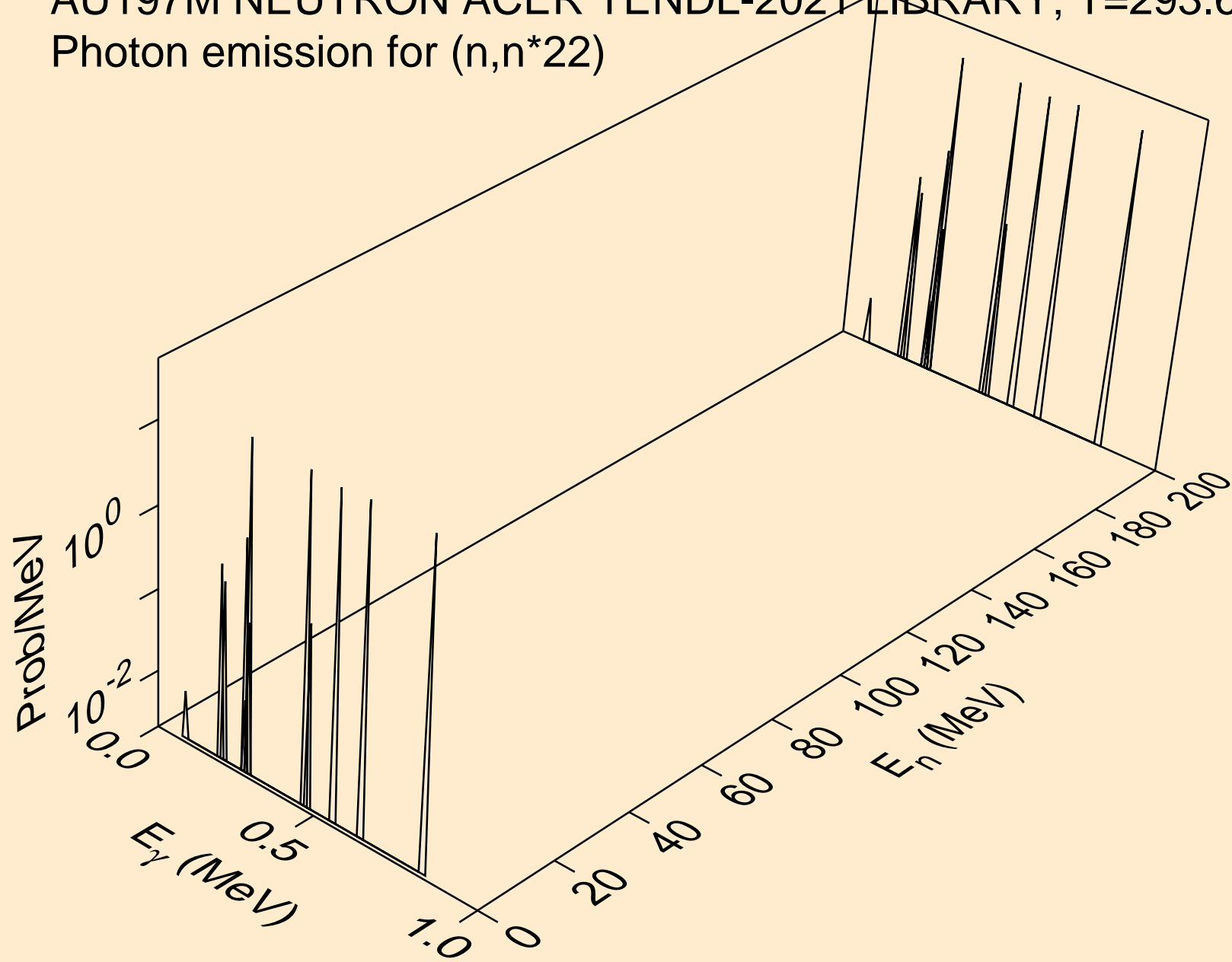

AU197M NEUTRON ACER TENDL-2021 LIBRARY; T=293.6K
Photon emission for (n,n*23)

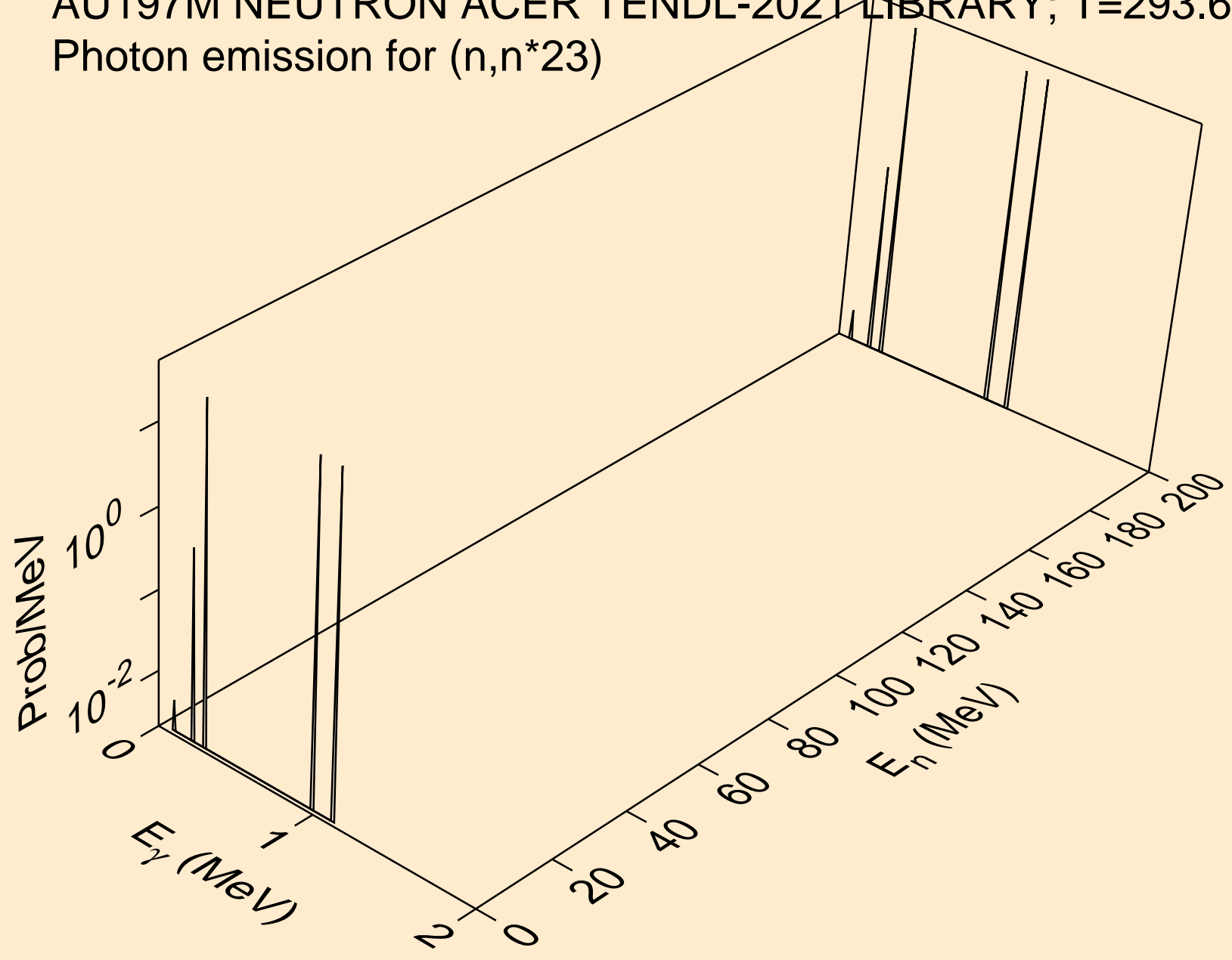

AU197M NEUTRON ACER TENDL-2021 LIBRARY; T=293.6K
Photon emission for (n,n*24)

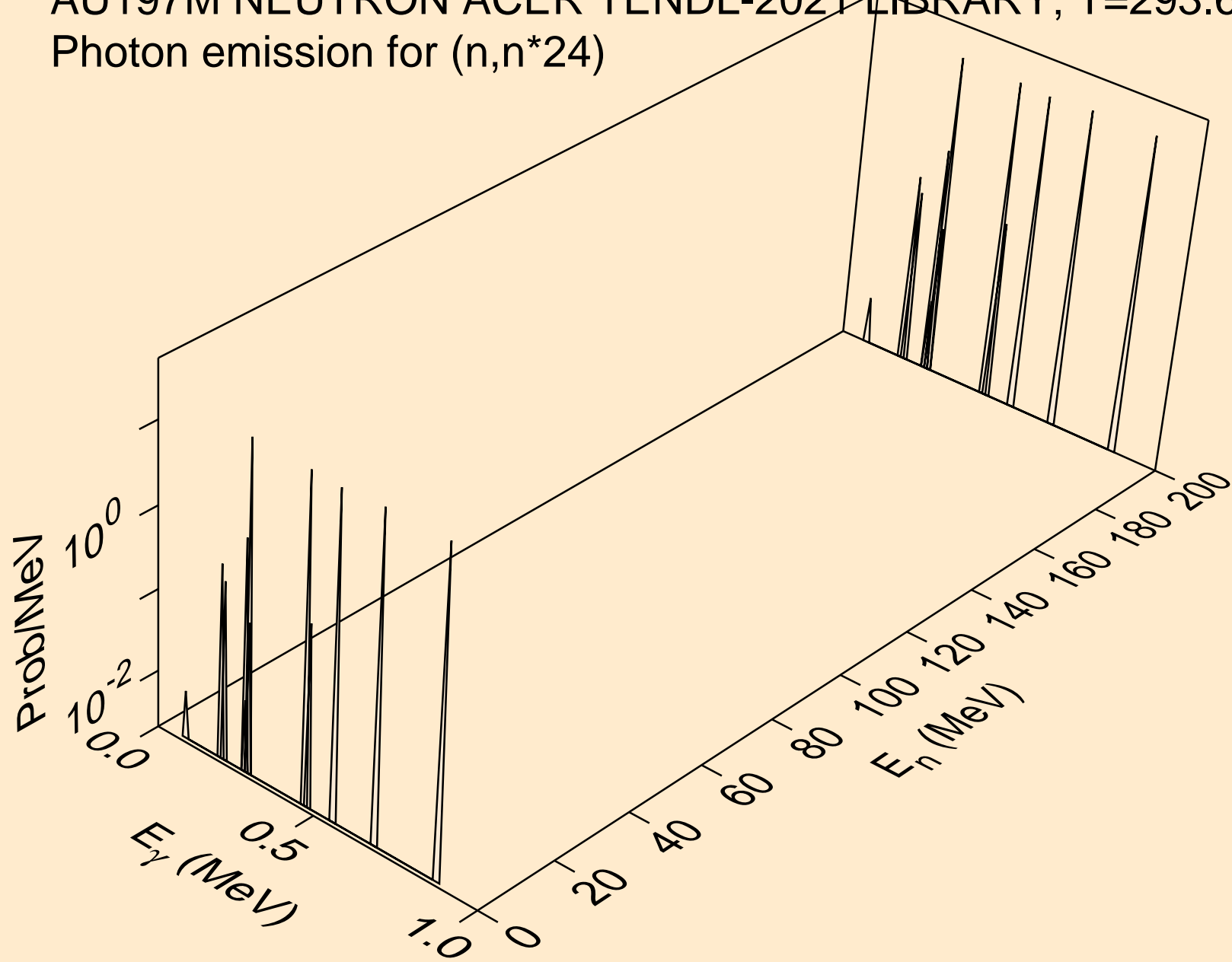

AU197M NEUTRON ACER TENDL-2021 LIBRARY; T=293.6K
Photon emission for (n,n*25)

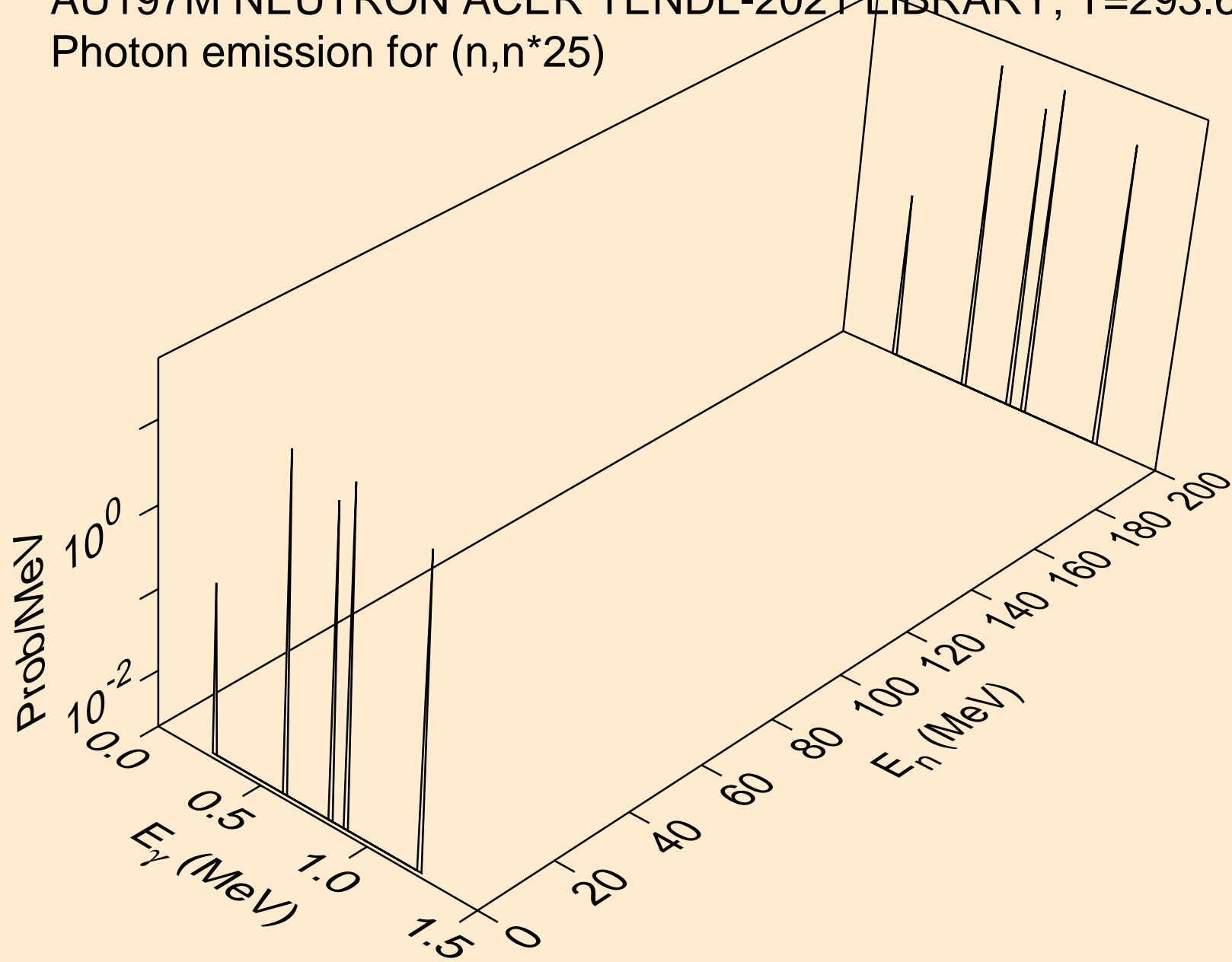

AU197M NEUTRON ACER TENDL-2021 LIBRARY; T=293.6K
Photon emission for (n,n*26)

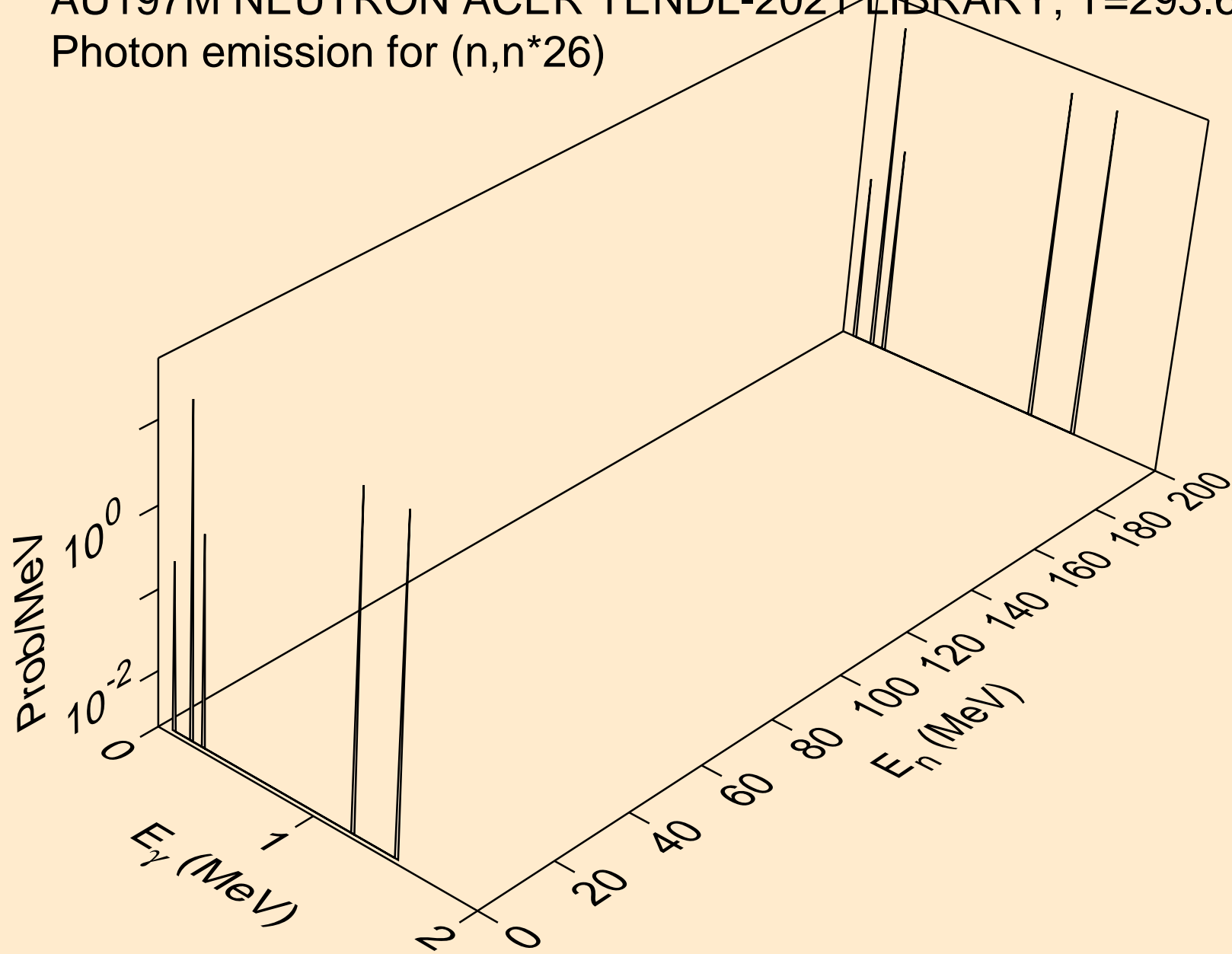

AU197M NEUTRON ACER TENDL-2021 LIBRARY; T=293.6K
Photon emission for (n,n*27)

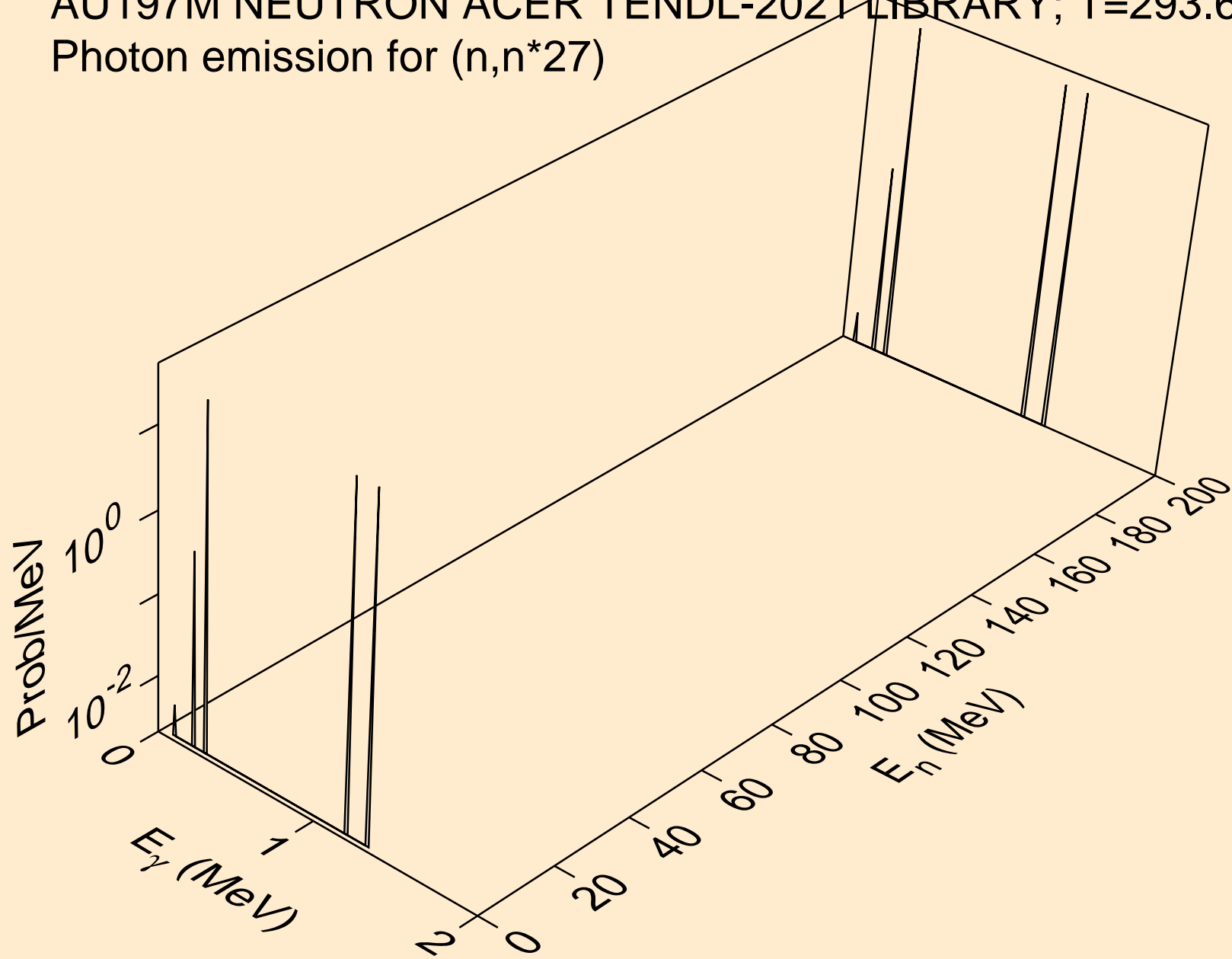

AU197M NEUTRON ACER TENDL-2021 LIBRARY; T=293.6K
Photon emission for (n,n*28)

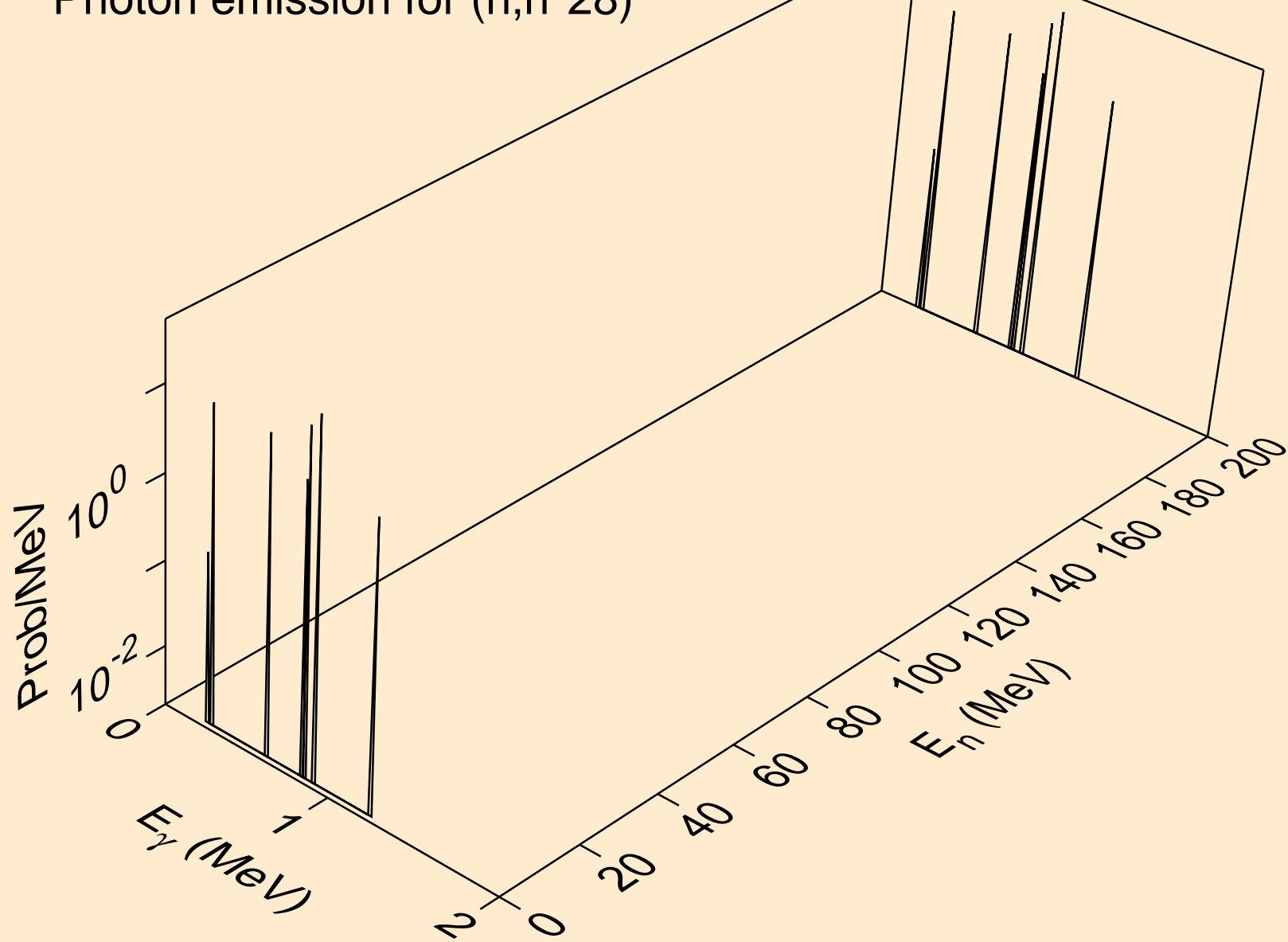

AU197M NEUTRON ACER TENDL-2021 LIBRARY; T=293.6K
Photon emission for (n,n*c)

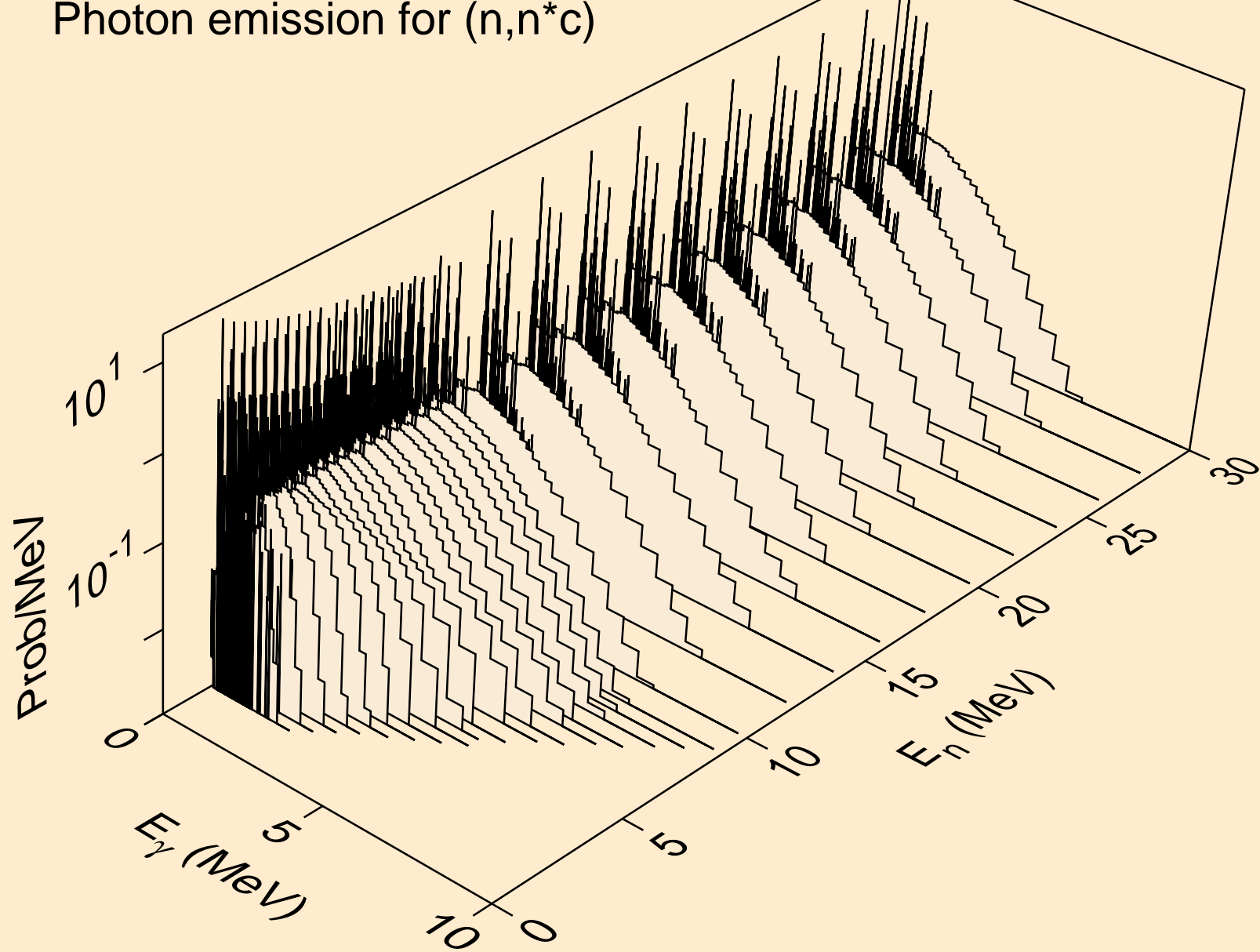

AU197M NEUTRON ACER TENDL-2021 LIBRARY; T=293.6K
Photon emission for (n,gma)

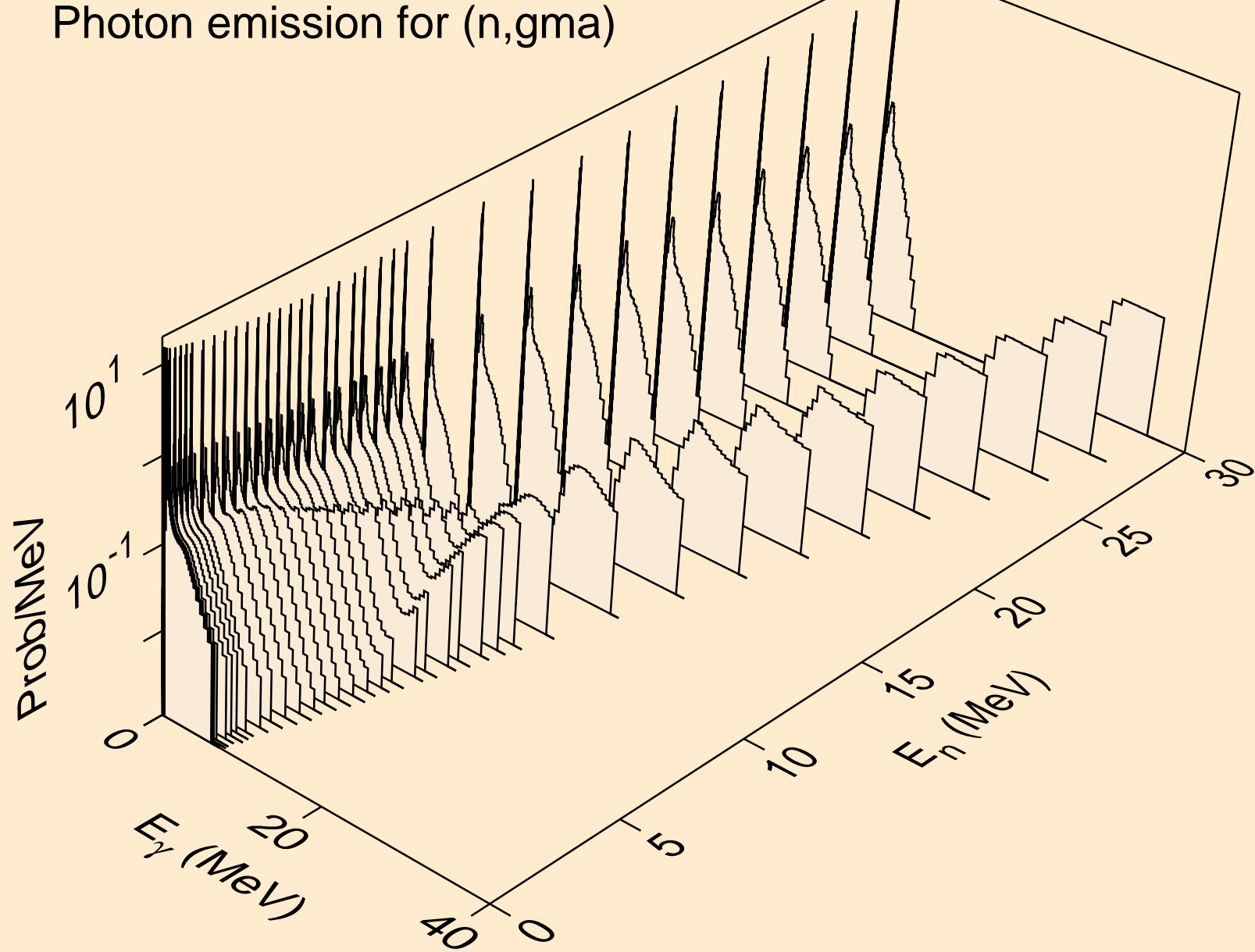

AU197M NEUTRON ACER TENDL-2021 LIBRARY; T=293.6K
Photon emission for (n,p)

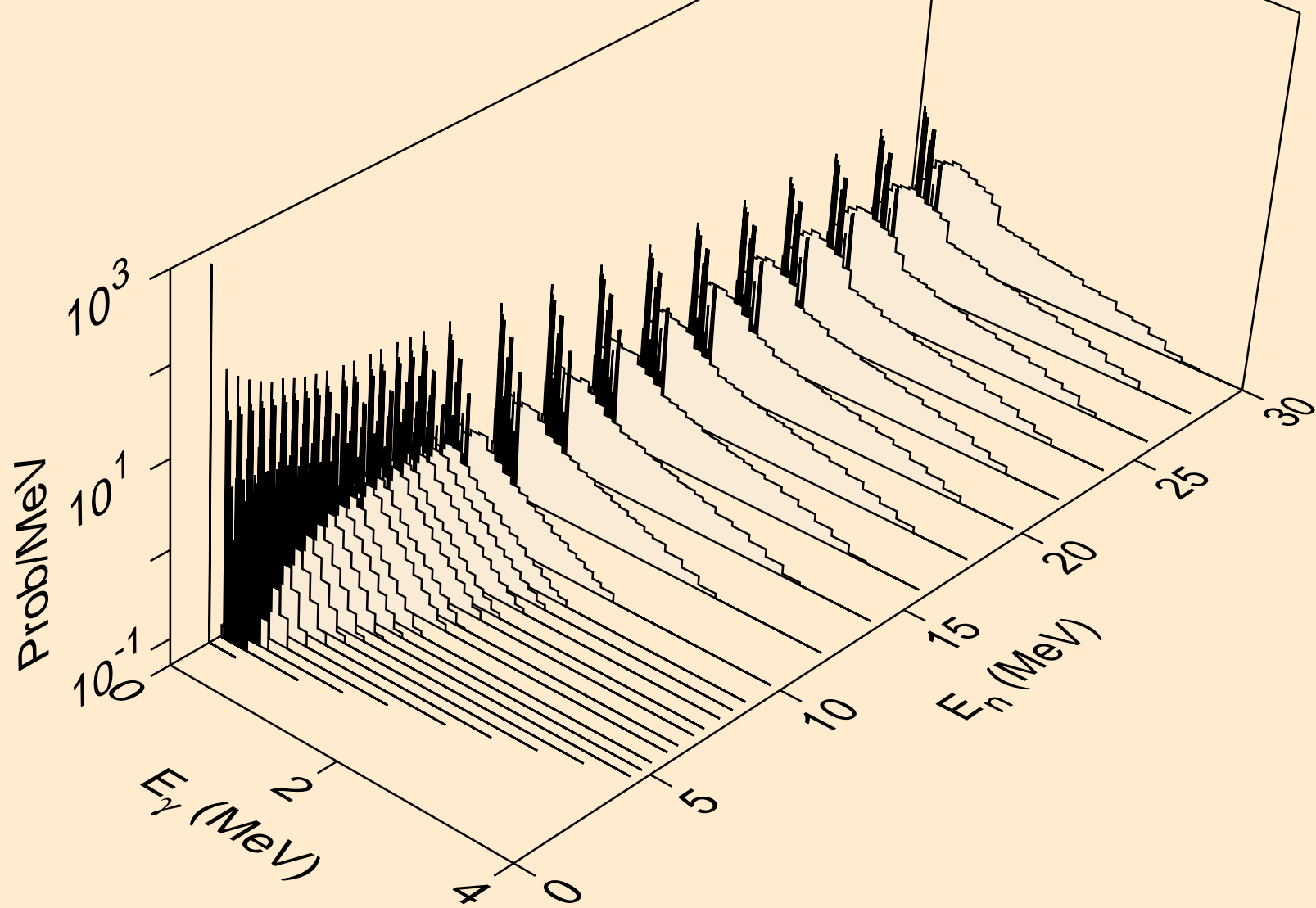

AU197M NEUTRON ACER TENDL-2021 LIBRARY; T=293.6K
Photon emission for (n,d)

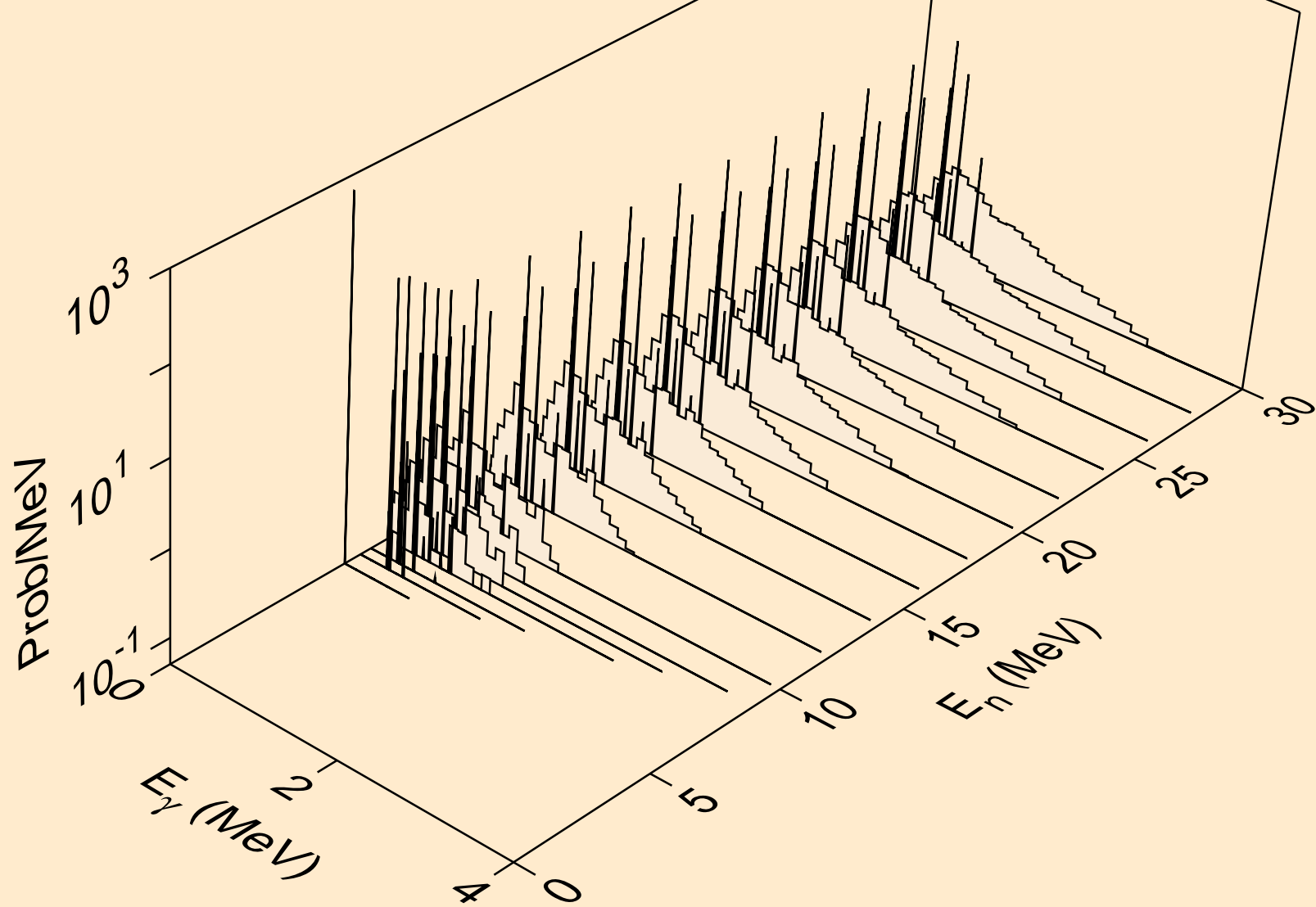

AU197M NEUTRON ACER TENDL-2021 LIBRARY; T=293.6K
Photon emission for (n,t)

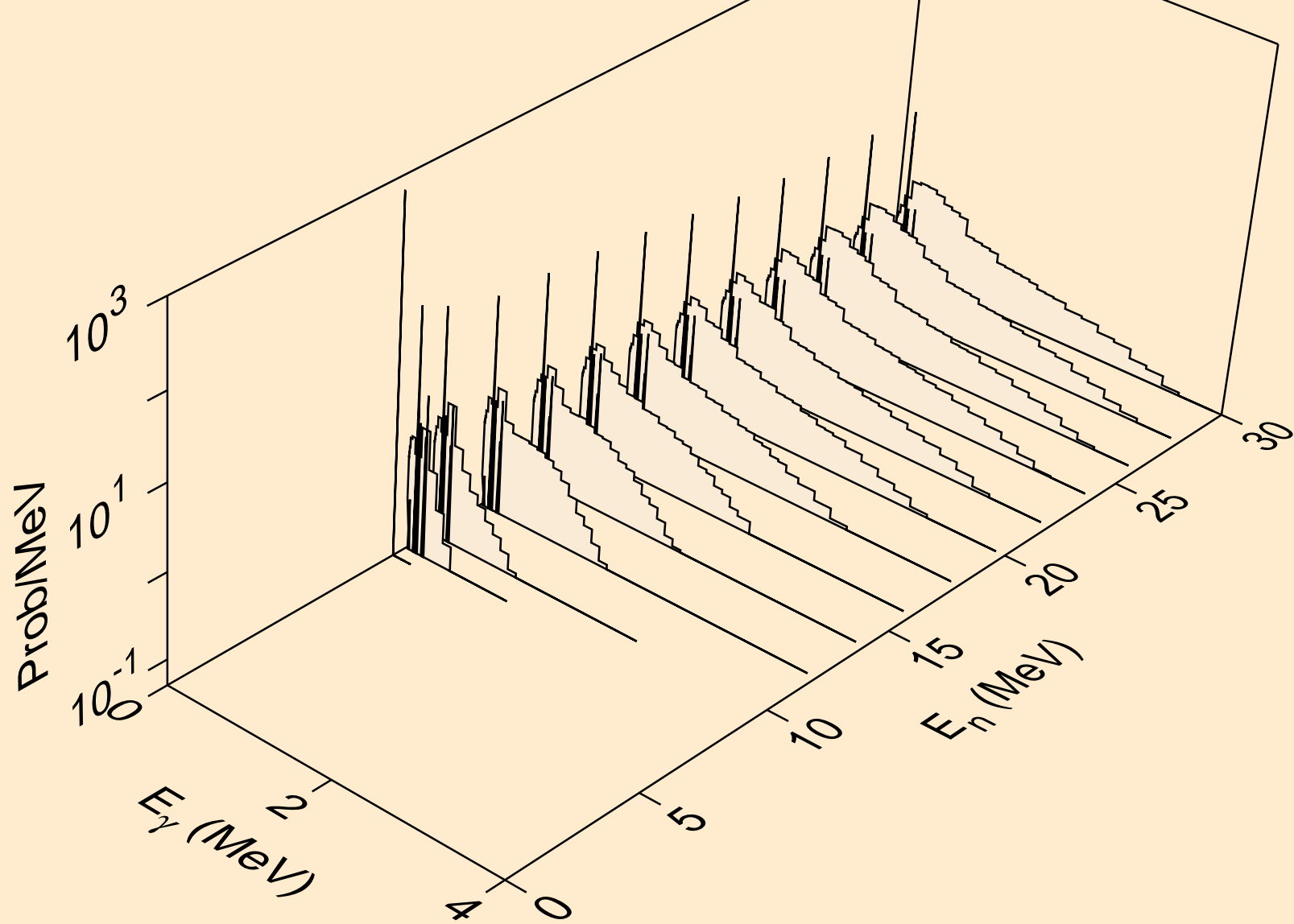

AU197M NEUTRON ACER TENDL-2021 LIBRARY; T=293.6K
Photon emission for (n,he3)

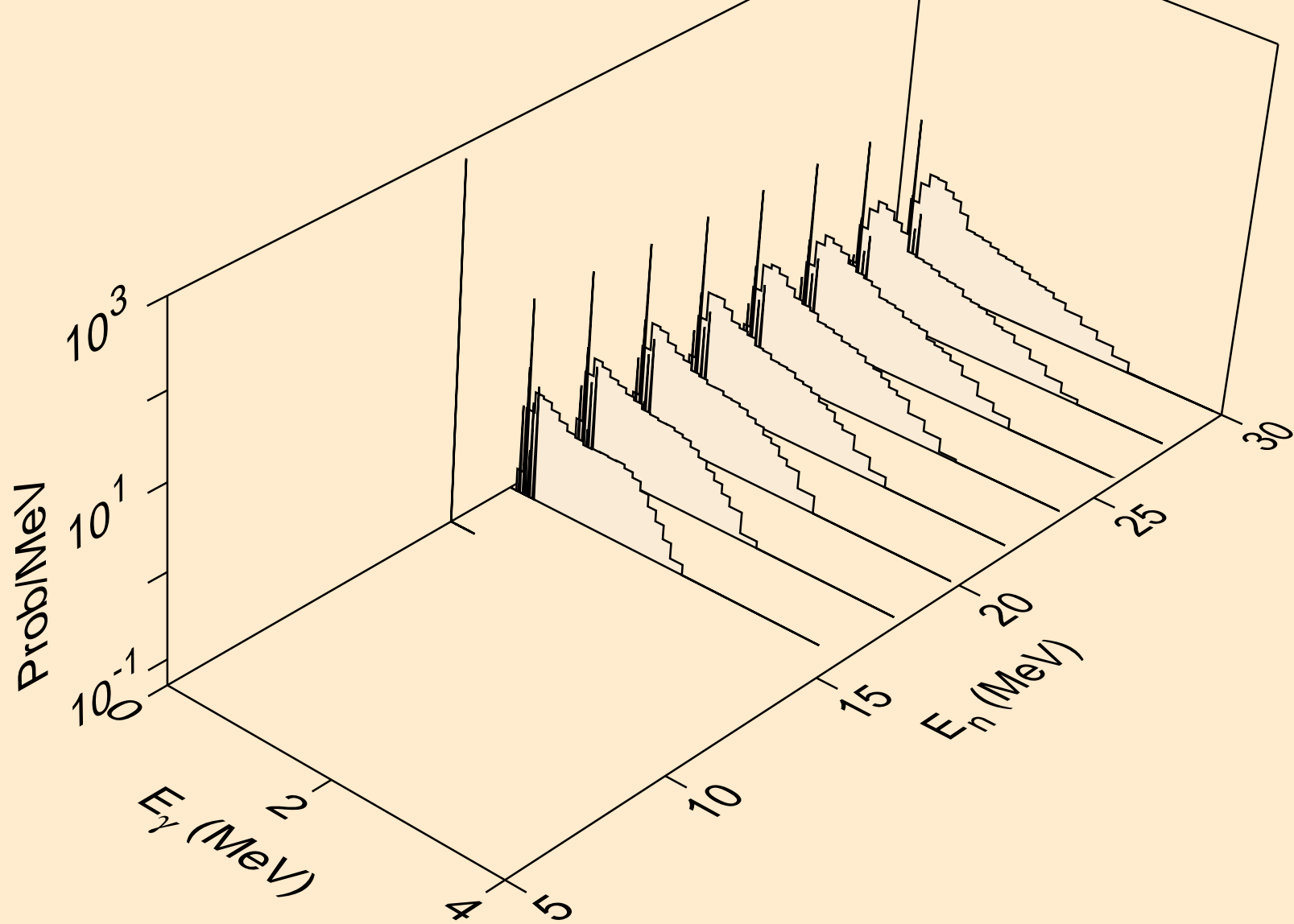

AU197M NEUTRON ACER TENDL-2021 LIBRARY; T=293.6K
Photon emission for (n,a)

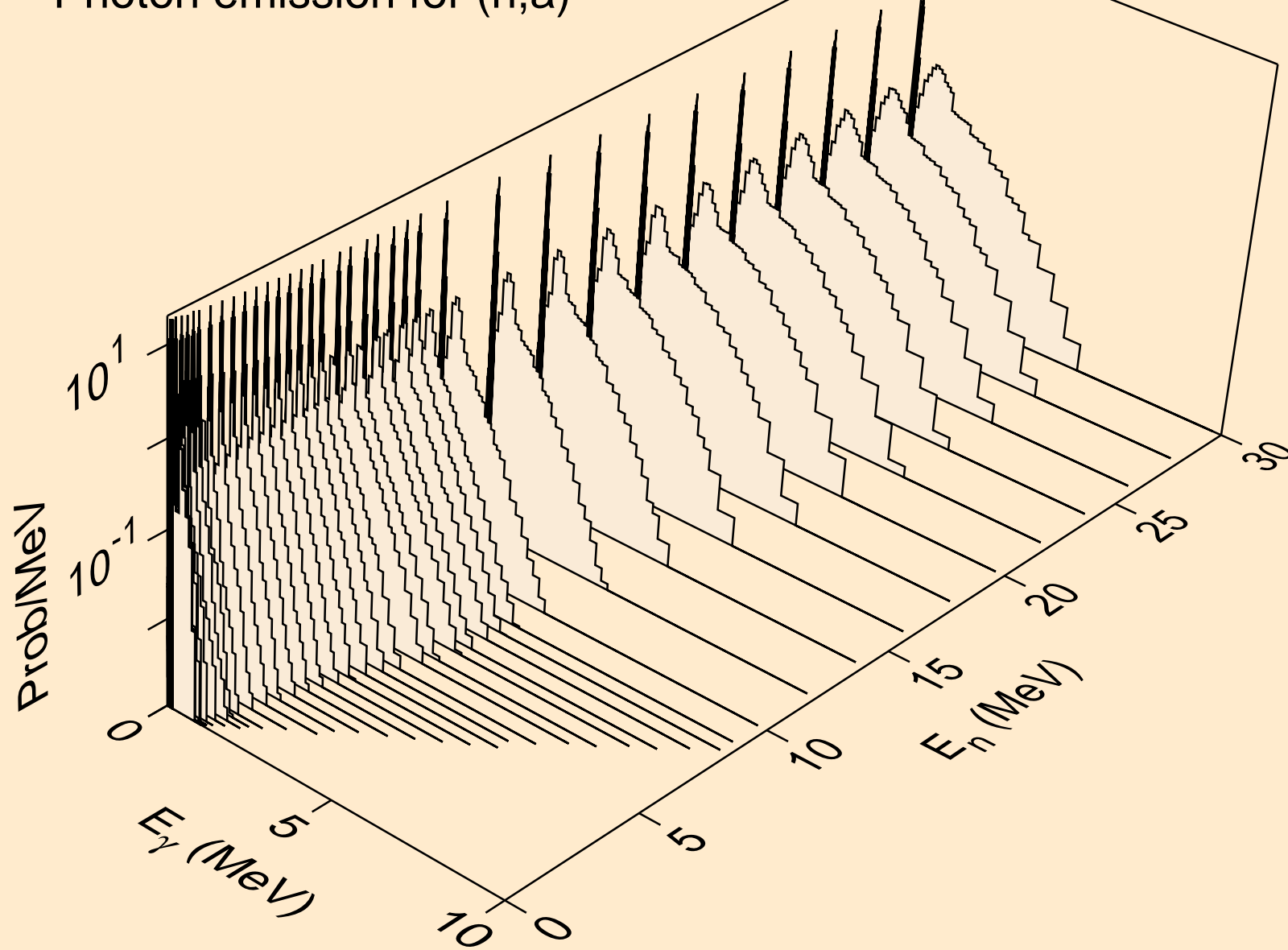

AU197M NEUTRON ACER TENDL-2021 LIBRARY; T=293.6K
Photon emission for (n,2p)

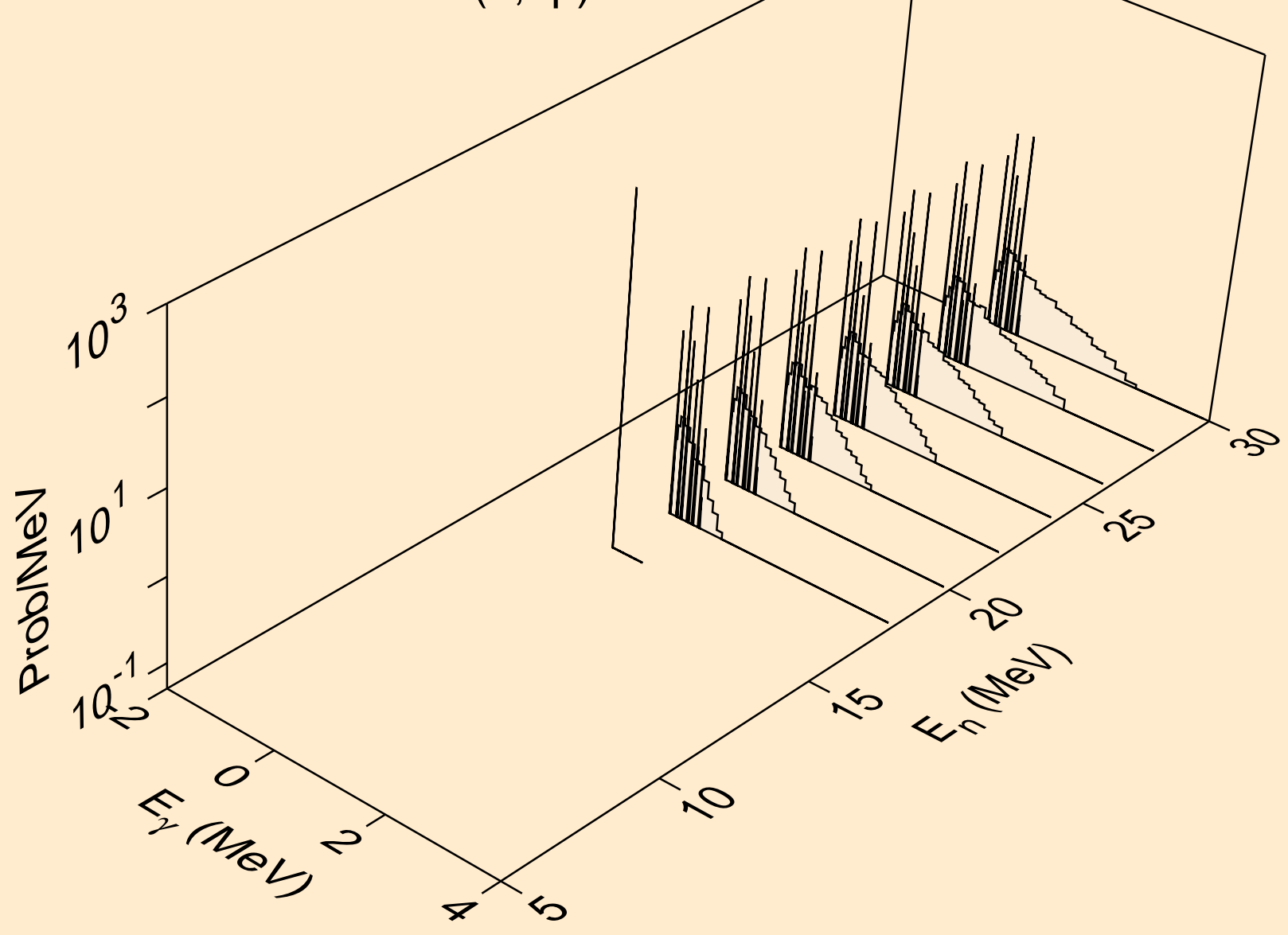

AU197M NEUTRON ACER TENDL-2021 LIBRARY; T=293.6K
Photon emission for (n,pa)

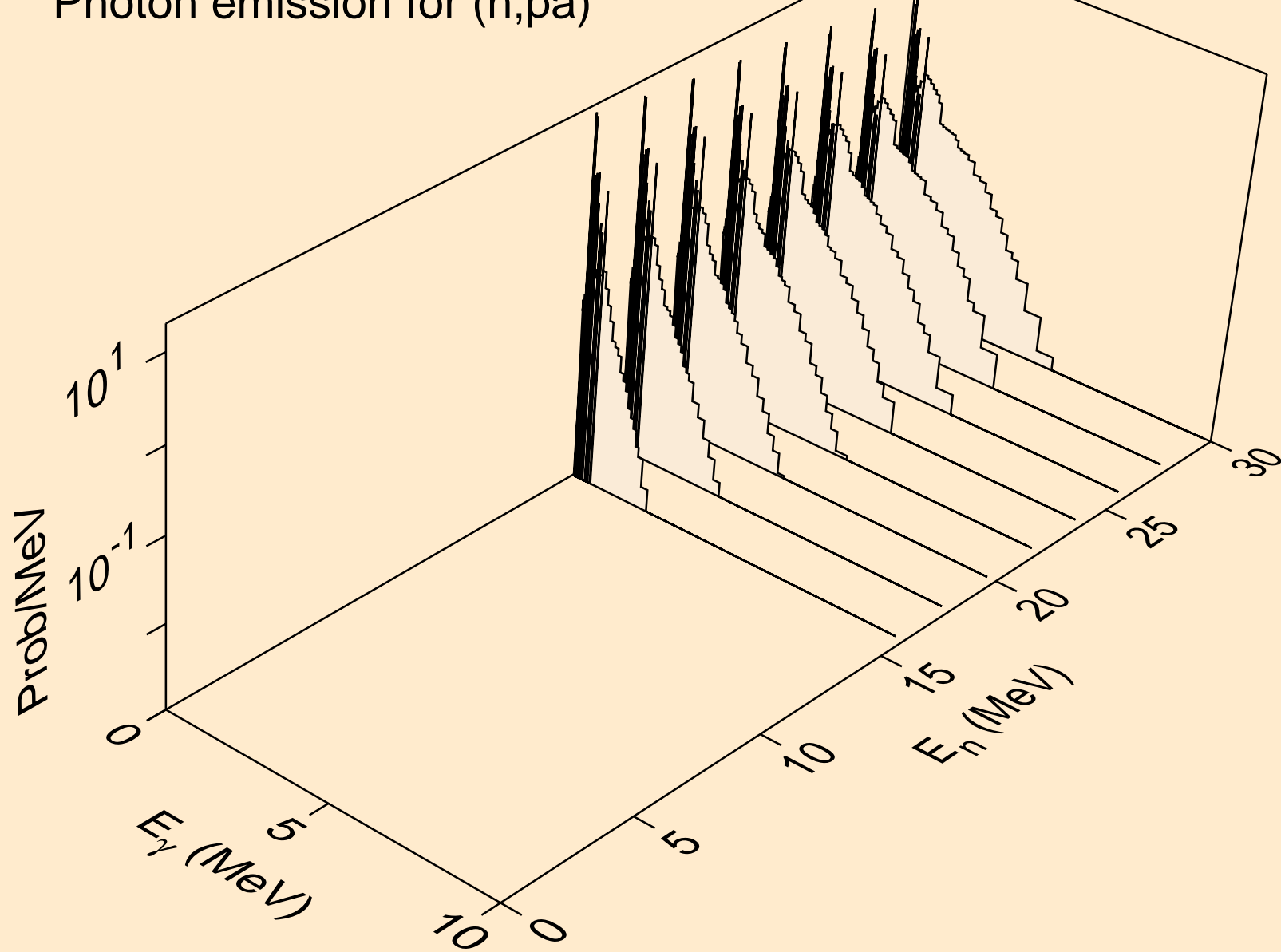

AU197M NEUTRON ACER TENDL-2021 LIBRARY; T=293.6K
thermal capture photon spectrum

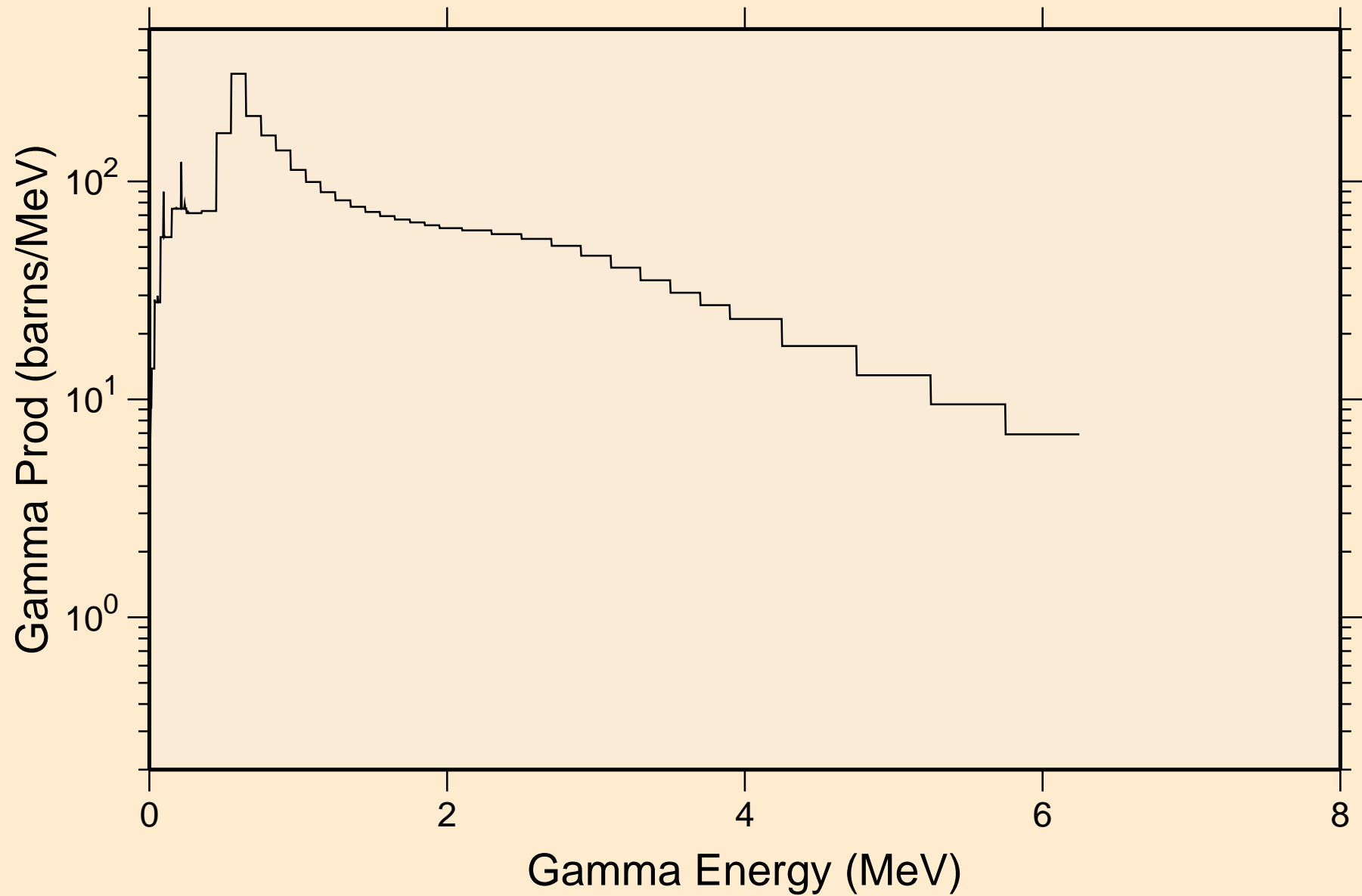

AU197M NEUTRON ACER TENDL-2021 LIBRARY; T=293.6K
14 MeV photon spectrum

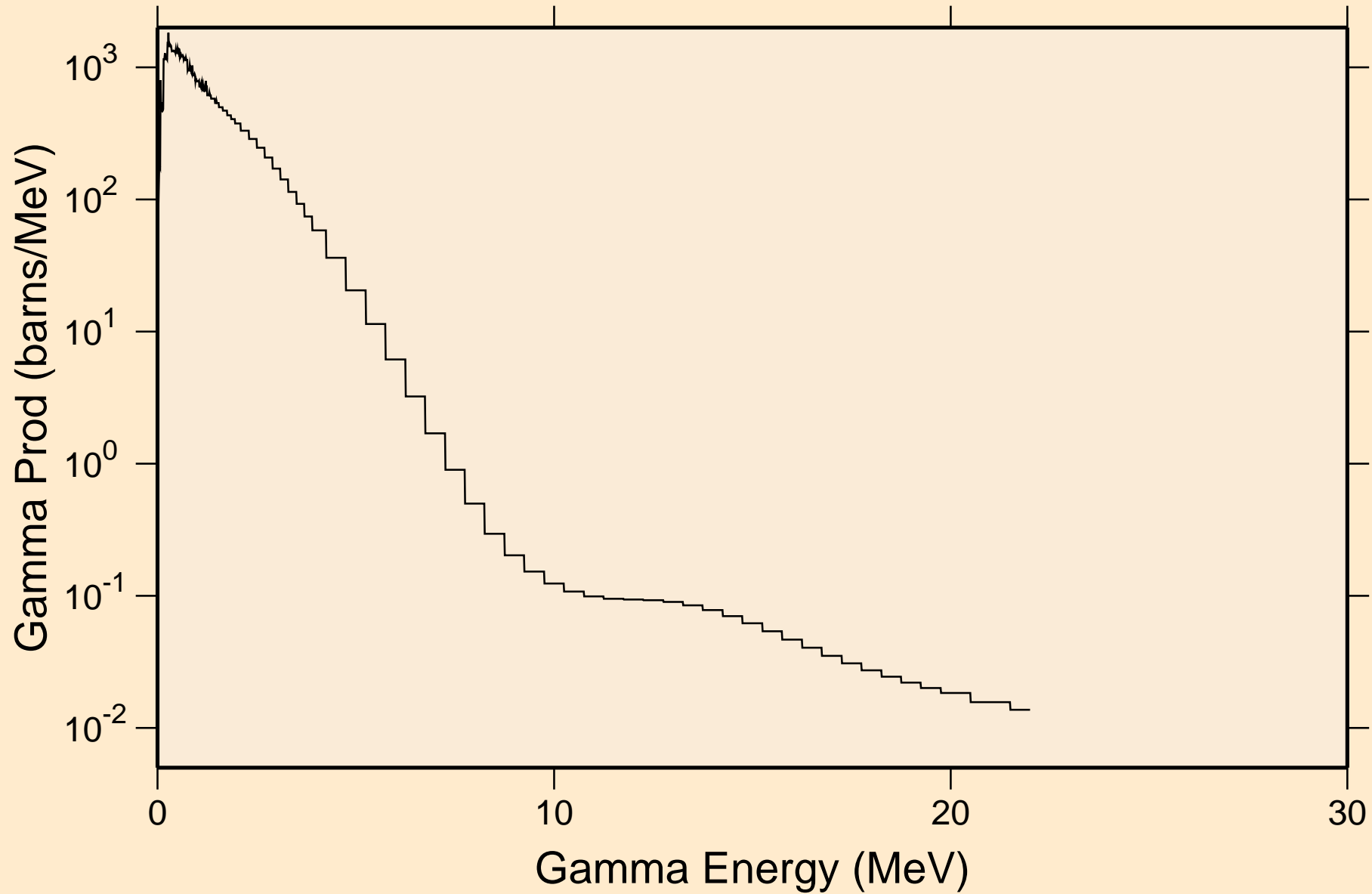

AU197M NEUTRON ACER TENDL-2021 LIBRARY; T=293.6K
Particle heating contributions

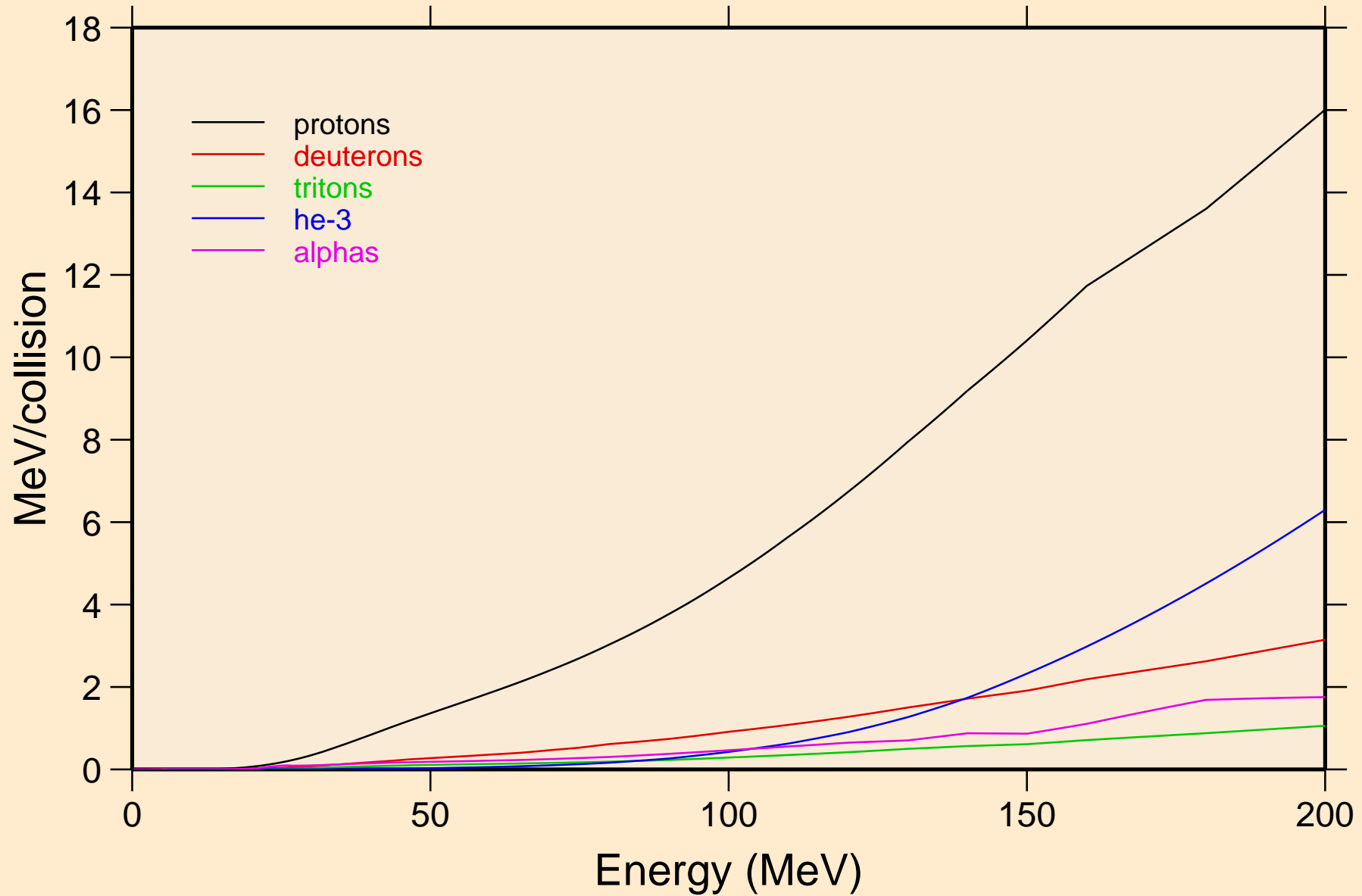

AU197M NEUTRON ACER TENDL-2021 LIBRARY; T=293.6K
Recoil Heating

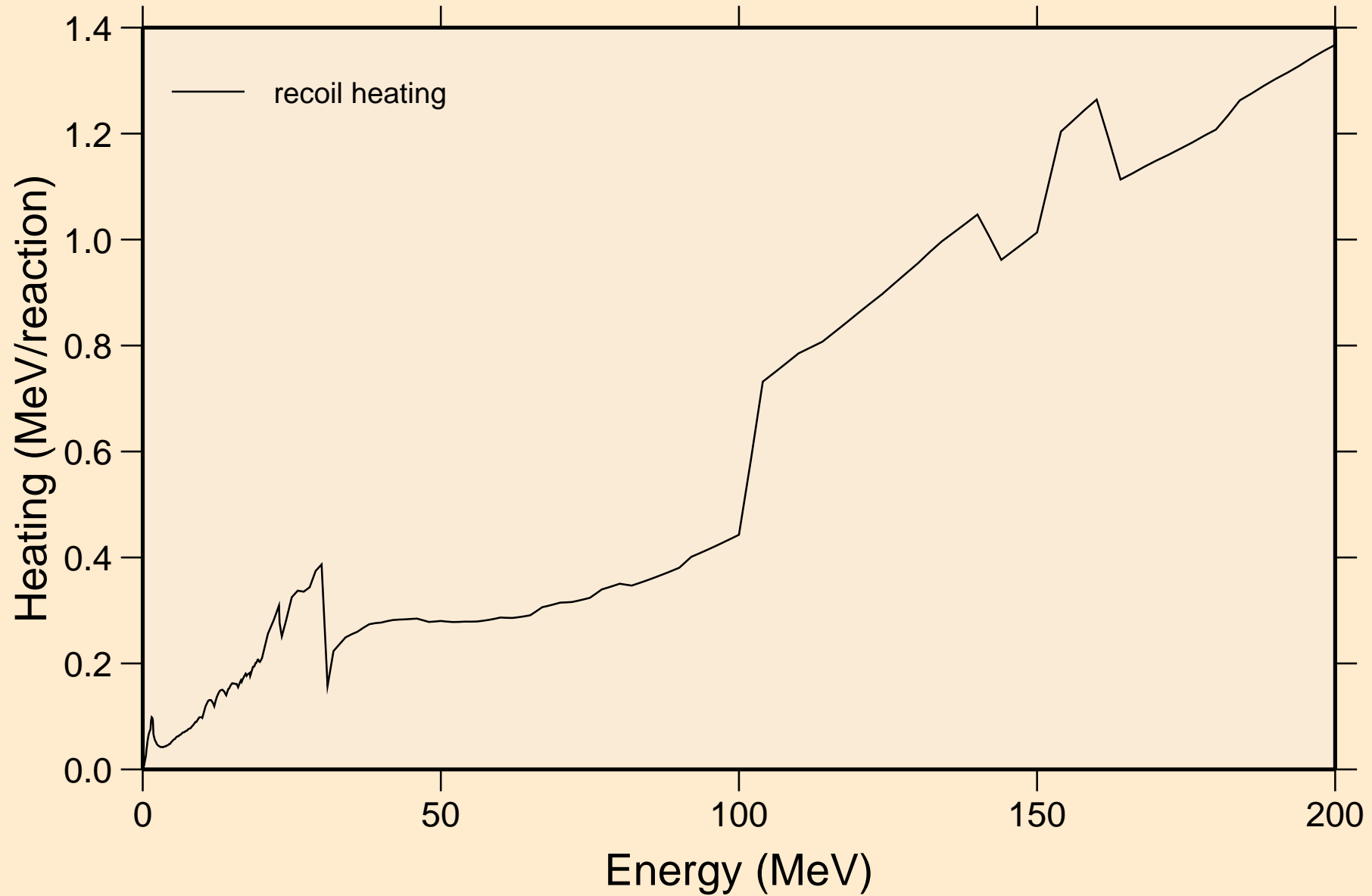

AU197M NEUTRON ACER TENDL-2021 LIBRARY; T=293.6K
Particle production cross sections

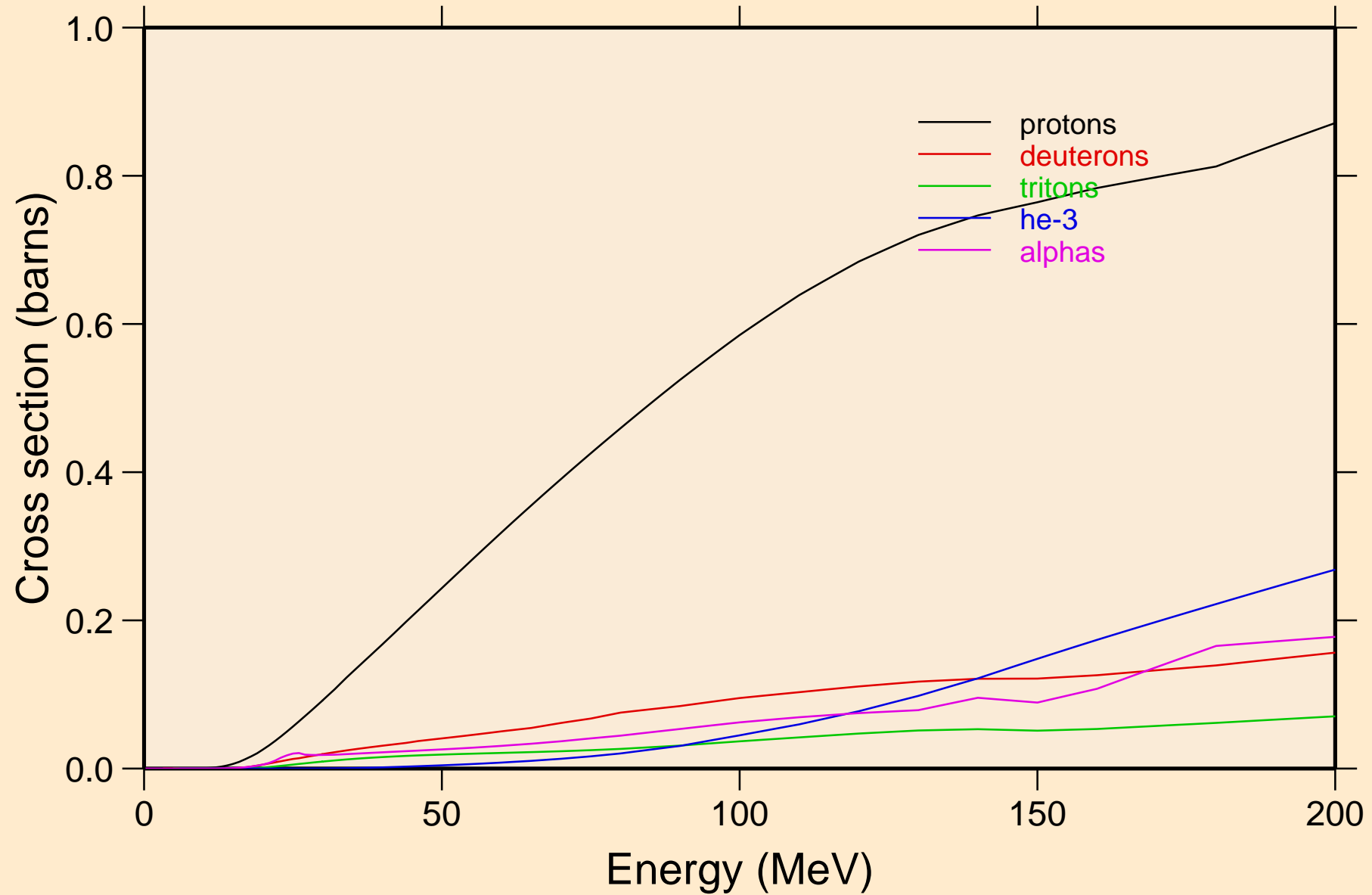

AU197M NEUTRON ACER TENDL-2021 LIBRARY; T=293.6K
protons from (n,x)

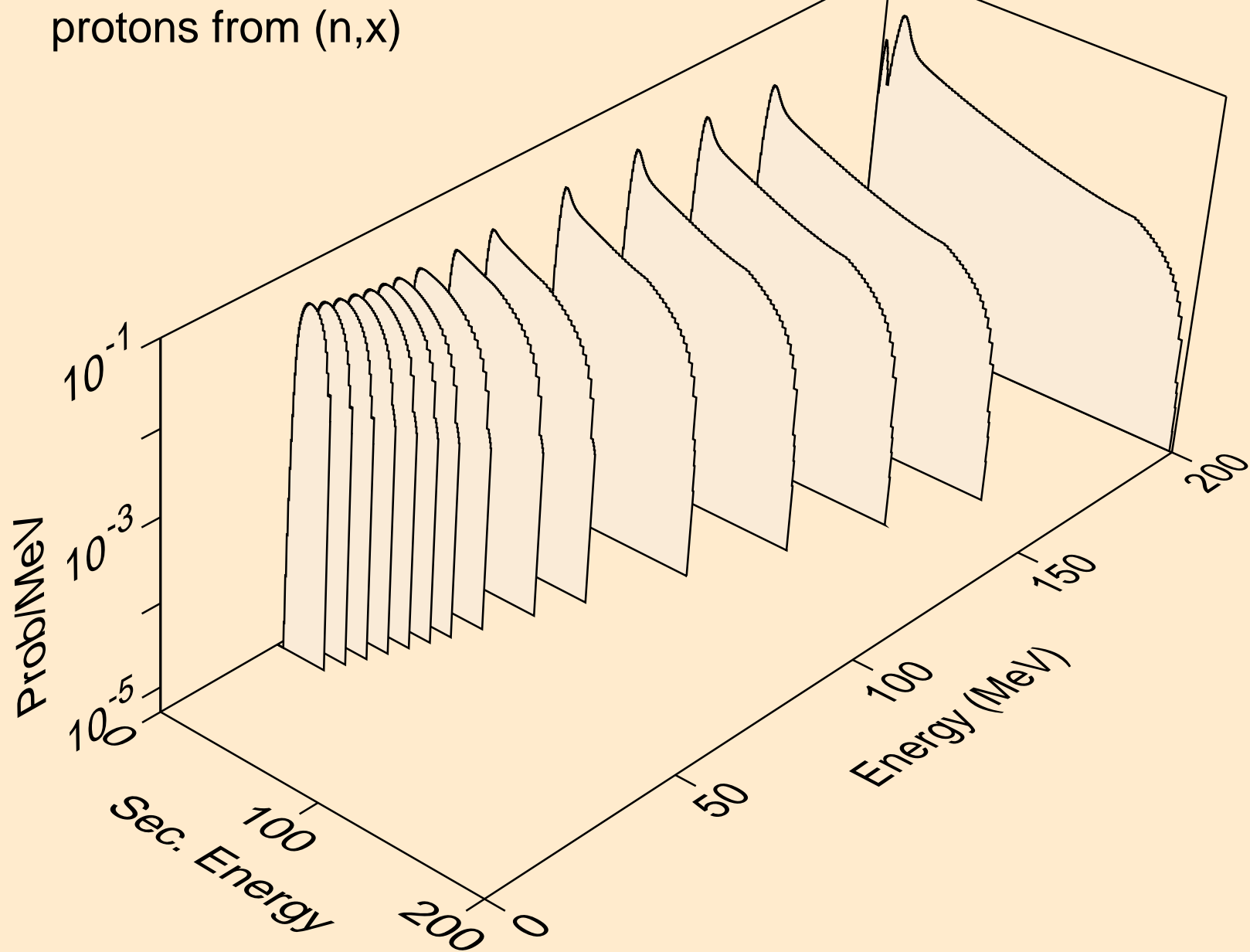

AU197M NEUTRON ACER TENDL-2021 LIBRARY; T=293.6K
protons from (n,n*)p

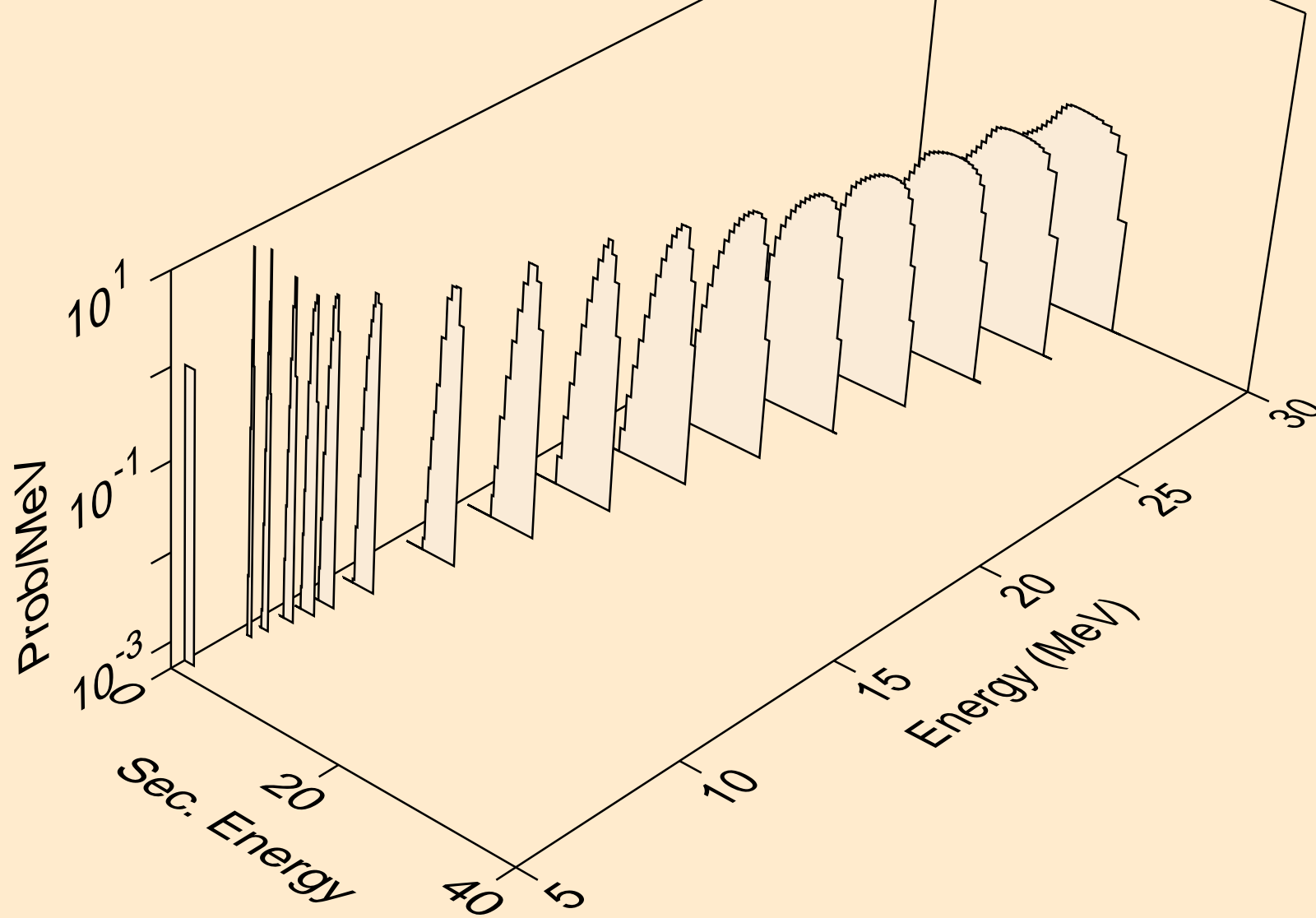

AU197M NEUTRON ACER TENDL-2021 LIBRARY; T=293.6K
protons from (n,2np)

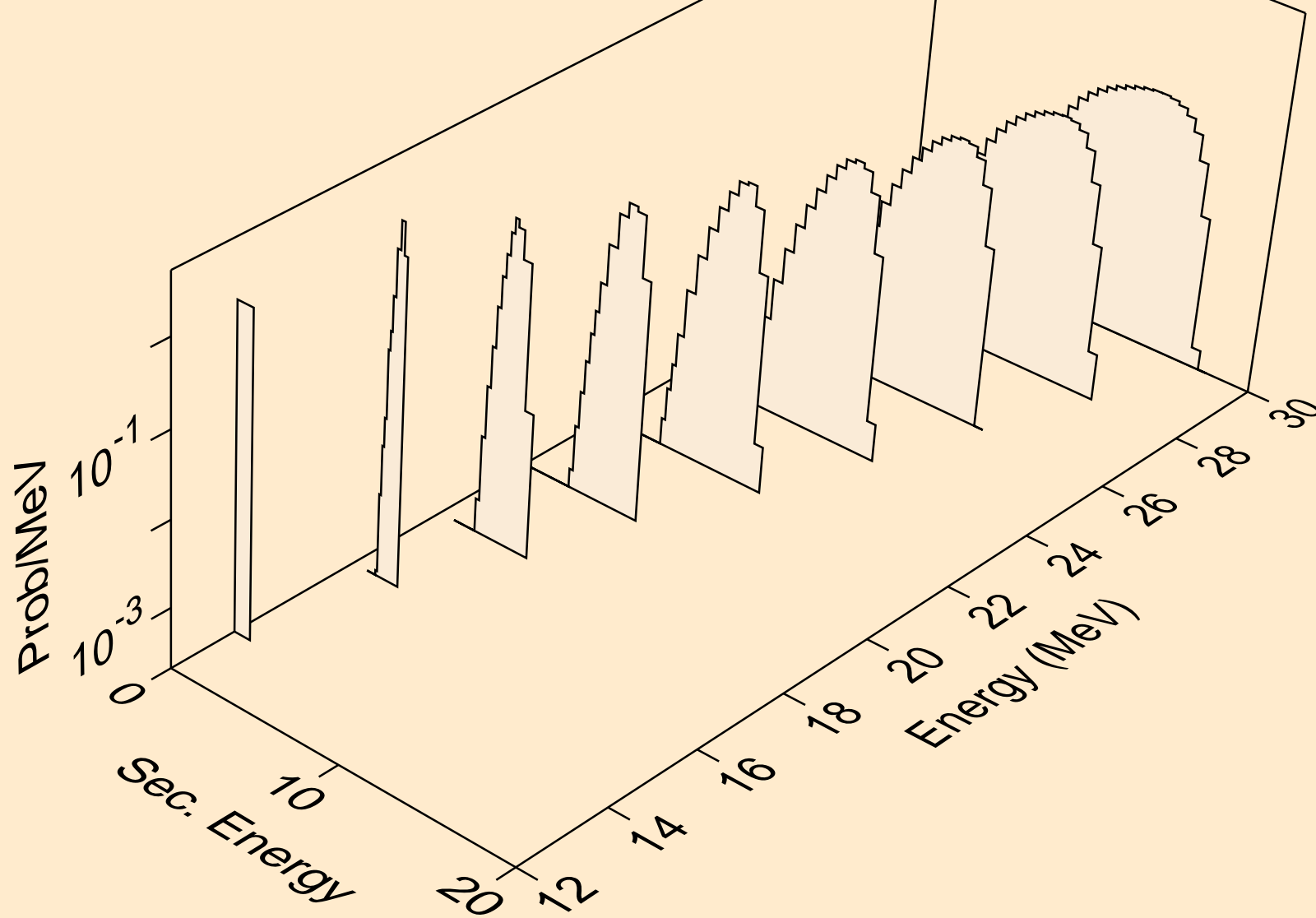

AU197M NEUTRON ACER TENDL-2021 LIBRARY; T=293.6K
protons from (n,3np)

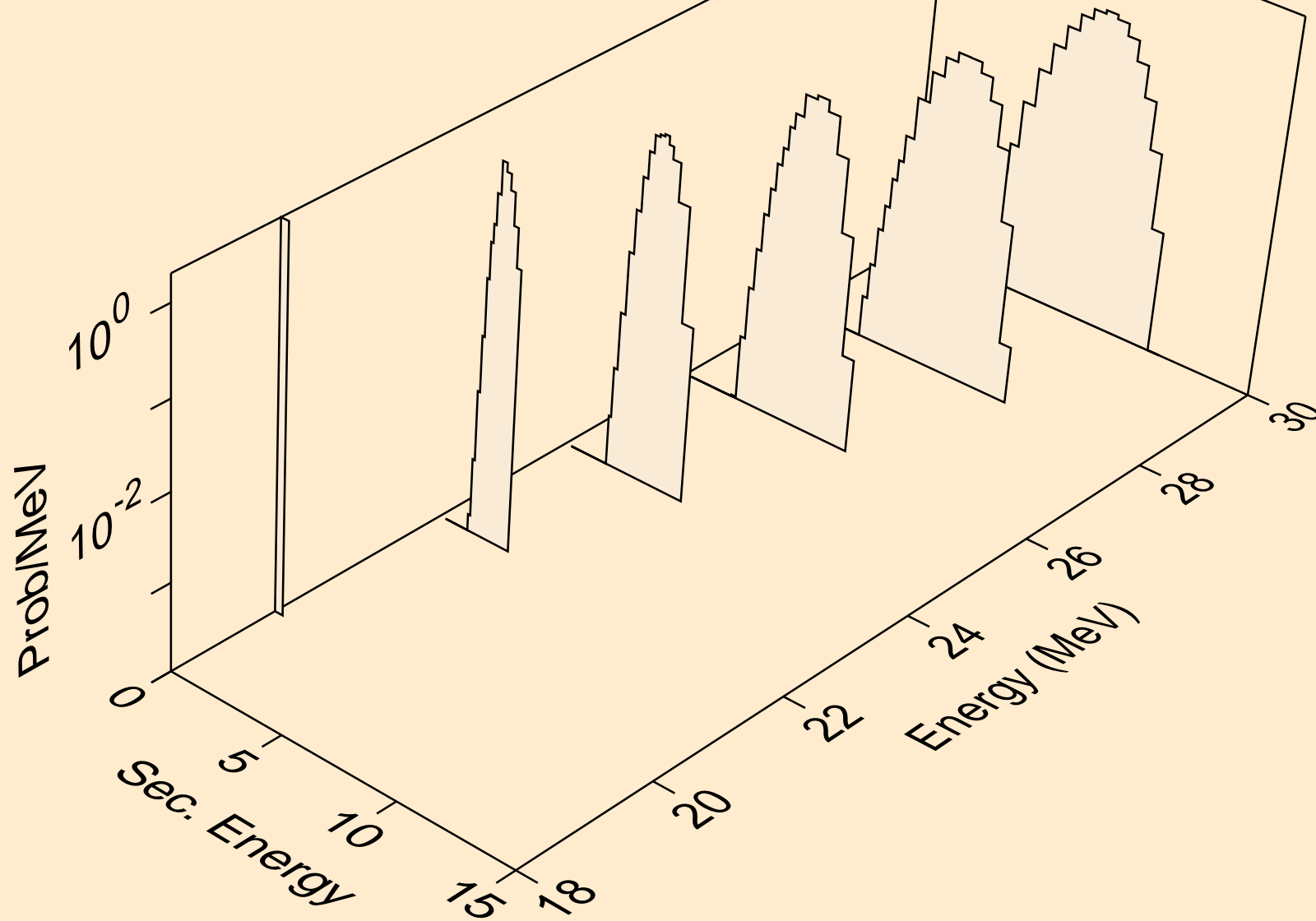

AU197M NEUTRON ACER TENDL-2021 LIBRARY; T=293.6K
protons from (n,2np)

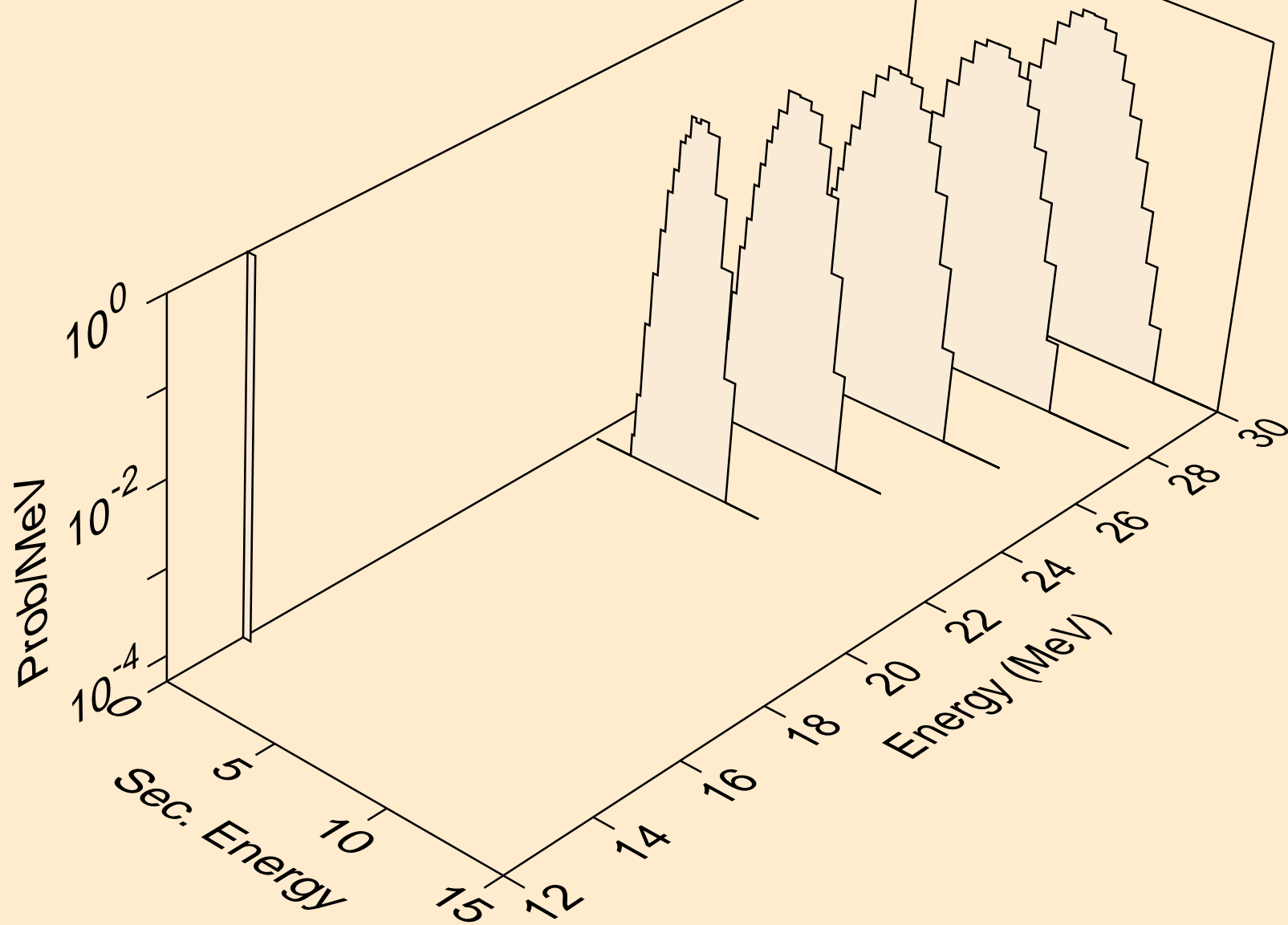

AU197M NEUTRON ACER TENDL-2021 LIBRARY; T=293.6K
protons from (n,npa)

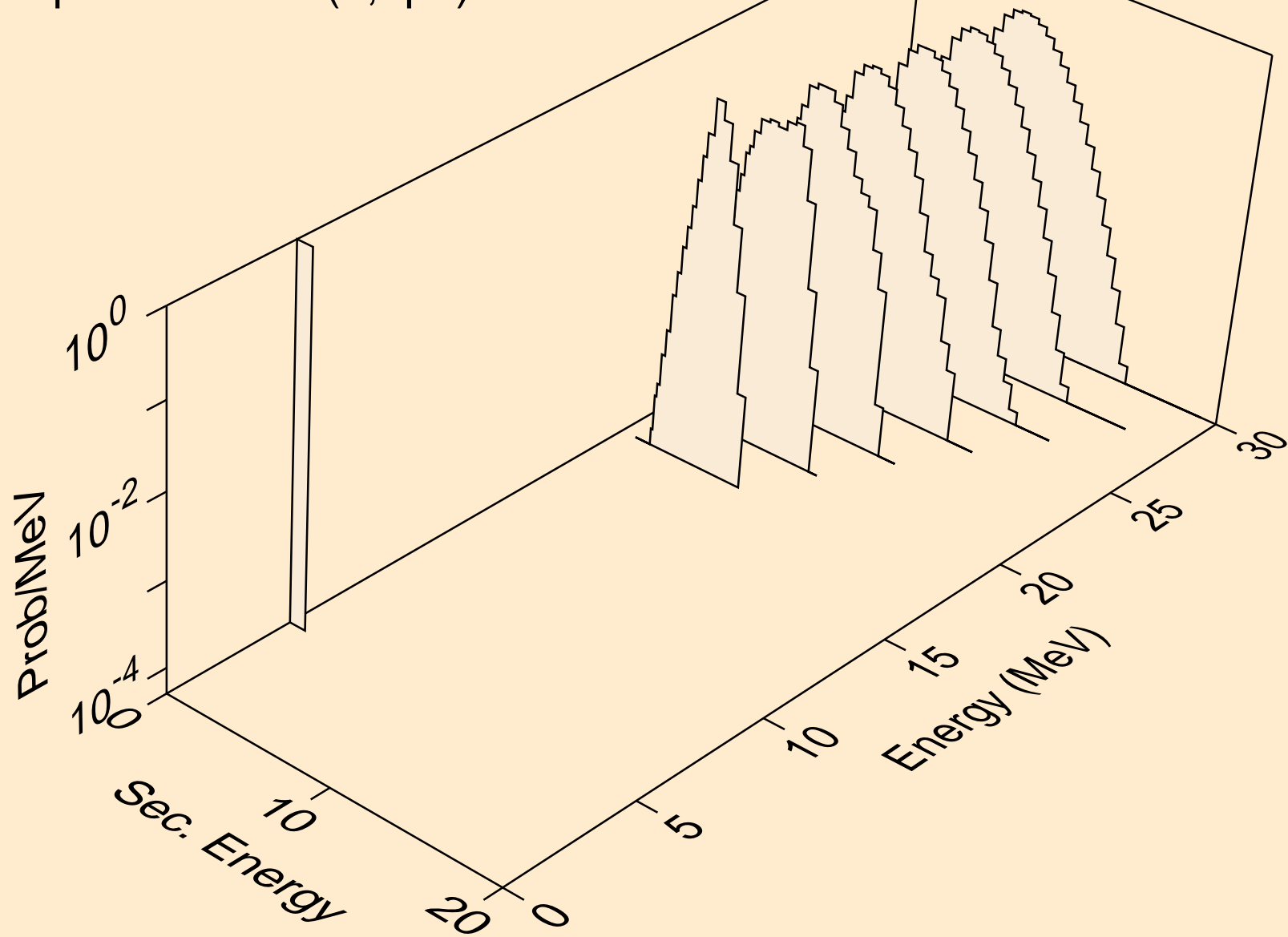

AU197M NEUTRON ACER TENDL-2021 LIBRARY; T=293.6K
protons from (n,p)

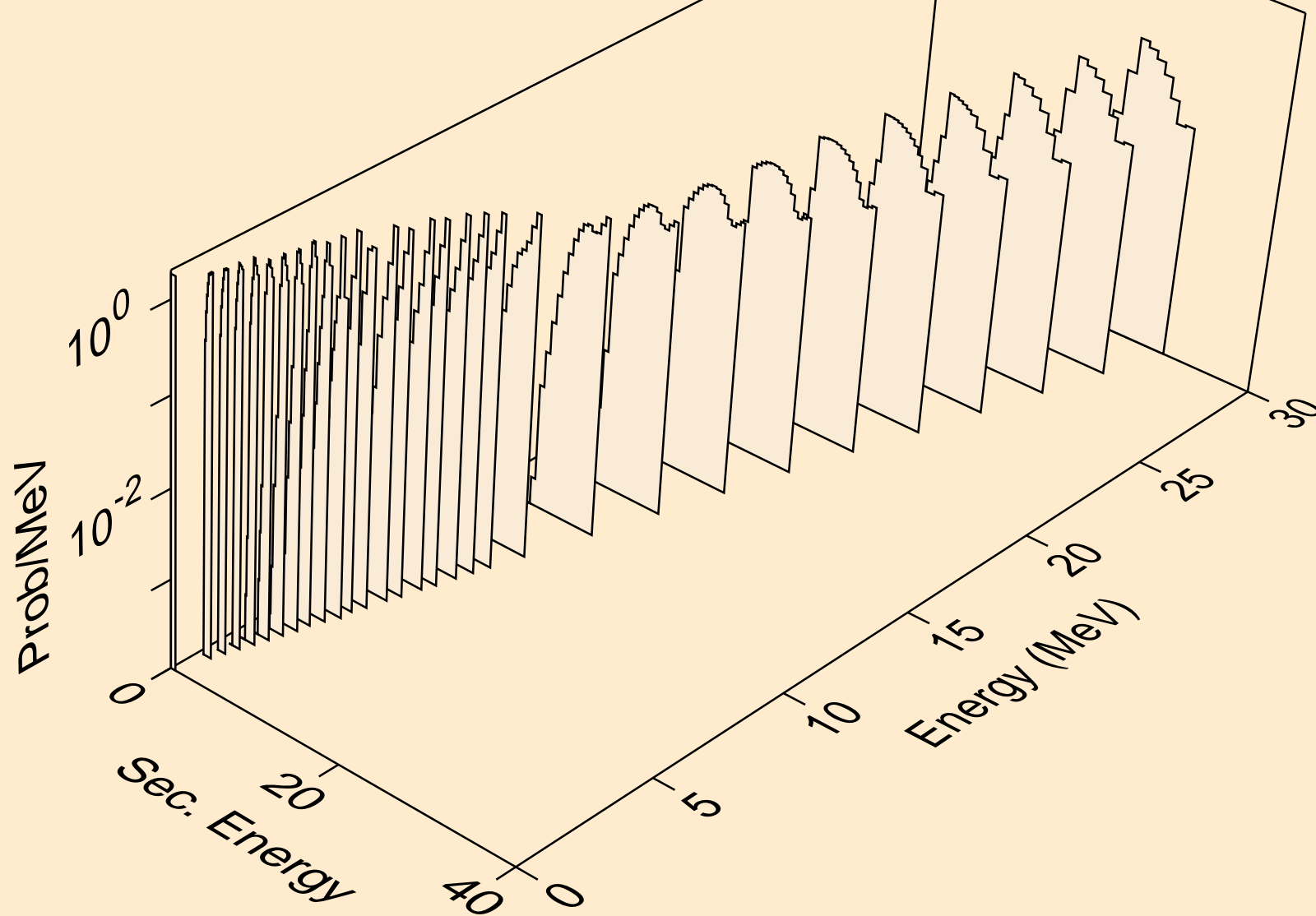

AU197M NEUTRON ACER TENDL-2021 LIBRARY; T=293.6K
protons from (n,2p)

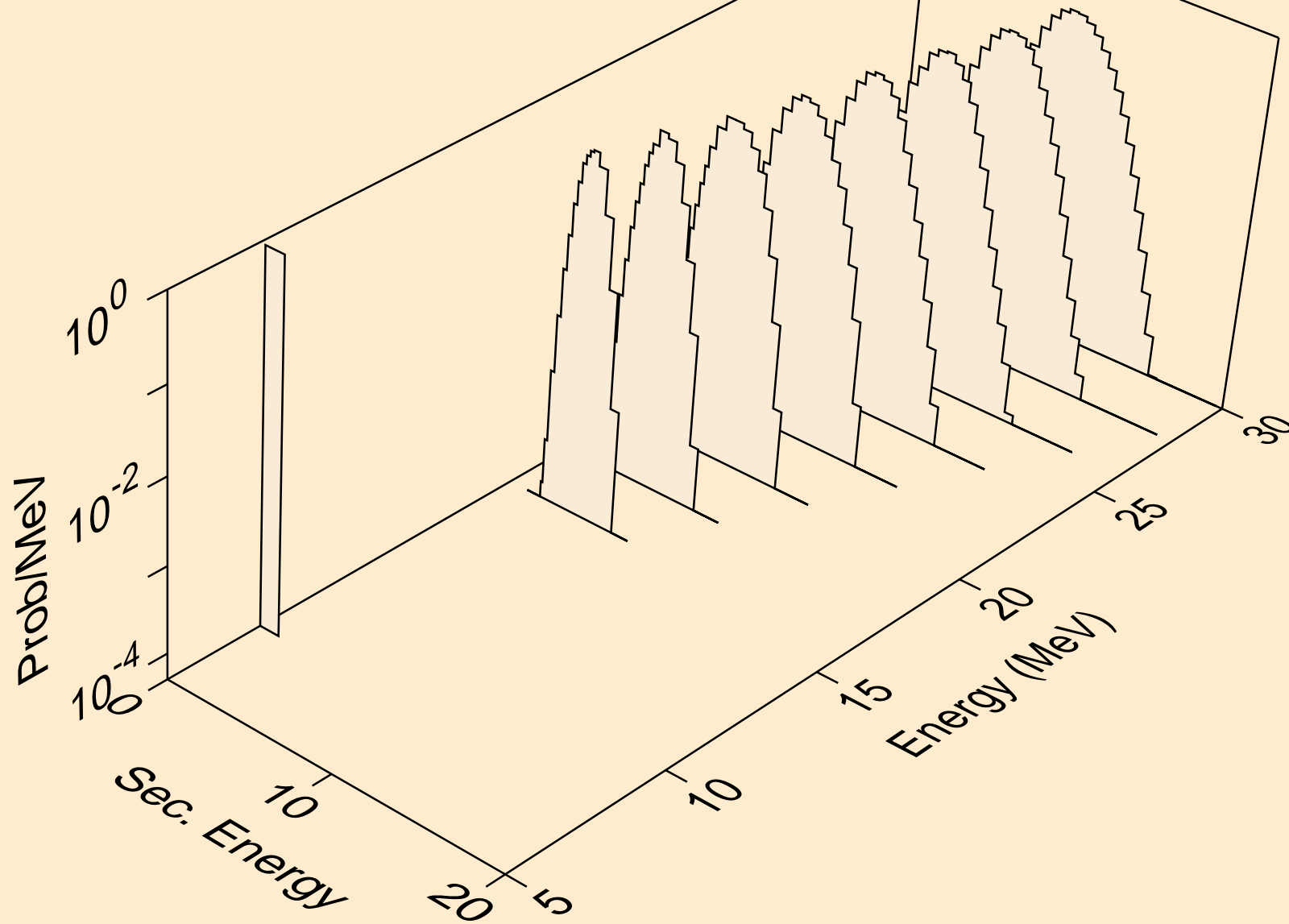

AU197M NEUTRON ACER TENDL-2021 LIBRARY; T=293.6K
protons from (n,p)

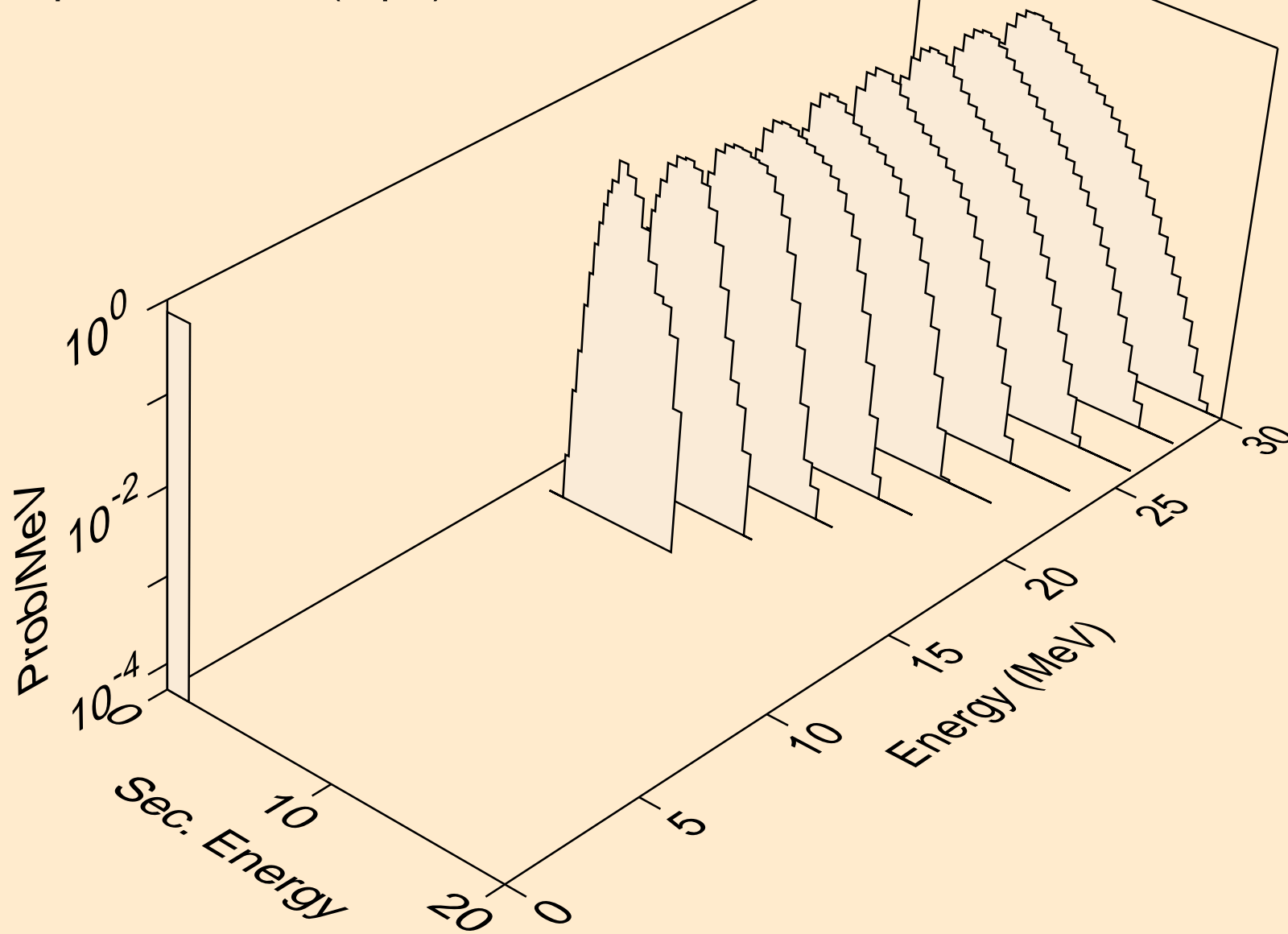

AU197M NEUTRON ACER TENDL-2021 LIBRARY; T=293.6K
deuterons from (n,x)

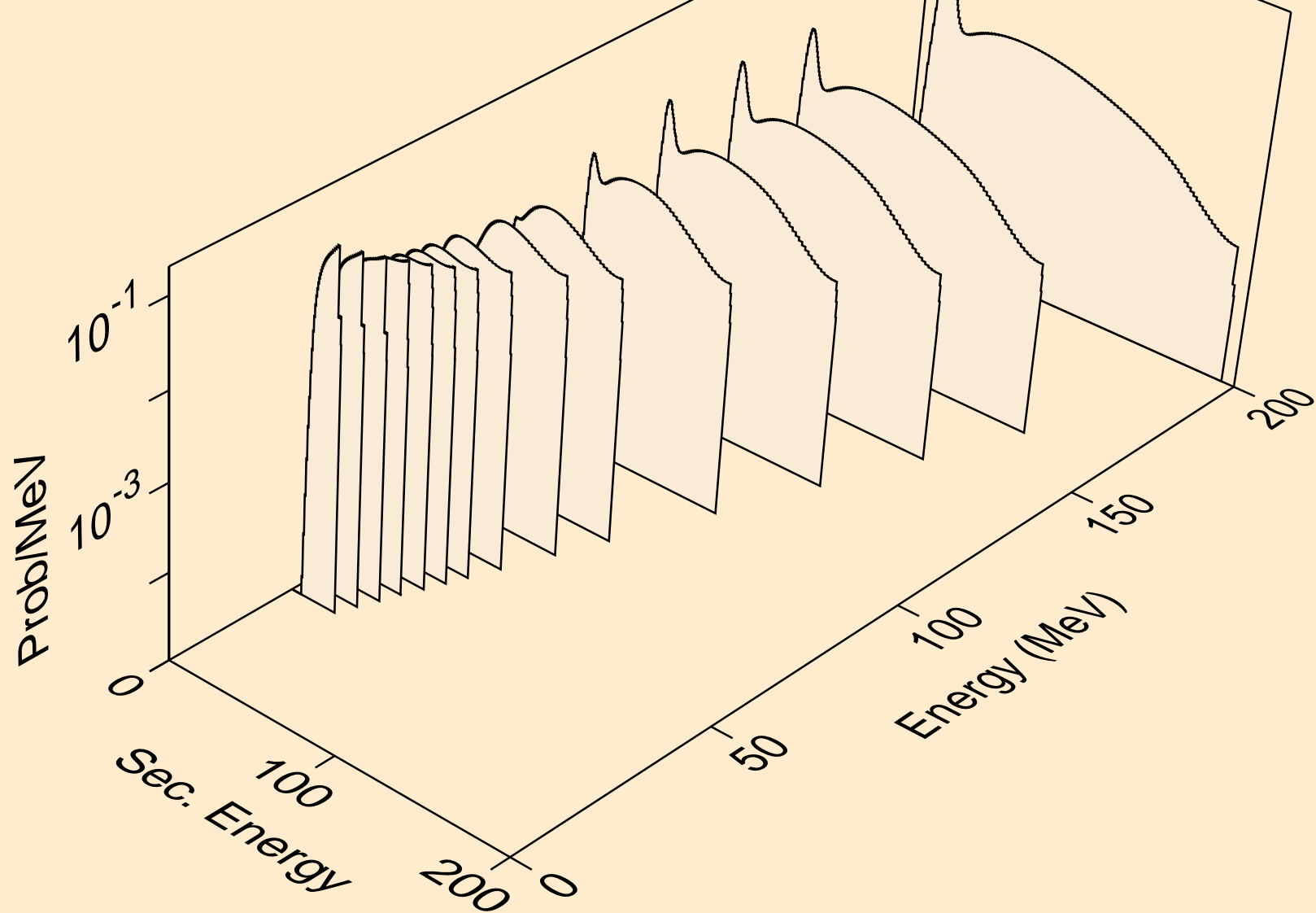

AU197M NEUTRON ACER TENDL-2021 LIBRARY; T=293.6K
deuterons from (n,2nd)

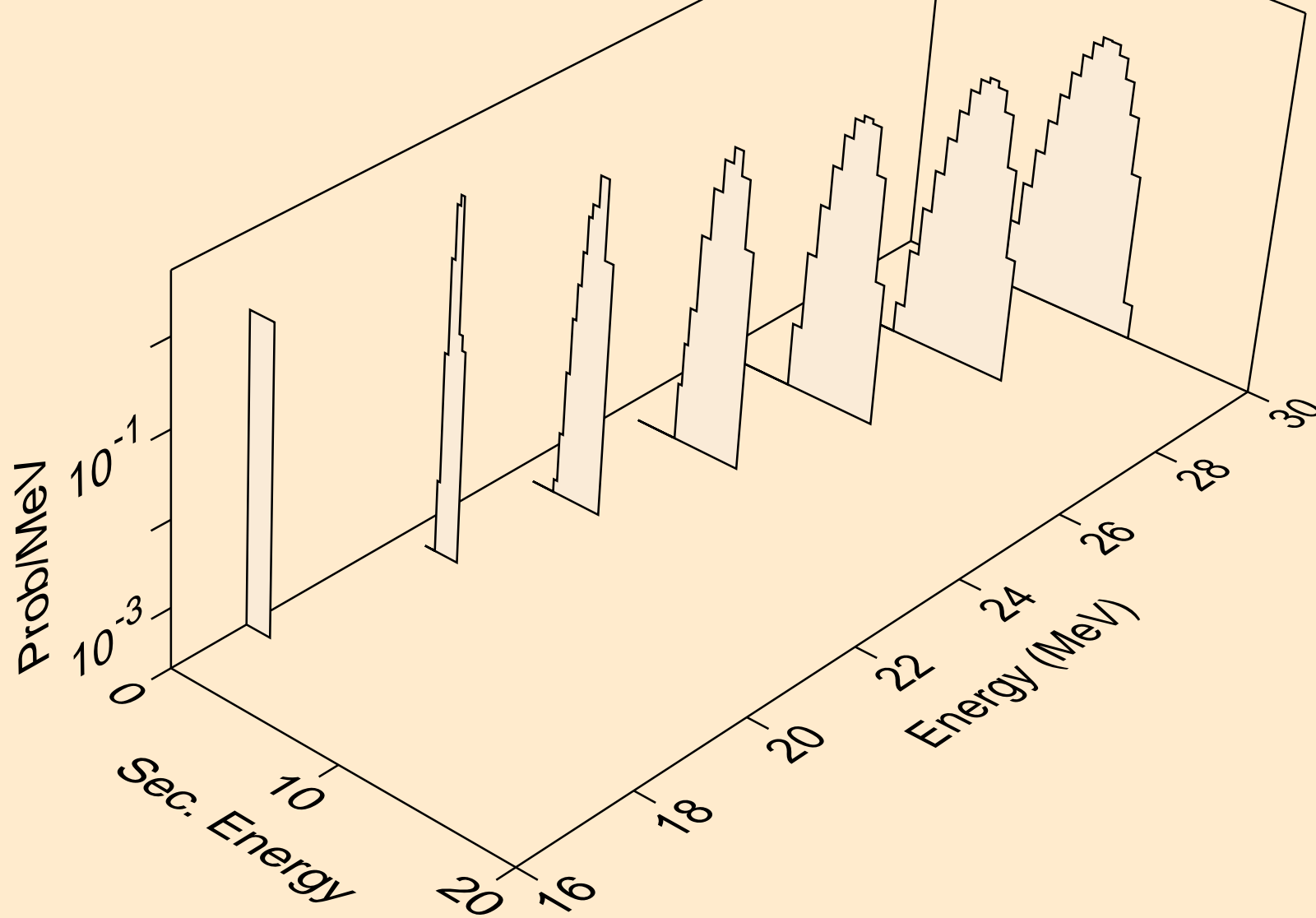

AU197M NEUTRON ACER TENDL-2021 LIBRARY; T=293.6K
deuterons from (n,n*)d

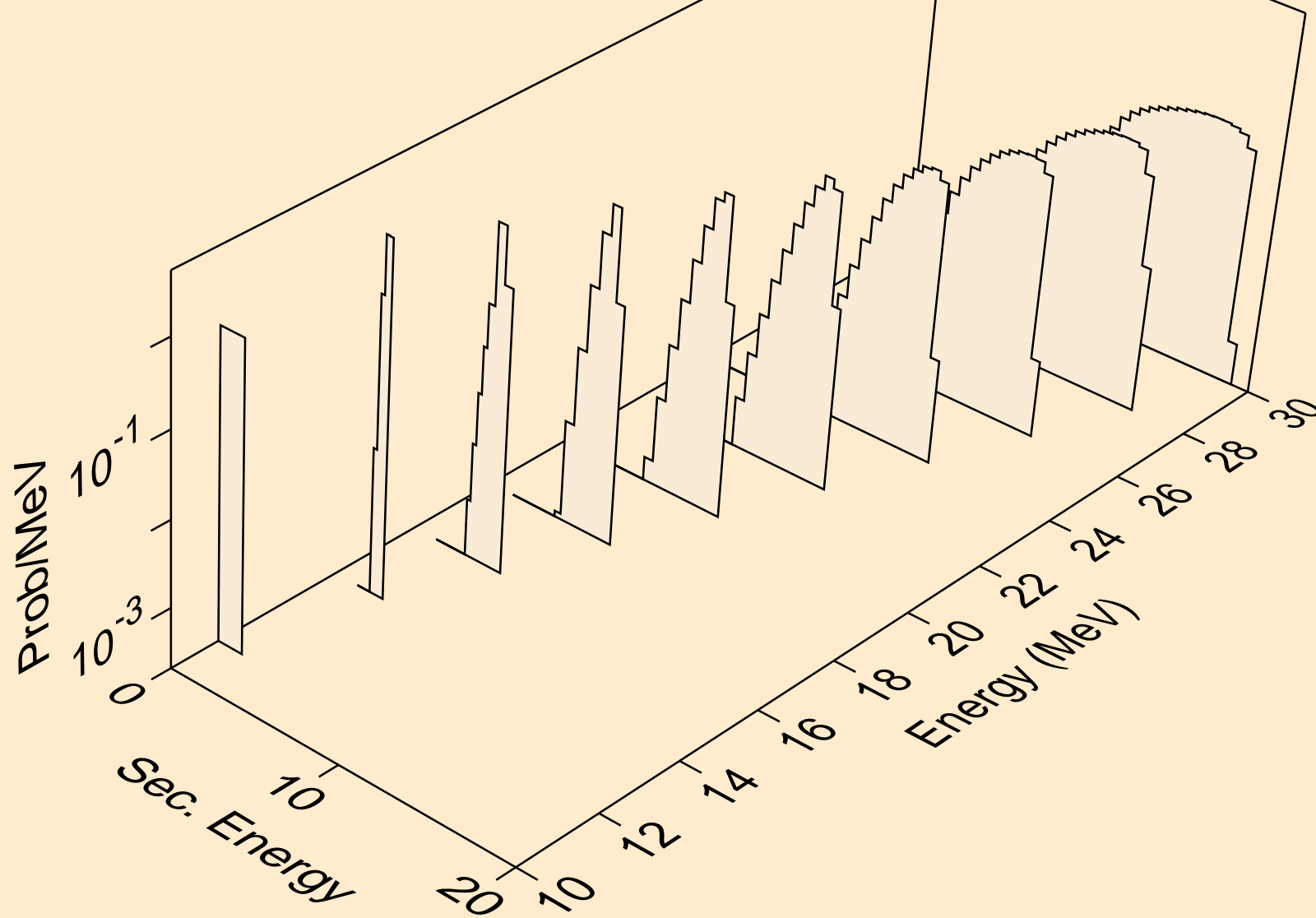

AU197M NEUTRON ACER TENDL-2021 LIBRARY; T=293.6K
deuterons from (n,d)

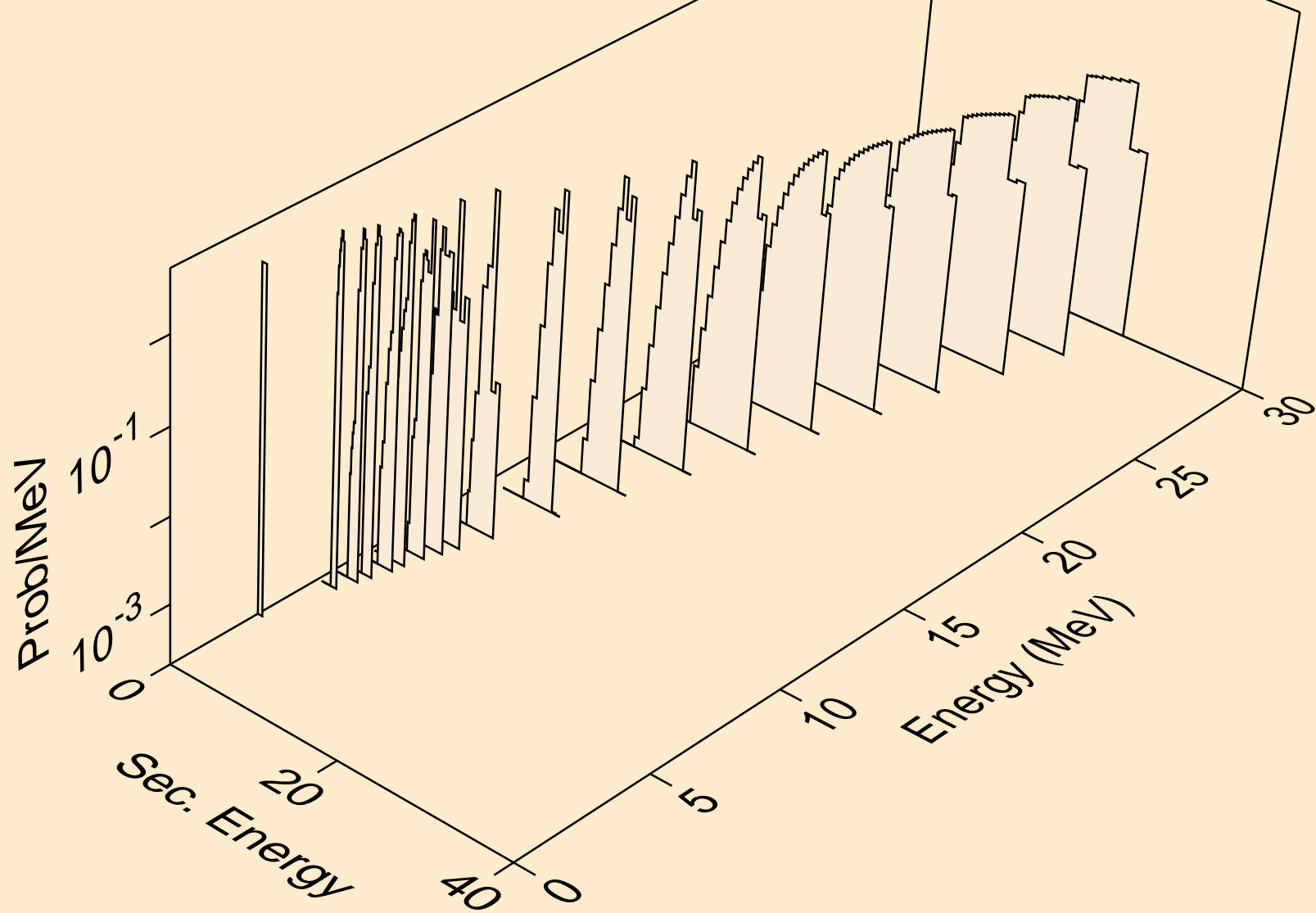

AU197M NEUTRON ACER TENDL-2021 LIBRARY; T=293.6K
tritons from (n,x)

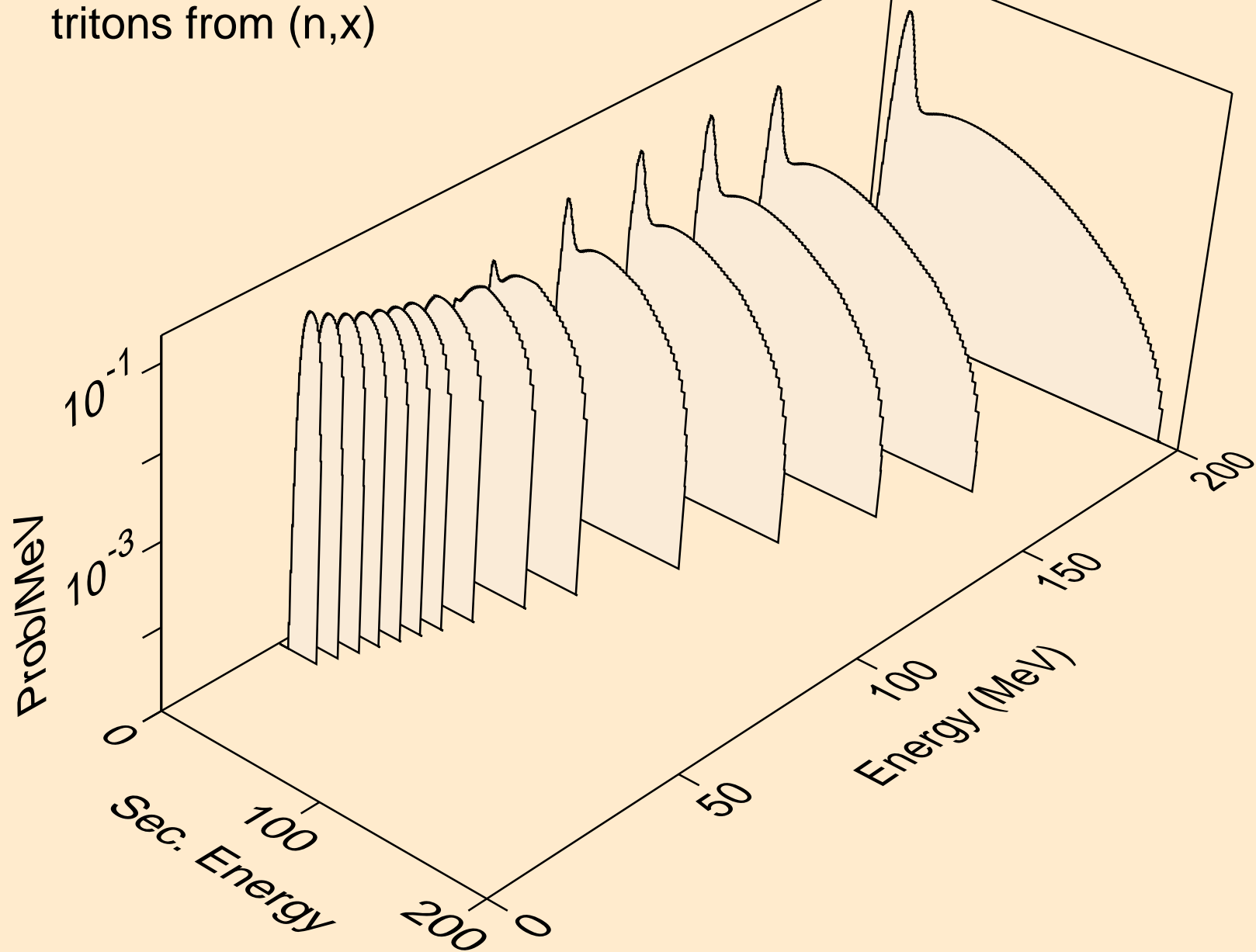

AU197M NEUTRON ACER TENDL-2021 LIBRARY; T=293.6K
tritons from (n,n*)t

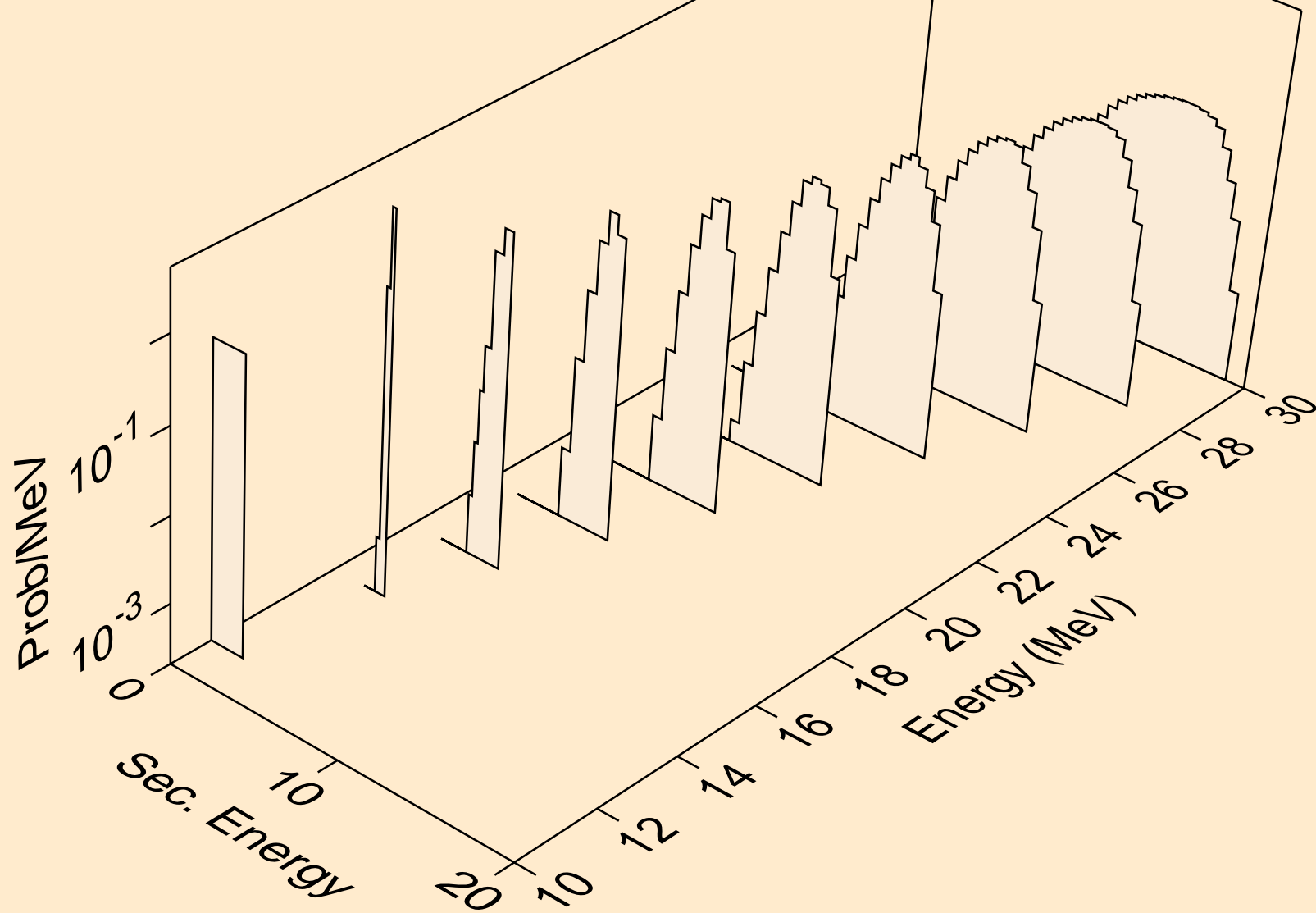

AU197M NEUTRON ACER TENDL-2021 LIBRARY; T=293.6K
tritons from (n,t)

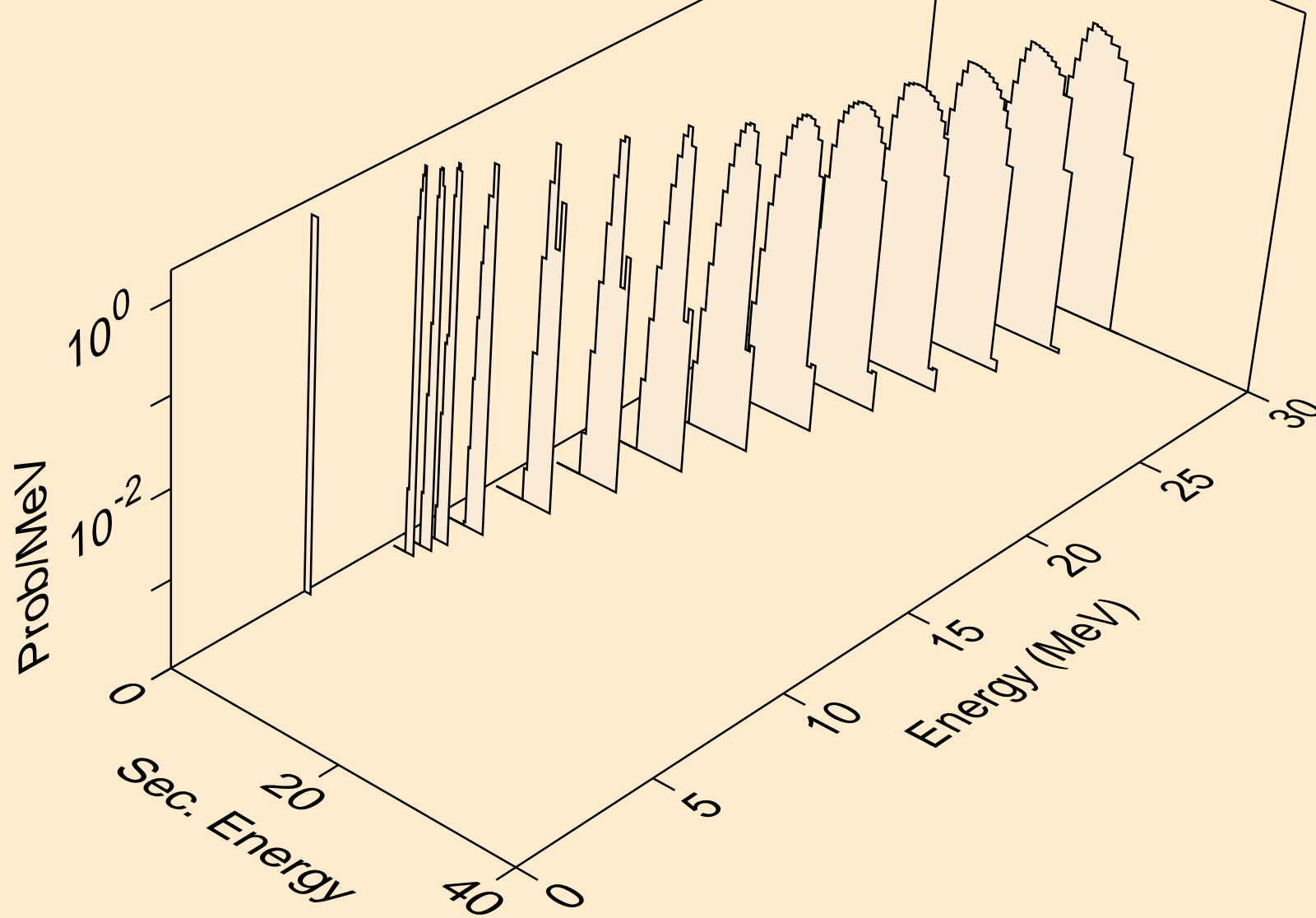

AU197M NEUTRON ACER TENDL-2021 LIBRARY; T=293.6K
he3s from (n,x)

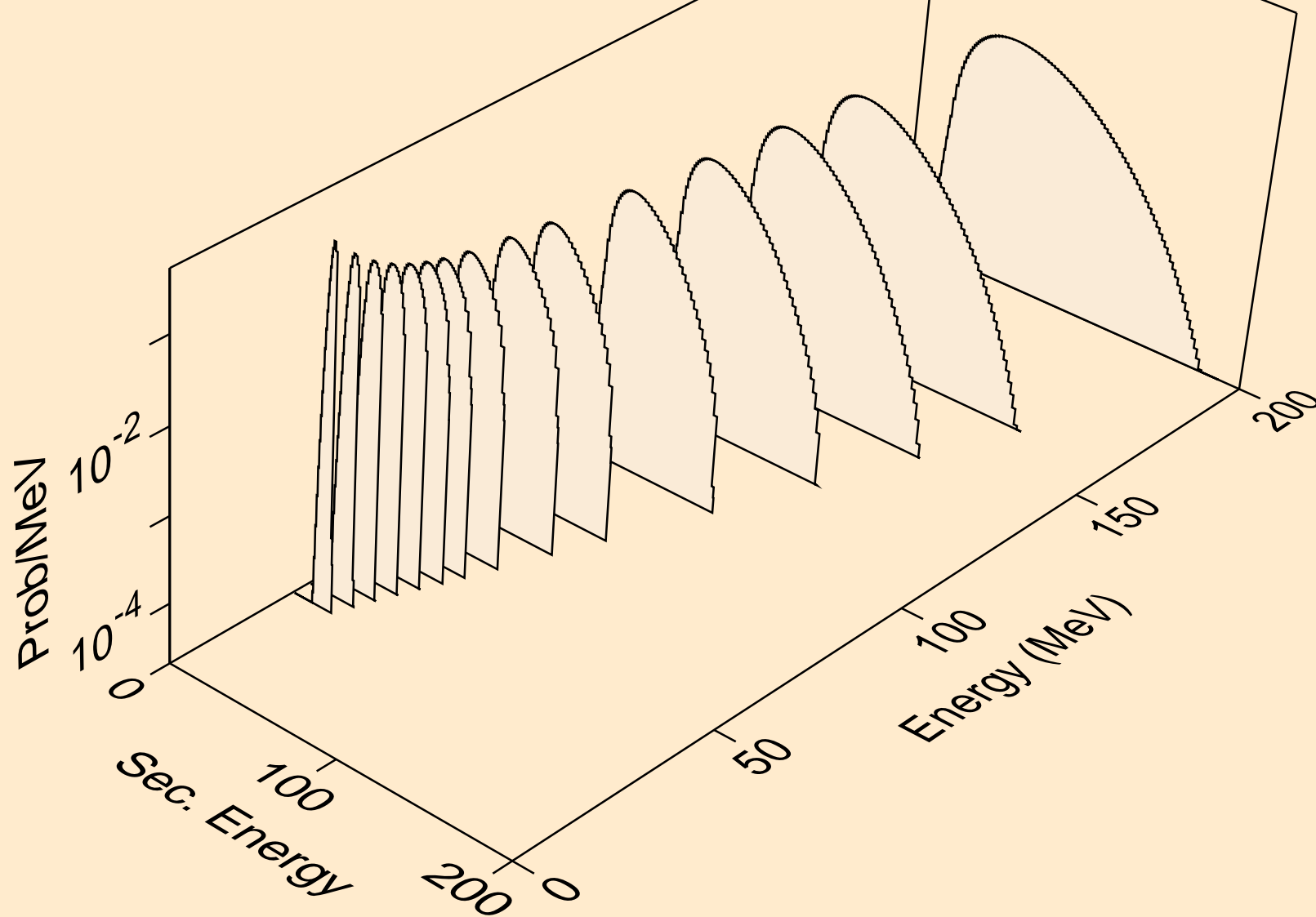

AU197M NEUTRON ACER TENDL-2021 LIBRARY; T=293.6K
he3s from (n,n*)he3

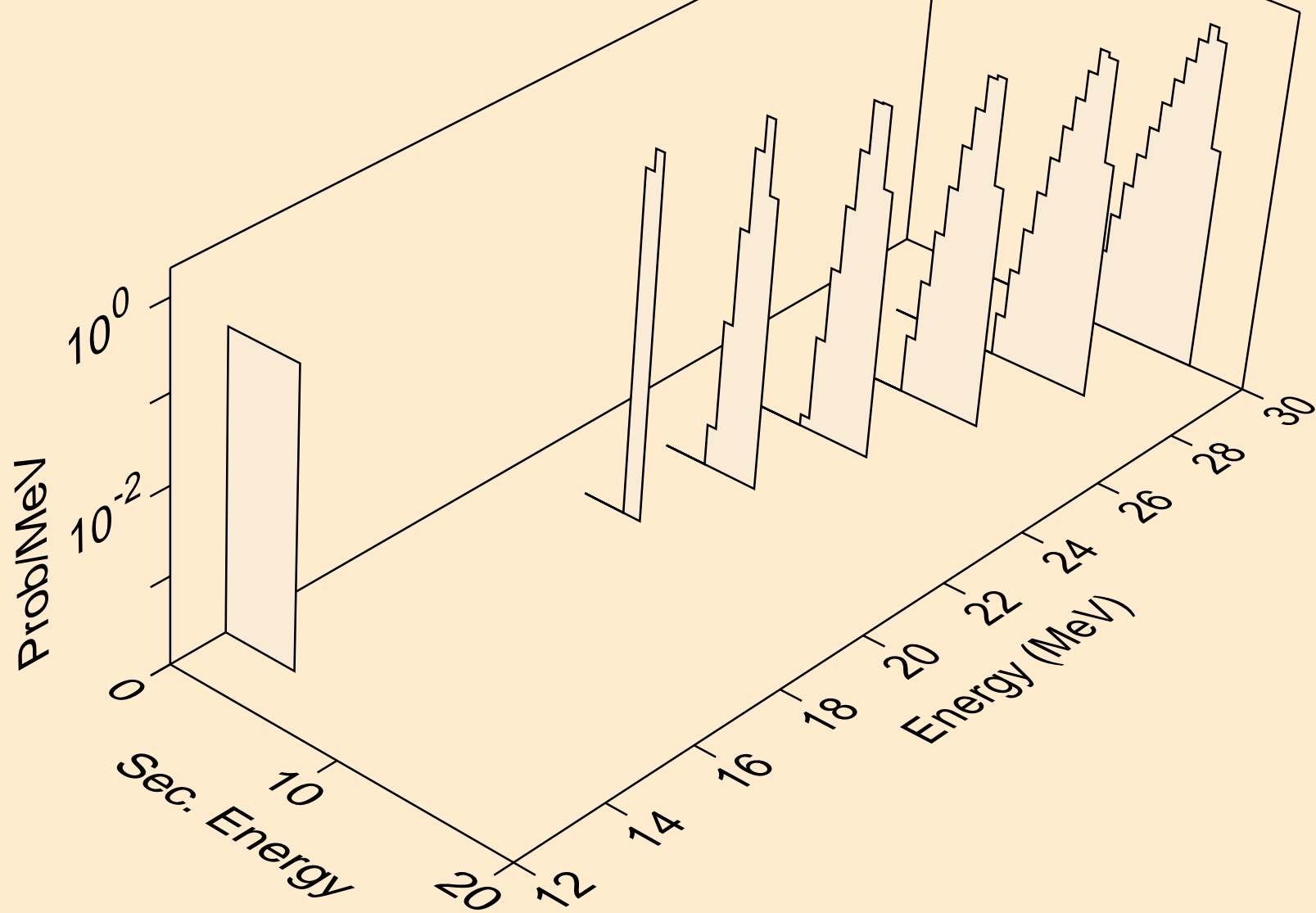

AU197M NEUTRON ACER TENDL-2021 LIBRARY; T=293.6K
he3s from (n,he3)

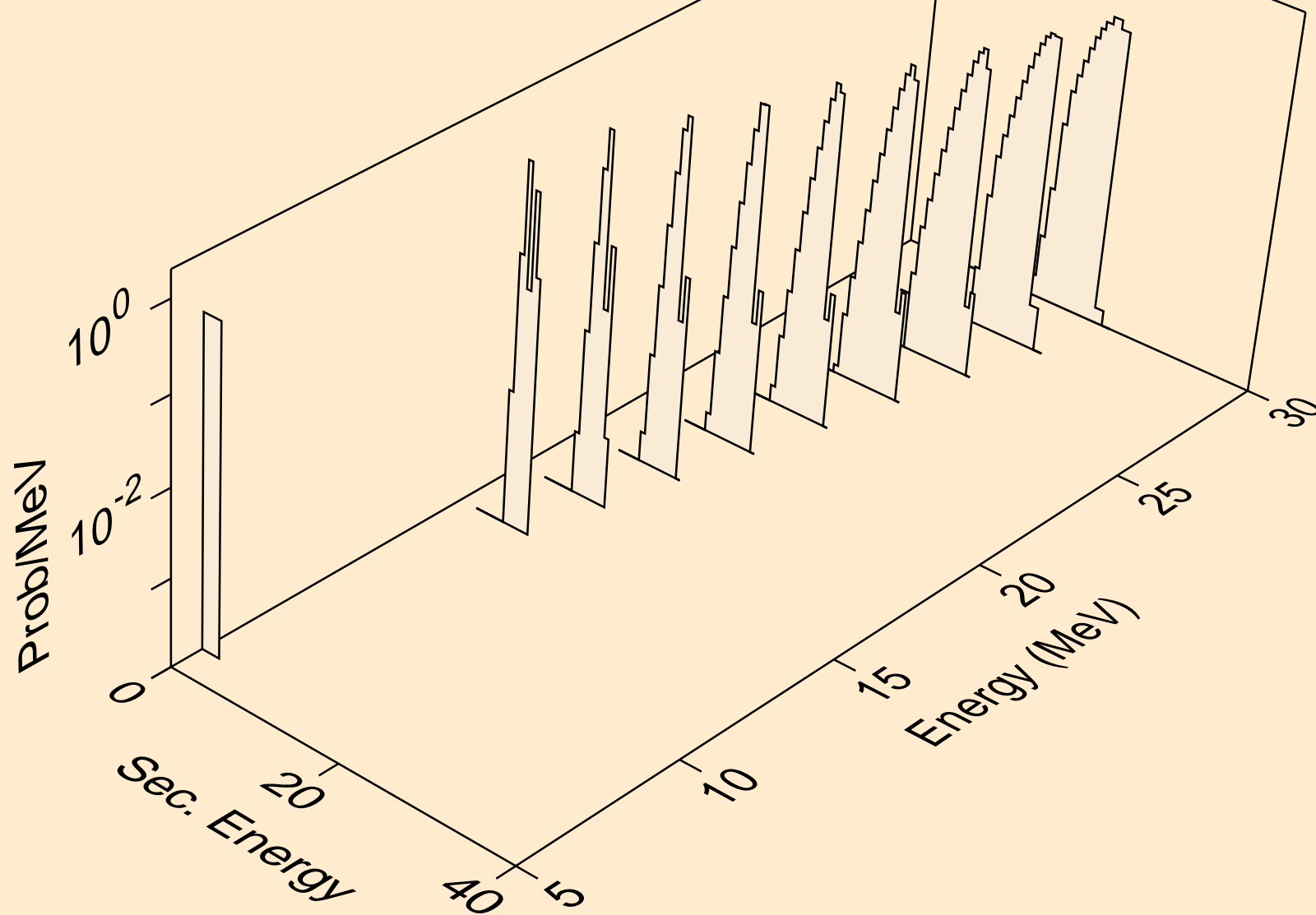

AU197M NEUTRON ACER TENDL-2021 LIBRARY; T=293.6K
alphas from (n,x)

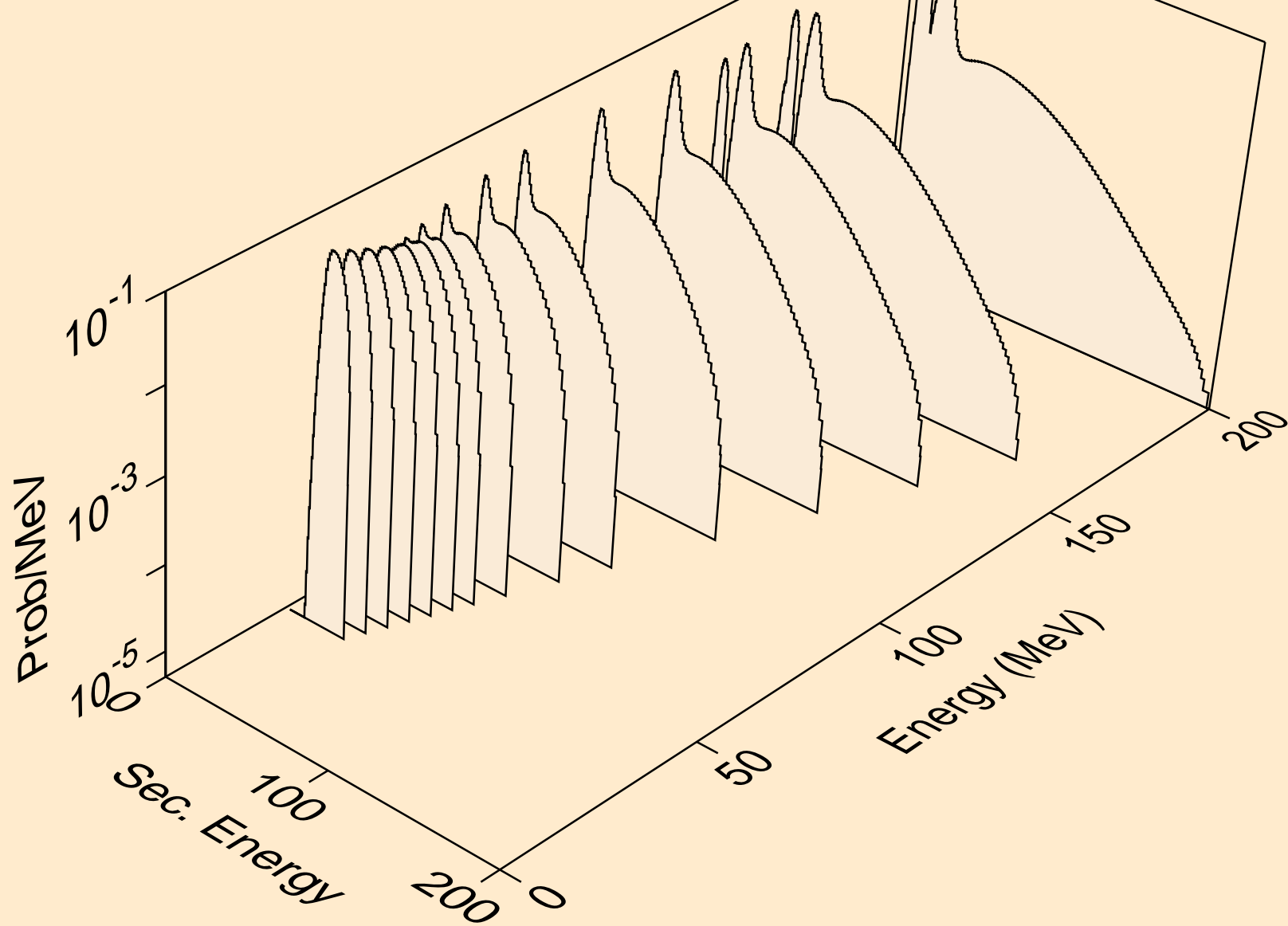

AU197M NEUTRON ACER TENDL-2021 LIBRARY; T=293.6K
alphas from (n,n*)a

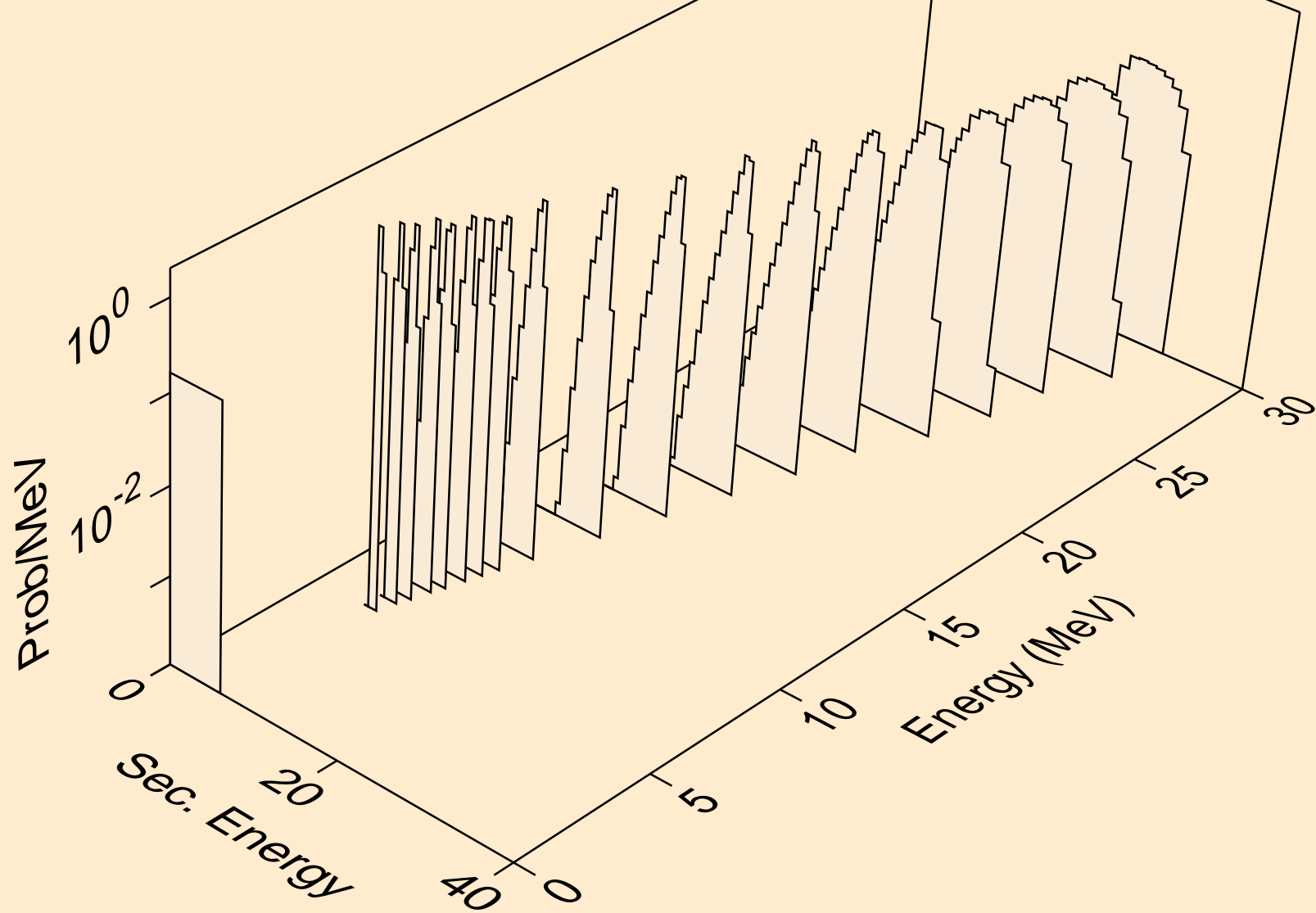

AU197M NEUTRON ACER TENDL-2021 LIBRARY; T=293.6K
alphas from (n,2n)a

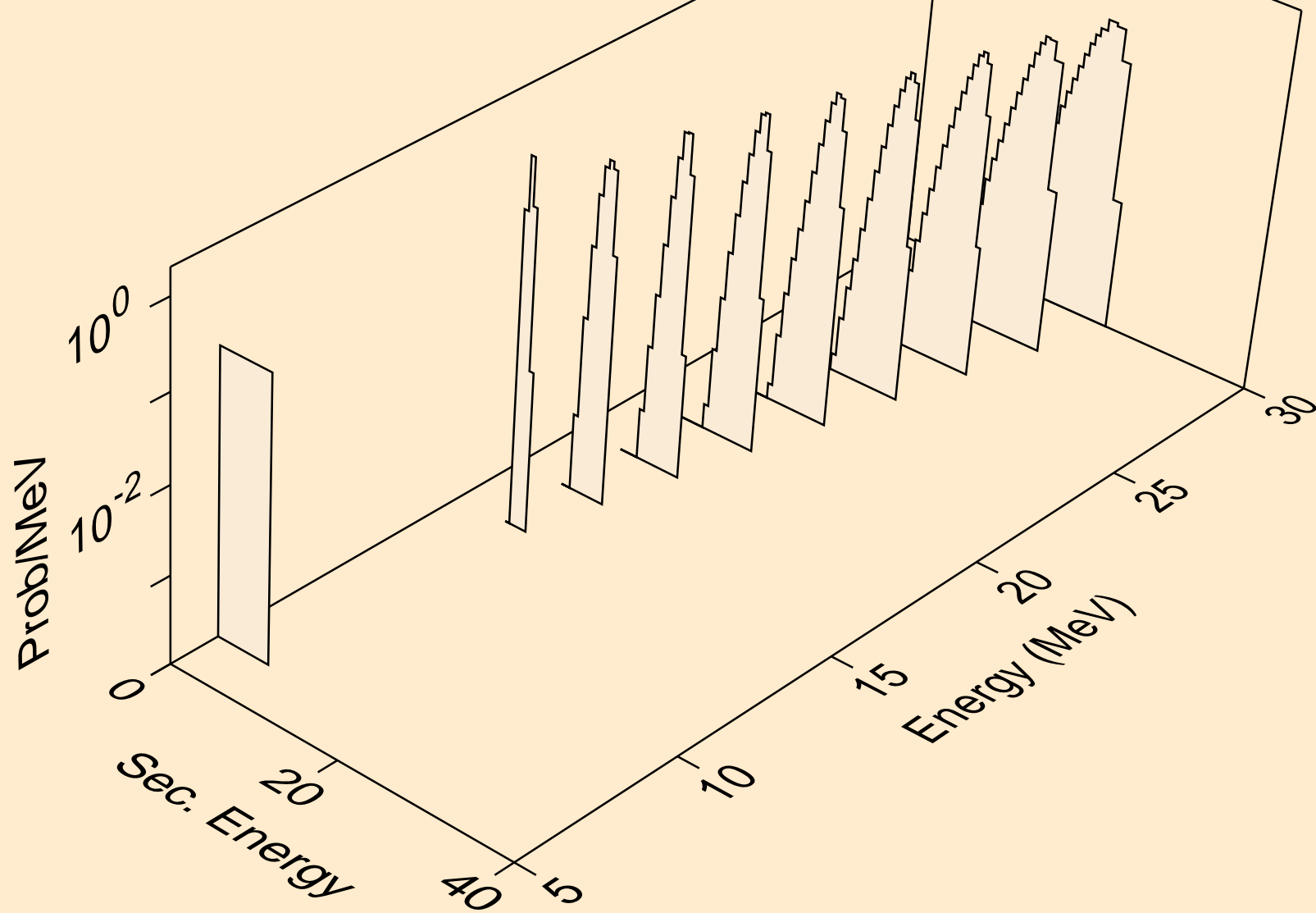

AU197M NEUTRON ACER TENDL-2021 LIBRARY; T=293.6K
alphas from (n,3n)a

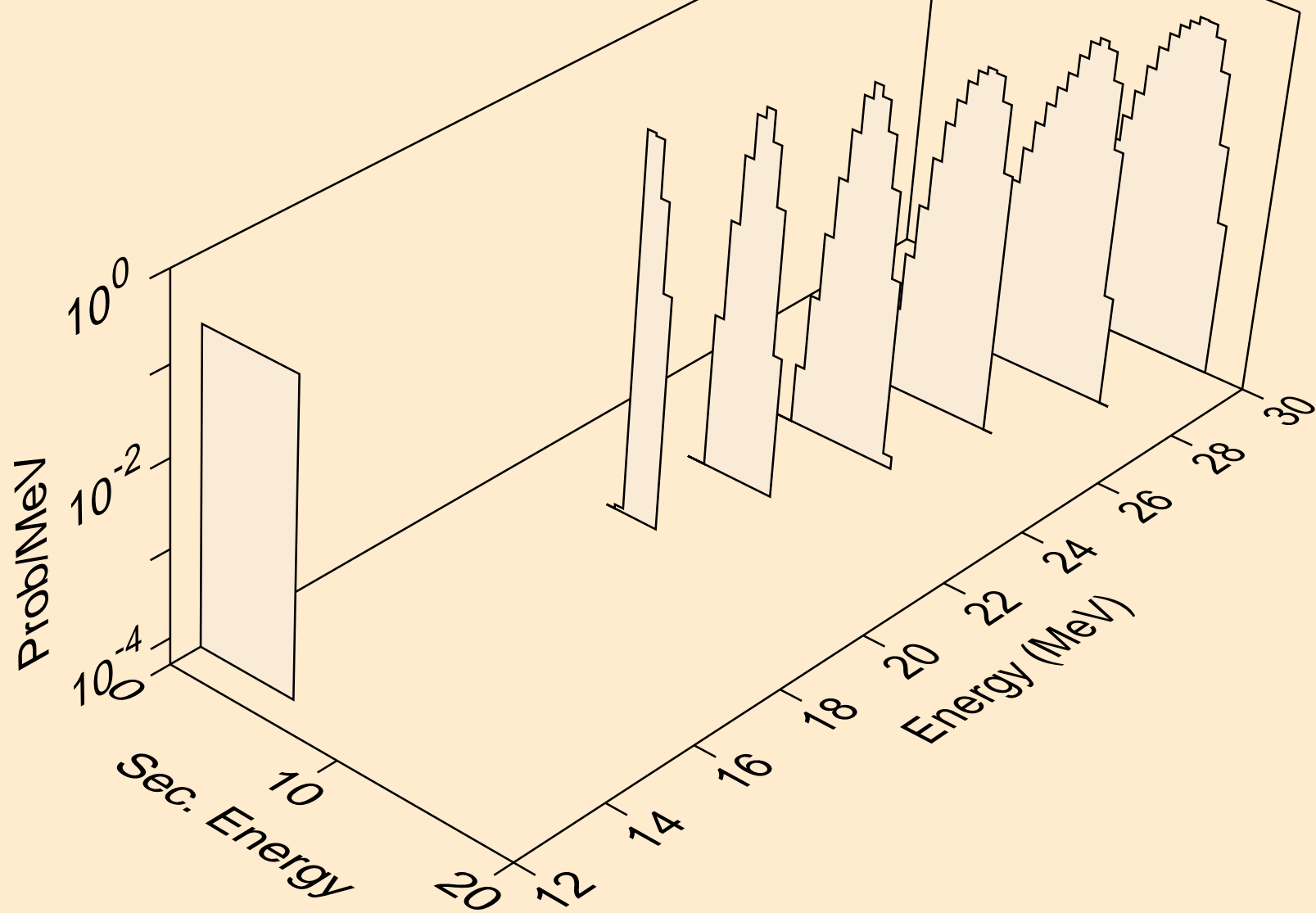

AU197M NEUTRON ACER TENDL-2021 LIBRARY; T=293.6K
alphas from (n,npa)

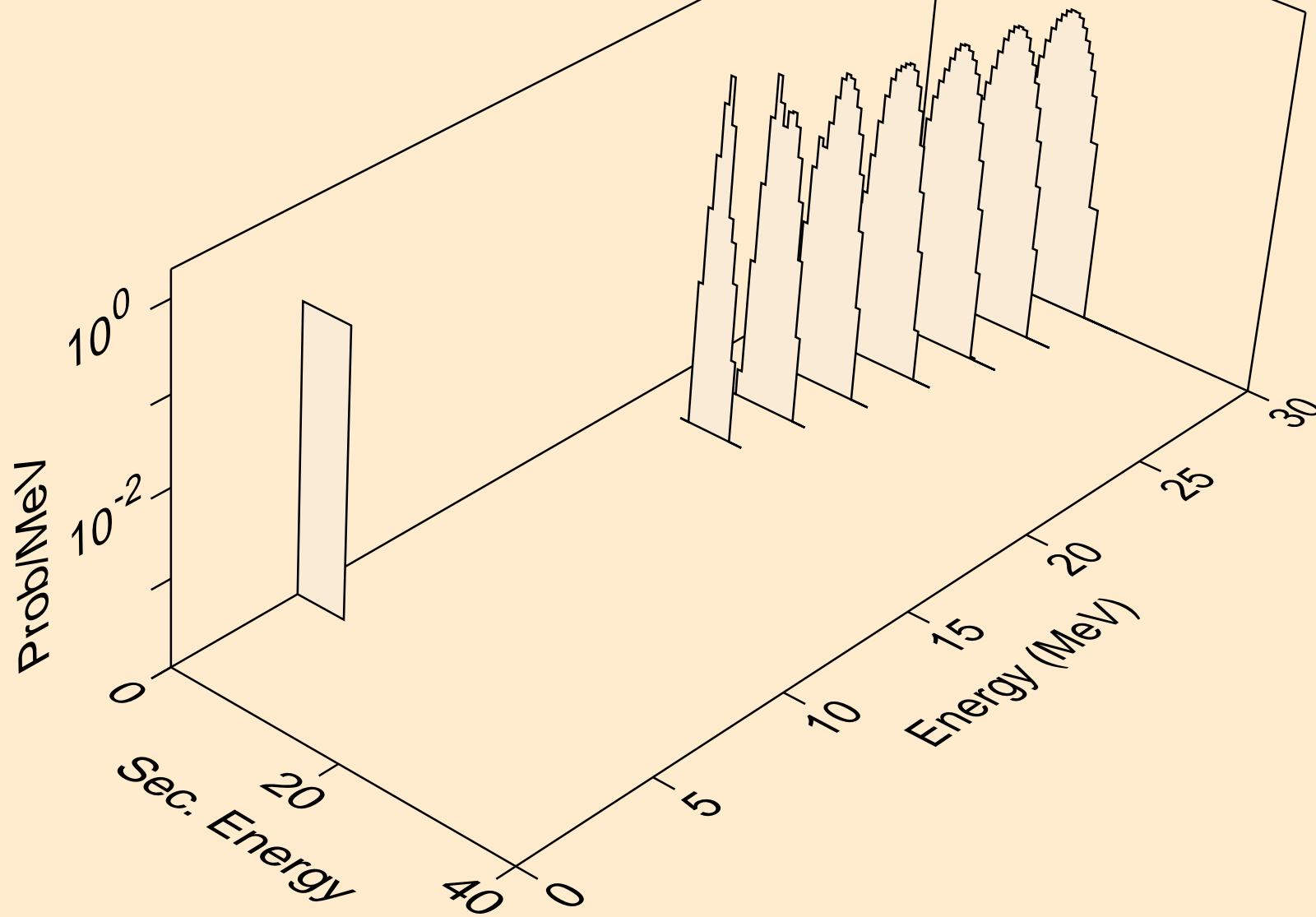

AU197M NEUTRON ACER TENDL-2021 LIBRARY; T=293.6K
alphas from (n,a)

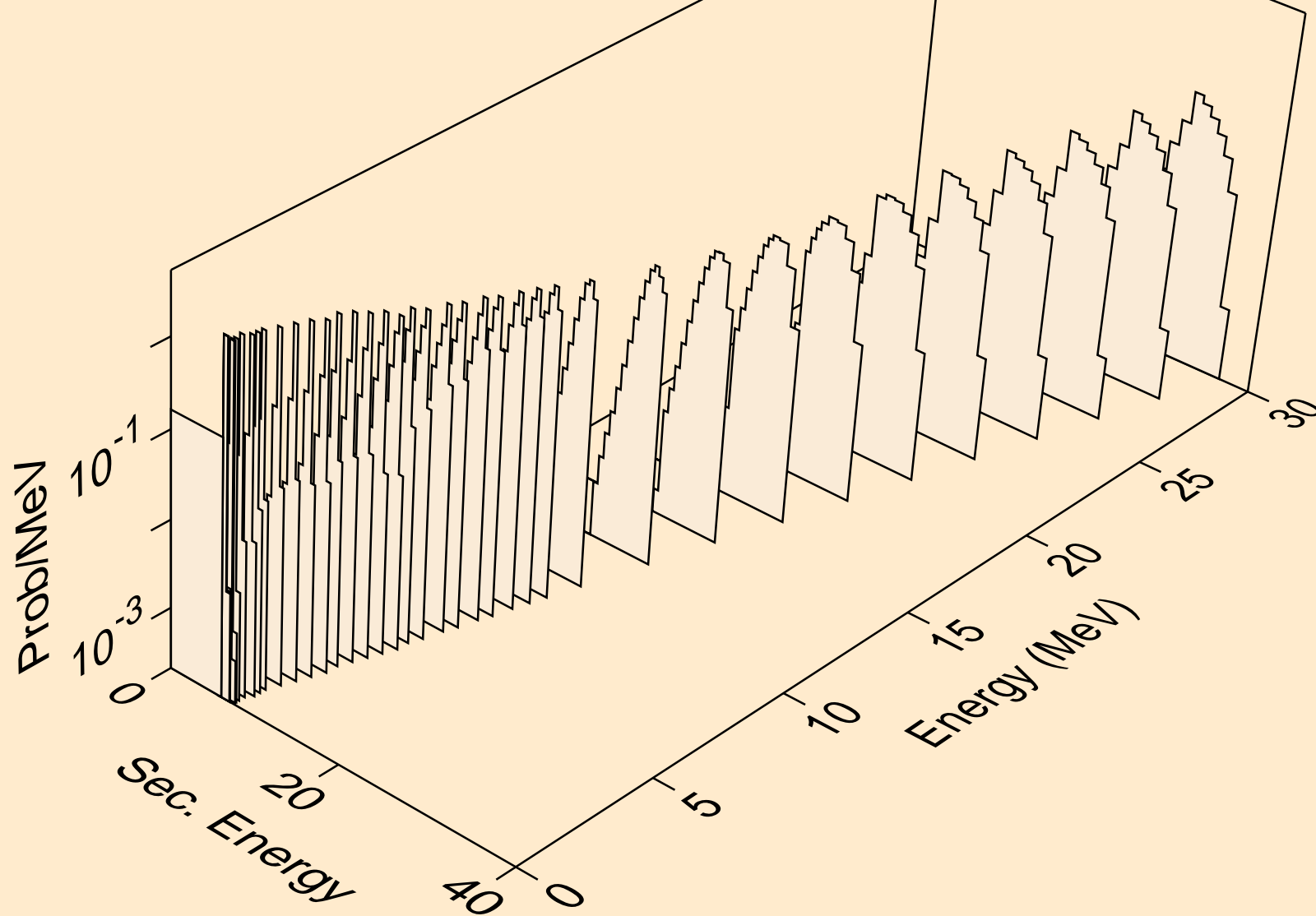

AU197M NEUTRON ACER TENDL-2021 LIBRARY; T=293.6K
alphas from (n,pa)

