

BA118 NEUTRON ACER TENDL-2021 LIBRARY; T=293.6K
Principal cross sections

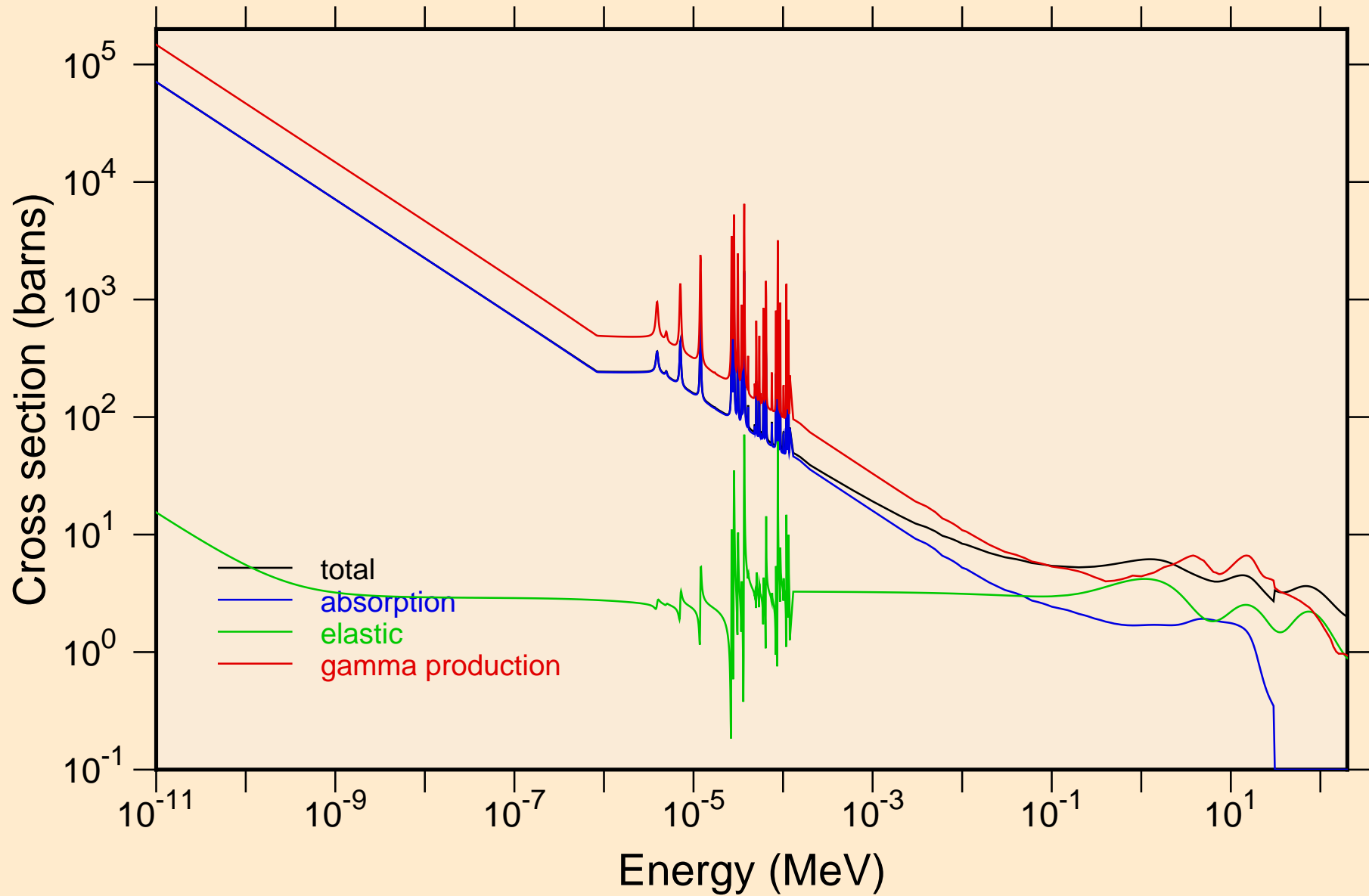

BA118 NEUTRON ACER TENDL-2021 LIBRARY; T=293.6K
resonance total cross section

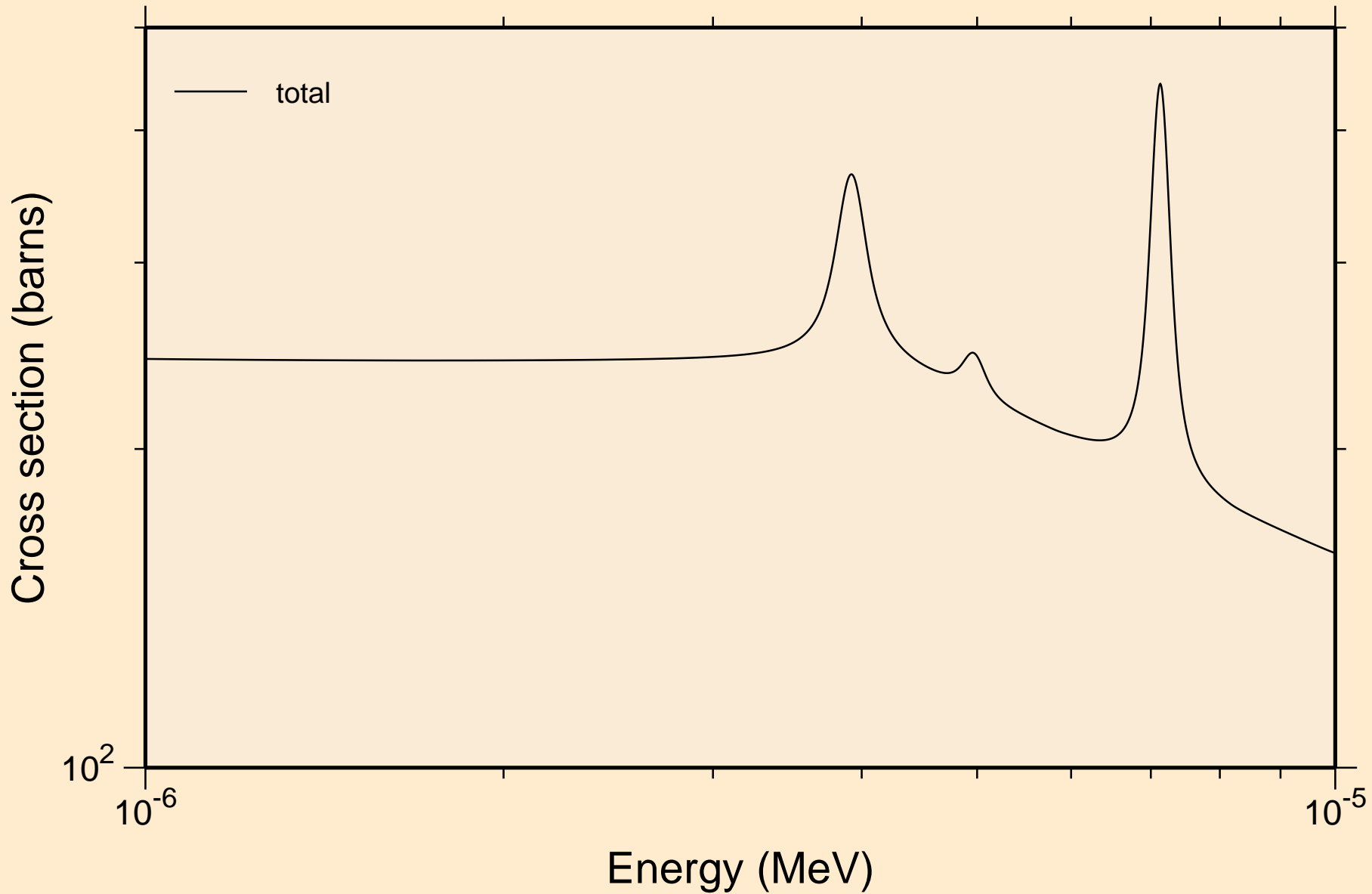

BA118 NEUTRON ACER TENDL-2021 LIBRARY; T=293.6K
resonance total cross section

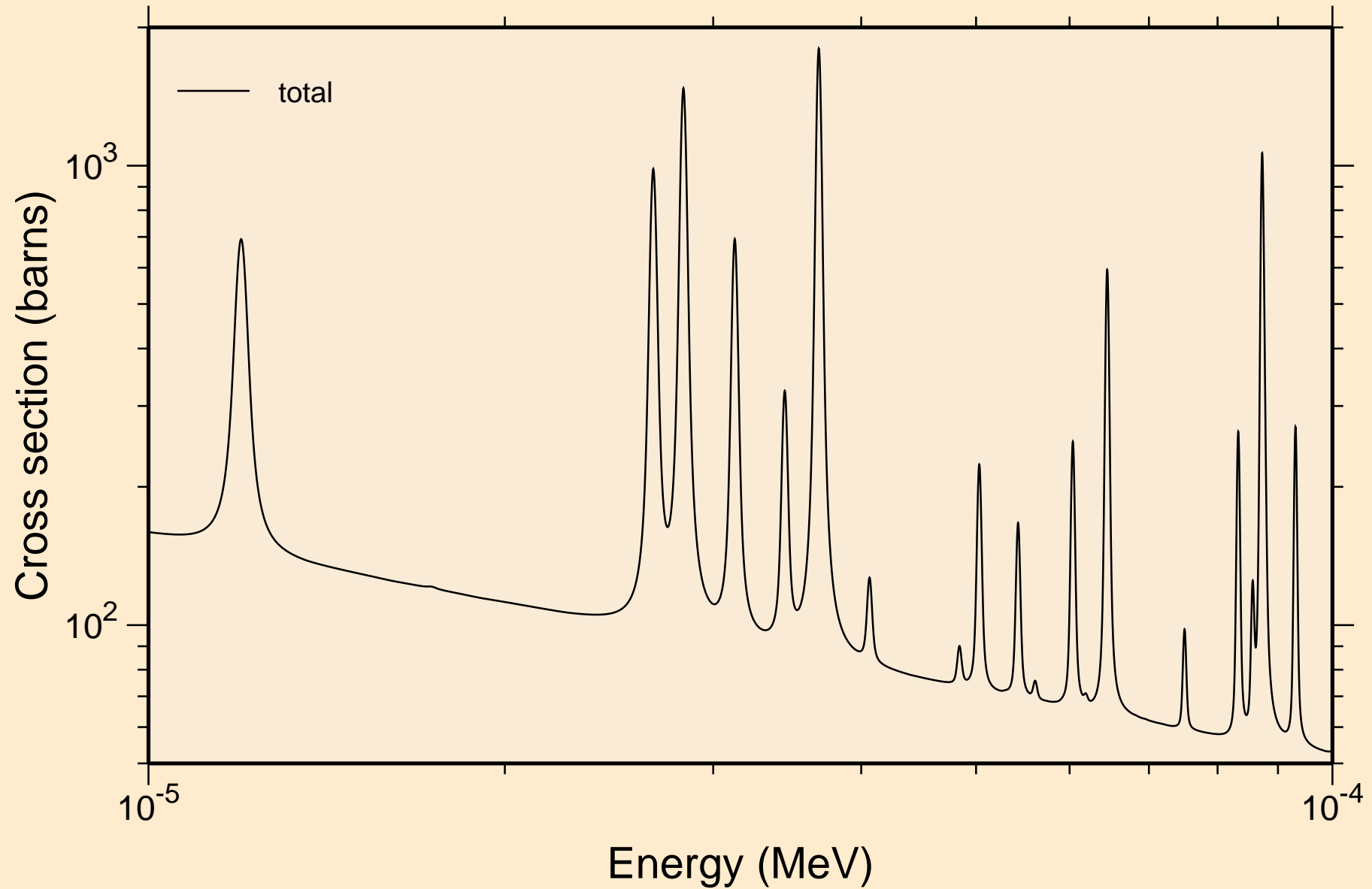

BA118 NEUTRON ACER TENDL-2021 LIBRARY; T=293.6K
resonance total cross section

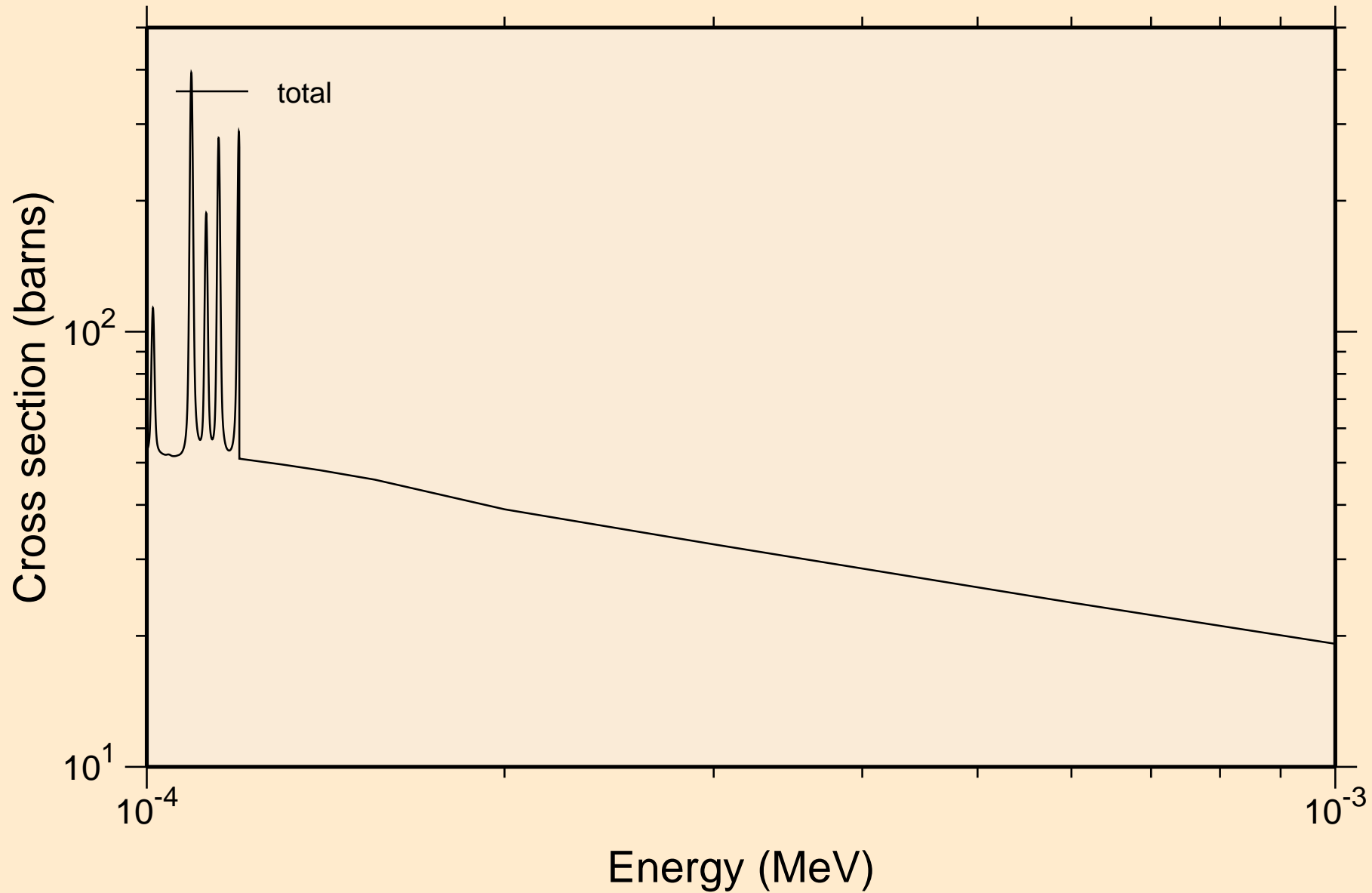

BA118 NEUTRON ACER TENDL-2021 LIBRARY; T=293.6K
resonance total cross section

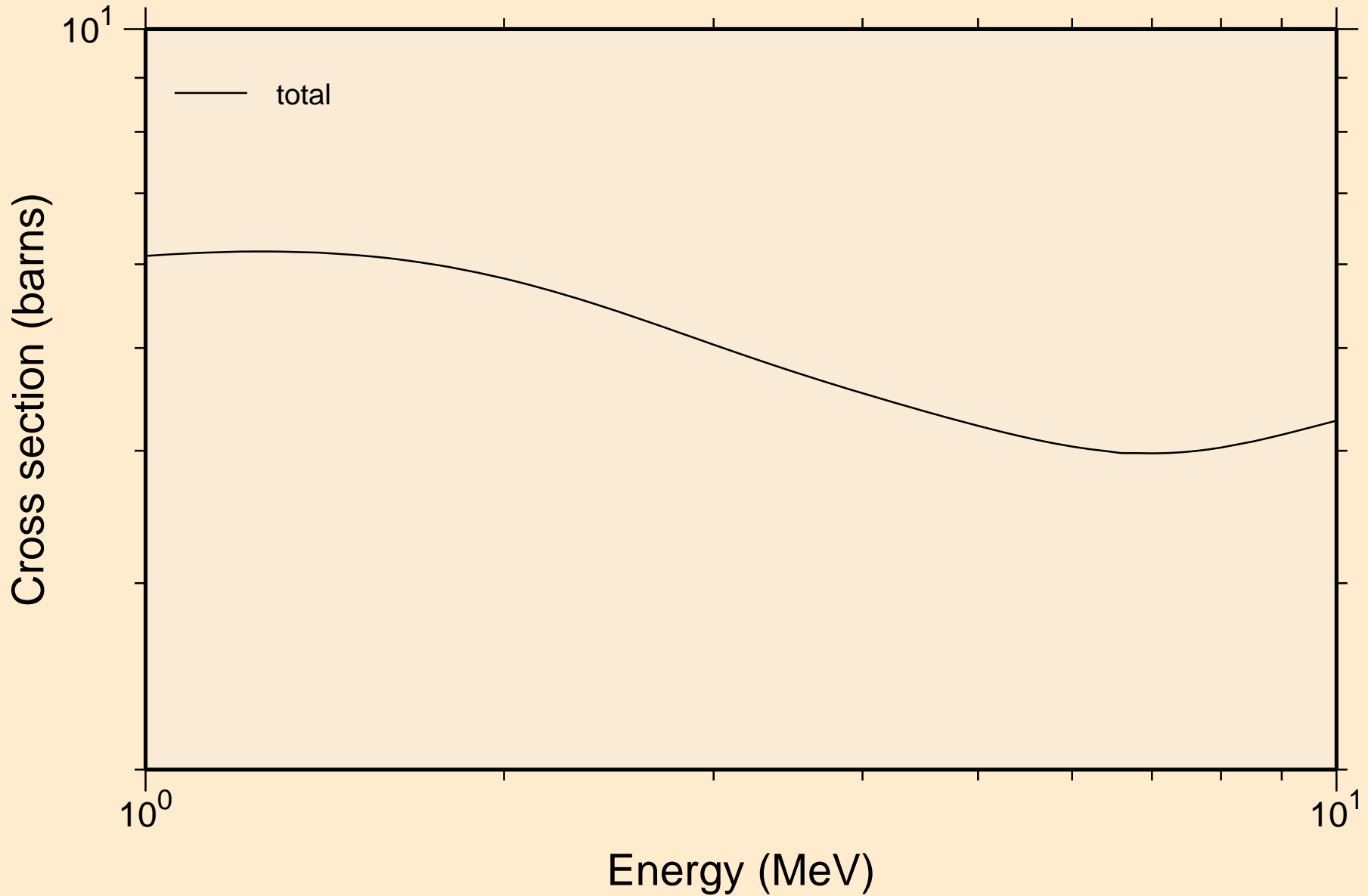

BA118 NEUTRON ACER TENDL-2021 LIBRARY; T=293.6K
resonance absorption cross sections

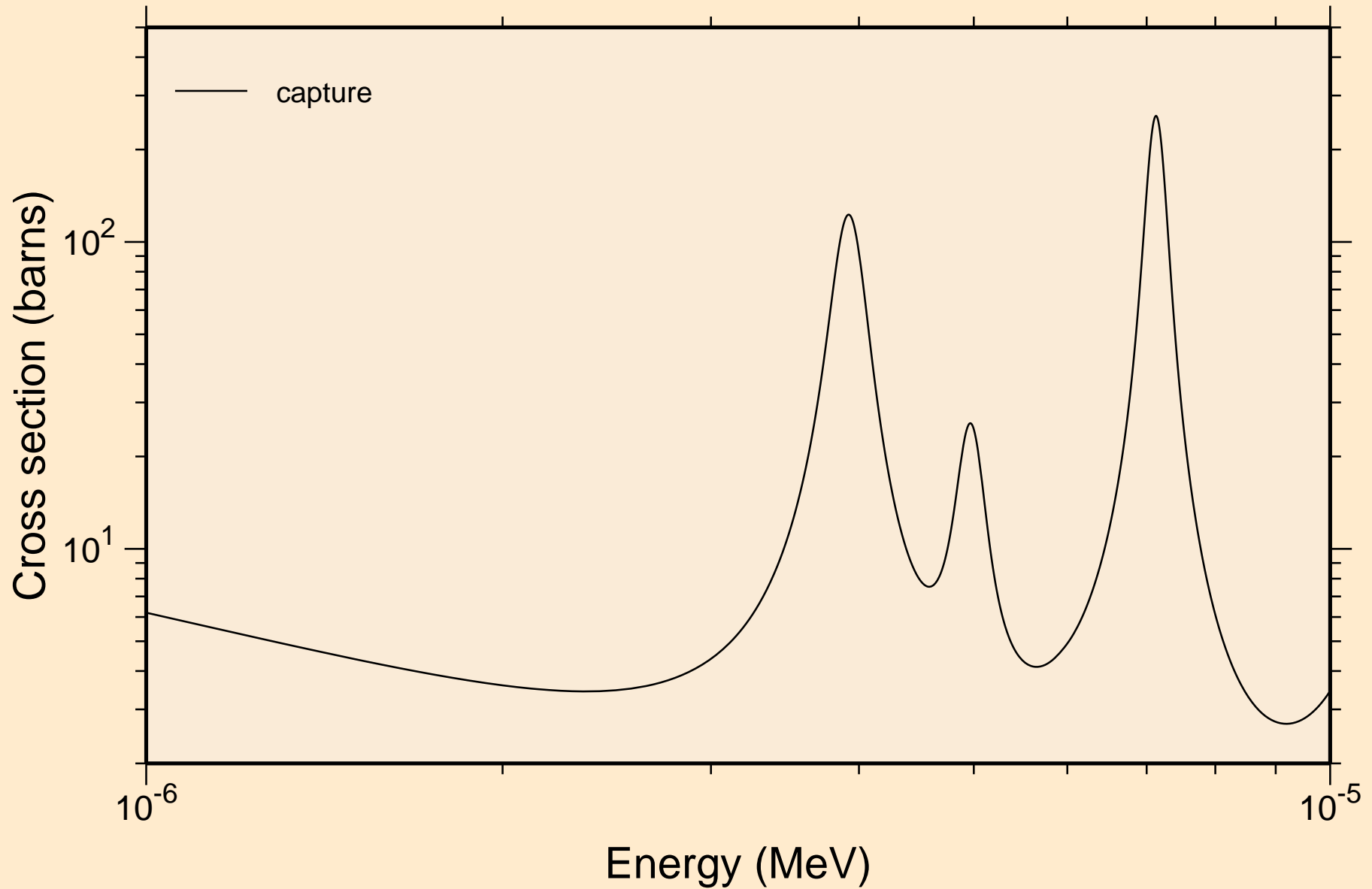

BA118 NEUTRON ACER TENDL-2021 LIBRARY; T=293.6K
resonance absorption cross sections

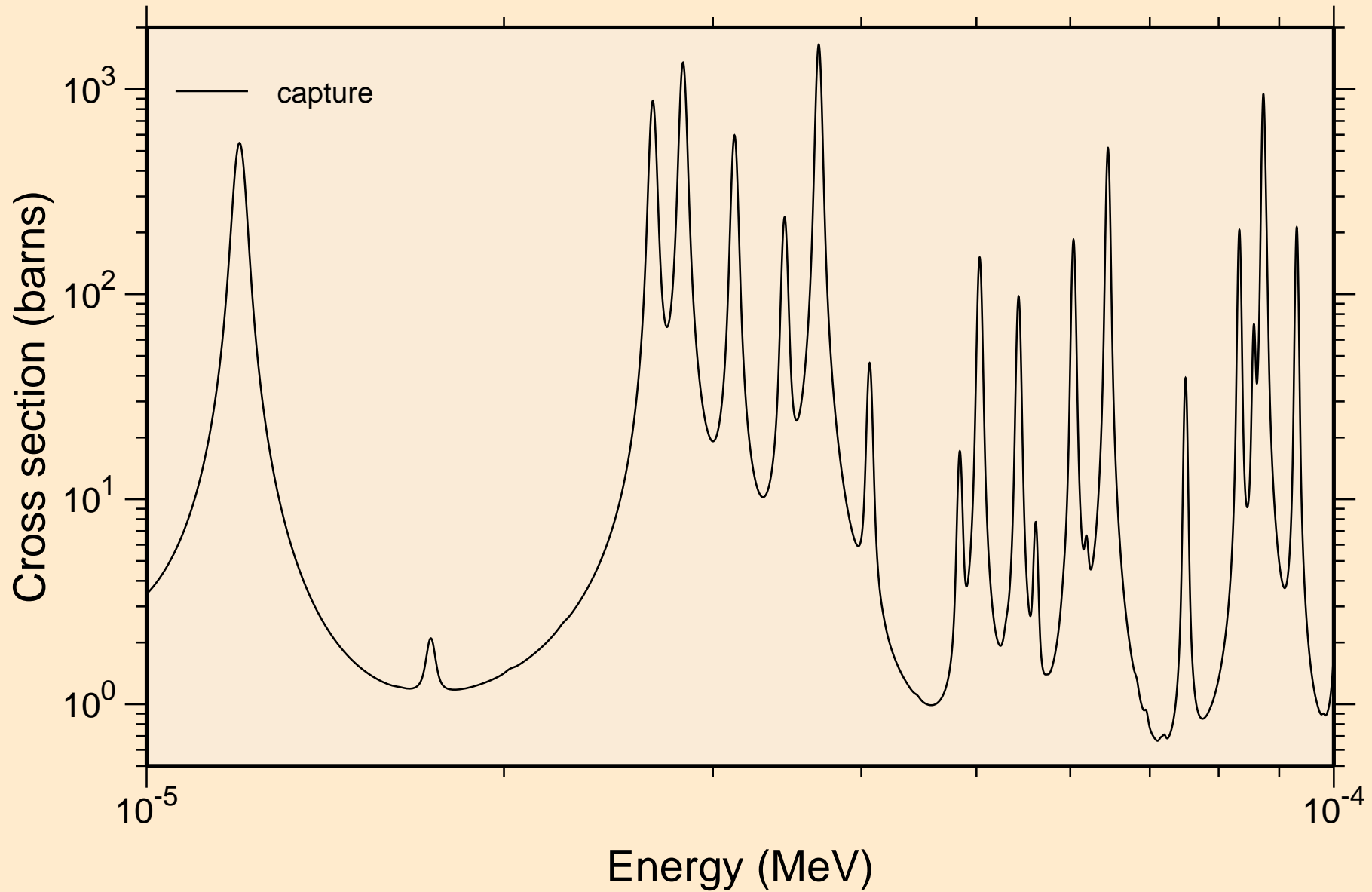

BA118 NEUTRON ACER TENDL-2021 LIBRARY; T=293.6K
resonance absorption cross sections

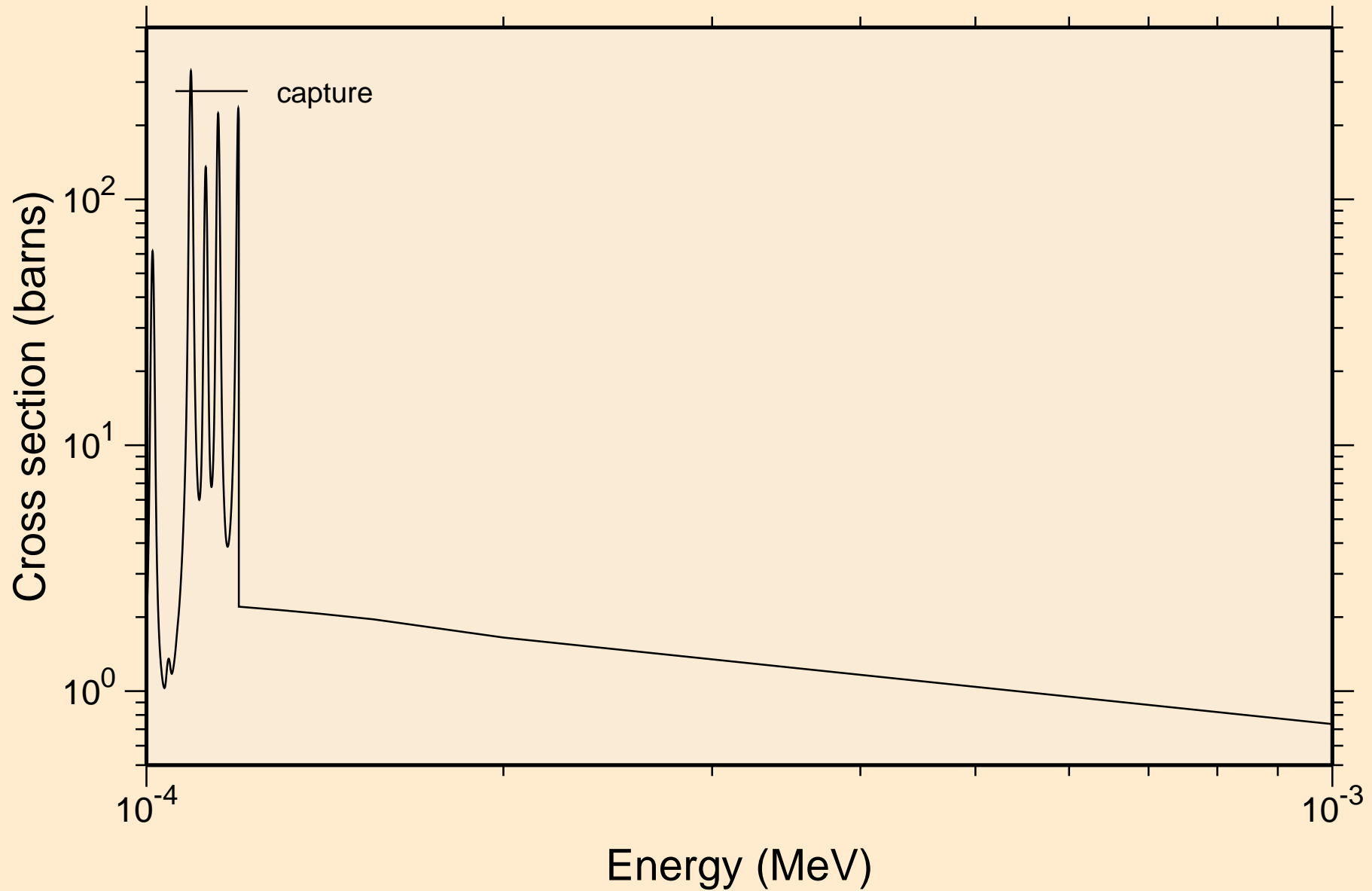

BA118 NEUTRON ACER TENDL-2021 LIBRARY; T=293.6K
resonance absorption cross sections

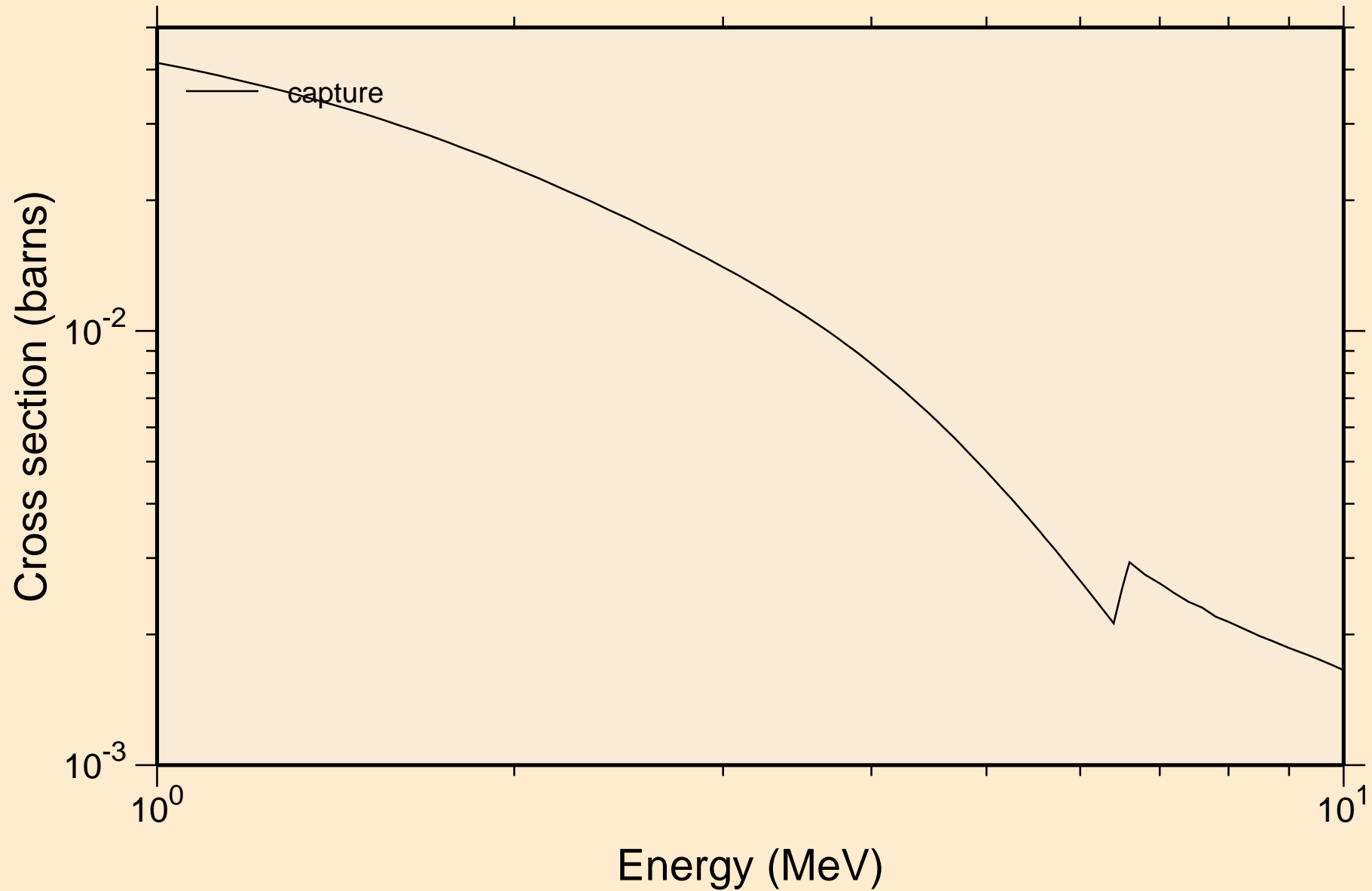

BA118 NEUTRON ACER TENDL-2021 LIBRARY; T=293.6K
Heating

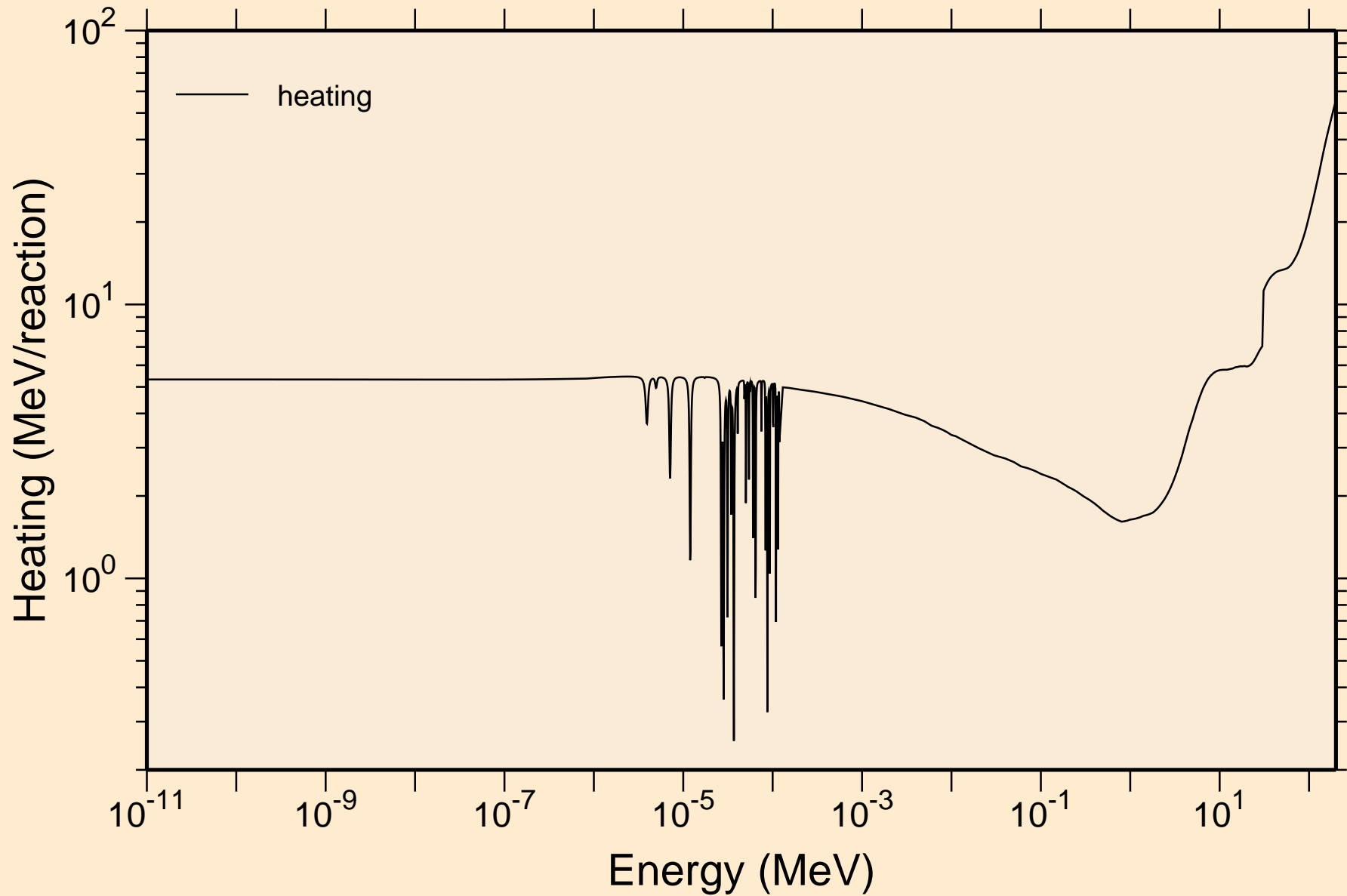

BA118 NEUTRON ACER TENDL-2021 LIBRARY; T=293.6K
Damage

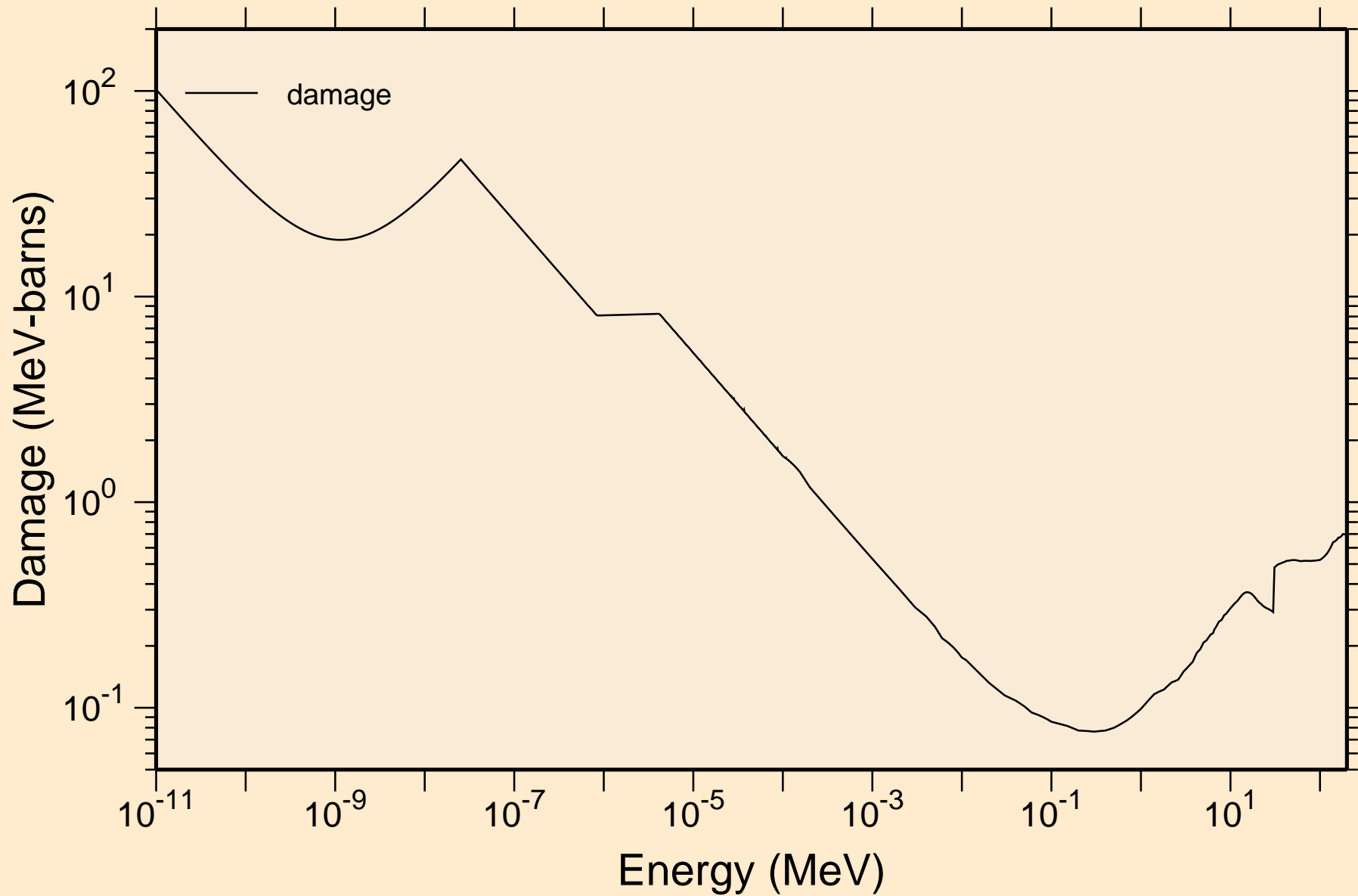

BA118 NEUTRON ACER TENDL-2021 LIBRARY; T=293.6K
Non-threshold reactions

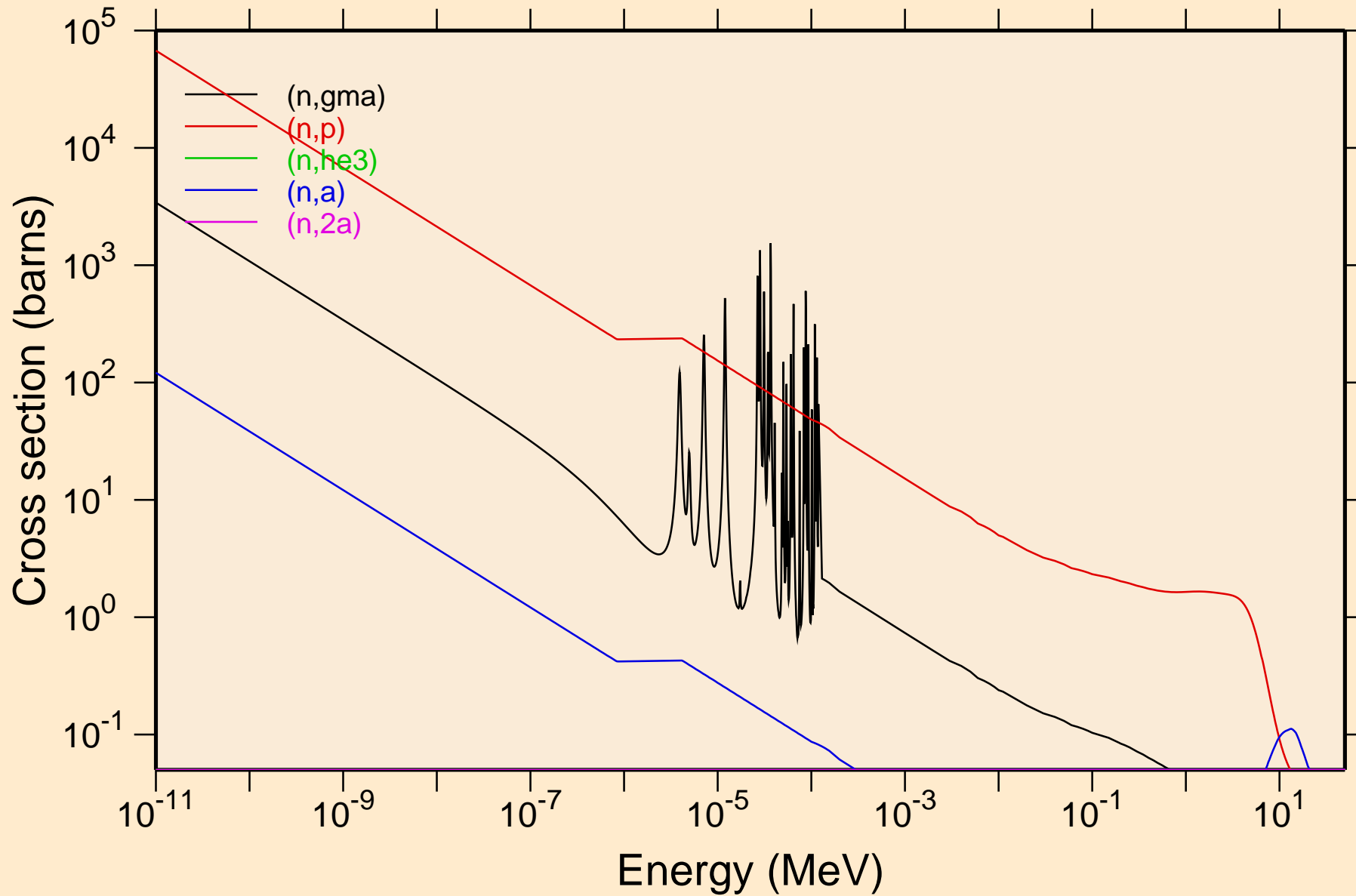

BA118 NEUTRON ACER TENDL-2021 LIBRARY; T=293.6K

Non-threshold reactions

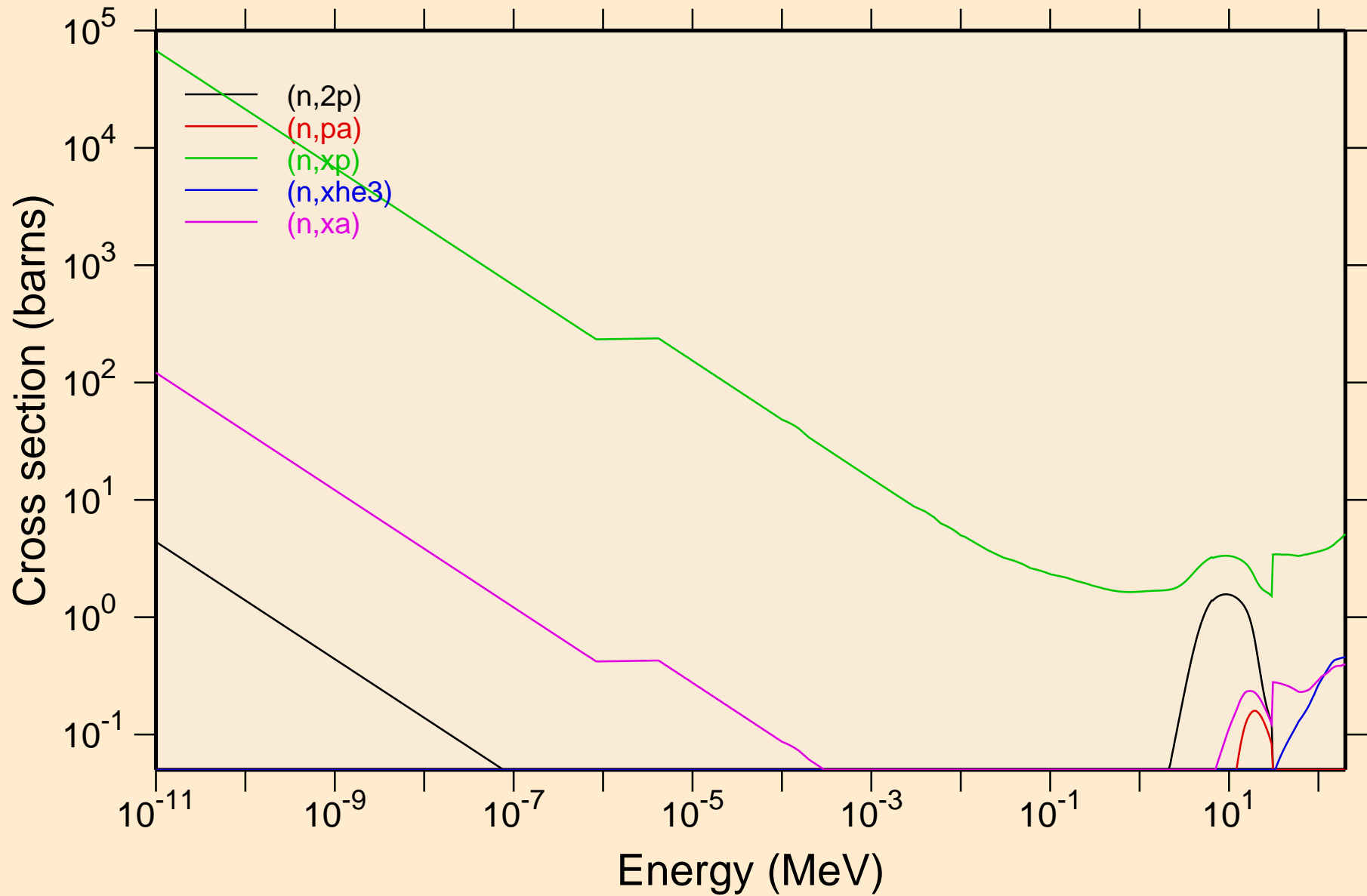

BA118 NEUTRON ACER TENDL-2021 LIBRARY; T=293.6K
Principal cross sections

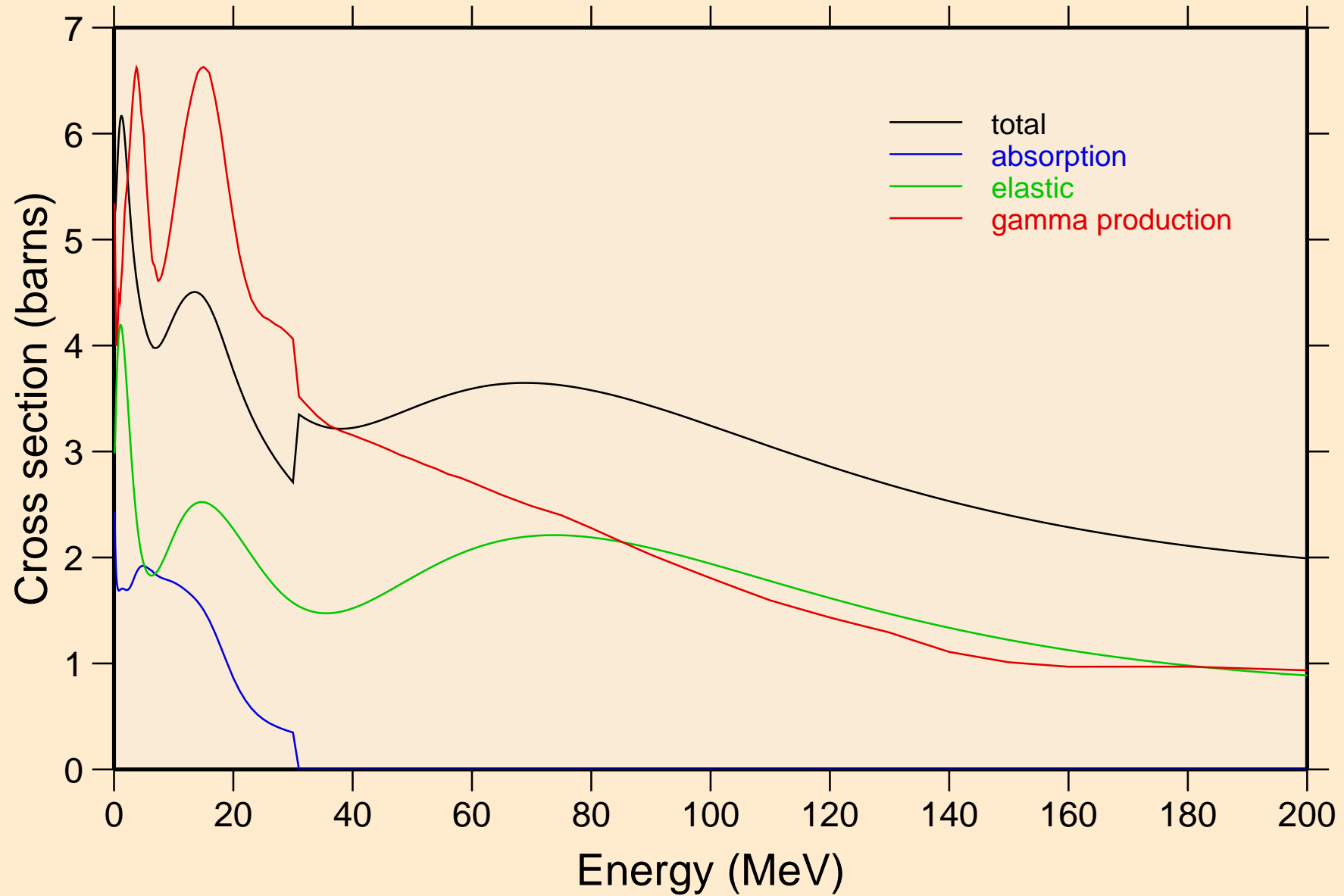

BA118 NEUTRON ACER TENDL-2021 LIBRARY; T=293.6K
Heating

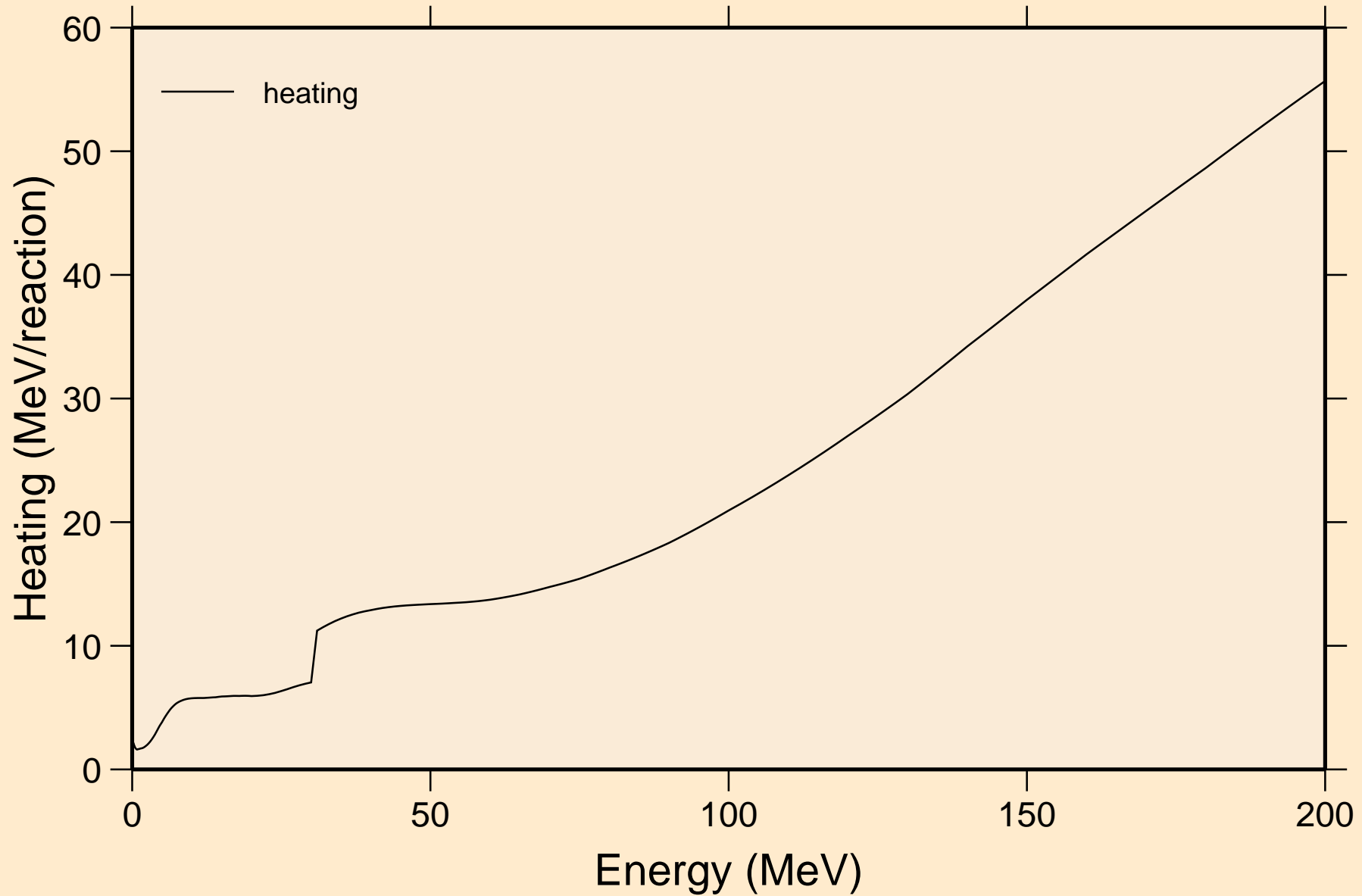

BA118 NEUTRON ACER TENDL-2021 LIBRARY; T=293.6K
Damage

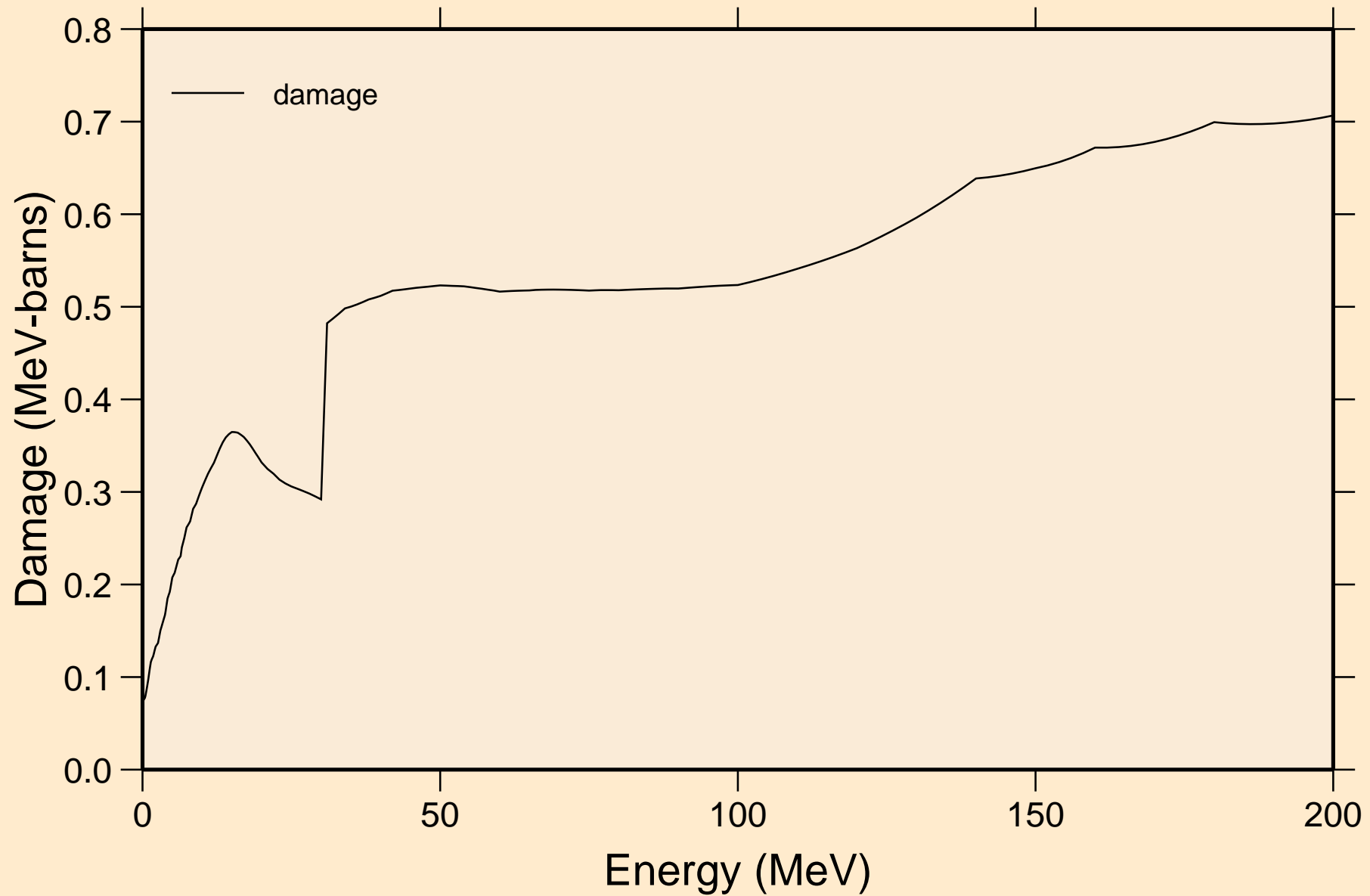

BA118 NEUTRON ACER TENDL-2021 LIBRARY; T=293.6K
Non-threshold reactions

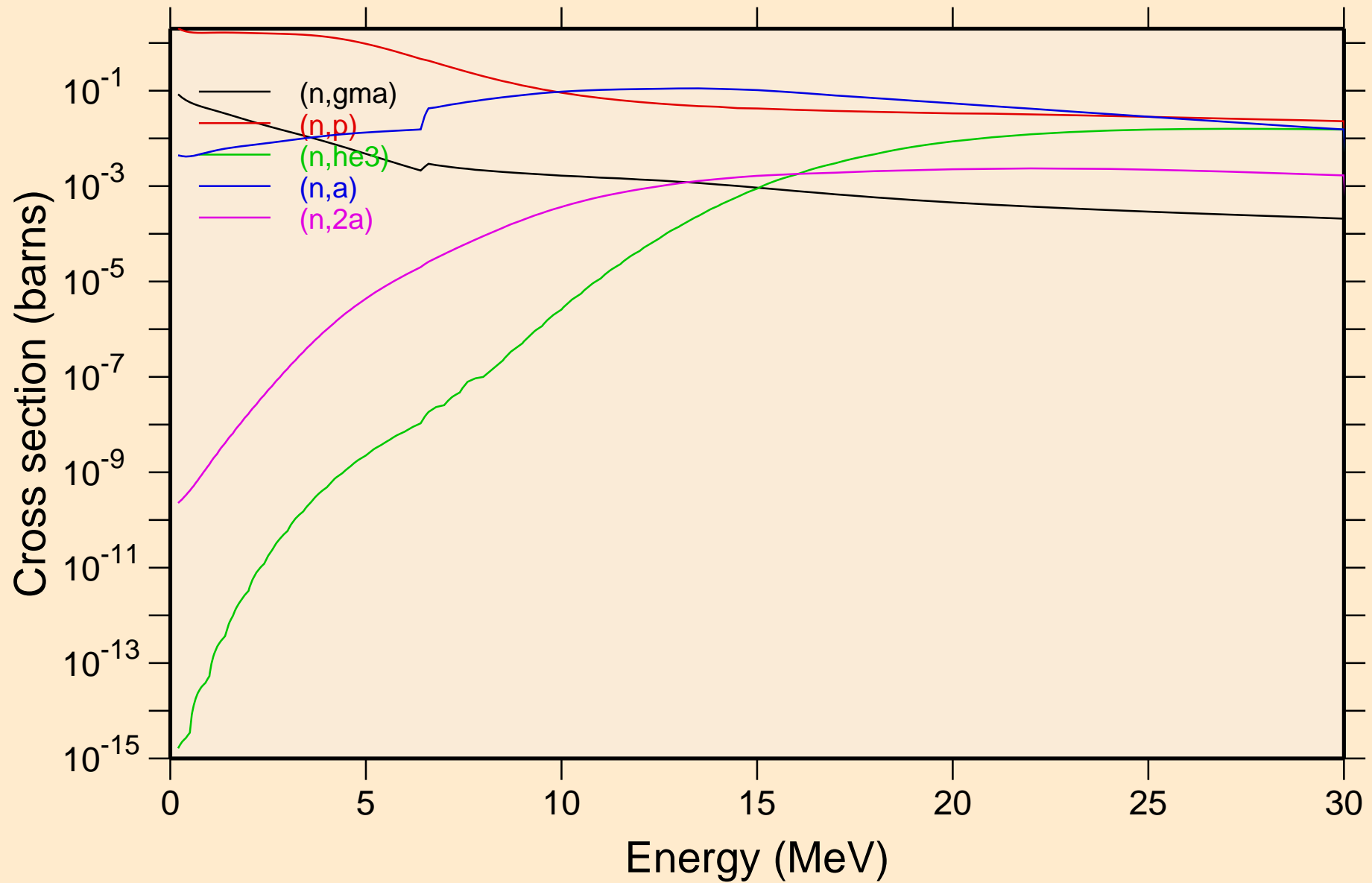

BA118 NEUTRON ACER TENDL-2021 LIBRARY; T=293.6K
Non-threshold reactions

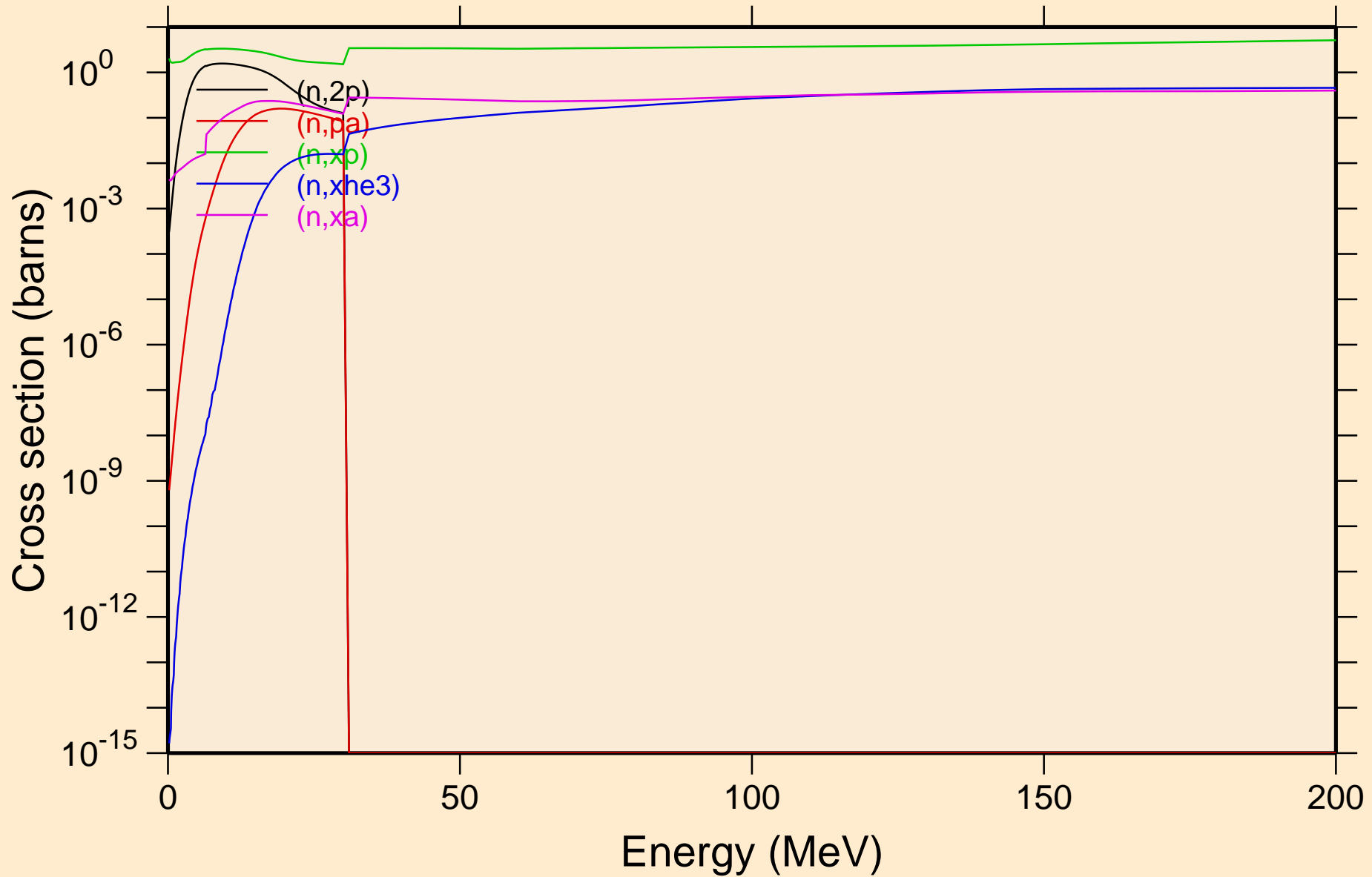

BA118 NEUTRON ACER TENDL-2021 LIBRARY; T=293.6K
Inelastic levels

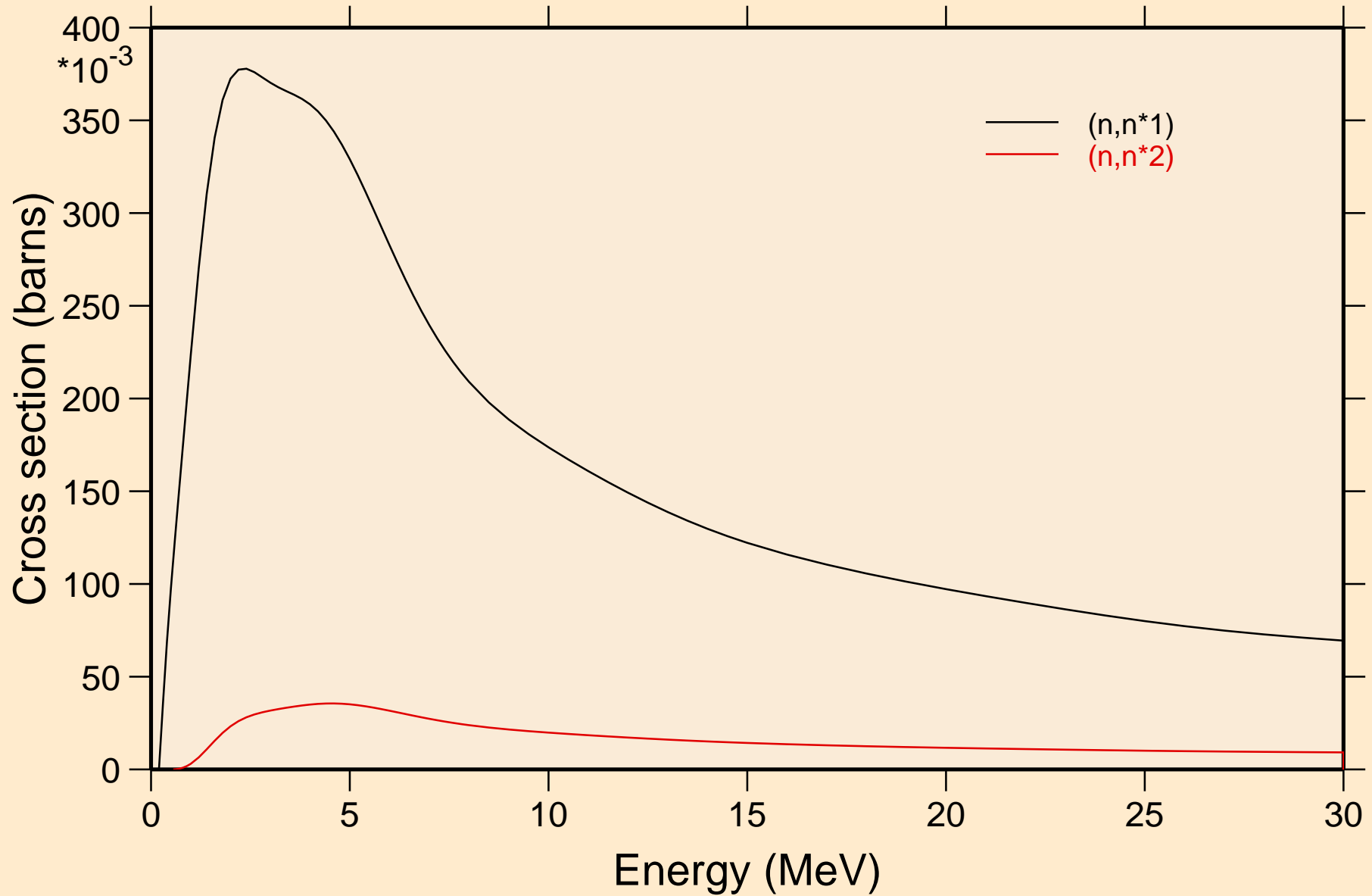

BA118 NEUTRON ACER TENDL-2021 LIBRARY; T=293.6K
Threshold reactions

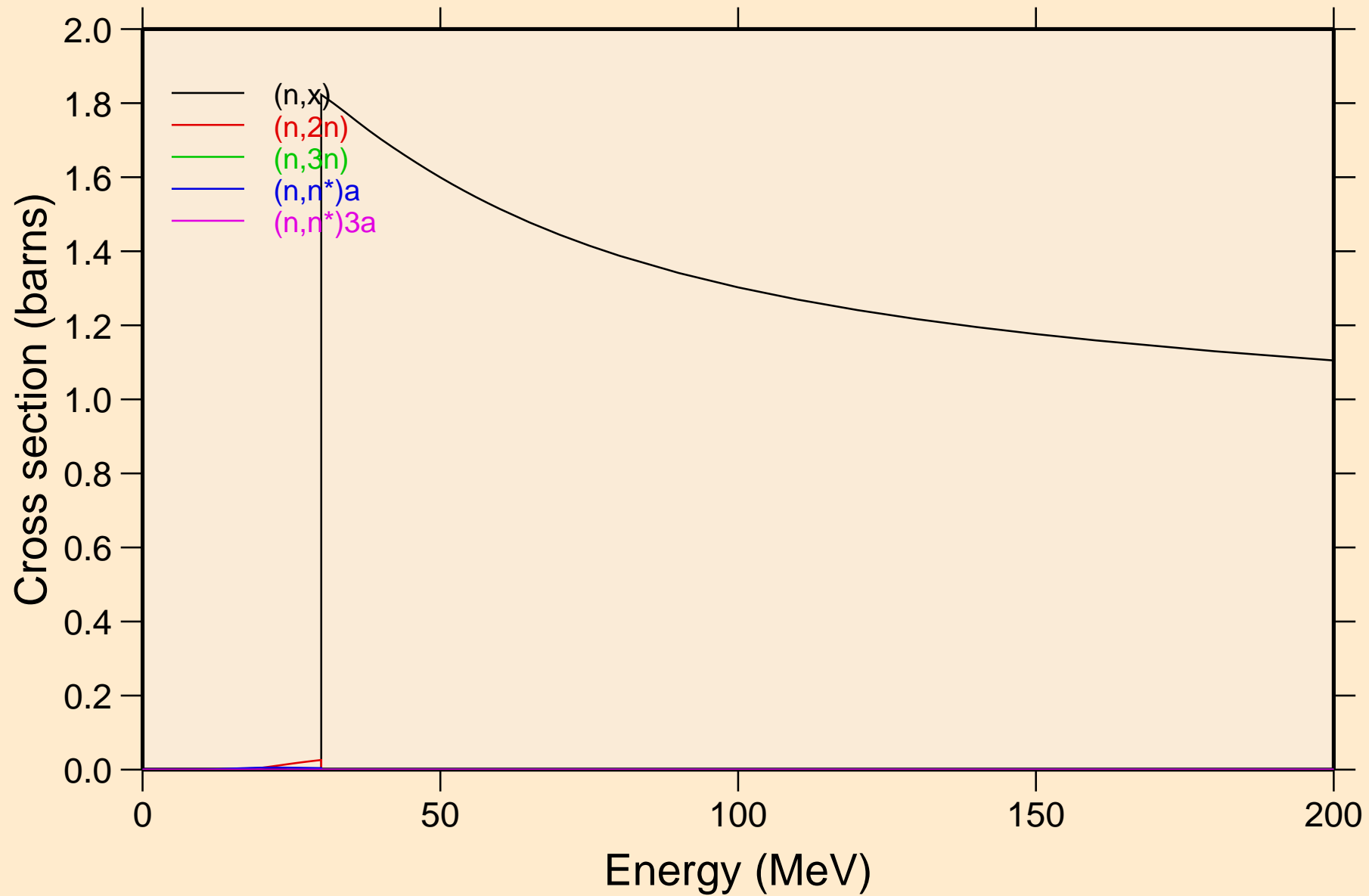

BA118 NEUTRON ACER TENDL-2021 LIBRARY; T=293.6K
Threshold reactions

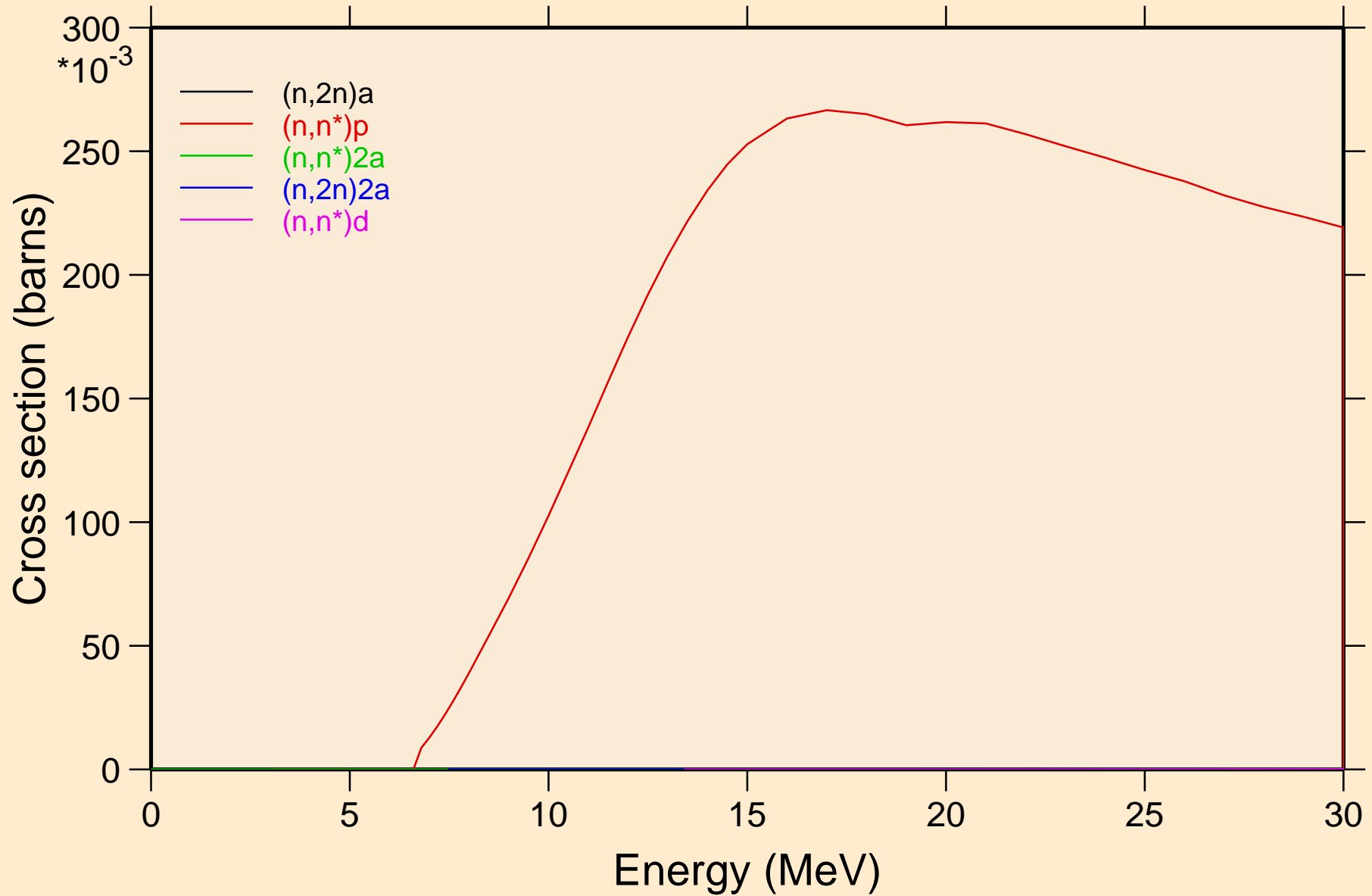

BA118 NEUTRON ACER TENDL-2021 LIBRARY; T=293.6K
Threshold reactions

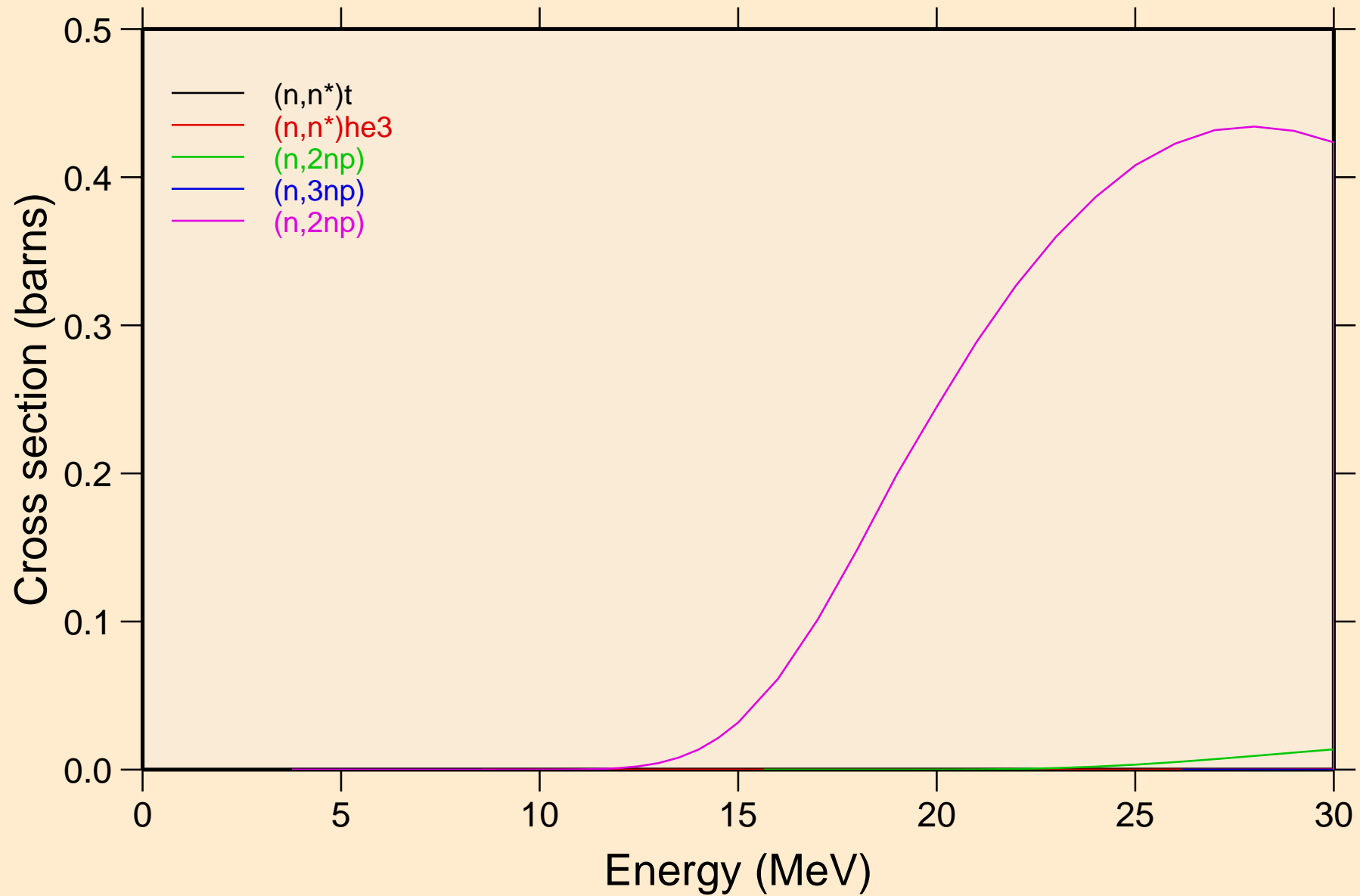

BA118 NEUTRON ACER TENDL-2021 LIBRARY; T=293.6K

Threshold reactions

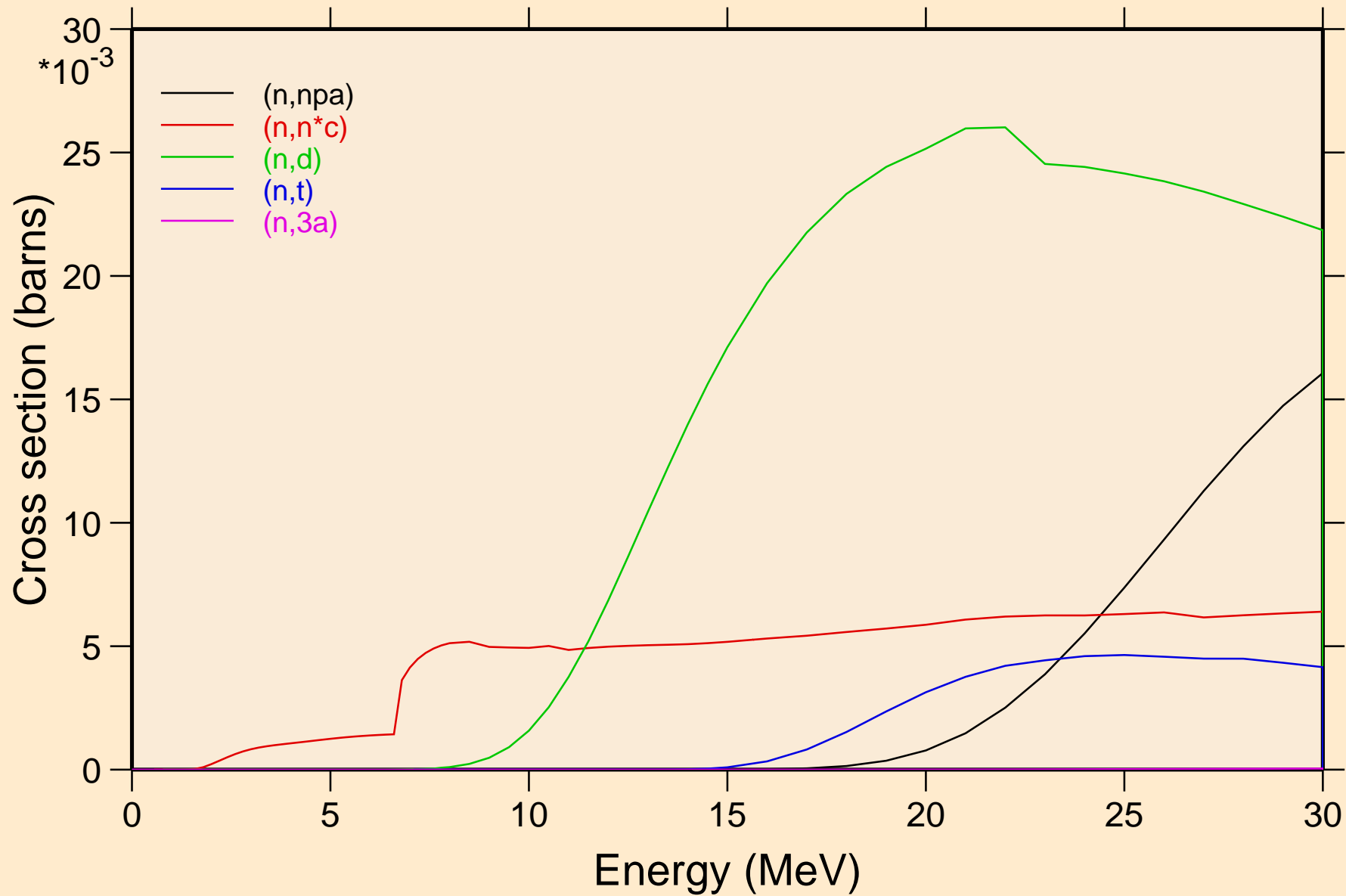

BA118 NEUTRON ACER TENDL-2021 LIBRARY; T=293.6K
Threshold reactions

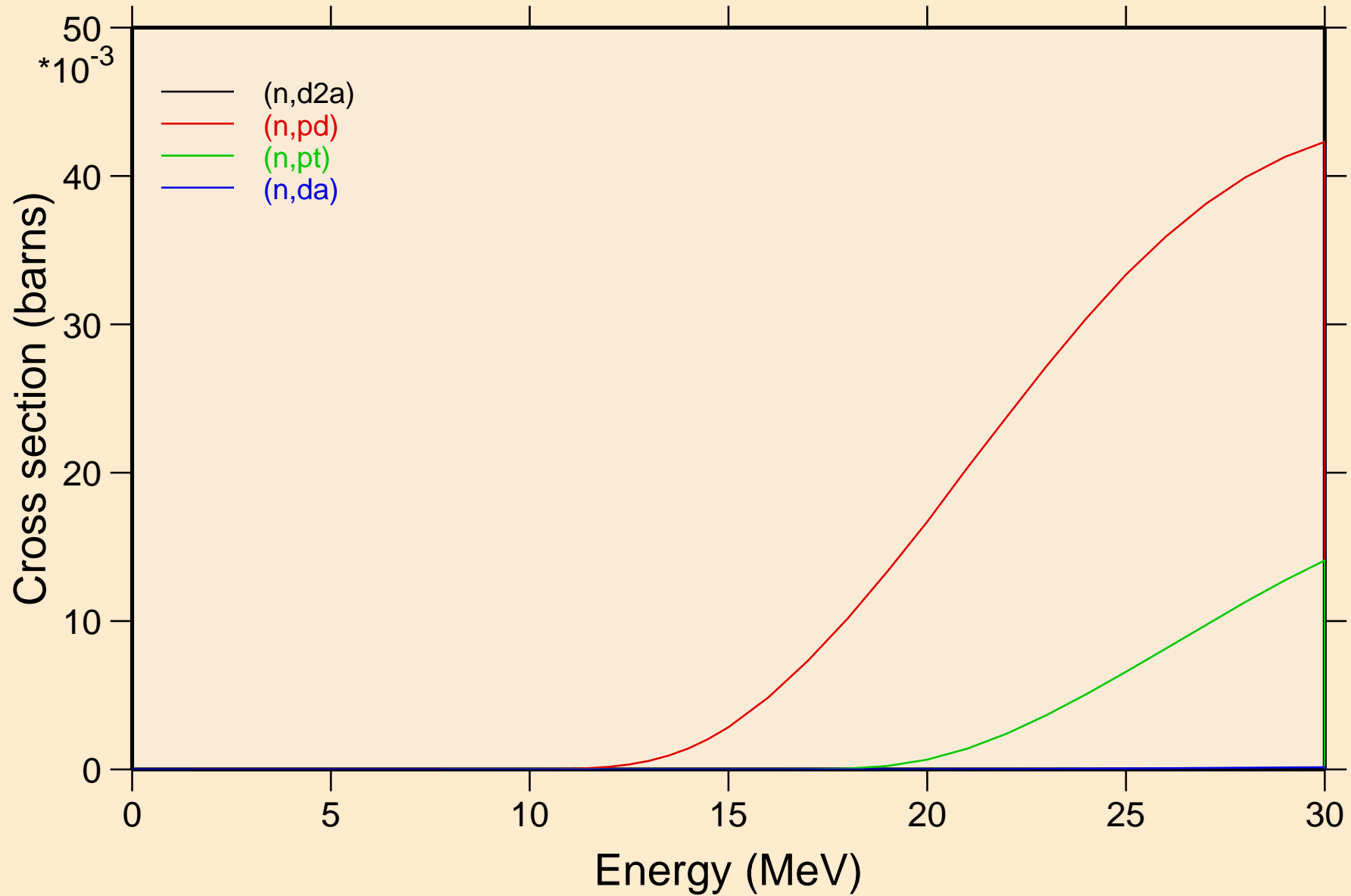

BA118 NEUTRON ACER TENDL-2021 LIBRARY; T=293.6K
Threshold reactions

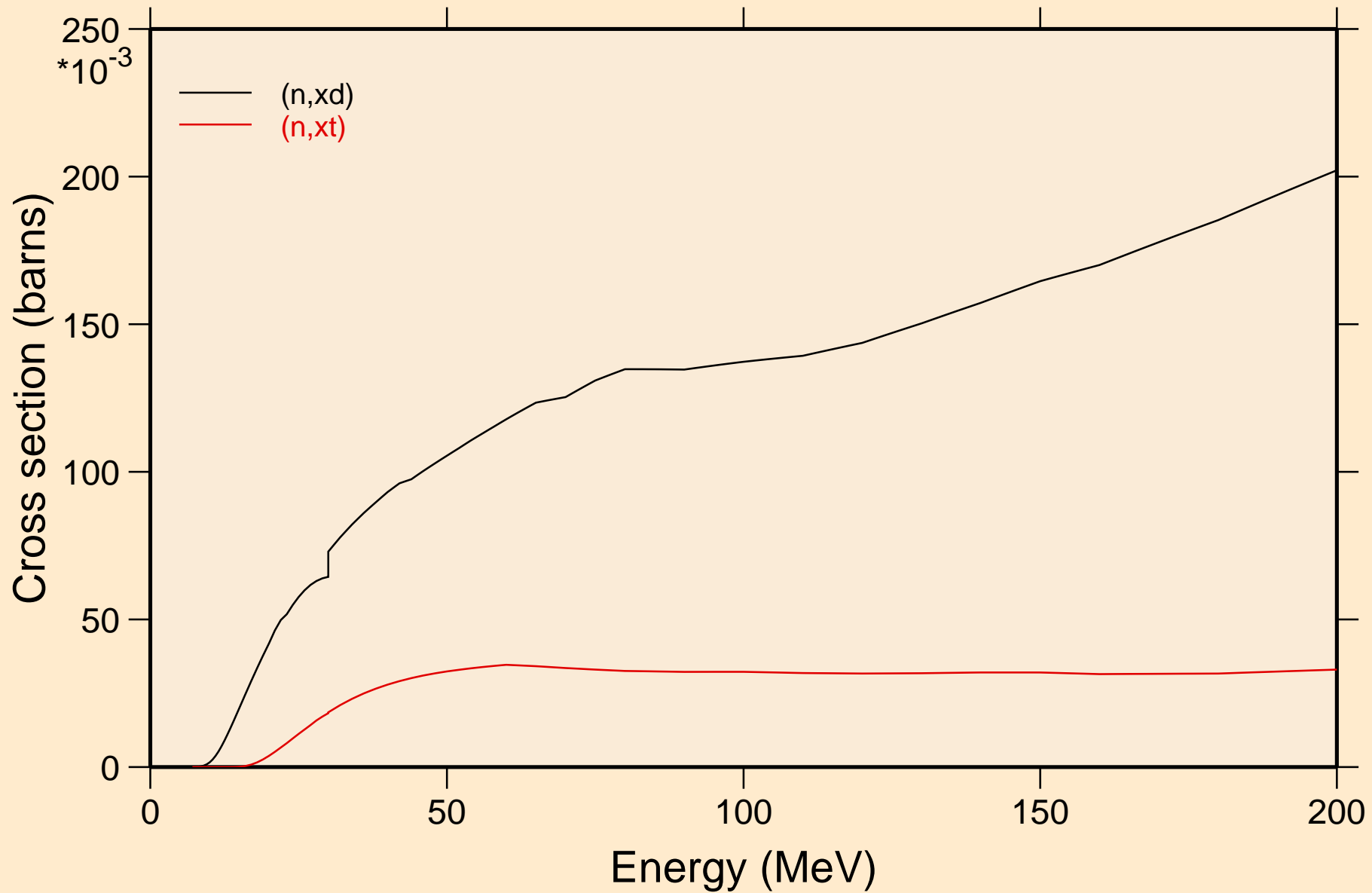

BA118 NEUTRON ACER TENDL-2021 LIBRARY; T=293.6K
angular distribution for elastic

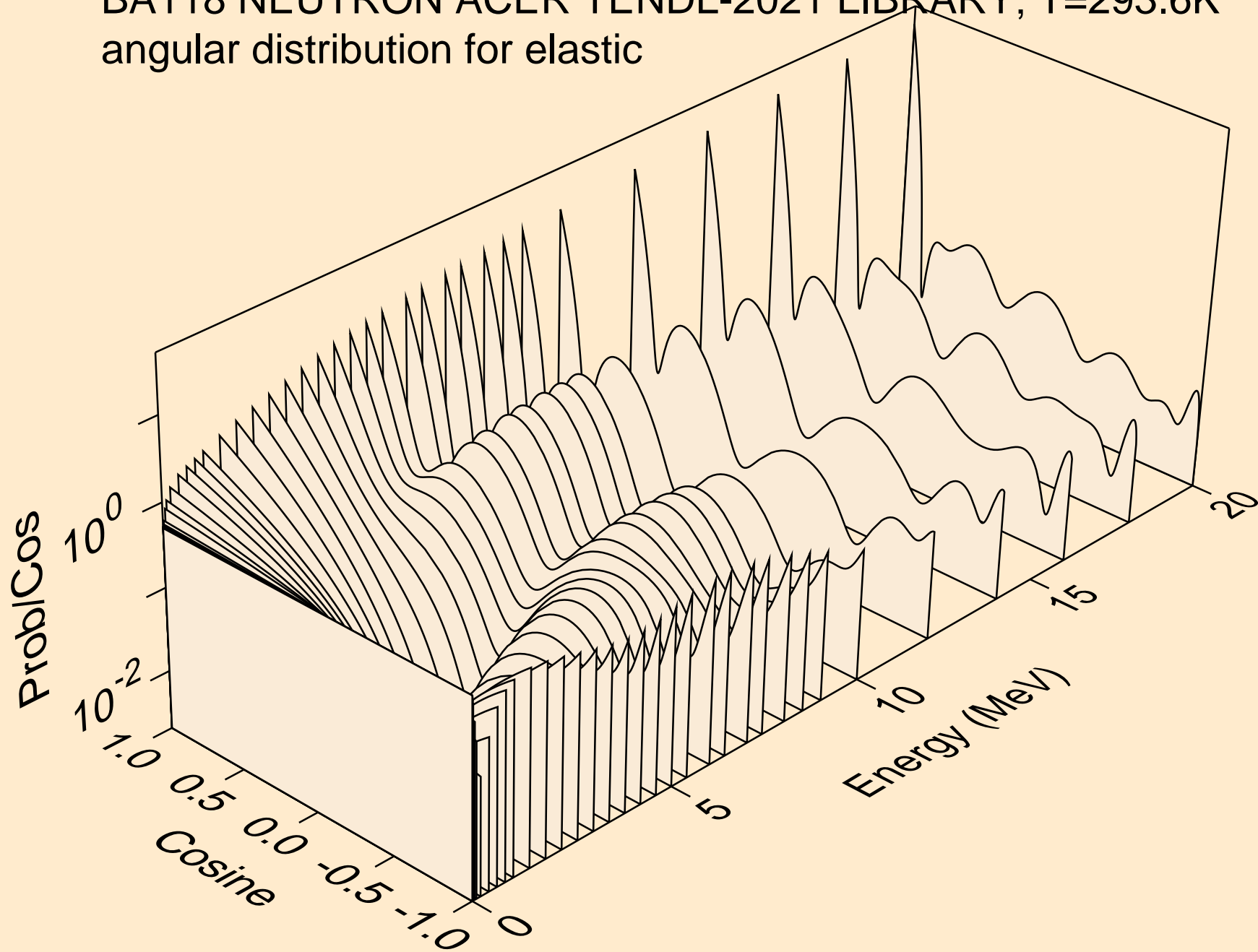

BA118 NEUTRON ACER TENDL-2021 LIBRARY; T=293.6K
angular distribution for elastic

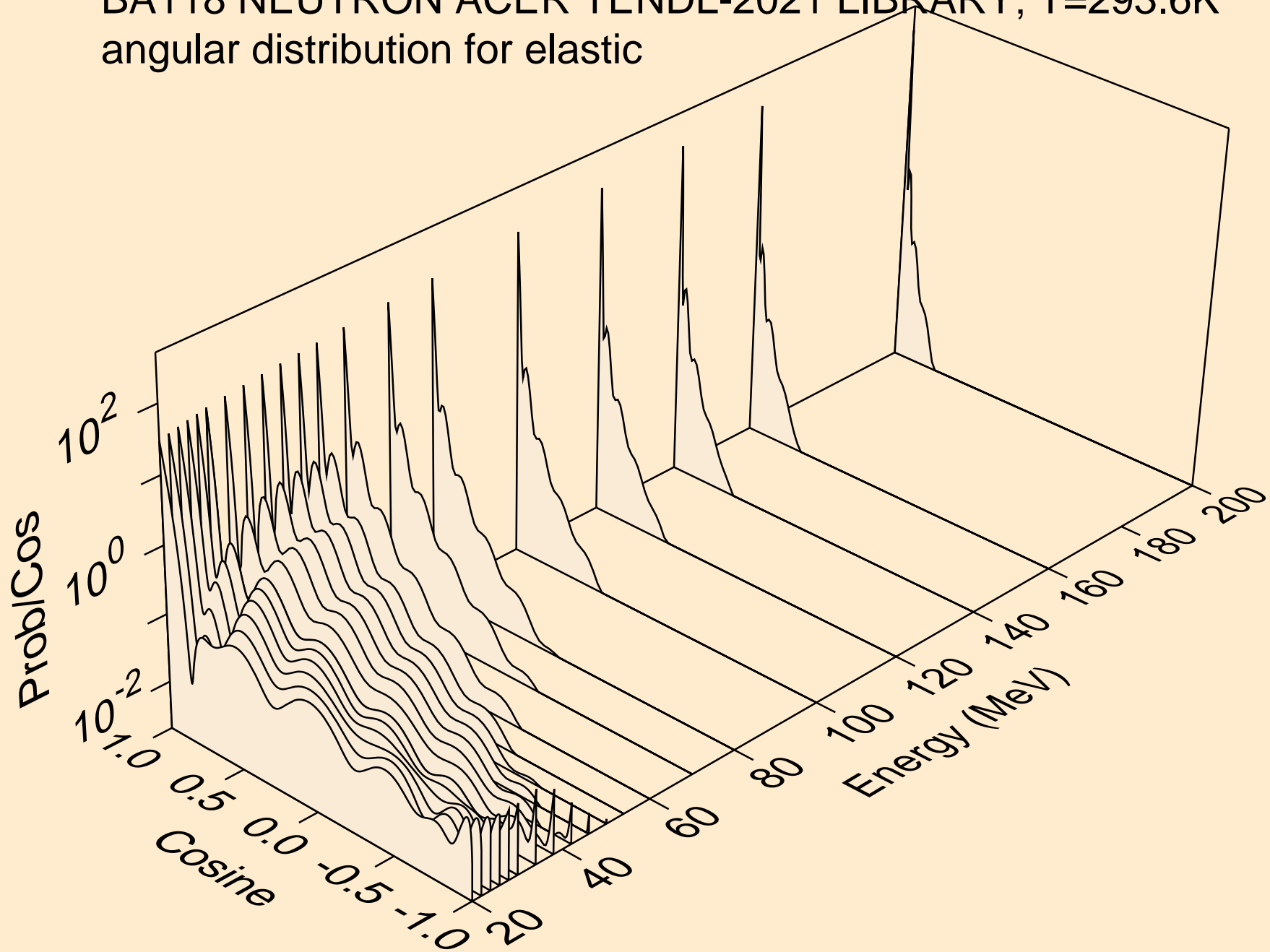

BA118 NEUTRON ACER TENDL-2021 LIBRARY; T=293.6K
angular distribution for (n,n*1)

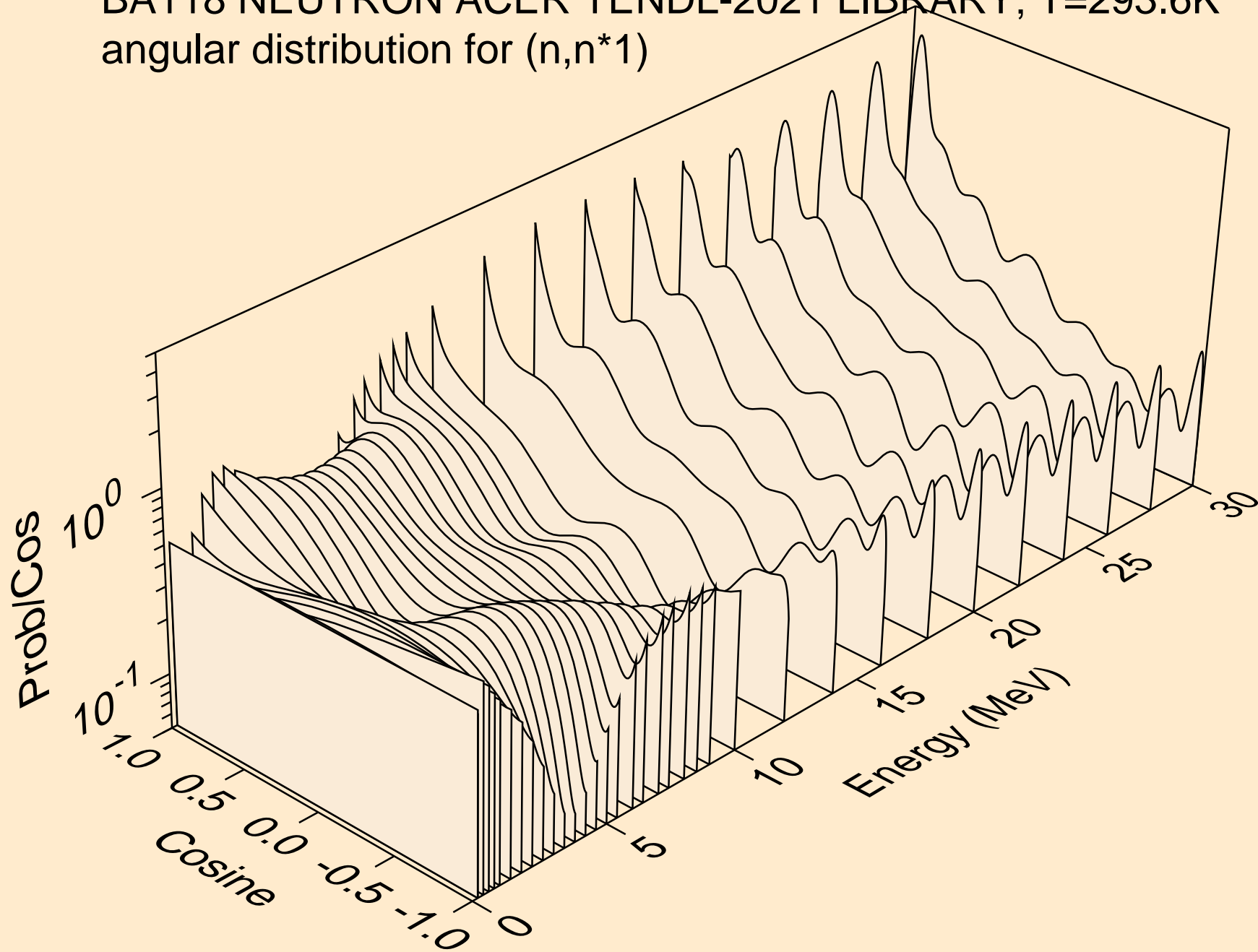

BA118 NEUTRON ACER TENDL-2021 LIBRARY; T=293.6K
angular distribution for (n,n*2)

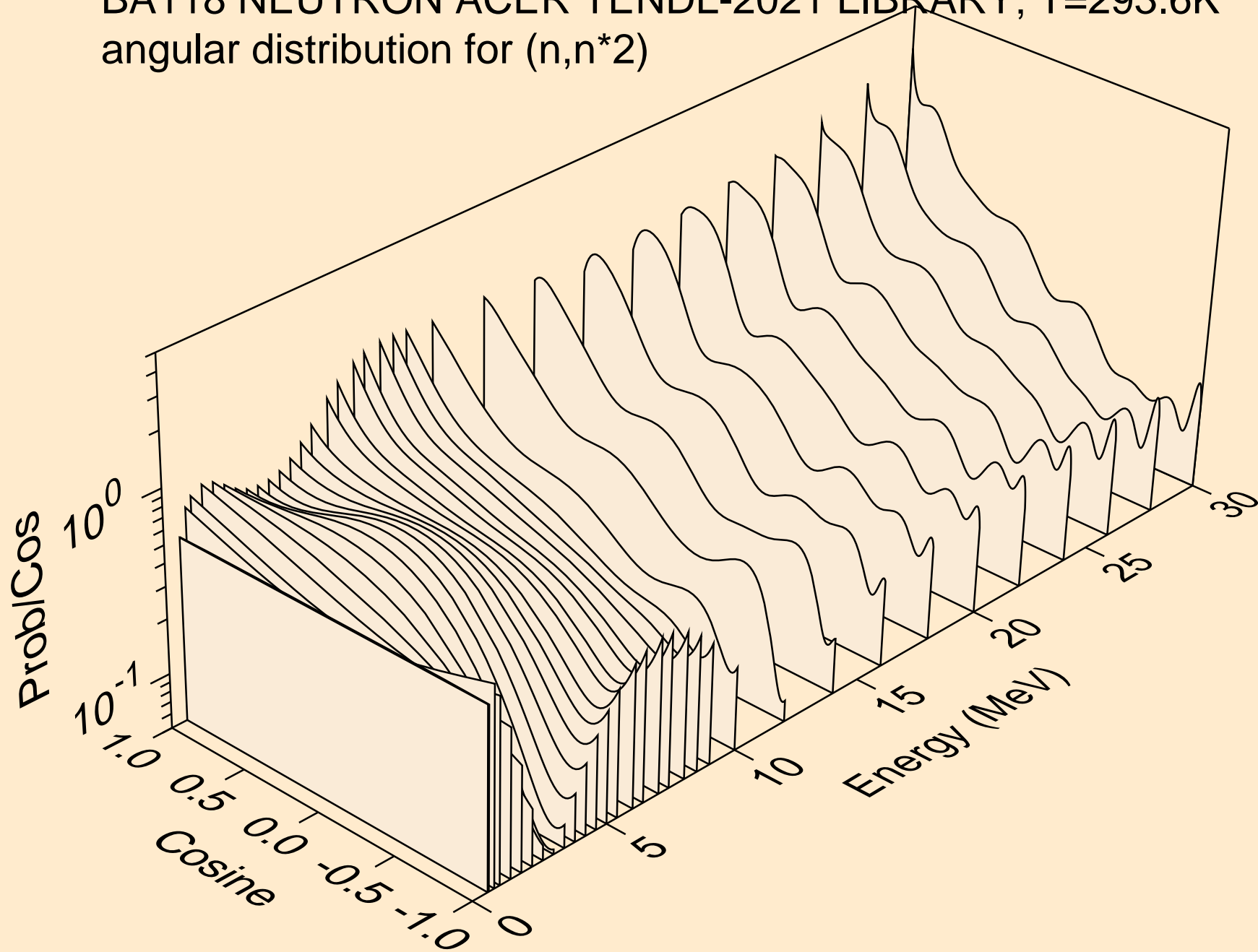

BA118 NEUTRON ACER TENDL-2021 LIBRARY; T=293.6K
Neutron emission for (n,x)

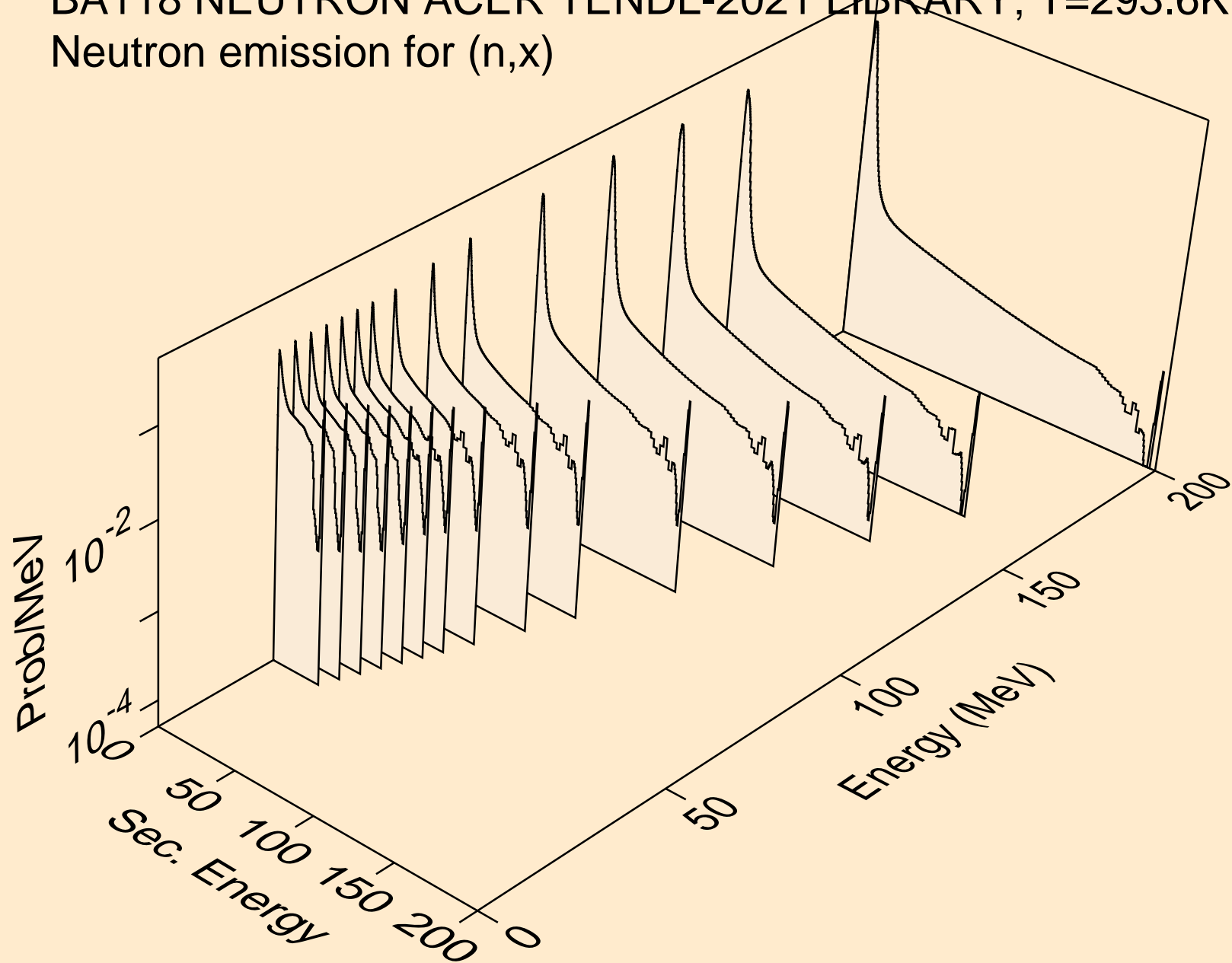

BA118 NEUTRON ACER TENDL-2021 LIBRARY; T=293.6K
Neutron emission for (n,2n)

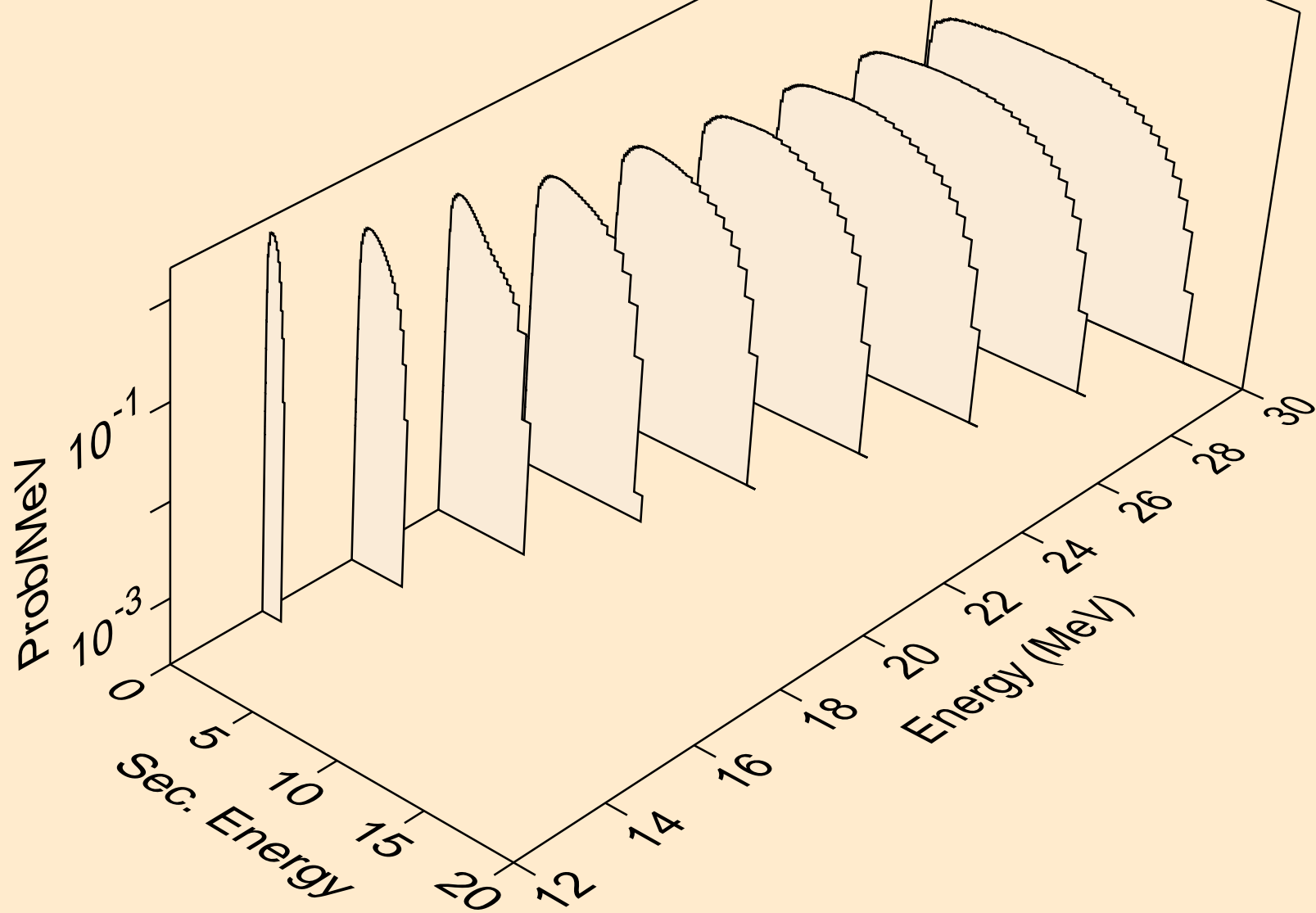

BA118 NEUTRON ACER TENDL-2021 LIBRARY; T=293.6K
Neutron emission for (n,3n)

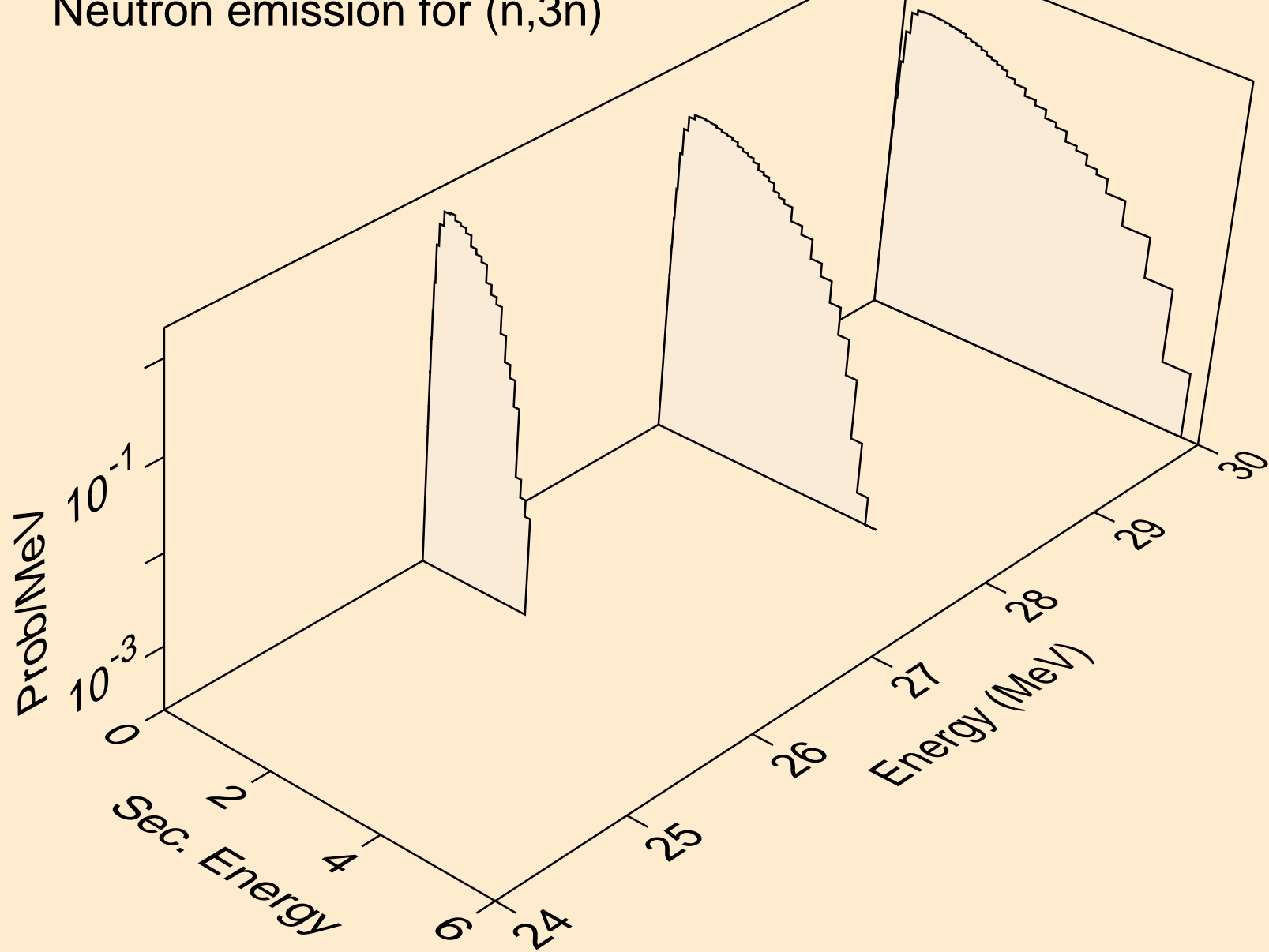

BA118 NEUTRON ACER TENDL-2021 LIBRARY; T=293.6K
Neutron emission for (n,n*)a

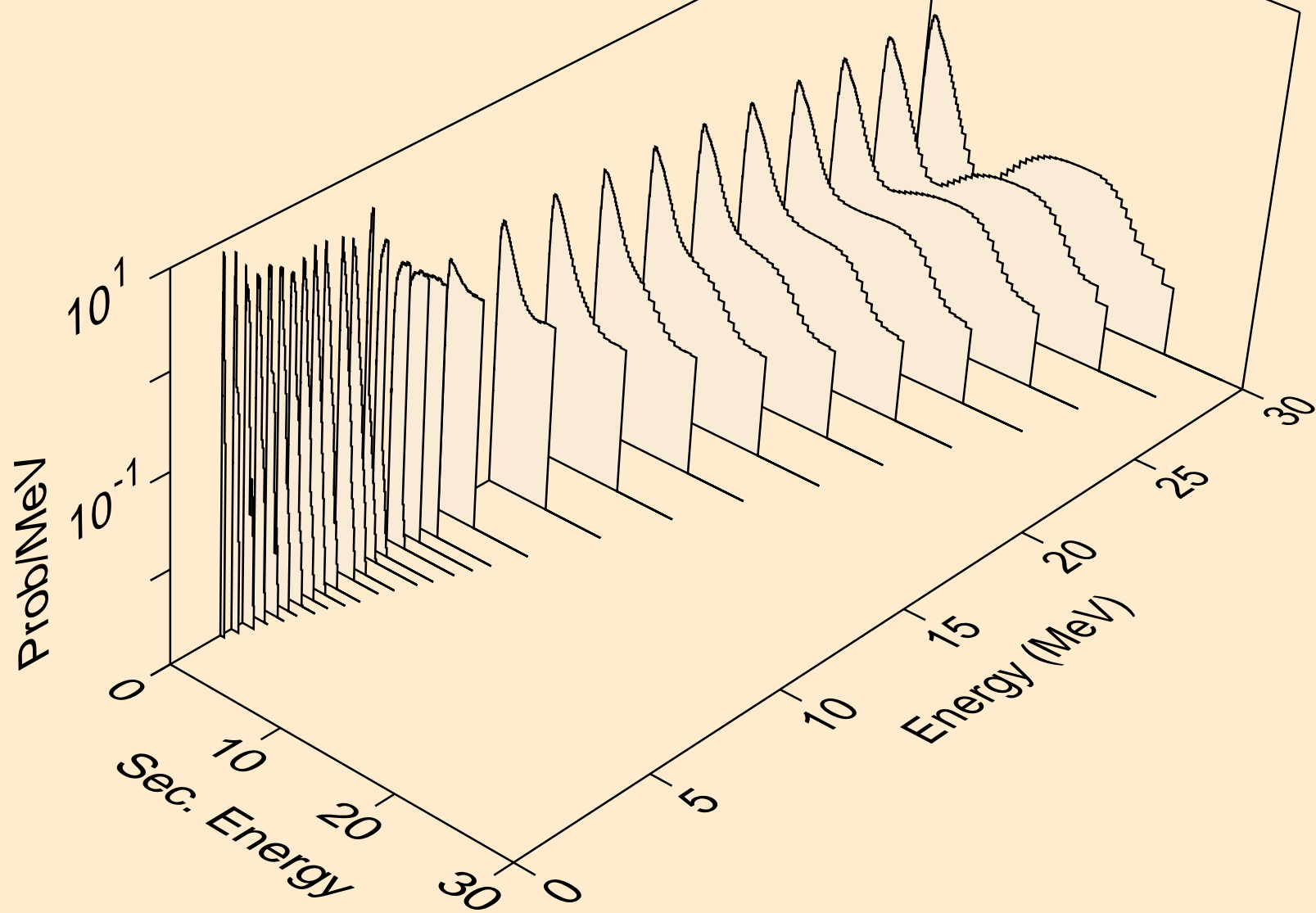

BA118 NEUTRON ACER TENDL-2021 LIBRARY; T=293.6K
Neutron emission for (n,n*)3a

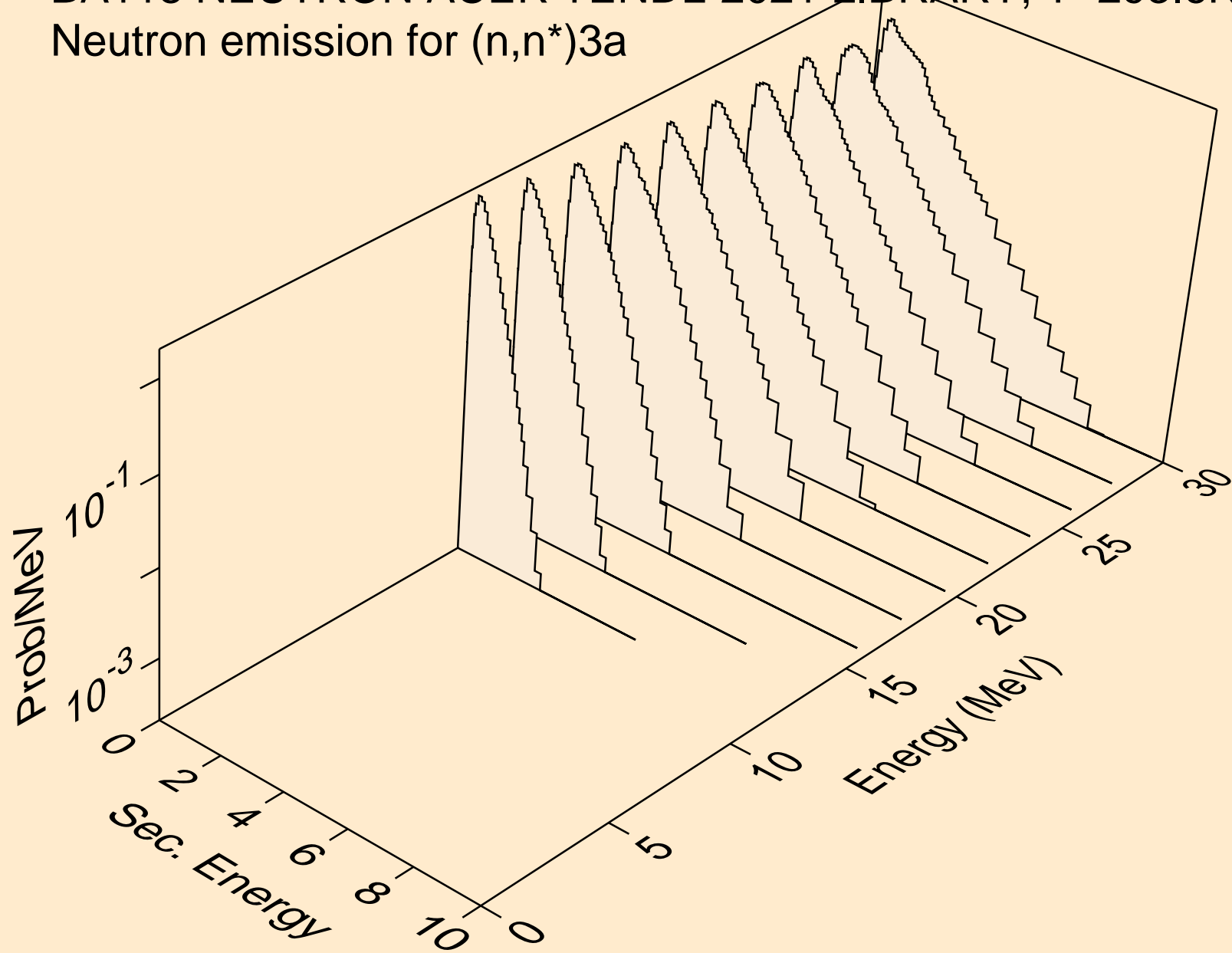

BA118 NEUTRON ACER TENDL-2021 LIBRARY; T=293.6K
Neutron emission for (n,2n)_a

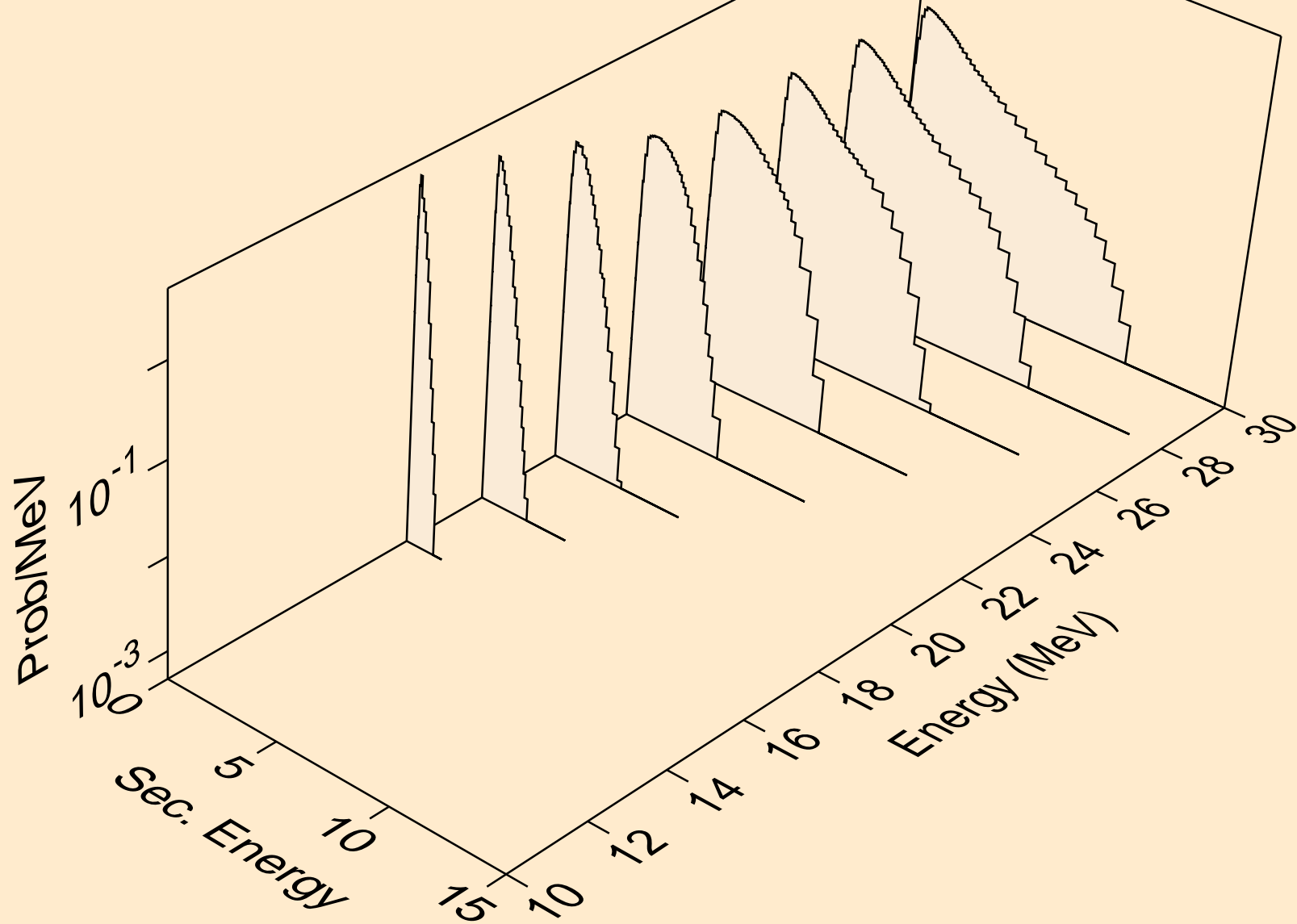

BA118 NEUTRON ACER TENDL-2021 LIBRARY; T=293.6K
Neutron emission for (n,n*)p

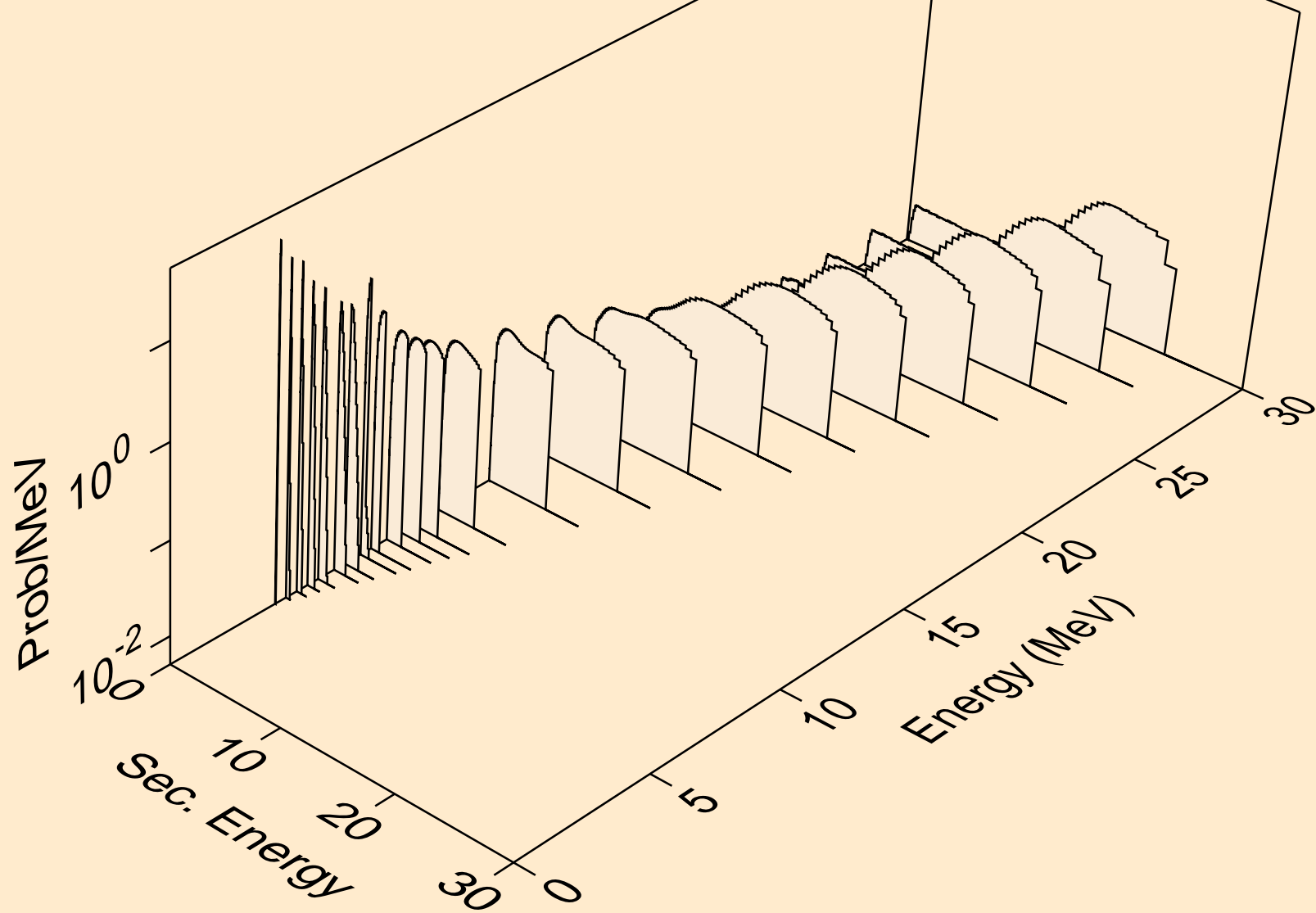

BA118 NEUTRON ACER TENDL-2021 LIBRARY; T=293.6K
Neutron emission for (n,n*)2a

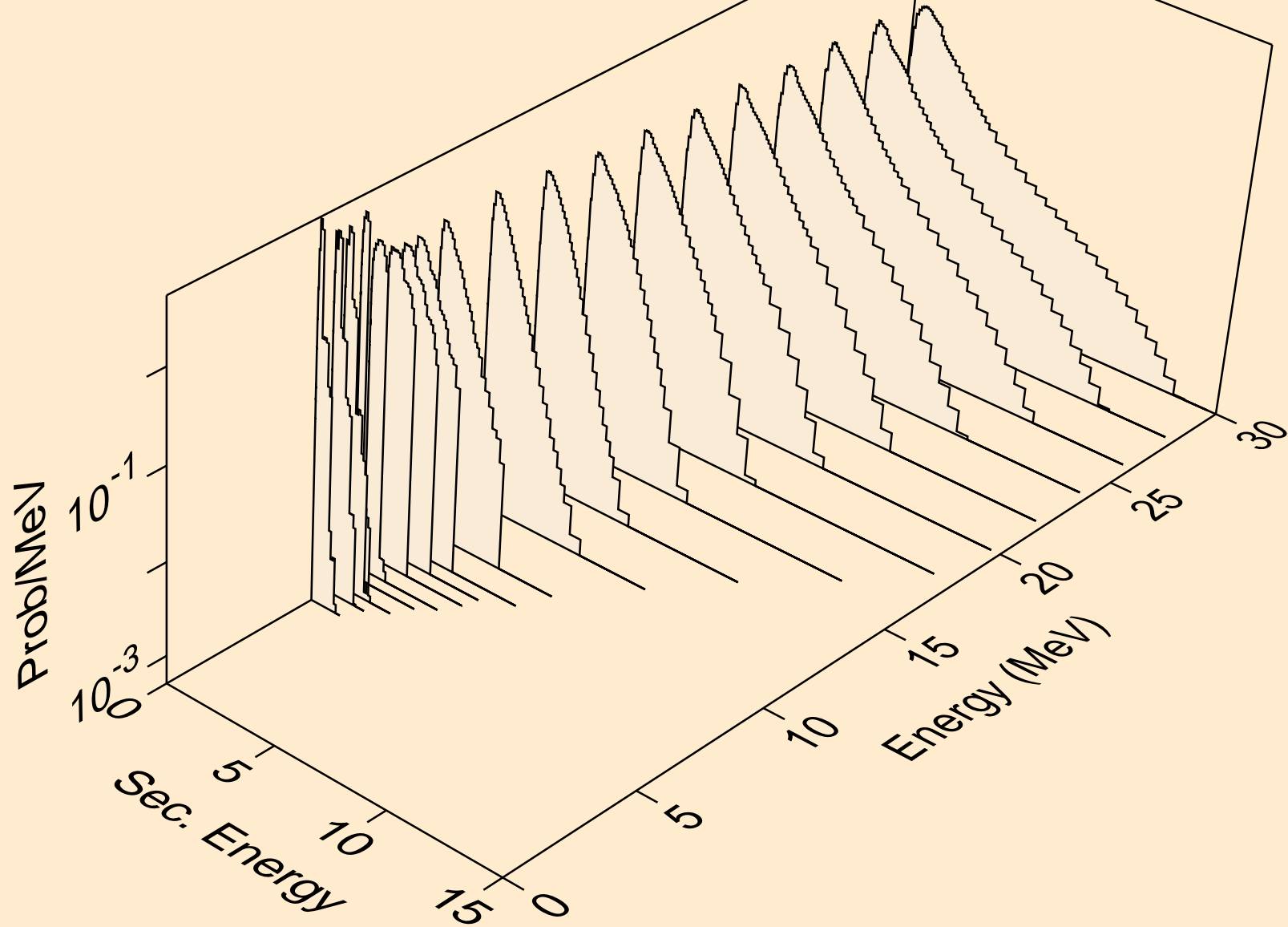

BA118 NEUTRON ACER TENDL-2021 LIBRARY; T=293.6K
Neutron emission for (n,2n)2a

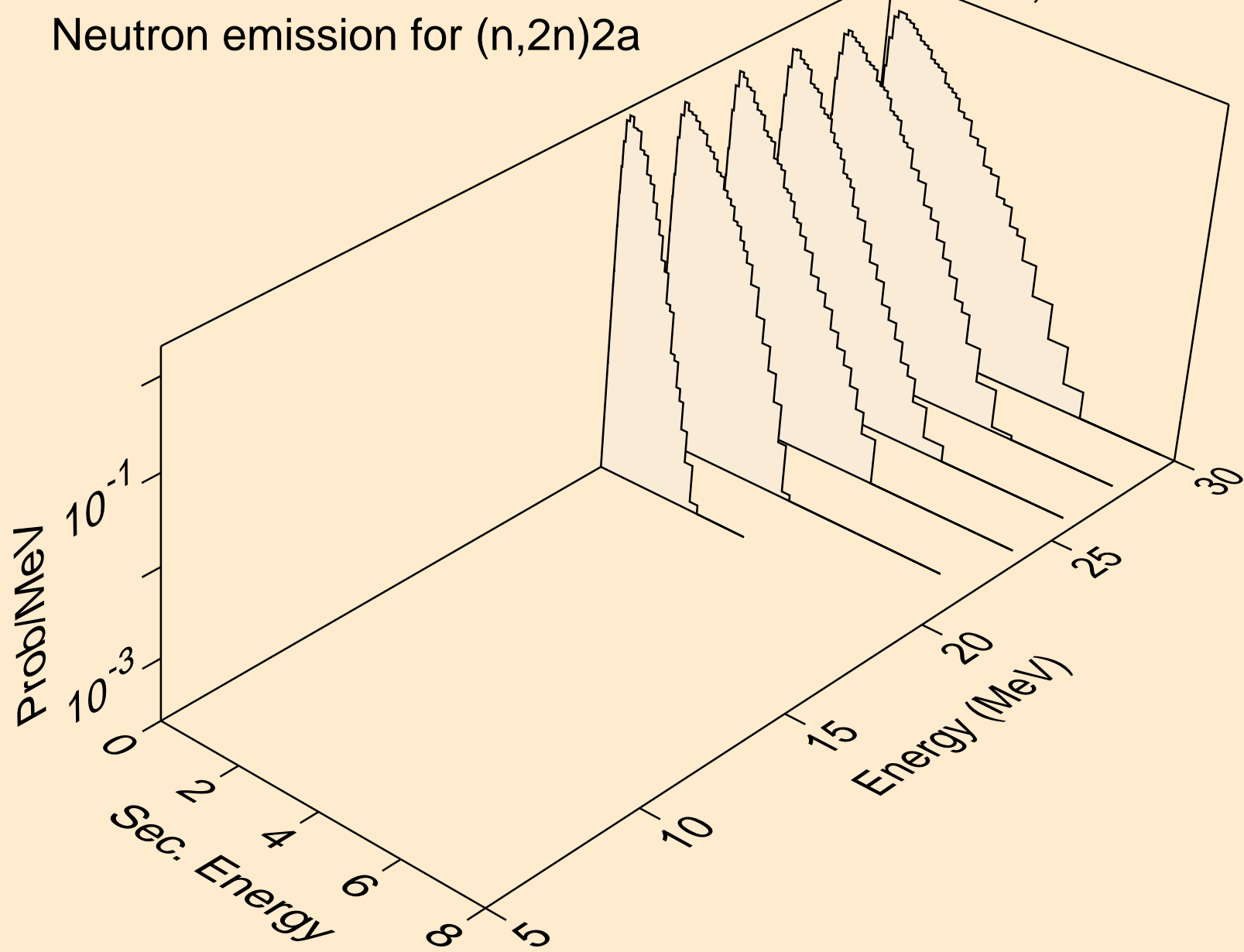

BA118 NEUTRON ACER TENDL-2021 LIBRARY; T=293.6K
Neutron emission for (n,n*)d

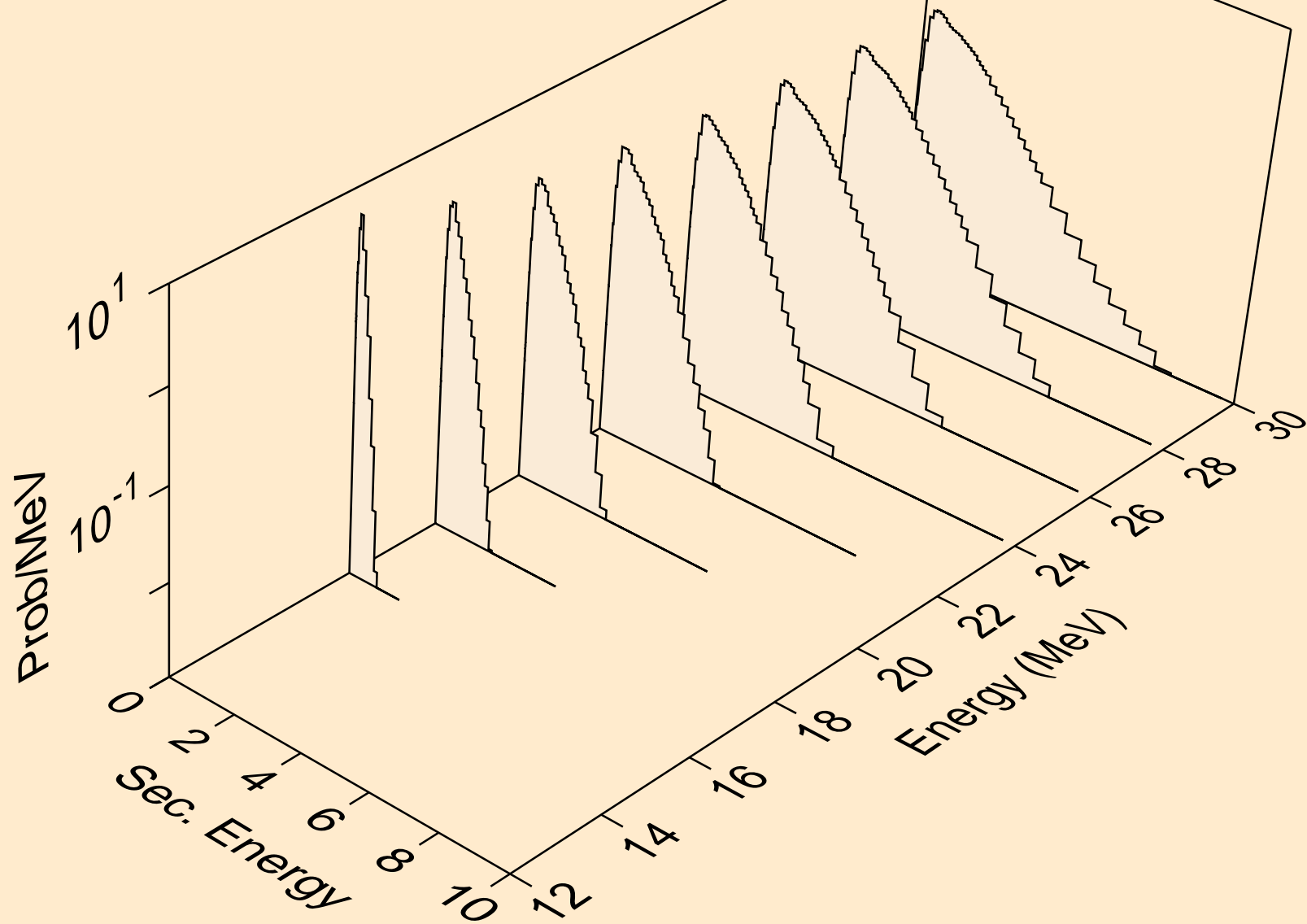

BA118 NEUTRON ACER TENDL-2021 LIBRARY; T=293.6K
Neutron emission for (n,n*)t

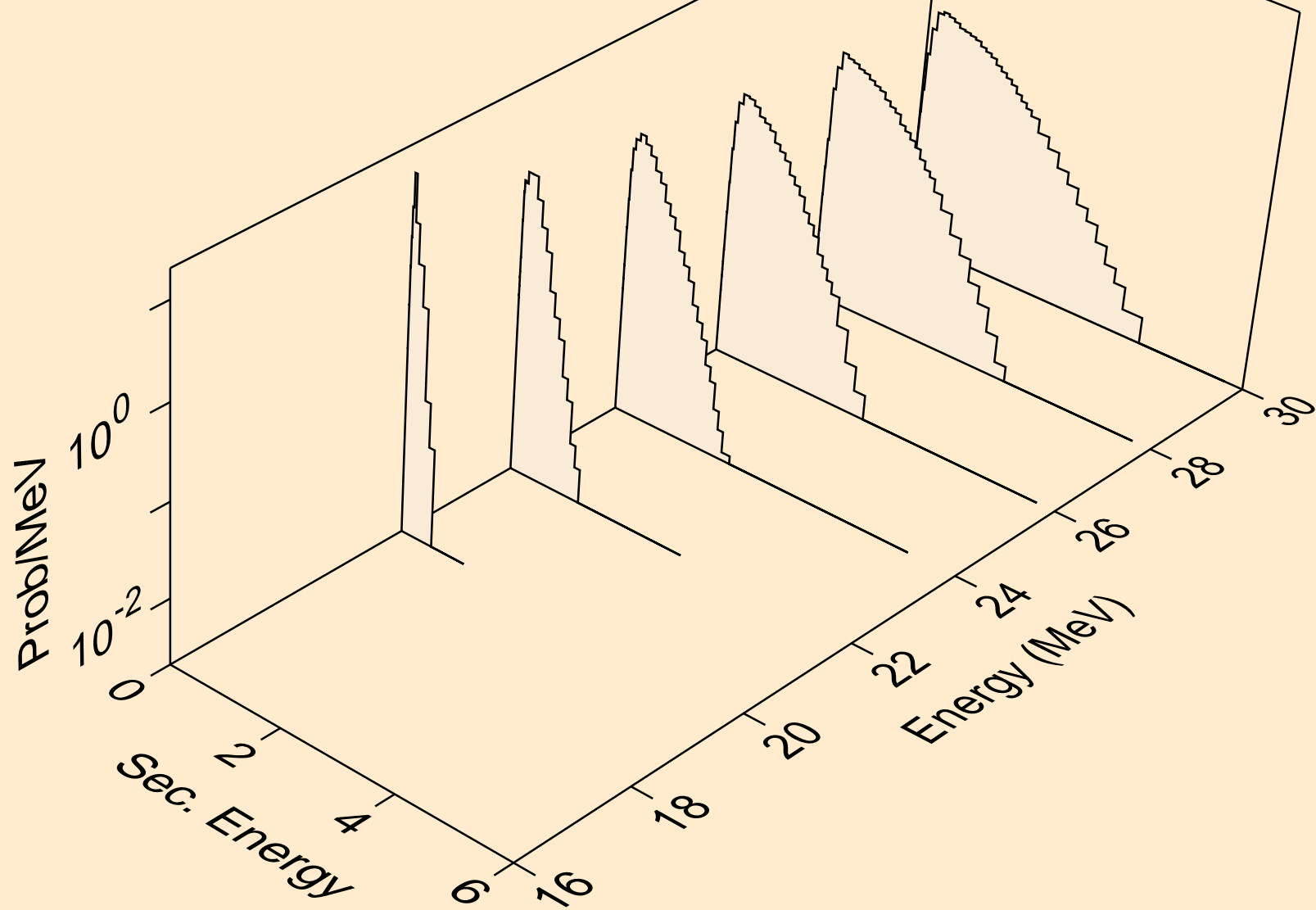

BA118 NEUTRON ACER TENDL-2021 LIBRARY; T=293.6K
Neutron emission for (n,n*)he3

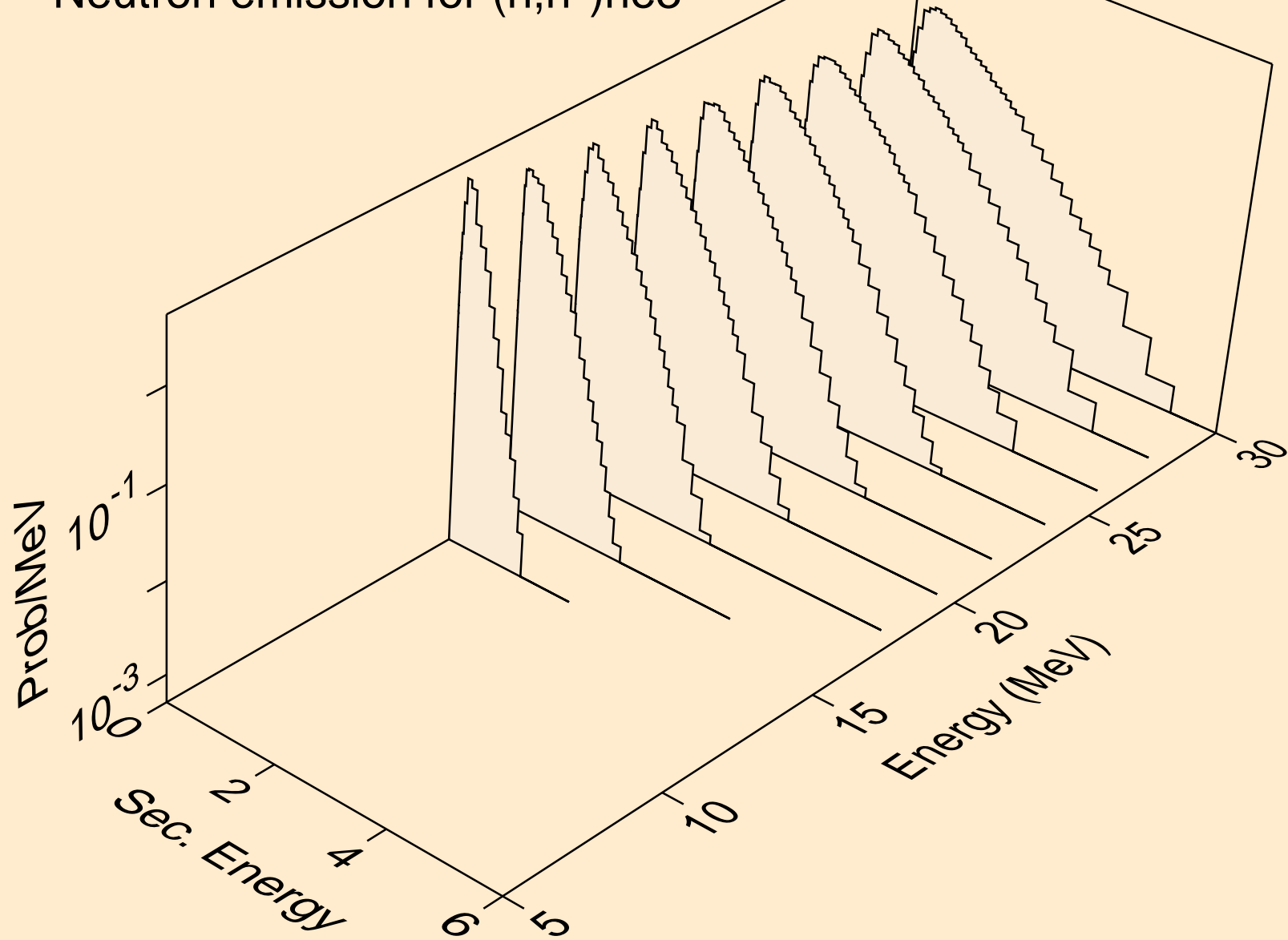

BA118 NEUTRON ACER TENDL-2021 LIBRARY; T=293.6K
Neutron emission for (n,2np)

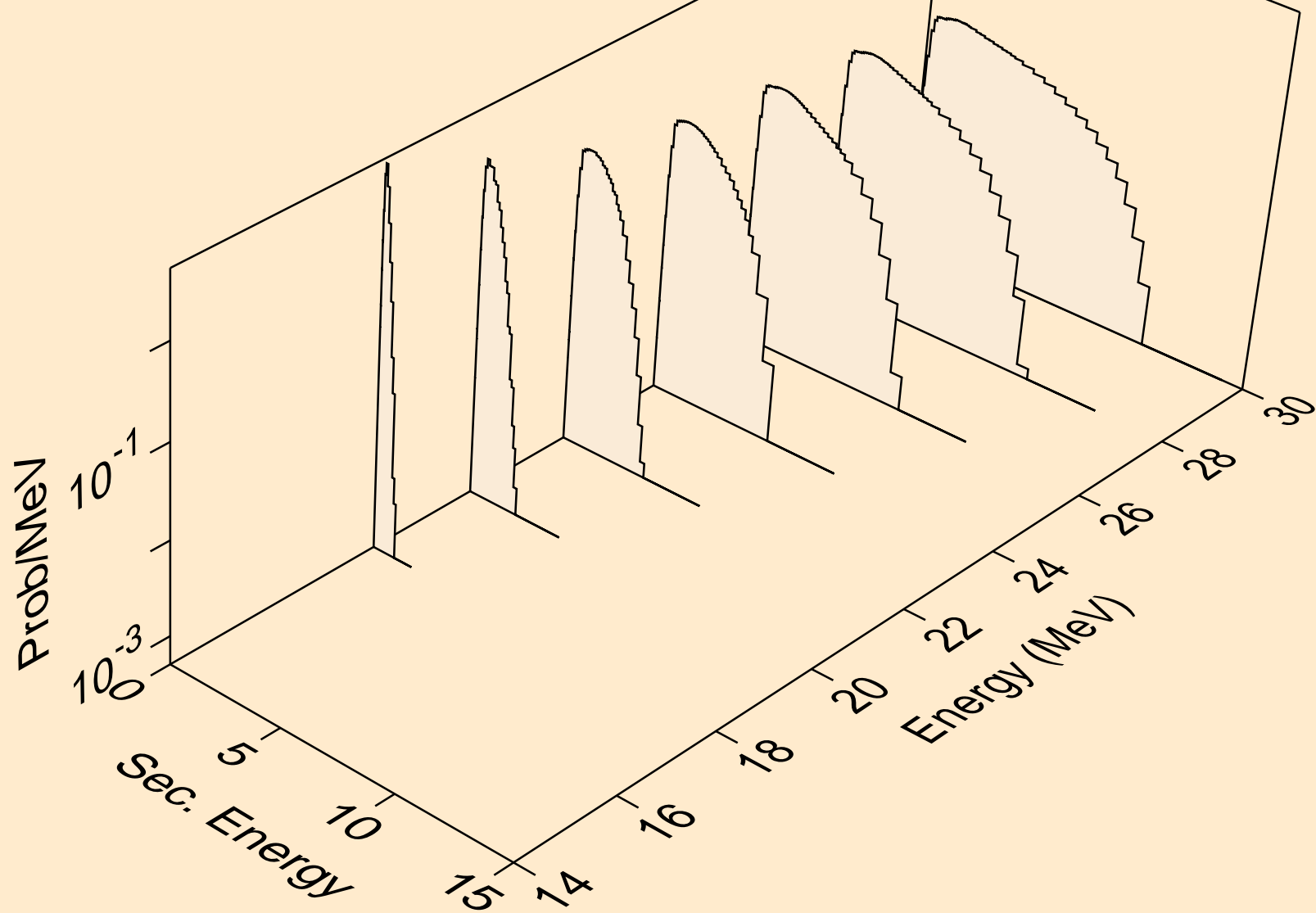

BA118 NEUTRON ACER TENDL-2021 LIBRARY; T=293.6K
Neutron emission for (n,3np)

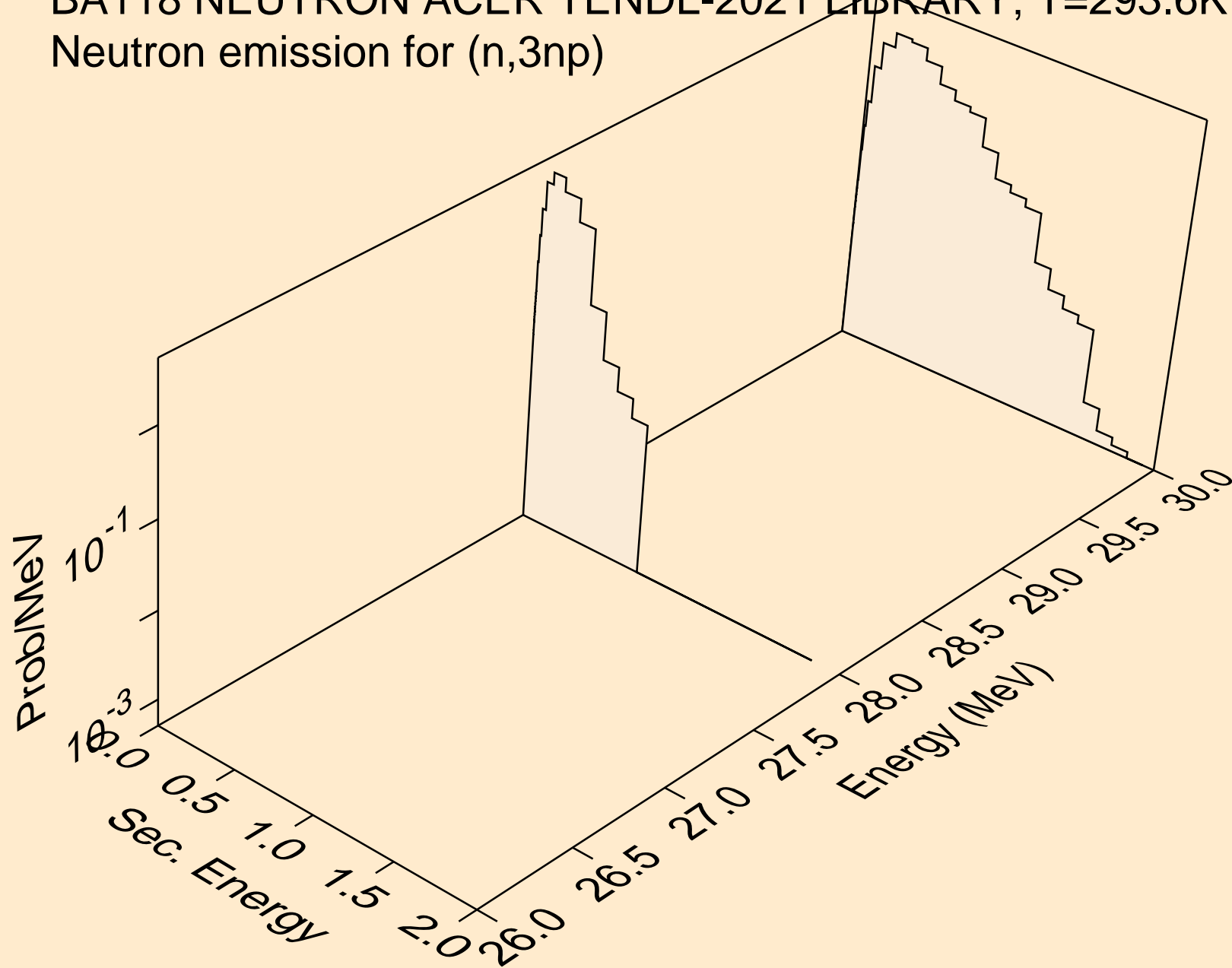

BA118 NEUTRON ACER TENDL-2021 LIBRARY; T=293.6K
Neutron emission for (n,2np)

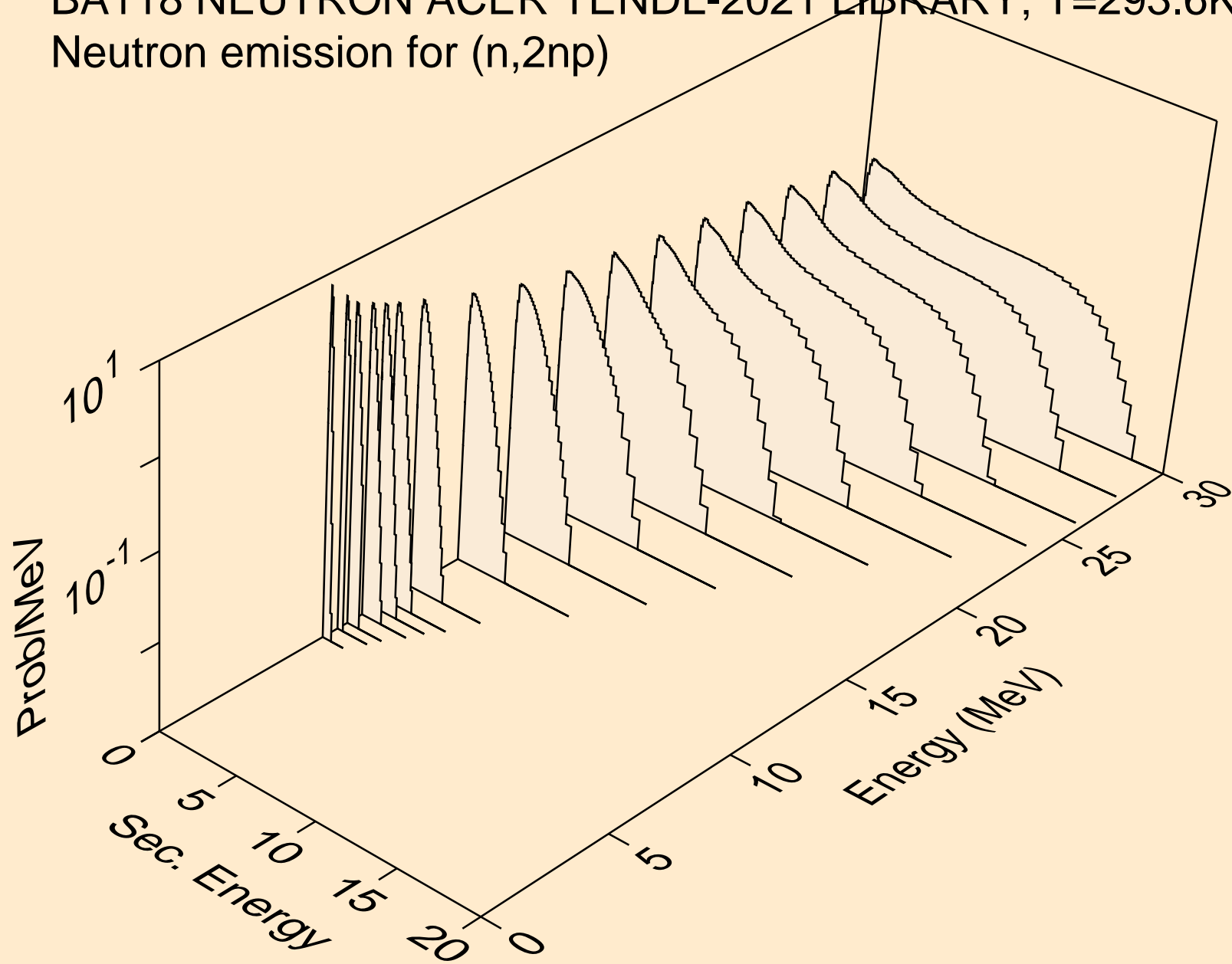

BA118 NEUTRON ACER TENDL-2021 LIBRARY; T=293.6K
Neutron emission for (n,npa)

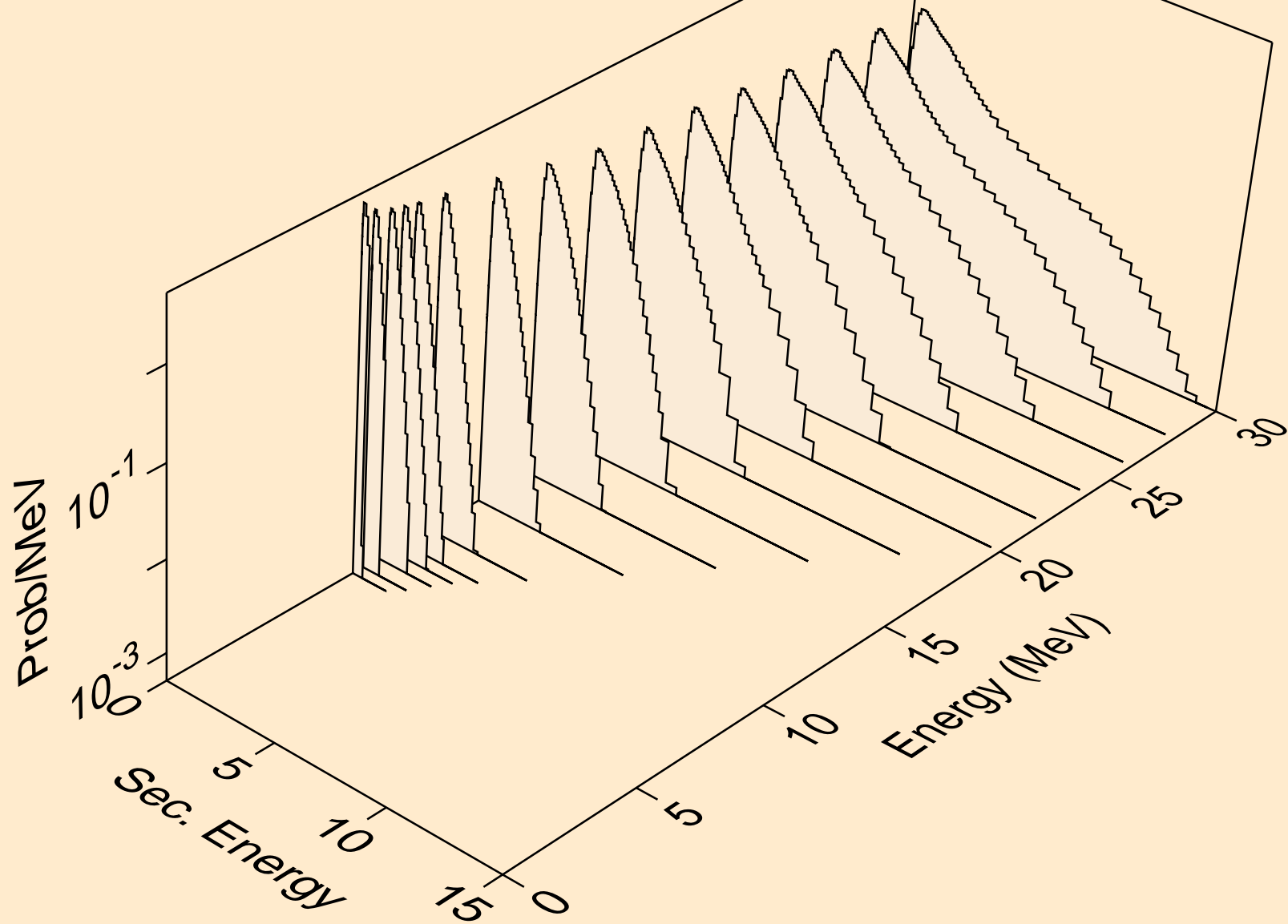

BA118 NEUTRON ACER TENDL-2021 LIBRARY; T=293.6K
Neutron emission for (n,n*c)

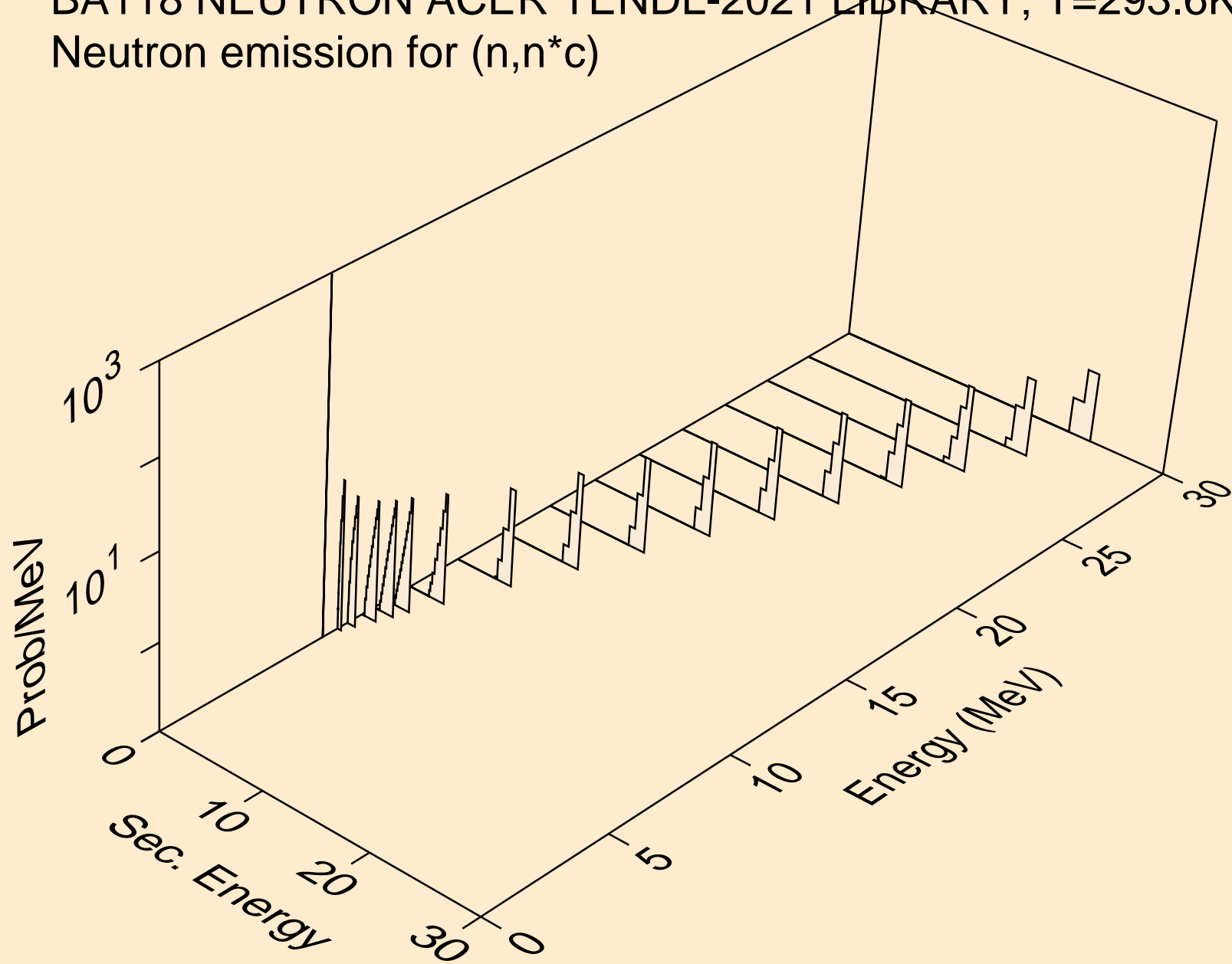

BA118 NEUTRON ACER TENDL-2021 LIBRARY; T=293.6K
Photon emission for (n,x)

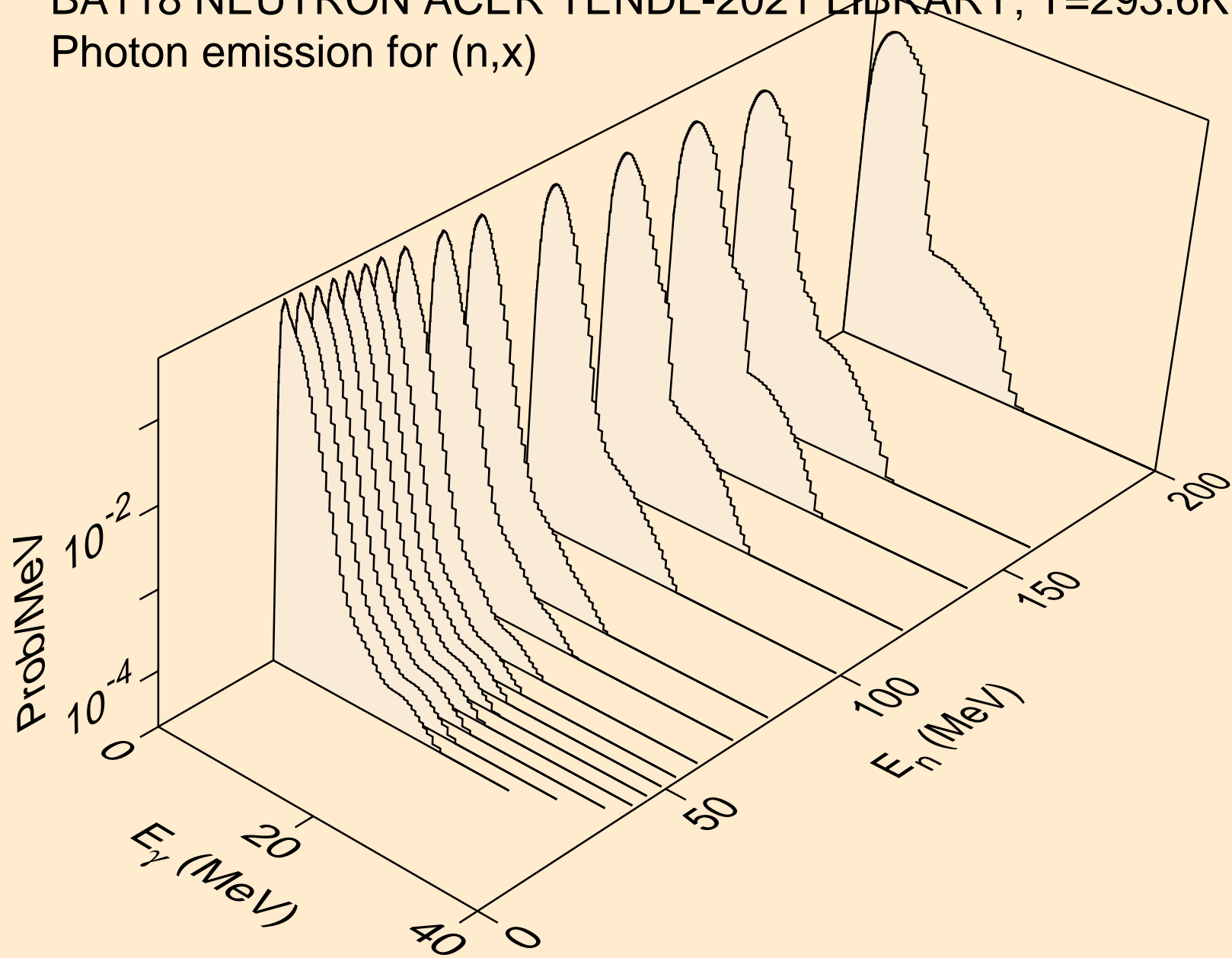

BA118 NEUTRON ACER TENDL-2021 LIBRARY; T=293.6K
Photon emission for (n,2n)

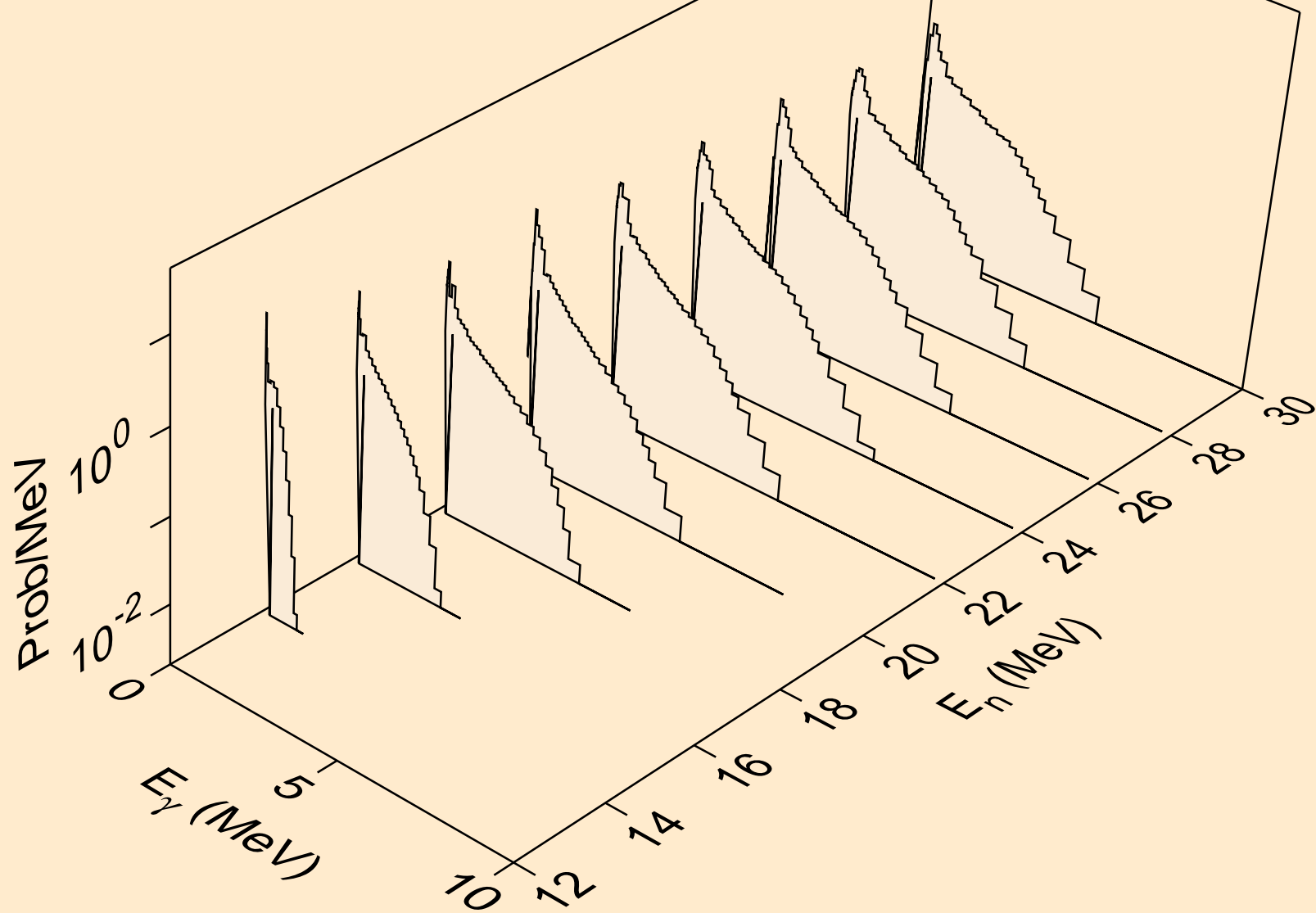

BA118 NEUTRON ACER TENDL-2021 LIBRARY; T=293.6K
Photon emission for (n,3n)

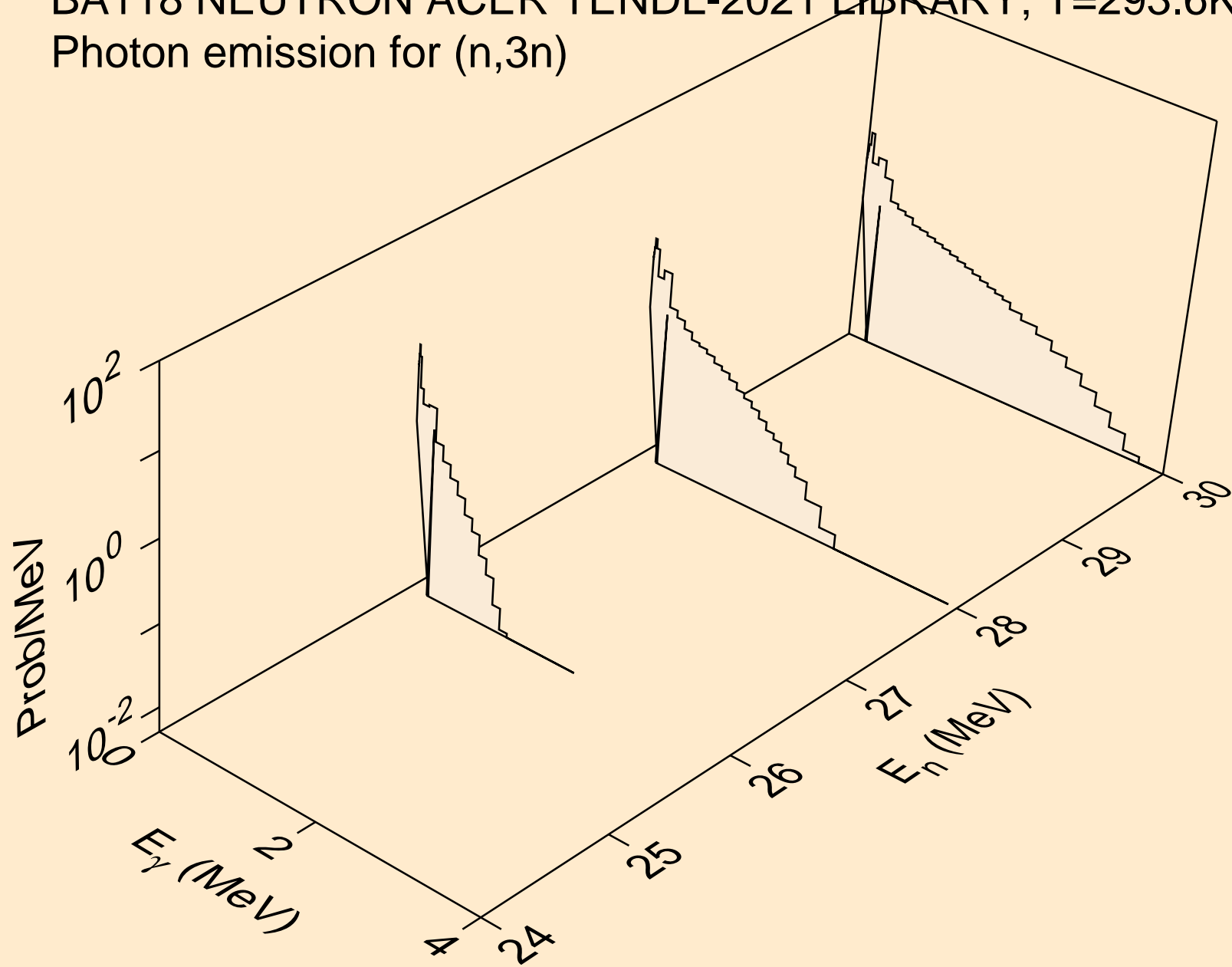

BA118 NEUTRON ACER TENDL-2021 LIBRARY; T=293.6K
Photon emission for (n,n*)a

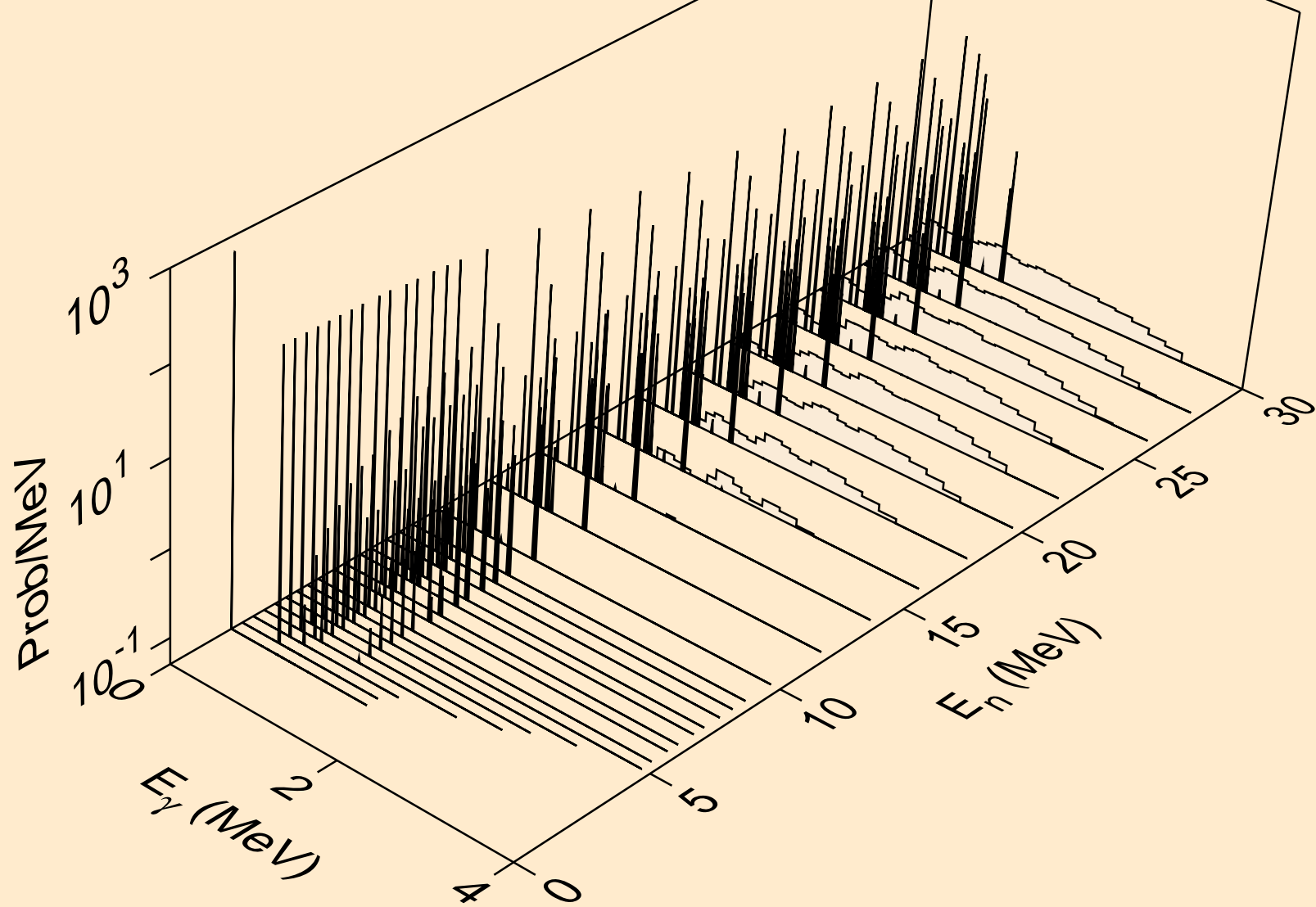

BA118 NEUTRON ACER TENDL-2021 LIBRARY; T=293.6K
Photon emission for (n,n*)3a

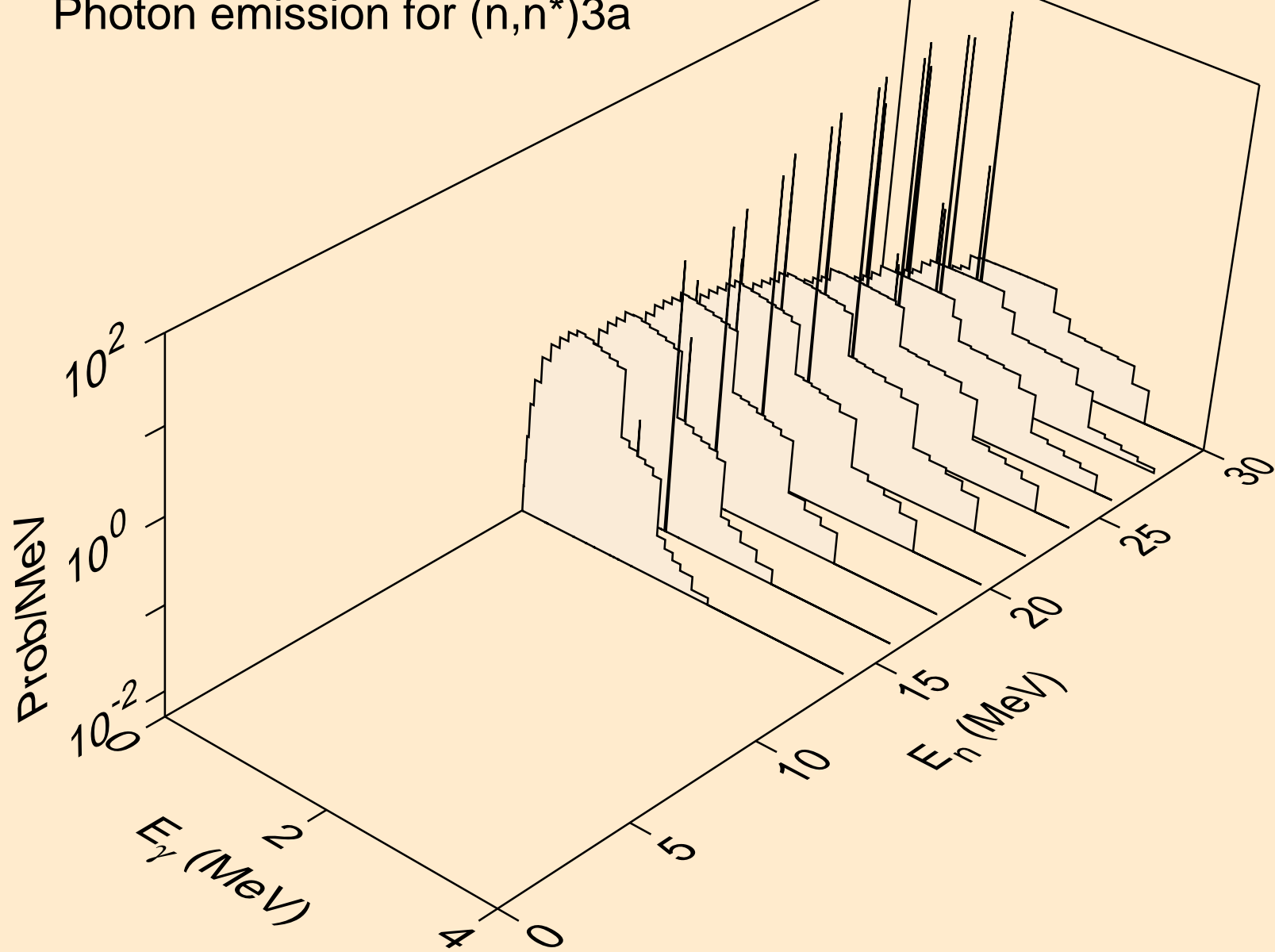

BA118 NEUTRON ACER TENDL-2021 LIBRARY; T=293.6K
Photon emission for (n,2n)a

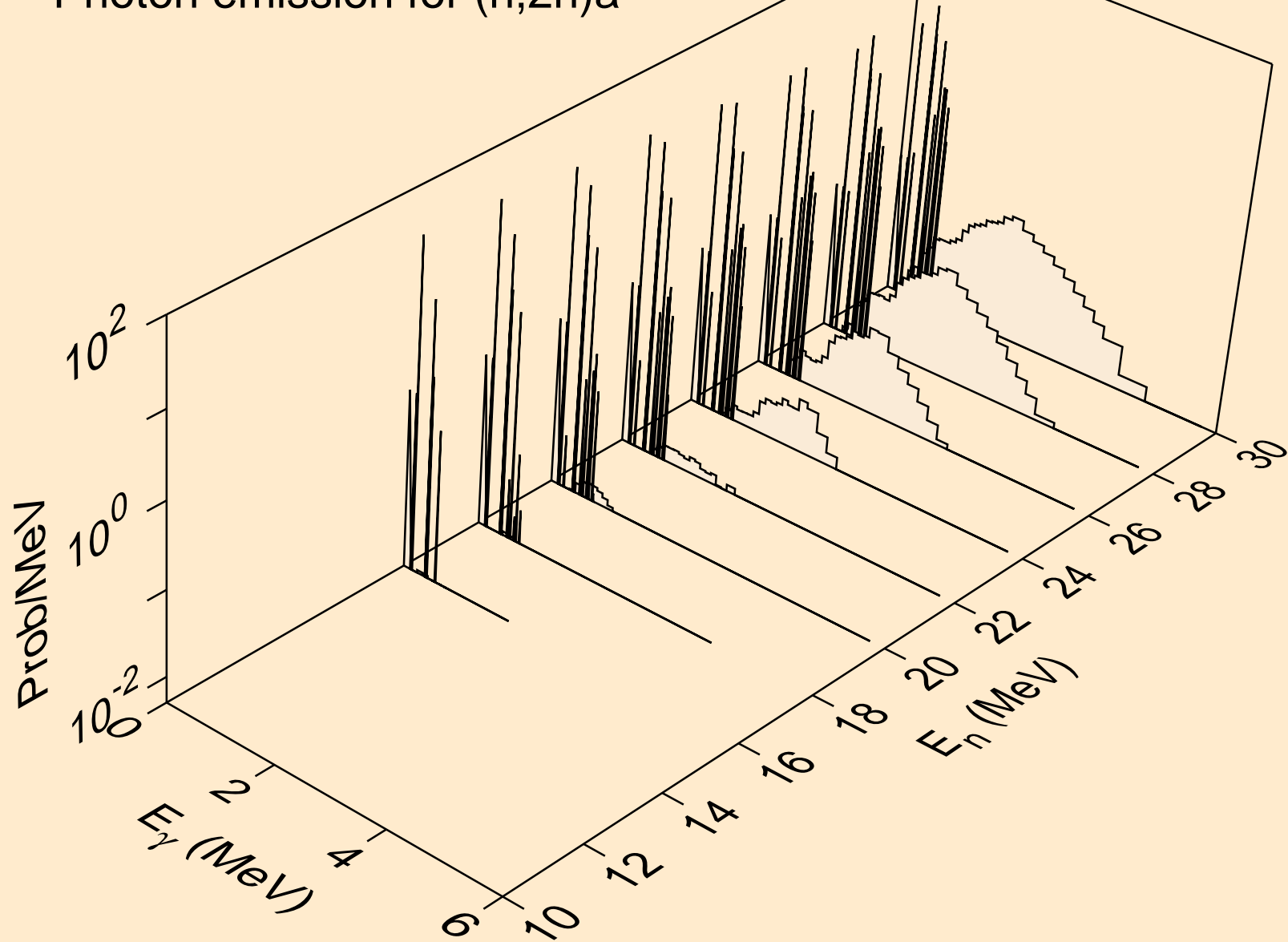

BA118 NEUTRON ACER TENDL-2021 LIBRARY; T=293.6K
Photon emission for (n,n*)p

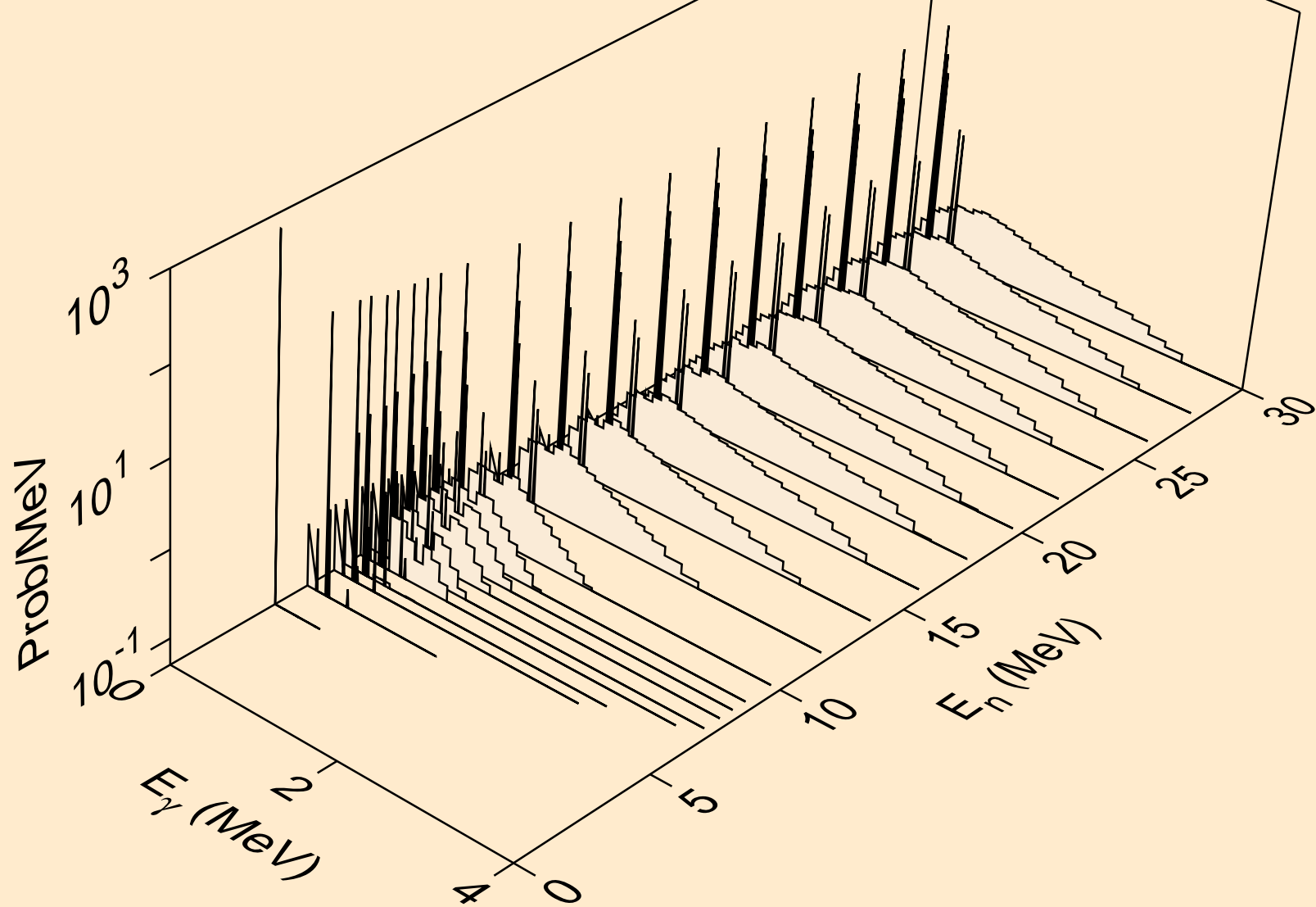

BA118 NEUTRON ACER TENDL-2021 LIBRARY; T=293.6K
Photon emission for (n,n*)2a

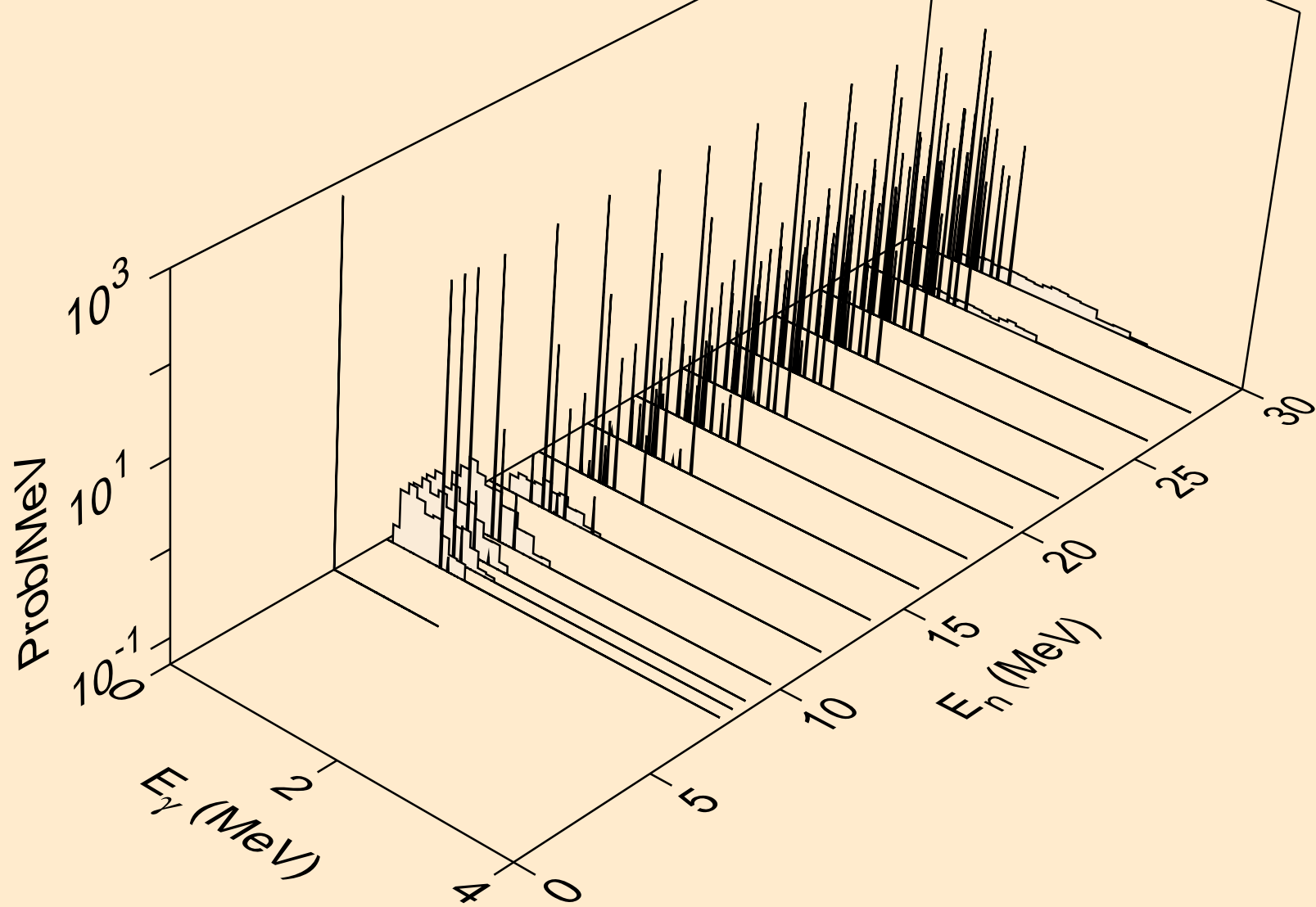

BA118 NEUTRON ACER TENDL-2021 LIBRARY; T=293.6K
Photon emission for (n,2n)2a

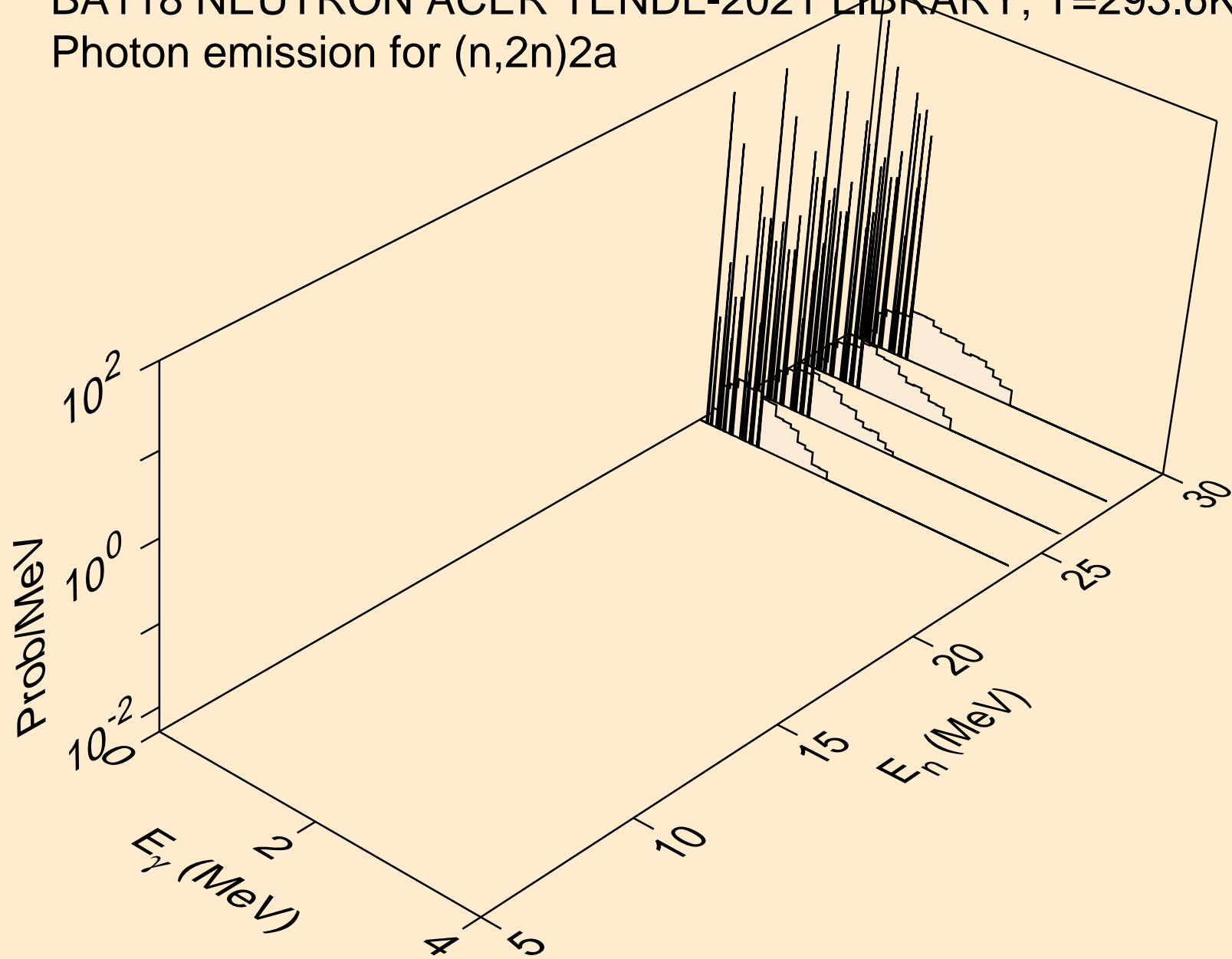

BA118 NEUTRON ACER TENDL-2021 LIBRARY; T=293.6K
Photon emission for (n,n*)d

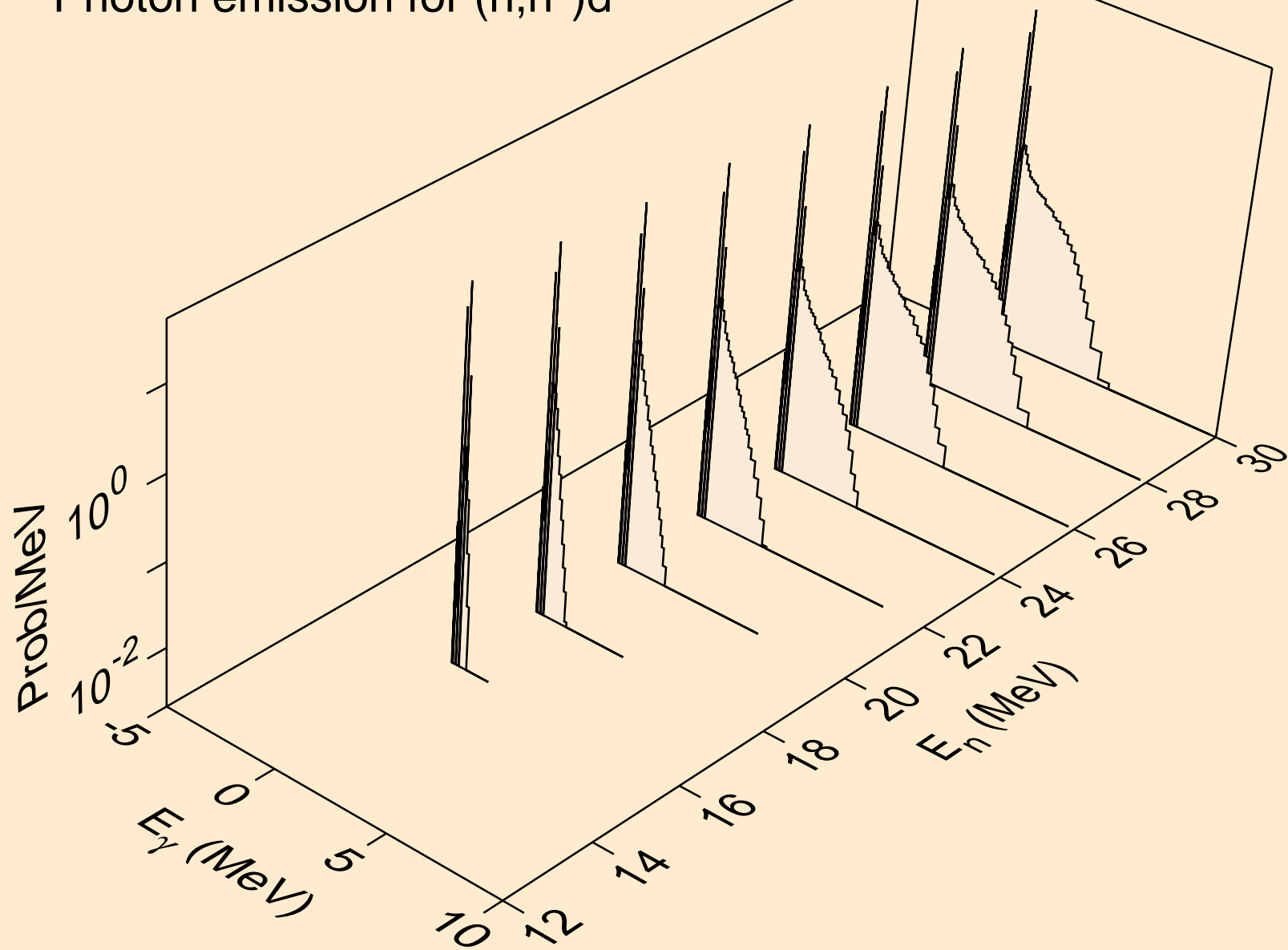

BA118 NEUTRON ACER TENDL-2021 LIBRARY; T=293.6K
Photon emission for (n,n*)t

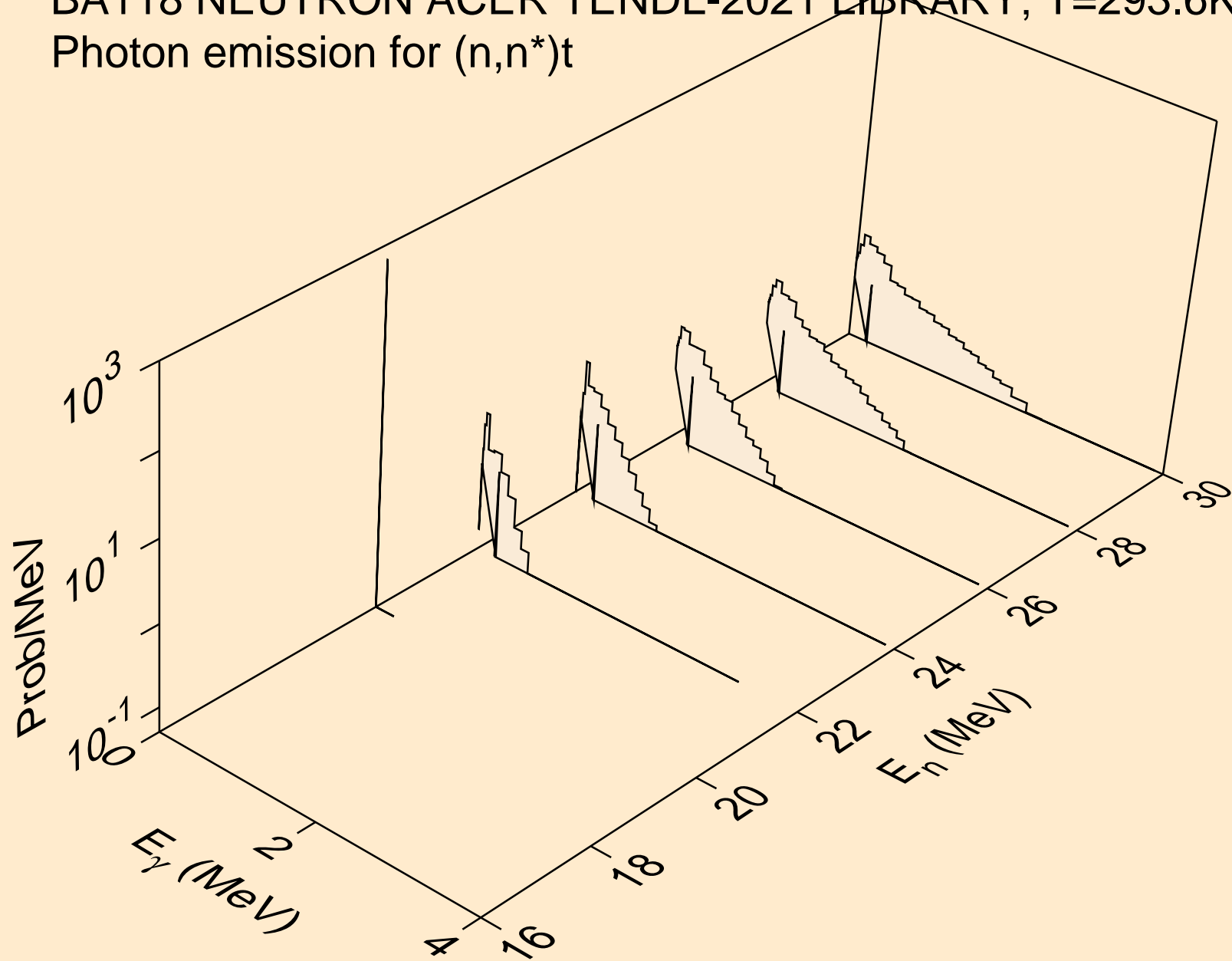

BA118 NEUTRON ACER TENDL-2021 LIBRARY; T=293.6K
Photon emission for (n,n*)he3

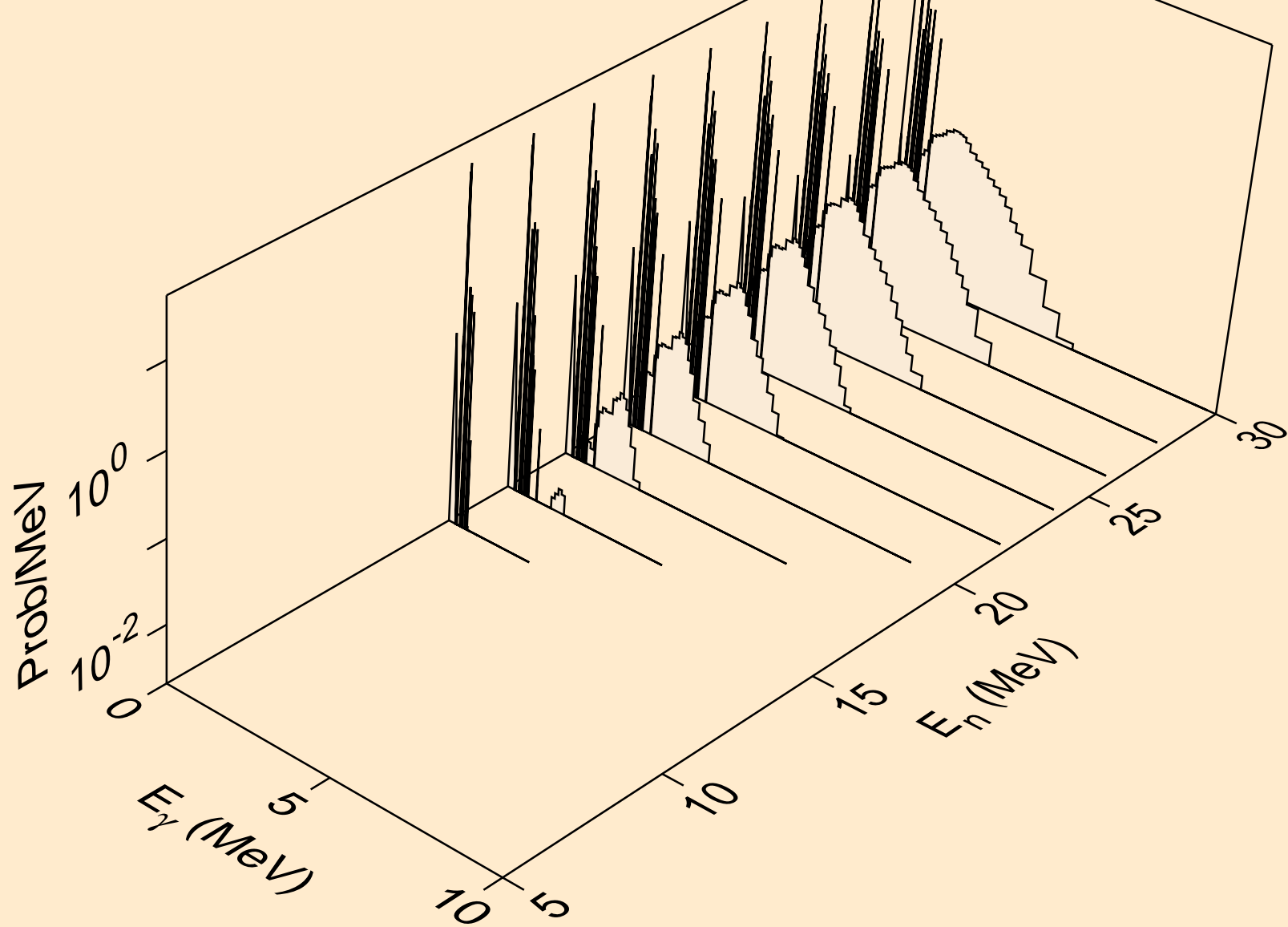

BA118 NEUTRON ACER TENDL-2021 LIBRARY; T=293.6K
Photon emission for (n,2np)

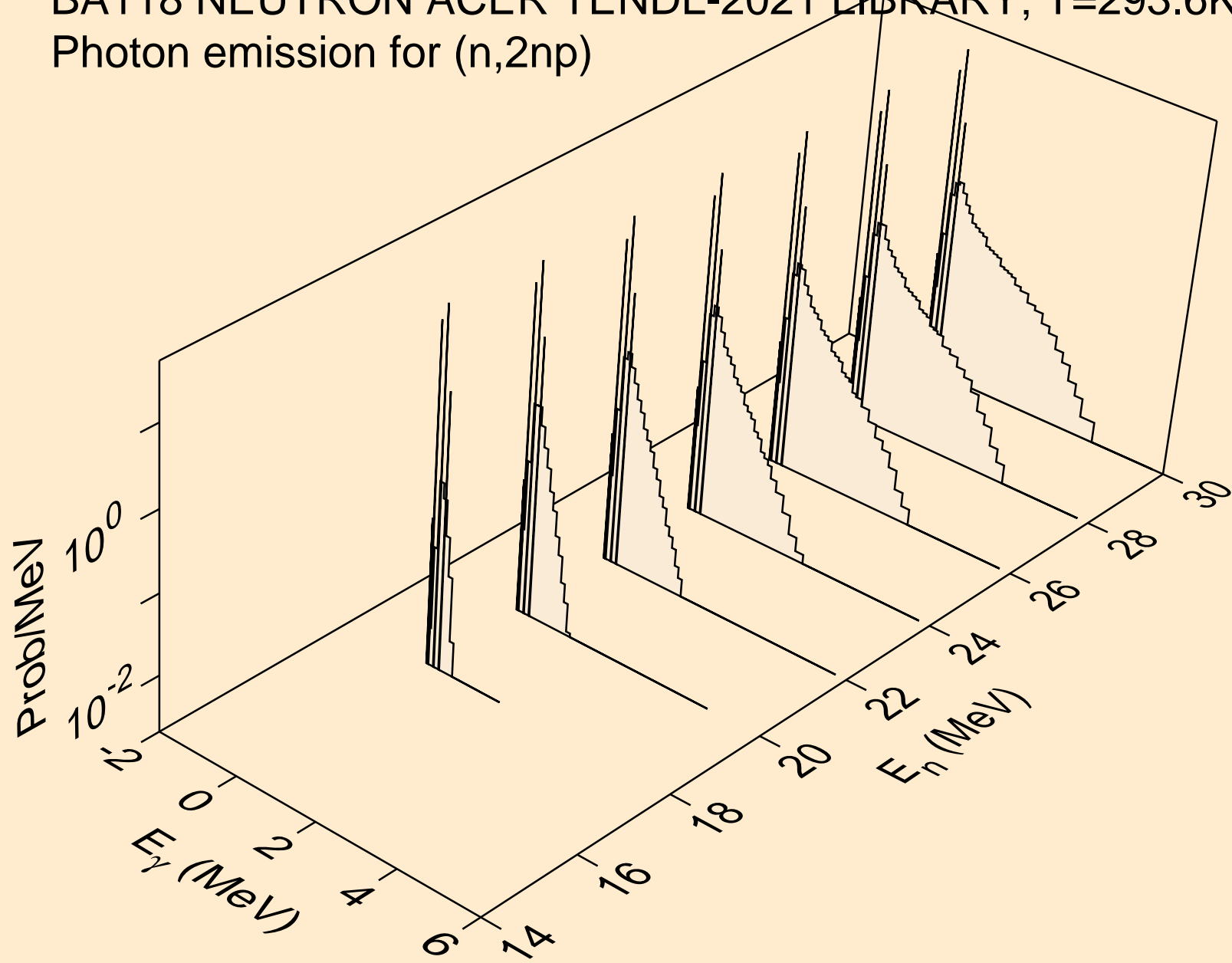

BA118 NEUTRON ACER TENDL-2021 LIBRARY; T=293.6K
Photon emission for (n,3np)

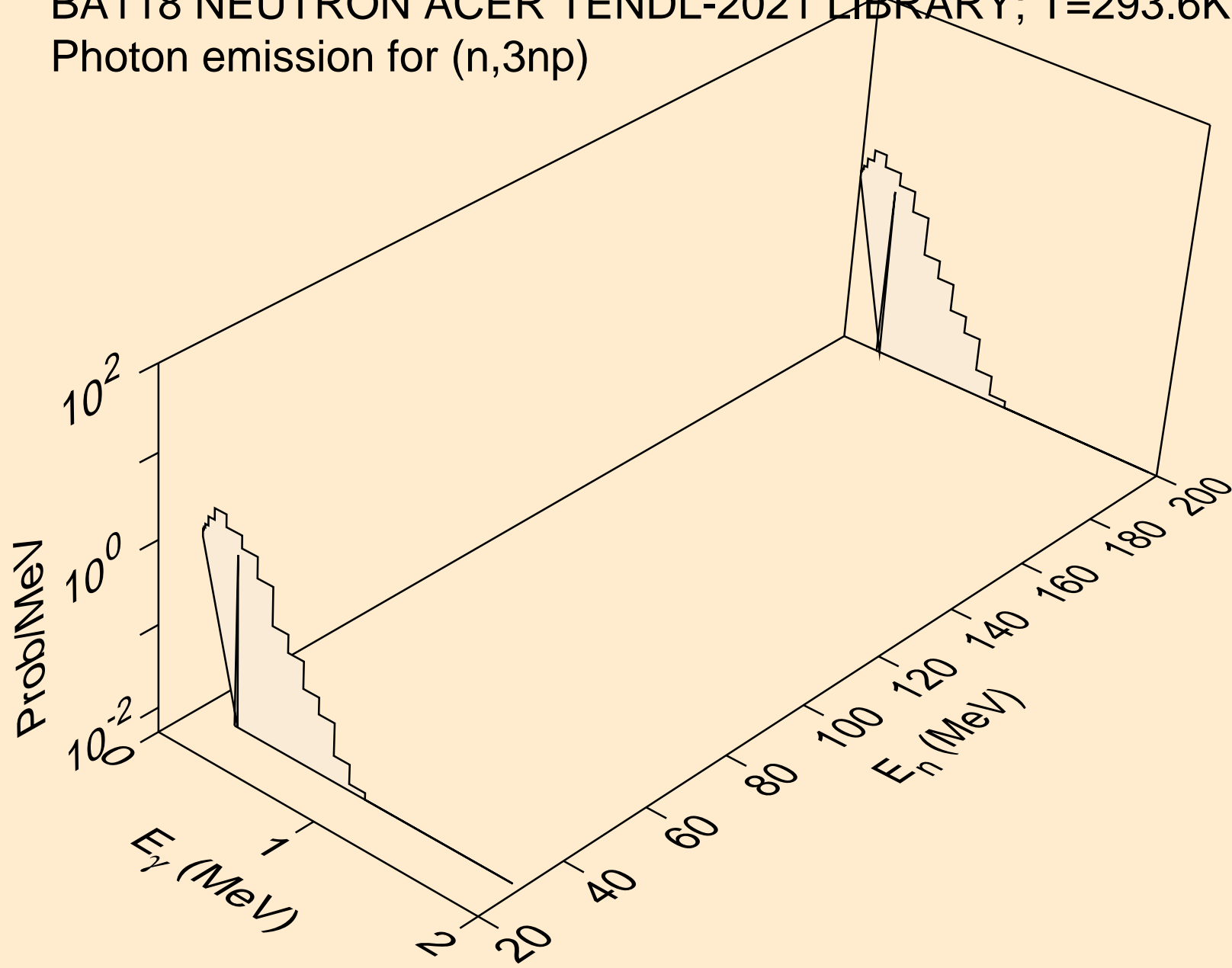

BA118 NEUTRON ACER TENDL-2021 LIBRARY; T=293.6K
Photon emission for (n,2np)

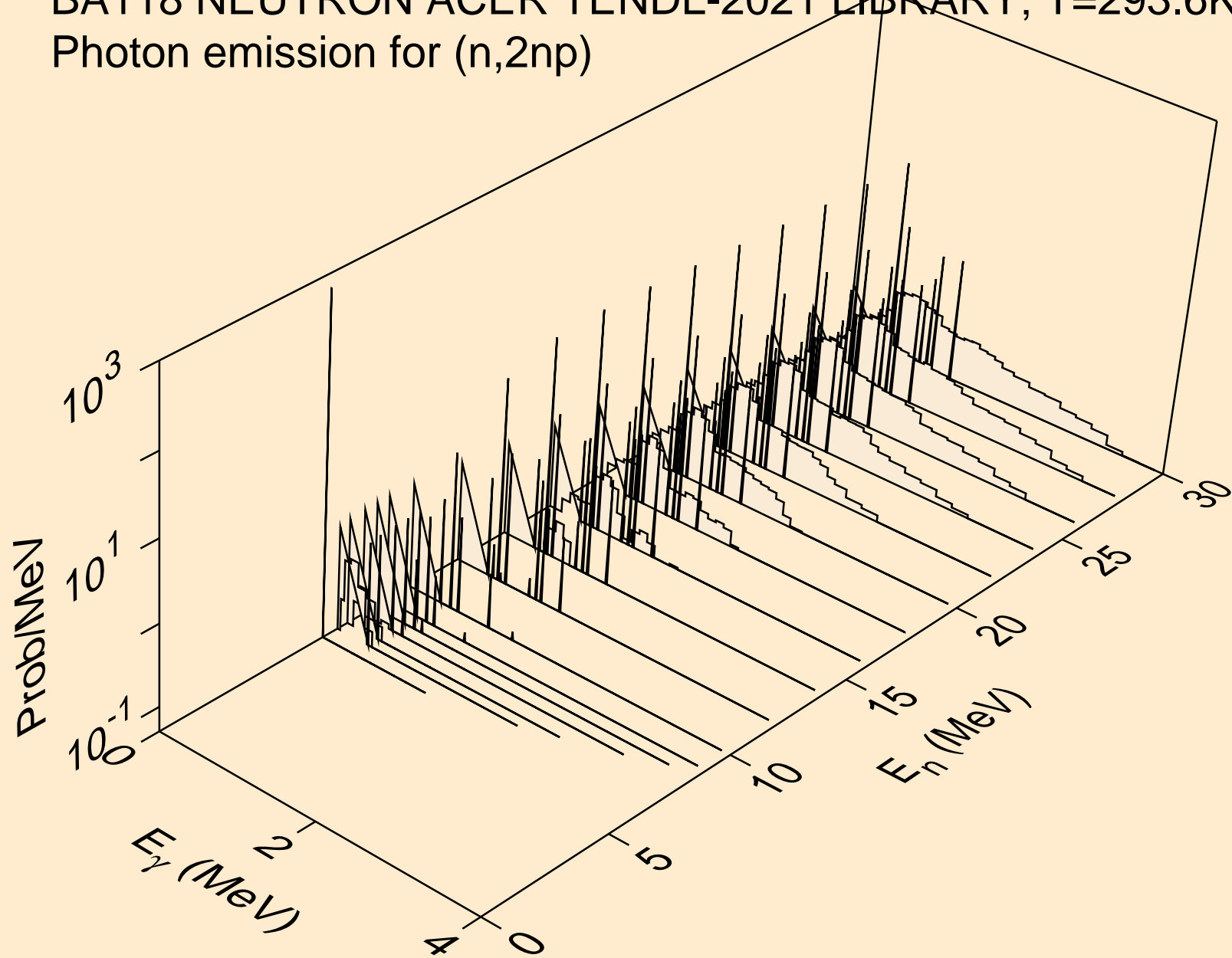

BA118 NEUTRON ACER TENDL-2021 LIBRARY; T=293.6K
Photon emission for (n,npa)

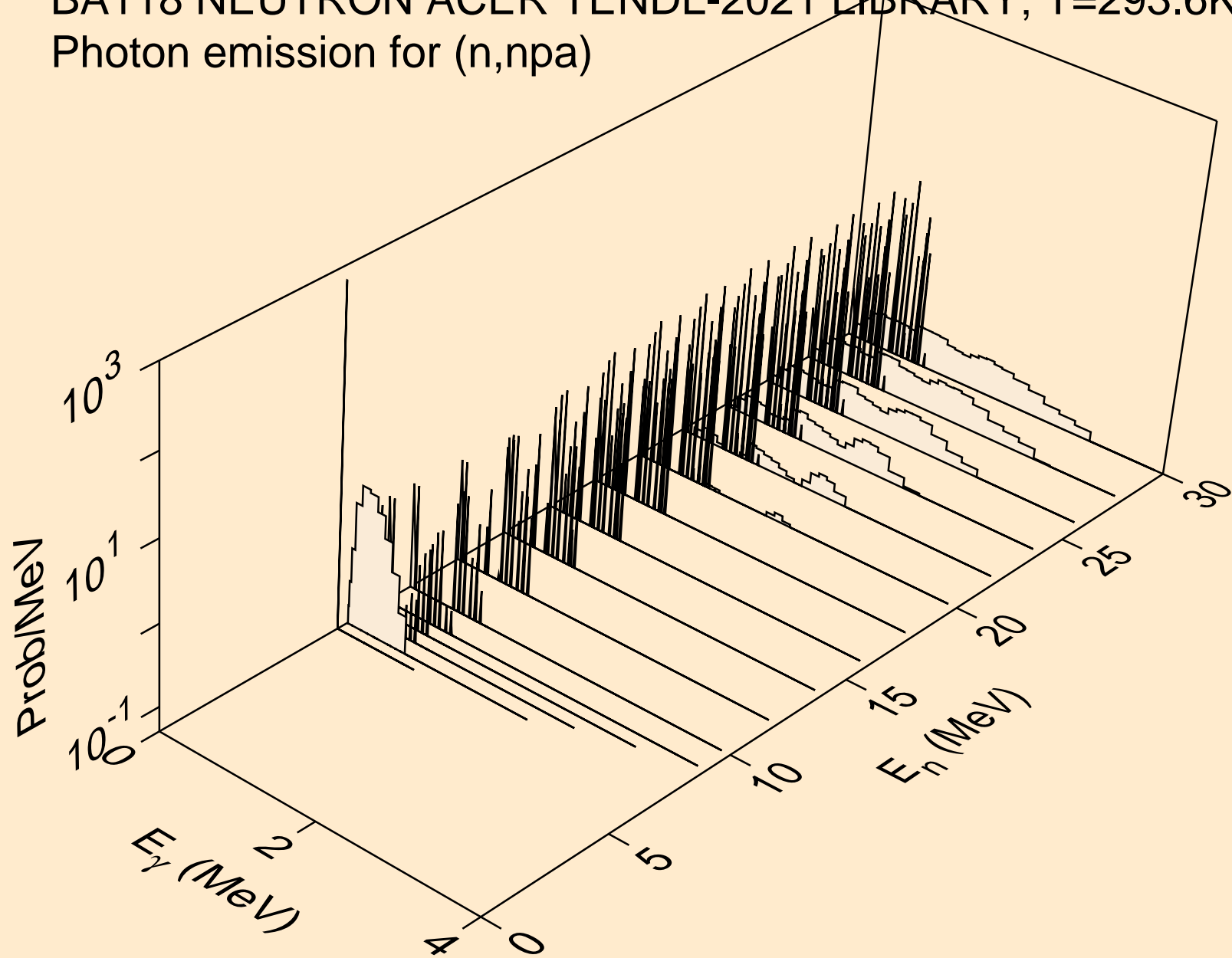

BA118 NEUTRON ACER TENDL-2021 LIBRARY; T=293.6K
Photon emission for (n,n*c)

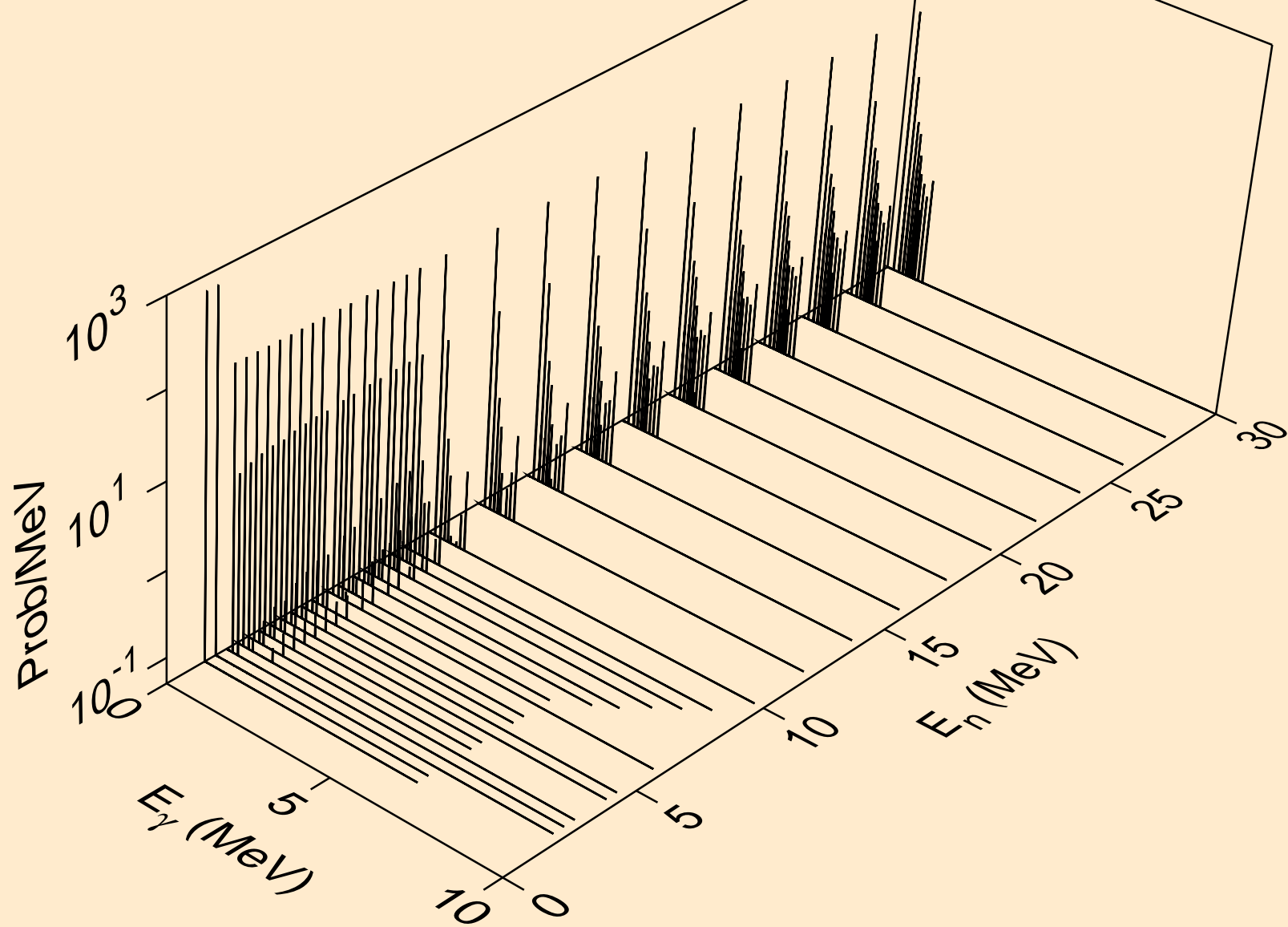

BA118 NEUTRON ACER TENDL-2021 LIBRARY; T=293.6K
Photon emission for (n,gma)

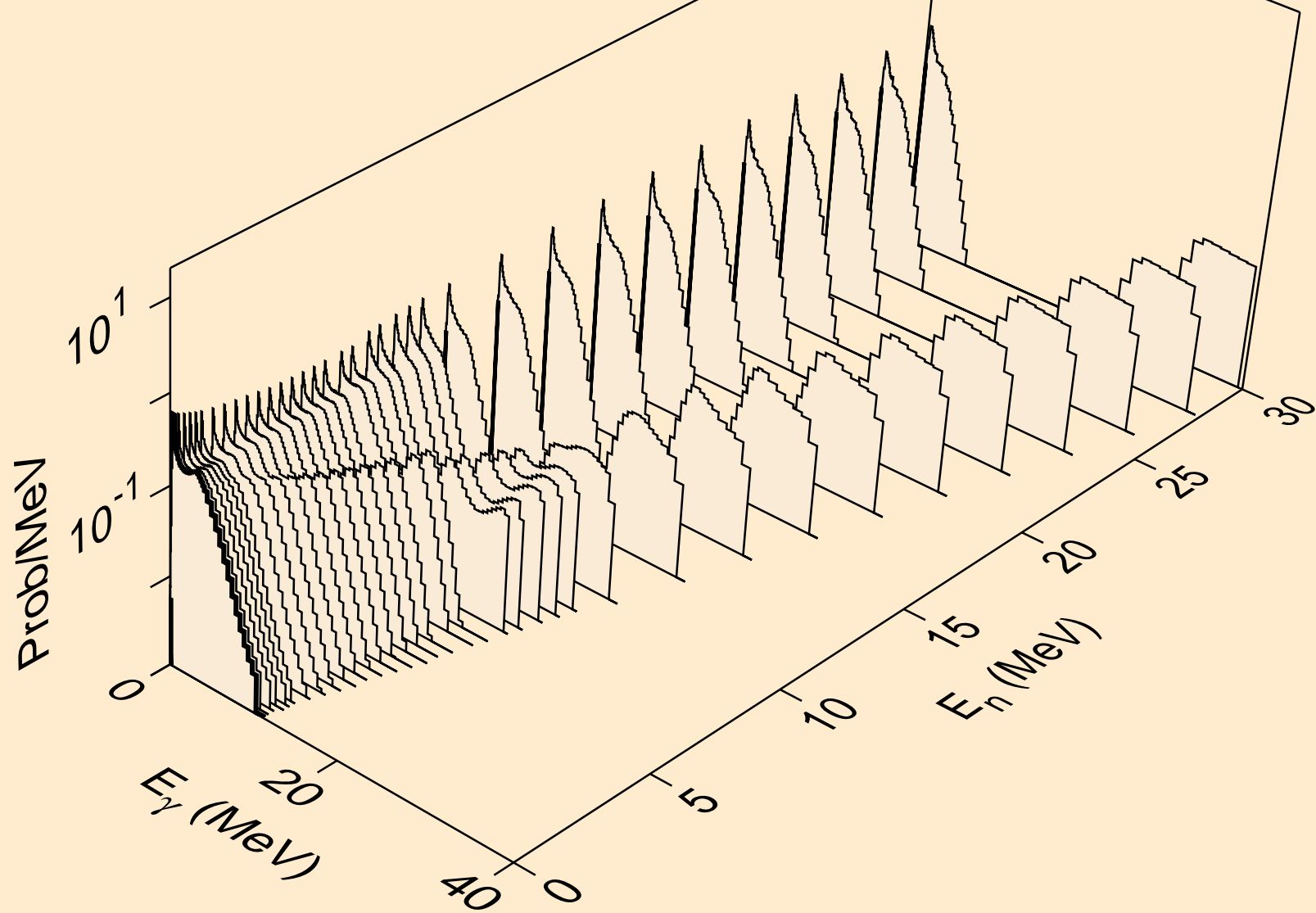

BA118 NEUTRON ACER TENDL-2021 LIBRARY; T=293.6K
Photon emission for (n,p)

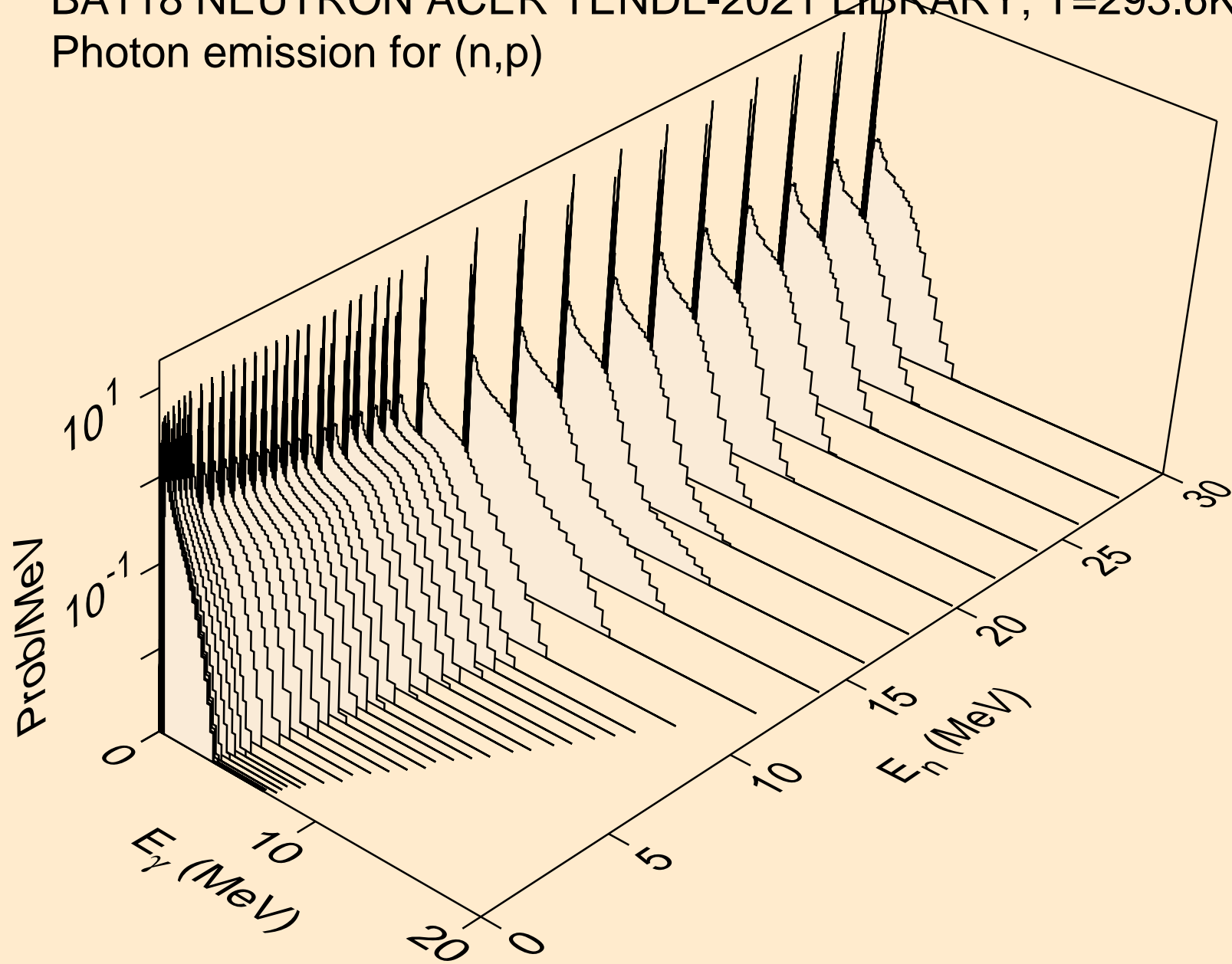

BA118 NEUTRON ACER TENDL-2021 LIBRARY; T=293.6K
Photon emission for (n,d)

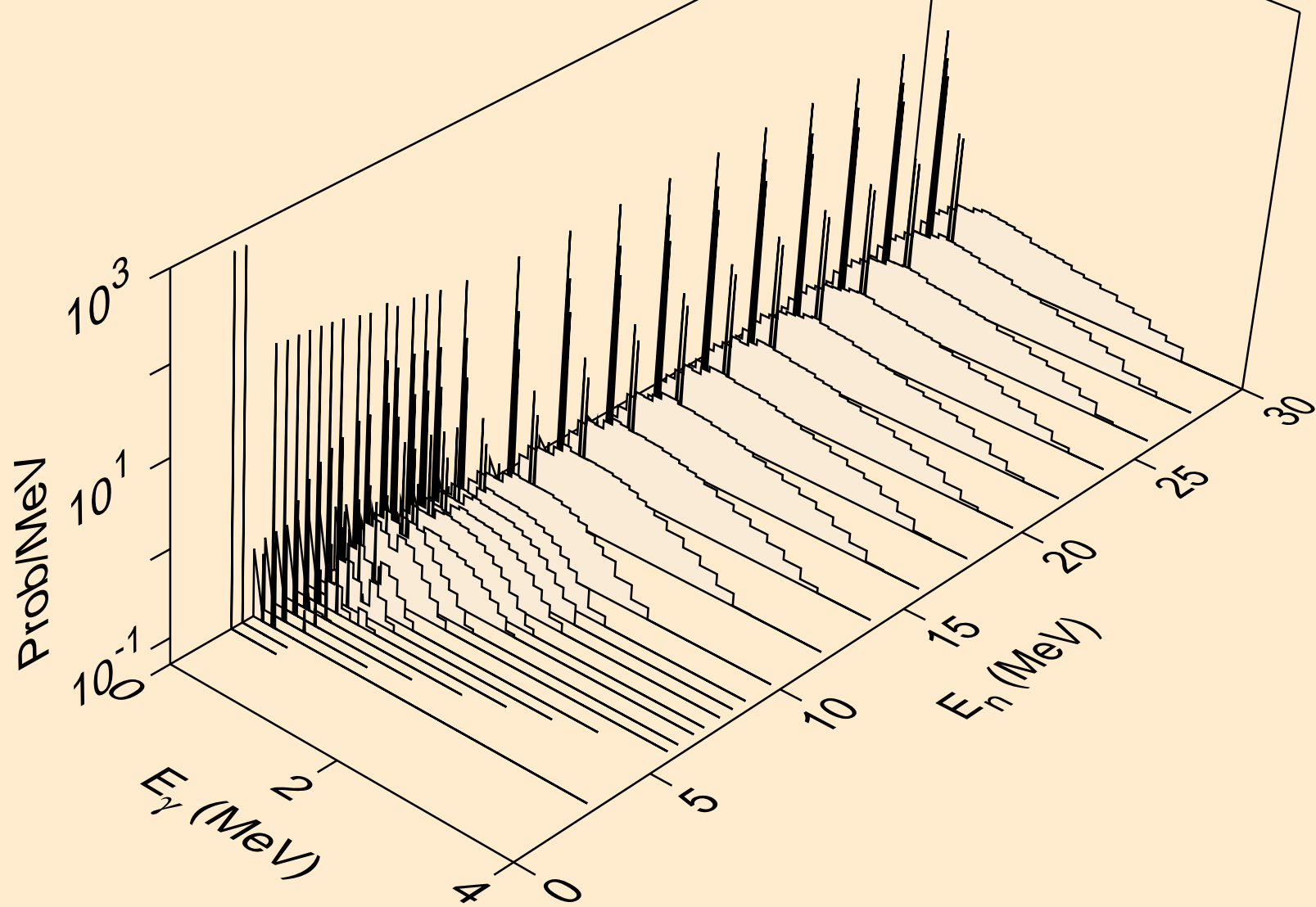

BA118 NEUTRON ACER TENDL-2021 LIBRARY; T=293.6K
Photon emission for (n,t)

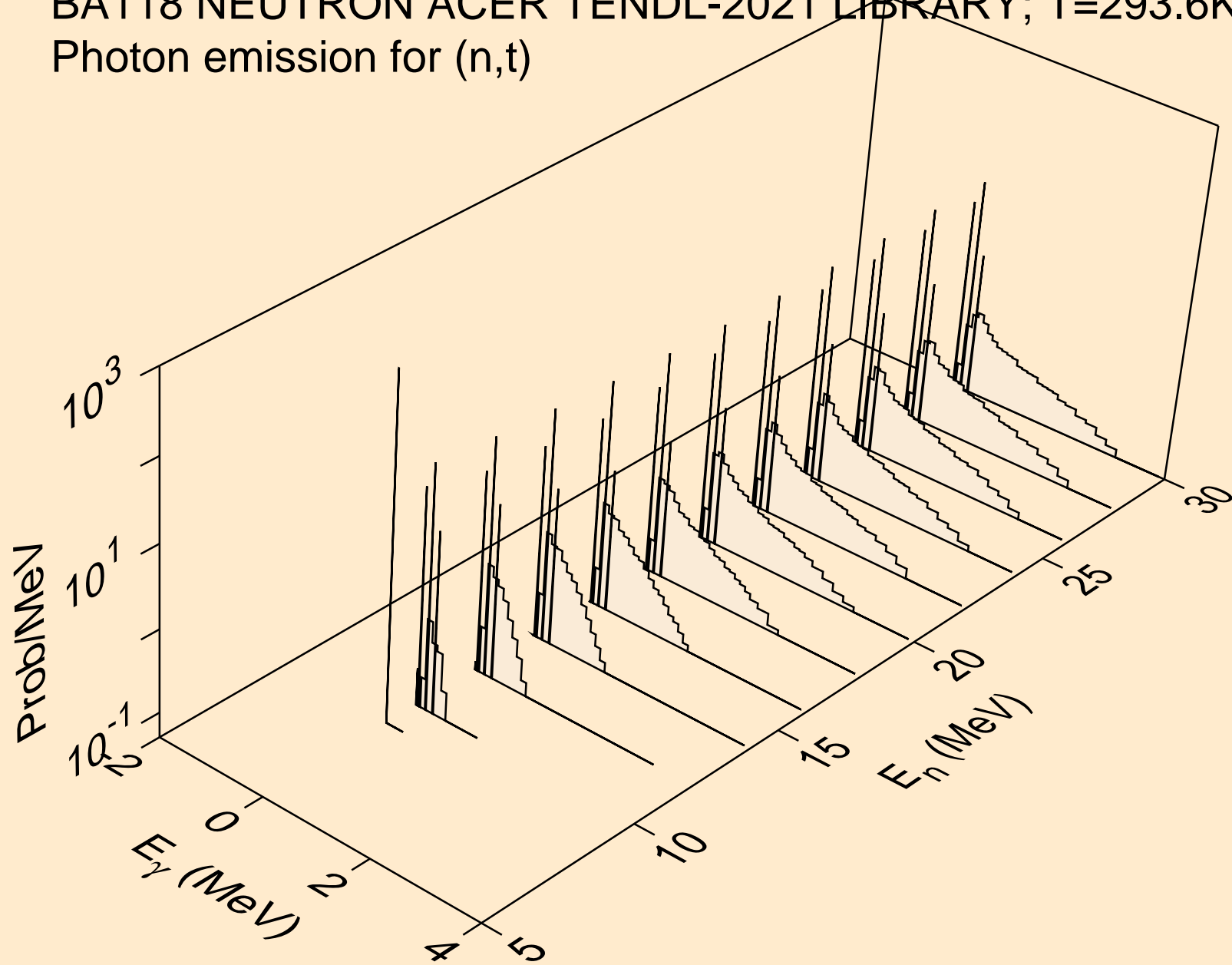

BA118 NEUTRON ACER TENDL-2021 LIBRARY; T=293.6K
Photon emission for (n,he3)

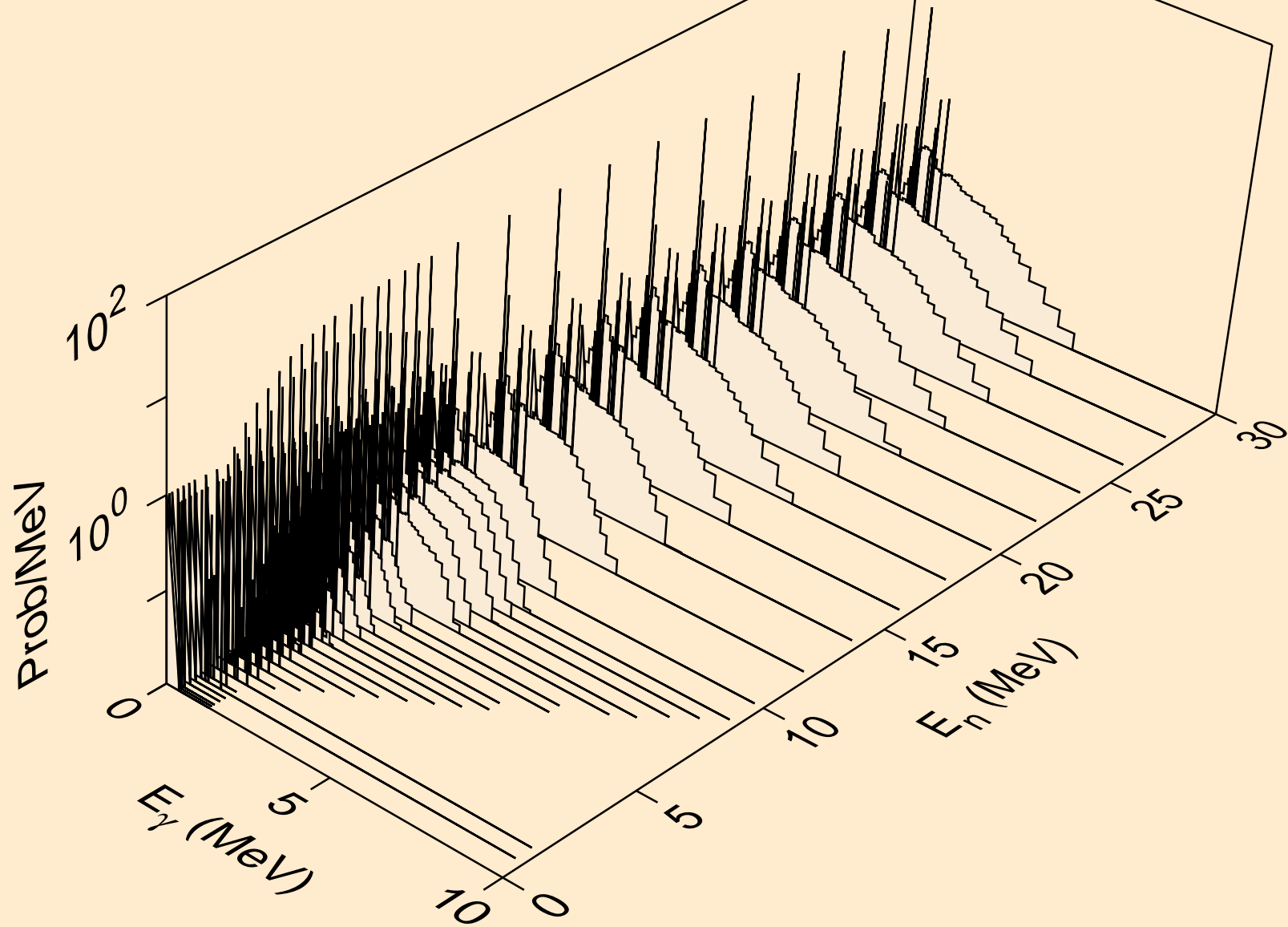

BA118 NEUTRON ACER TENDL-2021 LIBRARY; T=293.6K
Photon emission for (n,a)

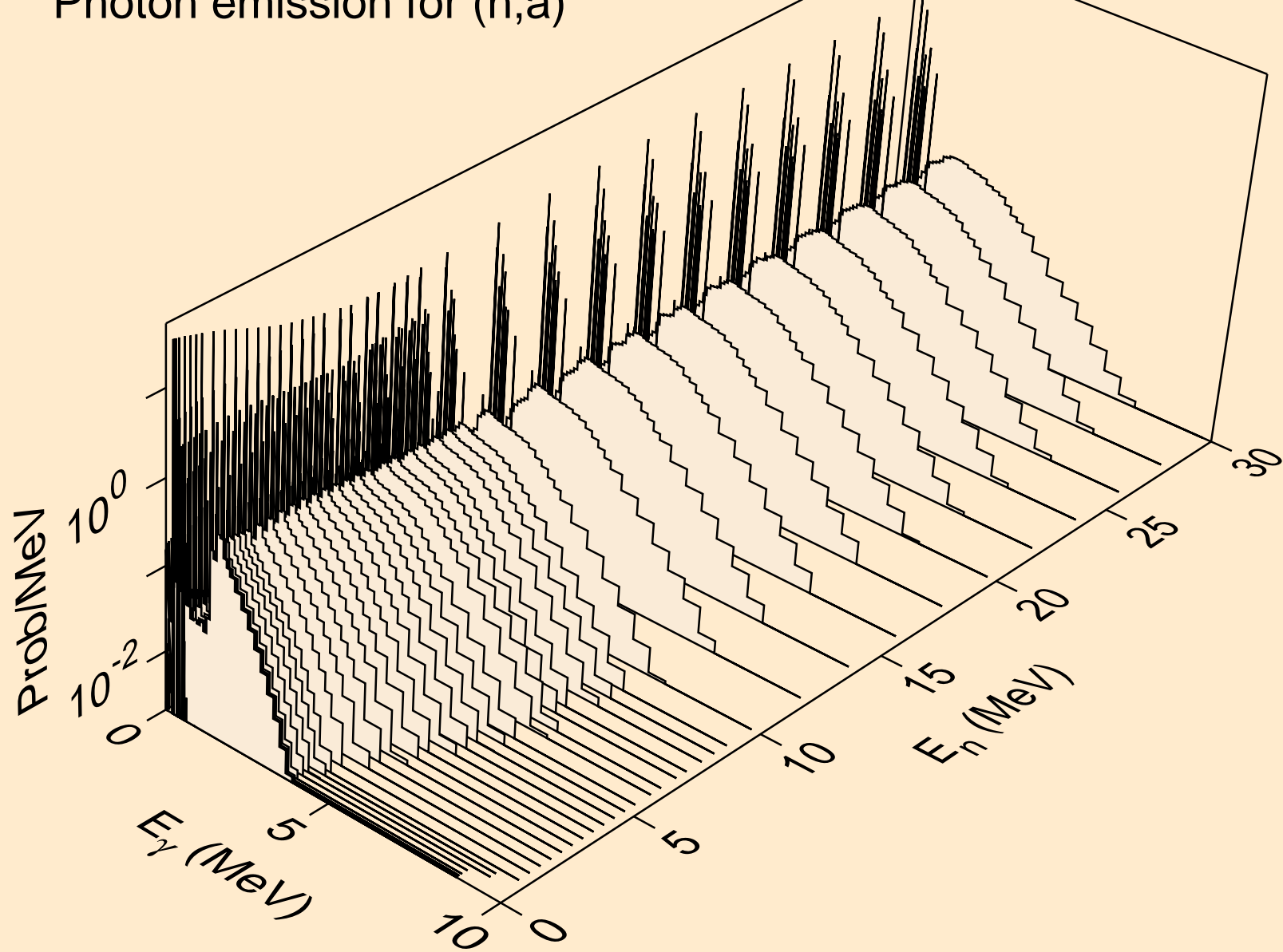

BA118 NEUTRON ACER TENDL-2021 LIBRARY; T=293.6K
Photon emission for (n,2a)

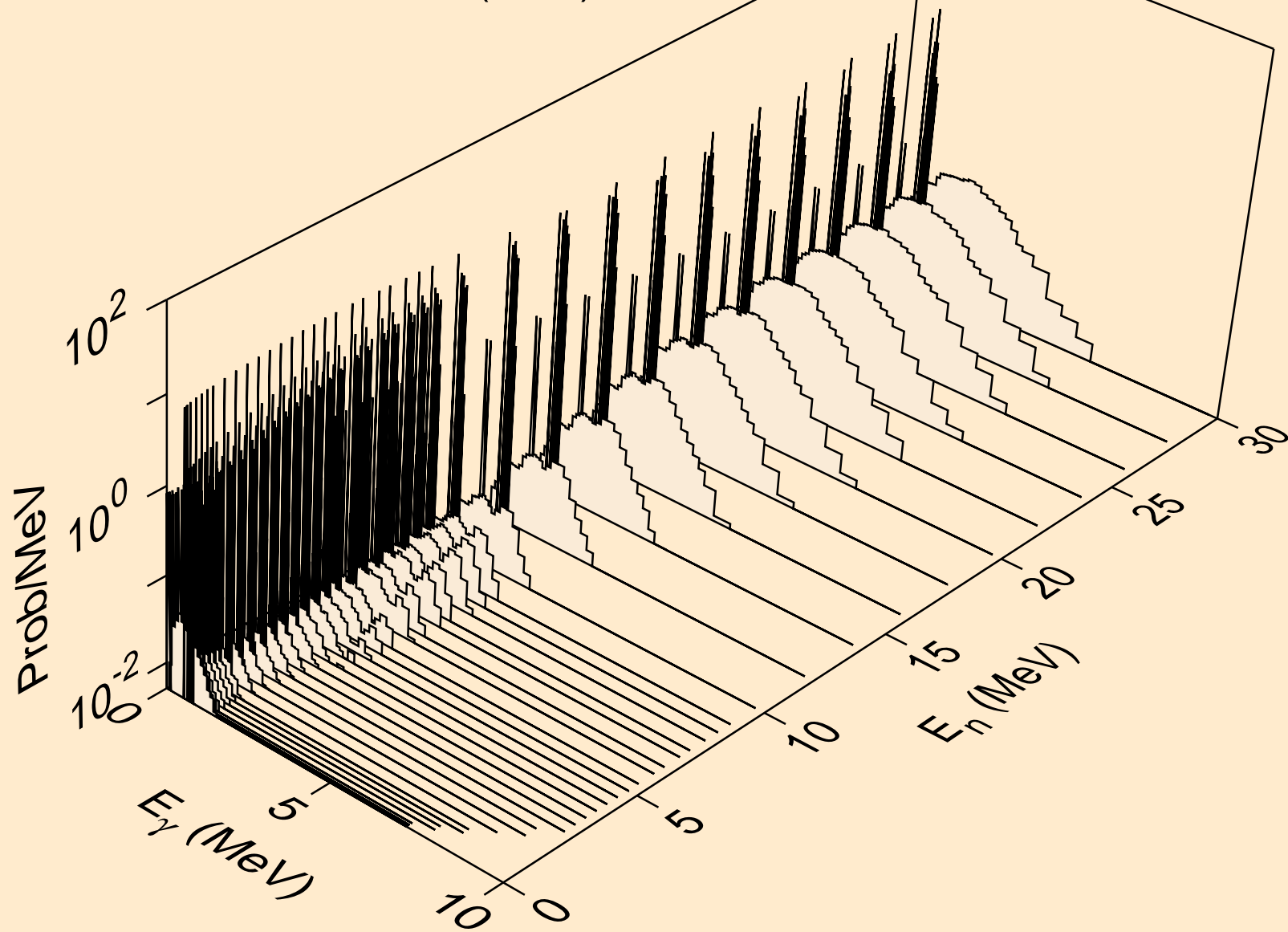

BA118 NEUTRON ACER TENDL-2021 LIBRARY; T=293.6K
Photon emission for (n,3a)

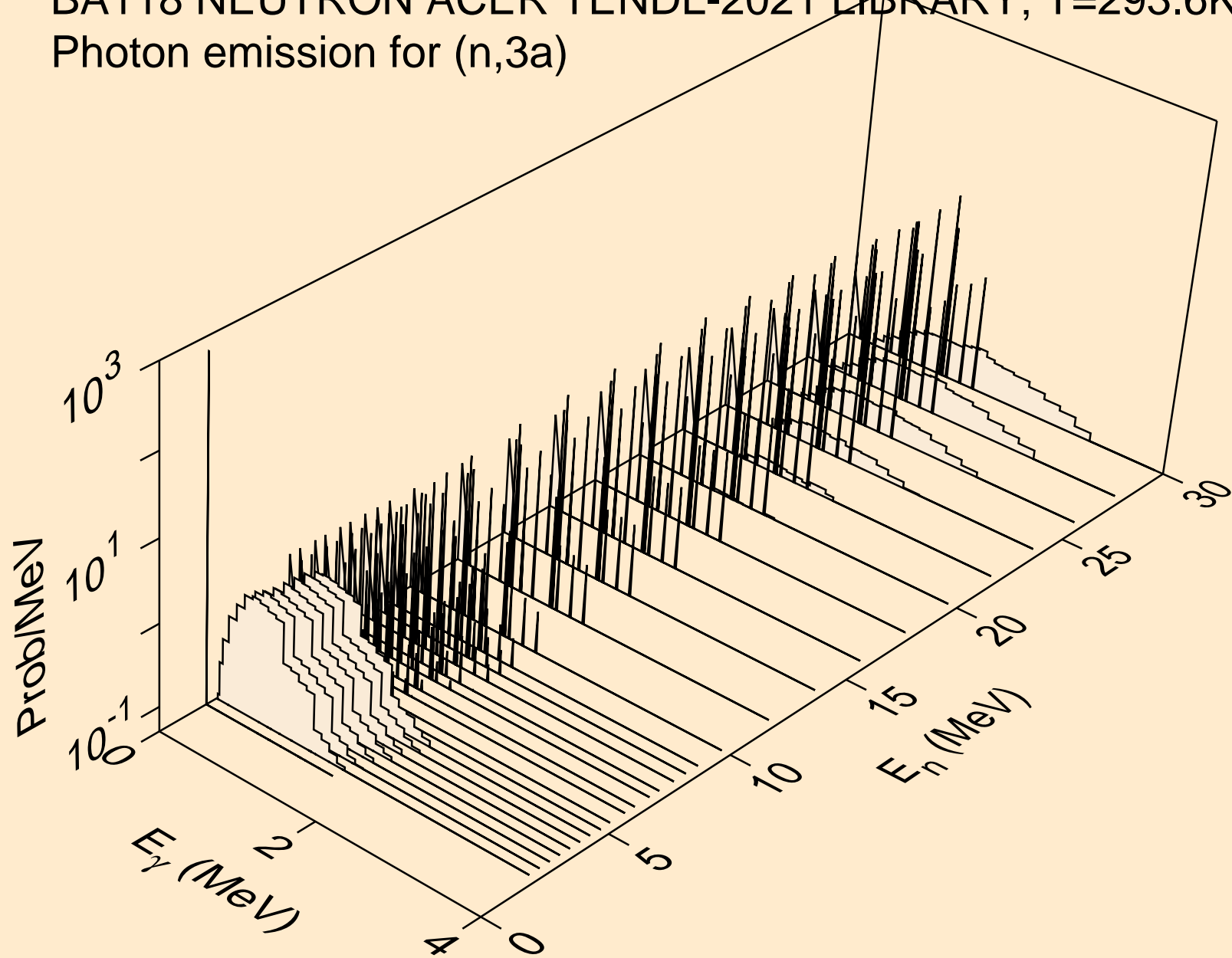

BA118 NEUTRON ACER TENDL-2021 LIBRARY; T=293.6K
Photon emission for (n,2p)

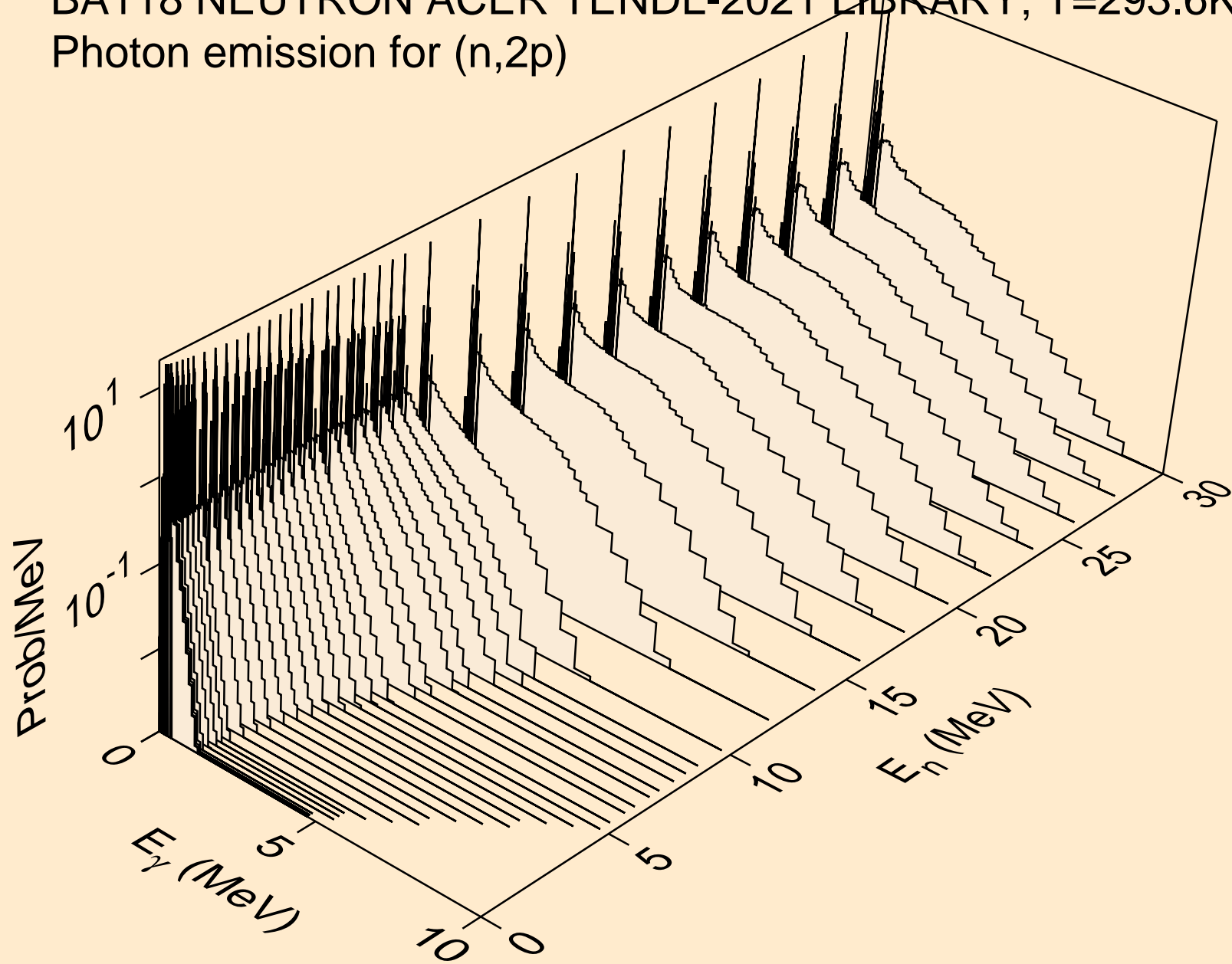

BA118 NEUTRON ACER TENDL-2021 LIBRARY; T=293.6K
Photon emission for (n,p)

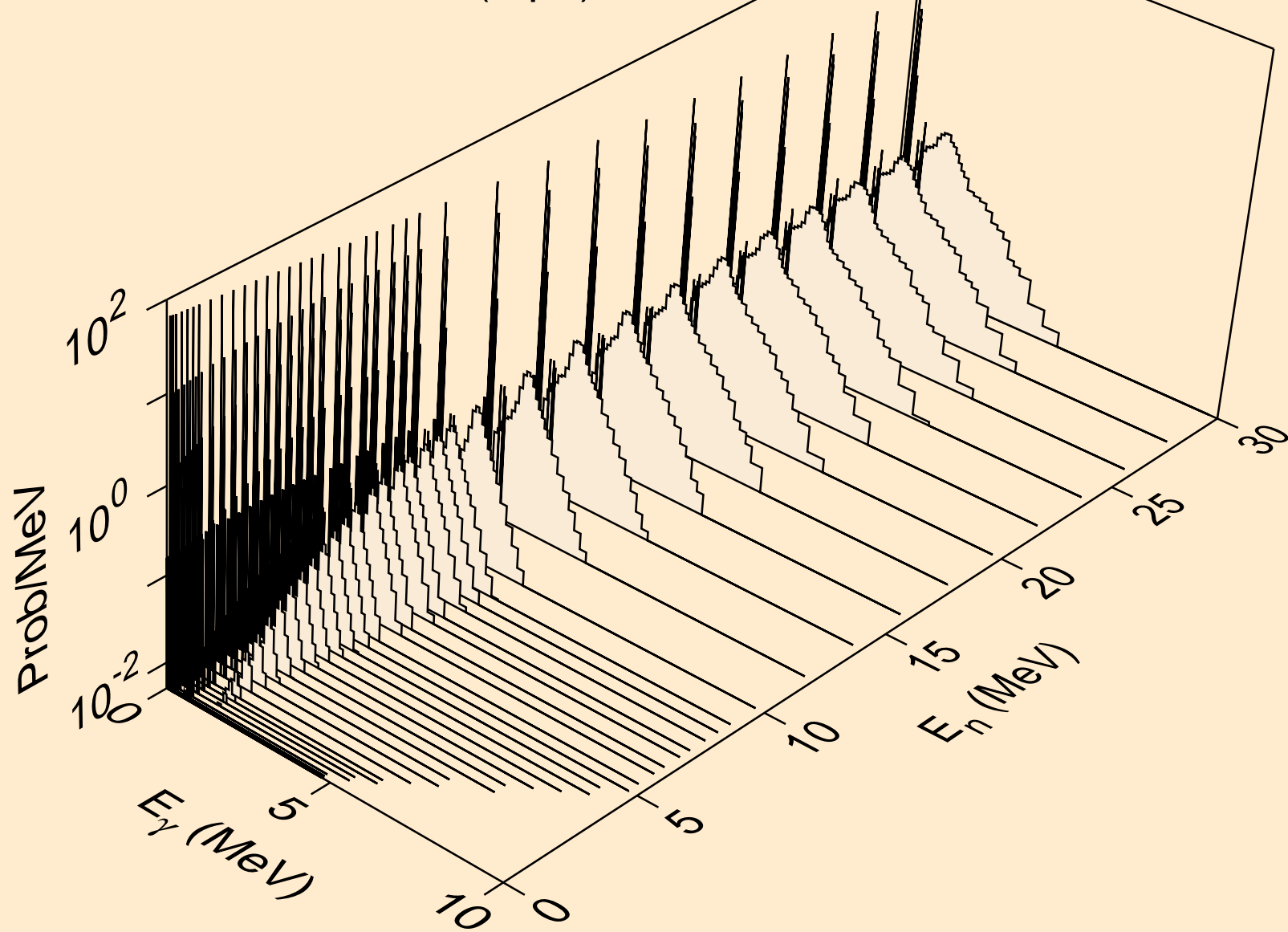

BA118 NEUTRON ACER TENDL-2021 LIBRARY; T=293.6K
Photon emission for (n,d2a)

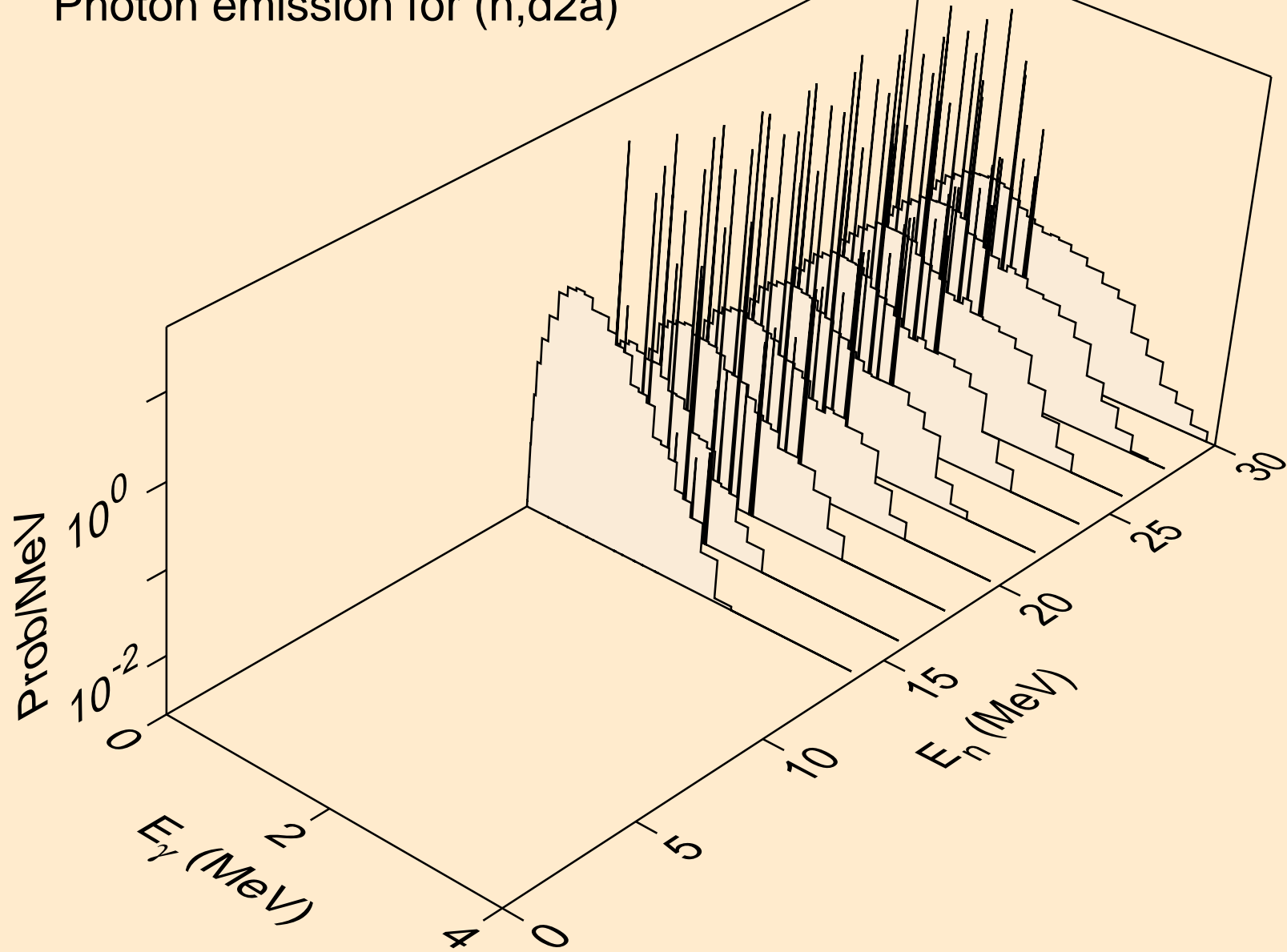

BA118 NEUTRON ACER TENDL-2021 LIBRARY; T=293.6K
Photon emission for (n,pd)

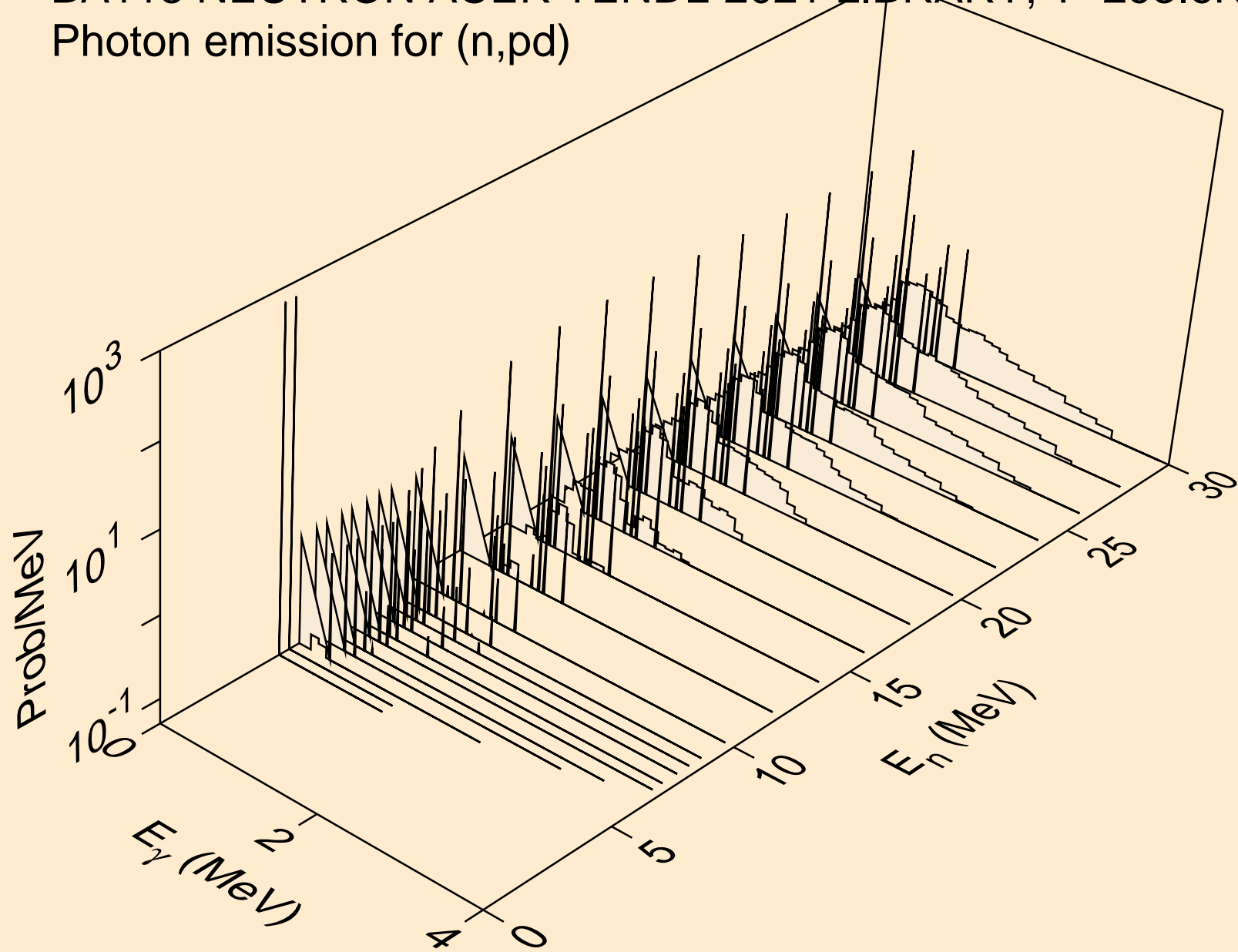

BA118 NEUTRON ACER TENDL-2021 LIBRARY; T=293.6K
Photon emission for (n,pt)

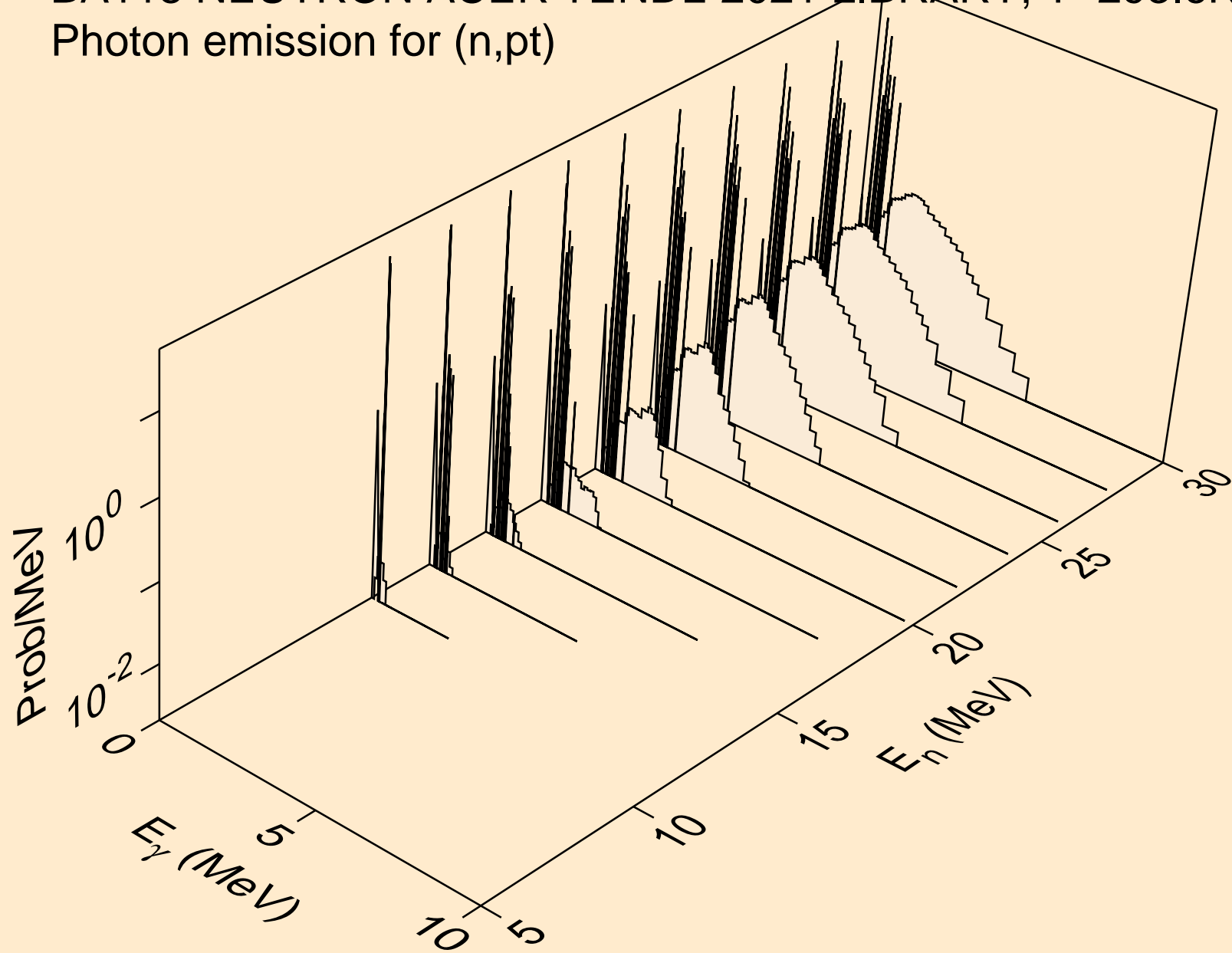

BA118 NEUTRON ACER TENDL-2021 LIBRARY; T=293.6K
Photon emission for (n,da)

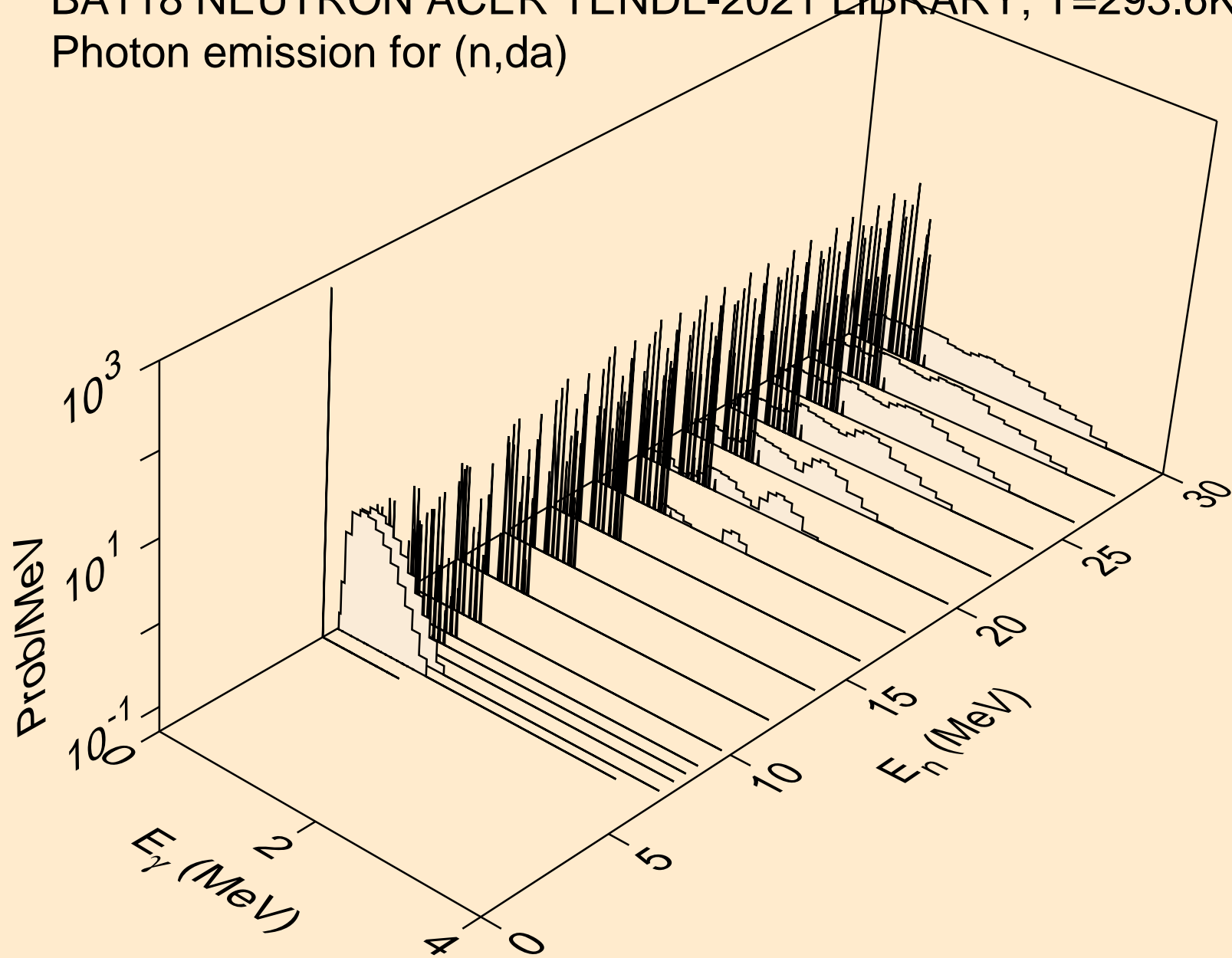

BA118 NEUTRON ACER TENDL-2021 LIBRARY; T=293.6K
thermal capture photon spectrum

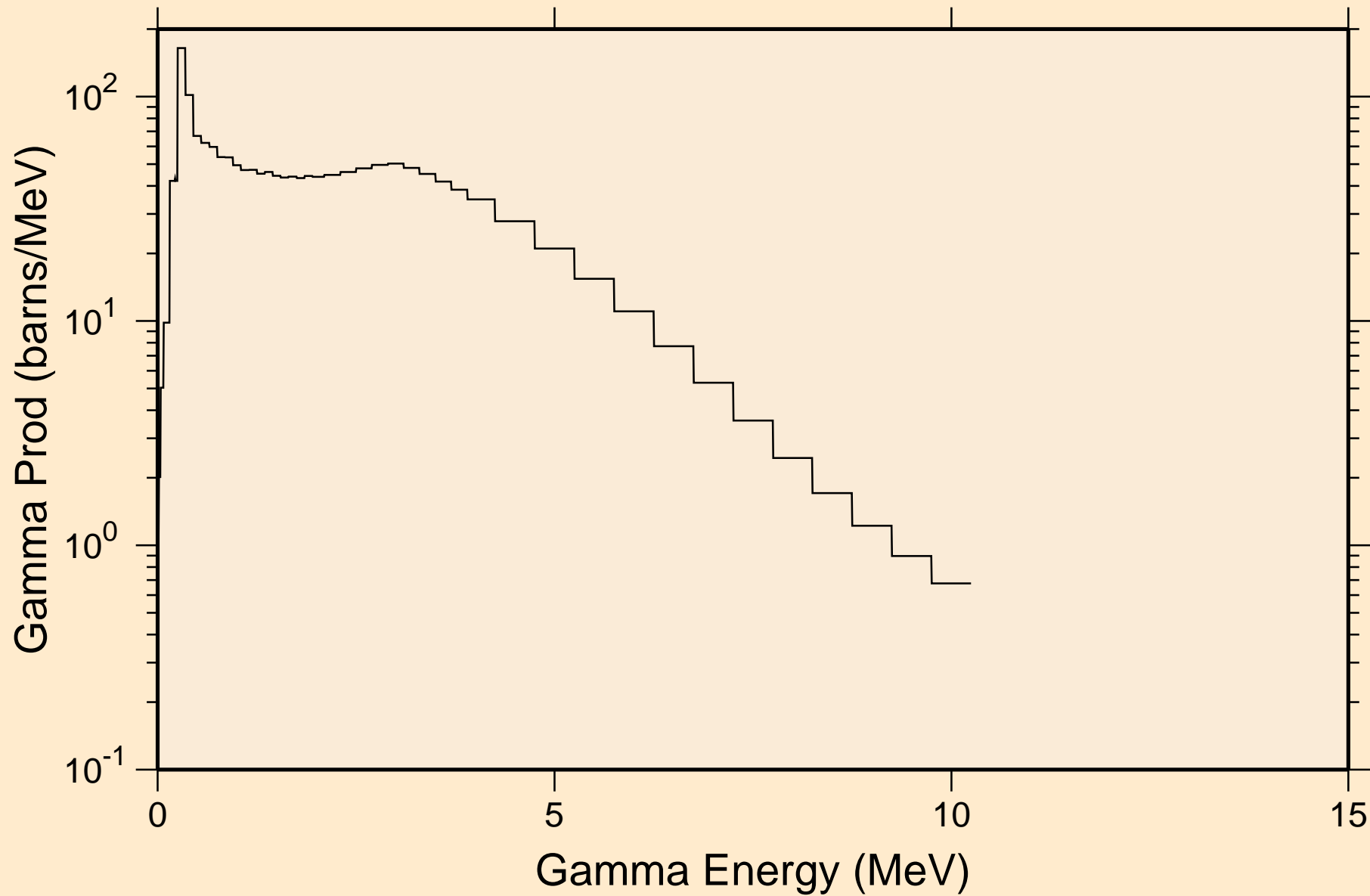

BA118 NEUTRON ACER TENDL-2021 LIBRARY; T=293.6K
14 MeV photon spectrum

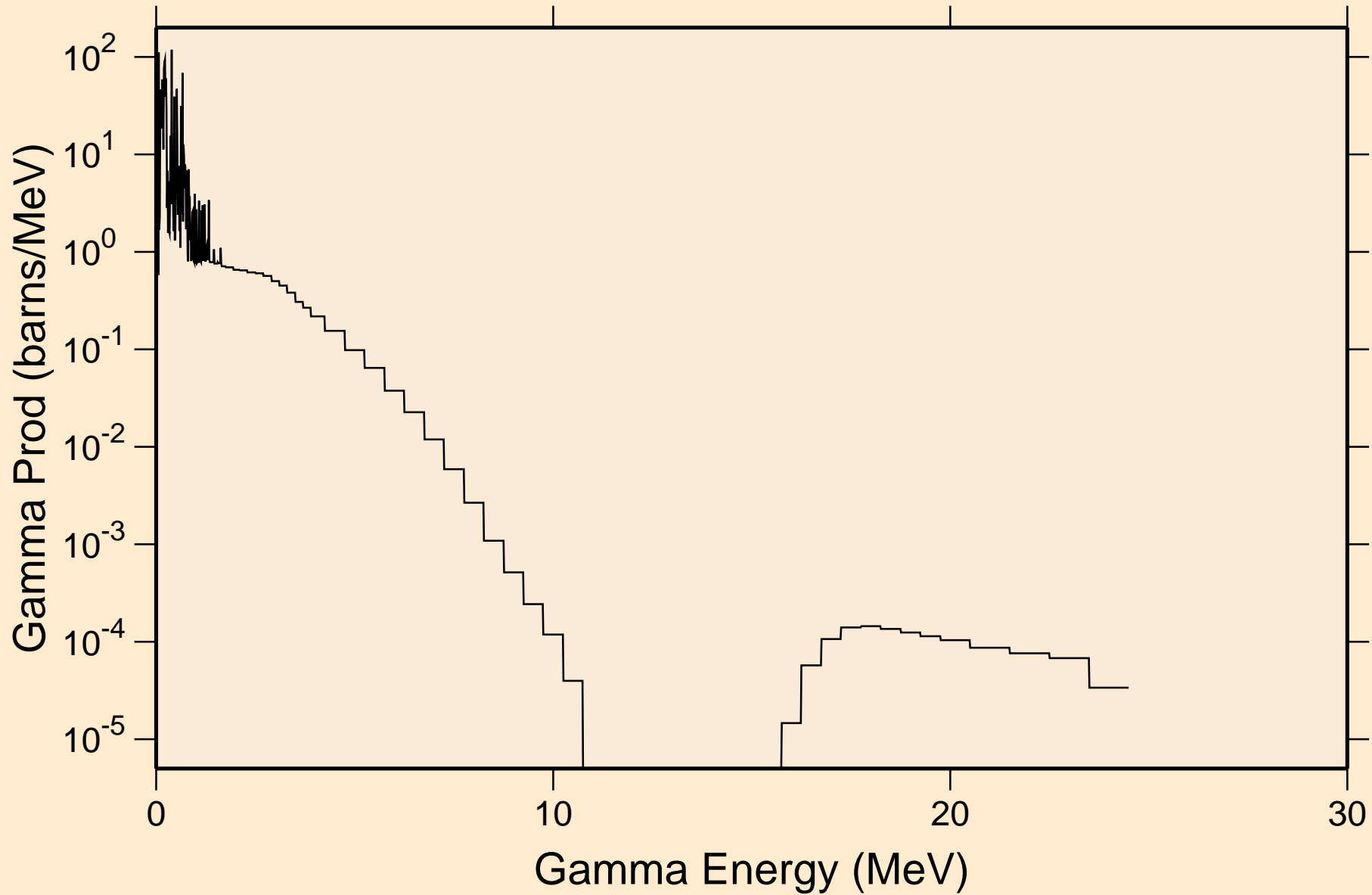

BA118 NEUTRON ACER TENDL-2021 LIBRARY; T=293.6K

Particle heating contributions

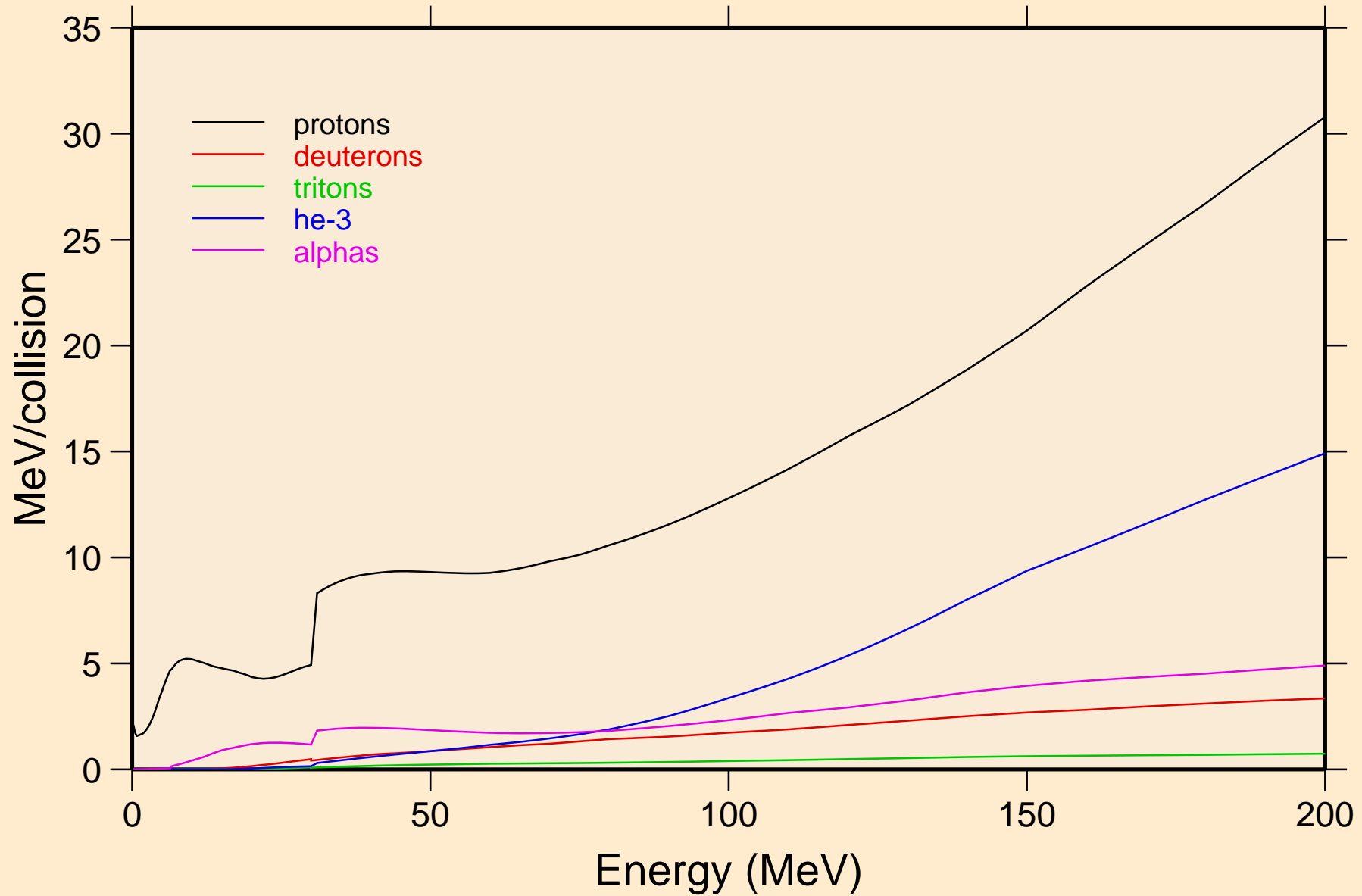

BA118 NEUTRON ACER TENDL-2021 LIBRARY; T=293.6K
Recoil Heating

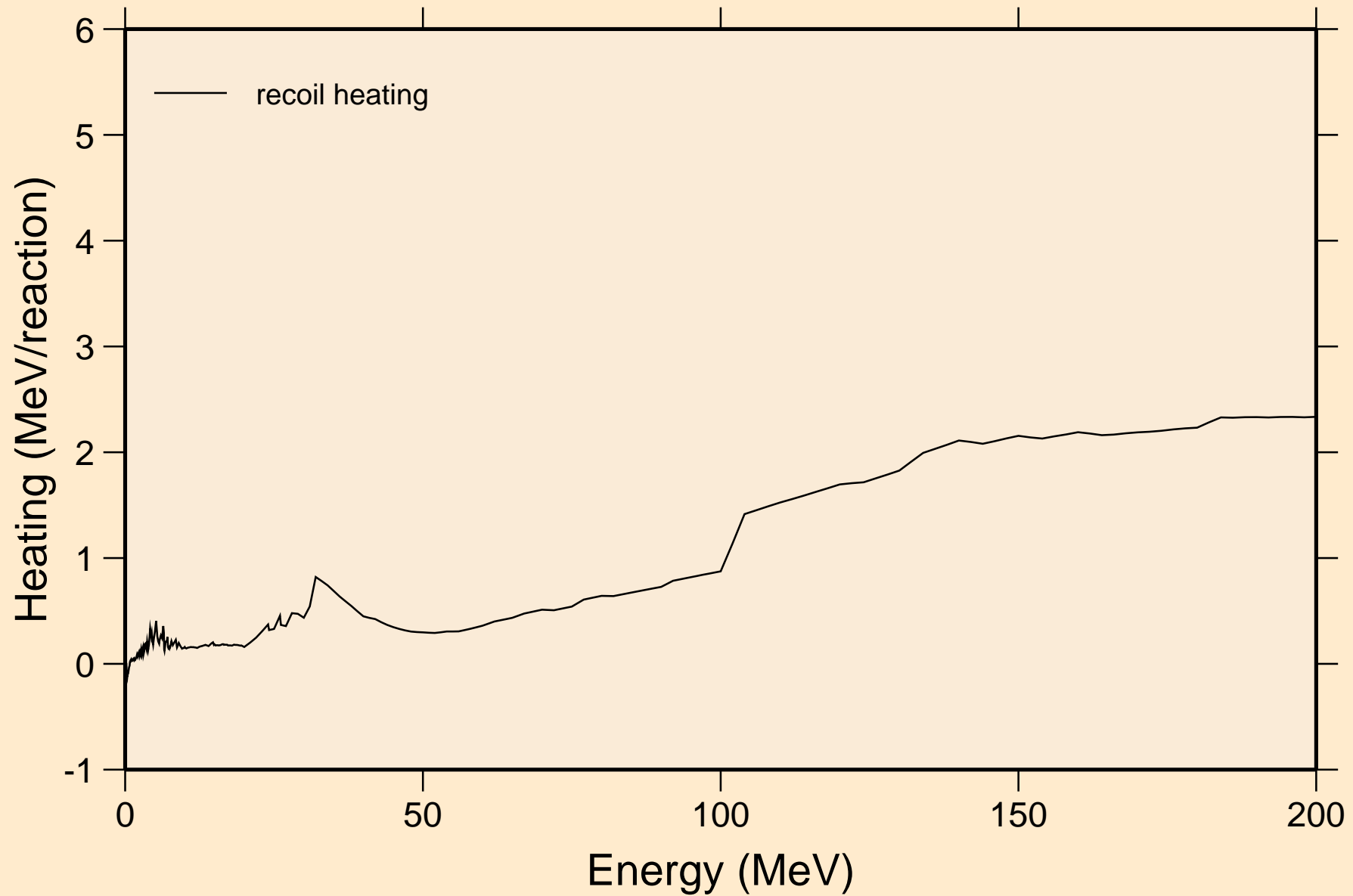

BA118 NEUTRON ACER TENDL-2021 LIBRARY; T=293.6K
Particle production cross sections

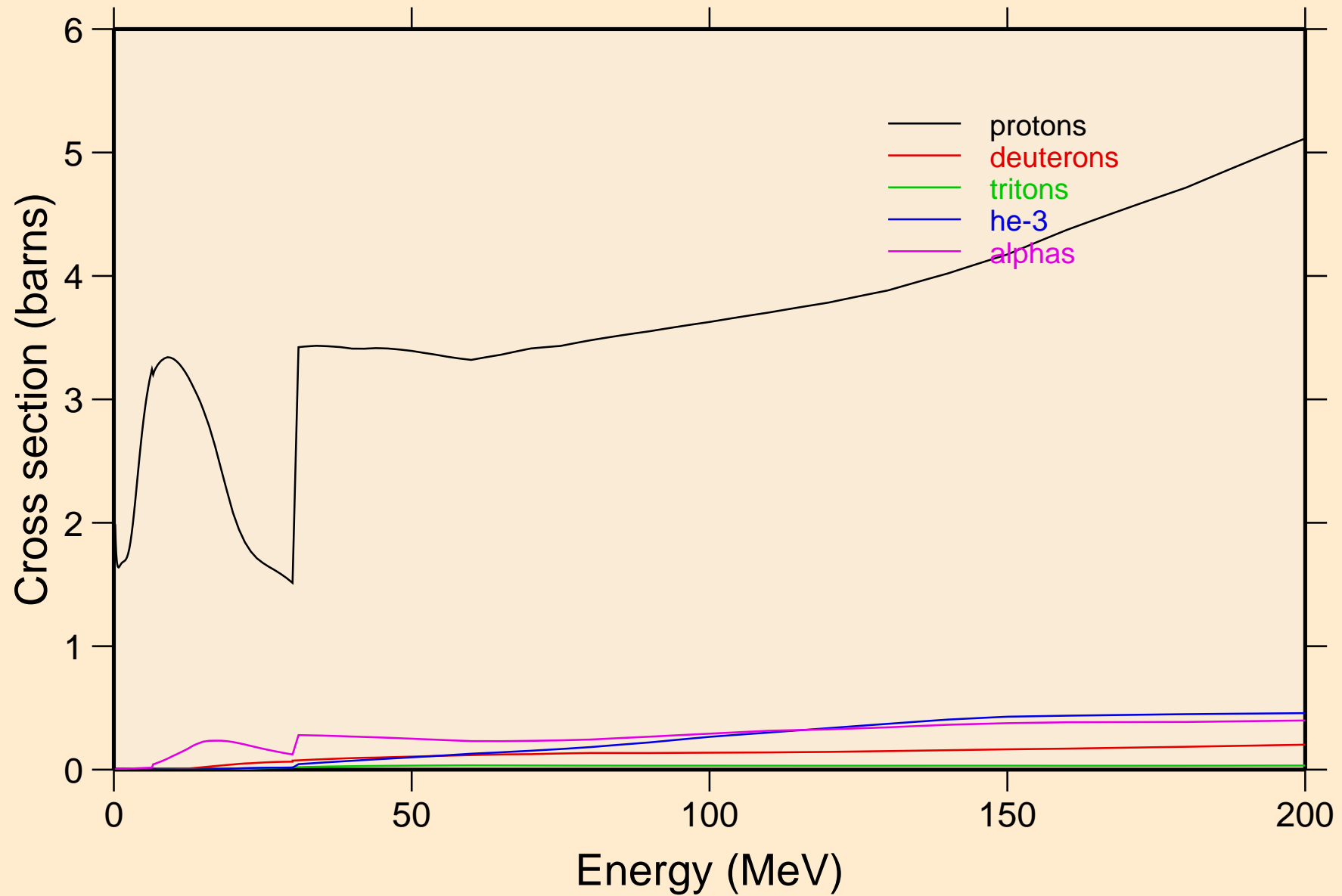

BA118 NEUTRON ACER TENDL-2021 LIBRARY; T=293.6K
protons from (n,x)

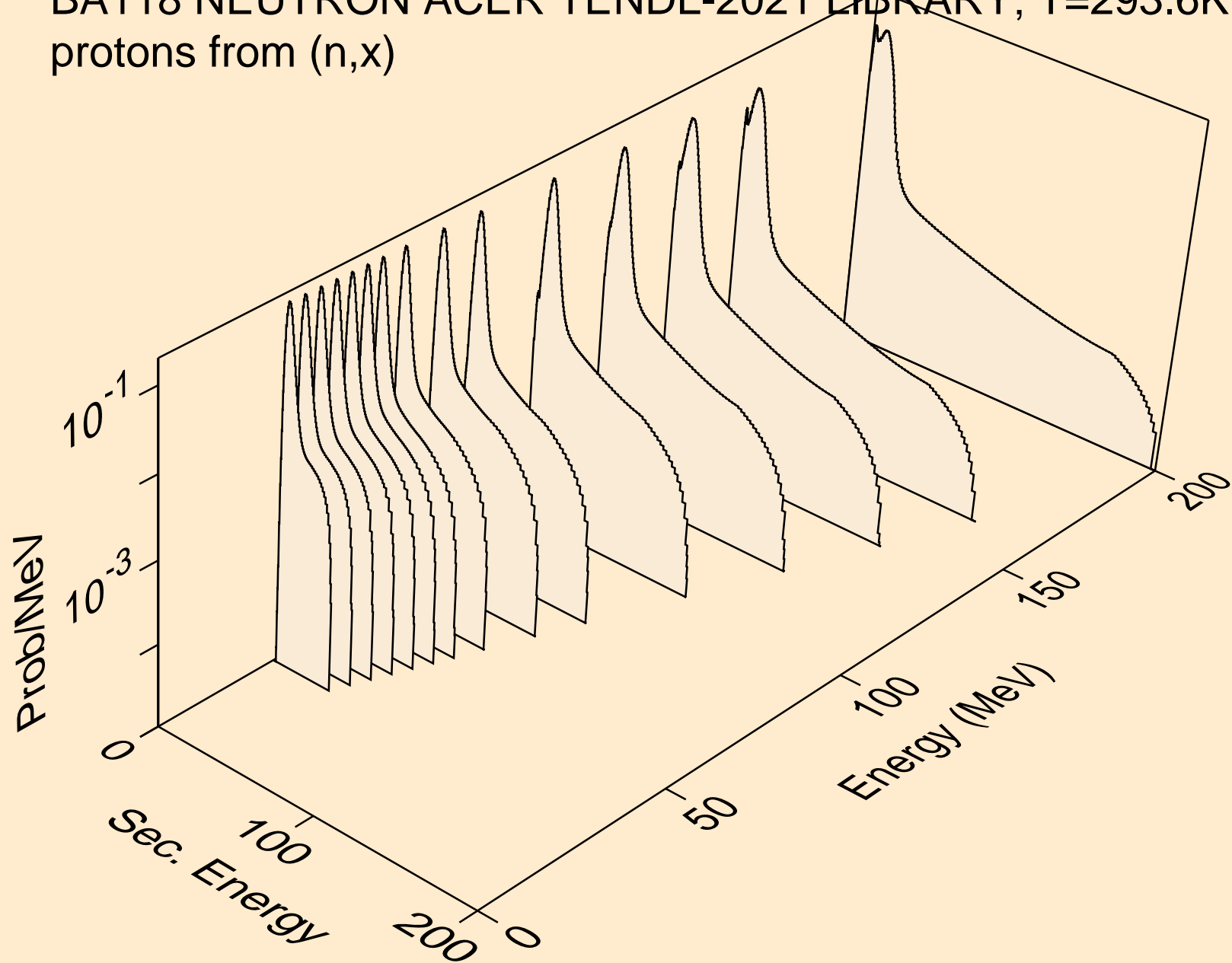

BA118 NEUTRON ACER TENDL-2021 LIBRARY; T=293.6K
protons from (n,n*)p

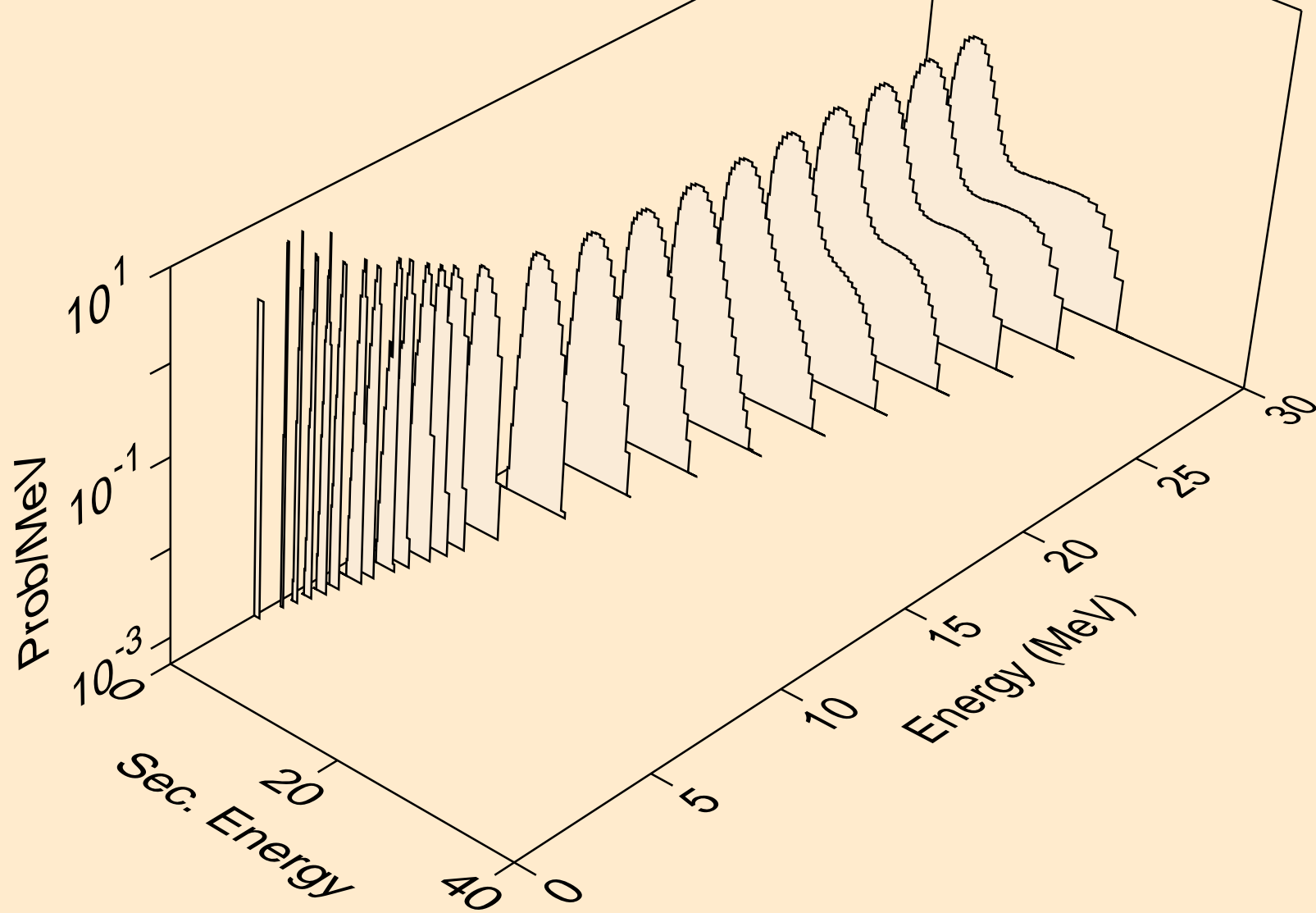

BA118 NEUTRON ACER TENDL-2021 LIBRARY; T=293.6K
protons from (n,2np)

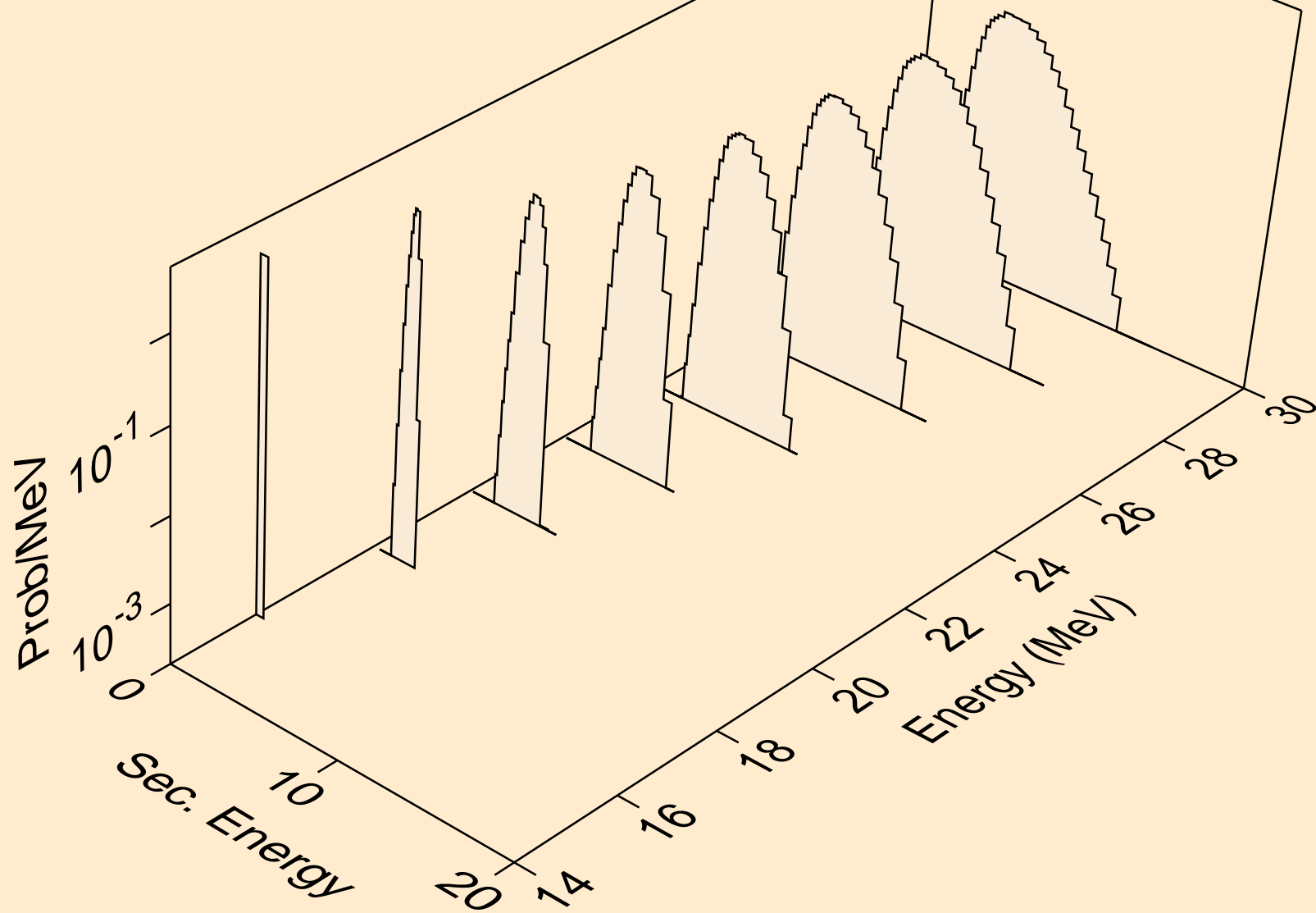

BA118 NEUTRON ACER TENDL-2021 LIBRARY; T=293.6K
protons from (n,3np)

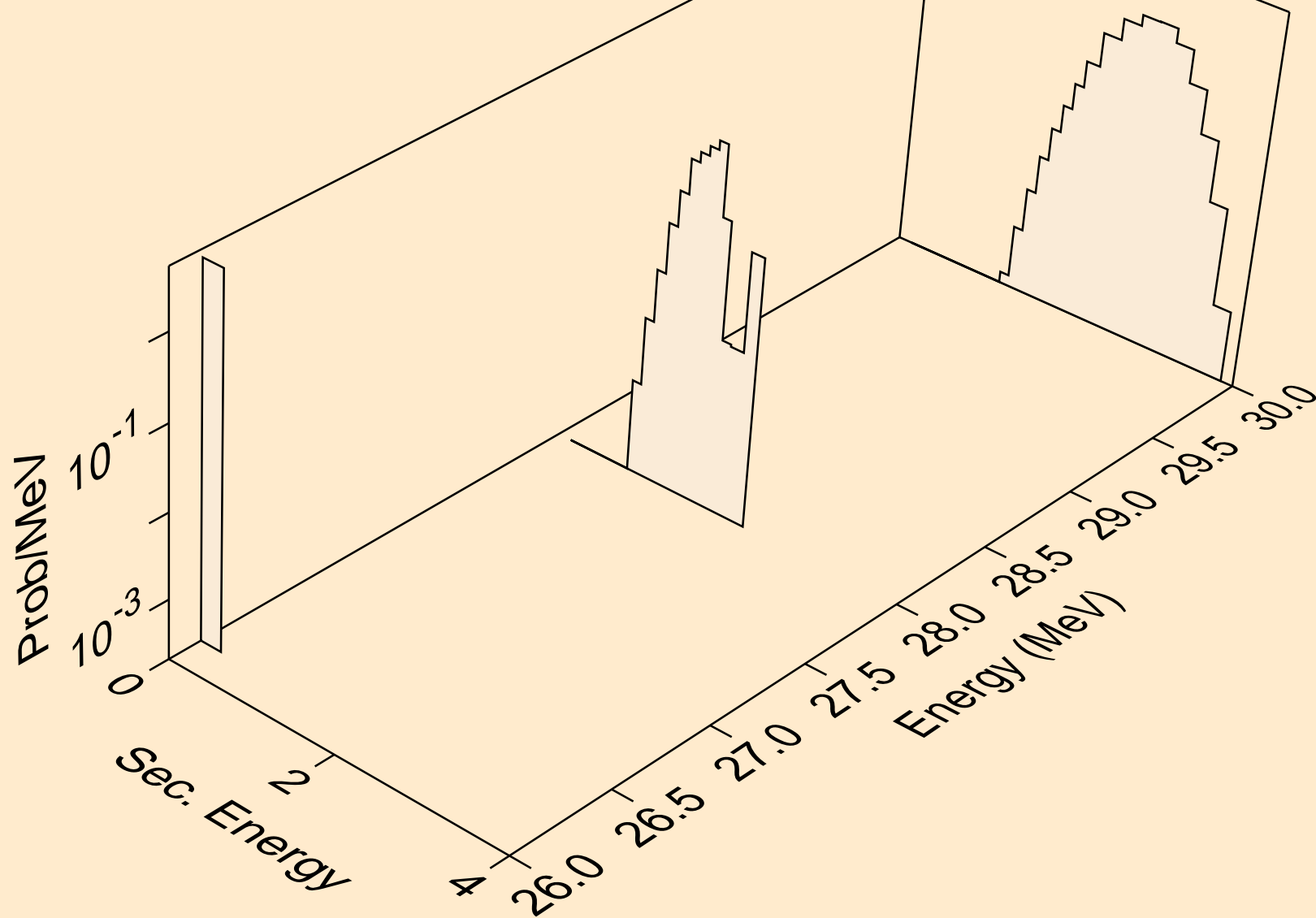

BA118 NEUTRON ACER TENDL-2021 LIBRARY; T=293.6K
protons from (n,2np)

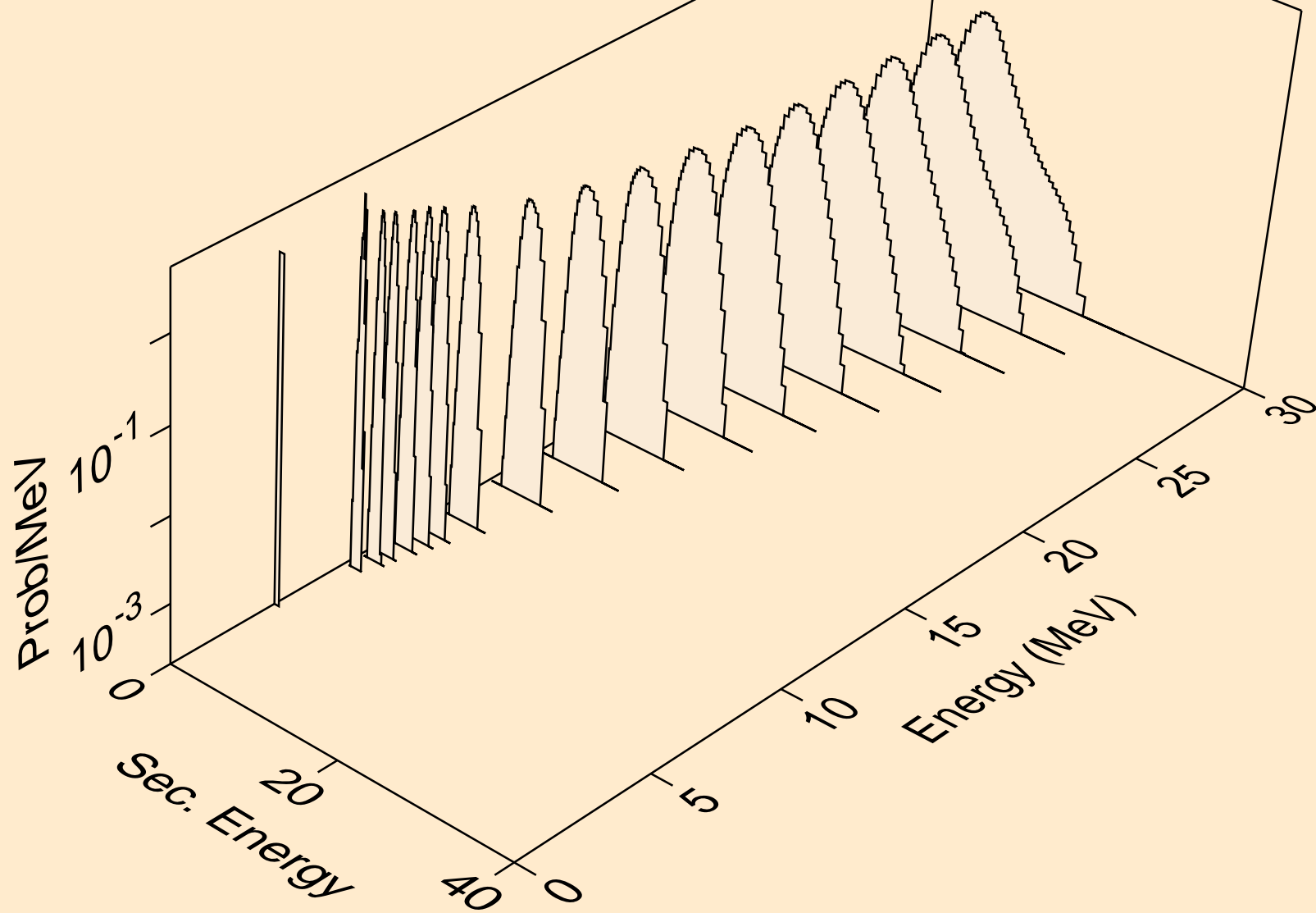

BA118 NEUTRON ACER TENDL-2021 LIBRARY; T=293.6K
protons from (n,npa)

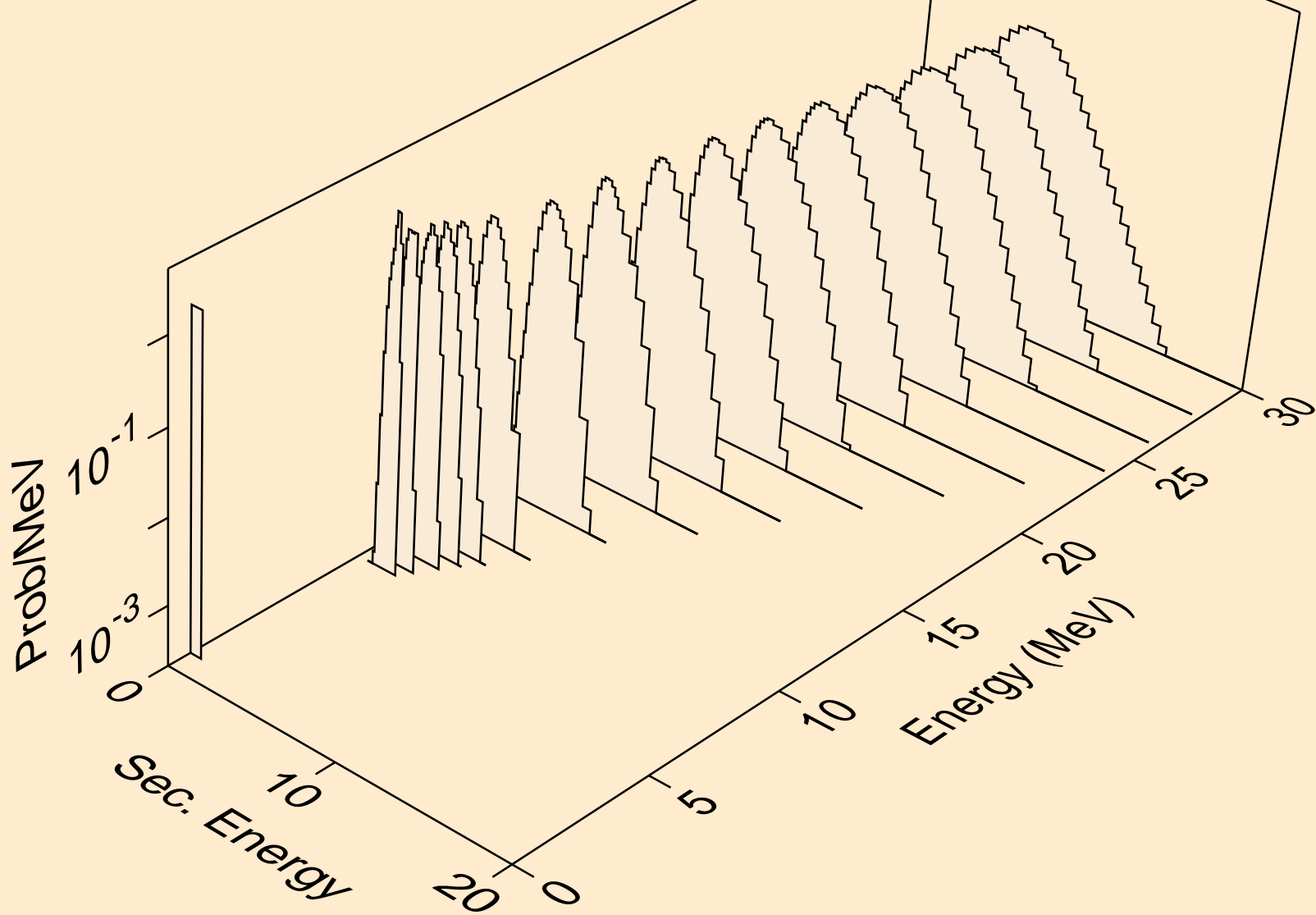

BA118 NEUTRON ACER TENDL-2021 LIBRARY; T=293.6K
protons from (n,p)

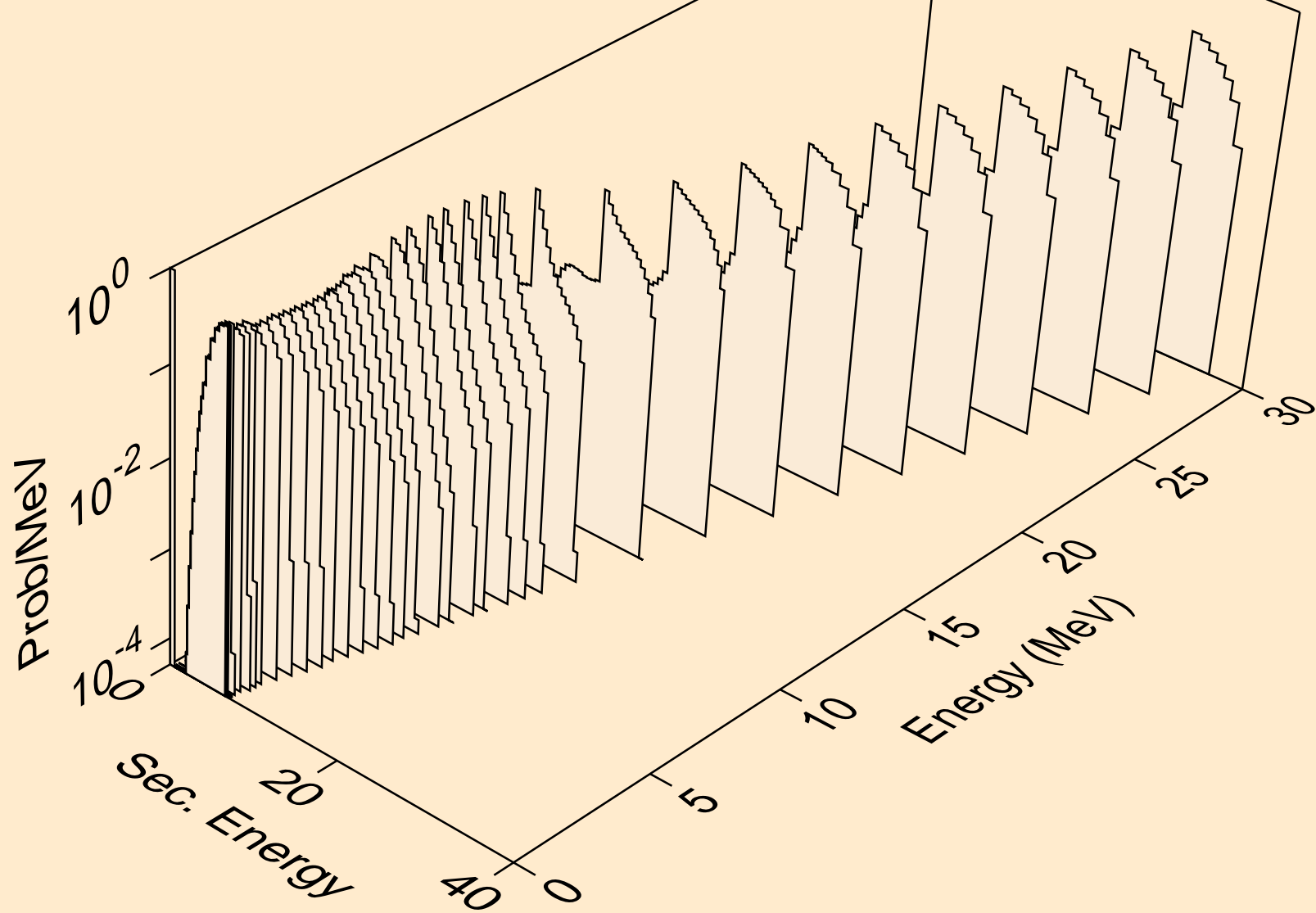

BA118 NEUTRON ACER TENDL-2021 LIBRARY; T=293.6K
protons from (n,2p)

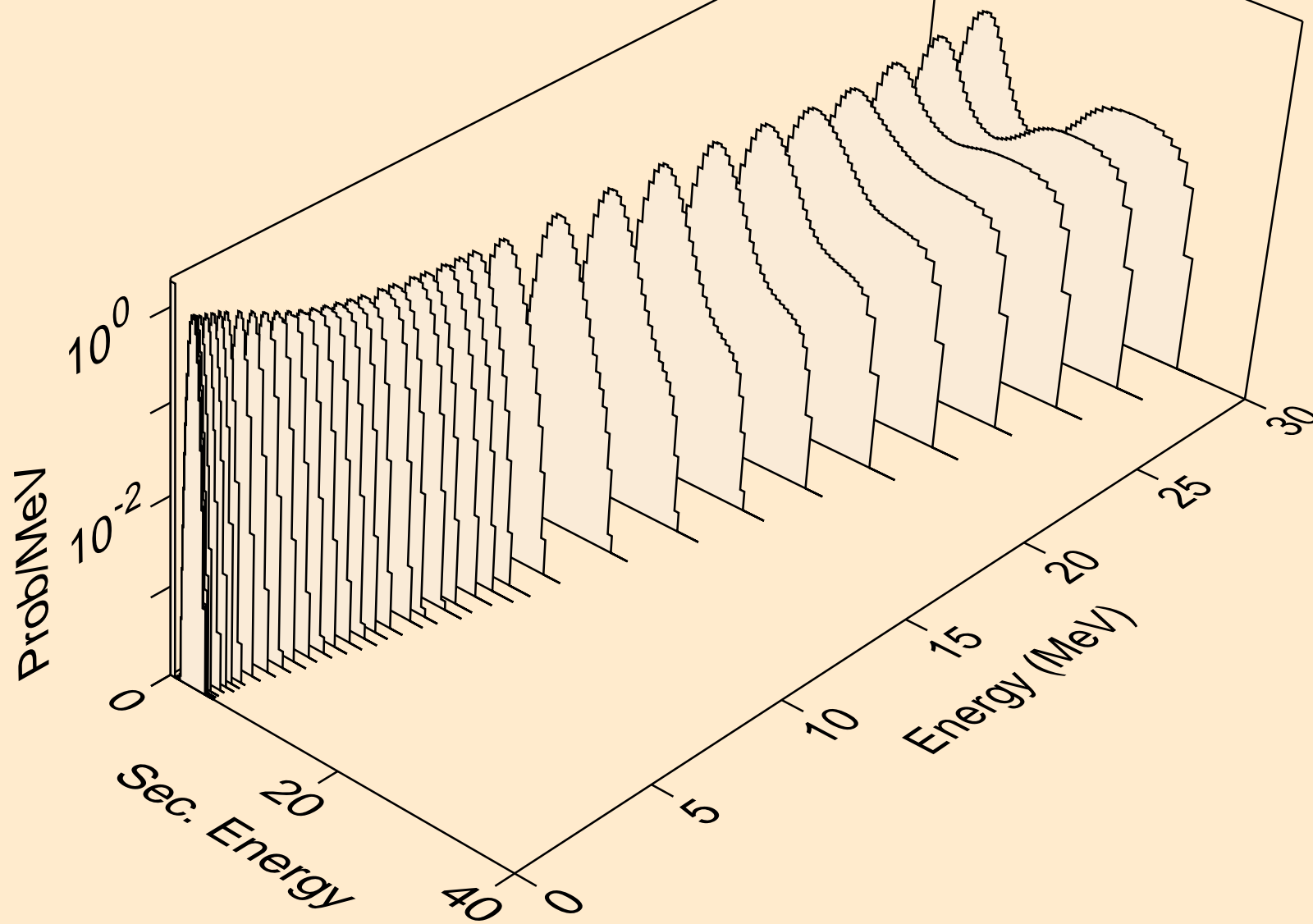

BA118 NEUTRON ACER TENDL-2021 LIBRARY; T=293.6K
protons from (n,p)

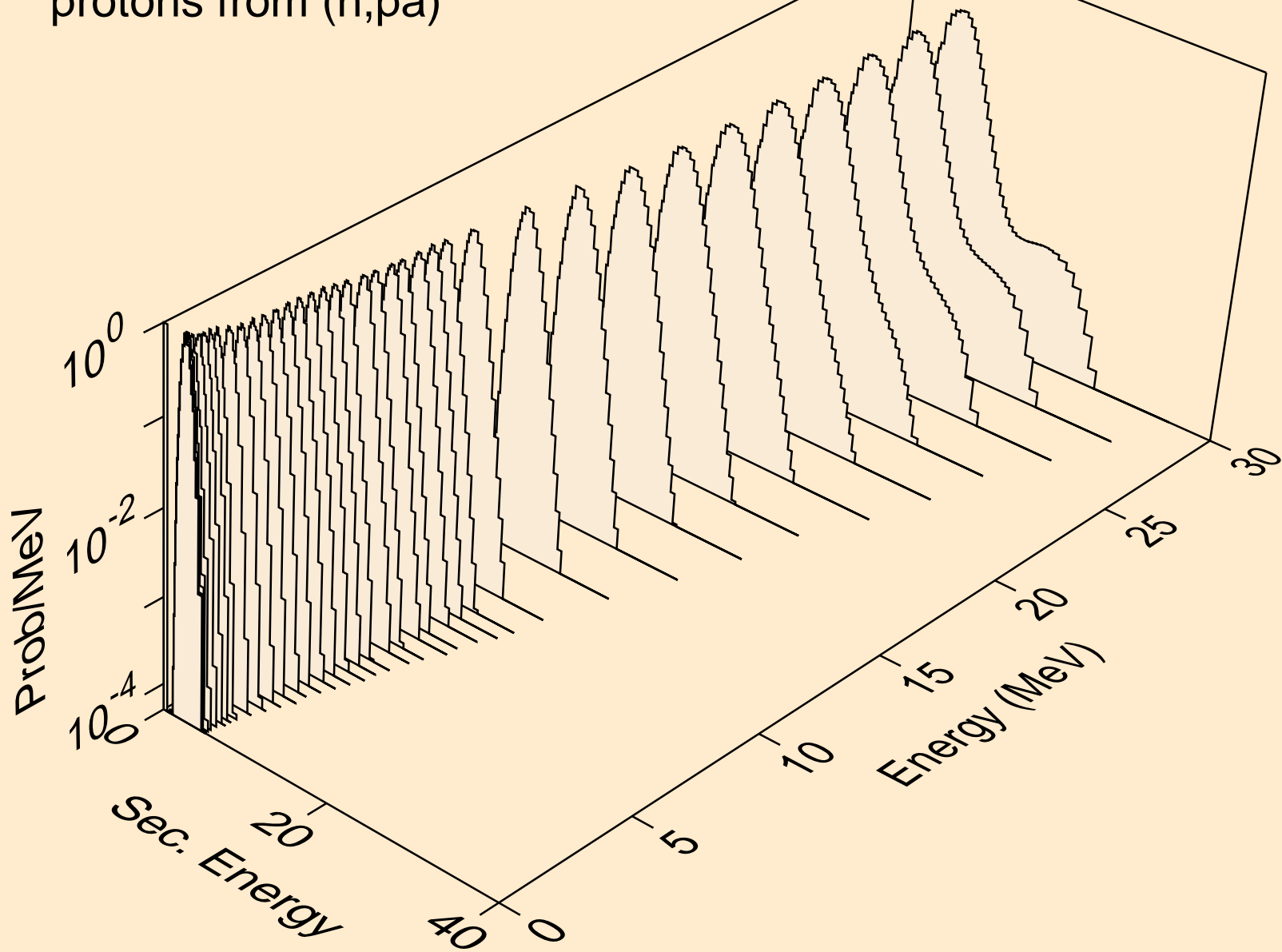

BA118 NEUTRON ACER TENDL-2021 LIBRARY; T=293.6K
protons from (n,pd)

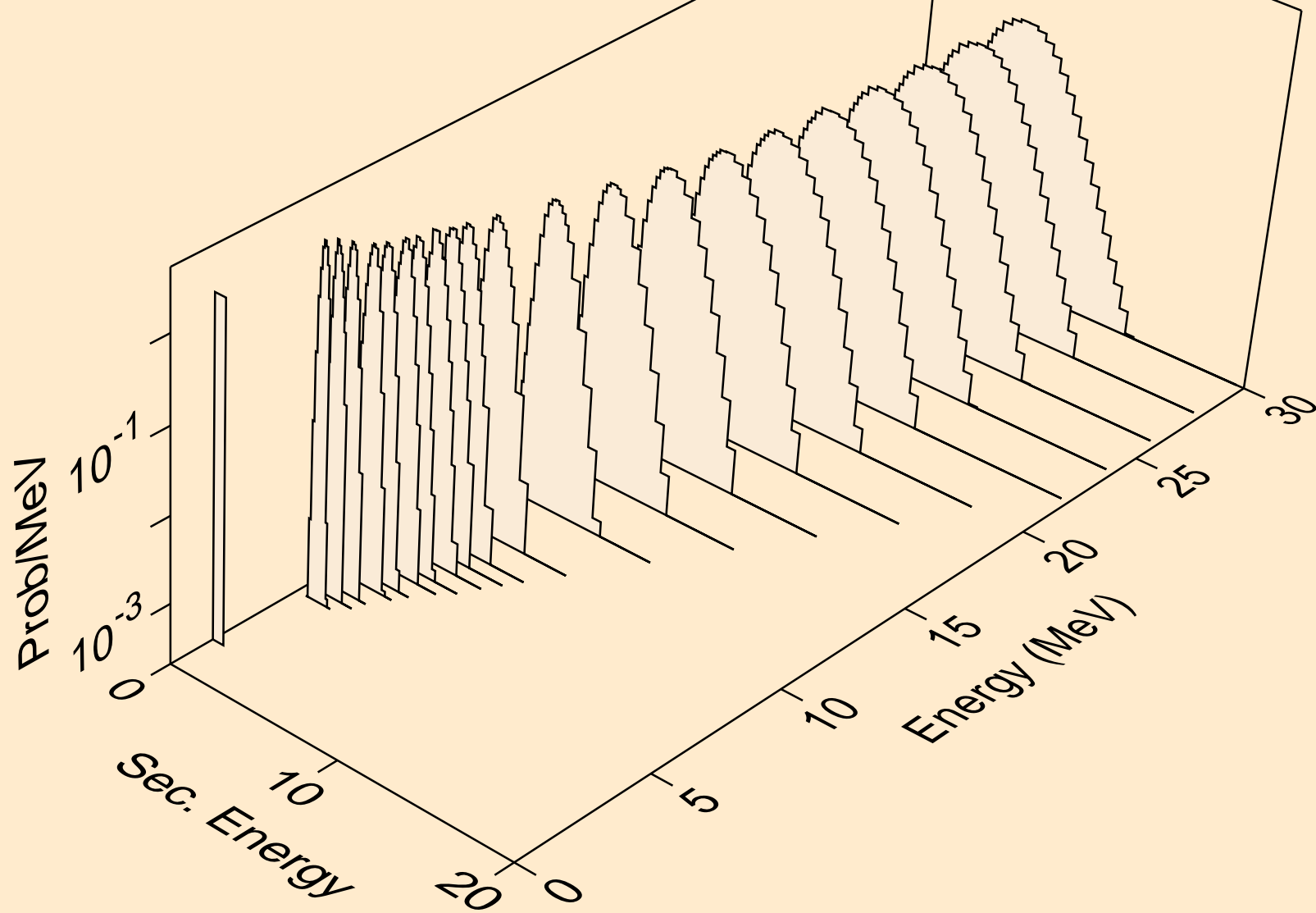

BA118 NEUTRON ACER TENDL-2021 LIBRARY; T=293.6K
protons from (n,pt)

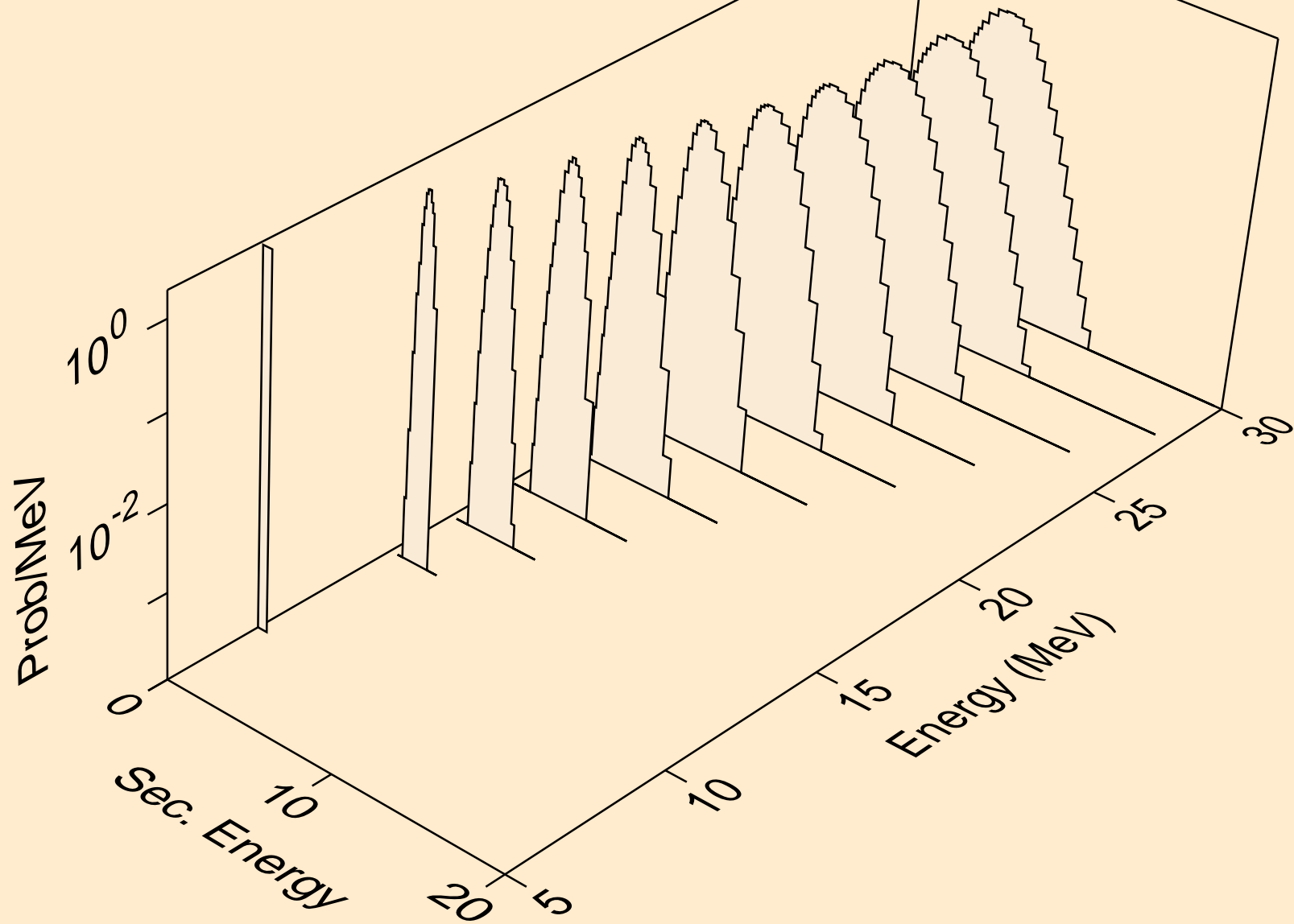

BA118 NEUTRON ACER TENDL-2021 LIBRARY; T=293.6K
deuterons from (n,x)

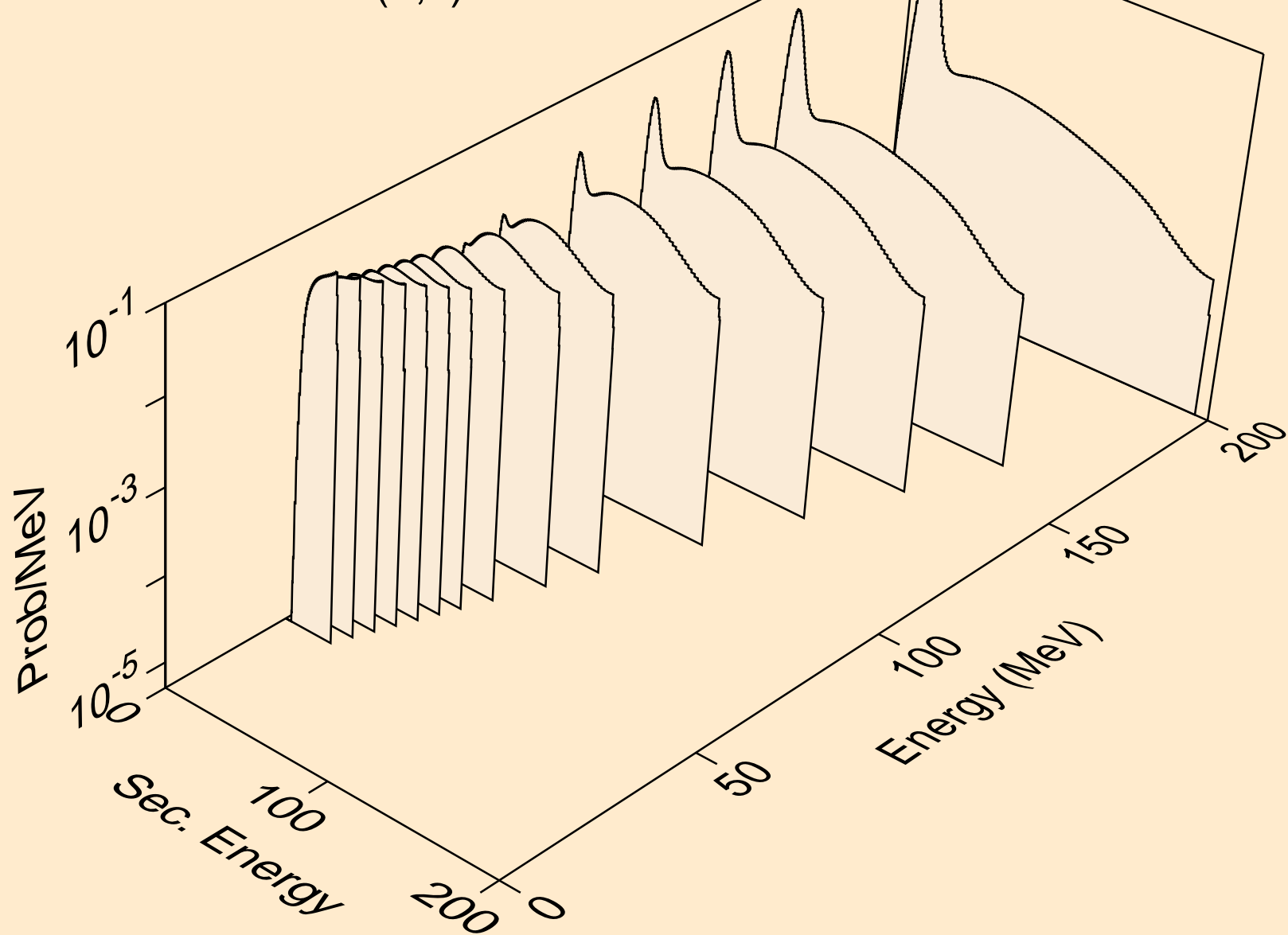

BA118 NEUTRON ACER TENDL-2021 LIBRARY; T=293.6K
deuterons from (n,n*)d

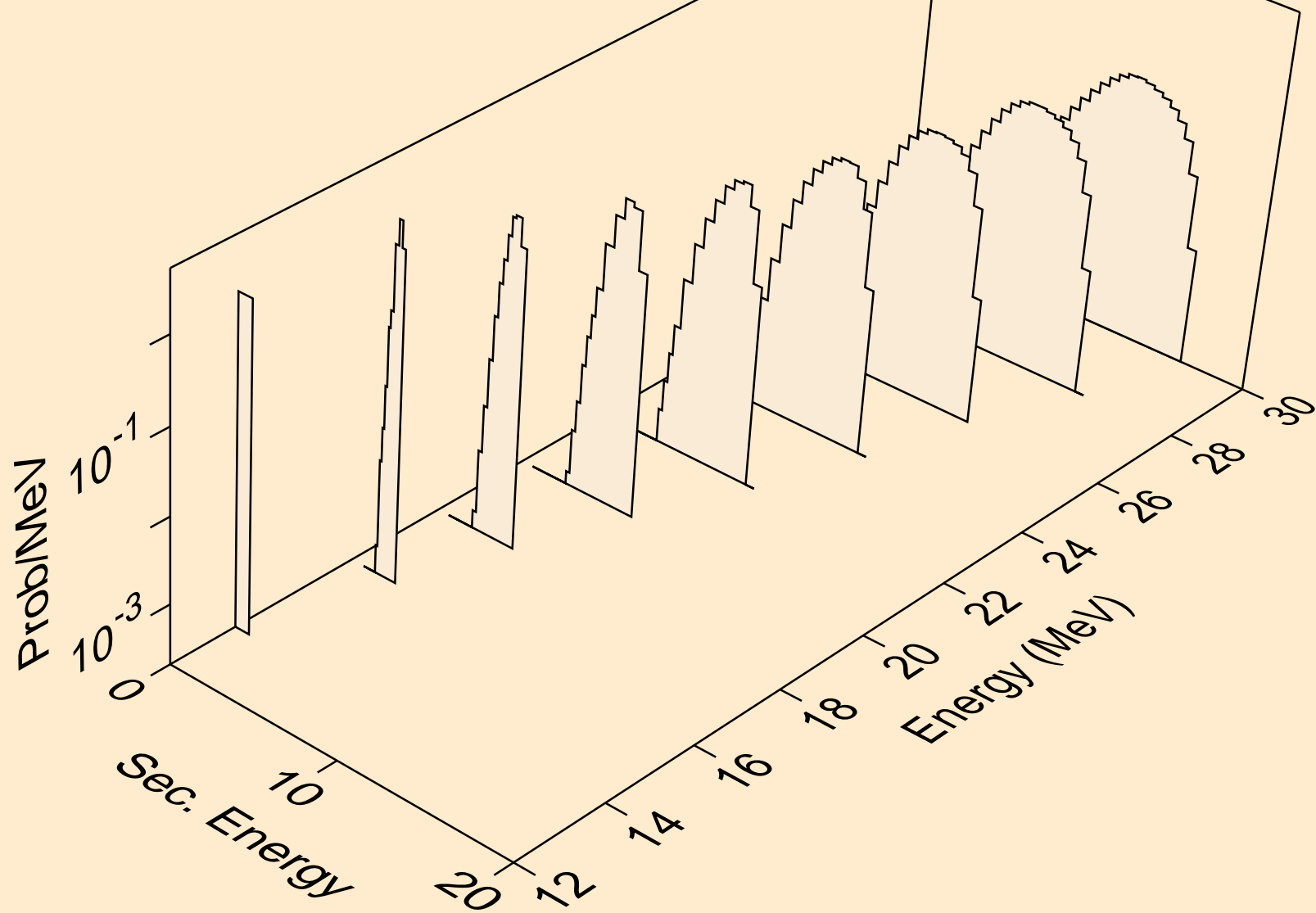

BA118 NEUTRON ACER TENDL-2021 LIBRARY; T=293.6K
deuterons from (n,d)

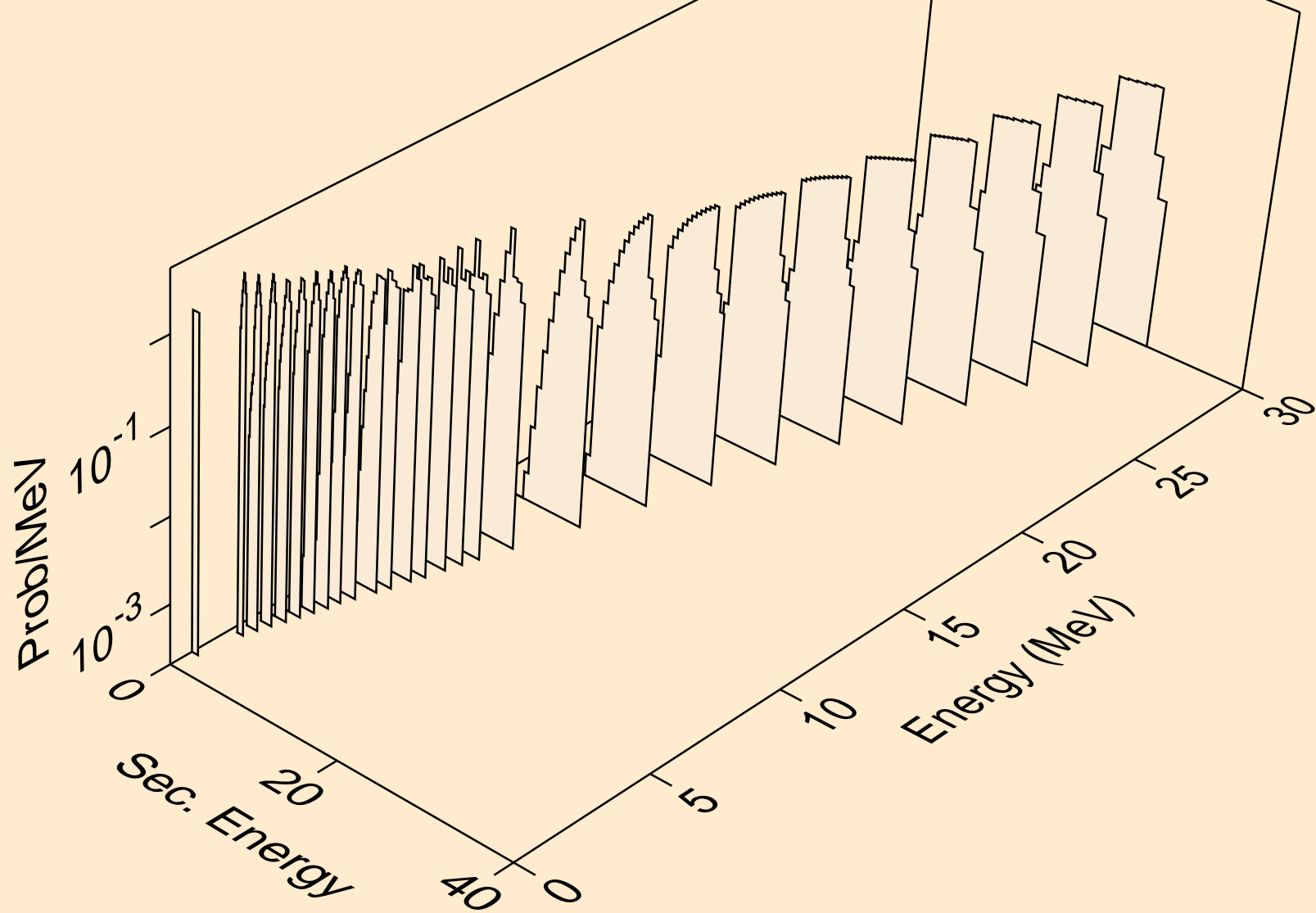

BA118 NEUTRON ACER TENDL-2021 LIBRARY; T=293.6K
deuterons from (n,d2a)

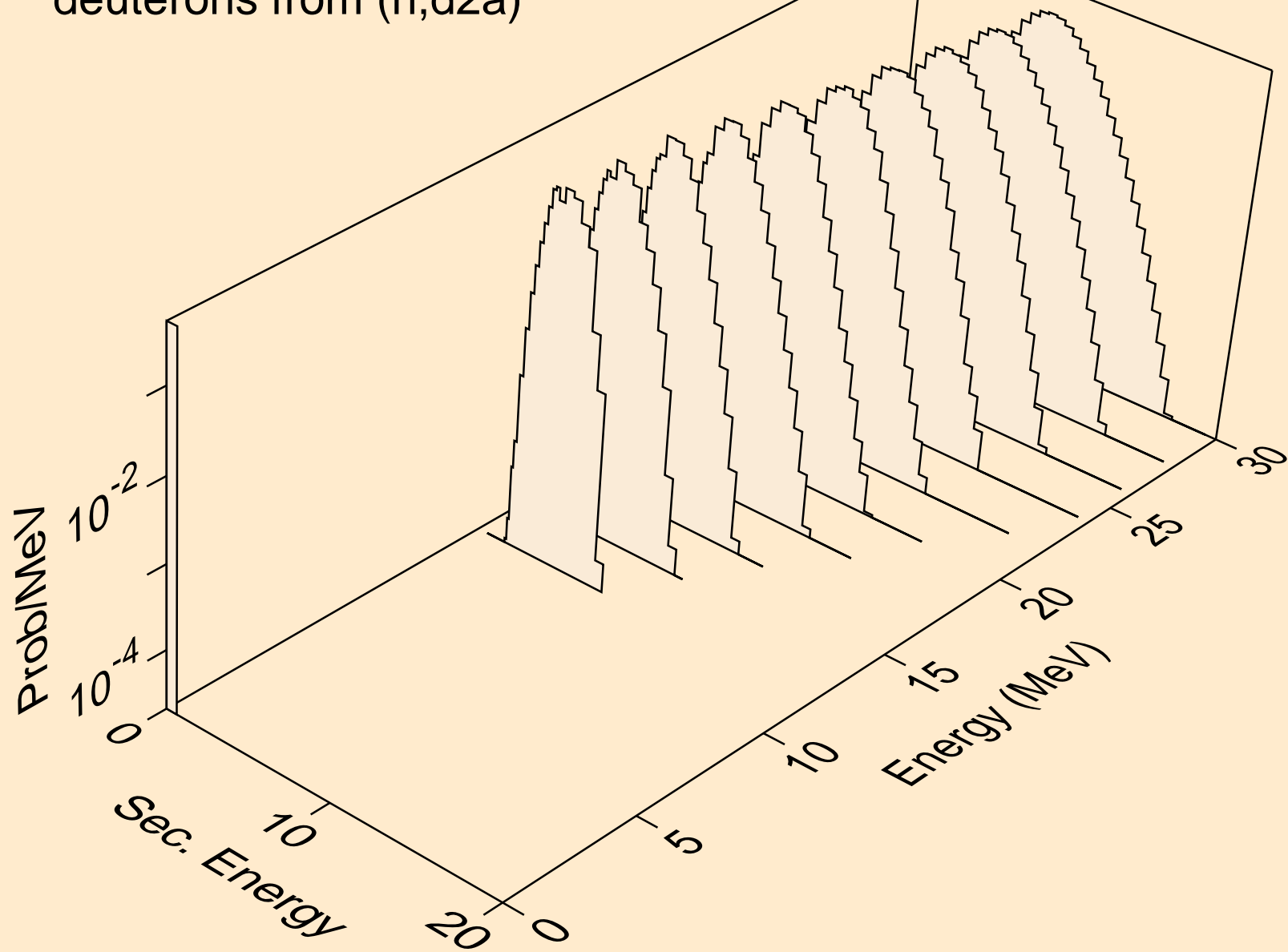

BA118 NEUTRON ACER TENDL-2021 LIBRARY; T=293.6K
deuterons from (n,pd)

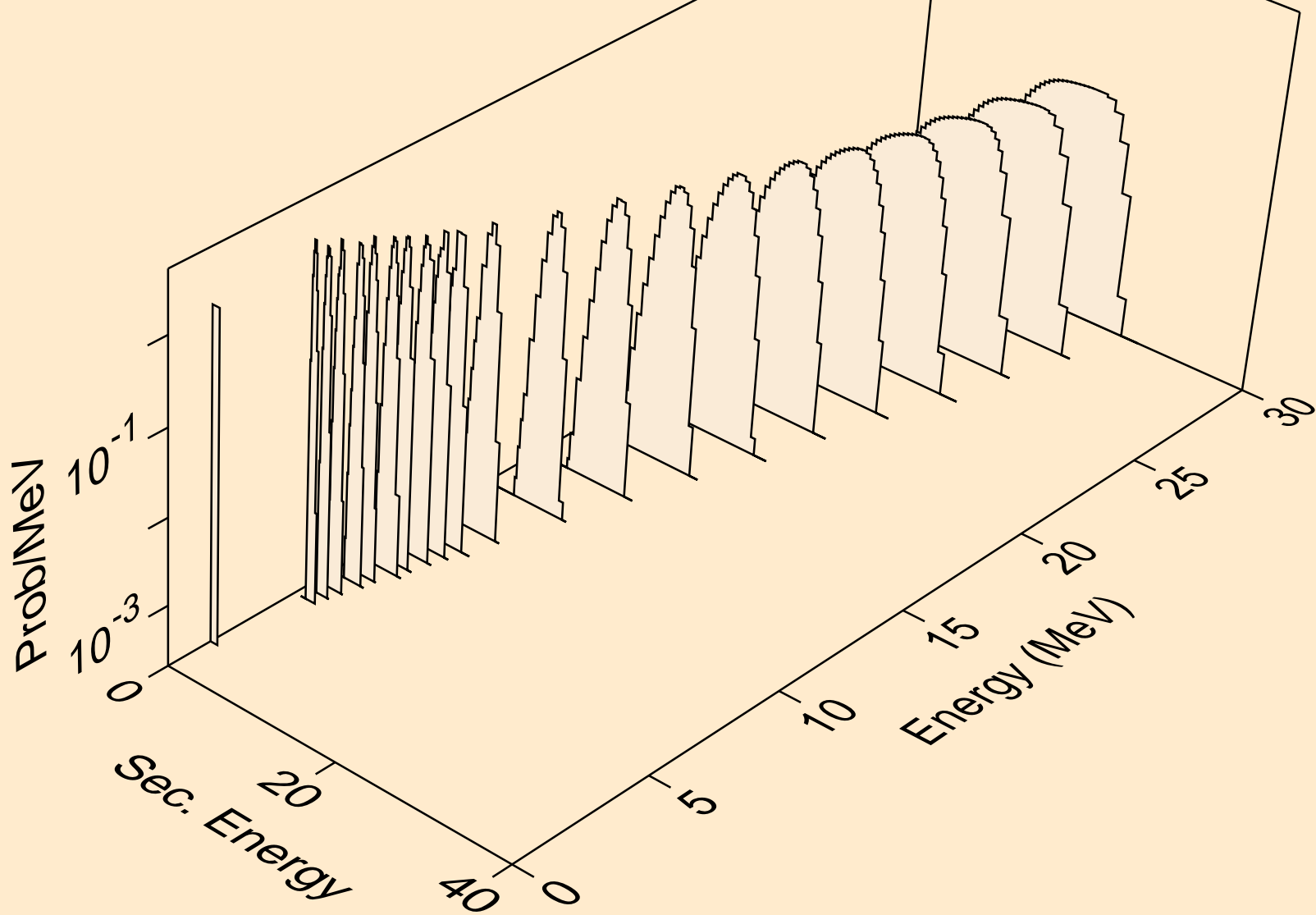

BA118 NEUTRON ACER TENDL-2021 LIBRARY; T=293.6K
deuterons from (n,da)

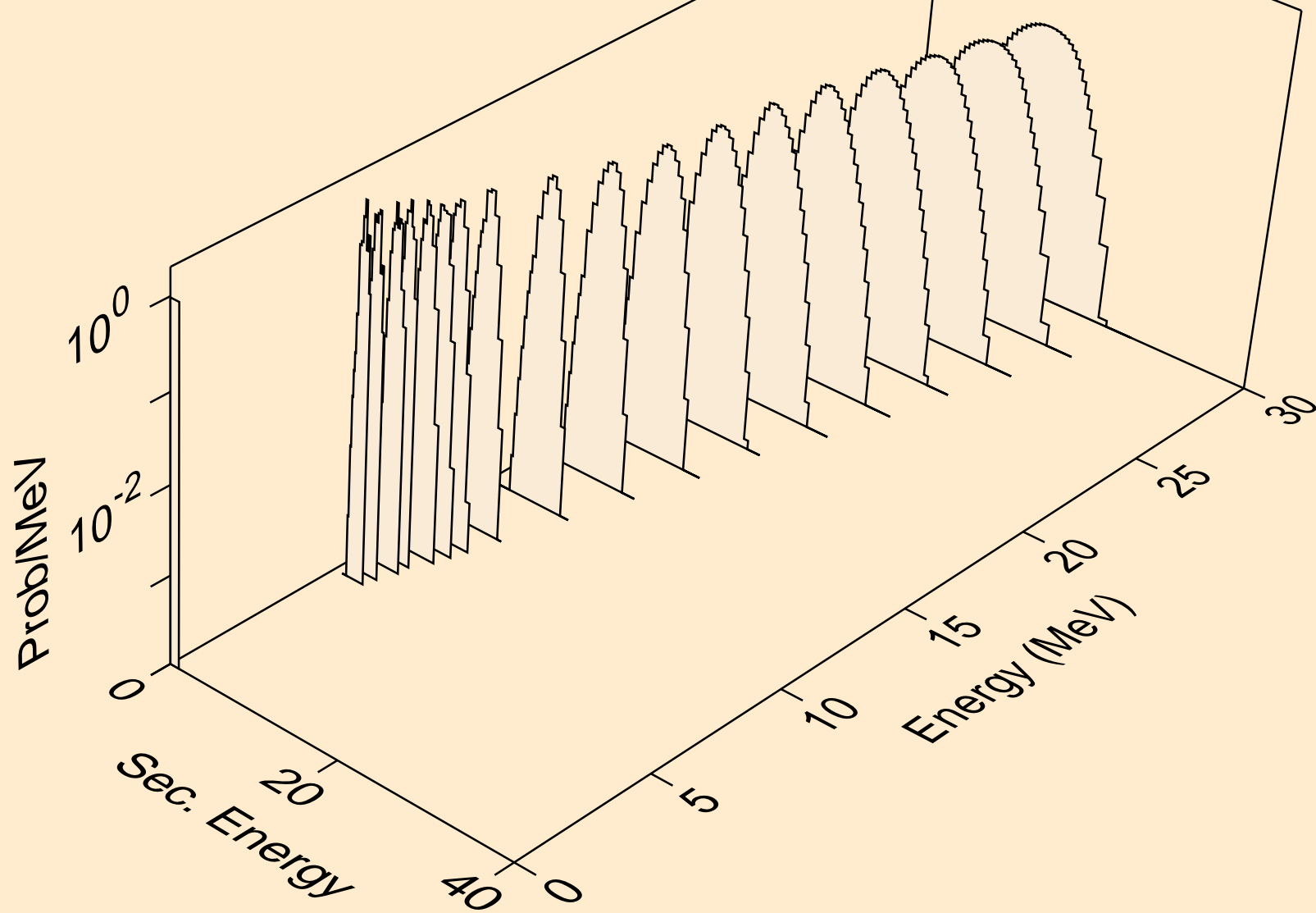

BA118 NEUTRON ACER TENDL-2021 LIBRARY; T=293.6K
tritons from (n,x)

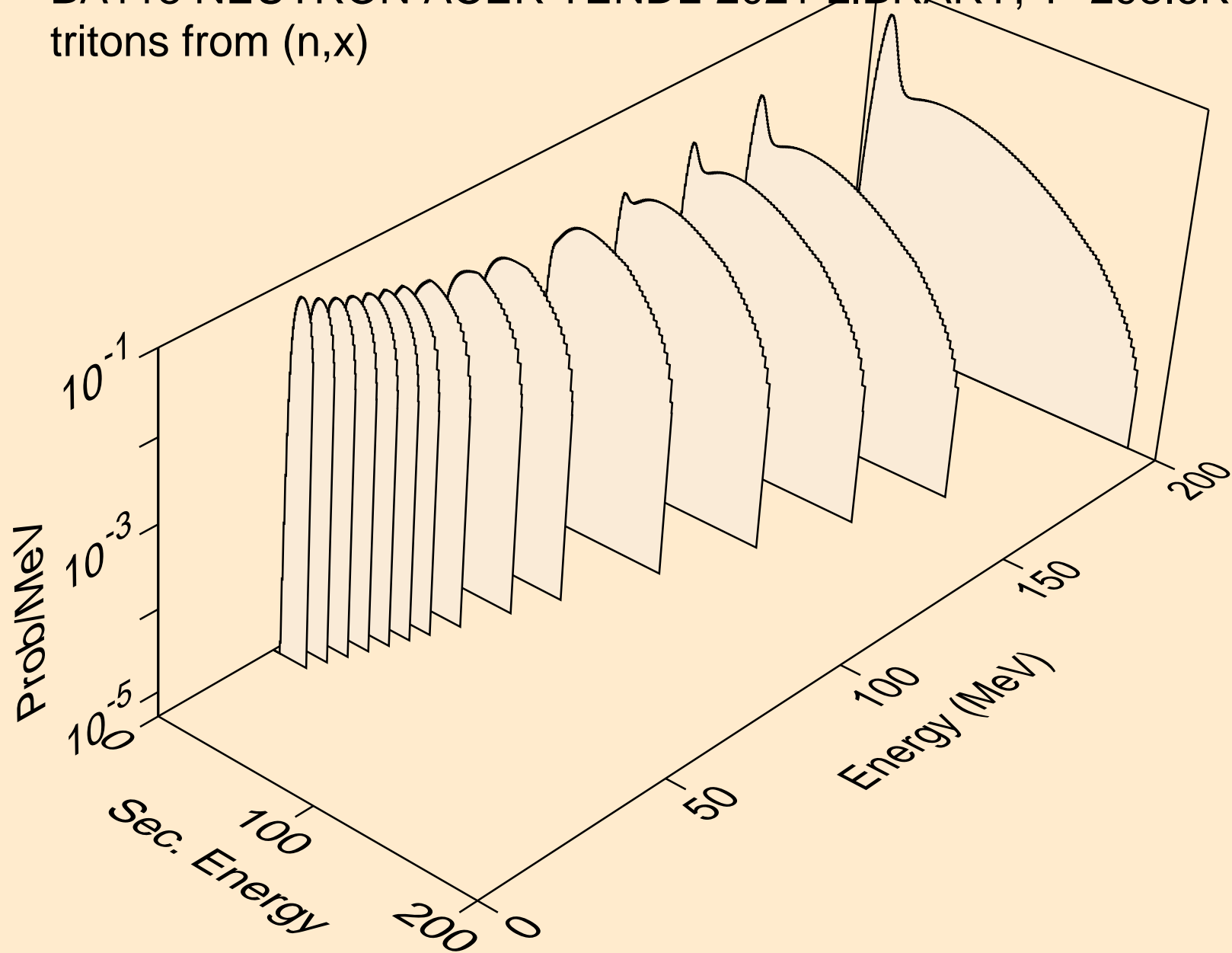

BA118 NEUTRON ACER TENDL-2021 LIBRARY; T=293.6K
tritons from (n,n*)t

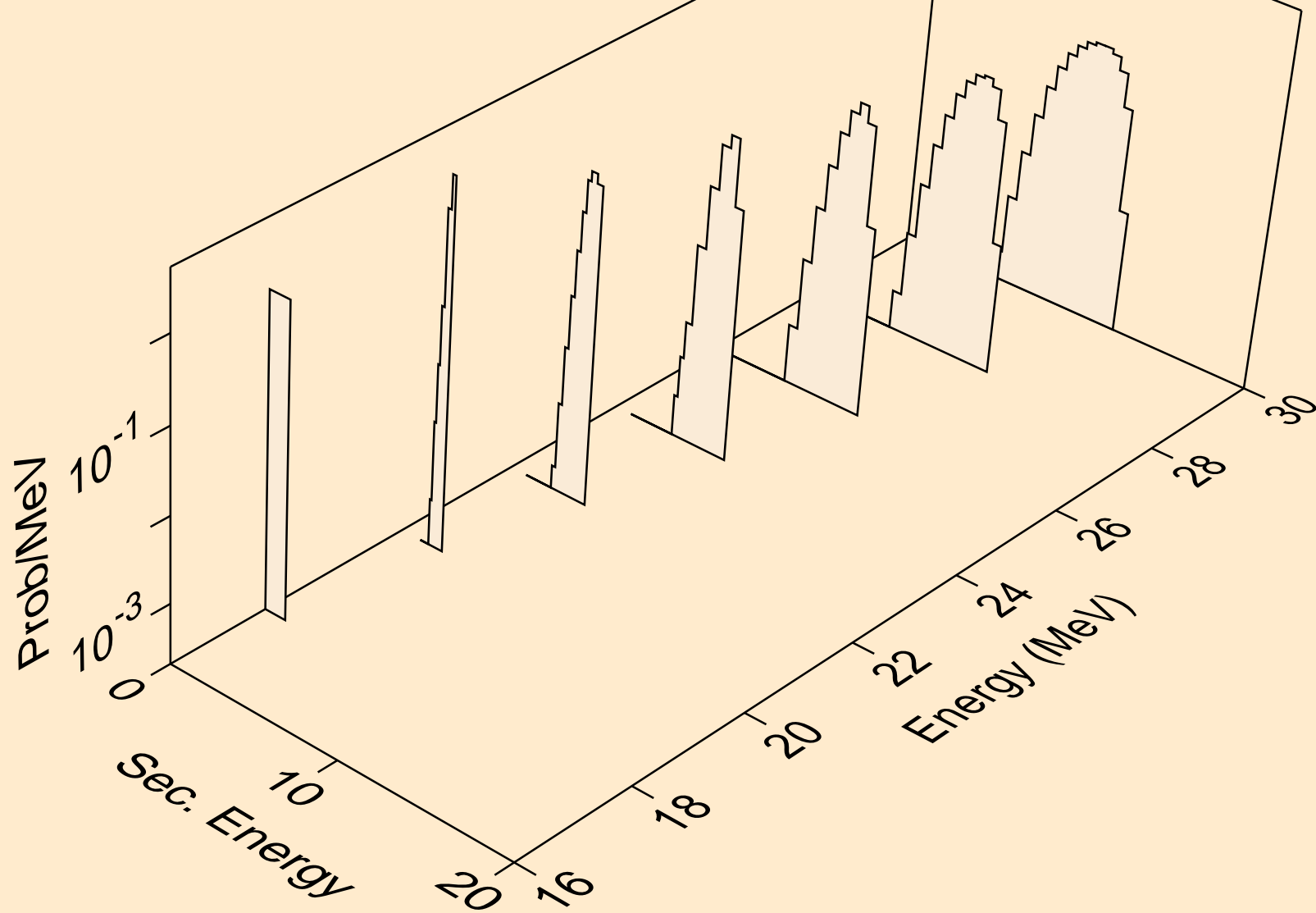

BA118 NEUTRON ACER TENDL-2021 LIBRARY; T=293.6K
tritons from (n,t)

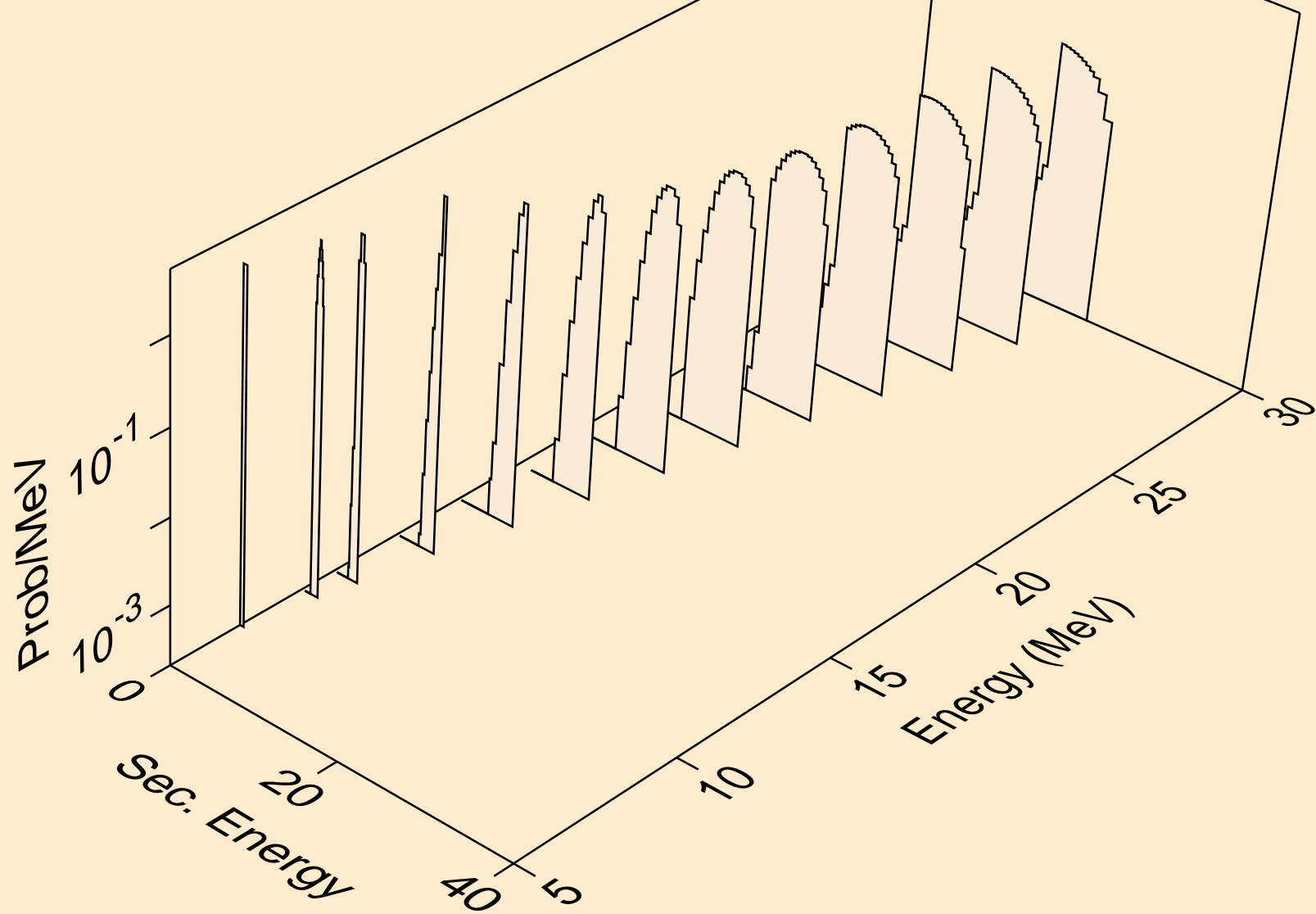

BA118 NEUTRON ACER TENDL-2021 LIBRARY; T=293.6K
tritons from (n,pt)

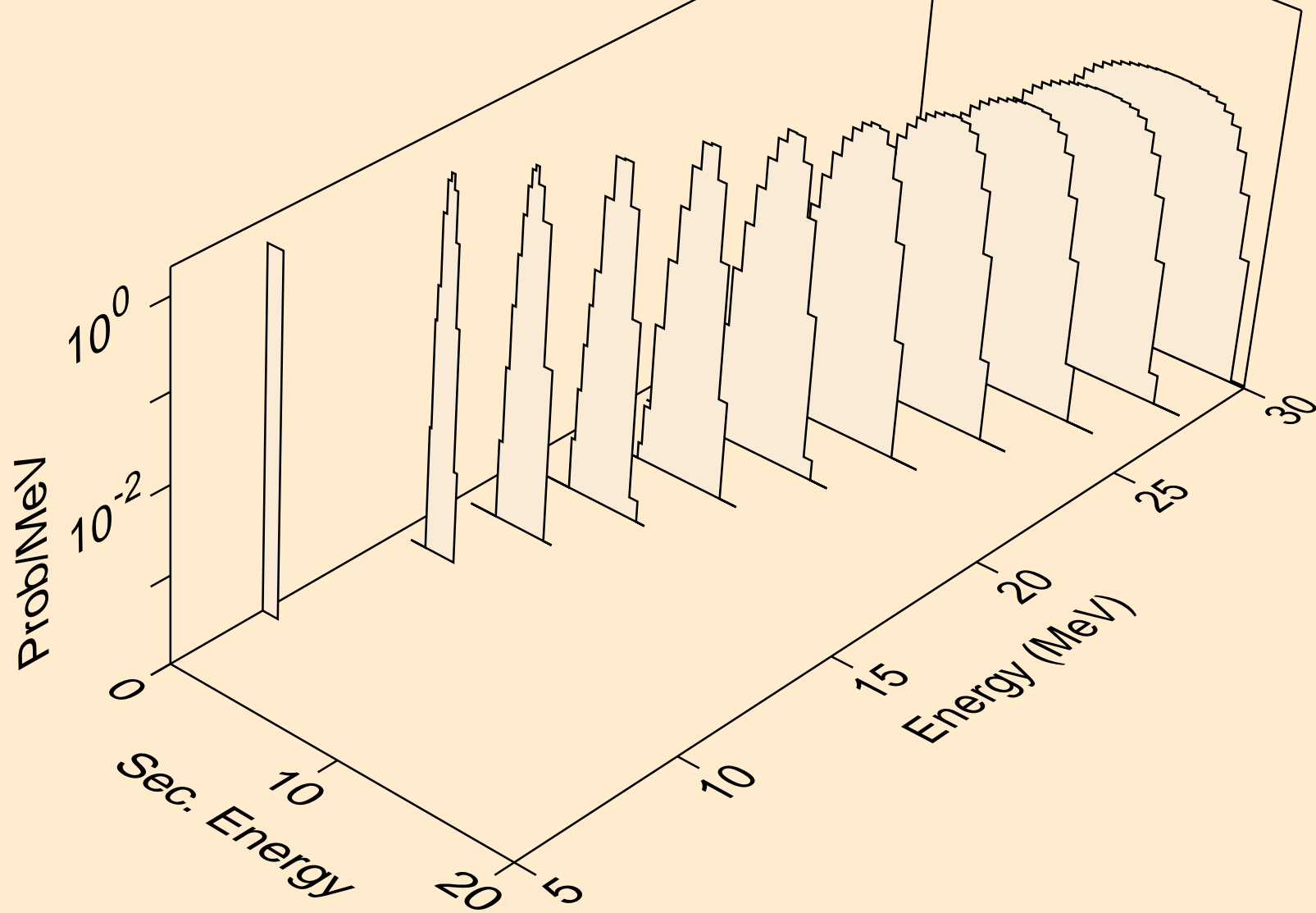

BA118 NEUTRON ACER TENDL-2021 LIBRARY; T=293.6K
he3s from (n,x)

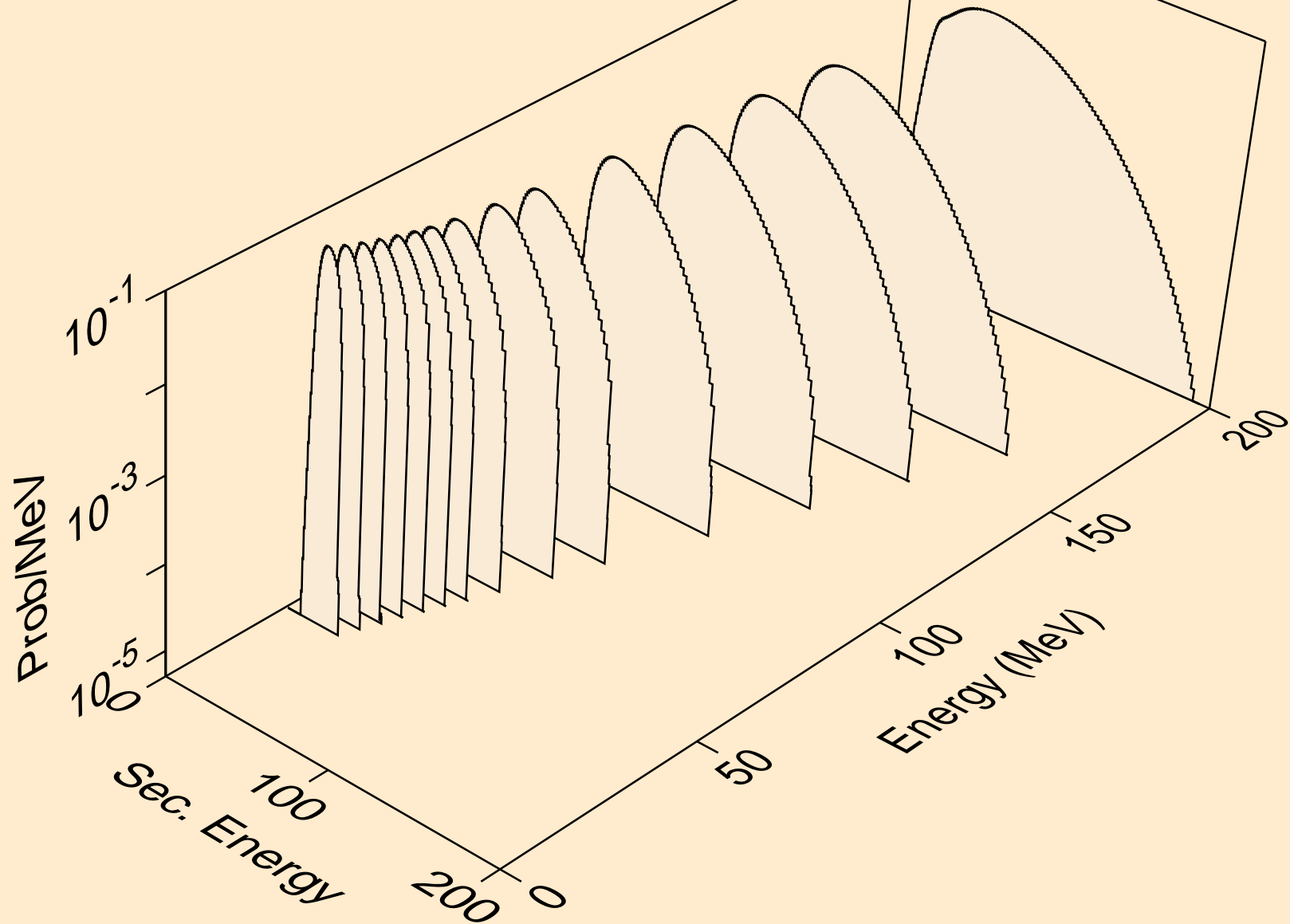

BA118 NEUTRON ACER TENDL-2021 LIBRARY; T=293.6K
he3s from (n,n*)he3

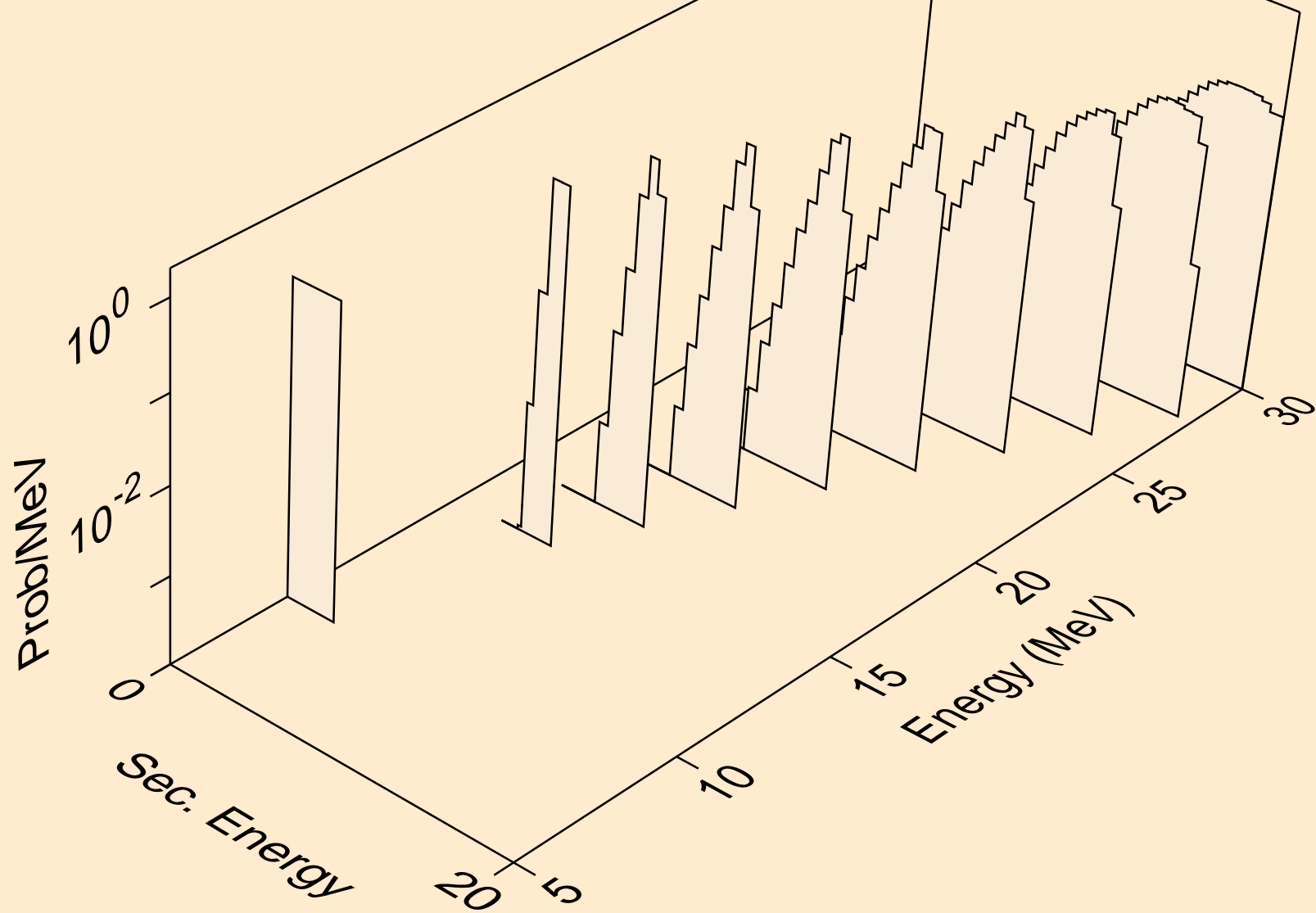

BA118 NEUTRON ACER TENDL-2021 LIBRARY; T=293.6K
he3s from (n,he3)

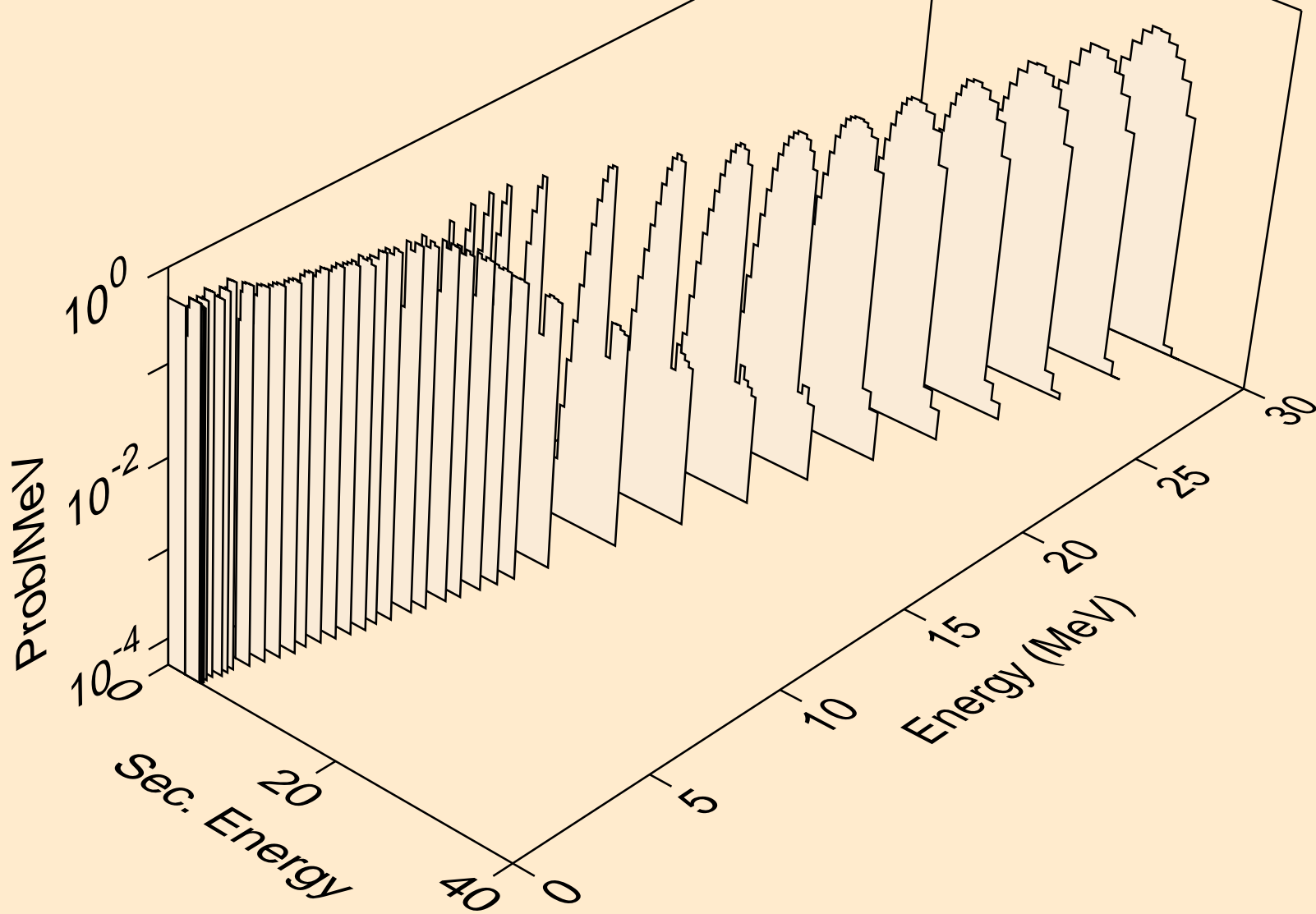

BA118 NEUTRON ACER TENDL-2021 LIBRARY; T=293.6K
alphas from (n,x)

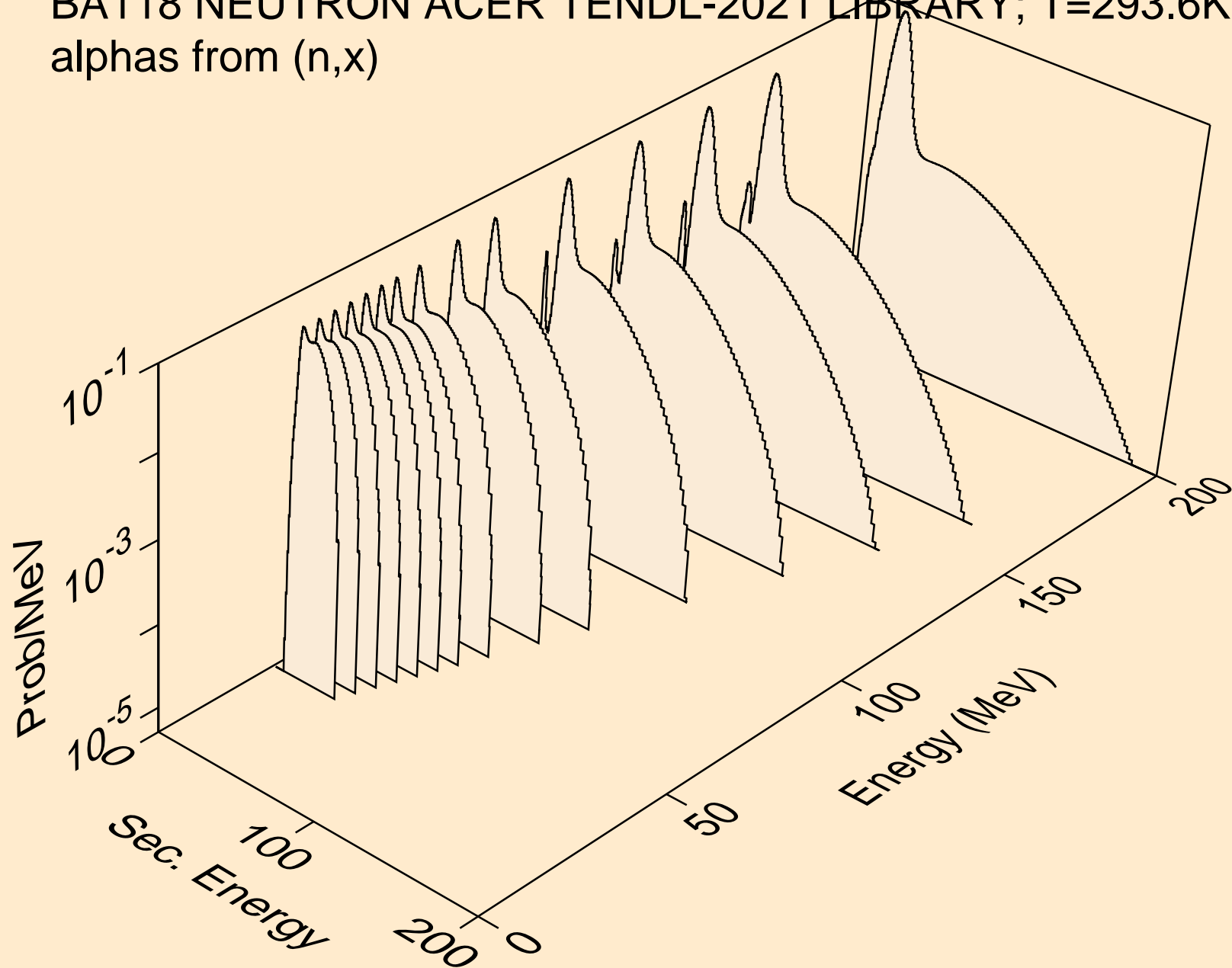

BA118 NEUTRON ACER TENDL-2021 LIBRARY; T=293.6K
alphas from (n,n*)a

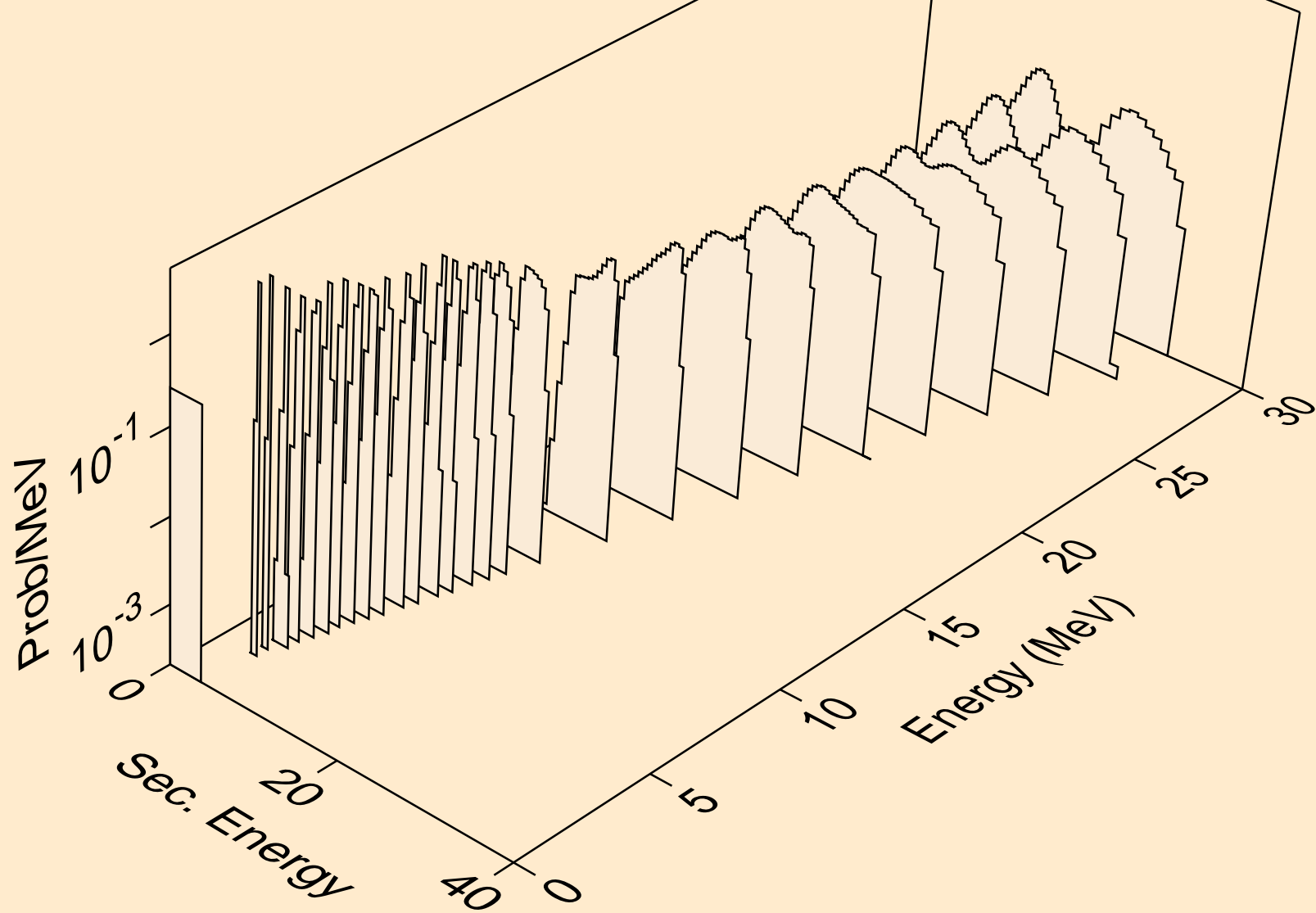

BA118 NEUTRON ACER TENDL-2021 LIBRARY; T=293.6K
alphas from (n,n*)3a

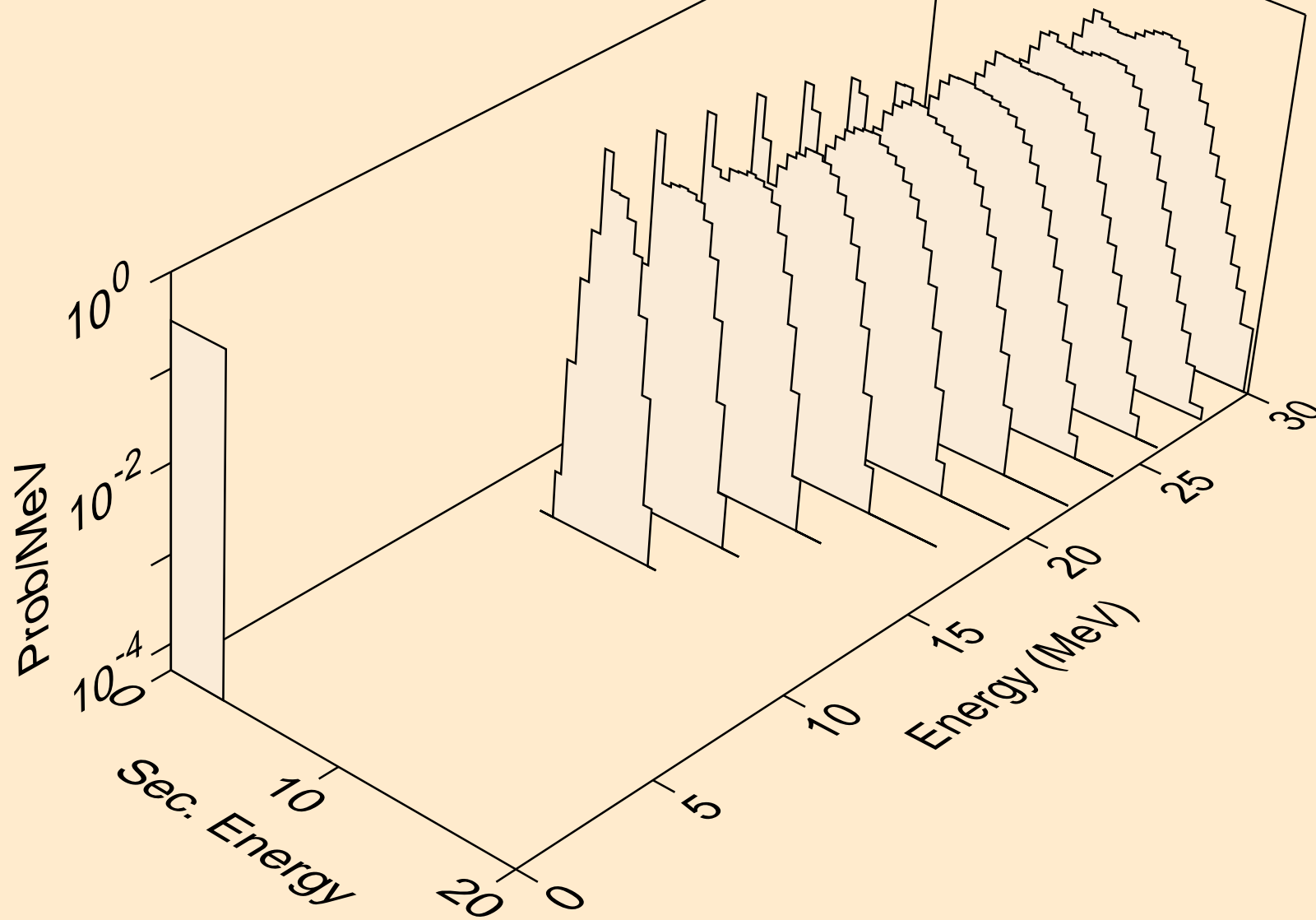

BA118 NEUTRON ACER TENDL-2021 LIBRARY; T=293.6K
alphas from (n,2n)a

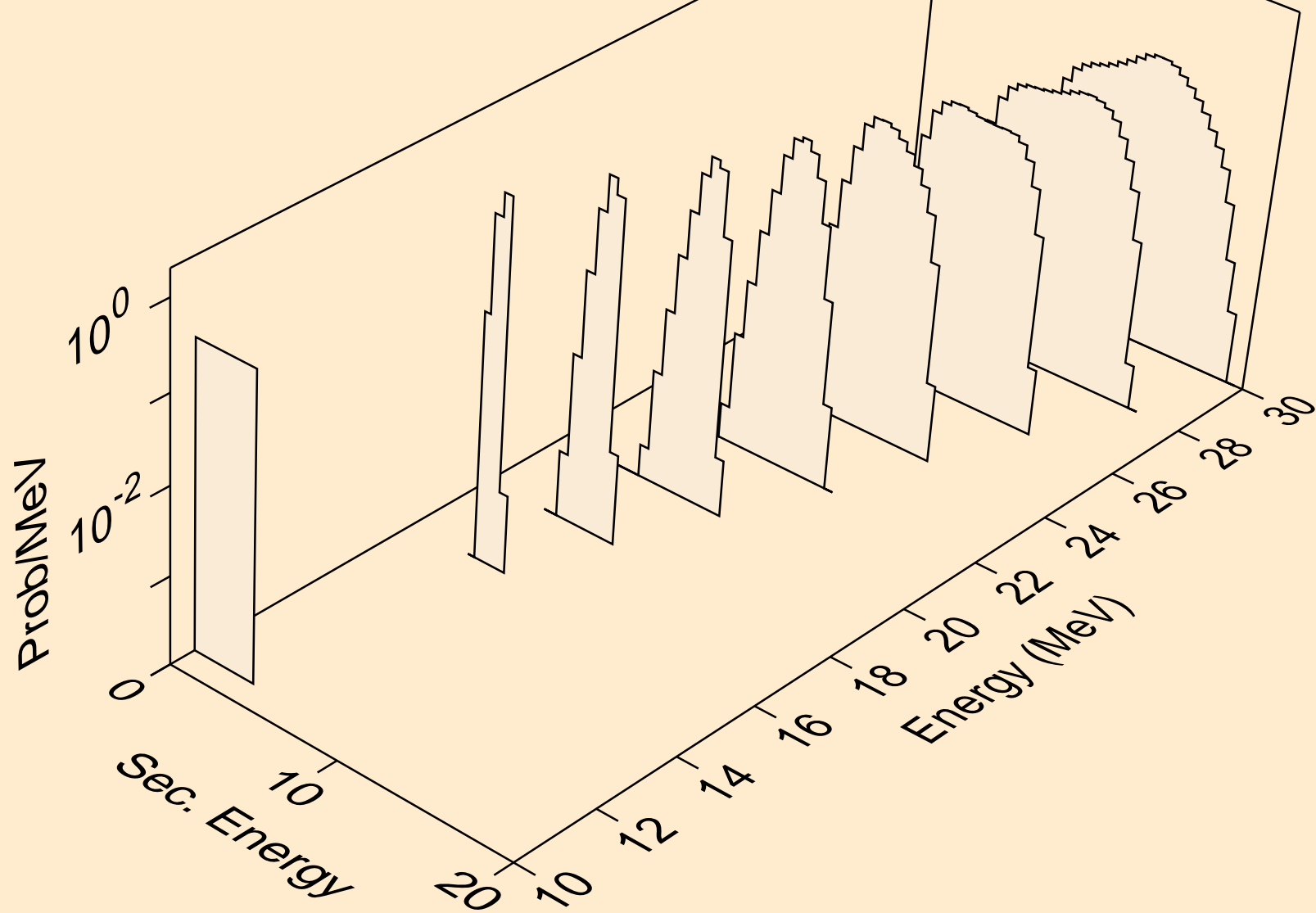

BA118 NEUTRON ACER TENDL-2021 LIBRARY; T=293.6K
alphas from (n,n*)2a

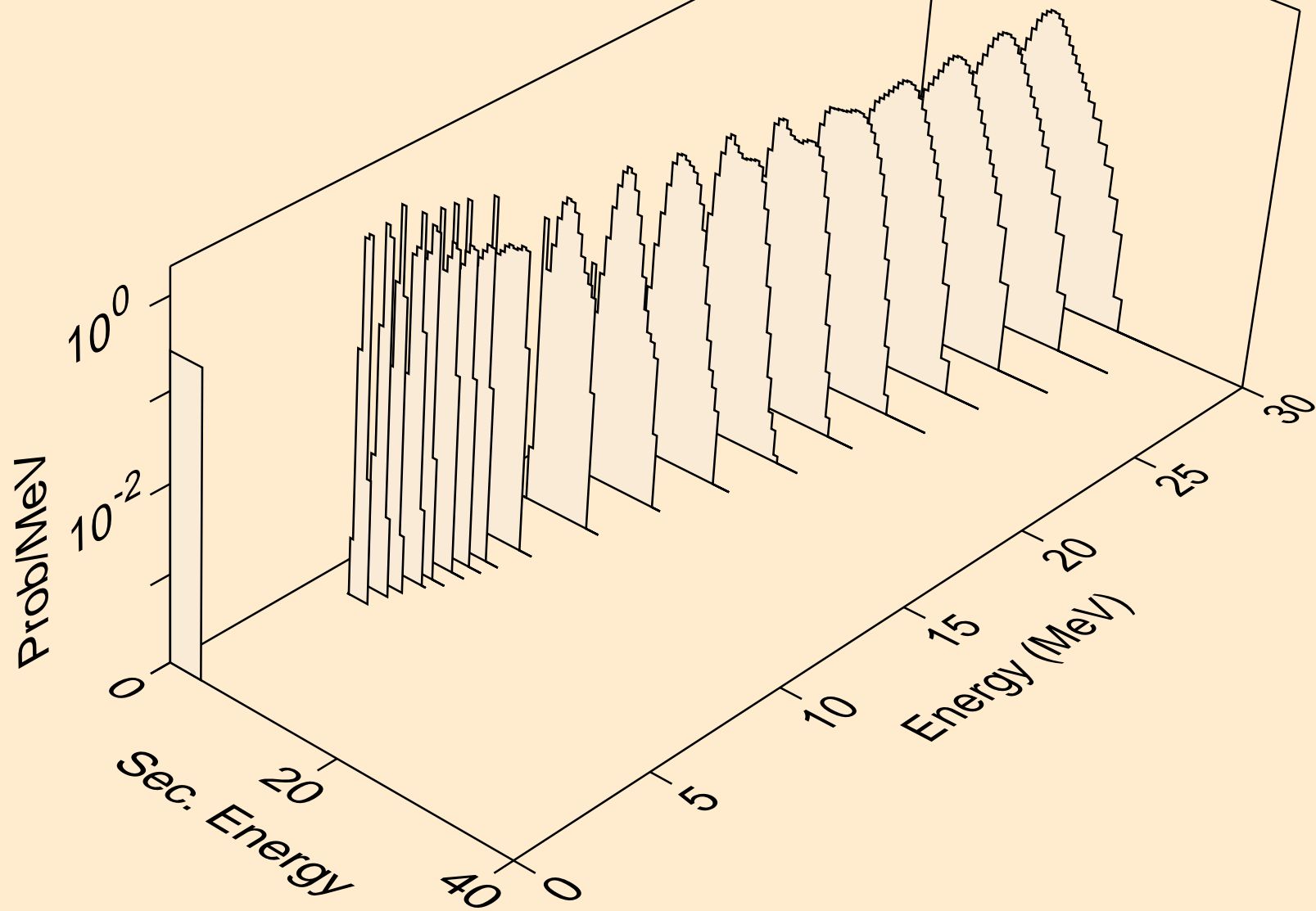

BA118 NEUTRON ACER TENDL-2021 LIBRARY; T=293.6K
alphas from (n,2n)2a

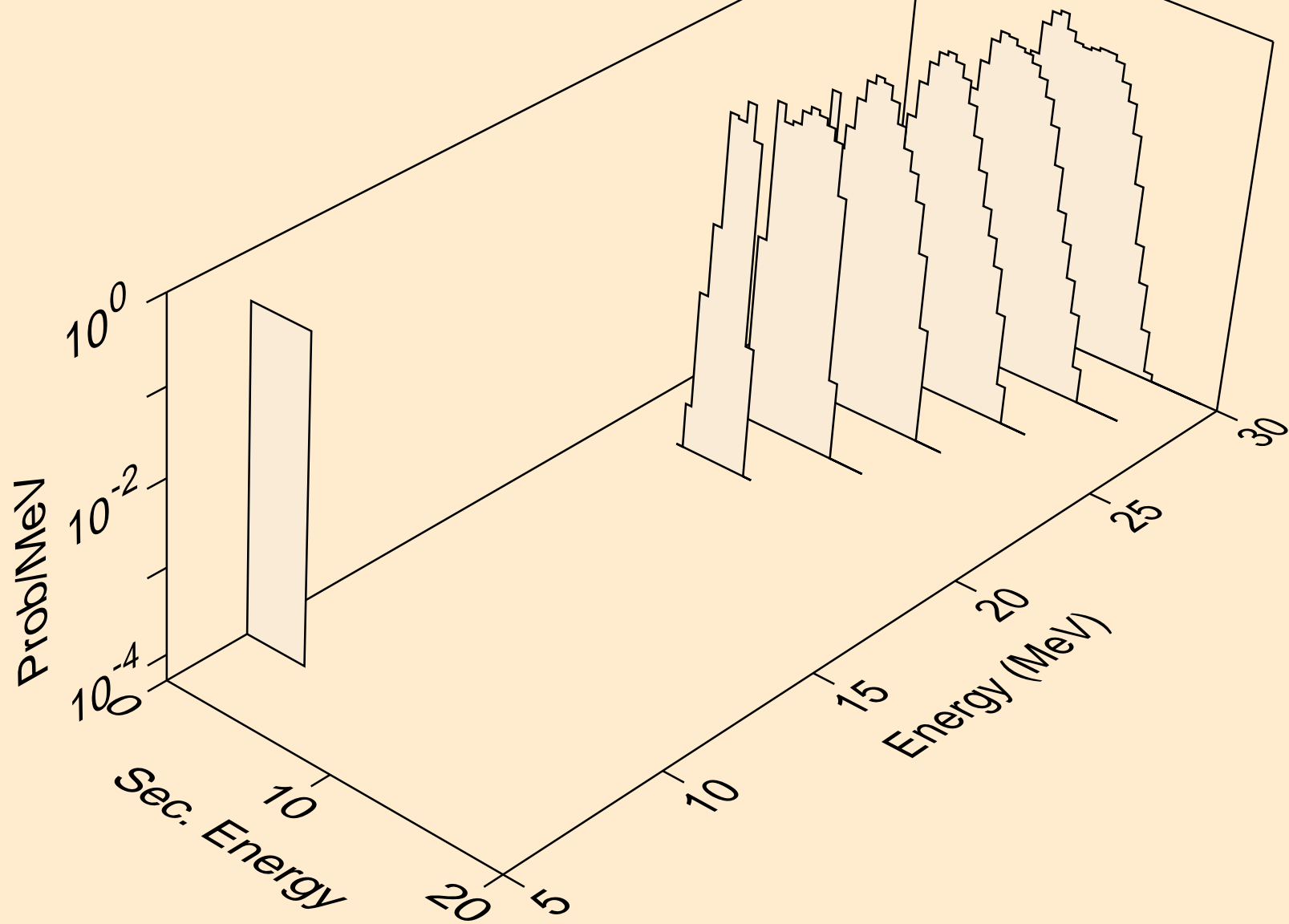

BA118 NEUTRON ACER TENDL-2021 LIBRARY; T=293.6K
alphas from (n,npa)

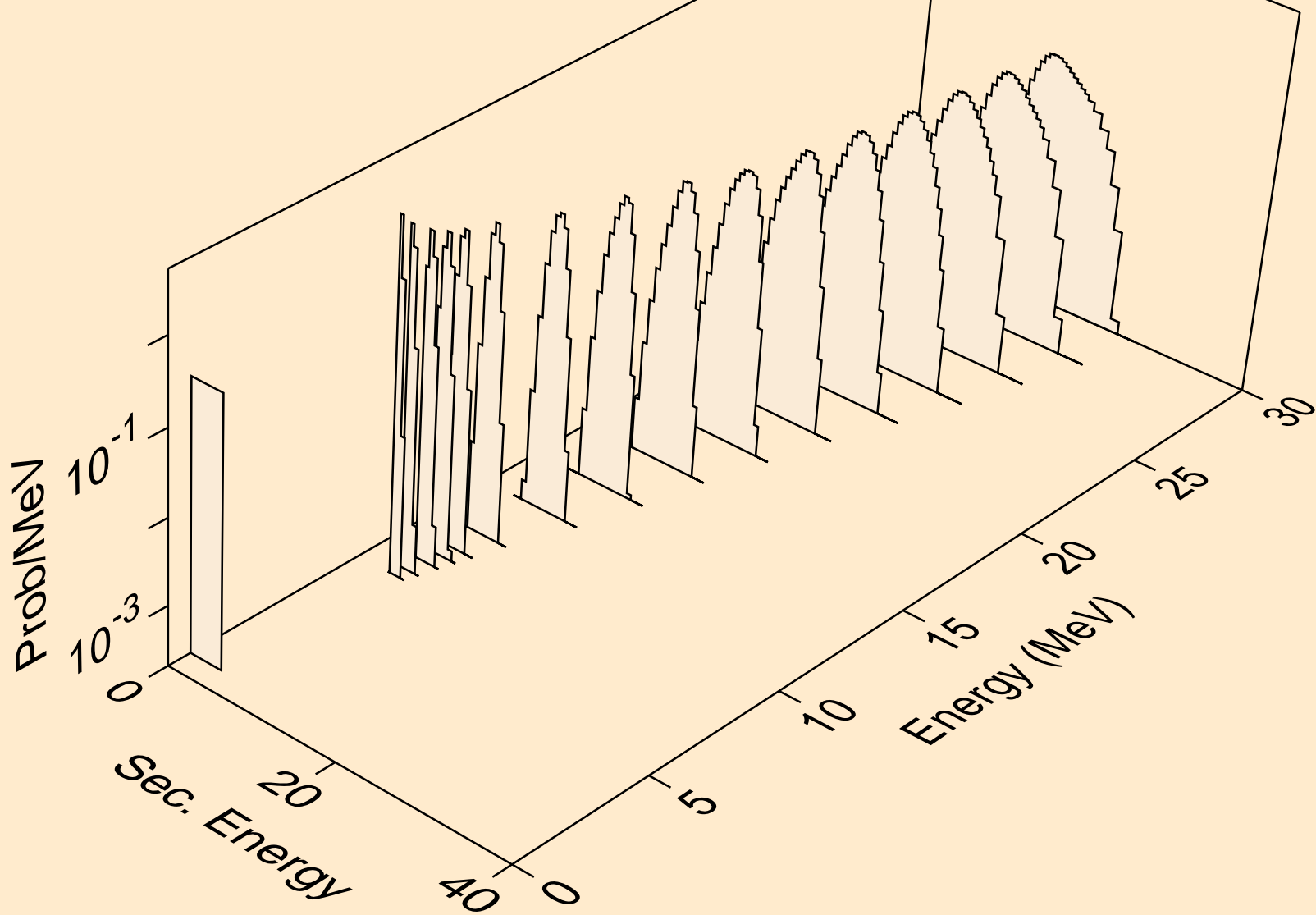

BA118 NEUTRON ACER TENDL-2021 LIBRARY; T=293.6K
alphas from (n,a)

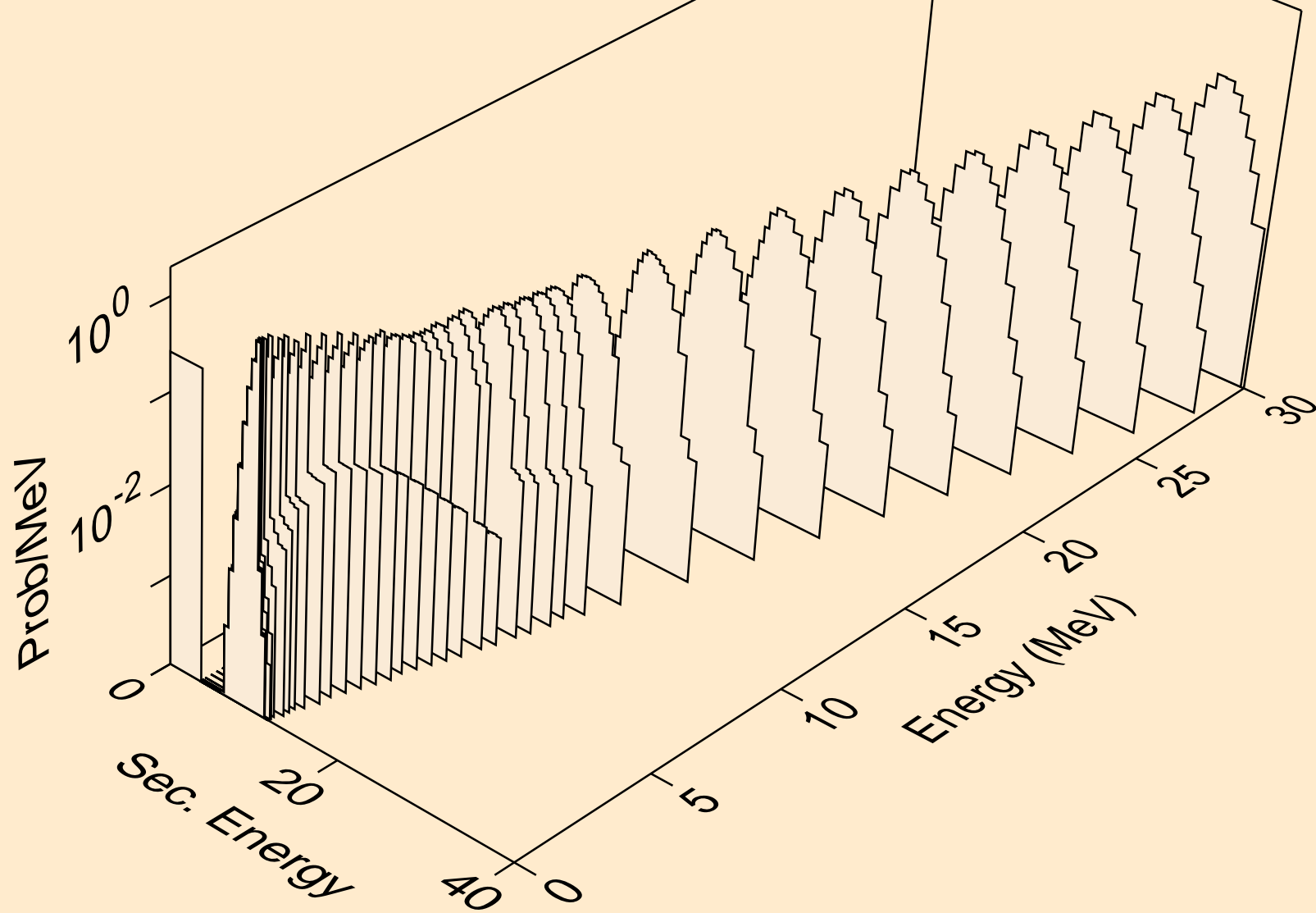

BA118 NEUTRON ACER TENDL-2021 LIBRARY; T=293.6K
alphas from (n,2a)

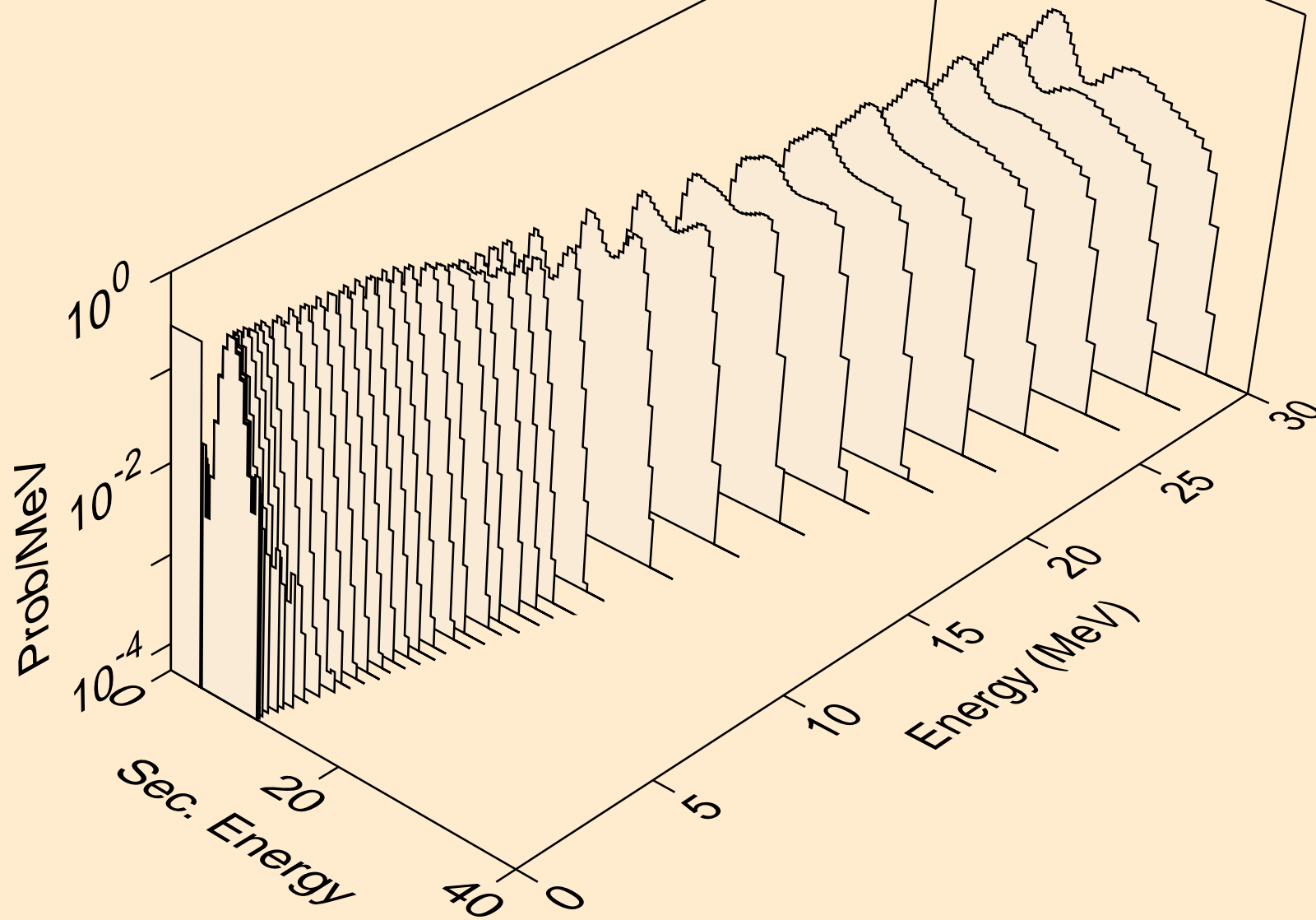

BA118 NEUTRON ACER TENDL-2021 LIBRARY; T=293.6K
alphas from (n,3a)

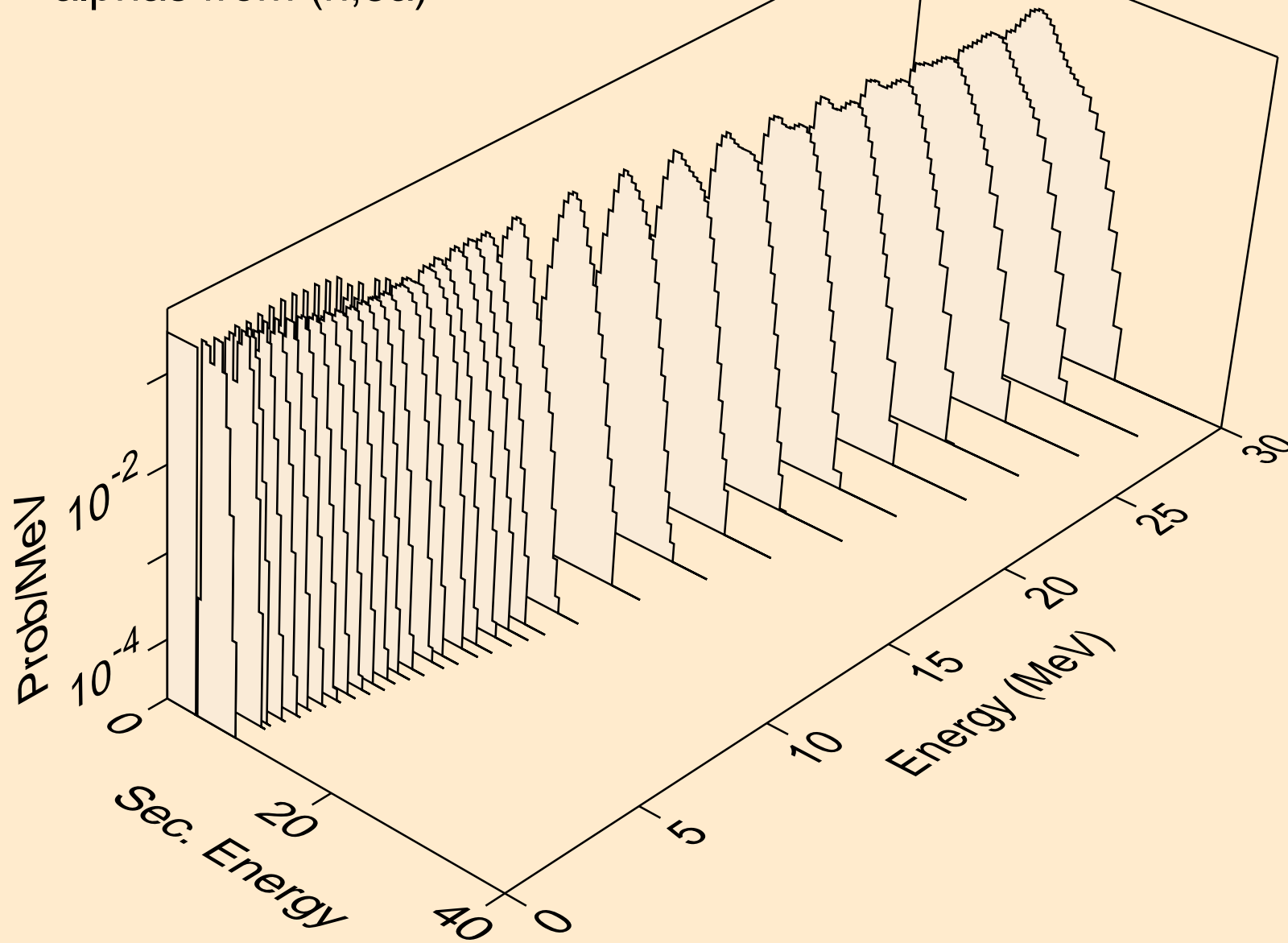

BA118 NEUTRON ACER TENDL-2021 LIBRARY; T=293.6K
alphas from (n,p)

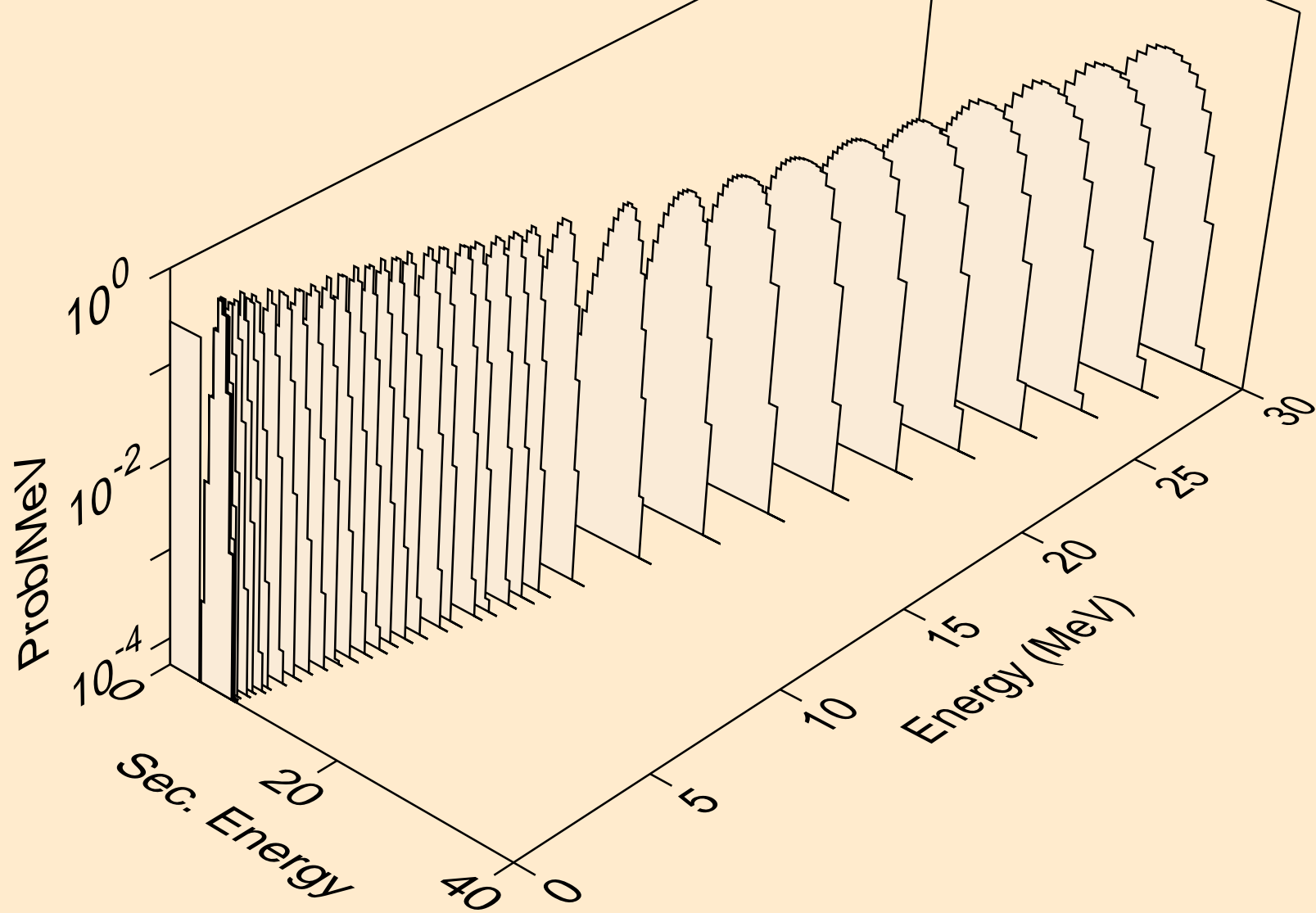

BA118 NEUTRON ACER TENDL-2021 LIBRARY; T=293.6K
alphas from (n,d2a)

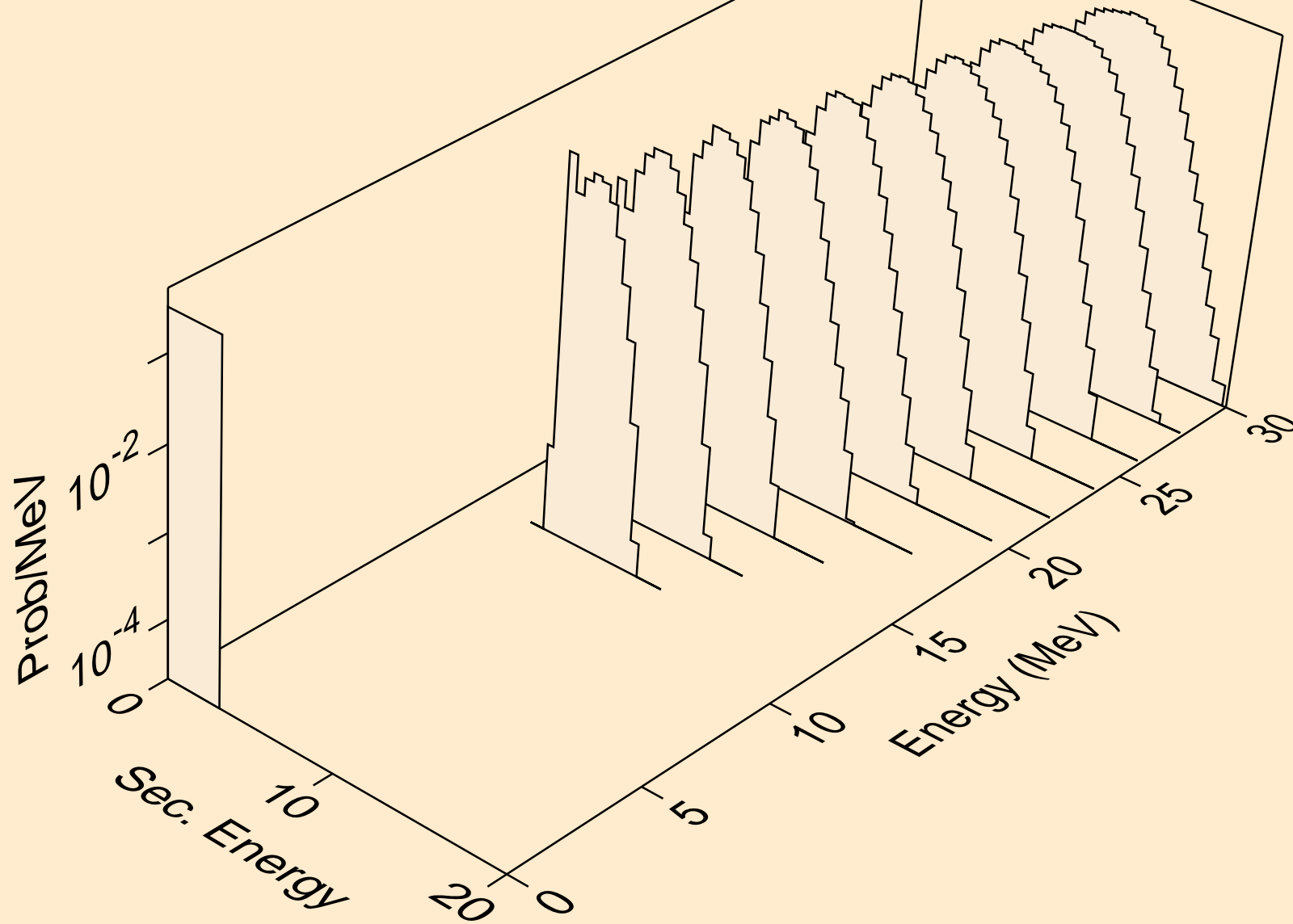

BA118 NEUTRON ACER TENDL-2021 LIBRARY; T=293.6K
alphas from (n,da)

