

# BA120 NEUTRON ACER TENDL-2021 LIBRARY; T=293.6K

## Principal cross sections

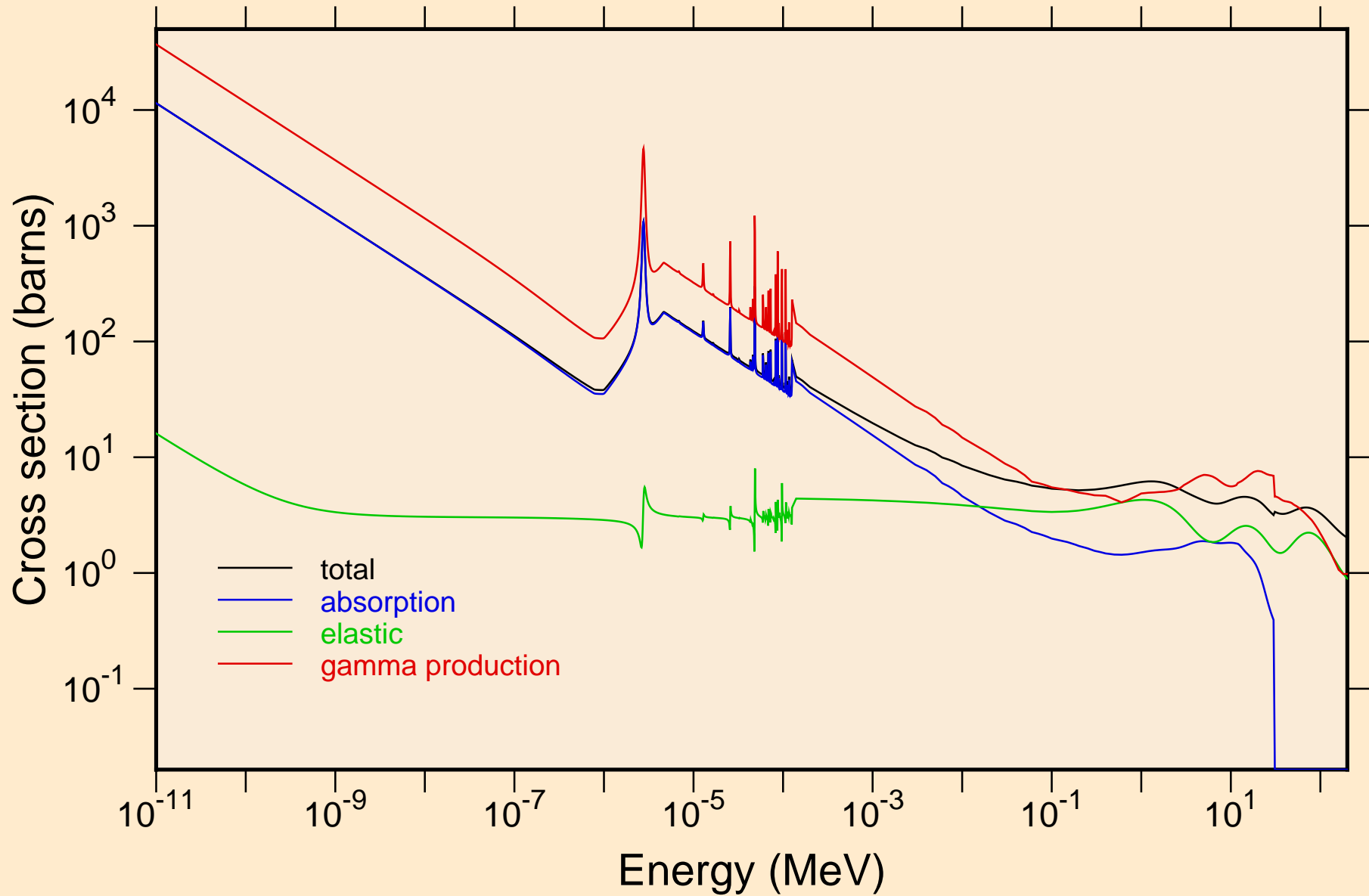

BA120 NEUTRON ACER TENDL-2021 LIBRARY; T=293.6K  
resonance total cross section

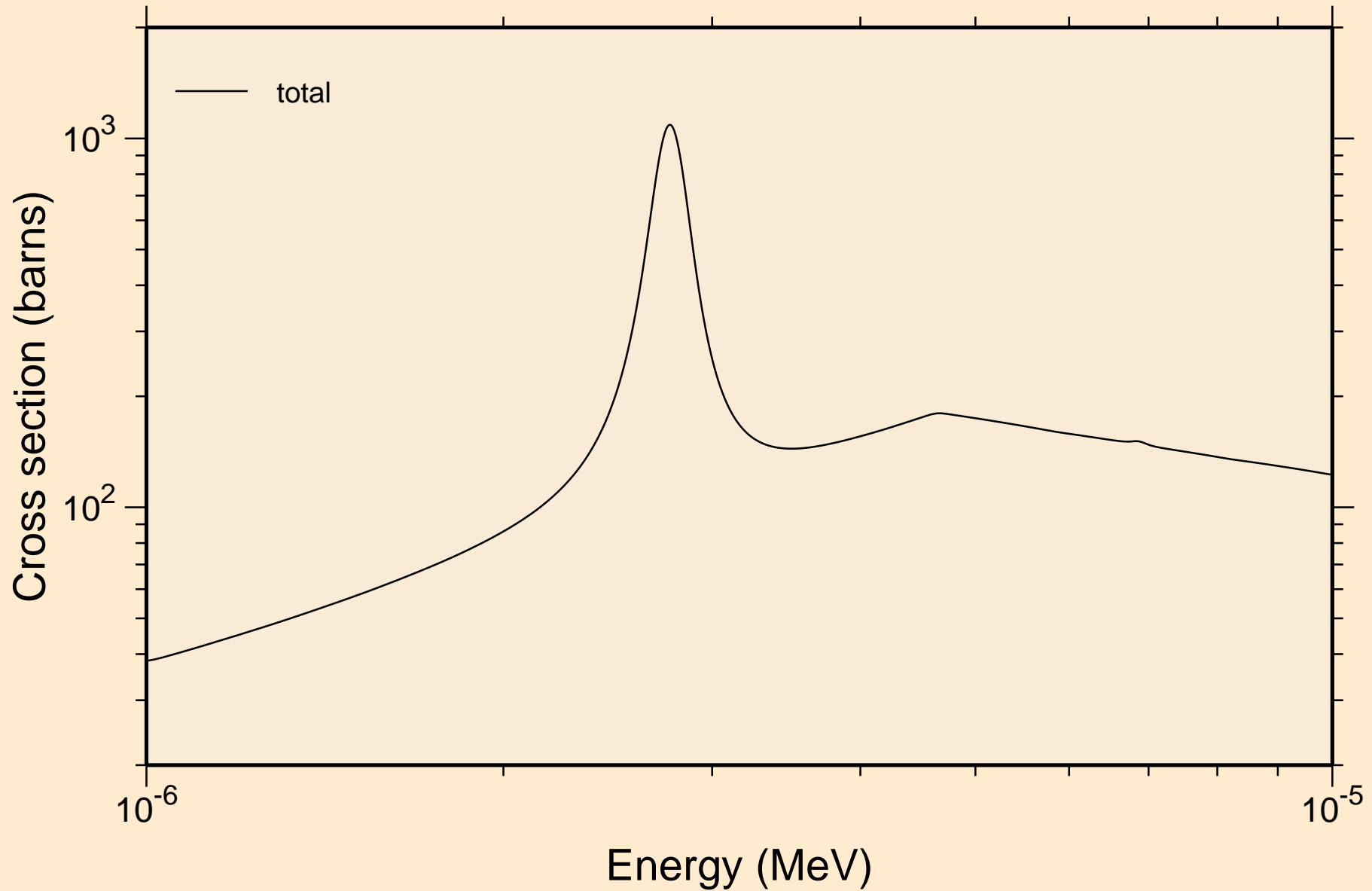

BA120 NEUTRON ACER TENDL-2021 LIBRARY; T=293.6K  
resonance total cross section

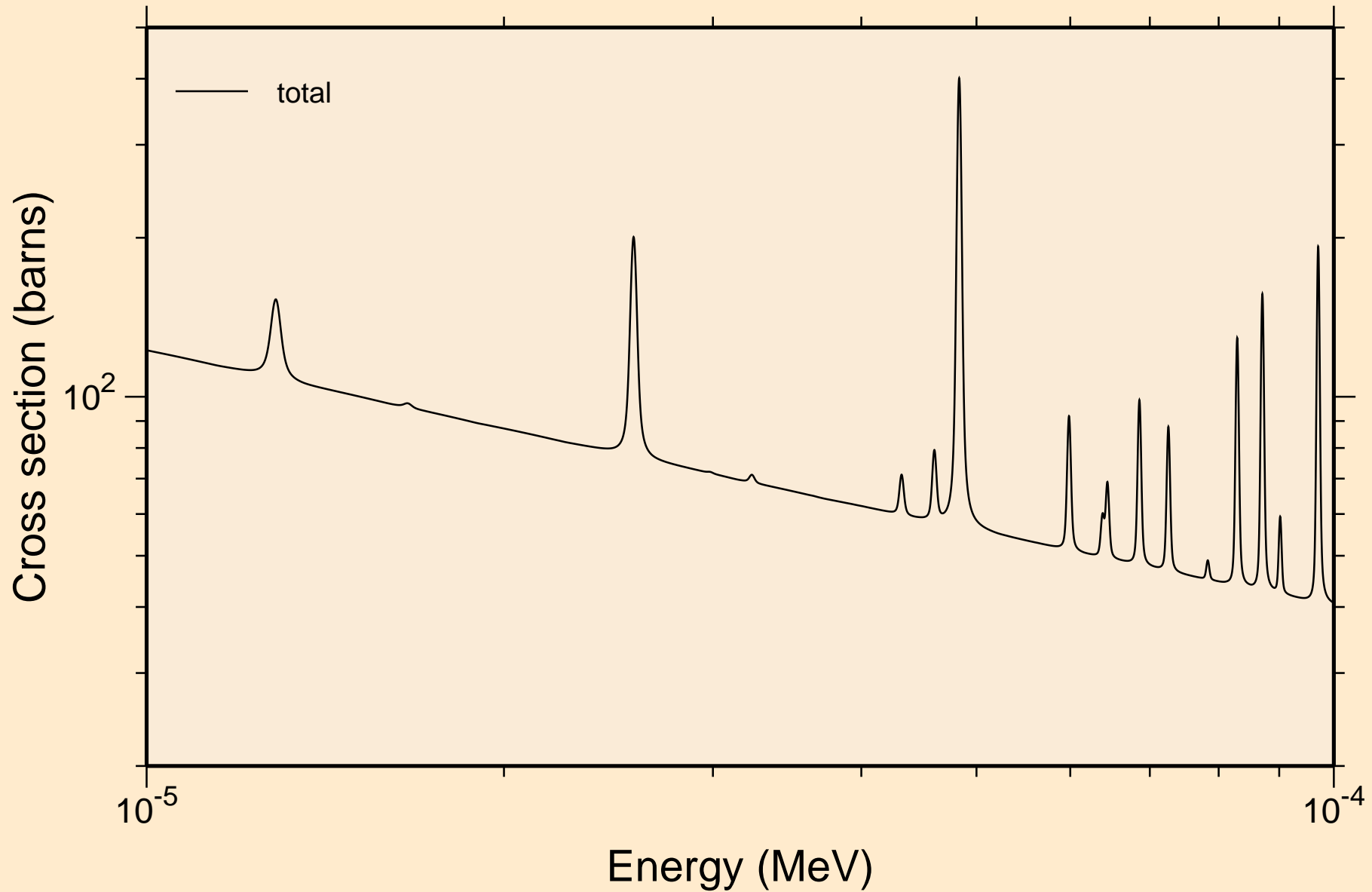

BA120 NEUTRON ACER TENDL-2021 LIBRARY; T=293.6K  
resonance total cross section

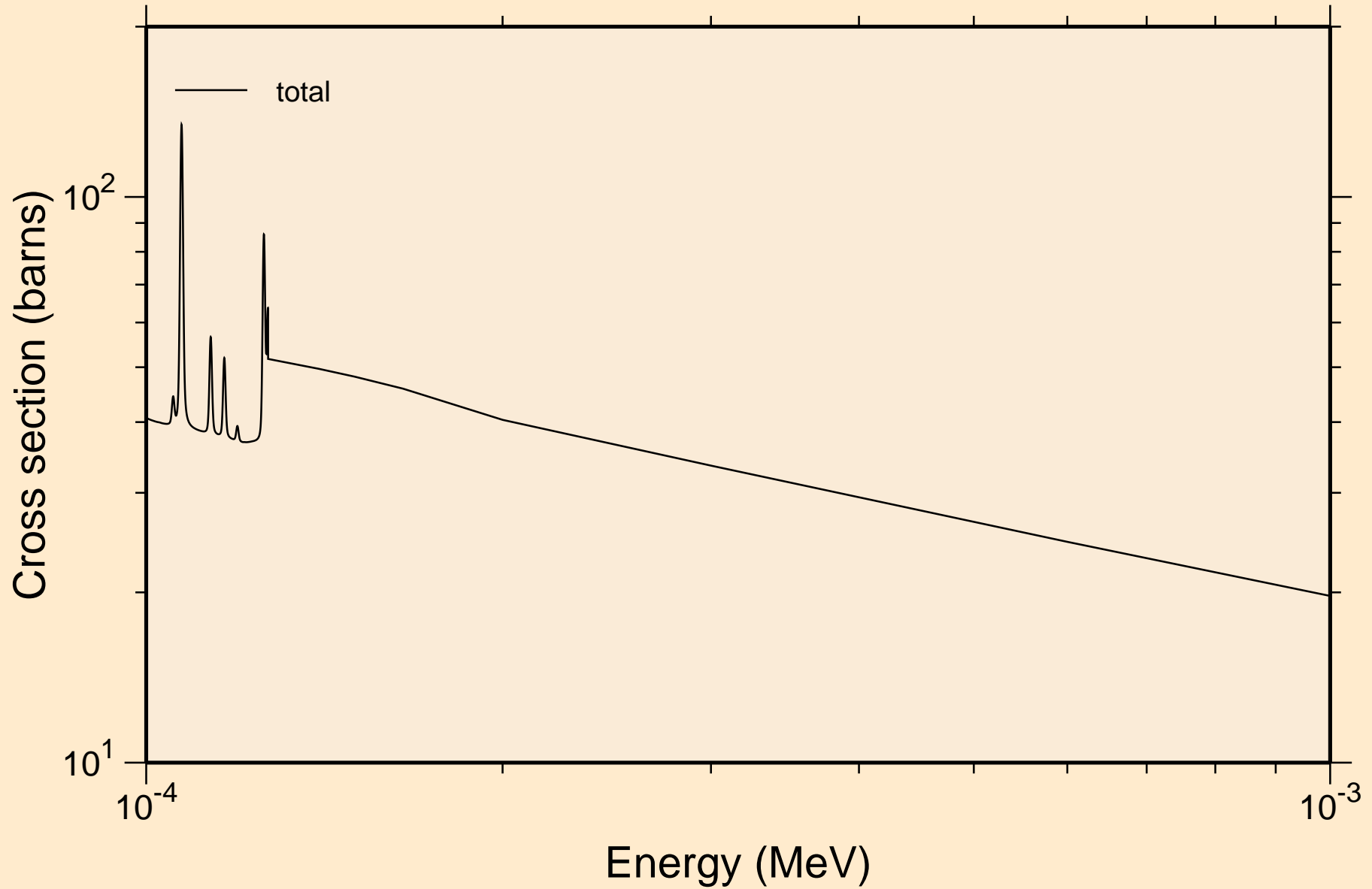

BA120 NEUTRON ACER TENDL-2021 LIBRARY; T=293.6K  
resonance total cross section

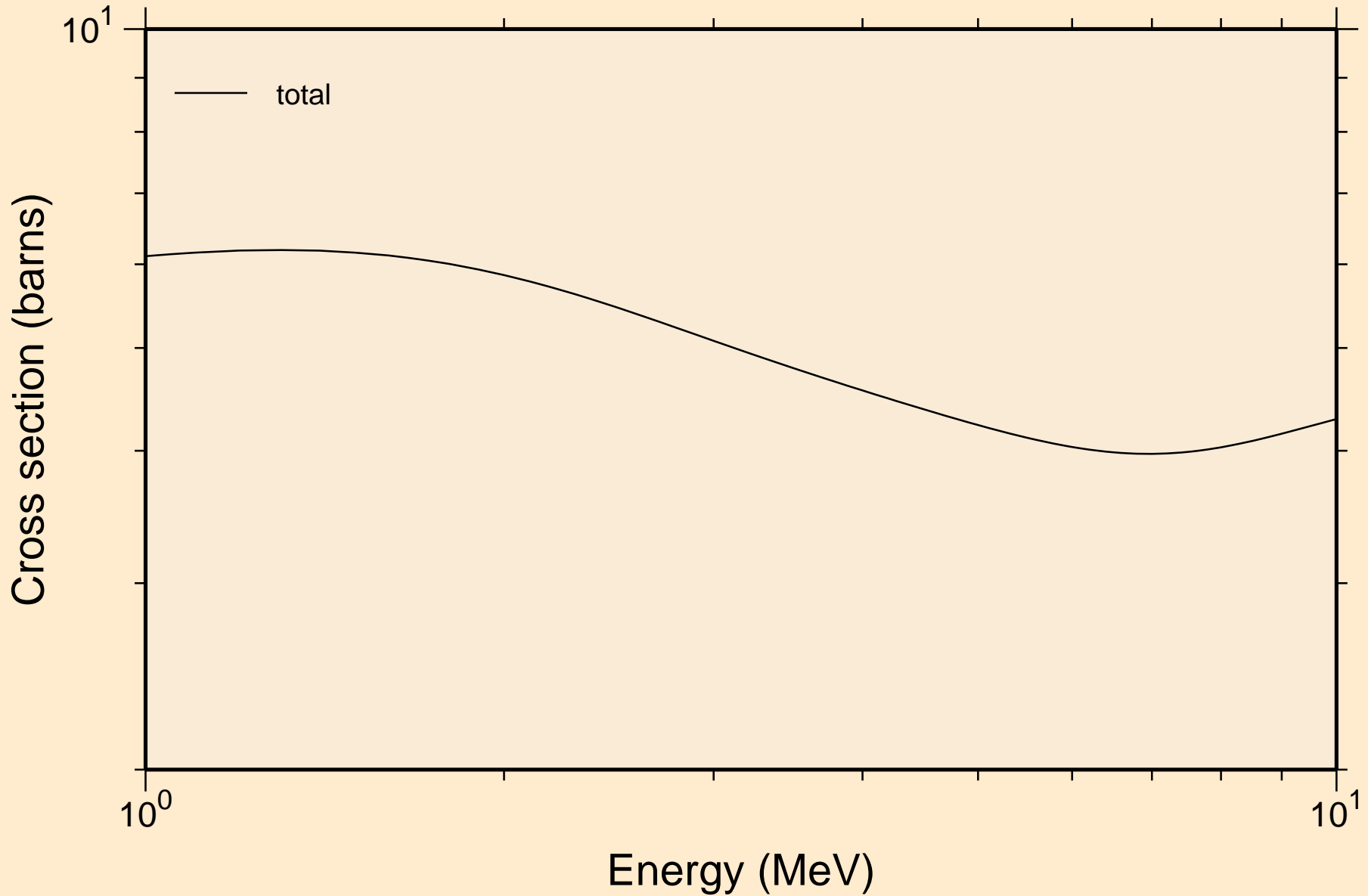

BA120 NEUTRON ACER TENDL-2021 LIBRARY; T=293.6K  
resonance absorption cross sections

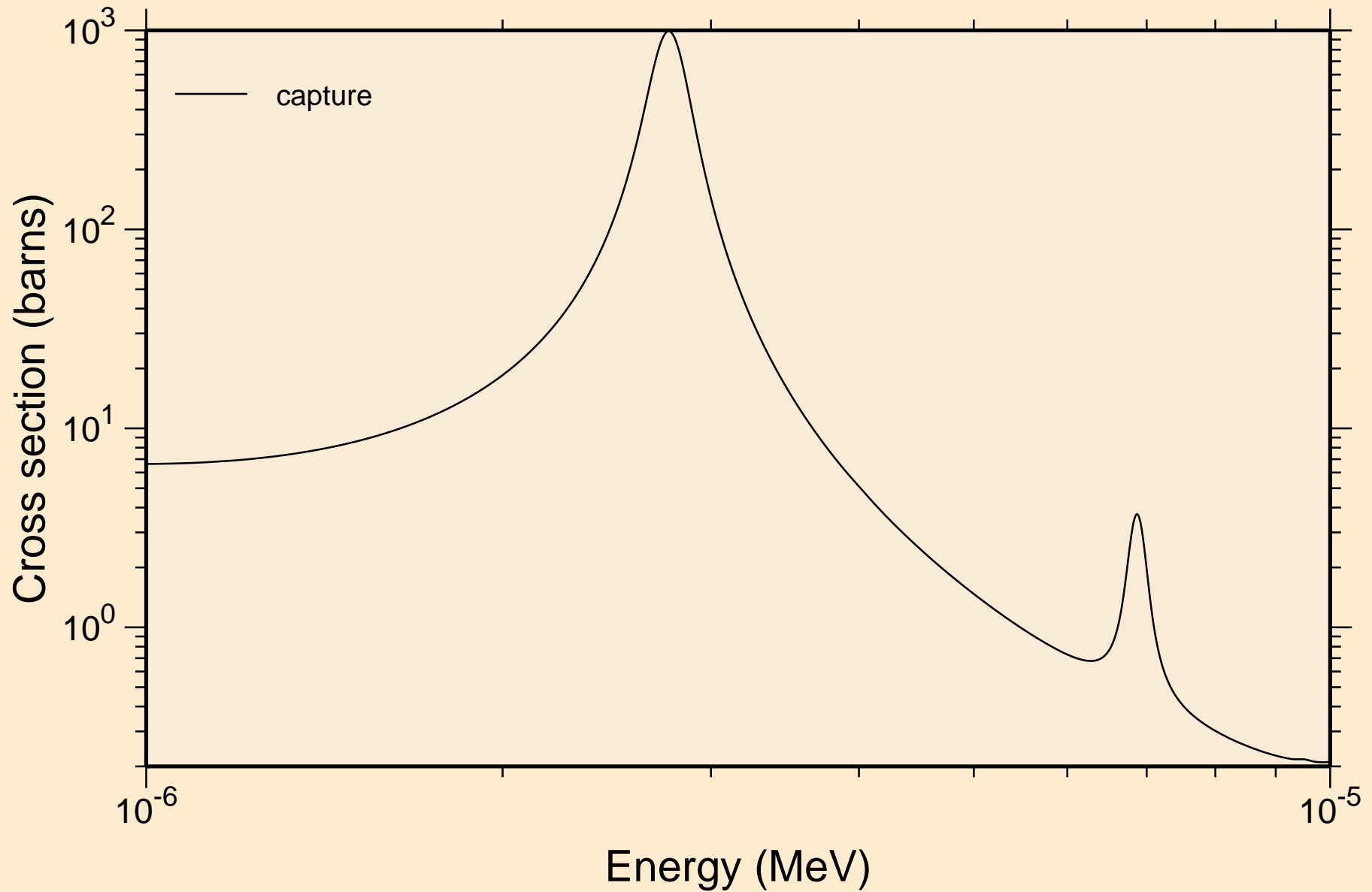

BA120 NEUTRON ACER TENDL-2021 LIBRARY; T=293.6K  
resonance absorption cross sections

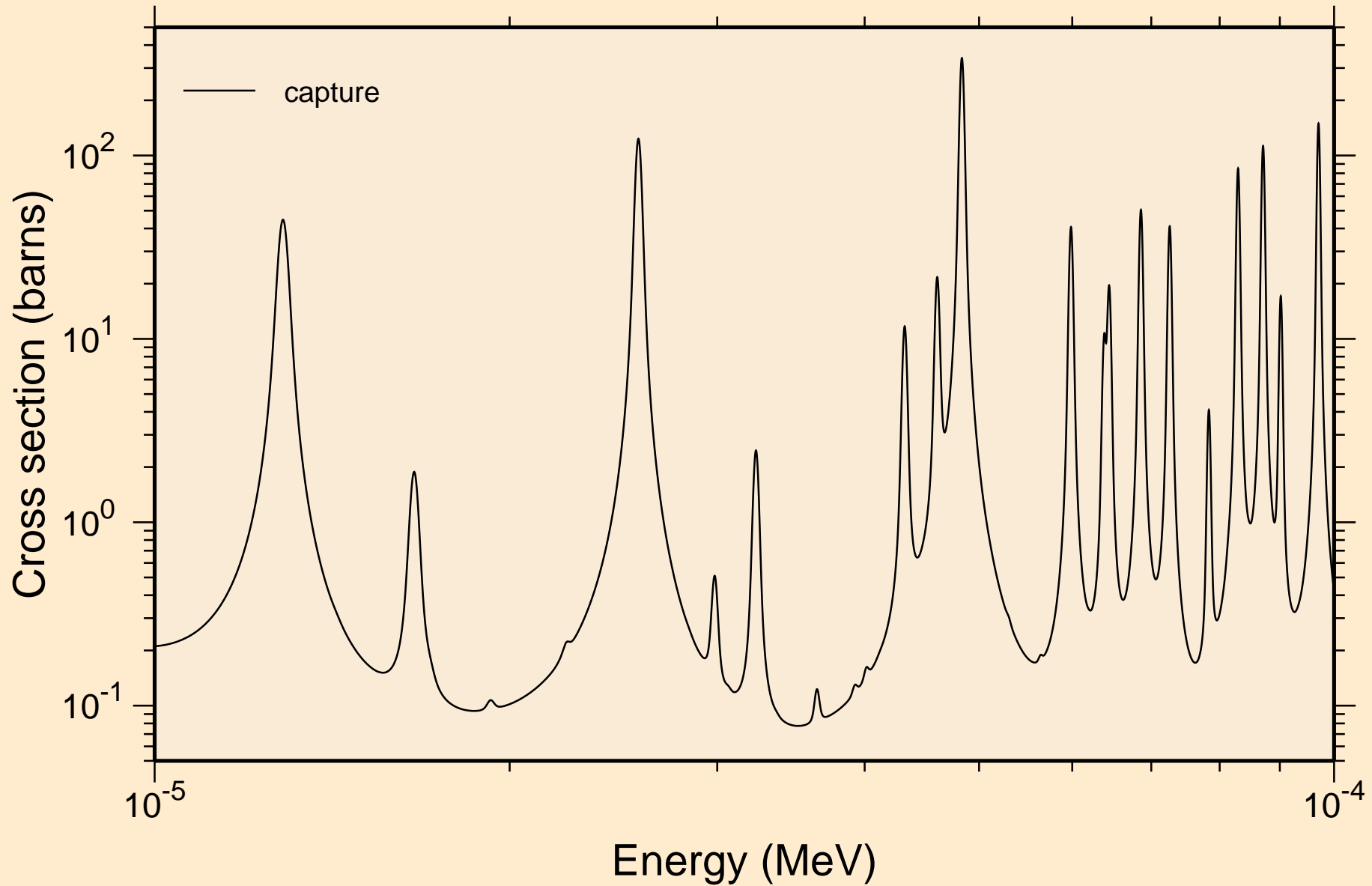

BA120 NEUTRON ACER TENDL-2021 LIBRARY; T=293.6K  
resonance absorption cross sections

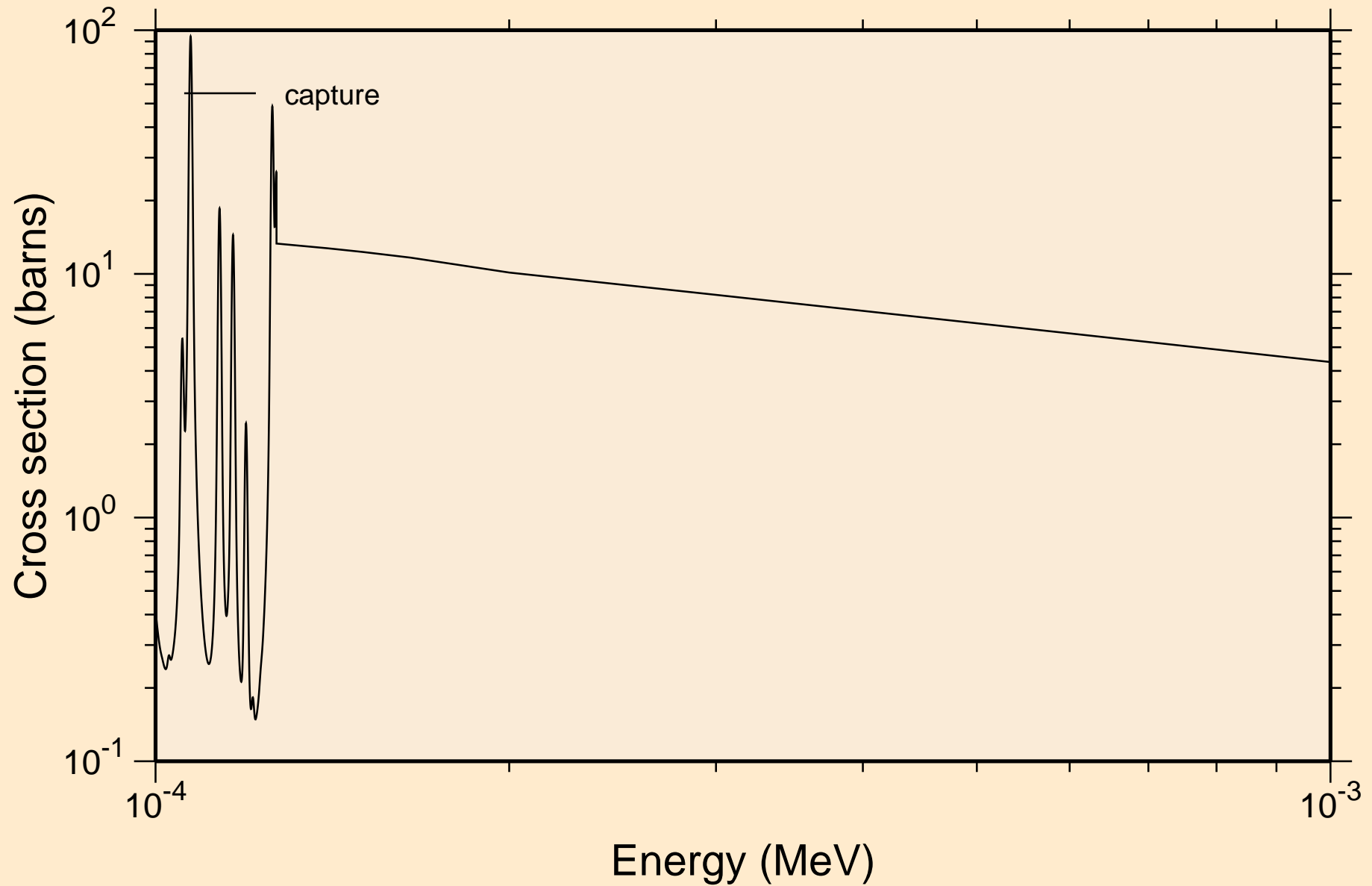



BA120 NEUTRON ACER TENDL-2021 LIBRARY; T=293.6K  
resonance absorption cross sections

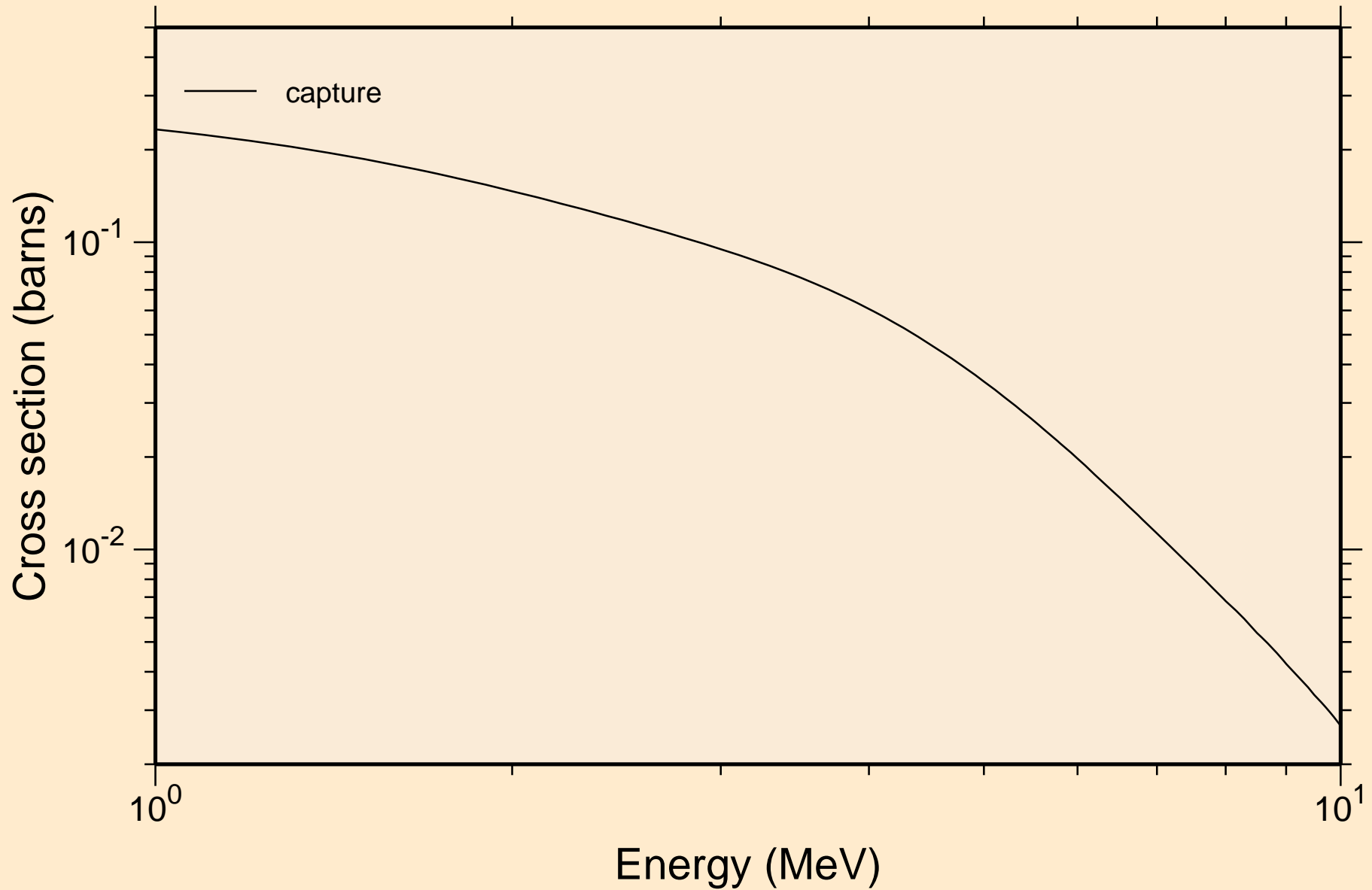

BA120 NEUTRON ACER TENDL-2021 LIBRARY; T=293.6K  
Heating

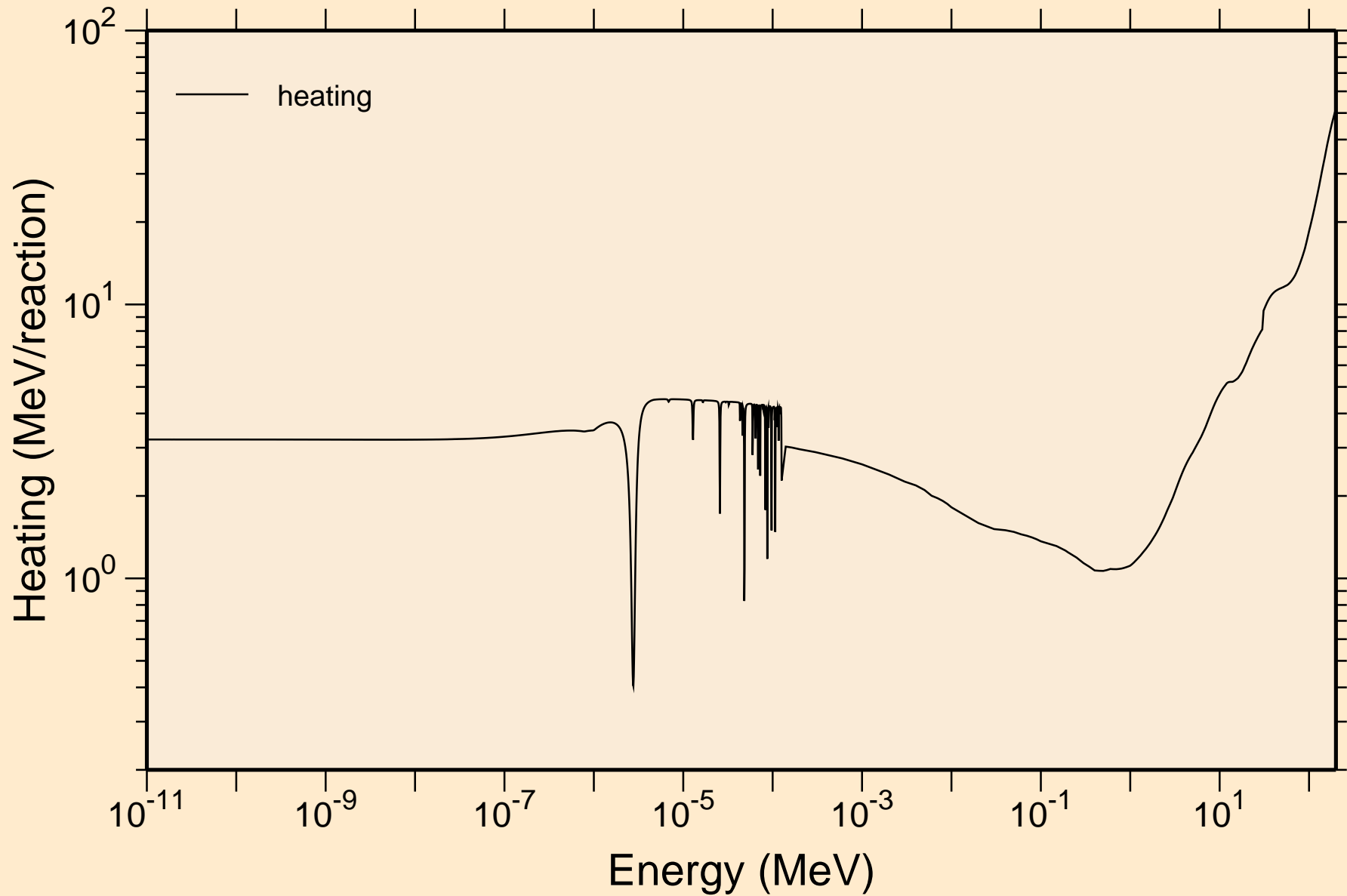

BA120 NEUTRON ACER TENDL-2021 LIBRARY; T=293.6K  
Damage

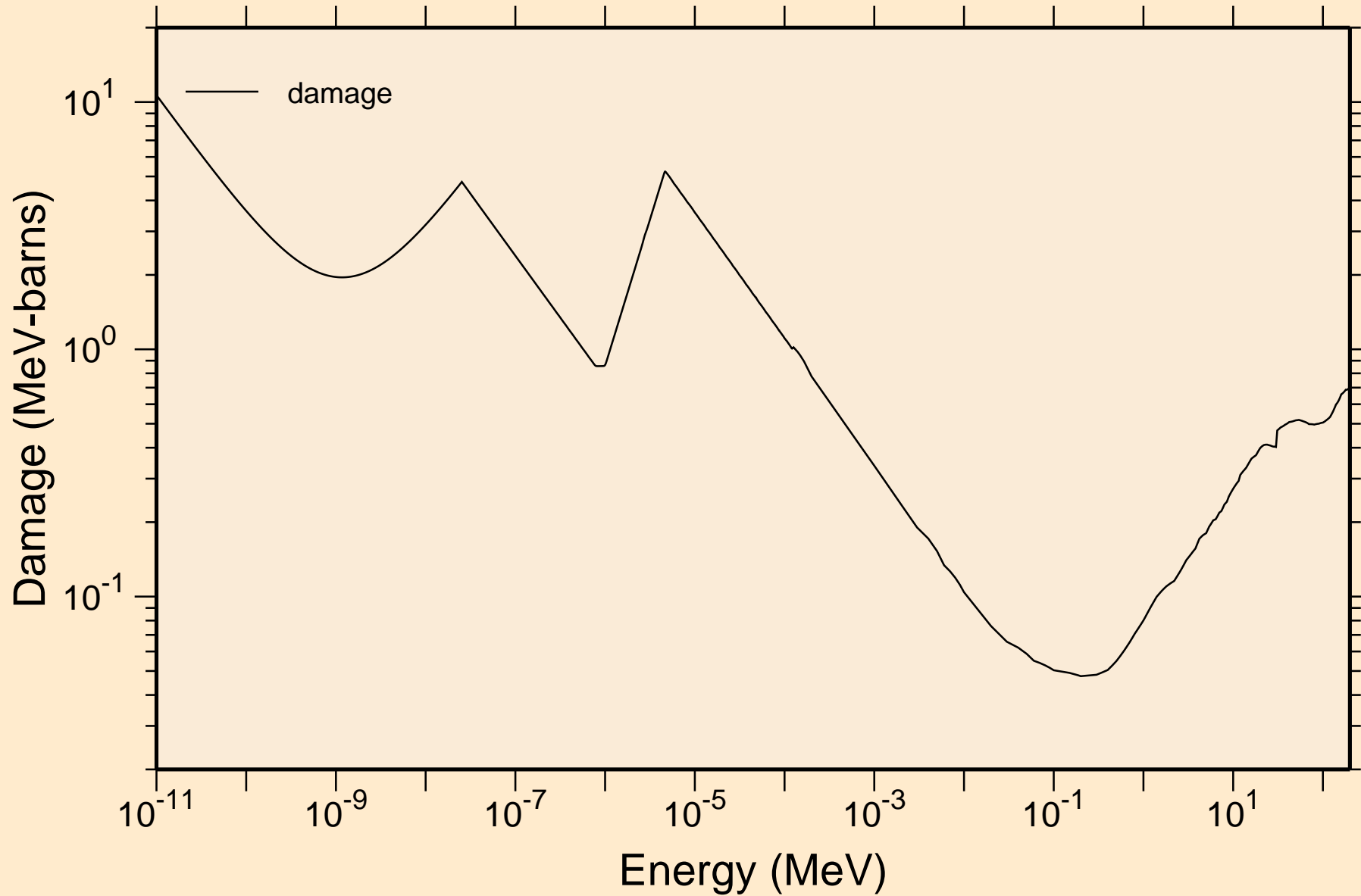

BA120 NEUTRON ACER TENDL-2021 LIBRARY; T=293.6K  
Non-threshold reactions

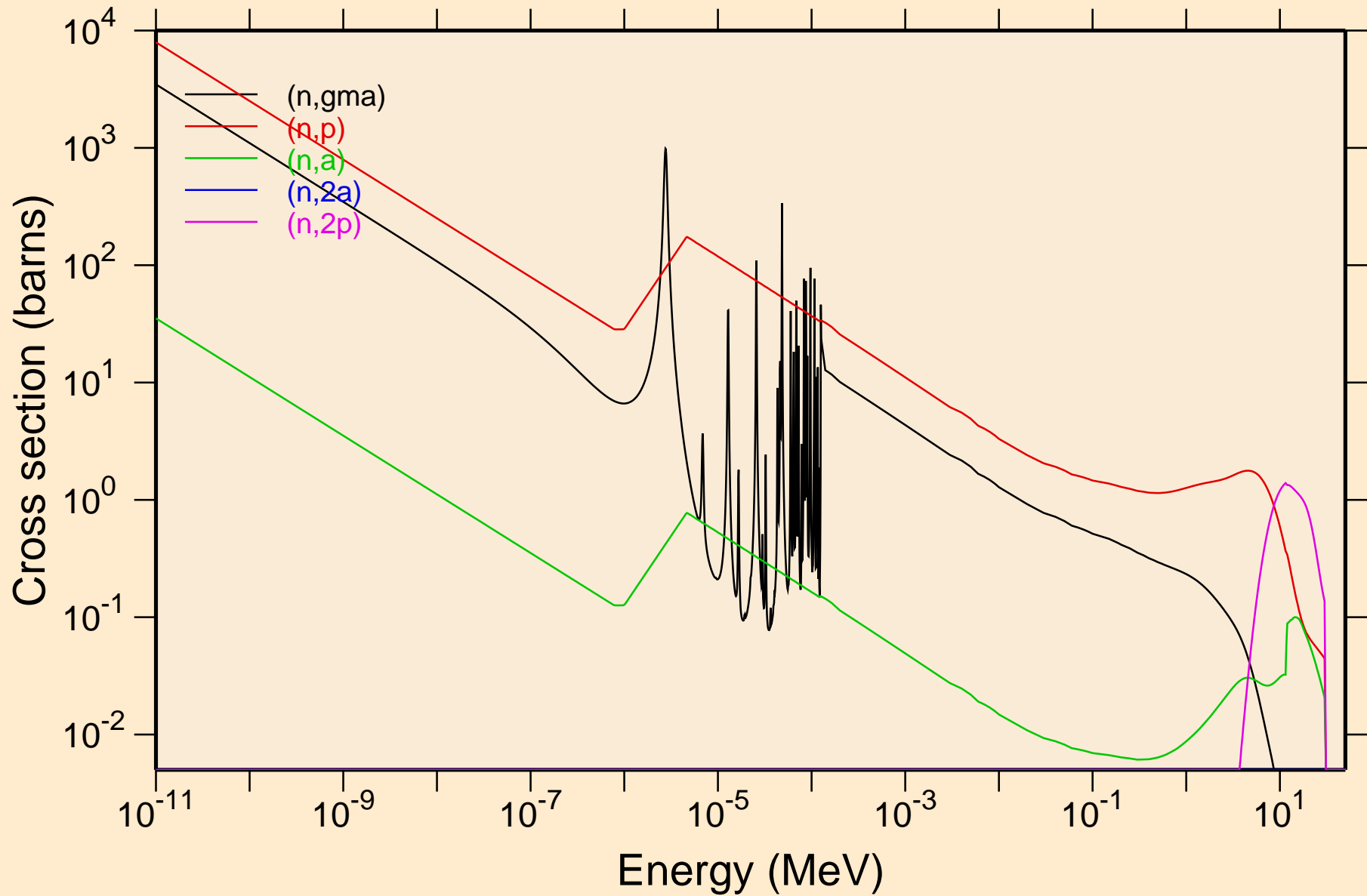

BA120 NEUTRON ACER TENDL-2021 LIBRARY; T=293.6K  
Non-threshold reactions

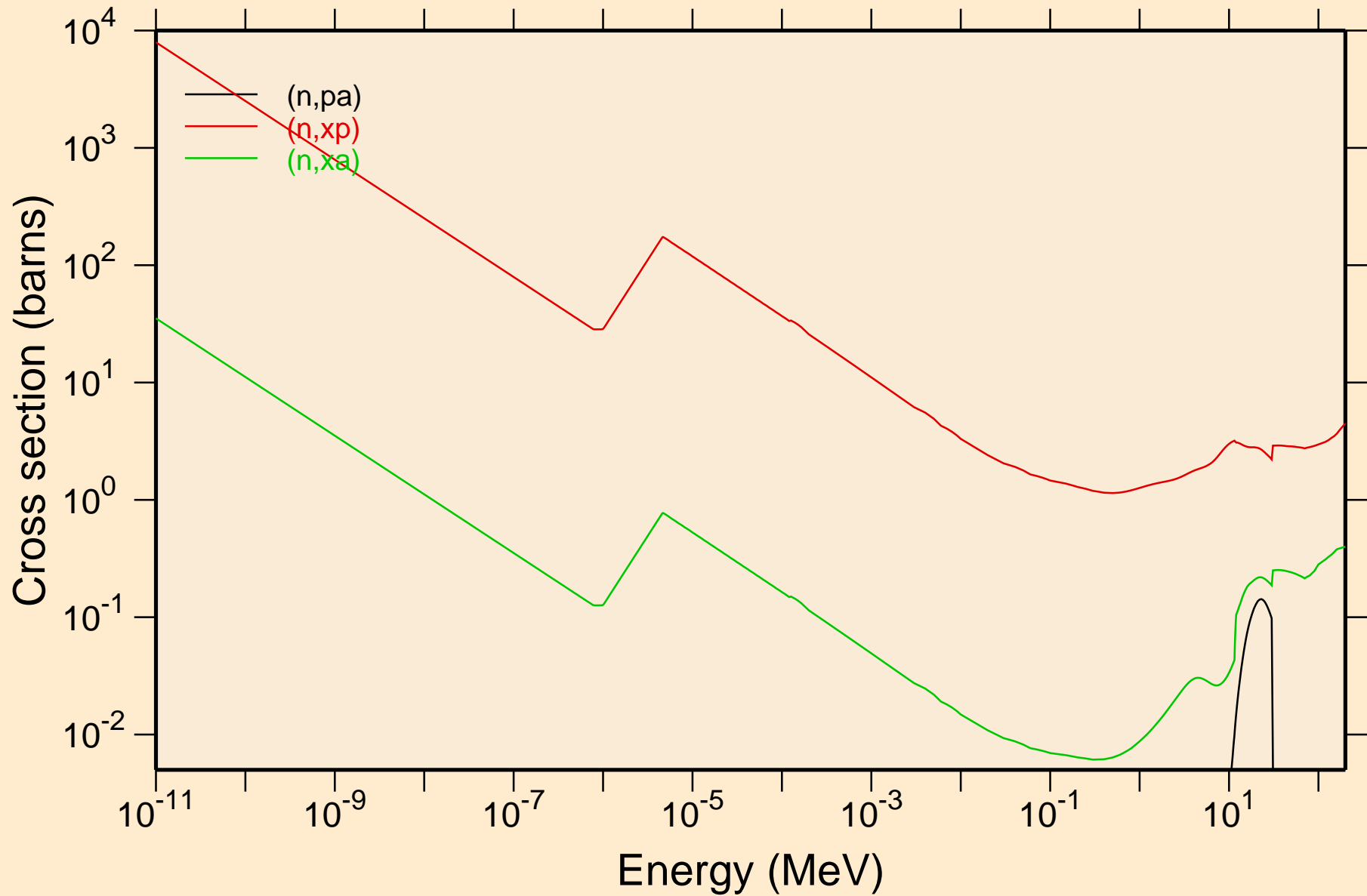

BA120 NEUTRON ACER TENDL-2021 LIBRARY; T=293.6K  
Principal cross sections

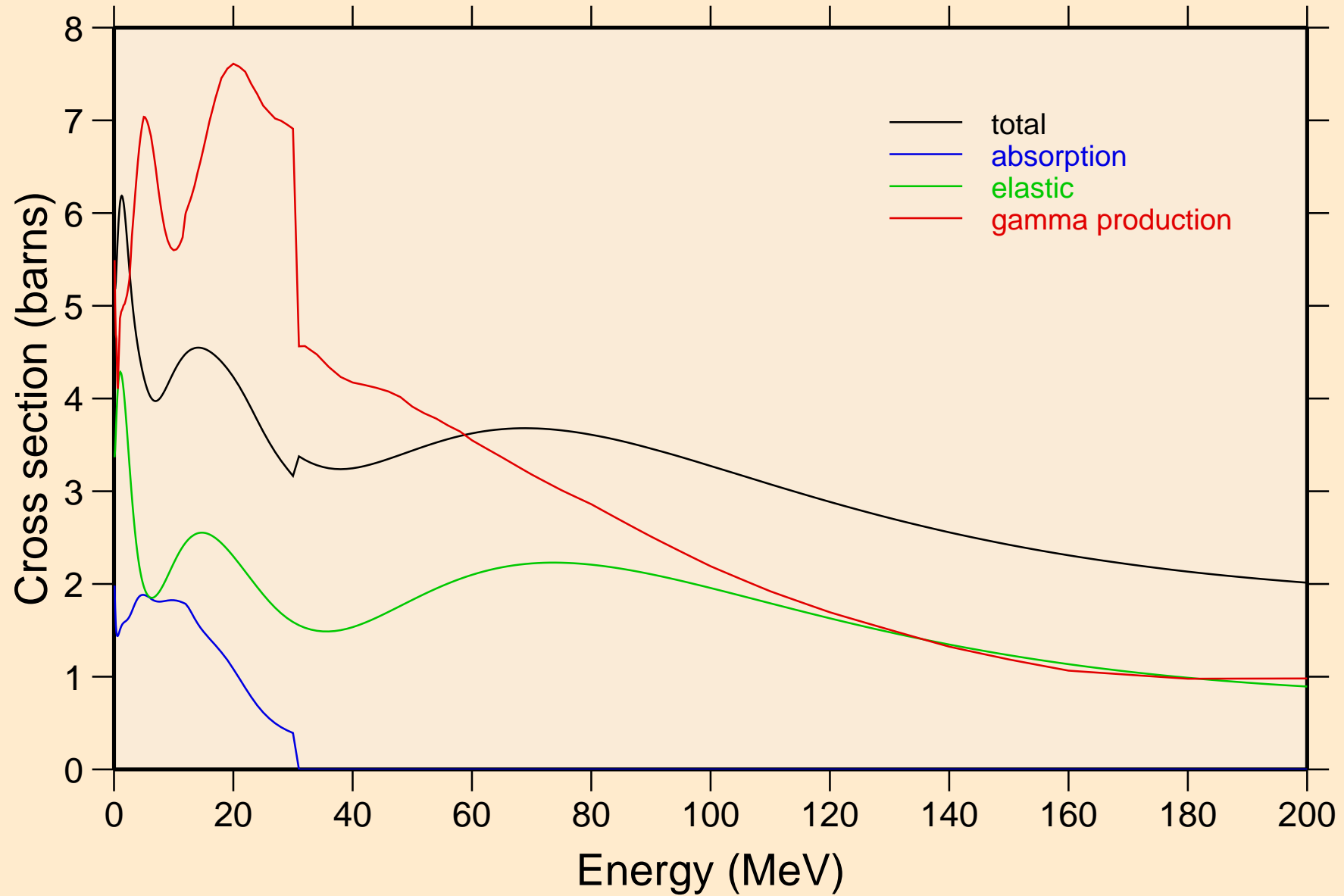

BA120 NEUTRON ACER TENDL-2021 LIBRARY; T=293.6K

Heating

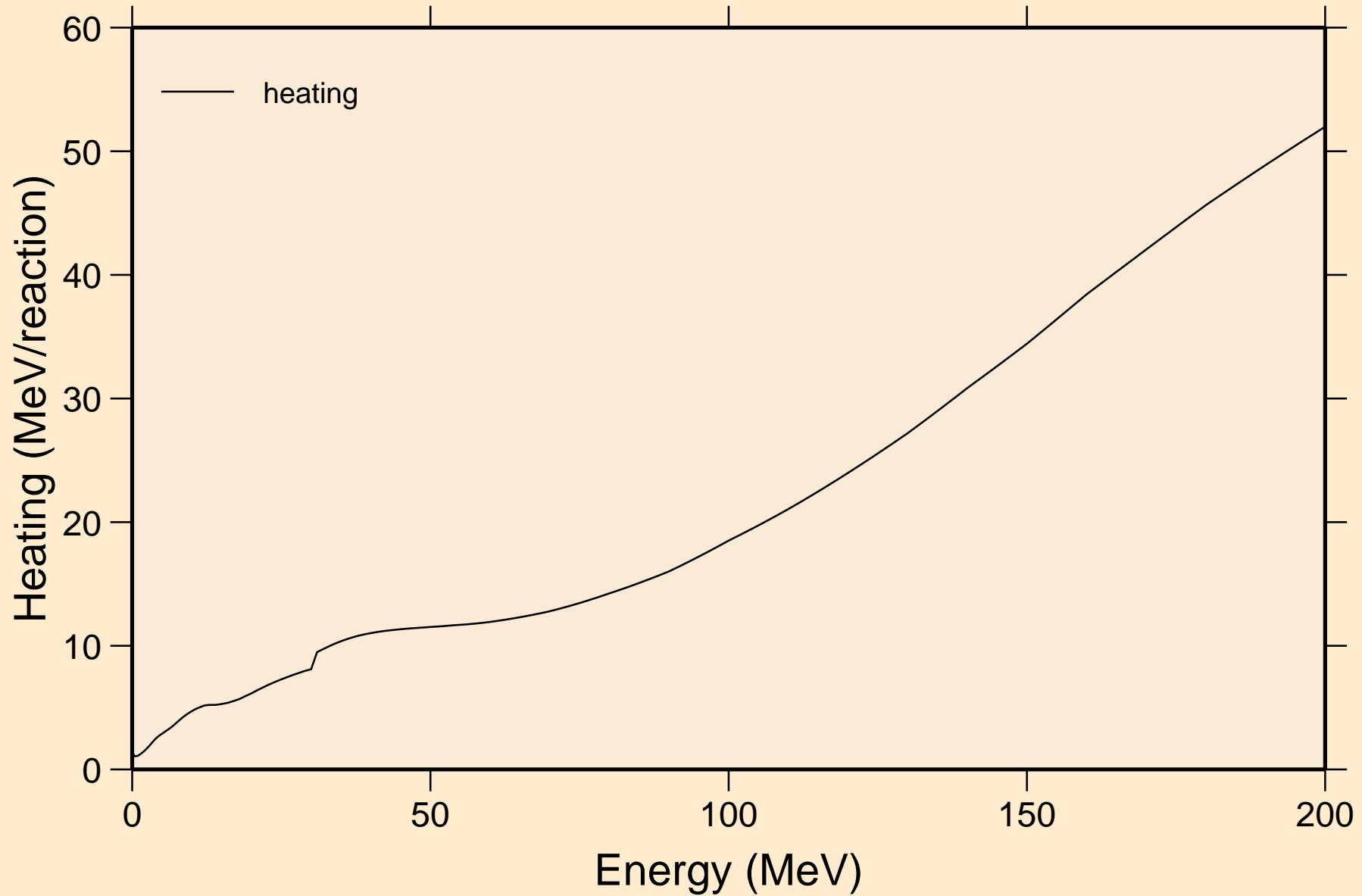

BA120 NEUTRON ACER TENDL-2021 LIBRARY; T=293.6K  
Damage

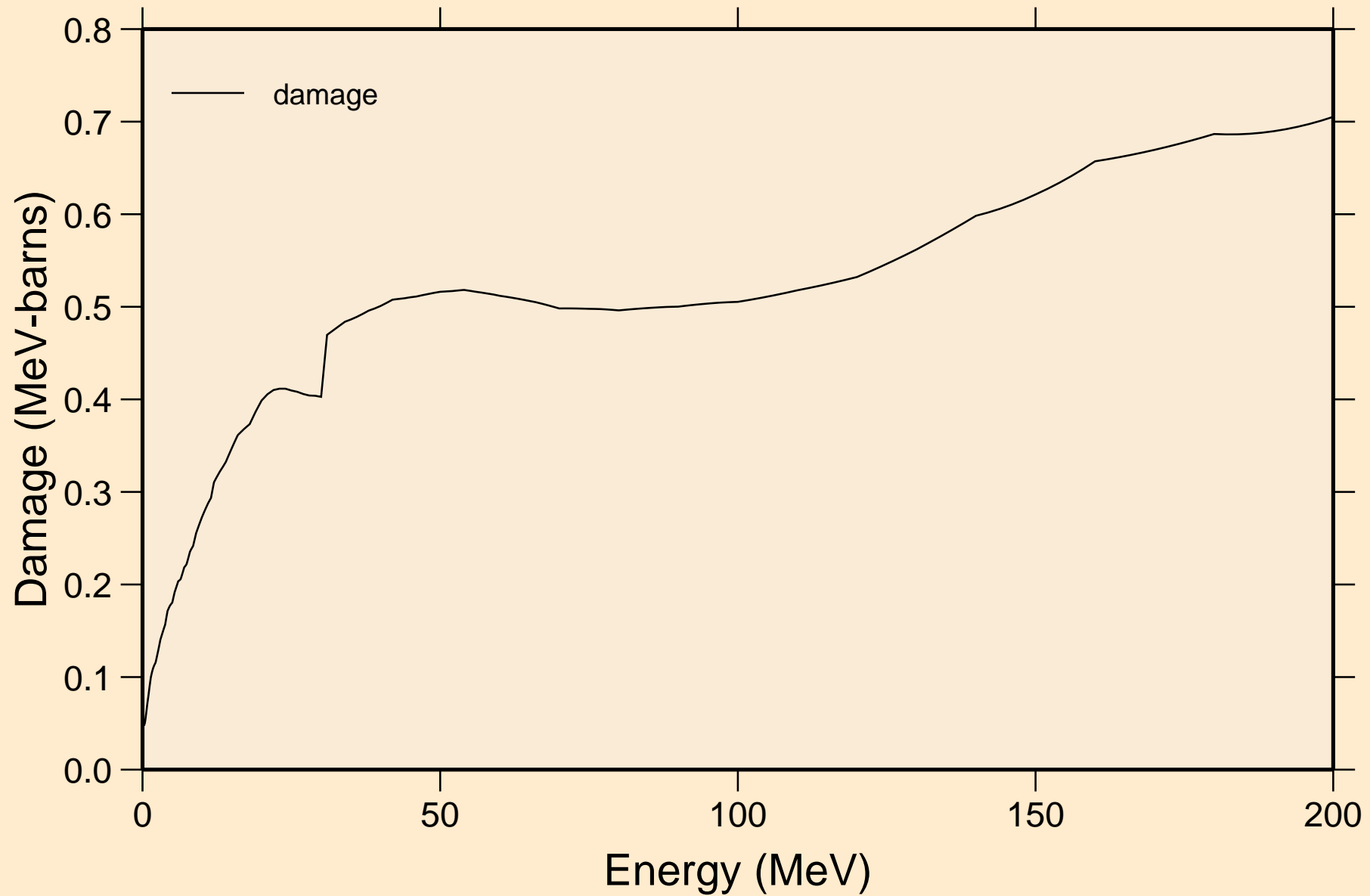



BA120 NEUTRON ACER TENDL-2021 LIBRARY; T=293.6K  
Non-threshold reactions

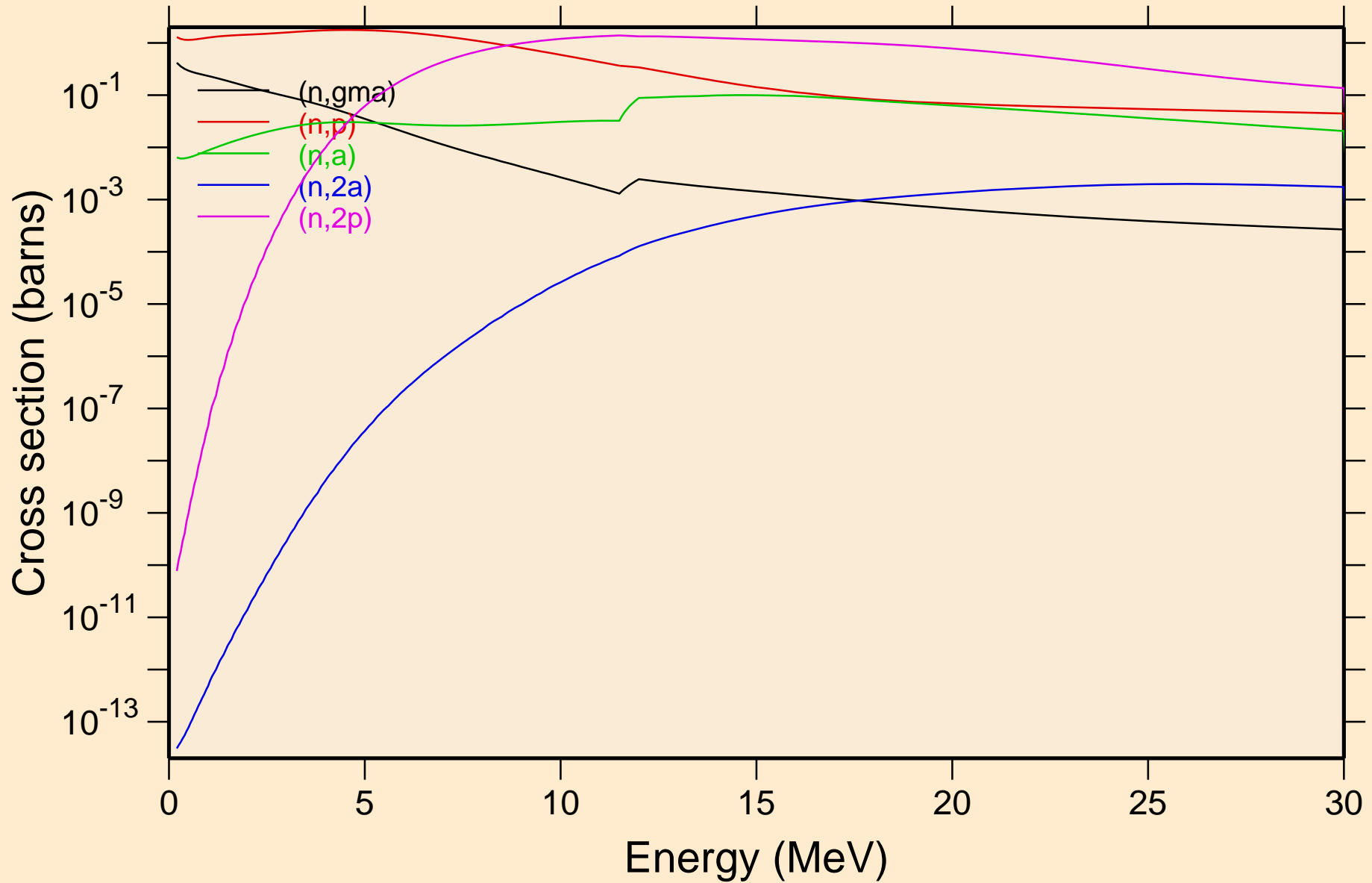

BA120 NEUTRON ACER TENDL-2021 LIBRARY; T=293.6K  
Non-threshold reactions

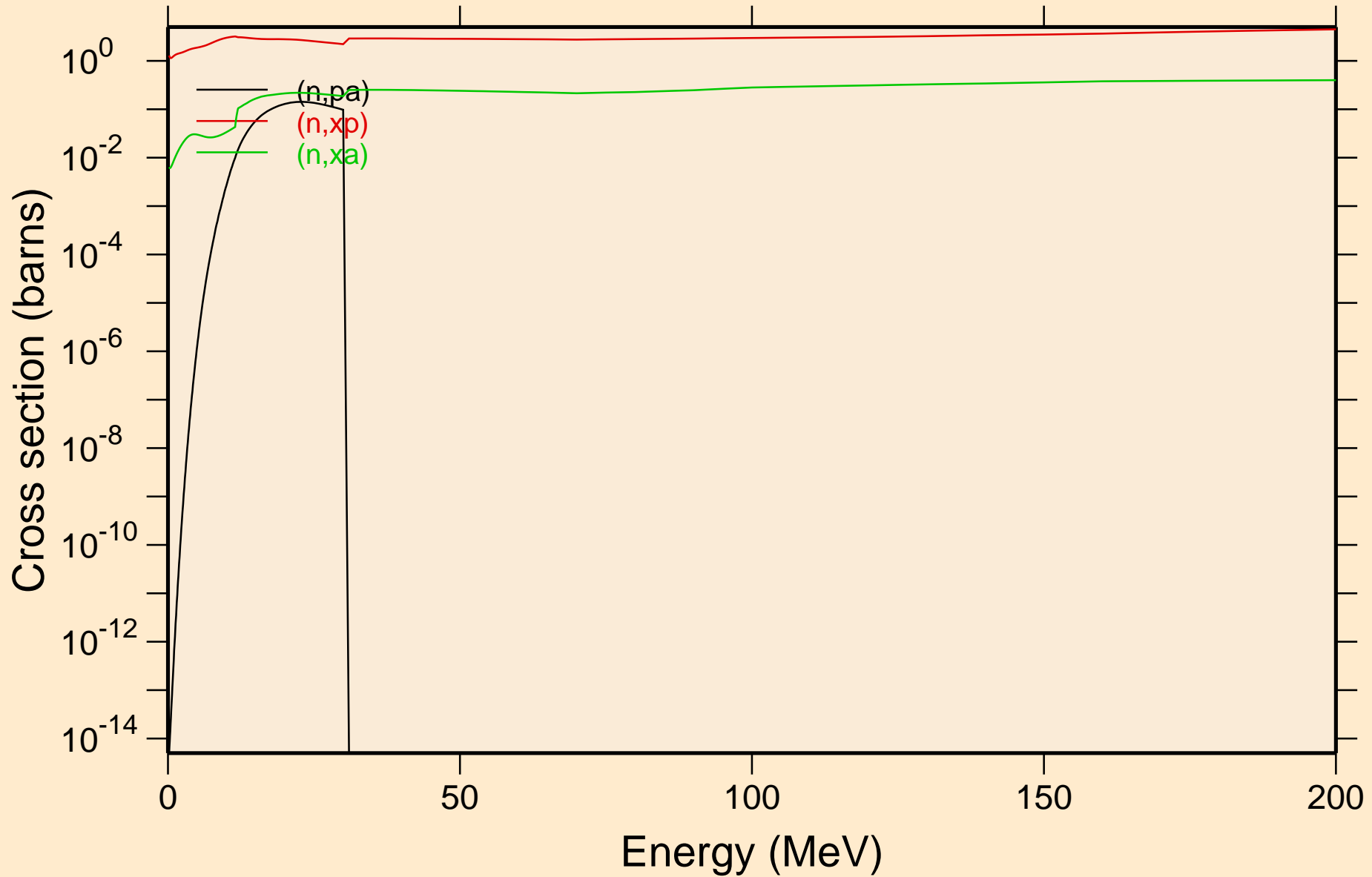

BA120 NEUTRON ACER TENDL-2021 LIBRARY; T=293.6K  
Inelastic levels

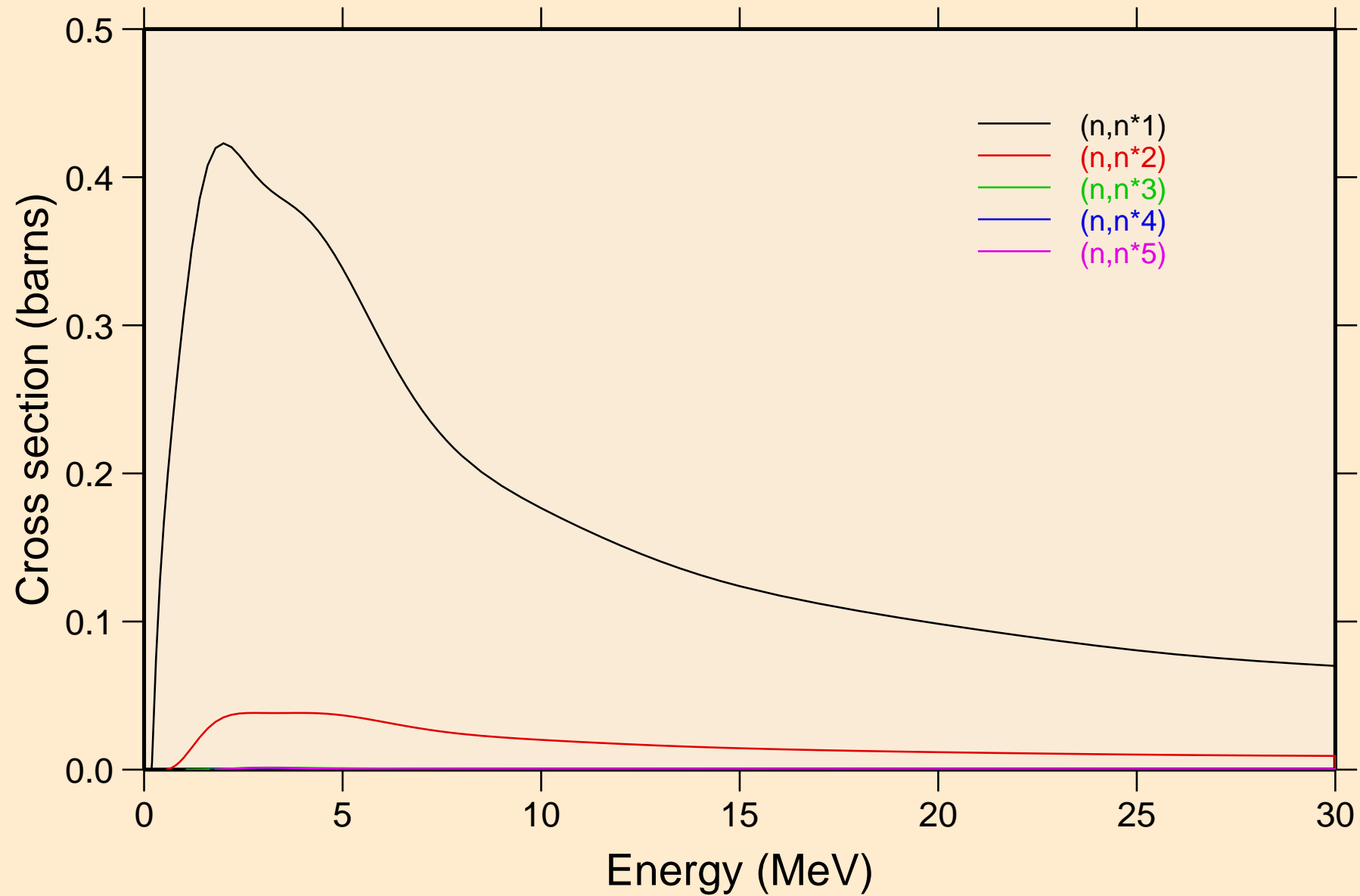

BA120 NEUTRON ACER TENDL-2021 LIBRARY; T=293.6K  
Inelastic levels

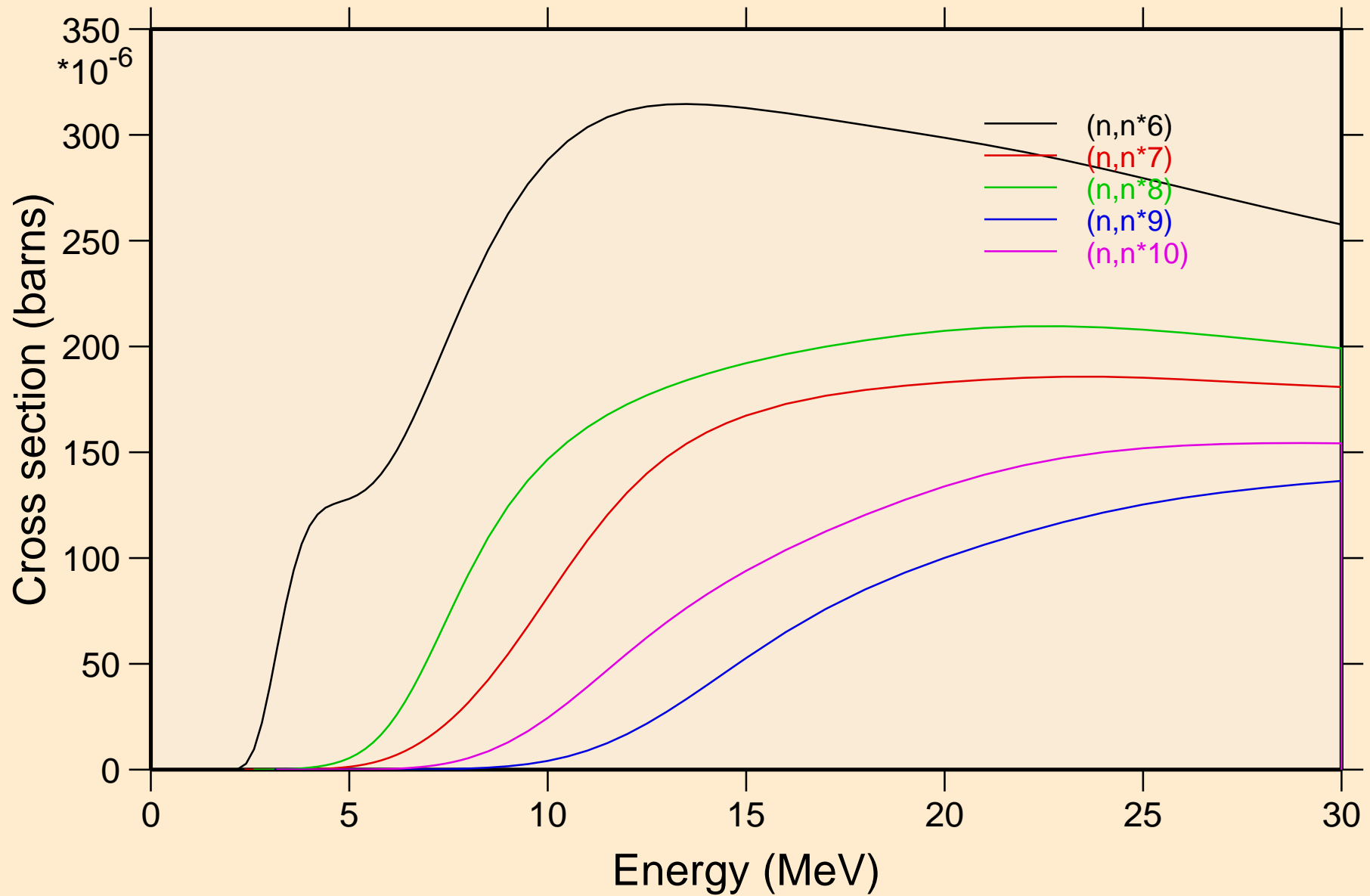

BA120 NEUTRON ACER TENDL-2021 LIBRARY; T=293.6K  
Inelastic levels

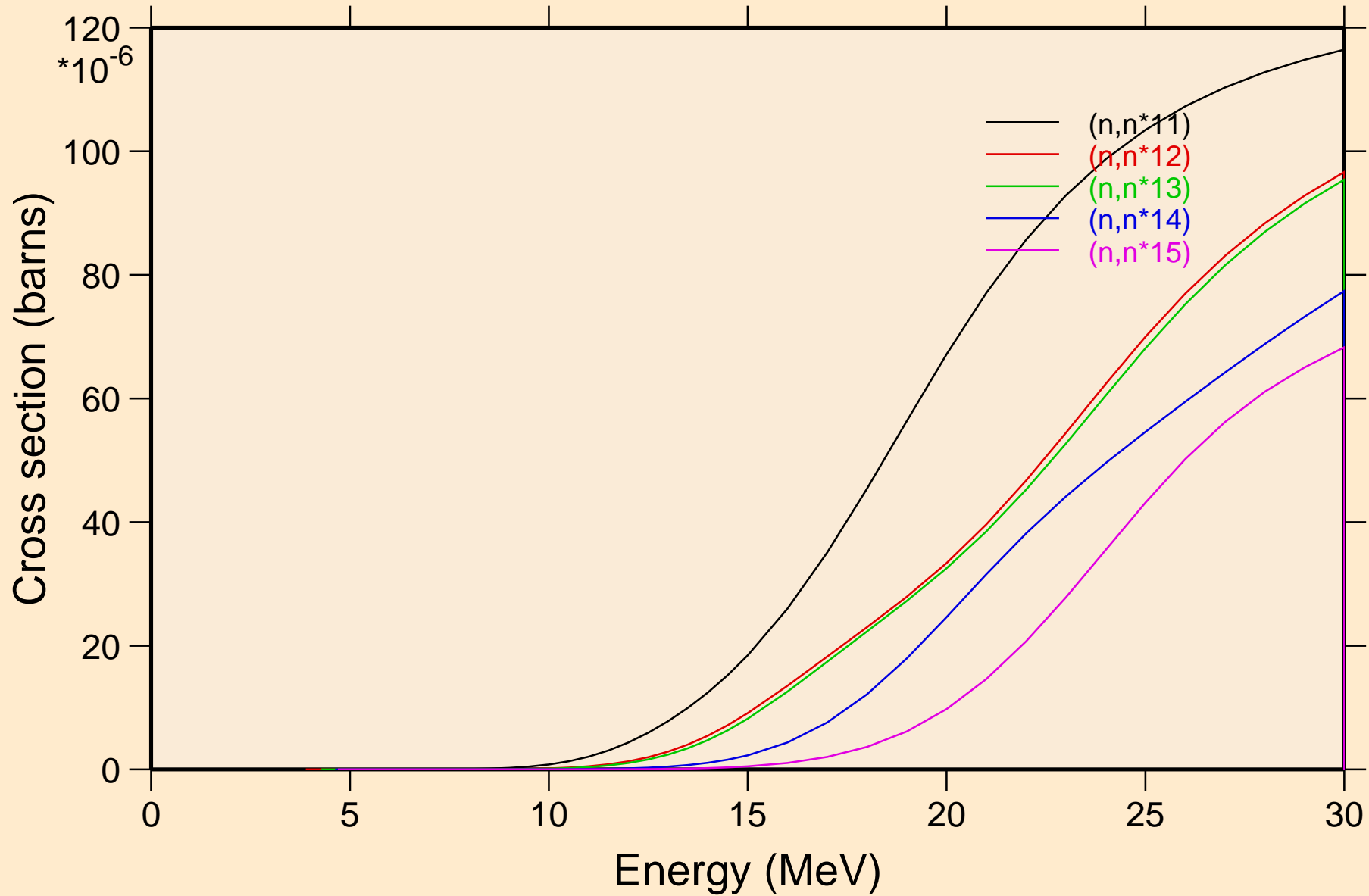

BA120 NEUTRON ACER TENDL-2021 LIBRARY; T=293.6K  
Inelastic levels

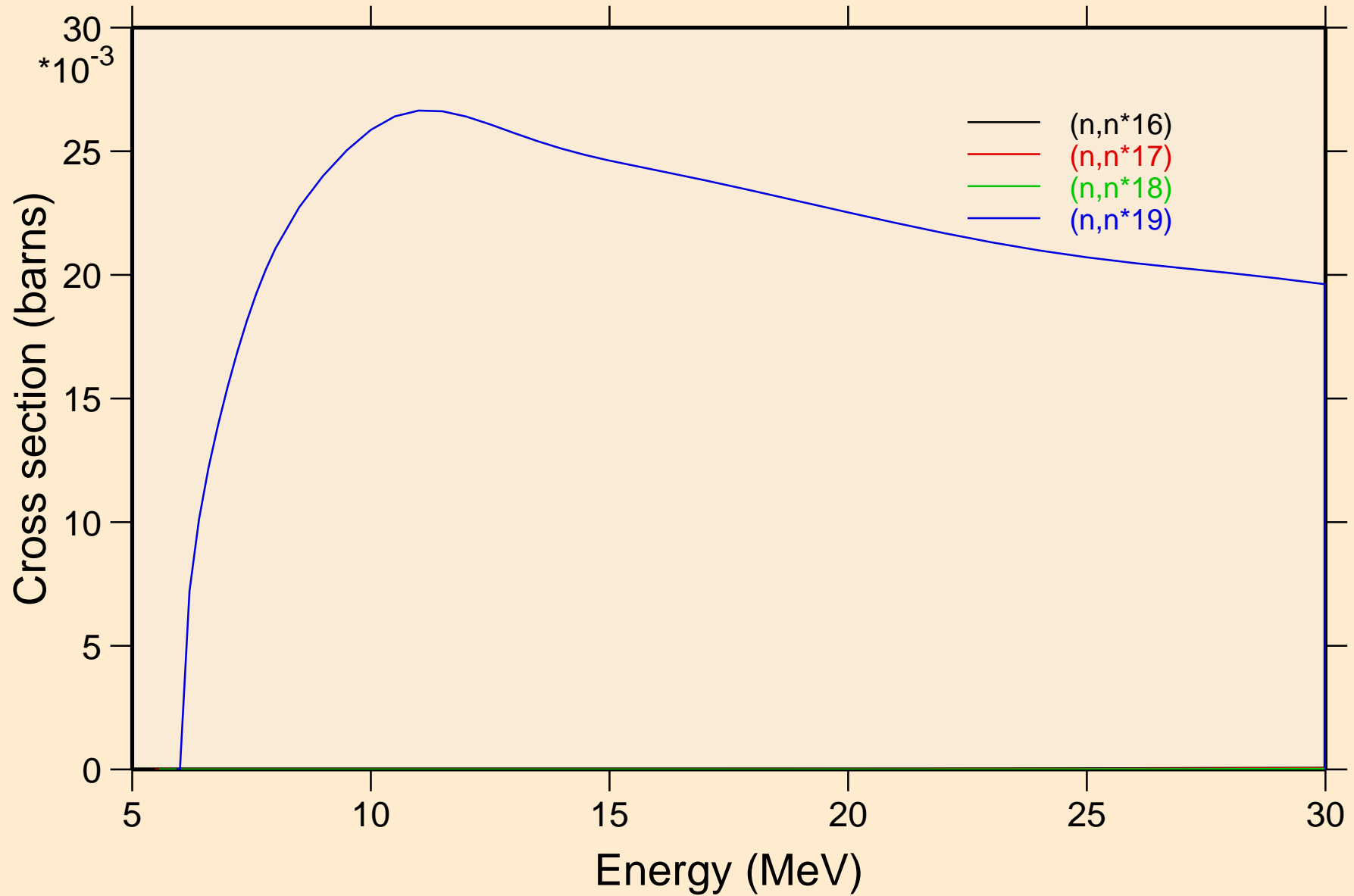

BA120 NEUTRON ACER TENDL-2021 LIBRARY; T=293.6K  
Threshold reactions

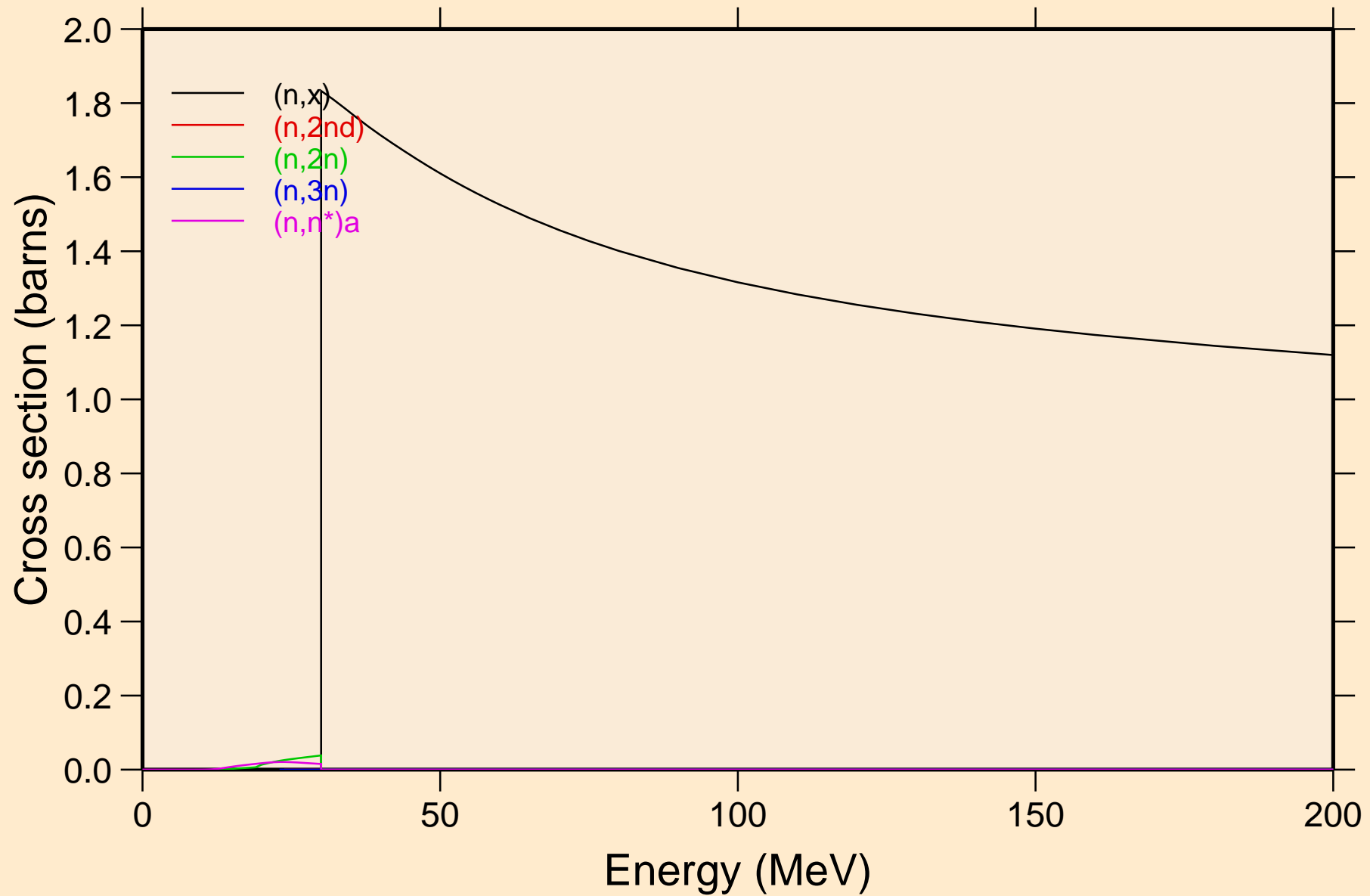

BA120 NEUTRON ACER TENDL-2021 LIBRARY; T=293.6K  
Threshold reactions

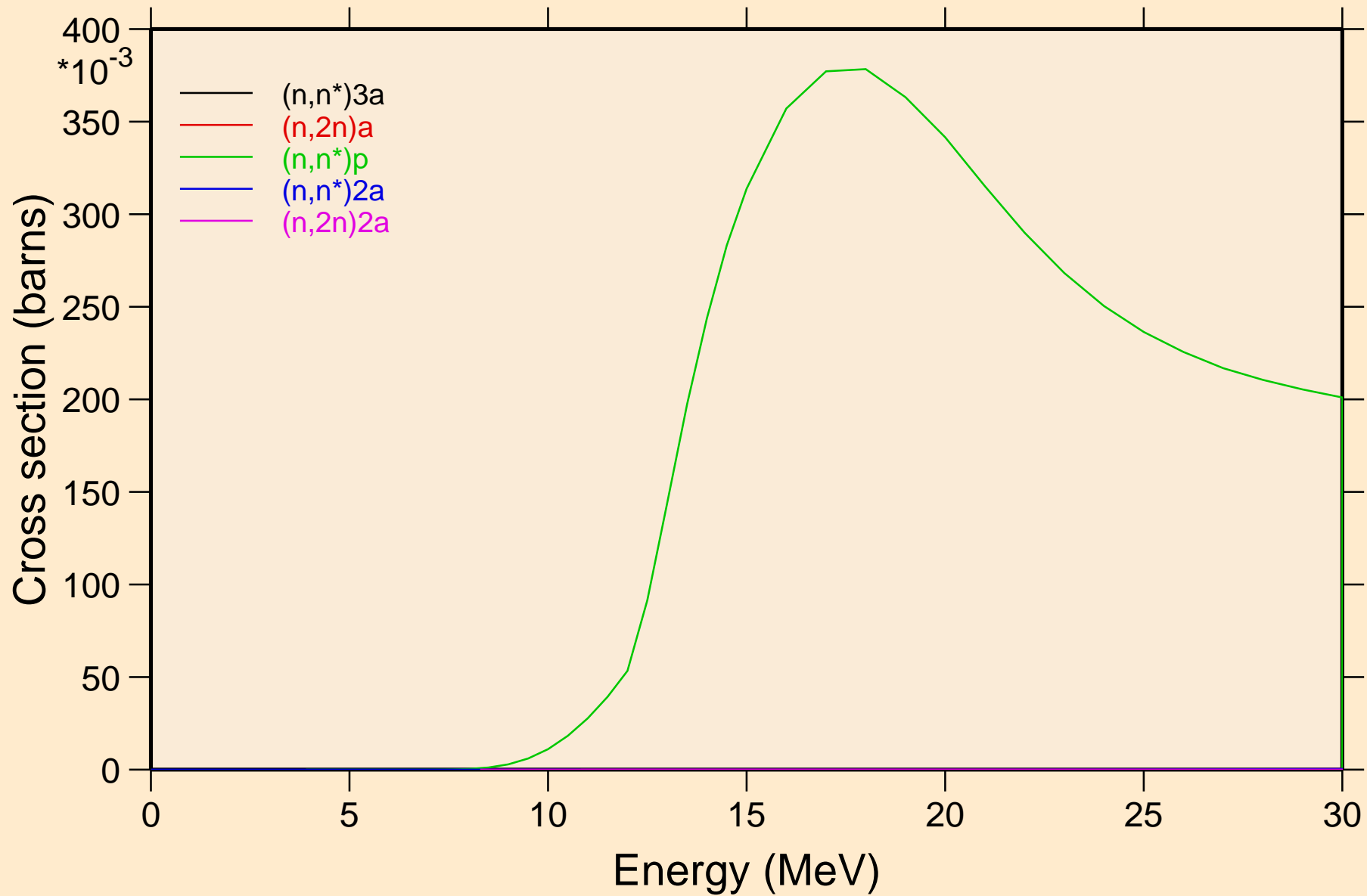



BA120 NEUTRON ACER TENDL-2021 LIBRARY; T=293.6K  
Threshold reactions

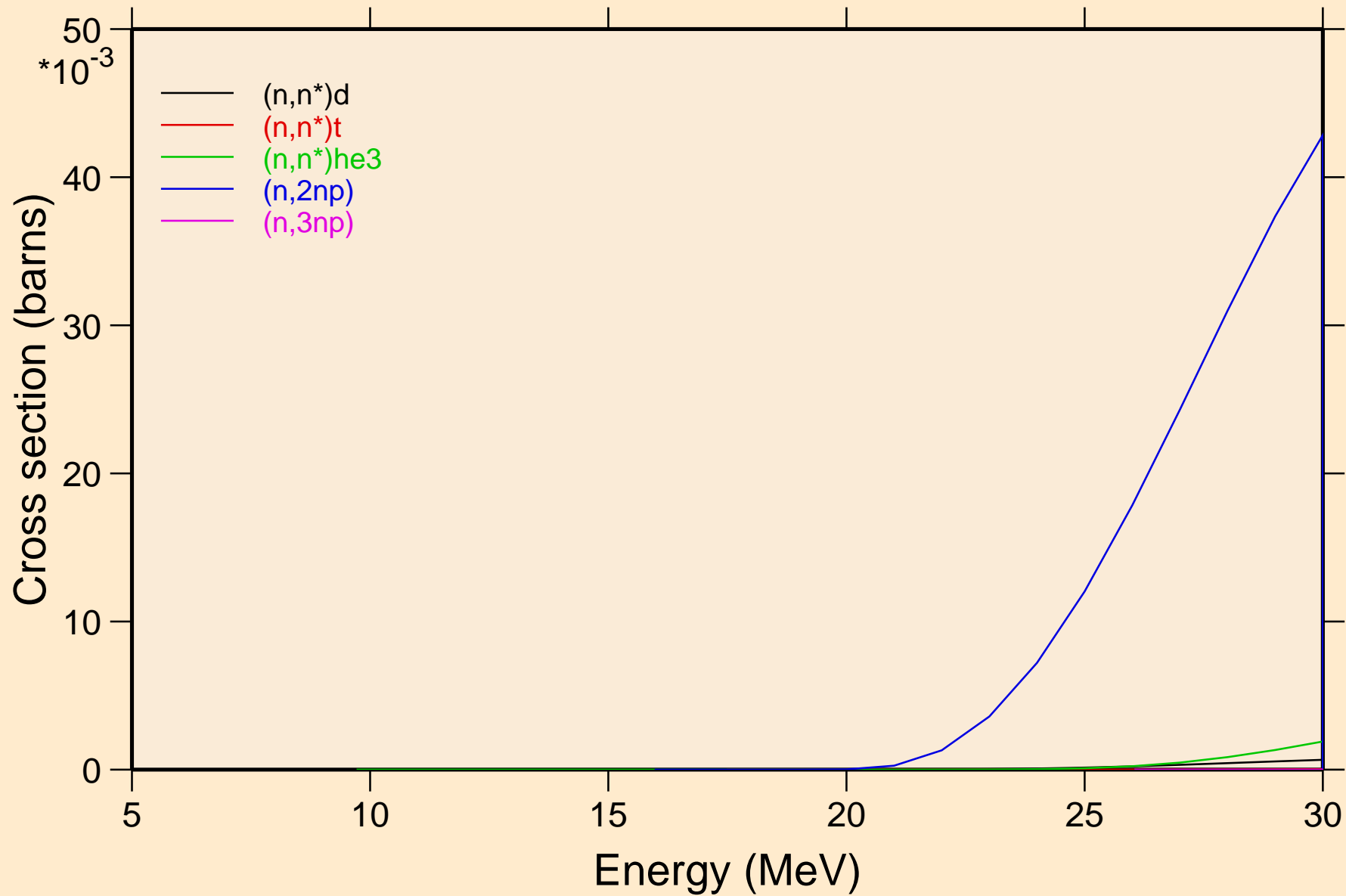

BA120 NEUTRON ACER TENDL-2021 LIBRARY; T=293.6K  
Threshold reactions

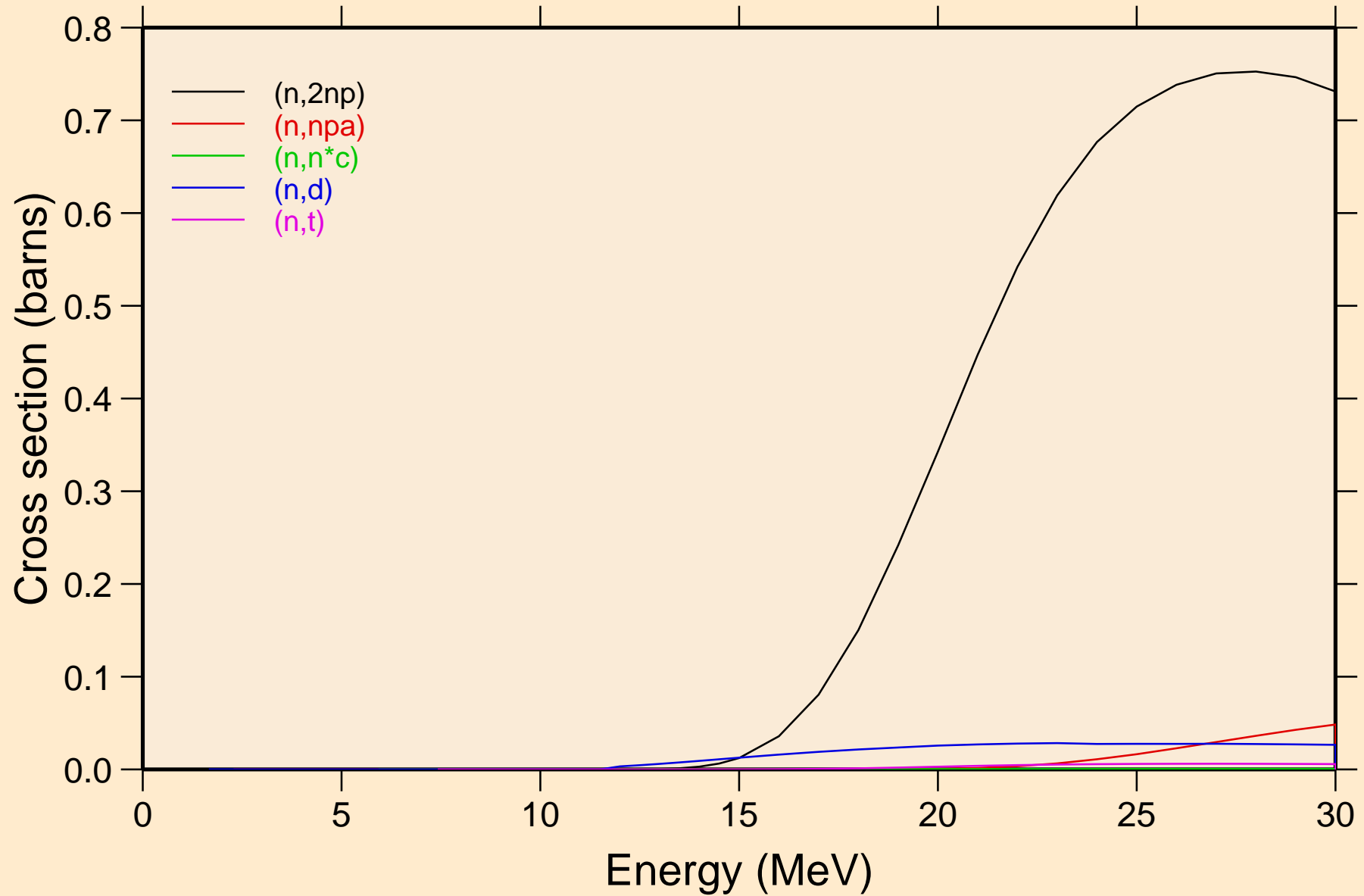

BA120 NEUTRON ACER TENDL-2021 LIBRARY; T=293.6K  
Threshold reactions

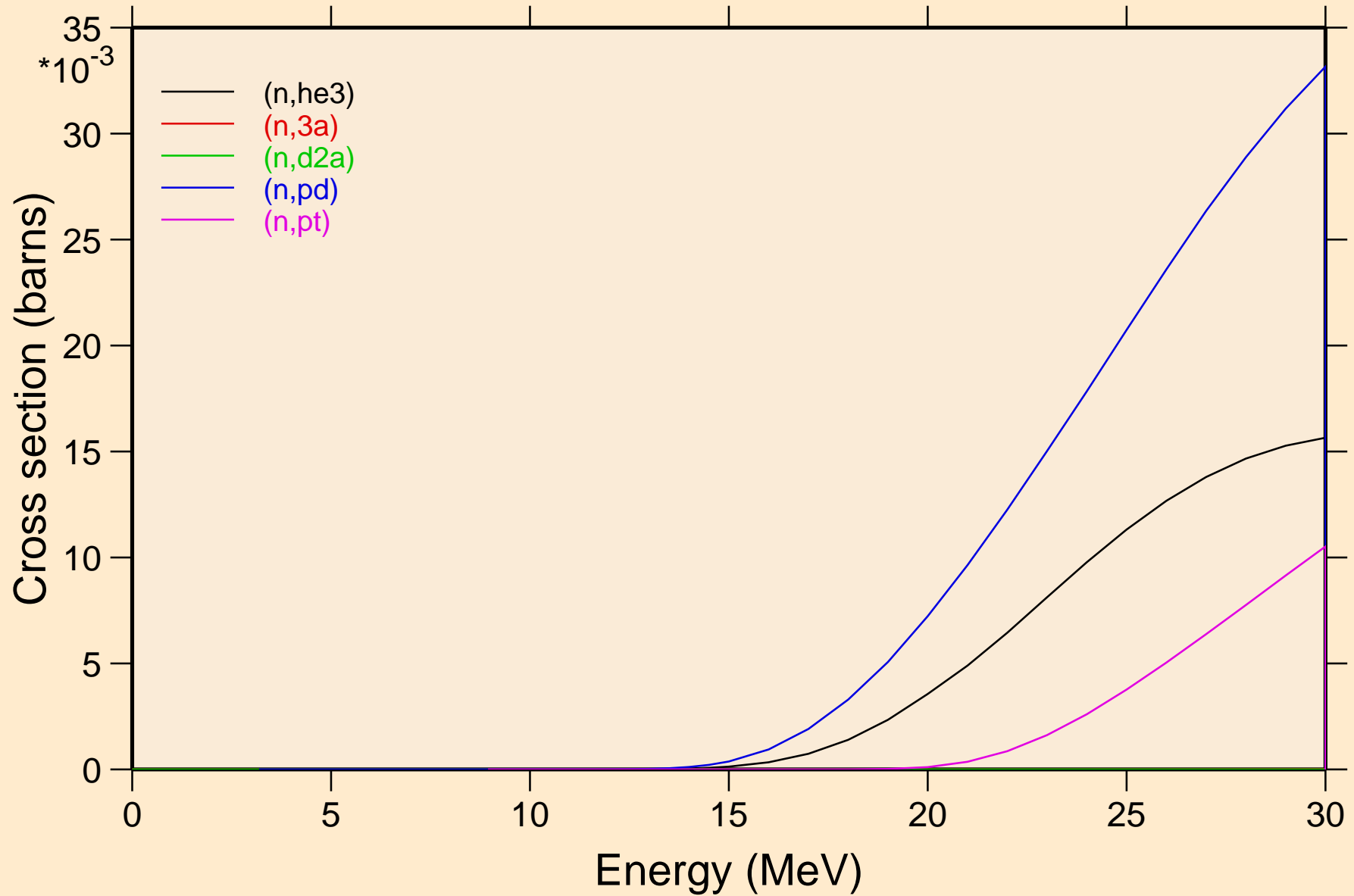

BA120 NEUTRON ACER TENDL-2021 LIBRARY; T=293.6K  
Threshold reactions

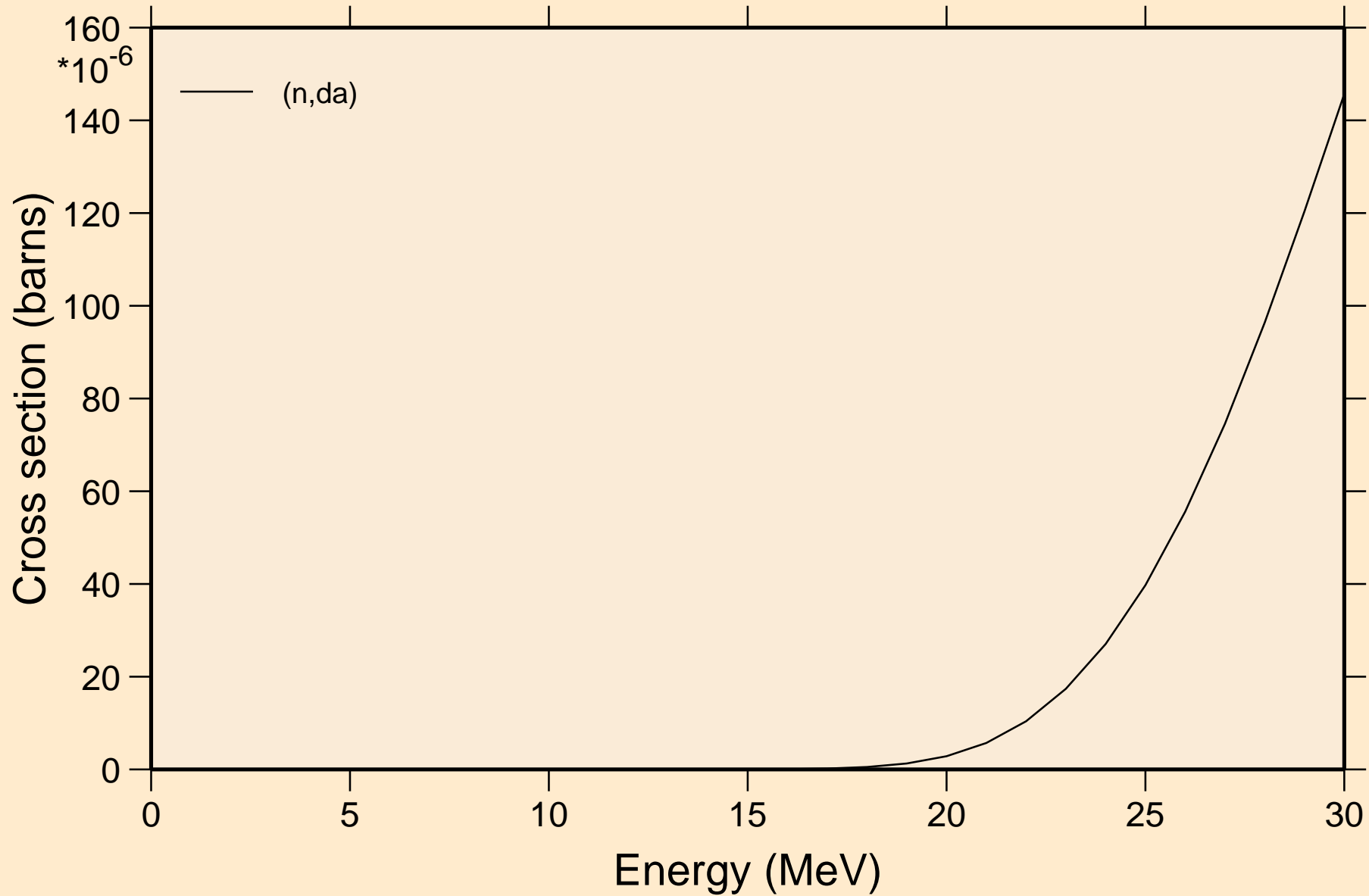

BA120 NEUTRON ACER TENDL-2021 LIBRARY; T=293.6K  
Threshold reactions

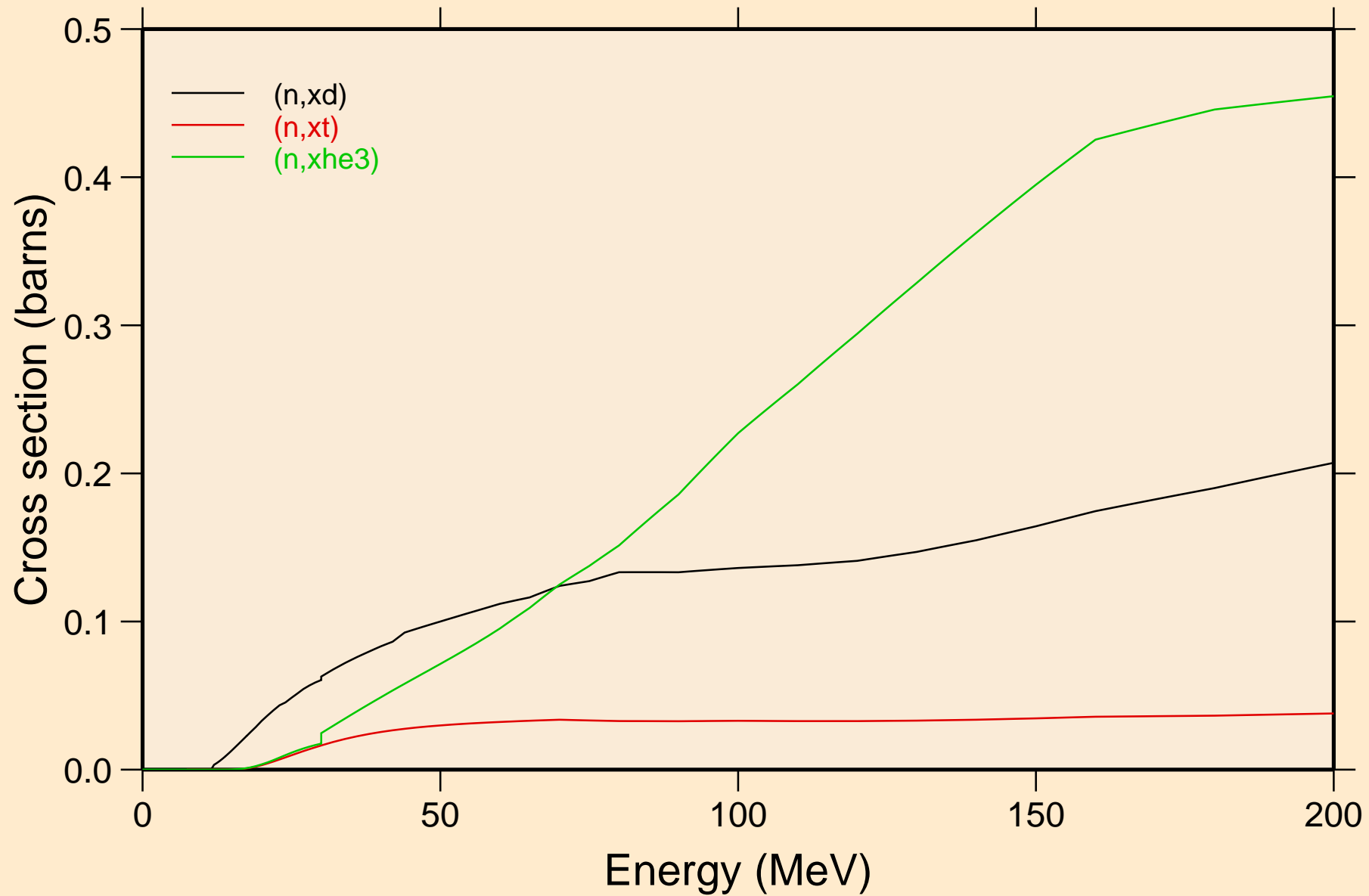

BA120 NEUTRON ACER TENDL-2021 LIBRARY; T=293.6K  
angular distribution for elastic

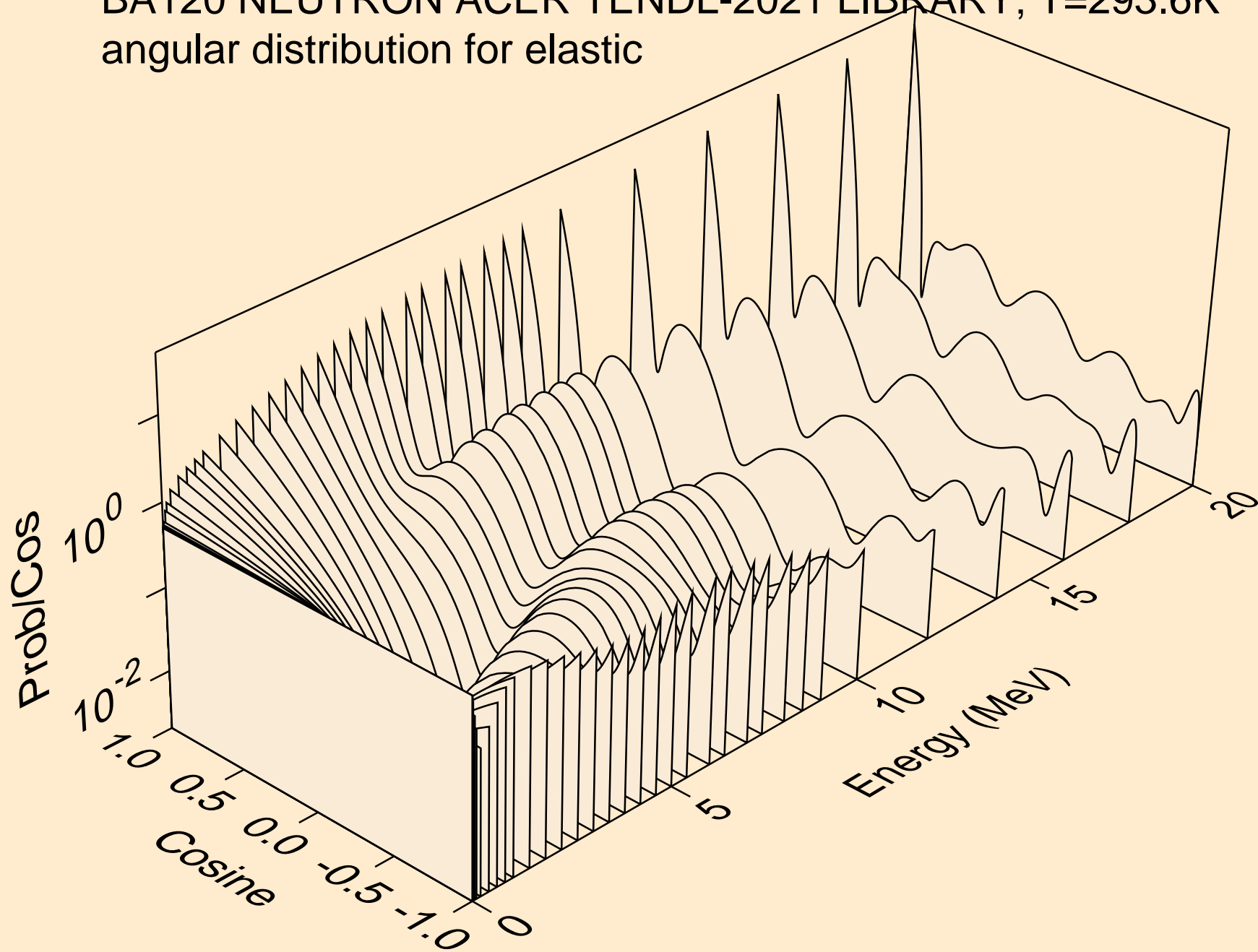

BA120 NEUTRON ACER TENDL-2021 LIBRARY; T=293.6K  
angular distribution for elastic

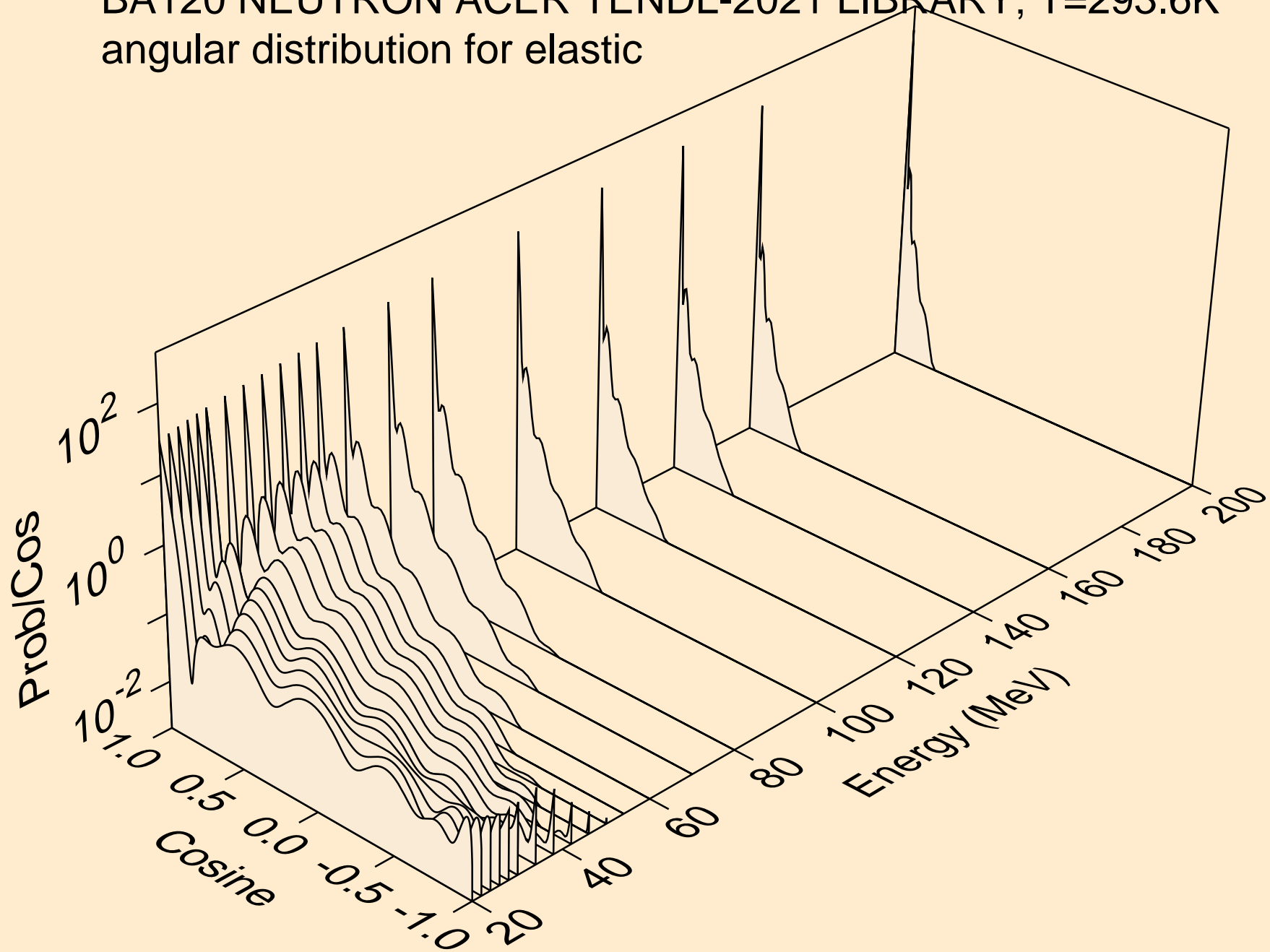

BA120 NEUTRON ACER TENDL-2021 LIBRARY; T=293.6K  
angular distribution for (n,n\*1)

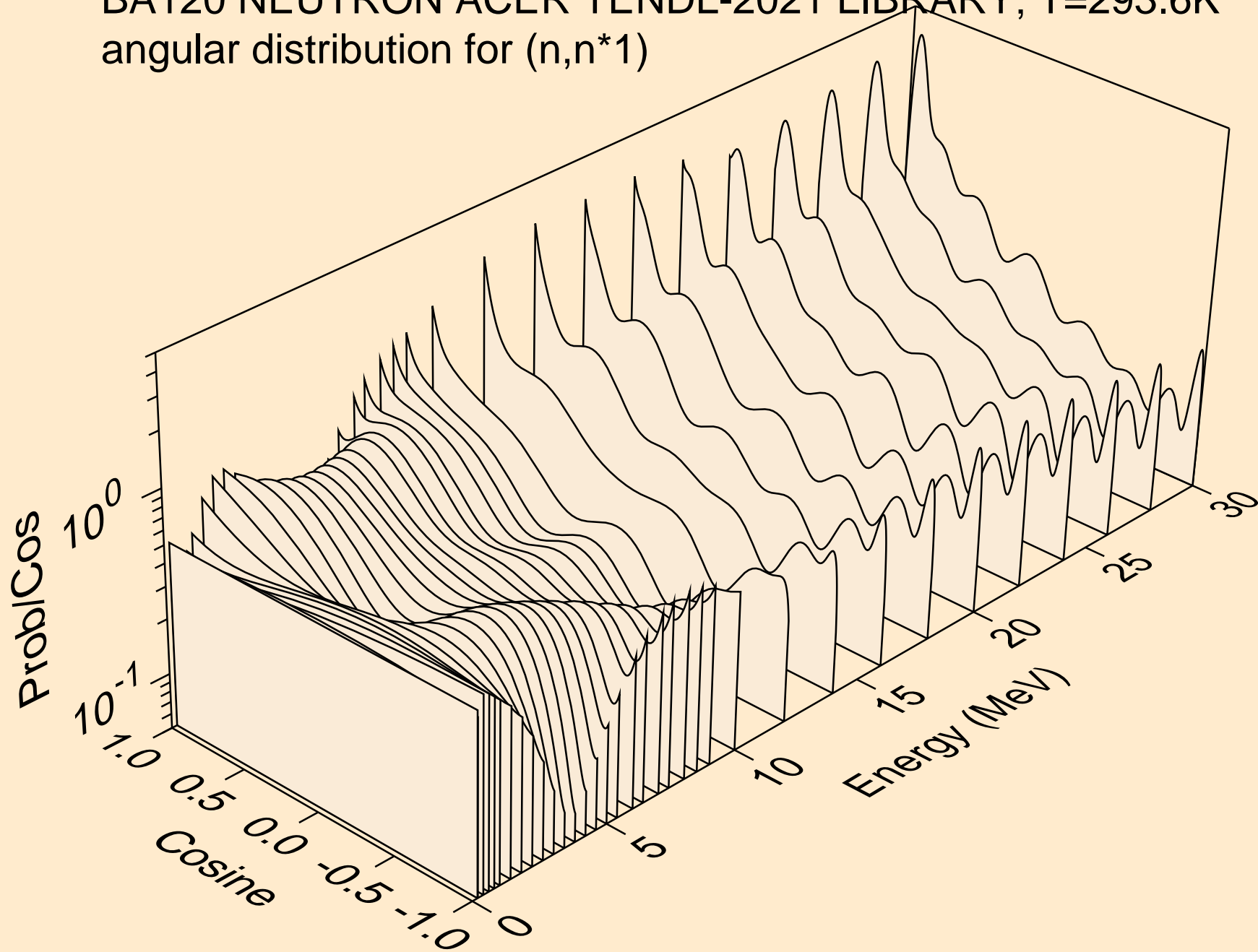



BA120 NEUTRON ACER TENDL-2021 LIBRARY; T=293.6K  
angular distribution for (n,n\*2)

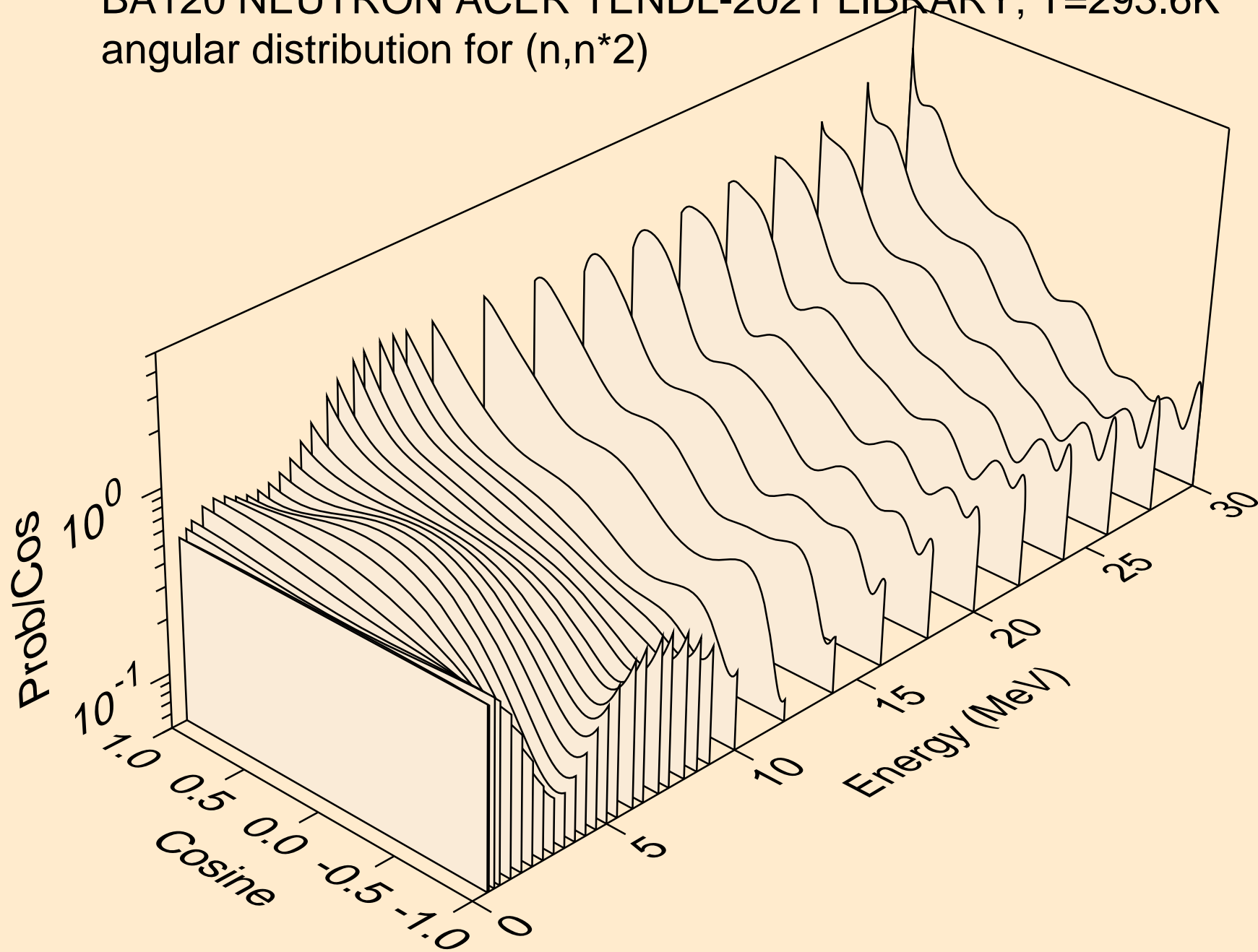

BA120 NEUTRON ACER TENDL-2021 LIBRARY; T=293.6K  
angular distribution for (n,n\*3)

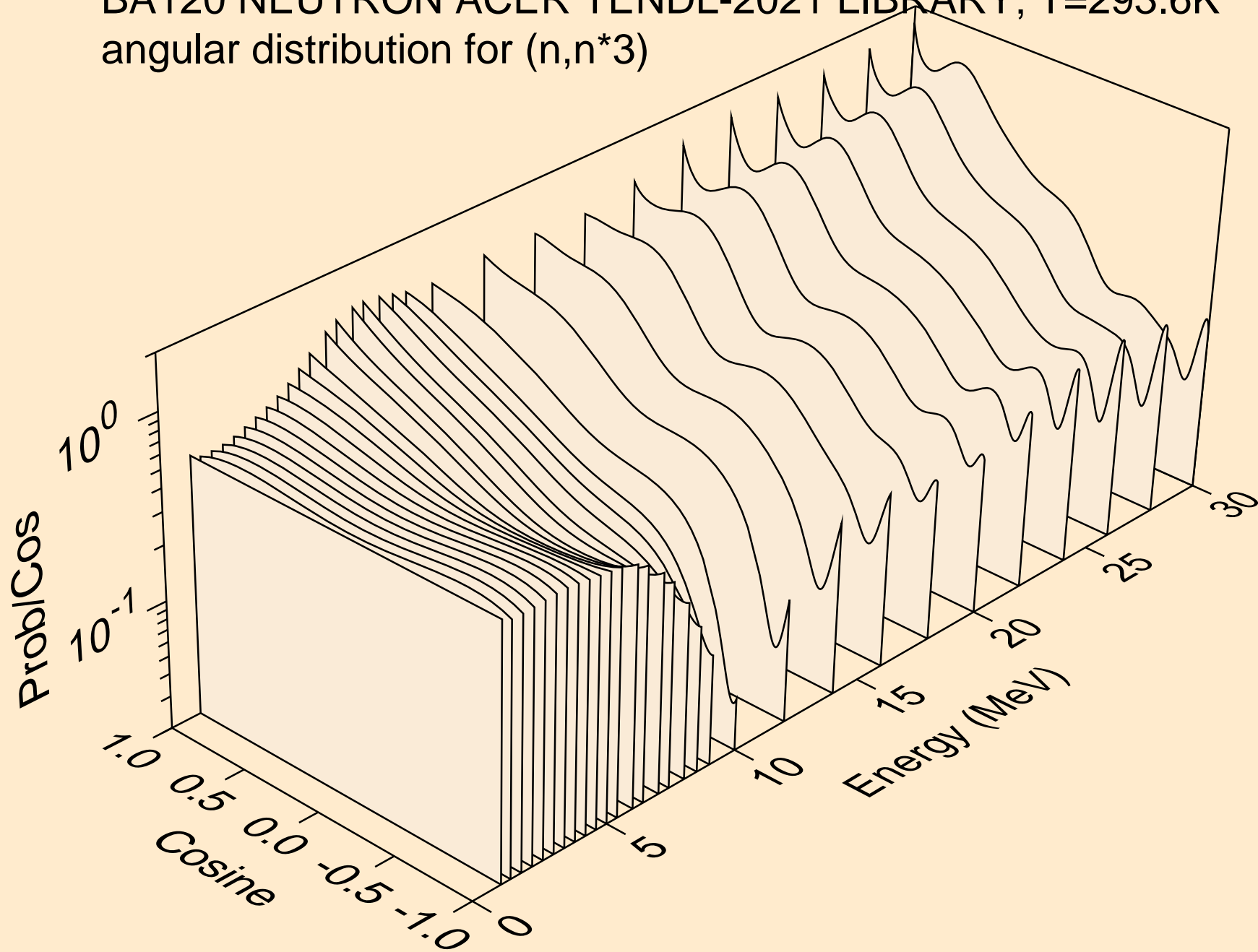

BA120 NEUTRON ACER TENDL-2021 LIBRARY; T=293.6K  
angular distribution for (n,n\*4)

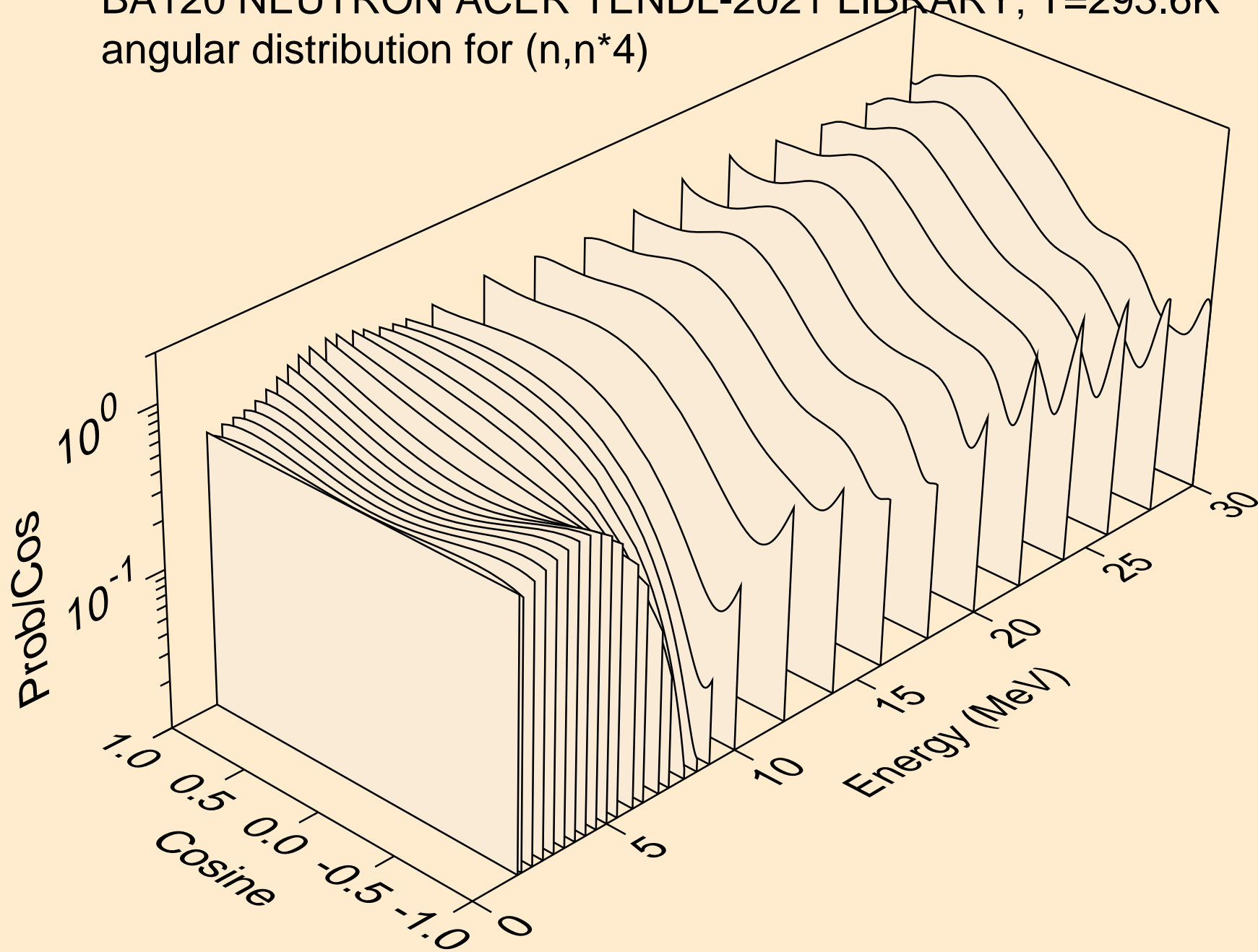

BA120 NEUTRON ACER TENDL-2021 LIBRARY; T=293.6K  
angular distribution for (n,n\*5)

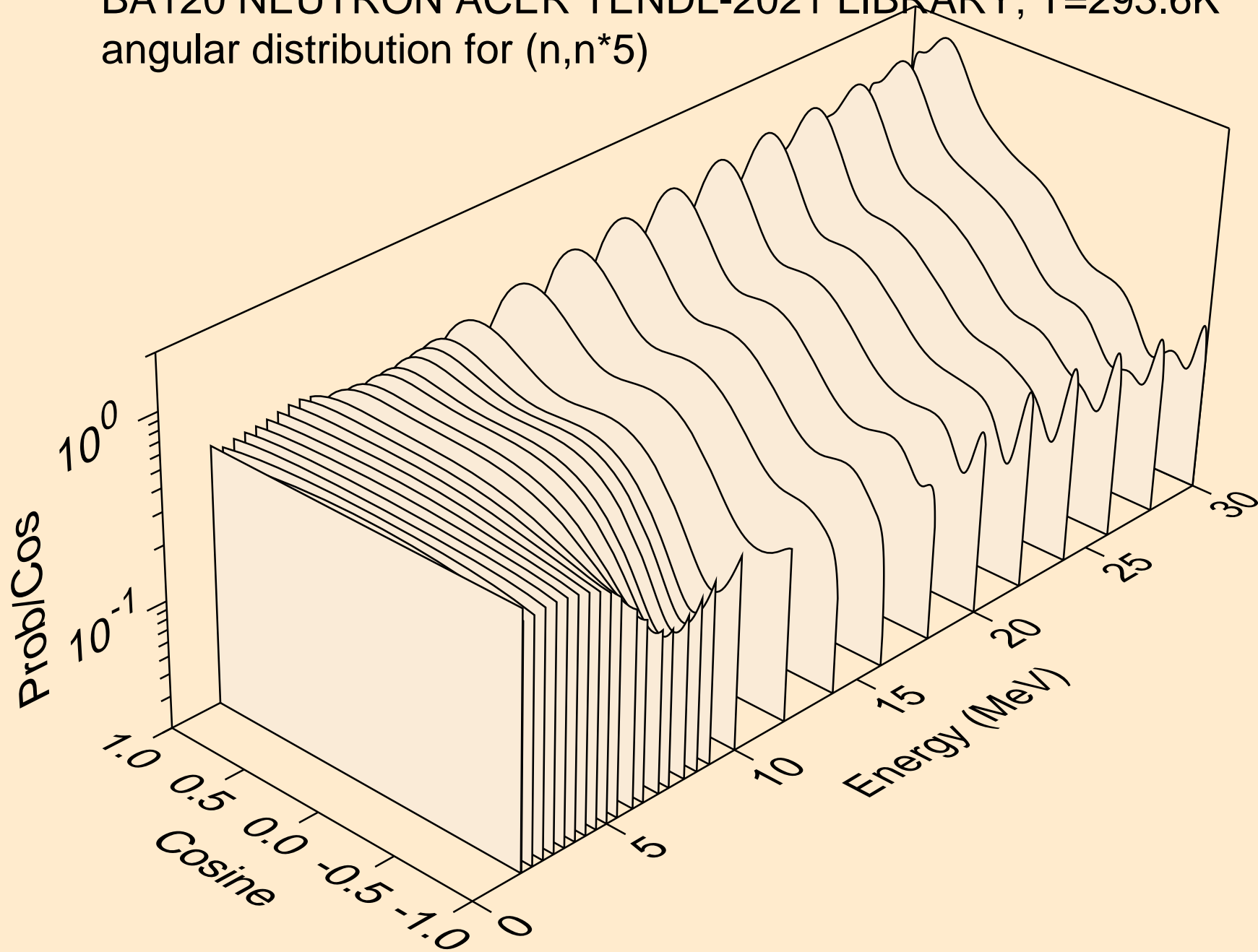

BA120 NEUTRON ACER TENDL-2021 LIBRARY; T=293.6K  
angular distribution for (n,n\*6)

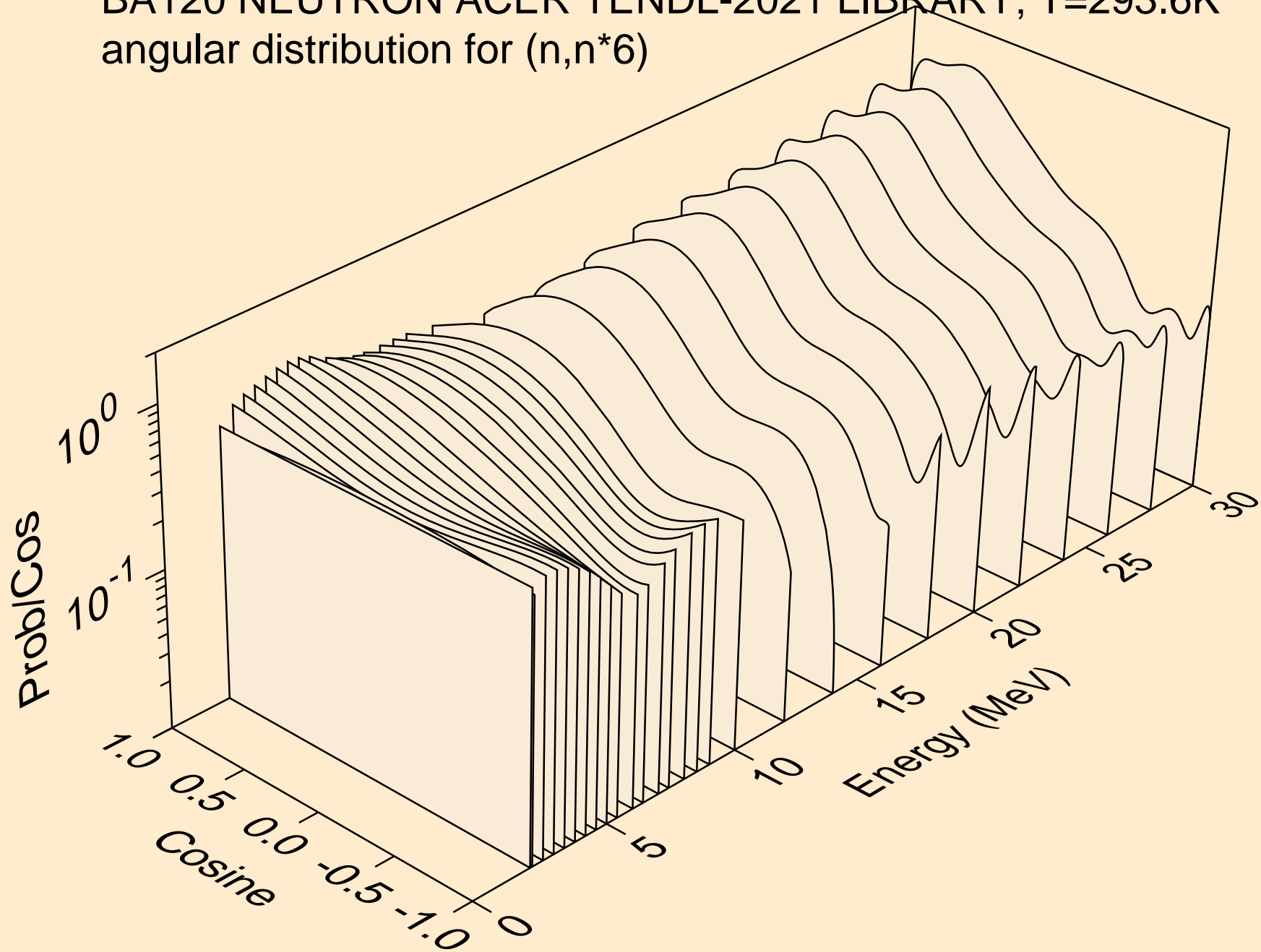

BA120 NEUTRON ACER TENDL-2021 LIBRARY; T=293.6K  
angular distribution for (n,n\*7)

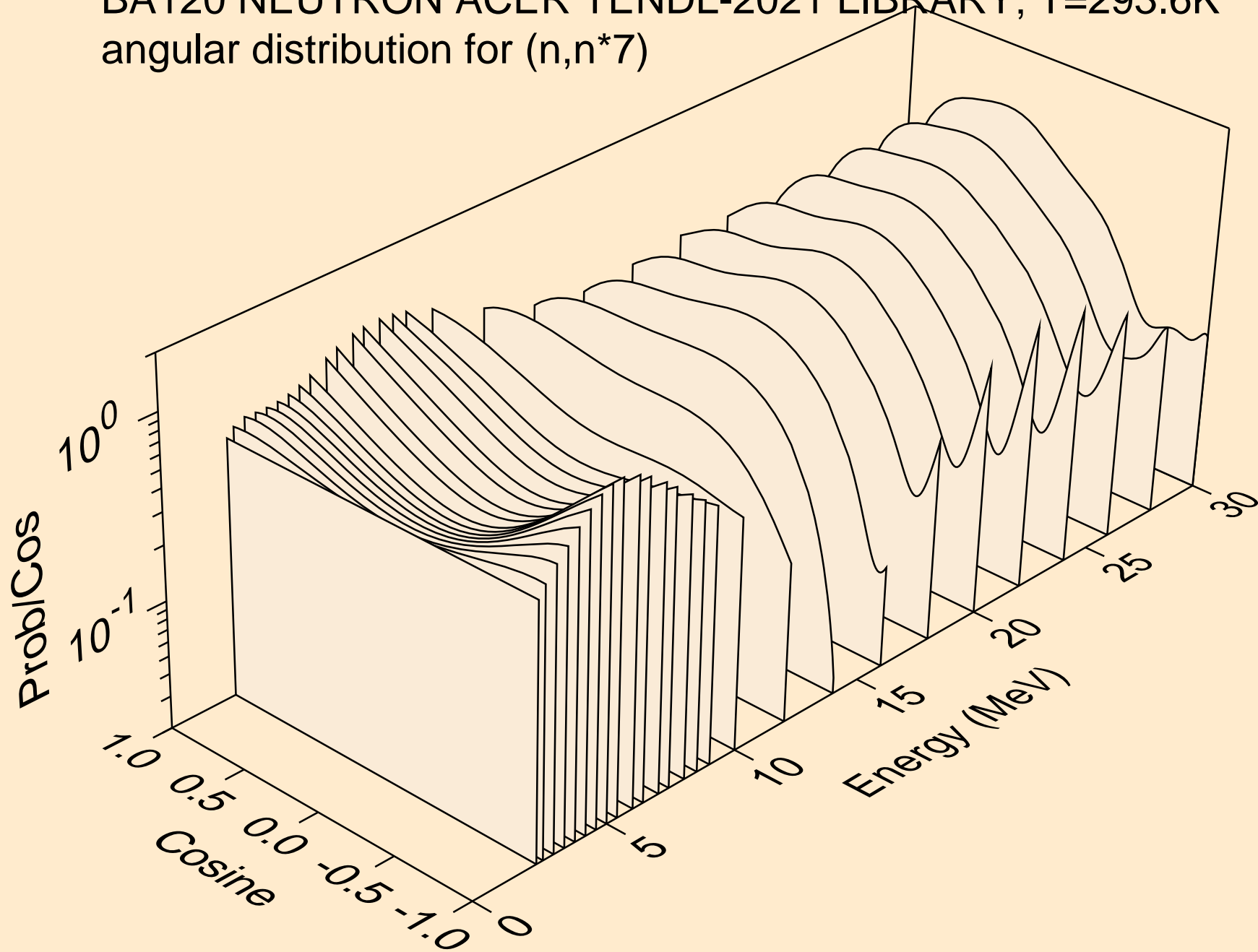

BA120 NEUTRON ACER TENDL-2021 LIBRARY; T=293.6K  
angular distribution for (n,n\*8)

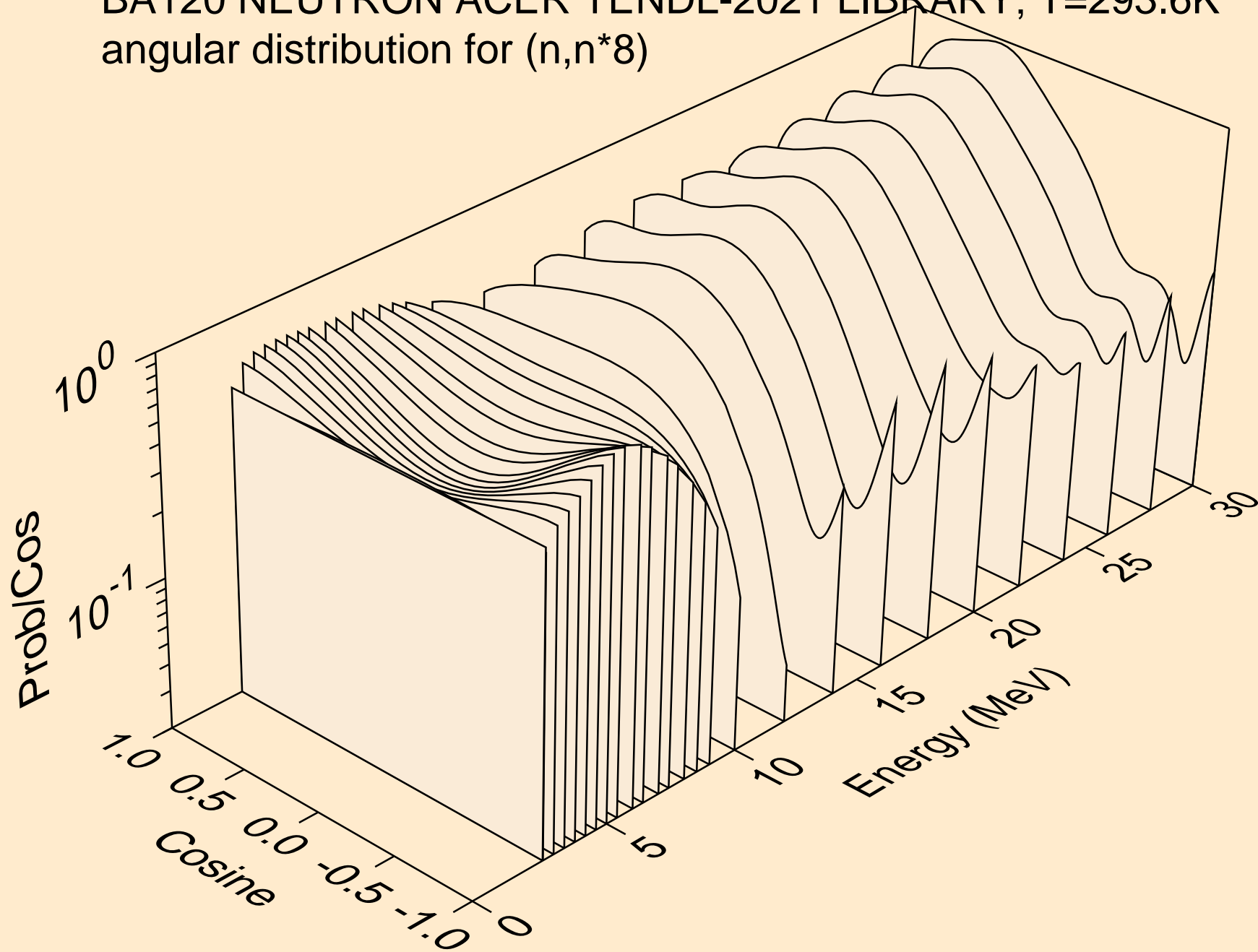

BA120 NEUTRON ACER TENDL-2021 LIBRARY; T=293.6K  
angular distribution for (n,n\*9)

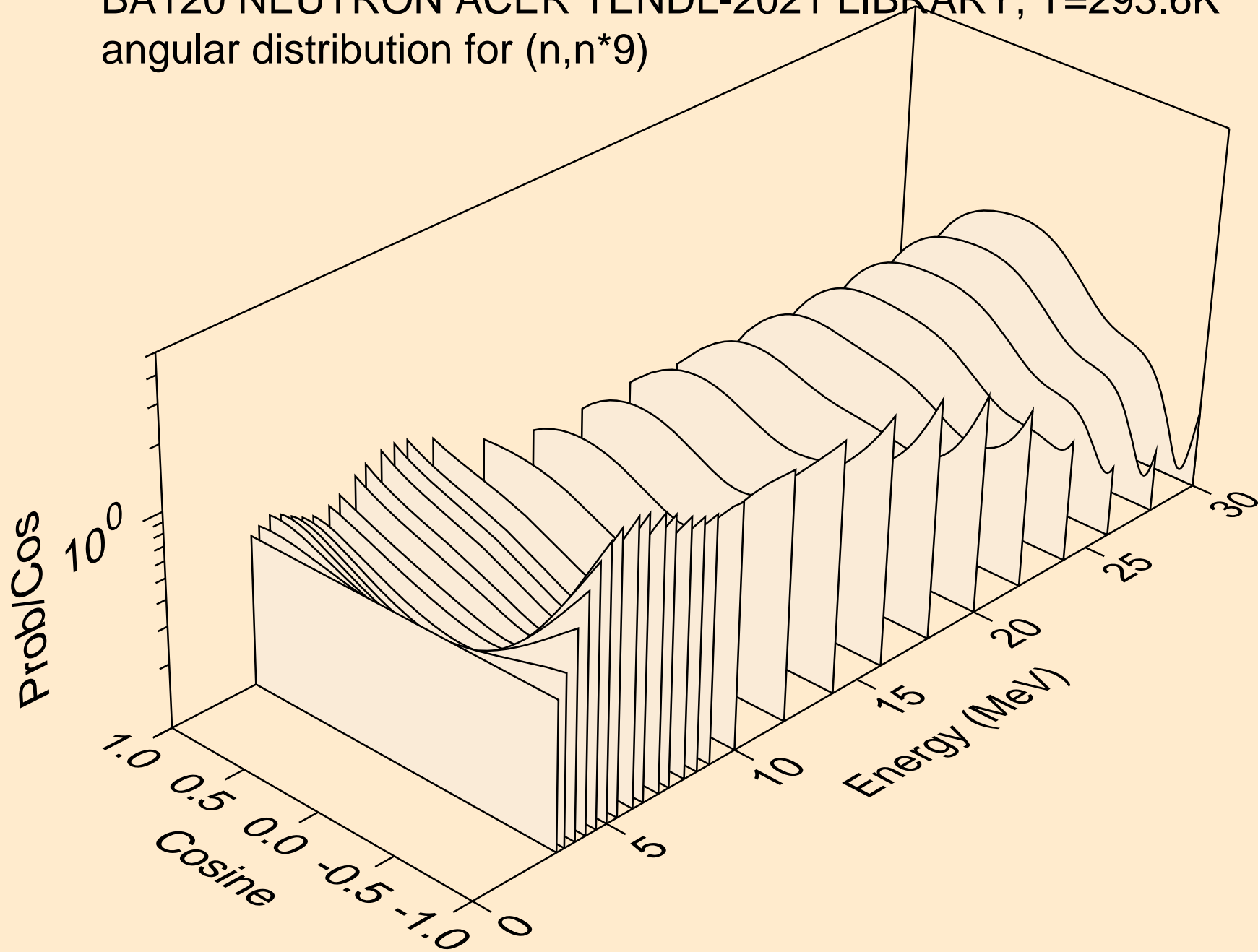



BA120 NEUTRON ACER TENDL-2021 LIBRARY; T=293.6K  
angular distribution for (n,n\*10)

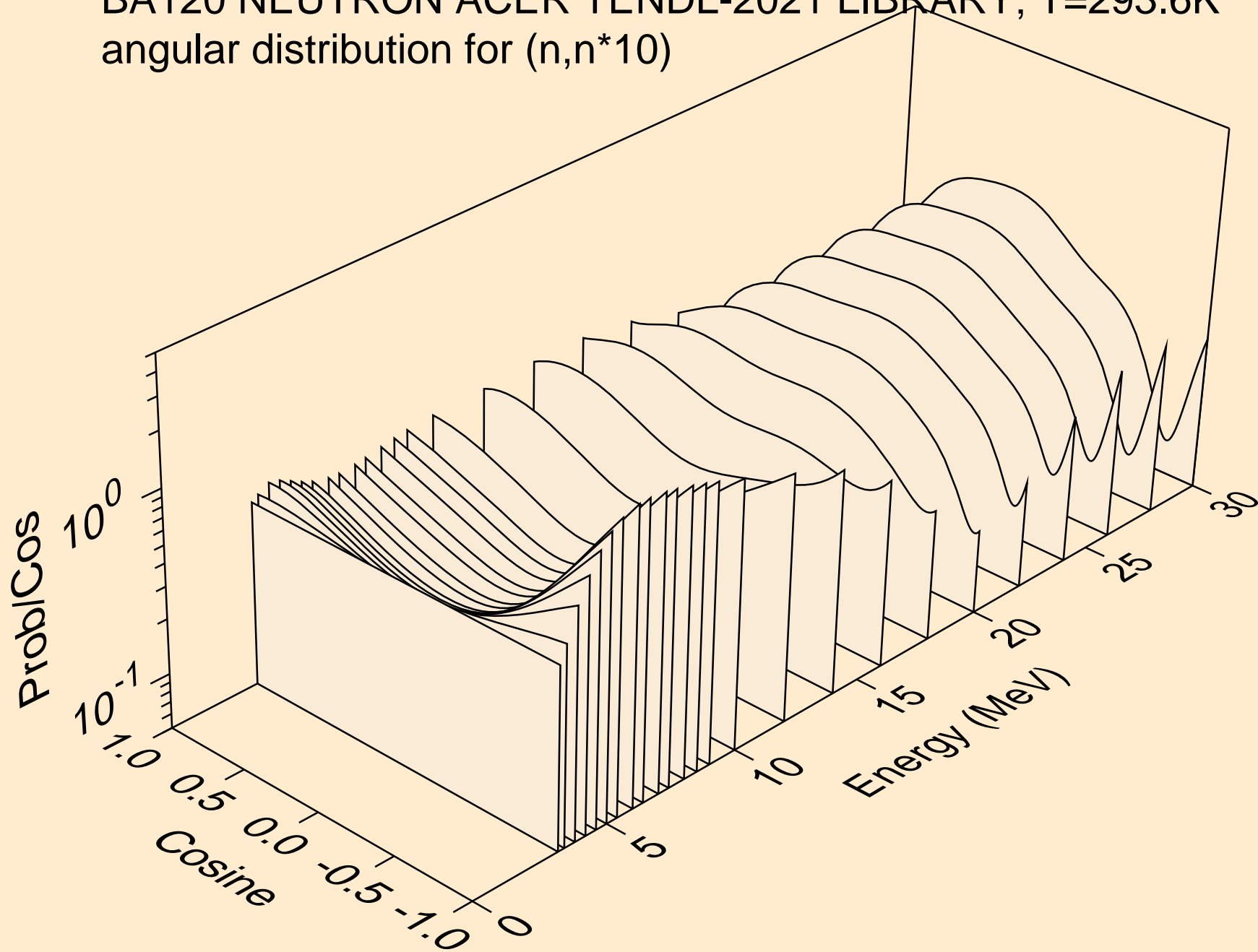

BA120 NEUTRON ACER TENDL-2021 LIBRARY; T=293.6K  
angular distribution for (n,n\*11)

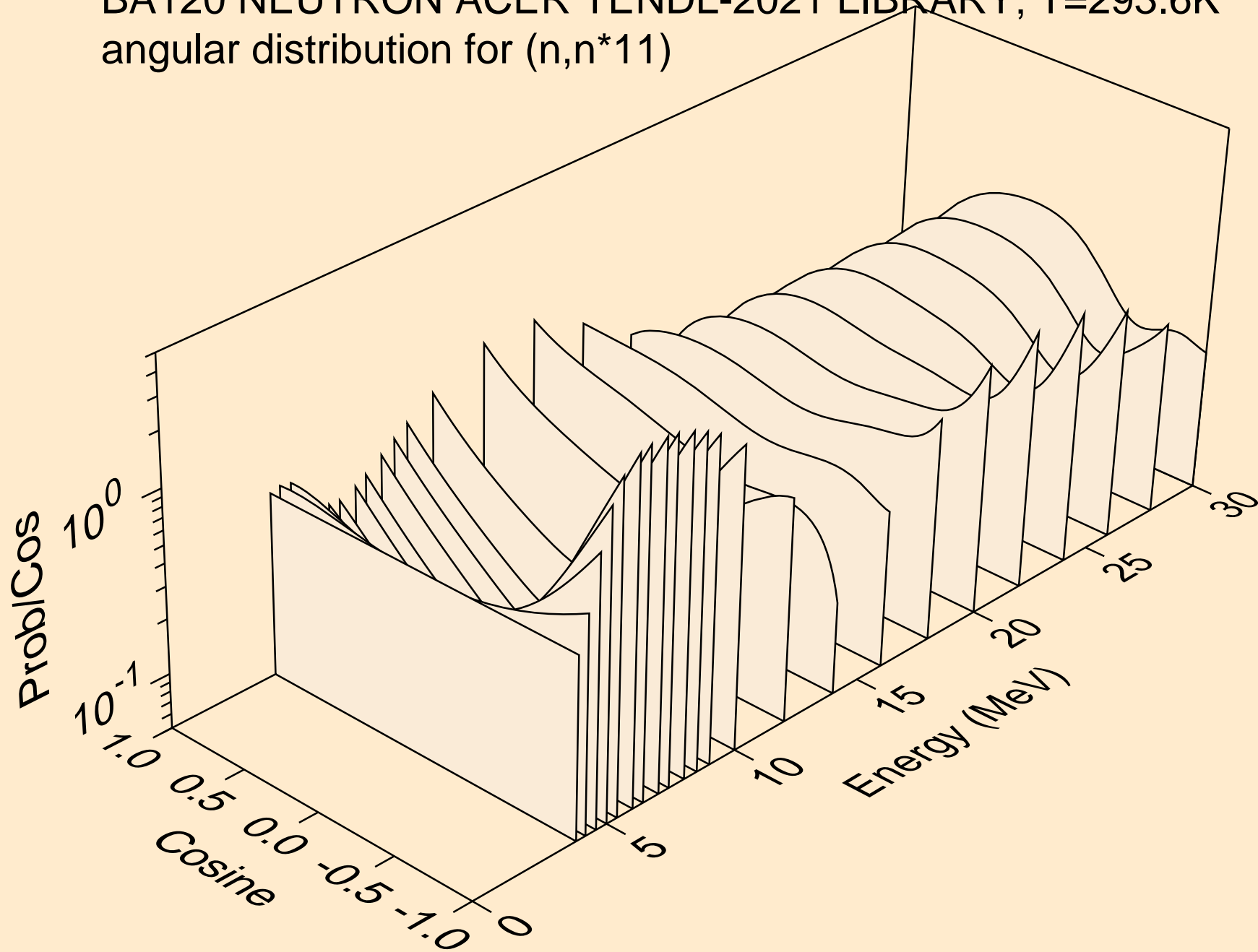

BA120 NEUTRON ACER TENDL-2021 LIBRARY; T=293.6K  
angular distribution for (n,n\*12)

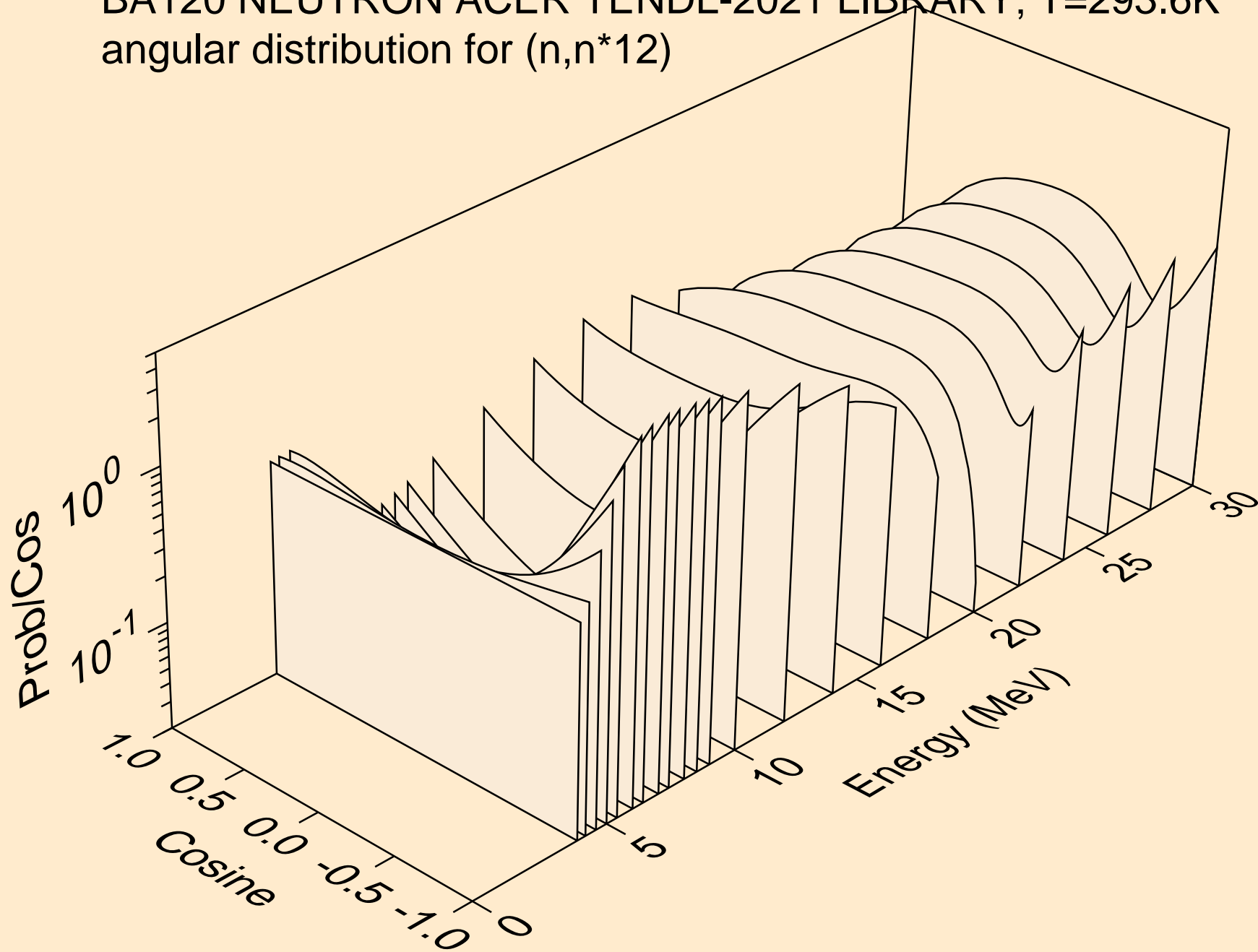

BA120 NEUTRON ACER TENDL-2021 LIBRARY; T=293.6K  
angular distribution for (n,n\*13)

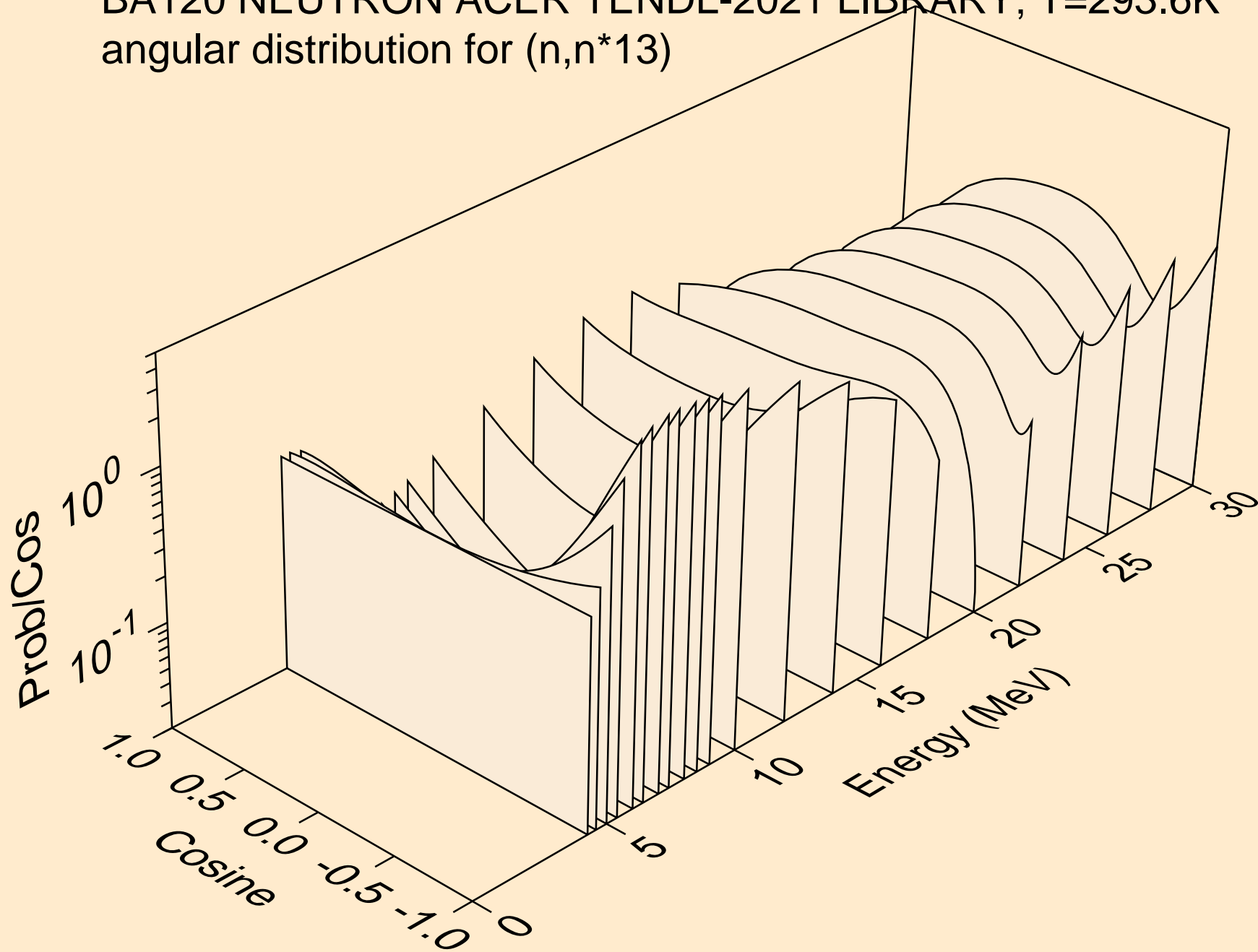

BA120 NEUTRON ACER TENDL-2021 LIBRARY; T=293.6K  
angular distribution for (n,n\*14)

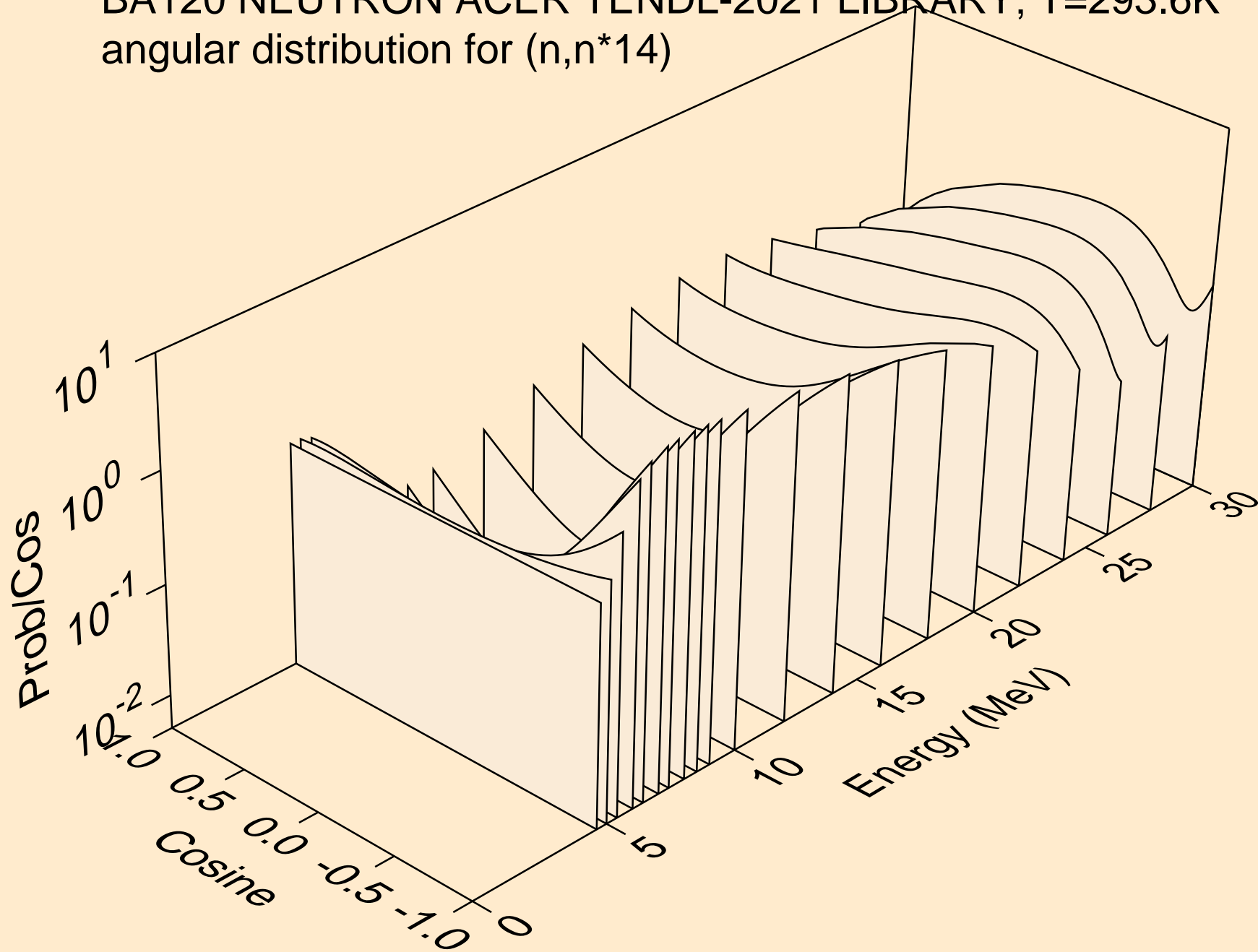

BA120 NEUTRON ACER TENDL-2021 LIBRARY; T=293.6K  
angular distribution for (n,n\*15)

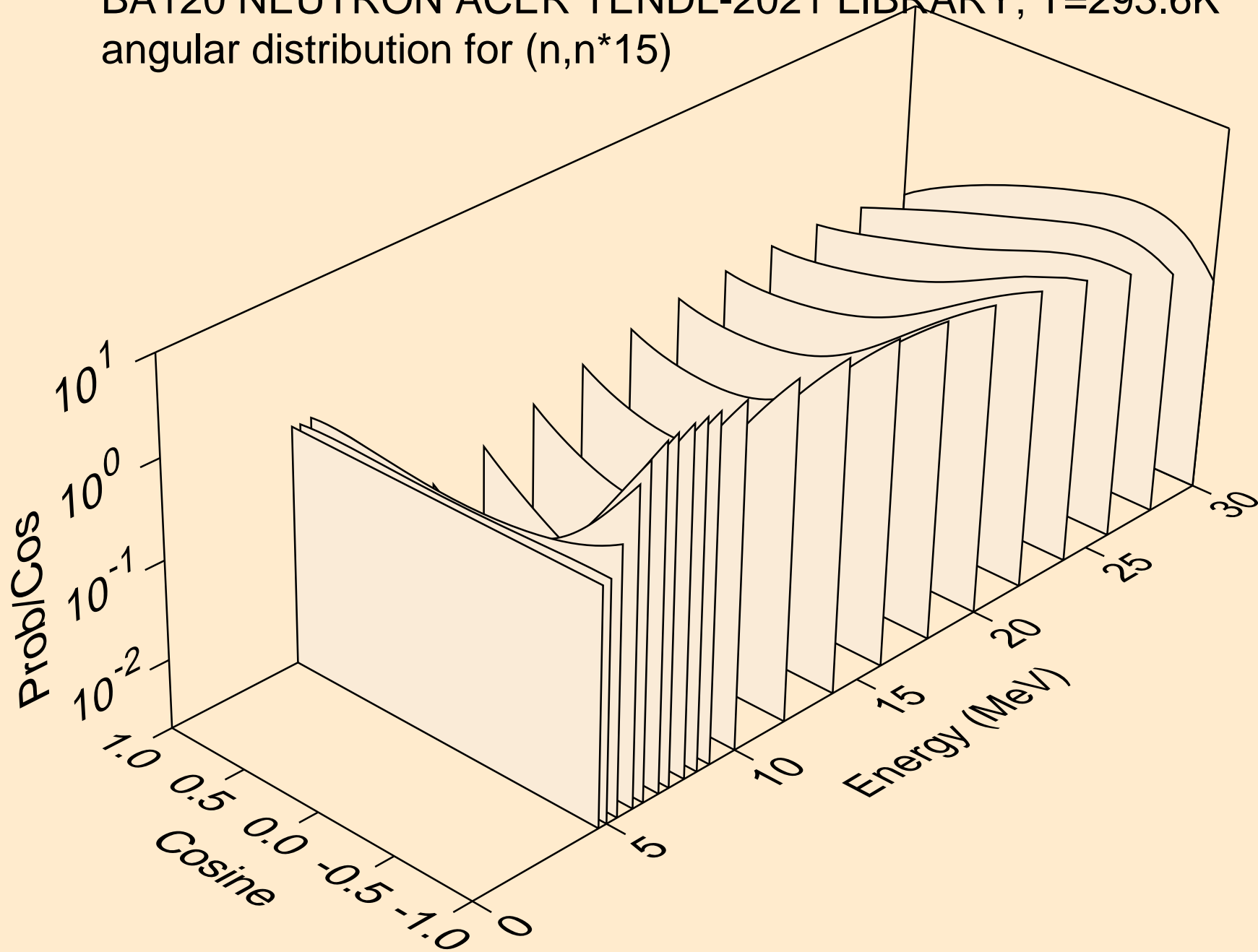

BA120 NEUTRON ACER TENDL-2021 LIBRARY; T=293.6K  
angular distribution for (n,n\*16)

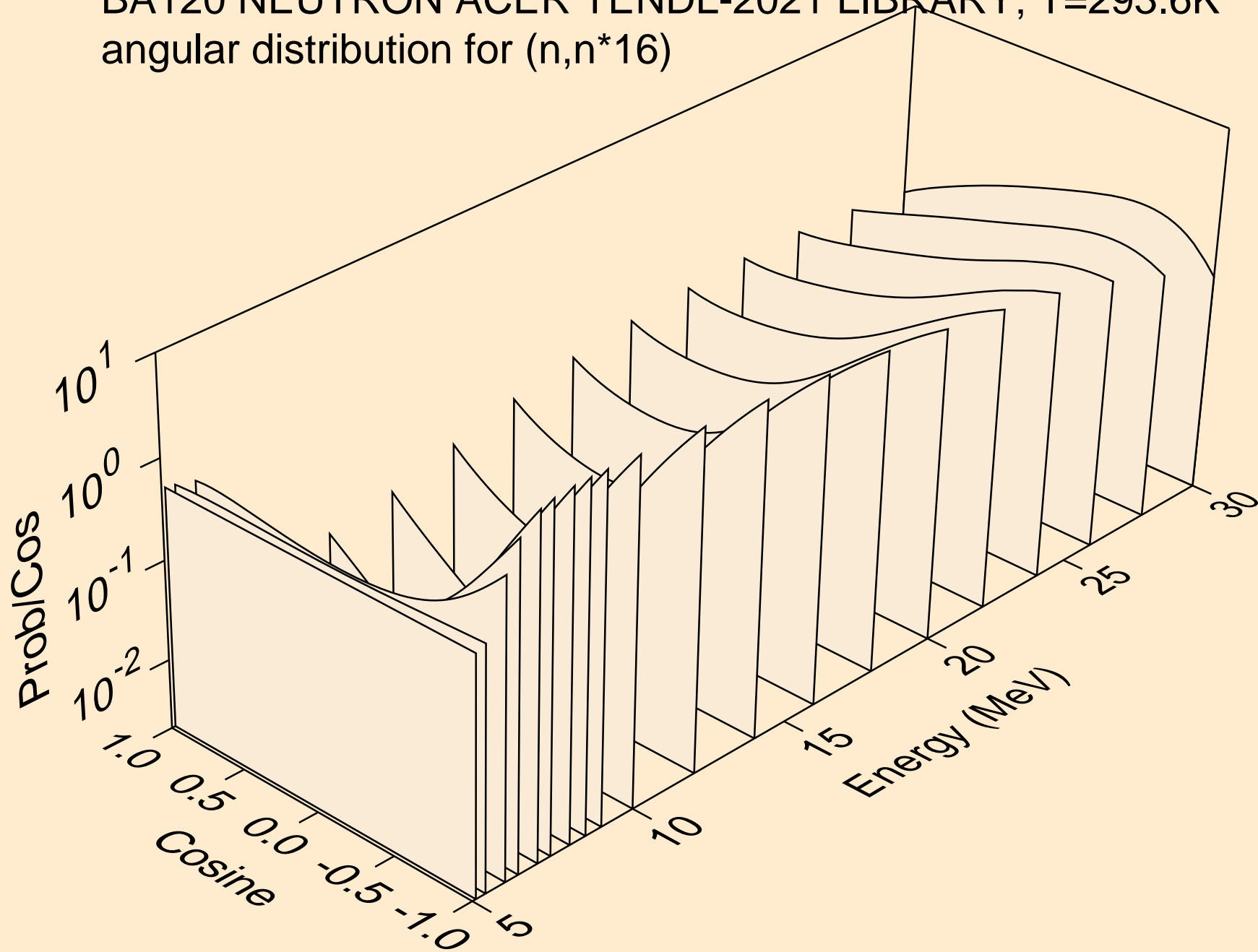

BA120 NEUTRON ACER TENDL-2021 LIBRARY; T=293.6K  
angular distribution for (n,n\*17)

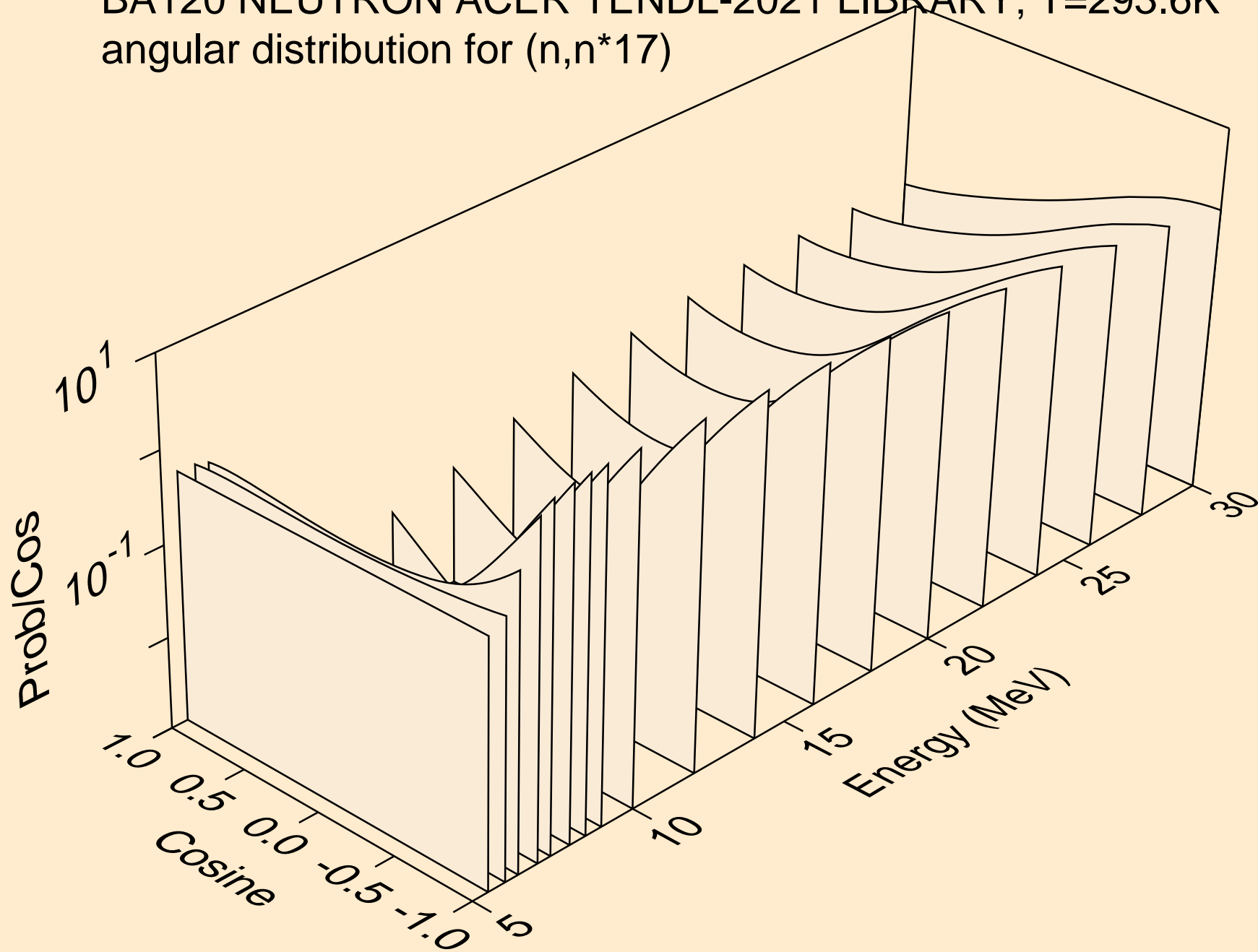



BA120 NEUTRON ACER TENDL-2021 LIBRARY; T=293.6K  
angular distribution for (n,n\*18)

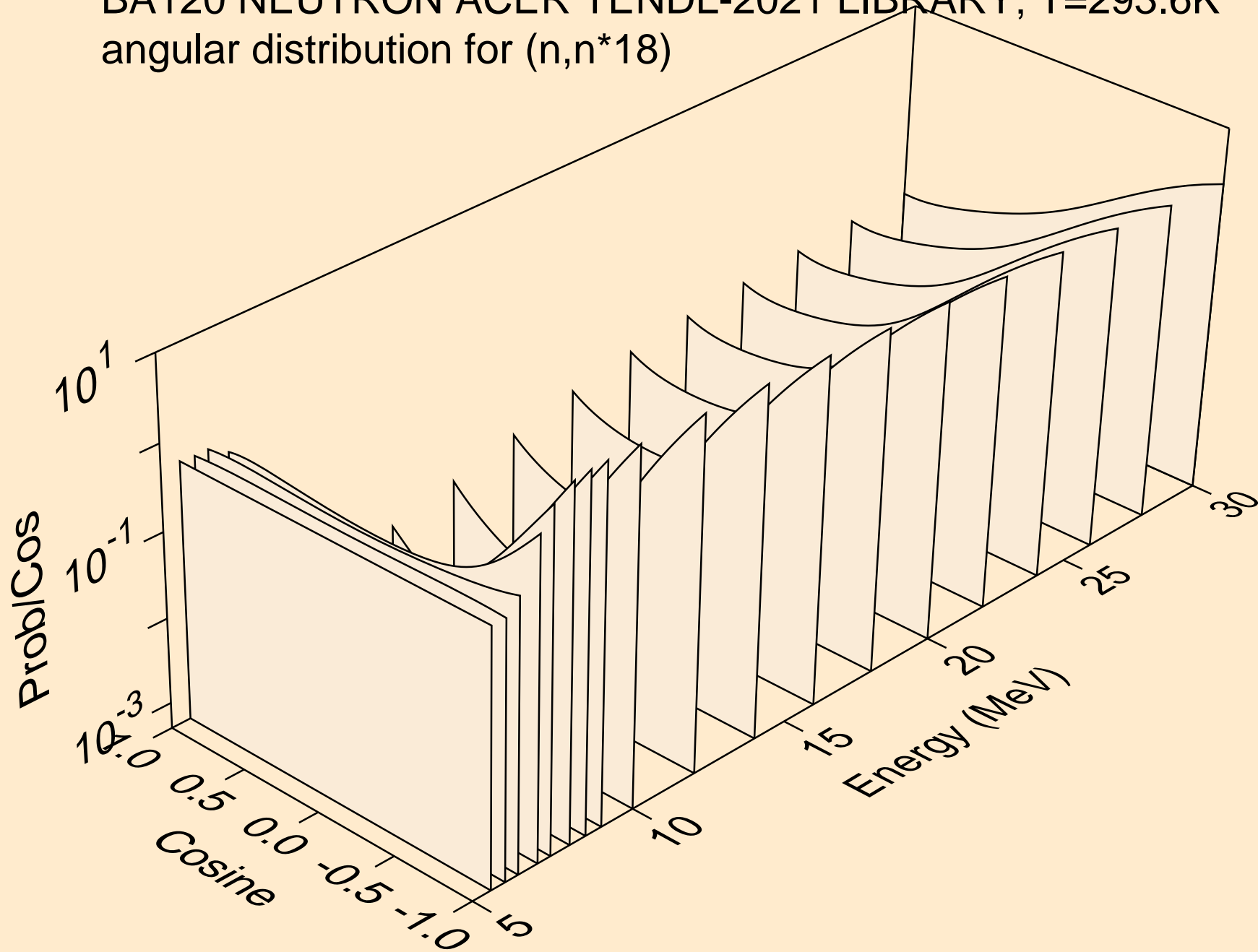

BA120 NEUTRON ACER TENDL-2021 LIBRARY; T=293.6K  
angular distribution for (n,n\*19)

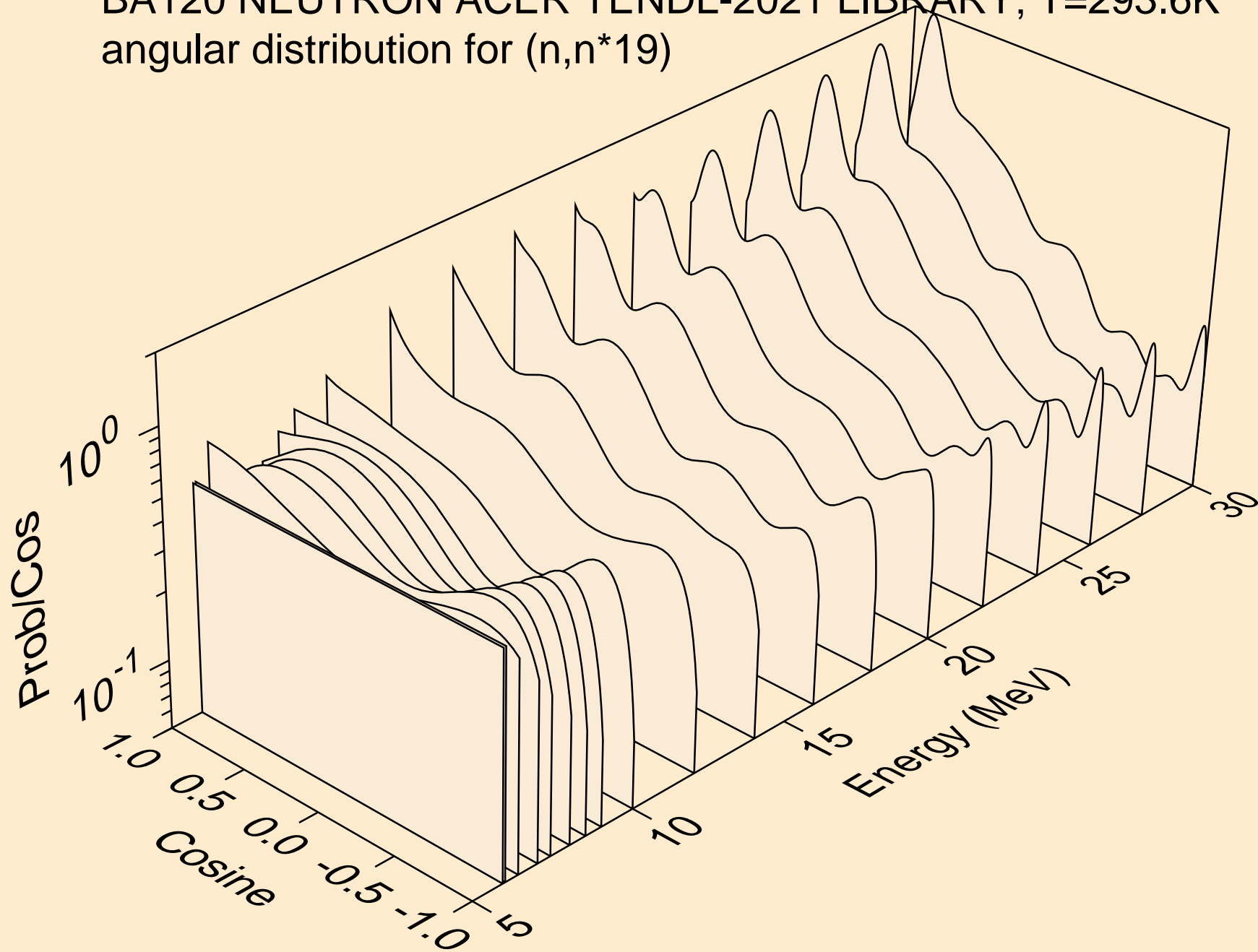

BA120 NEUTRON ACER TENDL-2021 LIBRARY; T=293.6K  
Neutron emission for (n,x)

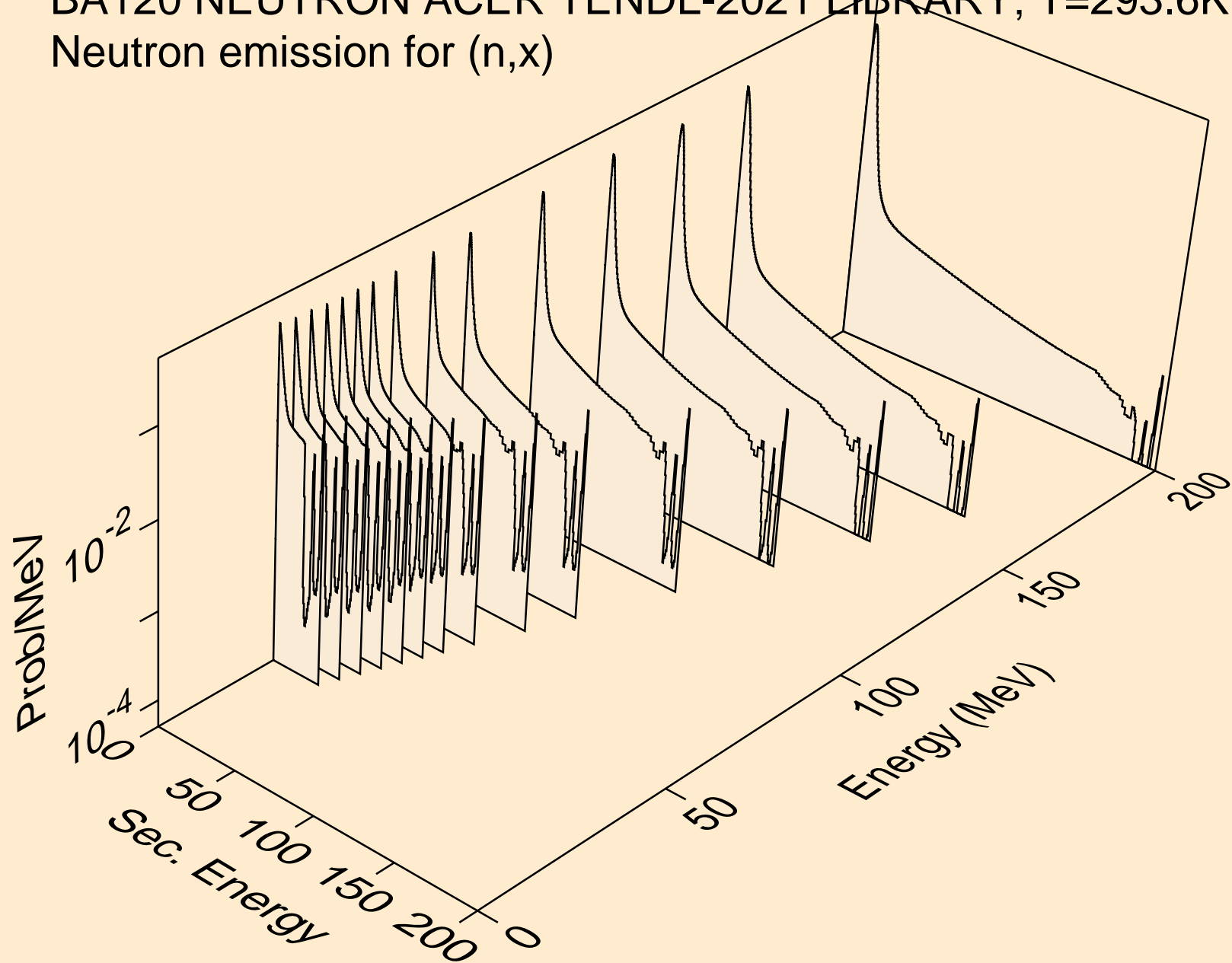

BA120 NEUTRON ACER TENDL-2021 LIBRARY; T=293.6K  
Neutron emission for (n,2nd)

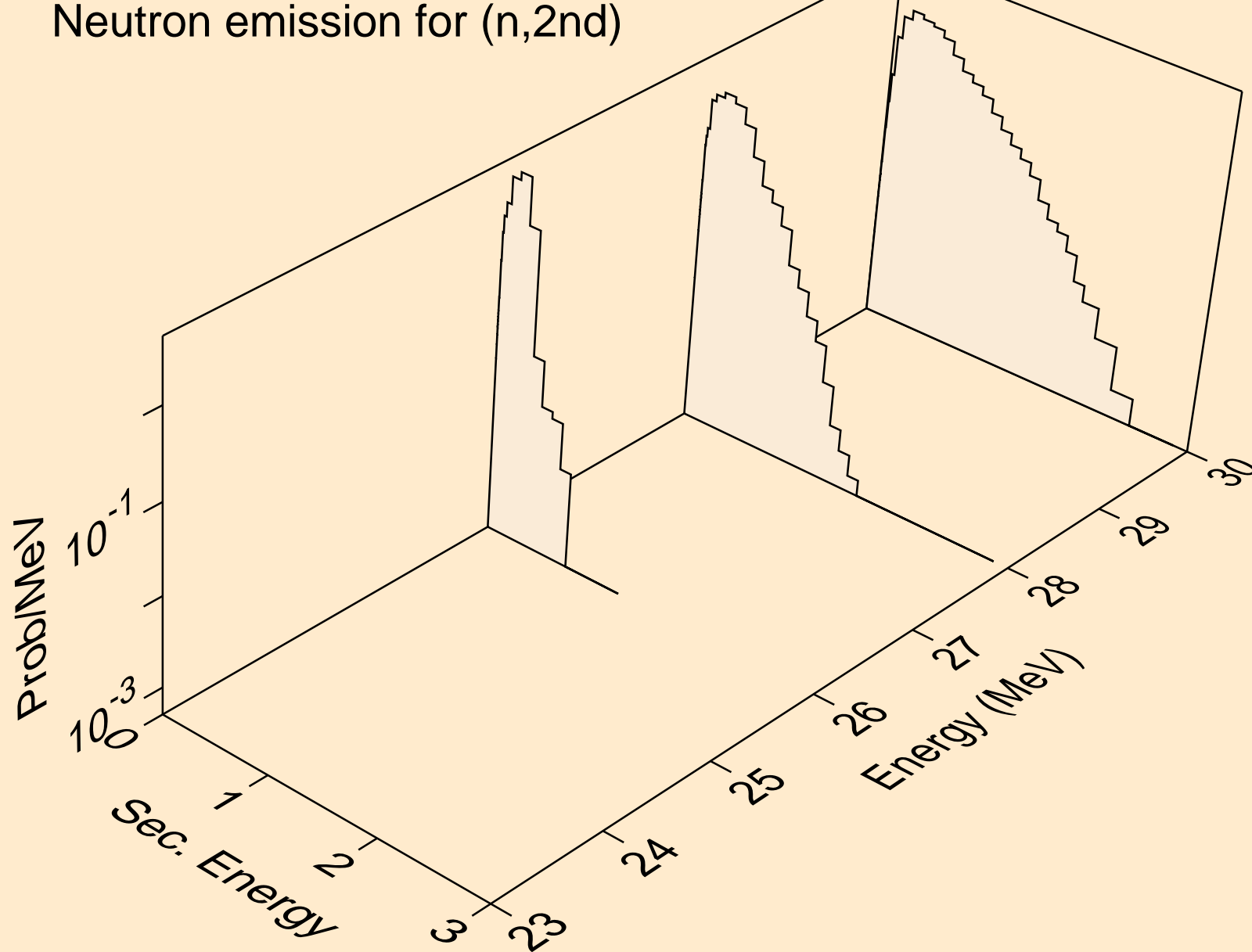

BA120 NEUTRON ACER TENDL-2021 LIBRARY; T=293.6K  
Neutron emission for (n,2n)

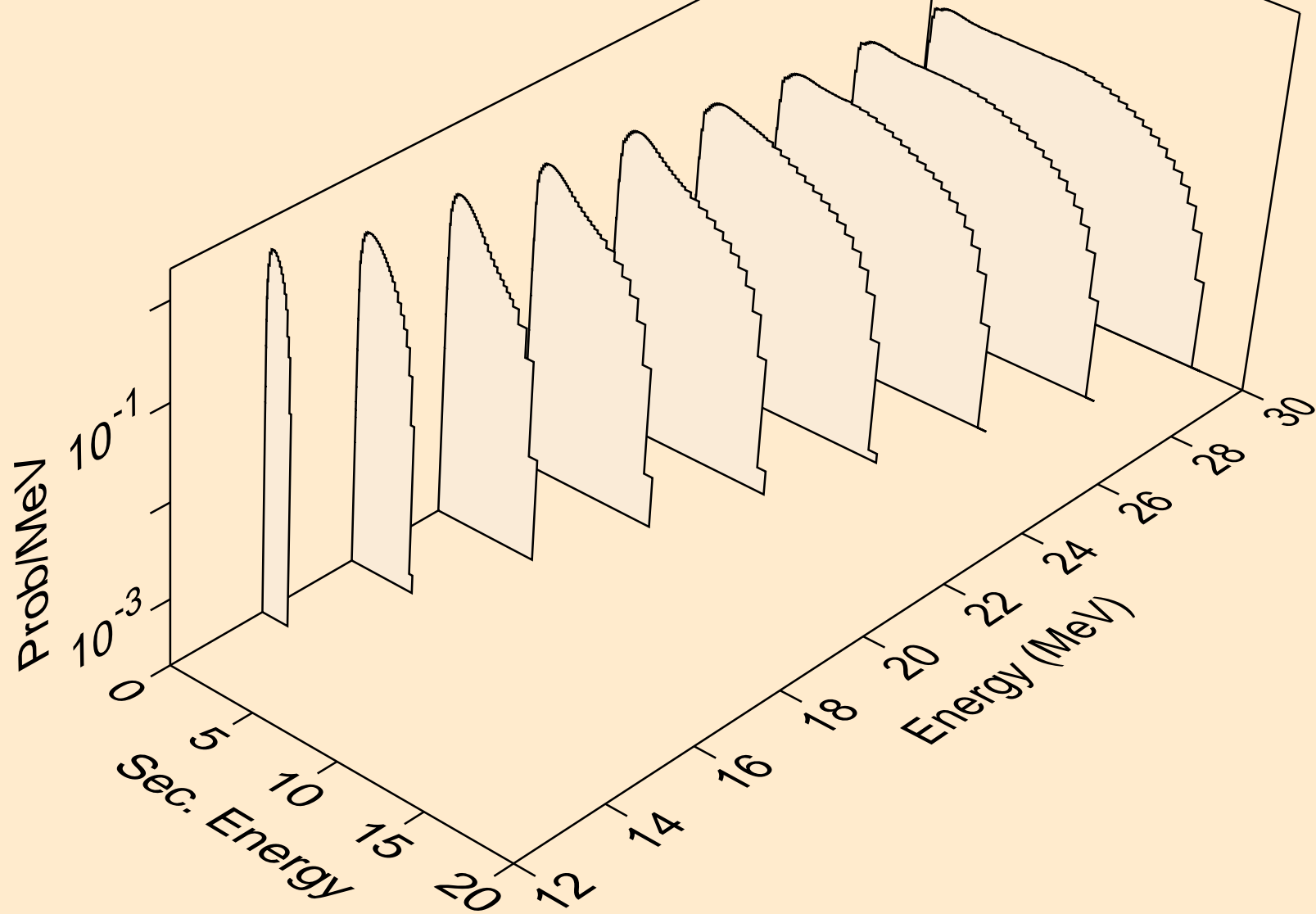

BA120 NEUTRON ACER TENDL-2021 LIBRARY; T=293.6K  
Neutron emission for (n,3n)

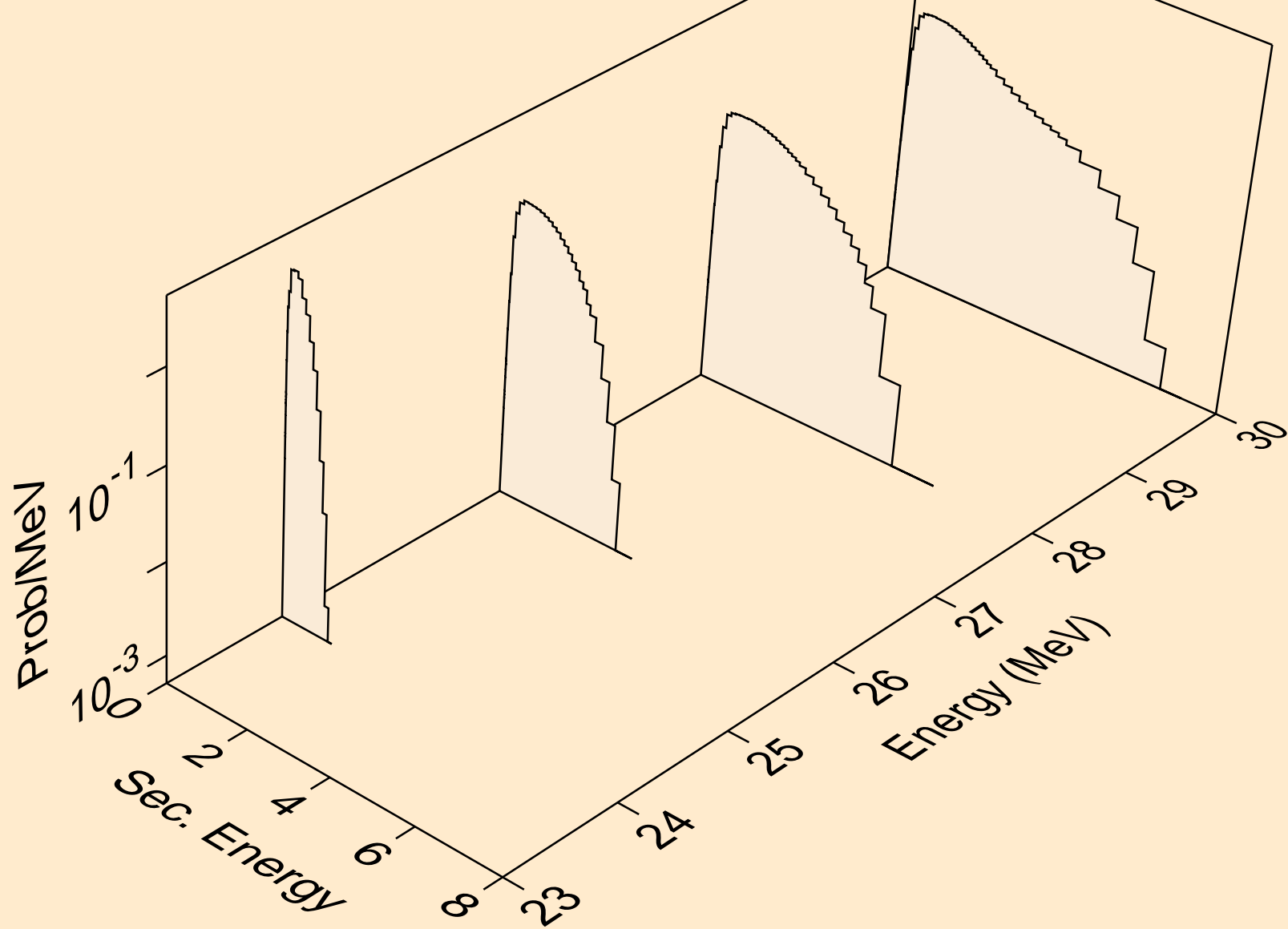

BA120 NEUTRON ACER TENDL-2021 LIBRARY; T=293.6K  
Neutron emission for (n,n\*)a

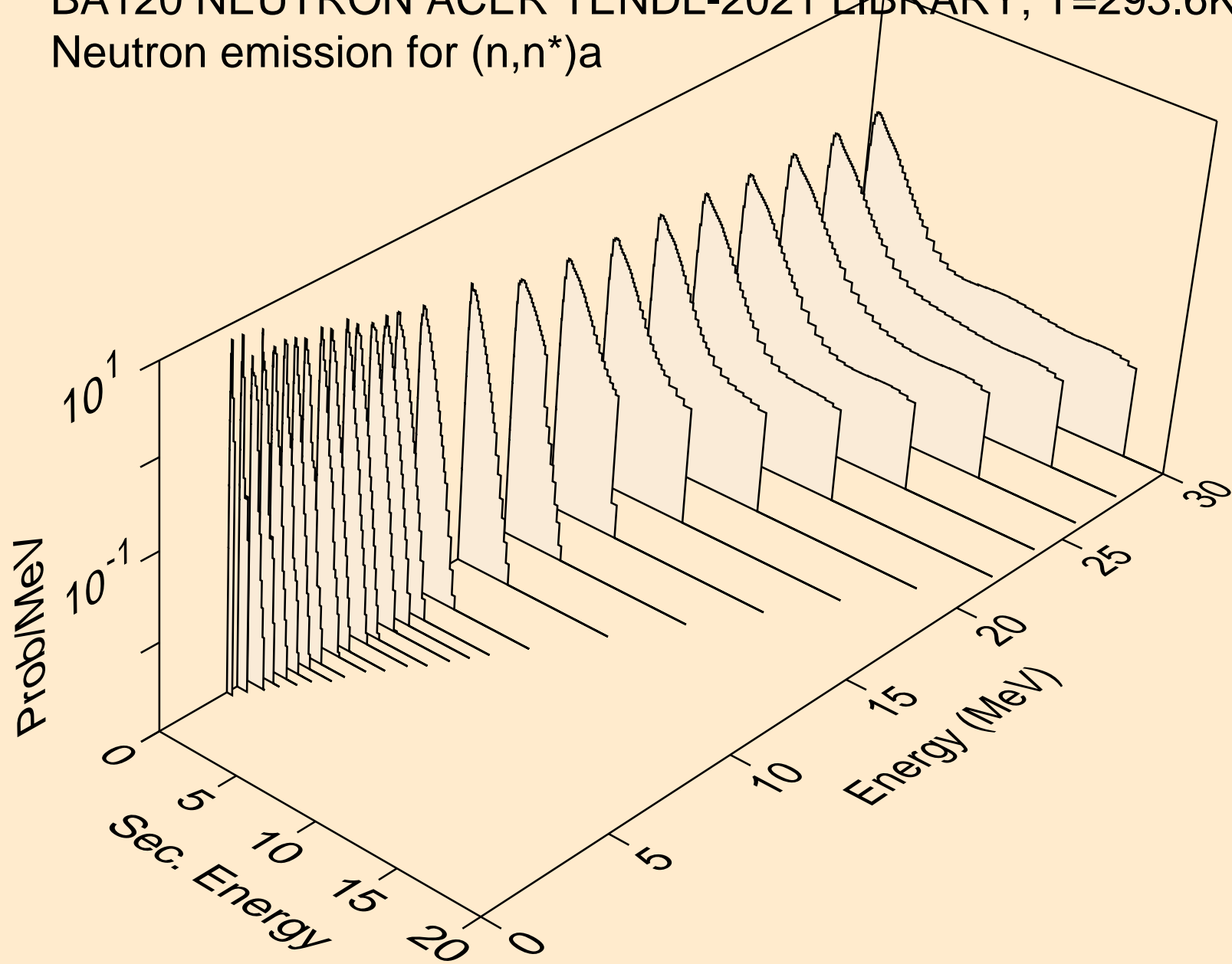

BA120 NEUTRON ACER TENDL-2021 LIBRARY; T=293.6K  
Neutron emission for (n,n\*)3a

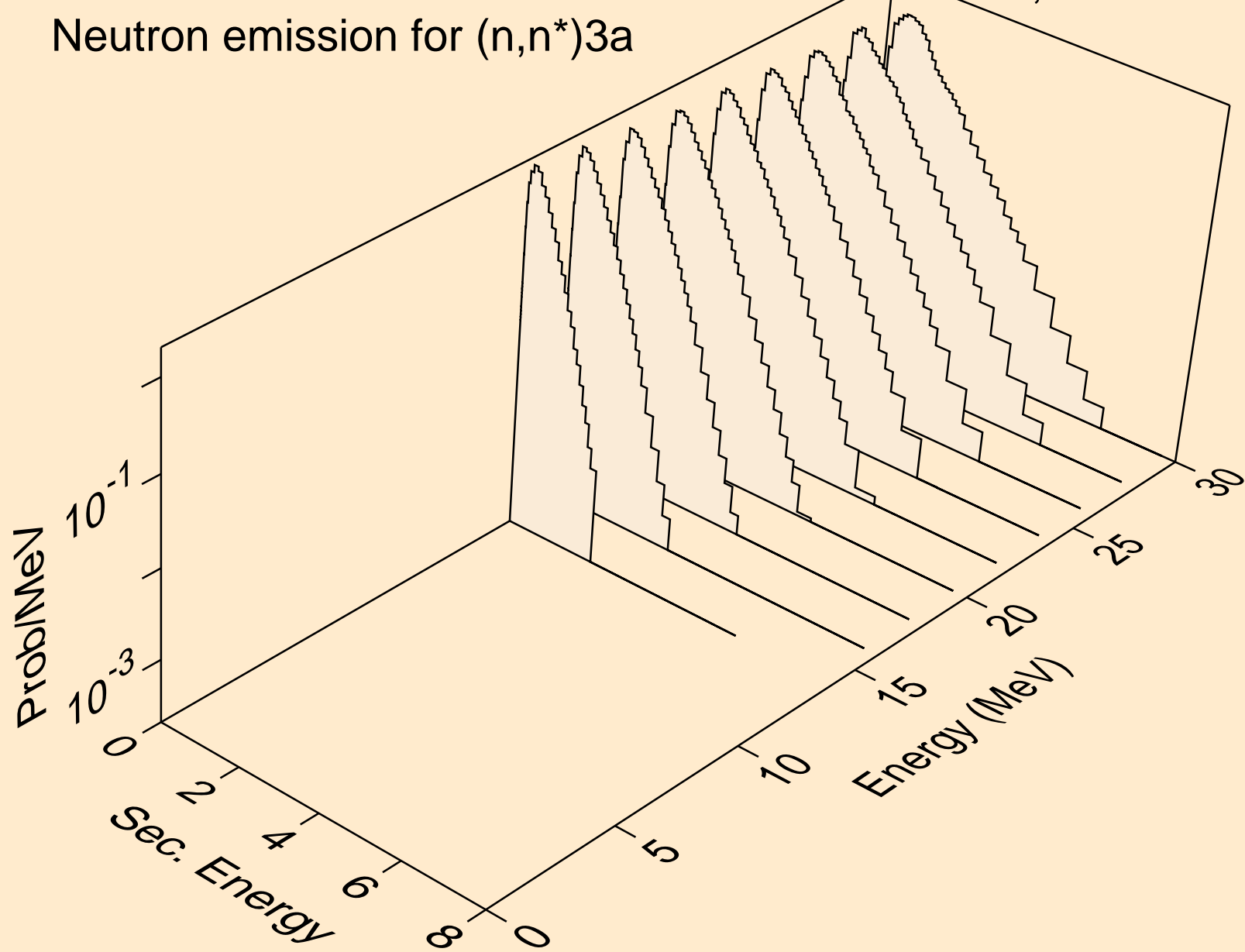



BA120 NEUTRON ACER TENDL-2021 LIBRARY; T=293.6K  
Neutron emission for (n,2n)<sub>a</sub>

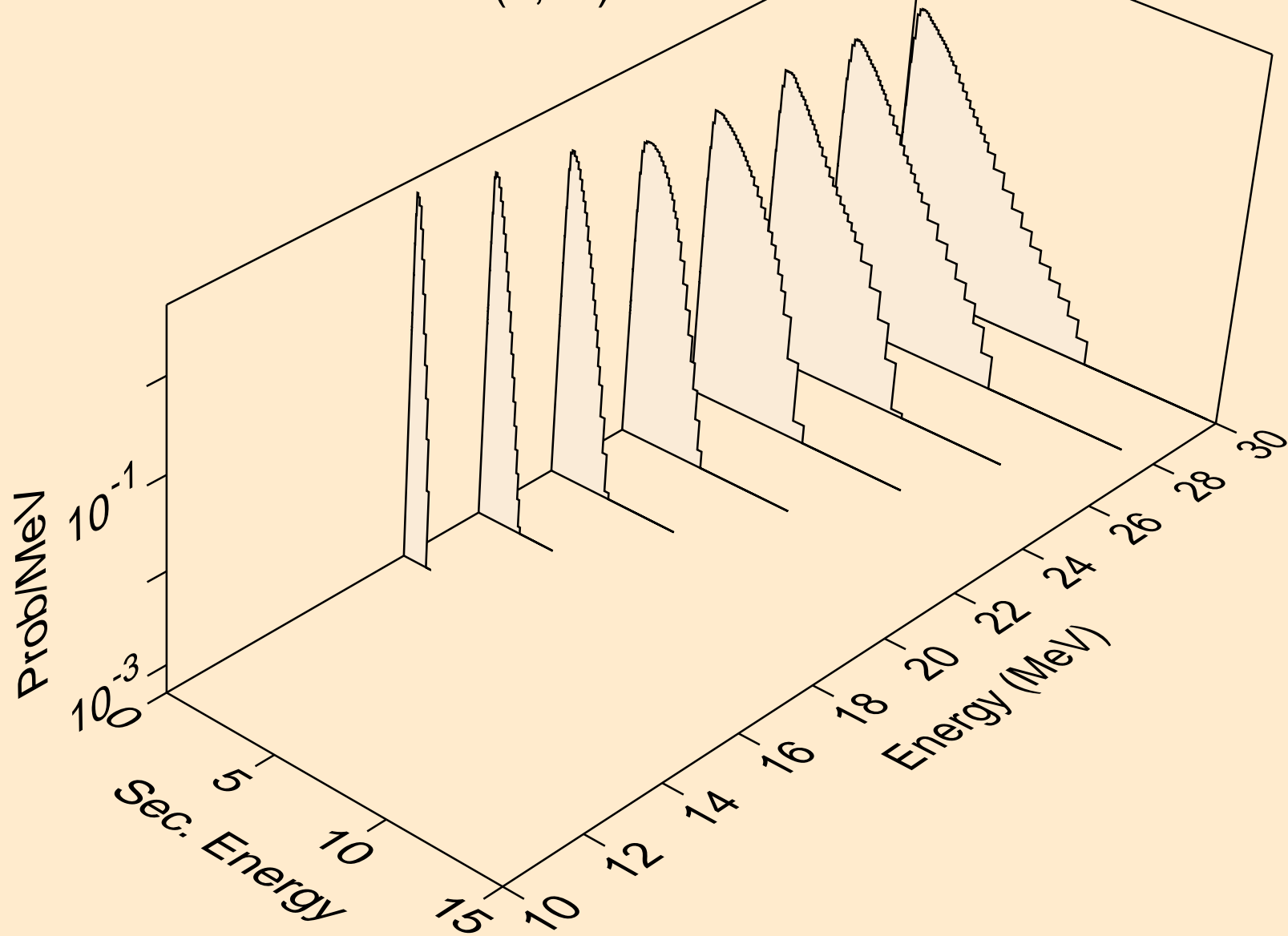

BA120 NEUTRON ACER TENDL-2021 LIBRARY; T=293.6K  
Neutron emission for (n,n\*)p

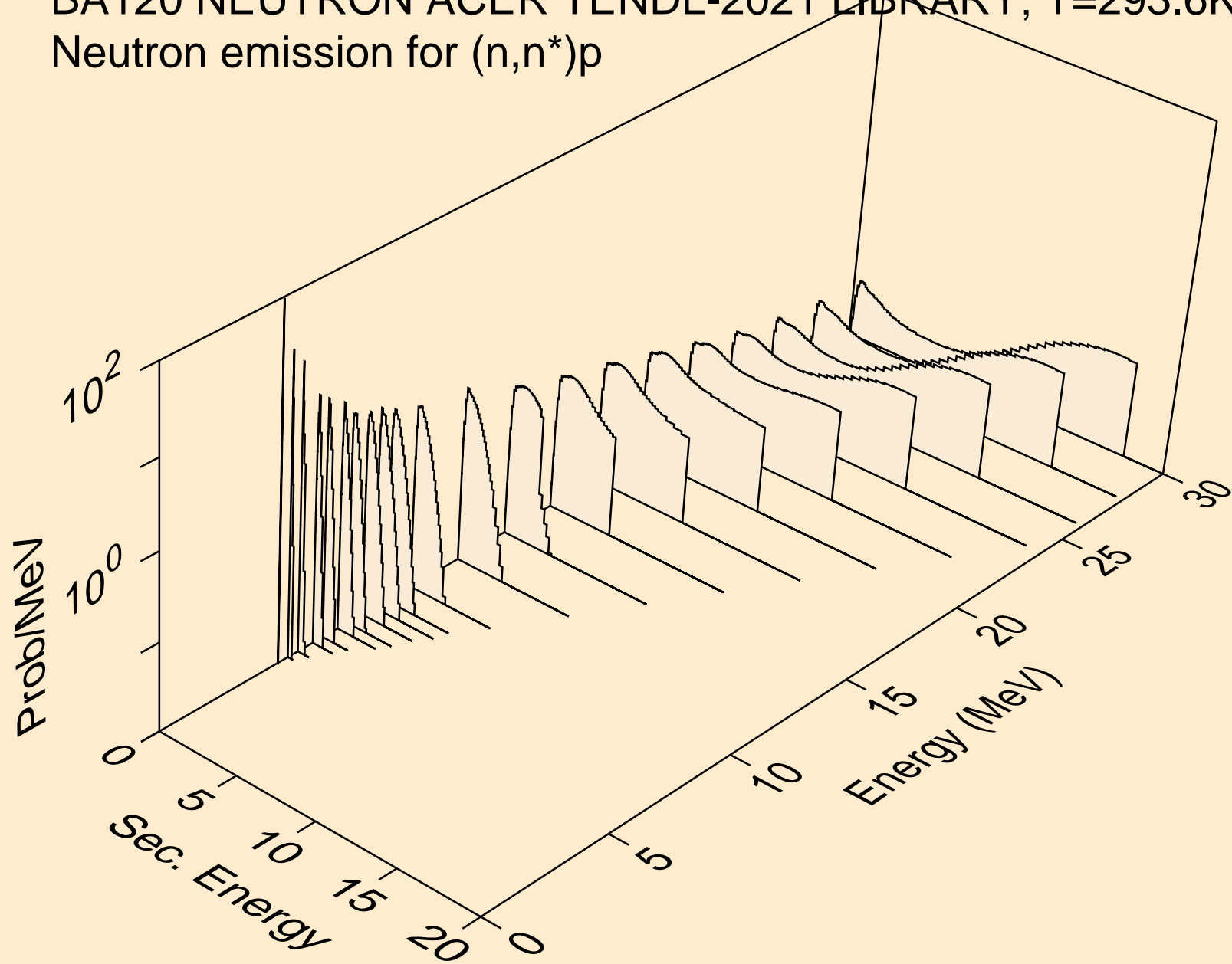

BA120 NEUTRON ACER TENDL-2021 LIBRARY; T=293.6K  
Neutron emission for (n,n\*)2a

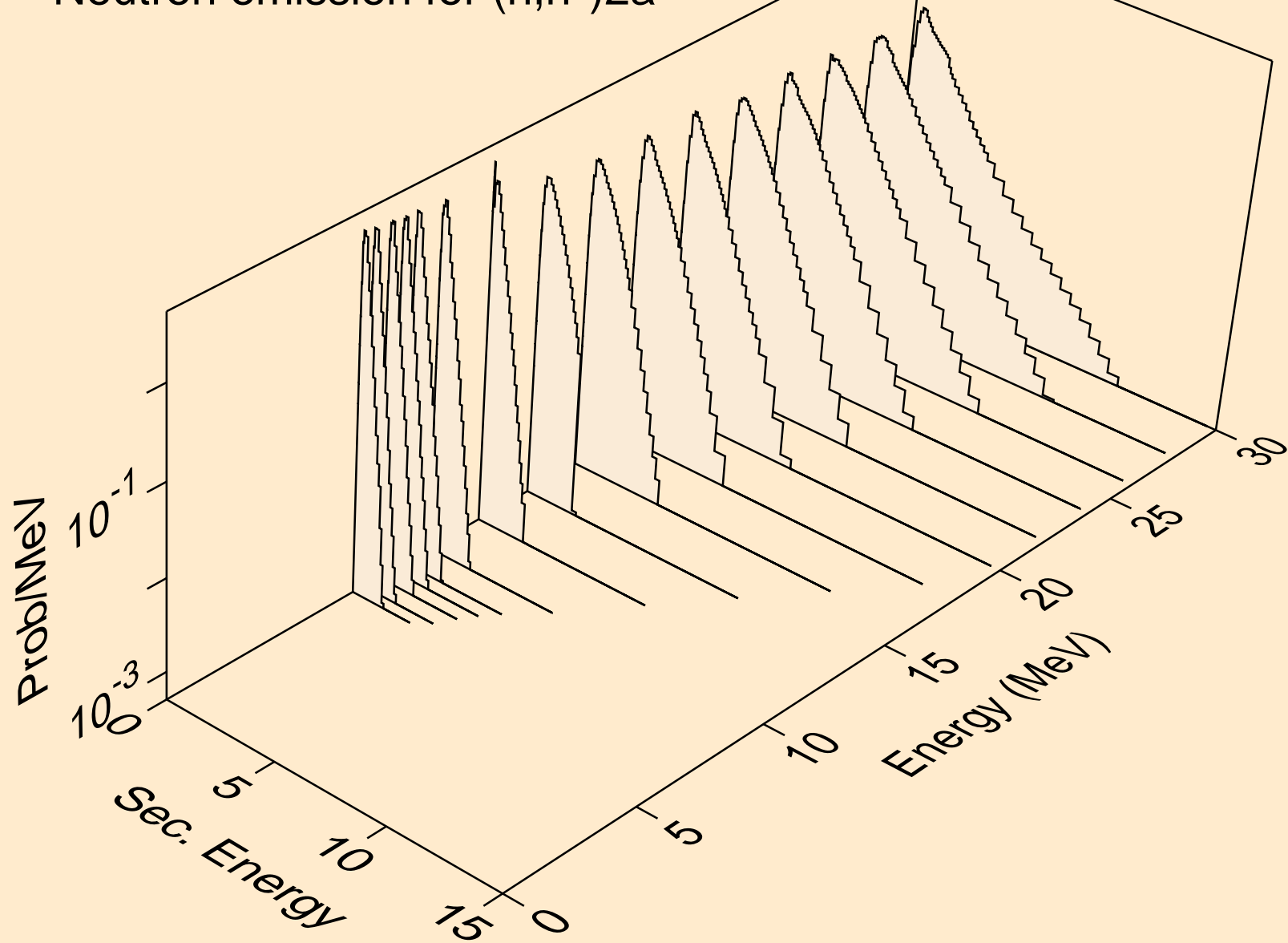

BA120 NEUTRON ACER TENDL-2021 LIBRARY; T=293.6K  
Neutron emission for (n,2n)2a

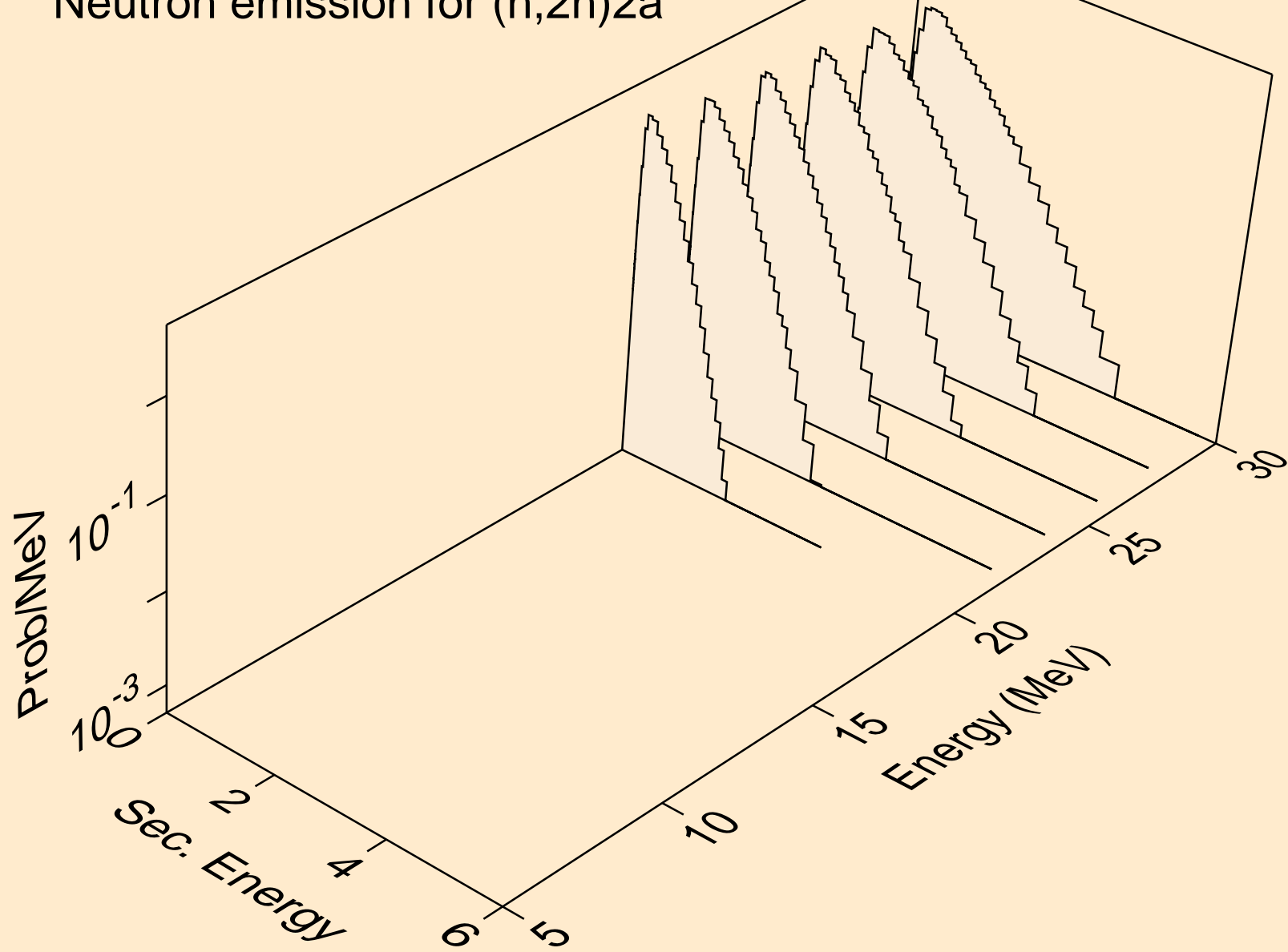

BA120 NEUTRON ACER TENDL-2021 LIBRARY; T=293.6K  
Neutron emission for (n,n\*)d

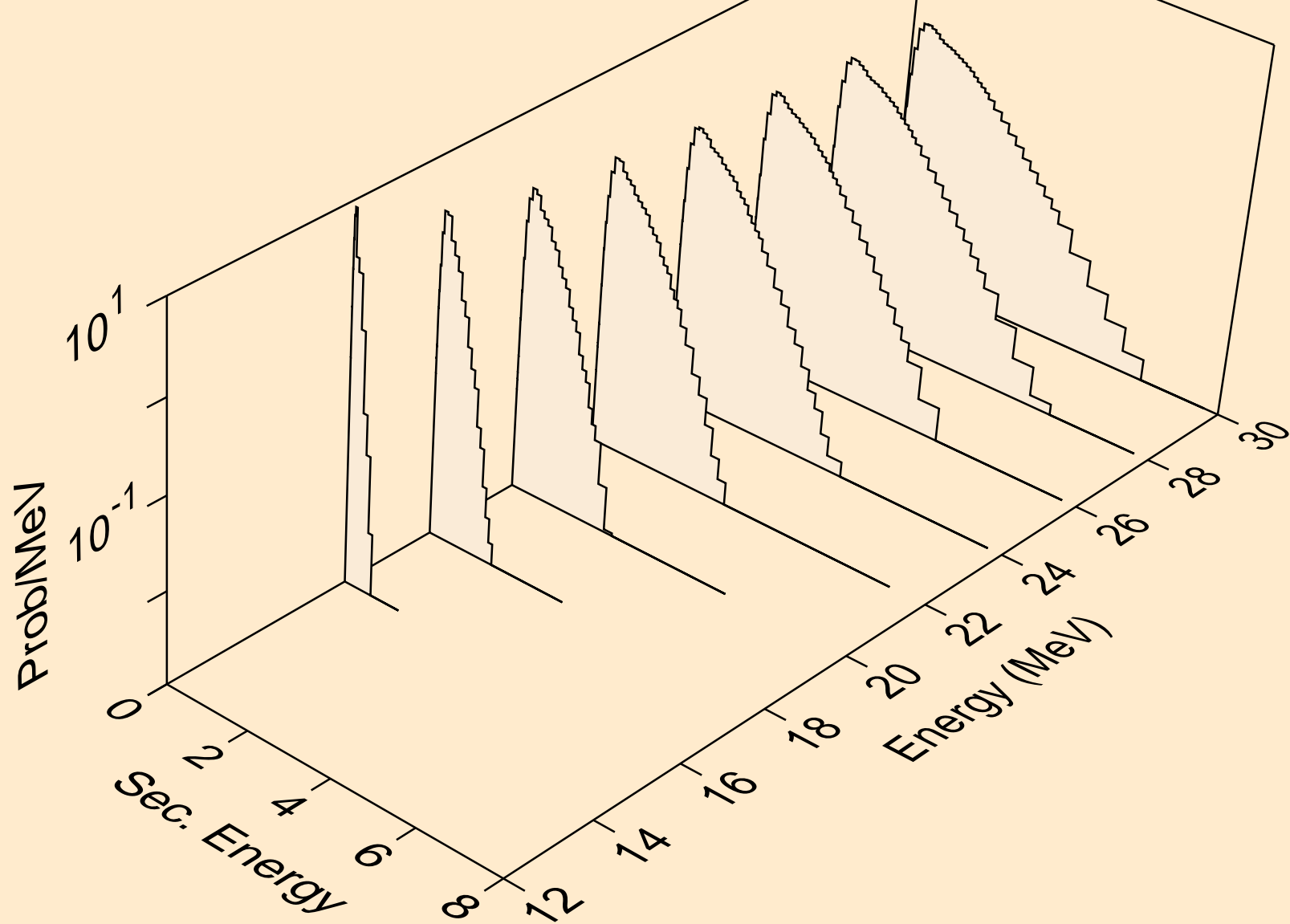

BA120 NEUTRON ACER TENDL-2021 LIBRARY; T=293.6K  
Neutron emission for (n,n\*)t

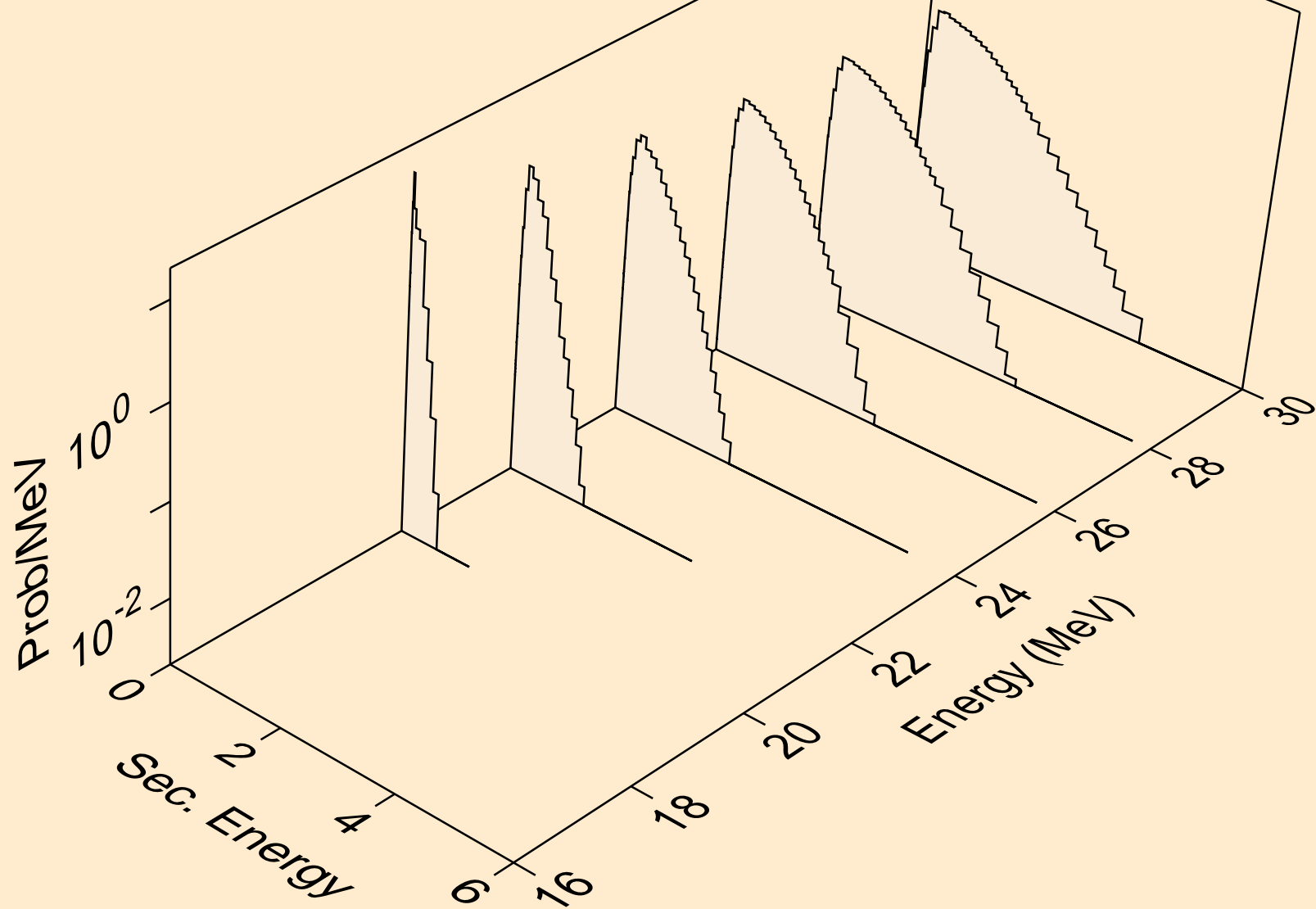

BA120 NEUTRON ACER TENDL-2021 LIBRARY; T=293.6K  
Neutron emission for (n,n\*)he3

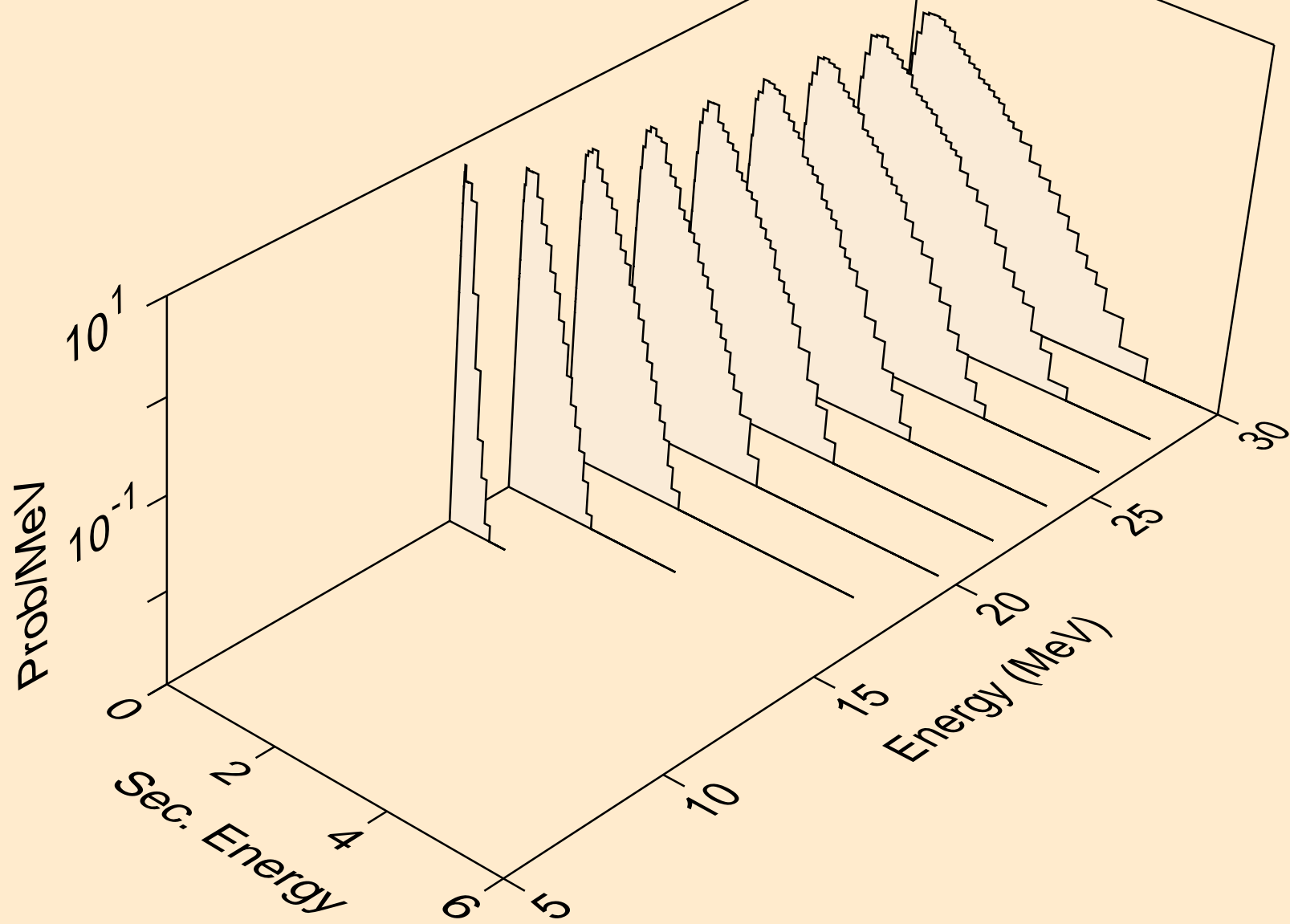

BA120 NEUTRON ACER TENDL-2021 LIBRARY; T=293.6K  
Neutron emission for (n,2np)

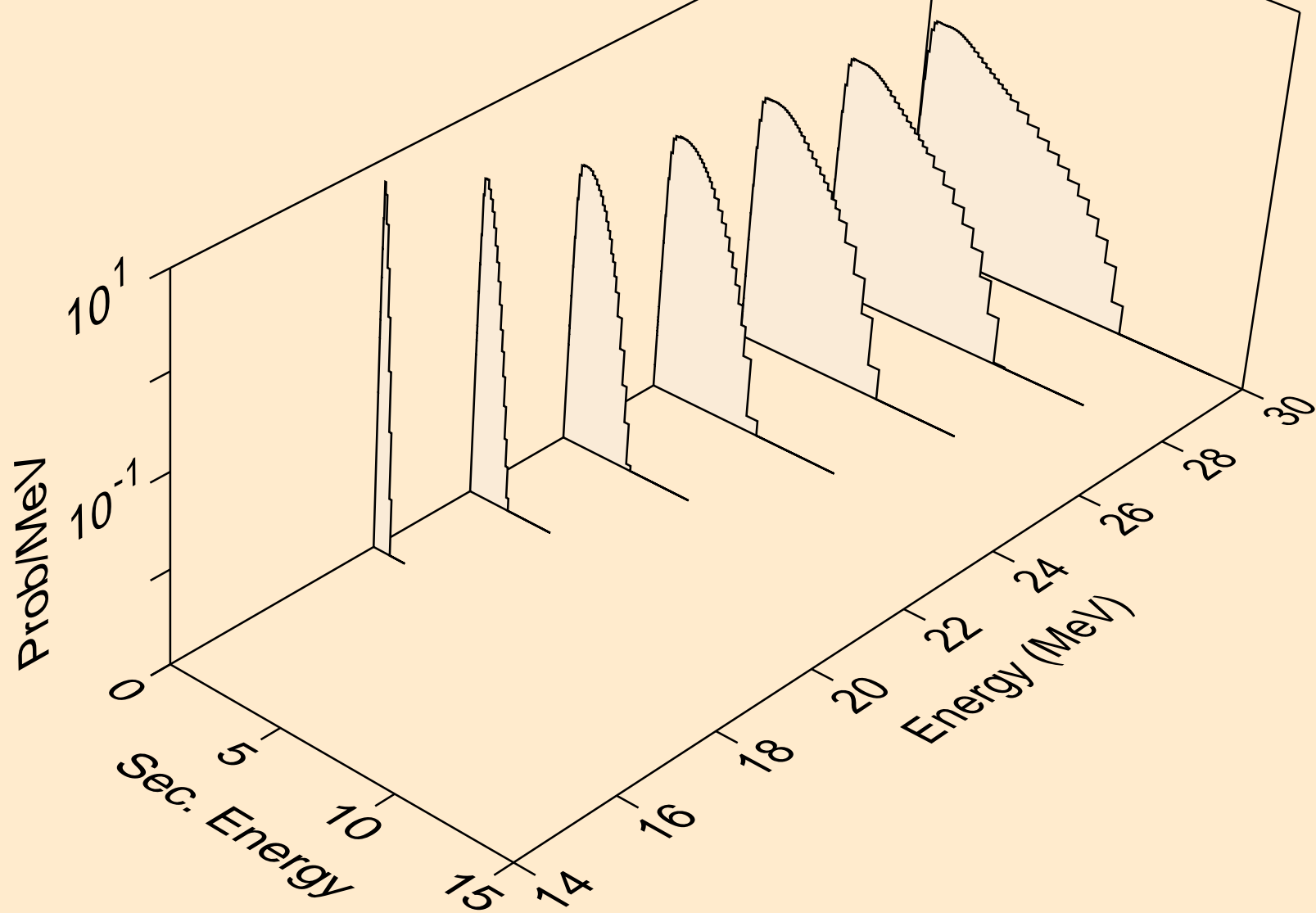



BA120 NEUTRON ACER TENDL-2021 LIBRARY; T=293.6K  
Neutron emission for (n,3np)

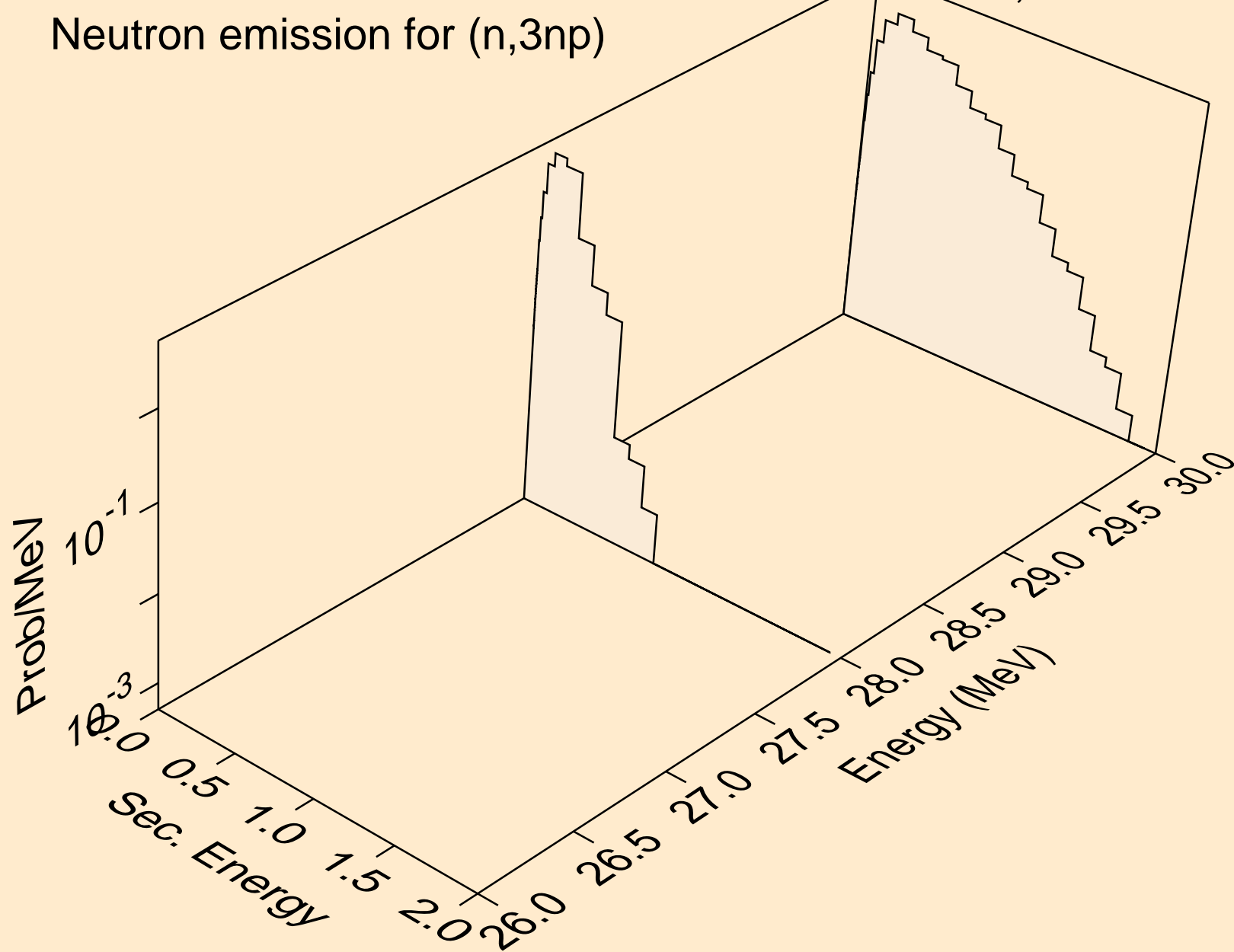

BA120 NEUTRON ACER TENDL-2021 LIBRARY; T=293.6K  
Neutron emission for (n,2np)

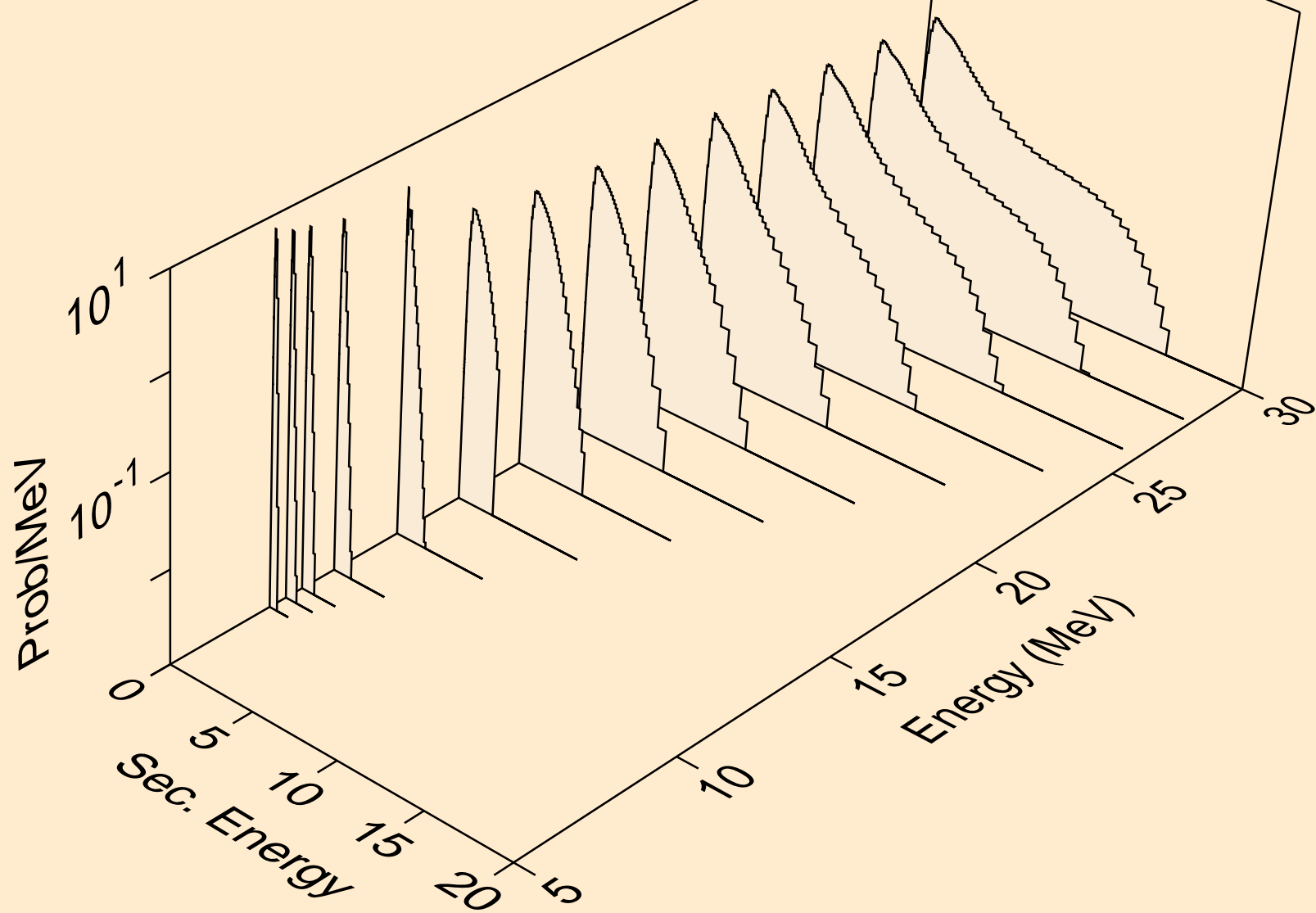

BA120 NEUTRON ACER TENDL-2021 LIBRARY; T=293.6K  
Neutron emission for (n,npa)

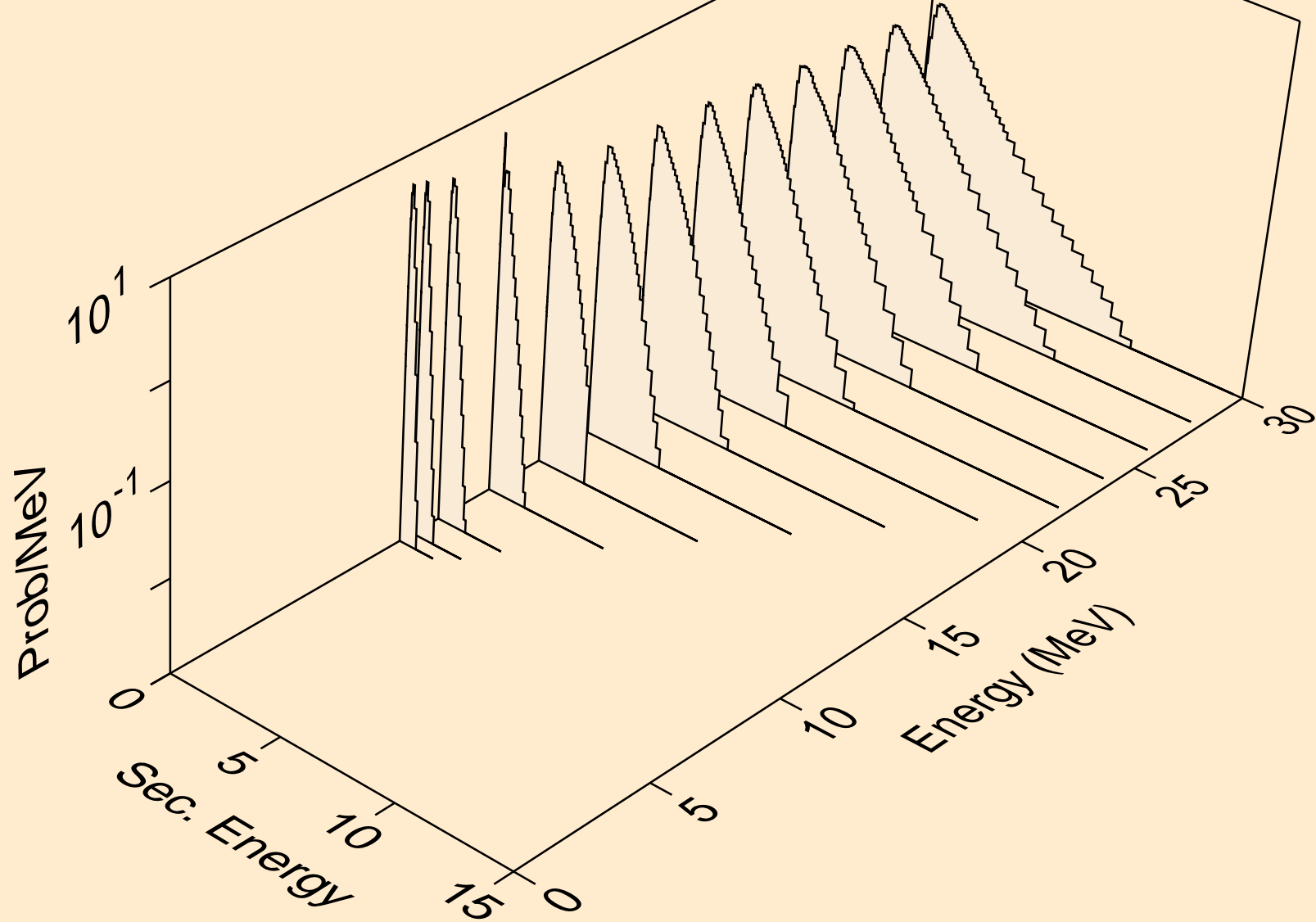

BA120 NEUTRON ACER TENDL-2021 LIBRARY; T=293.6K  
Neutron emission for (n,n\*c)

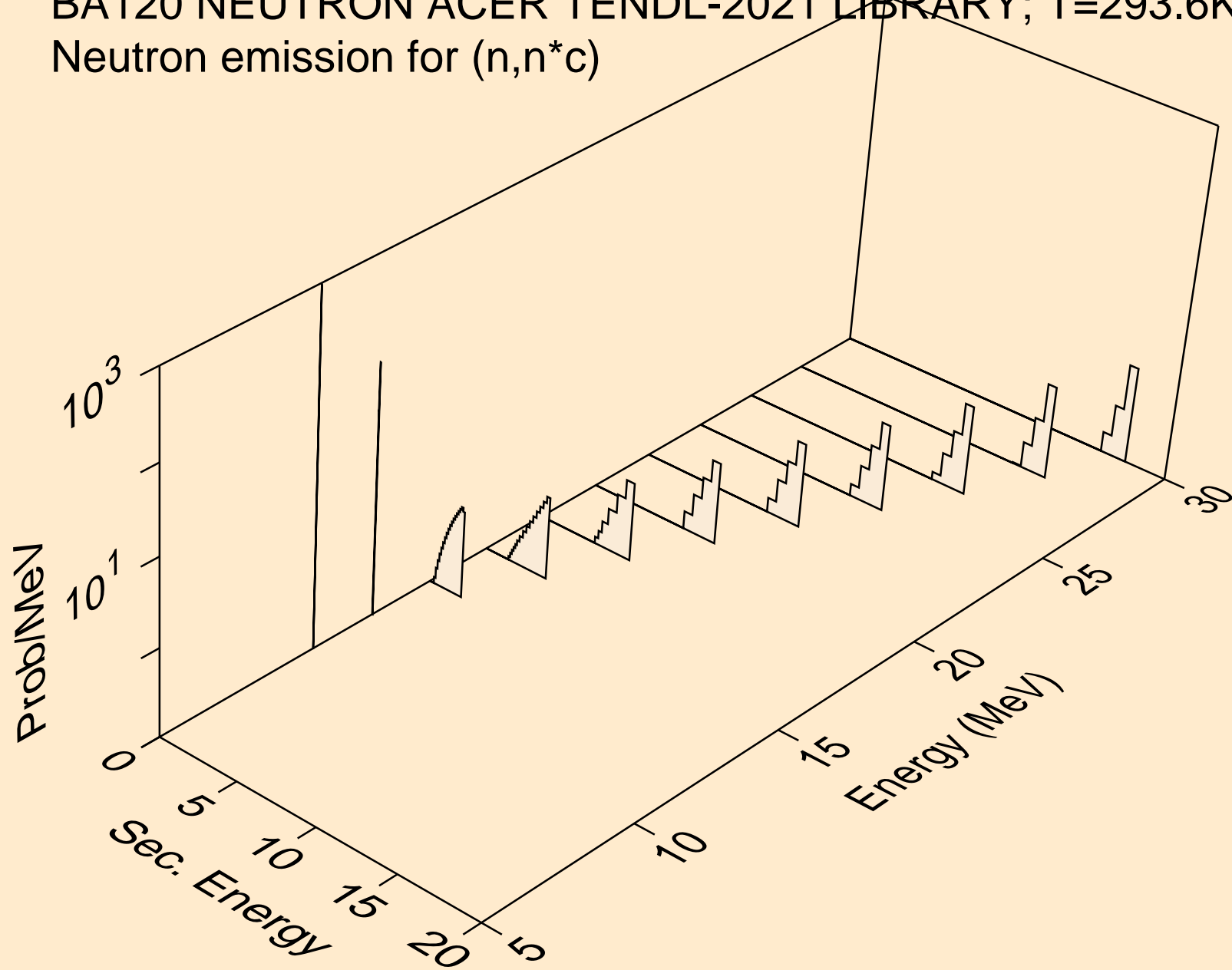

BA120 NEUTRON ACER TENDL-2021 LIBRARY; T=293.6K  
Photon emission for (n,x)

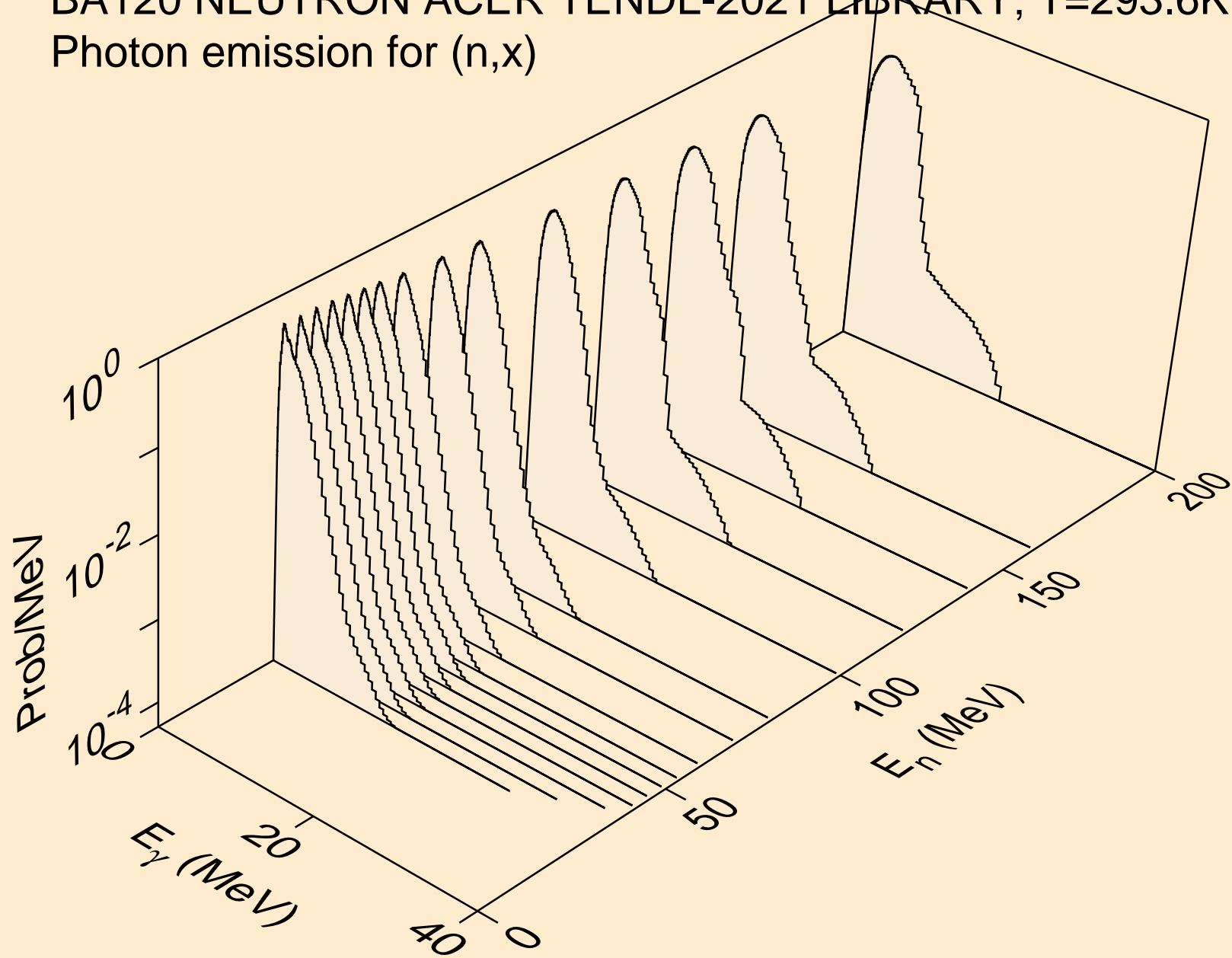

BA120 NEUTRON ACER TENDL-2021 LIBRARY; T=293.6K  
Photon emission for (n,2nd)

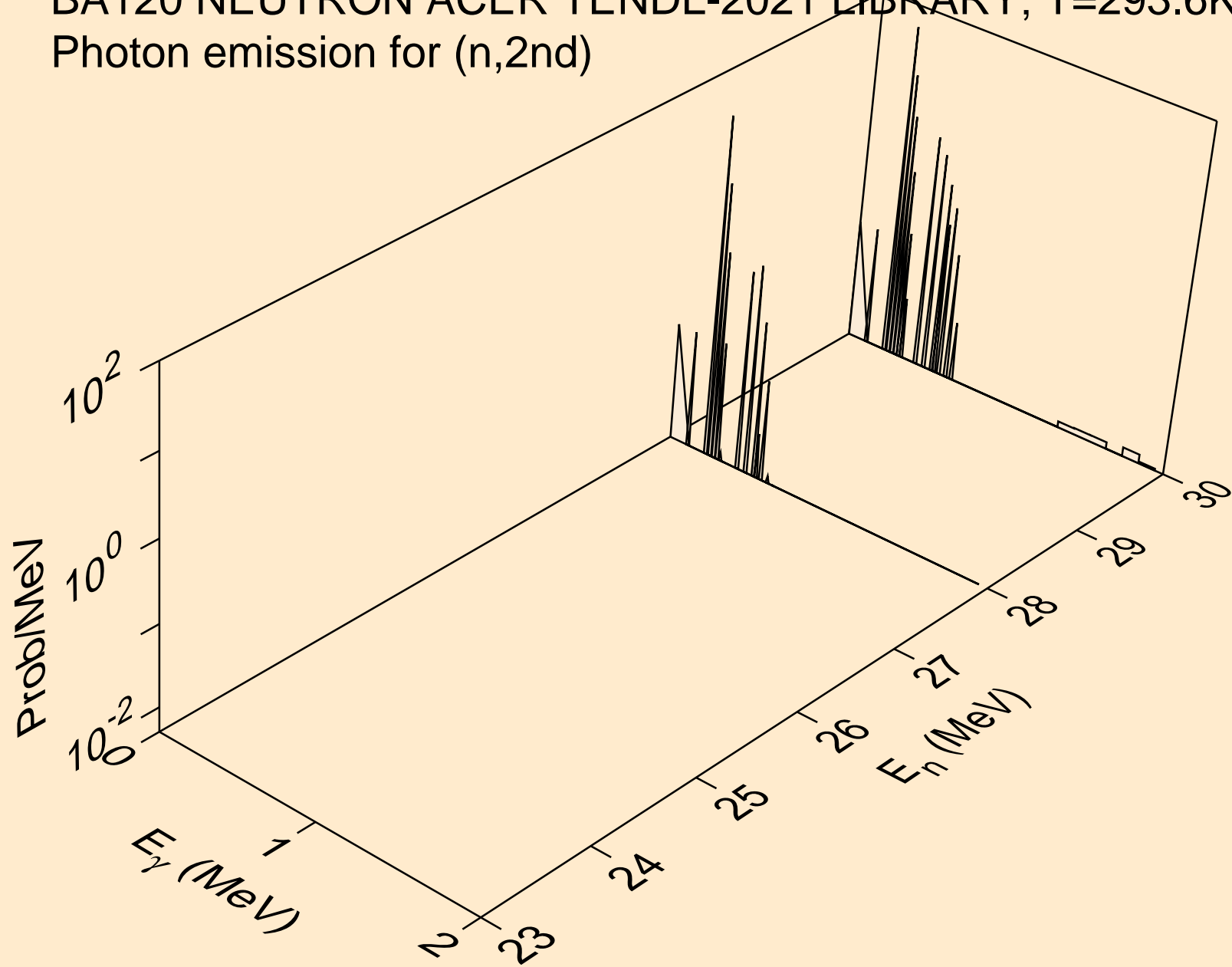

BA120 NEUTRON ACER TENDL-2021 LIBRARY; T=293.6K  
Photon emission for (n,2n)

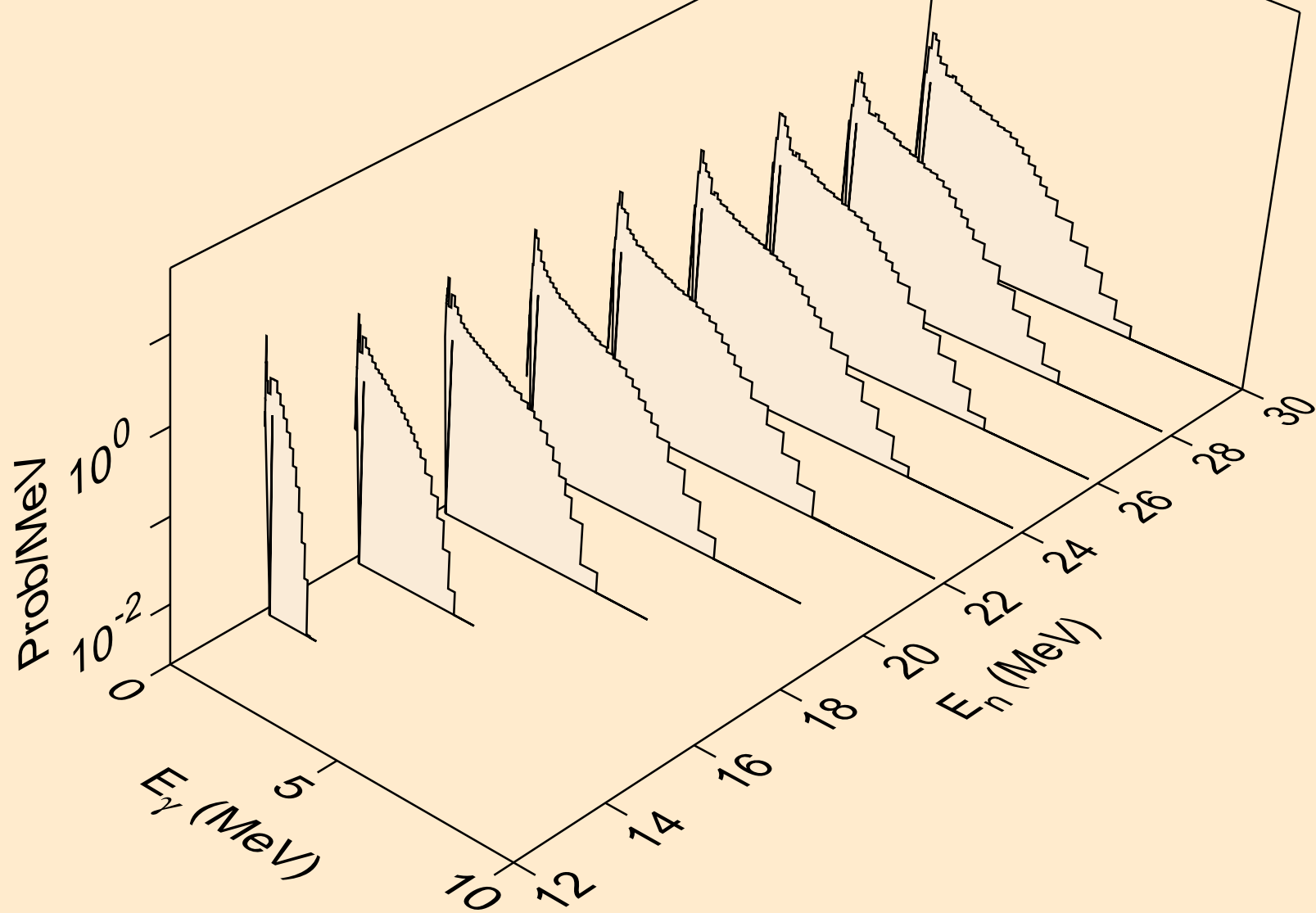

BA120 NEUTRON ACER TENDL-2021 LIBRARY; T=293.6K  
Photon emission for (n,3n)

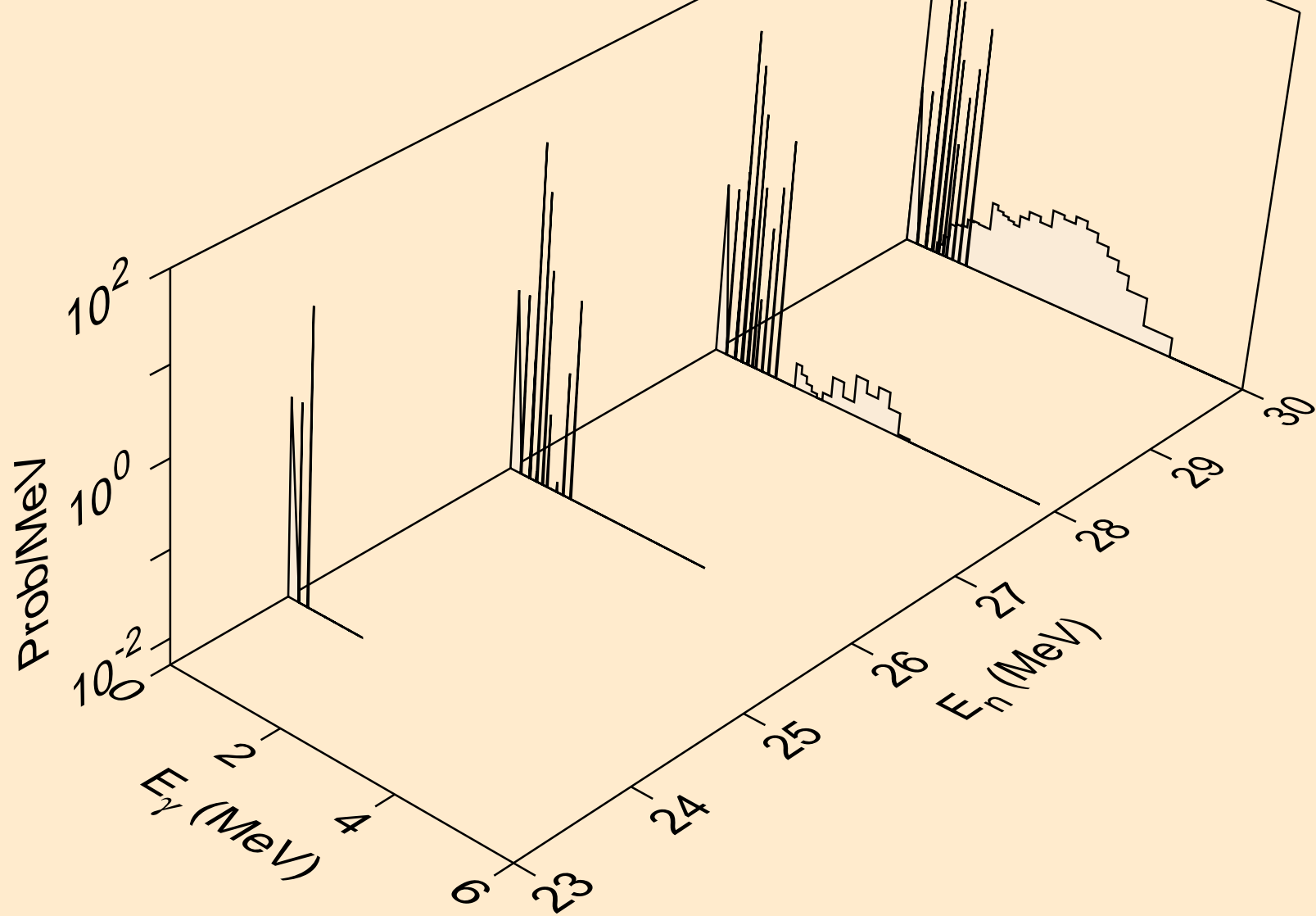



BA120 NEUTRON ACER TENDL-2021 LIBRARY; T=293.6K  
Photon emission for (n,n\*)a

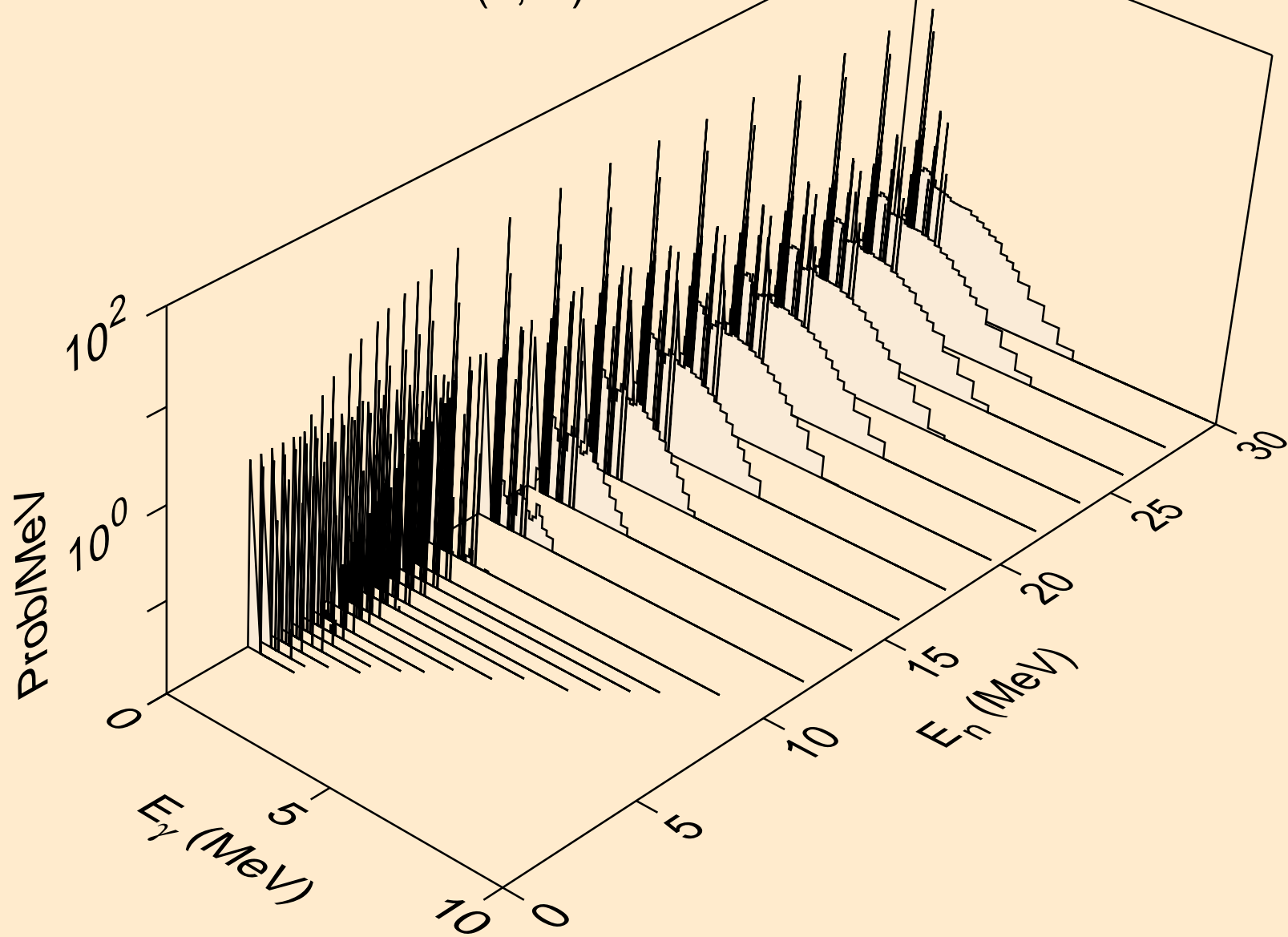

BA120 NEUTRON ACER TENDL-2021 LIBRARY; T=293.6K  
Photon emission for (n,n\*)3a

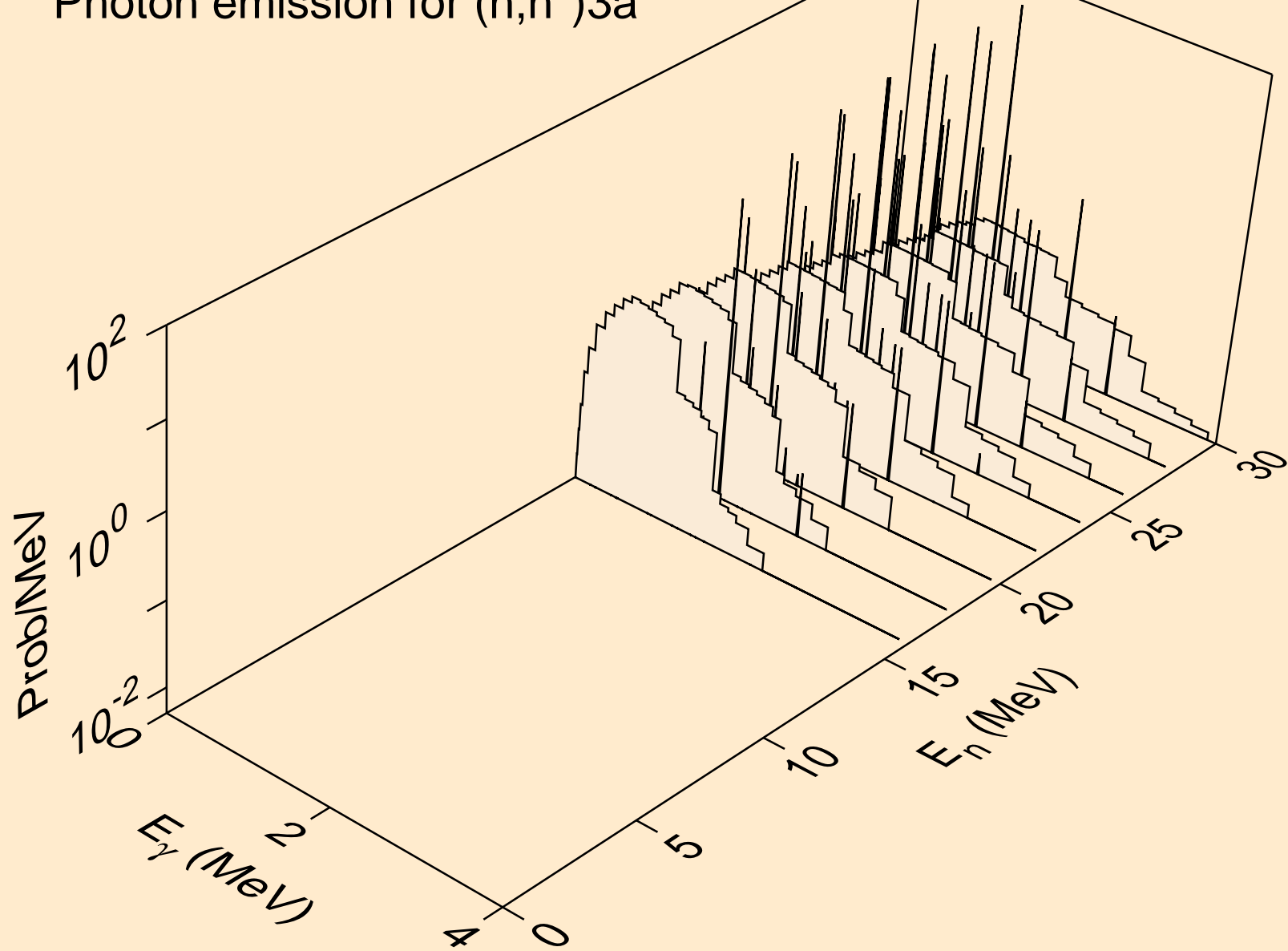

BA120 NEUTRON ACER TENDL-2021 LIBRARY; T=293.6K  
Photon emission for (n,2n)a

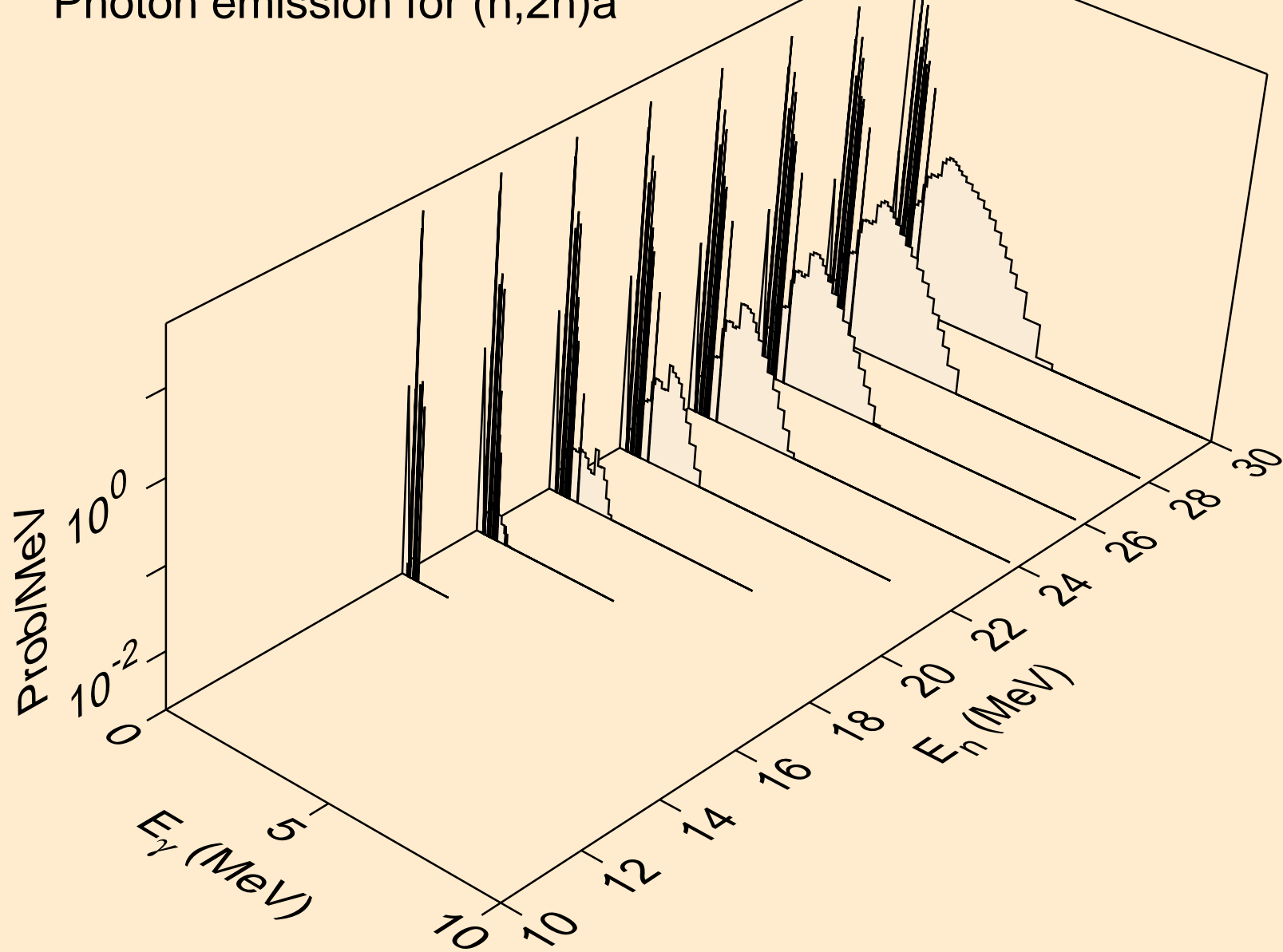

BA120 NEUTRON ACER TENDL-2021 LIBRARY; T=293.6K  
Photon emission for (n,n\*)p

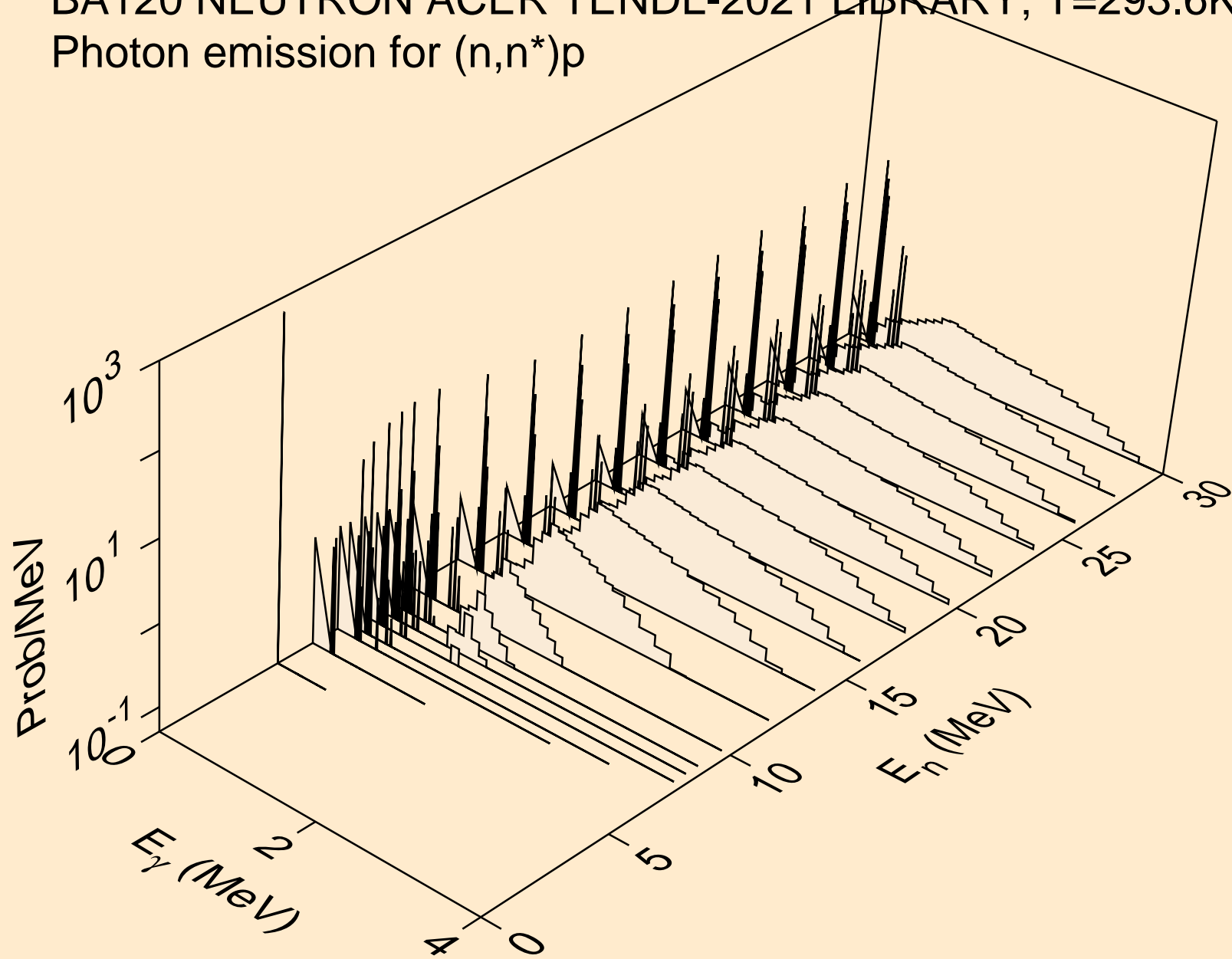

BA120 NEUTRON ACER TENDL-2021 LIBRARY; T=293.6K  
Photon emission for (n,n\*)2a

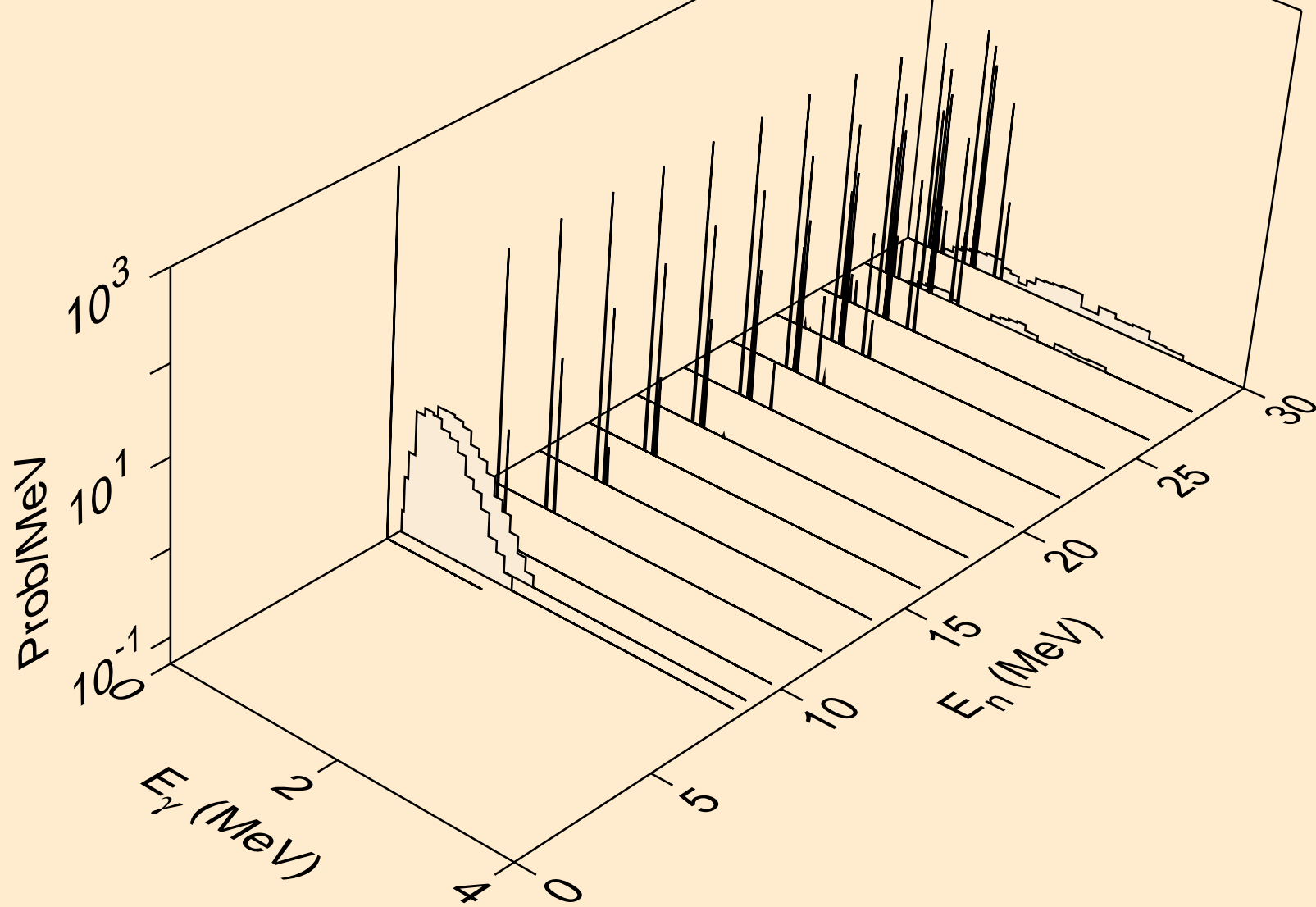

BA120 NEUTRON ACER TENDL-2021 LIBRARY; T=293.6K  
Photon emission for (n,2n)2a

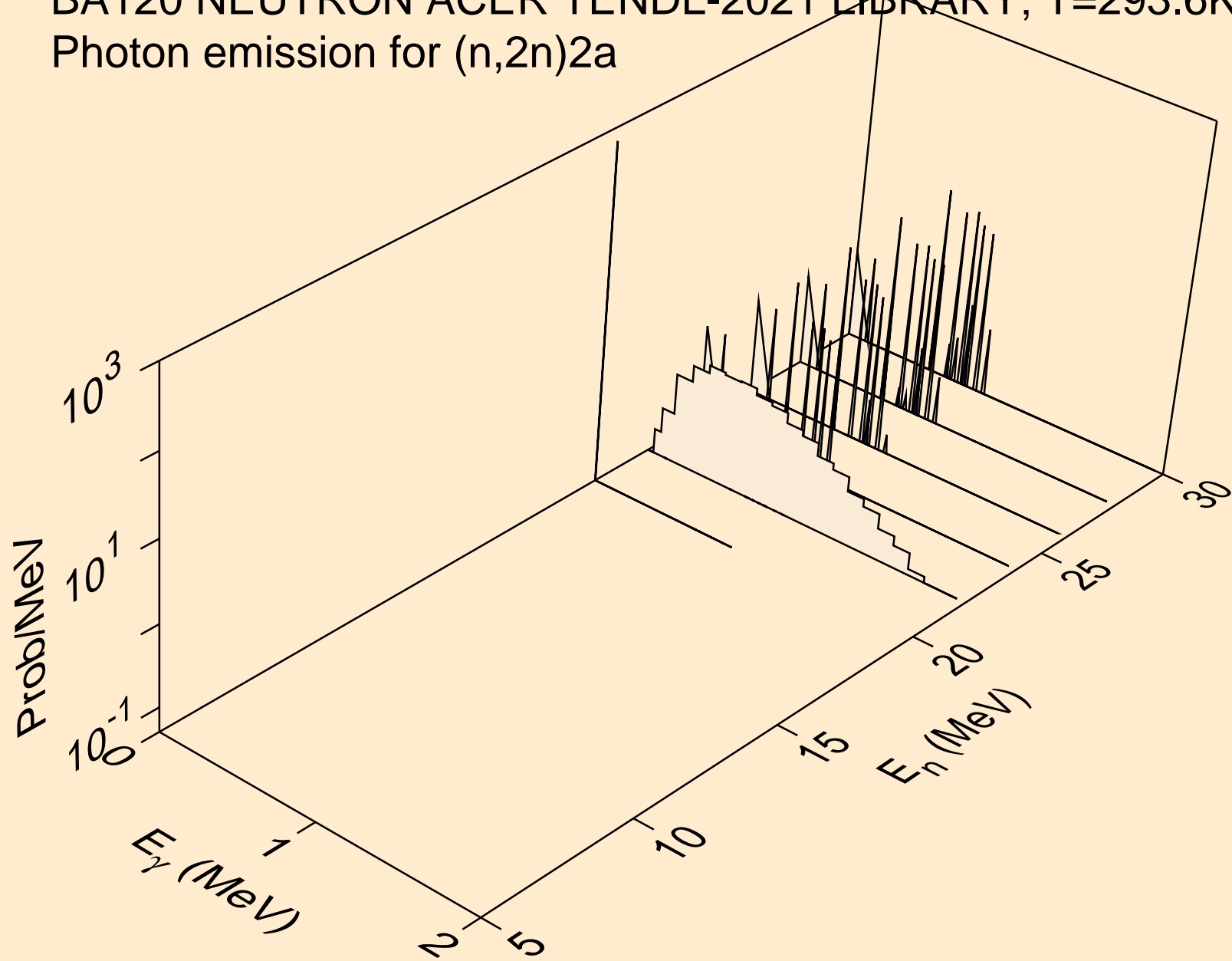

BA120 NEUTRON ACER TENDL-2021 LIBRARY; T=293.6K  
Photon emission for (n,n\*)d

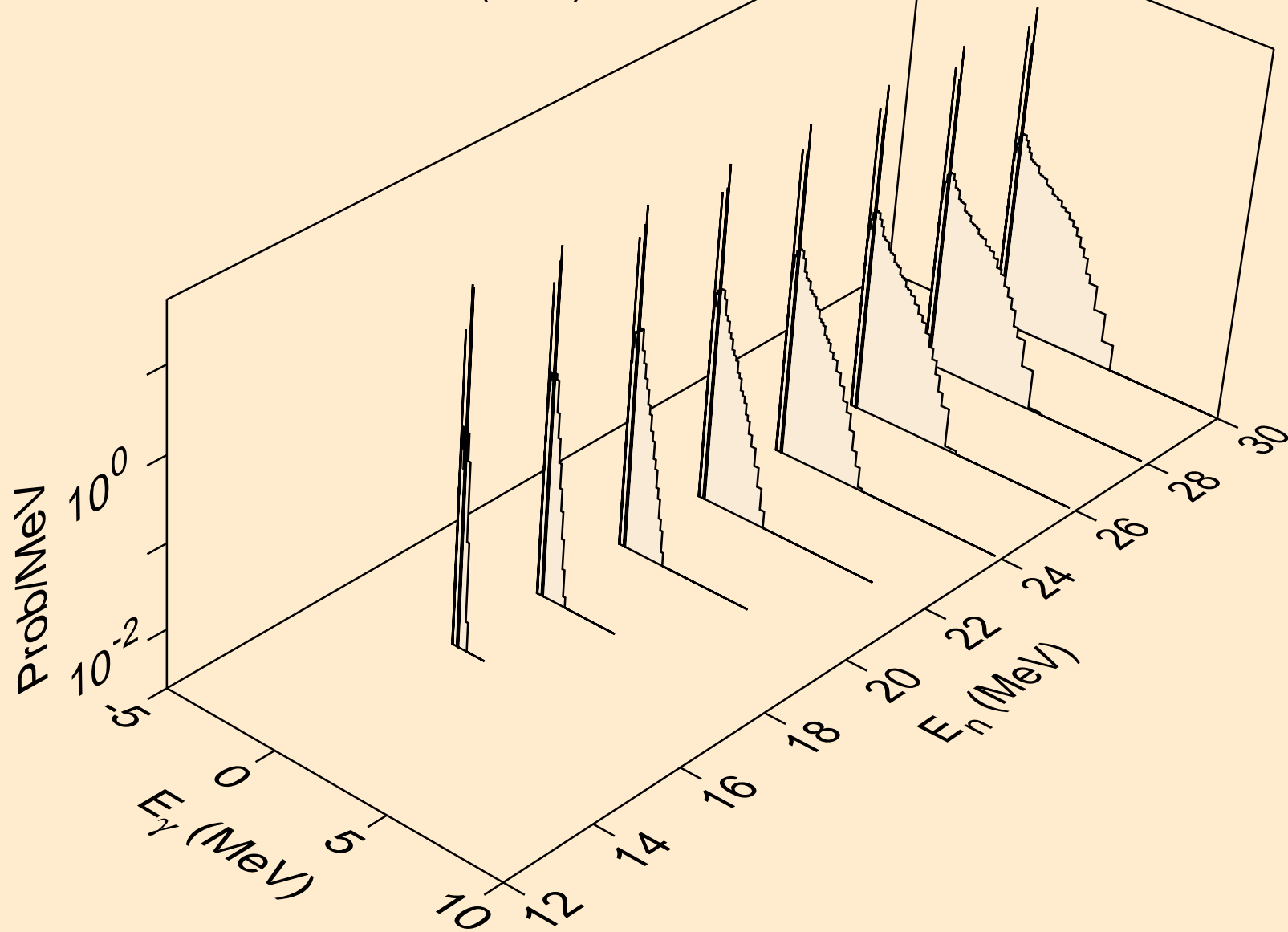

BA120 NEUTRON ACER TENDL-2021 LIBRARY; T=293.6K  
Photon emission for (n,n\*)t

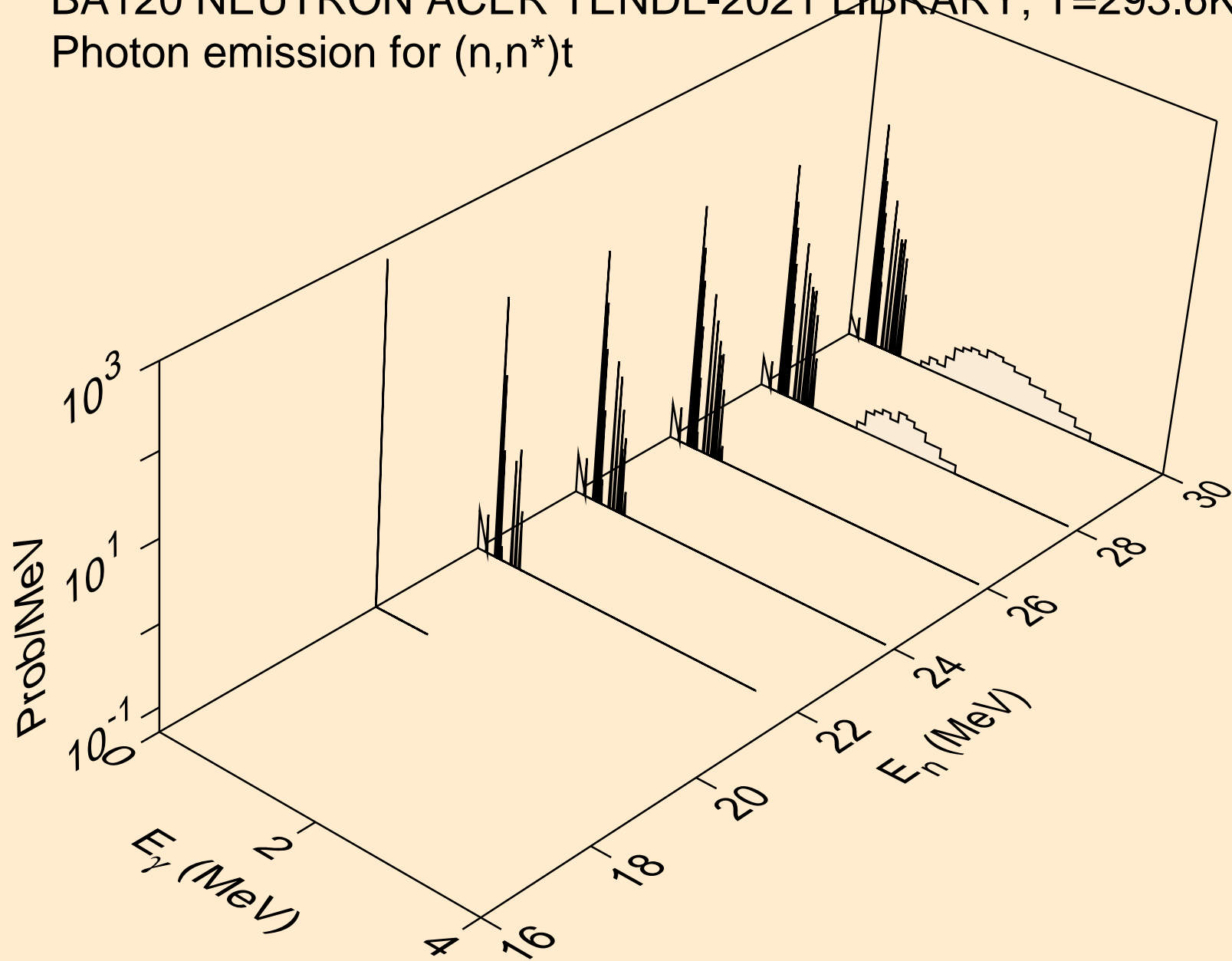



BA120 NEUTRON ACER TENDL-2021 LIBRARY; T=293.6K  
Photon emission for (n,n\*)he3

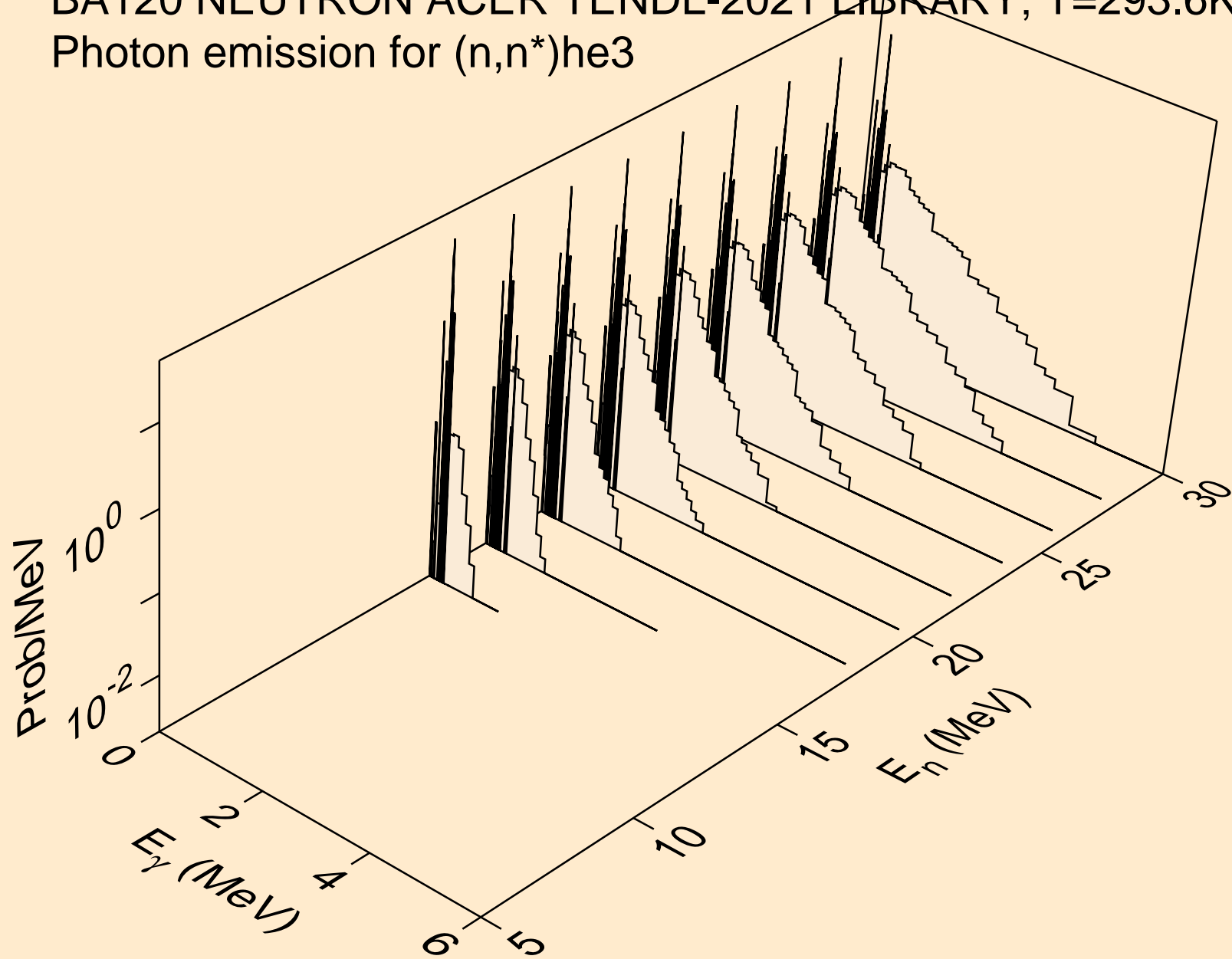

BA120 NEUTRON ACER TENDL-2021 LIBRARY; T=293.6K  
Photon emission for (n,2np)

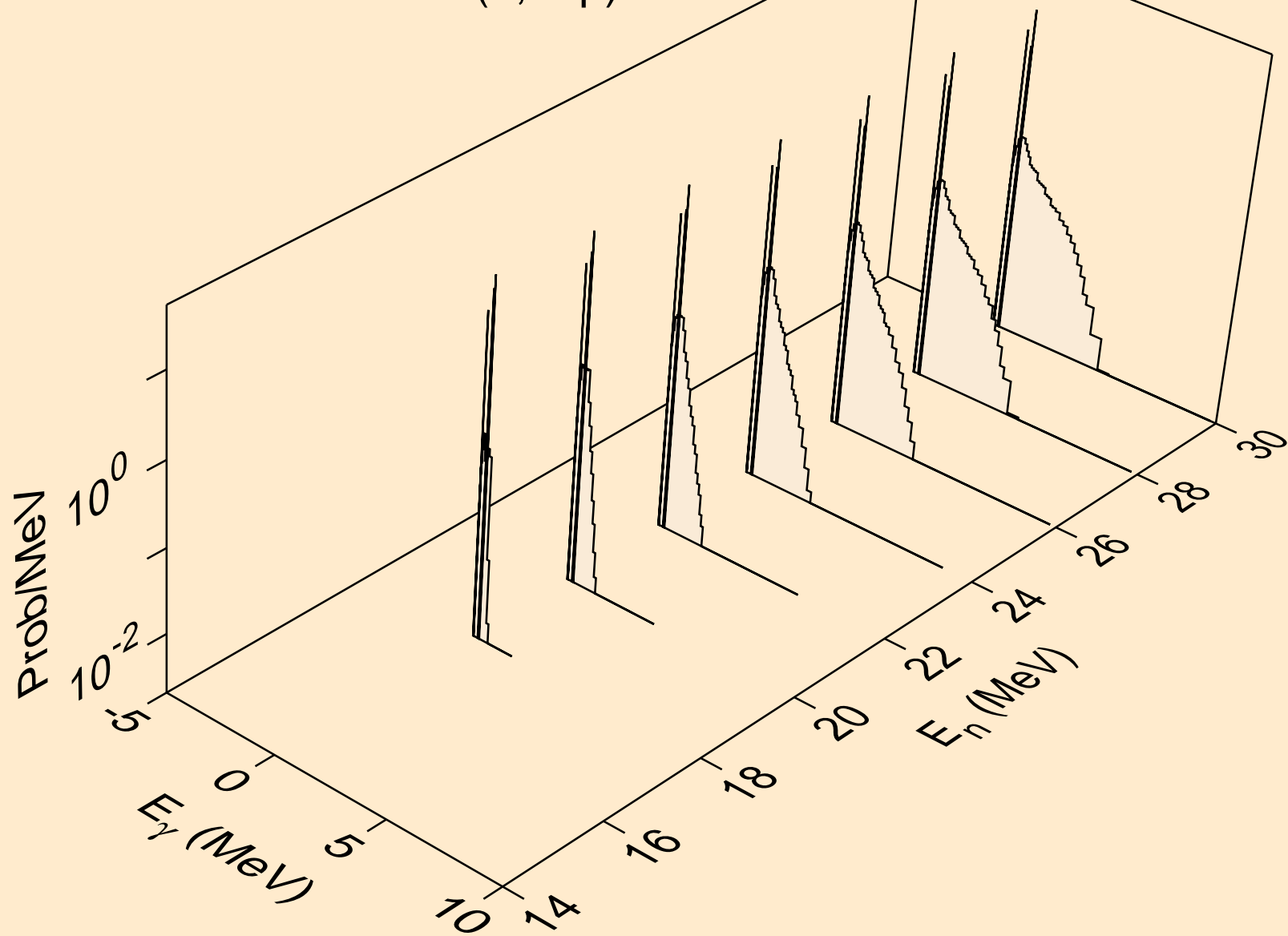

BA120 NEUTRON ACER TENDL-2021 LIBRARY; T=293.6K  
Photon emission for (n,3np)

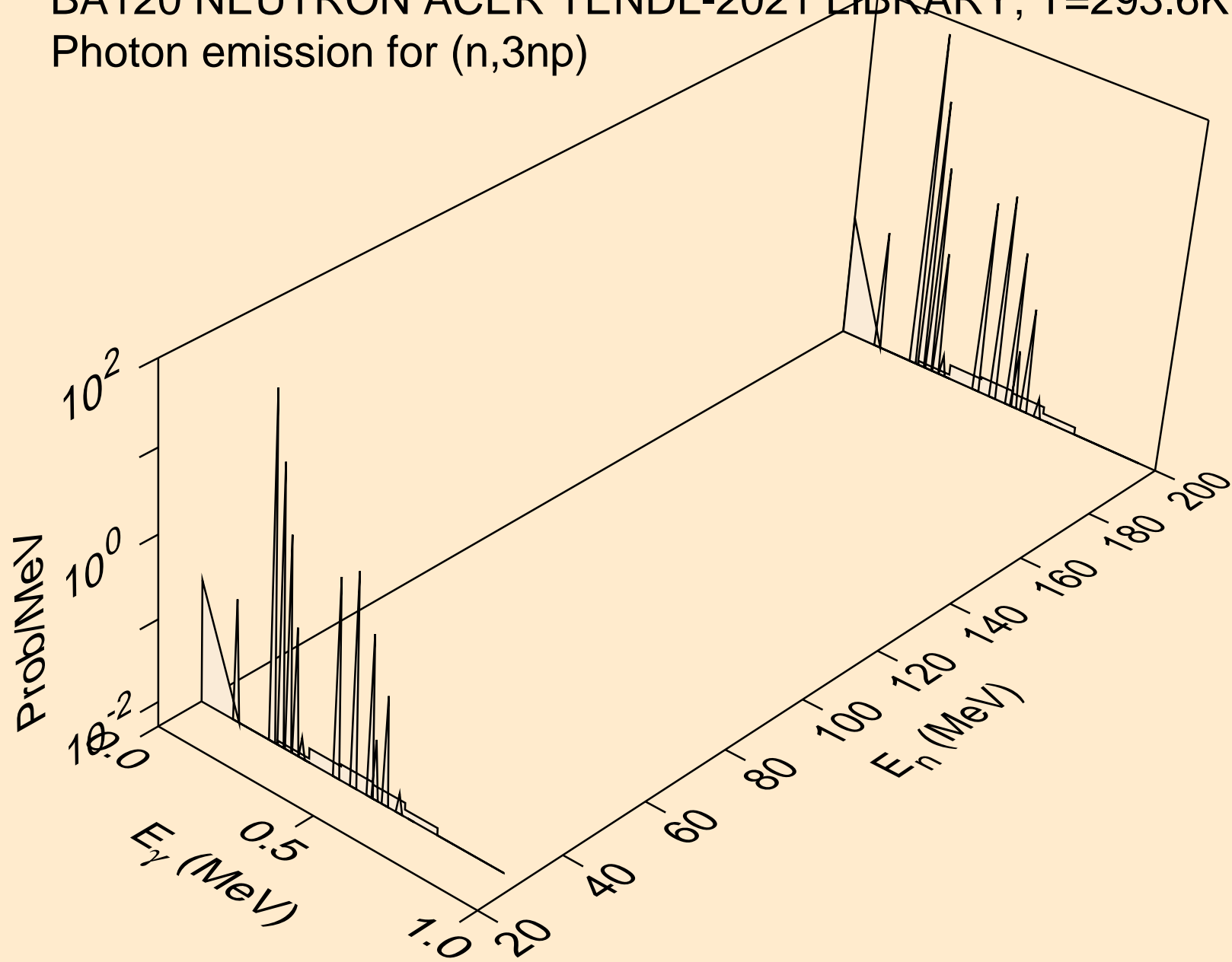

BA120 NEUTRON ACER TENDL-2021 LIBRARY; T=293.6K  
Photon emission for (n,2np)

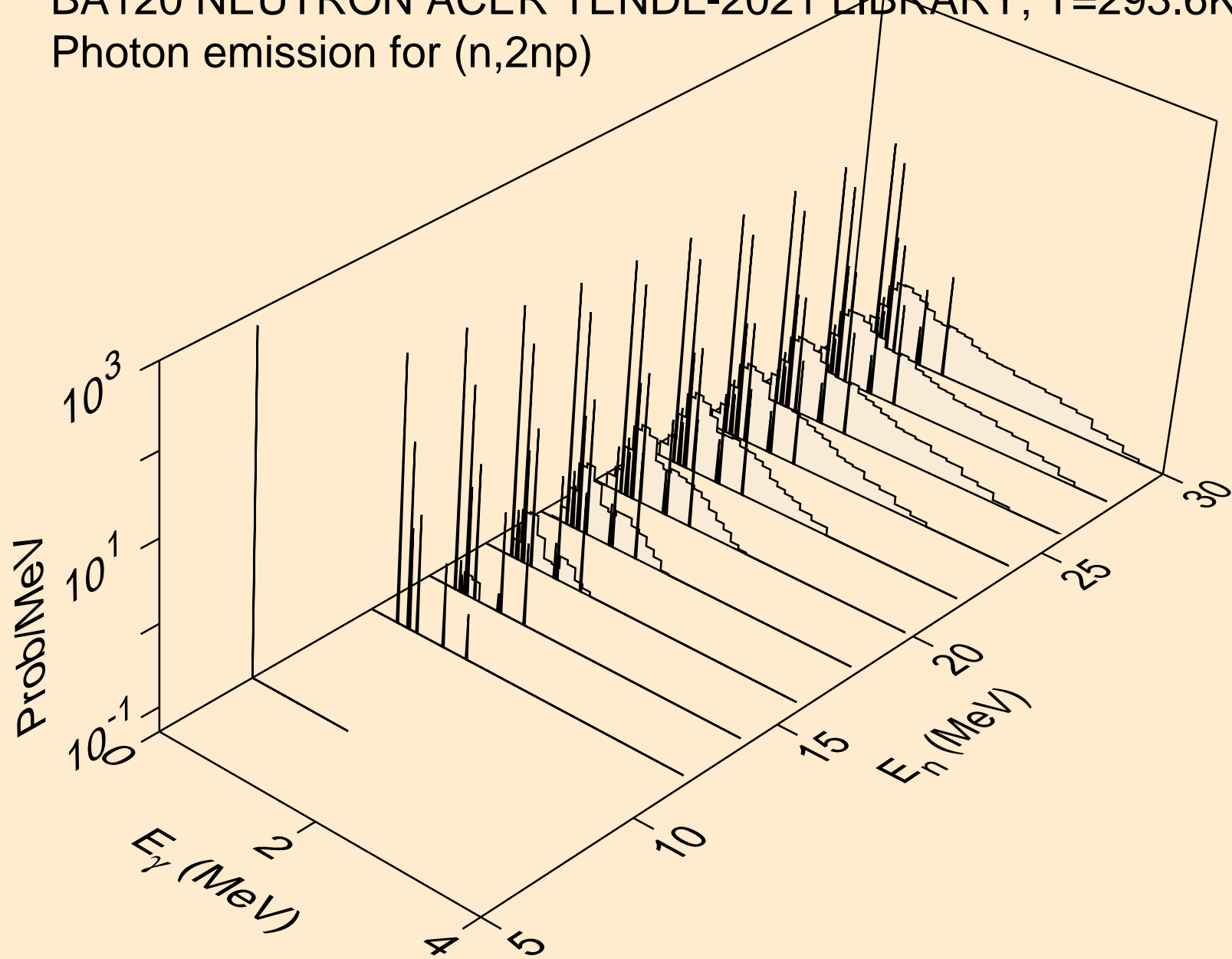

BA120 NEUTRON ACER TENDL-2021 LIBRARY; T=293.6K  
Photon emission for (n,npa)

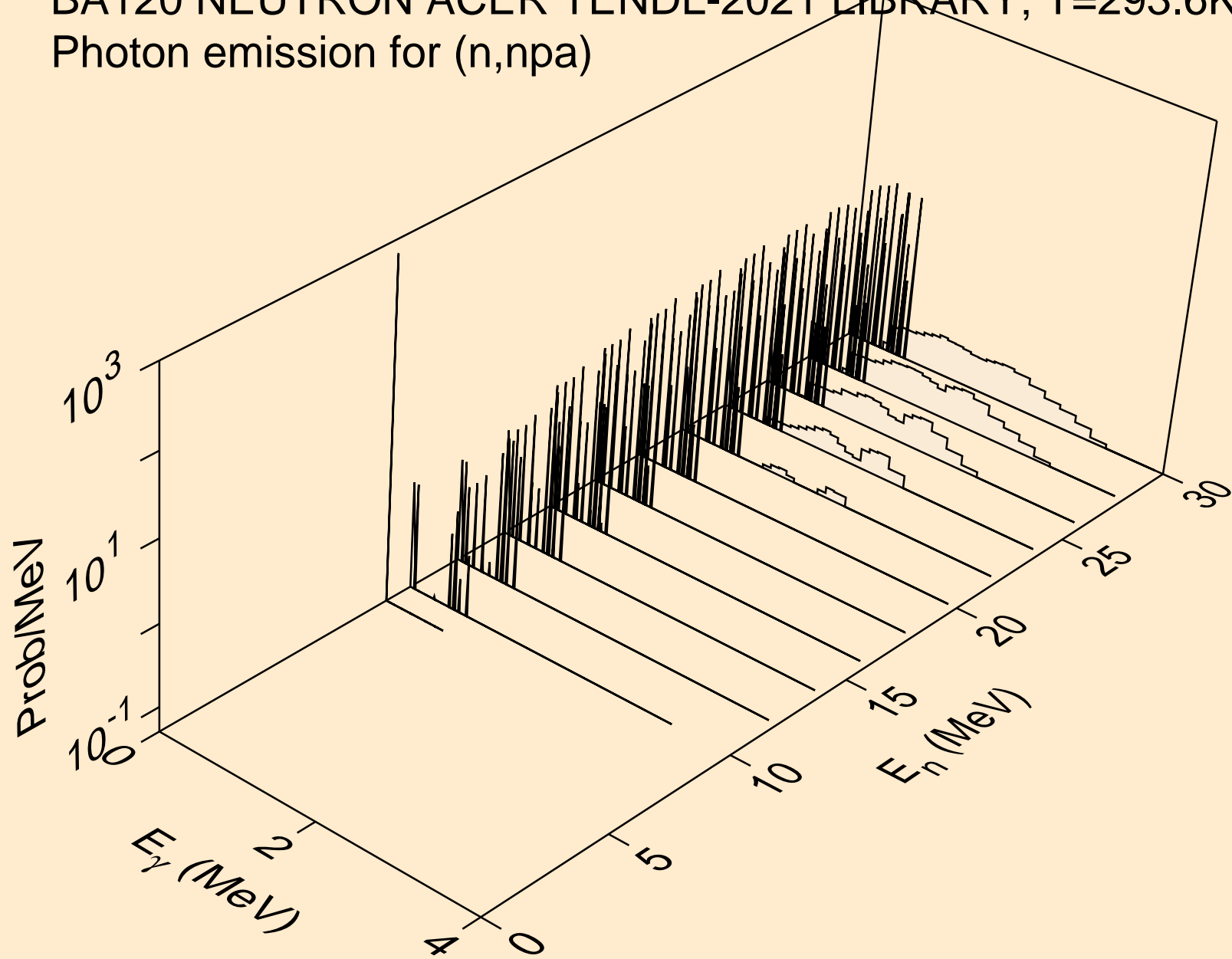

BA120 NEUTRON ACER TENDL-2021 LIBRARY; T=293.6K  
Photon emission for (n,n\*c)

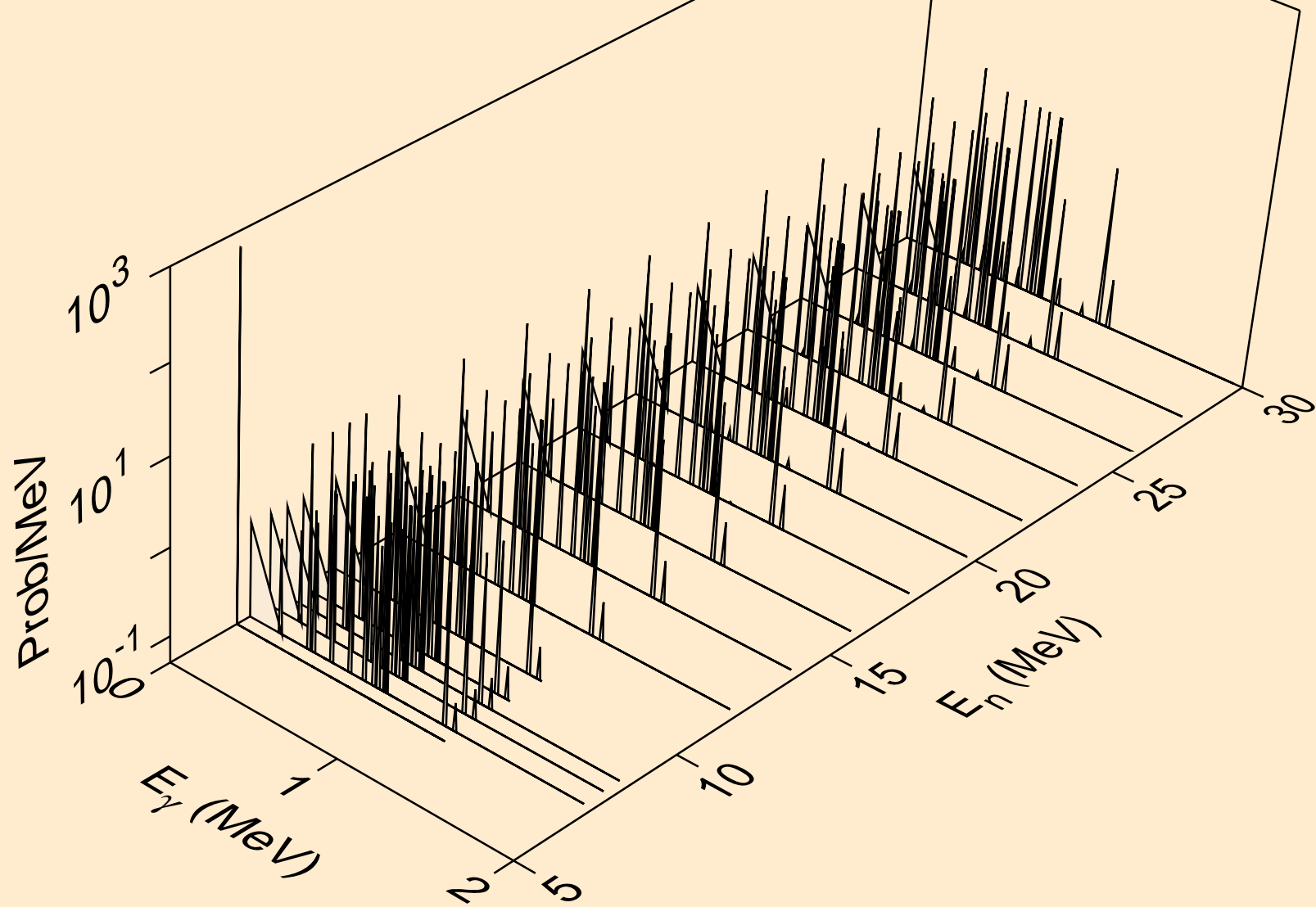

BA120 NEUTRON ACER TENDL-2021 LIBRARY; T=293.6K  
Photon emission for (n,gma)

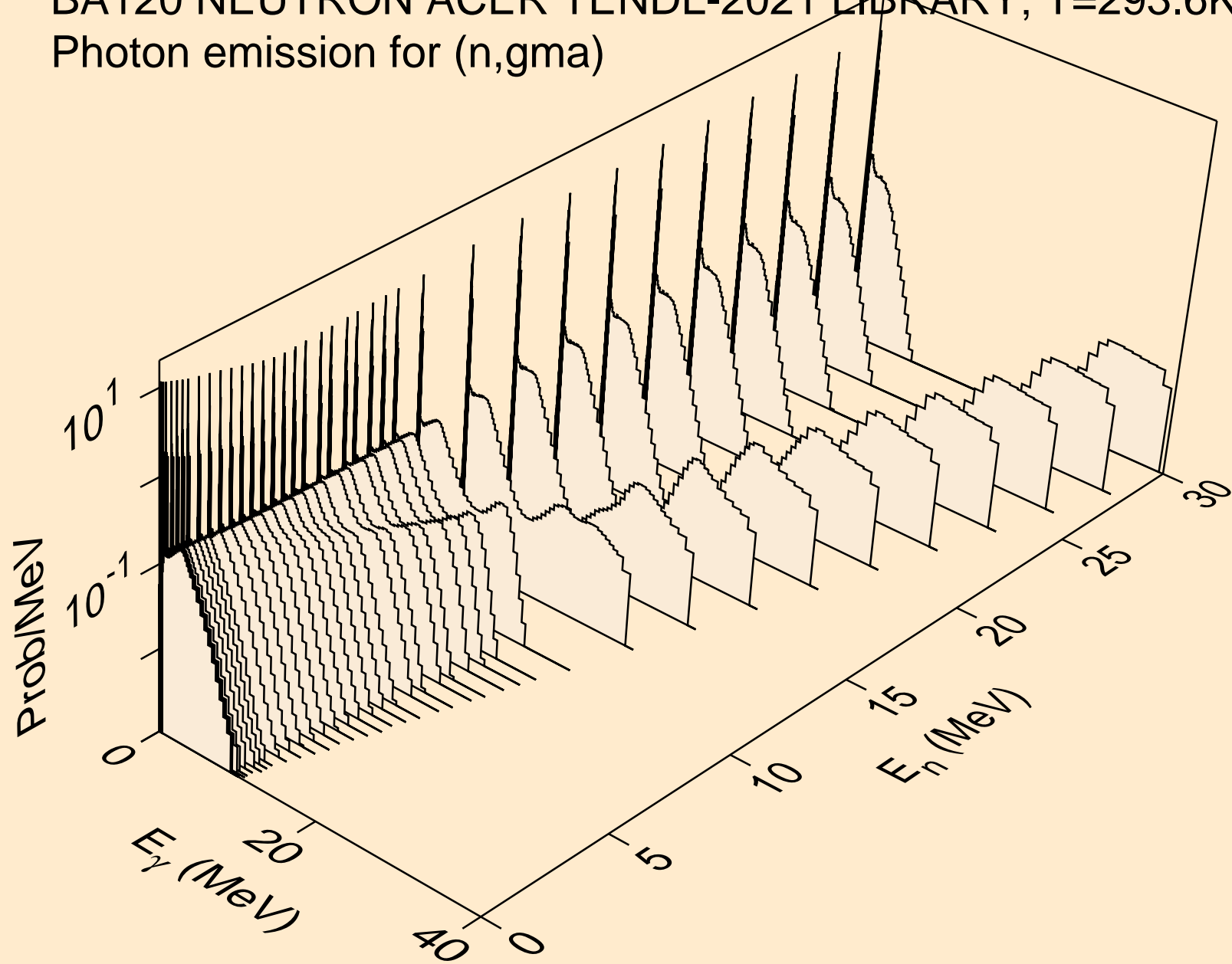

BA120 NEUTRON ACER TENDL-2021 LIBRARY; T=293.6K  
Photon emission for (n,p)

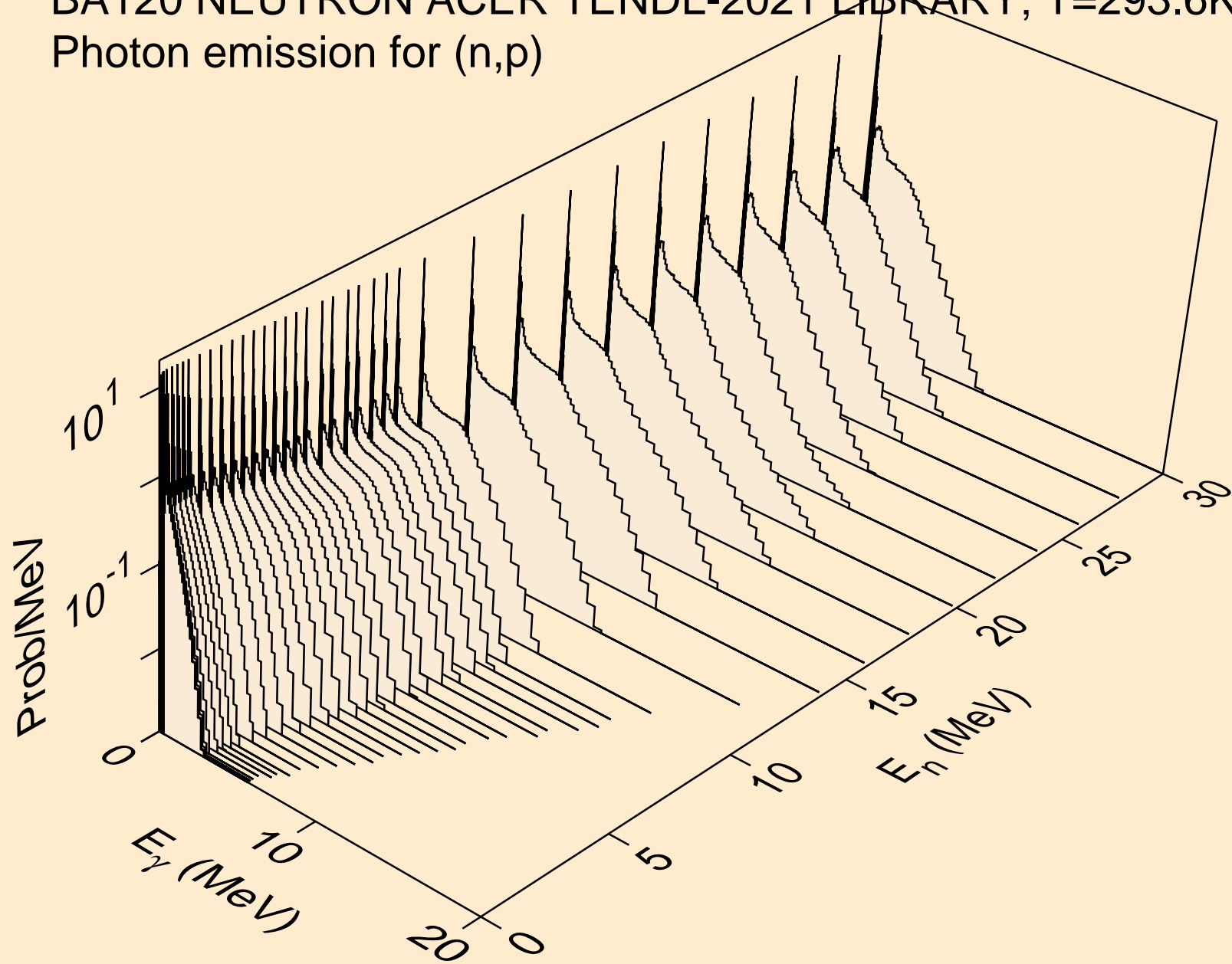



BA120 NEUTRON ACER TENDL-2021 LIBRARY; T=293.6K  
Photon emission for (n,d)

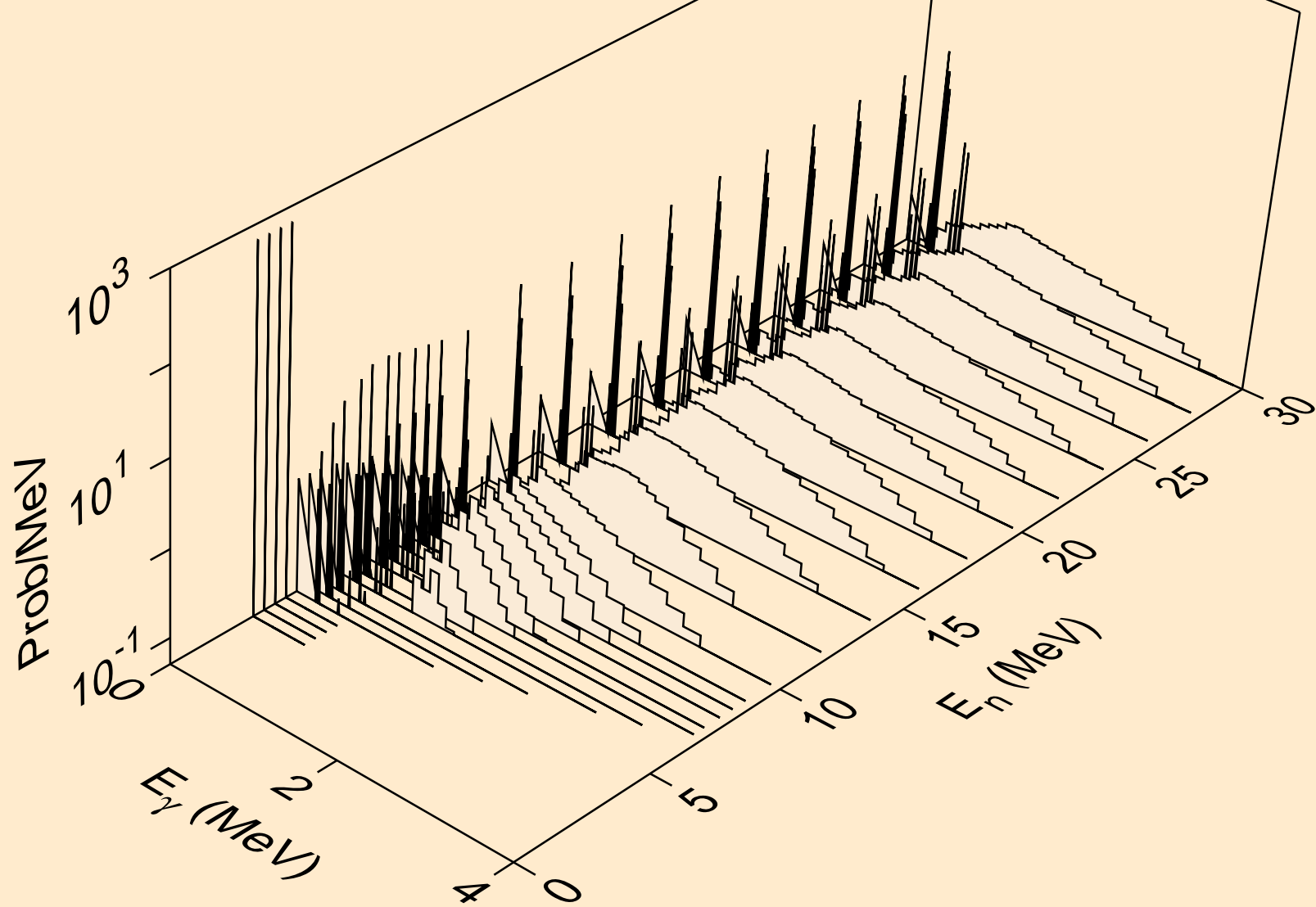

BA120 NEUTRON ACER TENDL-2021 LIBRARY; T=293.6K  
Photon emission for (n,t)

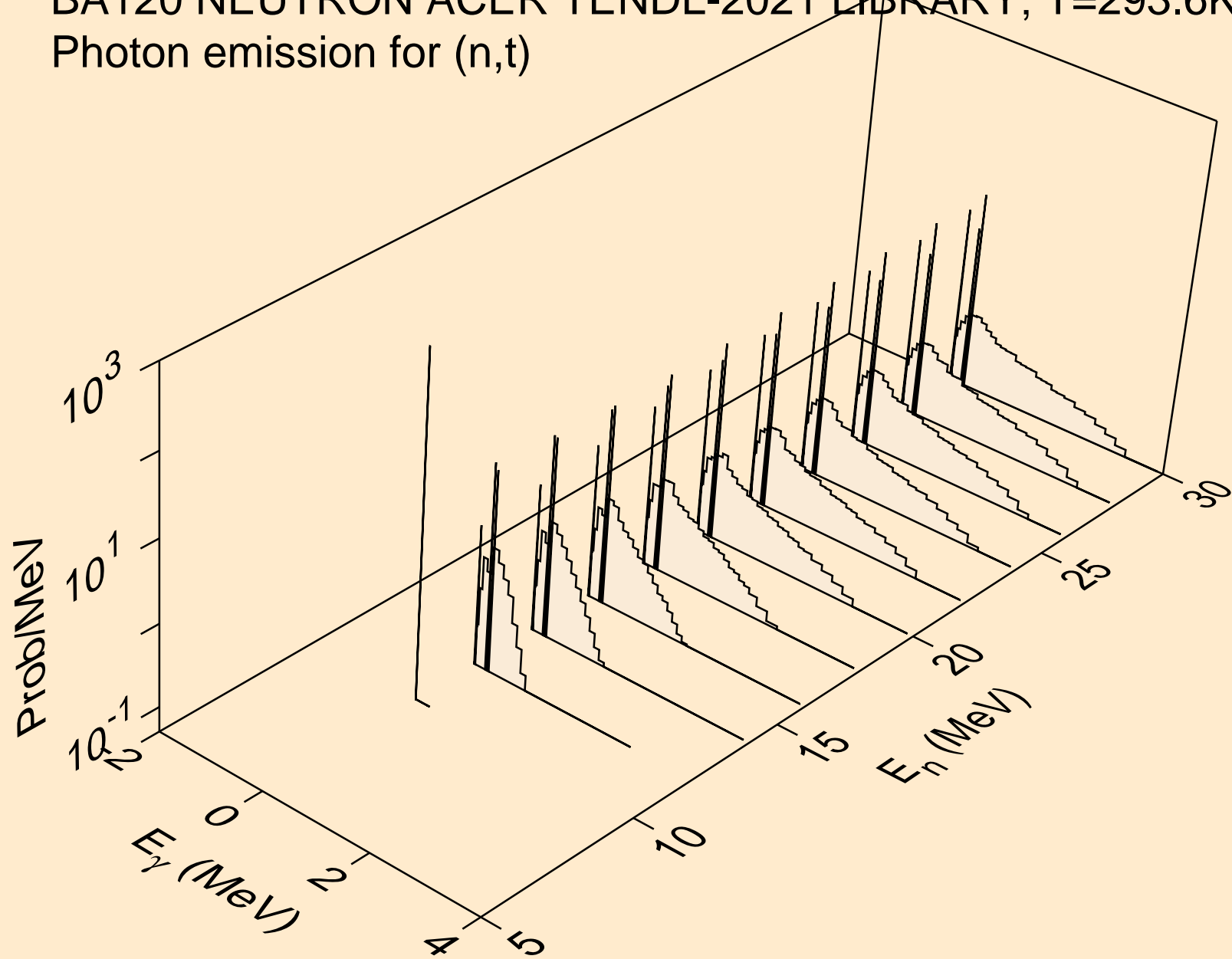

BA120 NEUTRON ACER TENDL-2021 LIBRARY; T=293.6K  
Photon emission for (n,he3)

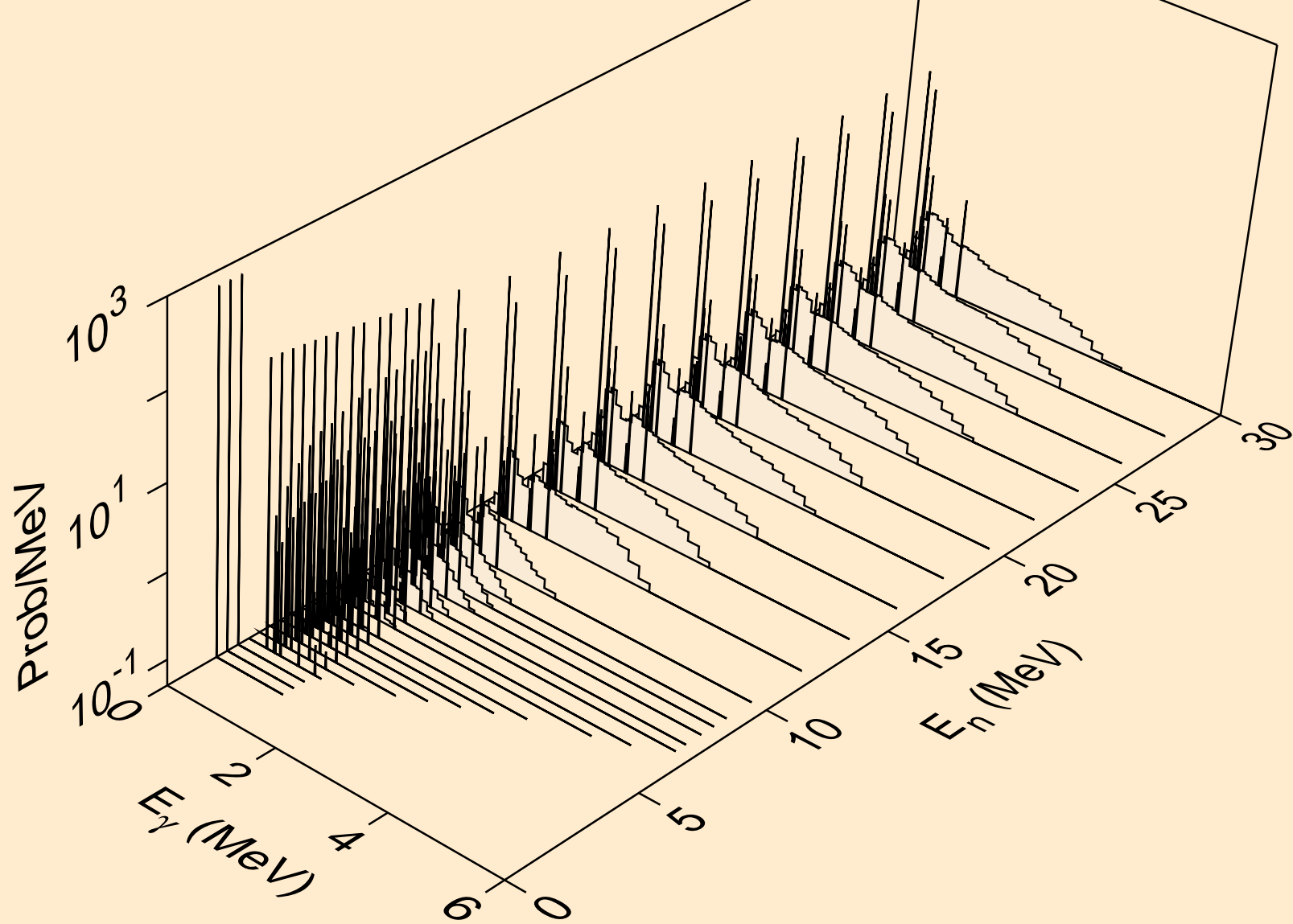

BA120 NEUTRON ACER TENDL-2021 LIBRARY; T=293.6K  
Photon emission for (n,a)

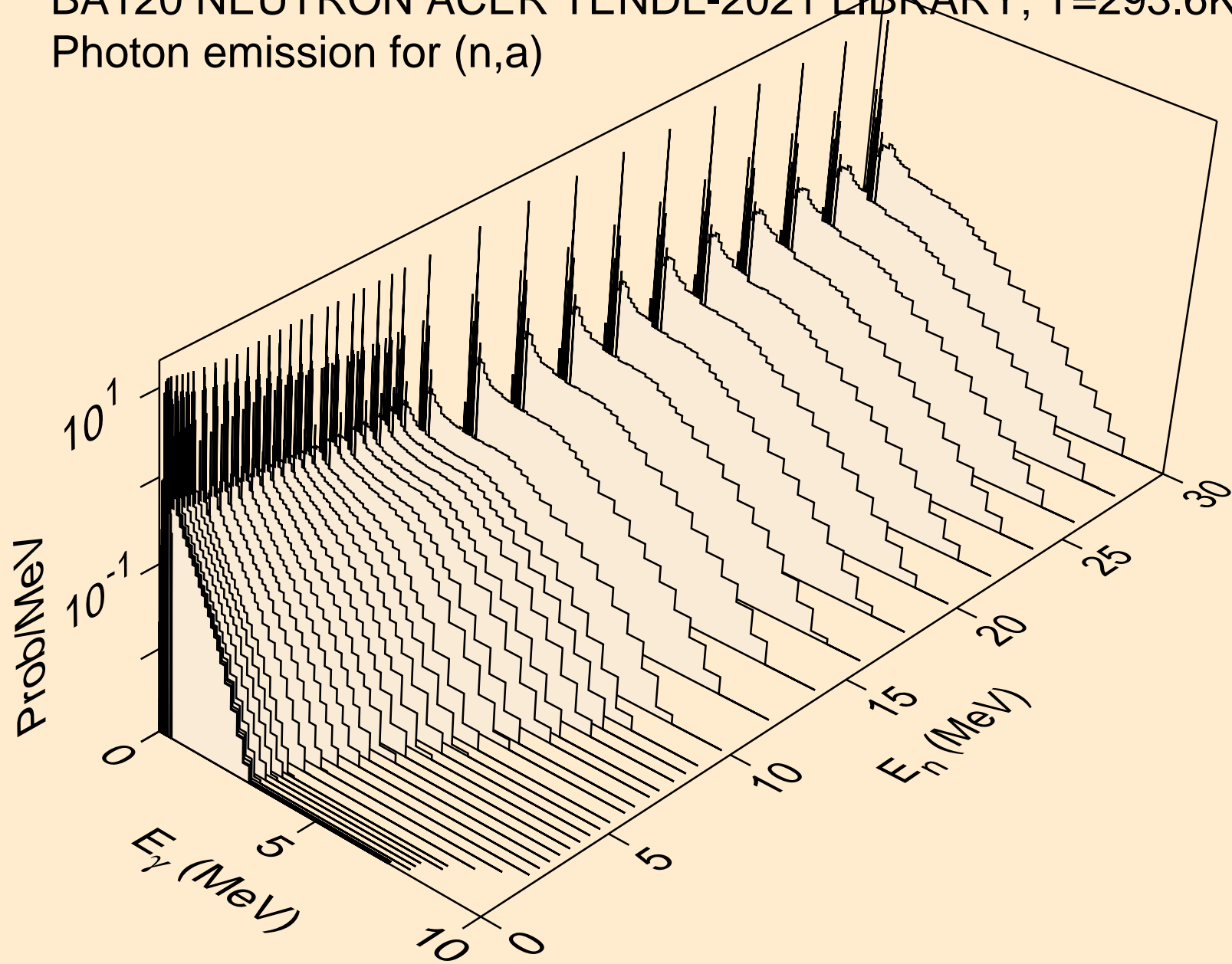

BA120 NEUTRON ACER TENDL-2021 LIBRARY; T=293.6K  
Photon emission for (n,2a)

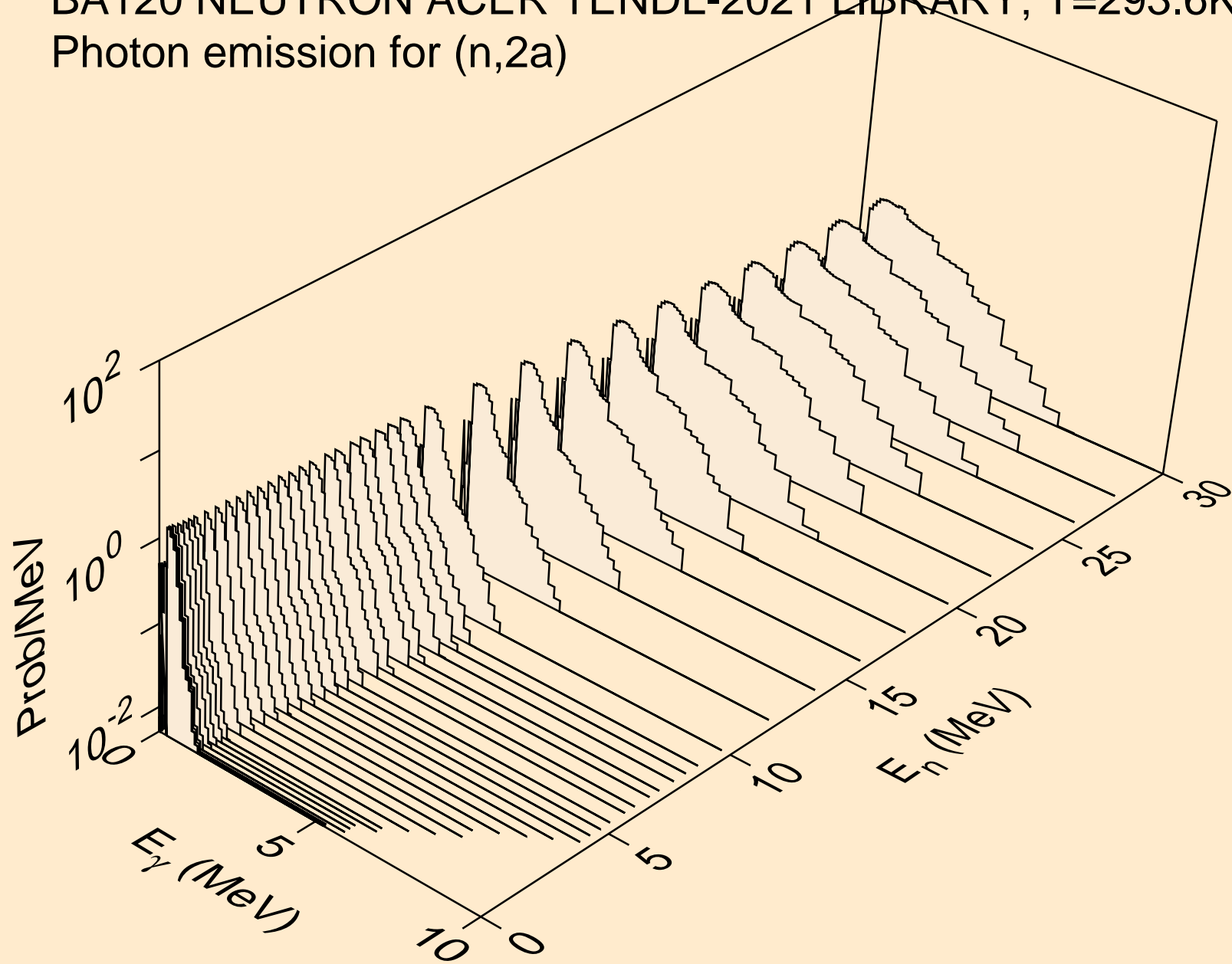

BA120 NEUTRON ACER TENDL-2021 LIBRARY; T=293.6K  
Photon emission for (n,3a)

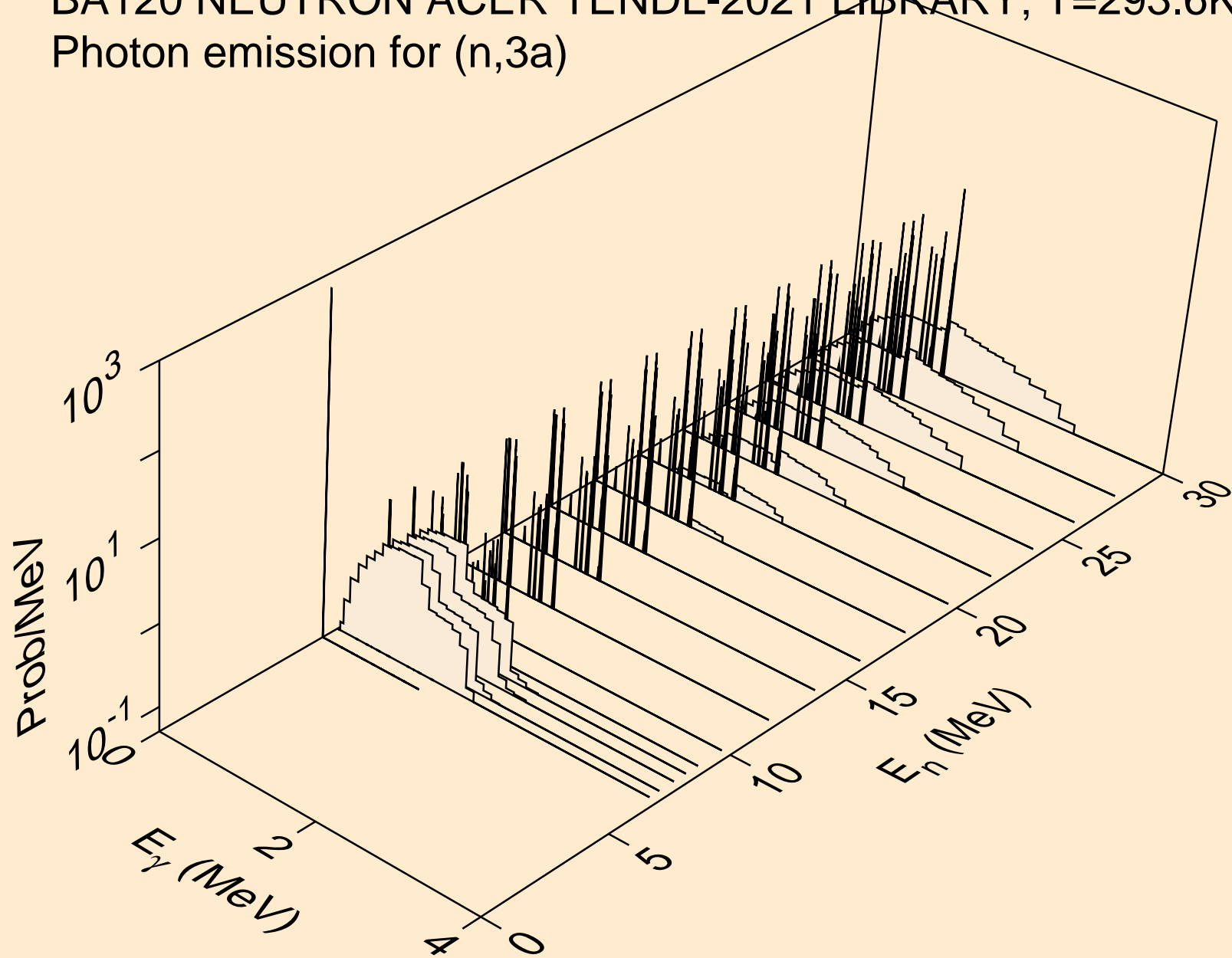

BA120 NEUTRON ACER TENDL-2021 LIBRARY; T=293.6K  
Photon emission for (n,2p)

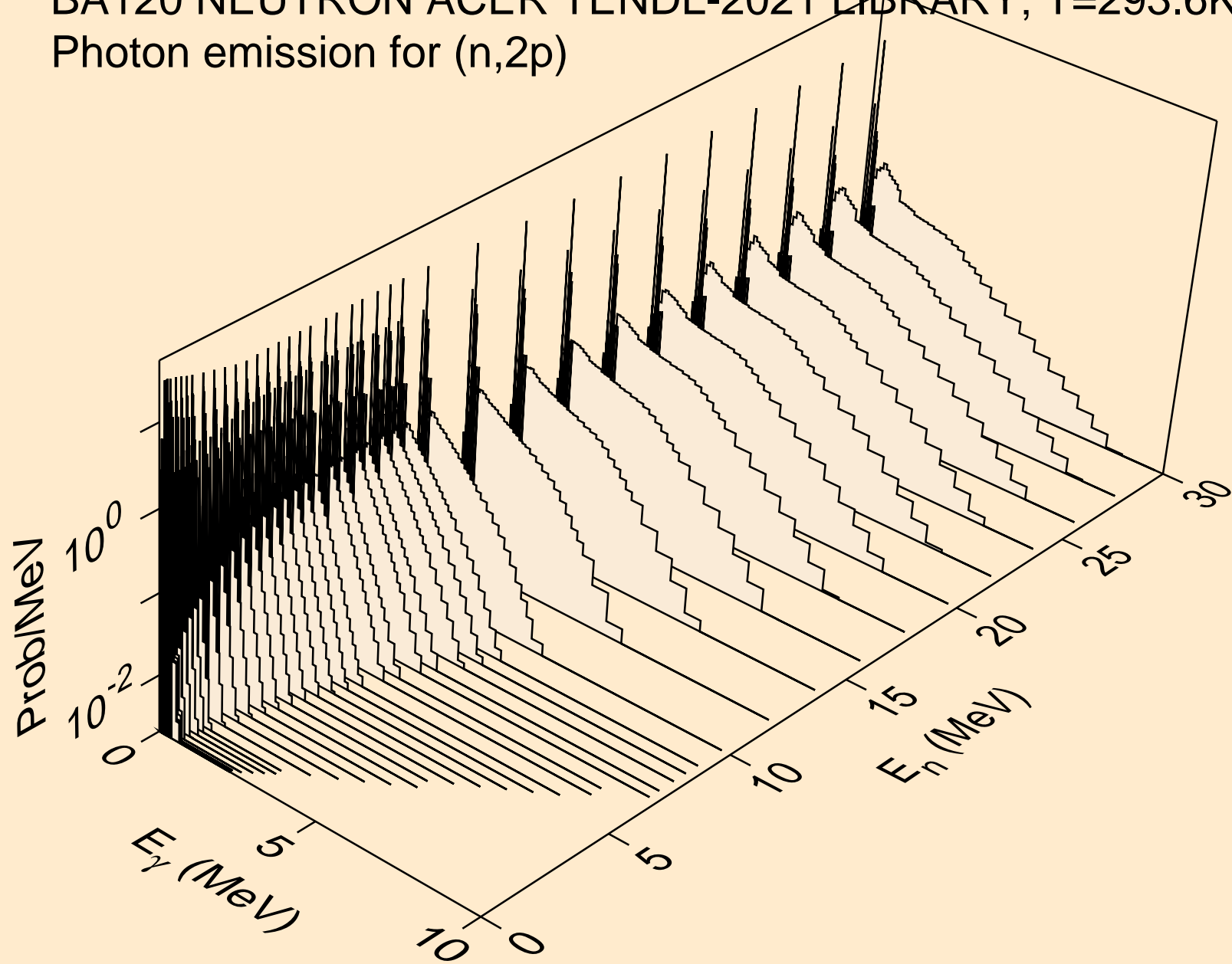

BA120 NEUTRON ACER TENDL-2021 LIBRARY; T=293.6K  
Photon emission for (n,p $\alpha$ )

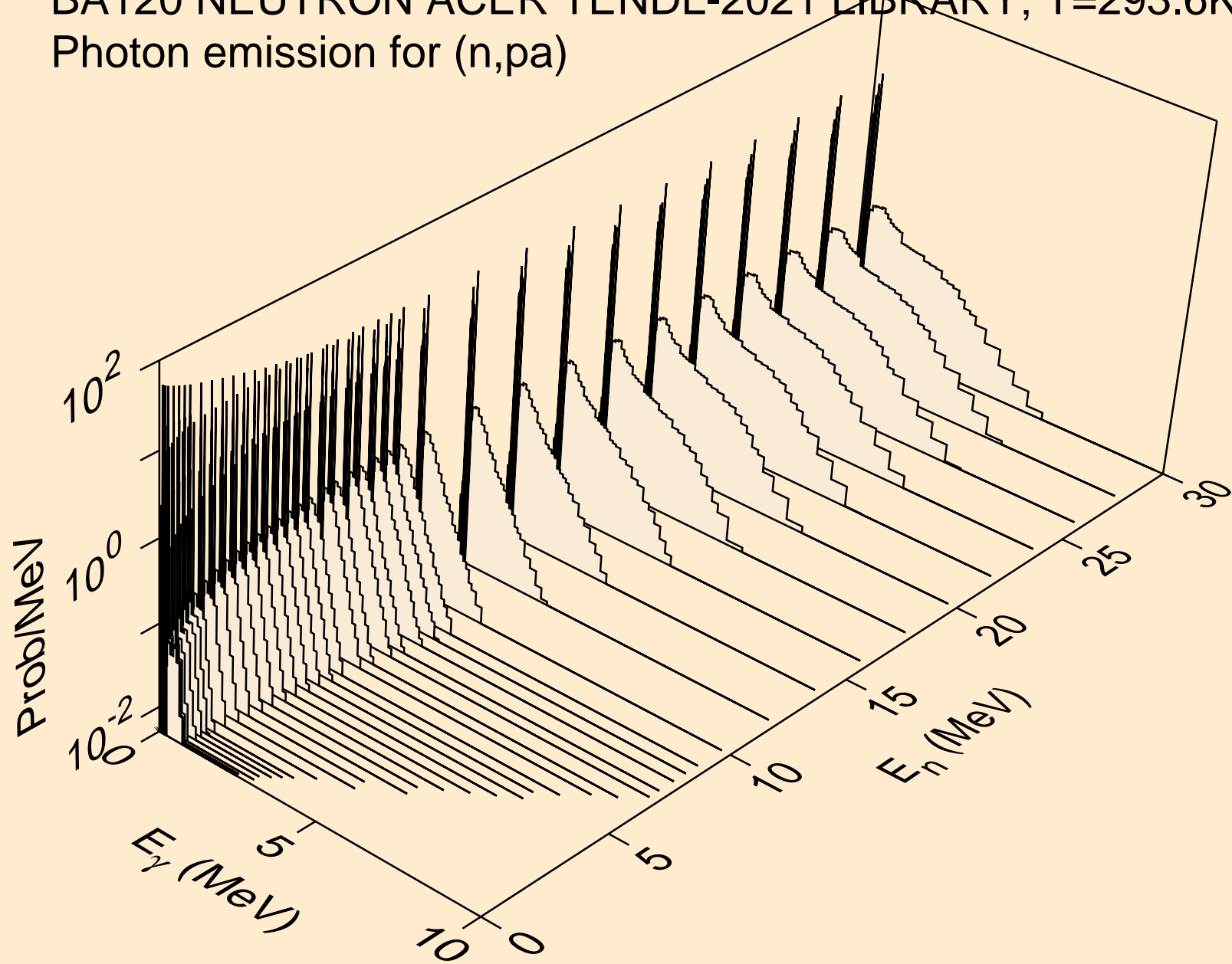



BA120 NEUTRON ACER TENDL-2021 LIBRARY; T=293.6K  
Photon emission for (n,d2a)

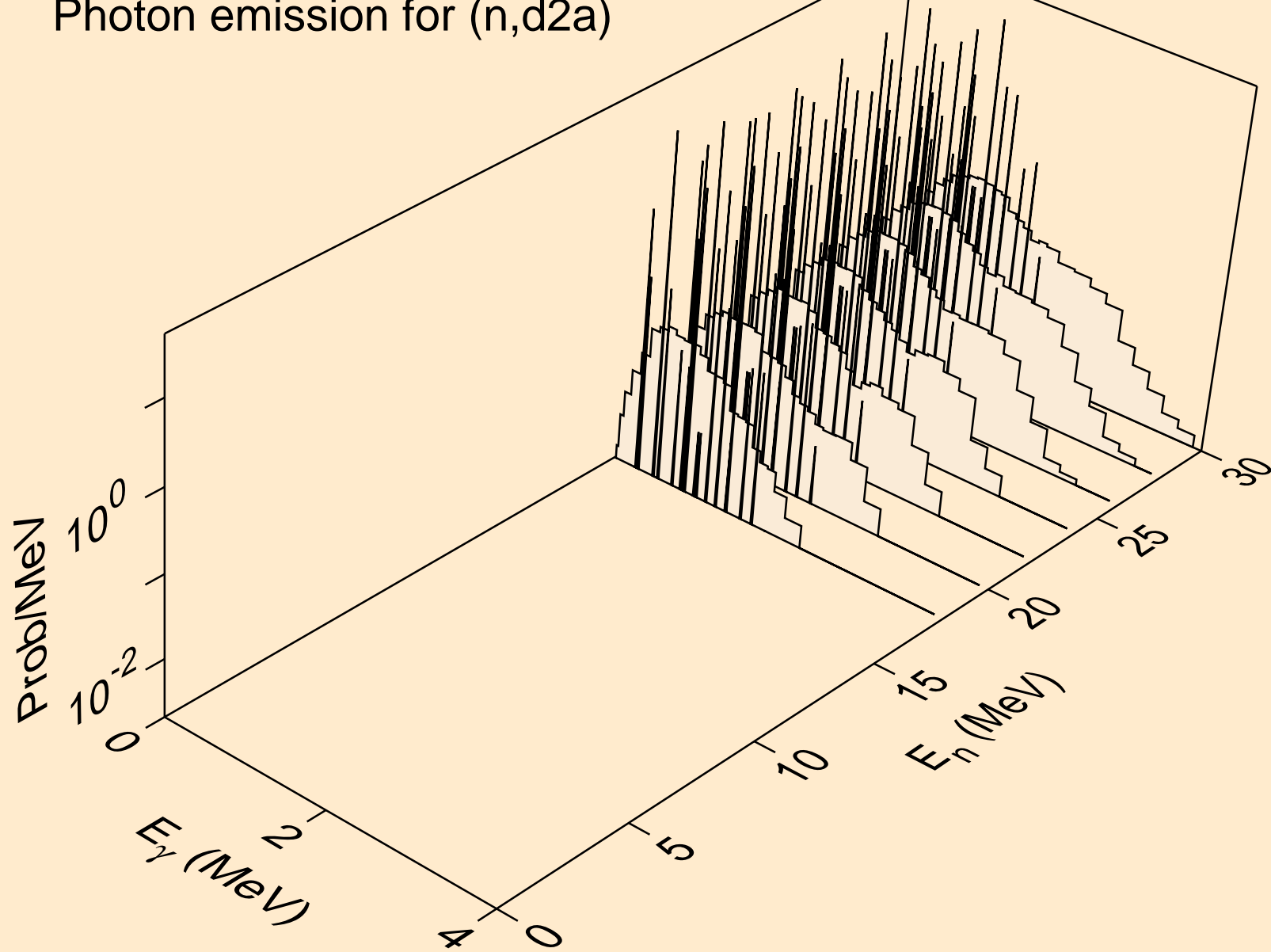

BA120 NEUTRON ACER TENDL-2021 LIBRARY; T=293.6K  
Photon emission for (n,pd)

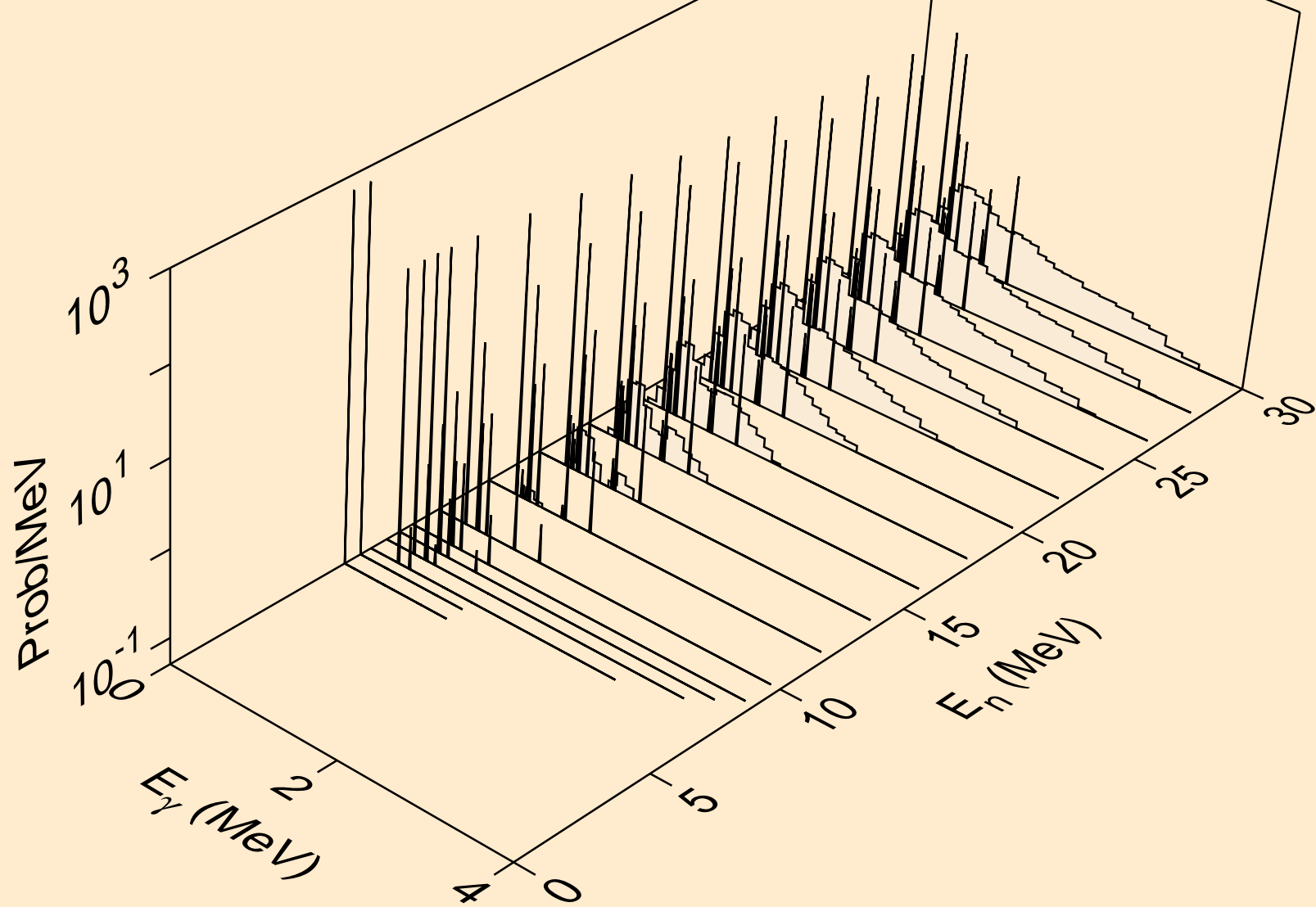

BA120 NEUTRON ACER TENDL-2021 LIBRARY; T=293.6K  
Photon emission for (n,pt)

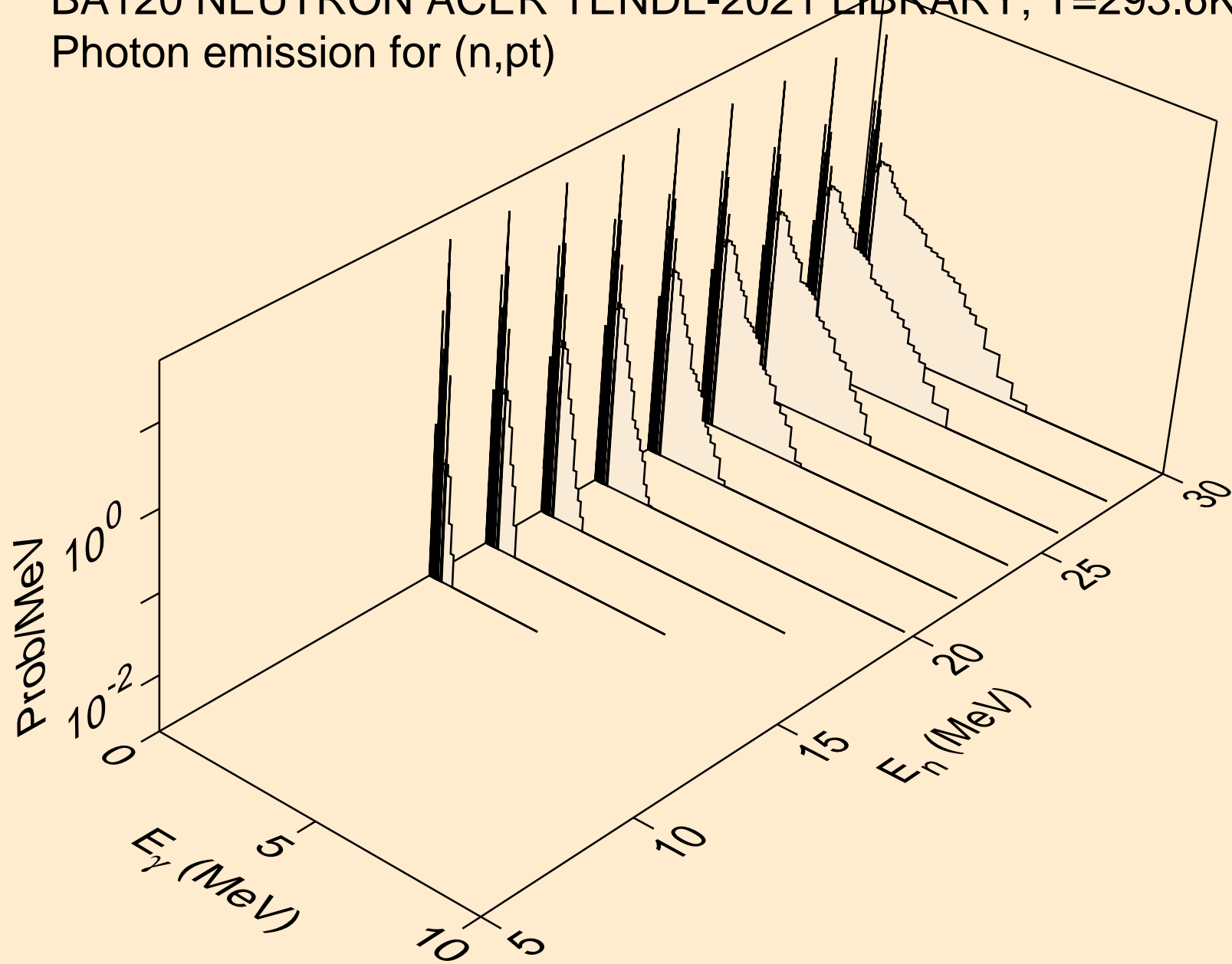

BA120 NEUTRON ACER TENDL-2021 LIBRARY; T=293.6K  
Photon emission for (n,da)

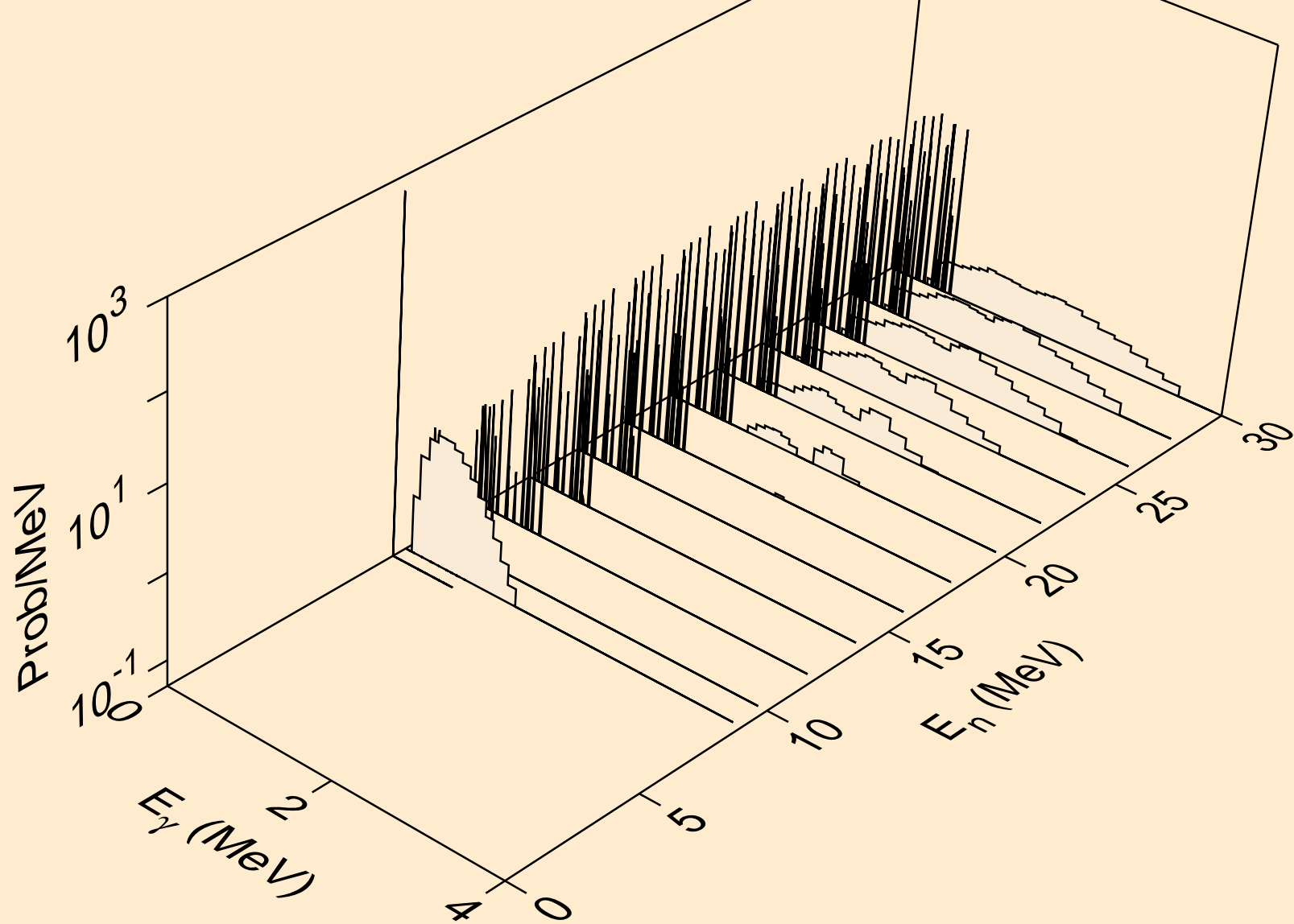

BA120 NEUTRON ACER TENDL-2021 LIBRARY; T=293.6K  
thermal capture photon spectrum

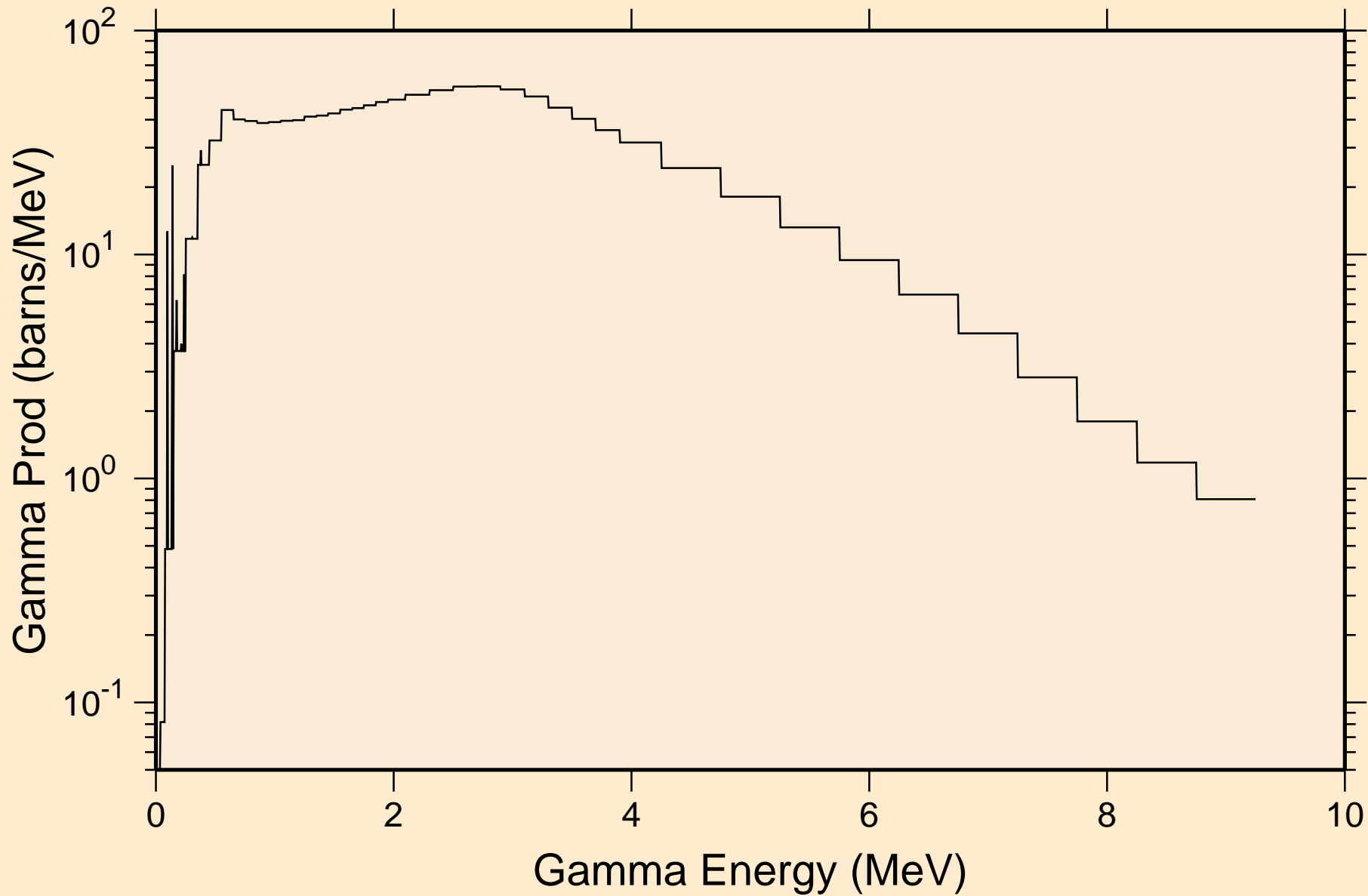

BA120 NEUTRON ACER TENDL-2021 LIBRARY; T=293.6K  
14 MeV photon spectrum

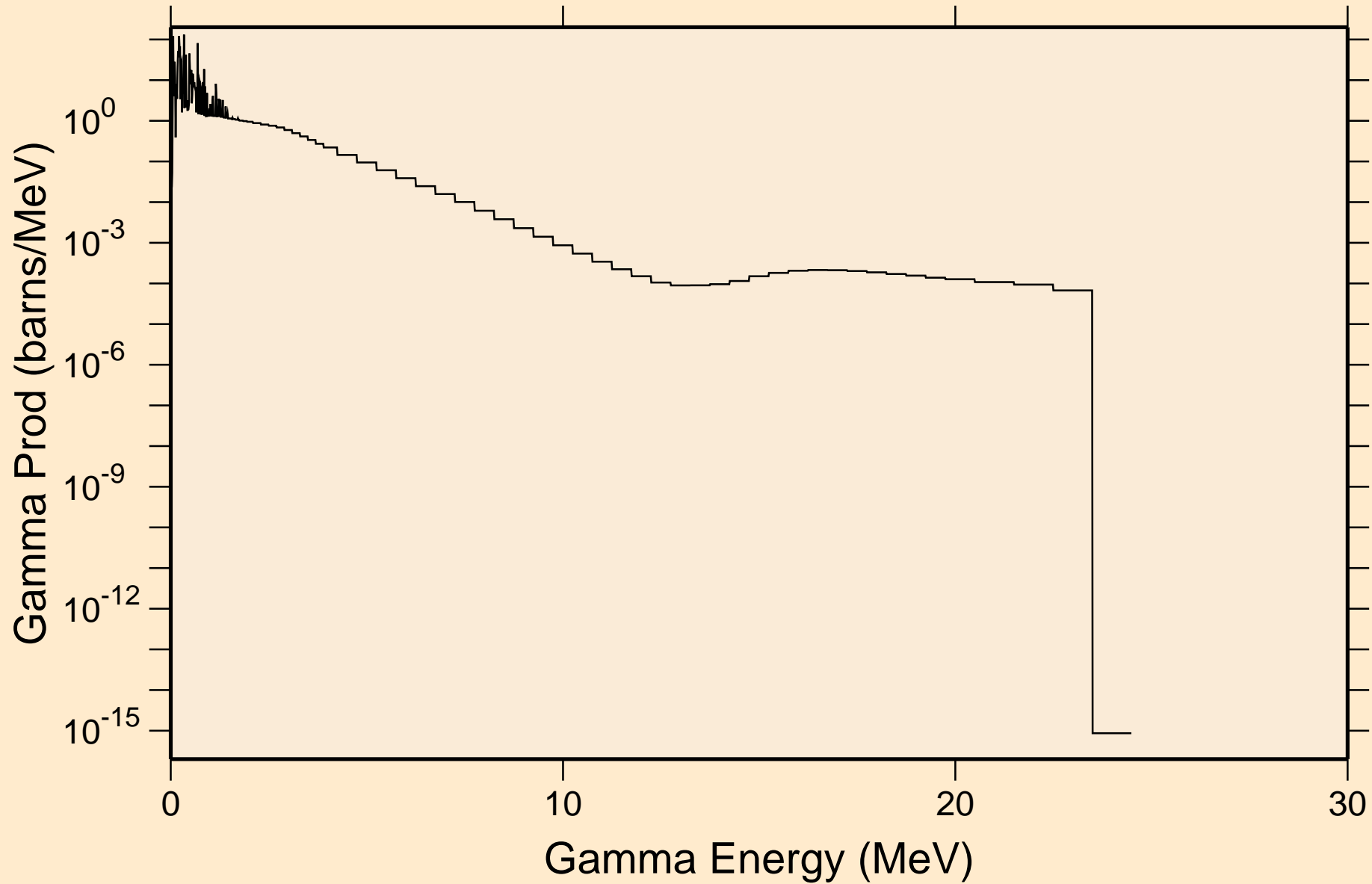

BA120 NEUTRON ACER TENDL-2021 LIBRARY; T=293.6K  
Particle heating contributions

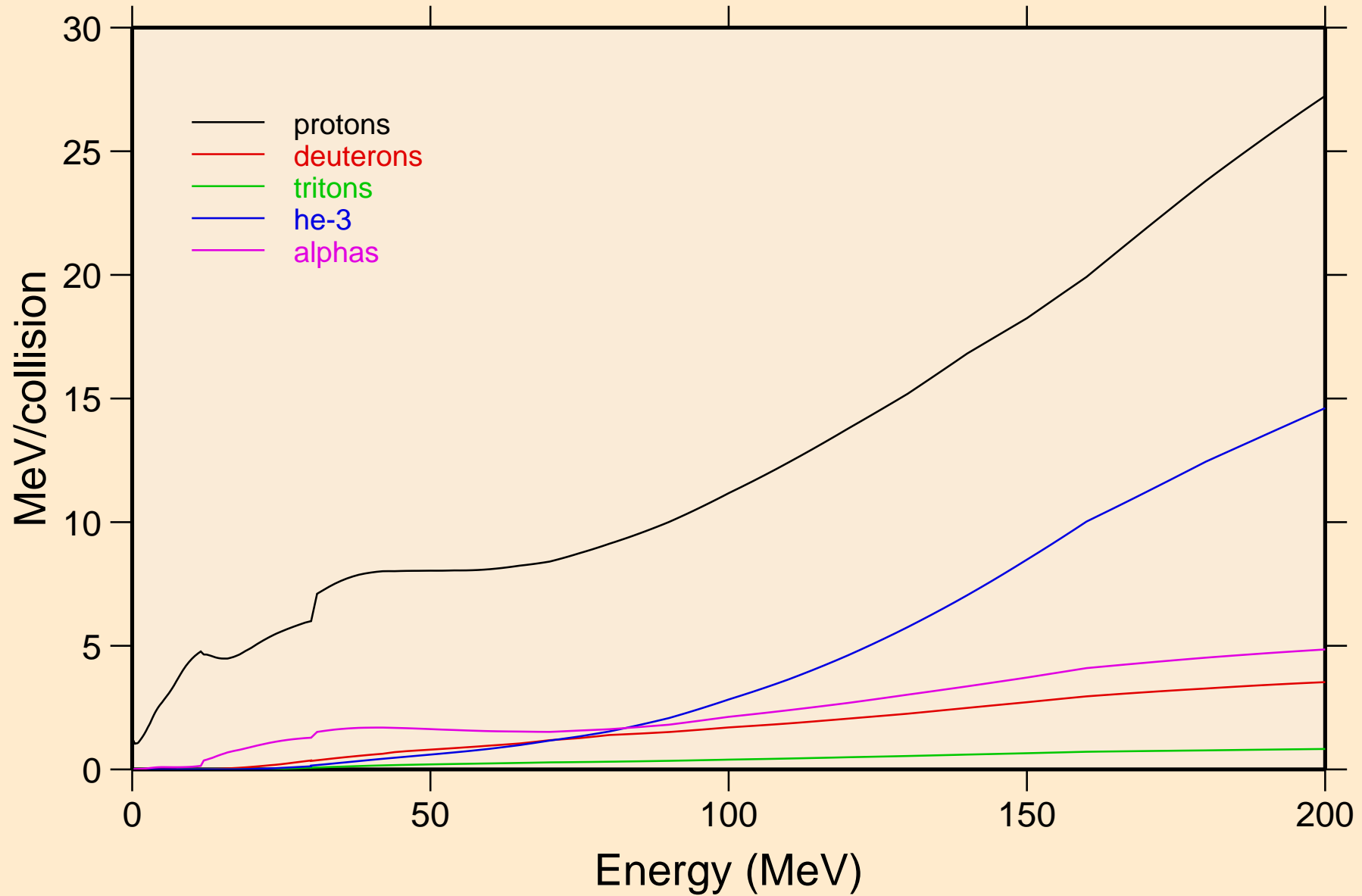

BA120 NEUTRON ACER TENDL-2021 LIBRARY; T=293.6K  
Recoil Heating

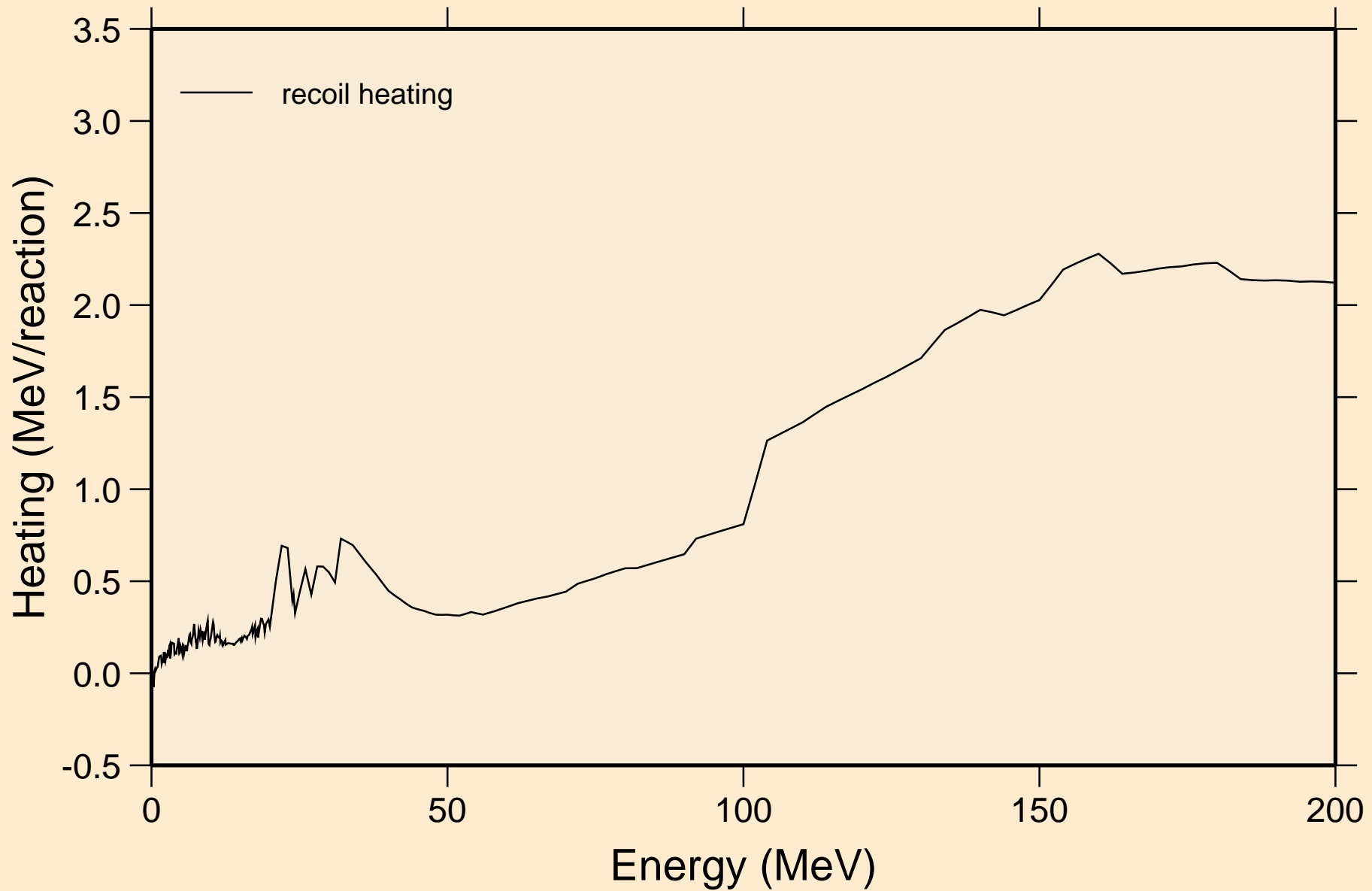



BA120 NEUTRON ACER TENDL-2021 LIBRARY; T=293.6K  
Particle production cross sections

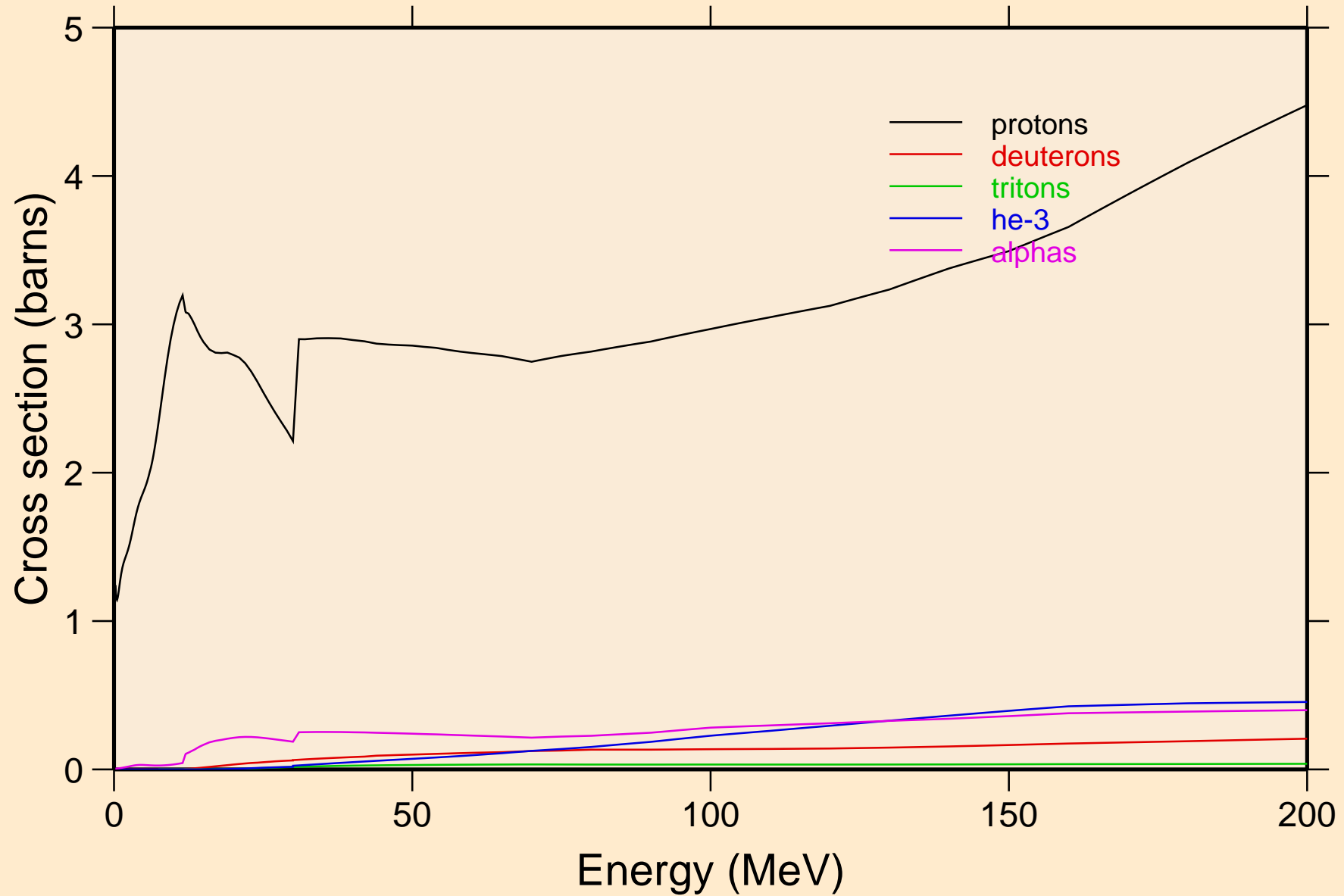

BA120 NEUTRON ACER TENDL-2021 LIBRARY; T=293.6K  
protons from (n,x)

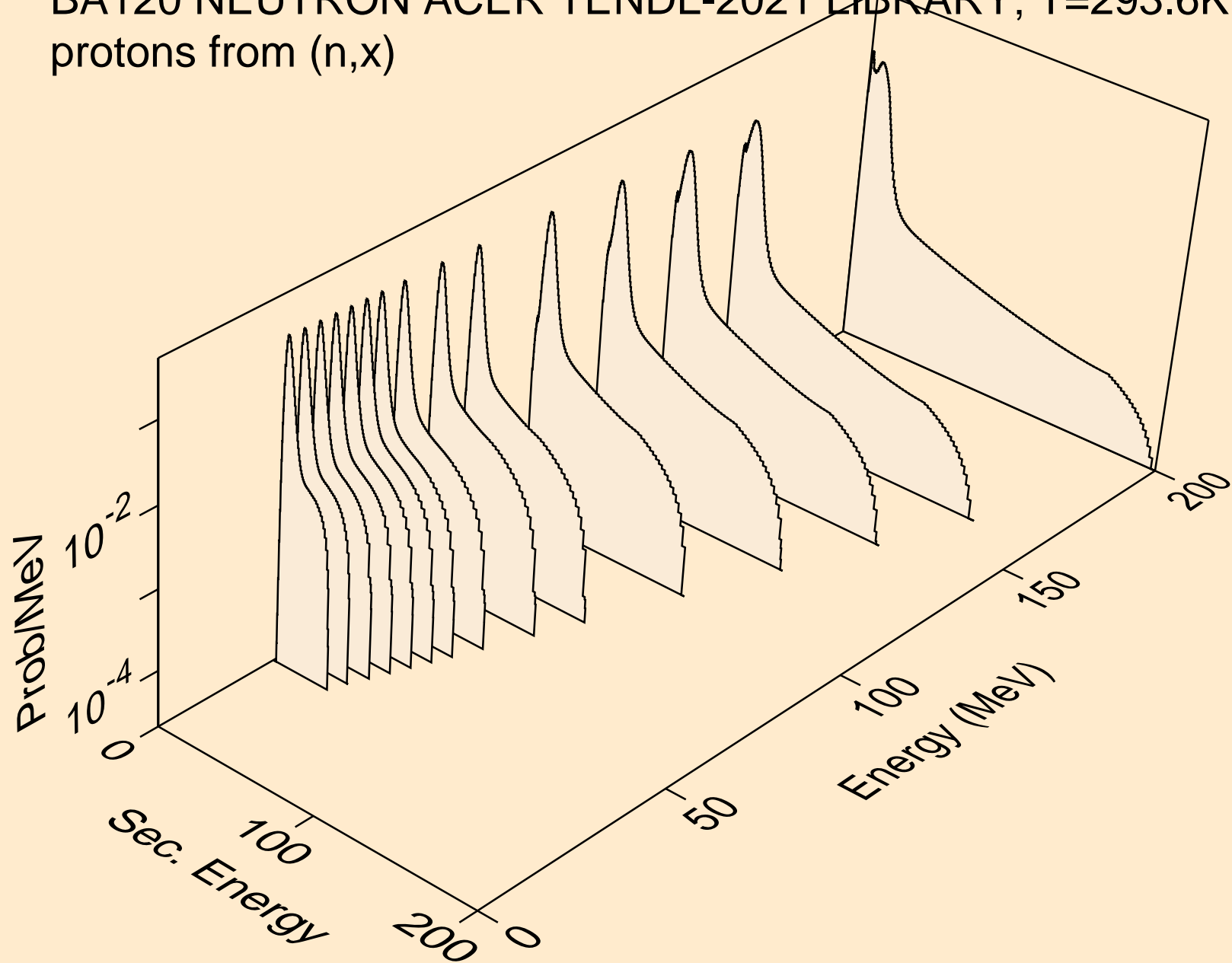

BA120 NEUTRON ACER TENDL-2021 LIBRARY; T=293.6K  
protons from (n,n\*)p

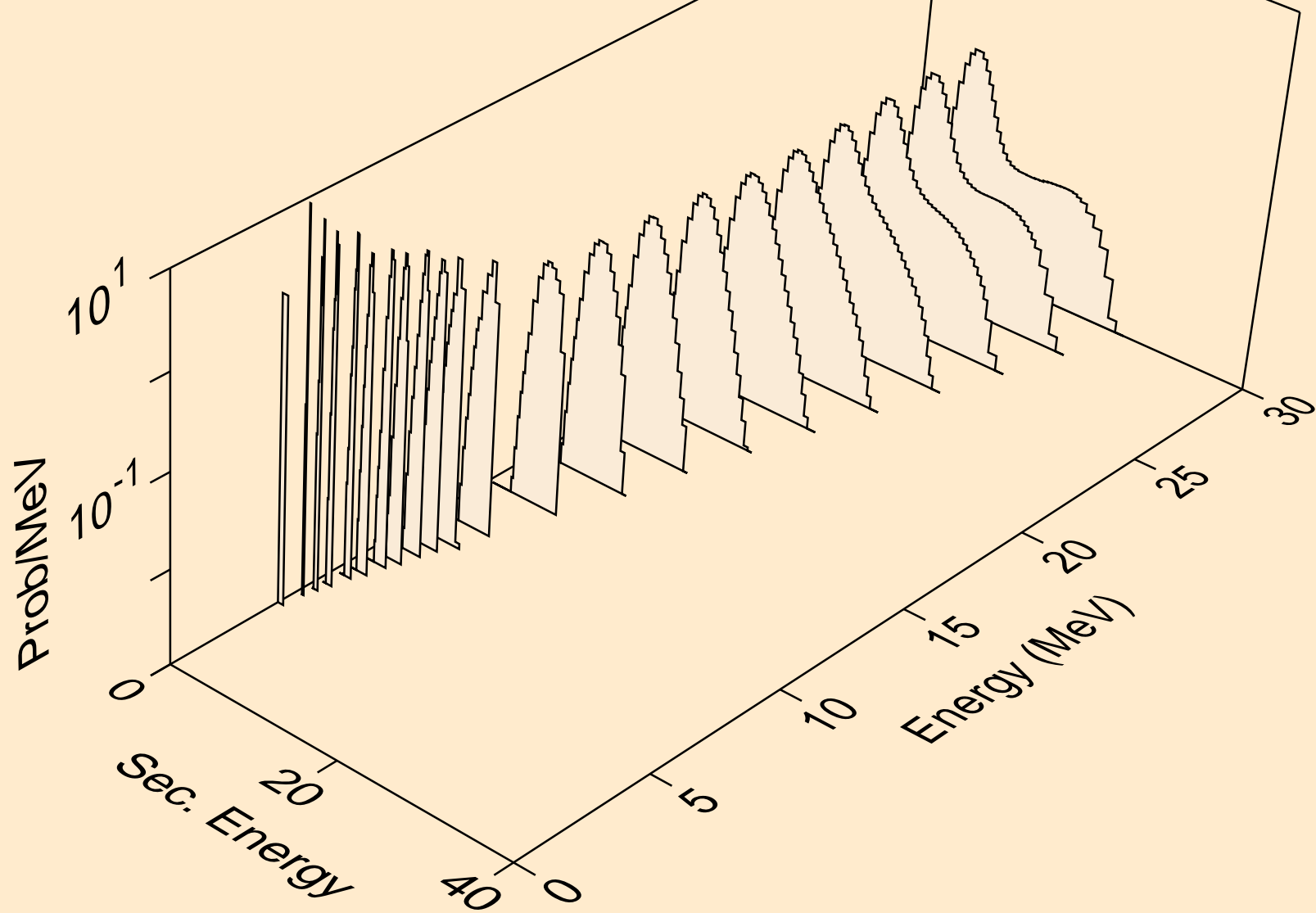

BA120 NEUTRON ACER TENDL-2021 LIBRARY; T=293.6K  
protons from (n,2np)

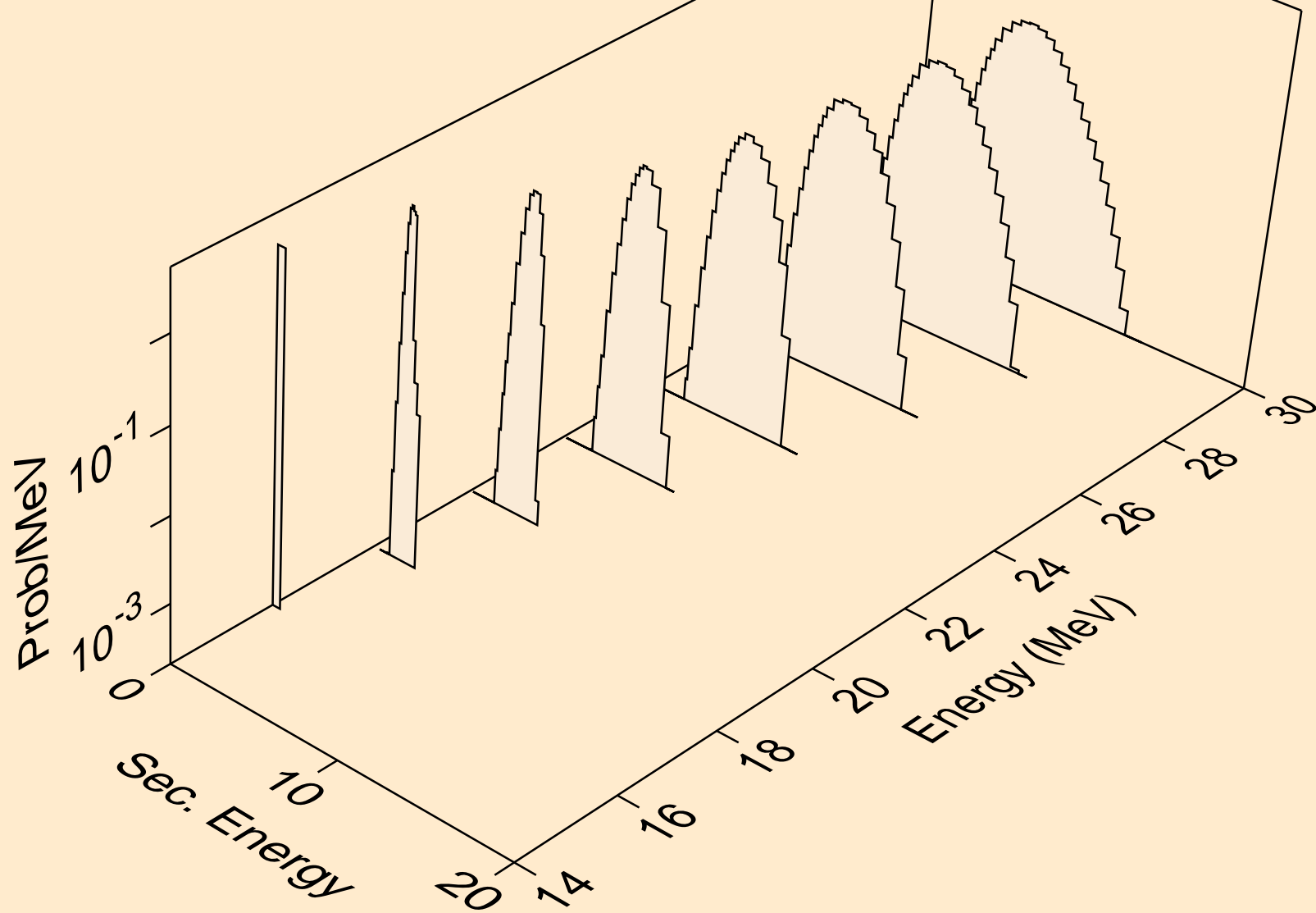

BA120 NEUTRON ACER TENDL-2021 LIBRARY; T=293.6K  
protons from (n,3np)

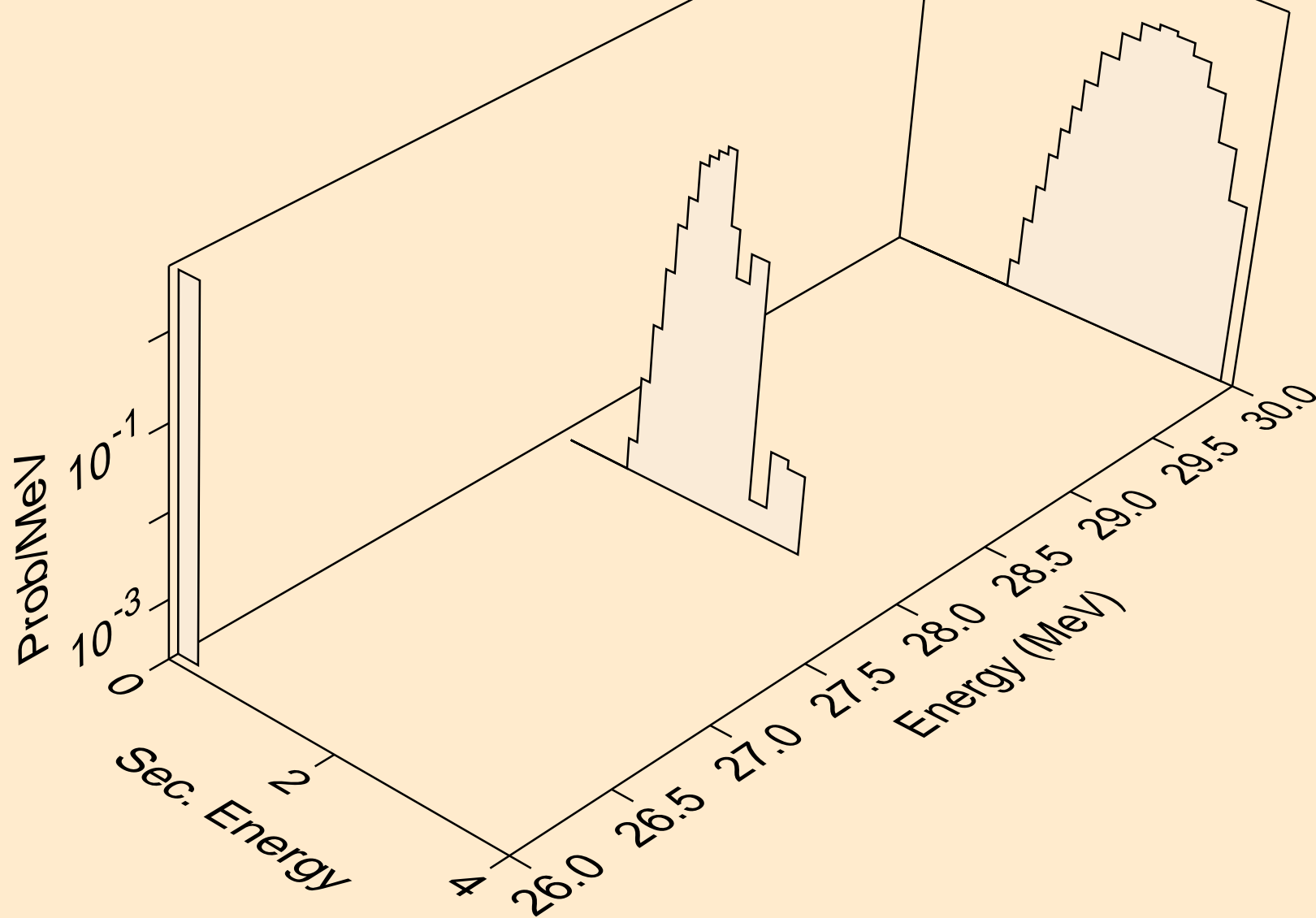

BA120 NEUTRON ACER TENDL-2021 LIBRARY; T=293.6K  
protons from (n,2np)

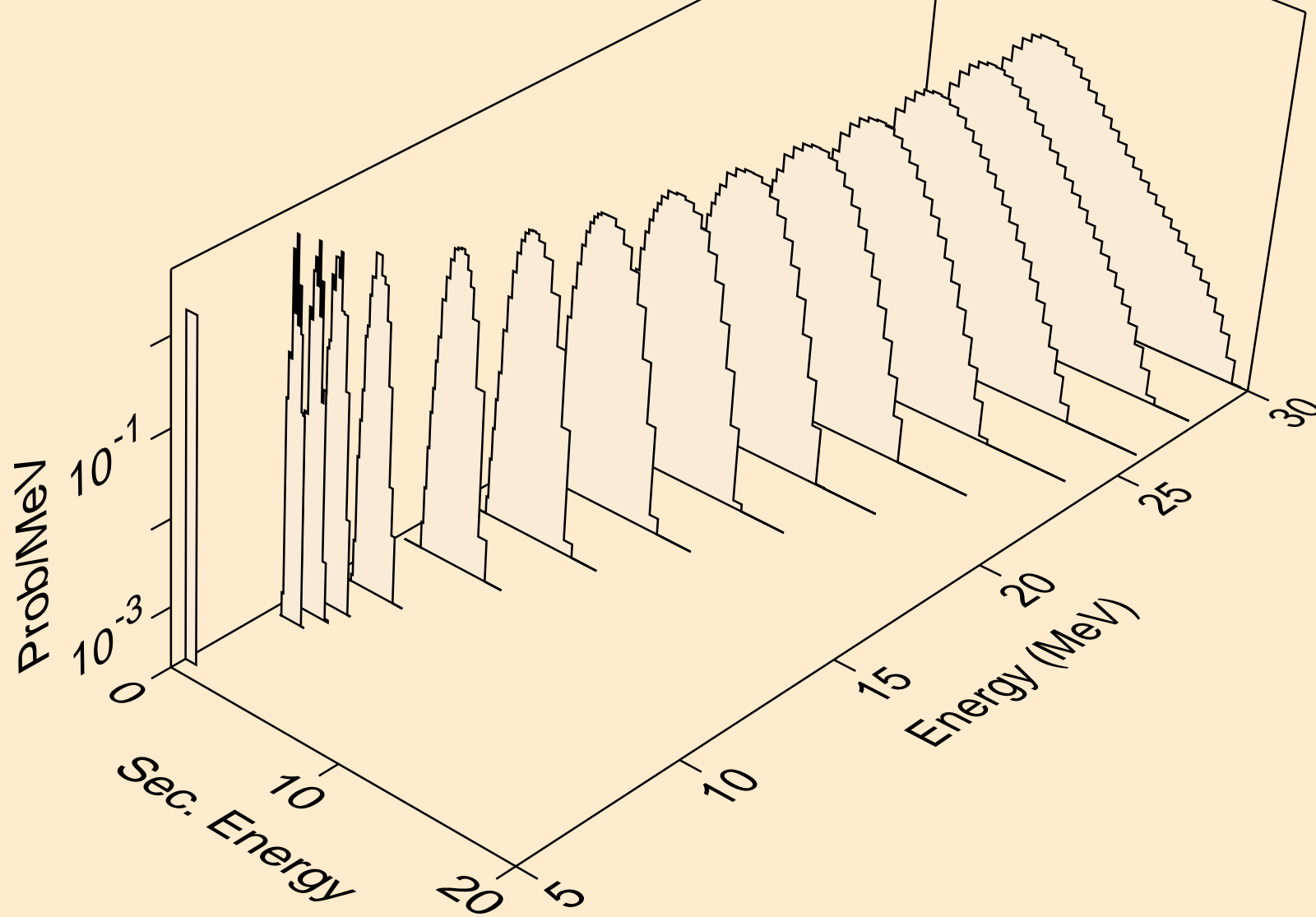

BA120 NEUTRON ACER TENDL-2021 LIBRARY; T=293.6K  
protons from (n,npa)

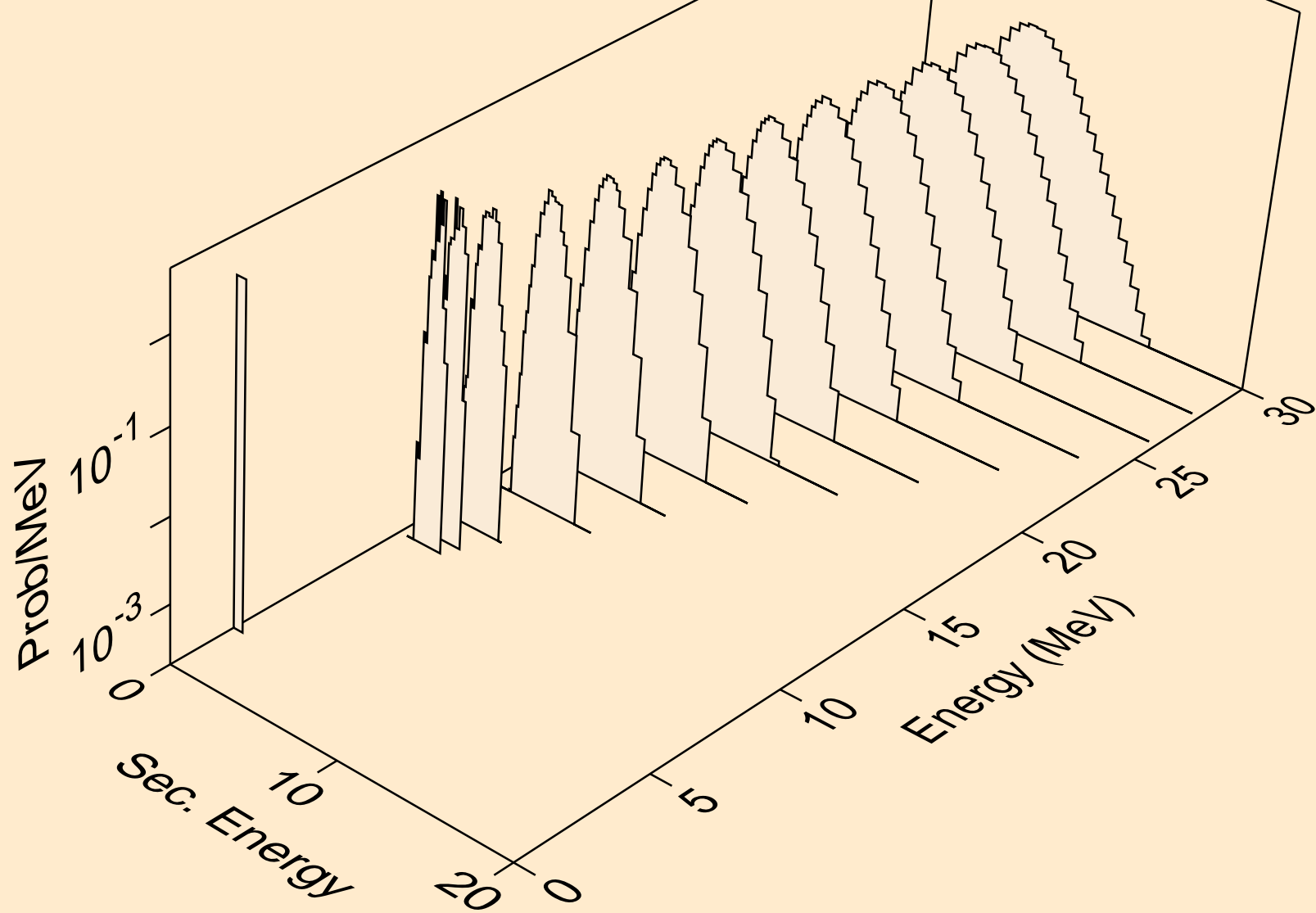

BA120 NEUTRON ACER TENDL-2021 LIBRARY; T=293.6K  
protons from (n,p)

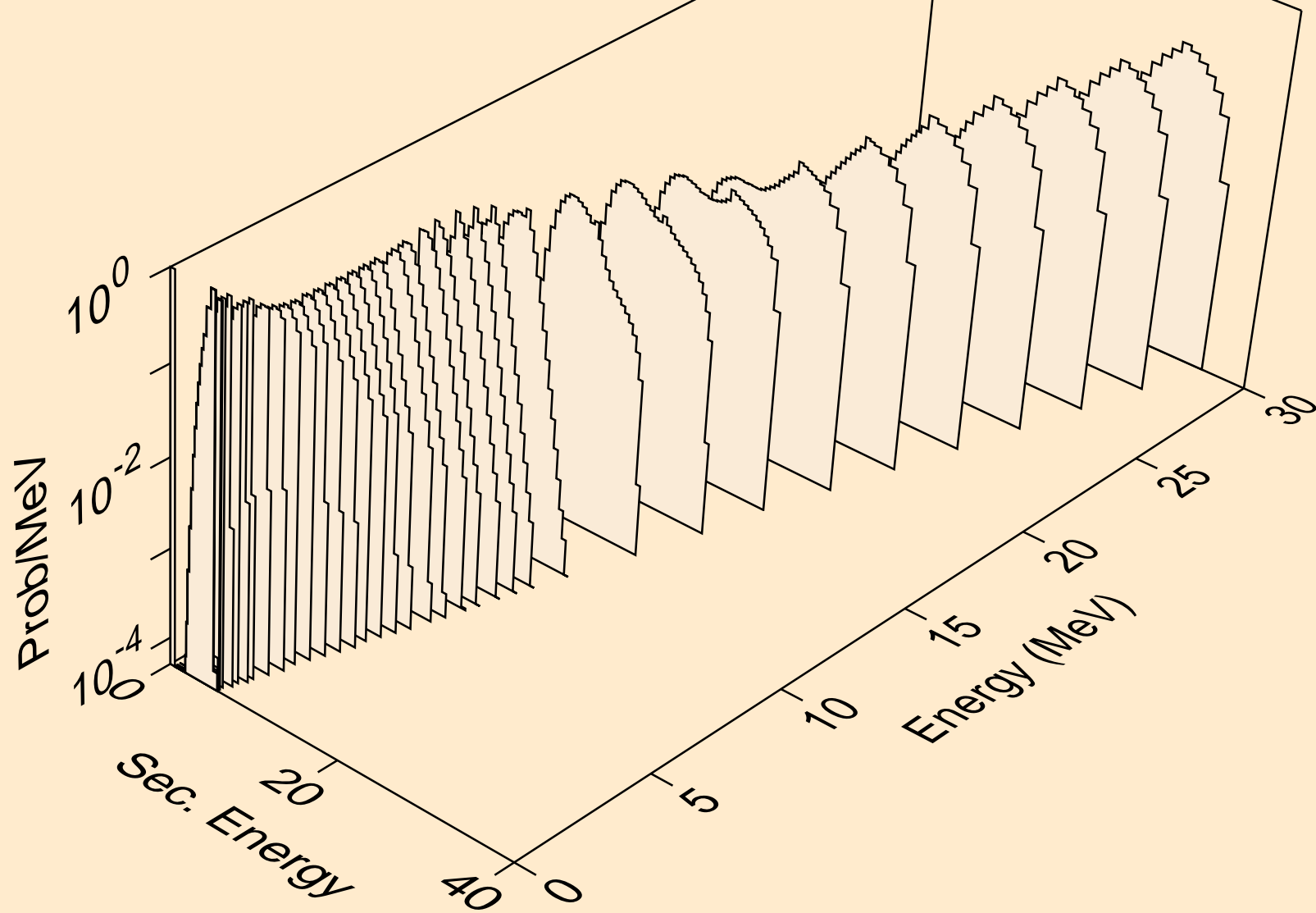



BA120 NEUTRON ACER TENDL-2021 LIBRARY; T=293.6K  
protons from (n,2p)

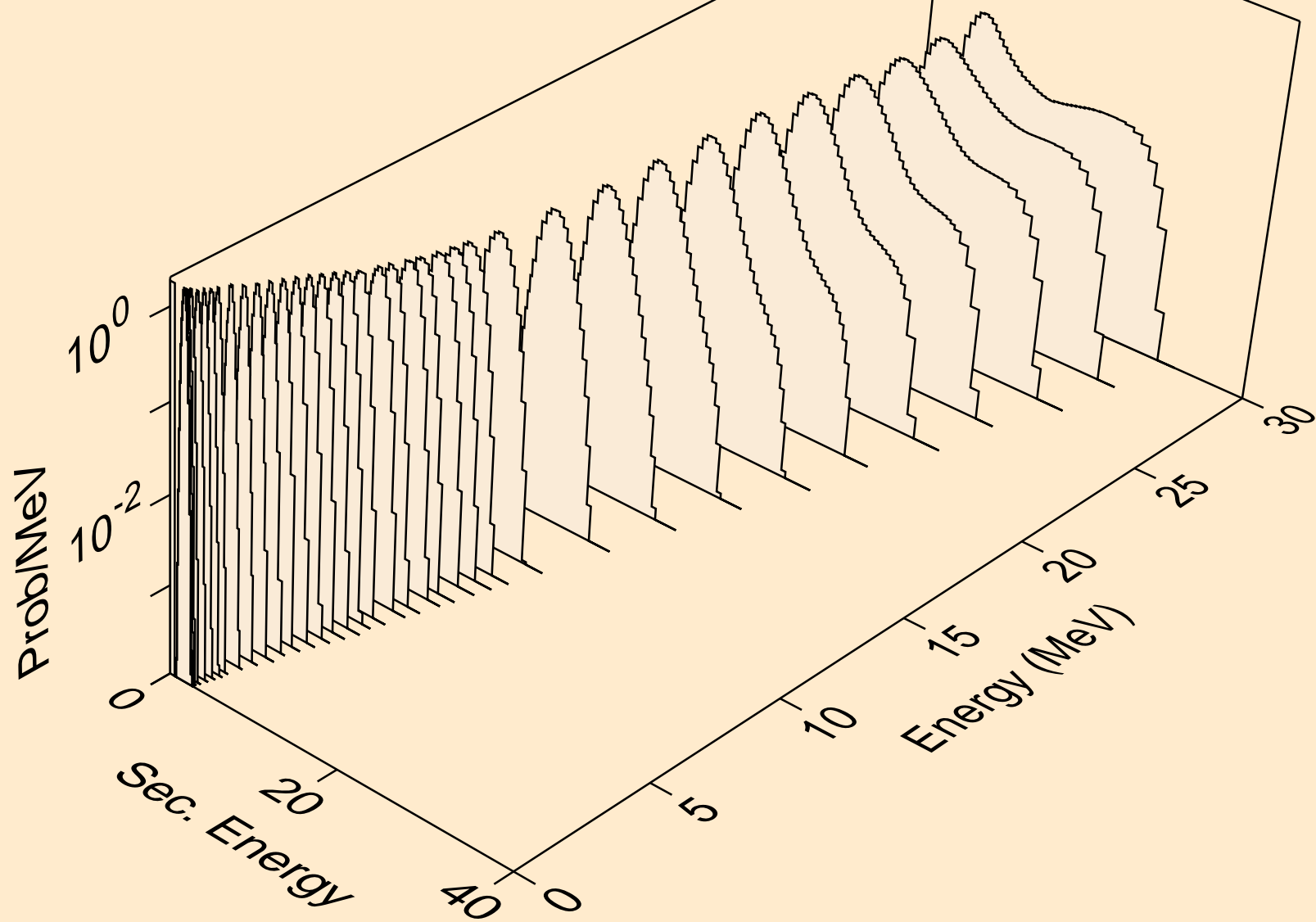

BA120 NEUTRON ACER TENDL-2021 LIBRARY; T=293.6K  
protons from (n,p)

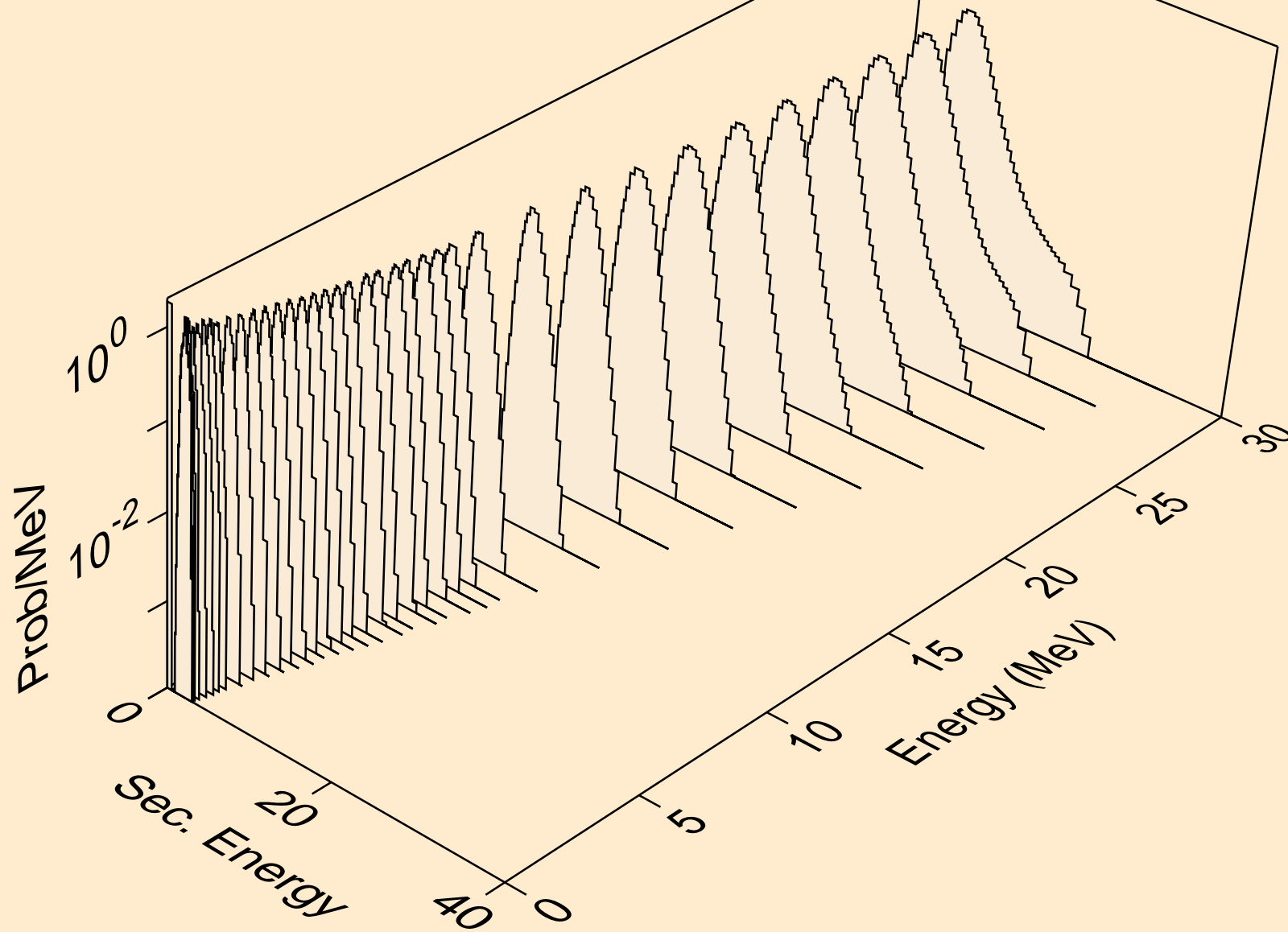

BA120 NEUTRON ACER TENDL-2021 LIBRARY; T=293.6K  
protons from (n,pd)

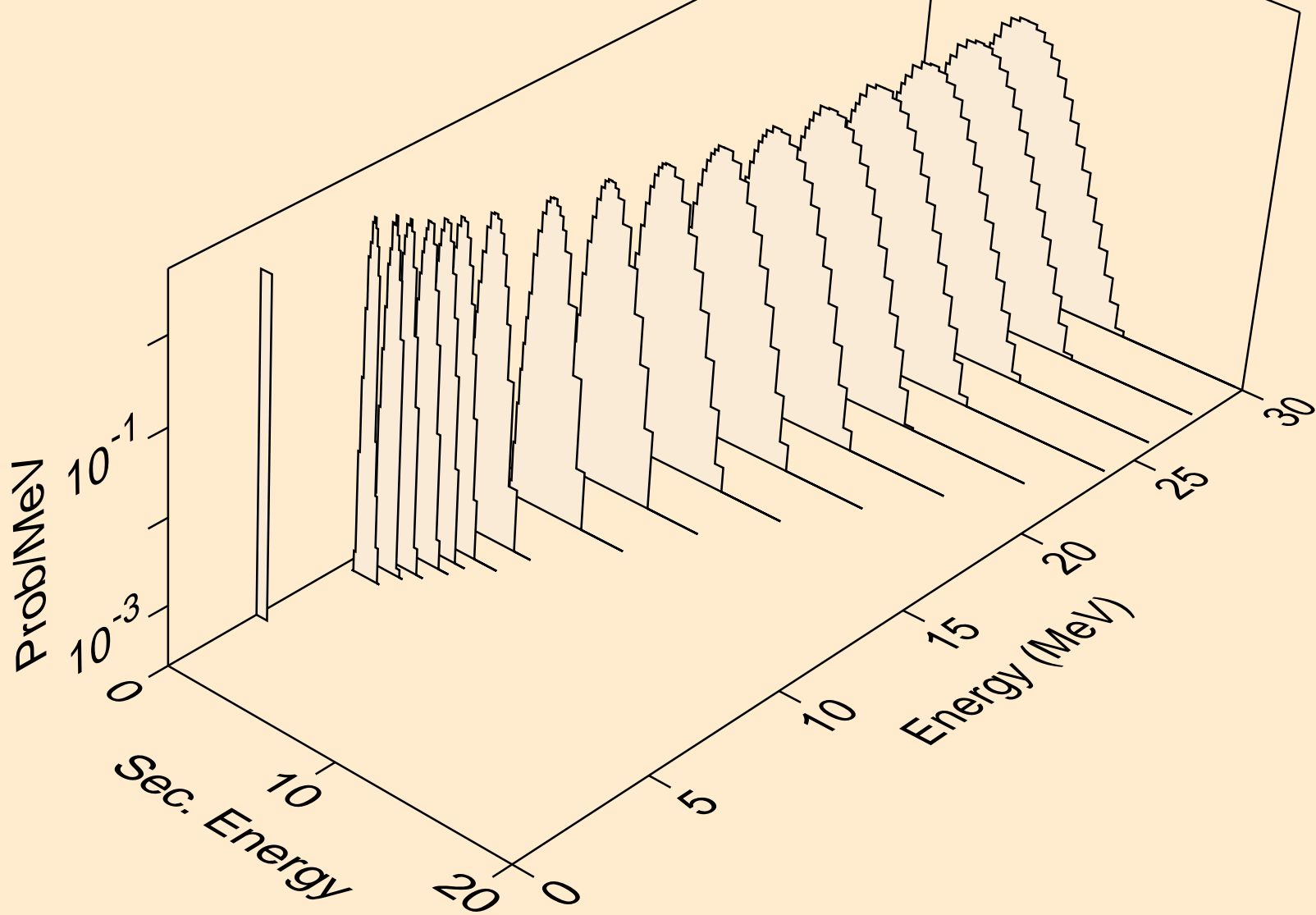

BA120 NEUTRON ACER TENDL-2021 LIBRARY; T=293.6K  
protons from (n,pt)

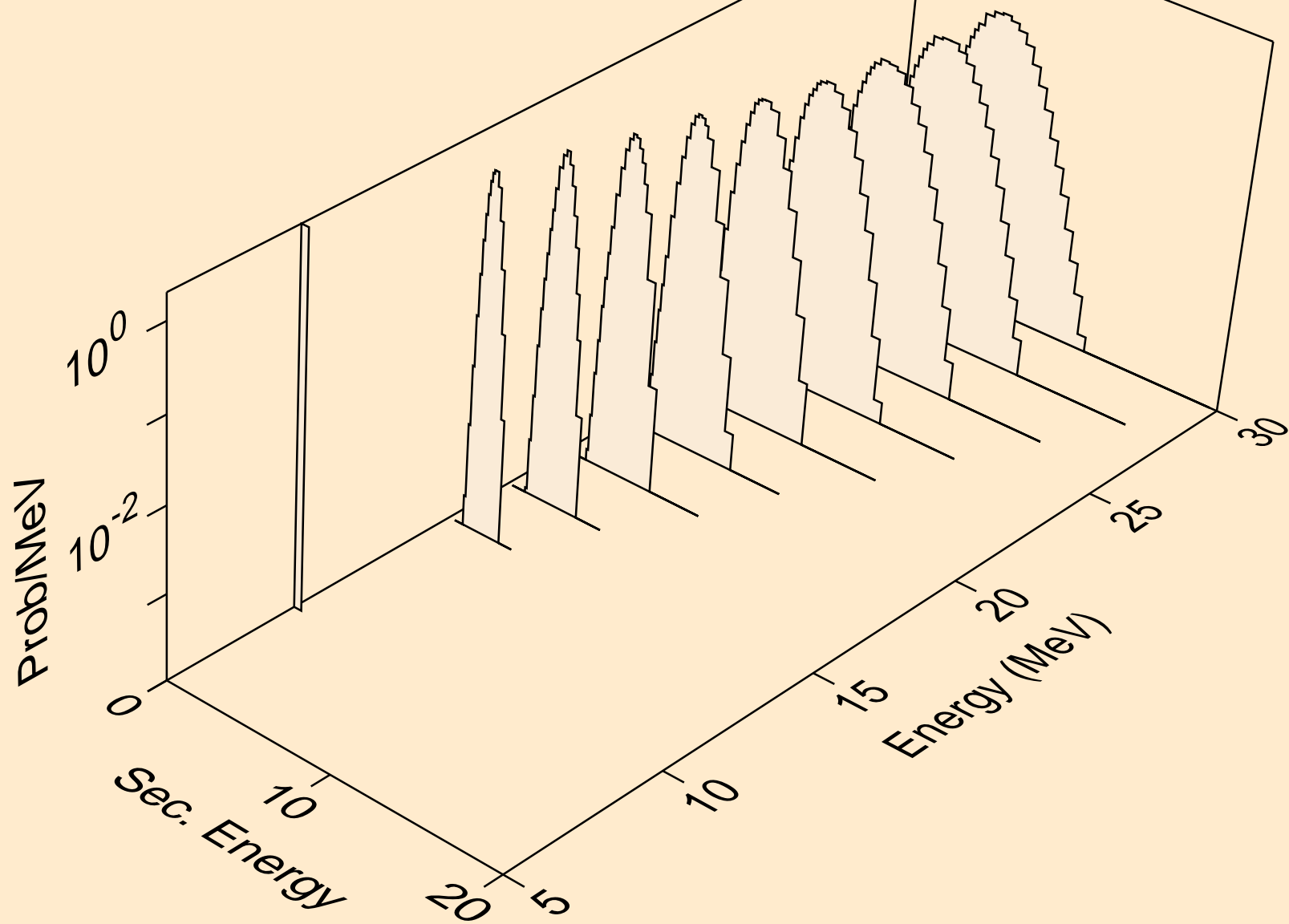

BA120 NEUTRON ACER TENDL-2021 LIBRARY; T=293.6K  
deuterons from (n,x)

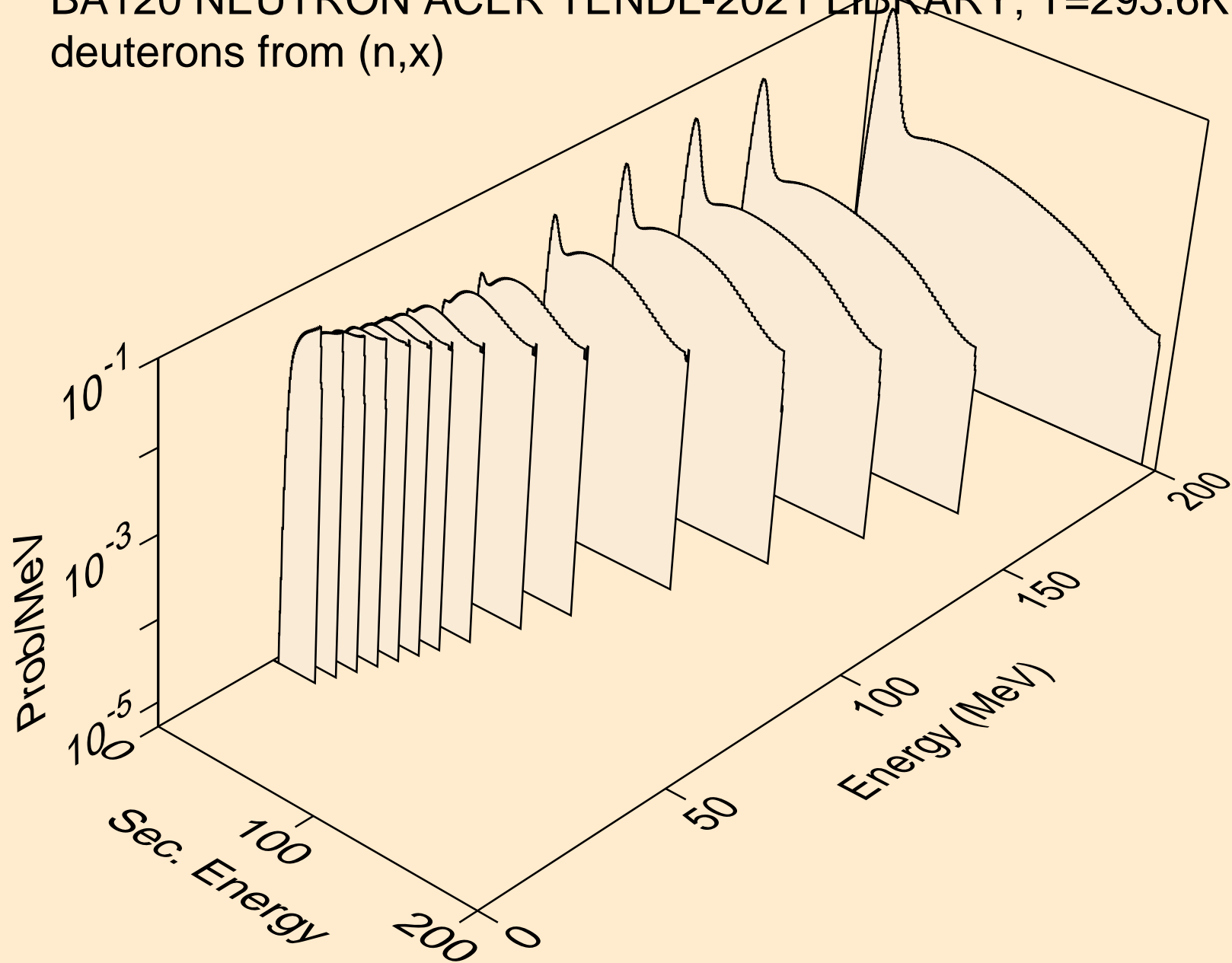

BA120 NEUTRON ACER TENDL-2021 LIBRARY; T=293.6K  
deuterons from (n,2nd)

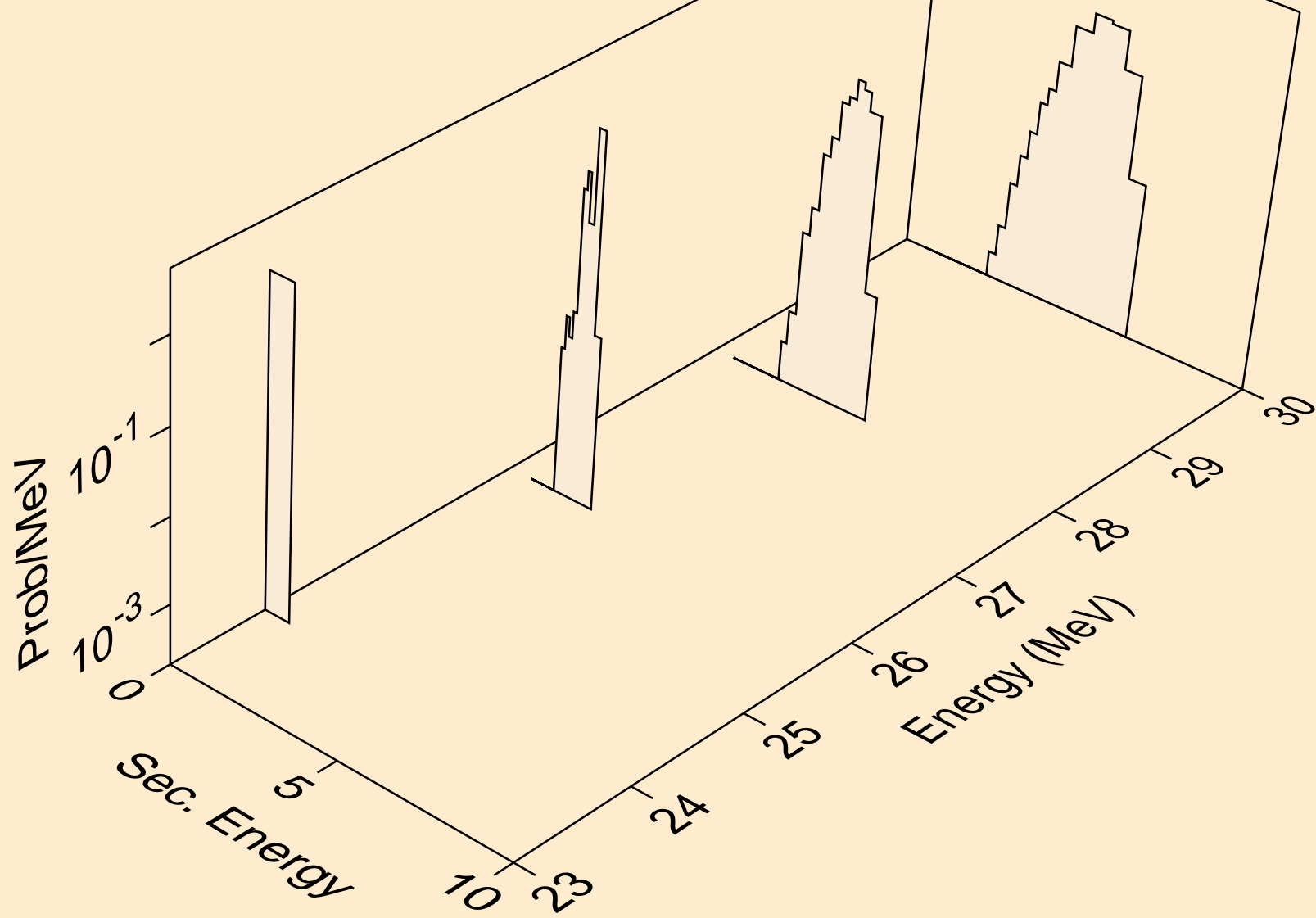

BA120 NEUTRON ACER TENDL-2021 LIBRARY; T=293.6K  
deuterons from (n,n\*)d

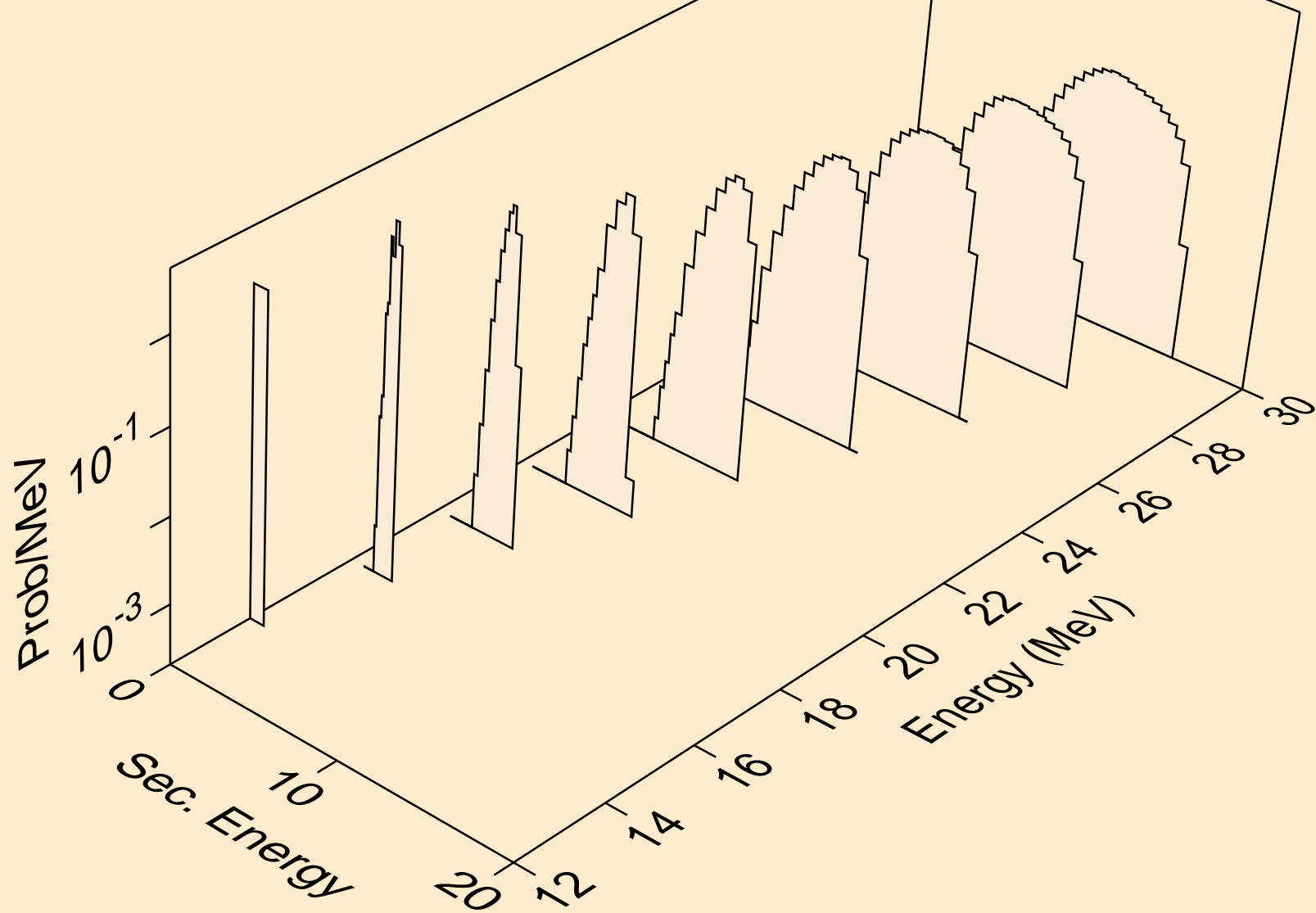

BA120 NEUTRON ACER TENDL-2021 LIBRARY; T=293.6K  
deuterons from (n,d)

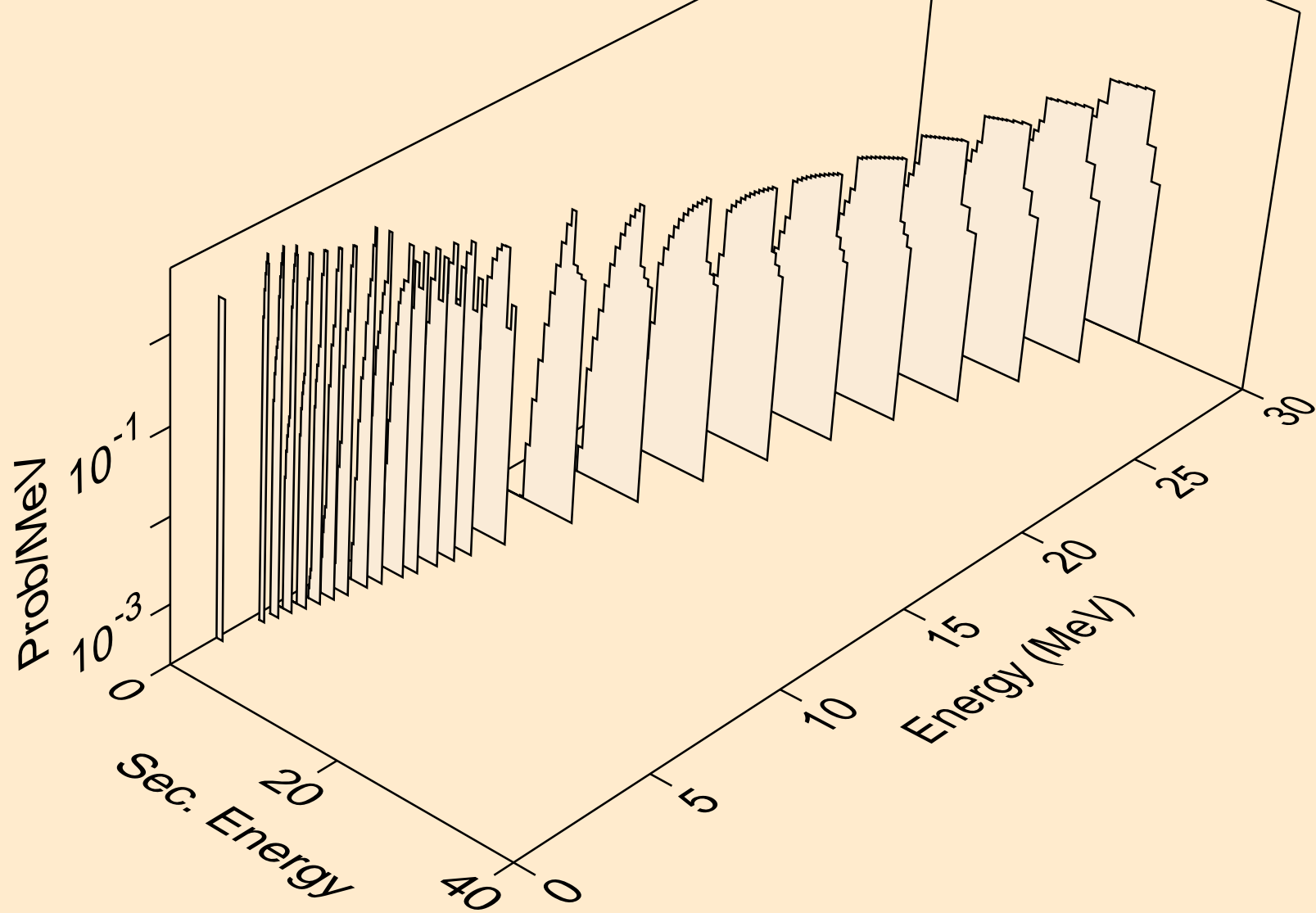



BA120 NEUTRON ACER TENDL-2021 LIBRARY; T=293.6K  
deuterons from (n,d2a)

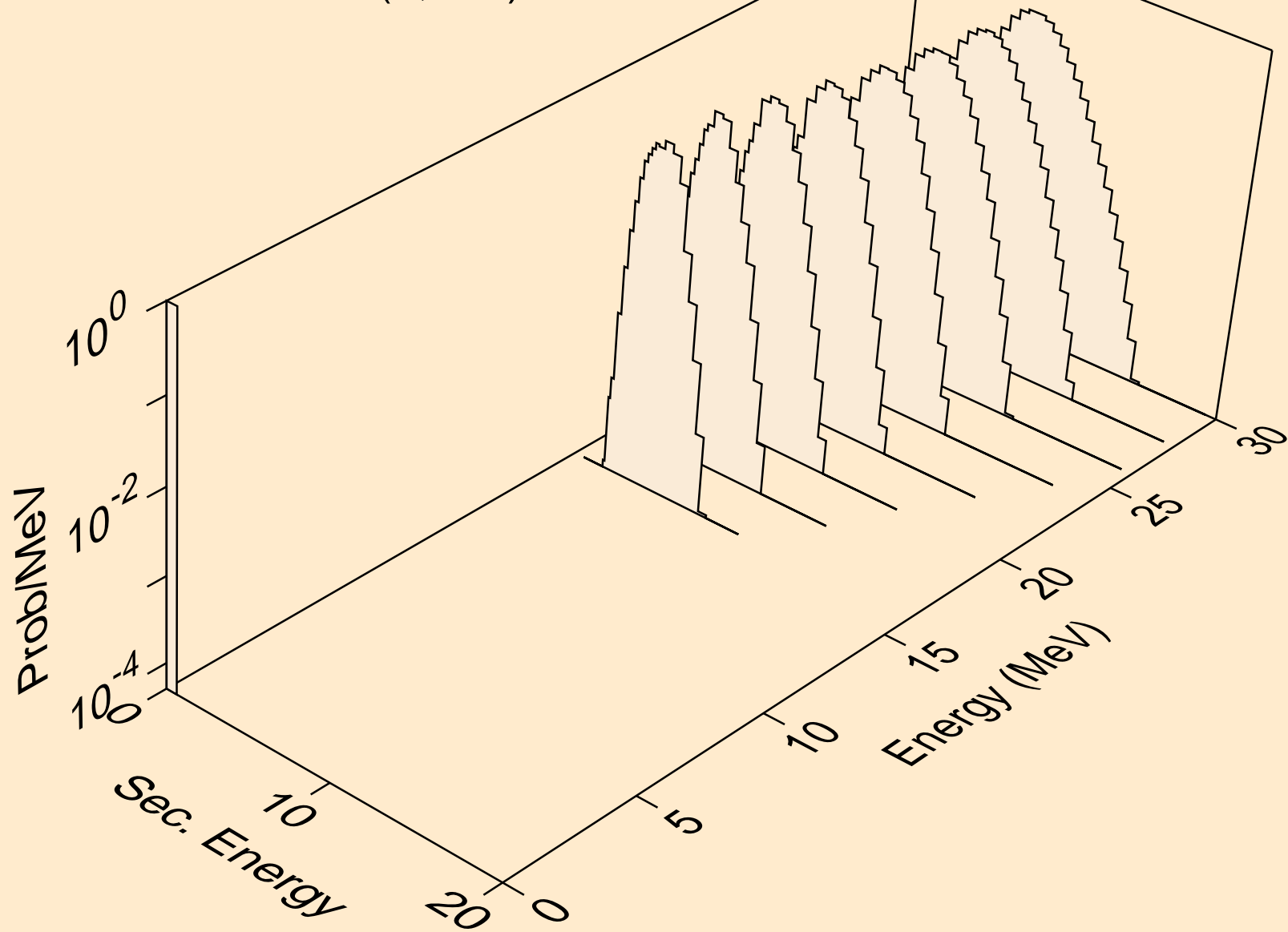

BA120 NEUTRON ACER TENDL-2021 LIBRARY; T=293.6K  
deuterons from (n,pd)

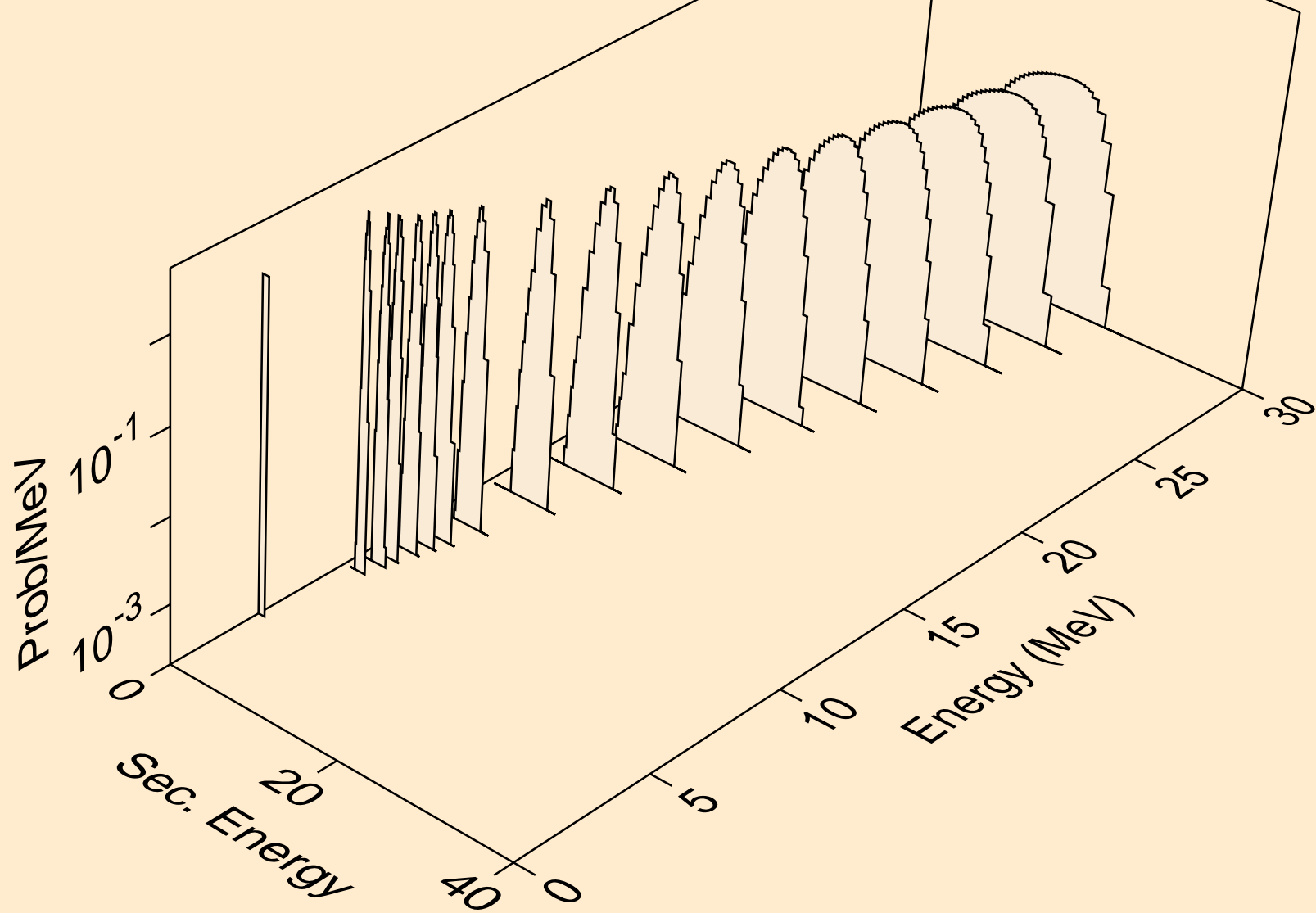

BA120 NEUTRON ACER TENDL-2021 LIBRARY; T=293.6K  
deuterons from (n,da)

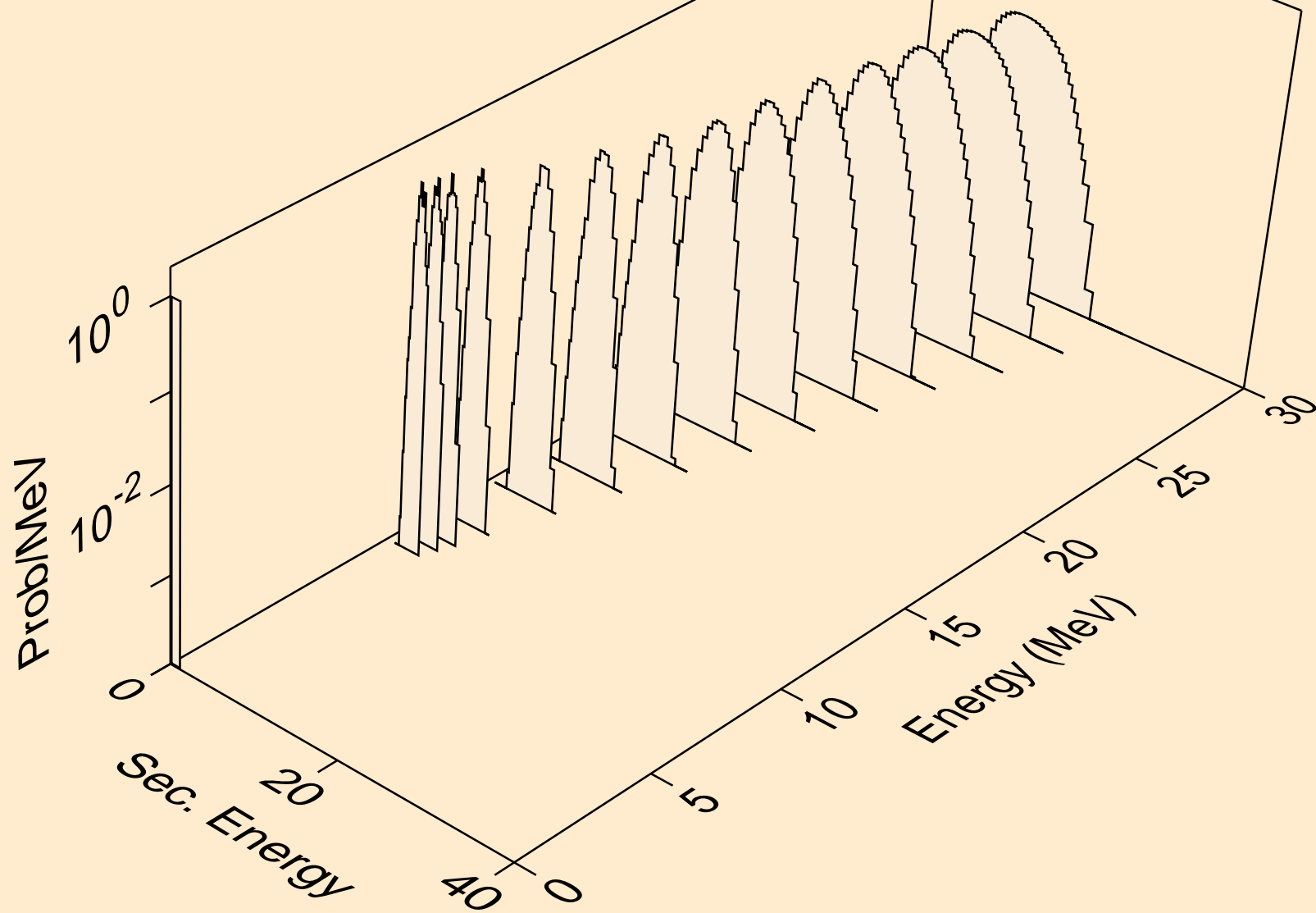

BA120 NEUTRON ACER TENDL-2021 LIBRARY; T=293.6K  
tritons from (n,x)

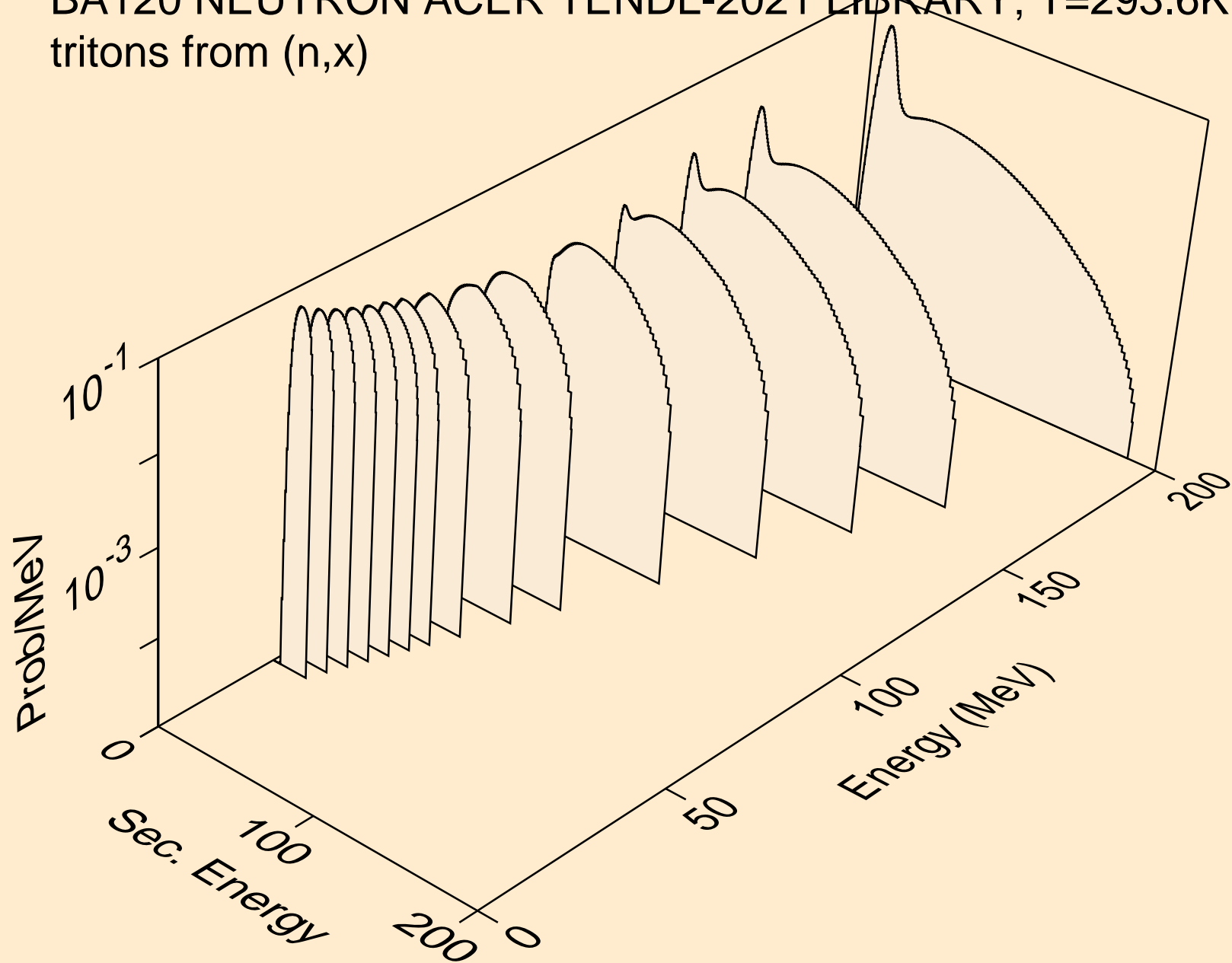

BA120 NEUTRON ACER TENDL-2021 LIBRARY; T=293.6K  
tritons from (n,n\*)t

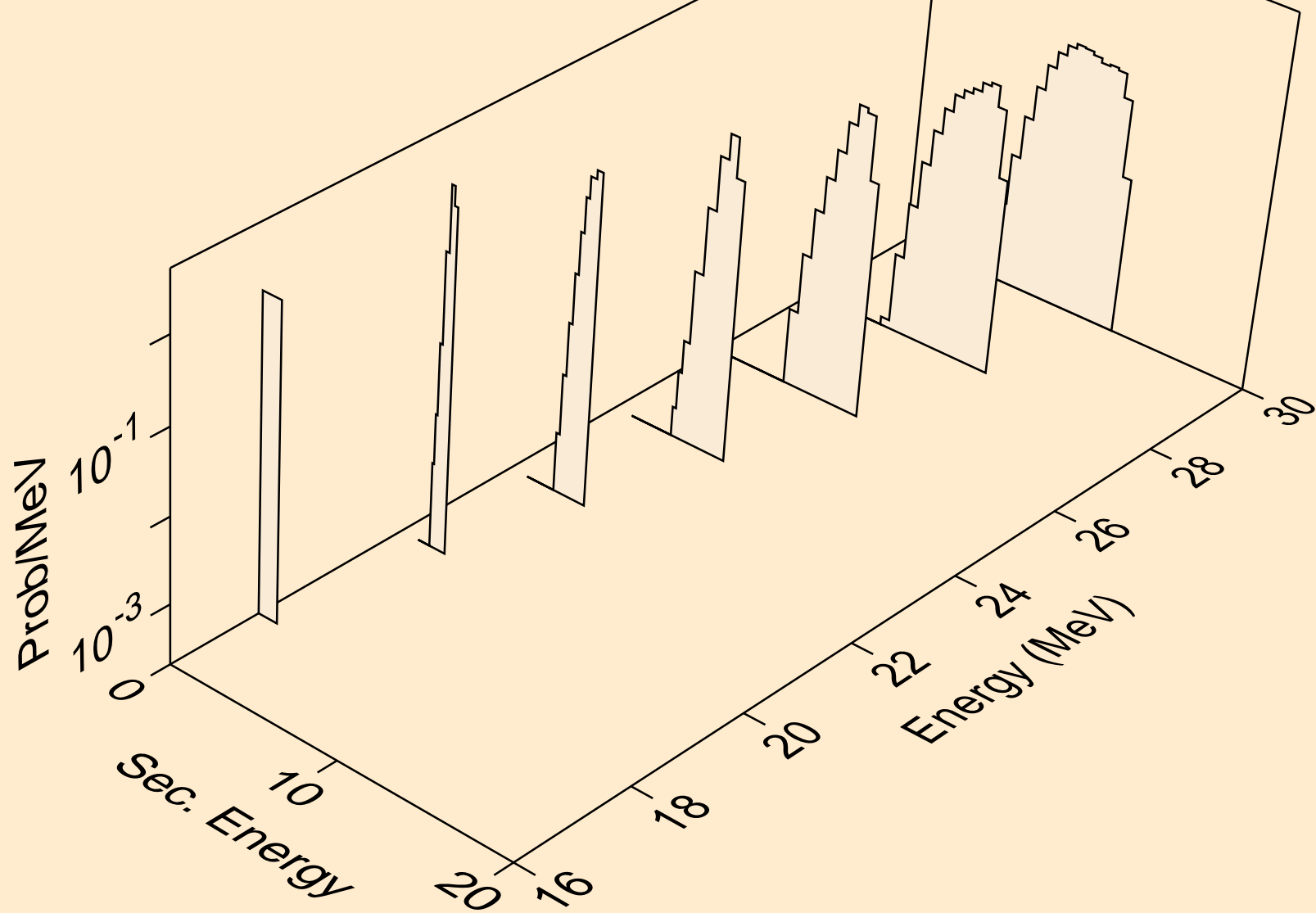

BA120 NEUTRON ACER TENDL-2021 LIBRARY; T=293.6K  
tritons from (n,t)

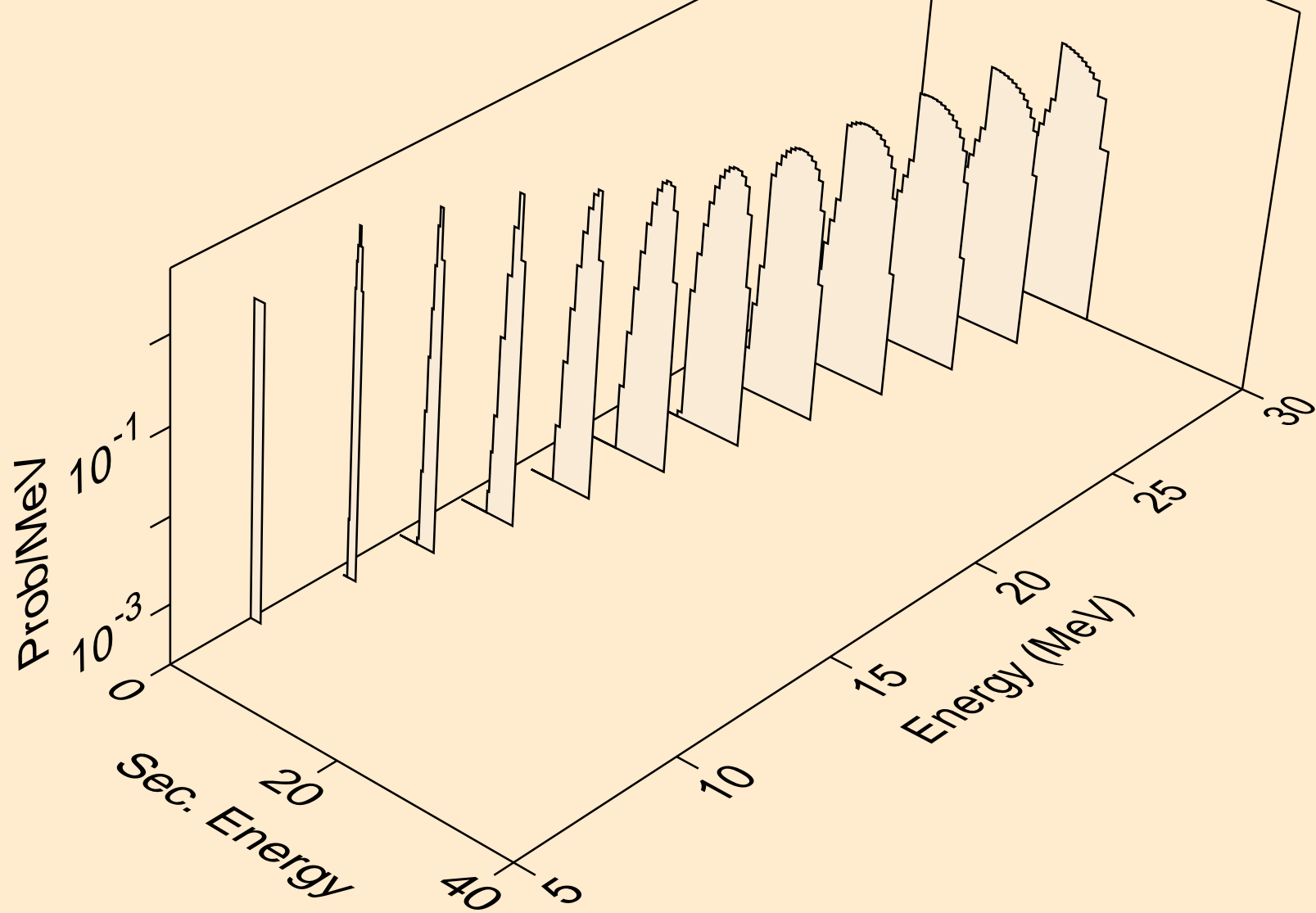

BA120 NEUTRON ACER TENDL-2021 LIBRARY; T=293.6K  
tritons from (n,pt)

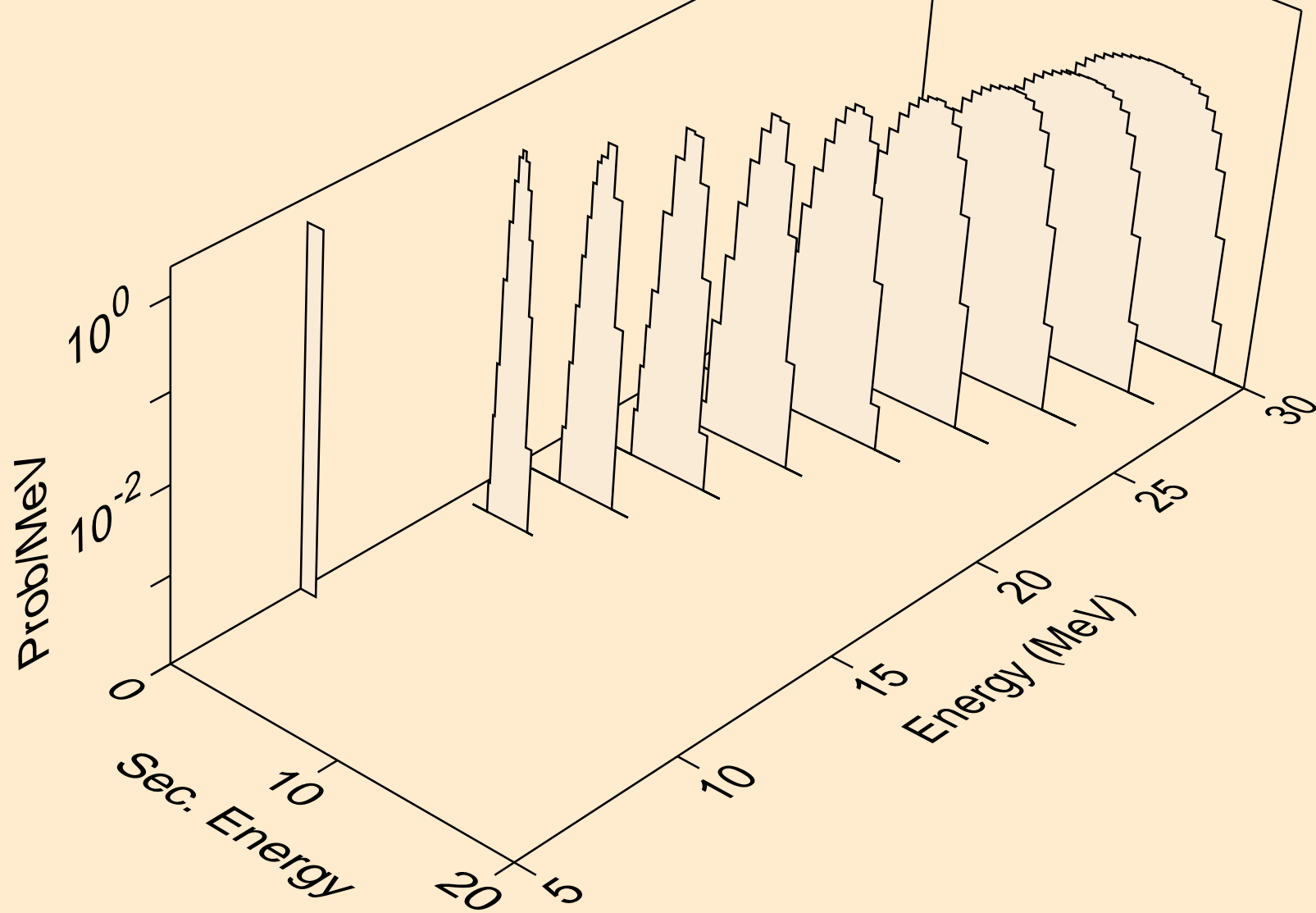

BA120 NEUTRON ACER TENDL-2021 LIBRARY; T=293.6K  
he3s from (n,x)

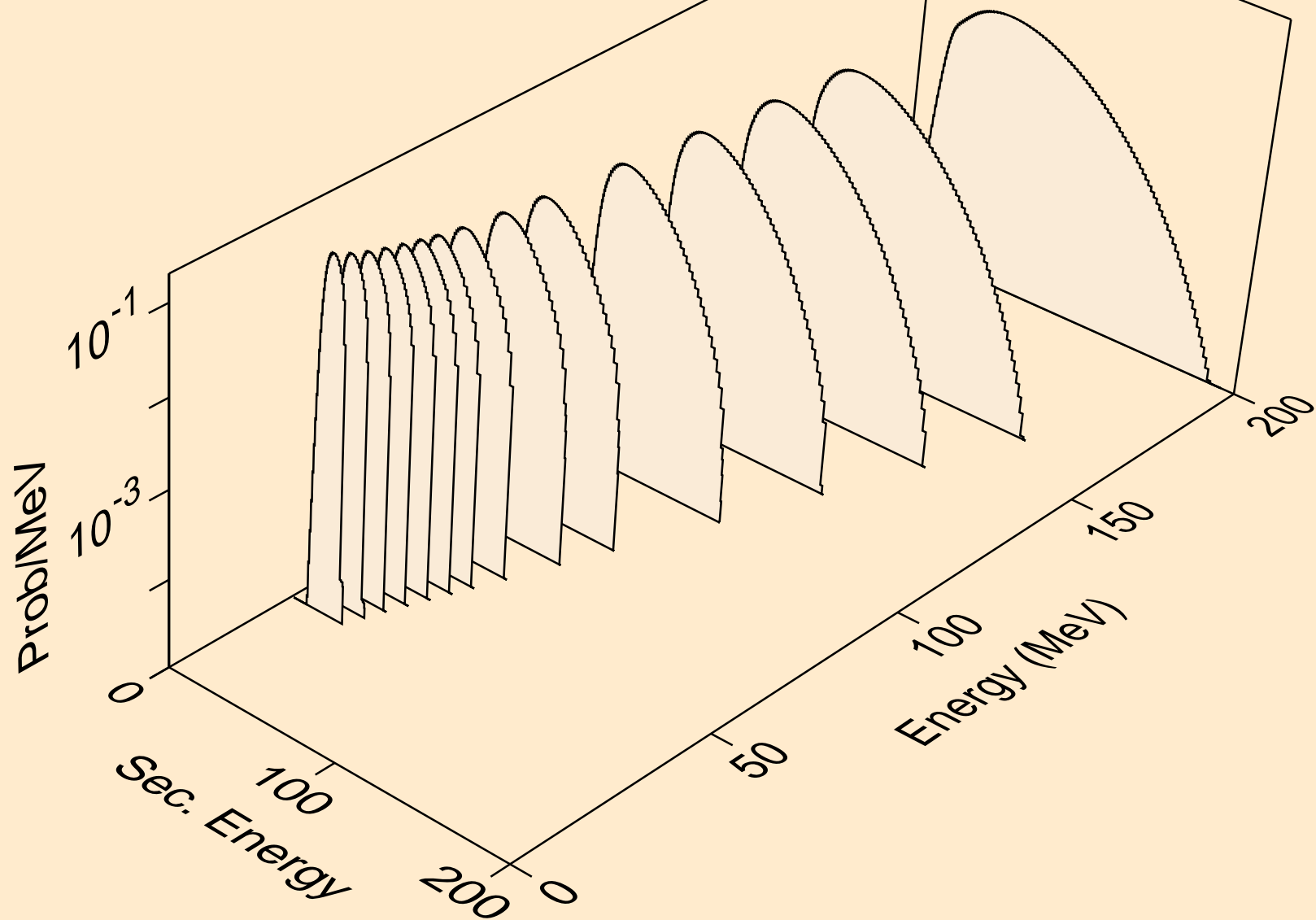



BA120 NEUTRON ACER TENDL-2021 LIBRARY; T=293.6K  
he3s from (n,n\*)he3

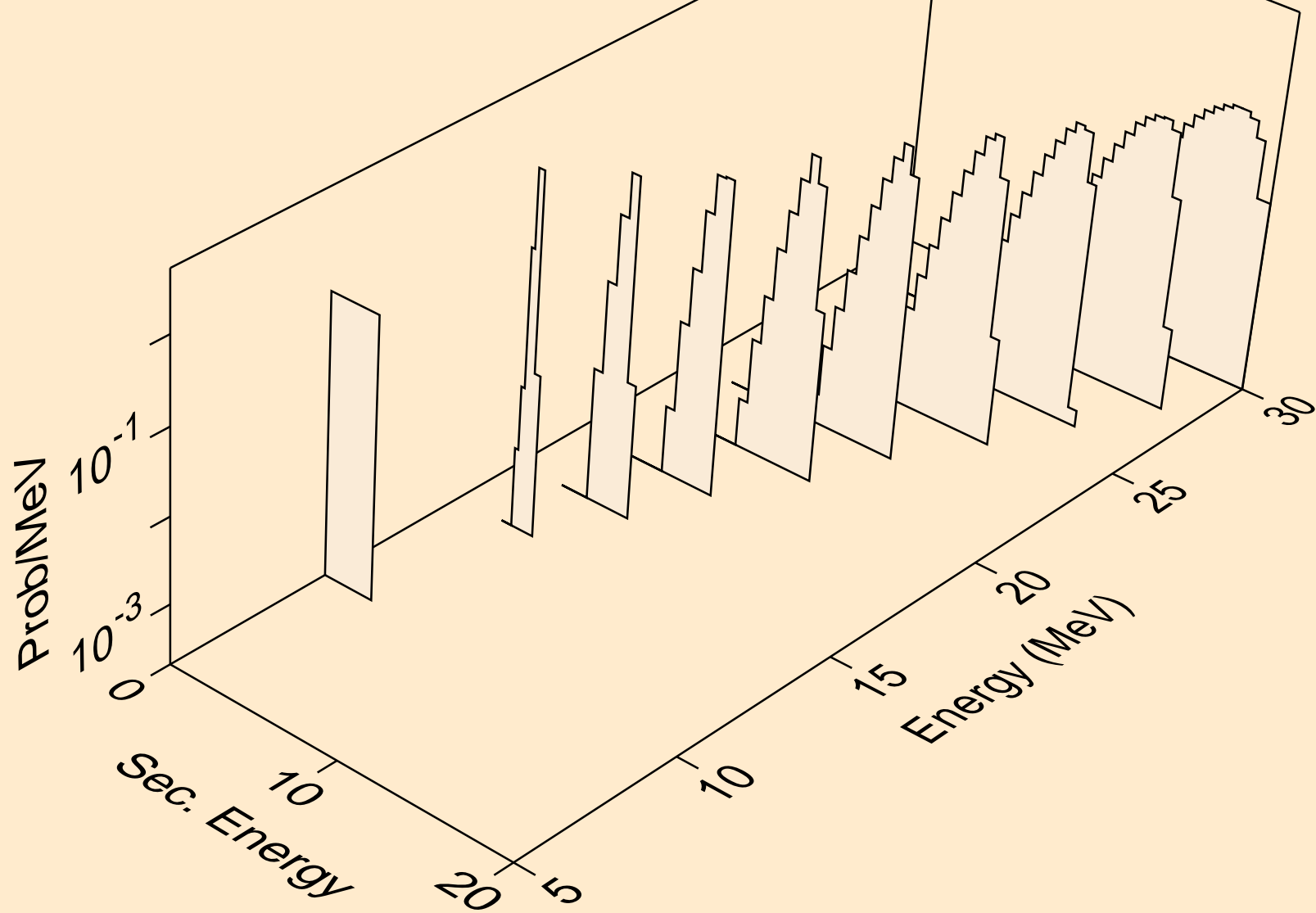

BA120 NEUTRON ACER TENDL-2021 LIBRARY; T=293.6K  
he3s from (n,he3)

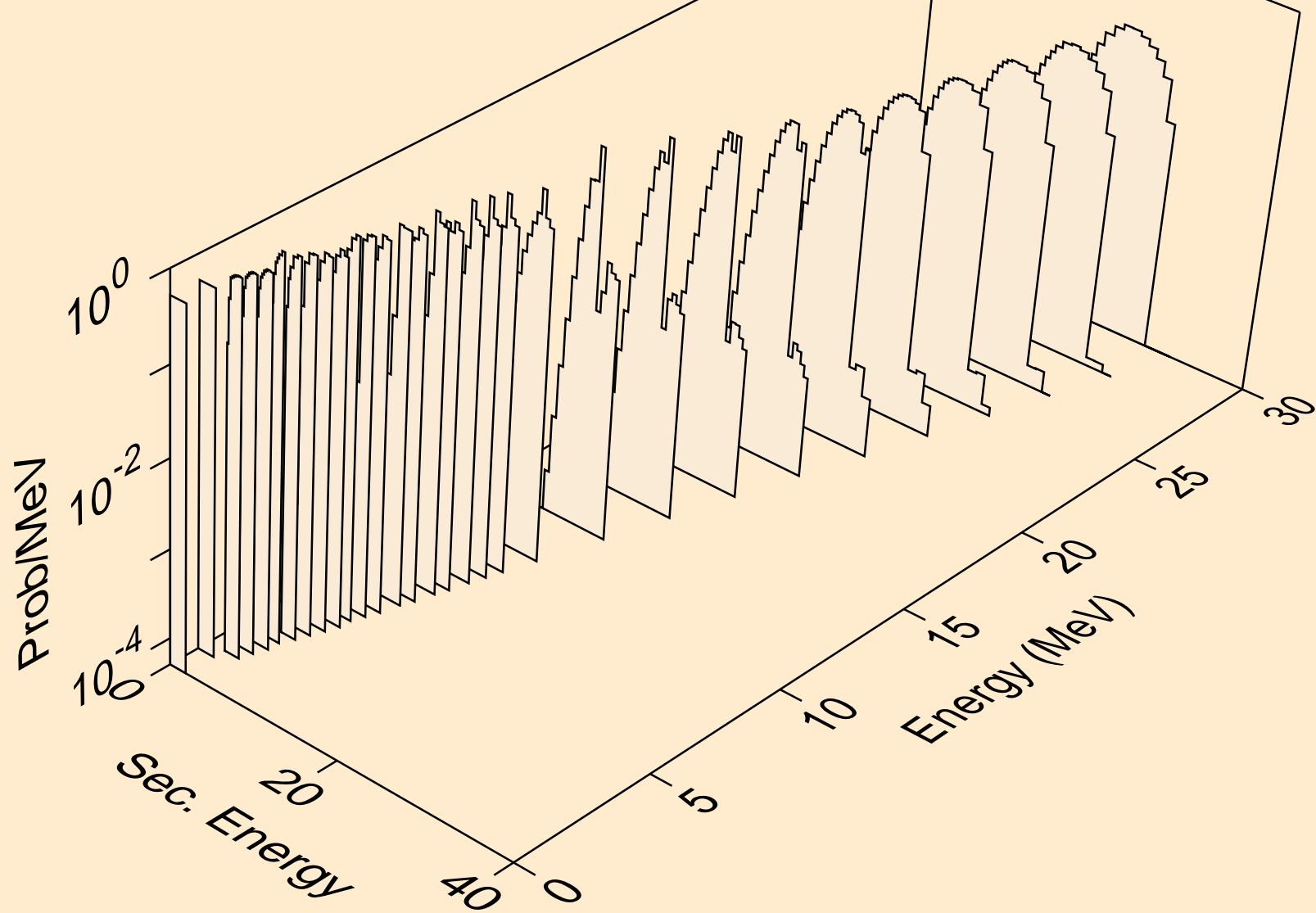

BA120 NEUTRON ACER TENDL-2021 LIBRARY; T=293.6K  
alphas from (n,x)

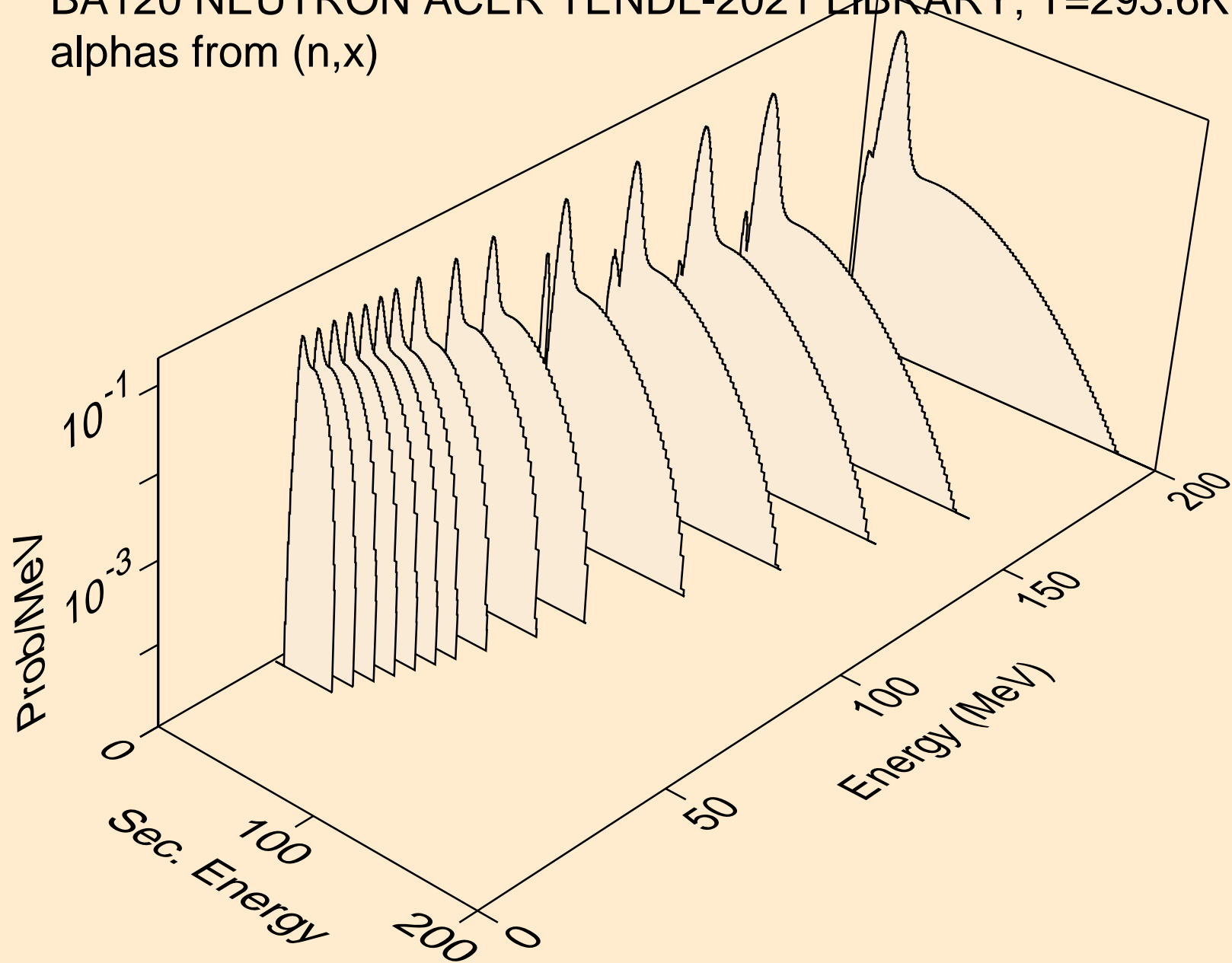

BA120 NEUTRON ACER TENDL-2021 LIBRARY; T=293.6K  
alphas from (n,n\*)a

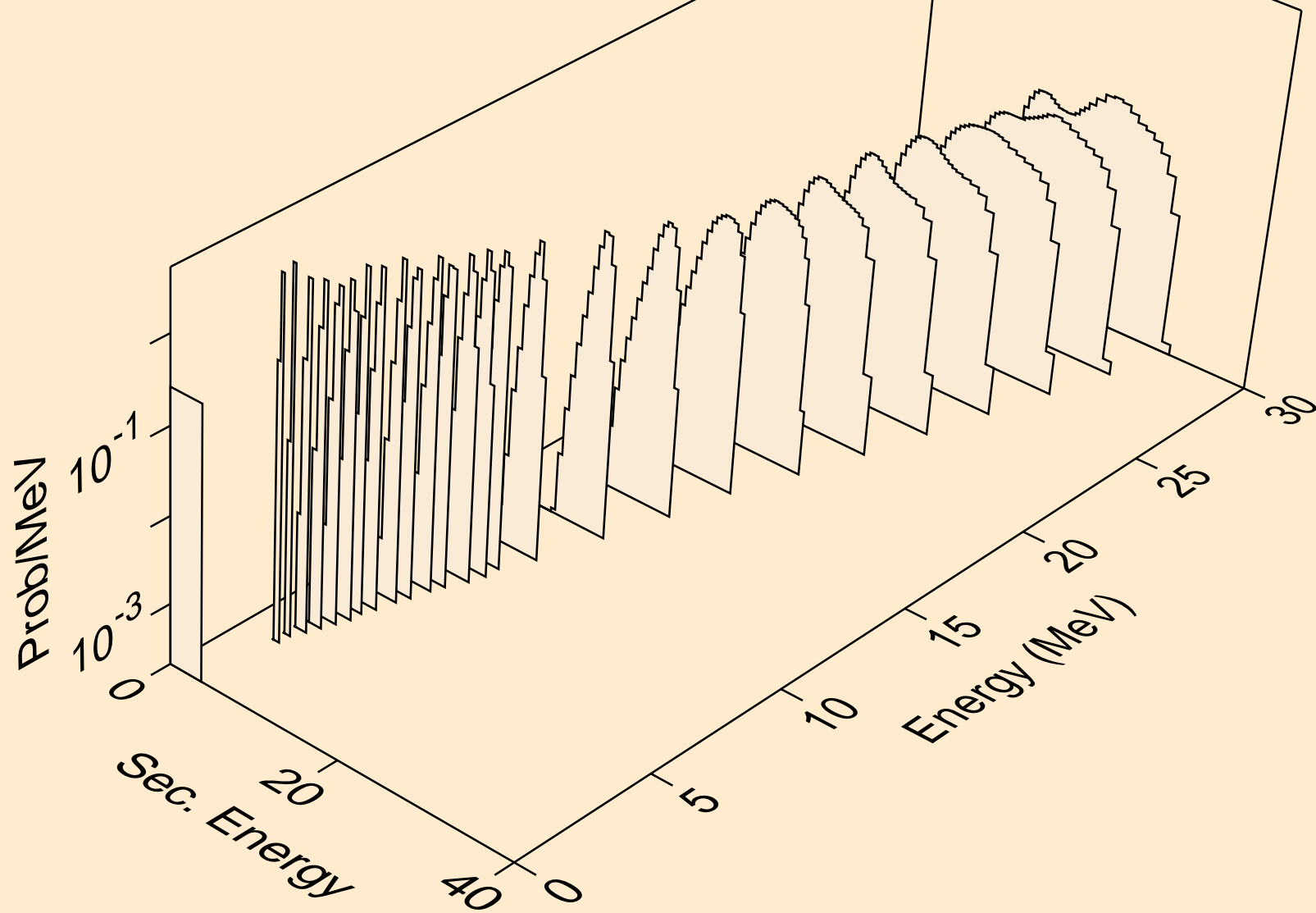

BA120 NEUTRON ACER TENDL-2021 LIBRARY; T=293.6K  
alphas from (n,n\*)3a

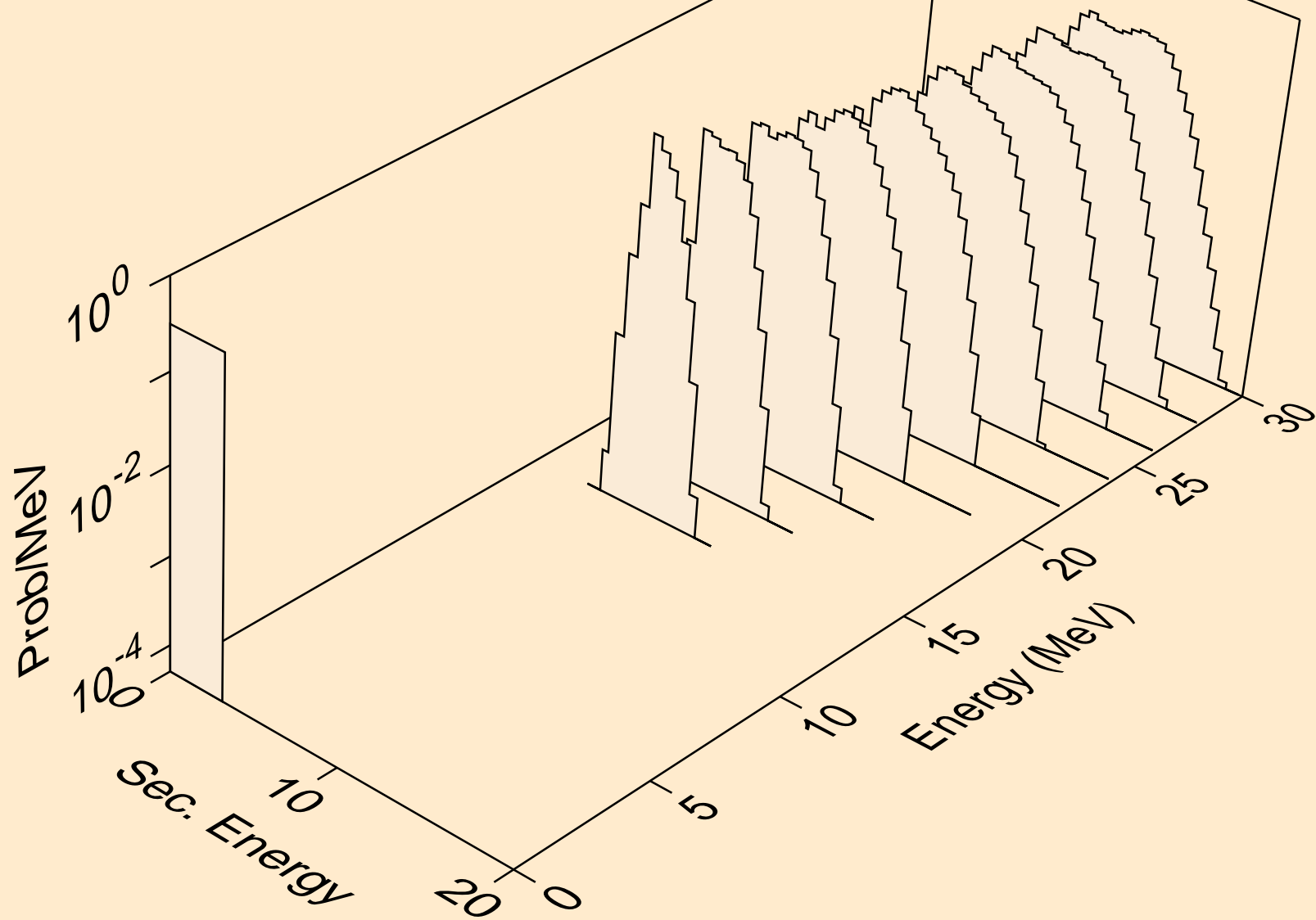

BA120 NEUTRON ACER TENDL-2021 LIBRARY; T=293.6K  
alphas from (n,2n)a

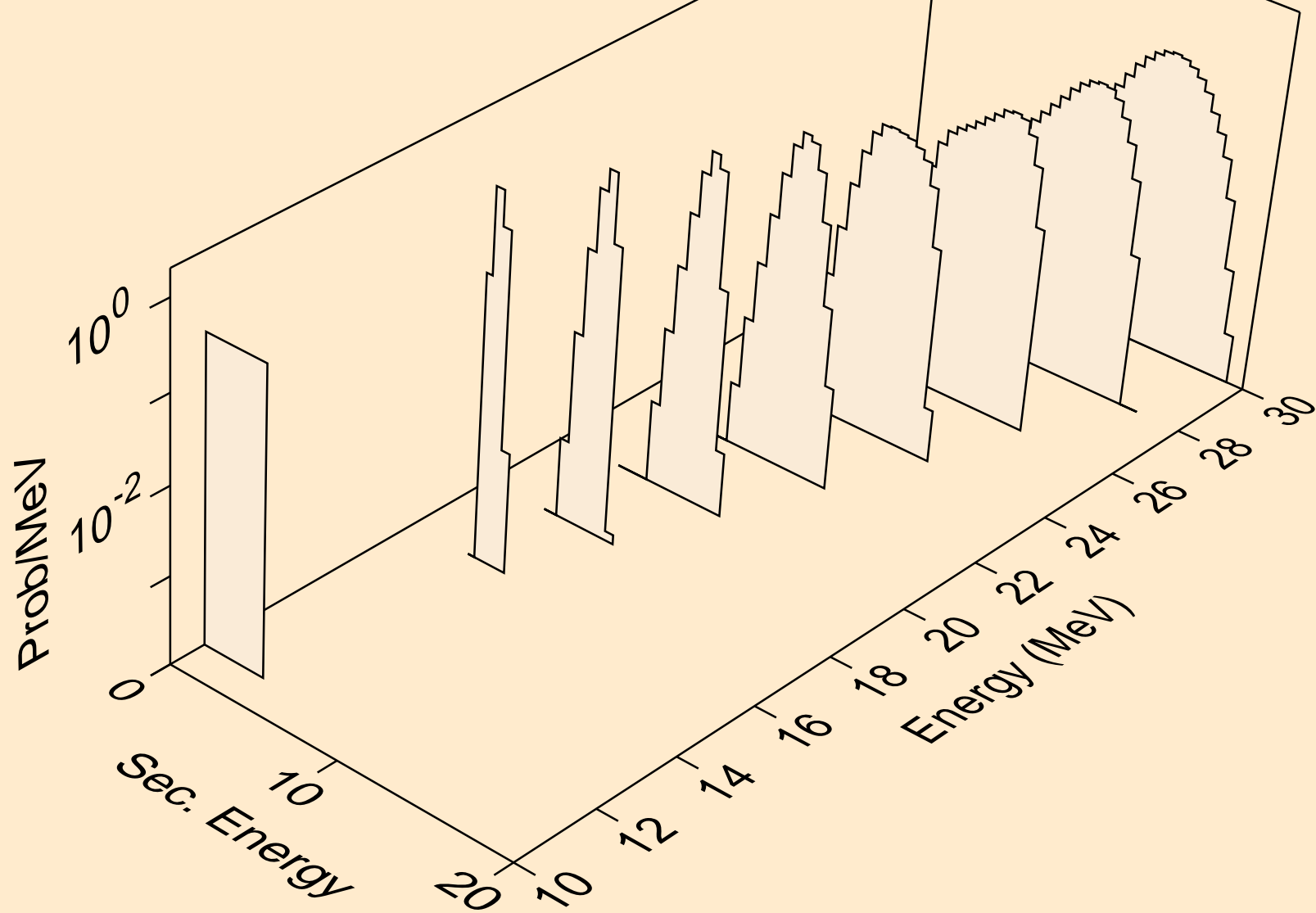

BA120 NEUTRON ACER TENDL-2021 LIBRARY; T=293.6K  
alphas from (n,n\*)2a

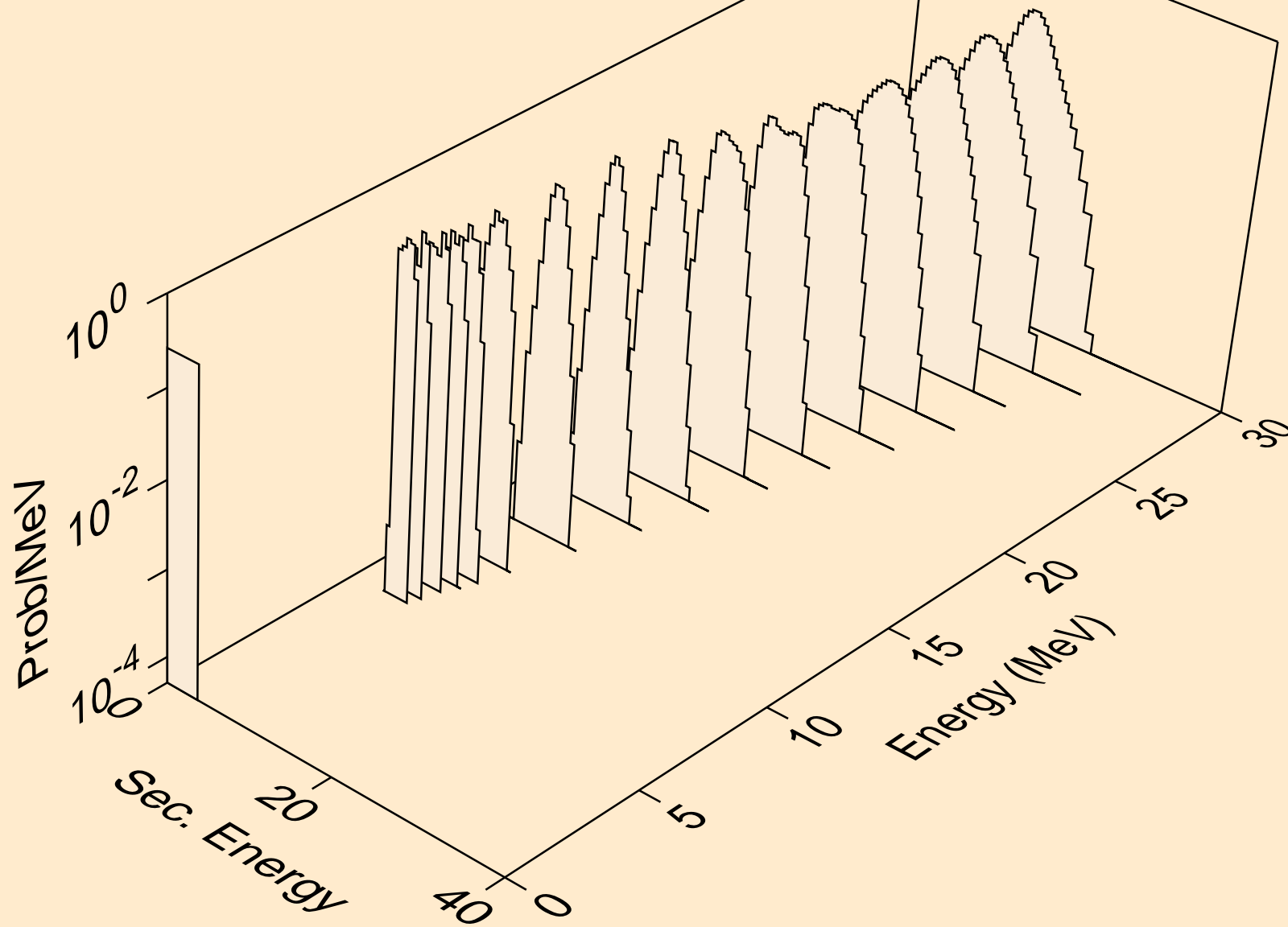

BA120 NEUTRON ACER TENDL-2021 LIBRARY; T=293.6K  
alphas from (n,2n)2a

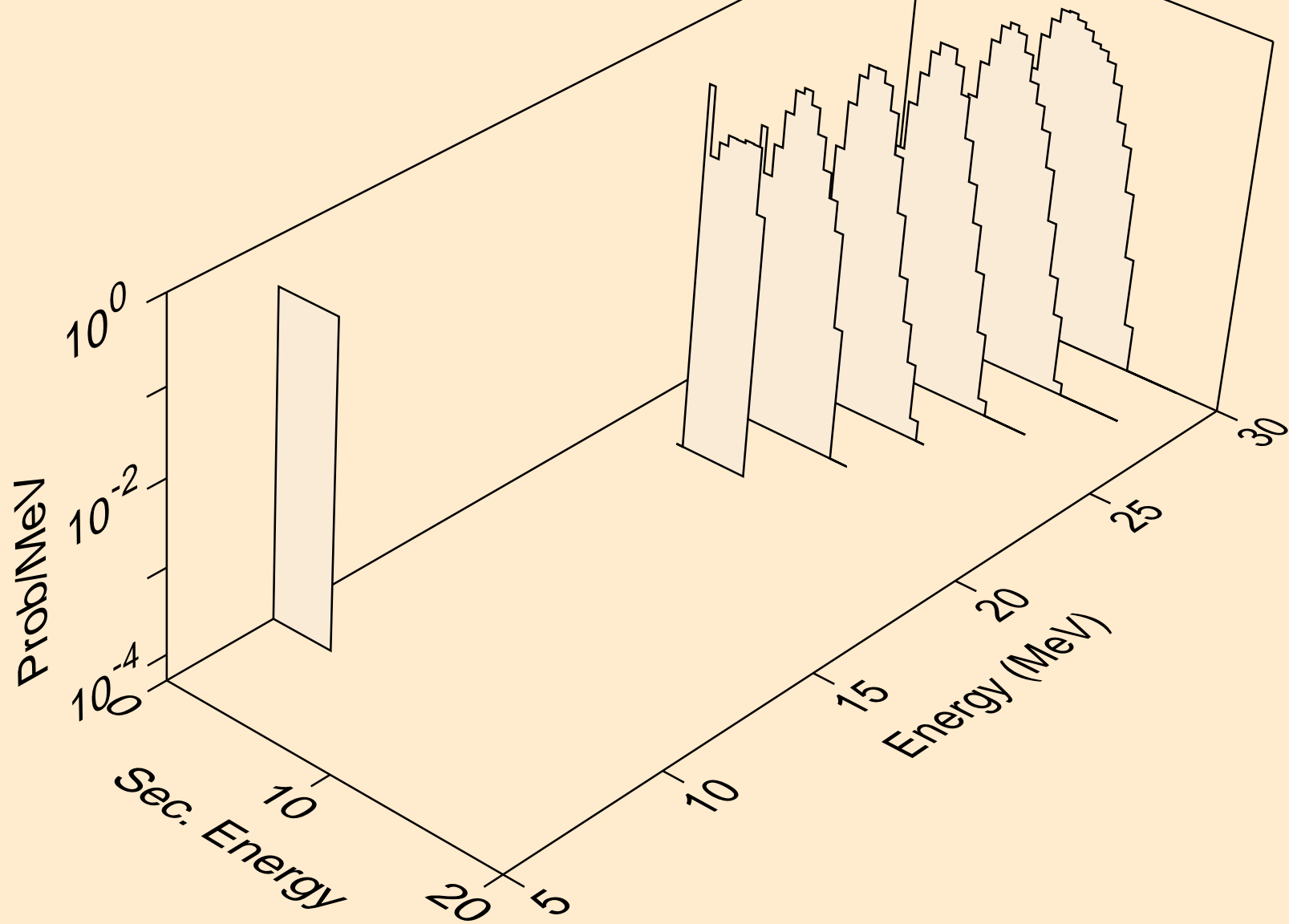



BA120 NEUTRON ACER TENDL-2021 LIBRARY; T=293.6K  
alphas from (n,npa)

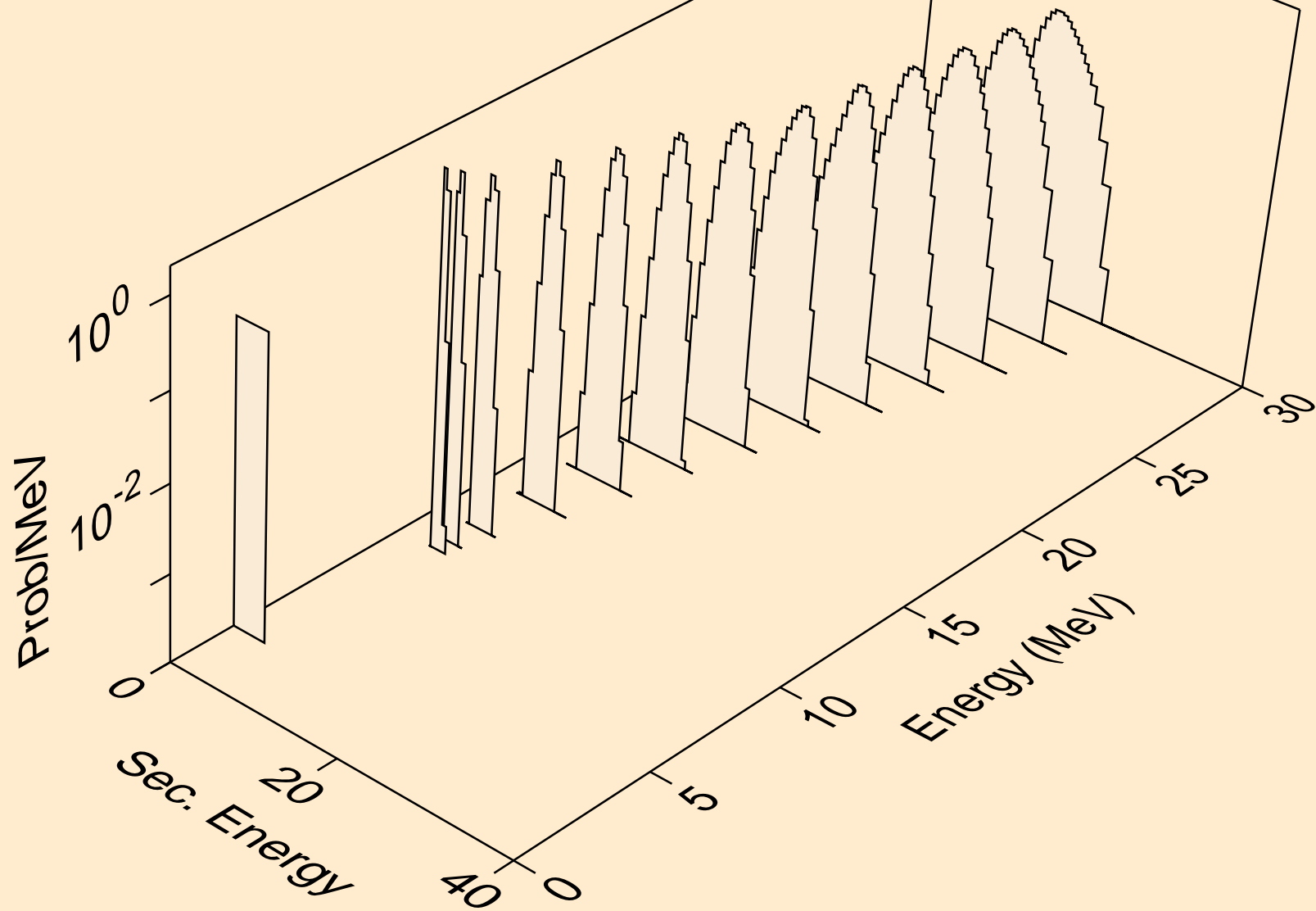

BA120 NEUTRON ACER TENDL-2021 LIBRARY; T=293.6K  
alphas from (n,a)

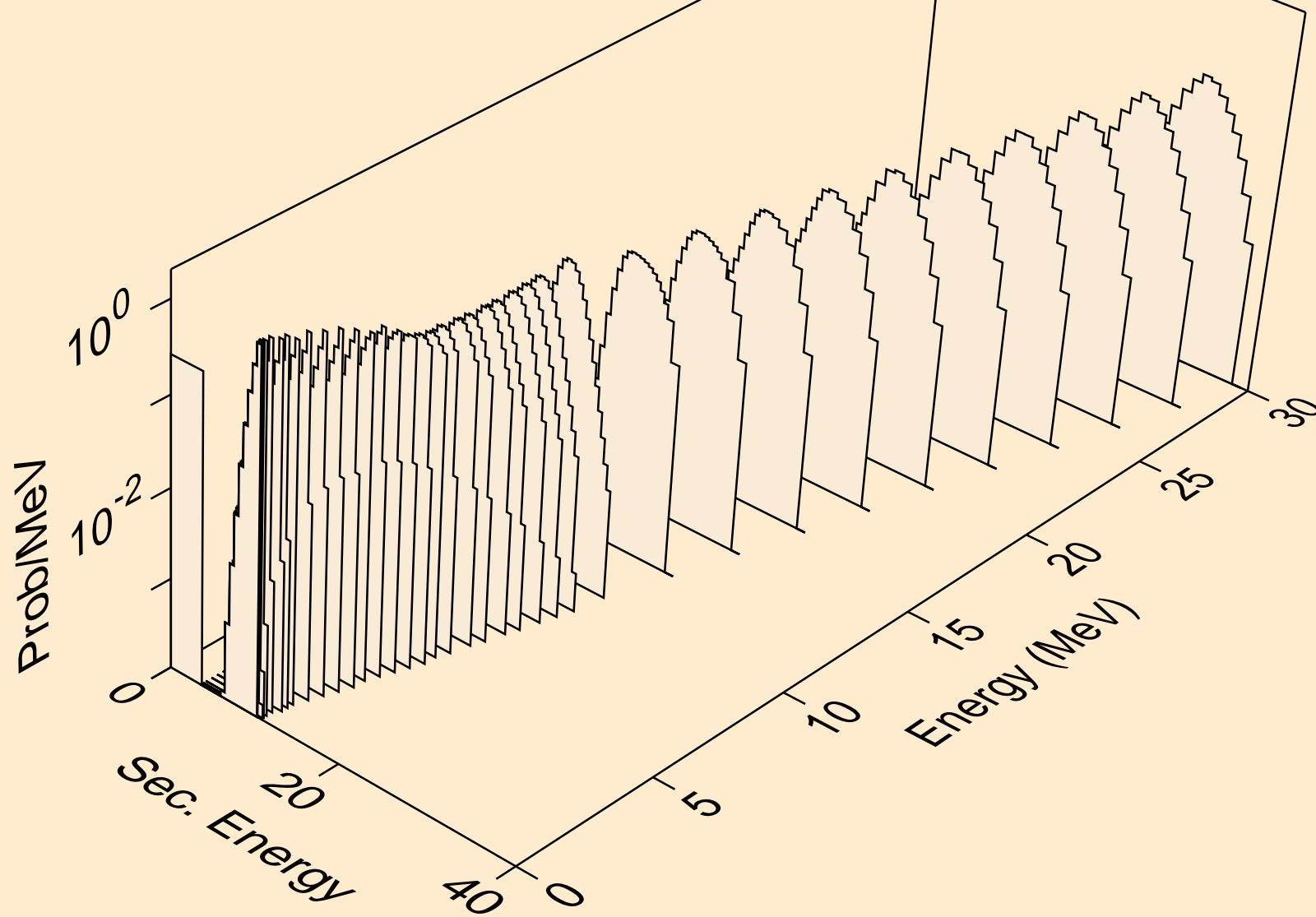

BA120 NEUTRON ACER TENDL-2021 LIBRARY; T=293.6K  
alphas from (n,2a)

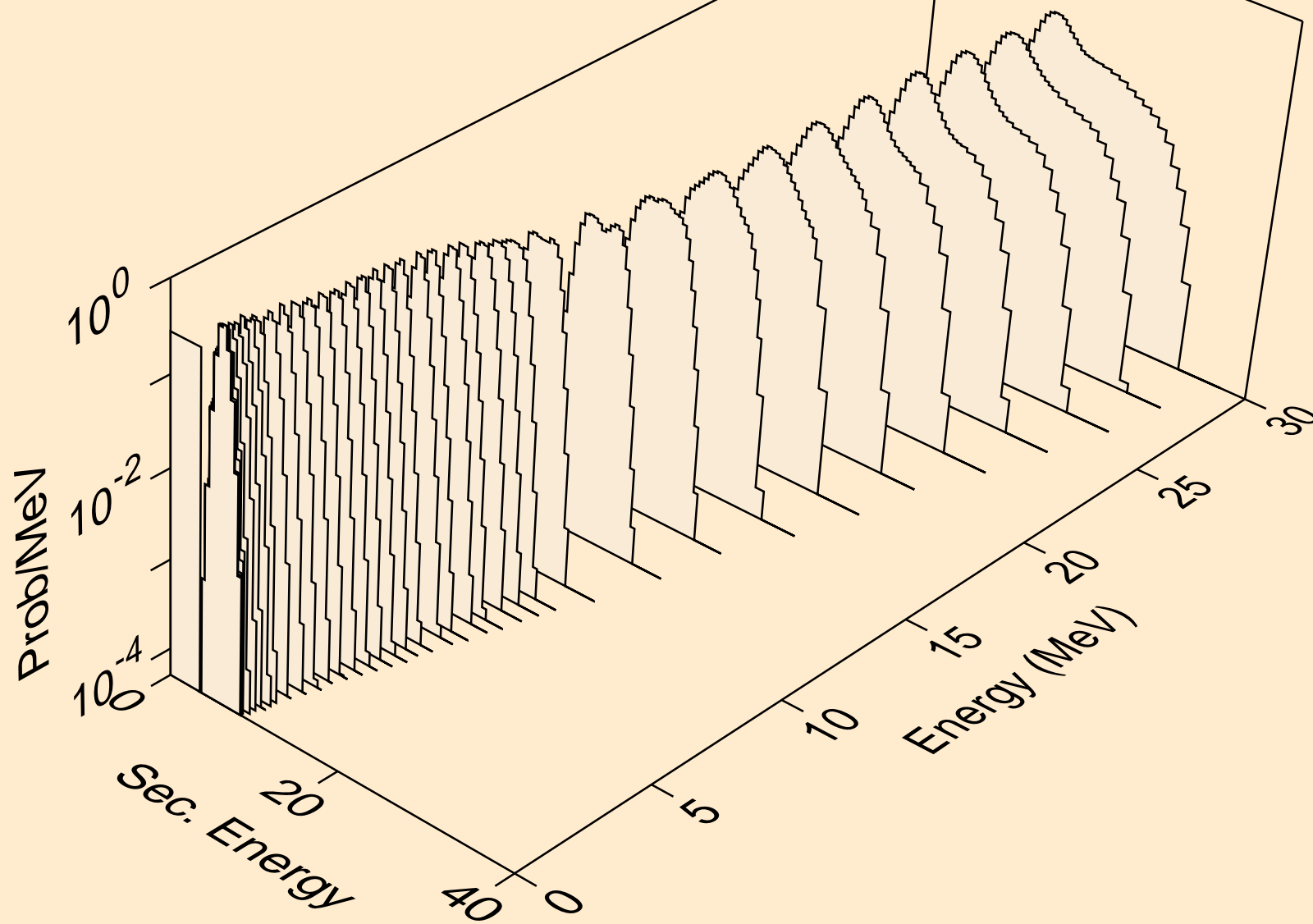

BA120 NEUTRON ACER TENDL-2021 LIBRARY; T=293.6K  
alphas from (n,3a)

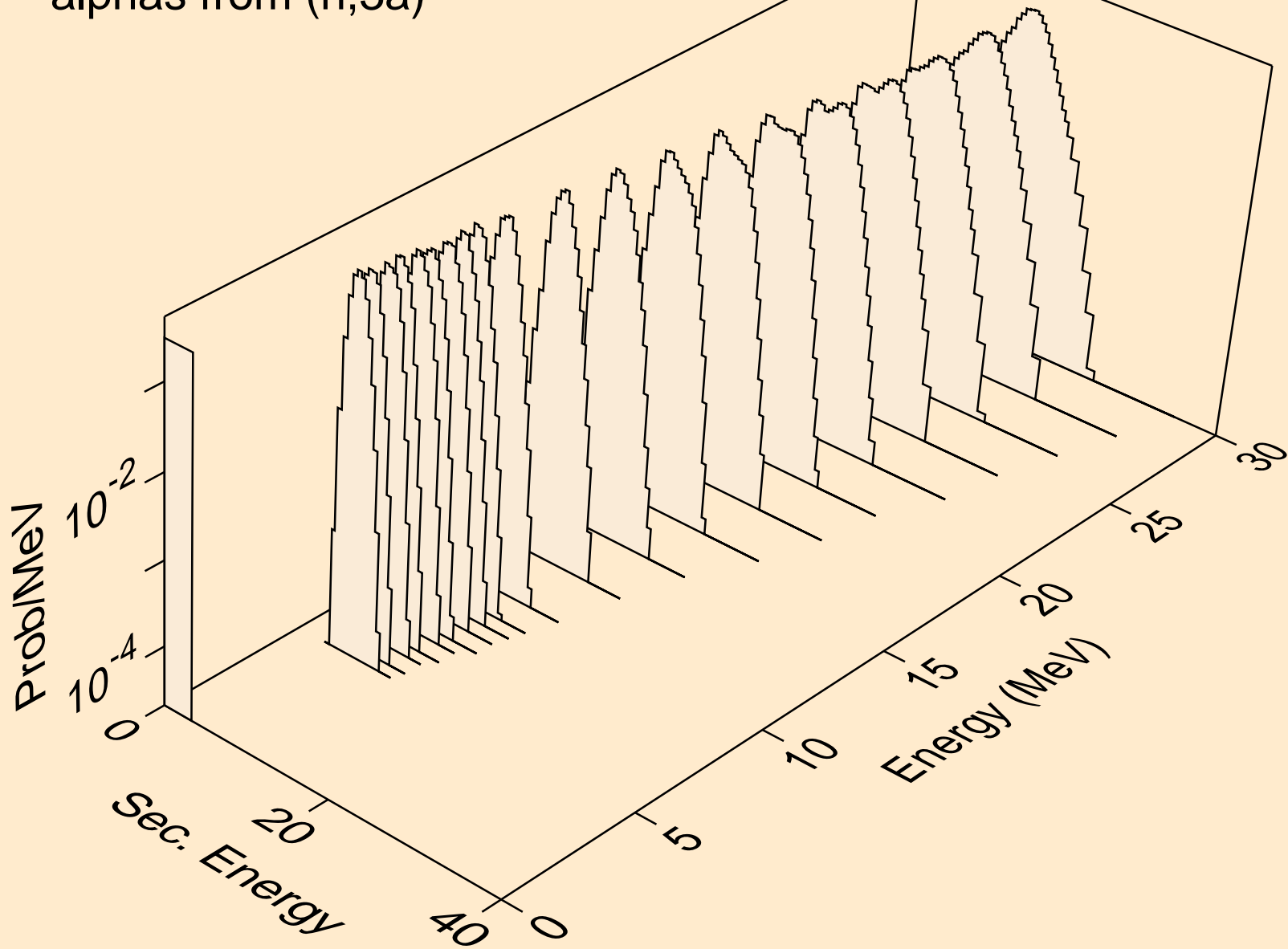

BA120 NEUTRON ACER TENDL-2021 LIBRARY; T=293.6K  
alphas from (n,pa)

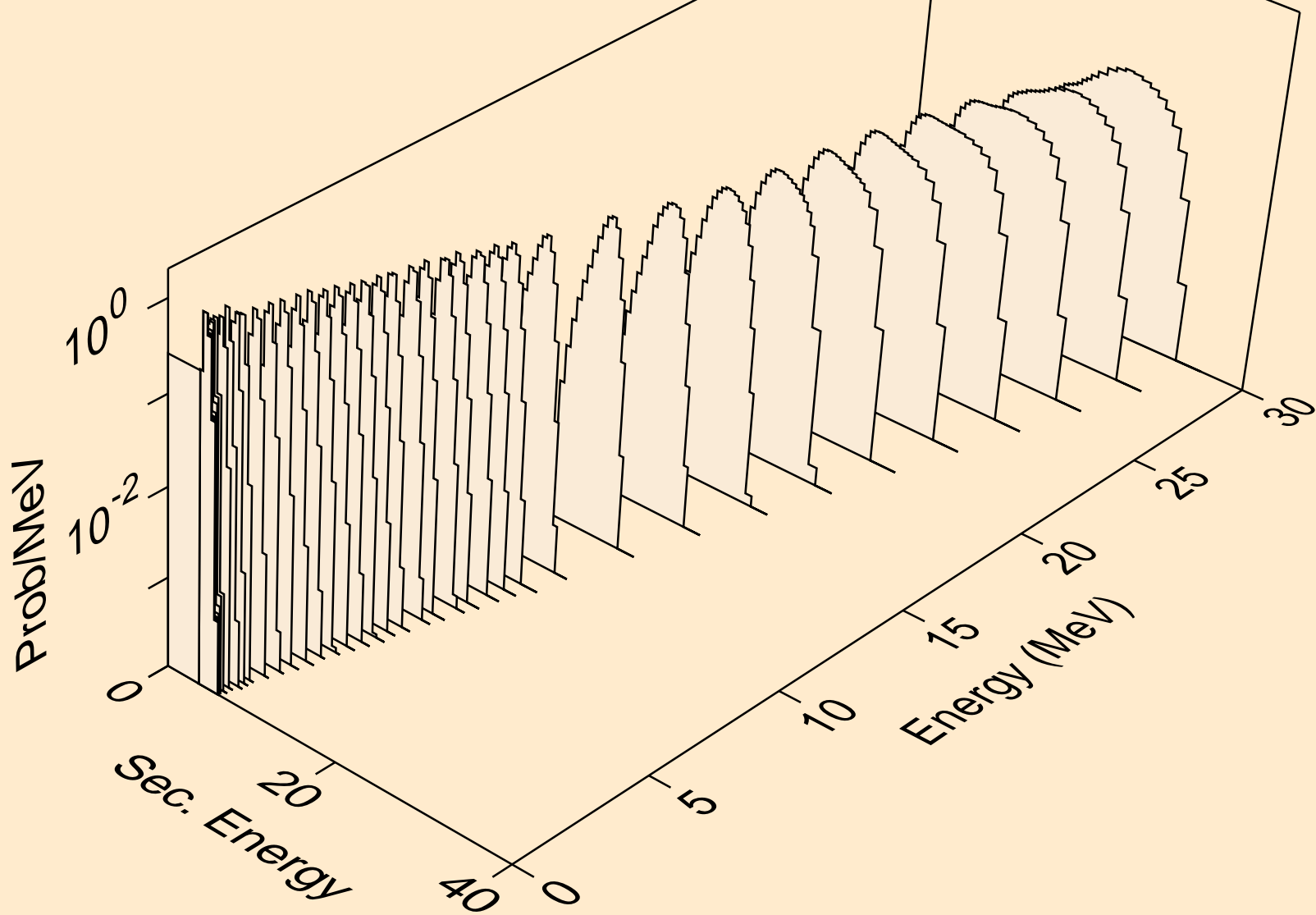

BA120 NEUTRON ACER TENDL-2021 LIBRARY; T=293.6K  
alphas from (n,d2a)

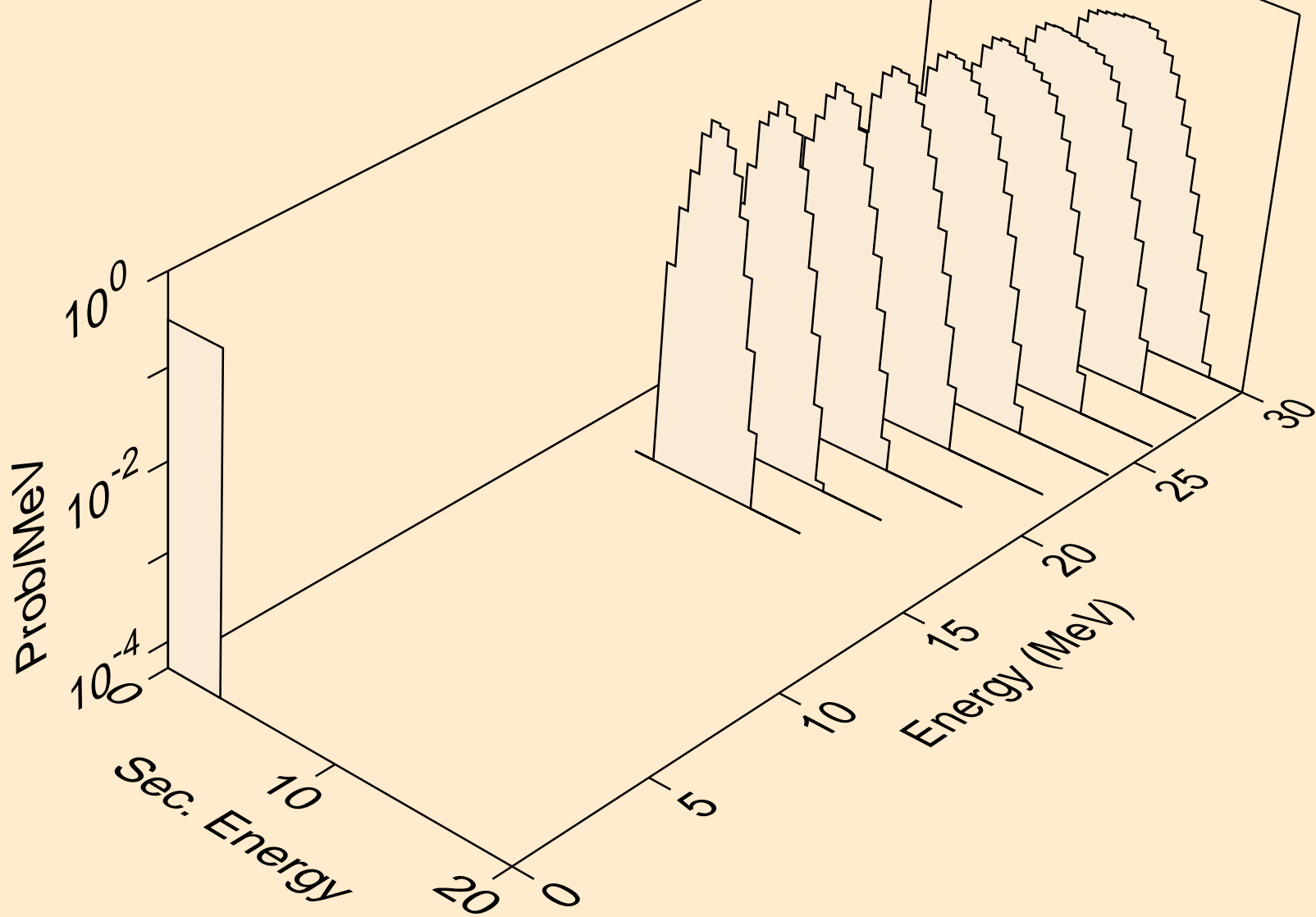

BA120 NEUTRON ACER TENDL-2021 LIBRARY; T=293.6K  
alphas from (n,da)

