

Program EVALPLOT  
(Version 2018-1)

by

Dermott E. Cullen  
(Present Contact Information)

Dermott E. Cullen  
1466 Hudson Way  
Livermore, CA 94550  
U.S.A.

Tele: 925-443-1911

E.Mail: [redcullen1@comcast.net](mailto:redcullen1@comcast.net)

Web: [redcullen1.net/HOMEPAGE.NEW](http://redcullen1.net/HOMEPAGE.NEW)

Press Mouse Button to Start

MAT 5658

Major

293 Kelvin Cross Sections

56-Ba-141

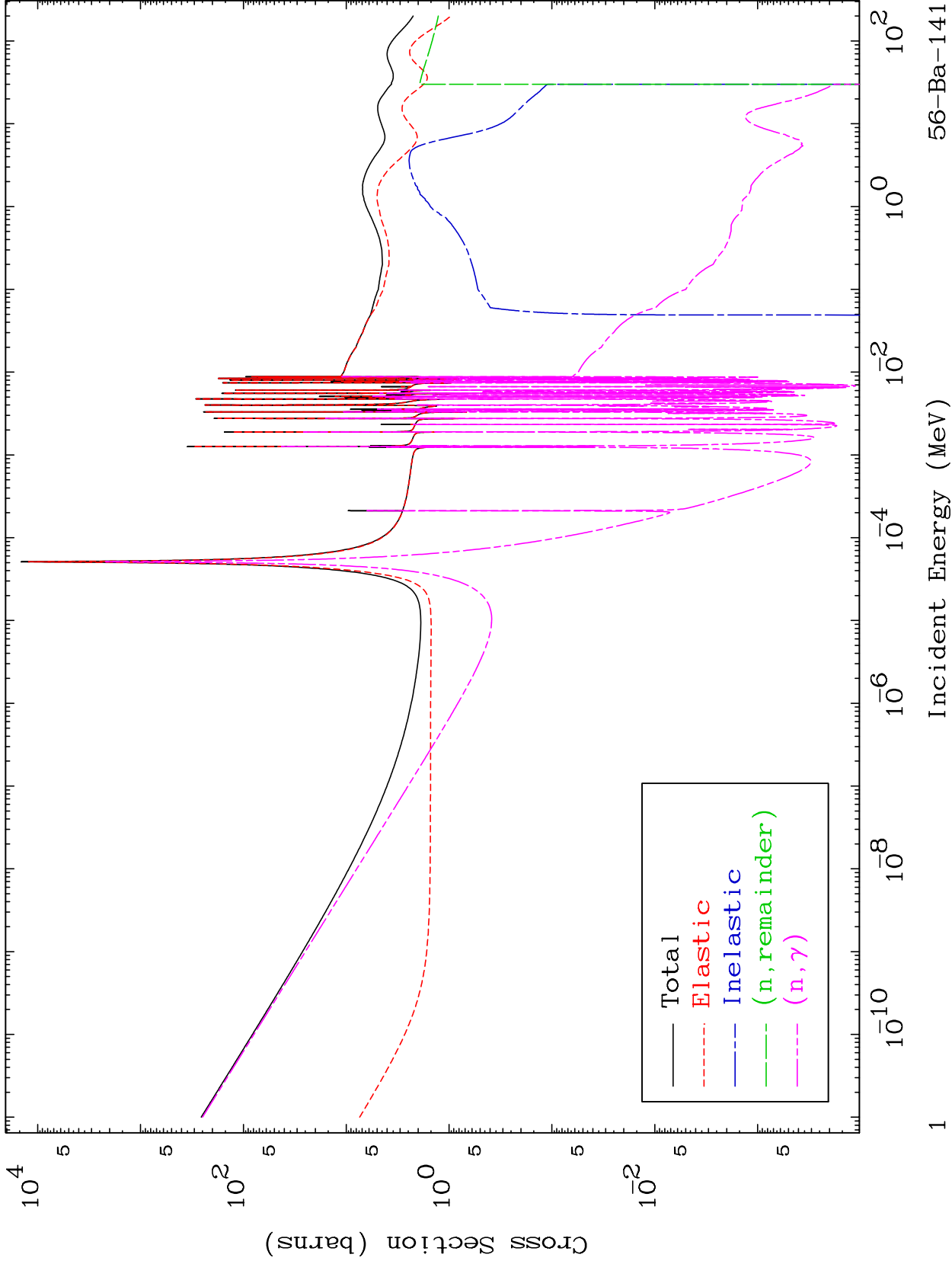

MAT 5658

Neutron Production  
293 Kelvin Cross Sections

56-Ba-141

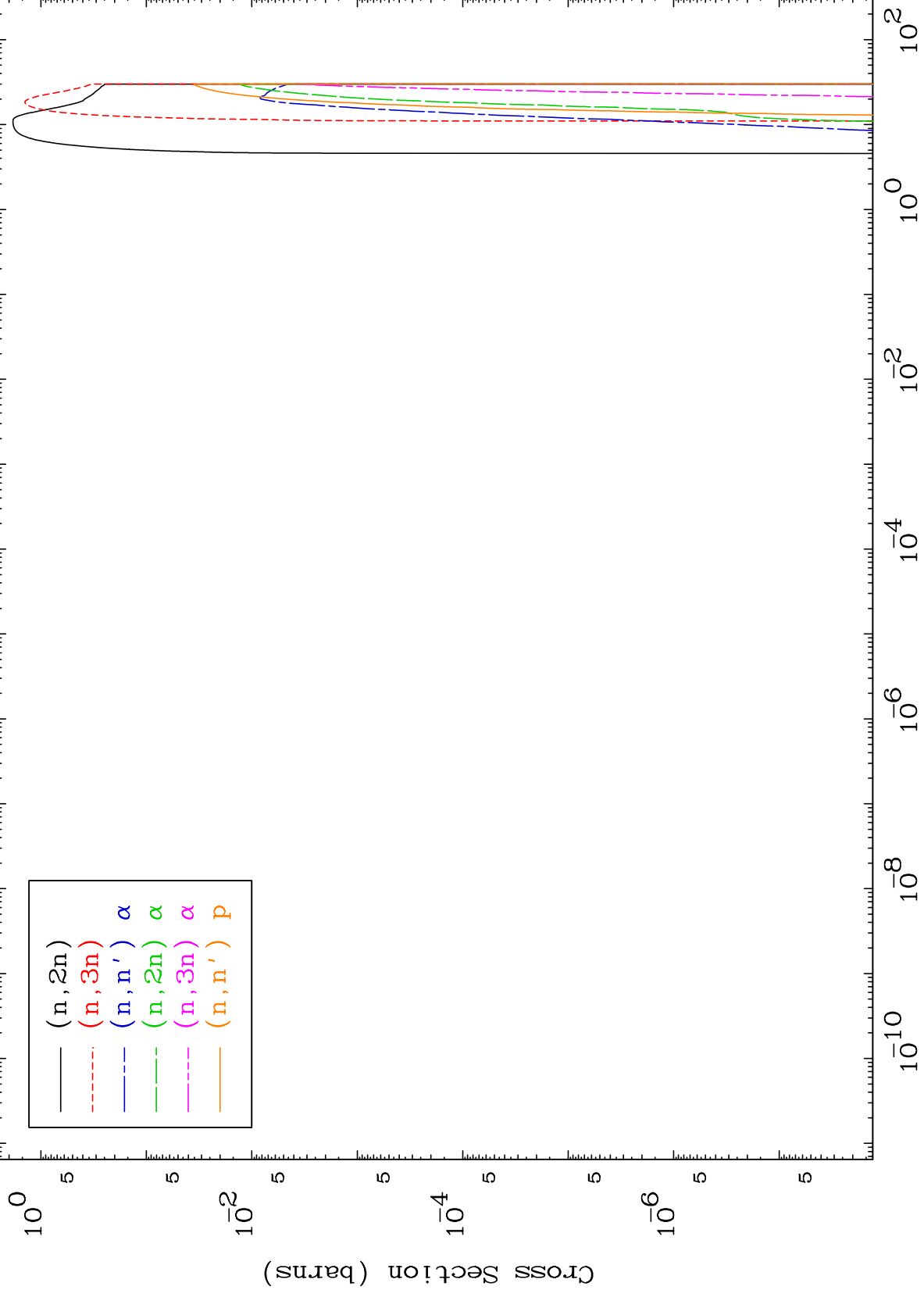

56-Ba-141

Incident Energy (MeV)

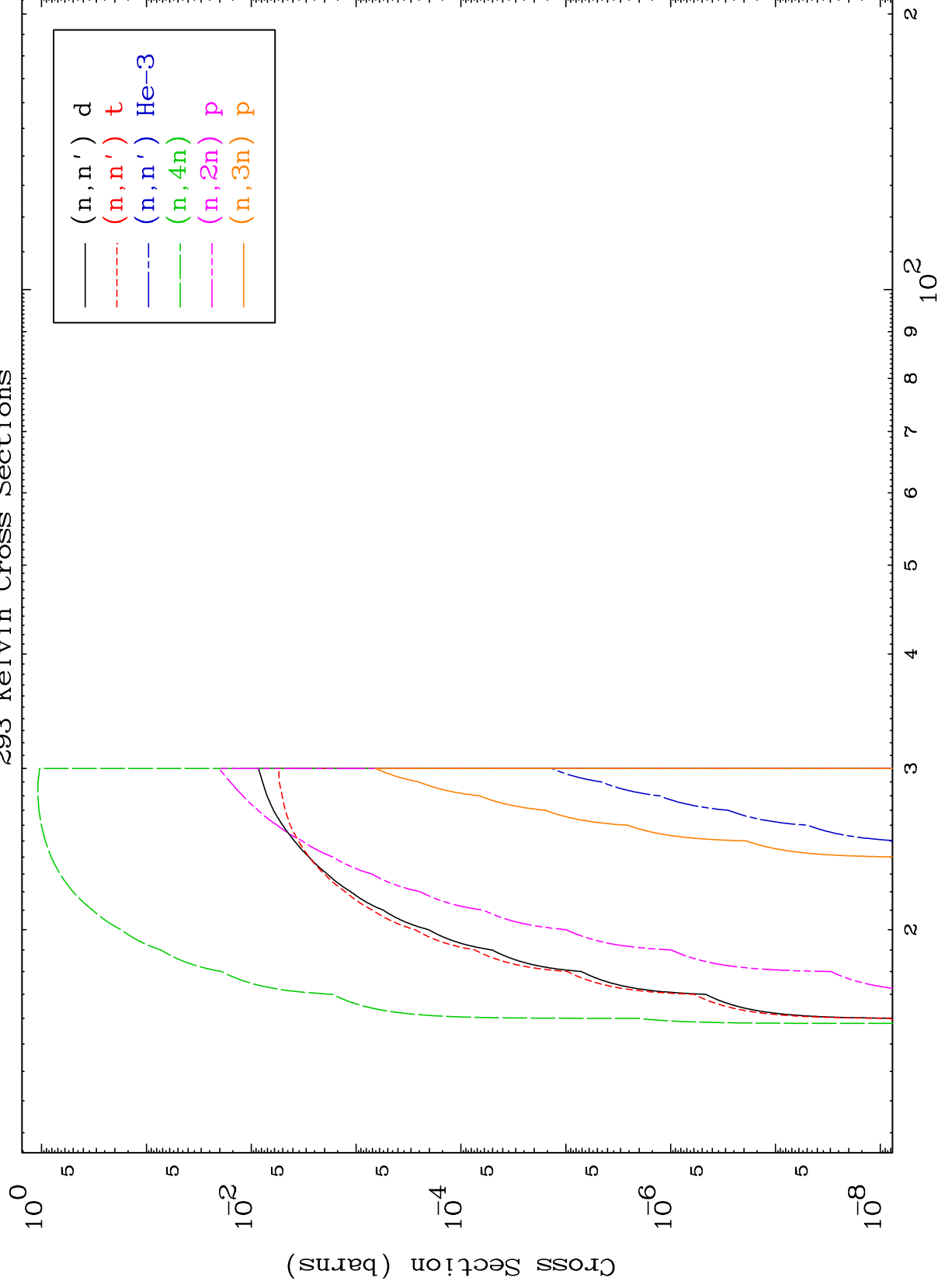

MAT 5658

Charged Particle  
293 Kelvin Cross Sections

56-Ba-141

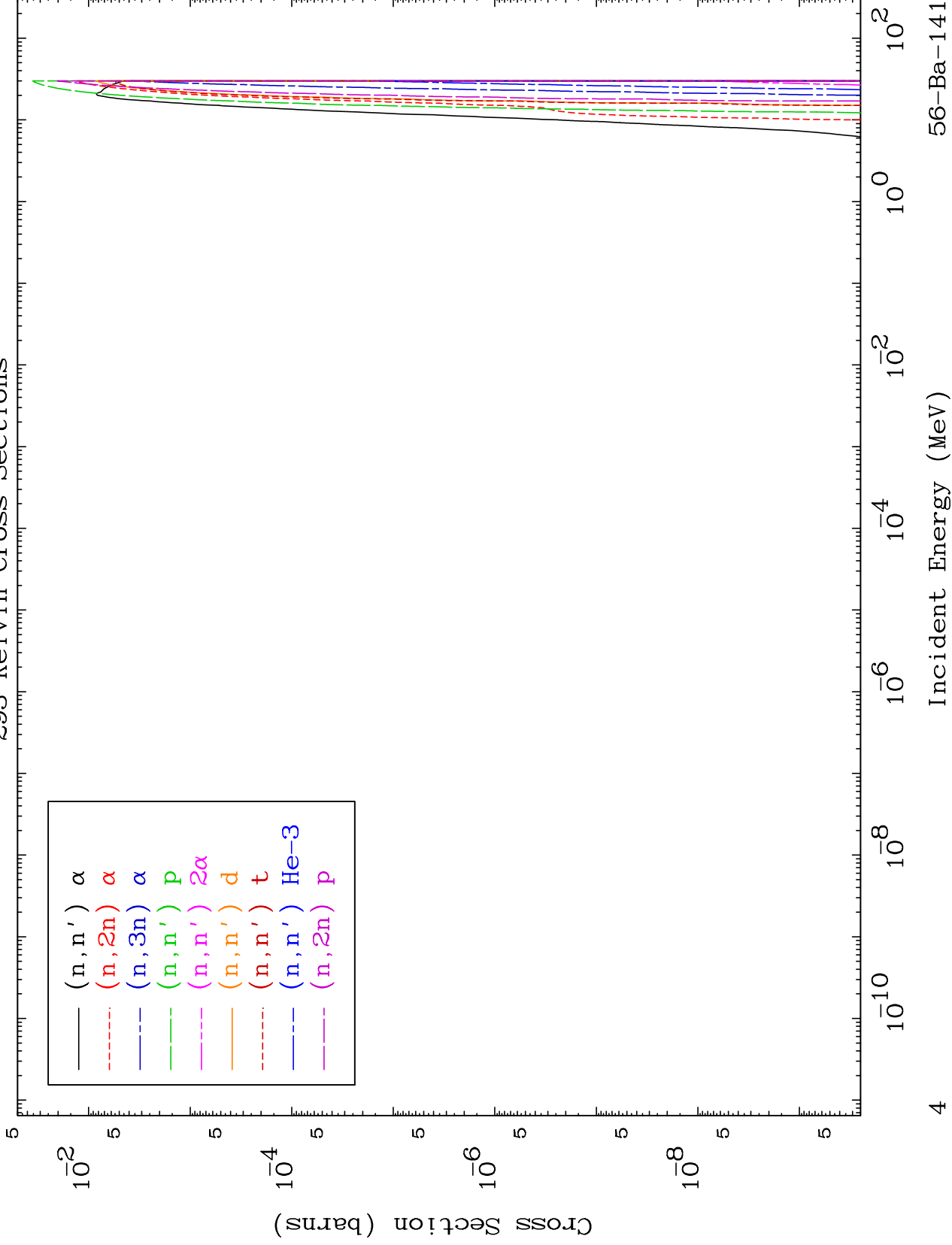

MAT 5658

Charged Particle  
293 Kelvin Cross Sections

56-Ba-141

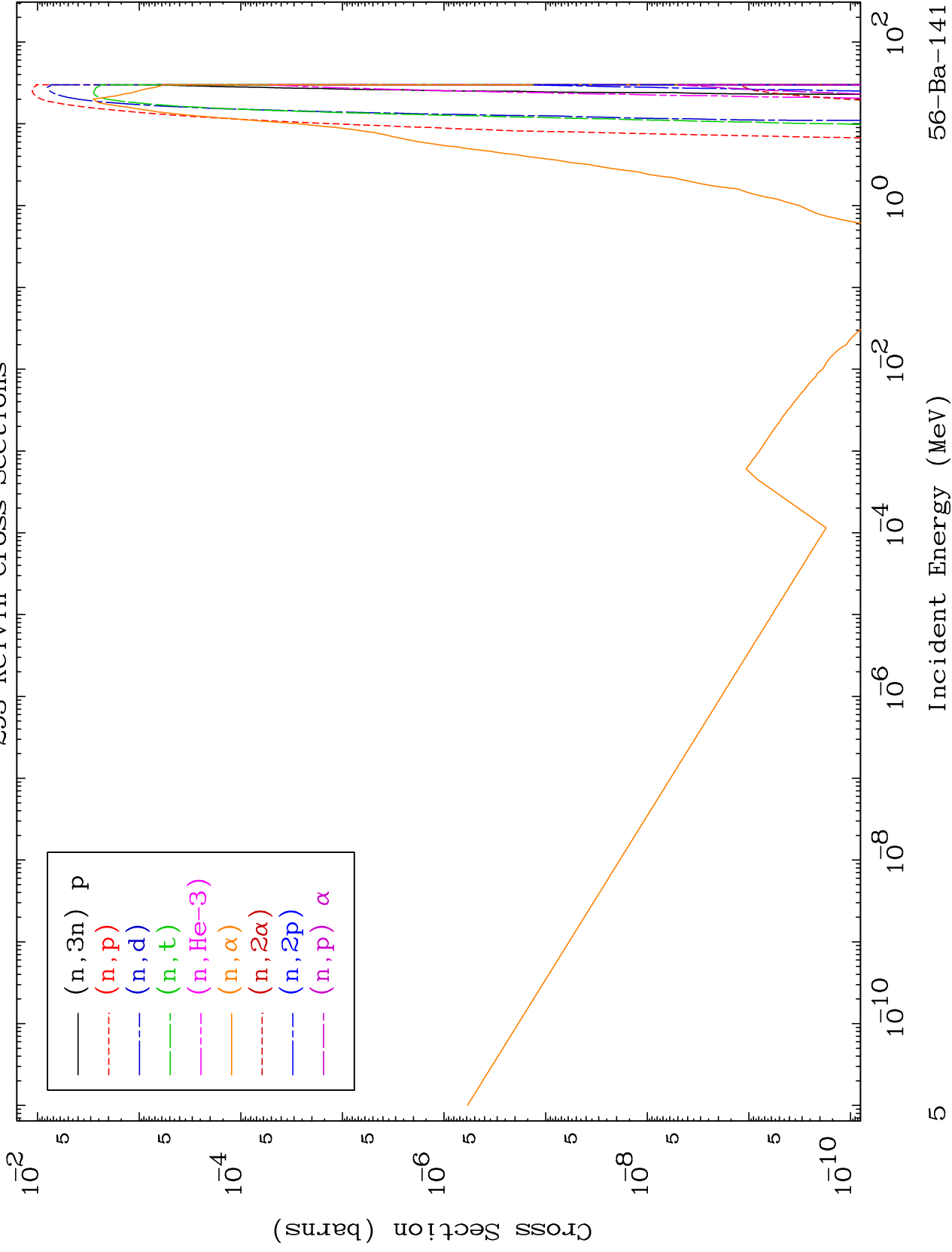

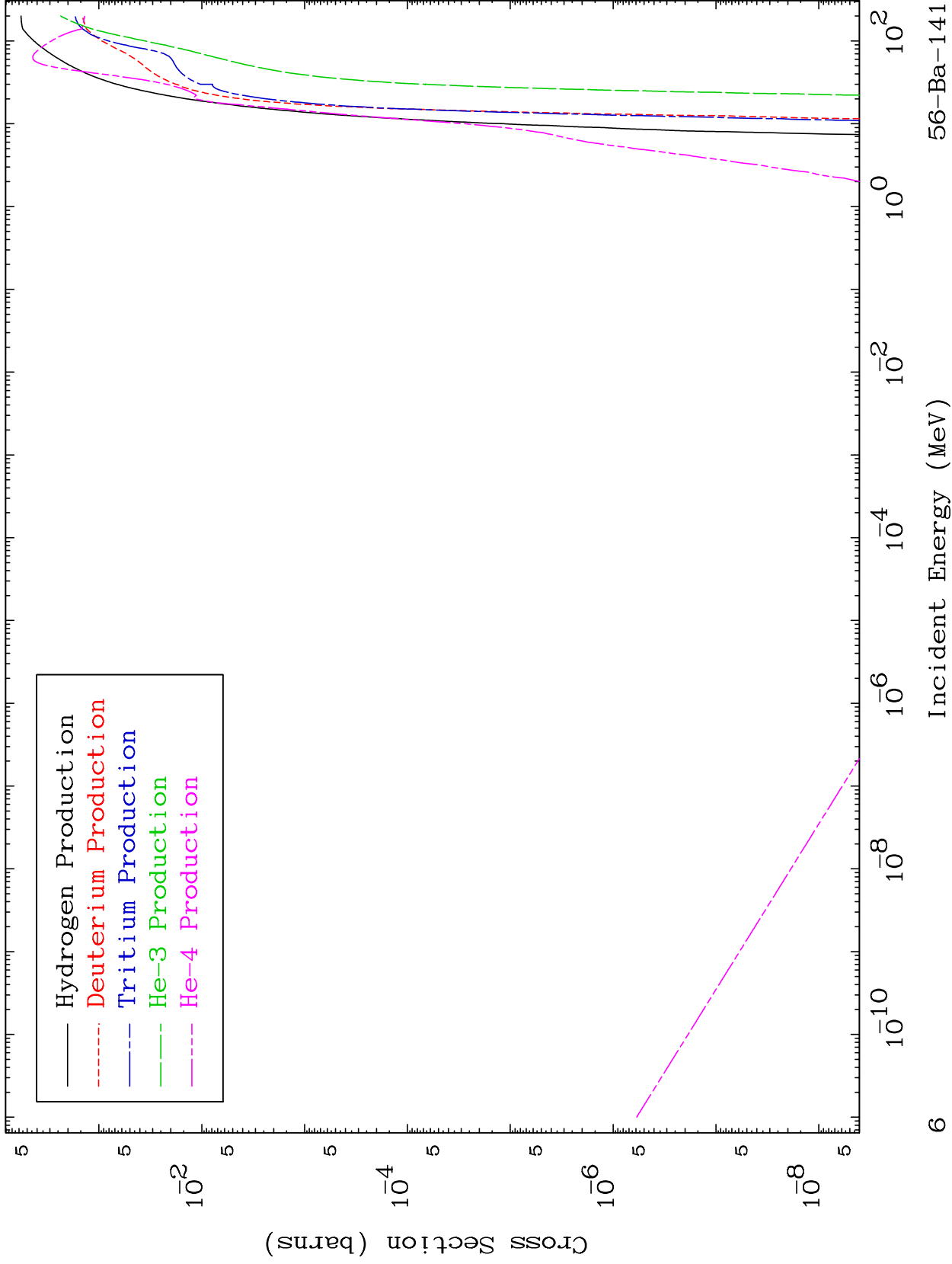

MAT 5658

(n,n') Level

56-Ba-141

293 Kelvin Cross Sections

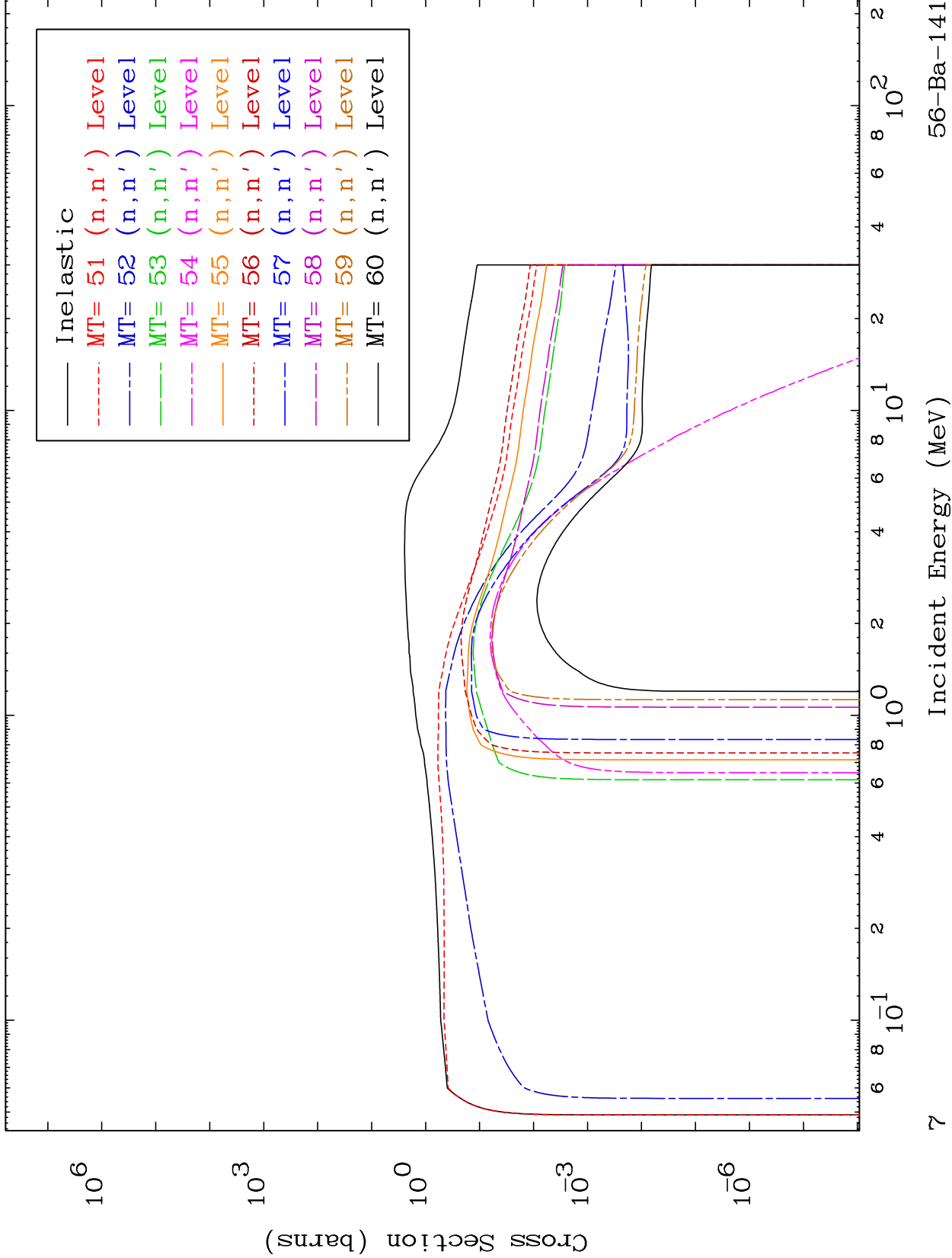



MAT 5658

(n,n') Level

56-Ba-141

293 Kelvin Cross Sections

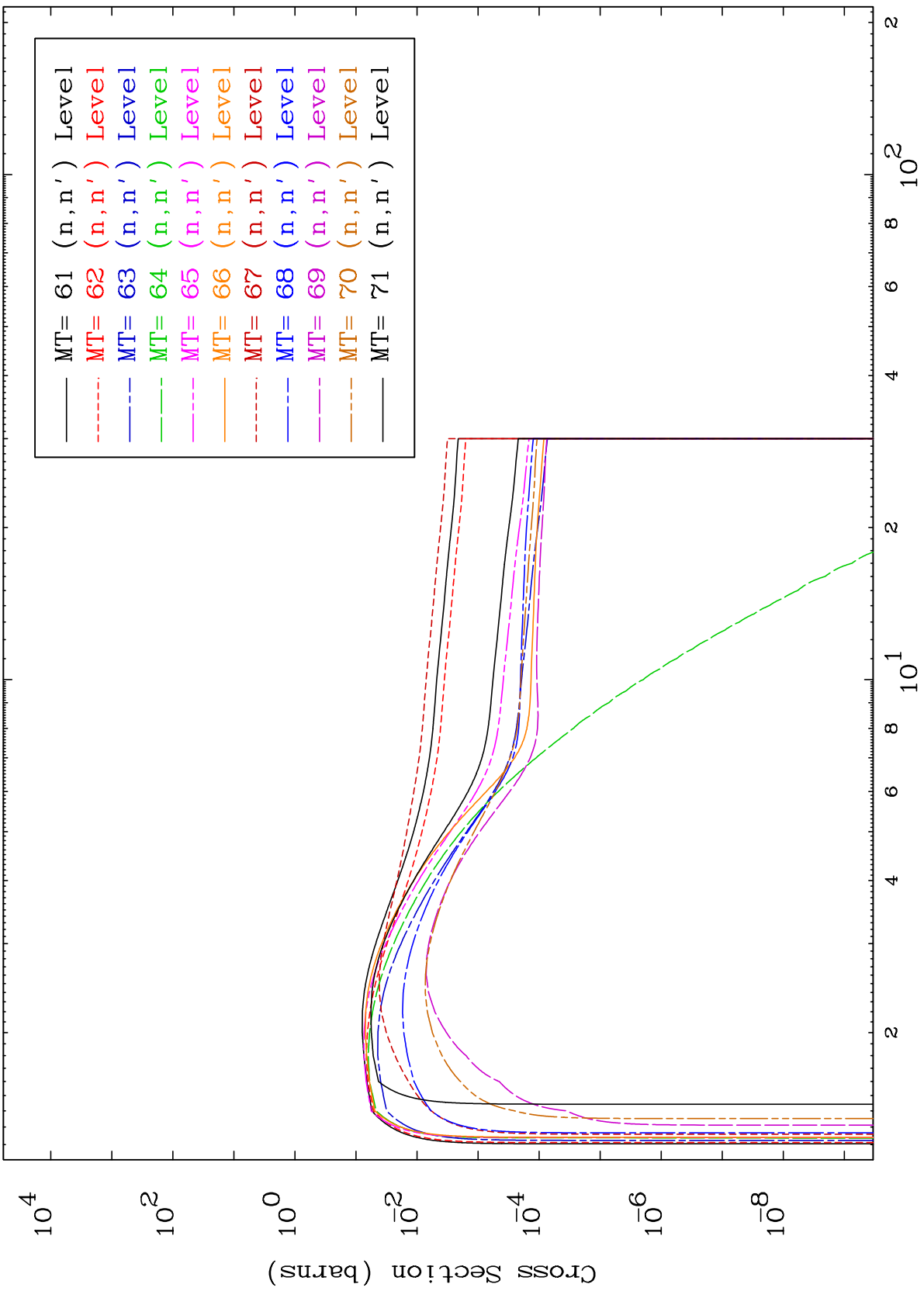

8

Incident Energy (MeV)

56-Ba-141

MAT 5658

(n,n') Level

56-Ba-141

293 Kelvin Cross Sections

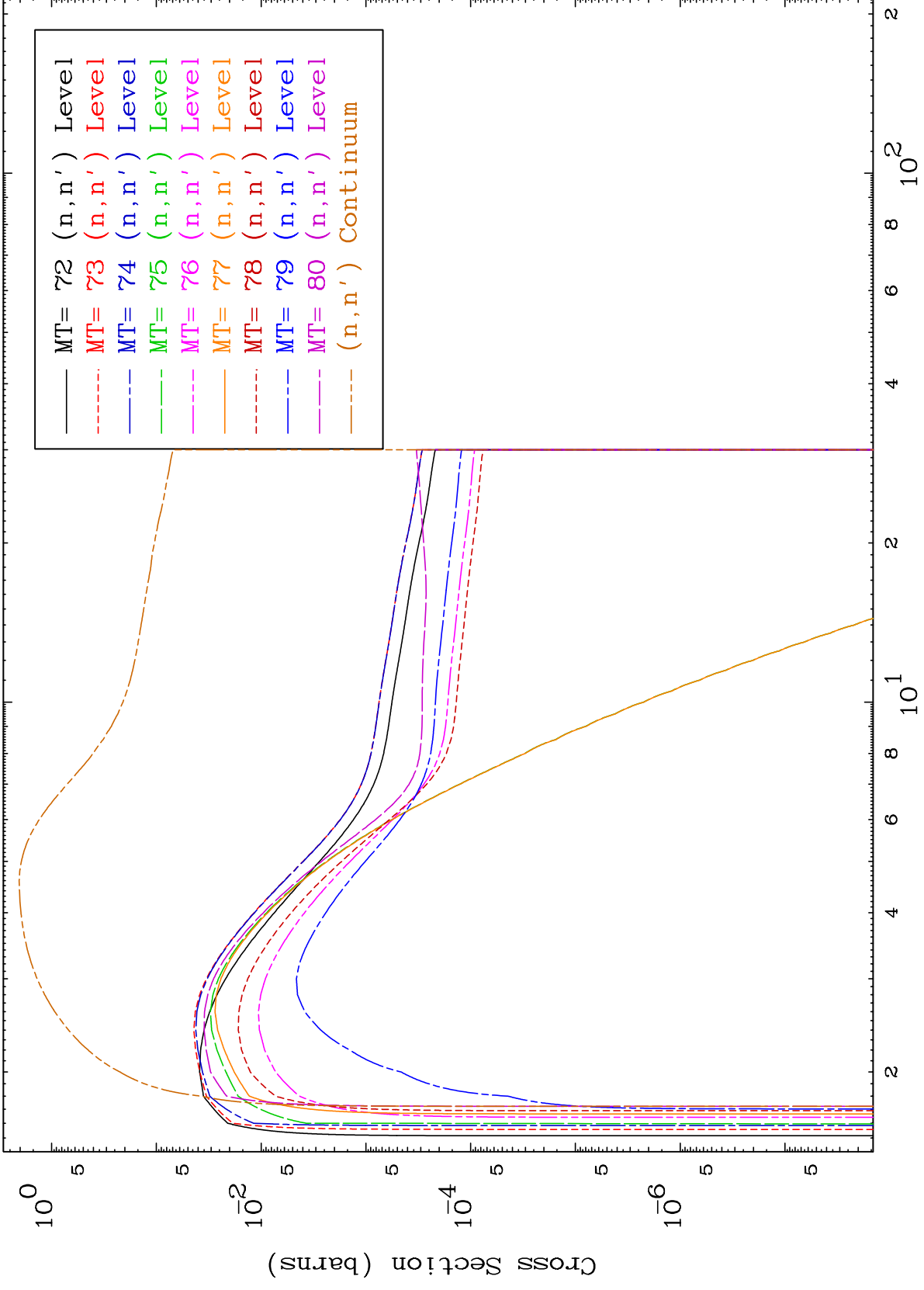

9

Incident Energy (MeV)

56-Ba-141

MAT 5658

(n,p) Levels  
293 Kelvin Cross Sections

56-Ba-141

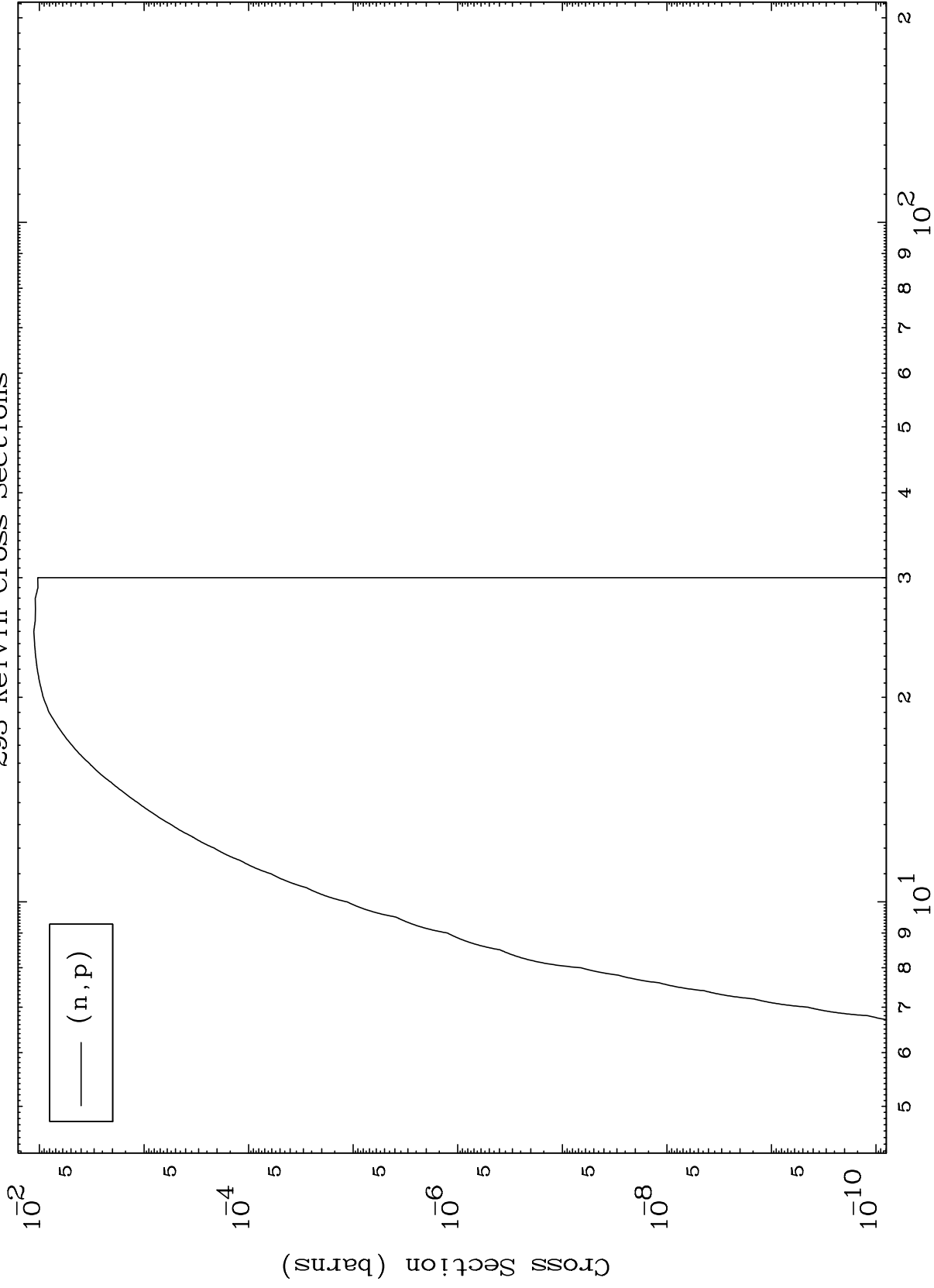

10

Incident Energy (MeV)

56-Ba-141

MAT 5658

(n,d) Levels  
293 Kelvin Cross Sections

56-Ba-141

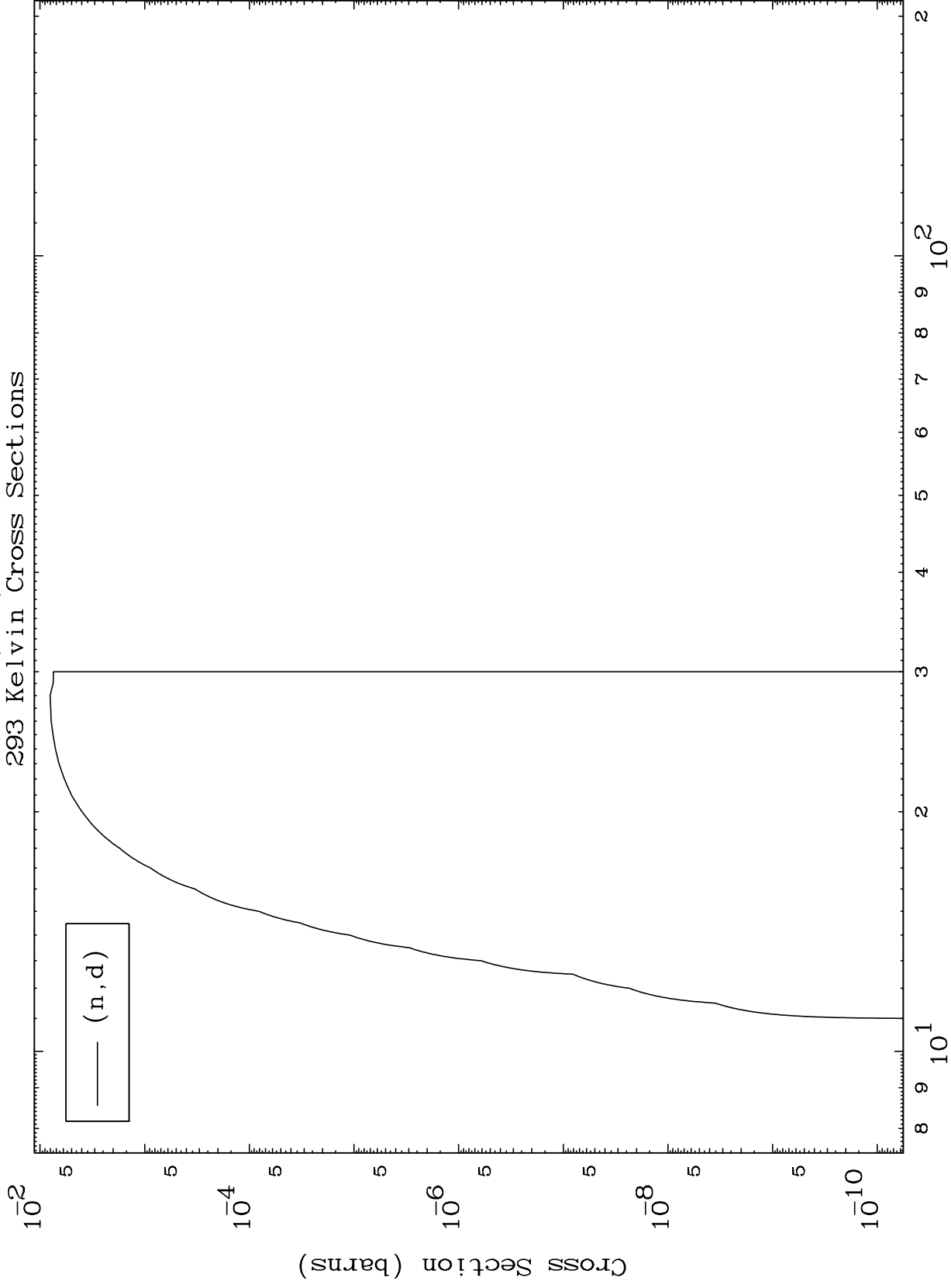

11

Incident Energy (MeV)

56-Ba-141

MAT 5658

(n,t) Levels  
293 Kelvin Cross Sections

56-Ba-141

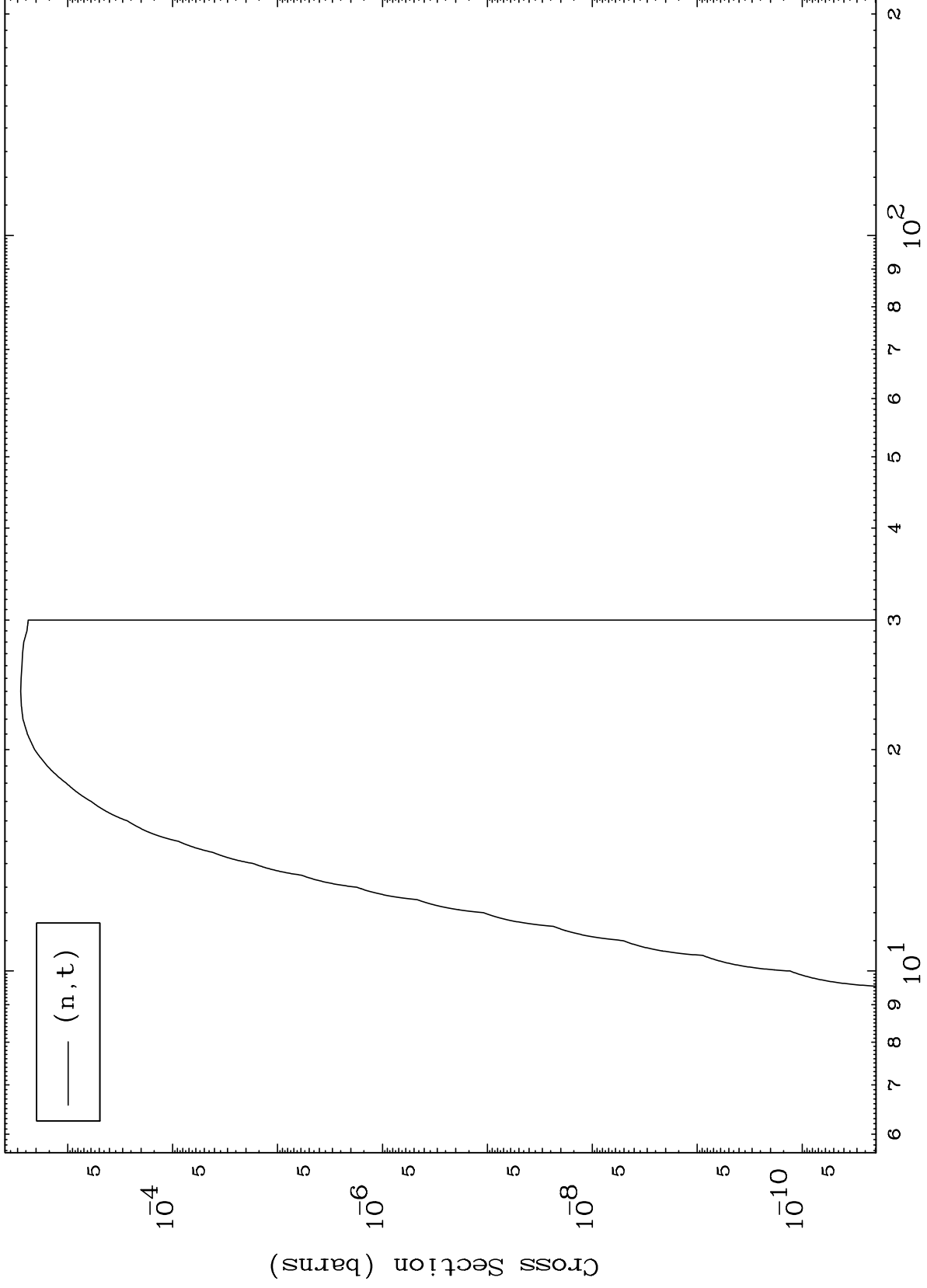

12

Incident Energy (MeV)

56-Ba-141

MAT 5658

(n,He3) Levels  
293 Kelvin Cross Sections

56-Ba-141

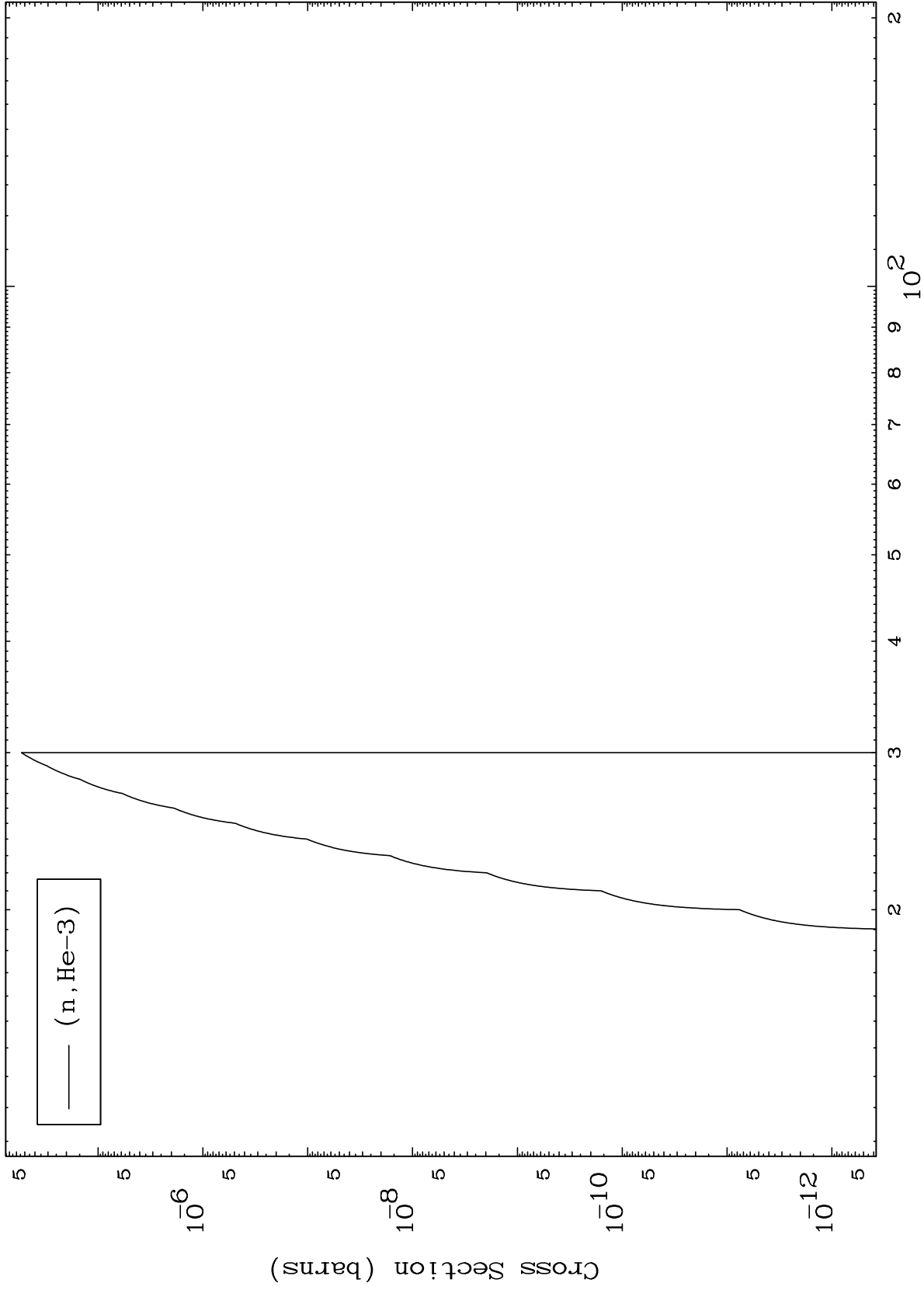

13

Incident Energy (MeV)

56-Ba-141

MAT 5658

(n,  $\alpha$ ) Levels  
293 Kelvin Cross Sections

56-Ba-141

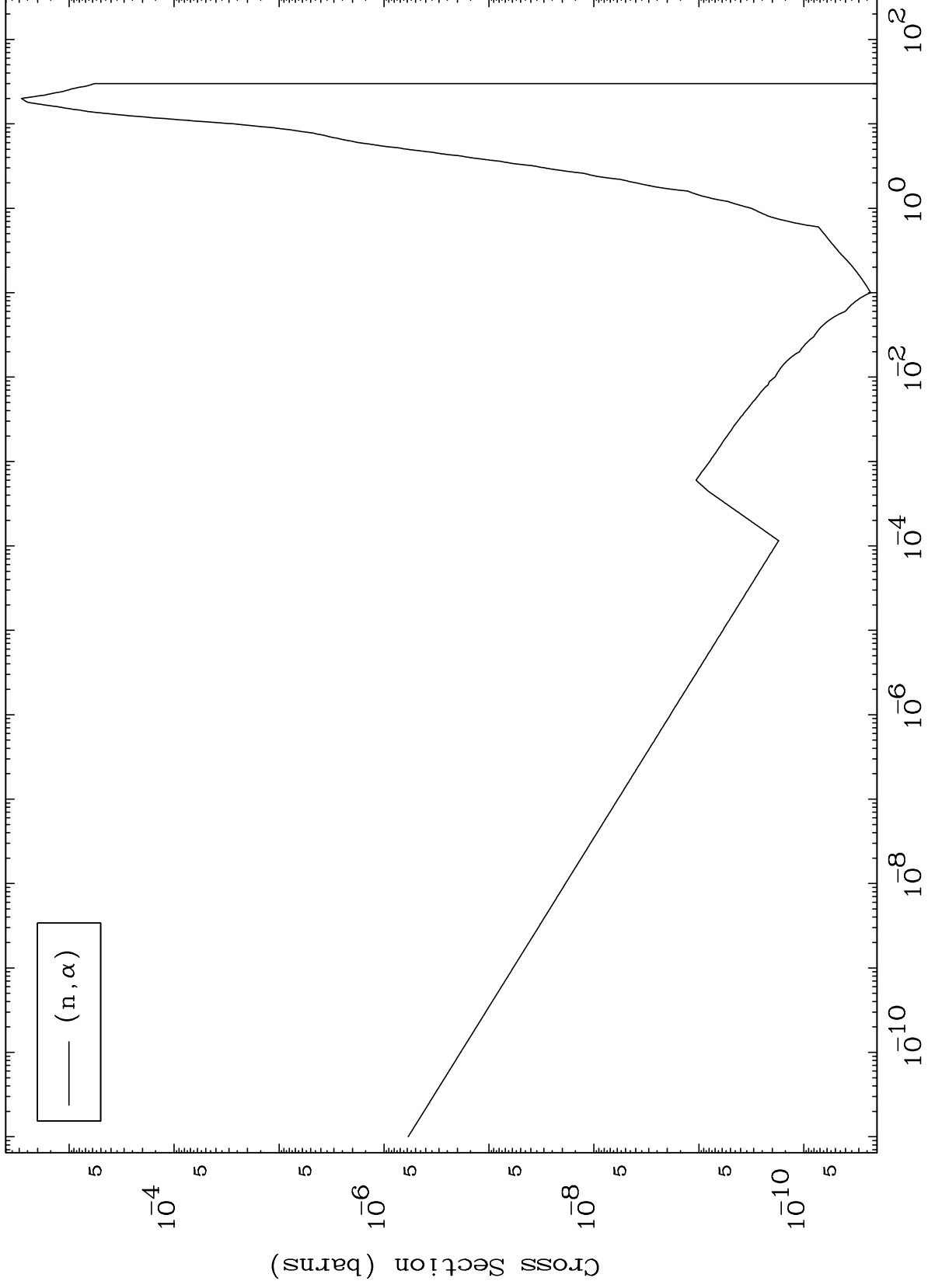

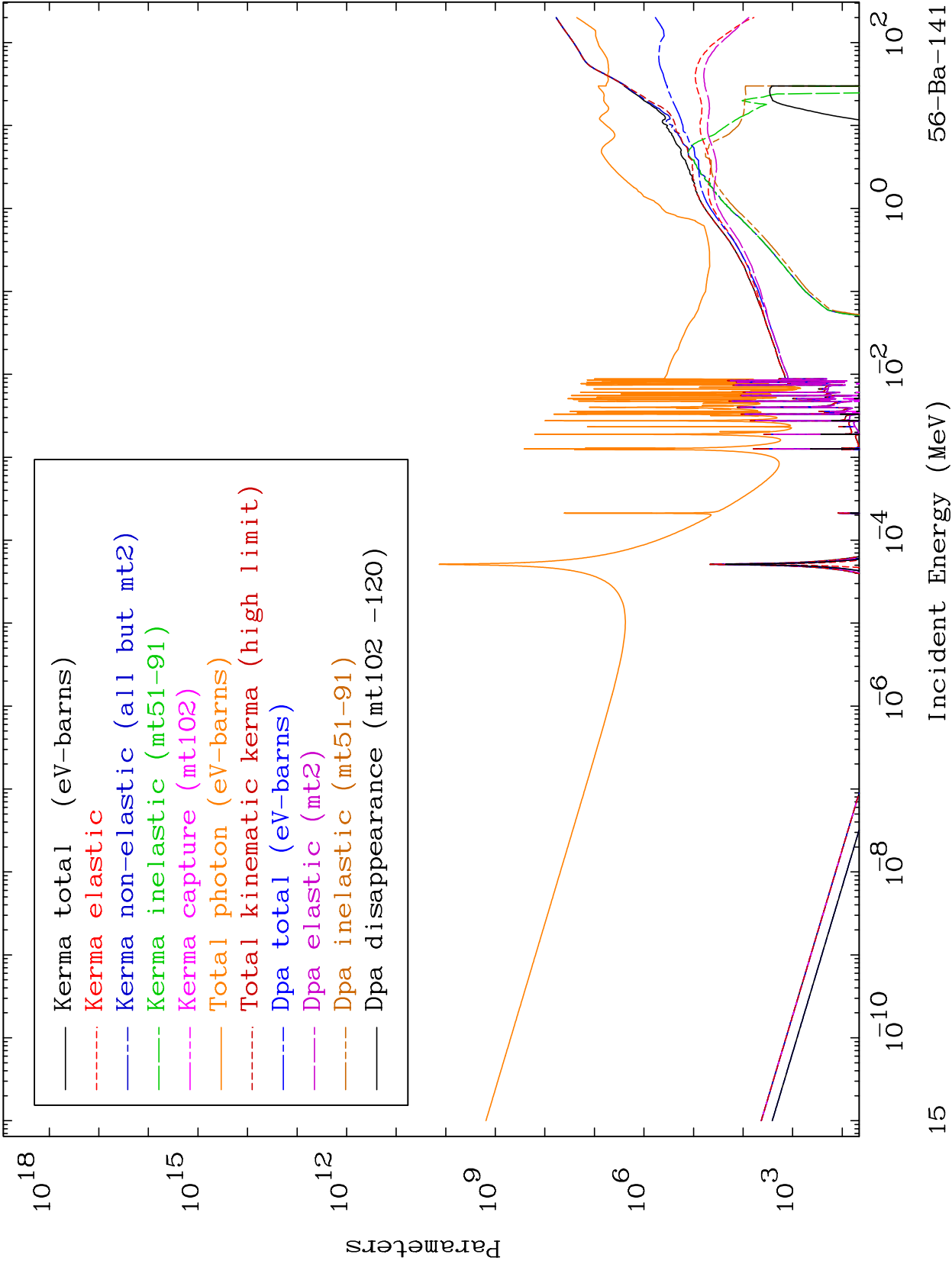



MAT 5658

Elastic Legendre Coefficients

56-Ba-141

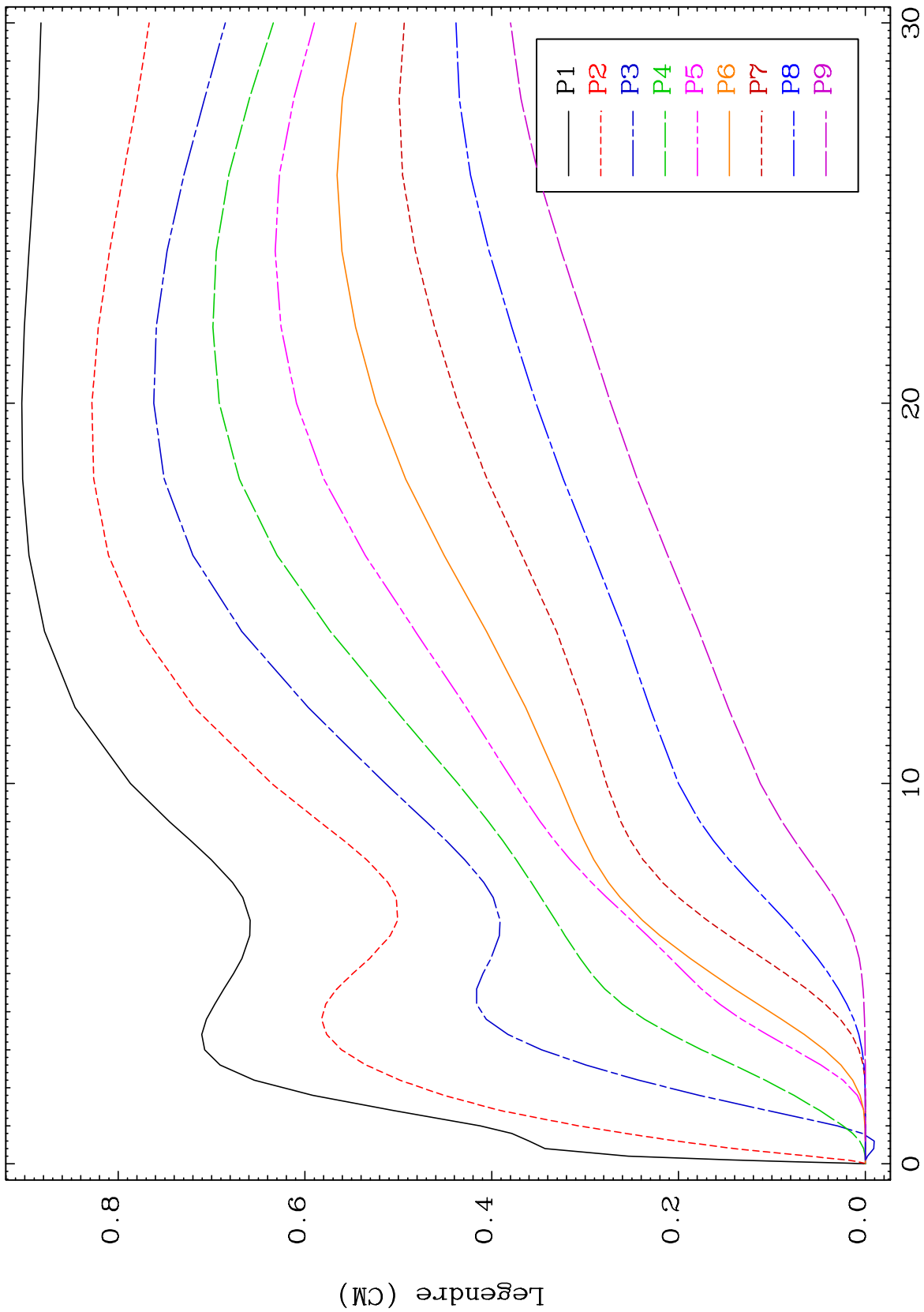

16

Incident Energy (MeV)

56-Ba-141

MAT 5658

Elastic Legendre Coefficients

56-Ba-141

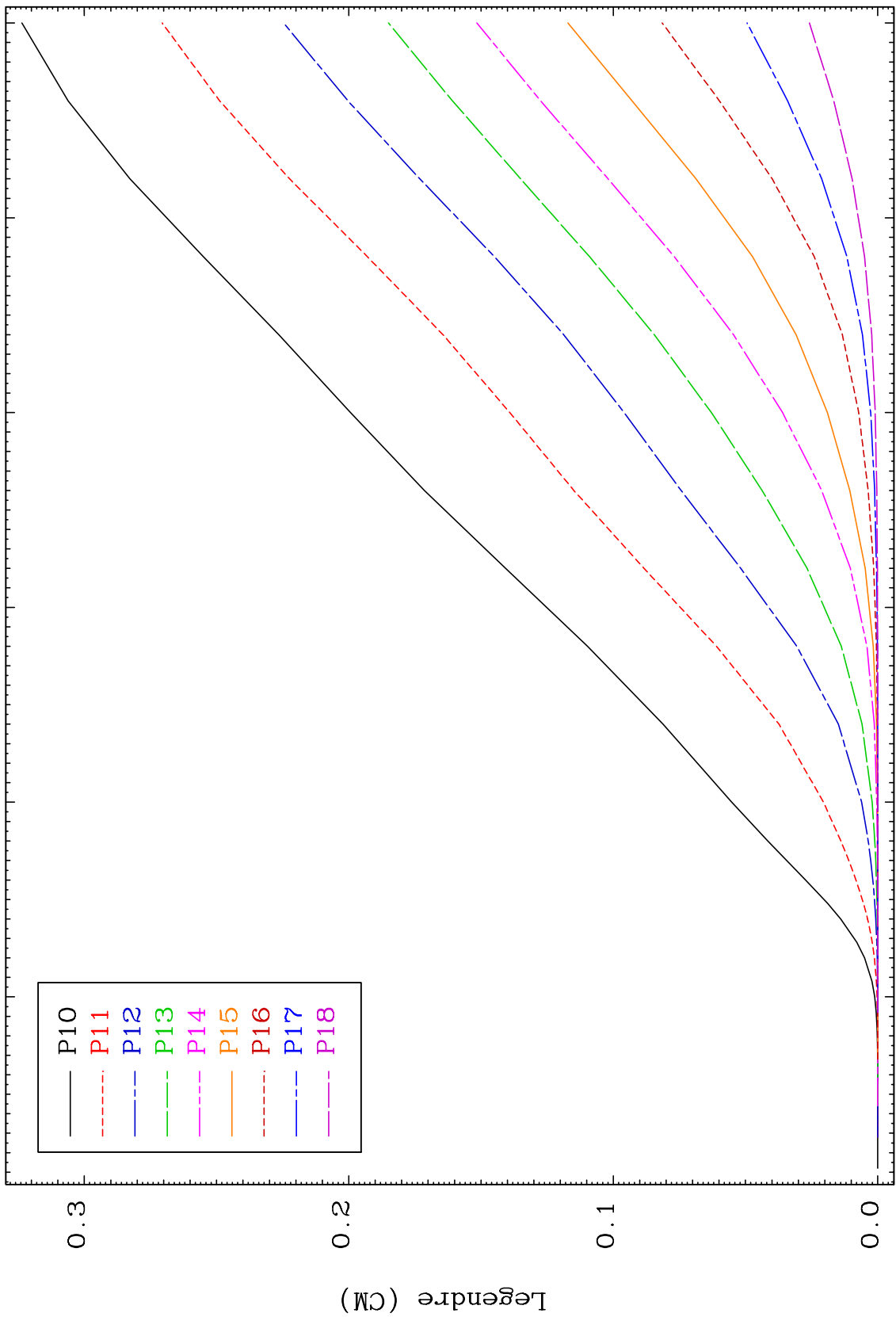

17

56-Ba-141

MAT 5658

Elastic  
Legendre Coefficients

56-Ba-141

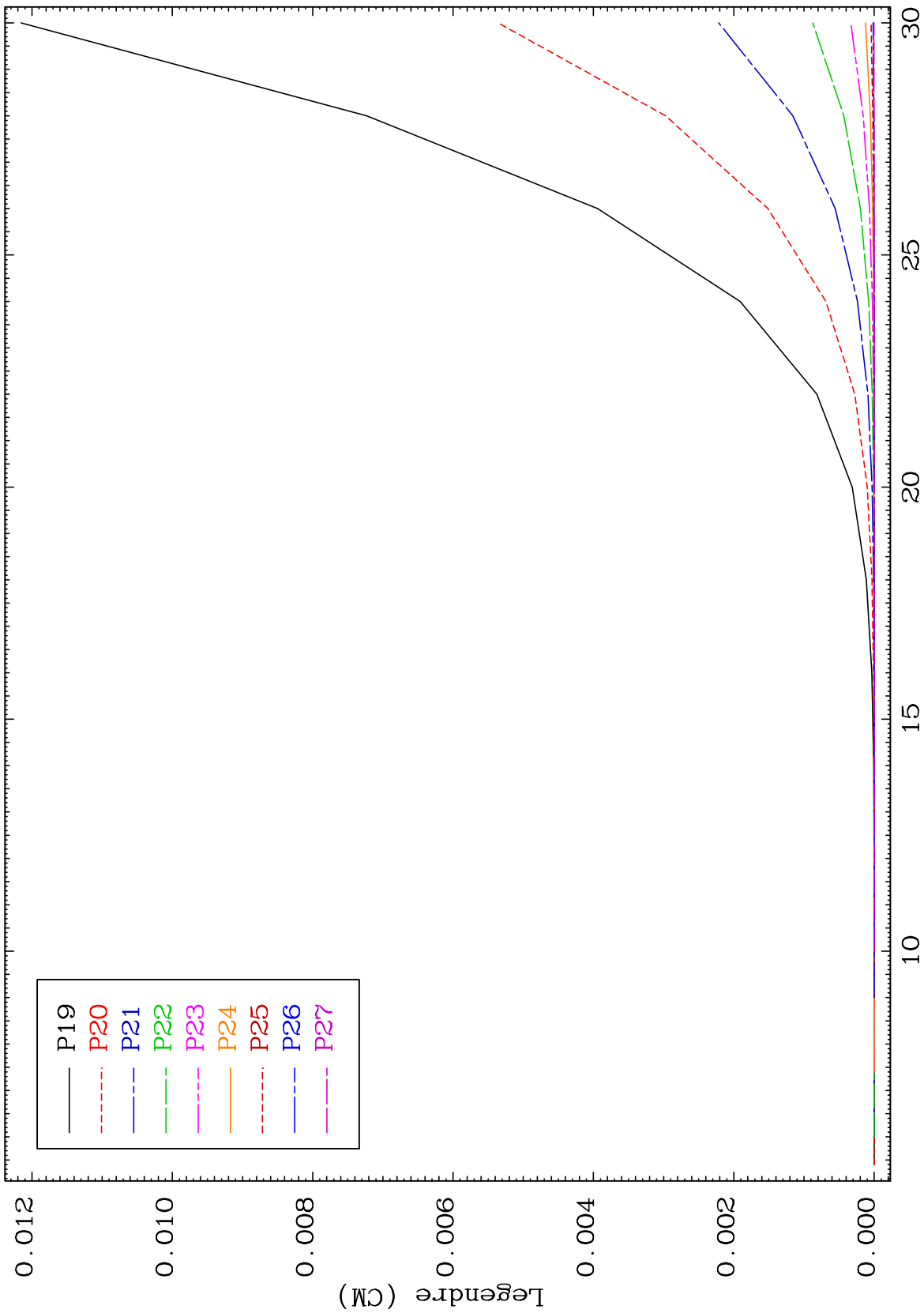

18

Incident Energy (MeV)

56-Ba-141

MAT 5658

Elastic Legendre Coefficients

56-Ba-141

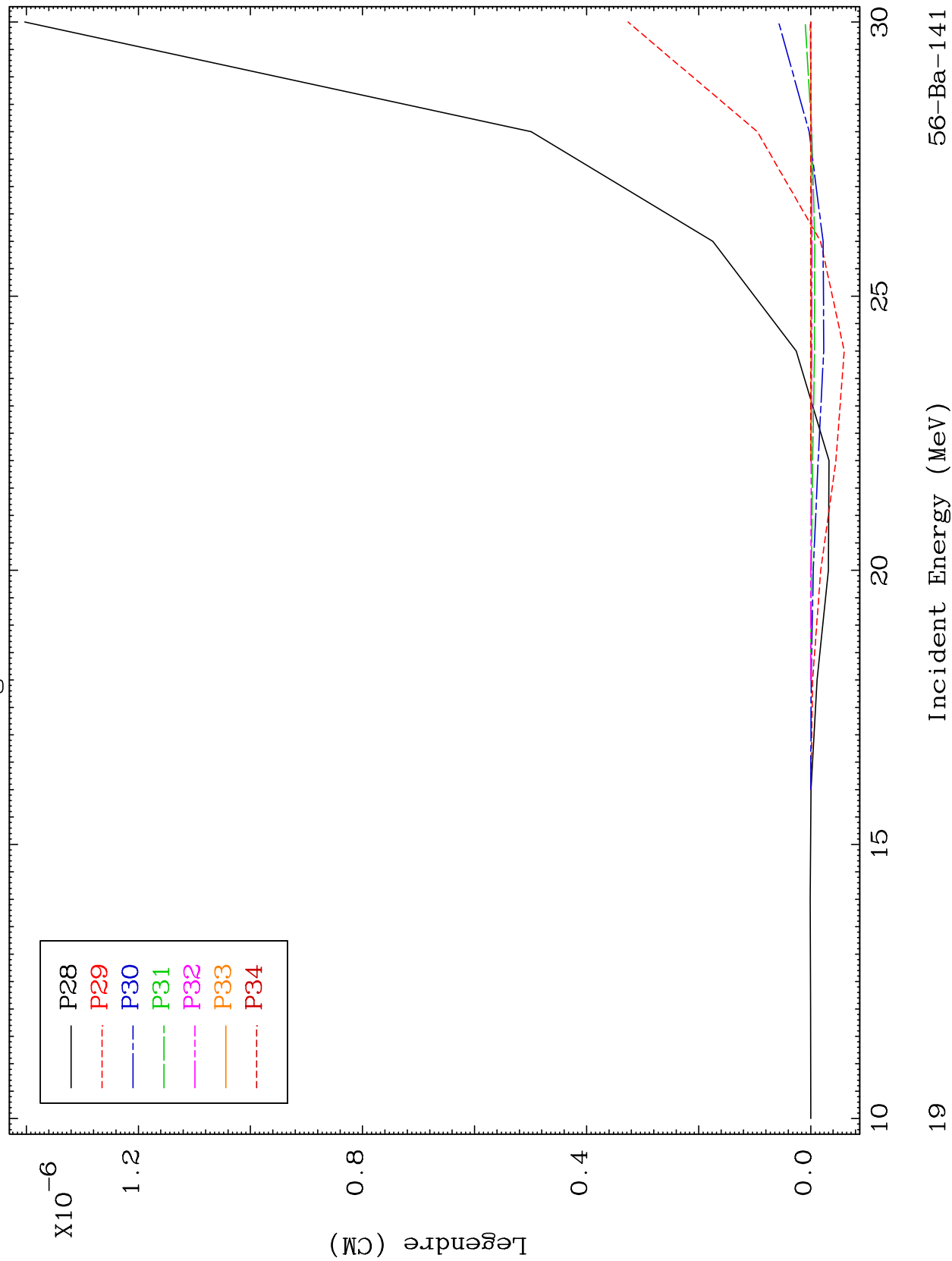

19

Incident Energy (MeV)

56-Ba-141

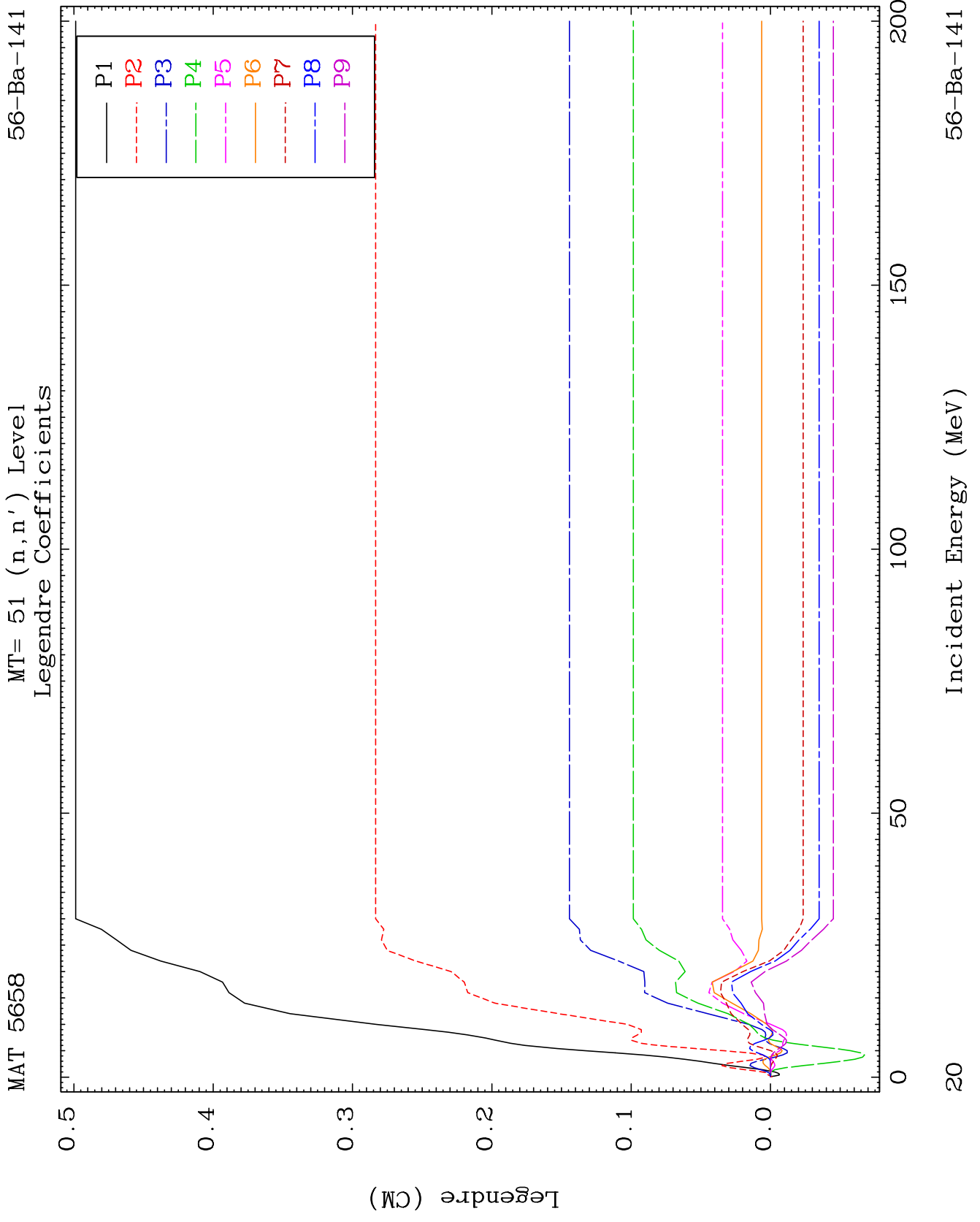

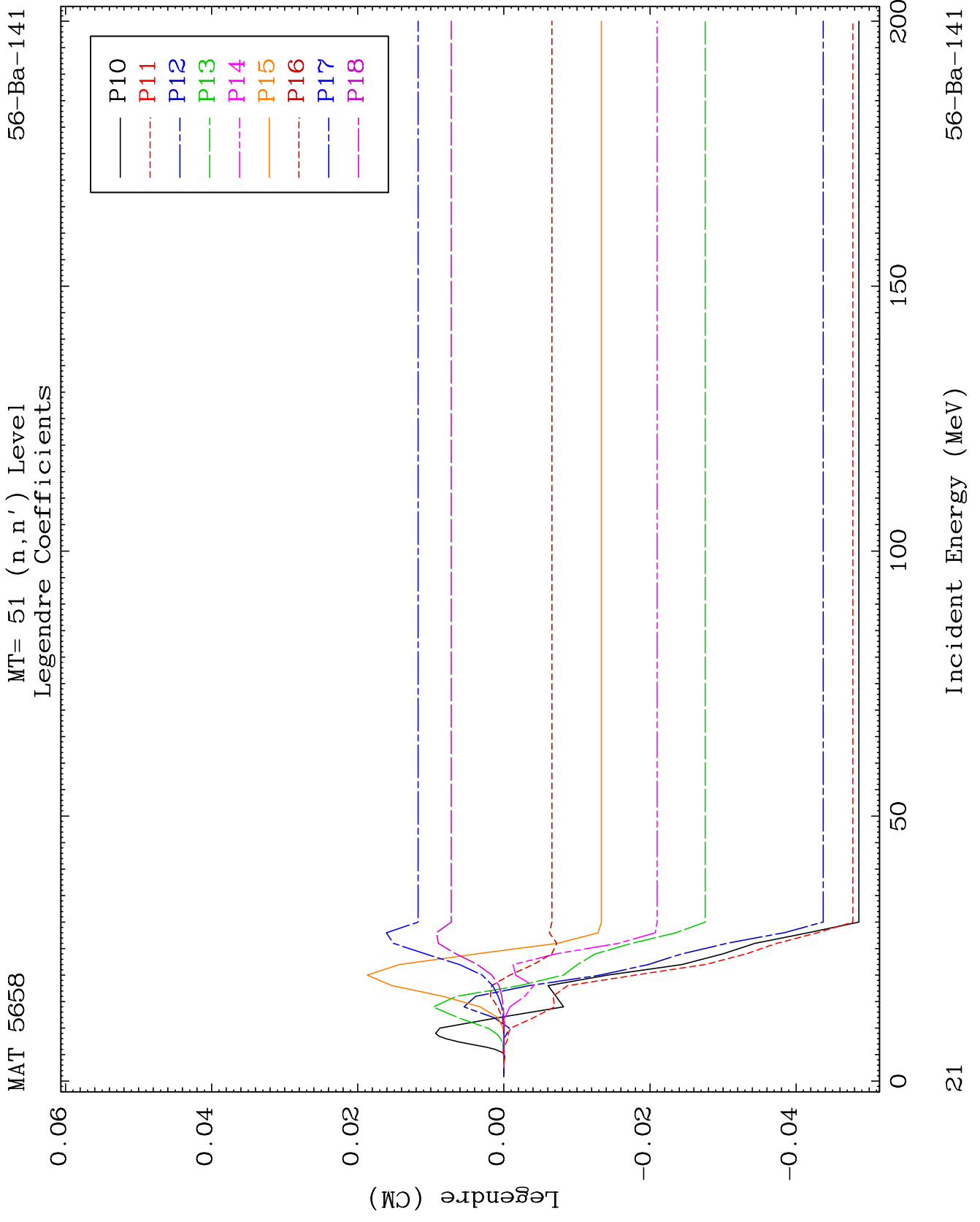

MAT 5658

MT= 51 (n,n') Level  
Legendre Coefficients

56-Ba-141

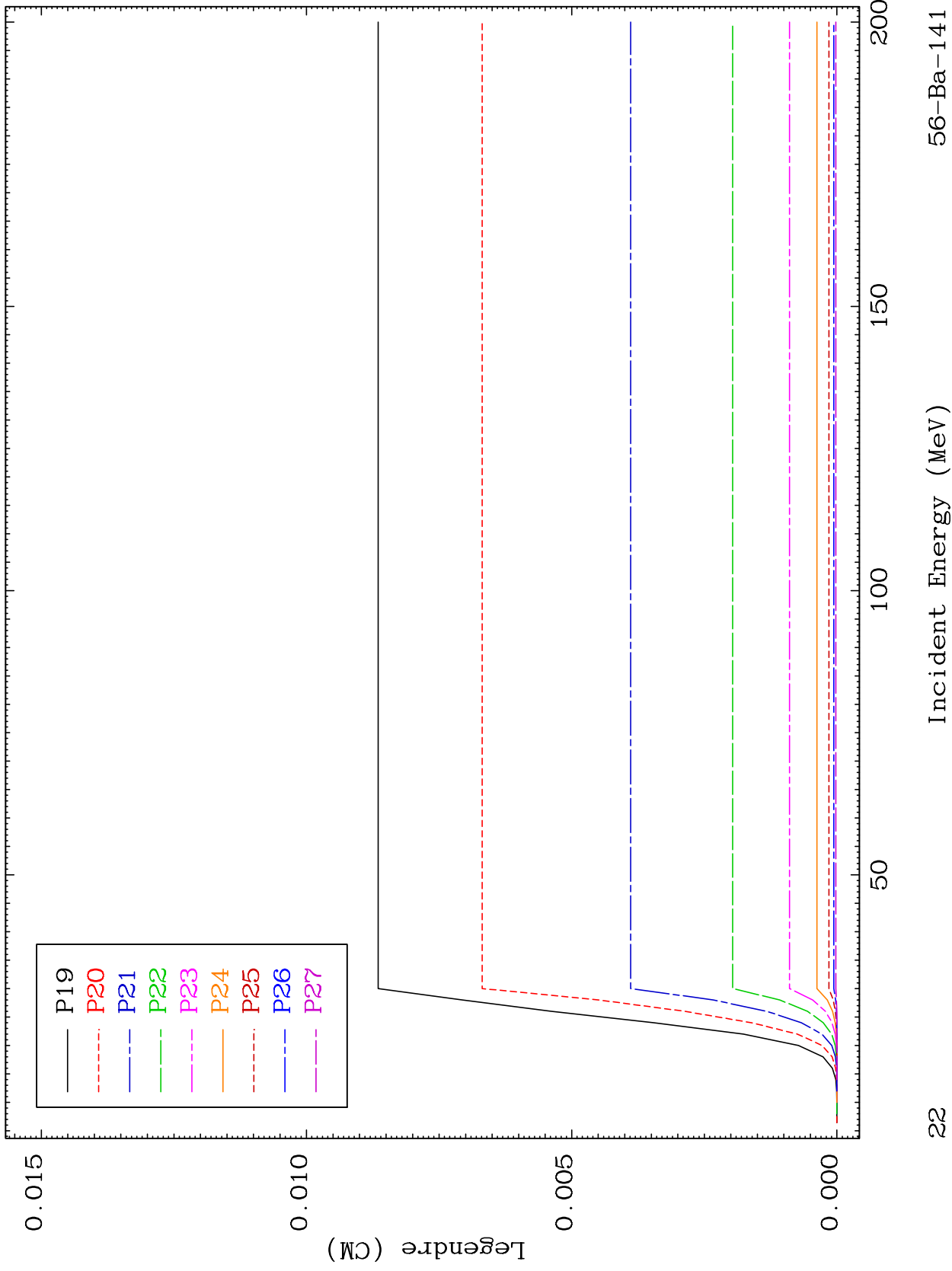

22

56-Ba-141

MAT 5658

MT= 51 (n,n') Level  
Legendre Coefficients

56-Ba-141

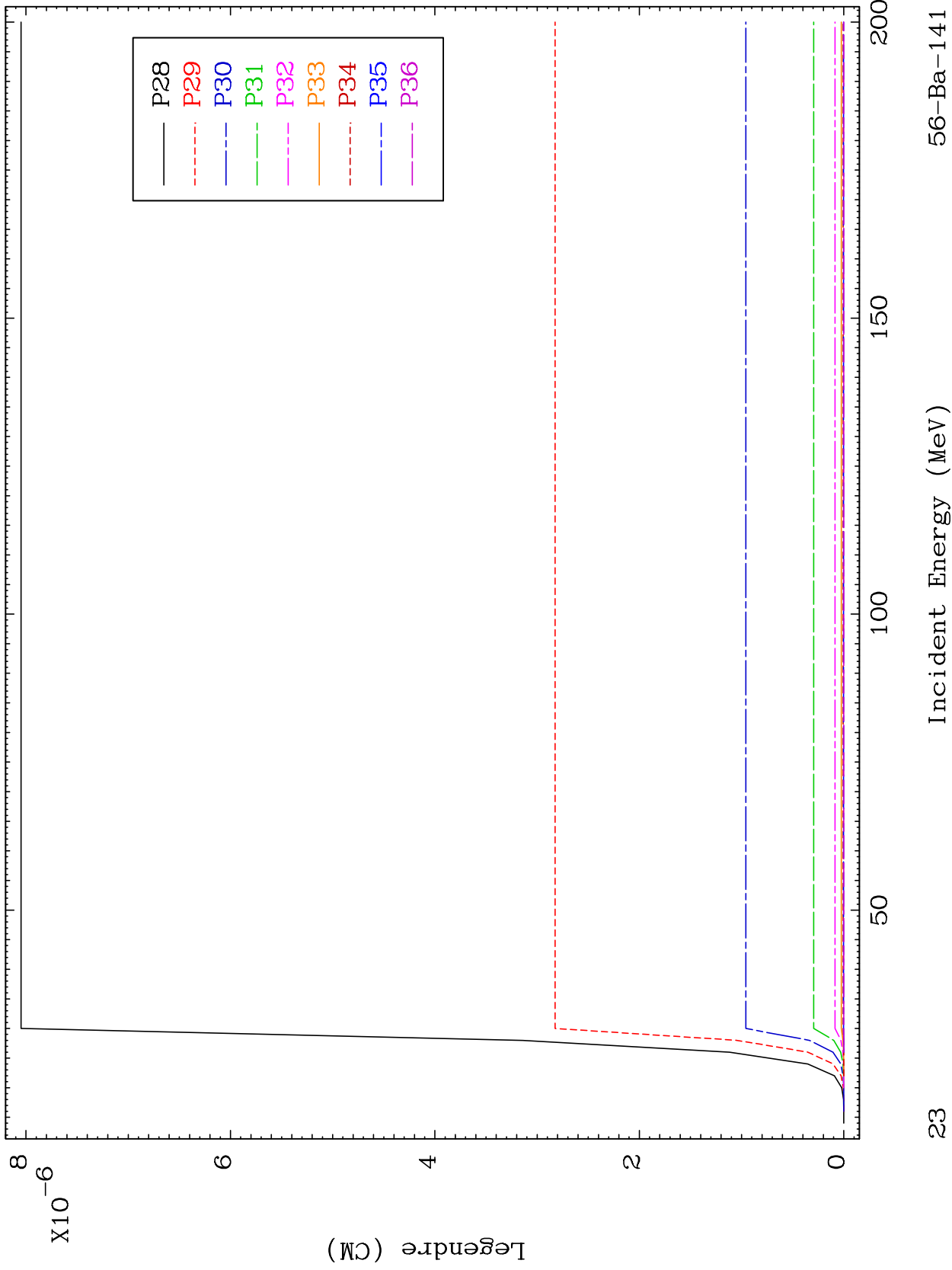

23

56-Ba-141



MAT 5658

MT= 52 (n,n') Level  
Legendre Coefficients

56-Ba-141

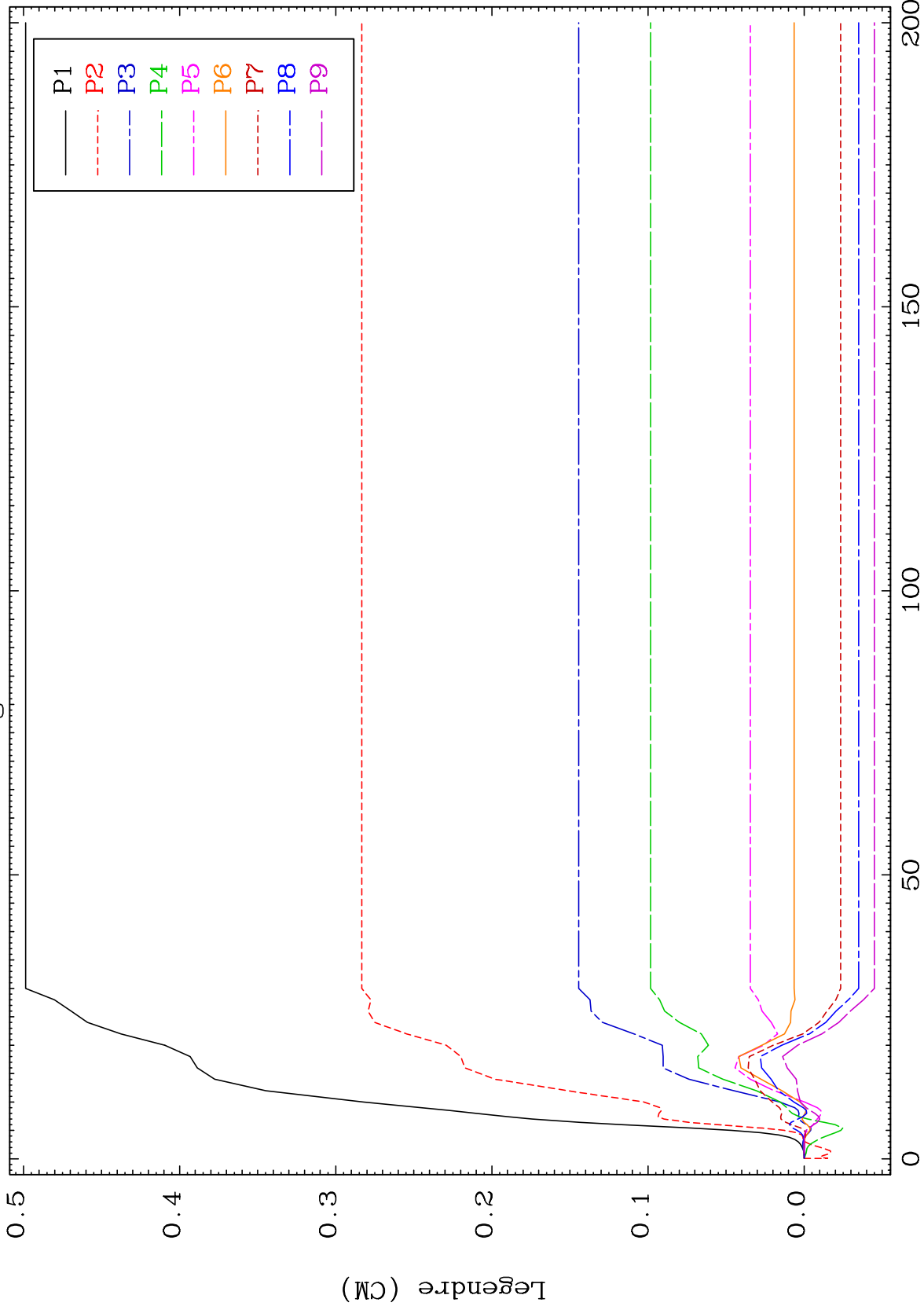

56-Ba-141

Incident Energy (MeV)

24

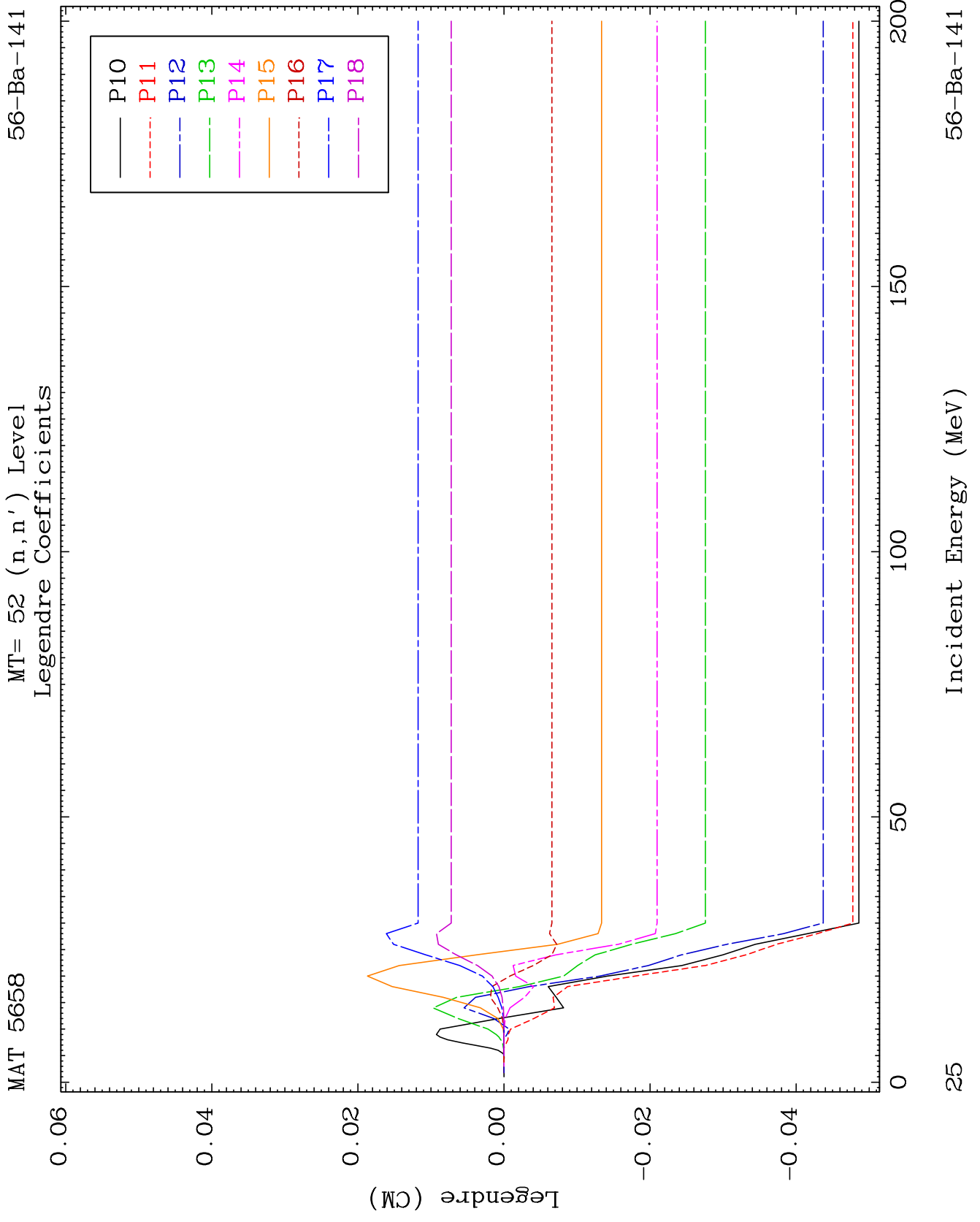

MAT 5658

MT= 52 (n,n') Level  
Legendre Coefficients

56-Ba-141

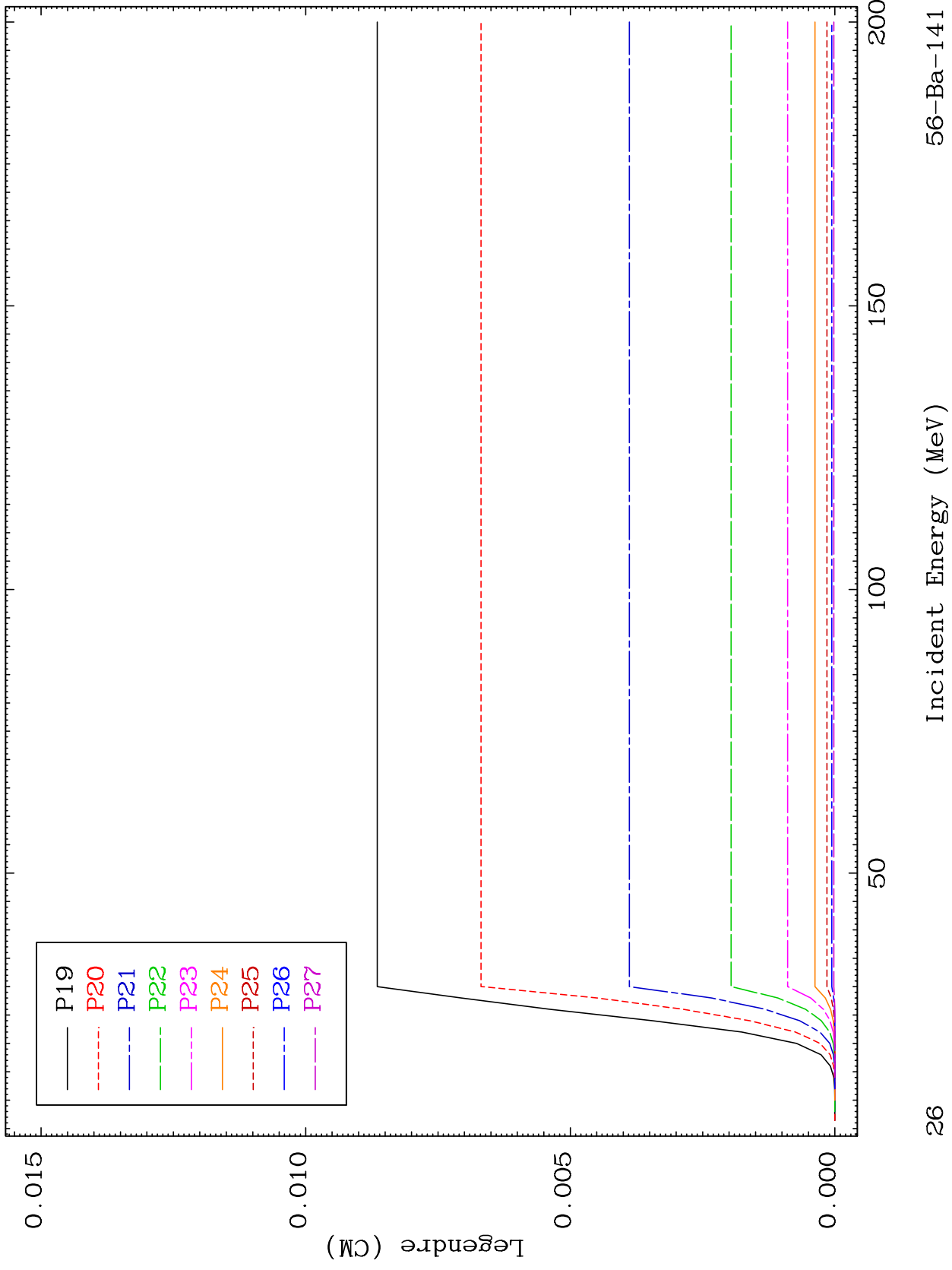

26

Incident Energy (MeV)

56-Ba-141

MAT 5658

MT= 52 (n,n') Level  
Legendre Coefficients

56-Ba-141

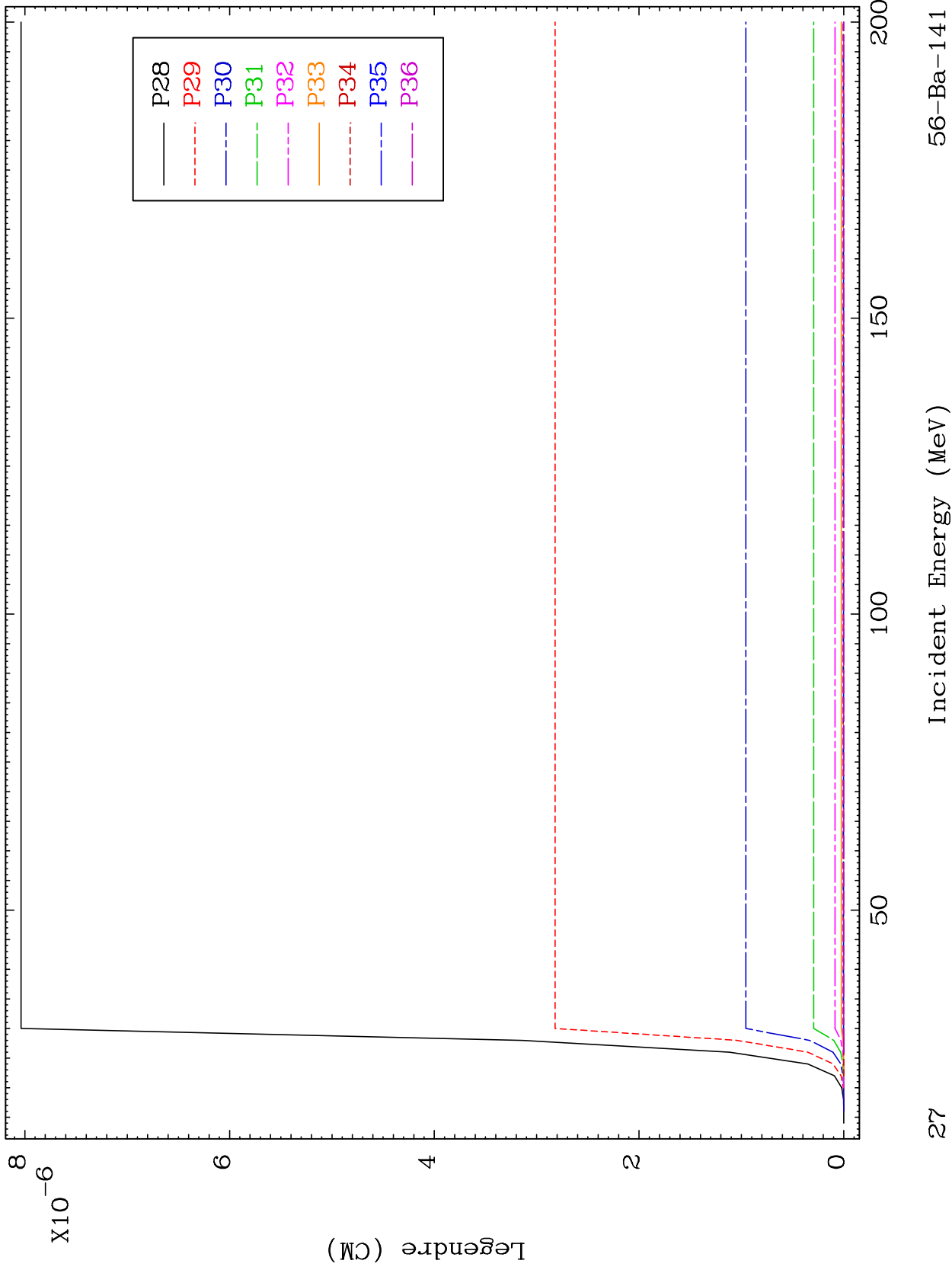

27

Incident Energy (MeV)

56-Ba-141

MAT 5658

MT= 53 (n,n') Level  
Legendre Coefficients

56-Ba-141

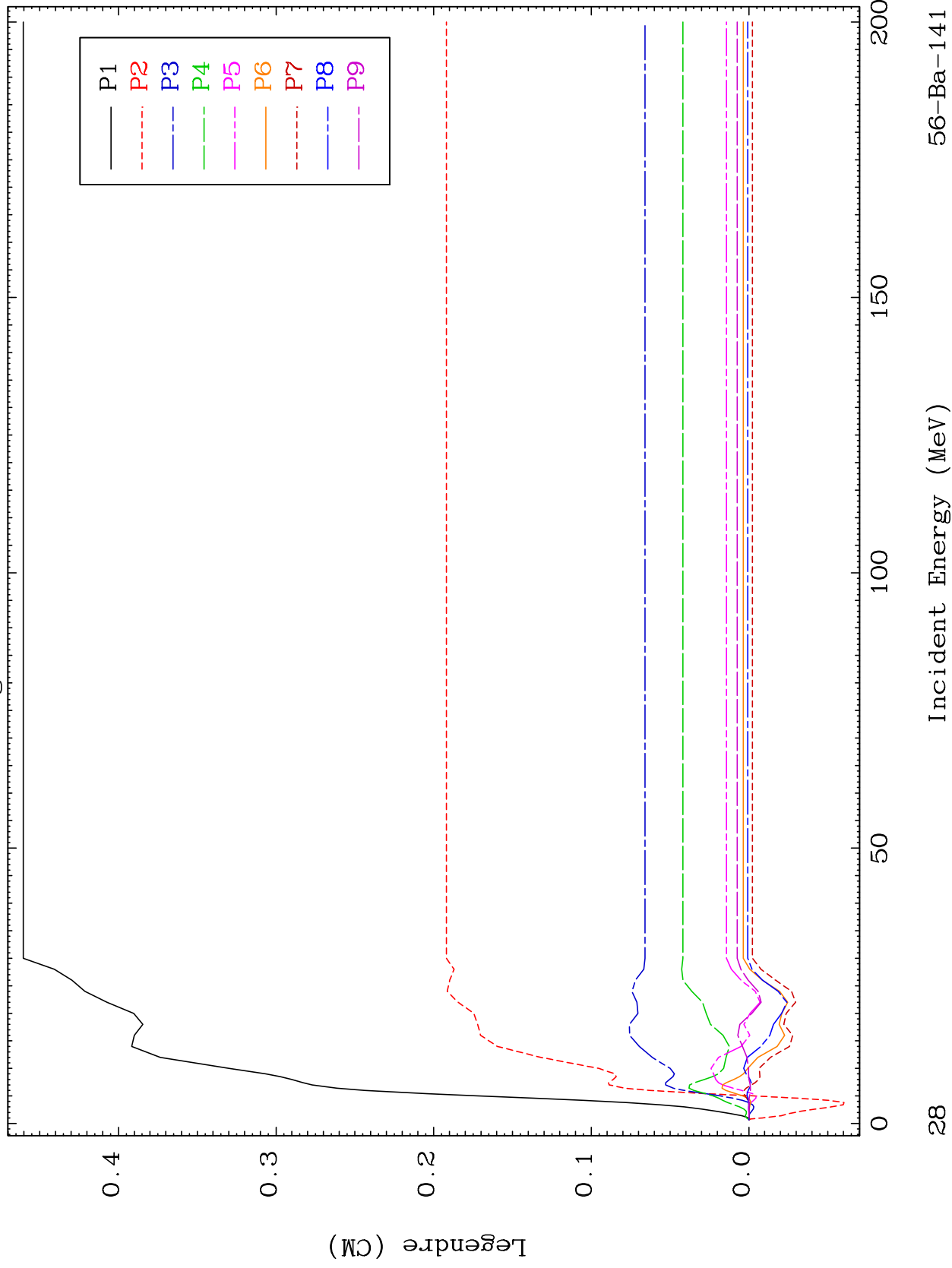

56-Ba-141

Incident Energy (MeV)

28

MAT 5658

MT= 53 (n,n') Level  
Legendre Coefficients

56-Ba-141

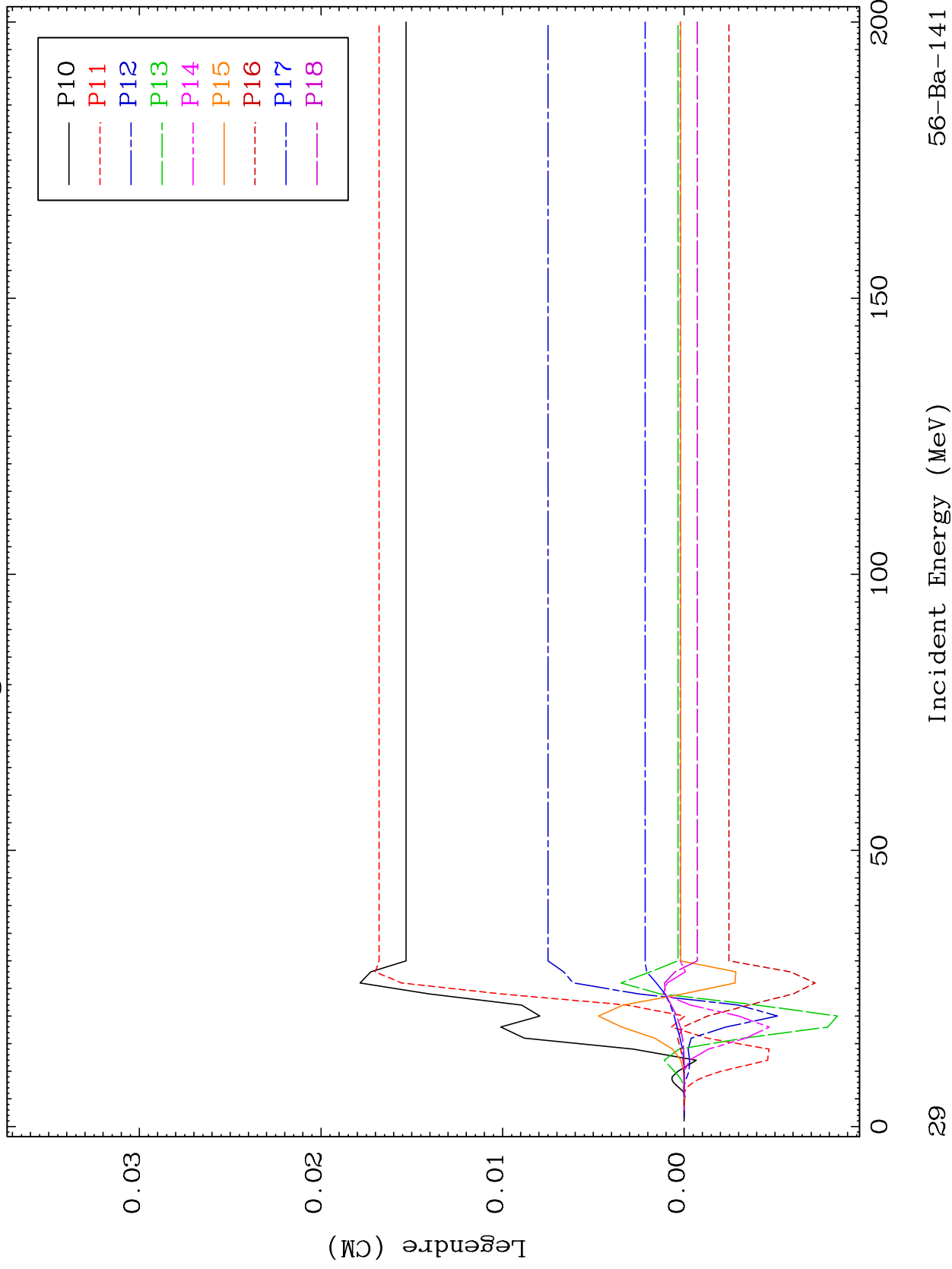

56-Ba-141

Incident Energy (MeV)

29

MAT 5658

MT= 53 (n,n') Level  
Legendre Coefficients

56-Ba-141

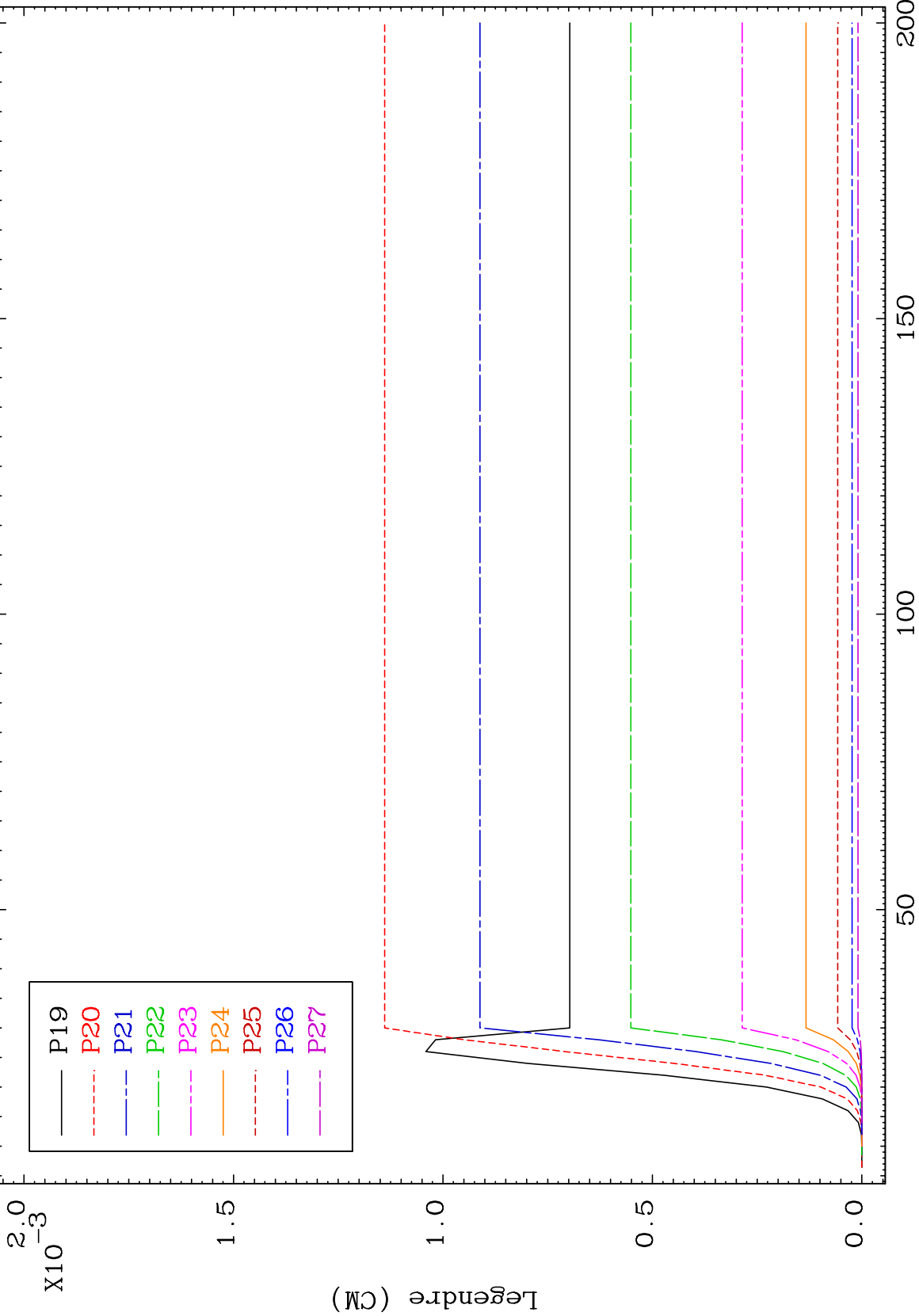

30

Incident Energy (MeV)

56-Ba-141

MAT 5658

MT= 53 (n,n') Level  
Legendre Coefficients

56-Ba-141

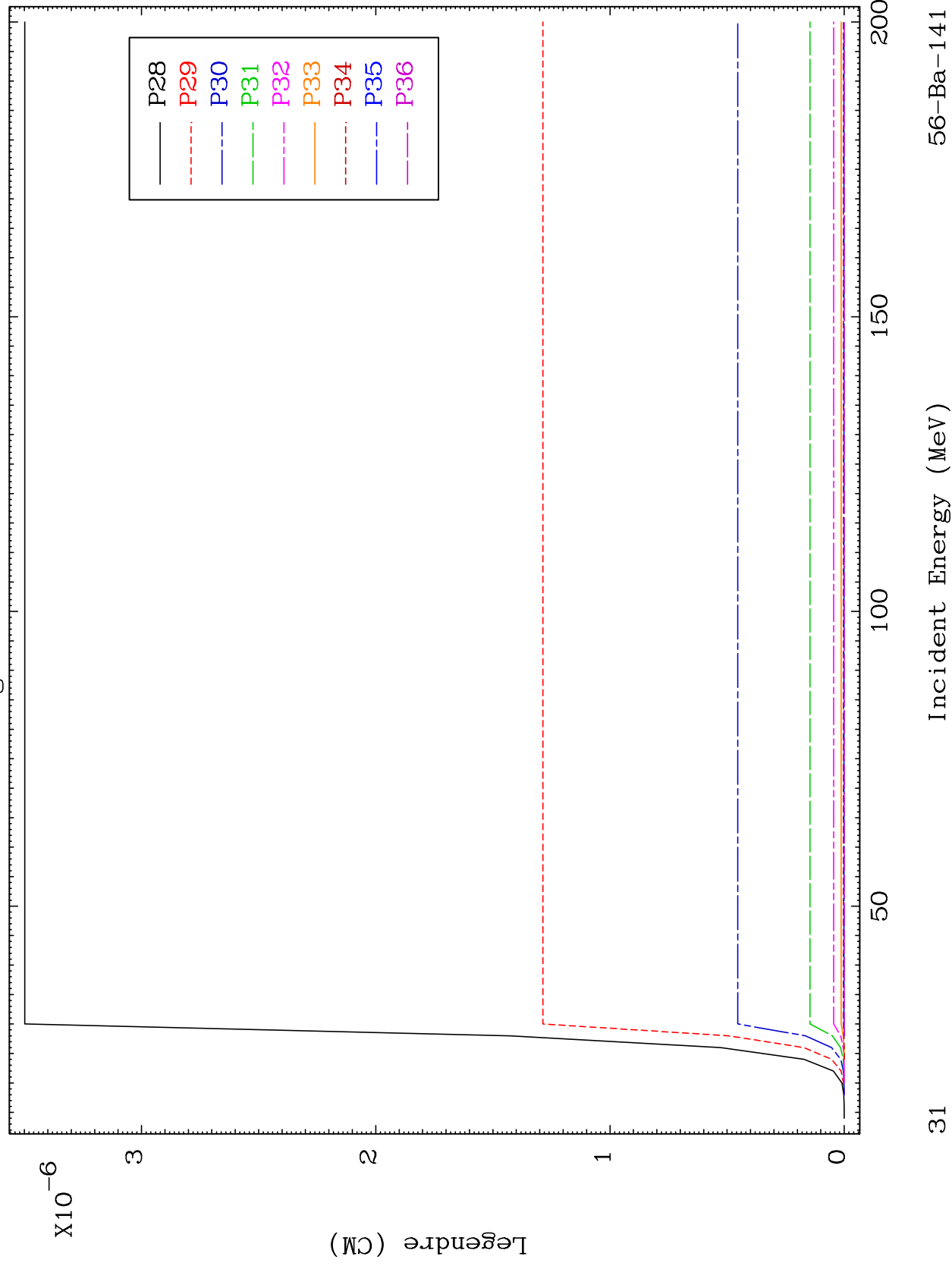

31

Incident Energy (MeV)

56-Ba-141

200

150

100

50



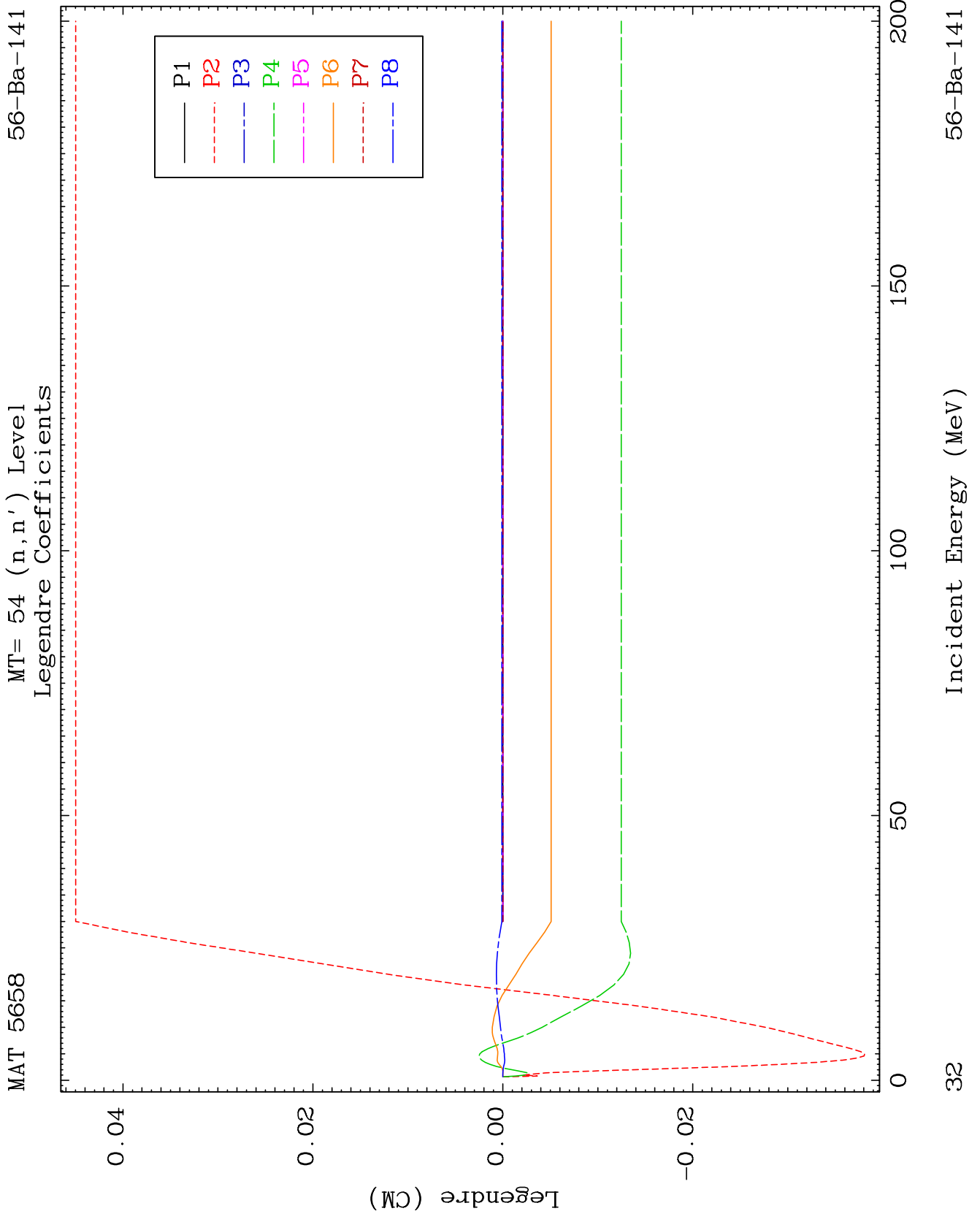

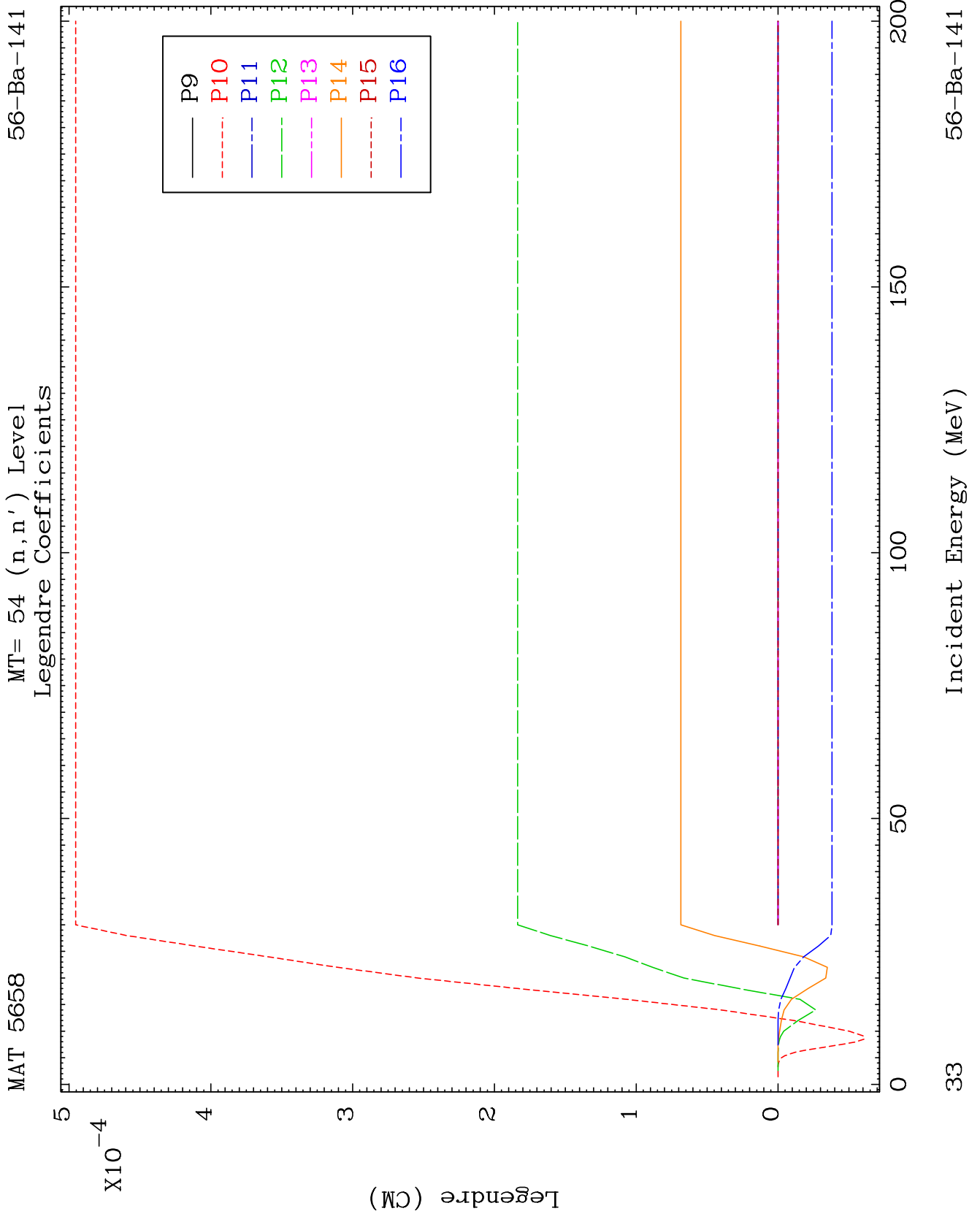

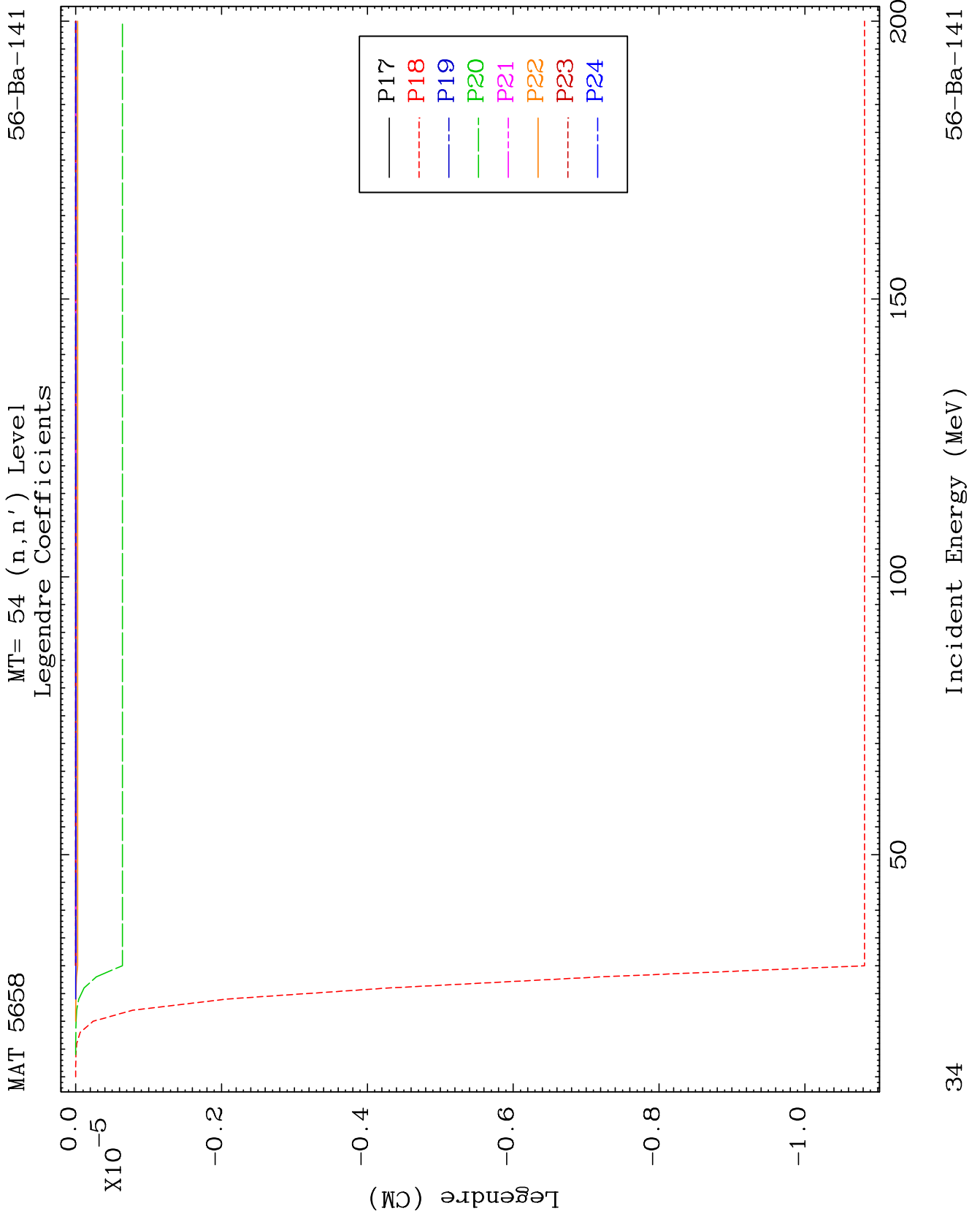

MAT 5658

MT= 55 (n,n') Level  
Legendre Coefficients

56-Ba-141

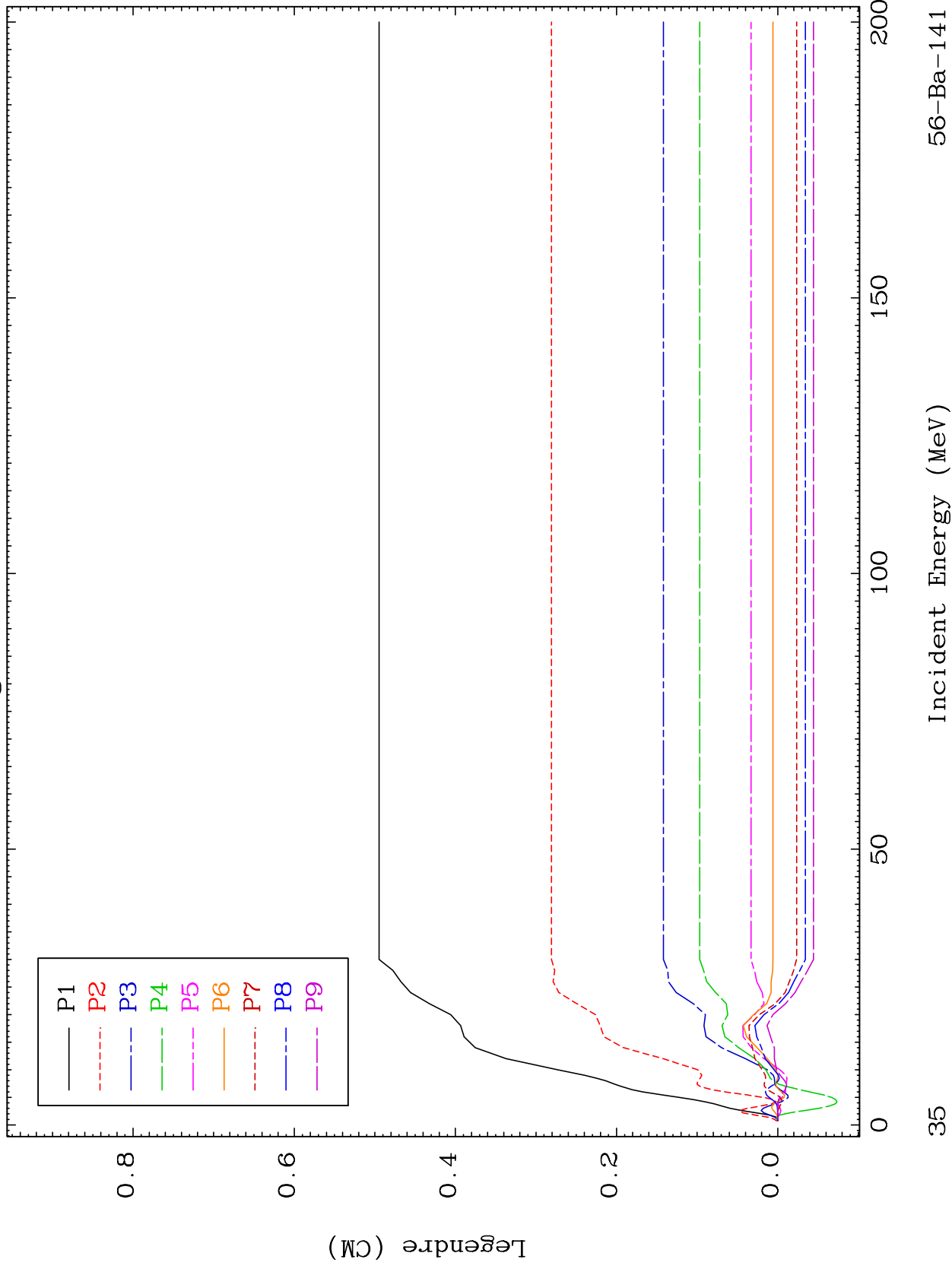

56-Ba-141

Incident Energy (MeV)

35

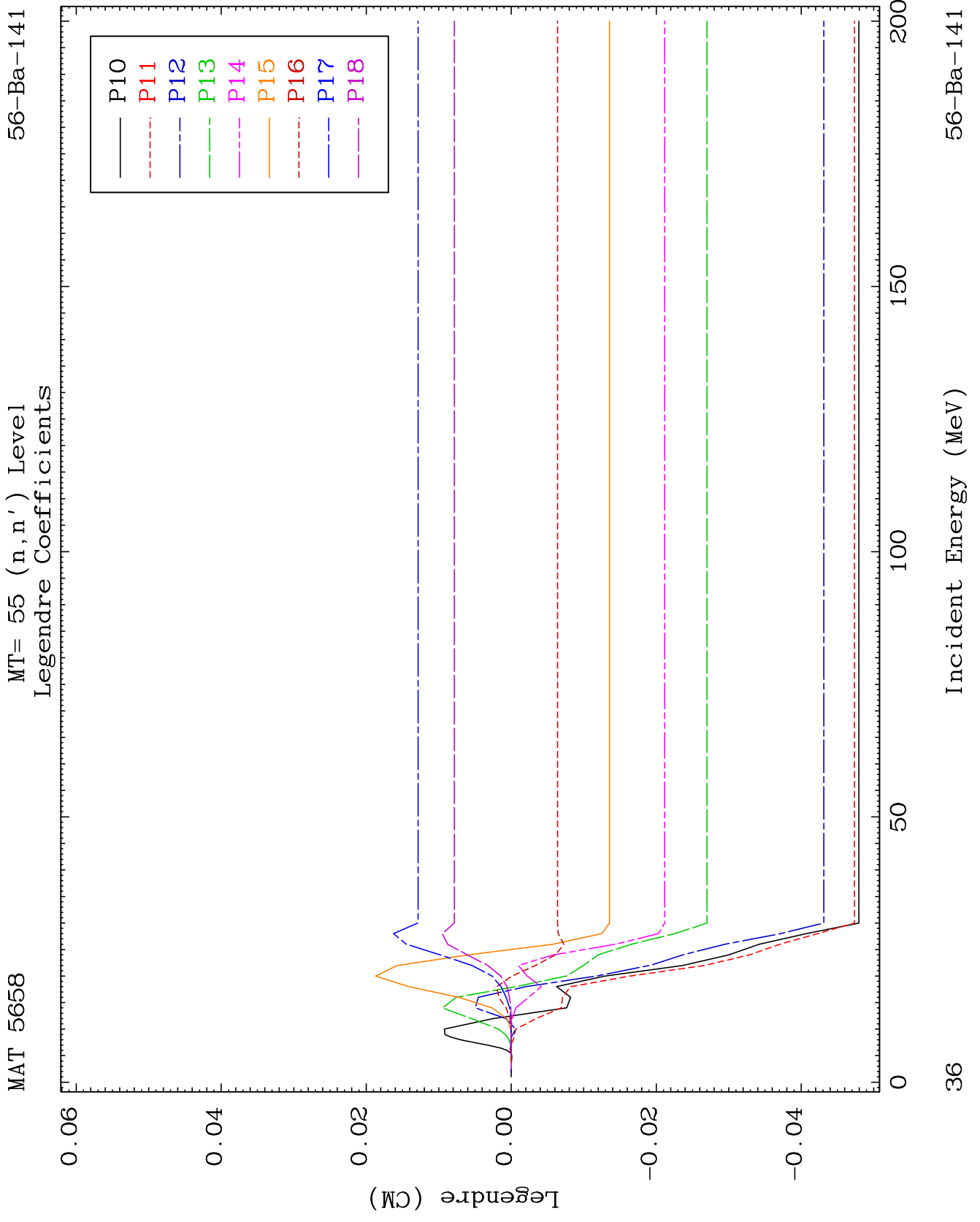

MAT 5658

MT= 55 (n,n') Level  
Legendre Coefficients

56-Ba-141

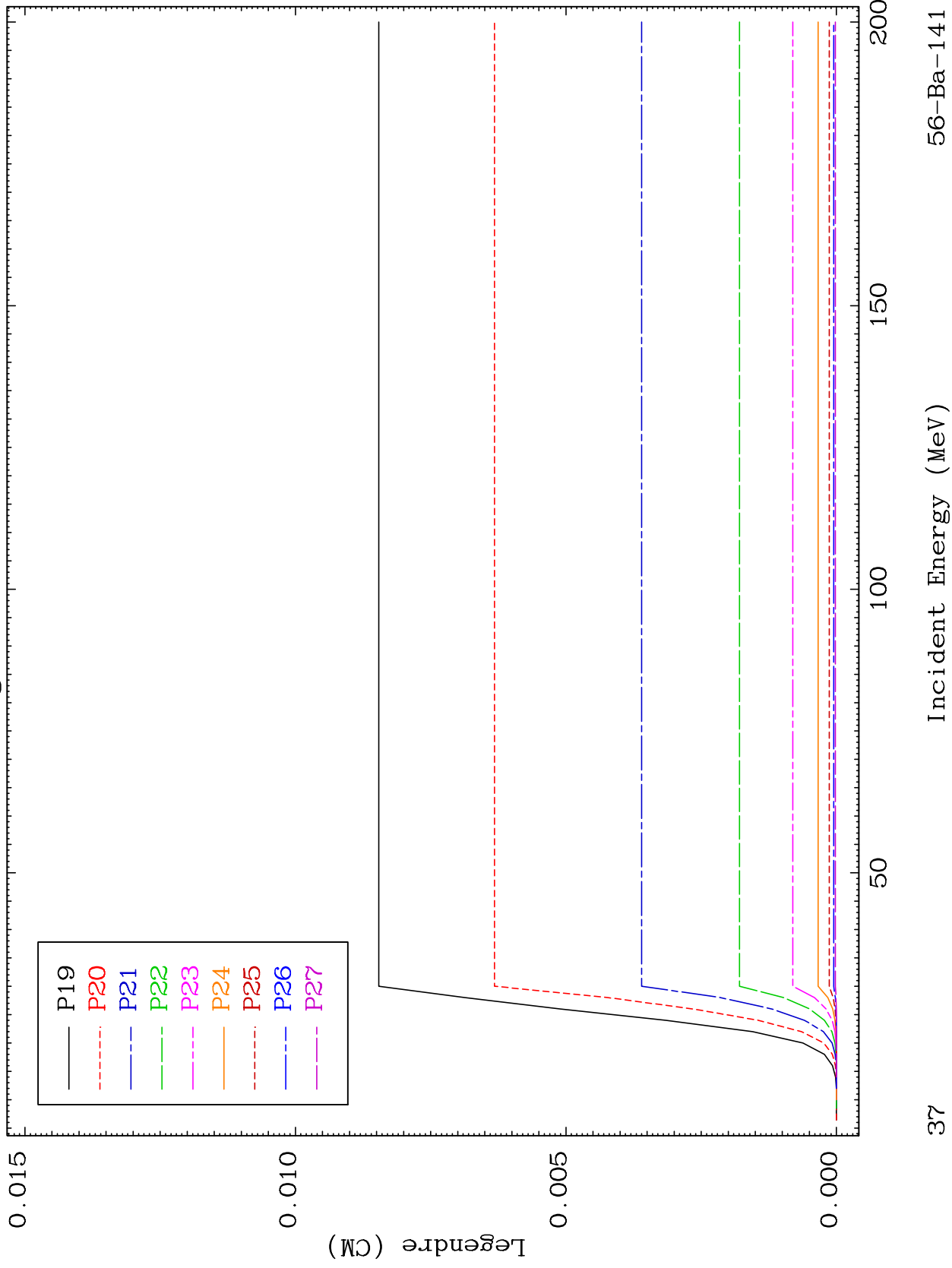

37

Incident Energy (MeV)

56-Ba-141

MAT 5658

MT= 55 (n,n') Level  
Legendre Coefficients

56-Ba-141

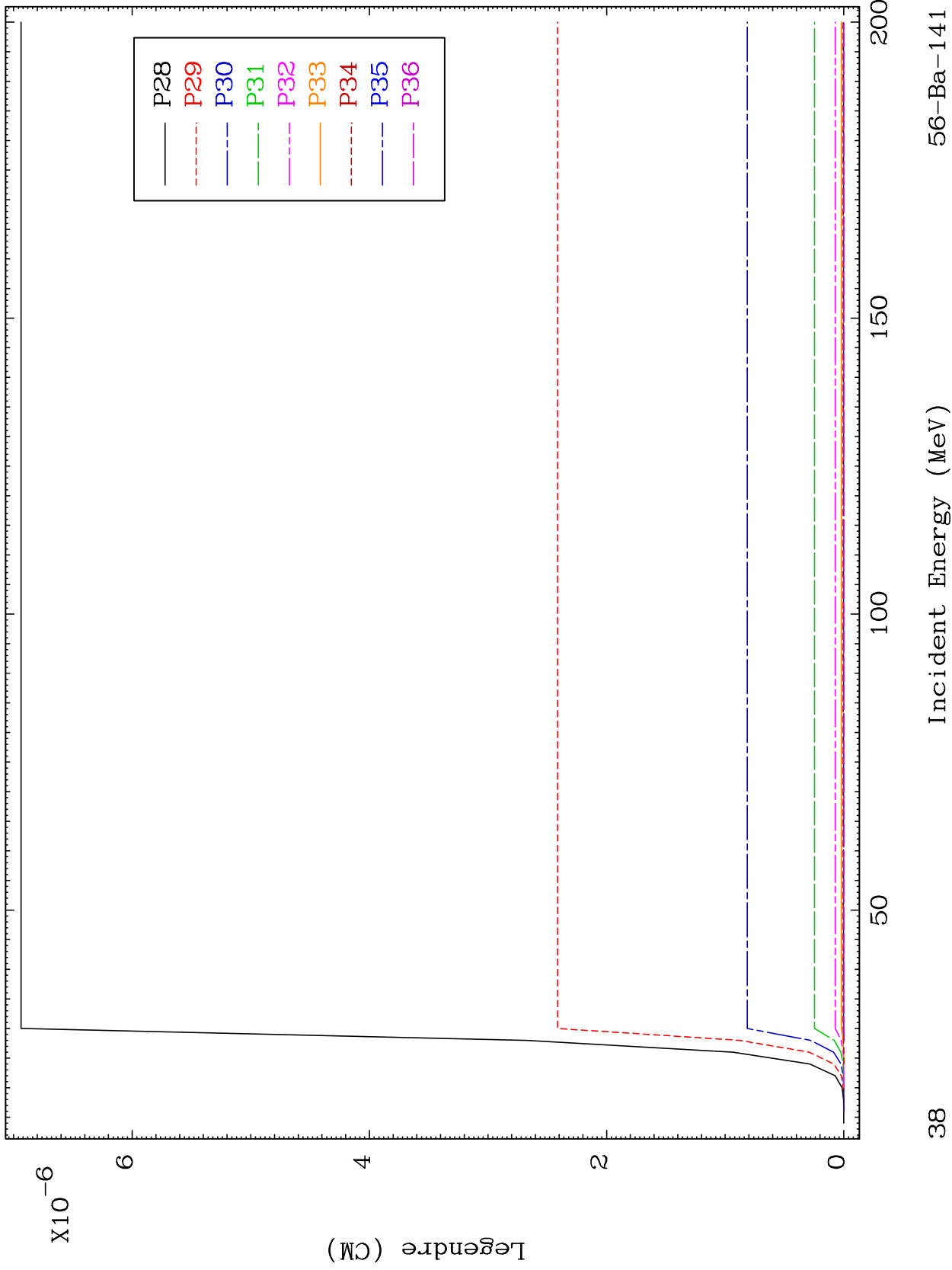

38

Incident Energy (MeV)

56-Ba-141

MAT 5658

MT= 56 (n,n') Level  
Legendre Coefficients

56-Ba-141

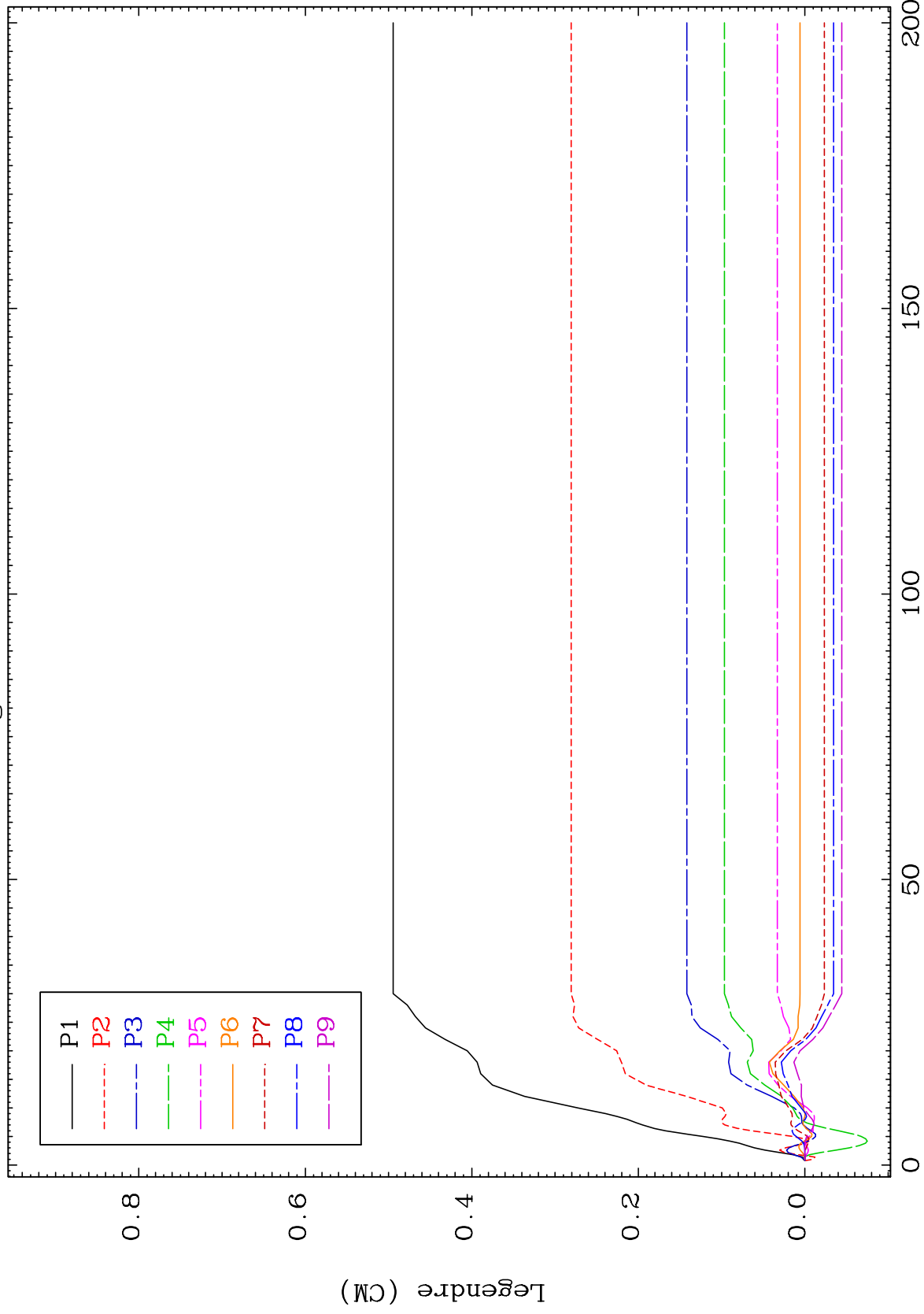

39

Incident Energy (MeV)

56-Ba-141





MAT 5658

MT= 56 (n,n') Level  
Legendre Coefficients

56-Ba-141

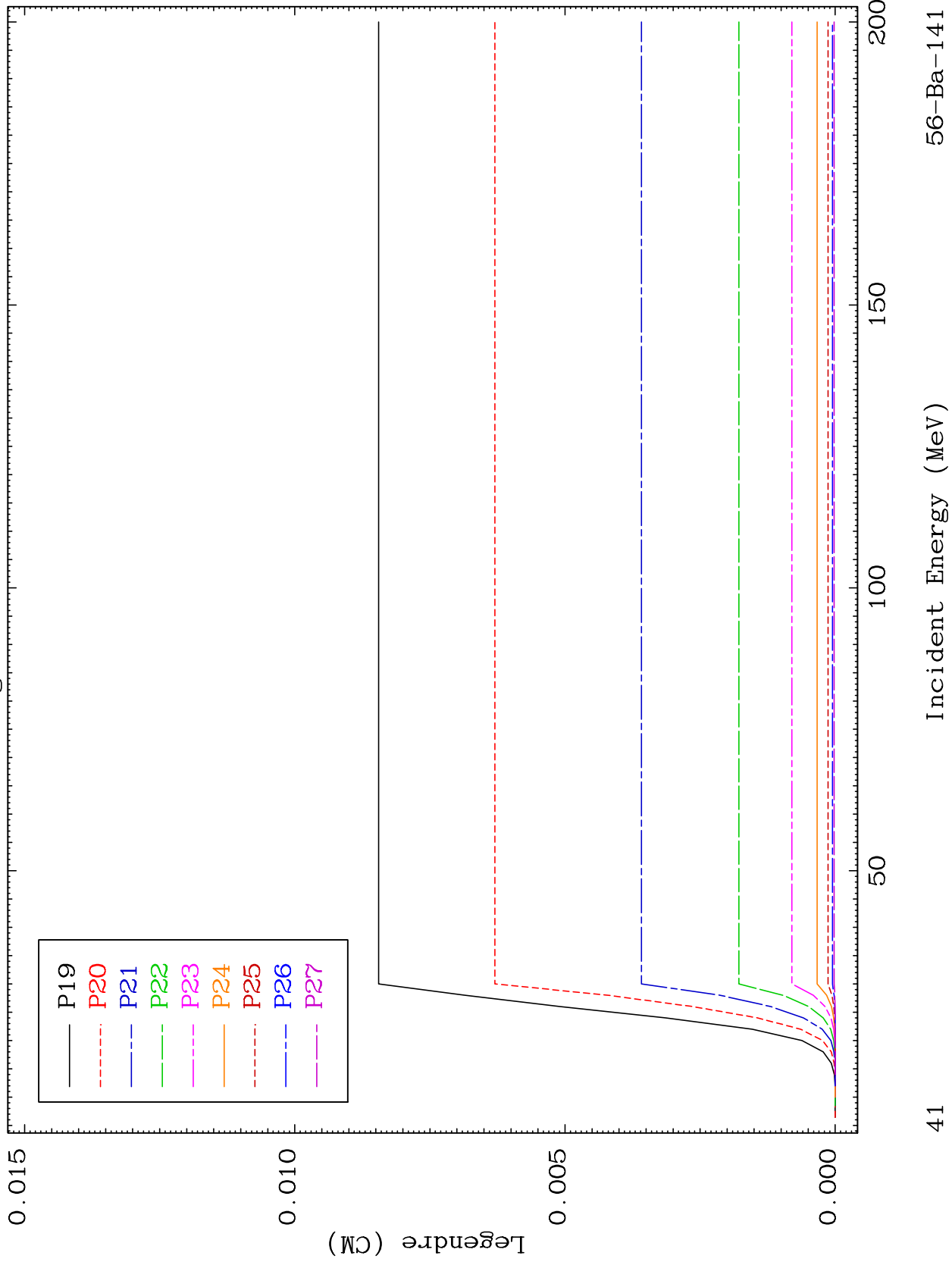

MAT 5658

MT= 56 (n,n') Level  
Legendre Coefficients

56-Ba-141

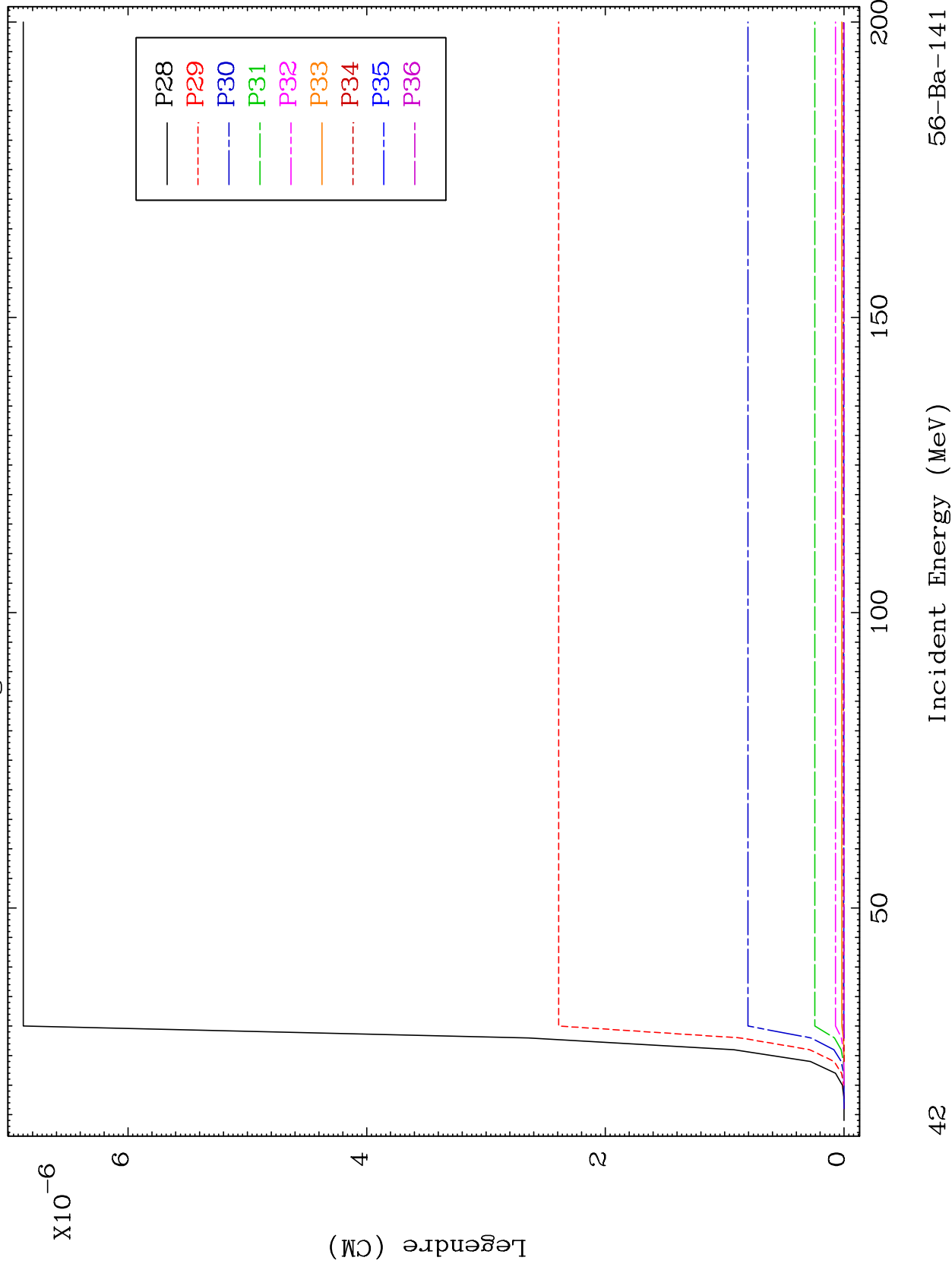

42

Incident Energy (MeV)

56-Ba-141

MAT 5658

MT= 57 (n,n') Level  
Legendre Coefficients

56-Ba-141

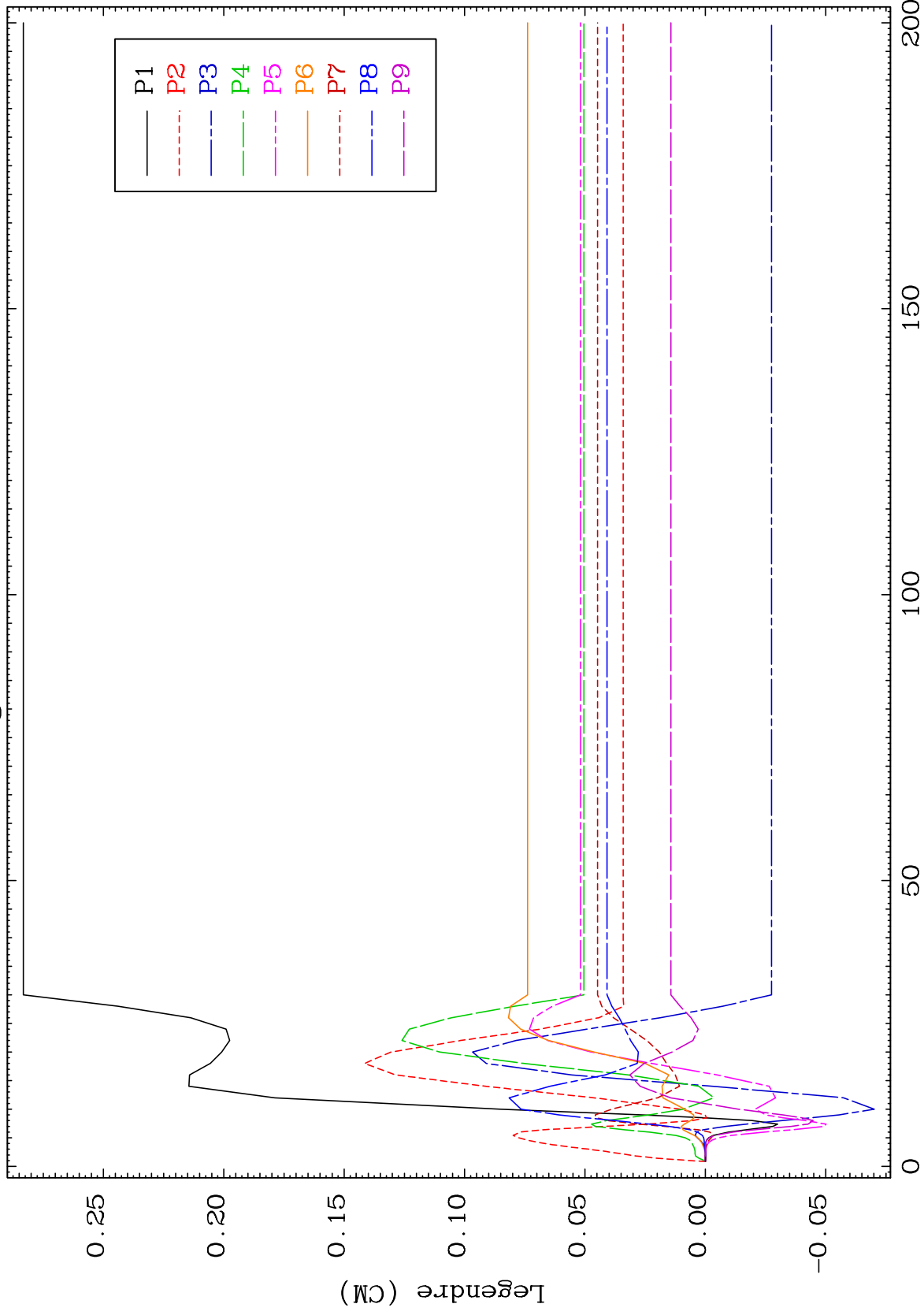

43

Incident Energy (MeV)

56-Ba-141

MAT 5658

56-Ba-141

MT= 57 (n,n') Level  
Legendre Coefficients

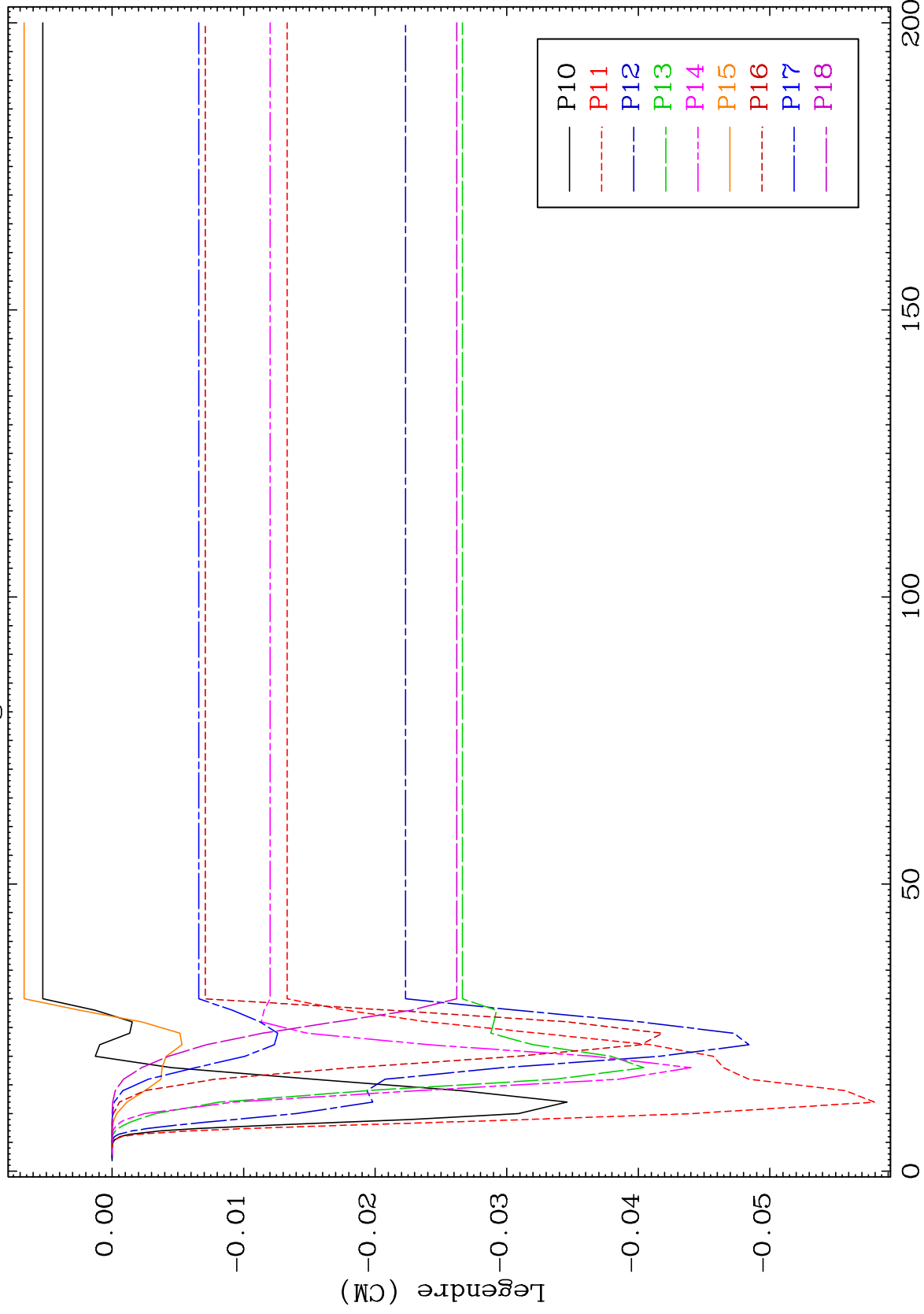

44

Incident Energy (MeV)

56-Ba-141

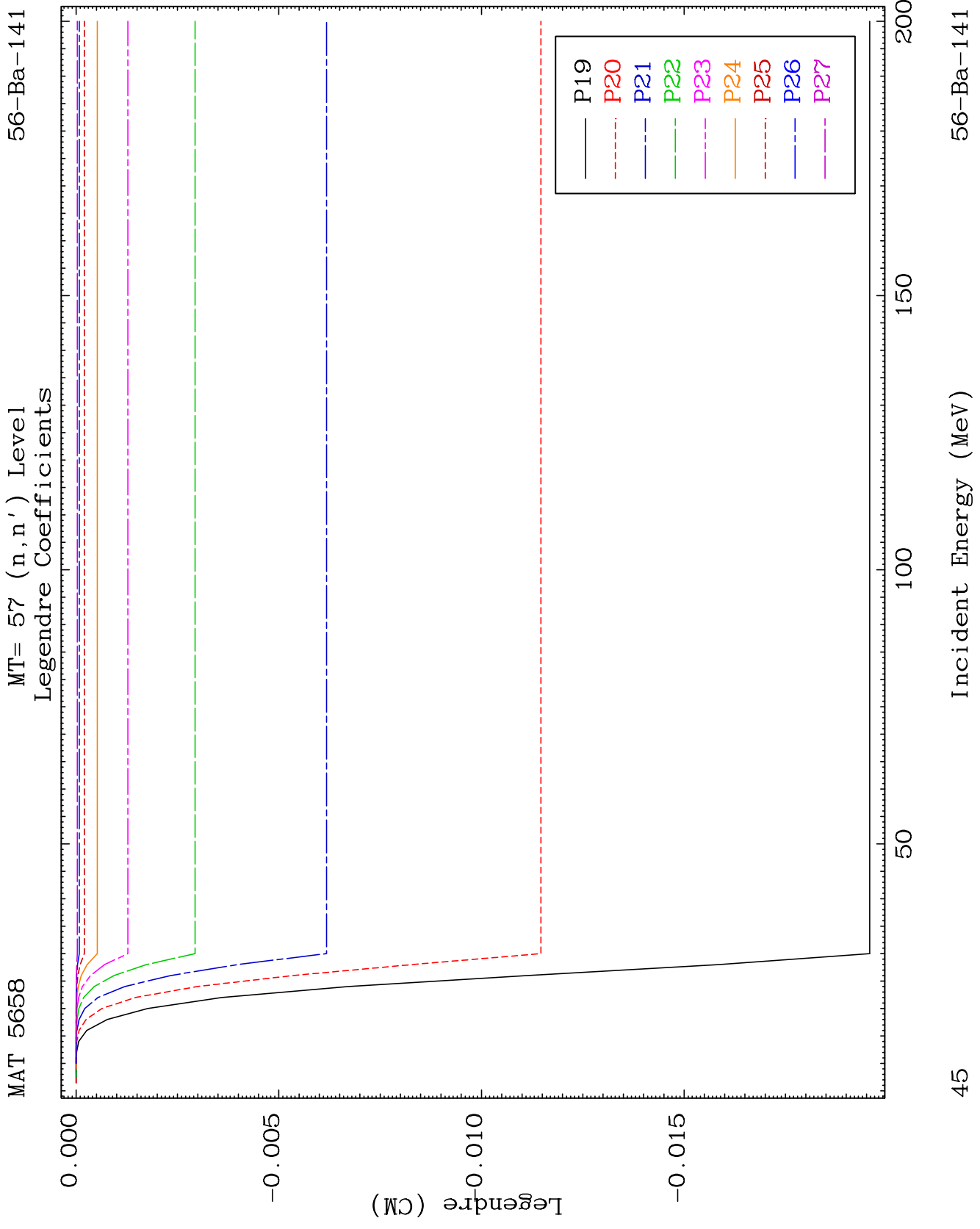

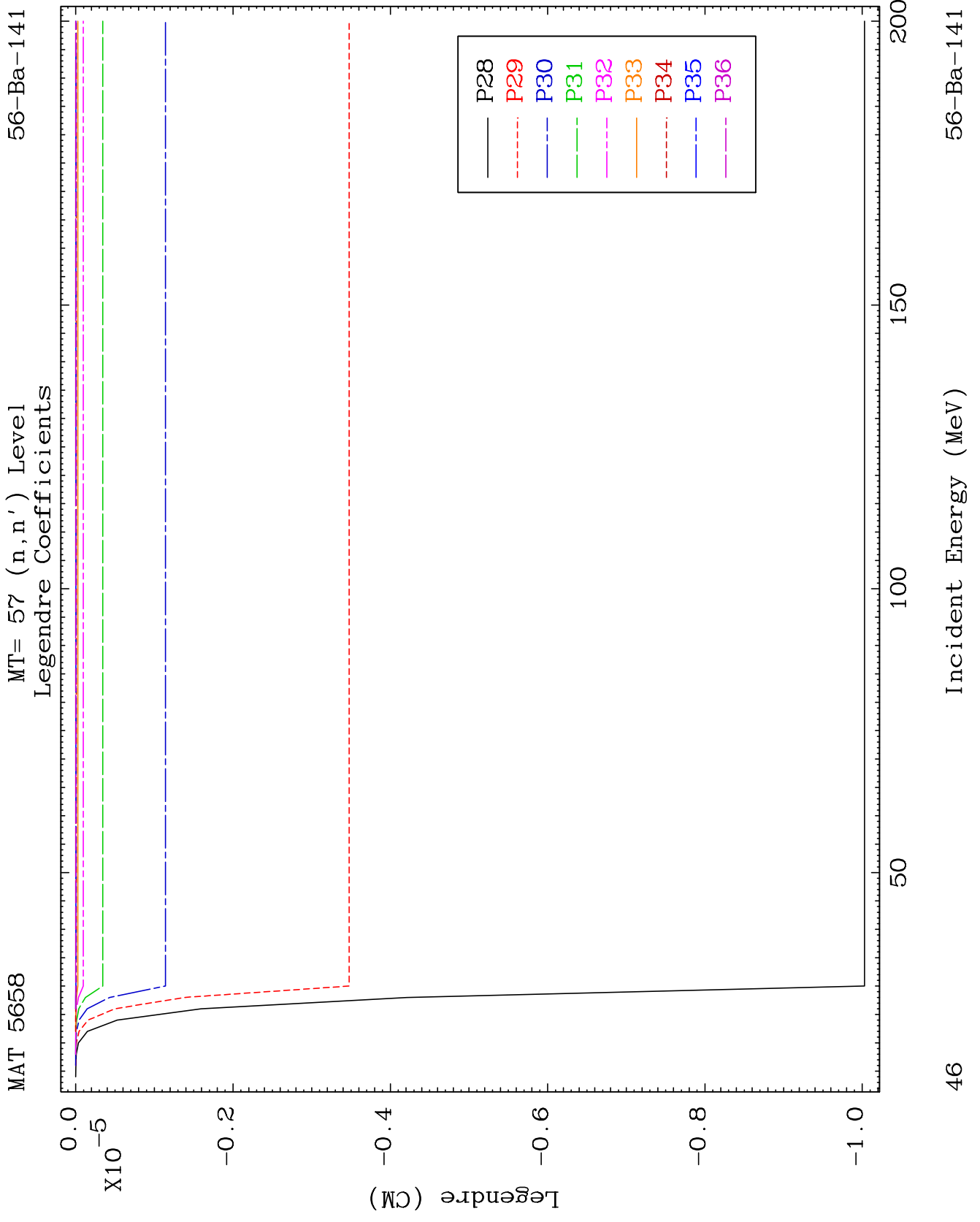

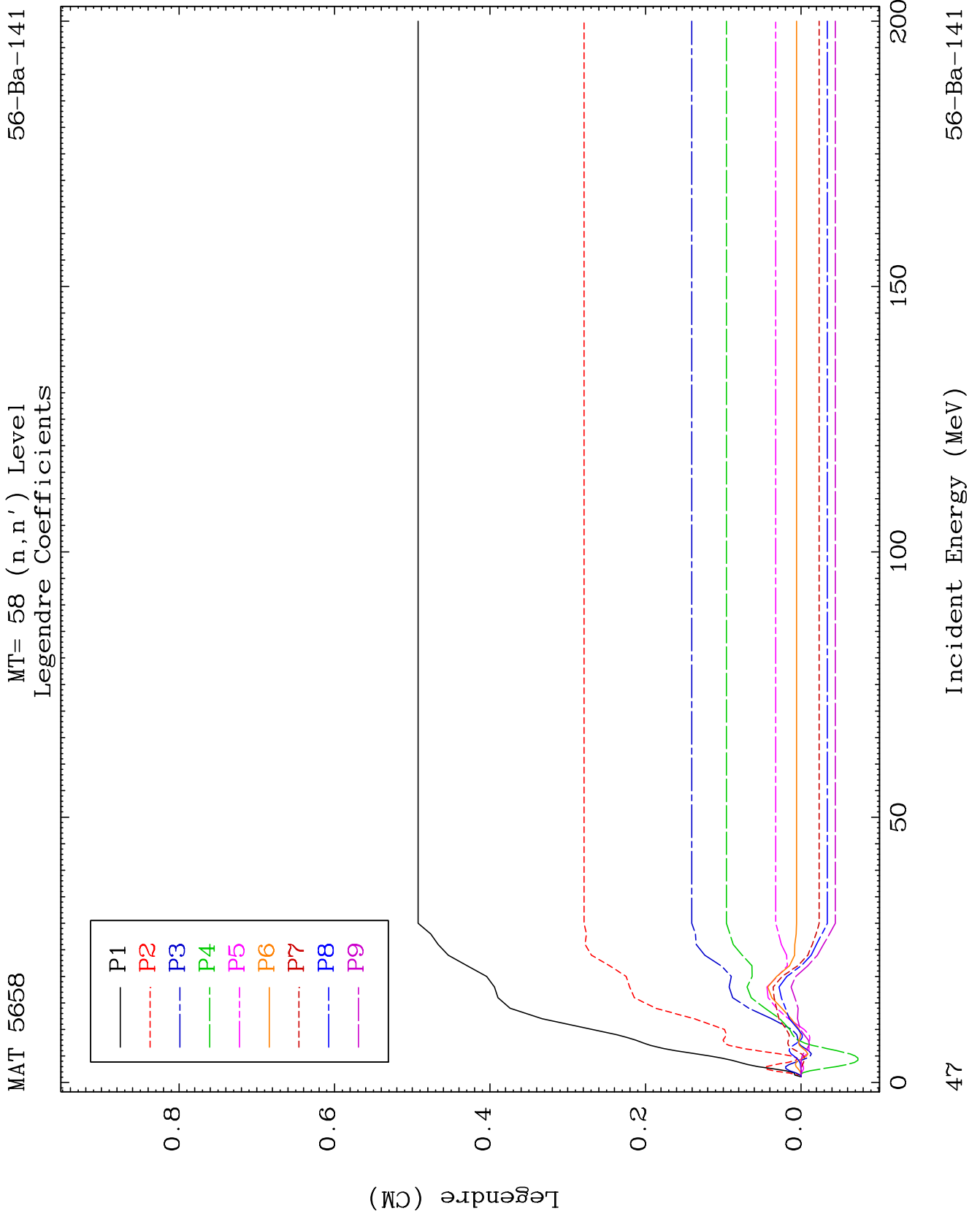



MAT 5658

MT= 58 (n,n') Level  
Legendre Coefficients

56-Ba-141

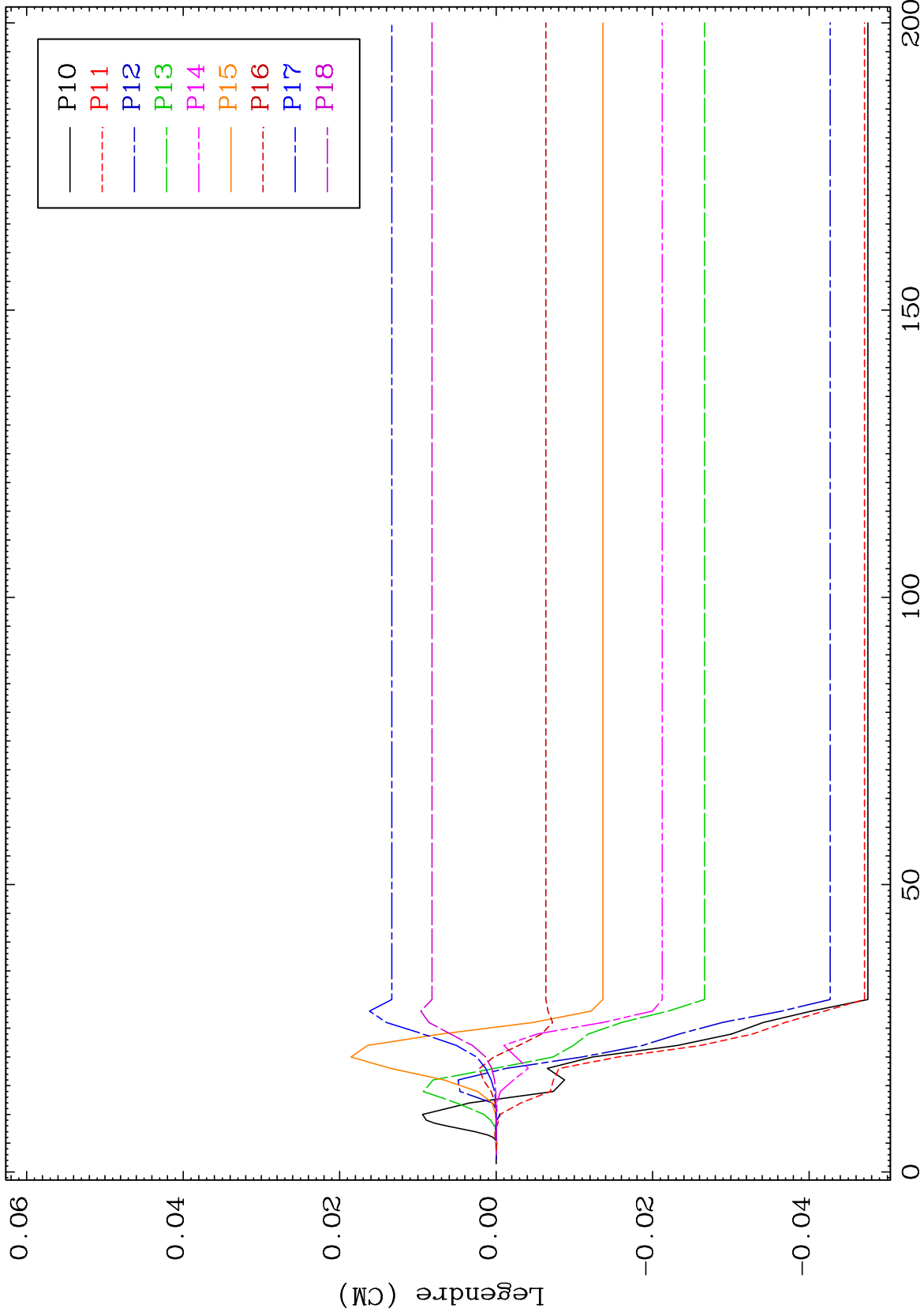

48

Incident Energy (MeV)

56-Ba-141

MAT 5658

MT= 58 (n,n') Level  
Legendre Coefficients

56-Ba-141

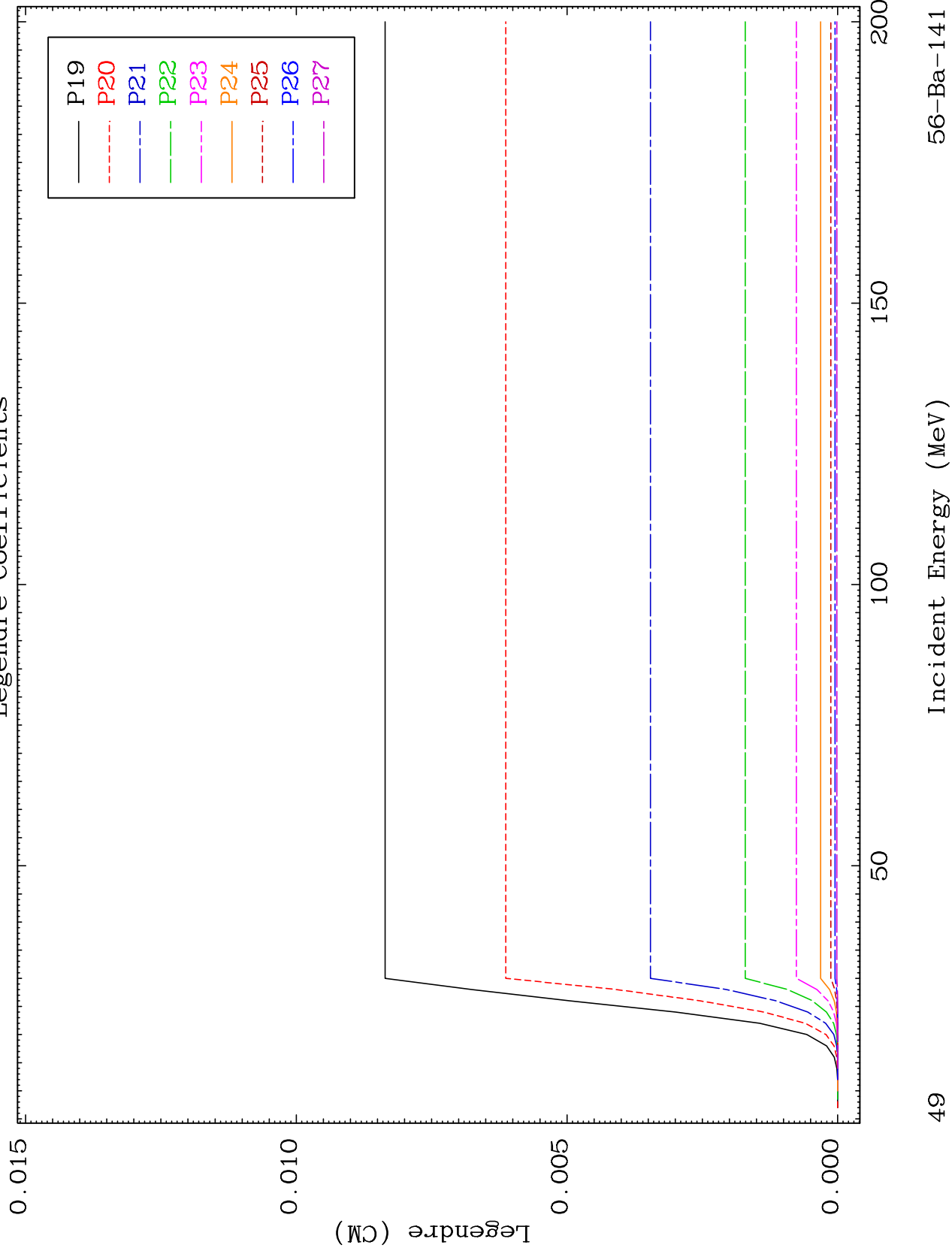

49

56-Ba-141

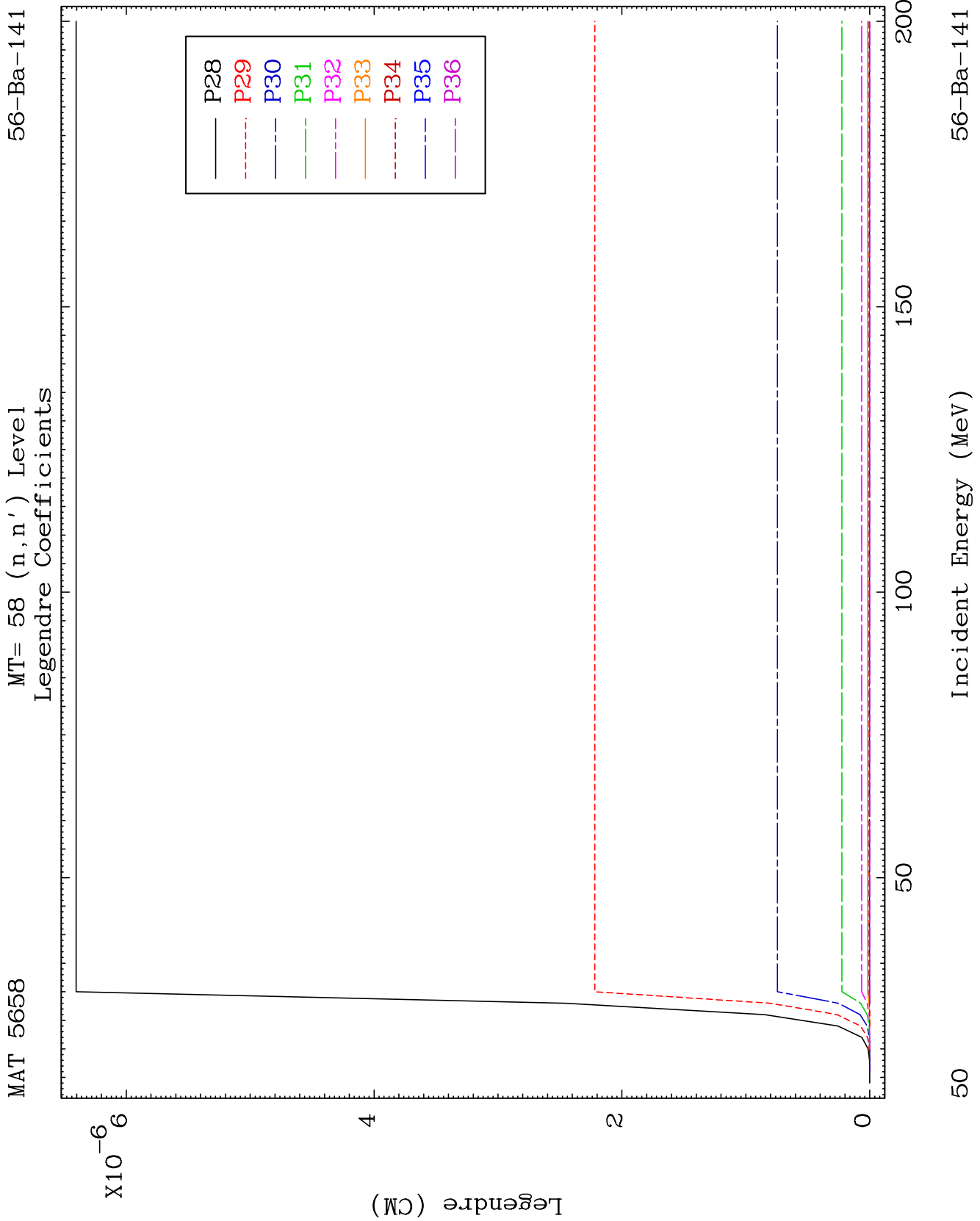

MAT 5658

MT= 59 (n,n') Level  
Legendre Coefficients

56-Ba-141

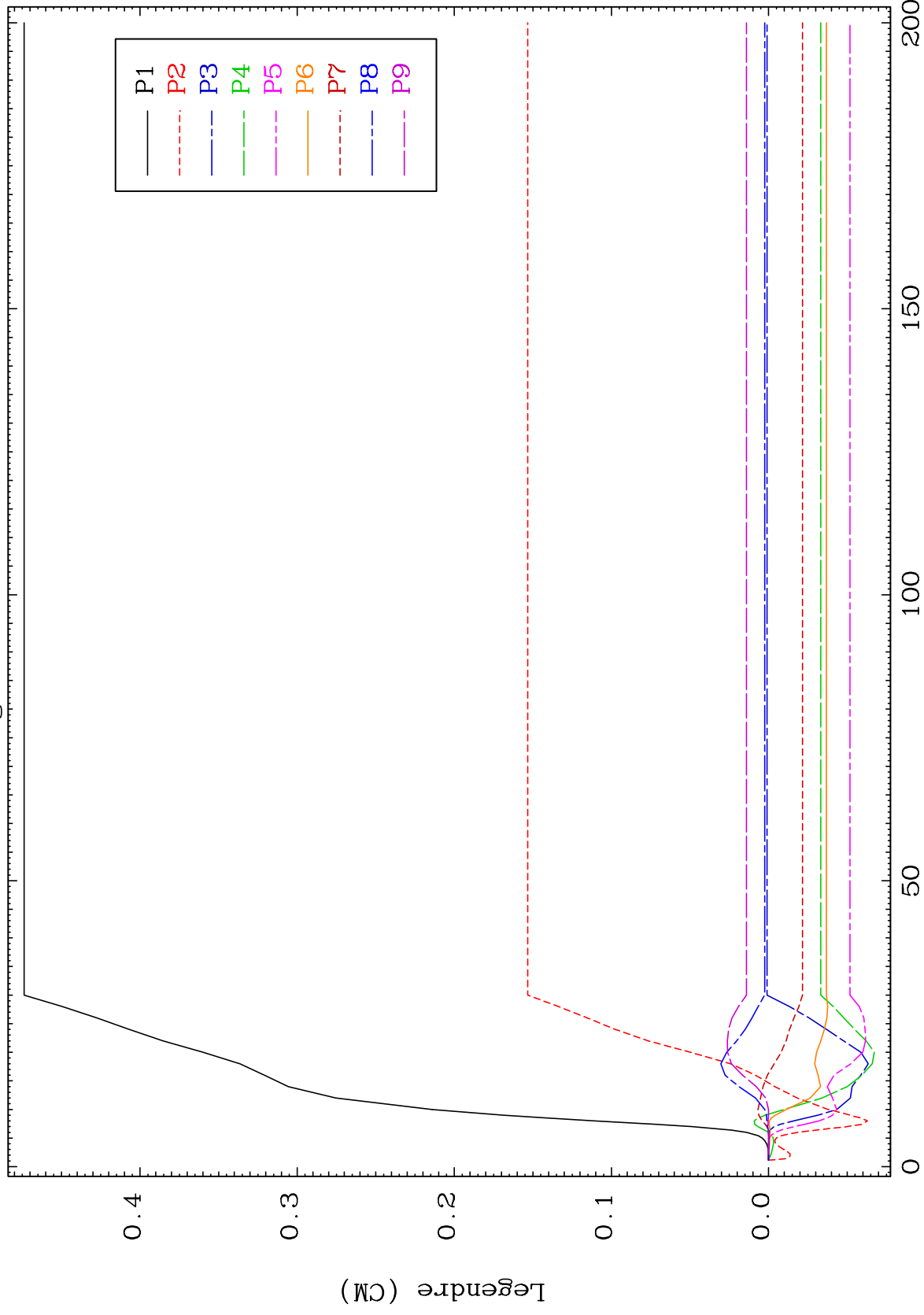

56-Ba-141

Incident Energy (MeV)

51

MAT 5658

MT= 59 (n,n') Level  
Legendre Coefficients

56-Ba-141

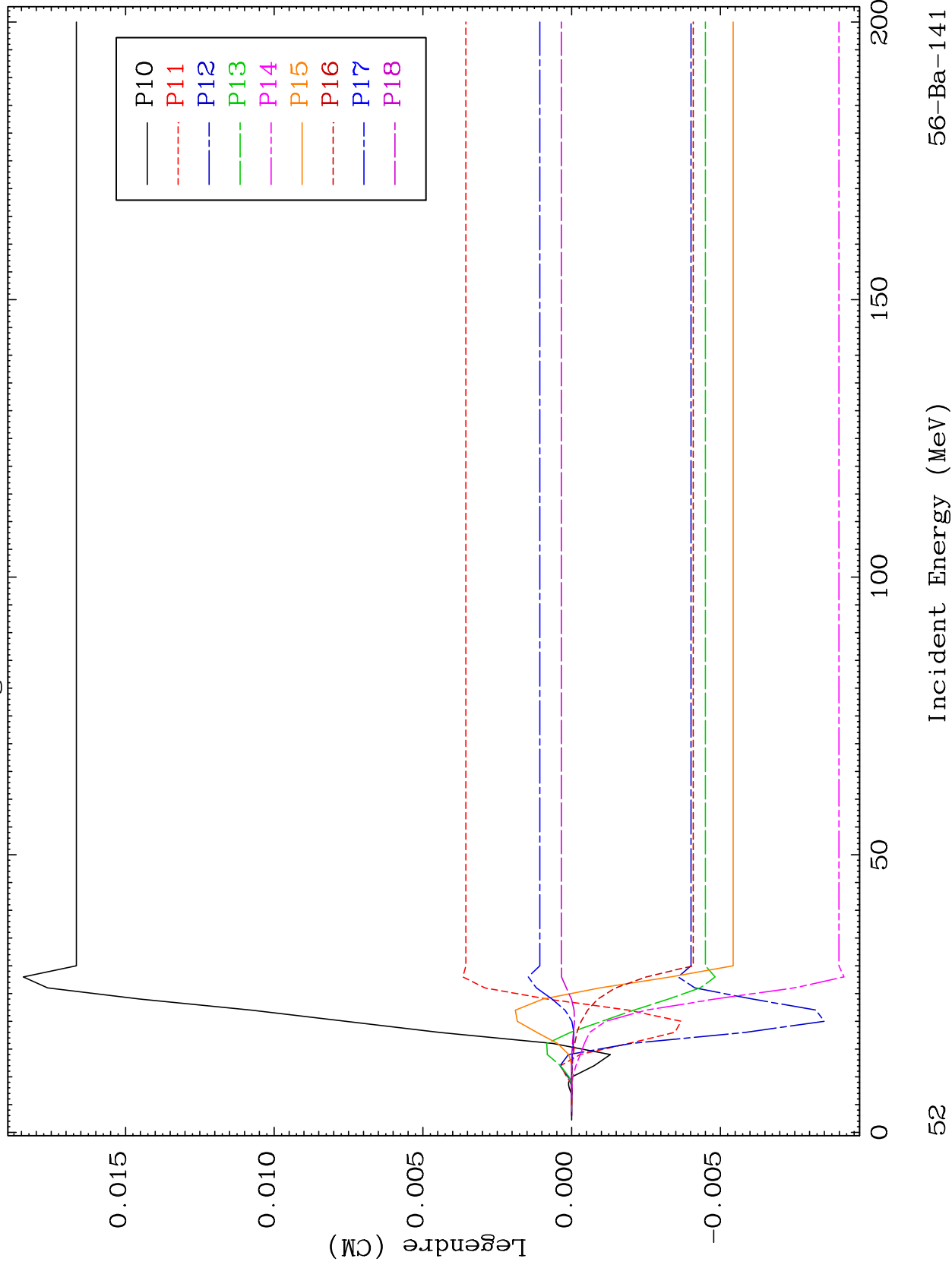

56-Ba-141

Incident Energy (MeV)

52

MAT 5658

MT= 59 (n,n') Level  
Legendre Coefficients

56-Ba-141

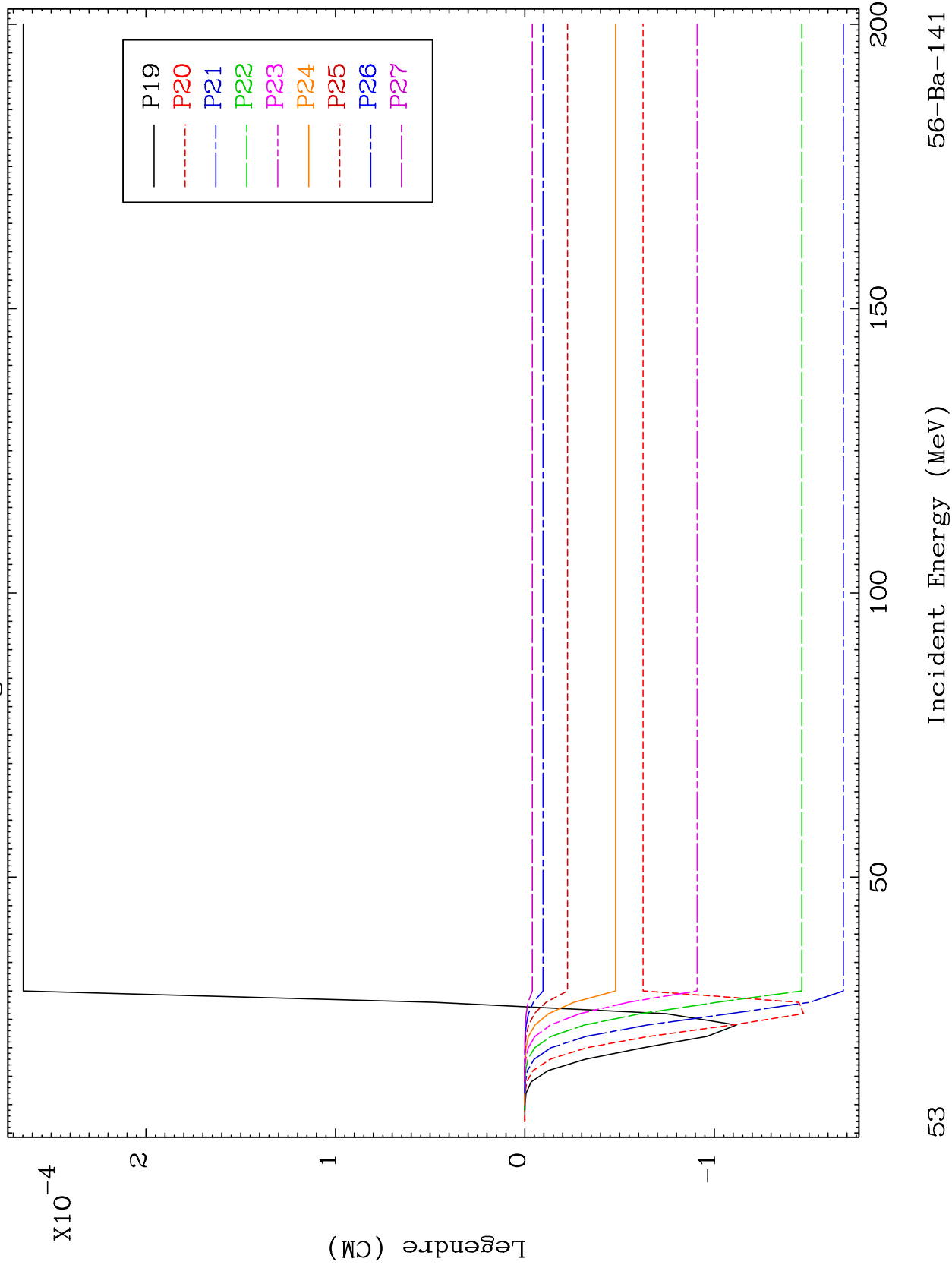

53

56-Ba-141







MAT 5658

MT= 60 (n,n') Level  
Legendre Coefficients

56-Ba-141

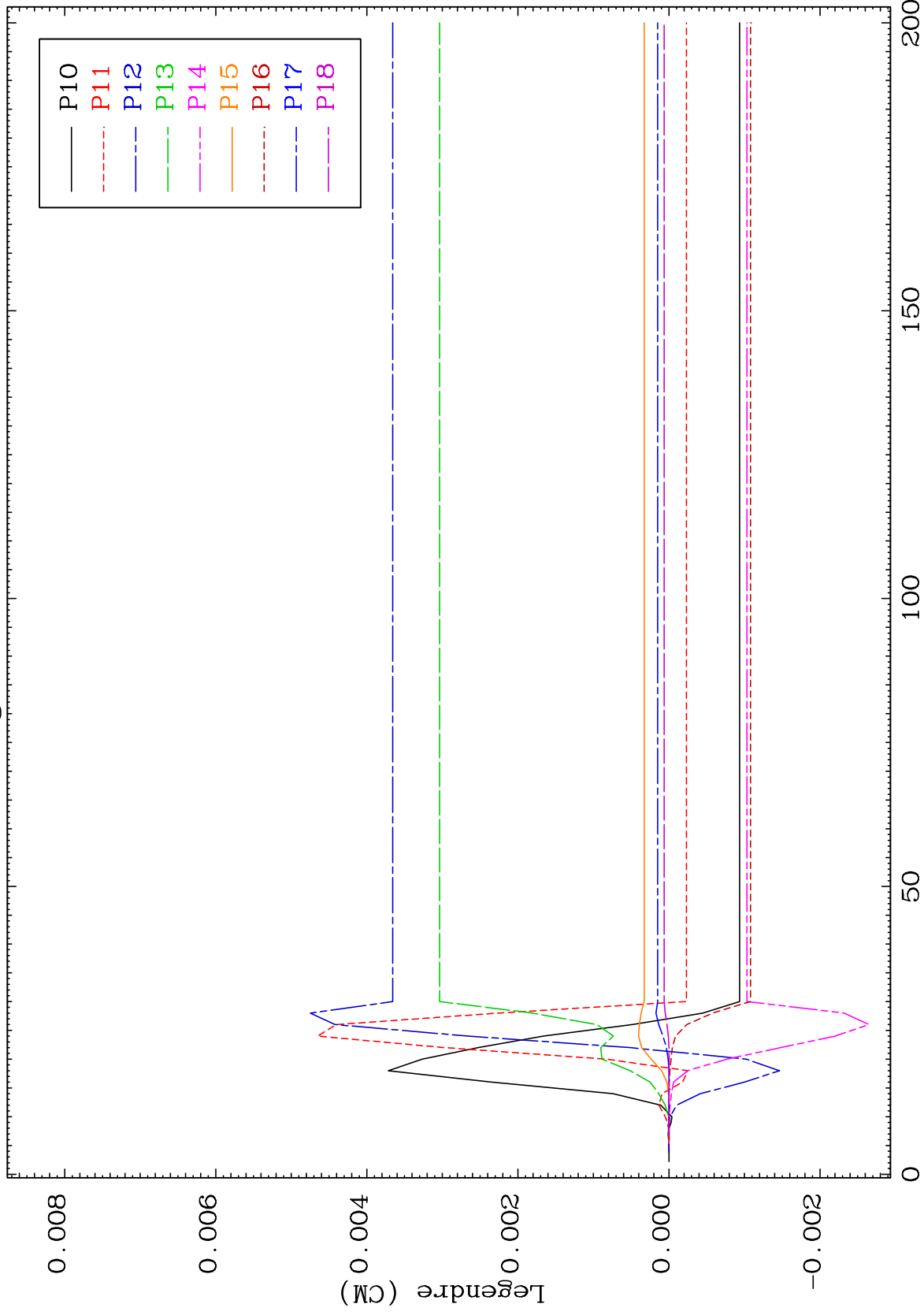

56

Incident Energy (MeV)

56-Ba-141

MAT 5658

MT= 60 (n,n') Level  
Legendre Coefficients

56-Ba-141

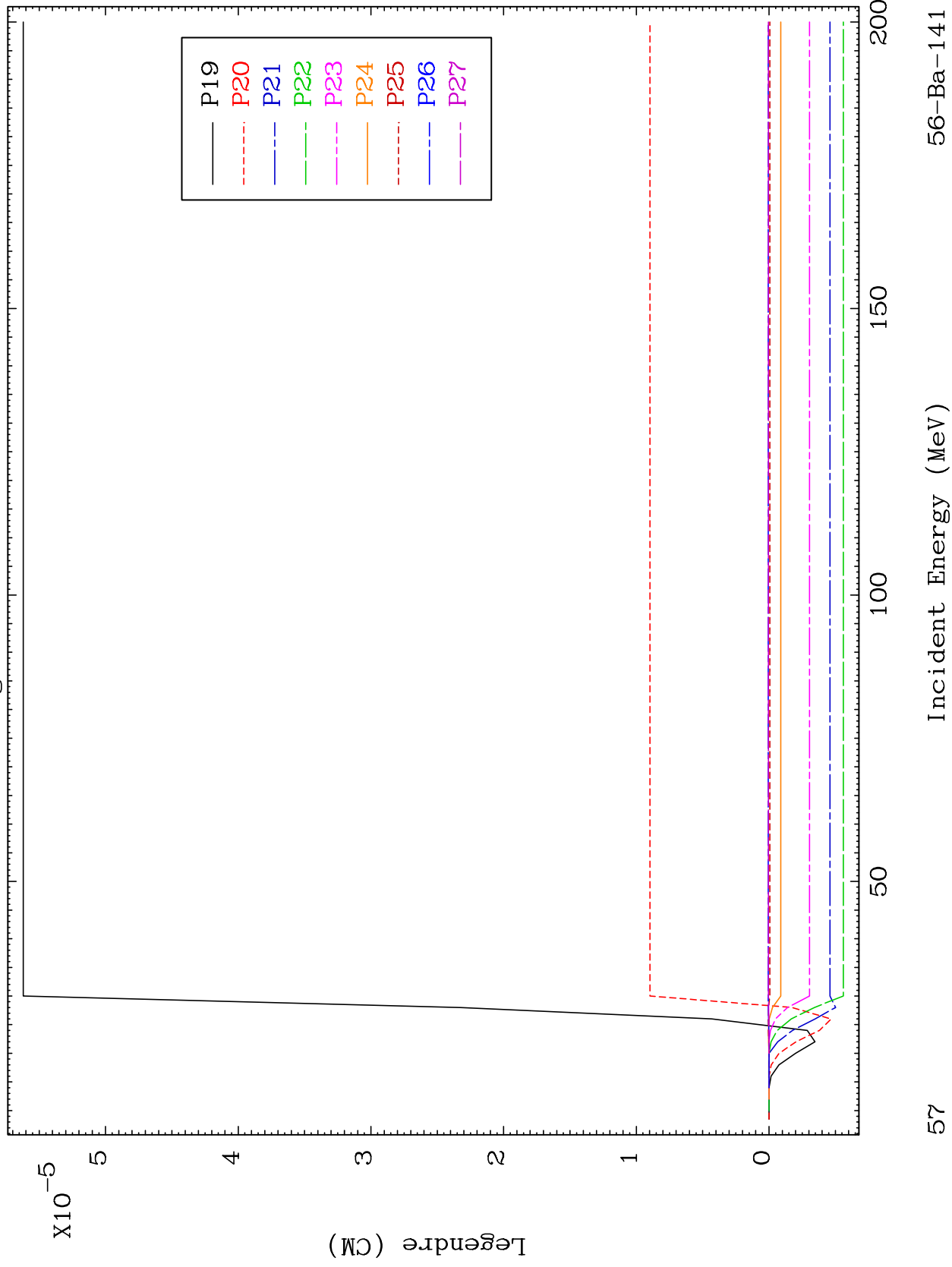

57

MAT 5658

MT= 60 (n,n') Level  
Legendre Coefficients

56-Ba-141

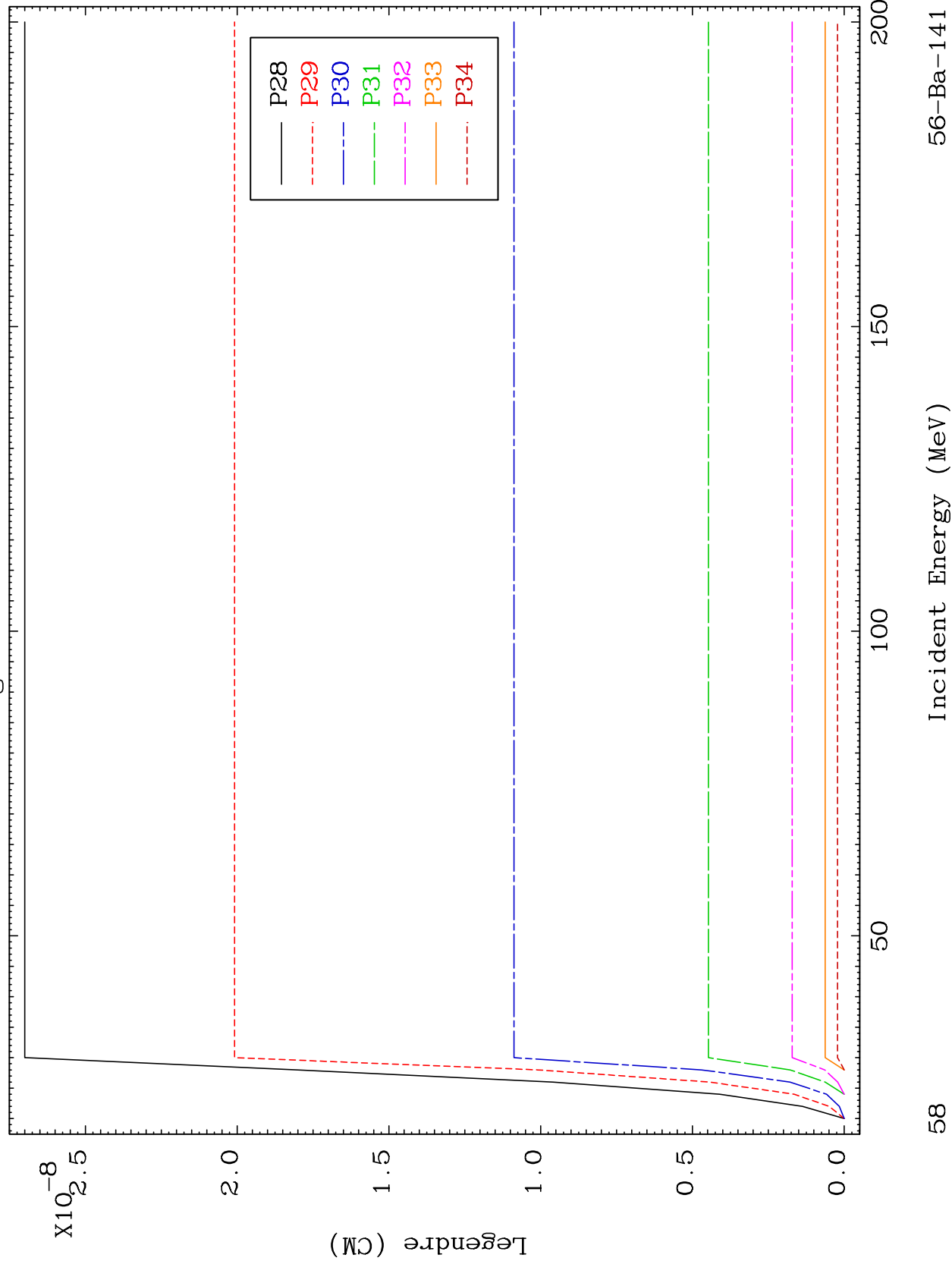

58

Incident Energy (MeV)

56-Ba-141

MAT 5658

MT= 61 (n,n') Level  
Legendre Coefficients

56-Ba-141

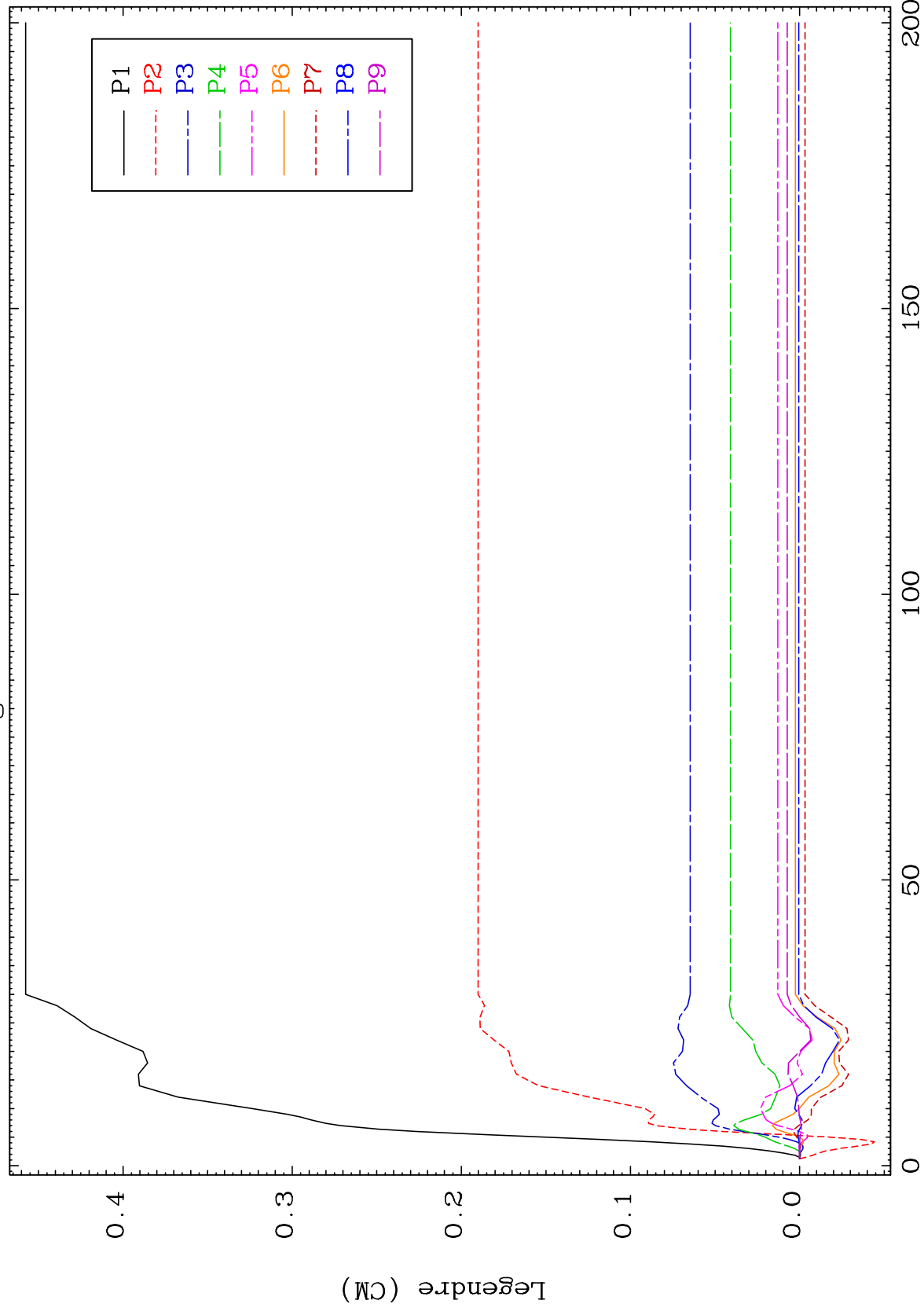

59

Incident Energy (MeV)

56-Ba-141

MAT 5658

MT= 61 (n,n') Level  
Legendre Coefficients

56-Ba-141

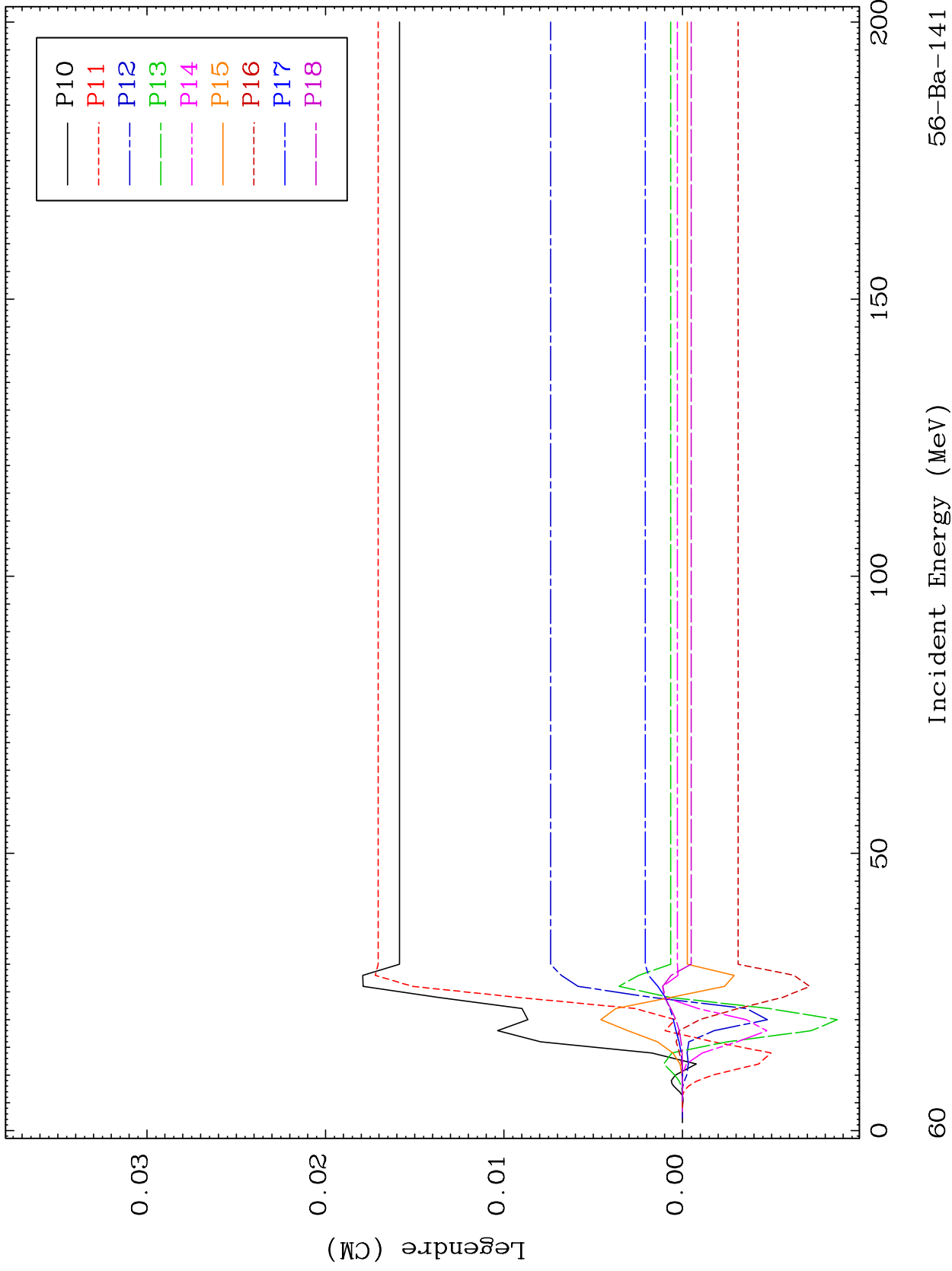

56-Ba-141

Incident Energy (MeV)

60

MAT 5658

MT= 61 (n,n') Level  
Legendre Coefficients

56-Ba-141

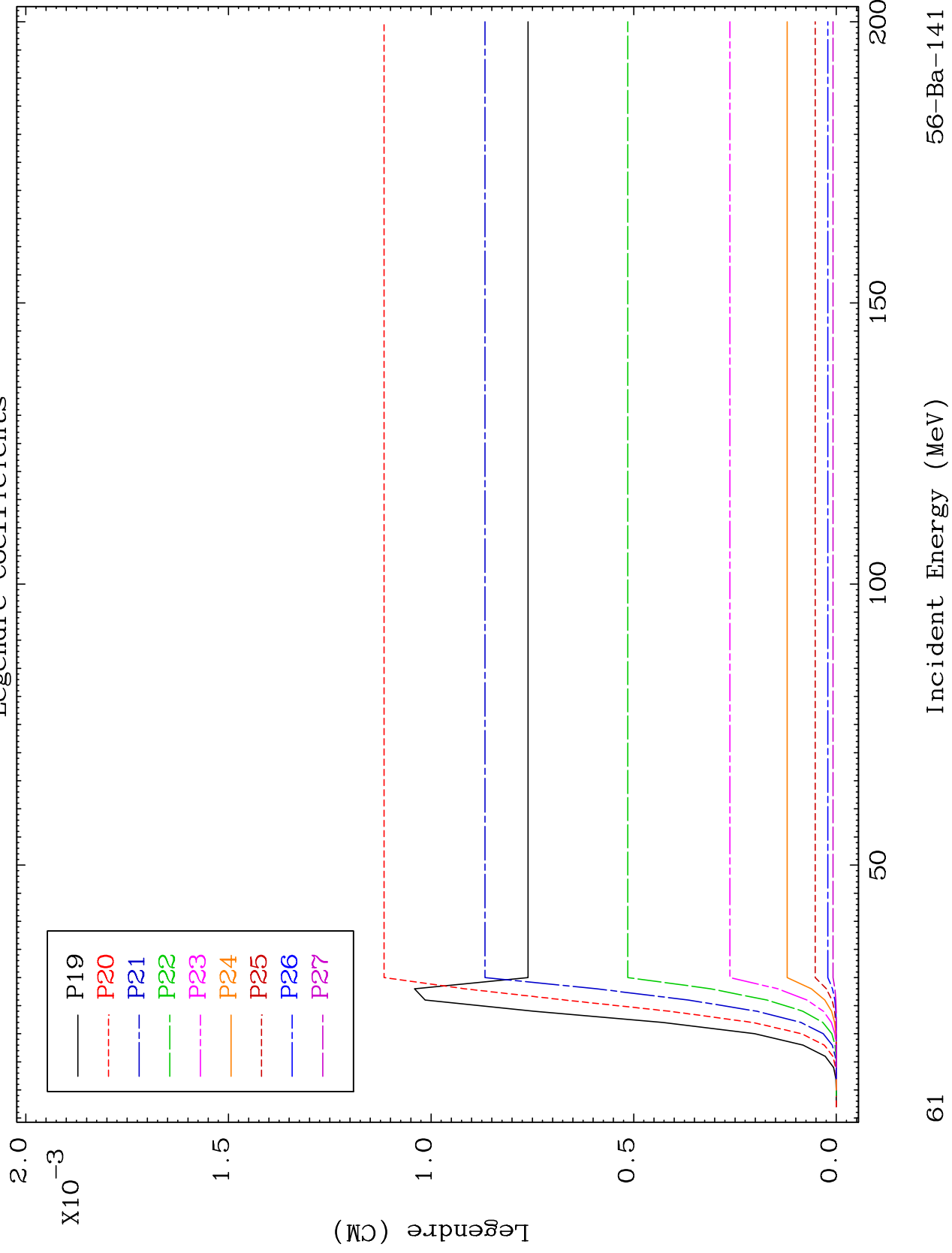

MAT 5658

MT= 61 (n,n') Level  
Legendre Coefficients

56-Ba-141

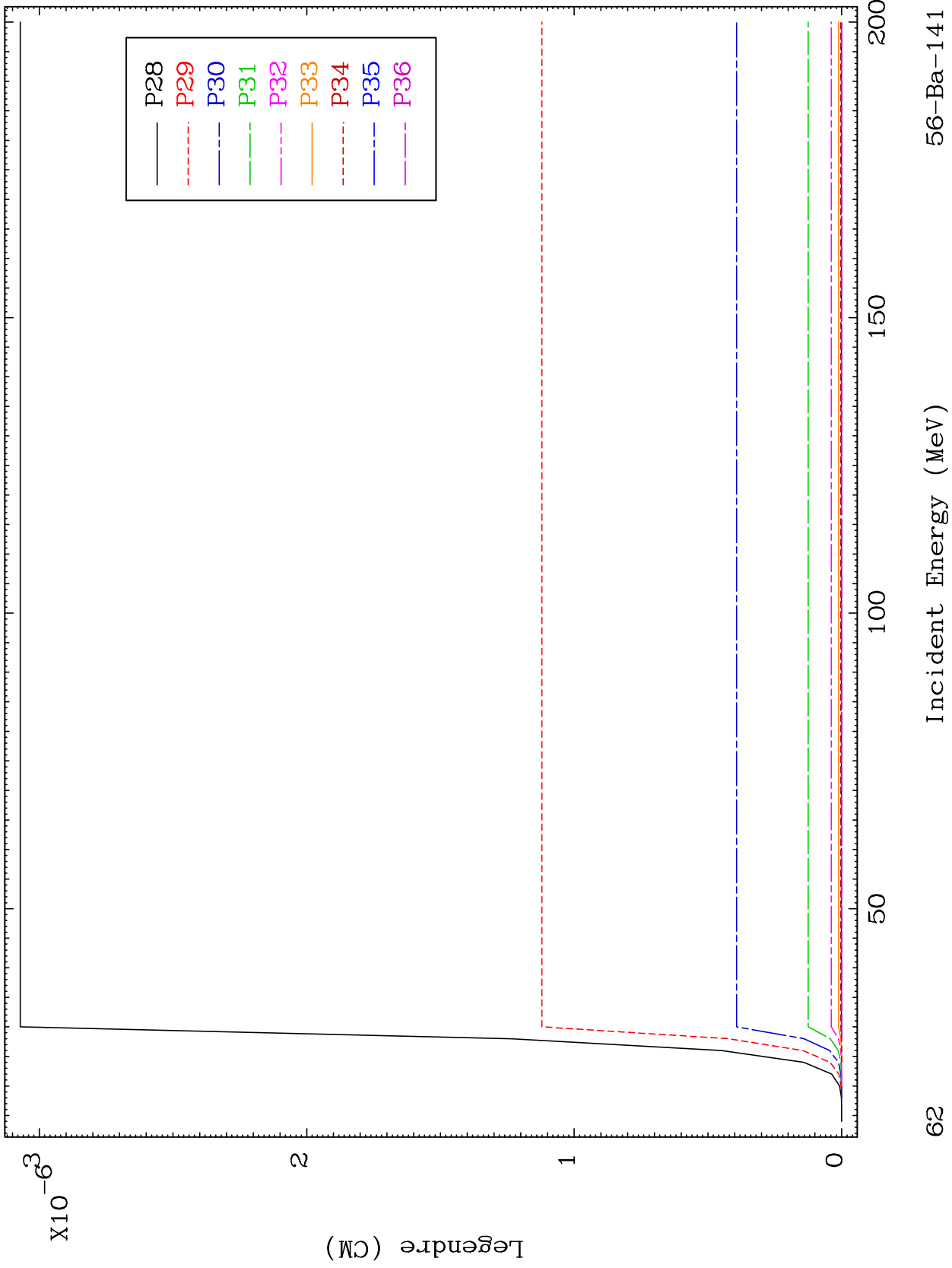

62

Incident Energy (MeV)

56-Ba-141

MAT 5658

MT= 62 (n,n') Level  
Legendre Coefficients

56-Ba-141

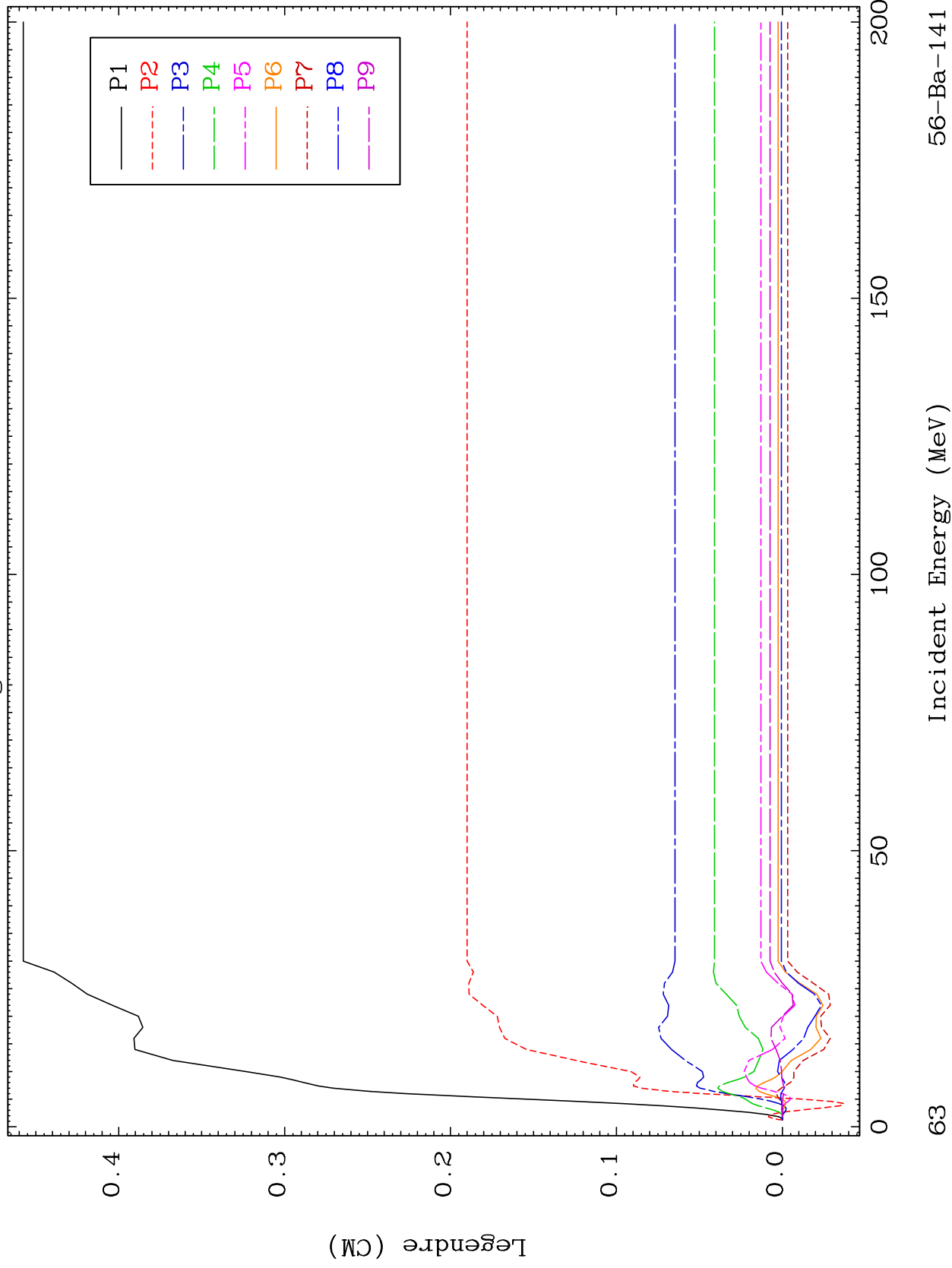

56-Ba-141

Incident Energy (MeV)

63



MAT 5658

MT= 62 (n,n') Level  
Legendre Coefficients

56-Ba-141

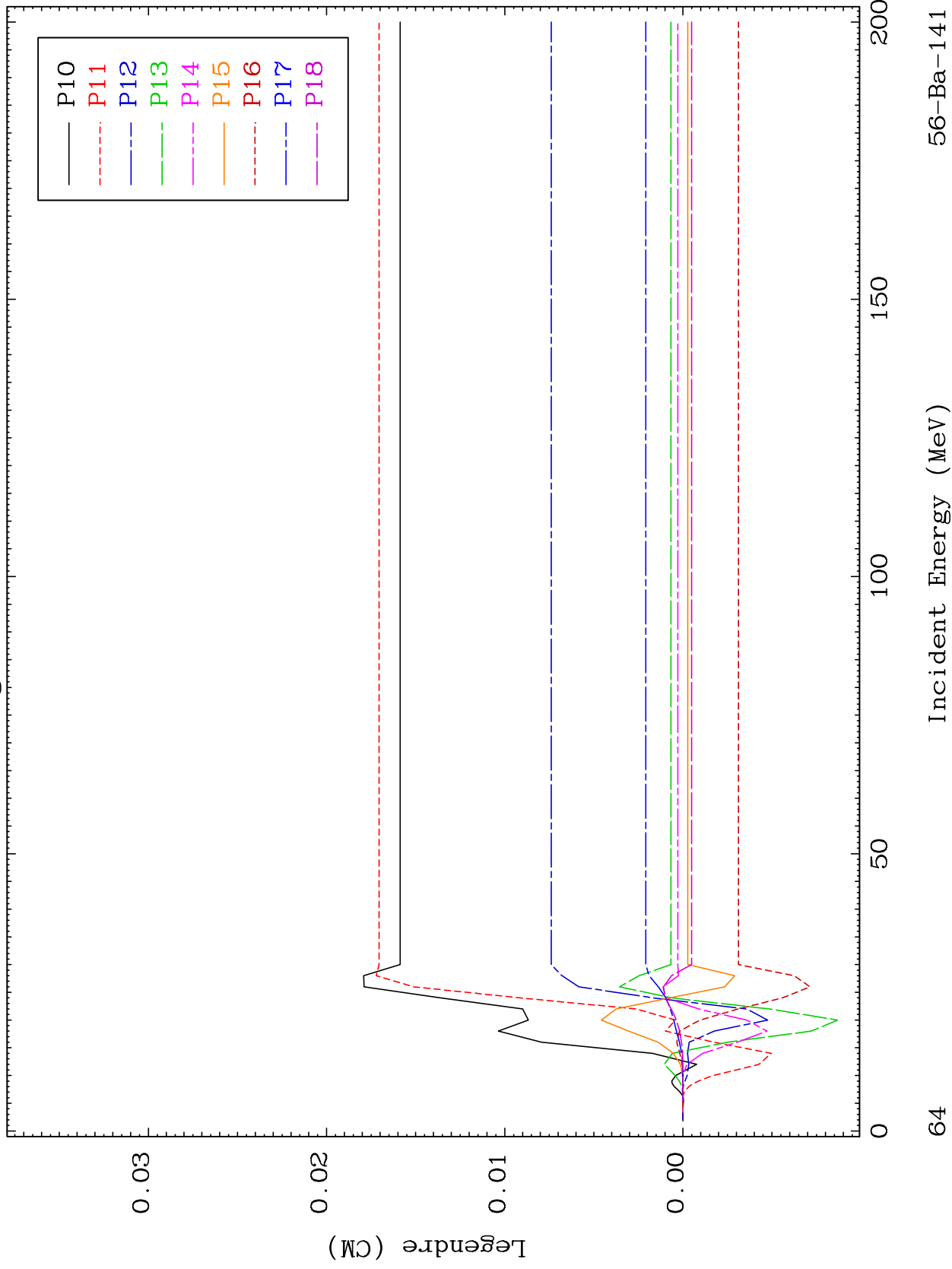

56-Ba-141

Incident Energy (MeV)

64

MAT 5658

MT= 62 (n,n') Level  
Legendre Coefficients

56-Ba-141

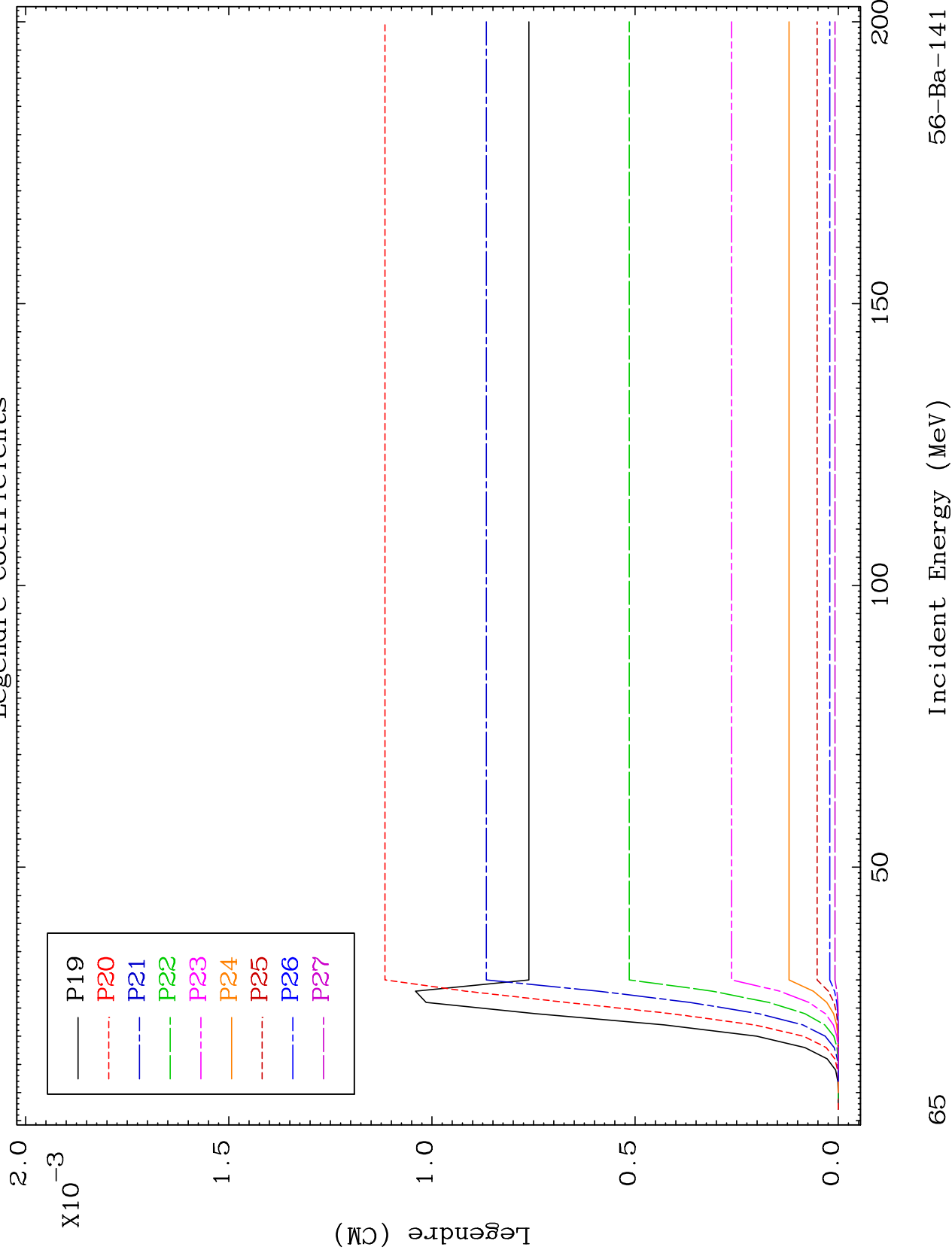

65

Incident Energy (MeV)

56-Ba-141

MAT 5658

MT= 62 (n,n') Level  
Legendre Coefficients

56-Ba-141

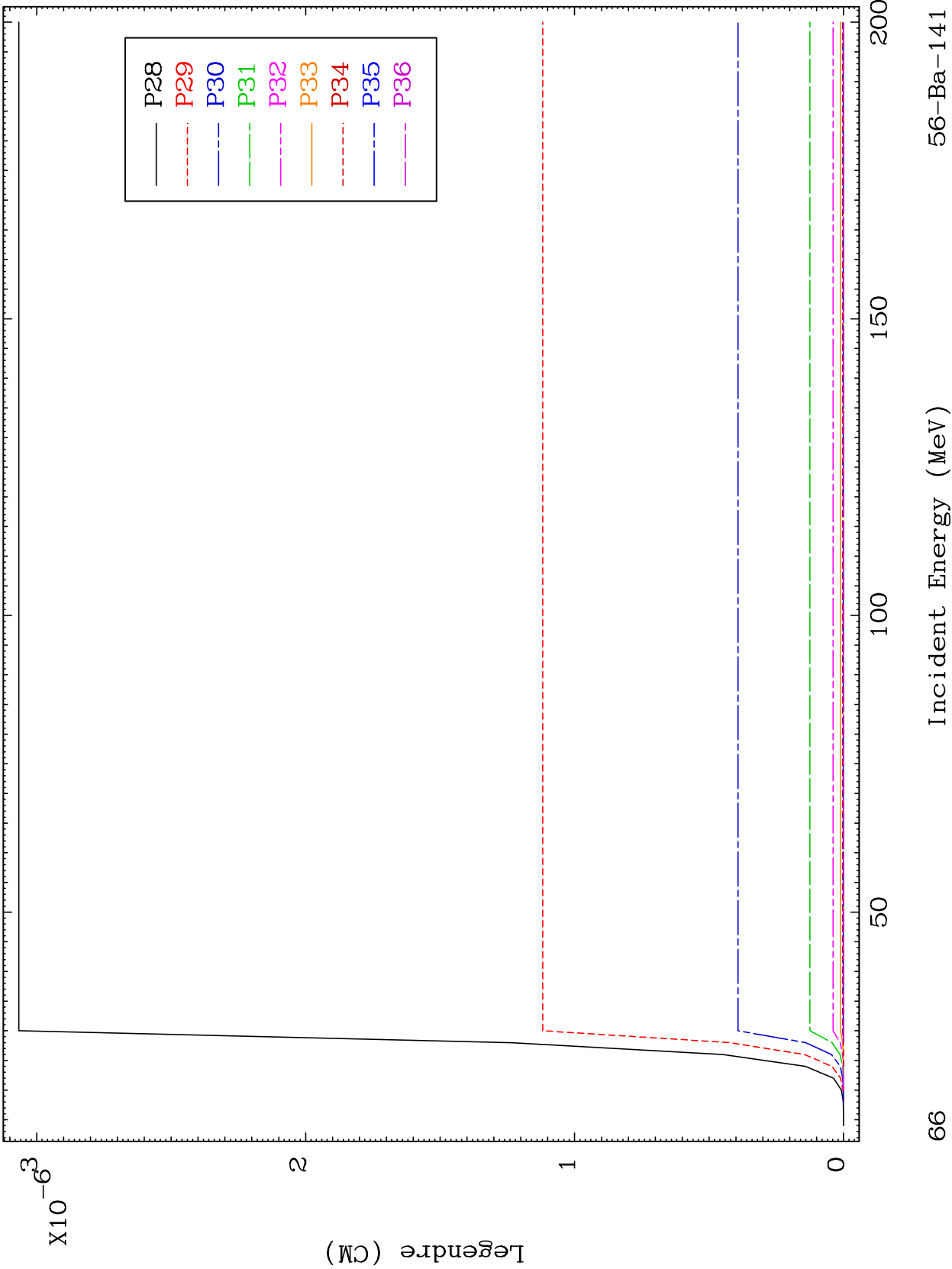

66

56-Ba-141



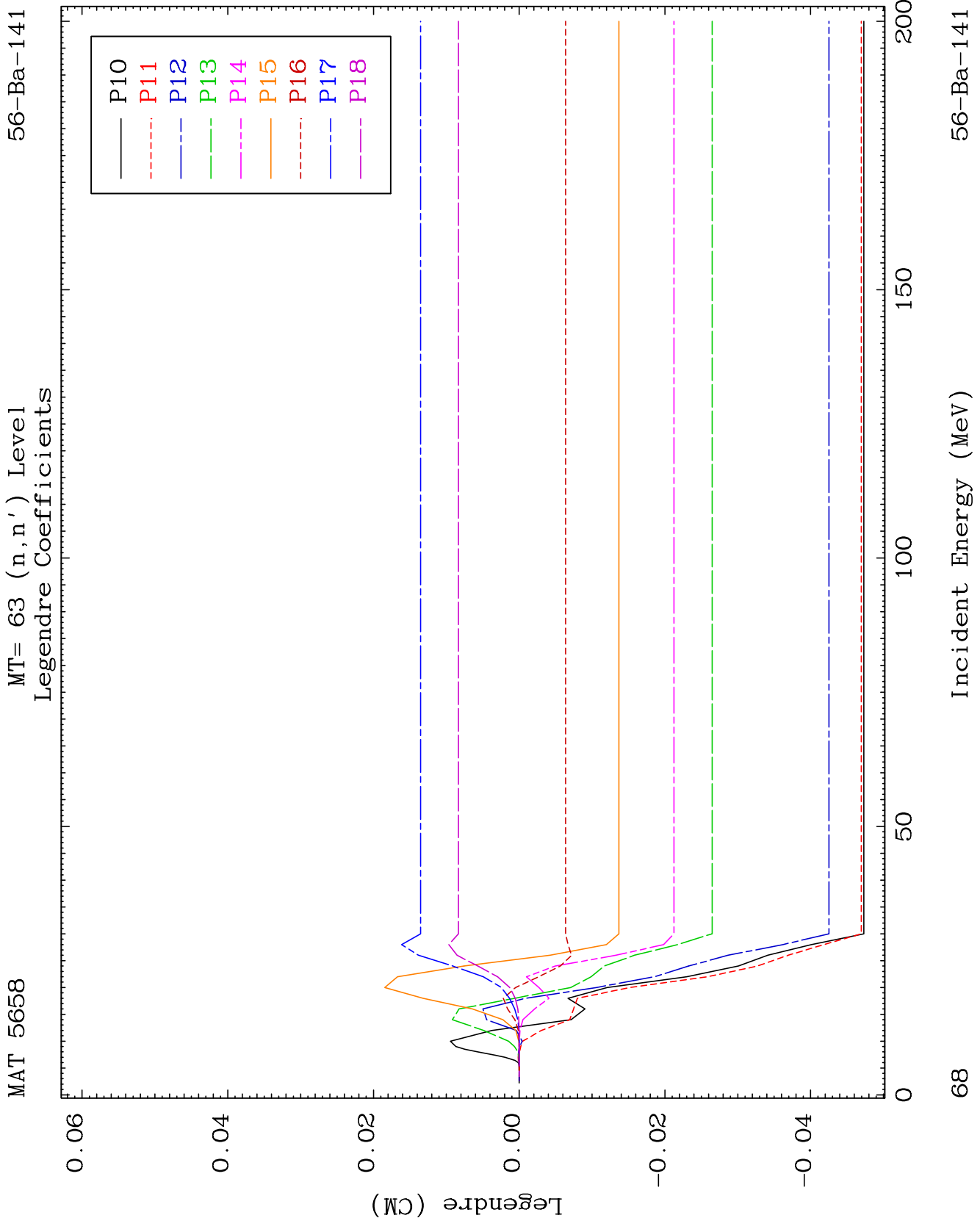

MAT 5658

MT= 63 (n,n') Level  
Legendre Coefficients

56-Ba-141

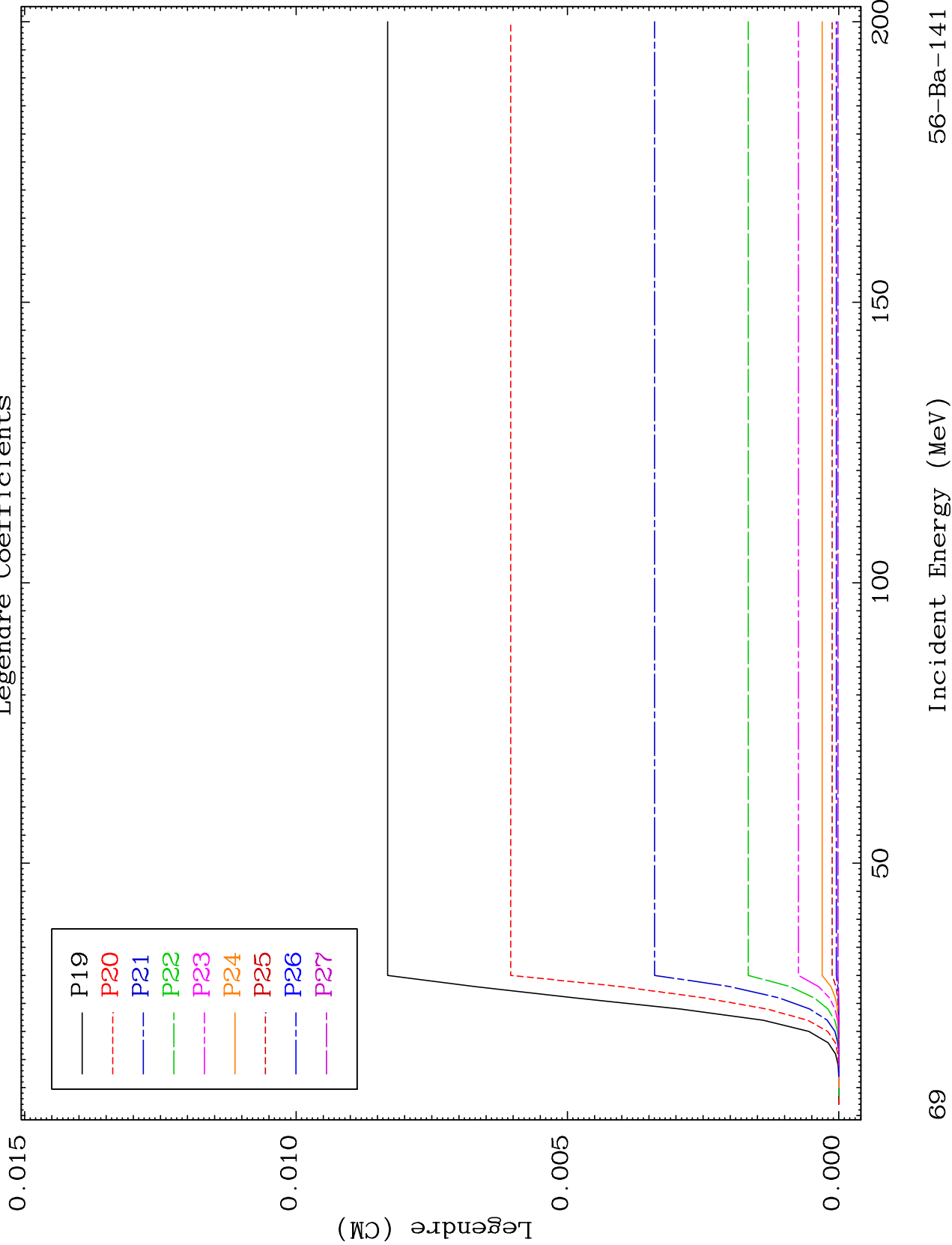

69

56-Ba-141

Incident Energy (MeV)

MAT 5658

MT= 63 (n,n') Level  
Legendre Coefficients

56-Ba-141

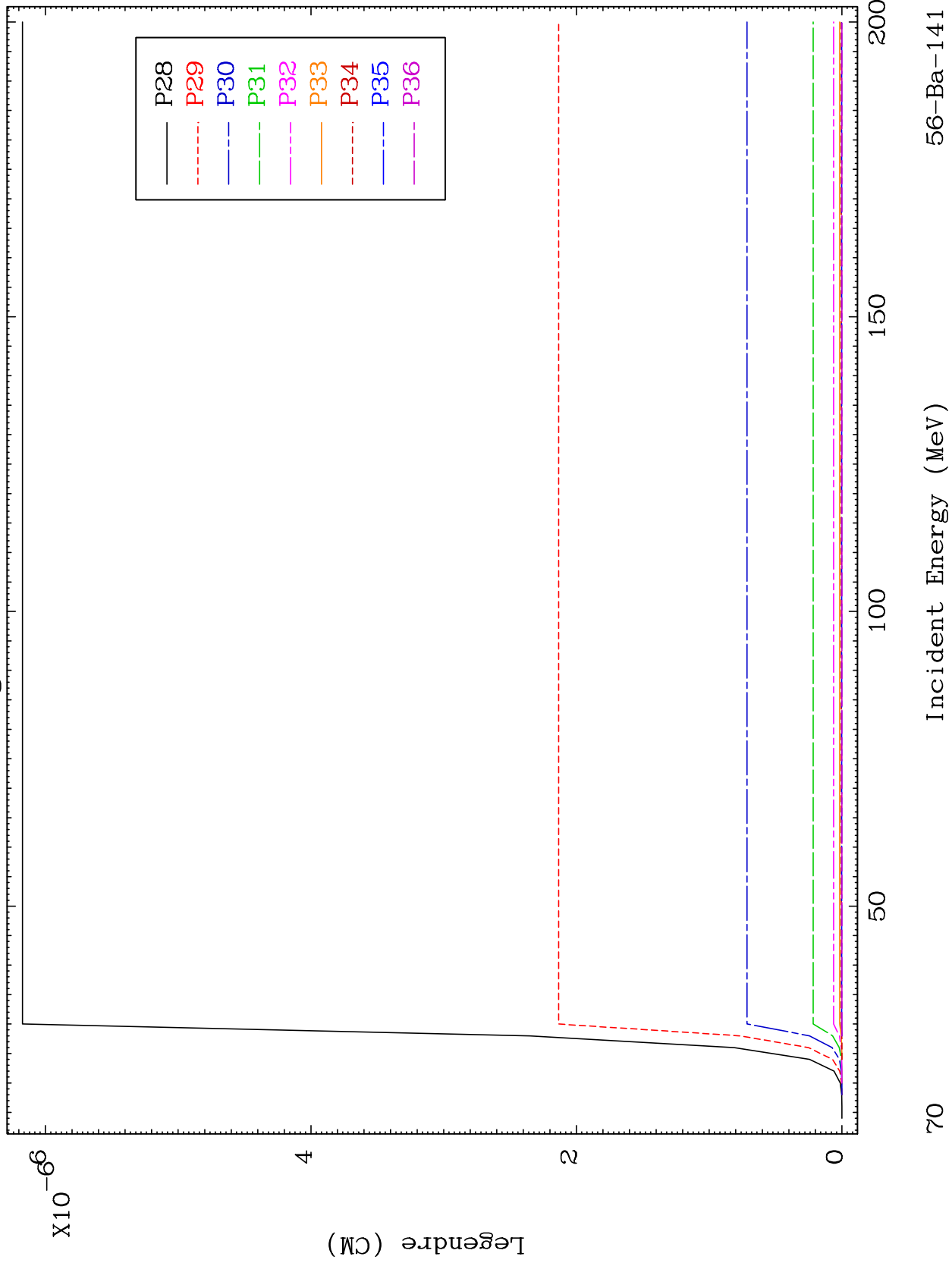

70

Incident Energy (MeV)

56-Ba-141





MAT 5658

MT= 64 (n,n') Level  
Legendre Coefficients

56-Ba-141

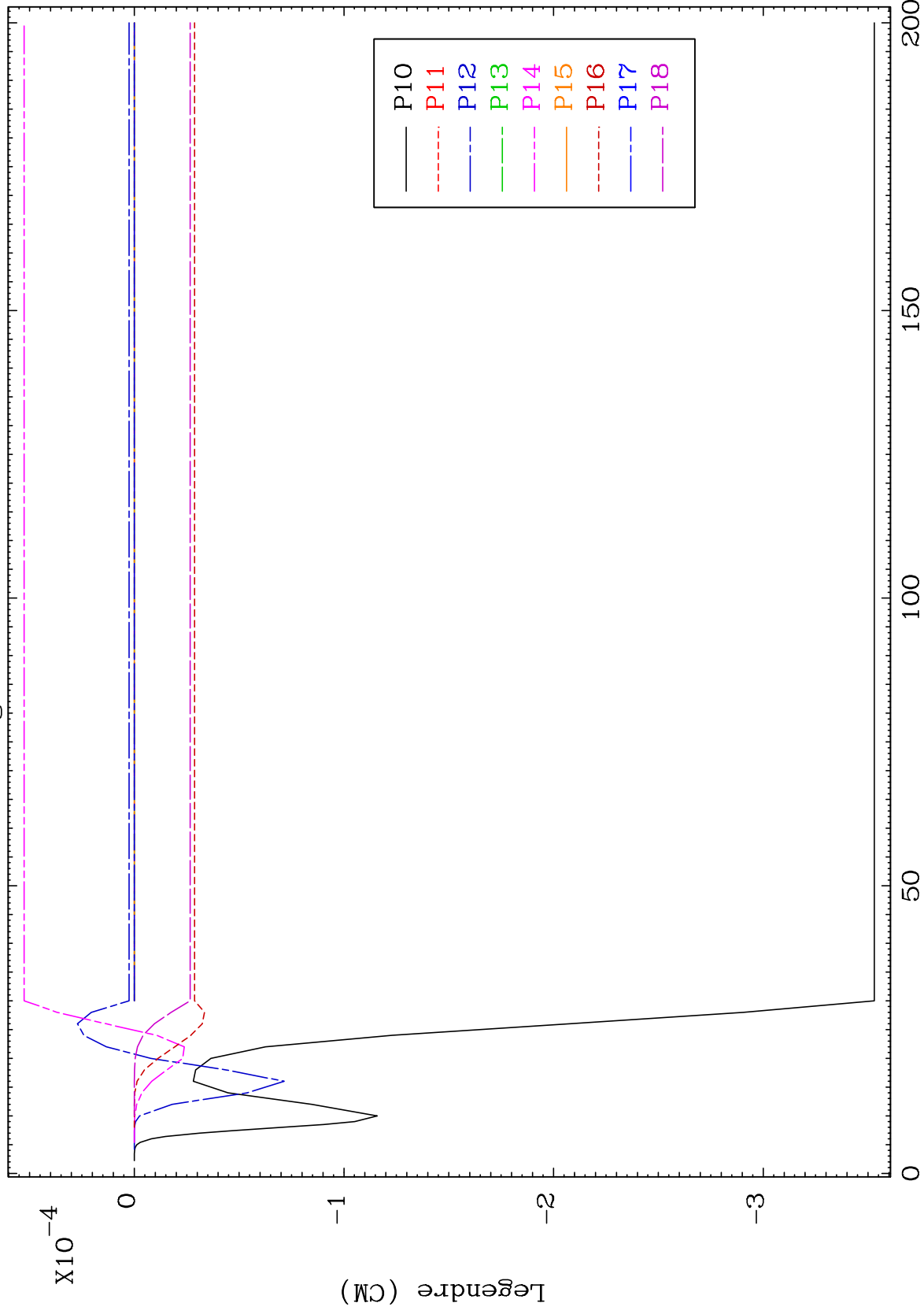

72

Incident Energy (MeV)

56-Ba-141

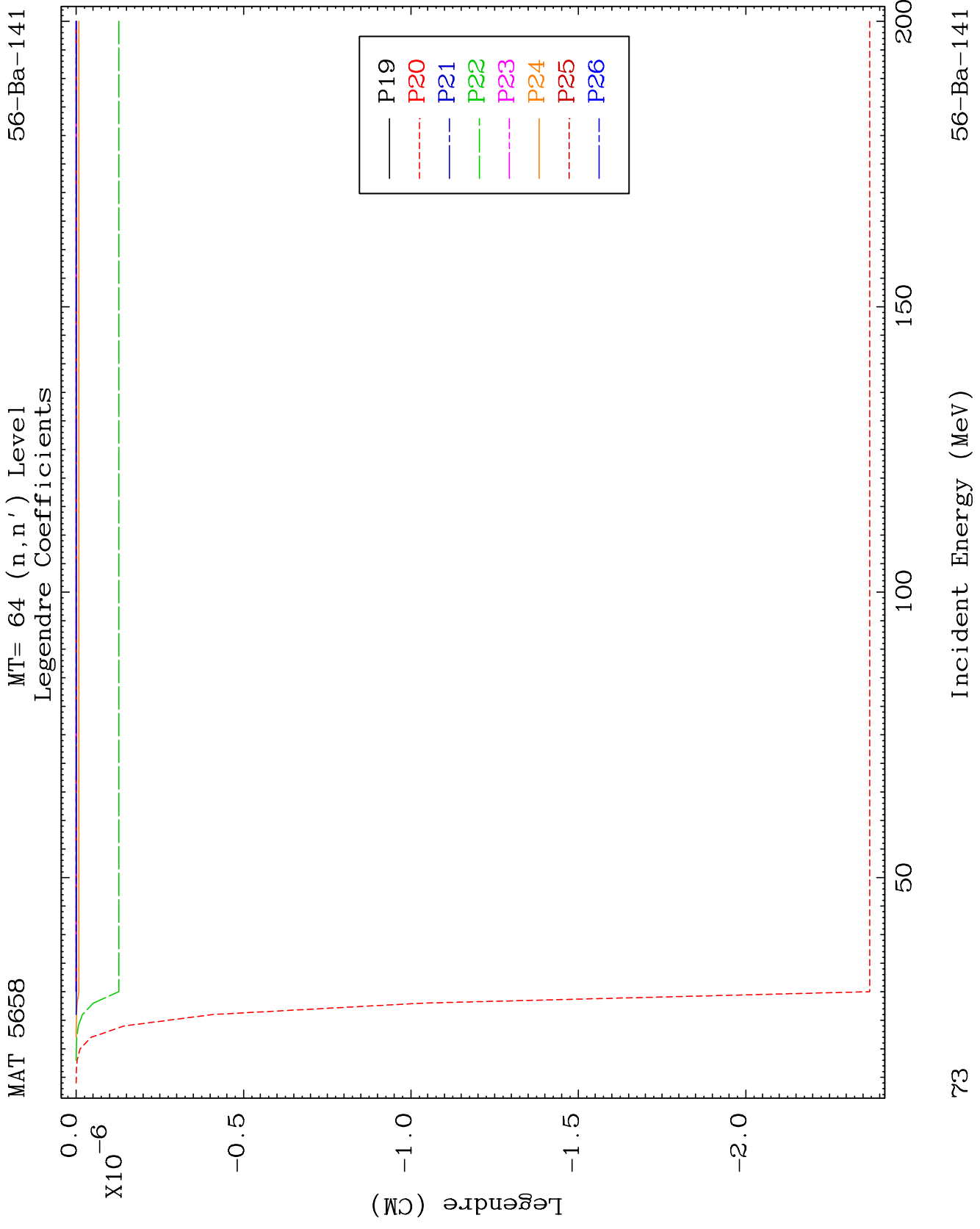

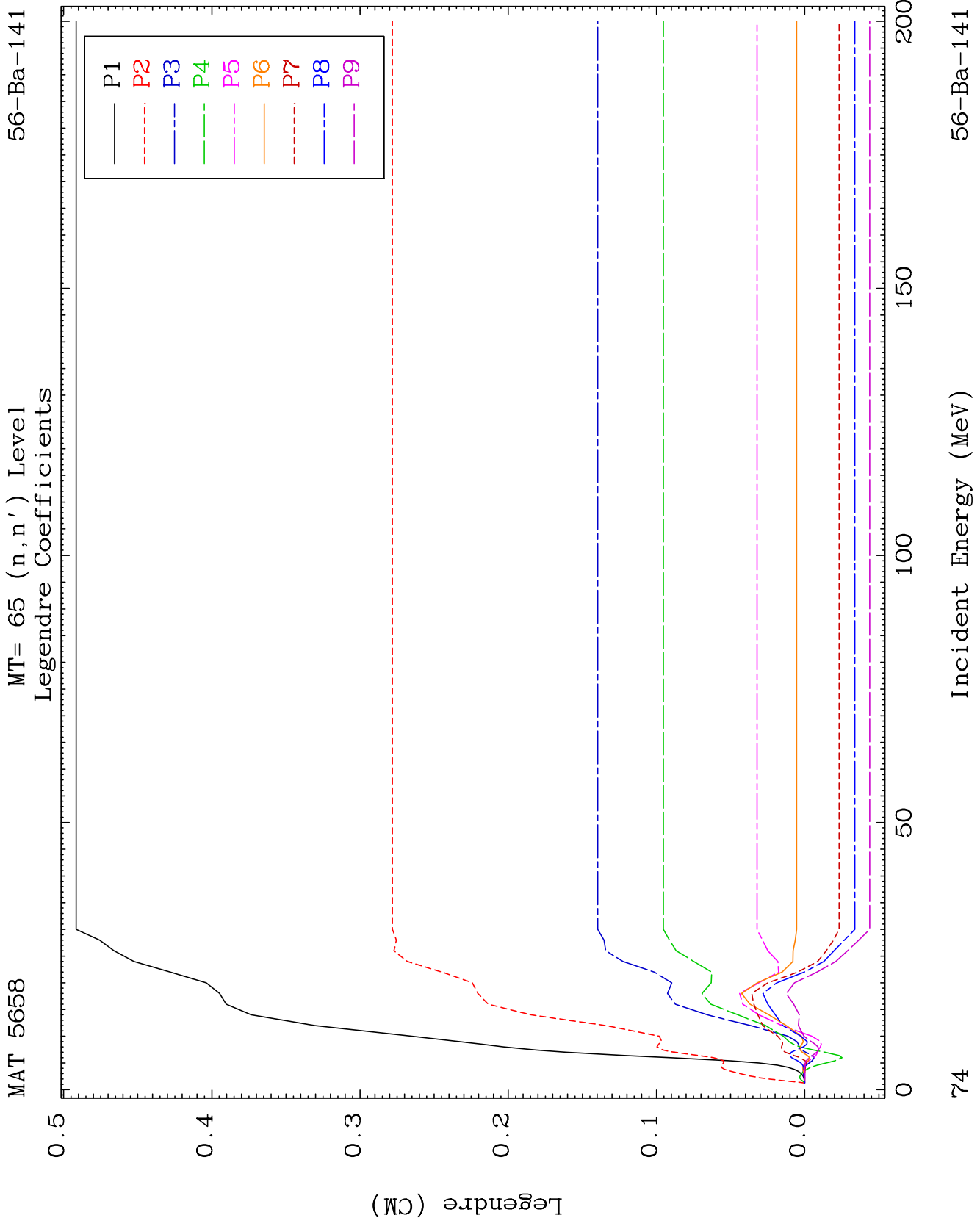

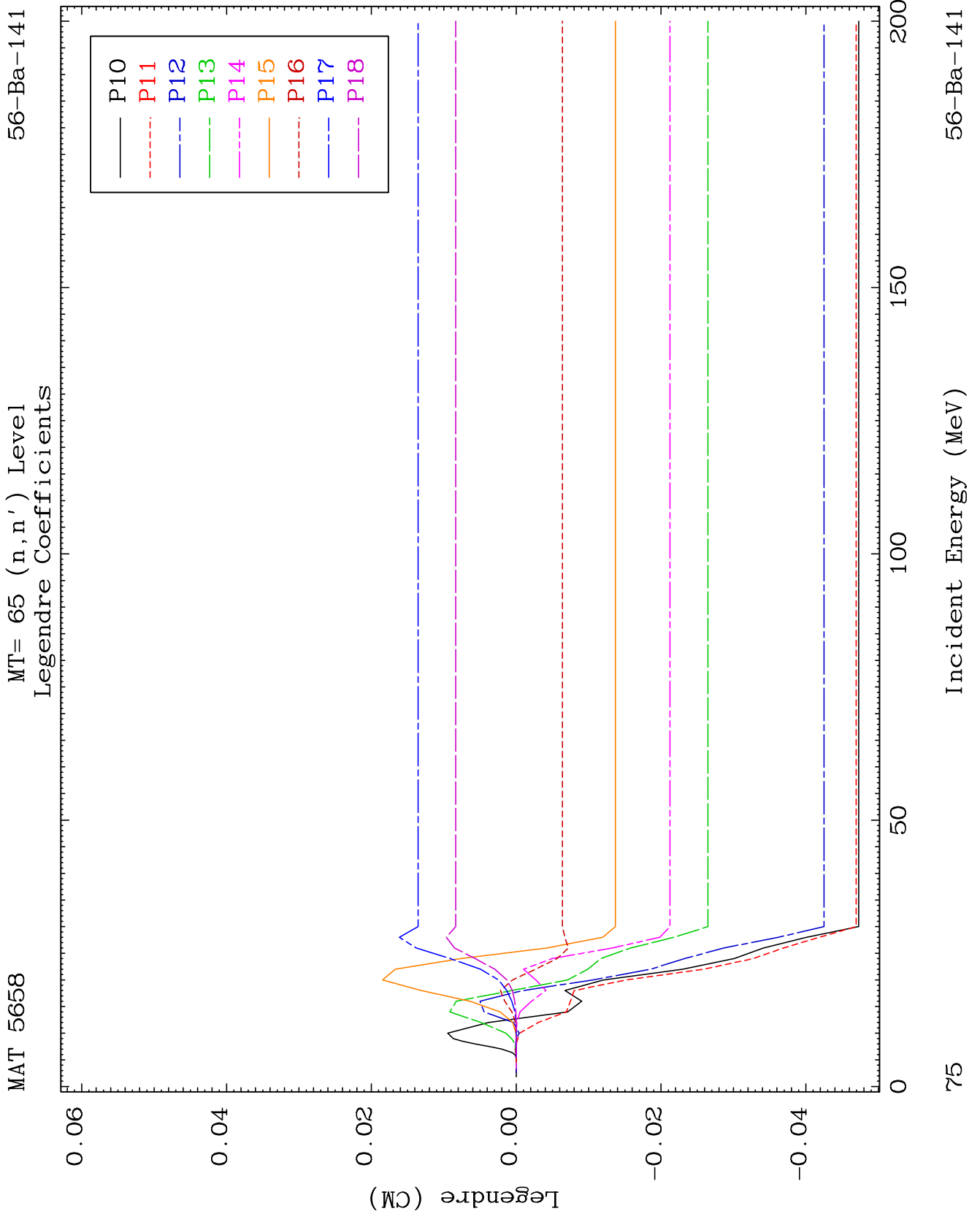

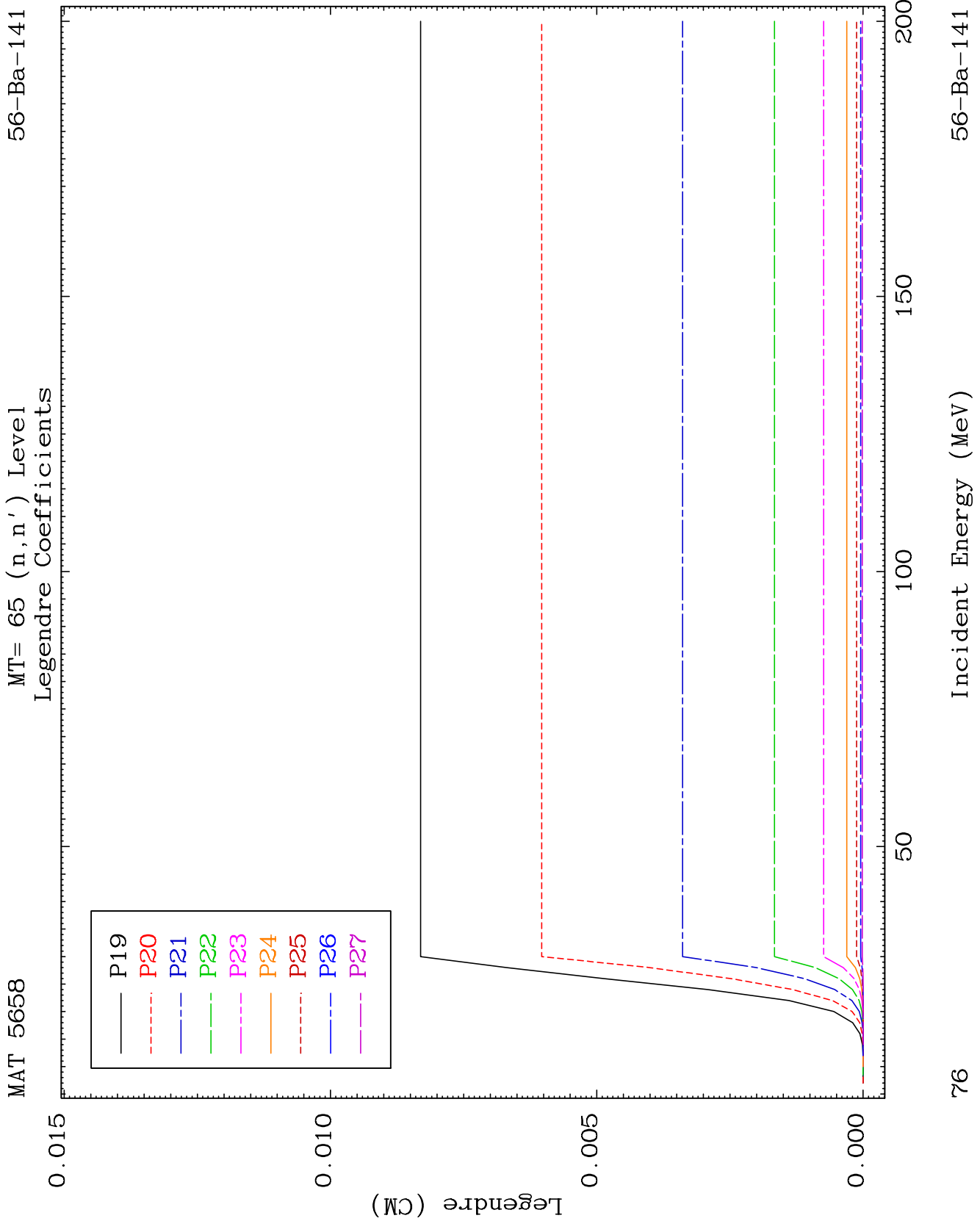

MAT 5658

MT= 65 (n,n') Level  
Legendre Coefficients

56-Ba-141

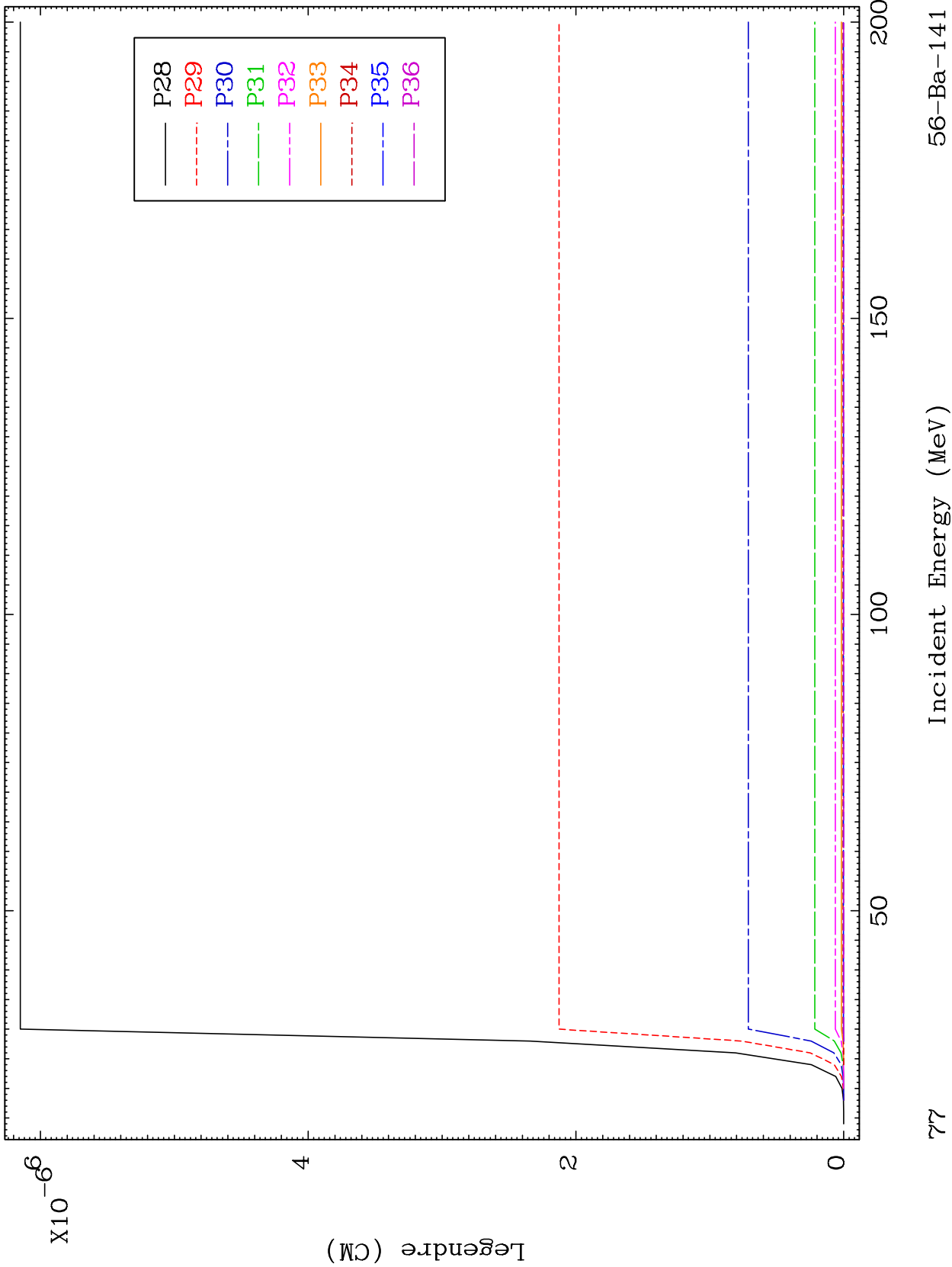

77

56-Ba-141

MAT 5658

MT= 66 (n,n') Level  
Legendre Coefficients

56-Ba-141

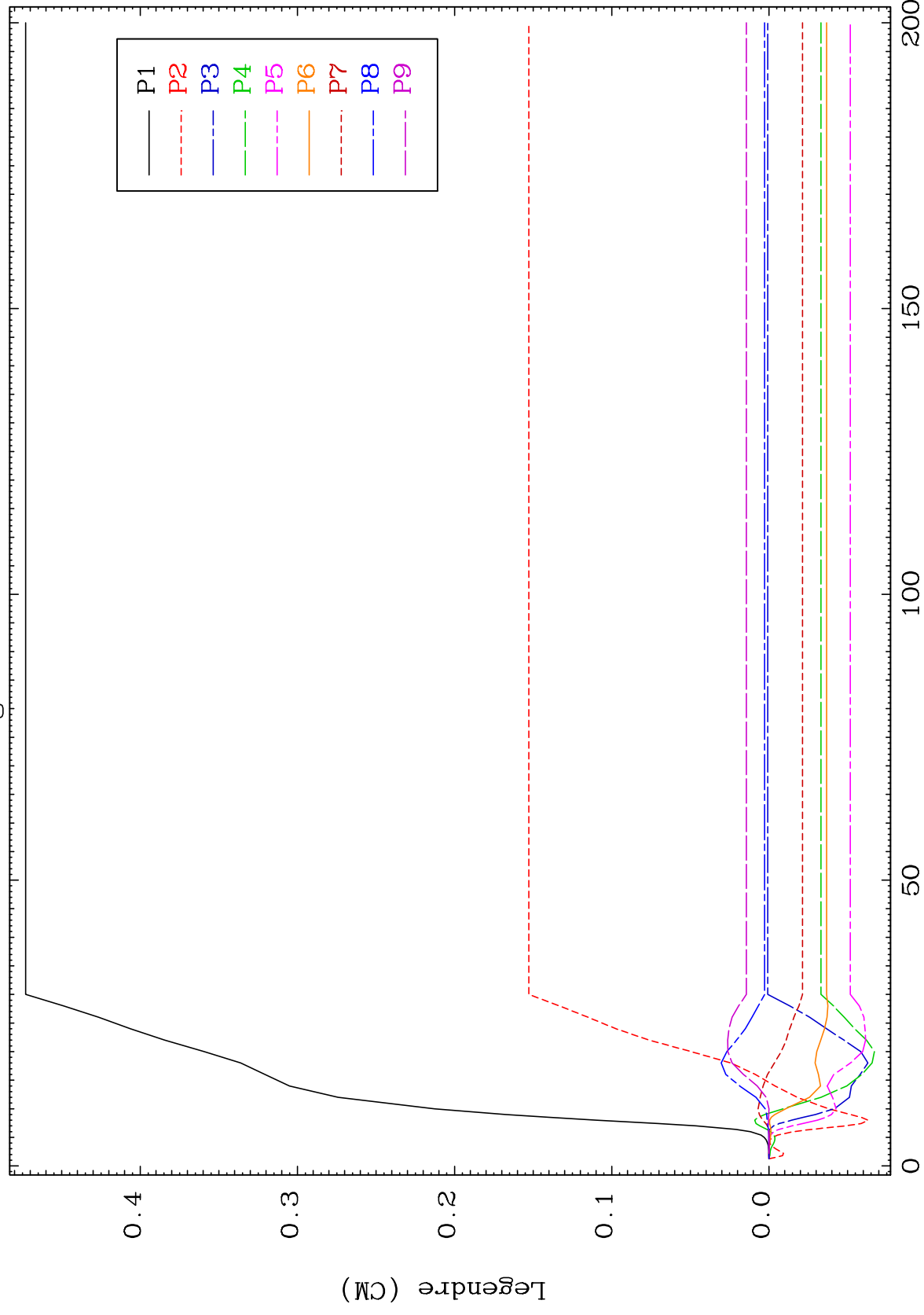

56-Ba-141

Incident Energy (MeV)

78

MAT 5658

MT= 66 (n,n') Level  
Legendre Coefficients

56-Ba-141

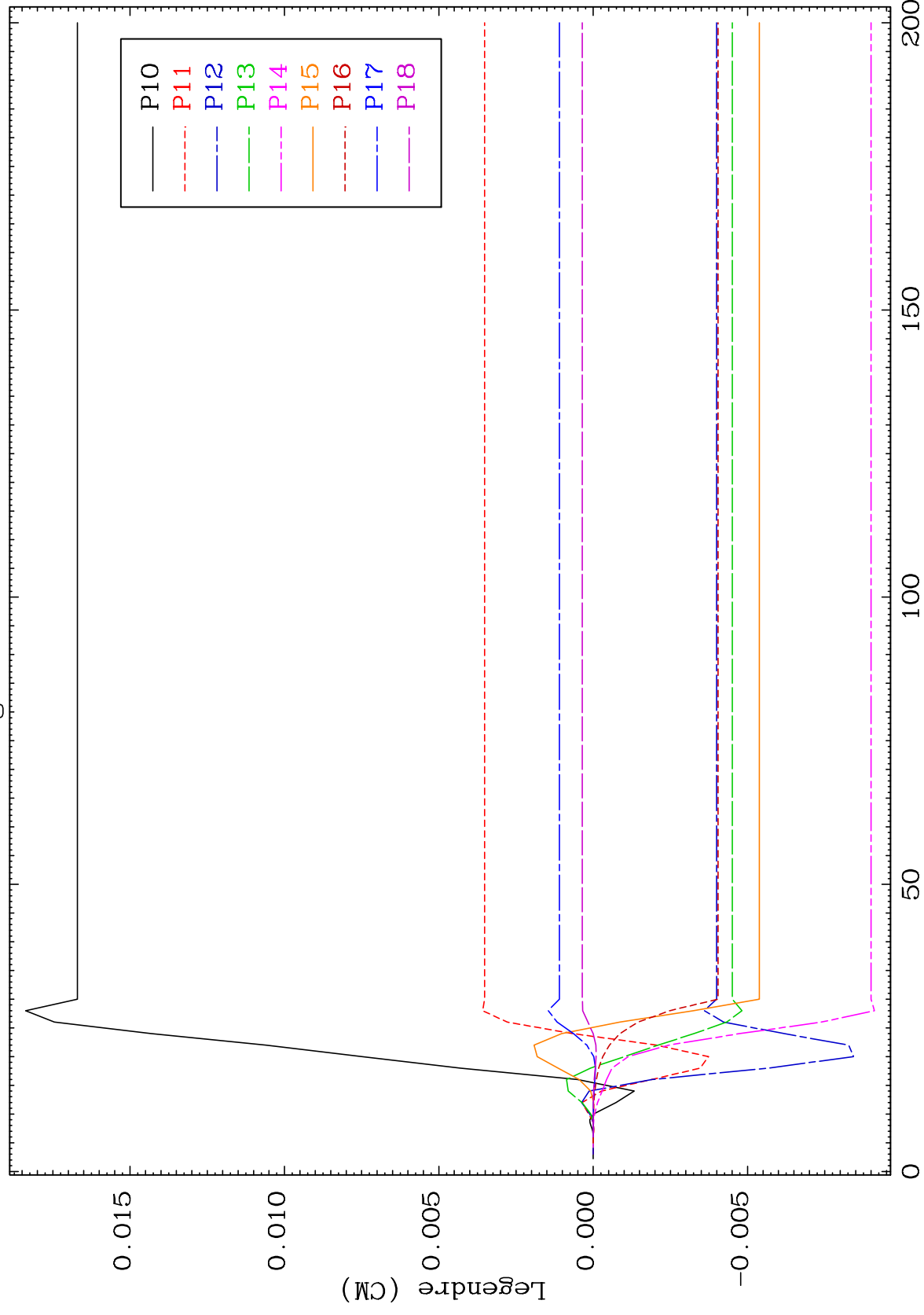

79

Incident Energy (MeV)

56-Ba-141



MAT 5658

MT= 66 (n,n') Level  
Legendre Coefficients

56-Ba-141

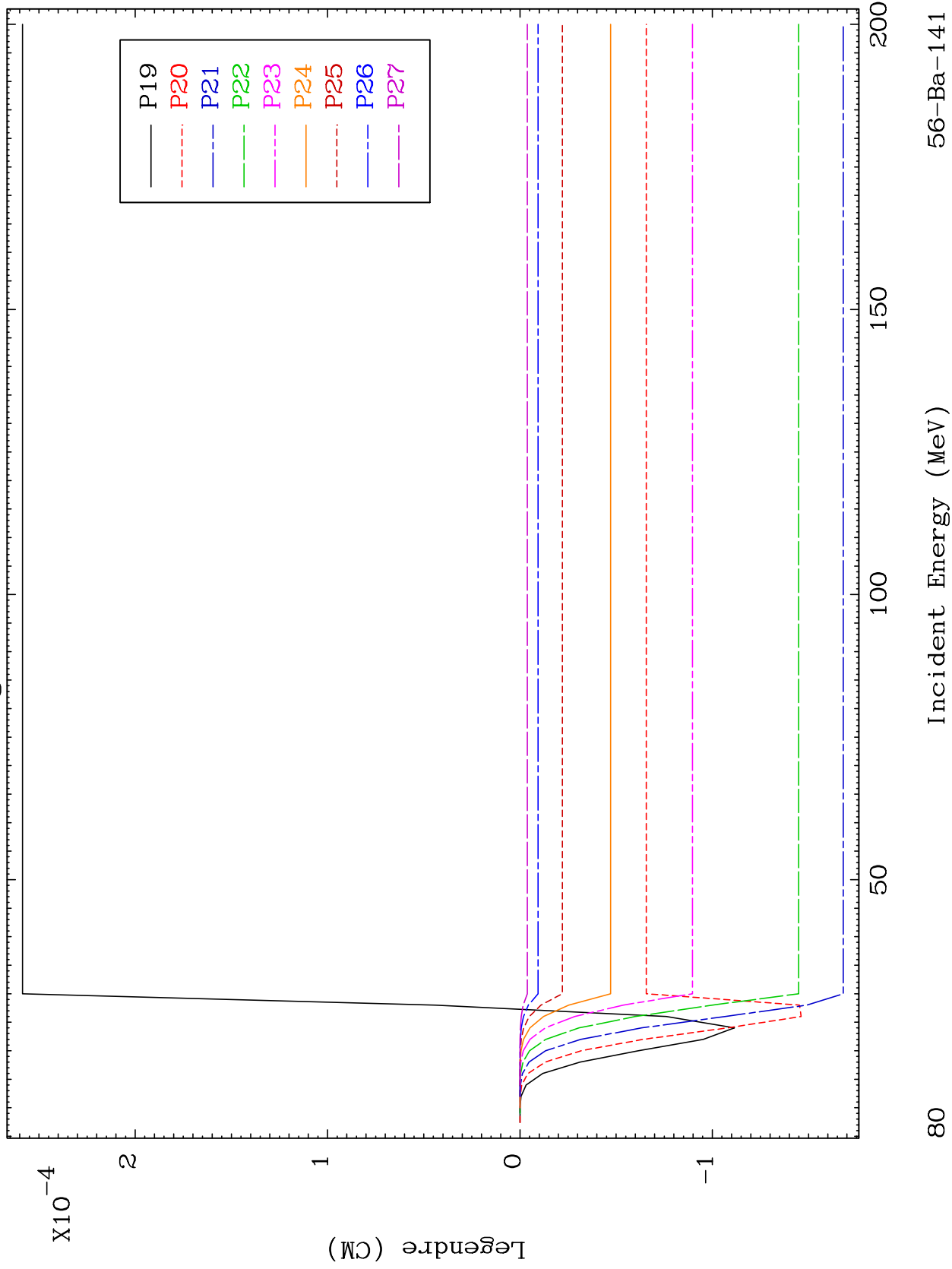

80

Incident Energy (MeV)

56-Ba-141

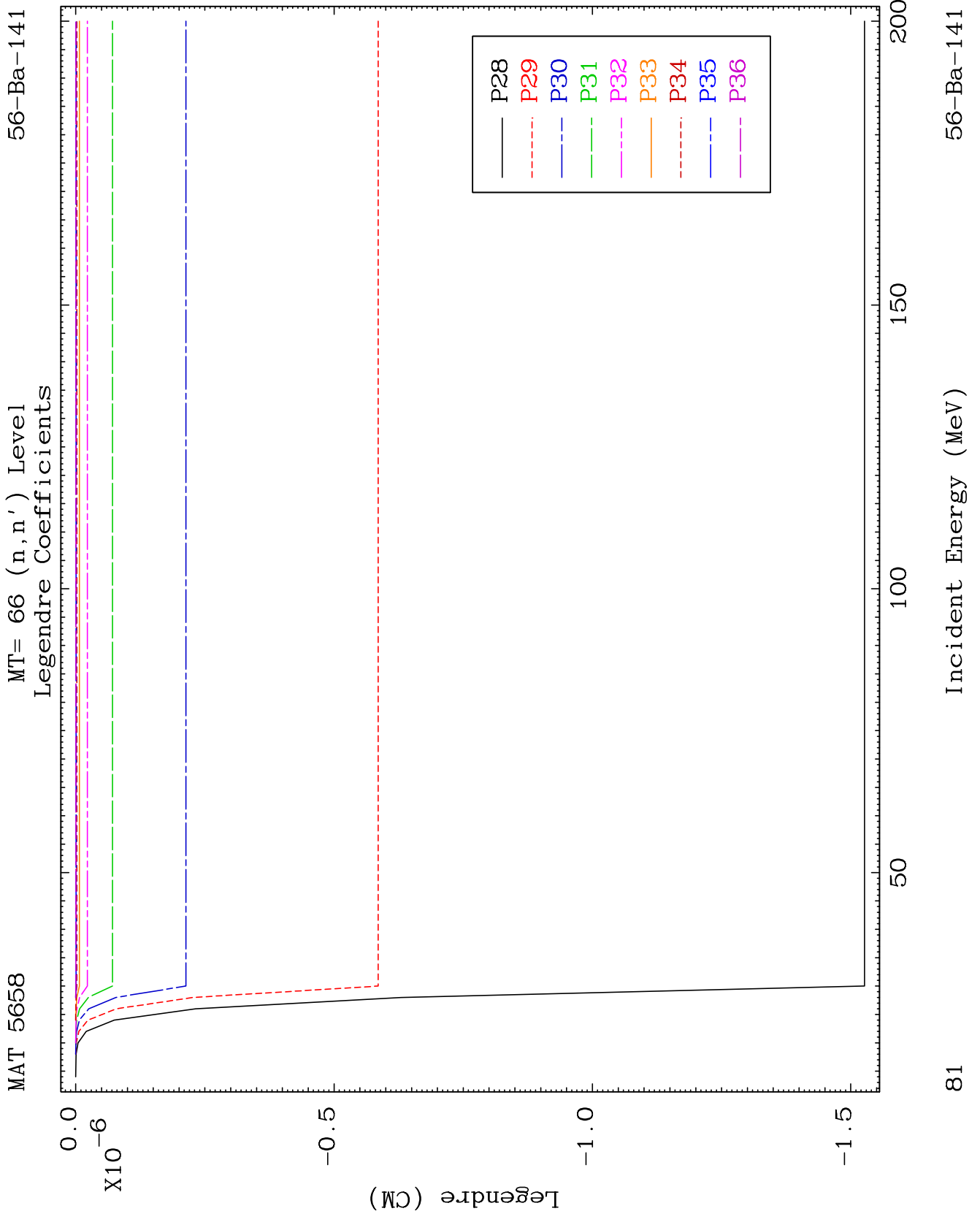

MAT 5658

MT= 67 (n,n') Level  
Legendre Coefficients

56-Ba-141

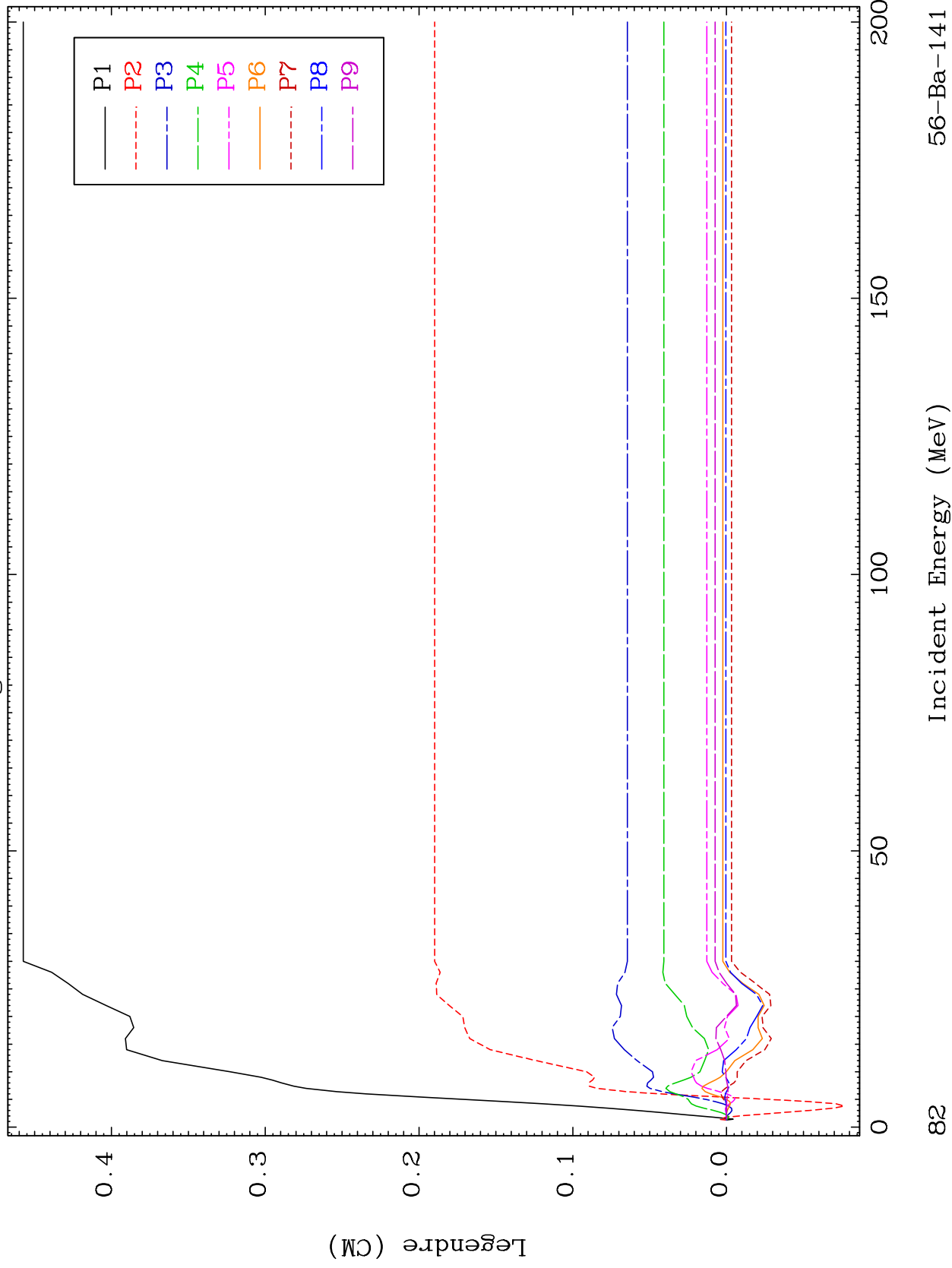

56-Ba-141

Incident Energy (MeV)

82

MAT 5658

MT= 67 (n,n') Level  
Legendre Coefficients

56-Ba-141

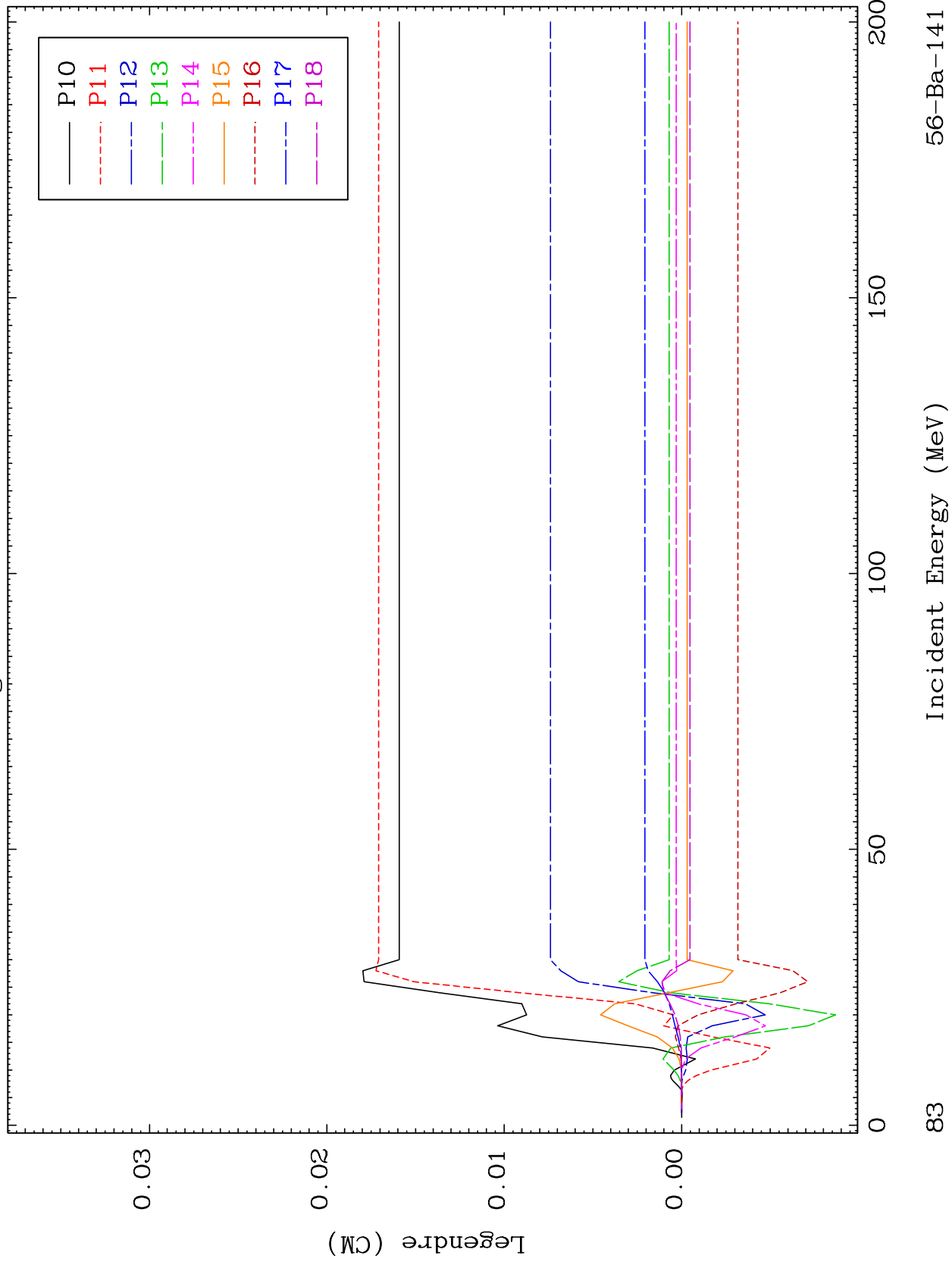

83

Incident Energy (MeV)

56-Ba-141

MAT 5658

MT= 67 (n,n') Level  
Legendre Coefficients

56-Ba-141

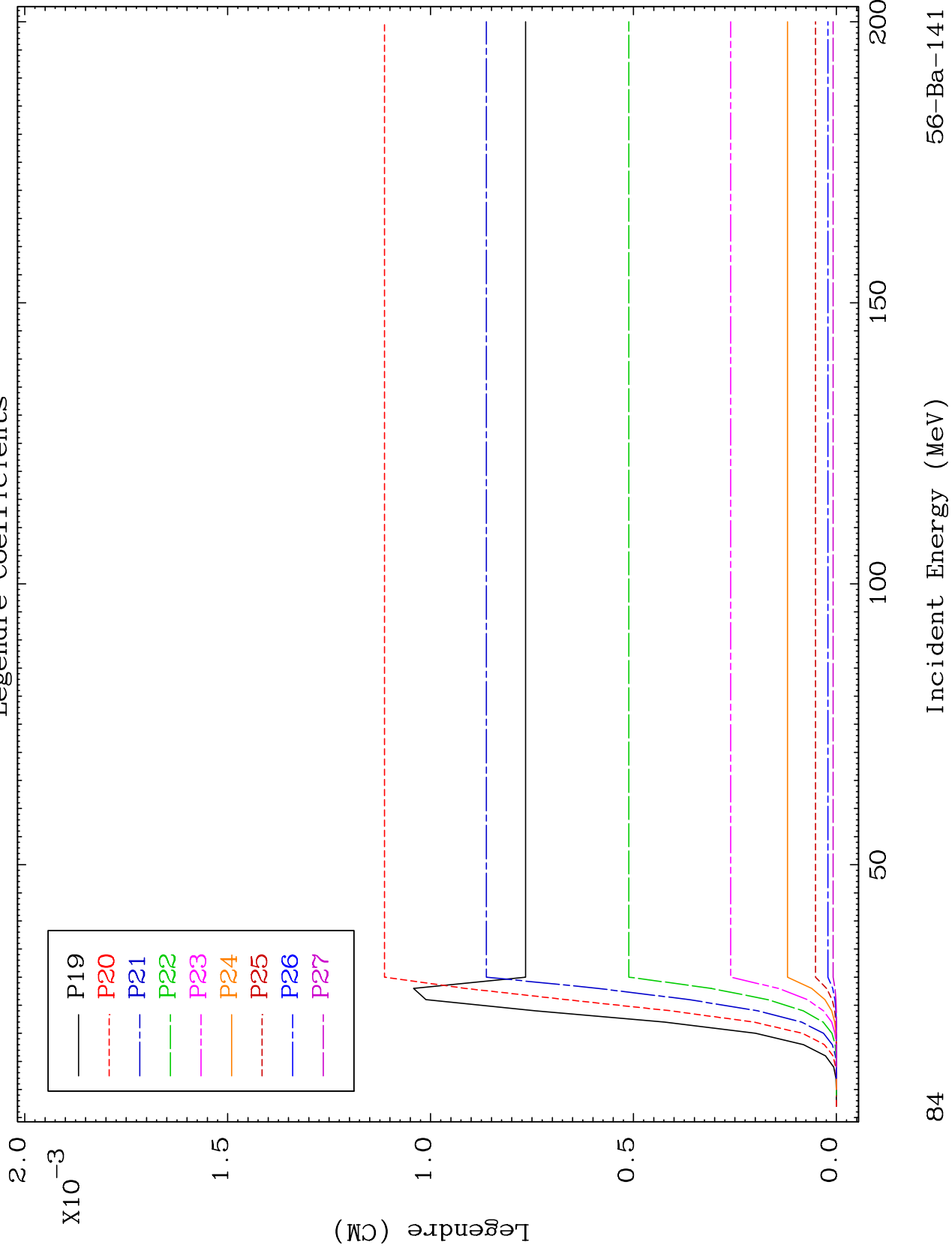

MAT 5658

MT= 67 (n,n') Level  
Legendre Coefficients

56-Ba-141

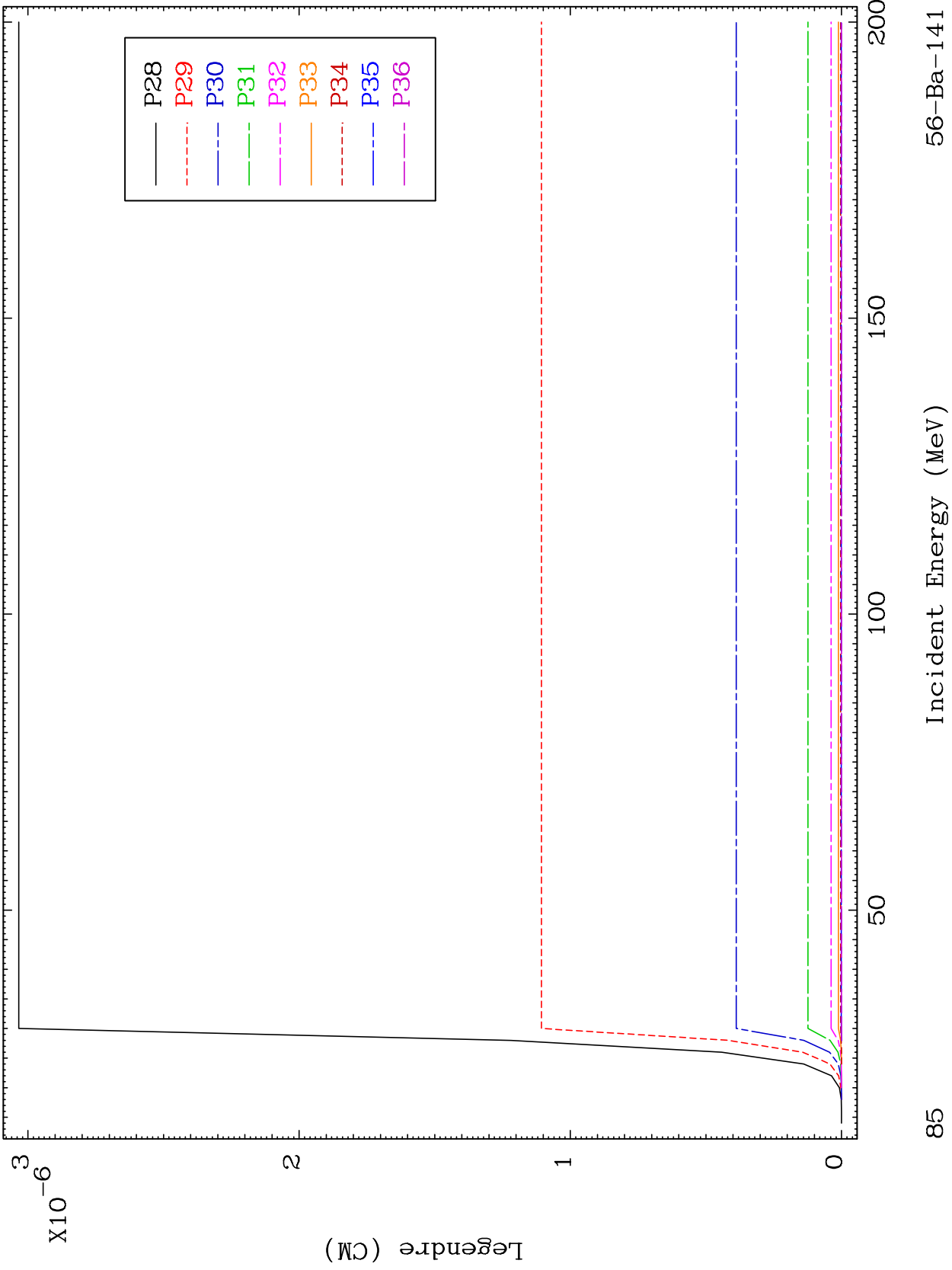

MAT 5658

MT= 68 (n,n') Level  
Legendre Coefficients

56-Ba-141

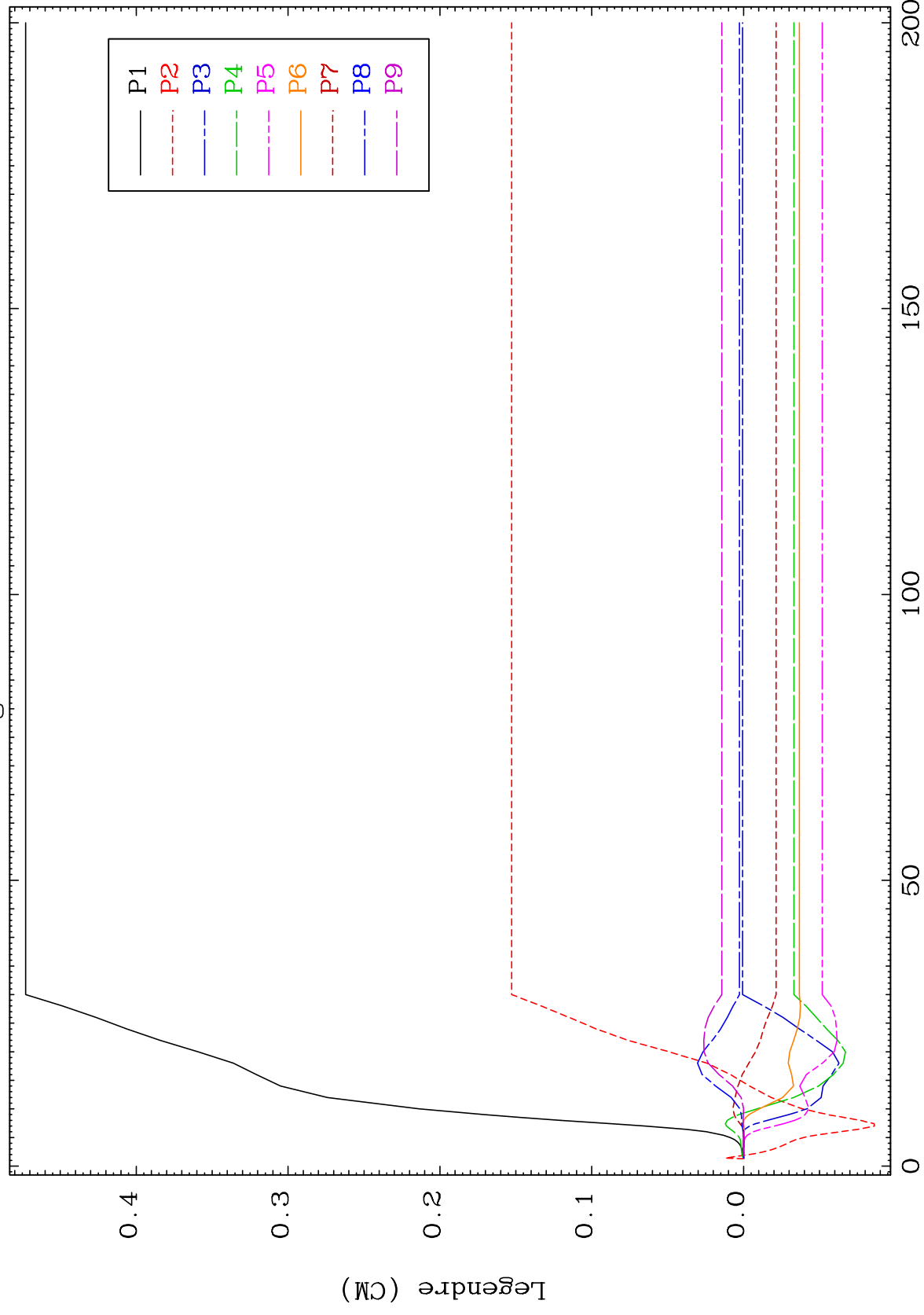

86

Incident Energy (MeV)

56-Ba-141

MAT 5658

MT= 68 (n,n') Level  
Legendre Coefficients

56-Ba-141

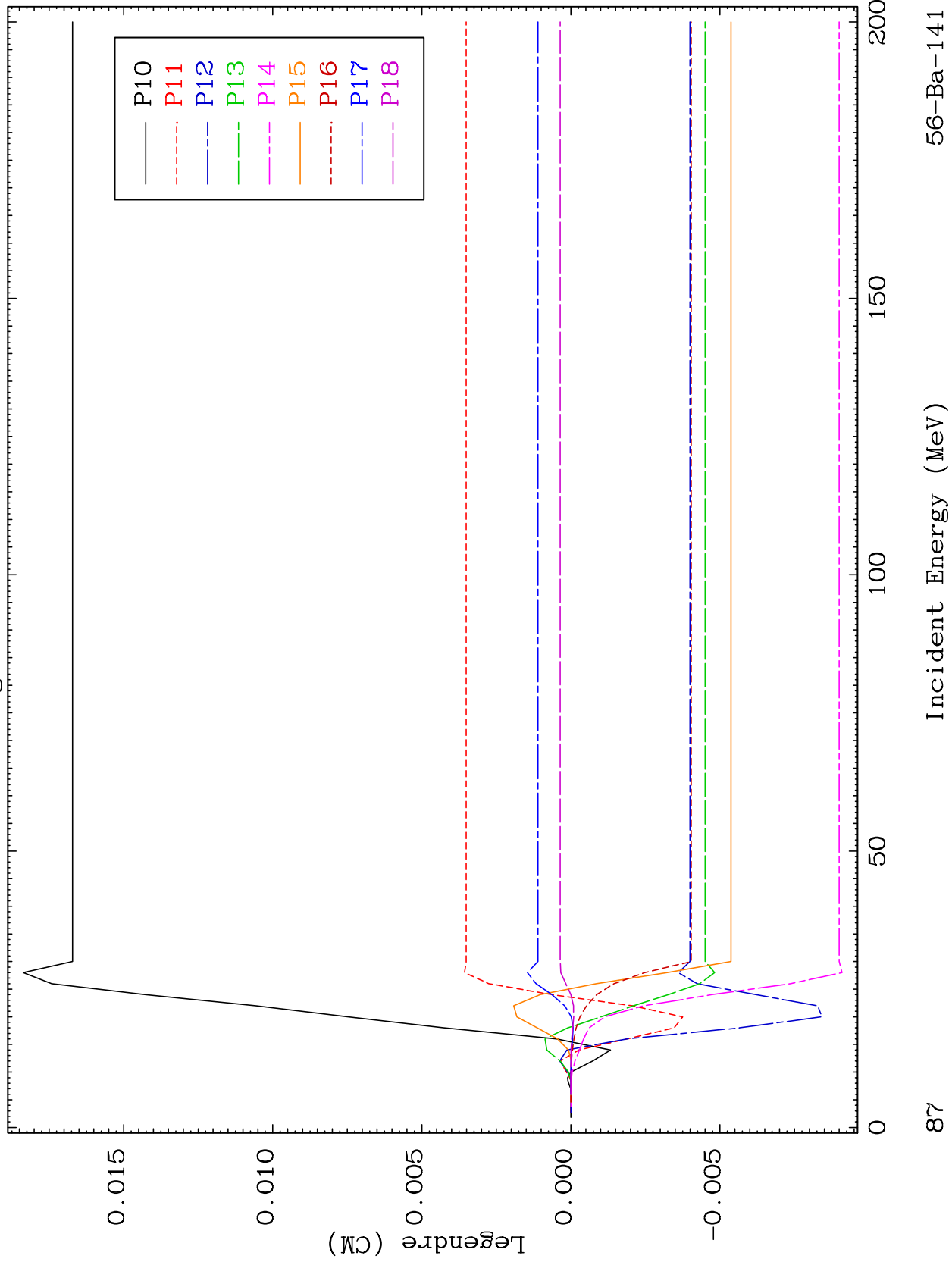

87

Incident Energy (MeV)

56-Ba-141



MAT 5658

MT= 68 (n,n') Level  
Legendre Coefficients

56-Ba-141

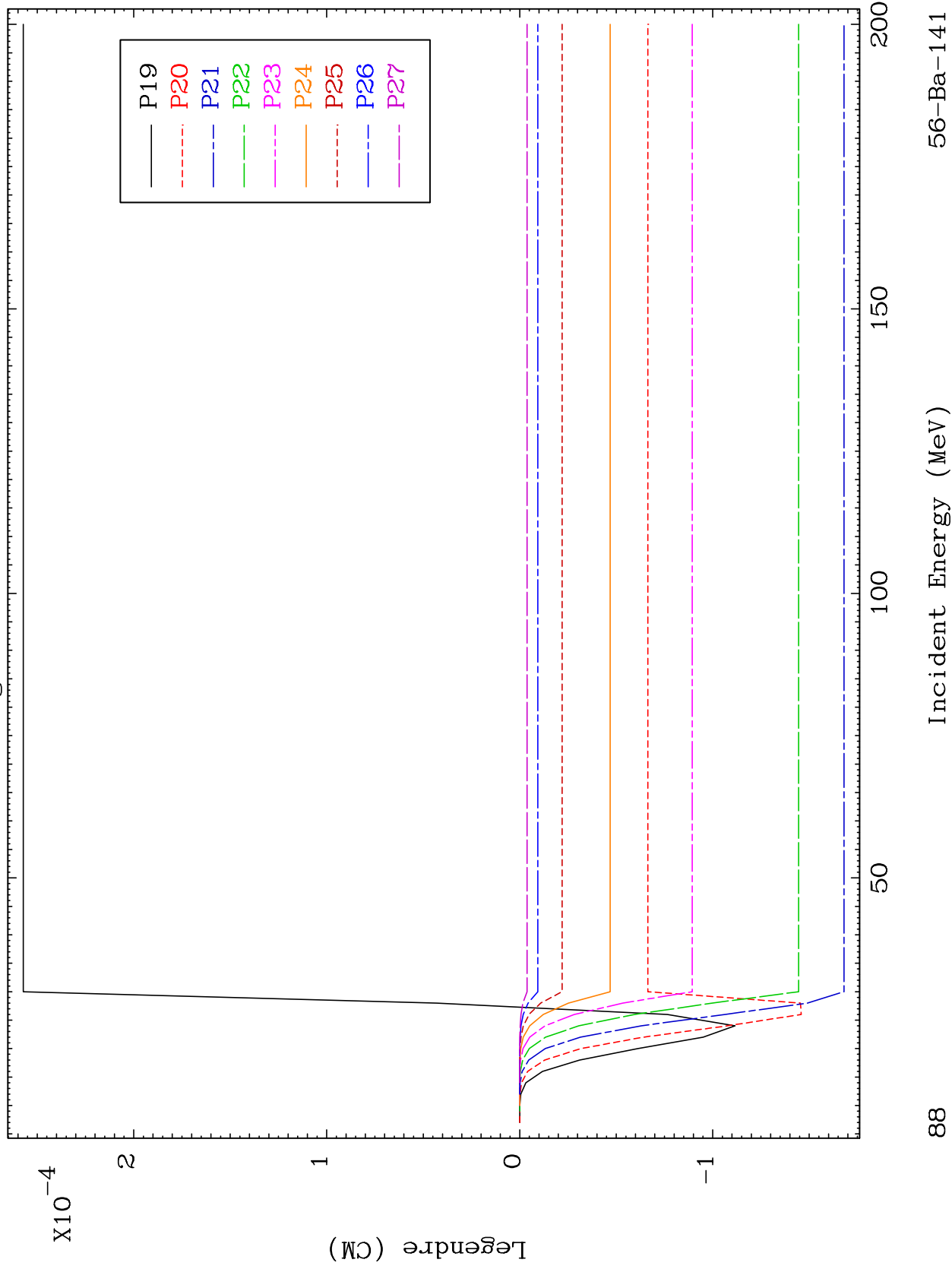

88

56-Ba-141



MAT 5658

MT= 69 (n,n') Level  
Legendre Coefficients

56-Ba-141

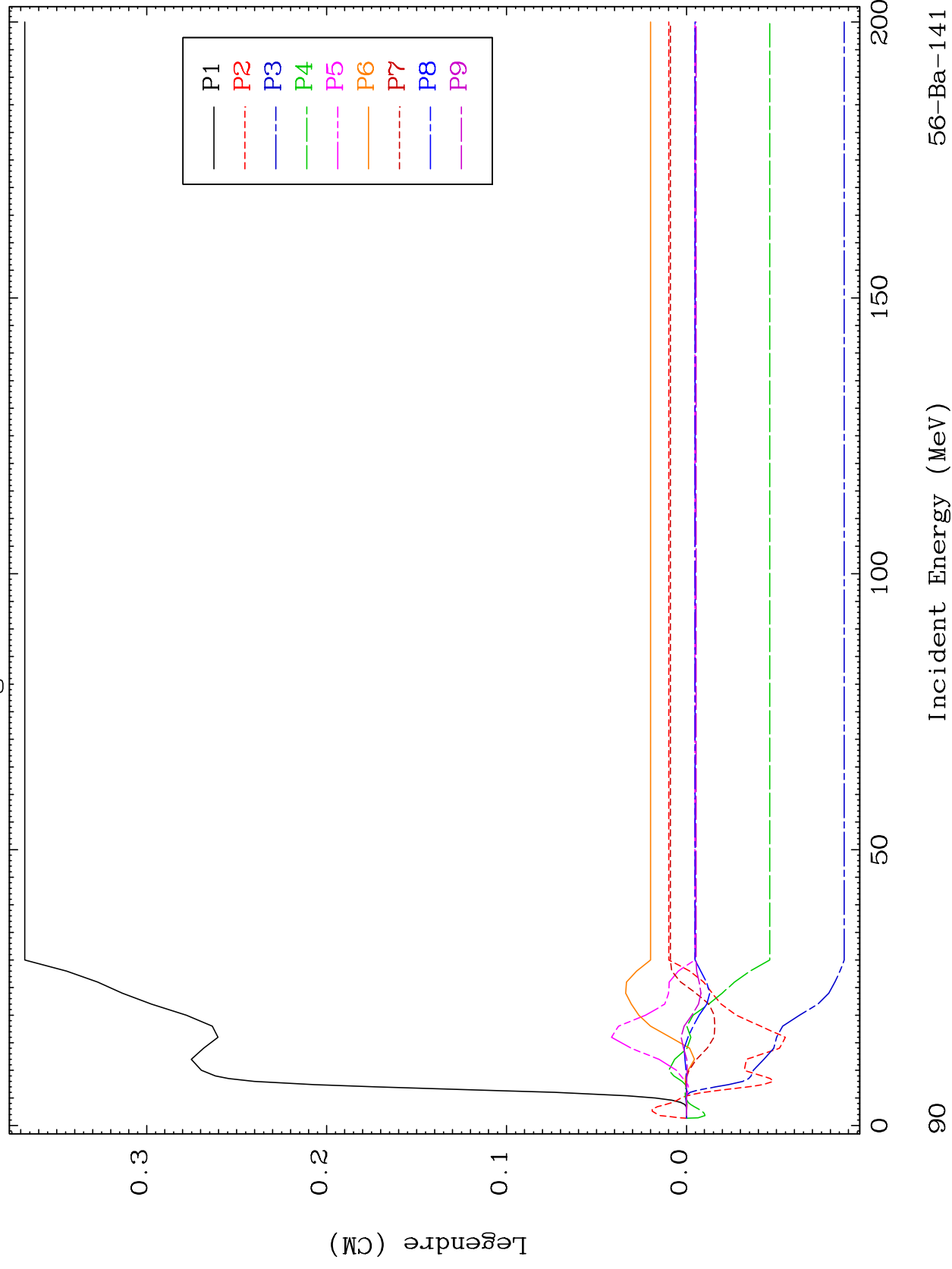

56-Ba-141

Incident Energy (MeV)

90

MAT 5658

MT= 69 (n,n') Level  
Legendre Coefficients

56-Ba-141

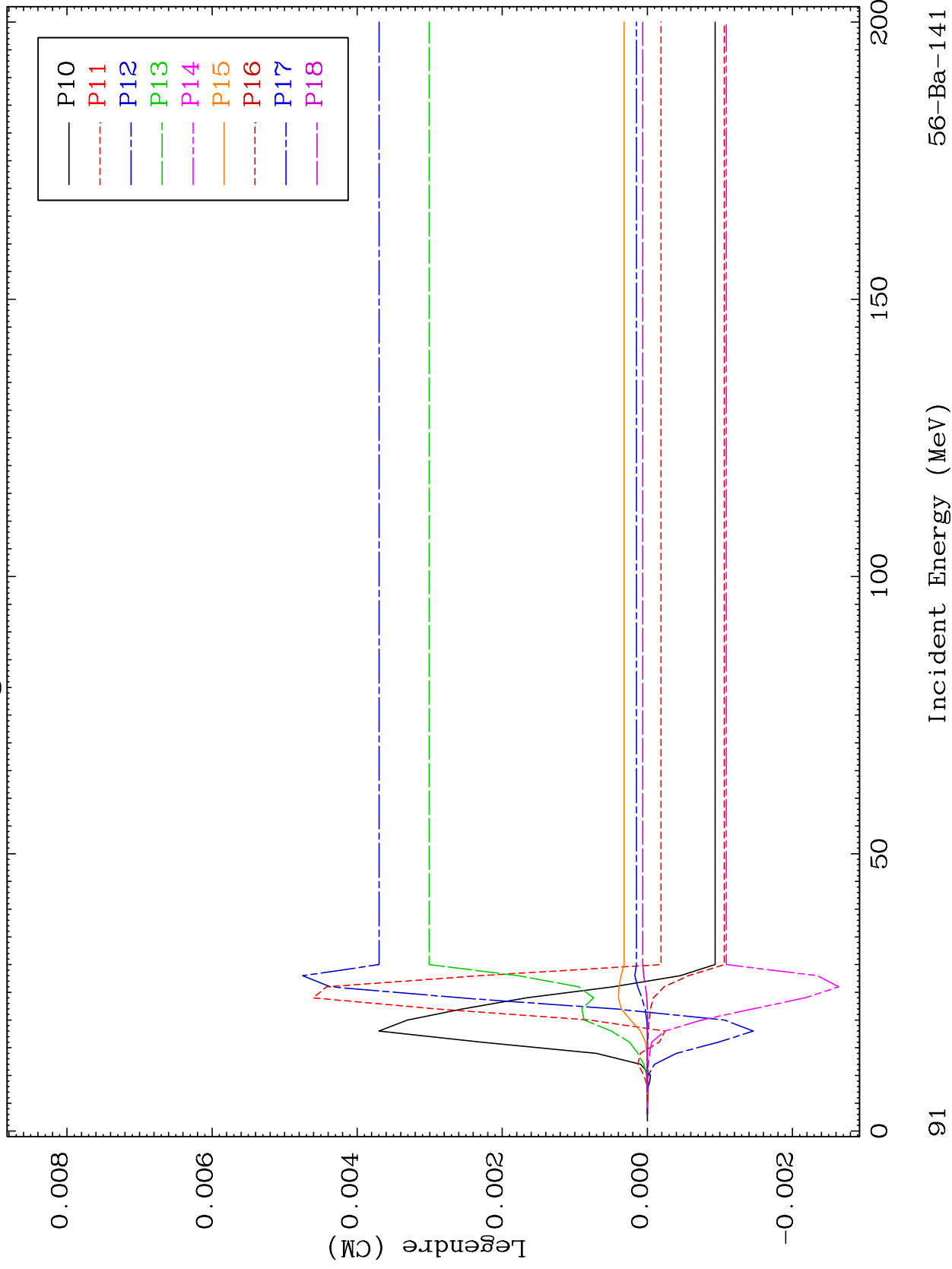

56-Ba-141

Incident Energy (MeV)

91

MAT 5658

MT= 69 (n,n') Level  
Legendre Coefficients

56-Ba-141

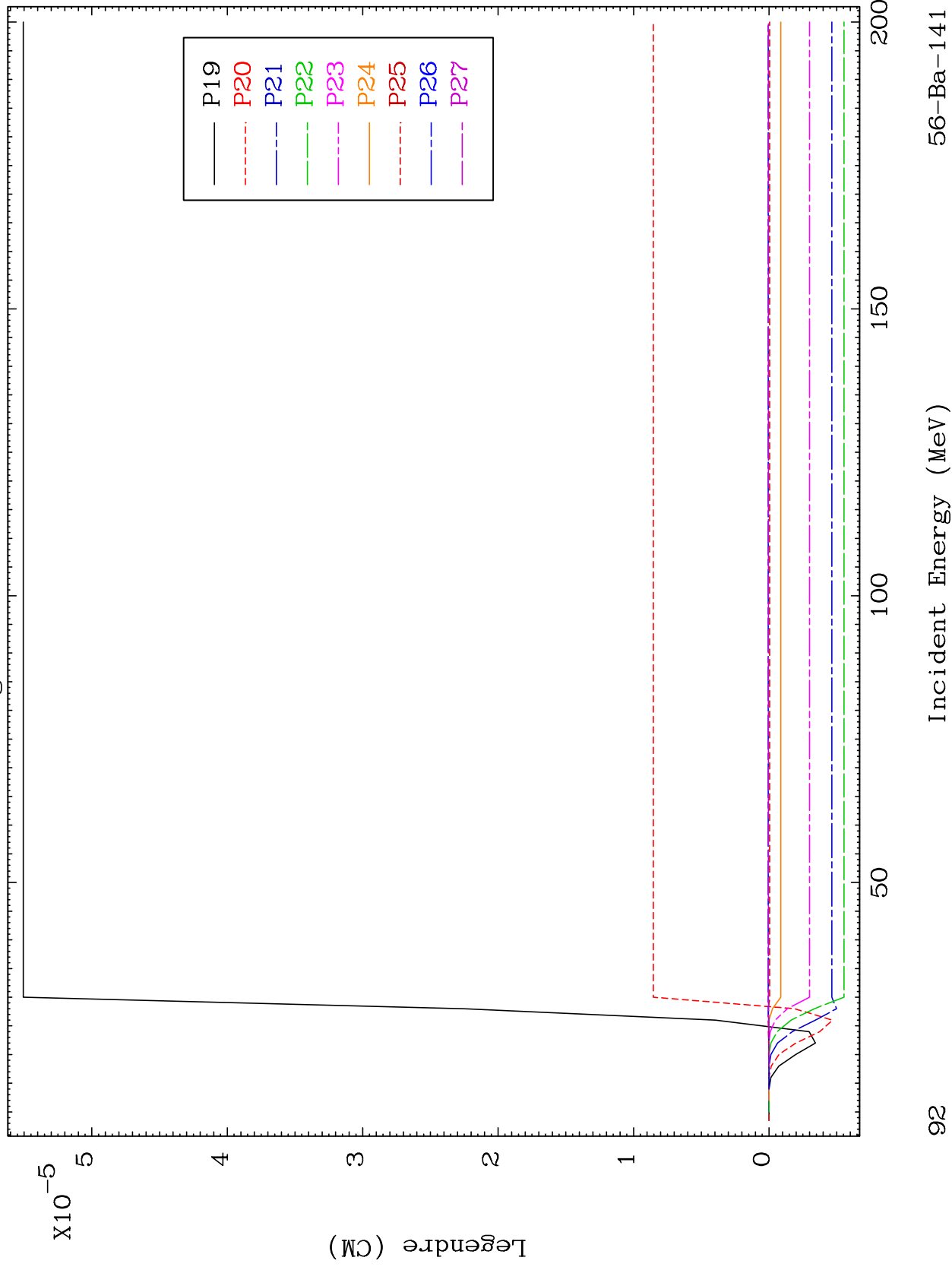

92

Incident Energy (MeV)

56-Ba-141

MAT 5658

MT= 69 (n,n') Level  
Legendre Coefficients

56-Ba-141

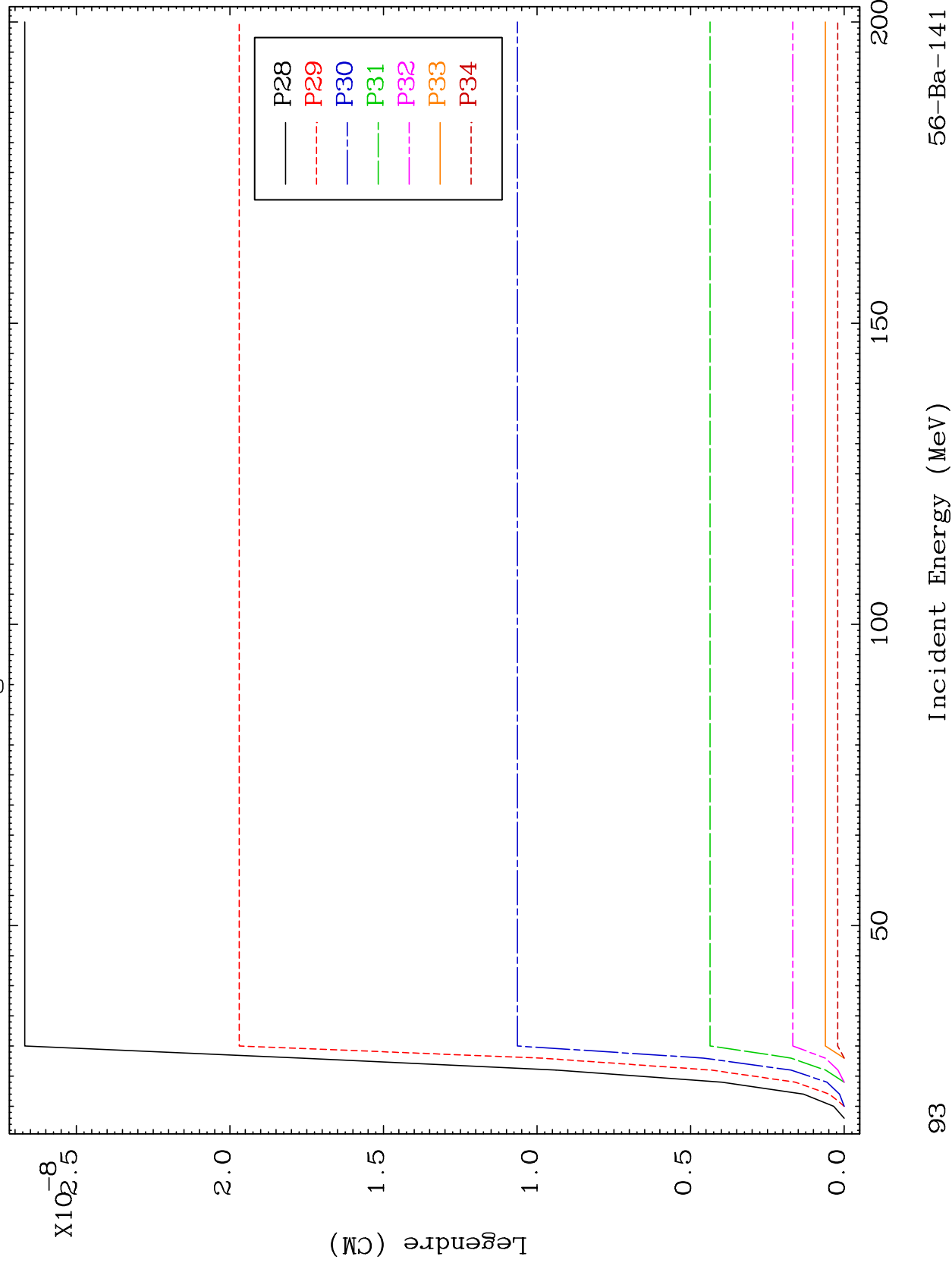

93

56-Ba-141

MAT 5658

MT= 70 (n,n') Level  
Legendre Coefficients

56-Ba-141

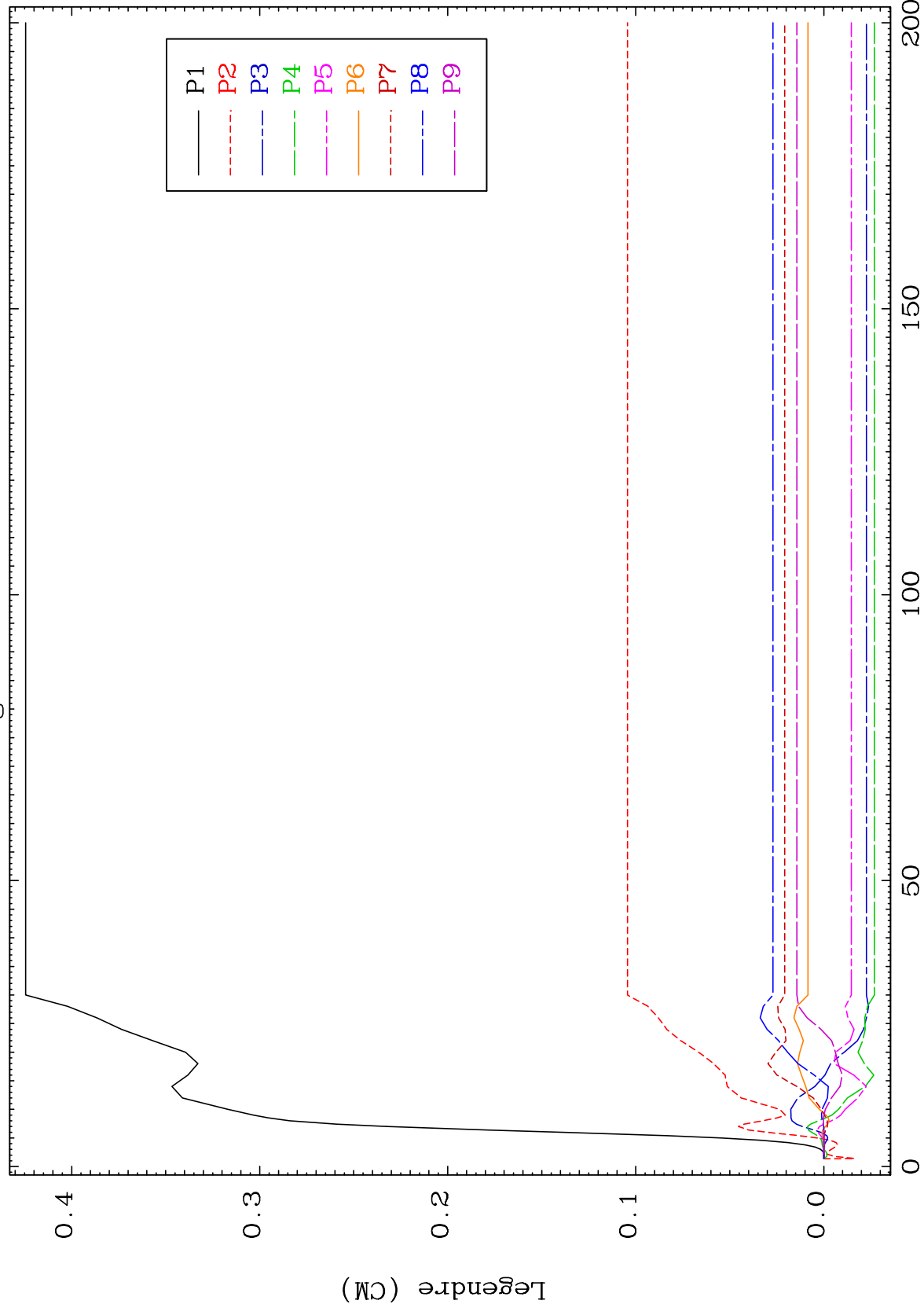

94

Incident Energy (MeV)

56-Ba-141

MAT 5658

MT= 70 (n,n') Level  
Legendre Coefficients

56-Ba-141

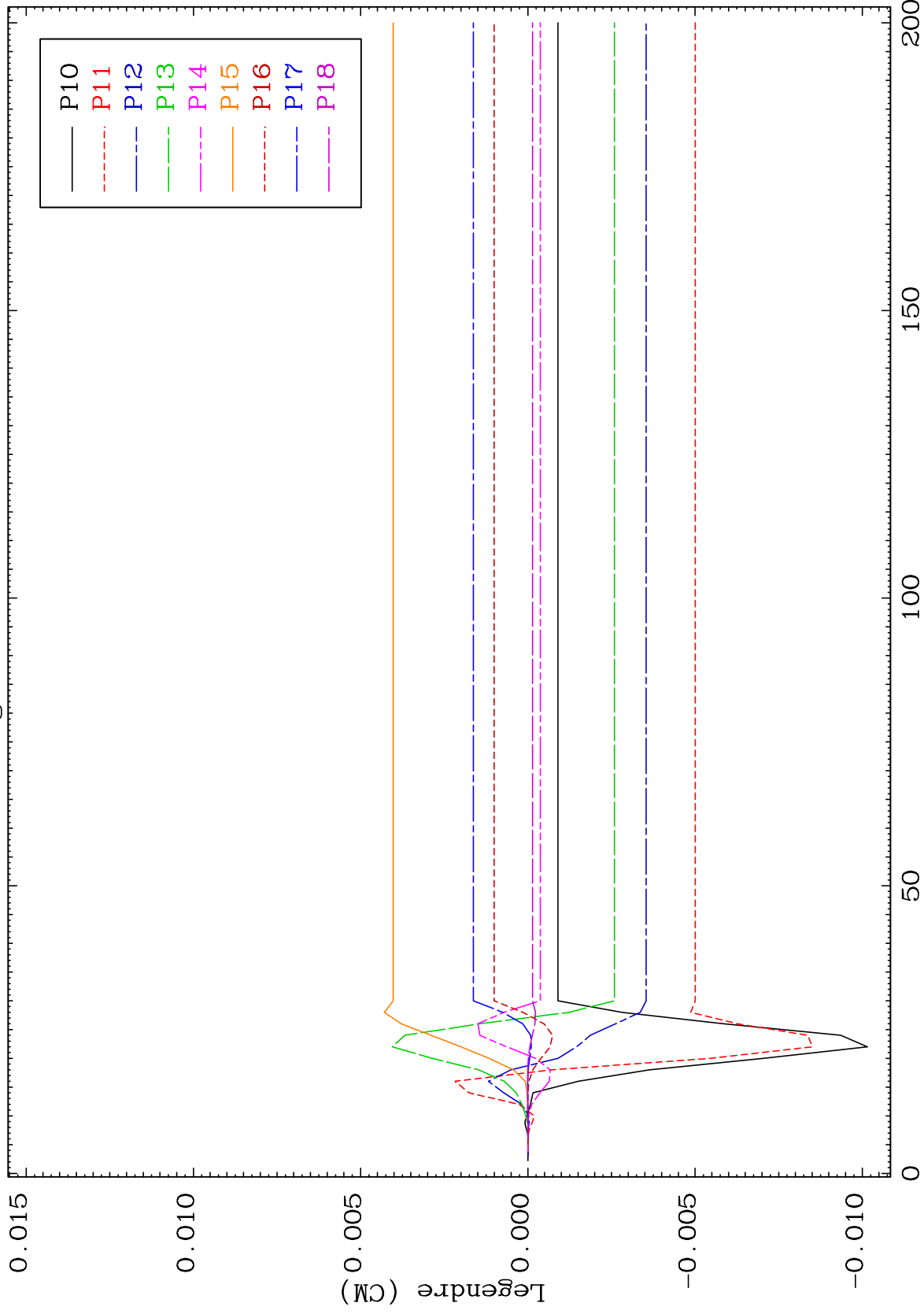

95

Incident Energy (MeV)

56-Ba-141



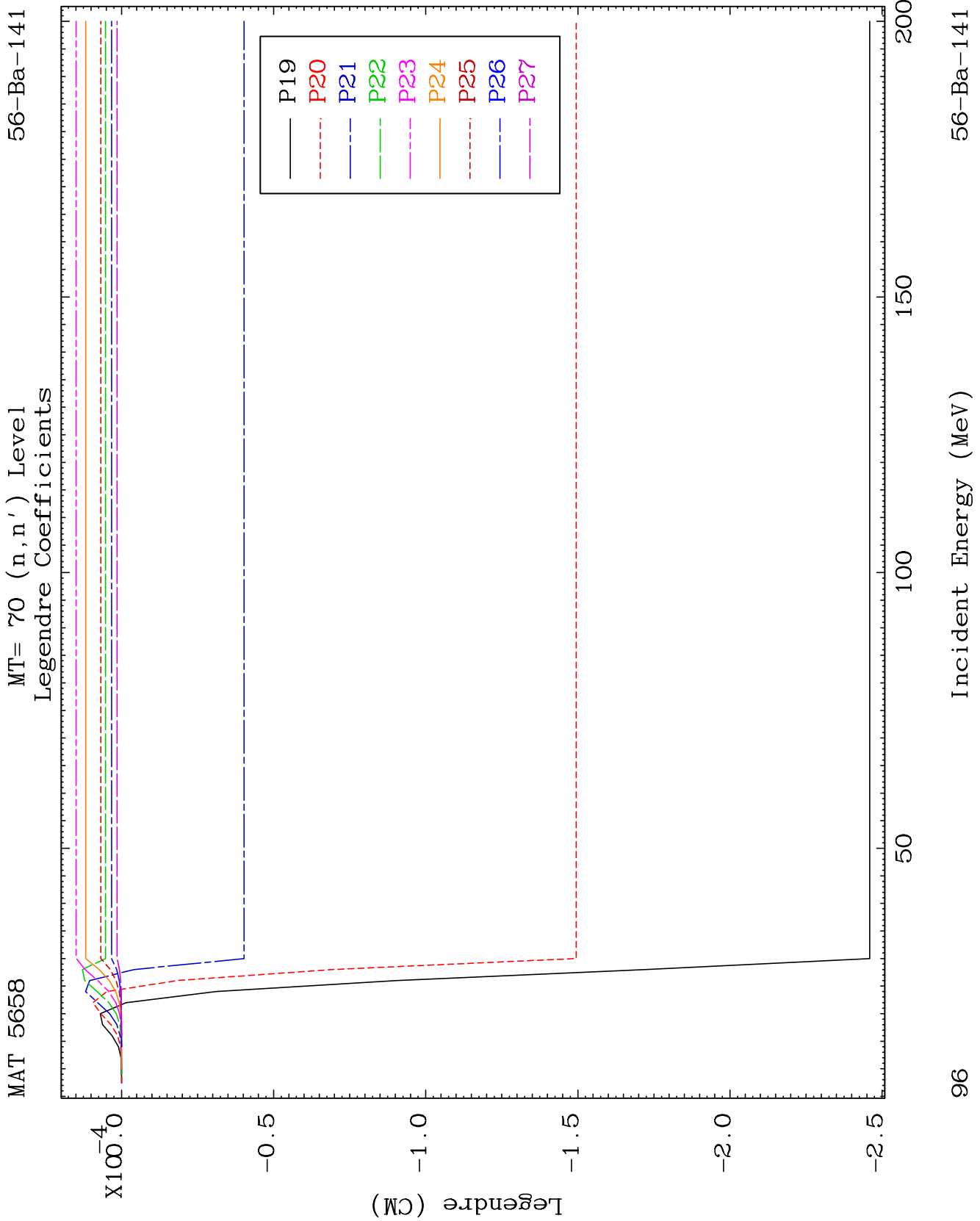

MAT 5658

56-Ba-141

MT= 70 (n,n') Level  
Legendre Coefficients

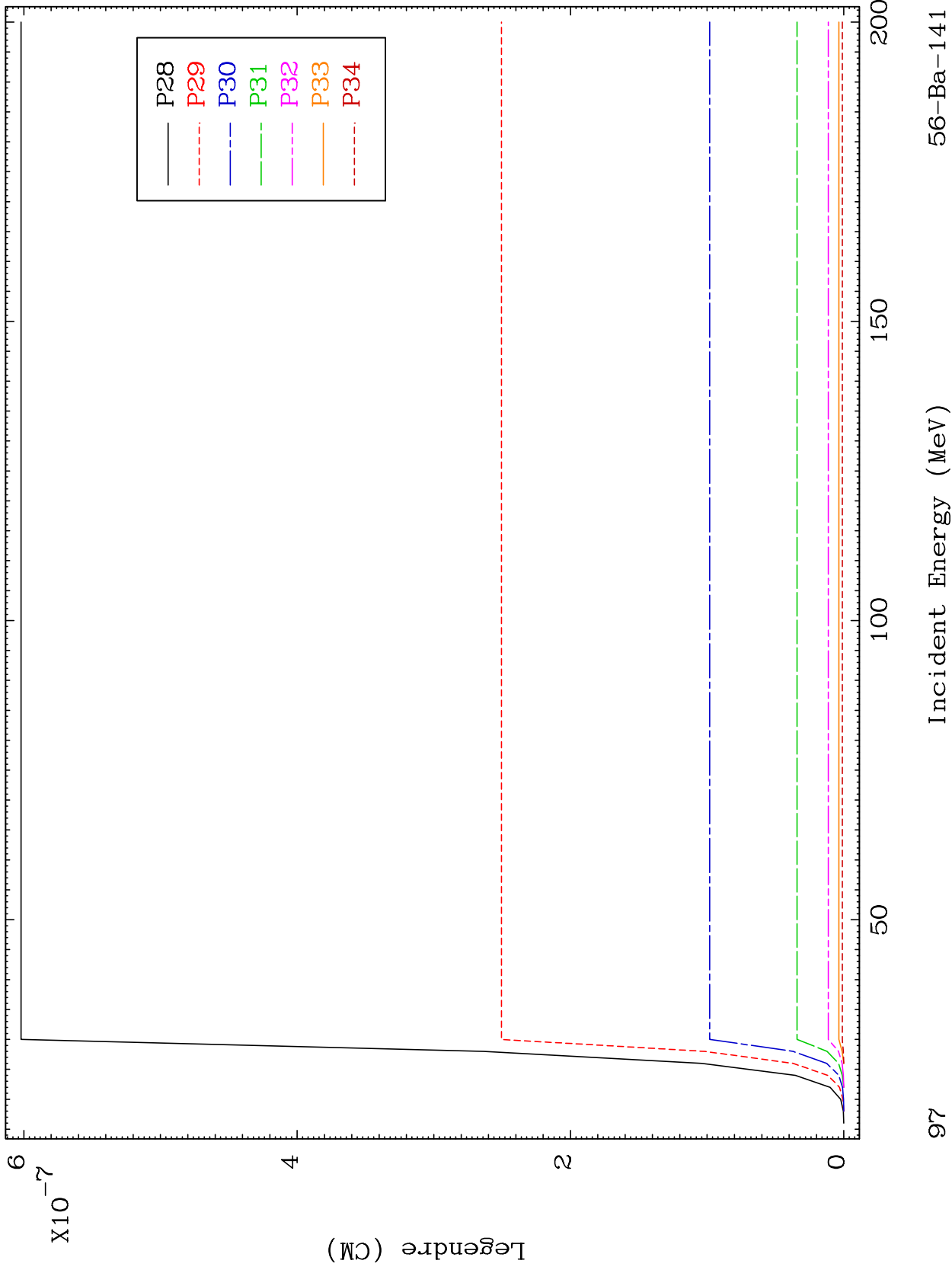

97

56-Ba-141

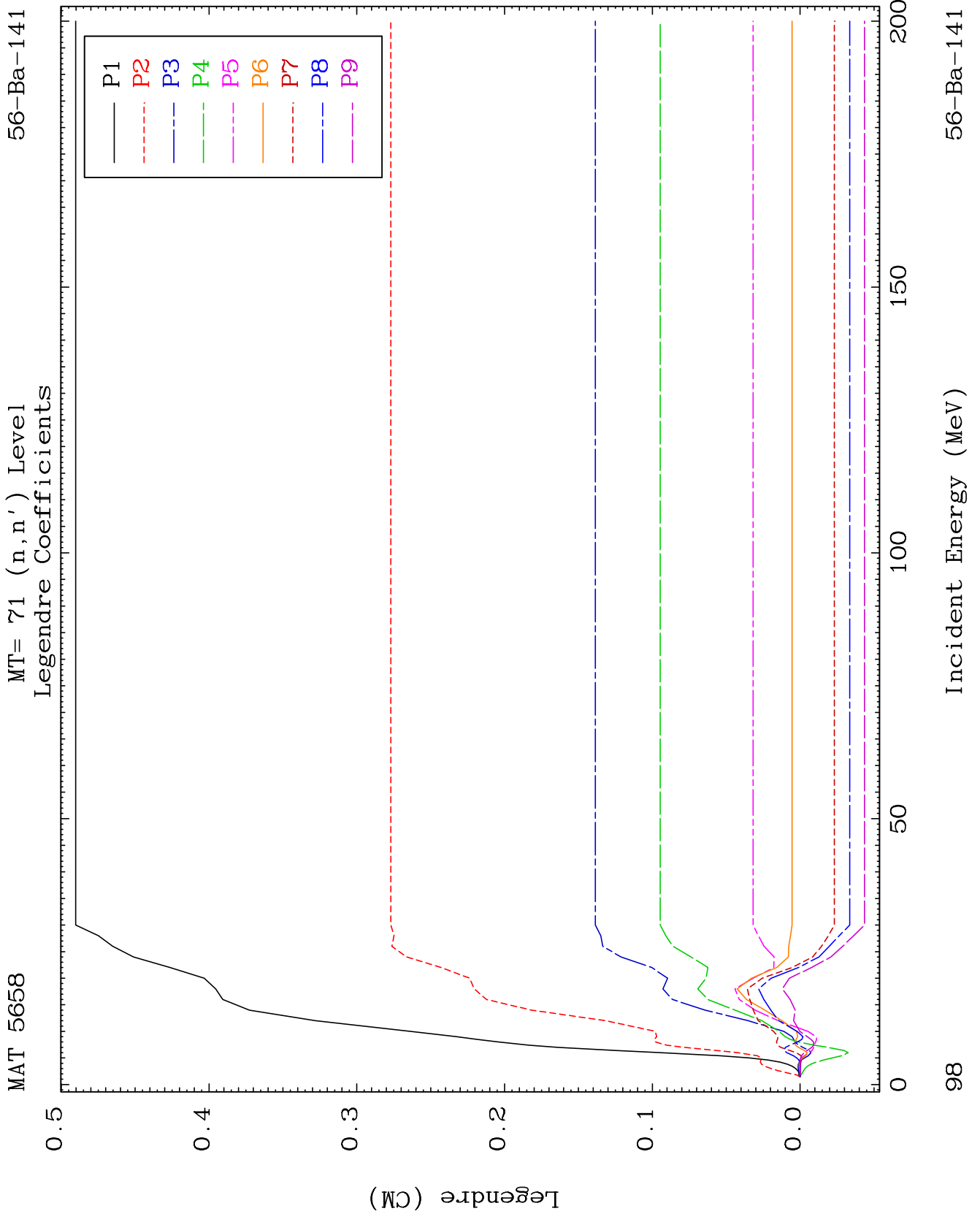

MAT 5658

MT= 71 (n,n') Level  
Legendre Coefficients

56-Ba-141

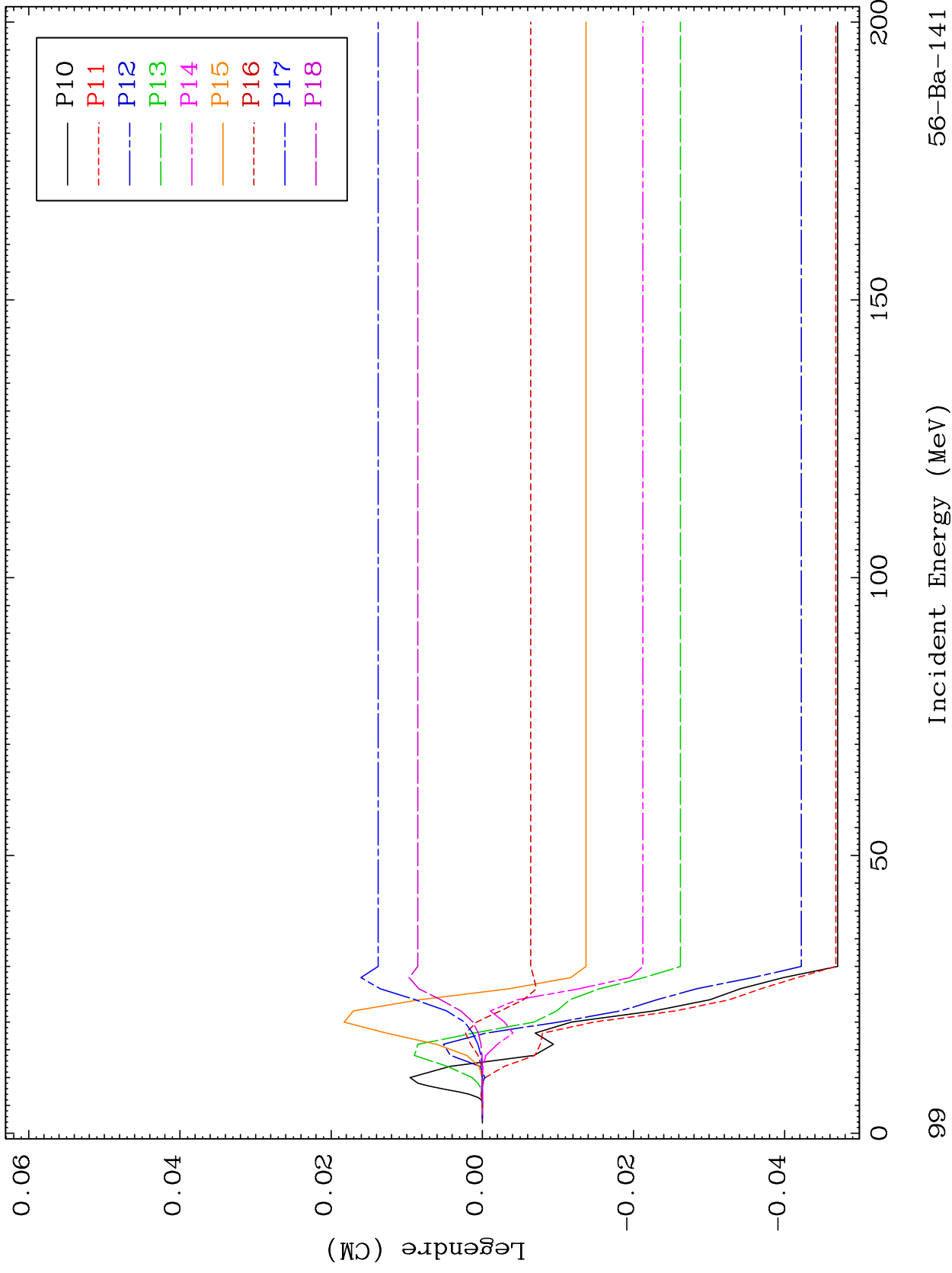

56-Ba-141

Incident Energy (MeV)

99

MAT 5658

MT= 71 (n,n') Level  
Legendre Coefficients

56-Ba-141

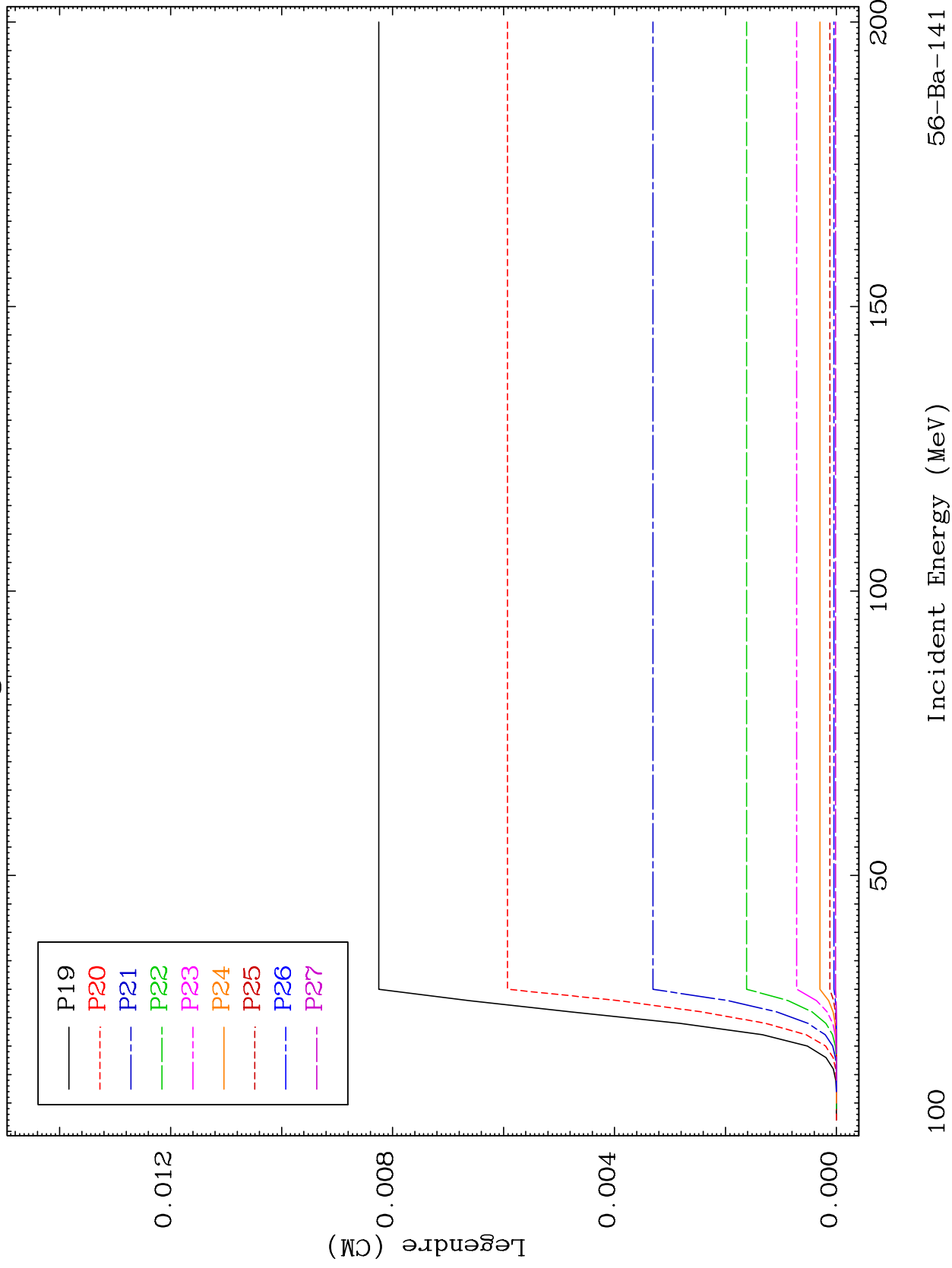

56-Ba-141

Incident Energy (MeV)

100

MAT 5658

MT= 71 (n,n') Level  
Legendre Coefficients

56-Ba-141

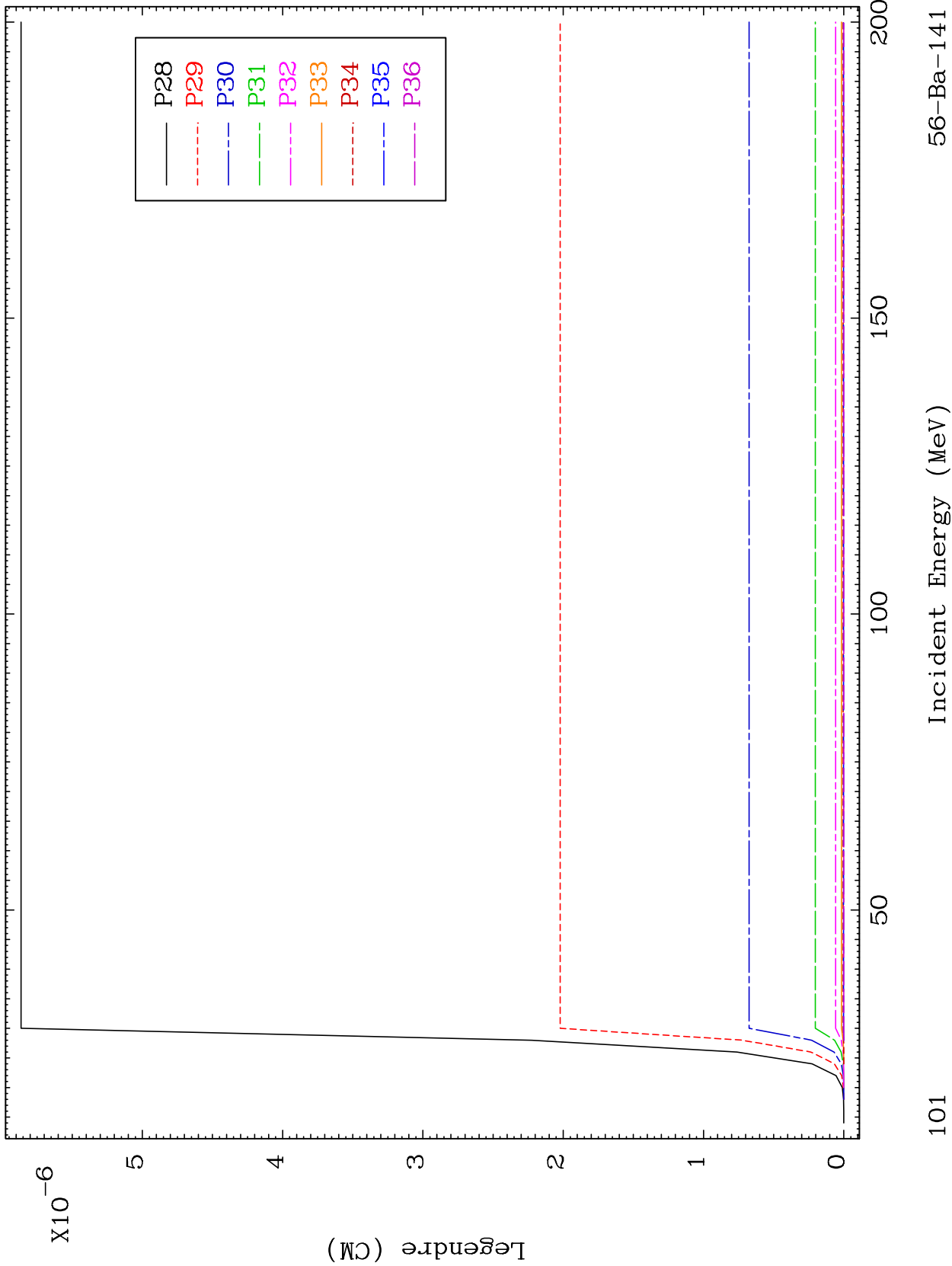

101

Incident Energy (MeV)

56-Ba-141

MAT 5658

MT= 72 (n,n') Level  
Legendre Coefficients

56-Ba-141

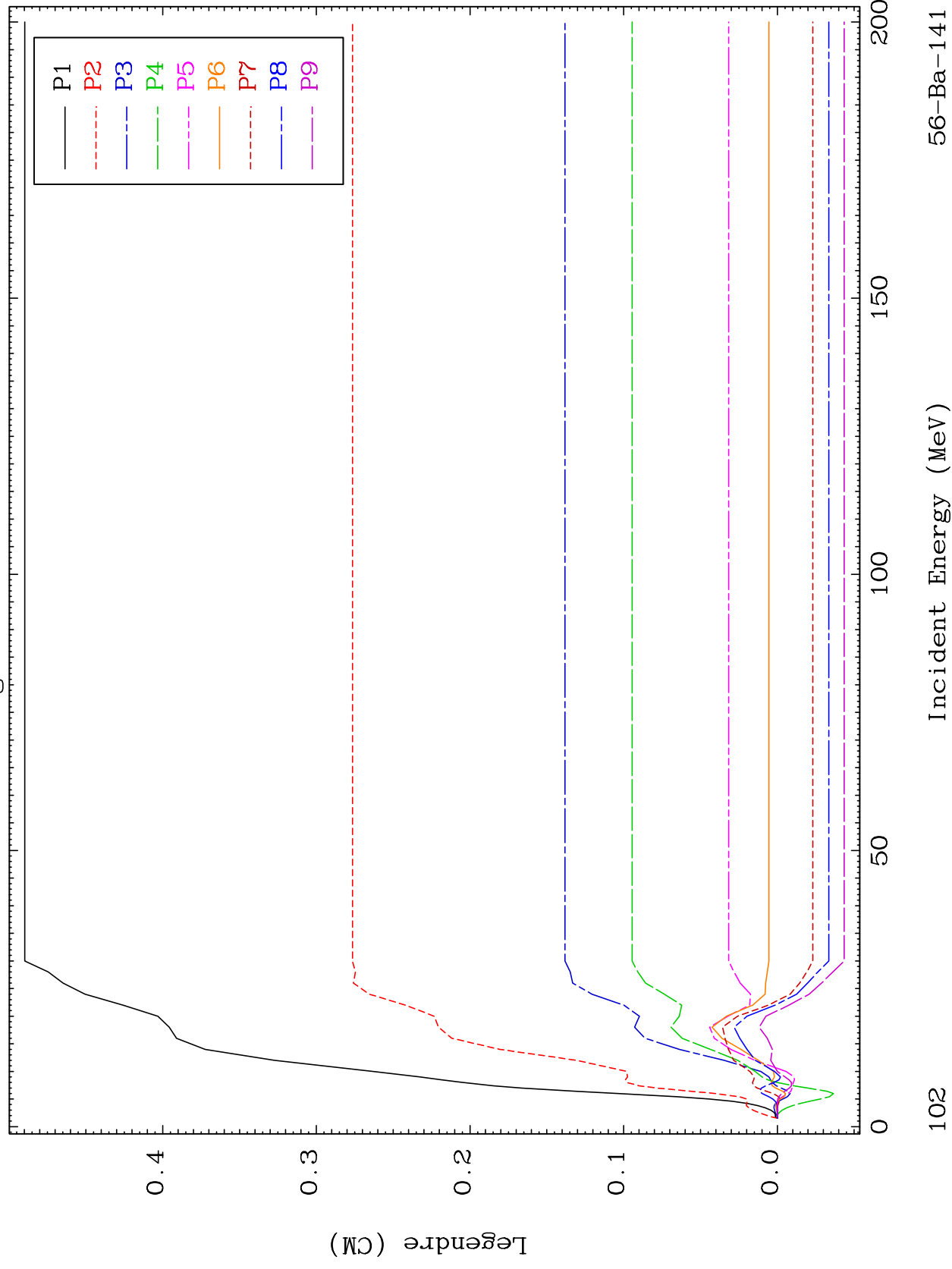

MAT 5658

MT= 72 (n,n') Level  
Legendre Coefficients

56-Ba-141

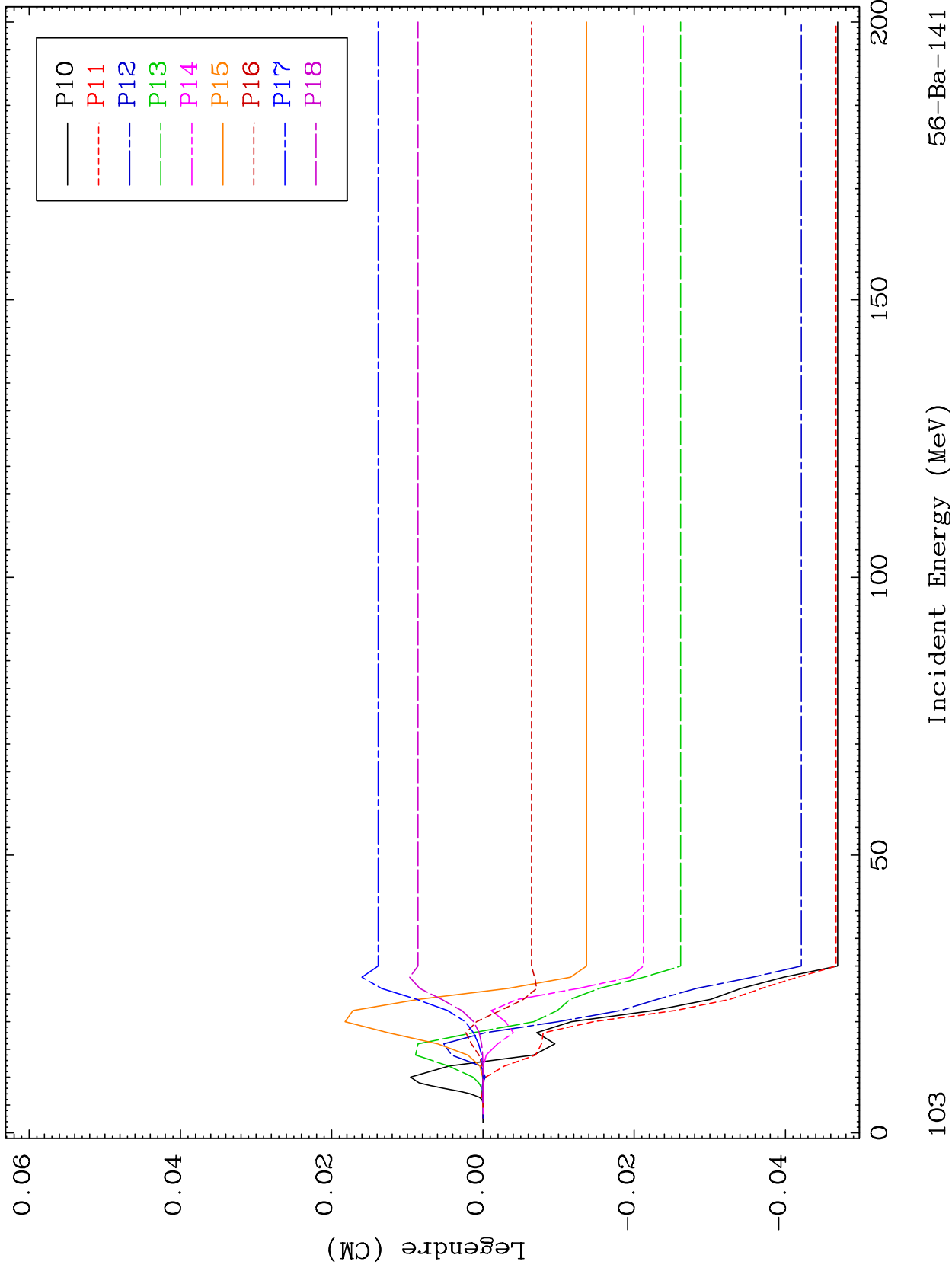

56-Ba-141

Incident Energy (MeV)

103



MAT 5658

MT= 72 (n,n') Level  
Legendre Coefficients

56-Ba-141

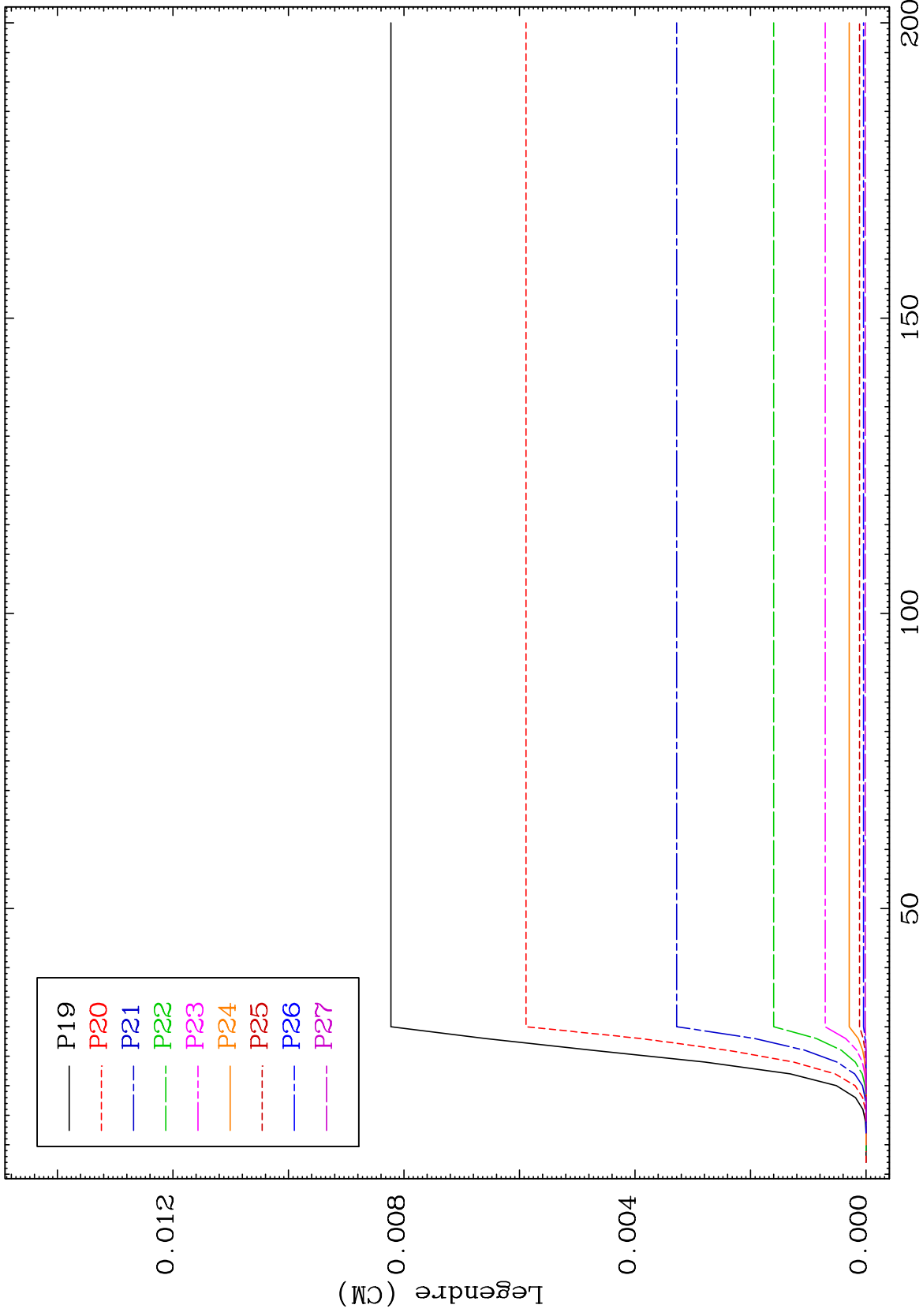

104

Incident Energy (MeV)

56-Ba-141

MAT 5658

MT= 72 (n,n') Level  
Legendre Coefficients

56-Ba-141

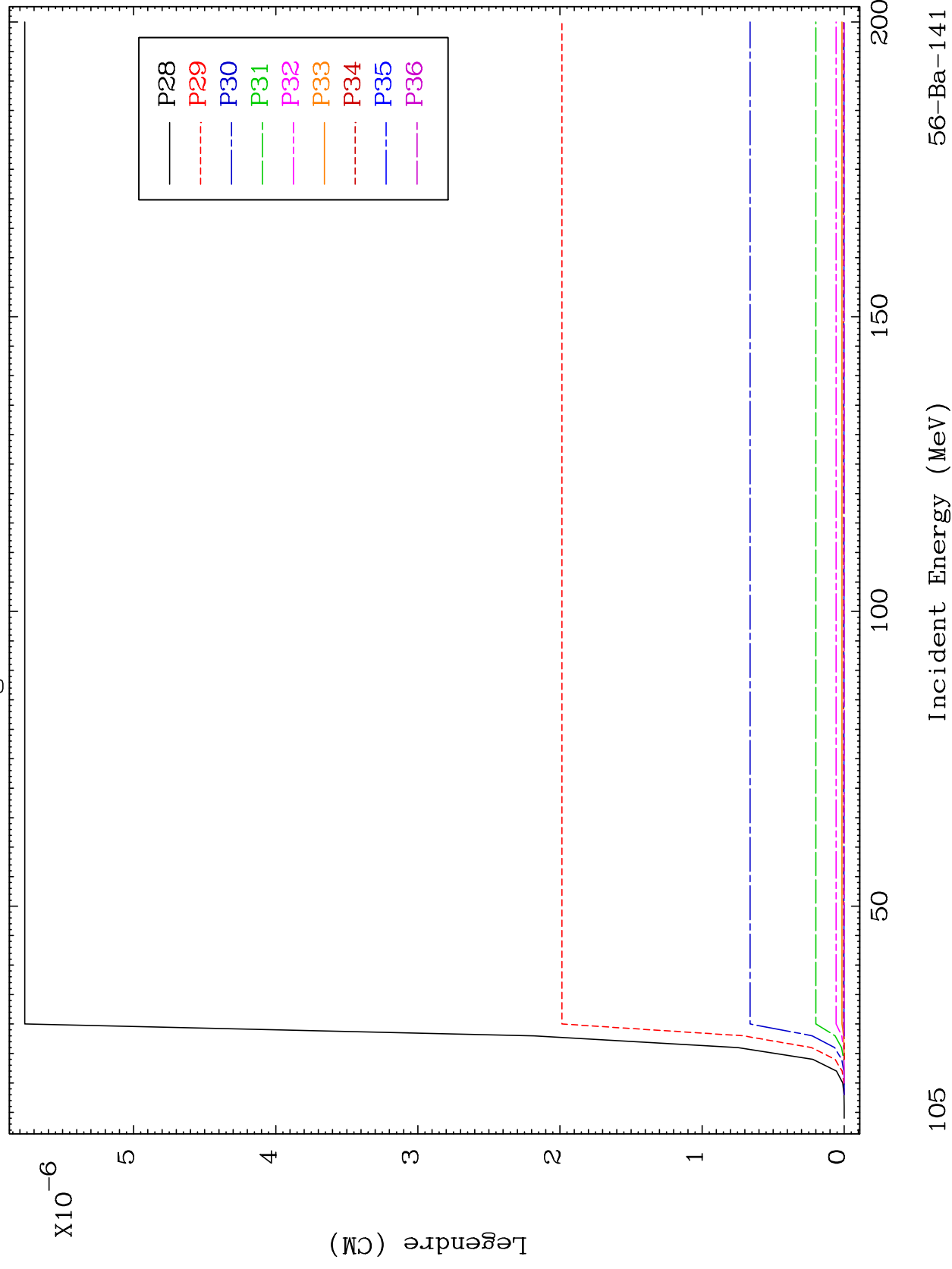

56-Ba-141

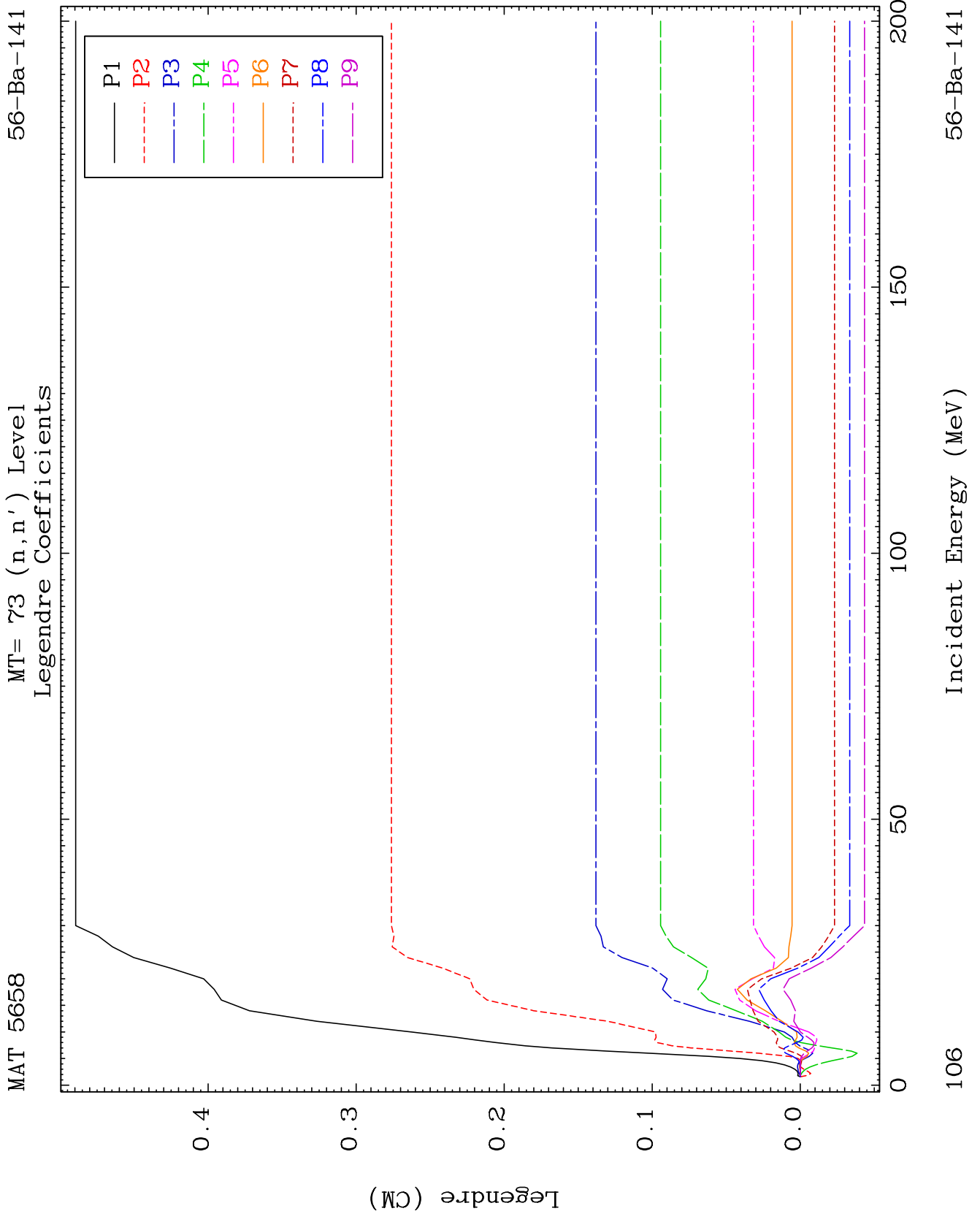

MAT 5658

MT= 73 (n,n') Level  
Legendre Coefficients

56-Ba-141

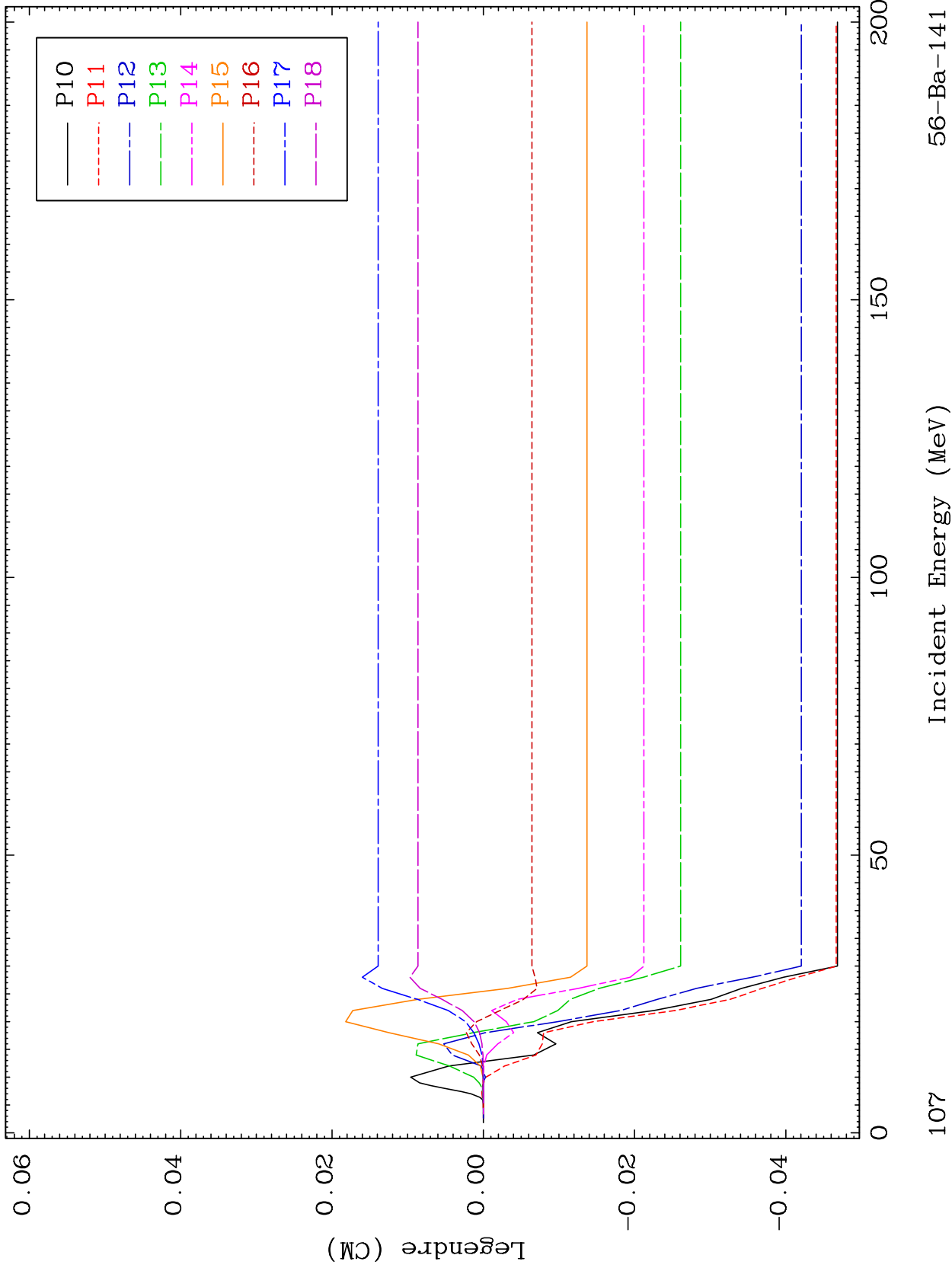

56-Ba-141

Incident Energy (MeV)

107

MAT 5658

MT= 73 (n,n') Level  
Legendre Coefficients

56-Ba-141

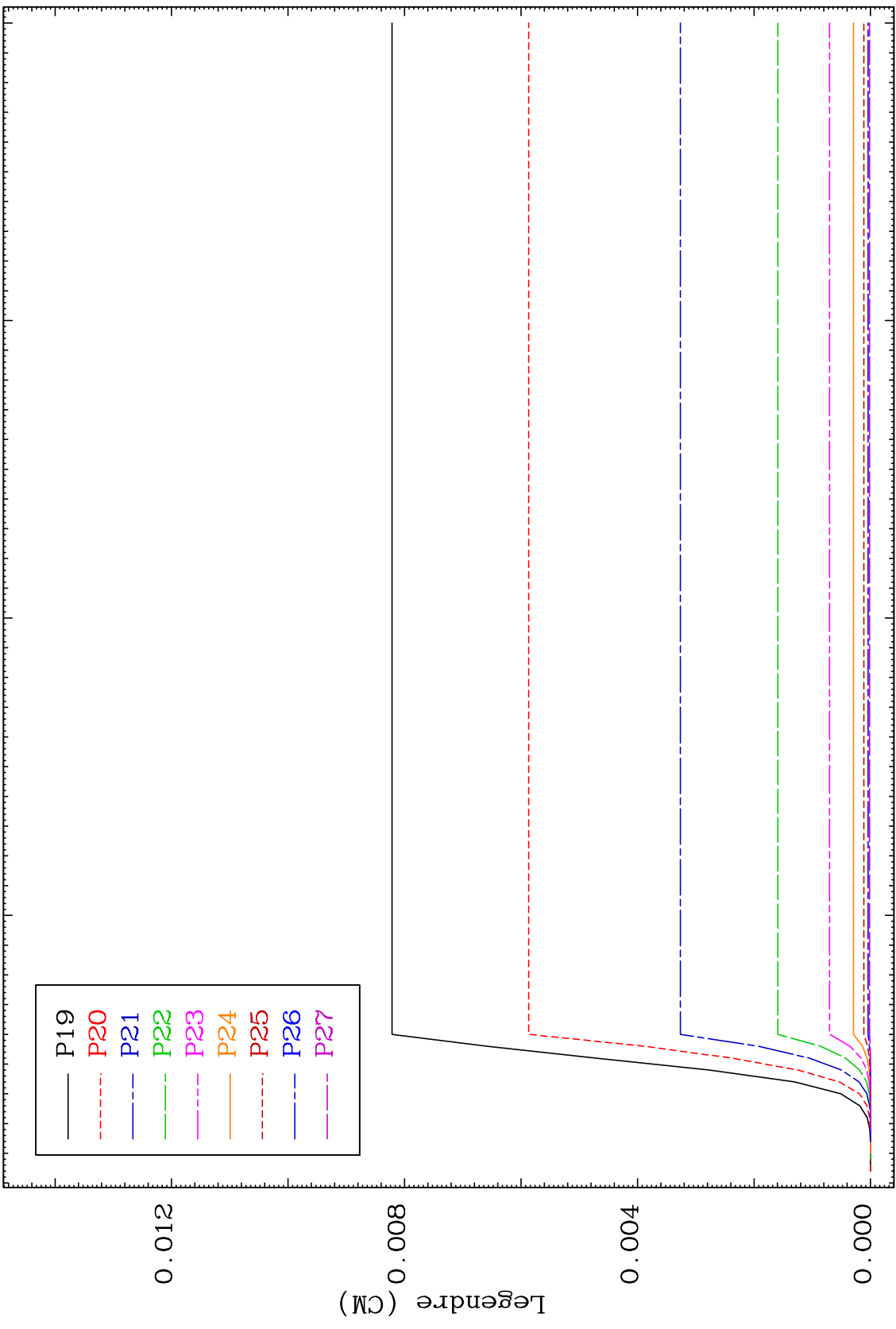

108

Incident Energy (MeV)

56-Ba-141

MAT 5658

MT= 73 (n,n') Level  
Legendre Coefficients

56-Ba-141

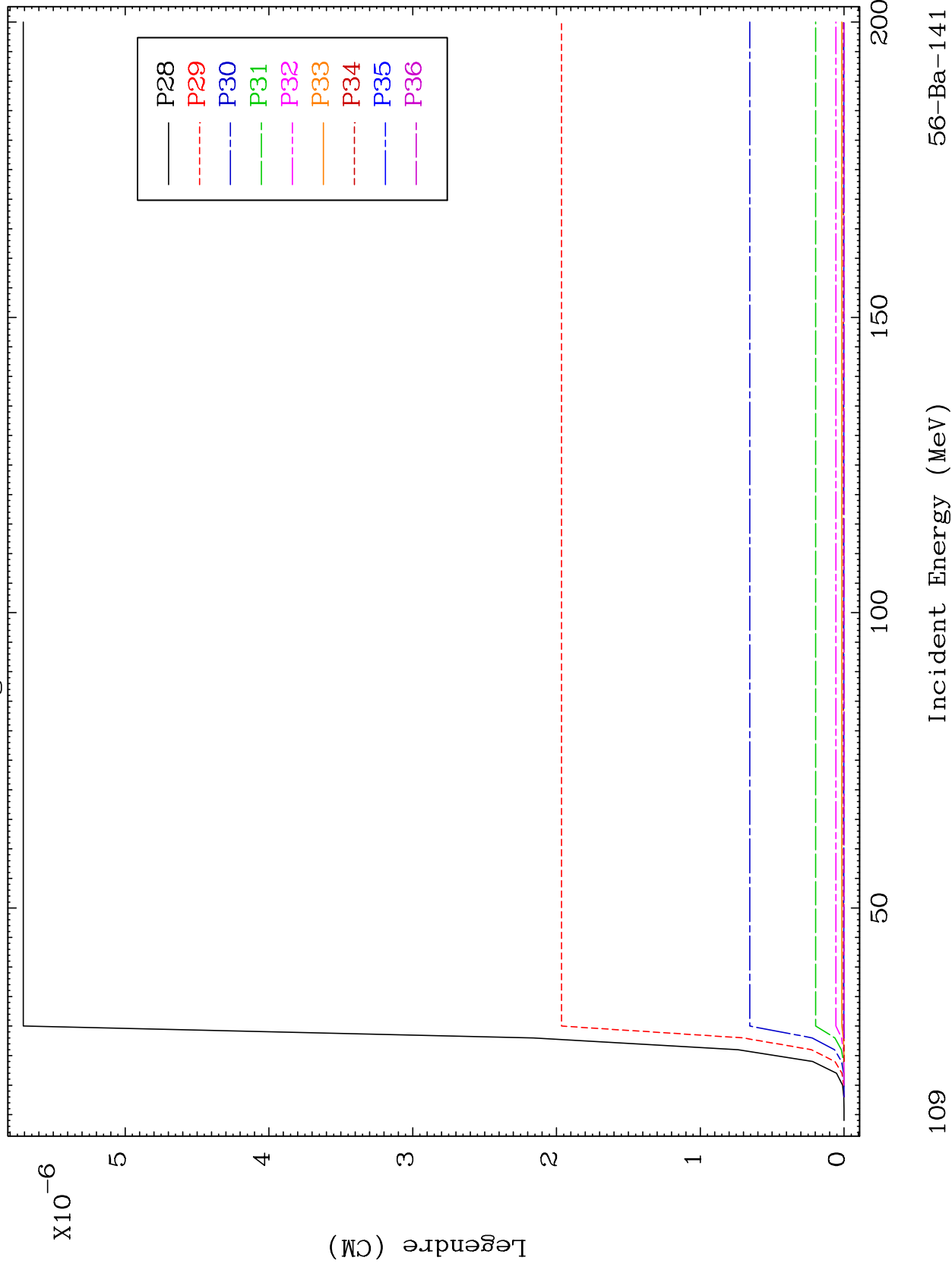

109

Incident Energy (MeV)

56-Ba-141

MAT 5658

MT= 74 (n,n') Level  
Legendre Coefficients

56-Ba-141

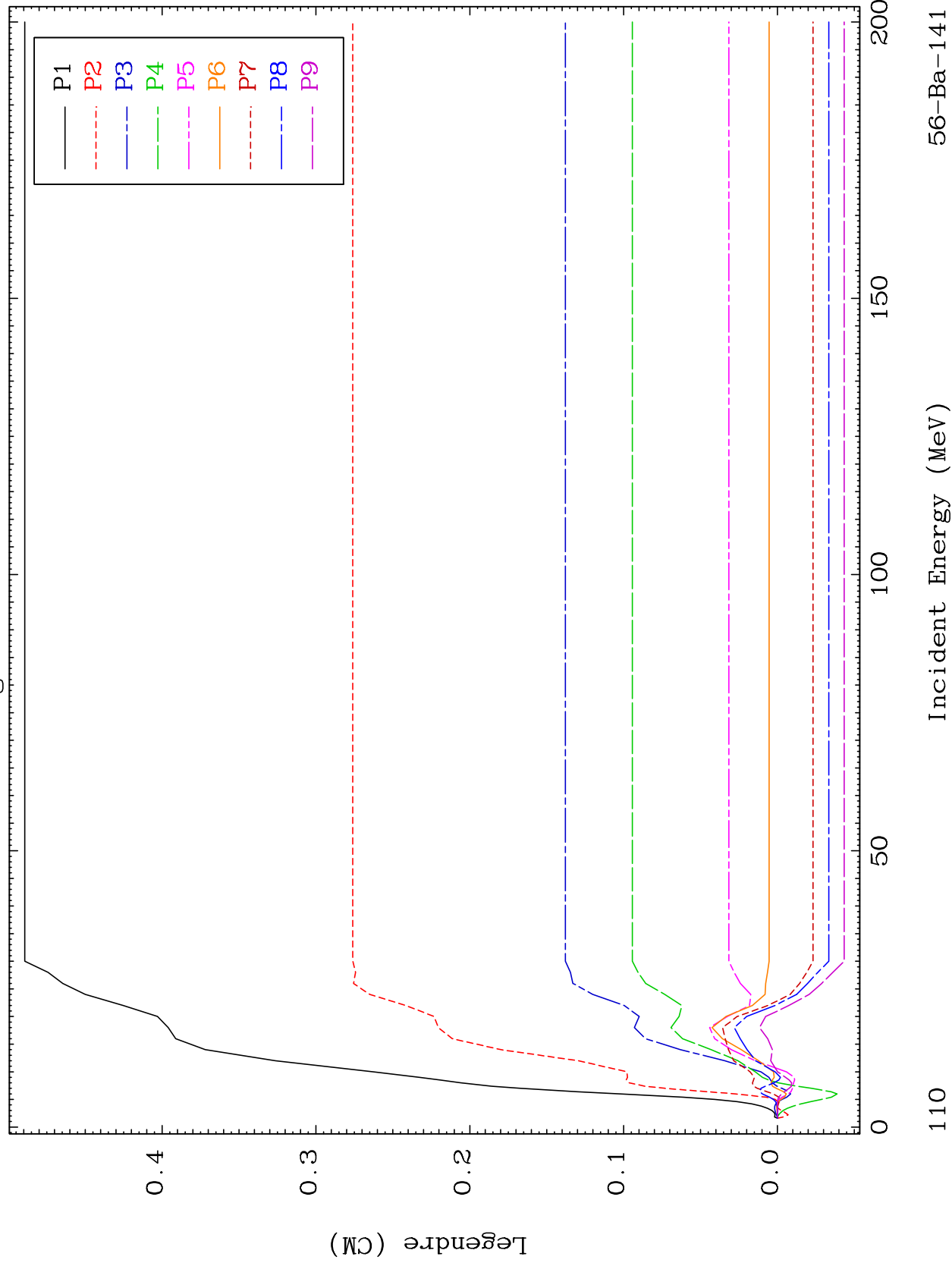

56-Ba-141

Incident Energy (MeV)

110

MAT 5658

MT= 74 (n,n') Level  
Legendre Coefficients

56-Ba-141

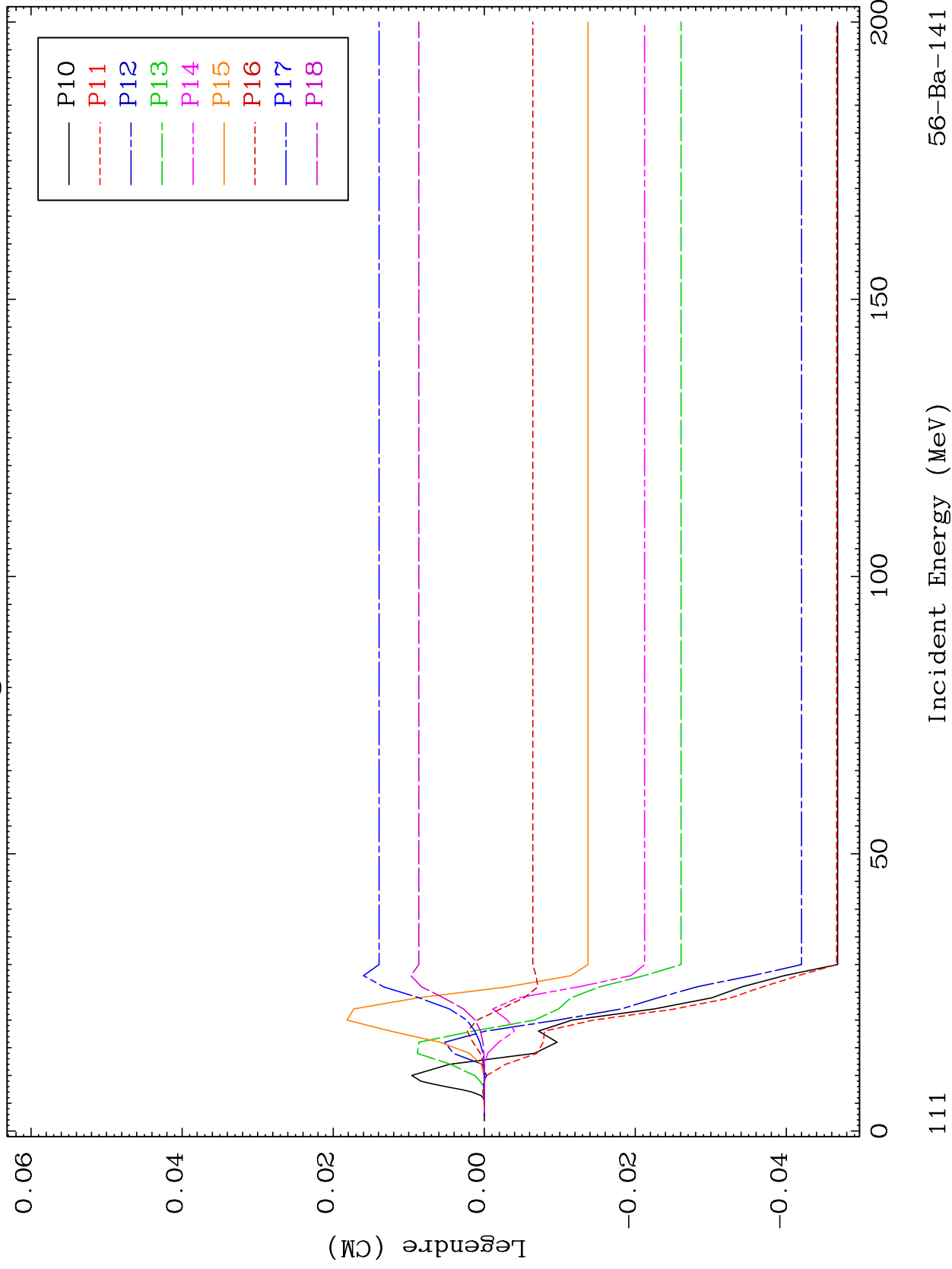

111

Incident Energy (MeV)

56-Ba-141



MAT 5658

MT= 74 (n,n') Level  
Legendre Coefficients

56-Ba-141

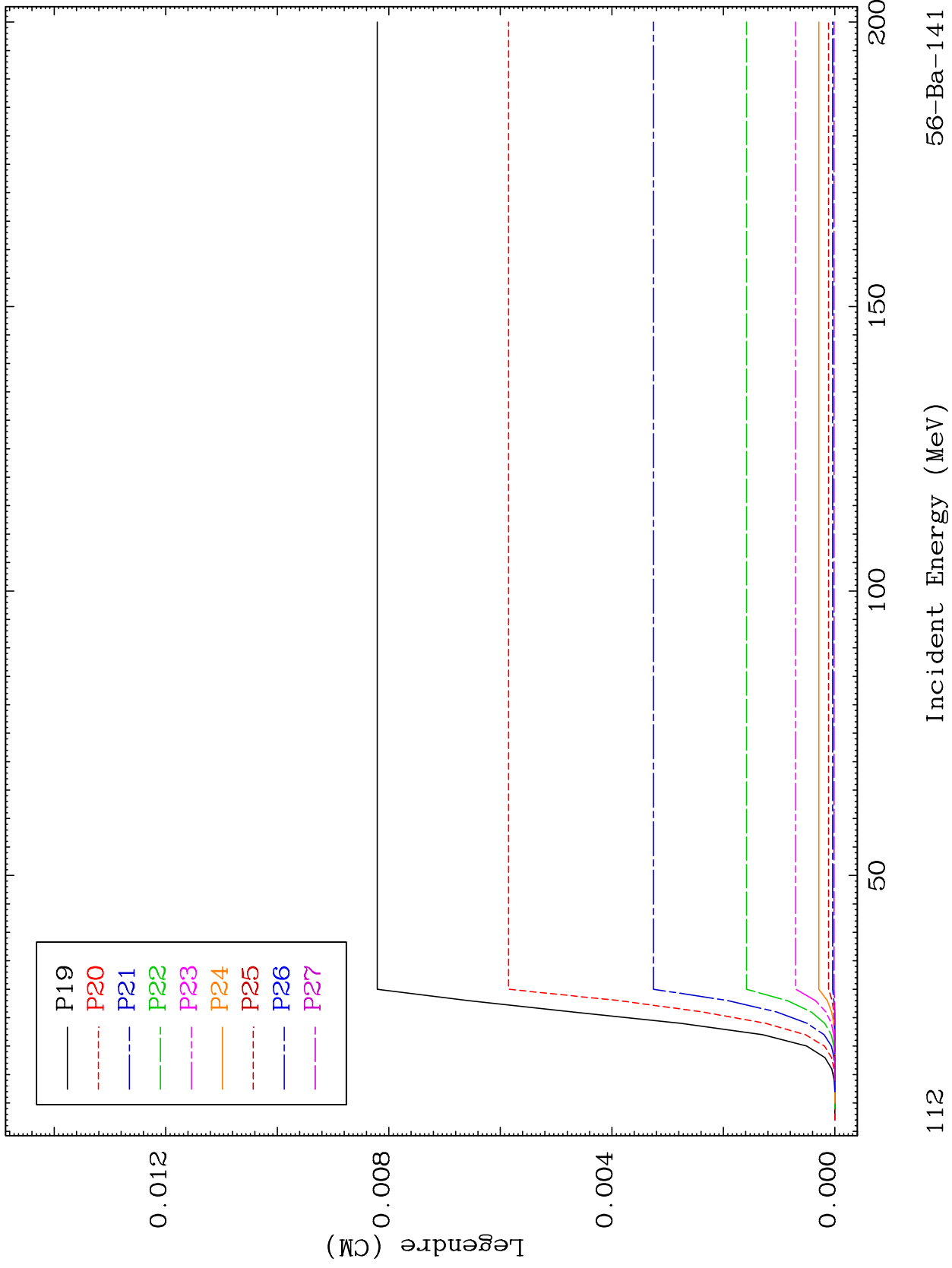

112

56-Ba-141

MAT 5658

MT= 74 (n,n') Level  
Legendre Coefficients

56-Ba-141

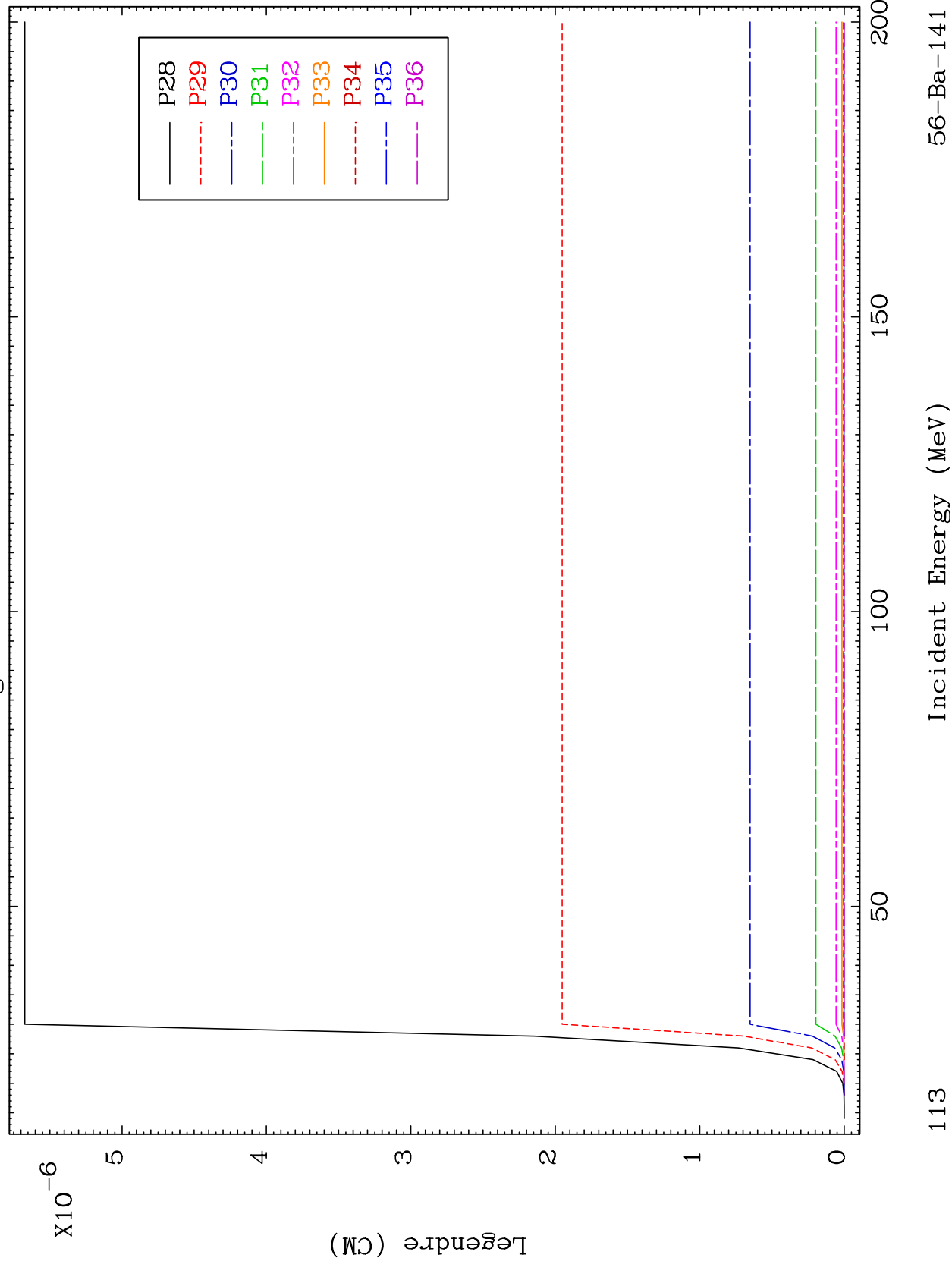

113

Incident Energy (MeV)

56-Ba-141

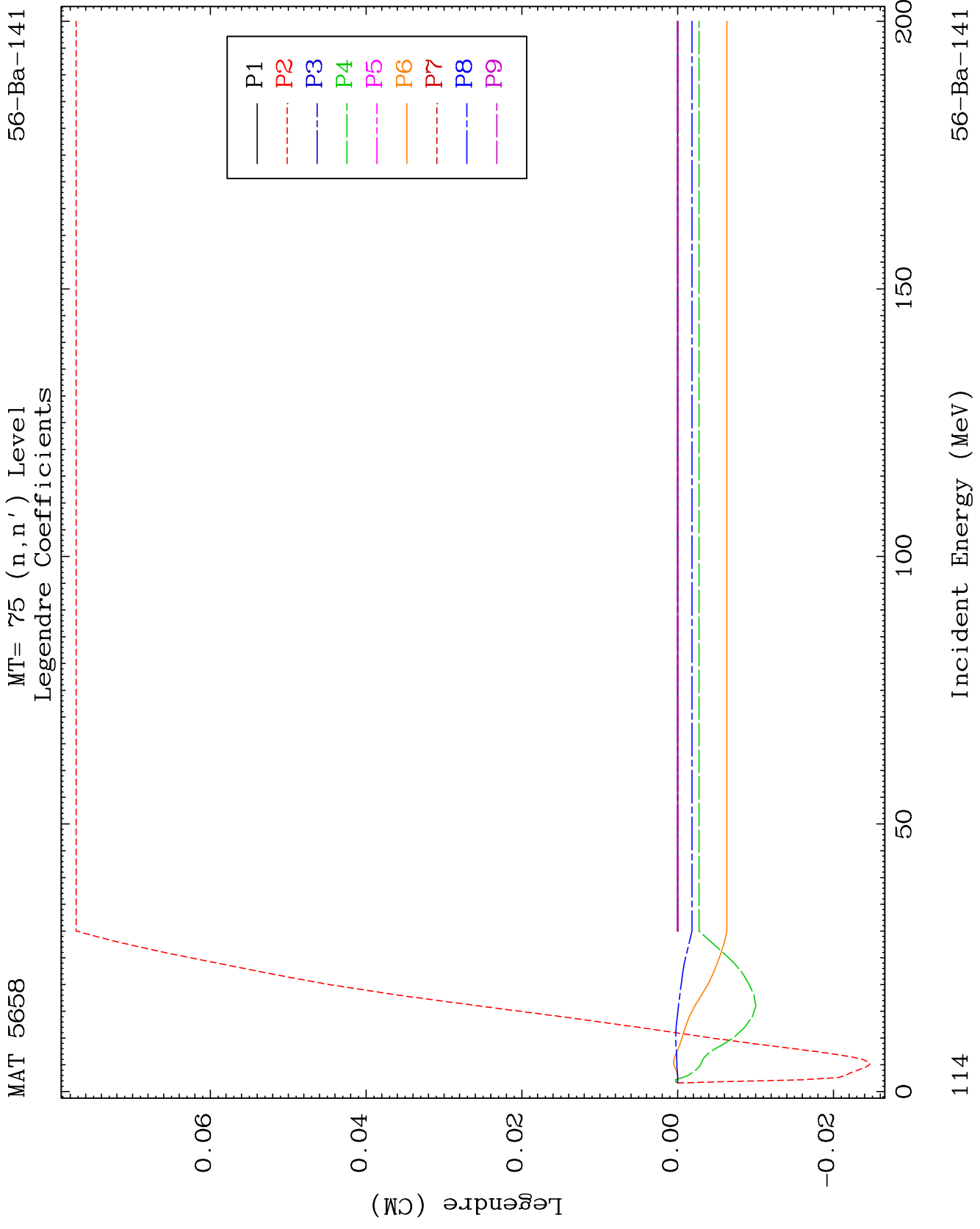

MAT 5658

MT= 75 (n,n') Level  
Legendre Coefficients

56-Ba-141

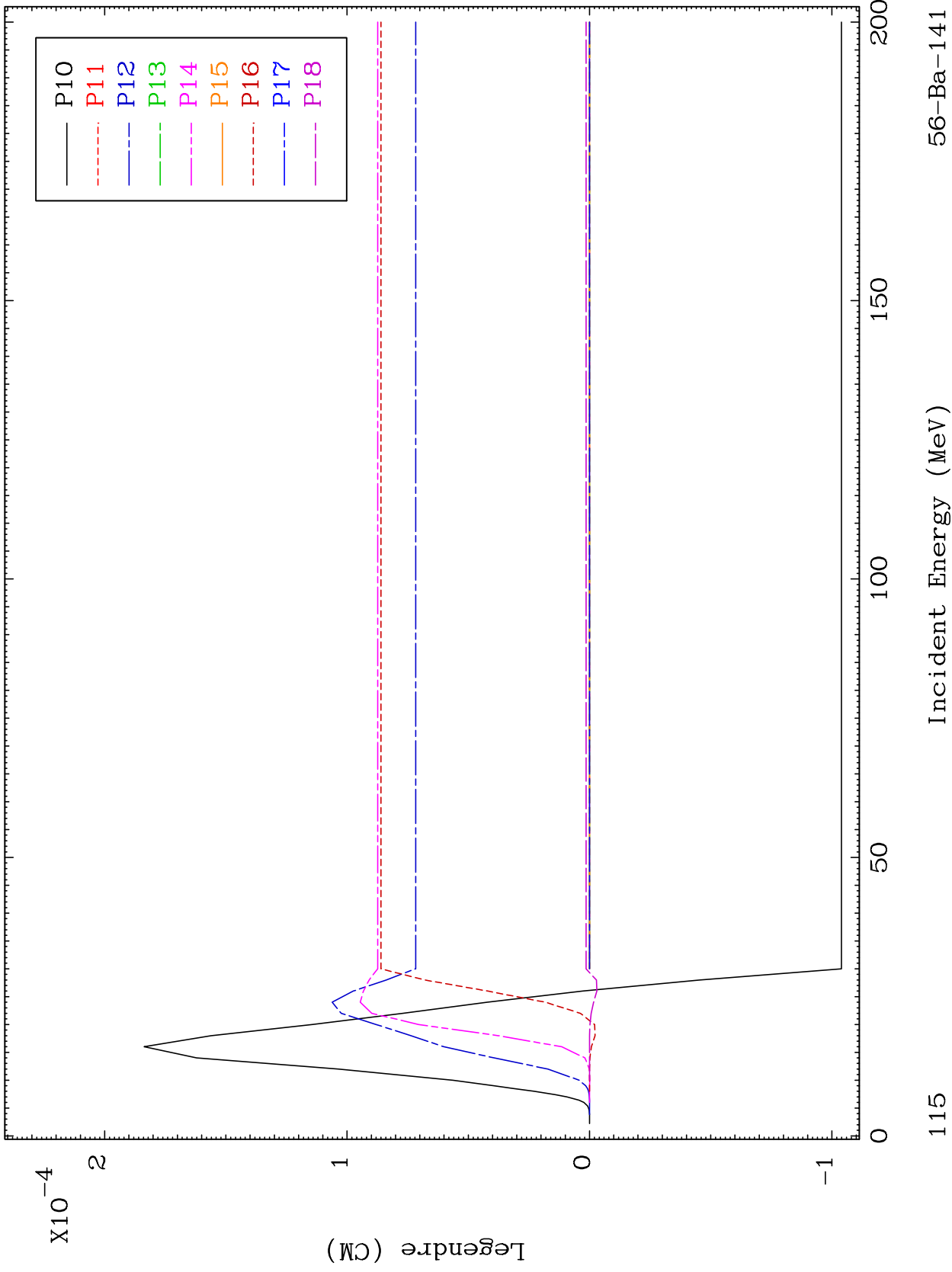

56-Ba-141

Incident Energy (MeV)

115

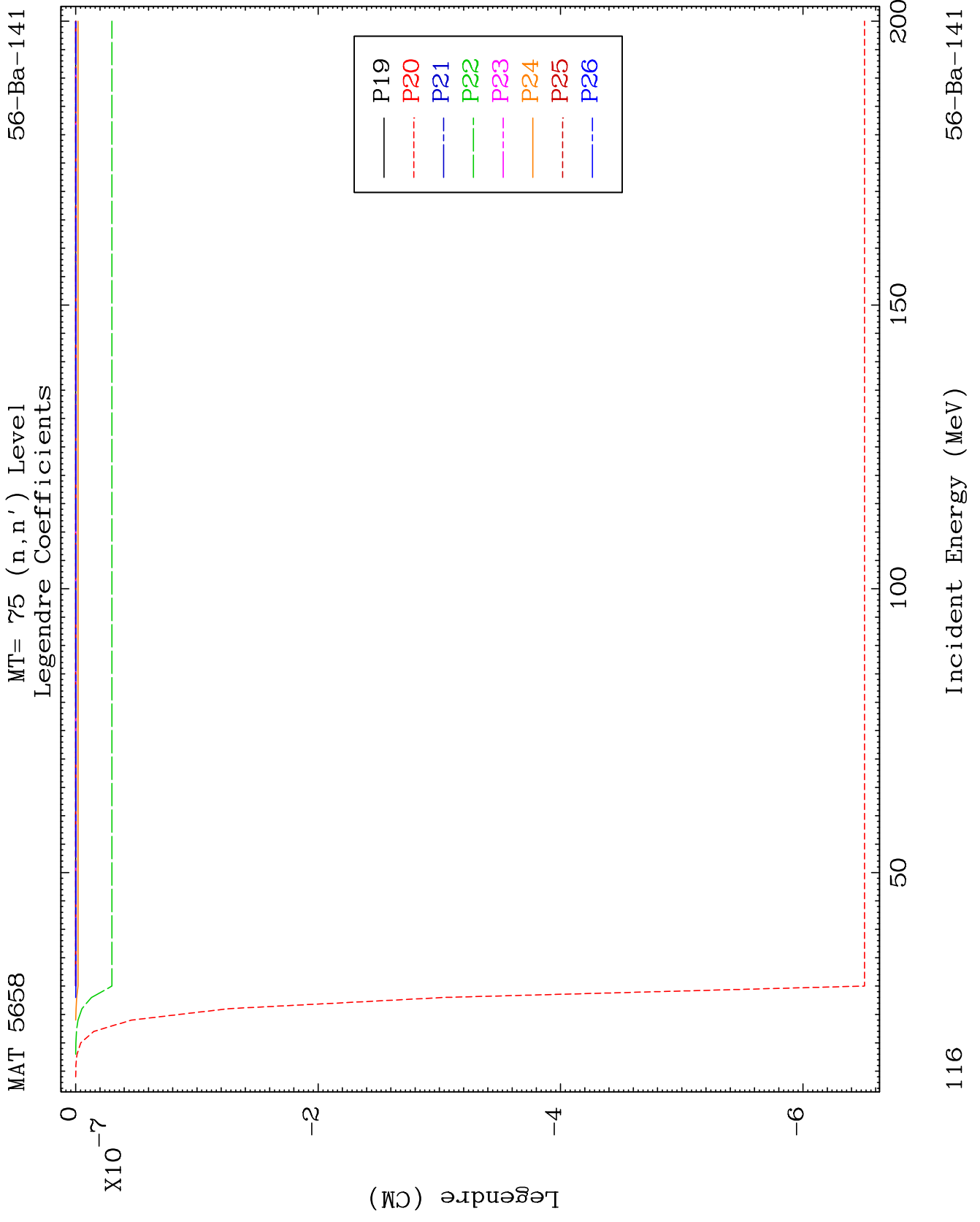



MAT 5658

MT= 76 (n,n') Level  
Legendre Coefficients

56-Ba-141

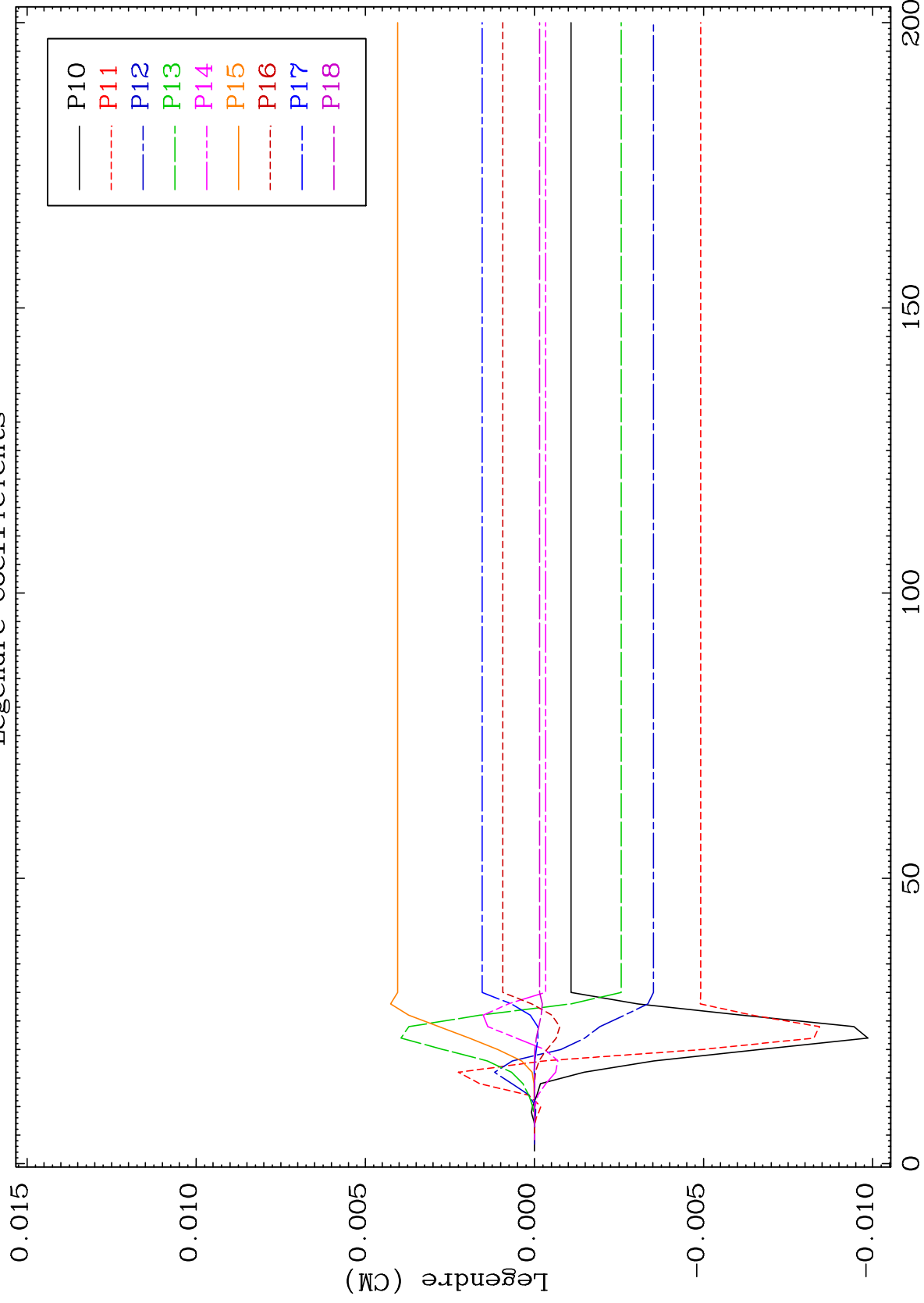

118

Incident Energy (MeV)

56-Ba-141

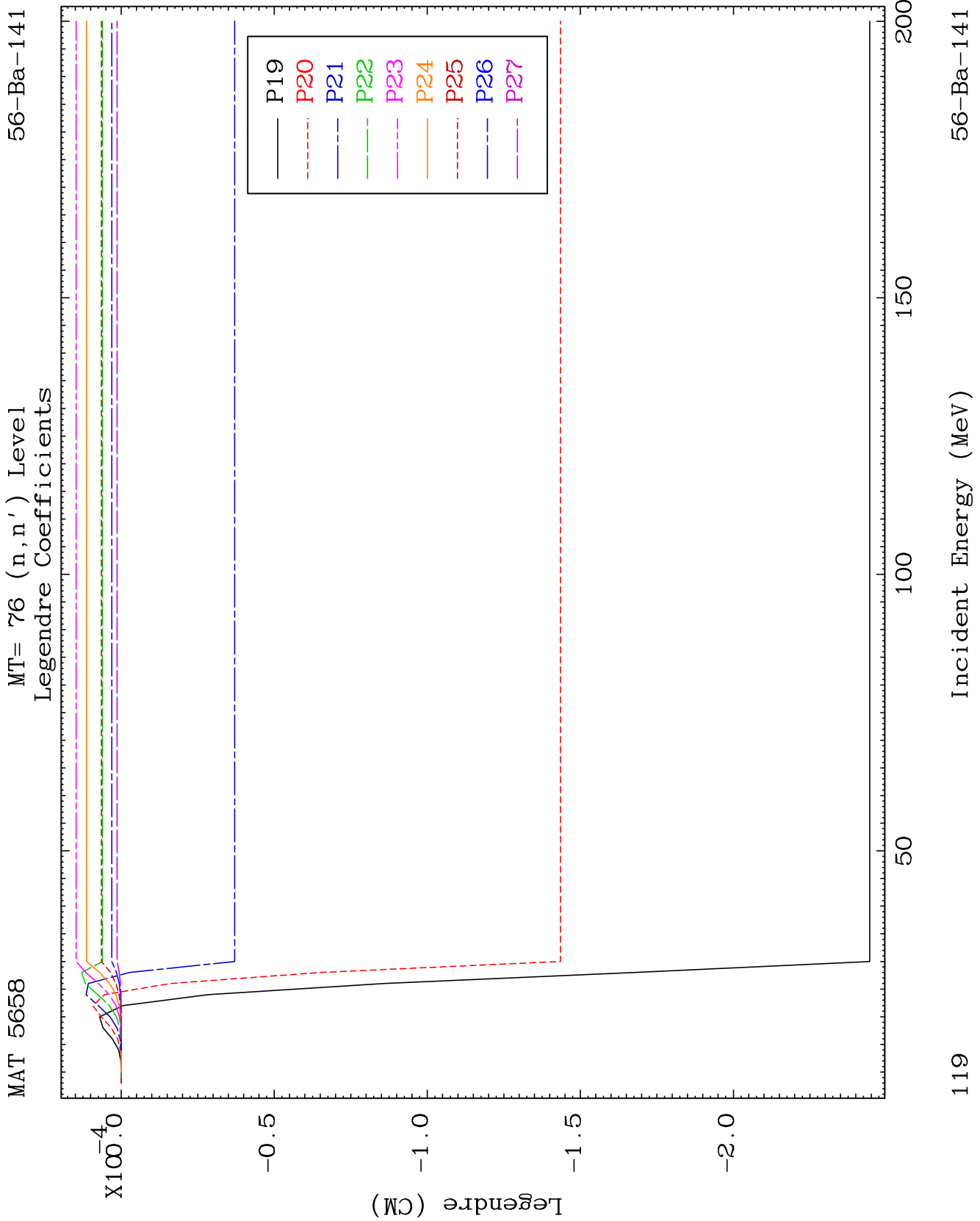



MAT 5658

MT= 76 (n,n') Level  
Legendre Coefficients

56-Ba-141

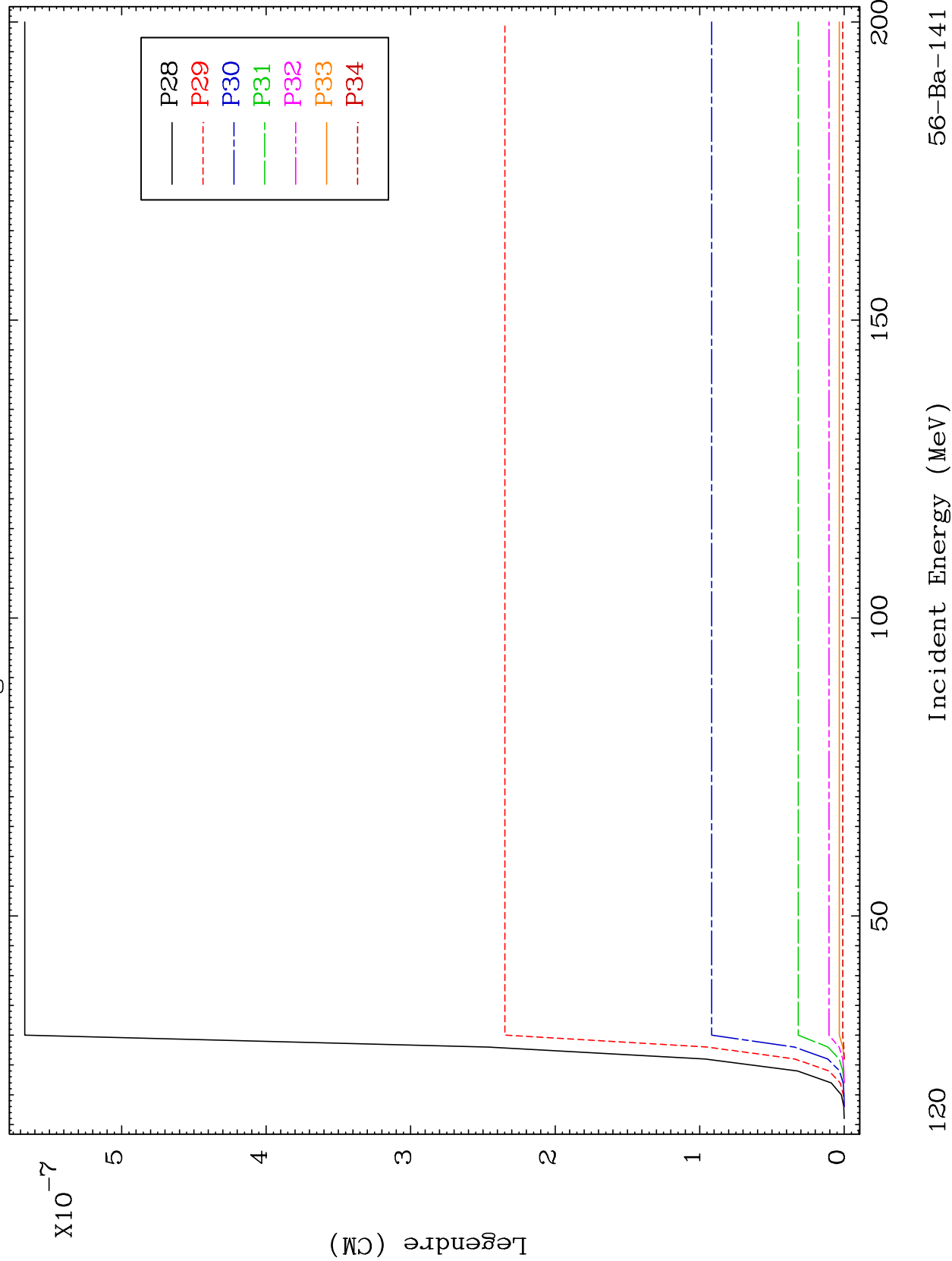

120

Incident Energy (MeV)

56-Ba-141

MAT 5658

MT= 77 (n,n') Level  
Legendre Coefficients

56-Ba-141

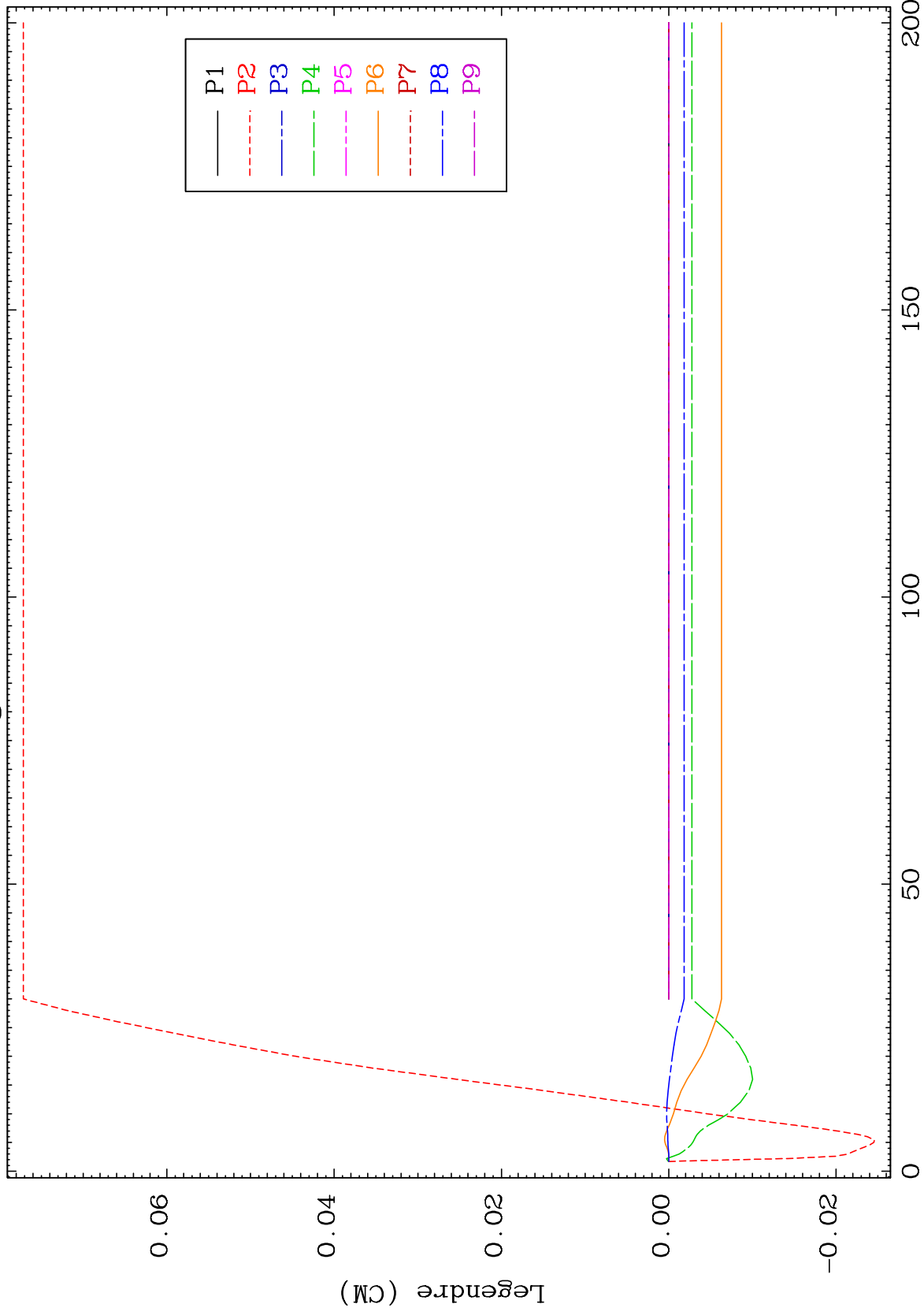

121

Incident Energy (MeV)

56-Ba-141

MAT 5658

MT= 77 (n,n') Level  
Legendre Coefficients

56-Ba-141

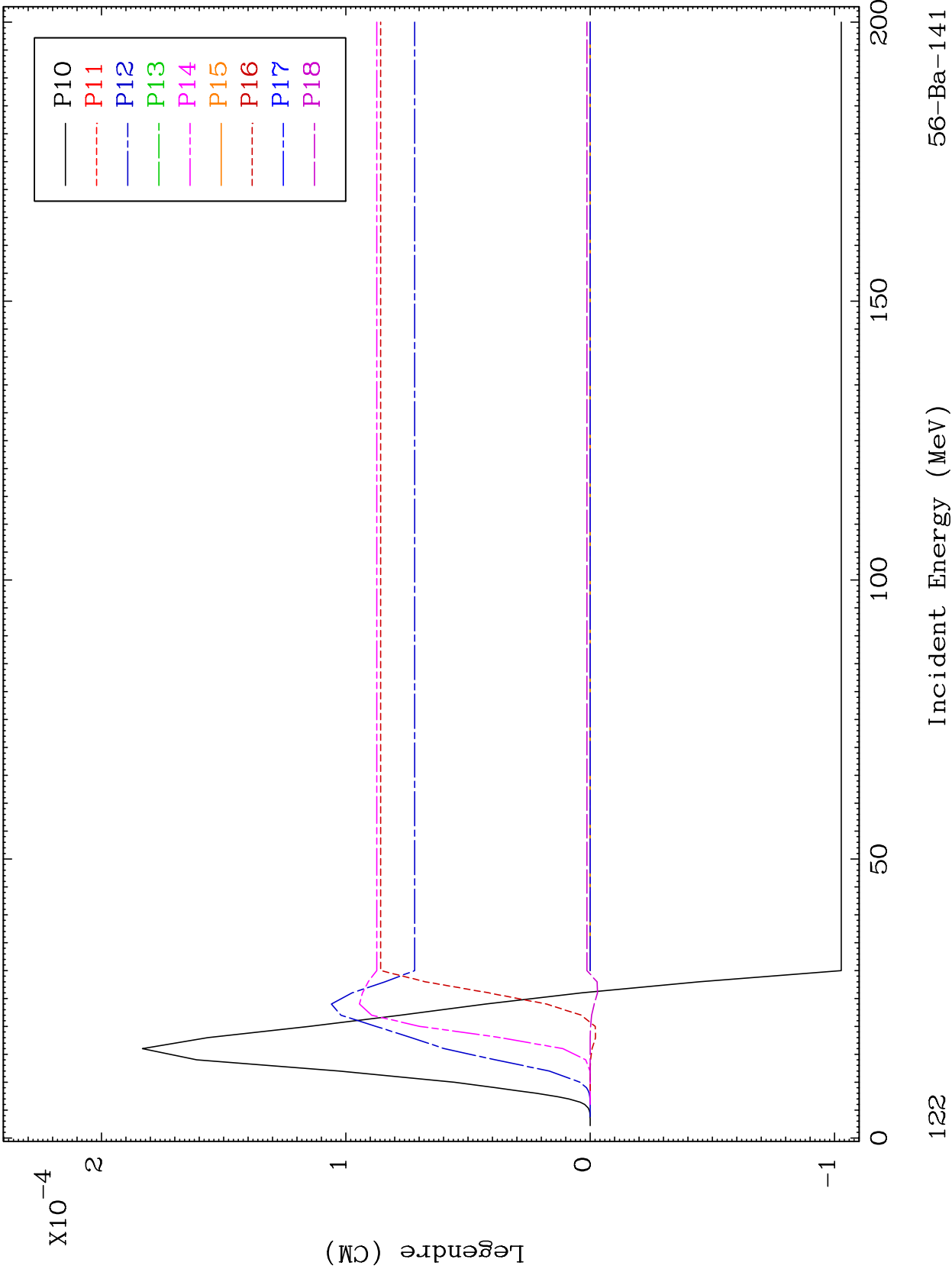

122

56-Ba-141

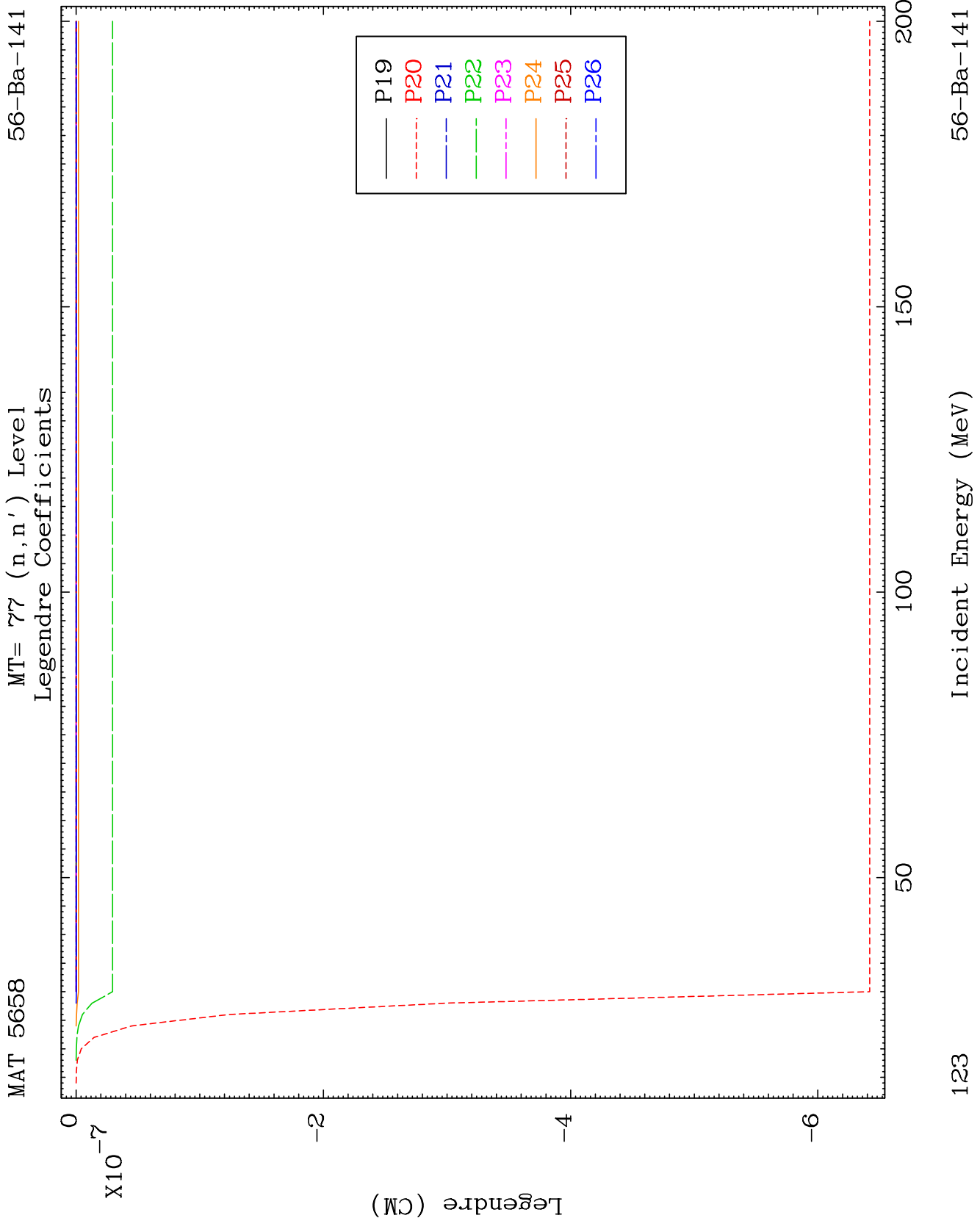

MAT 5658

MT= 78 (n,n') Level  
Legendre Coefficients

56-Ba-141

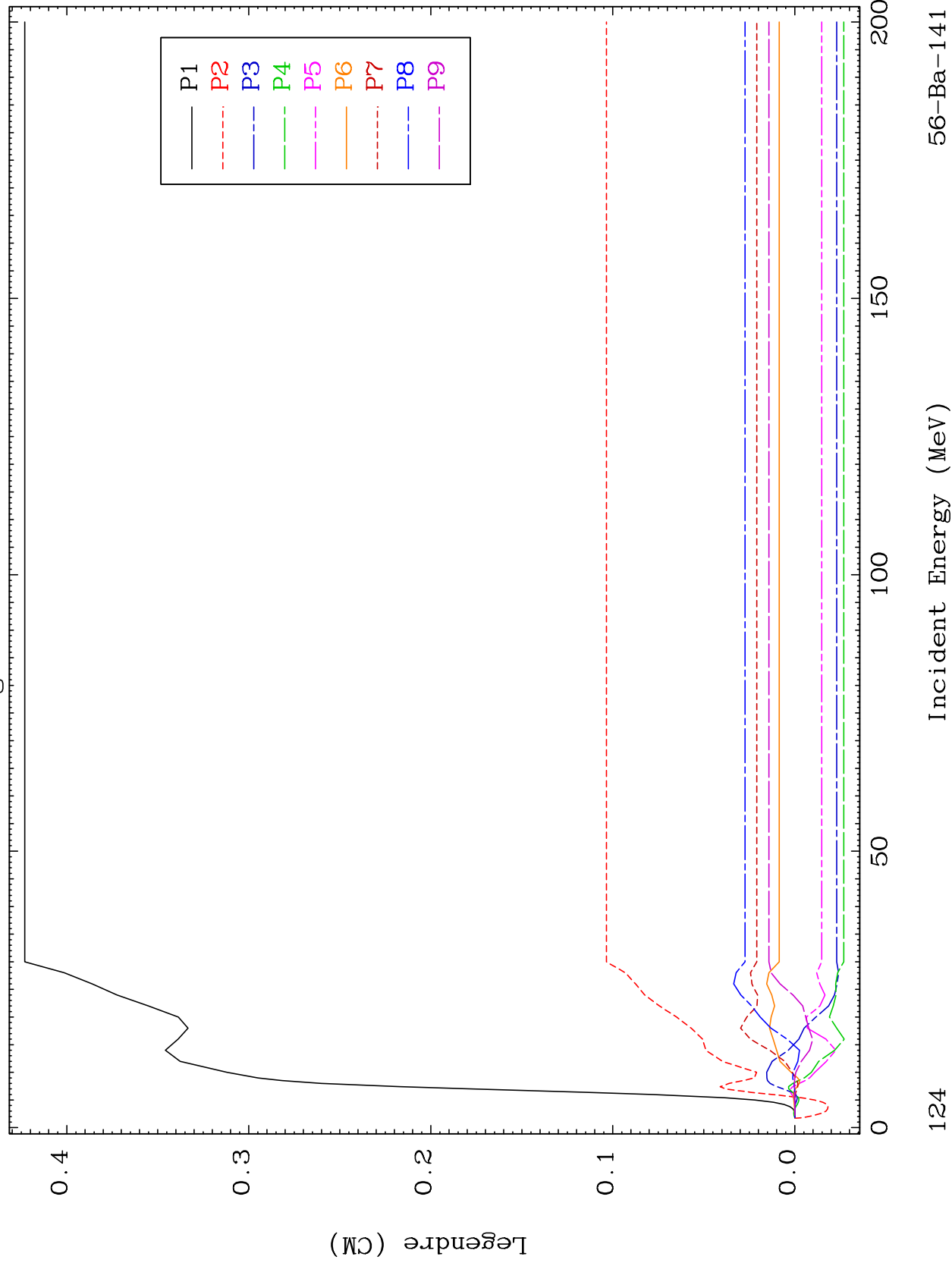

56-Ba-141

Incident Energy (MeV)

124



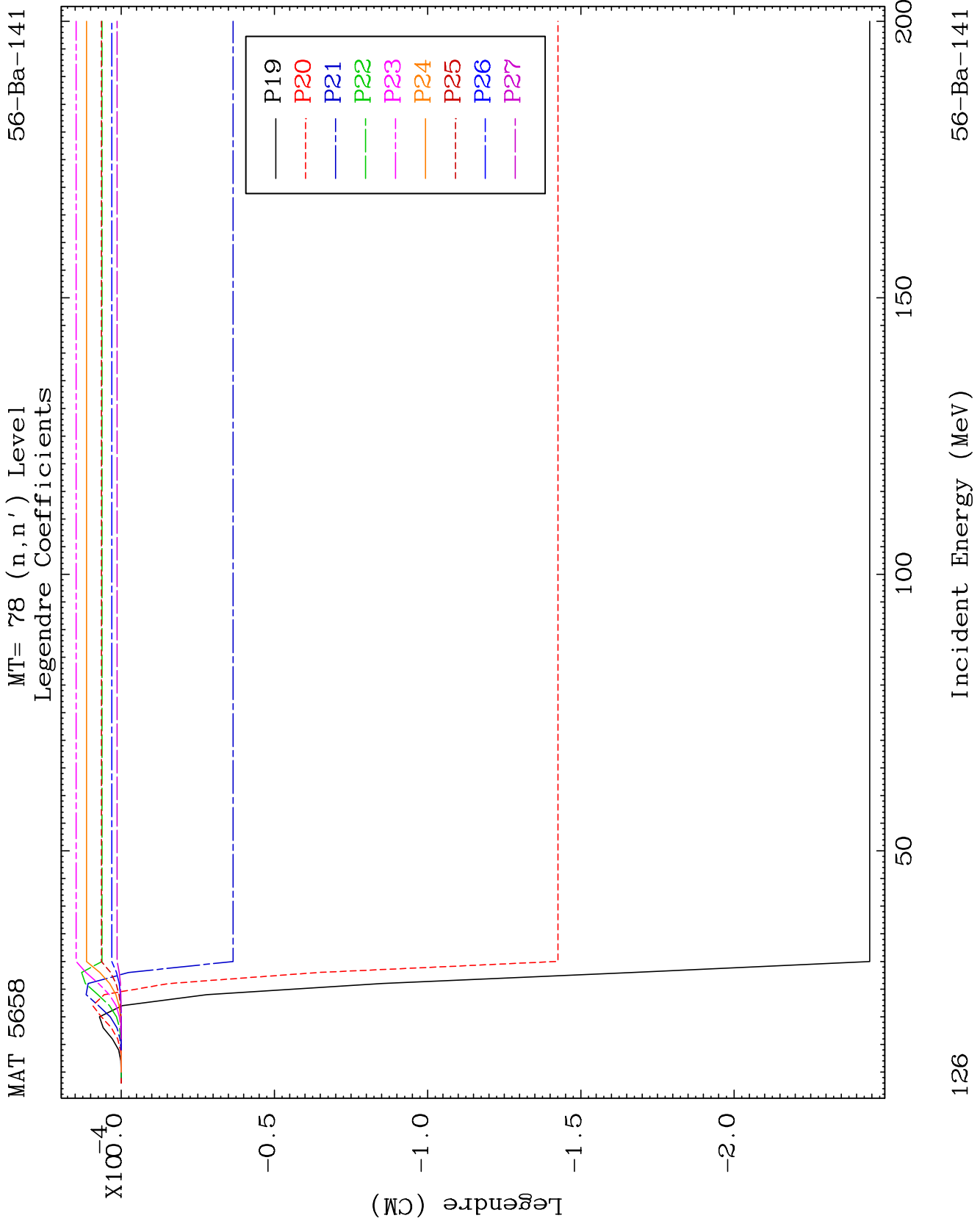

MAT 5658

MT= 78 (n,n') Level  
Legendre Coefficients

56-Ba-141

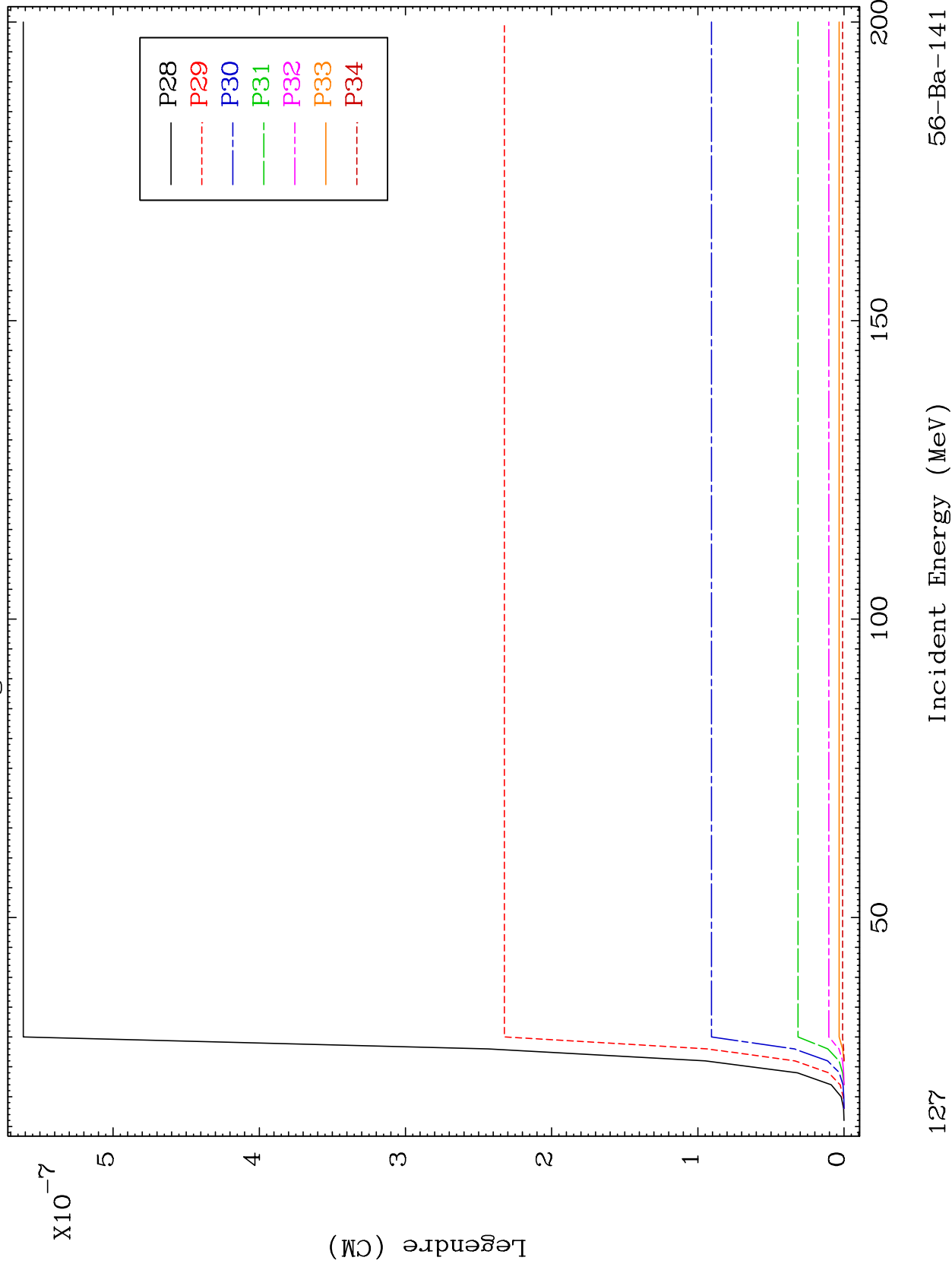

127

Incident Energy (MeV)

56-Ba-141



MAT 5658

MT= 79 (n,n') Level  
Legendre Coefficients

56-Ba-141

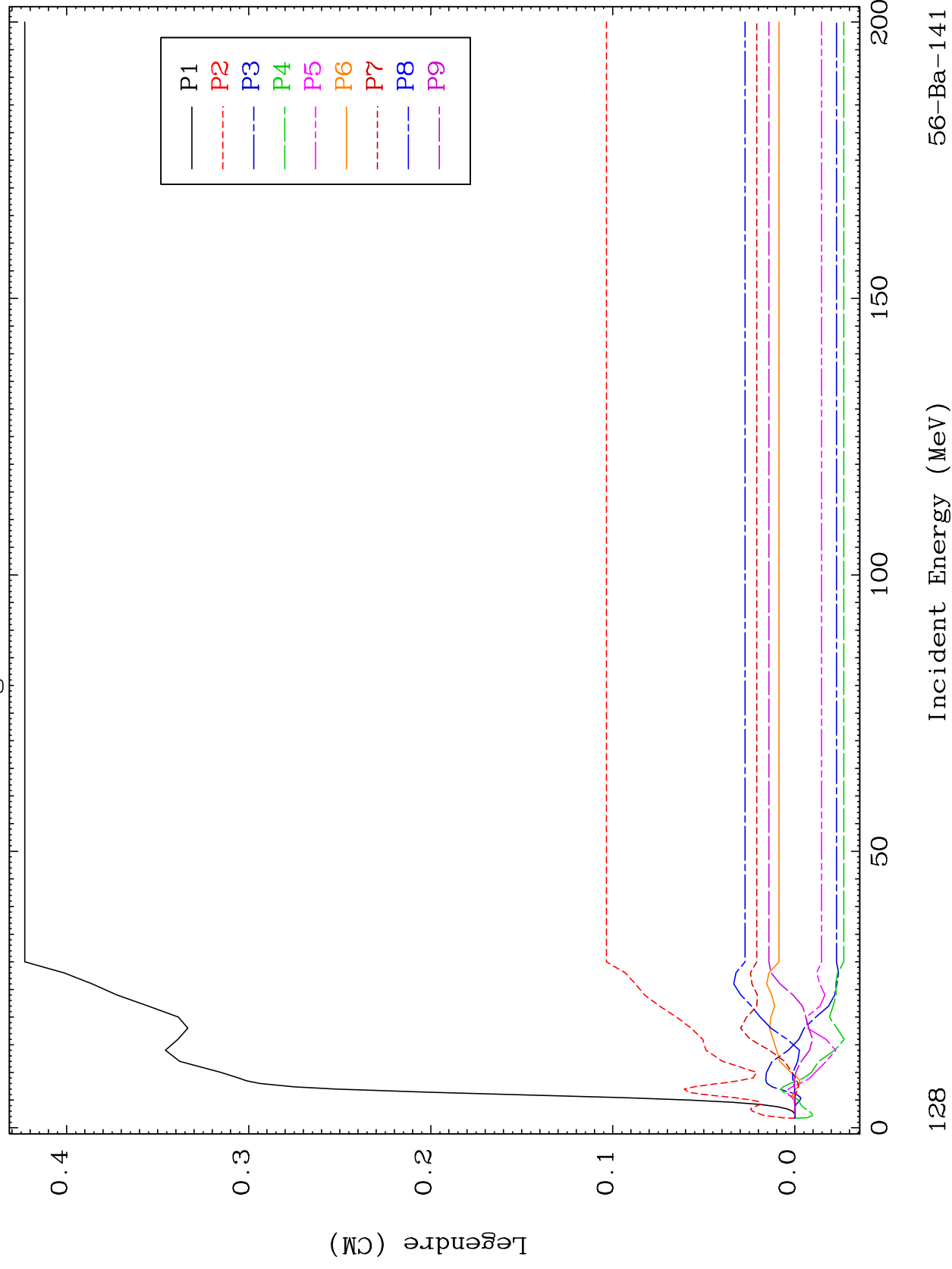

56-Ba-141

Incident Energy (MeV)

128

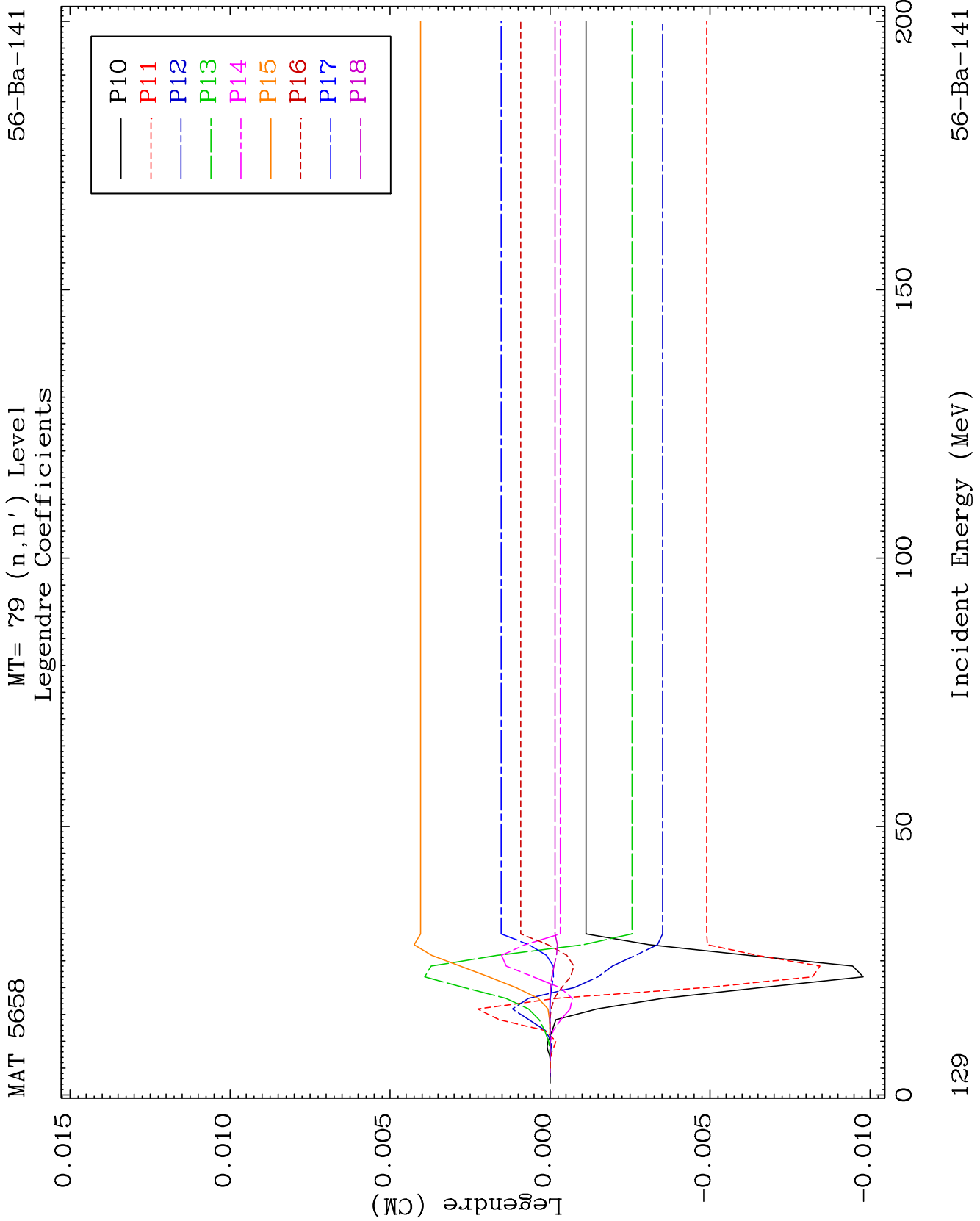

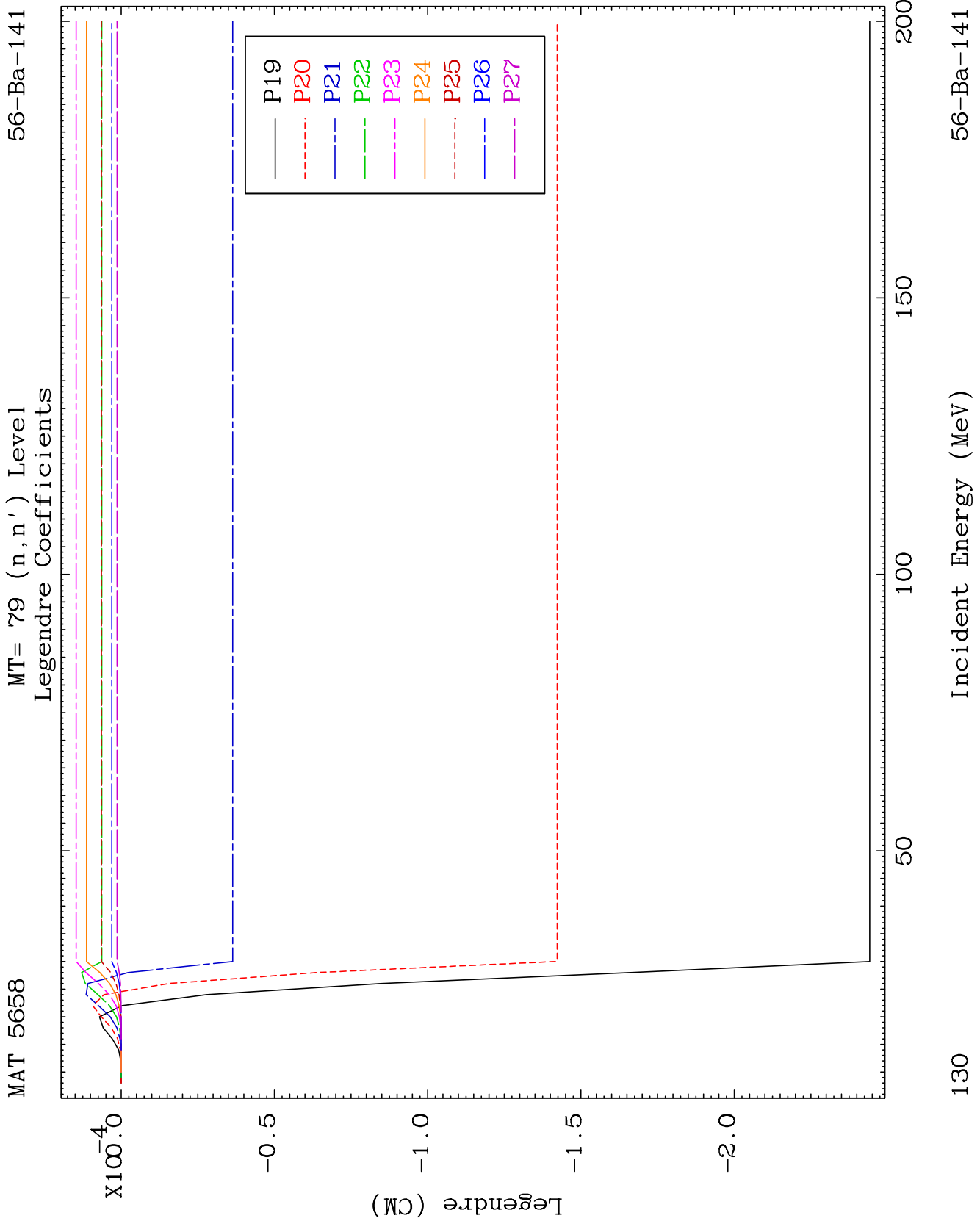

MAT 5658

MT= 79 (n,n') Level  
Legendre Coefficients

56-Ba-141

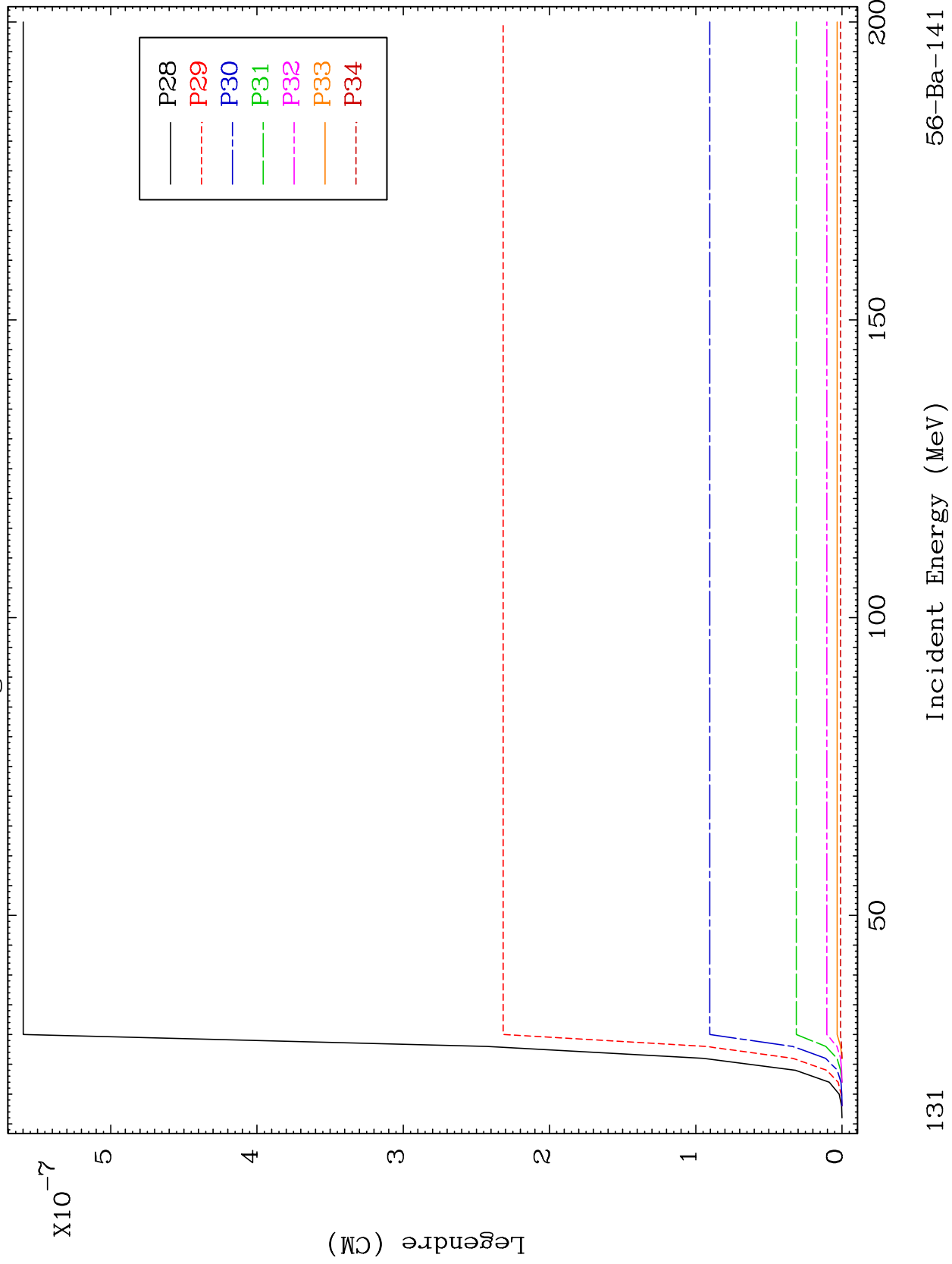

131

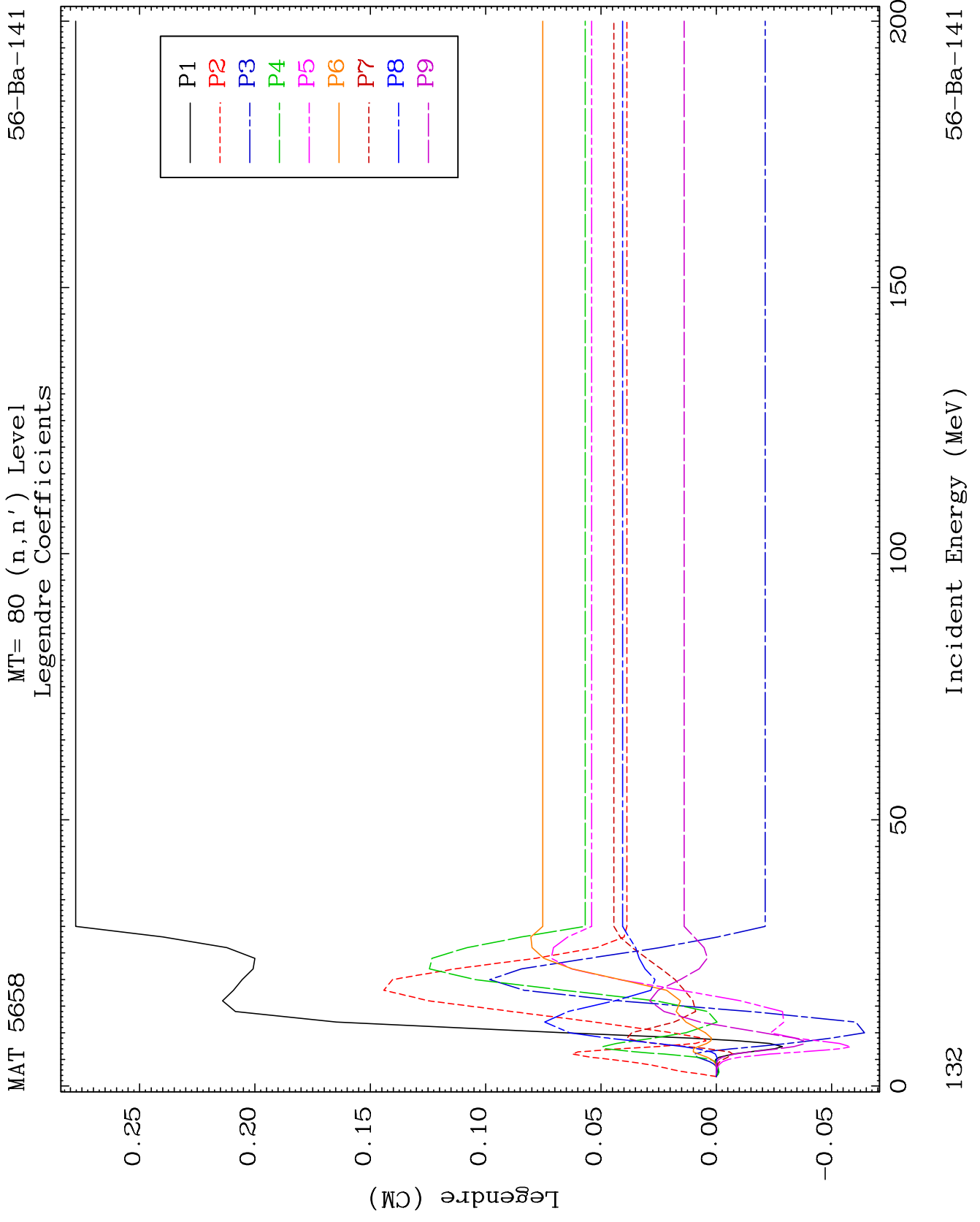

MAT 5658

MT= 80 (n,n') Level  
Legendre Coefficients

56-Ba-141

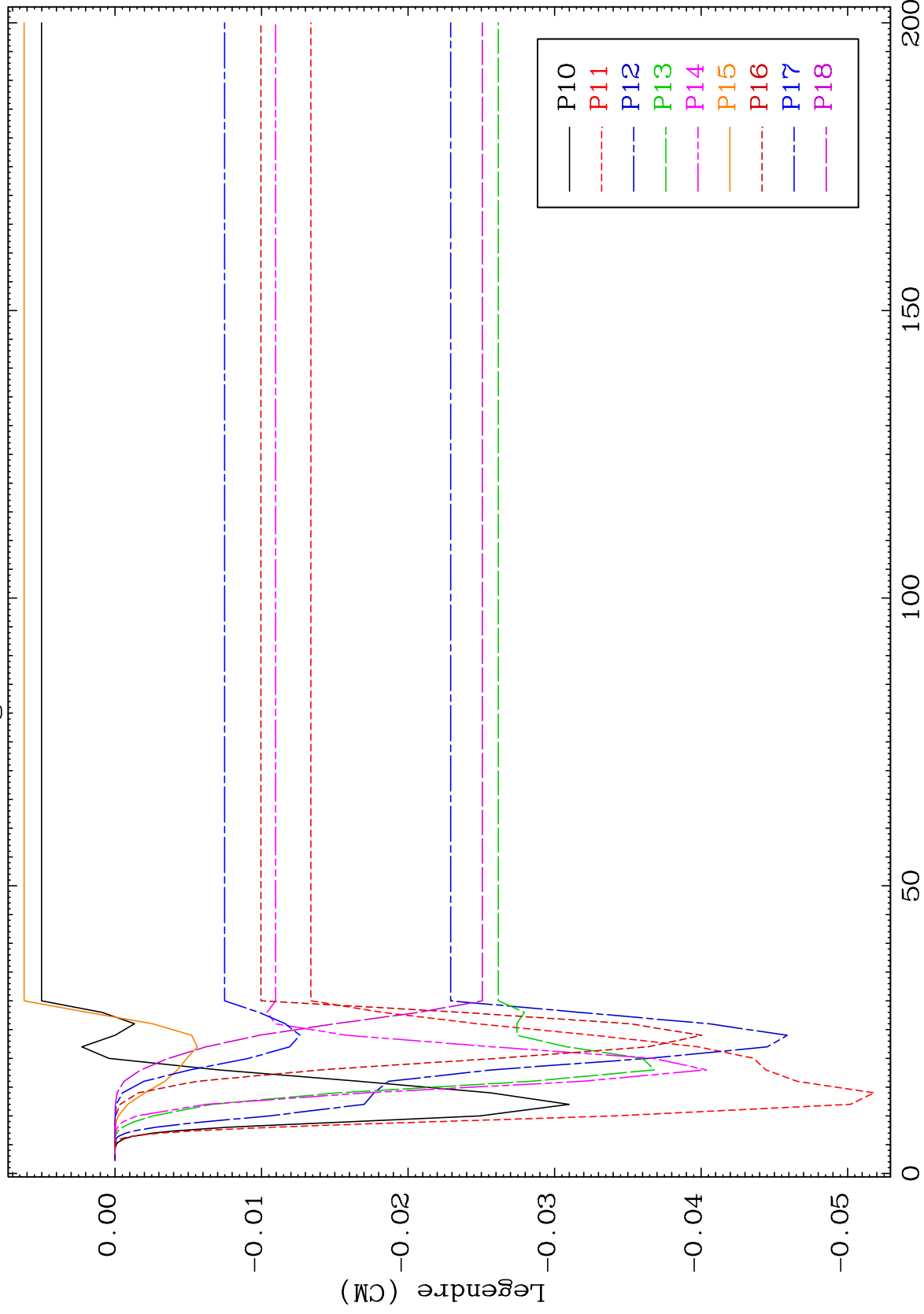

133

Incident Energy (MeV)

56-Ba-141

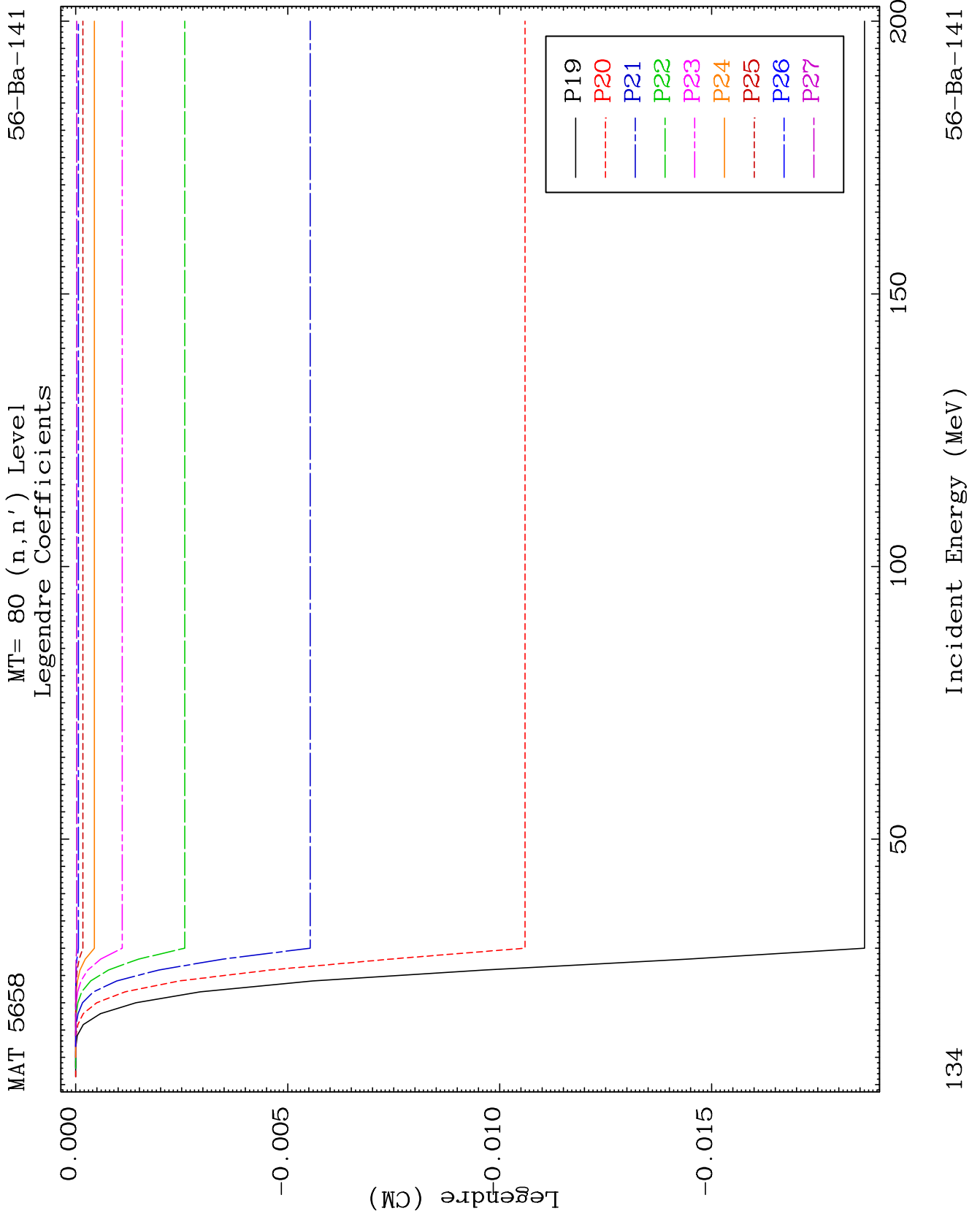

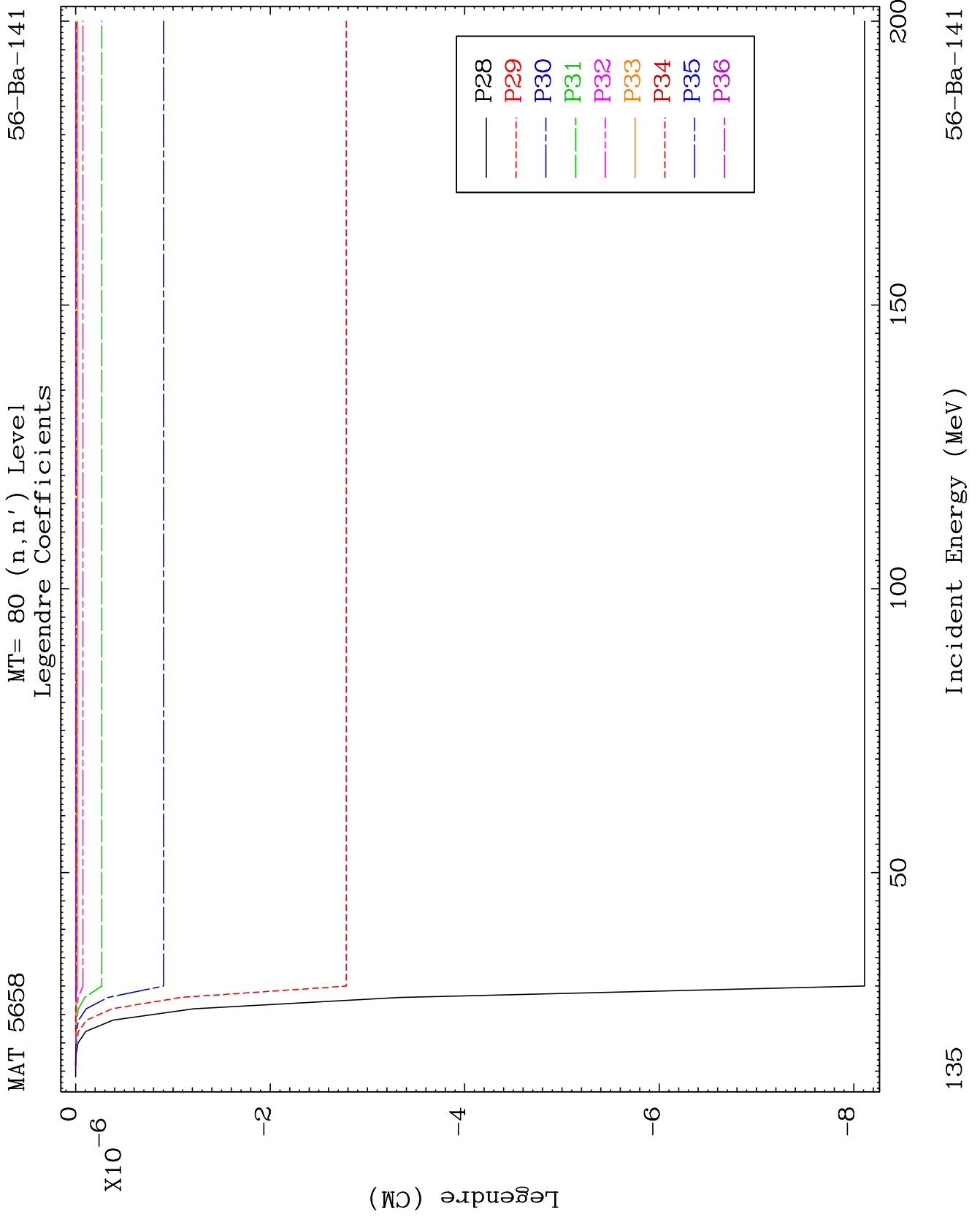



MAT 5658

(n,2n) d

56-Ba-141

Radionuclide Production Cross Section

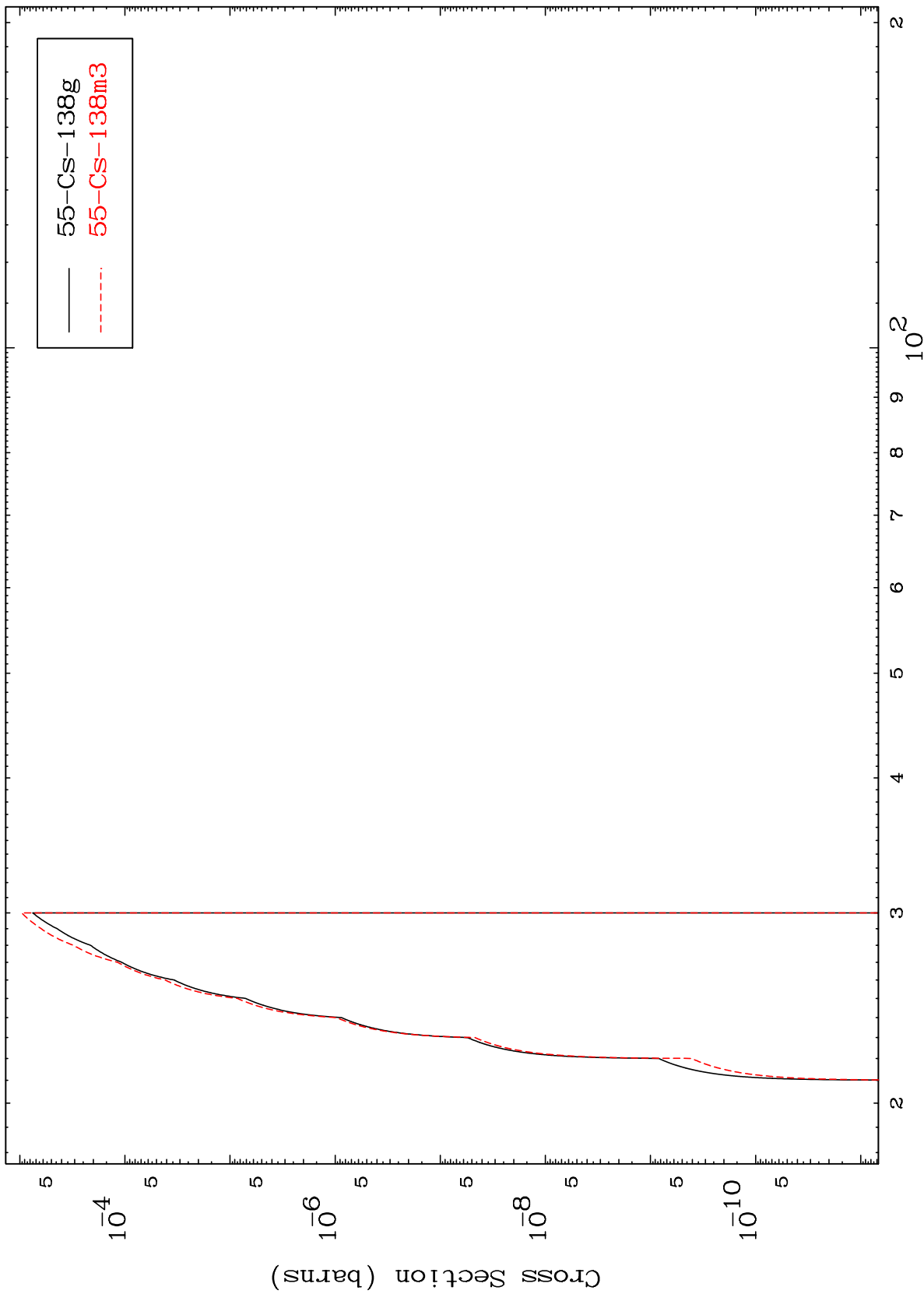

136

Incident Energy (MeV)

56-Ba-141

MAT 5658

(n,3n)  $\alpha$

56-Ba-141

Radionuclide Production Cross Section

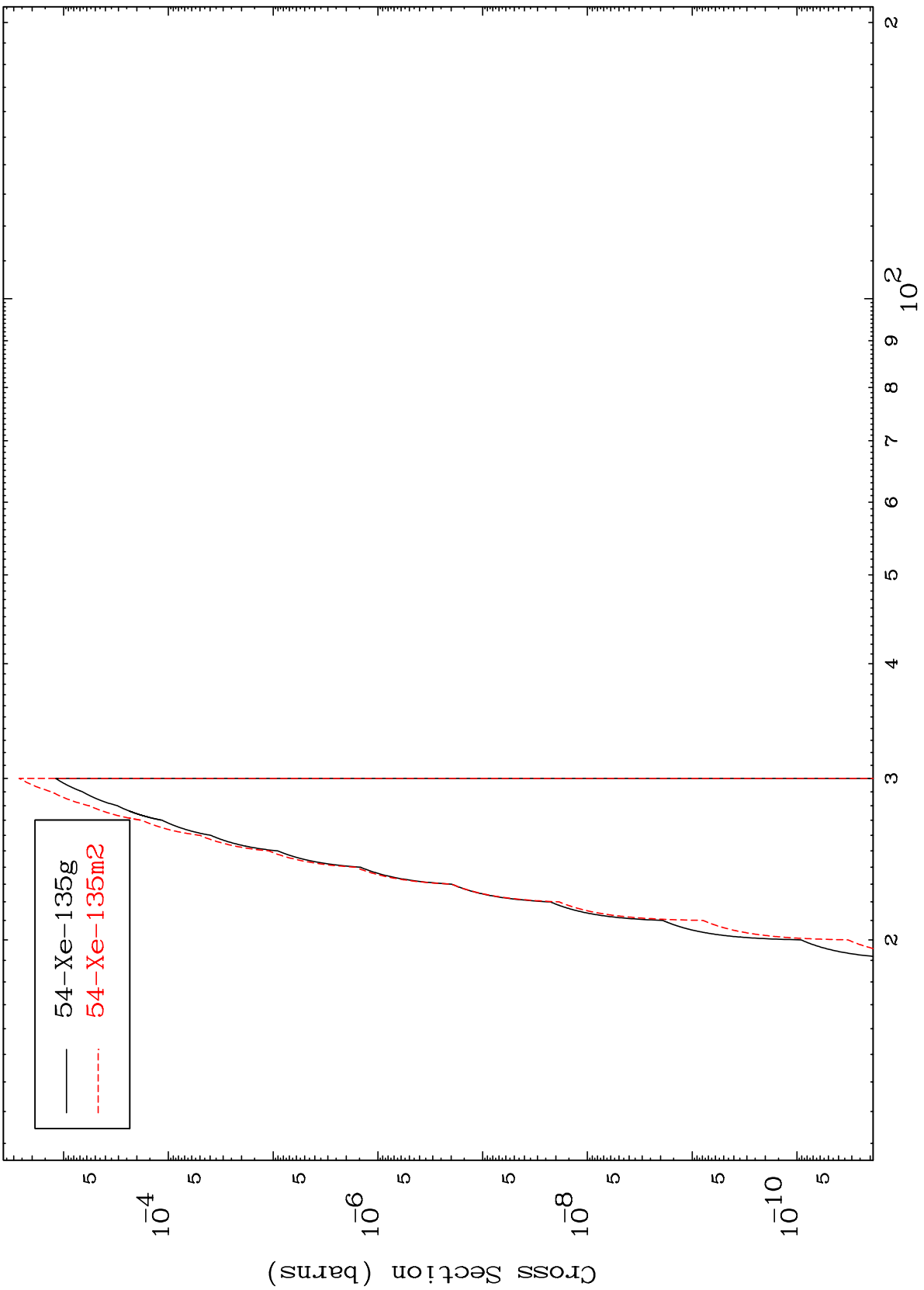

137

Incident Energy (MeV)

56-Ba-141

MAT 5658

(n,n') 2 $\alpha$

56-Ba-141

Radionuclide Production Cross Section

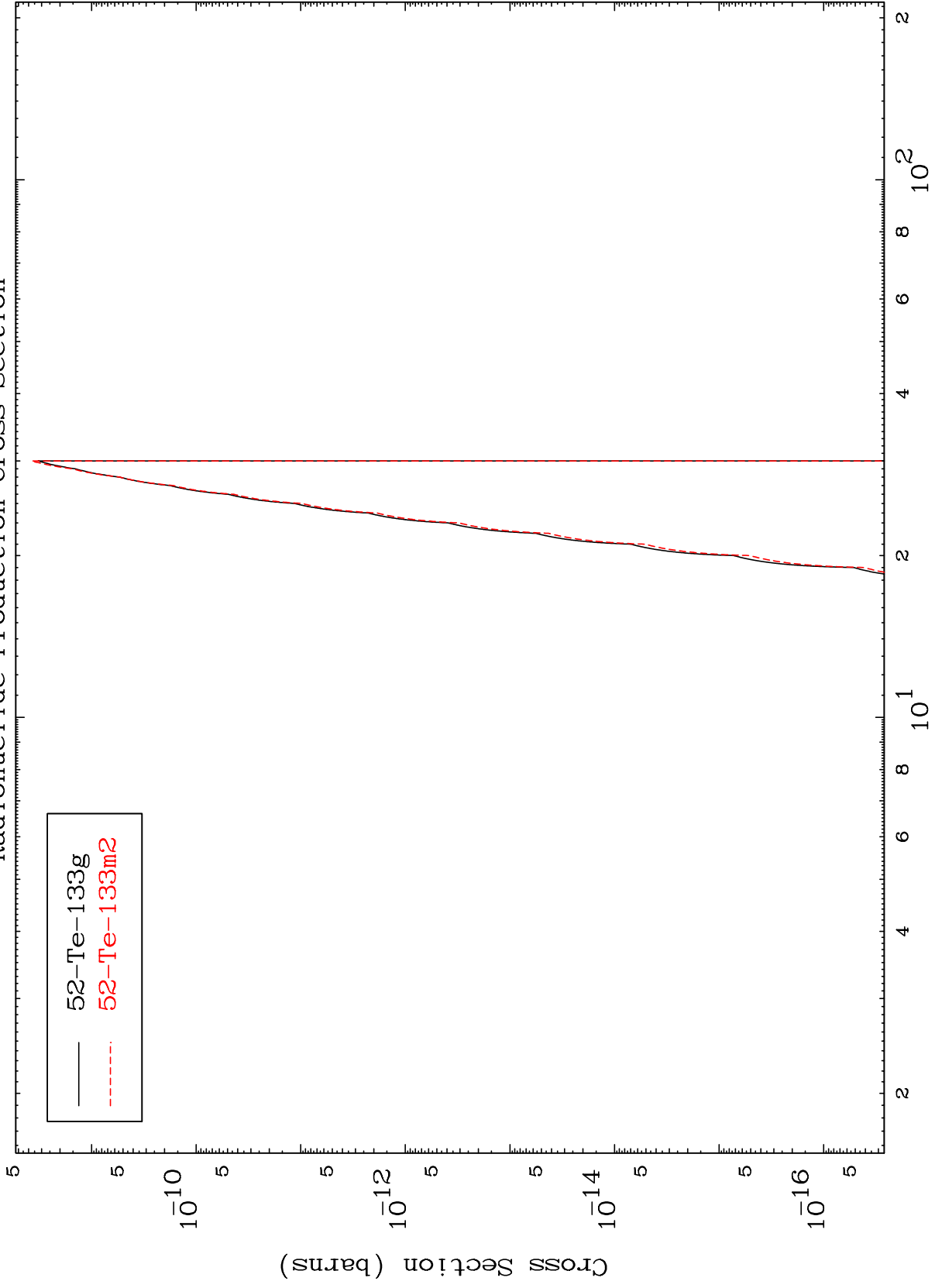

52-Te-133g  
52-Te-133m2

138

Incident Energy (MeV)

56-Ba-141

MAT 5658

(n,n') t

56-Ba-141

Radionuclide Production Cross Section

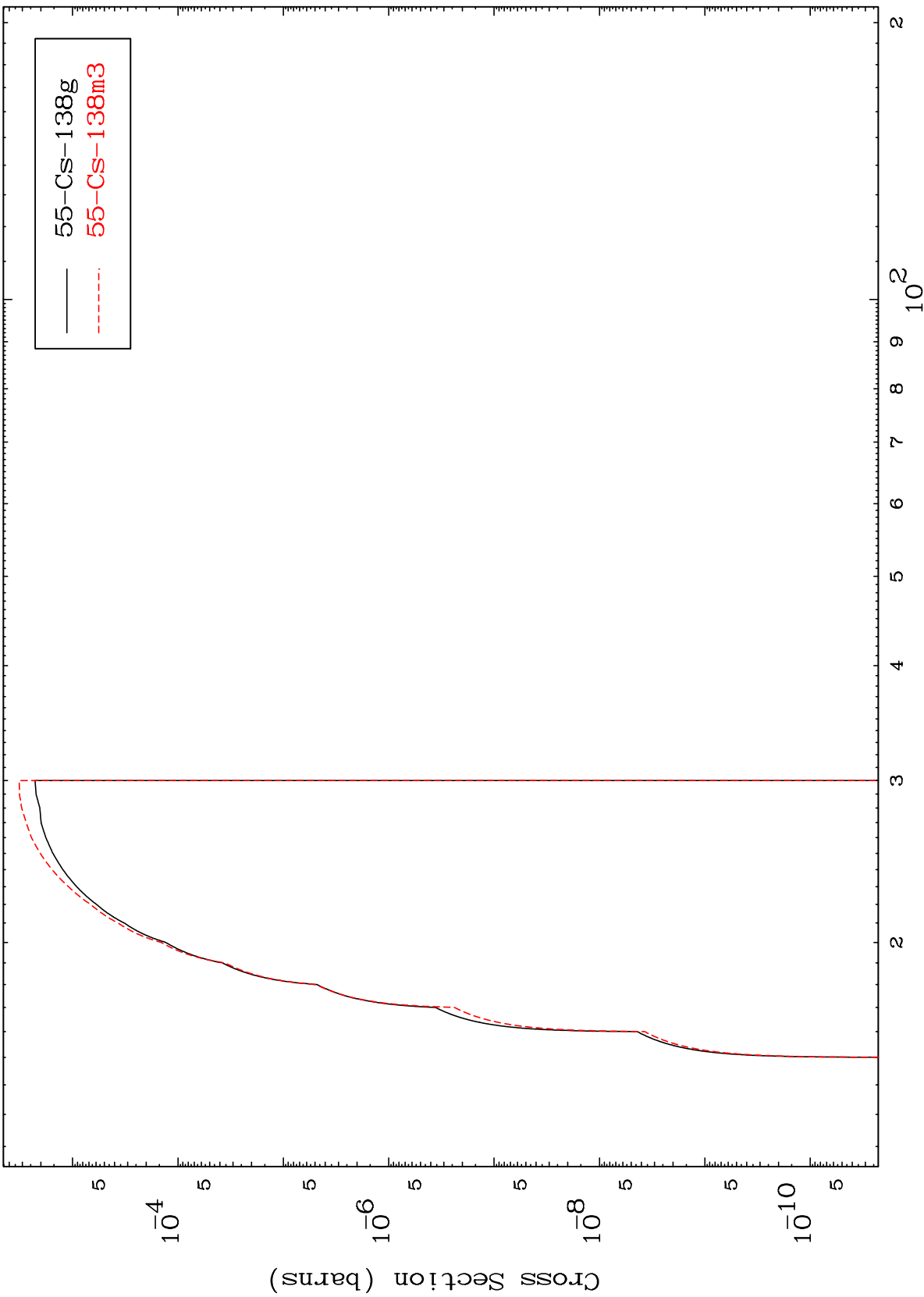

139

Incident Energy (MeV)

56-Ba-141

MAT 5658

(n,3n) p

56-Ba-141

Radionuclide Production Cross Section

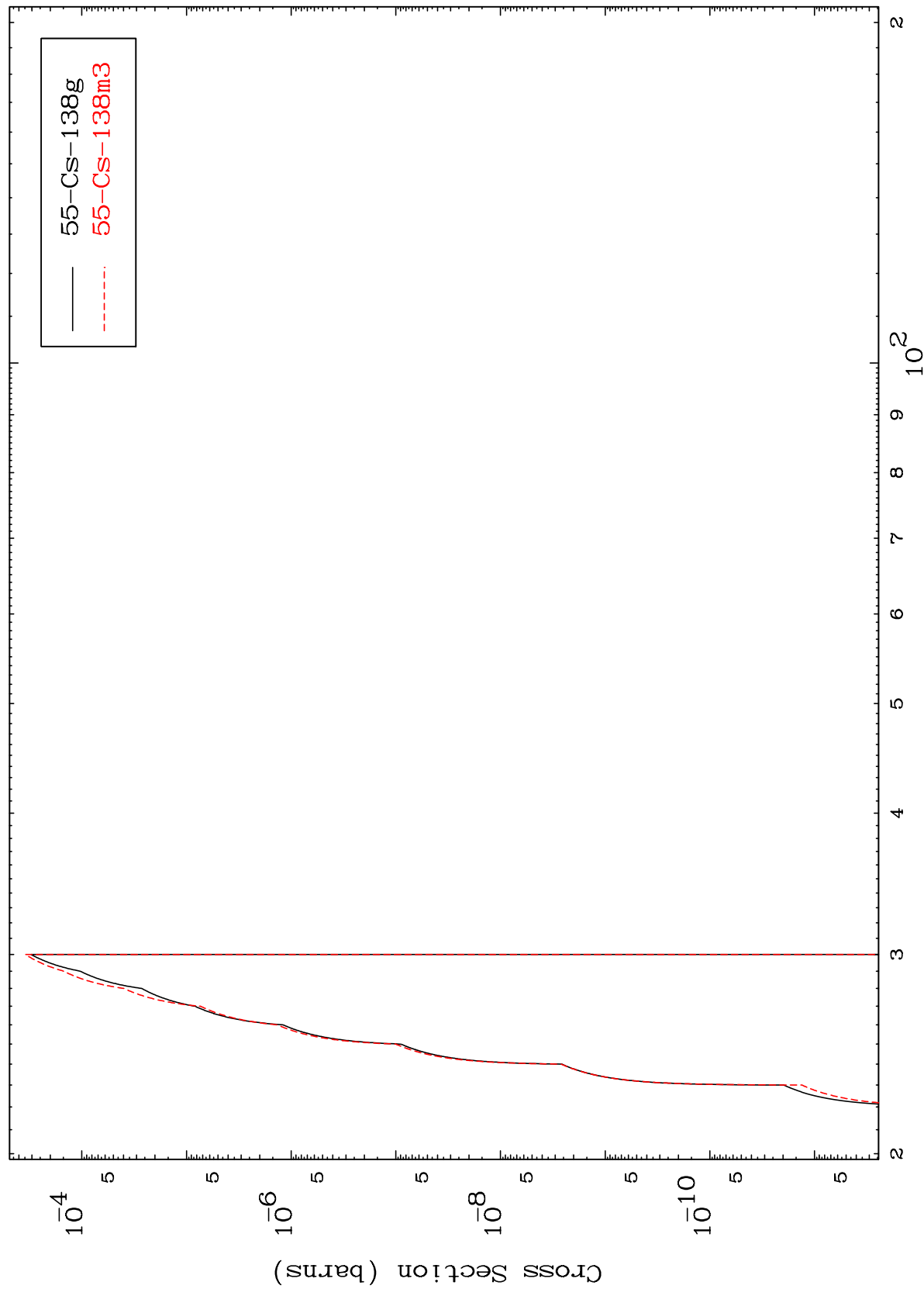

140

Incident Energy (MeV)

56-Ba-141

MAT 5658

(n,n') p  $\alpha$

56-Ba-141

Radionuclide Production Cross Section

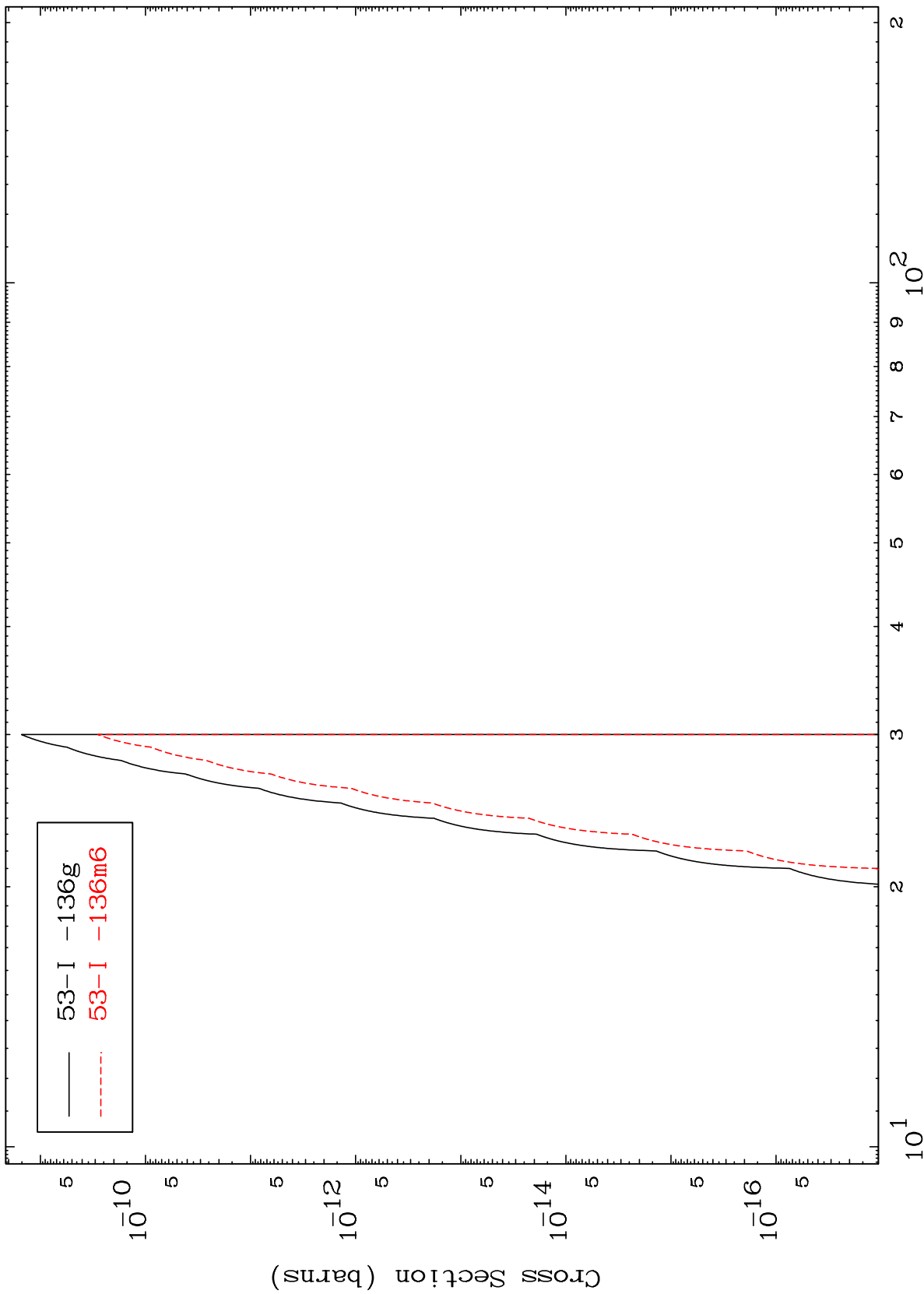

141

Incident Energy (MeV)

56-Ba-141

MAT 5658

(n,d)  $\alpha$

56-Ba-141

Radionuclide Production Cross Section

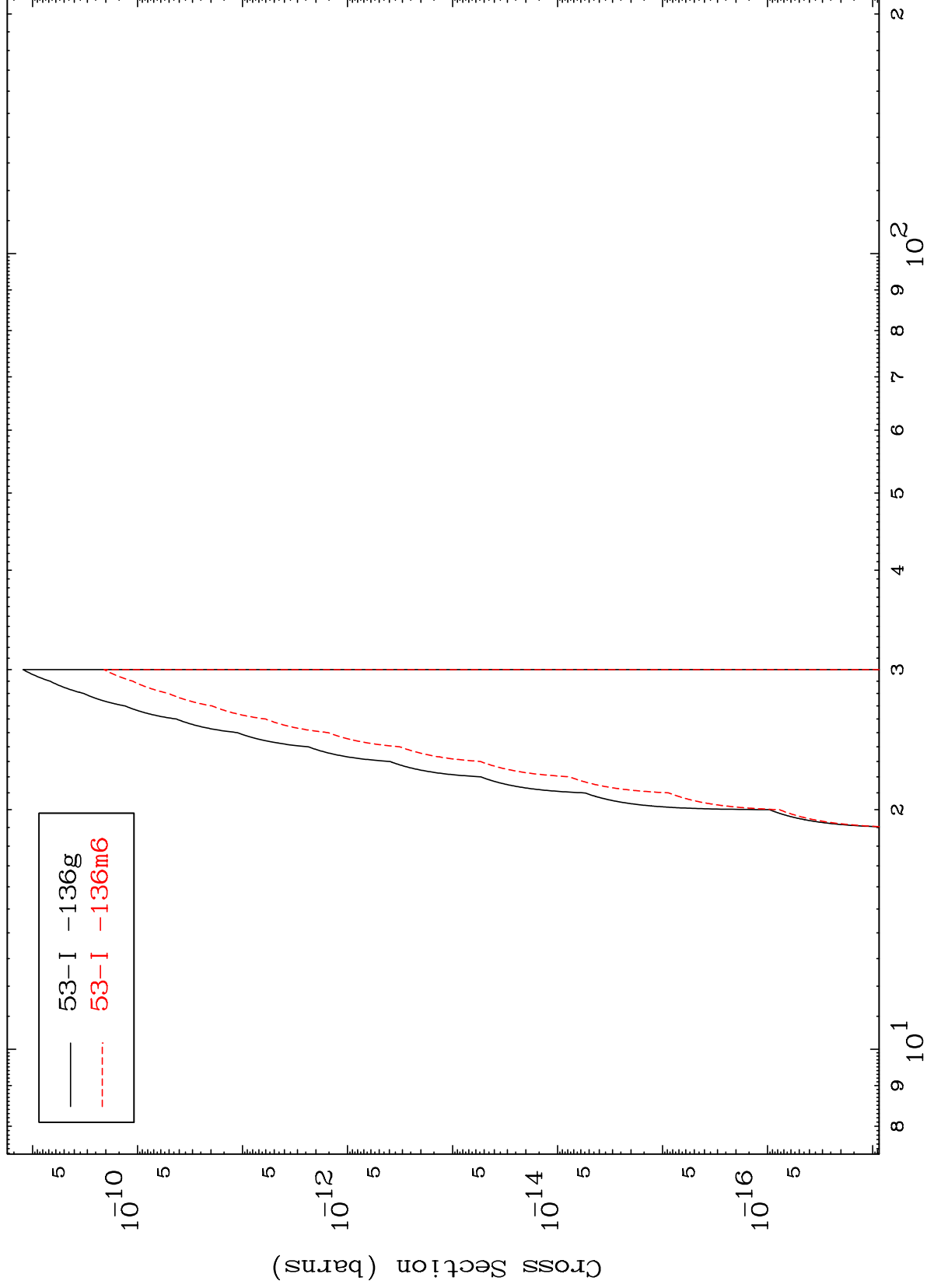

142

Incident Energy (MeV)

56-Ba-141