

BA142 NEUTRON ACER TENDL-2021 LIBRARY; T=293.6K

Principal cross sections

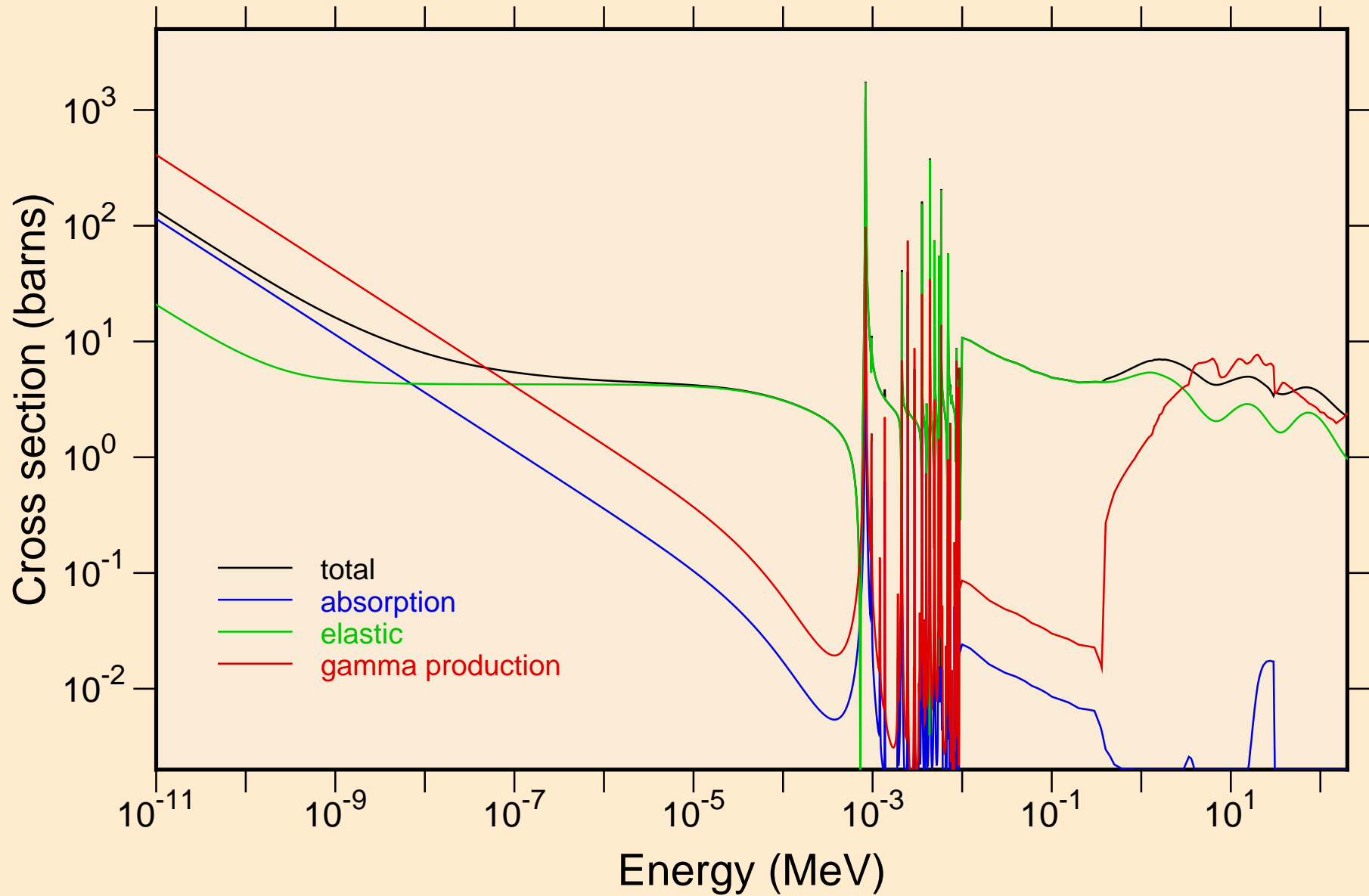

BA142 NEUTRON ACER TENDL-2021 LIBRARY; T=293.6K
resonance total cross section

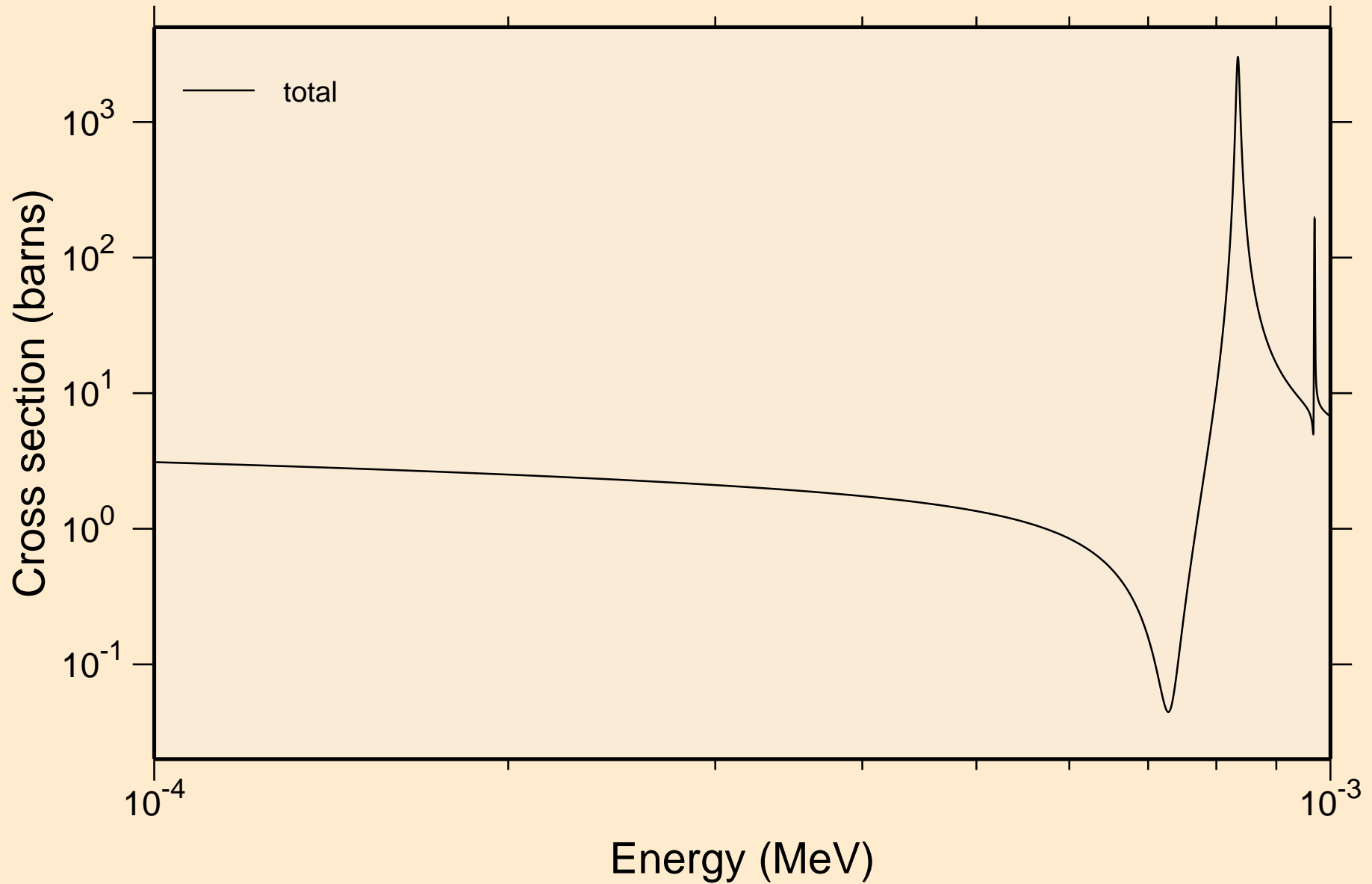

BA142 NEUTRON ACER TENDL-2021 LIBRARY; T=293.6K
resonance total cross section

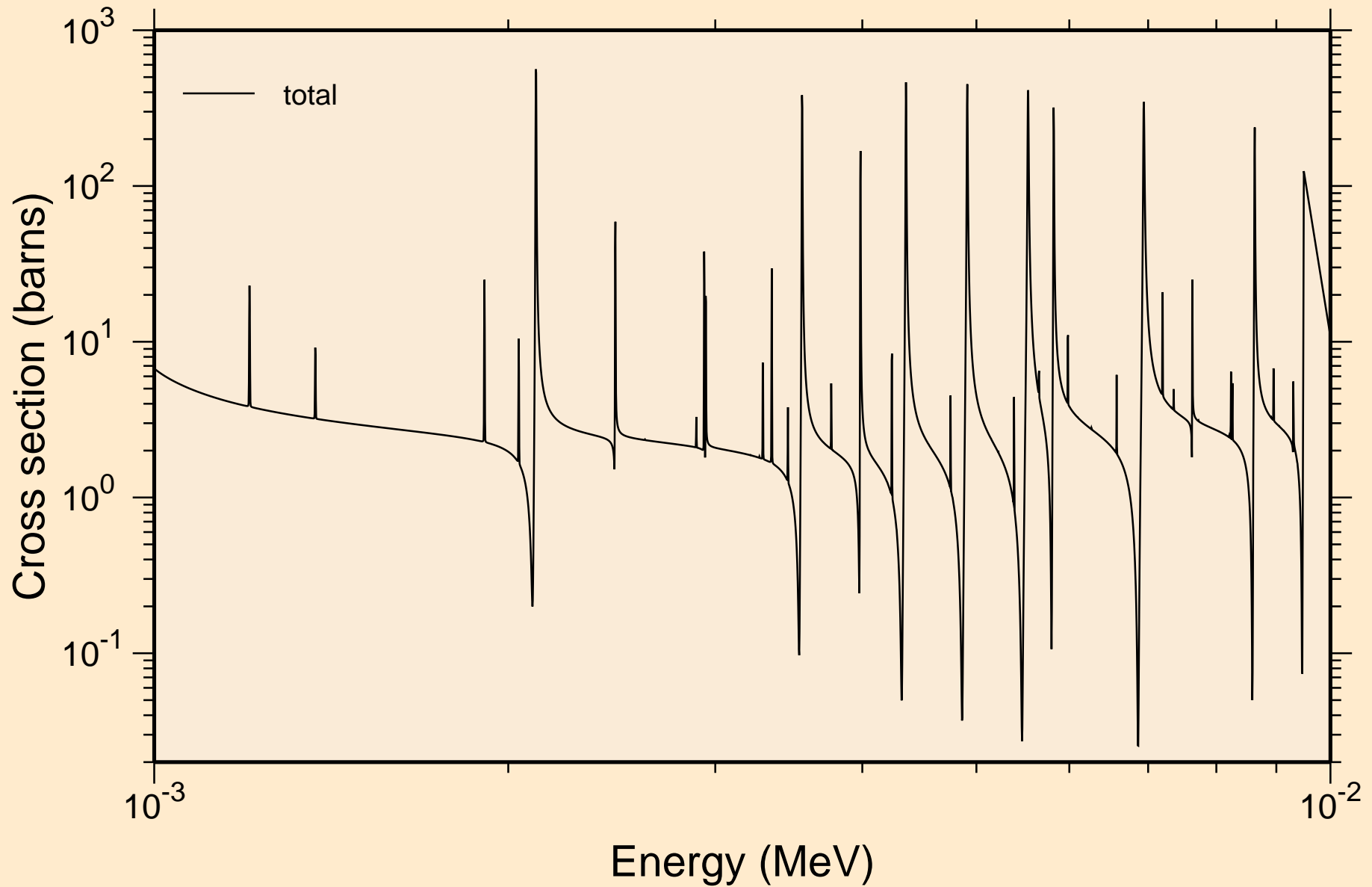

BA142 NEUTRON ACER TENDL-2021 LIBRARY; T=293.6K
resonance total cross section

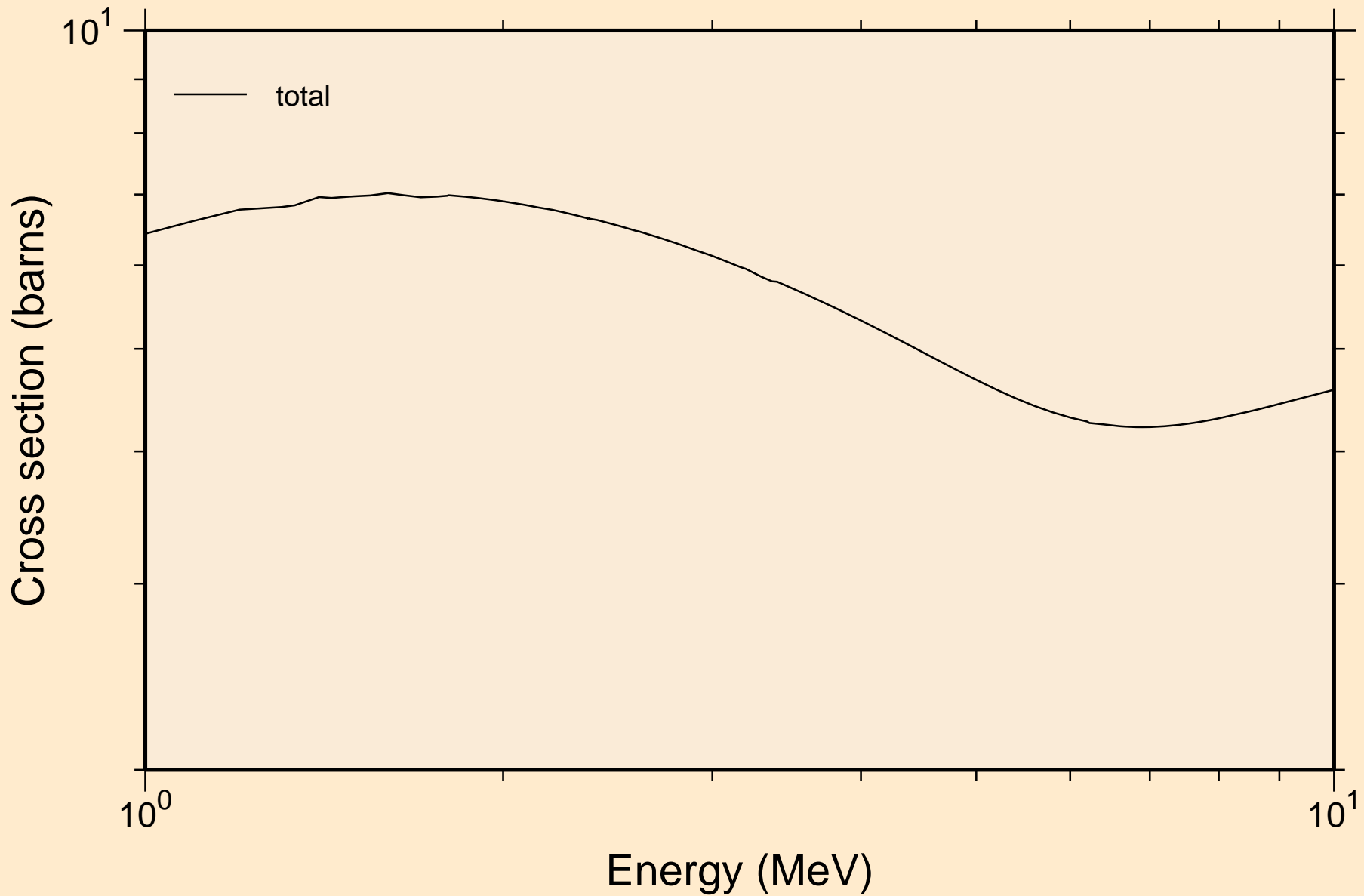

BA142 NEUTRON ACER TENDL-2021 LIBRARY; T=293.6K
resonance absorption cross sections

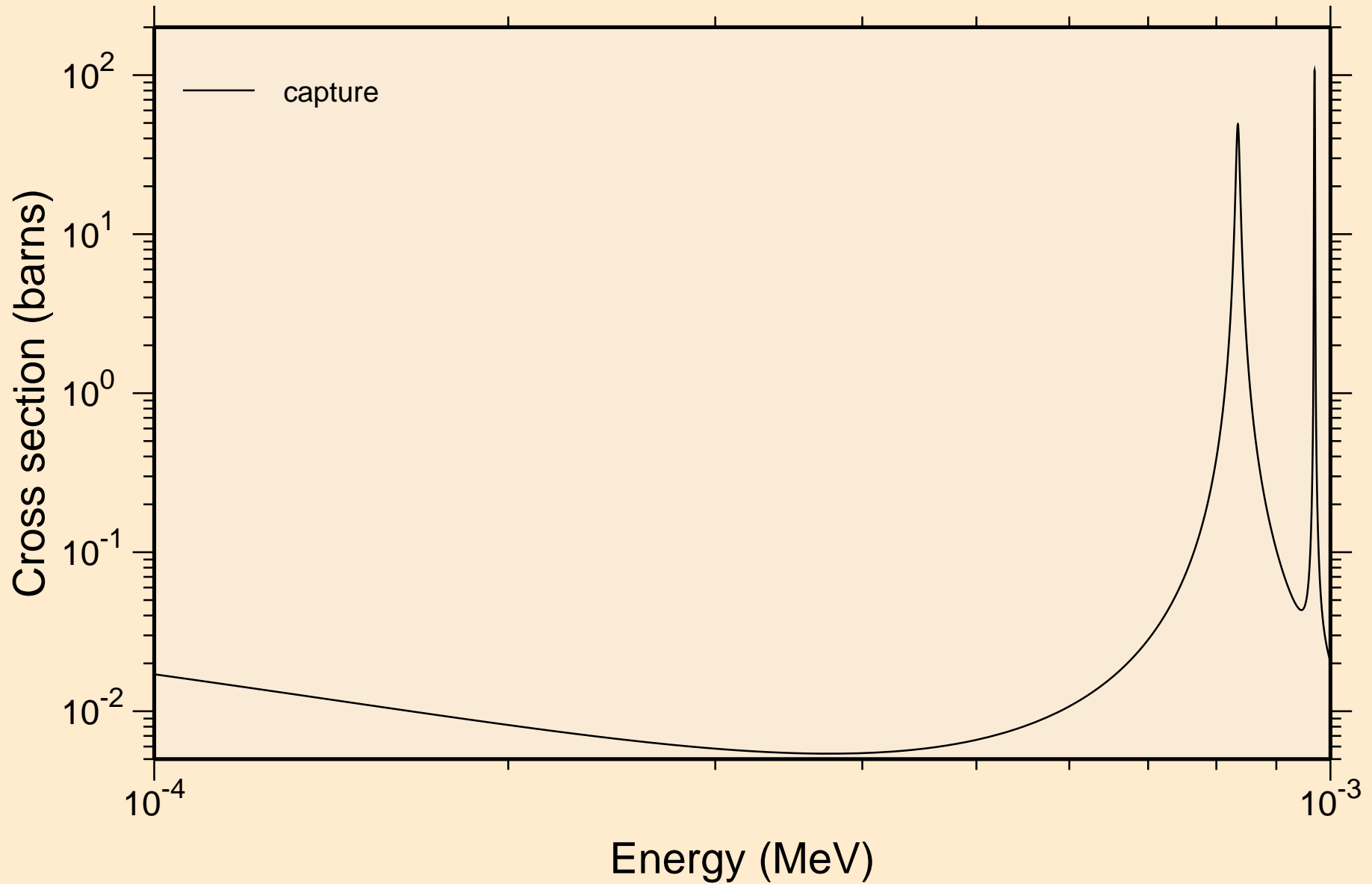

BA142 NEUTRON ACER TENDL-2021 LIBRARY; T=293.6K
resonance absorption cross sections

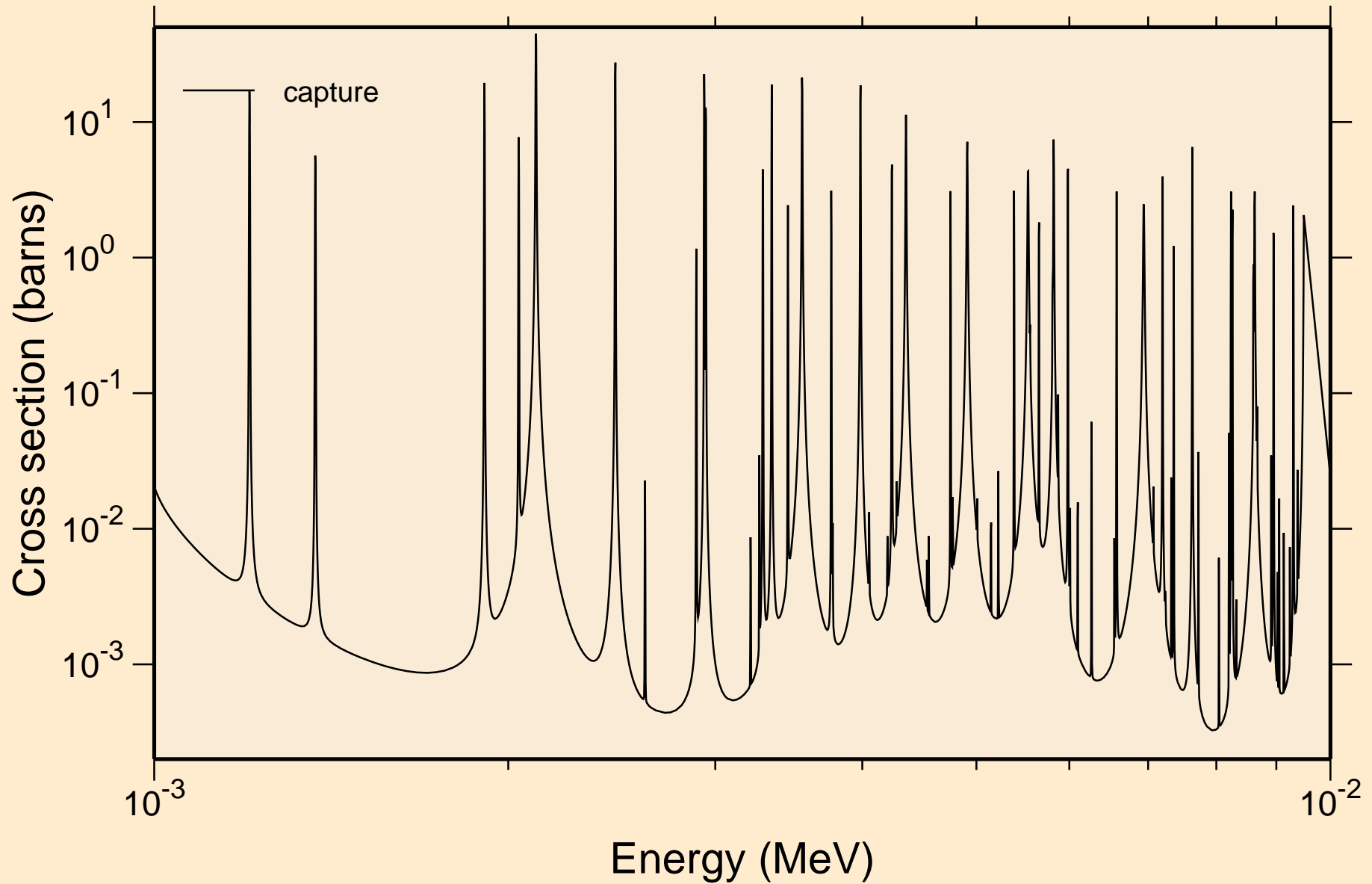

BA142 NEUTRON ACER TENDL-2021 LIBRARY; T=293.6K
resonance absorption cross sections

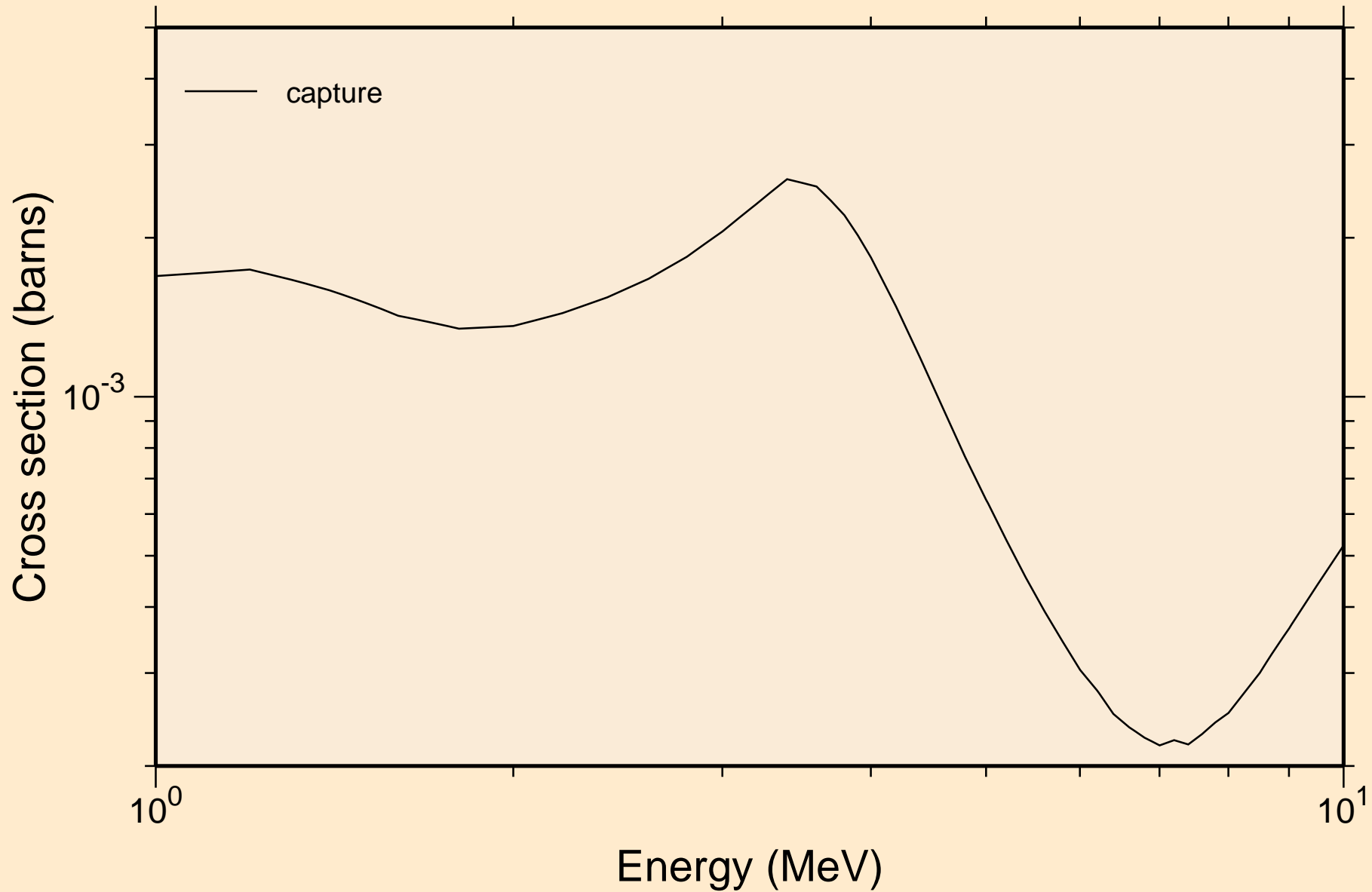

BA142 NEUTRON ACER TENDL-2021 LIBRARY; T=293.6K
Heating

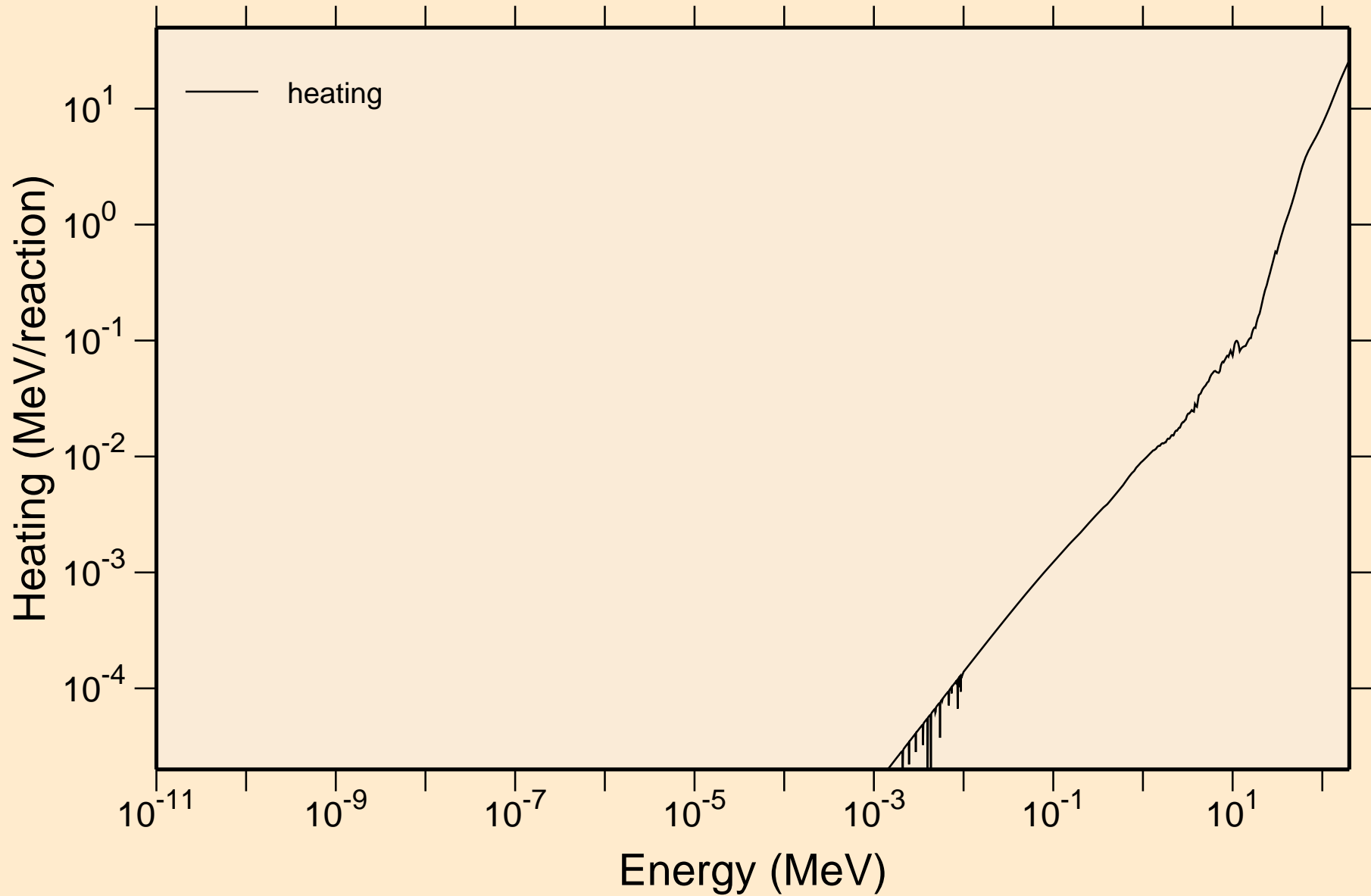

BA142 NEUTRON ACER TENDL-2021 LIBRARY; T=293.6K
Damage

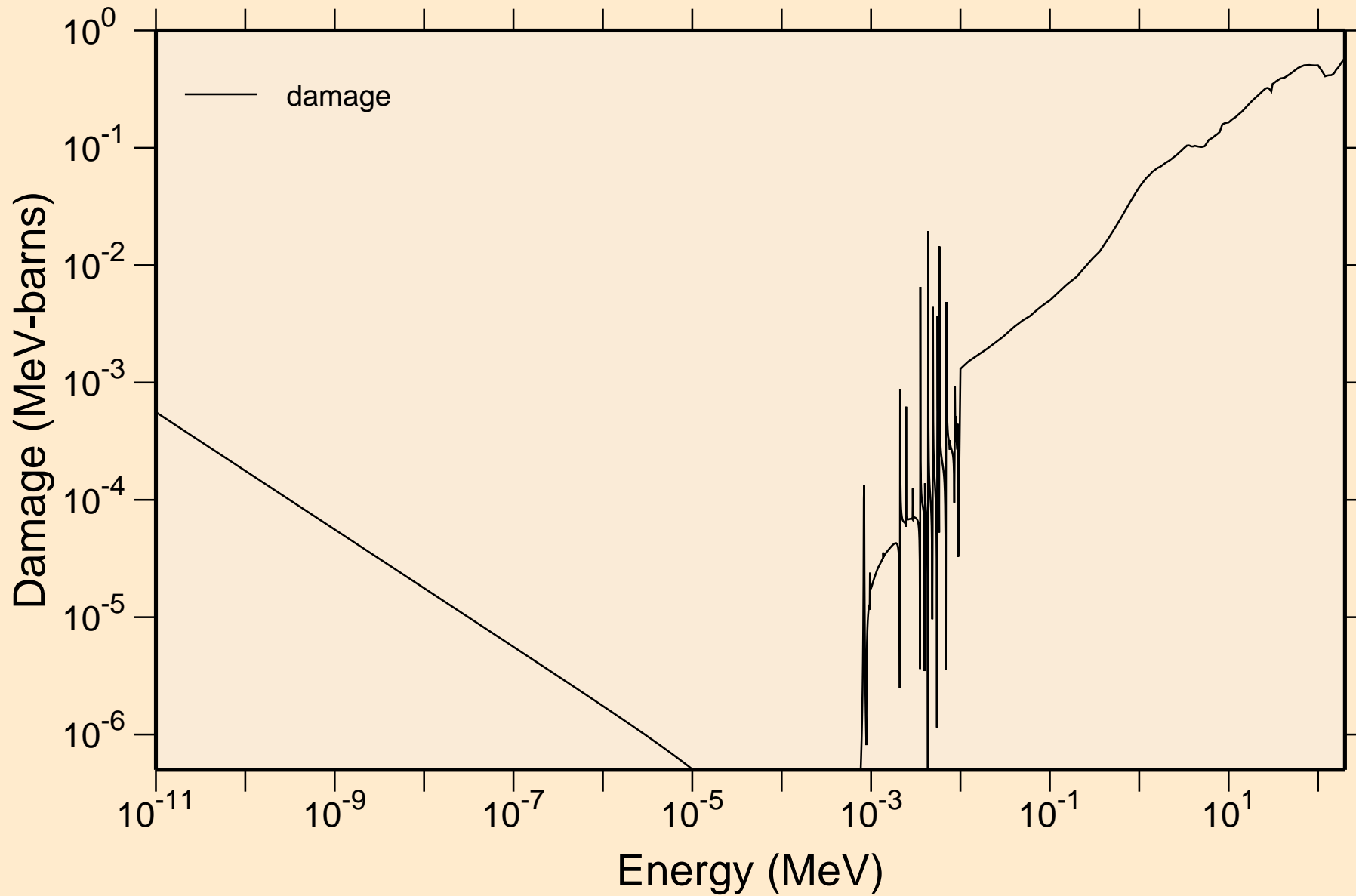

BA142 NEUTRON ACER TENDL-2021 LIBRARY; T=293.6K
Non-threshold reactions

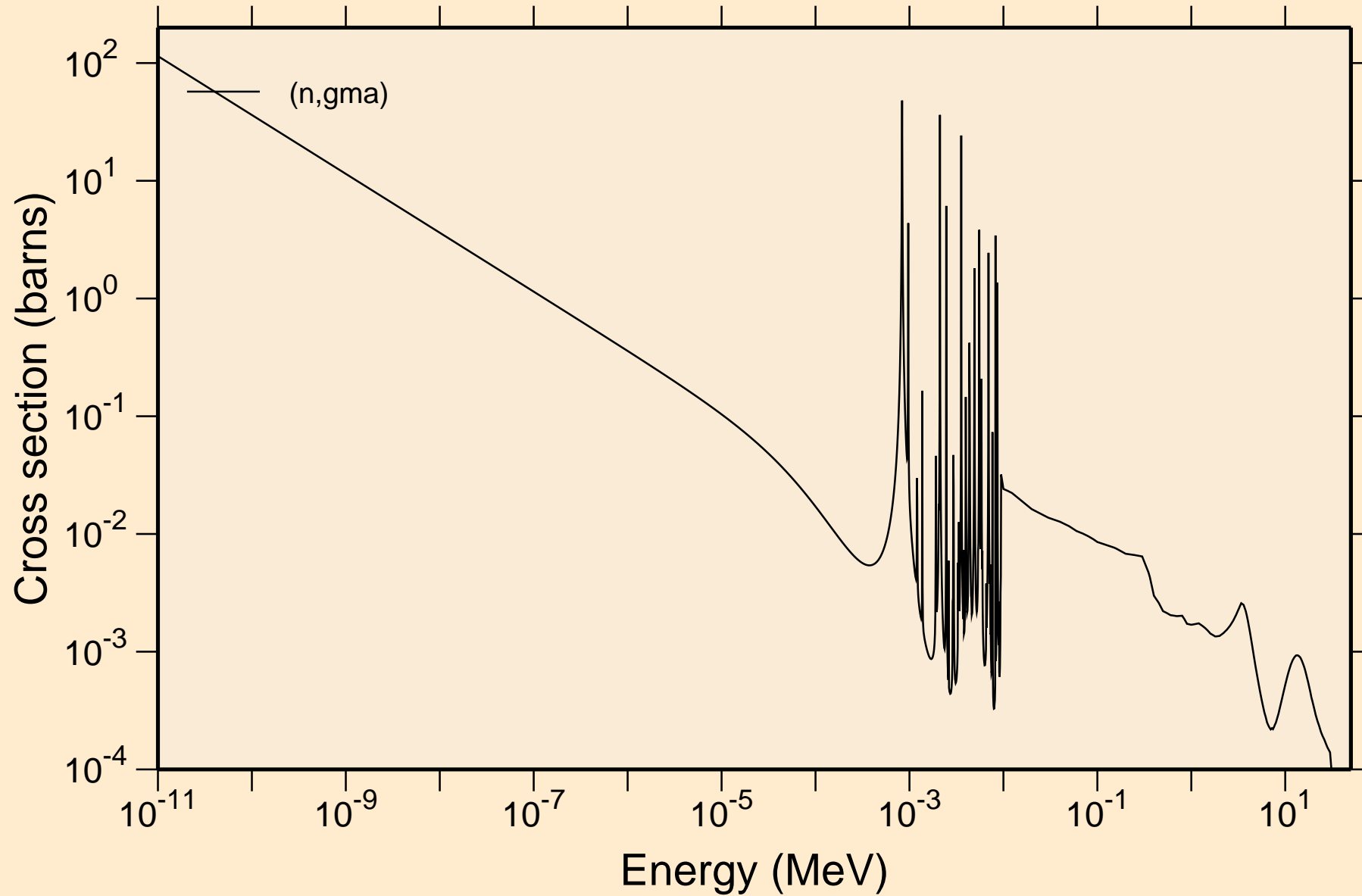

BA142 NEUTRON ACER TENDL-2021 LIBRARY; T=293.6K
Principal cross sections

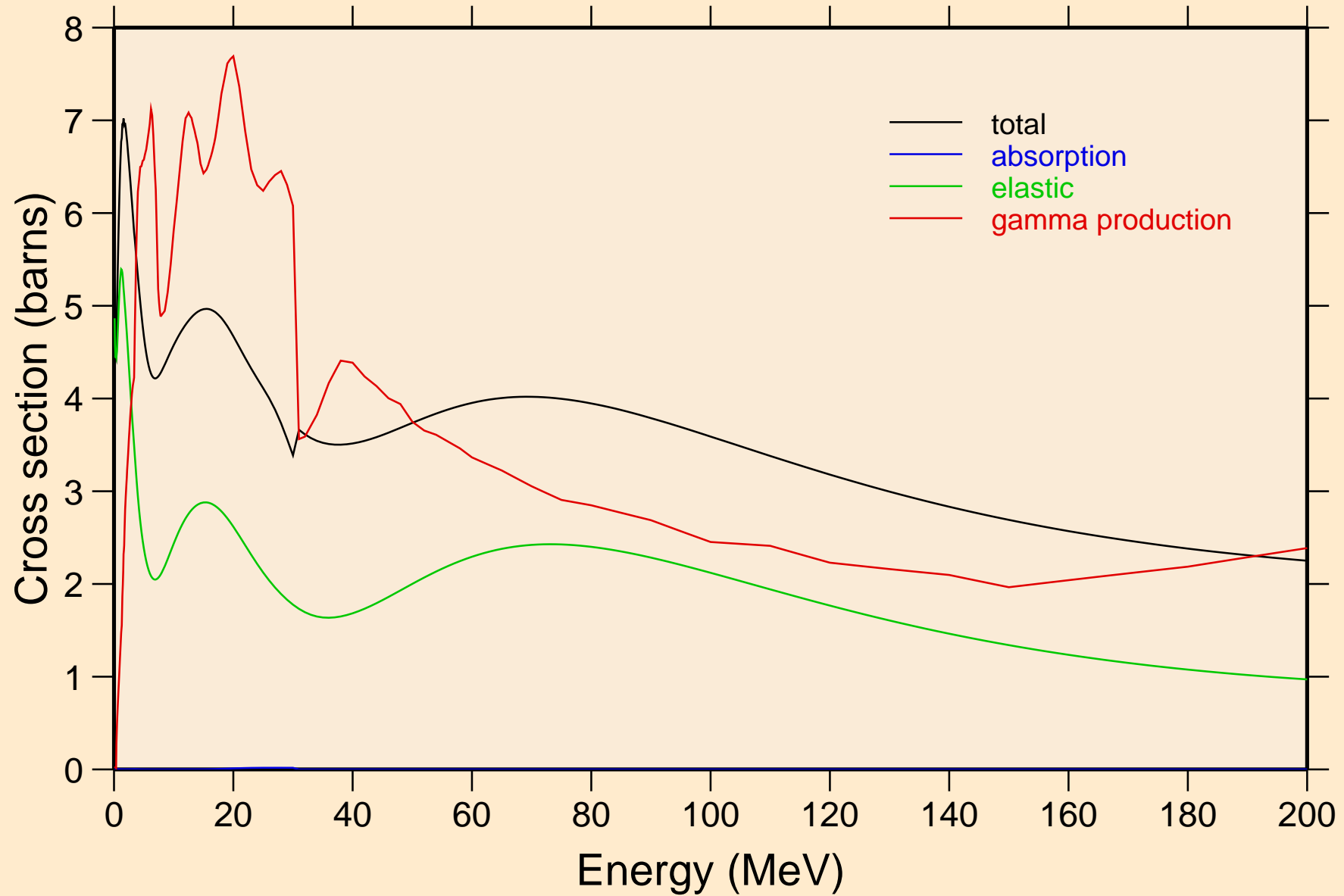

BA142 NEUTRON ACER TENDL-2021 LIBRARY; T=293.6K
Heating

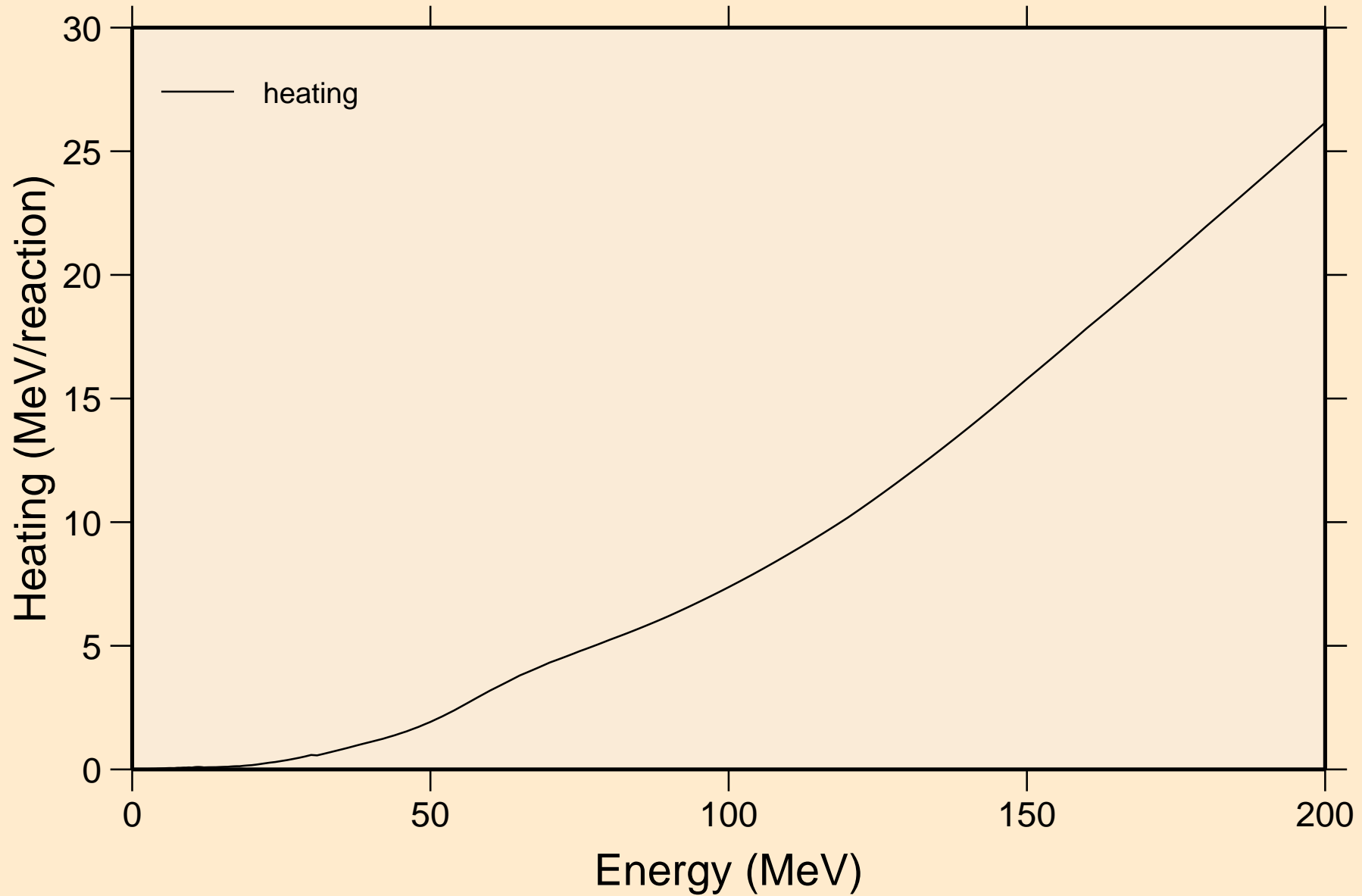

BA142 NEUTRON ACER TENDL-2021 LIBRARY; T=293.6K
Damage

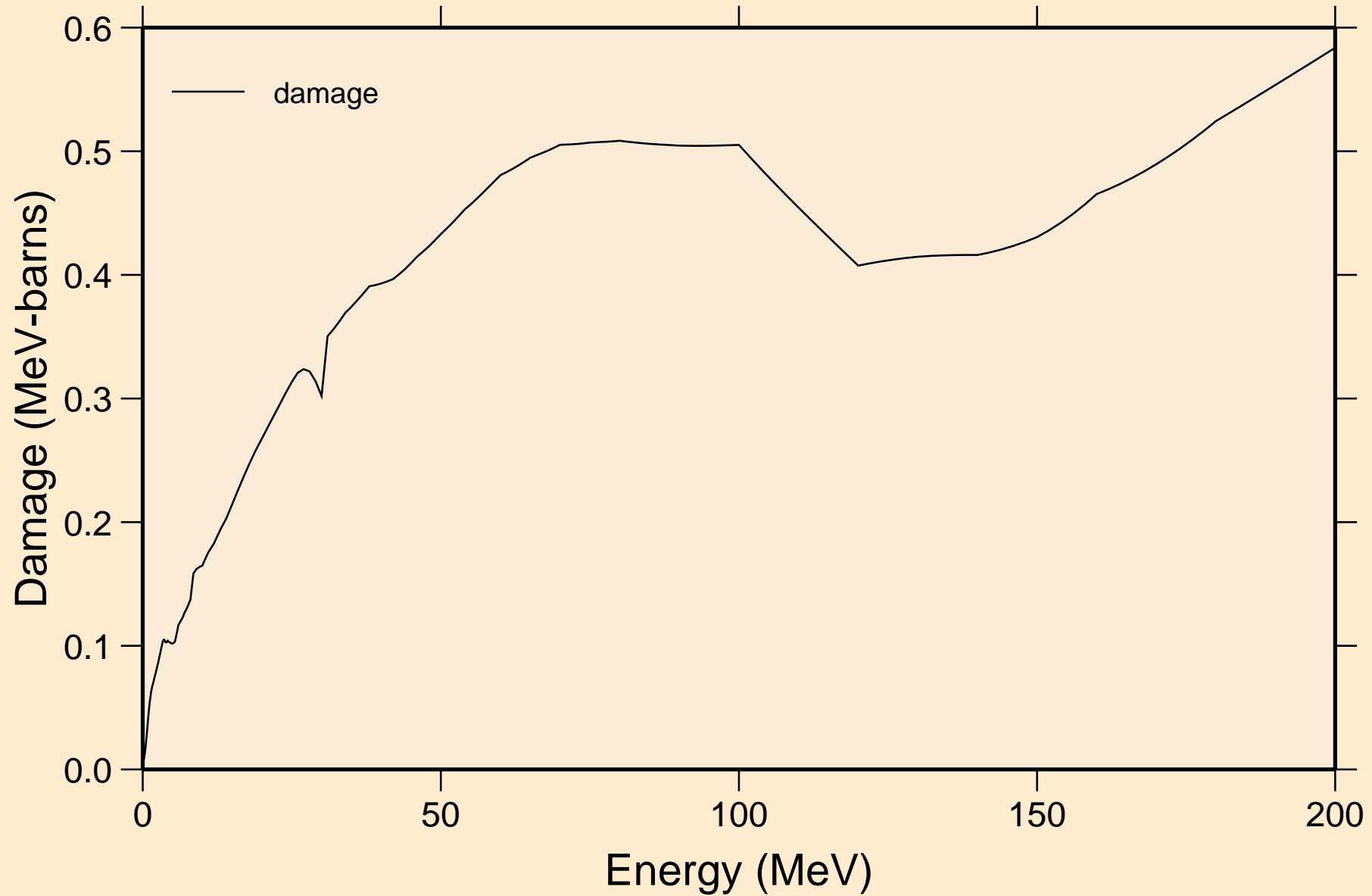

BA142 NEUTRON ACER TENDL-2021 LIBRARY; T=293.6K
Non-threshold reactions

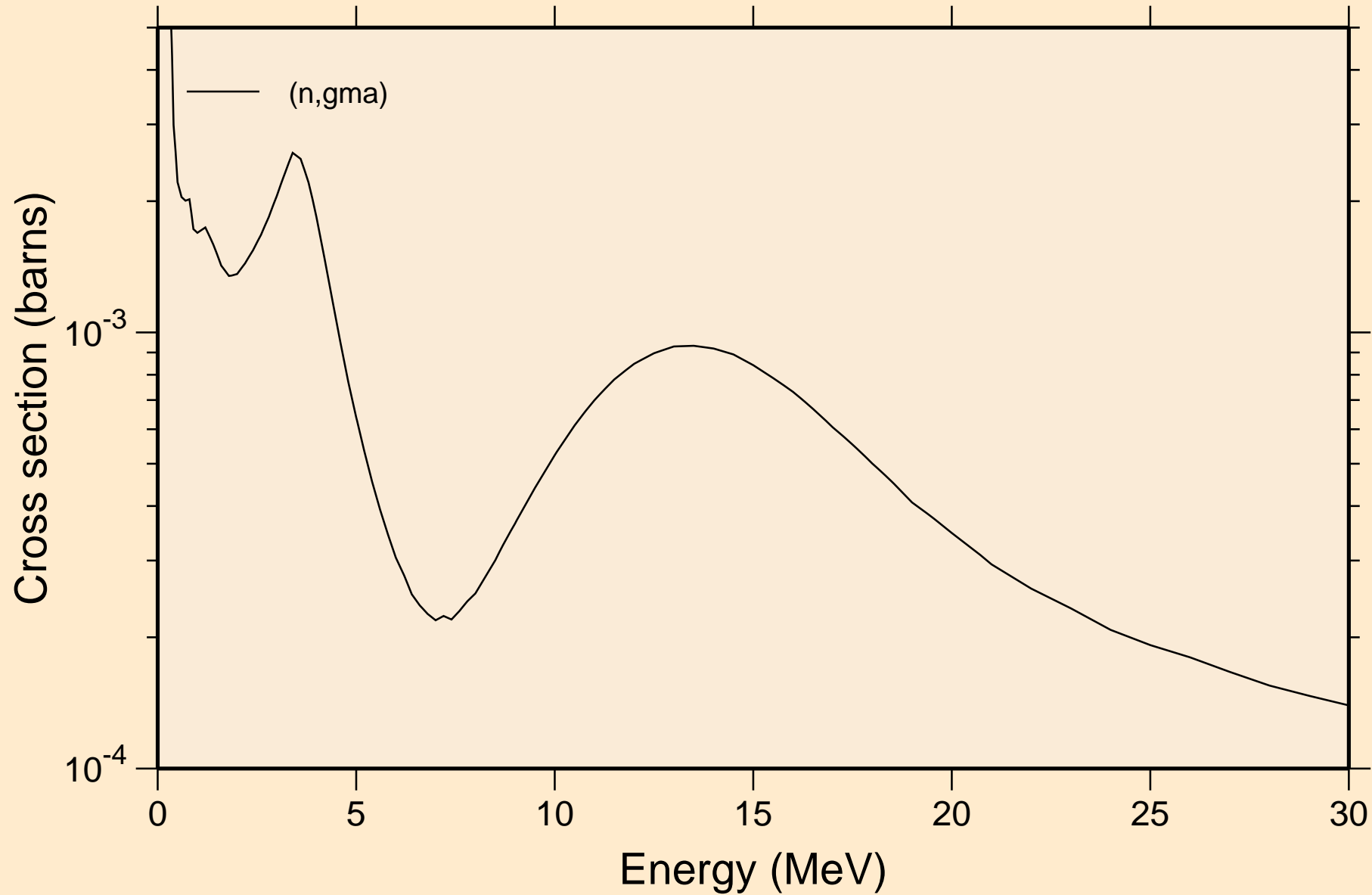

BA142 NEUTRON ACER TENDL-2021 LIBRARY; T=293.6K
Inelastic levels

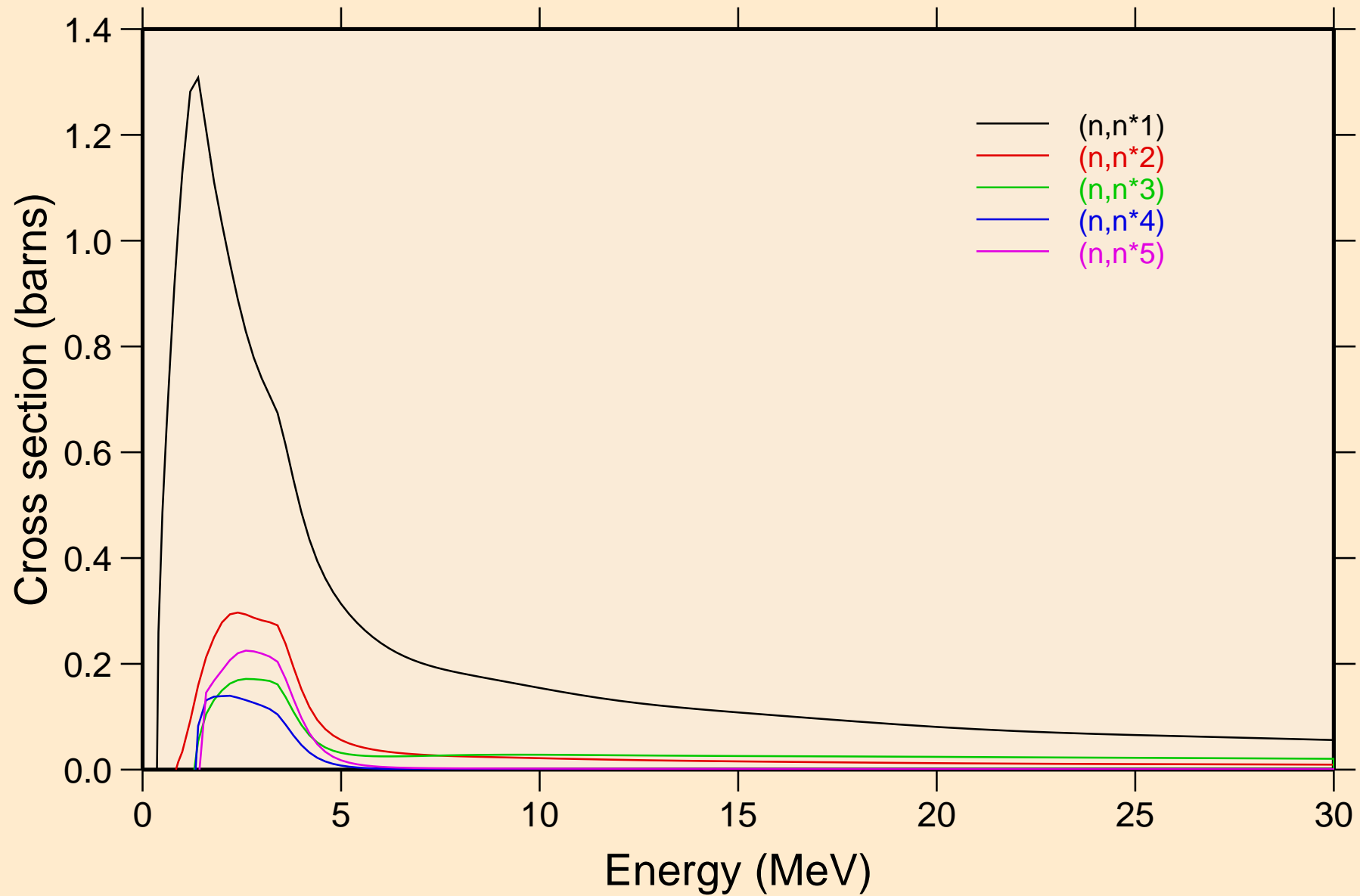

BA142 NEUTRON ACER TENDL-2021 LIBRARY; T=293.6K
Inelastic levels

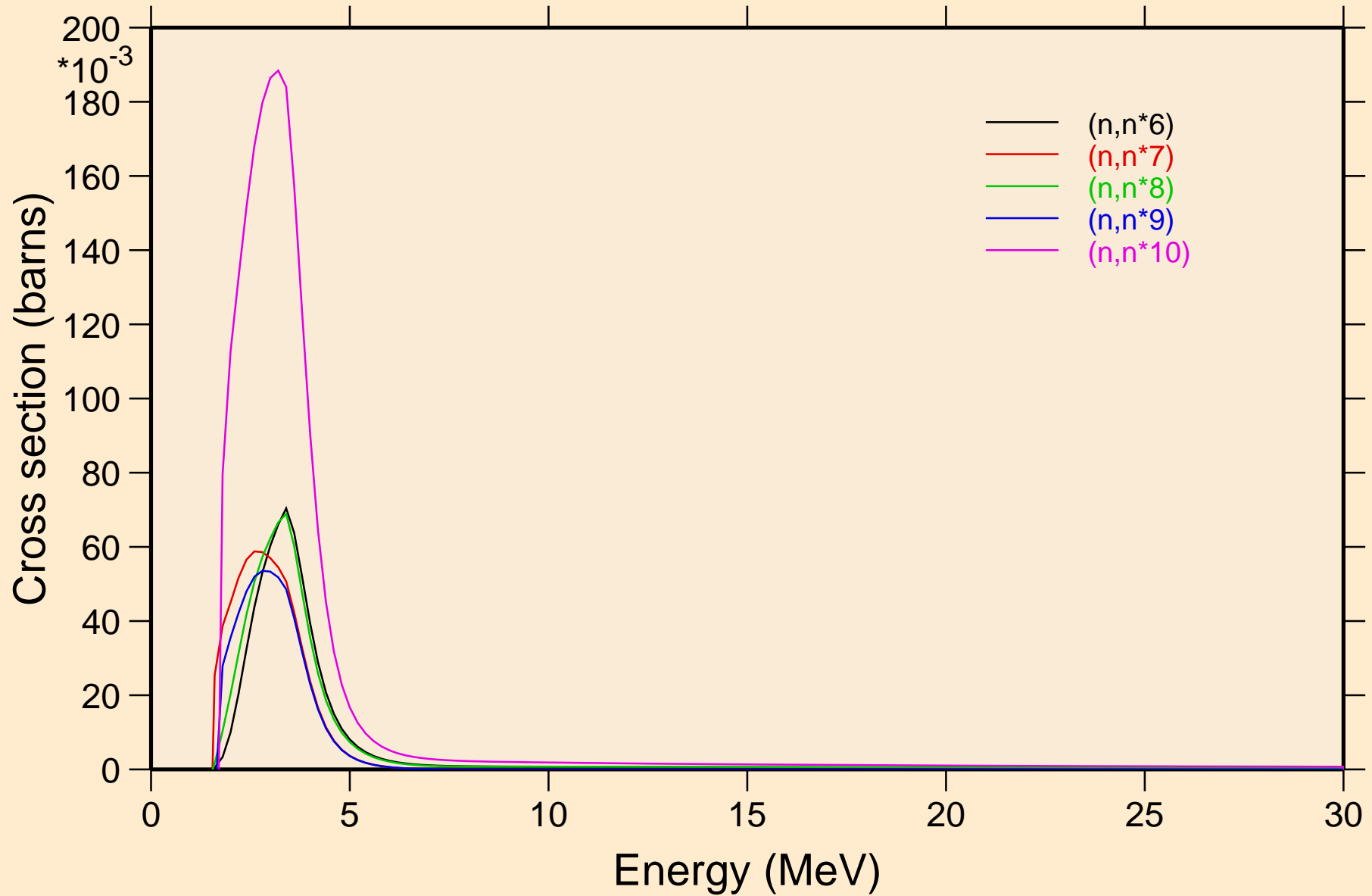

BA142 NEUTRON ACER TENDL-2021 LIBRARY; T=293.6K
Inelastic levels

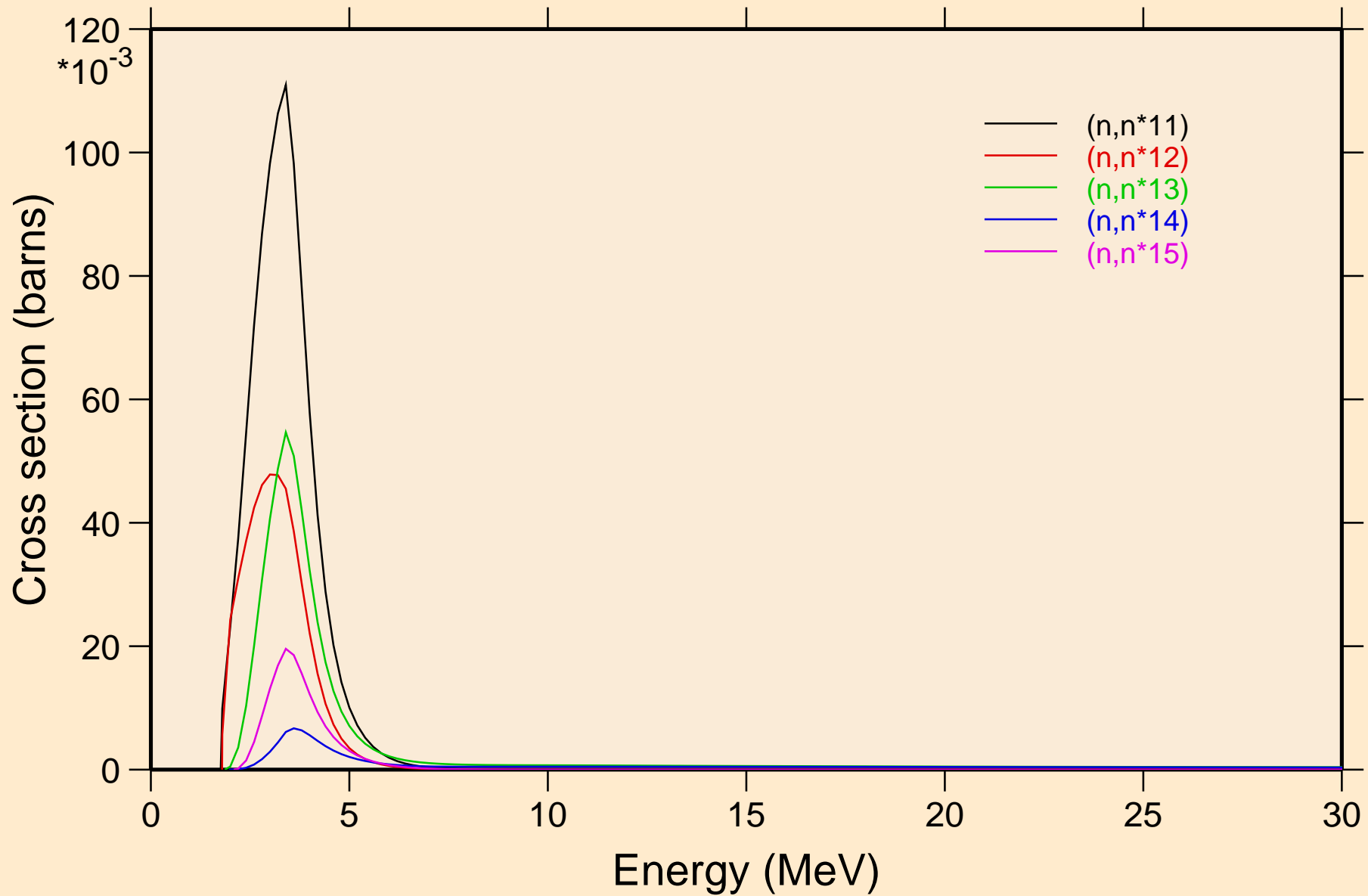

BA142 NEUTRON ACER TENDL-2021 LIBRARY; T=293.6K
Inelastic levels

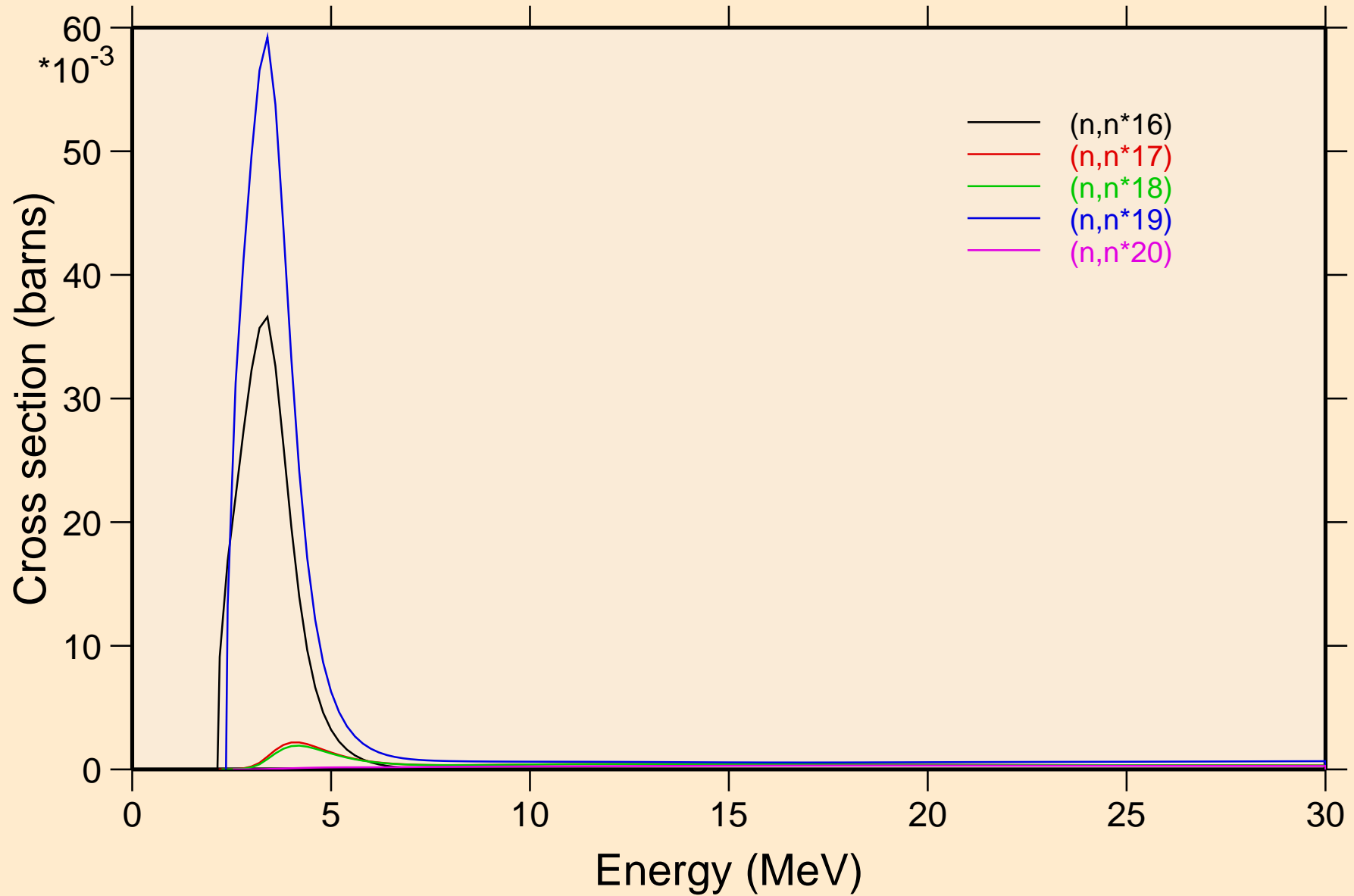

BA142 NEUTRON ACER TENDL-2021 LIBRARY; T=293.6K
Inelastic levels

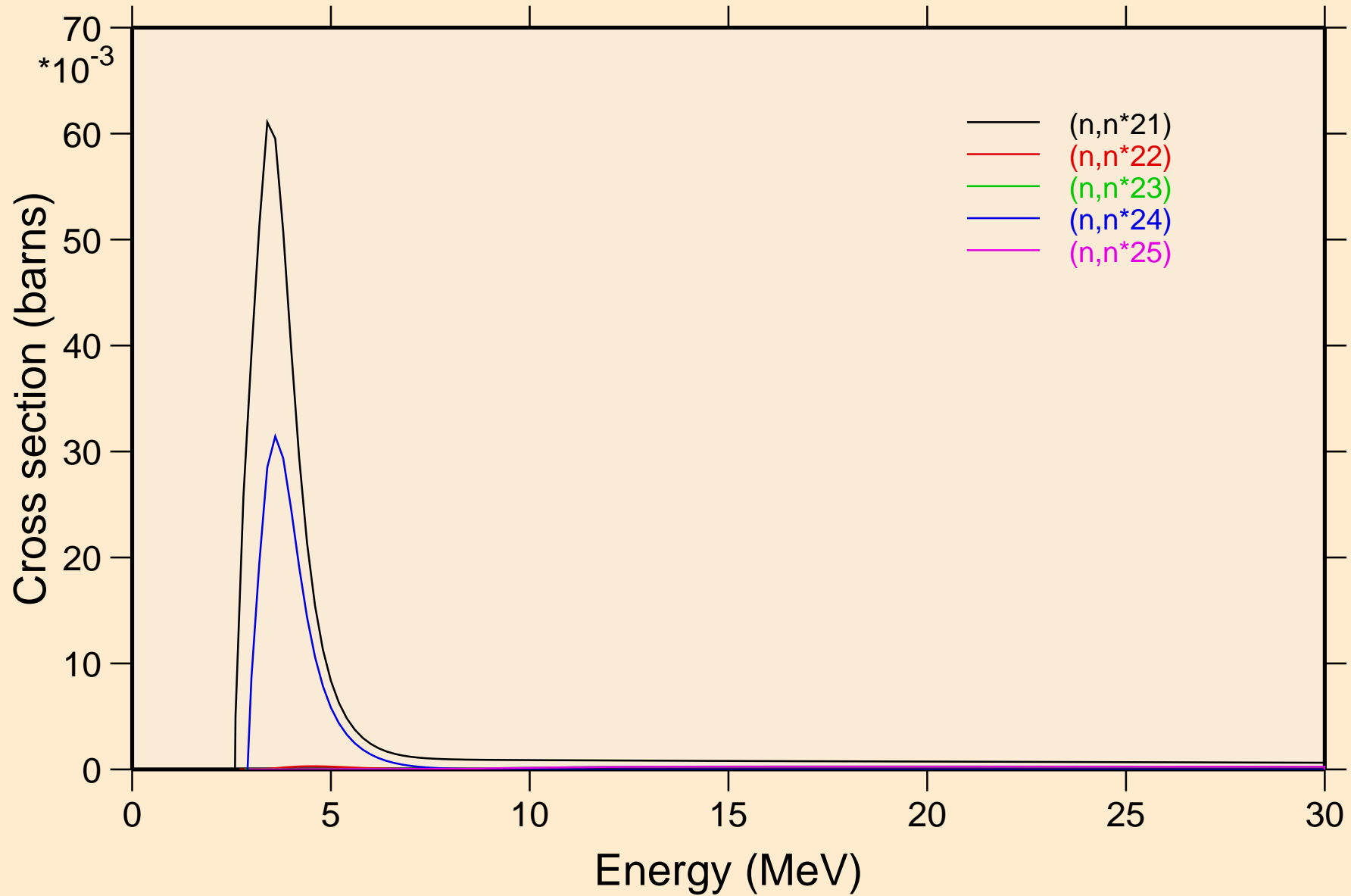

BA142 NEUTRON ACER TENDL-2021 LIBRARY; T=293.6K
Inelastic levels

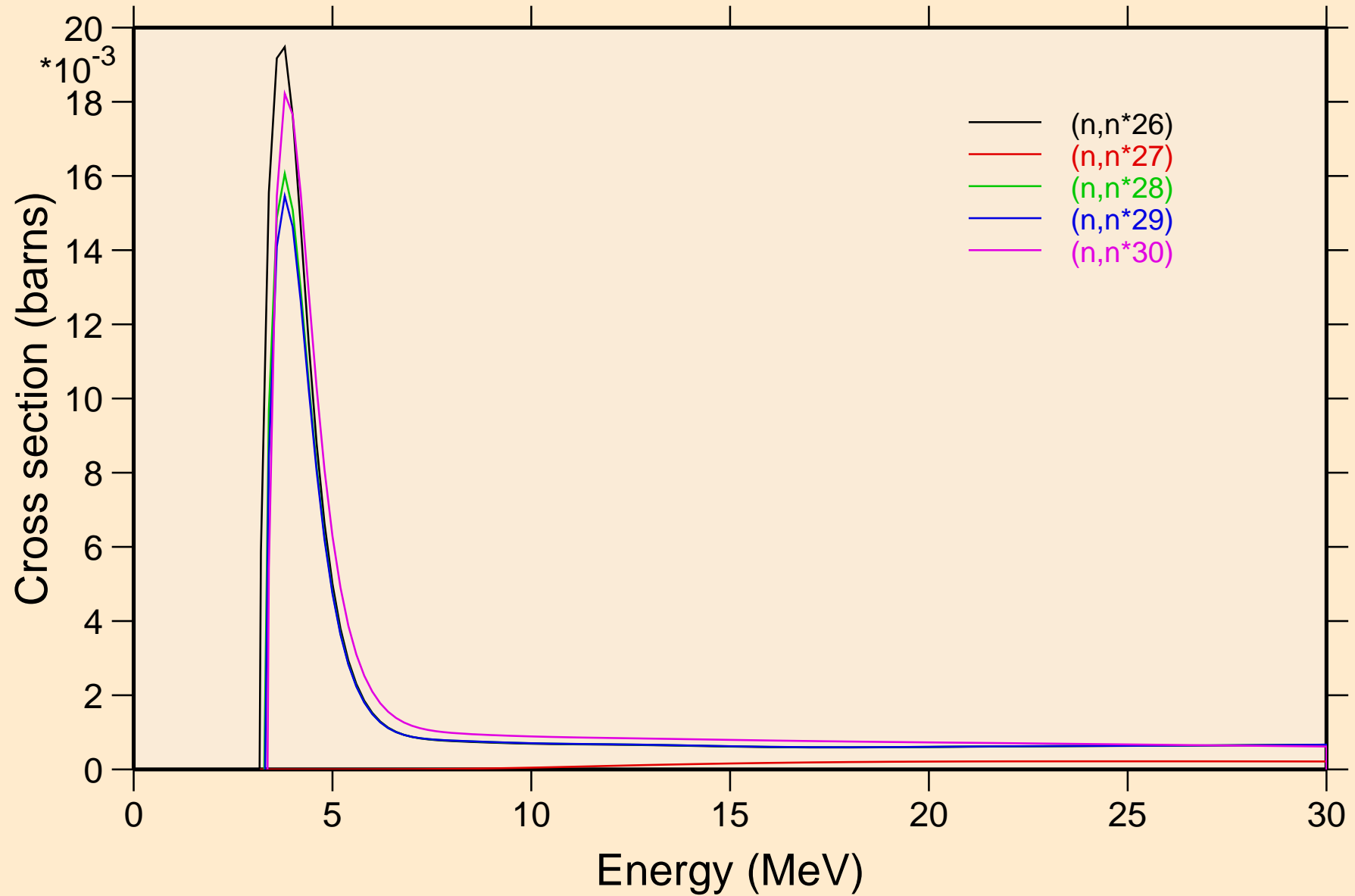

BA142 NEUTRON ACER TENDL-2021 LIBRARY; T=293.6K
Threshold reactions

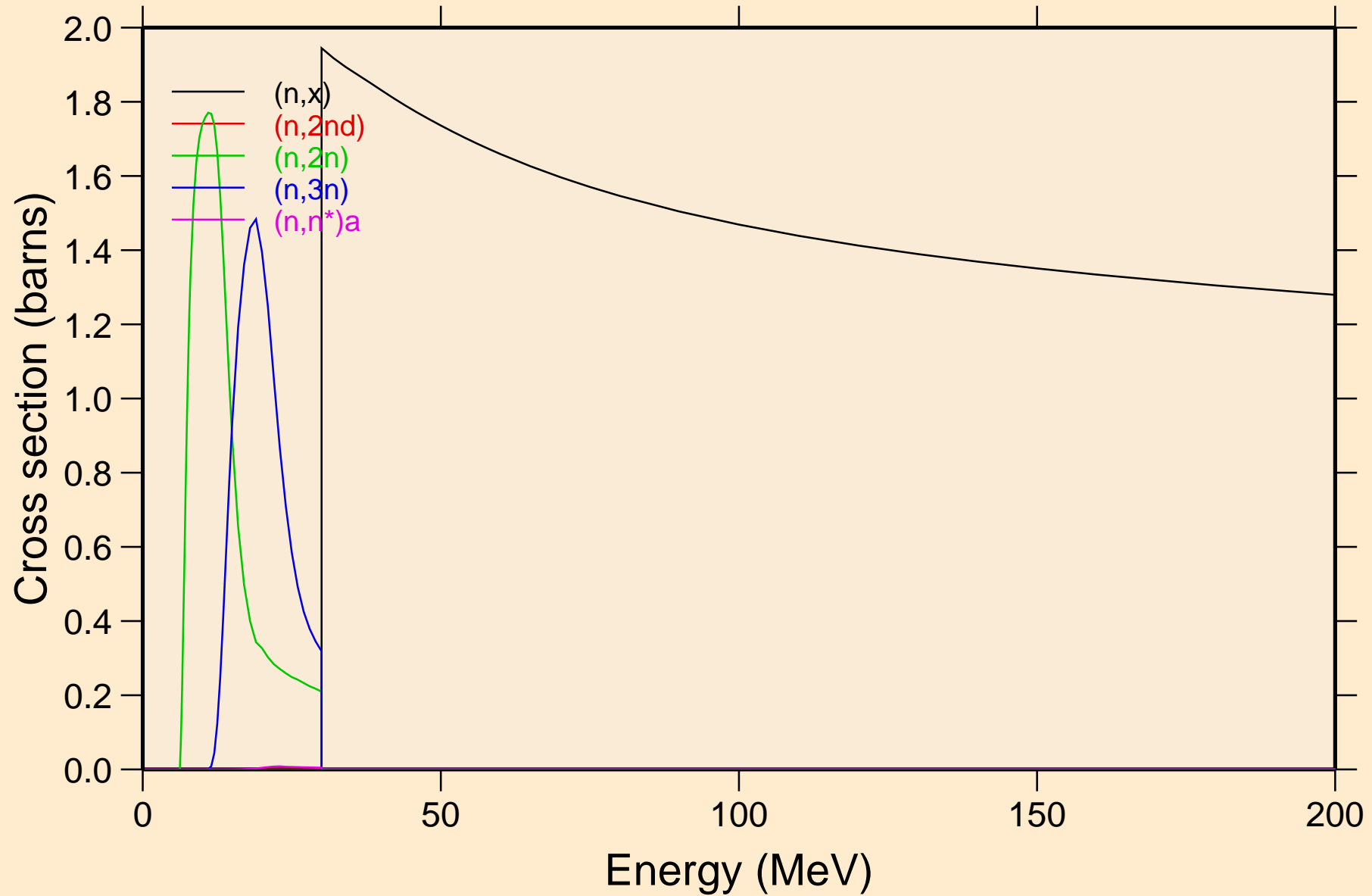

BA142 NEUTRON ACER TENDL-2021 LIBRARY; T=293.6K
Threshold reactions

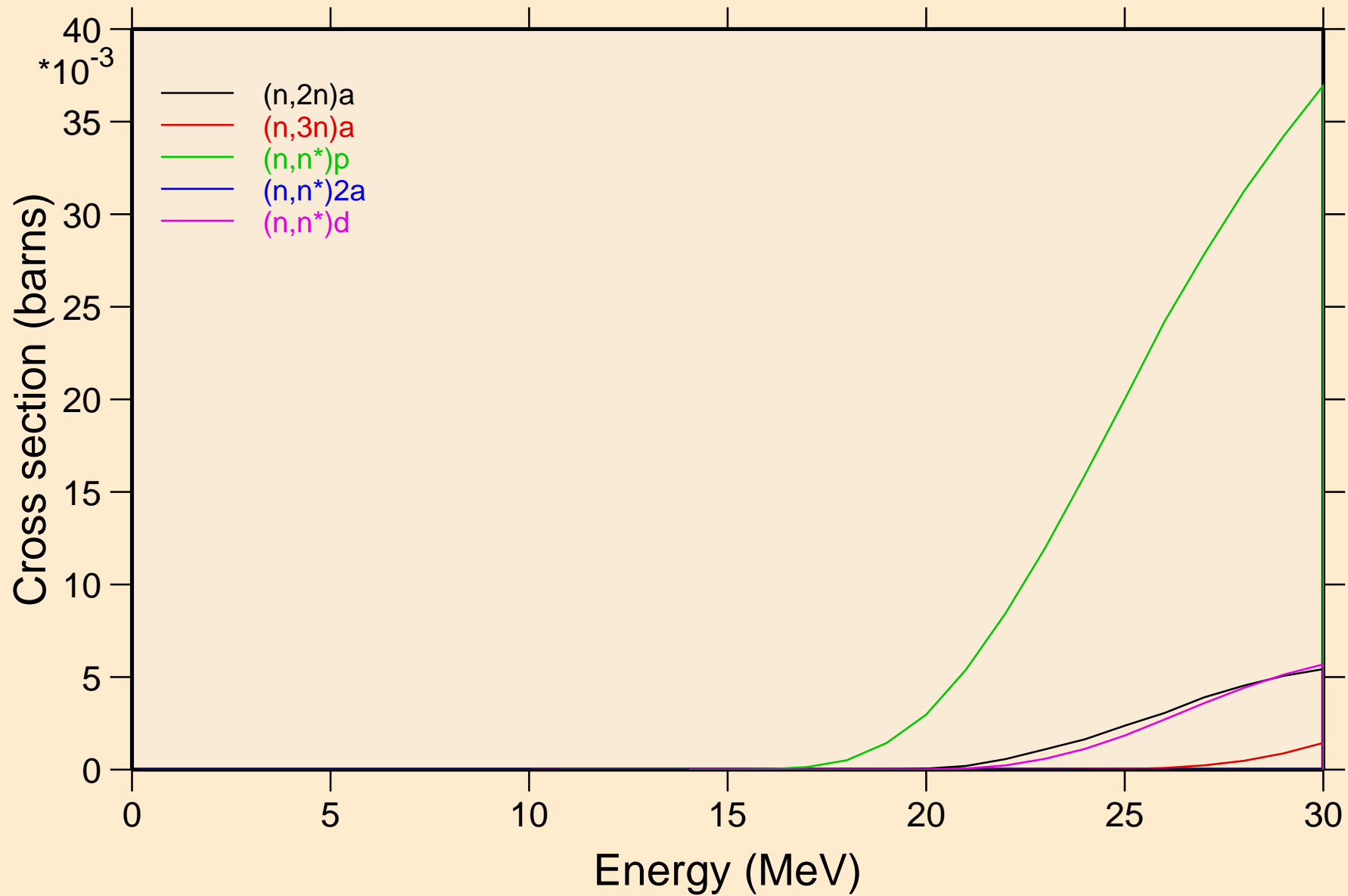

BA142 NEUTRON ACER TENDL-2021 LIBRARY; T=293.6K
Threshold reactions

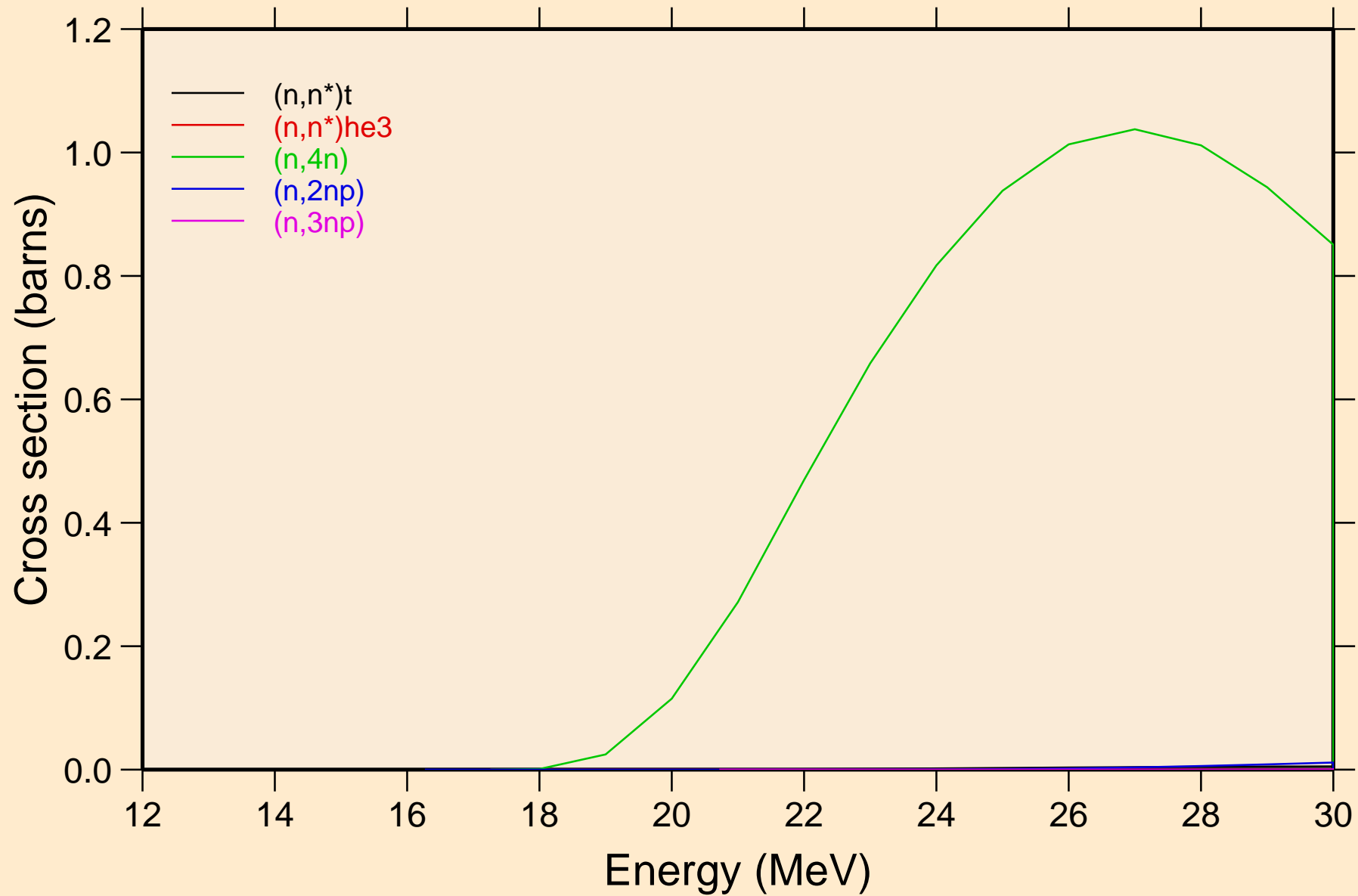

BA142 NEUTRON ACER TENDL-2021 LIBRARY; T=293.6K
Threshold reactions

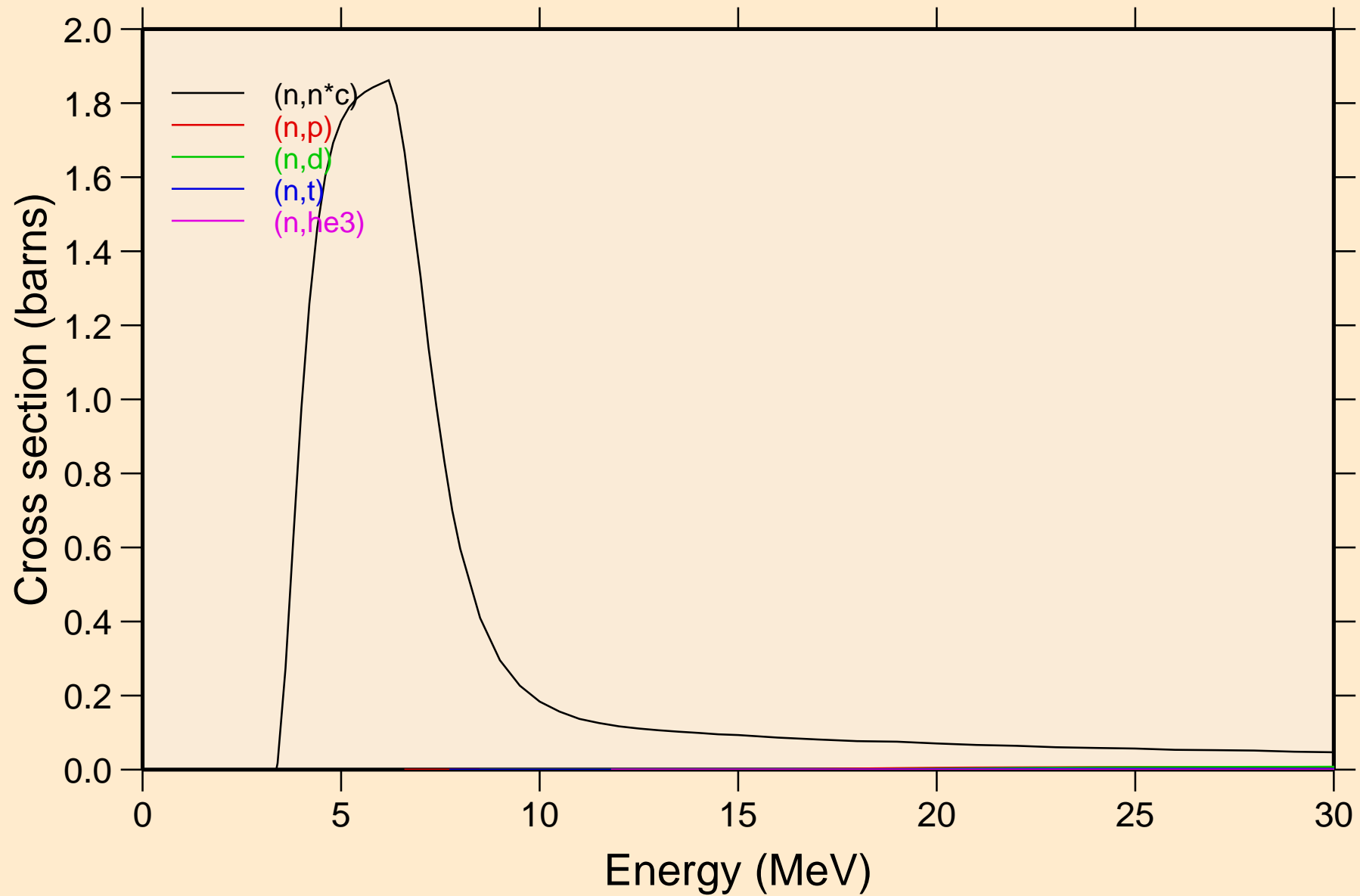

BA142 NEUTRON ACER TENDL-2021 LIBRARY; T=293.6K
Threshold reactions

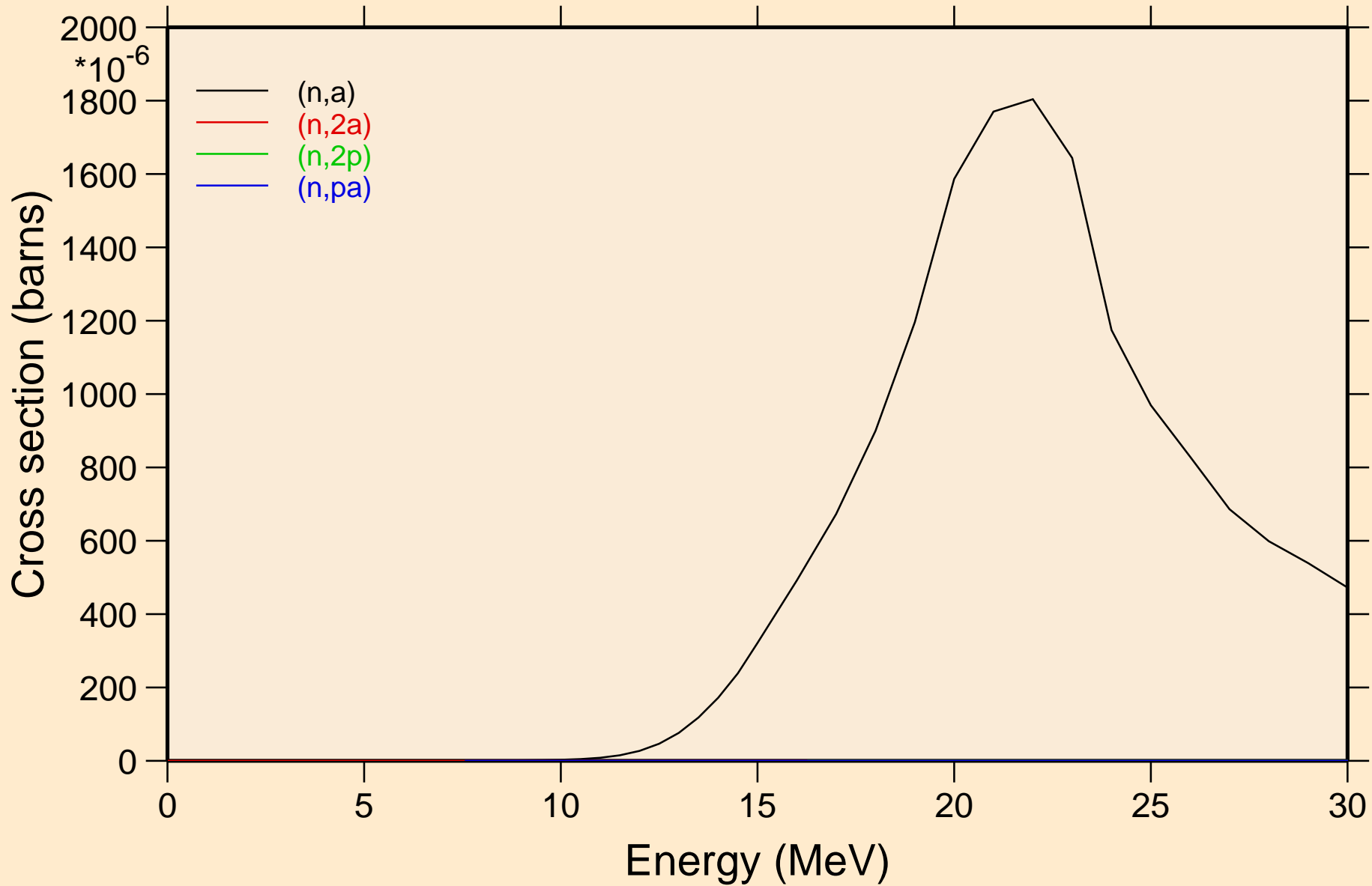

BA142 NEUTRON ACER TENDL-2021 LIBRARY; T=293.6K

Threshold reactions

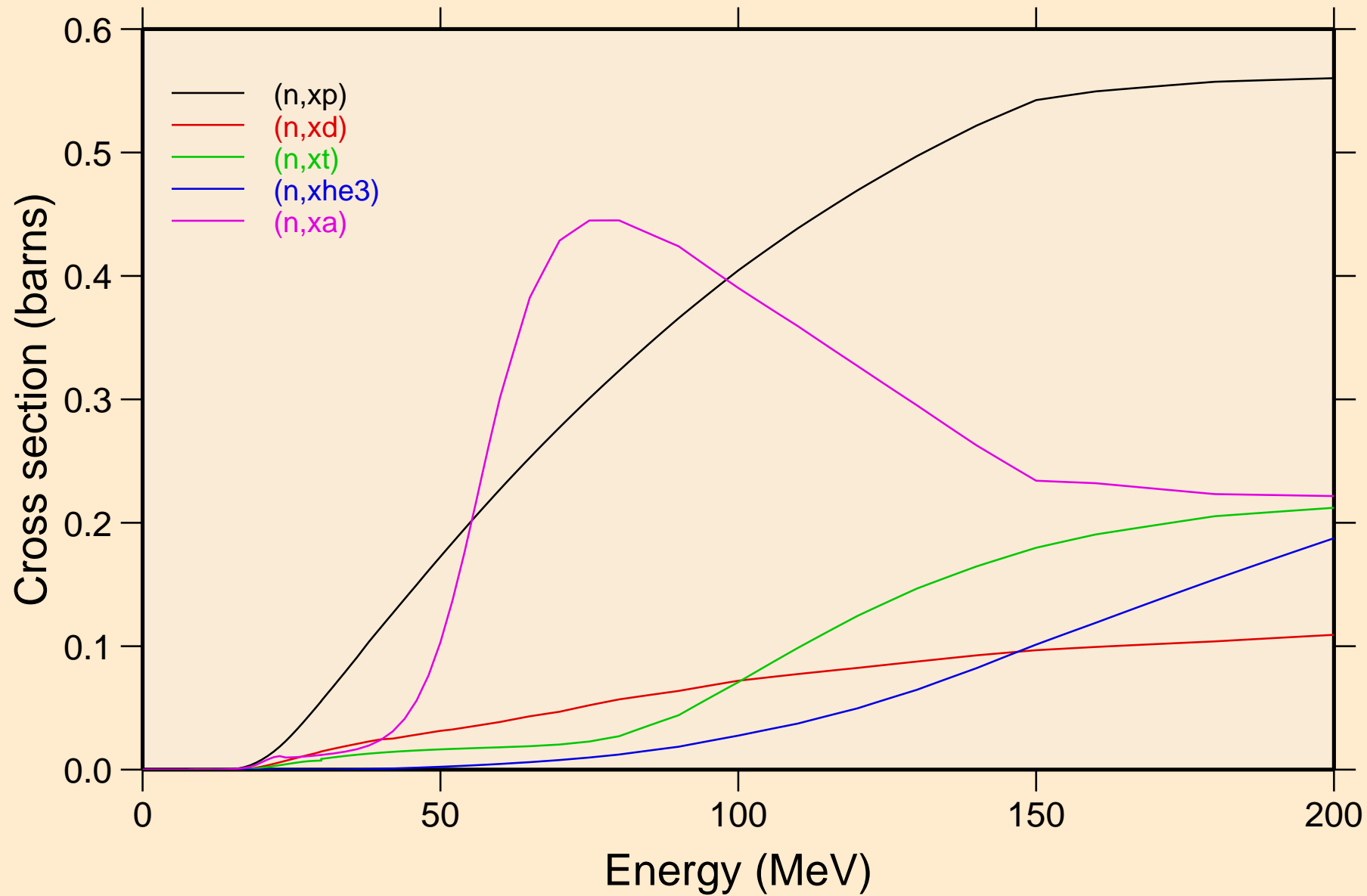

BA142 NEUTRON ACER TENDL-2021 LIBRARY; T=293.6K
angular distribution for elastic

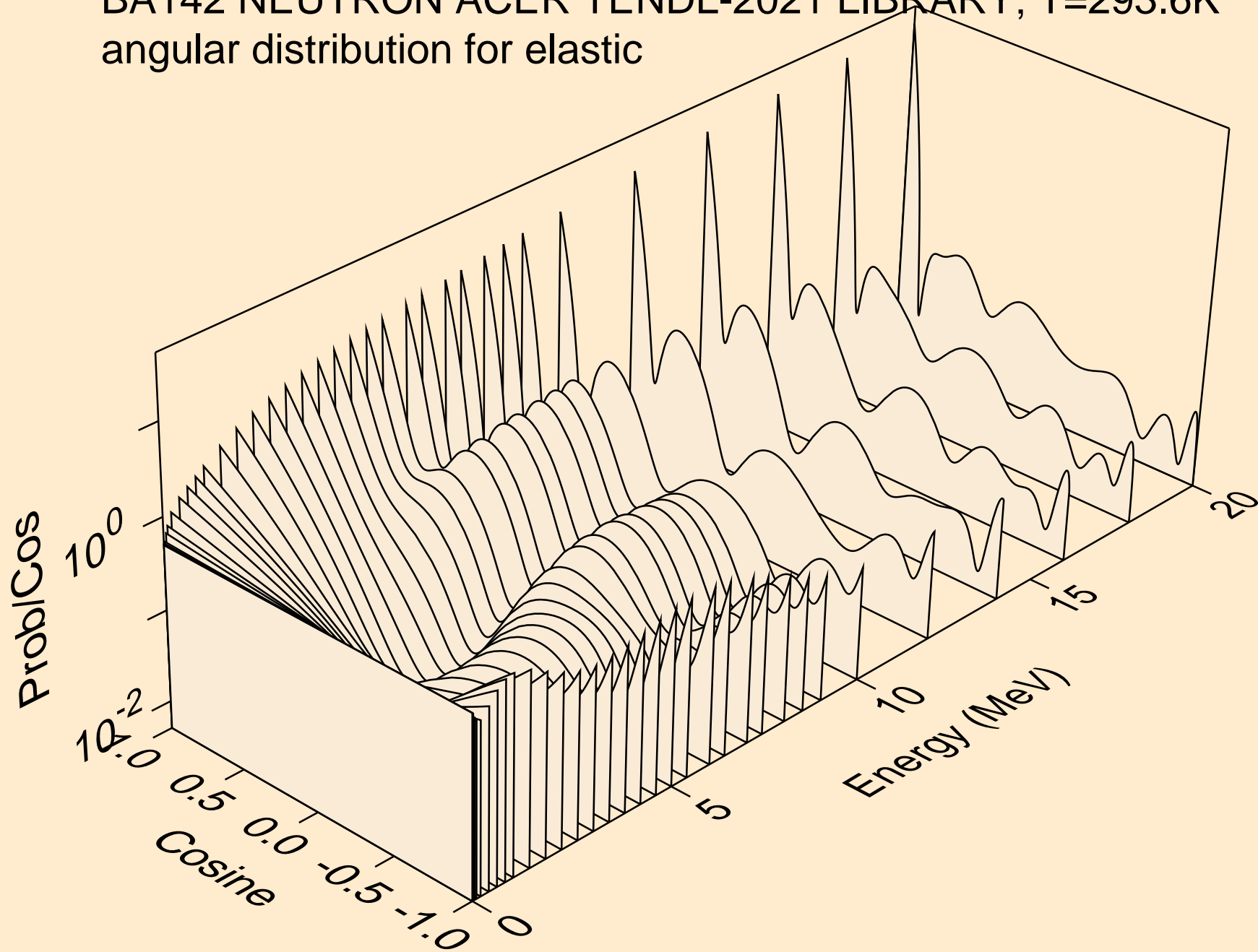

BA142 NEUTRON ACER TENDL-2021 LIBRARY; T=293.6K
angular distribution for elastic

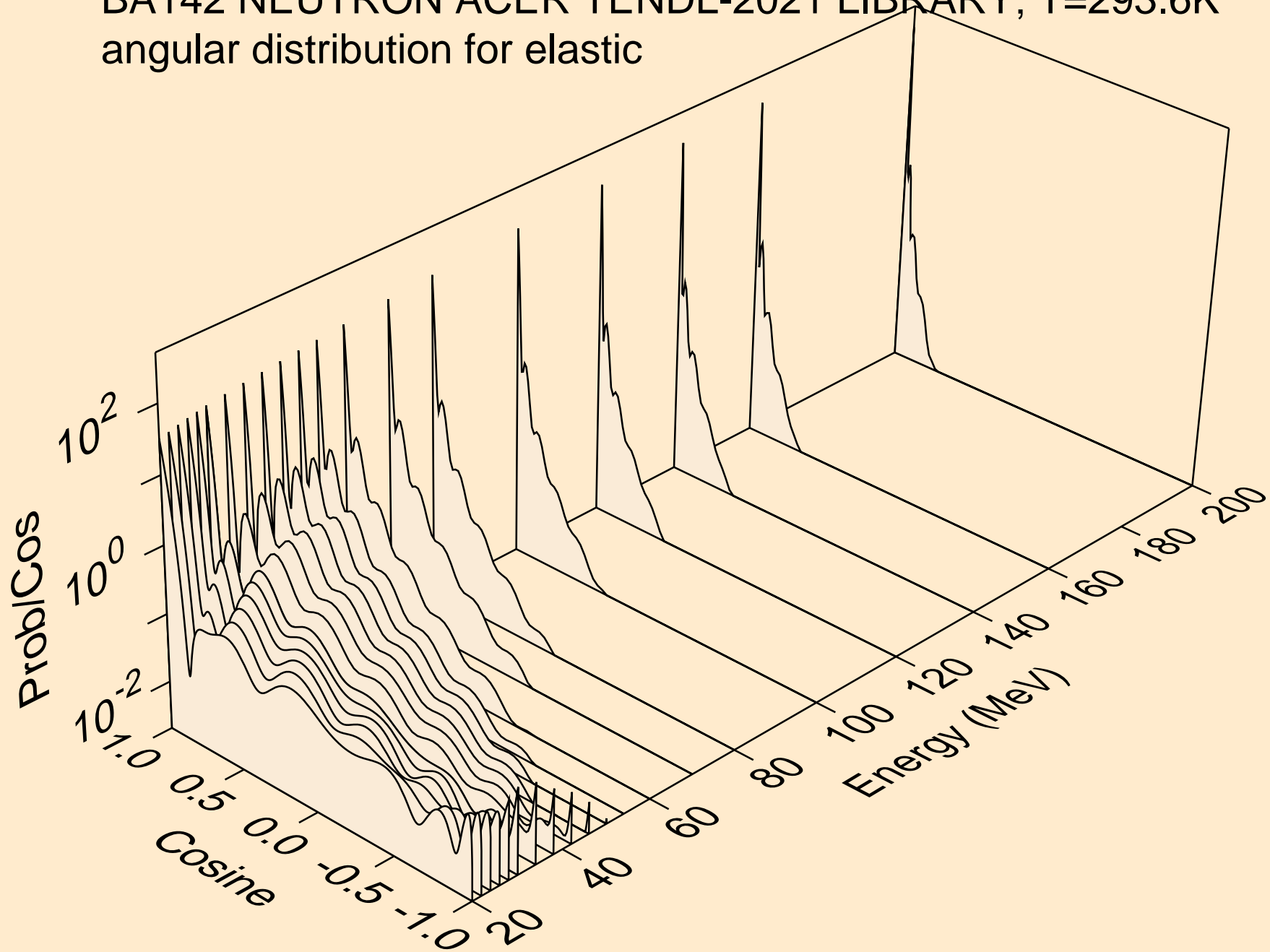

BA142 NEUTRON ACER TENDL-2021 LIBRARY; T=293.6K
angular distribution for (n,n*1)

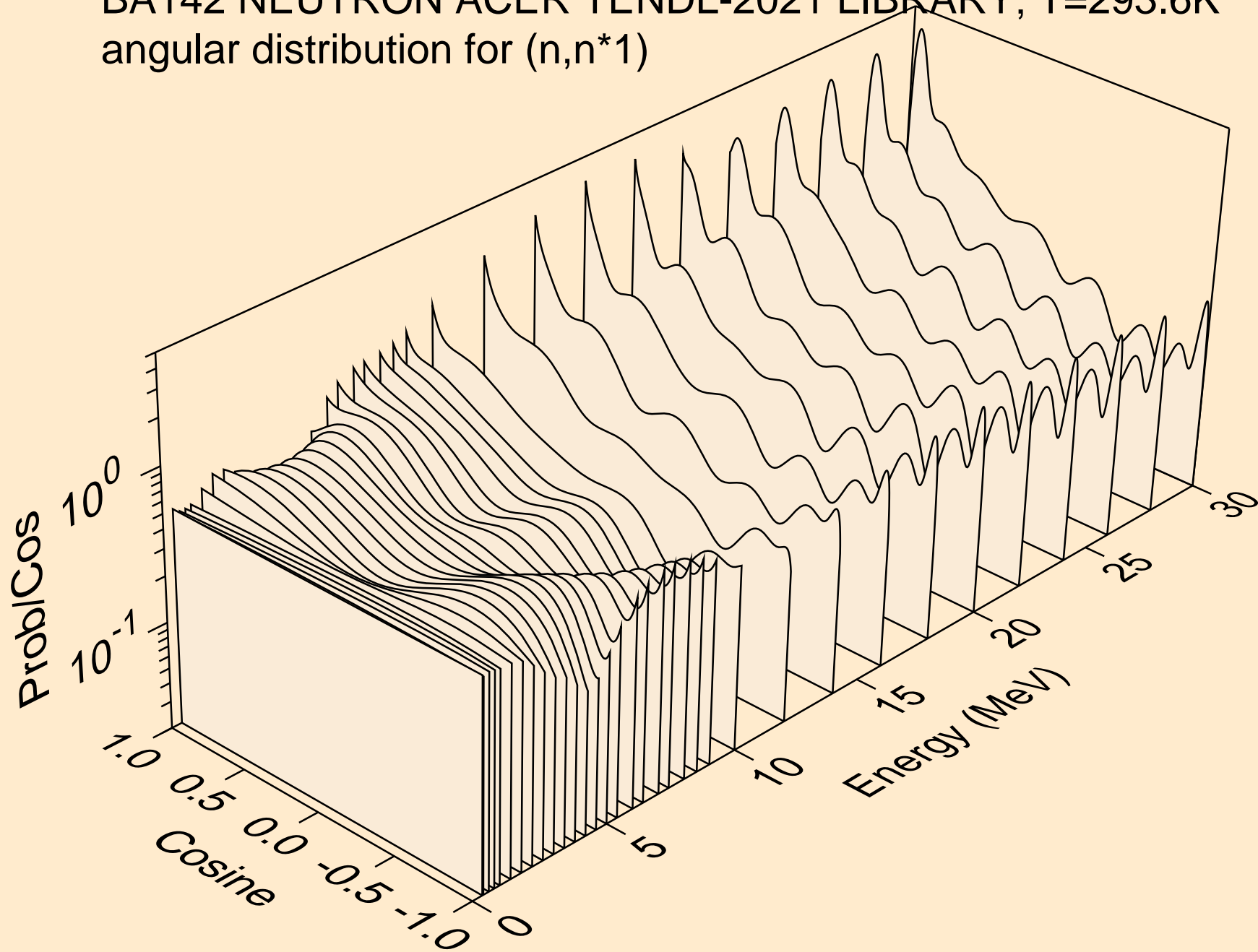

BA142 NEUTRON ACER TENDL-2021 LIBRARY; T=293.6K
angular distribution for (n,n*2)

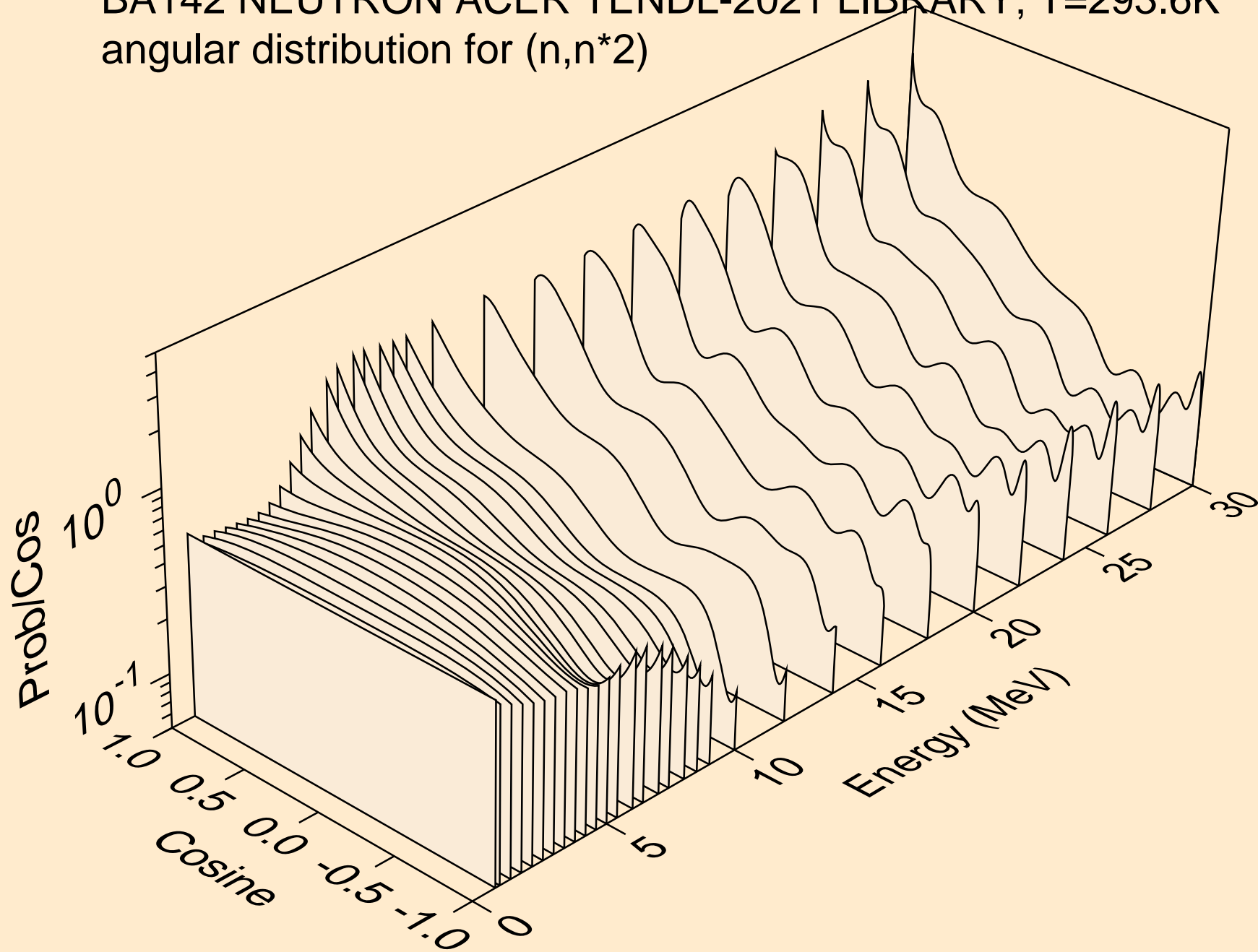

BA142 NEUTRON ACER TENDL-2021 LIBRARY; T=293.6K
angular distribution for (n,n*3)

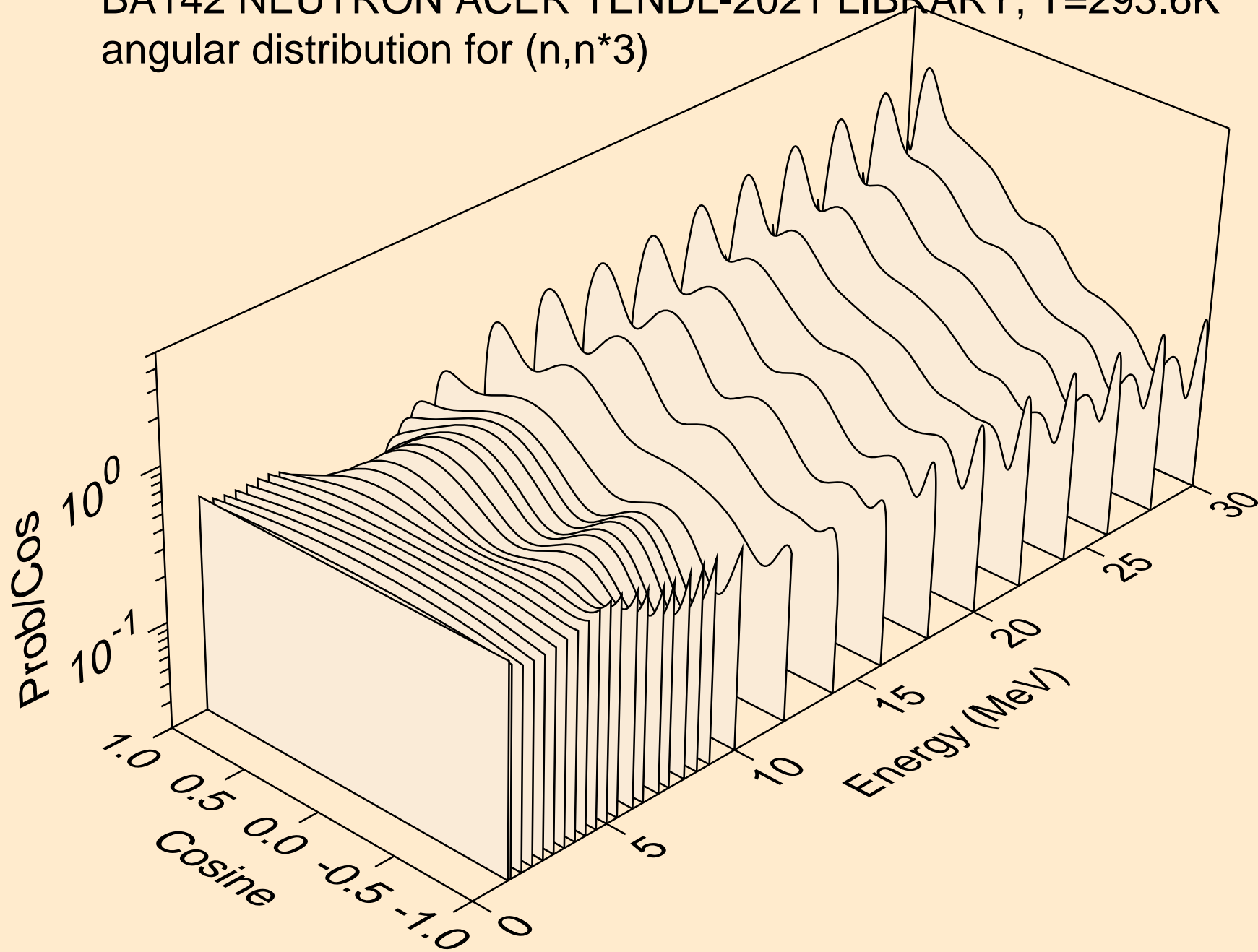

BA142 NEUTRON ACER TENDL-2021 LIBRARY; T=293.6K
angular distribution for (n,n*4)

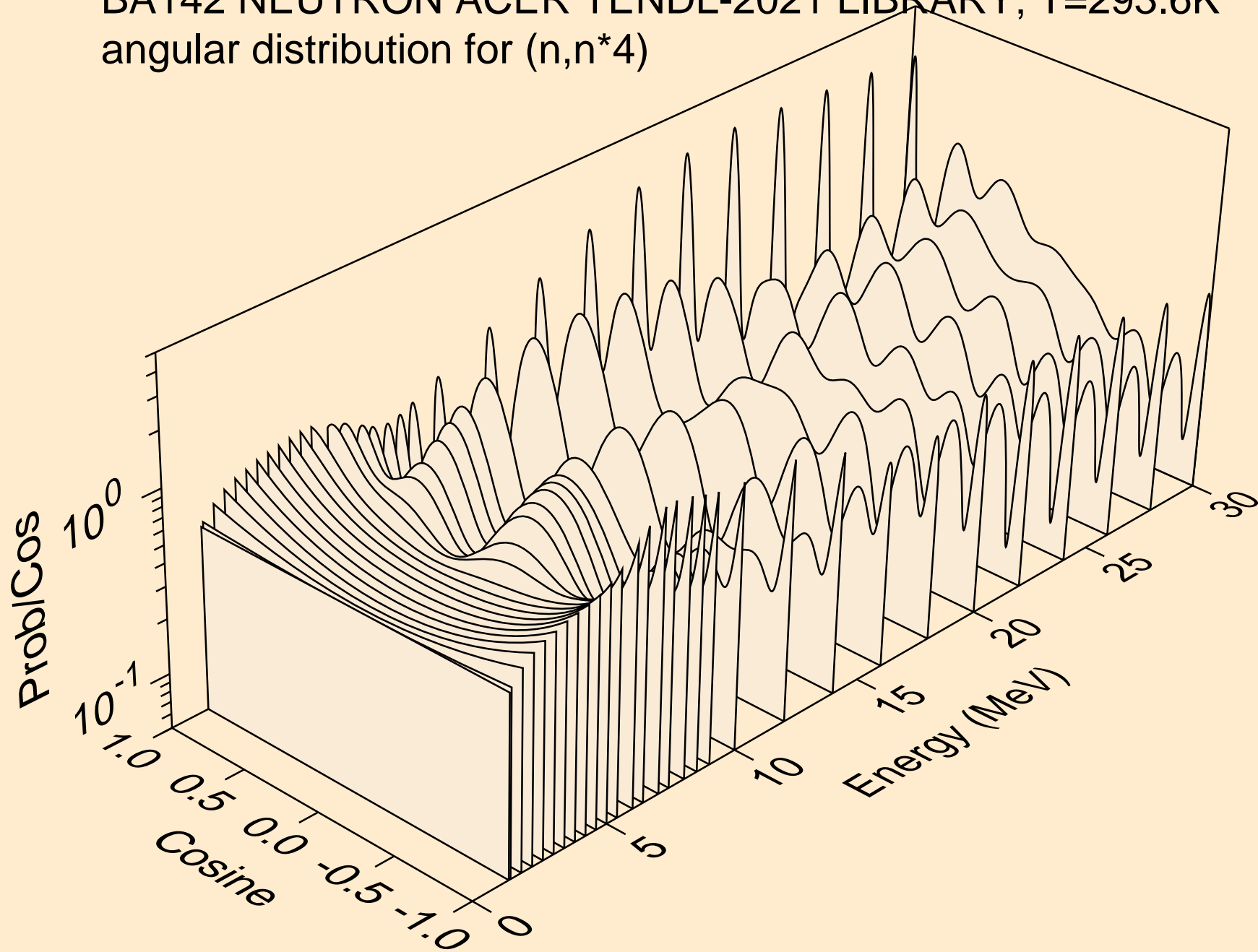

BA142 NEUTRON ACER TENDL-2021 LIBRARY; T=293.6K
angular distribution for (n,n*5)

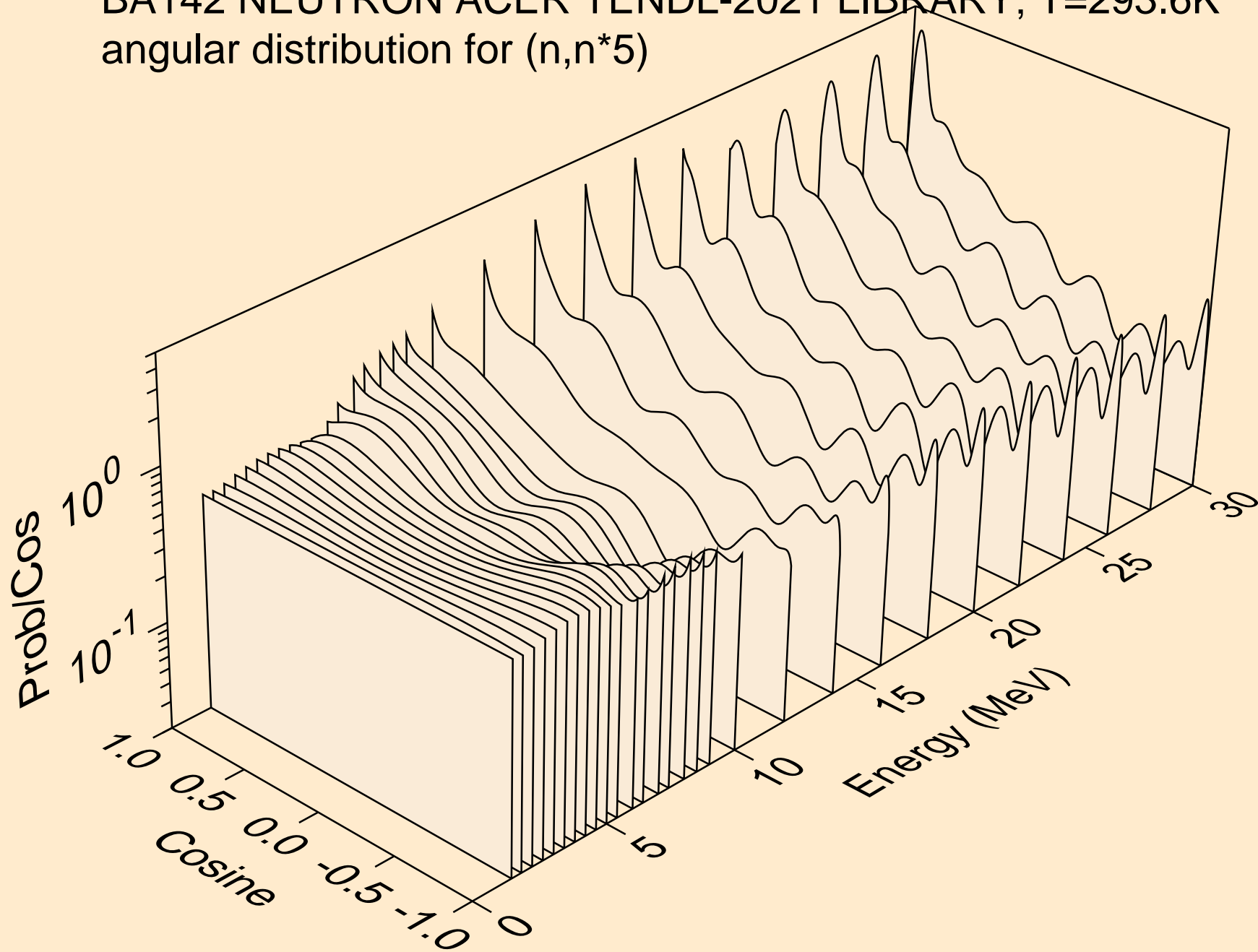

BA142 NEUTRON ACER TENDL-2021 LIBRARY; T=293.6K
angular distribution for (n,n*6)

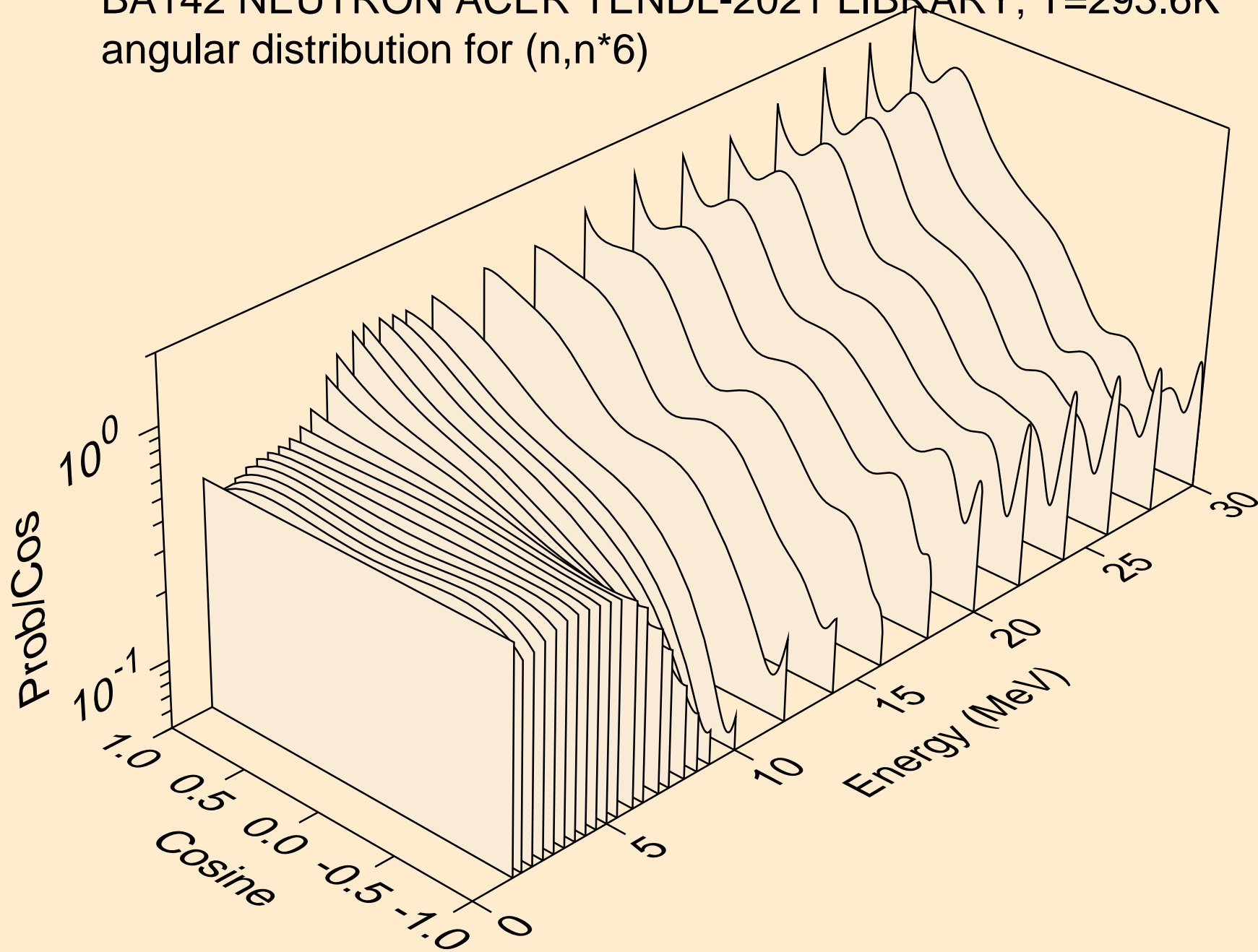

BA142 NEUTRON ACER TENDL-2021 LIBRARY; T=293.6K
angular distribution for (n,n*7)

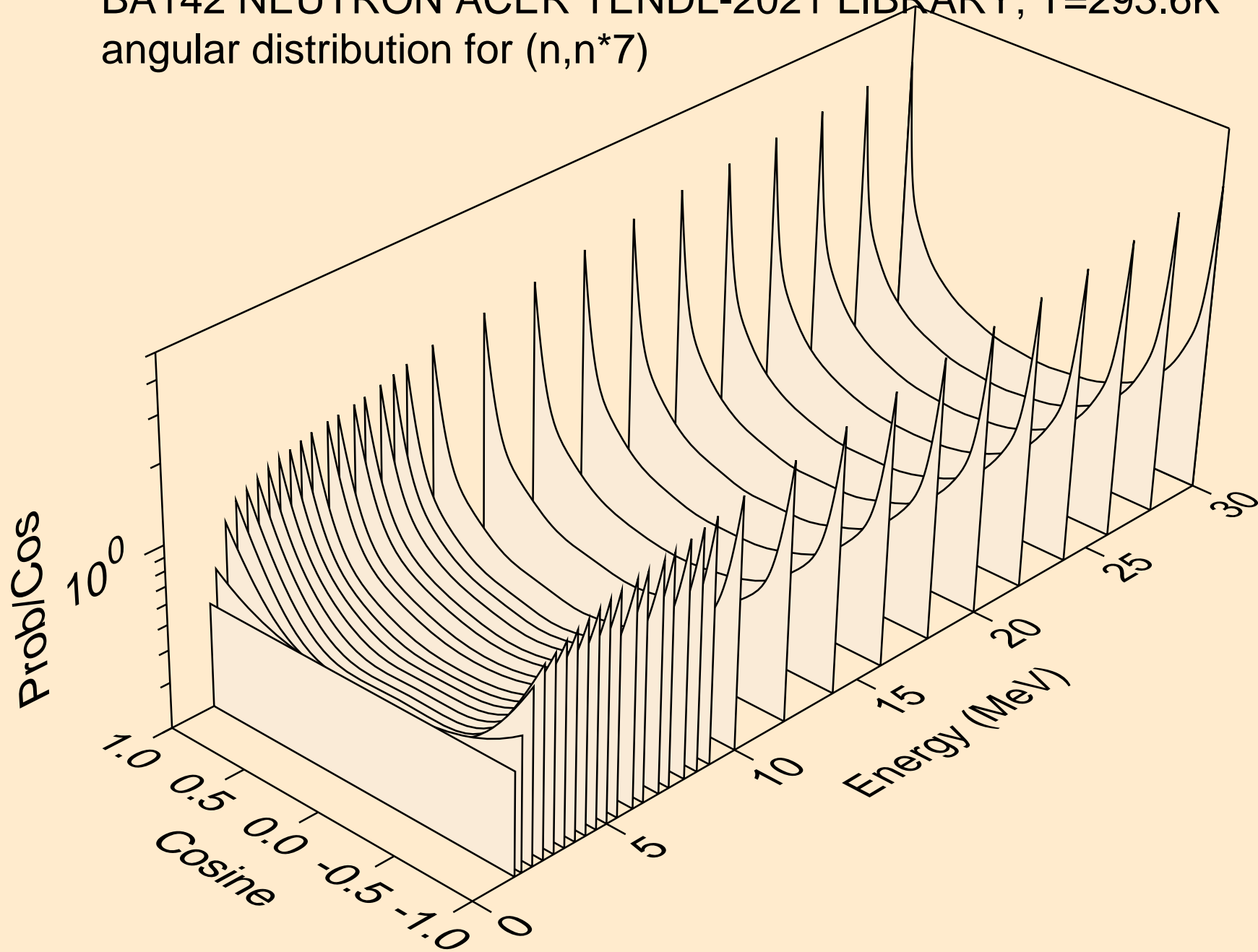

BA142 NEUTRON ACER TENDL-2021 LIBRARY; T=293.6K
angular distribution for (n,n*8)

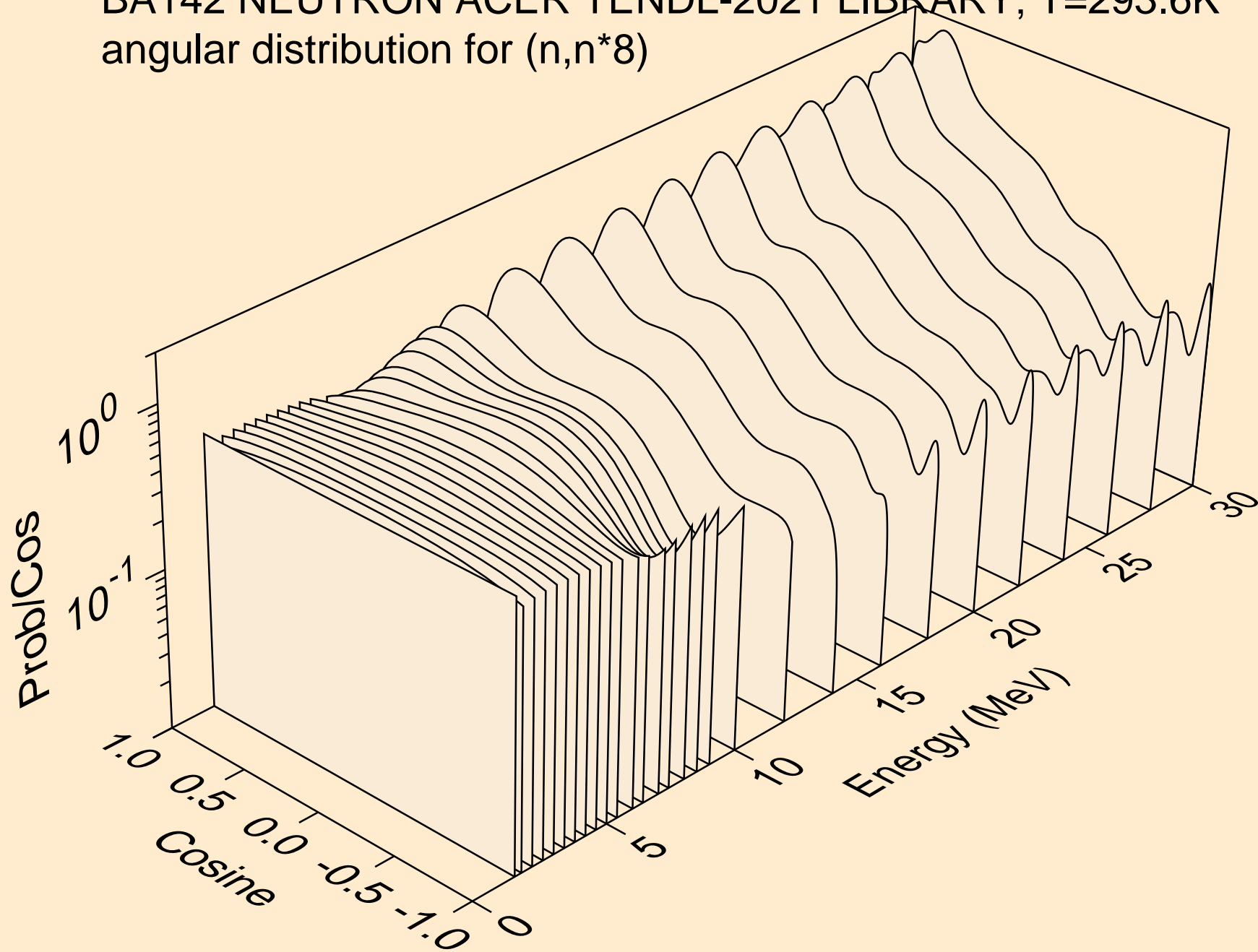

BA142 NEUTRON ACER TENDL-2021 LIBRARY; T=293.6K
angular distribution for (n,n*9)

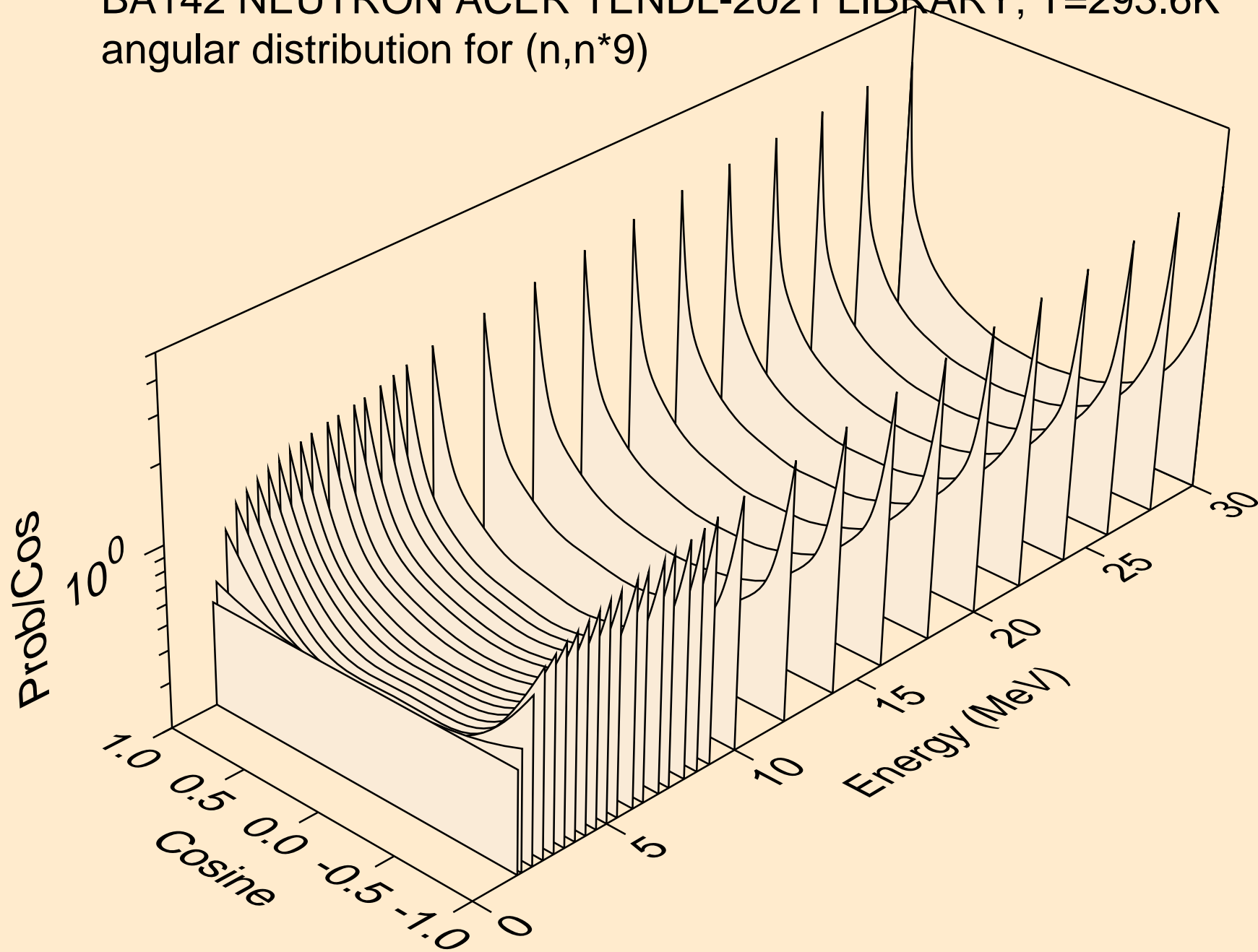

BA142 NEUTRON ACER TENDL-2021 LIBRARY; T=293.6K
angular distribution for (n,n*10)

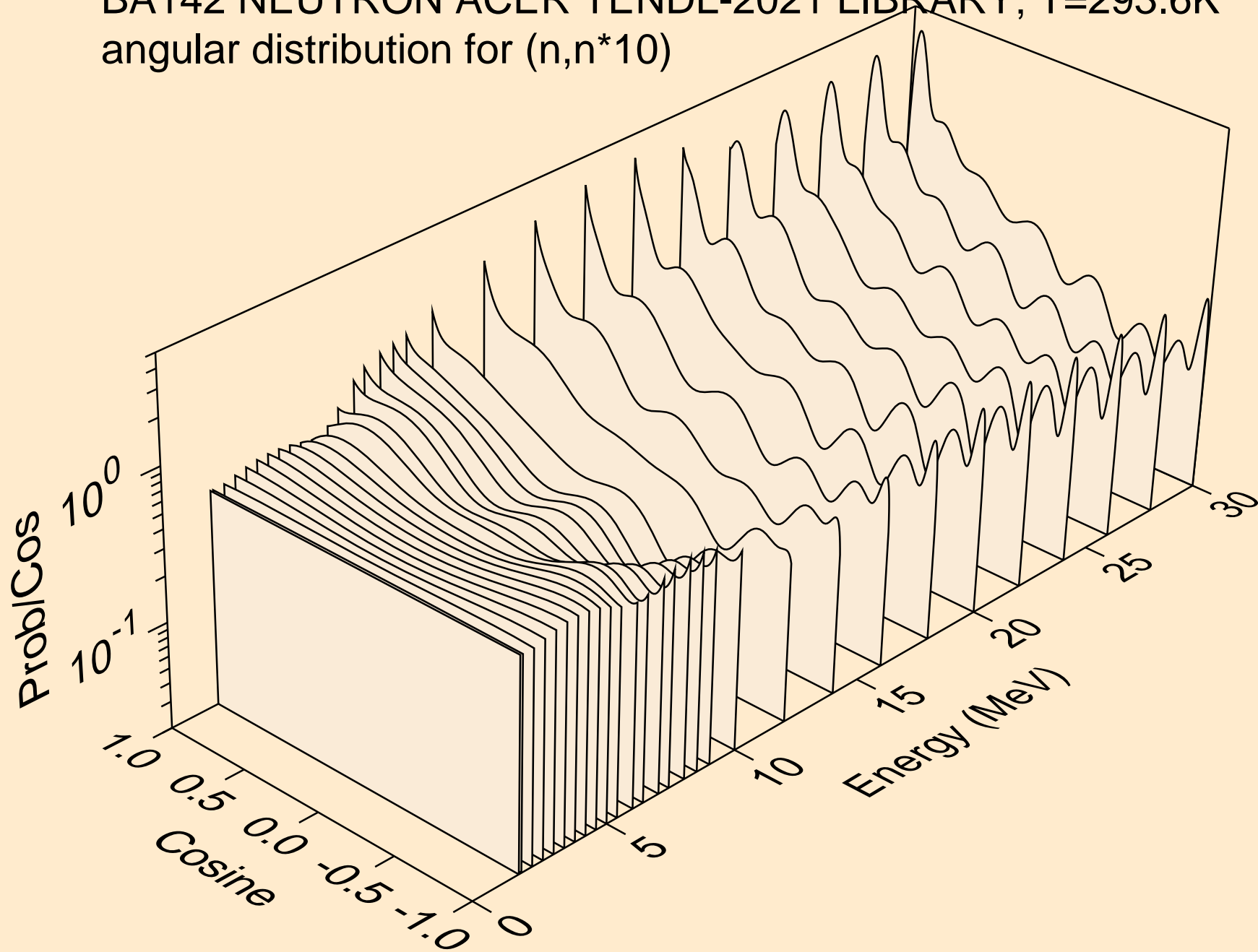

BA142 NEUTRON ACER TENDL-2021 LIBRARY; T=293.6K
angular distribution for (n,n*11)

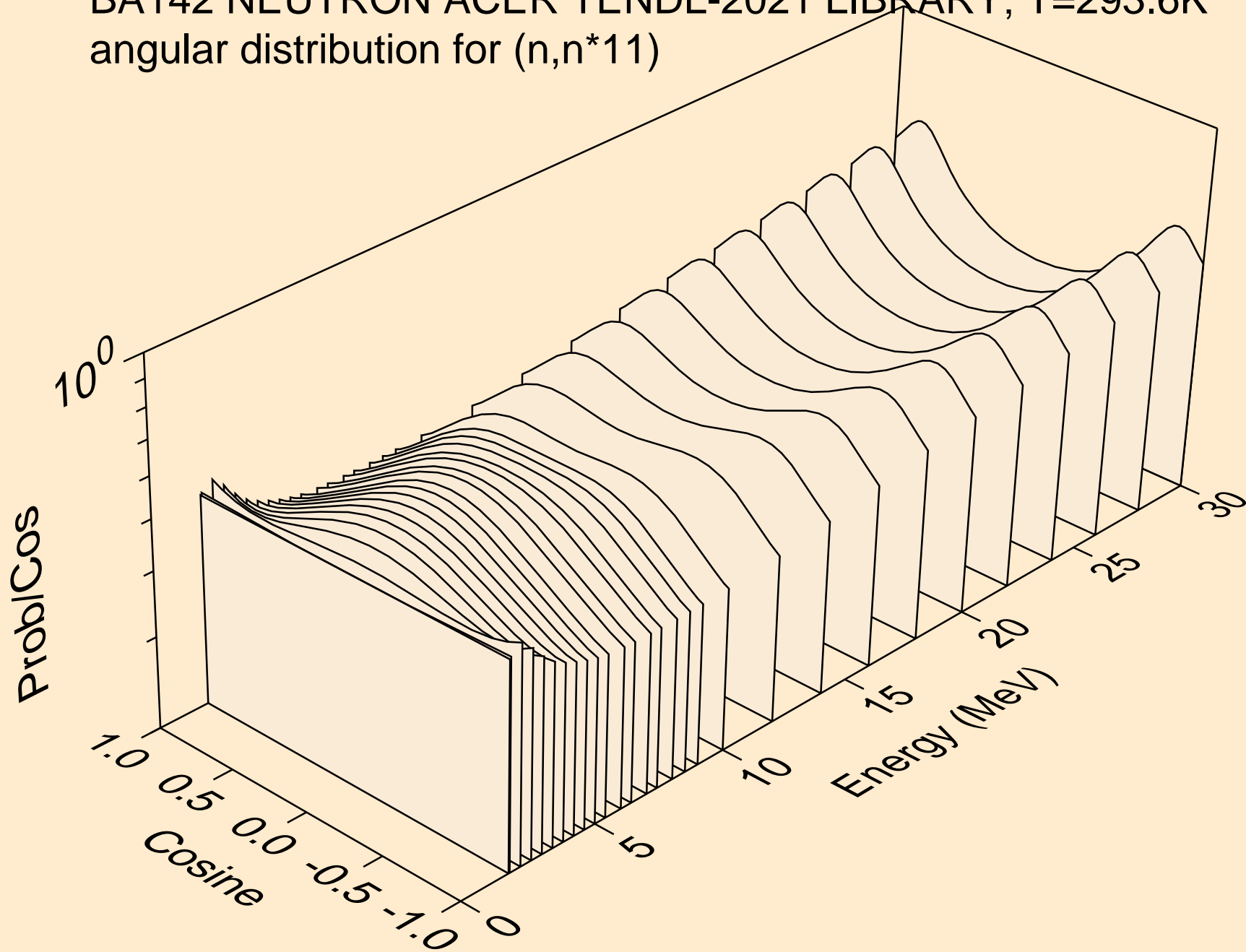

BA142 NEUTRON ACER TENDL-2021 LIBRARY; T=293.6K
angular distribution for (n,n*12)

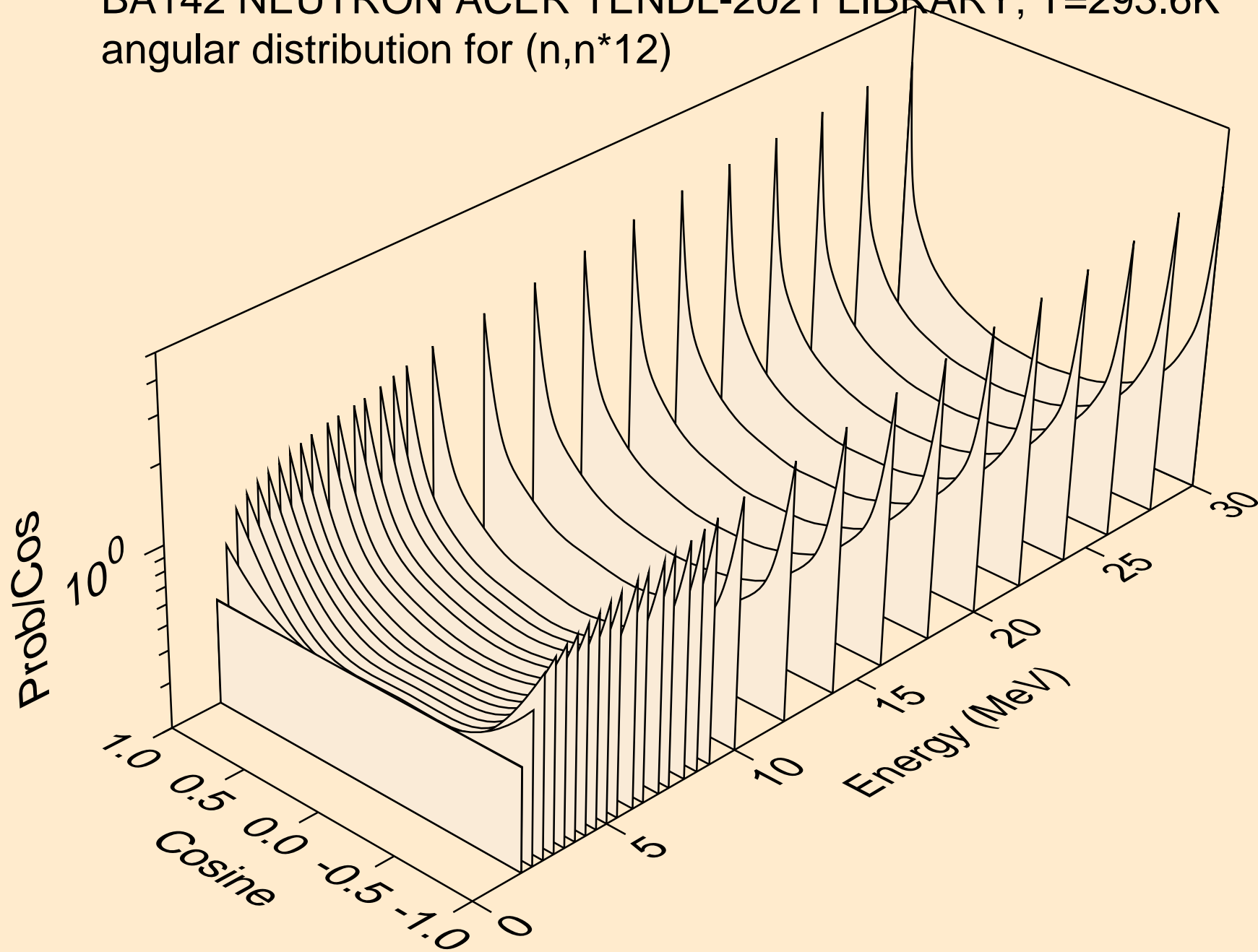

BA142 NEUTRON ACER TENDL-2021 LIBRARY; T=293.6K
angular distribution for (n,n*13)

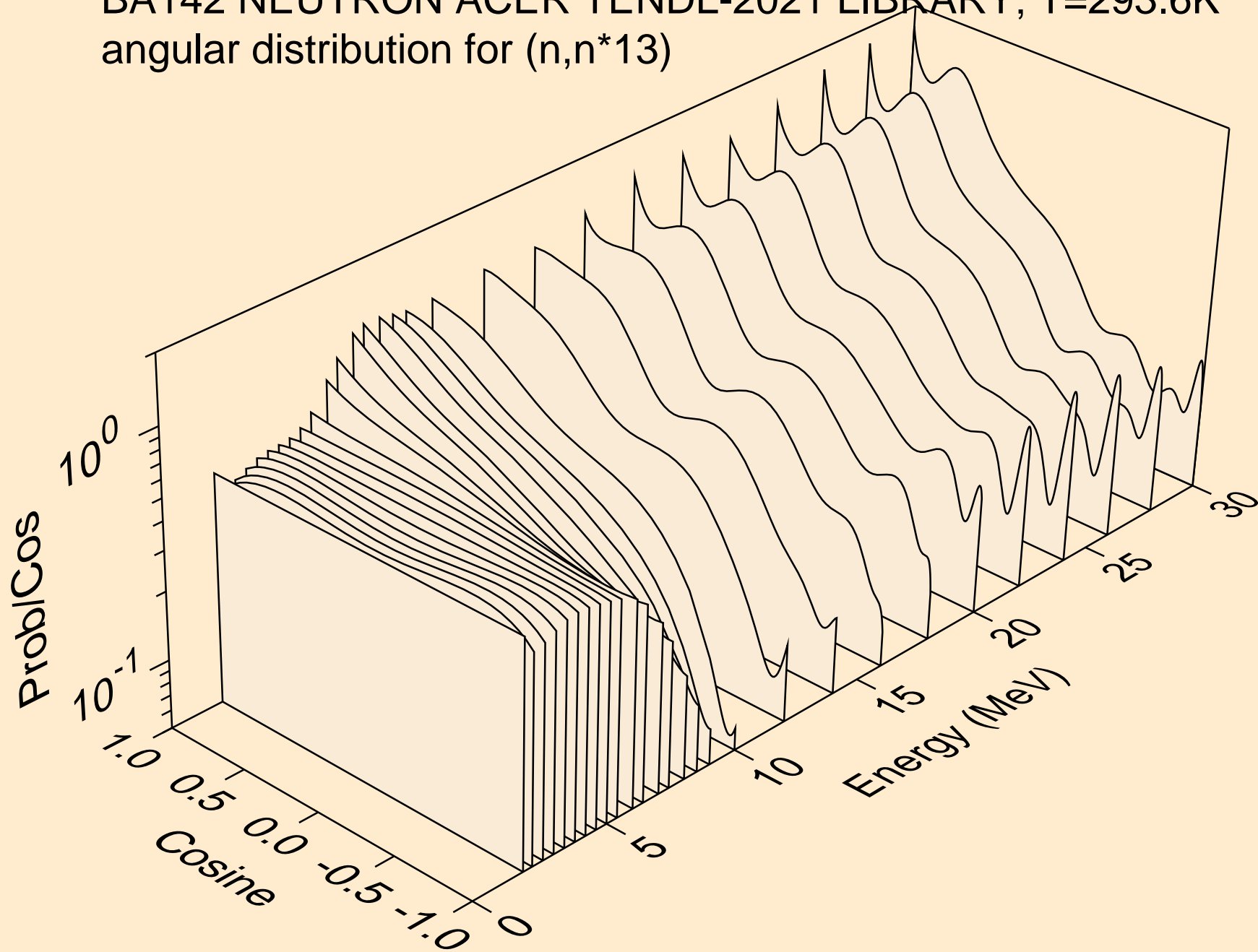

BA142 NEUTRON ACER TENDL-2021 LIBRARY; T=293.6K
angular distribution for (n,n*14)

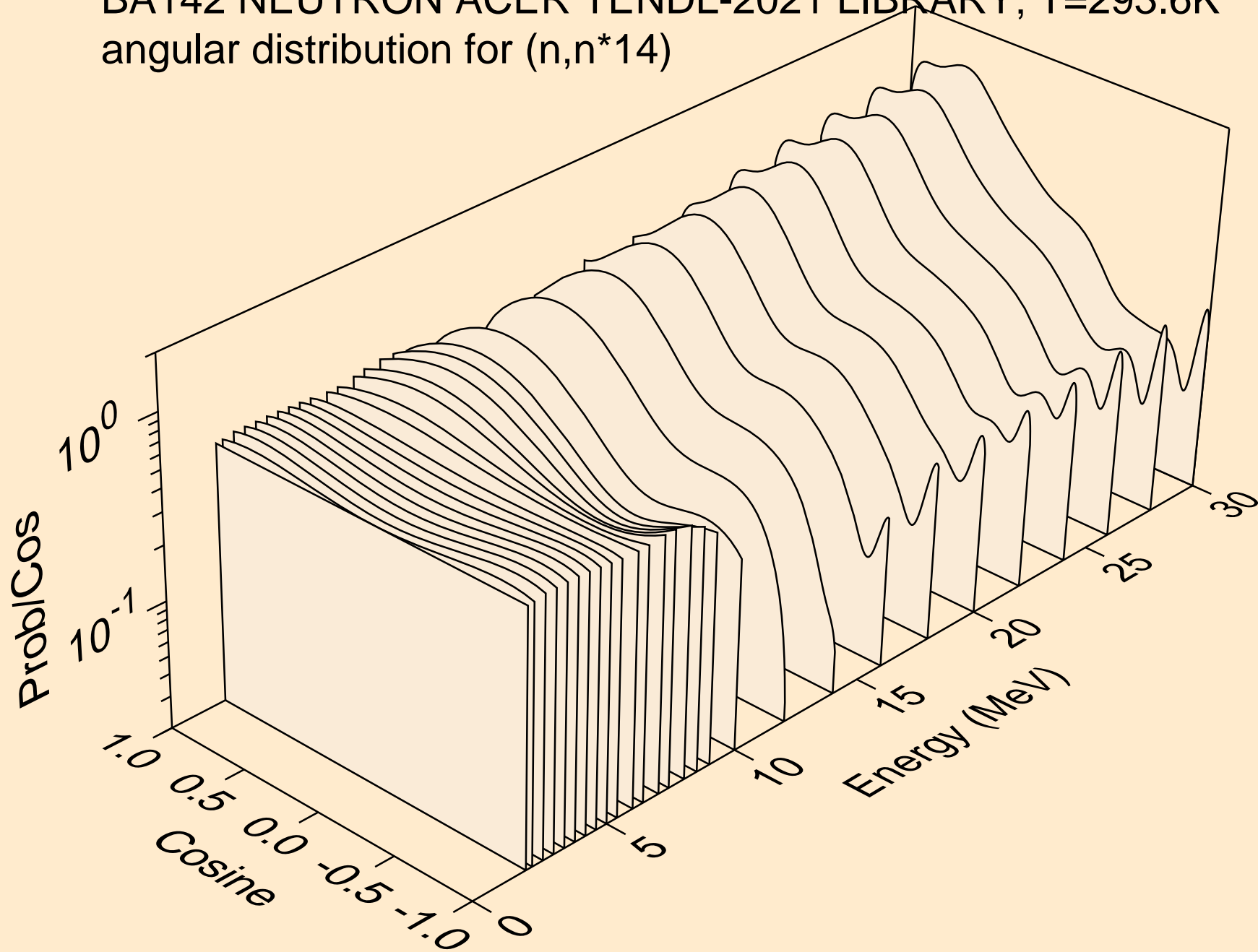

BA142 NEUTRON ACER TENDL-2021 LIBRARY; T=293.6K
angular distribution for (n,n*15)

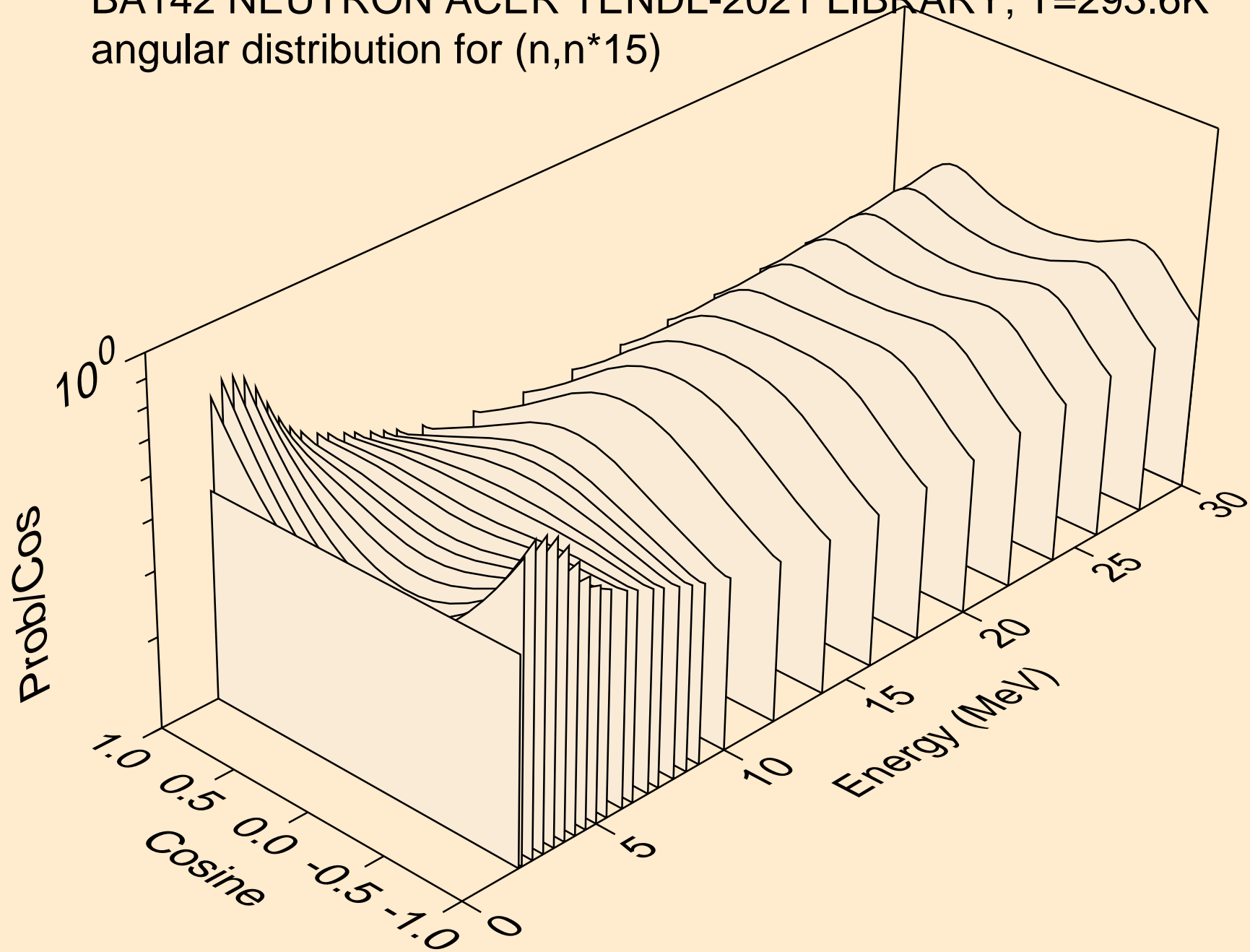

BA142 NEUTRON ACER TENDL-2021 LIBRARY; T=293.6K
angular distribution for (n,n*16)

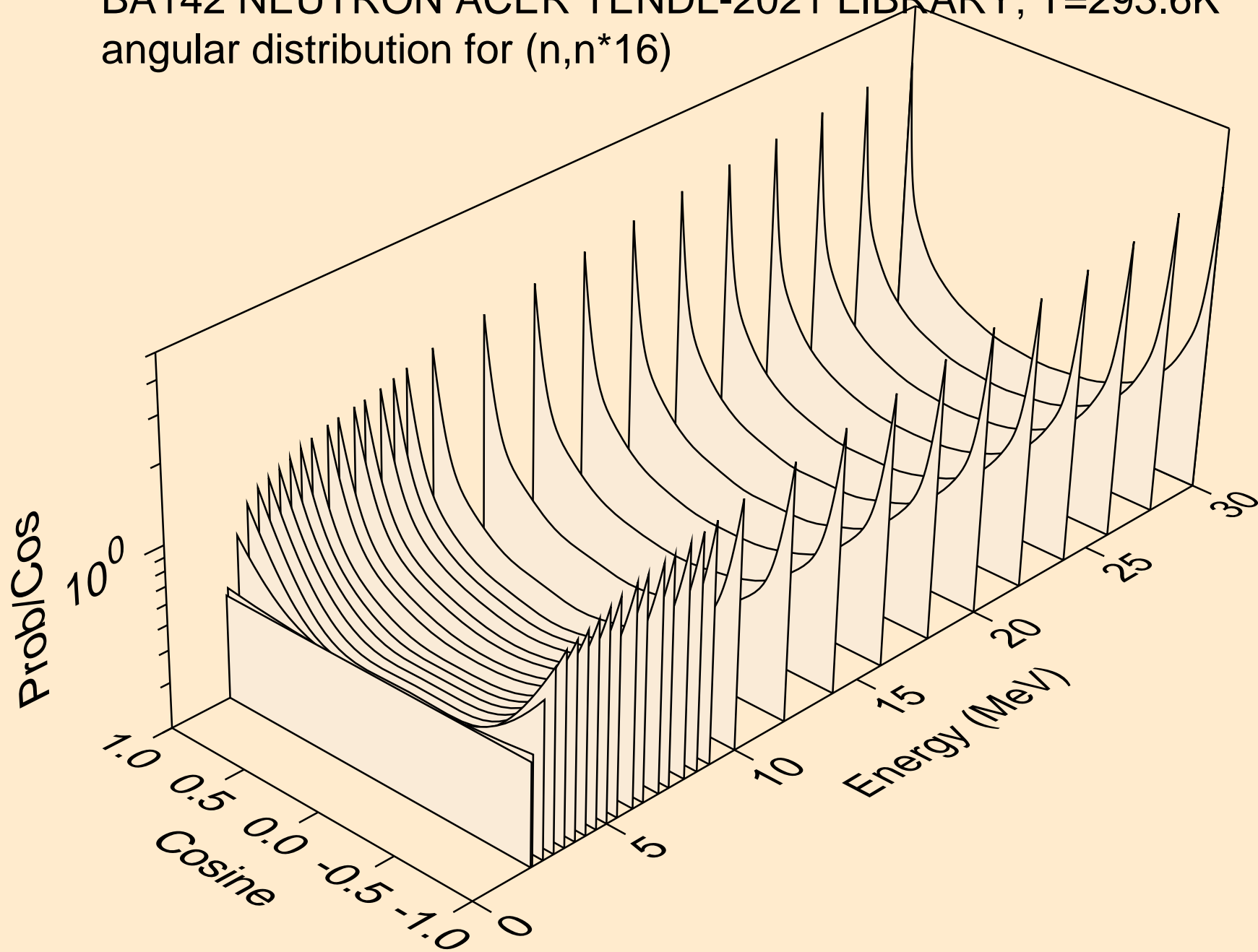

BA142 NEUTRON ACER TENDL-2021 LIBRARY; T=293.6K
angular distribution for (n,n*17)

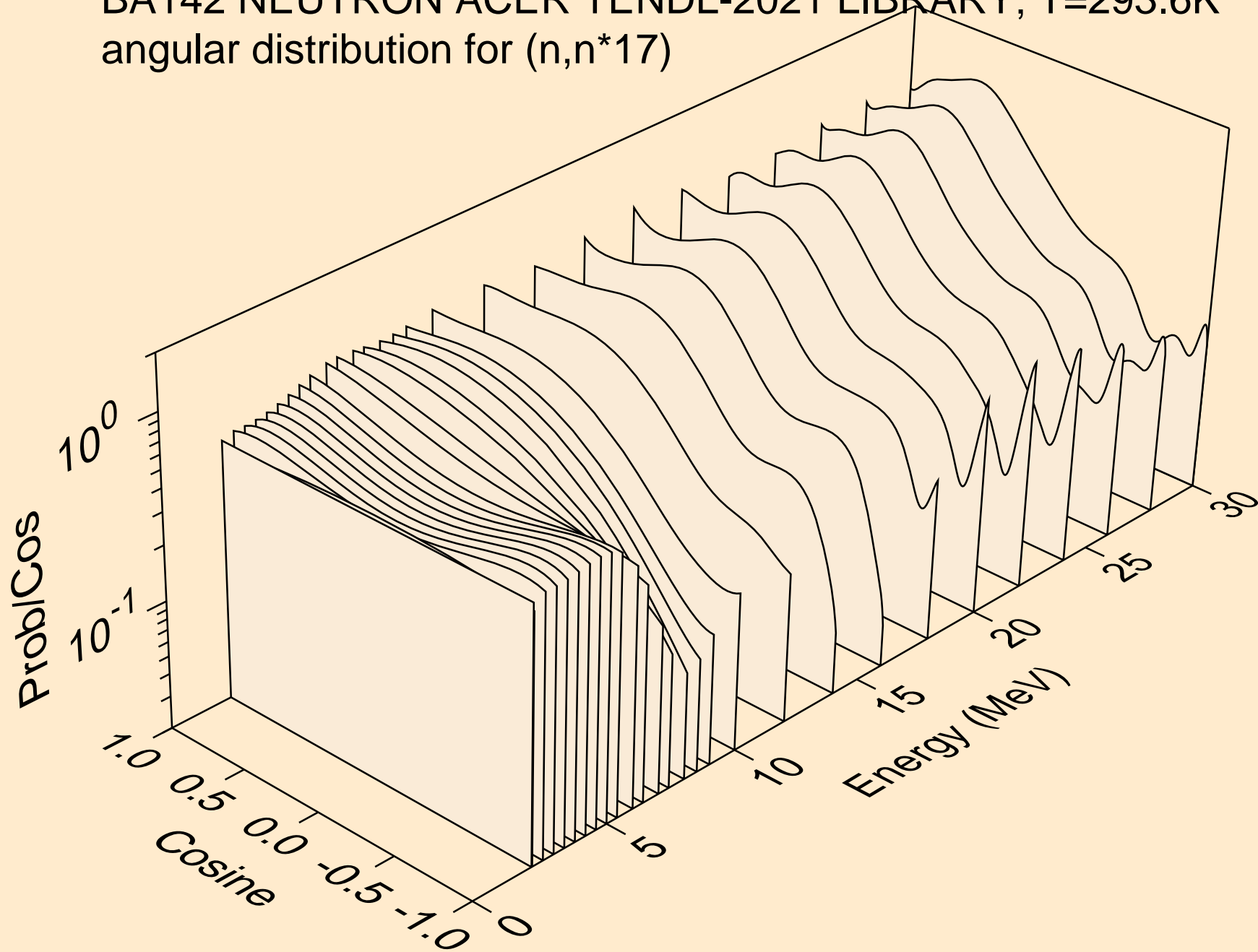

BA142 NEUTRON ACER TENDL-2021 LIBRARY; T=293.6K
angular distribution for (n,n*18)

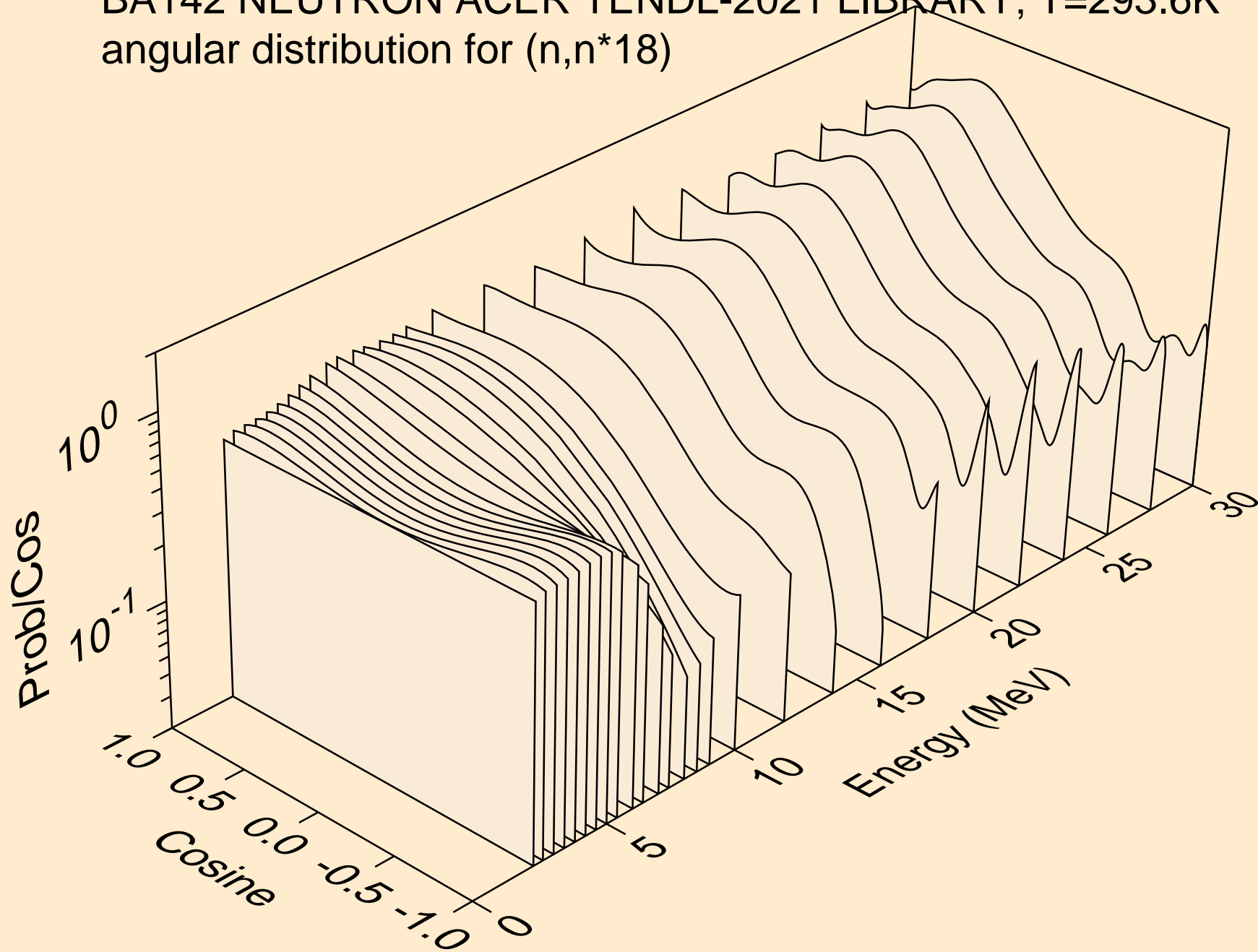

BA142 NEUTRON ACER TENDL-2021 LIBRARY; T=293.6K
angular distribution for (n,n*19)

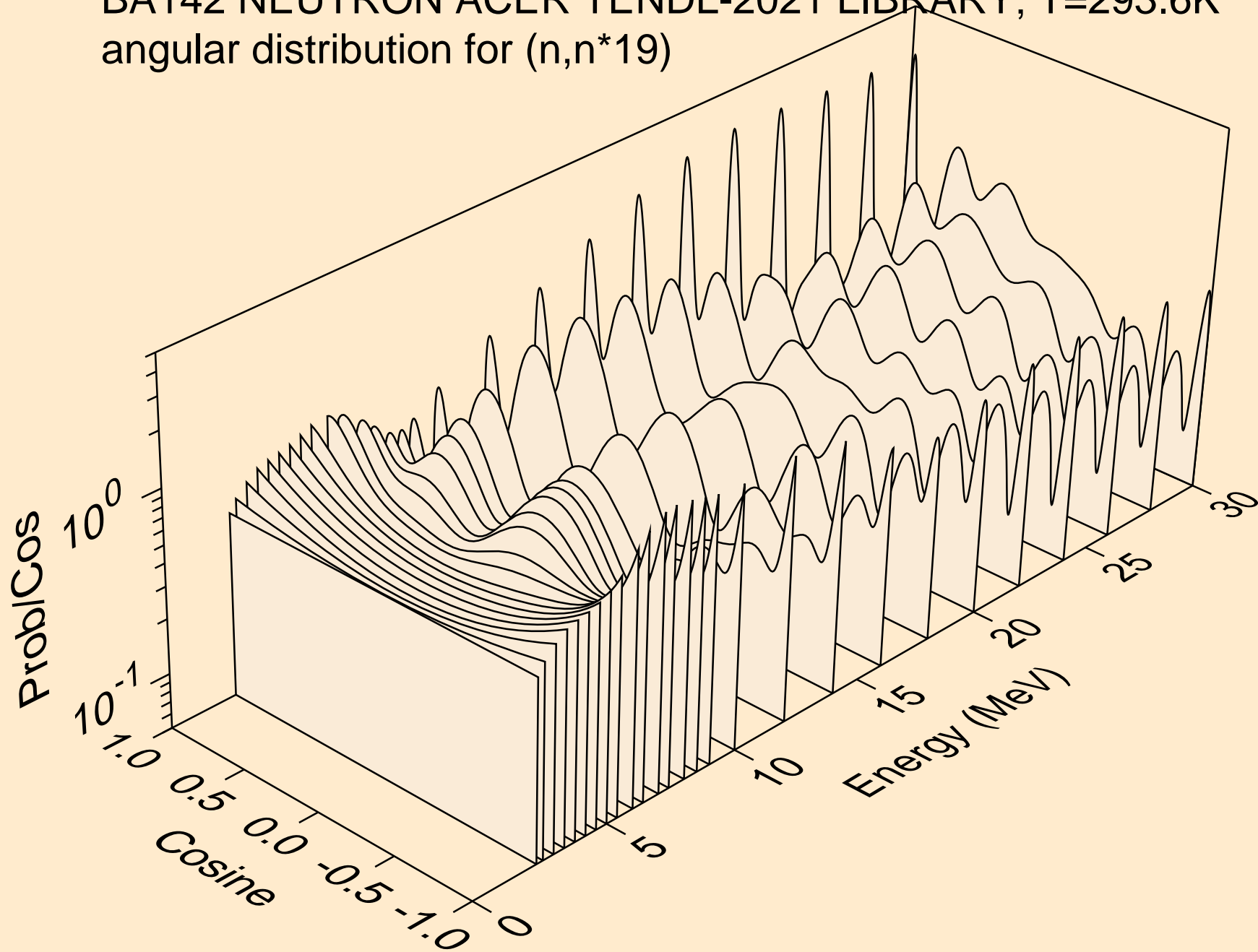

BA142 NEUTRON ACER TENDL-2021 LIBRARY; T=293.6K
angular distribution for (n,n*20)

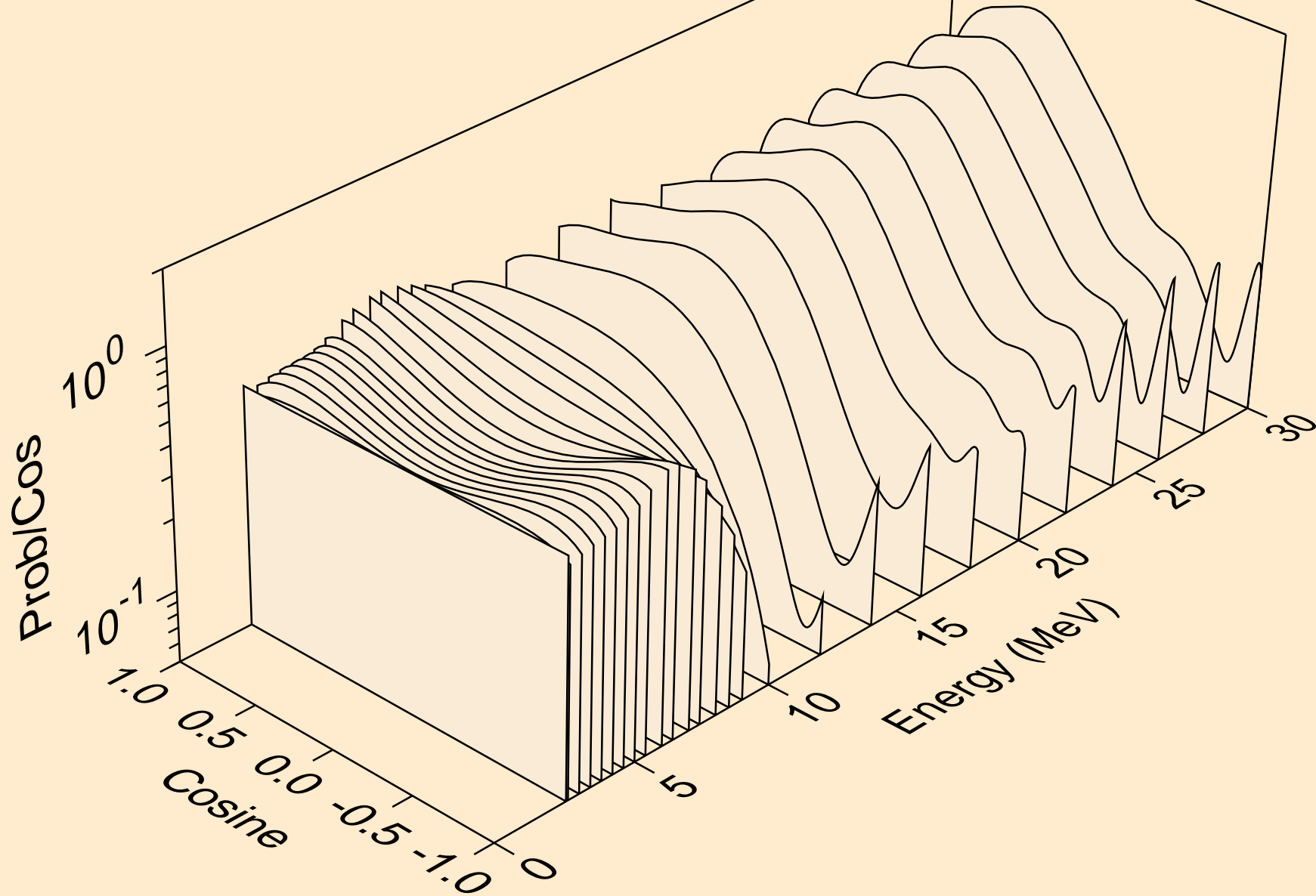

BA142 NEUTRON ACER TENDL-2021 LIBRARY; T=293.6K
angular distribution for (n,n*21)

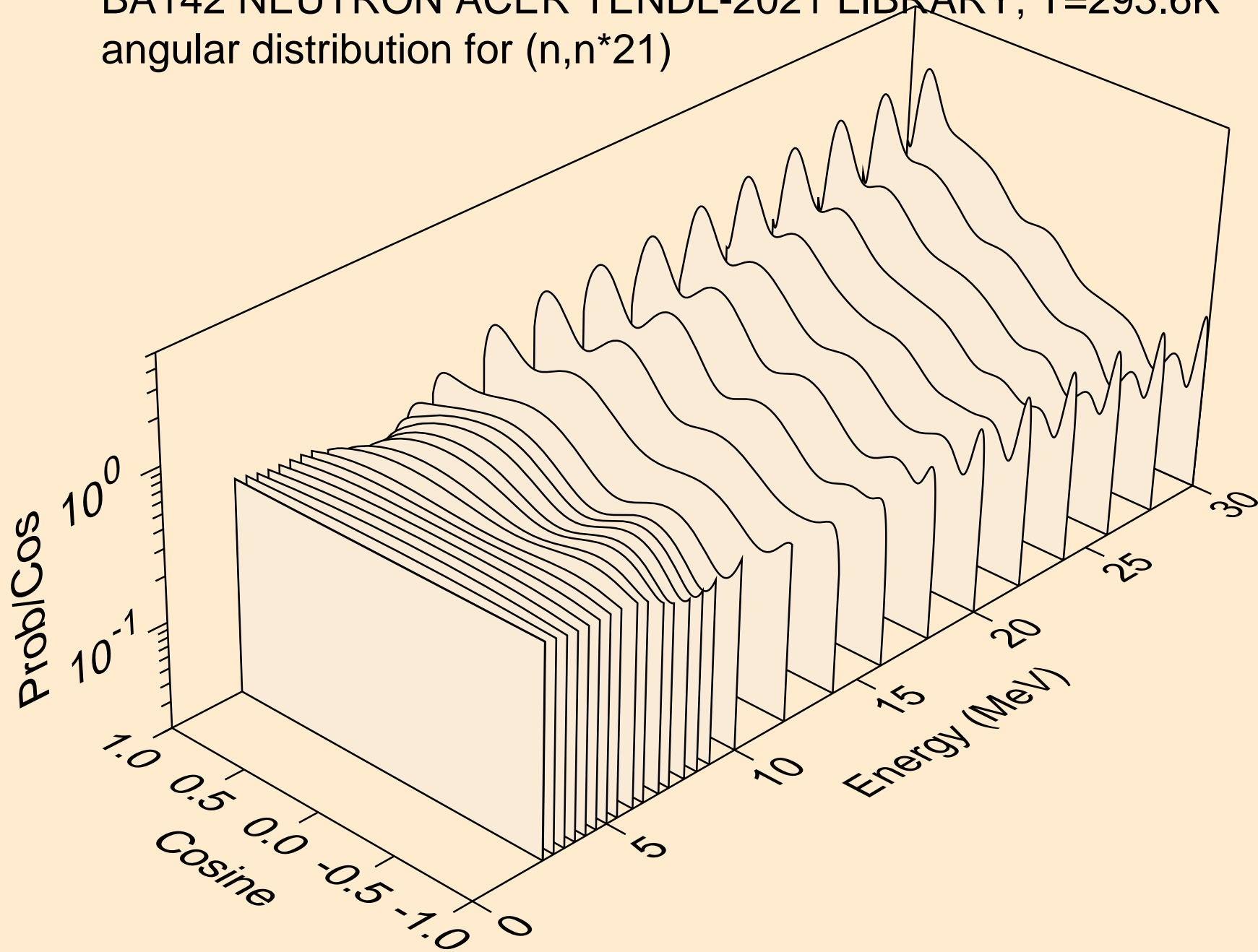

BA142 NEUTRON ACER TENDL-2021 LIBRARY; T=293.6K
angular distribution for (n,n*22)

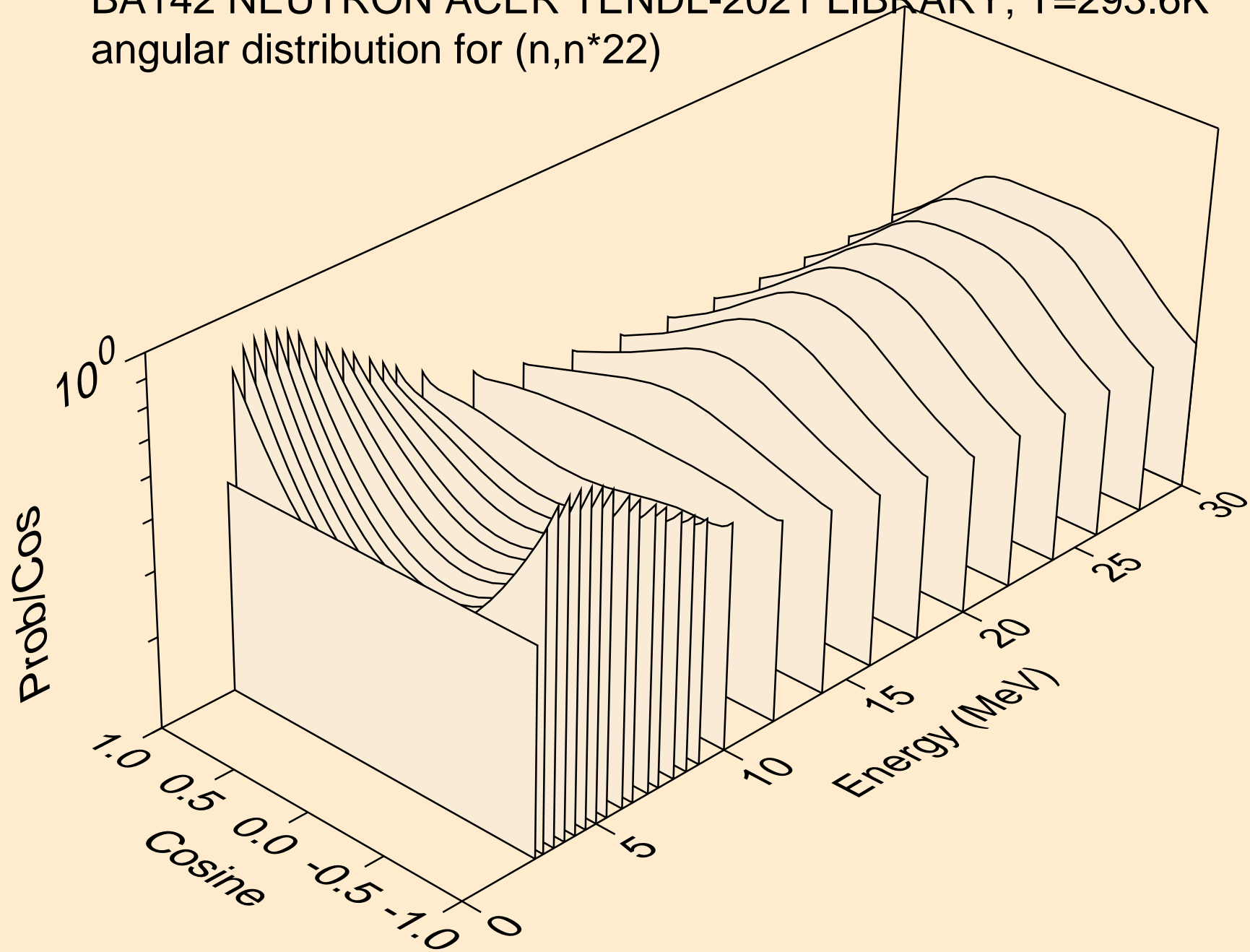

BA142 NEUTRON ACER TENDL-2021 LIBRARY; T=293.6K
angular distribution for (n,n*23)

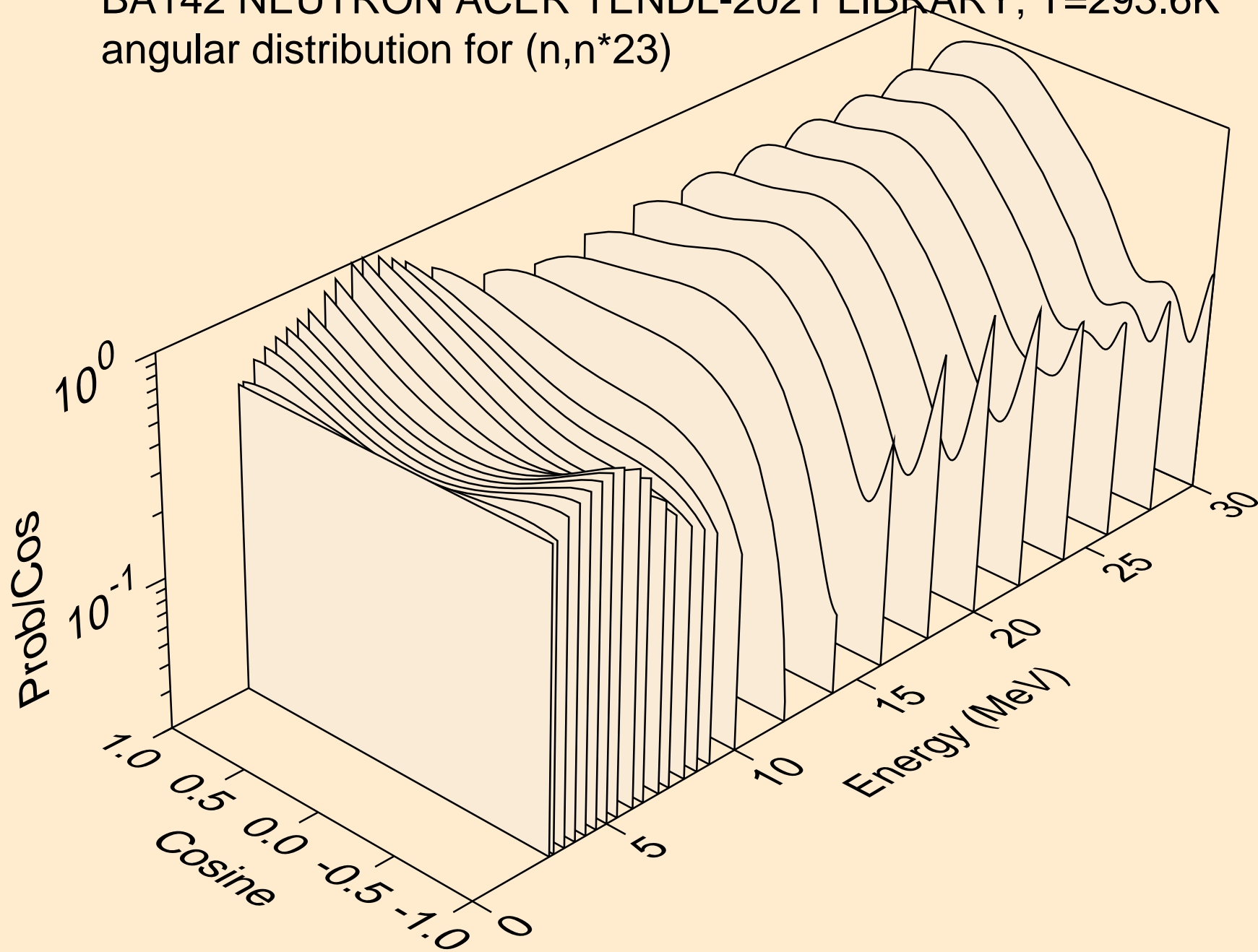

BA142 NEUTRON ACER TENDL-2021 LIBRARY; T=293.6K
angular distribution for (n,n*24)

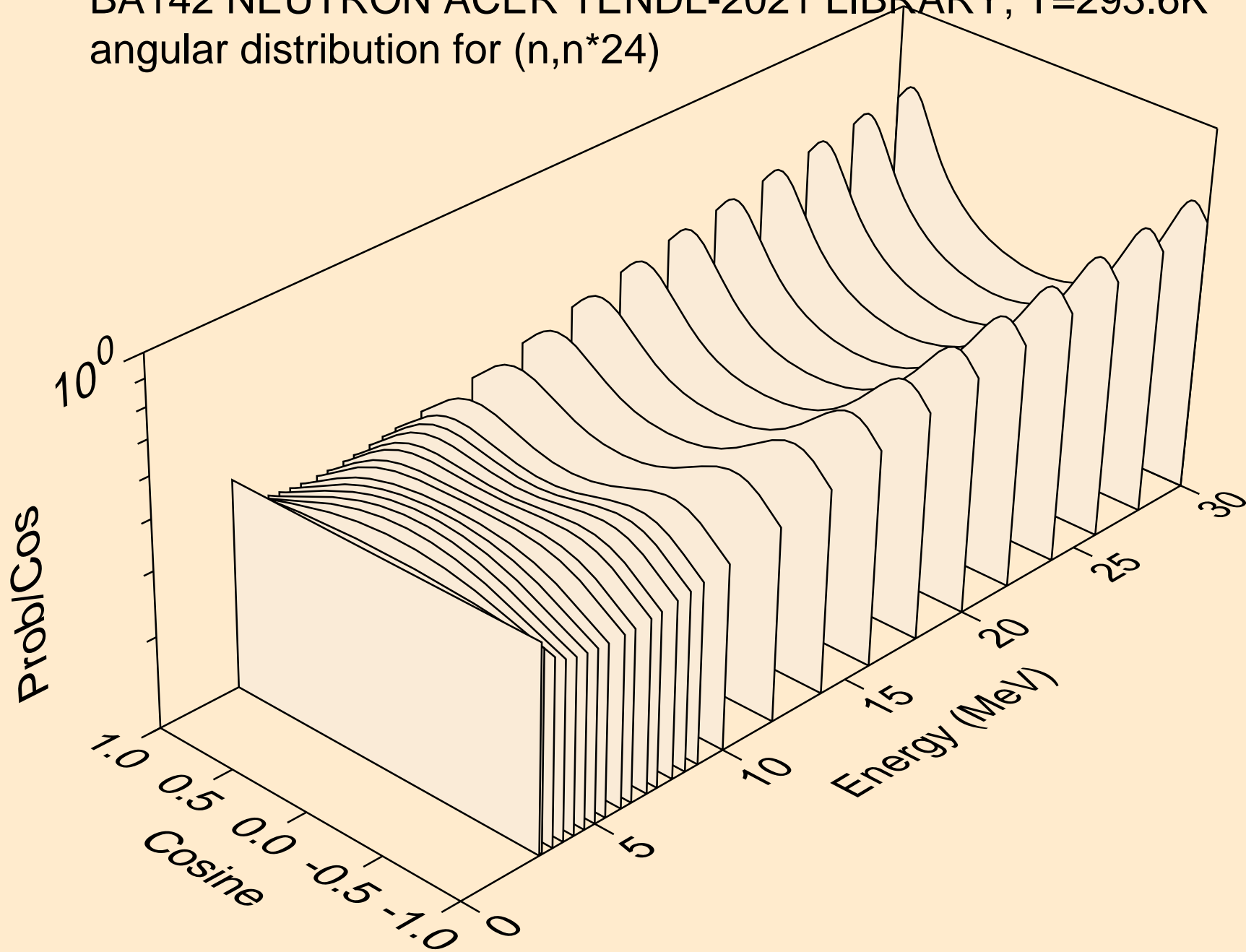

BA142 NEUTRON ACER TENDL-2021 LIBRARY; T=293.6K
angular distribution for (n,n*25)

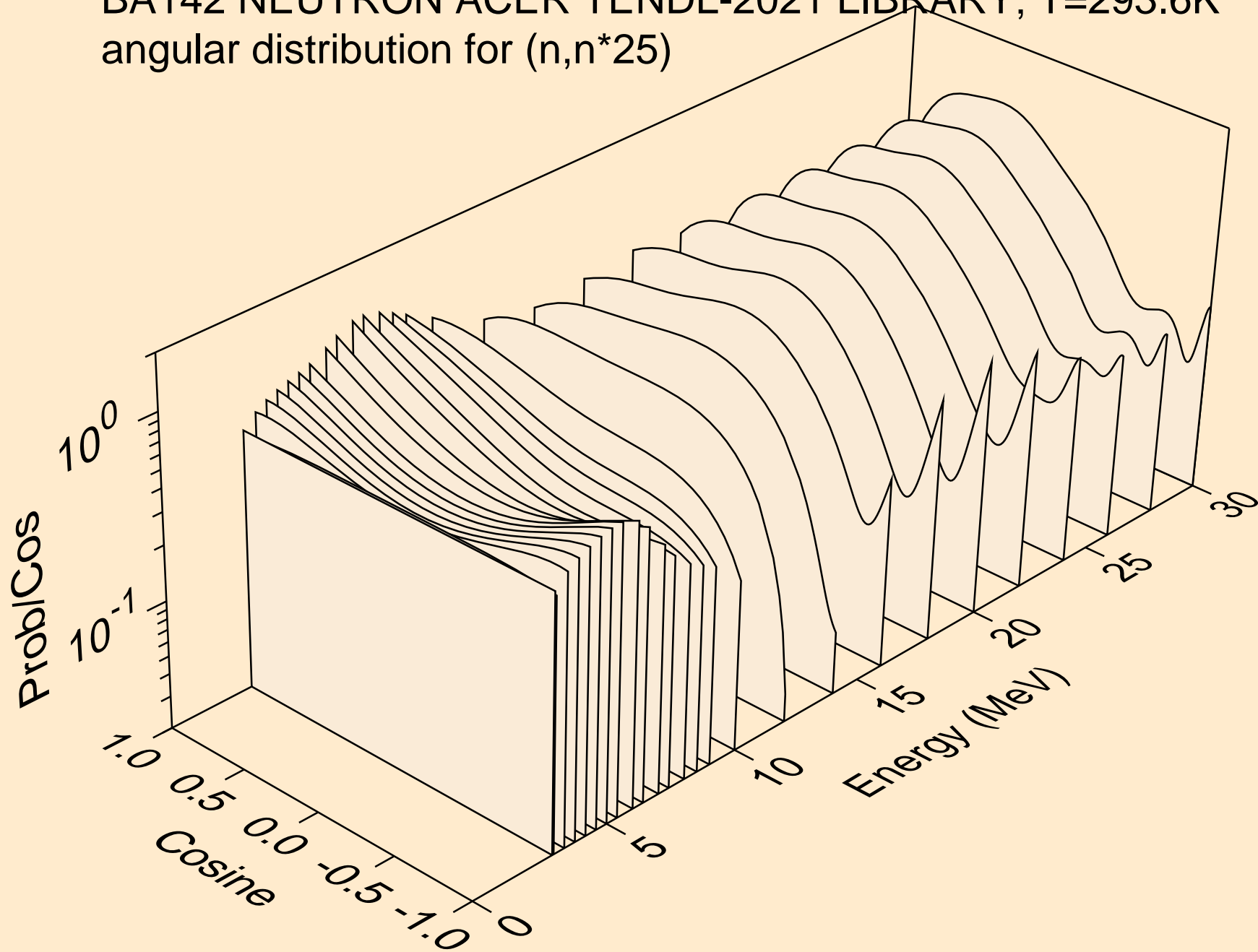

BA142 NEUTRON ACER TENDL-2021 LIBRARY; T=293.6K
angular distribution for (n,n*26)

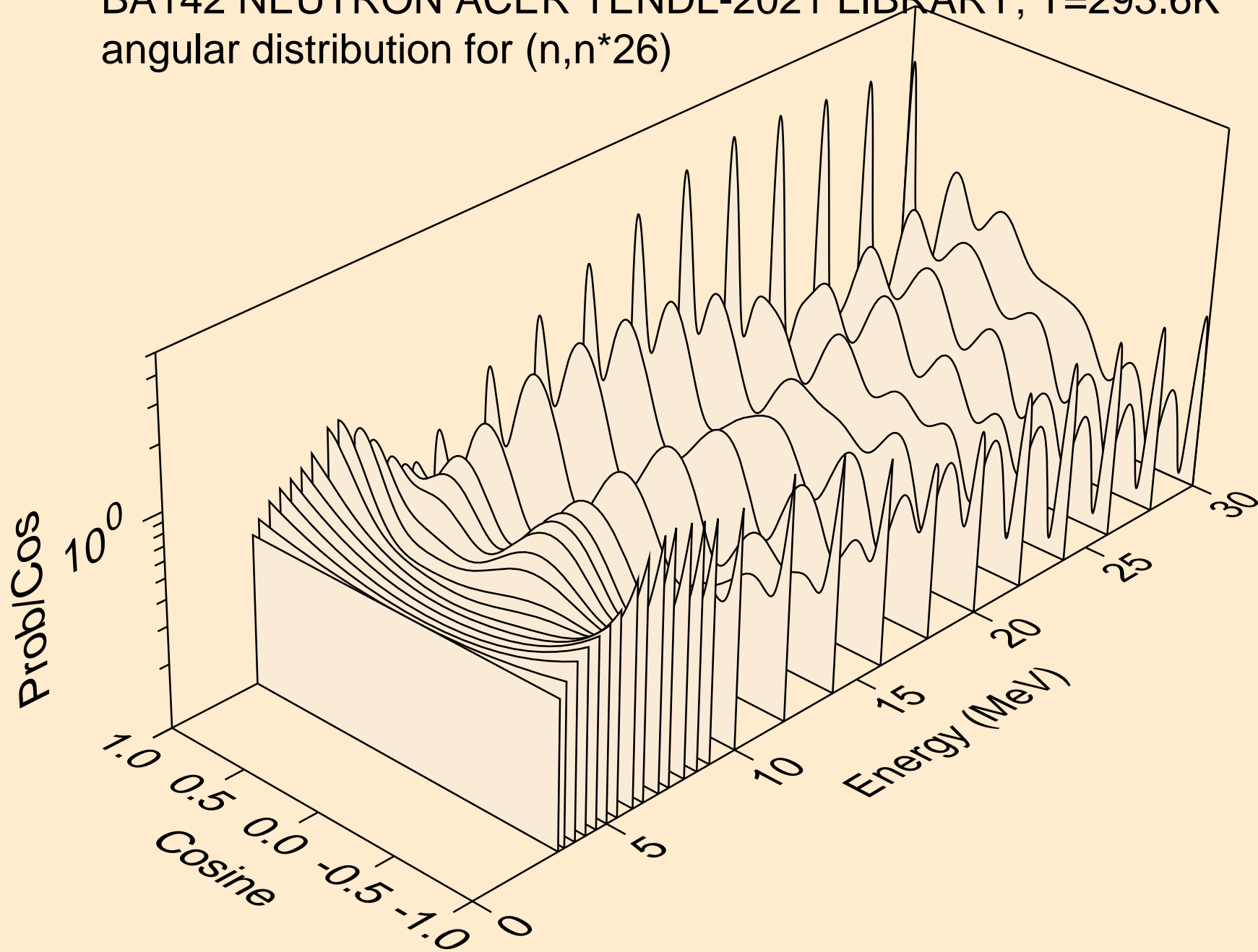

BA142 NEUTRON ACER TENDL-2021 LIBRARY; T=293.6K
angular distribution for (n,n*27)

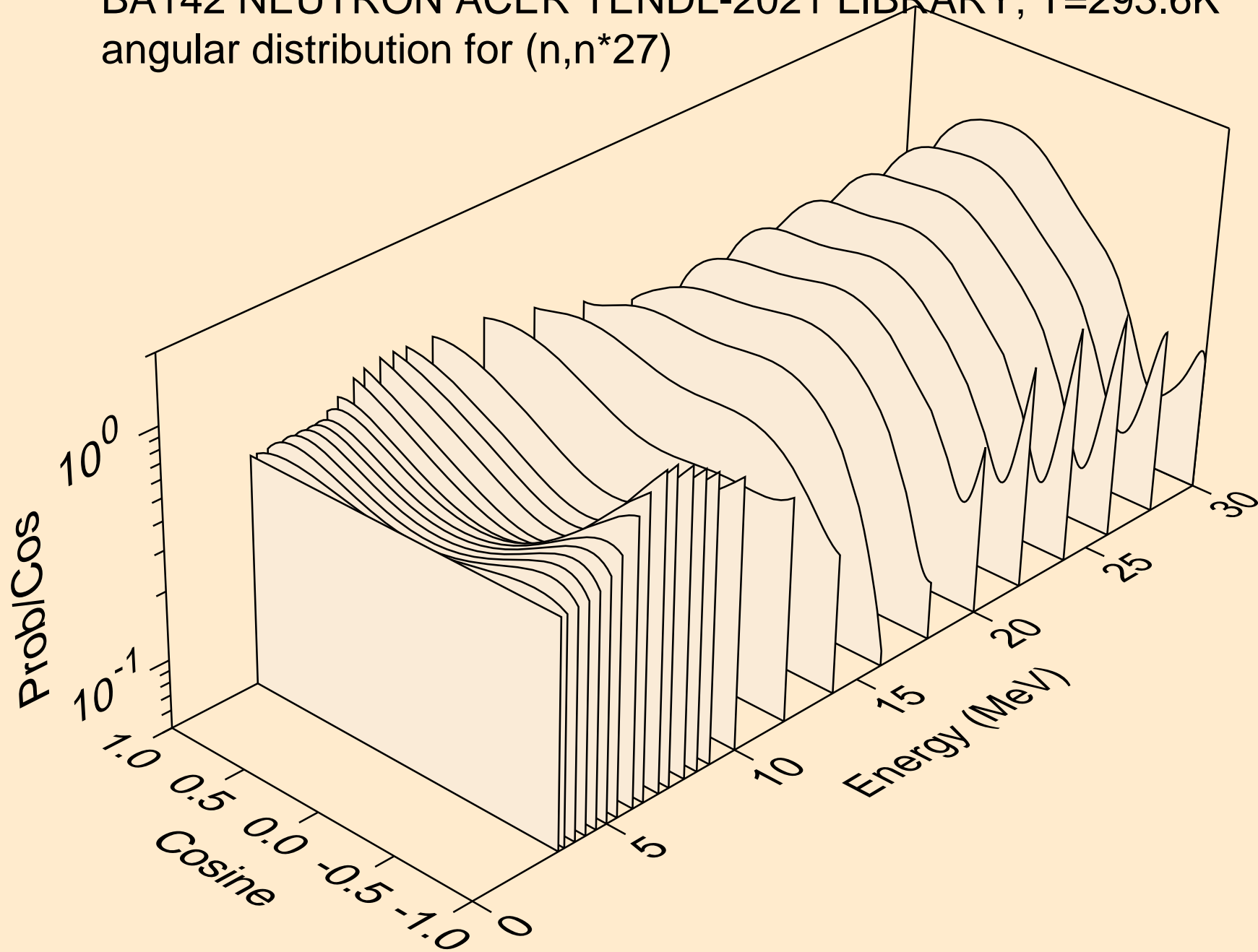

BA142 NEUTRON ACER TENDL-2021 LIBRARY; T=293.6K
angular distribution for (n,n*28)

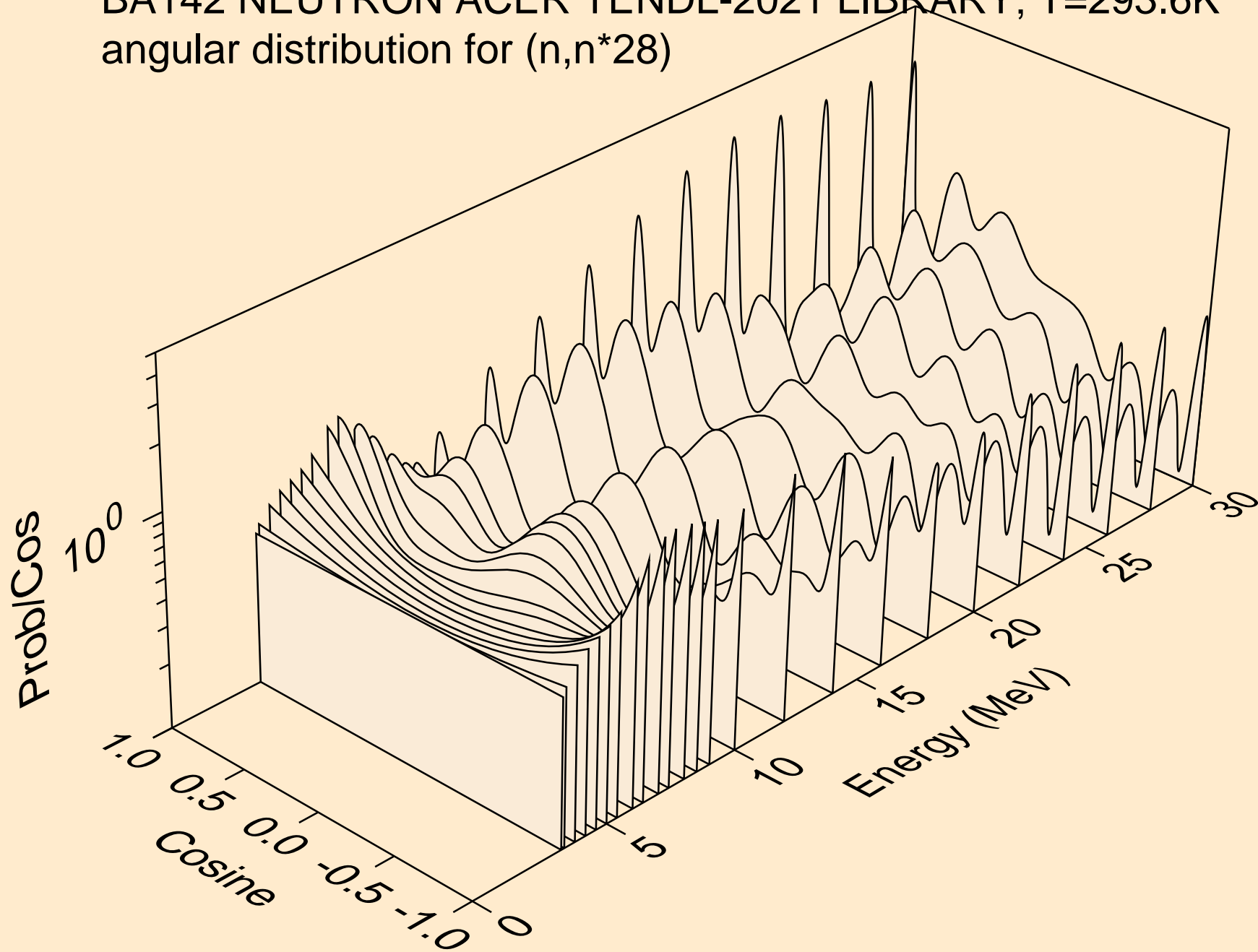

BA142 NEUTRON ACER TENDL-2021 LIBRARY; T=293.6K
angular distribution for (n,n*29)

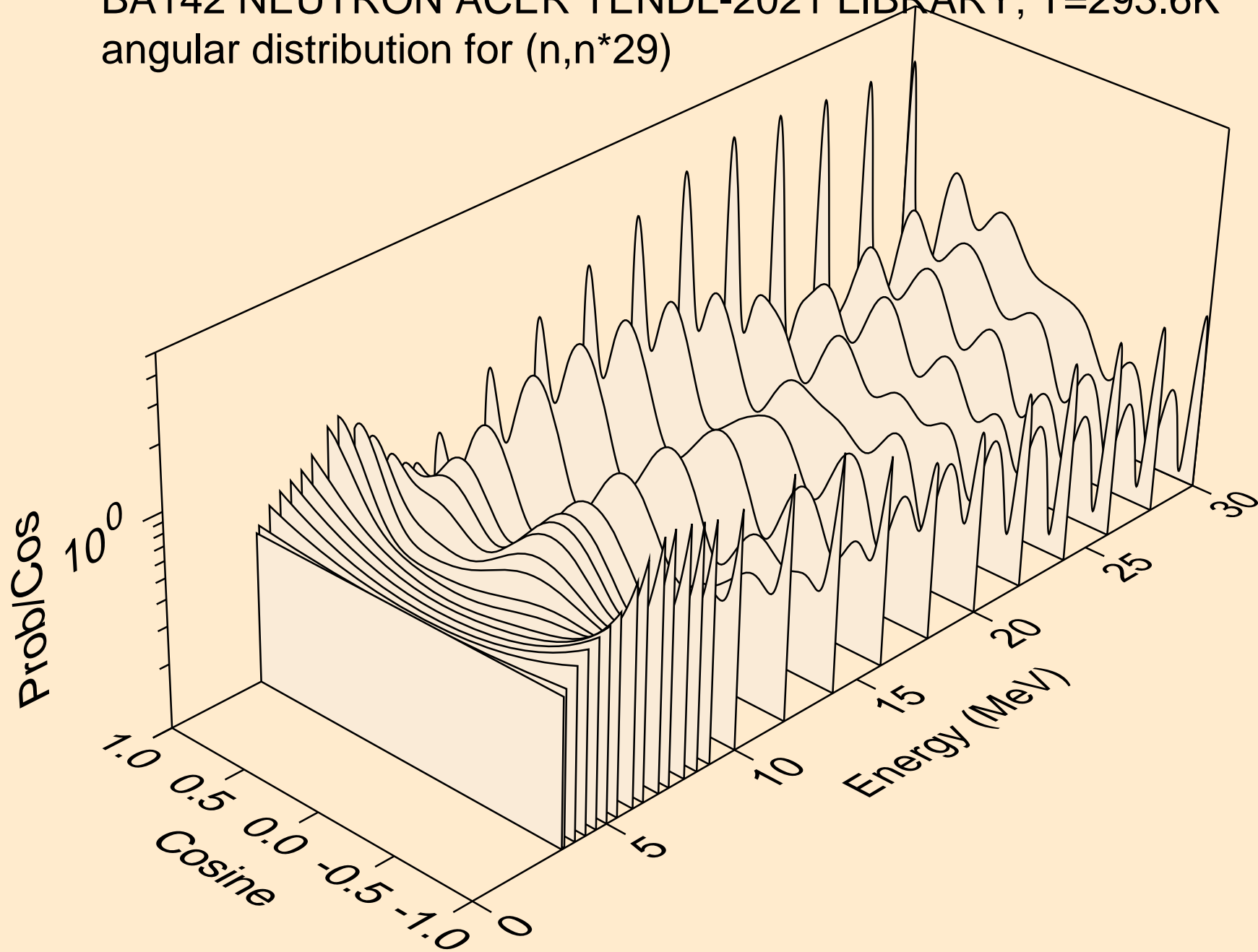

BA142 NEUTRON ACER TENDL-2021 LIBRARY; T=293.6K
angular distribution for (n,n*30)

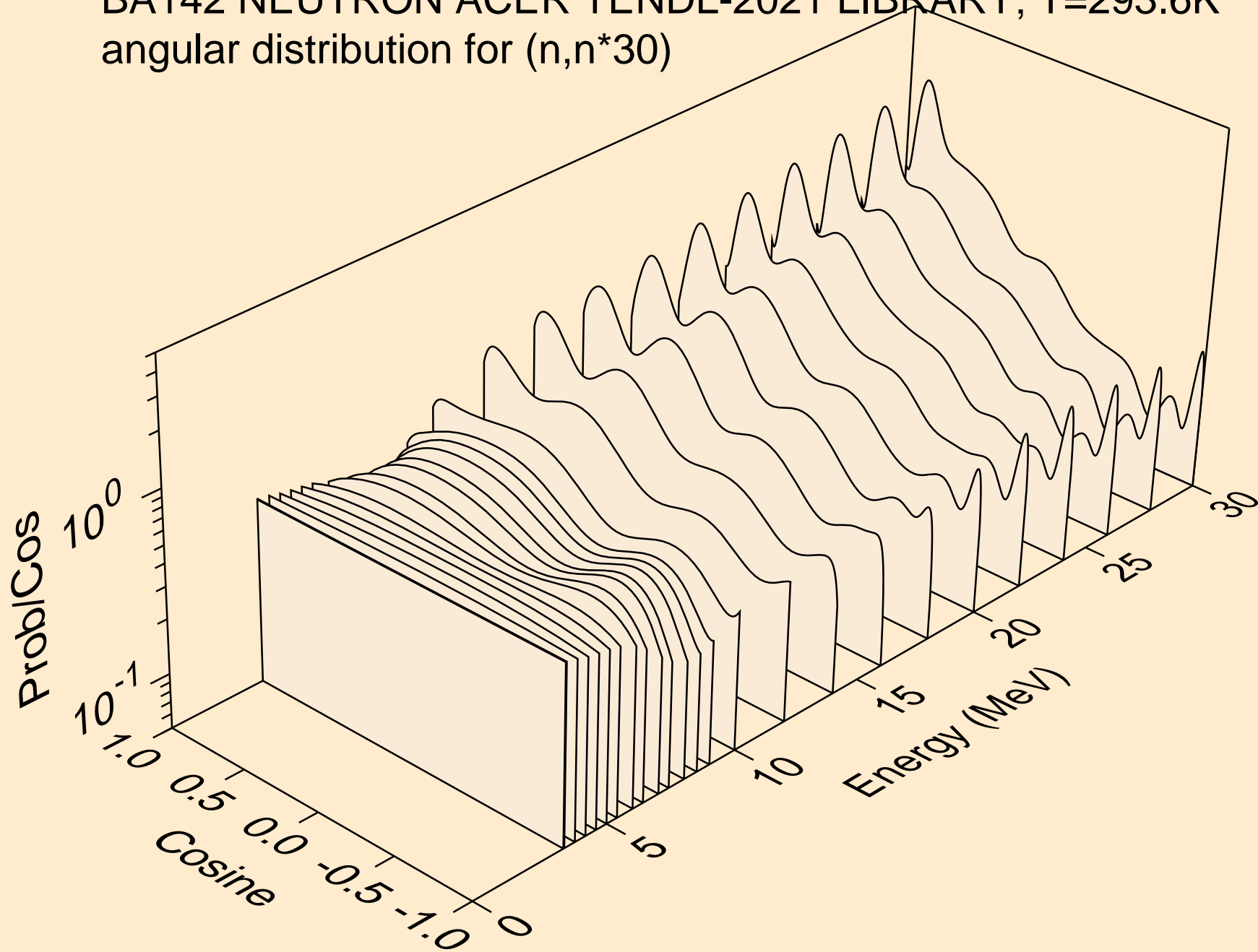

BA142 NEUTRON ACER TENDL-2021 LIBRARY; T=293.6K
Neutron emission for (n,x)

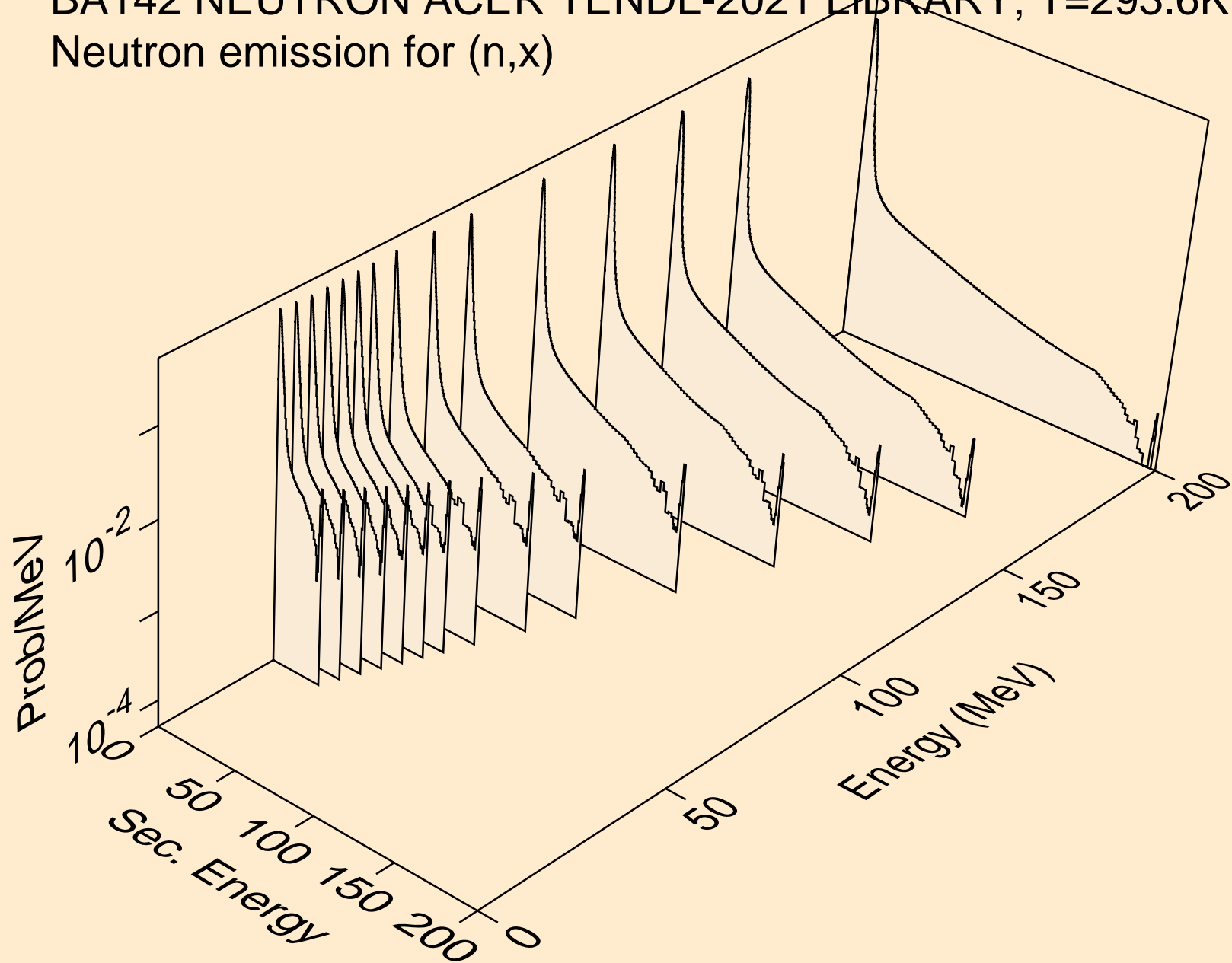

BA142 NEUTRON ACER TENDL-2021 LIBRARY; T=293.6K
Neutron emission for (n,2nd)

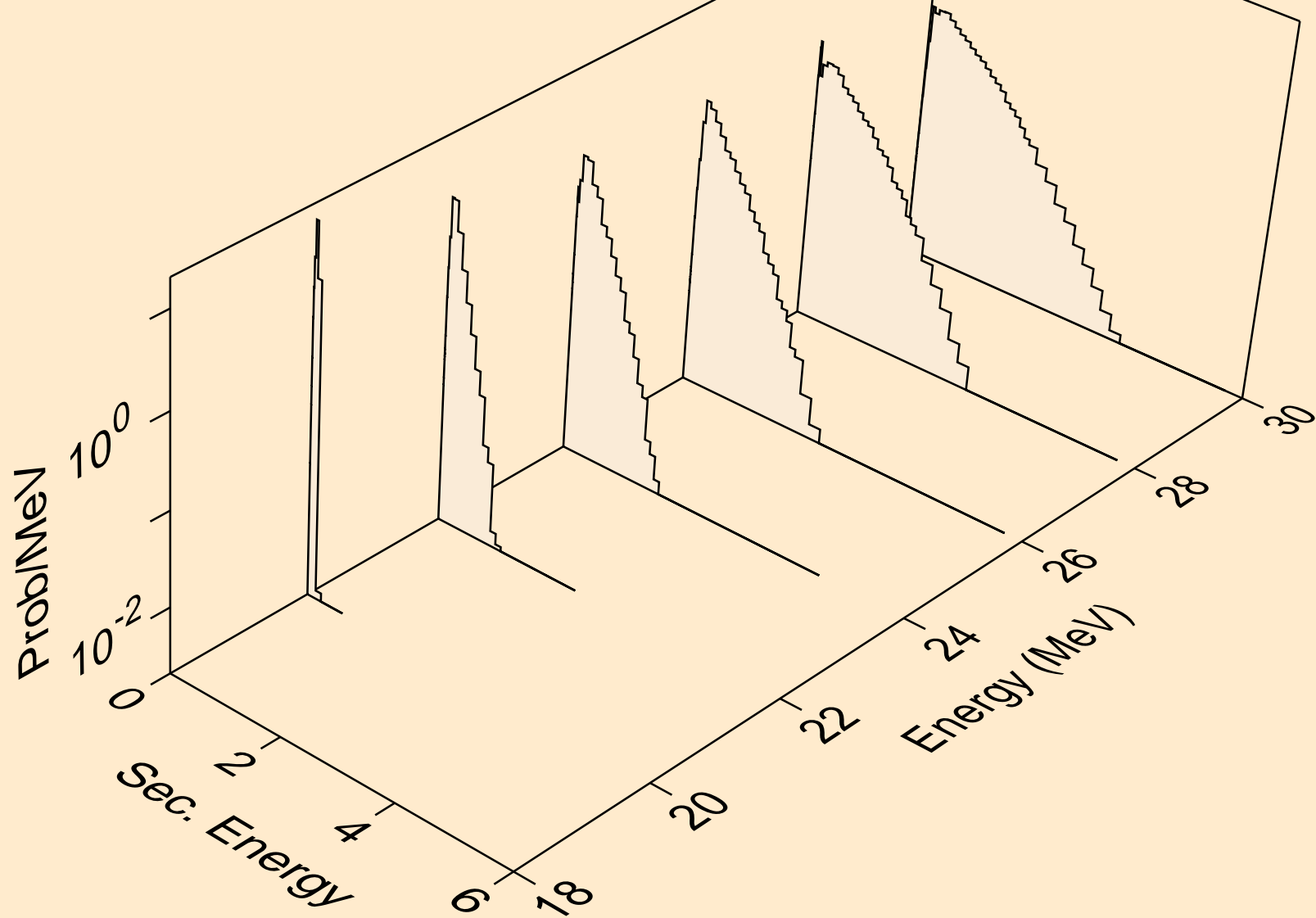

BA142 NEUTRON ACER TENDL-2021 LIBRARY; T=293.6K
Neutron emission for (n,2n)

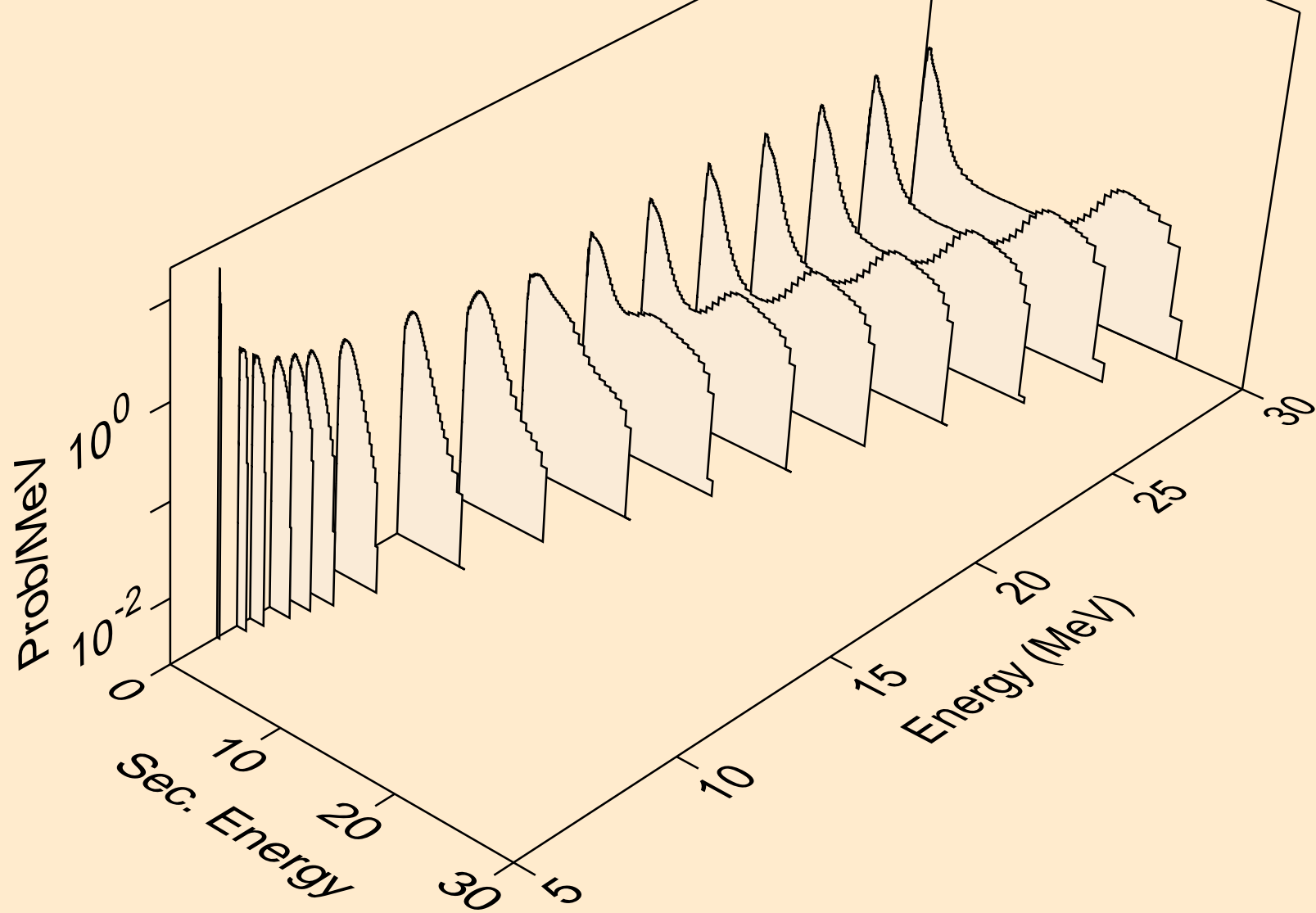

BA142 NEUTRON ACER TENDL-2021 LIBRARY; T=293.6K
Neutron emission for (n,3n)

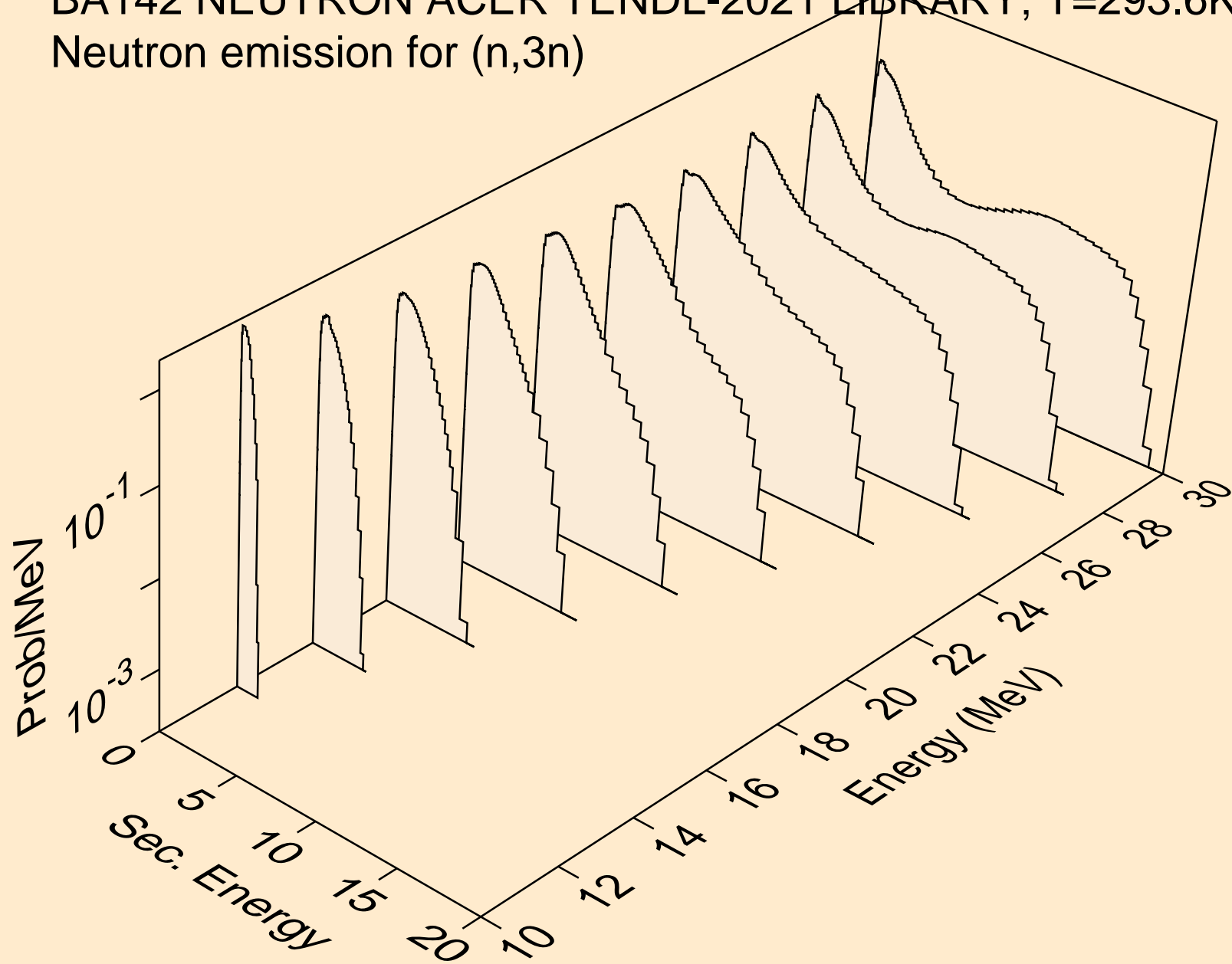

BA142 NEUTRON ACER TENDL-2021 LIBRARY; T=293.6K
Neutron emission for (n,n*)a

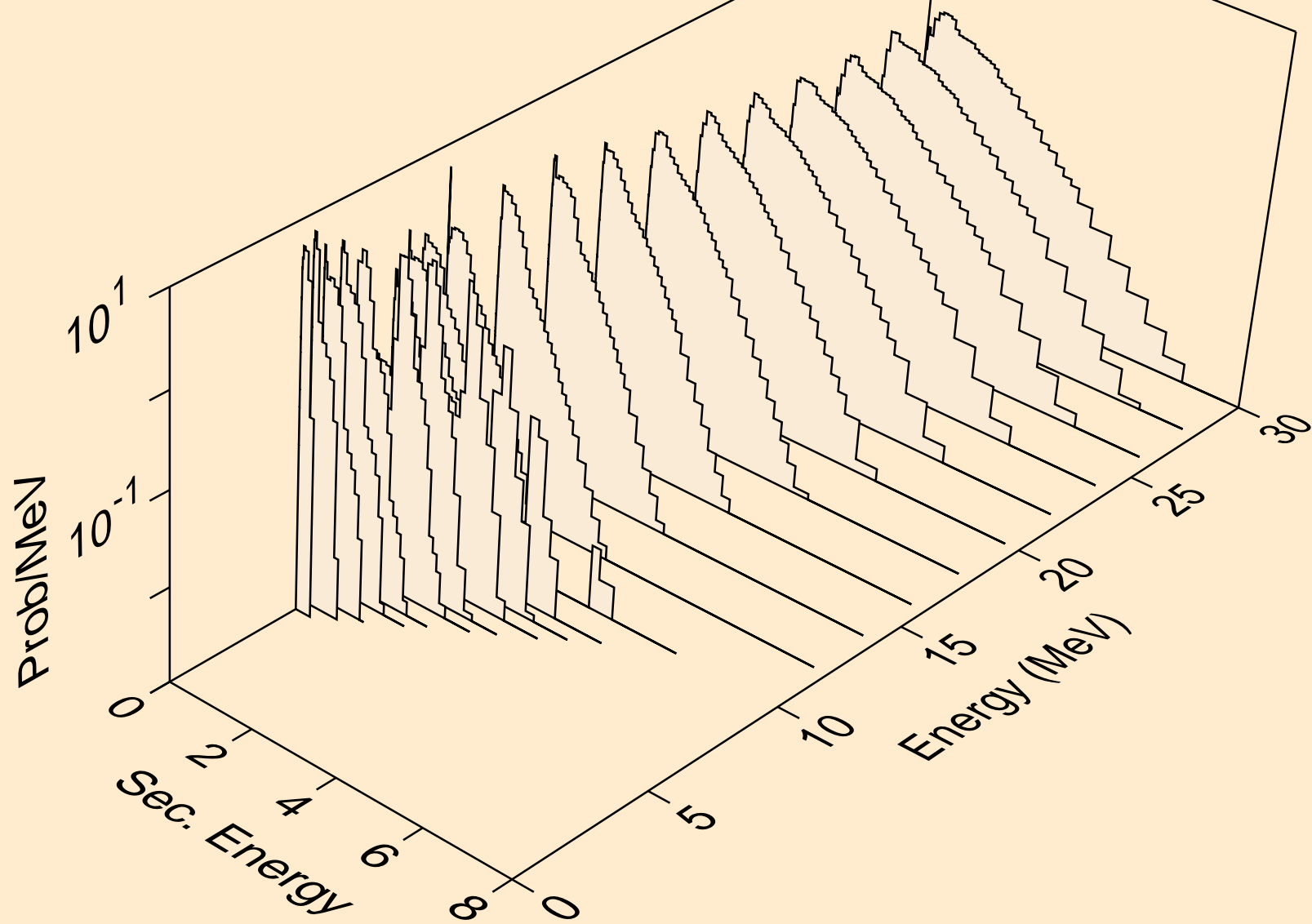

BA142 NEUTRON ACER TENDL-2021 LIBRARY; T=293.6K
Neutron emission for (n,2n)_a

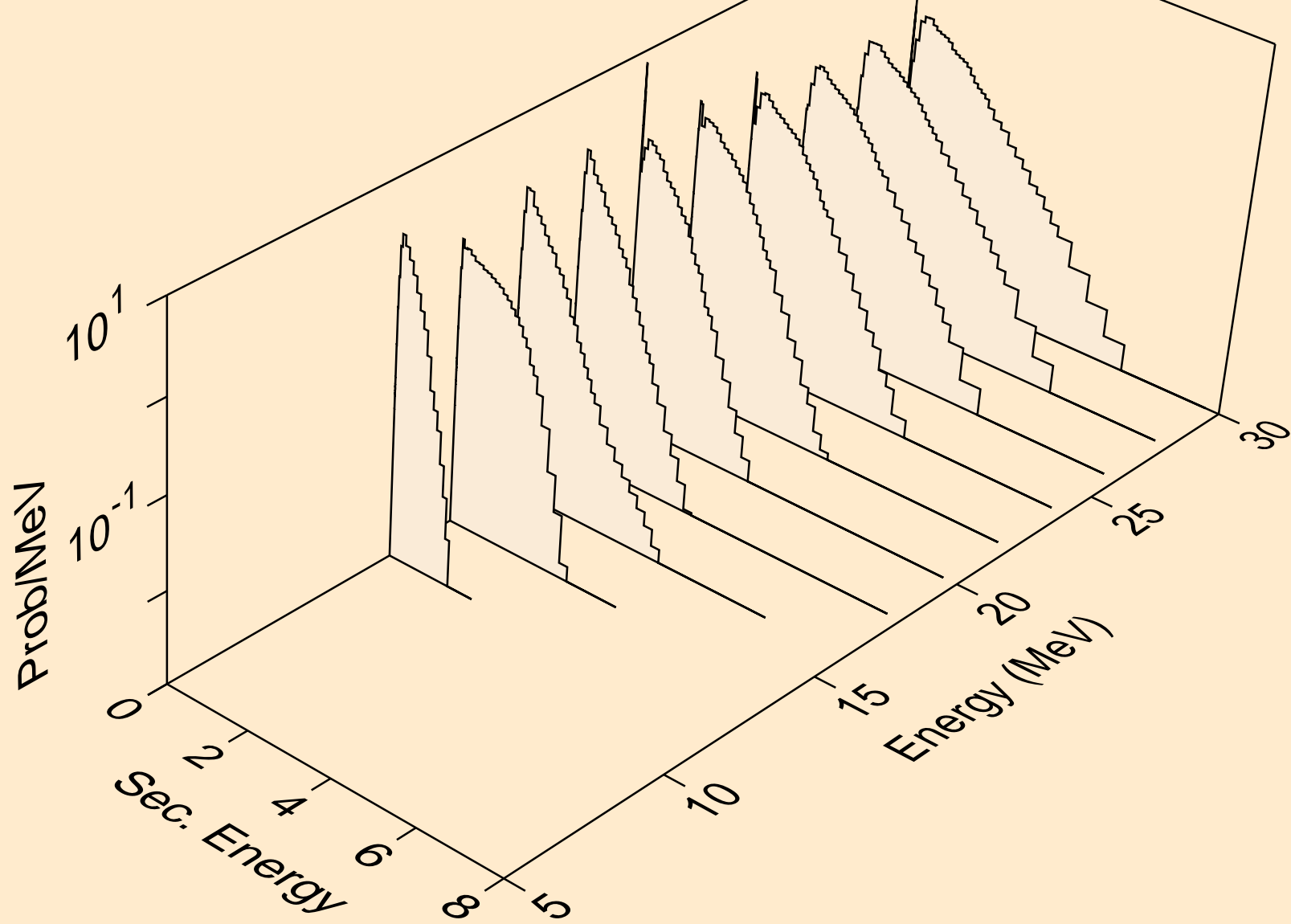

BA142 NEUTRON ACER TENDL-2021 LIBRARY; T=293.6K
Neutron emission for (n,3n)a

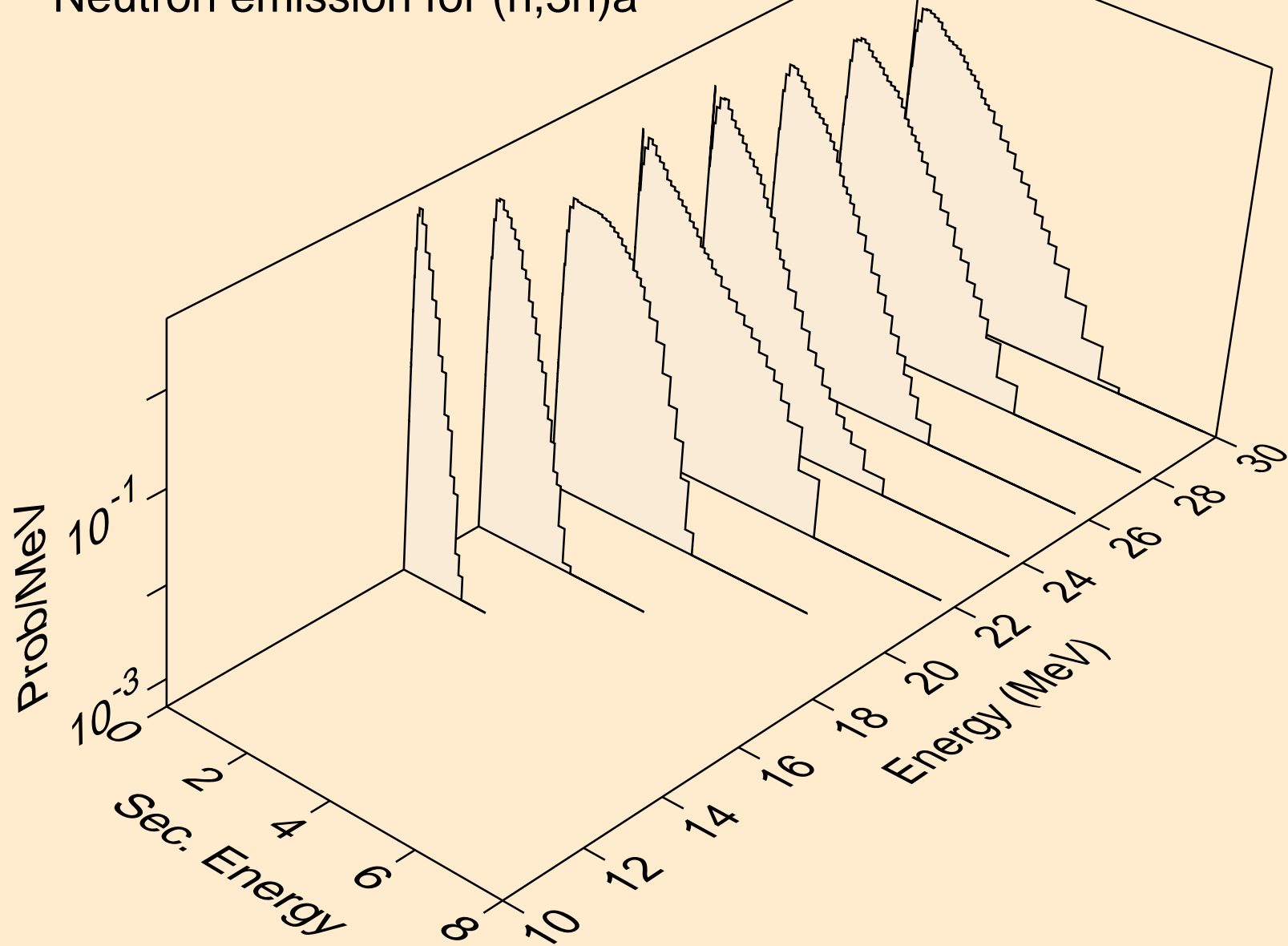

BA142 NEUTRON ACER TENDL-2021 LIBRARY; T=293.6K
Neutron emission for (n,n*)p

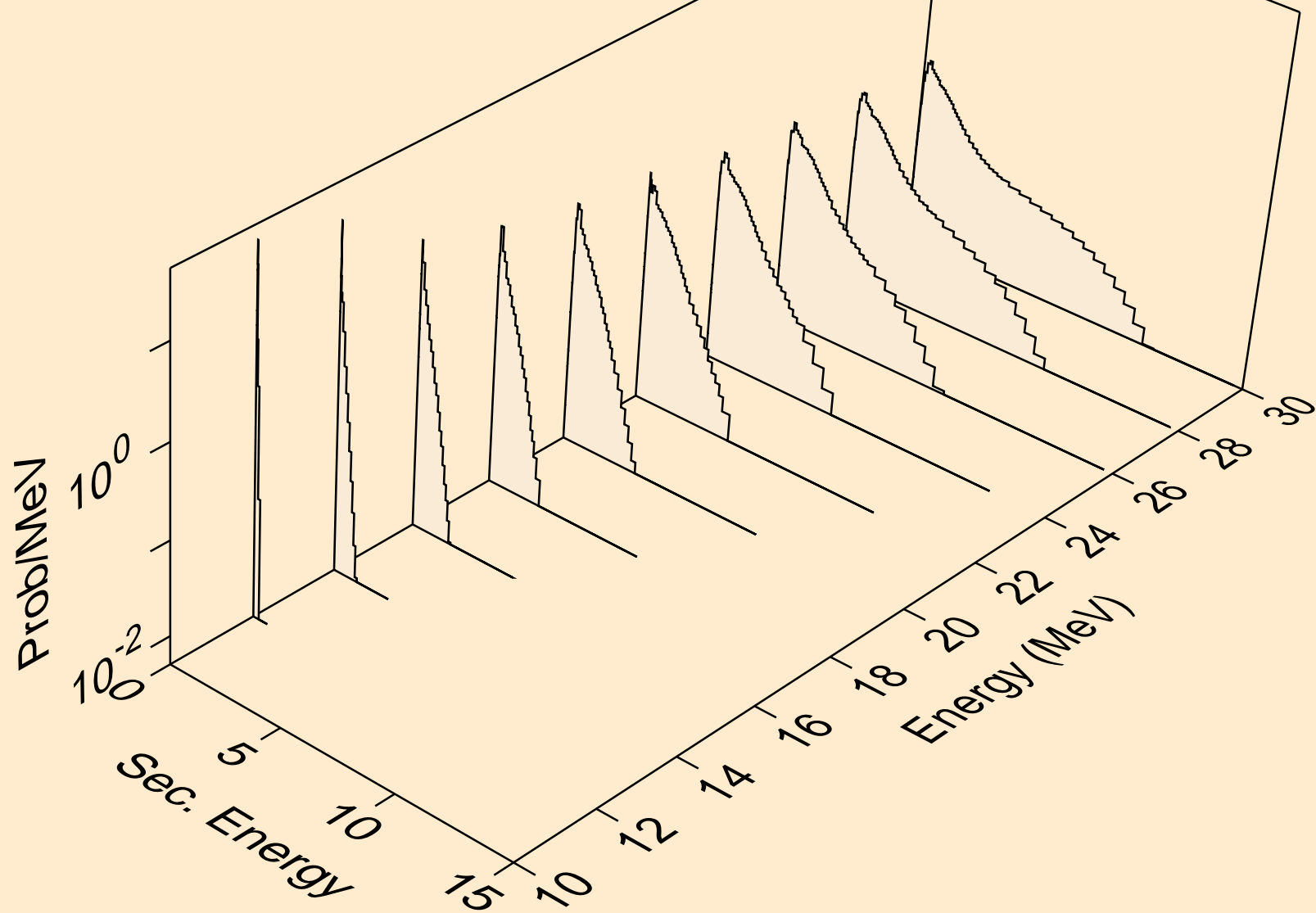

BA142 NEUTRON ACER TENDL-2021 LIBRARY; T=293.6K
Neutron emission for (n,n*)2a

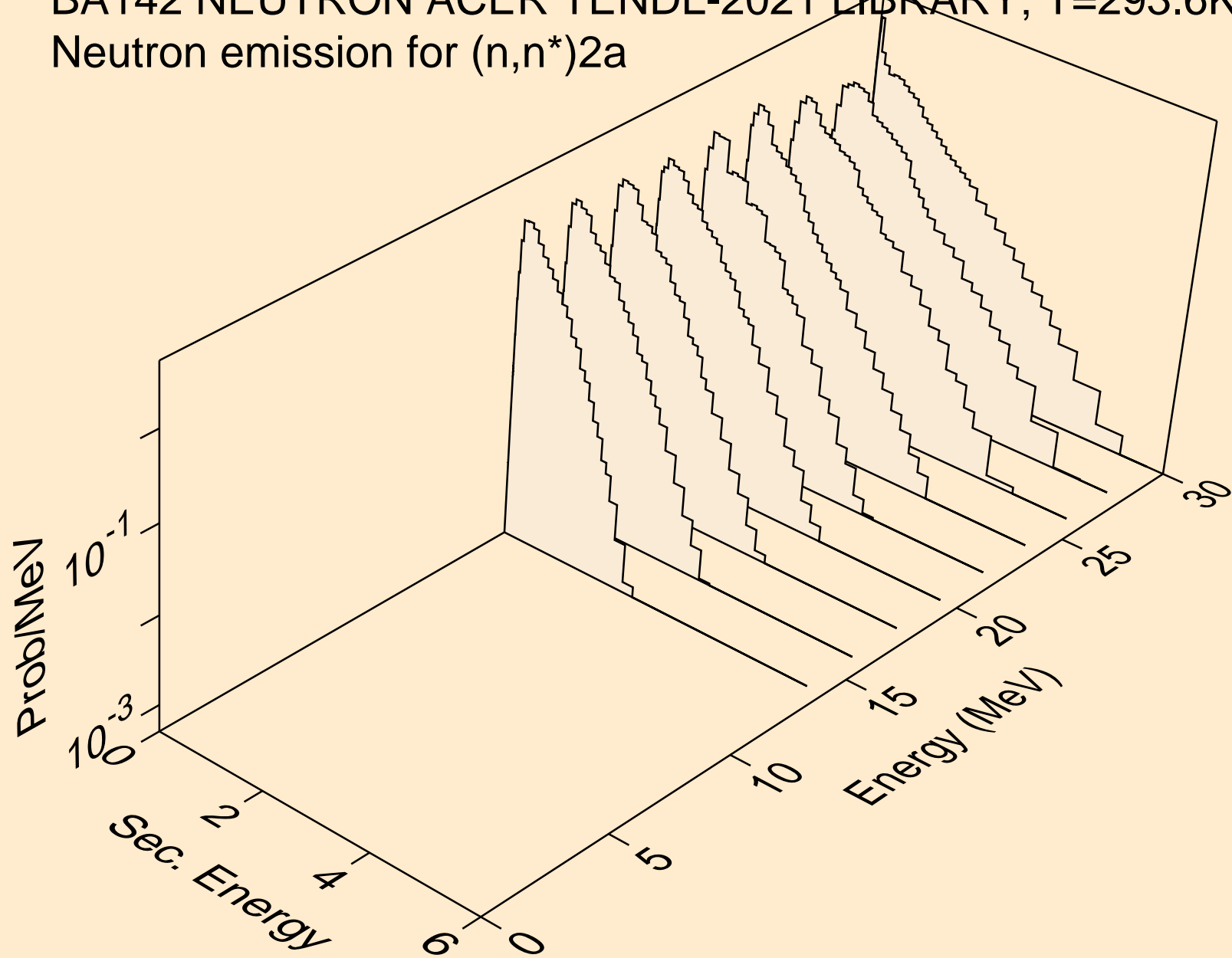

BA142 NEUTRON ACER TENDL-2021 LIBRARY; T=293.6K
Neutron emission for (n,n*)d

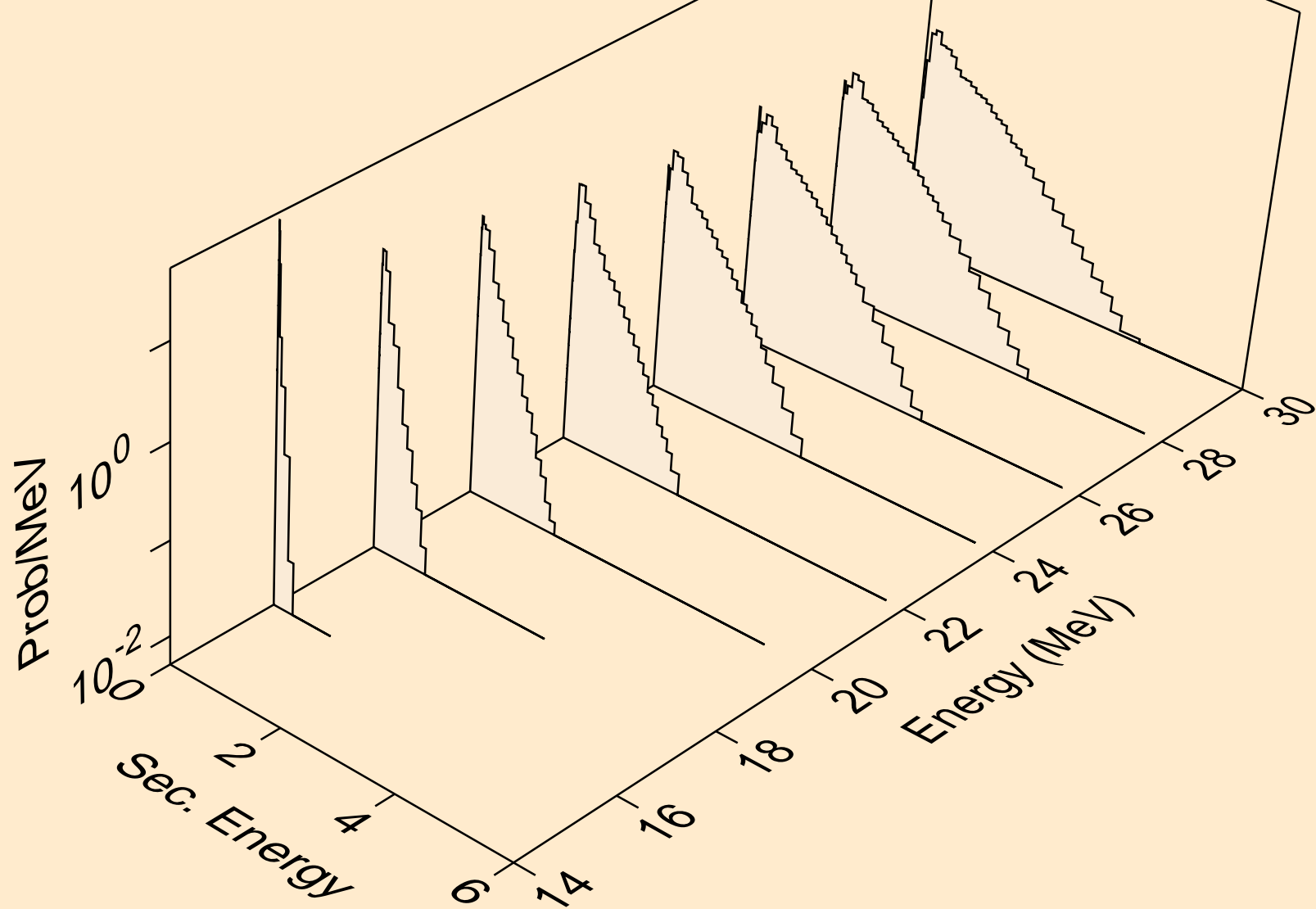

BA142 NEUTRON ACER TENDL-2021 LIBRARY; T=293.6K
Neutron emission for (n,n*)t

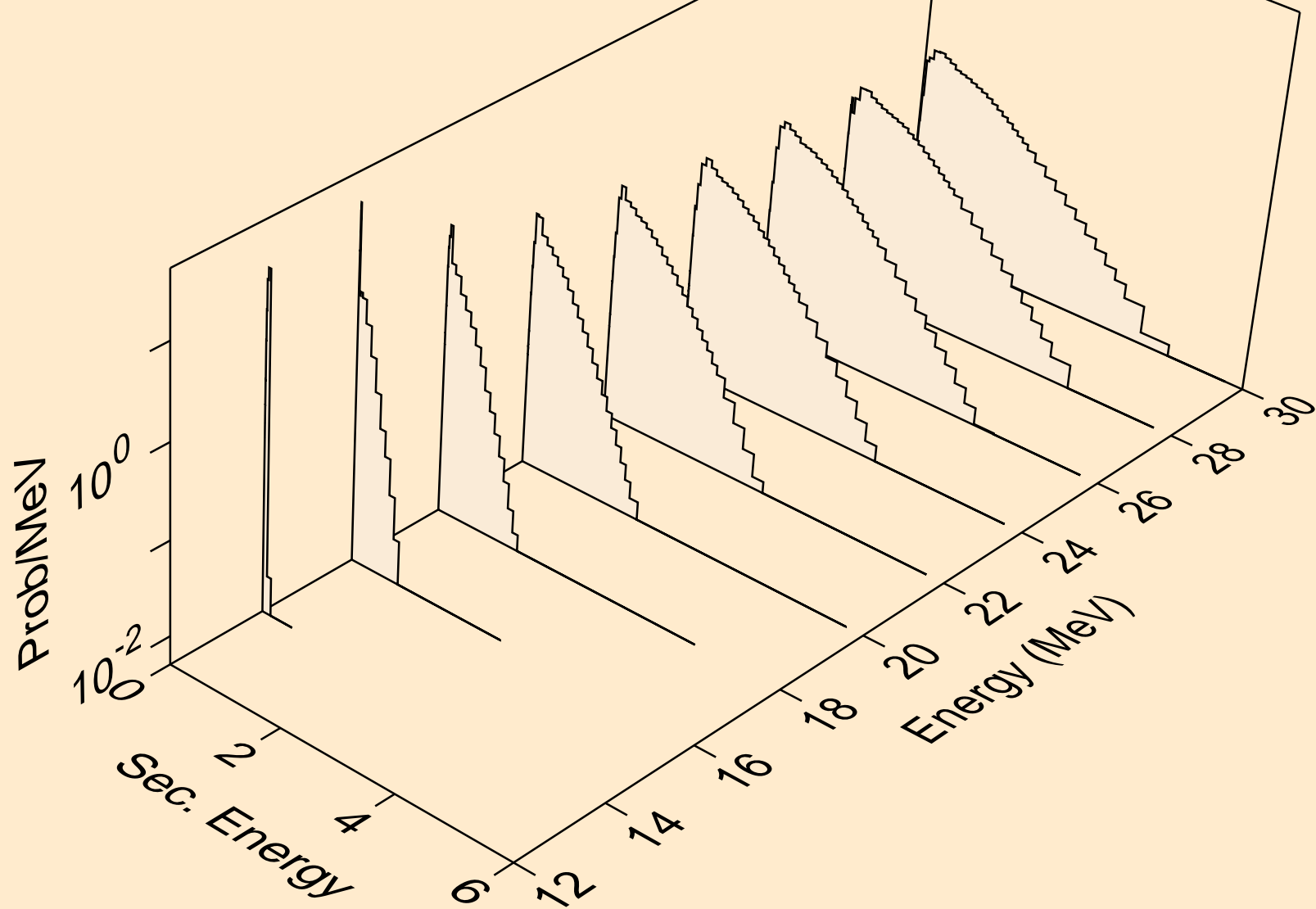

BA142 NEUTRON ACER TENDL-2021 LIBRARY; T=293.6K
Neutron emission for (n,n*)he3

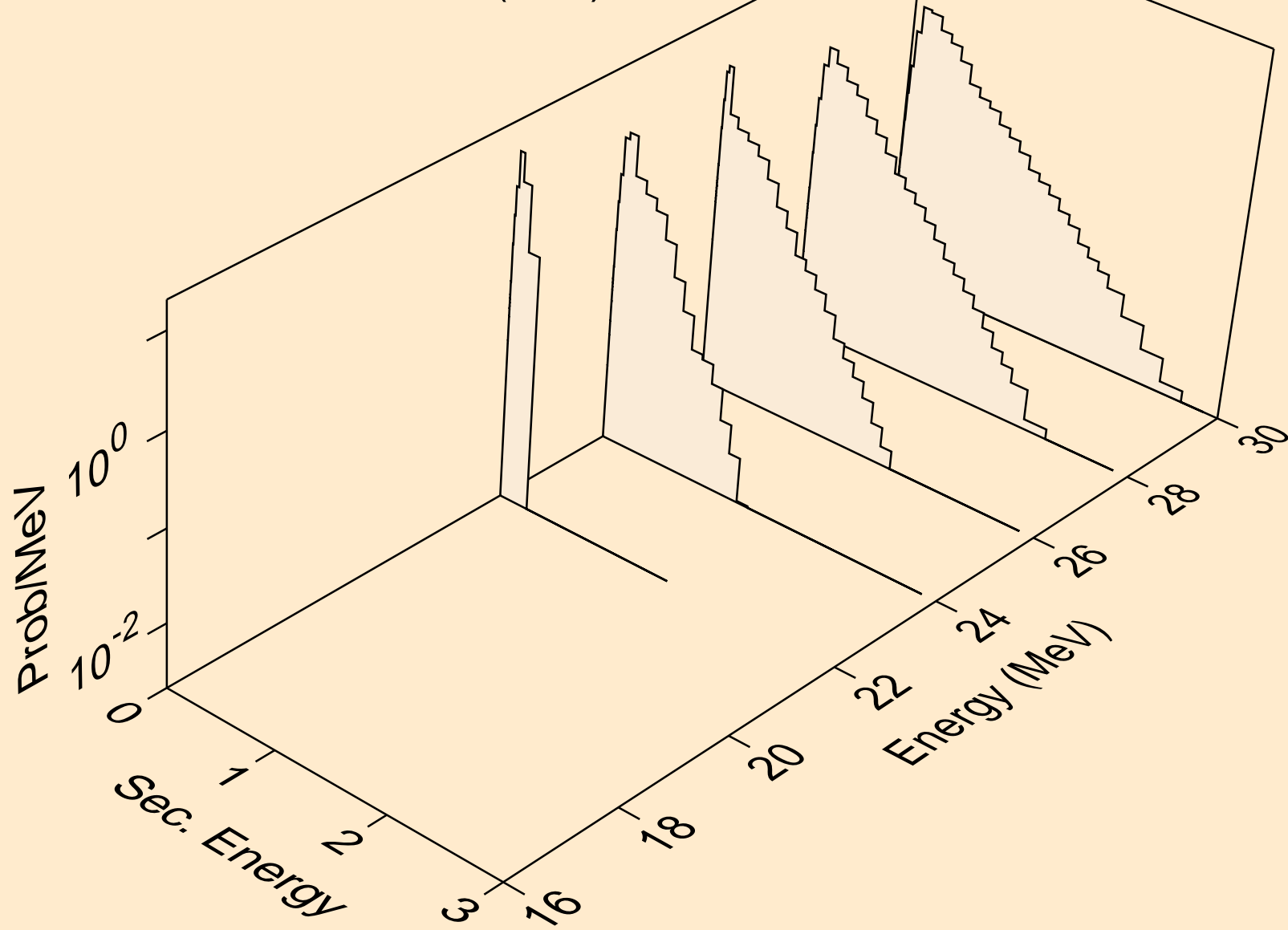

BA142 NEUTRON ACER TENDL-2021 LIBRARY; T=293.6K
Neutron emission for (n,4n)

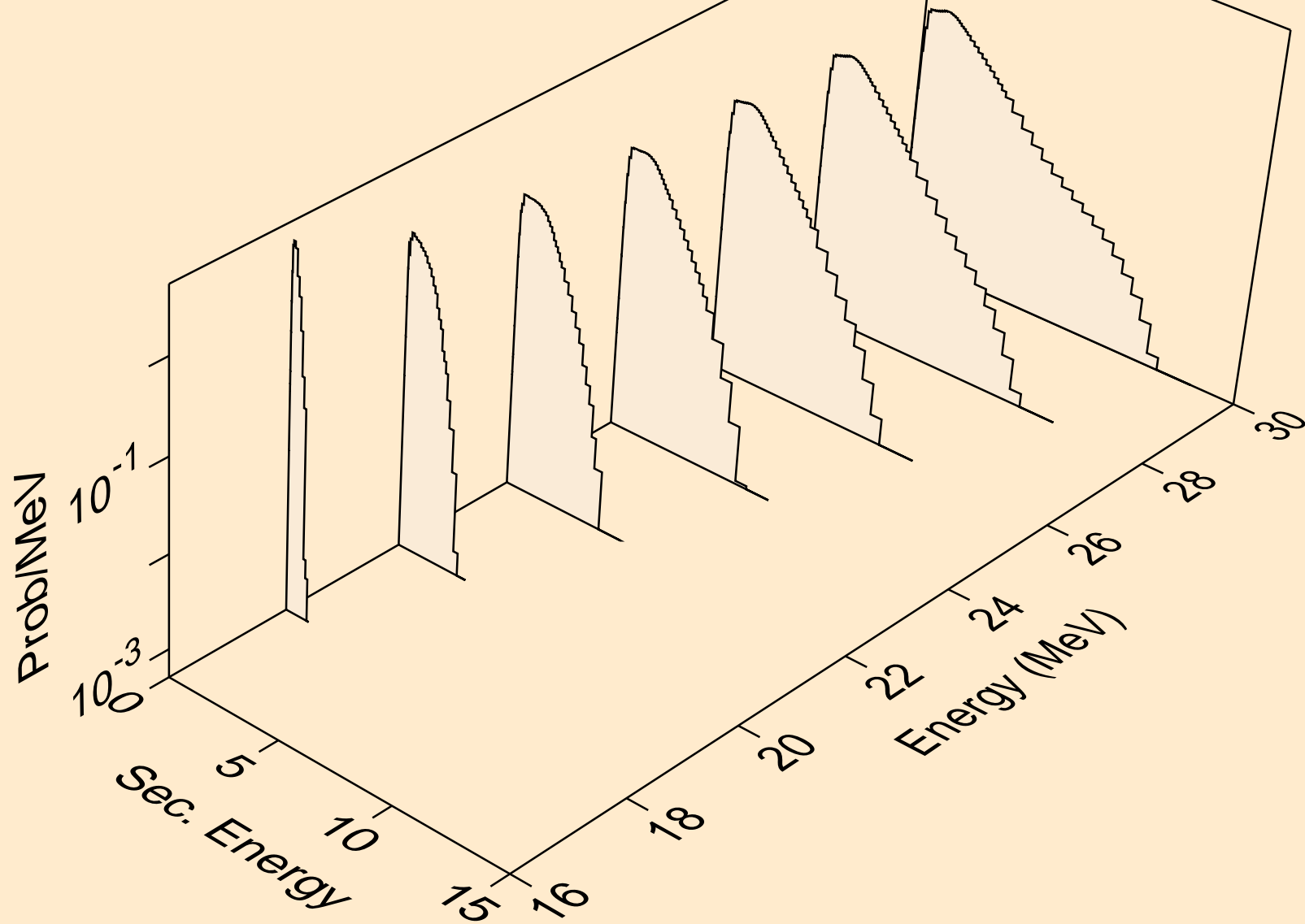

BA142 NEUTRON ACER TENDL-2021 LIBRARY; T=293.6K
Neutron emission for (n,2np)

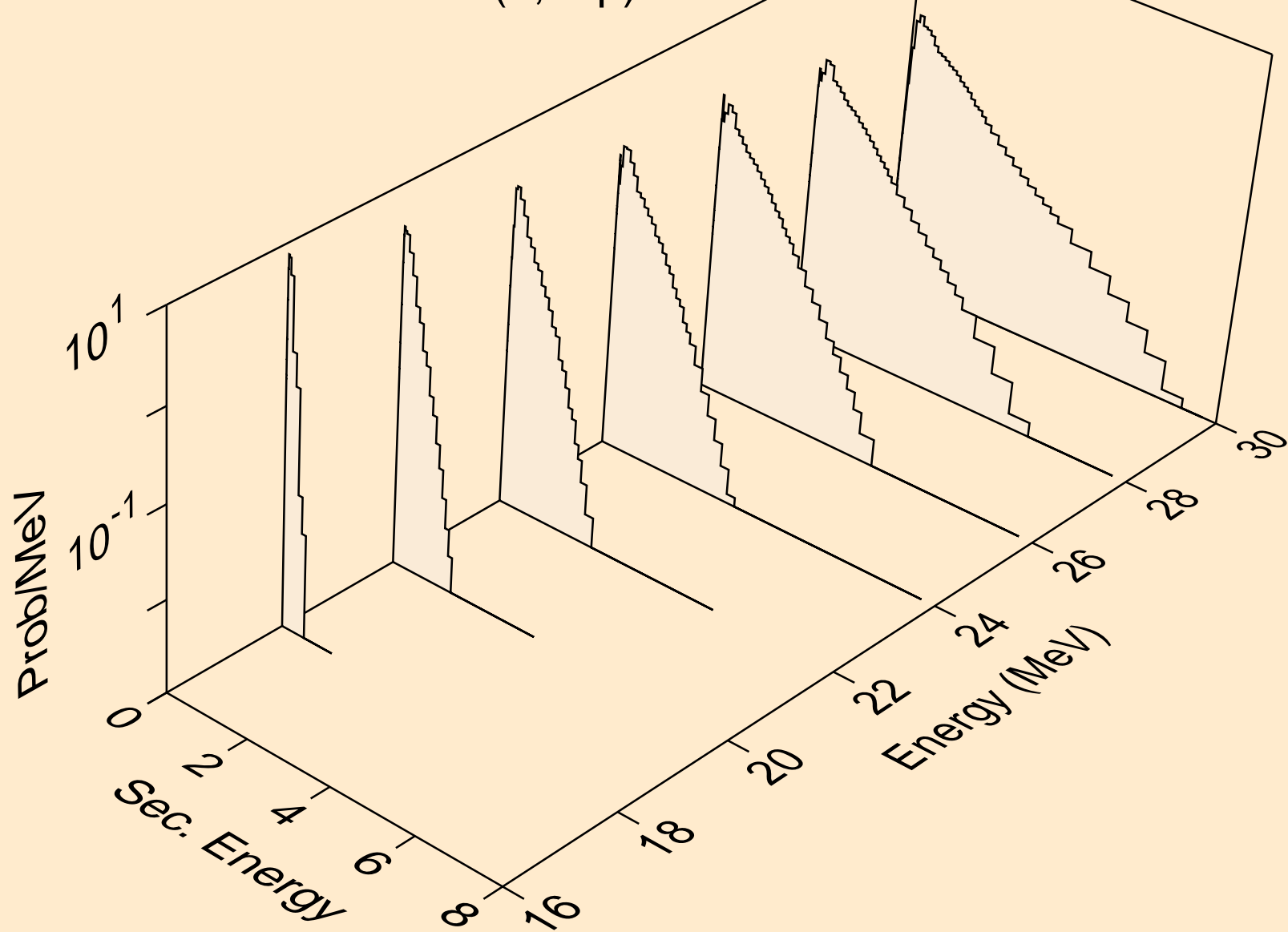

BA142 NEUTRON ACER TENDL-2021 LIBRARY; T=293.6K
Neutron emission for (n,3np)

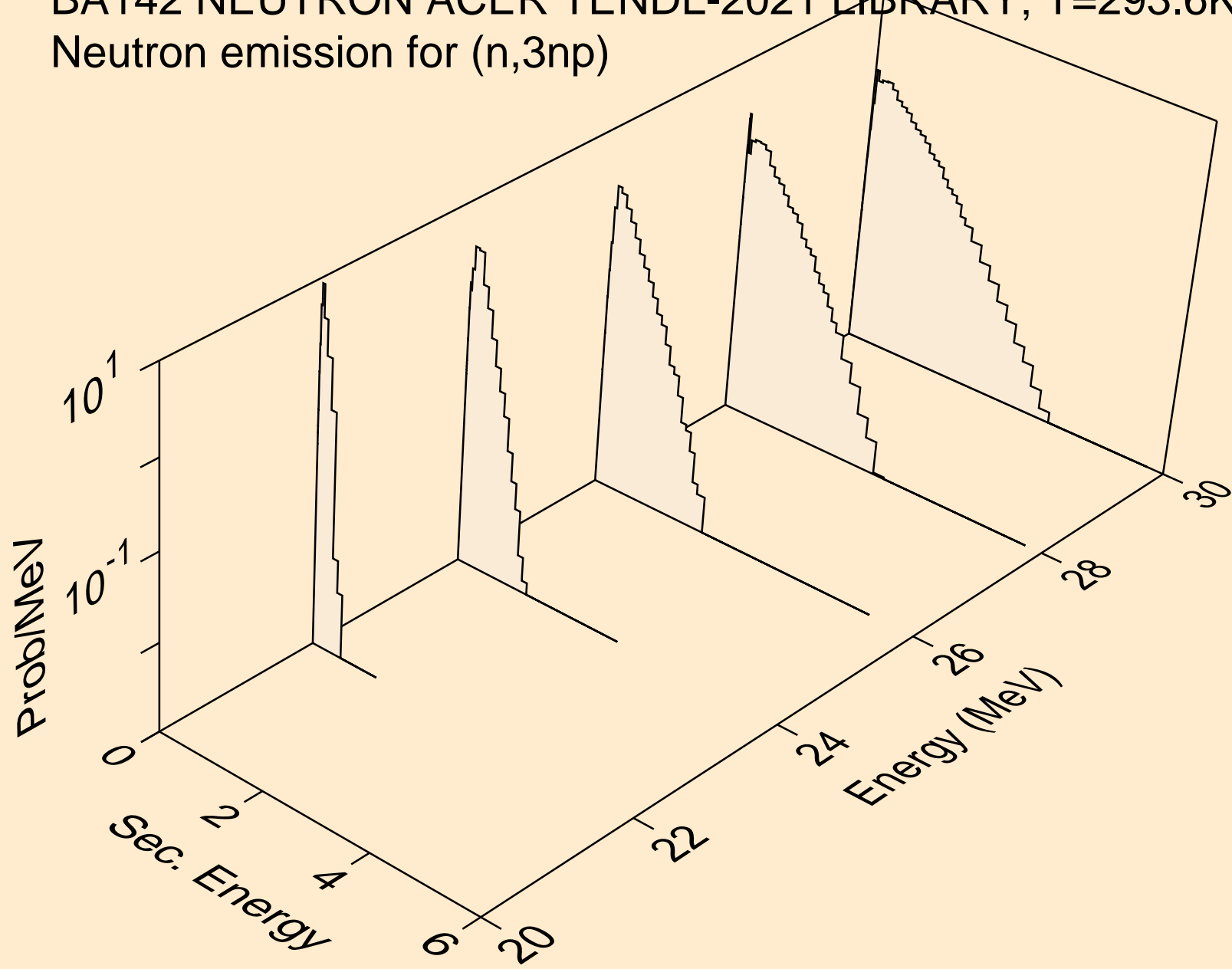

BA142 NEUTRON ACER TENDL-2021 LIBRARY; T=293.6K
Neutron emission for (n,n*c)

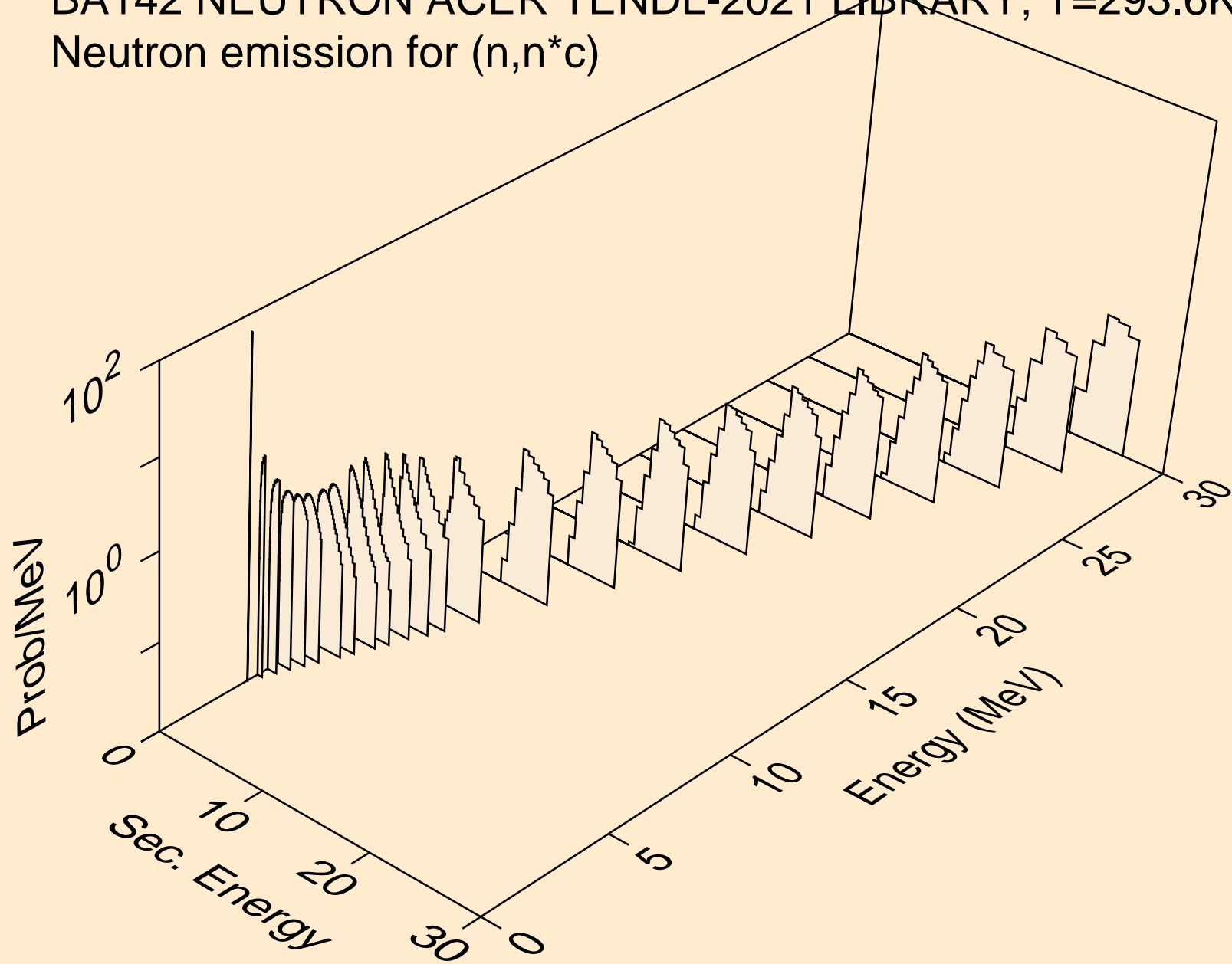

BA142 NEUTRON ACER TENDL-2021 LIBRARY; T=293.6K
Photon emission for (n,x)

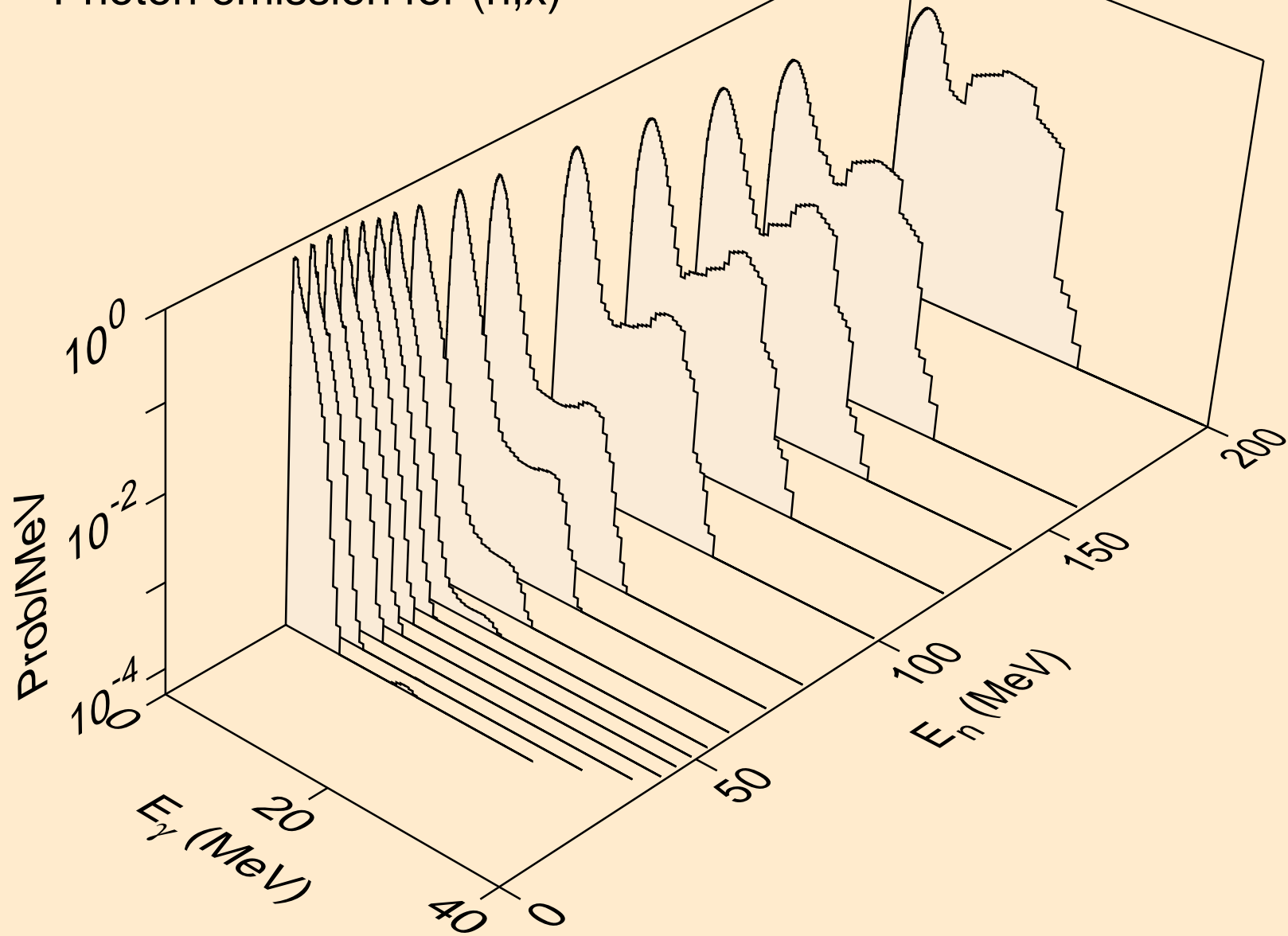

BA142 NEUTRON ACER TENDL-2021 LIBRARY; T=293.6K
Photon emission for (n,2nd)

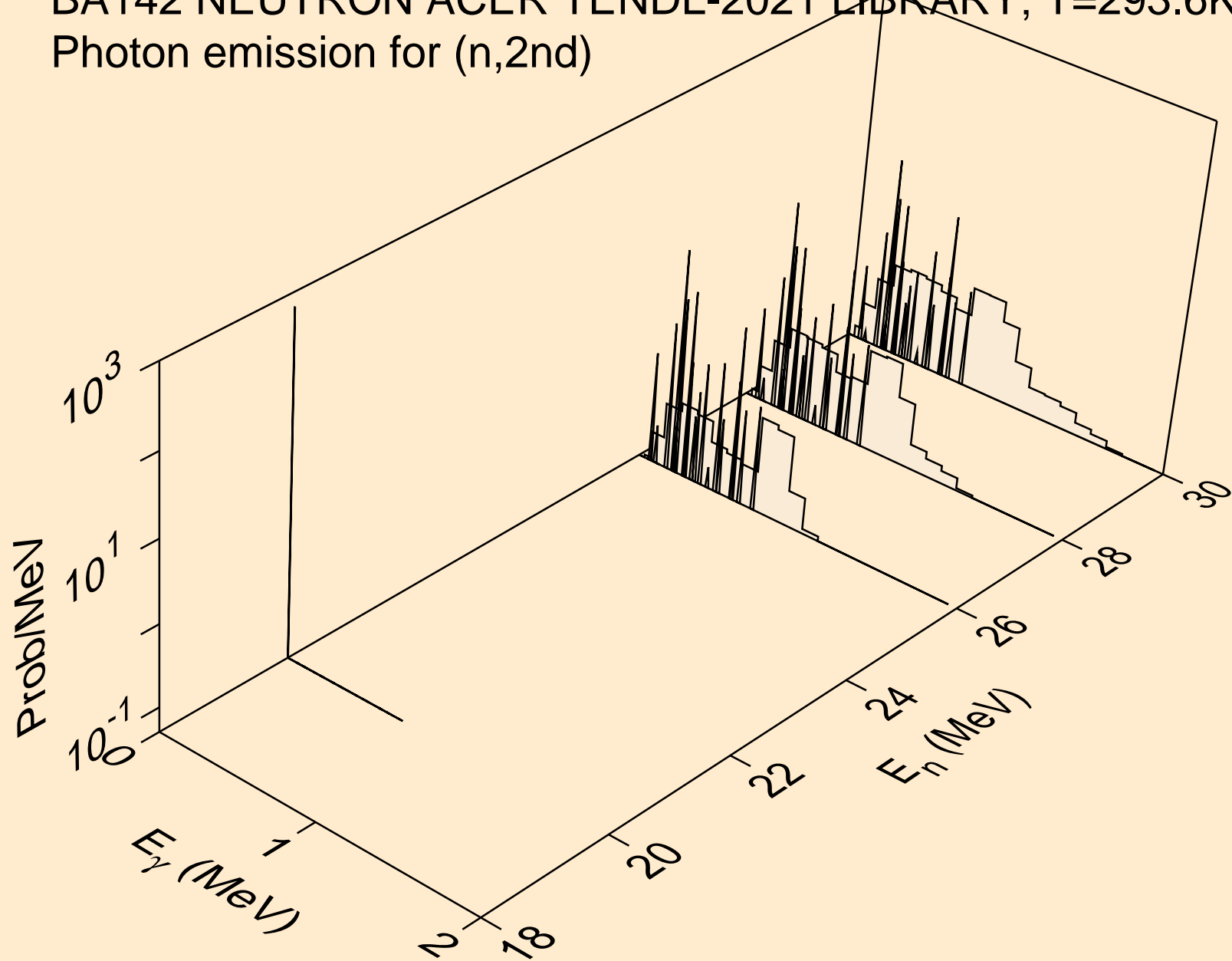

BA142 NEUTRON ACER TENDL-2021 LIBRARY; T=293.6K
Photon emission for (n,2n)

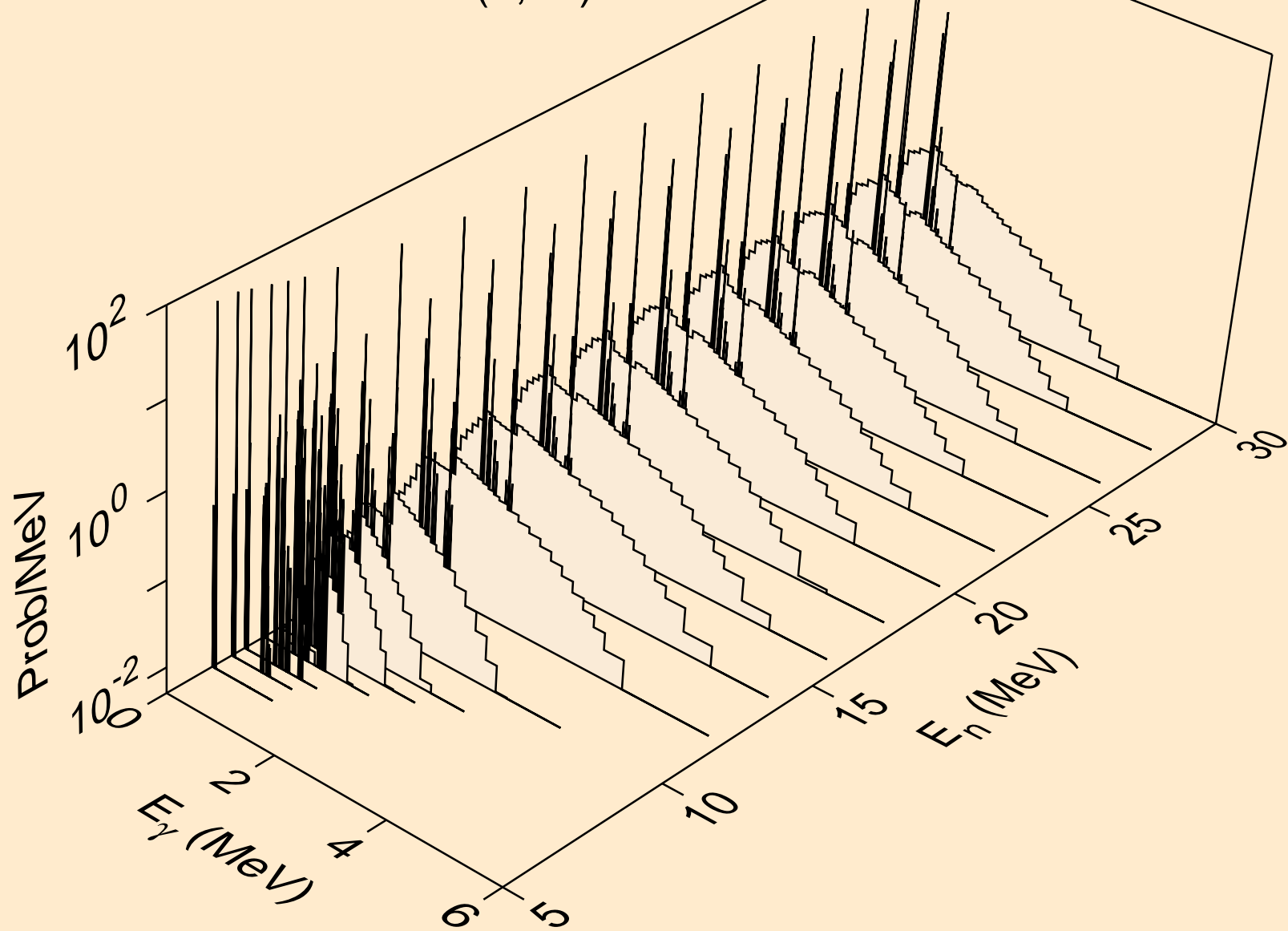

BA142 NEUTRON ACER TENDL-2021 LIBRARY; T=293.6K
Photon emission for (n,3n)

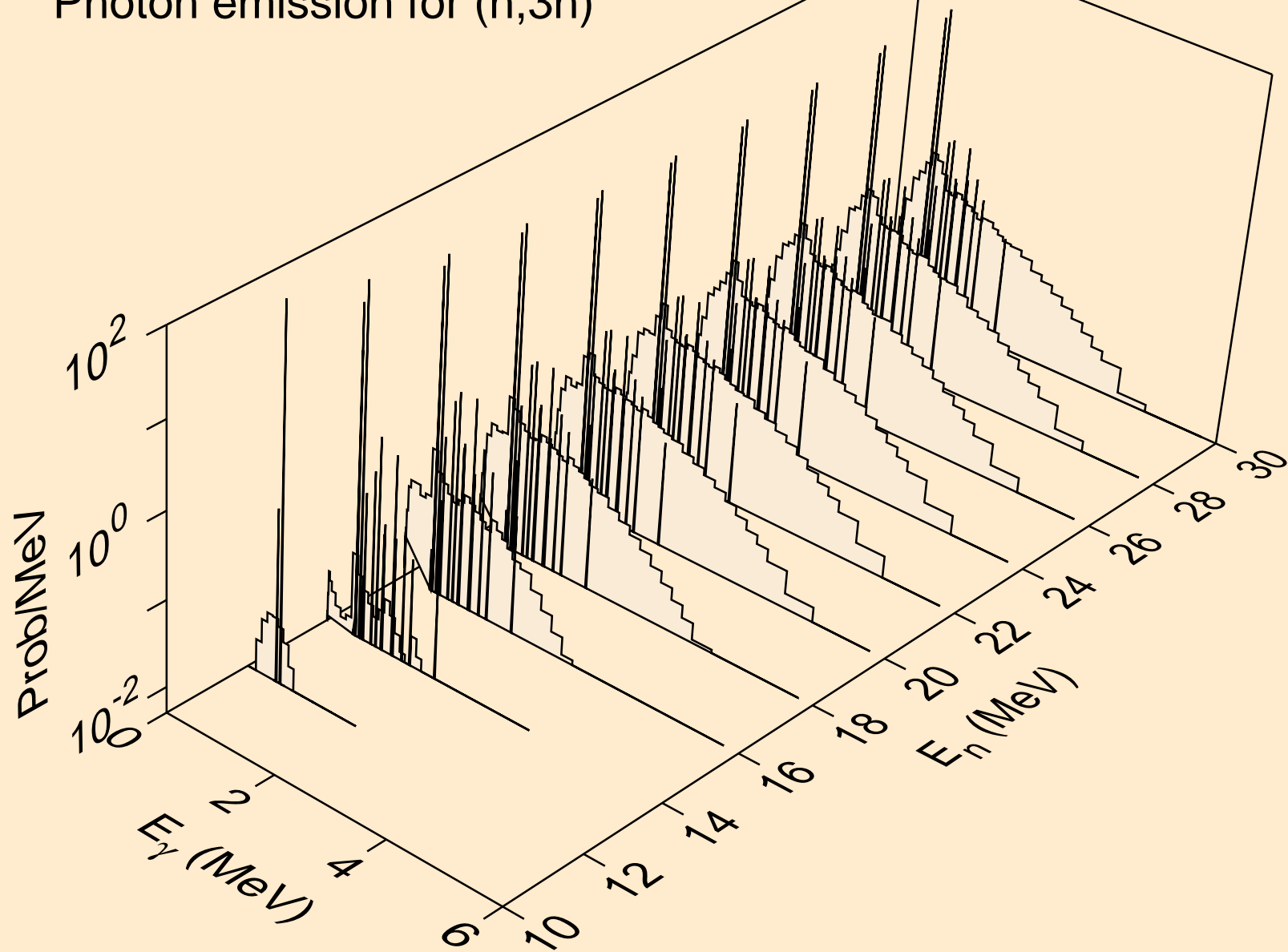

BA142 NEUTRON ACER TENDL-2021 LIBRARY; T=293.6K
Photon emission for (n,n*)a

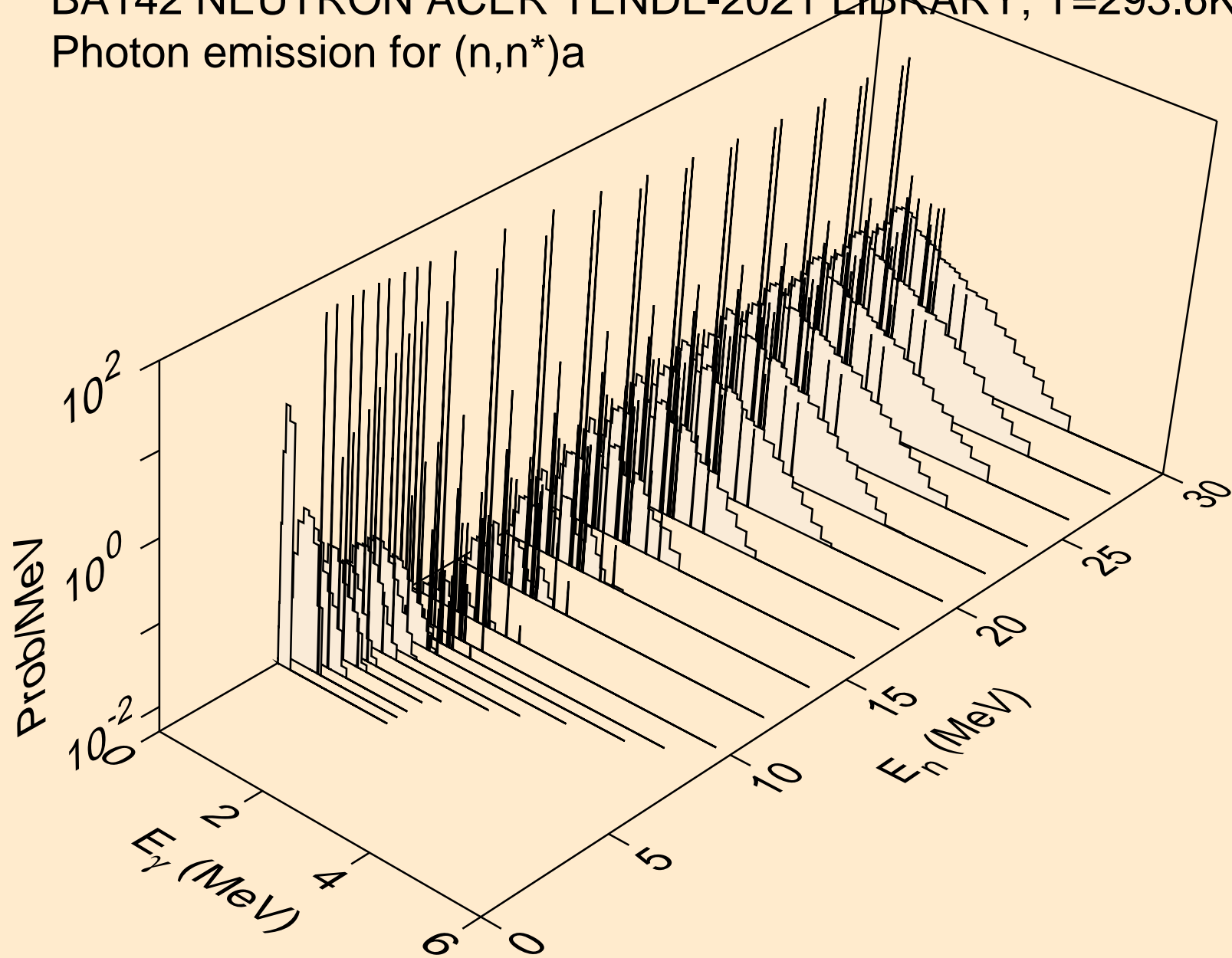

BA142 NEUTRON ACER TENDL-2021 LIBRARY; T=293.6K
Photon emission for (n,2n)a

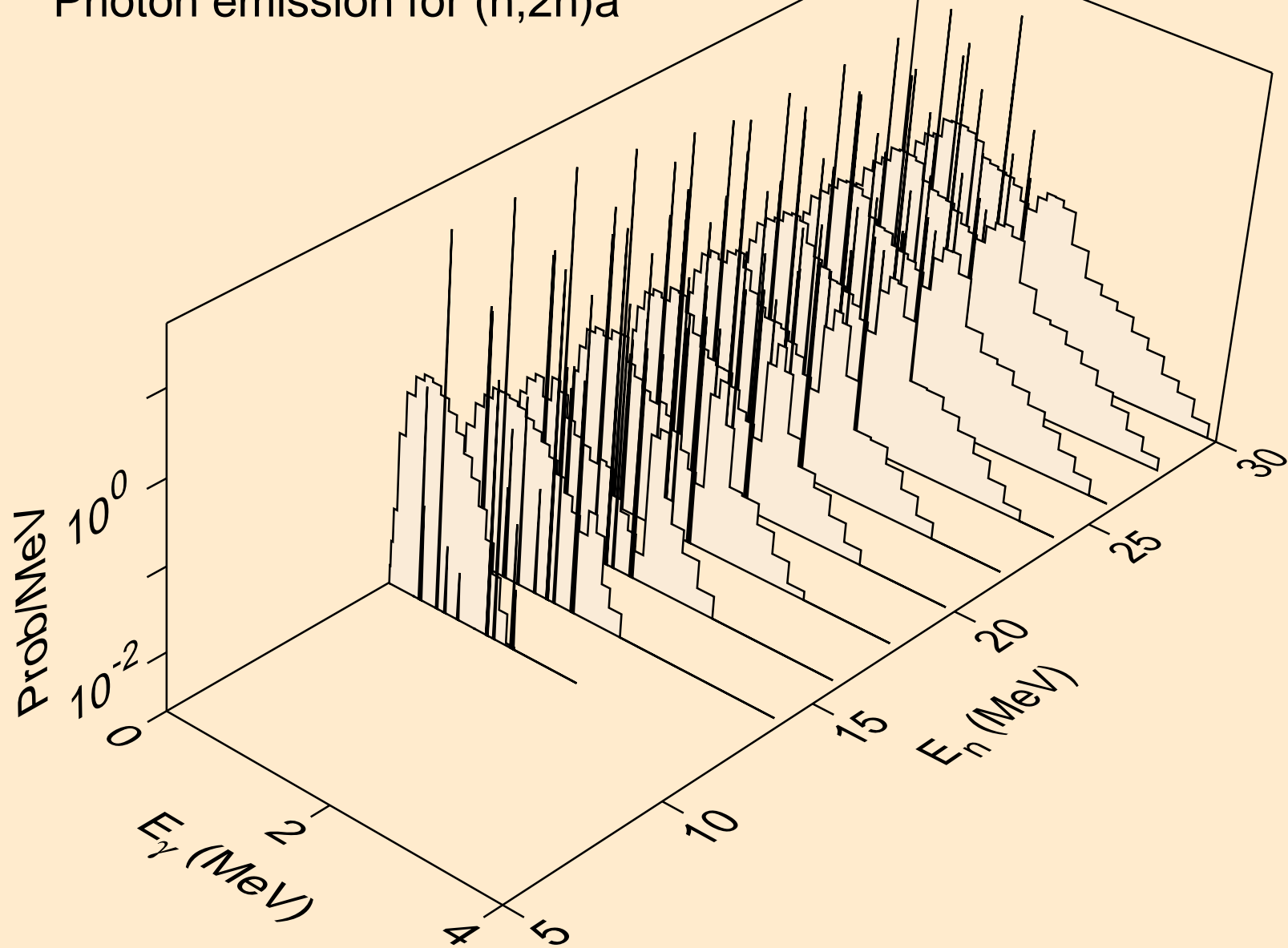

BA142 NEUTRON ACER TENDL-2021 LIBRARY; T=293.6K
Photon emission for (n,3n)a

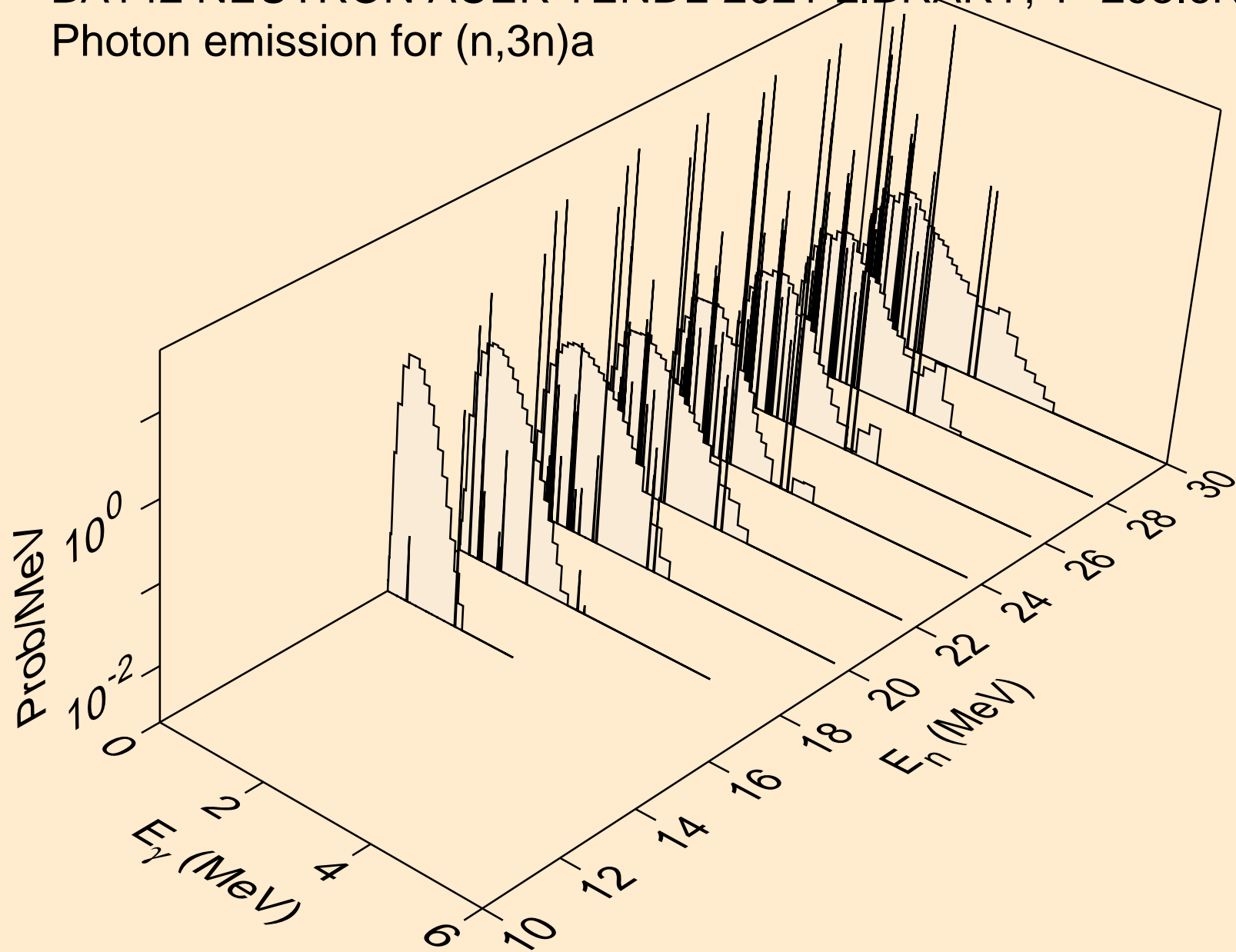

BA142 NEUTRON ACER TENDL-2021 LIBRARY; T=293.6K
Photon emission for (n,n*)p

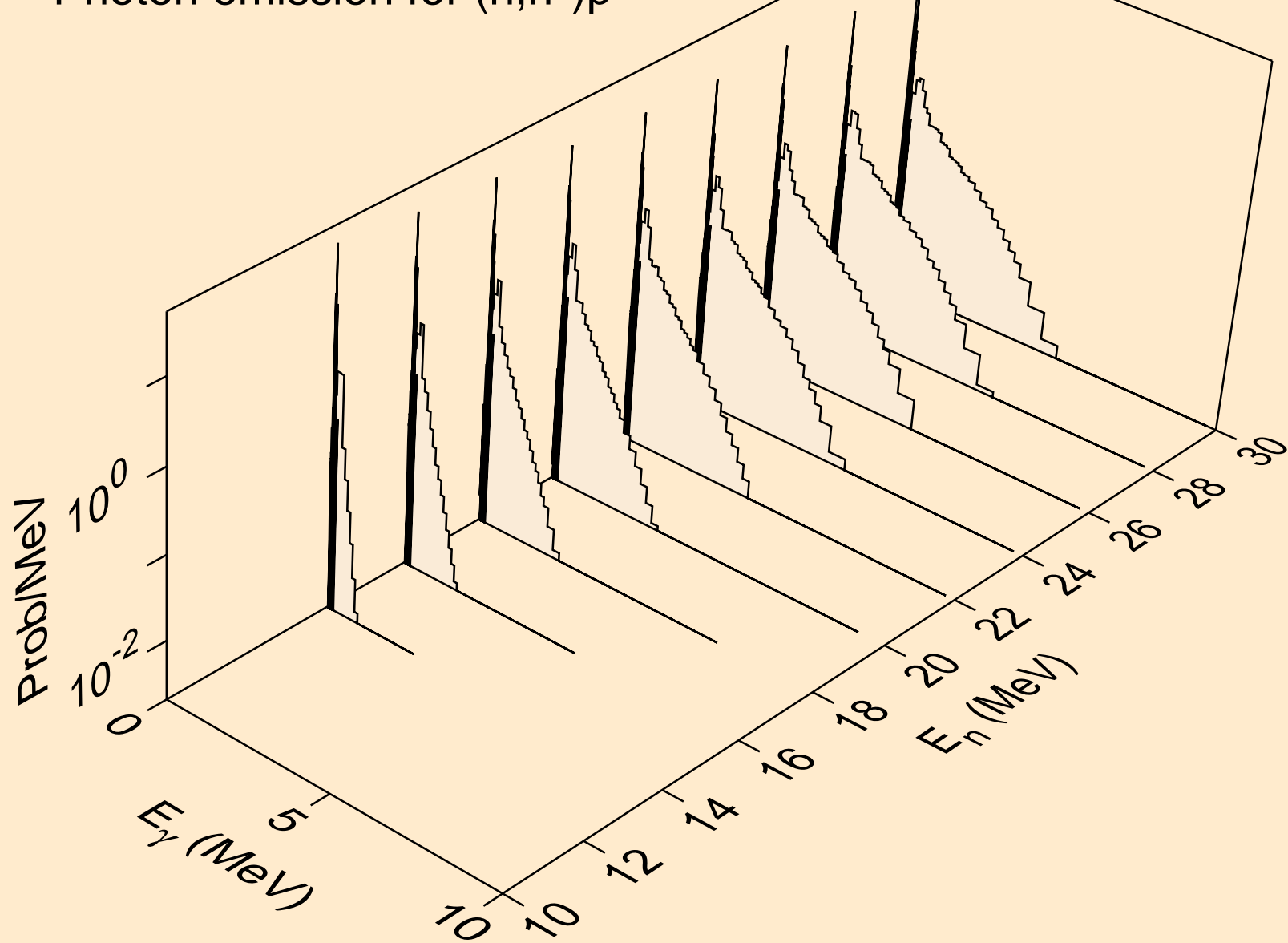

BA142 NEUTRON ACER TENDL-2021 LIBRARY; T=293.6K
Photon emission for (n,n*)2a

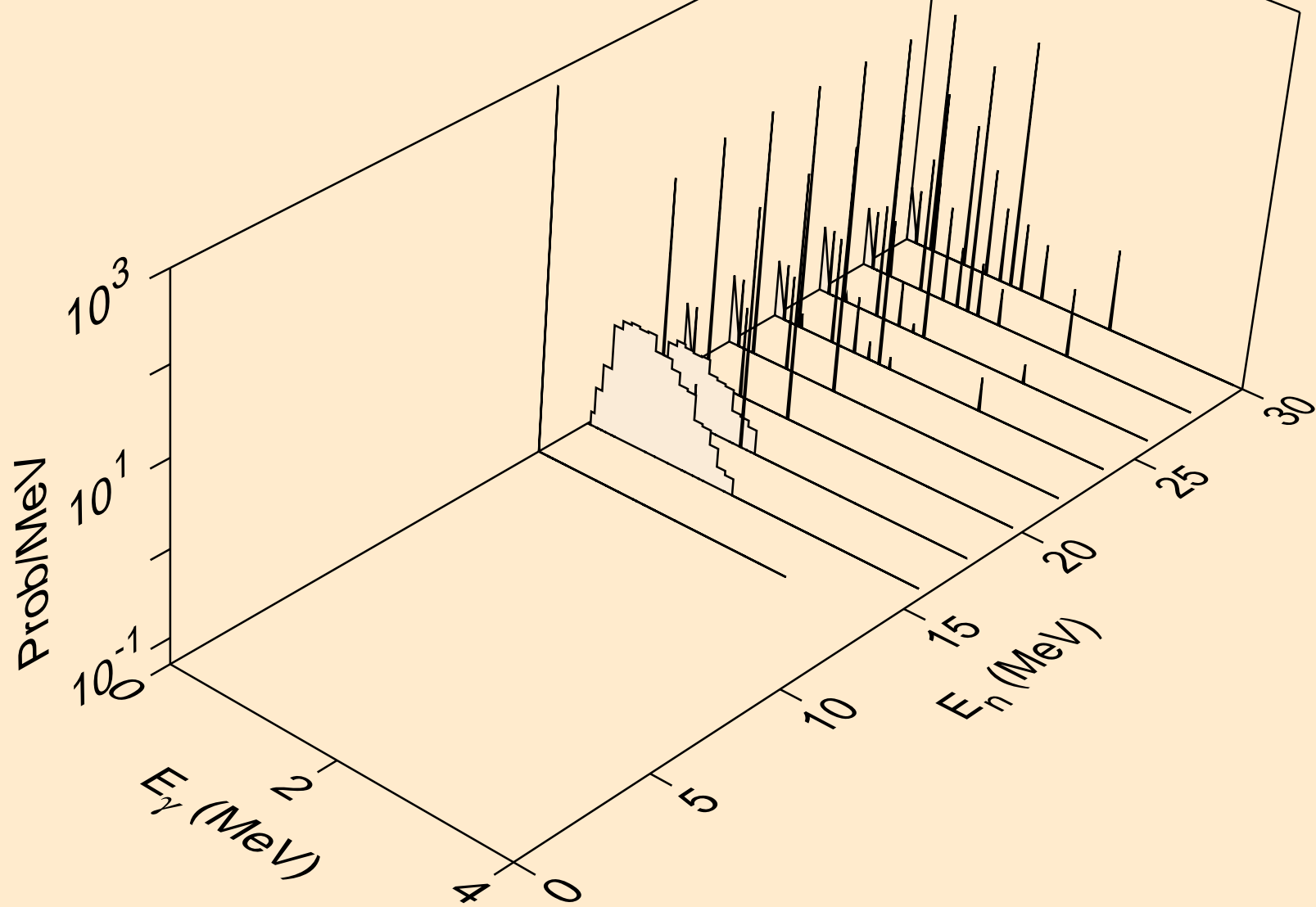

BA142 NEUTRON ACER TENDL-2021 LIBRARY; T=293.6K
Photon emission for (n,n*)d

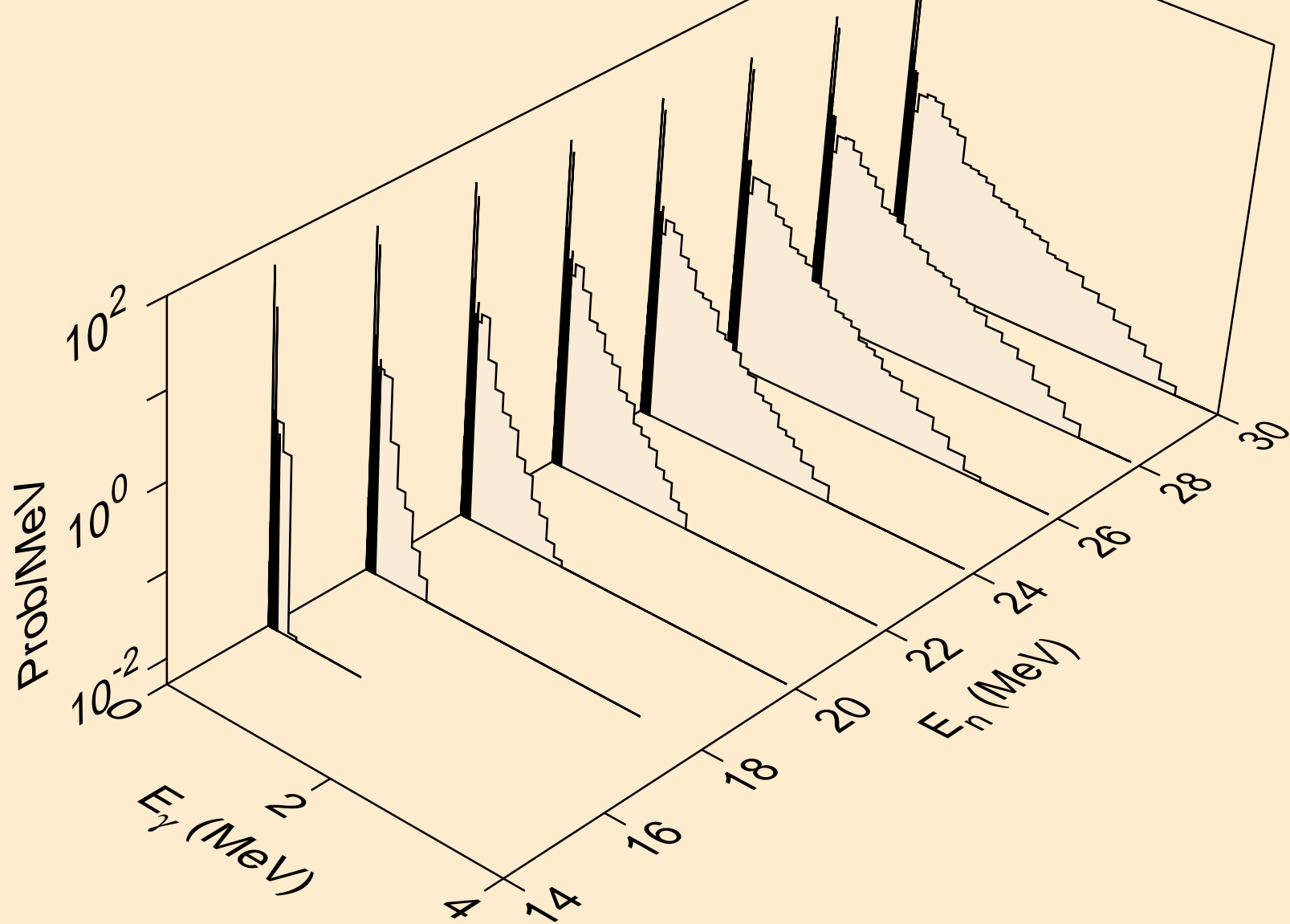

BA142 NEUTRON ACER TENDL-2021 LIBRARY; T=293.6K
Photon emission for (n,n*)t

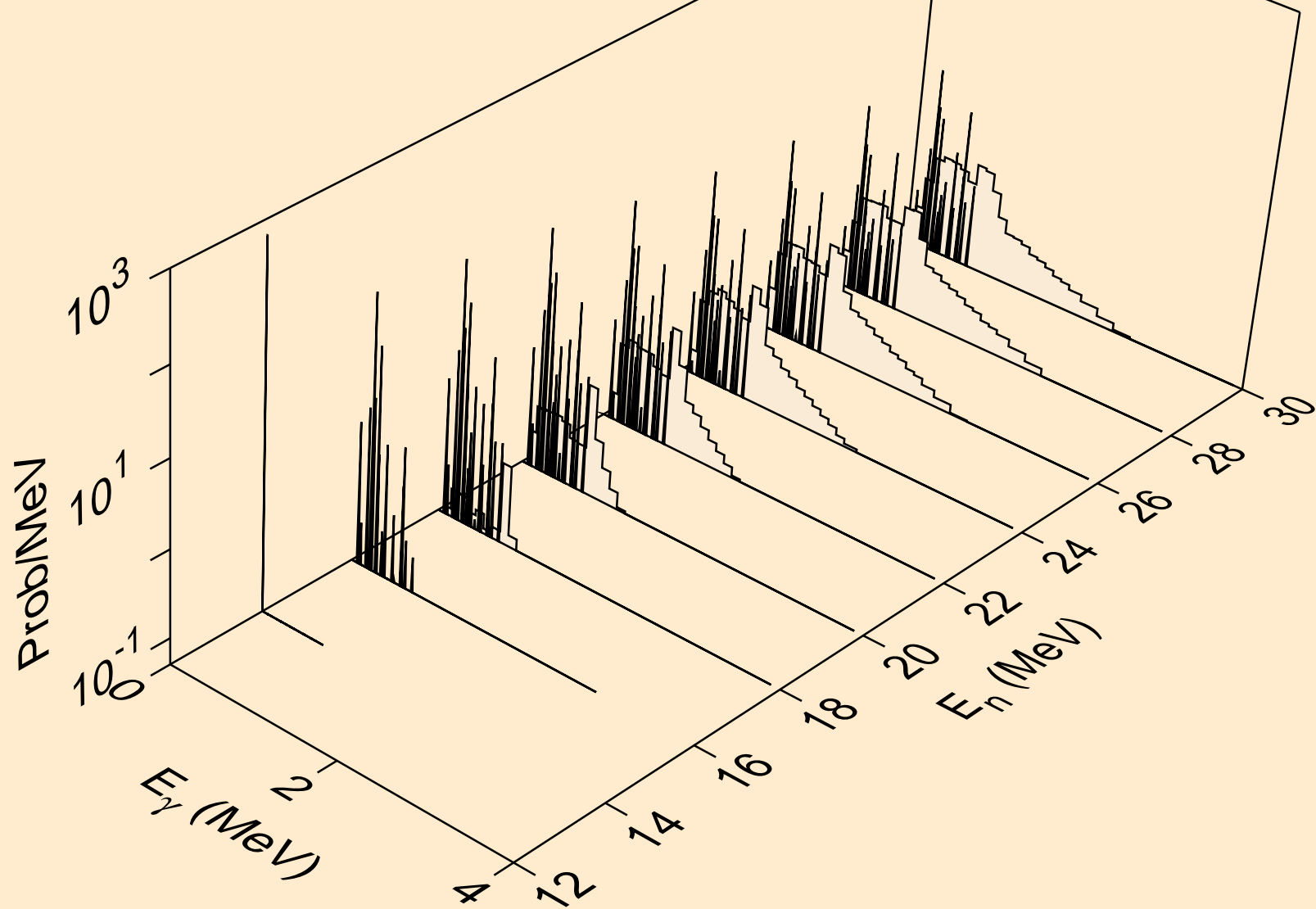

BA142 NEUTRON ACER TENDL-2021 LIBRARY; T=293.6K
Photon emission for (n,n*)he3

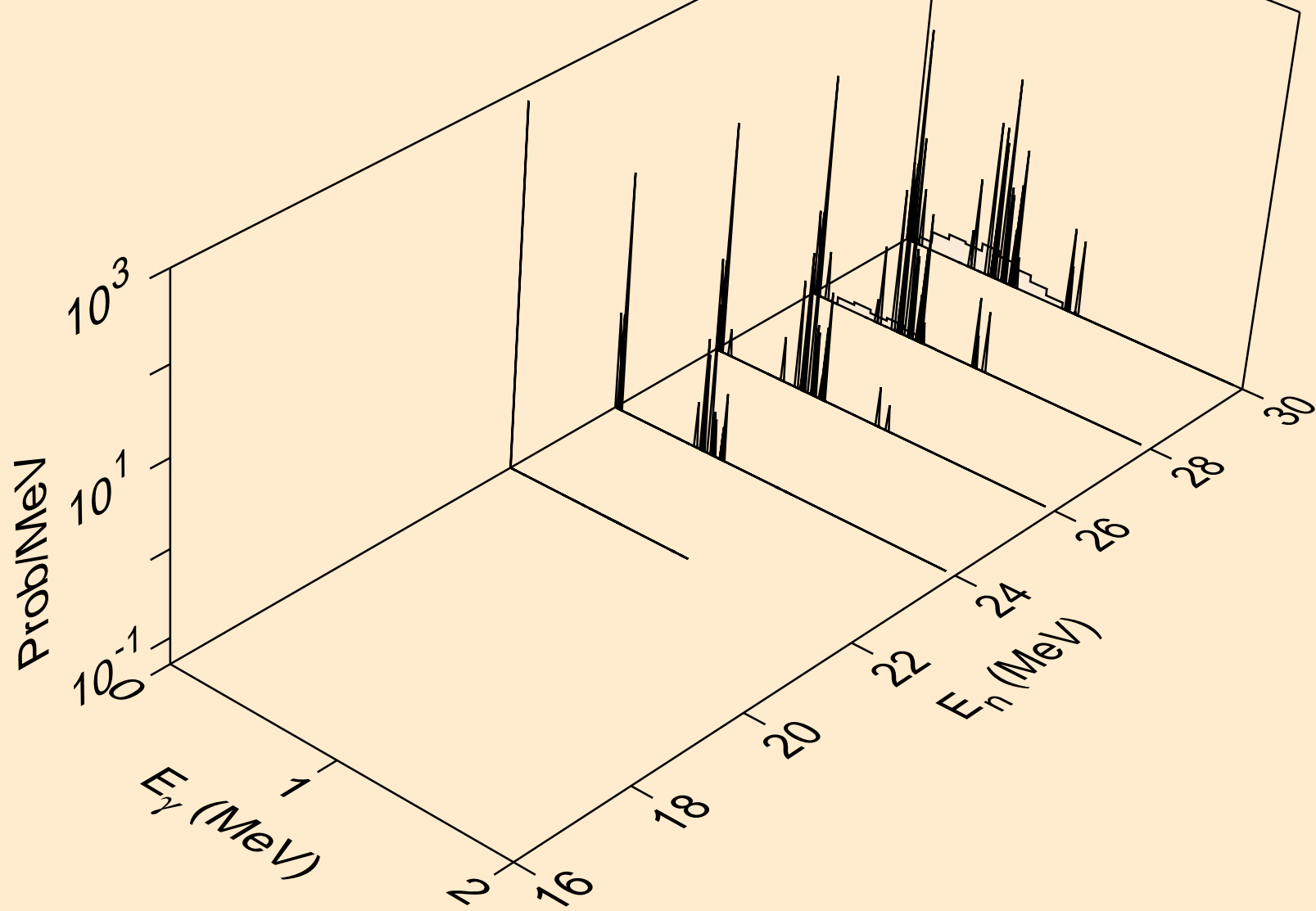

BA142 NEUTRON ACER TENDL-2021 LIBRARY; T=293.6K
Photon emission for (n,4n)

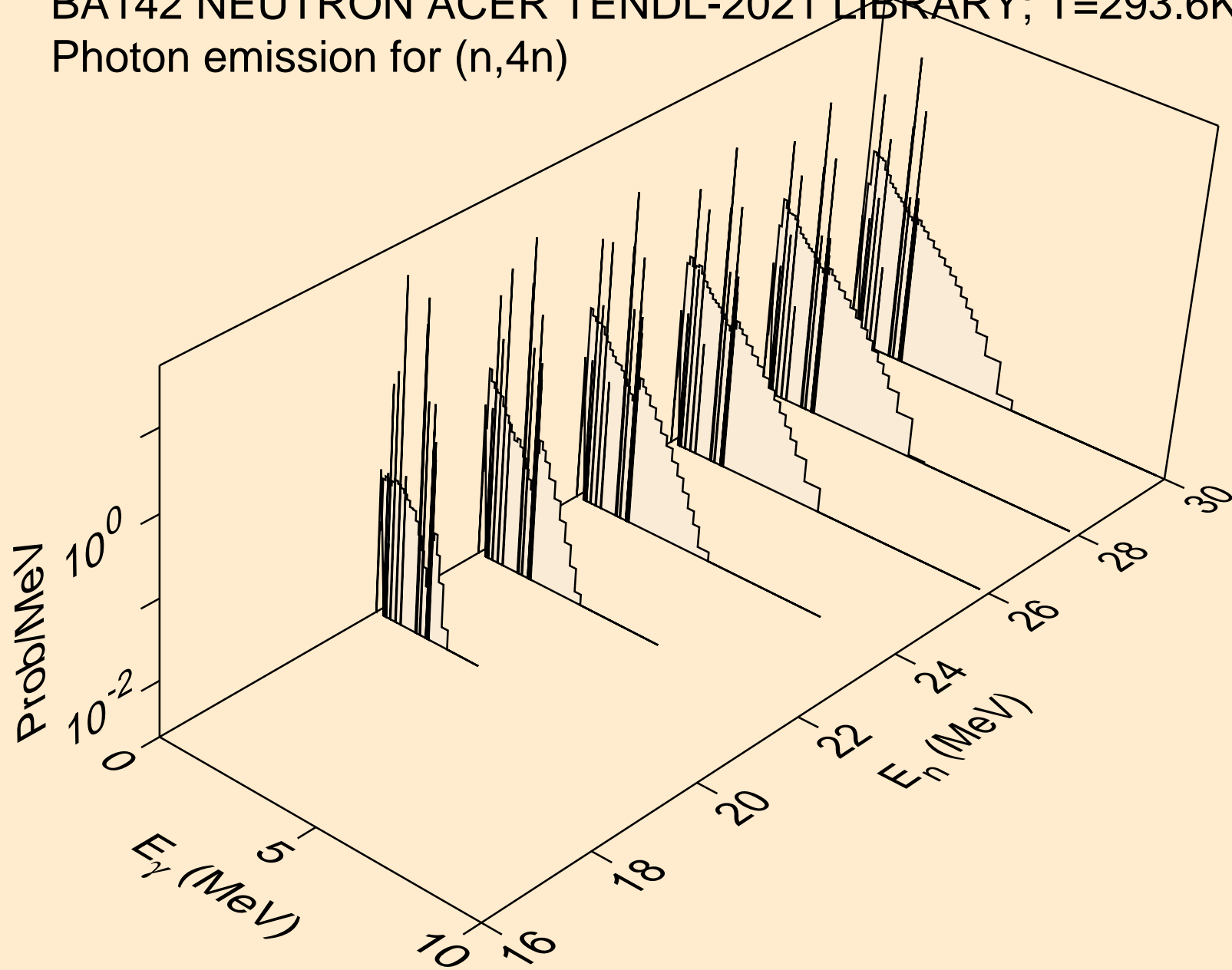

BA142 NEUTRON ACER TENDL-2021 LIBRARY; T=293.6K
Photon emission for (n,2np)

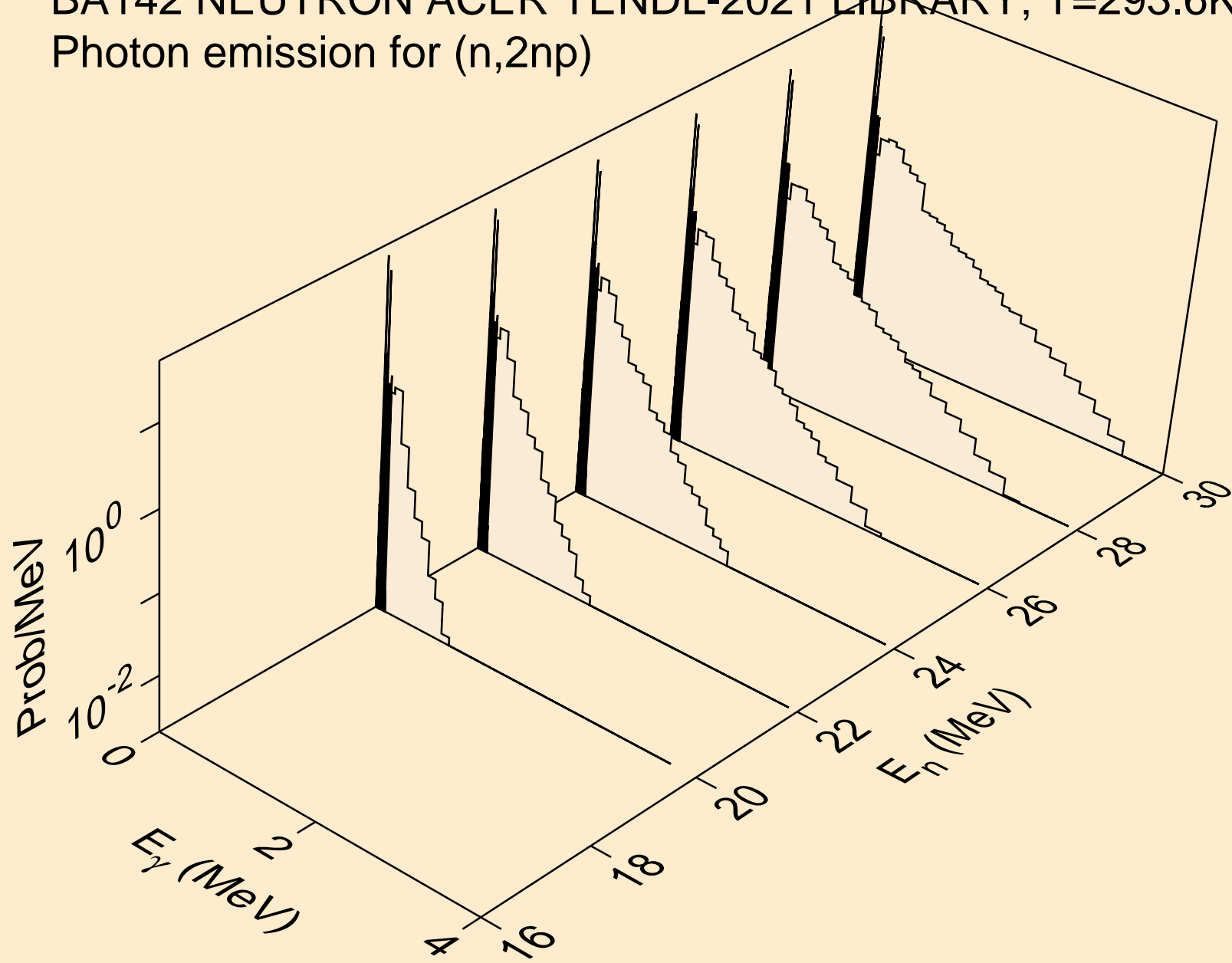

BA142 NEUTRON ACER TENDL-2021 LIBRARY; T=293.6K
Photon emission for (n,3np)

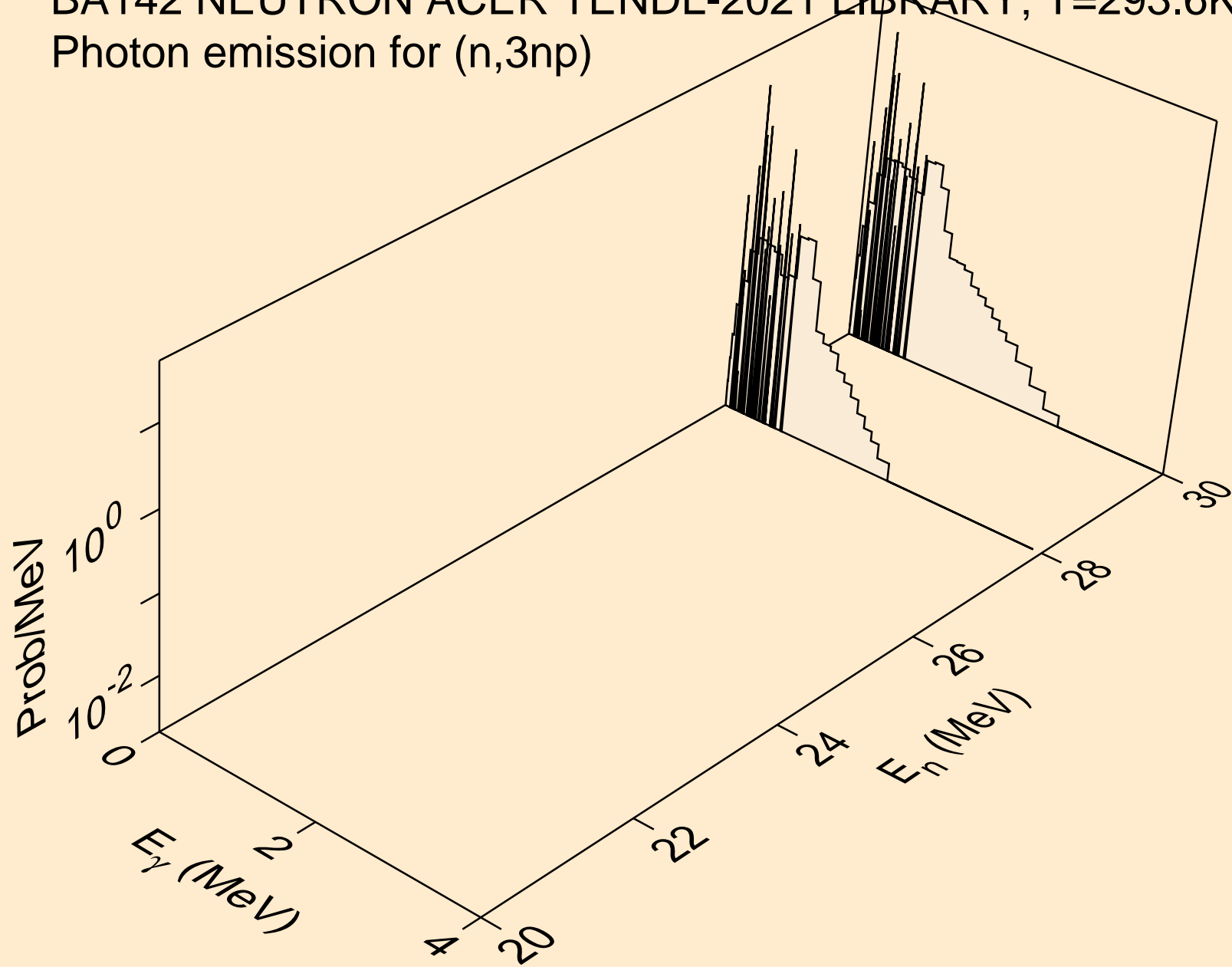

BA142 NEUTRON ACER TENDL-2021 LIBRARY; T=293.6K
Photon emission for (n,n*c)

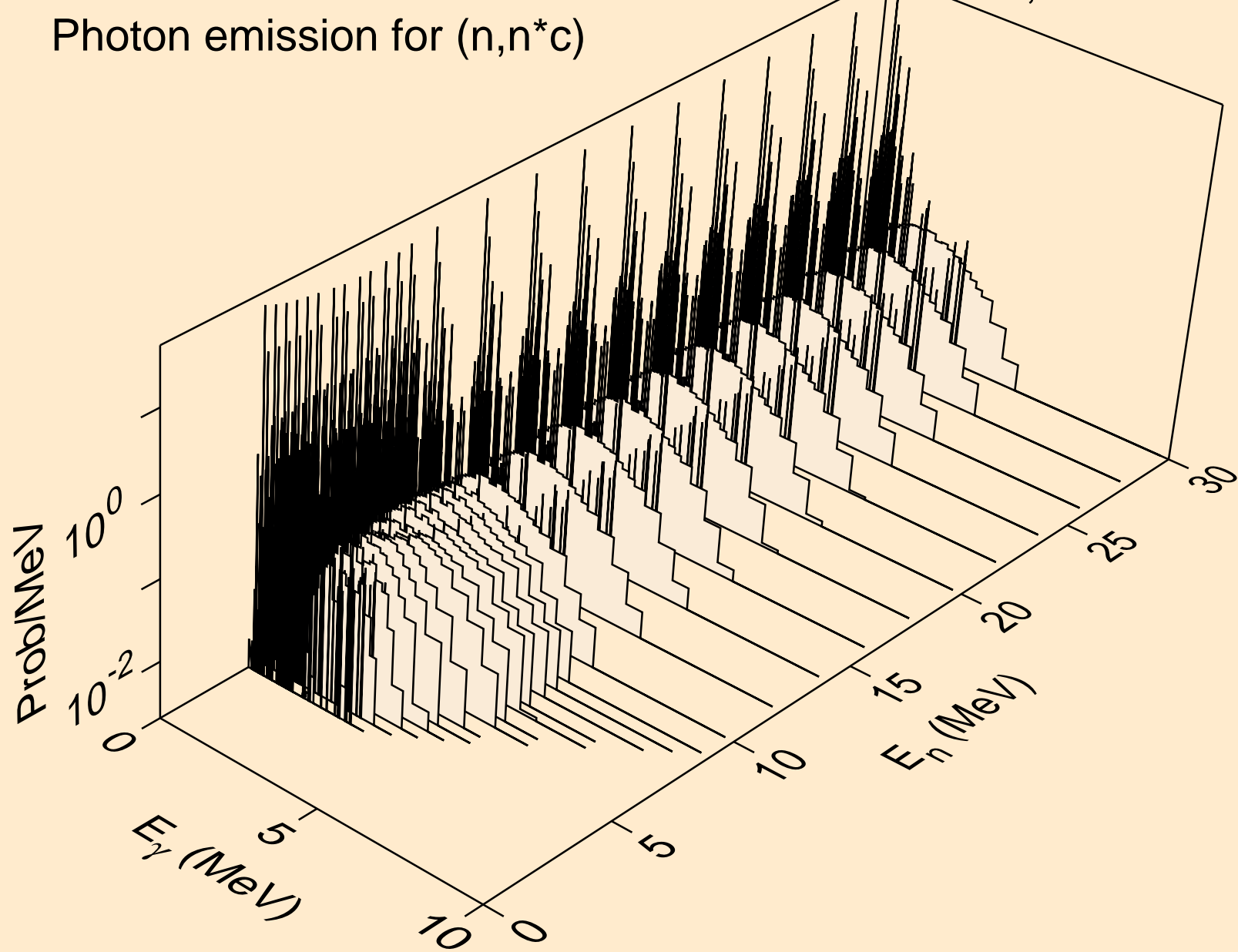

BA142 NEUTRON ACER TENDL-2021 LIBRARY; T=293.6K
Photon emission for (n,gma)

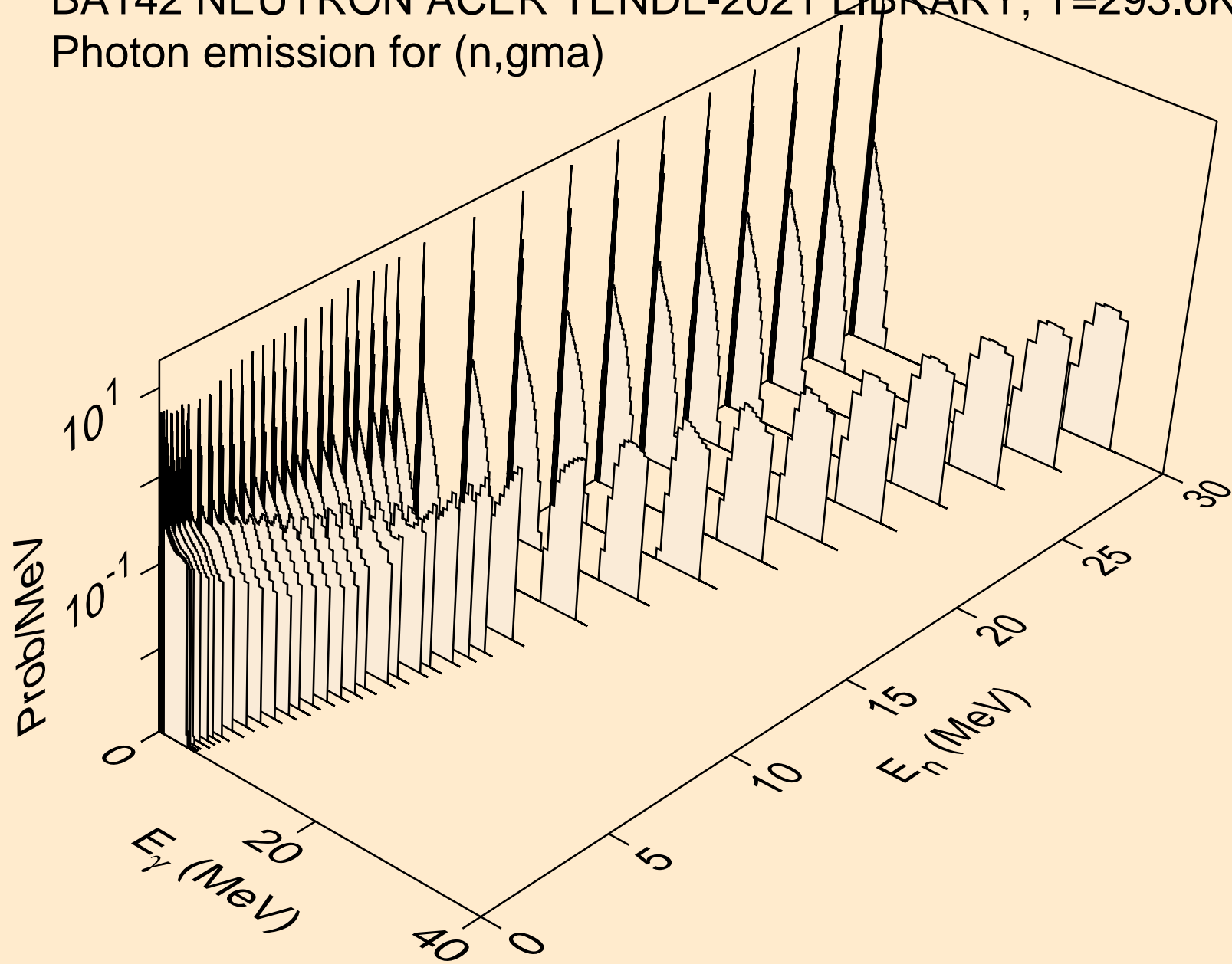

BA142 NEUTRON ACER TENDL-2021 LIBRARY; T=293.6K
Photon emission for (n,p)

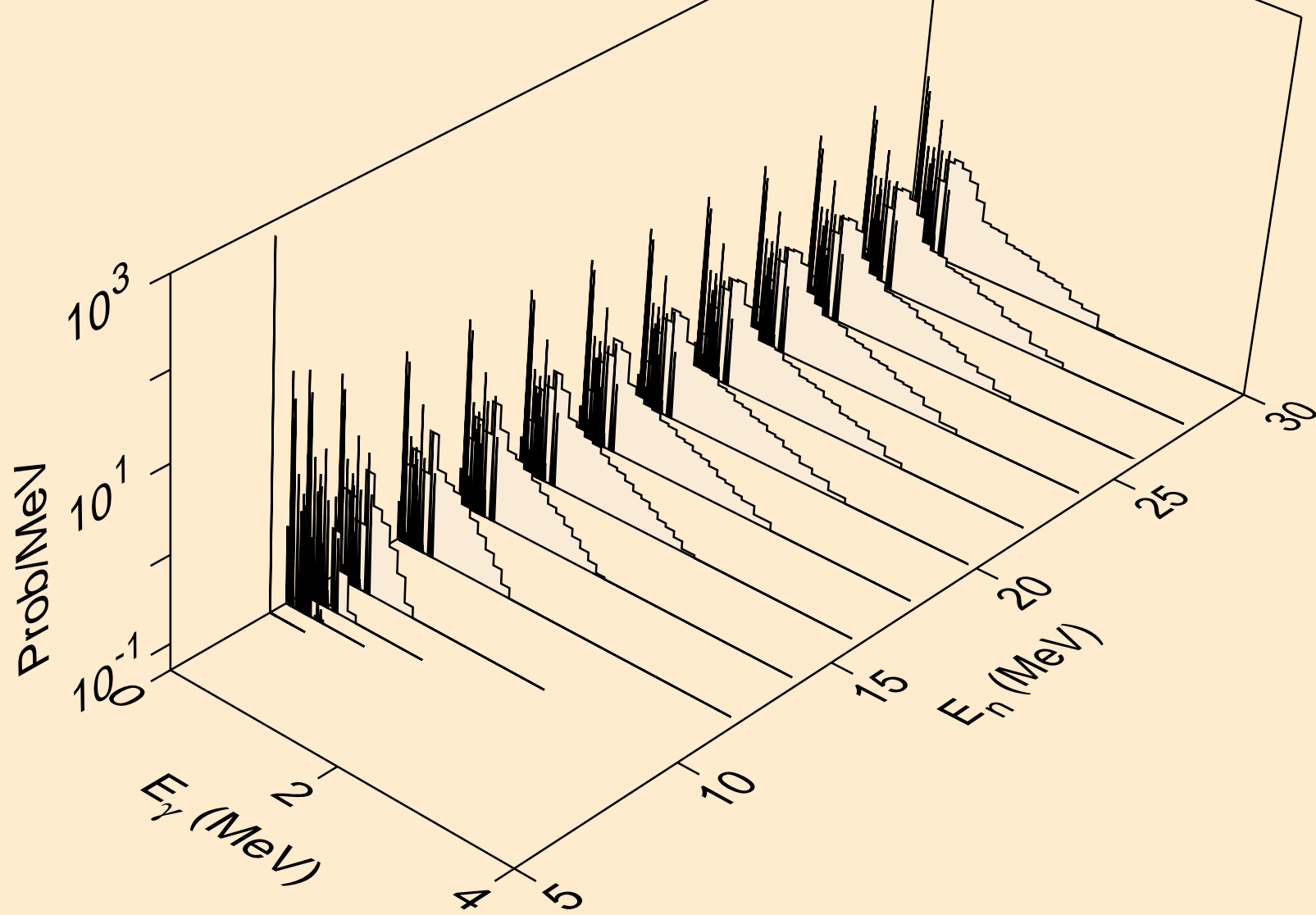

BA142 NEUTRON ACER TENDL-2021 LIBRARY; T=293.6K
Photon emission for (n,d)

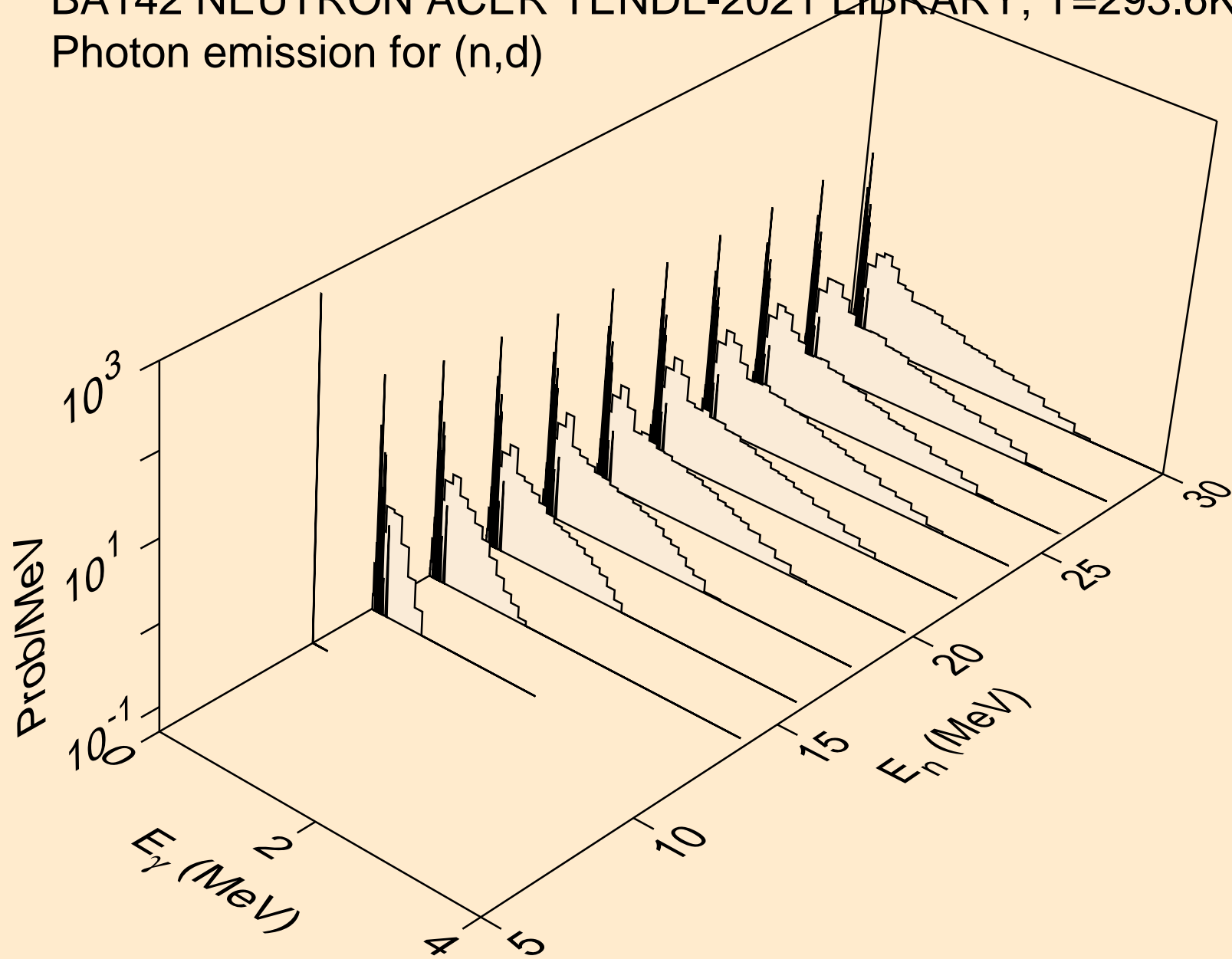

BA142 NEUTRON ACER TENDL-2021 LIBRARY; T=293.6K
Photon emission for (n,t)

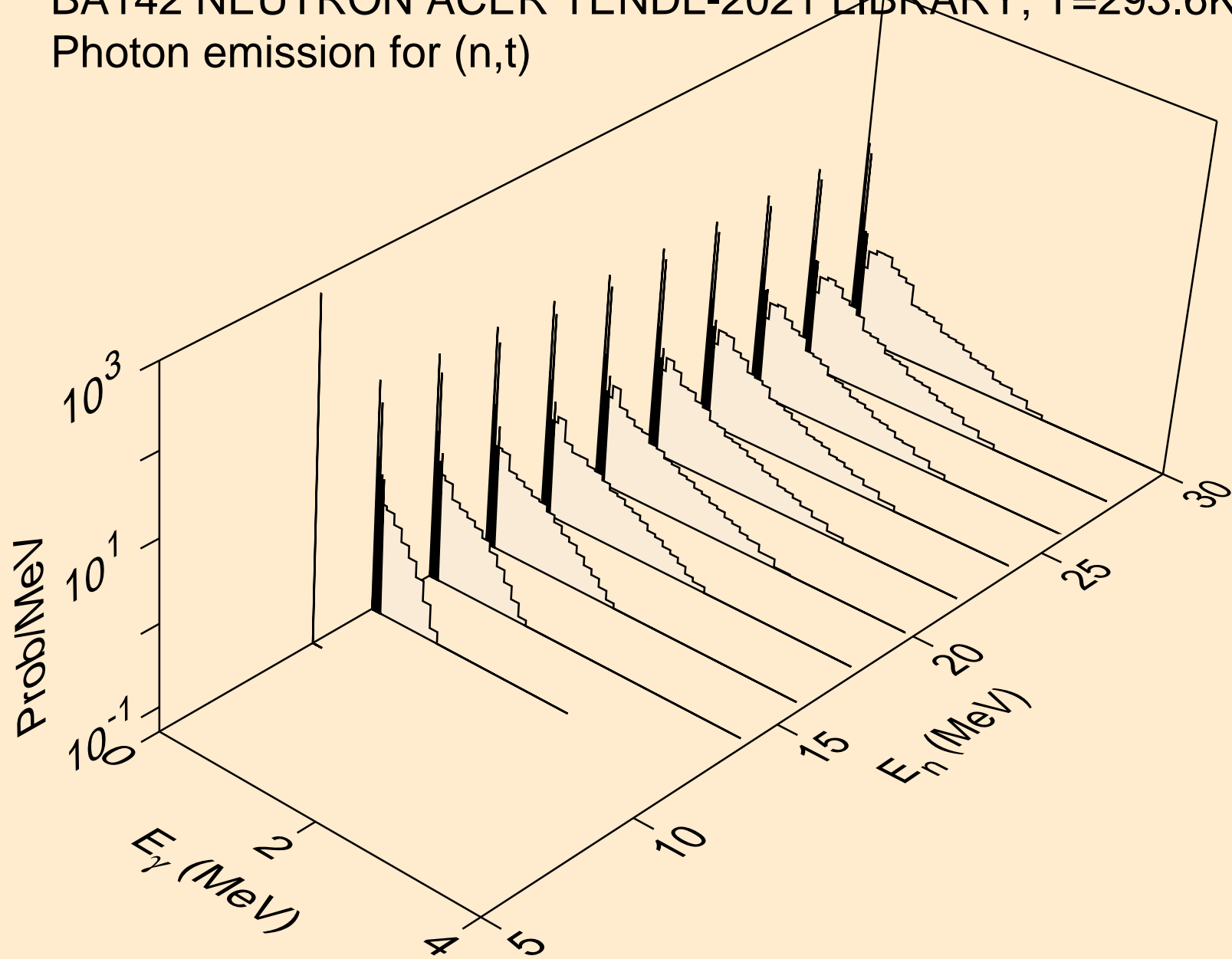

BA142 NEUTRON ACER TENDL-2021 LIBRARY; T=293.6K
Photon emission for (n,he3)

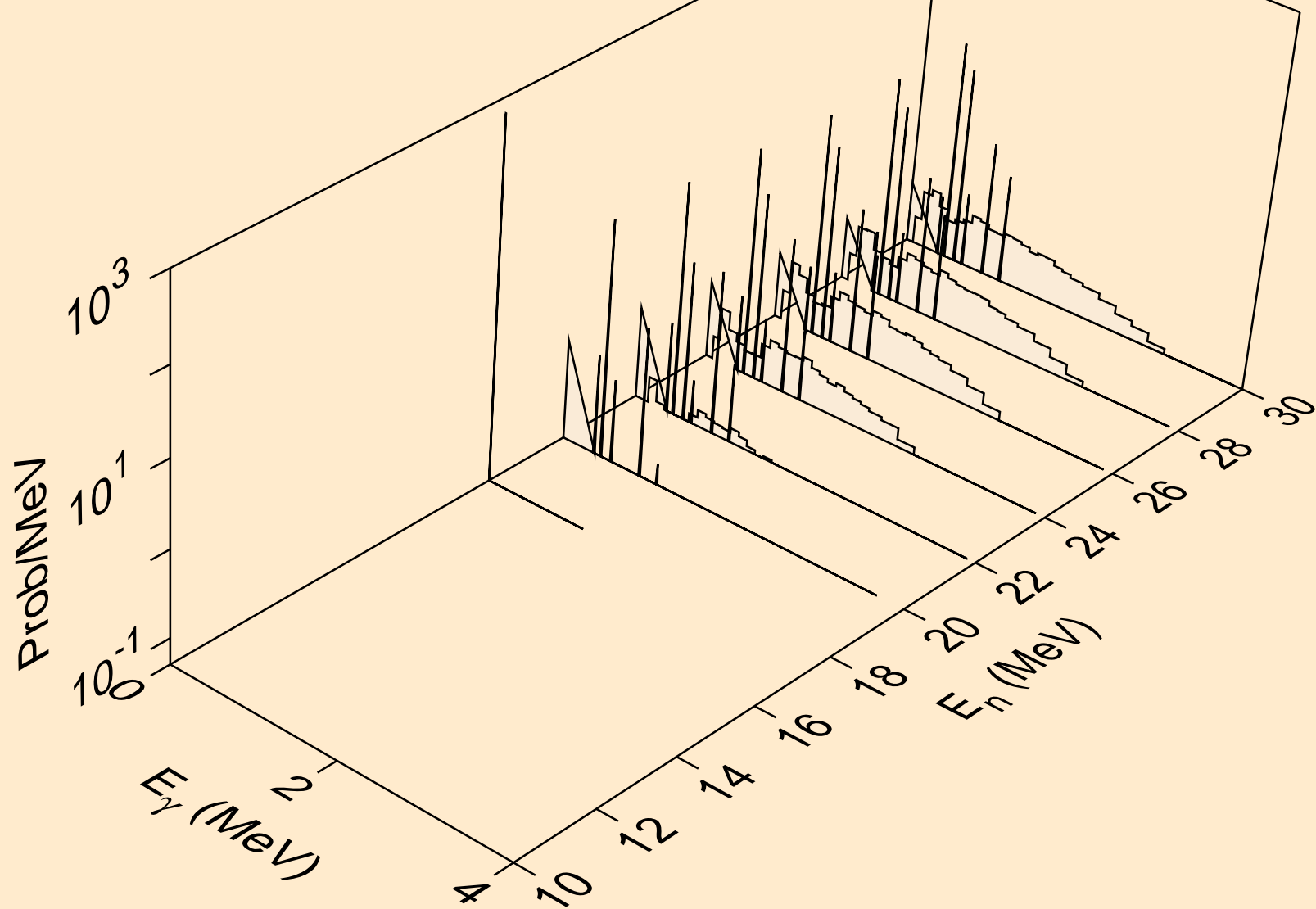

BA142 NEUTRON ACER TENDL-2021 LIBRARY; T=293.6K
Photon emission for (n,a)

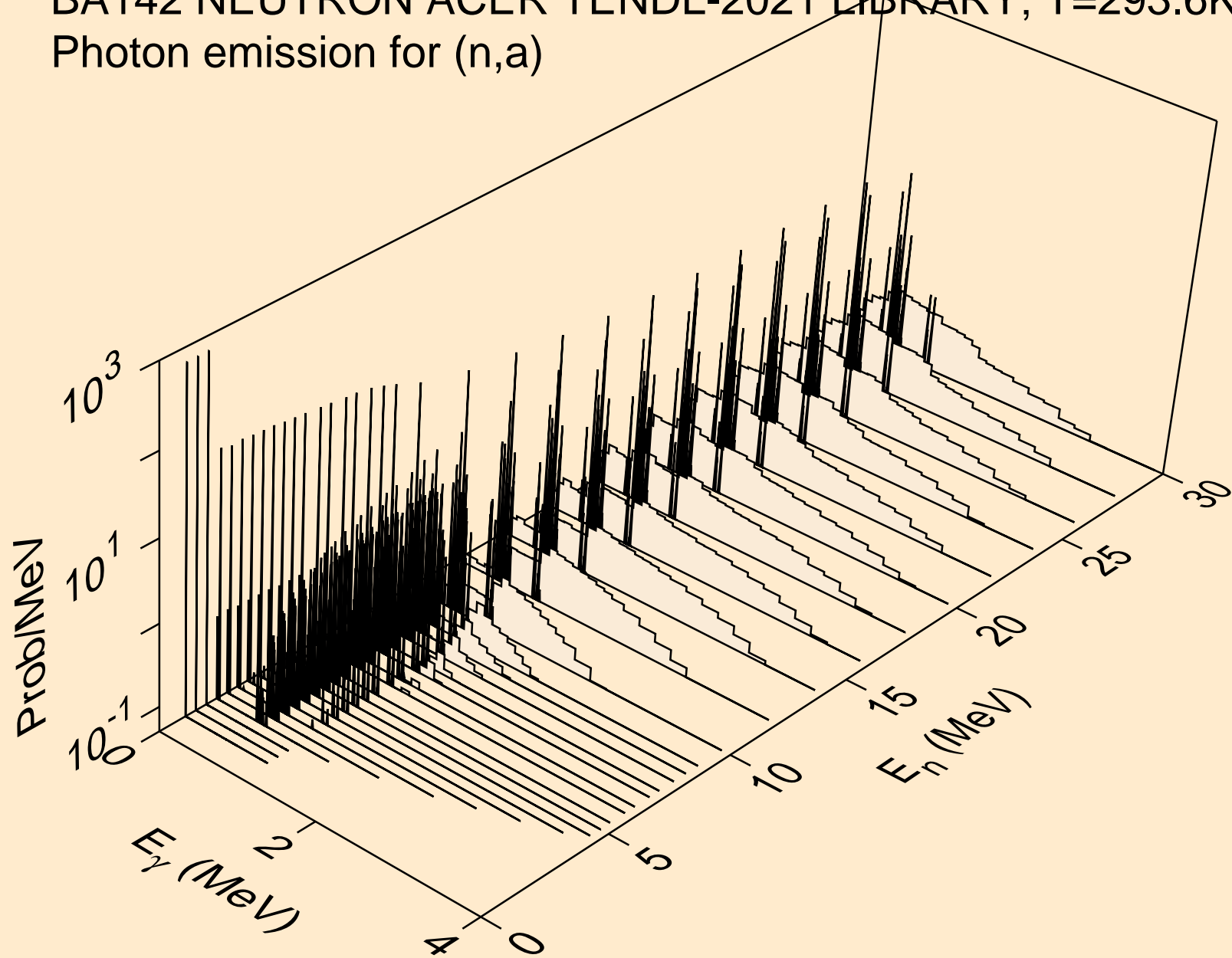

BA142 NEUTRON ACER TENDL-2021 LIBRARY; T=293.6K
Photon emission for (n,2a)

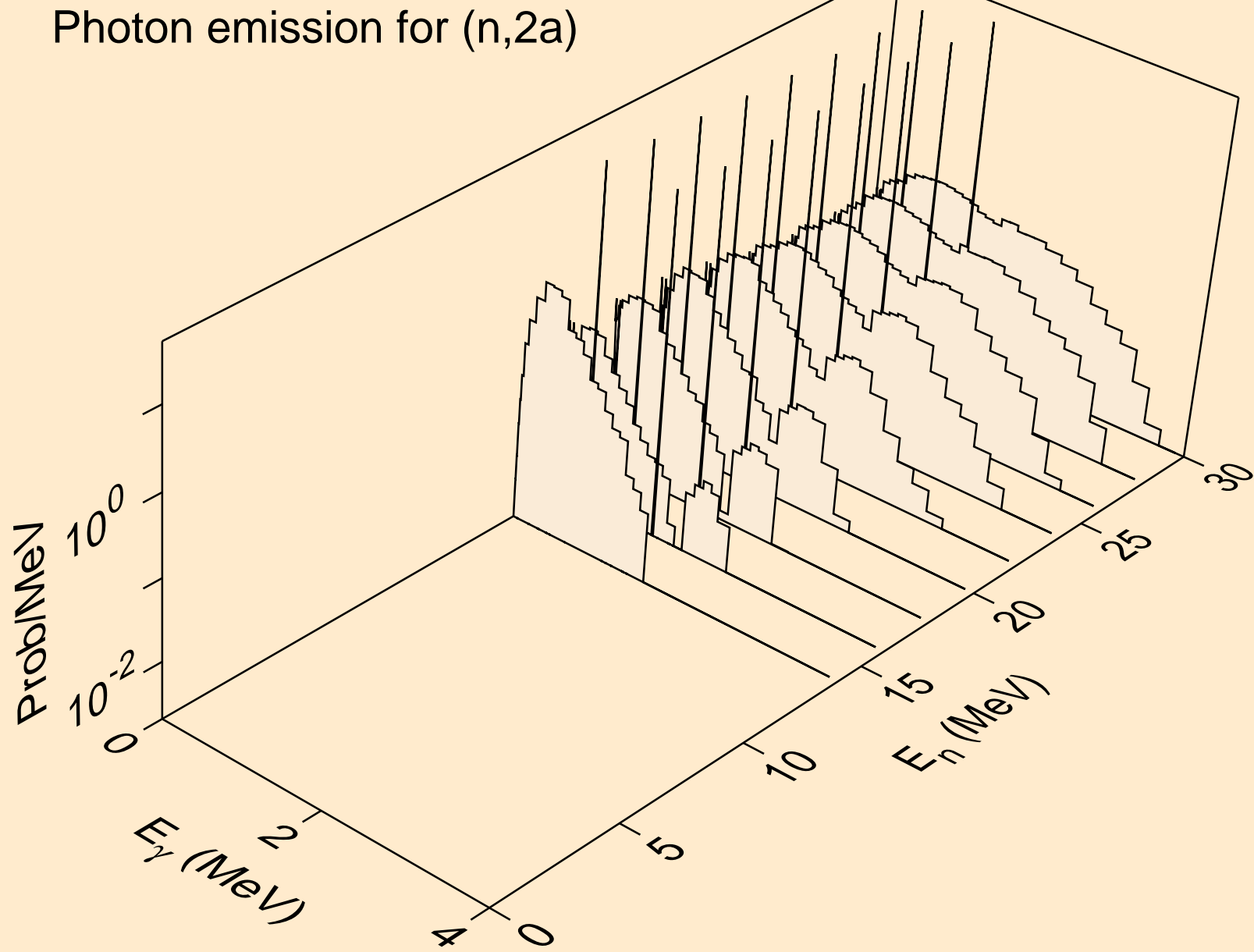

BA142 NEUTRON ACER TENDL-2021 LIBRARY; T=293.6K
Photon emission for (n,2p)

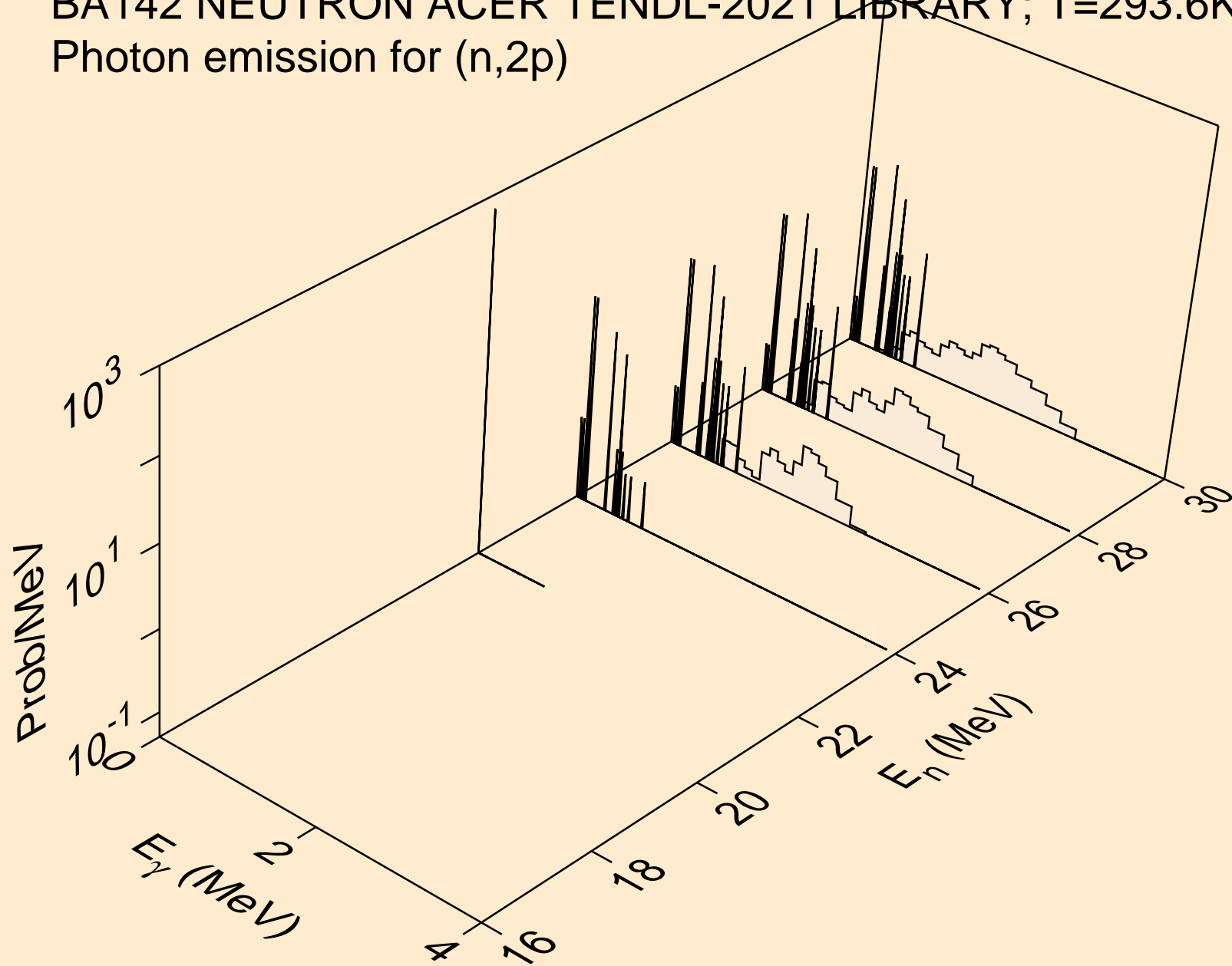

BA142 NEUTRON ACER TENDL-2021 LIBRARY; T=293.6K
Photon emission for (n,p)

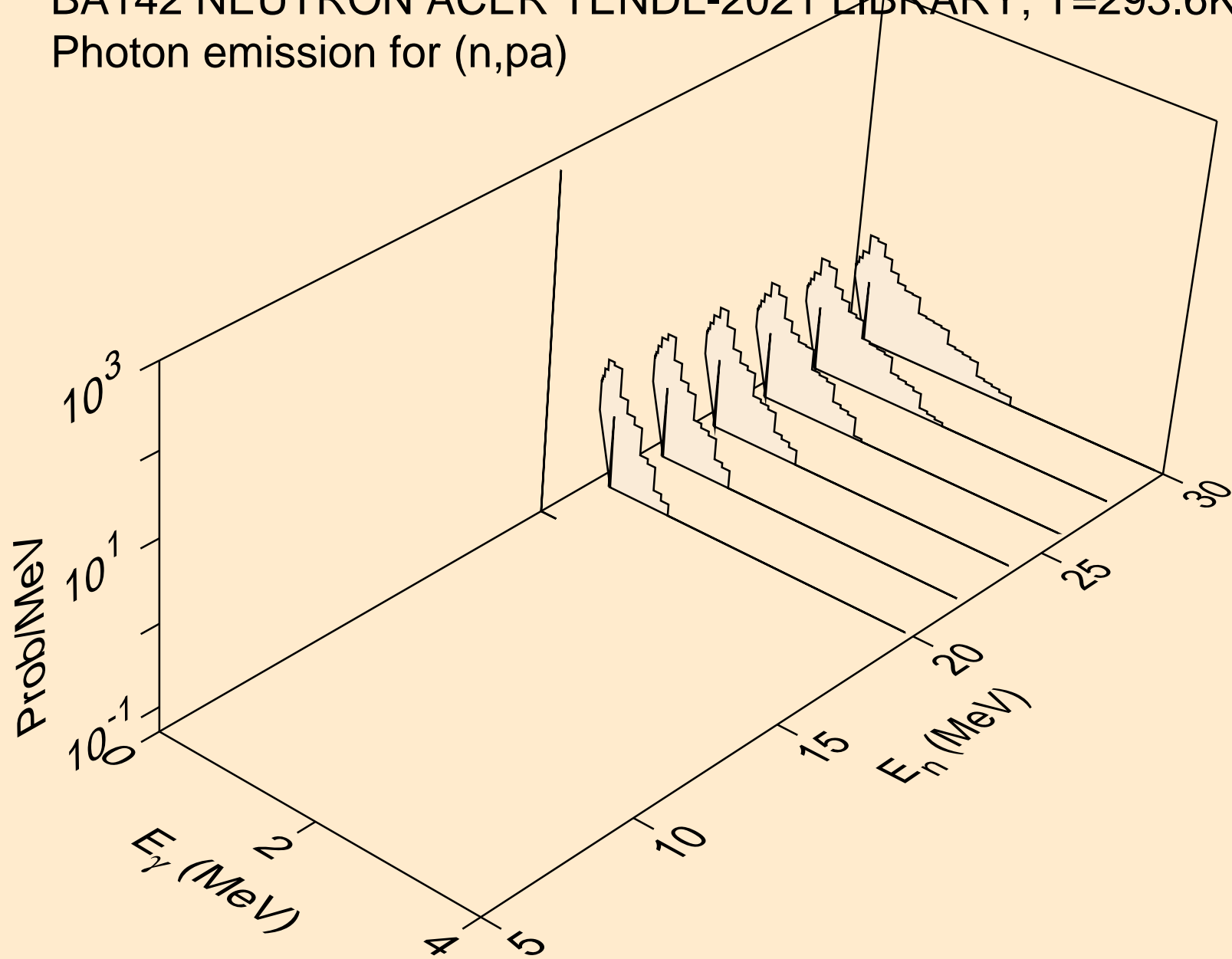

BA142 NEUTRON ACER TENDL-2021 LIBRARY; T=293.6K
14 MeV photon spectrum

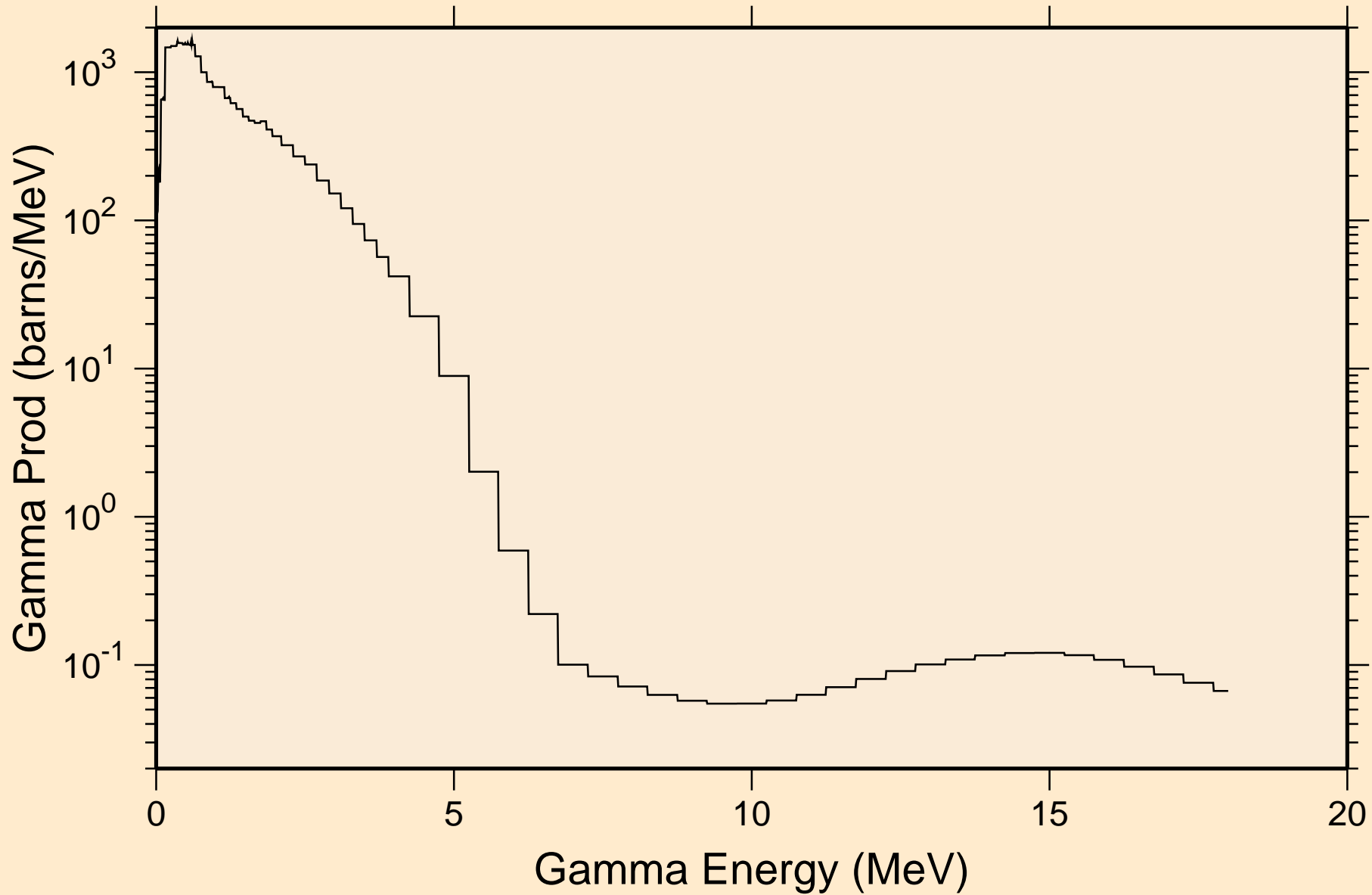

BA142 NEUTRON ACER TENDL-2021 LIBRARY; T=293.6K
Particle heating contributions

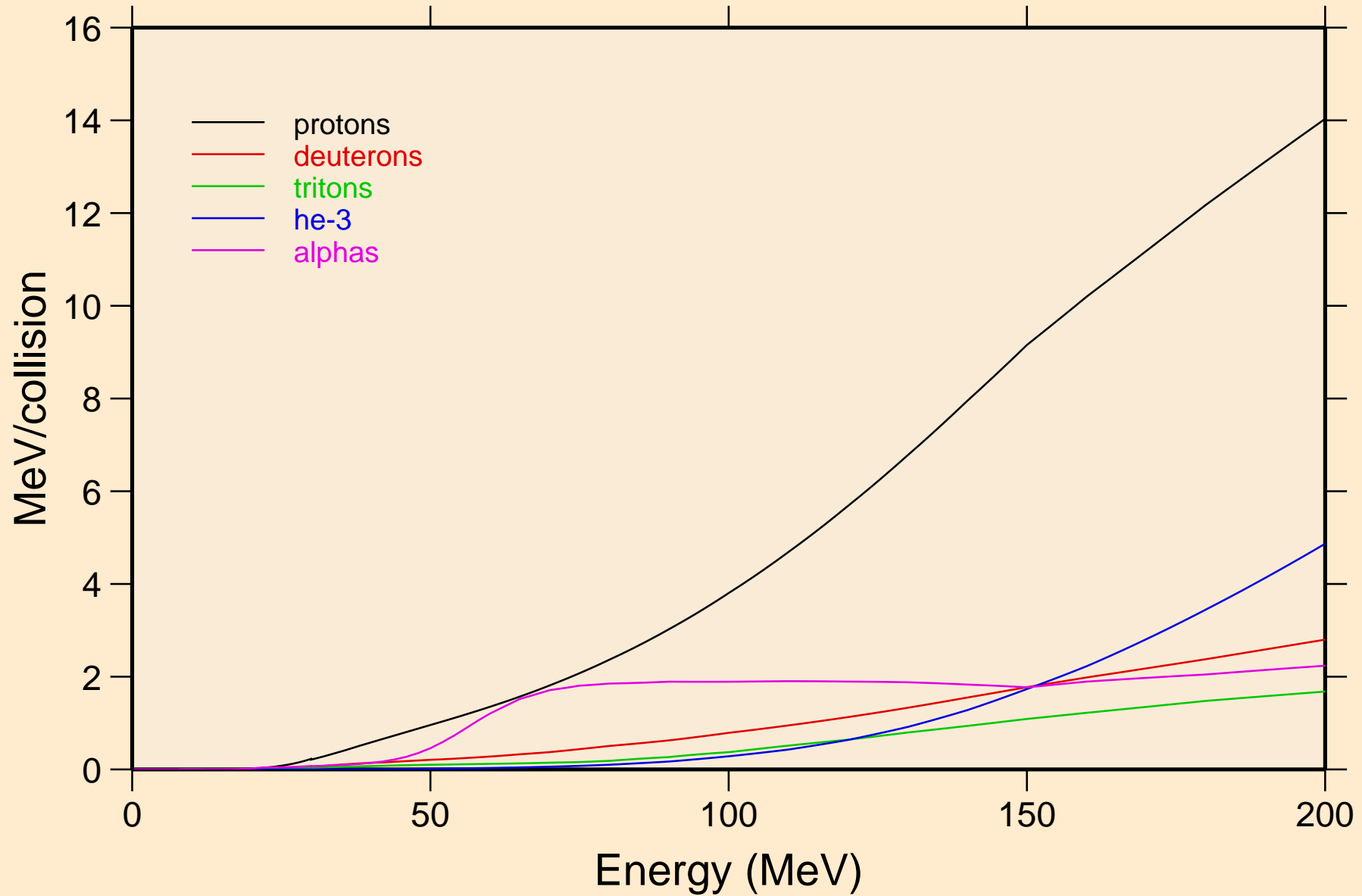

BA142 NEUTRON ACER TENDL-2021 LIBRARY; T=293.6K
Recoil Heating

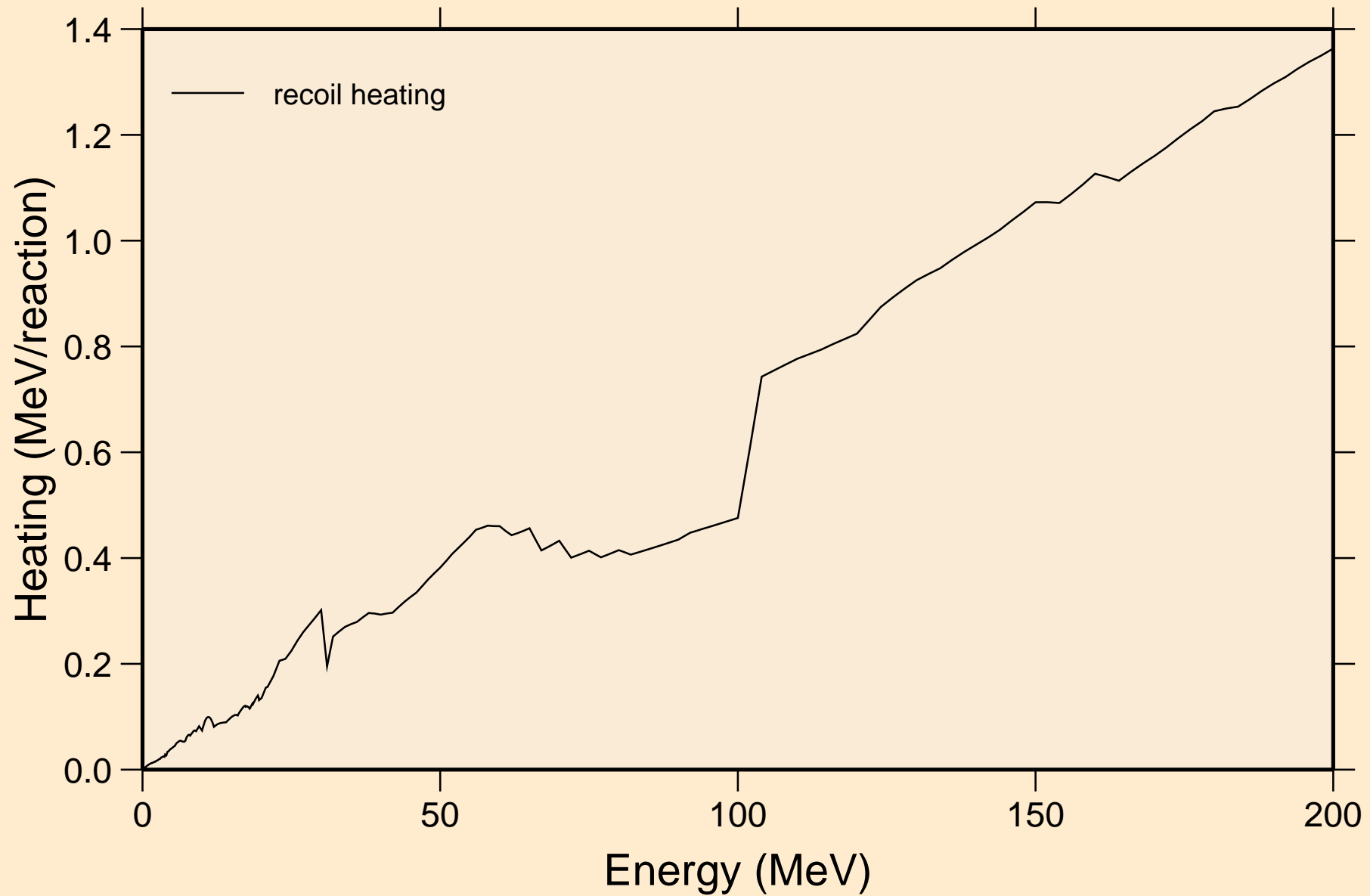

BA142 NEUTRON ACER TENDL-2021 LIBRARY; T=293.6K
Particle production cross sections

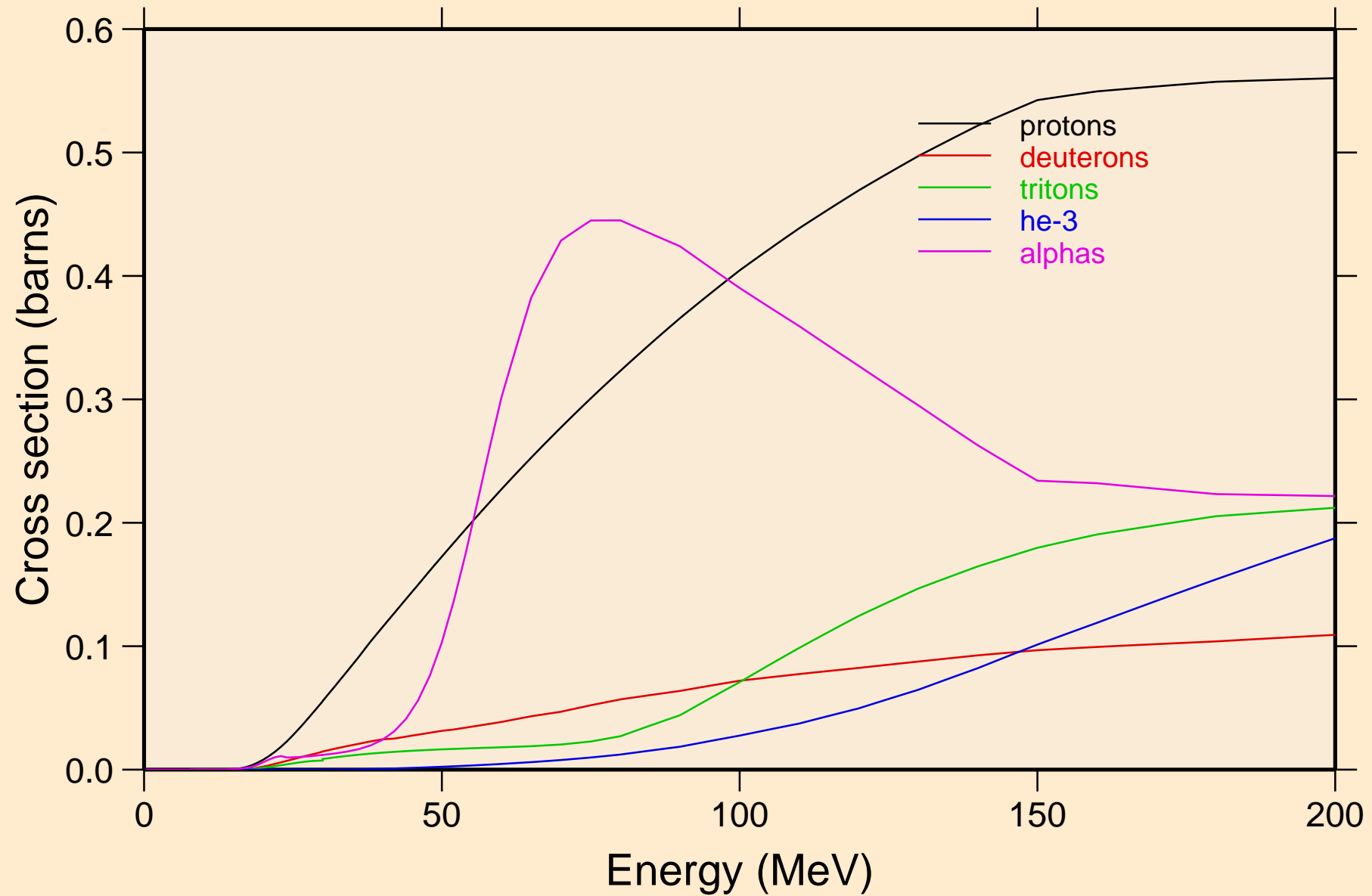

BA142 NEUTRON ACER TENDL-2021 LIBRARY; T=293.6K
protons from (n,x)

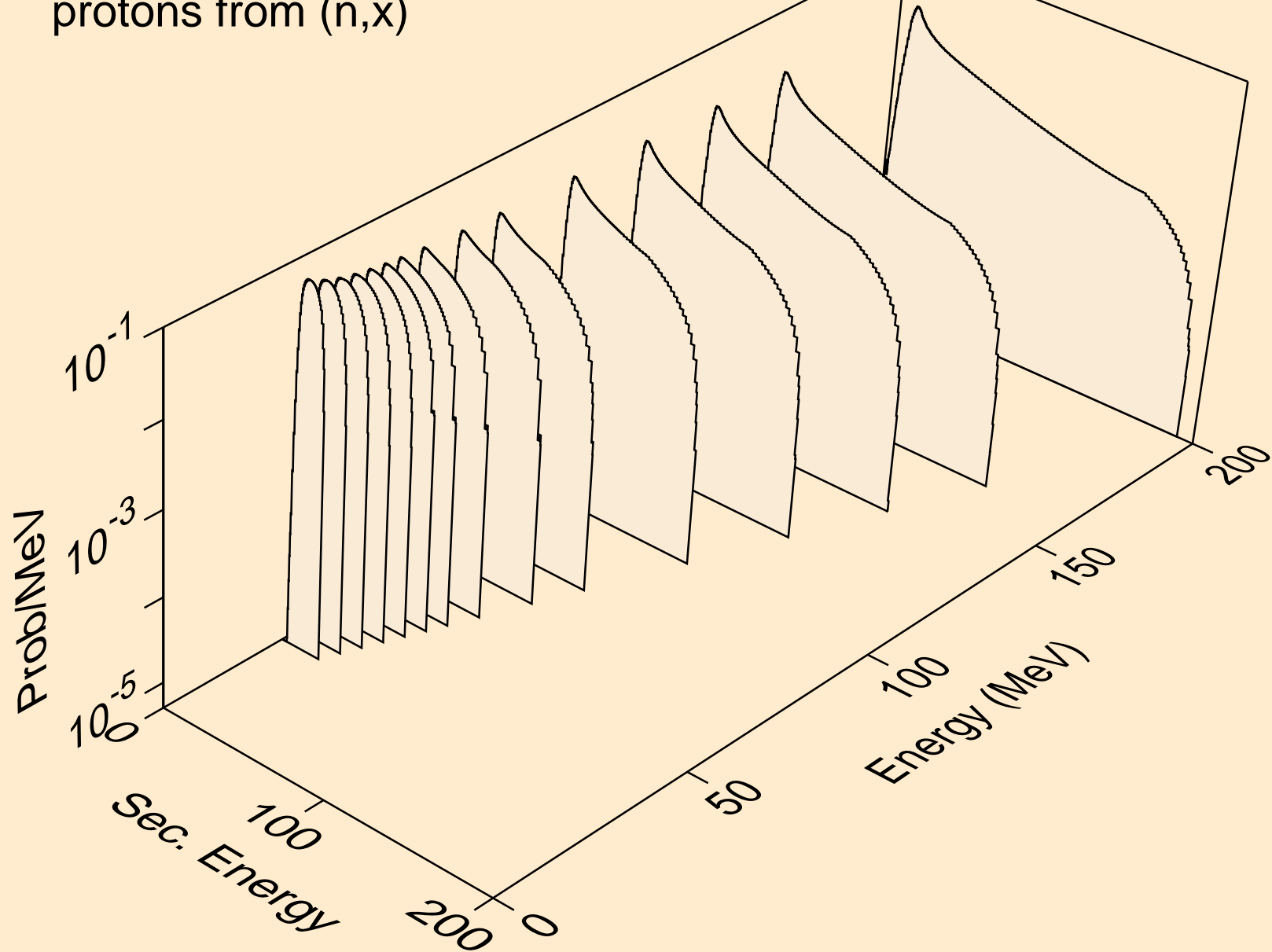

BA142 NEUTRON ACER TENDL-2021 LIBRARY; T=293.6K
protons from (n,n*)p

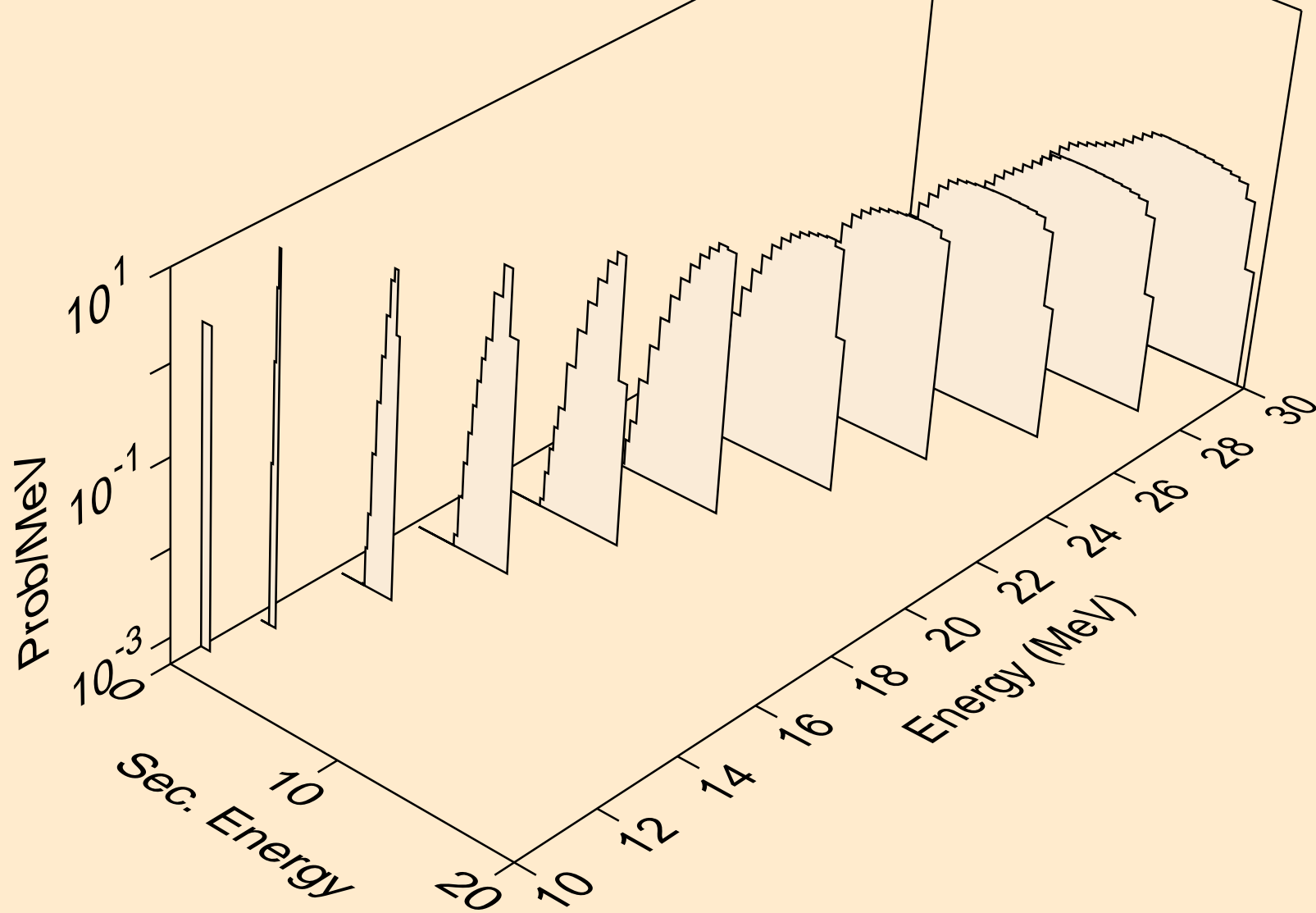

BA142 NEUTRON ACER TENDL-2021 LIBRARY; T=293.6K
protons from (n,2np)

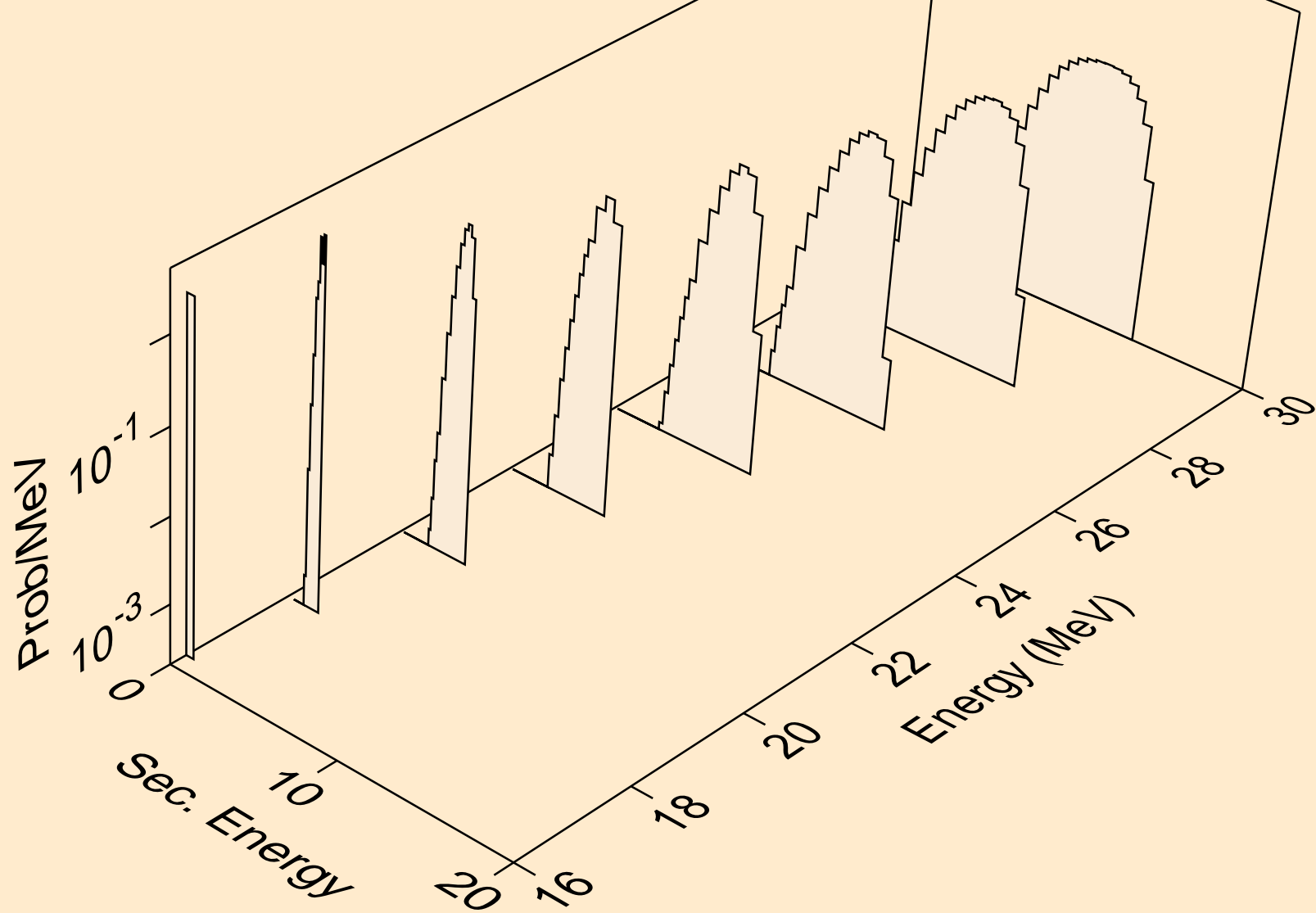

BA142 NEUTRON ACER TENDL-2021 LIBRARY; T=293.6K
protons from (n,3np)

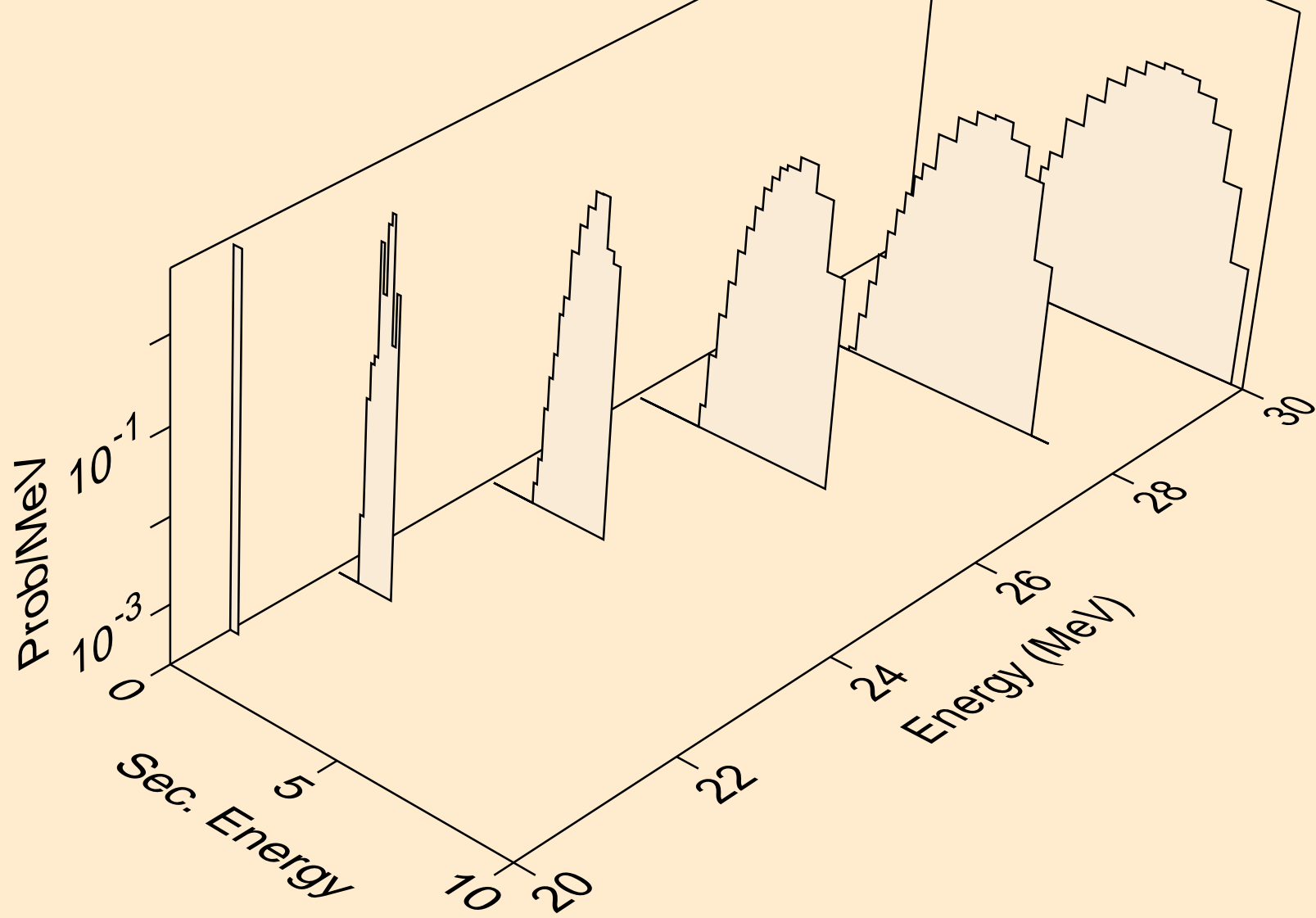

BA142 NEUTRON ACER TENDL-2021 LIBRARY; T=293.6K
protons from (n,p)

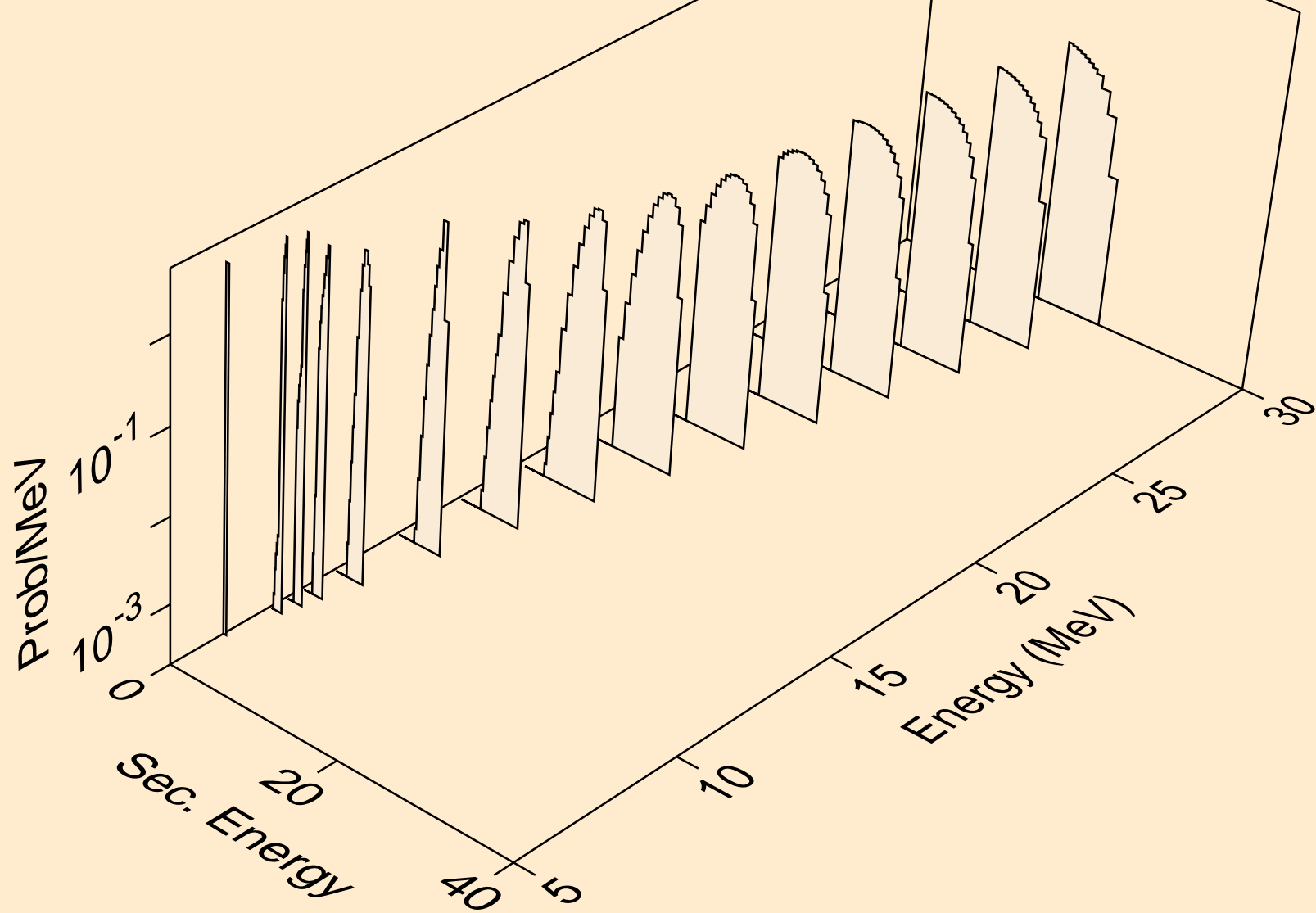

BA142 NEUTRON ACER TENDL-2021 LIBRARY; T=293.6K
protons from (n,2p)

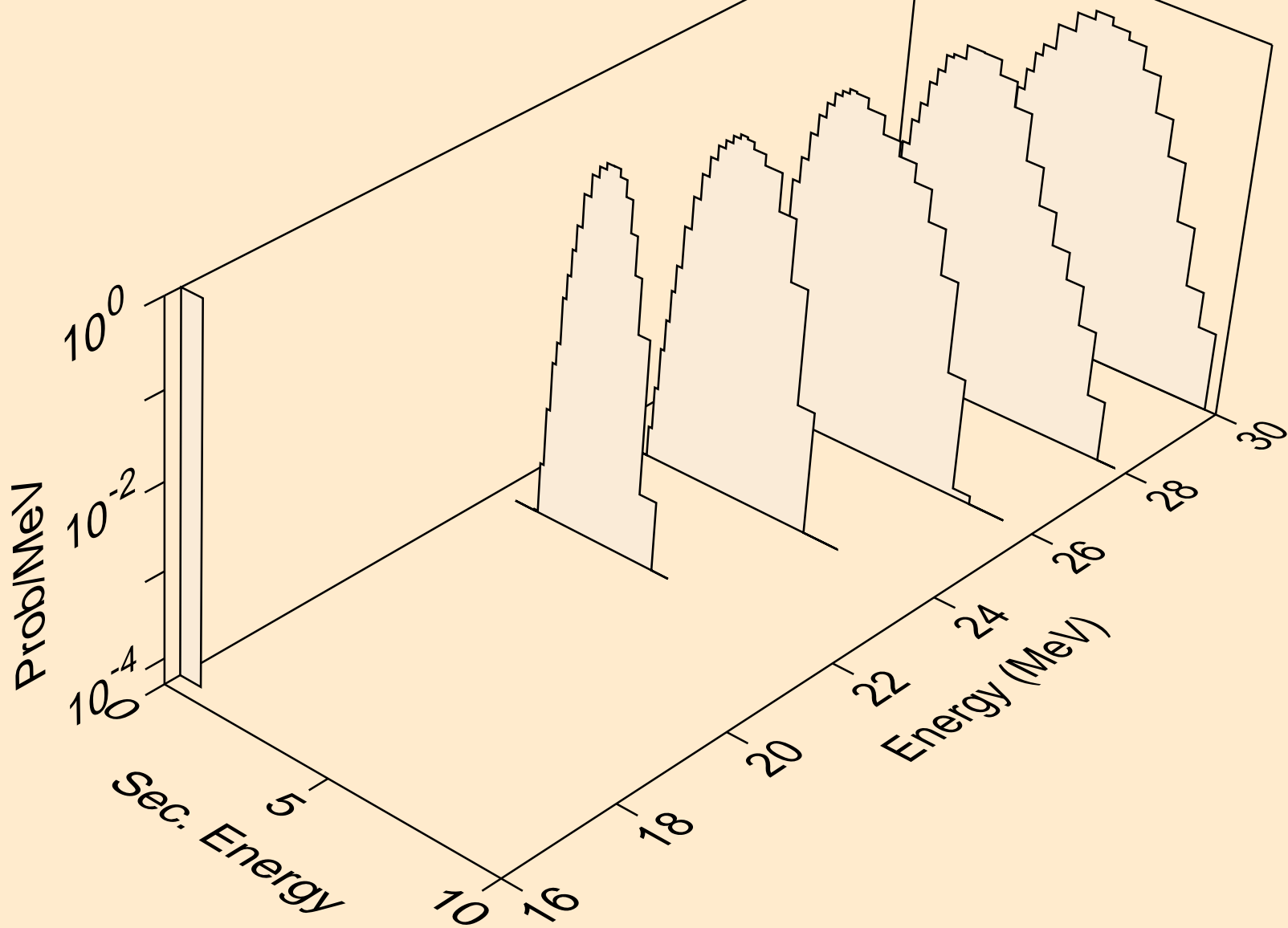

BA142 NEUTRON ACER TENDL-2021 LIBRARY; T=293.6K
protons from (n,p)

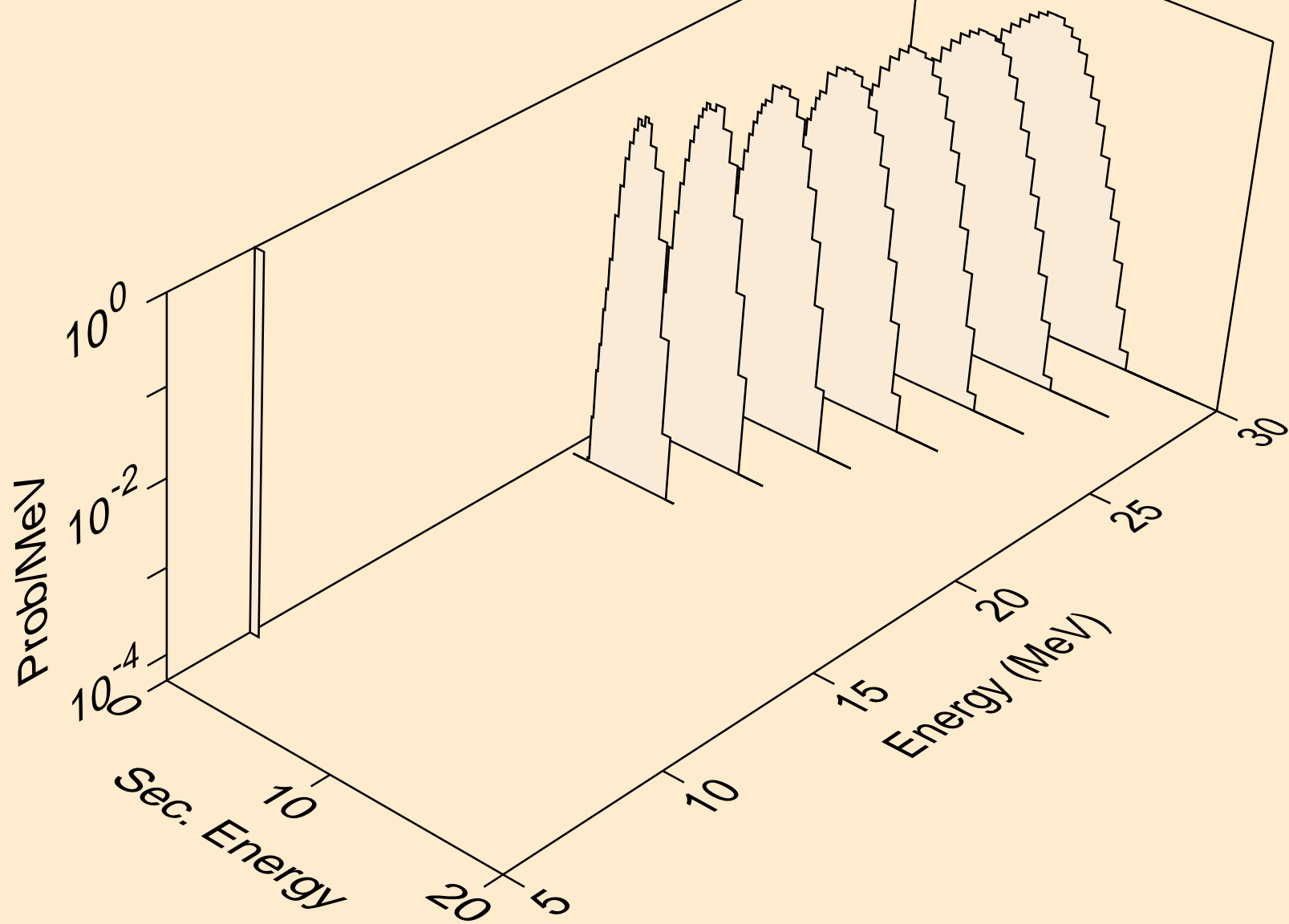

BA142 NEUTRON ACER TENDL-2021 LIBRARY; T=293.6K
deuterons from (n,x)

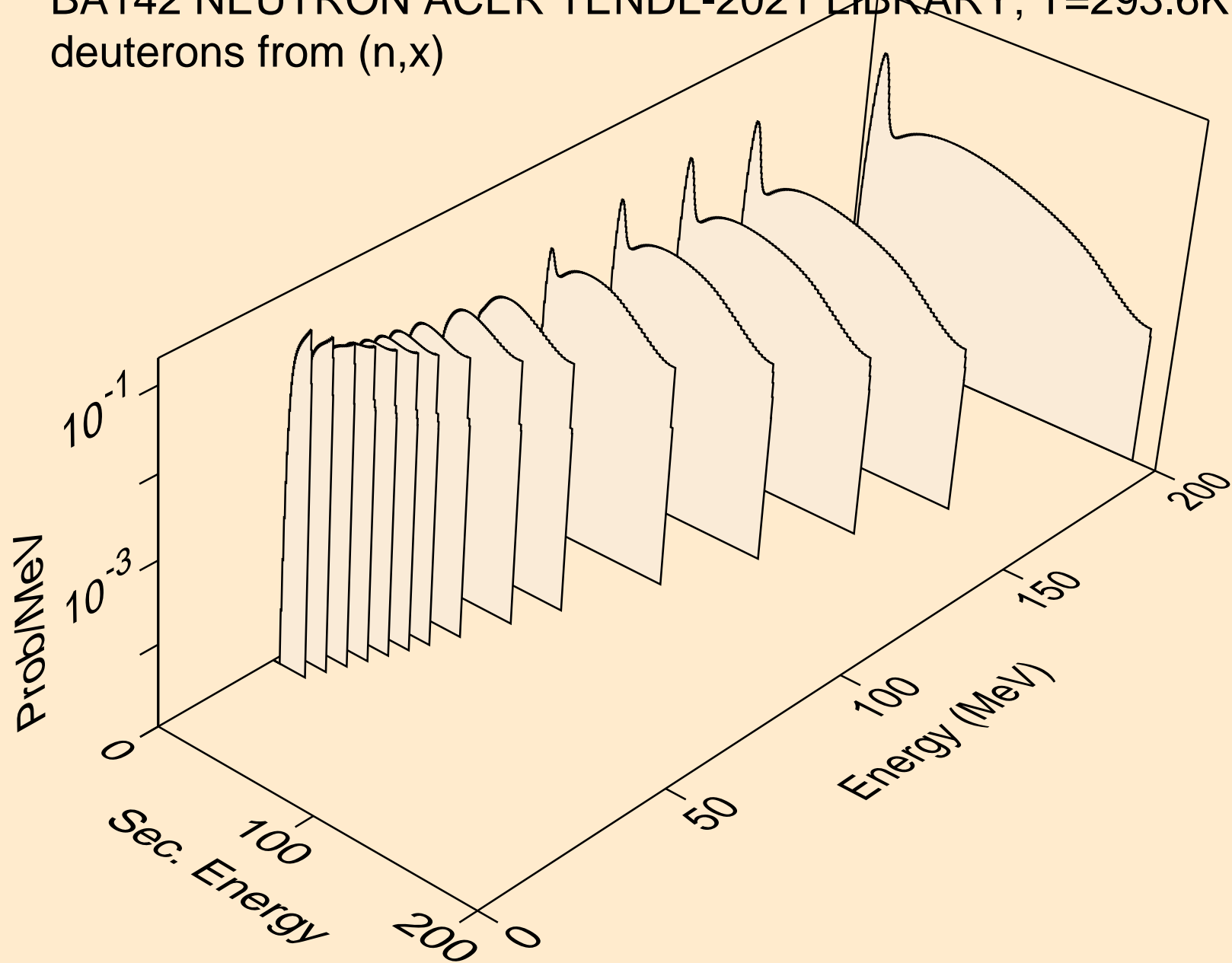

BA142 NEUTRON ACER TENDL-2021 LIBRARY; T=293.6K
deuterons from (n,2nd)

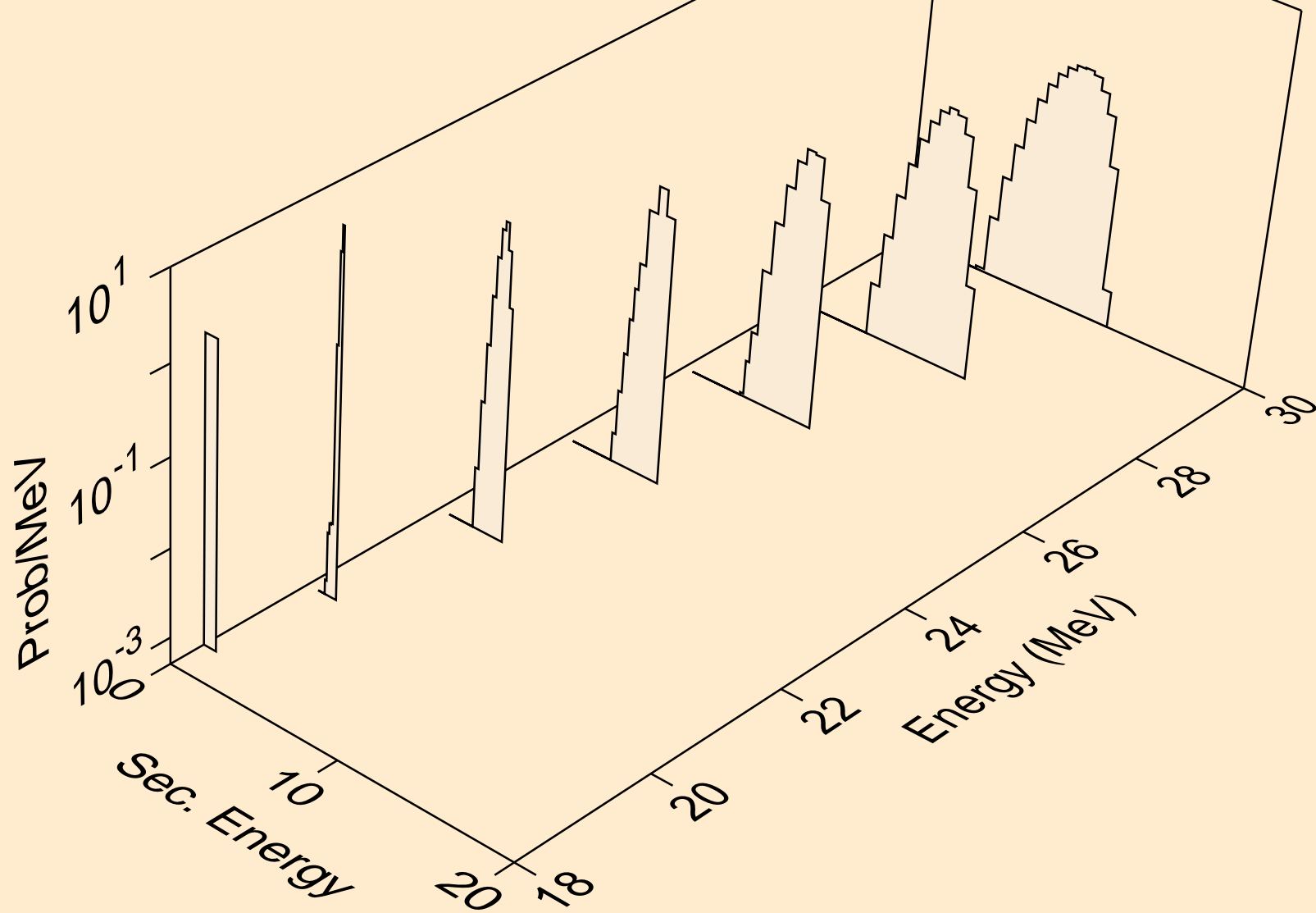

BA142 NEUTRON ACER TENDL-2021 LIBRARY; T=293.6K
deuterons from (n,n*)d

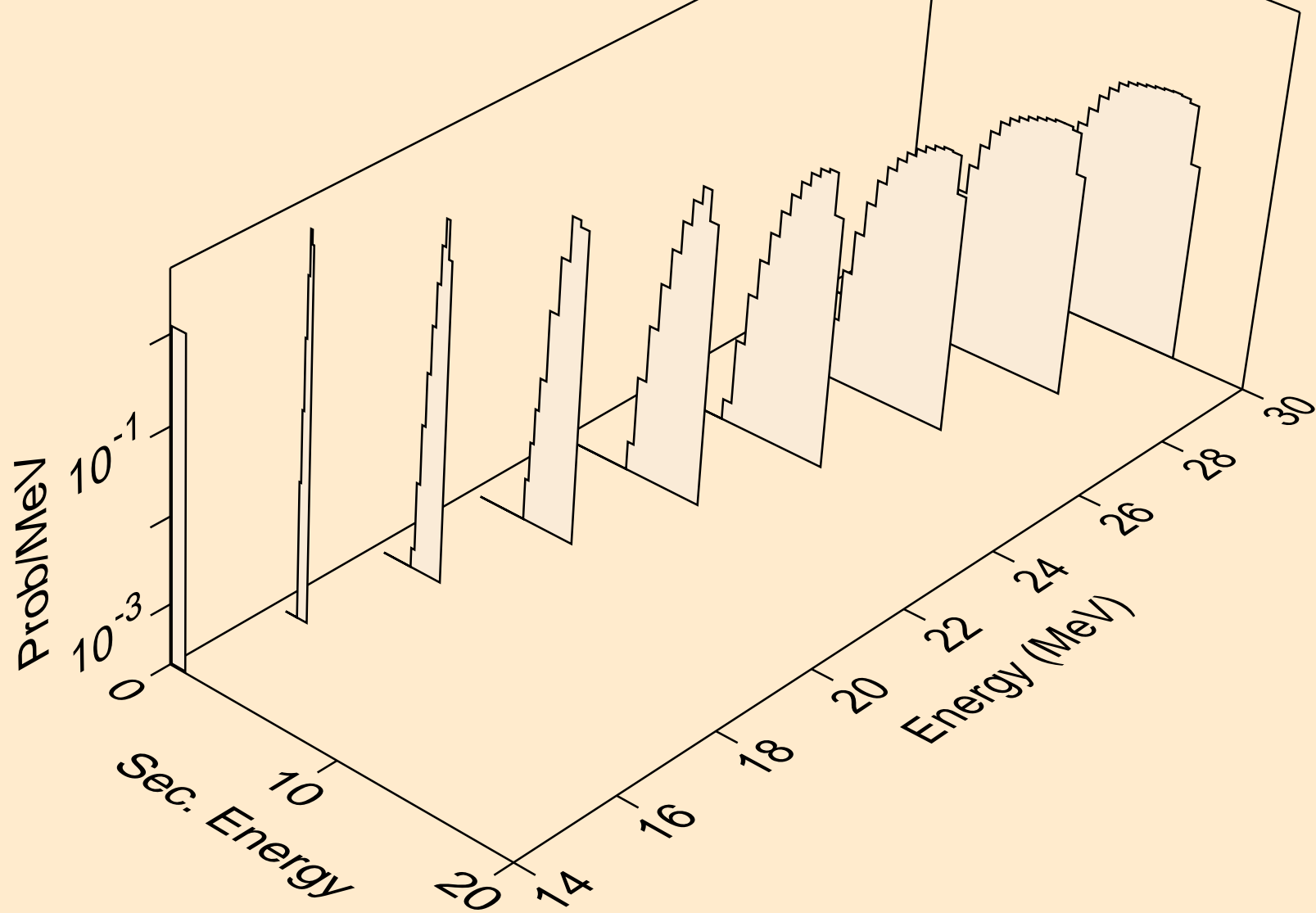

BA142 NEUTRON ACER TENDL-2021 LIBRARY; T=293.6K
deuterons from (n,d)

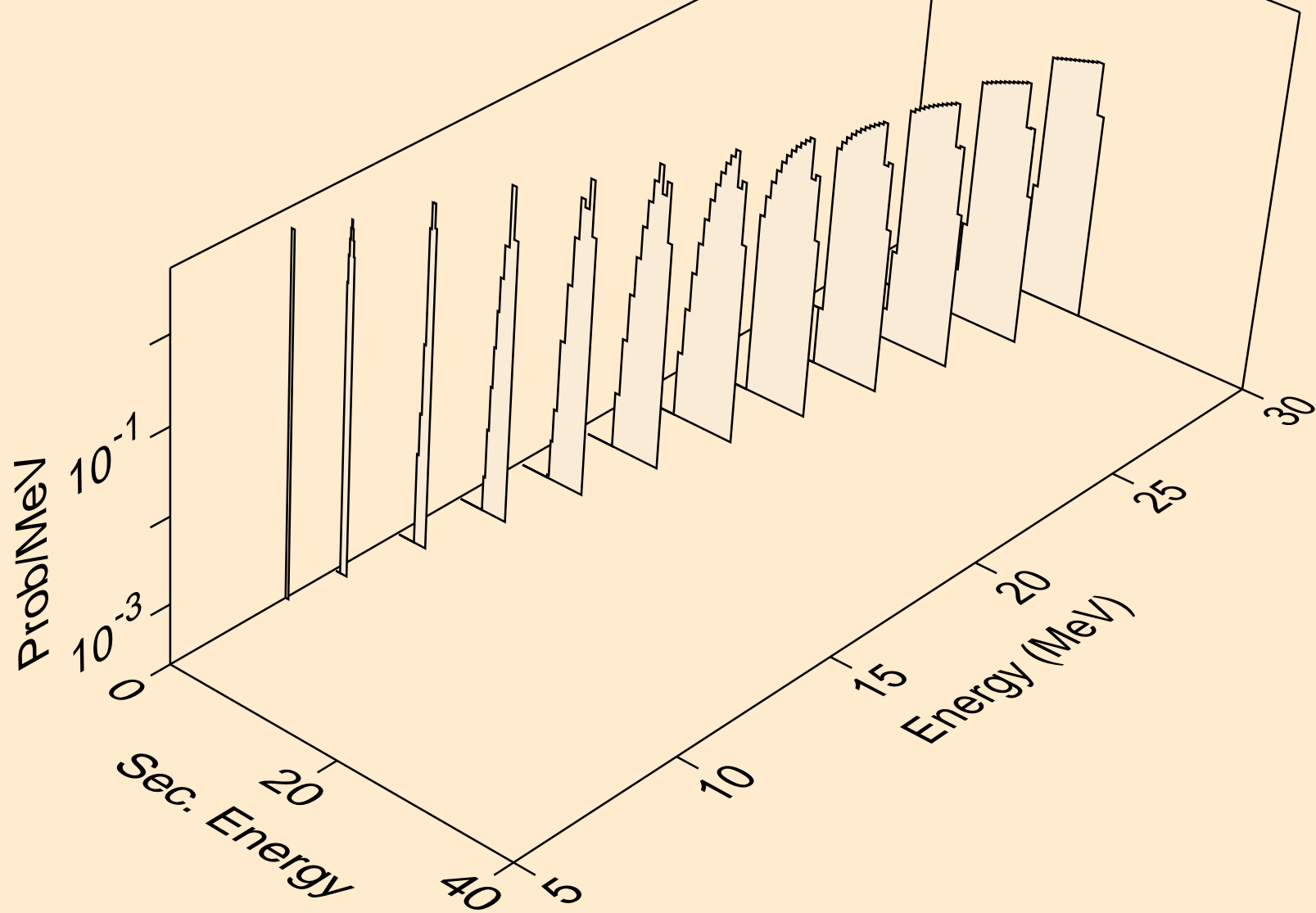

BA142 NEUTRON ACER TENDL-2021 LIBRARY; T=293.6K
tritons from (n,x)

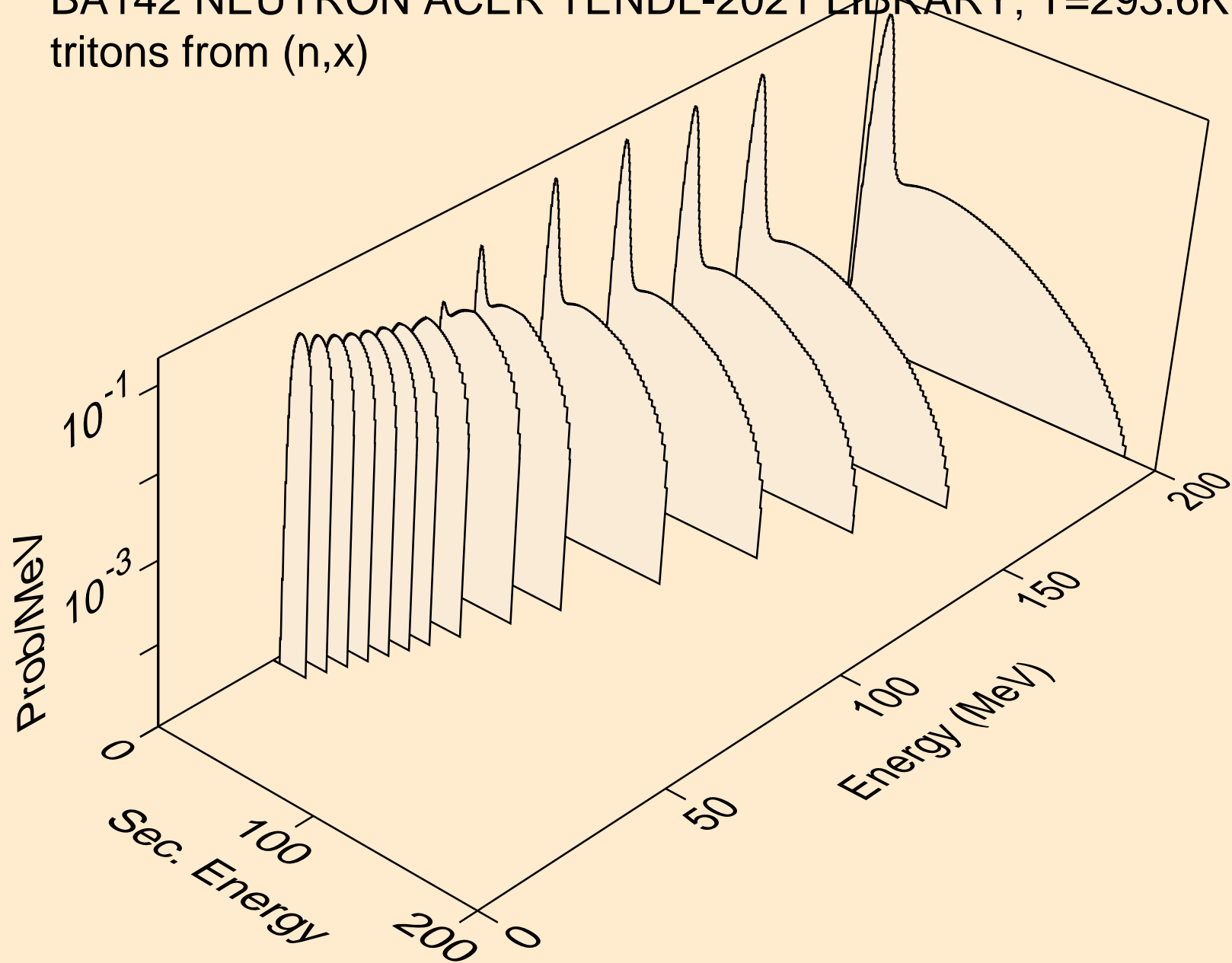

BA142 NEUTRON ACER TENDL-2021 LIBRARY; T=293.6K
tritons from (n,n*)t

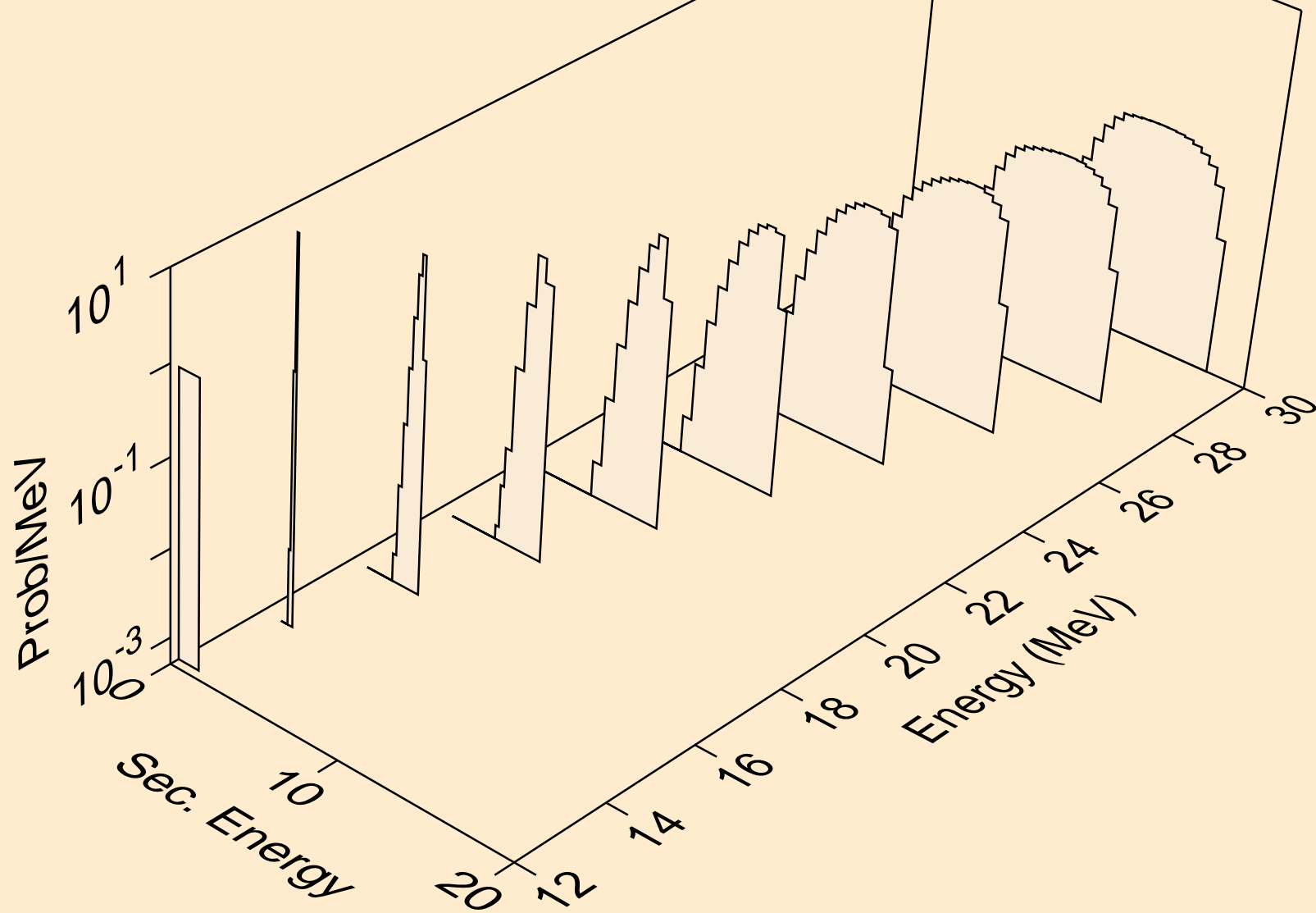

BA142 NEUTRON ACER TENDL-2021 LIBRARY; T=293.6K
tritons from (n,t)

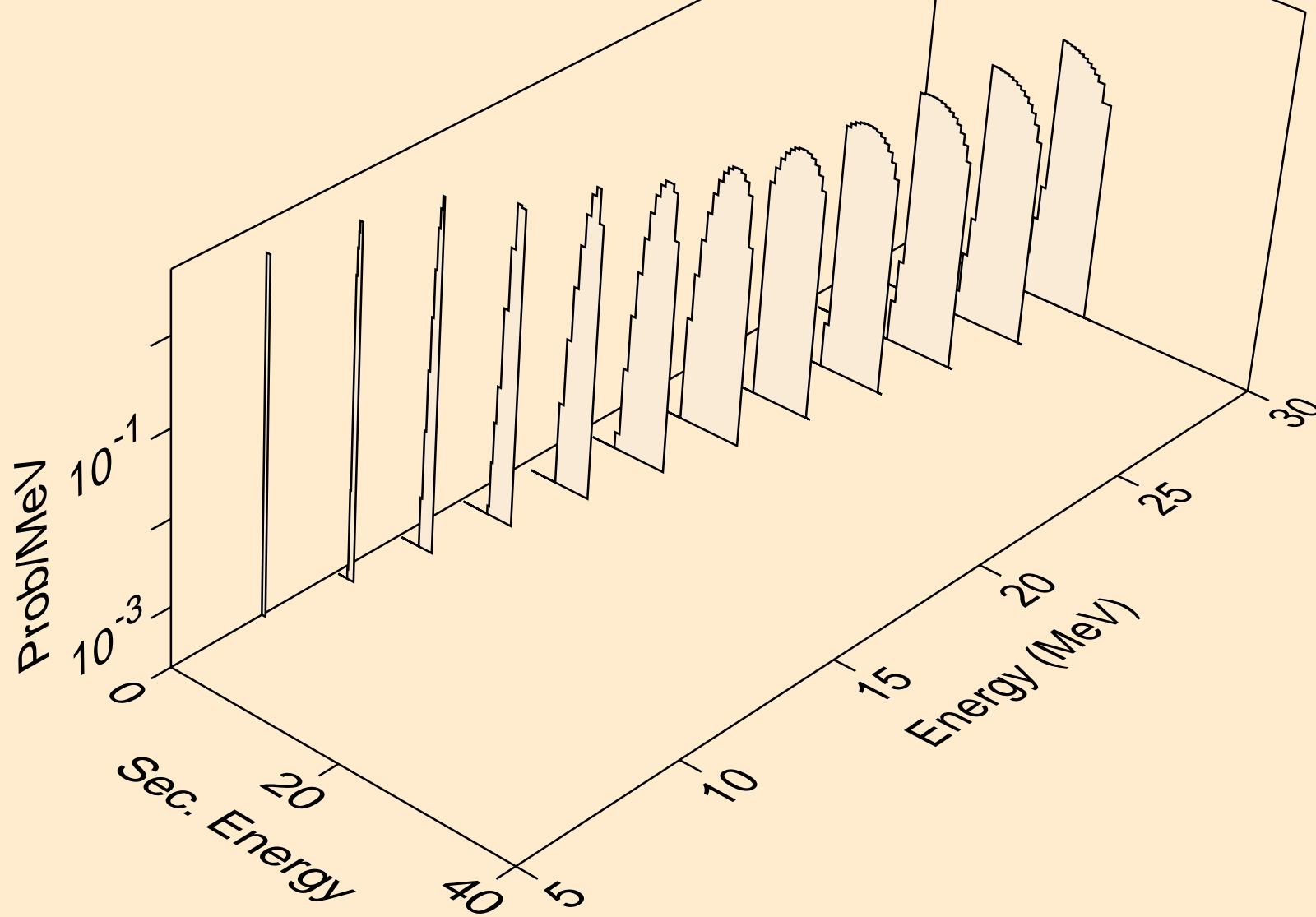

BA142 NEUTRON ACER TENDL-2021 LIBRARY; T=293.6K
he3s from (n,x)

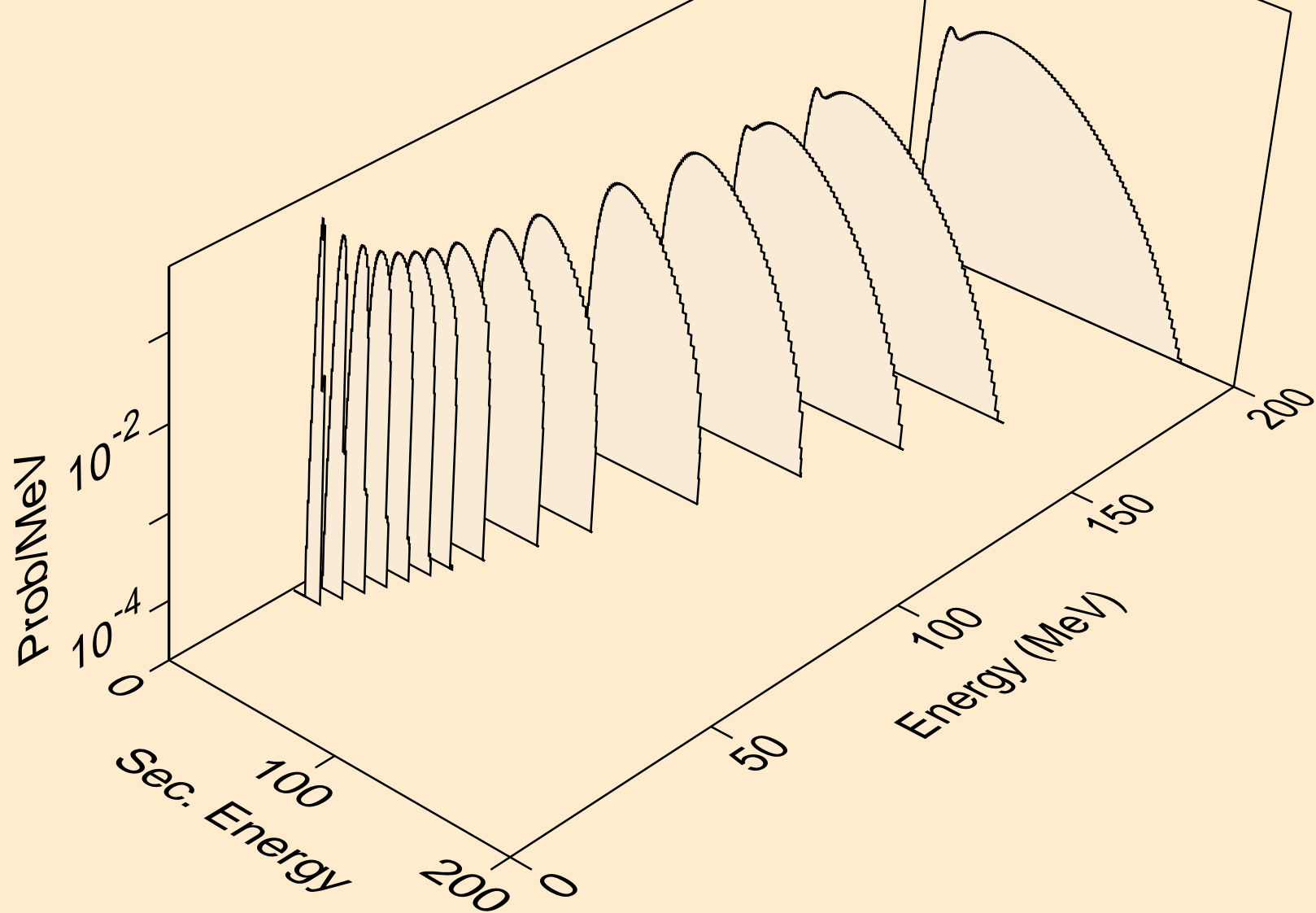

BA142 NEUTRON ACER TENDL-2021 LIBRARY; T=293.6K
he3s from (n,n*)he3

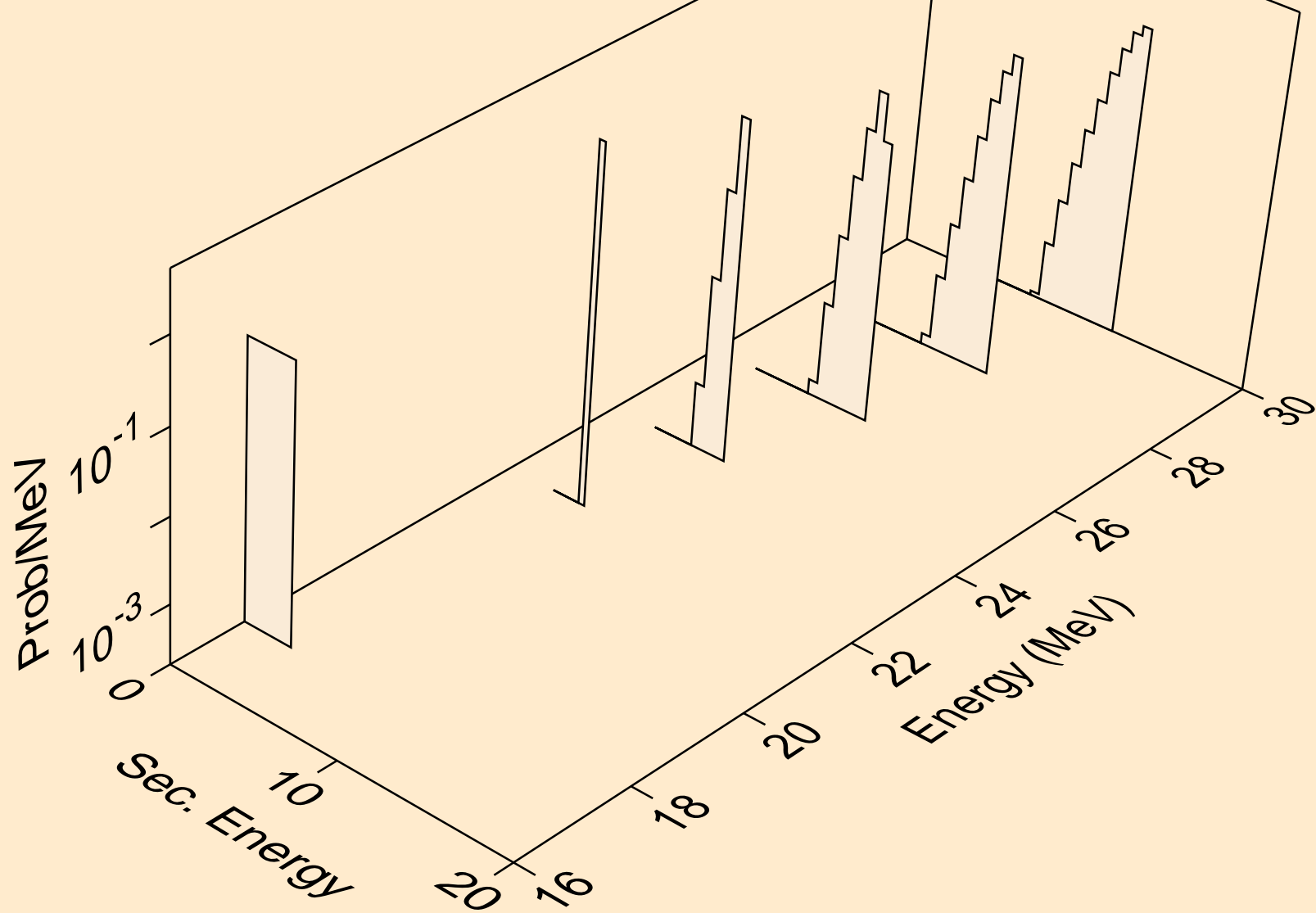

BA142 NEUTRON ACER TENDL-2021 LIBRARY; T=293.6K
he3s from (n,he3)

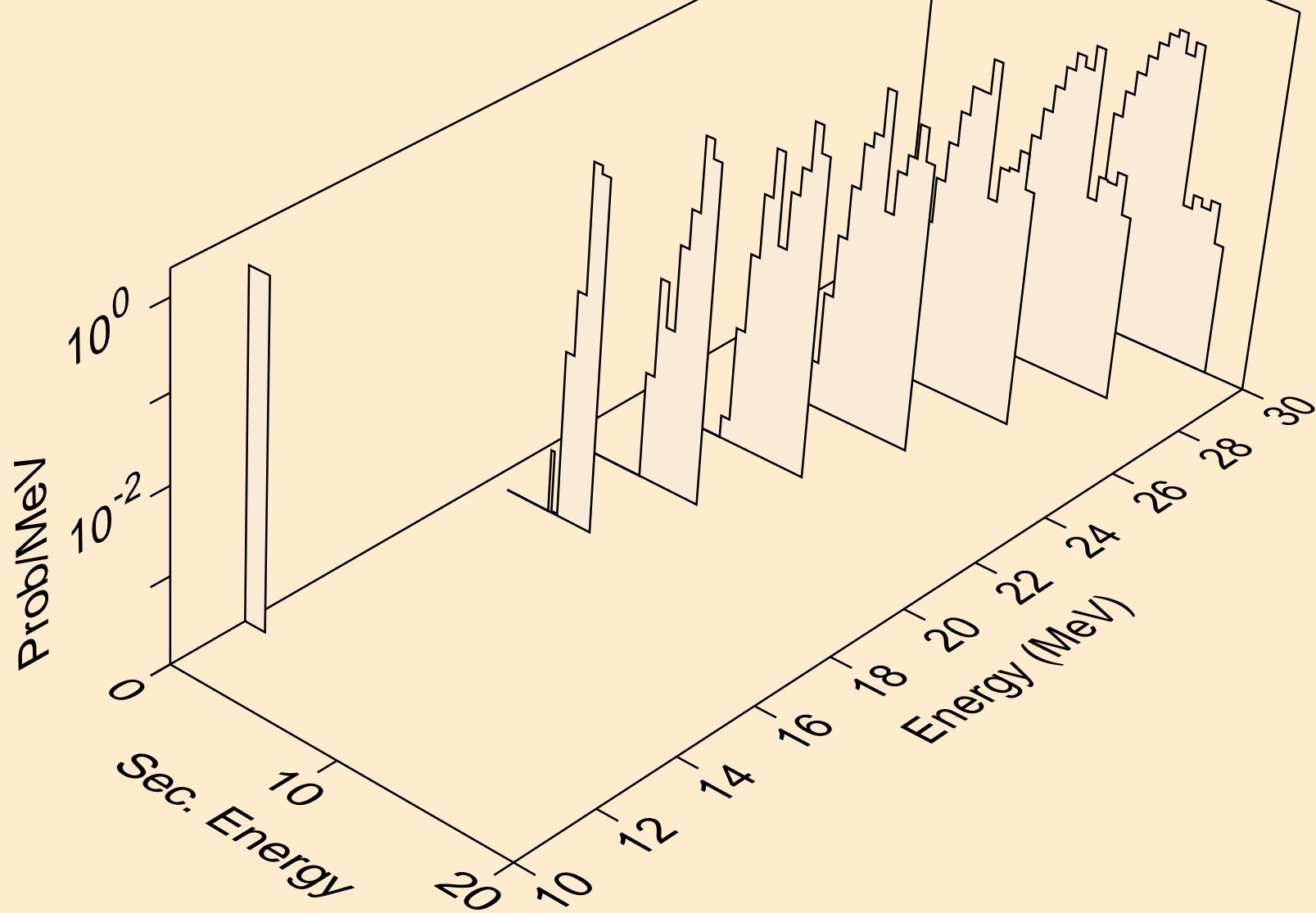

BA142 NEUTRON ACER TENDL-2021 LIBRARY; T=293.6K
alphas from (n,x)

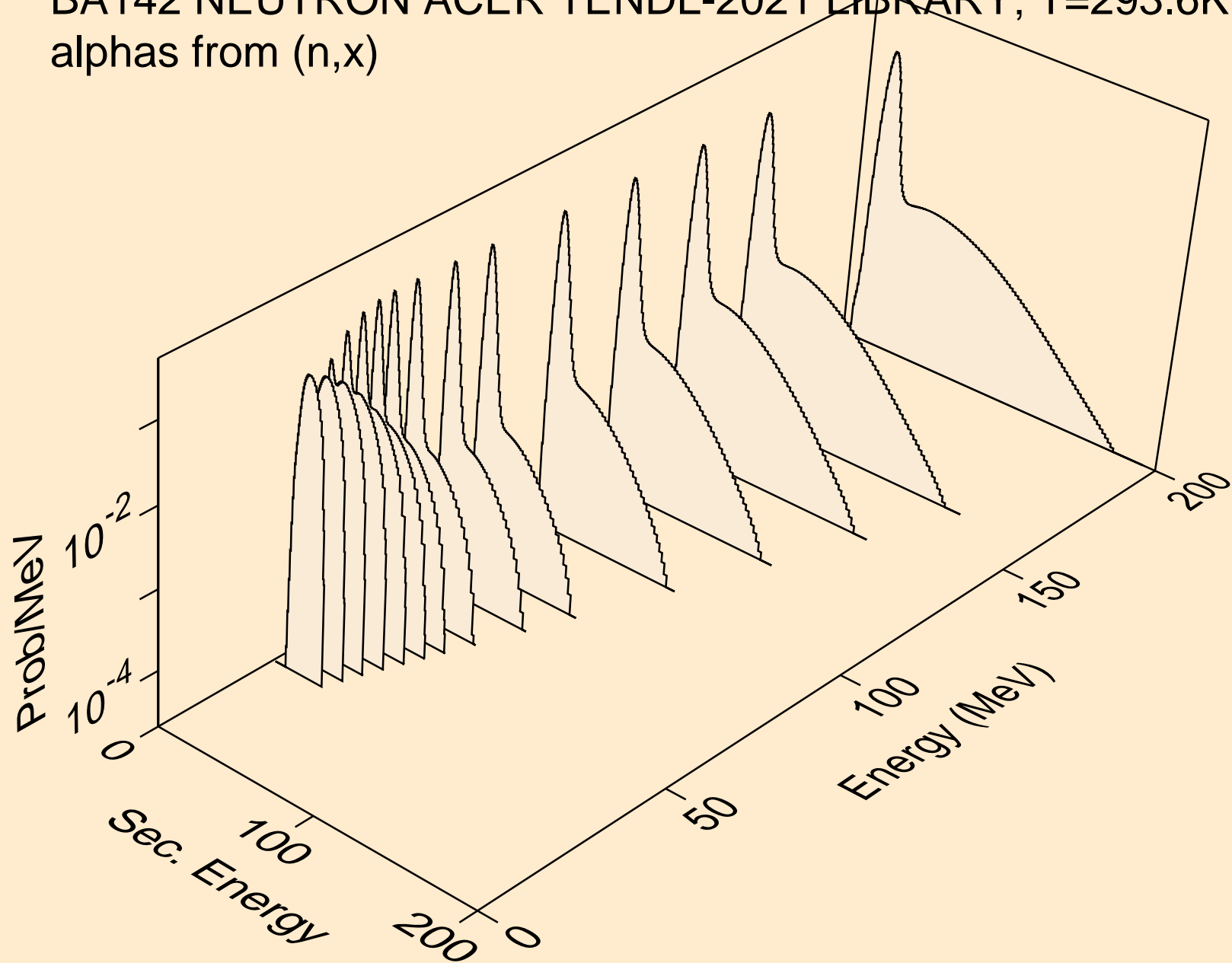

BA142 NEUTRON ACER TENDL-2021 LIBRARY; T=293.6K
alphas from (n,n*)a

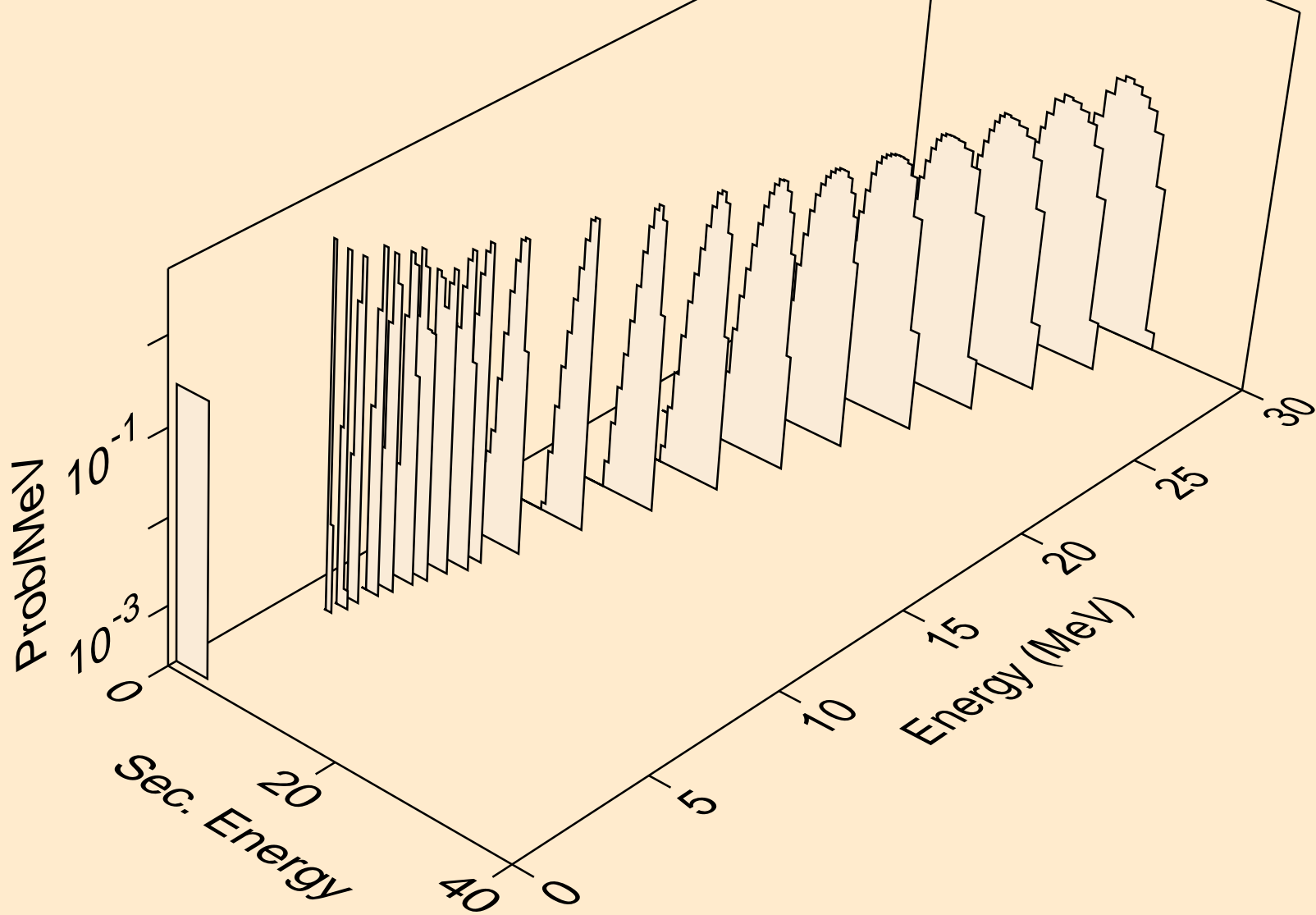

BA142 NEUTRON ACER TENDL-2021 LIBRARY; T=293.6K
alphas from (n,2n)a

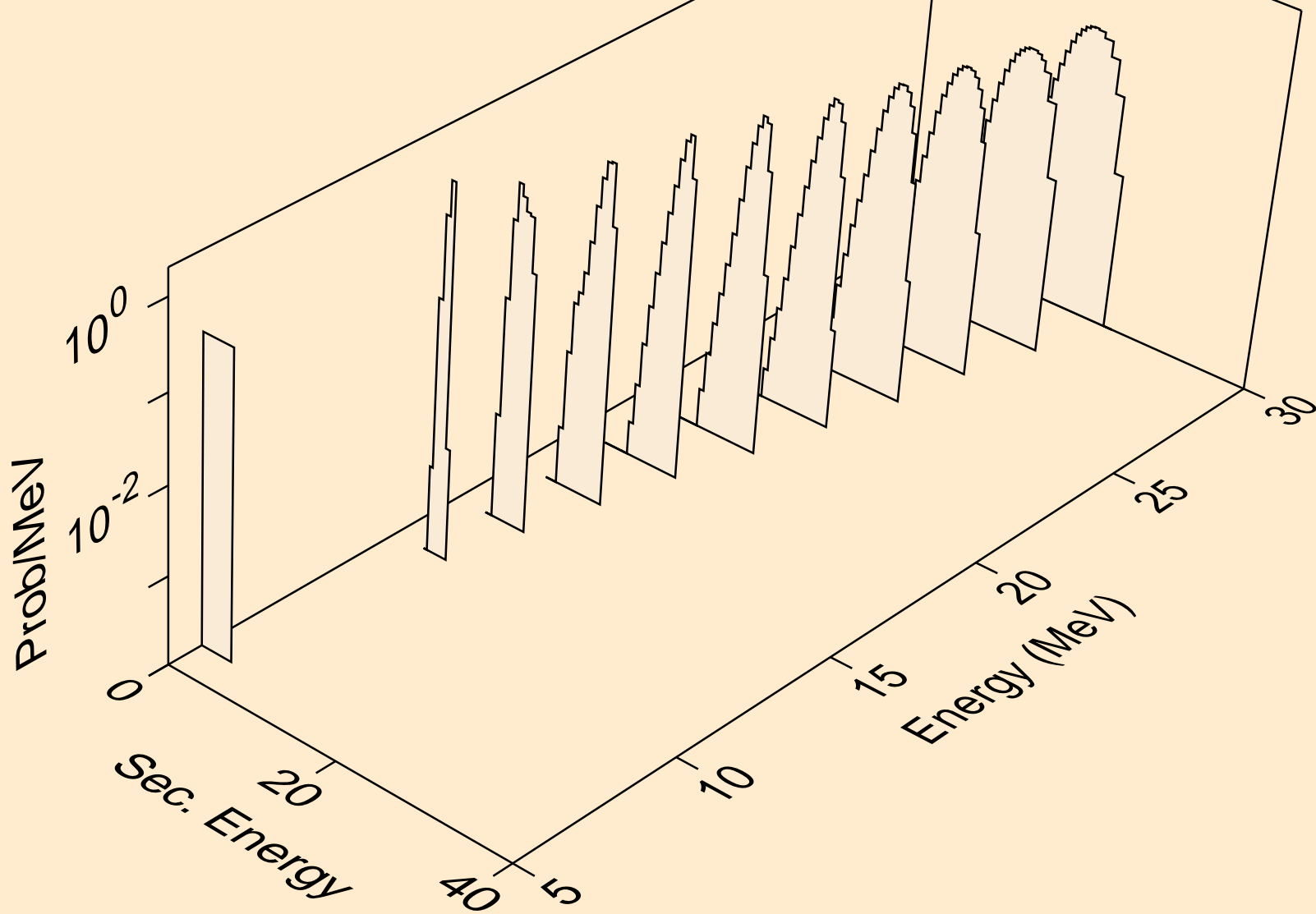

BA142 NEUTRON ACER TENDL-2021 LIBRARY; T=293.6K
alphas from (n,3n)a

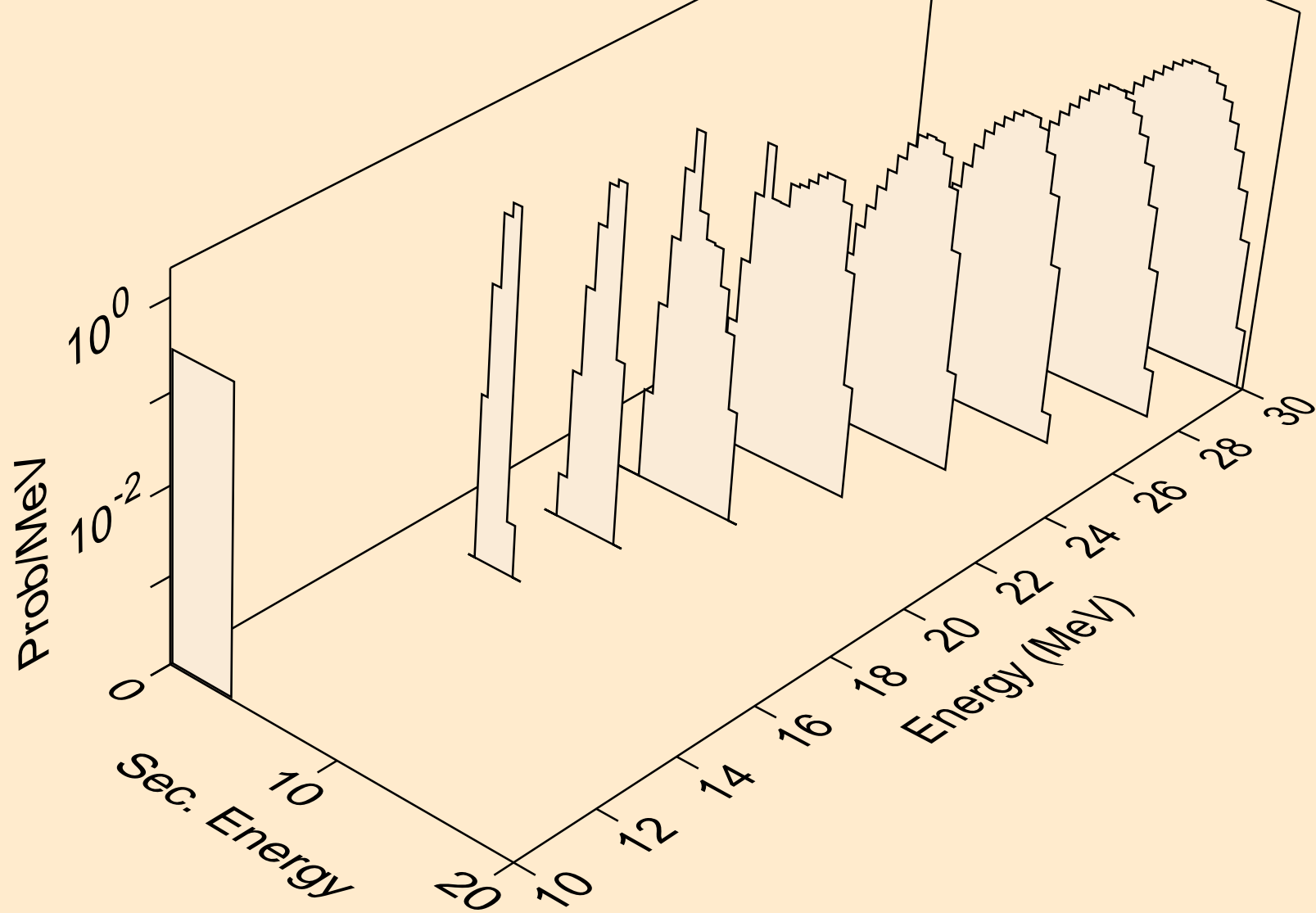

BA142 NEUTRON ACER TENDL-2021 LIBRARY; T=293.6K
alphas from (n,n*)2a

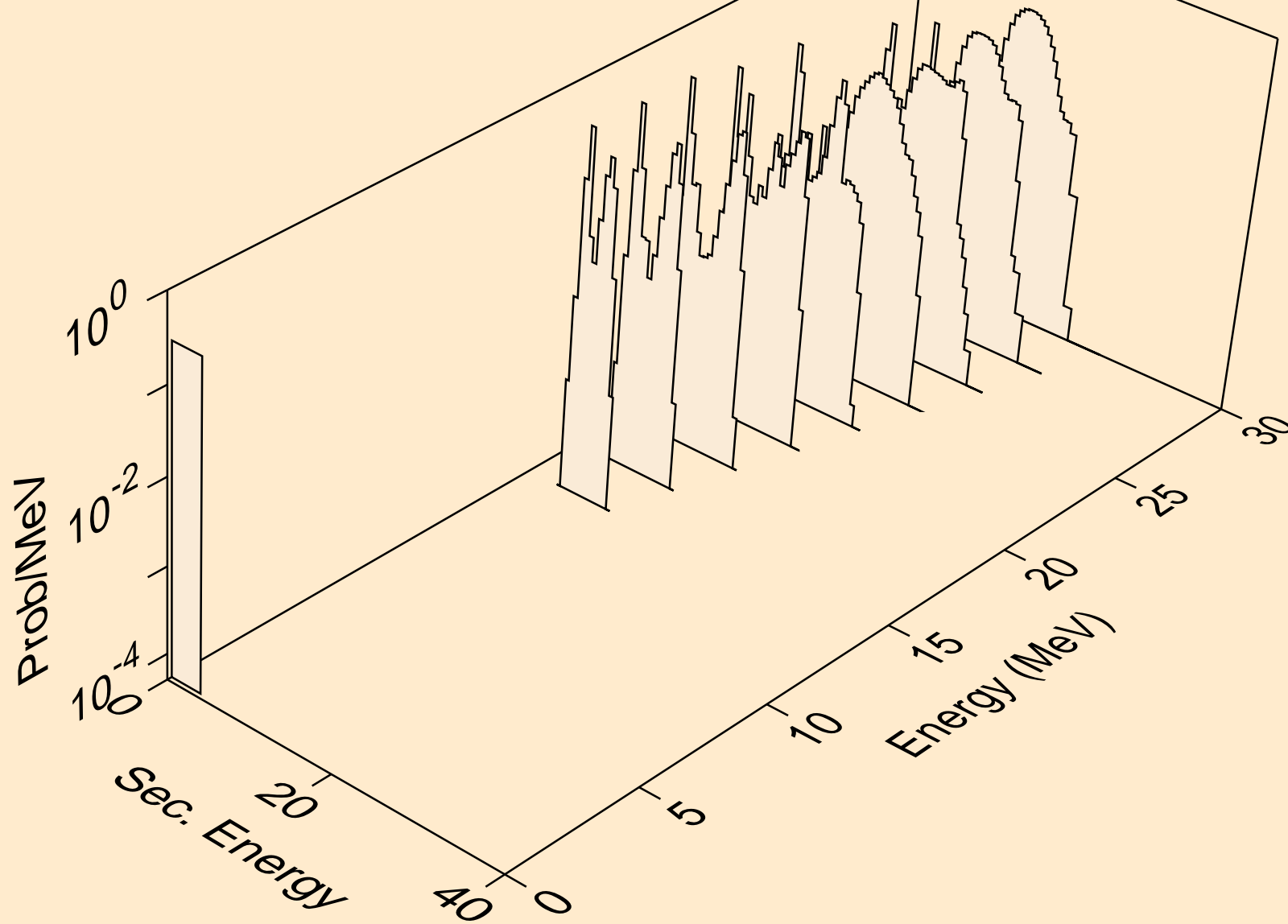

BA142 NEUTRON ACER TENDL-2021 LIBRARY; T=293.6K
alphas from (n,a)

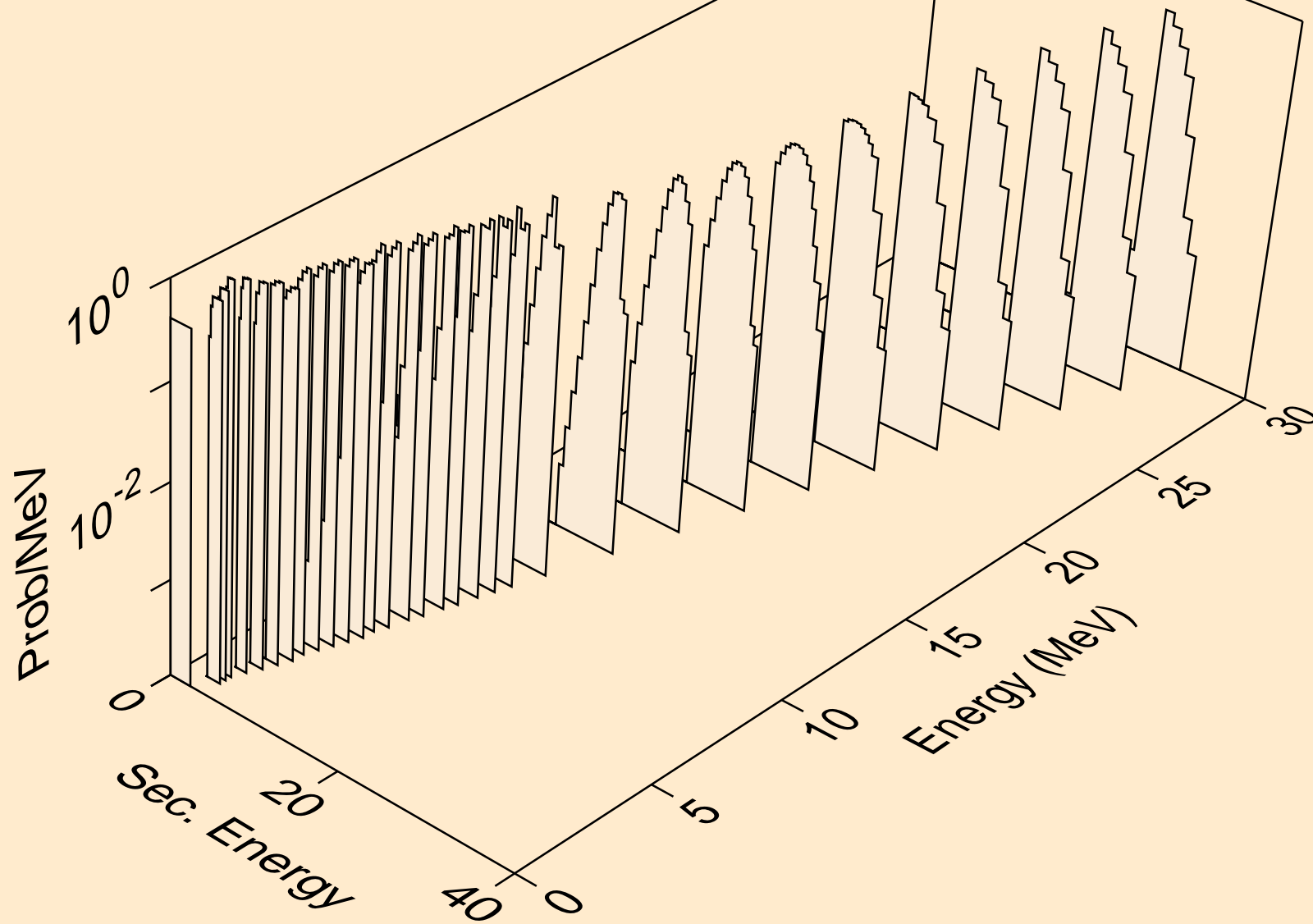

BA142 NEUTRON ACER TENDL-2021 LIBRARY; T=293.6K
alphas from (n,2a)

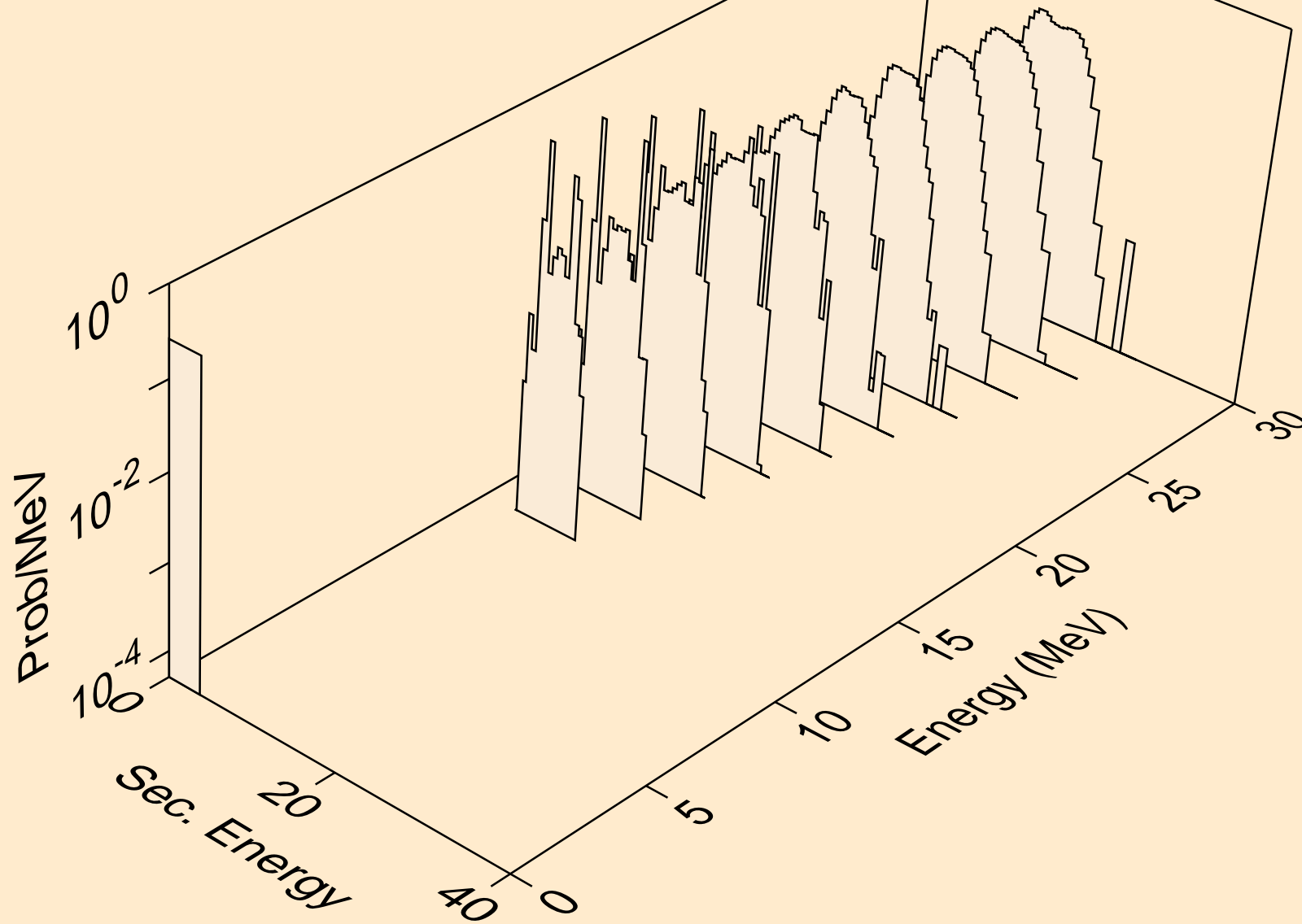

BA142 NEUTRON ACER TENDL-2021 LIBRARY; T=293.6K
alphas from (n,pa)

