

BH265 NEUTRON ACER TENDL-2021 LIBRARY; T=293.6K
Principal cross sections

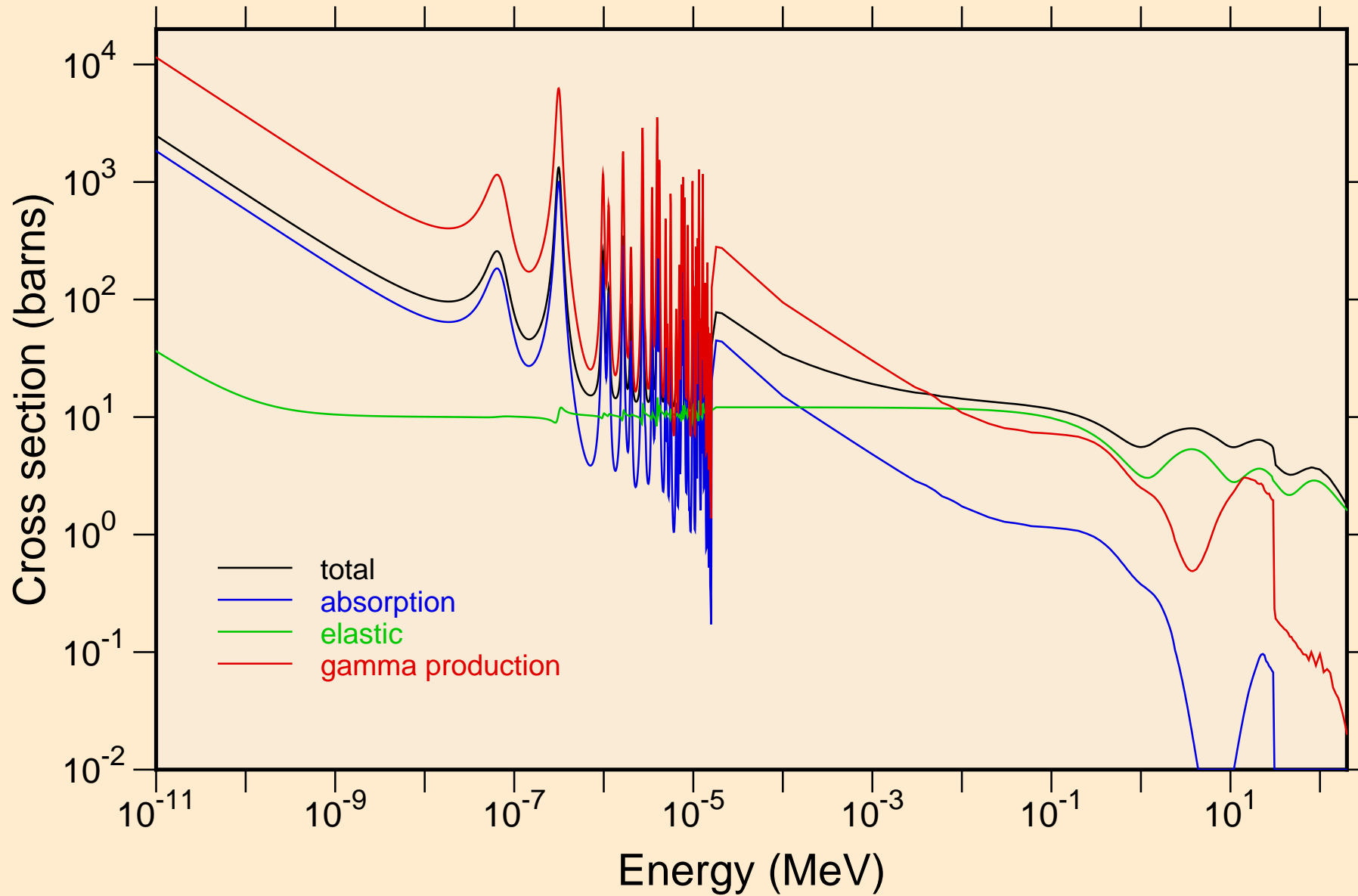

BH265 NEUTRON ACER TENDL-2021 LIBRARY; T=293.6K
resonance total cross section

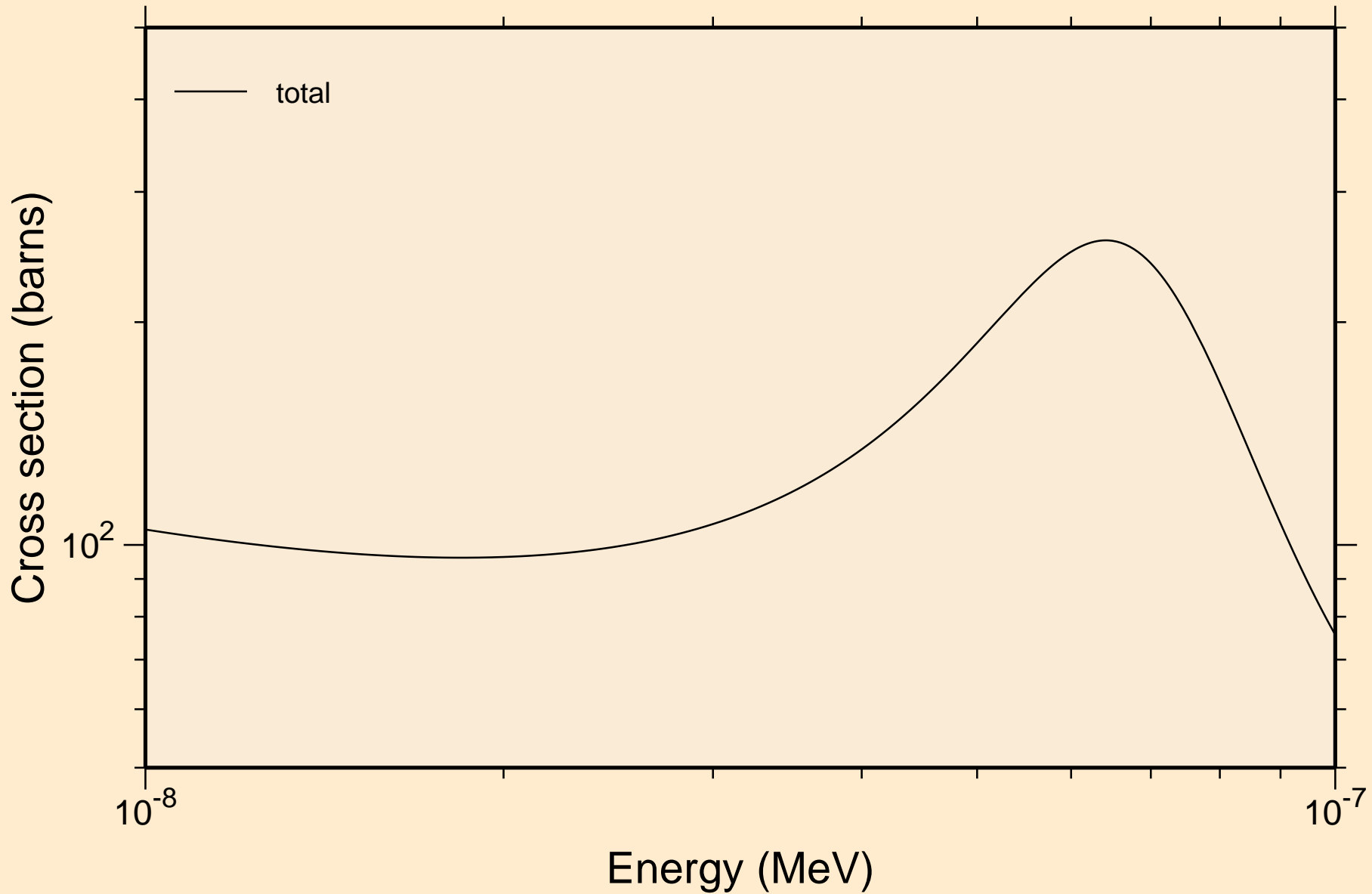

BH265 NEUTRON ACER TENDL-2021 LIBRARY; T=293.6K
resonance total cross section

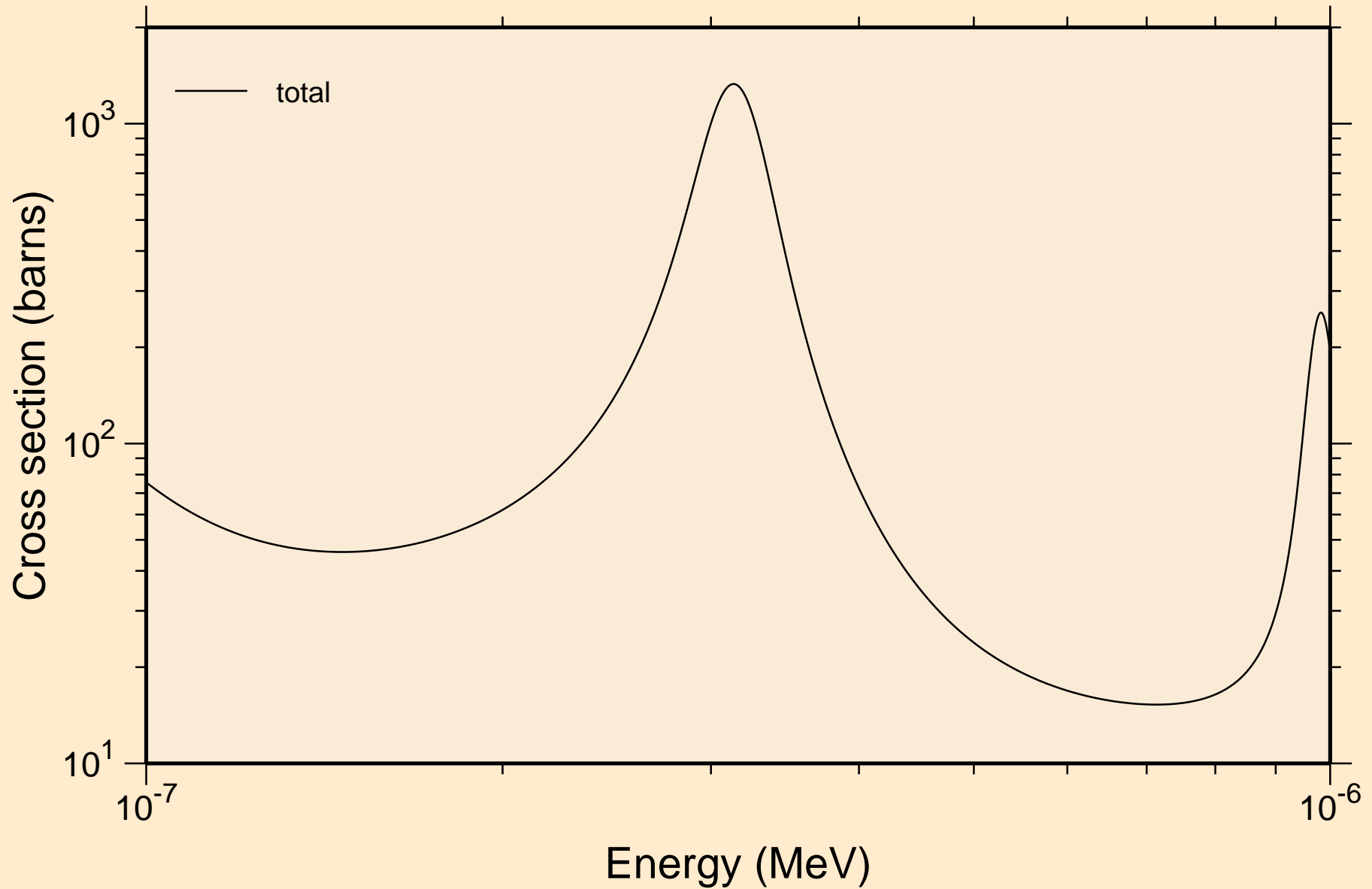

BH265 NEUTRON ACER TENDL-2021 LIBRARY; T=293.6K
resonance total cross section

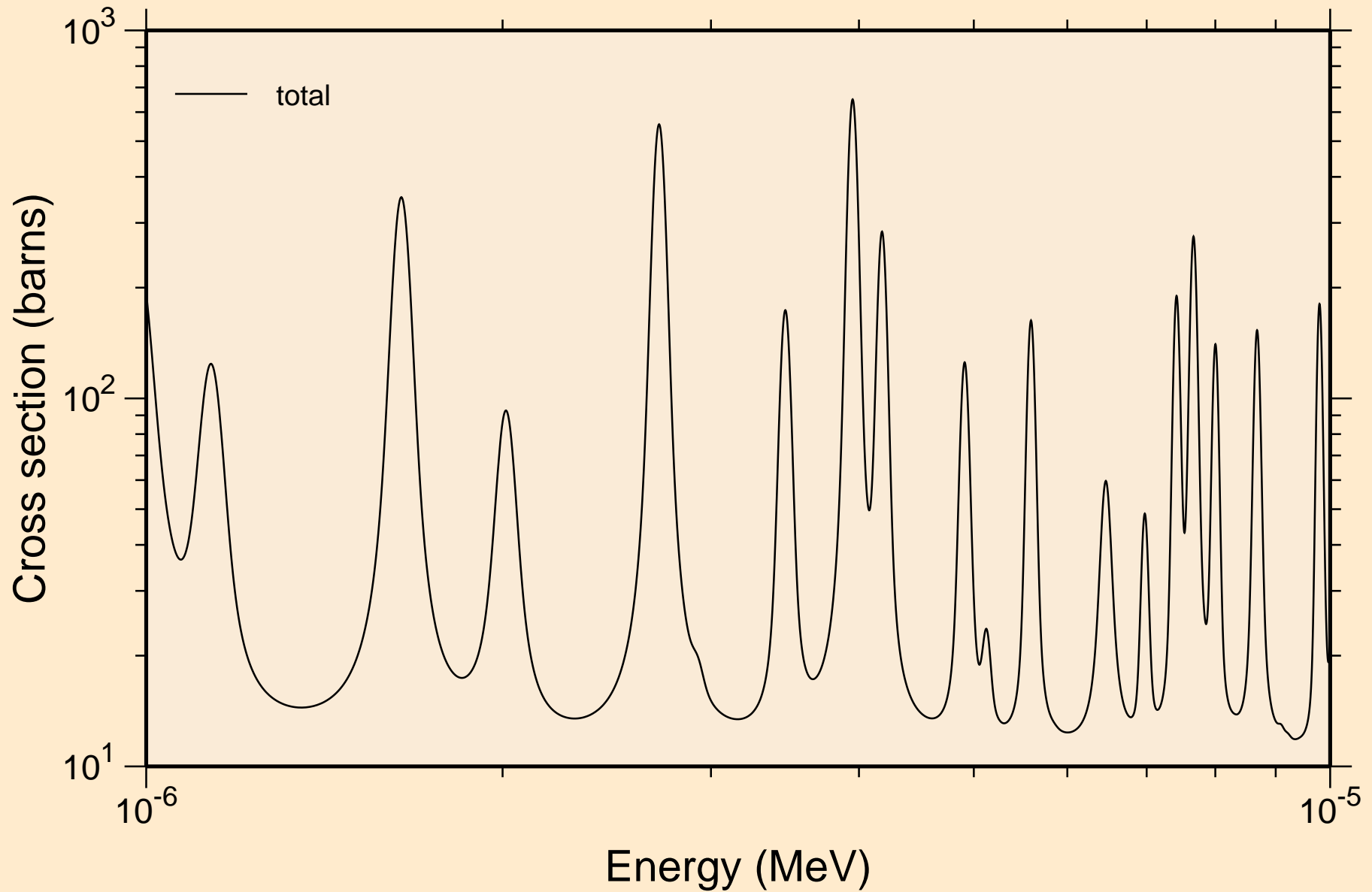

BH265 NEUTRON ACER TENDL-2021 LIBRARY; T=293.6K
resonance total cross section

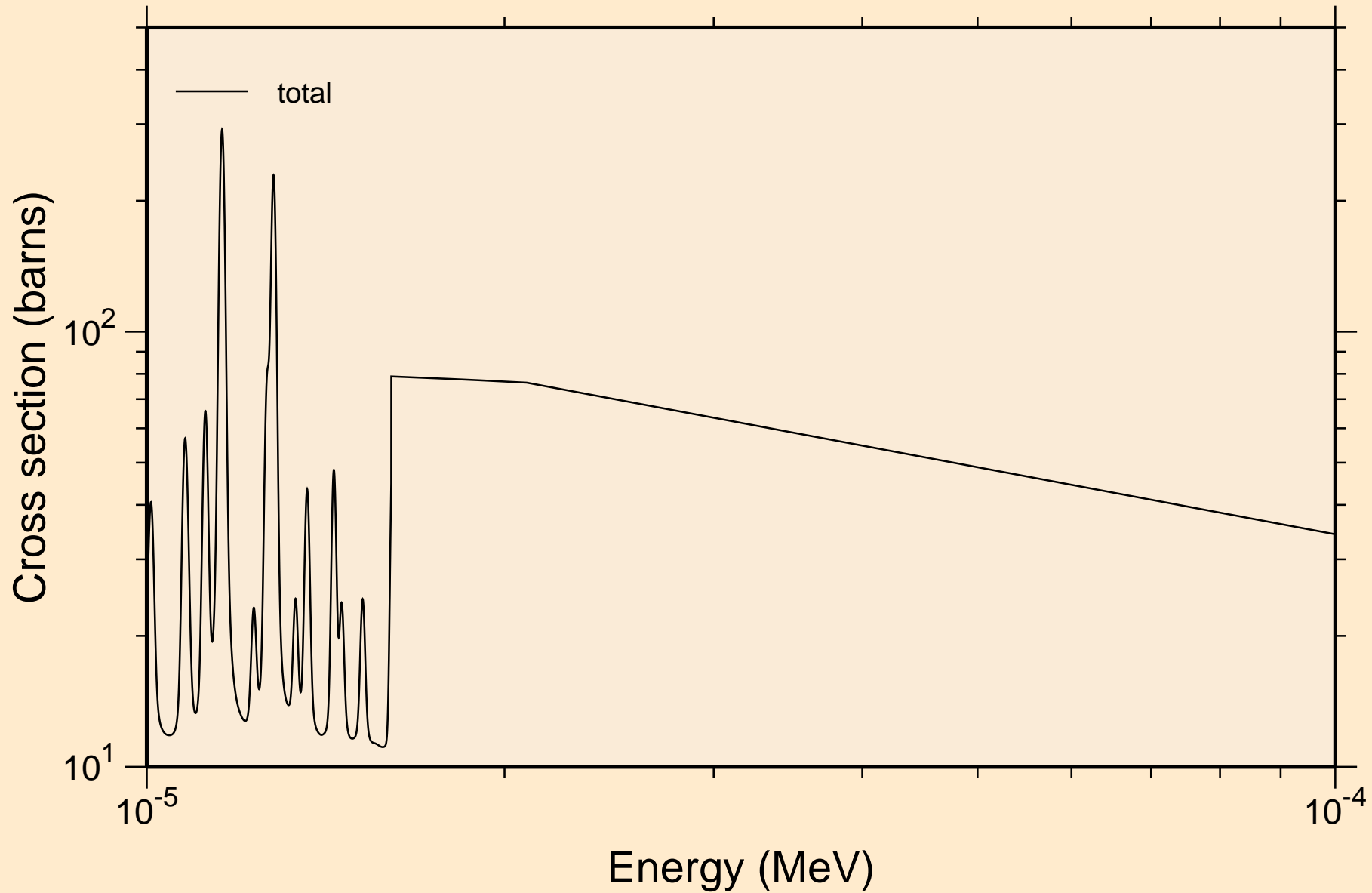

BH265 NEUTRON ACER TENDL-2021 LIBRARY; T=293.6K
resonance total cross section

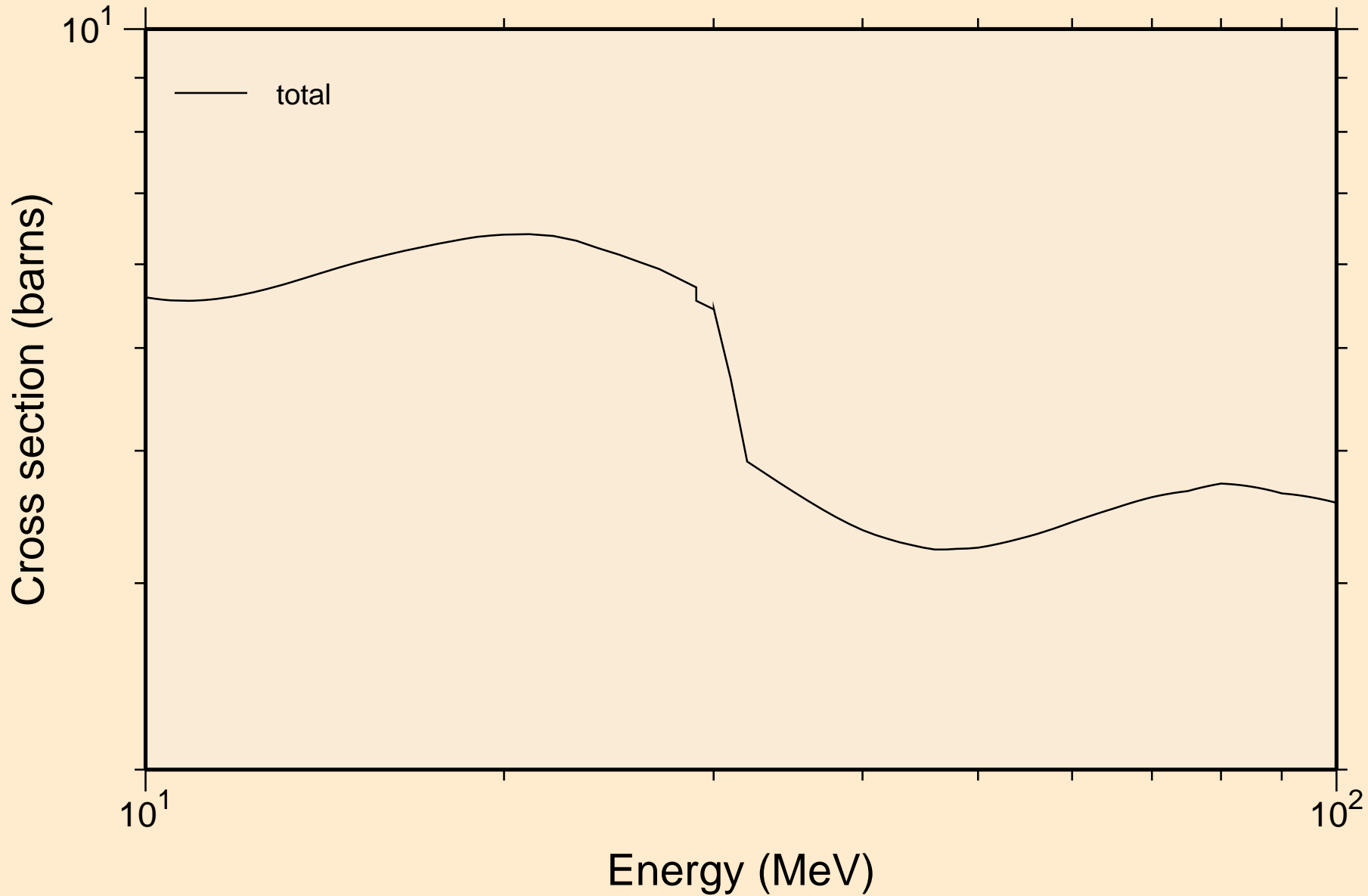

BH265 NEUTRON ACER TENDL-2021 LIBRARY; T=293.6K
resonance absorption cross sections

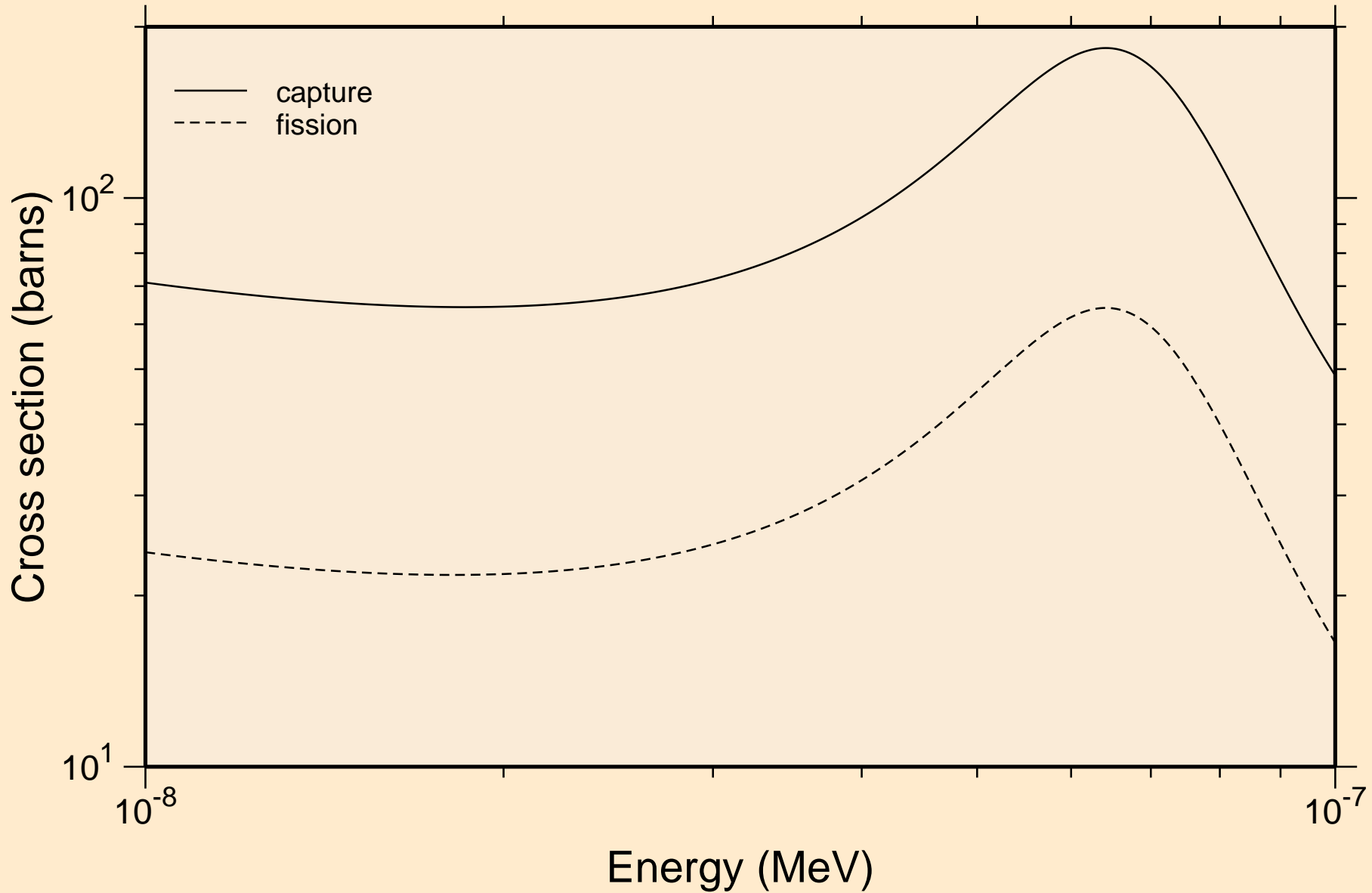

BH265 NEUTRON ACER TENDL-2021 LIBRARY; T=293.6K
resonance absorption cross sections

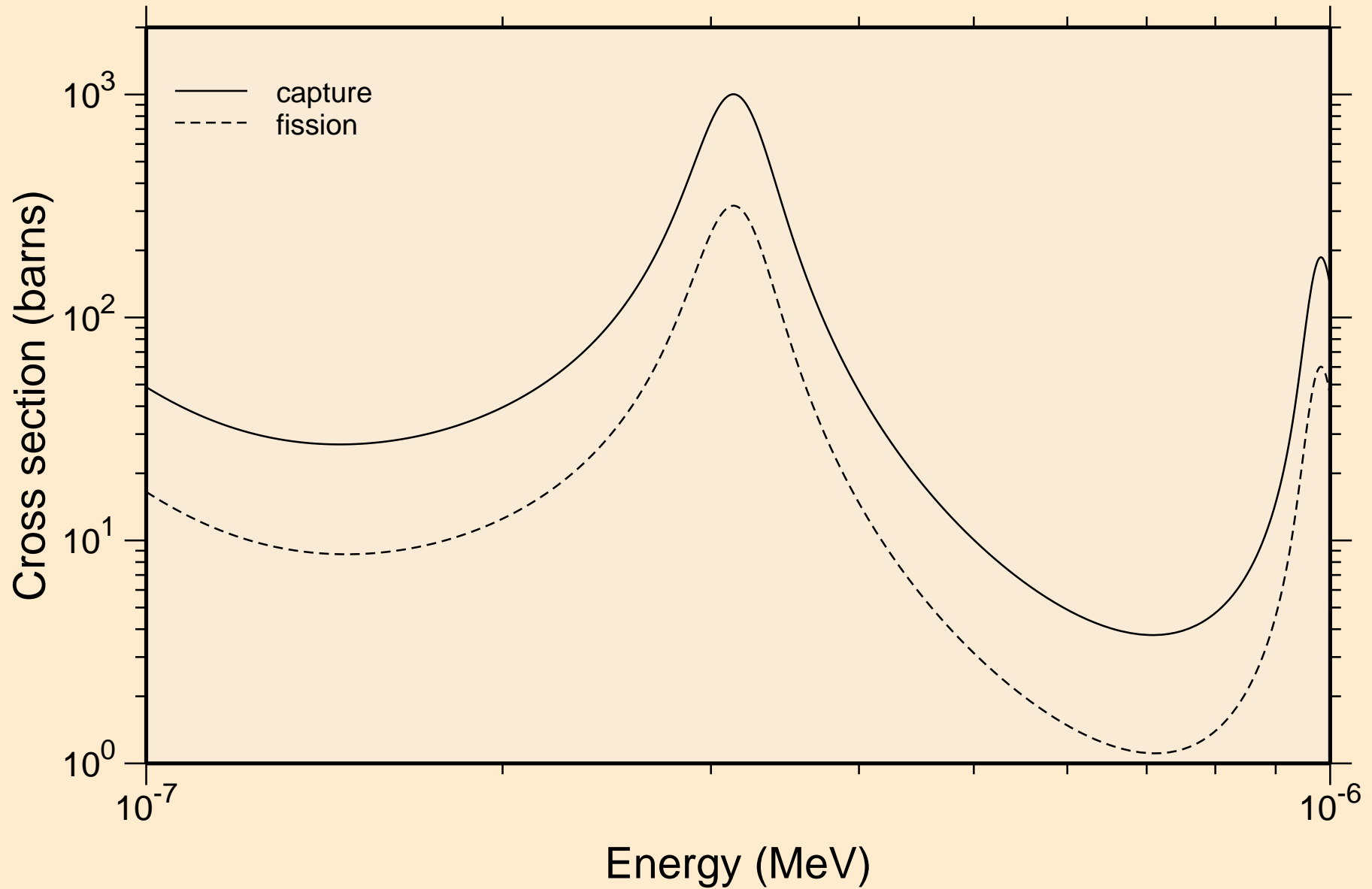

BH265 NEUTRON ACER TENDL-2021 LIBRARY; T=293.6K
resonance absorption cross sections

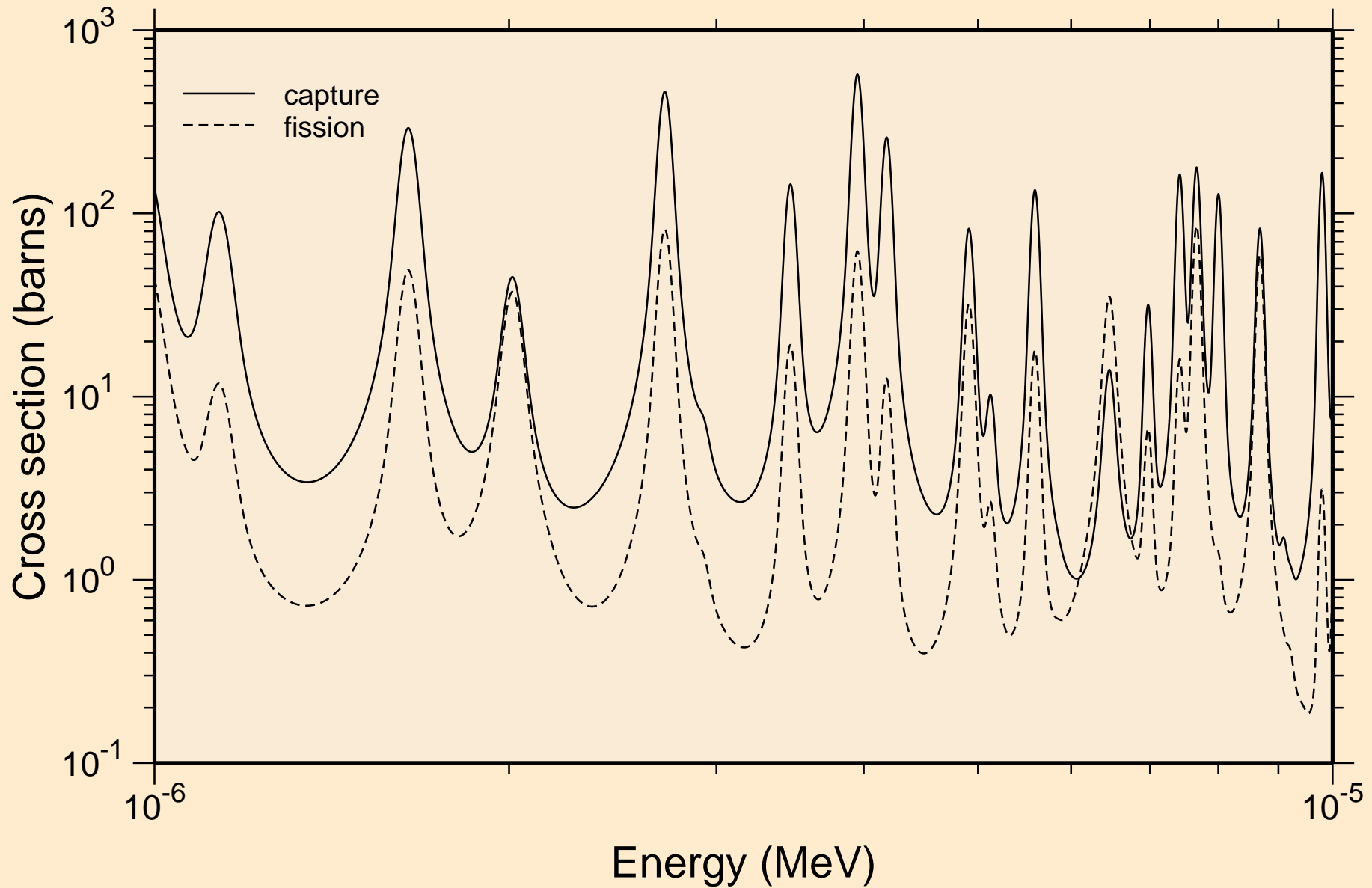

BH265 NEUTRON ACER TENDL-2021 LIBRARY; T=293.6K
resonance absorption cross sections

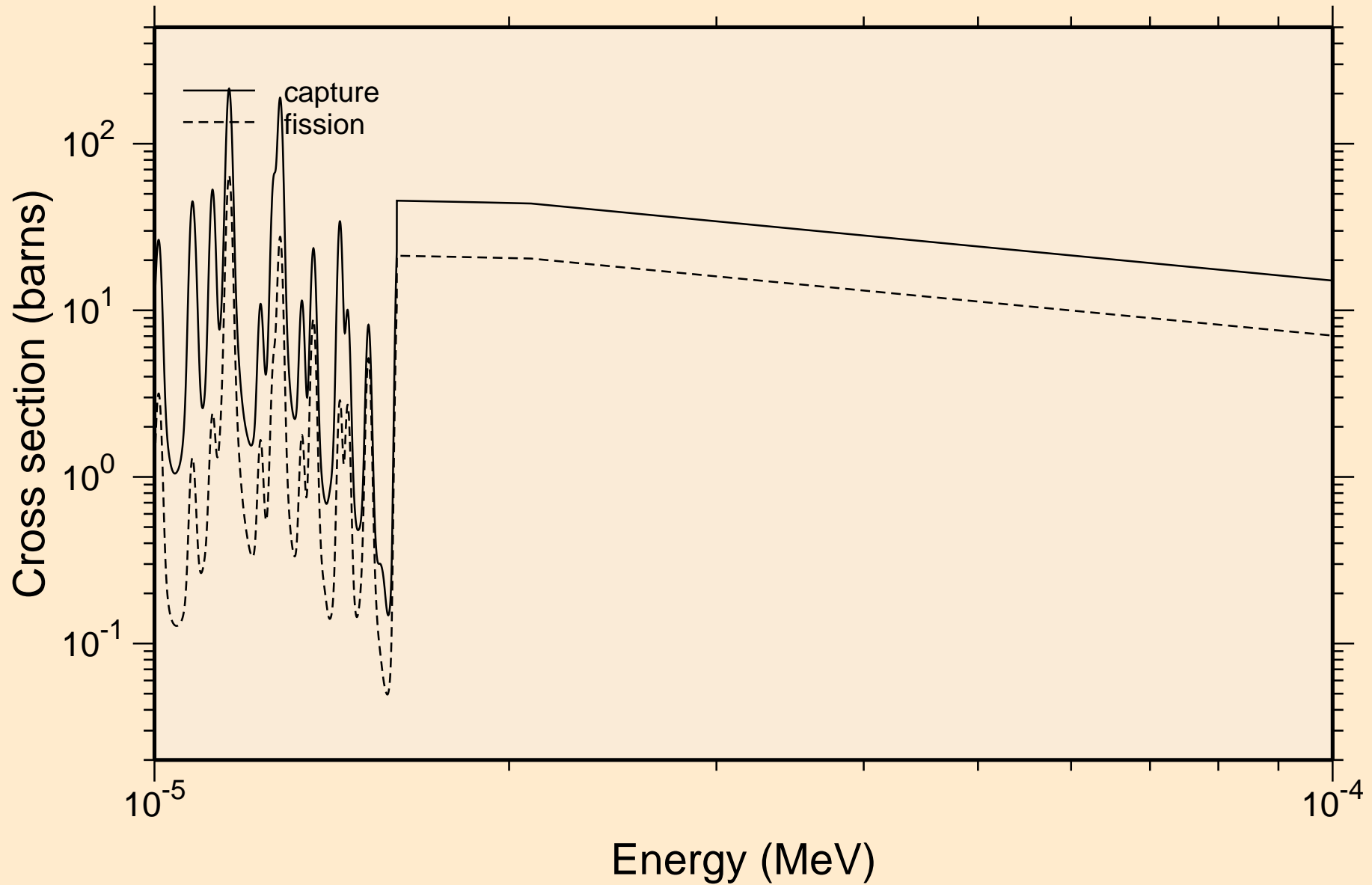

BH265 NEUTRON ACER TENDL-2021 LIBRARY; T=293.6K
resonance absorption cross sections

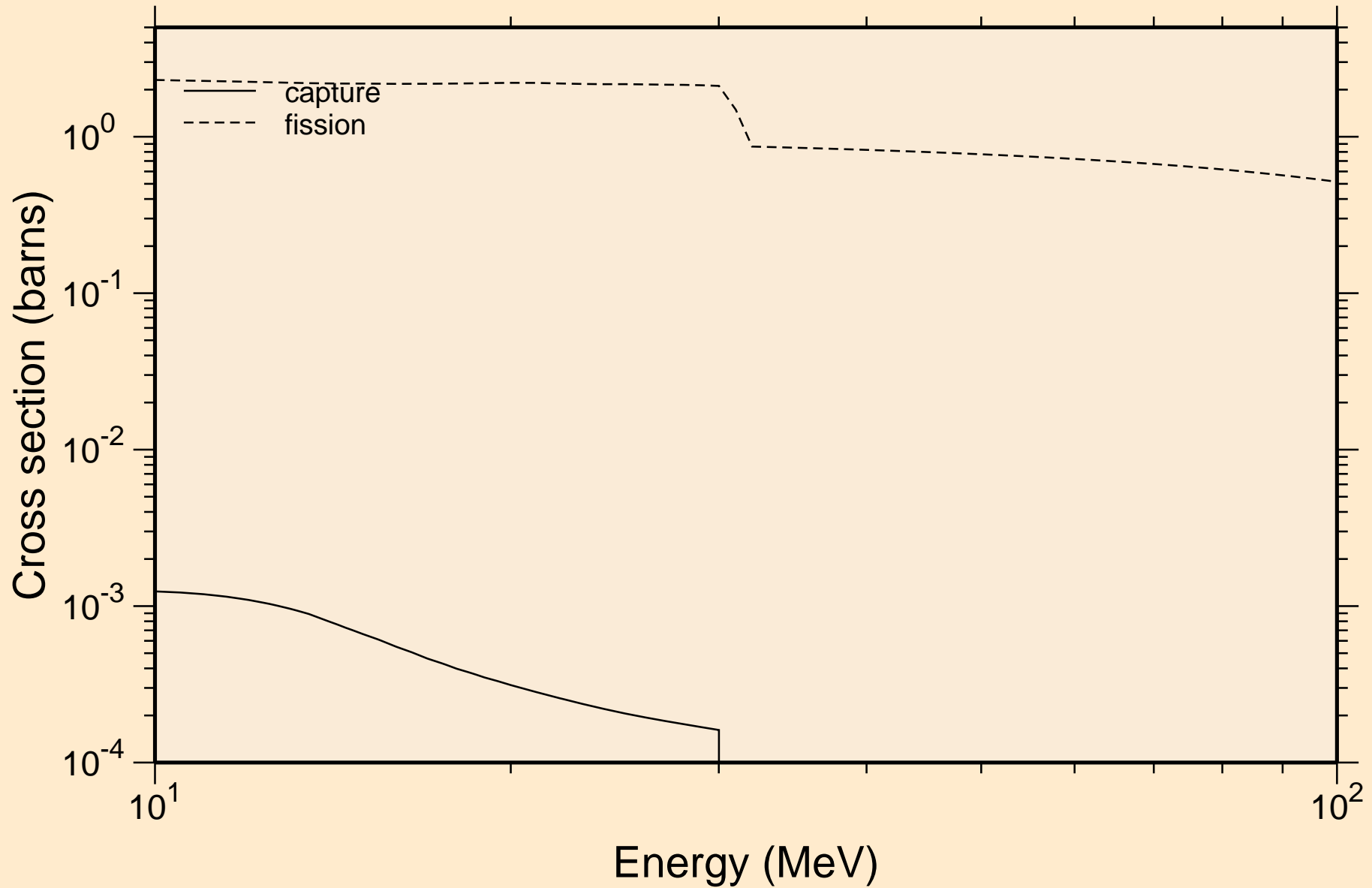

BH265 NEUTRON ACER TENDL-2021 LIBRARY; T=293.6K
Heating

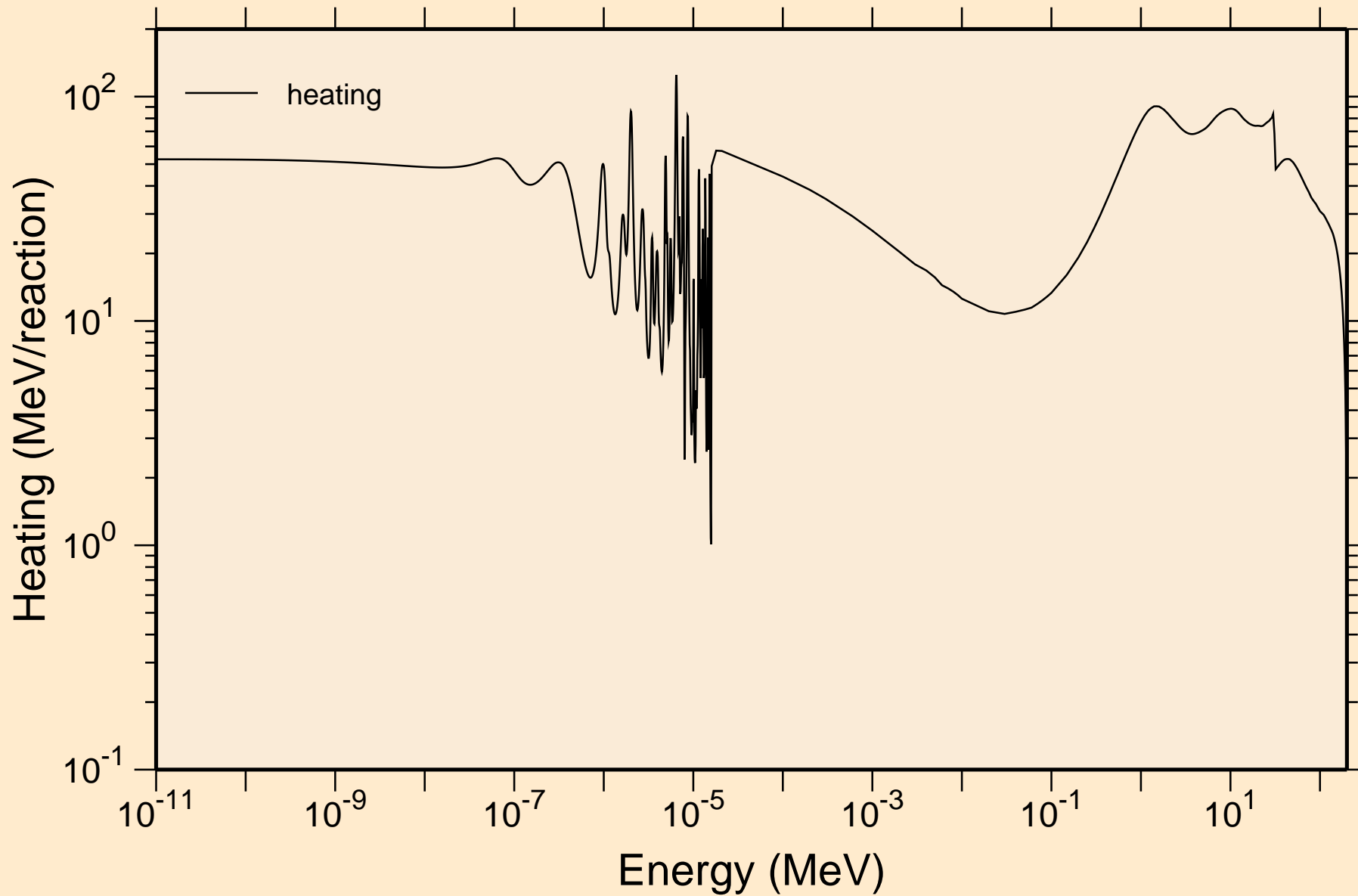

BH265 NEUTRON ACER TENDL-2021 LIBRARY; T=293.6K
Damage

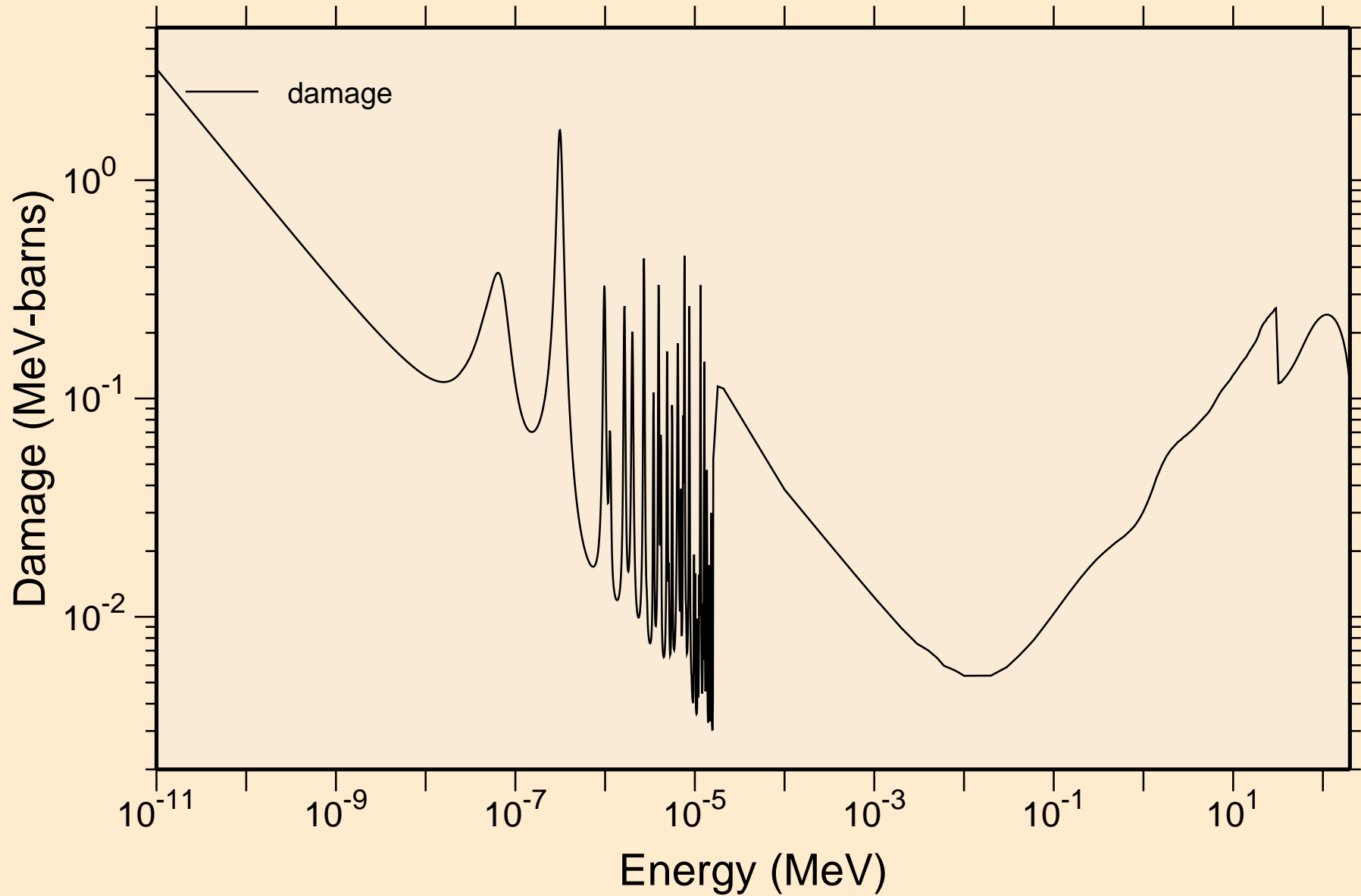

BH265 NEUTRON ACER TENDL-2021 LIBRARY; T=293.6K
Non-threshold reactions

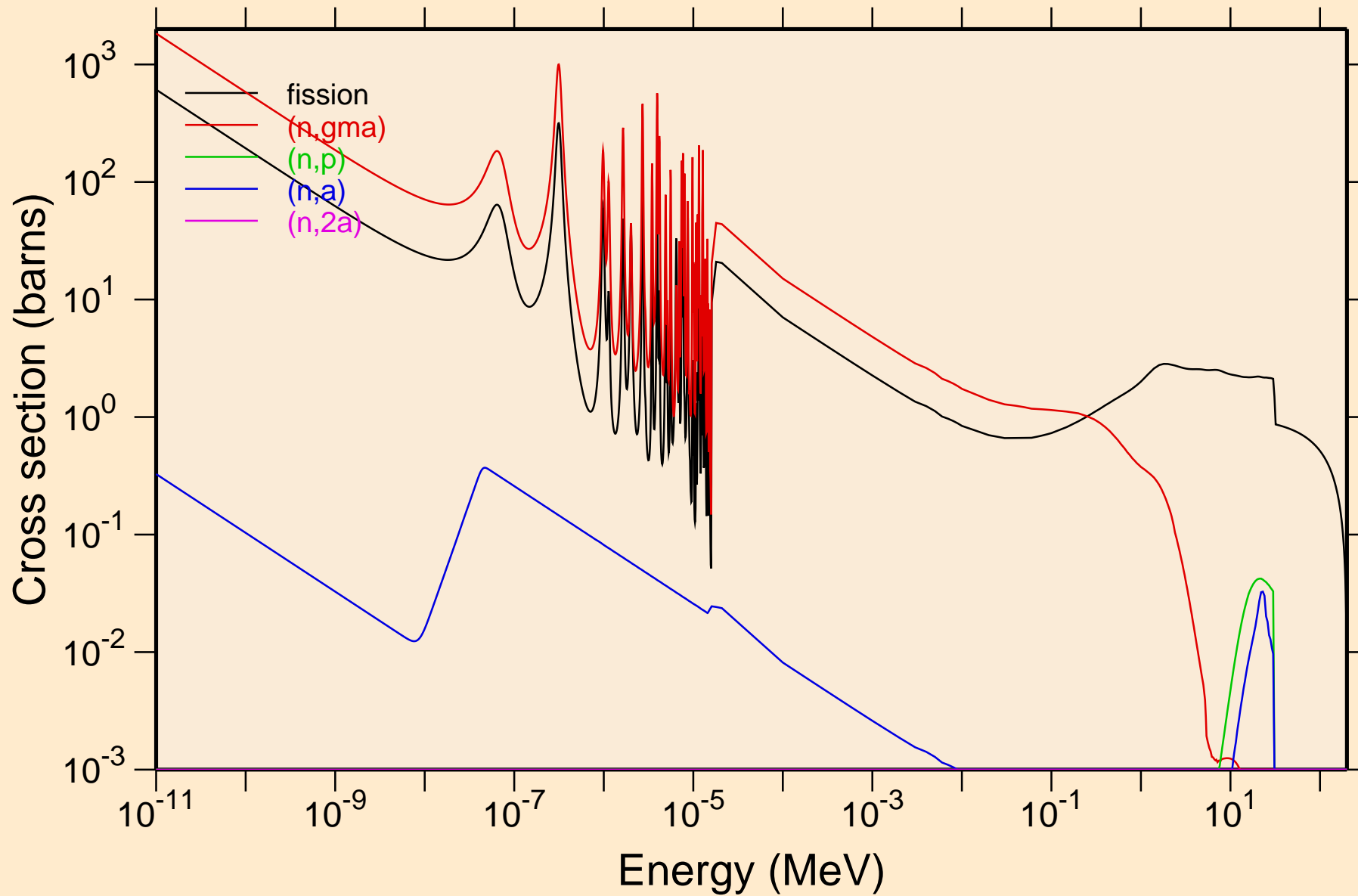

BH265 NEUTRON ACER TENDL-2021 LIBRARY; T=293.6K
Non-threshold reactions

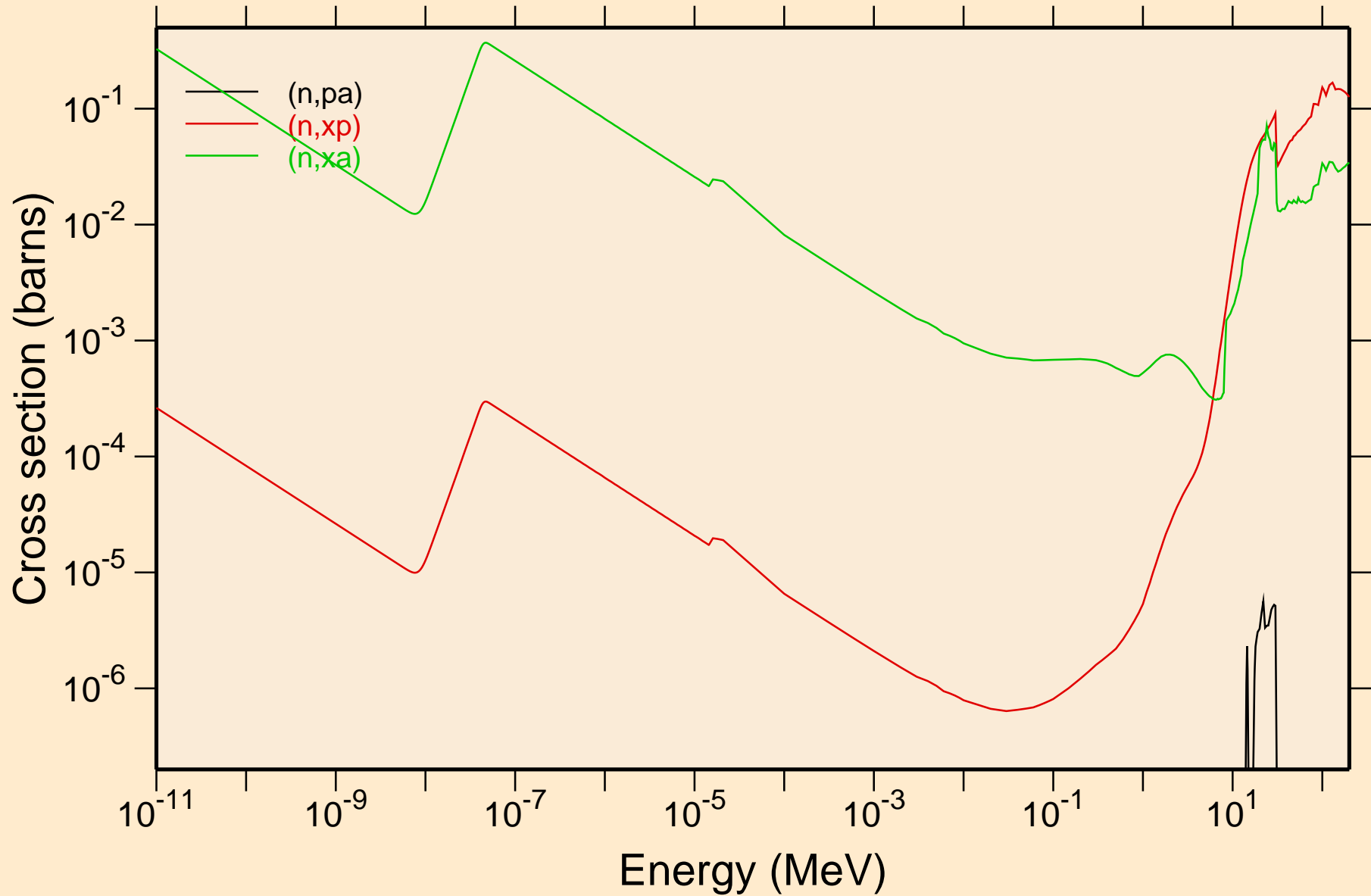

BH265 NEUTRON ACER TENDL-2021 LIBRARY; T=293.6K
Principal cross sections

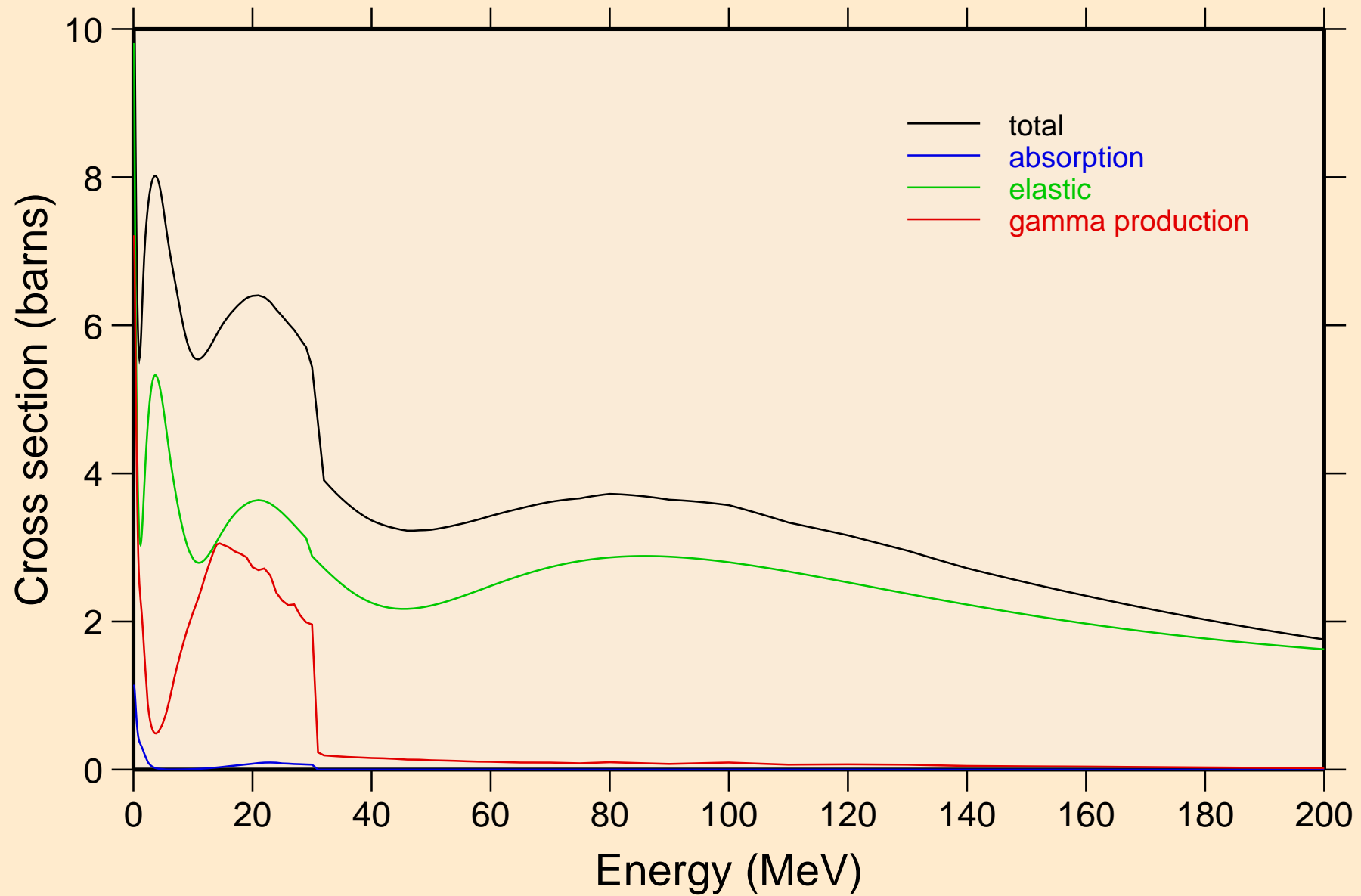

BH265 NEUTRON ACER TENDL-2021 LIBRARY; T=293.6K
Heating

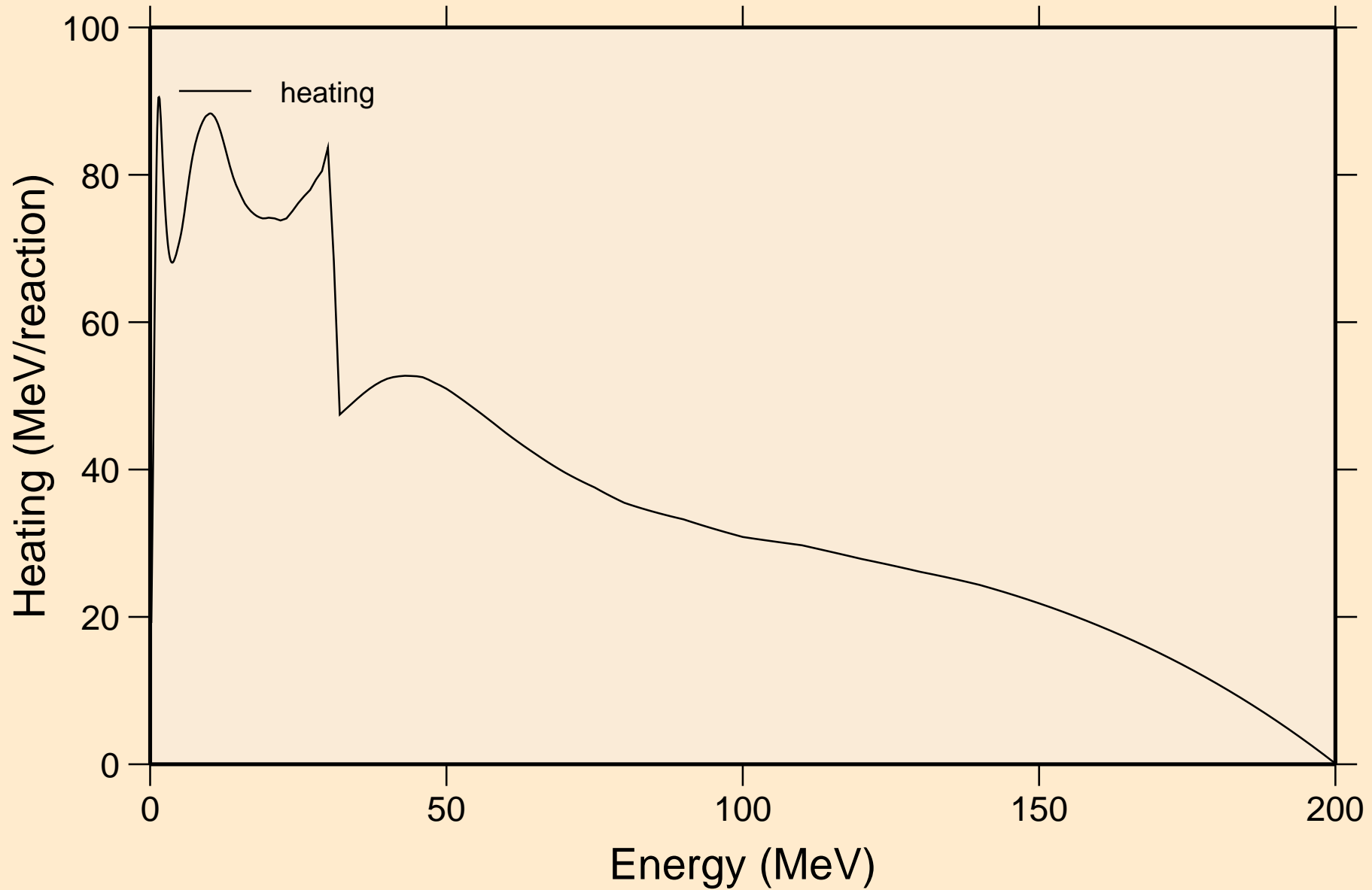

BH265 NEUTRON ACER TENDL-2021 LIBRARY; T=293.6K
Damage

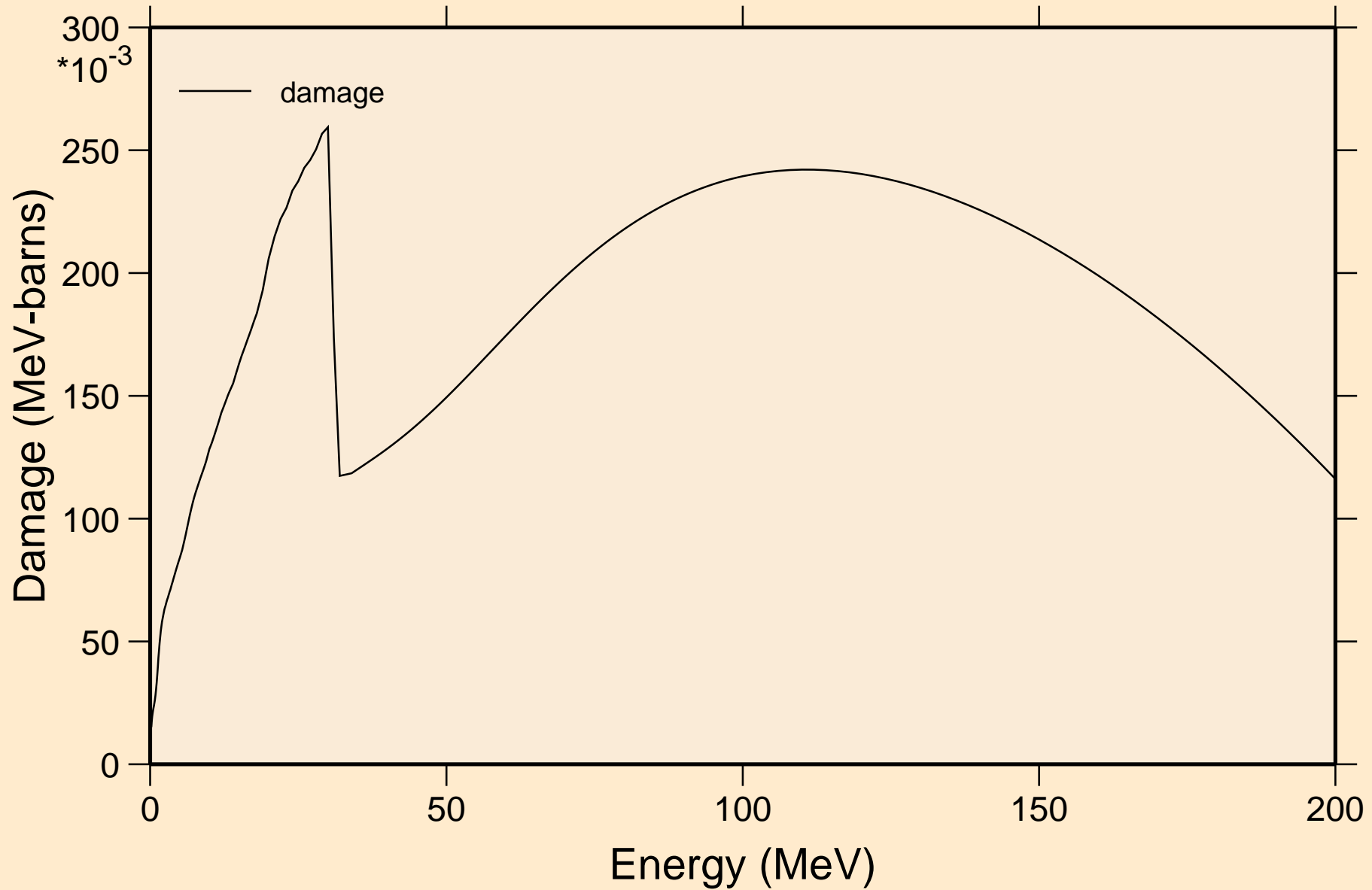

BH265 NEUTRON ACER TENDL-2021 LIBRARY; T=293.6K

Non-threshold reactions

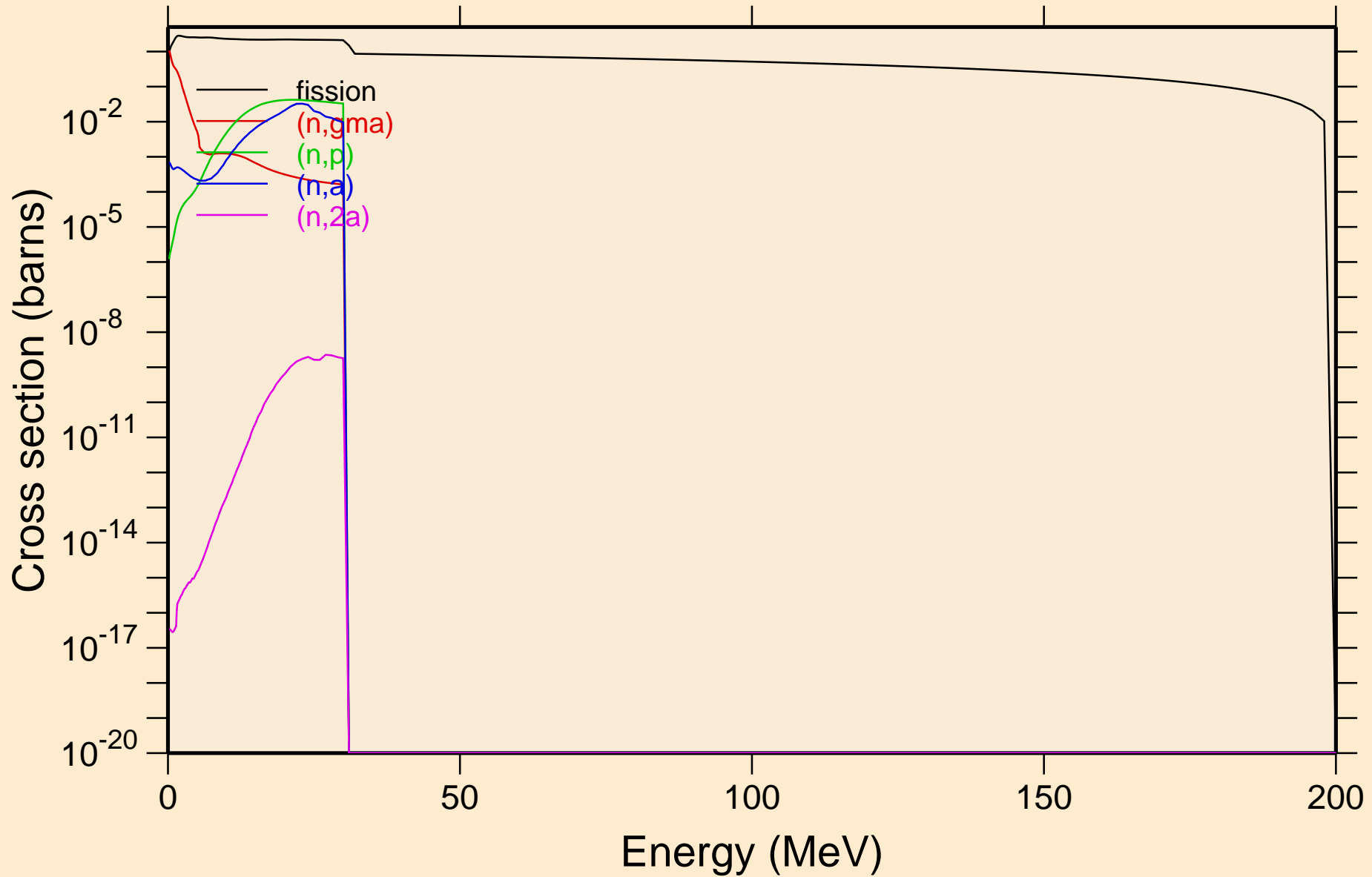

BH265 NEUTRON ACER TENDL-2021 LIBRARY; T=293.6K

Non-threshold reactions

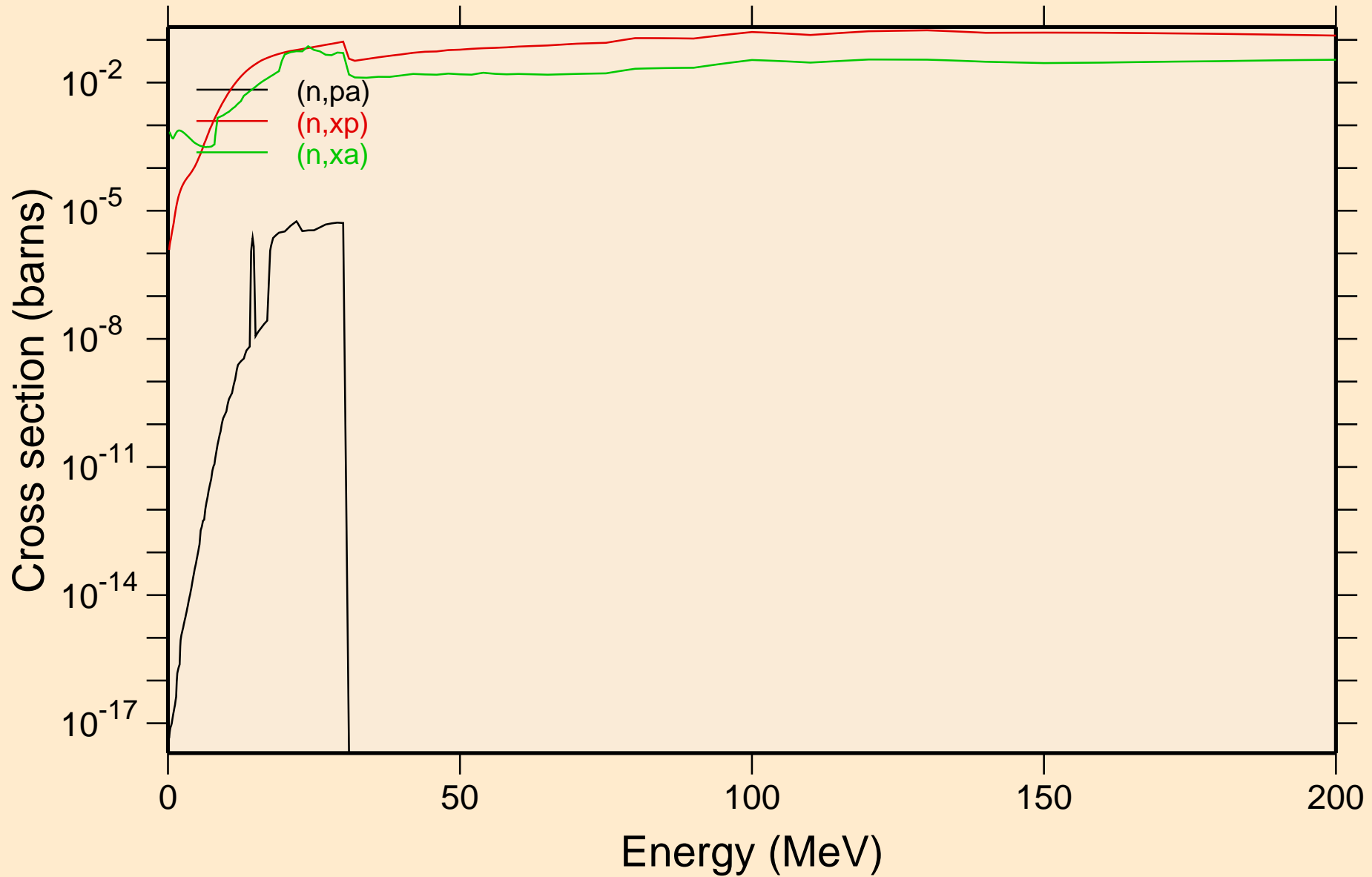

BH265 NEUTRON ACER TENDL-2021 LIBRARY; T=293.6K
Inelastic levels

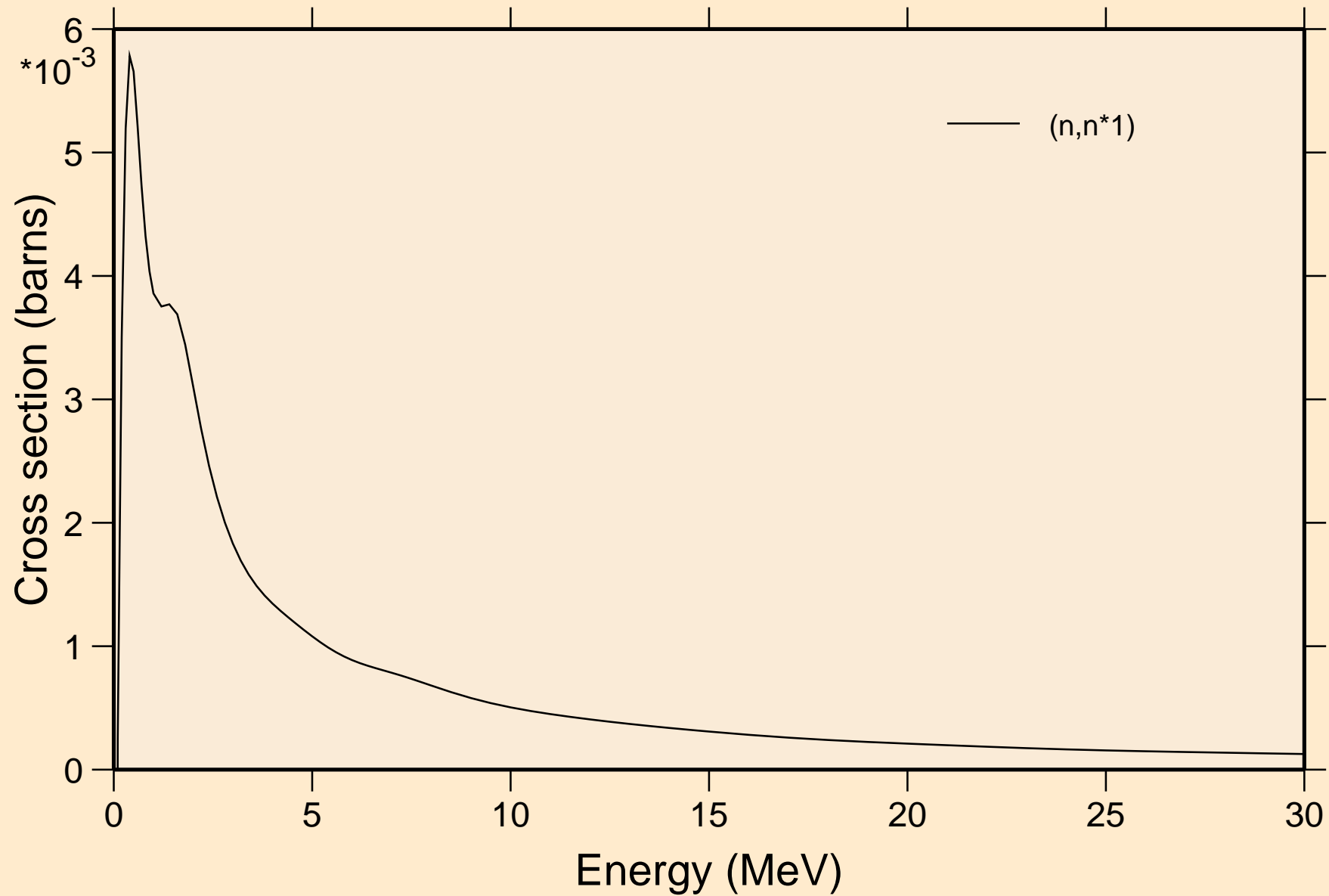

BH265 NEUTRON ACER TENDL-2021 LIBRARY; T=293.6K
Threshold reactions

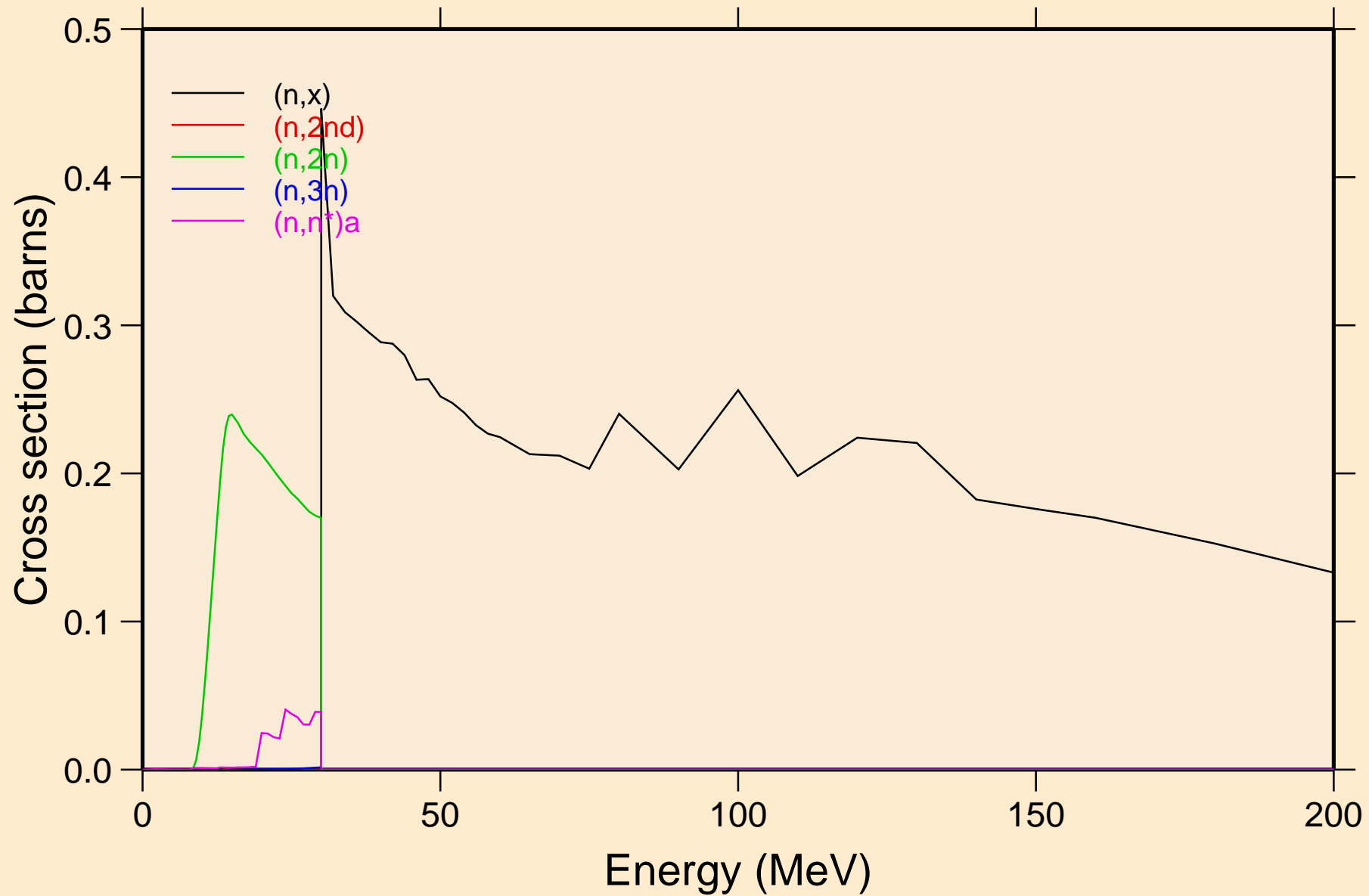

BH265 NEUTRON ACER TENDL-2021 LIBRARY; T=293.6K
Threshold reactions

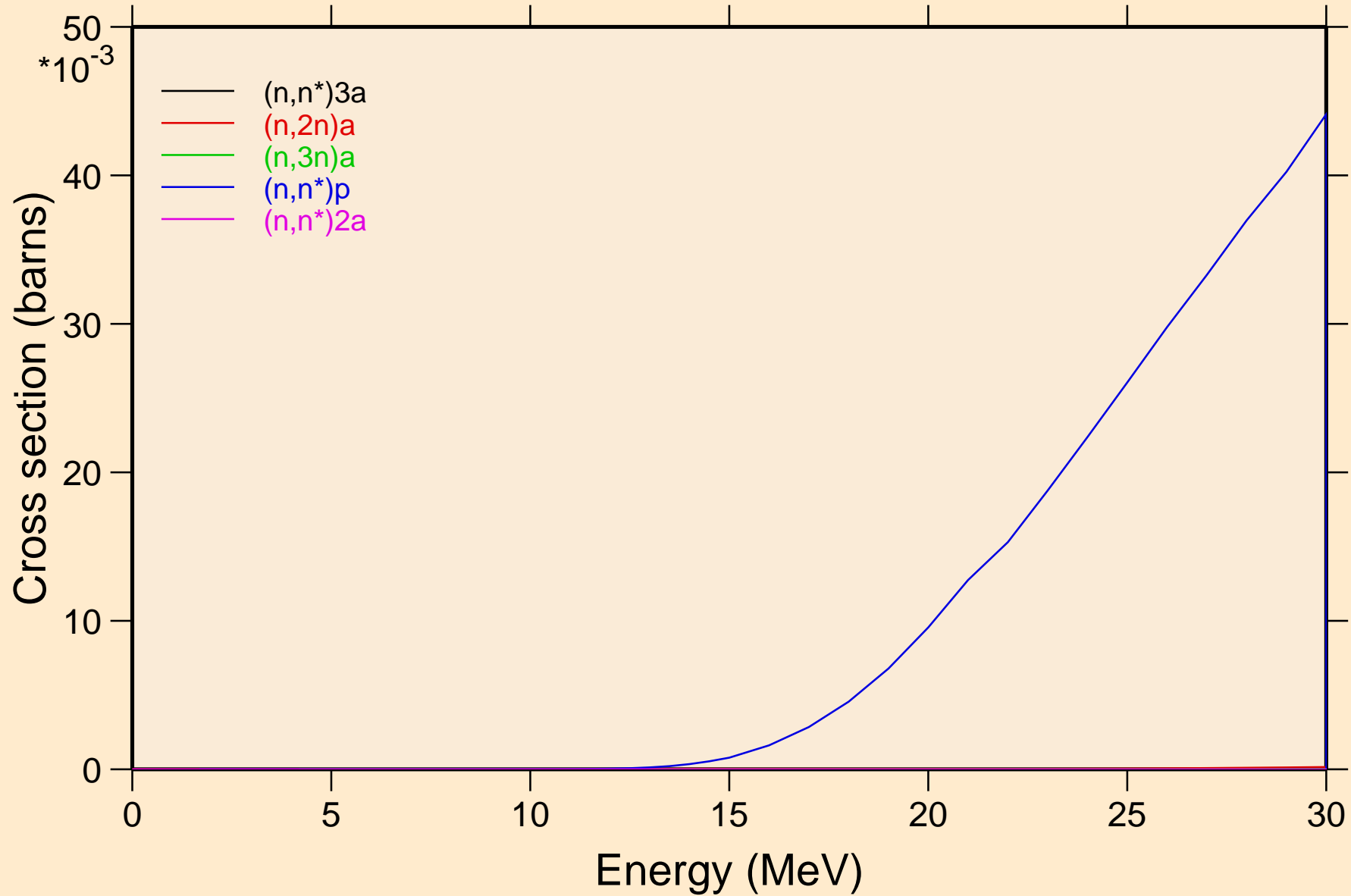

BH265 NEUTRON ACER TENDL-2021 LIBRARY; T=293.6K
Threshold reactions

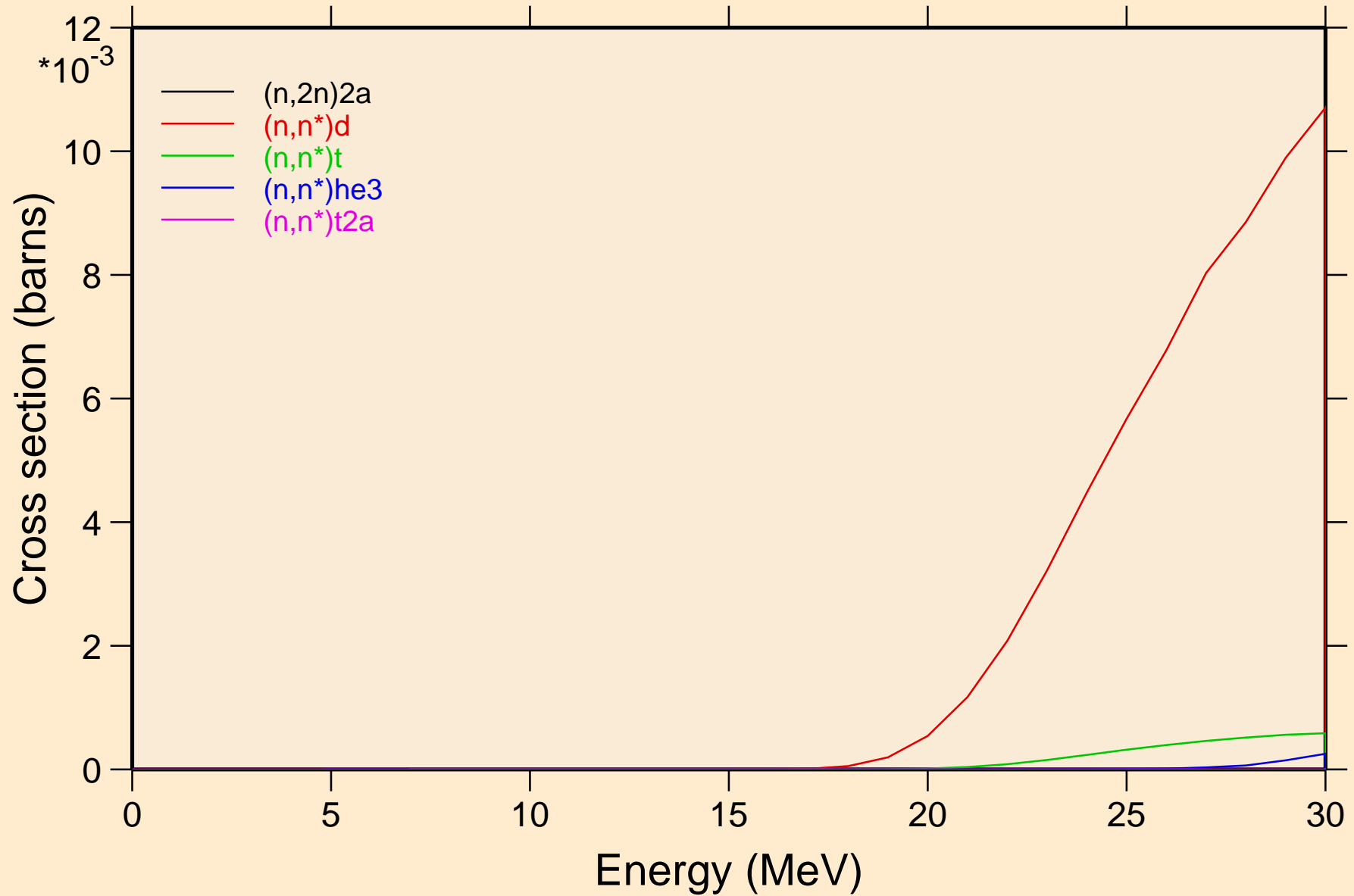

BH265 NEUTRON ACER TENDL-2021 LIBRARY; T=293.6K
Threshold reactions

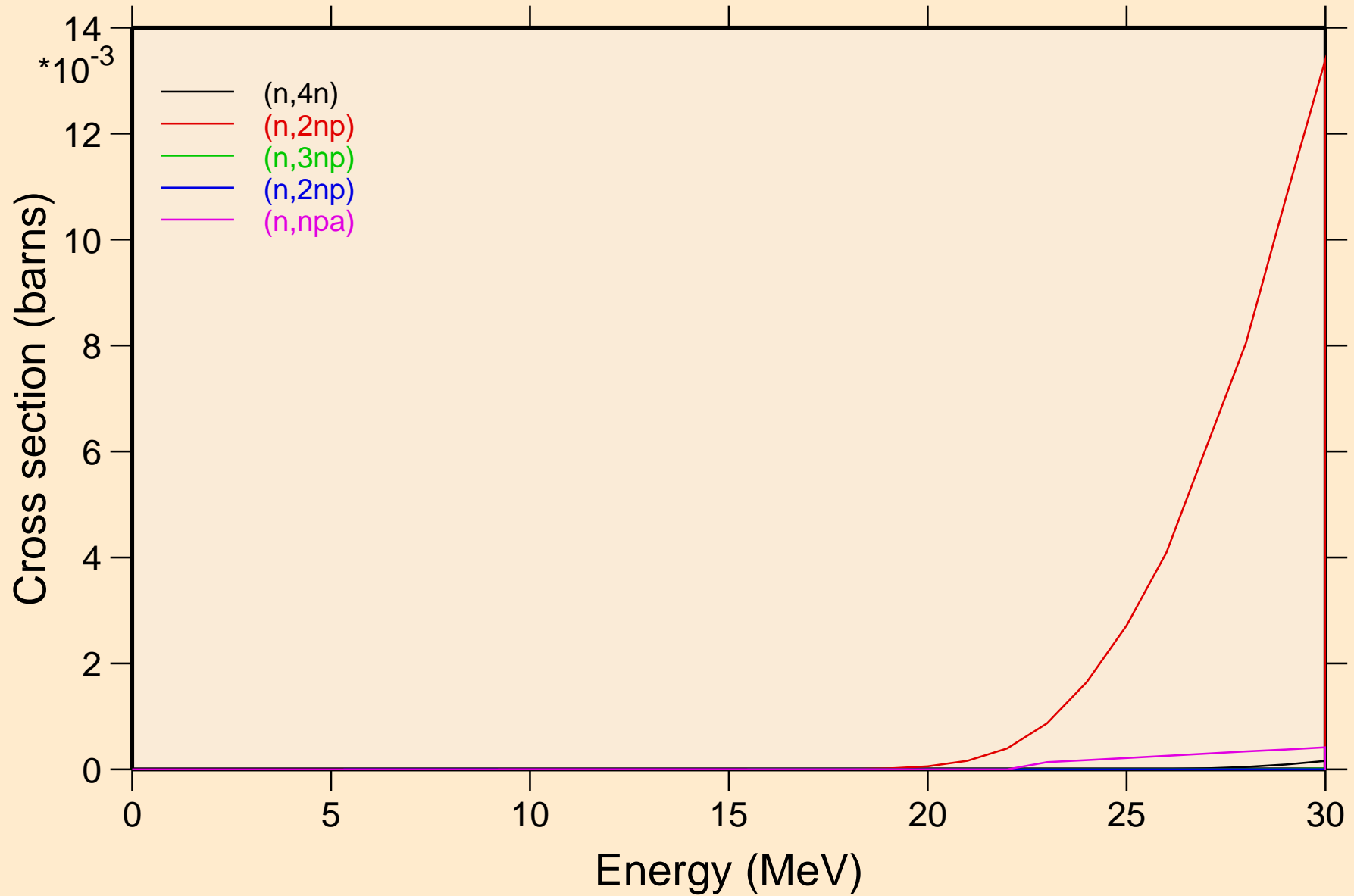

BH265 NEUTRON ACER TENDL-2021 LIBRARY; T=293.6K

Threshold reactions

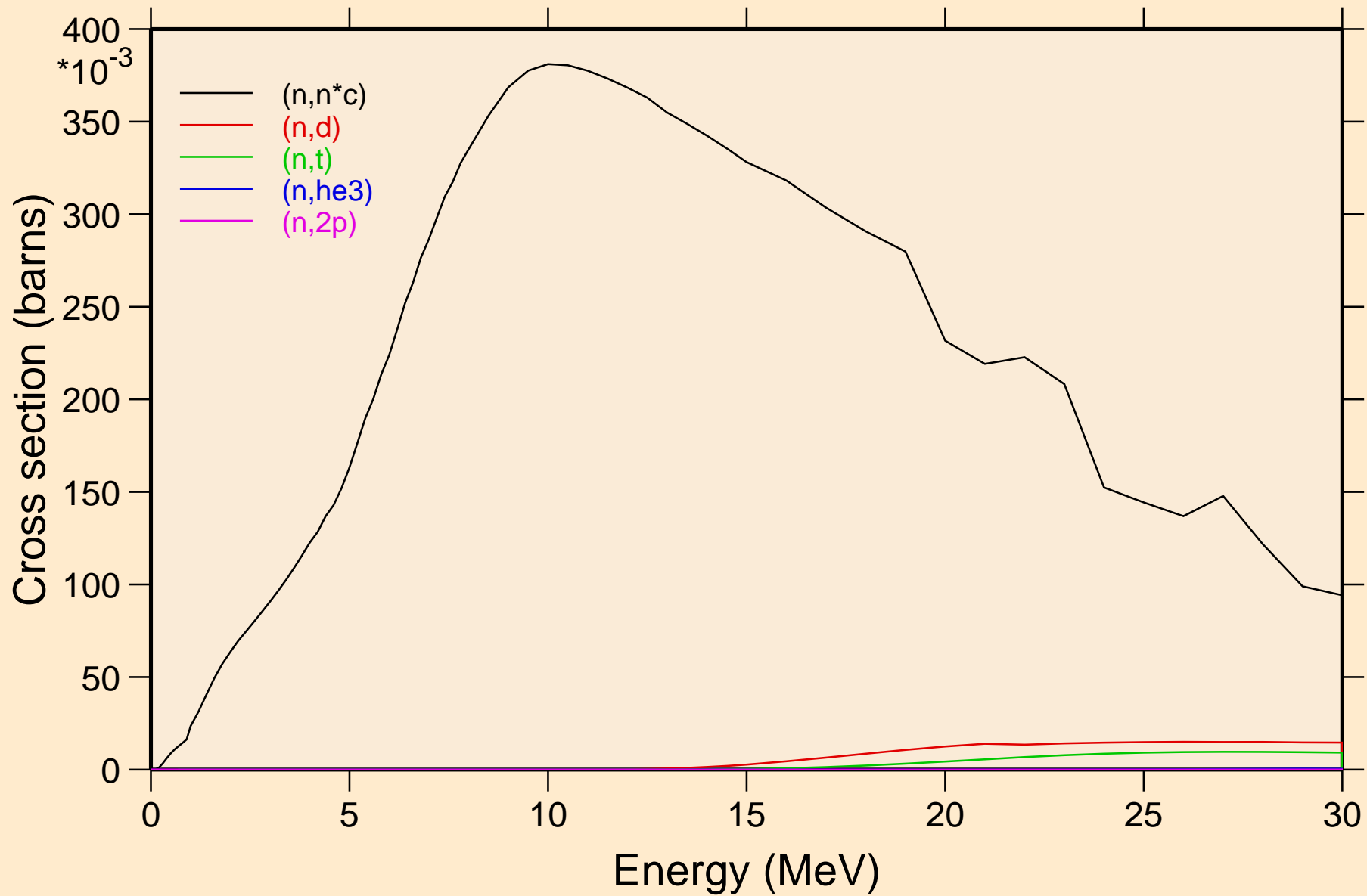

BH265 NEUTRON ACER TENDL-2021 LIBRARY; T=293.6K
Threshold reactions

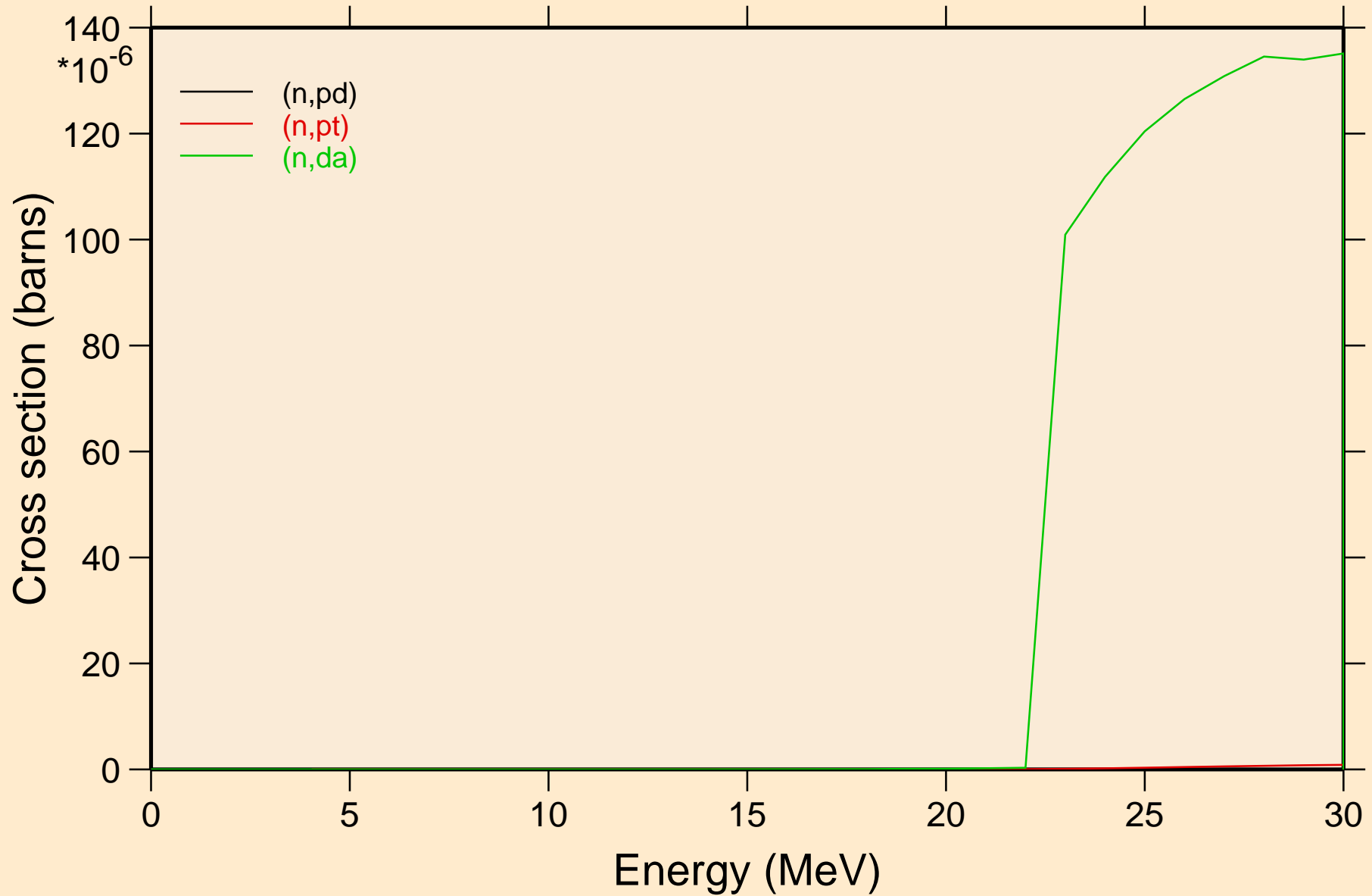

BH265 NEUTRON ACER TENDL-2021 LIBRARY; T=293.6K
Threshold reactions

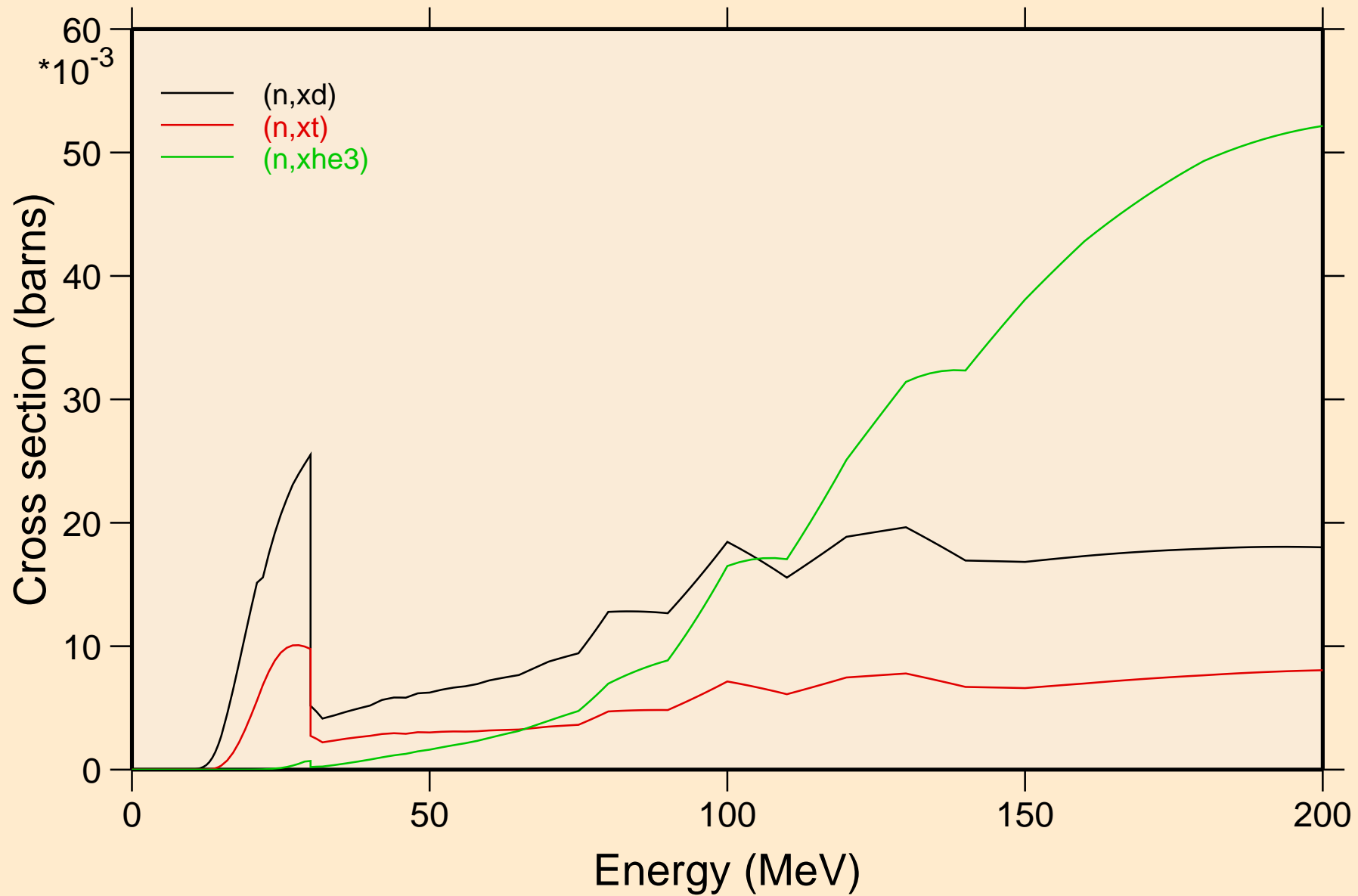

BH265 NEUTRON ACER TENDL-2021 LIBRARY; T=293.6K
angular distribution for elastic

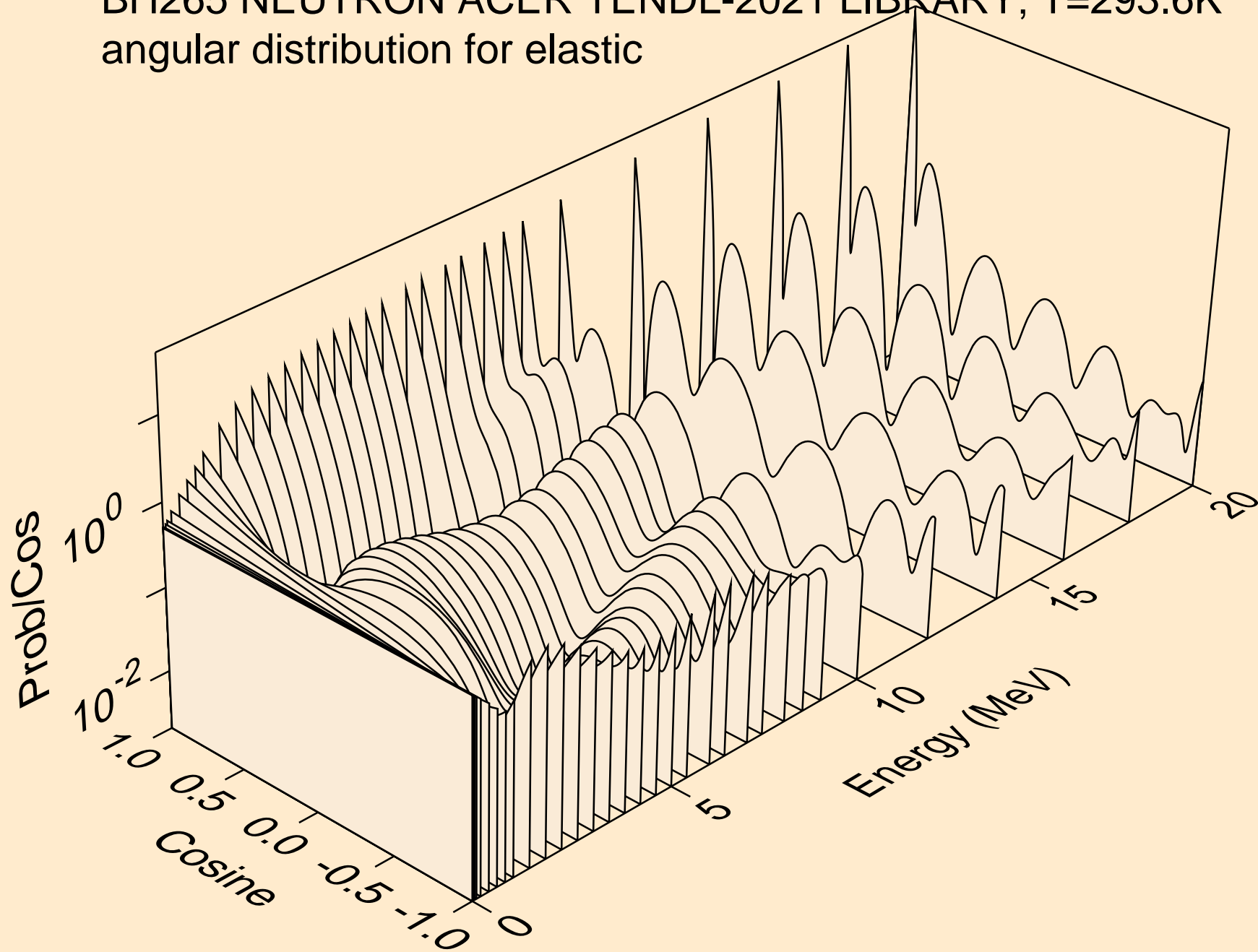

BH265 NEUTRON ACER TENDL-2021 LIBRARY; T=293.6K
angular distribution for elastic

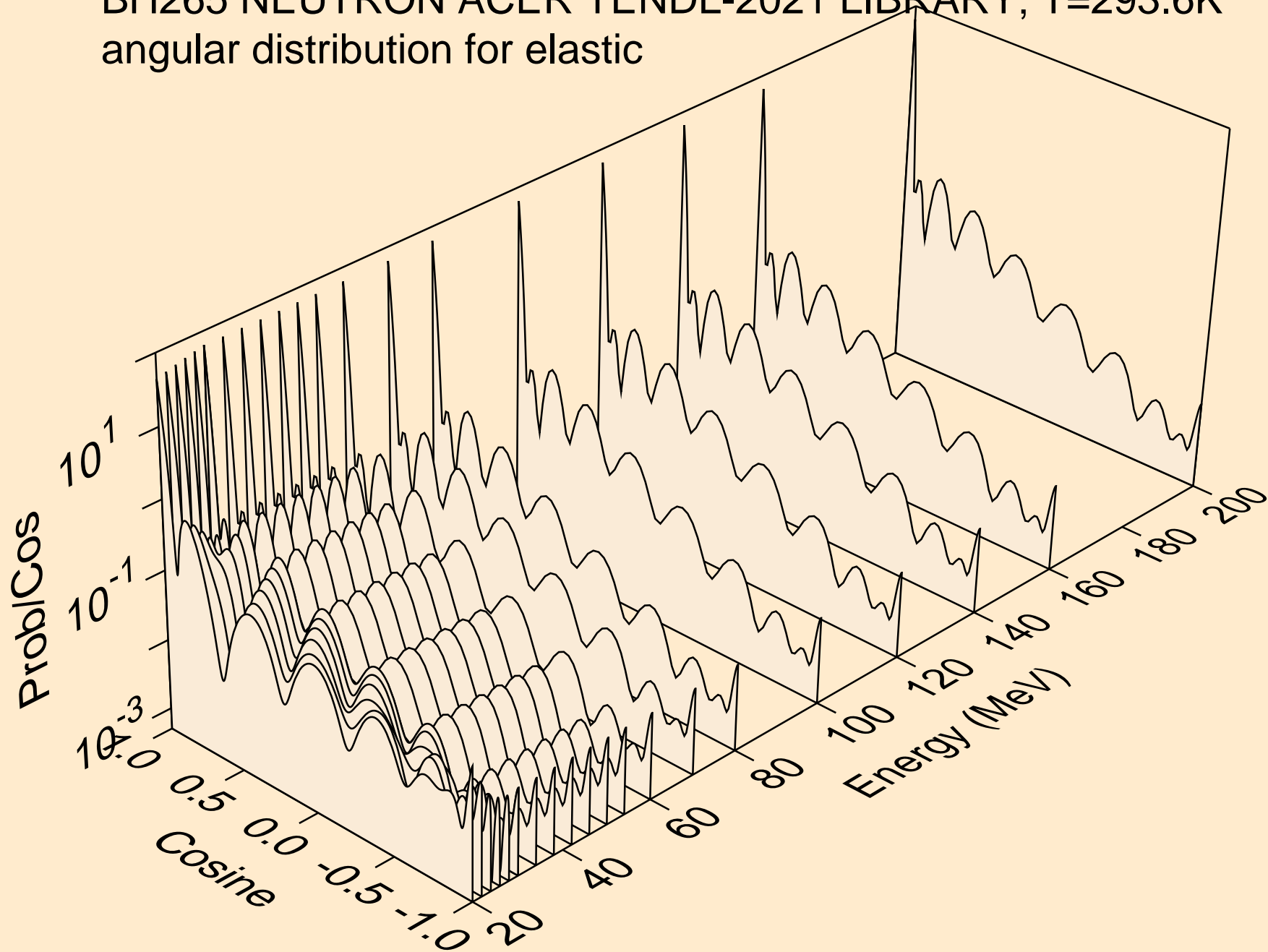

BH265 NEUTRON ACER TENDL-2021 LIBRARY; T=293.6K
angular distribution for (n,n*1)

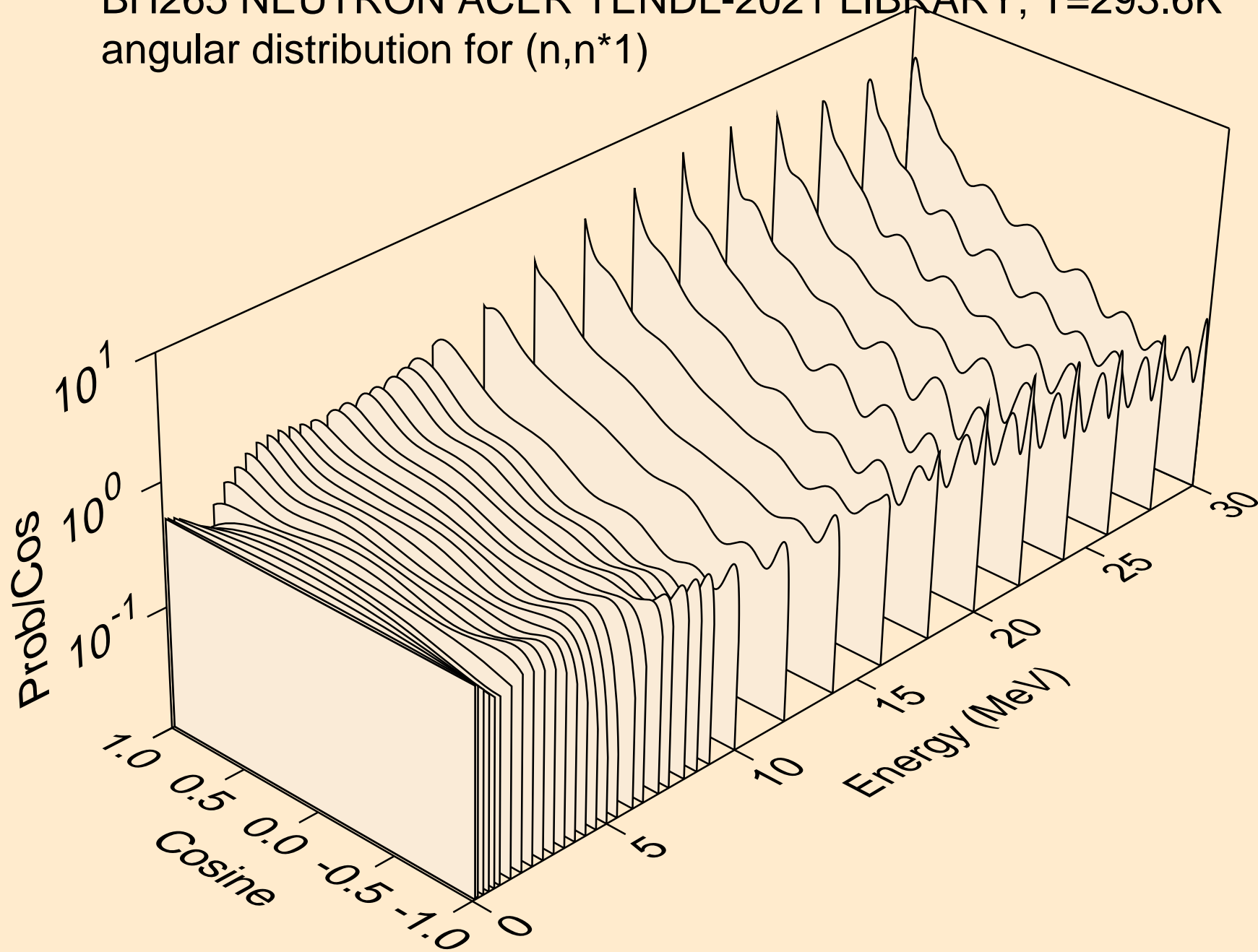

BH265 NEUTRON ACER TENDL-2021 LIBRARY; T=293.6K
Total fission nubar

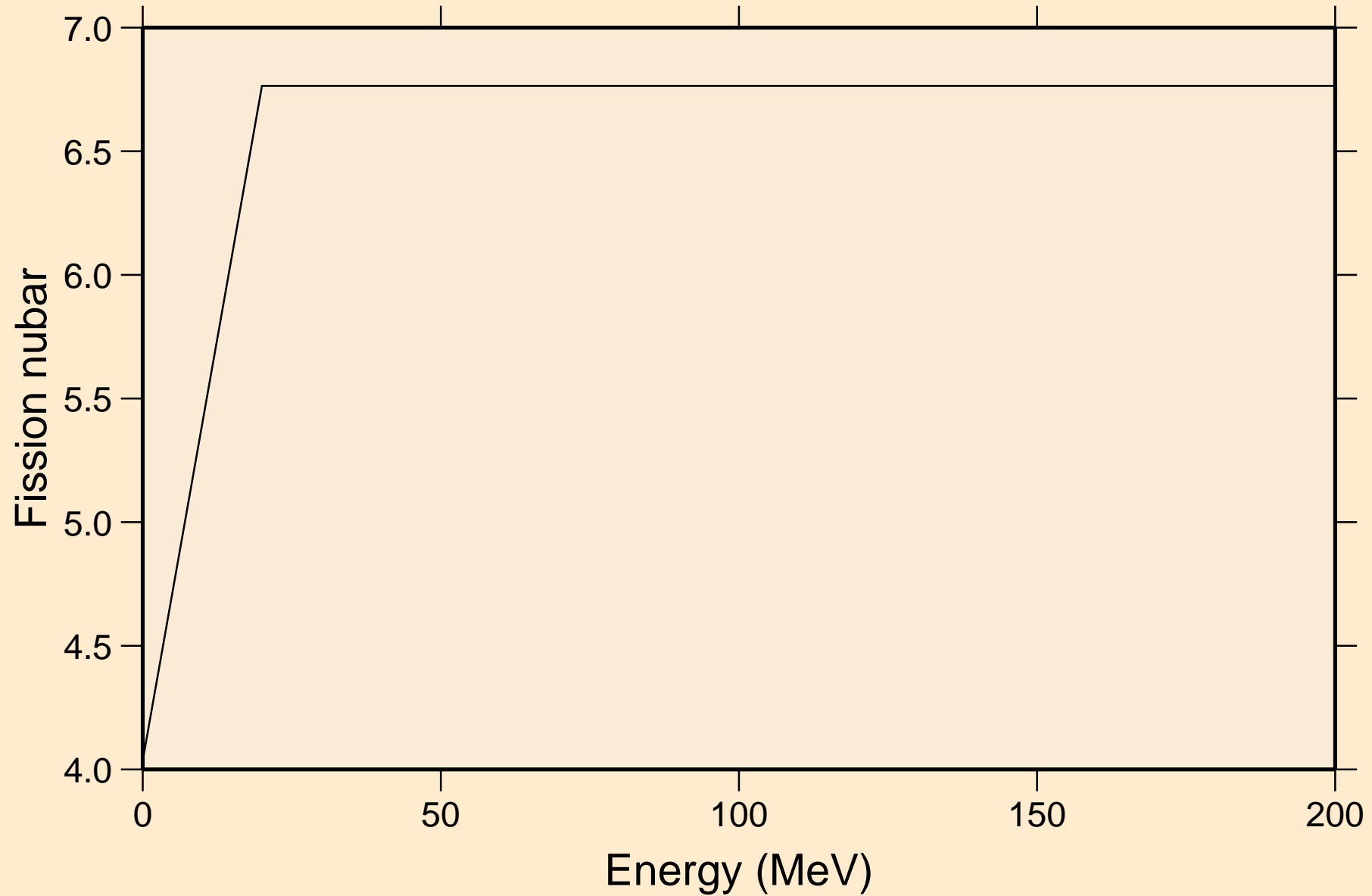

BH265 NEUTRON ACER TENDL-2021 LIBRARY; T=293.6K
Neutron emission for (n,x)

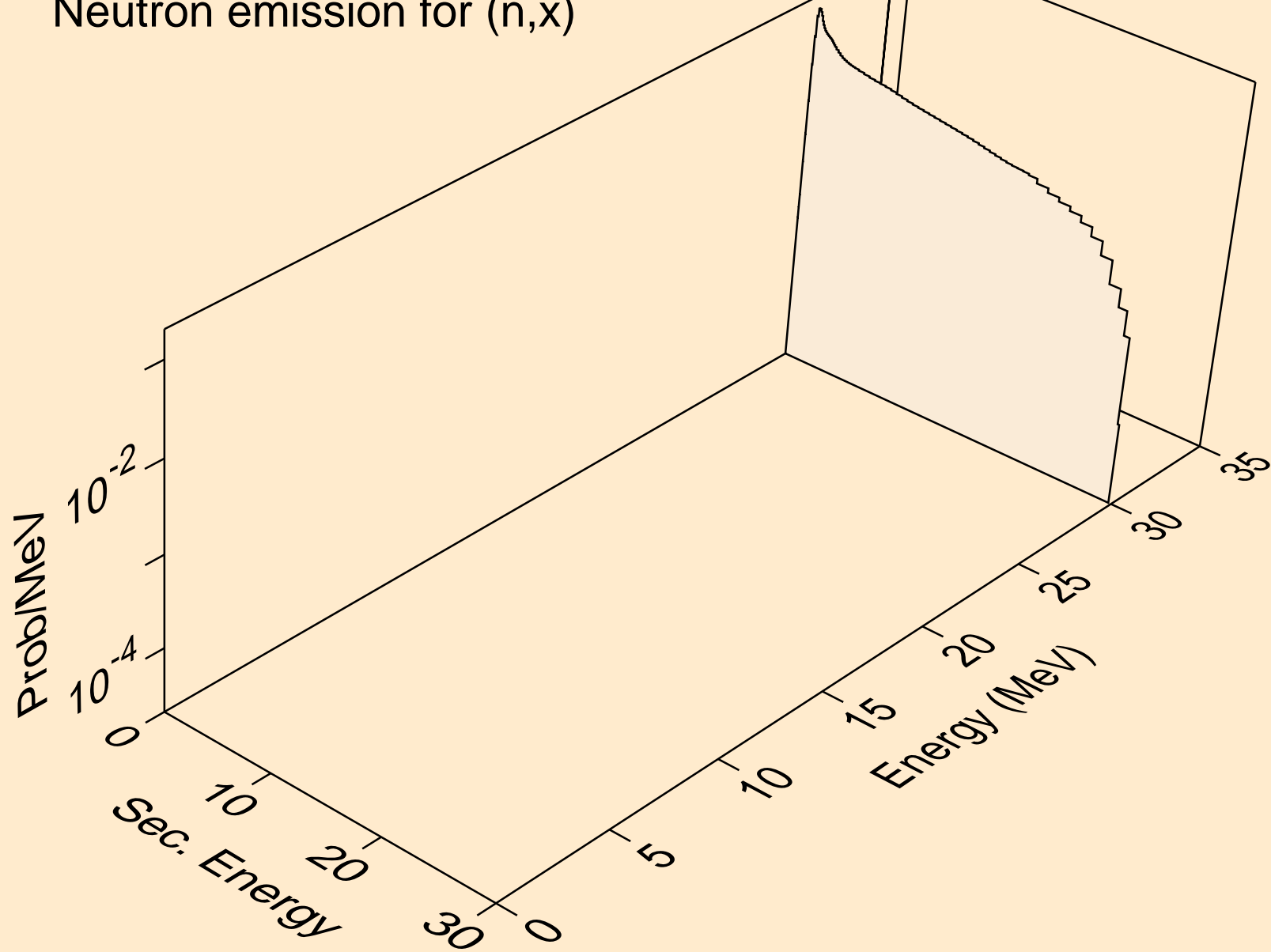

BH265 NEUTRON ACER TENDL-2021 LIBRARY; T=293.6K
Neutron emission for (n,2nd)

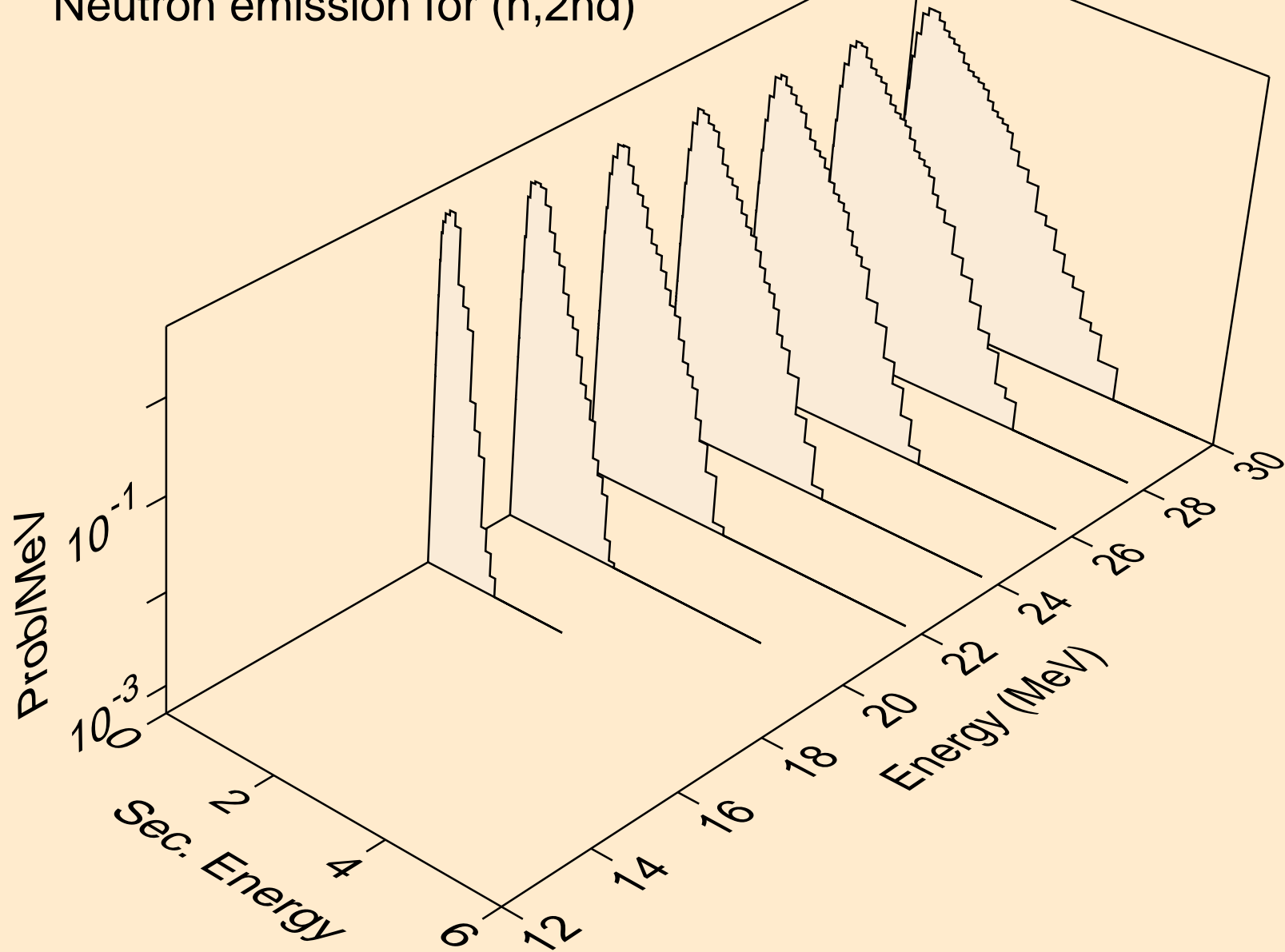

BH265 NEUTRON ACER TENDL-2021 LIBRARY; T=293.6K
Neutron emission for (n,2n)

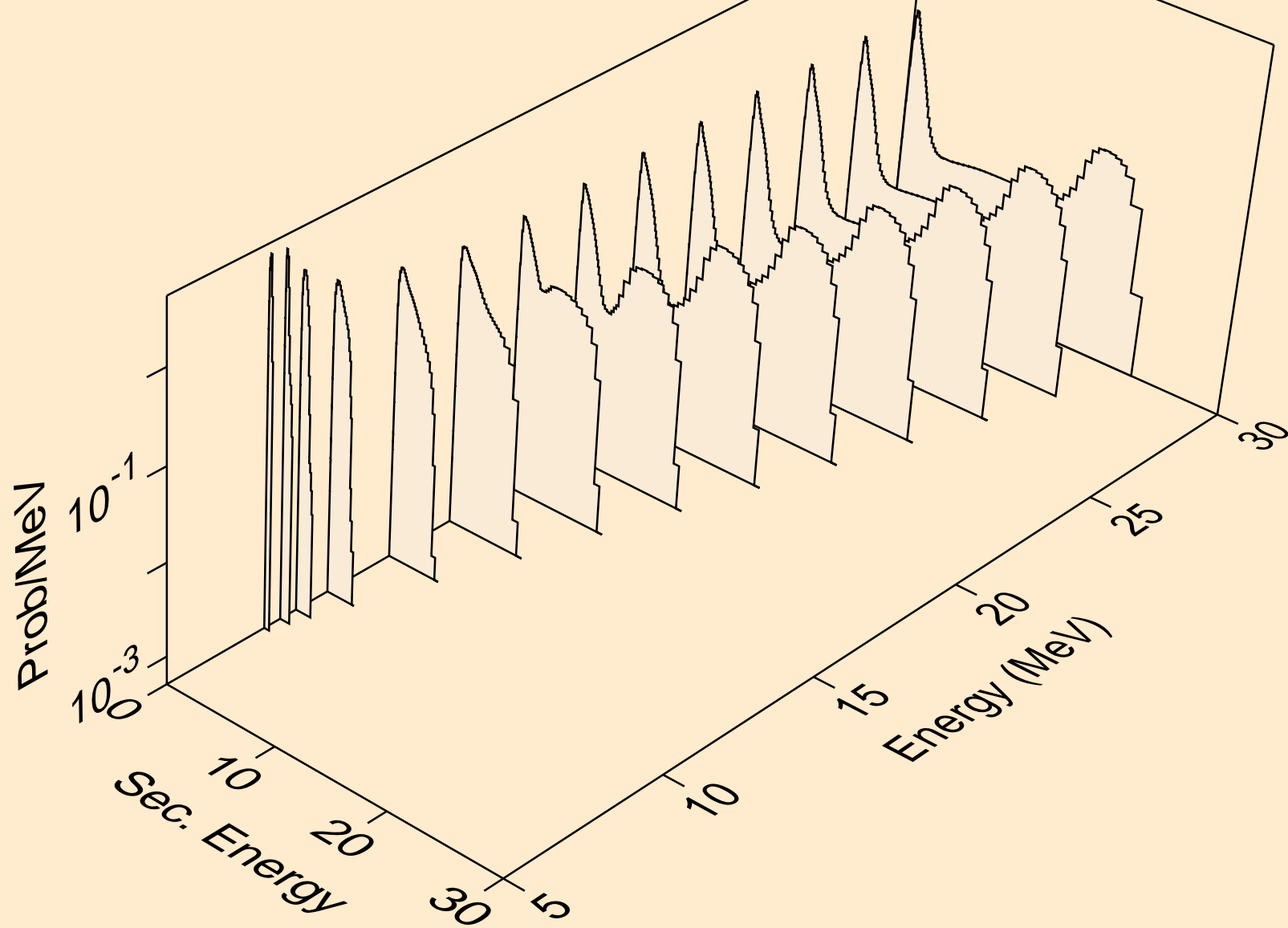

BH265 NEUTRON ACER TENDL-2021 LIBRARY; T=293.6K
Neutron emission for (n,3n)

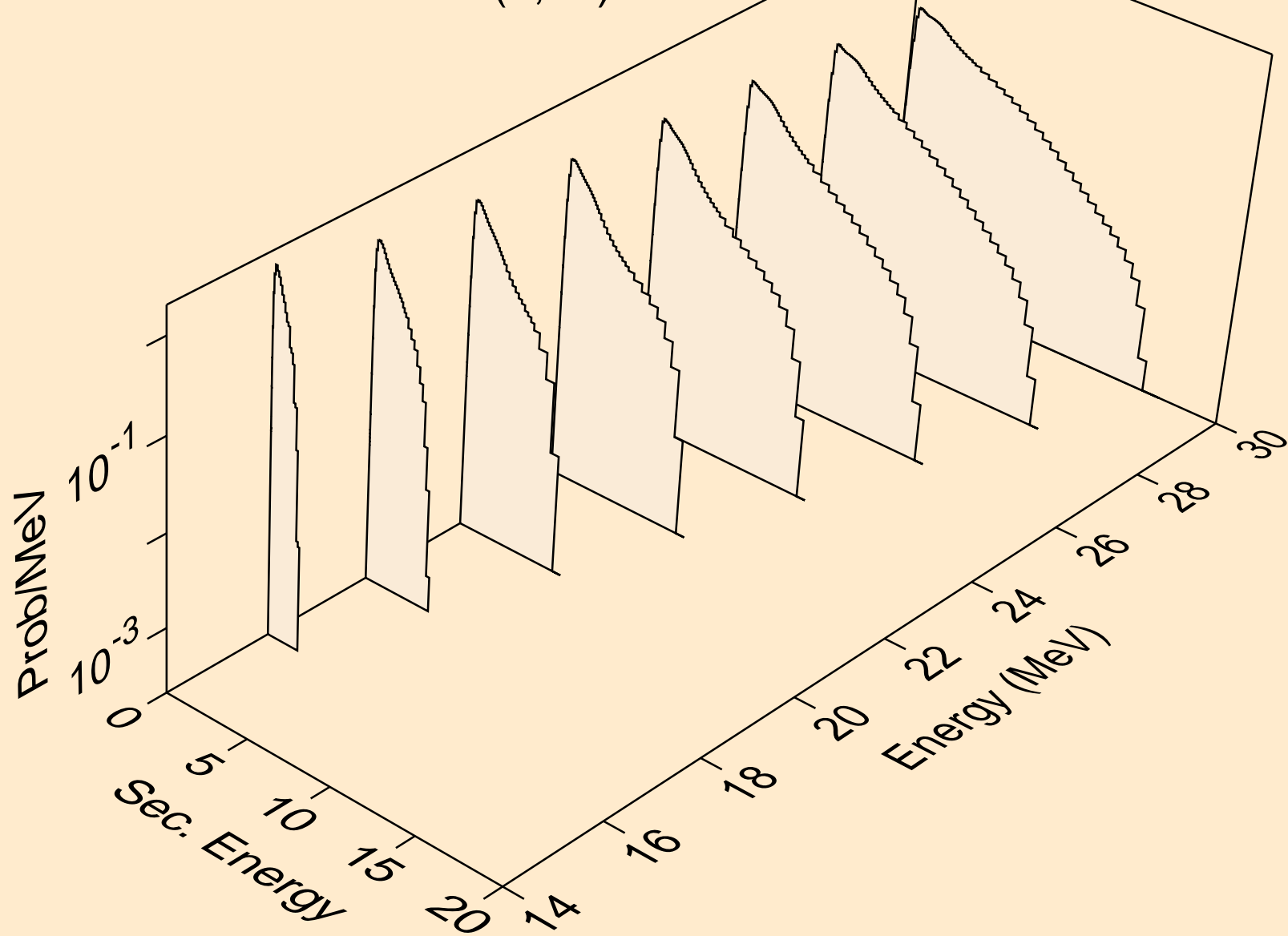

BH265 NEUTRON ACER TENDL-2021 LIBRARY; T=293.6K
Neutron emission for fission

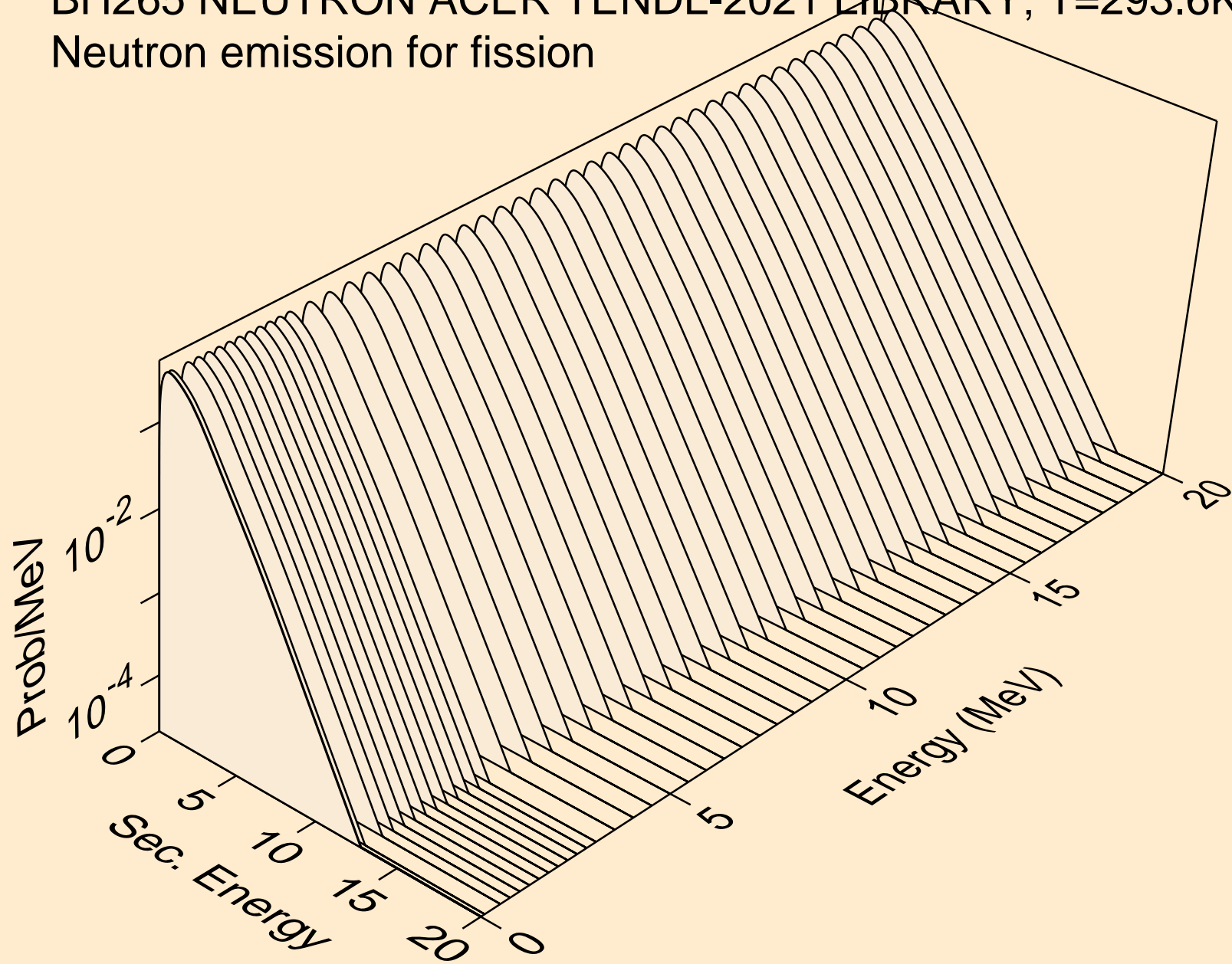

BH265 NEUTRON ACER TENDL-2021 LIBRARY; T=293.6K
Neutron emission for (n,n*)a

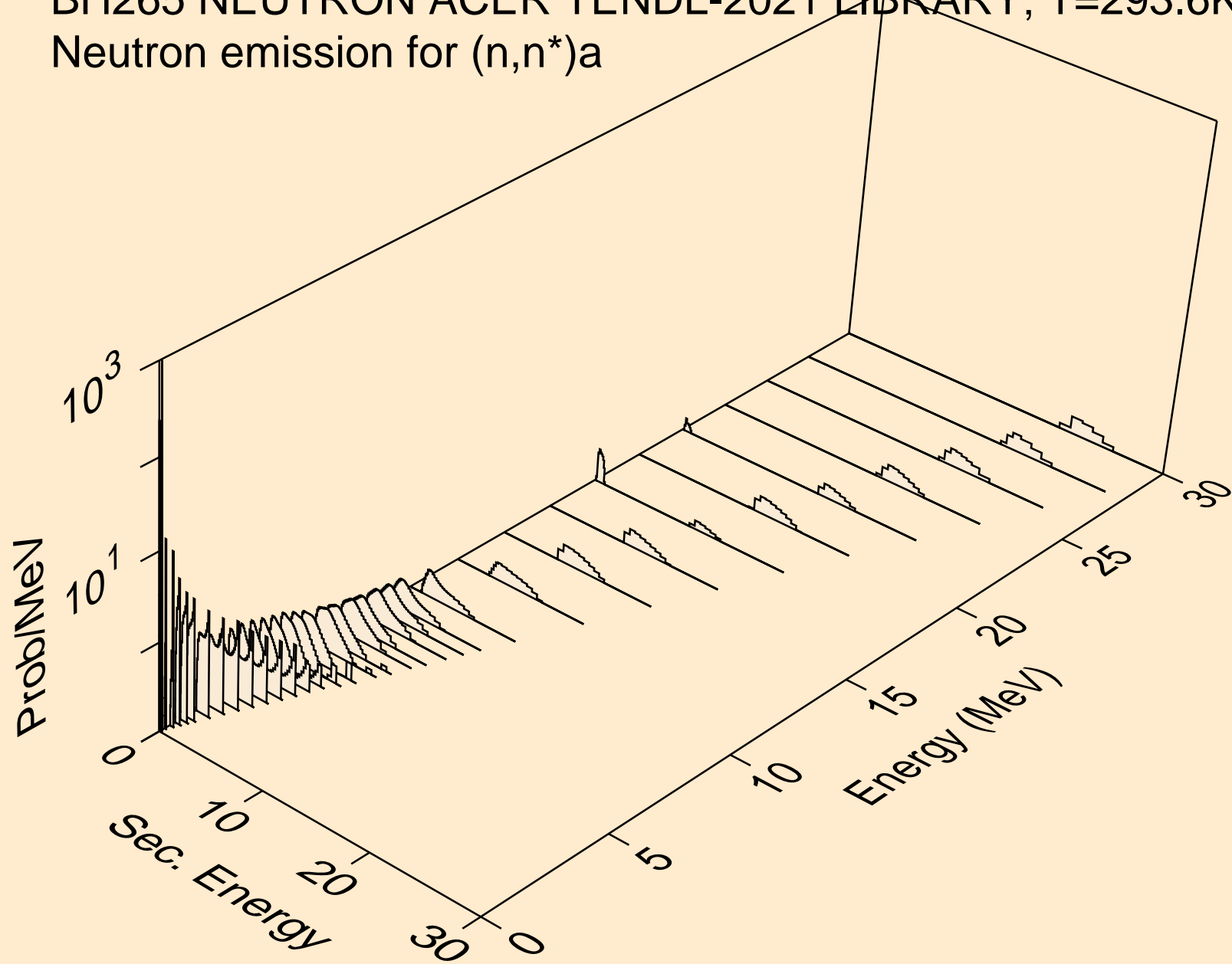

BH265 NEUTRON ACER TENDL-2021 LIBRARY; T=293.6K
Neutron emission for (n,n*)3a

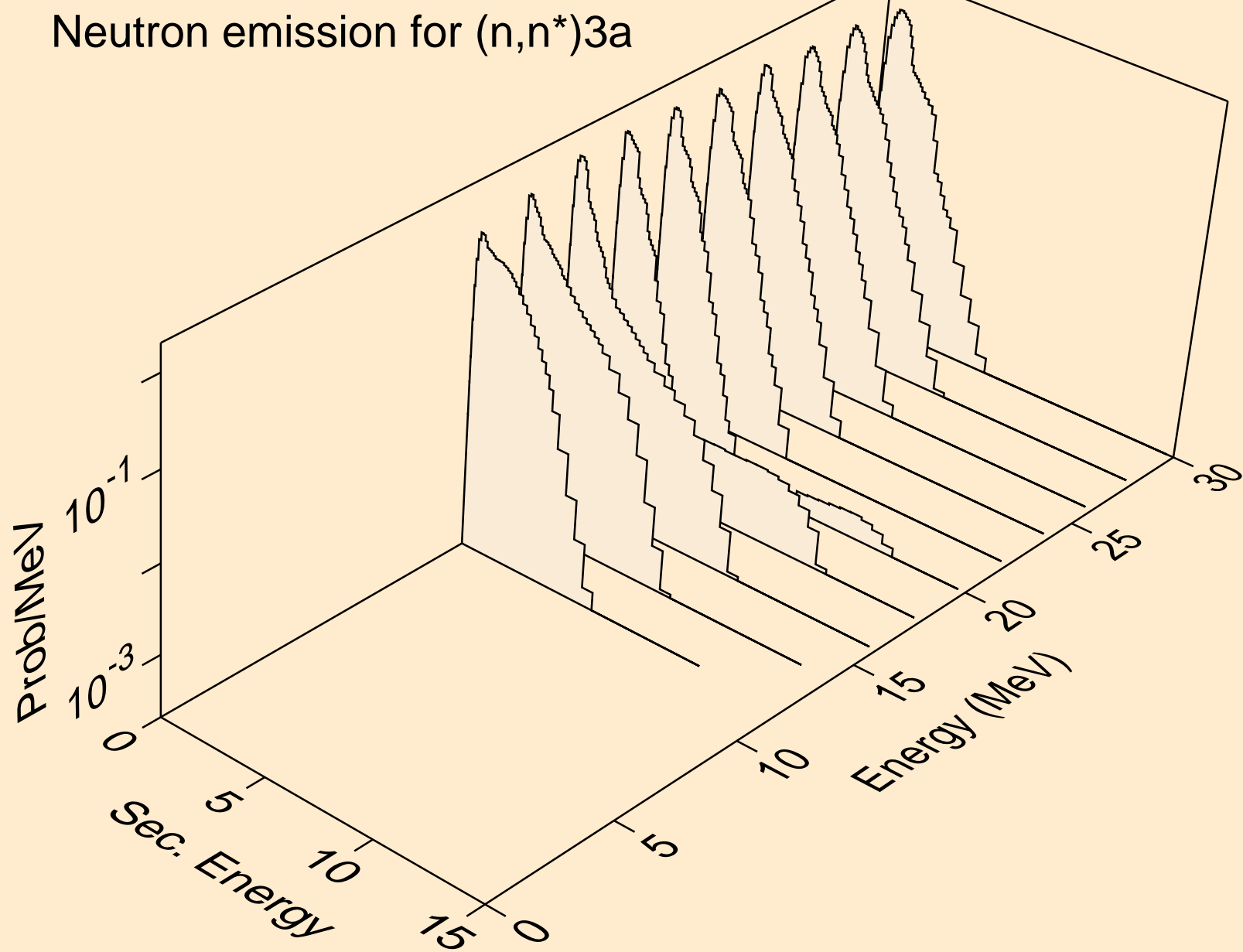

BH265 NEUTRON ACER TENDL-2021 LIBRARY; T=293.6K
Neutron emission for (n,2n)a

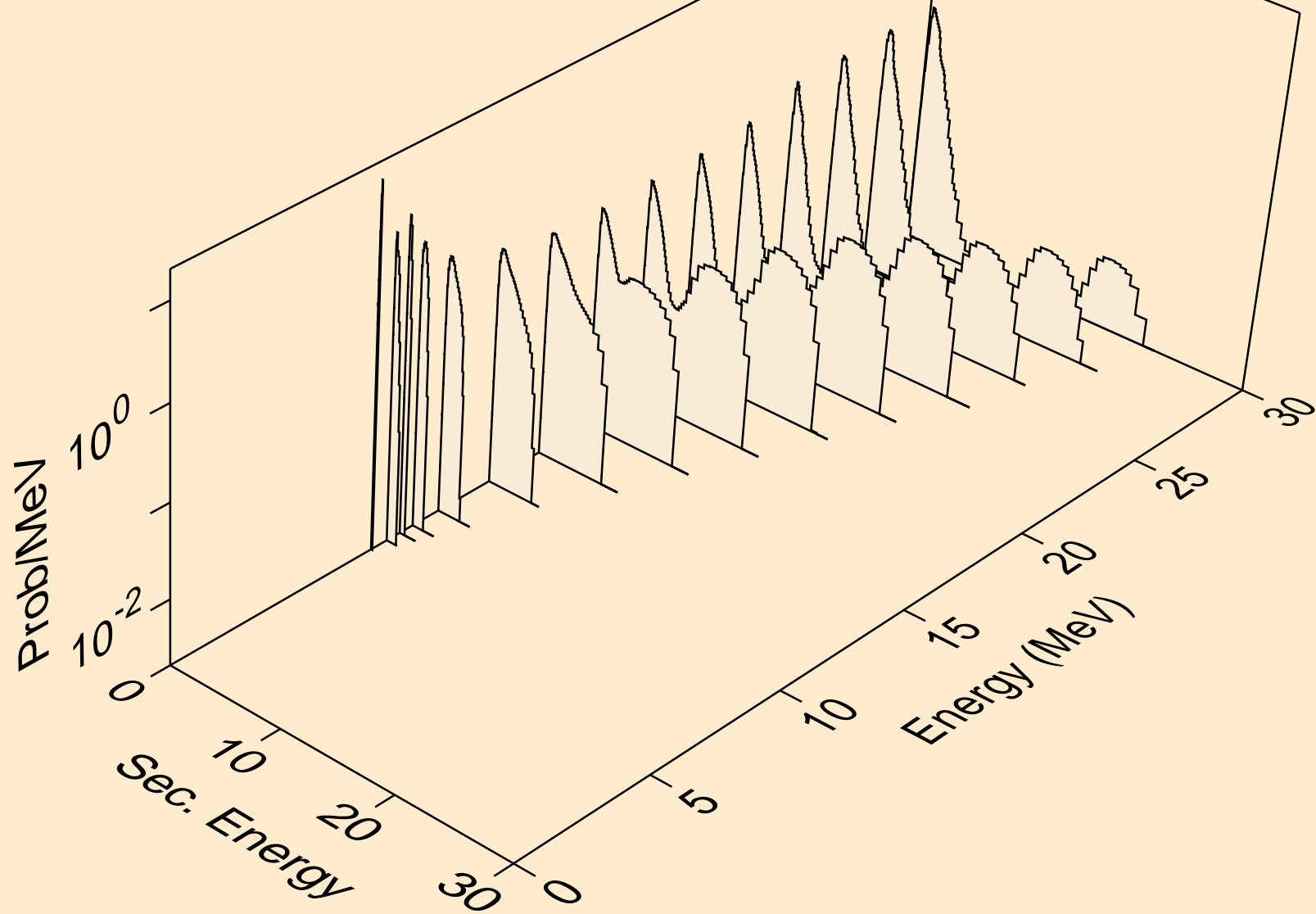

BH265 NEUTRON ACER TENDL-2021 LIBRARY; T=293.6K
Neutron emission for (n,3n)a

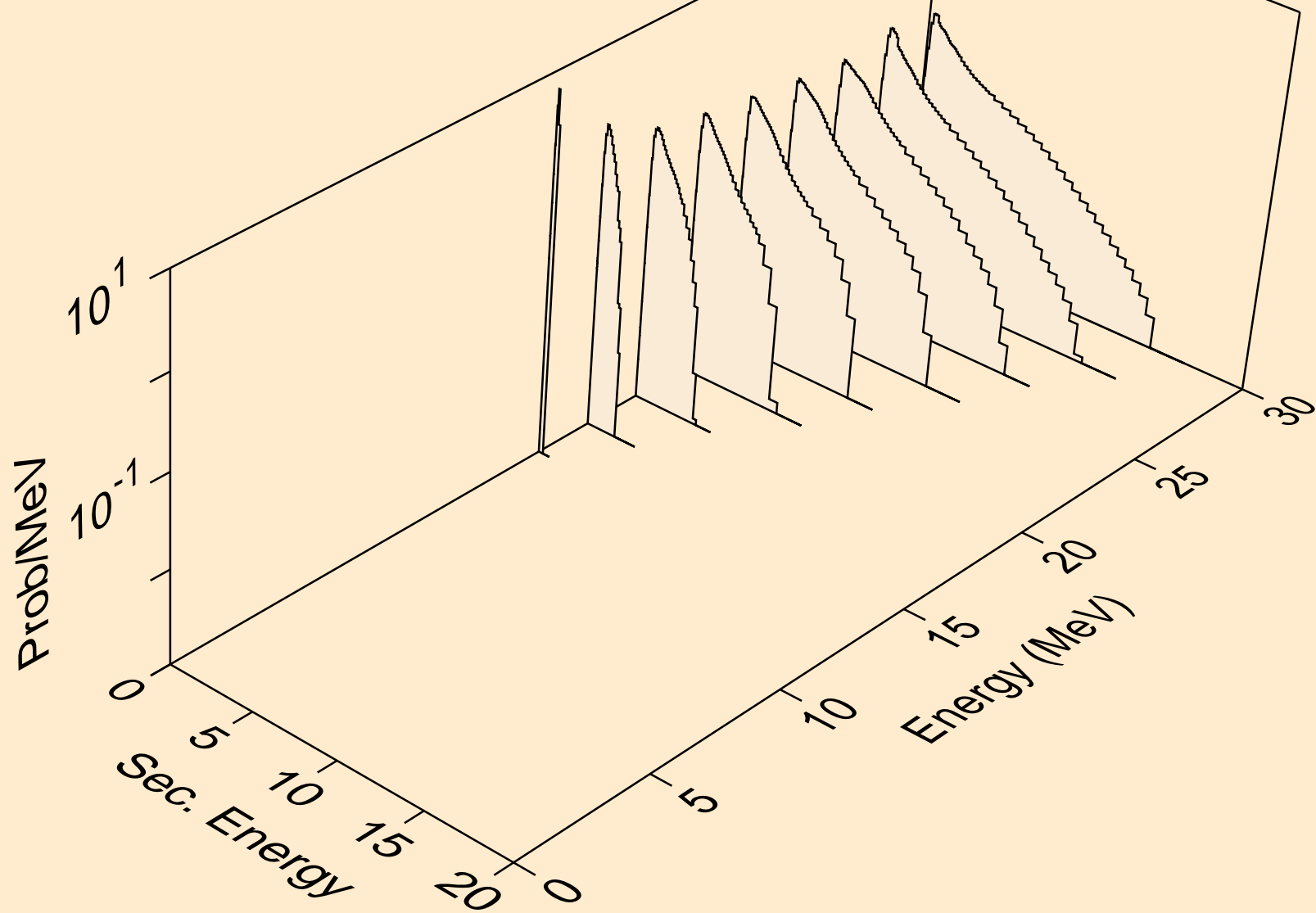

BH265 NEUTRON ACER TENDL-2021 LIBRARY; T=293.6K
Neutron emission for (n,n*)p

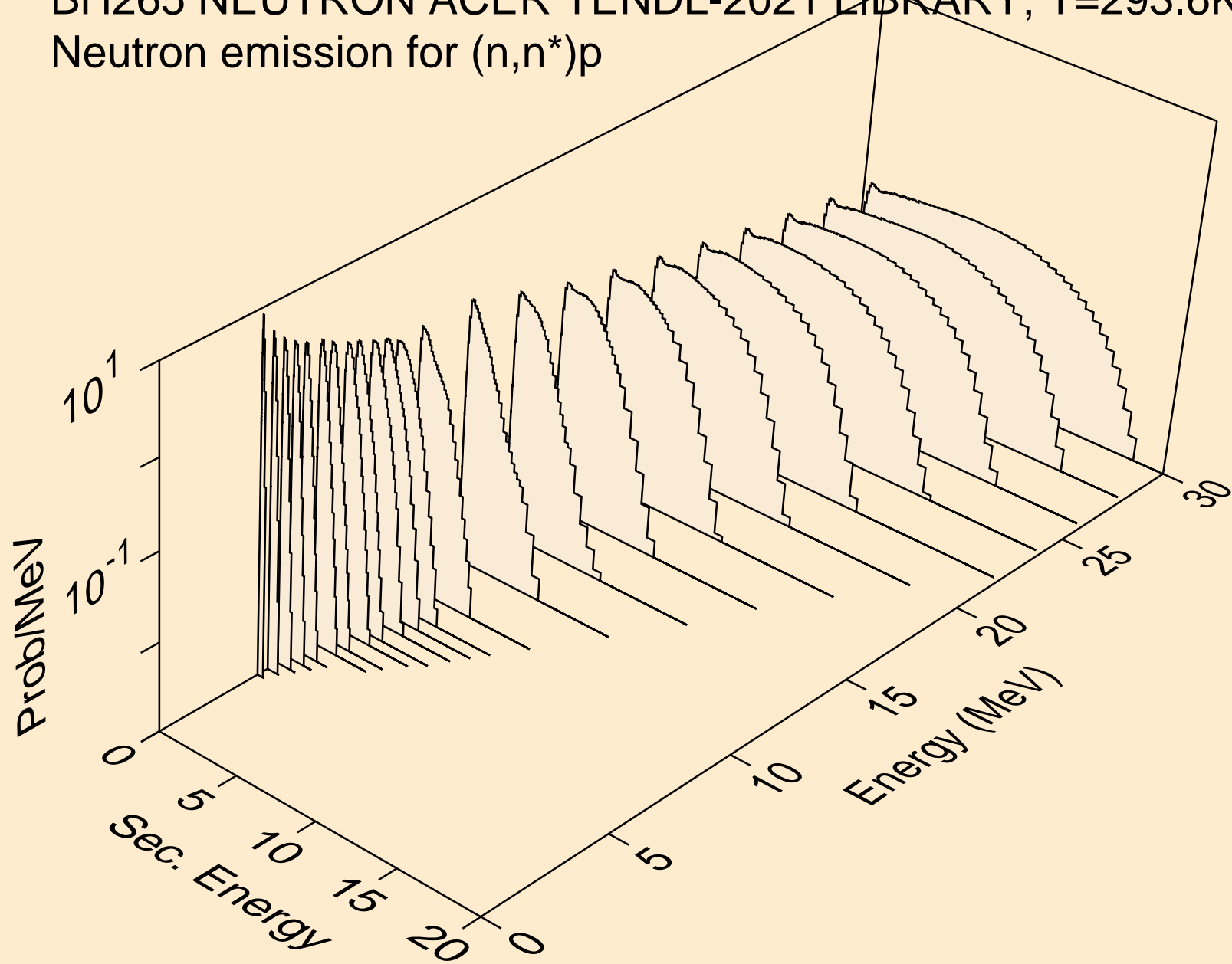

BH265 NEUTRON ACER TENDL-2021 LIBRARY; T=293.6K
Neutron emission for (n,n*)2a

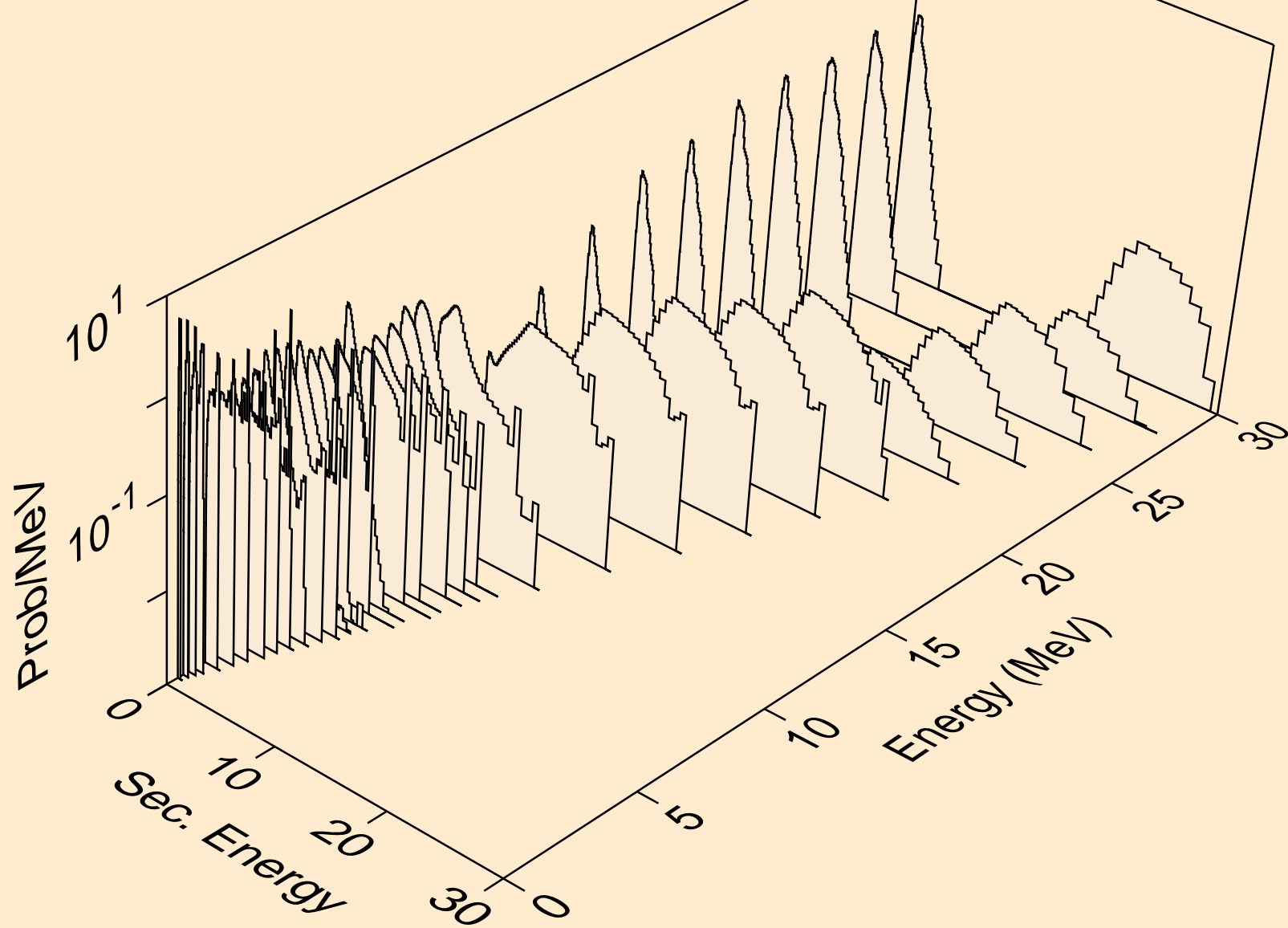

BH265 NEUTRON ACER TENDL-2021 LIBRARY; T=293.6K
Neutron emission for (n,2n)2a

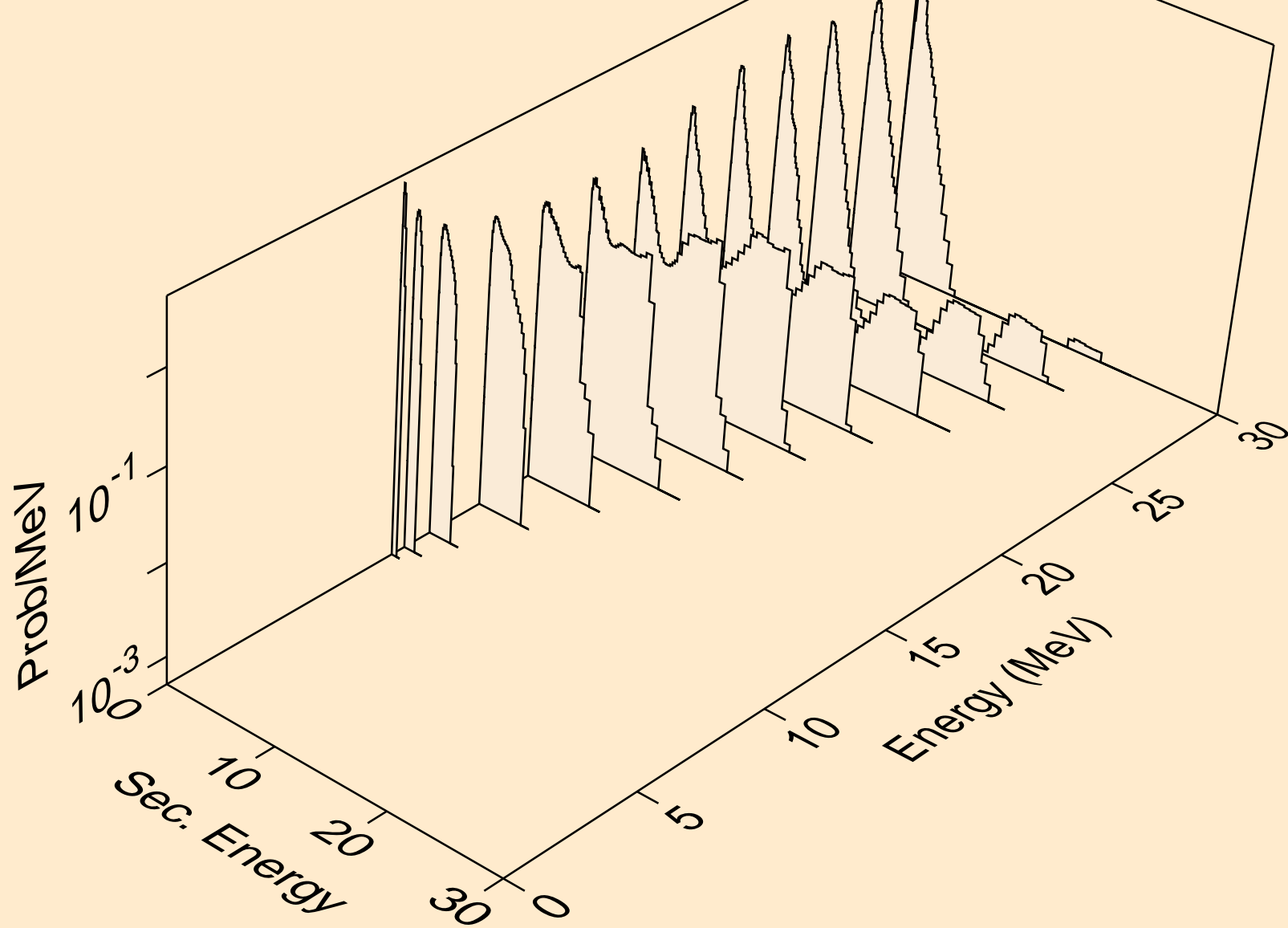

BH265 NEUTRON ACER TENDL-2021 LIBRARY; T=293.6K
Neutron emission for (n,n*)d

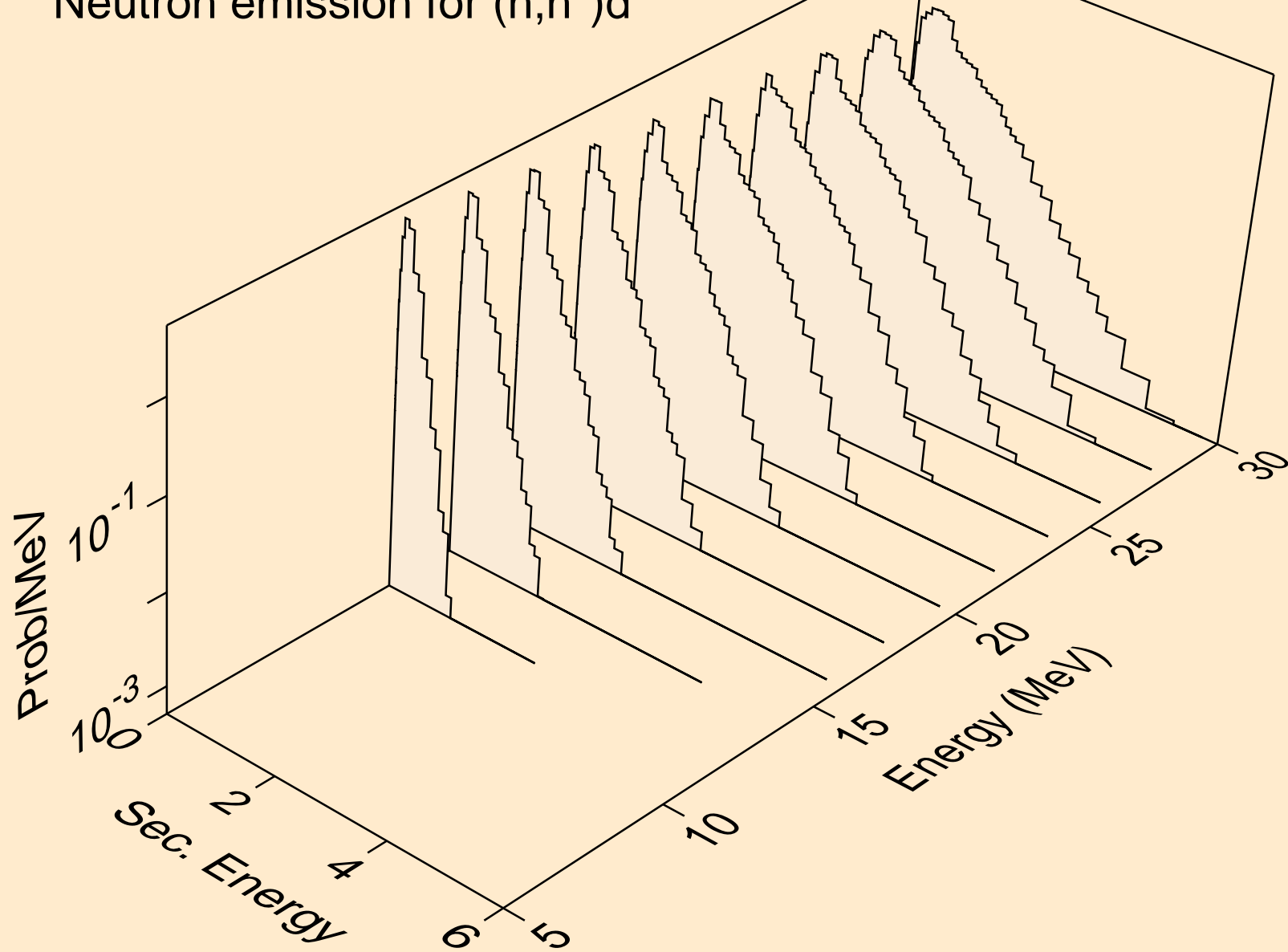

BH265 NEUTRON ACER TENDL-2021 LIBRARY; T=293.6K
Neutron emission for (n,n*)t

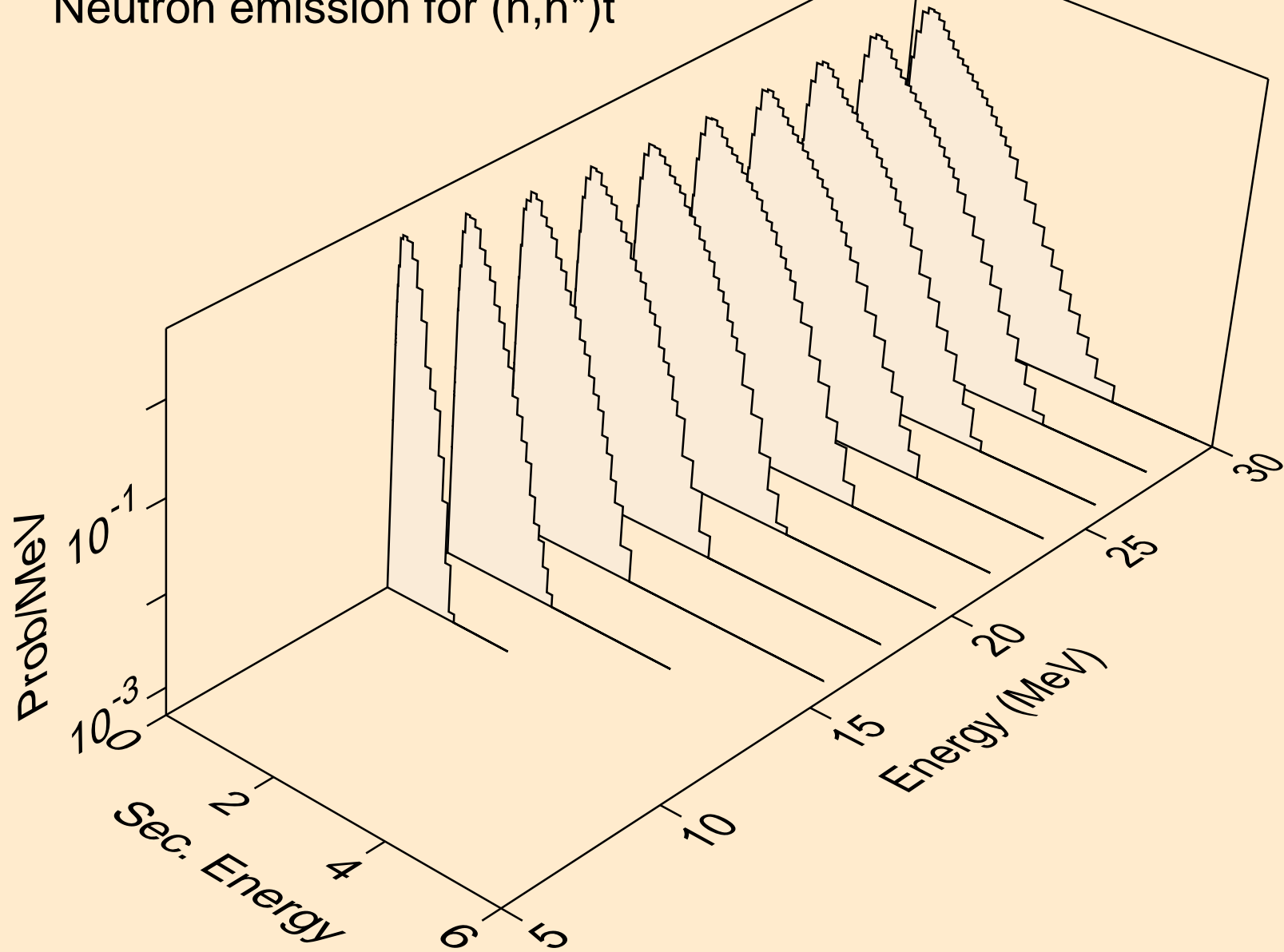

BH265 NEUTRON ACER TENDL-2021 LIBRARY; T=293.6K
Neutron emission for (n,n*)he3

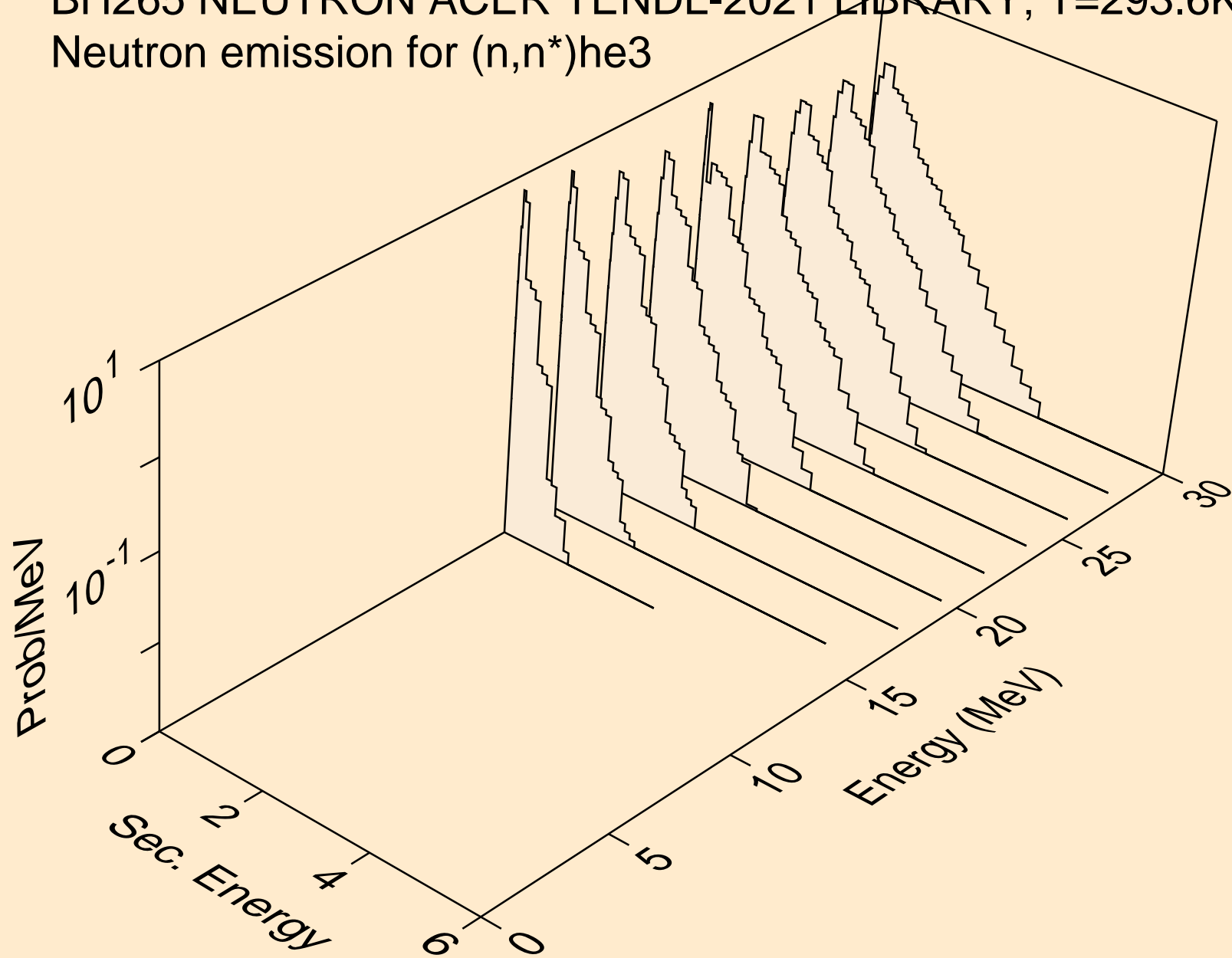

BH265 NEUTRON ACER TENDL-2021 LIBRARY; T=293.6K
Neutron emission for (n,n*)t2a

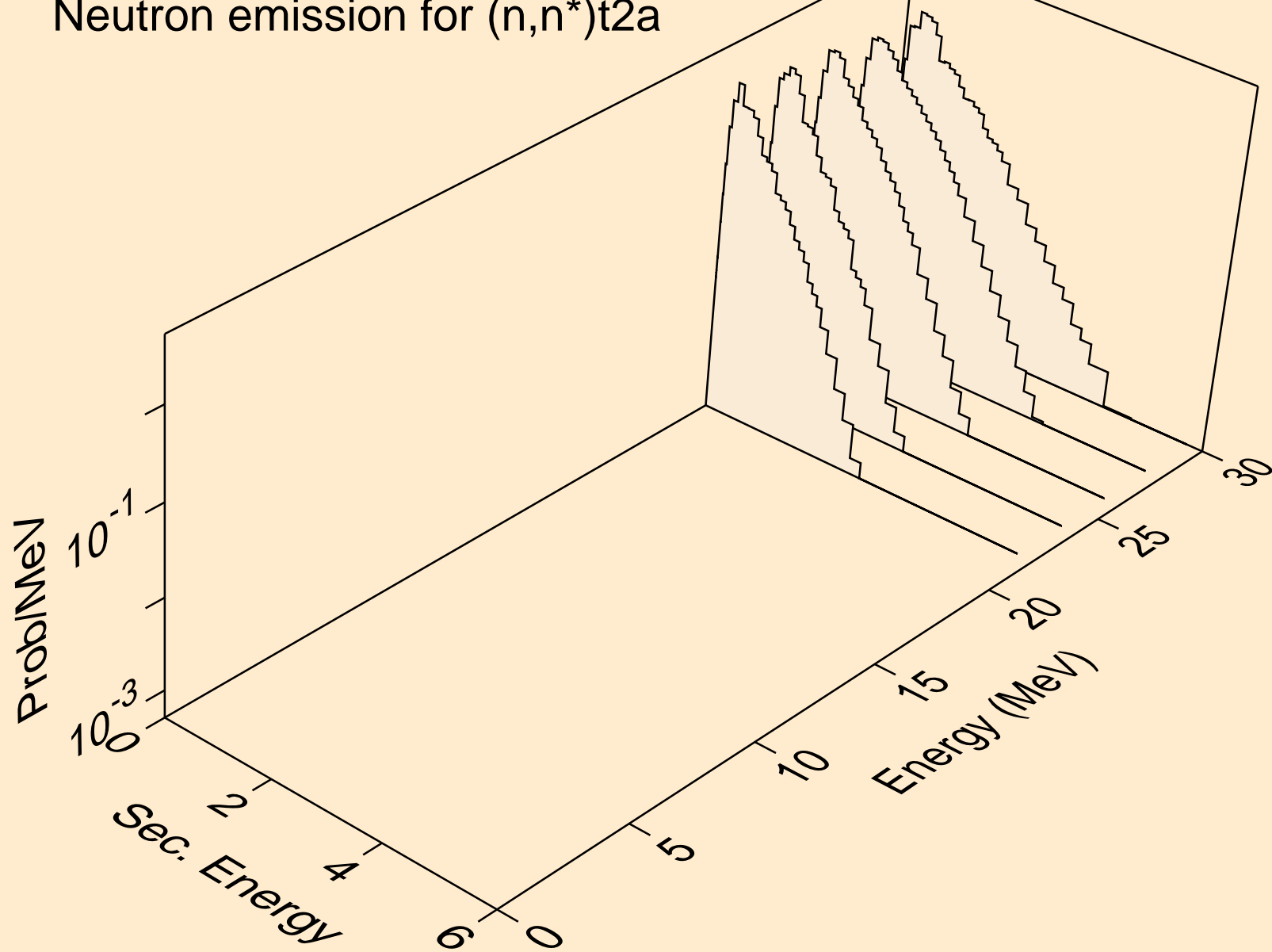

BH265 NEUTRON ACER TENDL-2021 LIBRARY; T=293.6K
Neutron emission for (n,4n)

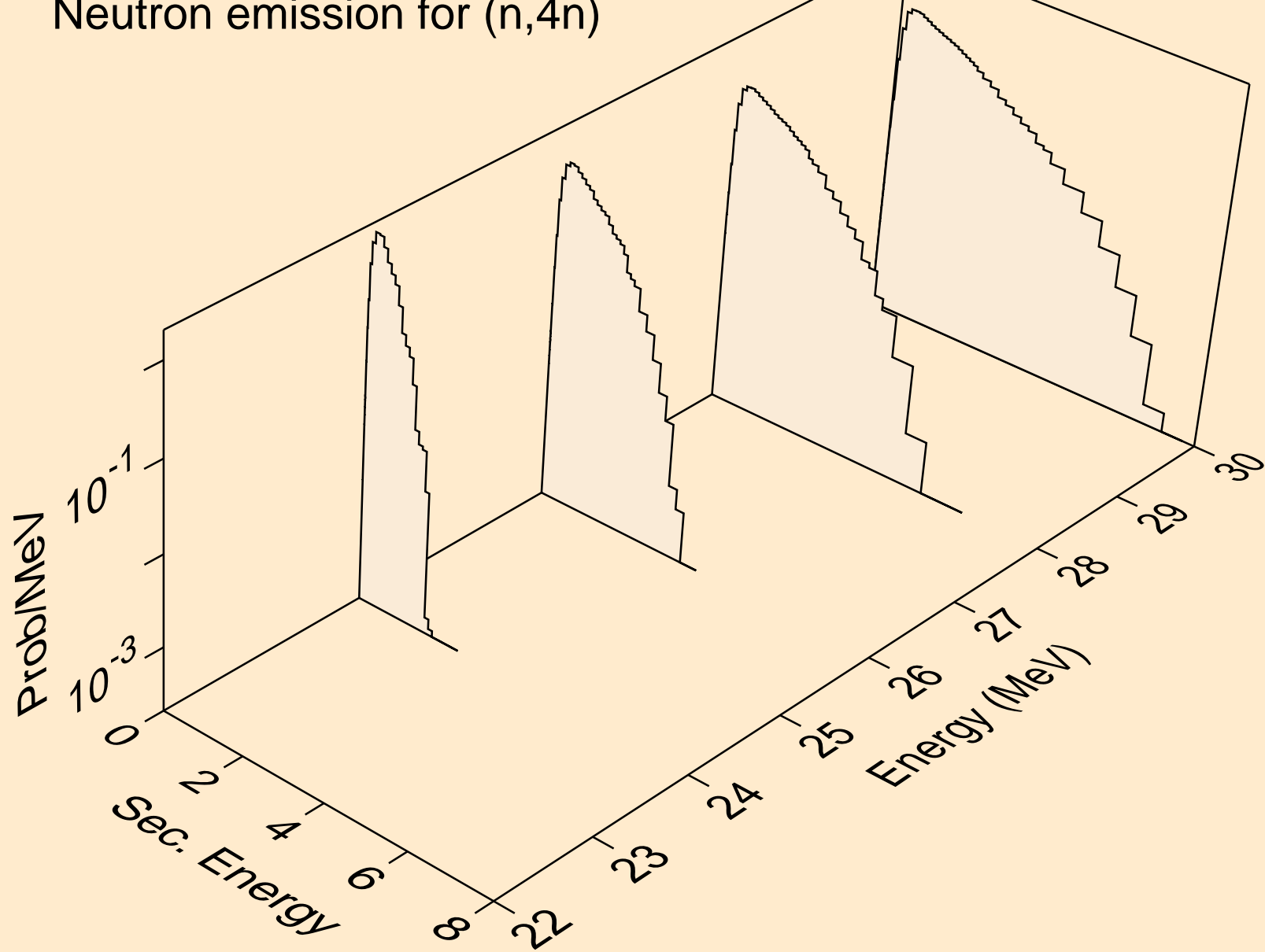

BH265 NEUTRON ACER TENDL-2021 LIBRARY; T=293.6K
Neutron emission for (n,2np)

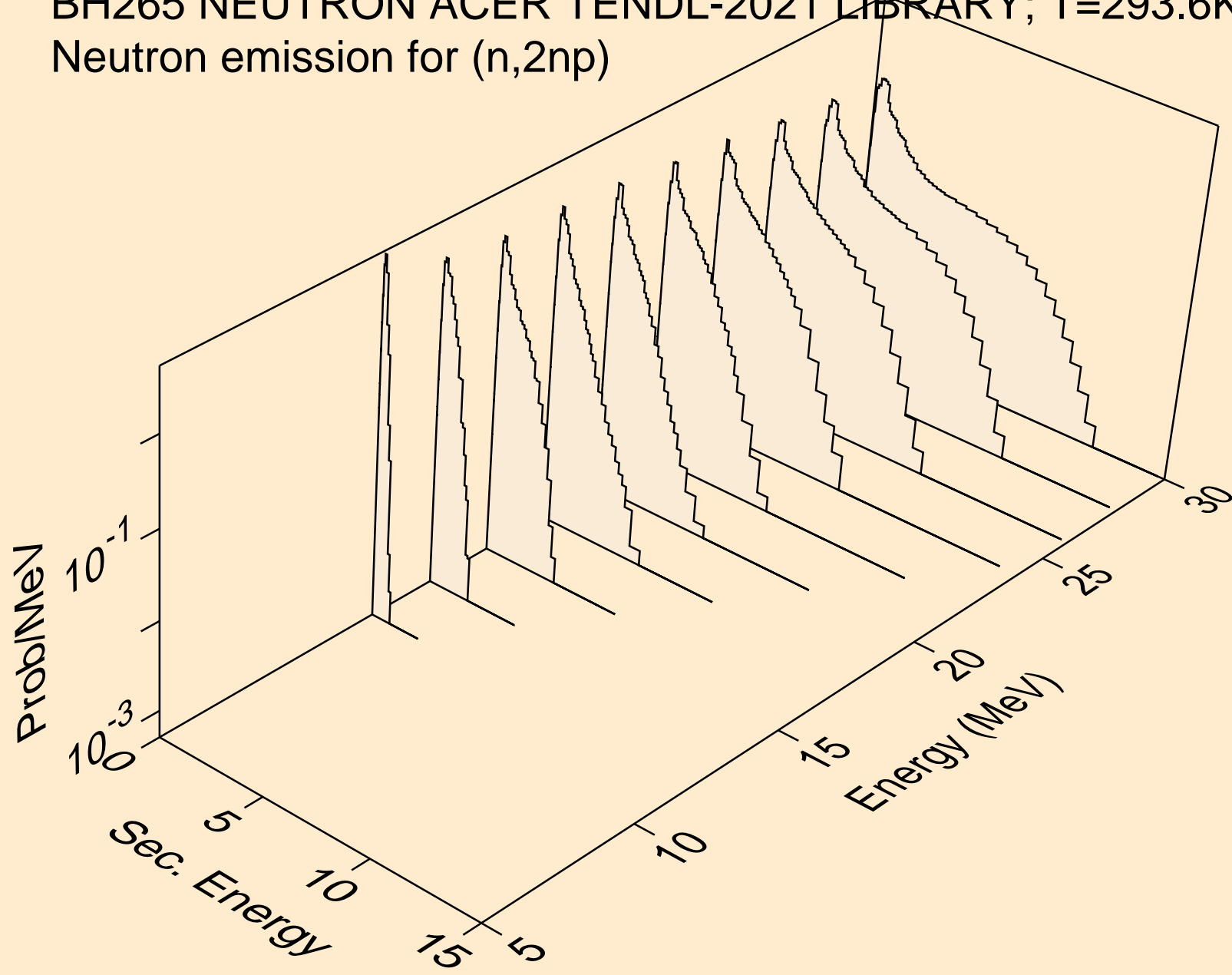

BH265 NEUTRON ACER TENDL-2021 LIBRARY; T=293.6K
Neutron emission for (n,3np)

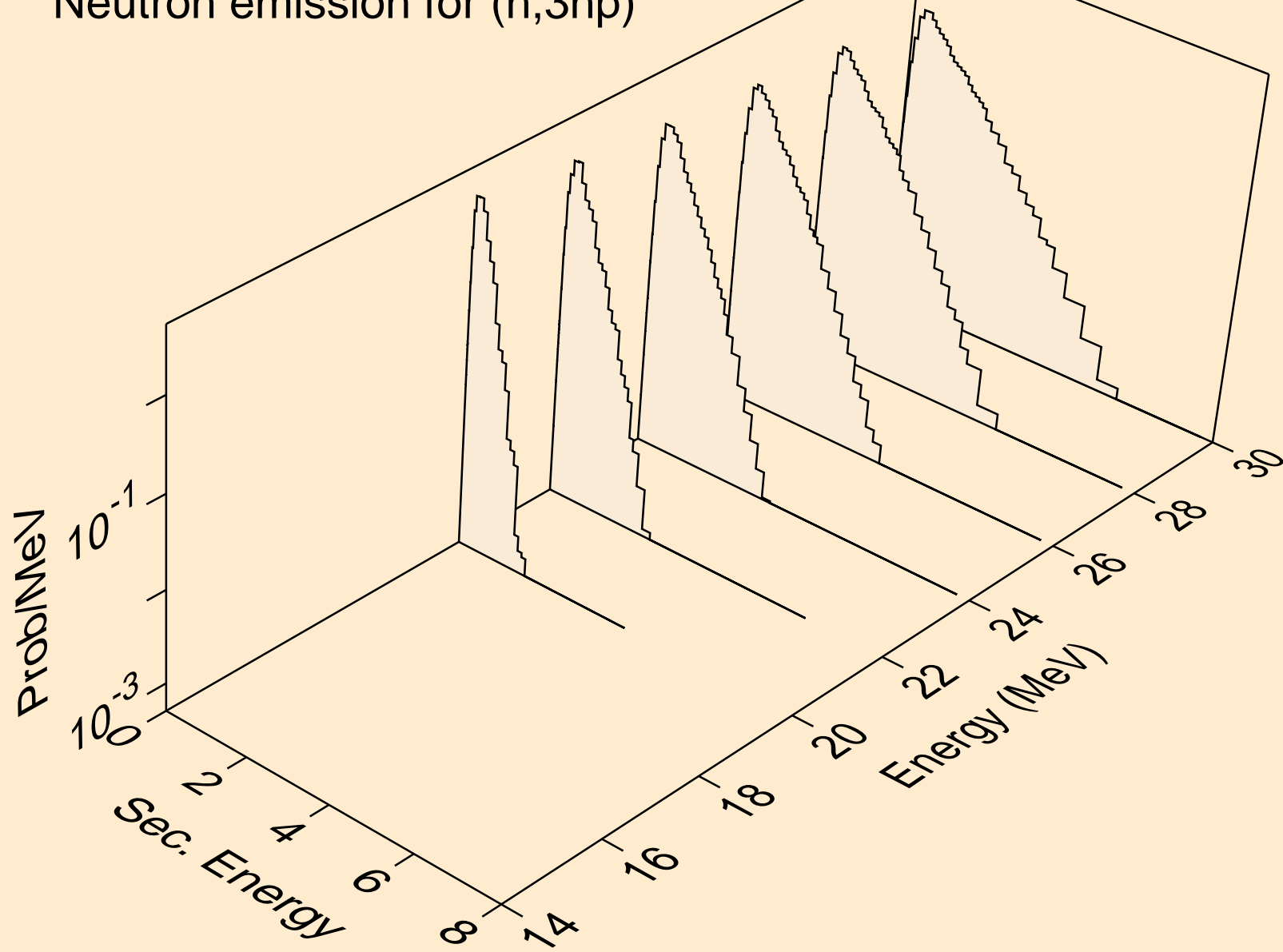

BH265 NEUTRON ACER TENDL-2021 LIBRARY; T=293.6K
Neutron emission for (n,2np)

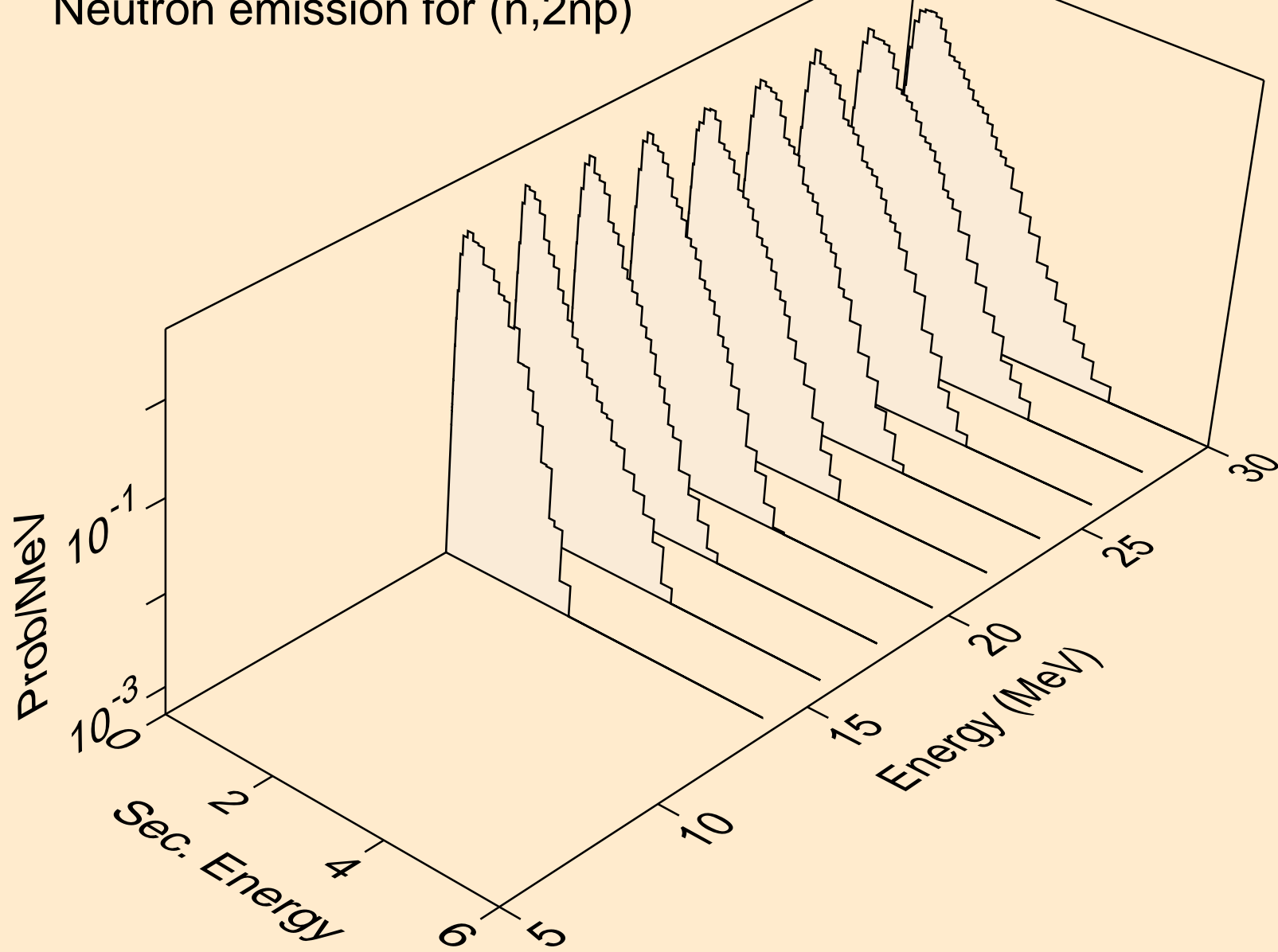

BH265 NEUTRON ACER TENDL-2021 LIBRARY; T=293.6K
Neutron emission for (n,npa)

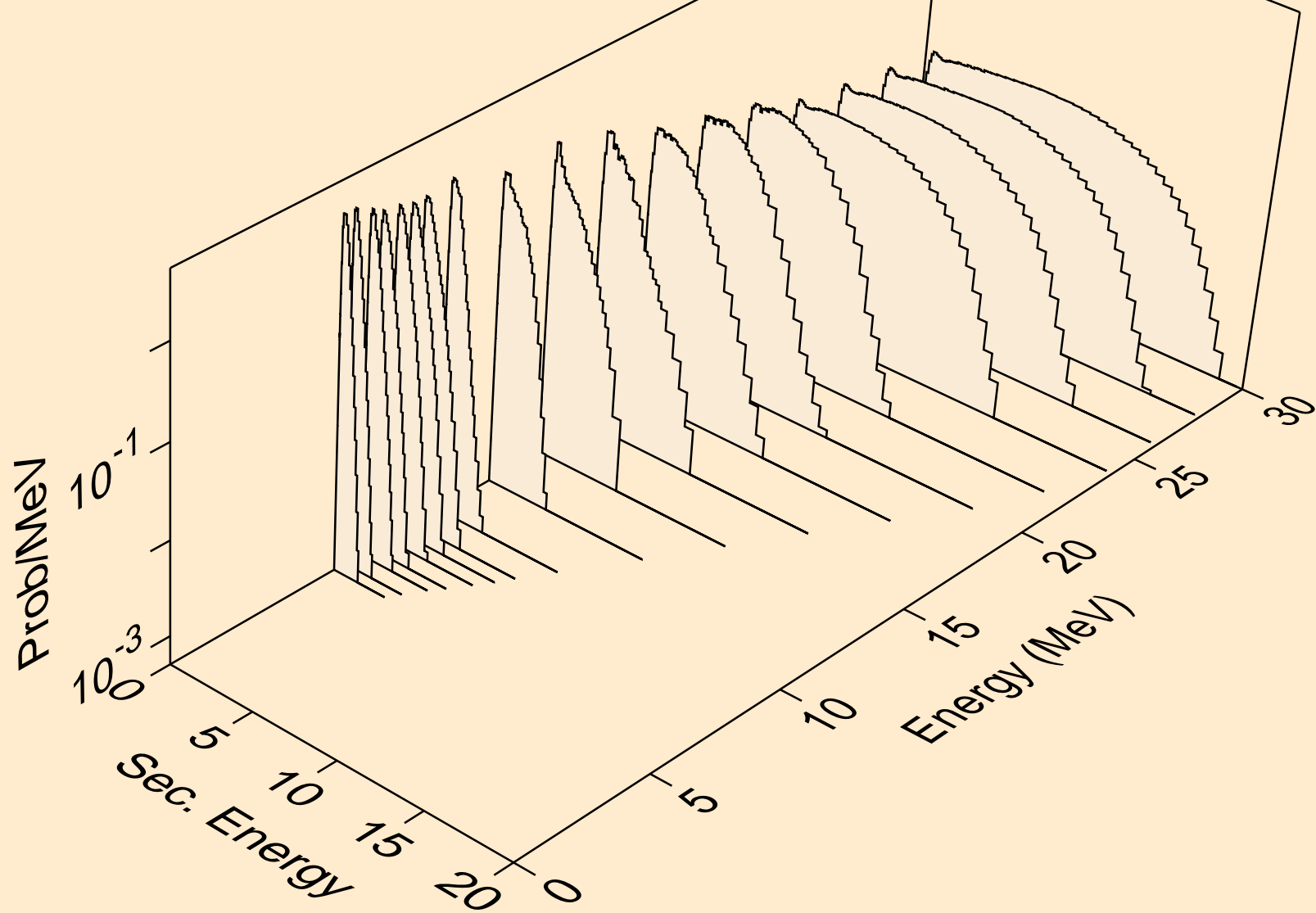

BH265 NEUTRON ACER TENDL-2021 LIBRARY; T=293.6K
Neutron emission for (n,n*c)

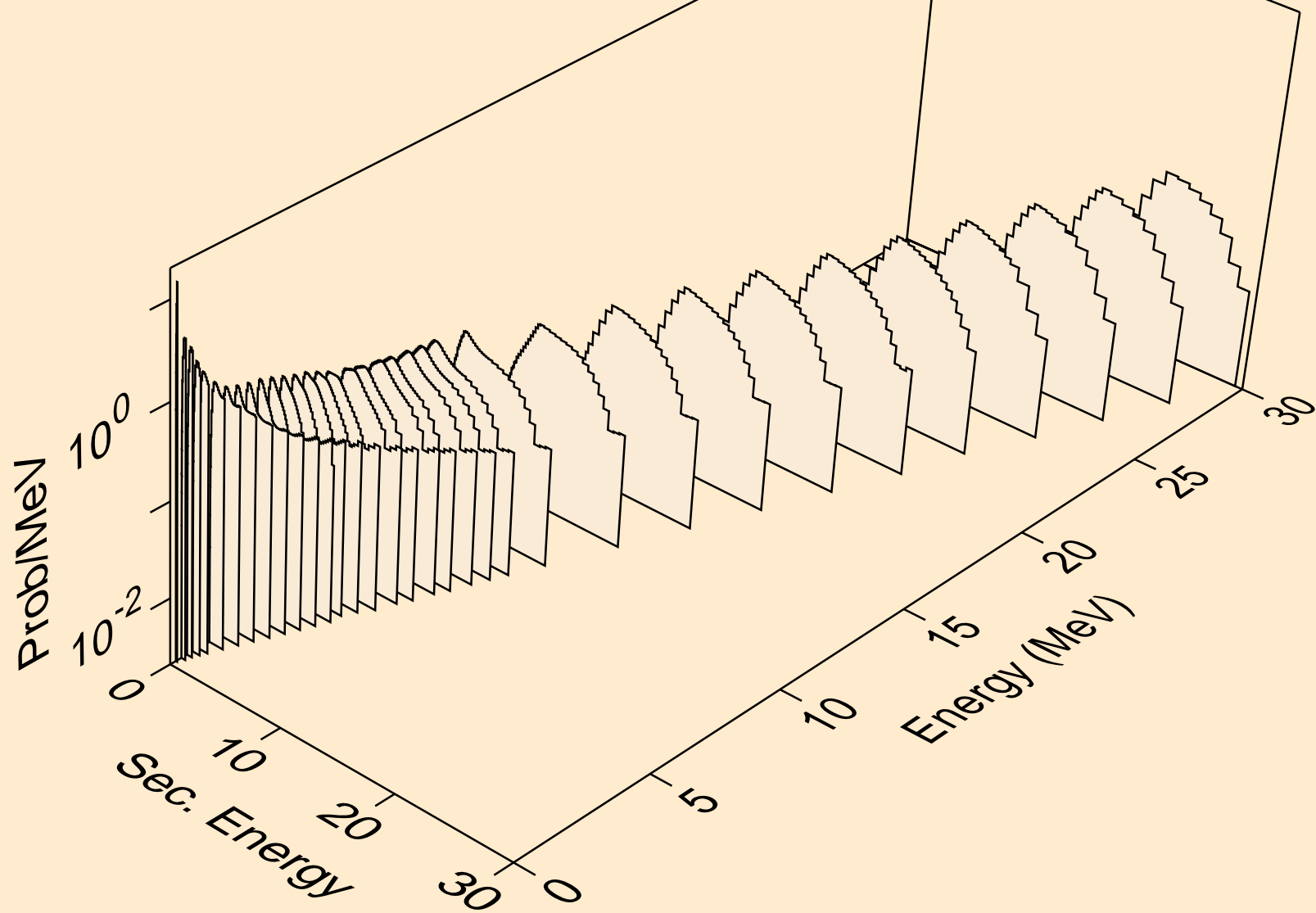

BH265 NEUTRON ACER TENDL-2021 LIBRARY; T=293.6K

Delayed nubar

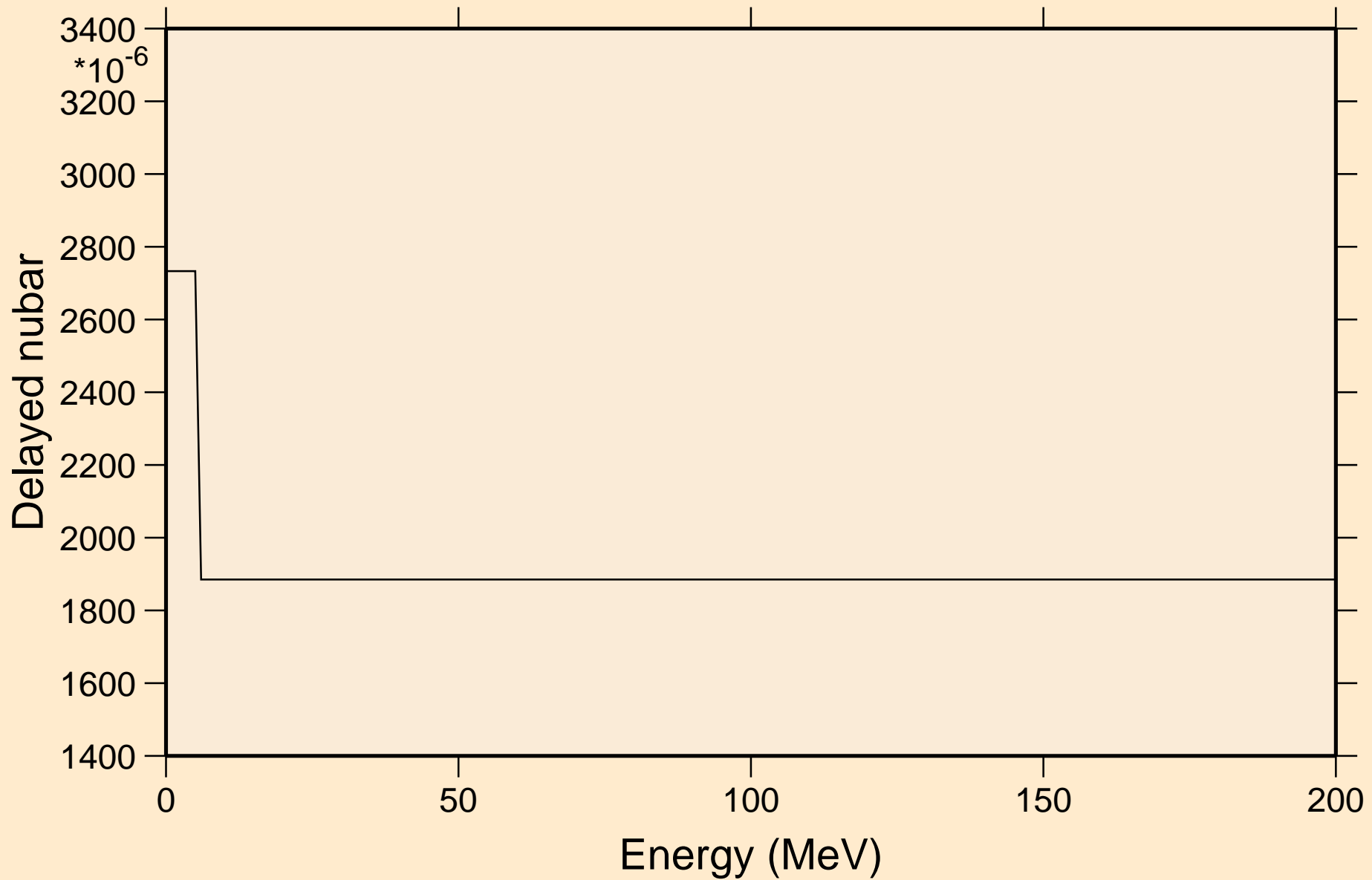

BH265 NEUTRON ACER TENDL-2021 LIBRARY; T=293.6K

Delayed neutron spectra

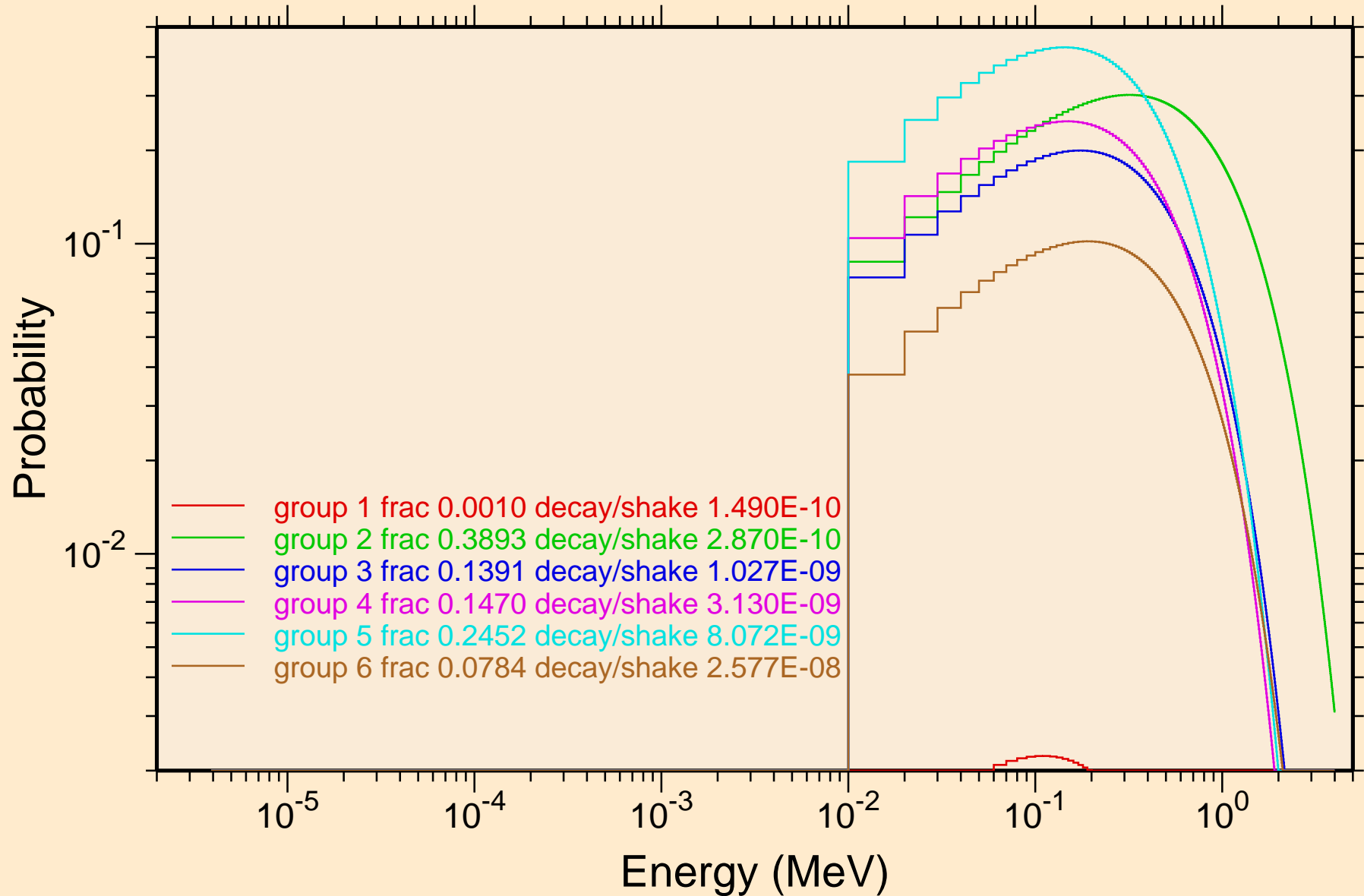

BH265 NEUTRON ACER TENDL-2021 LIBRARY; T=293.6K
Photon emission for (n,x)

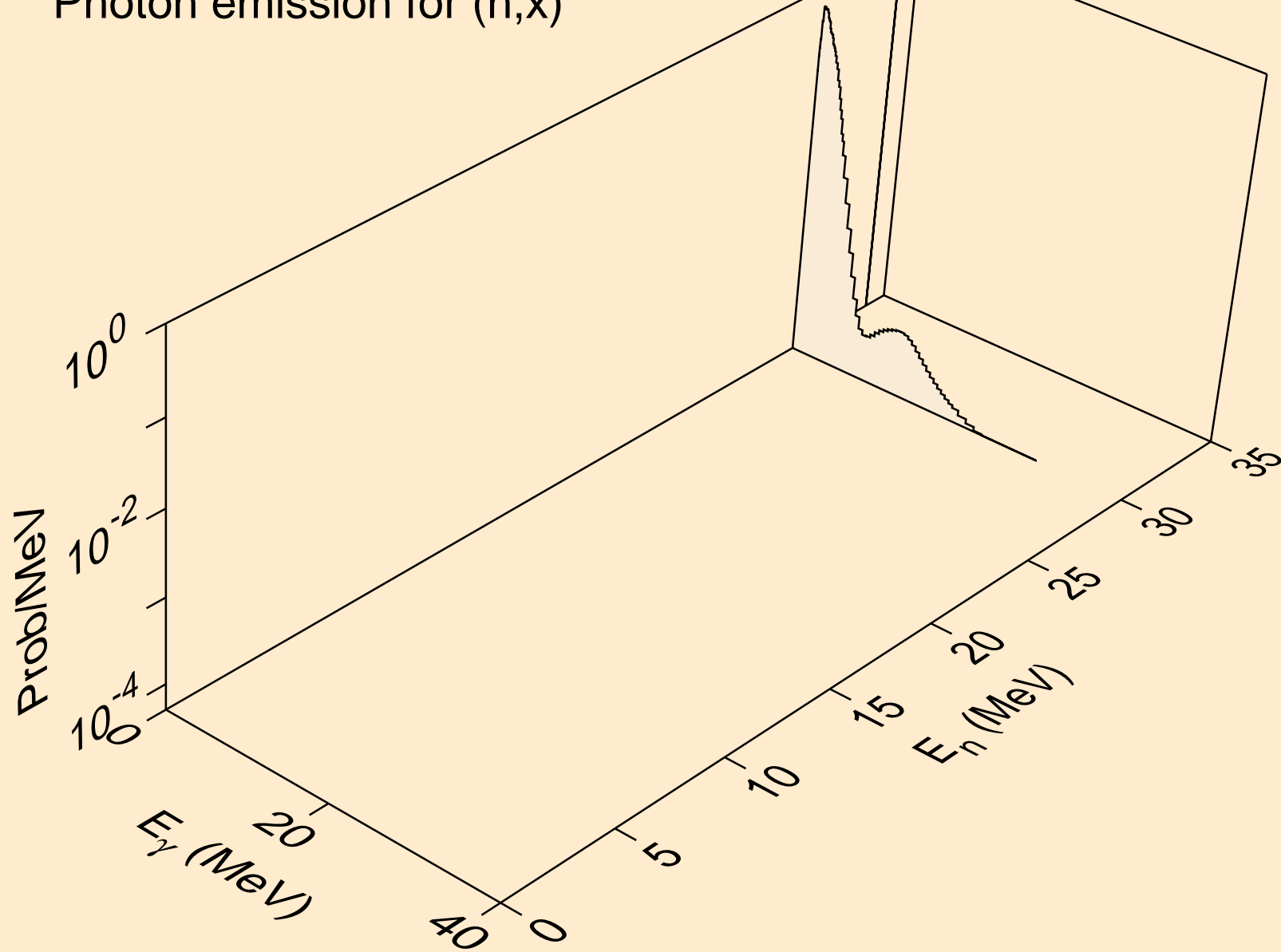

BH265 NEUTRON ACER TENDL-2021 LIBRARY; T=293.6K
Photon emission for (n,2nd)

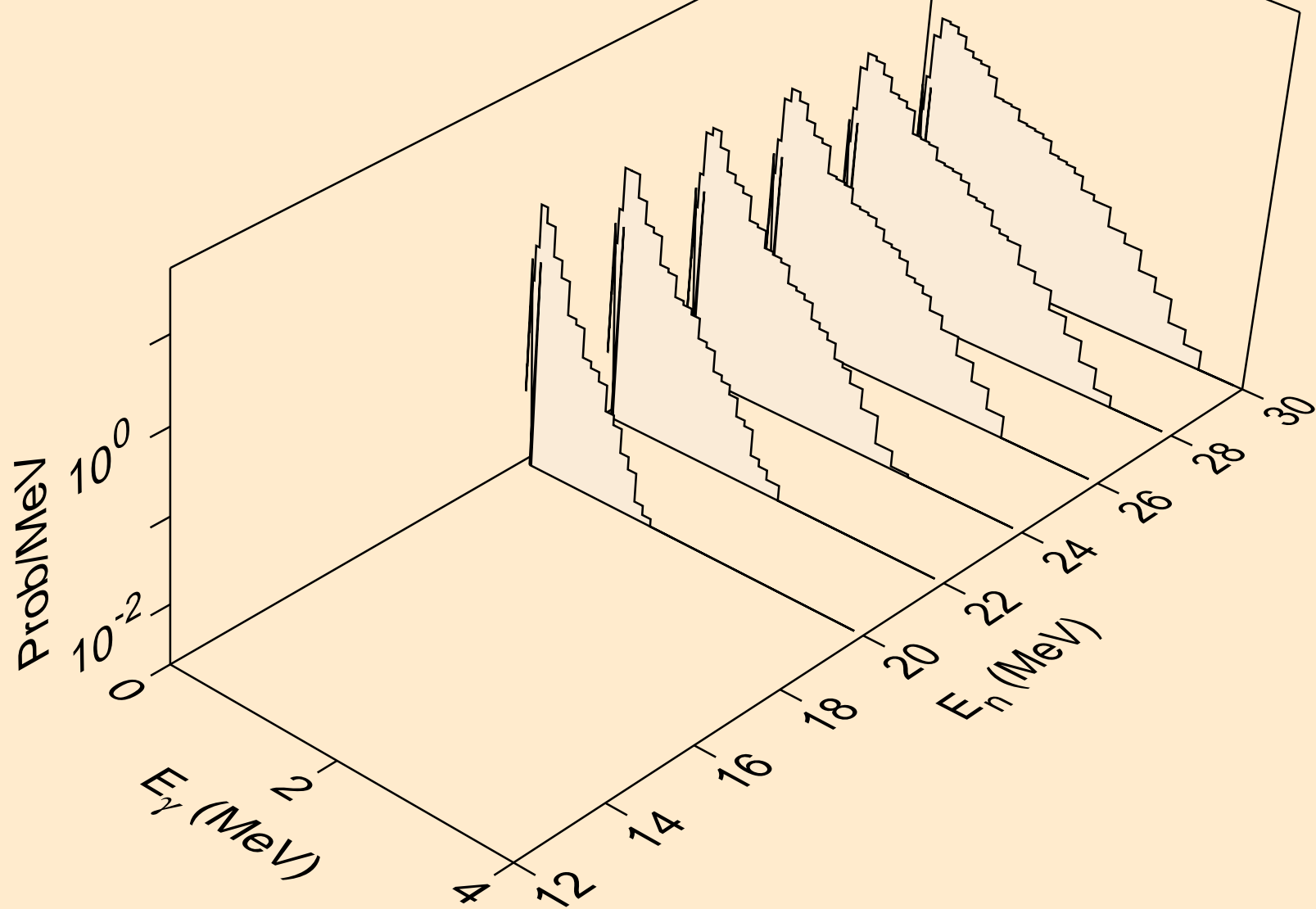

BH265 NEUTRON ACER TENDL-2021 LIBRARY; T=293.6K
Photon emission for (n,2n)

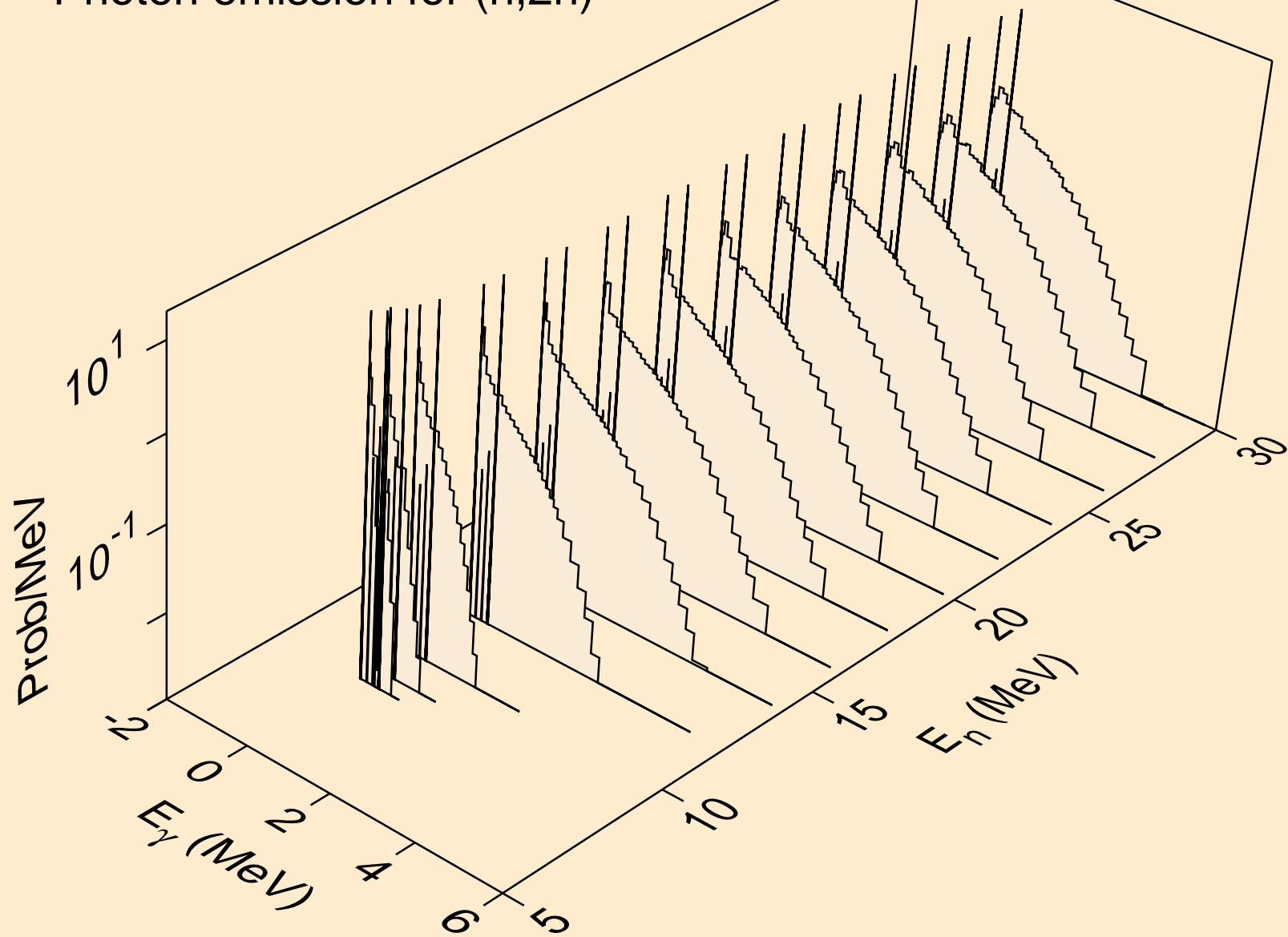

BH265 NEUTRON ACER TENDL-2021 LIBRARY; T=293.6K
Photon emission for (n,3n)

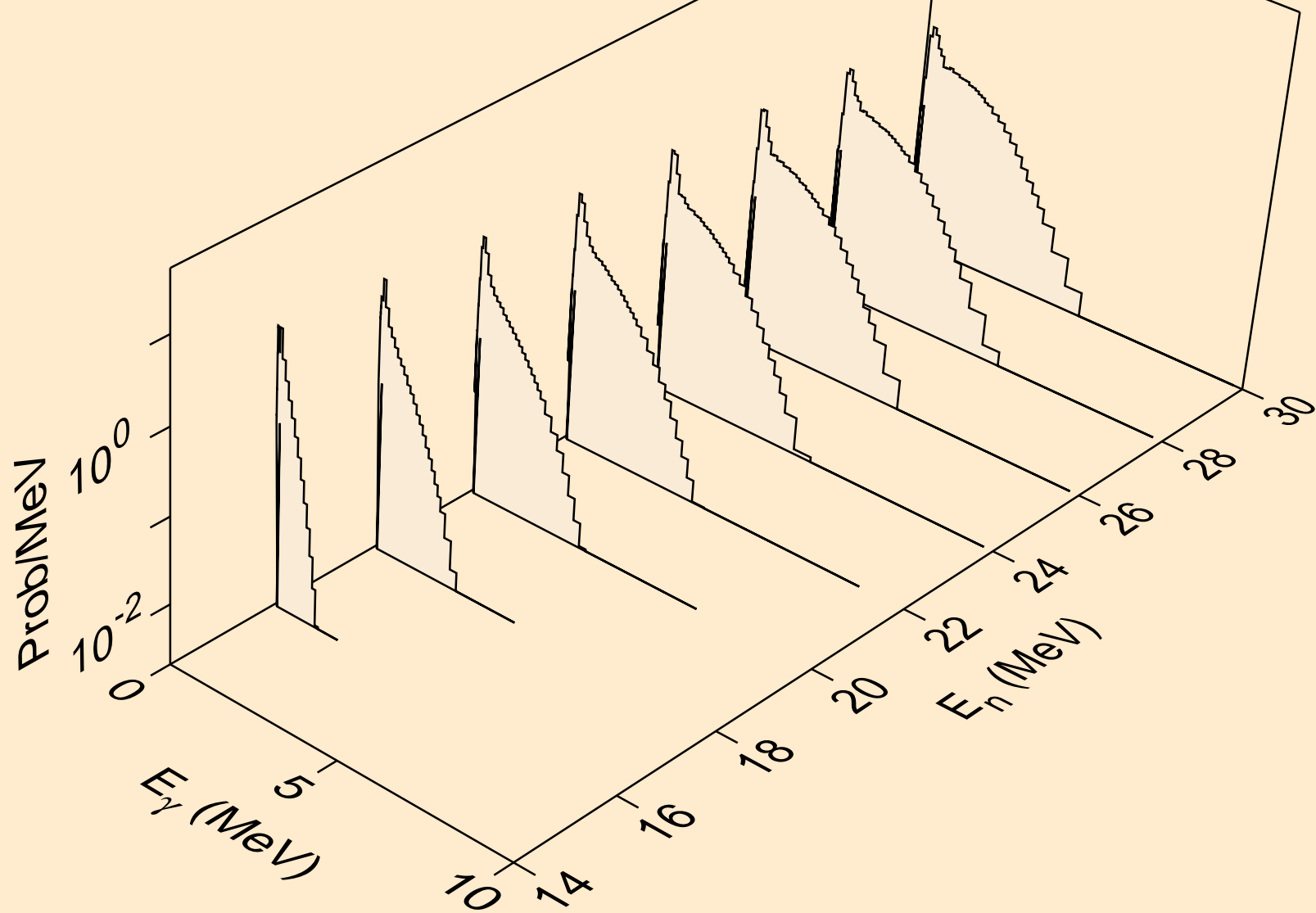

BH265 NEUTRON ACER TENDL-2021 LIBRARY; T=293.6K
Photon emission for (n,n*)a

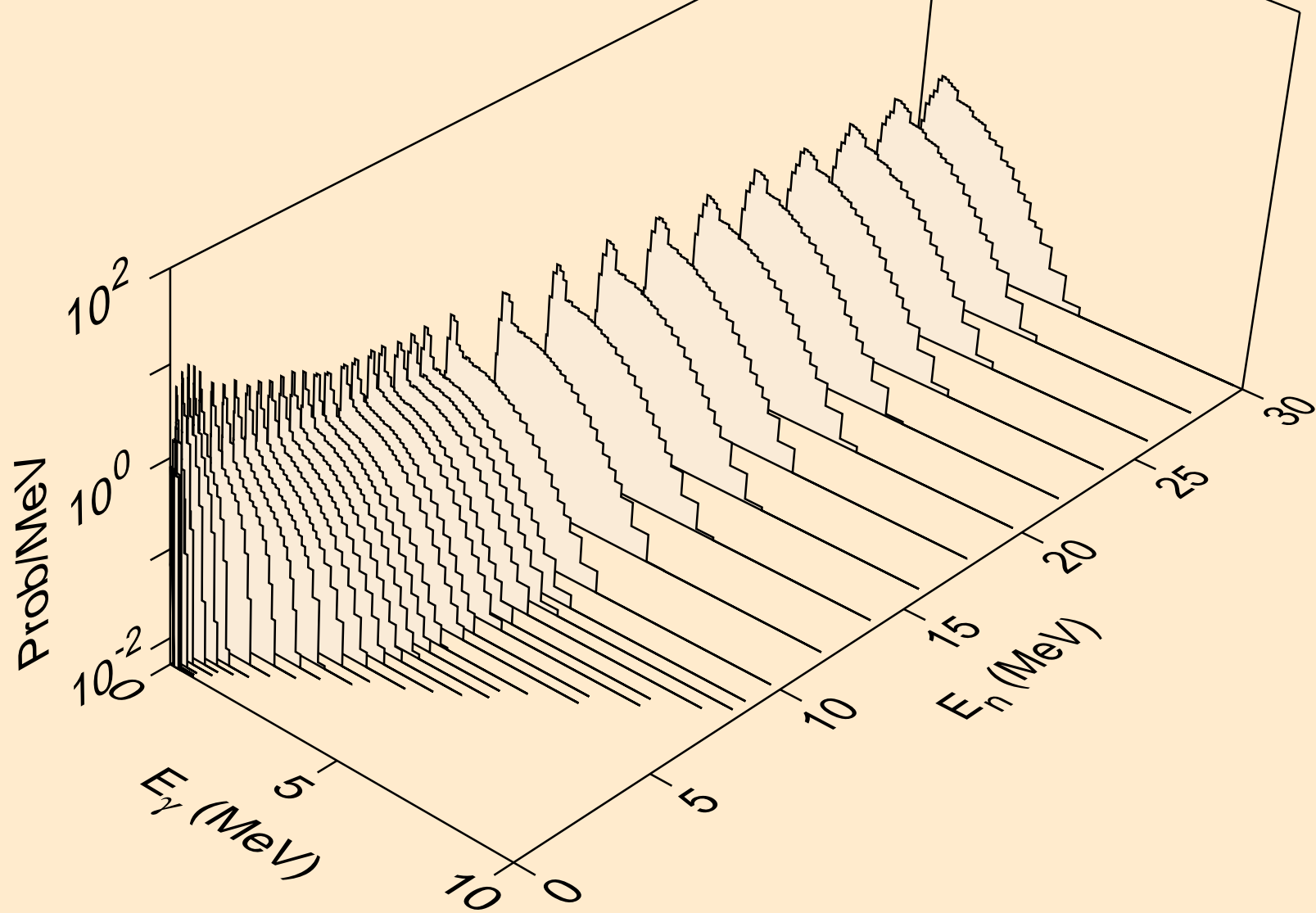

BH265 NEUTRON ACER TENDL-2021 LIBRARY; T=293.6K
Photon emission for (n,n*)3a

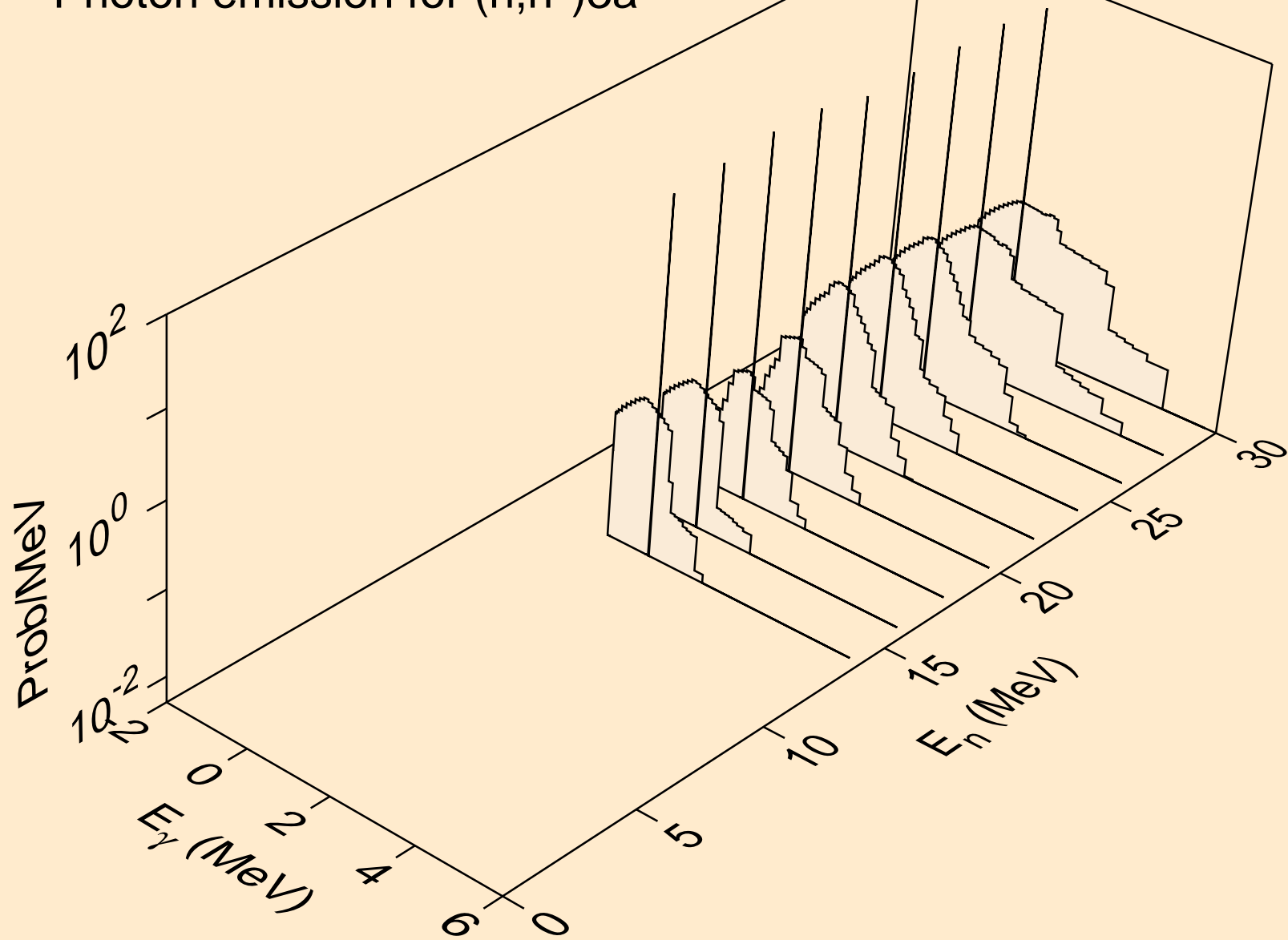

BH265 NEUTRON ACER TENDL-2021 LIBRARY; T=293.6K
Photon emission for (n,2n)a

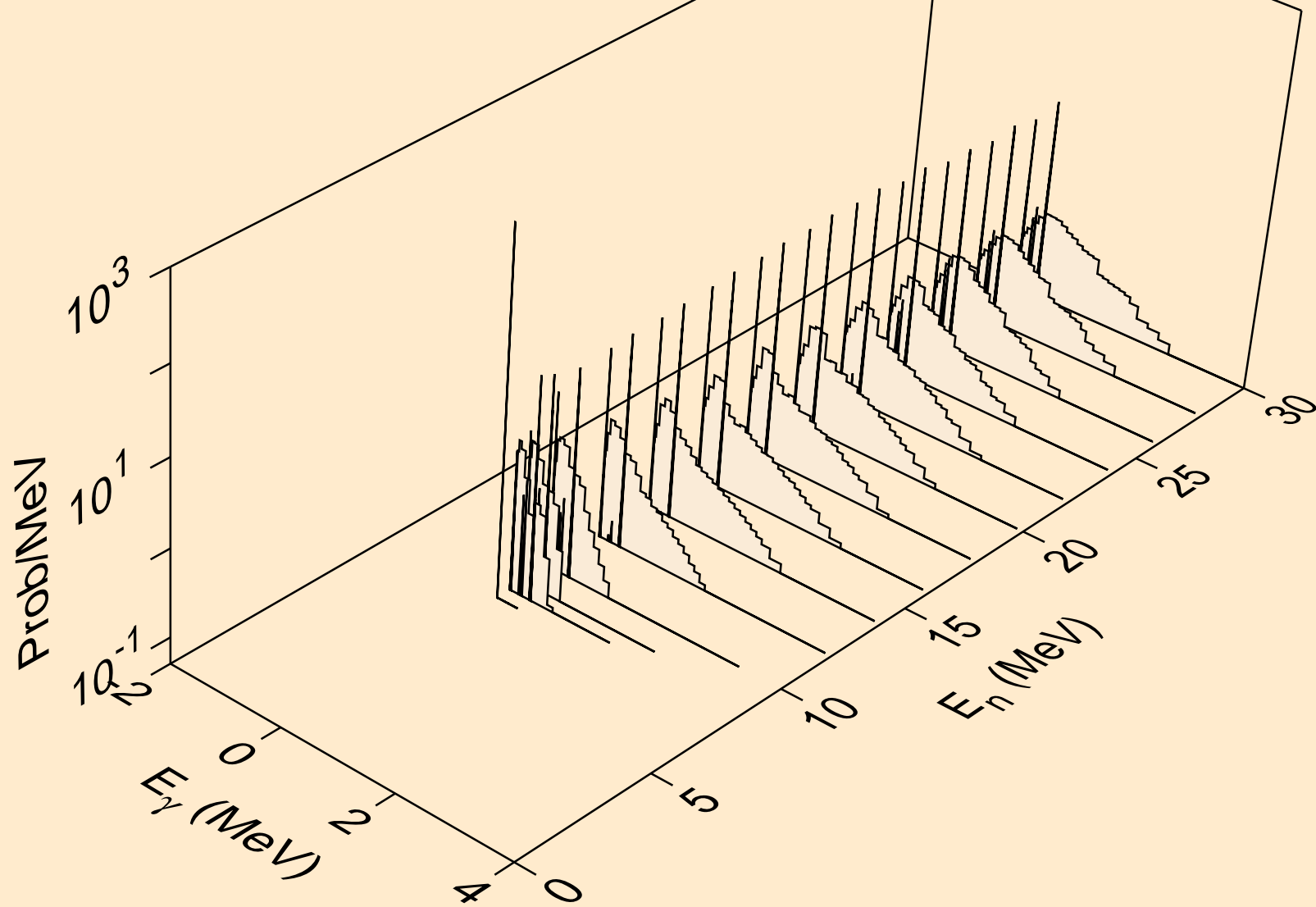

BH265 NEUTRON ACER TENDL-2021 LIBRARY; T=293.6K
Photon emission for (n,3n)a

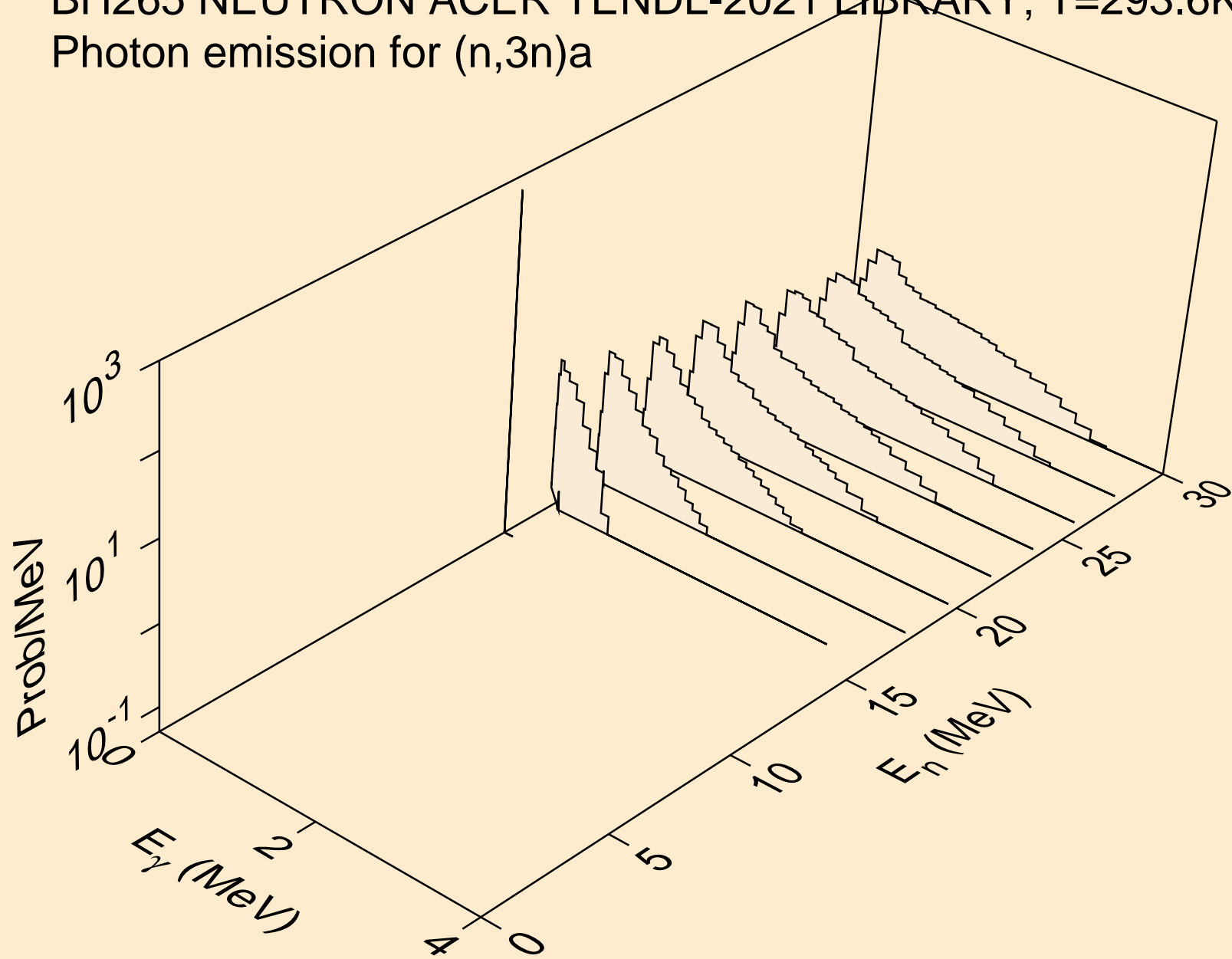

BH265 NEUTRON ACER TENDL-2021 LIBRARY; T=293.6K
Photon emission for (n,n*)p

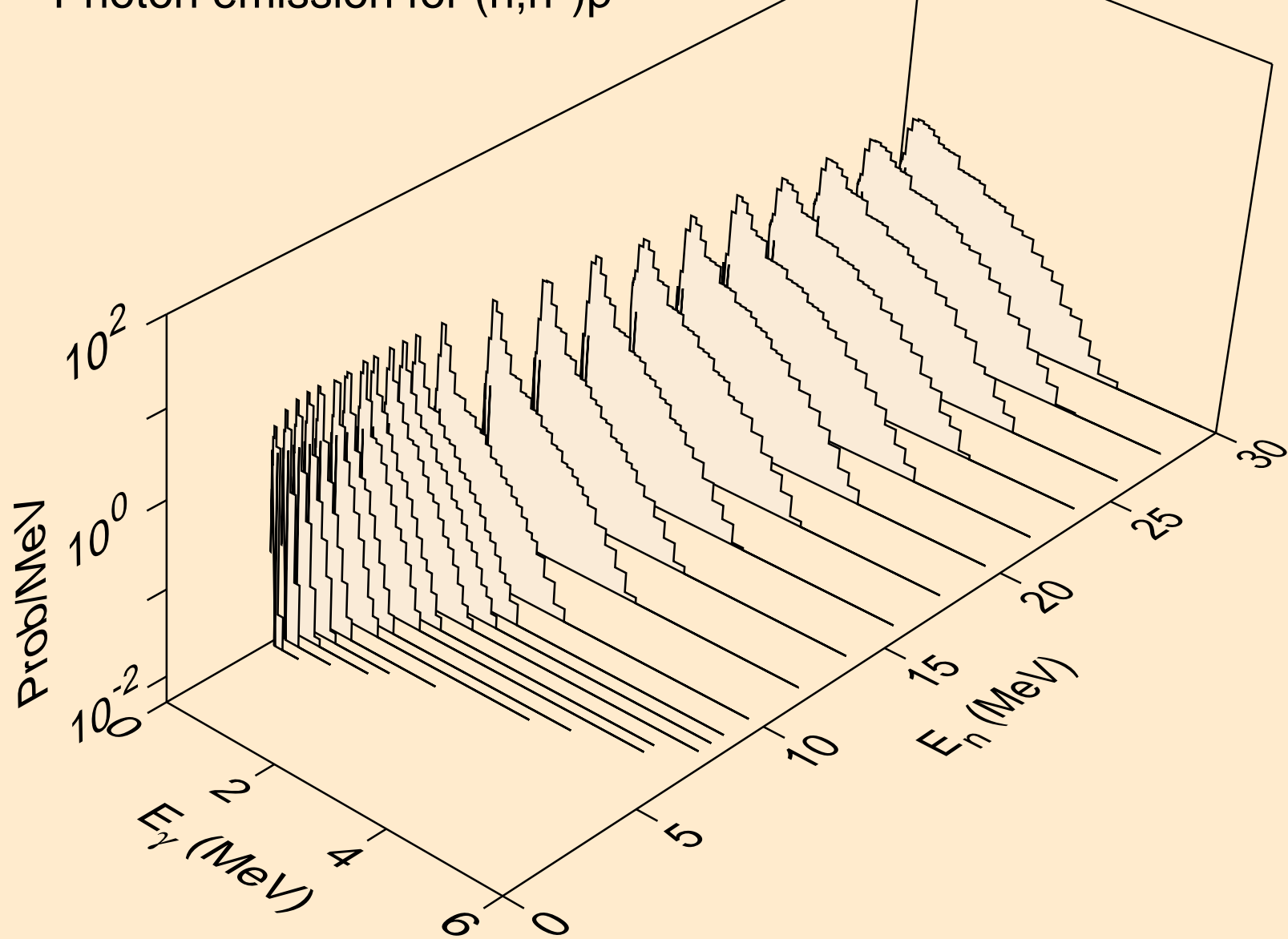

BH265 NEUTRON ACER TENDL-2021 LIBRARY; T=293.6K
Photon emission for (n,n*)2a

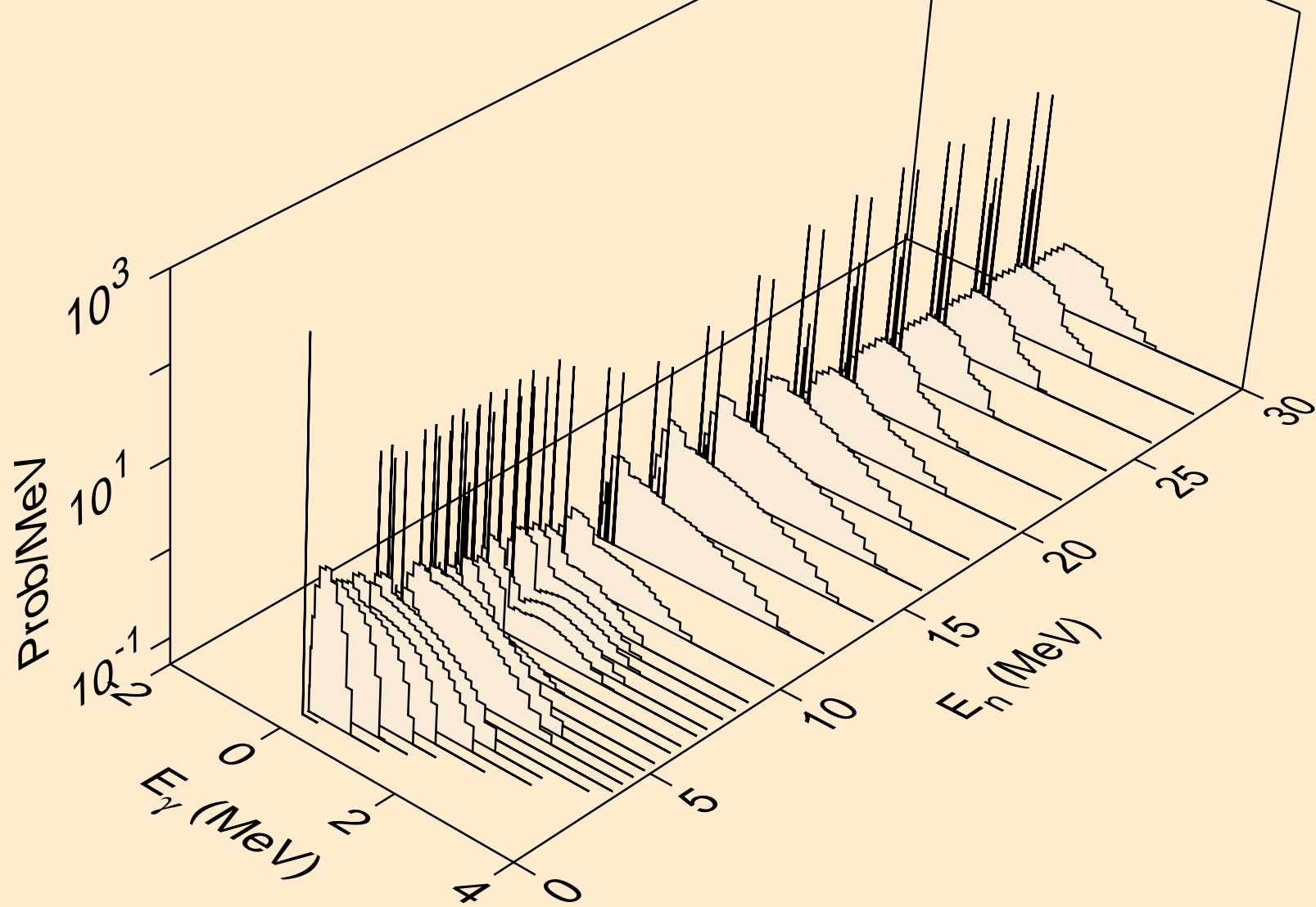

BH265 NEUTRON ACER TENDL-2021 LIBRARY; T=293.6K
Photon emission for (n,2n)2a

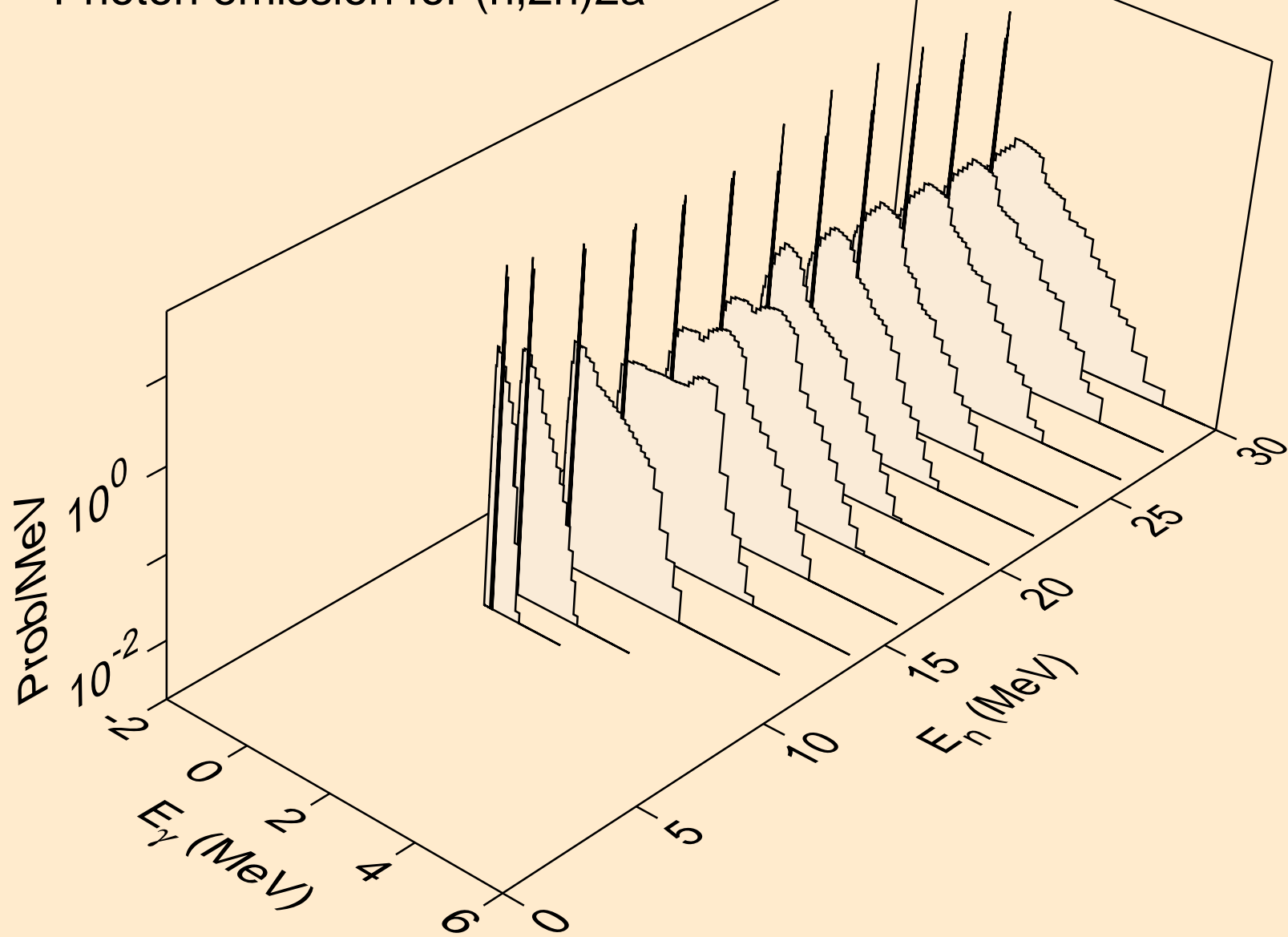

BH265 NEUTRON ACER TENDL-2021 LIBRARY; T=293.6K
Photon emission for (n,n*)d

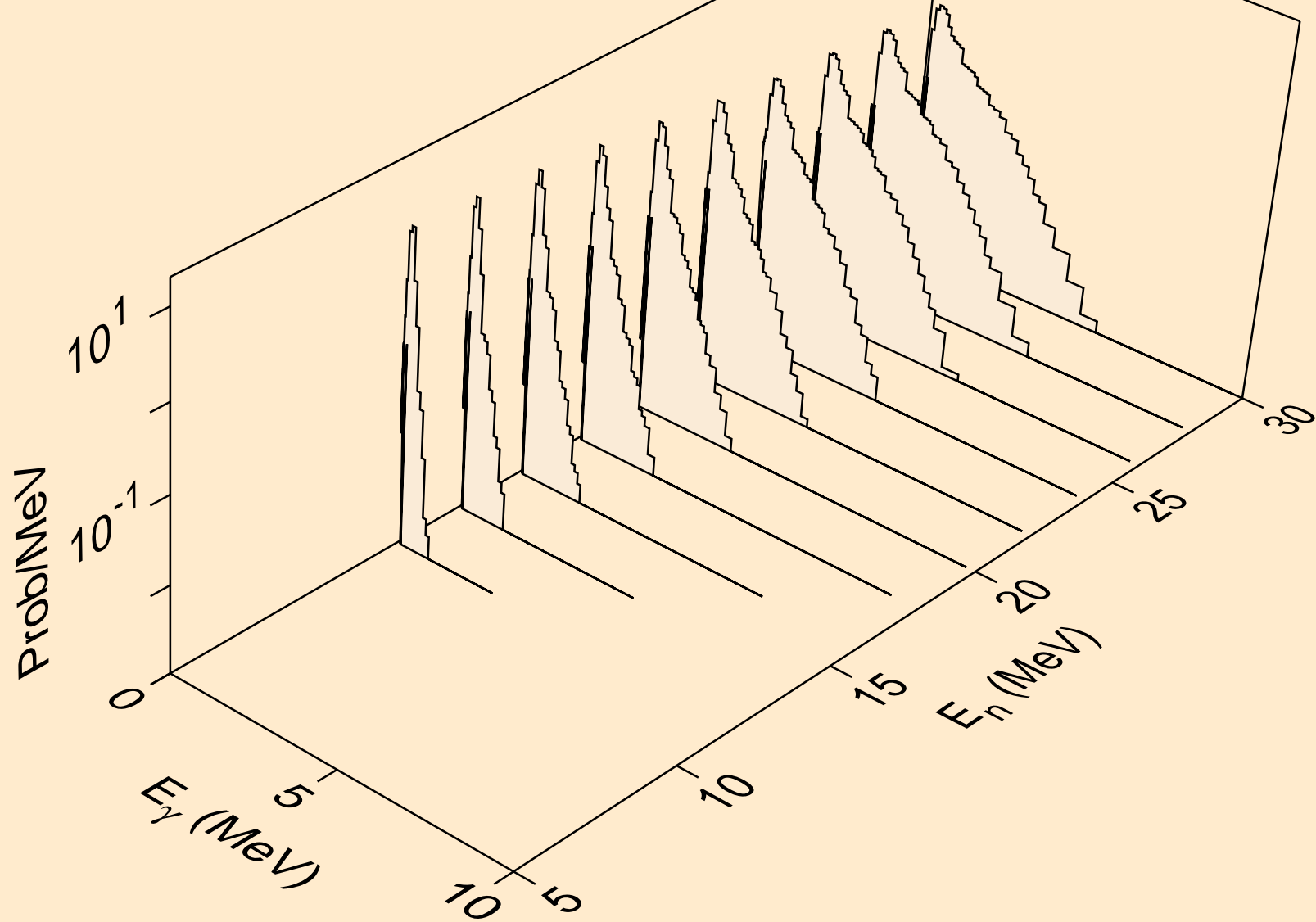

BH265 NEUTRON ACER TENDL-2021 LIBRARY; T=293.6K
Photon emission for (n,n*)t

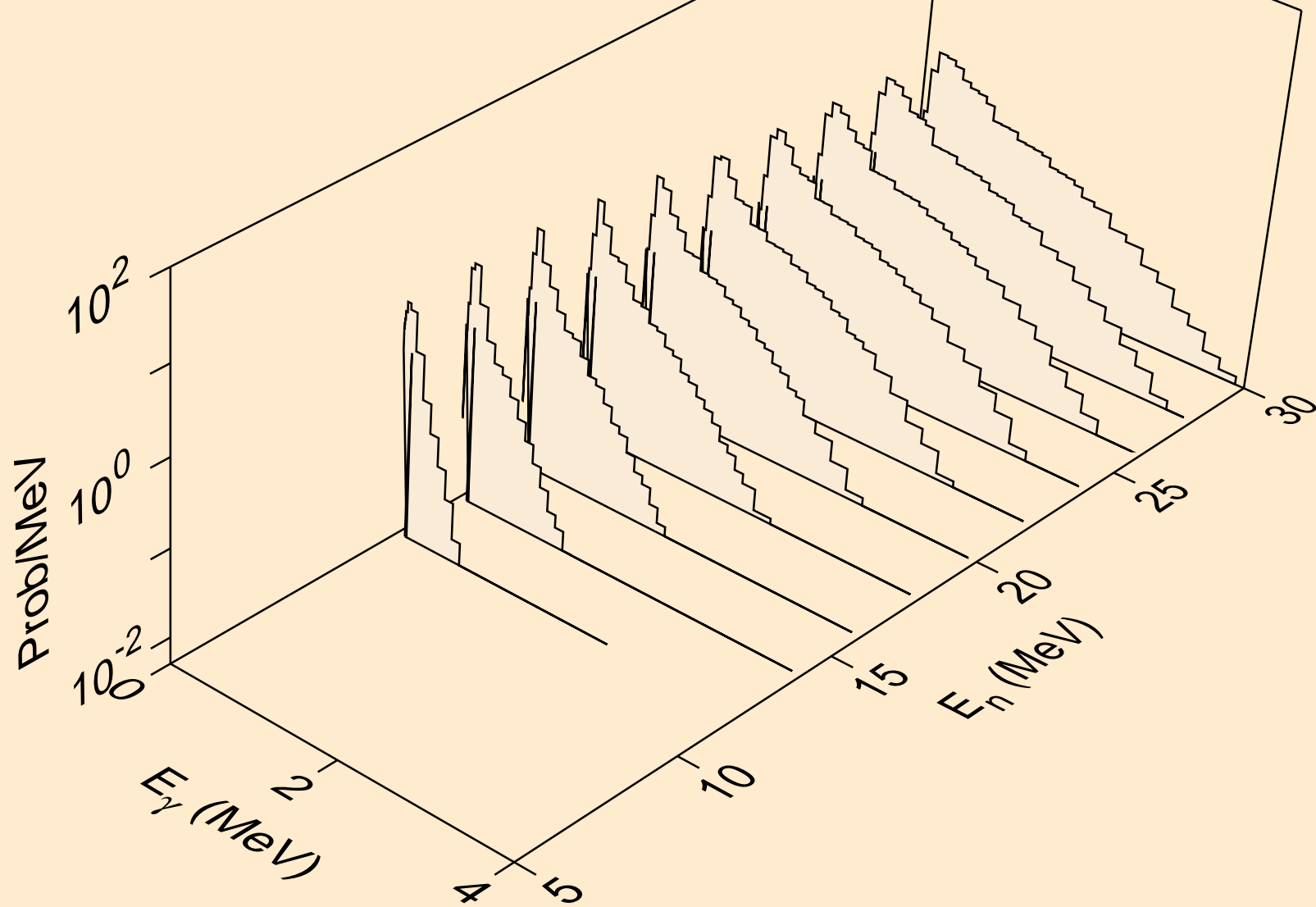

BH265 NEUTRON ACER TENDL-2021 LIBRARY; T=293.6K
Photon emission for (n,n*)he3

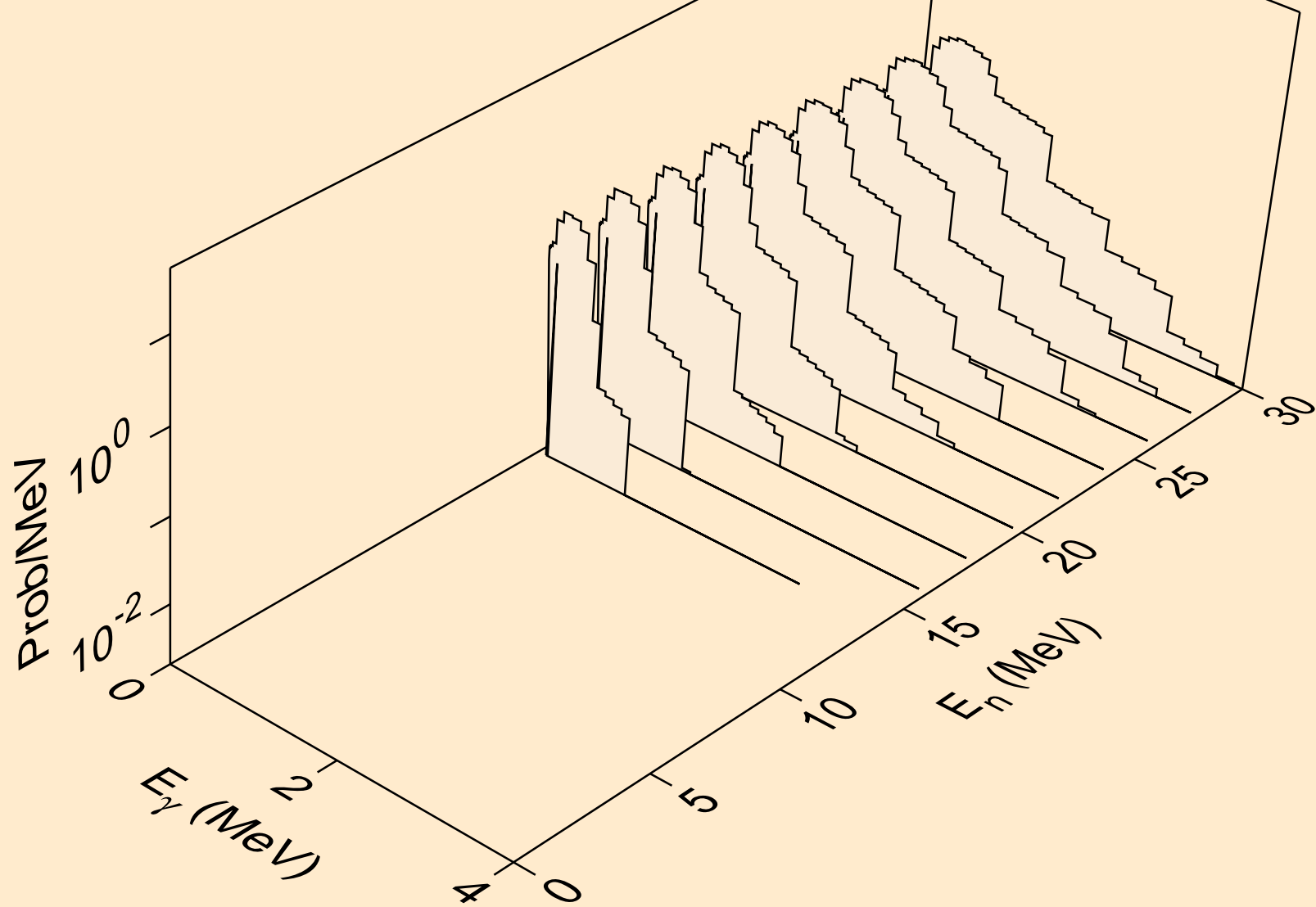

BH265 NEUTRON ACER TENDL-2021 LIBRARY; T=293.6K
Photon emission for (n,n*)t2a

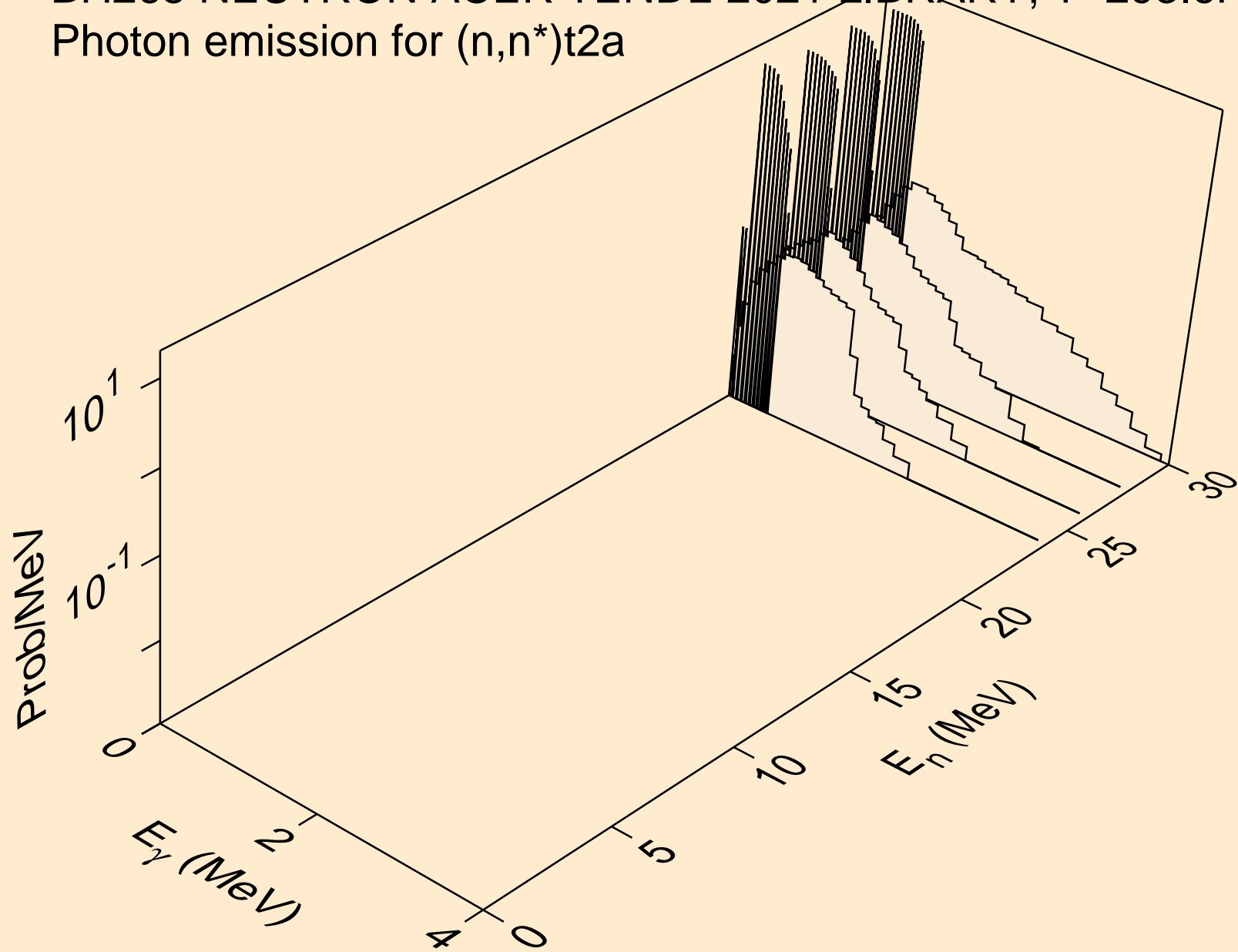

BH265 NEUTRON ACER TENDL-2021 LIBRARY; T=293.6K
Photon emission for (n,4n)

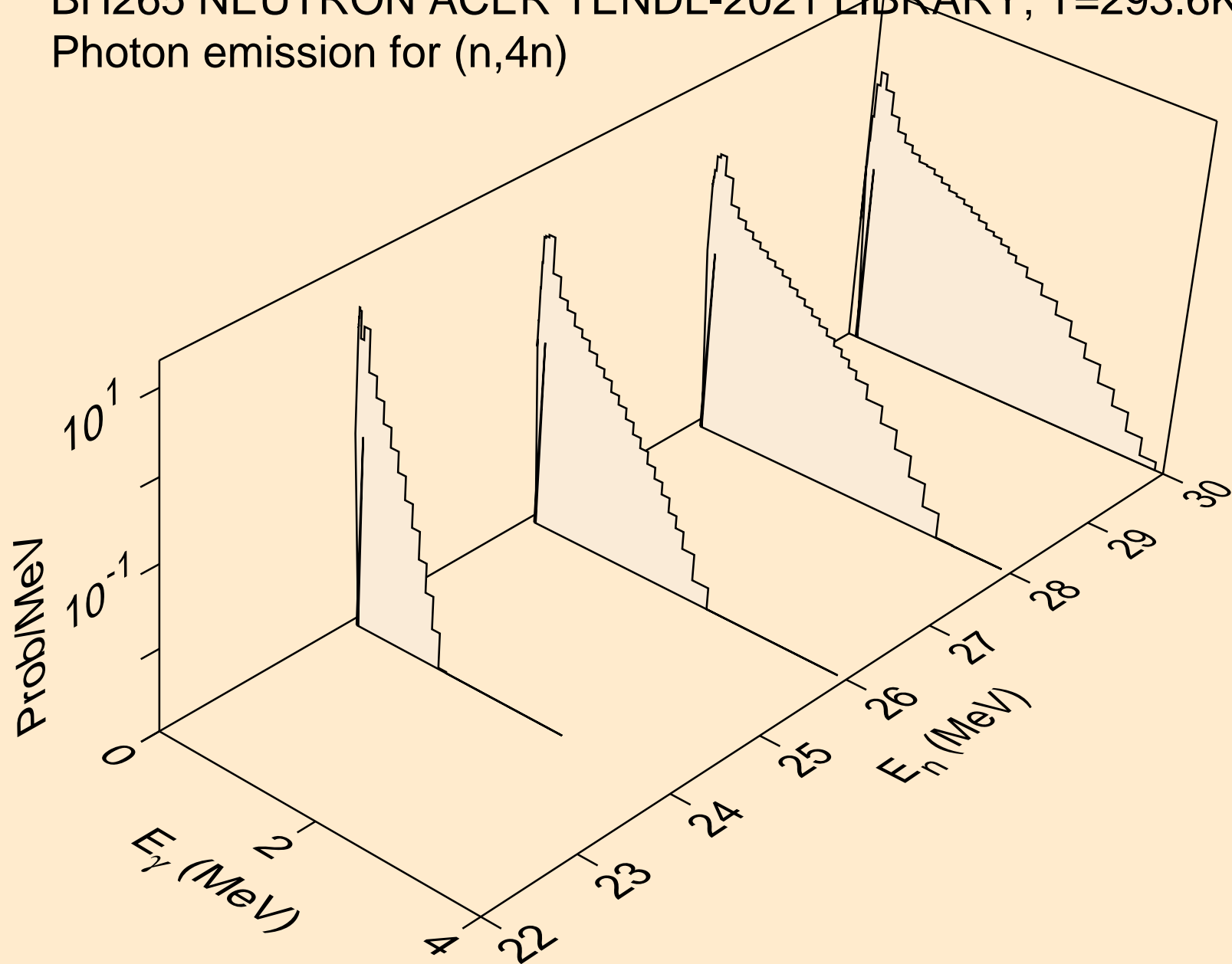

BH265 NEUTRON ACER TENDL-2021 LIBRARY; T=293.6K
Photon emission for (n,2np)

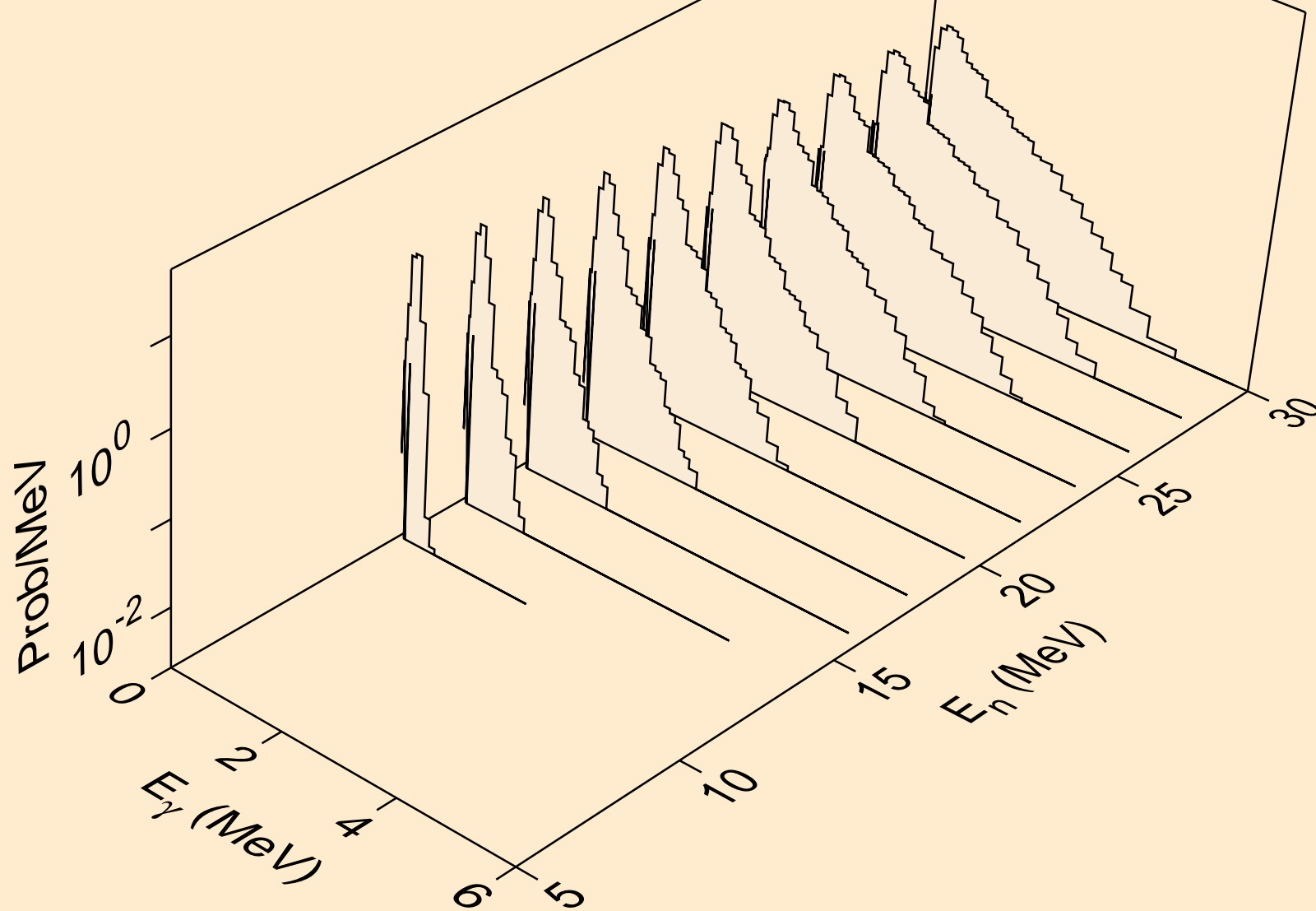

BH265 NEUTRON ACER TENDL-2021 LIBRARY; T=293.6K
Photon emission for (n,3np)

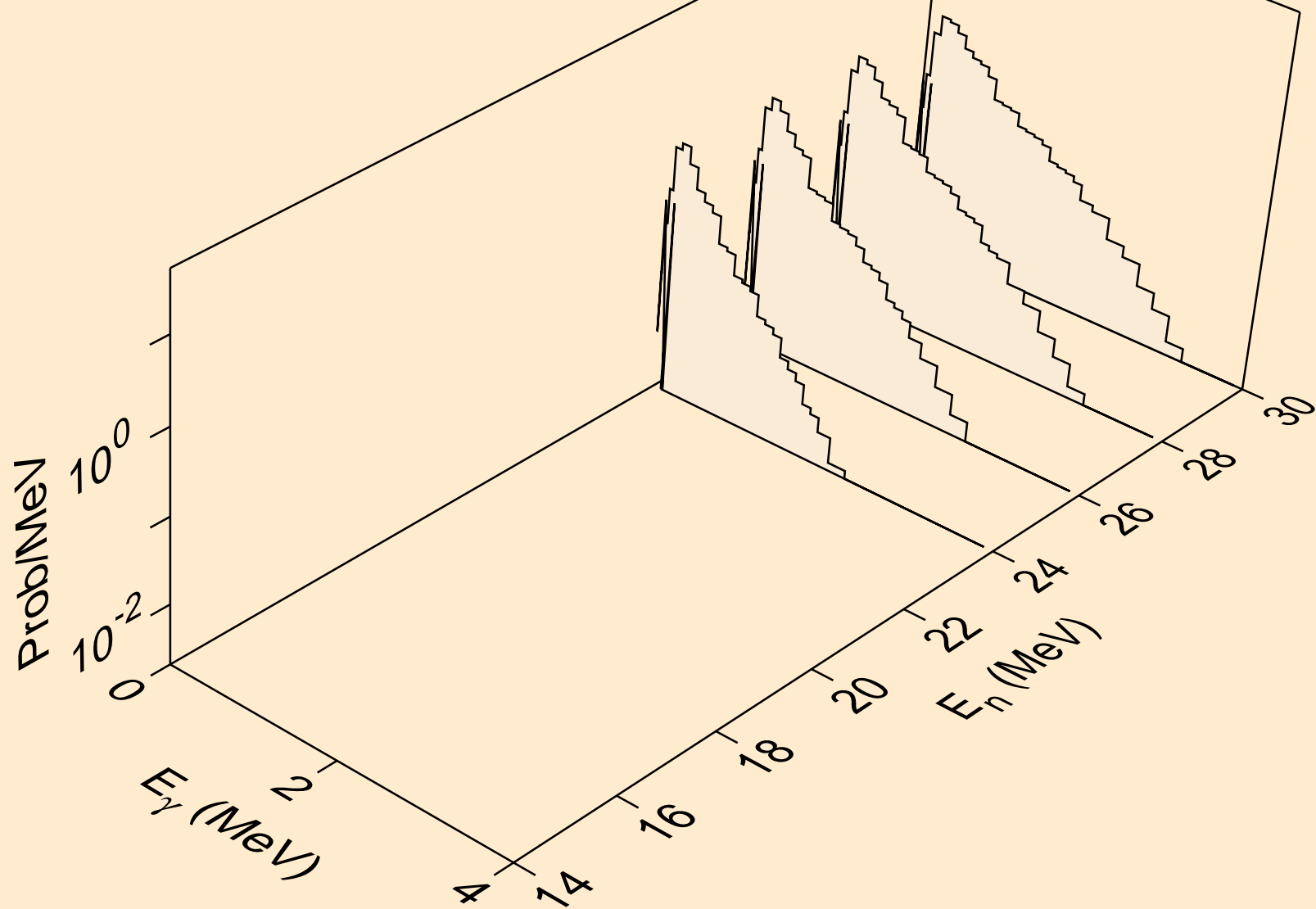

BH265 NEUTRON ACER TENDL-2021 LIBRARY; T=293.6K
Photon emission for (n,2np)

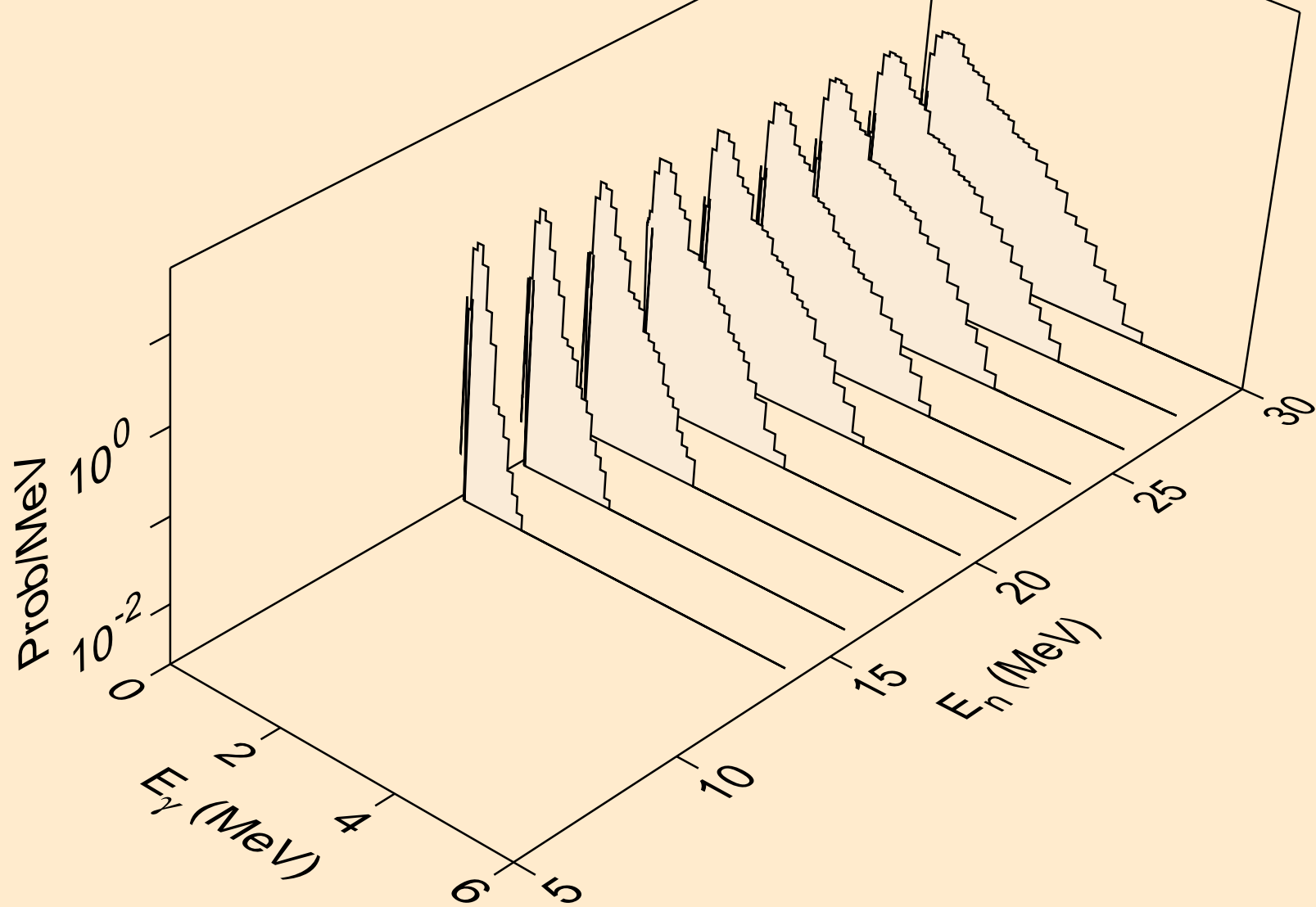

BH265 NEUTRON ACER TENDL-2021 LIBRARY; T=293.6K
Photon emission for (n,npa)

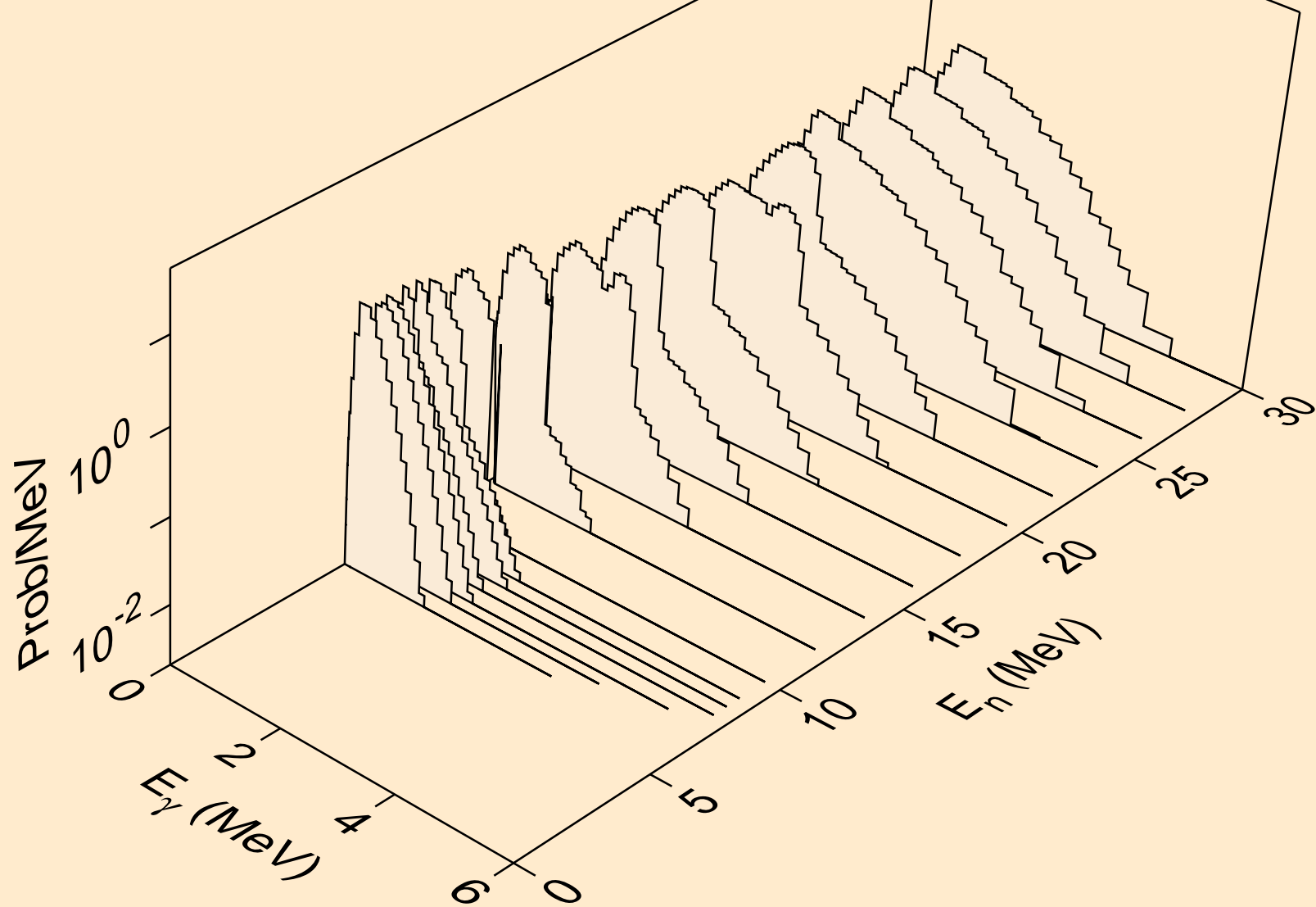

BH265 NEUTRON ACER TENDL-2021 LIBRARY; T=293.6K
Photon emission for (n,n*c)

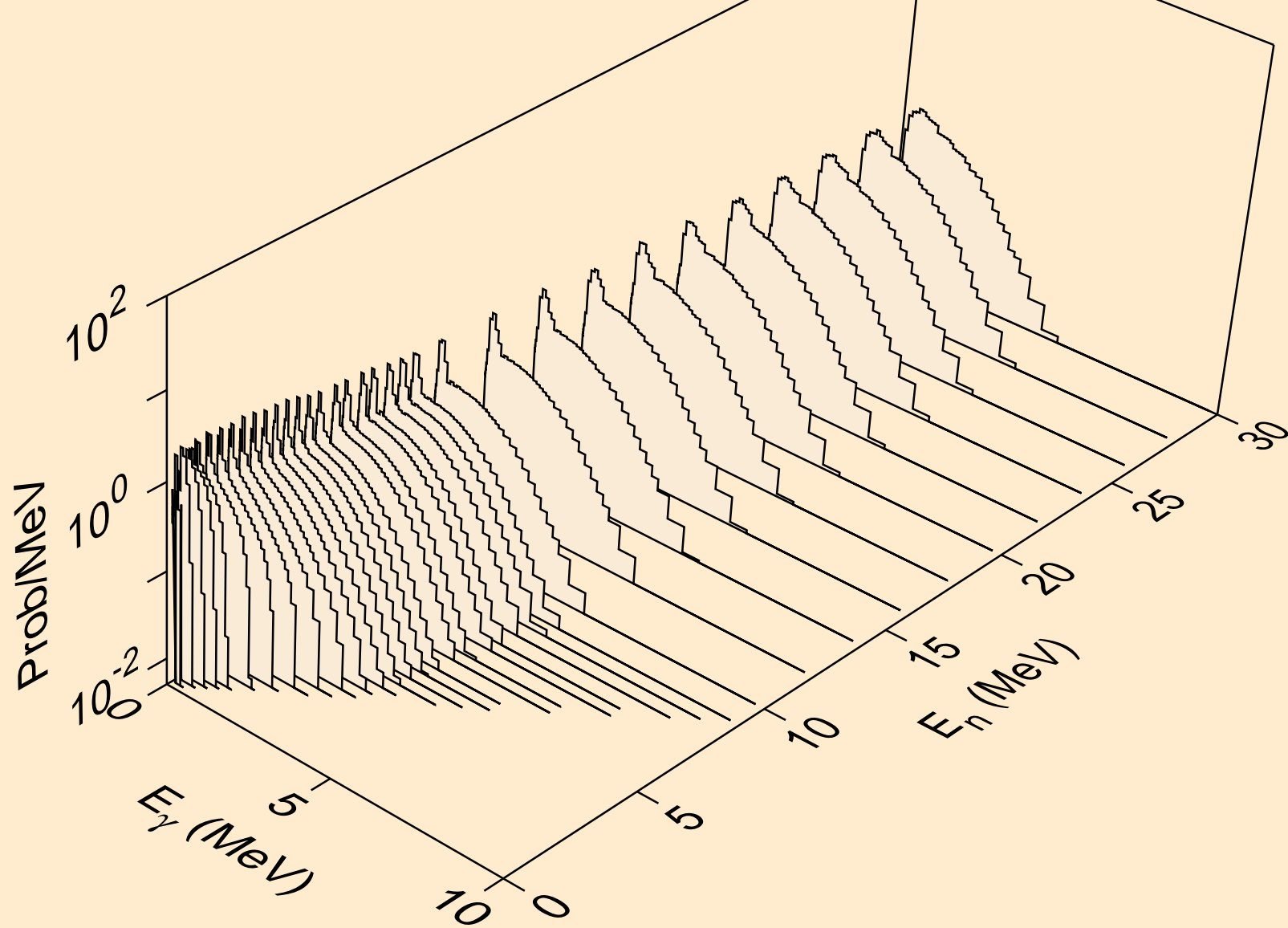

BH265 NEUTRON ACER TENDL-2021 LIBRARY; T=293.6K
Photon emission for (n,gma)

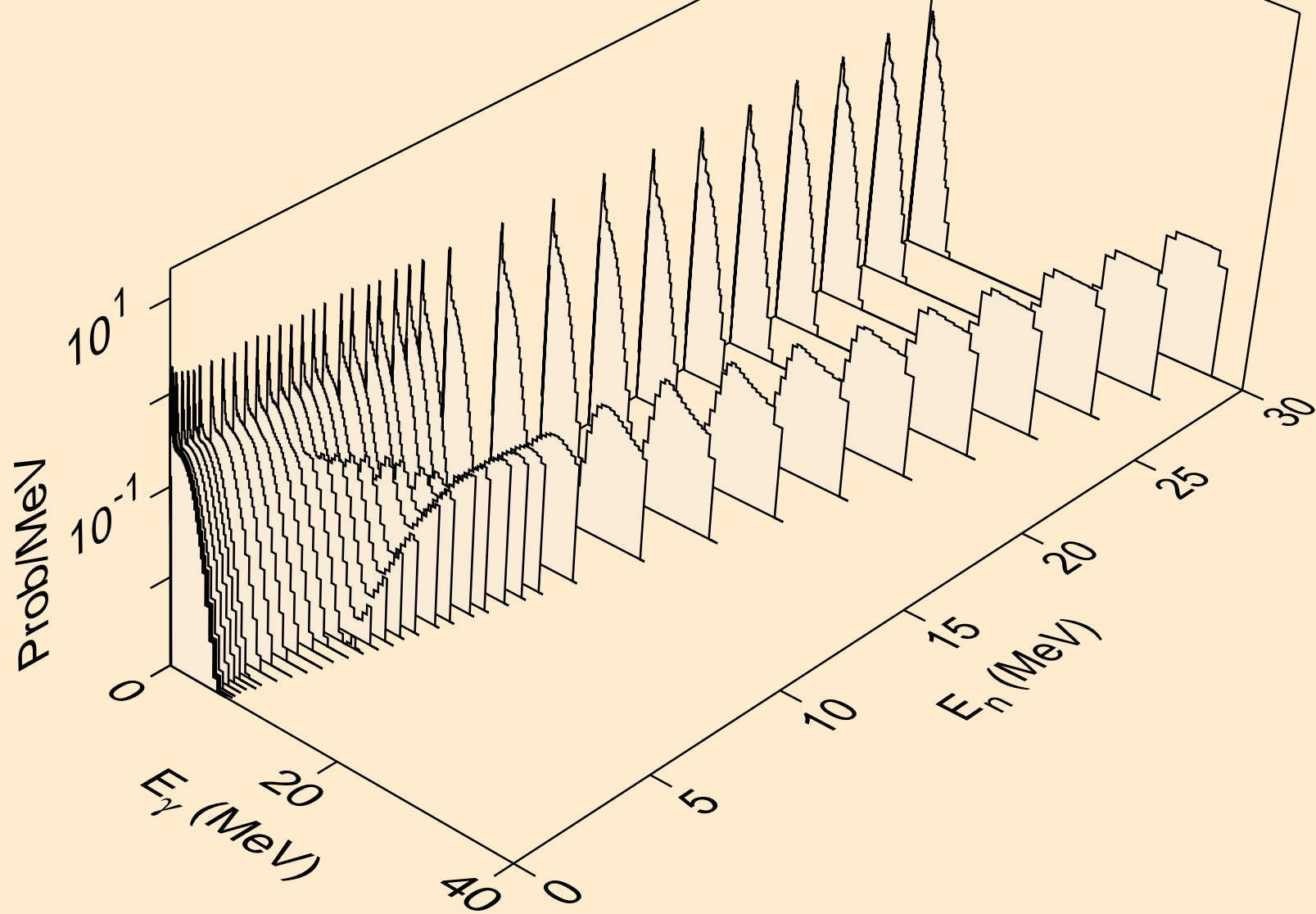

BH265 NEUTRON ACER TENDL-2021 LIBRARY; T=293.6K
Photon emission for (n,p)

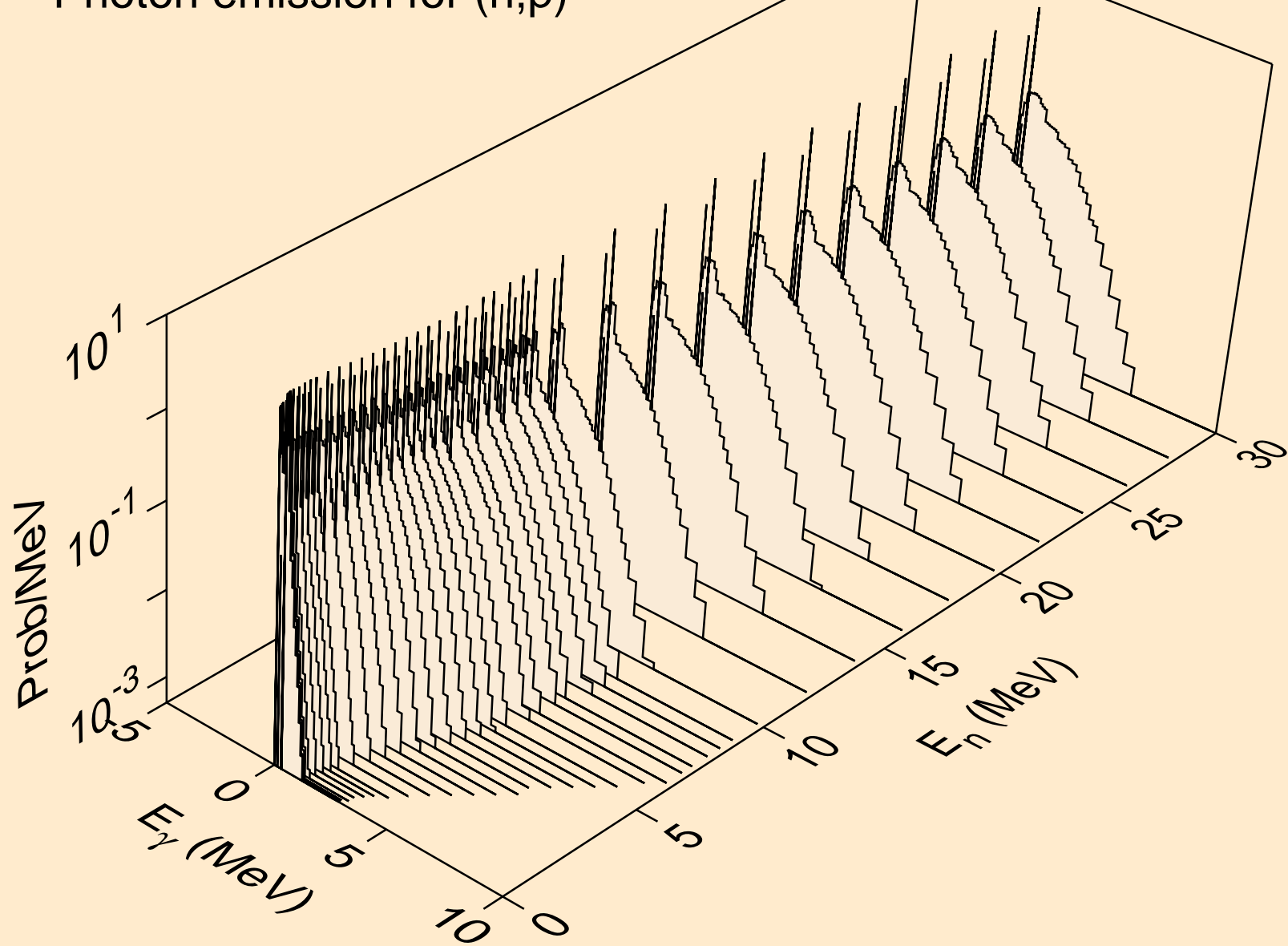

BH265 NEUTRON ACER TENDL-2021 LIBRARY; T=293.6K
Photon emission for (n,d)

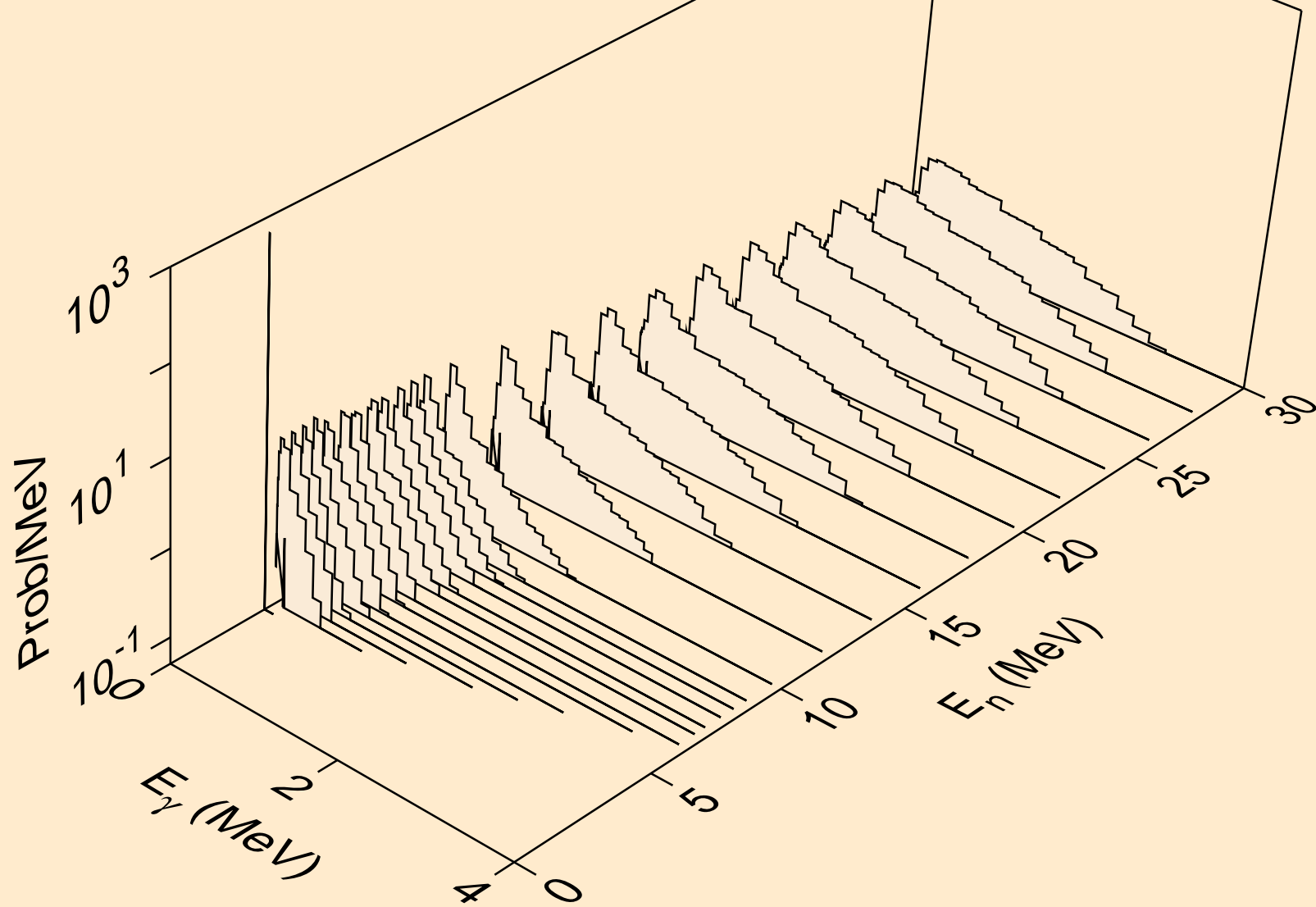

BH265 NEUTRON ACER TENDL-2021 LIBRARY; T=293.6K
Photon emission for (n,t)

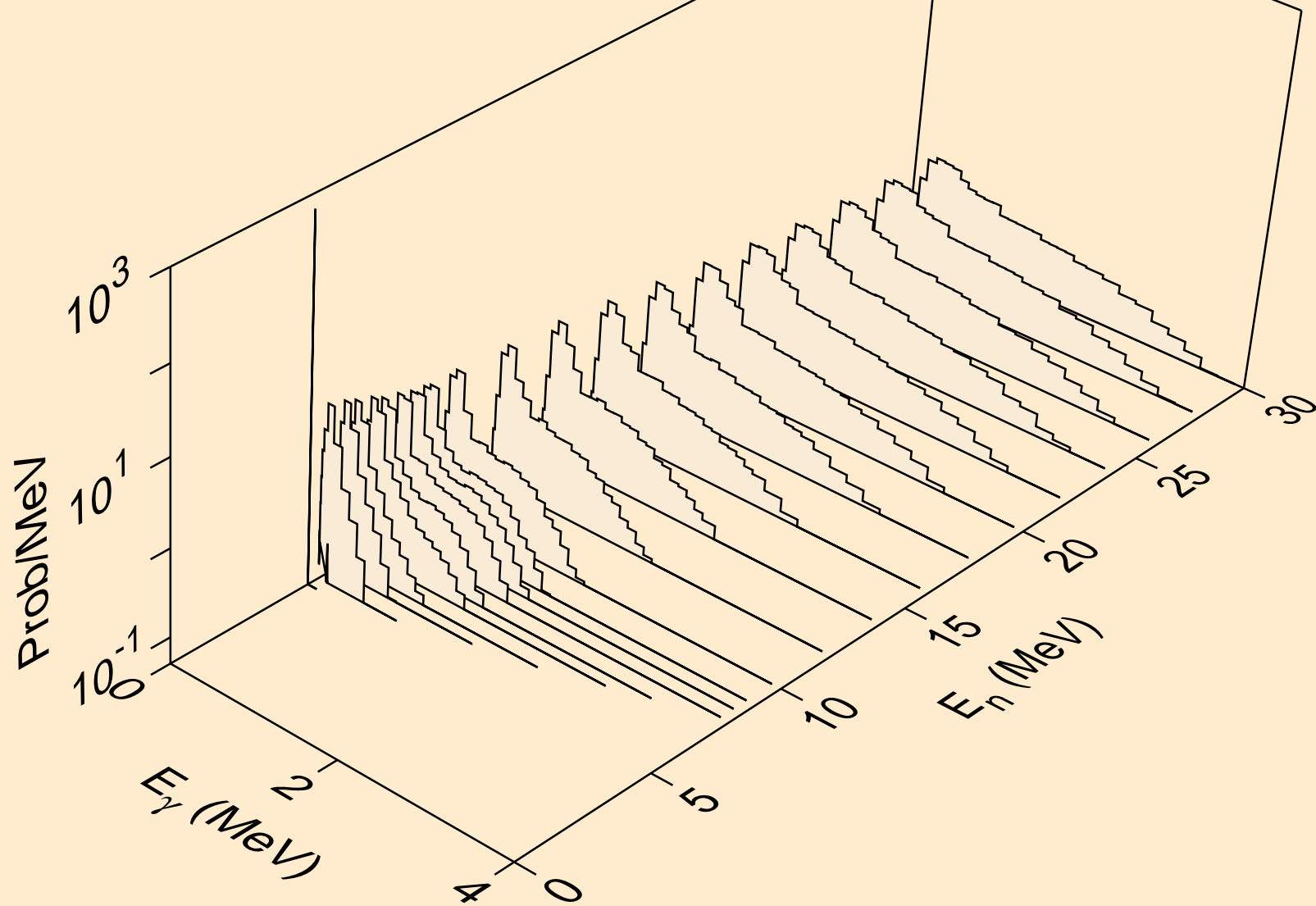

BH265 NEUTRON ACER TENDL-2021 LIBRARY; T=293.6K
Photon emission for (n,he3)

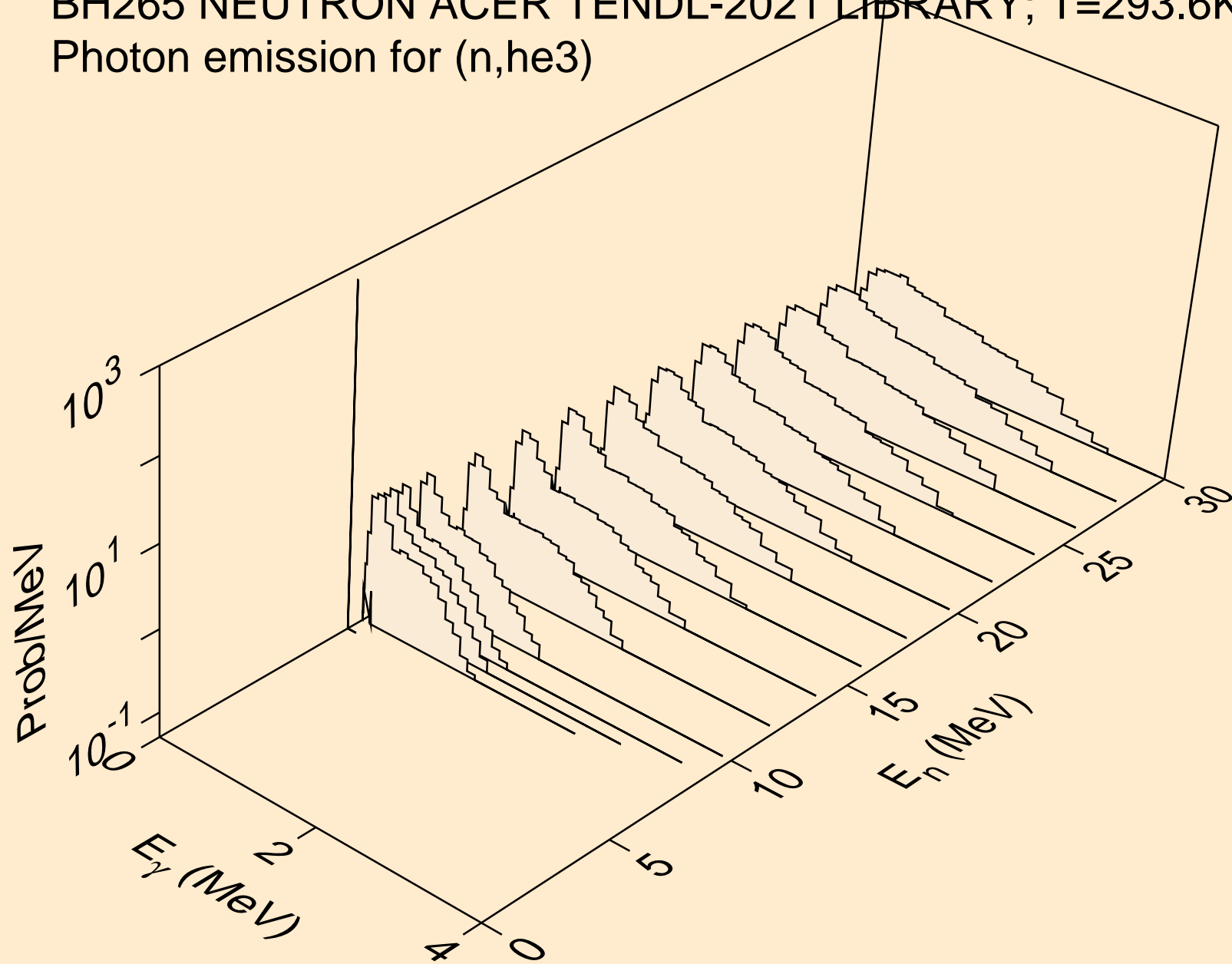

BH265 NEUTRON ACER TENDL-2021 LIBRARY; T=293.6K
Photon emission for (n,a)

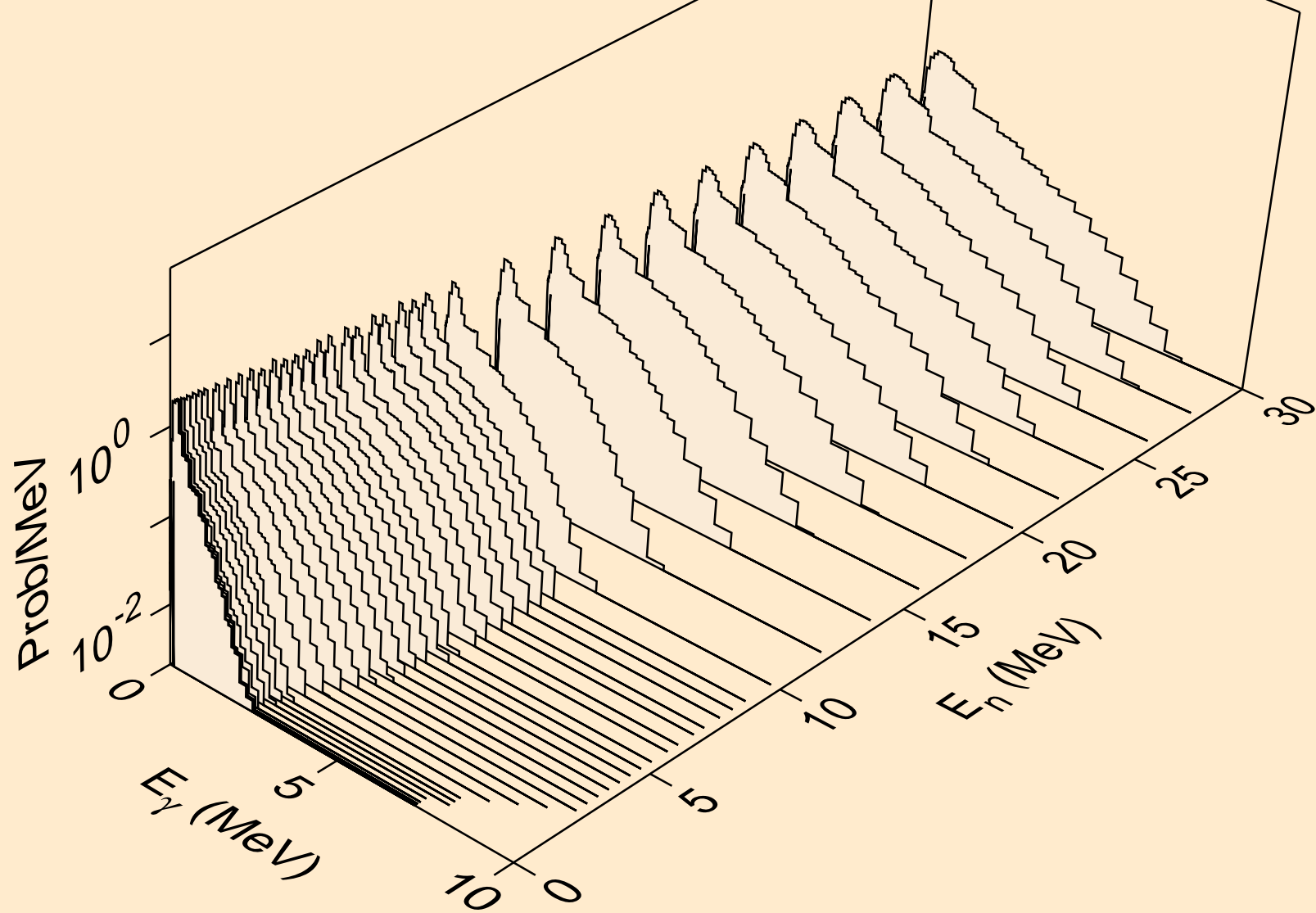

BH265 NEUTRON ACER TENDL-2021 LIBRARY; T=293.6K
Photon emission for (n,2a)

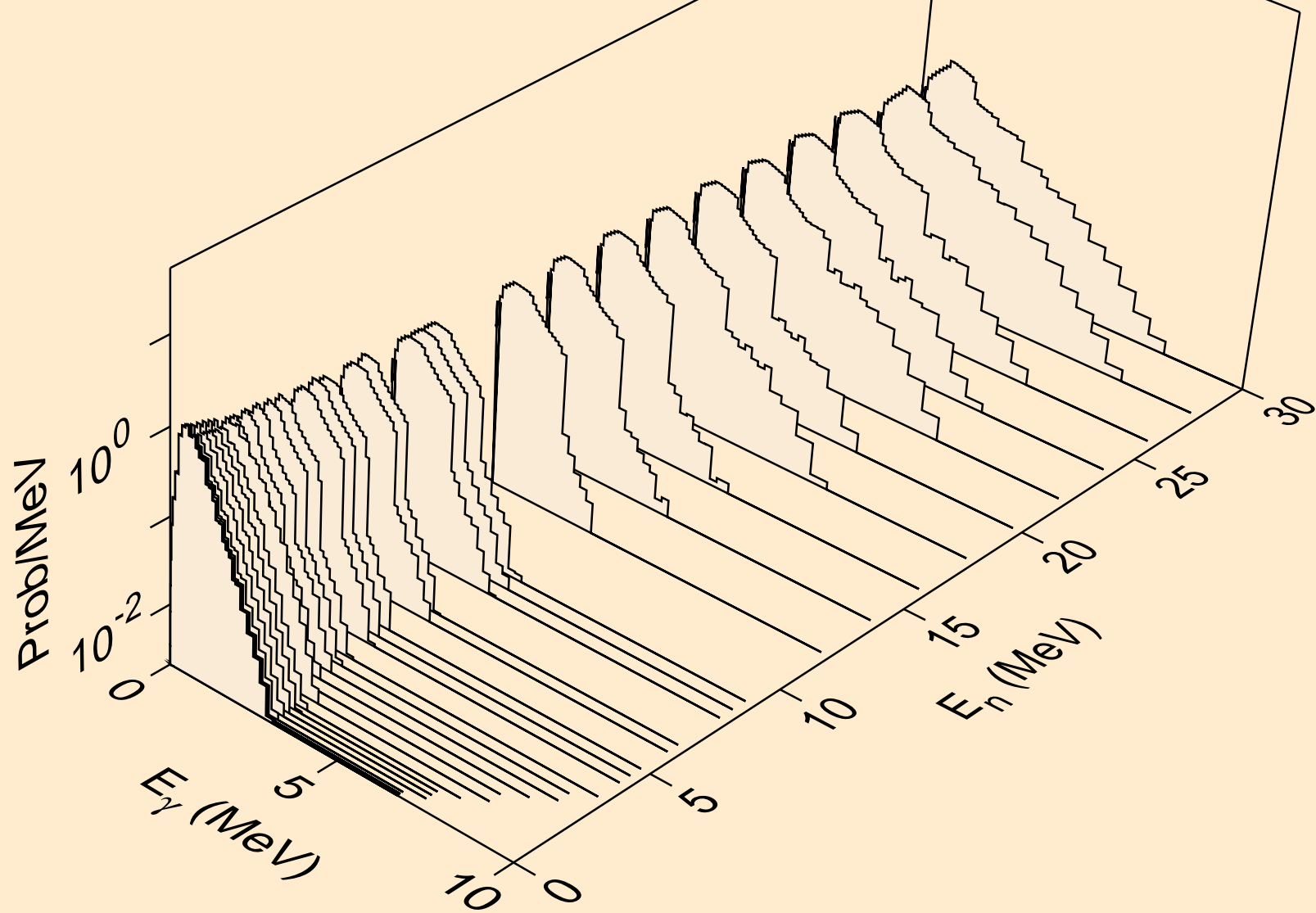

BH265 NEUTRON ACER TENDL-2021 LIBRARY; T=293.6K
Photon emission for (n,2p)

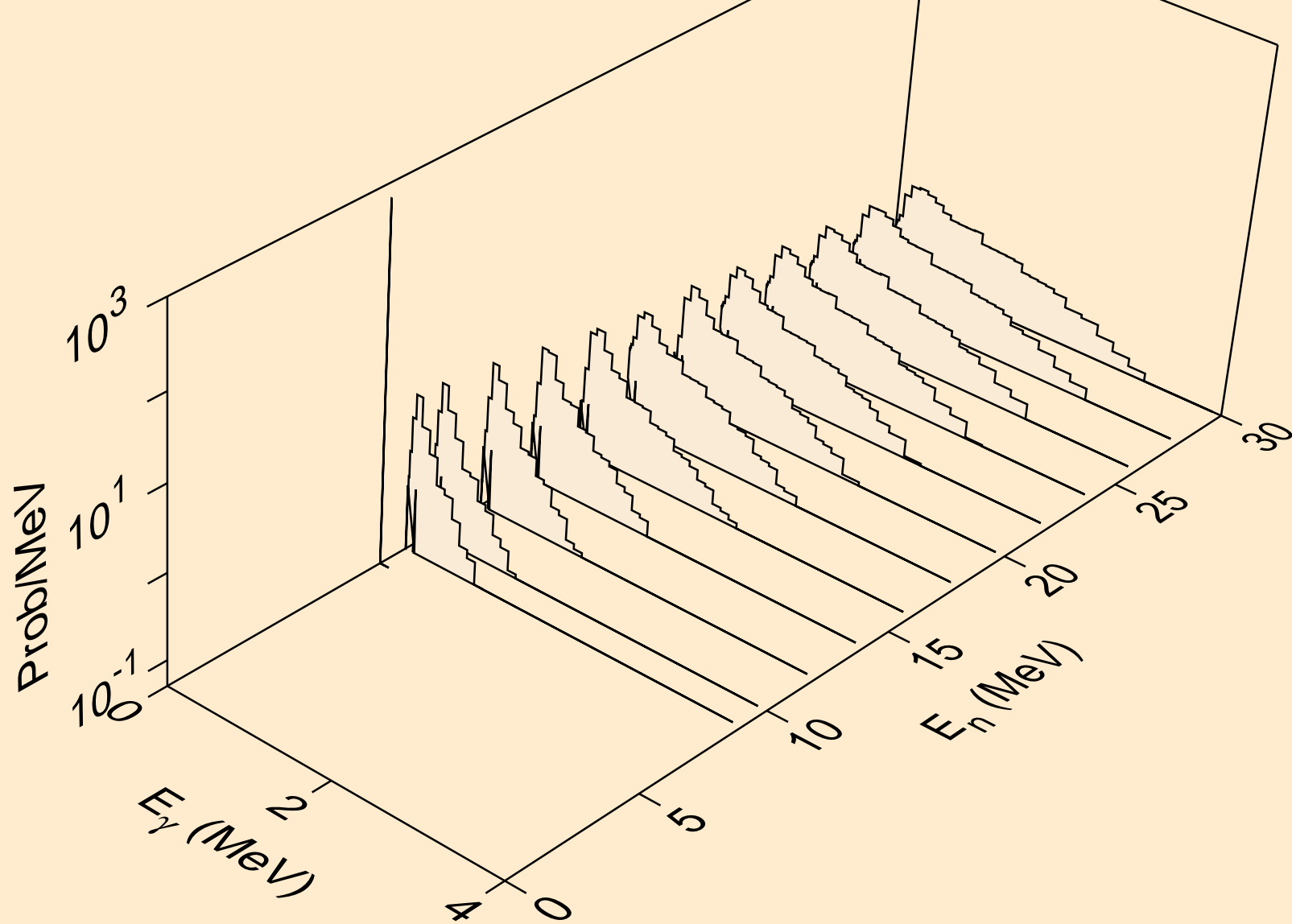

BH265 NEUTRON ACER TENDL-2021 LIBRARY; T=293.6K
Photon emission for (n,p)

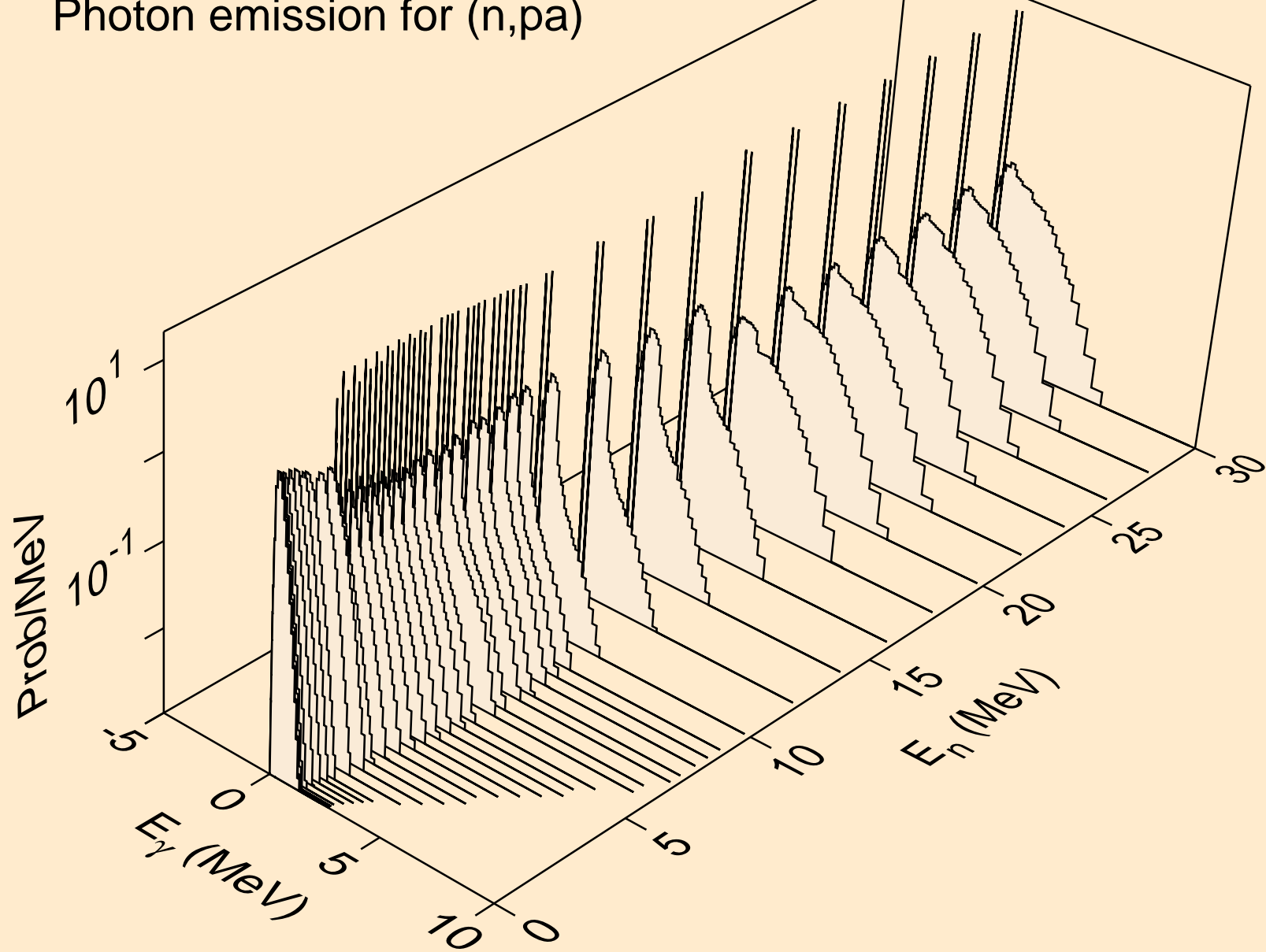

BH265 NEUTRON ACER TENDL-2021 LIBRARY; T=293.6K
Photon emission for (n,pd)

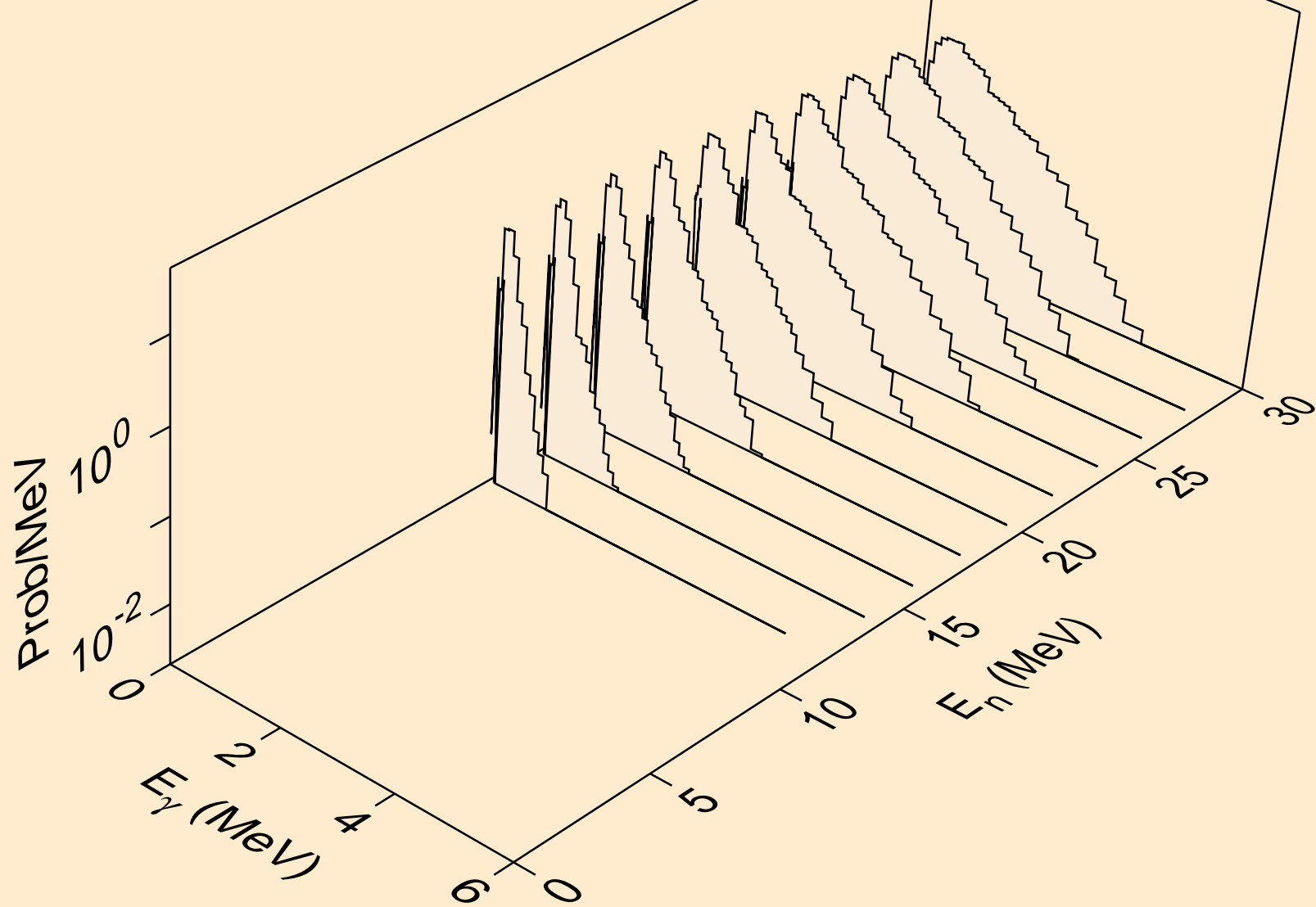

BH265 NEUTRON ACER TENDL-2021 LIBRARY; T=293.6K
Photon emission for (n,pt)

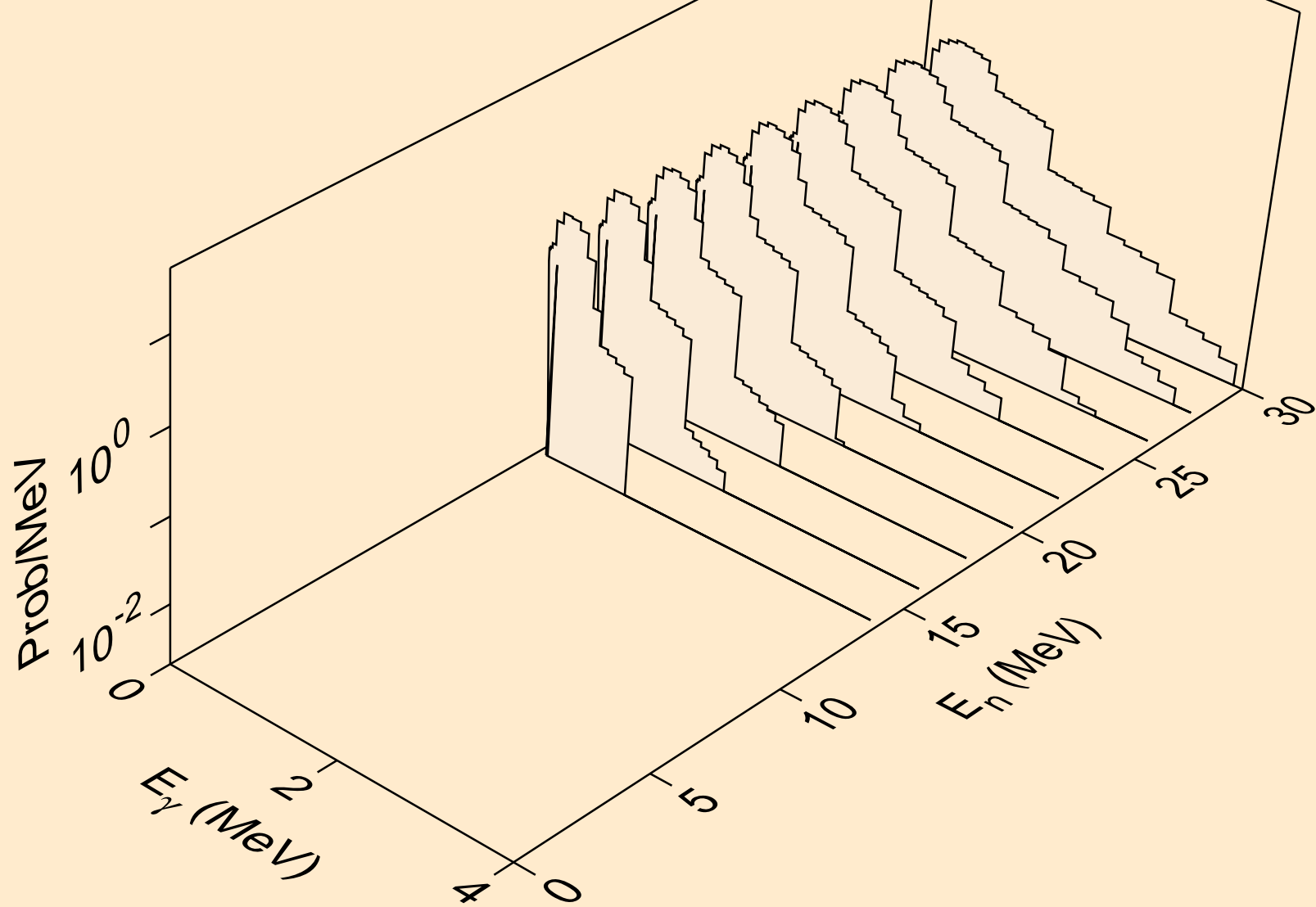

BH265 NEUTRON ACER TENDL-2021 LIBRARY; T=293.6K
Photon emission for (n,da)

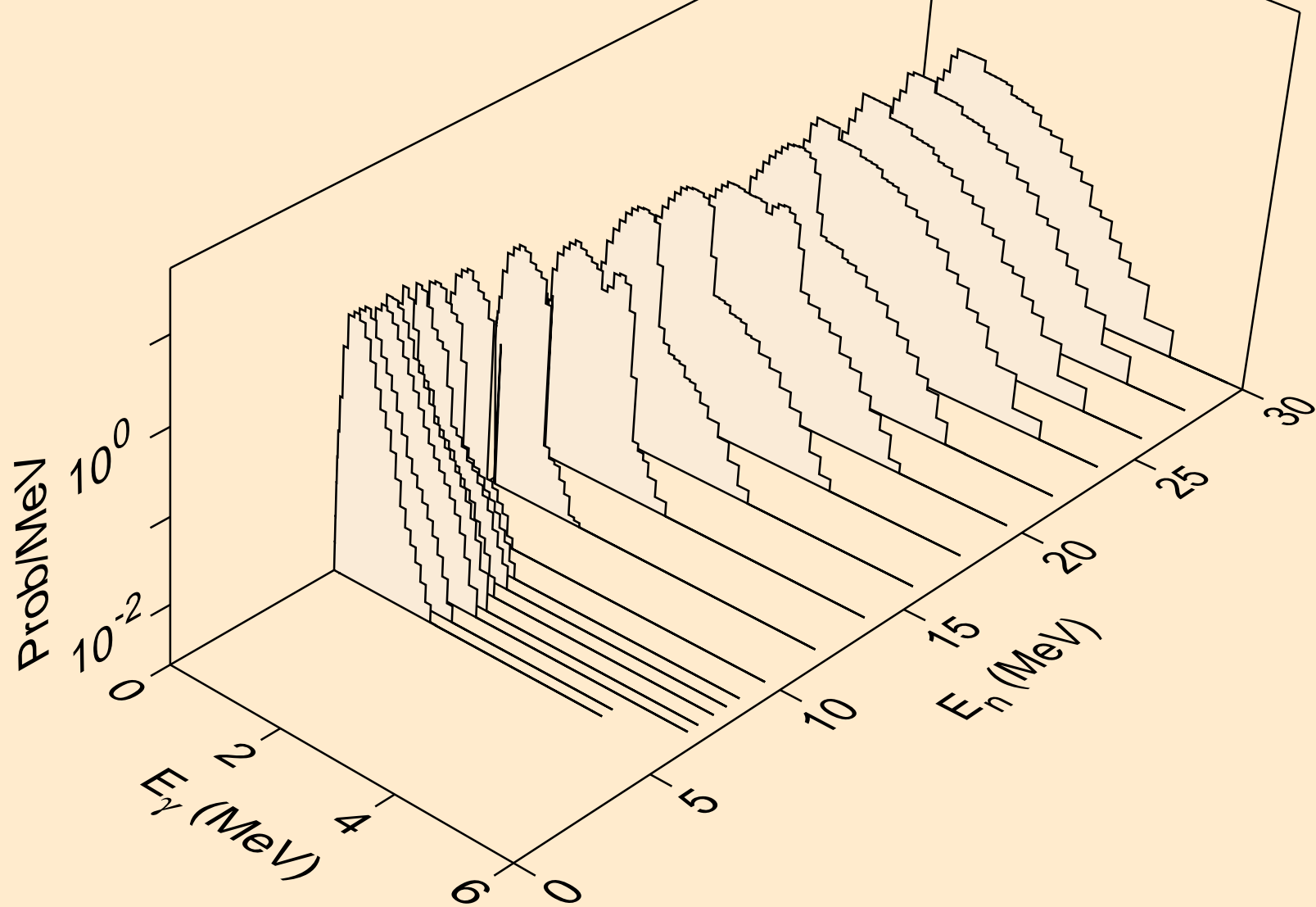

BH265 NEUTRON ACER TENDL-2021 LIBRARY; T=293.6K
thermal capture photon spectrum

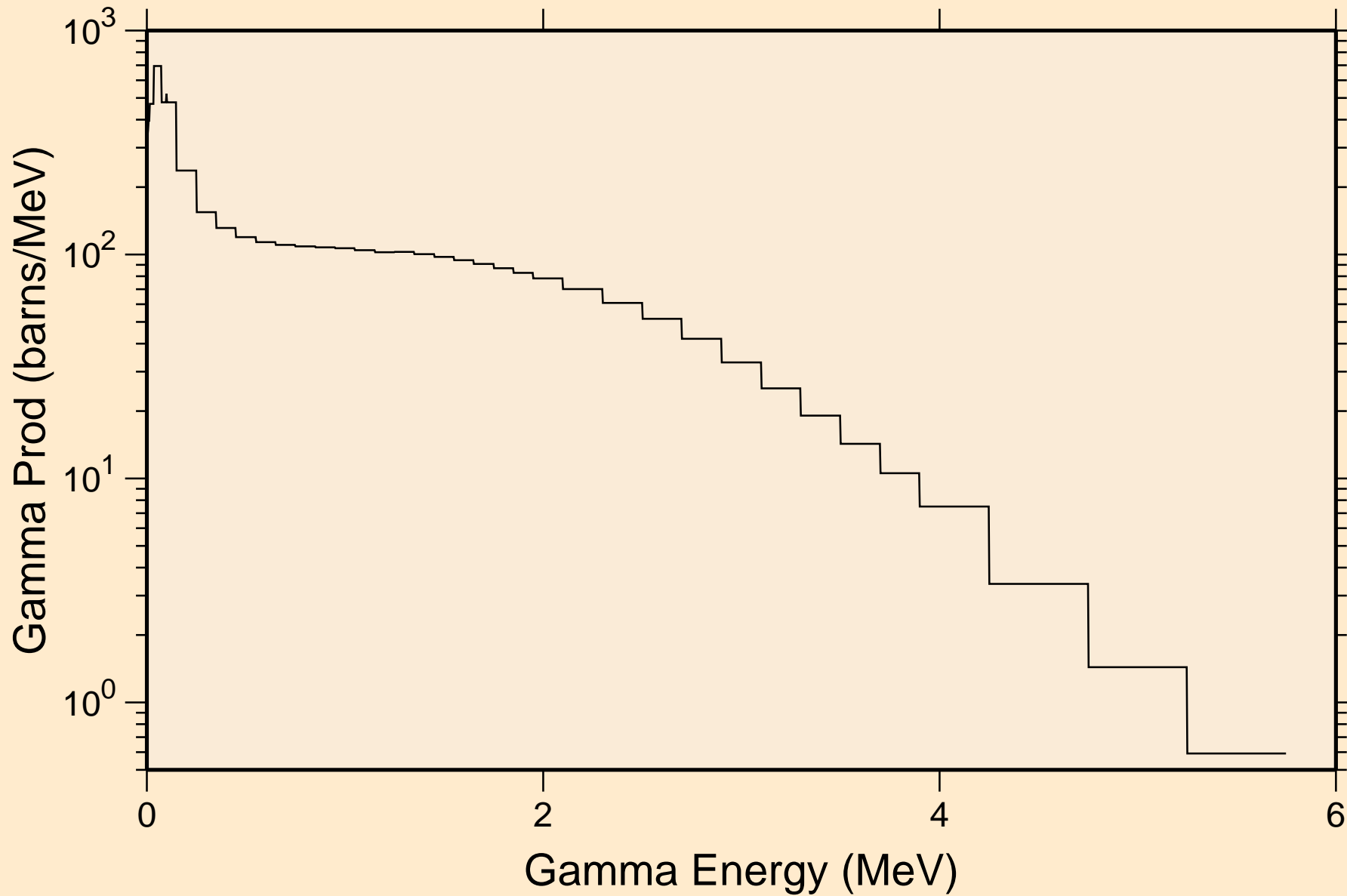

BH265 NEUTRON ACER TENDL-2021 LIBRARY; T=293.6K
14 MeV photon spectrum

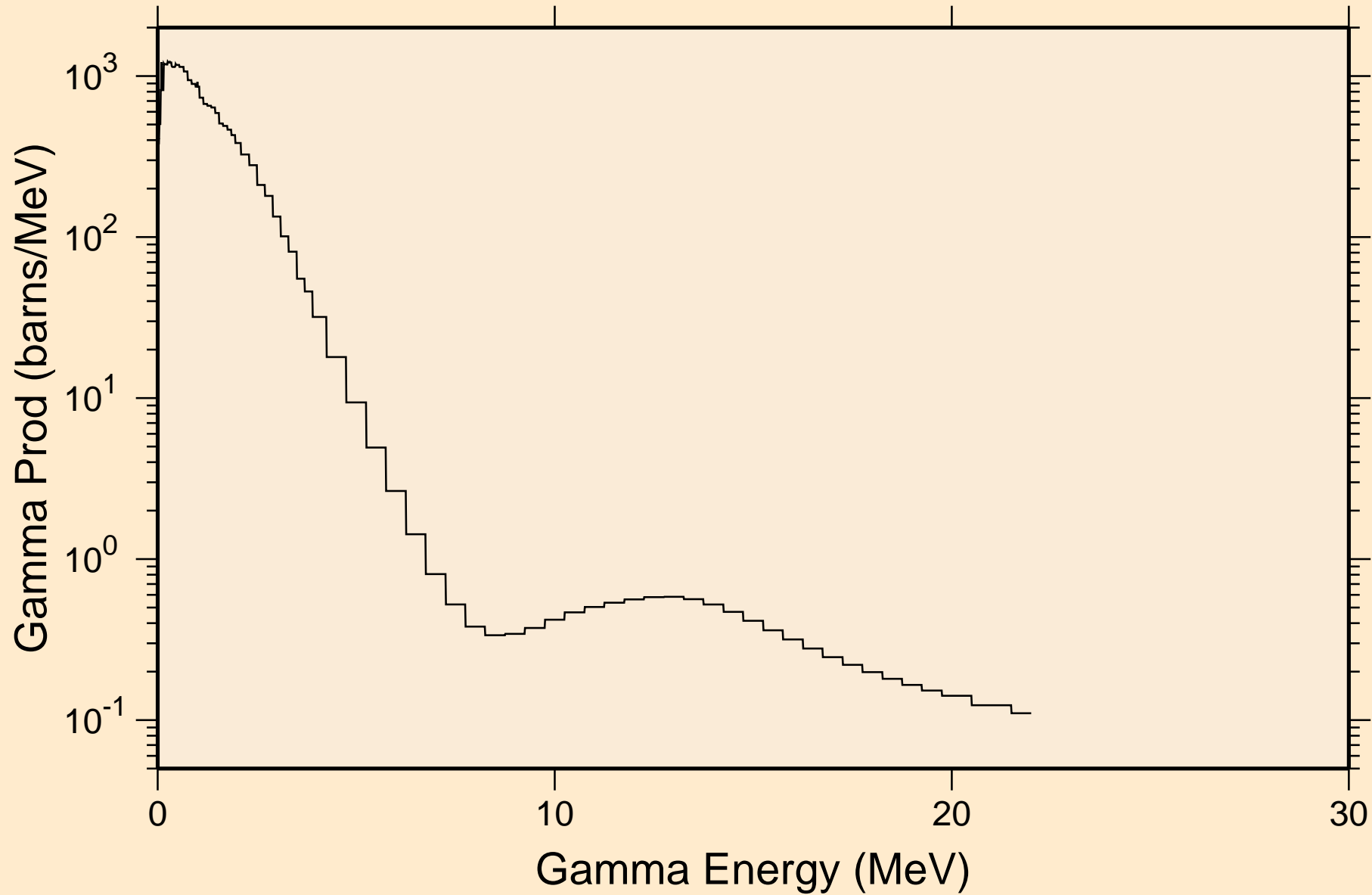

BH265 NEUTRON ACER TENDL-2021 LIBRARY; T=293.6K

Particle heating contributions

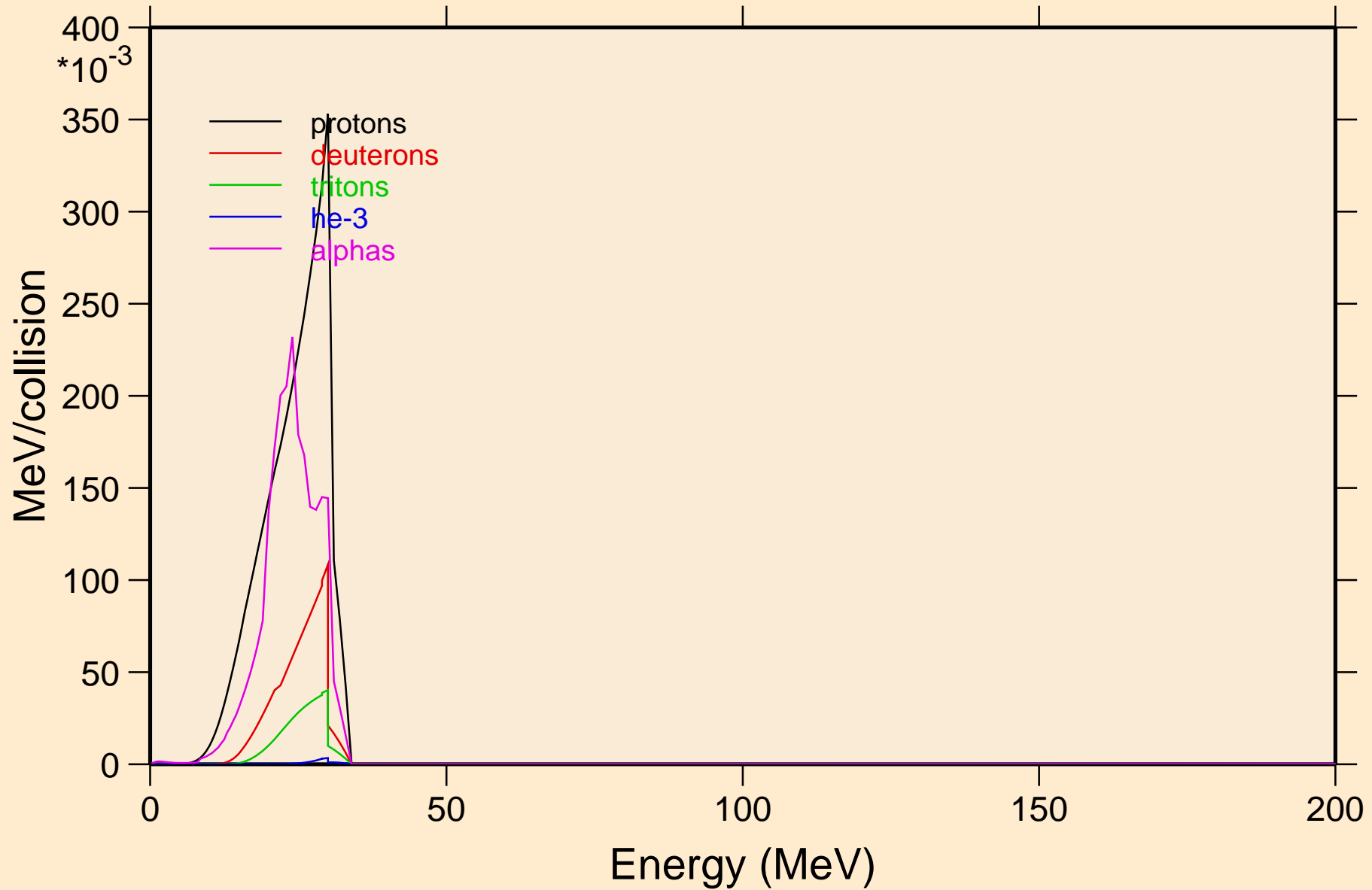

BH265 NEUTRON ACER TENDL-2021 LIBRARY; T=293.6K
Recoil Heating

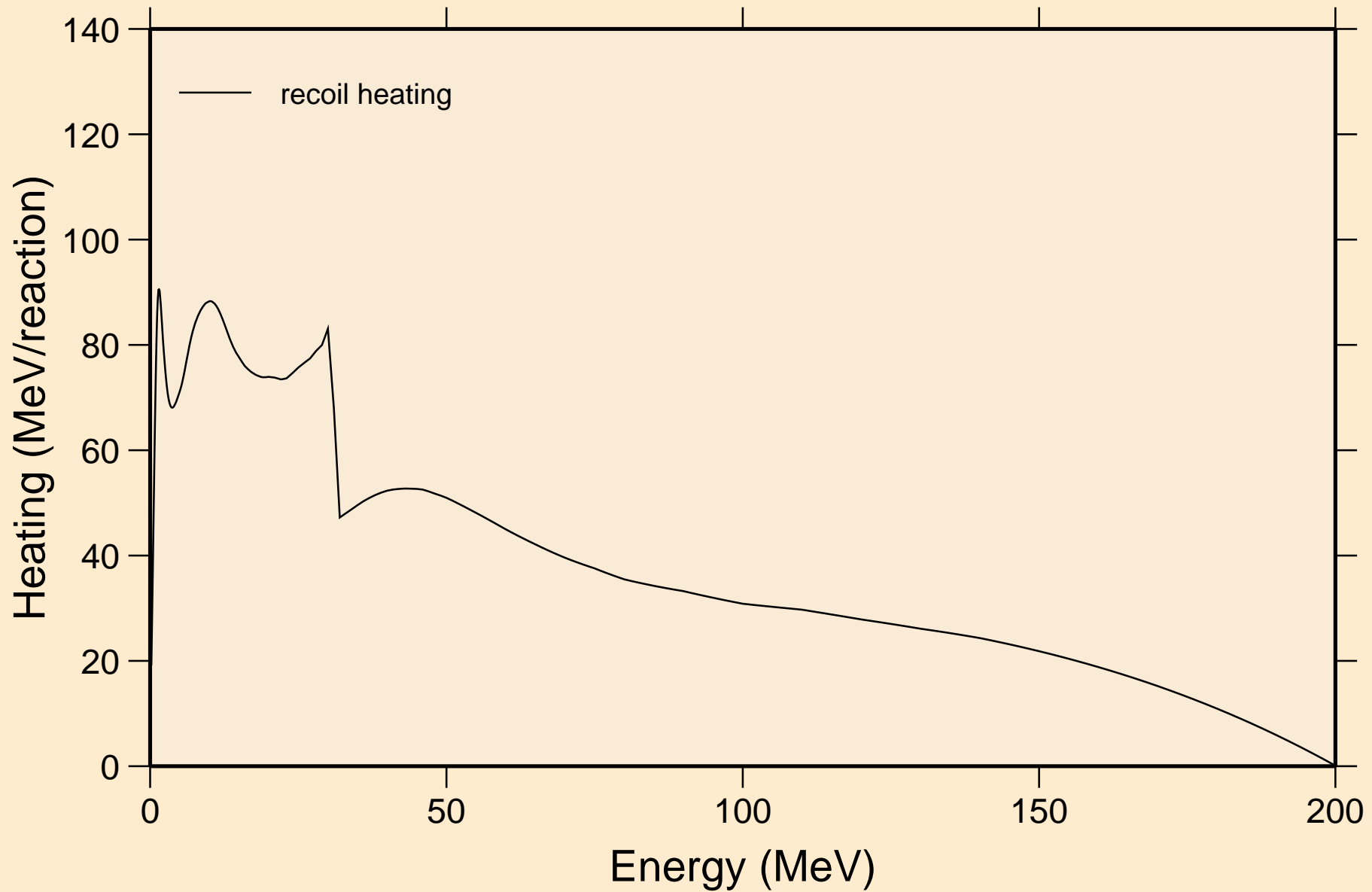

BH265 NEUTRON ACER TENDL-2021 LIBRARY; T=293.6K

Particle production cross sections

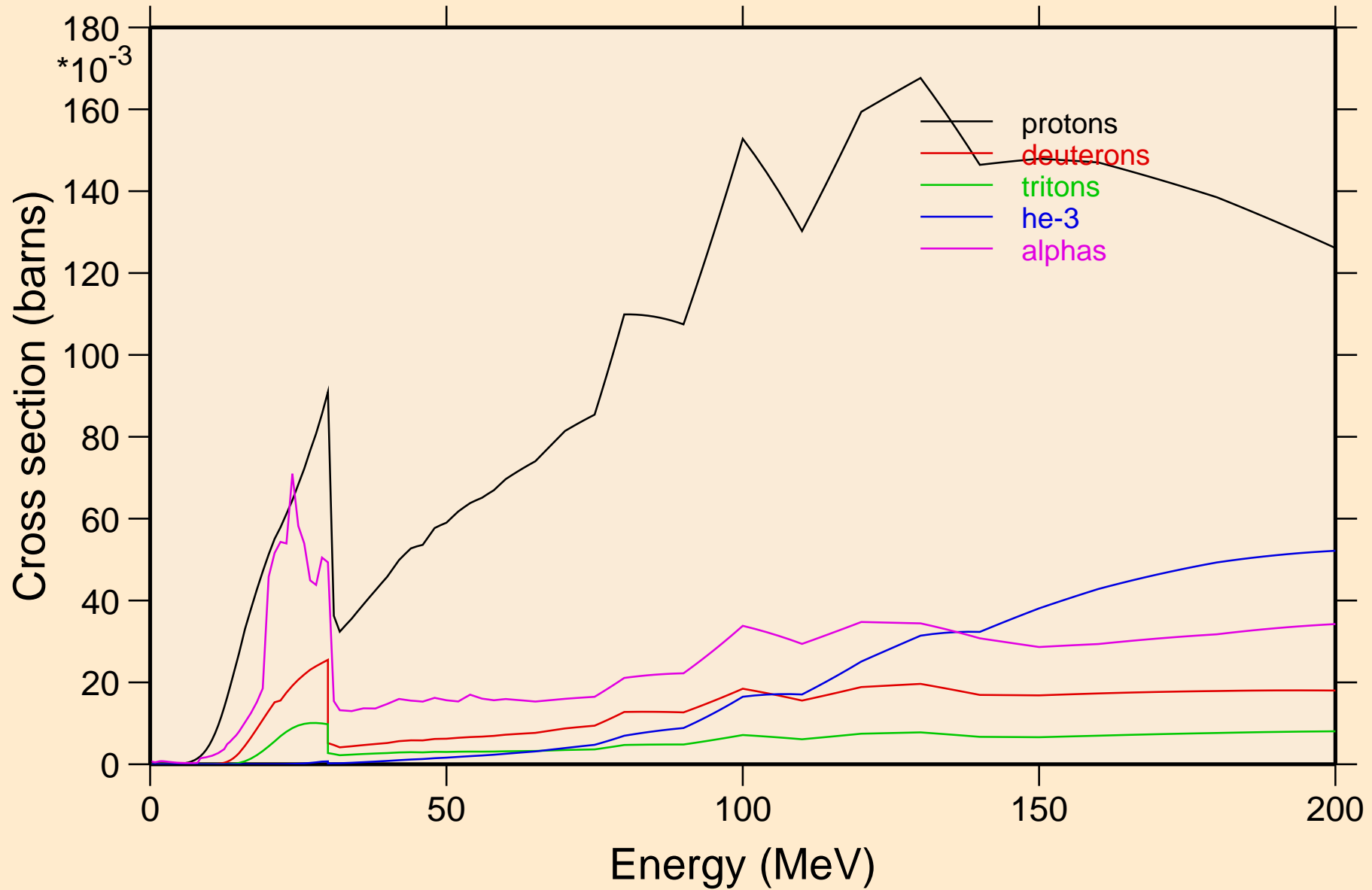

BH265 NEUTRON ACER TENDL-2021 LIBRARY; T=293.6K
protons from (n,x)

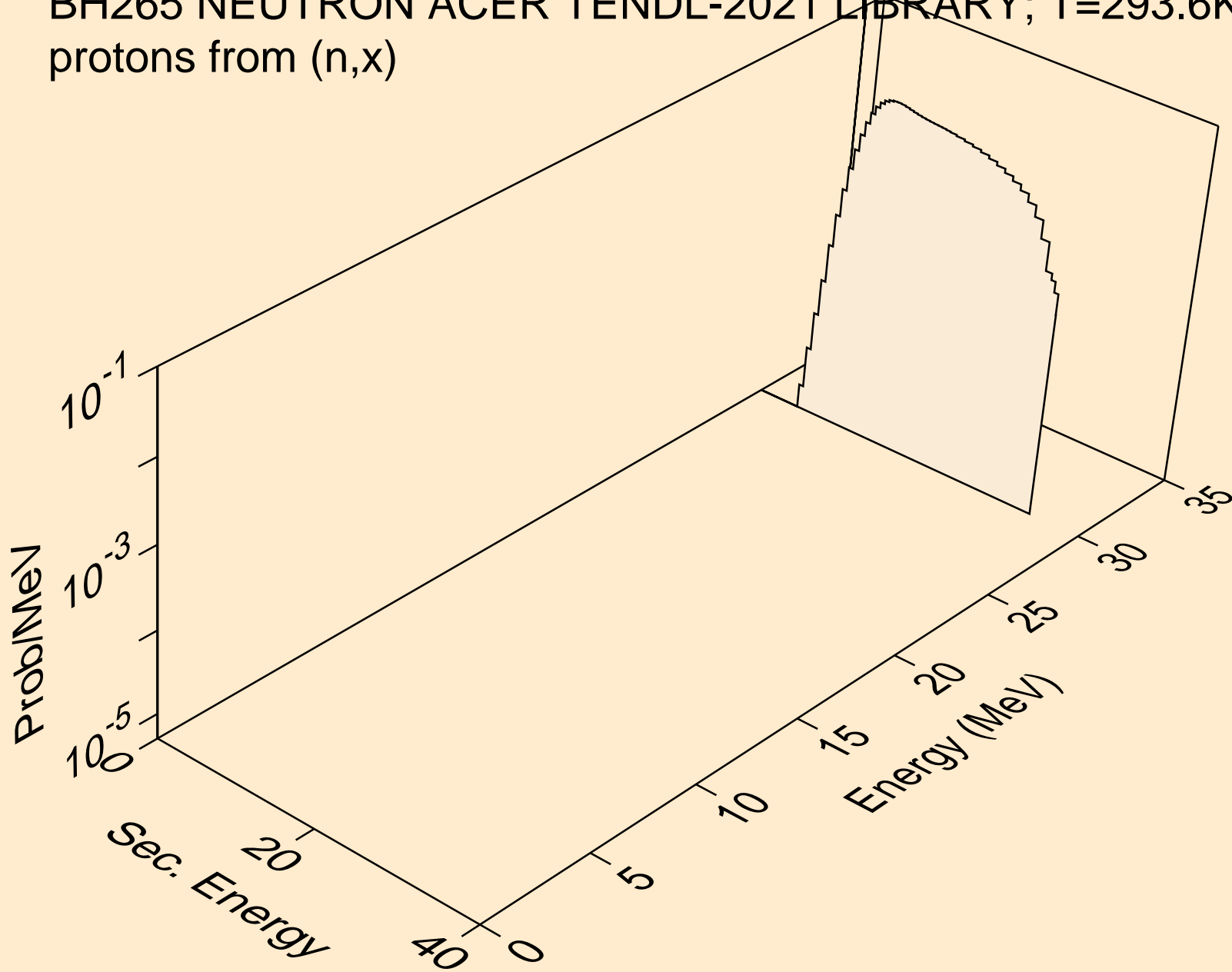

BH265 NEUTRON ACER TENDL-2021 LIBRARY; T=293.6K
protons from (n,n*)p

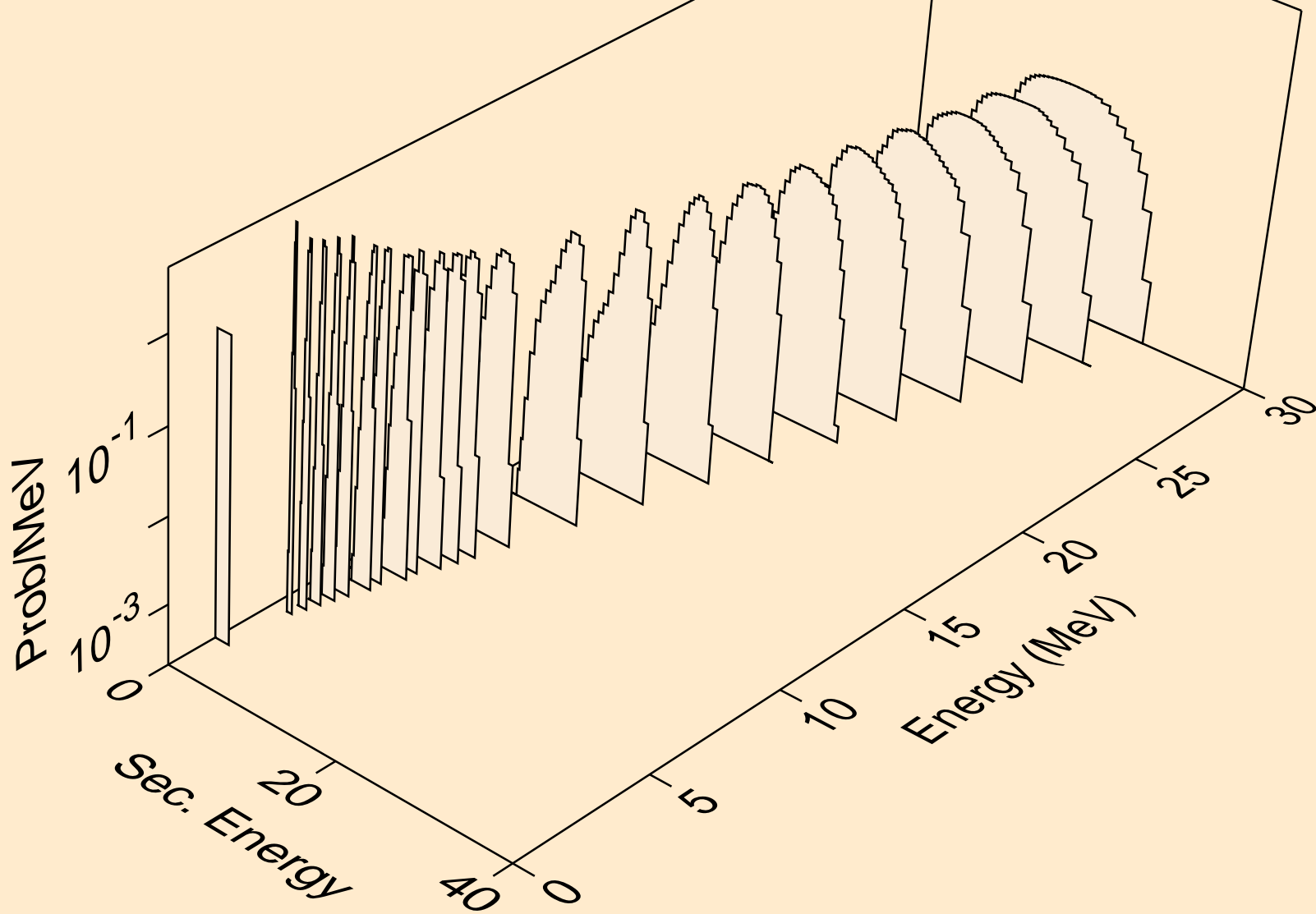

BH265 NEUTRON ACER TENDL-2021 LIBRARY; T=293.6K
protons from (n,2np)

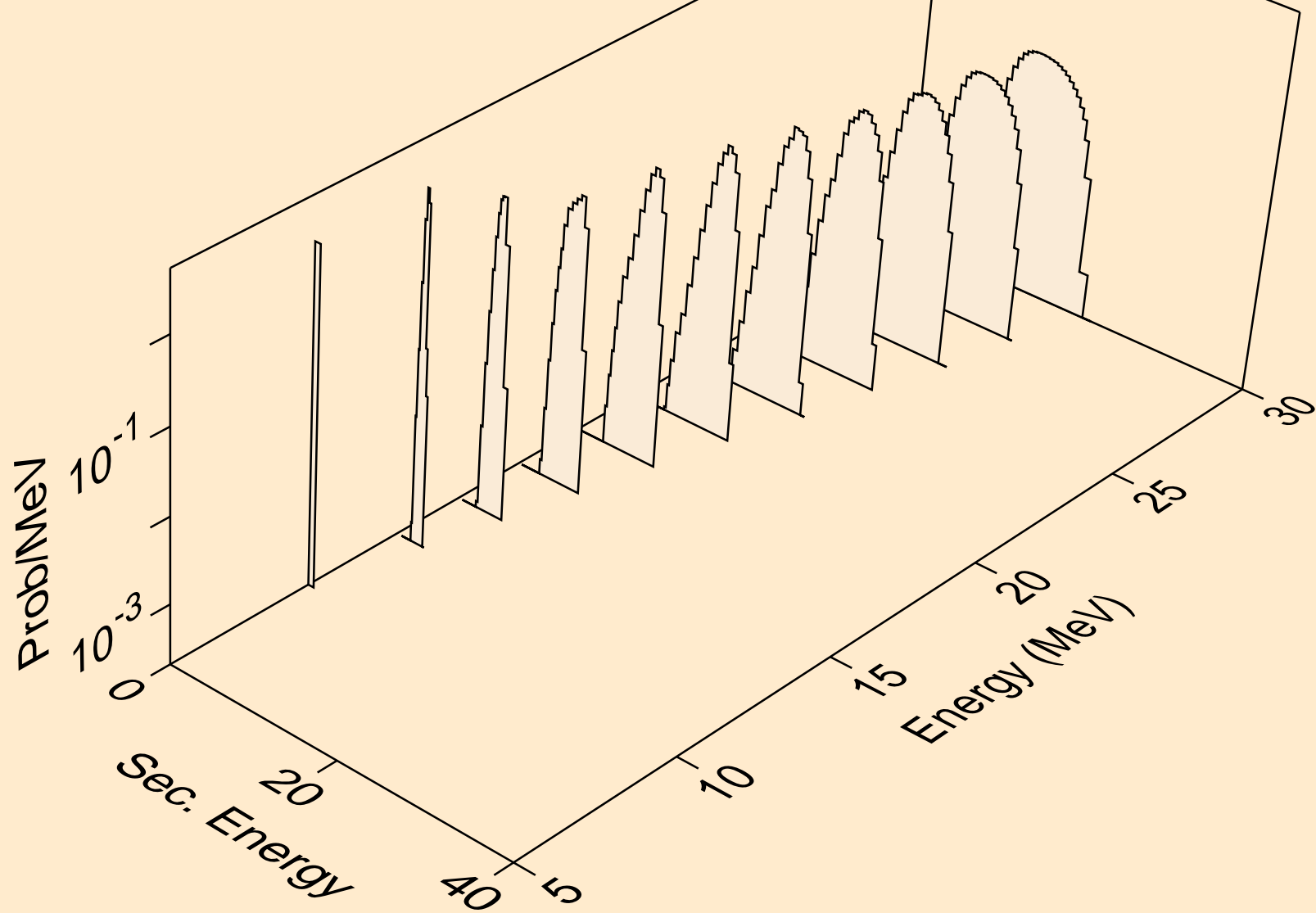

BH265 NEUTRON ACER TENDL-2021 LIBRARY; T=293.6K
protons from (n,3np)

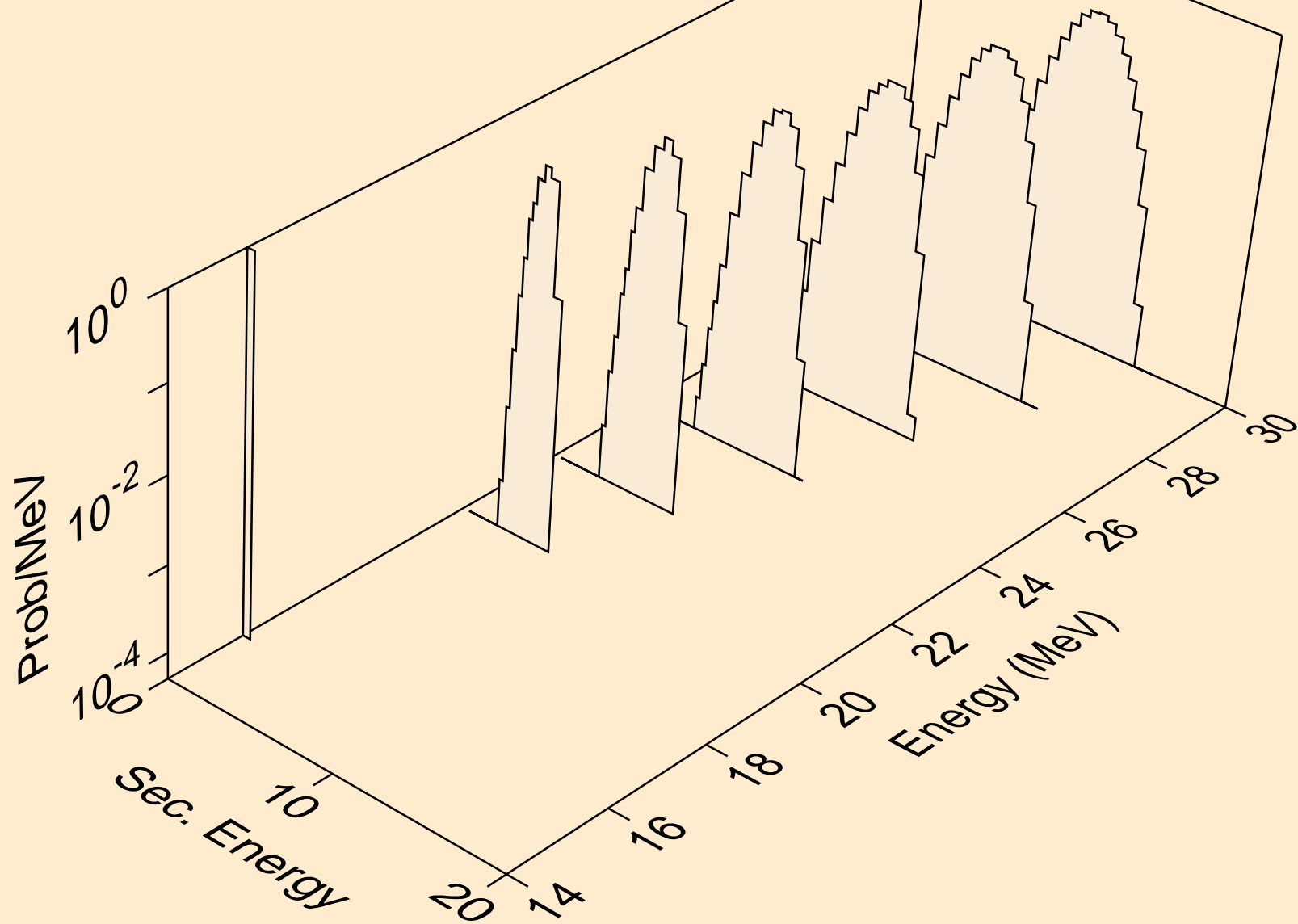

BH265 NEUTRON ACER TENDL-2021 LIBRARY; T=293.6K
protons from (n,2np)

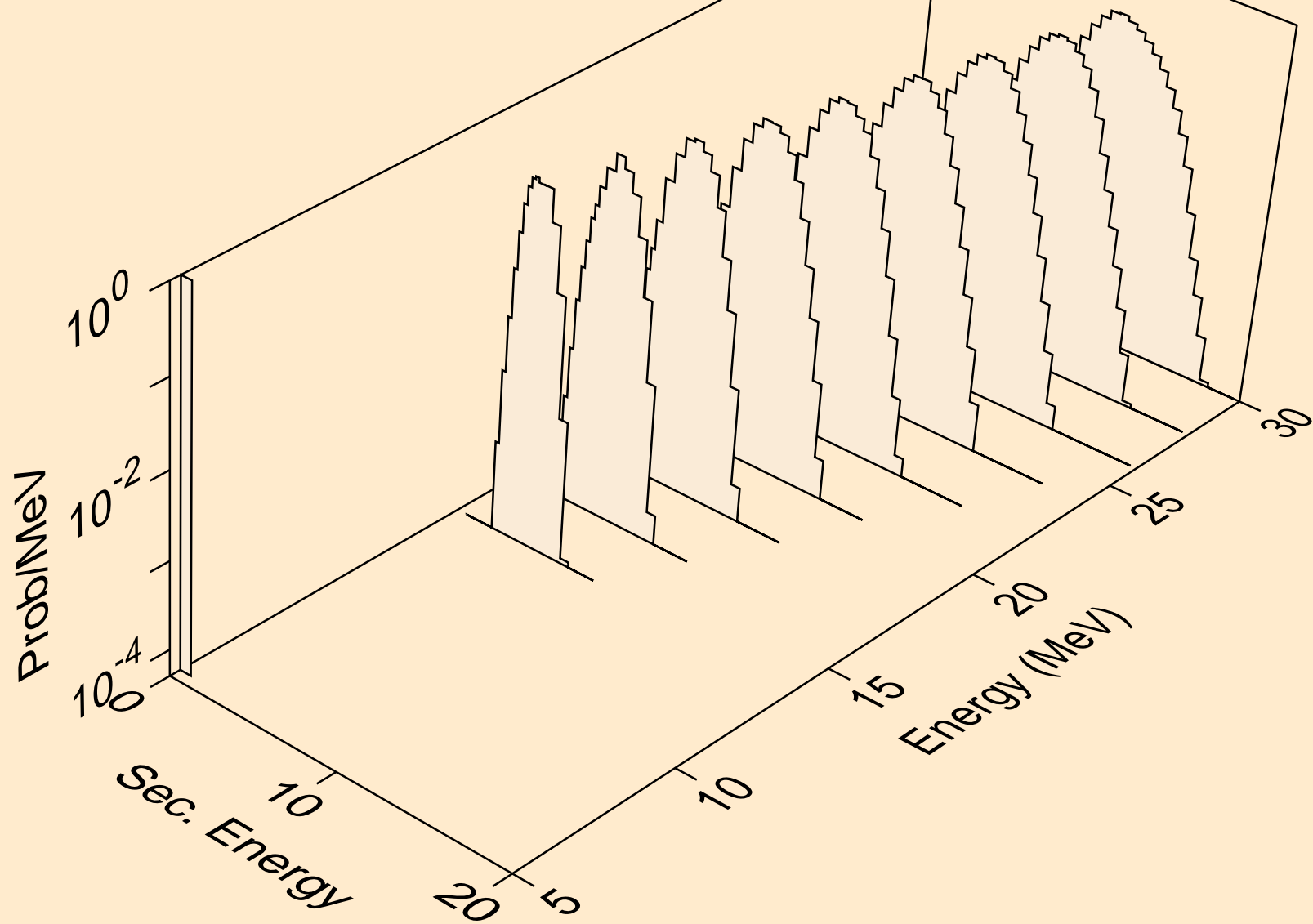

BH265 NEUTRON ACER TENDL-2021 LIBRARY; T=293.6K
protons from (n,npa)

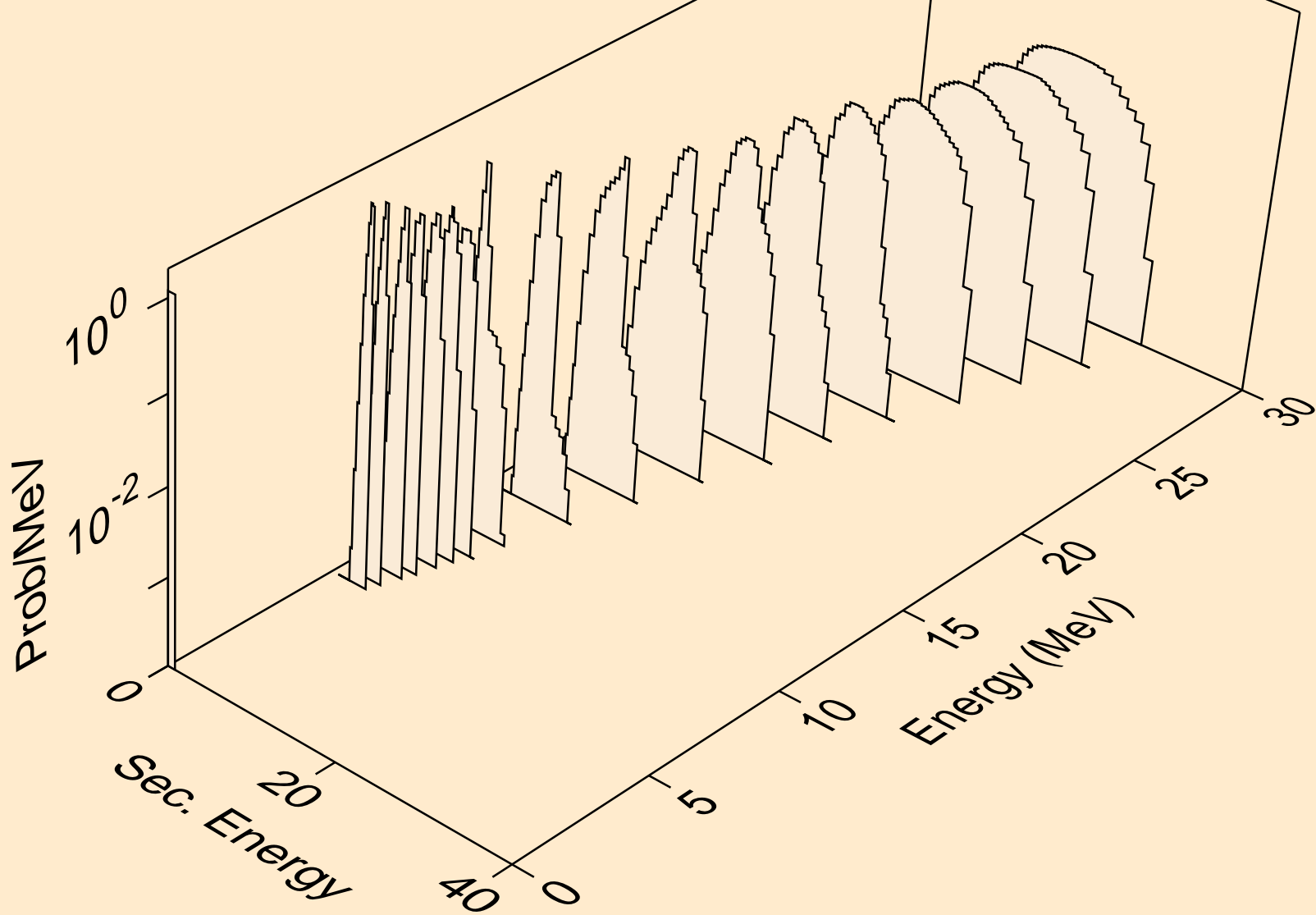

BH265 NEUTRON ACER TENDL-2021 LIBRARY; T=293.6K
protons from (n,p)

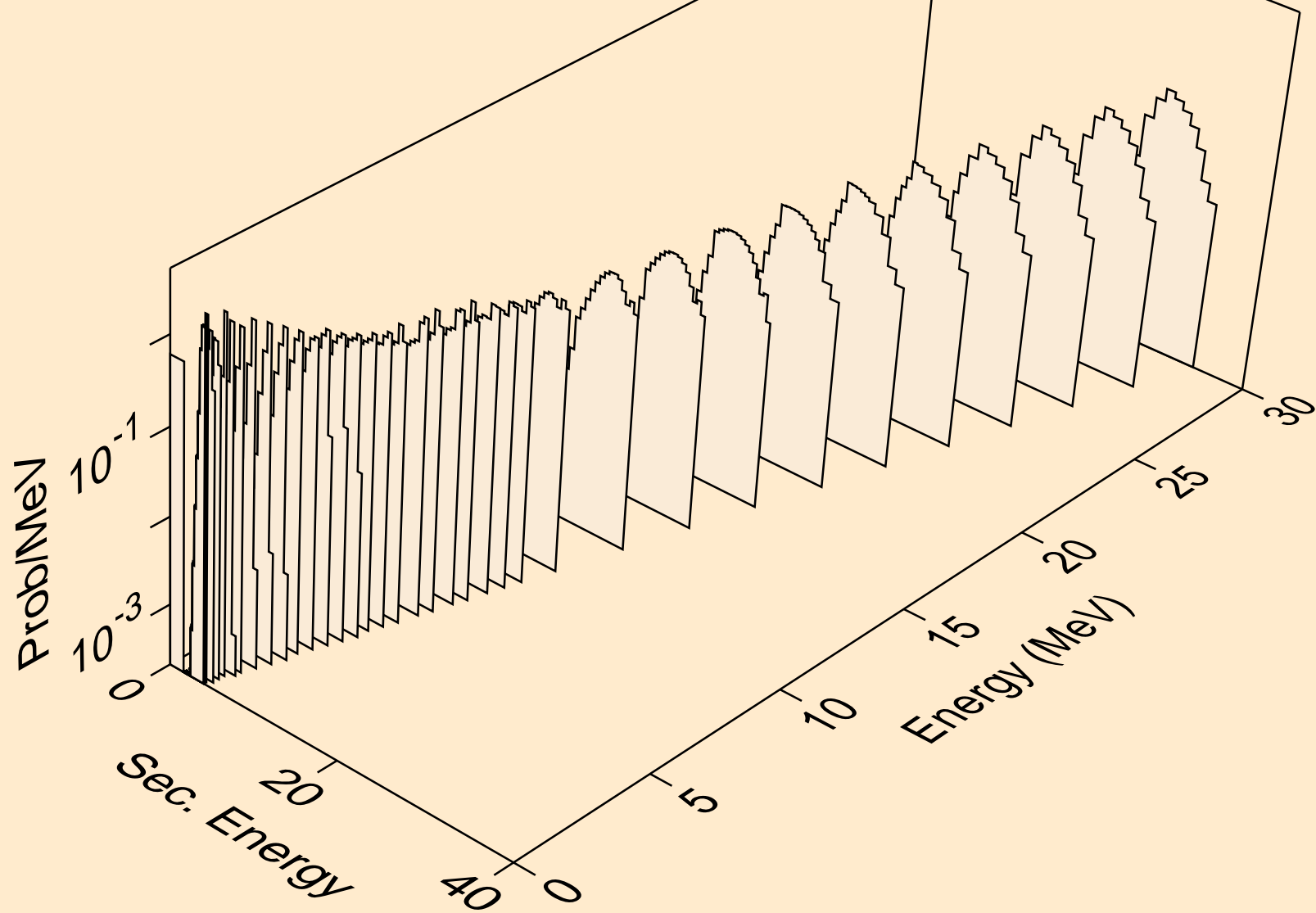

BH265 NEUTRON ACER TENDL-2021 LIBRARY; T=293.6K
protons from (n,2p)

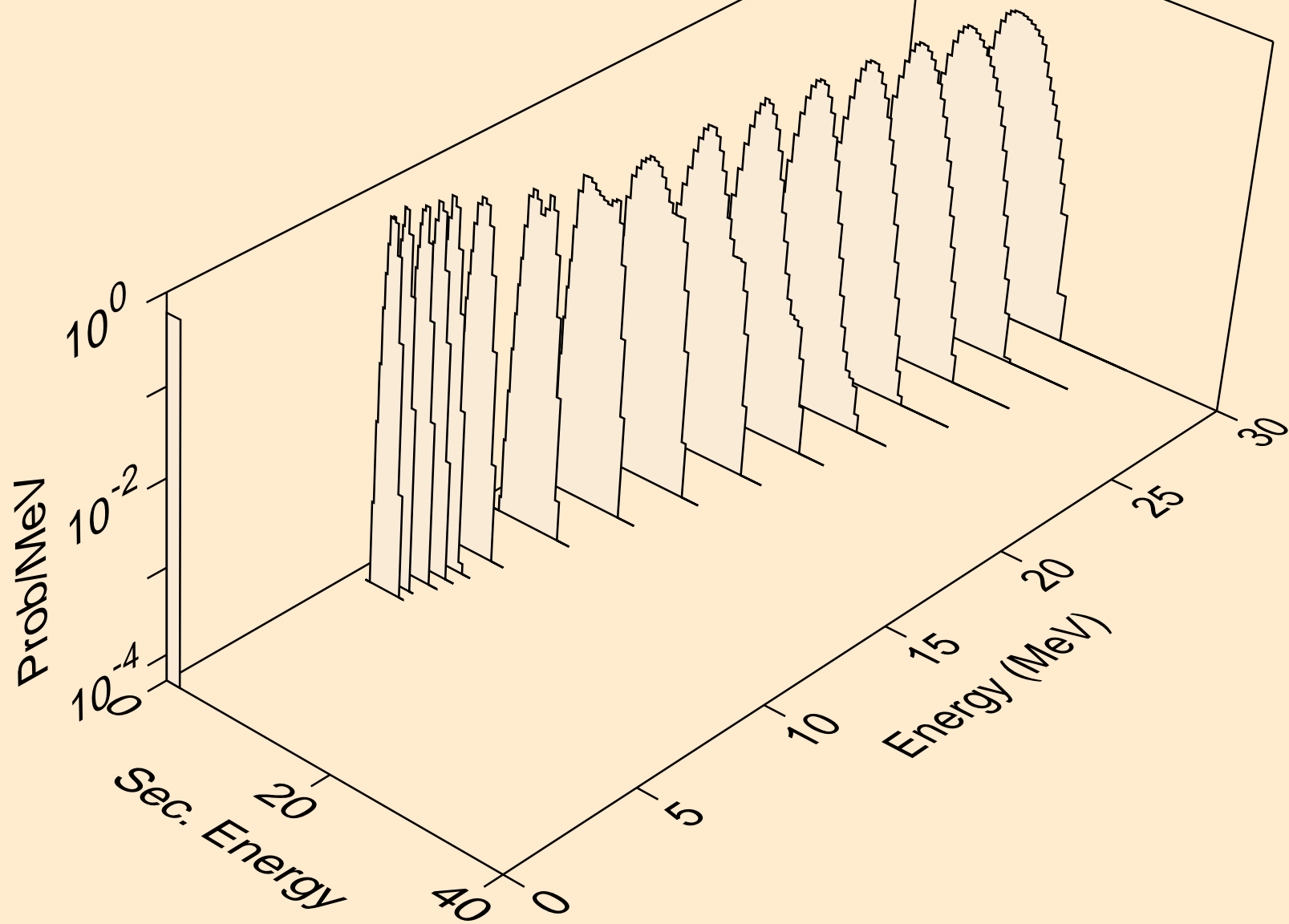

BH265 NEUTRON ACER TENDL-2021 LIBRARY; T=293.6K
protons from (n,p)

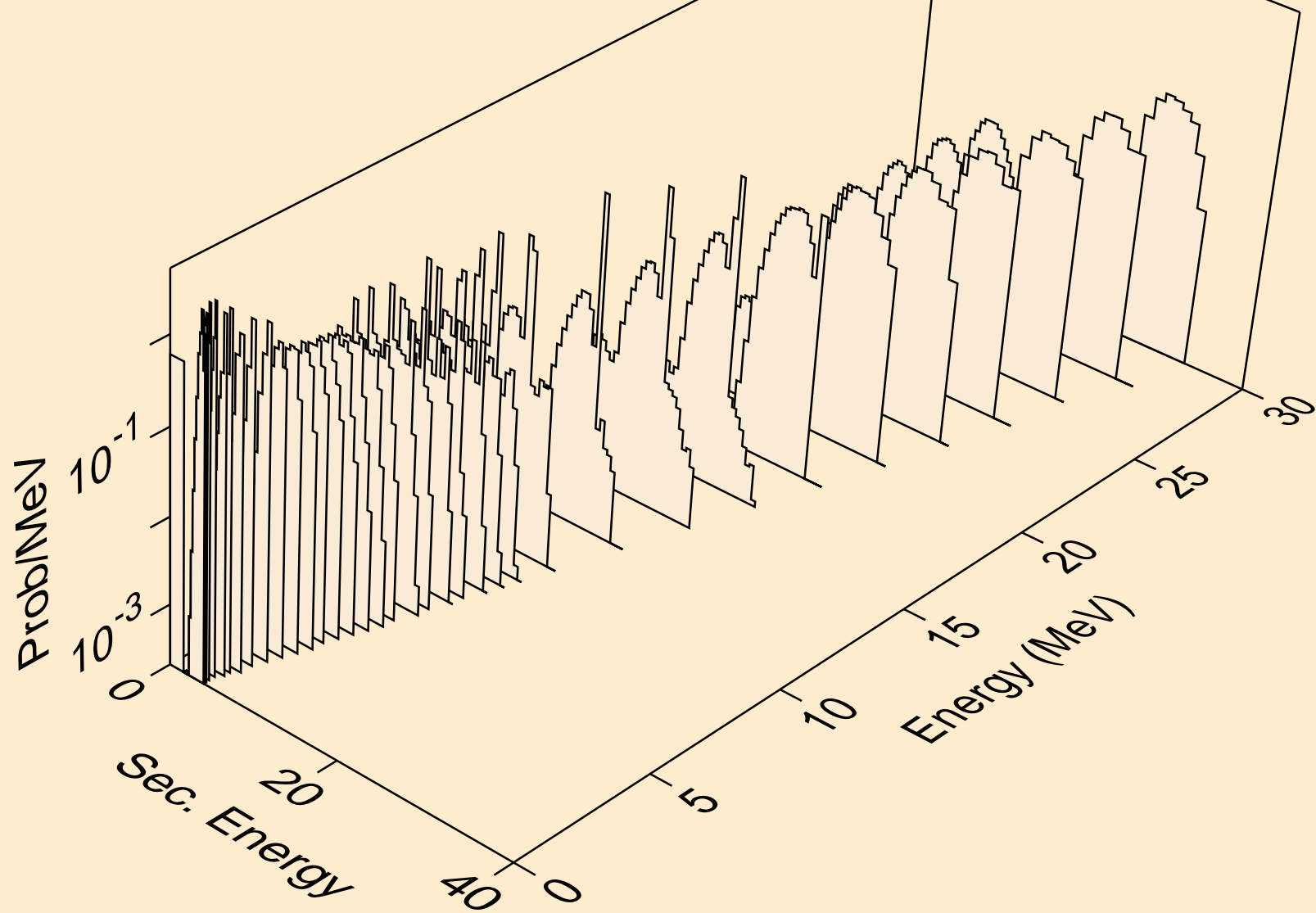

BH265 NEUTRON ACER TENDL-2021 LIBRARY; T=293.6K
protons from (n,pd)

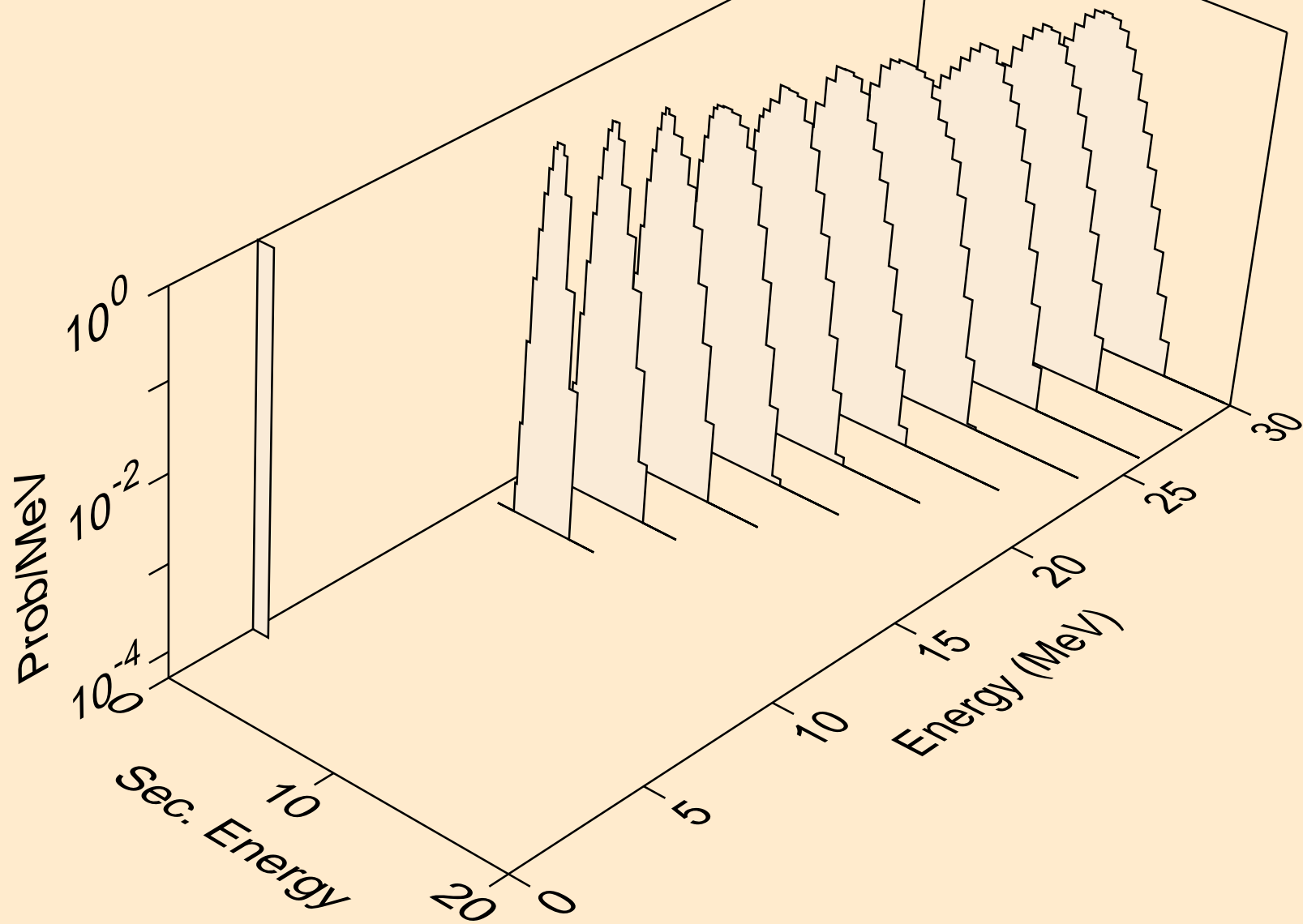

BH265 NEUTRON ACER TENDL-2021 LIBRARY; T=293.6K
protons from (n,pt)

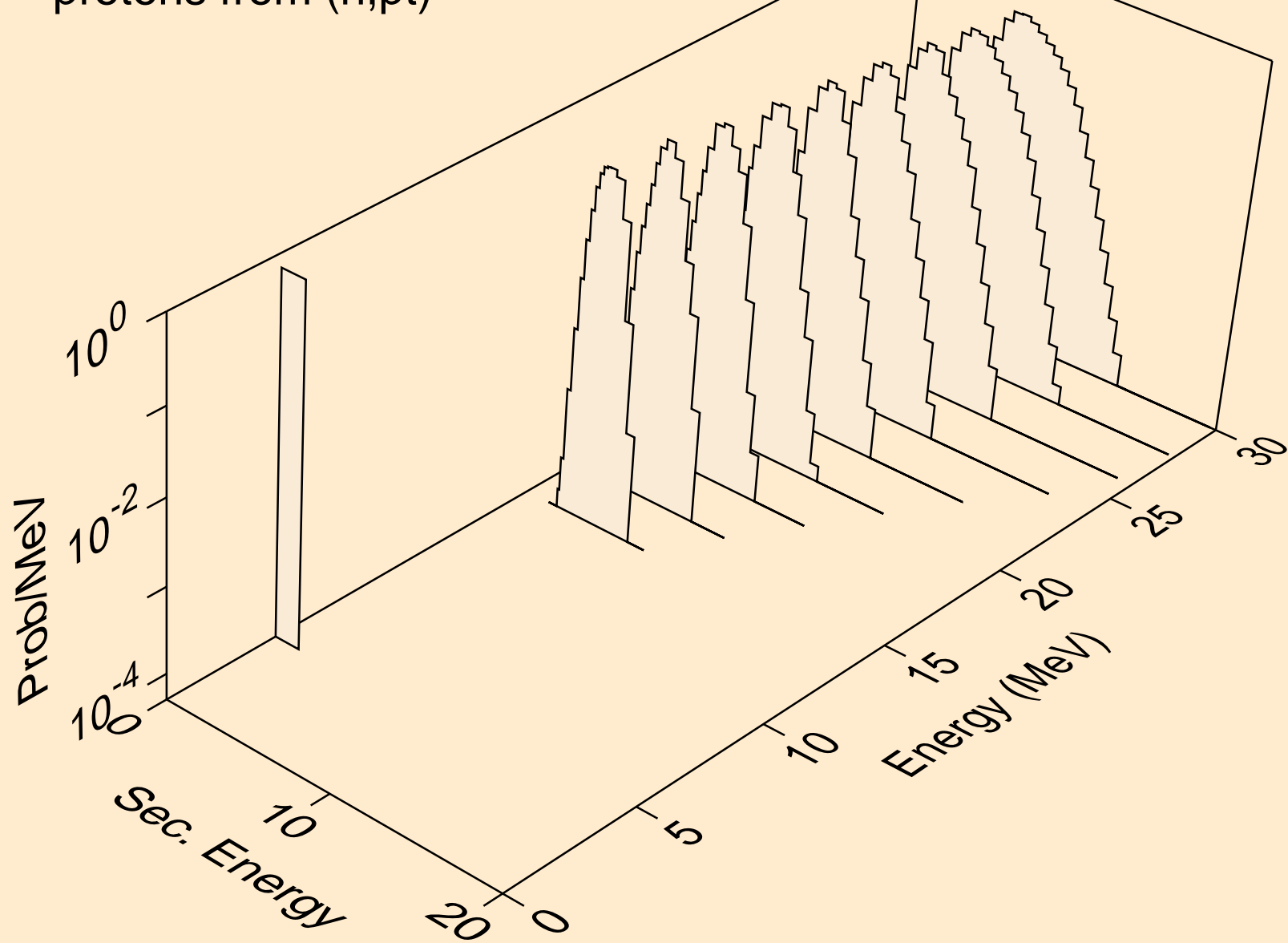

BH265 NEUTRON ACER TENDL-2021 LIBRARY; T=293.6K
deuterons from (n,x)

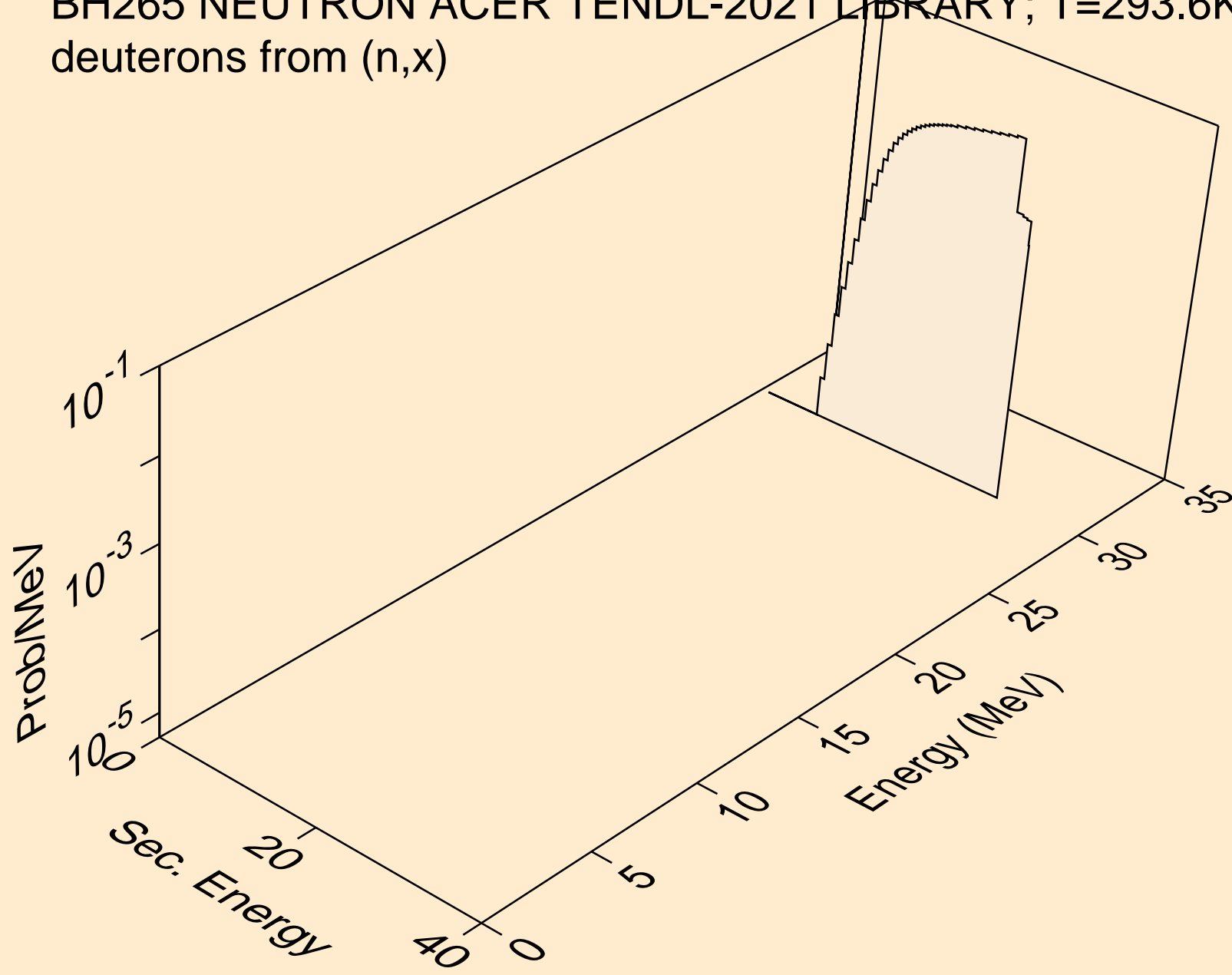

BH265 NEUTRON ACER TENDL-2021 LIBRARY; T=293.6K
deuterons from (n,2nd)

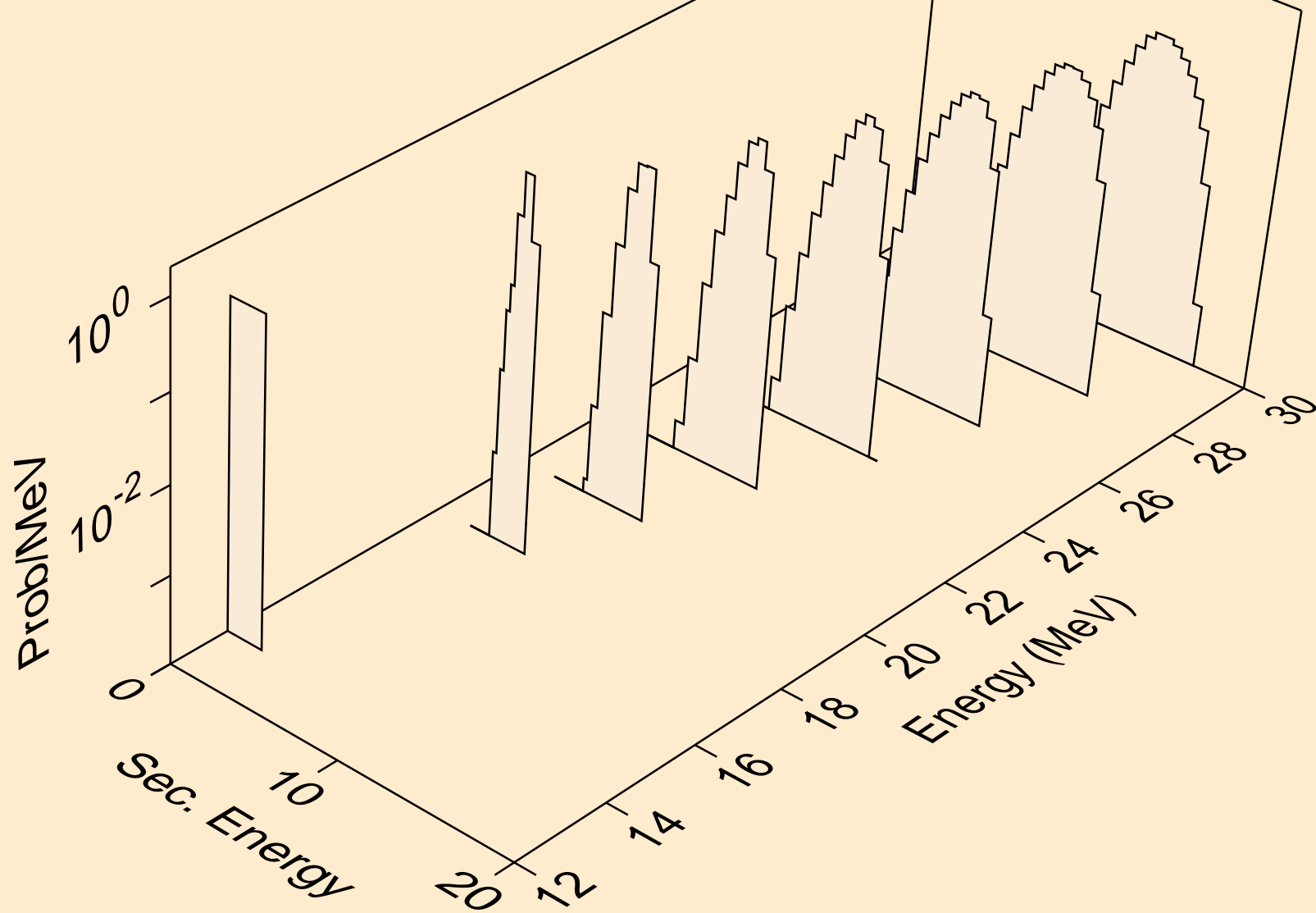

BH265 NEUTRON ACER TENDL-2021 LIBRARY; T=293.6K
deuterons from (n,n*)d

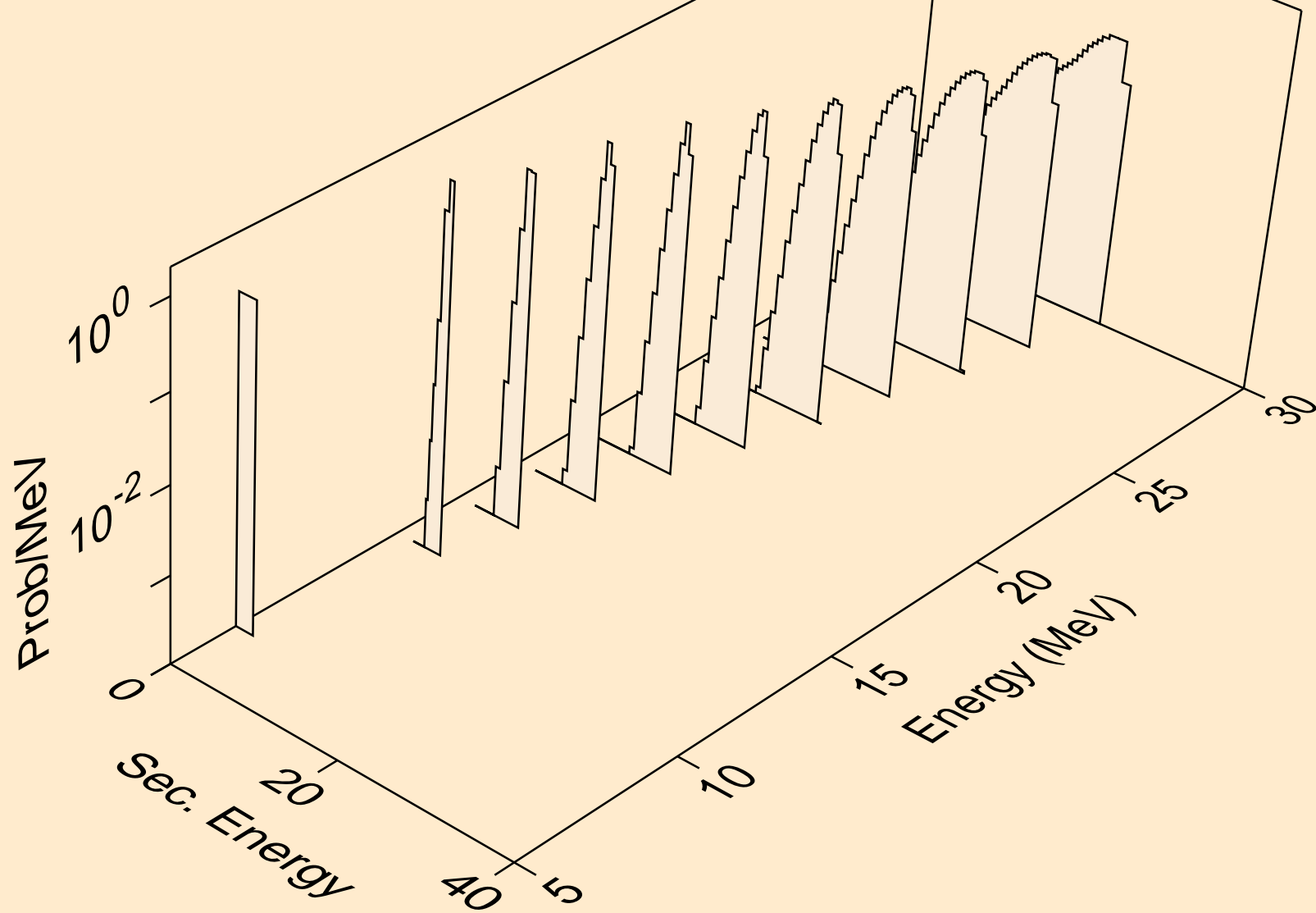

BH265 NEUTRON ACER TENDL-2021 LIBRARY; T=293.6K
deuterons from (n,d)

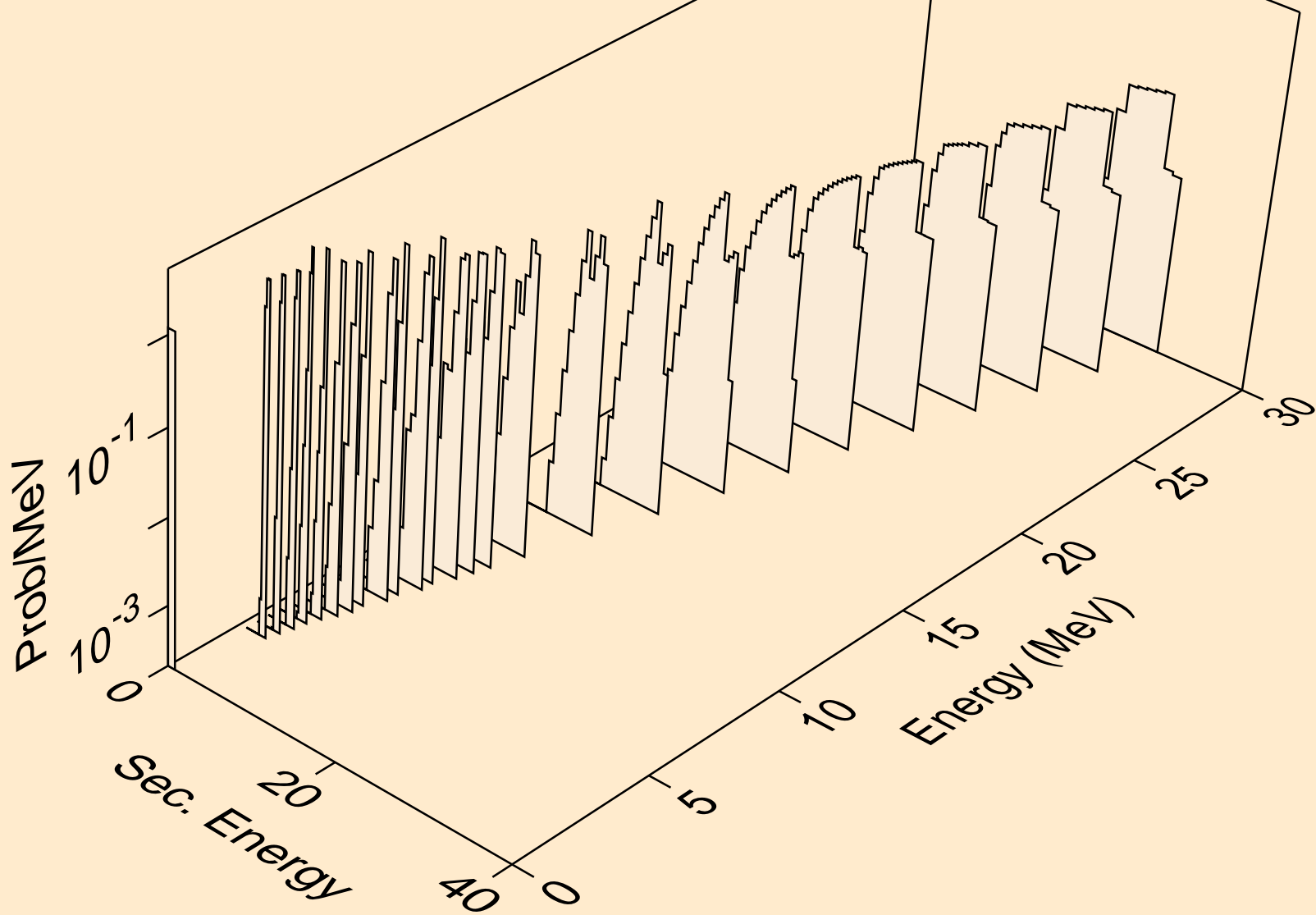

BH265 NEUTRON ACER TENDL-2021 LIBRARY; T=293.6K
deuterons from (n,pd)

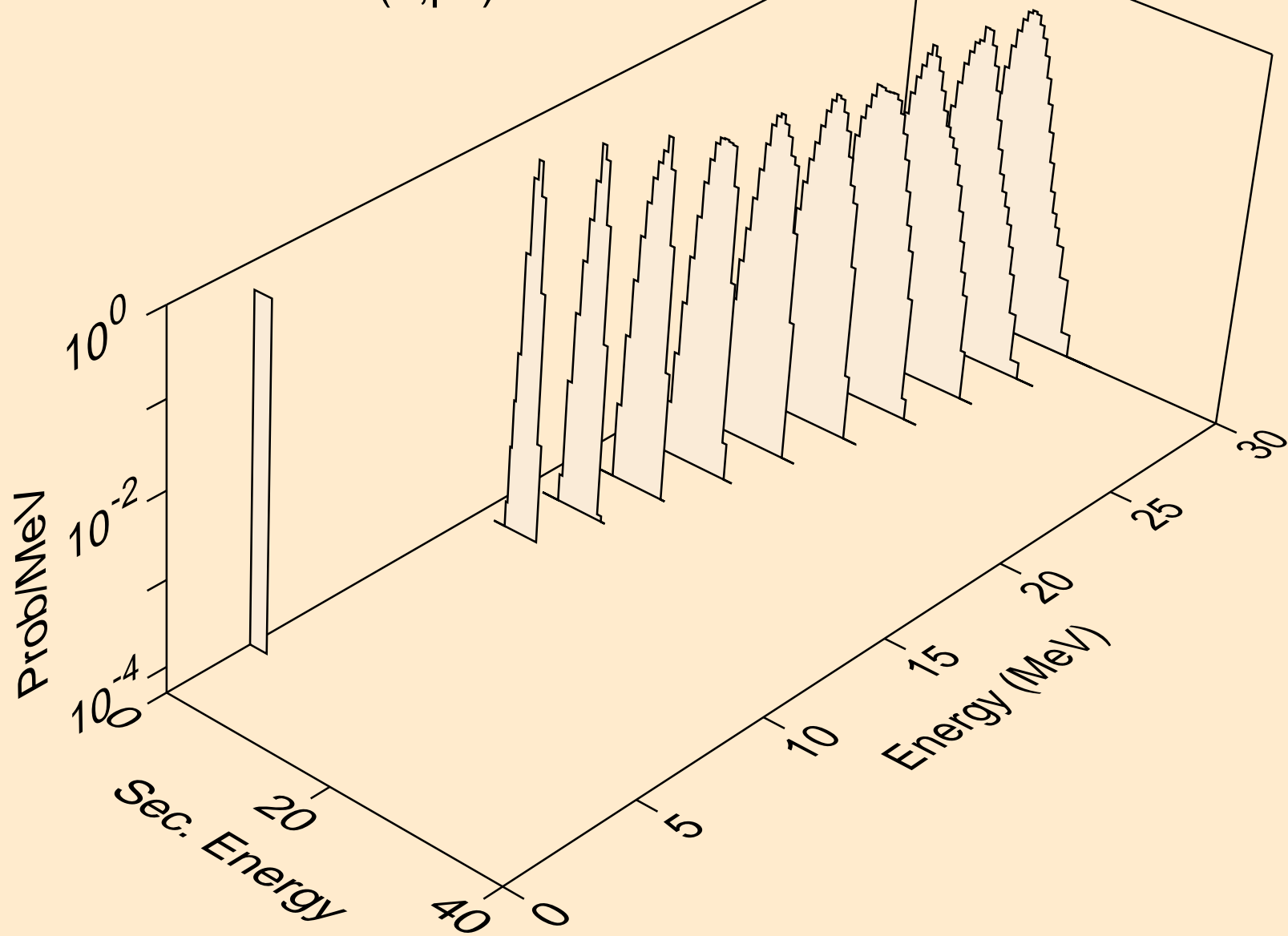

BH265 NEUTRON ACER TENDL-2021 LIBRARY; T=293.6K
deuterons from (n,da)

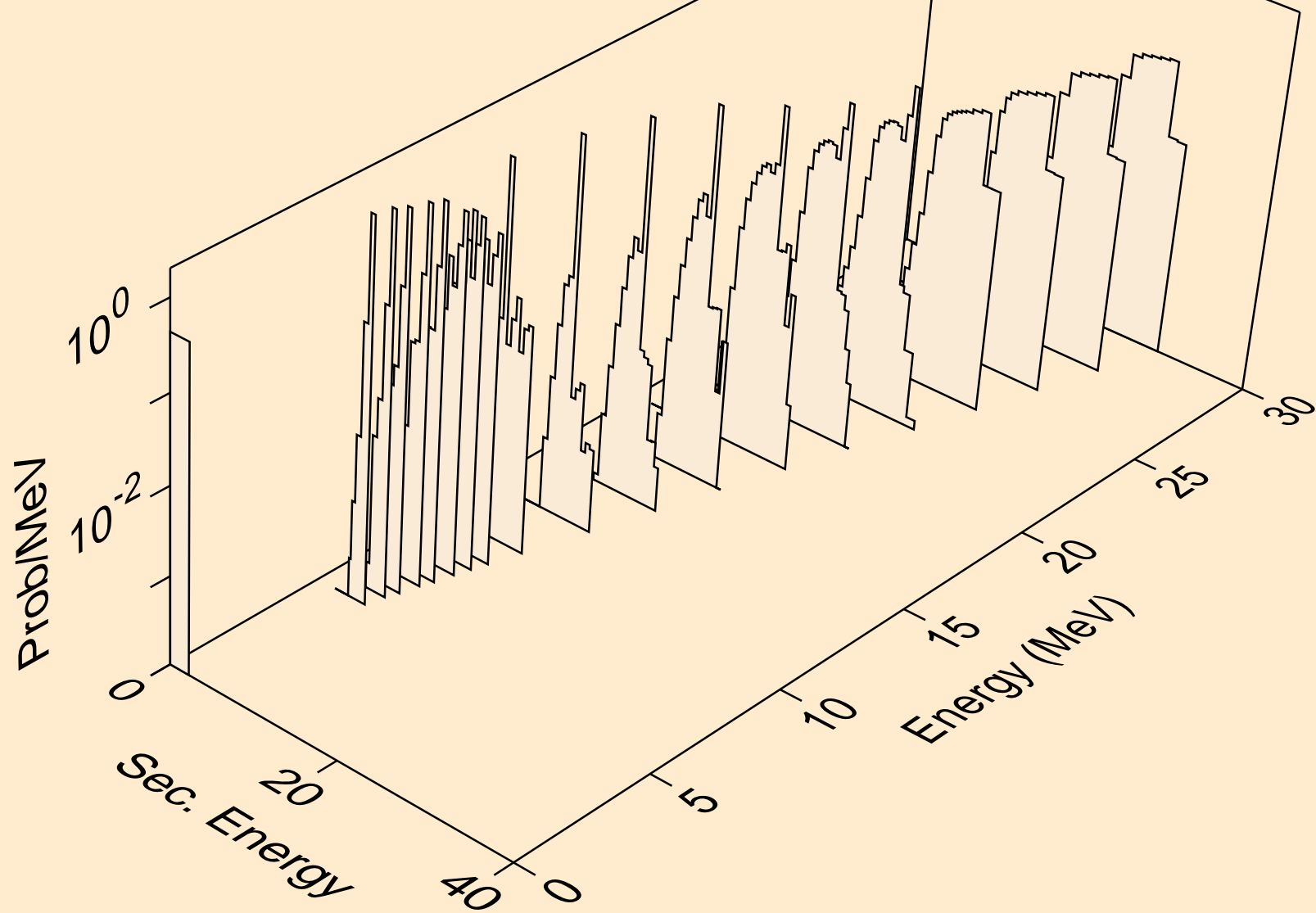

BH265 NEUTRON ACER TENDL-2021 LIBRARY; T=293.6K
tritons from (n,x)

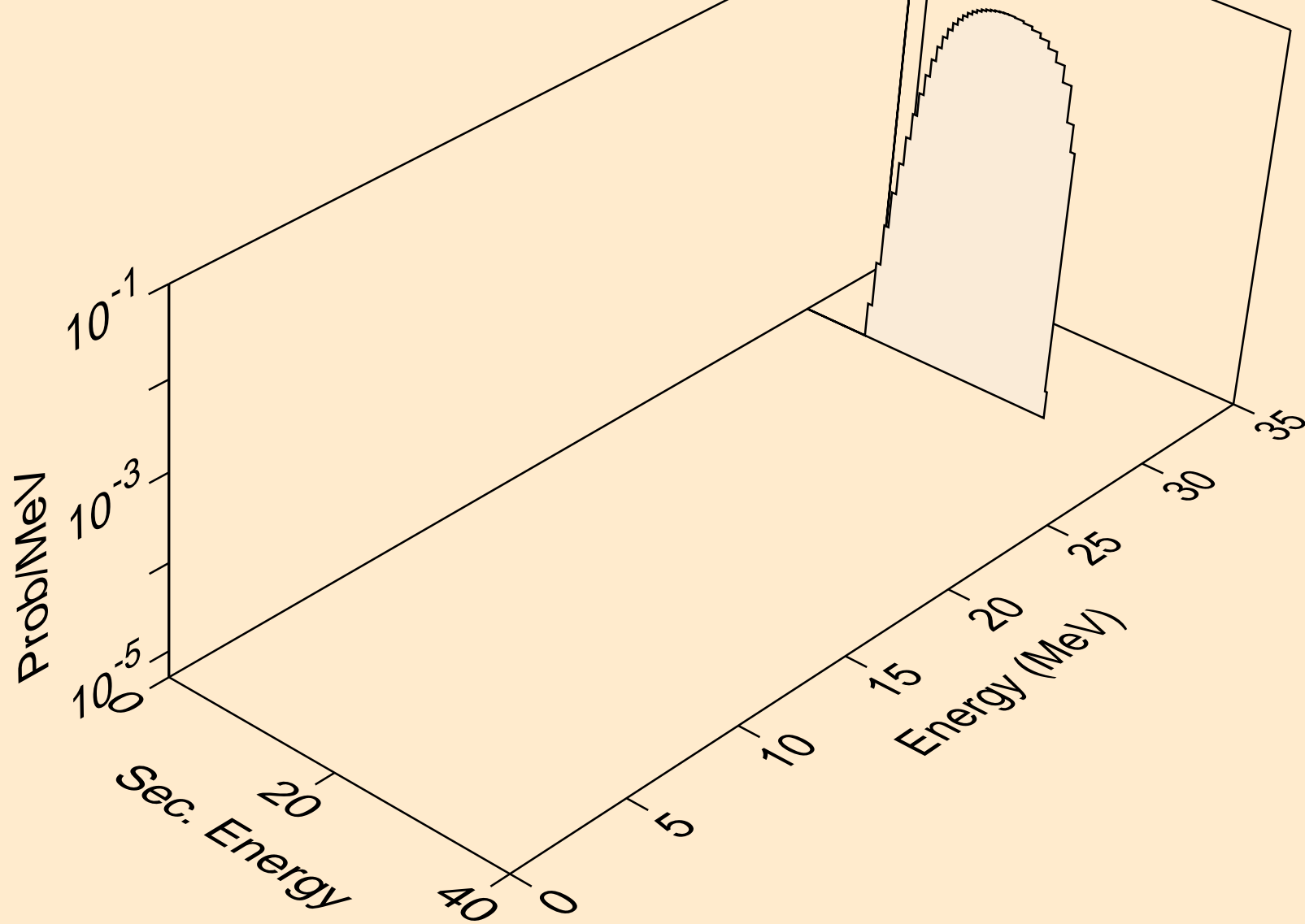

BH265 NEUTRON ACER TENDL-2021 LIBRARY; T=293.6K
tritons from (n,n*)t

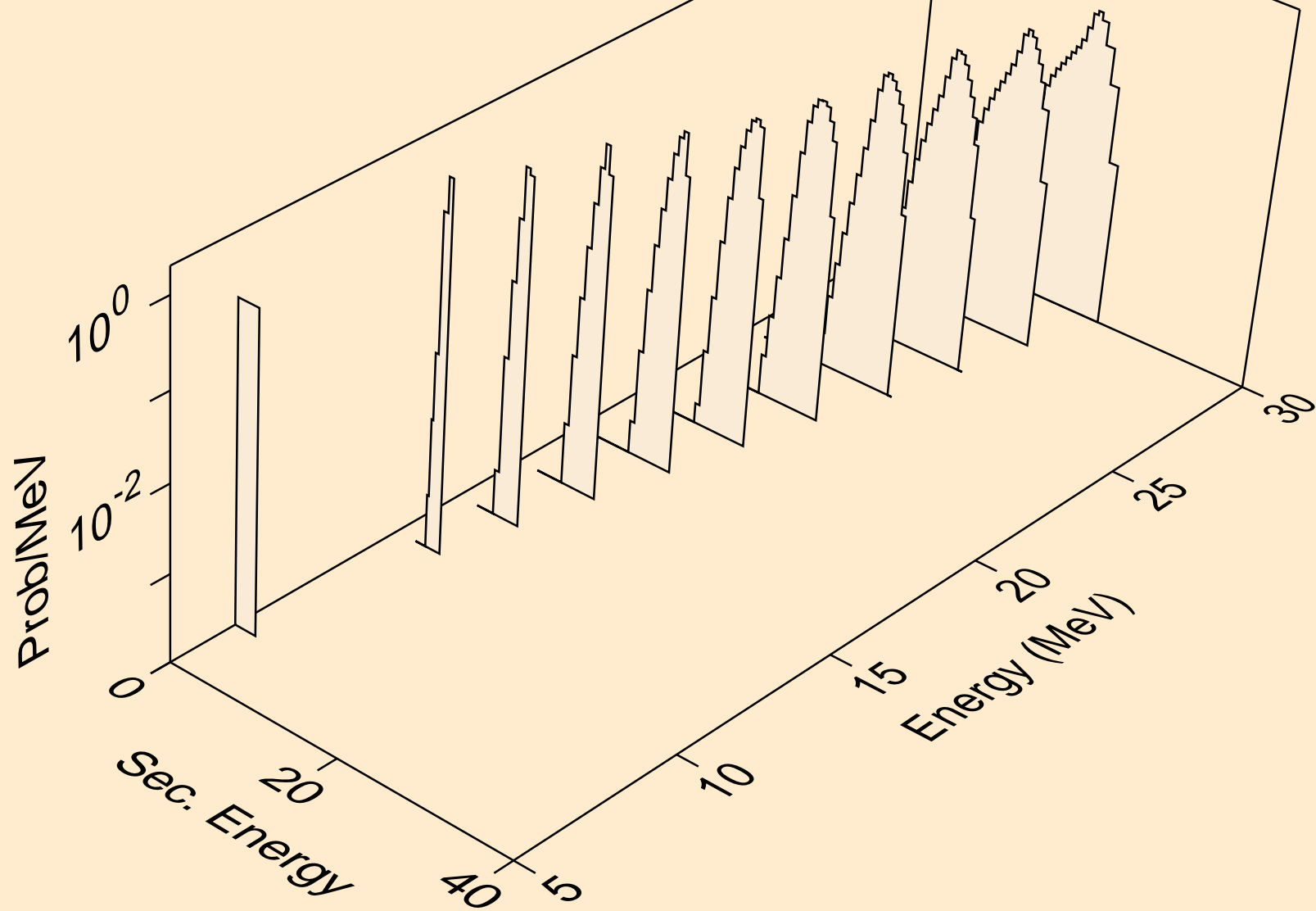

BH265 NEUTRON ACER TENDL-2021 LIBRARY; T=293.6K
tritons from (n,n*)t2a

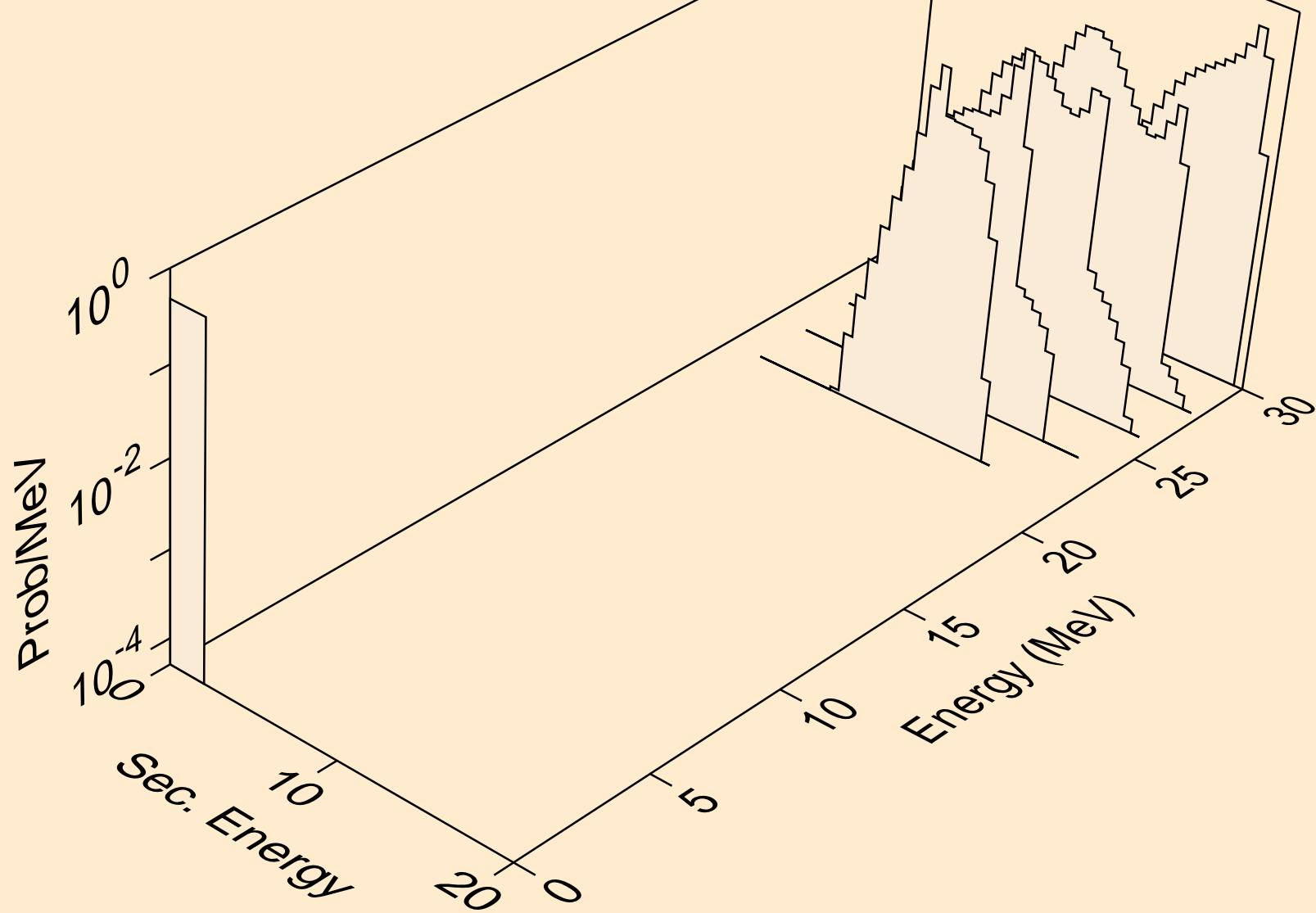

BH265 NEUTRON ACER TENDL-2021 LIBRARY; T=293.6K
tritons from (n,t)

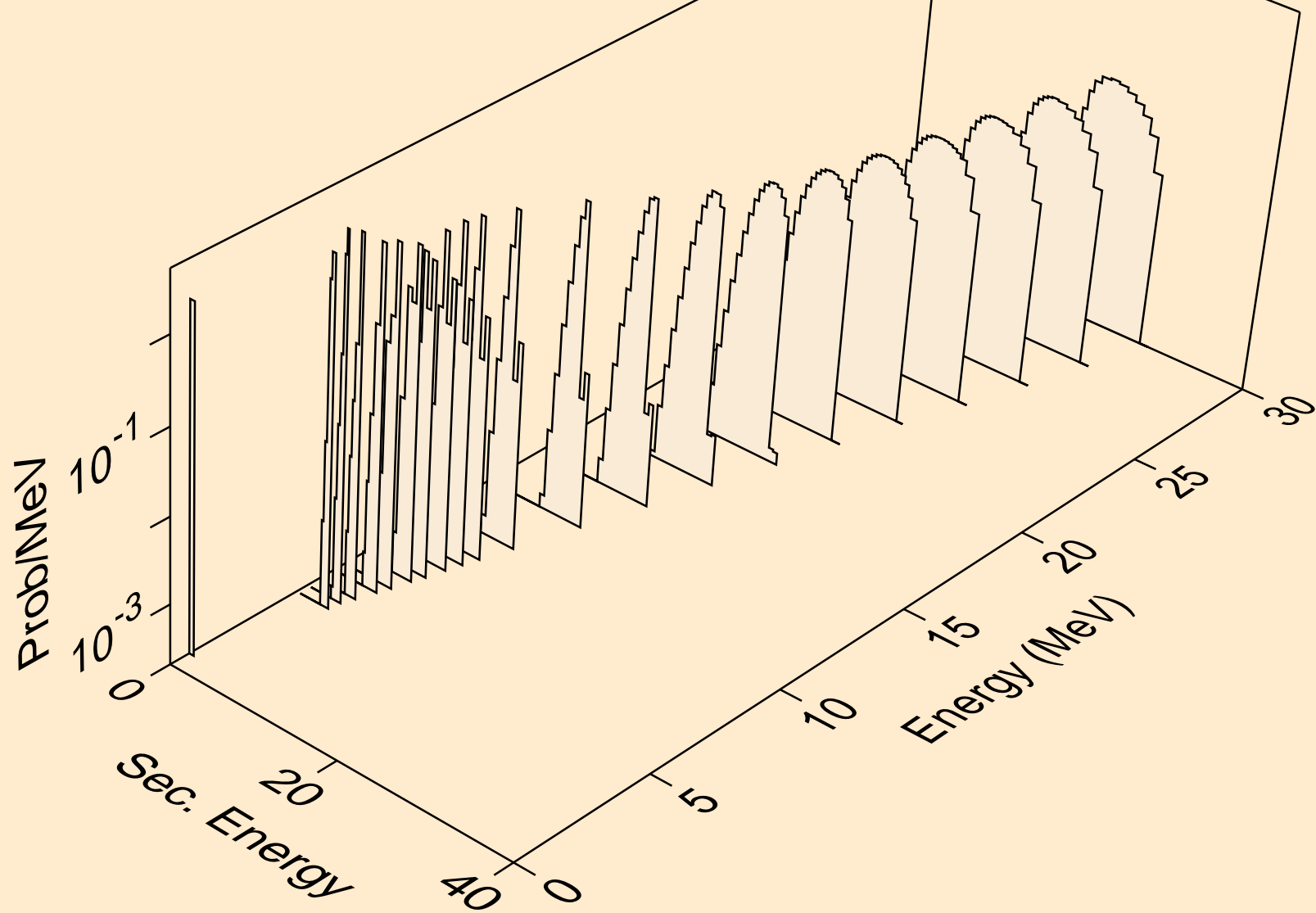

BH265 NEUTRON ACER TENDL-2021 LIBRARY; T=293.6K
tritons from (n,pt)

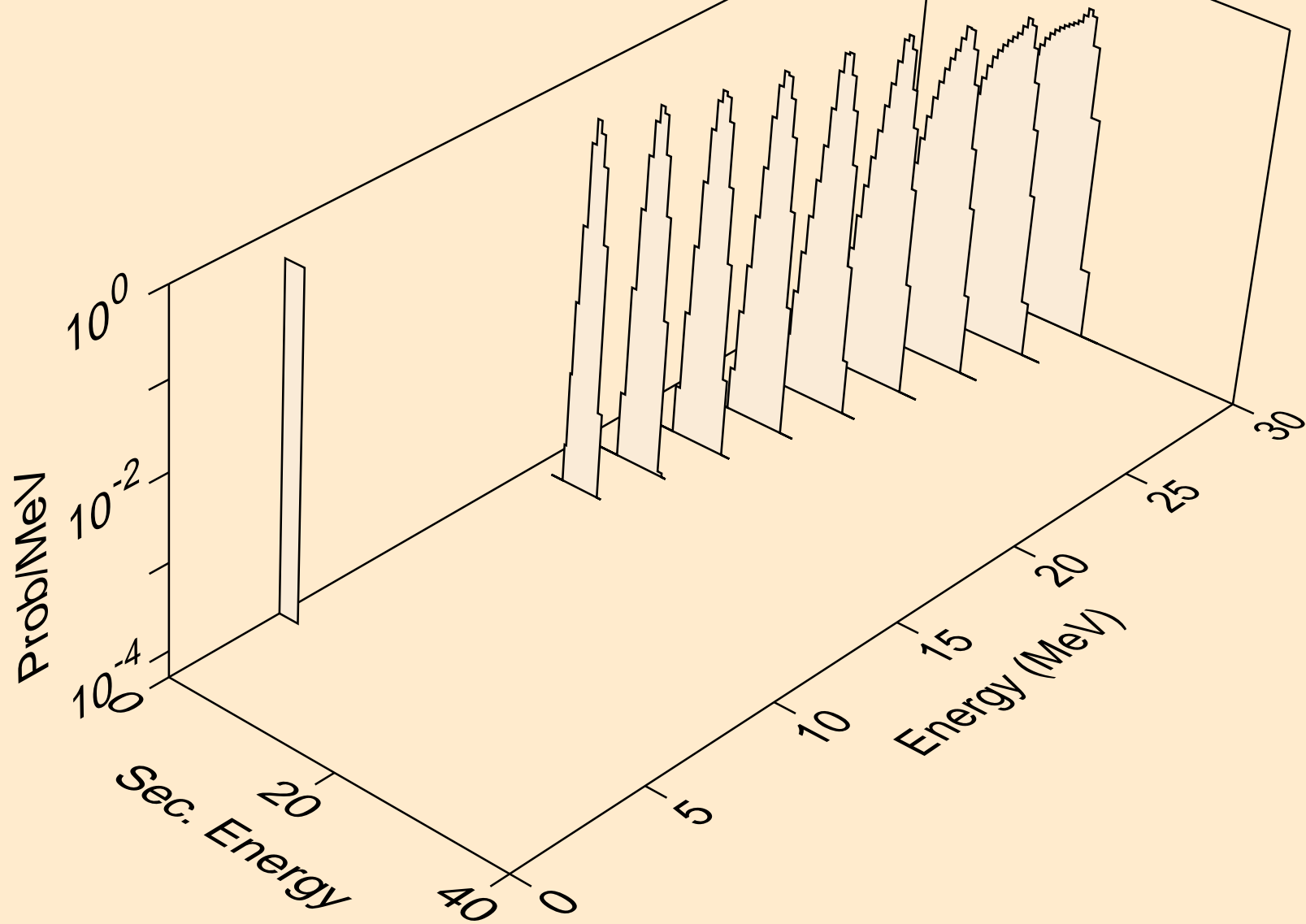

BH265 NEUTRON ACER TENDL-2021 LIBRARY; T=293.6K
he3s from (n,x)

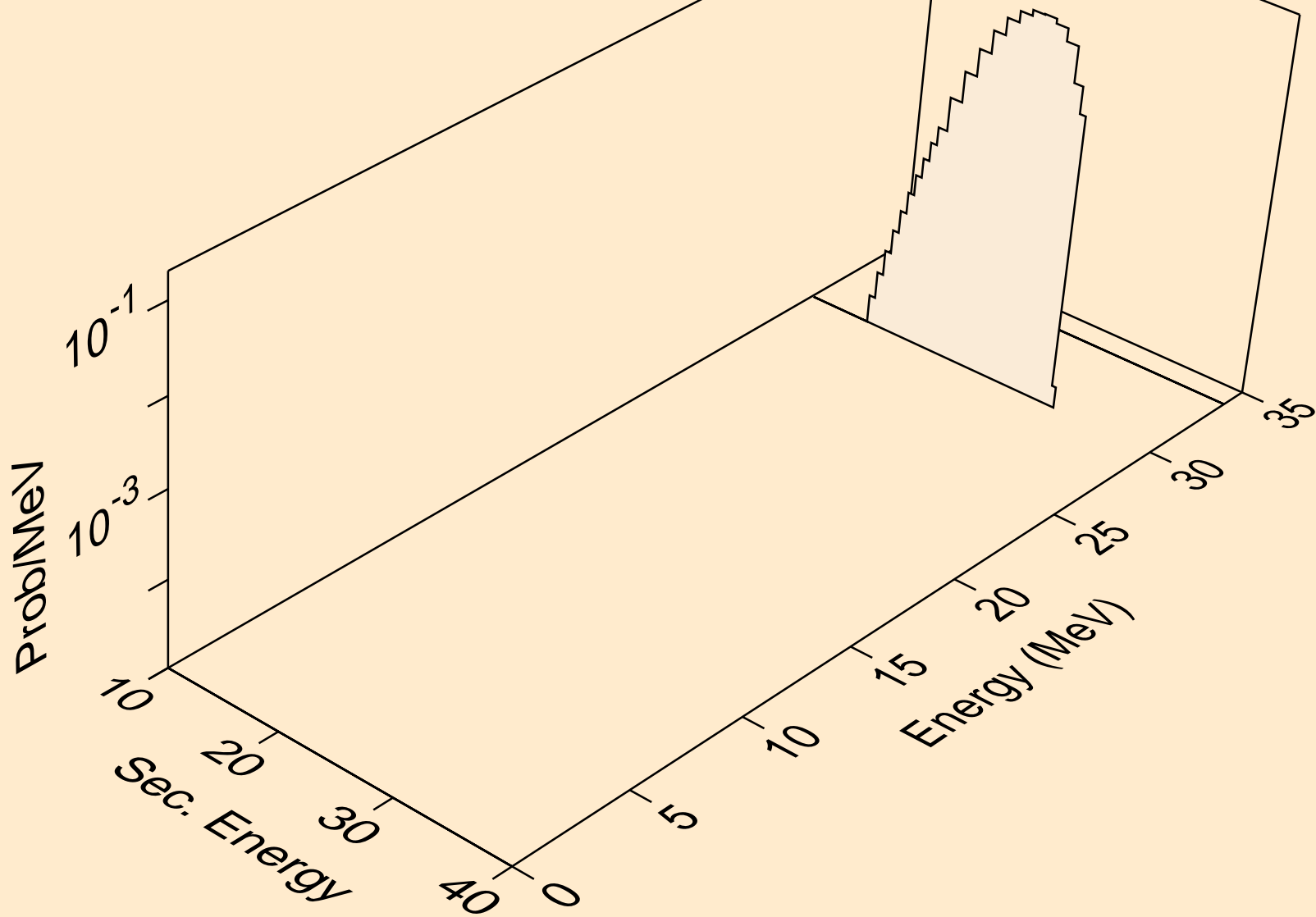

BH265 NEUTRON ACER TENDL-2021 LIBRARY; T=293.6K
he3s from (n,n*)he3

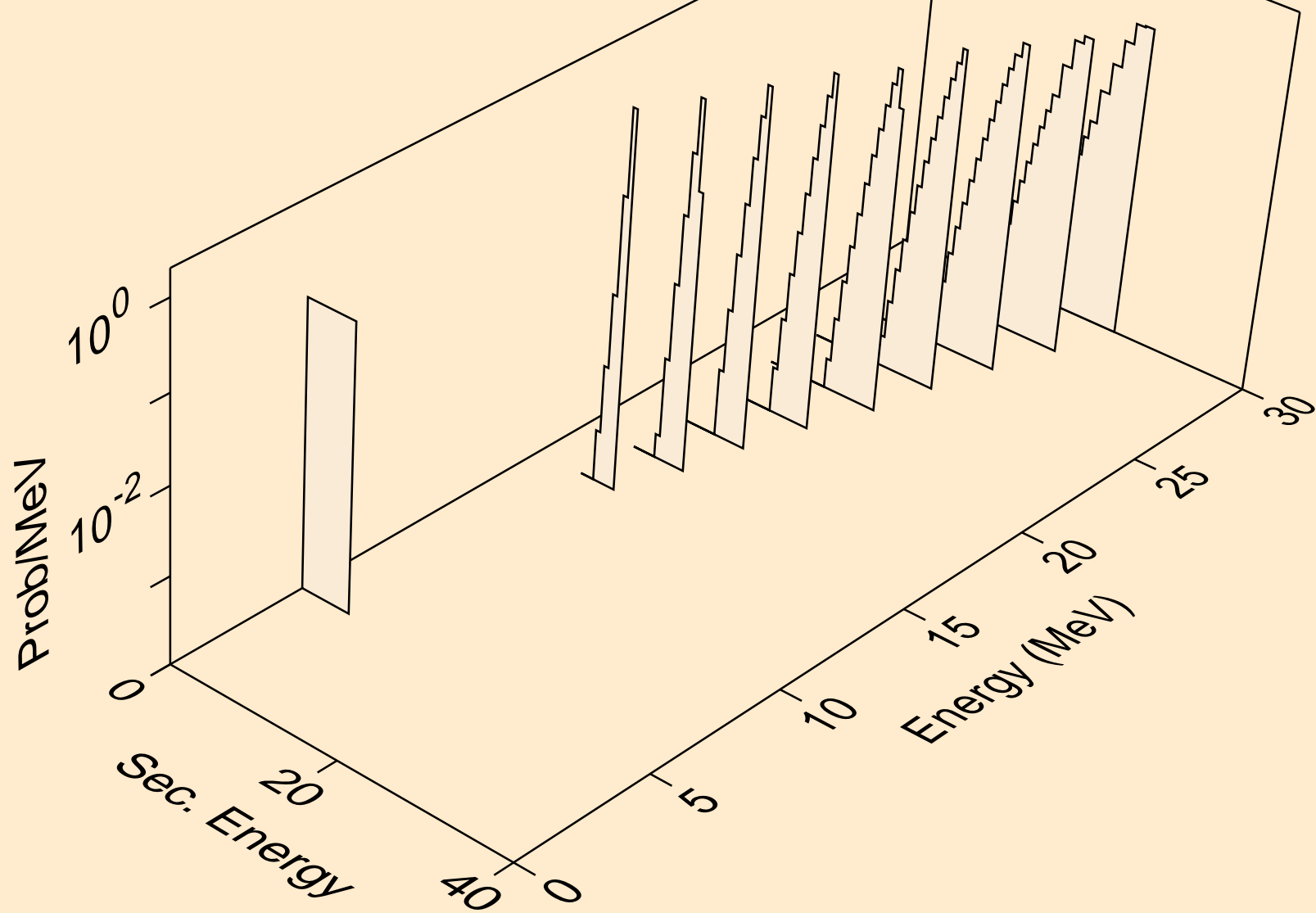

BH265 NEUTRON ACER TENDL-2021 LIBRARY; T=293.6K
he3s from (n,he3)

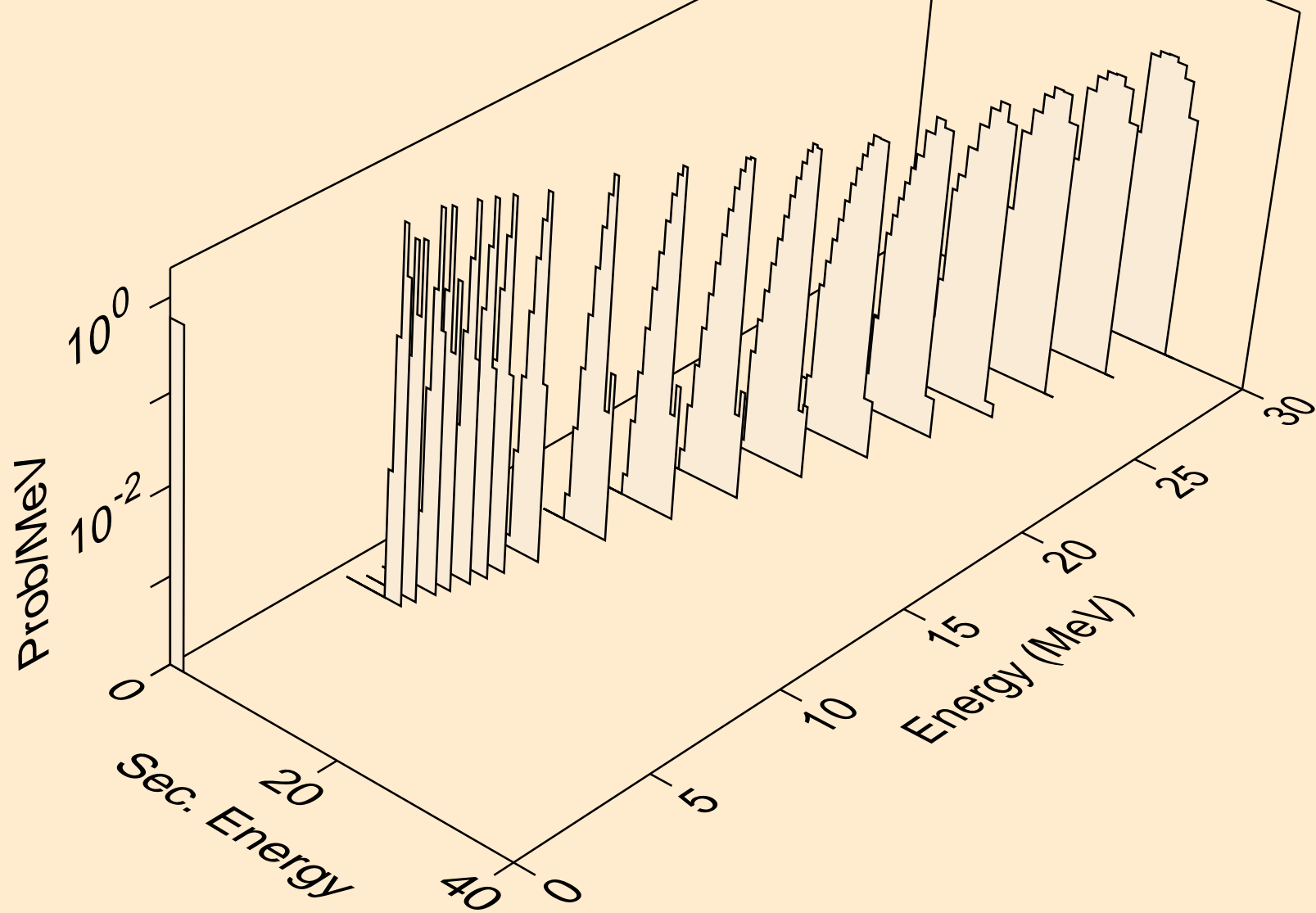

BH265 NEUTRON ACER TENDL-2021 LIBRARY; T=293.6K
alphas from (n,x)

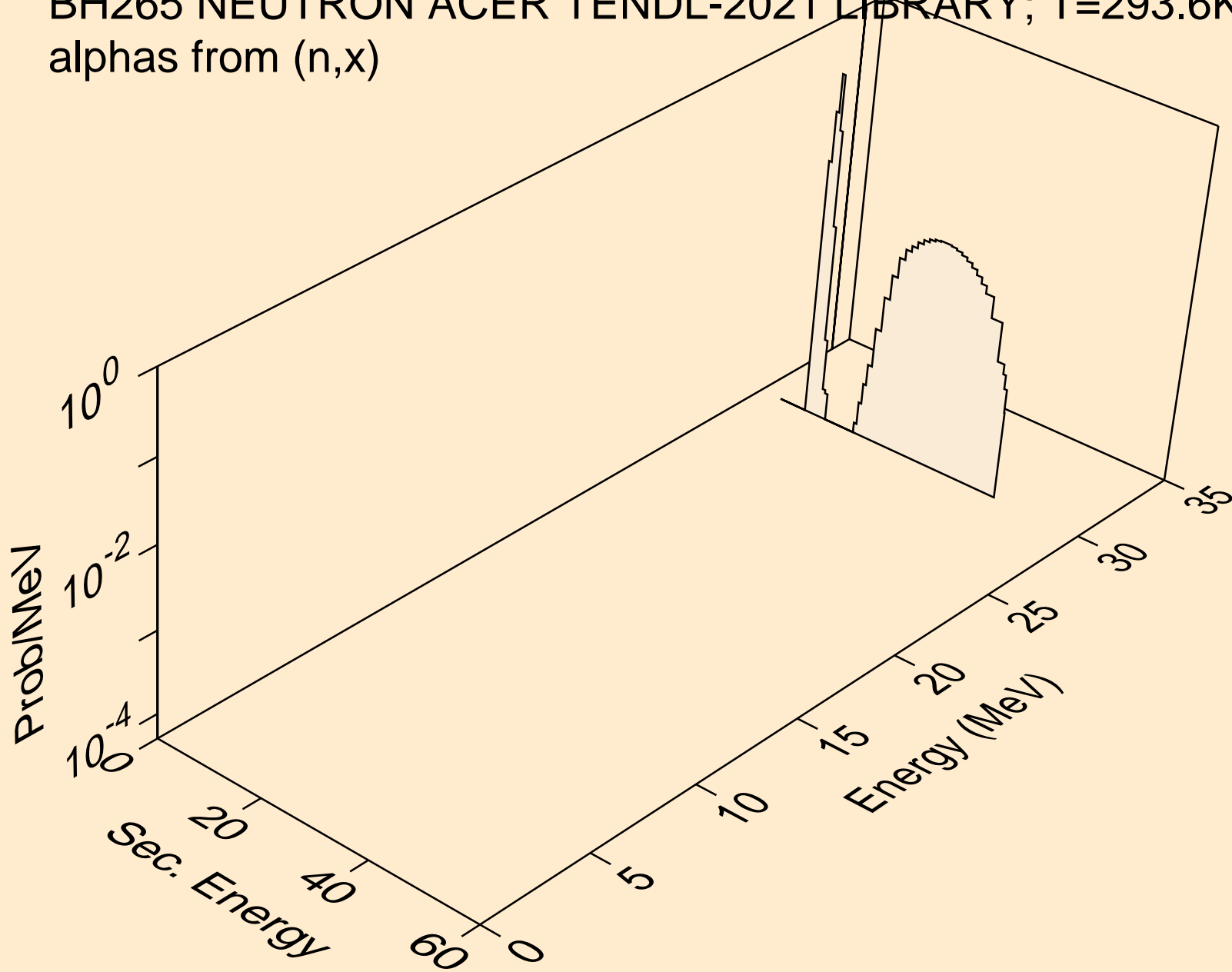

BH265 NEUTRON ACER TENDL-2021 LIBRARY; T=293.6K
alphas from (n,n*)a

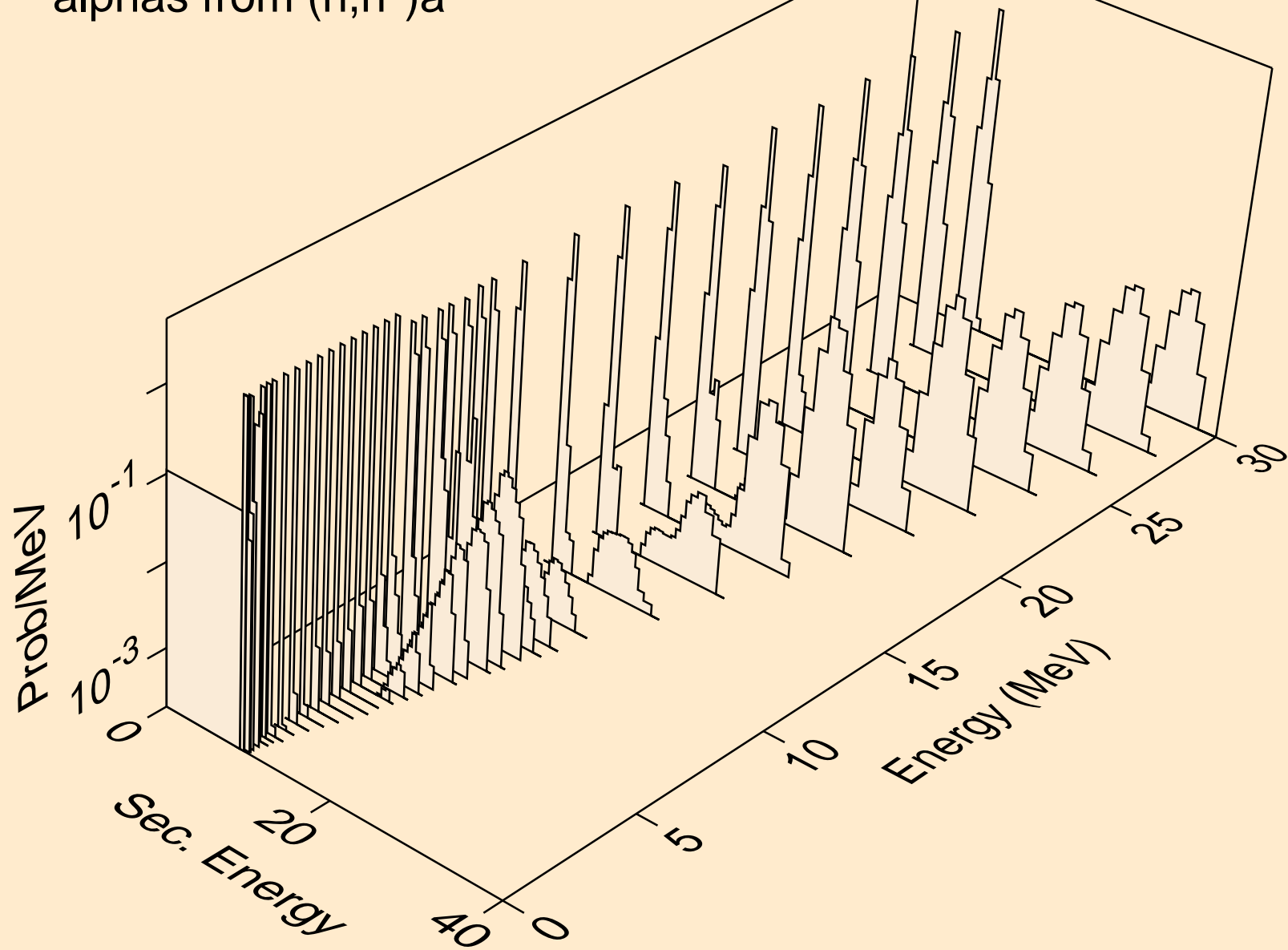

BH265 NEUTRON ACER TENDL-2021 LIBRARY; T=293.6K
alphas from (n,n*)3a

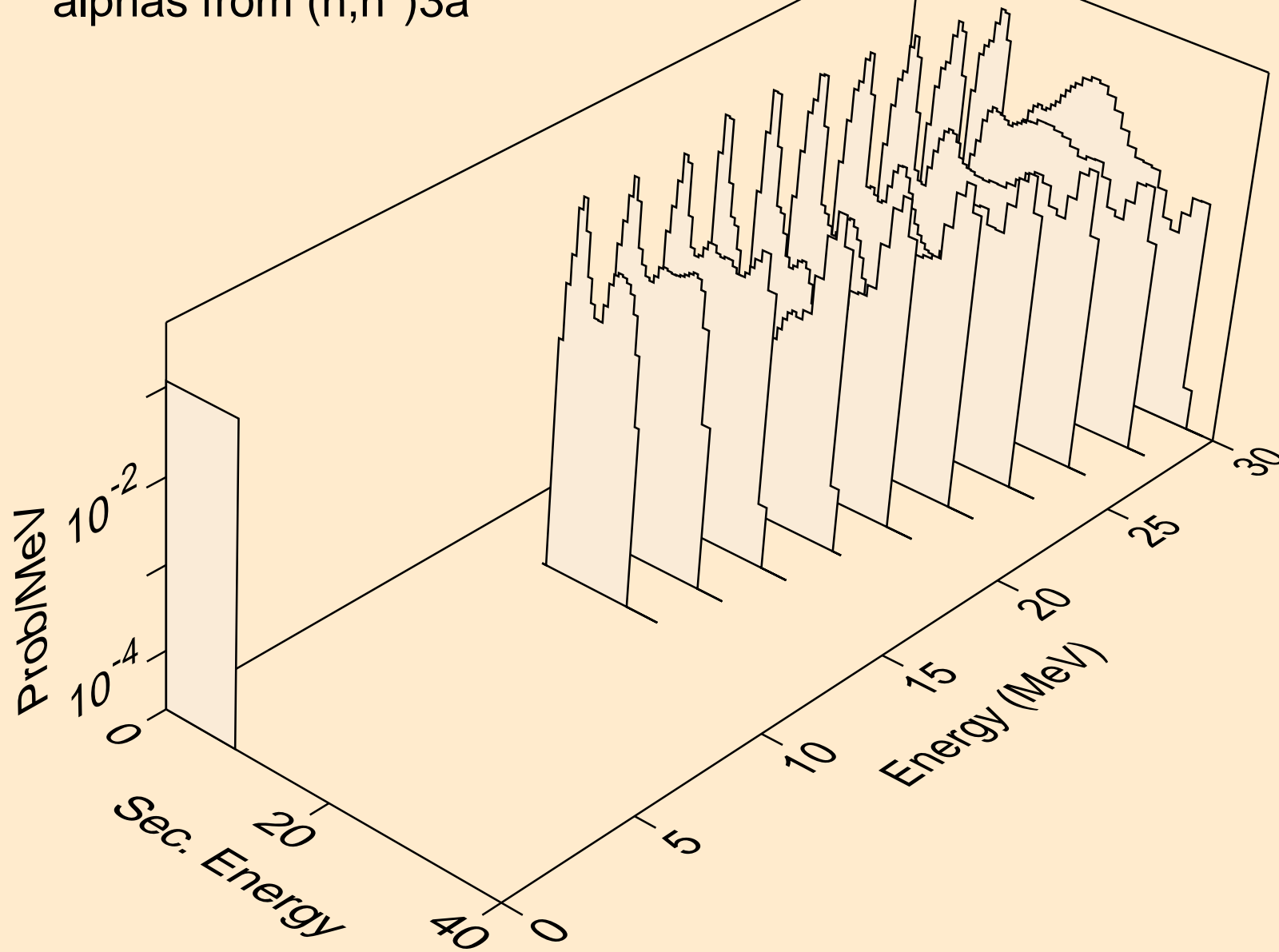

BH265 NEUTRON ACER TENDL-2021 LIBRARY; T=293.6K
alphas from (n,2n)a

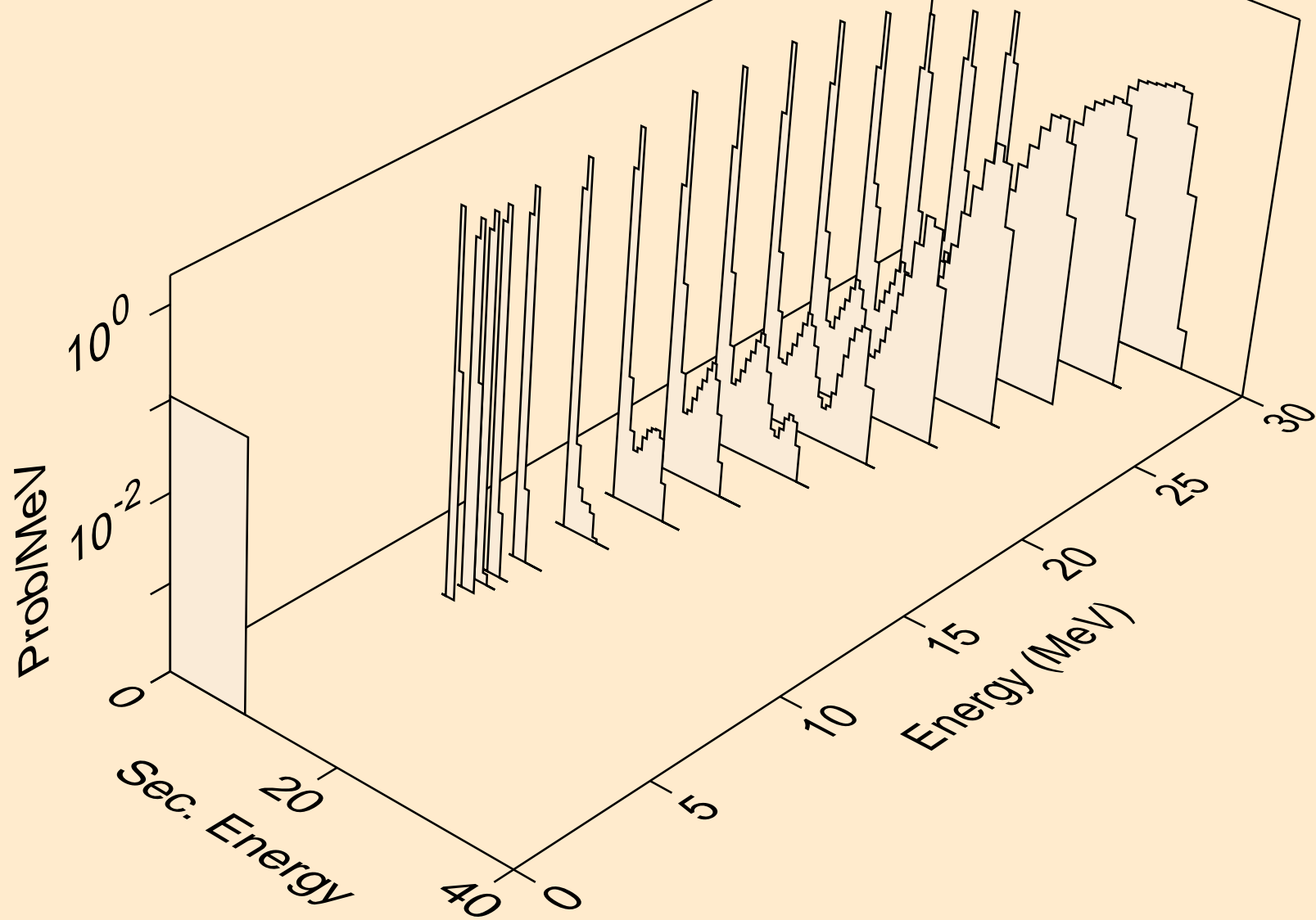

BH265 NEUTRON ACER TENDL-2021 LIBRARY; T=293.6K
alphas from (n,3n)a

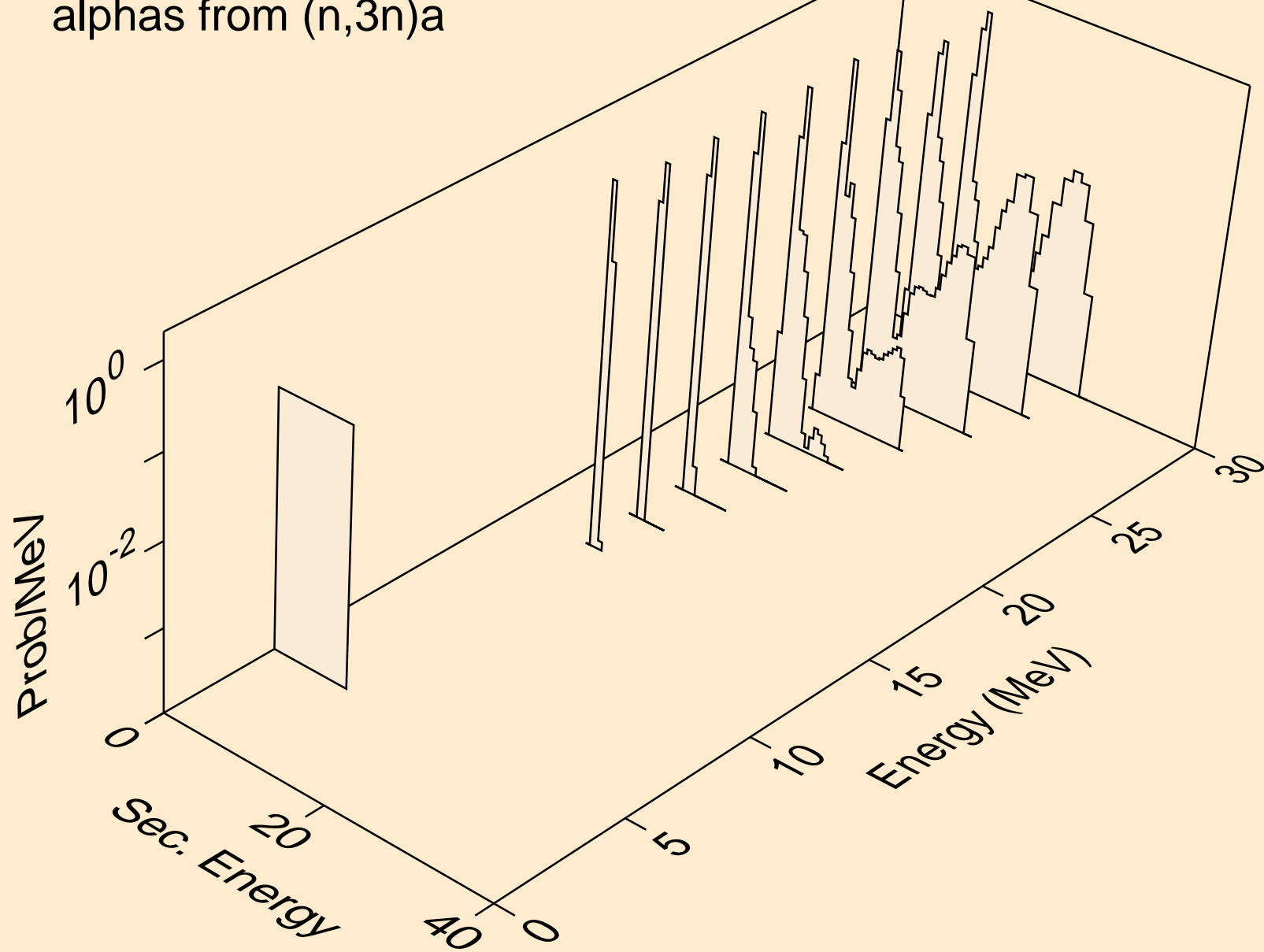

BH265 NEUTRON ACER TENDL-2021 LIBRARY; T=293.6K
alphas from (n,n*)2a

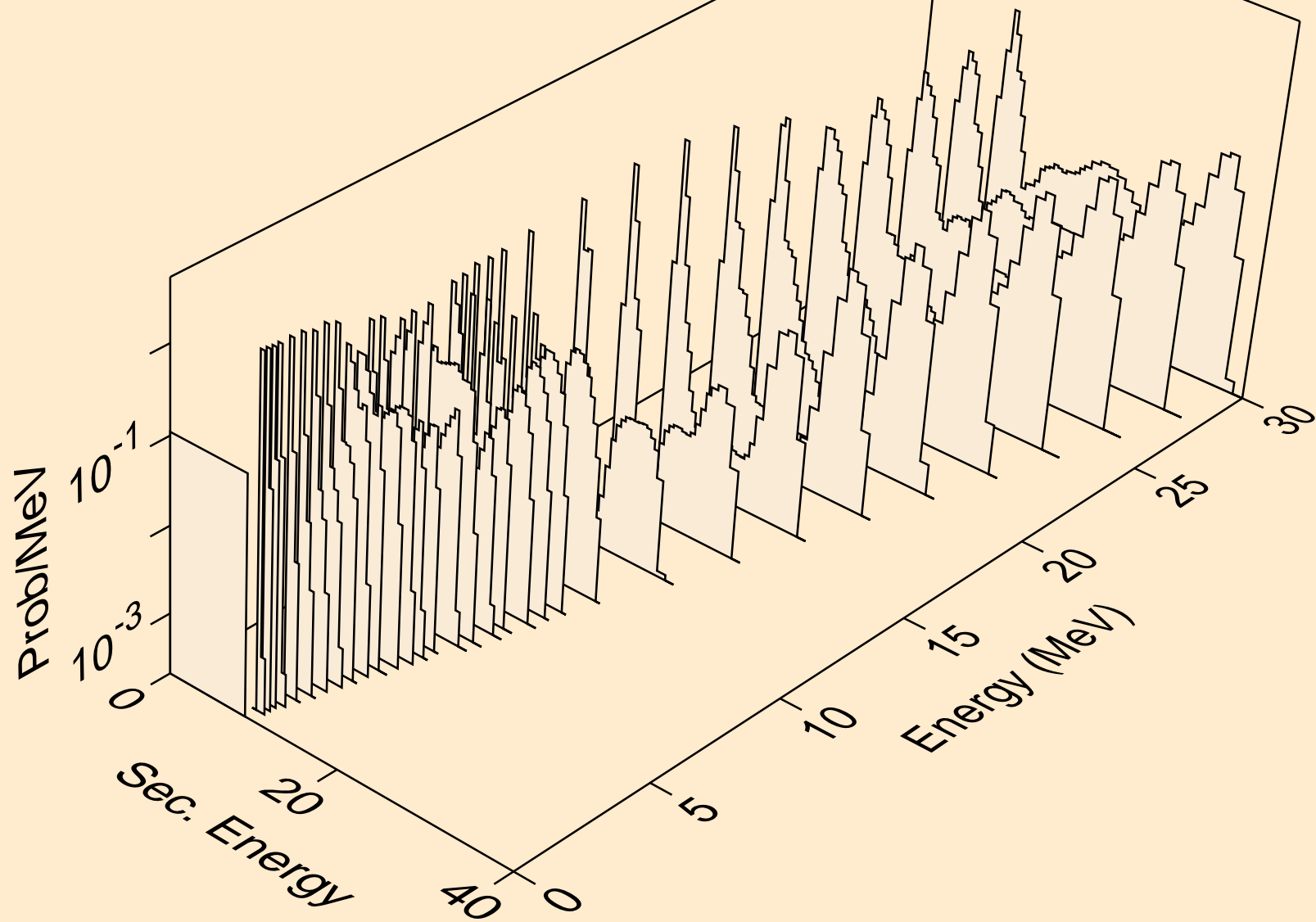

BH265 NEUTRON ACER TENDL-2021 LIBRARY; T=293.6K
alphas from (n,2n)2a

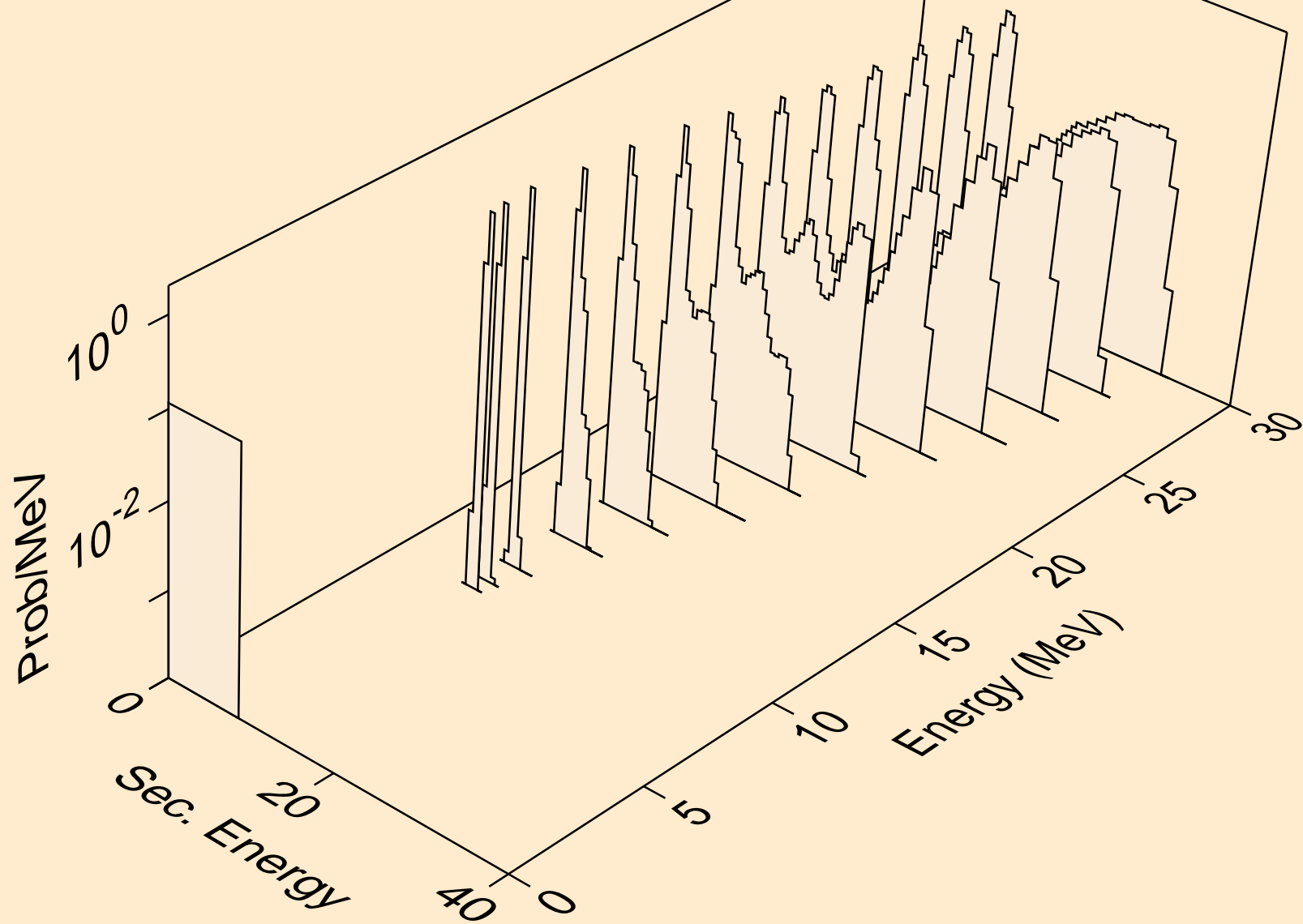

BH265 NEUTRON ACER TENDL-2021 LIBRARY; T=293.6K
alphas from (n,n*)t2a

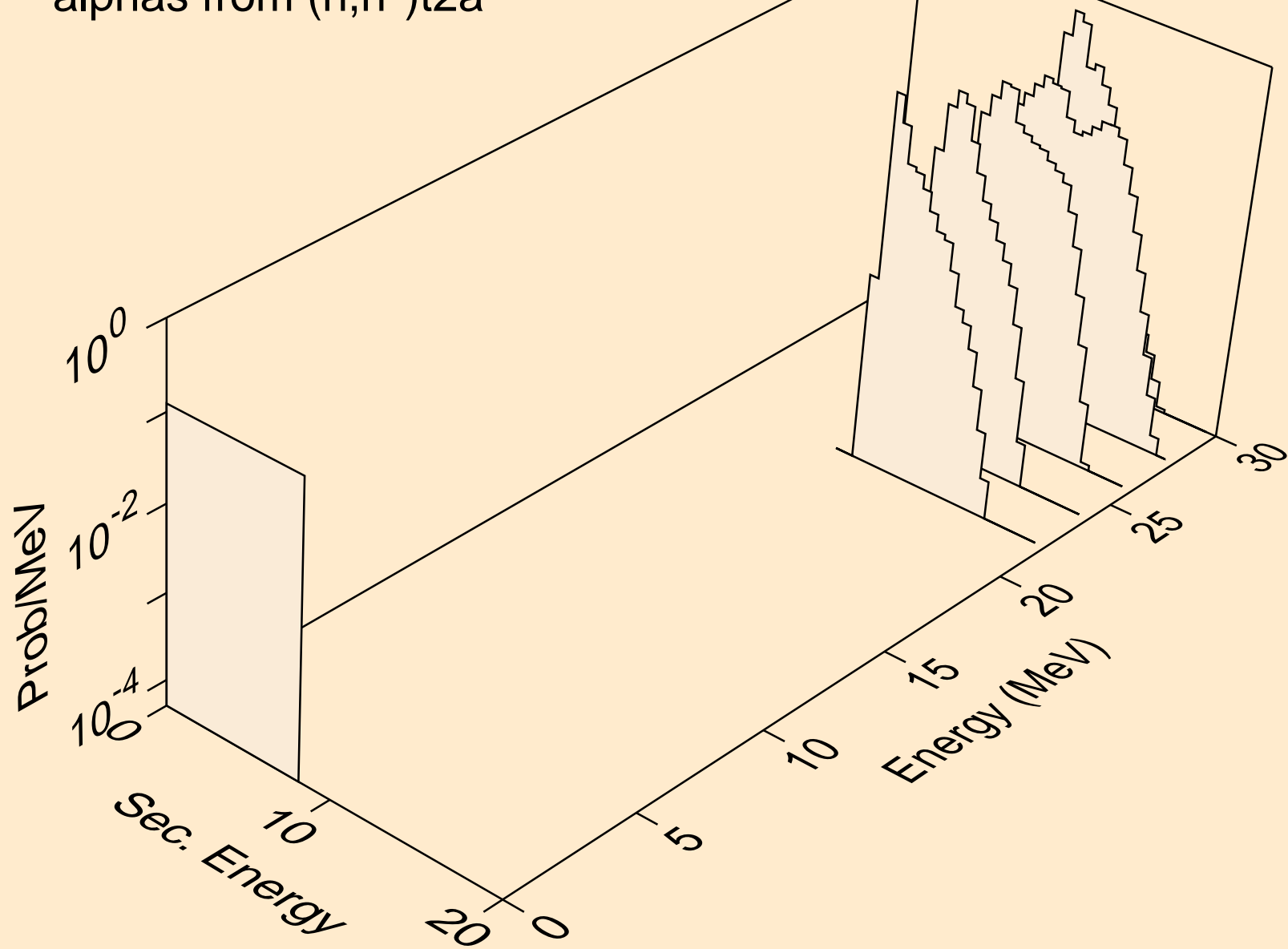

BH265 NEUTRON ACER TENDL-2021 LIBRARY; T=293.6K
alphas from (n,npa)

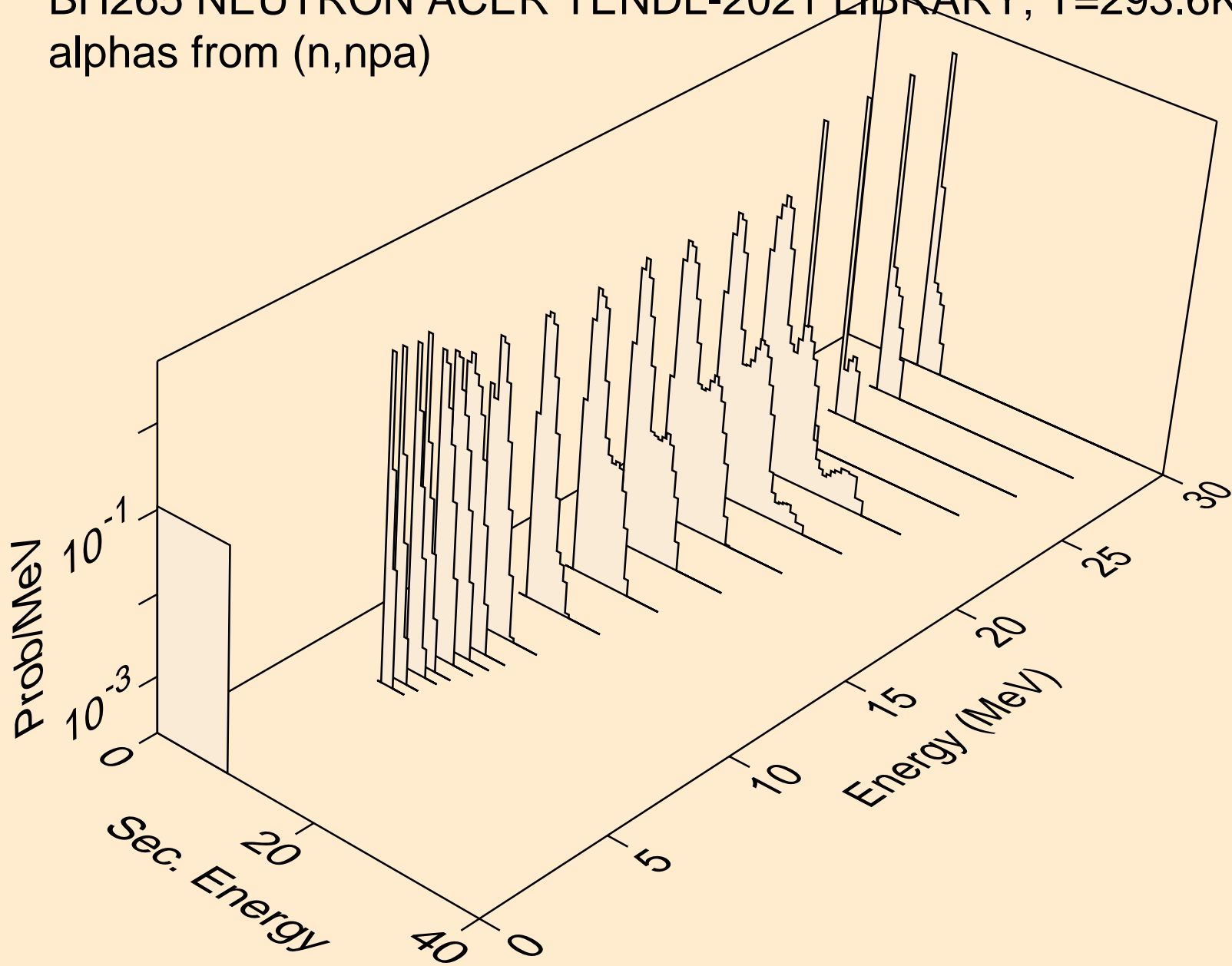

BH265 NEUTRON ACER TENDL-2021 LIBRARY; T=293.6K
alphas from (n,a)

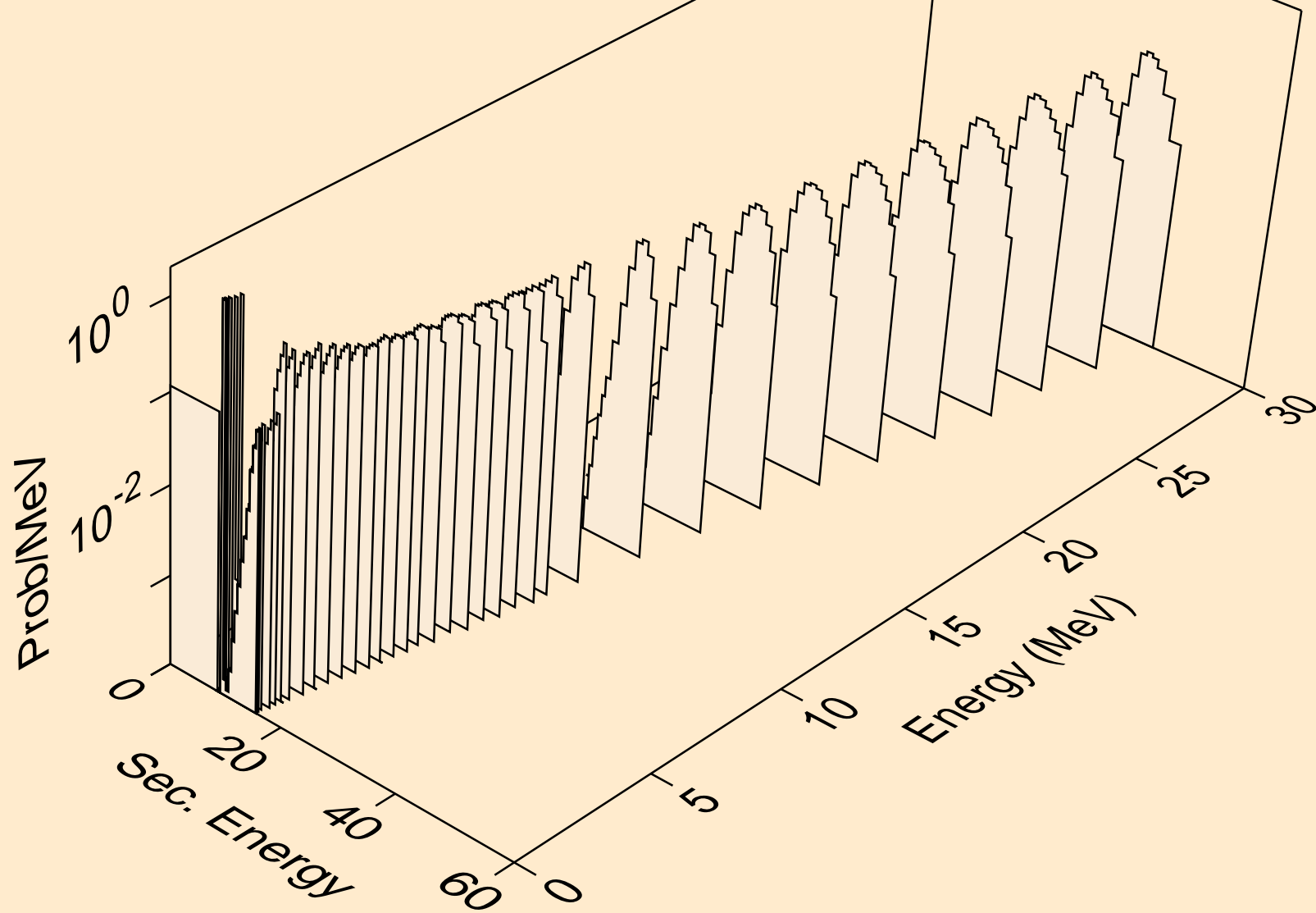

BH265 NEUTRON ACER TENDL-2021 LIBRARY; T=293.6K
alphas from (n,2a)

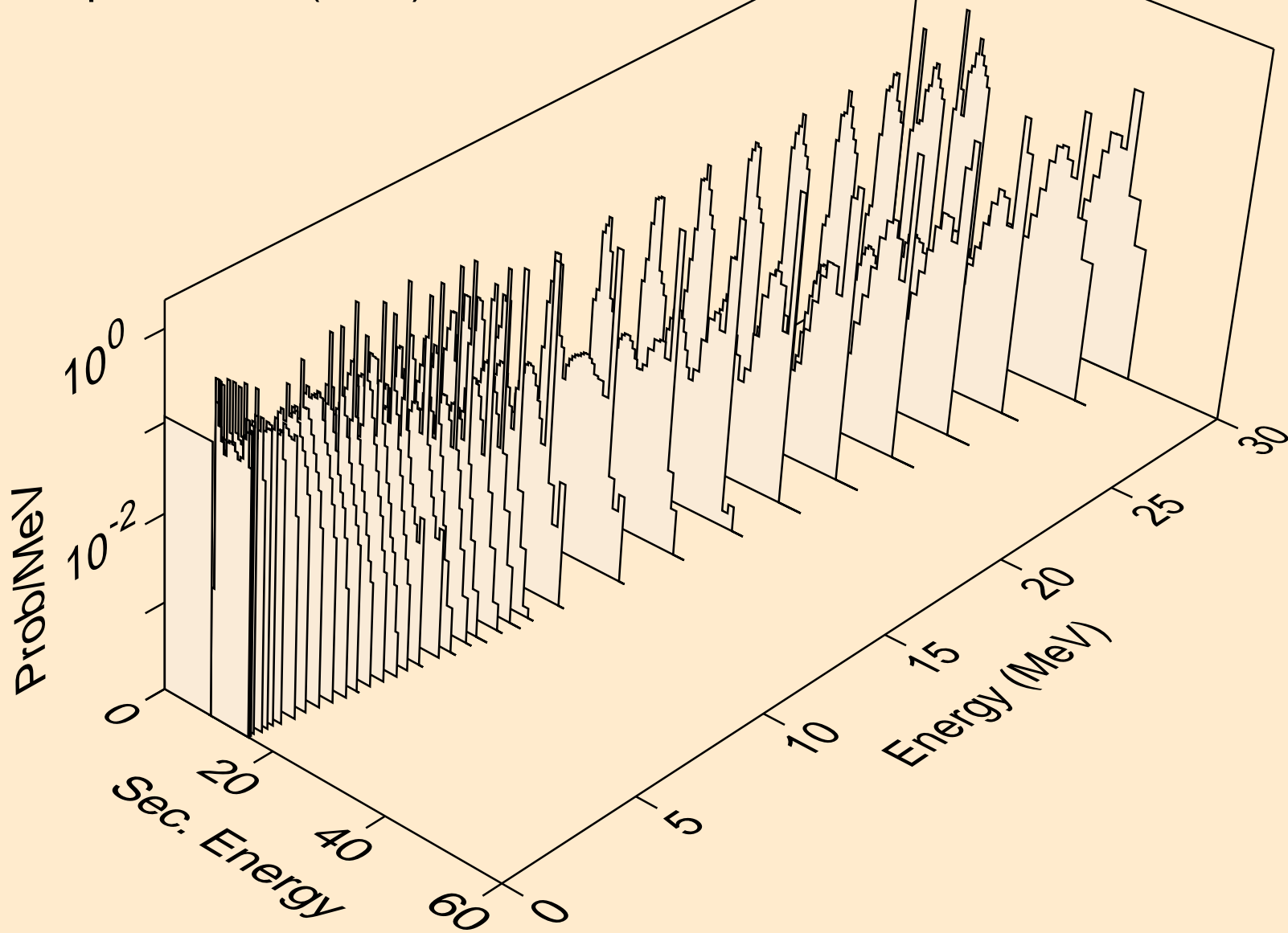

BH265 NEUTRON ACER TENDL-2021 LIBRARY; T=293.6K
alphas from (n,pa)

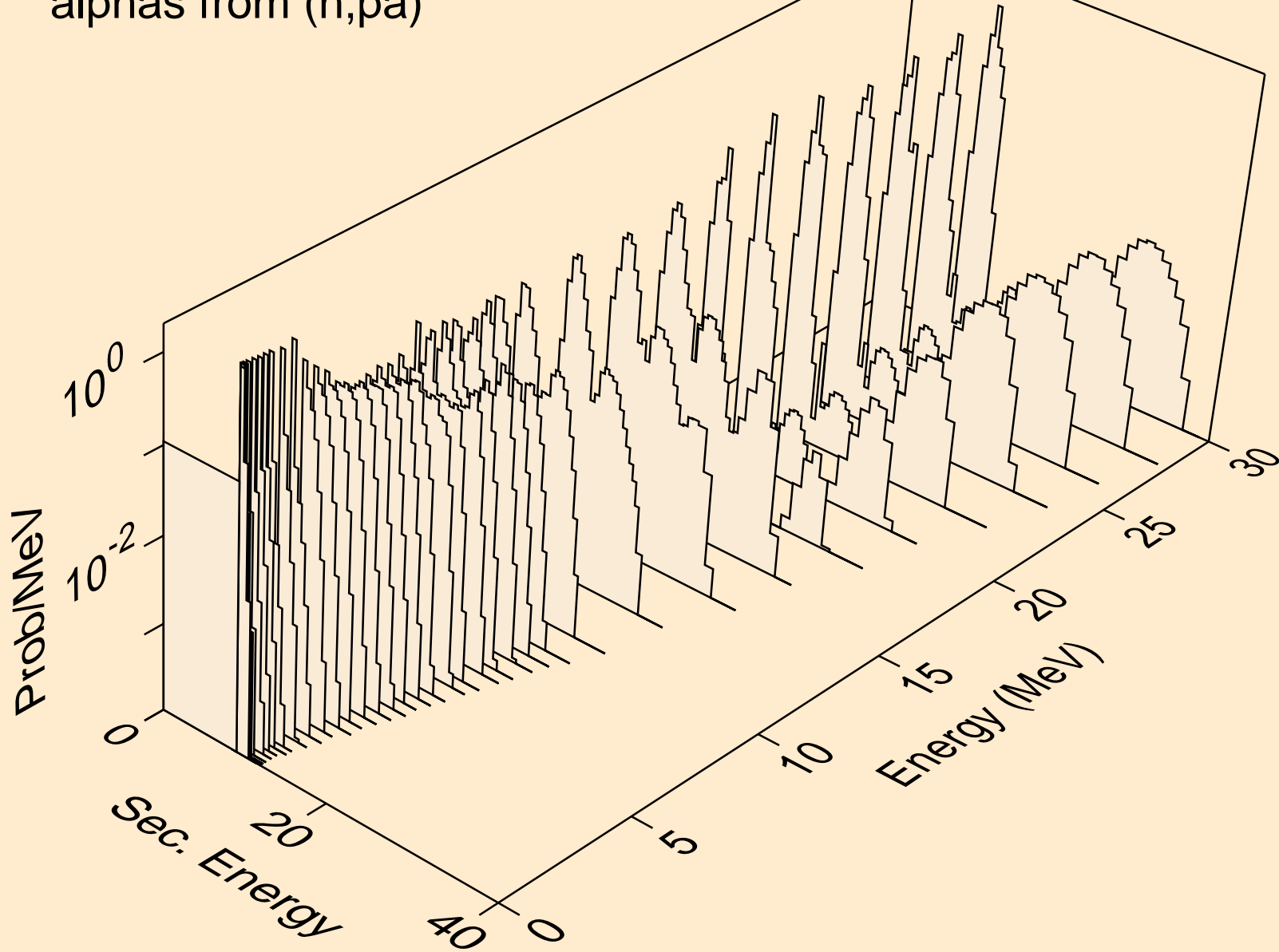

BH265 NEUTRON ACER TENDL-2021 LIBRARY; T=293.6K
alphas from (n,da)

