

BH275 NEUTRON ACER TENDL-2021 LIBRARY; T=293.6K

Principal cross sections

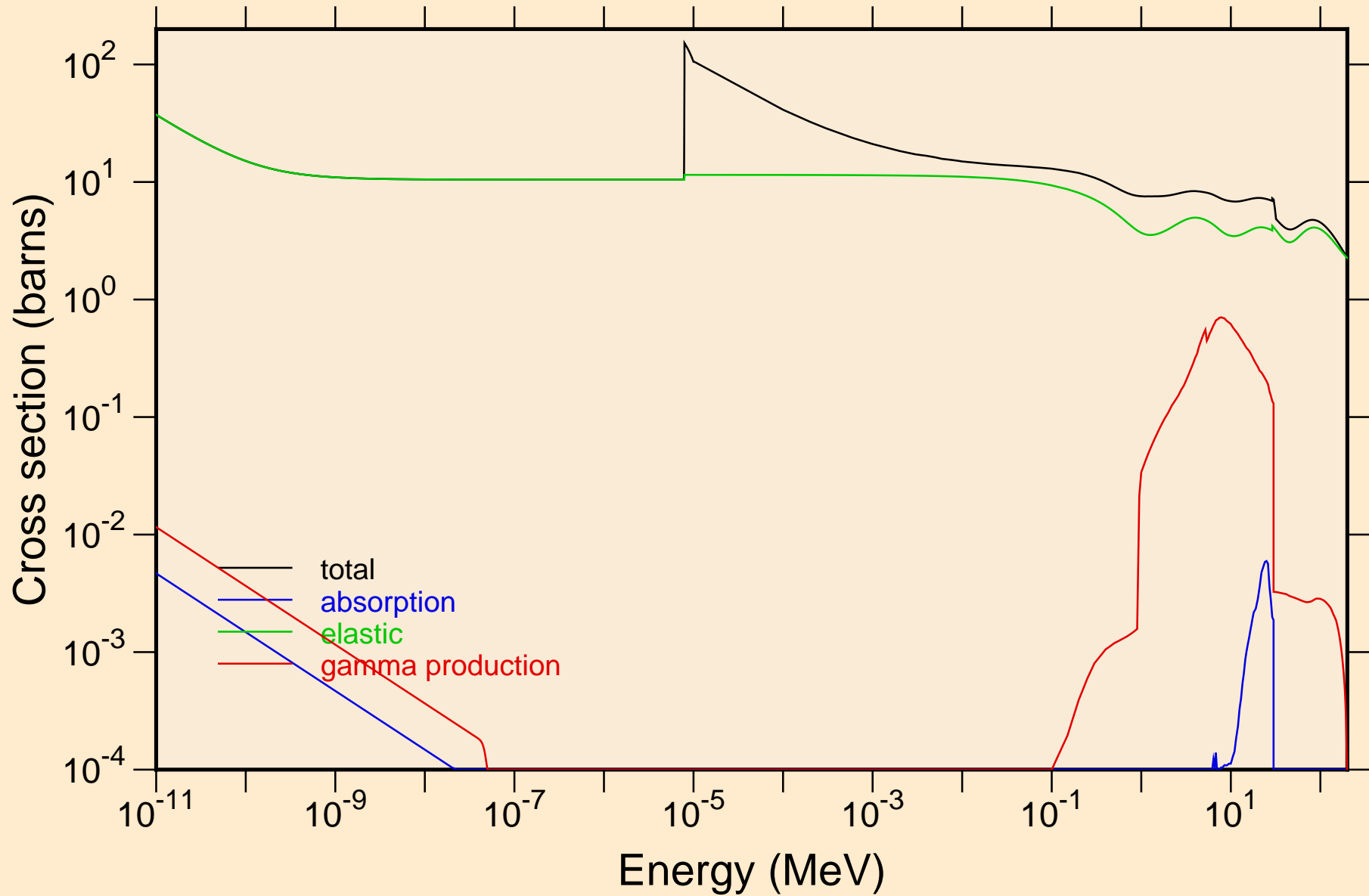

BH275 NEUTRON ACER TENDL-2021 LIBRARY; T=293.6K
Heating

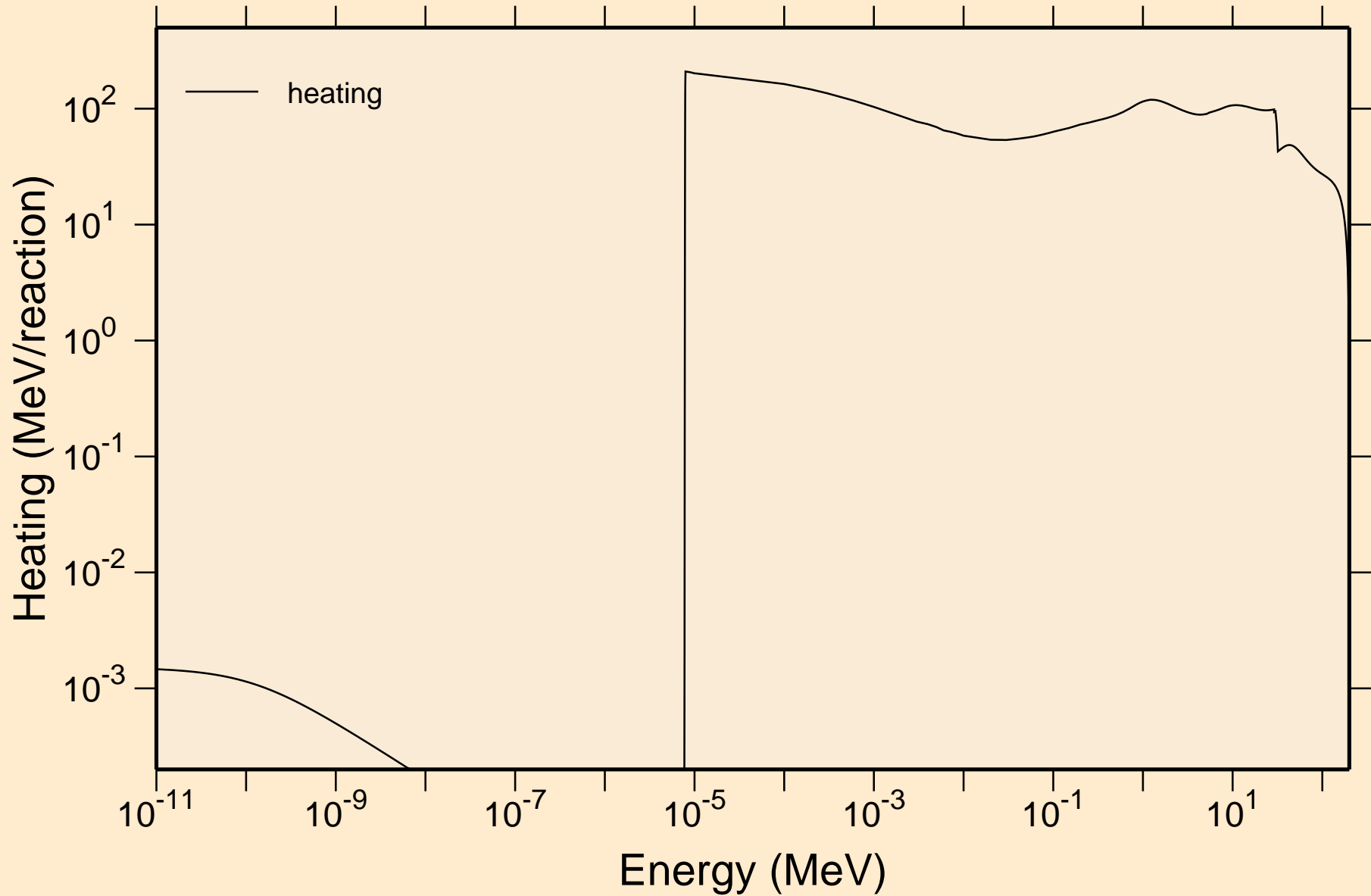

BH275 NEUTRON ACER TENDL-2021 LIBRARY; T=293.6K
Damage

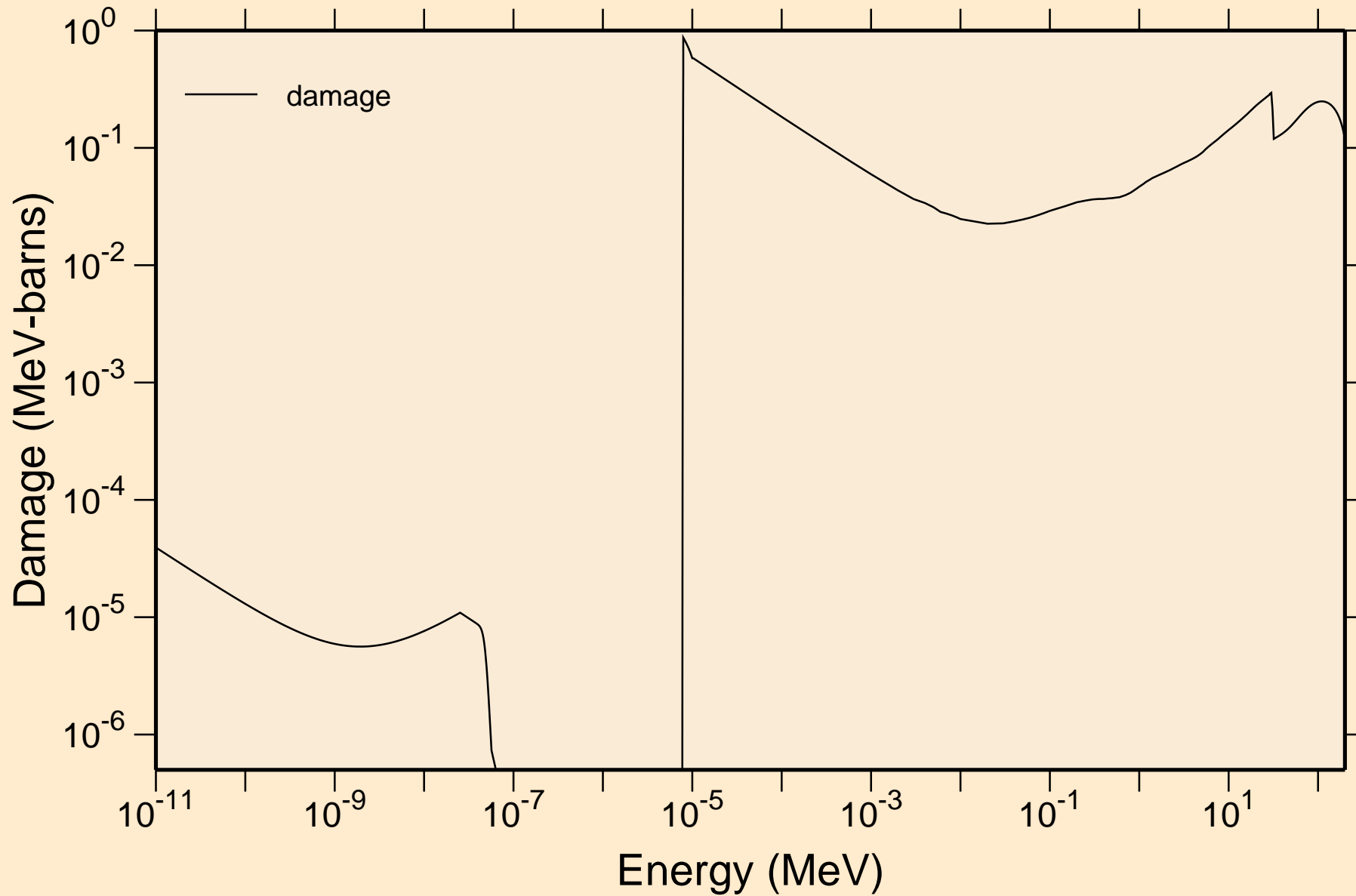

BH275 NEUTRON ACER TENDL-2021 LIBRARY; T=293.6K

Non-threshold reactions

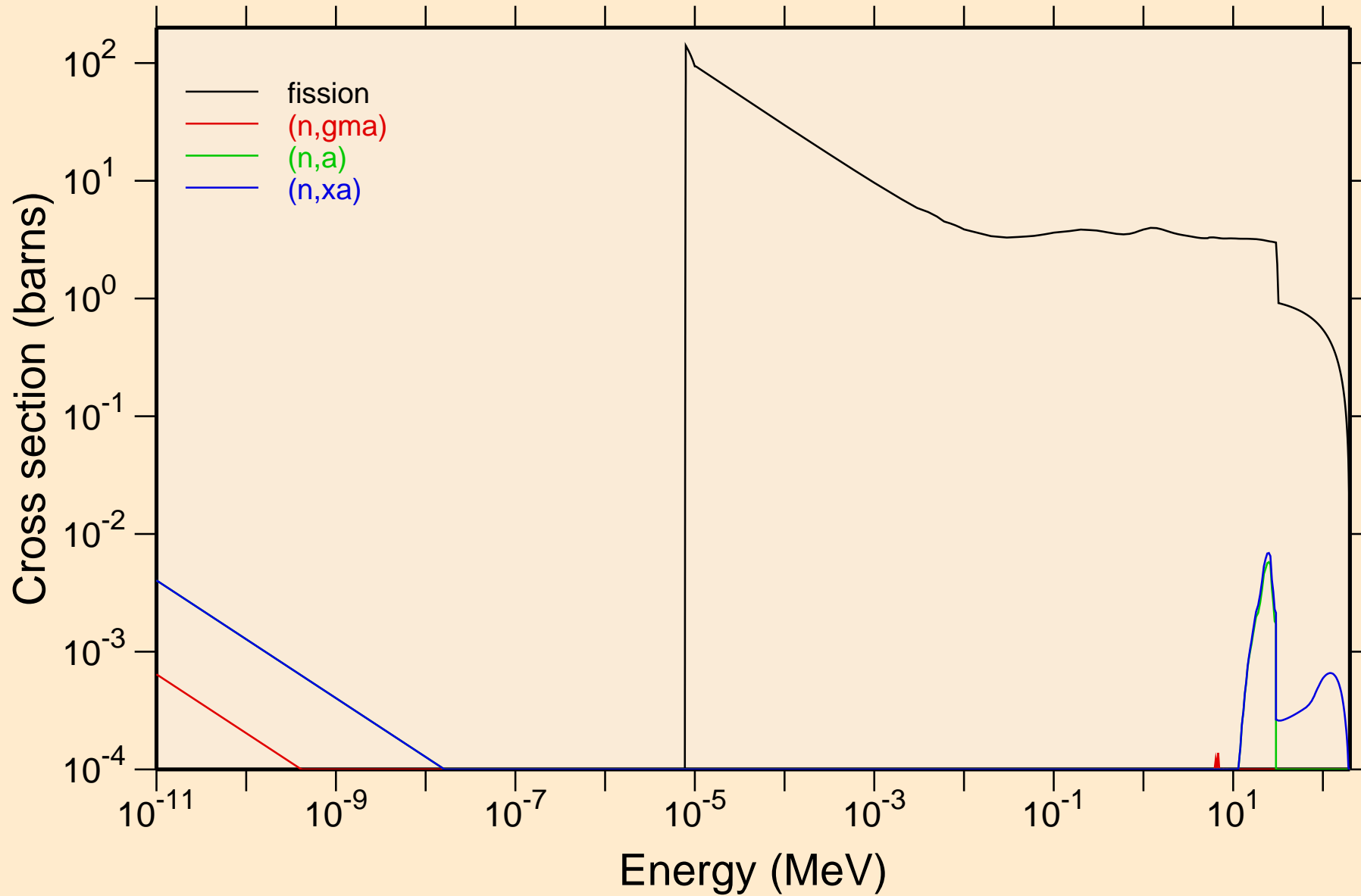

BH275 NEUTRON ACER TENDL-2021 LIBRARY; T=293.6K
Principal cross sections

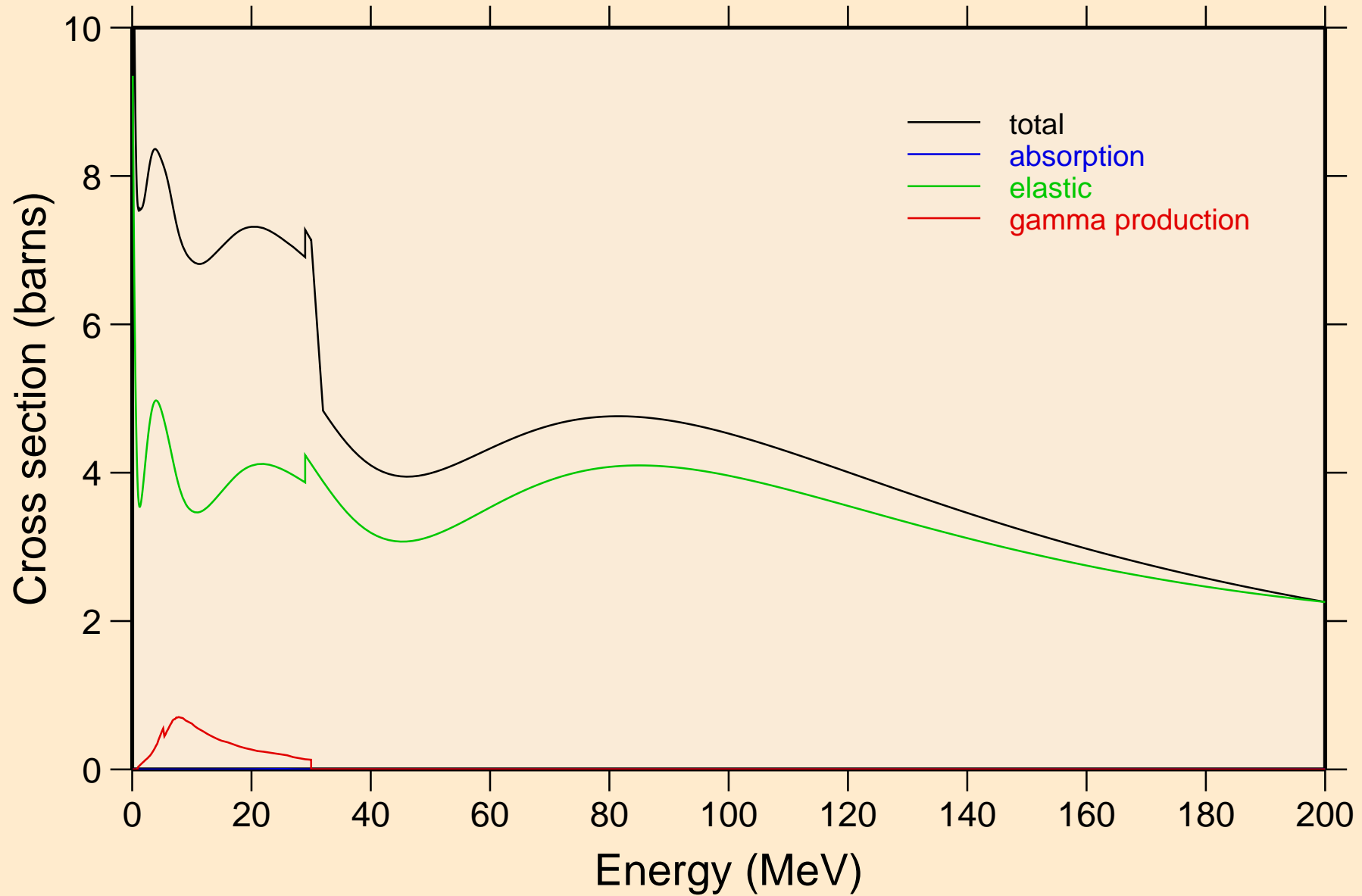

BH275 NEUTRON ACER TENDL-2021 LIBRARY; T=293.6K
Heating

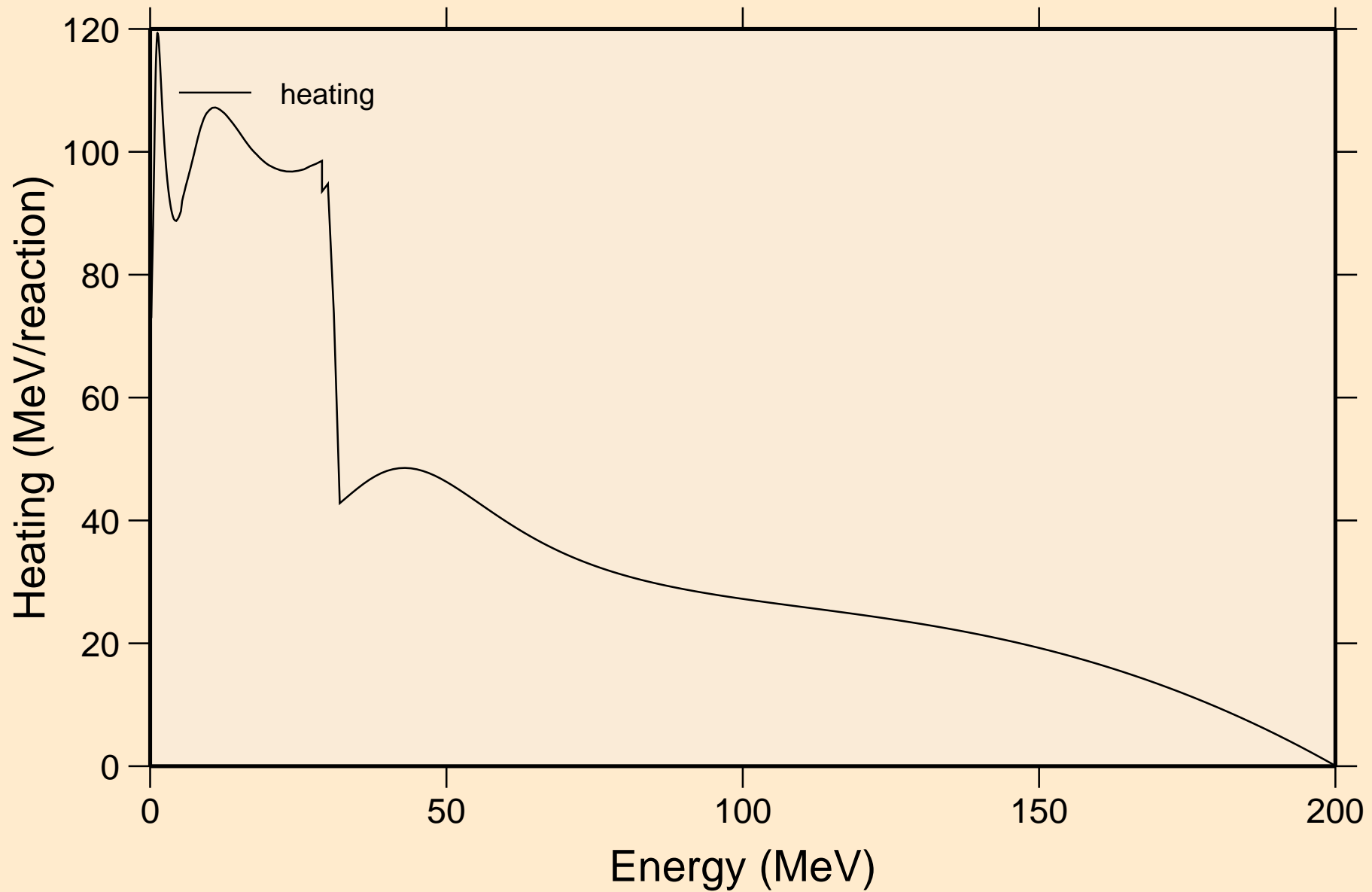

BH275 NEUTRON ACER TENDL-2021 LIBRARY; T=293.6K
Damage

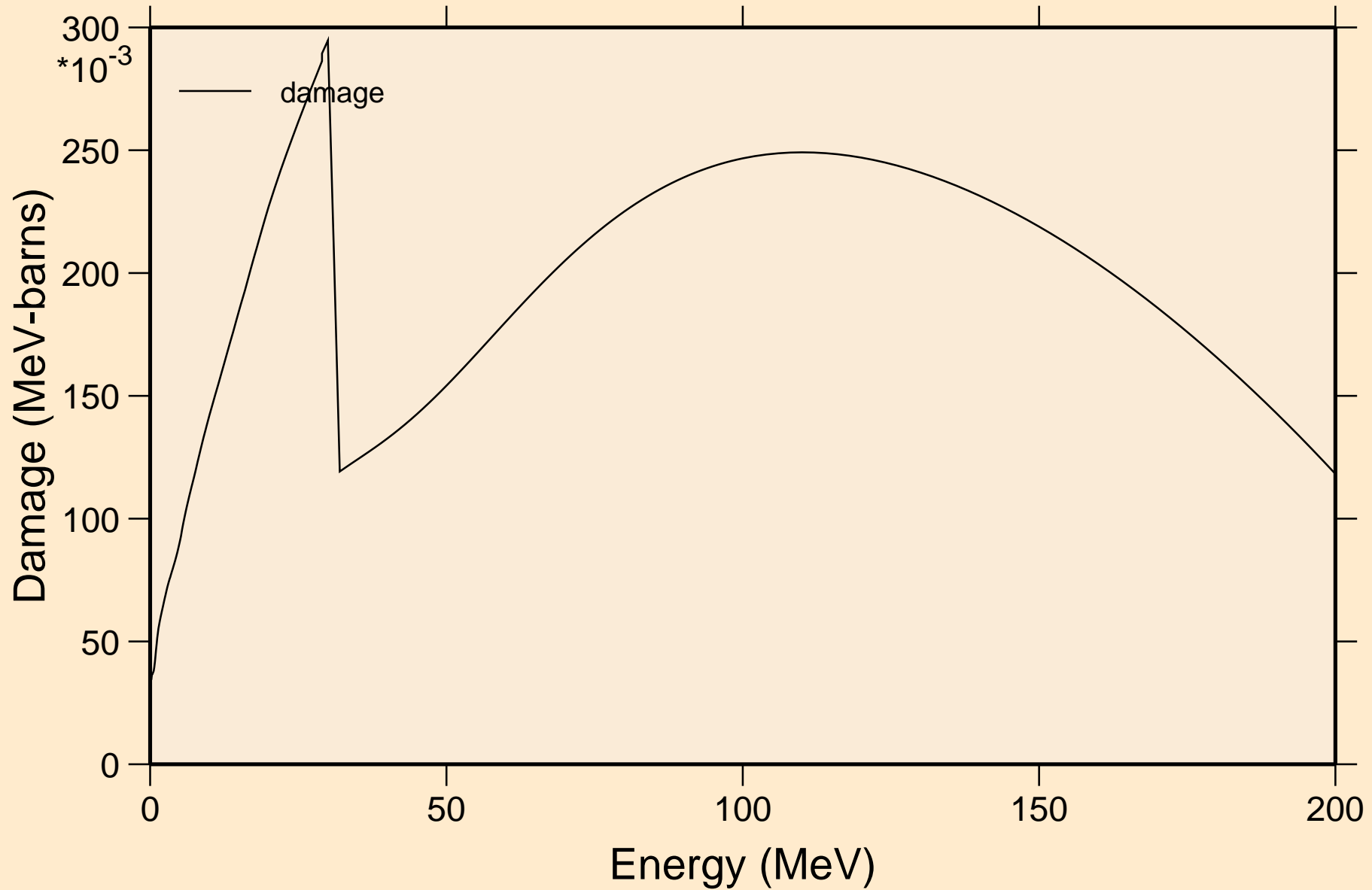

BH275 NEUTRON ACER TENDL-2021 LIBRARY; T=293.6K
Non-threshold reactions

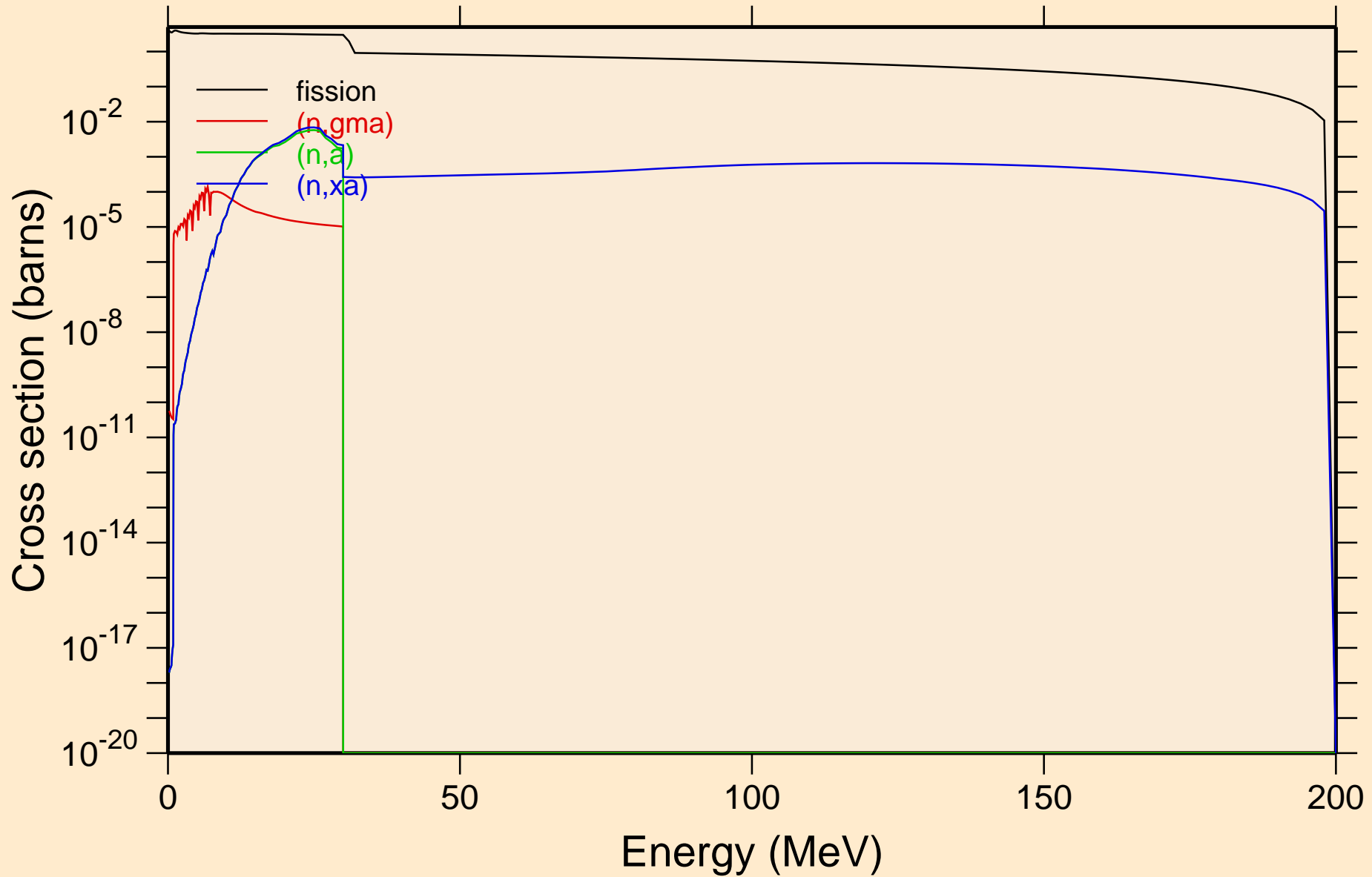

BH275 NEUTRON ACER TENDL-2021 LIBRARY; T=293.6K
Inelastic levels

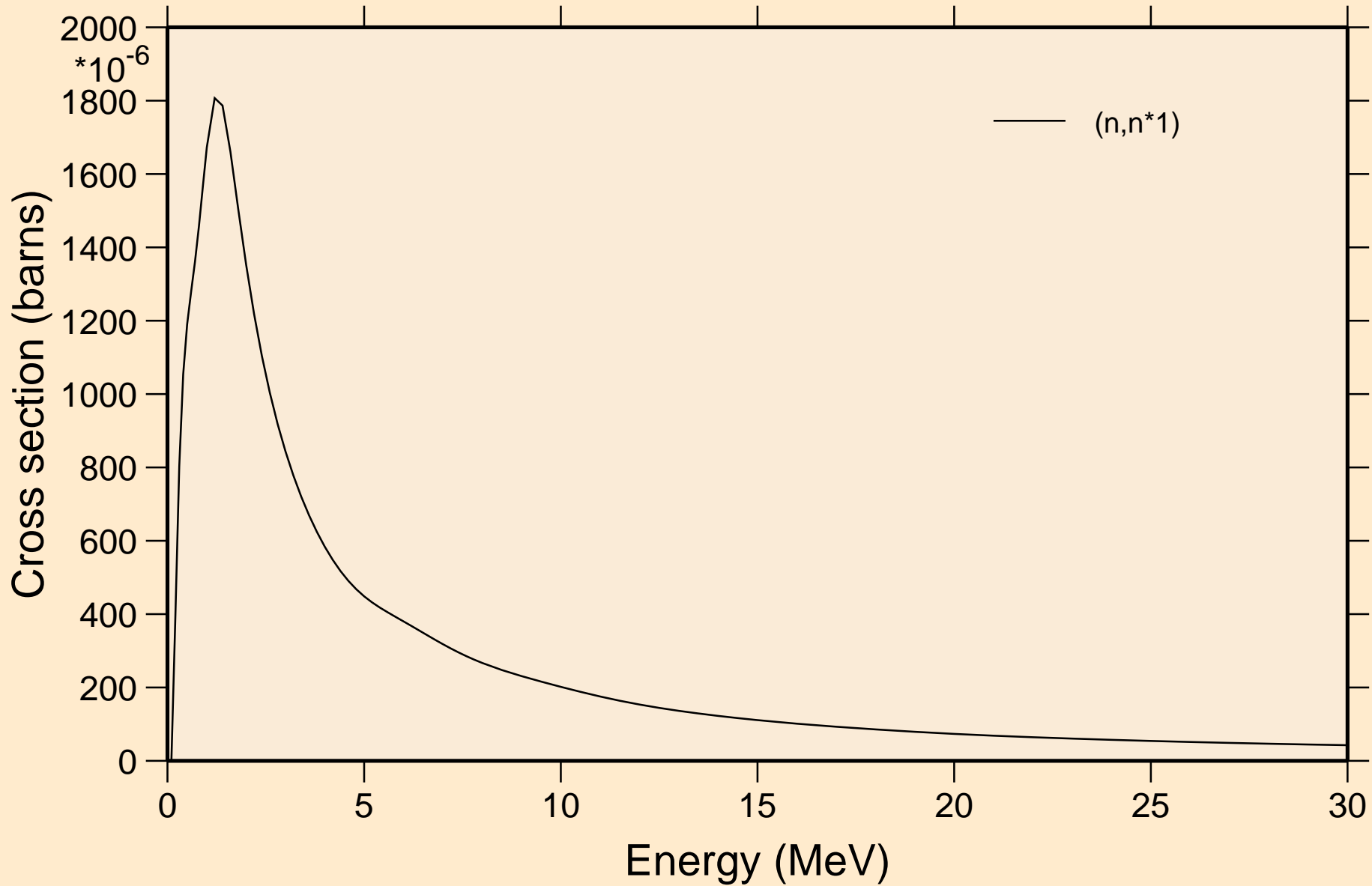

BH275 NEUTRON ACER TENDL-2021 LIBRARY; T=293.6K
Threshold reactions

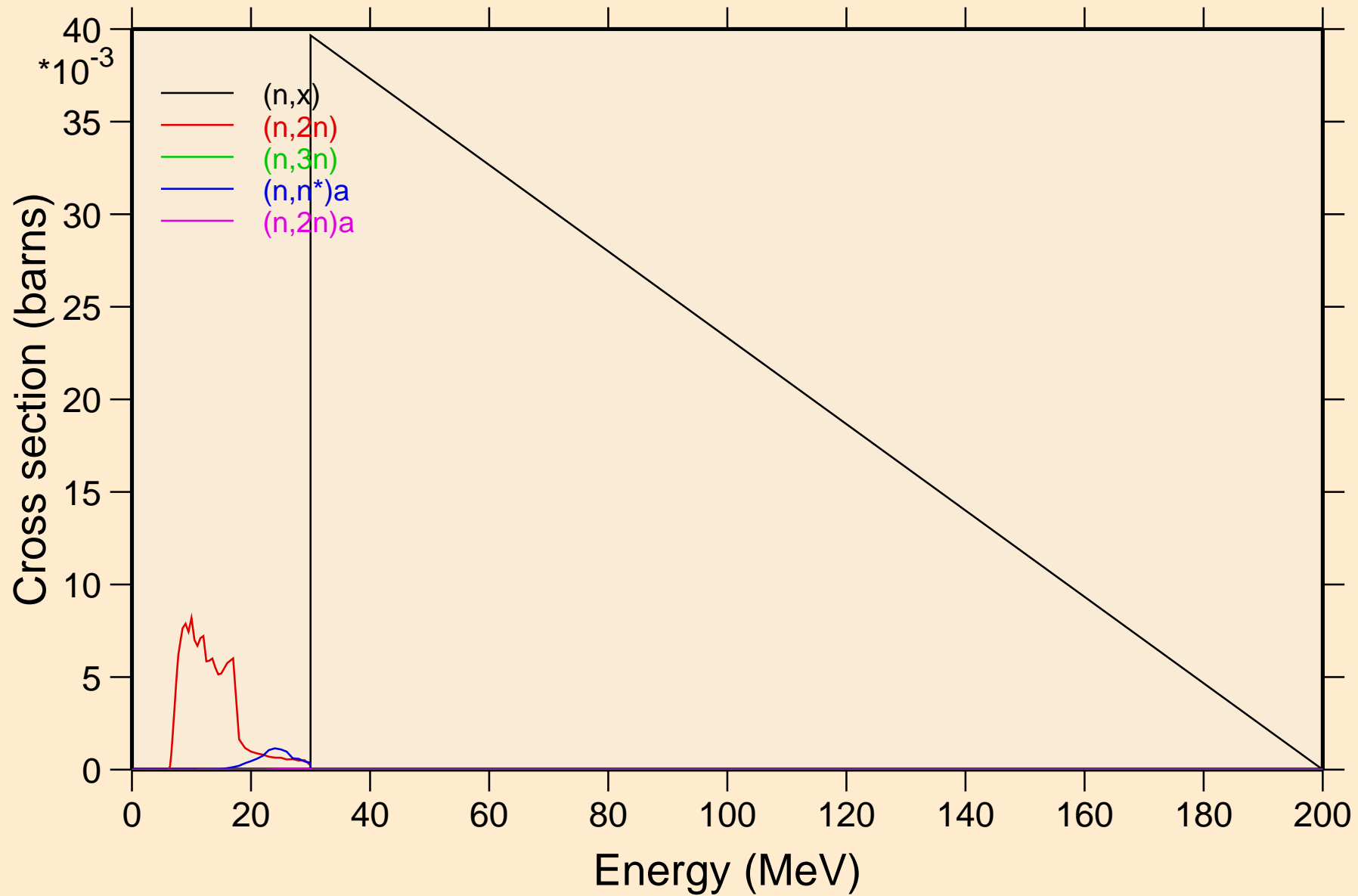

BH275 NEUTRON ACER TENDL-2021 LIBRARY; T=293.6K
Threshold reactions

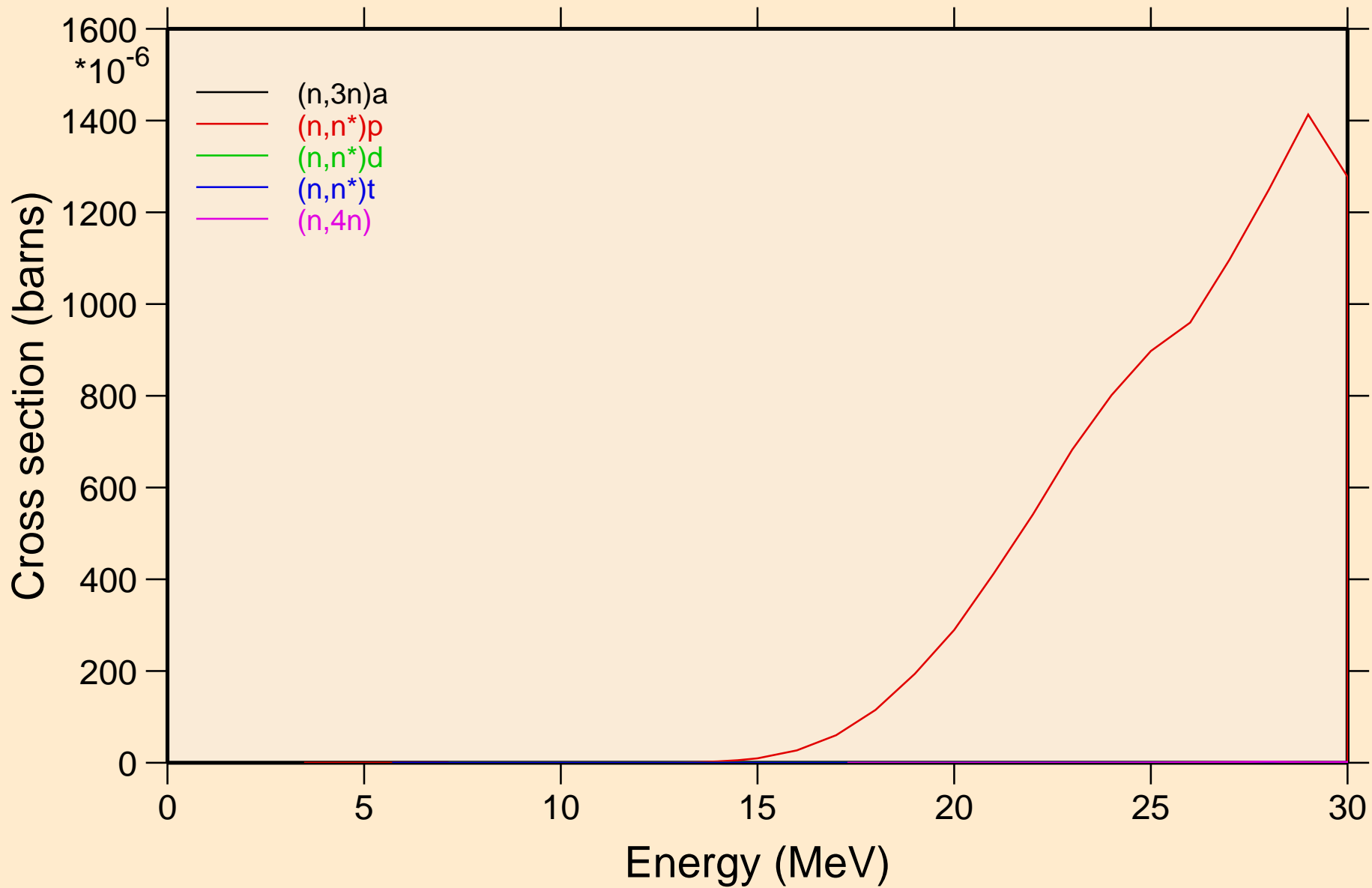

BH275 NEUTRON ACER TENDL-2021 LIBRARY; T=293.6K
Threshold reactions

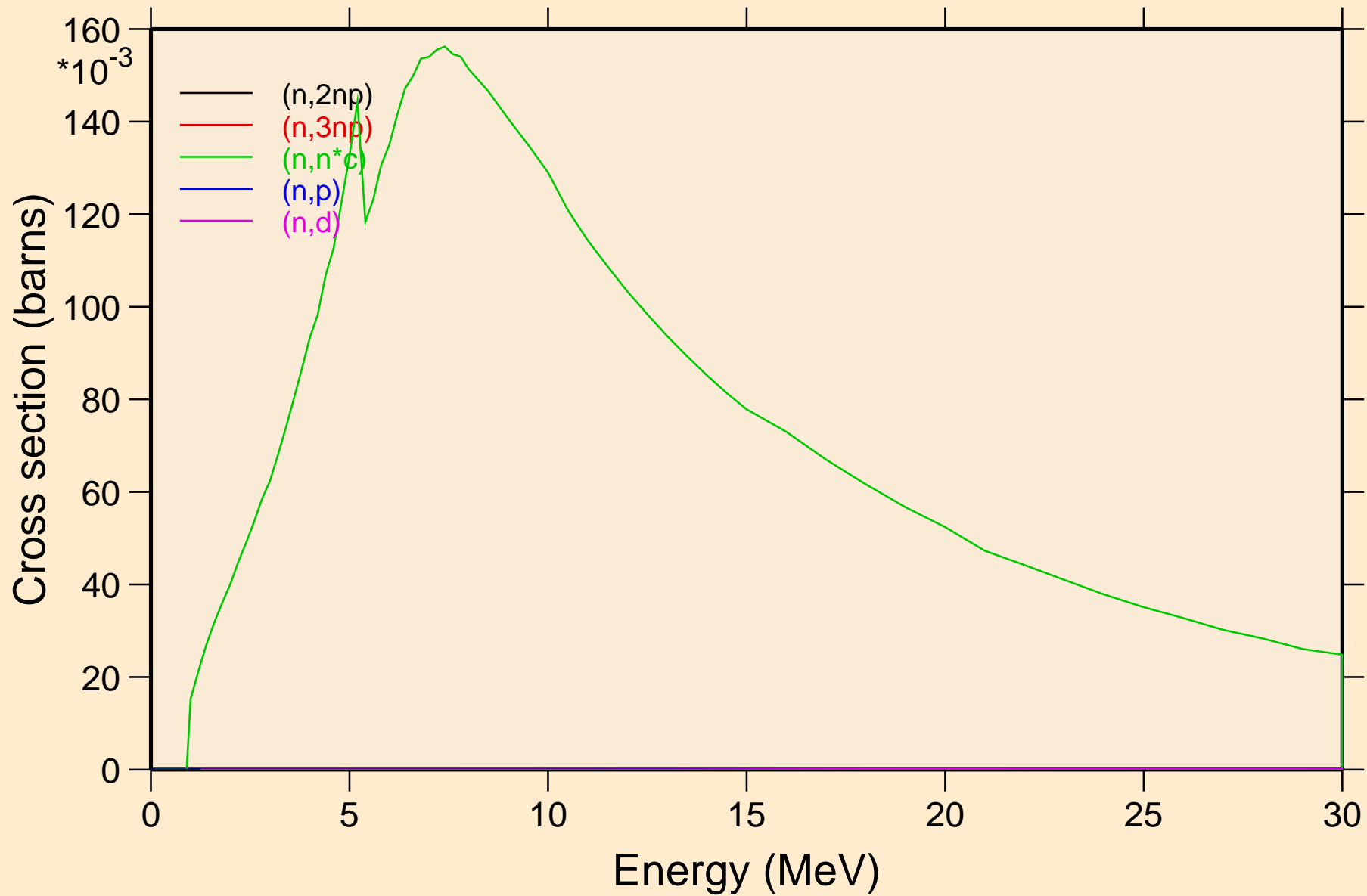

BH275 NEUTRON ACER TENDL-2021 LIBRARY; T=293.6K
Threshold reactions

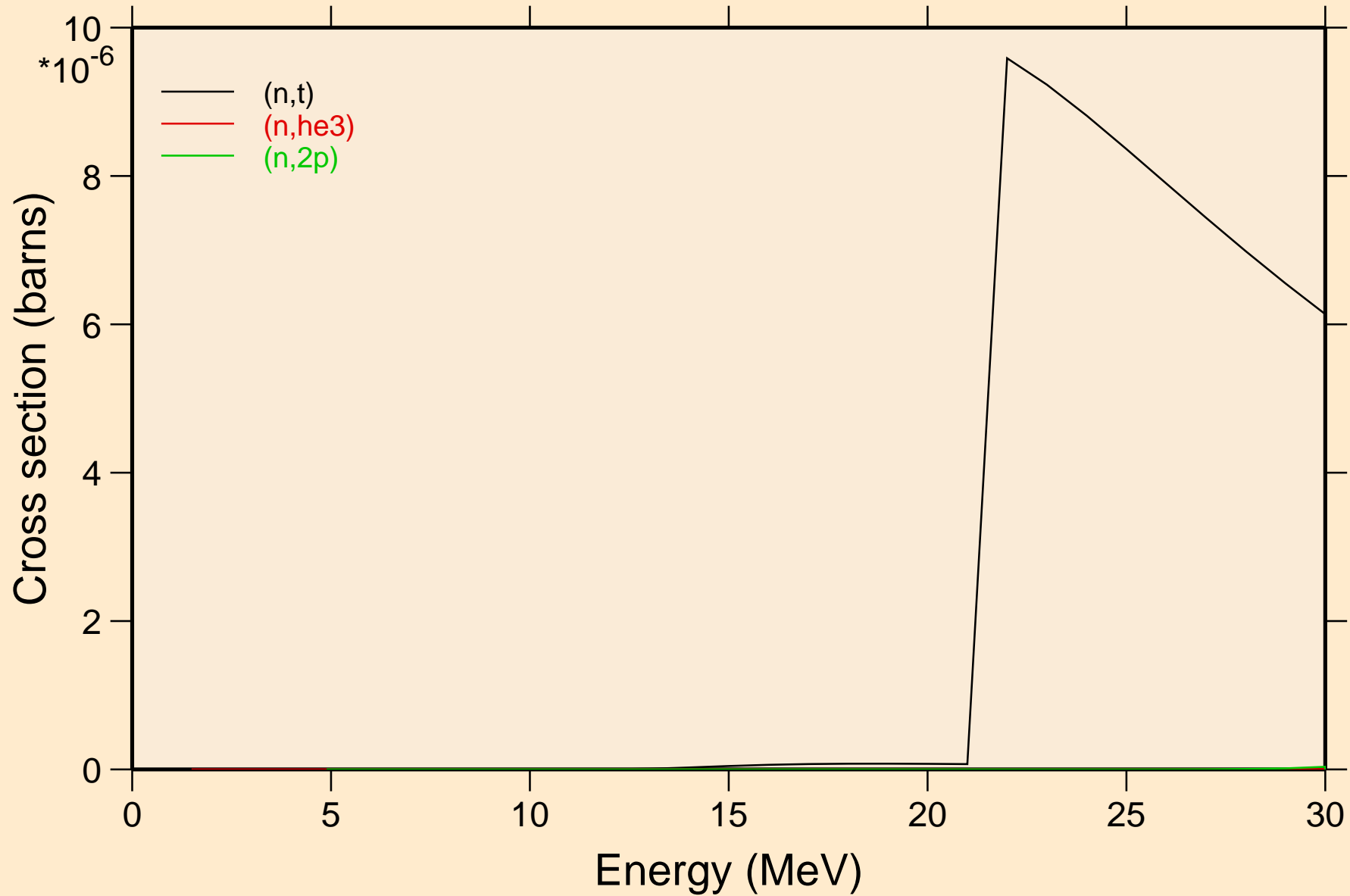

BH275 NEUTRON ACER TENDL-2021 LIBRARY; T=293.6K
Threshold reactions

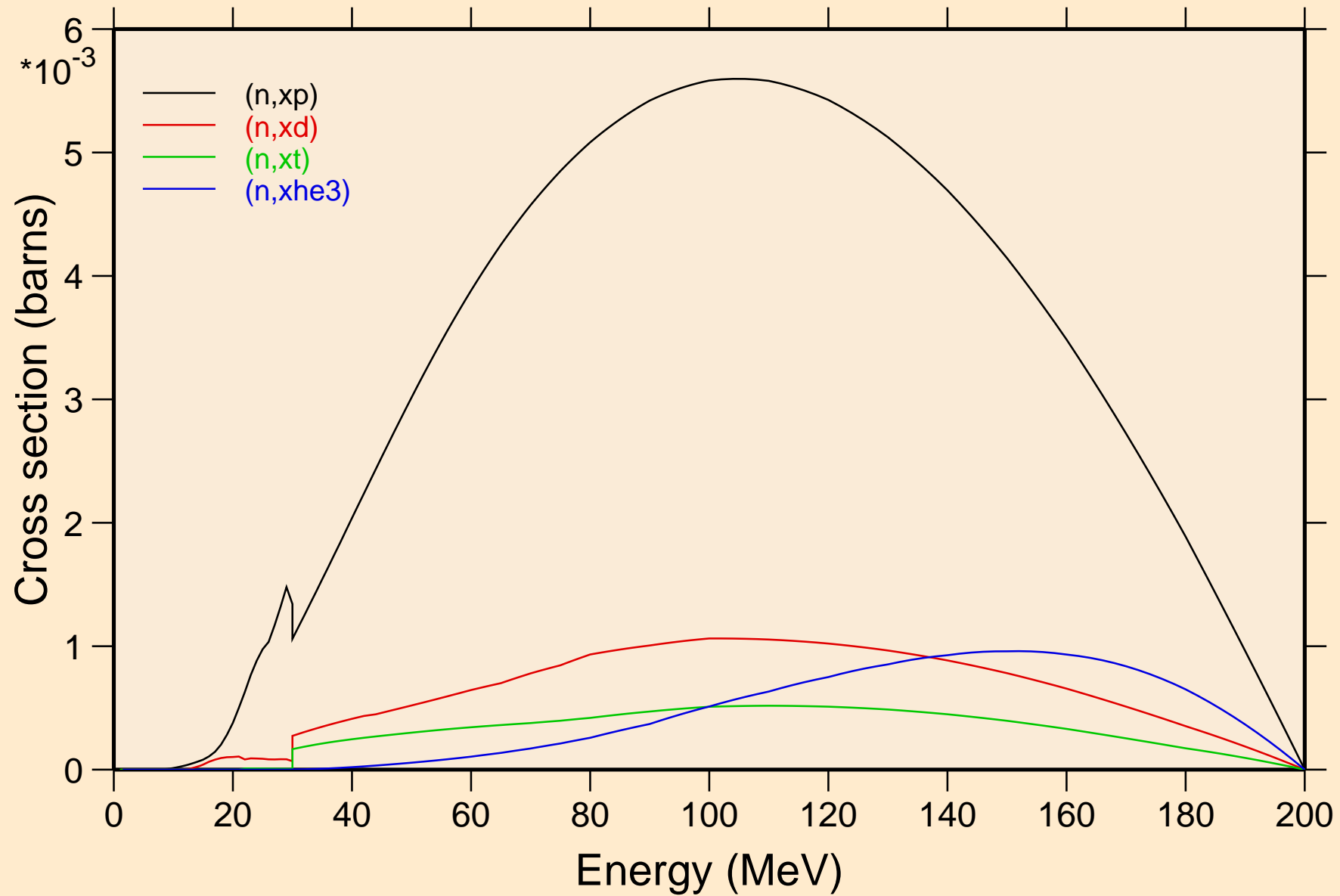

BH275 NEUTRON ACER TENDL-2021 LIBRARY; T=293.6K
angular distribution for elastic

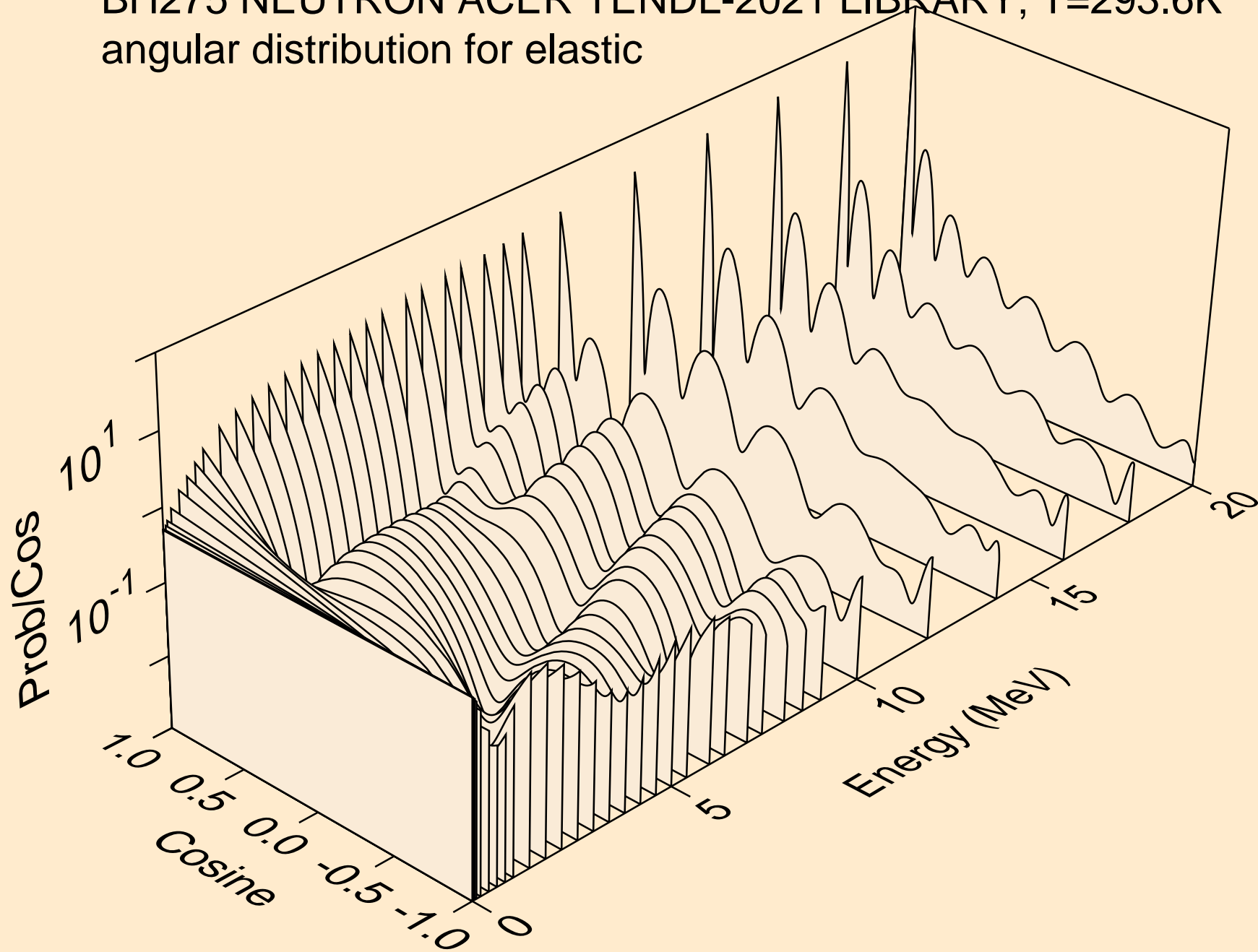

BH275 NEUTRON ACER TENDL-2021 LIBRARY; T=293.6K
angular distribution for elastic

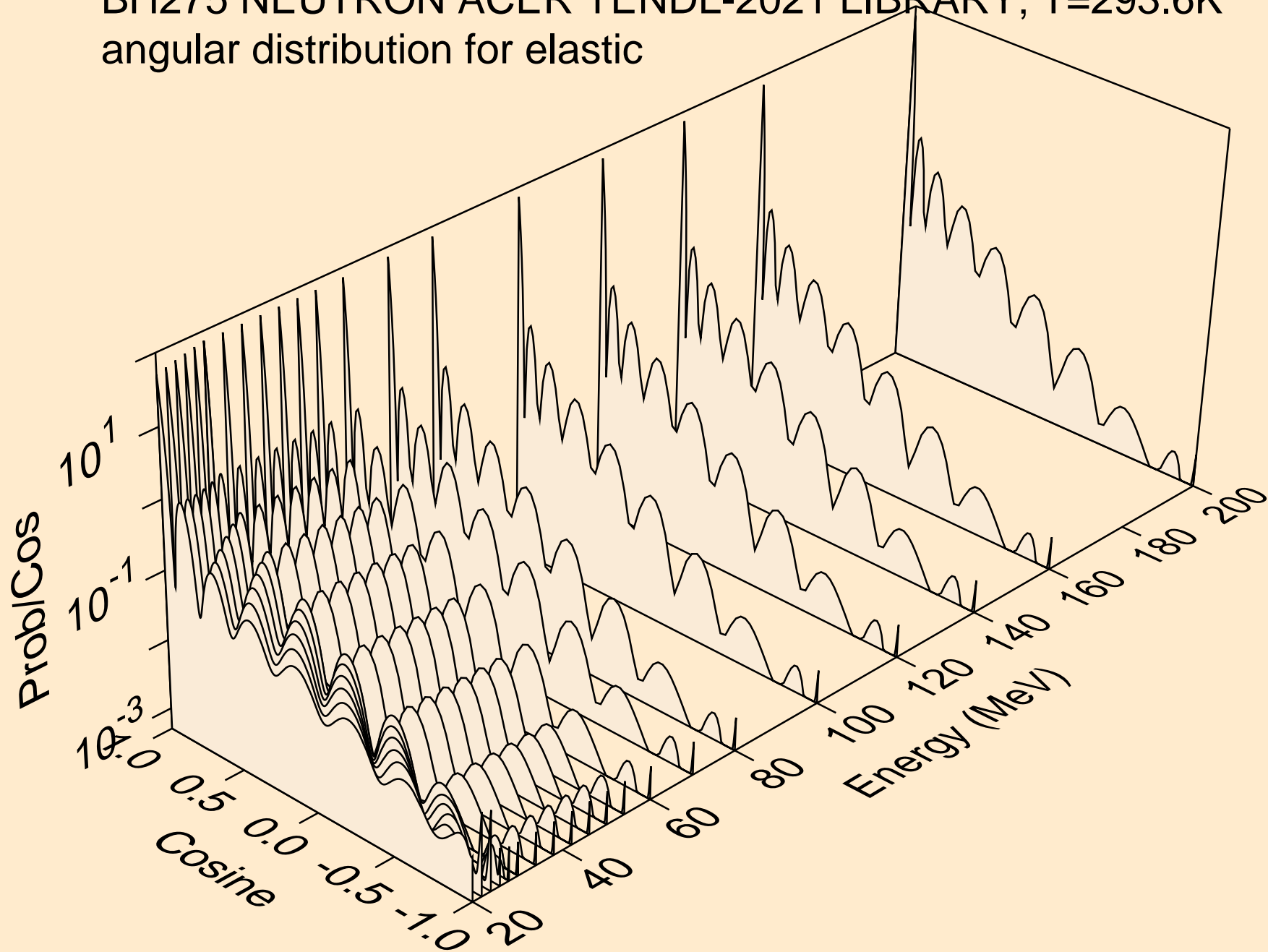

BH275 NEUTRON ACER TENDL-2021 LIBRARY; T=293.6K
angular distribution for (n,n*1)

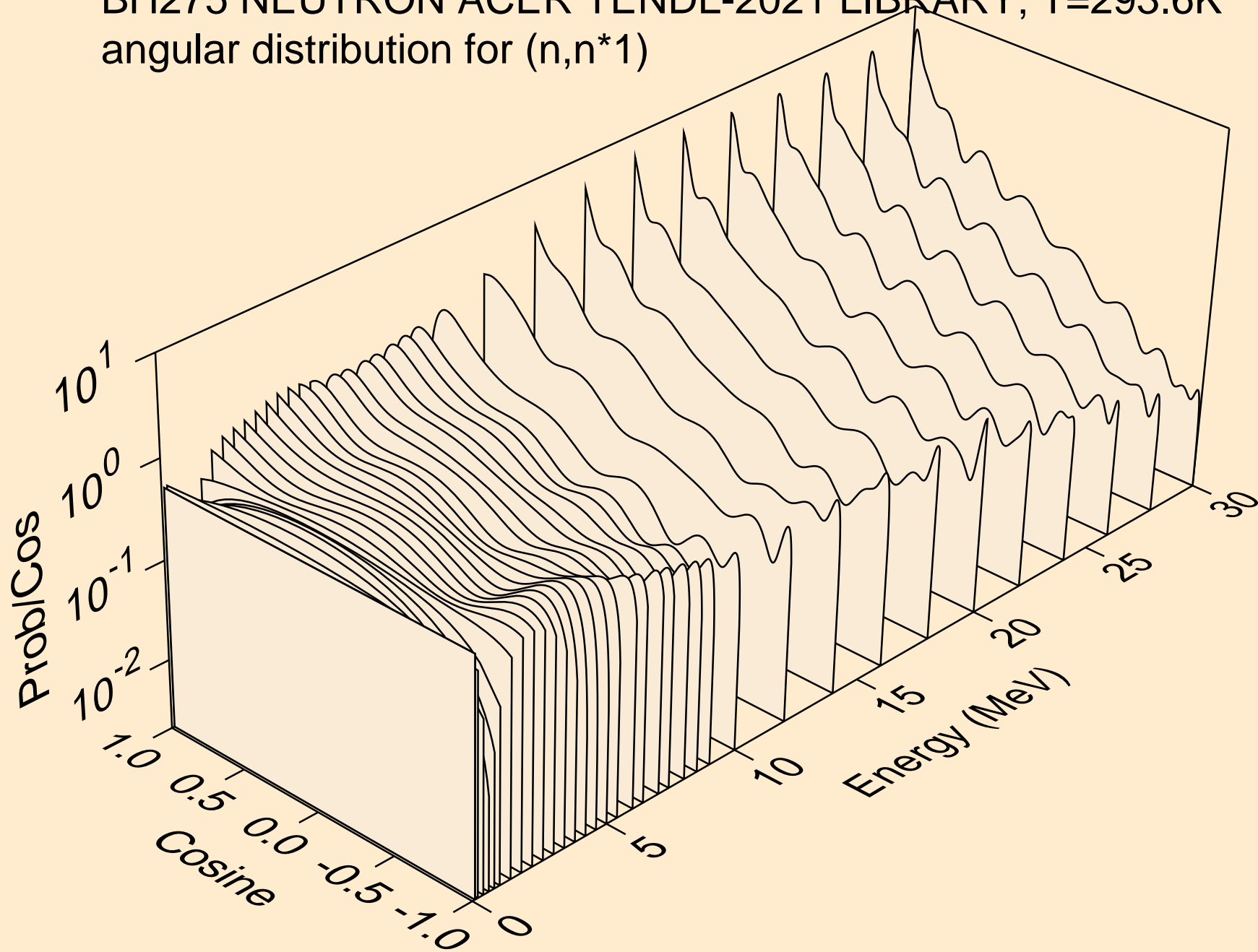

BH275 NEUTRON ACER TENDL-2021 LIBRARY; T=293.6K
Total fission nubar

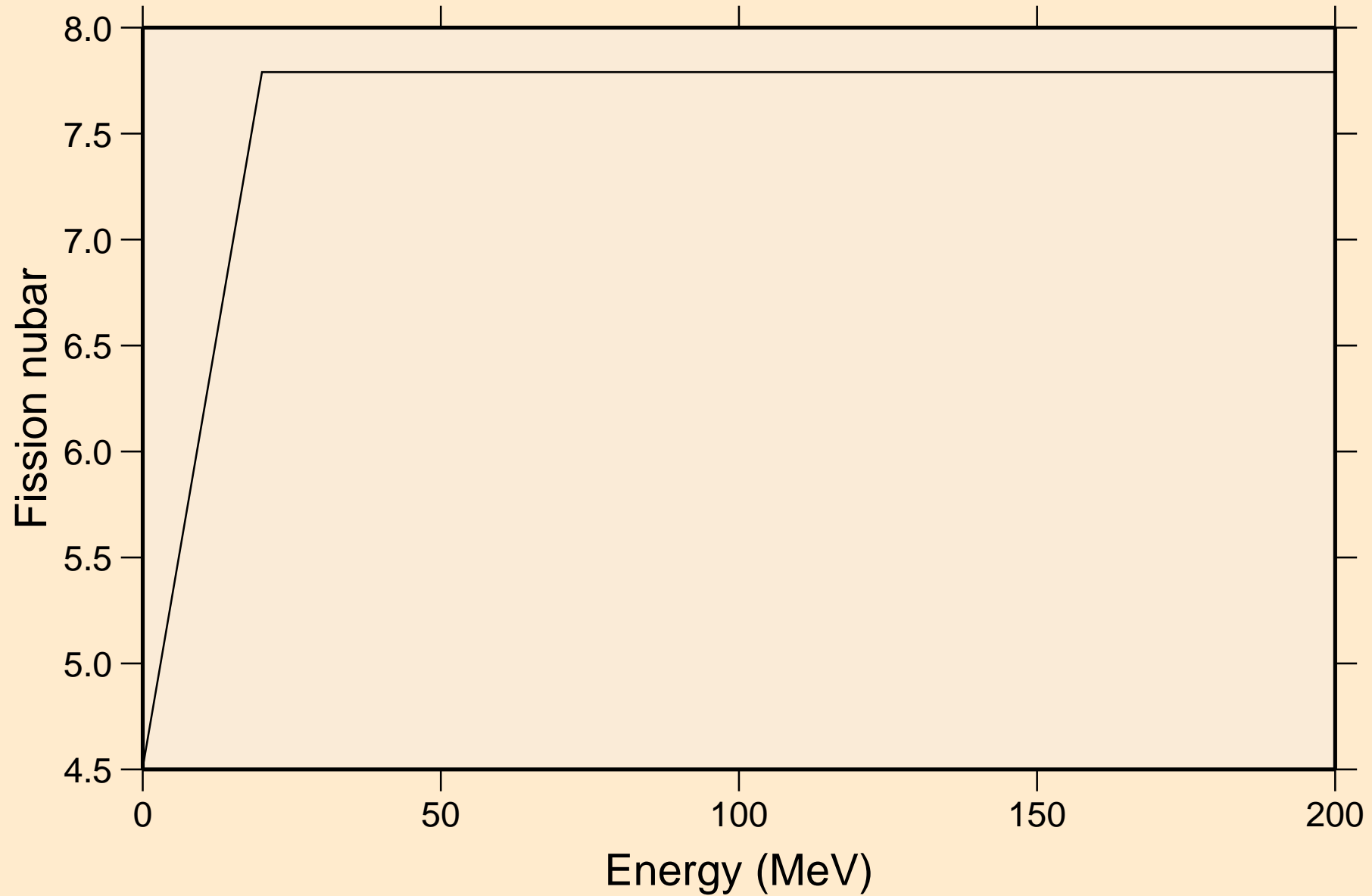

BH275 NEUTRON ACER TENDL-2021 LIBRARY; T=293.6K
Neutron emission for (n,x)

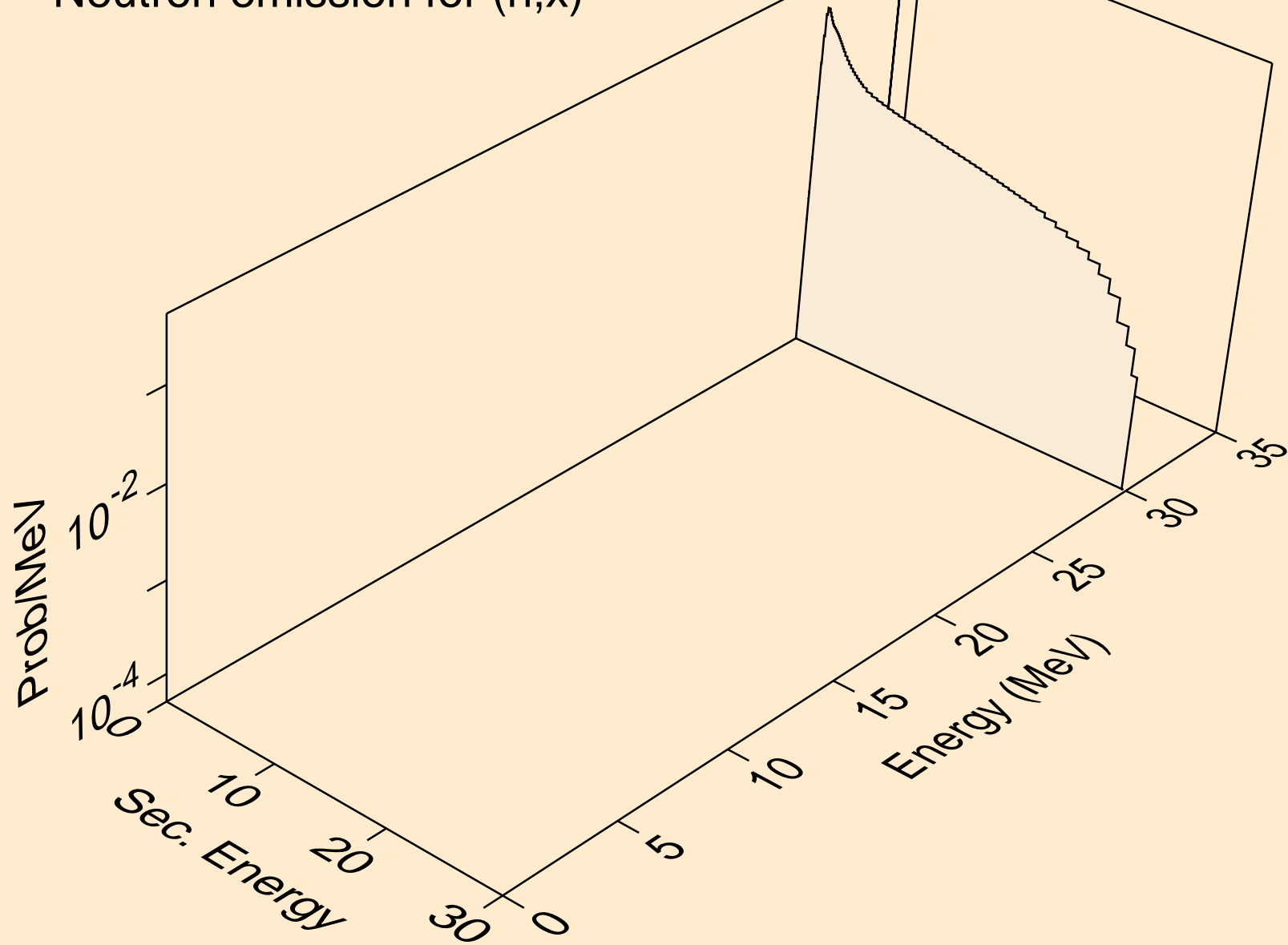

BH275 NEUTRON ACER TENDL-2021 LIBRARY; T=293.6K
Neutron emission for (n,2n)

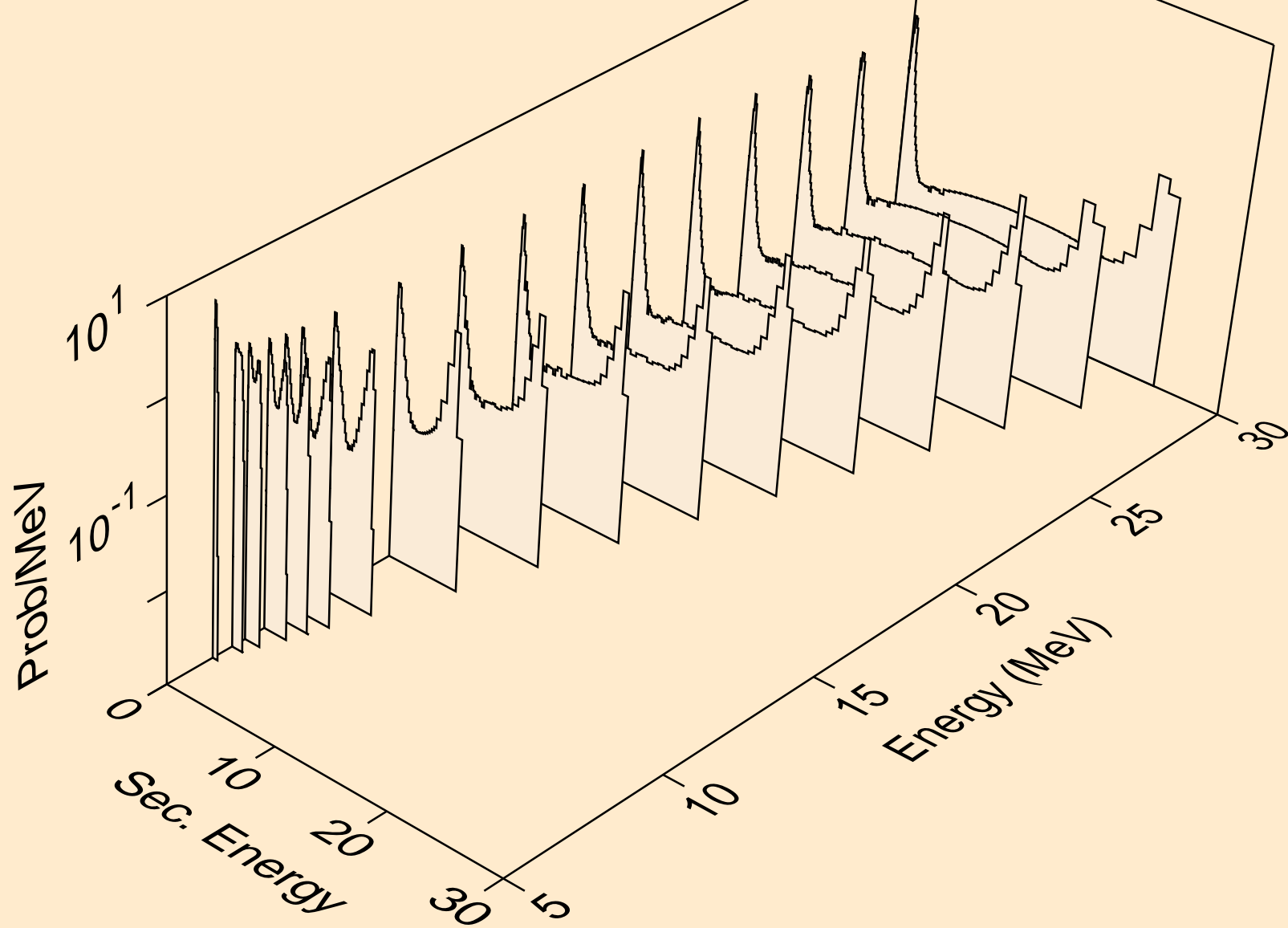

BH275 NEUTRON ACER TENDL-2021 LIBRARY; T=293.6K
Neutron emission for (n,3n)

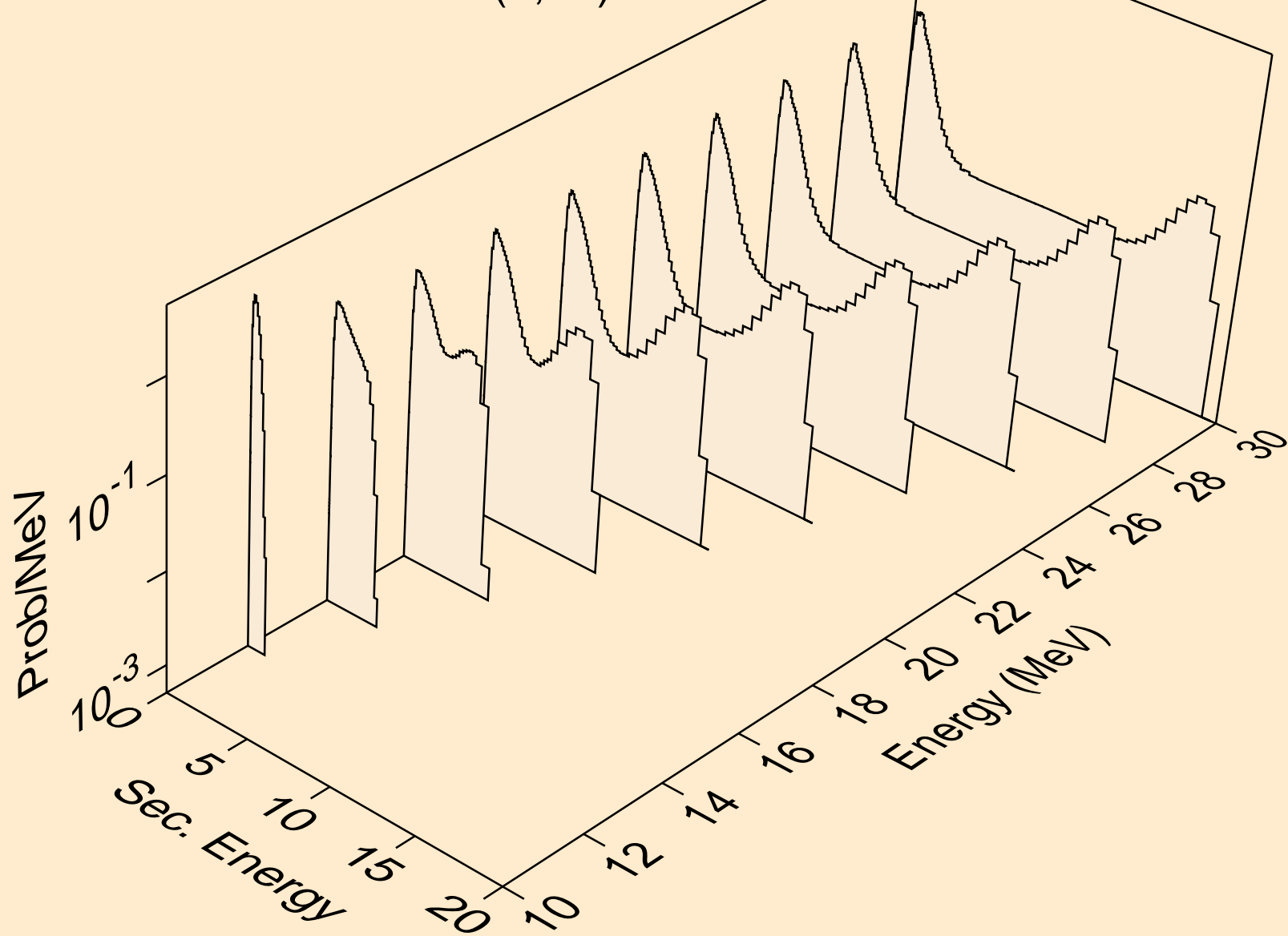

BH275 NEUTRON ACER TENDL-2021 LIBRARY; T=293.6K
Neutron emission for fission

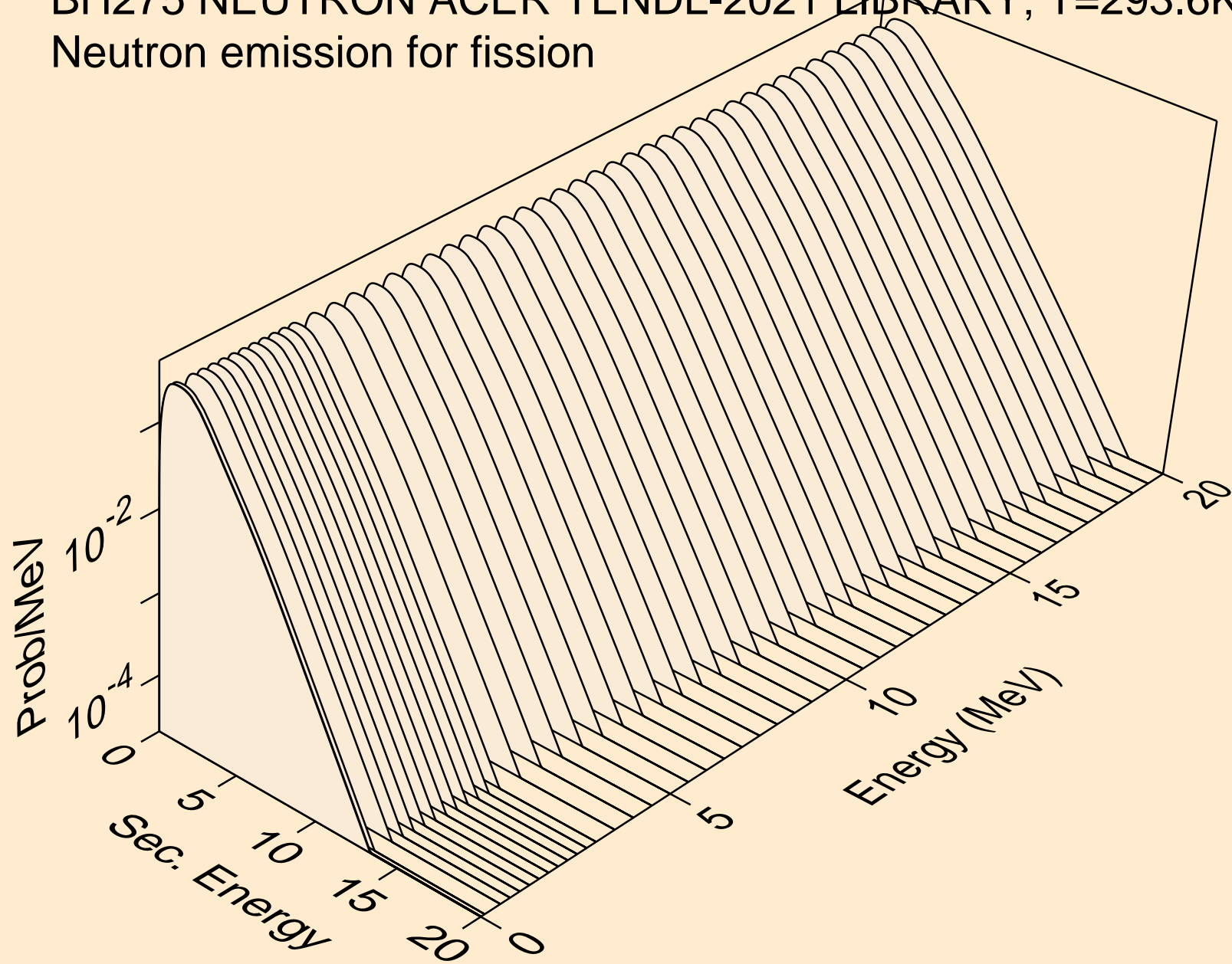

BH275 NEUTRON ACER TENDL-2021 LIBRARY; T=293.6K
Neutron emission for (n,n*)a

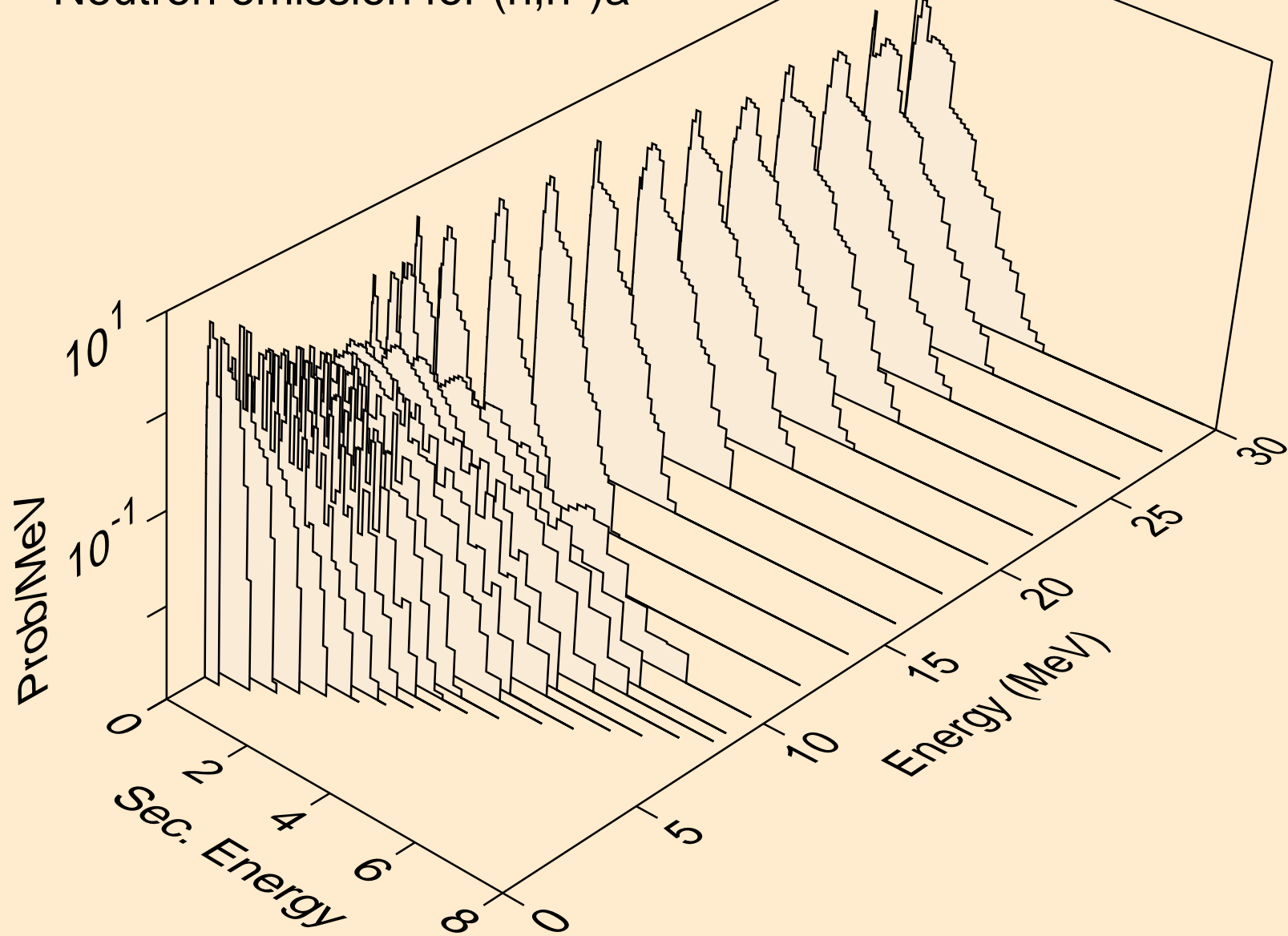

BH275 NEUTRON ACER TENDL-2021 LIBRARY; T=293.6K
Neutron emission for (n,2n)a

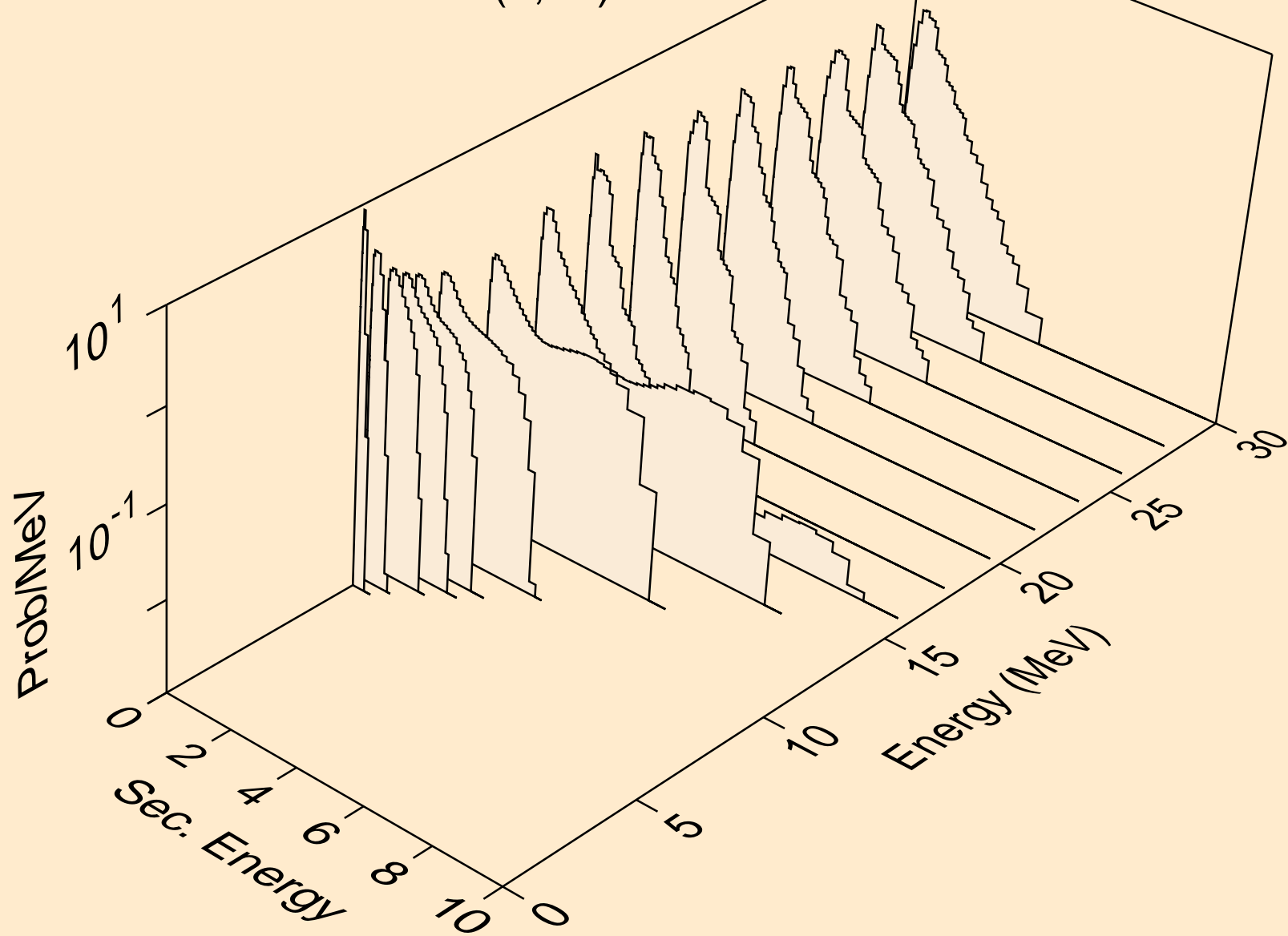

BH275 NEUTRON ACER TENDL-2021 LIBRARY; T=293.6K
Neutron emission for (n,3n)a

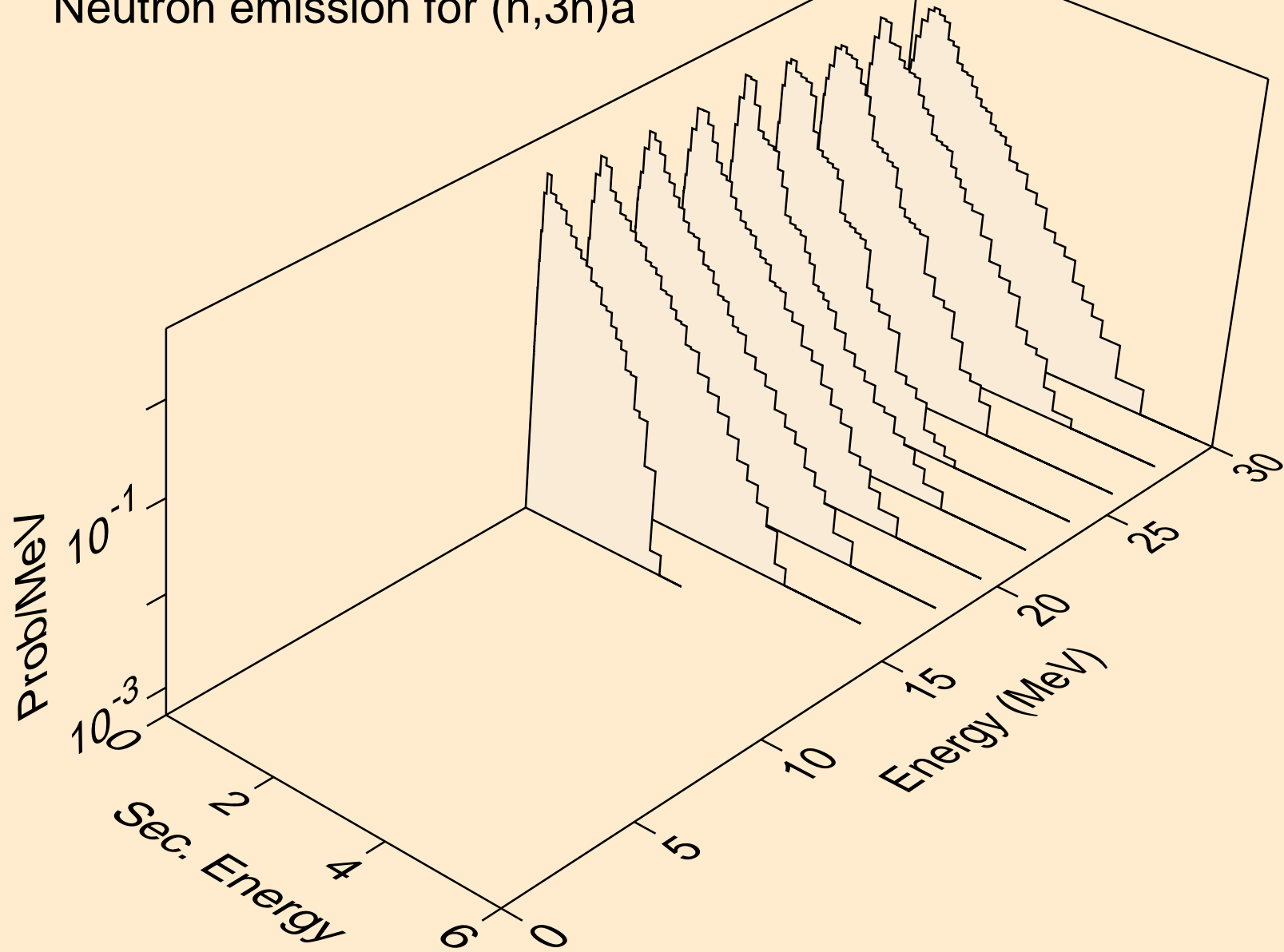

BH275 NEUTRON ACER TENDL-2021 LIBRARY; T=293.6K
Neutron emission for (n,n*)p

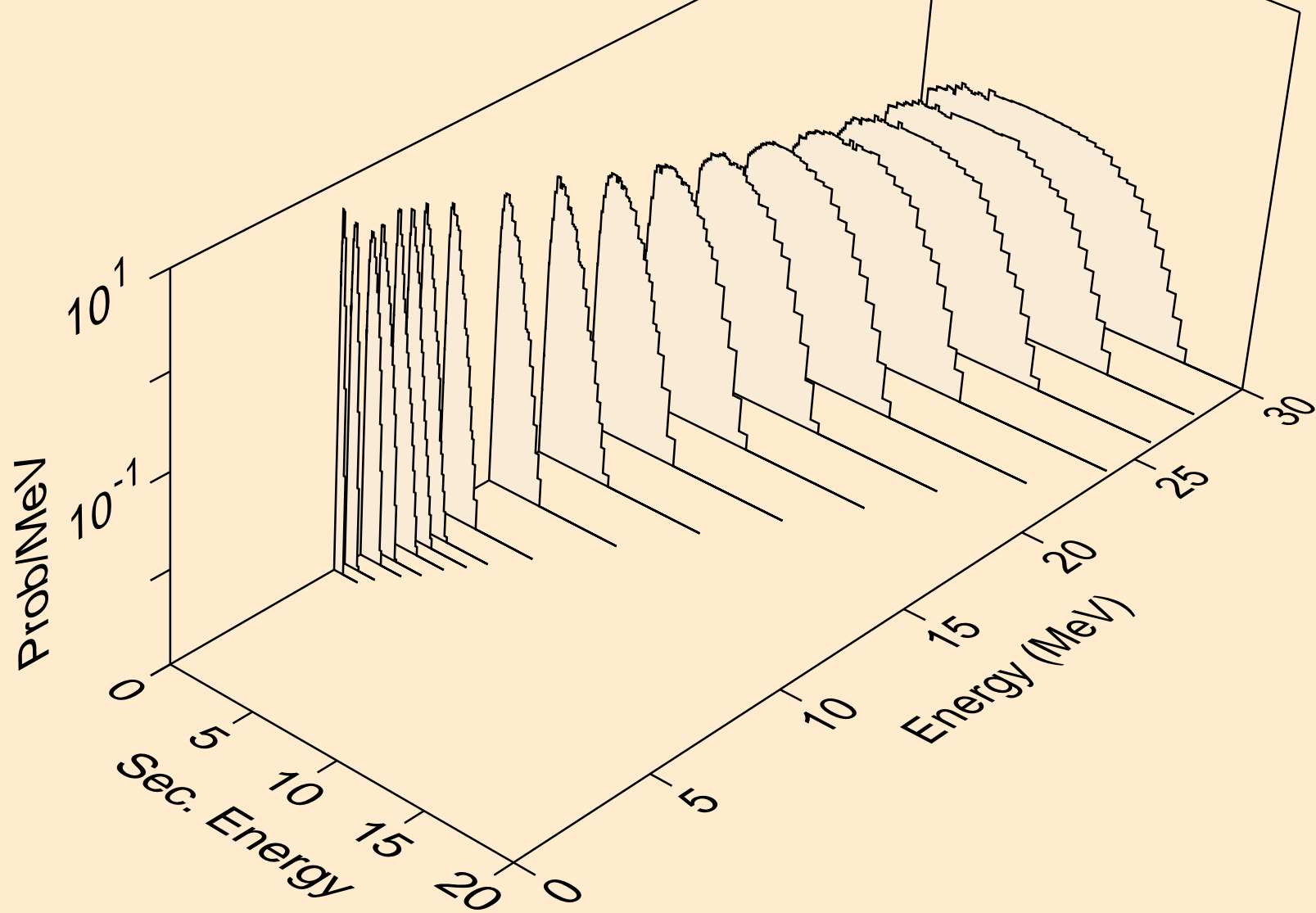

BH275 NEUTRON ACER TENDL-2021 LIBRARY; T=293.6K
Neutron emission for (n,n*)d

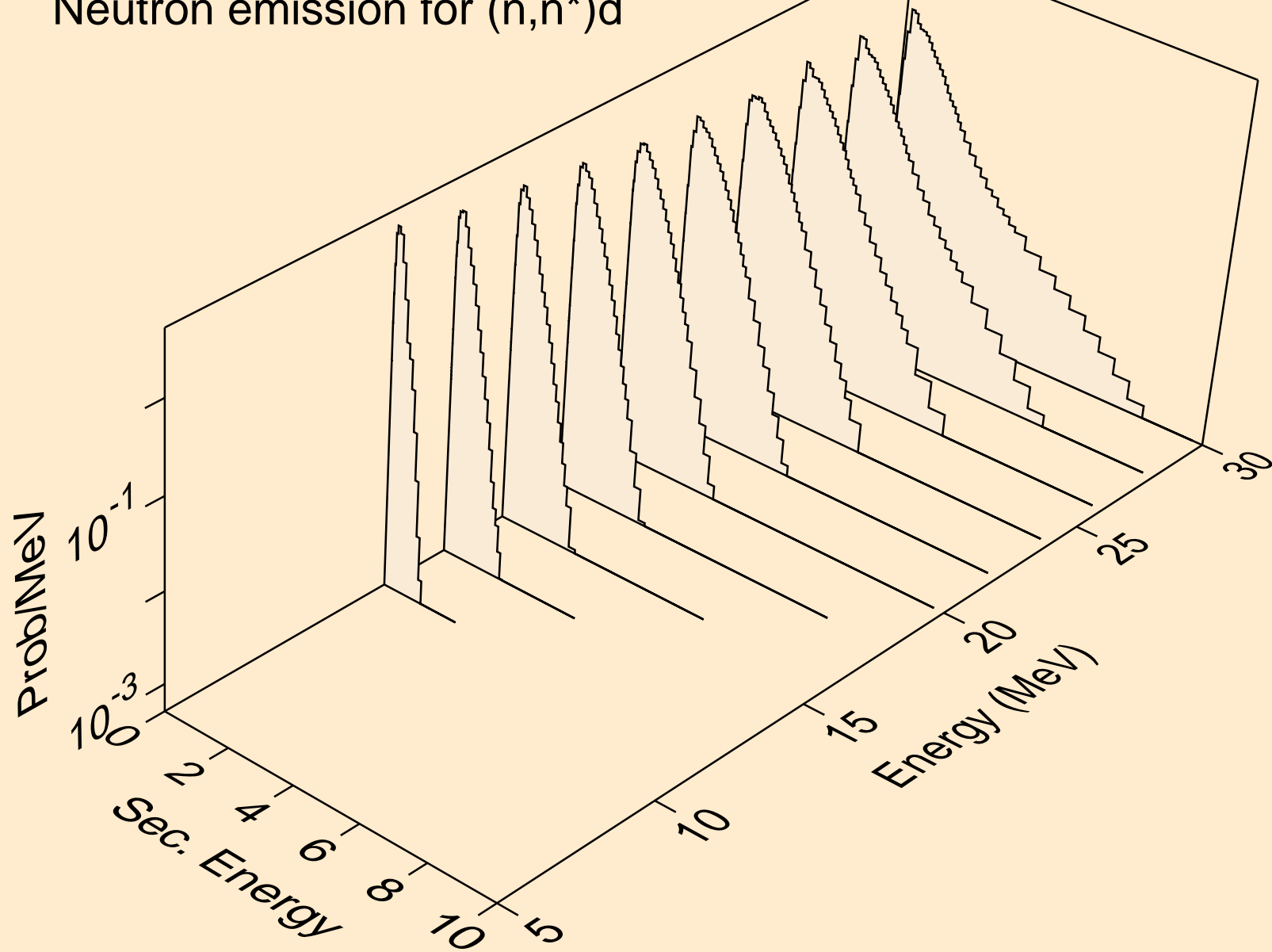

BH275 NEUTRON ACER TENDL-2021 LIBRARY; T=293.6K
Neutron emission for (n,n*)t

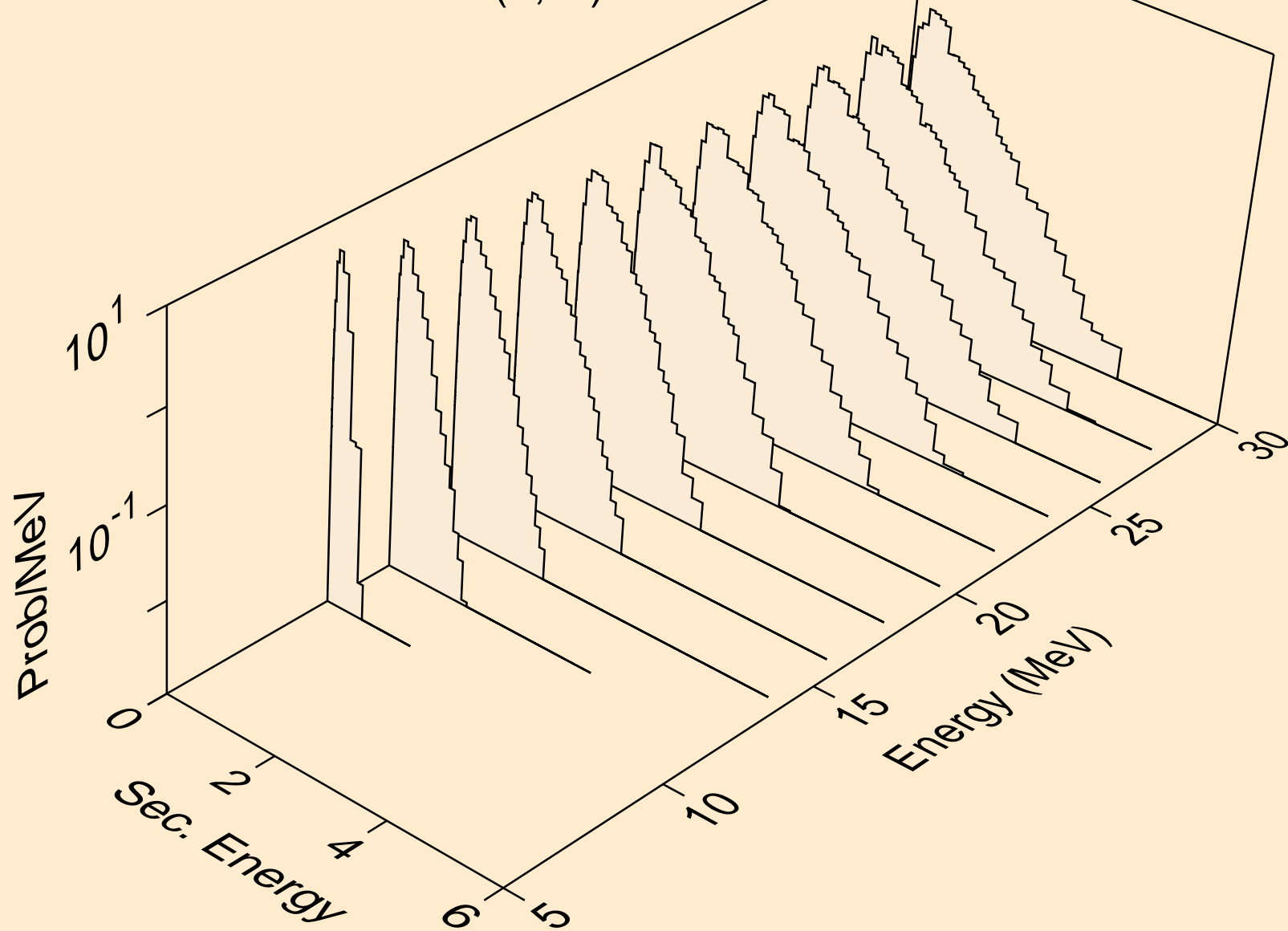

BH275 NEUTRON ACER TENDL-2021 LIBRARY; T=293.6K
Neutron emission for (n,4n)

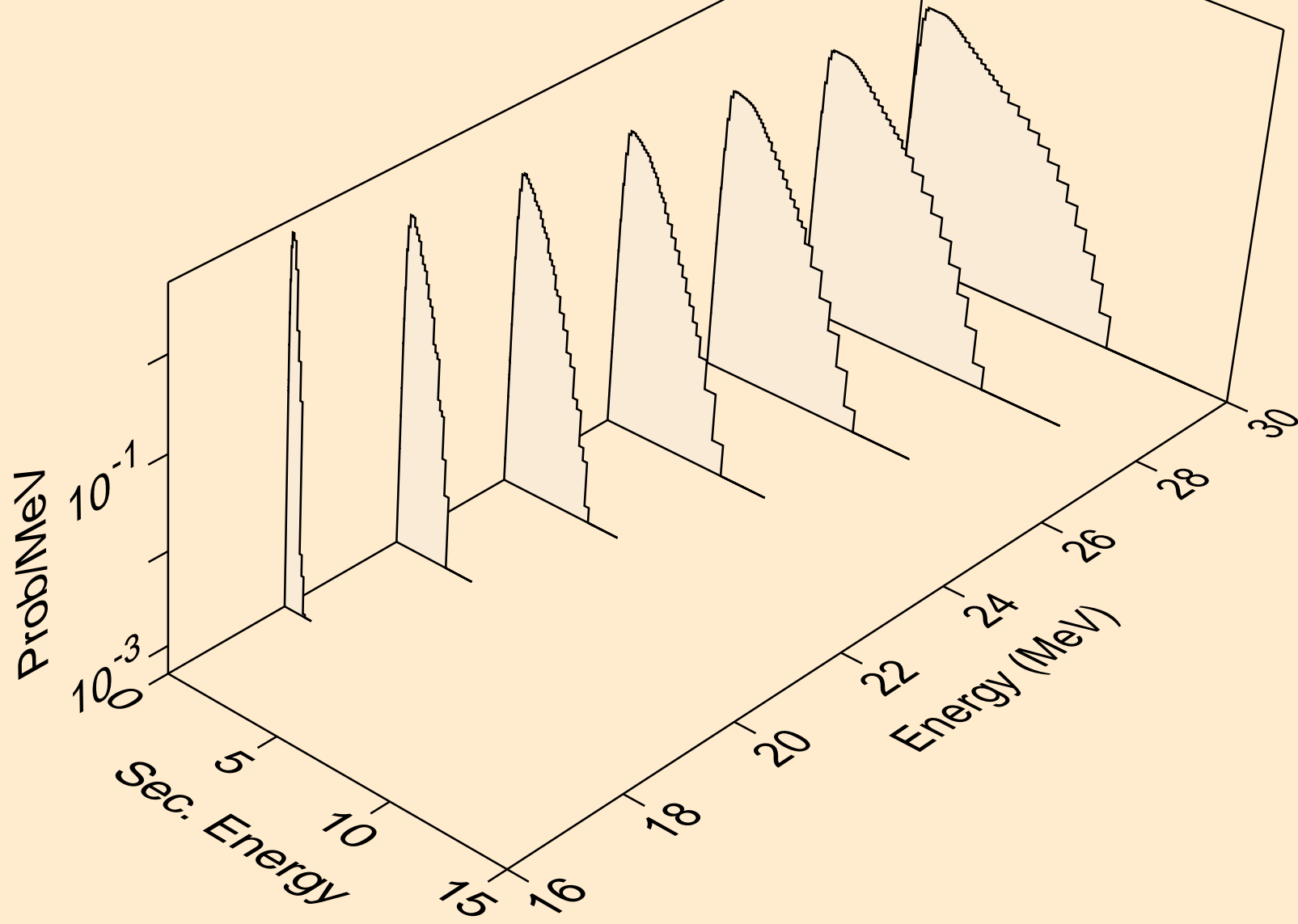

BH275 NEUTRON ACER TENDL-2021 LIBRARY; T=293.6K
Neutron emission for (n,2np)

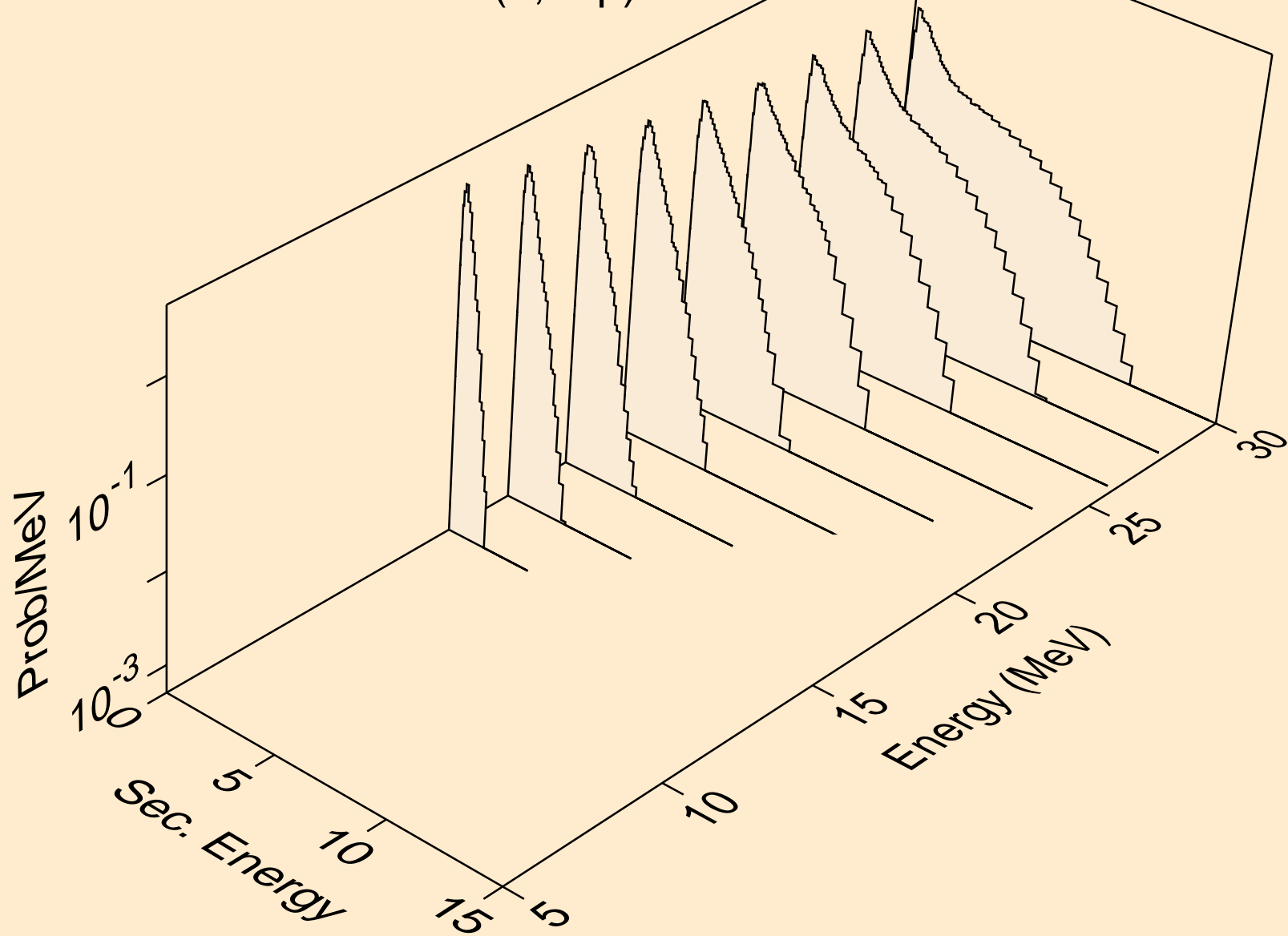

BH275 NEUTRON ACER TENDL-2021 LIBRARY; T=293.6K
Neutron emission for (n,3np)

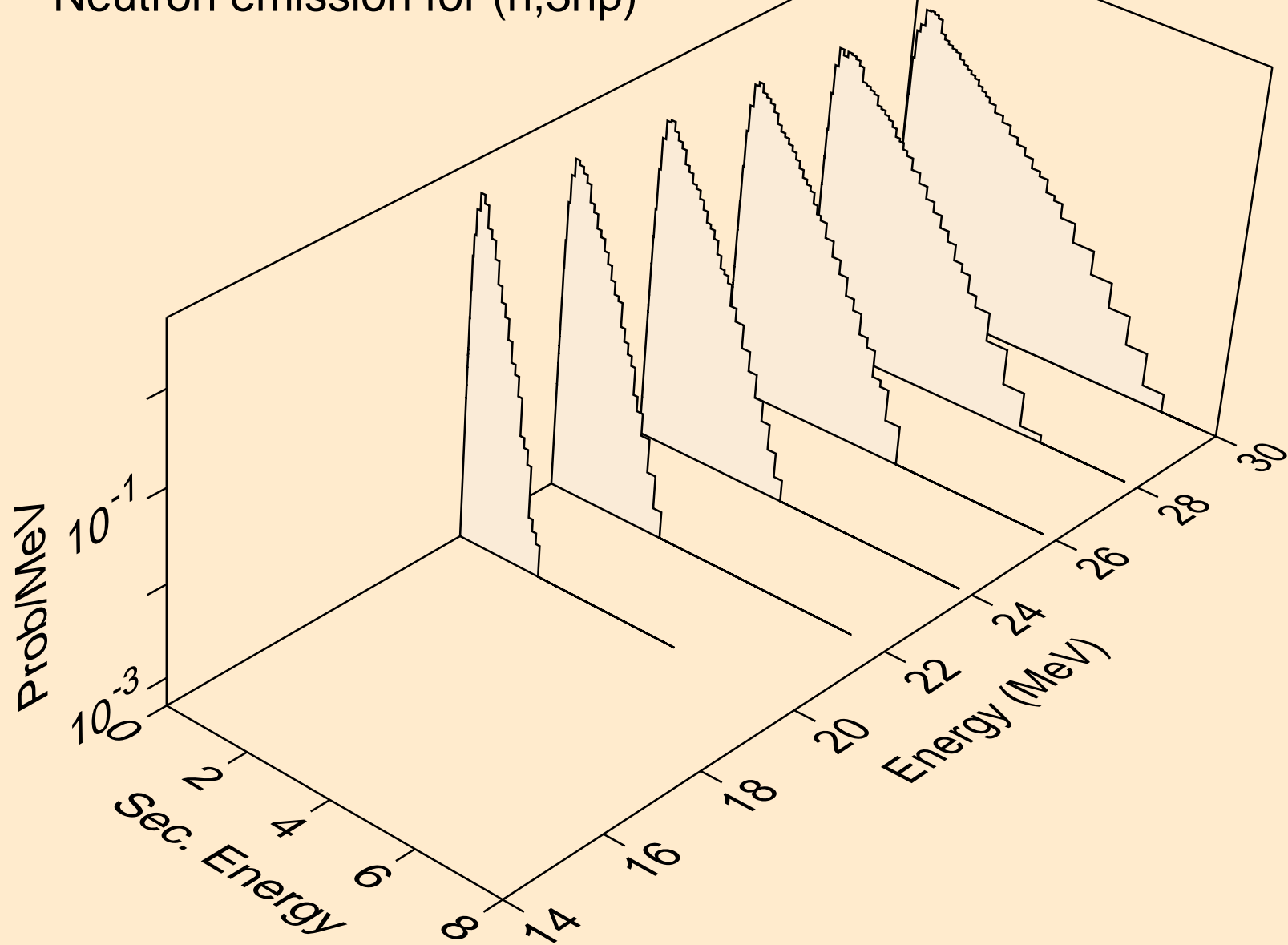

BH275 NEUTRON ACER TENDL-2021 LIBRARY; T=293.6K
Neutron emission for (n,n*c)

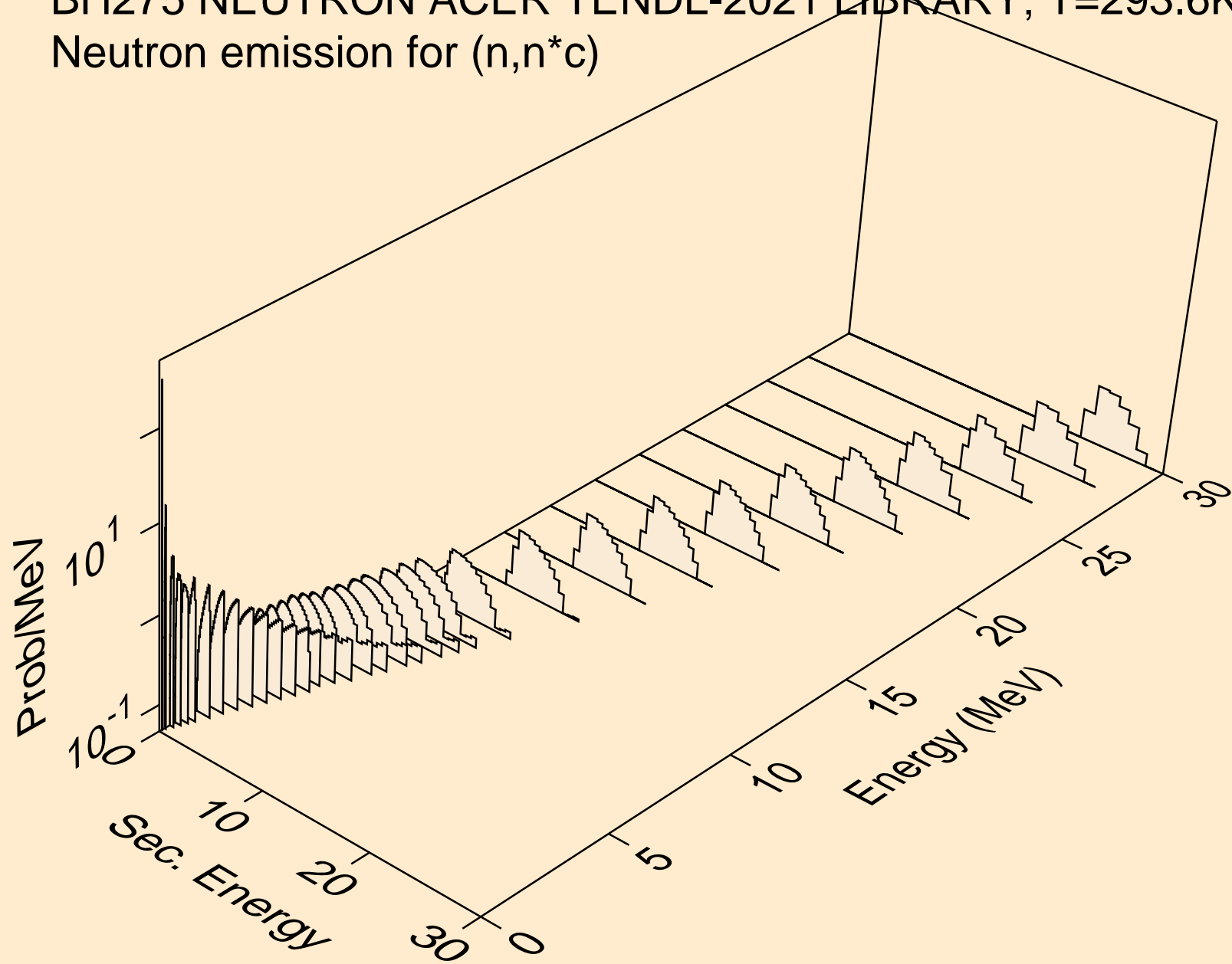

BH275 NEUTRON ACER TENDL-2021 LIBRARY; T=293.6K

Delayed nubar

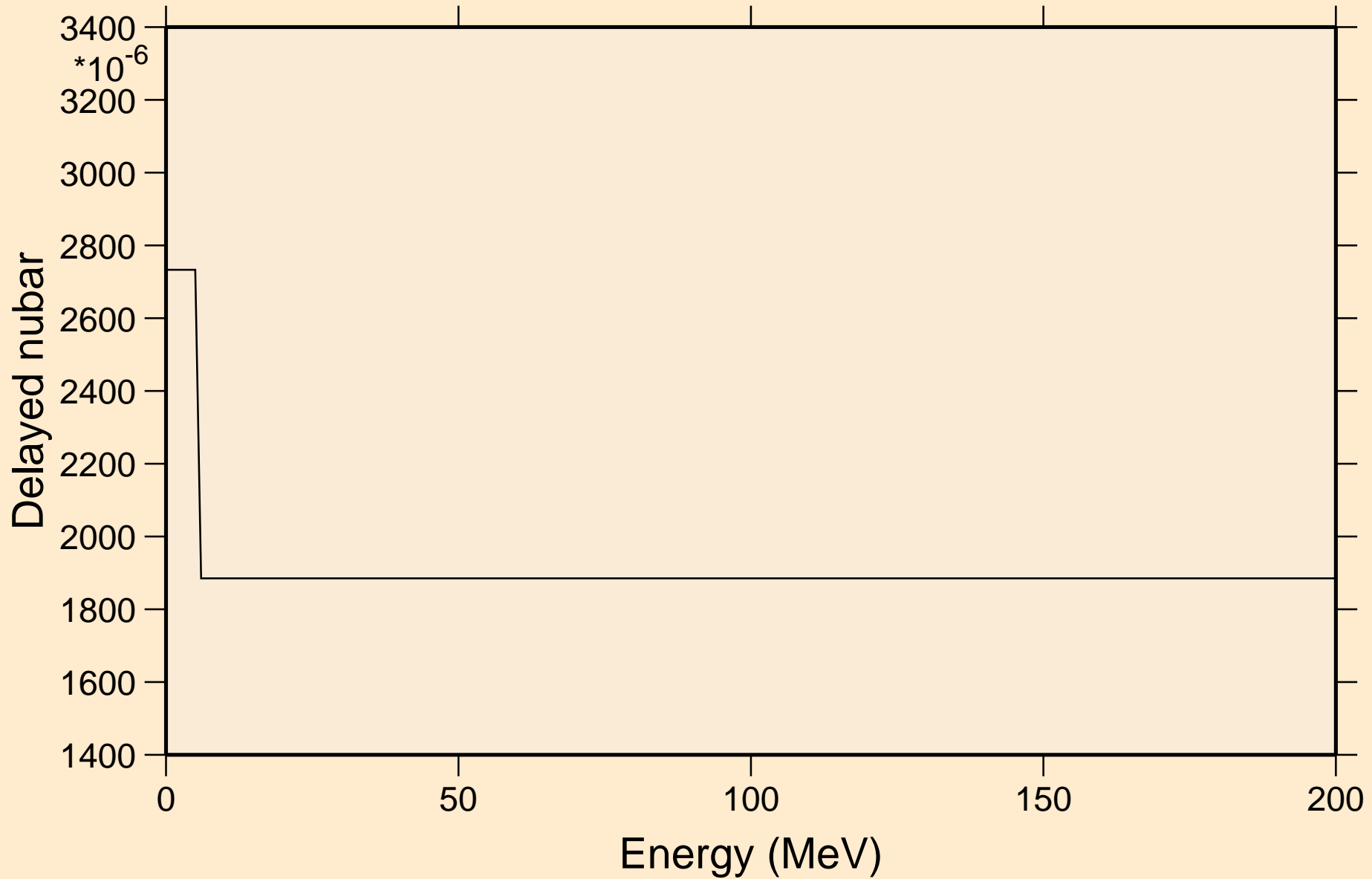

BH275 NEUTRON ACER TENDL-2021 LIBRARY; T=293.6K

Delayed neutron spectra

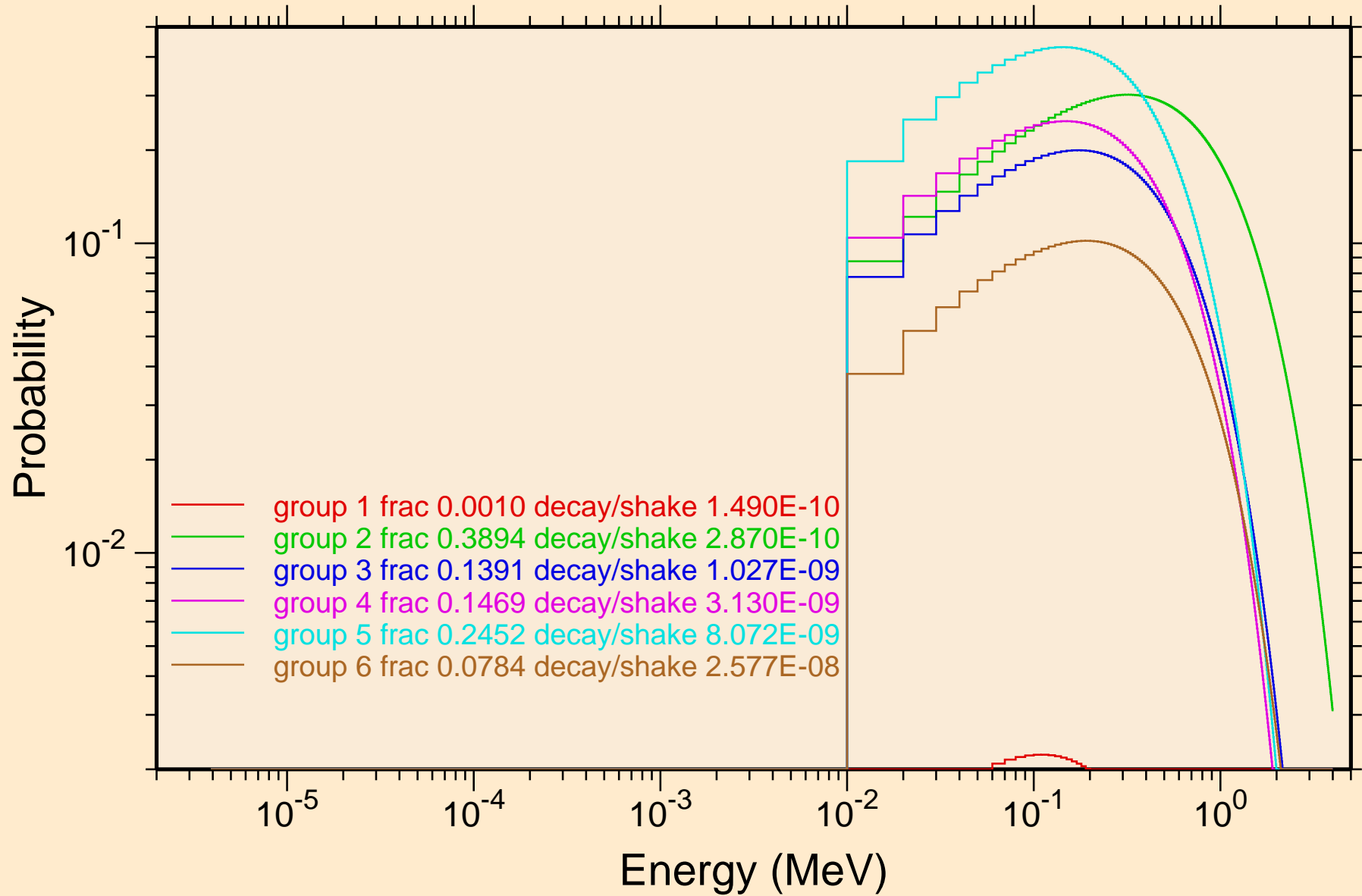

BH275 NEUTRON ACER TENDL-2021 LIBRARY; T=293.6K
Photon emission for (n,x)

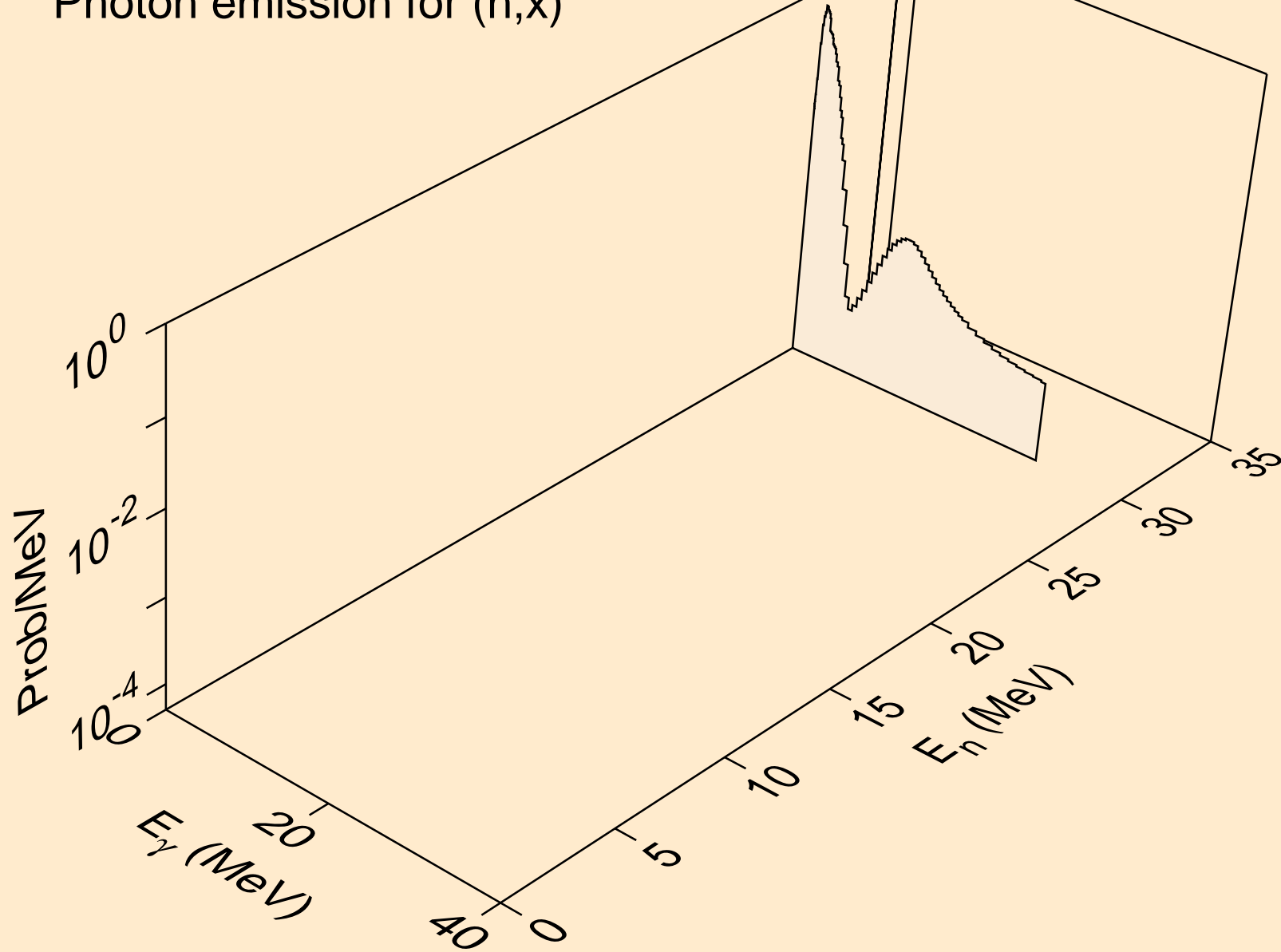

BH275 NEUTRON ACER TENDL-2021 LIBRARY; T=293.6K
Photon emission for (n,2n)

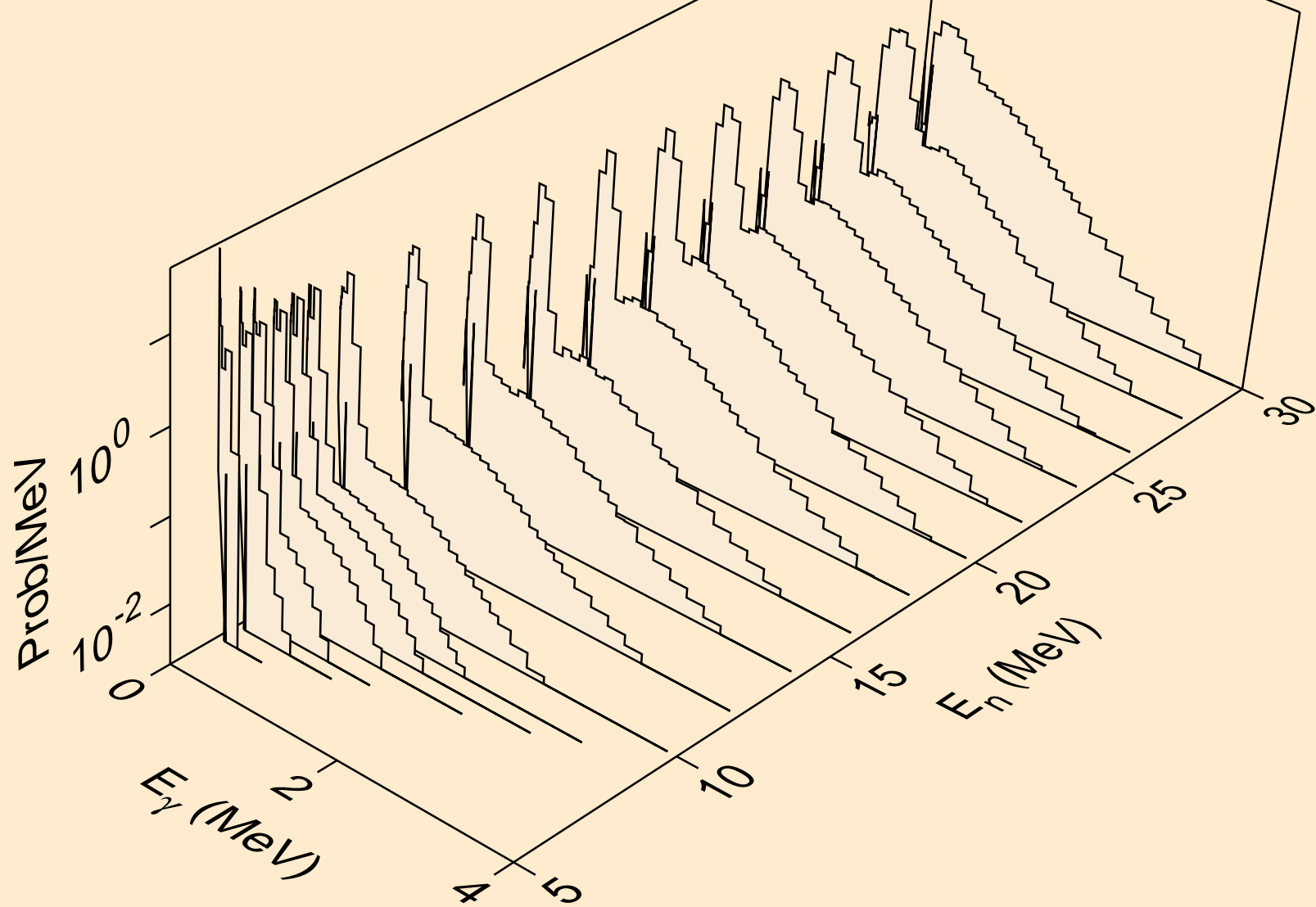

BH275 NEUTRON ACER TENDL-2021 LIBRARY; T=293.6K
Photon emission for (n,3n)

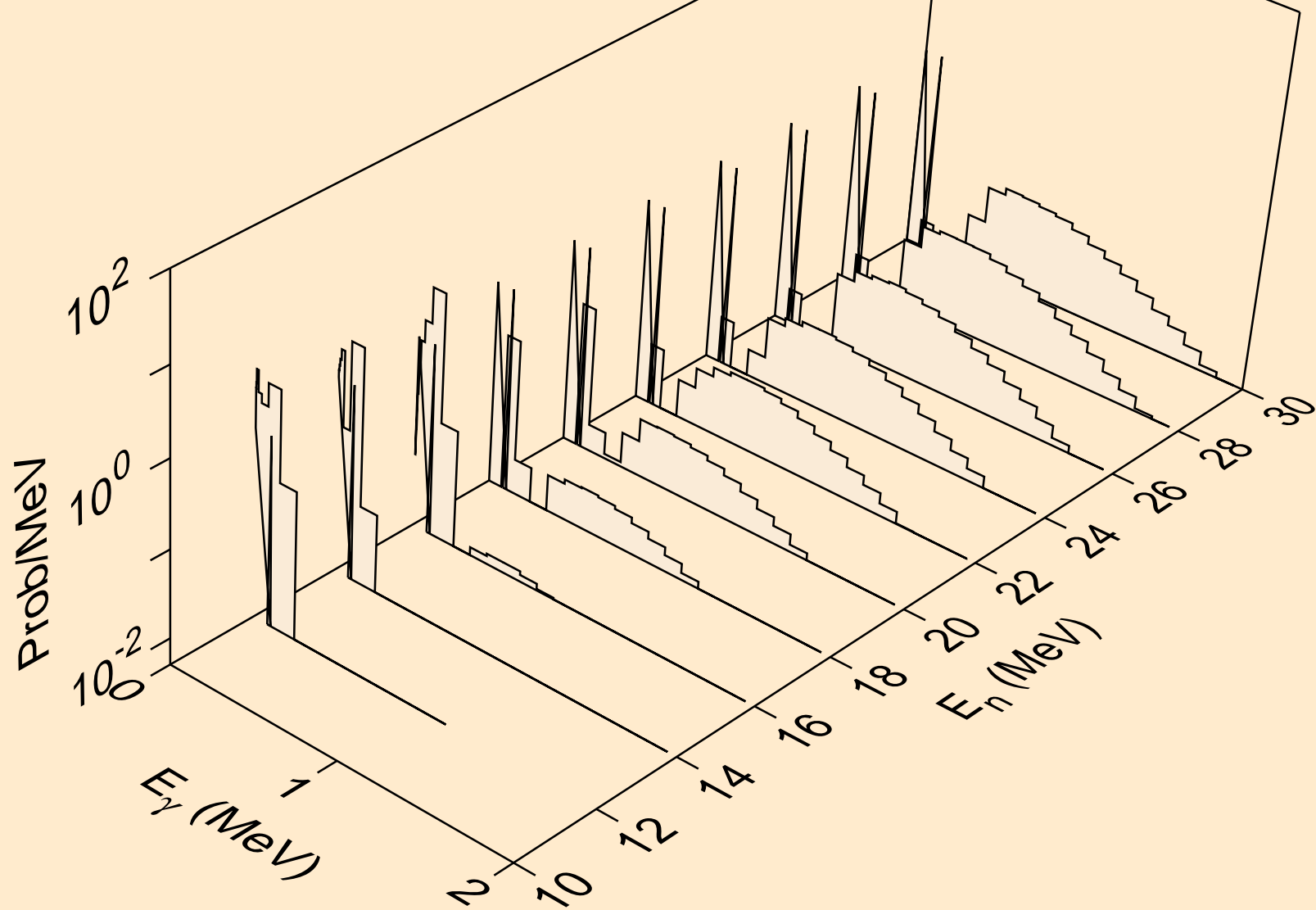

BH275 NEUTRON ACER TENDL-2021 LIBRARY; T=293.6K
Photon emission for (n,n*)a

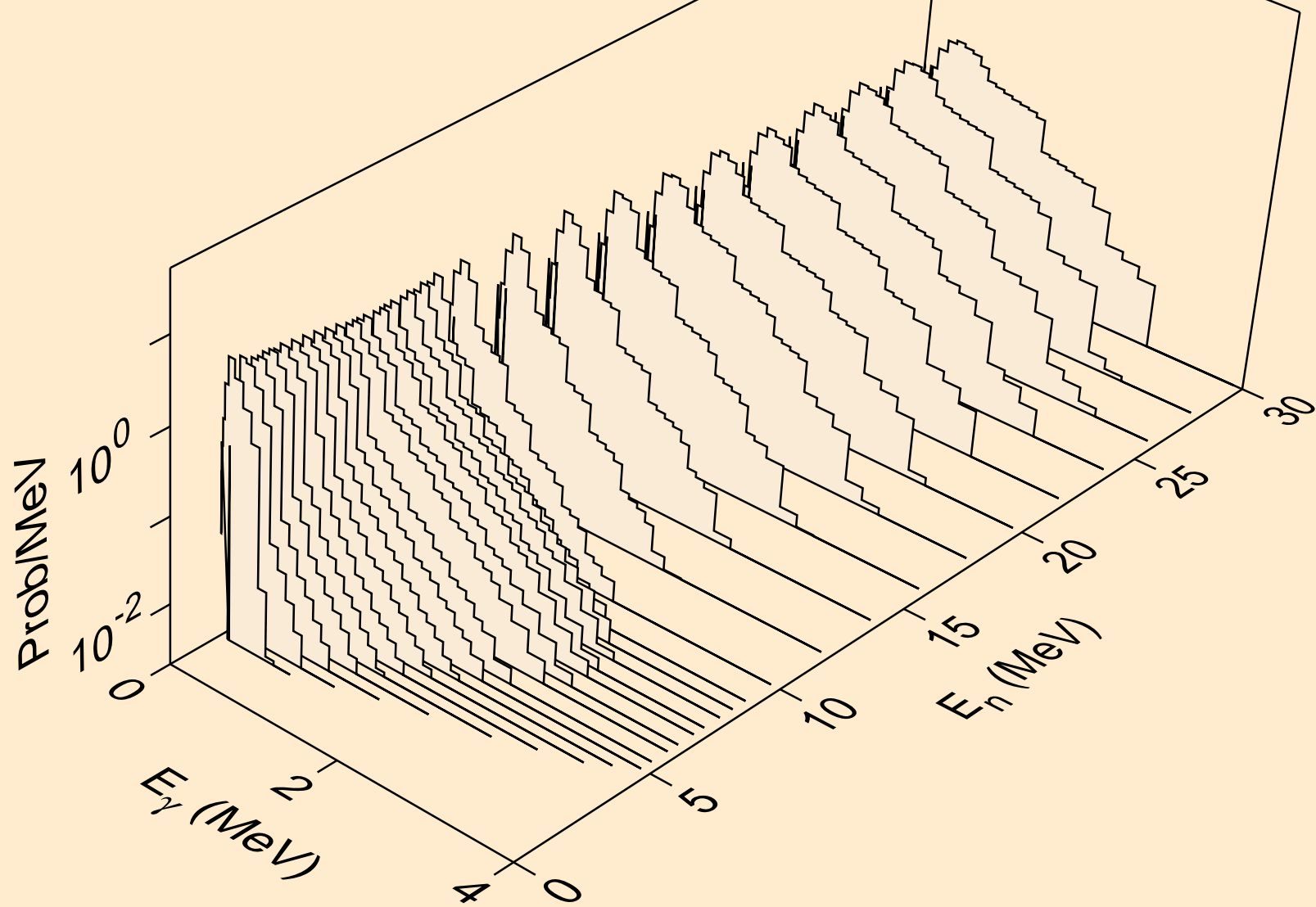

BH275 NEUTRON ACER TENDL-2021 LIBRARY; T=293.6K
Photon emission for (n,2n)a

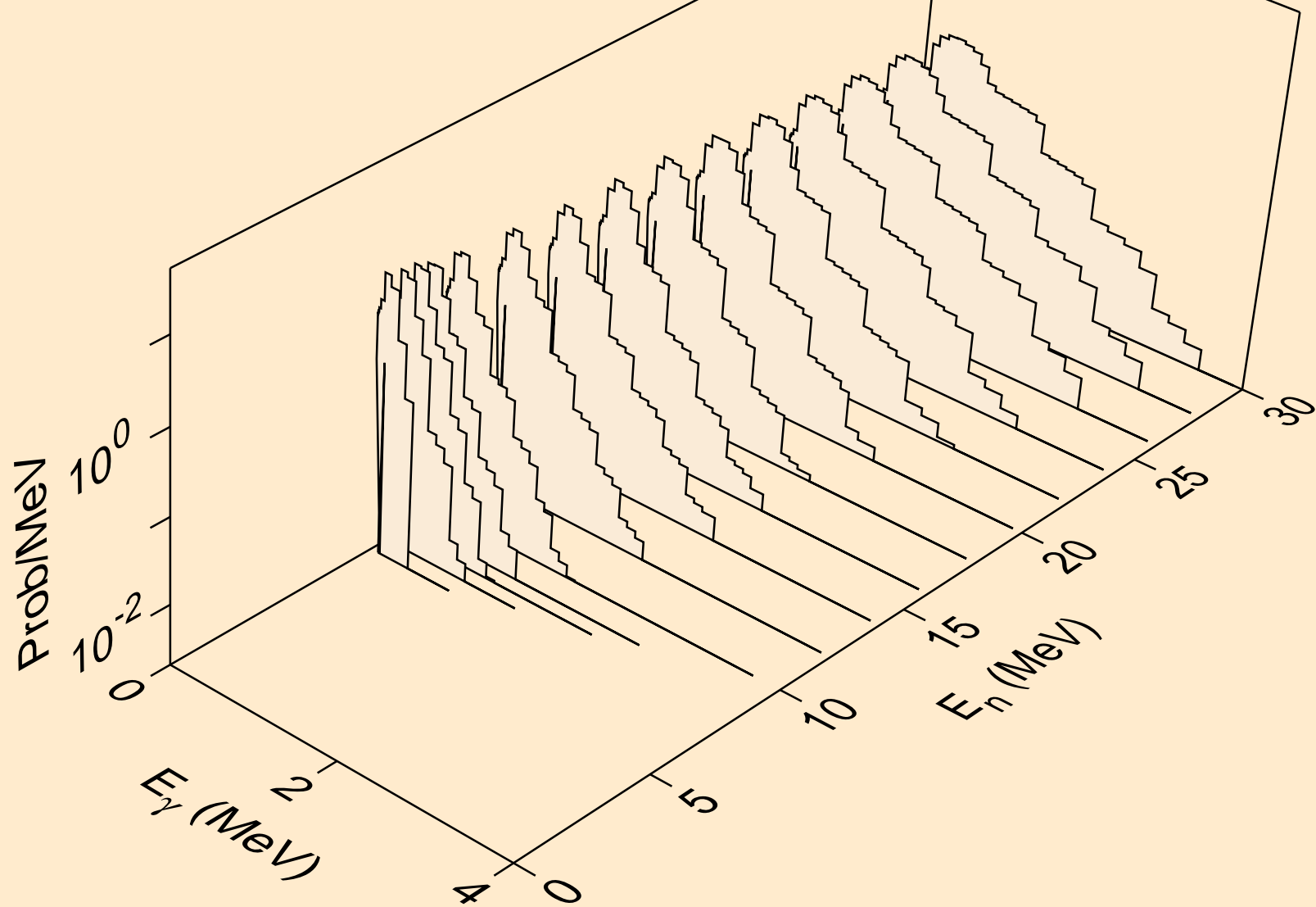

BH275 NEUTRON ACER TENDL-2021 LIBRARY; T=293.6K
Photon emission for (n,3n)a

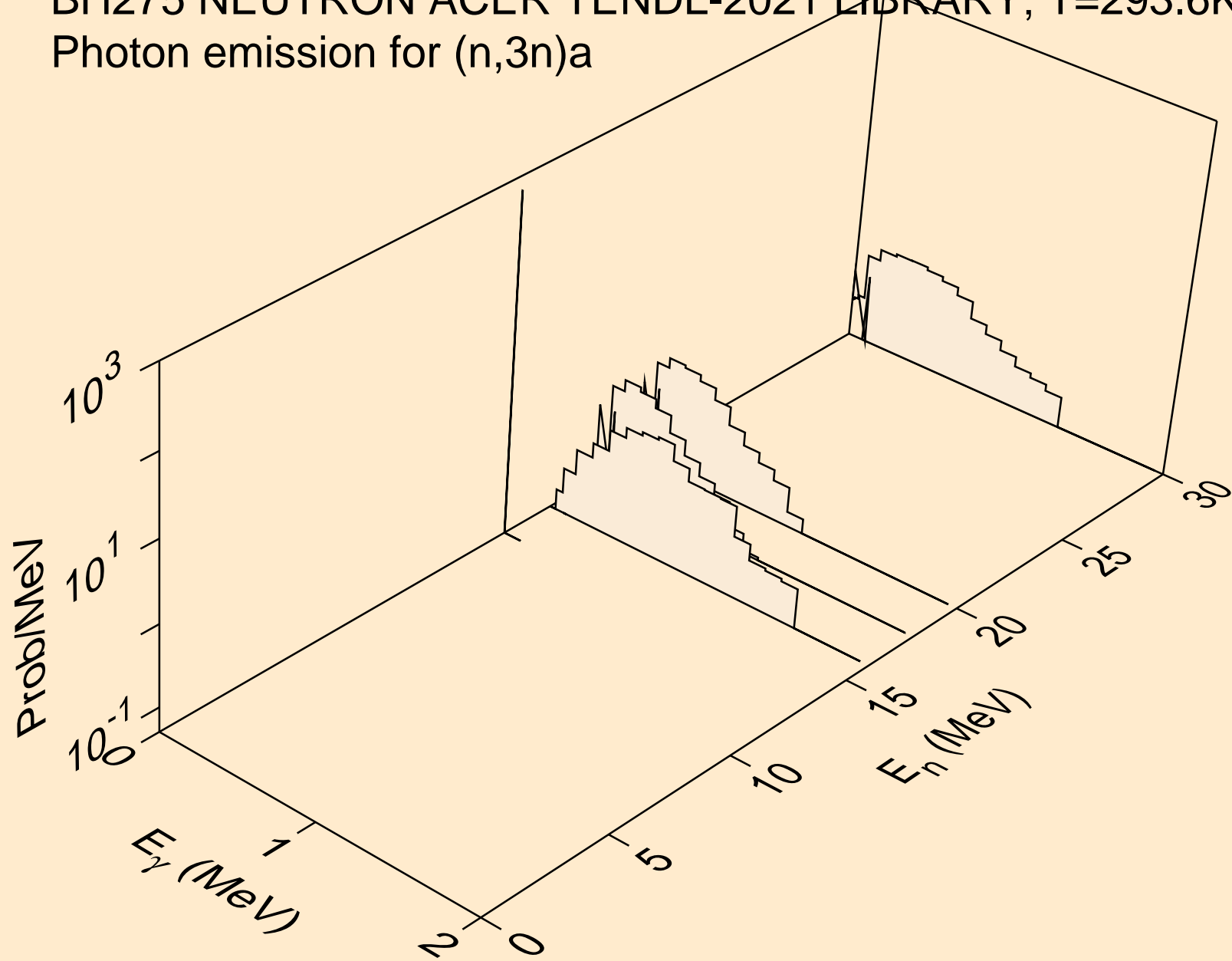

BH275 NEUTRON ACER TENDL-2021 LIBRARY; T=293.6K
Photon emission for (n,n*)p

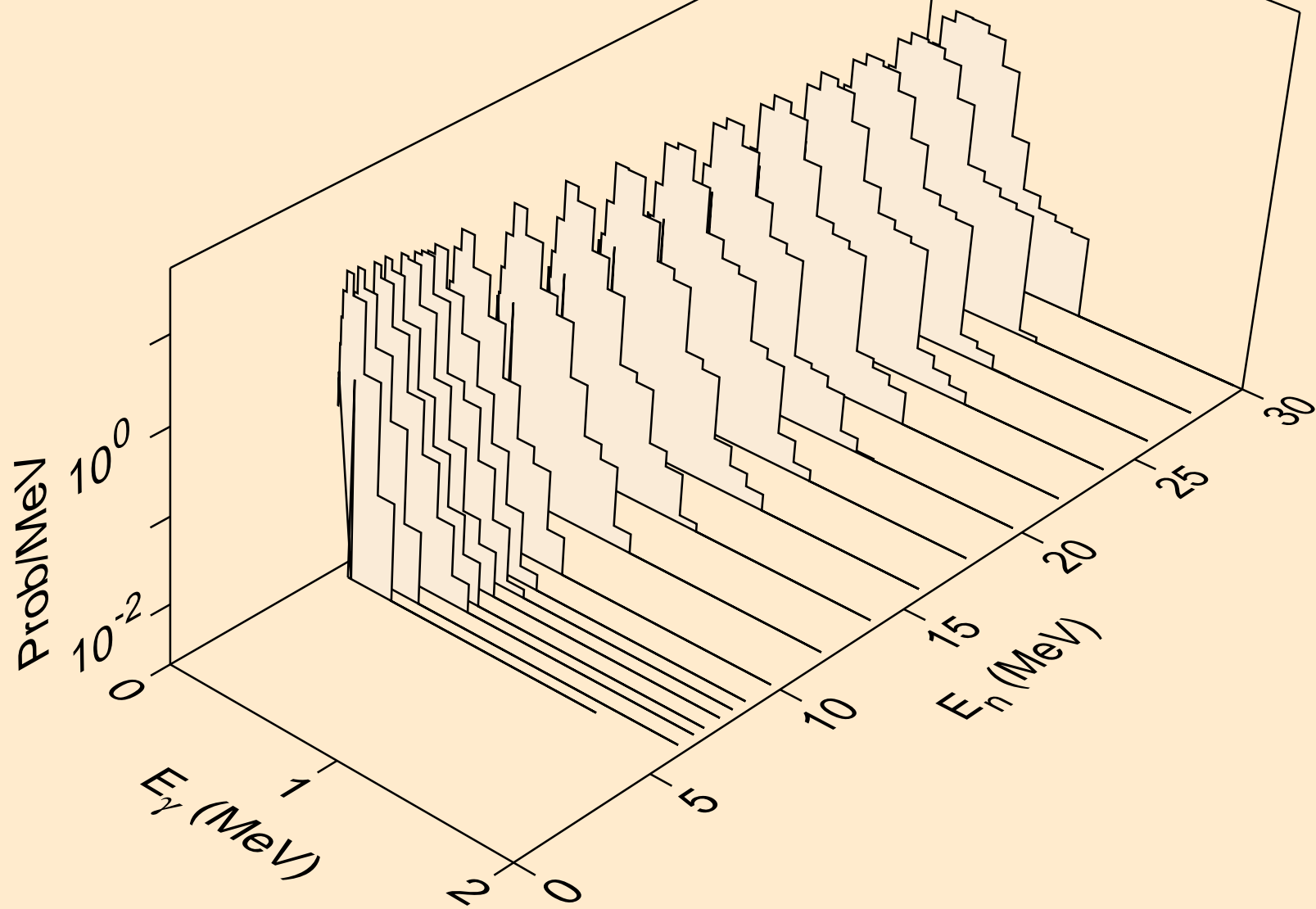

BH275 NEUTRON ACER TENDL-2021 LIBRARY; T=293.6K
Photon emission for (n,n*)d

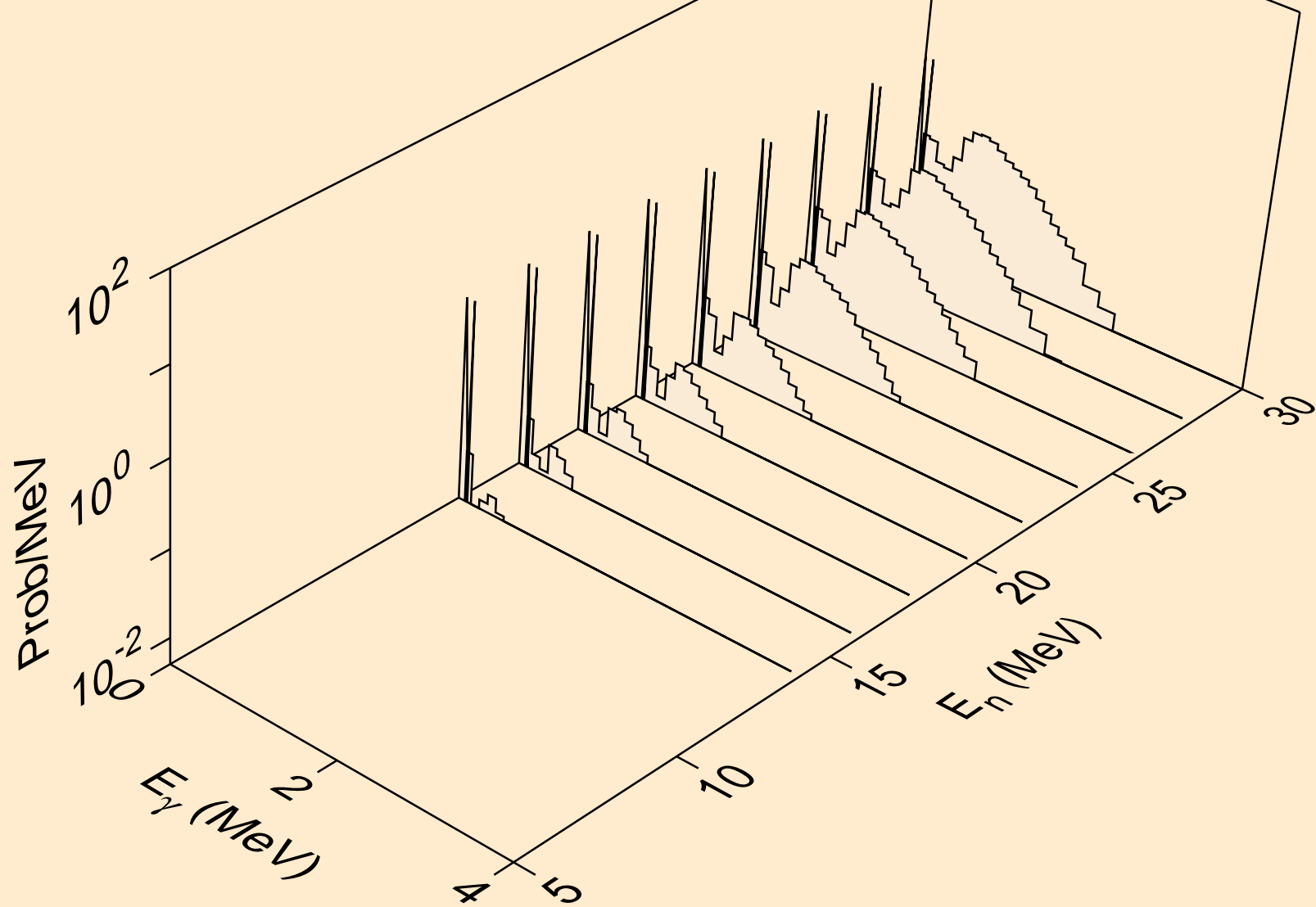

BH275 NEUTRON ACER TENDL-2021 LIBRARY; T=293.6K
Photon emission for (n,n*)t

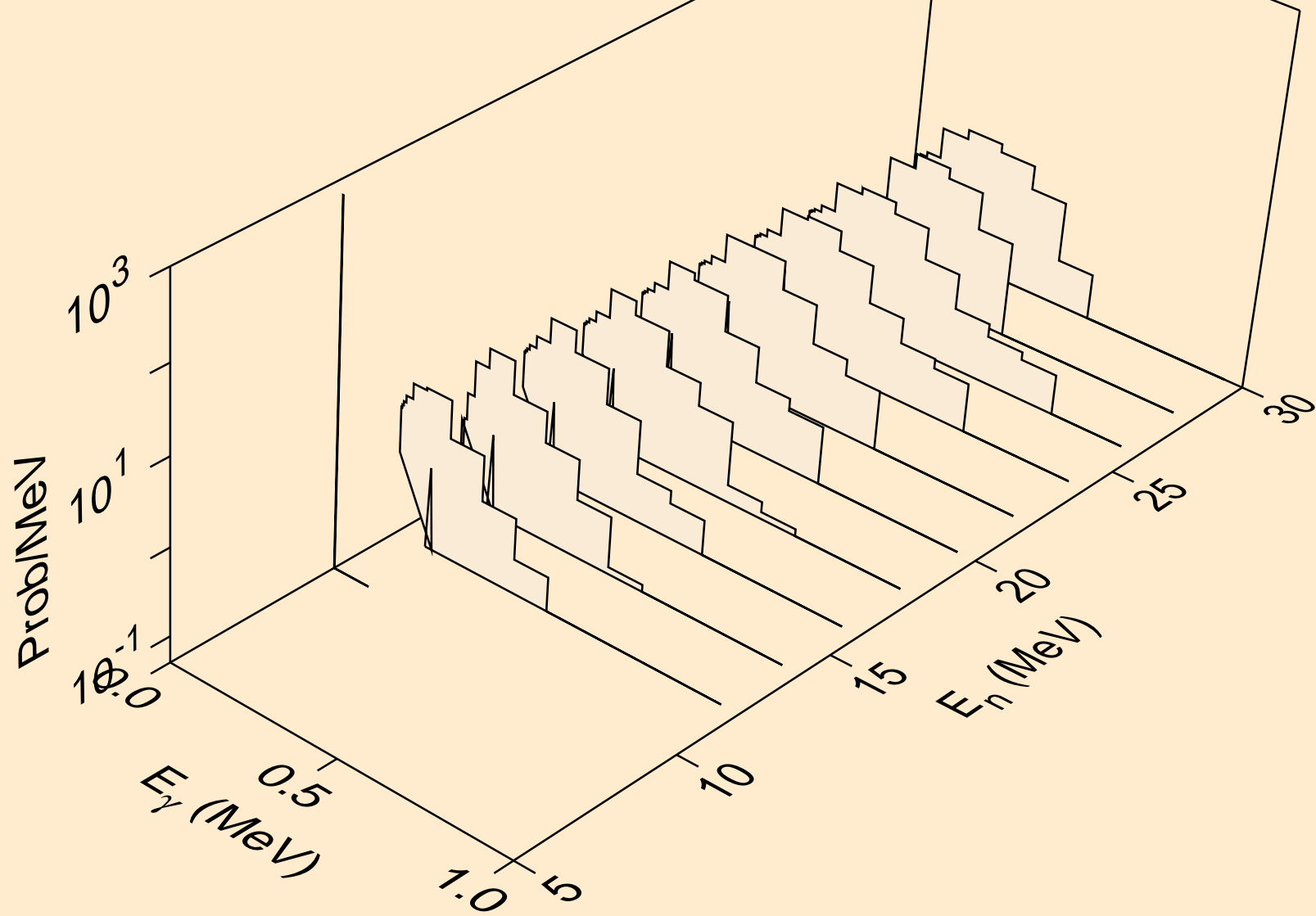

BH275 NEUTRON ACER TENDL-2021 LIBRARY; T=293.6K
Photon emission for (n,4n)

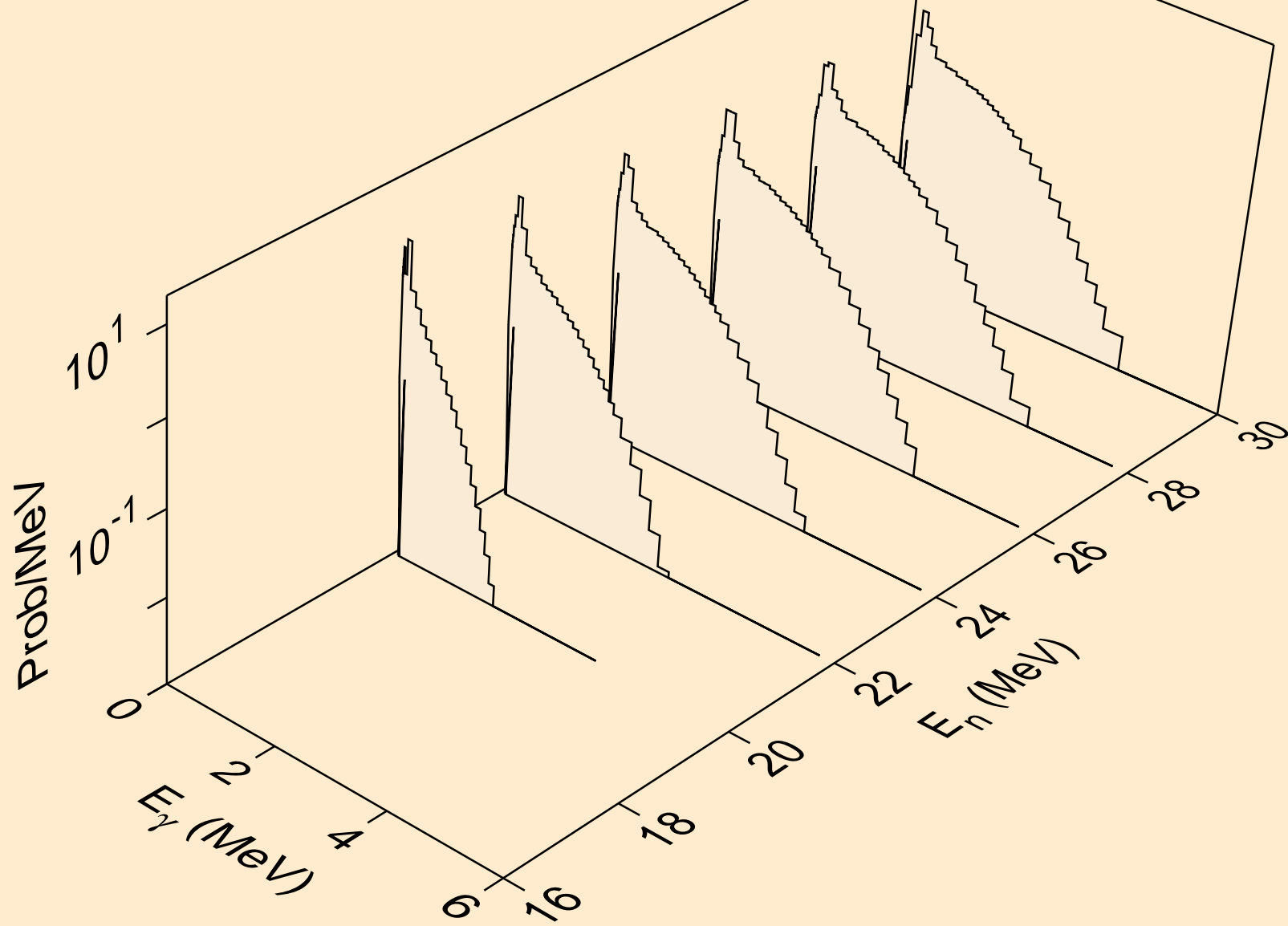

BH275 NEUTRON ACER TENDL-2021 LIBRARY; T=293.6K
Photon emission for (n,2np)

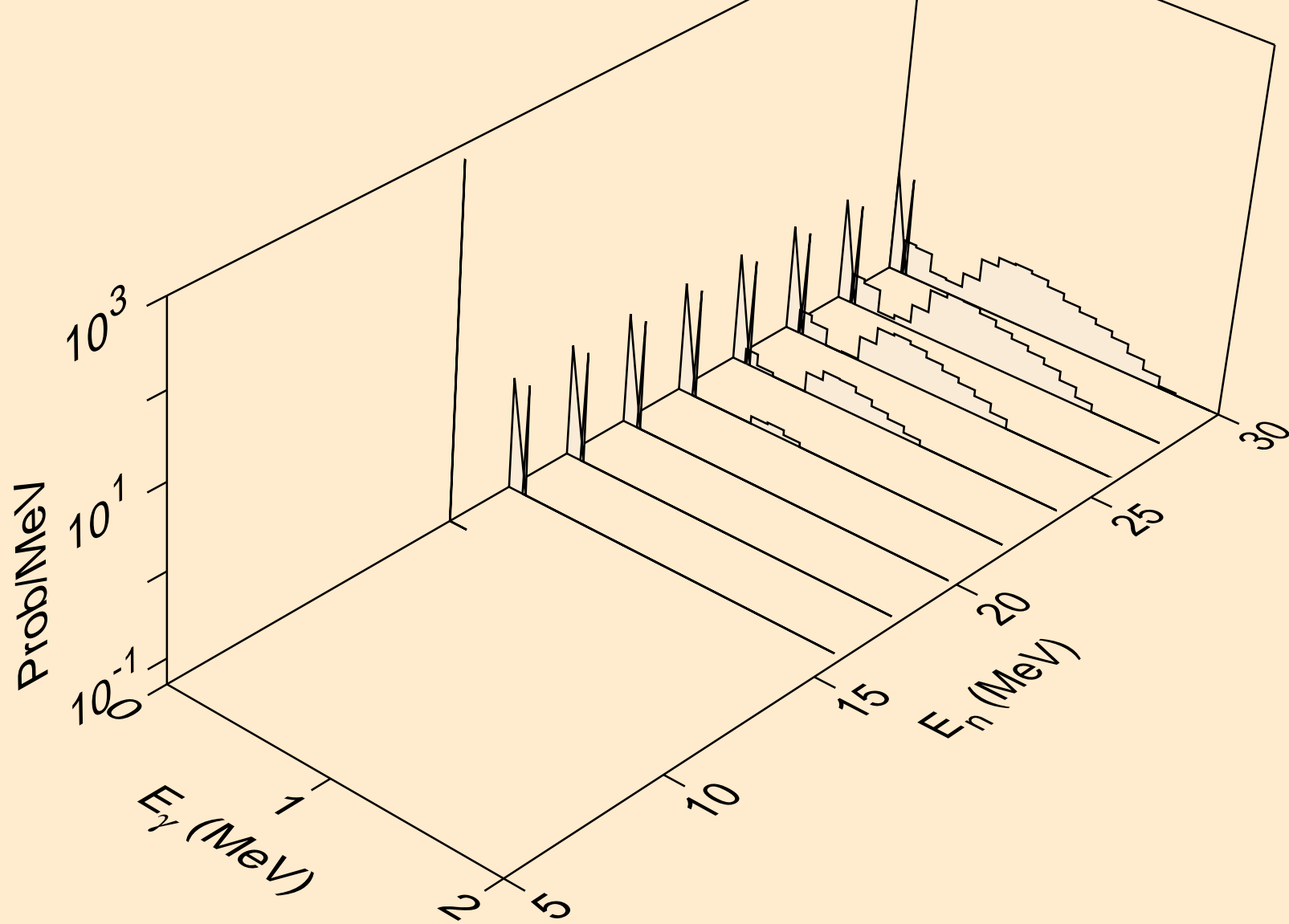

BH275 NEUTRON ACER TENDL-2021 LIBRARY; T=293.6K
Photon emission for (n,3np)

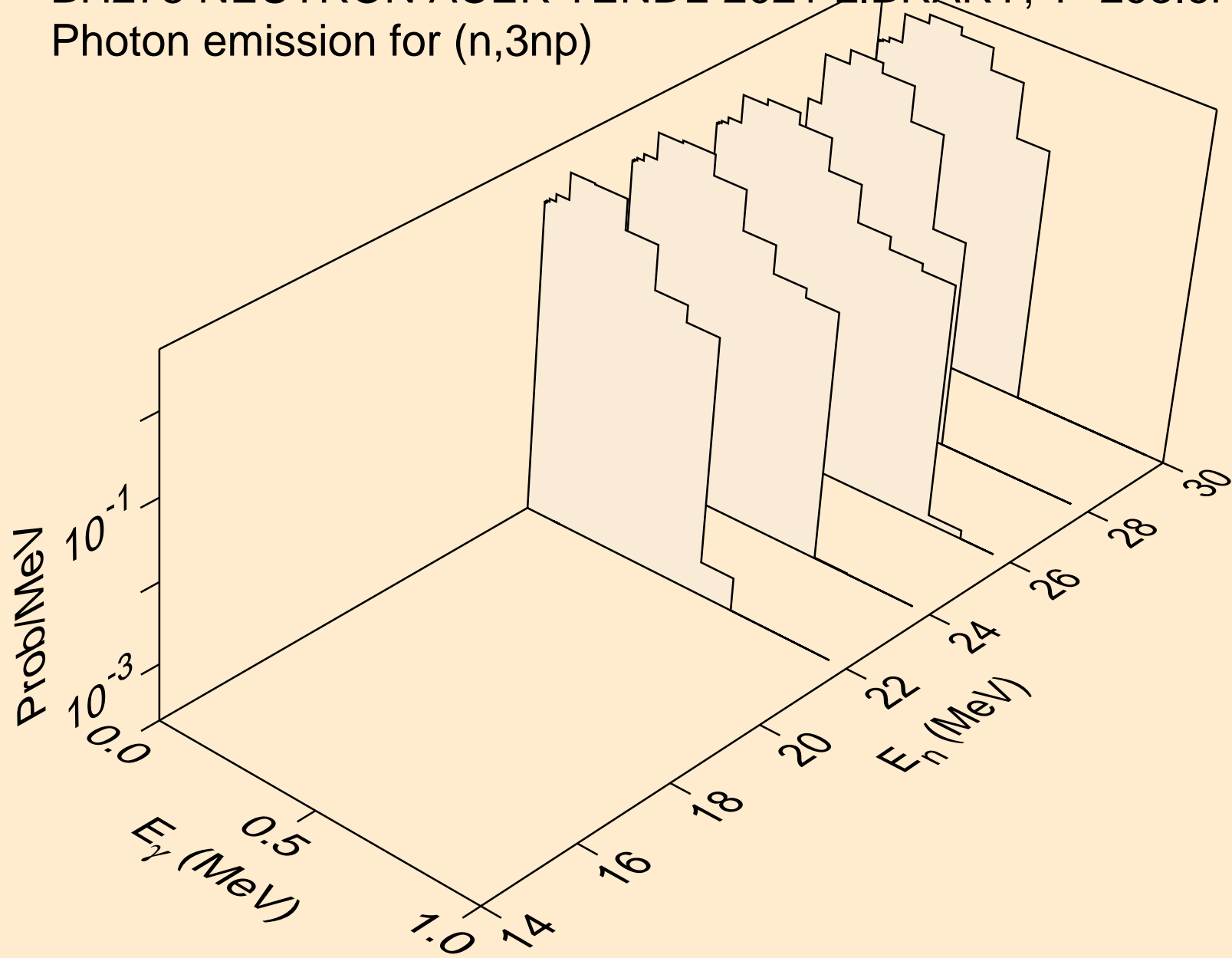

BH275 NEUTRON ACER TENDL-2021 LIBRARY; T=293.6K
Photon emission for (n,n*c)

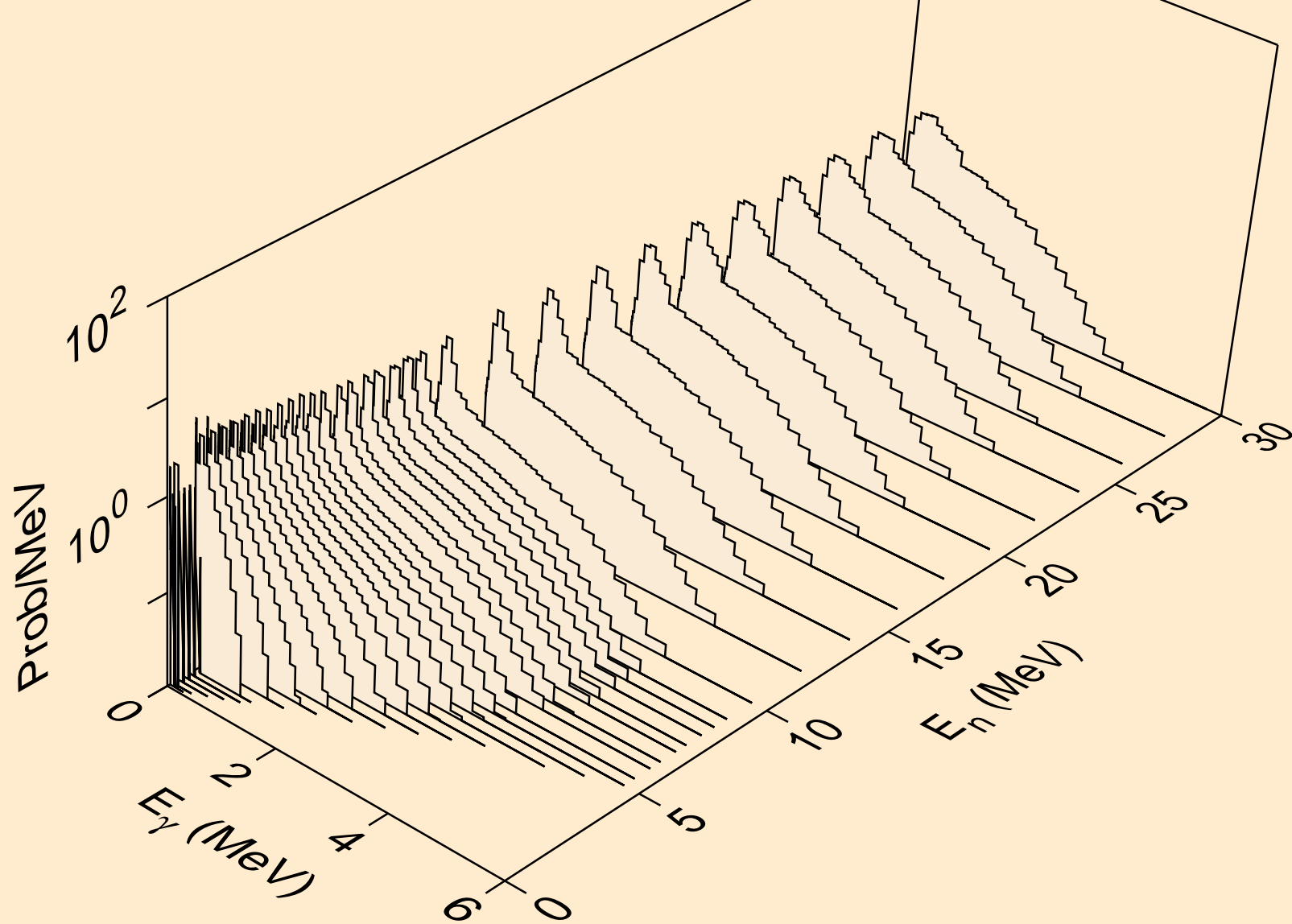

BH275 NEUTRON ACER TENDL-2021 LIBRARY; T=293.6K
Photon emission for (n,gma)

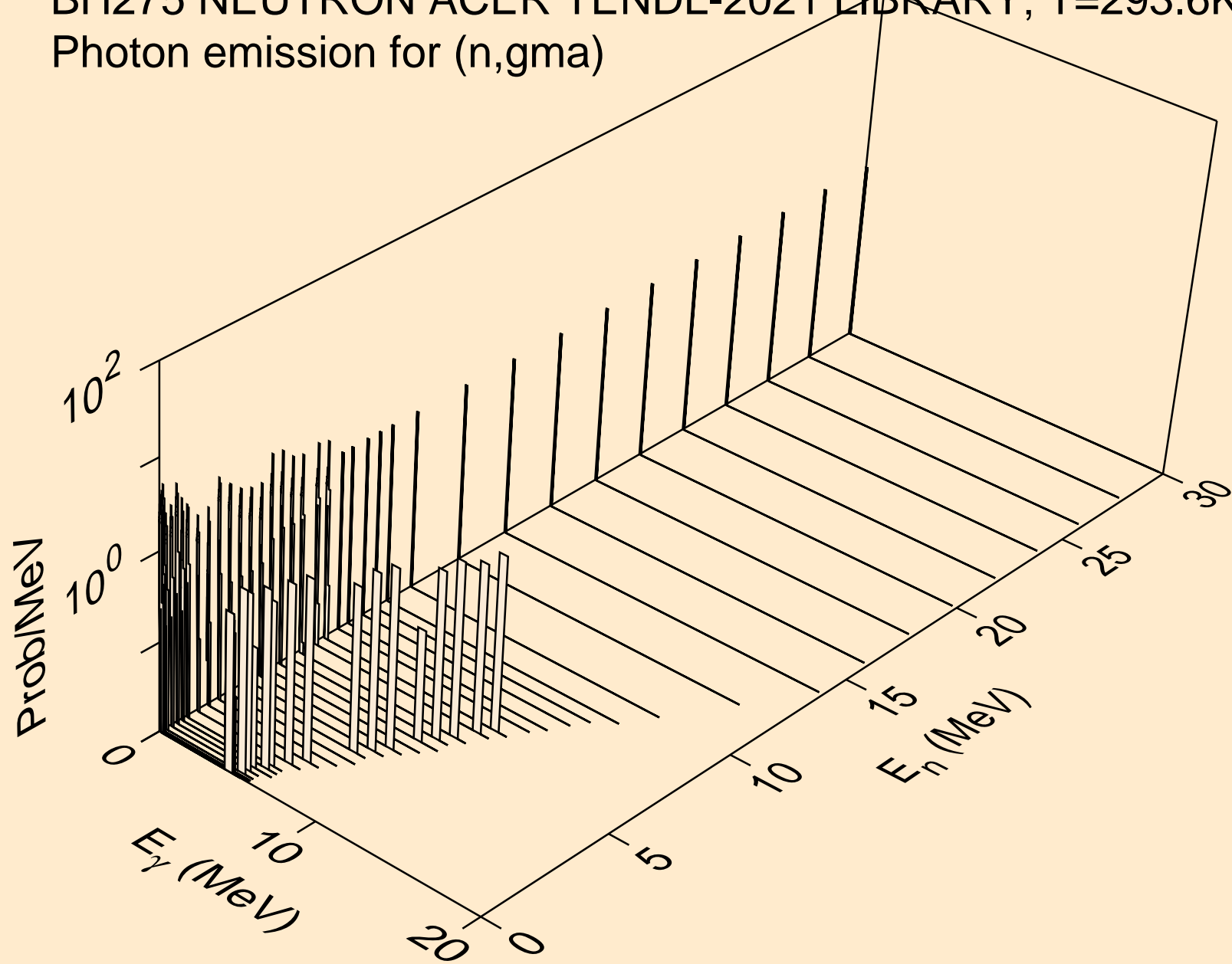

BH275 NEUTRON ACER TENDL-2021 LIBRARY; T=293.6K
Photon emission for (n,p)

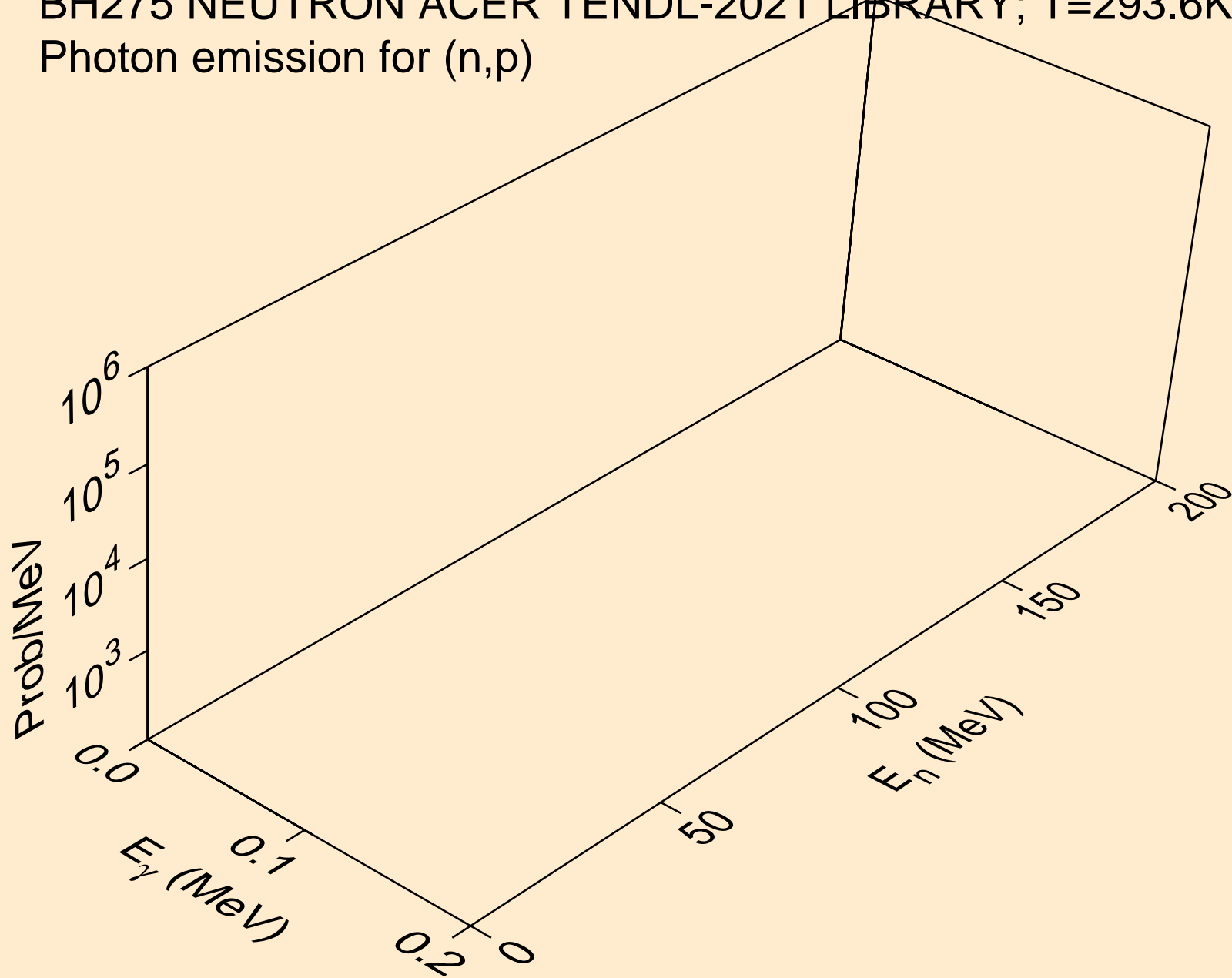

BH275 NEUTRON ACER TENDL-2021 LIBRARY; T=293.6K
Photon emission for (n,d)

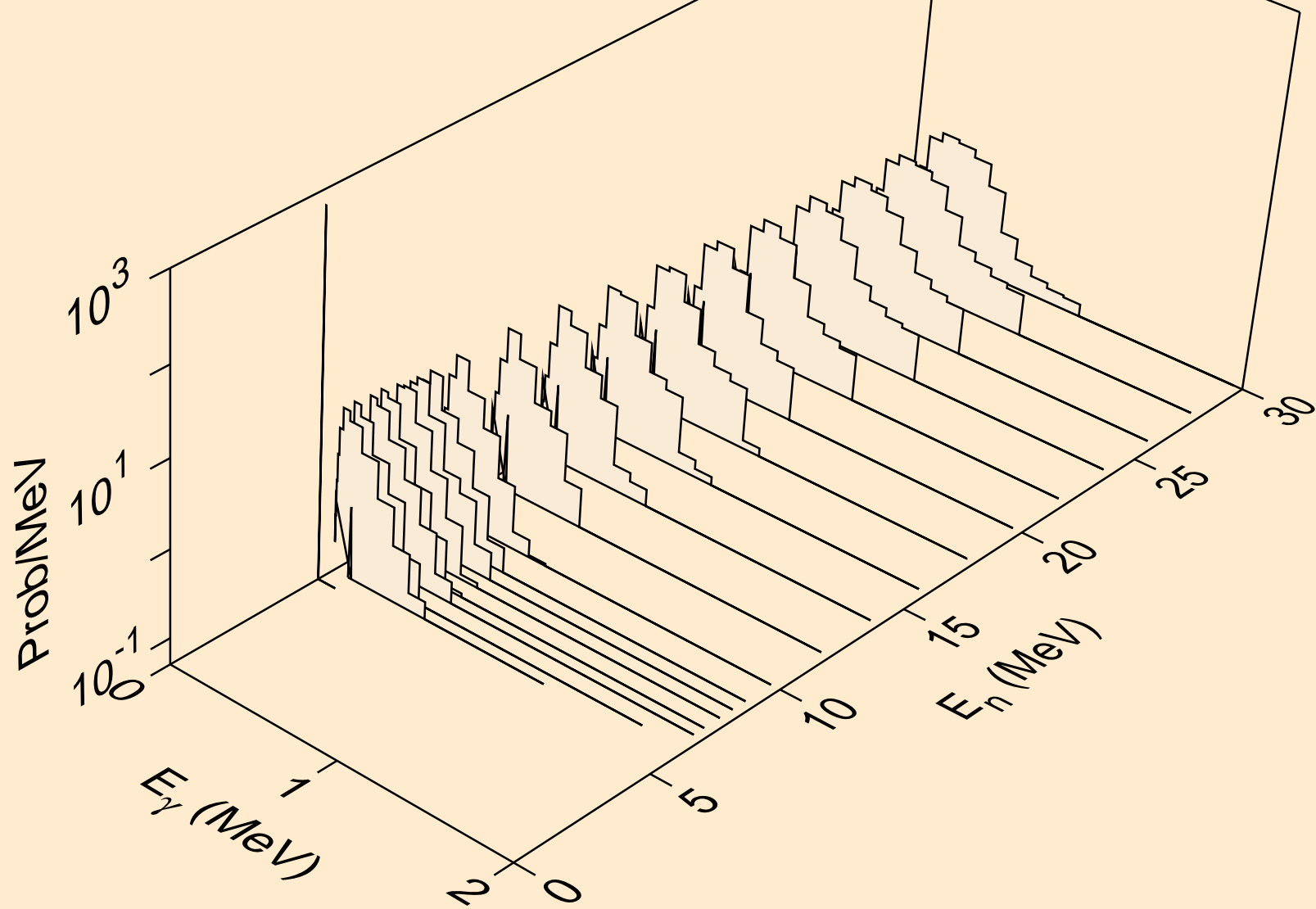

BH275 NEUTRON ACER TENDL-2021 LIBRARY; T=293.6K
Photon emission for (n,t)

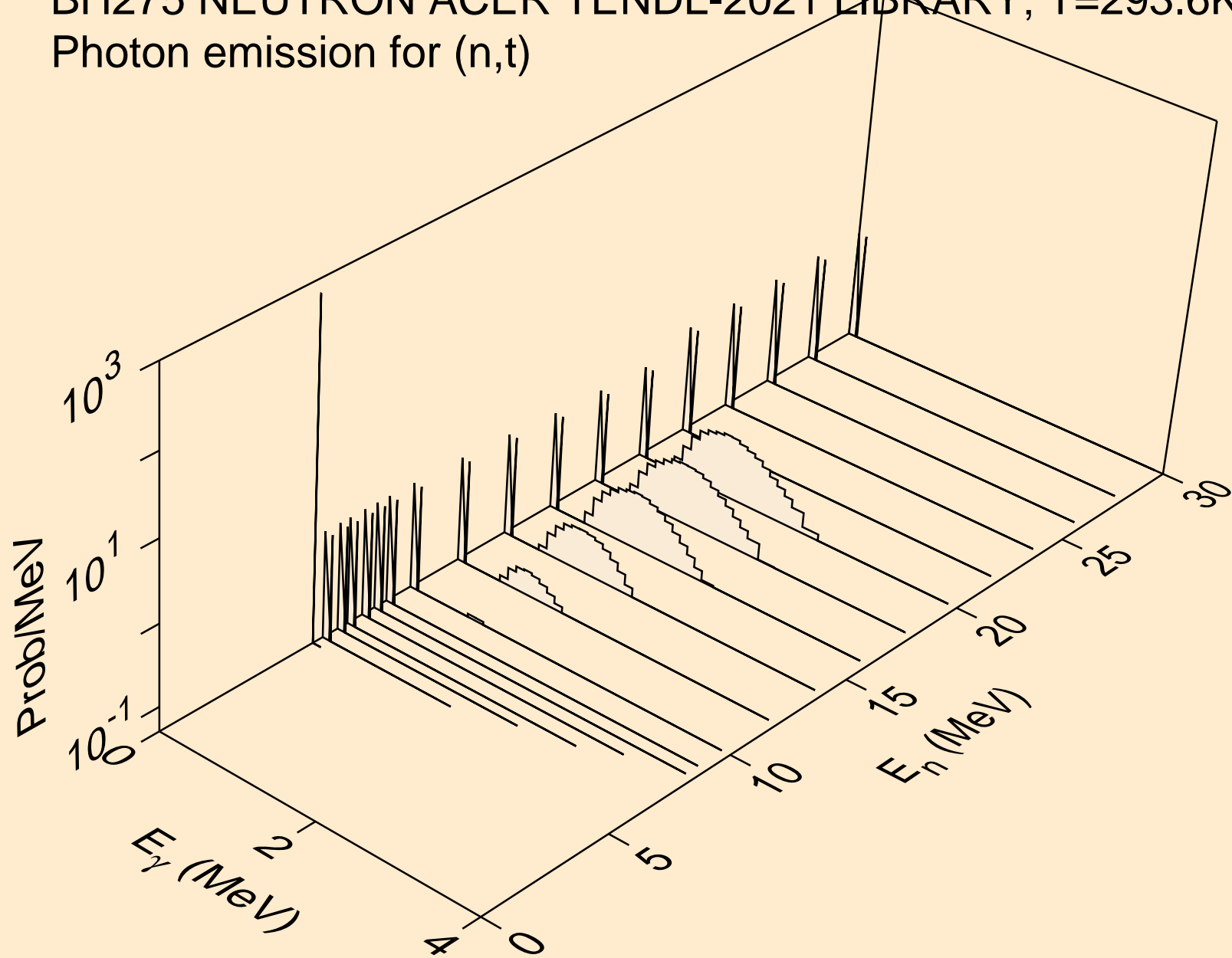

BH275 NEUTRON ACER TENDL-2021 LIBRARY; T=293.6K
Photon emission for (n,he3)

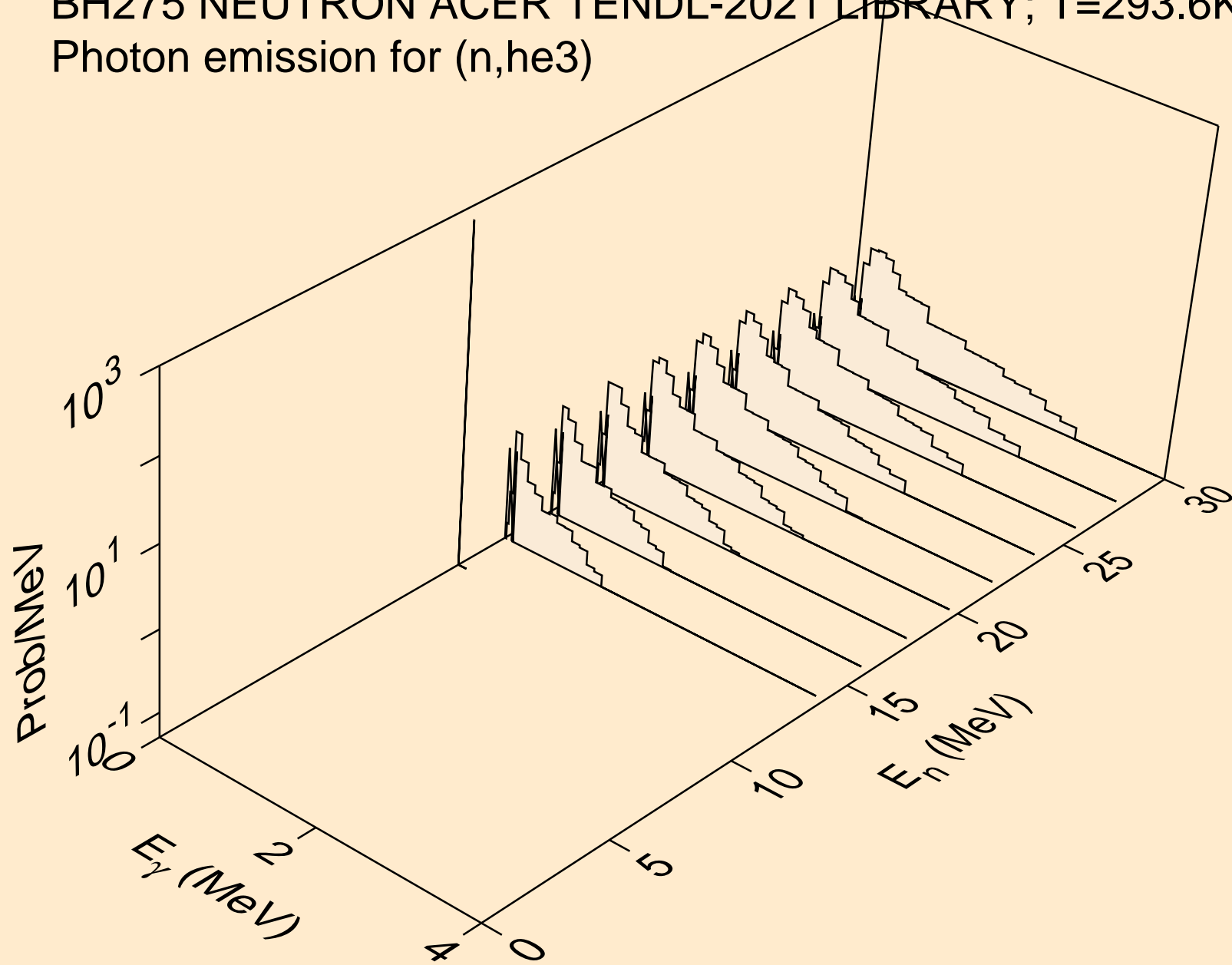

BH275 NEUTRON ACER TENDL-2021 LIBRARY; T=293.6K
Photon emission for (n,a)

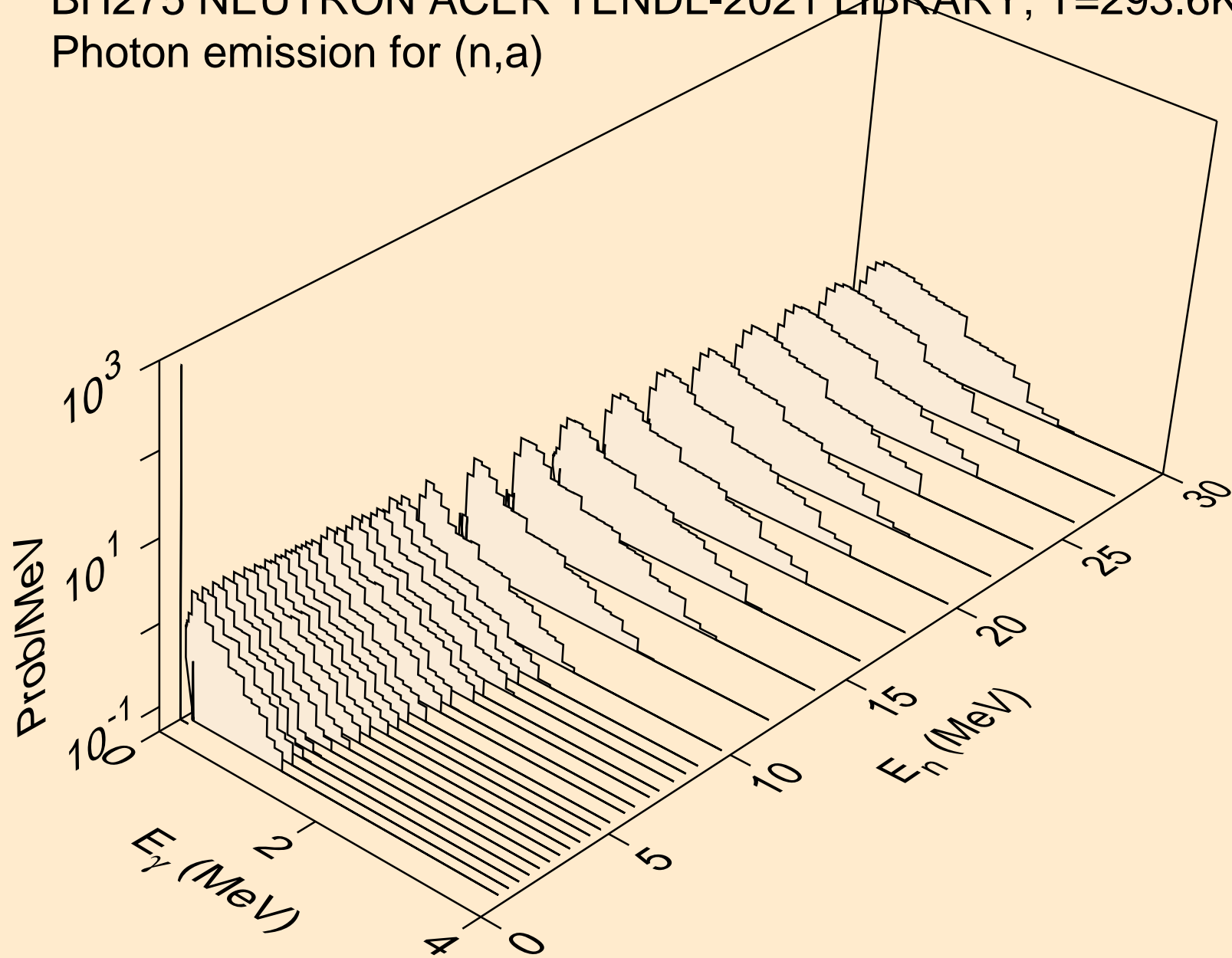

BH275 NEUTRON ACER TENDL-2021 LIBRARY; T=293.6K
Photon emission for (n,2p)

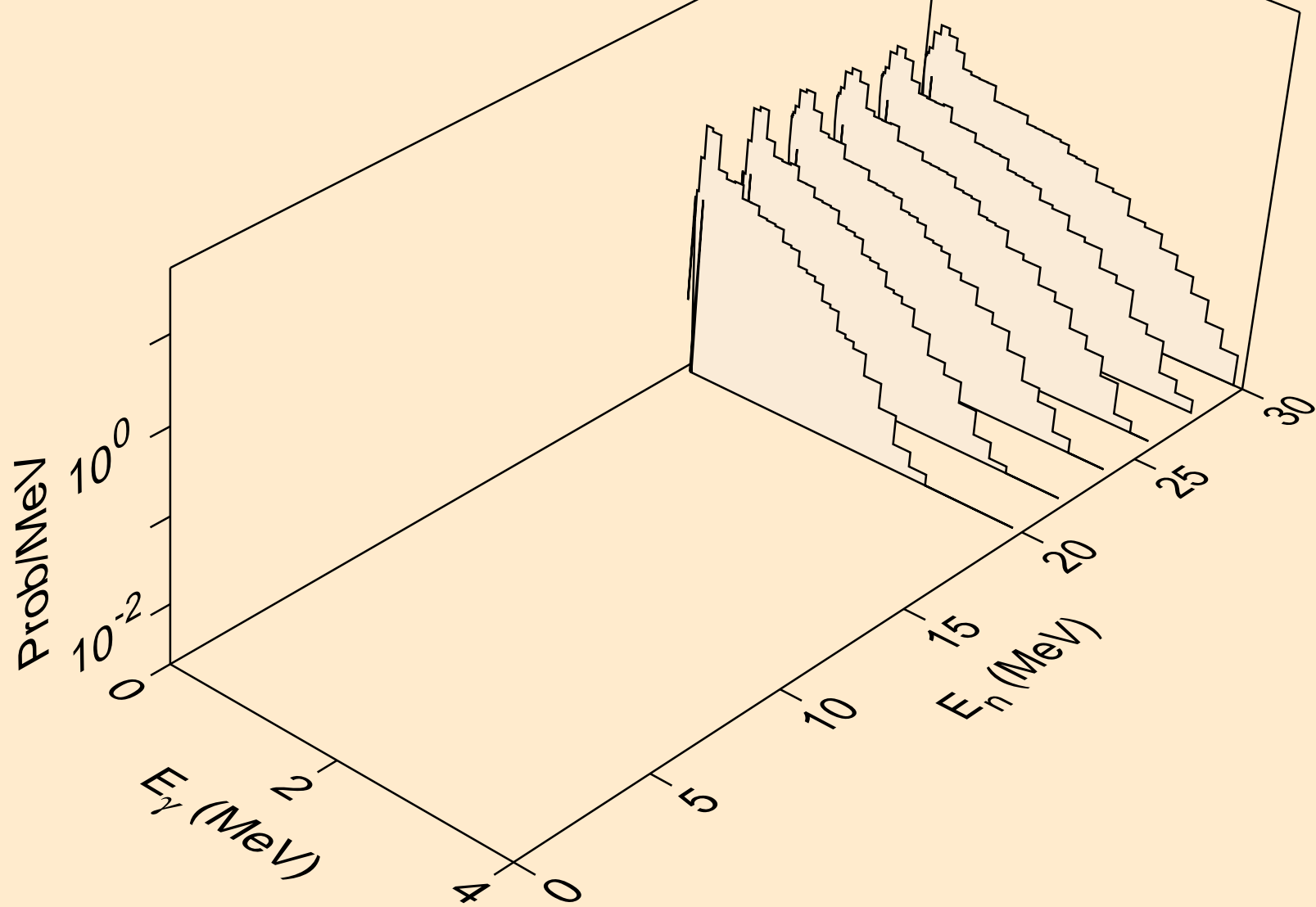

BH275 NEUTRON ACER TENDL-2021 LIBRARY; T=293.6K
thermal capture photon spectrum

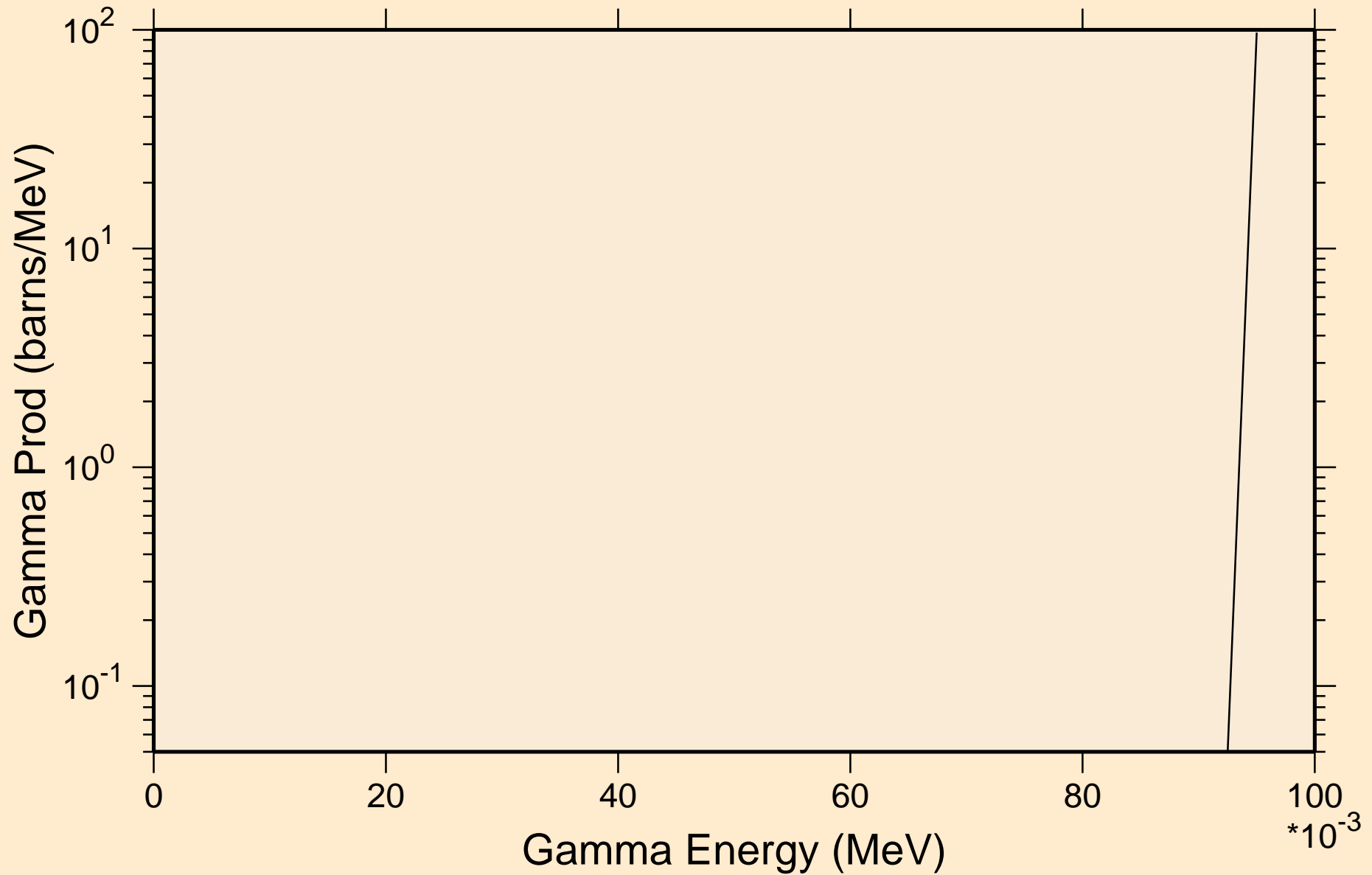

BH275 NEUTRON ACER TENDL-2021 LIBRARY; T=293.6K
14 MeV photon spectrum

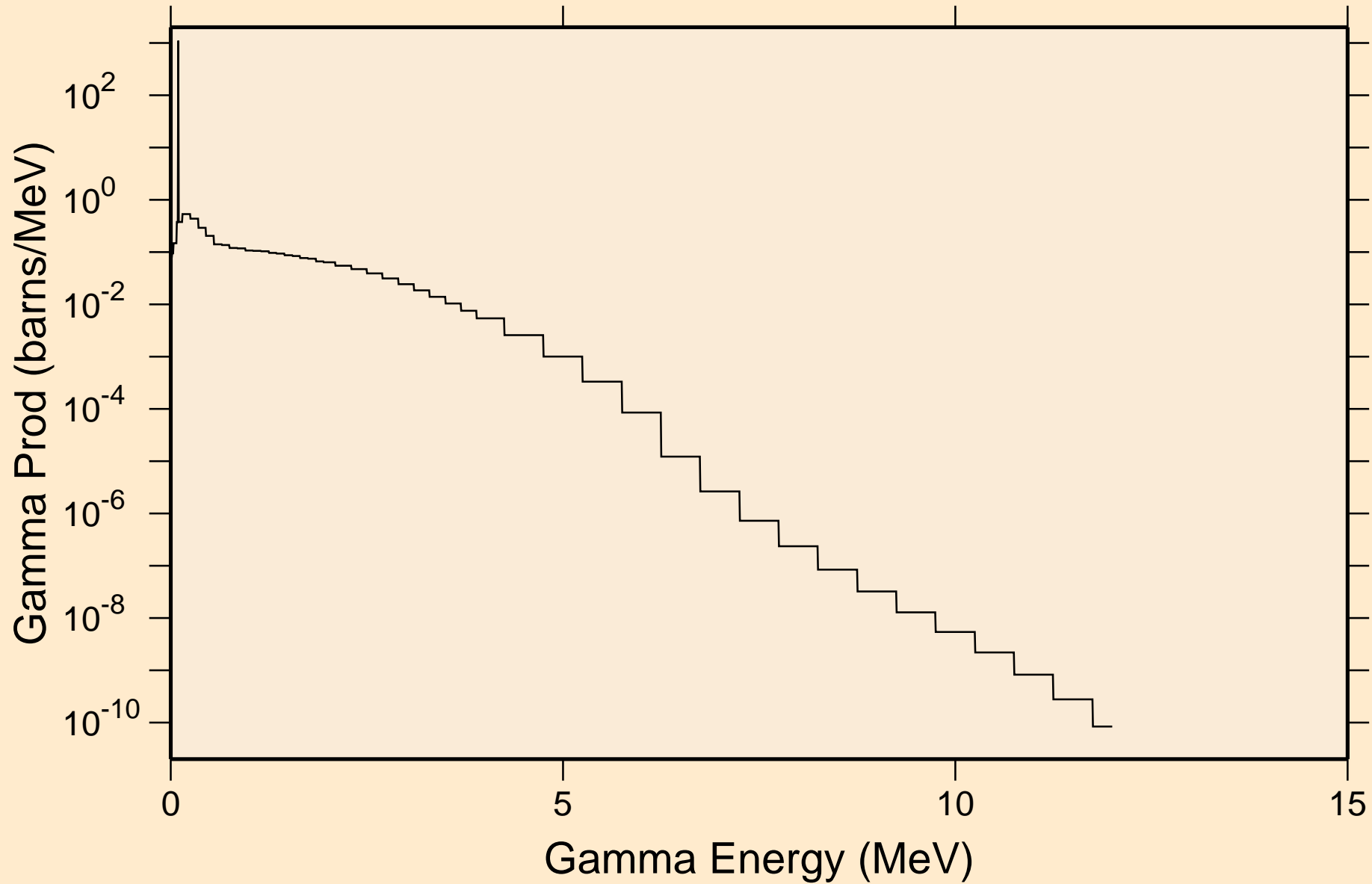

BH275 NEUTRON ACER TENDL-2021 LIBRARY; T=293.6K

Particle heating contributions

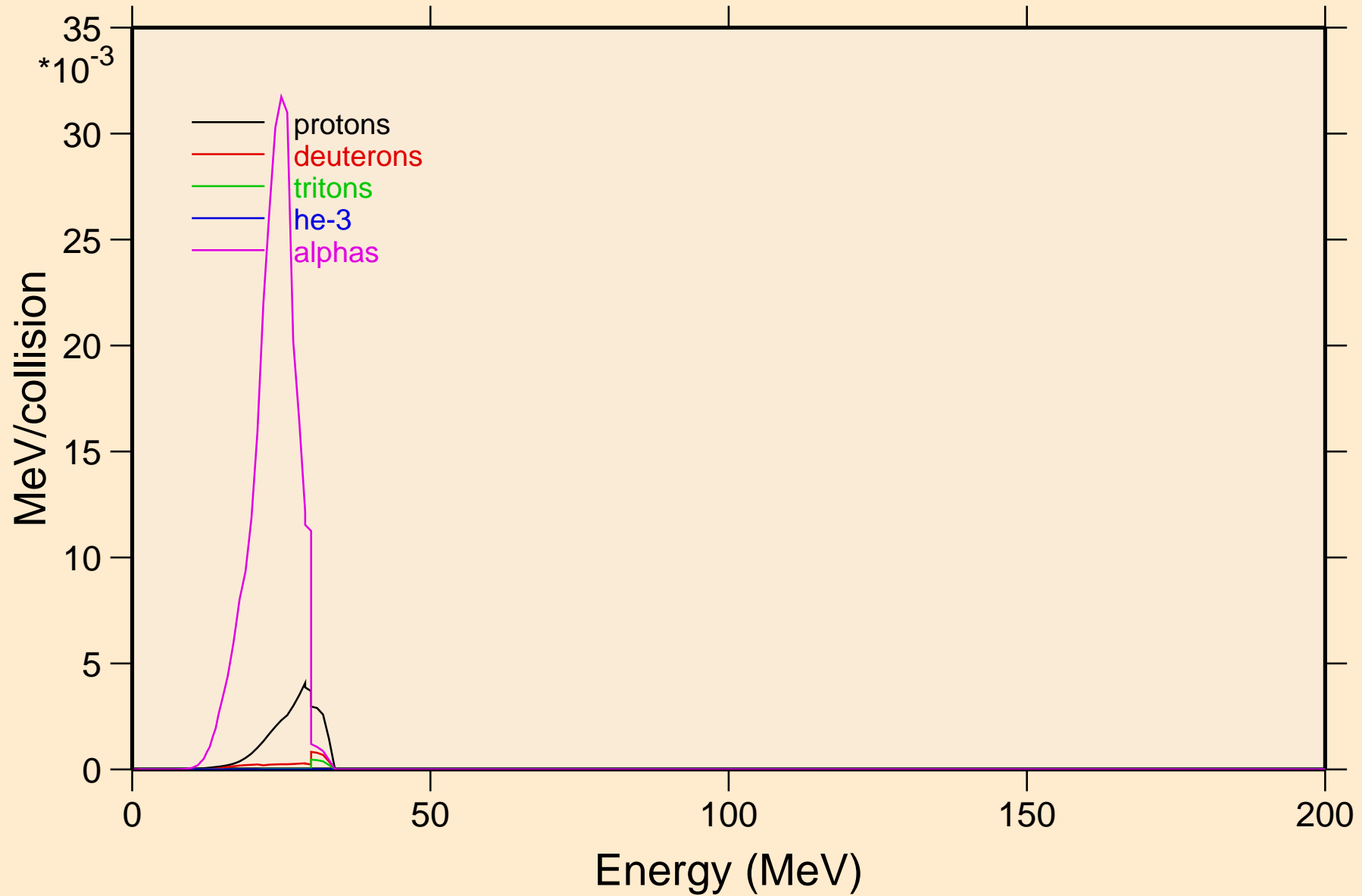

BH275 NEUTRON ACER TENDL-2021 LIBRARY; T=293.6K
Recoil Heating

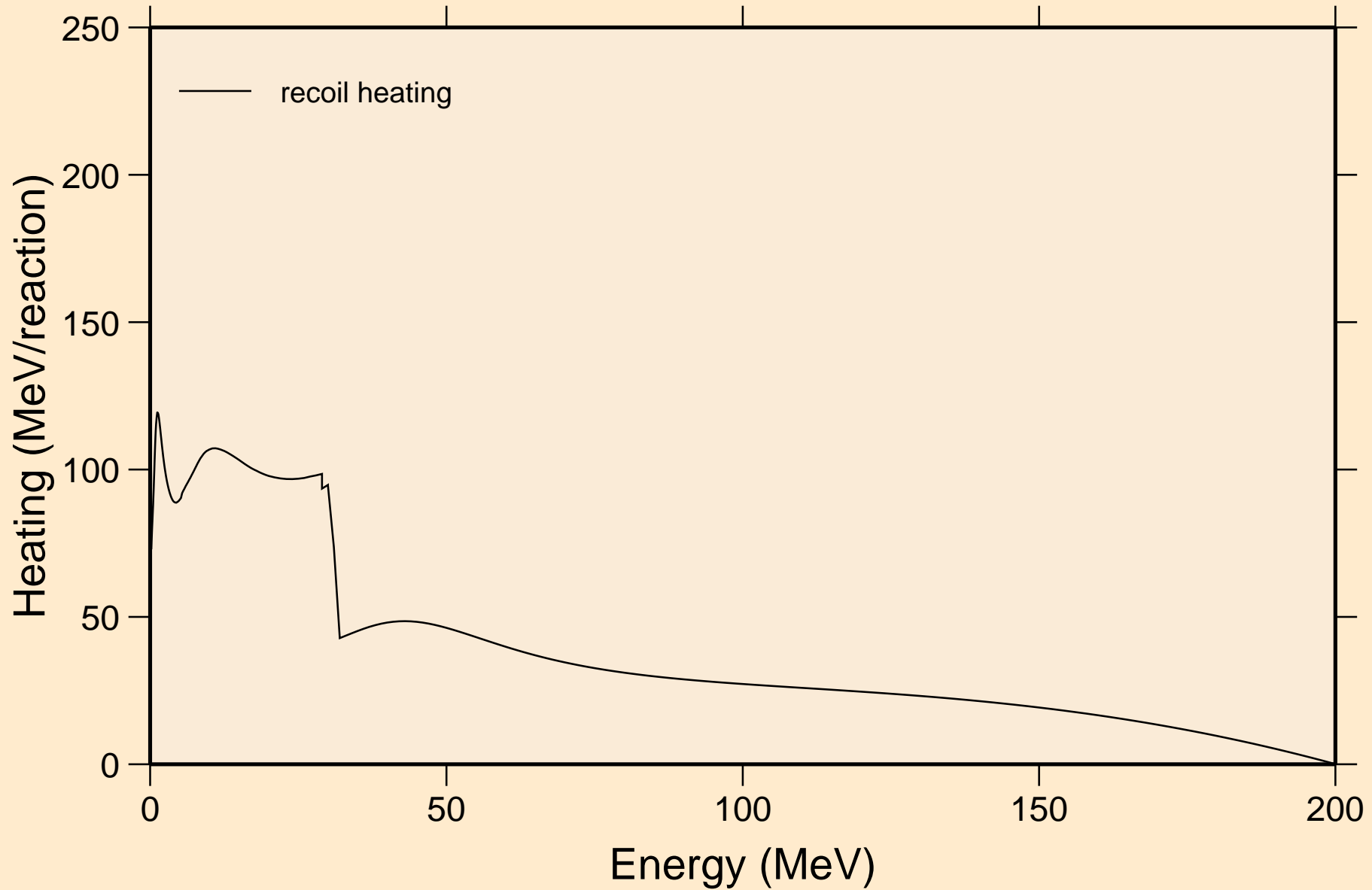

BH275 NEUTRON ACER TENDL-2021 LIBRARY; T=293.6K
Particle production cross sections

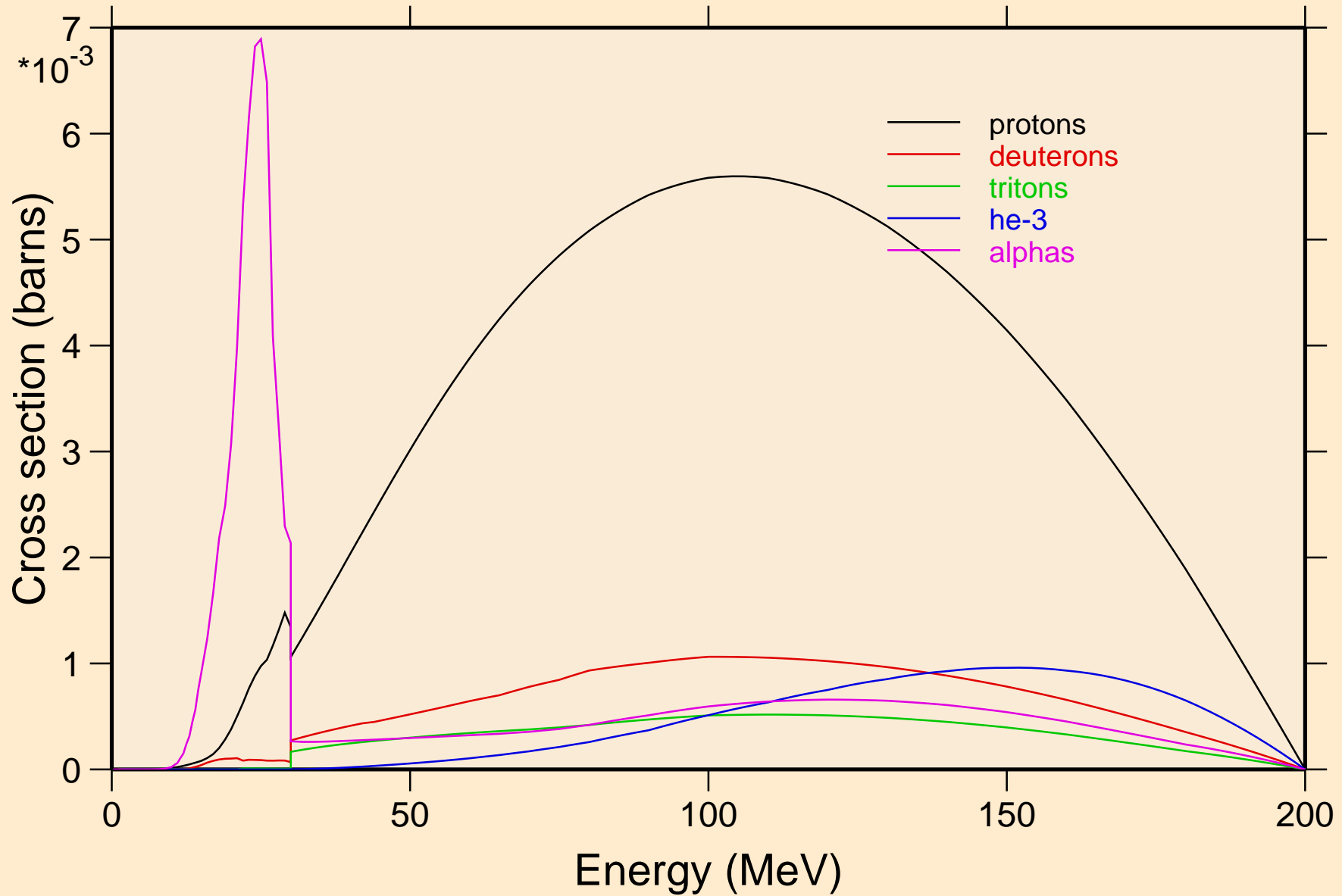

BH275 NEUTRON ACER TENDL-2021 LIBRARY; T=293.6K
protons from (n,x)

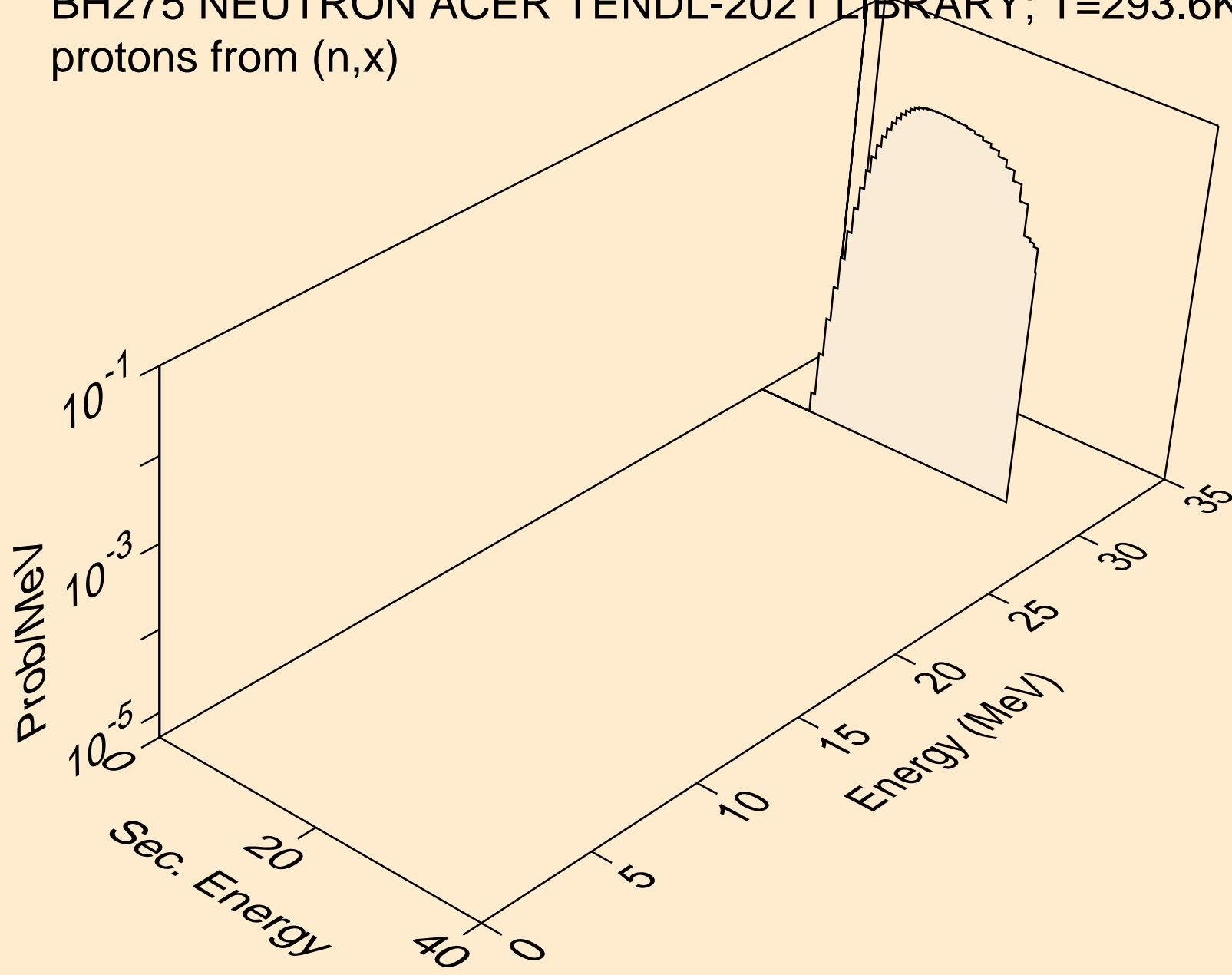

BH275 NEUTRON ACER TENDL-2021 LIBRARY; T=293.6K
protons from (n,n*)p

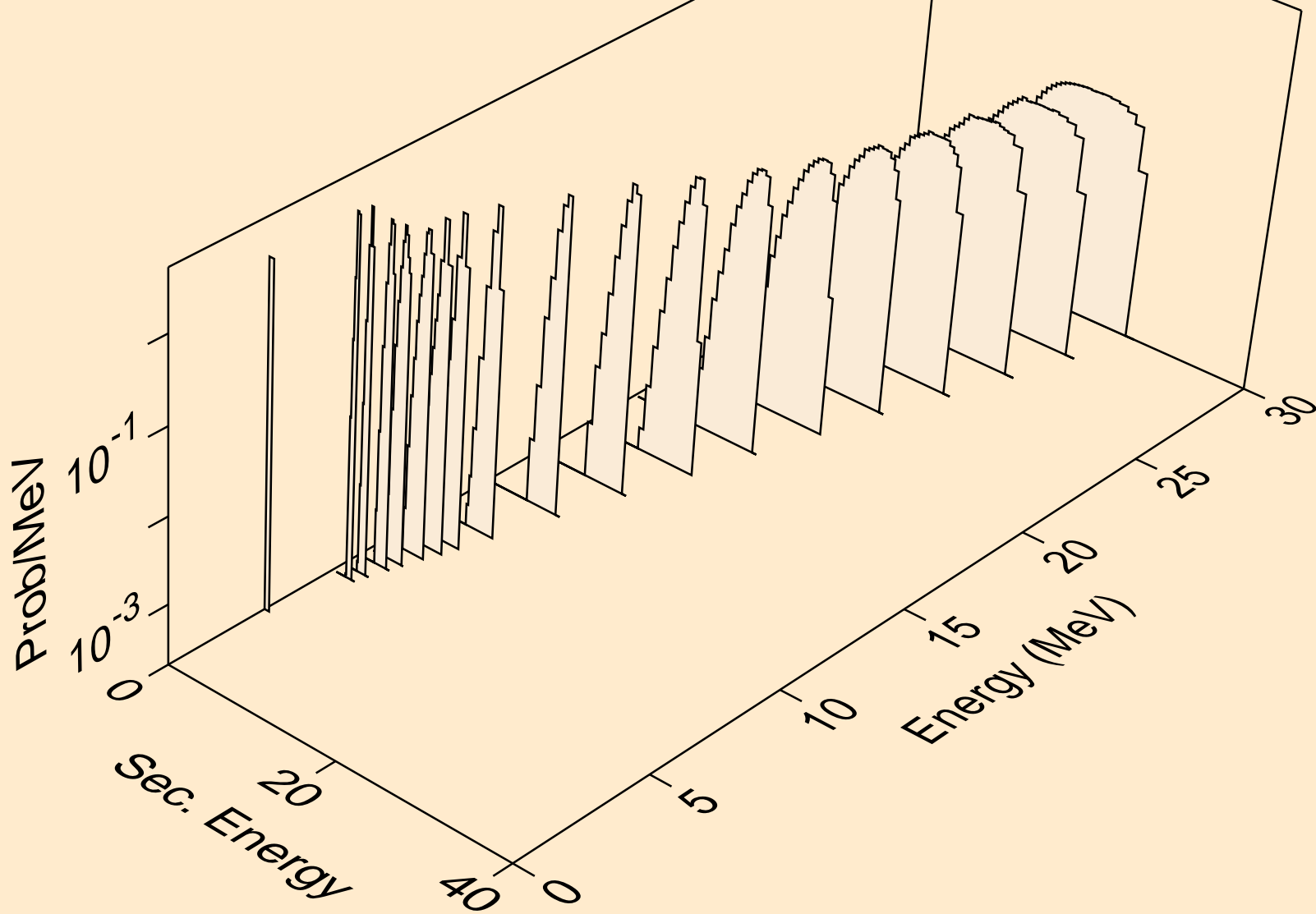

BH275 NEUTRON ACER TENDL-2021 LIBRARY; T=293.6K
protons from (n,2np)

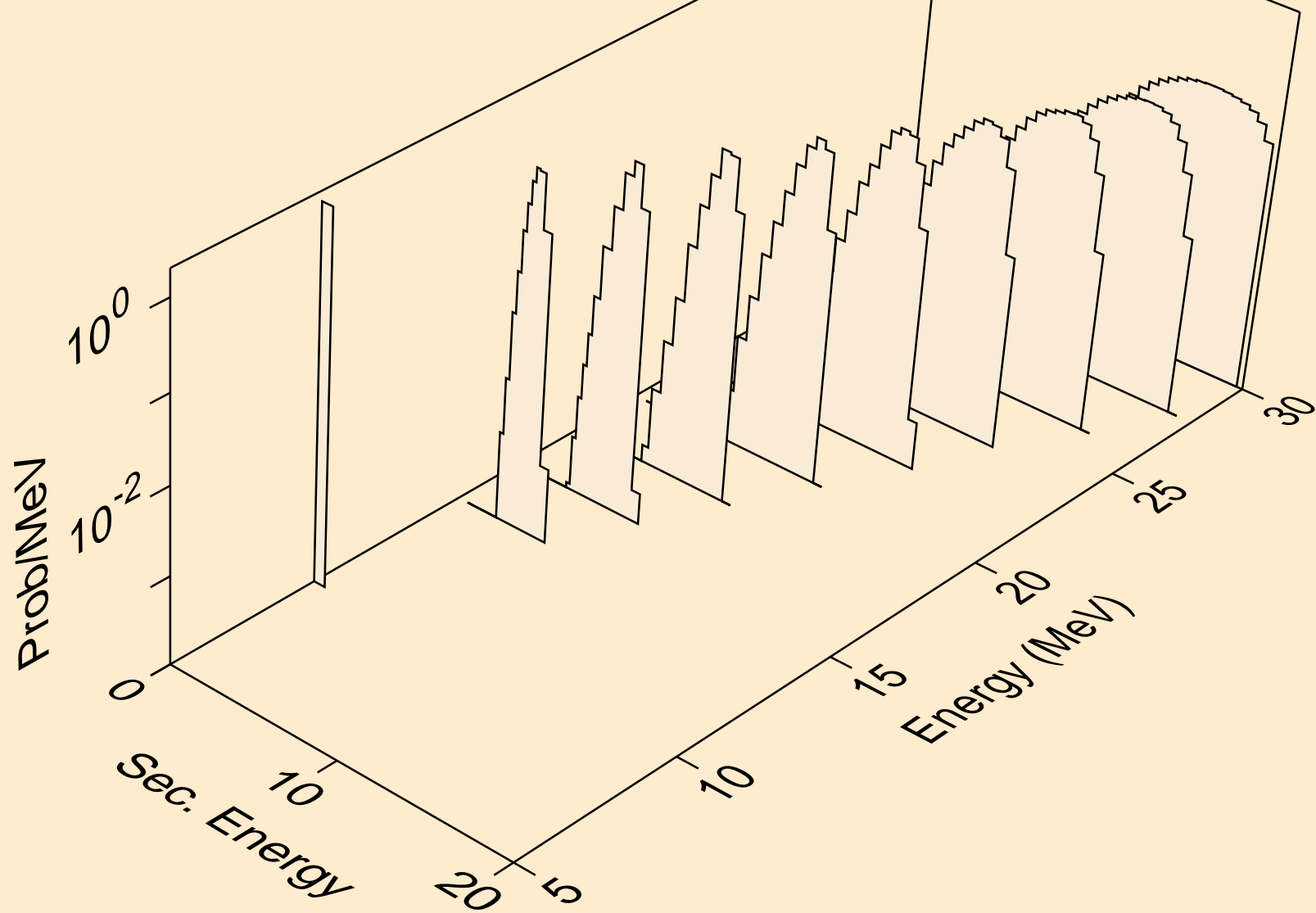

BH275 NEUTRON ACER TENDL-2021 LIBRARY; T=293.6K
protons from (n,3np)

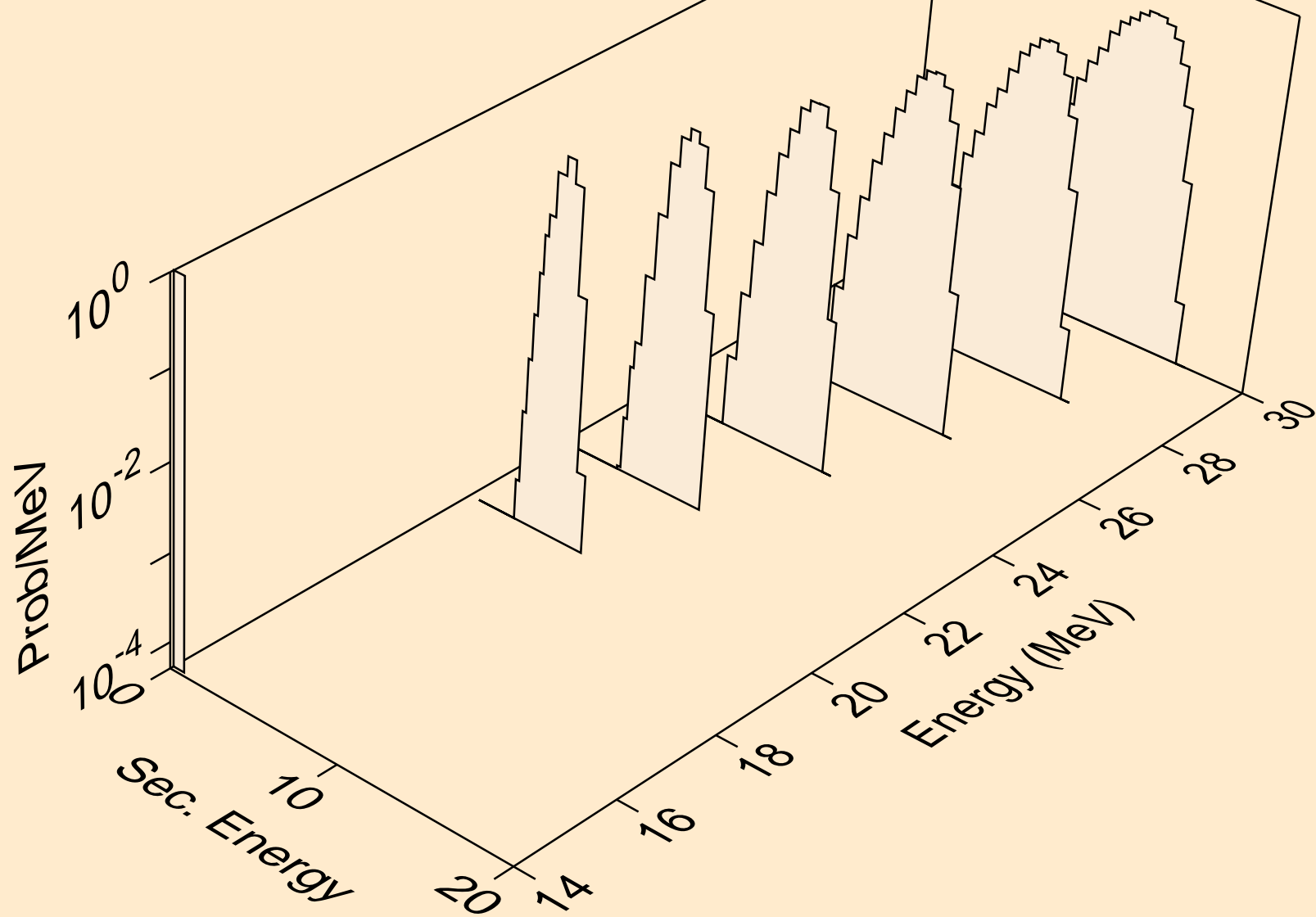

BH275 NEUTRON ACER TENDL-2021 LIBRARY; T=293.6K
protons from (n,p)

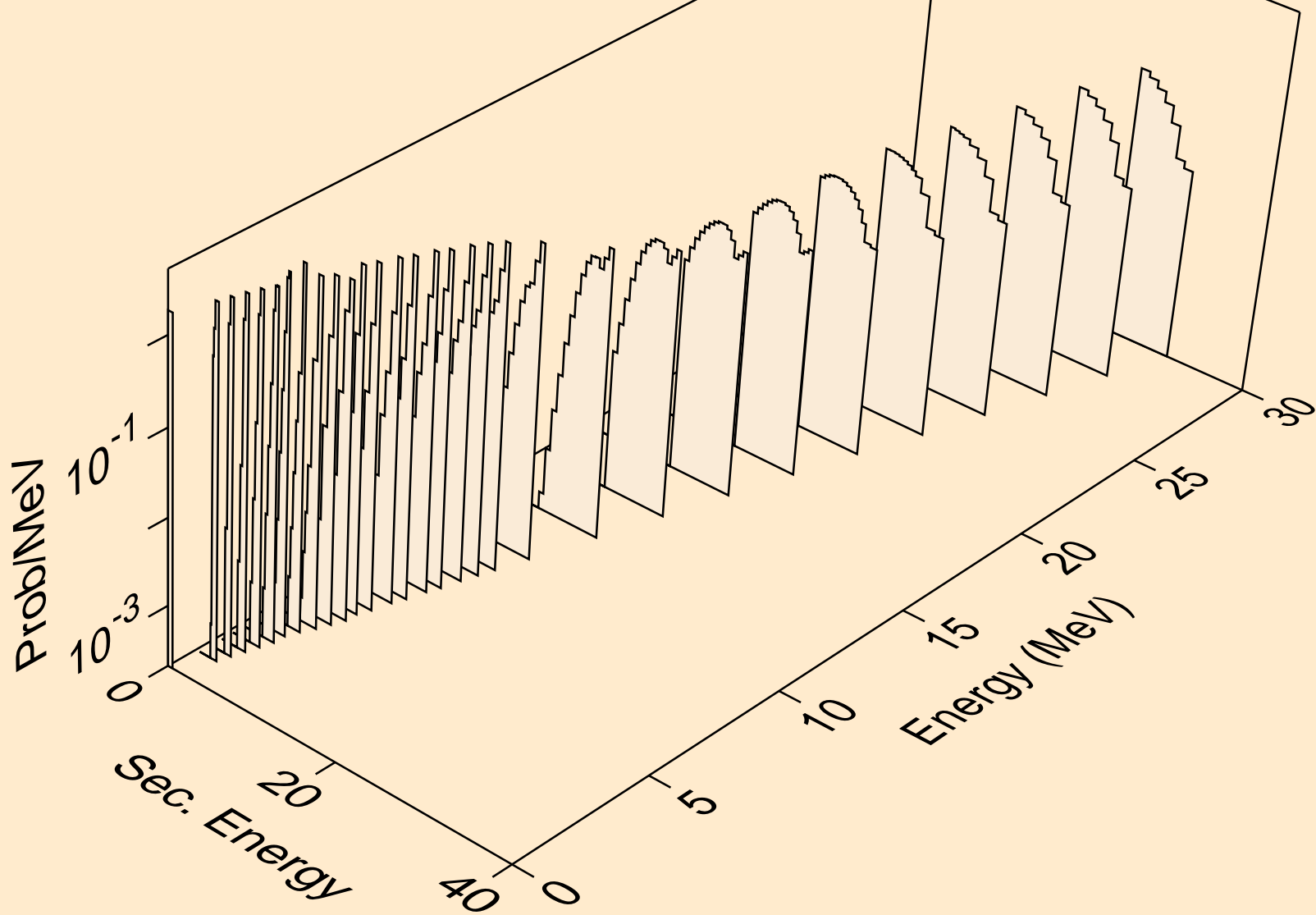

BH275 NEUTRON ACER TENDL-2021 LIBRARY; T=293.6K
protons from (n,2p)

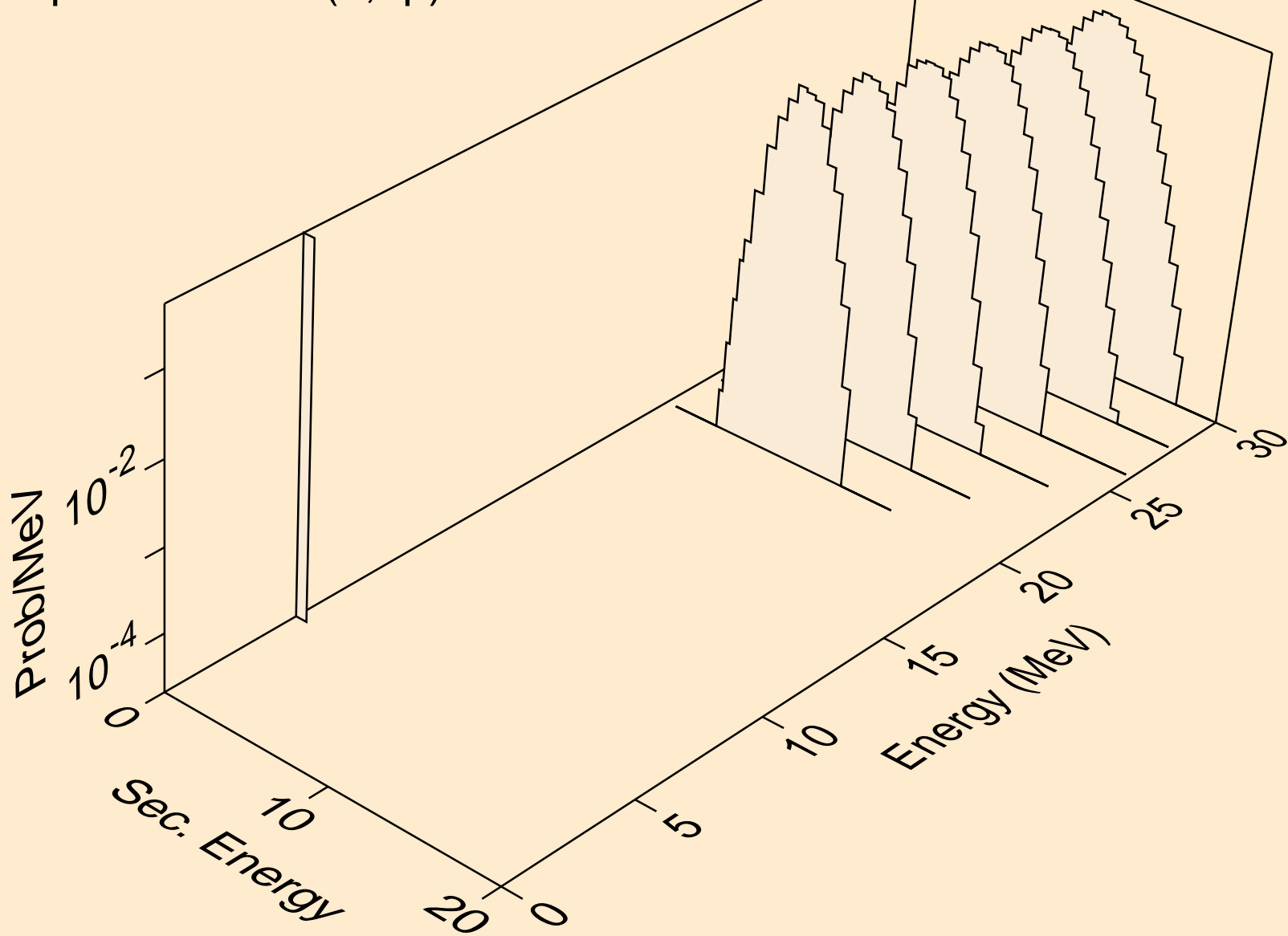

BH275 NEUTRON ACER TENDL-2021 LIBRARY; T=293.6K
deuterons from (n,x)

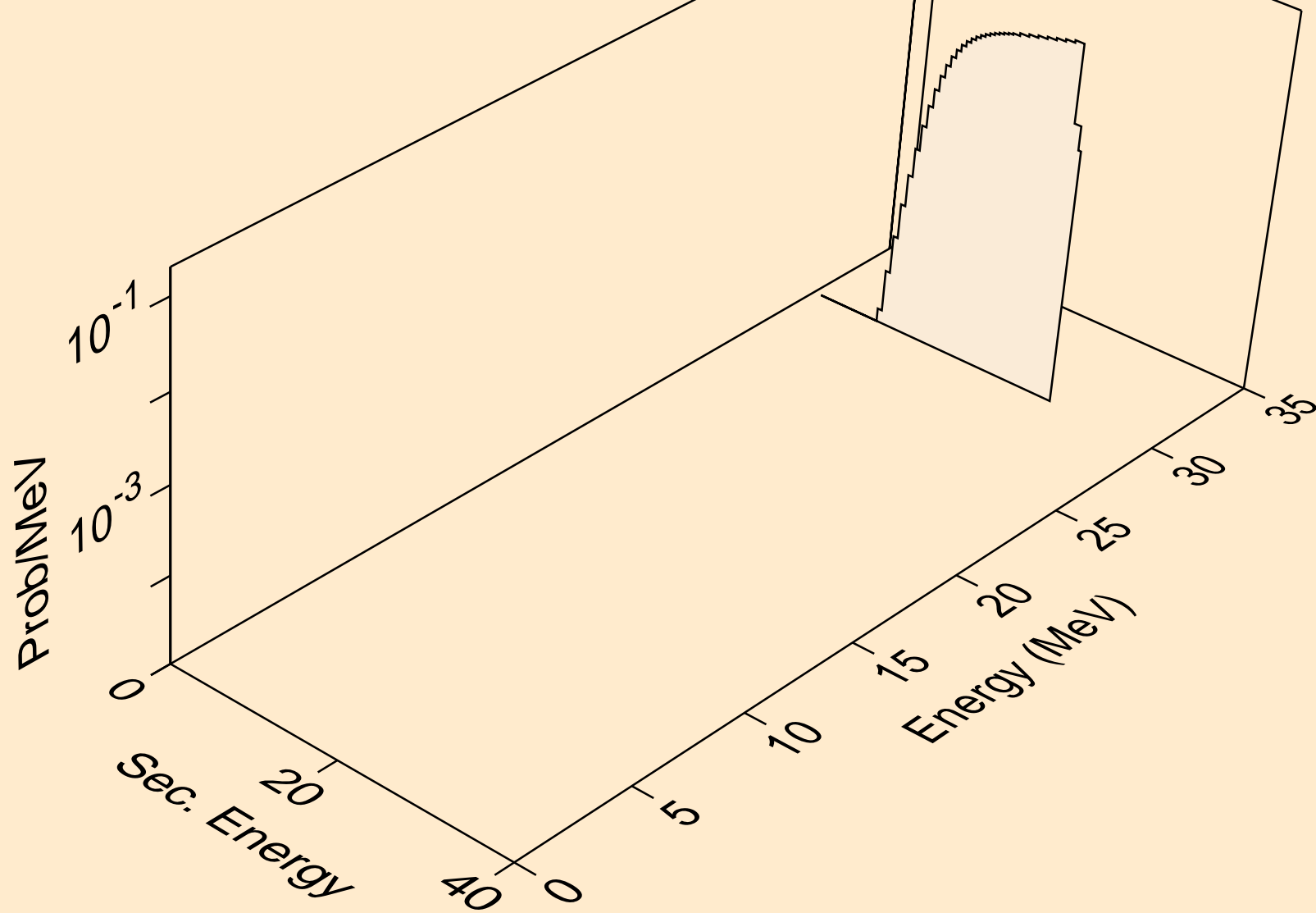

BH275 NEUTRON ACER TENDL-2021 LIBRARY; T=293.6K
deuterons from (n,n*)d

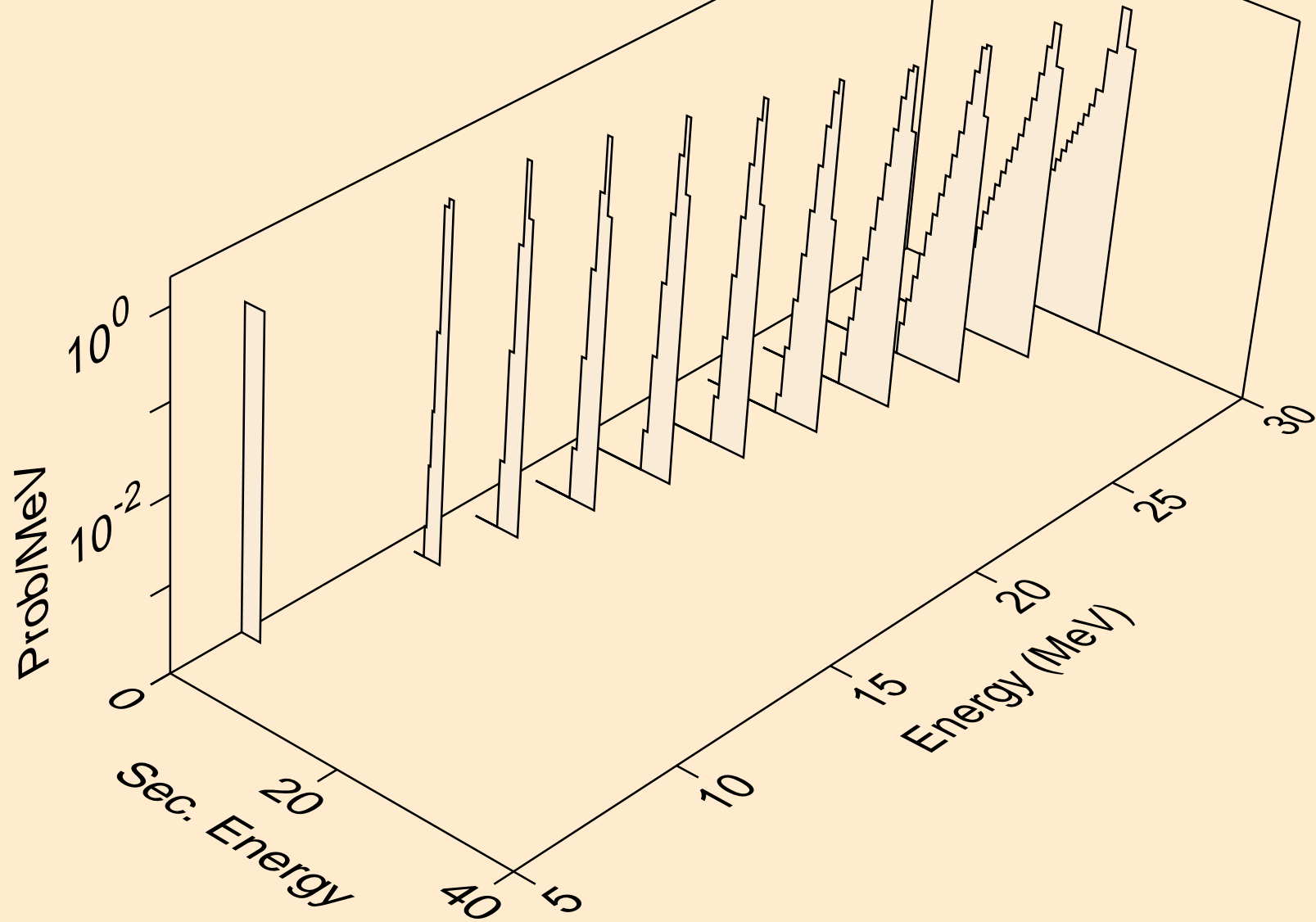

BH275 NEUTRON ACER TENDL-2021 LIBRARY; T=293.6K
deuterons from (n,d)

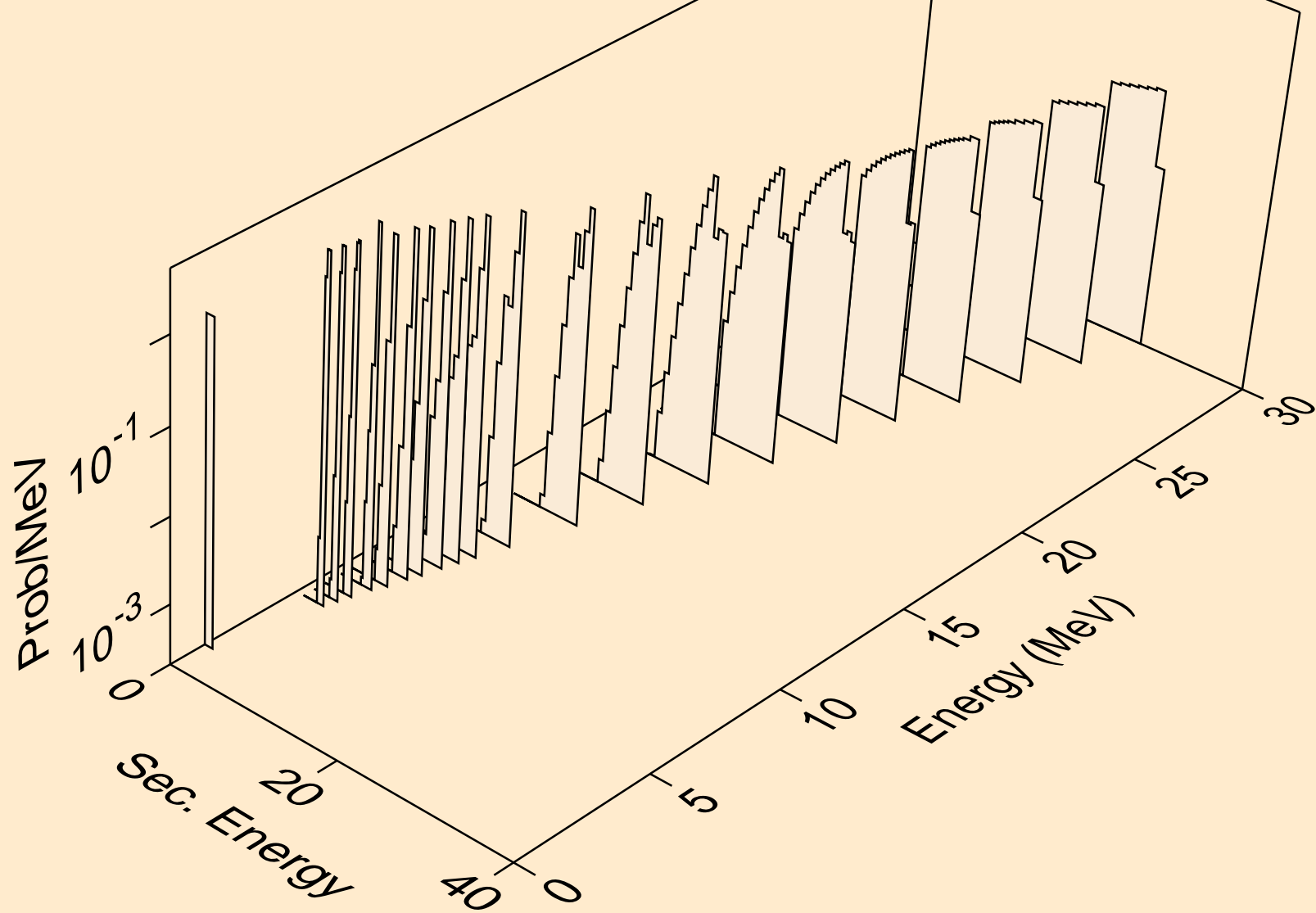

BH275 NEUTRON ACER TENDL-2021 LIBRARY; T=293.6K
tritons from (n,x)

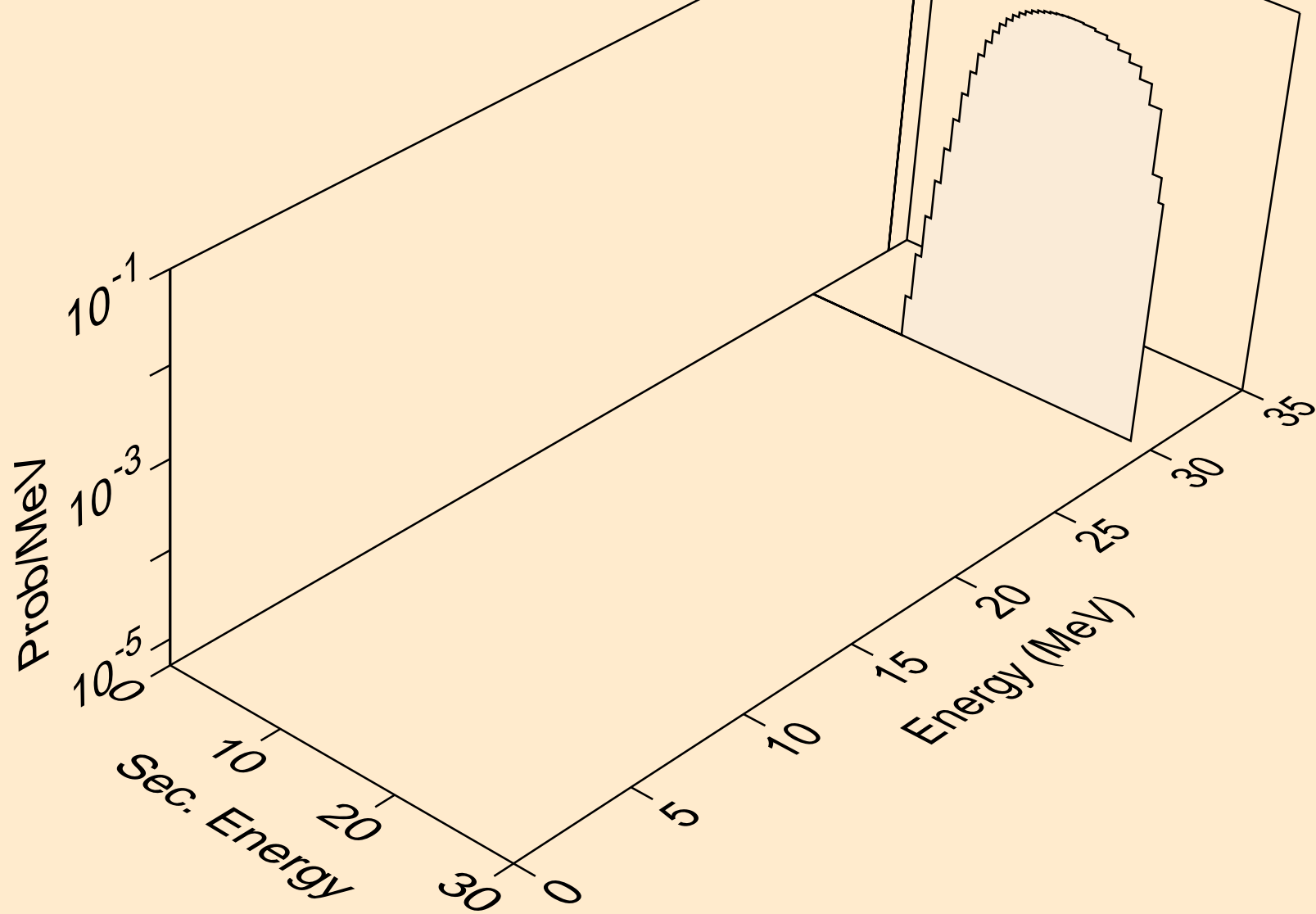

BH275 NEUTRON ACER TENDL-2021 LIBRARY; T=293.6K
tritons from (n,n*)t

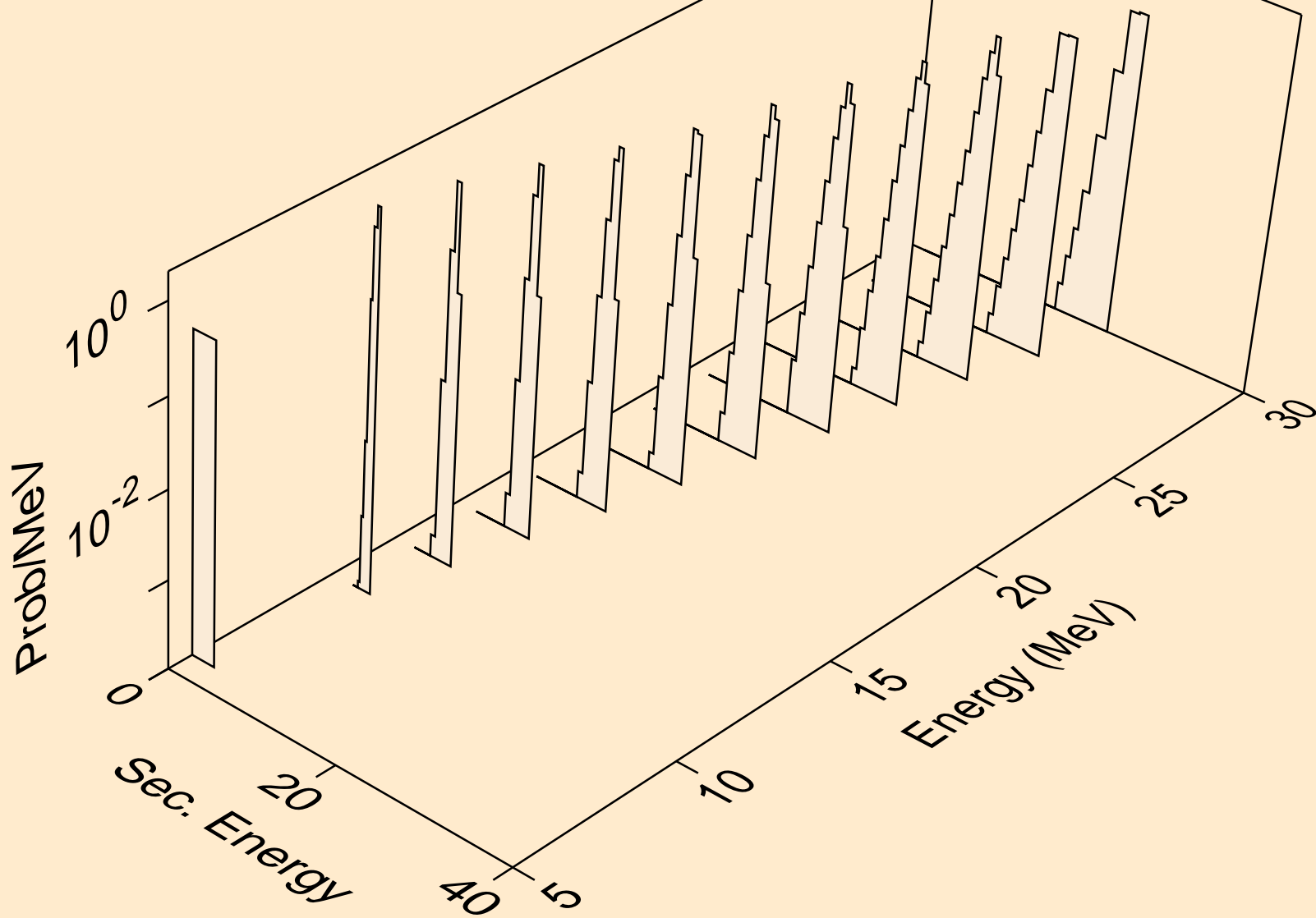

BH275 NEUTRON ACER TENDL-2021 LIBRARY; T=293.6K
tritons from (n,t)

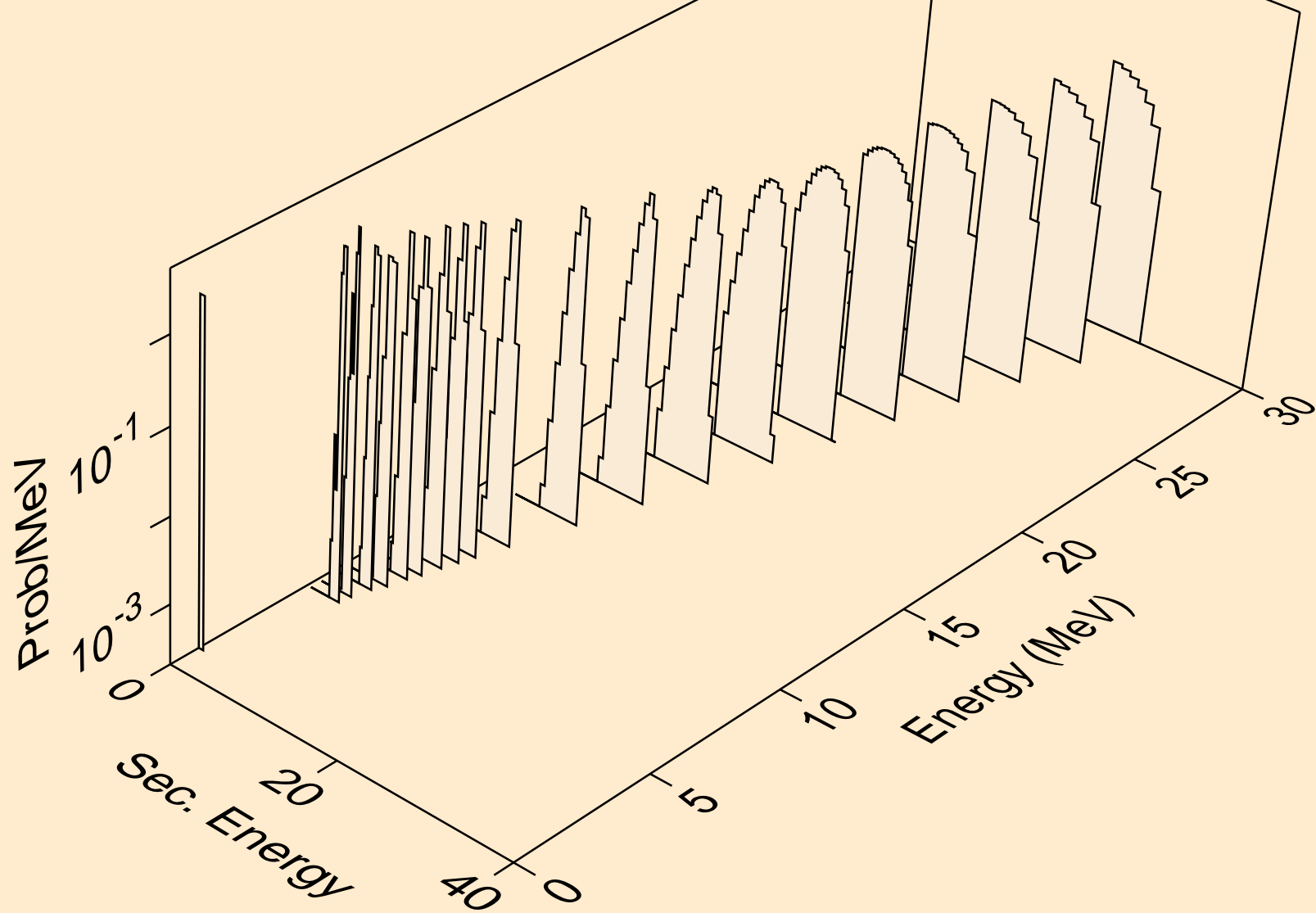

BH275 NEUTRON ACER TENDL-2021 LIBRARY; T=293.6K
he3s from (n,x)

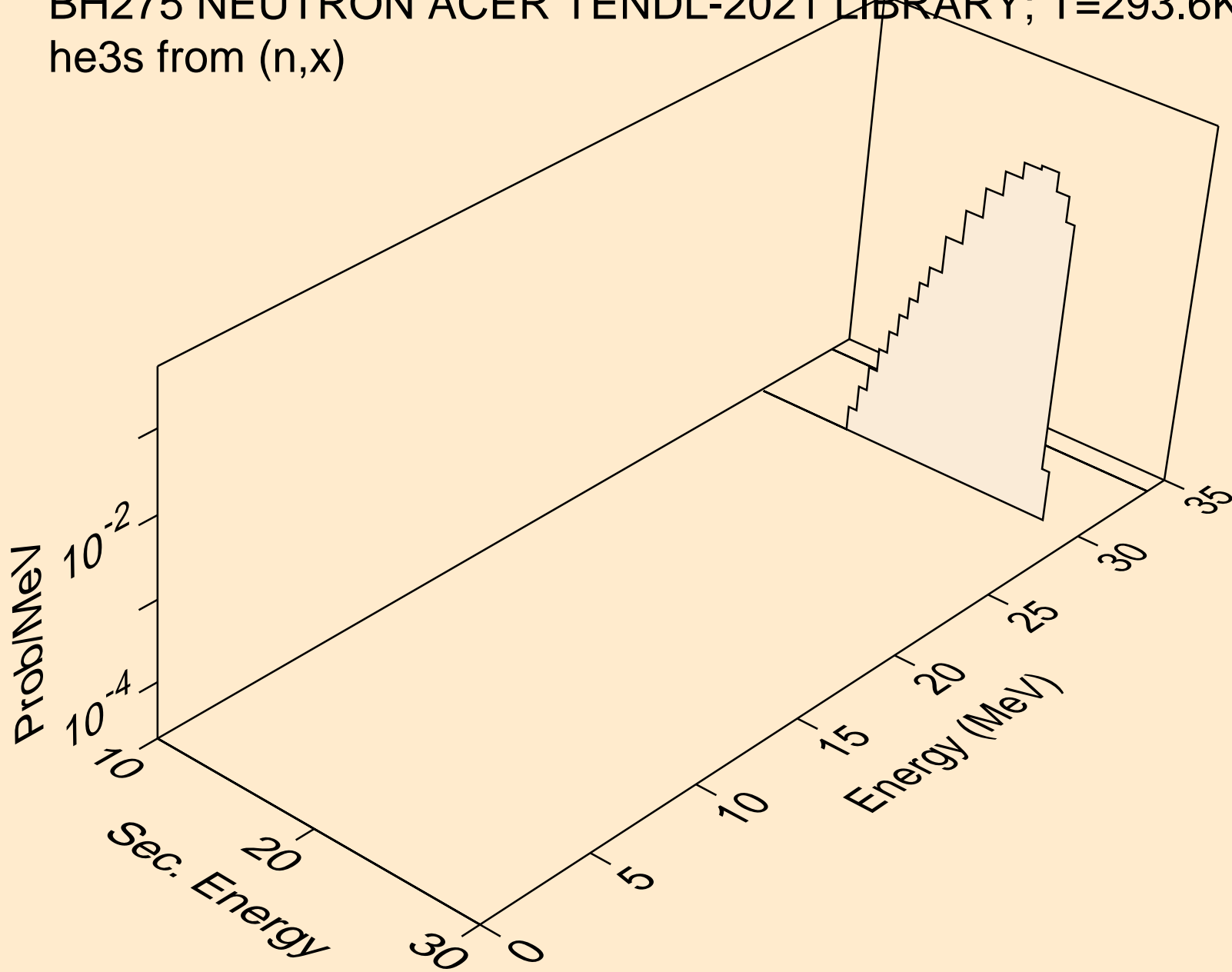

BH275 NEUTRON ACER TENDL-2021 LIBRARY; T=293.6K
he3s from (n,he3)

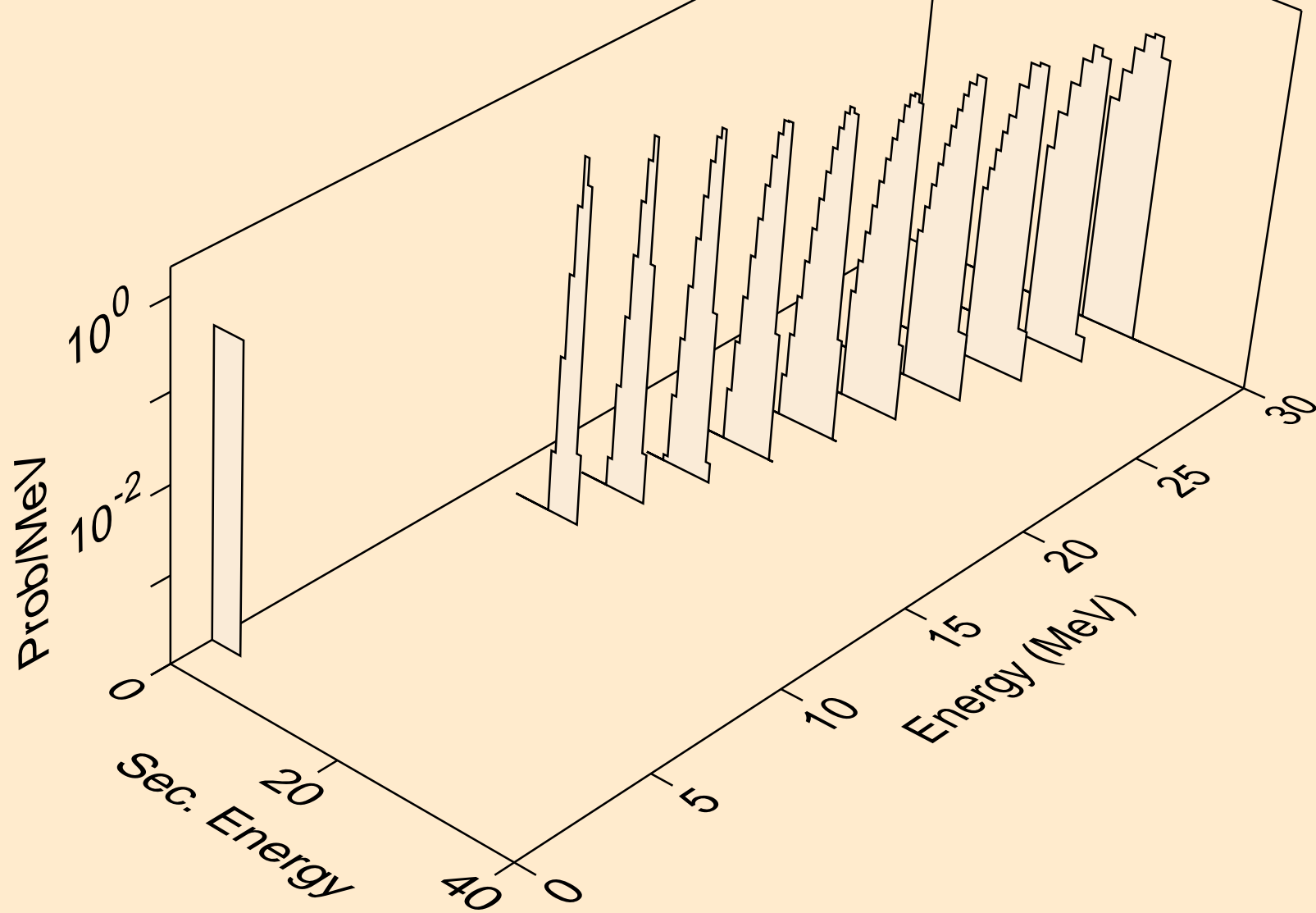

BH275 NEUTRON ACER TENDL-2021 LIBRARY; T=293.6K
alphas from (n,x)

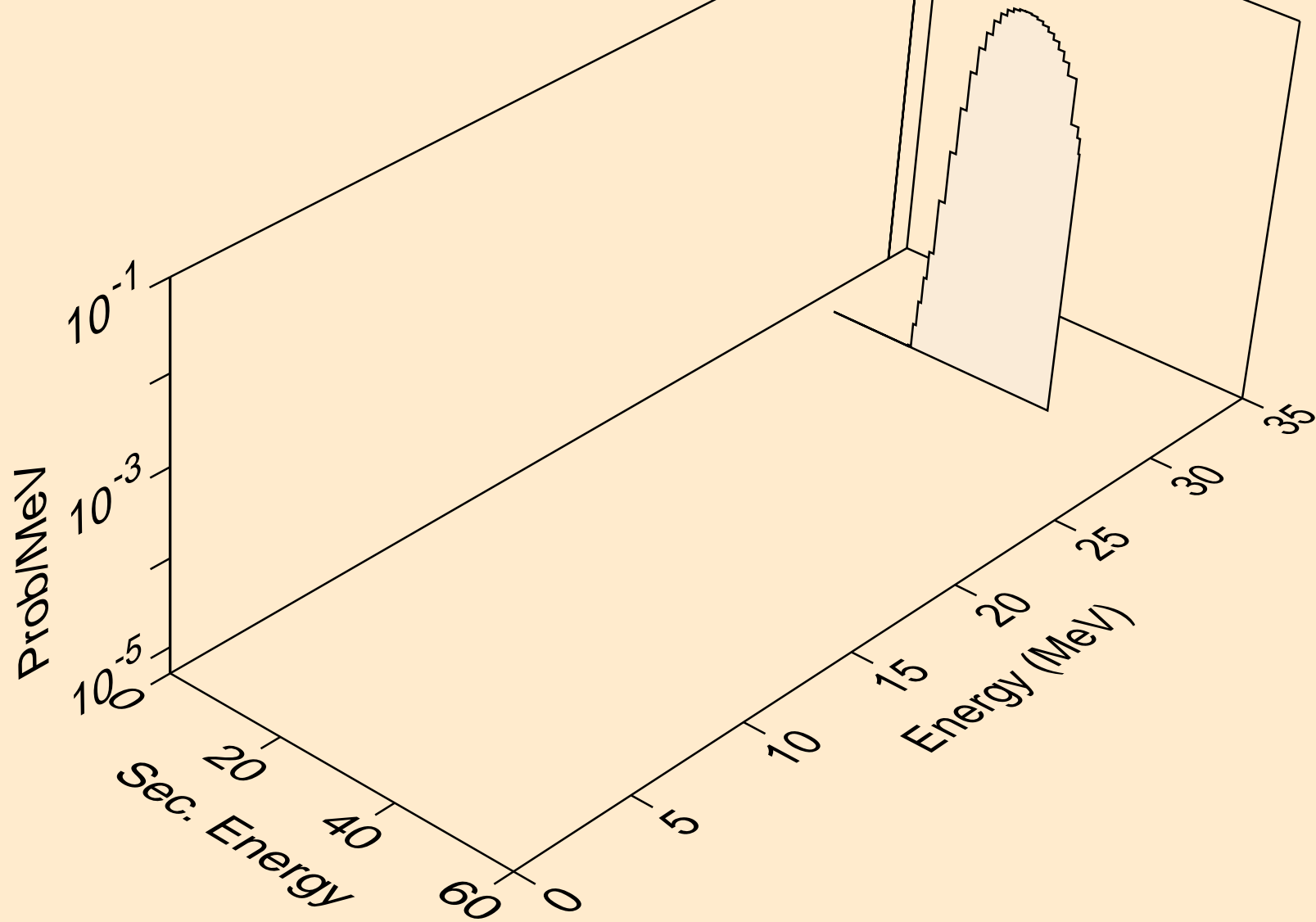

BH275 NEUTRON ACER TENDL-2021 LIBRARY; T=293.6K
alphas from (n,n*)a

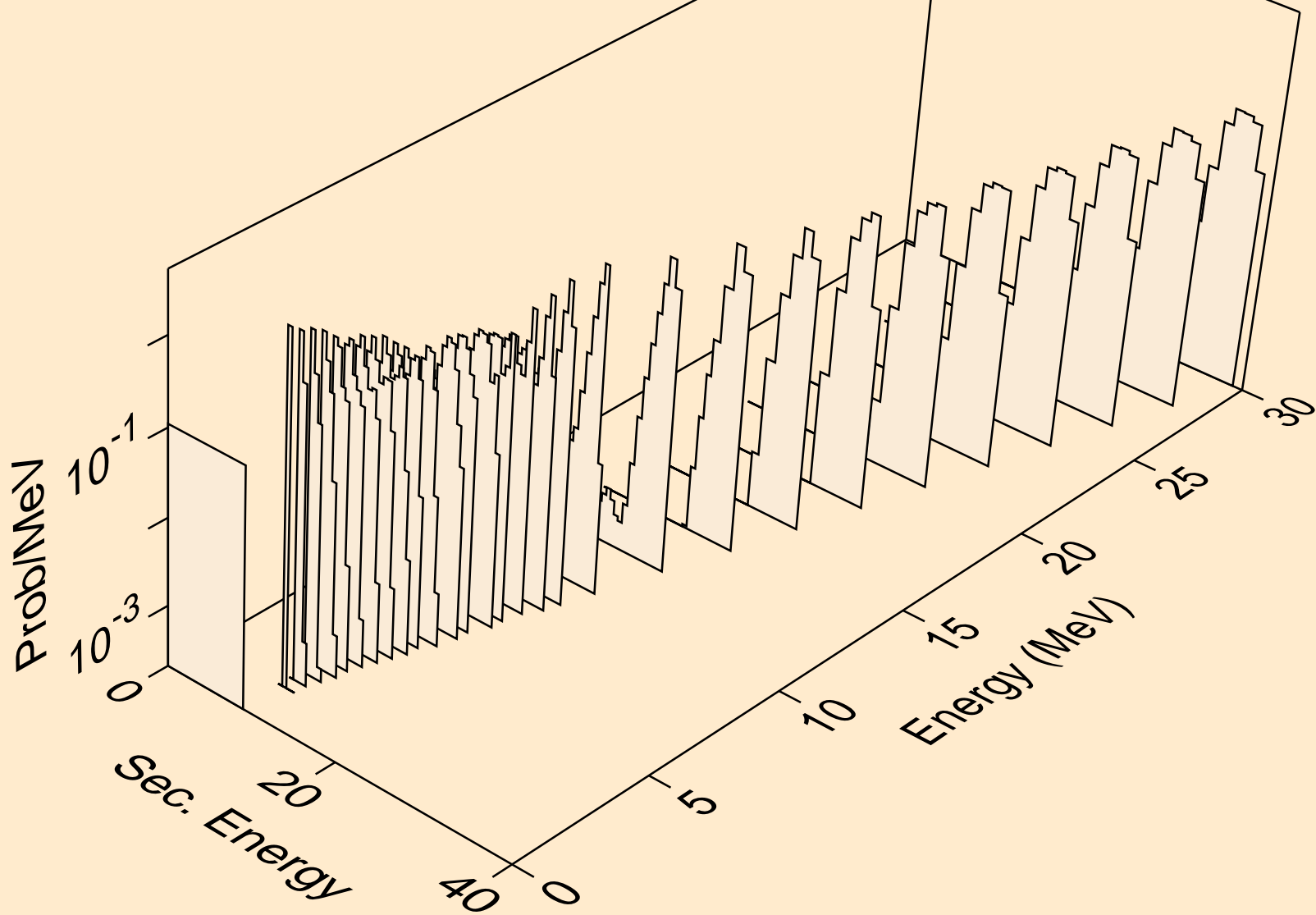

BH275 NEUTRON ACER TENDL-2021 LIBRARY; T=293.6K
alphas from (n,2n)a

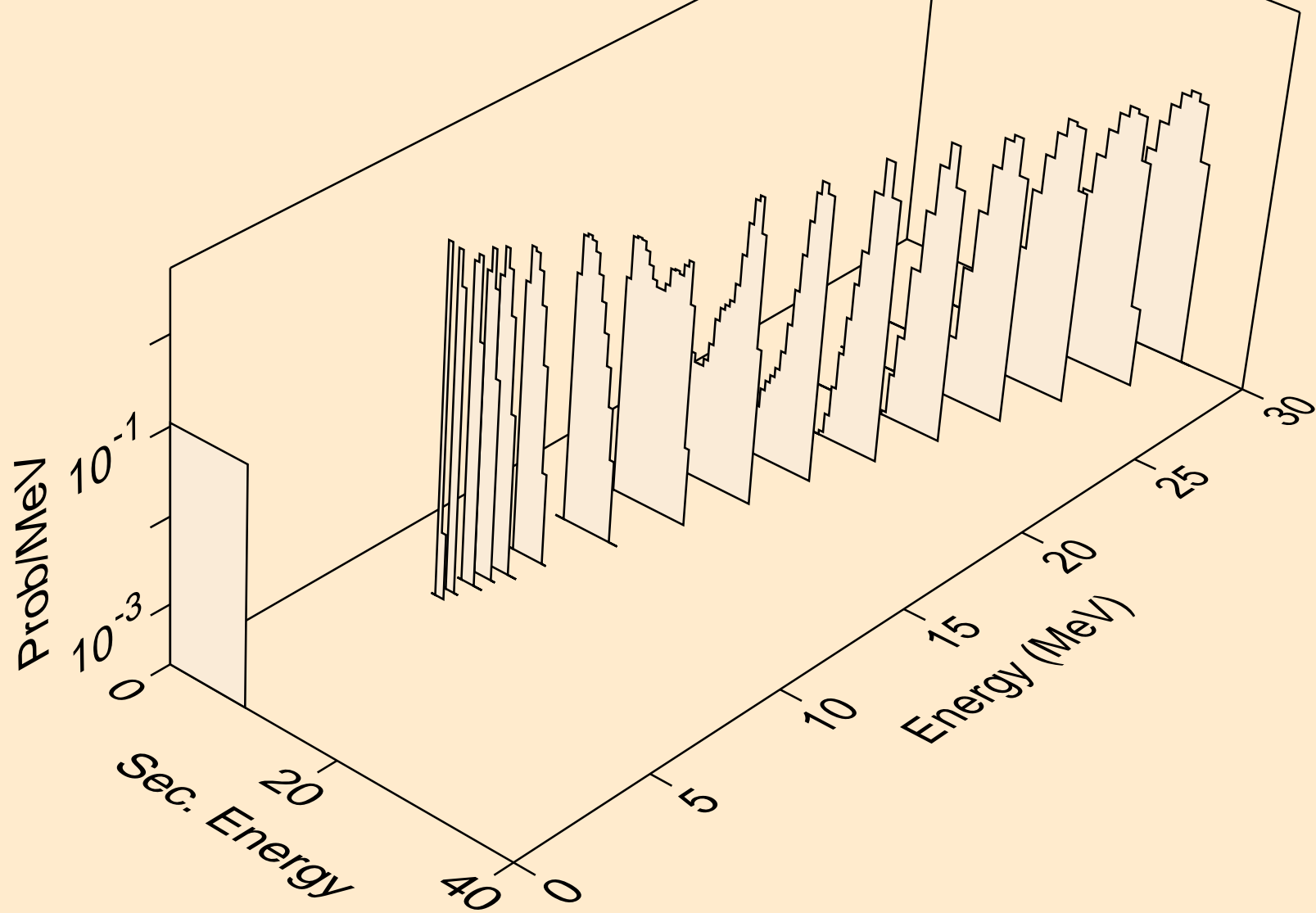

BH275 NEUTRON ACER TENDL-2021 LIBRARY; T=293.6K
alphas from (n,3n)a

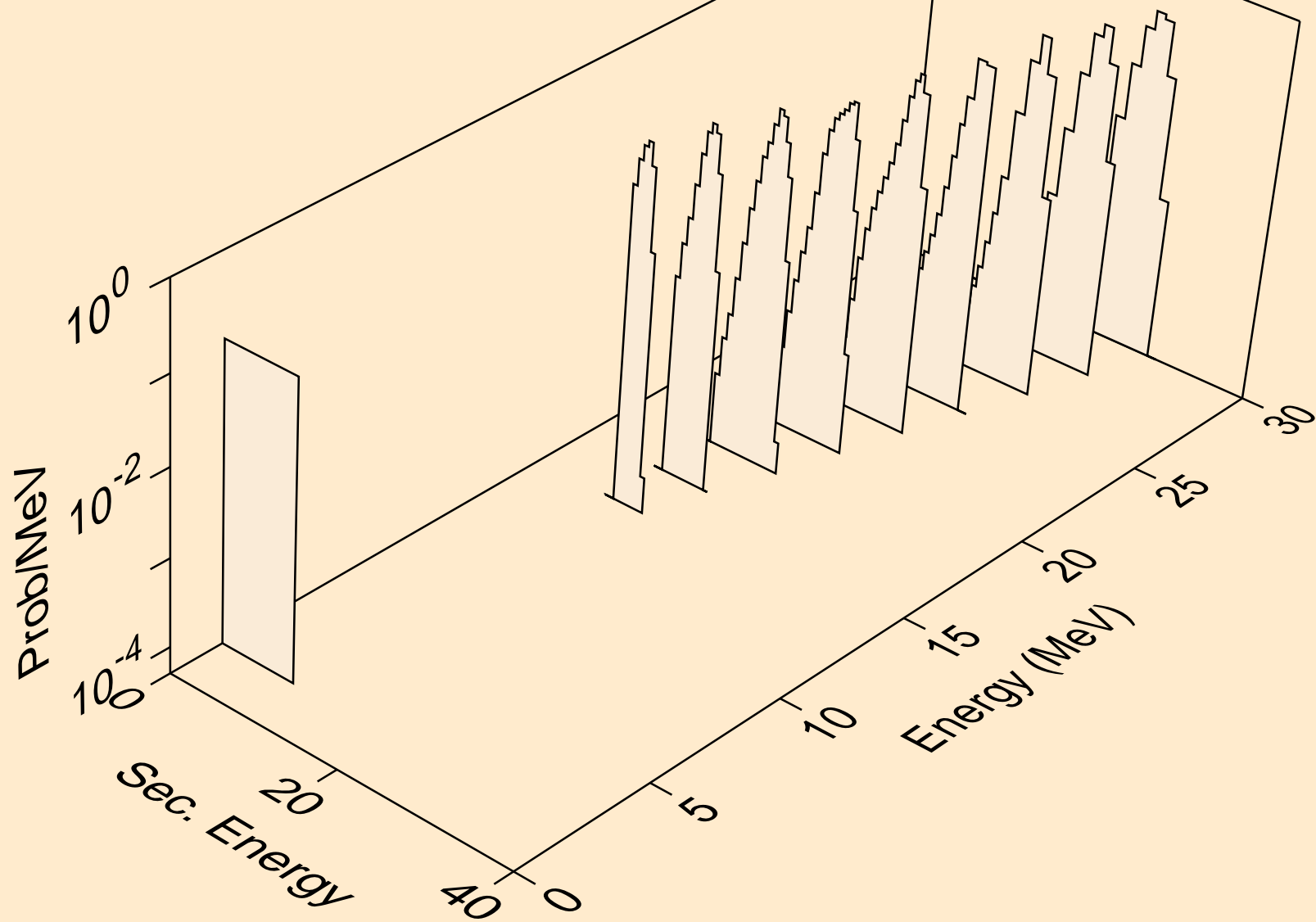

BH275 NEUTRON ACER TENDL-2021 LIBRARY; T=293.6K
alphas from (n,a)

