

BI192M NEUTRON ACER TENDL-2021 LIBRARY; T=293.6K
Principal cross sections

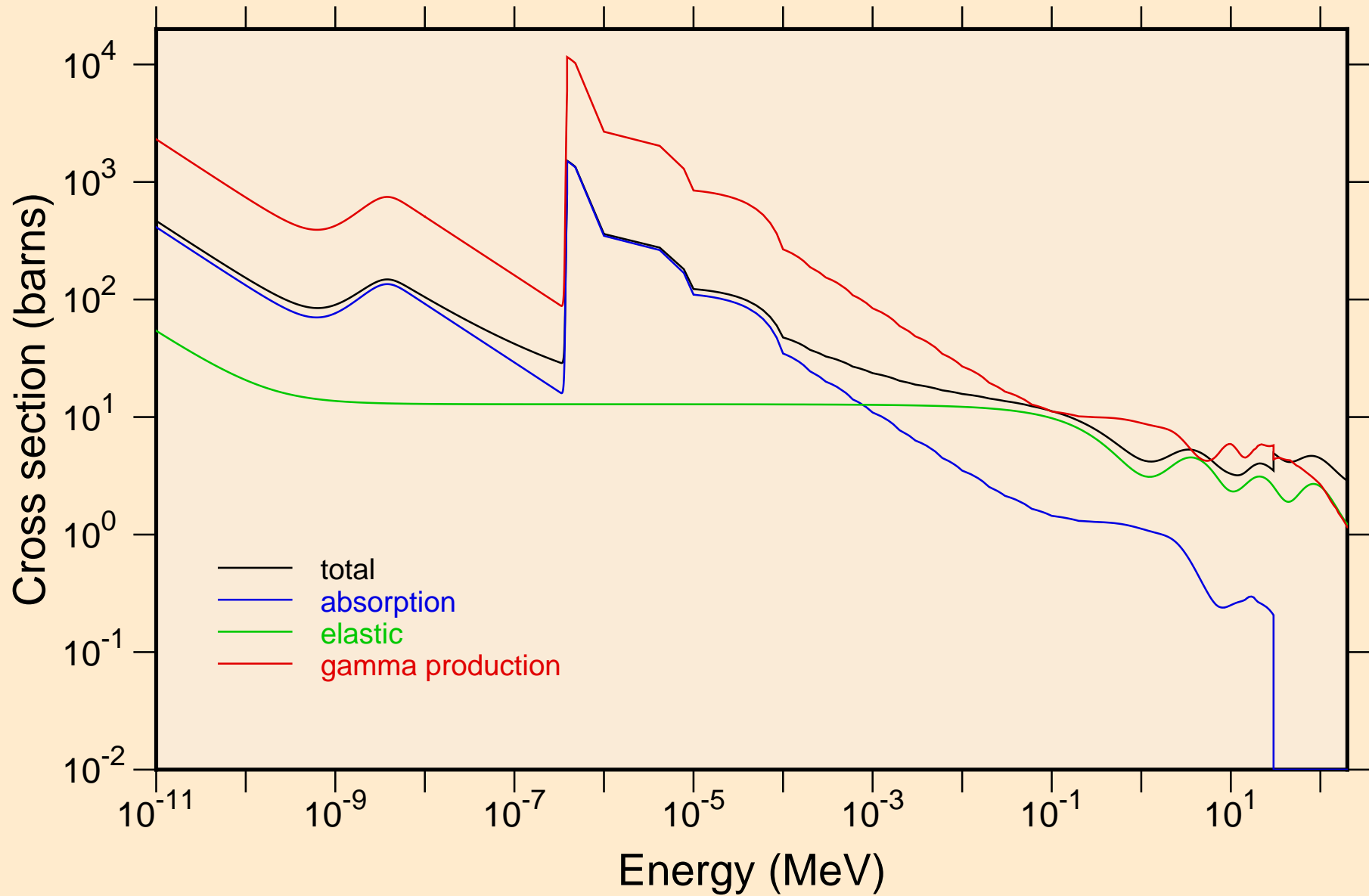

BI192M NEUTRON ACER TENDL-2021 LIBRARY; T=293.6K
Heating

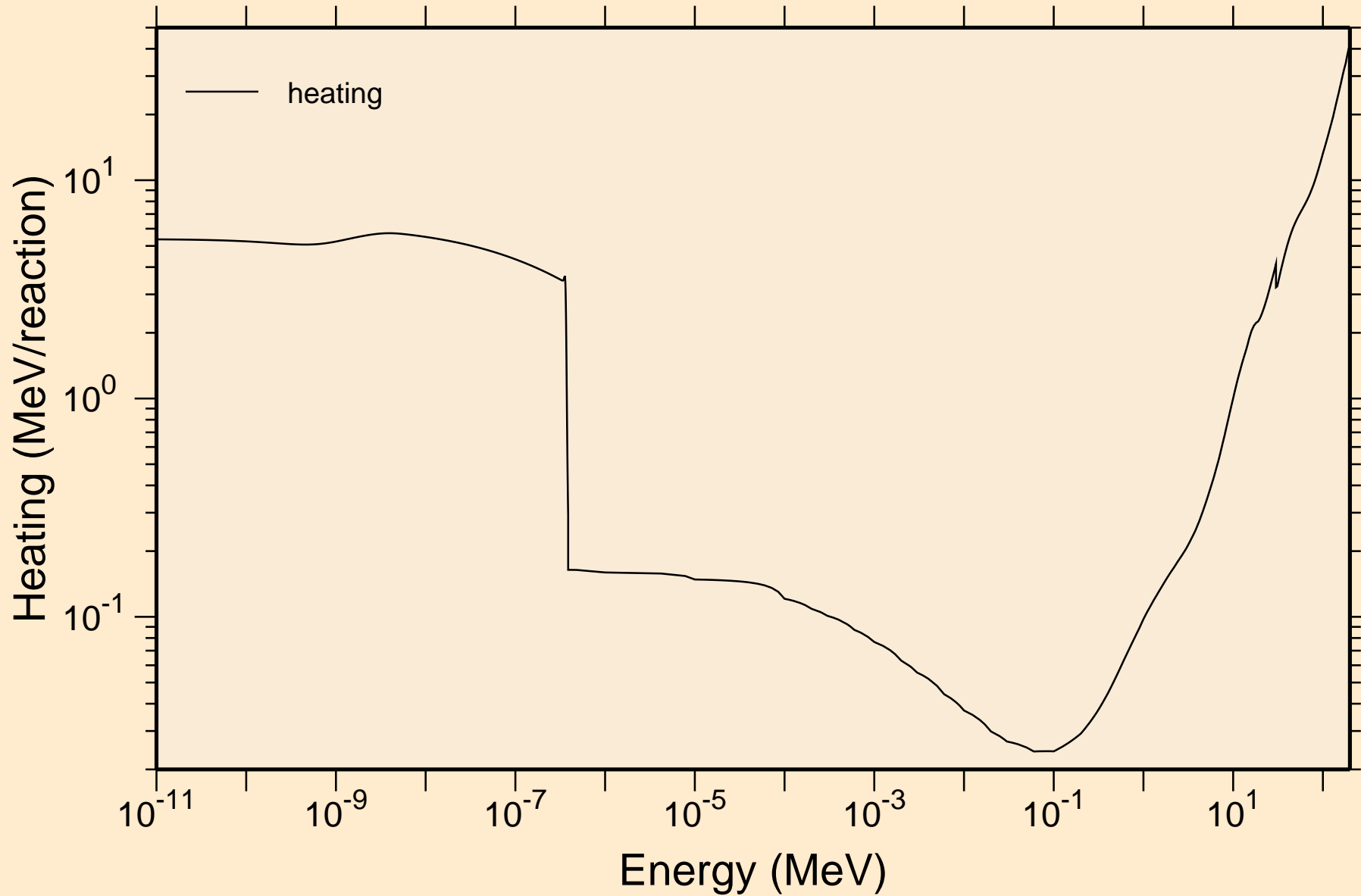

BI192M NEUTRON ACER TENDL-2021 LIBRARY; T=293.6K
Damage

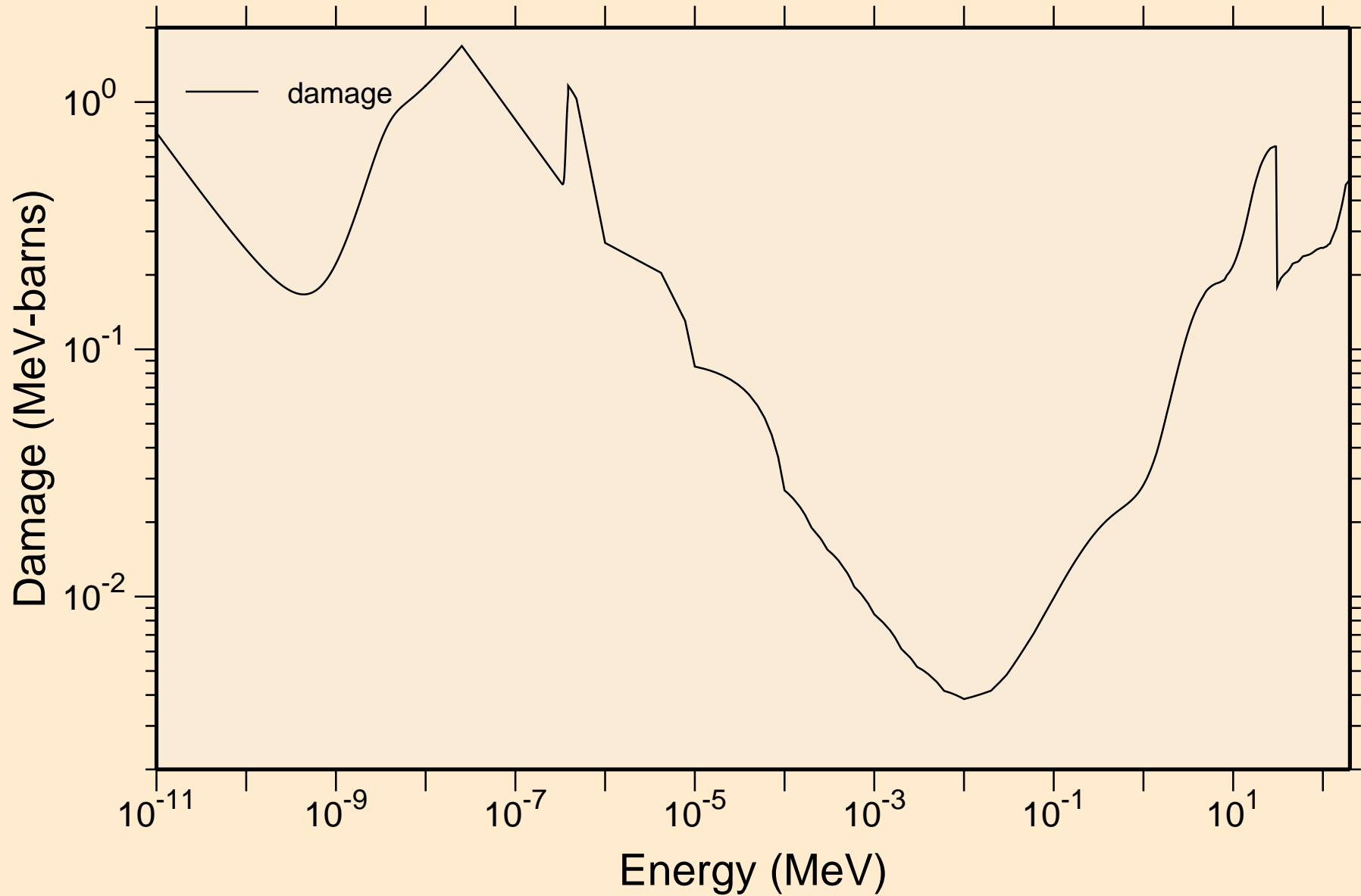

BI192M NEUTRON ACER TENDL-2021 LIBRARY; T=293.6K
Non-threshold reactions

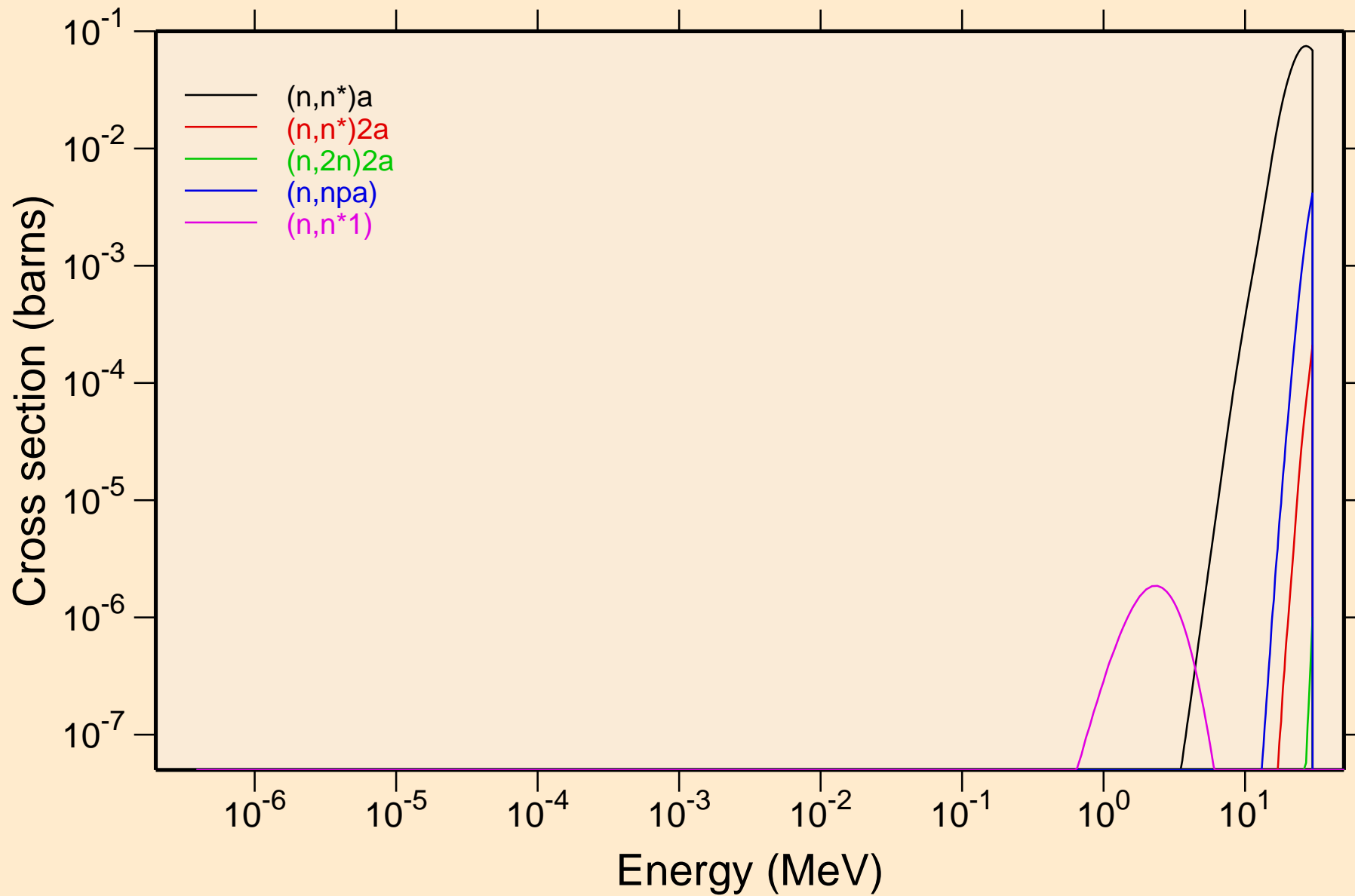

BI192M NEUTRON ACER TENDL-2021 LIBRARY; T=293.6K
Non-threshold reactions

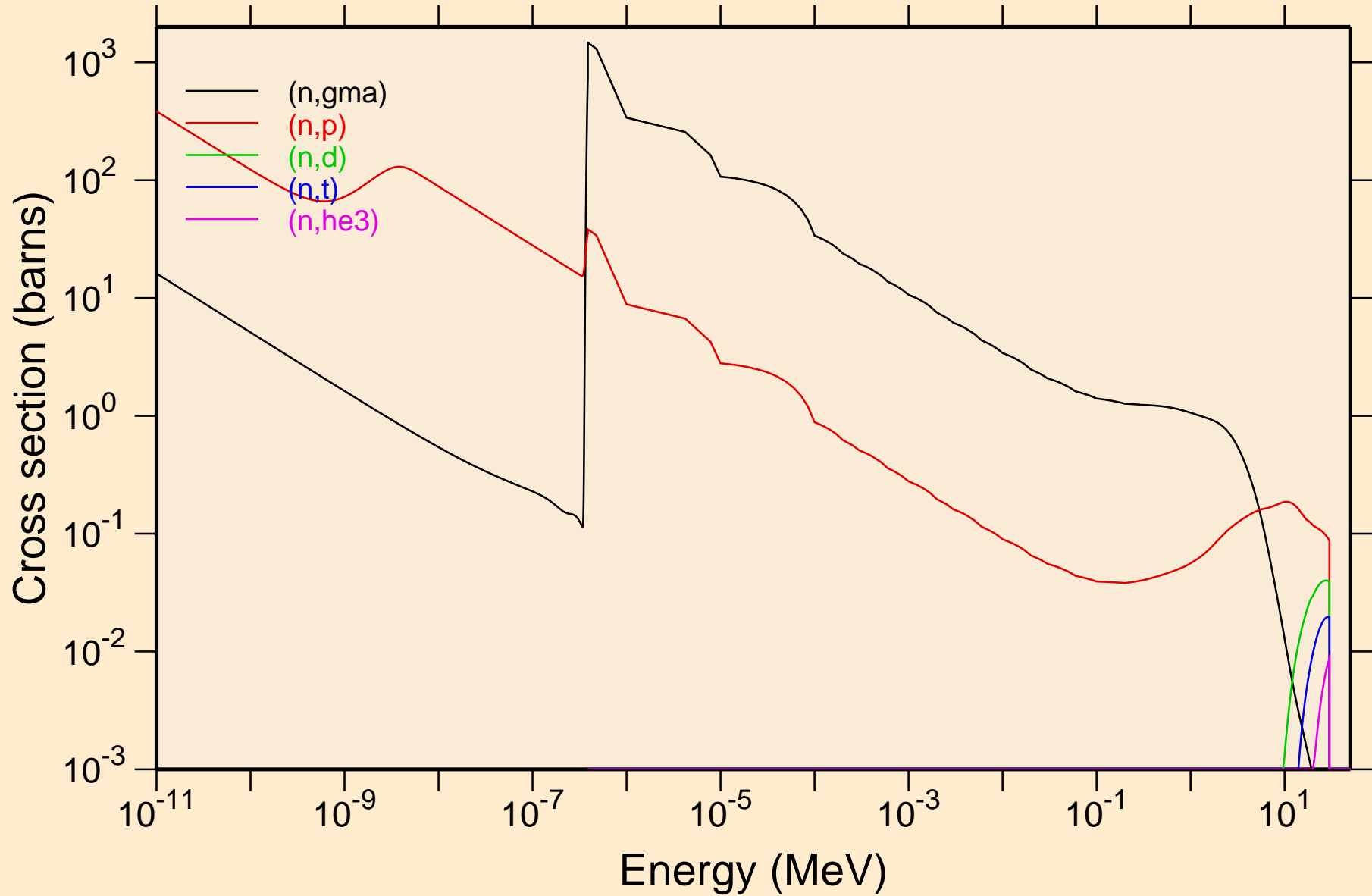

BI192M NEUTRON ACER TENDL-2021 LIBRARY; T=293.6K
Non-threshold reactions

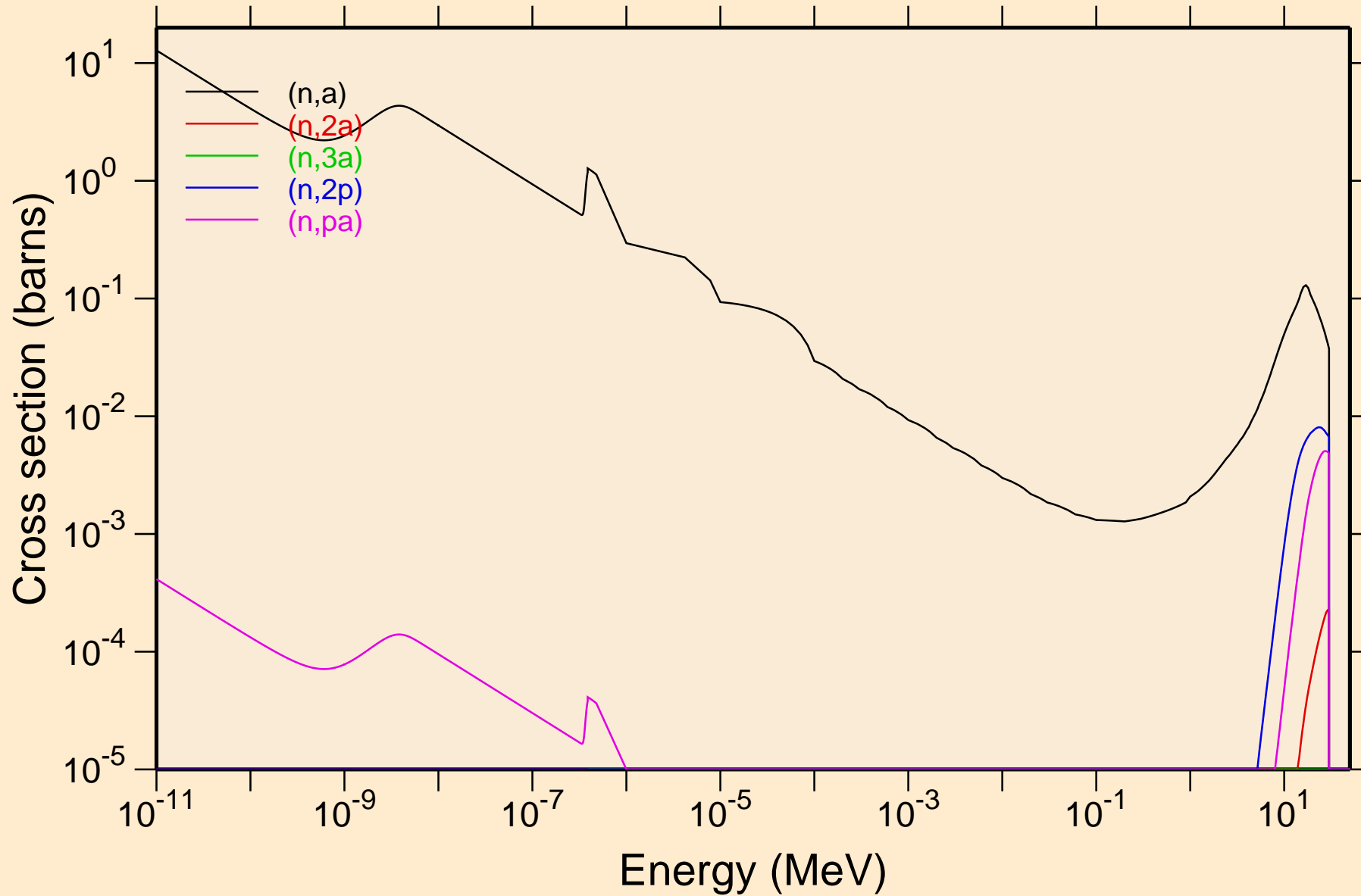

BI192M NEUTRON ACER TENDL-2021 LIBRARY; T=293.6K
Non-threshold reactions

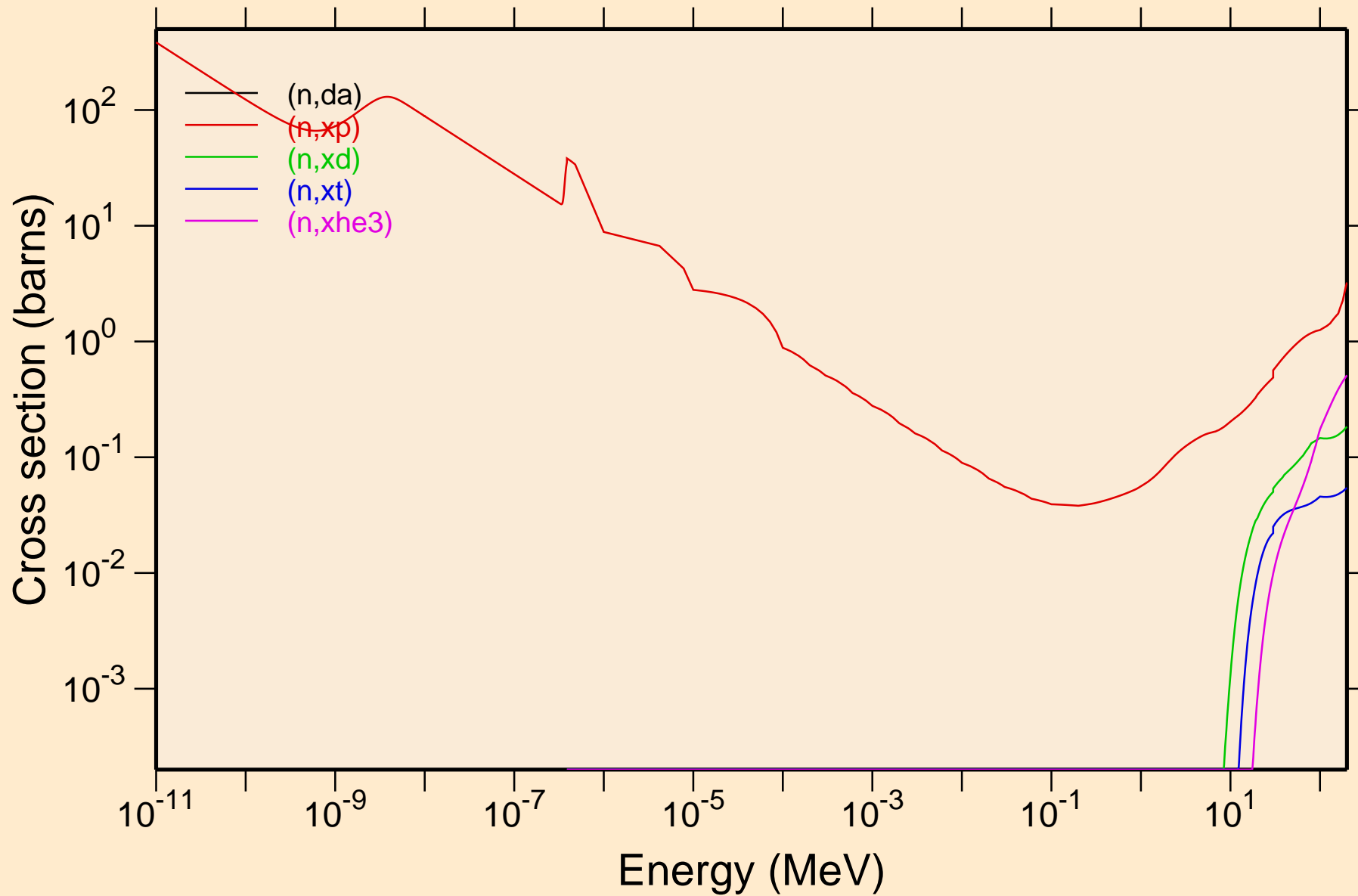

BI192M NEUTRON ACER TENDL-2021 LIBRARY; T=293.6K
Non-threshold reactions

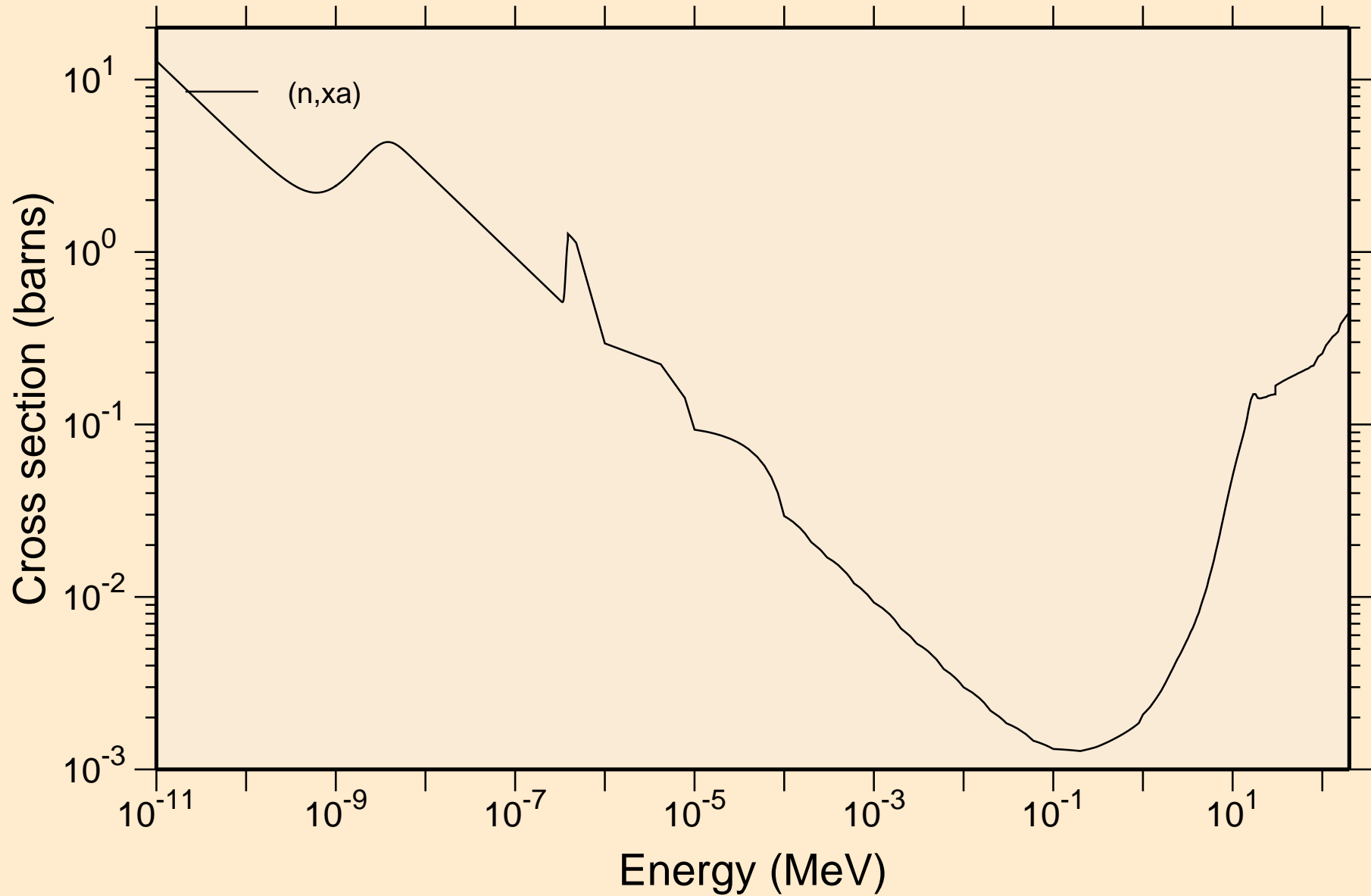

BI192M NEUTRON ACER TENDL-2021 LIBRARY; T=293.6K
Principal cross sections

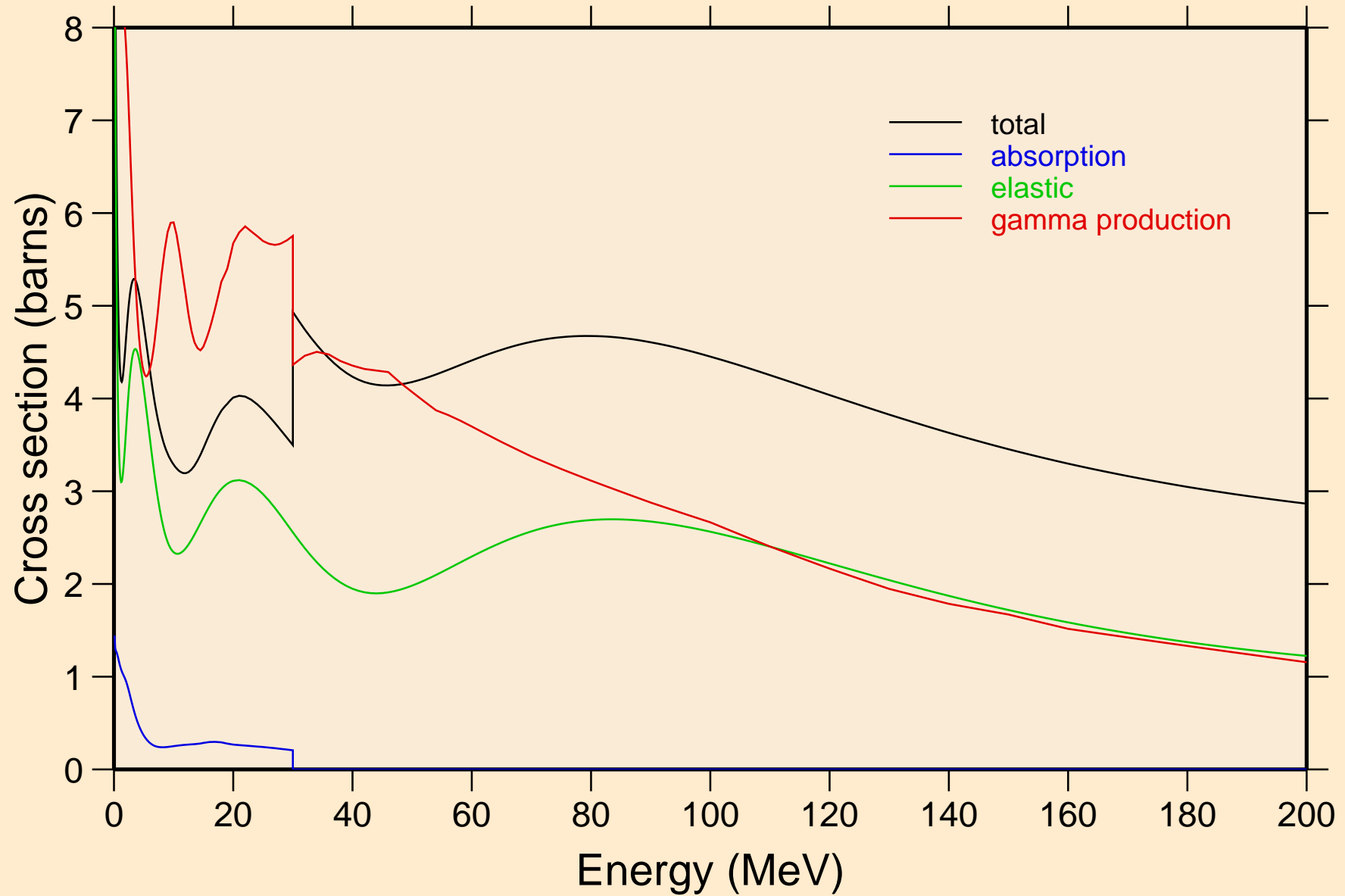

BI192M NEUTRON ACER TENDL-2021 LIBRARY; T=293.6K

Heating

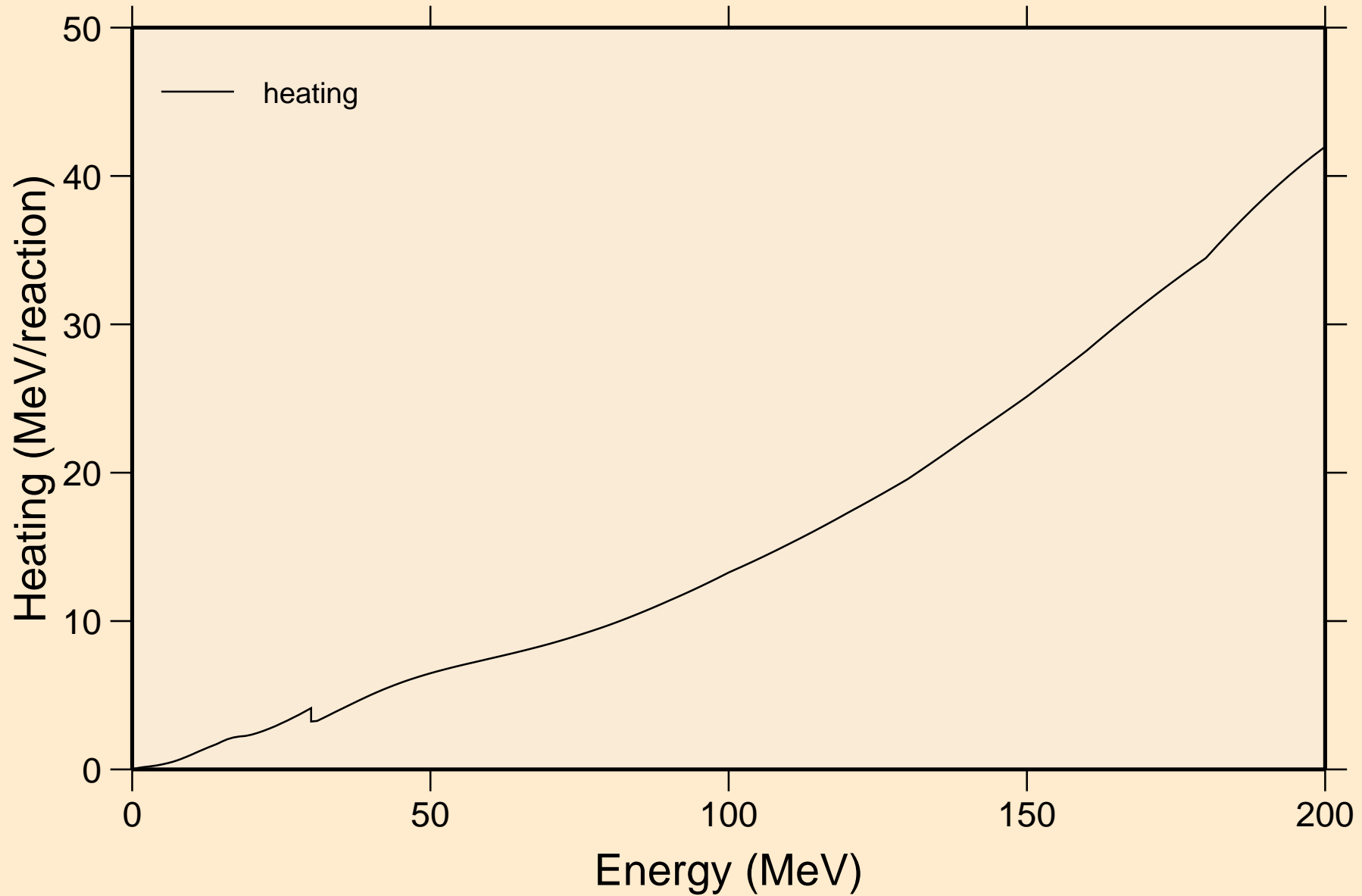

BI192M NEUTRON ACER TENDL-2021 LIBRARY; T=293.6K
Damage

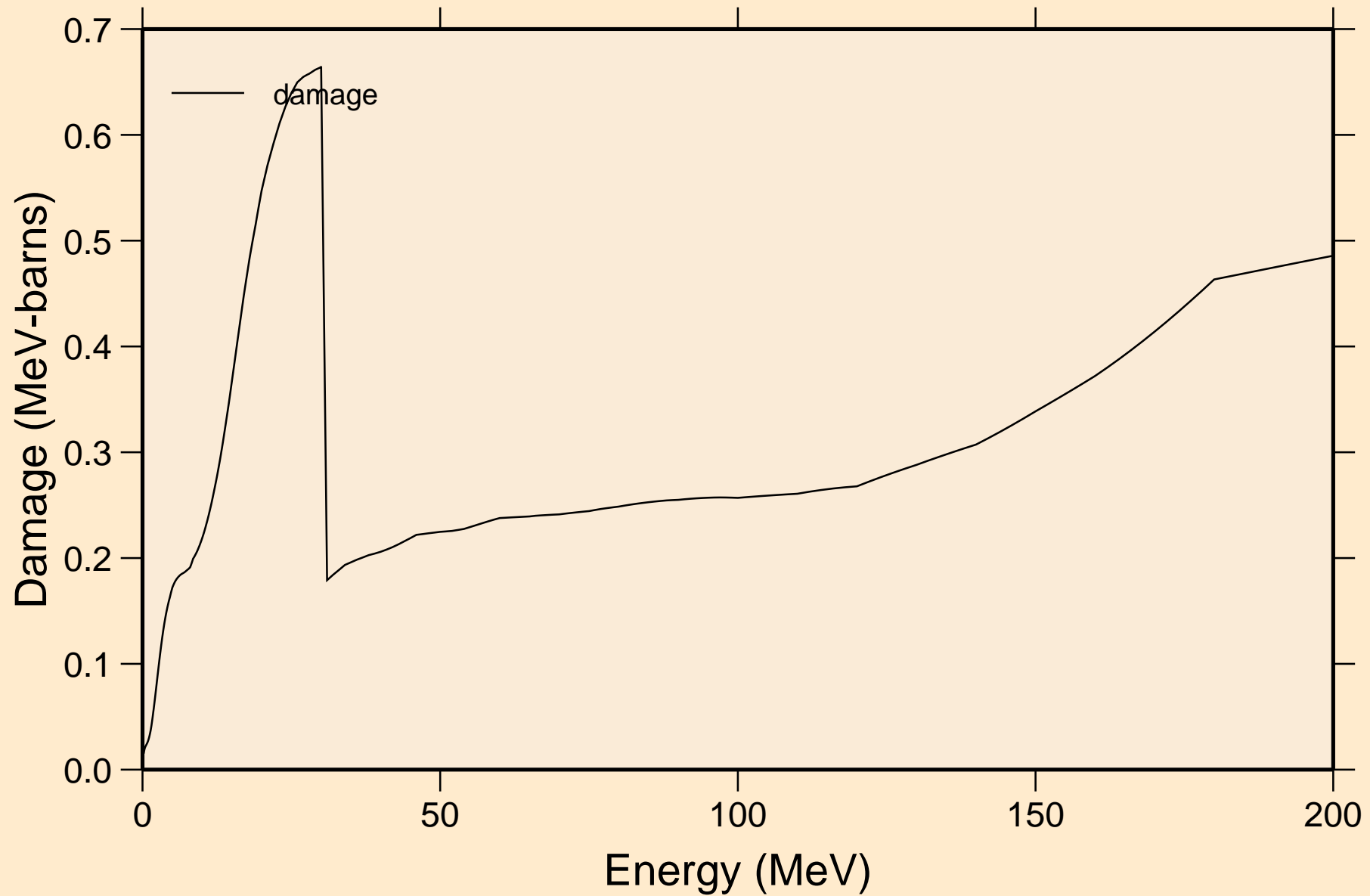

BI192M NEUTRON ACER TENDL-2021 LIBRARY; T=293.6K
Non-threshold reactions

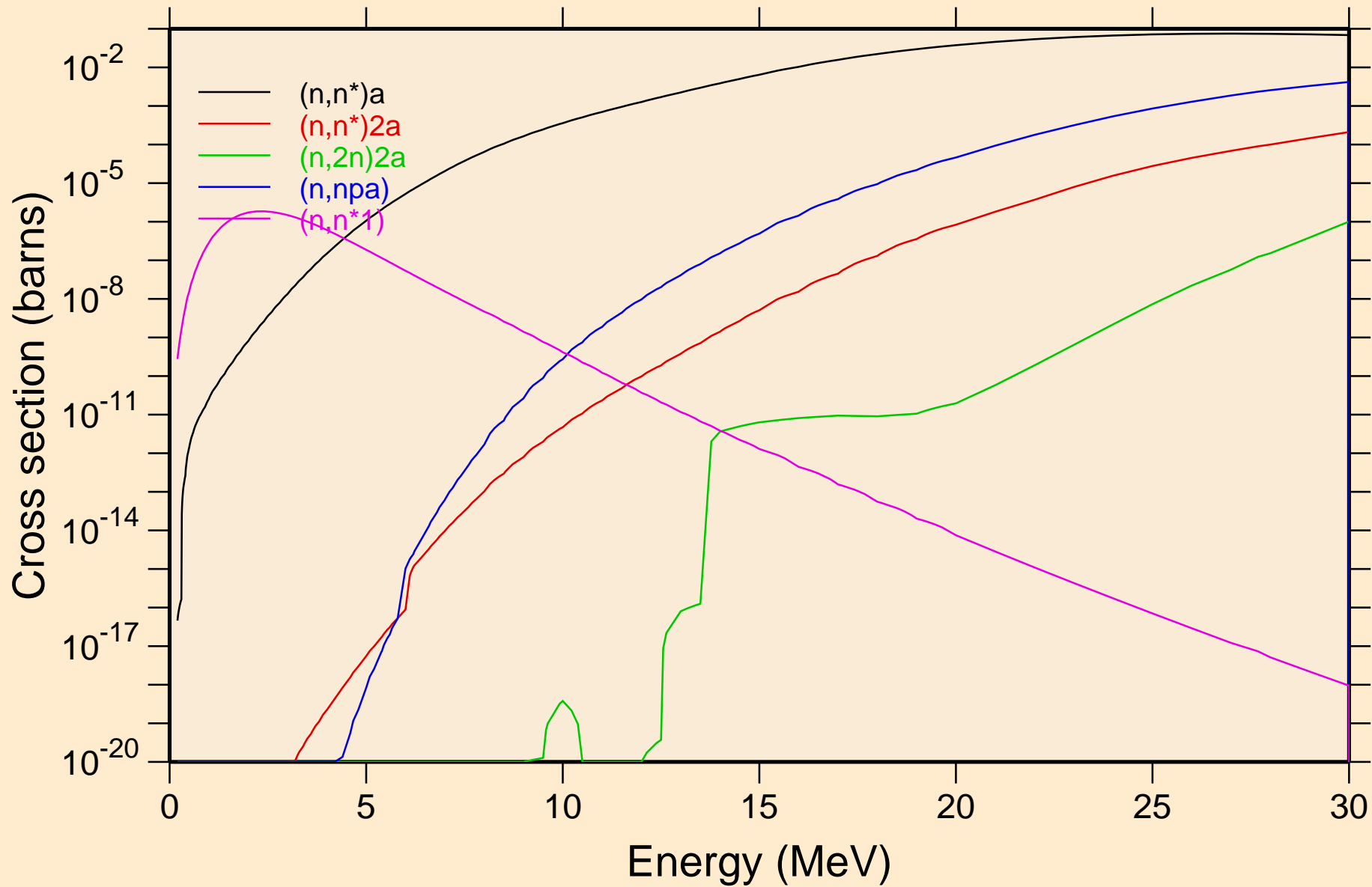

BI192M NEUTRON ACER TENDL-2021 LIBRARY; T=293.6K
Non-threshold reactions

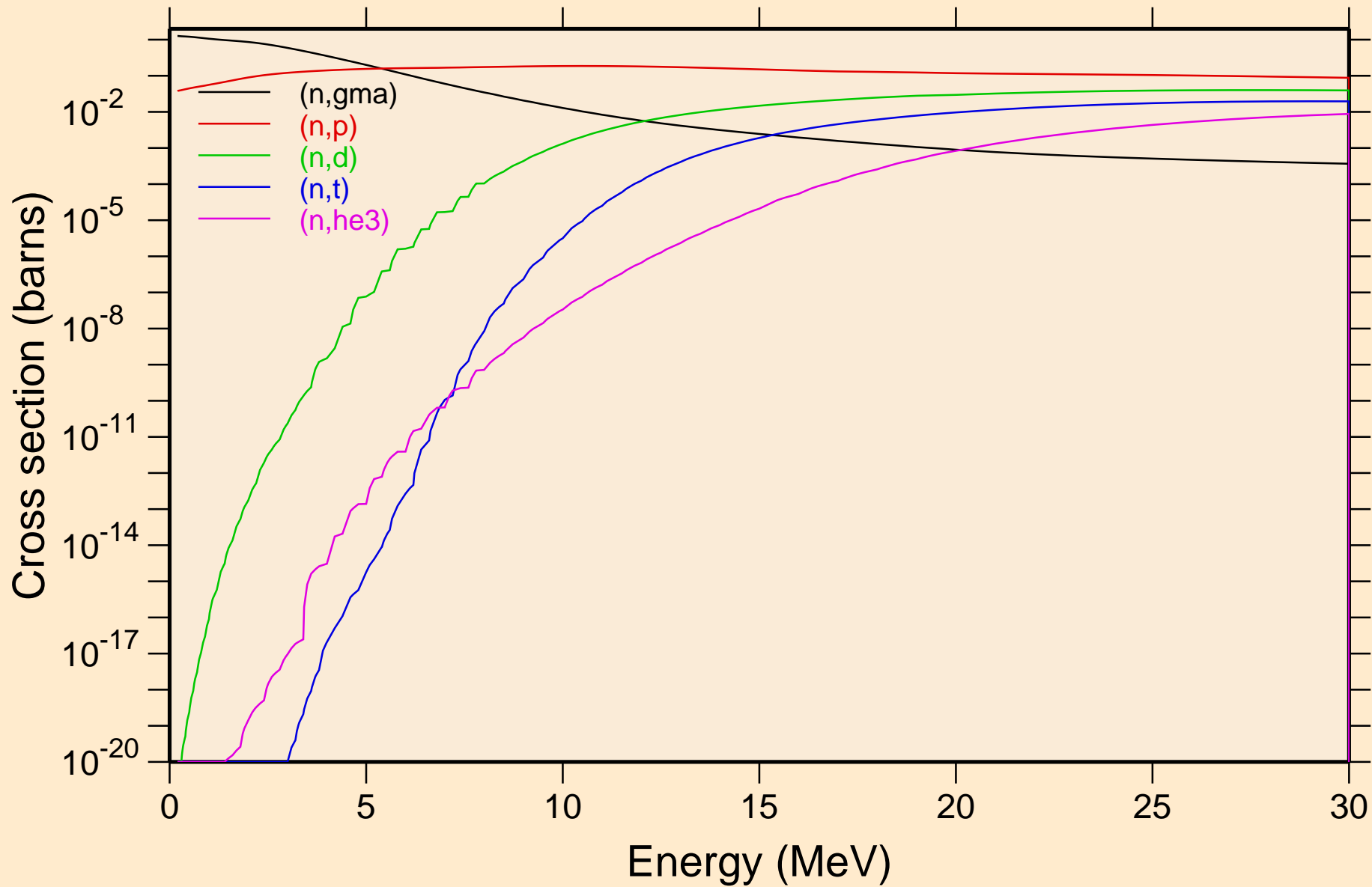

BI192M NEUTRON ACER TENDL-2021 LIBRARY; T=293.6K
Non-threshold reactions

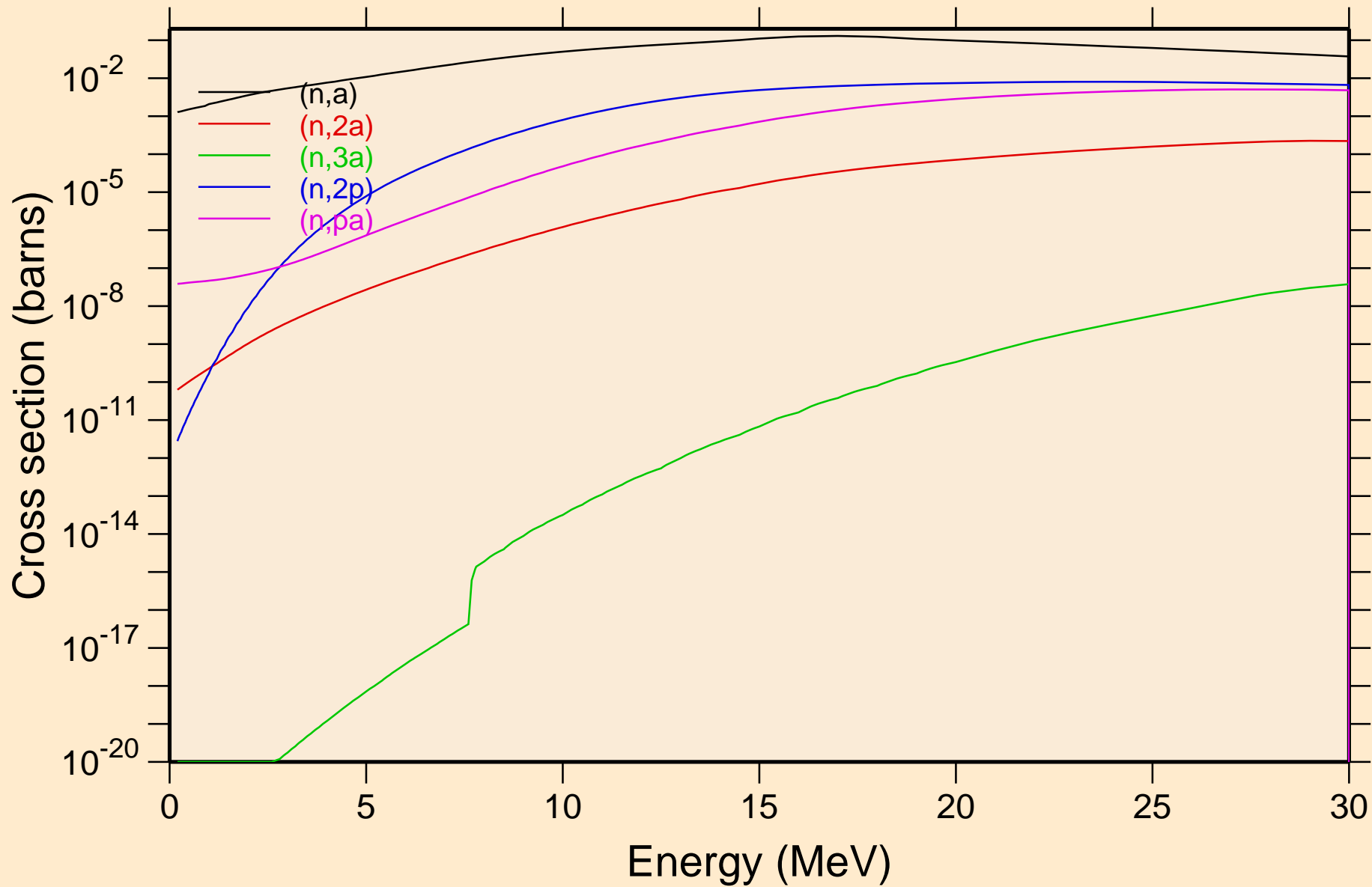

BI192M NEUTRON ACER TENDL-2021 LIBRARY; T=293.6K
Non-threshold reactions

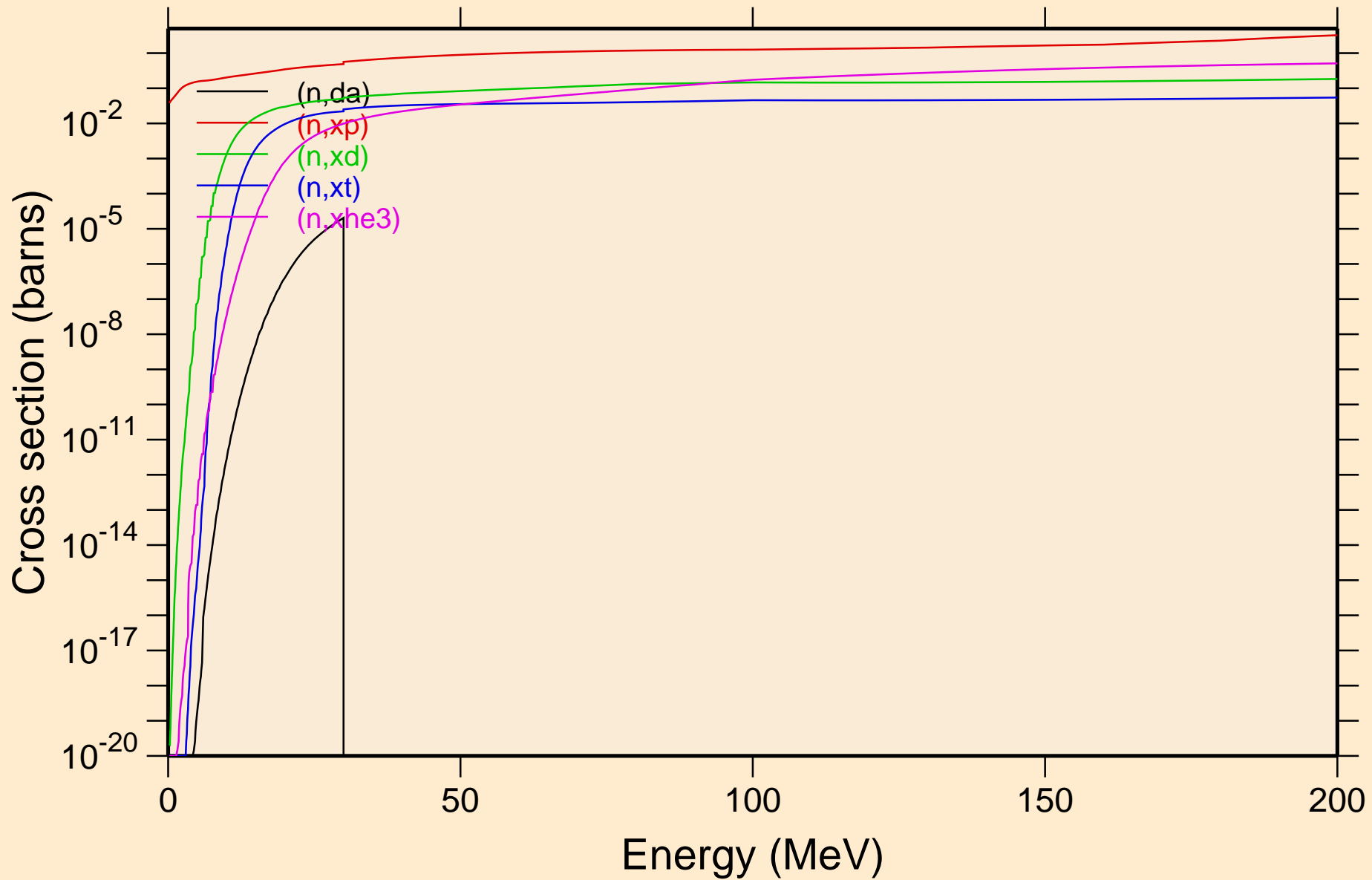

BI192M NEUTRON ACER TENDL-2021 LIBRARY; T=293.6K
Non-threshold reactions

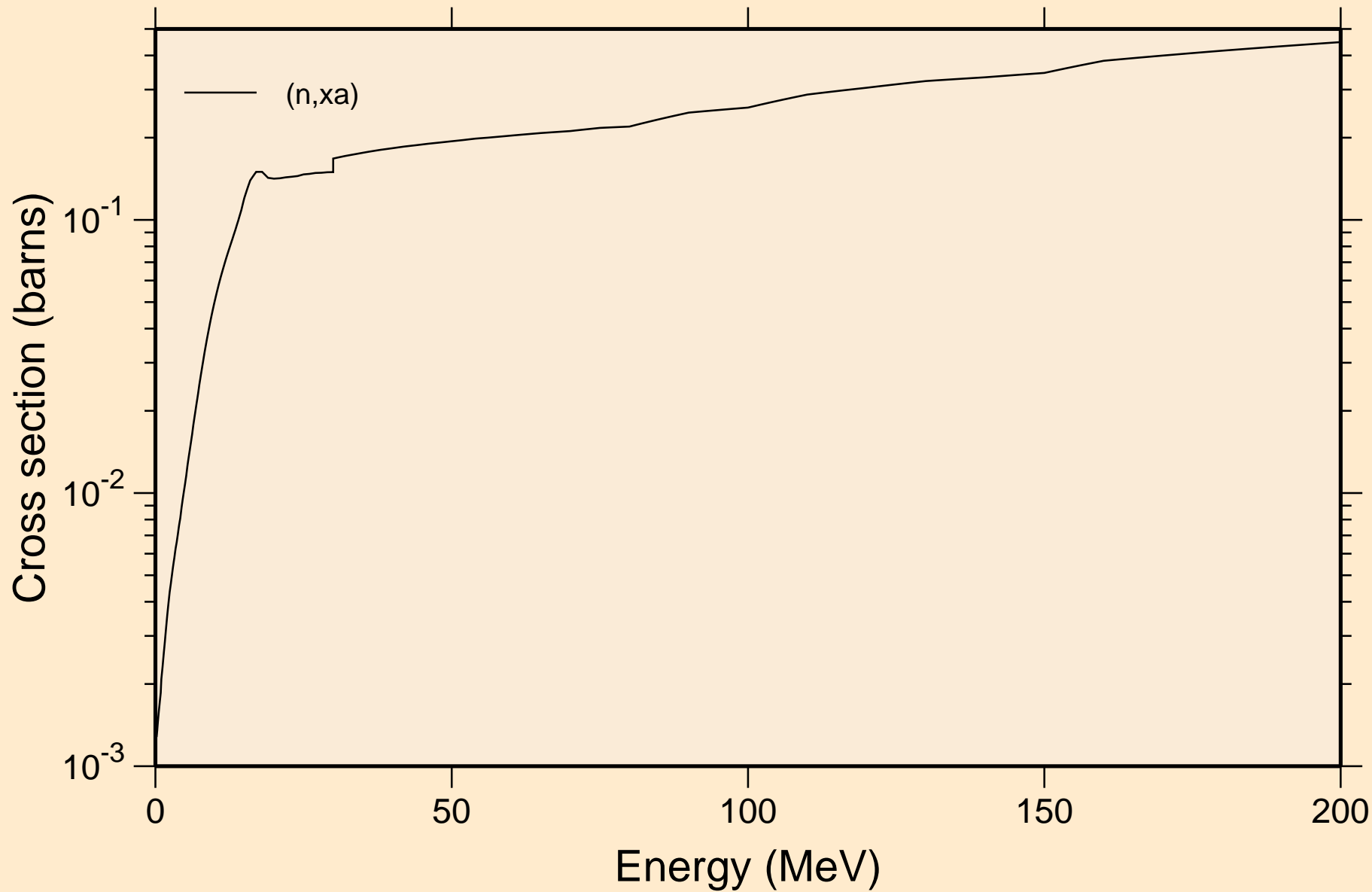

BI192M NEUTRON ACER TENDL-2021 LIBRARY; T=293.6K
Inelastic levels

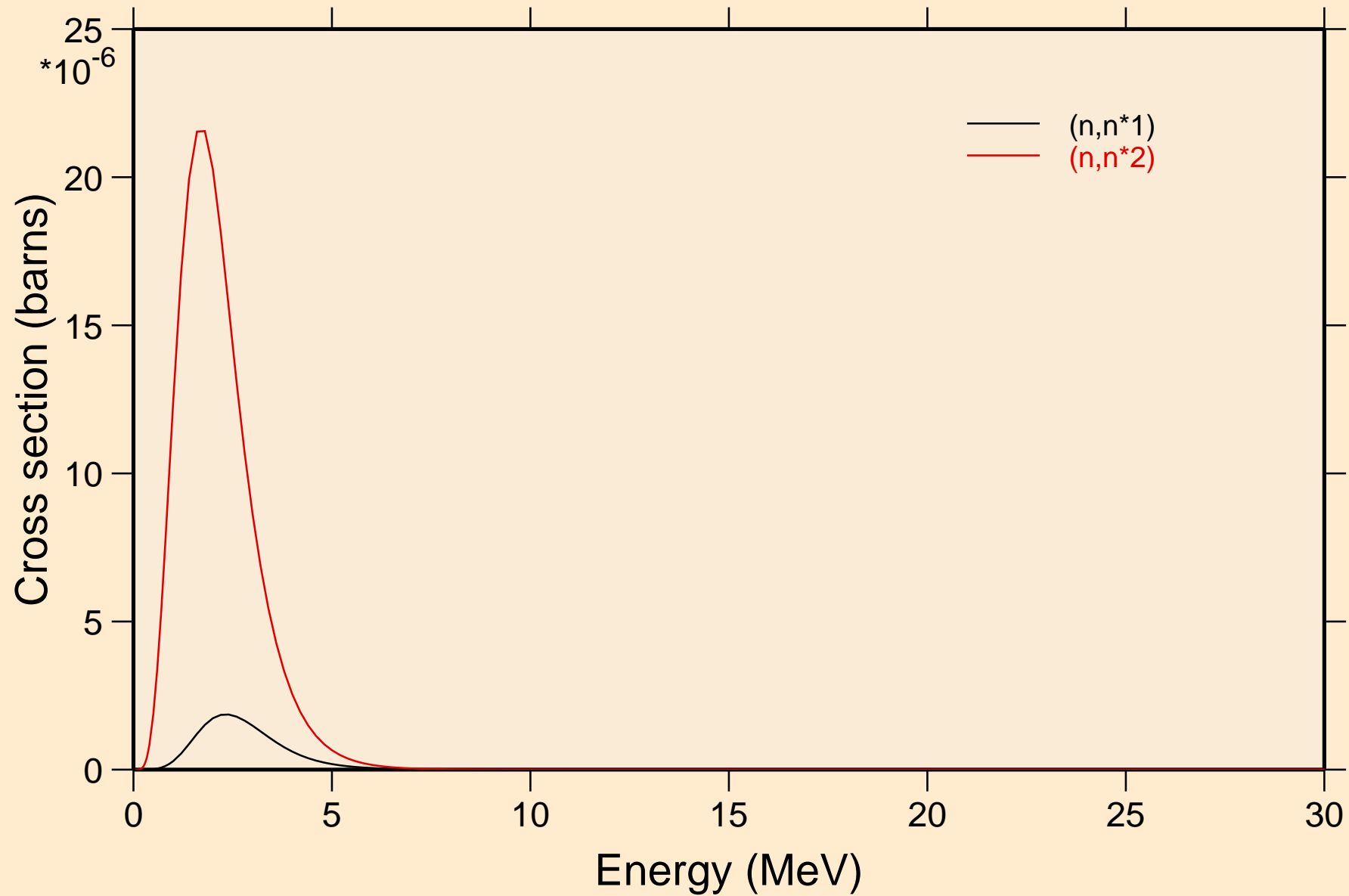

BI192M NEUTRON ACER TENDL-2021 LIBRARY; T=293.6K
Threshold reactions

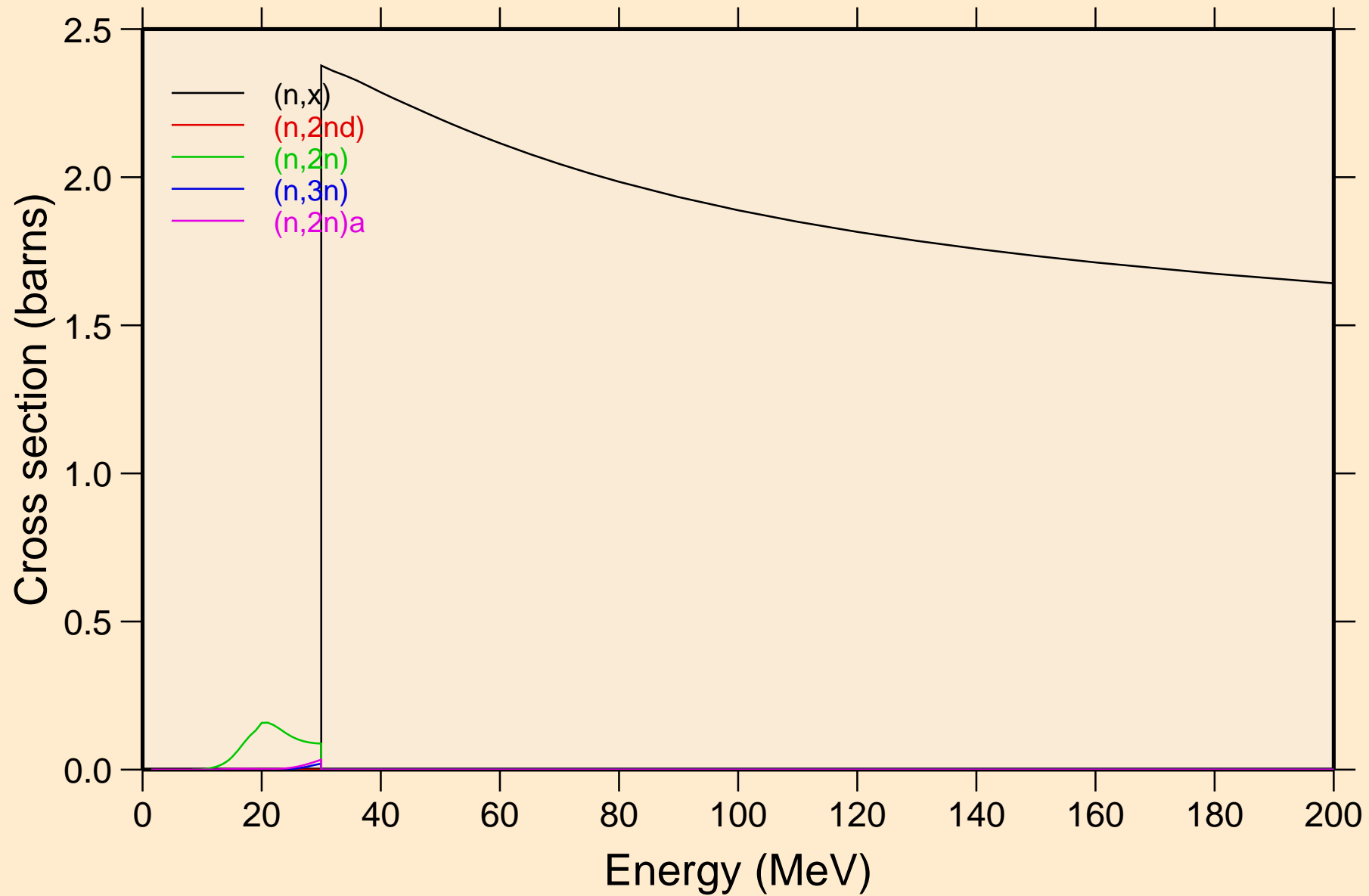

BI192M NEUTRON ACER TENDL-2021 LIBRARY; T=293.6K
Threshold reactions

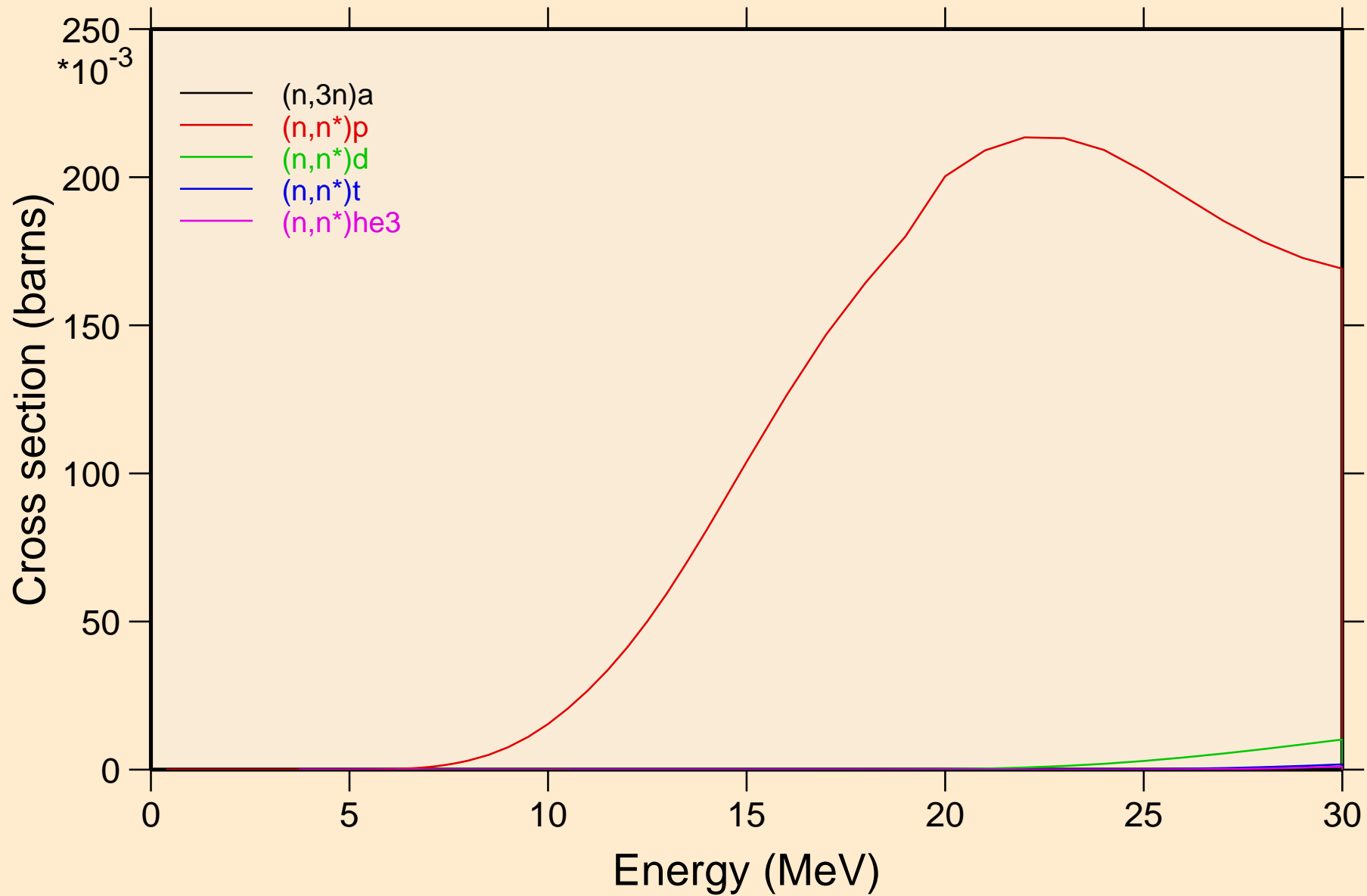

BI192M NEUTRON ACER TENDL-2021 LIBRARY; T=293.6K
Threshold reactions

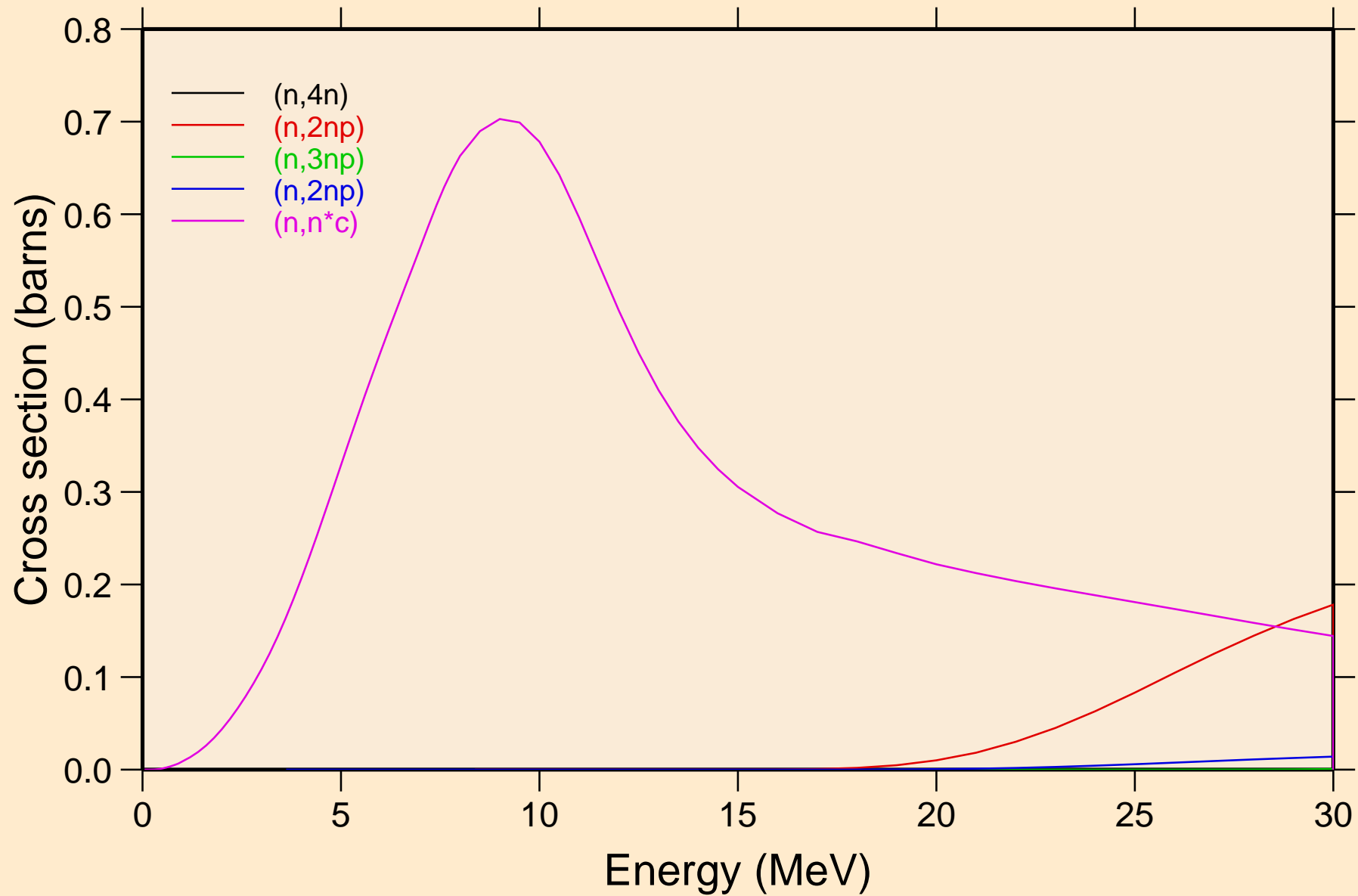

BI192M NEUTRON ACER TENDL-2021 LIBRARY; T=293.6K
Threshold reactions

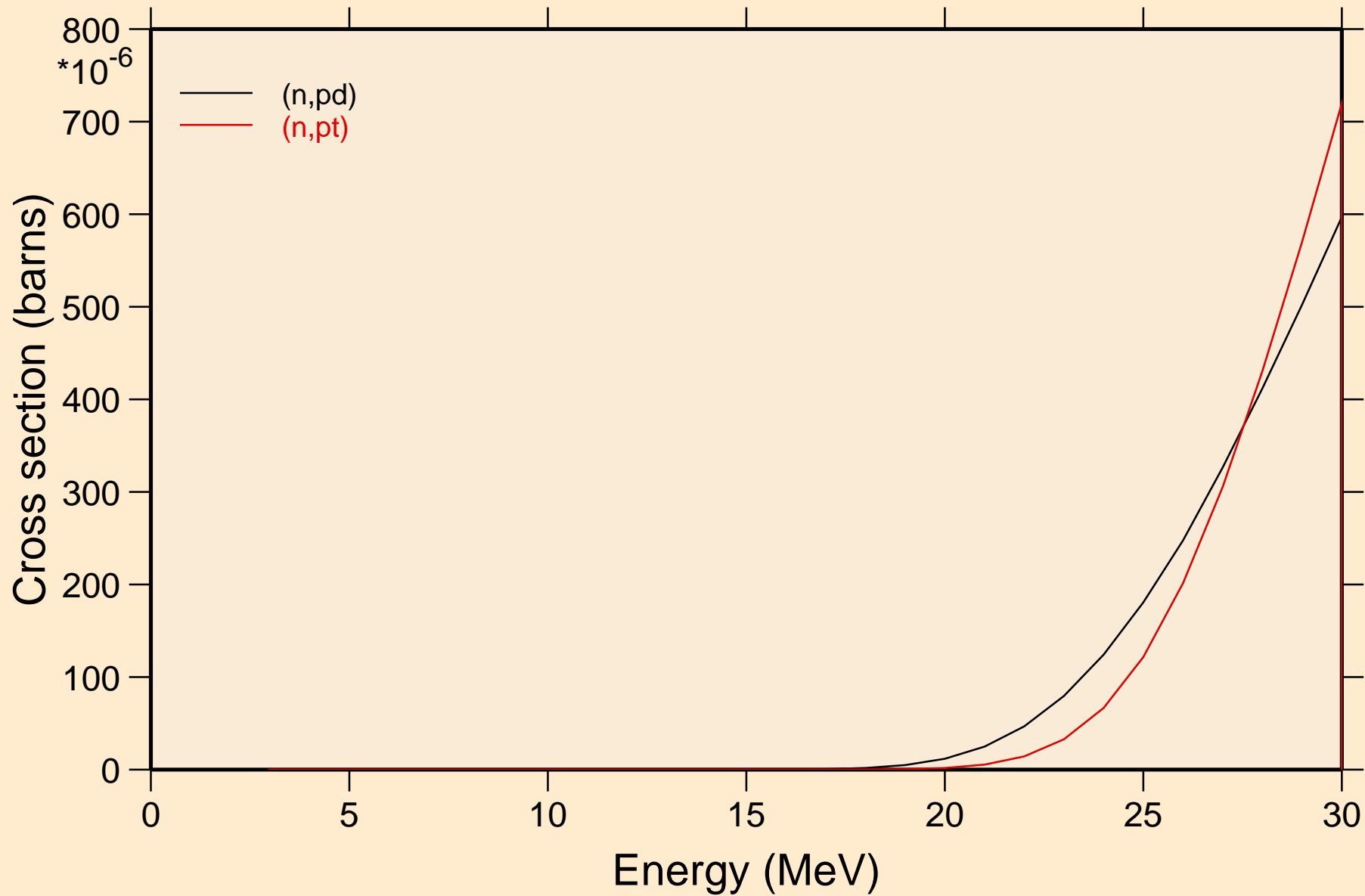

BI192M NEUTRON ACER TENDL-2021 LIBRARY; T=293.6K
angular distribution for elastic

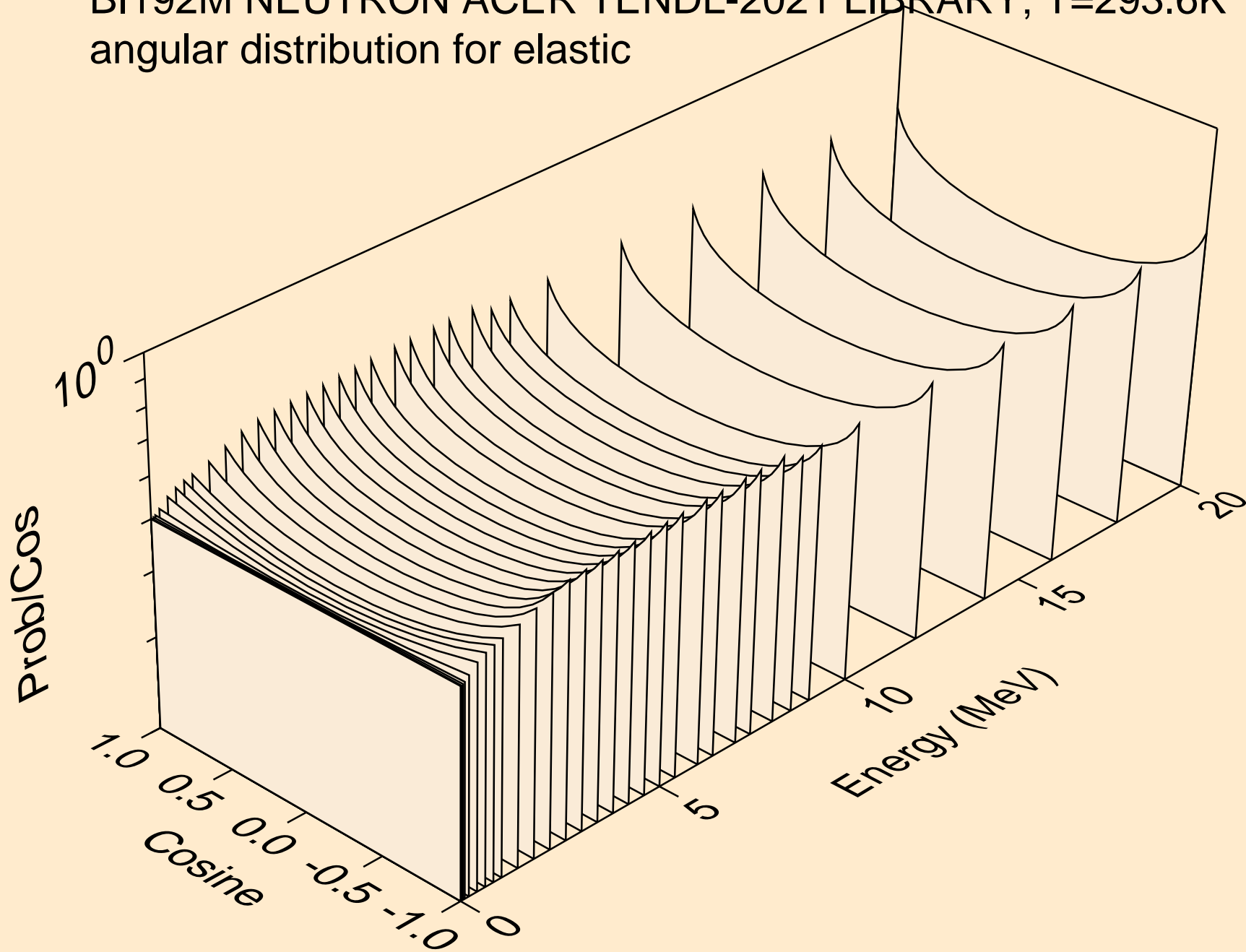

BI192M NEUTRON ACER TENDL-2021 LIBRARY; T=293.6K
angular distribution for elastic

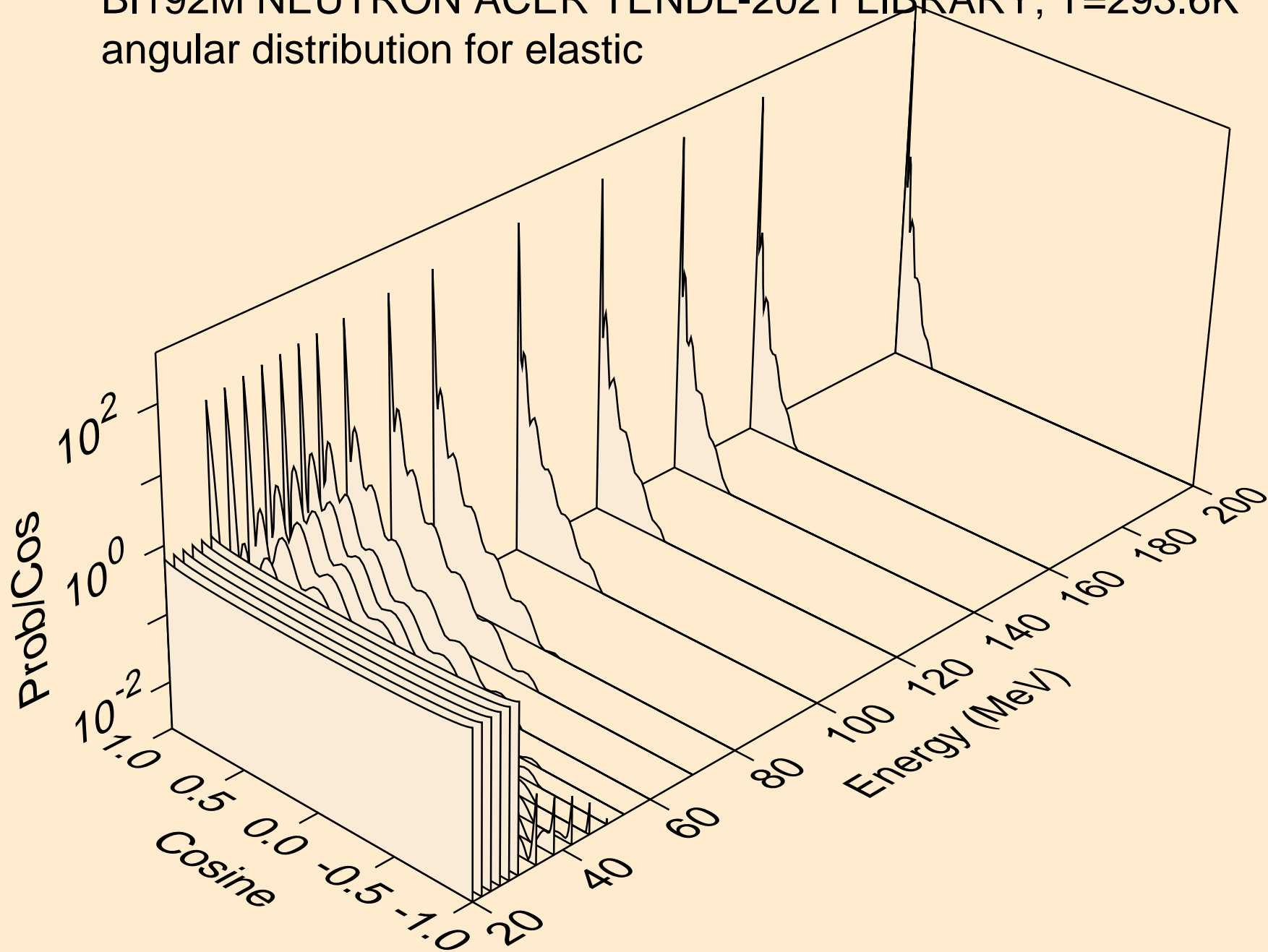

BI192M NEUTRON ACER TENDL-2021 LIBRARY; T=293.6K
angular distribution for (n,n*1)

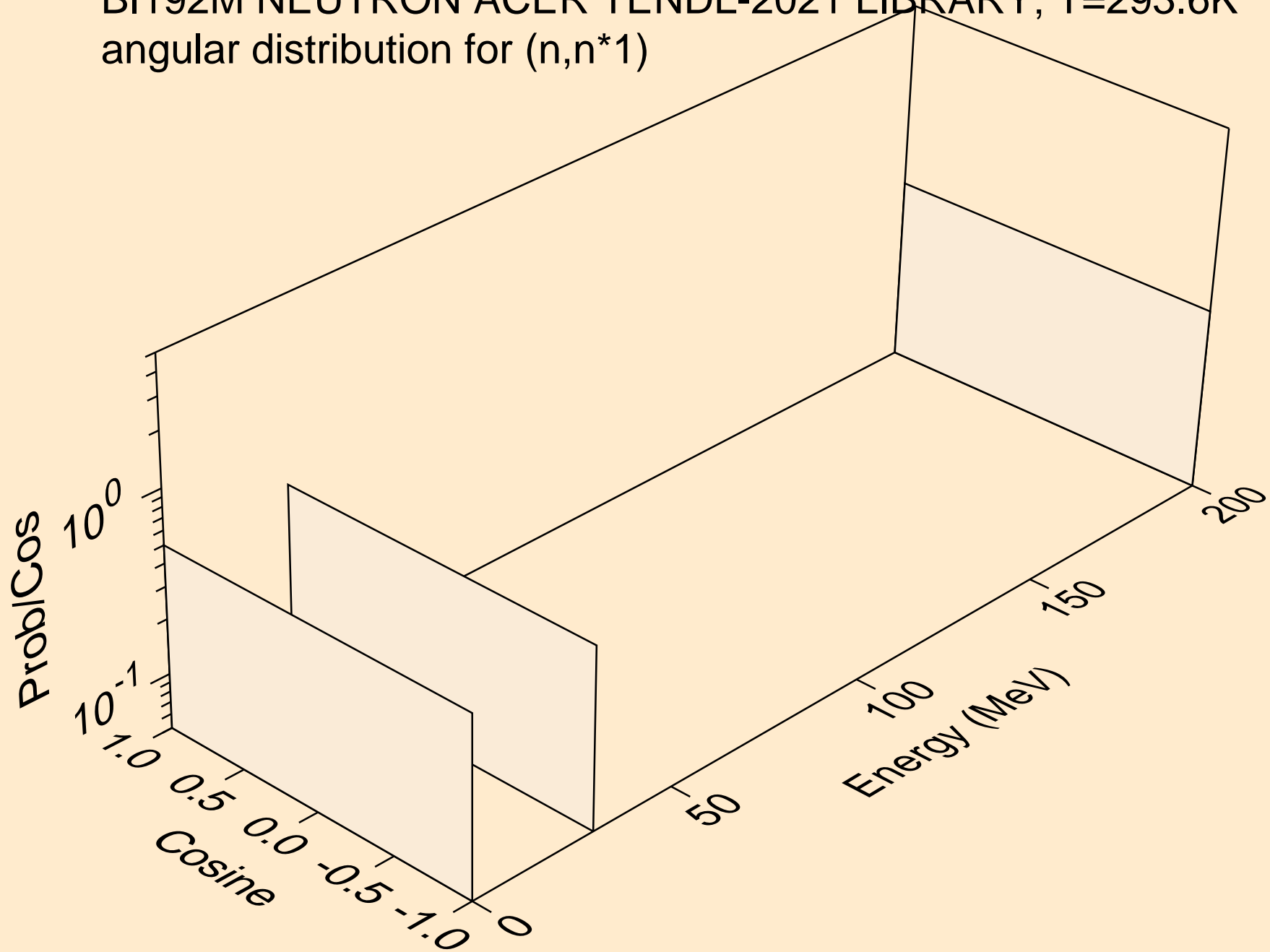

BI192M NEUTRON ACER TENDL-2021 LIBRARY; T=293.6K
angular distribution for (n,n*2)

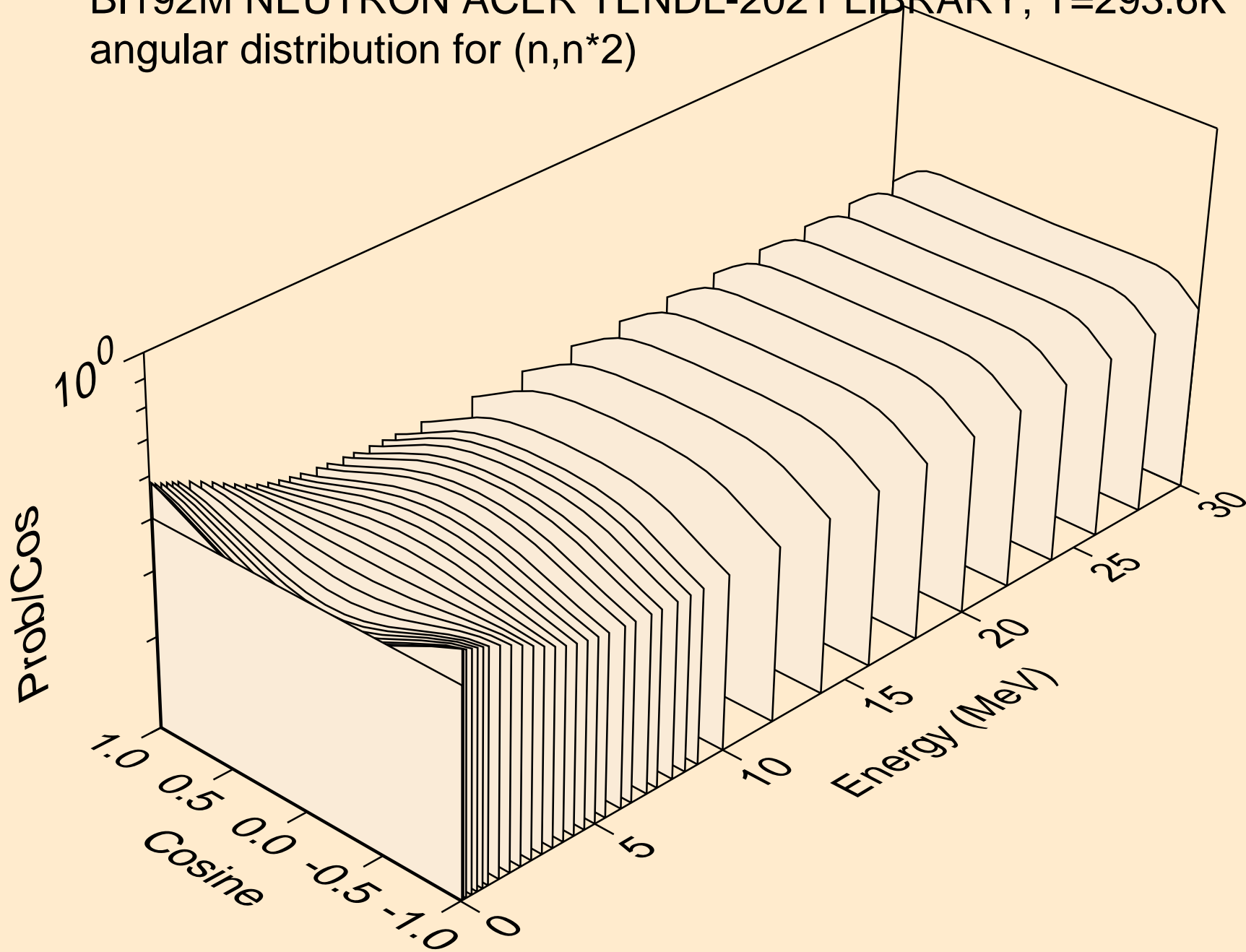

BI192M NEUTRON ACER TENDL-2021 LIBRARY; T=293.6K
Neutron emission for (n,x)

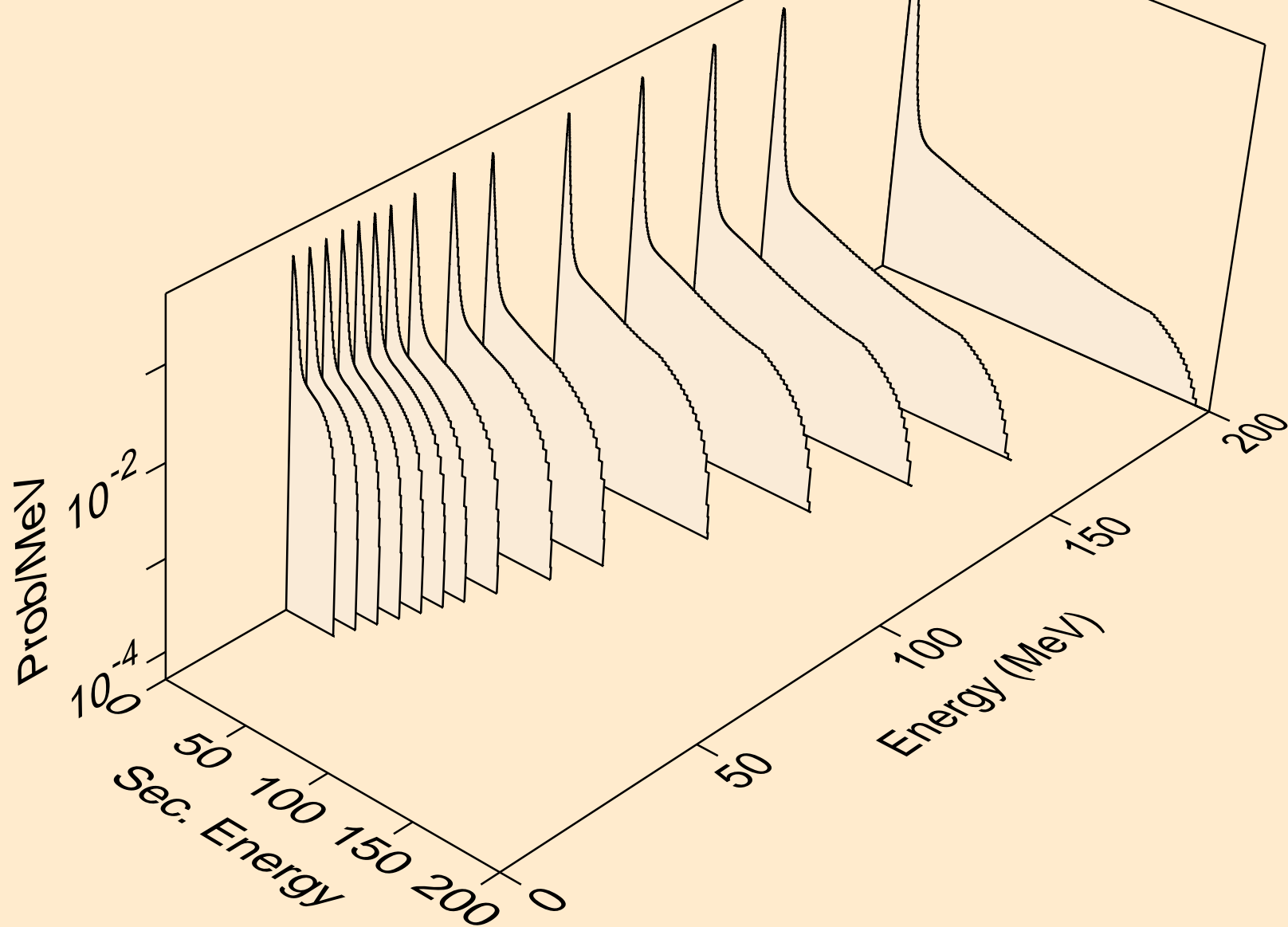

BI192M NEUTRON ACER TENDL-2021 LIBRARY; T=293.6K
Neutron emission for (n,2nd)

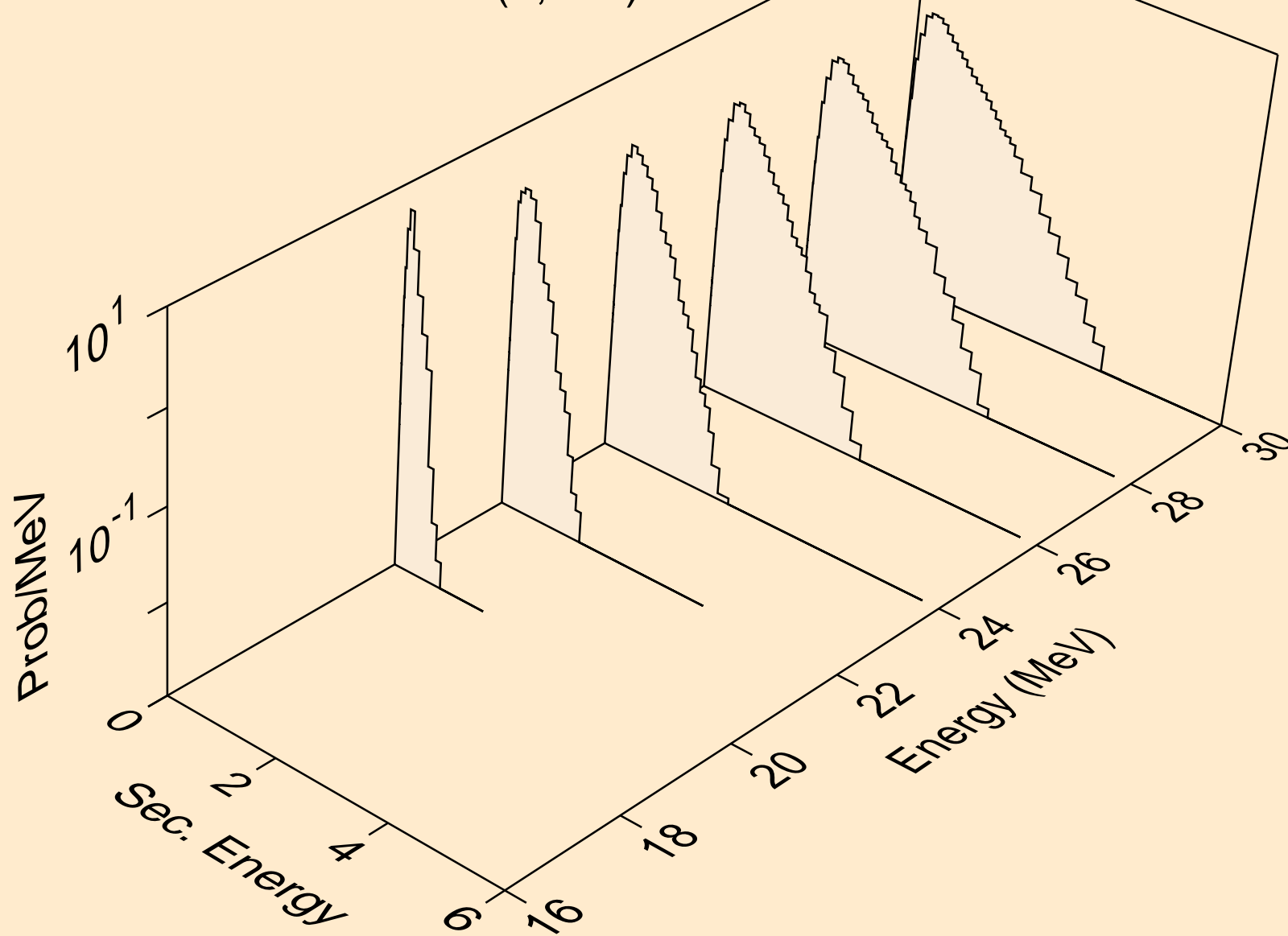

BI192M NEUTRON ACER TENDL-2021 LIBRARY; T=293.6K
Neutron emission for (n,2n)

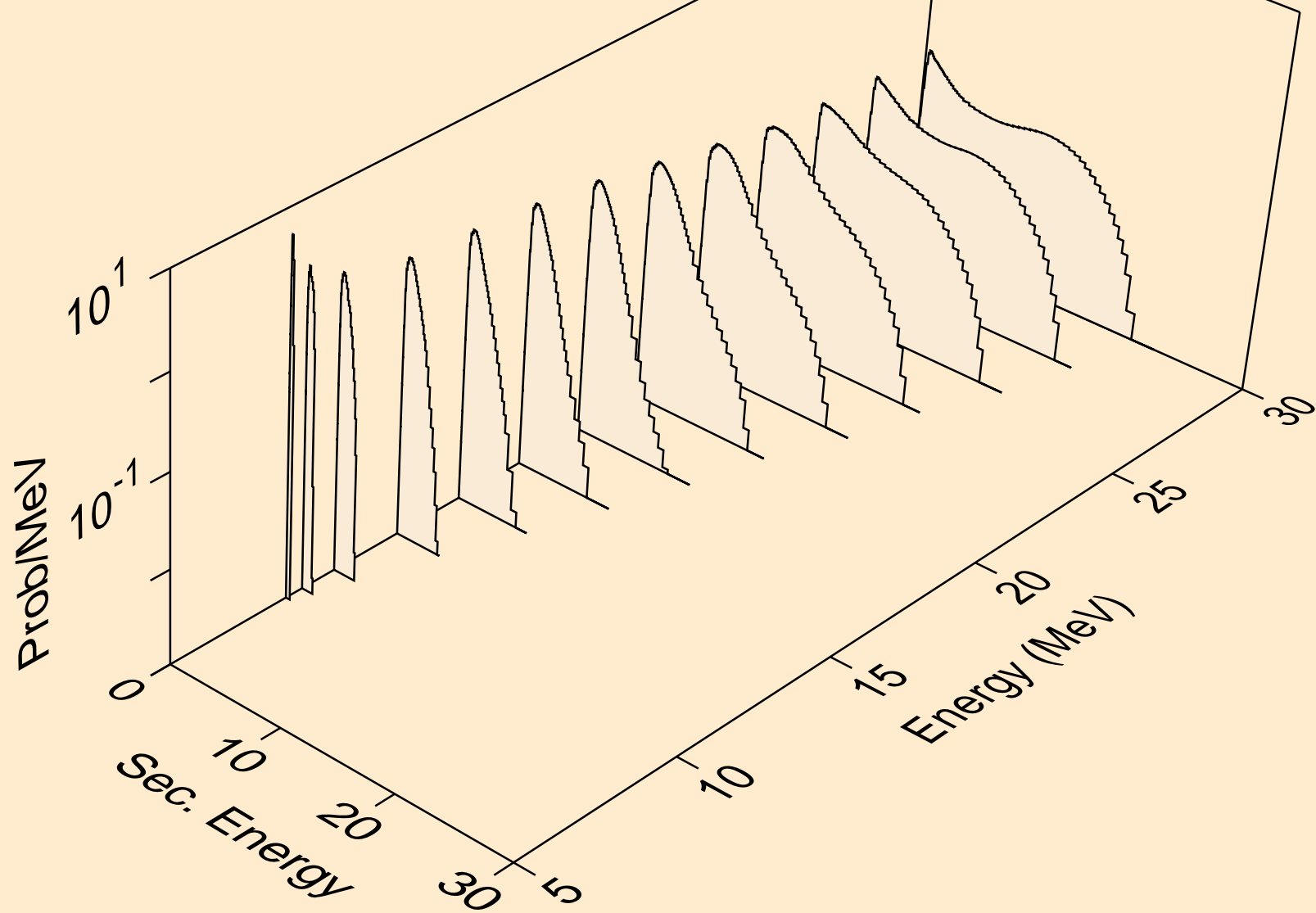

BI192M NEUTRON ACER TENDL-2021 LIBRARY; T=293.6K
Neutron emission for (n,3n)

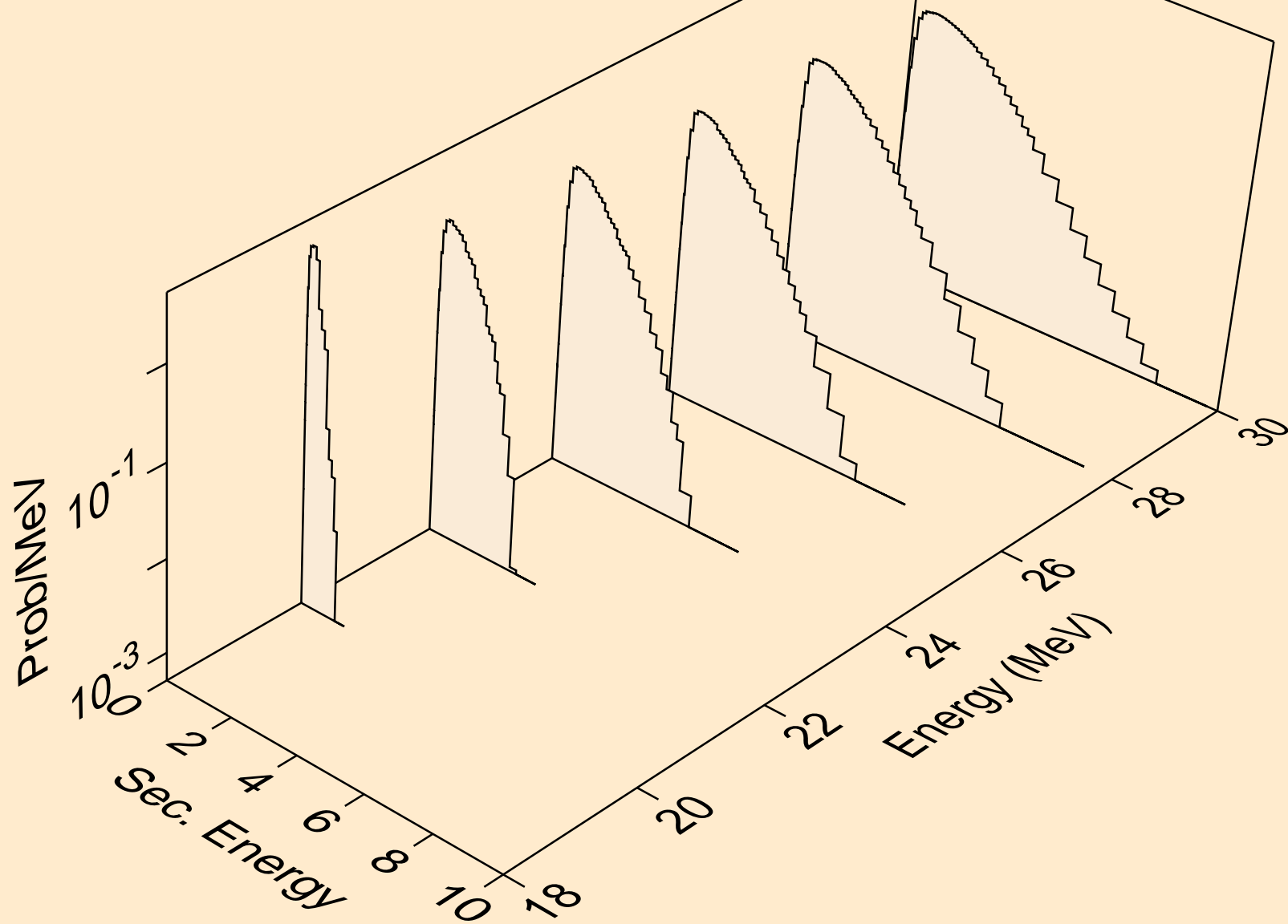

BI192M NEUTRON ACER TENDL-2021 LIBRARY; T=293.6K
Neutron emission for (n,n*)a

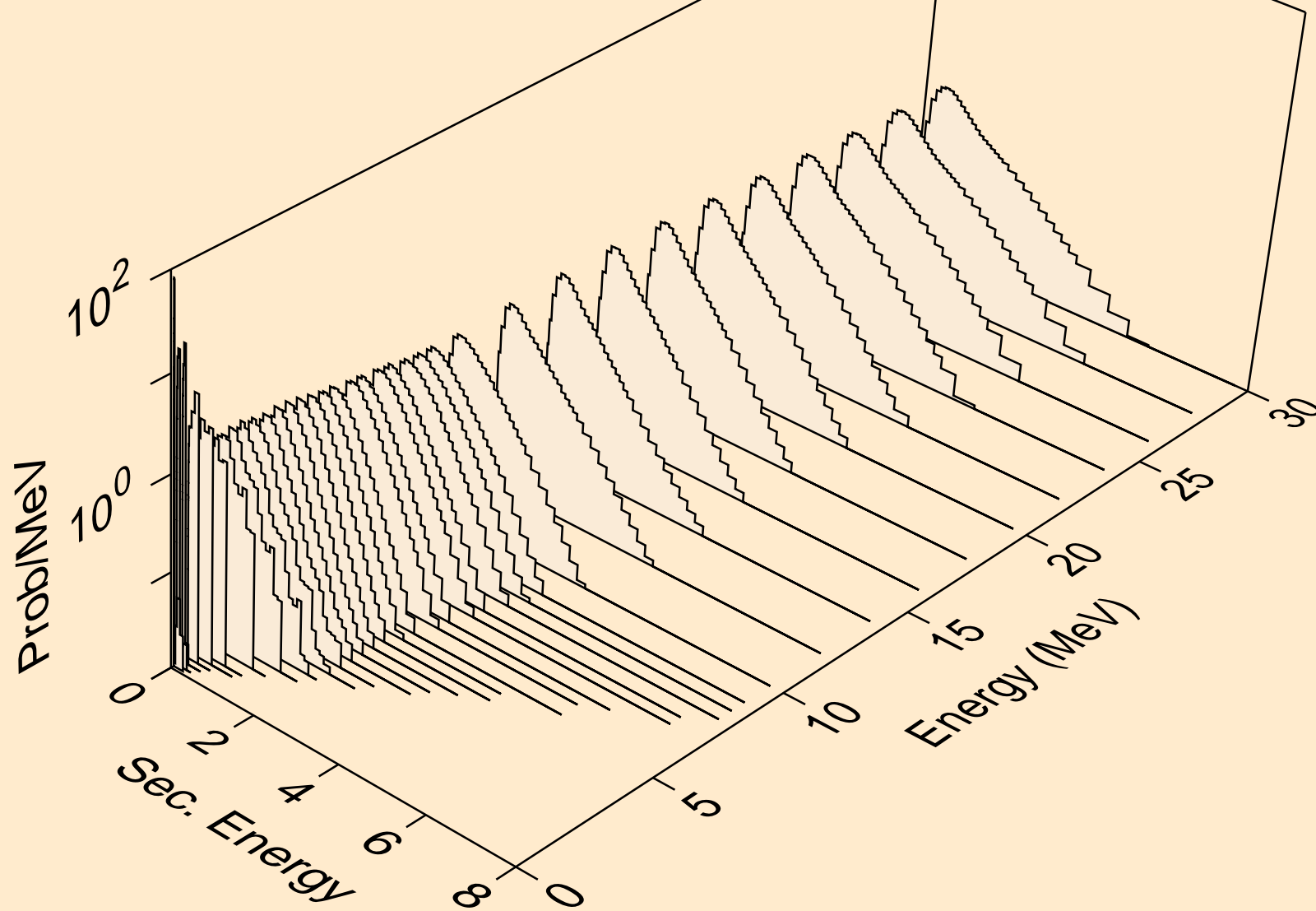

BI192M NEUTRON ACER TENDL-2021 LIBRARY; T=293.6K
Neutron emission for (n,2n)a

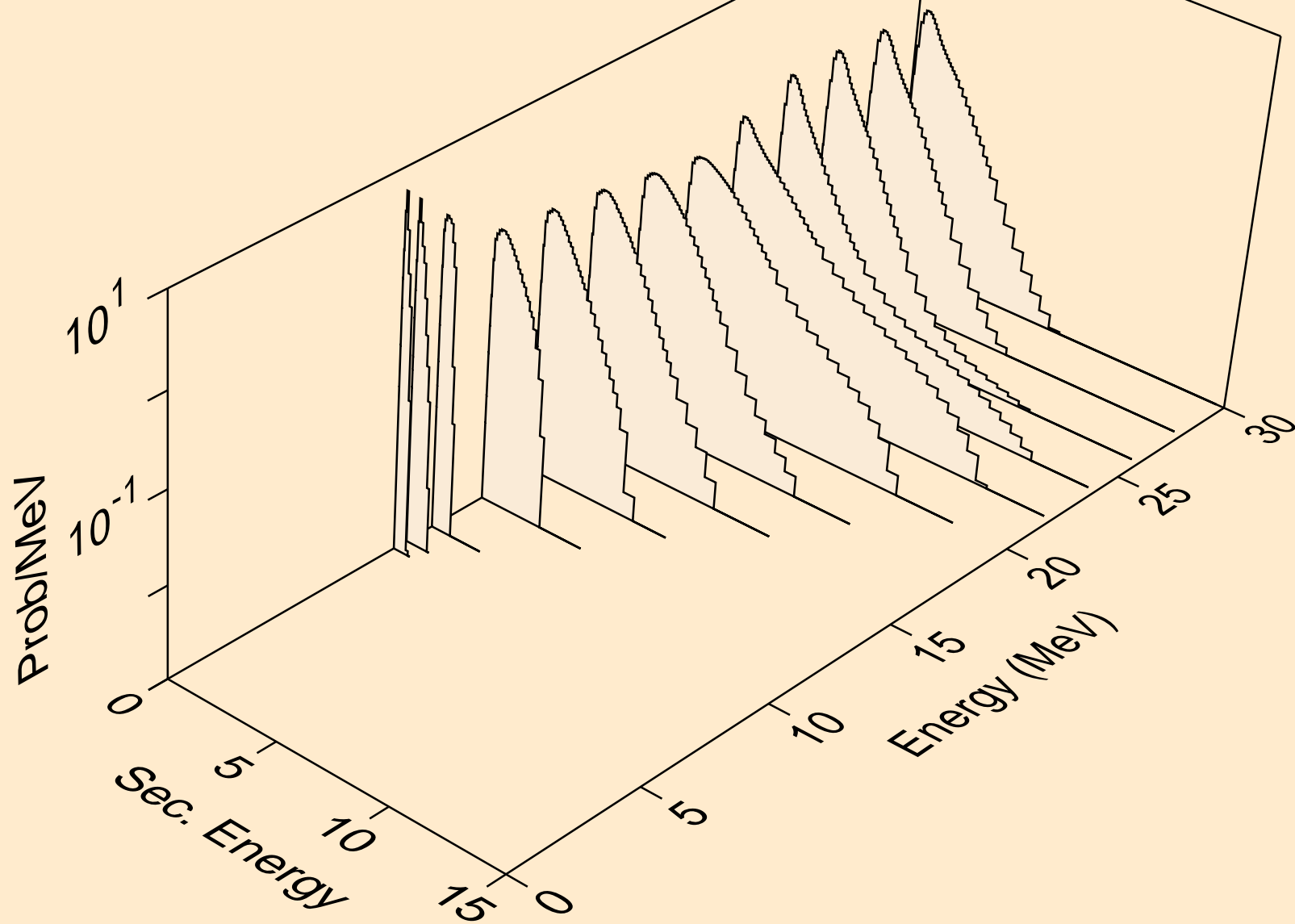

BI192M NEUTRON ACER TENDL-2021 LIBRARY; T=293.6K
Neutron emission for (n,3n)a

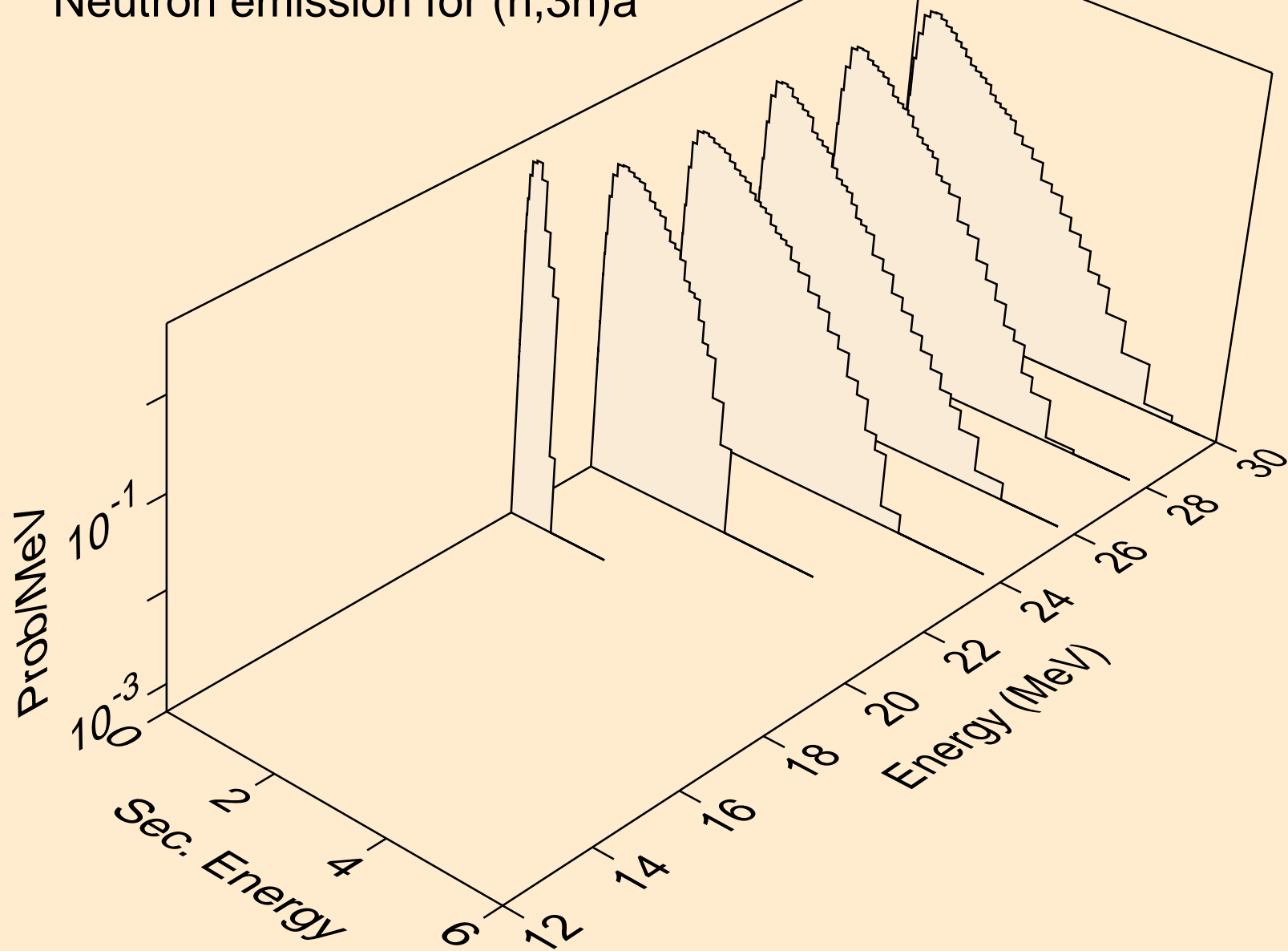

BI192M NEUTRON ACER TENDL-2021 LIBRARY; T=293.6K
Neutron emission for (n,n*)p

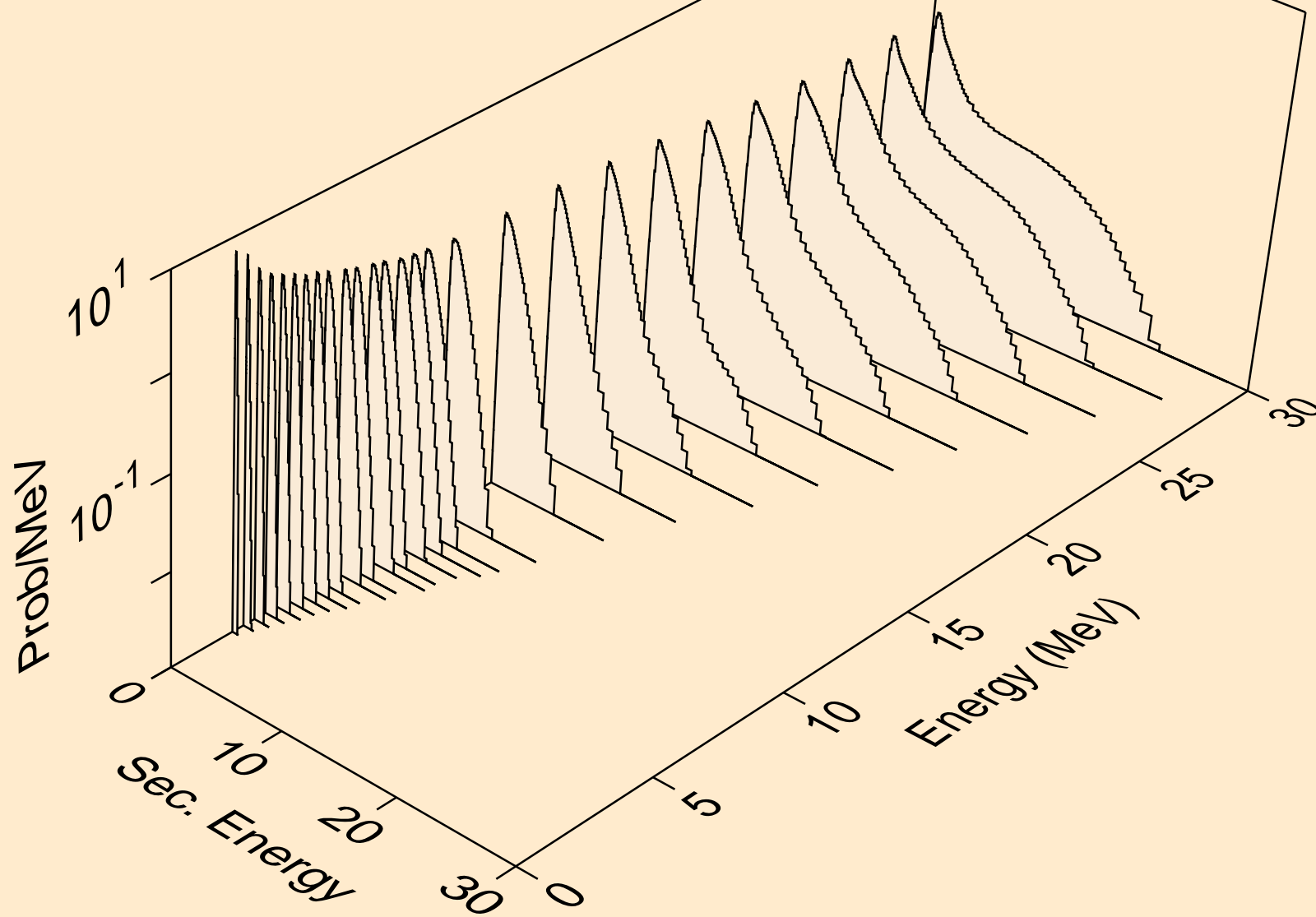

BI192M NEUTRON ACER TENDL-2021 LIBRARY; T=293.6K
Neutron emission for (n,n*)2a

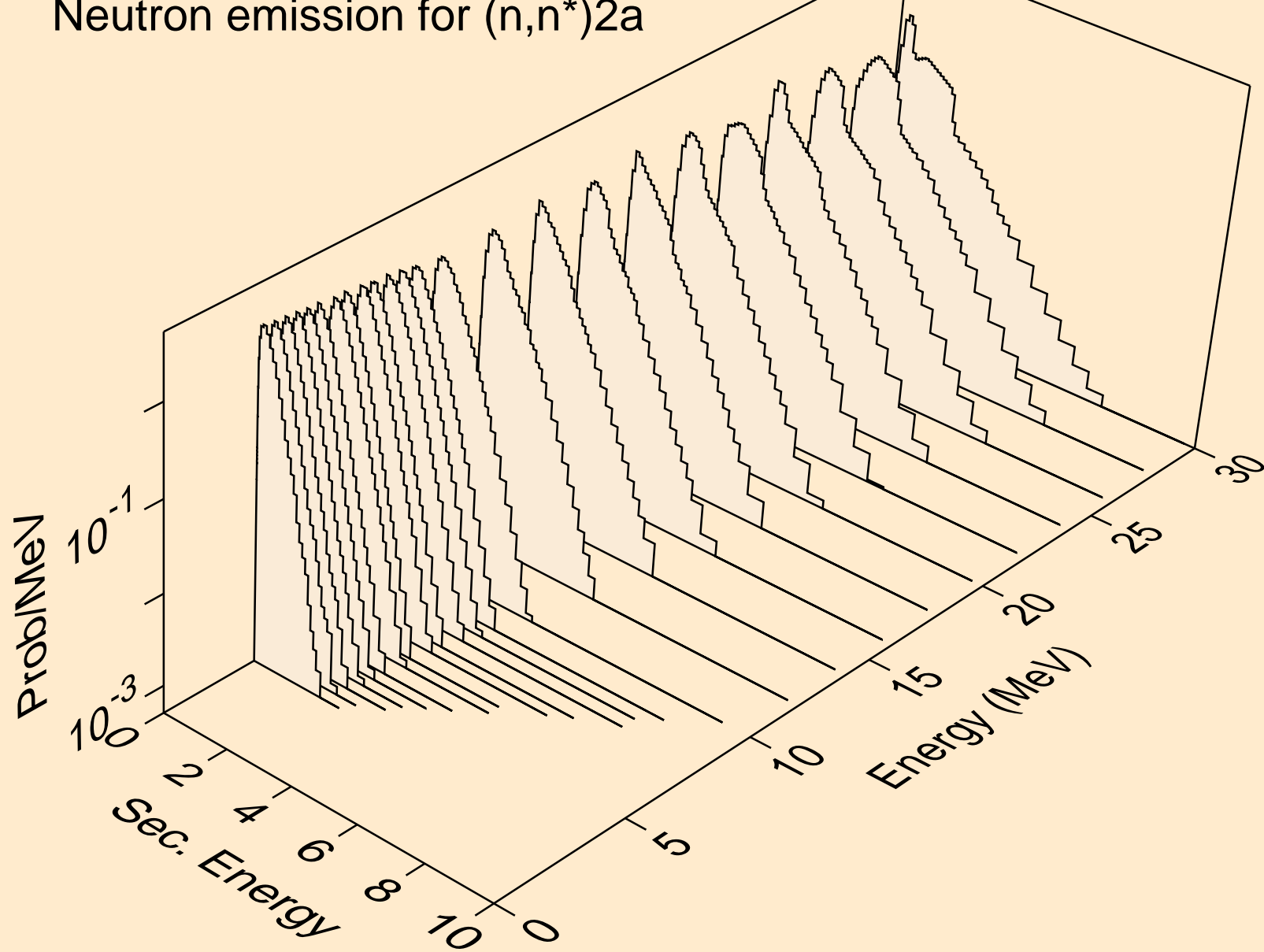

BI192M NEUTRON ACER TENDL-2021 LIBRARY; T=293.6K
Neutron emission for (n,2n)2a

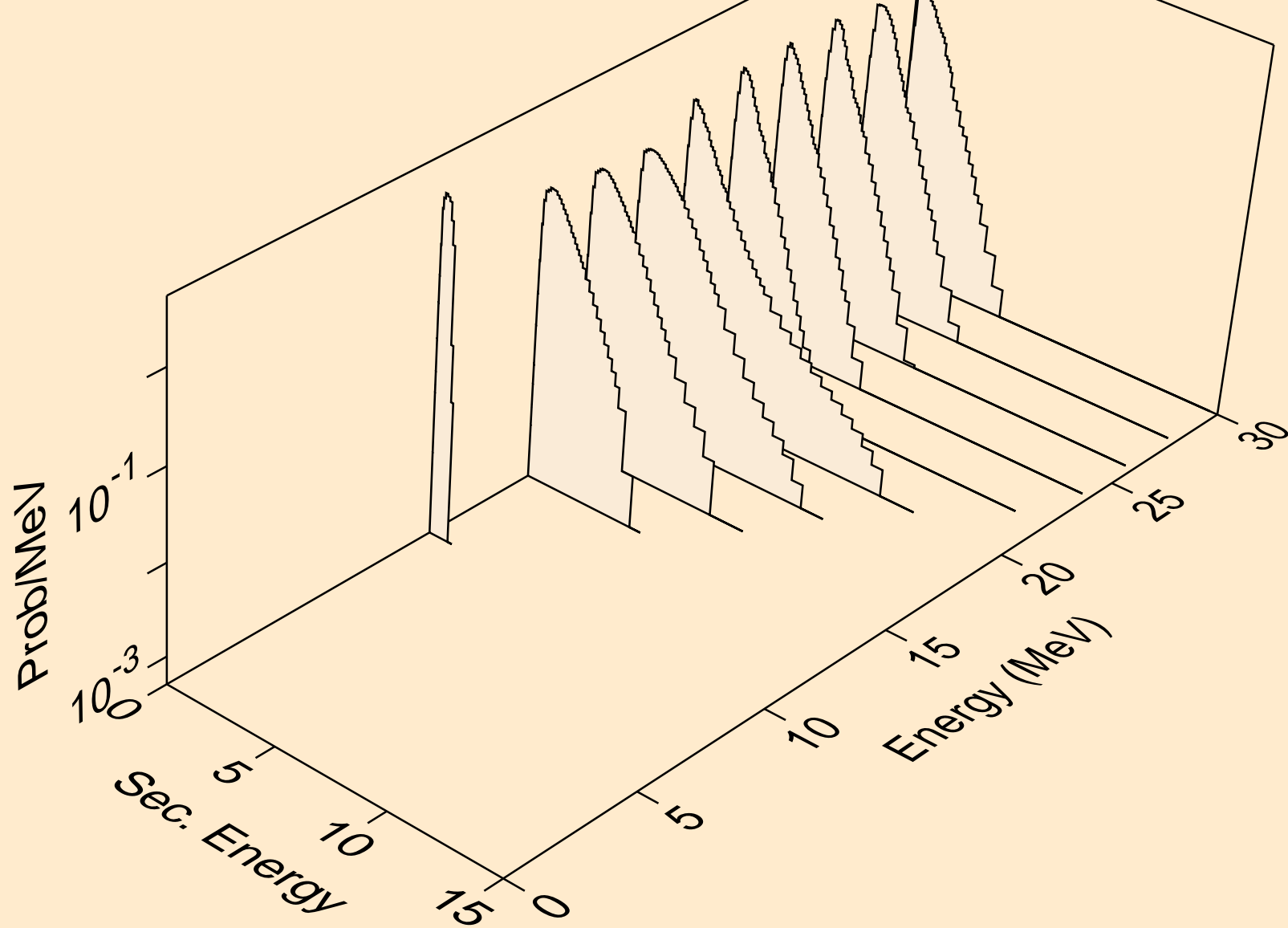

BI192M NEUTRON ACER TENDL-2021 LIBRARY; T=293.6K
Neutron emission for (n,n*)d

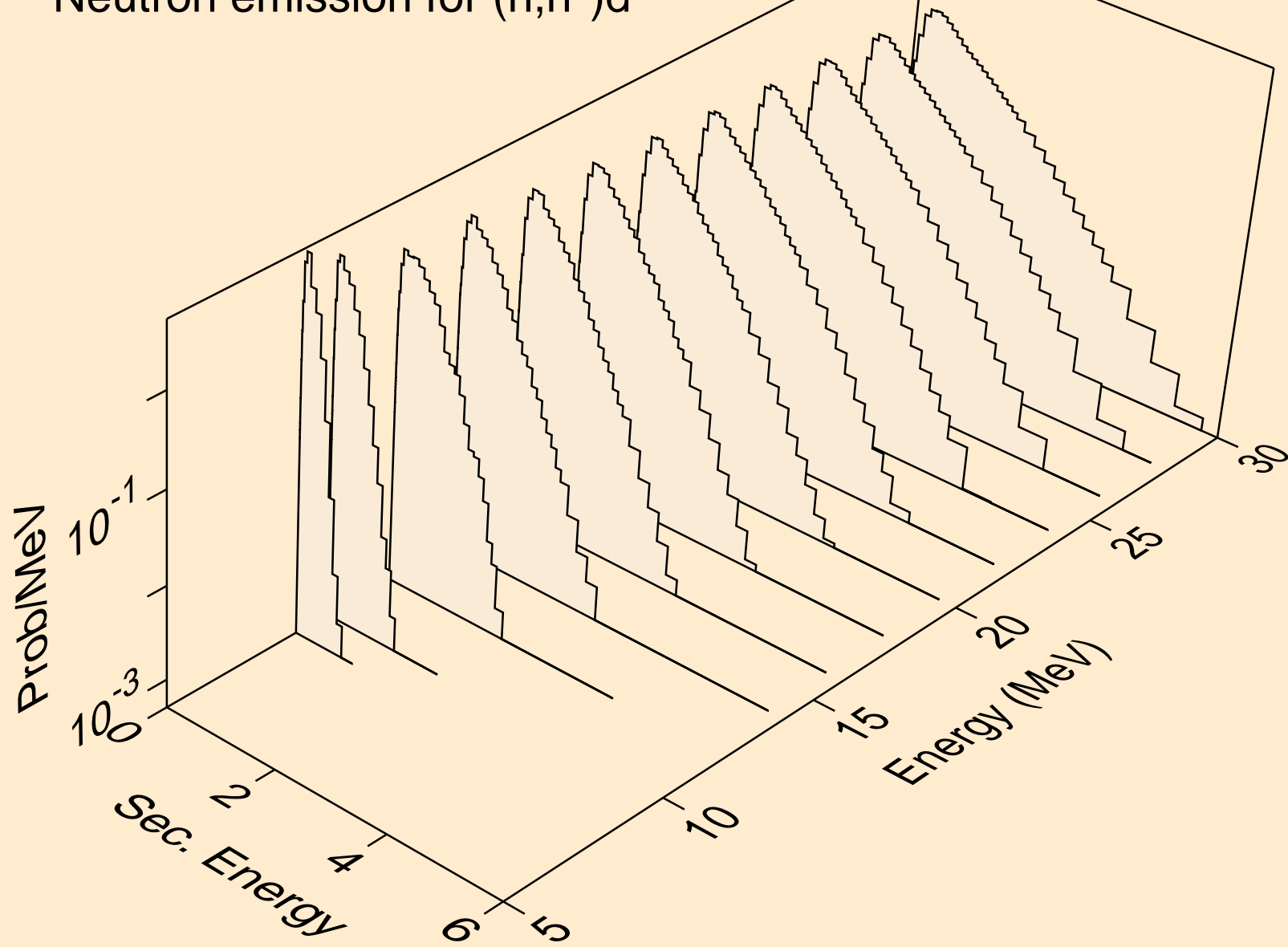

BI192M NEUTRON ACER TENDL-2021 LIBRARY; T=293.6K
Neutron emission for (n,n*)t

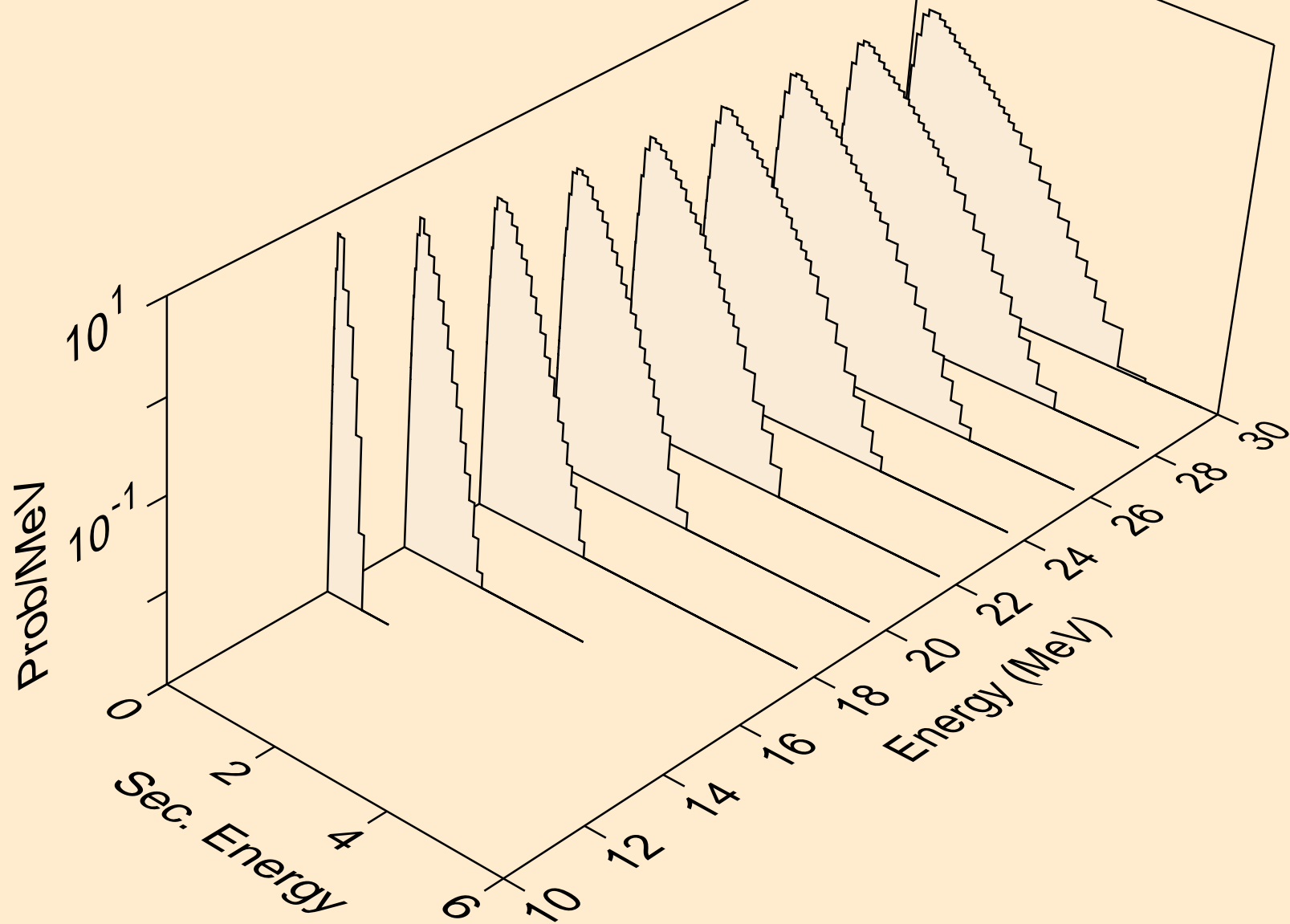

BI192M NEUTRON ACER TENDL-2021 LIBRARY; T=293.6K
Neutron emission for (n,n*)he3

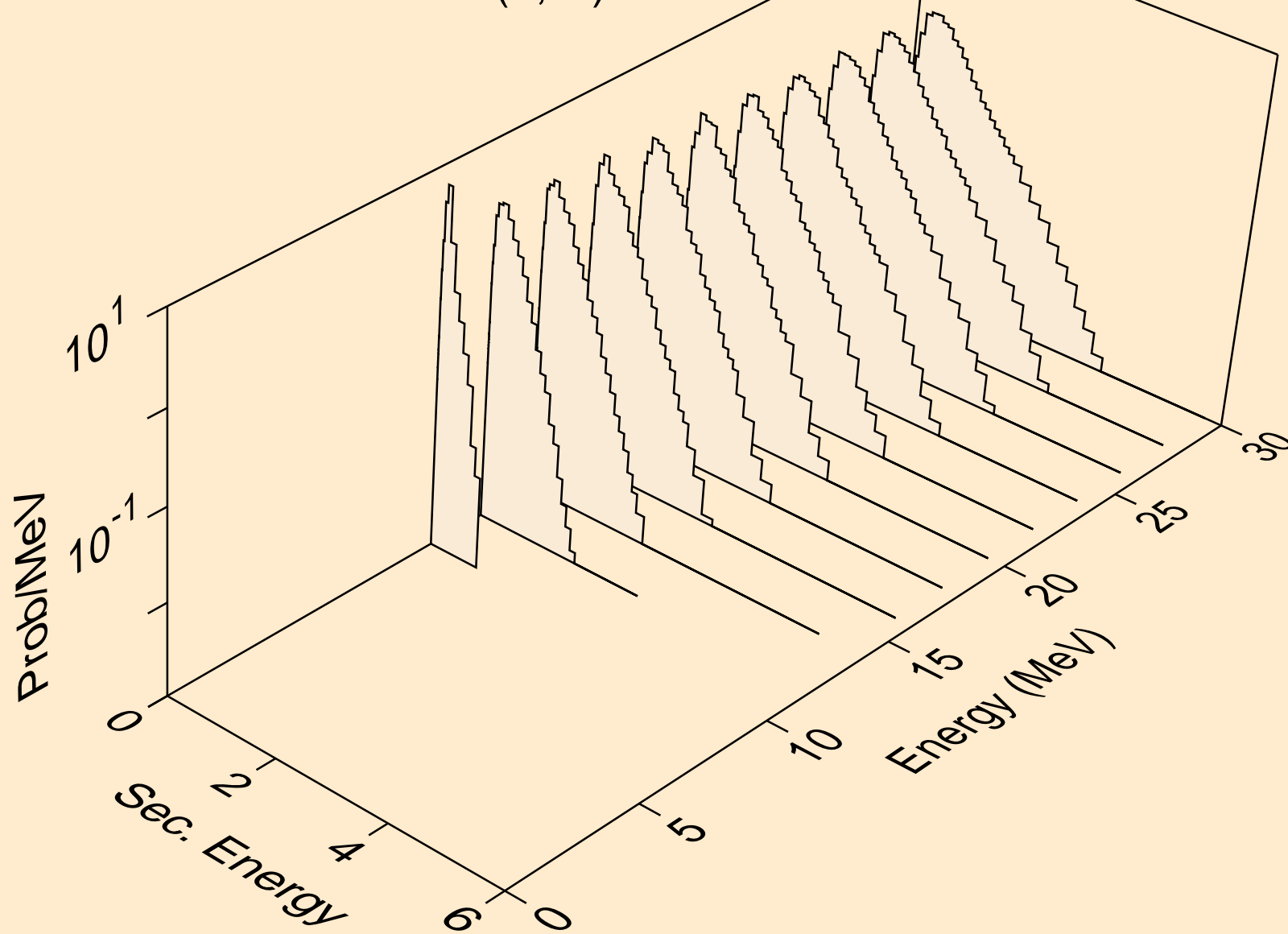

BI192M NEUTRON ACER TENDL-2021 LIBRARY; T=293.6K
Neutron emission for (n,4n)

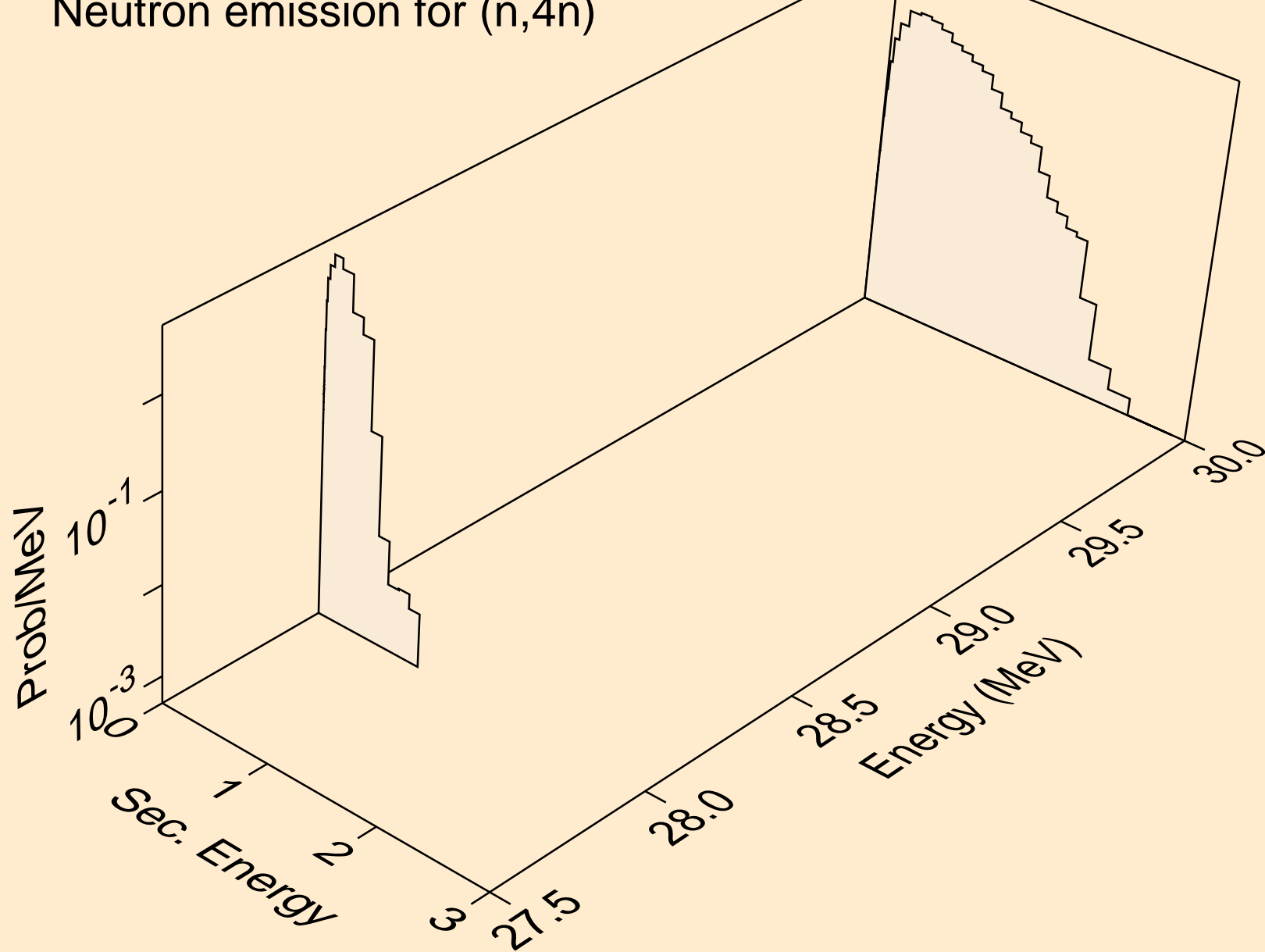

BI192M NEUTRON ACER TENDL-2021 LIBRARY; T=293.6K
Neutron emission for (n,2np)

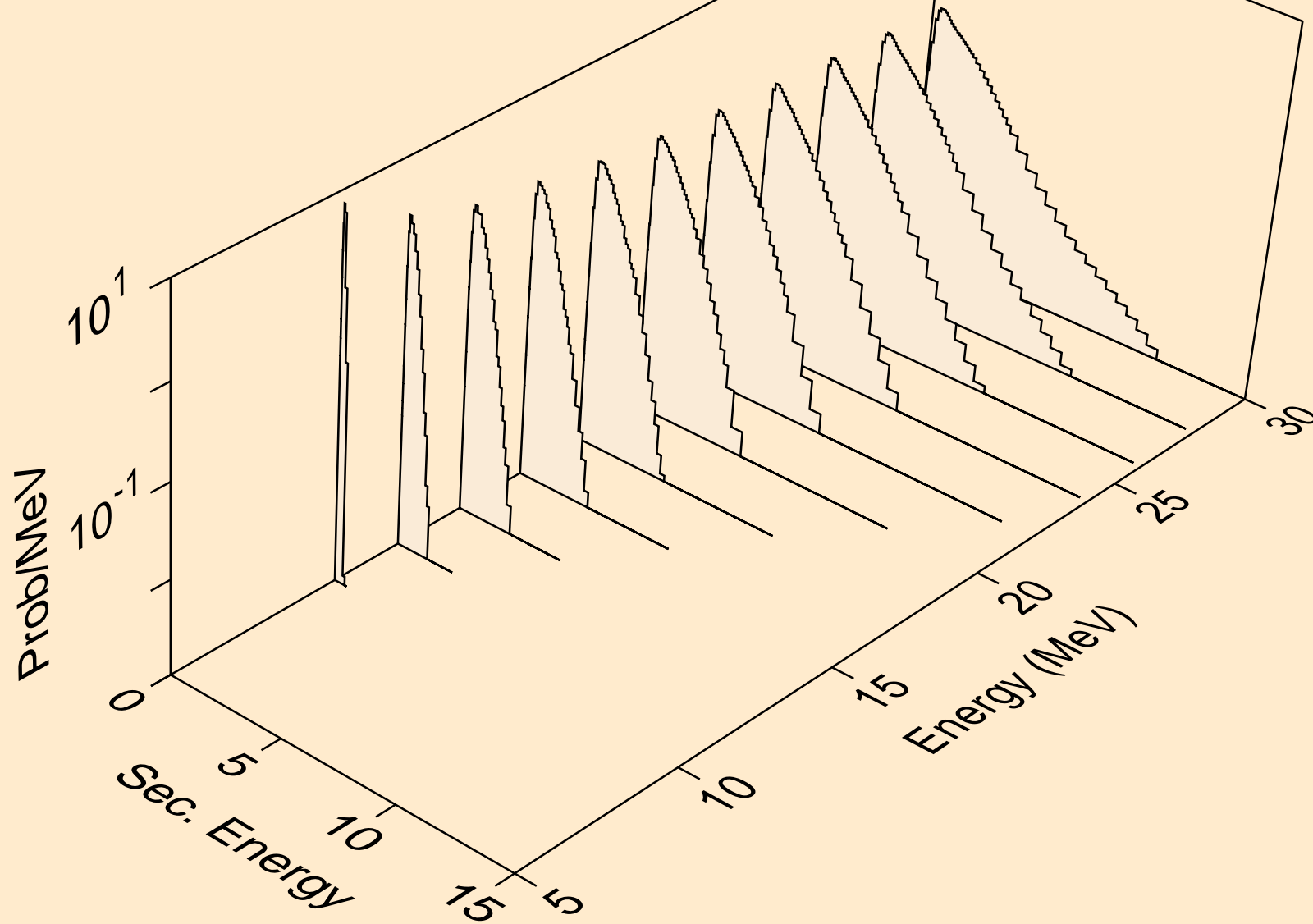

BI192M NEUTRON ACER TENDL-2021 LIBRARY; T=293.6K
Neutron emission for (n,3np)

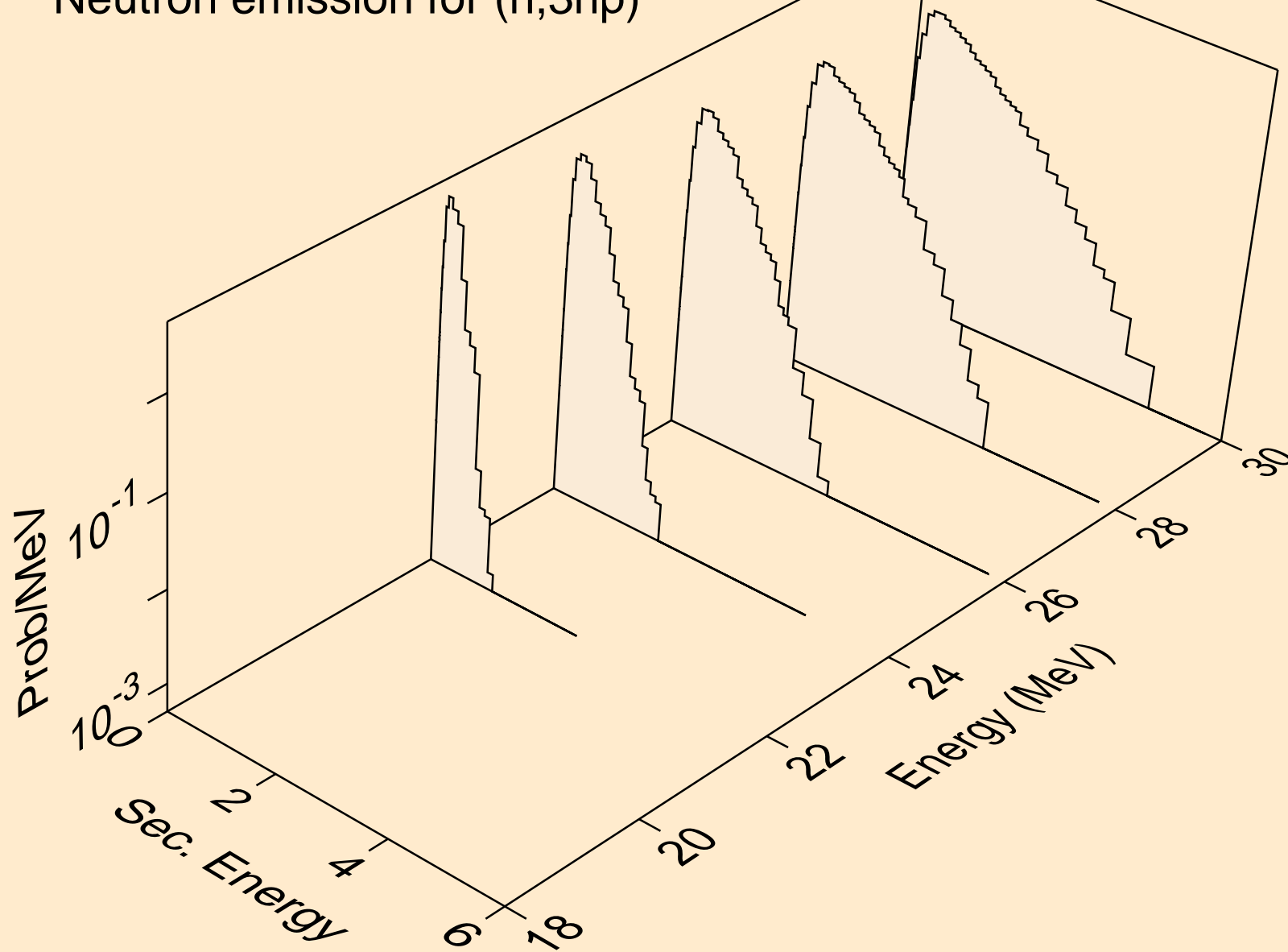

BI192M NEUTRON ACER TENDL-2021 LIBRARY; T=293.6K
Neutron emission for (n,2np)

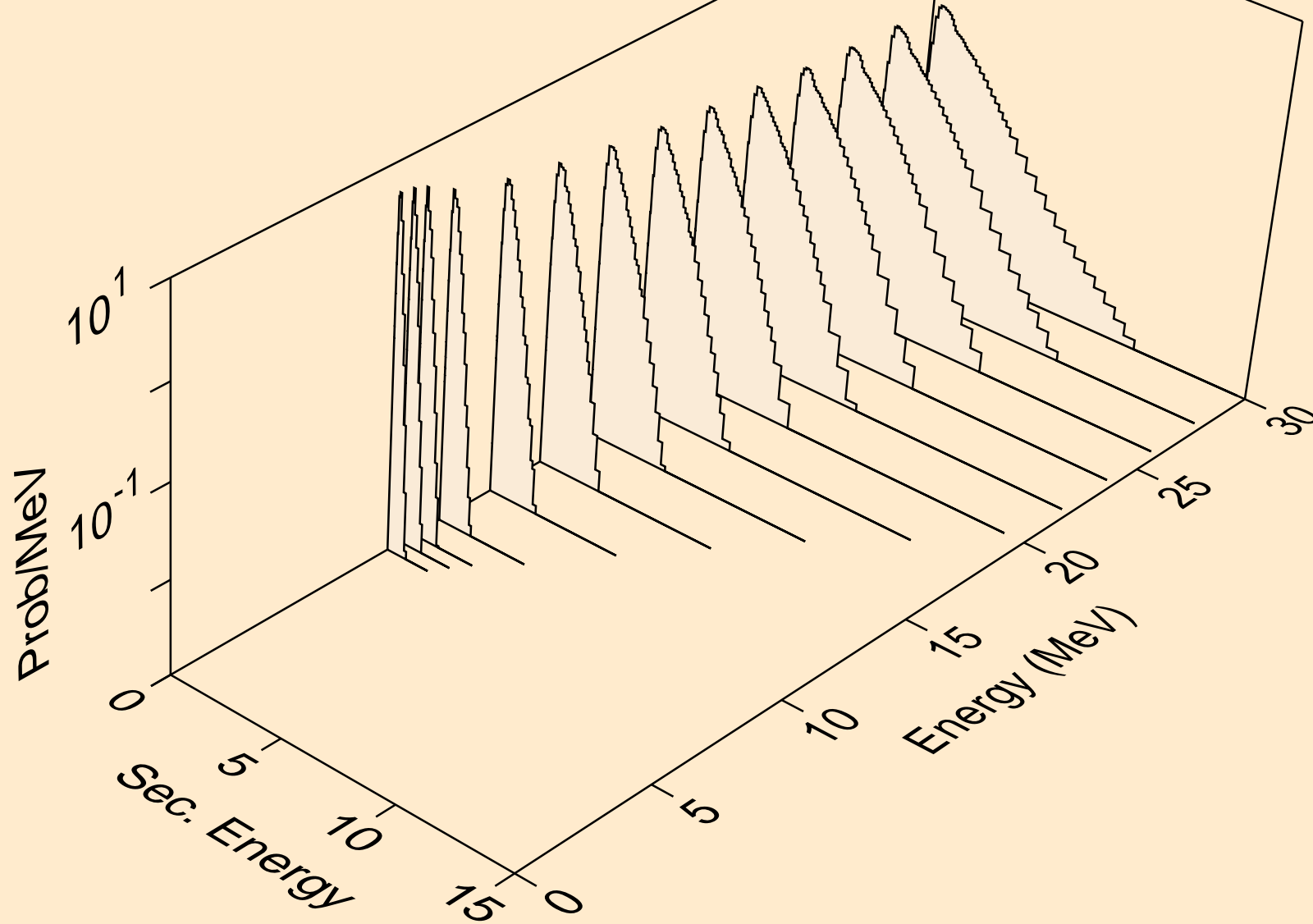

BI192M NEUTRON ACER TENDL-2021 LIBRARY; T=293.6K
Neutron emission for (n,npa)

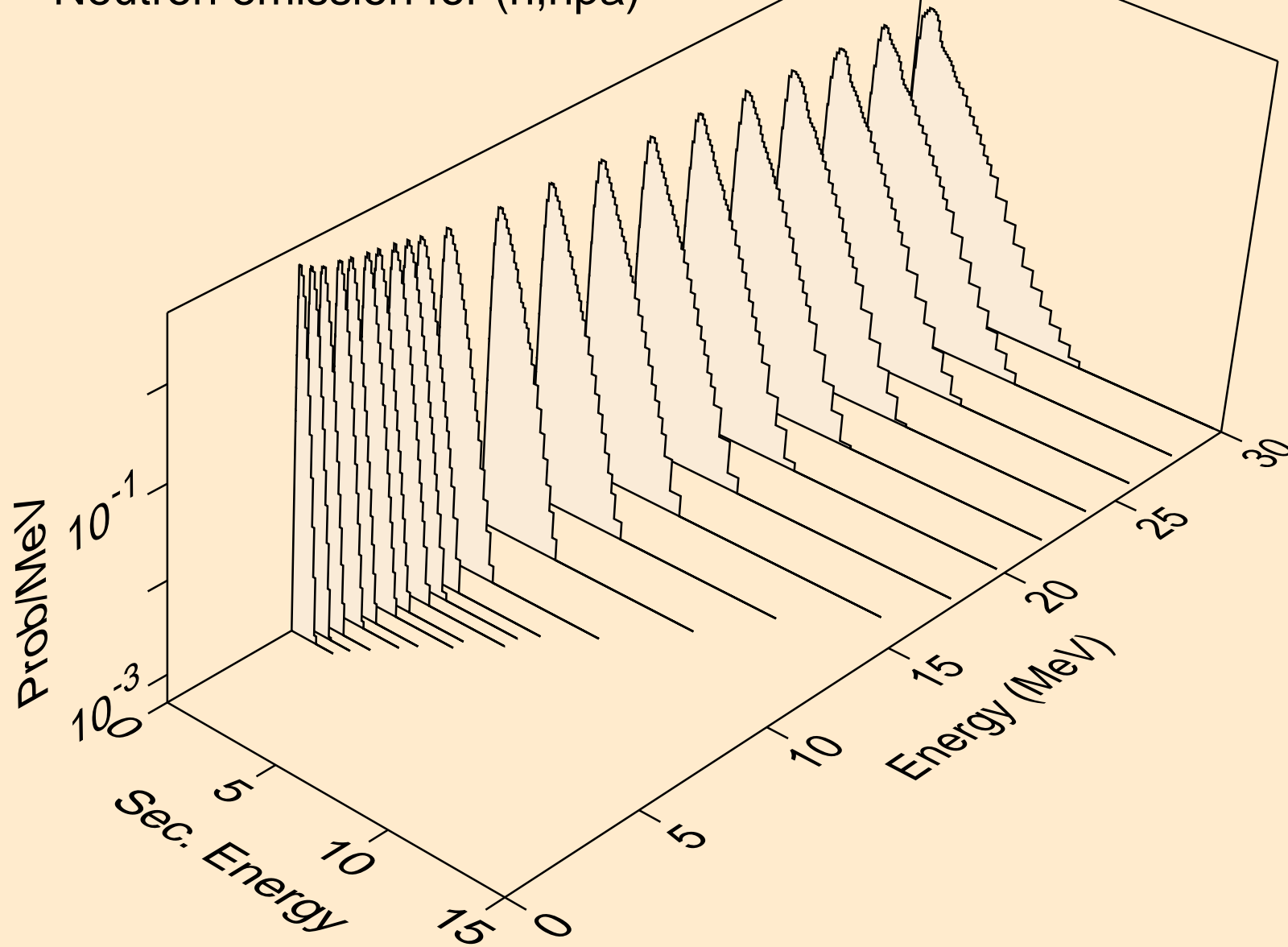

BI192M NEUTRON ACER TENDL-2021 LIBRARY; T=293.6K
Neutron emission for (n,n*c)

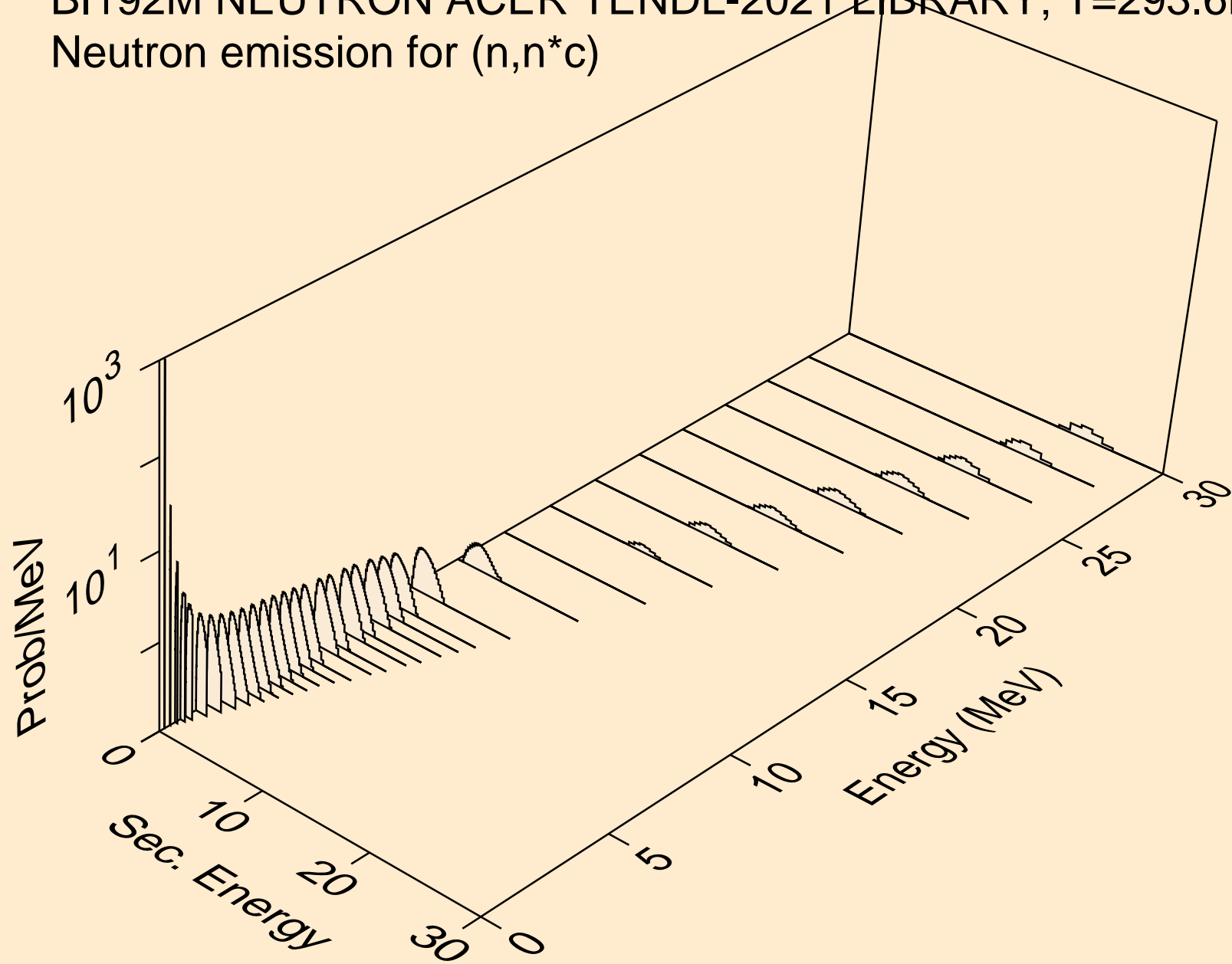

BI192M NEUTRON ACER TENDL-2021 LIBRARY; T=293.6K
Photon emission for (n,x)

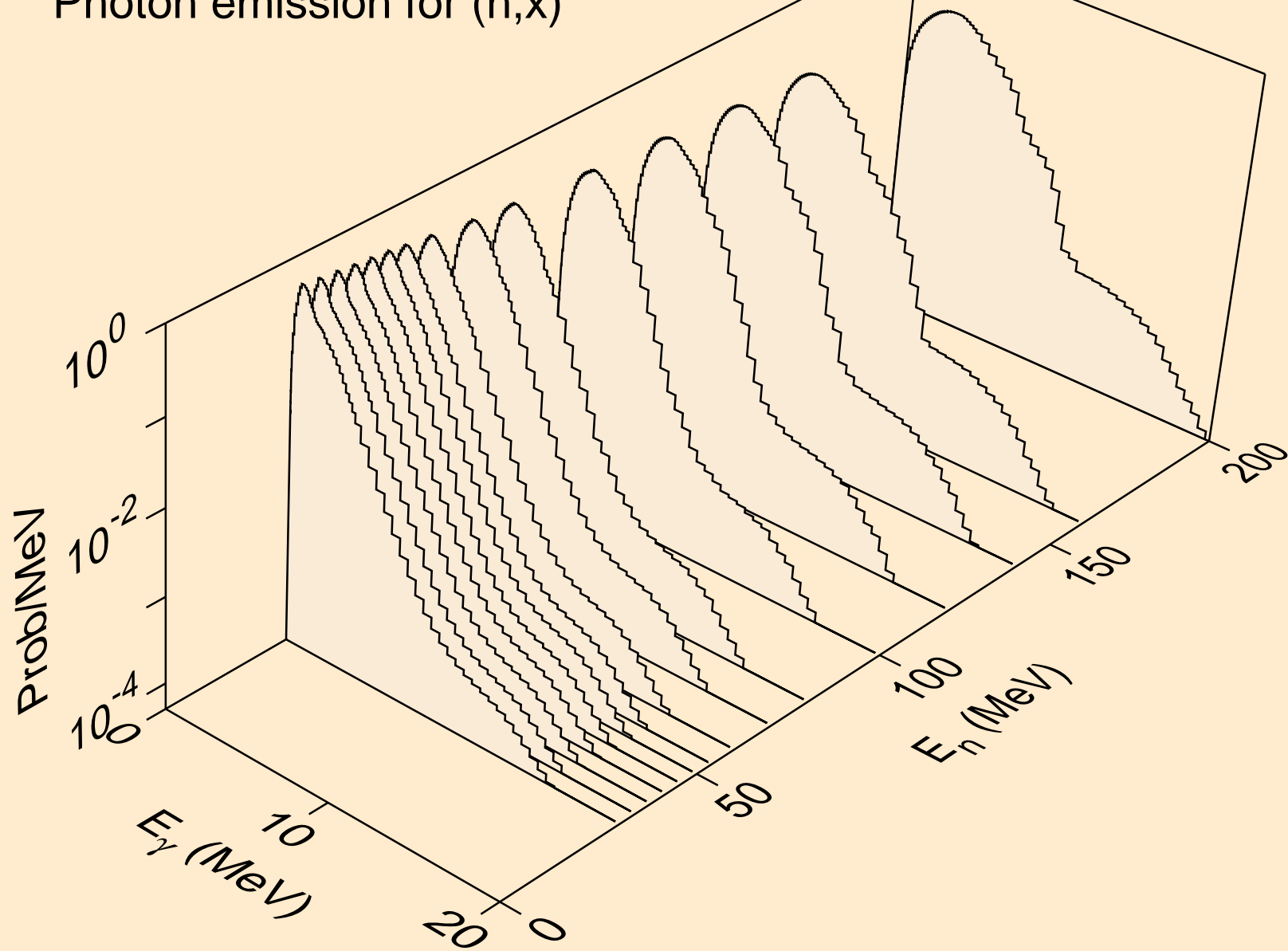

BI192M NEUTRON ACER TENDL-2021 LIBRARY; T=293.6K
Photon emission for (n,2nd)

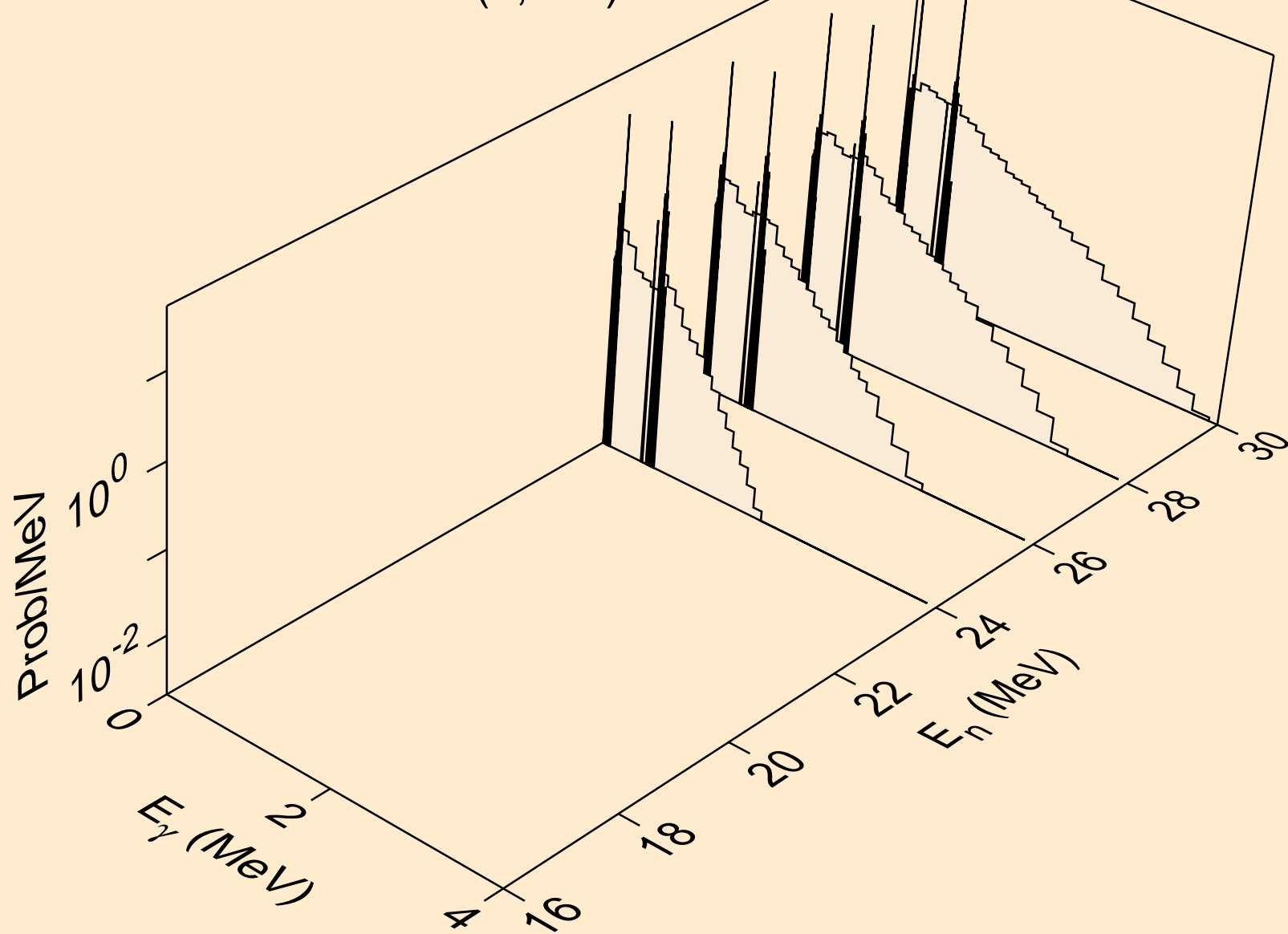

BI192M NEUTRON ACER TENDL-2021 LIBRARY; T=293.6K
Photon emission for (n,2n)

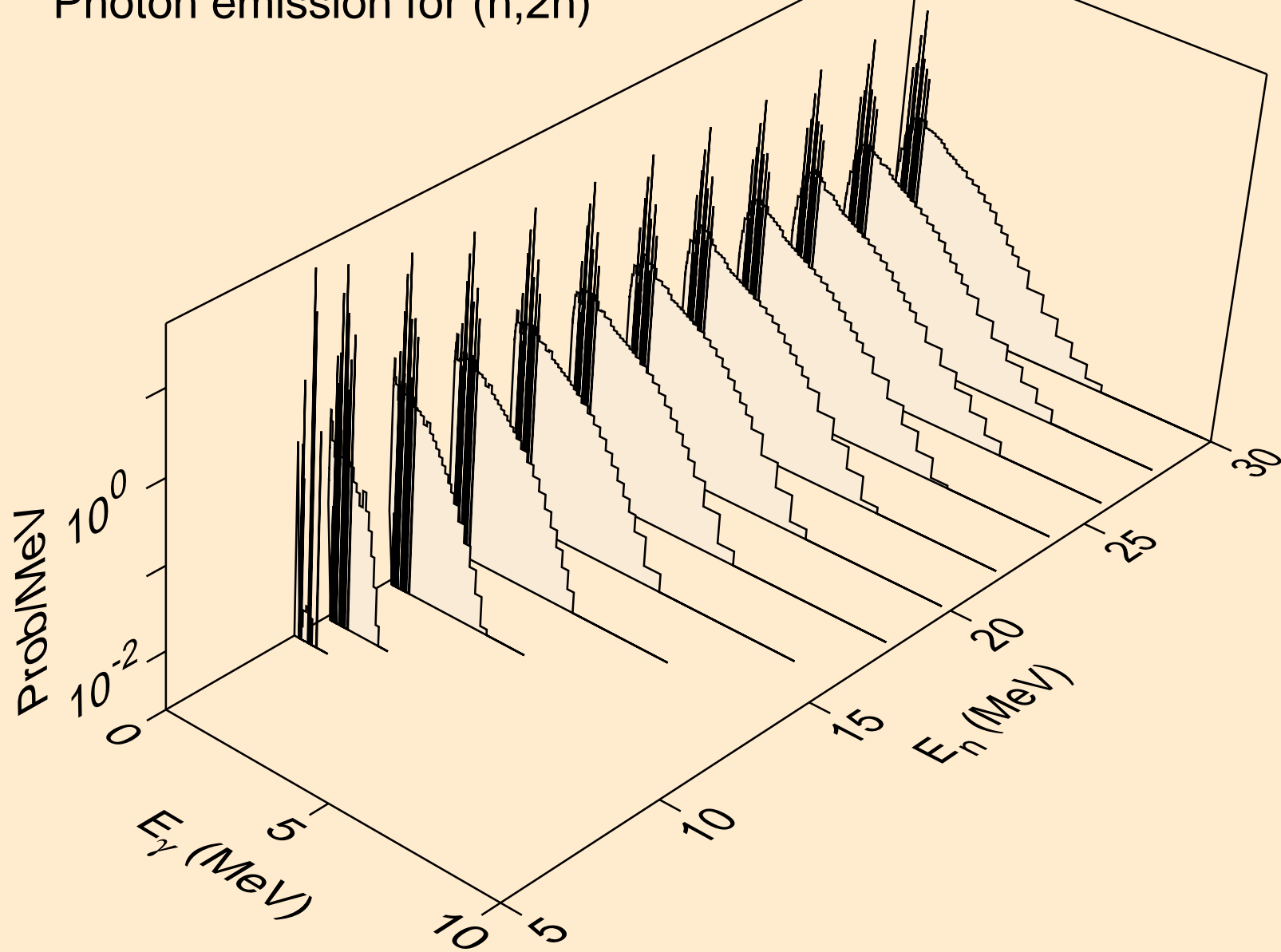

BI192M NEUTRON ACER TENDL-2021 LIBRARY; T=293.6K
Photon emission for (n,3n)

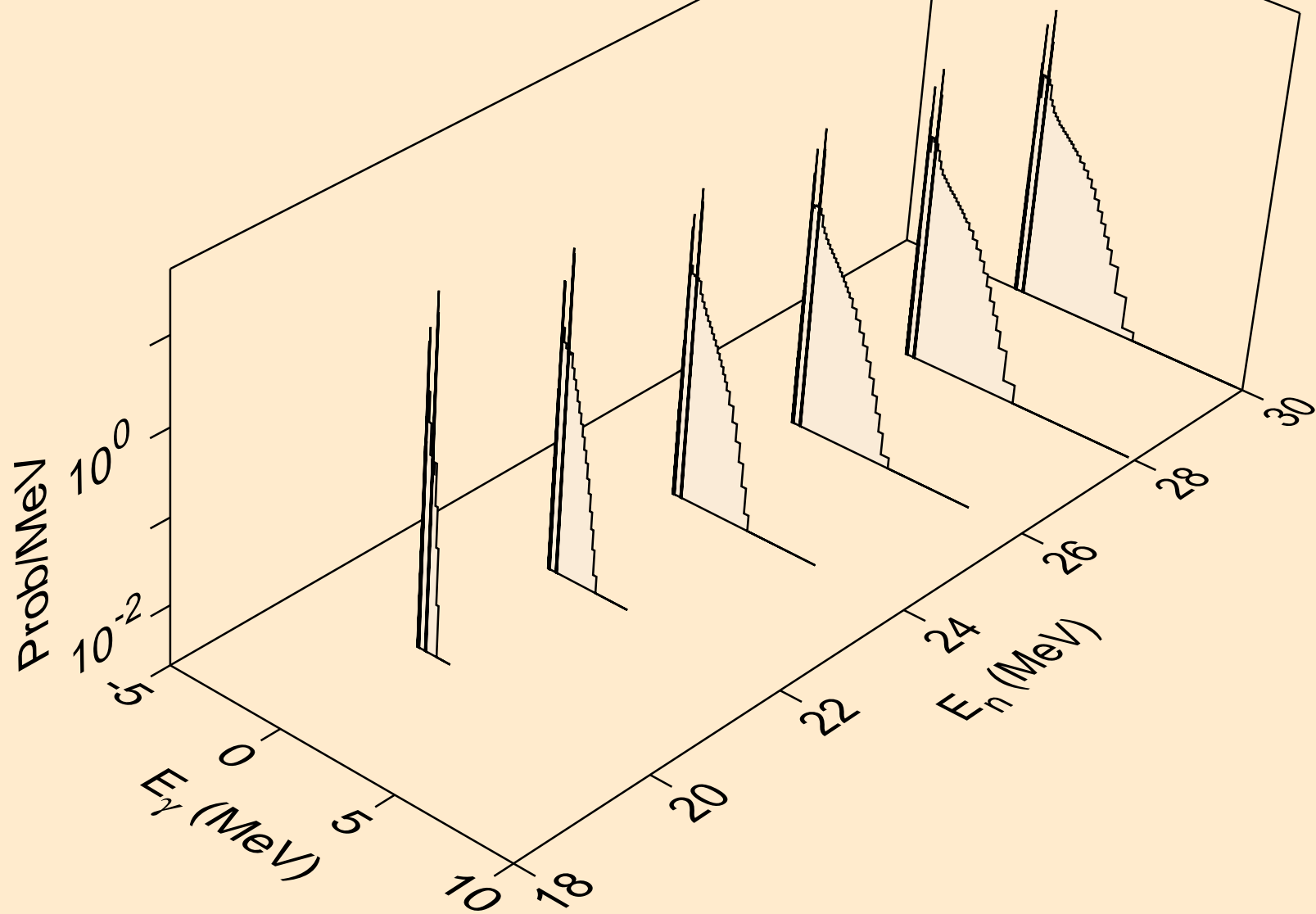

BI192M NEUTRON ACER TENDL-2021 LIBRARY; T=293.6K
Photon emission for (n,n*)a

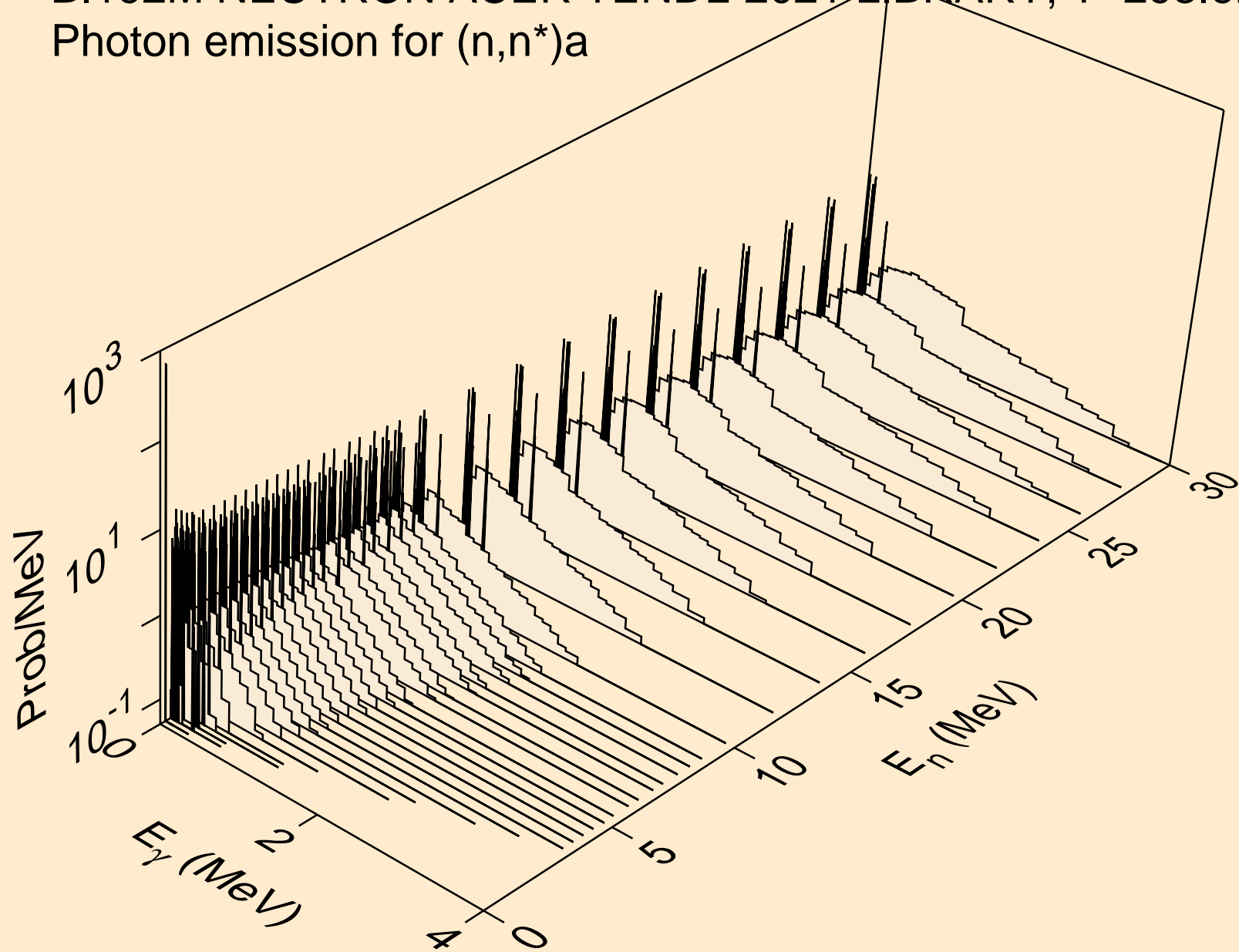

BI192M NEUTRON ACER TENDL-2021 LIBRARY; T=293.6K
Photon emission for (n,2n)a

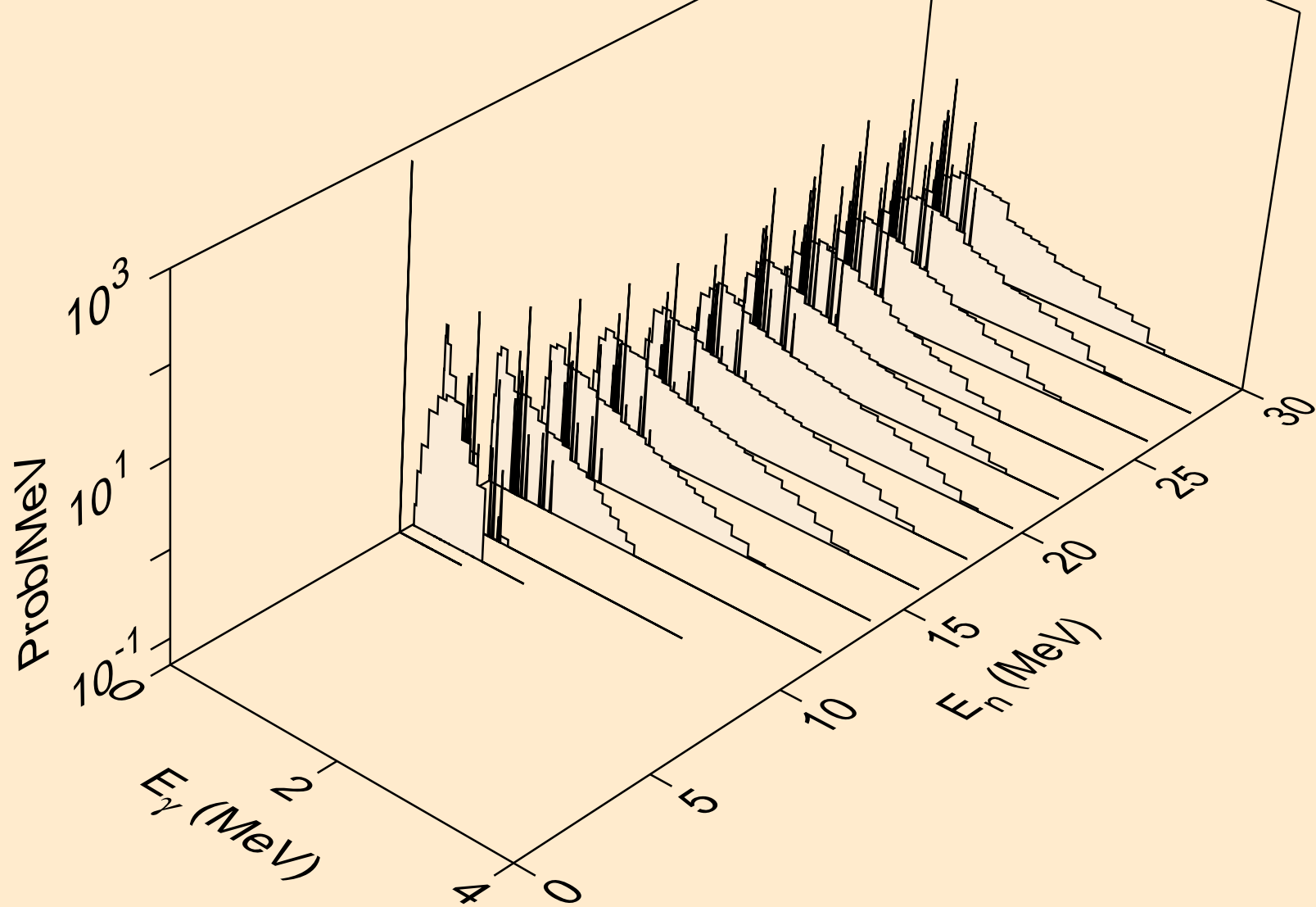

BI192M NEUTRON ACER TENDL-2021 LIBRARY; T=293.6K
Photon emission for (n,3n)a

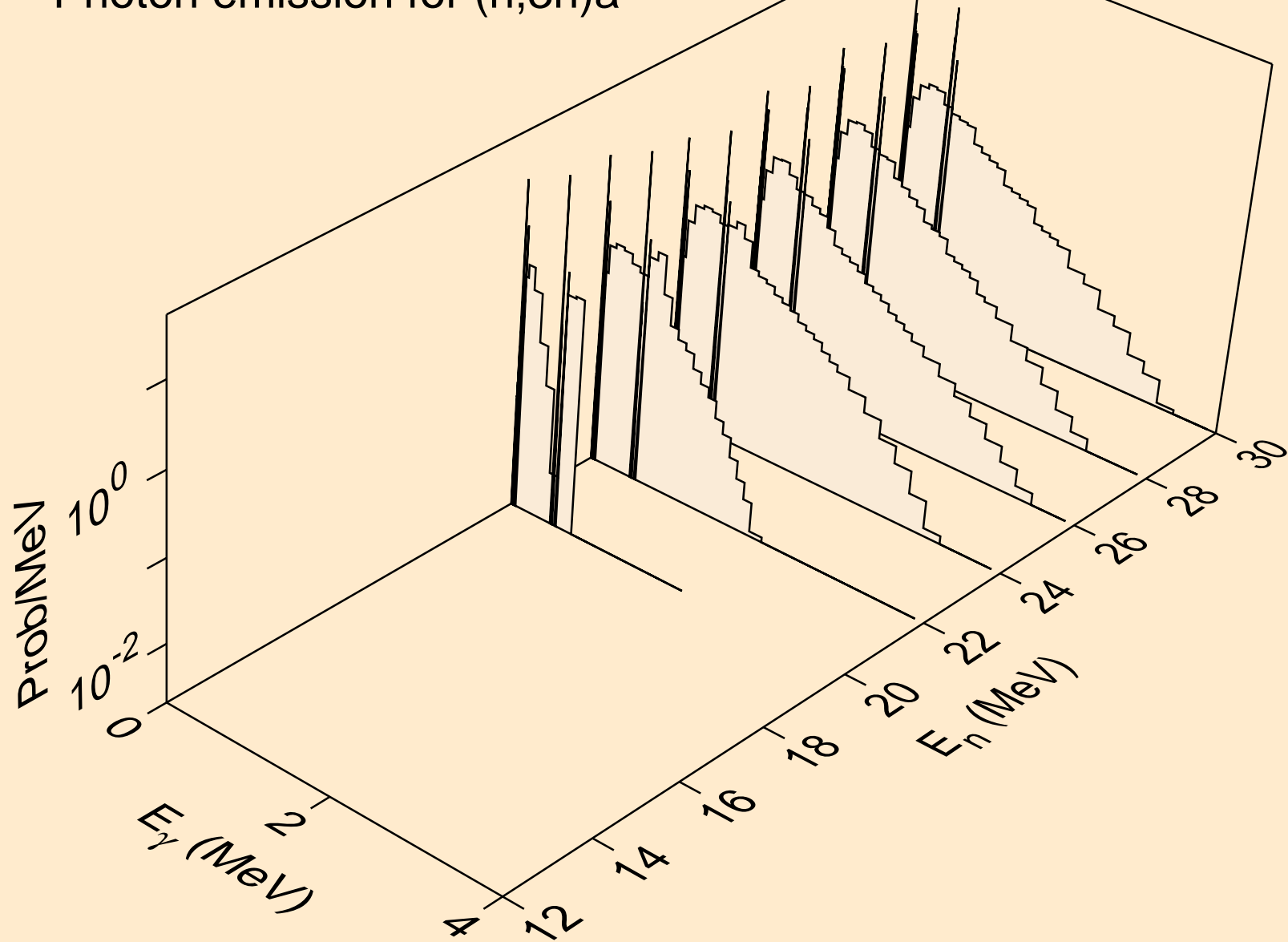

BI192M NEUTRON ACER TENDL-2021 LIBRARY; T=293.6K
Photon emission for (n,n*)p

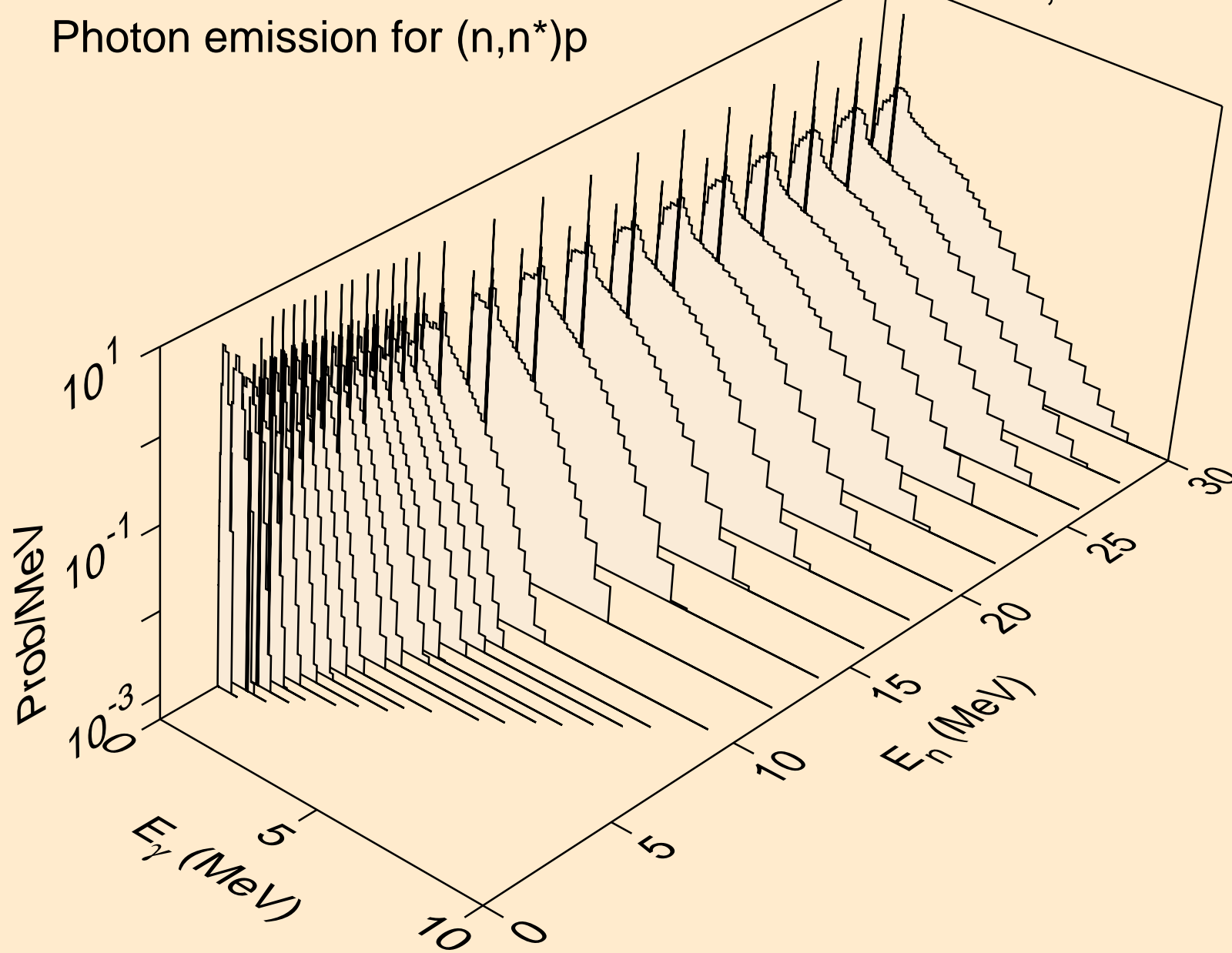

BI192M NEUTRON ACER TENDL-2021 LIBRARY; T=293.6K
Photon emission for (n,n*)2a

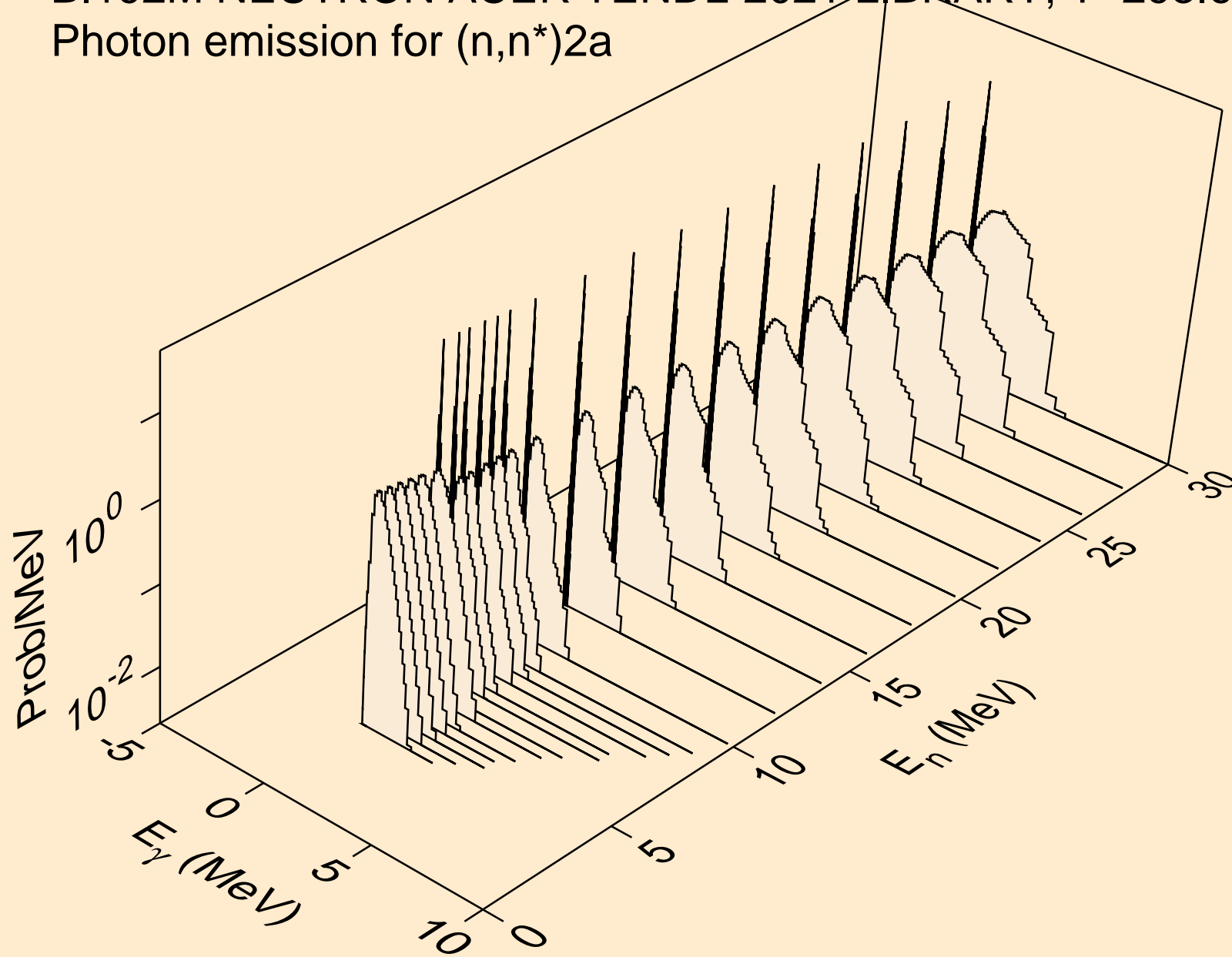

BI192M NEUTRON ACER TENDL-2021 LIBRARY; T=293.6K
Photon emission for (n,2n)2a

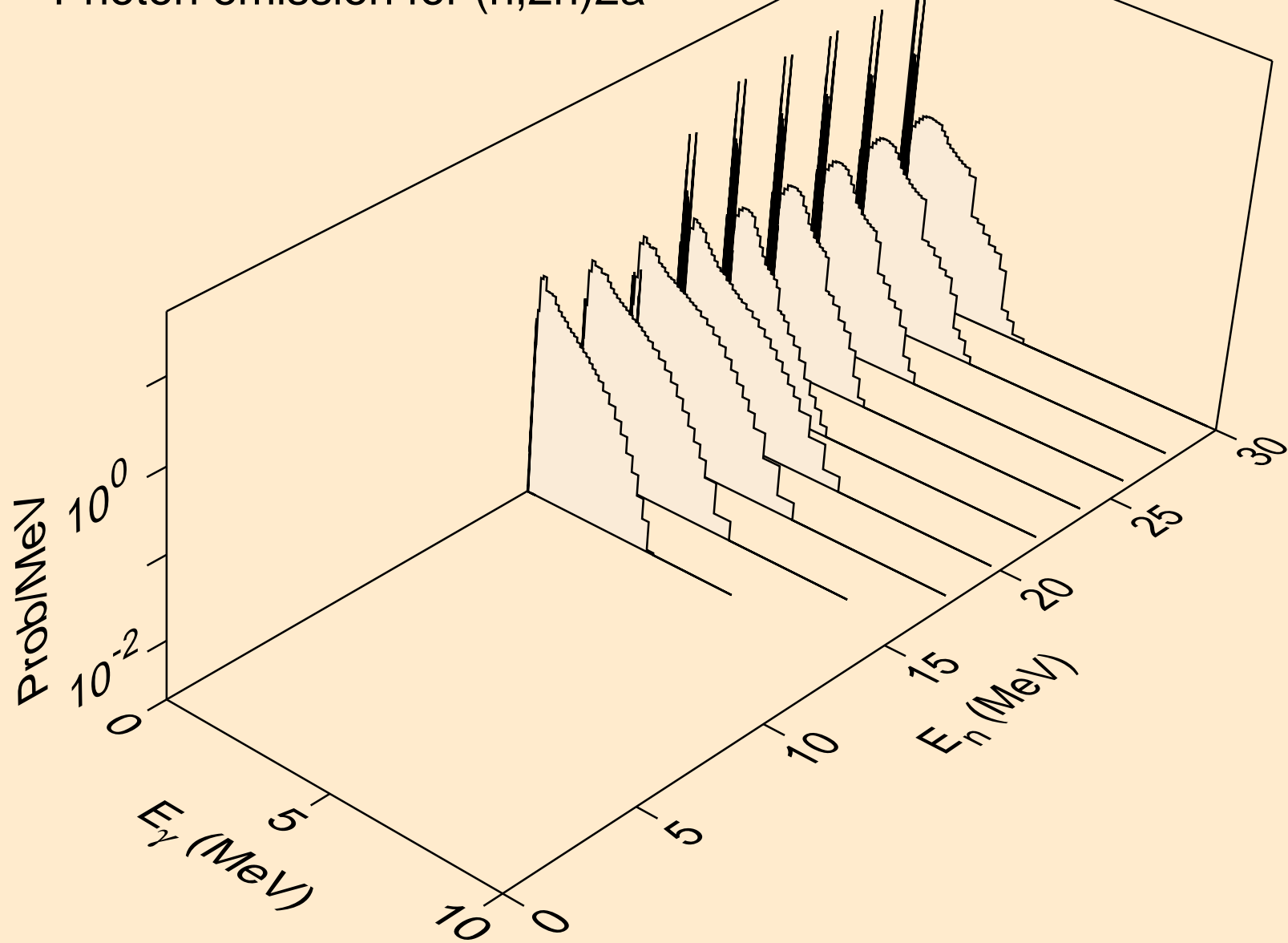

BI192M NEUTRON ACER TENDL-2021 LIBRARY; T=293.6K
Photon emission for (n,n*)d

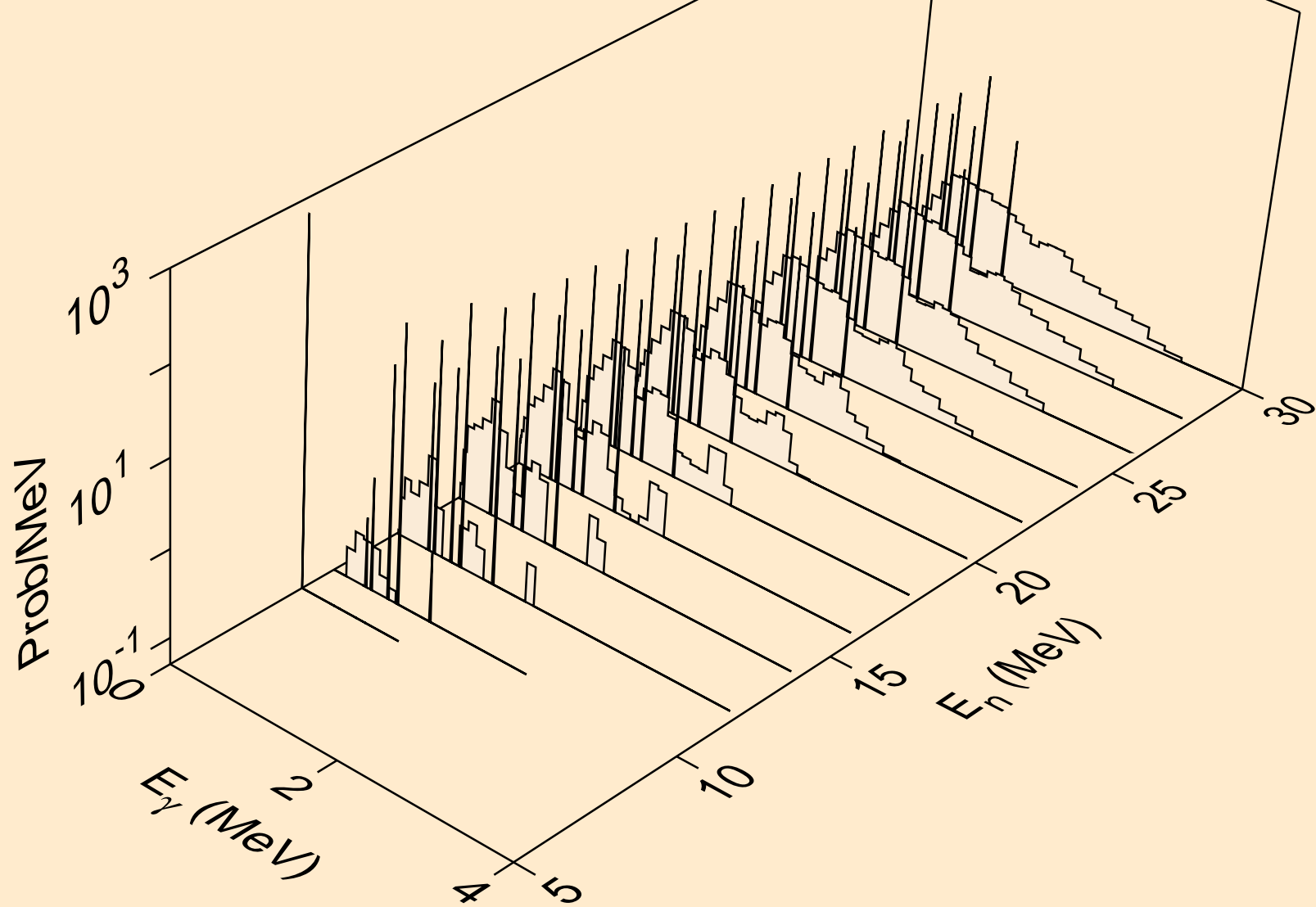

BI192M NEUTRON ACER TENDL-2021 LIBRARY; T=293.6K
Photon emission for (n,n*)t

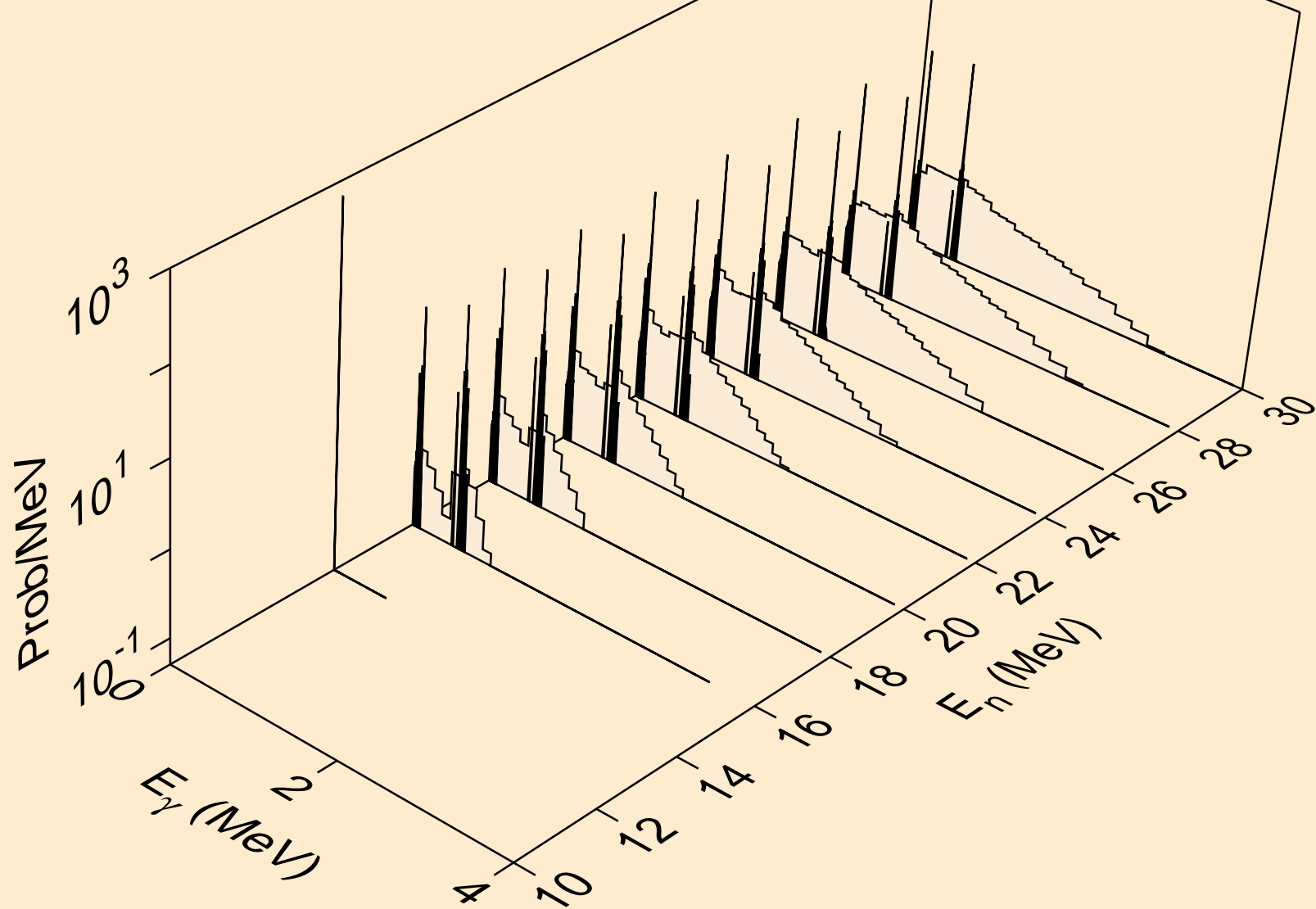

BI192M NEUTRON ACER TENDL-2021 LIBRARY; T=293.6K
Photon emission for (n,n*)he3

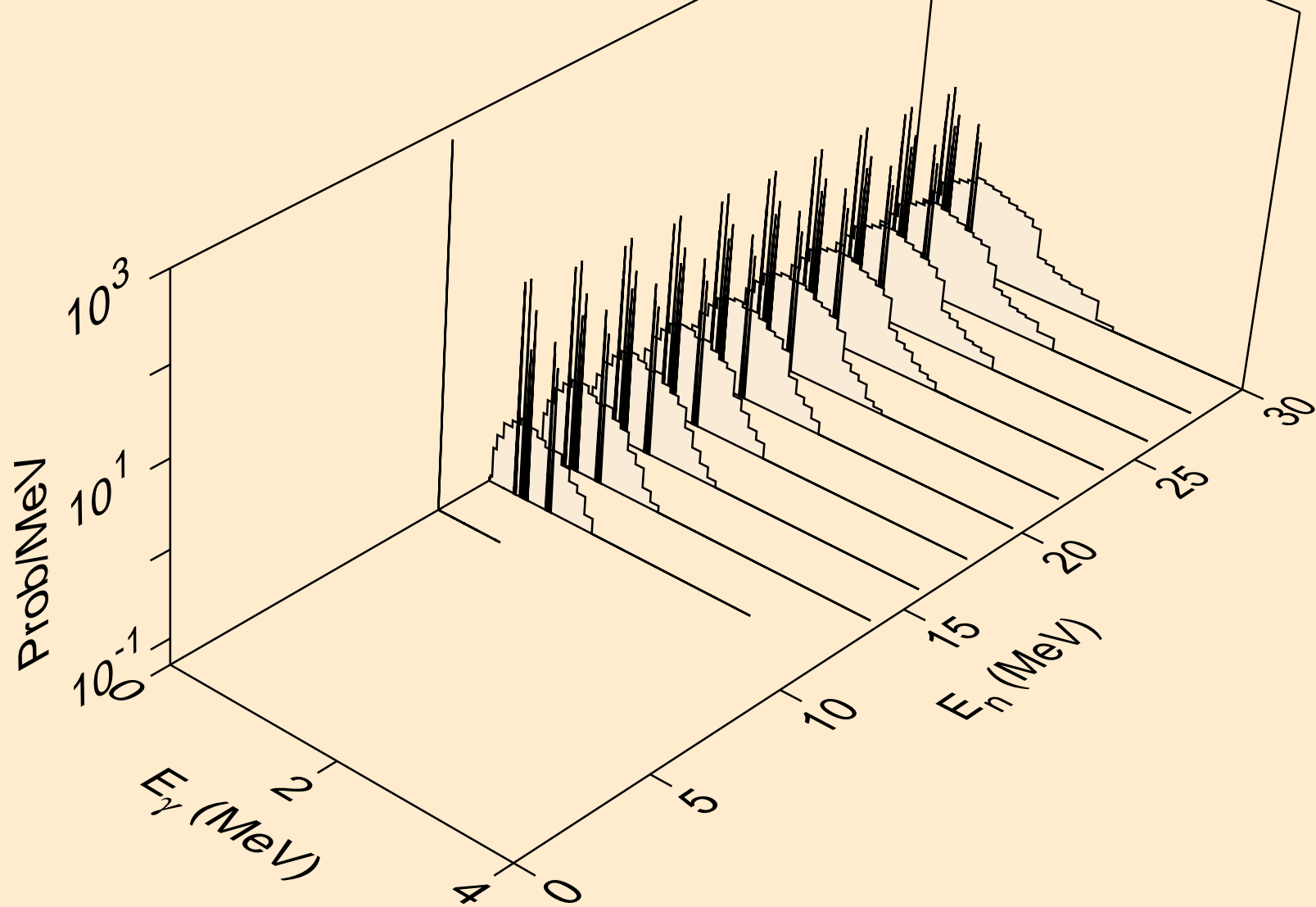

BI192M NEUTRON ACER TENDL-2021 LIBRARY; T=293.6K
Photon emission for (n,4n)

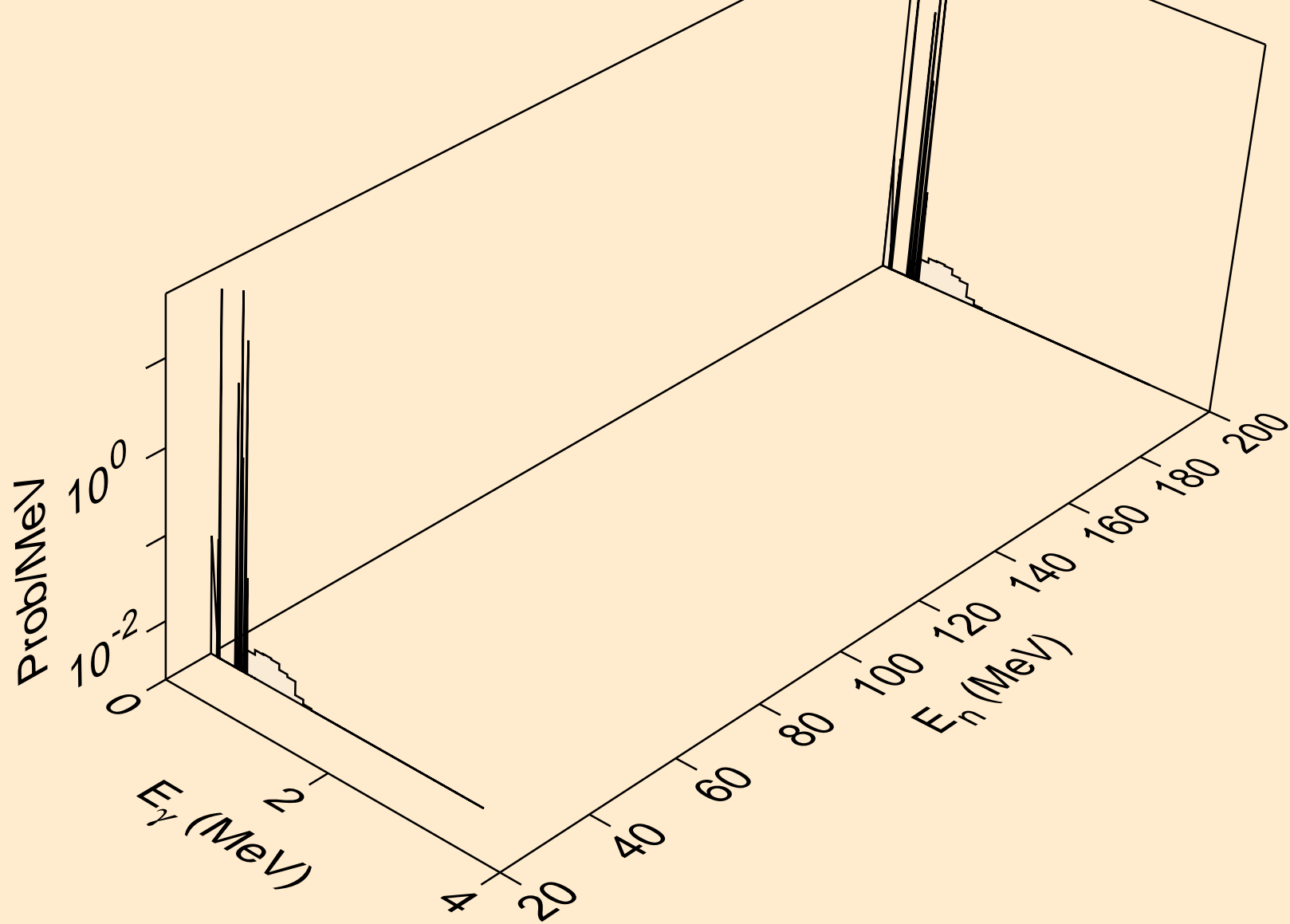

BI192M NEUTRON ACER TENDL-2021 LIBRARY; T=293.6K
Photon emission for (n,2np)

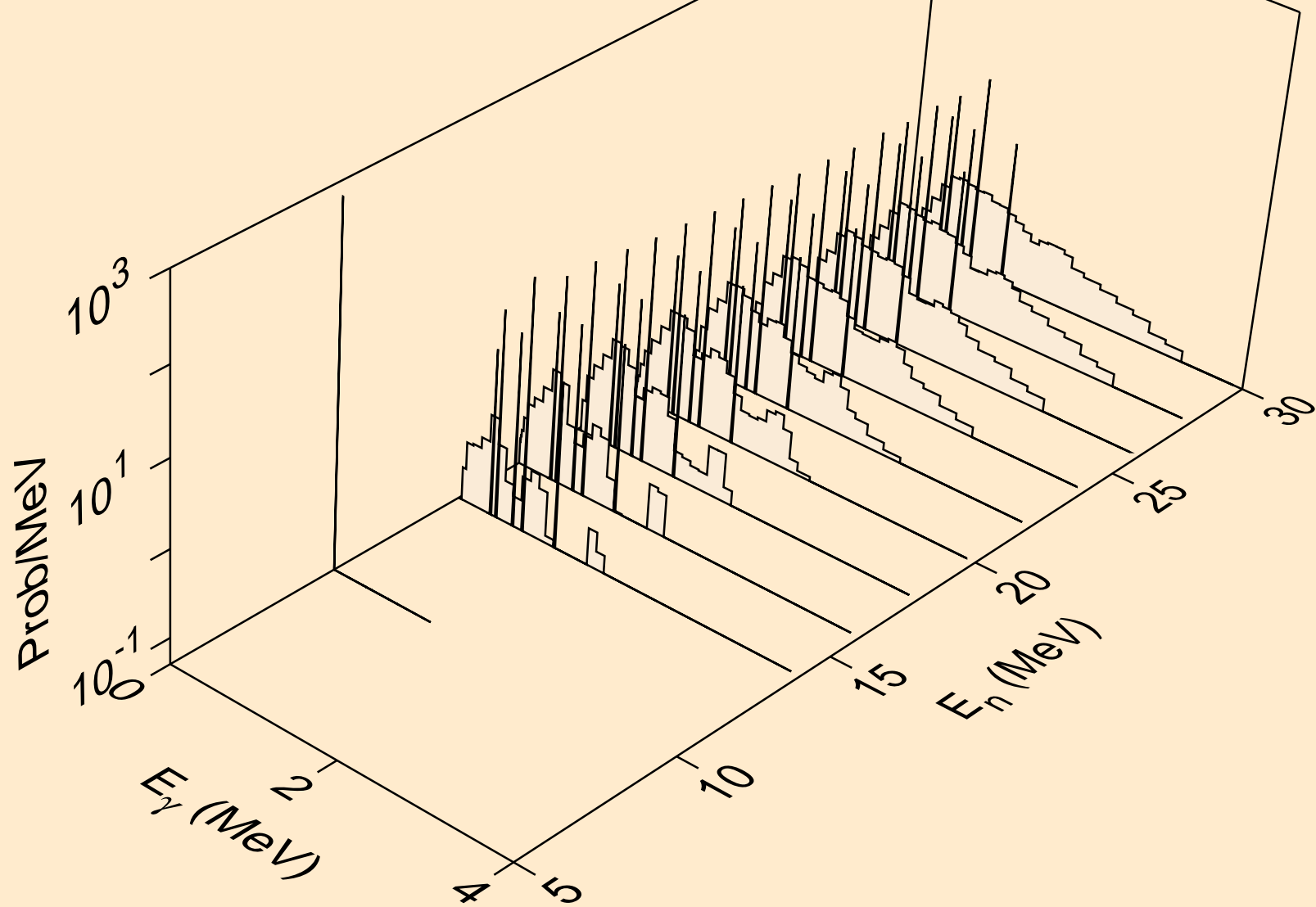

BI192M NEUTRON ACER TENDL-2021 LIBRARY; T=293.6K
Photon emission for (n,3np)

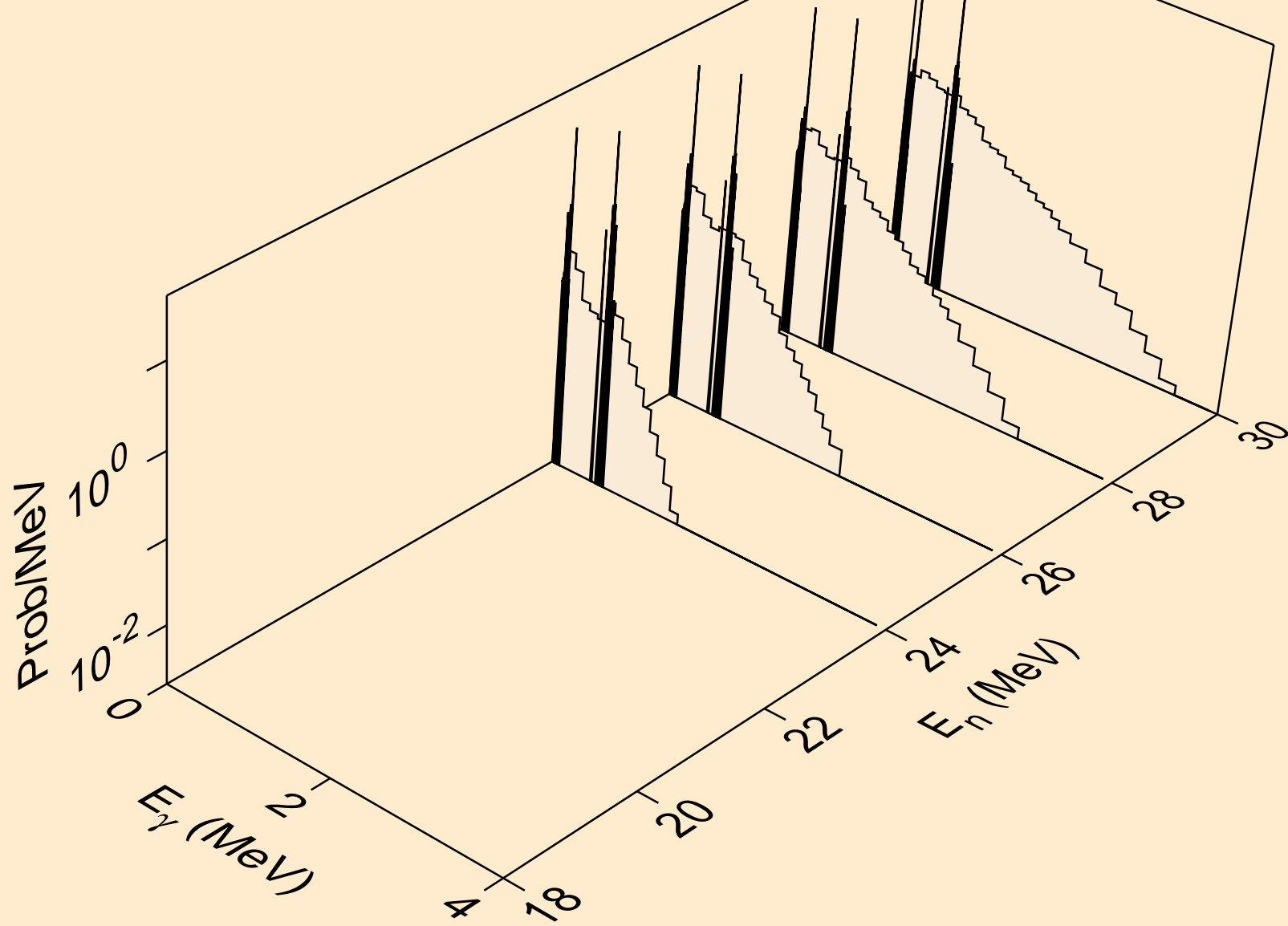

BI192M NEUTRON ACER TENDL-2021 LIBRARY; T=293.6K
Photon emission for (n,2np)

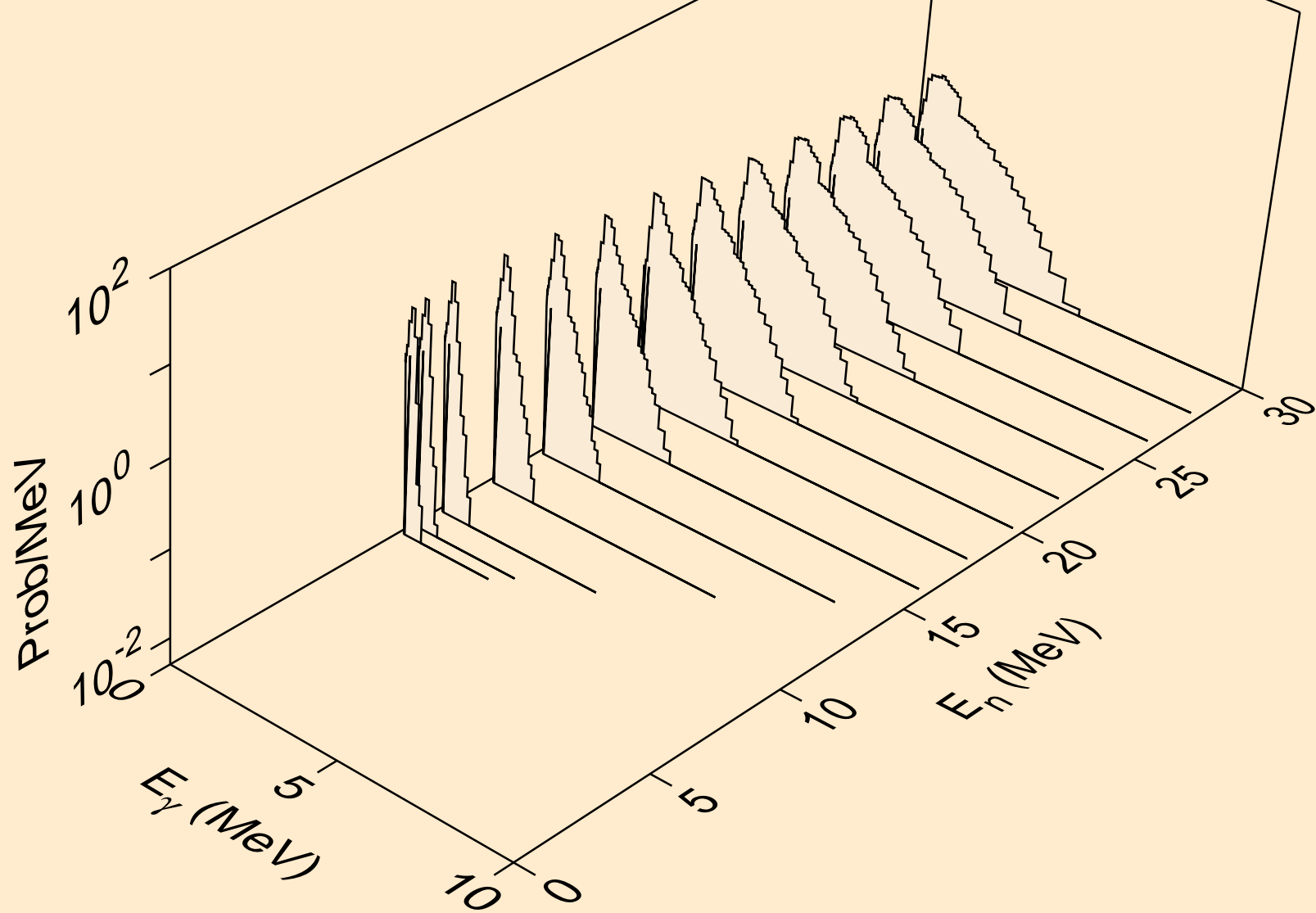

BI192M NEUTRON ACER TENDL-2021 LIBRARY; T=293.6K
Photon emission for (n,npa)

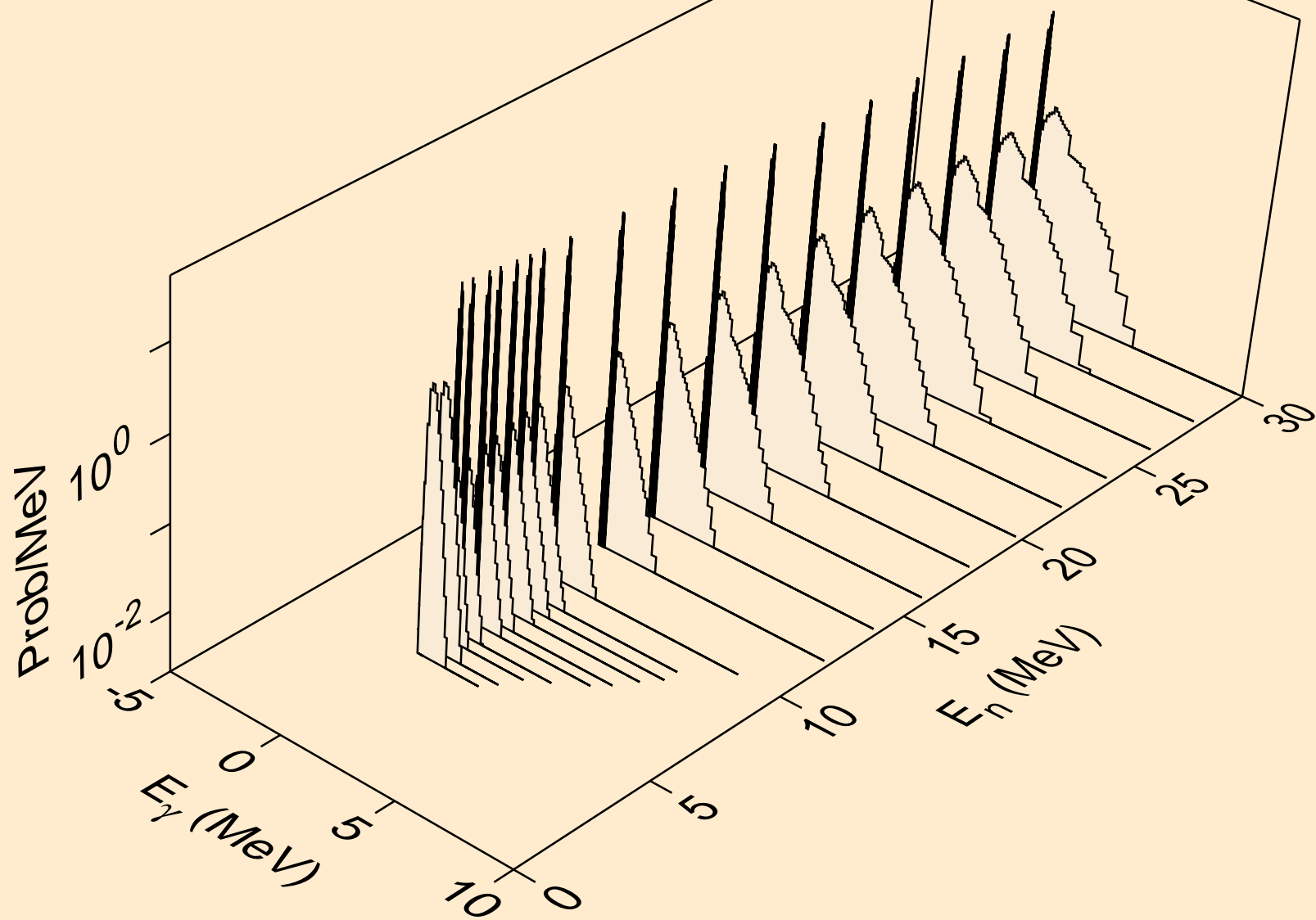

BI192M NEUTRON ACER TENDL-2021 LIBRARY; T=293.6K
Photon emission for (n,n*2)

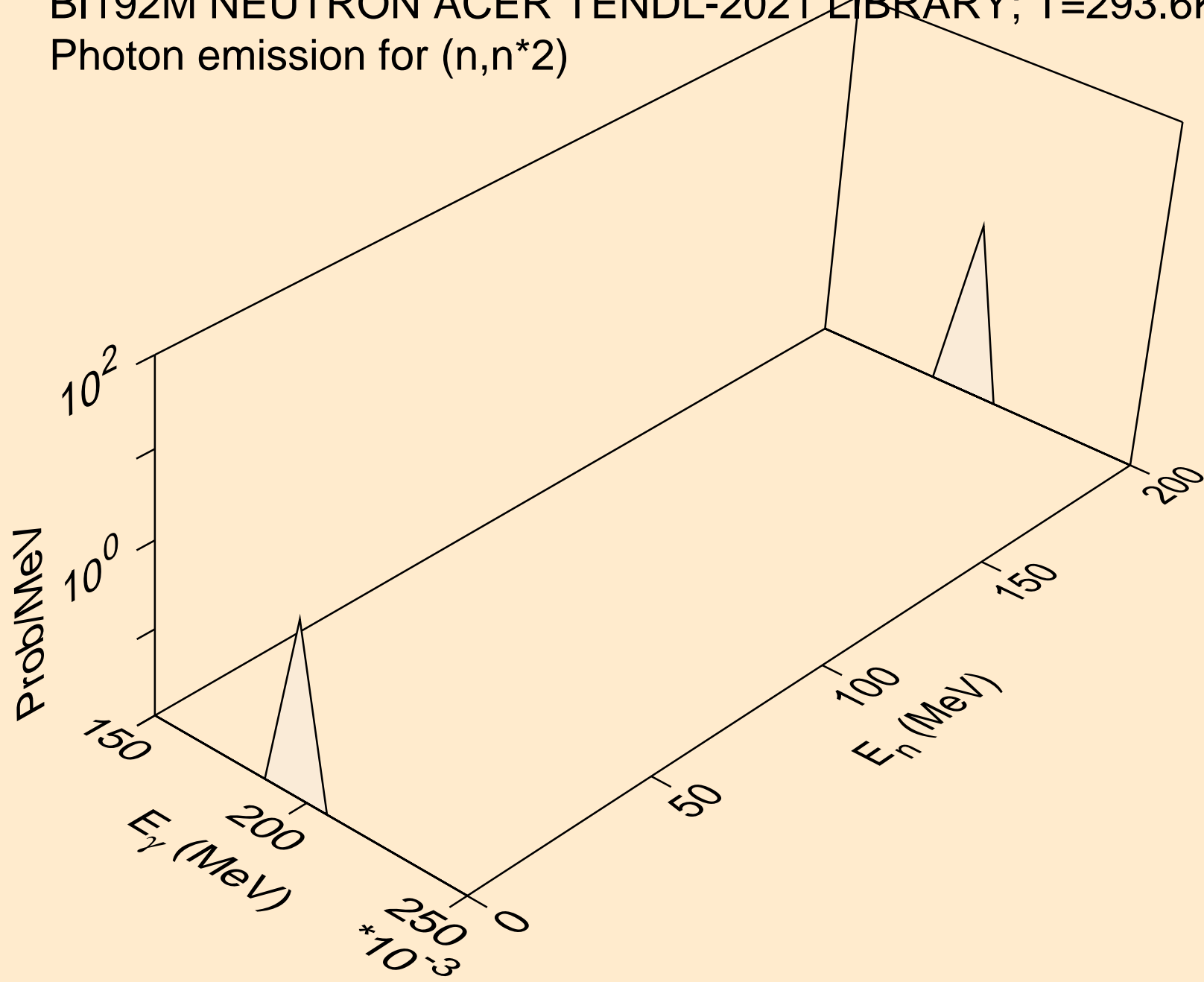

BI192M NEUTRON ACER TENDL-2021 LIBRARY; T=293.6K
Photon emission for (n,n*c)

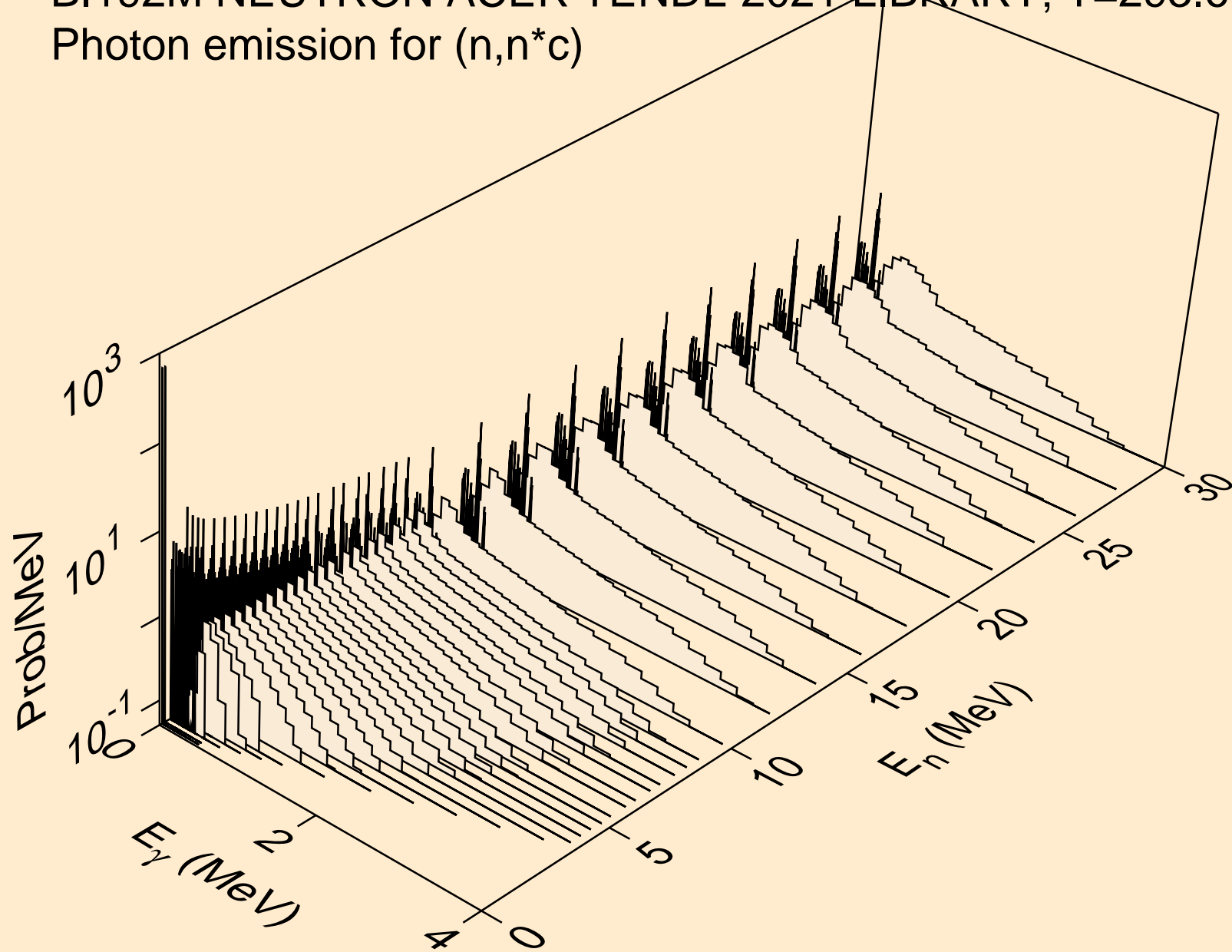

BI192M NEUTRON ACER TENDL-2021 LIBRARY; T=293.6K
Photon emission for (n,gma)

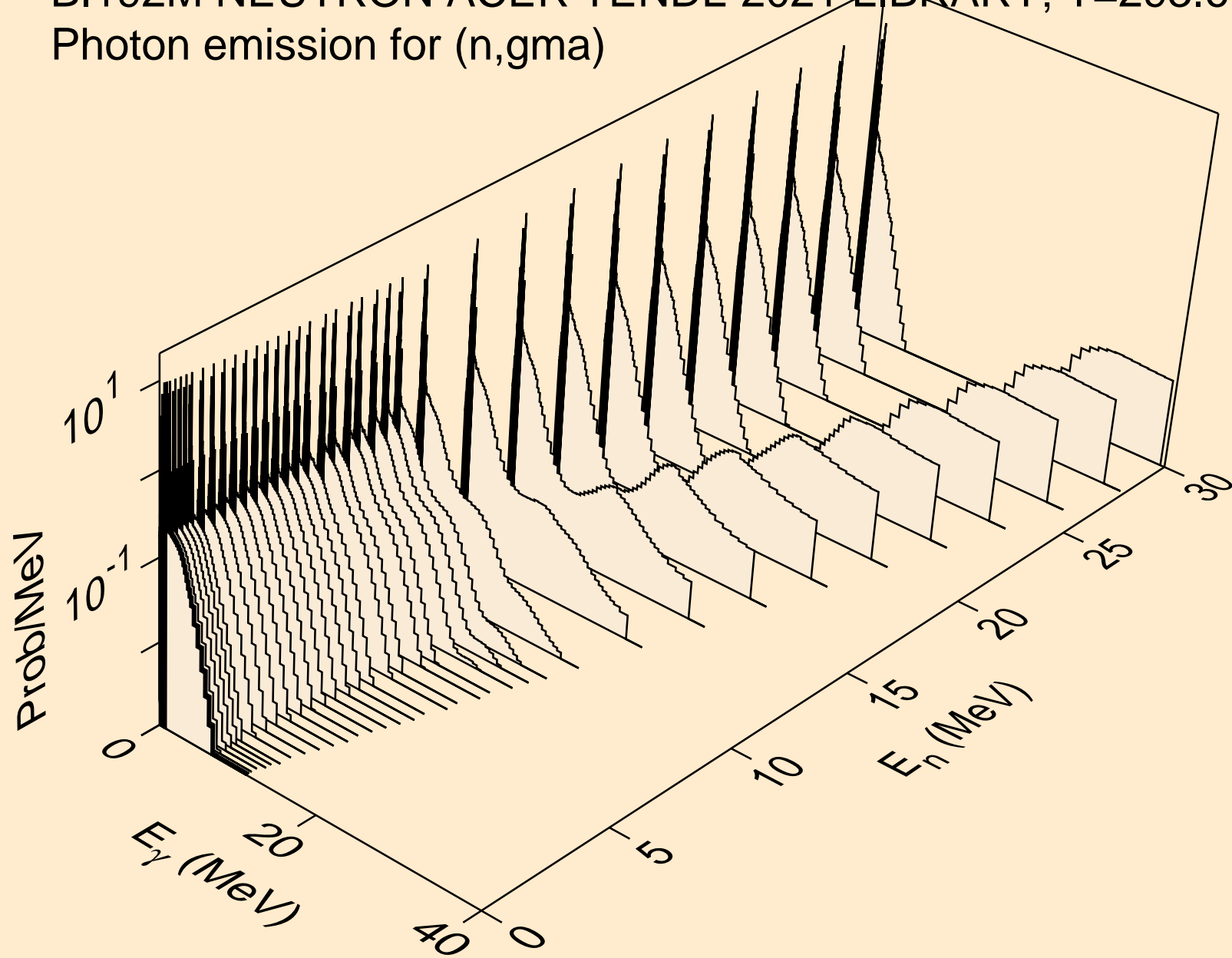

BI192M NEUTRON ACER TENDL-2021 LIBRARY; T=293.6K
Photon emission for (n,p)

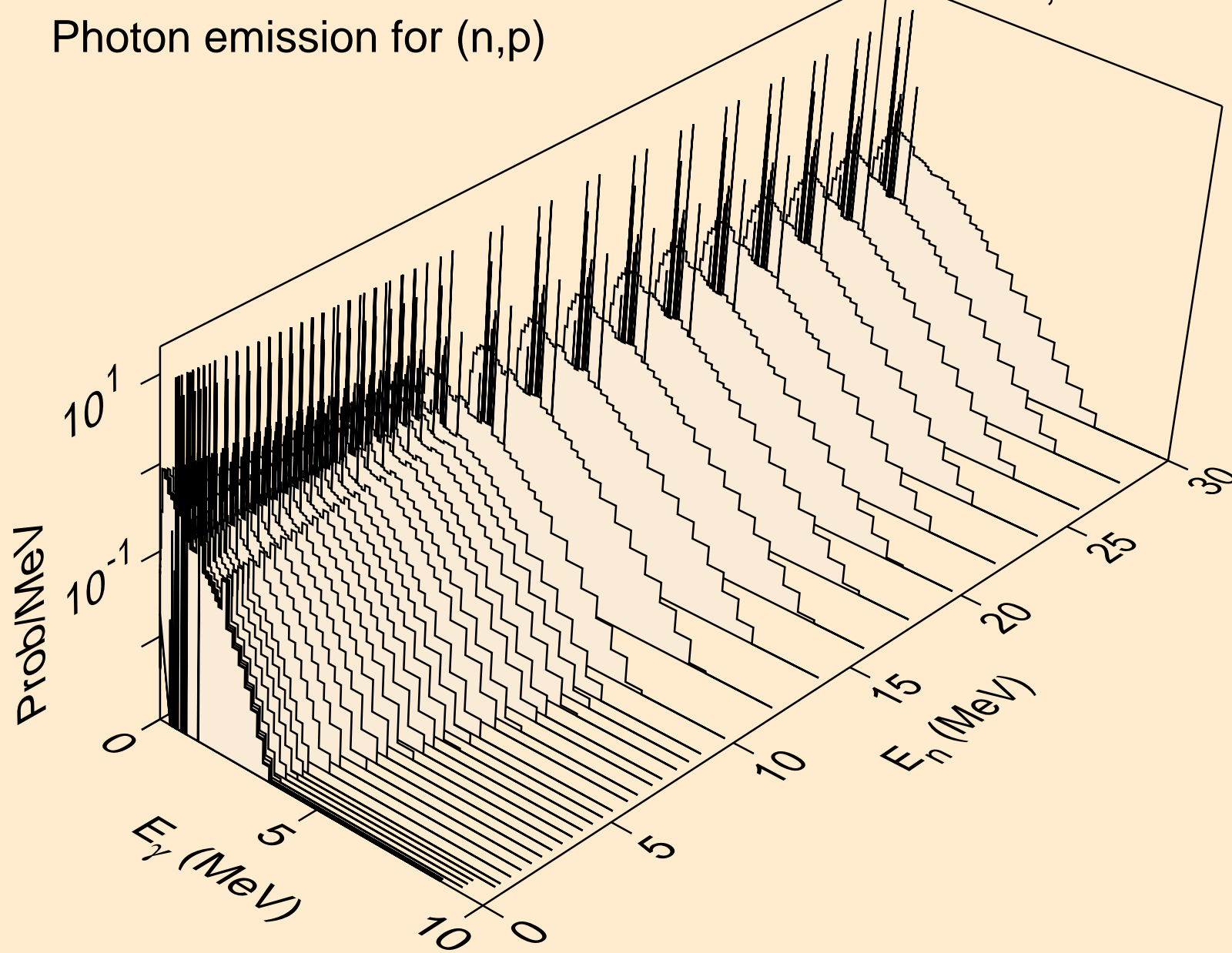

BI192M NEUTRON ACER TENDL-2021 LIBRARY; T=293.6K
Photon emission for (n,d)

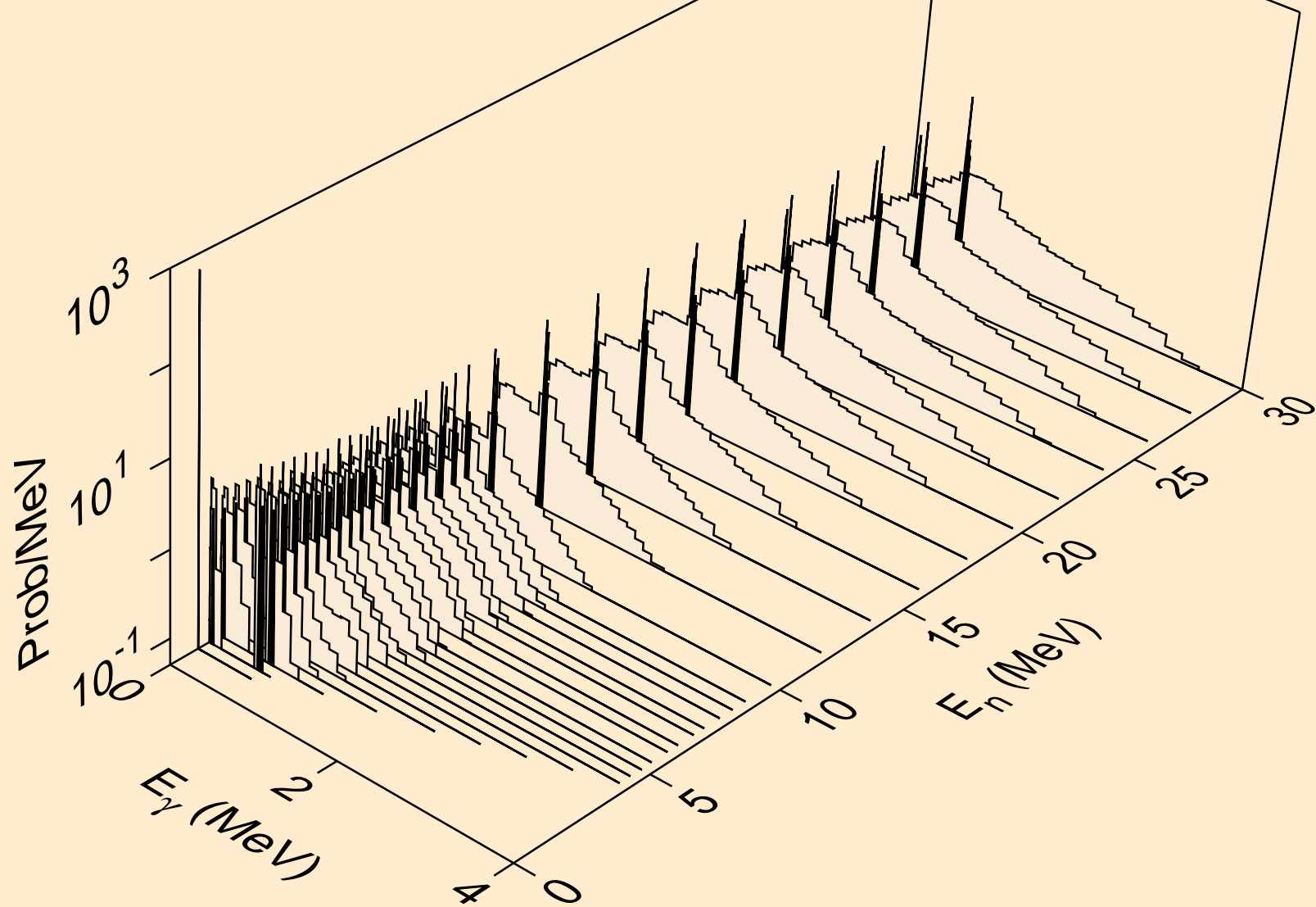

BI192M NEUTRON ACER TENDL-2021 LIBRARY; T=293.6K
Photon emission for (n,t)

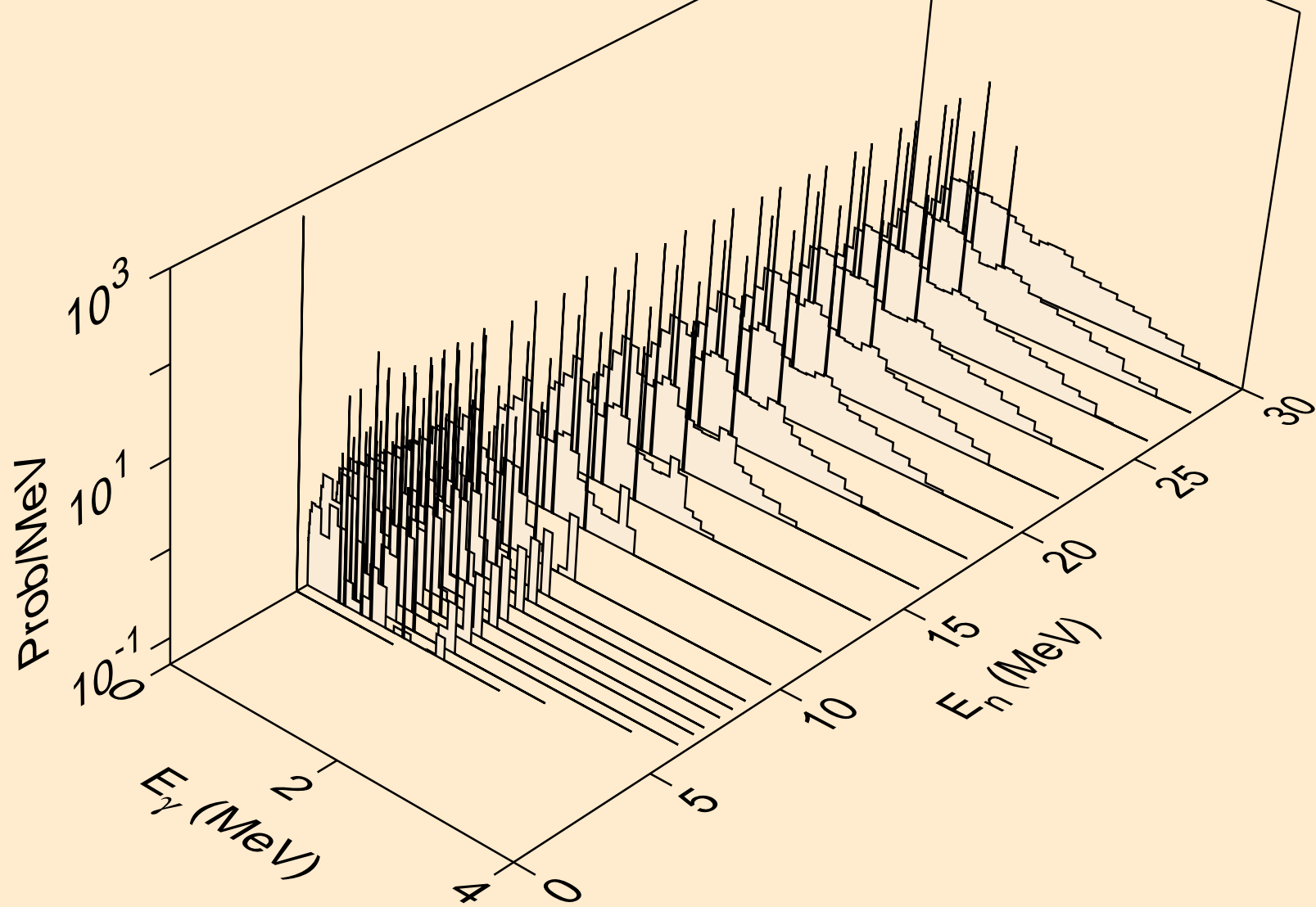

BI192M NEUTRON ACER TENDL-2021 LIBRARY; T=293.6K
Photon emission for (n,he3)

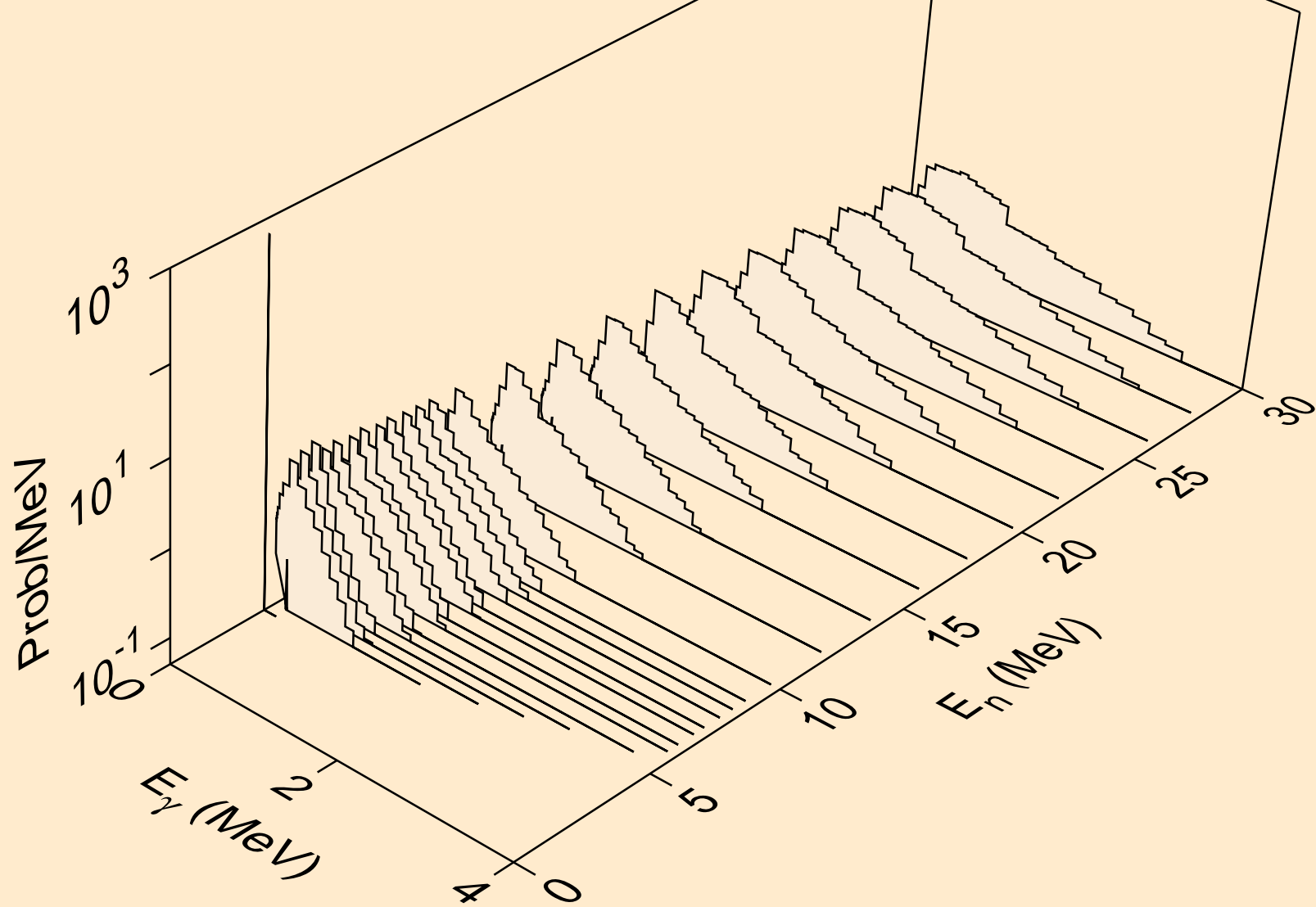

BI192M NEUTRON ACER TENDL-2021 LIBRARY; T=293.6K
Photon emission for (n,a)

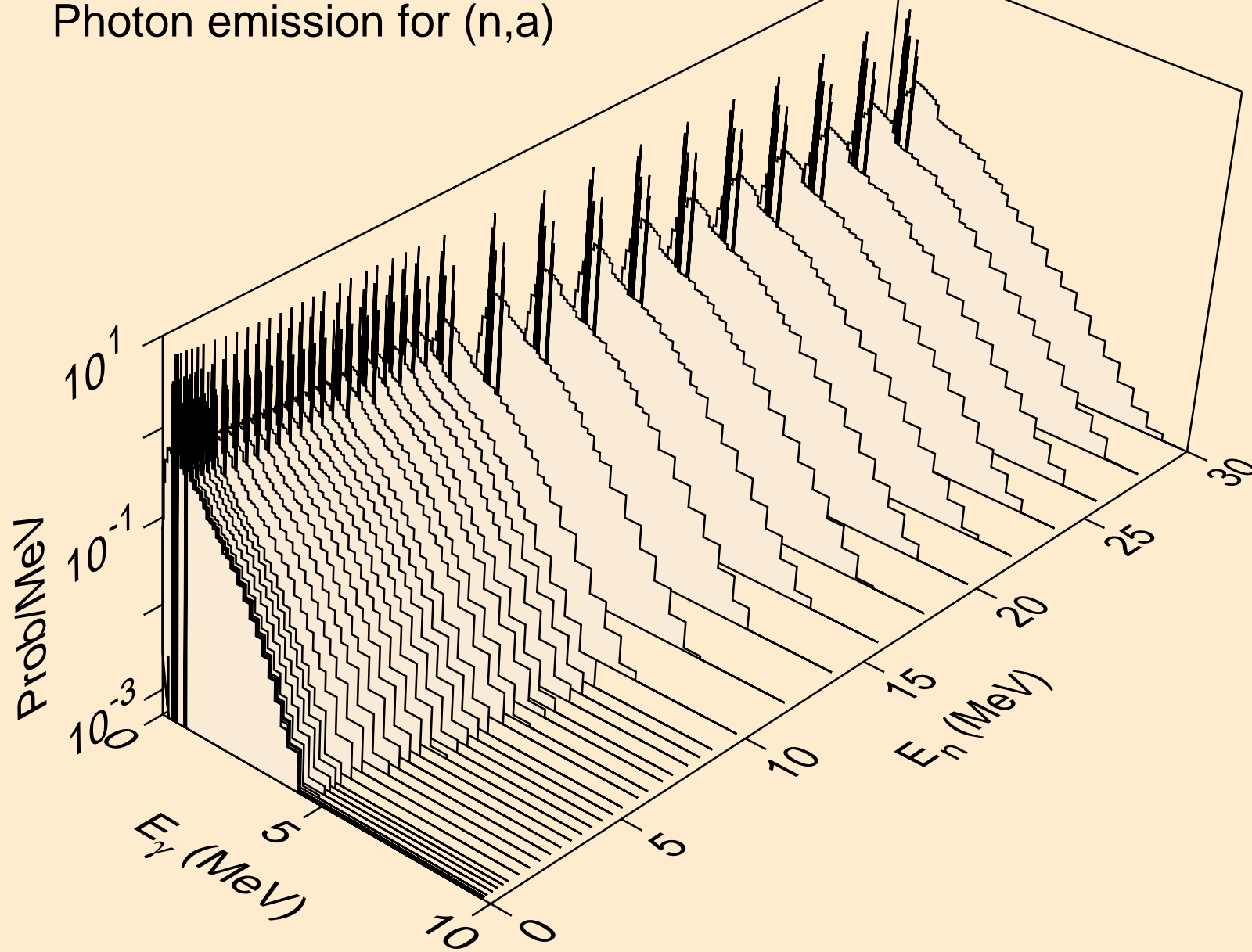

BI192M NEUTRON ACER TENDL-2021 LIBRARY; T=293.6K
Photon emission for (n,2a)

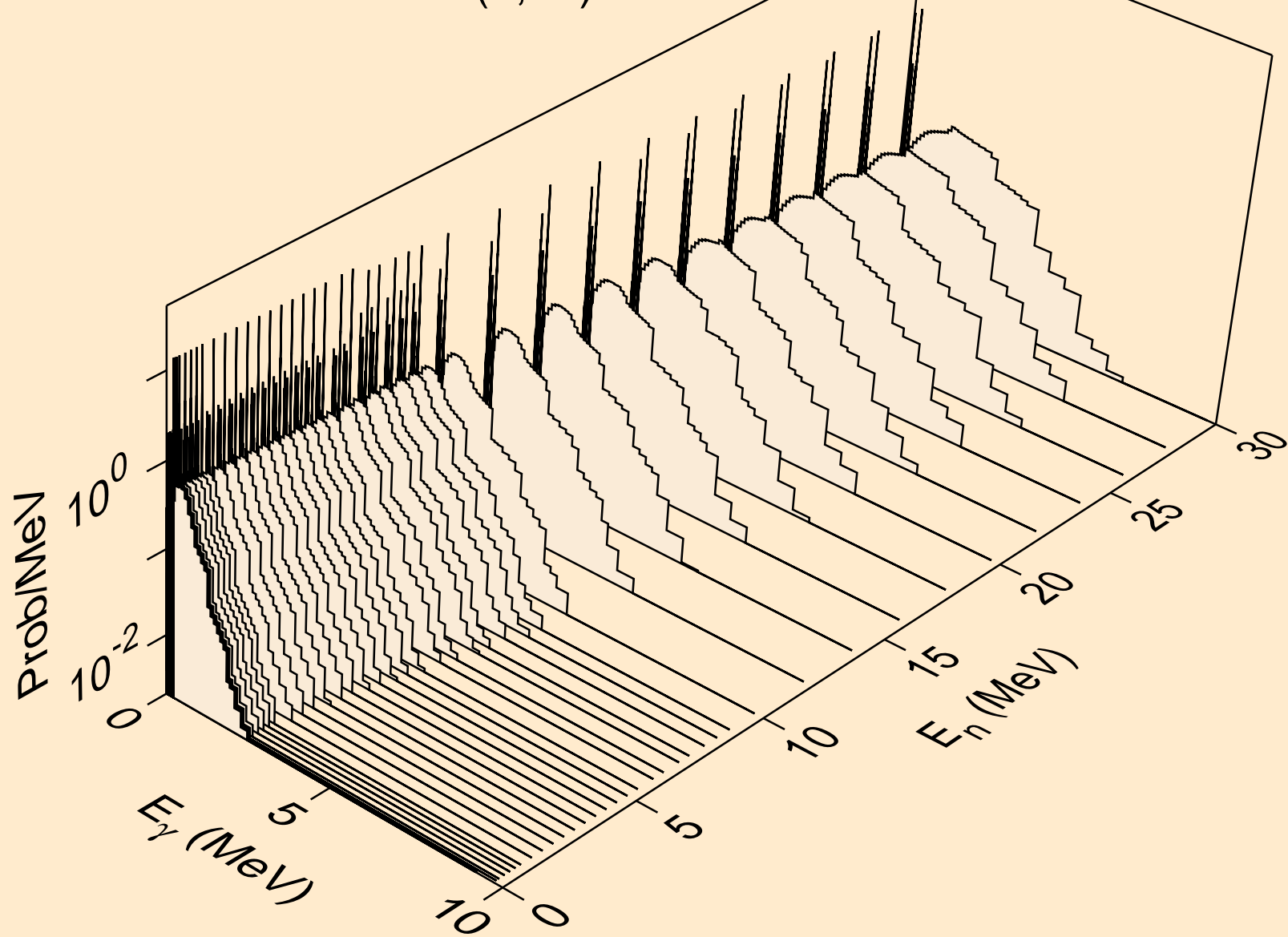

BI192M NEUTRON ACER TENDL-2021 LIBRARY; T=293.6K
Photon emission for (n,3a)

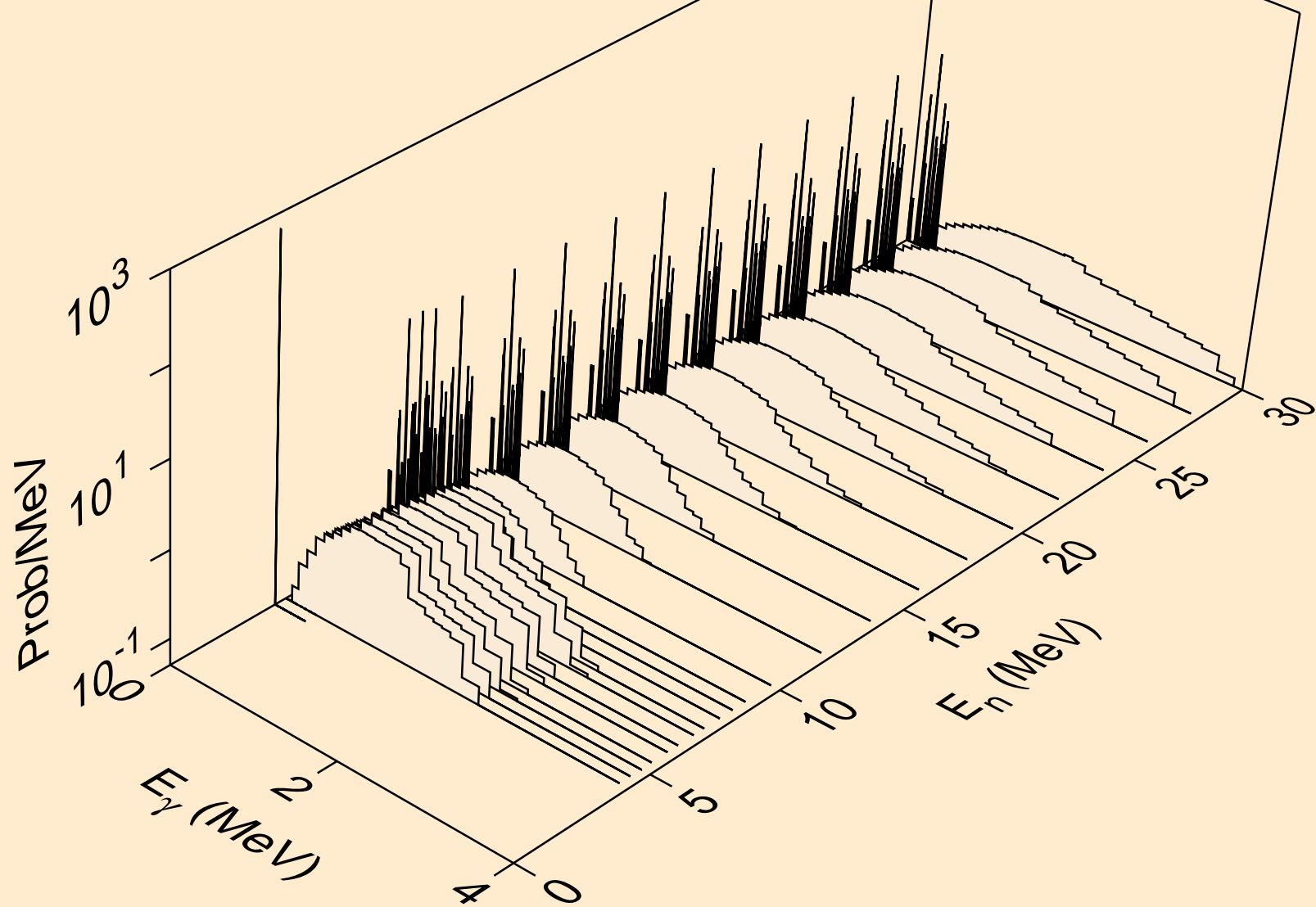

BI192M NEUTRON ACER TENDL-2021 LIBRARY; T=293.6K
Photon emission for (n,2p)

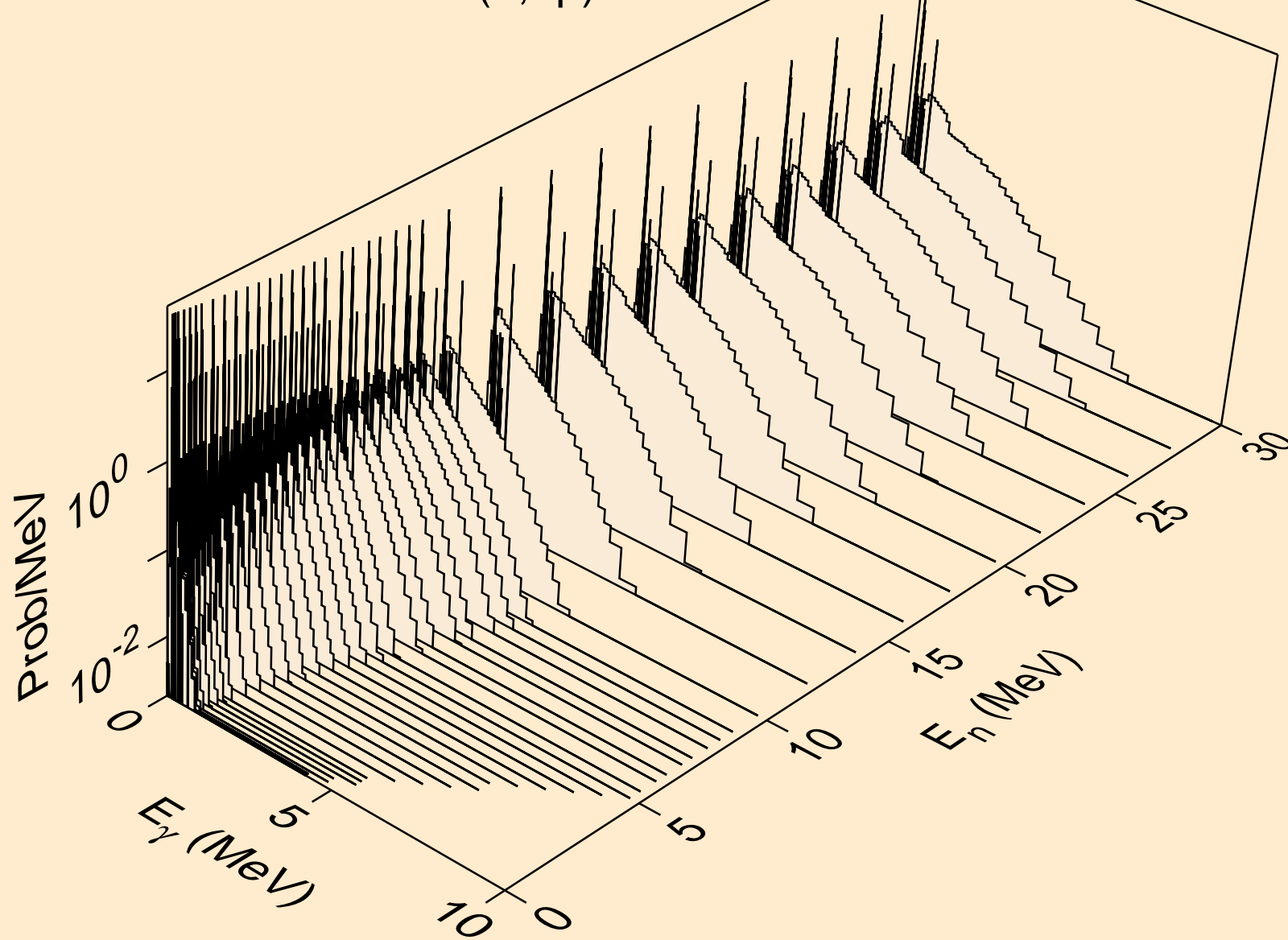

BI192M NEUTRON ACER TENDL-2021 LIBRARY; T=293.6K
Photon emission for (n,p α)

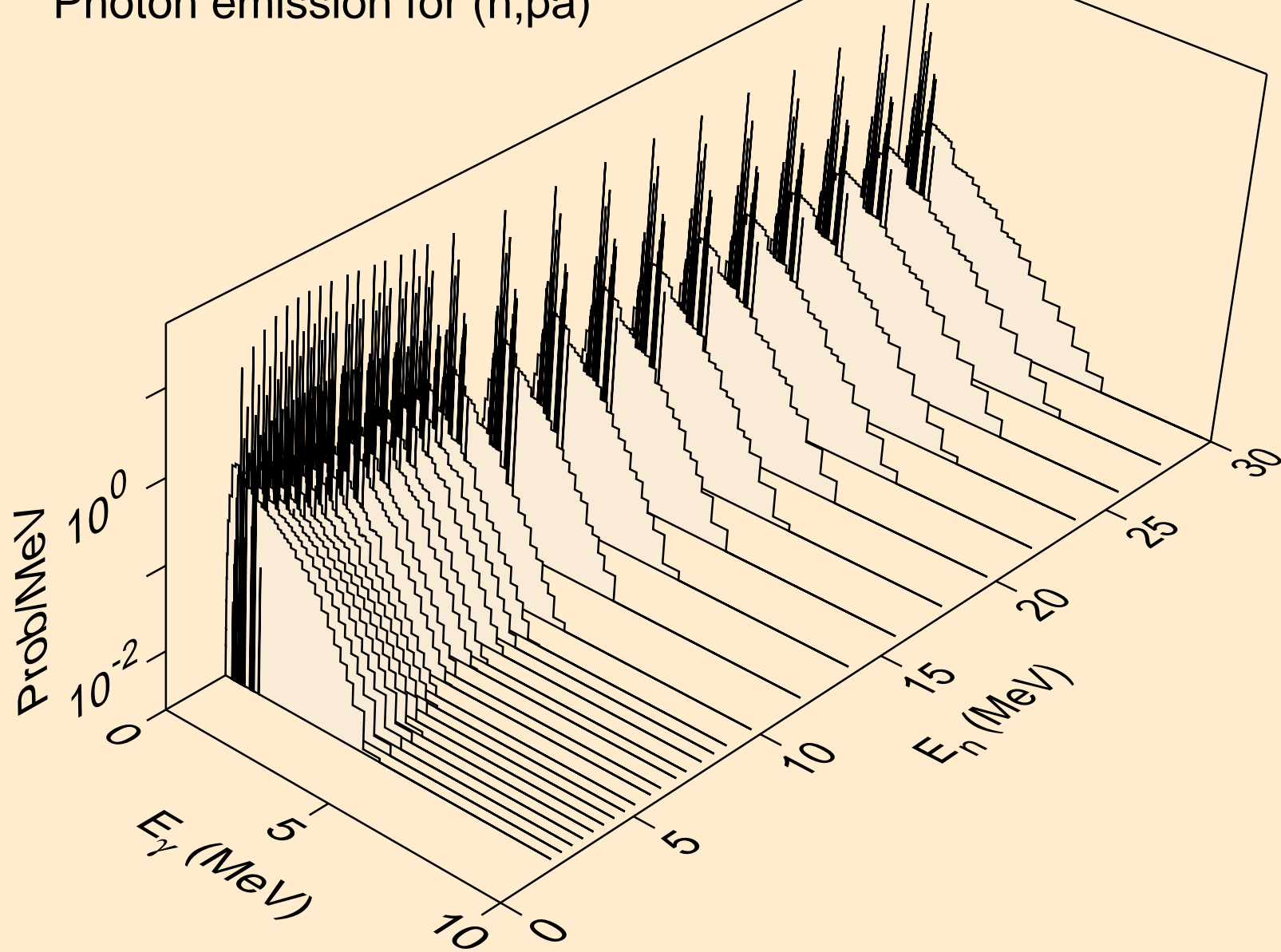

BI192M NEUTRON ACER TENDL-2021 LIBRARY; T=293.6K
Photon emission for (n,pd)

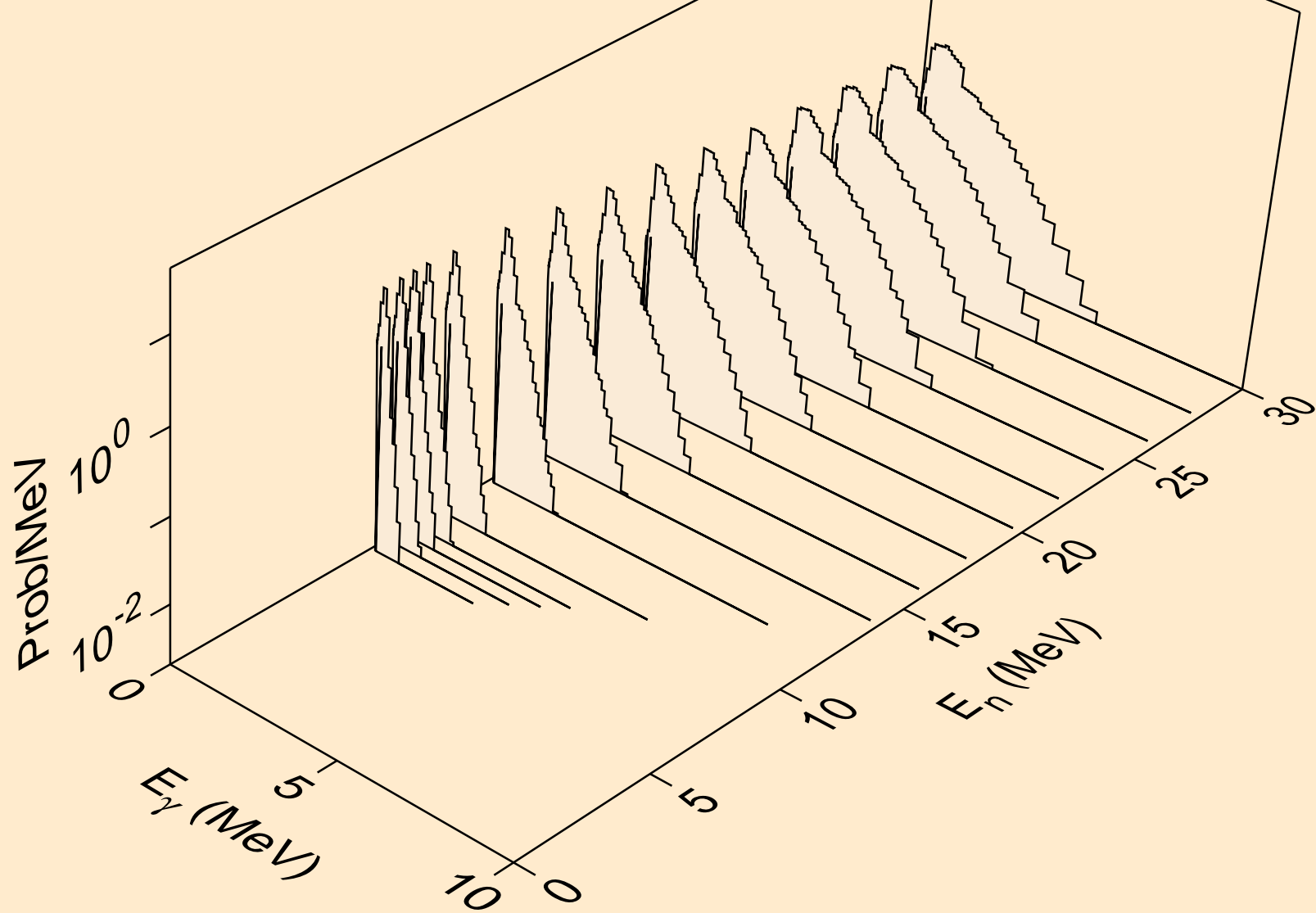

BI192M NEUTRON ACER TENDL-2021 LIBRARY; T=293.6K
Photon emission for (n,pt)

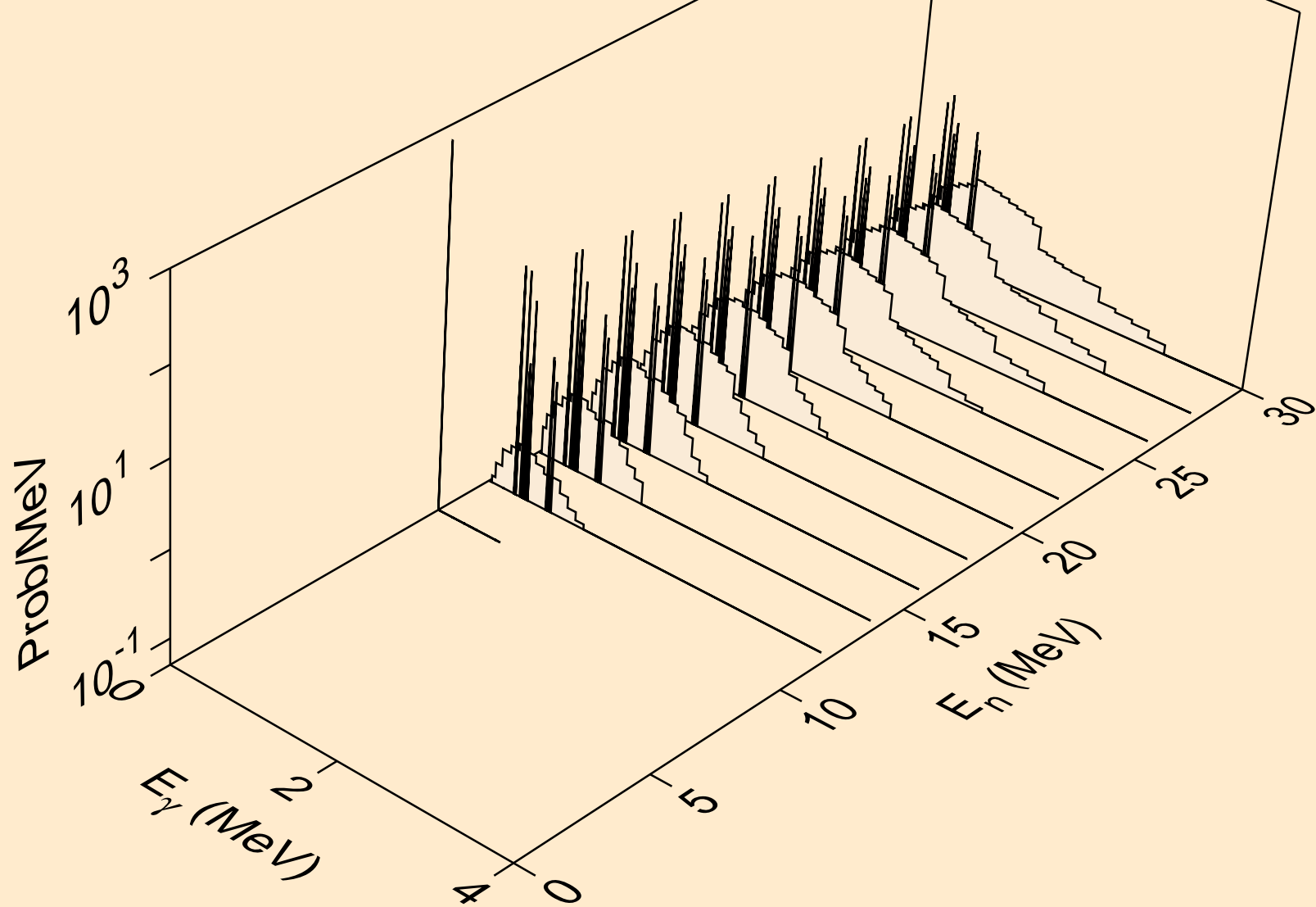

BI192M NEUTRON ACER TENDL-2021 LIBRARY; T=293.6K
Photon emission for (n,da)

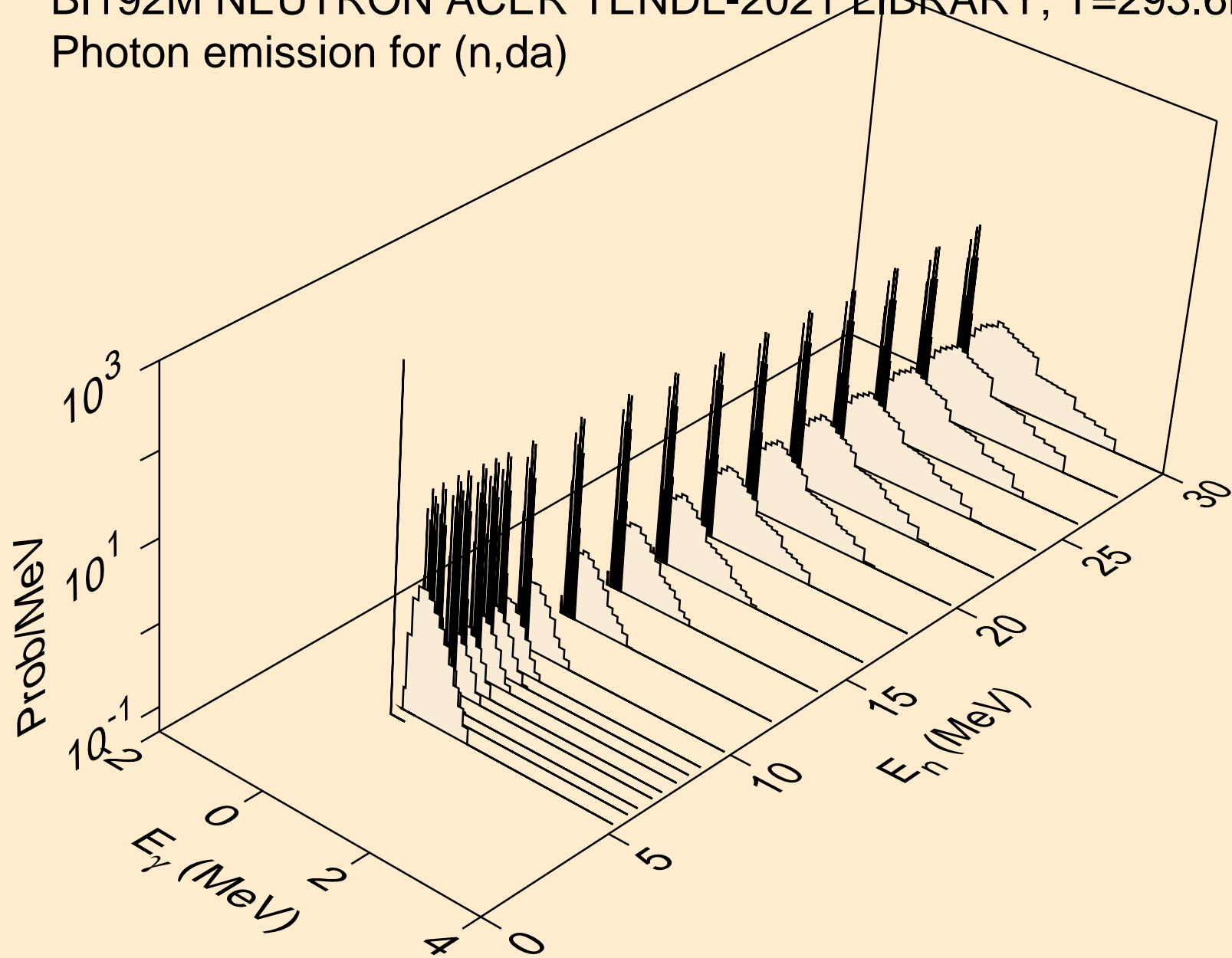

BI192M NEUTRON ACER TENDL-2021 LIBRARY; T=293.6K
thermal capture photon spectrum

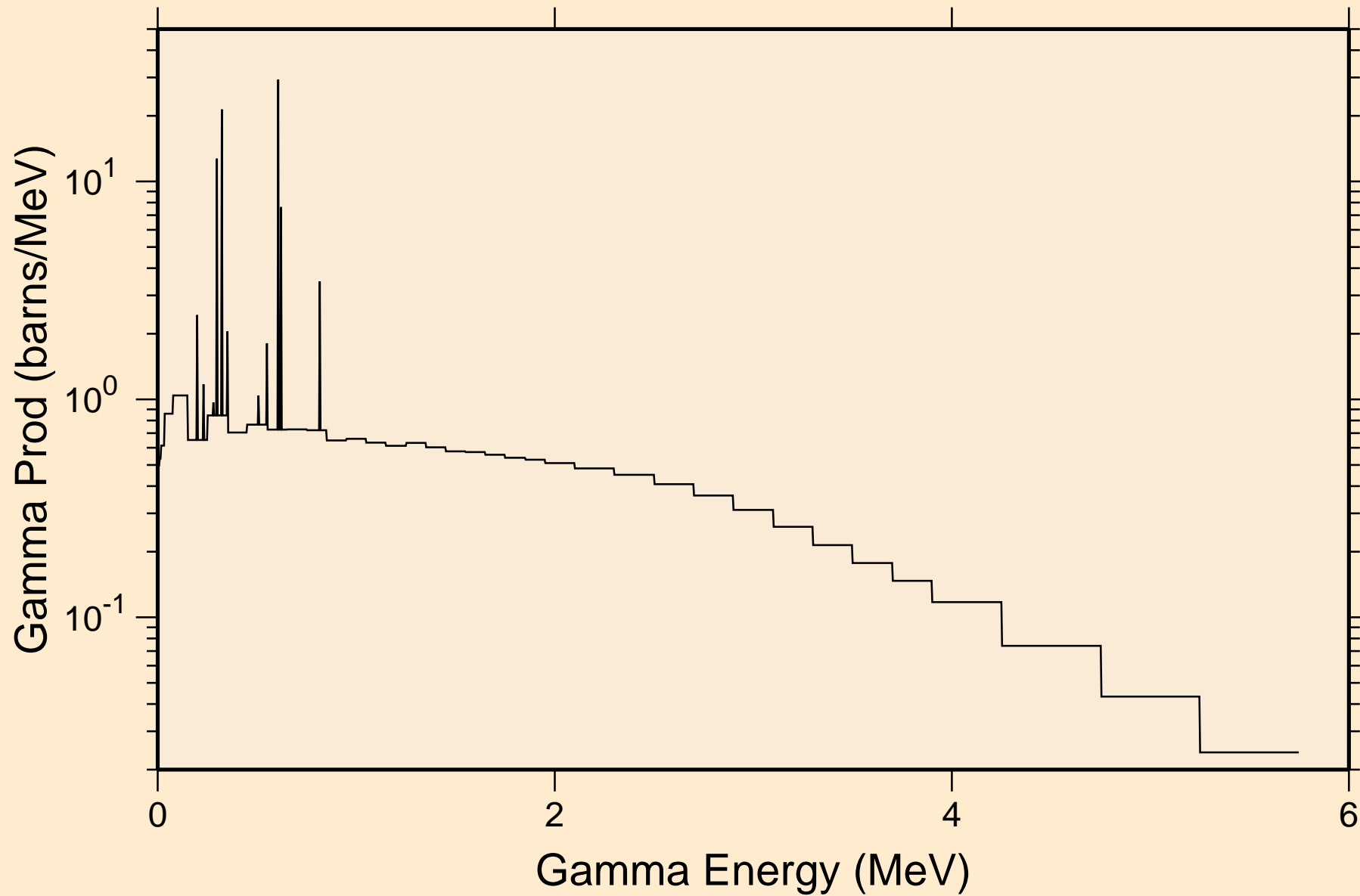

BI192M NEUTRON ACER TENDL-2021 LIBRARY; T=293.6K
14 MeV photon spectrum

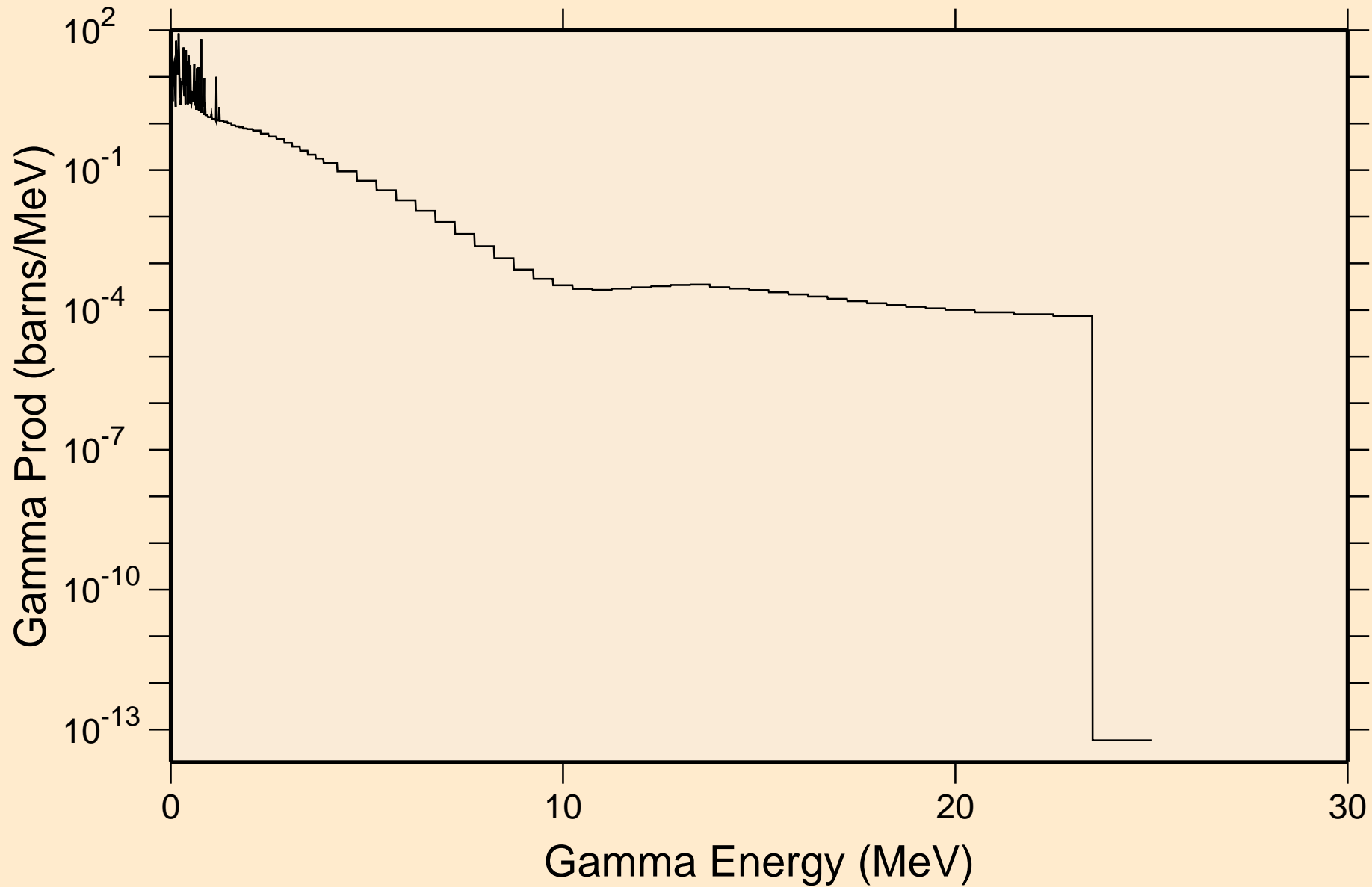

BI192M NEUTRON ACER TENDL-2021 LIBRARY; T=293.6K
Particle heating contributions

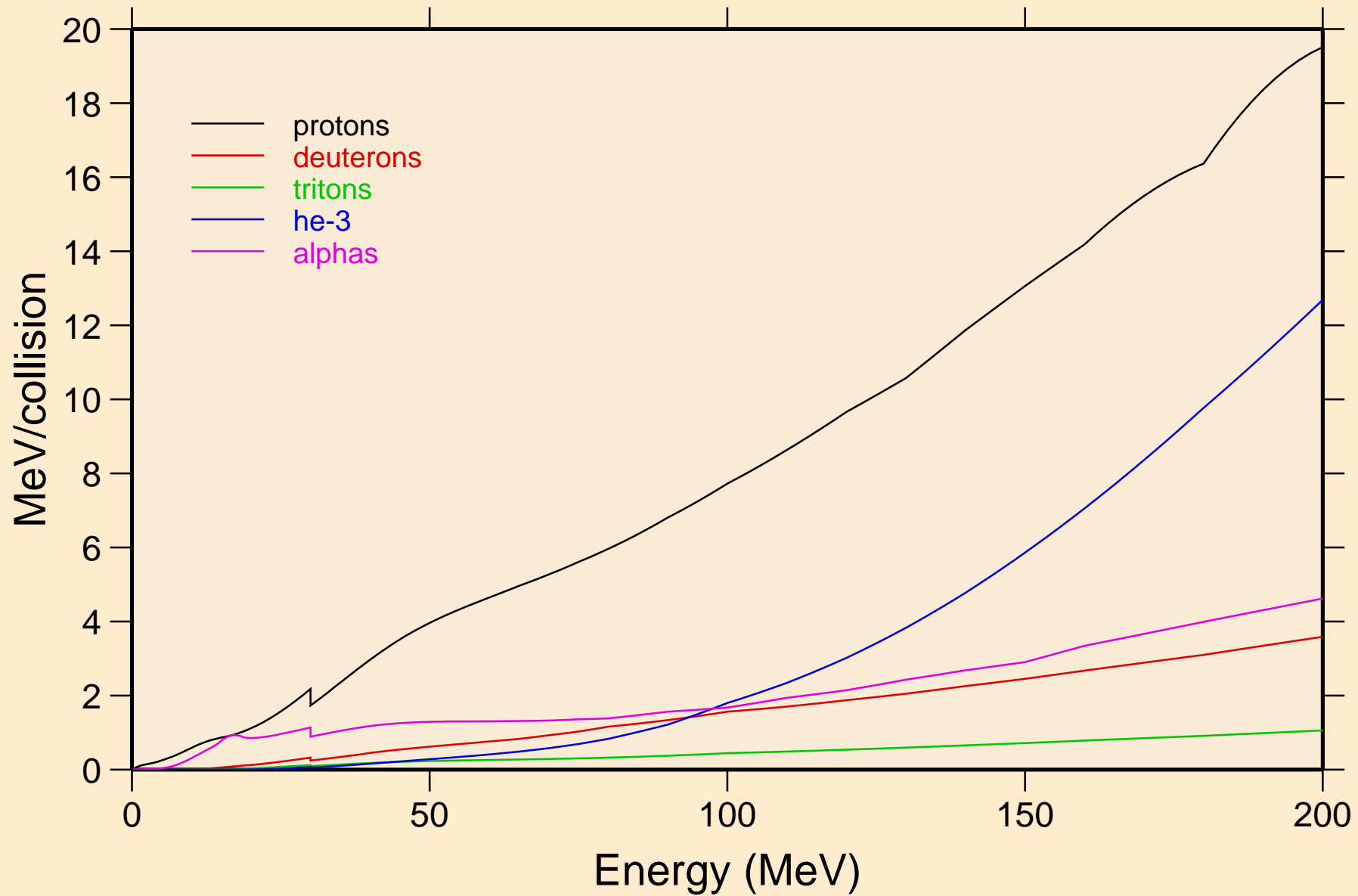

BI192M NEUTRON ACER TENDL-2021 LIBRARY; T=293.6K
Recoil Heating

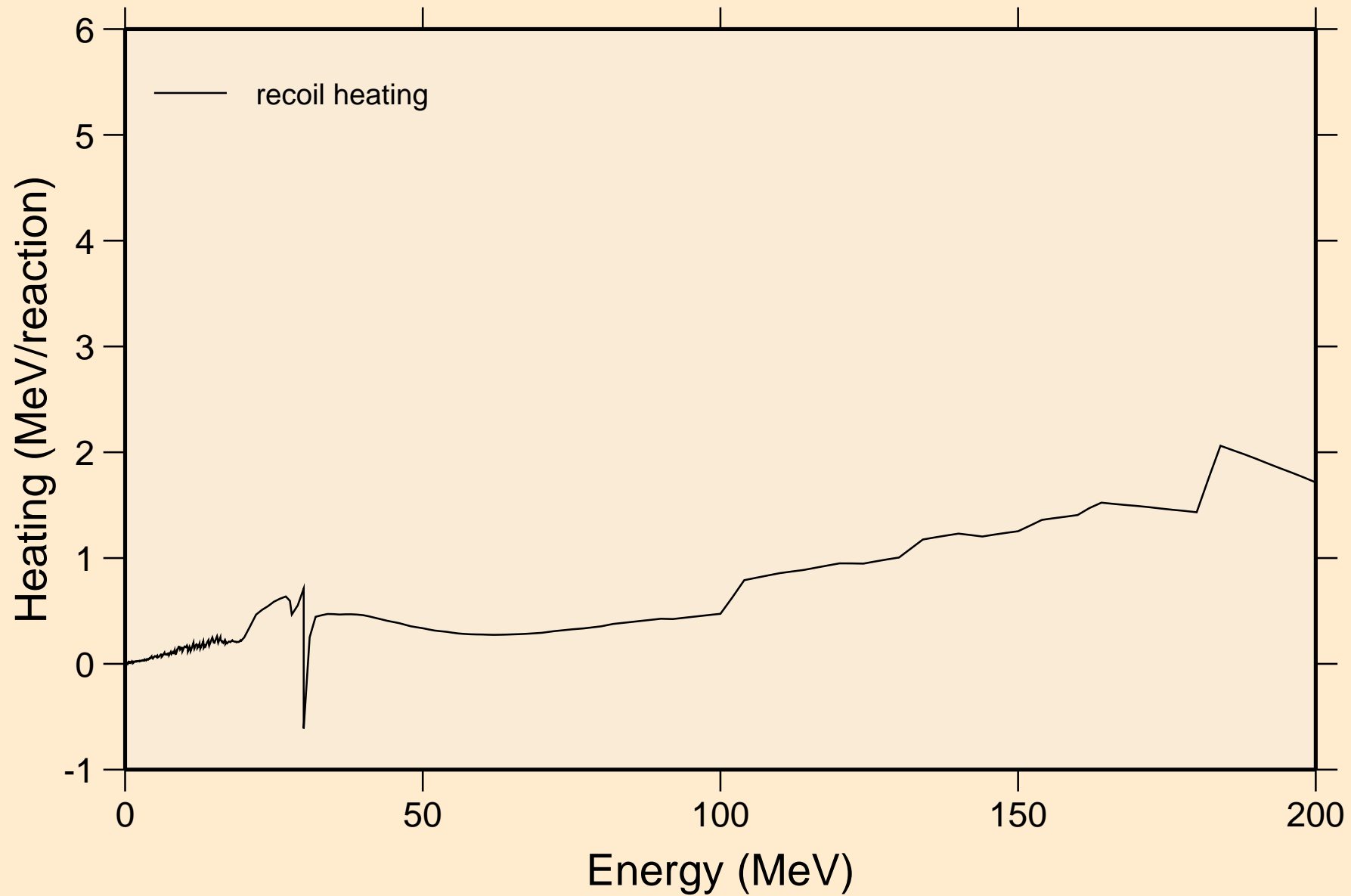

BI192M NEUTRON ACER TENDL-2021 LIBRARY; T=293.6K
Particle production cross sections

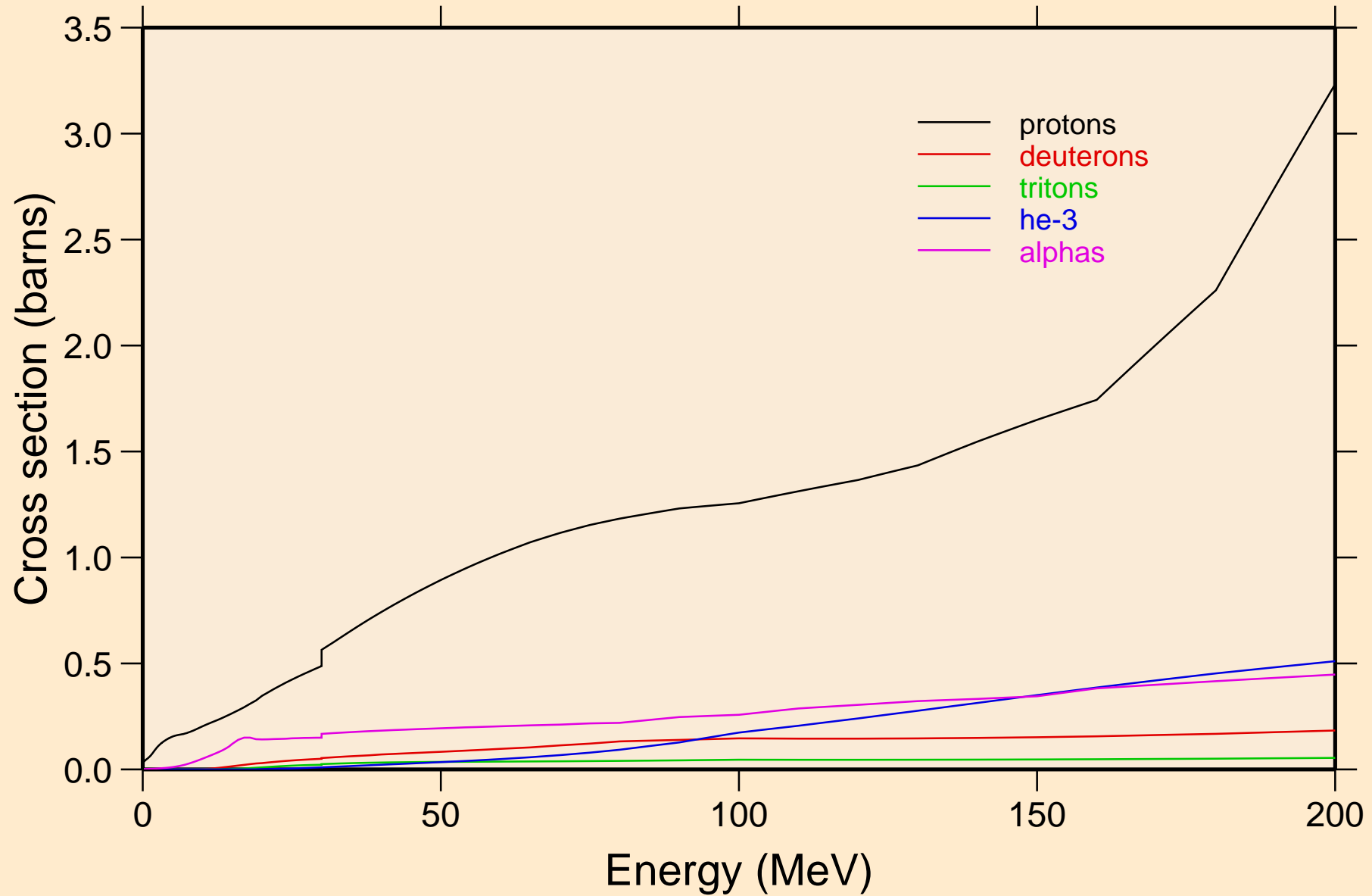

BI192M NEUTRON ACER TENDL-2021 LIBRARY; T=293.6K
protons from (n,x)

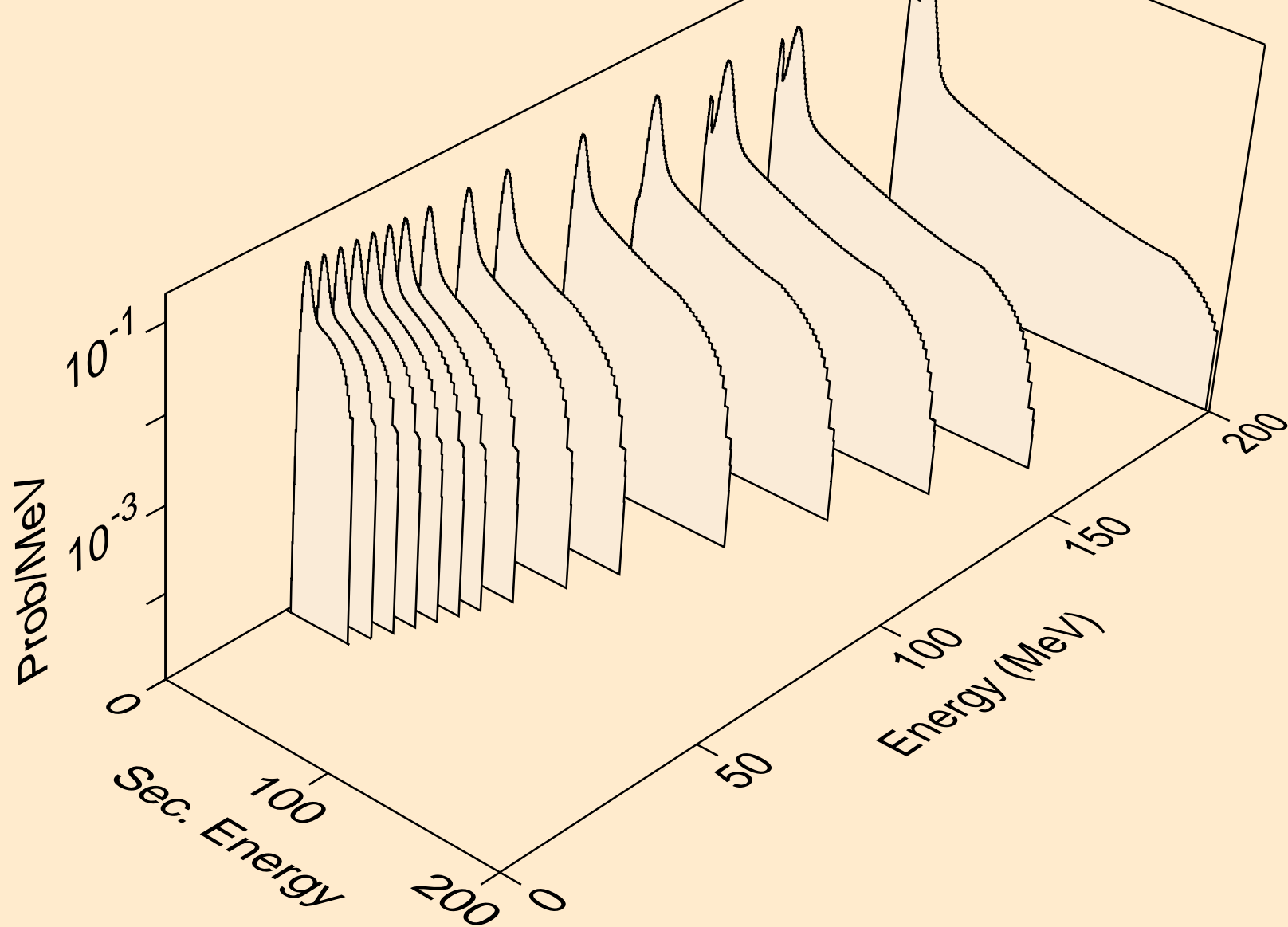

BI192M NEUTRON ACER TENDL-2021 LIBRARY; T=293.6K
protons from (n,n*)p

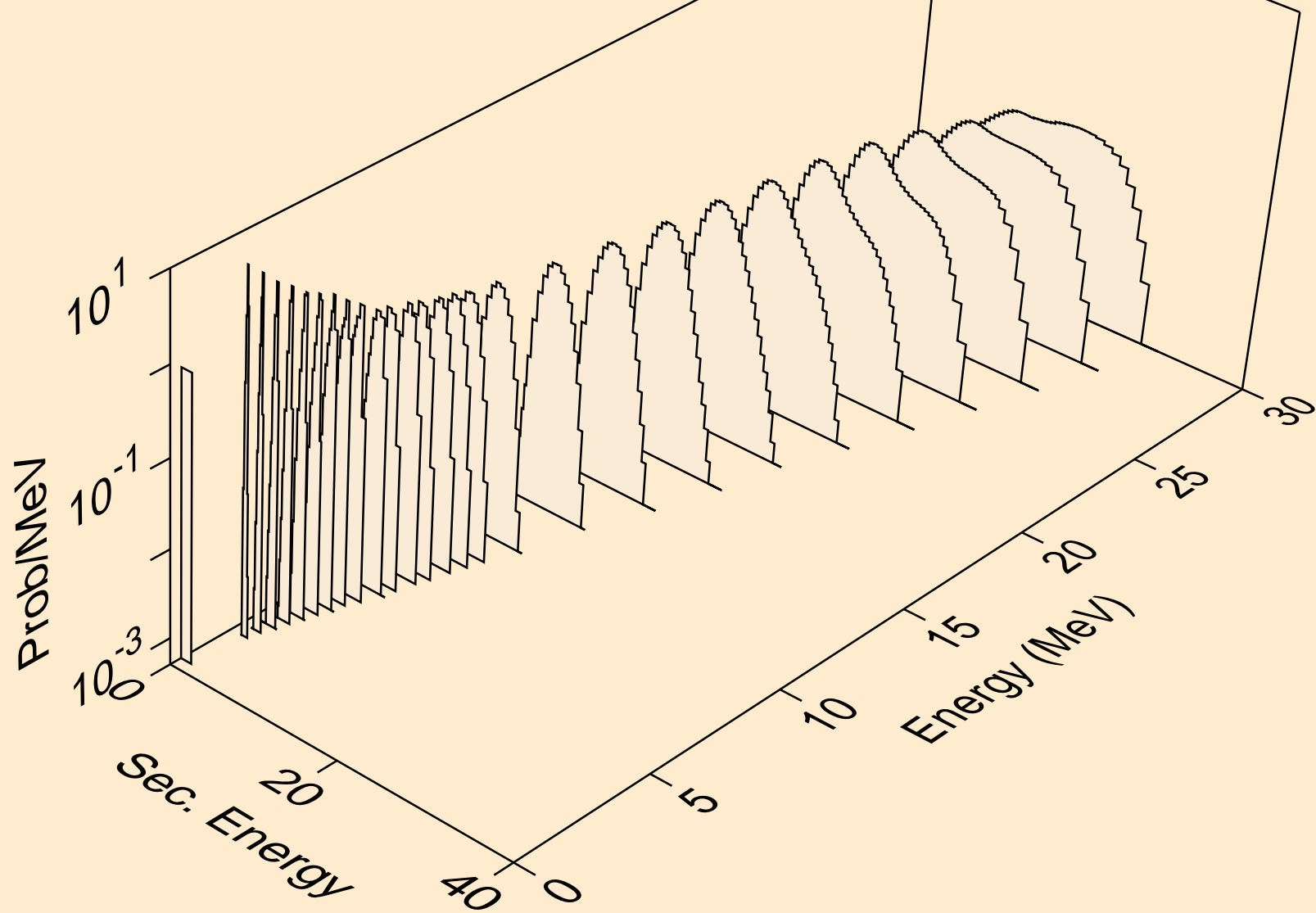

BI192M NEUTRON ACER TENDL-2021 LIBRARY; T=293.6K
protons from (n,2np)

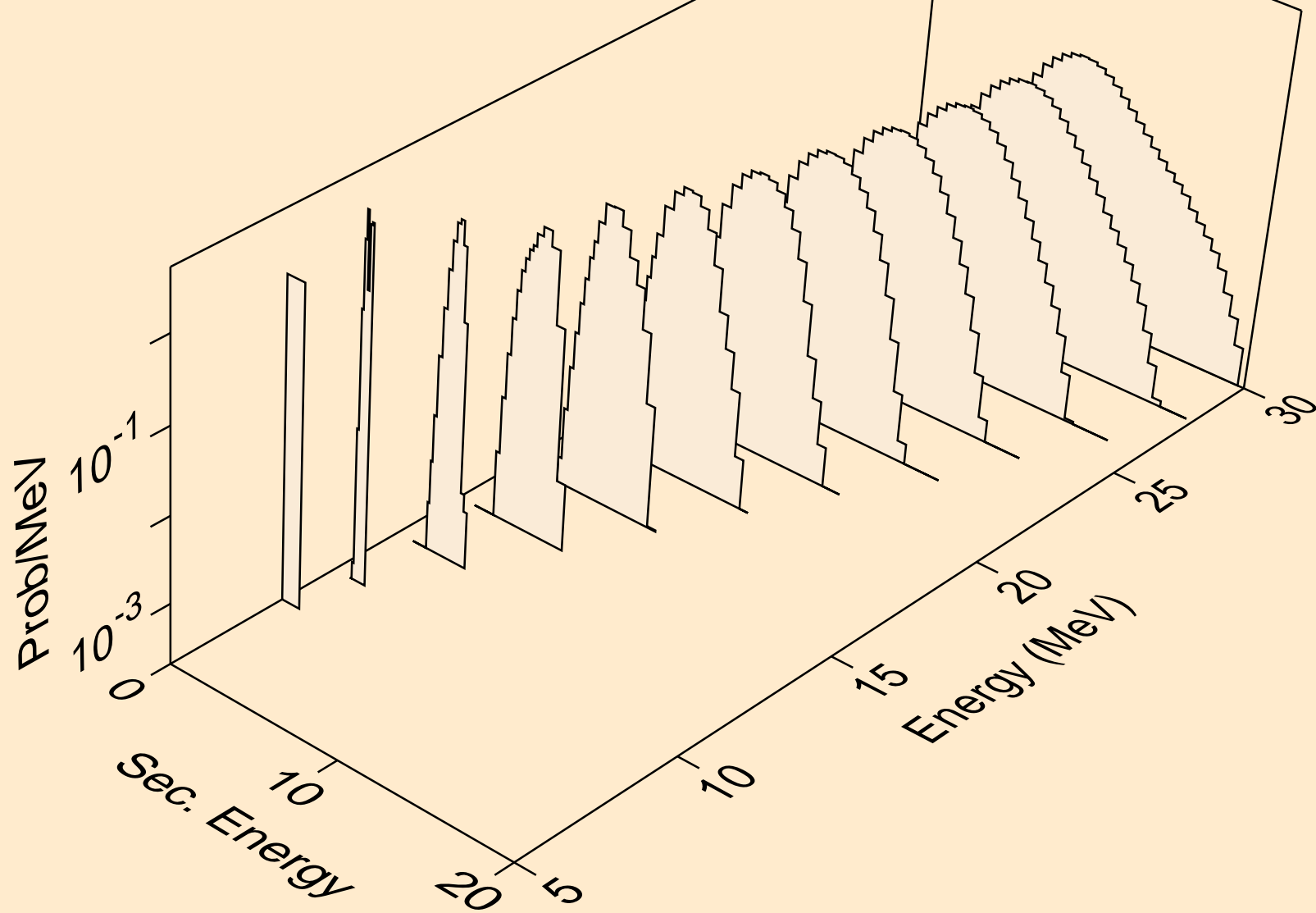

BI192M NEUTRON ACER TENDL-2021 LIBRARY; T=293.6K
protons from (n,3np)

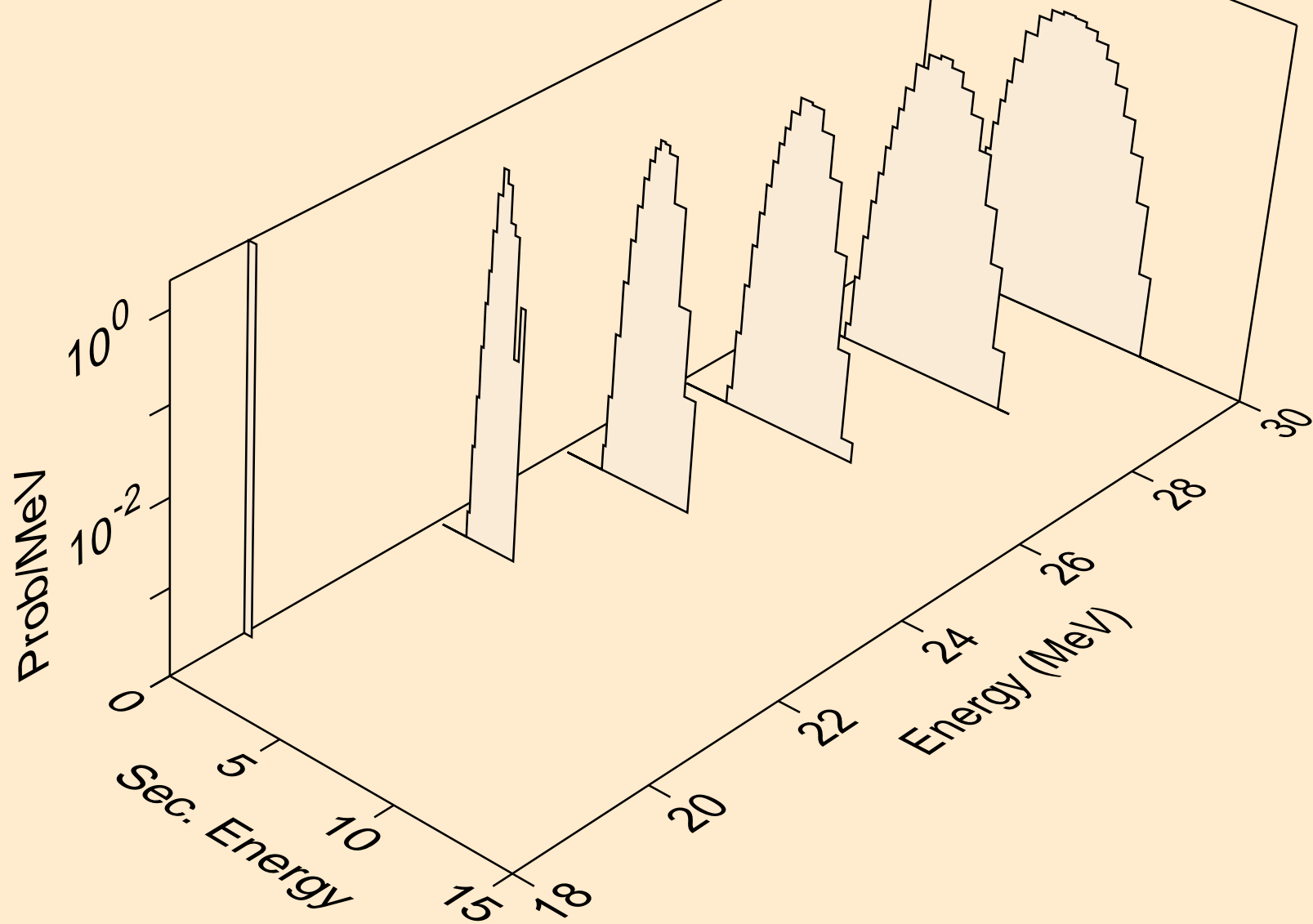

BI192M NEUTRON ACER TENDL-2021 LIBRARY; T=293.6K
protons from (n,2np)

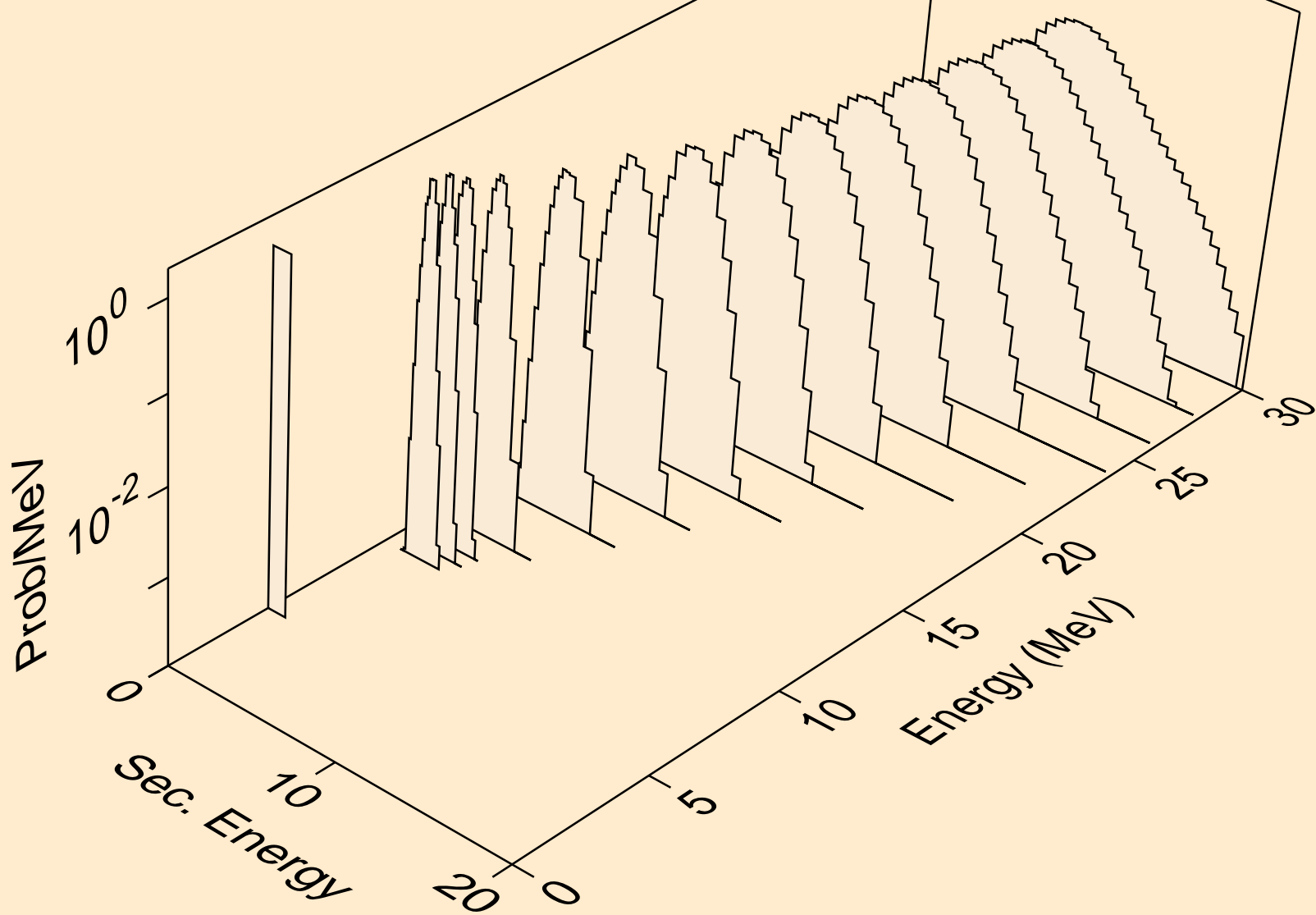

BI192M NEUTRON ACER TENDL-2021 LIBRARY; T=293.6K
protons from (n,npa)

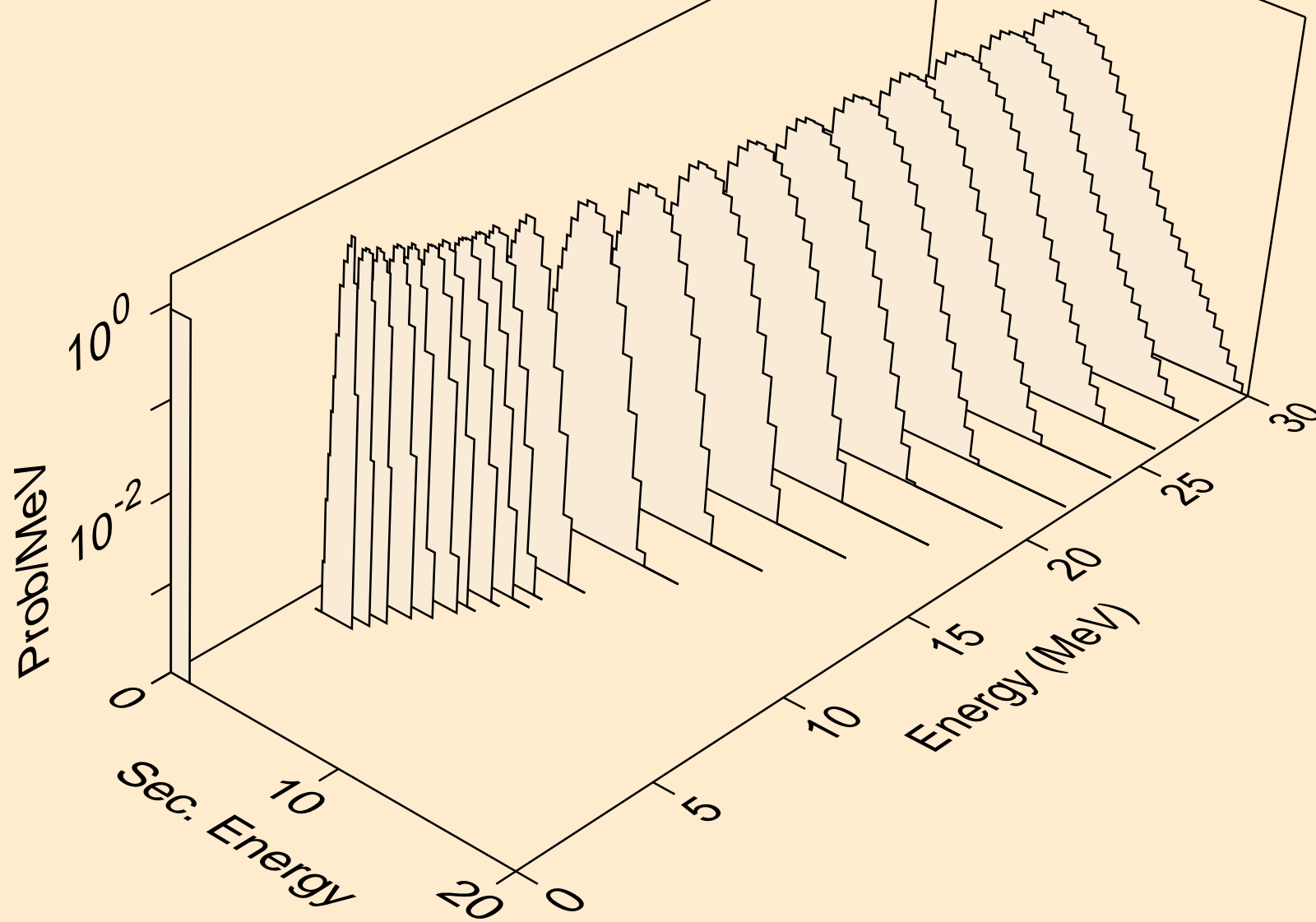

BI192M NEUTRON ACER TENDL-2021 LIBRARY; T=293.6K
protons from (n,p)

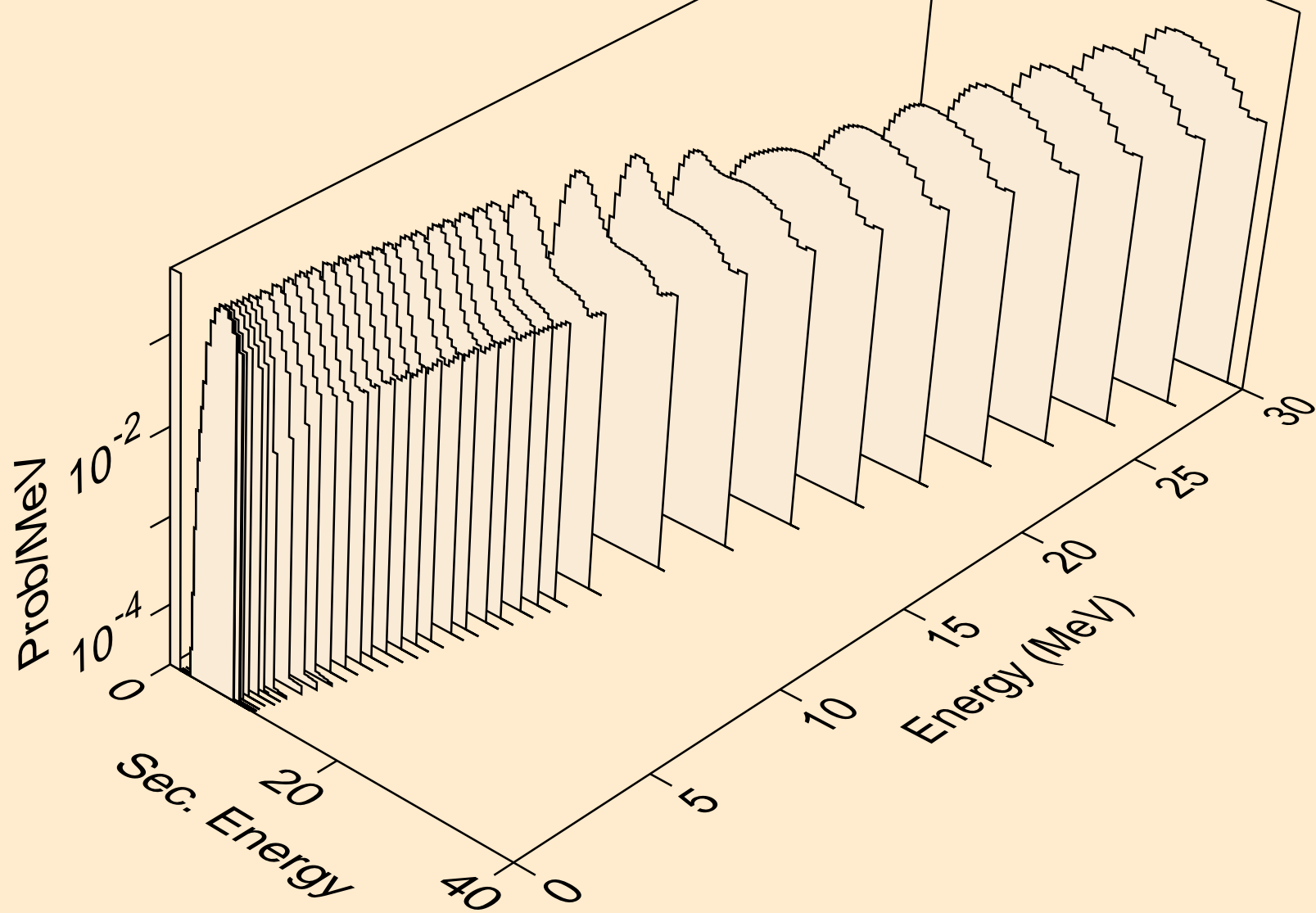

BI192M NEUTRON ACER TENDL-2021 LIBRARY; T=293.6K
protons from (n,2p)

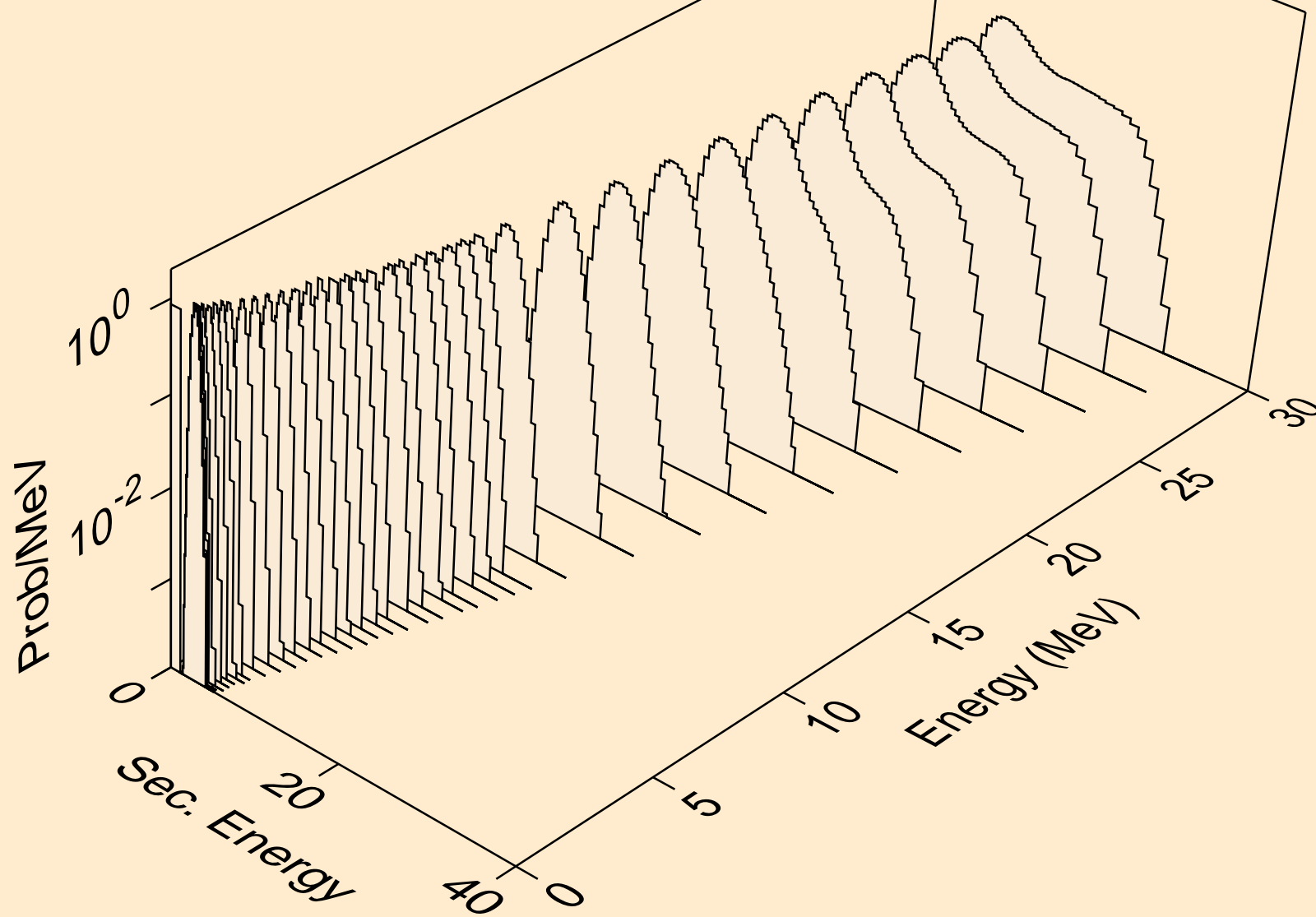

BI192M NEUTRON ACER TENDL-2021 LIBRARY; T=293.6K
protons from (n,p)

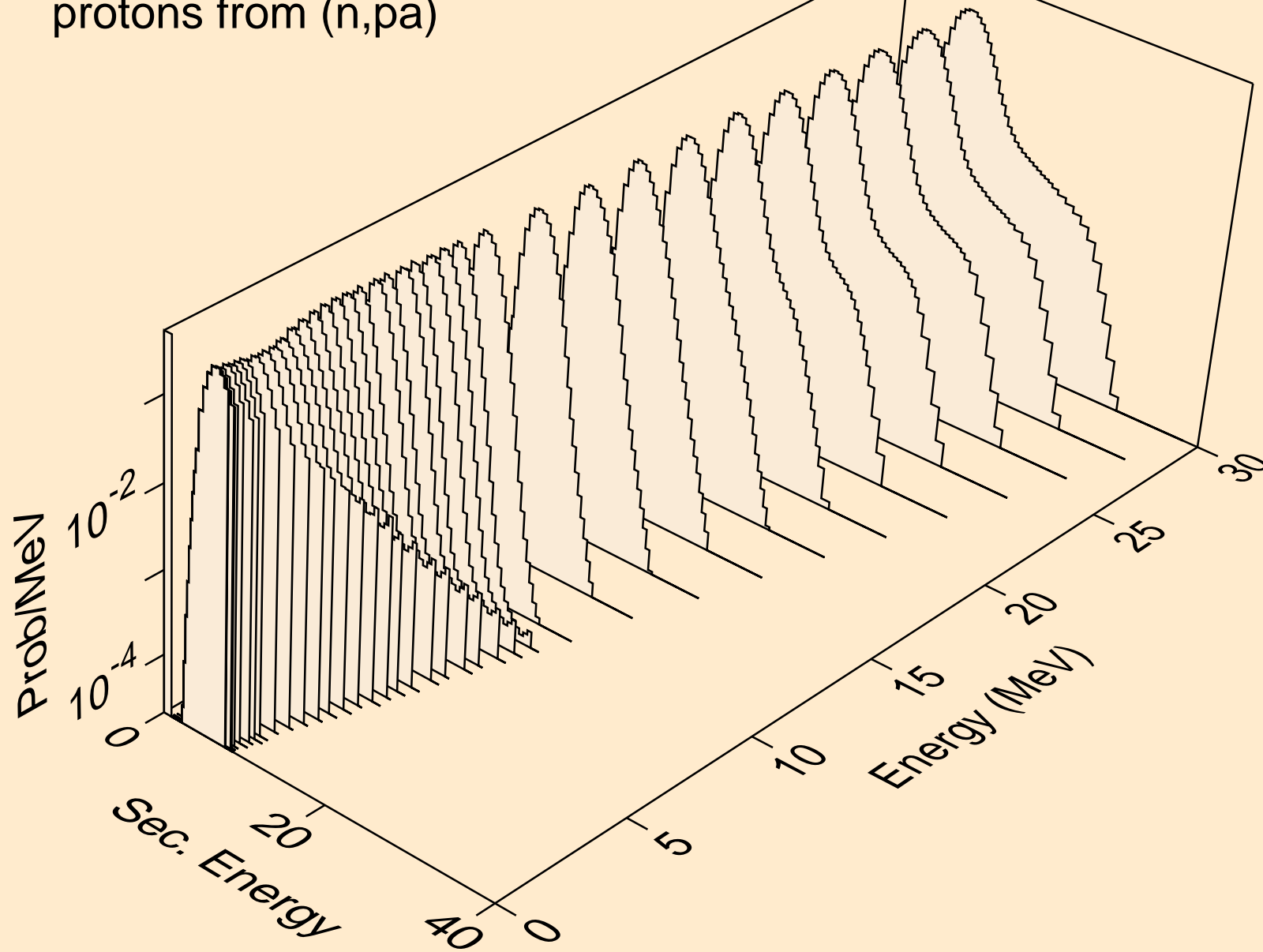

BI192M NEUTRON ACER TENDL-2021 LIBRARY; T=293.6K
protons from (n,pd)

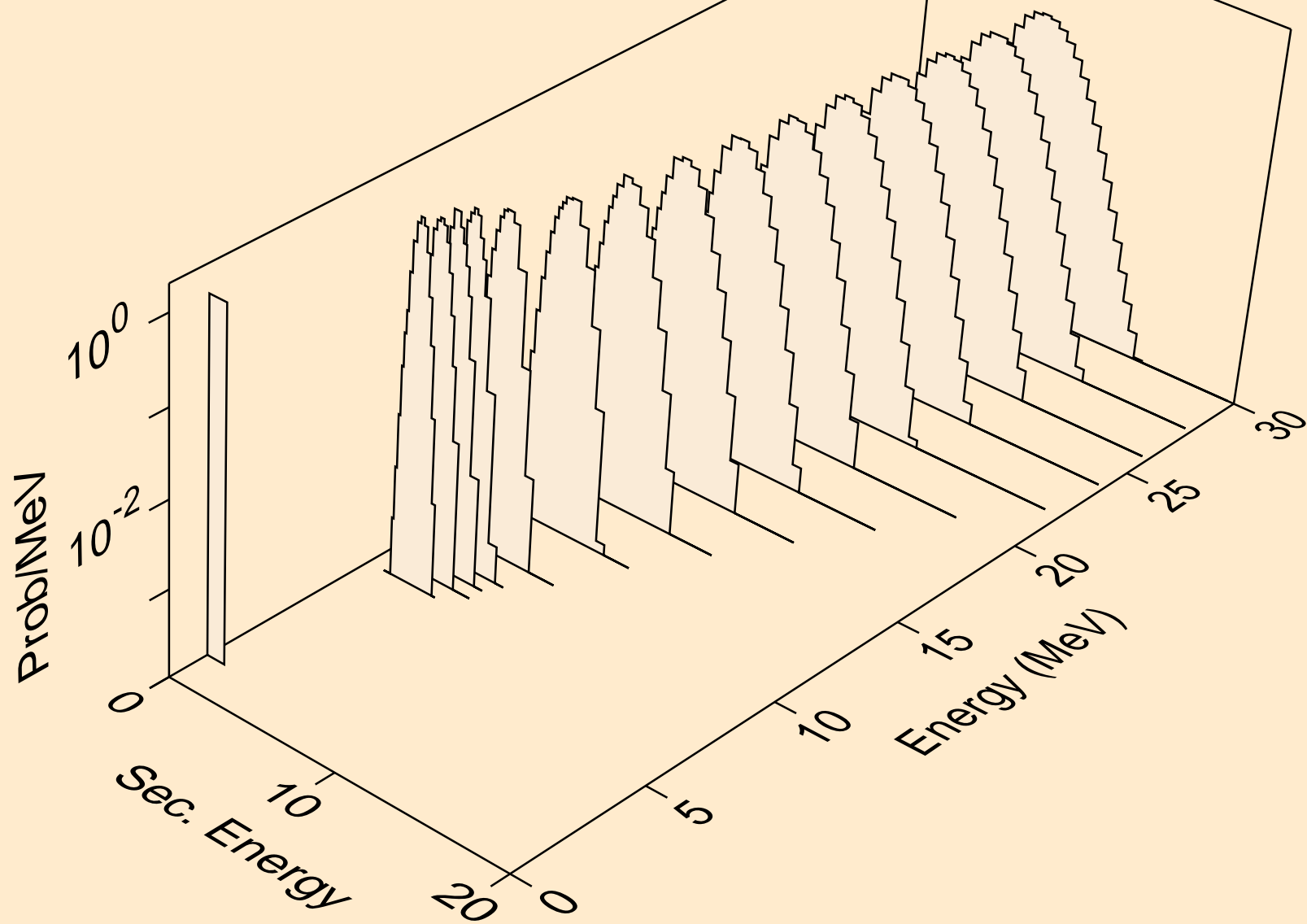

BI192M NEUTRON ACER TENDL-2021 LIBRARY; T=293.6K
protons from (n,pt)

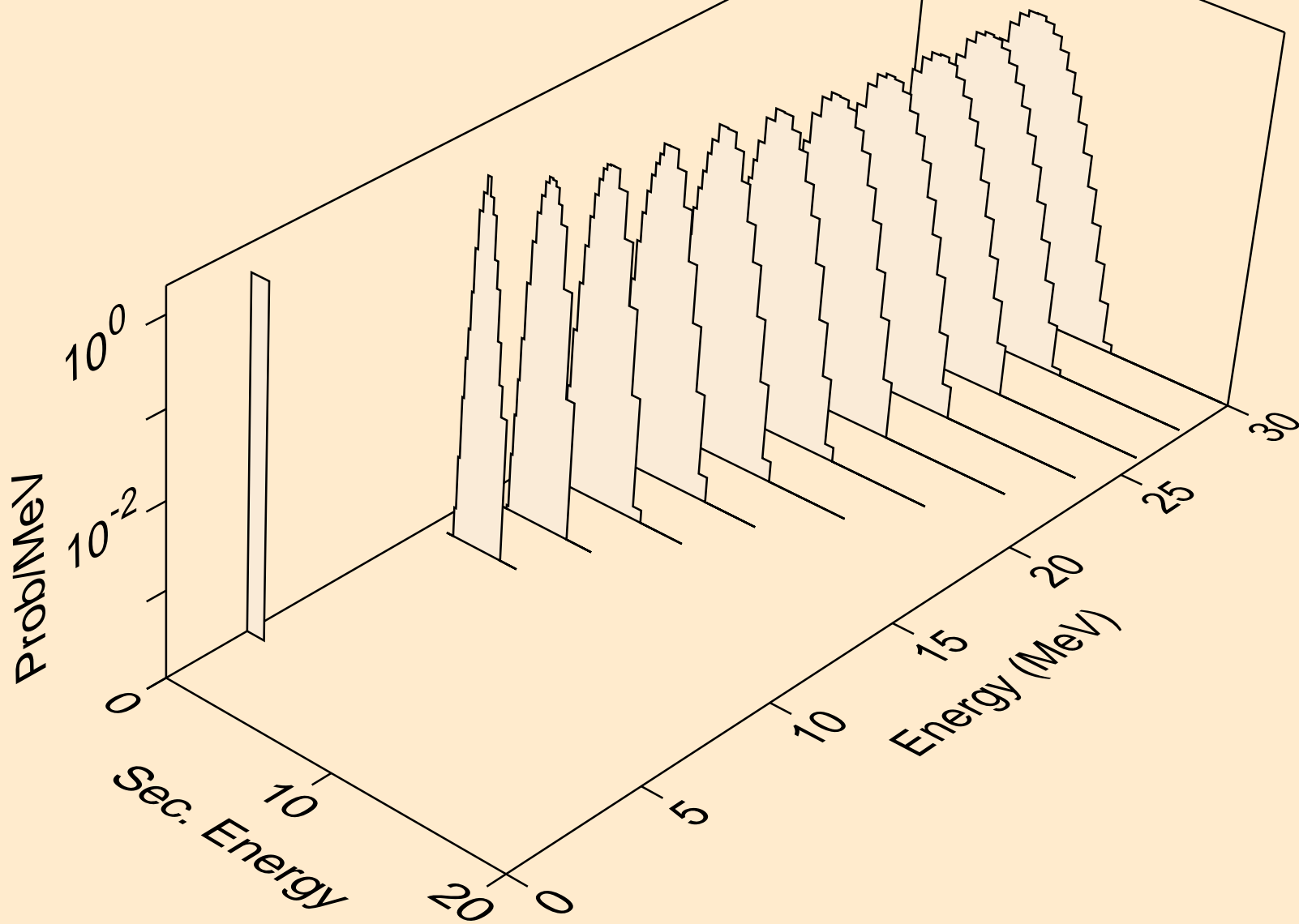

BI192M NEUTRON ACER TENDL-2021 LIBRARY; T=293.6K
deuterons from (n,x)

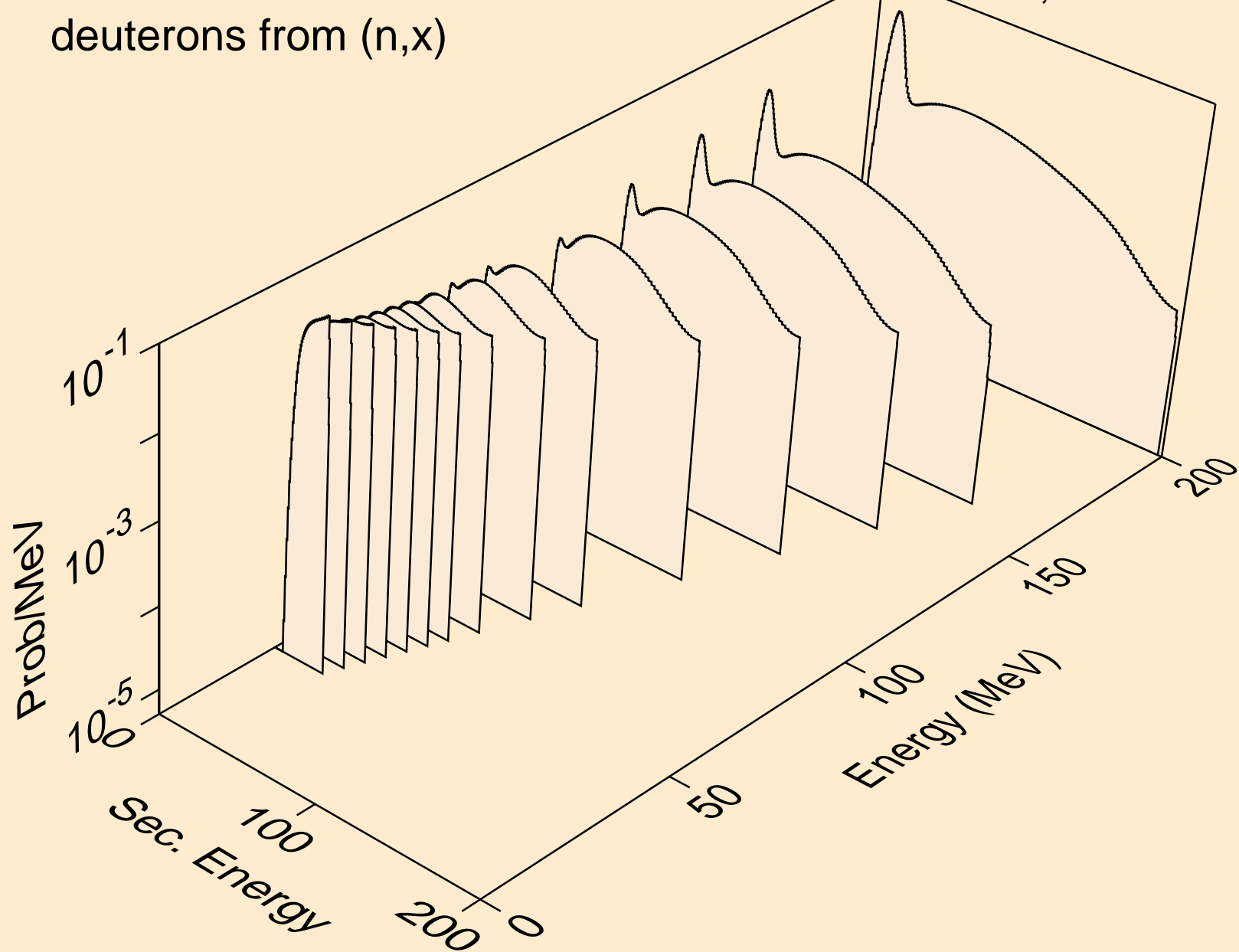

BI192M NEUTRON ACER TENDL-2021 LIBRARY; T=293.6K
deuterons from (n,2nd)

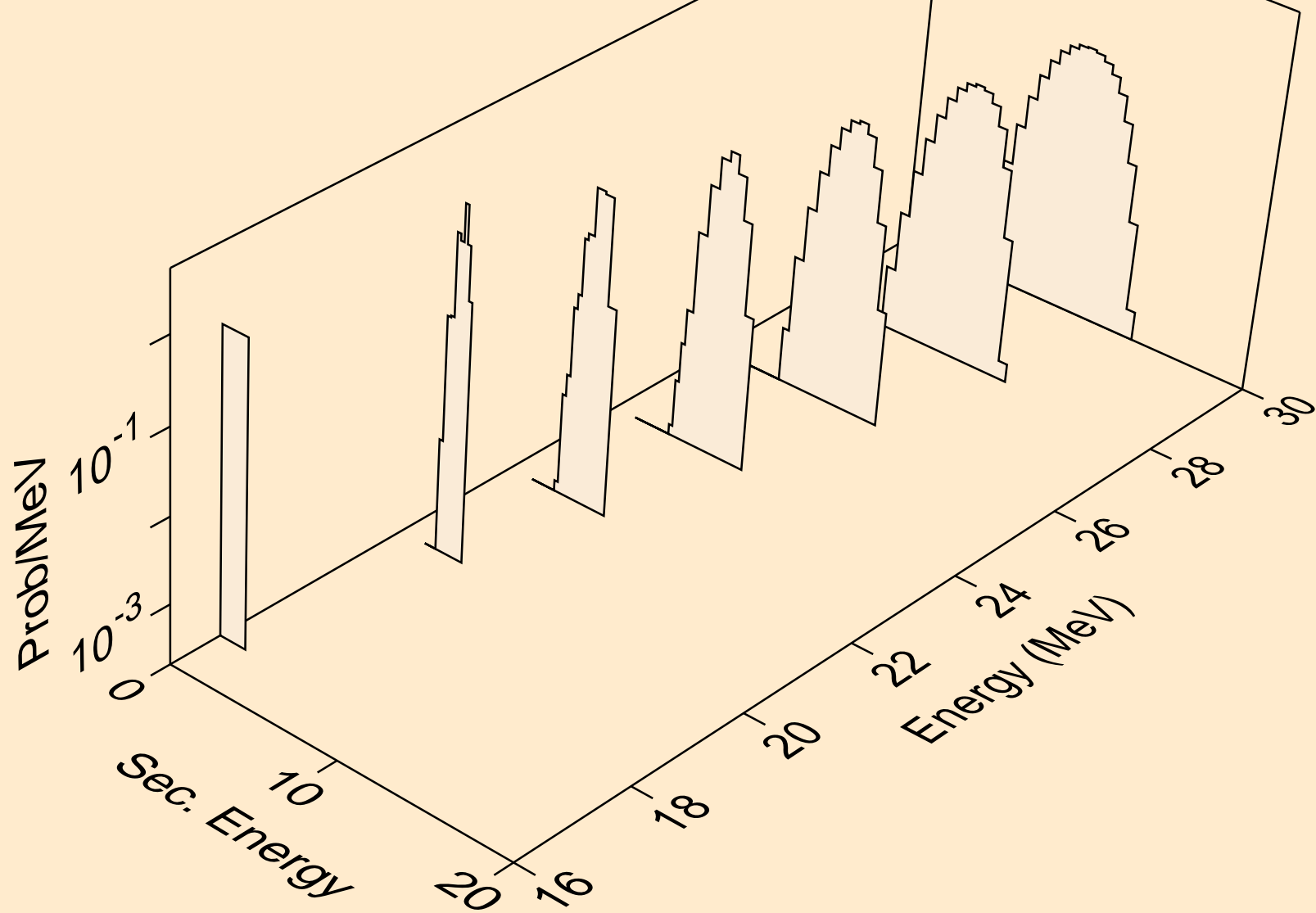

BI192M NEUTRON ACER TENDL-2021 LIBRARY; T=293.6K
deuterons from (n,n*)d

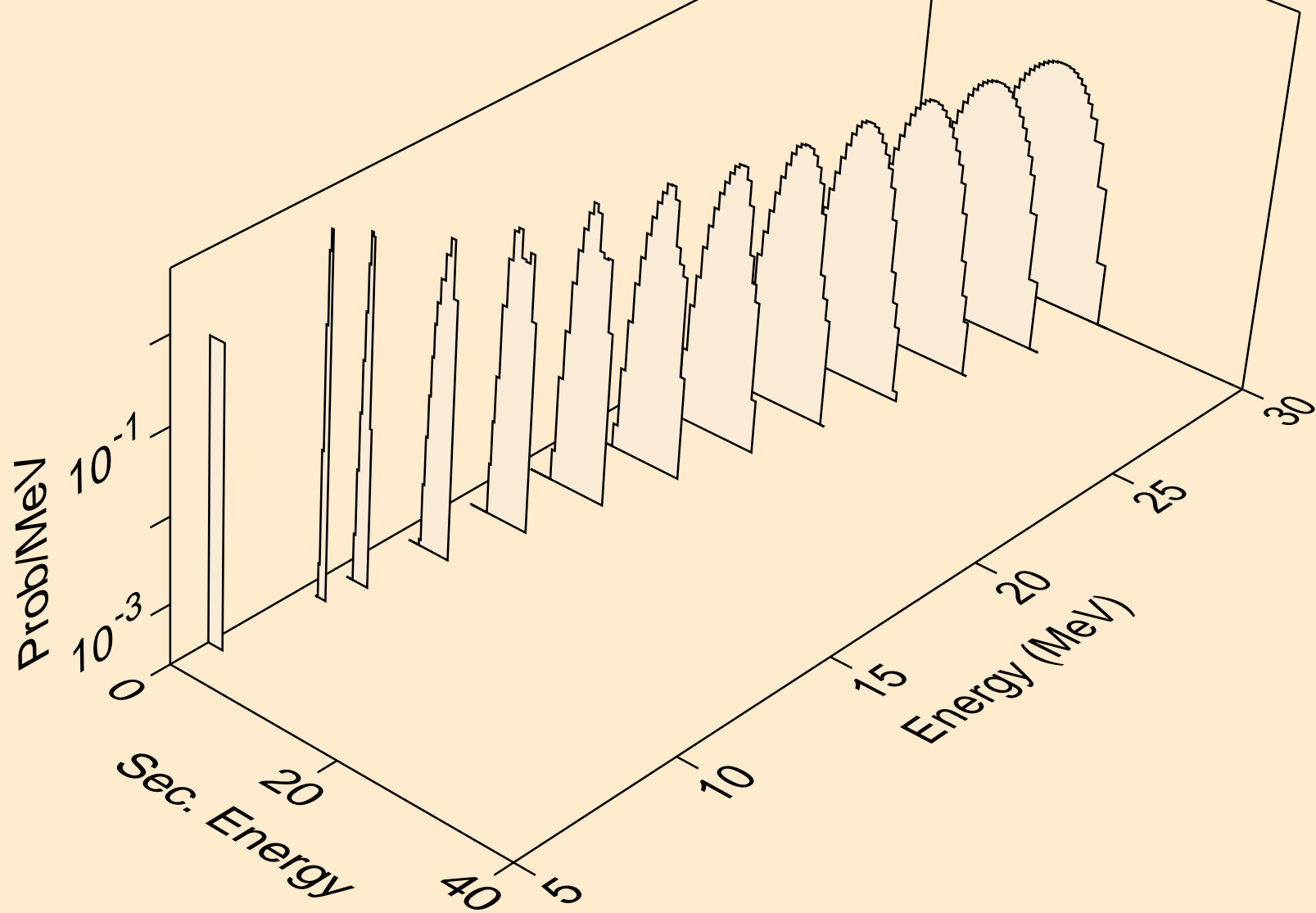

BI192M NEUTRON ACER TENDL-2021 LIBRARY; T=293.6K
deuterons from (n,d)

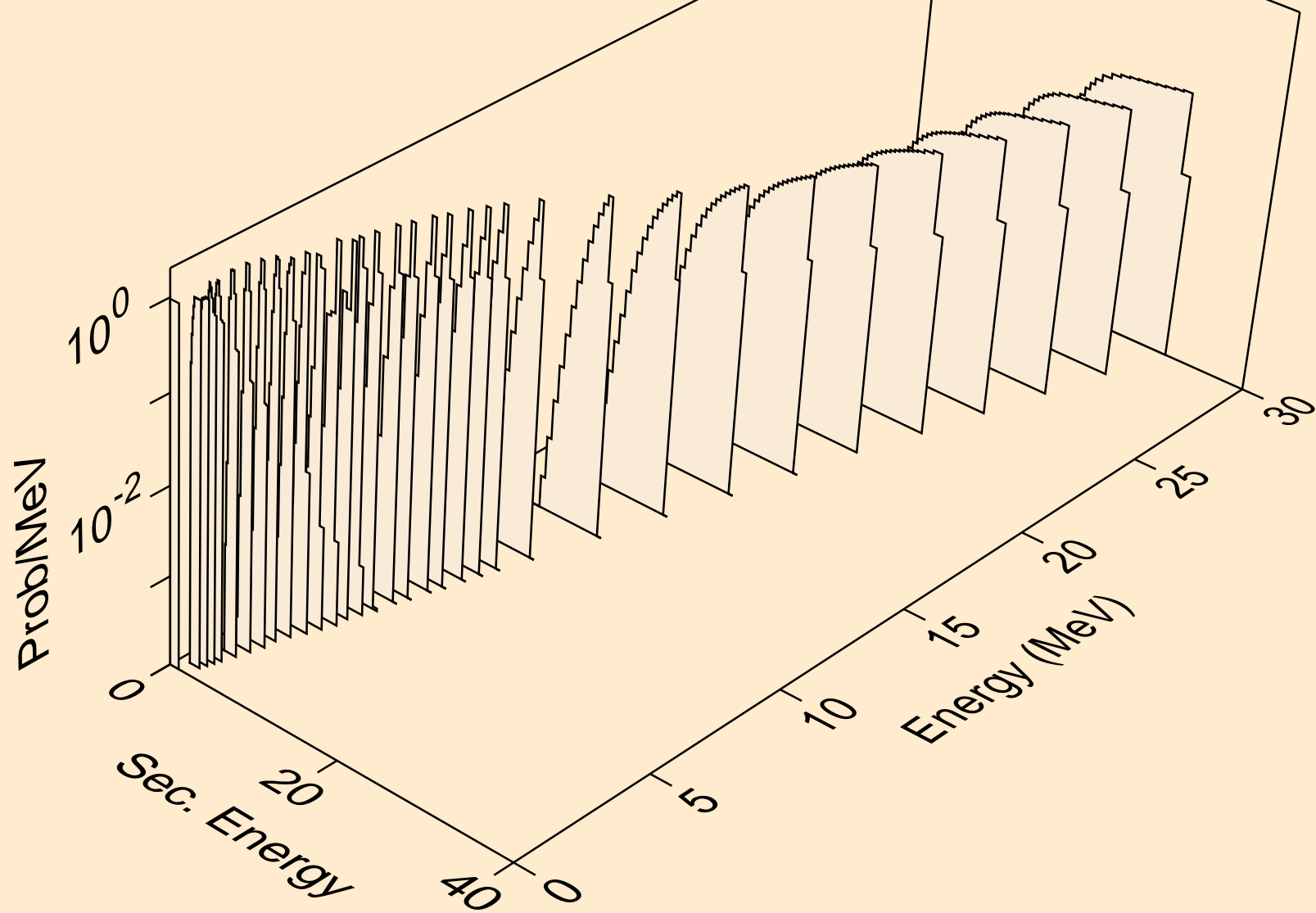

BI192M NEUTRON ACER TENDL-2021 LIBRARY; T=293.6K
deuterons from (n,pd)

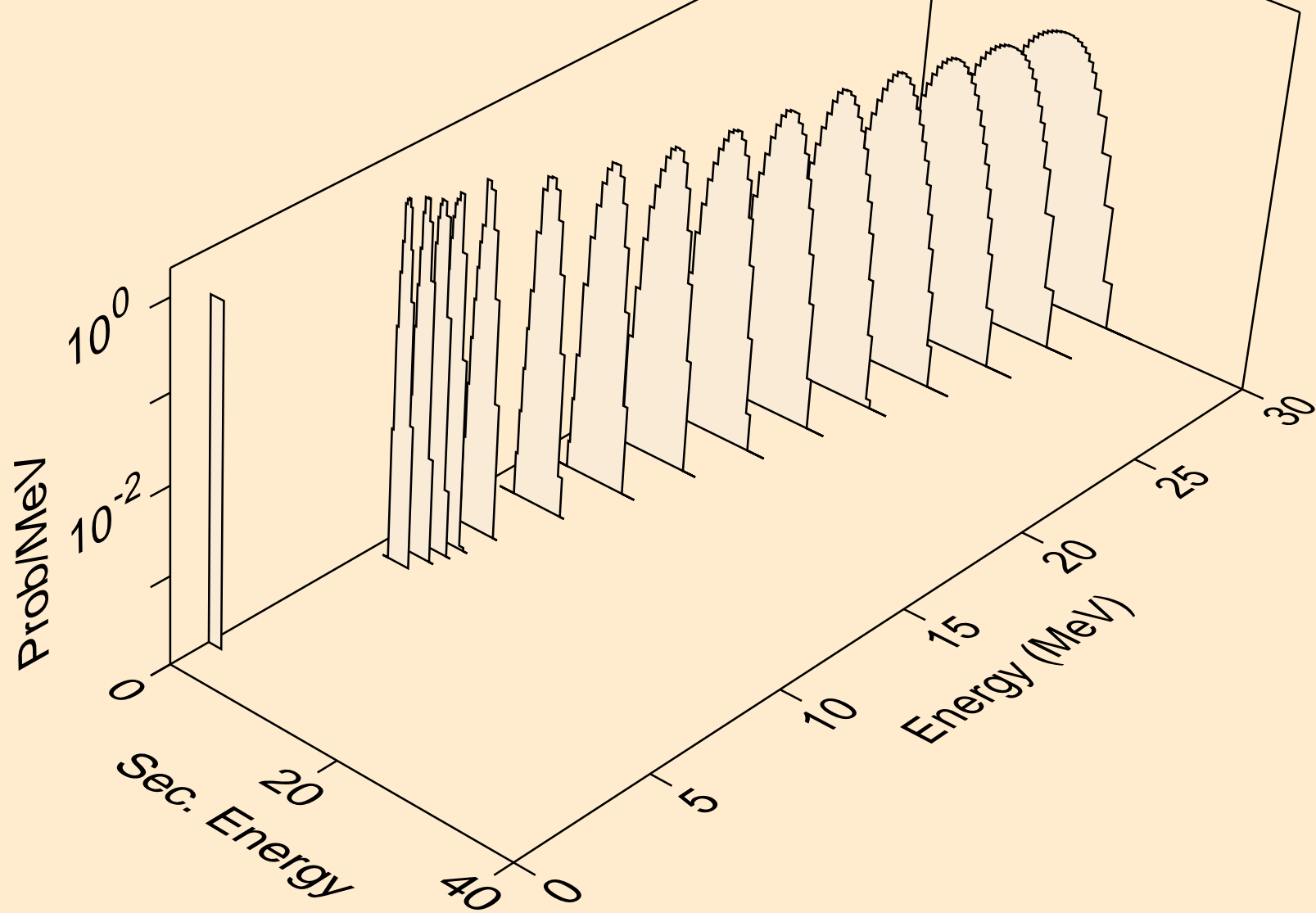

BI192M NEUTRON ACER TENDL-2021 LIBRARY; T=293.6K
deuterons from (n,da)

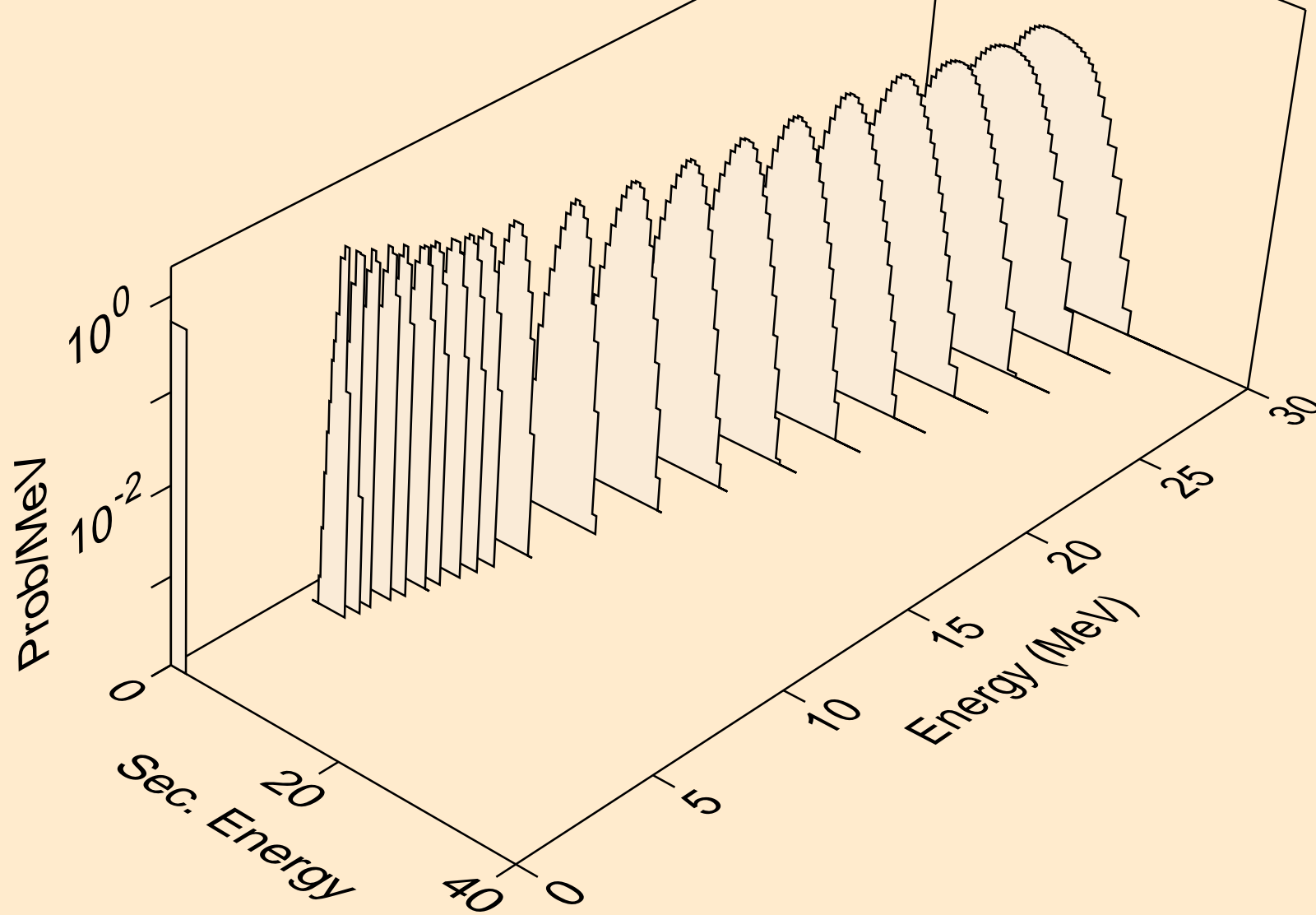

BI192M NEUTRON ACER TENDL-2021 LIBRARY; T=293.6K
tritons from (n,x)

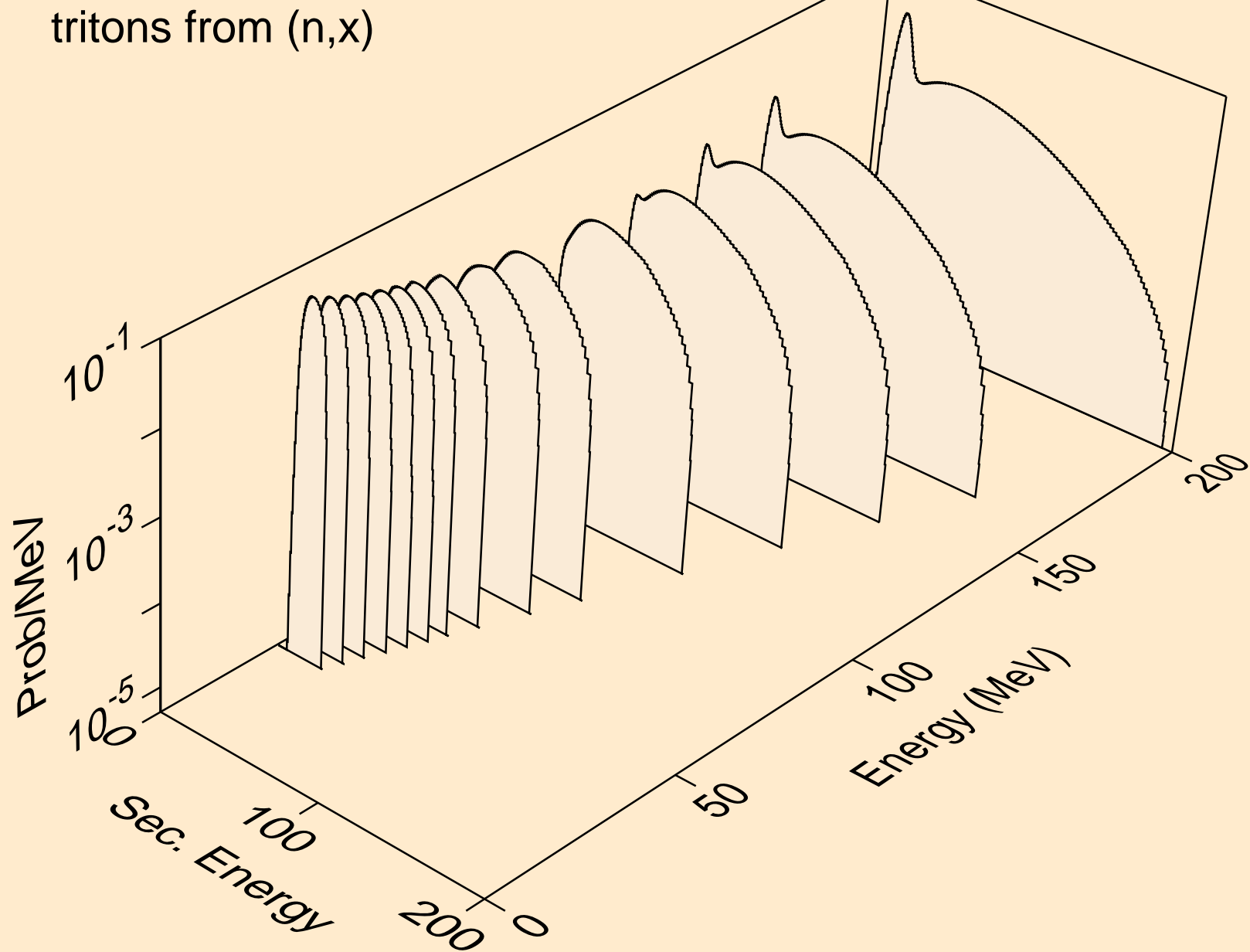

BI192M NEUTRON ACER TENDL-2021 LIBRARY; T=293.6K
tritons from (n,n*)t

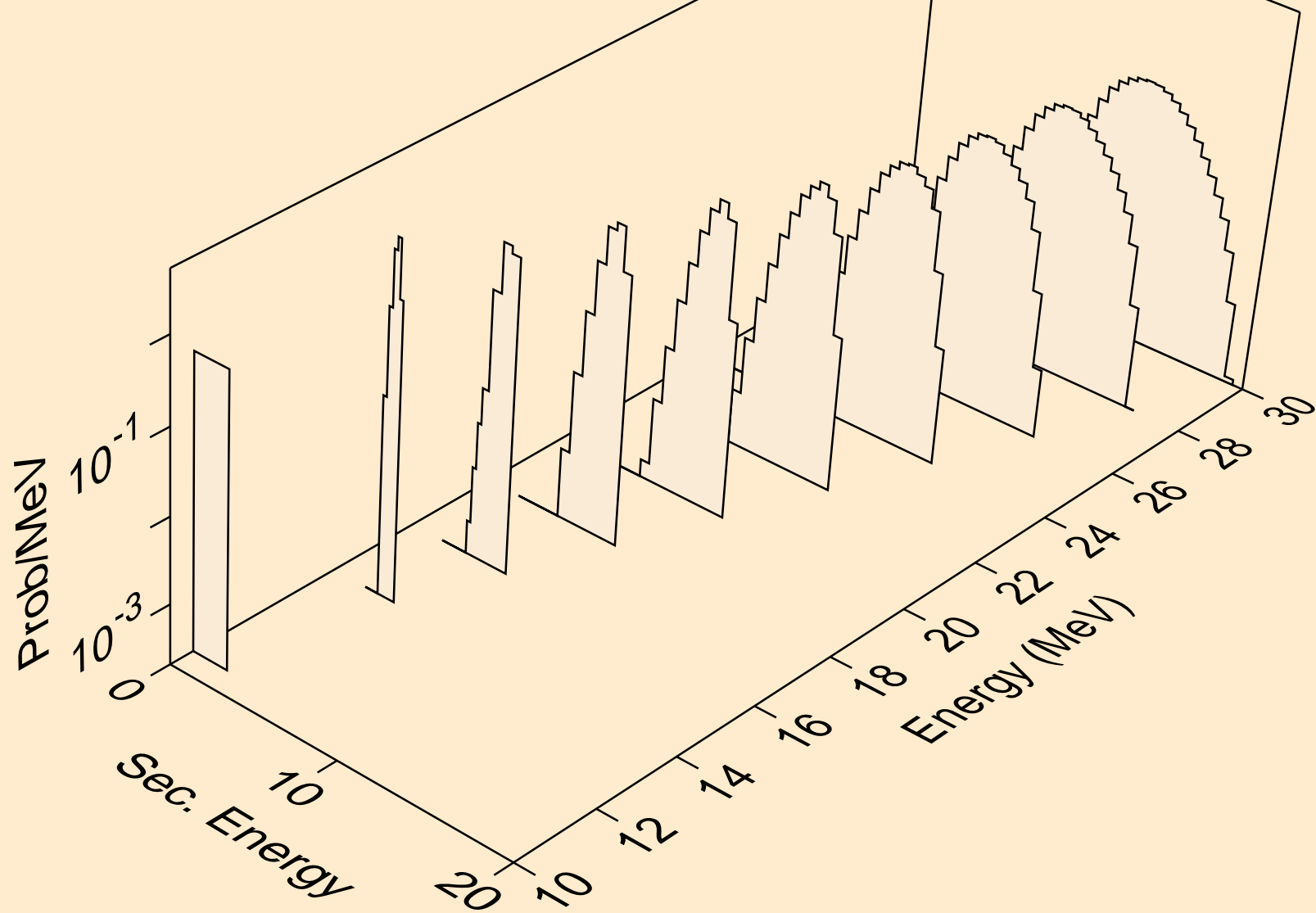

BI192M NEUTRON ACER TENDL-2021 LIBRARY; T=293.6K
tritons from (n,t)

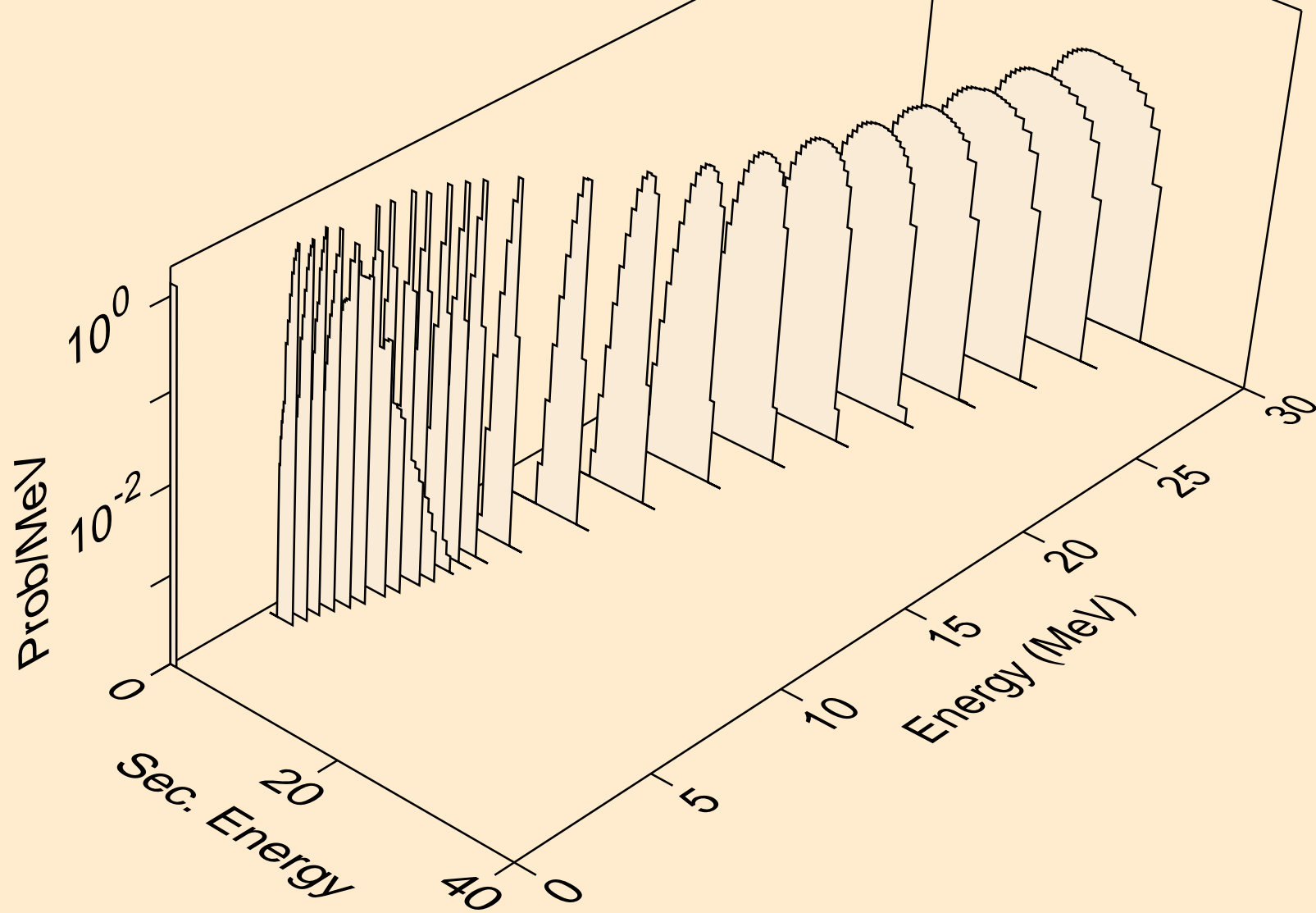

BI192M NEUTRON ACER TENDL-2021 LIBRARY; T=293.6K
tritons from (n,pt)

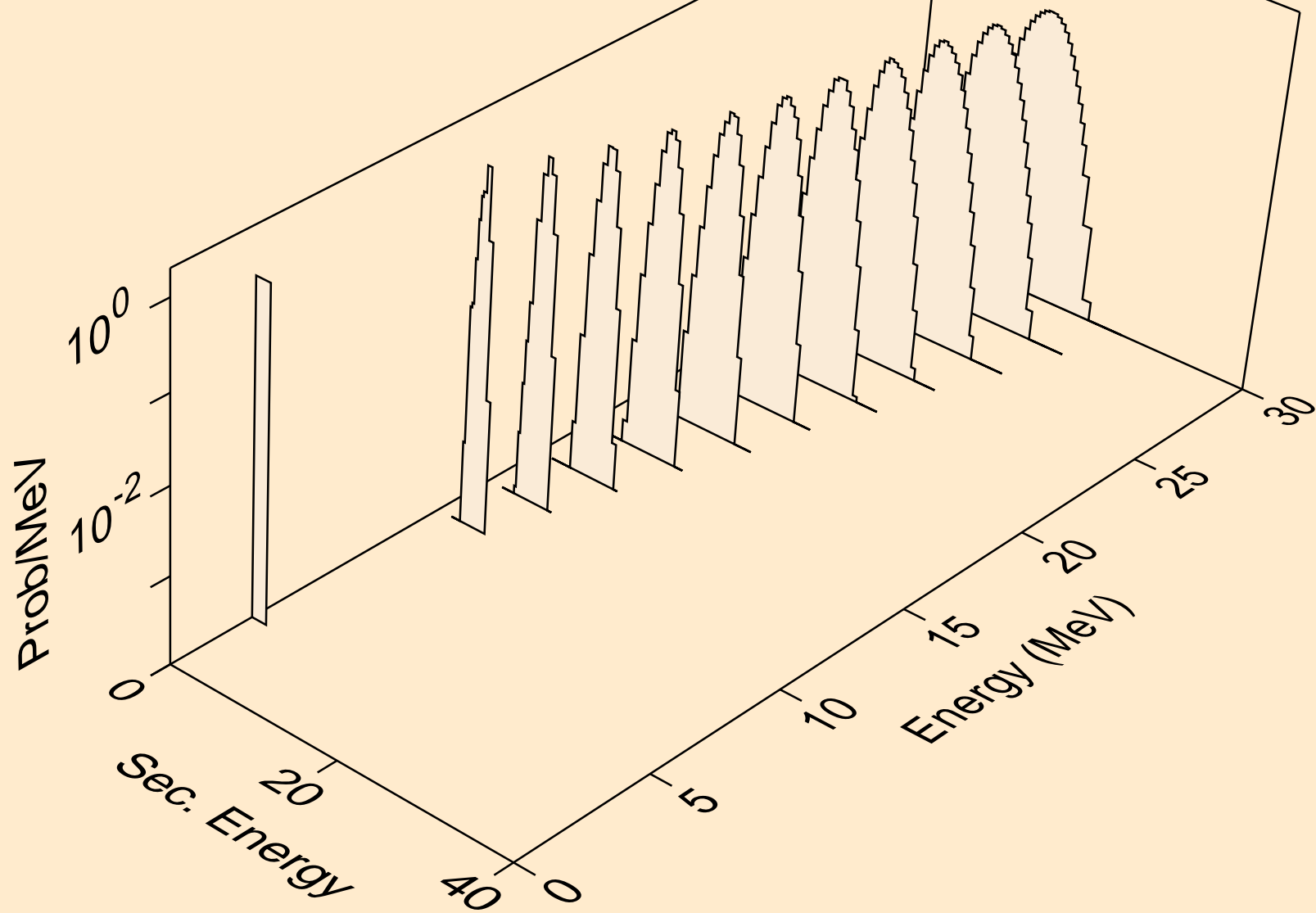

BI192M NEUTRON ACER TENDL-2021 LIBRARY; T=293.6K
he3s from (n,x)

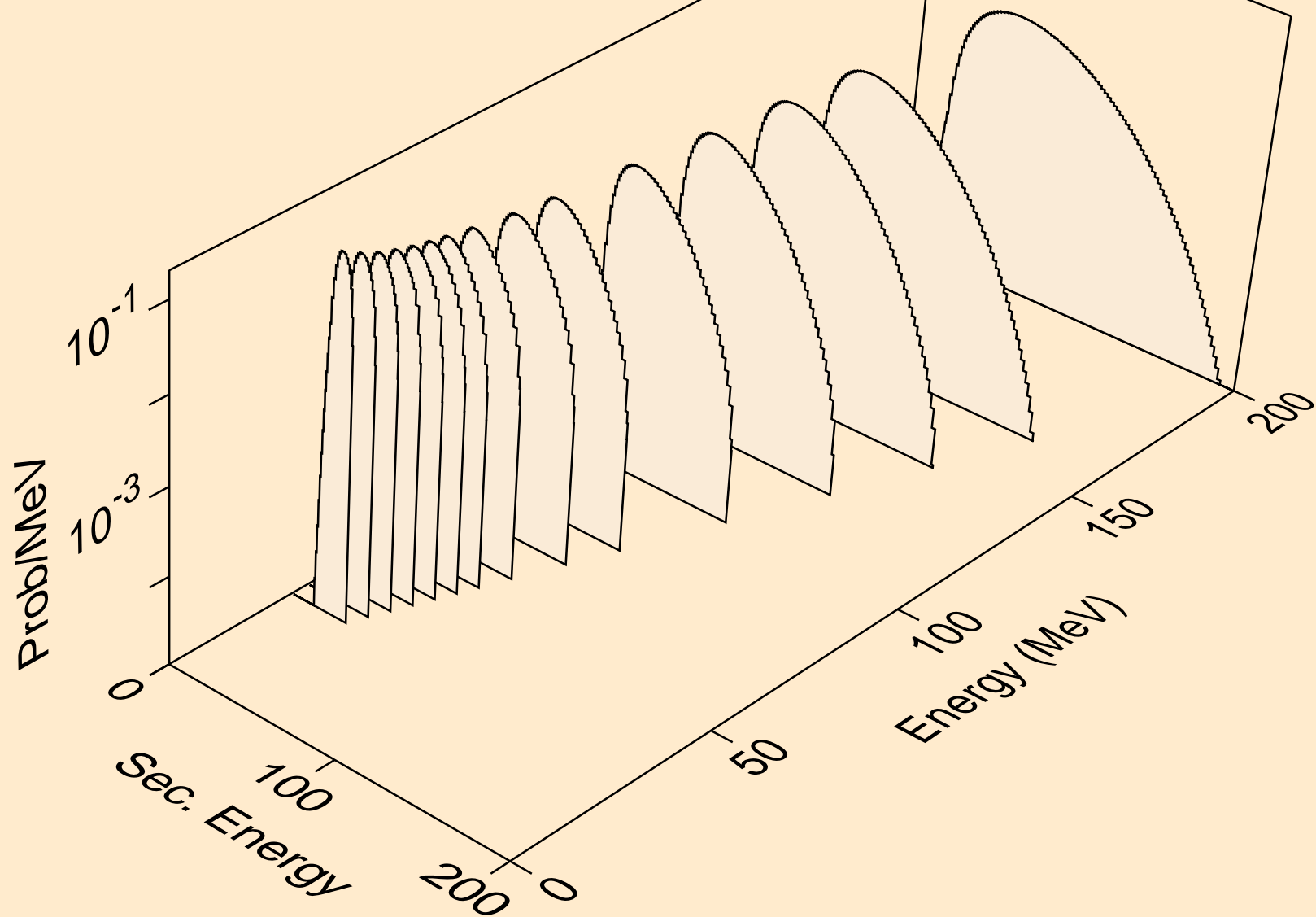

BI192M NEUTRON ACER TENDL-2021 LIBRARY; T=293.6K
he3s from (n,n*)he3

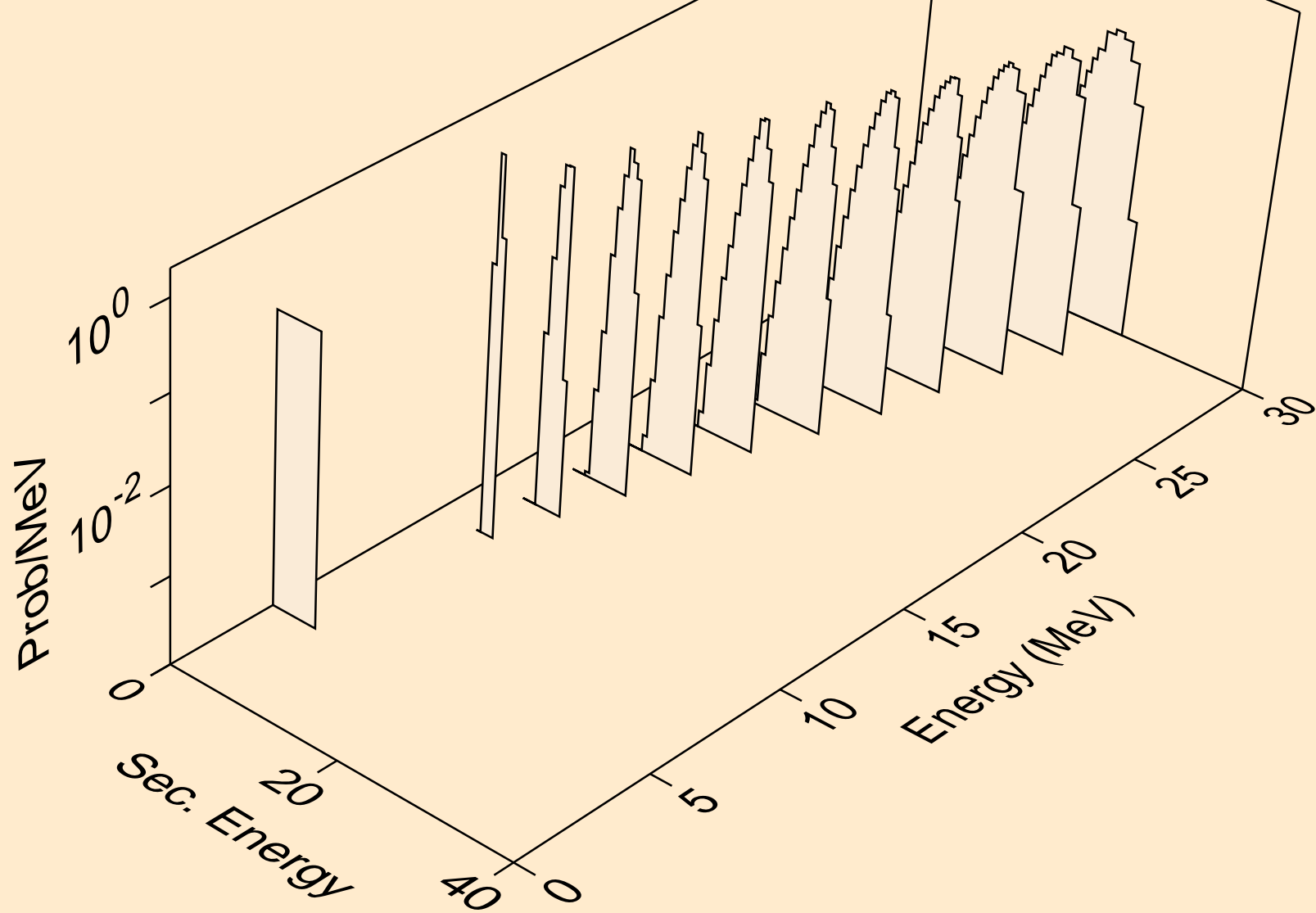

BI192M NEUTRON ACER TENDL-2021 LIBRARY; T=293.6K
he3s from (n,he3)

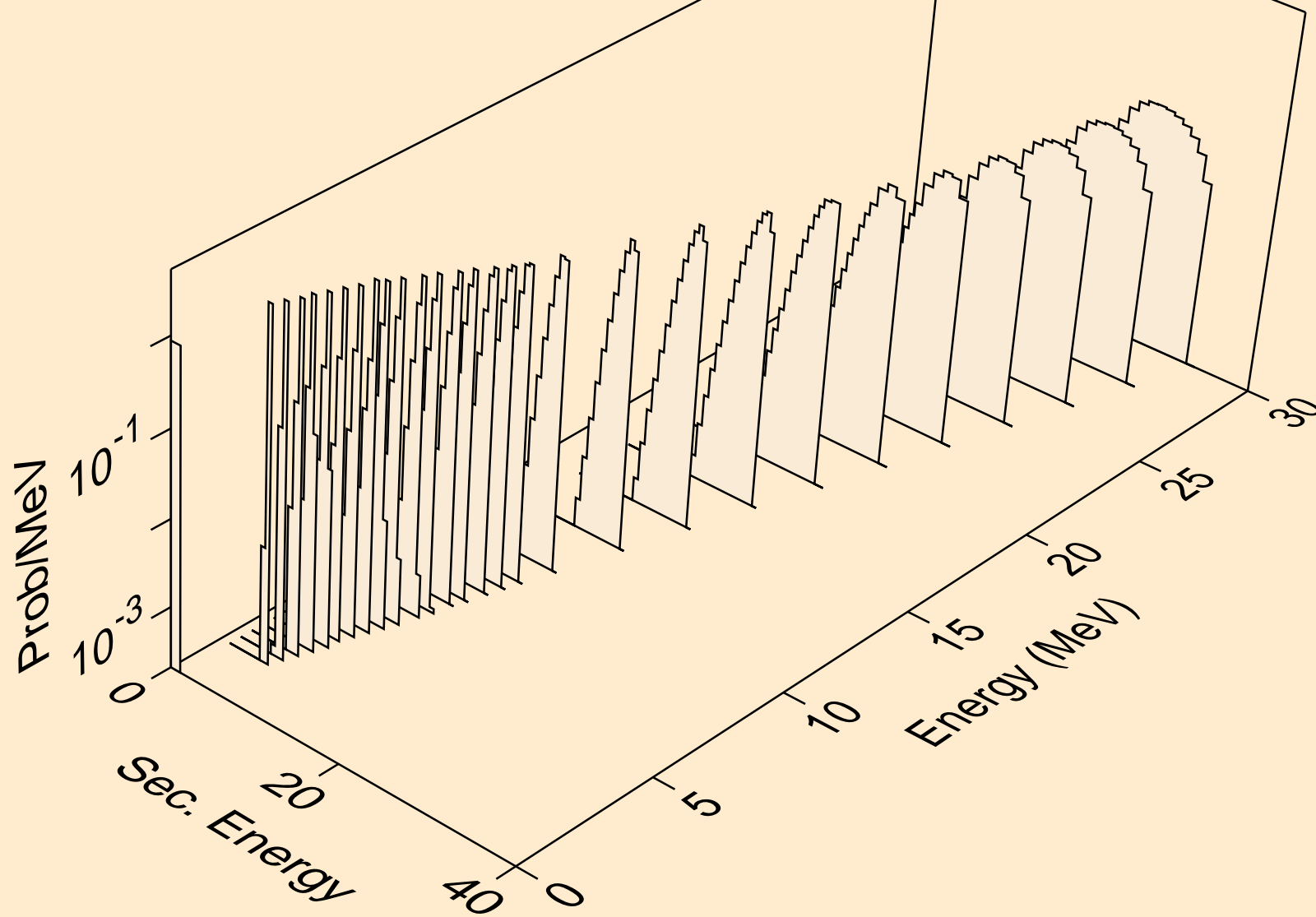

BI192M NEUTRON ACER TENDL-2021 LIBRARY; T=293.6K
alphas from (n,x)

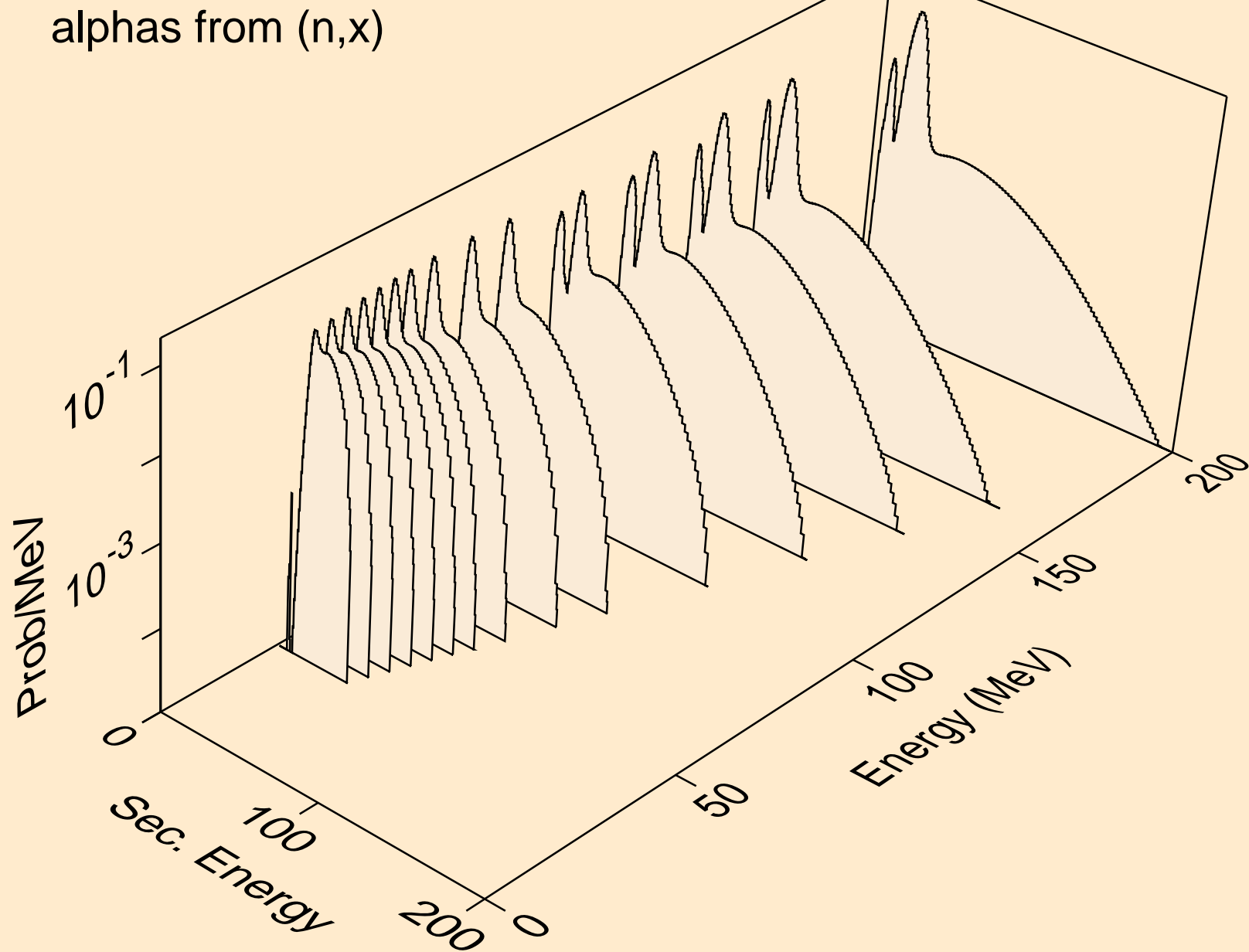

BI192M NEUTRON ACER TENDL-2021 LIBRARY; T=293.6K
alphas from (n,n*)a

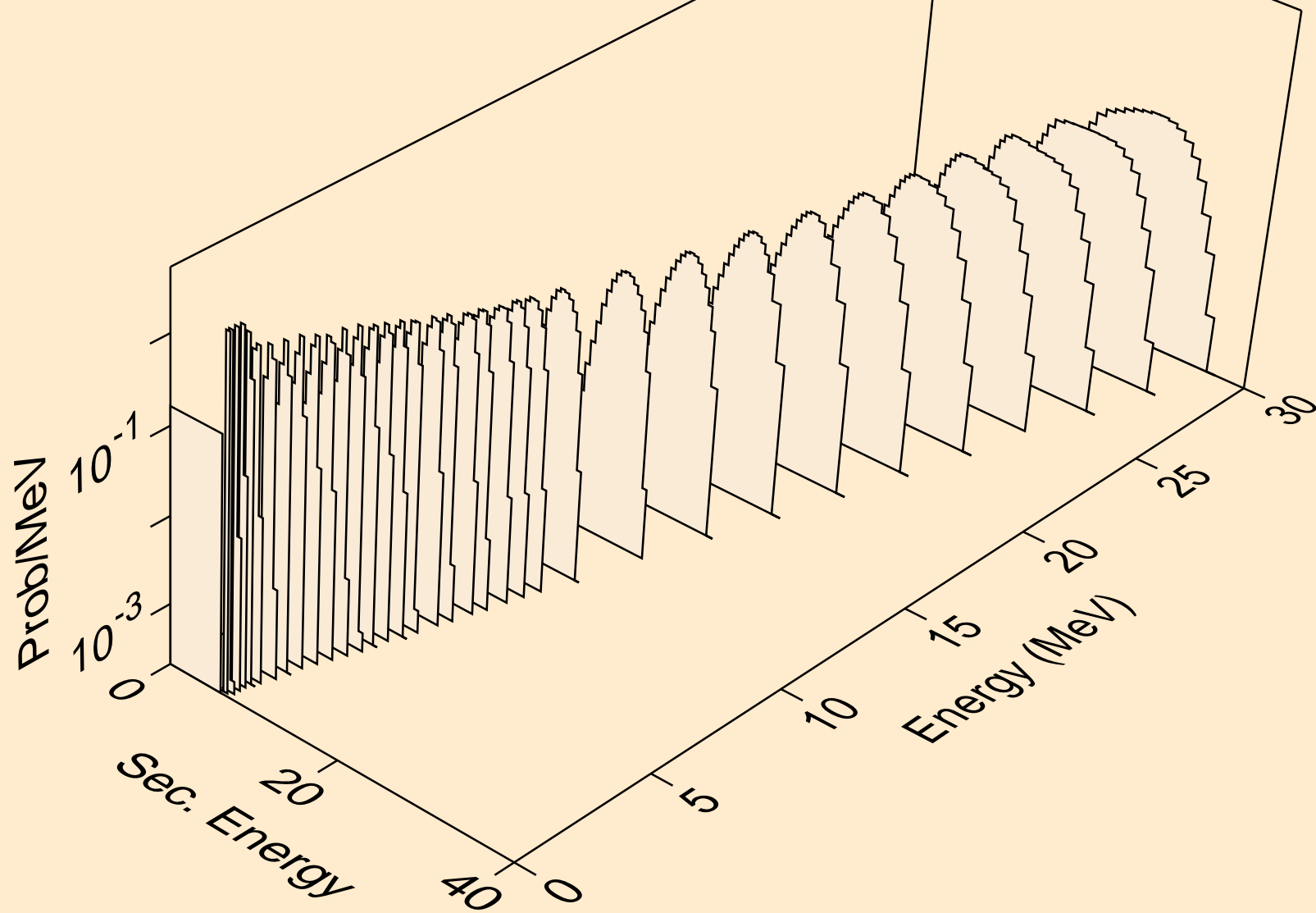

BI192M NEUTRON ACER TENDL-2021 LIBRARY; T=293.6K
alphas from (n,2n)a

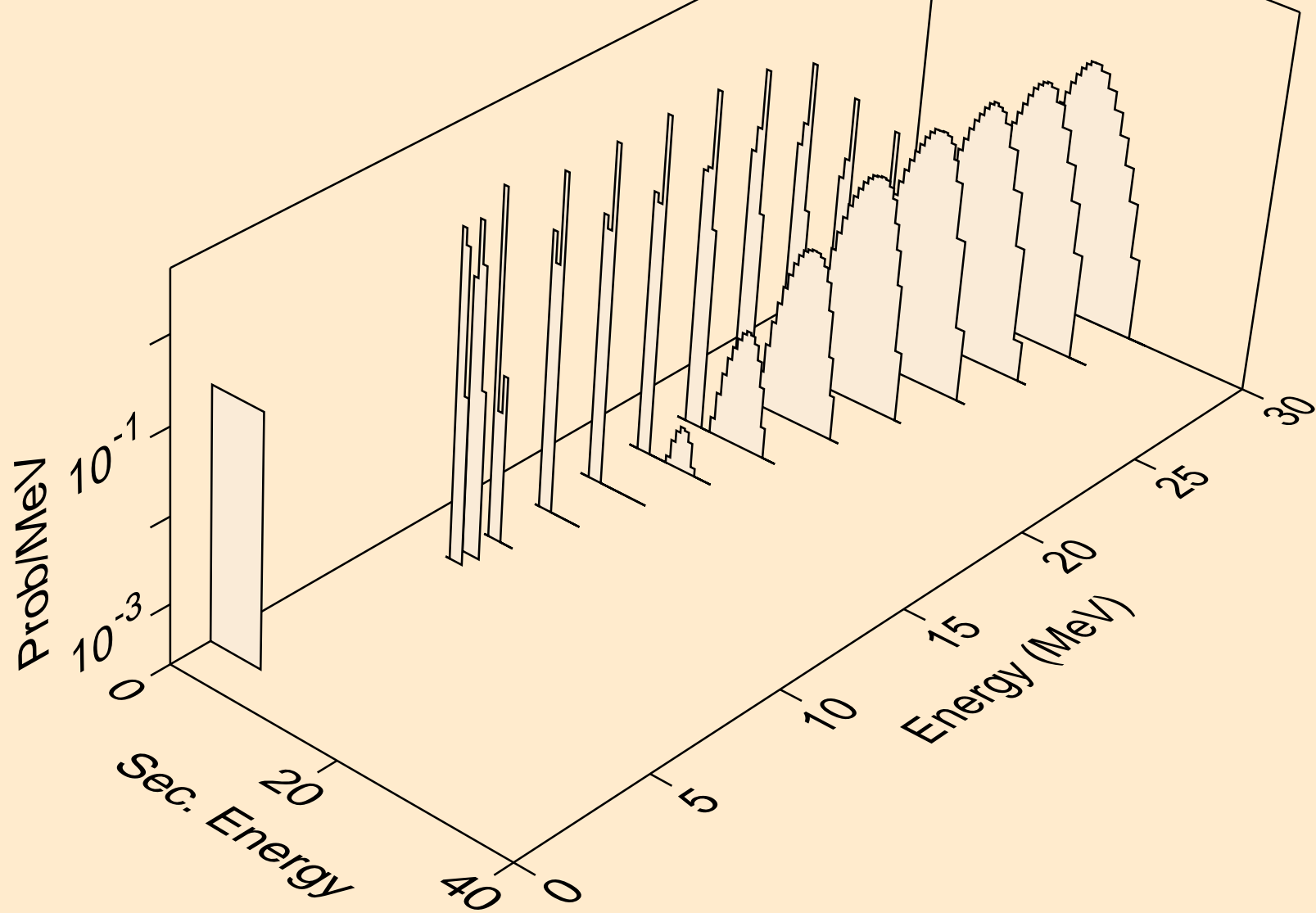

BI192M NEUTRON ACER TENDL-2021 LIBRARY; T=293.6K
alphas from (n,3n)a

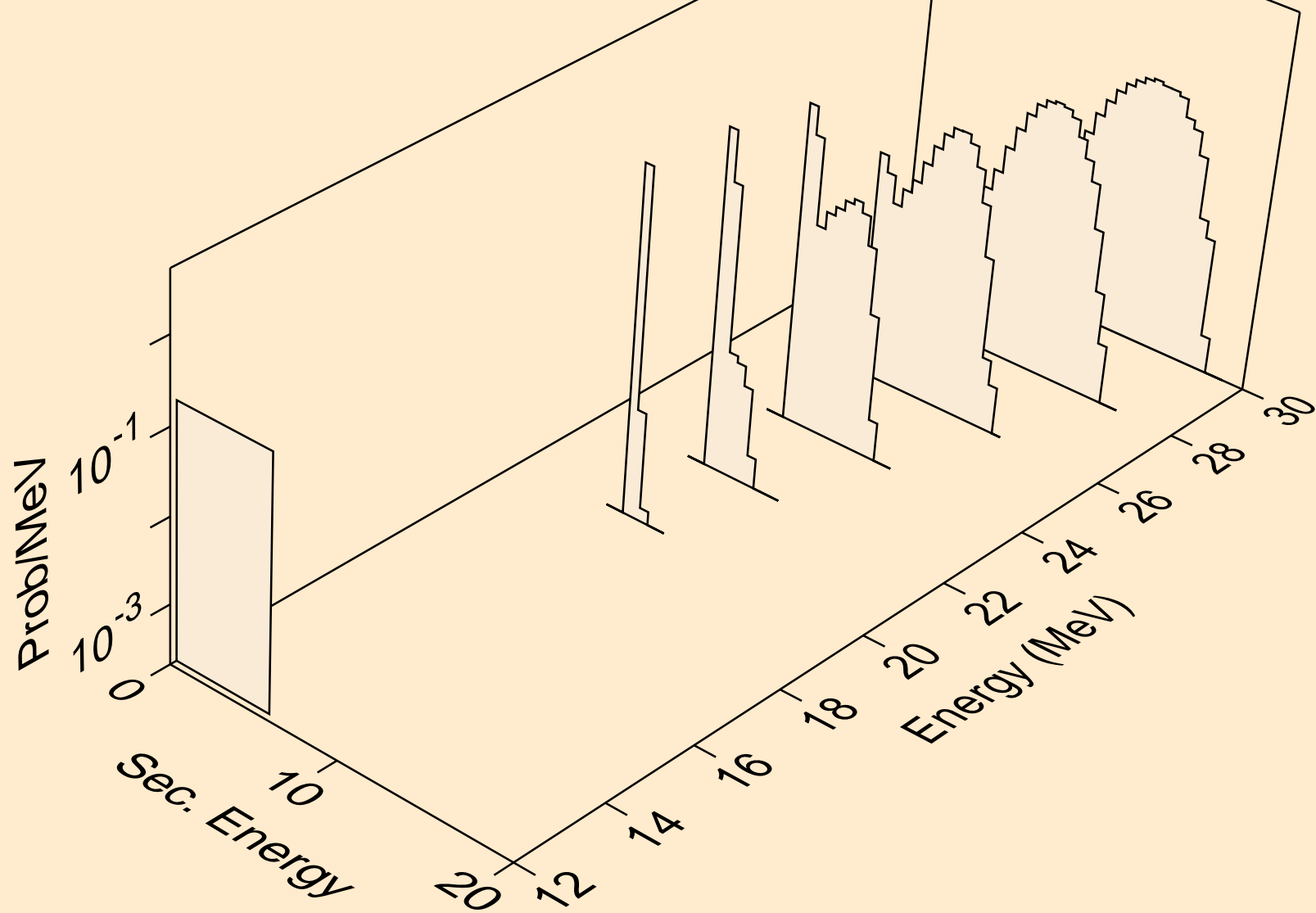

BI192M NEUTRON ACER TENDL-2021 LIBRARY; T=293.6K
alphas from (n,n*)2a

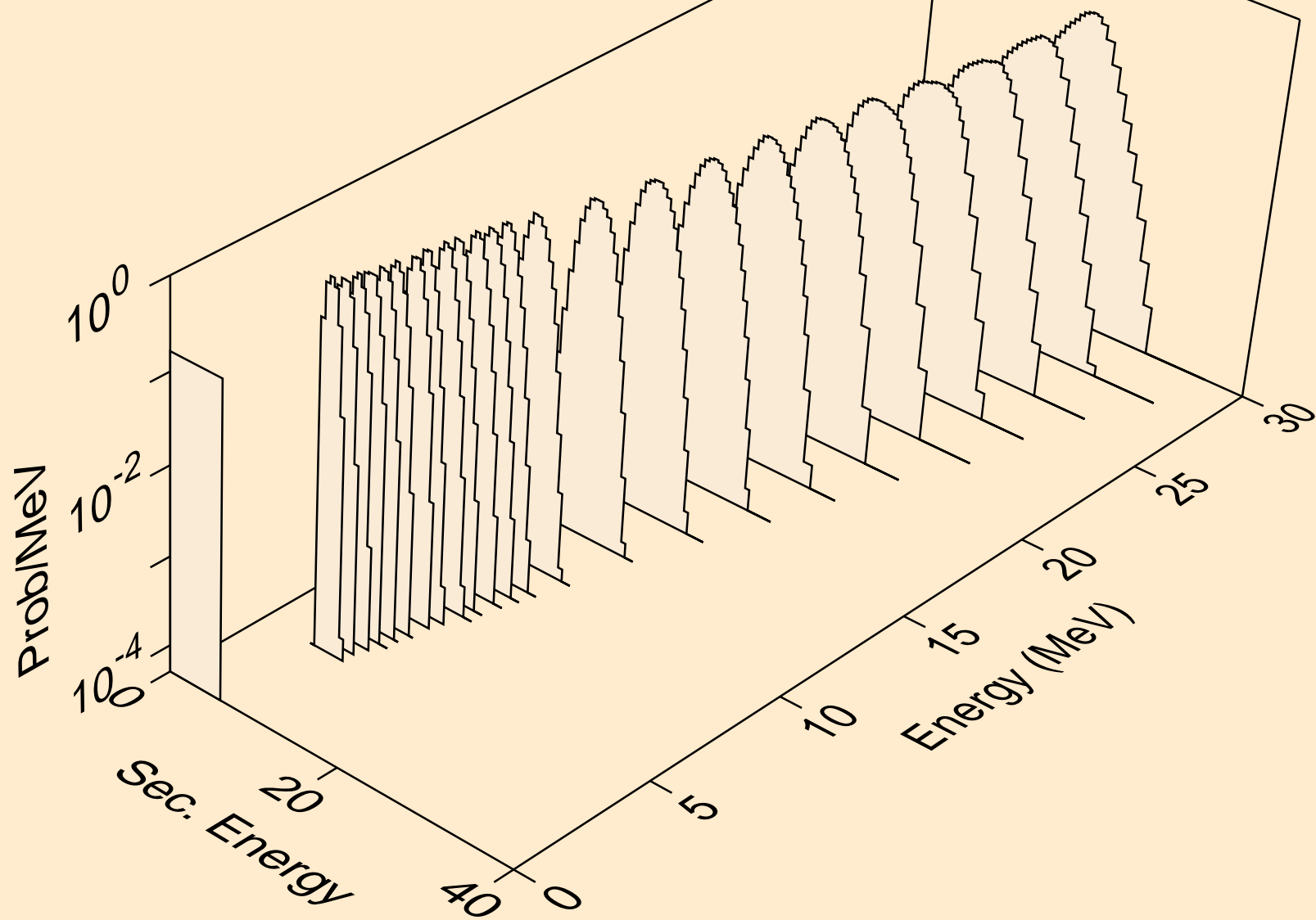

BI192M NEUTRON ACER TENDL-2021 LIBRARY; T=293.6K
alphas from (n,2n)2a

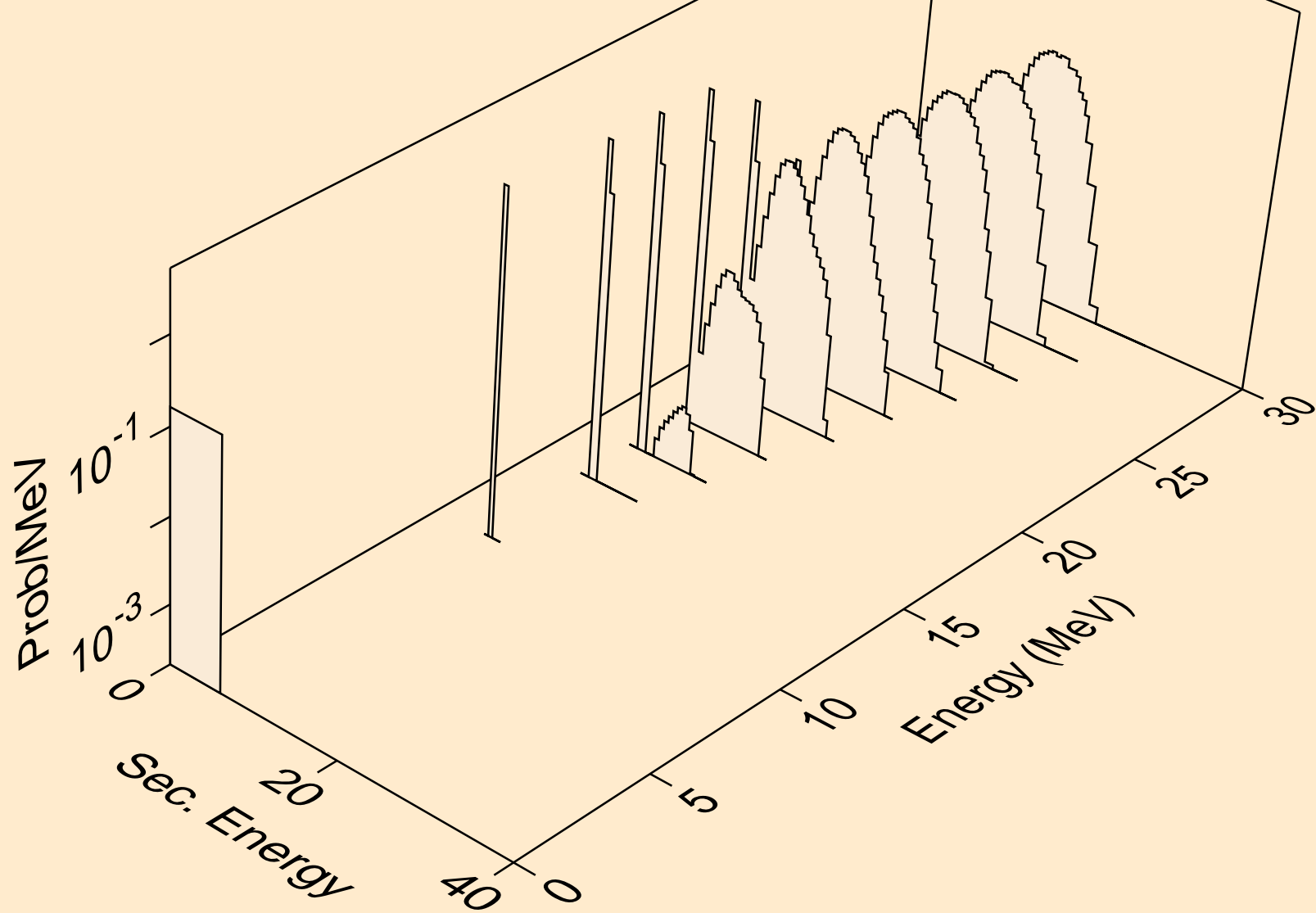

BI192M NEUTRON ACER TENDL-2021 LIBRARY; T=293.6K
alphas from (n,npa)

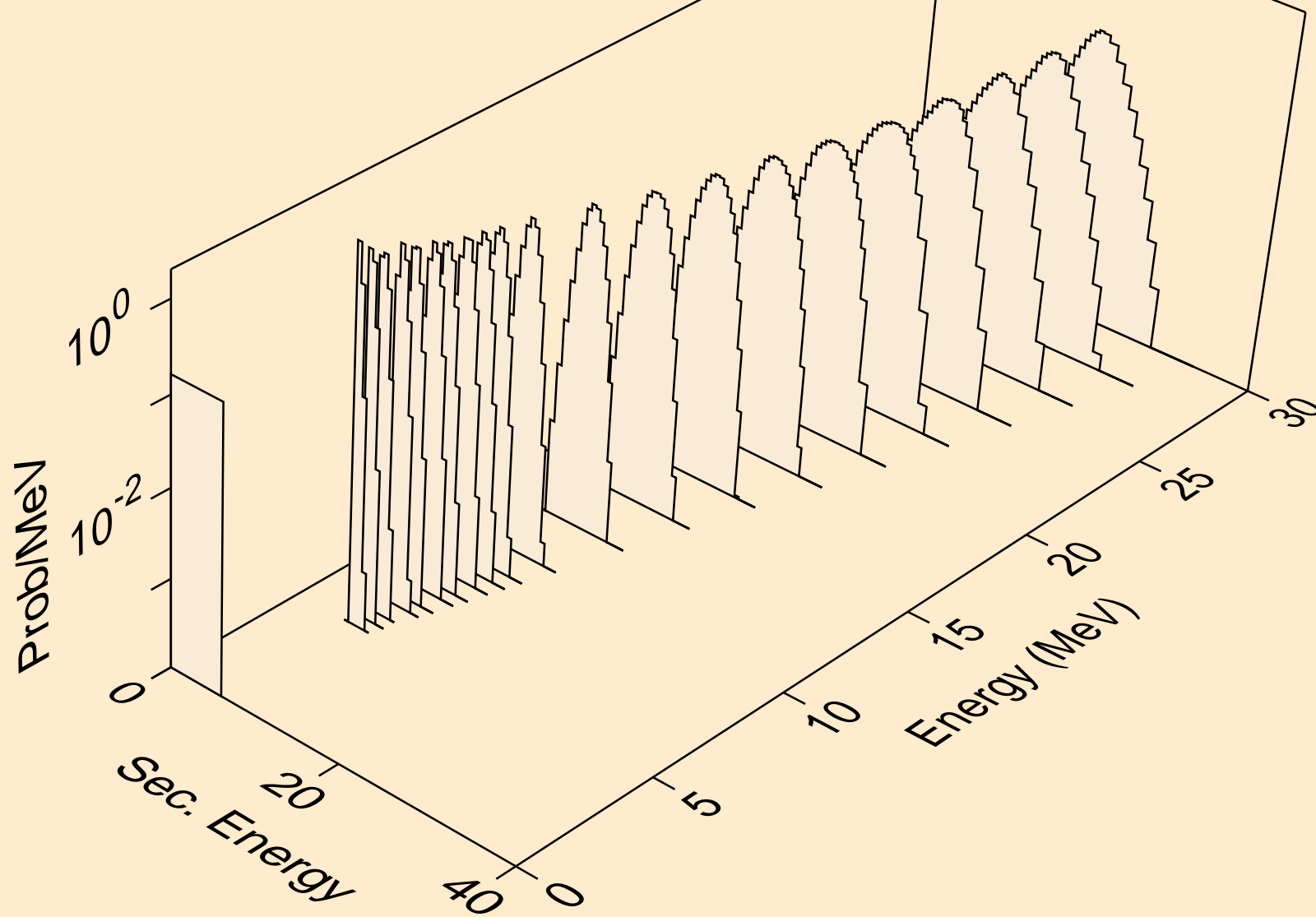

BI192M NEUTRON ACER TENDL-2021 LIBRARY; T=293.6K
alphas from (n,a)

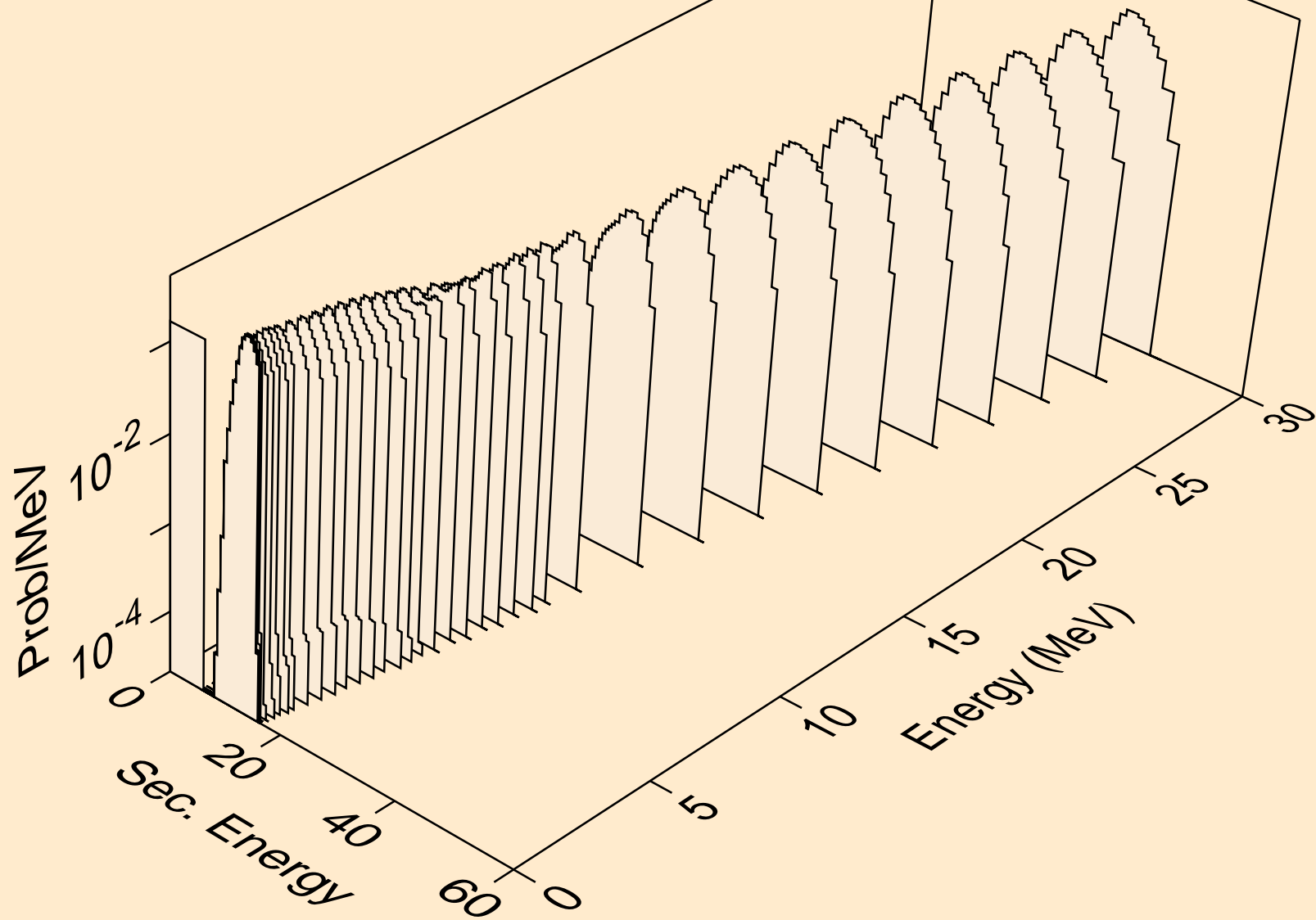

BI192M NEUTRON ACER TENDL-2021 LIBRARY; T=293.6K
alphas from (n,2a)

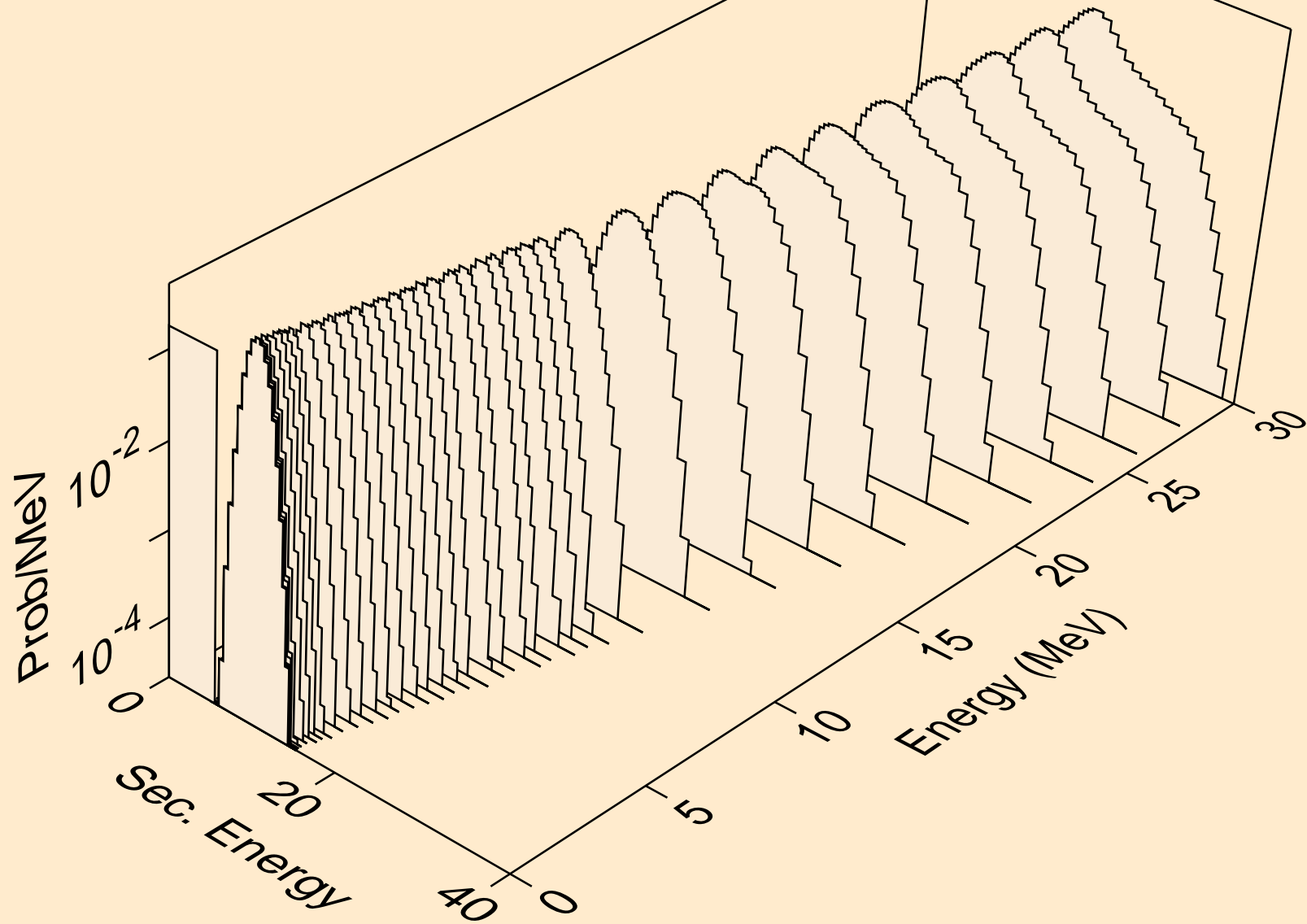

BI192M NEUTRON ACER TENDL-2021 LIBRARY; T=293.6K
alphas from (n,3a)

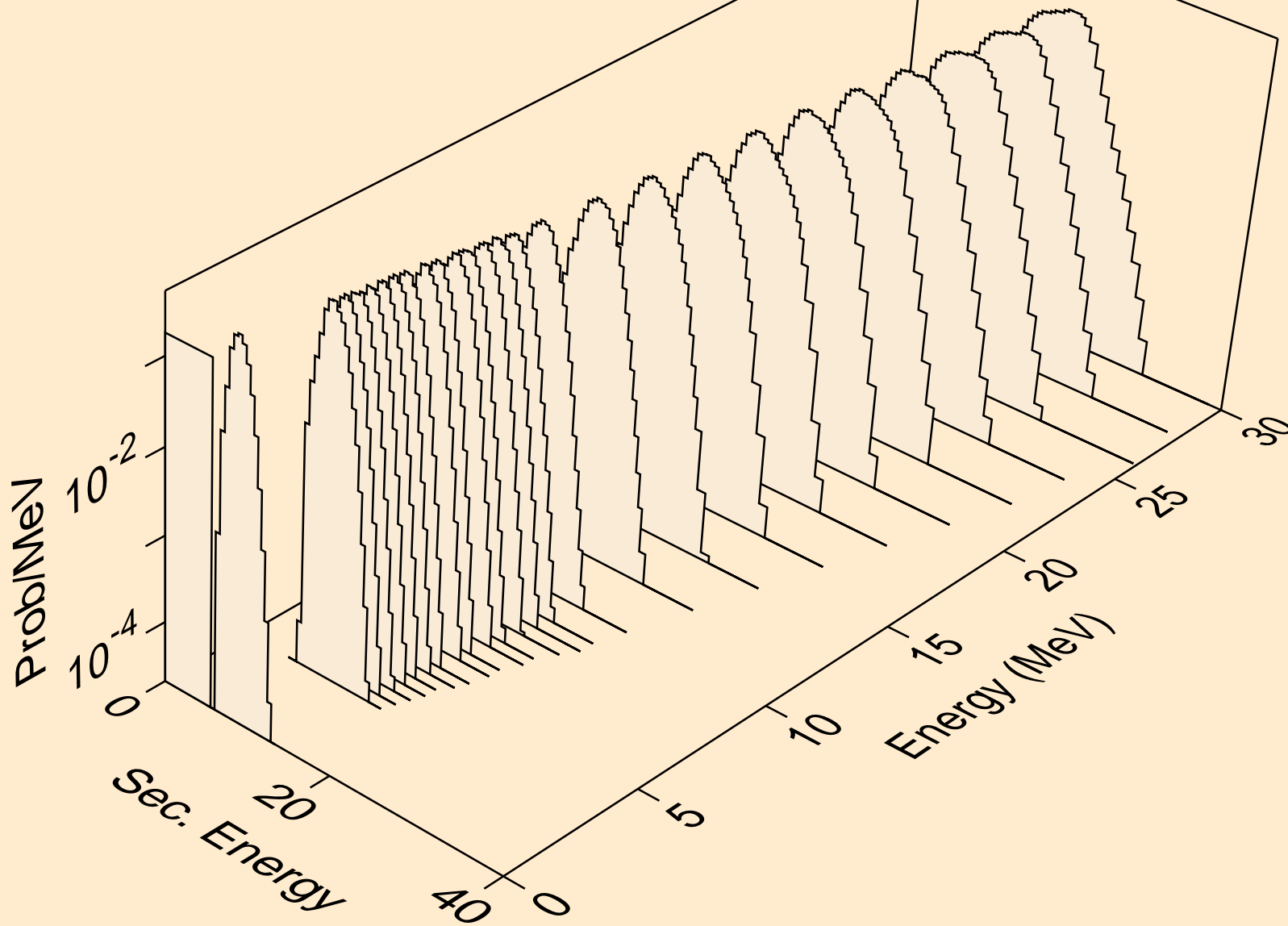

BI192M NEUTRON ACER TENDL-2021 LIBRARY; T=293.6K
alphas from (n,pa)

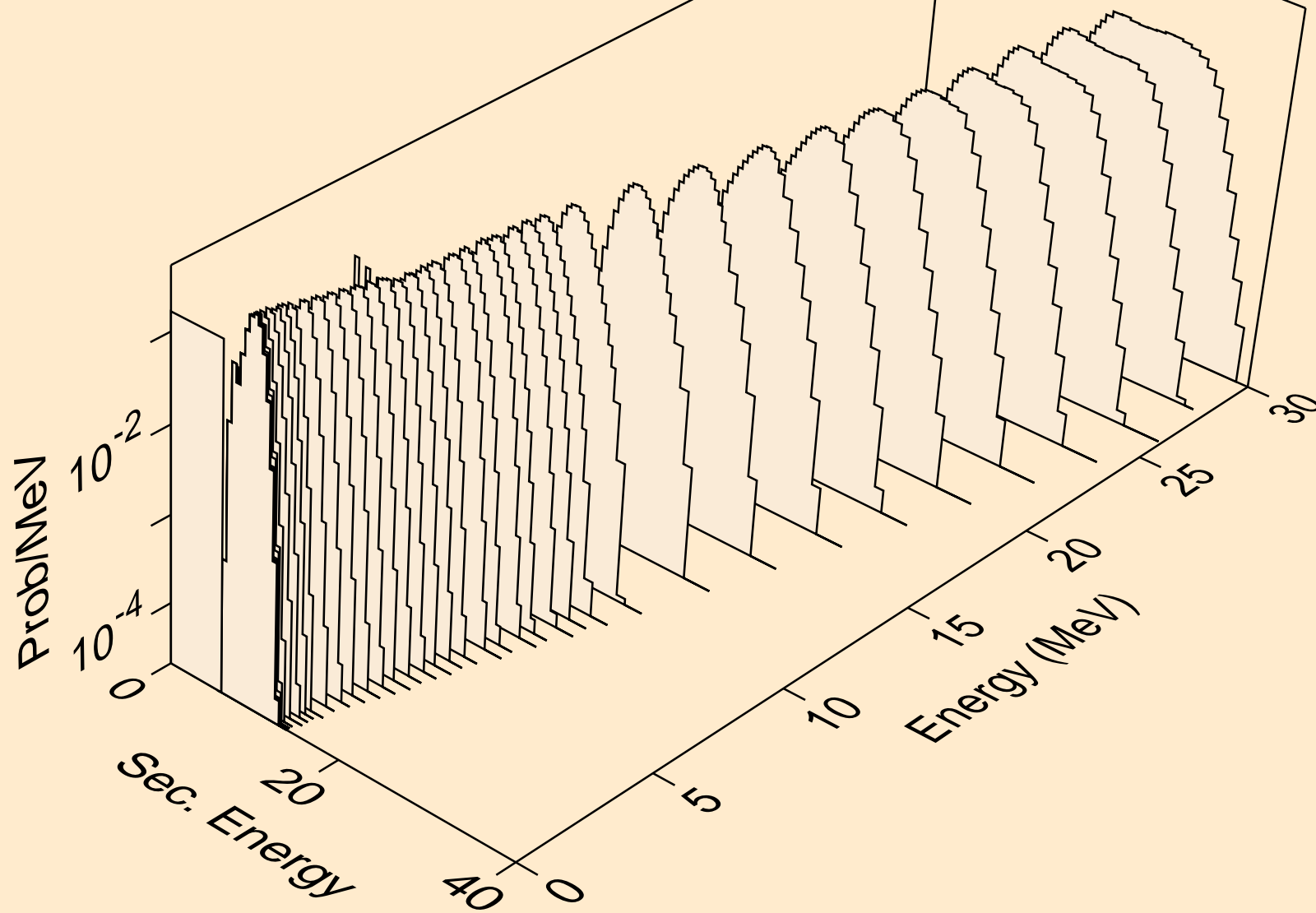

BI192M NEUTRON ACER TENDL-2021 LIBRARY; T=293.6K
alphas from (n,da)

